

Appendix N

Transportation

October 11, 2022

Mr. Dan Fairbanks
March Joint Powers Authority
14205 Meridian Parkway, Suite 140
Riverside, CA 92518

SUBJECT: WEST CAMPUS UPPER PLATEAU VEHICLE MILES TRAVELED (VMT) ANALYSIS

Dear Mr. Dan Fairbanks:

The following vehicle miles traveled (VMT) analysis has been prepared for the proposed West Campus Upper Plateau (**Project**) which is located on either side of Barton Street and Cactus Avenue in the March Joint Powers Authority (March JPA) and unincorporated Riverside County. (See Attachment A)

PROJECT OVERVIEW

The proposed Project (see Attachment A) consists of the following uses:

- Building B – 1,250,000 square feet (SF) of high-cube fulfillment center warehouse use
- Building C – 587,000 SF of high-cube fulfillment center warehouse use
- Industrial Area – 725,561 SF of high-cube fulfillment center warehouse use
- Industrial Area – 500,000 SF of high-cube cold storage warehouse use
- Business Park Area – 1,280,403 SF of business park use
- Mixed Use Area – 160,921 SF of retail use (25%)
- Mixed Use Area – 482,765 SF of business park use (75%)
- 42.2 Acre Active Park (with sports fields)
- 35.8 Acres of Park/Open Space (trails)
- 2.84 acres of Public Facilities for future sewer lift station and electrical substation

Mixed Use Areas include a variety of complimentary land uses; including commercial, business park, office, medical, educational and vocational, research and development, and services. Residential and outdoor storage is prohibited.

BACKGROUND

Changes to California Environmental Quality Act (CEQA) Guidelines were adopted in December 2018, which require all lead agencies to adopt VMT as a replacement for automobile delay-based level of service (LOS) as the new measure for identifying transportation impacts for land use projects. This statewide mandate went into effect July 1, 2020. To aid in this transition, the Governor's Office of Planning and Research (OPR) released a Technical Advisory on Evaluating Transportation Impacts in CEQA (December 2018) (**Technical Advisory**) (1). Based on OPR's Technical Advisory, the Western

Riverside Council of Governments (WRCOG) prepared a WRCOG SB 743 Implementation Pathway Document Package (March 2019) to assist its member agencies with implementation tools necessary to adopt analysis methodology, impact thresholds and mitigation approaches for VMT. To add to the previous work effort, WRCOG in February 2020 released its Recommended Traffic Impact Analysis Guidelines for Vehicle Miles Traveled and Level of Service Assessment (WRCOG Guidelines), which provides specific procedures for complying with the new CEQA requirements for VMT analysis (2). Through consultation with March JPA staff, it is our understanding that the March JPA has yet to adopt its own VMT analysis guidelines and thresholds. For the purposes of this analysis, the recommended VMT analysis methodology and thresholds identified within the Technical Advisory and WRCOG Guidelines have been used.

VMT ANALYSIS

VMT MODELING

WRCOG Guidelines identifies RIVCOM as the appropriate tool for conducting VMT analysis for land development projects in the March JPA. WRCOG is the developer/owner of RIVCOM and recently launched the new modeling tool for use by its member agencies in August 2021. At the time this analysis was prepared, the RIVCOM tool was in its 4th update (also referred to as version 3.0). It has been determined that this analysis would be prepared based on version 3.0 of RIVCOM.

VMT METRIC AND SIGNIFICANCE THRESHOLD

As stated in the Technical Advisory, “Lead agencies can evaluate each component of a mixed-use project independently and apply the significance threshold for each project type included (e.g., residential and retail).”¹ Consistent with OPR’s direction in the Technical Advisory, the VMT metric for retail projects greater than 50,000 sf of gross leasable area is to utilize the metric of net change in total VMT. Therefore, for purposes of this analysis a significant impact to VMT would occur if the addition of the Project’s retail component would result in a **net increase in total VMT for the region**. For purposes of this evaluation the region is defined as a 15-mile service area from the Project site (See Attachment B). A 15-mile service area is a conservatively estimated distance from the Project as the retail component is not anticipated as a regional shopping destination but instead is anticipated to serve the surrounding communities of Riverside, Moreno Valley, Perris, etc. Additionally, large boundaries such as Riverside County or WRCOG tend to be too large of an area to accurately measure an individual project’s effect on VMT without model noise (i.e., convergence criteria) influencing the results.

For projects that are not residential nor retail land use types, the Technical Advisory identifies VMT per employee as the appropriate VMT metric for analysis. Therefore, the Project’s industrial, business park,

¹ Technical Advisory; Page 17.

and non-retail mixed use land uses should be evaluated based on the metric of VMT per employee. A significant impact to VMT would occur if the addition of the Project’s industrial/business park/non-retail mixed use components would result in Project-generated **VMT per employee to exceed 15% below the WRCOG’s baseline of 29.97 VMT per employee for a regional average significance threshold of 25.47 VMT per employee.**

PROJECT LAND USE CONVERSION

In order to evaluate Project VMT, standard land use information must first be converted into a RIVCOM compatible input data. The RIVCOM model utilizes socio-economic data (SED) (e.g., population, households, employment, etc.) instead of land use information for the purposes of vehicle trip estimation. Project land use information such as building square footage must first be converted to SED for input into RIVCOM. RIVCOM output data can be found in Attachment C. The employment estimates are consistent with those used by the Project’s Water Supply Assessment (WSA). Table 1 presents the estimated number of Project employees by land use type used to populate the RIVCOM model.

TABLE 1: EMPLOYMENT ESTIMATES

Land Use	Building Area	Estimated Employees
Industrial	3,062,561 SF	2,000 Industrial Employees
Business Park ²	1,763,168 SF	340 Service Employees
Retail	160,921 SF	255 Retail Employees

The RIVCOM model was then run inclusive of the Project’s SED inputs.

PROJECT RETAIL VMT CALCULATION AND COMPARISON TO SIGNIFICANCE THRESHOLD

As described previously, retail land uses are evaluated utilizing the VMT metric of total VMT³. RIVCOM was used to calculate the baseline total link-level VMT for both “No Project” and “With Project” model runs. This calculation is commonly referred to as the “boundary method” and includes the total VMT for all vehicle trips with one or both trip ends within a specific geographic area – in this case 15-mile service area surrounding the Project site. As shown in Table 2, the addition of the Project results in a net decrease to total VMT, which falls below the OPR significance threshold.

² Includes 75% of “Business Park” Mixed Use Area.

³ Technical Advisory; Page 16.

TABLE 2: NET CHANGE IN TOTAL VMT FOR THE REGION

	15-mile Region
Total VMT for No Project	43,167,218
Total VMT for With Project	43,039,938
+/- to VMT	-127,280
Percent Change	-0.29%
Potentially Significant	No

PROJECT NON-RETAIL VMT CALCULATION AND COMPARISON TO IMPACT THRESHOLD

The Technical Advisory identifies that for land uses other than residential and retail, the measure of VMT should be VMT per employee. RIVCOM was utilized to calculate Project-generated VMT for the non-retail land uses and that value was then divided by the Project’s employment estimate to derive Project-generated VMT per employee. Project-generated home-based work (HBW) VMT was then calculated for both the base year model (2018) and cumulative year model (2045), and linear interpolation was used to determine the Project’s baseline (2022) HBW VMT. Table 3 HBW VMT as calculated from RIVCOM for the Project’s non-retail land uses, the number of Project non-retail employees and Project non-retail VMT per employee.

TABLE 3: NON-RETAIL VMT PER EMPLOYEE

	Project Non-Retail
VMT	58,874
Non-Retail Employment	2,340
VMT per Employee ⁴	24.12

Table 4 provides a comparison between Project VMT per employee to the WRCOG significance threshold of 25.47. The Project’s non-retail VMT per employee was found to be below the WRCOG significance threshold by 5.3%. Therefore, the Project’s impact on VMT is less than significant.

⁴ HBW VMT per Employee is a measure of all auto trips between home and work and does not include heavy duty truck trips or freight, which is consistent with OPR guidance.

TABLE 4: PROJECT NON-RETAIL VMT PER EMPLOYEE COMPARISON

	VMT per Employee
WRCOG Threshold	25.47
Project	24.12
Difference	-1.35
Percent Change	-5.30%
Potentially Significant	No

CONCLUSION

Based on the results of this analysis the following findings are made:

- The Project’s retail land uses were found to decrease total VMT in the 15-mile service area by 127,280 or about 0.29%. The Project’s retail land uses are determined to have a less than significant transportation impact for the retail uses.
- The Project’s non-retail land uses were found to be below the WRCOG region VMT per employee threshold by 5.30%. The Project’s non-retail employment uses are determined to also have a less than significant impact.
- The Project’s impact on VMT is considered less than significant.

If you have any questions, please contact me directly at aso@urbanxroads.com.

Respectfully submitted,

URBAN CROSSROADS, INC.



Alex So
Senior Associate

REFERENCES

1. **Office of Planning and Research.** *Technical Advisory on Evaluating Transportation Impacts in CEQA.* State of California : s.n., December 2018.
2. **Western Riverside Council of Governments (WRCOG).** *Recommended Traffic Impact Analysis Guidelines for Vehicle Miles Traveled and Level of Service Assessment.* February 13, 2020.

**ATTACHMENT A
PROJECT SITE PLAN**

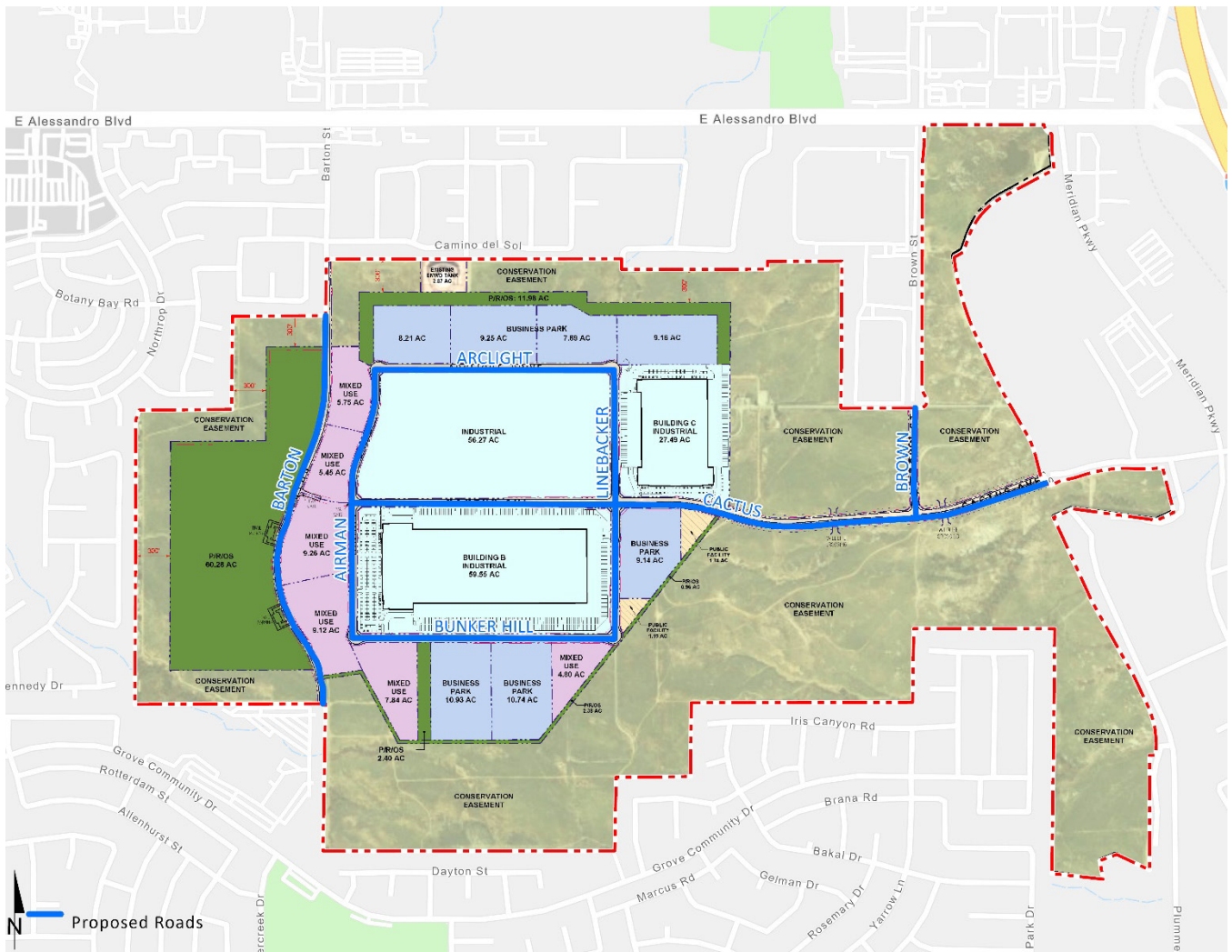

ATTACHMENT B
15-MILE BOUNDARY AREA

URBAN CROSSROADS

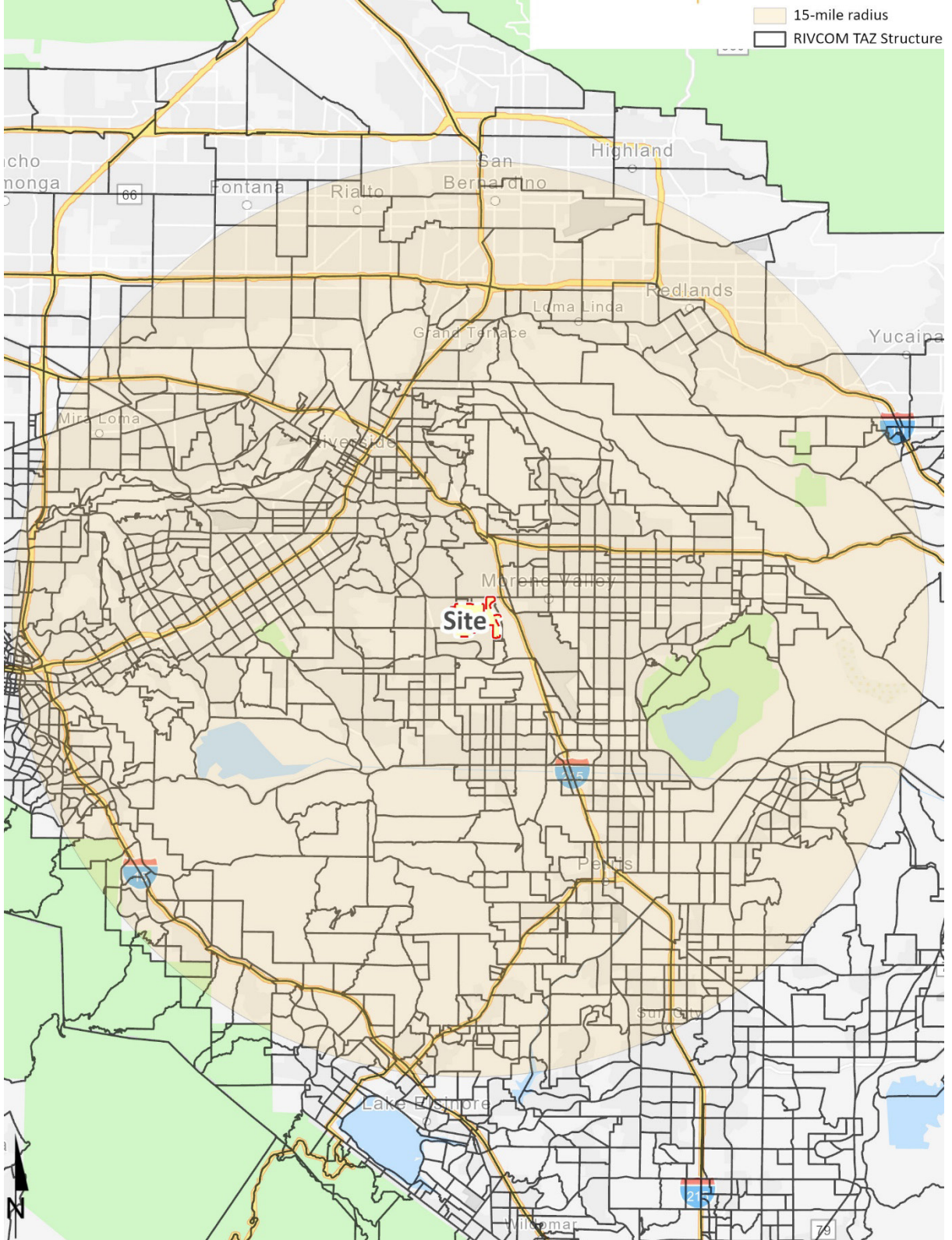

ATTACHMENT C
RIVCOM OUTPUTS

TABLE B-1: 2018 RIVCOM OUTPUT

TAZ	2749	3190
Daily_Home-Based (incl. IEHB) Prod VMT	0	9989.152344
Daily_HBW (incl. EIHBW) Attr VMT	61107.58203	8364.871094
Daily_Total Auto OD From VMT	33424.32422	21987.28125
Daily_Total Auto OD To VMT	35742.17578	23155.04102
Daily_Total Auto OD Intra VMT	1.56797	22.198938
Daily_Total Truck OD From VMT	788.576965	1914.549194
Daily_Total Truck OD To VMT	787.499084	1912.748291
Daily_Total Truck OD Intra VMT	0.217499	0.972057
Daily_Total OD From VMT	34212.90234	23901.83008
Daily_Total OD To VMT	36529.67578	25067.78906
Daily_Total OD Intra VMT	1.785468	23.170996
Daily_Total_TripLen	21.461998	11.228536
Population	0	498
Employment	2340	271
Enrollment	0	0

TABLE B-2: 2045 RIVCOM OUTPUT

TAZ	2749	3190
Daily_Home-Based (incl. IEHB) Prod VMT	0	10865.54883
Daily_HBW (incl. EIHBW) Attr VMT	95246.16406	18716.92383
Daily_Total Auto OD From VMT	63396.12109	28333.44531
Daily_Total Auto OD To VMT	71327.73438	29868.60156
Daily_Total Auto OD Intra VMT	12.964943	19.03054
Daily_Total Truck OD From VMT	744.898621	2004.05127
Daily_Total Truck OD To VMT	747.685059	2005.03894
Daily_Total Truck OD Intra VMT	0.215006	1.143409
Daily_Total OD From VMT	64141.01563	30337.49609
Daily_Total OD To VMT	72075.42188	31873.64258
Daily_Total OD Intra VMT	13.179949	20.173948
Daily_Total_TripLen	16.874808	11.918411
Population	0	562
Employment	3646	672
Enrollment	0	0



West Campus Upper Plateau

TRAFFIC ANALYSIS

MARCH JOINT POWERS AUTHORITY MARCH JPA

PREPARED BY:

Aric Evatt, PTP
aevatt@urbanxroads.com

Charlene So, PE
cso@urbanxroads.com

OCTOBER 18, 2022

14064-05 TA Report

TABLE OF CONTENTS

TABLE OF CONTENTS	I
APPENDICES	III
LIST OF EXHIBITS	V
LIST OF TABLES	VII
LIST OF ABBREVIATED TERMS	IX
1 SUMMARY OF FINDINGS	1
1.1 Summary of Findings.....	1
1.2 Project Overview.....	3
1.3 Analysis Scenarios	4
1.4 Study Area.....	5
1.5 Deficiencies	9
1.6 Recommendations	6
1.7 Queuing Analysis.....	13
1.8 Parking Assessment	16
1.9 Active Transportation	16
1.10 Traffic Calming – Barton Street.....	17
2 METHODOLOGIES	20
2.1 Level of Service	20
2.2 Intersection Capacity Analysis	20
2.3 Roadway Segment Capacity Analysis Methodology	22
2.4 Freeway Off-Ramp Queuing Analysis.....	24
2.5 Traffic Signal Warrant Analysis Methodology.....	24
2.6 Minimum Acceptable Levels of Service (LOS).....	26
2.7 Deficiency Criteria	28
2.8 Project Fair Share Calculation Methodology	30
3 AREA CONDITIONS	32
3.1 Existing Circulation Network.....	32
3.2 March JPA General Plan Circulation Element	32
3.3 County of Riverside, City of Moreno Valley, and City of Riverside General Plan Circulation Element.....	32
3.4 Bicycle & Pedestrian Facilities.....	32
3.5 Truck Routes	48
3.6 Transit Service	48
3.7 Existing (2021) Traffic Counts	48
3.8 Intersection Operations Analysis	52
3.9 Existing (2021) Conditions Roadway Segment Capacity Analysis	58
3.10 Traffic Signal Warrants Analysis.....	58
3.11 Off-Ramp Queuing Analysis	59
4 PROJECTED FUTURE TRAFFIC	60
4.1 Trip Generation	60
4.2 Project Trip Distribution.....	64
4.3 Modal Split	64
4.4 Project Trip Assignment	64
4.5 Background Traffic	71
4.6 Cumulative Development Traffic	71

4.7 Horizon Year (2045) Volume Development 72

5 E+P TRAFFIC CONDITIONS 80

5.1 Roadway Improvements 80

5.2 Existing plus Project Traffic Volume Forecasts 80

5.3 Intersection Operations Analysis 80

5.4 Roadway Segment Analysis..... 86

5.5 Traffic Signal Warrants Analysis..... 86

5.6 Off-Ramp Queuing Analysis 87

5.7 Deficiencies and Improvements 87

6 EAP (2028) TRAFFIC CONDITIONS 90

6.1 Roadway Improvements 90

6.2 Existing plus Ambient Growth plus Project (EAP) Traffic Volume Forecasts 90

6.3 Intersection Operations Analysis 90

6.4 Roadway Segment Analysis..... 96

6.5 Traffic Signal Warrants Analysis..... 96

6.6 Off-Ramp Queuing Analysis 97

6.7 Deficiencies and Improvements 97

7 OPENING YEAR CUMULATIVE (2028) TRAFFIC CONDITIONS 100

7.1 Roadway Improvements 100

7.2 Opening Year Cumulative (2028) Without Project Traffic Volume Forecasts 100

7.3 Opening Year Cumulative (2028) With Project Traffic Volume Forecasts 100

7.4 Intersection Operations Analysis 109

7.5 Roadway Segment Analysis..... 111

7.6 Traffic Signal Warrants Analysis..... 112

7.7 Off-Ramp Queuing Analysis 112

7.8 Deficiencies and Improvements 114

8 HORIZON YEAR (2045) TRAFFIC CONDITIONS 118

8.1 Roadway Improvements 118

8.2 Horizon Year (2045) Without Project Traffic Volume Forecasts..... 118

8.3 Horizon Year (2045) With Project Traffic Volume Forecasts 118

8.4 Intersection Operations Analysis 127

8.5 Roadway Segment Analysis..... 129

8.6 Traffic Signal Warrants Analysis..... 130

8.7 Off-Ramp Queuing Analysis 130

8.8 Deficiencies and Improvements 132

9 LOCAL AND REGIONAL FUNDING MECHANISMS 136

9.1 Riverside County Transportation Uniform Mitigation Fee (TUMF) 136

9.2 Measure A 136

9.3 Fair Share Contribution 136

10 REFERENCES..... 140

APPENDICES

- APPENDIX 1.1: TRAFFIC STUDY SCOPING AGREEMENT**
- APPENDIX 1.2: SITE ADJACENT QUEUES**
- APPENDIX 3.1: EXISTING (2021) AND HISTORIC TRAFFIC COUNTS – 2019**
- APPENDIX 3.2: EXISTING (2021) CONDITIONS INTERSECTION OPERATIONS ANALYSIS WORKSHEETS**
- APPENDIX 3.3: EXISTING (2021) CONDITIONS TRAFFIC SIGNAL WARRANT ANALYSIS WORKSHEETS**
- APPENDIX 3.4: EXISTING (2021) CONDITIONS FREEWAY OFF-RAMP QUEUING ANALYSIS WORKSHEETS**
- APPENDIX 4.1: POST-PROCESS WORKSHEETS**
- APPENDIX 5.1: E+P CONDITIONS INTERSECTION OPERATIONS ANALYSIS WORKSHEETS**
- APPENDIX 5.2: E+P CONDITIONS TRAFFIC SIGNAL WARRANT ANALYSIS WORKSHEETS**
- APPENDIX 5.3: E+P CONDITIONS FREEWAY OFF-RAMP QUEUING ANALYSIS WORKSHEETS**
- APPENDIX 5.4: E+P CONDITIONS INTERSECTION OPERATIONS ANALYSIS WORKSHEETS WITH IMPROVEMENTS**
- APPENDIX 6.1: EAP CONDITIONS INTERSECTION OPERATIONS ANALYSIS WORKSHEETS**
- APPENDIX 6.2: EAP CONDITIONS TRAFFIC SIGNAL WARRANT ANALYSIS WORKSHEETS**
- APPENDIX 6.3: EAP CONDITIONS FREEWAY OFF-RAMP QUEUING ANALYSIS WORKSHEETS**
- APPENDIX 6.4: EAP CONDITIONS INTERSECTION OPERATIONS ANALYSIS WORKSHEETS WITH IMPROVEMENTS**
- APPENDIX 7.1: OPENING YEAR CUMULATIVE (2028) WITHOUT PROJECT CONDITIONS INTERSECTION OPERATIONS ANALYSIS WORKSHEETS**
- APPENDIX 7.2: OPENING YEAR CUMULATIVE (2028) WITH PROJECT CONDITIONS INTERSECTION OPERATIONS ANALYSIS WORKSHEETS**
- APPENDIX 7.3: OPENING YEAR CUMULATIVE (2028) WITHOUT PROJECT CONDITIONS TRAFFIC SIGNAL WARRANT ANALYSIS WORKSHEETS**
- APPENDIX 7.4: OPENING YEAR CUMULATIVE (2028) WITH PROJECT CONDITIONS TRAFFIC SIGNAL WARRANT ANALYSIS WORKSHEETS**
- APPENDIX 7.5: OPENING YEAR CUMULATIVE (2028) WITHOUT PROJECT OFF-RAMP QUEUING ANALYSIS WORKSHEETS**
- APPENDIX 7.6: OPENING YEAR CUMULATIVE (2028) WITH PROJECT CONDITIONS OFF-RAMP QUEUING ANALYSIS WORKSHEETS**
- APPENDIX 7.7: OPENING YEAR CUMULATIVE (2028) WITH PROJECT CONDITIONS INTERSECTION OPERATIONS ANALYSIS WORKSHEETS WITH IMPROVEMENTS**
- APPENDIX 8.1: HORIZON YEAR (2045) WITHOUT PROJECT CONDITIONS INTERSECTION OPERATIONS ANALYSIS WORKSHEETS**
- APPENDIX 8.2: HORIZON YEAR (2045) WITH PROJECT CONDITIONS INTERSECTION OPERATIONS ANALYSIS WORKSHEETS**
- APPENDIX 8.3: HORIZON YEAR (2045) WITHOUT PROJECT CONDITIONS TRAFFIC SIGNAL WARRANT ANALYSIS WORKSHEETS**
- APPENDIX 8.4: HORIZON YEAR (2045) WITH PROJECT CONDITIONS TRAFFIC SIGNAL WARRANT ANALYSIS WORKSHEETS**
- APPENDIX 8.5: HORIZON YEAR (2045) WITHOUT PROJECT OFF-RAMP QUEUING ANALYSIS WORKSHEETS**
- APPENDIX 8.6: HORIZON YEAR (2045) WITH PROJECT CONDITIONS OFF-RAMP QUEUING ANALYSIS WORKSHEETS**
- APPENDIX 8.7: HORIZON YEAR (2045) WITH PROJECT CONDITIONS INTERSECTION OPERATIONS ANALYSIS WORKSHEETS WITH IMPROVEMENTS**

This Page Intentionally Left Blank

LIST OF EXHIBITS

EXHIBIT 1-1: PRELIMINARY LAND USE PLAN 2

EXHIBIT 1-2: LOCATION MAP..... 6

EXHIBIT 1-3: SUMMARY OF DEFICIENT INTERSECTIONS BY ANALYSIS SCENARIO 0

EXHIBIT 1-4: SUMMARY OF DEFICIENT ROADWAY SEGMENTS BY ANALYSIS SCENARIO 0

EXHIBIT 1-5: SITE ADJACENT ROADWAY AND SITE ACCESS RECOMMENDATIONS 7

EXHIBIT 1-5: WEST CAMPUS UPPER PLATEAU ROADWAY CROSS-SECTIONS 9

EXHIBIT 1-6: PROPOSED TRUCK ROUTES 11

EXHIBIT 3-1: EXISTING NUMBER OF THROUGH LANES AND INTERSECTION CONTROLS 33

EXHIBIT 3-2: MARCH JPA GENERAL PLAN CIRCULATION ELEMENT 36

EXHIBIT 3-3: MARCH JPA GENERAL PLAN ROADWAY CROSS-SECTIONS 37

EXHIBIT 3-4: COUNTY OF RIVERSIDE GENERAL PLAN CIRCULATION ELEMENT 38

EXHIBIT 3-5: COUNTY OF RIVERSIDE GENERAL PLAN ROADWAY CROSS-SECTIONS 39

EXHIBIT 3-6: CITY OF MORENO VALLEY GENERAL PLAN CIRCULATION ELEMENT 40

EXHIBIT 3-7: CITY OF MORENO VALLEY GENERAL PLAN ROADWAY CROSS-SECTIONS 41

EXHIBIT 3-8: CITY OF RIVERSIDE GENERAL PLAN CIRCULATION ELEMENT 42

EXHIBIT 3-9: CITY OF RIVERSIDE GENERAL PLAN ROADWAY CROSS-SECTIONS..... 43

EXHIBIT 3-10: CITY OF MORENO VALLEY BIKE PLAN..... 44

EXHIBIT 3-11: CITY OF MORENO VALLEY MASTER PLAN OF TRAILS 45

EXHIBIT 3-12: CITY OF RIVERSIDE PROPOSED BIKEWAYS AND TRAILS IMPROVEMENTS 46

EXHIBIT 3-13: EXISTING PEDESTRIAN FACILITIES AT STUDY AREA INTERSECTIONS 47

EXHIBIT 3-14: MARCH JPA TRUCK ROUTES 49

EXHIBIT 3-15: CITY OF MORENO VALLEY TRUCK ROUTES 50

EXHIBIT 3-16: EXISTING TRANSIT ROUTES 51

EXHIBIT 3-17: EXISTING (2021) WEEKDAY TRAFFIC VOLUMES..... 53

EXHIBIT 3-18: EXISTING (2021) WEEKEND TRAFFIC VOLUMES..... 55

EXHIBIT 4-1: PROJECT (TRUCK) TRIP DISTRIBUTION 65

EXHIBIT 4-2: PROJECT (PASSENGER CAR) TRIP DISTRIBUTION 66

EXHIBIT 4-3: PROJECT ONLY WEEKDAY TRAFFIC VOLUMES 67

EXHIBIT 4-4: PROJECT ONLY WEEKEND TRAFFIC VOLUMES 69

EXHIBIT 4-5: CUMULATIVE DEVELOPMENT LOCATION MAP 73

EXHIBIT 4-6: CUMULATIVE ONLY WEEKDAY TRAFFIC VOLUMES 74

EXHIBIT 4-7: CUMULATIVE ONLY WEEKEND TRAFFIC VOLUMES 76

EXHIBIT 5-1: E+P WEEKDAY TRAFFIC VOLUMES 81

EXHIBIT 5-2: E+P WEEKEND TRAFFIC VOLUMES 83

EXHIBIT 6-1: EAP (2028) WEEKDAY TRAFFIC VOLUMES 91

EXHIBIT 6-2: EAP (2028) WEEKEND TRAFFIC VOLUMES 93

EXHIBIT 7-1: OPENING YEAR CUMULATIVE (2028) WITHOUT PROJECT WEEKDAY TRAFFIC VOLUMES 101

EXHIBIT 7-2: OPENING YEAR CUMULATIVE (2028) WITHOUT PROJECT WEEKEND TRAFFIC VOLUMES 103

EXHIBIT 7-3: OPENING YEAR CUMULATIVE (2028) WITH PROJECT WEEKDAY TRAFFIC VOLUMES 105

EXHIBIT 7-3: OPENING YEAR CUMULATIVE (2028) WITH PROJECT WEEKEND TRAFFIC VOLUMES 107

EXHIBIT 8-1: HORIZON YEAR (2045) WITHOUT PROJECT WEEKDAY TRAFFIC VOLUMES..... 119

EXHIBIT 8-2: HORIZON YEAR (2045) WITHOUT PROJECT WEEKEND TRAFFIC VOLUMES 121

EXHIBIT 8-3: HORIZON YEAR (2045) WITH PROJECT WEEKDAY TRAFFIC VOLUMES 123

EXHIBIT 8-4: HORIZON YEAR (2045) WITH PROJECT WEEKEND TRAFFIC VOLUMES 125

This Page Intentionally Left Blank

LIST OF TABLES

TABLE 1-1: INTERSECTION ANALYSIS LOCATIONS 7

TABLE 1-2: ROADWAY SEGMENT ANALYSIS LOCATIONS 8

TABLE 1-3: TRAFFIC SIGNAL WARRANT ANALYSIS SUMMARY 6

TABLE 1-4: SUMMARY OF IMPROVEMENTS AND ROUGH ORDER OF MAGNITUDE COSTS..... 14

TABLE 2-1: SIGNALIZED INTERSECTION LOS THRESHOLDS..... 21

TABLE 2-2: UNSIGNALIZED INTERSECTION LOS THRESHOLDS 22

TABLE 2-3: ROADWAY SEGMENT CAPACITIES FOR COUNTY OF RIVERSIDE/MARCH JPA..... 23

TABLE 2-4: ROADWAY SEGMENT CAPACITIES FOR CITY OF RIVERSIDE 24

TABLE 2-5: TRAFFIC SIGNAL WARRANT ANALYSIS LOCATIONS 25

TABLE 2-6: MARCH JPA DEFICIENCY CRITERIA..... 28

TABLE 2-7: CITY OF RIVERISDE INTERSECTION DEFICIENCY CRITERIA 29

TABLE 3-1: INTERSECTION ANALYSIS FOR EXISTING (2021) CONDITIONS 57

TABLE 3-2: ROADWAY SEGMENT CAPACITY ANALYSIS FOR EXISTING (2021) CONDITIONS..... 58

**TABLE 3-3: PEAK HOUR FREEWAY OFF-RAMP QUEUING SUMMARY FOR EXISTING (2021) CONDITIONS
59**

TABLE 4-1: CALCULATED TRIP GENERATION RATES..... 62

TABLE 4-2: PROJECT TRIP GENERATION SUMMARY 63

TABLE 4-3: CUMULATIVE DEVELOPMENT LAND USE SUMMARY 78

TABLE 5-1: INTERSECTION ANALYSIS FOR E+P CONDITIONS..... 85

TABLE 5-2: ROADWAY SEGMENT ANALYSIS FOR E+P CONDITIONS 86

TABLE 5-3: PEAK HOUR FREEWAY OFF-RAMP QUEUING SUMMARY FOR E+P CONDITIONS 88

TABLE 5-4: INTERSECTION ANALYSIS FOR E+P CONDITIONS WITH IMPROVEMENTS 89

TABLE 6-1: INTERSECTION ANALYSIS FOR EAP (2028) CONDITIONS 95

TABLE 6-2: ROADWAY SEGMENT ANALYSIS FOR EAP (2028) CONDITIONS 96

TABLE 6-3: PEAK HOUR FREEWAY OFF-RAMP QUEUING SUMMARY FOR EAP (2028) CONDITIONS 98

TABLE 6-4: INTERSECTION ANALYSIS FOR EAP (2028) CONDITIONS WITH IMPROVEMENTS 99

TABLE 7-1: INTERSECTION ANALYSIS FOR OPENING YEAR CUMULATIVE (2028) CONDITIONS 110

TABLE 7-2: ROADWAY SEGMENT ANALYSIS FOR OPENING YEAR CUMULATIVE (2028) CONDITIONS. 112

**TABLE 7-3: PEAK HOUR FREEWAY OFF-RAMP QUEUING SUMMARY FOR OPENING YEAR CUMULATIVE
(2028) CONDITIONS 113**

**TABLE 7-4: INTERSECTION ANALYSIS FOR OPENING YEAR CUMULATIVE (2028) CONDITIONS WITH
IMPROVEMENTS 115**

TABLE 8-1: INTERSECTION ANALYSIS FOR HORIZON YEAR (2045) CONDITIONS 128

TABLE 8-2: ROADWAY SEGMENT ANALYSIS FOR HORIZON YEAR (2045) CONDITIONS 130

**TABLE 8-3: PEAK HOUR FREEWAY OFF-RAMP QUEUING SUMMARY FOR HORIZON YEAR (2045)
CONDITIONS 131**

**TABLE 8-4: INTERSECTION ANALYSIS FOR HORIZON YEAR (2045) CONDITIONS WITH IMPROVEMENTS
133**

TABLE 9-1: PROJECT FAIR SHARE CALCULATIONS FOR INTERSECTIONS 137

This Page Intentionally Left Blank

LIST OF ABBREVIATED TERMS

(1)	Reference
ADT	Average Daily Traffic
CA MUTCD	California Manual on Uniform Traffic Control Devices
Caltrans	California Department of Transportation
CEQA	California Environmental Quality Act
CMP	Congestion Management Program
DIF	Development Impact Fee
E+P	Existing Plus Project
EAP	Existing plus Ambient Growth plus Project
EVA	Emergency Vehicle Access
HCM	Highway Capacity Manual
ITE	Institute of Transportation Engineers
LOS	Level of Service
March JPA	March Joint Powers Authority
NCHRP	National Cooperative Highway Research Program
PHF	Peak Hour Factor
Project	West Campus Upper Plateau
RCTC	Riverside County Transportation Commission
RIVCOM	Riverside Transportation Analysis Model
RTA	Riverside Transit Agency
RTP	Regional Transportation Plan
SCAG	Southern California Association of Governments
SCS	Sustainable Communities Strategy
TA	Traffic Analysis
TUMF	Transportation Uniform Mitigation Fee
v/c	Volume to Capacity
vphgpl	Vehicles per Hour Green per Lane
WRCOG	Western Riverside Council of Governments

This Page Intentionally Left Blank

1 SUMMARY OF FINDINGS

This report presents the results of the traffic analysis (TA) for the proposed West Campus Upper Plateau (Project), which is within the jurisdiction of the March Joint Powers Authority (March JPA) and located west of Cactus Avenue's current terminus, to the east and south of the Mission Grove neighborhood, and to the north of the Orangecrest neighborhood in the City of Riverside, California, as shown on Exhibit 1-1. The Project would include the extensions of Cactus Avenue, Brown Street, and Barton Street.

The purpose of this TA is to evaluate the potential circulation system deficiencies that may result from the development of the proposed Project, and where necessary recommend improvements to achieve acceptable operations consistent with General Plan level of service goals and policies. This traffic study has been prepared in accordance with the March JPA's Final Traffic Impact Study Preparation Guide (February 2020), guidance from the California Department of Transportation (Caltrans), and through consultation with March JPA, County of Riverside, City of Riverside, and City of Moreno Valley staff during the scoping process. (1) The Project Traffic Study Scoping agreement is provided in Appendix 1.1 of this TA.

1.1 SUMMARY OF FINDINGS

The Project is to construct the following improvements as design features in conjunction with development of the site:

- Project to construct signalized intersections at along Cactus Avenue at Airman Drive, Linebacker Drive, and Brown Street.
- Cactus Avenue will be constructed to its ultimate cross-section as a Modified Secondary Highway from Linebacker Drive to the easterly Specific Plan boundary with a 98-foot right-of-way and 76-foot curb-to-curb pavement width. Cactus Avenue will be constructed to its ultimate cross-section as a Modified Industrial Collector west of Linebacker Drive to Airman Drive with a 76-foot right-of-way and 54-foot curb-to-curb pavement width. However, the eastbound approach of Cactus Avenue towards Linebacker Drive will require additional right-of-way to accommodate the lane geometrics needed at the intersection (2nd eastbound through).
- Barton Street will be constructed to its ultimate cross-section as a Collector from the existing northerly and southerly termini with a 66-foot right-of-way and 40-foot curb-to-curb pavement width consistent with the City of Riverside's Circulation Element. Once completed, the roadway will provide a connection between the existing Mission Grove community to the north and Orangecrest community to the south
- Brown Street will be constructed to its ultimate cross-section as an Industrial Collector from its existing terminus south of Alessandro Boulevard to Cactus Avenue with a 78-foot right-of-way and 56-foot curb-to-curb pavement width.
- Other streets internal to the Specific Plan such as Arclight Drive, Airman Drive, Bunker Hill Drive, and Linebacker Drive will be constructed at their ultimate cross-section as Modified Industrial Collectors that have a 76-foot right-of-way with 54-foot curb-to-curb pavement width.

EXHIBIT 1-1: PRELIMINARY LAND USE PLAN

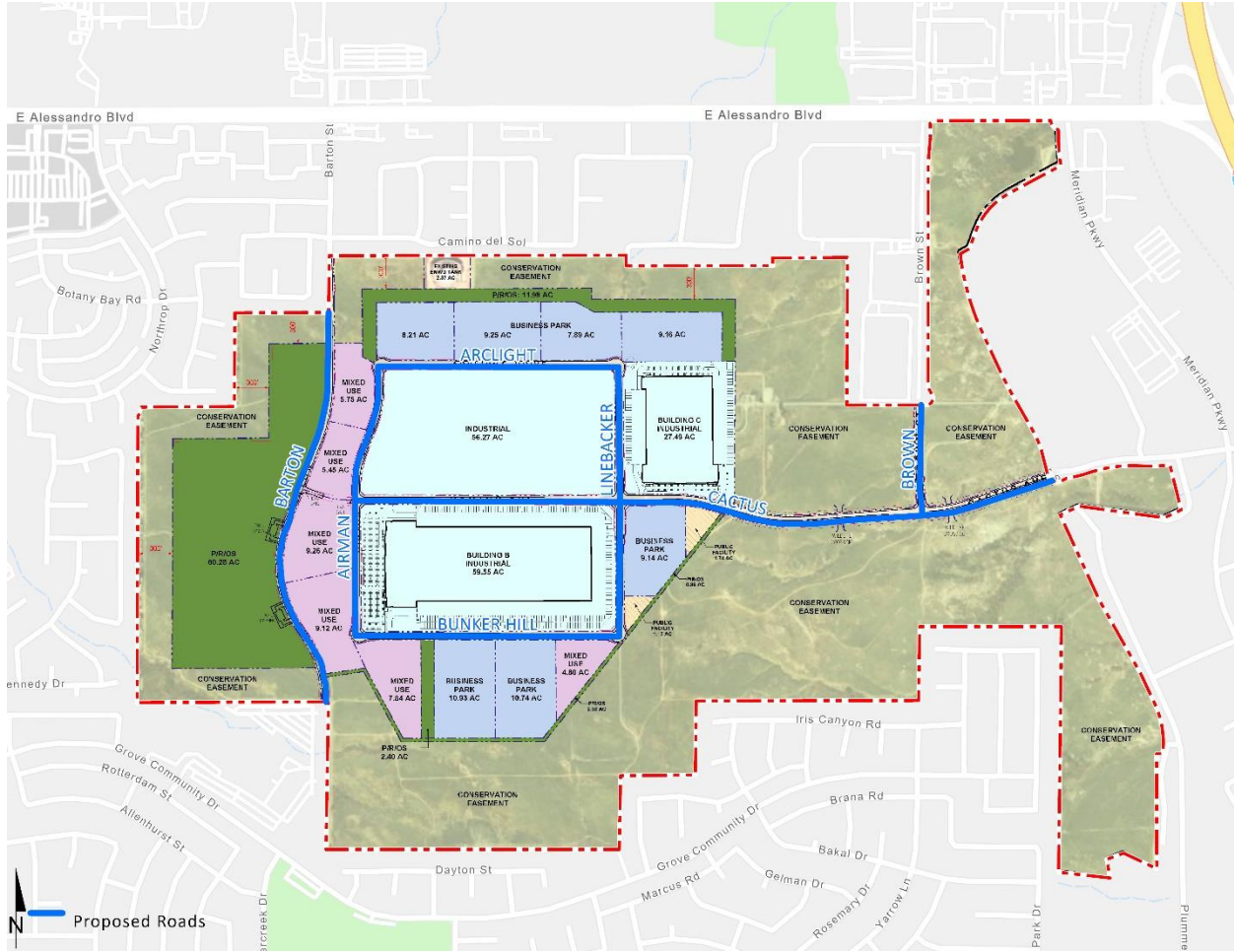

Additional details and intersection lane geometrics are provided in Section 1.6 *Recommendations* of this report.

The development of the proposed Project is anticipated to require the construction of off-site improvements, in conjunction with additional improvement needs at off-site intersections for future traffic analysis scenarios where the Project would contribute traffic (as measured by 50 or more peak hour trips). As such, the Project Applicant's responsibility for the Project's contributions towards off-site intersection deficiencies is fulfilled through a combination of construction, payment of fair share, and/or participation in the pre-existing fee programs that would be assigned to construction of the identified recommended improvements (see Section 9 *Local and Regional Funding Mechanisms*).

1.2 PROJECT OVERVIEW

The Project site is located on either side of Barton Street and Cactus Avenue in the jurisdiction of the March Joint Powers Authority (March JPA) and unincorporated Riverside County. Interstate 215 (I-215) is located approximately 2.5 miles east of the Project site via Cactus Avenue, Alessandro Boulevard, and Van Buren Boulevard. Cactus Avenue will not extend west of Airman Drive to Barton Street; however, an emergency vehicle access (EVA) only connection will be maintained and not be accessible by any vehicular traffic.

The proposed Project (see Exhibit 1-1) consists of the following uses:

- Building B – 1,250,000 square feet (SF) of high-cube fulfillment center warehouse use
- Building C – 587,000 SF of high-cube fulfillment center warehouse use
- Industrial Area – 725,561 SF of high-cube fulfillment center warehouse use and 500,000 SF of high-cube cold storage warehouse use
- Business Park Area – 1,280,403 SF of business park use
- Mixed Use Area – 160,921 SF of retail use (25%)
- Mixed Use Area – 482,765 SF of business park use (75%)
- 42.20 Acre Active Park (with sports fields)
- 18.08 Acres of Public Park
- The proposed Project also includes an approximately 445-acre Conservation Area that is not anticipated to generate traffic.

The proposed Project is anticipated to generate a total of 35,314 trip-ends per day with 1,761 AM peak hour trips, 3,389 PM peak hour trips, and 1,642 Saturday peak hour trips (in actual vehicles). The assumptions and methods used to estimate the Project's trip generation characteristics are discussed in greater detail in Section 4.1 *Project Trip Generation* of this report.

1.3 ANALYSIS SCENARIOS

For the purposes of this TA, potential deficiencies to traffic and circulation have been assessed for each of the following conditions:

- Existing (2021) Conditions
- Existing plus Project (E+P) Conditions
- Existing plus Ambient Growth plus Project (EAP)
- Opening Year Cumulative (2028) Without Project Conditions
- Opening Year Cumulative (2028) With Project Conditions
- Horizon Year (2045) Without Project Conditions
- Horizon Year (2045) With Project Conditions

1.3.1 EXISTING (2021) CONDITIONS

The intersection LOS analysis is based on the traffic volumes observed during the peak hour conditions using traffic data based on an adjustment of both historic (2019) traffic count data and new (2021) traffic count data collected in November 2021. Traffic counts were adjusted due to the currently ongoing COVID-19 pandemic. Adjusted factors was calculated based on historic (2019) traffic counts in conjunction with a 2.0% per year growth rate (compounded annually) to reflect 2021 conditions and compared to new (2021) traffic count data at the same intersections. Other locations where historic count data was not available, the traffic counts were adjusted and increased from the 2021 collected data based on a factor derived from the locations with both historic and 2021 traffic count data.

1.3.2 EXISTING PLUS PROJECT CONDITIONS

The E+P analysis determines traffic deficiencies that would occur on the existing roadway system with the addition of Project traffic. This analysis scenario is a hypothetical analysis scenario in which Project traffic is added to existing traffic without any additional growth; however, the analysis has been presented for the purposes of identifying improvement needs that are attributable to the addition of Project traffic alone.

1.3.3 EXISTING PLUS AMBIENT GROWTH PLUS PROJECT (EAP) (2028) CONDITIONS

The EAP (2028) analysis determines traffic deficiencies that would occur on the existing roadway system with the addition of Project traffic along with additional ambient background traffic that is calculated at 2.0% per year compounded annually over 7 years, or 14.87%.

1.3.4 OPENING YEAR CUMULATIVE (2028) CONDITIONS

The Opening Year Cumulative (2028) conditions analysis determines the potential near-term cumulative circulation system deficiencies. To account for background traffic growth, traffic associated with other known cumulative development projects in conjunction with an ambient growth from Existing (2021) conditions of 14.87% is included for Opening Year Cumulative (2028) traffic conditions (2.0% per year compounded annually over 7 years). A list of cumulative

development projects was compiled from information provided by the March JPA and is consistent with other recent studies in the study area. Relevant projects from other nearby agencies (including the cities of Moreno Valley and Riverside as provided by those respective agencies) have also been included for the purposes of this TA.

1.3.5 HORIZON YEAR (2045) CONDITIONS

Traffic projections for Horizon Year (2045) with Project conditions were derived from the latest Riverside Transportation Analysis Model (RIVCOM). The Horizon Year (2045) conditions analysis has been utilized to determine if improvements funded through regional transportation fee programs, such as the Development Impact Fee (DIF) program or Western Riverside Council of Governments (WRCOG) Transportation Uniform Mitigation Fee (TUMF), or other approved funding mechanisms can accommodate the long-range cumulative traffic at the target level of service (LOS) identified by the March JPA (lead agency). Other improvements needed beyond the “funded” improvements (such as localized improvements to non-DIF facilities) are identified as such.

1.4 STUDY AREA

To ensure that this TA satisfies the March JPA’s requirements, Urban Crossroads, Inc. prepared a Project TA scoping package for review by March JPA staff prior to the preparation of this report. The Agreement provides an outline of the Project study area, trip generation, trip distribution, and analysis methodology. The agreement is included in Appendix 1.1 of this TA. The scoping agreement was also shared with the County of Riverside, City of Riverside, and City of Moreno Valley for review and comment, and those comments have also been taken into consideration as part of this TA.

The following 38 study area intersections shown on Exhibit 1-2 and listed in Table 1-1 were selected for this TA based on consultation with March JPA staff. The “50 peak hour trip” criterion generally represents a minimum number of trips at which a typical intersection would have the potential to be affected by a given development proposal. Although each intersection may have unique operating characteristics, this traffic engineering rule of thumb is a widely utilized tool for estimating a potential area of influence (i.e., study area). Other analysis intersections, within the adjacent cities were not selected for evaluation as the Project is anticipated to contribute less than 50 weekday peak hour trips.

1.4.1 INTERSECTIONS

The following 38 study area intersections listed in Table 1-1 and shown on Exhibit 1-2 were selected for this TA.

EXHIBIT 1-2: LOCATION MAP

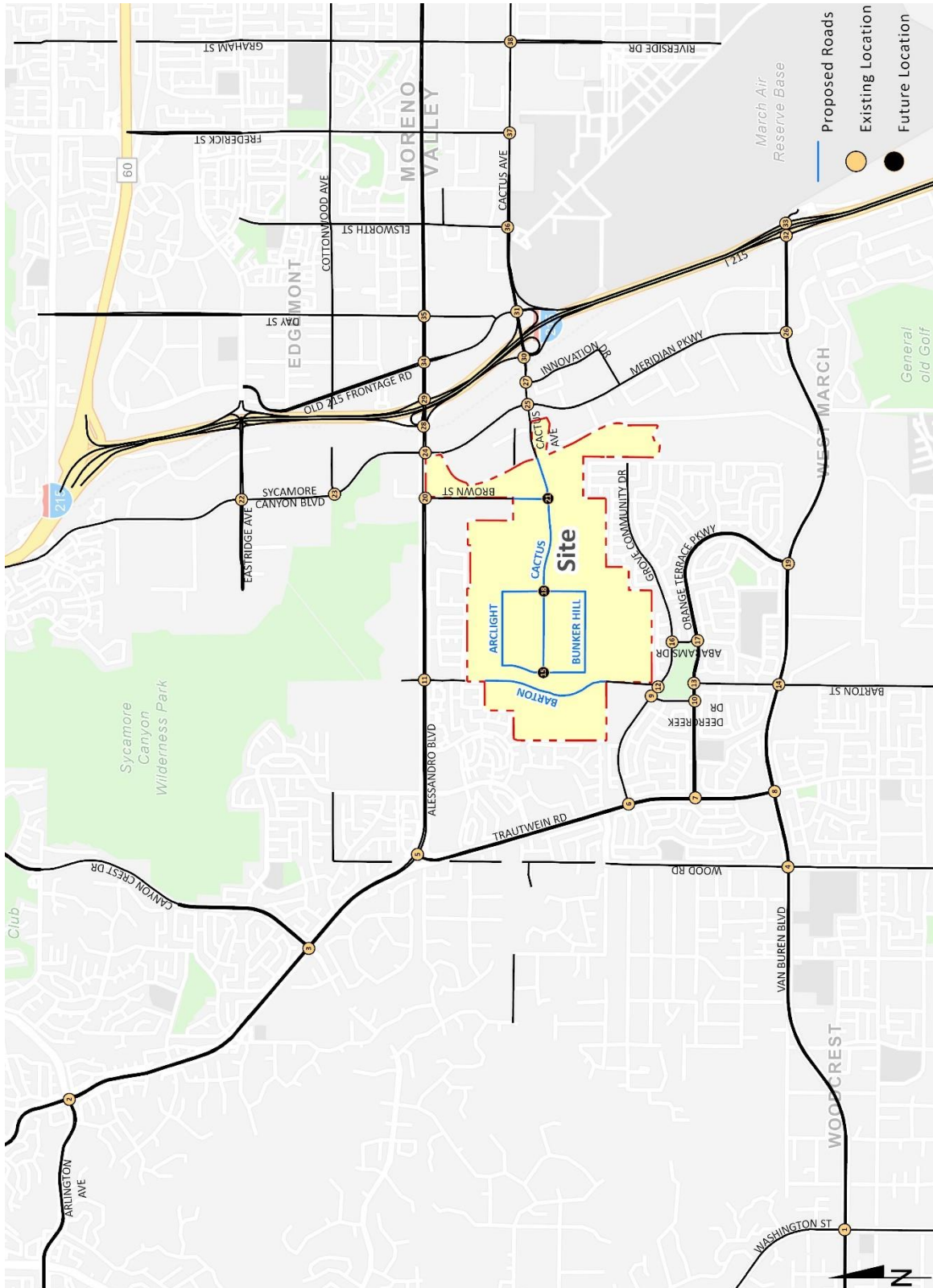

TABLE 1-1: INTERSECTION ANALYSIS LOCATIONS

ID	Intersection Location	Jurisdiction	CMP?
1	Washington St. & Van Buren Blvd.	County of Riv.	No
2	Alessandro Blvd. & Arlington Av./Chicago Av.	City of Riverside	No
3	Canyon Crest Dr./Overlook Pkwy. & Alessandro Blvd.	City of Riverside	No
4	Wood Rd. & Van Buren Blvd.	City of Riverside	No
5	Trautwein Rd. & Alessandro Blvd.	City of Riverside	No
6	Trautwein Rd. & Grove Community Dr.	City of Riverside	No
7	Trautwein Rd. & Orange Terrace Pkwy.	City of Riverside	No
8	Trautwein Rd. & Van Buren Blvd.	City of Riverside	No
9	Deercreek Dr. & Grove Community Dr.	City of Riverside	No
10	Deercreek Dr. & Orange Terrace Pkwy.	City of Riverside	No
11	Barton St. & Alessandro Blvd.	City of Riverside, March JPA	No
12	Barton St. & Grove Community Dr.	City of Riverside	No
13	Barton St. & Orange Terrace Pkwy.	City of Riverside	No
14	Barton St. & Van Buren Blvd.	County of Riv., City of Riverside, March JPA	No
15	Airman Dr. & Cactus Av.	March JPA	No
16	Abrams Dr. & Grove Community Dr.	City of Riverside	No
17	Abrams Dr. & Orange Terrace Pkwy.	City of Riverside	No
18	Linebacker Dr. & Cactus Av.	March JPA	No
19	Orange Terrace Pkwy. & Van Buren Blvd.	County of Riv., City of Riverside, March JPA	No
20	Brown St. & Alessandro Blvd.	County of Riv., City of Riverside, March JPA	No
21	Brown St. & Cactus Av.	March JPA	No
22	Sycamore Canyon Blvd. & Eastridge Av.	City of Riverside	No
23	Sycamore Canyon Blvd. & Cottonwood Av.	City of Riverside	No
24	Meridian Pkwy. & Alessandro Blvd.	County of Riv., City of Riverside, March JPA	No
25	Meridian Pkwy. & Cactus Av.	March JPA	No
26	Meridian Pkwy. & Van Buren Blvd.	County of Riv., March JPA	No
27	Innovation Dr. & Cactus Av.	March JPA	No
28	I-215 SB Ramps & Alessandro Blvd.	City of Riv., JPA, Caltrans	No
29	I-215 NB Ramps & Alessandro Blvd.	City of Riv., JPA, Caltrans	No
30	I-215 SB Ramps & Cactus Av.	March JPA, Caltrans	No
31	I-215 NB Ramps & Cactus Av.	JPA, City of MV, Caltrans	No
32	I-215 SB Ramps & Van Buren Blvd.	March JPA, Caltrans	No
33	I-215 NB Ramps & Van Buren Blvd.	March JPA, Caltrans	No
34	Old 215 Frontage Rd. & Alessandro Blvd.	County of Riv., March JPA, City of MV	No
35	Day St. & Alessandro Blvd.	City of Moreno Valley	No
36	Elsworth St. & Cactus Av.	City of Moreno Valley	No
37	Frederick St. & Cactus Av.	City of Moreno Valley	No
38	Graham St./Riverside Dr. & Cactus Av.	City of Moreno Valley	No

The intent of a Congestion Management Program (CMP) is to more directly link land use, transportation, and air quality, thereby prompting reasonable growth management programs that will effectively utilize new transportation funds, alleviate traffic congestion and related deficiencies, and improve air quality. The County of Riverside CMP became effective with the passage of Proposition 111 in 1990 and most recently updated in 2019 as part of the Riverside County Long Range Transportation Study. The Riverside County Transportation Commission (RCTC) adopted the 2019 CMP for the County of Riverside in December 2019. (3) There are no study area intersections identified as a Riverside County CMP intersection.

1.4.2 ROADWAY SEGMENTS

Pursuant to the approved scoping agreement, the following study area roadway segments have been evaluated for the purposes of this TA (see Exhibit 1-2 and Table 1-2):

TABLE 1-2: ROADWAY SEGMENT ANALYSIS LOCATIONS

ID	Roadway Segment	Limits	Jurisdiction
1	Alessandro Bl.	Trautwein Rd. to Mission Grove Pkwy.	City of Riverside
2	Alessandro Bl.	Mission Grove Pkwy. to Barton St.	City of Riverside
3	Alessandro Bl.	Barton St. to Brown St.	County of Riverside, City of Riverside, March JPA
4	Alessandro Bl.	Brown St. to Meridian Pkwy.	County of Riverside, City of Riverside, March JPA
5	Alessandro Bl.	Meridian Pkwy. to I-215 Freeway	County of Riverside, JPA, Caltrans
6	Cactus Av.	Airman Dr. to Linebacker Dr.	March JPA
7	Cactus Av.	Linebacker Dr. to Brown St.	March JPA
8	Cactus Av.	Brown St. to Meridian Pkwy.	March JPA
9	Cactus Av.	Meridian Pkwy. to I-215 Freeway	March JPA
10	Barton St.	Alessandro Bl. to Cactus Av. (EVA)	City of Riverside, March JPA
11	Barton St.	Cactus Av. (EVA) to Grove Community Dr.	City of Riverside, March JPA
12	Brown St.	Alessandro Bl. to Cactus Av.	March JPA
13	Sycamore Canyon Bl.	Cottonwood Av. to Alessandro Bl.	City of Riverside
14	Meridian Pkwy.	Alessandro Bl. to Cactus Av.	March JPA
15	Meridian Pkwy.	Cactus Av. to Van Buren Bl.	March JPA

1.5 DEFICIENCIES

This section provides a summary of deficiencies by analysis scenario. Section 2 *Methodologies* provides information on the methodologies used in the analysis and Section 3 *Existing Traffic Conditions*, Section 5 *E+P Traffic Conditions*, Section 6 *EAP (2028) Traffic Conditions*, Section 7 *Opening Year Cumulative (2028) Traffic Conditions*, and Section 8 *Horizon Year (2045) Traffic Conditions* includes the detailed analysis. A summary of LOS results for all analysis scenarios is presented on Exhibit 1-3 for study area intersections and Exhibit 1-4 for study area roadway segments. For the purposes of this analysis, the minimum LOS at study area intersections and roadway segments for all applicable agencies is LOS D.

1.5.1 EXISTING (2021) CONDITIONS

Intersections

The following study area intersections are currently operating at an unacceptable LOS during one or more peak hours under Existing (2021) traffic conditions:

- Alessandro Bl. & Arlington Av./Chicago Av. (#2) – LOS E AM peak hour; LOS F PM peak hour
- Trautwein Rd. & Alessandro Bl. (#5) – LOS F AM peak hour only
- Deercreek Dr. & Orange Terrace Pkwy. (#10) – LOS F AM peak hour only
- Barton St. & Orange Terrace Pkwy. (#13) – LOS F AM and Saturday peak hours
- Barton St. & Van Buren Bl. (#14) – LOS E AM peak hour only
- Meridian Pkwy. & Alessandro Bl. (#24) – LOS F AM peak hour only
- I-215 NB Ramps & Alessandro Bl. (#29) – LOS F AM peak hour only
- I-215 NB Ramps & Cactus Av. (#31) – LOS E AM peak hour only
- Elsworth St. & Cactus Av. (#36) – LOS F AM peak hour; LOS E PM peak hour

Roadway Segments

The following study area roadway segment is currently operating at an unacceptable LOS under Existing (2021) traffic conditions:

- Meridian Pkwy. from Alessandro Bl. to Cactus Av. (#14) – LOS E

Off-Ramp Queuing Analysis

A queuing analysis was performed for the I-215 Freeway off-ramps at Alessandro Boulevard, Cactus Avenue, and Van Buren Boulevard for Existing (2021) traffic conditions. The analysis indicates there are currently no queuing issues that may potentially “spill back” onto the I-215 Freeway mainline at the study area interchanges

EXHIBIT 1-3: SUMMARY OF DEFICIENT INTERSECTIONS BY ANALYSIS SCENARIO

#	Intersection	Existing (2021)			E+P			EAP			OYC (2028) Without Project			OYC (2028) With Project			Horizon Year (2045) Without Project			Horizon Year (2045) With Project		
		AM	PM	SAT	AM	PM	SAT	AM	PM	SAT	AM	PM	SAT	AM	PM	SAT	AM	PM	SAT	AM	PM	SAT
1	Washington St. & Van Buren Blvd.	●	●	●	●	●	●	●	●	●	●	●	●	●	●	●	●	●	●	●	●	●
2	Alessandro Blvd. & Arlington Av./Chicago Av. ⁵	●	●	●	●	●	●	●	●	●	●	●	●	●	●	●	●	●	●	●	●	●
3	Canyon Crest Dr./Overlook Pkwy. & Alessandro Blvd.	●	●	●	●	●	●	●	●	●	●	●	●	●	●	●	●	●	●	●	●	●
4	Wood Rd. & Van Buren Blvd.	●	●	●	●	●	●	●	●	●	●	●	●	●	●	●	●	●	●	●	●	●
5	Trautwein Rd. & Alessandro Blvd.	●	●	●	●	●	●	●	●	●	●	●	●	●	●	●	●	●	●	●	●	●
6	Trautwein Rd. & Grove Community Dr.	●	●	●	●	●	●	●	●	●	●	●	●	●	●	●	●	●	●	●	●	●
7	Trautwein Rd. & Orange Terrace Pkwy. ²	●	●	●	●	●	●	●	●	●	●	●	●	●	●	●	●	●	●	●	●	●
8	Trautwein Rd. & Van Buren Blvd.	●	●	●	●	●	●	●	●	●	●	●	●	●	●	●	●	●	●	●	●	●
9	Deercreek Dr. & Grove Community Dr.	●	●	●	●	●	●	●	●	●	●	●	●	●	●	●	●	●	●	●	●	●
10	Deercreek Dr. & Orange Terrace Pkwy.	●	●	●	●	●	●	●	●	●	●	●	●	●	●	●	●	●	●	●	●	●
11	Barton St. & Alessandro Blvd. ^{2,8}	●	●	●	●	●	●	●	●	●	●	●	●	●	●	●	●	●	●	●	●	●
12	Barton St. & Grove Community Dr.	●	●	●	●	●	●	●	●	●	●	●	●	●	●	●	●	●	●	●	●	●
13	Barton St. & Orange Terrace Pkwy.	●	●	●	●	●	●	●	●	●	●	●	●	●	●	●	●	●	●	●	●	●
14	Barton St. & Van Buren Blvd.	●	●	●	●	●	●	●	●	●	●	●	●	●	●	●	●	●	●	●	●	●
15	Airman Dr. & Cactus Av.	N/A	N/A	N/A	●	●	●	●	●	●	●	●	●	●	●	●	●	●	●	●	●	●
16	Abrams Dr. & Grove Community Dr.	●	●	●	●	●	●	●	●	●	●	●	●	●	●	●	●	●	●	●	●	●
17	Abrams Dr. & Orange Terrace Pkwy.	●	●	●	●	●	●	●	●	●	●	●	●	●	●	●	●	●	●	●	●	●
18	Linebacker Dr. & Cactus Av.	N/A	N/A	N/A	●	●	●	●	●	●	●	●	●	●	●	●	●	●	●	●	●	●
19	Orange Terrace Pkwy. & Van Buren Blvd.	●	●	●	●	●	●	●	●	●	●	●	●	●	●	●	●	●	●	●	●	●
20	Brown St. & Alessandro Blvd. ³	●	●	●	●	●	●	●	●	●	●	●	●	●	●	●	●	●	●	●	●	●
21	Brown St. & Cactus Av.	N/A	N/A	N/A	●	●	●	●	●	●	●	●	●	●	●	●	●	●	●	●	●	●
22	Sycamore Canyon Blvd. & Eastridge Av.	●	●	●	●	●	●	●	●	●	●	●	●	●	●	●	●	●	●	●	●	●
23	Sycamore Canyon Blvd. & Cottonwood Av.	●	●	●	●	●	●	●	●	●	●	●	●	●	●	●	●	●	●	●	●	●
24	Meridian Pkwy. & Alessandro Blvd. ⁵	●	●	●	●	●	●	●	●	●	●	●	●	●	●	●	●	●	●	●	●	●
25	Meridian Pkwy. & Cactus Av. ^{2,5}	●	●	●	●	●	●	●	●	●	●	●	●	●	●	●	●	●	●	●	●	●
26	Meridian Pkwy. & Van Buren Blvd. ⁶	●	●	●	●	●	●	●	●	●	●	●	●	●	●	●	●	●	●	●	●	●
27	Innovation Dr. & Cactus Av.	●	●	●	●	●	●	●	●	●	●	●	●	●	●	●	●	●	●	●	●	●
28	I-215 SB Ramps & Alessandro Blvd.	●	●	●	●	●	●	●	●	●	●	●	●	●	●	●	●	●	●	●	●	●
29	I-215 NB Ramps & Alessandro Blvd.	●	●	●	●	●	●	●	●	●	●	●	●	●	●	●	●	●	●	●	●	●
30	I-215 SB Ramps & Cactus Av.	●	●	●	●	●	●	●	●	●	●	●	●	●	●	●	●	●	●	●	●	●
31	I-215 NB Ramps & Cactus Av.	●	●	●	●	●	●	●	●	●	●	●	●	●	●	●	●	●	●	●	●	●
32	I-215 SB Ramps & Van Buren Blvd. ⁵	●	●	●	●	●	●	●	●	●	●	●	●	●	●	●	●	●	●	●	●	●
33	I-215 NB Ramps & Van Buren Blvd.	●	●	●	●	●	●	●	●	●	●	●	●	●	●	●	●	●	●	●	●	●
34	Old 215 Frontage Rd. & Alessandro Blvd.	●	●	●	●	●	●	●	●	●	●	●	●	●	●	●	●	●	●	●	●	●
35	Day St. & Alessandro Blvd.	●	●	●	●	●	●	●	●	●	●	●	●	●	●	●	●	●	●	●	●	●
36	Elsworth St. & Cactus Av. ⁷	●	●	●	●	●	●	●	●	●	●	●	●	●	●	●	●	●	●	●	●	●
37	Frederick St. & Cactus Av.	●	●	●	●	●	●	●	●	●	●	●	●	●	●	●	●	●	●	●	●	●
38	Graham St./Riverside Dr. & Cactus Av.	●	●	●	●	●	●	●	●	●	●	●	●	●	●	●	●	●	●	●	●	●

● LOS=A-D
● LOS=E
● LOS=F

EXHIBIT 1-4: SUMMARY OF DEFICIENT ROADWAY SEGMENTS BY ANALYSIS SCENARIO

#	Roadway Segment	Existing (2021)	E+P	EAP	OYC (2028) Without Project	OYC (2028) With Project	Horizon Year (2045) Without Project	Horizon Year (2045) With Project
1	Alessandro Bl., Trautwein Rd. to Mission Grove Pkwy.	●	●	●	●	●	●	●
2	Alessandro Bl., Mission Grove Pkwy. to Barton St.	●	●	●	●	●	●	●
3	Alessandro Bl., Barton St. to Brown St.	●	●	●	●	●	●	●
4	Alessandro Bl., Brown St. to Meridian Pkwy.	●	●	●	●	●	●	●
5	Alessandro Bl., Meridian Pkwy. to I-215 Freeway	●	●	●	●	●	●	●
6	Cactus Av., Airman Dr. to Linebacker Dr.	●	●	●	●	●	●	●
7	Cactus Av., Linebacker Dr. to Brown St.	●	●	●	●	●	●	●
8	Cactus Av., Brown St. to Meridian Pkwy.	●	●	●	●	●	●	●
9	Cactus Av. Meridian Pkwy. to I-215 Freeway	●	●	●	●	●	●	●
10	Barton St., Alessandro Bl. to Cactus Av. (EVA)	●	●	●	●	●	●	●
11	Barton St., Cactus Av. (EVA) to Grove Community Dr.	●	●	●	●	●	●	●
12	Brown St., Alessandro Bl. to Cactus Av.	●	●	●	●	●	●	●
13	Sycamore Canyon Bl., Cottonwood Av. to Alessandro Bl.	●	●	●	●	●	●	●
14	Meridian Pkwy., Alessandro Bl. to Cactus Av.	●	●	●	●	●	●	●
15	Meridian Pkwy., Cactus Av. to Van Buren Bl.	●	●	●	●	●	●	●

- LOS=A-D
- LOS=E
- LOS=F

1.5.2 E+P CONDITIONS

Intersections

The study area intersections are anticipated to continue to operate at an acceptable LOS during the peak hours with the addition of Project traffic (for E+P traffic condition), with the exception of the following intersections, which are in addition to those identified previously under Existing (2021) traffic conditions:

- Canyon Crest Dr./Overlook Pkwy. & Alessandro Bl. (#3) – LOS E AM peak hour; LOS F PM peak hour
- Brown St. & Alessandro Bl. (#20) – LOS F PM and Saturday peak hours
- Meridian Pkwy. & Cactus Av. (#25) – LOS F PM peak hour only

Roadway Segments

The following additional study area roadway segments are anticipated to operate at an unacceptable LOS under E+P traffic conditions, in addition to the location previously identified under Existing (2021) traffic conditions:

- Cactus Av., from Airman Dr. to Linebacker Dr. (#6) – LOS F
- Cactus Av. from Linebacker Dr. to Brown St. (#7) – LOS E
- Cactus Av., from Brown St. to Meridian Pkwy. (#8) – LOS E
- Barton Rd. from Alessandro Bl. to Cactus Av. (#10) – LOS E
- Brown St., from Alessandro Bl. to Cactus Av. (#12) – LOS F
- Meridian Pkwy. from Cactus Av. to Van Buren Bl. (#15) – LOS F

Off-Ramp Queues

There are no movements that are anticipated to experience queuing issues during the weekday AM or weekday PM peak 95th percentile traffic flows for E+P traffic conditions, consistent with Existing (2021) traffic conditions.

1.5.3 EAP (2028) CONDITIONS

Intersections

The following study area intersections are anticipated to operate at an unacceptable LOS during one or more peak hours under EAP (2028) traffic conditions, in addition to those locations identified previously under Existing (2021) traffic conditions:

- Washington St. & Van Buren Bl. (#1) – LOS E AM and PM peak hours
- Canyon Crest Dr./Overlook Pkwy. & Alessandro Bl. (#3) – LOS E AM peak hour; LOS F PM peak hour
- Wood Rd. & Van Buren Bl. (#4) – LOS E AM and PM peak hours
- Trautwein Rd. & Orange Terrace Pkwy. (#7) – LOS E AM peak hour only
- Trautwein Rd. & Van Buren Bl. (#8) – LOS E AM peak hour only
- Brown St. & Alessandro Bl. (#20) – LOS F PM and Saturday peak hours
- Meridian Pkwy. & Cactus Av. (#25) – LOE E AM peak hour; LOS F PM peak hour

Roadway Segments

The following study area roadway segments are anticipated to operate at an unacceptable LOS under EAP (2028) traffic conditions:

- Cactus Av., from Airman Dr. to Linebacker Dr. (#6) – LOS F
- Cactus Av. from Linebacker Dr. to Brown St. (#7) – LOS E
- Cactus Av., from Brown St. to Meridian Pkwy. (#8) – LOS E
- Barton Rd. from Alessandro Bl. to Cactus Av. (#10) – LOS E
- Brown St., from Alessandro Bl. to Cactus Av. (#12) – LOS F
- Meridian Pkwy. from Cactus Av. to Van Buren Bl. (#15) – LOS F

Off-Ramp Queues

There are no movements that are anticipated to experience queuing issues during the weekday AM or weekday PM peak 95th percentile traffic flows for EAP (2028) traffic conditions, consistent with Existing (2021) traffic conditions.

1.5.4 OPENING YEAR CUMULATIVE (2028) CONDITIONS

Intersections

The following study area intersections are anticipated to operate at an unacceptable LOS during one or more peak hours under Opening Year Cumulative (2028) Without Project traffic conditions:

- Washington St. & Van Buren Bl. (#1) – LOS F AM and PM peak hours
- Alessandro Bl. & Arlington Av./Chicago Av. (#2) – LOS F AM and PM peak hours
- Canyon Crest Dr./Overlook Pkwy. & Alessandro Bl. (#3) – LOS F AM and PM peak hours
- Wood Rd. & Van Buren Bl. (#4) – LOS F AM and PM peak hours
- Trautwein Rd. & Alessandro Bl. (#5) – LOS F AM peak hour only
- Trautwein Rd. & Grove Community Dr. (#6) – LOS E AM peak hour only
- Trautwein Rd. & Orange Terrace Pkwy. (#7) – LOS F AM peak hour only
- Trautwein Rd. & Van Buren Bl. (#8) – LOS F AM and PM peak hours
- Deercreek Dr. & Orange Terrace Pkwy. (#10) – LOS F AM peak hour only
- Barton St. & Alessandro Bl. (#11) – LOS E AM peak hour only
- Barton St. & Orange Terrace Pkwy. (#13) – LOS F AM and Saturday peak hours
- Barton St. & Van Buren Bl. (#14) – LOS F AM and PM peak hours; LOS E Saturday peak hour
- Meridian Pkwy. & Alessandro Bl. (#24) – LOS F AM and PM peak hours
- Meridian Pkwy. & Cactus Av. (#25) – LOS E AM peak hour; LOS F PM peak hour
- Meridian Pkwy. & Van Buren Bl. (#26) – LOS F AM and PM peak hours
- I-215 NB Ramps & Alessandro Bl. (#29) – LOS F AM peak hour only
- I-215 NB Ramps & Cactus Av. (#31) – LOS F AM and PM peak hours
- I-215 SB Ramps & Van Buren Bl. (#32) – LOS F PM peak hour only
- Old 215 Frontage Rd. & Alessandro Bl. (#34) – LOS E AM peak hour only
- Elsworth St. & Cactus Av. (#36) – LOS F AM and PM peak hours
- Frederick St. & Cactus Av. (#37) – LOS E AM peak hour only

With the addition of Project traffic, the following additional study area intersection is anticipated to operate at a deficient LOS during one or more peak hours:

- Brown St. & Alessandro Bl. (#20) – LOS F PM and Saturday peak hours

Roadway Segments

The following study area roadway segments are anticipated to operate at an unacceptable LOS under Opening Year Cumulative (2028) Without Project traffic conditions:

- Meridian Pkwy. from Alessandro Bl. to Cactus Av. (#14) – LOS F
- Meridian Pkwy. from Cactus Av. to Van Buren Bl. (#15) – LOS F

With the addition of Project traffic, the following additional study area roadway segments are anticipated to operate at a deficient LOS:

- Alessandro Bl., from Meridian Pkwy. to I-215 Freeway (#5) – LOS E
- Cactus Av., from Airman Dr. to Linebacker Dr. (#6) – LOS F
- Cactus Av. from Linebacker Dr. to Brown St. (#7) – LOS E
- Cactus Av., from Brown St. to Meridian Pkwy. (#8) – LOS E
- Barton Rd. from Alessandro Bl. to Cactus Av. (#10) – LOS E
- Brown St., from Alessandro Bl. to Cactus Av. (#12) – LOS F

Off-Ramp Queues

There are no movements that are anticipated to experience queuing issues during the weekday AM or weekday PM peak 95th percentile traffic flows for Opening Year Cumulative (2028) Without and With Project traffic conditions, consistent with Existing (2021) traffic conditions.

1.5.5 HORIZON YEAR (2045) CONDITIONS

Intersections

The following study area intersections are anticipated to operate at an unacceptable LOS during the peak hours under Horizon Year (2045) Without Project traffic conditions:

- Washington St. & Van Buren Bl. (#1) – LOS F AM and PM peak hours
- Alessandro Bl. & Arlington Av./Chicago Av. (#2) – LOS F AM and PM peak hours
- Canyon Crest Dr./Overlook Pkwy. & Alessandro Bl. (#3) – LOS F AM and PM peak hours
- Wood Rd. & Van Buren Bl. (#4) – LOS F AM and PM peak hours; LOS E Saturday peak hour
- Trautwein Rd. & Alessandro Bl. (#5) – LOS F AM and PM peak hours
- Trautwein Rd. & Grove Community Dr. (#6) – LOS E AM peak hour only
- Trautwein Rd. & Orange Terrace Pkwy. (#7) – LOS F AM and PM peak hours
- Trautwein Rd. & Van Buren Bl. (#8) – LOS F AM and PM peak hours; LOS E Saturday peak hour
- Deercreek Dr. & Orange Terrace Pkwy. (#10) – LOS F AM peak hour only
- Barton St. & Alessandro Bl. (#11) – LOS F AM and PM peak hours
- Barton St. & Orange Terrace Pkwy. (#13) – LOS F AM and Saturday peak hours
- Barton St. & Van Buren Bl. (#14) – LOS F AM, PM, and Saturday peak hours
- Brown St. & Alessandro Bl. (#20) – LOS E AM peak hour only
- Meridian Pkwy. & Alessandro Bl. (#24) – LOS F AM and PM peak hours
- Meridian Pkwy. & Cactus Av. (#25) – LOS F AM and PM peak hours
- Meridian Pkwy. & Van Buren Bl. (#26) – LOS F AM and PM peak hours
- I-215 NB Ramps & Alessandro Bl. (#29) – LOS F AM peak hour only
- I-215 NB Ramps & Cactus Av. (#31) – LOS F AM and PM peak hours

- I-215 SB Ramps & Van Buren Bl. (#32) – LOS F AM and PM peak hours
- Old 215 Frontage Rd. & Alessandro Bl. (#34) – LOS F AM peak hour only
- Day St. & Alessandro Bl. (#35) – LOS F AM peak hour; LOS E PM peak hour
- Elsworth St. & Cactus Av. (#36) – LOS F AM and PM peak hours
- Frederick St. & Cactus Av. (#37) – LOS F AM peak hour only
- Graham St./Riverside Dr. & Cactus Av. (#38) – LOS F AM and PM peak hours

With the addition of Project traffic, the following additional study area intersections are anticipated to operate at a deficient LOS during one or more peak hours:

- Orange Terrace Pkwy. & Van Buren Bl. (#19) – LOS E PM peak hour only
- I-215 SB Ramps & Cactus Av. (#30) – LOS F PM peak hour only

Roadway Segment Capacity Analysis

The following study area roadway segments are anticipated to operate at an unacceptable LOS under Horizon Year (2045) Without Project traffic conditions:

- Alessandro Bl. from Trautwein Rd. to Mission Grove Pkwy. (#1) – LOS F
- Alessandro Bl. from Mission Grove Pkwy. to Barton St. (#2) – LOS E
- Alessandro Bl. from Barton St. to Brown St. (#3) – LOS E
- Alessandro Bl. from Brown St. to Meridian Pkwy. (#4) – LOS E
- Alessandro Bl. from Meridian Pkwy. to I-215 Freeway (#5) – LOS F
- Meridian Pkwy. from Alessandro Bl. to Cactus Av. (#14) – LOS F
- Meridian Pkwy. from Cactus Av. to Van Buren Bl. (#15) – LOS F

With the addition of Project traffic, the following additional study area roadway segments are anticipated to operate at a deficient LOS:

- Cactus Av., from Airman Dr. to Linebacker Dr. (#6) – LOE F
- Cactus Av. from Linebacker Dr. to Brown St. (#7) – LOS E
- Cactus Av., from Brown St. to Meridian Pkwy. (#8) – LOS F
- Barton Rd. from Alessandro Bl. to Cactus Av. (#10) – LOS F
- Brown St., from Alessandro Bl. to Cactus Av. (#12) – LOS F

Off-Ramp Queues

There are no movements that are anticipated to experience queuing issues during the weekday AM or weekday PM peak 95th percentile traffic flows for Horizon Year (2045) Without and With Project traffic conditions, consistent with Existing (2021) traffic conditions.

A Summary of the traffic signal warrant analysis is shown in Table 1-3.

TABLE 1-3: TRAFFIC SIGNAL WARRANT ANALYSIS SUMMARY

INTERSECTION		Existing	E+P	EAP	OYC NP	OYC WP	2045 NP	2045 WP
9	Deercreek Dr. & Grove Community Dr.						Met	
10	Deercreek Dr. & Orange Terrace Pkwy.	Met						
12	Barton Rd. & Grove Community Dr.							
13	Barton St. & Orange Terrace Pkwy.	Met						
15	Airman Dr. & Cactus Av.	DNE			DNE		DNE	
16	Abrams Dr. & Grove Community Dr.							
17	Abrams Dr. & Orange Terrace Pkwy.							
18	Linebacker Dr. & Cactus Av.	DNE	Met		DNE		DNE	
21	Brown St. & Cactus Av.	DNE	Met		DNE		DNE	

*DNE = Does Not Exist

1.6 RECOMMENDATIONS

1.6.1 SITE ADJACENT AND SITE ACCESS RECOMMENDATIONS

The following recommendations are based on the improvements needed to accommodate site access. The site adjacent recommendations are shown on Exhibit 1-4.

Recommendation 1 – Airman Dr. & Cactus Av. (#15) – The following improvements are necessary to accommodate site access:

- Project to install a traffic signal.
- Project to construct a northbound shared through lane and right turn lane (225-feet of storage).
- Project to construct a dual southbound left turn lanes (225-feet of storage) and a through lane.
- Project to construct a westbound left turn lane (300-feet of storage) and a right turn lane.

EXHIBIT 1-4: SITE ADJACENT ROADWAY AND SITE ACCESS RECOMMENDATIONS



15	Airman Dr. & Cactus Av.	18	Linebacker Dr. & Cactus Av.	21	Brown St. & Cactus Av.

- = New Traffic Signal
- = Existing Lane
- = Lane Improvement
- 100'** = Recommended Turn Pocket Length
- TRAP** = Trap Lane
- RTO** = Right Turn Overlap
- TWLTL** = Two Way Left turn Lane

Recommendation 2 – Linebacker Dr. & Cactus Av. (#18) – The following improvements are necessary to accommodate site access:

- Project to install a traffic signal.
- Project to construct the northbound approach with a left turn lane (200-feet of storage), through lane, and right turn lane (250-feet) with overlap phasing.
- Project to construct the southbound approach with dual left turn lanes (325-feet of storage) and shared through-right turn lane.
- Project to construct eastbound approach with one left turn lane (200-feet of storage), one through lane, and one shared through-right turn lane.
- Project to construct westbound approach with one left turn lane (300-feet of storage), one through lane, and one right turn lane (trap lane, no pocket length).

Recommendation 3 – Brown St. & Cactus Av. (#21) – The following improvements are necessary to accommodate site access:

- Project to install a traffic signal.
- Project to construct the southbound approach with a shared left-right turn lane.
- Project to construct the eastbound approach with a left turn lane (two-way-left-turn lane) and two through lanes.
- Project to construct the westbound approach with a through lane and shared through-right turn lane.

Recommendation 4 – Cactus Avenue is an east-west oriented roadway bisecting the Project and will provide the main access to and from the site. The Project will construct Cactus Avenue at its ultimate full-section width as a Modified Secondary Highway (98-foot right-of-way, 76-foot curb-to-curb) between Linebacker Drive and the existing terminus west of Meridian Parkway. The right-of-way will accommodate 6-foot sidewalks and 4.5-feet of parkway on both sides along with a 5-foot bike lane, landscaped median, and two traveled lanes in each direction. The West Campus Upper Plateau roadway cross-sections are shown on Exhibit 1-5.

The Project will construct Cactus Avenue at its ultimate full-section width as a Modified Industrial Collector (76-foot right-of-way, 54-foot curb-to-curb) west of Linebacker Drive to Airman Drive. The right-of-way will accommodate 5-foot sidewalks on both sides along with a 5-foot bike lane and a single traveled lane in each direction (of 16-feet) separated by a 12-foot striped median. Sidewalks along Cactus Avenue, west of Linebacker Drive, will be detached sidewalks. Additional right-of-way will be required on approach to the intersection of Linebacker Drive at Cactus Avenue in order to accommodate the recommended lanes identified on Exhibit 1-4.

An emergency access only connection will be maintained between the terminus of Cactus Avenue at Airman Drive and Barton Street.

EXHIBIT 1-5: WEST CAMPUS UPPER PLATEAU ROADWAY CROSS-SECTIONS

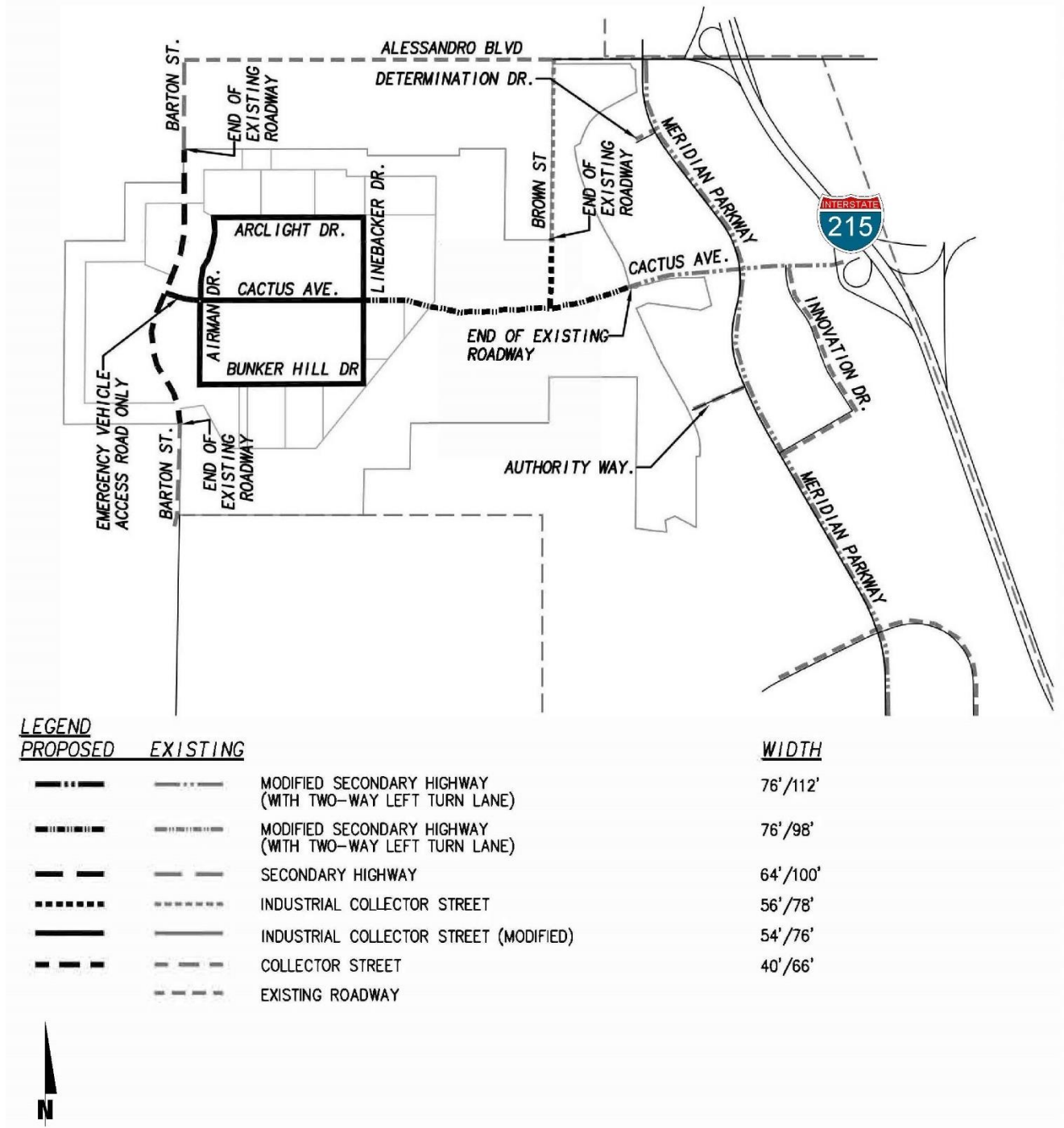

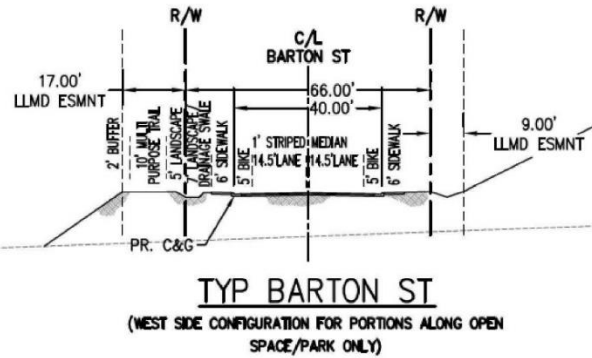
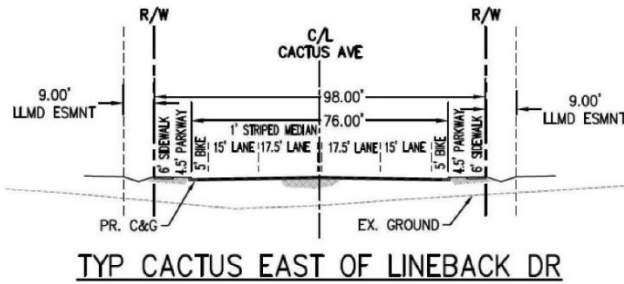
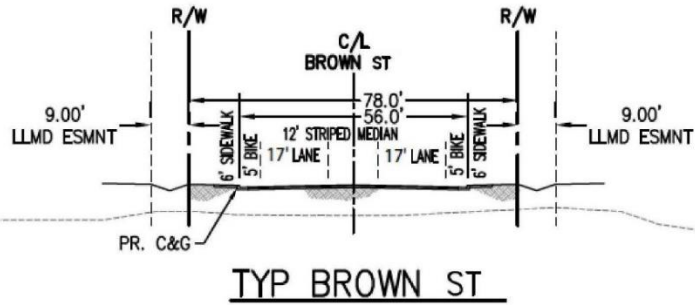
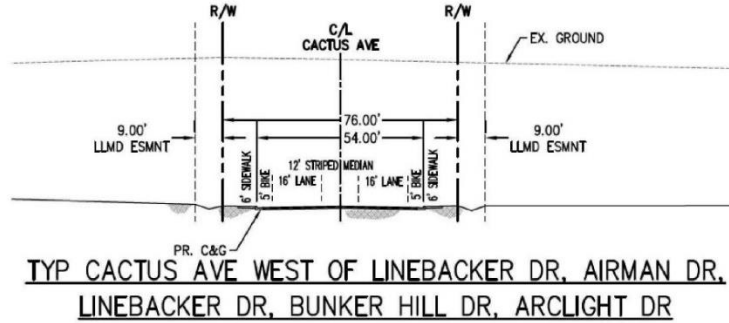
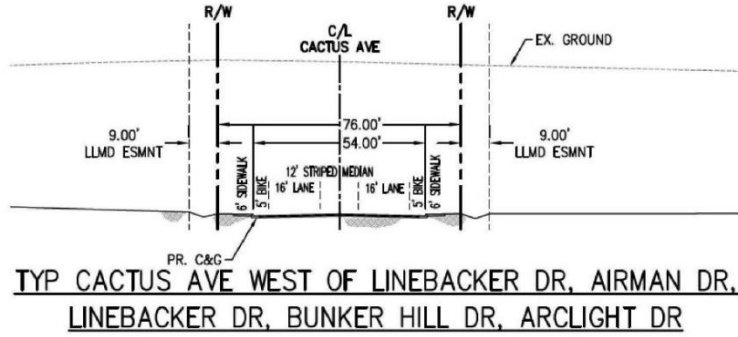
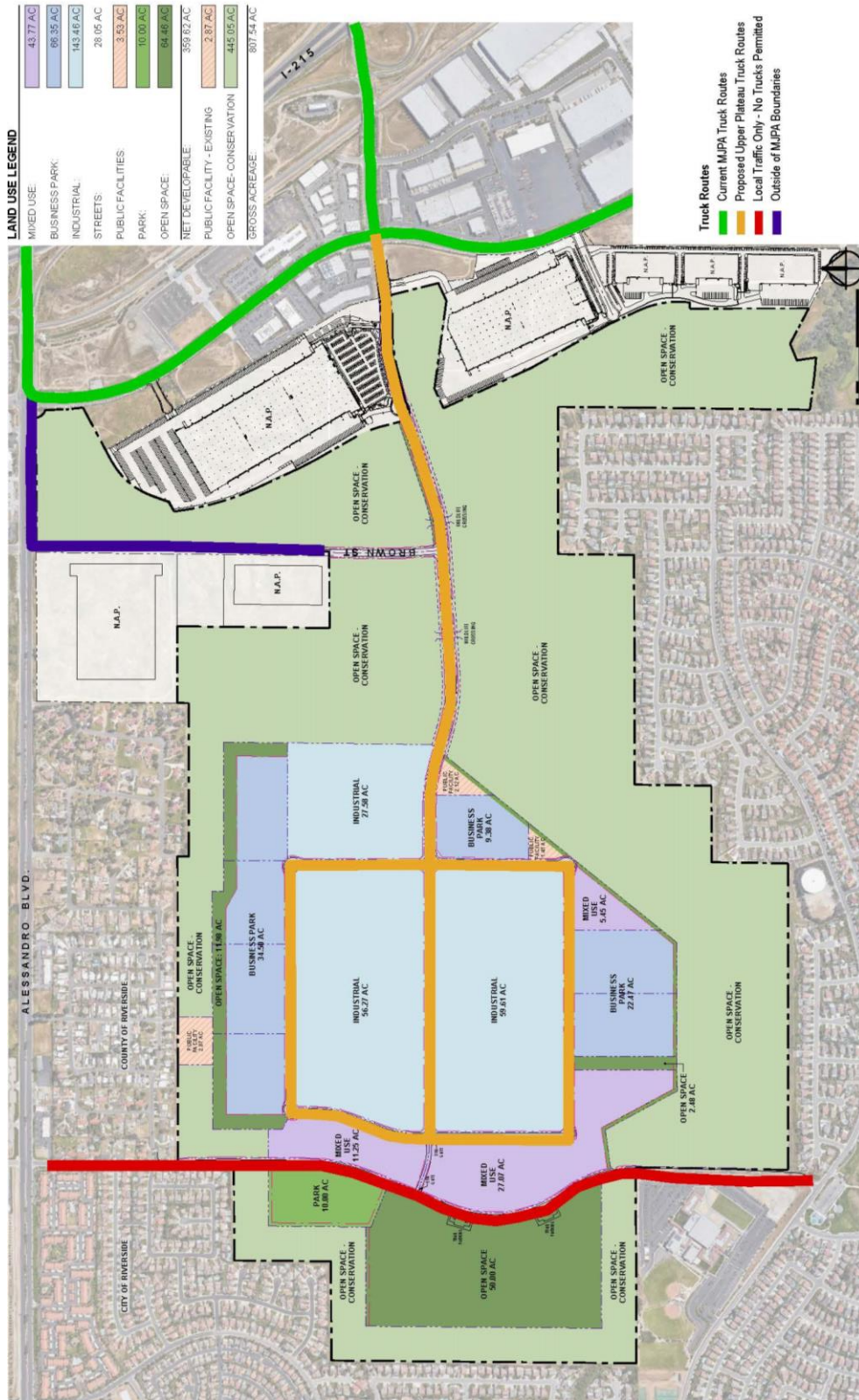

EXHIBIT 1-6: PROPOSED TRUCK ROUTES



Recommendation 5 – Barton Street is a north-south oriented roadway located adjacent to the open space and mixed-use areas of the Project. The Project will construct Barton Street at its ultimate full-section width as a Collector (66-foot right-of-way, 40-foot curb-to-curb) between the existing northerly and southerly termini. Once completed, the roadway will provide a connection between the existing Mission Grove community to the north and Orangecrest community to the south. The right-of-way will accommodate 6-foot sidewalks on the east side with 10-foot multipurpose trail and 5-feet of landscape on the other side along with a 5-foot bike lane and a single traveled lane in each direction (of 14.5-feet). The multipurpose trail will only be accommodated for portions of Barton Street adjacent to the open space/parks. “No Parking” signs should be added along Barton Road to restrict on-street parking. It should be noted, the traffic safety mitigation for Barton Street will be approved by the March JPA Civil Engineer and installed by the developer, in compliance with a three-party memorandum of understanding mitigation executed by the City of Riverside, March JPA, and Meridian Park, LLC.

Recommendation 6 – Brown Street is a north-south oriented roadway providing secondary access to the Project from Alessandro Boulevard. The Project will construct Brown Street at its ultimate full-section width as an Industrial Collector (78-foot right-of-way, 56-foot curb-to-curb) between the existing northerly terminus and Cactus Avenue. The right-of-way will accommodate 6-foot sidewalks on both sides along with a 5-foot bike lane and a single traveled lane in each direction (of 17-feet) separated by a 12-foot striped median.

Recommendation 7 – Remaining Internal Streets such as Linebacker Drive, Airman Drive, Bunker Hill Drive, and Arclight Drive are internal Project roadways. The Project will construct these roadways at their ultimate full-section width as an Industrial Collector (76-foot right-of-way, 54-foot curb-to-curb). The right-of-way will accommodate 6-foot sidewalks on both sides along with a 5-foot bike lane and a single traveled lane in each direction (of 16-feet) separated by a 12-foot striped median.

The Project will extend the existing March JPA truck routes as shown on Exhibit 1-6. Truck routes will be extended along Barton Street to Cactus Avenue, and Cactus Avenue west from Meridian Parkway. Internal Project roadways of Linebacker Drive, Arclight Drive, Bunker Hill Drive, and Airman Drive will also be truck routes. No trucks access is permitted along Barton Street. The Project Applicant and the City should work together on an appropriate mitigation measure to ensure Project truck traffic adheres to the routes as shown on the Project (Truck) trip distribution exhibit.

On-site traffic signing and striping should be implemented consistent with the provisions of the California Manual on Uniform Traffic Control Devices (CA MUTCD) and in conjunction with detailed construction plans for the Project site. Sight distance at each project access point should be reviewed with respect to standard Caltrans and March JPA sight distance standards at the time of preparation of final grading, landscape, and street improvement plans.

1.6.2 OFF-SITE RECOMMENDATIONS

The improvements needed to address the cumulative deficiencies identified under Existing (2021), E+P, EAP (2028), Opening Year Cumulative (2028), and Horizon Year (2045) traffic conditions are summarized in Table 1-4. For those improvements listed in Table 1-4 and not constructed as part of the Project, the Project Applicant's responsibility for the Project's contributions towards deficient intersections is fulfilled through payment of fair share and/or fees. Table 1-4 also summarizes the applicable cost associated with each of the recommended improvements.

1.7 QUEUING ANALYSIS

A queuing analysis was performed for the intersections of Airman Drive and Linebacker Drive on Cactus Avenue. The traffic modeling and signal timing optimization software package SimTraffic has been utilized to assess the queues. SimTraffic is designed to model networks of signalized and unsignalized intersections, with the primary purpose of checking and fine-tuning signal operations. SimTraffic uses the input parameters from Synchro to generate random simulations. These random simulations generated by SimTraffic have been utilized to determine the 95th percentile queue lengths observed for each applicable turn lane. A SimTraffic simulation has been recorded up to 5 times, during the weekday AM, weekday PM, and Saturday peak hours, and has been seeded for 15-minute periods with 60-minute recording intervals. Queuing analysis worksheets are provided in Appendix 1.2 of this report. The turn pocket storage length recommendations reflected on Exhibit 1-4 are recommended to support the 95th percentile peak hour queues reported in Appendix 1.2.

TABLE 1-4: SUMMARY OF IMPROVEMENTS AND ROUGH ORDER OF MAGNITUDE COSTS

#	Intersection Location	Jurisdiction	E+P	EAP	Opening Year Cumulative (2028) With Project	Horizon Year (2045) With Project	Improvements in TUMF? ¹	Project Responsibility ²	Total Cost ⁴	Fair Share % ³	Fair Share Cost ¹¹
1	Washington St. & Van Buren Blvd.	County of Riverside	- None	- Add EB 3rd Through Lane - Add WB 3rd Through Lane	- Same	- Same	No	Fair Share	\$301,320	7.6%	\$22,792
					- Same	- Same	No	Fair Share	\$301,320		\$22,792
									\$602,640		\$45,584
2	Alessandro Blvd. & Arlington Av./Chicago Av.	Riverside	- None ¹³	- None ¹³	- None ¹³	- None ¹³	--	--	--	--	--
									\$0		\$0
3	Canyon Crest Dr./Overlook Pkwy. & Alessandro Blvd.	Riverside	- Add SB 3rd left lane by restriping adjacent lane	- Same	- Same	- Same	No	Fair Share	\$41,850	8.5%	\$3,548
									\$41,850		\$3,548
4	Wood Rd. & Van Buren Blvd.	Riverside	- None	- Add EB 3rd through lane - Add WB 3rd through lane	- Same - Same	- Same - Same	Yes (TUMF) Yes (TUMF)	Fees Fees	-- --		-- --
									\$0		\$0
5	Trautwein Rd. & Alessandro Blvd.	Riverside	- None	- None ¹³	- None ¹³	- None ¹³	--	--	--	--	--
									\$0		\$0
7	Trautwein Rd. & Orange Terrace Pkwy.	Riverside	- None	- Restripe to accommodate WB 2nd left turn lane	- None ¹⁵	- None ¹⁵	No	Fair Share	\$41,850	0.0%	\$0
									\$41,850		\$0
8	Trautwein Rd. & Van Buren Blvd.	Riverside	- None	- Add EB 3rd through lane	- Same	- Same	Yes (TUMF)	Fees	--		--
									\$0		\$0
10	Deercreek Dr. & Orange Terrace Pkwy.	Riverside	- None	- Install a traffic signal	- Same	- None ¹⁵	No	Fair Share	\$600,000	0.0%	\$0
									\$600,000		\$0
11	Barton St. & Alessandro Blvd.	Riverside / March JPA	- None	- None	- Restripe NB through as left turn lane	- Same	No	Construct	--	20.6%	--
					- Restripe NB right as shared	- Same	No	Construct	--	--	
					- Restripe SB through as left turn lane ¹²	- Same	No	Fair Share	\$41,850	\$8,617	
					- Restripe SB right as shared through-right lane ¹²	- Same	No	Fair Share	\$41,850	\$8,617	
					- Modify TS for N/S left turn from permissive to protected phasing	- Same	No	Fair Share	\$12,555	\$2,585	
									\$96,255		\$19,820
13	Barton St. & Orange Terrace Pkwy.	Riverside	- None	- Install a traffic signal	- Same	- Same	No	Fair Share	\$600,000	17.7%	\$106,267
									\$600,000		\$106,267
14	Barton St. & Van Buren Blvd.	Riverside / March JPA / County	- Add an EB right turn lane - Modify the TS to implement EB right turn lane with overlap phasing	- Same	- Same	- Same	No	Fair Share	\$83,700	12.6%	\$10,526
				- Same	- Same	- Same	No	Fair Share	\$12,555	\$1,579	
				- Add 3rd EB through lane	- Same	- Same	Yes (TUMF)	Fees	--	--	
									\$83,700		\$10,526
									\$179,955		\$22,631
19	Orange Terrace Pkwy. & Van Buren Blvd.	Riverside / March JPA / County	- None	- None	- None	- Modify the TS to implement NB/EB/WB right turn lanes with overlap phasing ¹⁴	No	Fair Share	\$12,555	11.9%	\$1,494
									\$12,555		\$1,494
20	Brown St. & Alessandro Blvd.	Riverside / March JPA / County	- None ¹³	- None ¹³	- None ¹³	- None ¹³	--	--	--	--	--
									\$0		\$0
24	Meridian Pkwy. & Alessandro Blvd.	Riverside / County	- None	- None ¹³	- None ¹³	- None ¹³	--	--	--	--	--
									\$0		\$0

#	Intersection Location	Jurisdiction	E+P	EAP	2025 With Project	Horizon Year (2045) With Project	Improvements in TUMF? ¹	Project Responsibility ²	Total Cost ⁴	Fair Share % ³	Fair Share Cost ¹¹
25	Meridian Pkwy. & Cactus Av.	March JPA	- Restripe EB right lane as shared through-right lane - Modify the TS to implement WB right turn lane with overlap phasing	- Same	- Same	- Same	No	Construct	--	68.7%	--
				- Same	- Same	- Same	No	Construct	--	--	
				- Same	- Same	- Add SB 3rd through lane by restripe right lane as shared through-right lane	No	Fair Share	\$41,850		\$28,746
								\$41,850		\$28,746	
26	Meridian Pkwy. & Van Buren Blvd.	County / March JPA	- None	- None	- Restripe SB through as shared left-through lane	- Same	No	Fair Share	\$41,850	15.6%	\$6,514
									\$41,850		\$6,514
29	I-215 NB Ramps & Alessandro Blvd.	Riverside / March JPA / Caltrans	- Add NB 2nd left turn lane	- Same	- Same	- Same	No	Fair Share	\$83,700	20.2%	\$16,926
									\$83,700		\$16,926
30	I-215 SB Ramps & Cactus Av. ⁵	March JPA, Caltrans	- None	- None	- None	- Add EB 3rd through lane - Add WB 3rd through lane	Yes (TUMF) Yes (TUMF)	Fees Fees	-- \$0		-- \$0
31	I-215 NB Ramps & Cactus Av. ⁵	Moreno Valley / March JPA / Caltrans	- Add NB 2nd left turn lane - Add EB right turn lane - Add WB 3rd through lane	- Same - Same - Same	- Same - Same - Same	- Same - Same - Add EB 3rd through lane - Add 4th WB through lane	Yes (TUMF) Yes (TUMF) Yes (TUMF) Yes (TUMF)	Fees Fees Fees Fees	-- \$0		-- \$0
32	I-215 SB Ramps & Van Buren Blvd.	March JPA / Caltrans	- None	- None	- Restripe SB through as a left lane	- Same	No	Fair Share	\$41,850	4.7%	\$1,962
					- Modify EB right turn lane to single free right turn lane	- Same	No	Fair Share	\$41,850		\$1,962
					- Add WB 3rd through lane	- Same	Yes (TUMF)	Fees	--		--
								\$83,700		\$3,925	
34	Old 215 Frontage Rd. & Alessandro Blvd.	Moreno Valley / Riverside / County	- None	- None	- Add WB 3rd through lane	- Same	Yes (TUMF)	Fees	-- \$0		-- \$0
35	Day St. & Alessandro Blvd.	Moreno Valley	- None	- None	- None	- Add EB right turn lane - Add WB 3rd through lane	No Yes (TUMF)	Fair Share Fees	\$83,700 -- \$83,700	9.8%	\$8,233 -- \$8,233
36	Elsworth St. & Cactus Av.	Moreno Valley	- Modify TS to Implement N/S from split phasing to protected left turn phasing.	- Same	- Same	- Same	No	Fair Share	\$12,555	10.9%	\$1,363
					- Add EB 4th through lane	- Same	No	Fair Share	\$301,320		\$32,709
					- Add WB 4th through lane	- Same	No	Fair Share	\$301,320		\$32,709
					- Add NB 2nd left turn lane	- Same	No	Fair Share	\$83,700		\$9,086
								\$698,895		\$75,867	
38	Graham St./Riverside Dr. & Cactus Av.	Moreno Valley	- None	- None	- None	- Add SB 2nd left turn lane	No	Fair Share	\$83,700	3.7%	\$3,097
								\$83,700		\$3,097	
Total Project Fair Share Contribution to the March JPA (non-TUMF)⁶									\$89,978		\$36,553
Total Project Fair Share Contribution to the City of Riverside⁷									\$1,566,188		\$152,467
Total Project Fair Share Contribution to the County of Riverside⁸									\$602,640		\$45,584
Total Project Fair Share Contribution to the City of Moreno Valley⁹									\$866,295		\$87,196
Total									\$3,125,100		\$321,799

¹ Improvements included in TUMF fee program. Although identified as a TUMF facility, the improvement is not currently identified on the Central Zone 5-Year Transportation Improvement Program Amendment (2021).

² Identifies the Project's responsibility to construct an improvement or contribute fair share or fee payment towards the implementation of the improvements shown. If identified as a Project construct obligation, then no fair share percentage has been identified.

³ Program improvements constructed by Project may be eligible for fee credit, at discretion of the March JPA. See Table 9-1 for Fair Share Calculations. The highest peak hour fair share percentage for each intersection, as shown in Table 9-1, has been utilized.

⁴ Costs have been estimated using the data provided in Appendix "G" of the CMP (2003) for preliminary construction costs. A growth factor of 1.674 has been utilized to reflect 2022 costs.

⁵ The 2016 TUMF nexus update study identifies I-215/Cactus overcrossing (\$25,558,000). Although the individual improvements are not specifically identified in the nexus study, they are likely to be part of the overall interchange improvements.

⁶ Total project fair share contribution consists of the improvements which are not already included in the County TUMF for those intersections wholly or partially within the March JPA.

⁷ Total project fair share contribution consists of the improvements which are not already included in a fee program for those intersections wholly or partially within the City of Riverside.

⁸ Total project fair share contribution consists of the improvements which are not already included in a fee program for those intersections wholly or partially within the County of Riverside.

⁹ Total project fair share contribution consists of the improvements which are not already included in a fee program for those intersections wholly or partially within the City of Moreno Valley.

¹⁰ Total project fair share contribution consists of the improvements which are not already included in a fee program for those intersections wholly or partially within Caltrans' jurisdiction.

¹¹ Rough order of magnitude cost estimate.

¹² Per the City of Riverside, improvements will be constructed as part of the Sycamore Hills project.

¹³ There are no feasible intersection improvements. As such, no improvements have been identified.

¹⁴ Improvement includes restricting U-turn movements for the westbound approach. Proper signage should be installed.

¹⁵ Intersection does not meet the City's criteria for a project-related traffic deficiency, based on the thresholds identified in the City's traffic study guidelines. Therefore, no improvements have been identified for this scenario.

1.8 PARKING ASSESSMENT

Parking has been assessed for only Buildings B and C as they are the only buildings being processed. Other areas of the Project are comprised of land use assumptions only and no specific development is being proposed for those areas at this time. Per the minimum passenger car parking requirements per the Specific Plan (see Table 3-3 of the Specific Plan), the off-street parking requirements for warehouse/distribution uses are as follows:

- 1 space per 1,000 square feet for the first 20,000 square feet, 1 space per 2,000 square feet of 20,000 – 100,000 square feet of building space, 1 space per 5,000 square feet for the square footage over 100,000 square feet, 1 space per 300 square feet for the office space.

Based on the criteria outlined above, the minimum parking requirements have been calculated for Buildings B and C below:

- Building B consists of 1,250,000 square feet of high-cube fulfillment warehousing use which includes 50,000 square feet of office space. The minimum parking required is 447 spaces:
 - 50,000 square feet of office x 1 space per 300 square feet = 167 spaces
 - 0-20,000 square feet of warehouse/distribution x 1 space per 1,000 square feet = 20 spaces
 - 20,000-100,000 square feet of warehouse/distribution x 1 space per 2,000 square feet = 40 spaces
 - 100,000-1,200,000 square feet of warehouse/distribution x 1 space per 5,000 square feet = 220 spaces
- Building C consists of 587,000 square feet of high-cube fulfillment warehousing use which includes 40,000 square feet of office space. The minimum parking required is 291 spaces:
 - 40,000 square feet of office x 1 space per 300 square feet = 133 spaces
 - 0-20,000 square feet of warehouse/distribution x 1 space per 1,000 square feet = 20 spaces
 - 20,000-100,000 square feet of warehouse/distribution x 1 space per 2,000 square feet = 40 spaces
 - 100,000-587,000 square feet of warehouse/distribution x 1 space per 5,000 square feet = 98 spaces

1.9 ACTIVE TRANSPORTATION

Bicycle and pedestrian connections within the Project will help reduce vehicle trips as well as provide recreational opportunities for future employees and visitors. The proposed roadway network includes Class II (on-street, striped) bike lanes along all roadways, a 10-foot-wide multi-purpose trail along the western side of Barton Street fronting the open space and park areas of the Project, and recreational trails. Recreational trails will be retained and maintained within the open space areas of the Project. The currently existing service roads within the Conservation Area may continue to be utilized by the public for passive recreation as authorized by the March JPA; however, public vehicular access will continue to be prohibited. In conjunction with the 5-foot bike lanes on all Project roadways, there are also 6-foot sidewalks to promote walkability. All

these connections within the Project enhance connectivity to the existing Metrolink Station approximately 1.2-miles to the east on Meridian Parkway and travel to and from recreational amenities within the Project from other surrounding existing residential developments in close proximity to the Project. Sidewalks and bike lanes will provide direct access to the proposed Project uses. The Project should construct sidewalk improvements up to the intersection of Grove Community Drive and Barton Street and provide bike racks and bike lockers.

1.10 TRAFFIC CALMING – BARTON STREET

At the request of City of Riverside staff during the scoping process, traffic calming measures have been reviewed for Barton Street. The purpose of implementing traffic calming measures is to reduce volume and/or speed along roadways. In general, wider roadways encourage higher vehicular speeds and the implementation of traffic calming measures that either physically or psychologically encourage drivers to travel at slower speeds. Maintaining low speeds will help to create a pedestrian-friendly environment. In order for traffic calming measures to be effective, most measures should be placed every 250-400 feet. Spreading the measures out too far may lead to speeding between installations. A single traffic calming measure or a combination of multiple traffic calming measures can be utilized to achieve the desired speed control along roadways.

The Project is anticipated to complete the connection of Barton Street between the existing northerly and southerly termini and in order to address potential speeding, the following traffic calming measures have been reviewed for implementation. It should be noted that some of the recommendations listed below may be appropriate for retrofitting onto existing roadways, but for new roadways, such as Barton Street, the roadway should be designed in such a way to discourage speeding (by adding curvature, narrow lanes, etc.).

- **Raised Crosswalks/Sidewalk Extensions:**
 - Advantages: improve safety for both pedestrians and vehicles, add positive aesthetic value, effective in reducing speeds.
 - Disadvantages: textured material can be expensive, potential impacts on drainage should be considered, noise and air pollution may increase.
 - Speed humps are similar to the raised crosswalks but would not be recommended for a roadway like Barton Street. The implementation of speed humps may induce speeding between installations.
- **Raised Intersections:**
 - Could be a retrofit improvement for any existing intersection and/or could be implemented at any new intersections/driveways along the Barton Street extension.
 - Advantages: improved safety for both pedestrians and vehicles, add positive aesthetic value, calming two streets with one installation, ideal for locations with substantial pedestrian activity.
 - Disadvantages: cost of textured materials, potential impacts on drainage should be considered, found to be less effective in reducing speeds as compared to speed humps/speed tables/raised crosswalks.

- **Chicane:**
 - Advantages: effective method of changing the driver perception of the roadway, reduces speed without affecting emergency response, minimum inconvenience to local traffic, reduced crossing distances for pedestrians, greater visual obstruction.
 - Disadvantages: cost, appropriate for midblock locations only (not at intersections), most effective when traffic volumes are relatively equal in both directions of travel, increased maintenance.
- **Centerline & Curb Adjacent Striping (done to visually narrow the roadway):**
 - Advantages: fast and cost effective, typically used on rural roadways with no shoulders.
 - Disadvantages: low success rate
- **Roundabouts:**
 - Could be a retrofit improvement for any existing intersection and/or could be implemented at any new intersections/driveways along the Barton Street extension.
 - Advantages: reductions to potential crashes that typically occur at traditional intersections, reduces speed on approach, low-cost maintenance as compared to a signal, effective for multi-leg intersections, good for cyclists, restrictive for larger vehicles.
 - Disadvantages: may require additional signage and lighting, right-of-way, maintenance of landscaped areas, may push traffic onto adjacent streets.
- **Lane Narrowing (expanding sidewalks/landscaped areas, on-street parking, etc.):**
 - Advantages: good for pedestrians (shorter crossing distance), opportunities for additional landscaping, slows traffic without affecting emergency vehicle response time, effective when used in a series, single lane narrowing reduces vehicle speed and through traffic volume.
 - Disadvantages: double lane narrowing is not as effective as single lane narrowing, can be unfriendly to cyclists if not designed correctly, conflict of opposing drivers crossing simultaneously (especially for larger vehicles).

All of the aforementioned measures can also be supplemented with speed activated speed limit signs/warning signs, additional signage, flashing beacons, etc. Implementation of one or more of the aforementioned measures should be reviewed and discussed with the City of Riverside.

This Page Intentionally Left Blank

2 METHODOLOGIES

This section of the report presents the methodologies used to perform the traffic analyses summarized in this report. The methodologies described are consistent with March JPA's guidelines.

2.1 LEVEL OF SERVICE

Traffic operations of roadway facilities are described using the term "Level of Service" (LOS). LOS is a qualitative description of traffic flow based on several factors such as speed, travel time, delay, and freedom to maneuver. Six levels are typically defined ranging from LOS A, representing completely free-flow conditions, to LOS F, representing breakdown in flow resulting in stop-and-go conditions. LOS E represents operations at or near capacity, an unstable level where vehicles are operating with the minimum spacing for maintaining uniform flow.

2.2 INTERSECTION CAPACITY ANALYSIS

The definitions of LOS for interrupted traffic flow (flow restrained by the existence of traffic signals and other traffic control devices) differ slightly depending on the type of traffic control. The LOS is typically dependent on the quality of traffic flow at the intersections along a roadway. The 6th Edition Highway Capacity Manual (HCM) methodology expresses the LOS at an intersection in terms of delay time for the various intersection approaches. (4) The HCM uses different procedures depending on the type of intersection control.

2.2.1 SIGNALIZED INTERSECTIONS

The March JPA, City of Moreno Valley, City of Riverside, and County of Riverside require signalized intersection operations analysis based on the methodology described in the HCM. (4) Intersection LOS operations are based on an intersection's average control delay. Control delay includes initial deceleration delay, queue move-up time, stopped delay, and final acceleration delay. For signalized intersections LOS is directly related to the average control delay per vehicle and is correlated to a LOS designation as described in Table 2-1.

The traffic modeling and signal timing optimization software package Synchro (Version 11) is utilized to analyze signalized intersections. Synchro is a macroscopic traffic software program that is based on the signalized intersection capacity analysis as specified in the HCM. Macroscopic level models represent traffic in terms of aggregate measures for each movement at the study intersections. Equations are used to determine measures of effectiveness such as delay and queue length. The level of service and capacity analysis performed by Synchro takes into consideration optimization and coordination of signalized intersections within a network.

TABLE 2-1: SIGNALIZED INTERSECTION LOS THRESHOLDS

Description	Average Control Delay (Seconds), V/C ≤ 1.0	Level of Service, V/C ≤ 1.0	Level of Service, V/C > 1.0
Operations with very low delay occurring with favorable progression and/or short cycle length.	0 to 10.00	A	F
Operations with low delay occurring with good progression and/or short cycle lengths.	10.01 to 20.00	B	F
Operations with average delays resulting from fair progression and/or longer cycle lengths. Individual cycle failures begin to appear.	20.01 to 35.00	C	F
Operations with longer delays due to a combination of unfavorable progression, long cycle lengths, or high V/C ratios. Many vehicles stop and individual cycle failures are noticeable.	35.01 to 55.00	D	F
Operations with high delay values indicating poor progression, long cycle lengths, and high V/C ratios. Individual cycle failures are frequent occurrences. This is considered to be the limit of acceptable delay.	55.01 to 80.00	E	F
Operation with delays unacceptable to most drivers occurring due to over saturation, poor progression, or very long cycle lengths.	80.01 and up	F	F

Source: HCM (6th Edition)

As the March JPA guidelines does not provide saturation flow rates, a saturation flow rate of 1900 vphgpl has been utilized, consistent with County of Riverside guidelines. The peak hour traffic volumes have been adjusted using a peak hour factor (PHF) to reflect peak 15-minute volumes. Common practice for LOS analysis is to use a peak 15-minute rate of flow. However, flow rates are typically expressed in vehicles per hour. The PHF is the relationship between the peak 15-minute flow rate and the full hourly volume (e.g., $PHF = [Hourly Volume] / [4 \times Peak\ 15\text{-minute Flow Rate}]$). The use of a 15-minute PHF produces a more detailed analysis as compared to analyzing vehicles per hour. Existing PHFs have been used for all analysis scenarios. Per the HCM, PHF values over 0.95 often are indicative of high traffic volumes with capacity constraints on peak hour flows while lower PHF values are indicative of greater variability of flow during the peak hour. (4)

2.2.2 UNSIGNALIZED INTERSECTIONS

The March JPA, City of Moreno Valley, City of Riverside, and County of Riverside require the operations of unsignalized intersections be evaluated using the methodology described in the HCM. (4) The LOS rating is based on the weighted average control delay expressed in seconds per vehicle (see Table 2-2).

TABLE 2-2: UNSIGNALIZED INTERSECTION LOS THRESHOLDS

Description	Average Control Delay Per Vehicle (Seconds)	Level of Service, V/C ≤ 1.0	Level of Service, V/C > 1.0
Little or no delays.	0 to 10.00	A	F
Short traffic delays.	10.01 to 15.00	B	F
Average traffic delays.	15.01 to 25.00	C	F
Long traffic delays.	25.01 to 35.00	D	F
Very long traffic delays.	35.01 to 50.00	E	F
Extreme traffic delays with intersection capacity exceeded.	> 50.00	F	F

Source: HCM (6th Edition)

At two-way or side-street stop-controlled intersections, LOS is calculated for each controlled movement and for the left turn movement from the major street, as well as for the intersection as a whole. For approaches composed of a single lane, the delay is computed as the average of all movements in that lane. The worst LOS for any one movement is reported for any two-way or side-street stop-controlled intersection per HCM. For all-way stop controlled intersections, LOS is computed and reported for the intersection as a whole.

2.3 ROADWAY SEGMENT CAPACITY ANALYSIS METHODOLOGY

Roadway segment operations have been evaluated using the applicable average daily traffic (ADT) roadway capacity values provided in either the County or City of Riverside's guidelines (JPA's roadway segment criteria are consistent with the County's). The County guidelines have been used for the roadway segments located within the County or the March JPA. The roadway capacities utilized for the purposes of this analysis are considered "rule of thumb" estimates for planning purposes and are affected by such factors as intersections (spacing, configuration and control features), degree of access control, roadway grades, design geometrics (horizontal and vertical alignment standards), sight distance, vehicle mix (truck and bus traffic) and pedestrian bicycle traffic.

While using ADT for planning purposes is suitable with regards to evaluating potential volume to capacity with future forecasts, it is not suitable for operational analysis because it does not account for the factors listed previously. As such, where the ADT based roadway segment analysis indicates a deficiency (unacceptable LOS), a review of the more detailed peak hour intersection analysis and progression analysis are undertaken. The more detailed peak hour intersection analysis explicitly accounts for factors that affect roadway capacity. Therefore, roadway segment widening is typically only recommended if the peak hour intersection analysis indicates the need for additional through lanes.

The County of Riverside and City of Riverside roadway segment capacities are provided on Tables 2-3 and 2-4.

TABLE 2-3: ROADWAY SEGMENT CAPACITIES FOR COUNTY OF RIVERSIDE/MARCH JPA

Roadway Classification	Number of Lanes	Maximum Two-Way Traffic Volume (ADT) ²		
		Service Level C	Service Level D	Service Level E
Collector	2	10,400	11,700	13,000
Secondary	4	20,700	23,300	25,900
Major	4	27,300	30,700	34,100
Arterial	2	14,400	16,200	18,000
Arterial	4	28,700	32,300	35,900
Mountain Arterial ³	2	12,900	14,500	16,100
Mountain Arterial	3	16,700	18,800	20,900
Mountain Arterial	4	29,800	33,500	37,200
Urban Arterial	4	28,700	32,300	35,900
Urban Arterial	6	43,100	48,500	53,900
Urban Arterial	8	57,400	64,600	71,800
Expressway	4	32,700	36,800	40,900
Expressway	6	49,000	55,200	61,300
Expressway	8	65,400	73,500	81,700
Freeway	4	61,200	68,900	76,500
Freeway	6	94,000	105,800	117,500
Freeway	8	128,400	144,500	160,500
Freeway	10	160,500	180,500	200,600
Ramp ⁴	1	16,000	18,000	20,000

NOTES:

¹ All capacity figures are based on optimum conditions and are intended as guidelines for planning purposes only.

² Maximum two-way ADT values are based on the 1999 Modified Highway Capacity Manual Level of Service Tables as defined in the Riverside County Congestion Management Program.

³ Two-lane roadways designated as future arterials that conform to arterial design standards for vertical and horizontal alignments are analyzed as arterials.

⁴ Ramp capacity is given as a one-way traffic volume.

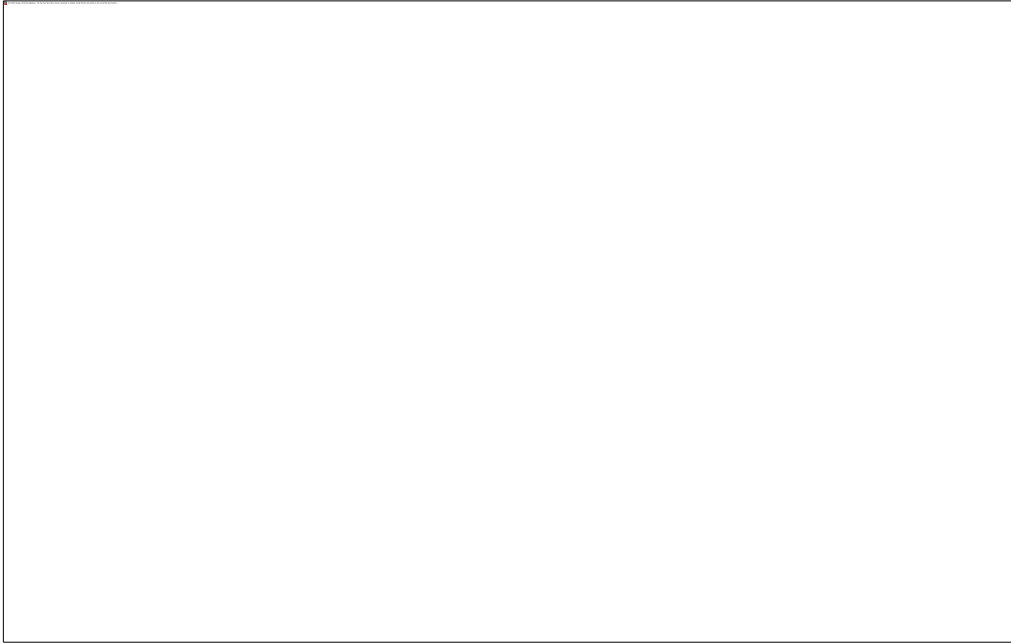
TABLE 2-4: ROADWAY SEGMENT CAPACITIES FOR CITY OF RIVERSIDE

2.4 FREEWAY OFF-RAMP QUEUING ANALYSIS

Consistent with Caltrans requirements, the 95th percentile queuing of vehicles has been assessed at the off-ramps to determine potential queuing deficiencies at the freeway ramp intersections at the I-215 Freeway at Alessandro Boulevard, Cactus Avenue, and Van Buren Boulevard interchanges. Specifically, the queuing analysis is utilized to identify any potential queuing and “spill back” onto the I-215 Freeway mainline from the off-ramps.

The traffic progression analysis tool and HCM intersection analysis program, Synchro, has been used to assess the potential deficiencies/needs of the intersections with traffic added from the proposed Project. Storage (turn-pocket) length recommendations at the ramps have been based upon the 95th percentile queue resulting from the Synchro progression analysis. The footnote from the Synchro output sheets indicates if the 95th percentile cycle exceeds capacity. Traffic is simulated for two complete cycles of the 95th percentile traffic in Synchro in order to account for the effects of spillover between cycles. In practice, the 95th percentile queue shown will rarely be exceeded and the queues shown with the footnote are acceptable for the design of storage bays.

2.5 TRAFFIC SIGNAL WARRANT ANALYSIS METHODOLOGY

The term “signal warrants” refers to the list of established criteria used by the California Department of Transportation (Caltrans) and other public agencies to quantitatively justify or ascertain the potential need for installation of a traffic signal at an otherwise unsignalized intersection. This TA uses the signal warrant criteria presented in the latest edition of the Caltrans California Manual on Uniform Traffic Control Devices (CA MUTCD). (5)

The signal warrant criteria for Existing study area intersections are based upon several factors, including volume of vehicular and pedestrian traffic, frequency of accidents, and location of school areas. The CA MUTCD indicates that the installation of a traffic signal should be considered if one or more of the signal warrants are met. (5) Specifically, this TA utilizes the Peak Hour Volume-based Warrant 3 as the appropriate representative traffic signal warrant analysis for existing traffic conditions. Warrant 3 is appropriate to use for this TA because it provides specialized warrant criteria for intersections with rural characteristics (e.g., located in communities with populations of less than 10,000 persons or with adjacent major streets operating above 40 miles per hour). For the purposes of this study, the speed limit was the basis for determining whether Urban or Rural warrants were used for a given intersection.

Future intersections that do not currently exist have been assessed regarding the potential need for new traffic signals based on future average daily traffic (ADT) volumes, using the Caltrans planning level ADT-based signal warrant analysis worksheets. Pursuant to the scoping agreement, traffic signal warrant analysis has been conducted for unsignalized intersections operating at LOS E or F, which consist of the following study area intersections shown in Table 2-5:

TABLE 2-5: TRAFFIC SIGNAL WARRANT ANALYSIS LOCATIONS

ID	Intersection Location	Jurisdiction	CMP?
9	Deercreek Dr. & Grove Community Dr.	City of Riverside	No
10	Deercreek Dr. & Orange Terrace Pkwy.	City of Riverside	No
12	Barton St. & Grove Community Dr.	City of Riverside	No
13	Barton St. & Orange Terrace Pkwy.	City of Riverside	No
15	Airman Dr. & Cactus Av.	March JPA	No
16	Abrams Dr. & Grove Community Dr.	City of Riverside	No
17	Abrams Dr. & Orange Terrace Pkwy.	City of Riverside	No
18	Linebacker Dr. & Cactus Av.	March JPA	No
21	Brown St. & Cactus Av.	March JPA	No

The Existing conditions traffic signal warrant analysis is presented in the subsequent section, Section 3 *Area Conditions* of this report. The traffic signal warrant analyses for future conditions are presented in Section 5 *E+P Traffic Conditions*, Section 6 *EAP (2028) Traffic Conditions*, Section 7 *Opening Year Cumulative (2028) Traffic Conditions*, and Section 8 *Horizon Year (2045) Traffic Conditions* of this report. It is important to note that a signal warrant defines the minimum condition under which the installation of a traffic signal might be warranted. Meeting this threshold condition does not require that a traffic control signal be installed at a particular location, but rather, that other traffic factors and conditions be evaluated in order to determine whether the signal is truly justified. It should also be noted that signal warrants do not necessarily correlate with LOS. An intersection may satisfy a signal warrant condition and operate at or above acceptable LOS or operate below acceptable LOS and not meet a signal warrant.

2.6 MINIMUM ACCEPTABLE LEVELS OF SERVICE (LOS)

Minimum Acceptable LOS and associated definitions of intersection deficiencies has been obtained from each of the applicable surrounding jurisdictions.

2.6.1 MARCH JPA

Based on the March Joint Powers Authority Traffic Impact Study Preparation Guide (February 10, 2021), all intersections and roadway segments within the March JPA Planning Area shall operate at LOS D or better with limited circumstances of LOS E to occur. LOS E may also be allowed to the extent that would support transit-oriented development (TOD) and walkable communities. LOS E is also acceptable during peak hours at interchange ramp intersections where ramp metering occurs. The Project is not proposed to be a TOD and neither the Alessandro Boulevard nor Cactus Avenue on-ramps are currently metered, as such, the minimum LOS utilized for the purposes of this analysis is LOS D. (1)

2.6.2 COUNTY OF RIVERSIDE

The definition of an intersection deficiency has been obtained from the County of Riverside General Plan. Riverside County General Plan Policy C 2.1 states that the County will maintain the following County-wide target LOS:

The following minimum target levels of service have been designated for the review of development proposals in the unincorporated areas of Riverside County with respect to transportation impacts on roadways designated in the Riverside County Circulation Plan which are currently County maintained, or are intended to be accepted into the County maintained roadway system:

- *LOS C shall apply to all development proposals in any area of the Riverside County not located within the boundaries of an Area Plan, as well as those areas located within the following Area Plans: REMAP, Eastern Coachella Valley, Desert Center, Palo Verde Valley, and those non-Community Development areas of the Elsinore, Lake Mathews/Woodcrest, Mead Valley and Temescal Canyon Area Plans.*
- *LOS D shall apply to all development proposals located within any of the following Area Plans: Eastvale, Jurupa, Highgrove, Reche Canyon/Badlands, Lakeview/Nuevo, Sun City/Meniffee Valley, Harvest Valley/Winchester, Southwest Area, The Pass, San Jacinto Valley, Western Coachella Valley and those Community Development Areas of the Elsinore, Lake Mathews/Woodcrest, Mead Valley and Temescal Canyon Area Plans.*
- *LOS E may be allowed by the Board of Supervisors within designated areas where transit-oriented development and walkable communities are proposed.*

The applicable minimum LOS utilized for the purposes of this analysis is LOS D per the County-wide target LOS for projects located within the Mead Valley Area Plans.

2.6.3 CITY OF MORENO VALLEY

The definition of an intersection deficiency has been obtained from the Moreno Valley General Plan. The City's General Plan policies states that the City will maintain the following City-wide target LOS:

- *Policy C.3-1: Strive to maintain Level of Service (LOS) C on roadway links, wherever possible, and LOS D in the vicinity of SR-60 Freeway and high employment centers. Strive to maintain LOS D at intersection during peak hours.*
- *Policy C.3-2: Allow for a list of locations to be exempt from the LOS policy based on right-of-way constraints and goals and values of the community. The City Engineer shall update the excepted intersections and roadway segments list periodically to be included with the traffic impact study guidelines and adopted by ordinance.*
- *Policy C.3-3: Where new developments would increase traffic flows beyond the LOS C (or LOS D, where applicable), require appropriate and feasible improvement measures as a condition of approval. Such measures may include extra right-of-way and improvements to accommodate additional left-turn and right-turn lanes at intersections, or other improvements*

The applicable minimum LOS utilized for the purposes of this analysis is LOS D for study area intersections located within the City of Moreno Valley. Policy C.3-2 is not applicable to the study area intersections.

2.6.4 CITY OF RIVERSIDE

The City of Riverside General Plan states the City will strive to maintain LOS D or better on arterial streets wherever possible. At some key locations, such as City arterial roadways, which are used as freeway bypass by regional through traffic and at heavily traveled freeway intersections, LOS E may be acceptable as determined on a case-by-case basis. Locations that may warrant the LOS E standard include portions of Arlington Avenue/Alessandro Boulevard, Van Buren Boulevard throughout the City, portions of La Sierra Avenue, and selected freeway interchanges. A higher standard, such as LOS C or better, may be adopted for Local and Collector streets in residential areas. The City recognizes that along key freeway feeder segments during peak commute hours, LOS F may be expected due to regional travel patterns.

At the City's request, the analysis for all study area intersections and roadway segments that lie within the City of Riverside will be evaluated based on the guidelines outlined in the City's Traffic Impact Analysis Guidelines for Vehicle Miles Traveled and Level of Service Assessment (July 2020). As such, the minimum LOS utilized for the purposes of this analysis is LOS D for intersections located partially or wholly within the City of Riverside.

2.6.5 CALTRANS

Caltrans endeavors to maintain a target LOS at the transition between LOS C and LOS D on State highway facilities; however, Caltrans acknowledges that this may not always be feasible and recommends that the lead agency consult with Caltrans to determine the appropriate target LOS. If an existing State highway facility is operating at less than this target LOS, the existing measure of effectiveness should be maintained. In general, the region-wide goal for an acceptable LOS on

all freeways, roadways segments, and intersections is LOS D. For undeveloped or not densely developed locations, the goal may be to achieve LOS C. As such, the minimum LOS utilized for the purposes of this analysis is LOS D.

2.7 DEFICIENCY CRITERIA

2.7.1 MARCH JPA

March JPA has determined that the effect of a project’s traffic would result in a deficiency if project traffic (during the AM and/or PM peak hours or during the project’s peak hour or period) is 2%, or more, of total peak hour traffic on a roadway segment or at an intersection. As summarized below and on Table 2-6. The following is a summary of the criteria:

A project-related traffic deficiency will be designated if both of the following conditions occur:

- Peak hour project traffic plus existing traffic causes a roadway segment or intersection to operate at LOS “E” or “F”; and
- Peak hour project traffic comprises 2% or more of the total peak hour traffic on the roadway segment or intersection for LOS “E” and 2% or more for LOS “F”.

A traffic deficiency will be designated if both of the following conditions occur:

- Peak hours project traffic plus existing peak hour traffic and peak hour traffic from other near-term and future projects causes a roadway segment or intersection to operate at LOS “E” or “F”; and
- Peak hour project traffic comprises 2% or more of total peak hour traffic on the roadway segment or intersection for LOS “E” and 2% or more for LOS “F”.

TABLE 2-6: MARCH JPA DEFICIENCY CRITERIA

Level of Service with Project	Allowable Percent Increase Due To Project During the Project Peak Hour	
	Roadway Segments	Intersections
E	2%	2%
F	2%	2%

2.7.2 COUNTY OF RIVERSIDE

This section outlines the methodology used in this analysis related to identifying circulation system deficiencies. The following deficiency criteria has been utilized for the County of Riverside. To determine whether the addition of project-related traffic at a study intersection would result in a deficiency, the following will be utilized:

- A deficiency occurs at study area intersections if the pre-Project condition is at or better than LOS D (i.e., acceptable LOS), and the addition of project trips causes the peak hour LOS of the study area intersection to operate at unacceptable LOS (i.e., LOS E or F). Per the County of Riverside traffic study guidelines, for intersections currently operating at unacceptable LOS (LOS E or F), a deficiency will occur if the Project contributes 50 or more peak hour trips to pre-project traffic conditions.

2.7.3 CITY OF MORENO VALLEY

This section outlines the methodology used in this analysis related to identifying circulation system deficiencies. The following deficiency criteria is utilized for the City per its Guidelines. To determine whether the addition of project-related traffic at a study intersection would result in a deficiency at a signalized intersection, the following will be utilized:

- Any signalized intersection operating at an acceptable LOS without project traffic in which the addition of project traffic causes the intersection to degrade to unacceptable LOS shall identify improvements to provide acceptable LOS.
- Any signalized study intersection that is operating at an unacceptable LOS without project traffic where the project increases delay by 5.0 or more seconds shall identify improvements to offset the increase in delay.

An operational improvement would be required if the study determines that either section a) or both sections b) and c) occur for unsignalized intersections:

- a) The addition of project related traffic causes the intersection to degrade from an acceptable LOS to unacceptable LOS.
- OR
- b) The project adds 5.0 seconds or more of delay to an intersection hat is already projected to operate without project traffic at unacceptable LOS,
 - c) The intersection meets the peak hour traffic signal warrant after the addition of project traffic.

If the conditions above are satisfied, improvement should be identified to achieve LOS D or better for conditions a) above and pre-project LOS and delay for case b) above.

2.7.4 CITY OF RIVERSIDE

To determine whether the addition of Project traffic (as defined through the comparison of Existing traffic conditions to E+P traffic conditions) at a study intersection would result in a direct project-specific traffic deficiency, the following will be utilized:

- When the pre-Project condition is at or better than LOS D (i.e., acceptable LOS), and project-generated traffic, as measured by 50 or more peak hour trips, causes deterioration below LOS D (i.e., unacceptable LOS) or increases to the peak hour delay as defined in Table 2-4, a deficiency is deemed to occur.

TABLE 2-7: CITY OF RIVERISDE INTERSECTION DEFICIENCY CRITERIA

Pre-Project LOS	Project-Related Delay Increase	Recommended Improvements
A/B	10.0 Seconds or More	Achieve Pre-project delay or better
C	8.0 Seconds or More	Achieve Pre-project delay or better
D	5.0 Seconds or More	Achieve Pre-project delay or better
E	2.0 Seconds or More	Achieve Pre-project delay or better
F	1.0 Second or More	Achieve Pre-project delay or better

However, when the pre-Project condition is already below LOS D (i.e., unacceptable LOS), the Project will be responsible for recommending improvements to achieve a level of service equal to or better than it was without the Project for intersections that receive 50 or more peak hour project-related trips. For intersections currently operating at unacceptable LOS during one or more peak hours under Existing traffic conditions, improvements have been identified to achieve an intersection LOS that is equal to or better than pre-Project conditions.

Cumulative traffic deficiencies are created as a result of a combination of the proposed Project together with other future developments contributing to the overall traffic deficiencies requiring additional improvements to maintain acceptable level of service operations with or without the Project.

2.7.5 CALTRANS

Per guidance from Caltrans, intersections operating at a deficient LOS (LOS E or F) should identify improvements to achieve acceptable LOS (LOS D or better) during the peak hours.

2.8 PROJECT FAIR SHARE CALCULATION METHODOLOGY

Improvements found to be included in the TUMF and/or DIF will be identified as such. For improvements that do not appear to be in either of the pre-existing fee programs, a fair share contribution based on the Project's proportional share may be imposed in order to address the Project's share of deficiencies in lieu of construction. It should be noted that fair share calculations are for informational purposes only and the March JPA will determine the appropriate improvements to be implemented by a project (to be identified in the conditions of approval).

If the intersection is currently operating at acceptable LOS under Existing traffic conditions, the Project's fair share cost of improvements would be determined based on the following equation, which is the ratio of Project traffic to new traffic, where new traffic is total future traffic less existing baseline traffic:

$$\text{Project Fair Share \%} = \frac{\text{Project Traffic}}{(\text{Horizon Year (2045) Total Traffic} - \text{Existing (2021) Traffic})}$$

This Page Intentionally Left Blank

3 AREA CONDITIONS

This section provides a summary of the existing circulation network, the March JPA General Plan Circulation Network, and a review of existing peak hour intersection operations, roadway segment analysis, traffic signal warrant, and off-ramp queuing analyses.

3.1 EXISTING CIRCULATION NETWORK

Pursuant to the agreement with March JPA, County of Riverside, City of Riverside, and City of Moreno Valley staff (Appendix 1.1), the study area includes a total of 38 existing and future intersections as shown previously on Exhibit 1-2. Exhibit 3-1 illustrates the study area intersections located near the proposed Project and identifies the number of through traffic lanes for existing roadways and intersection traffic controls.

3.2 MARCH JPA GENERAL PLAN CIRCULATION ELEMENT

The roadway classifications and planned (ultimate) roadway cross-sections of the major roadways within the study area, as identified on the March JPA General Plan Circulation Element, are described subsequently. Exhibit 3-2 shows the March JPA General Plan Circulation Element and Exhibit 3-3 illustrates the March JPA General Plan roadway cross-sections.

3.3 COUNTY OF RIVERSIDE, CITY OF MORENO VALLEY, AND CITY OF RIVERSIDE GENERAL PLAN CIRCULATION ELEMENT

Exhibits 3-4 and 3-5 show the County of Riverside's General Plan Circulation Element and roadway cross-sections, respectively. Exhibits 3-6 and 3-7 show the City of Moreno Valley's General Plan Circulation Element and roadway cross-sections, respectively. Exhibits 3-8 and 3-9 show the City of Riverside's General Plan Circulation Element and roadway cross-sections, respectively.

3.4 BICYCLE & PEDESTRIAN FACILITIES

Field observations conducted in 2019 indicate moderate pedestrian and bicycle activity within the study area (last observed pre-COVID), specifically during the lunch time and afternoon hours when employees utilize sidewalks during breaks. March JPA does not have a bike/pedestrian facilities exhibit. Exhibit 3-10 illustrates the City of Moreno Valley Bike Plan and Exhibit 3-11 shows the City of Moreno Valley Master Plan of Trails. Exhibit 3-12 illustrates the City of Riverside Proposed Bikeways and Trails Improvements. Existing pedestrian facilities adjacent to the study area intersections are shown on Exhibit 3-13. It should be noted, the existing pedestrian facilities shown on Exhibit 3-13 are for facilities adjacent to the study area intersections only, and not the study area as a whole.

EXHIBIT 3-1: EXISTING NUMBER OF THROUGH LANES AND INTERSECTION CONTROLS

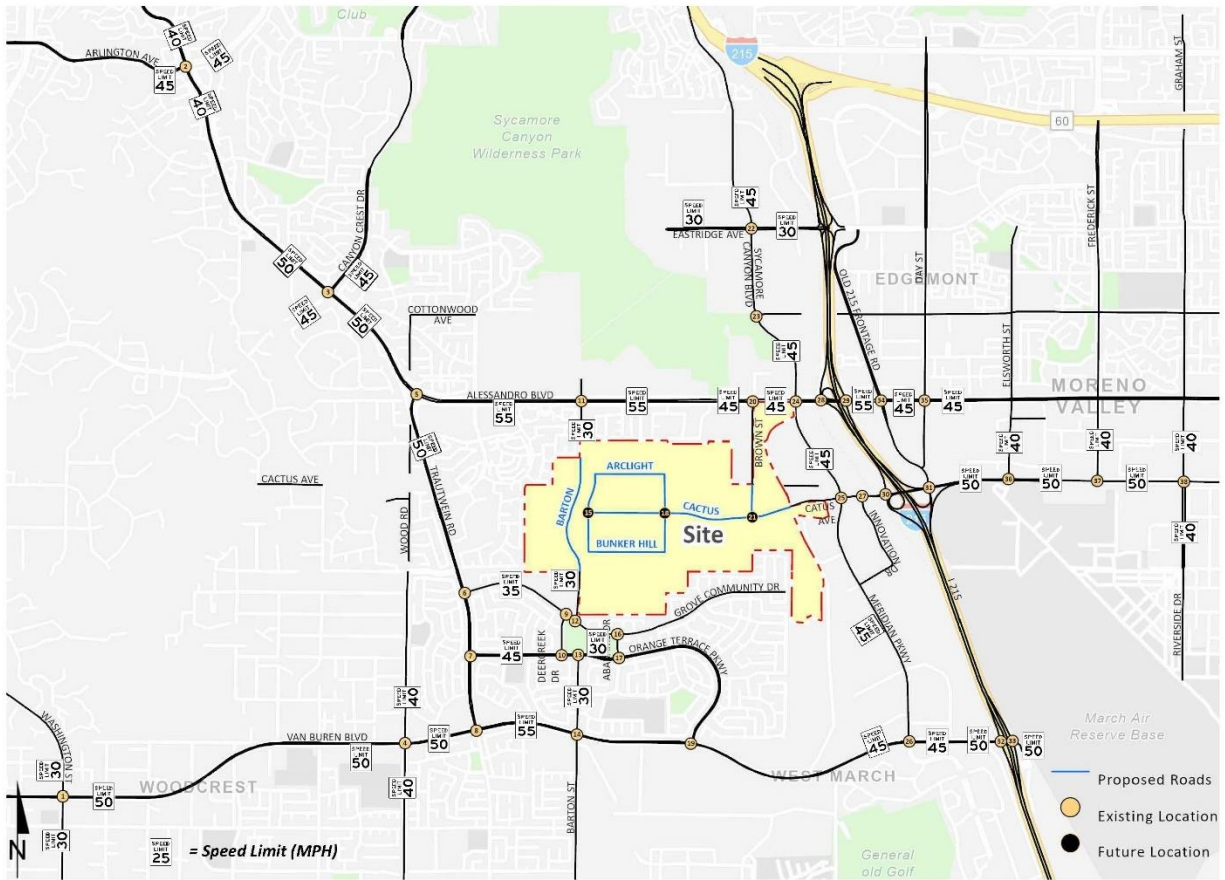

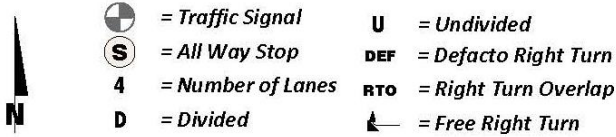
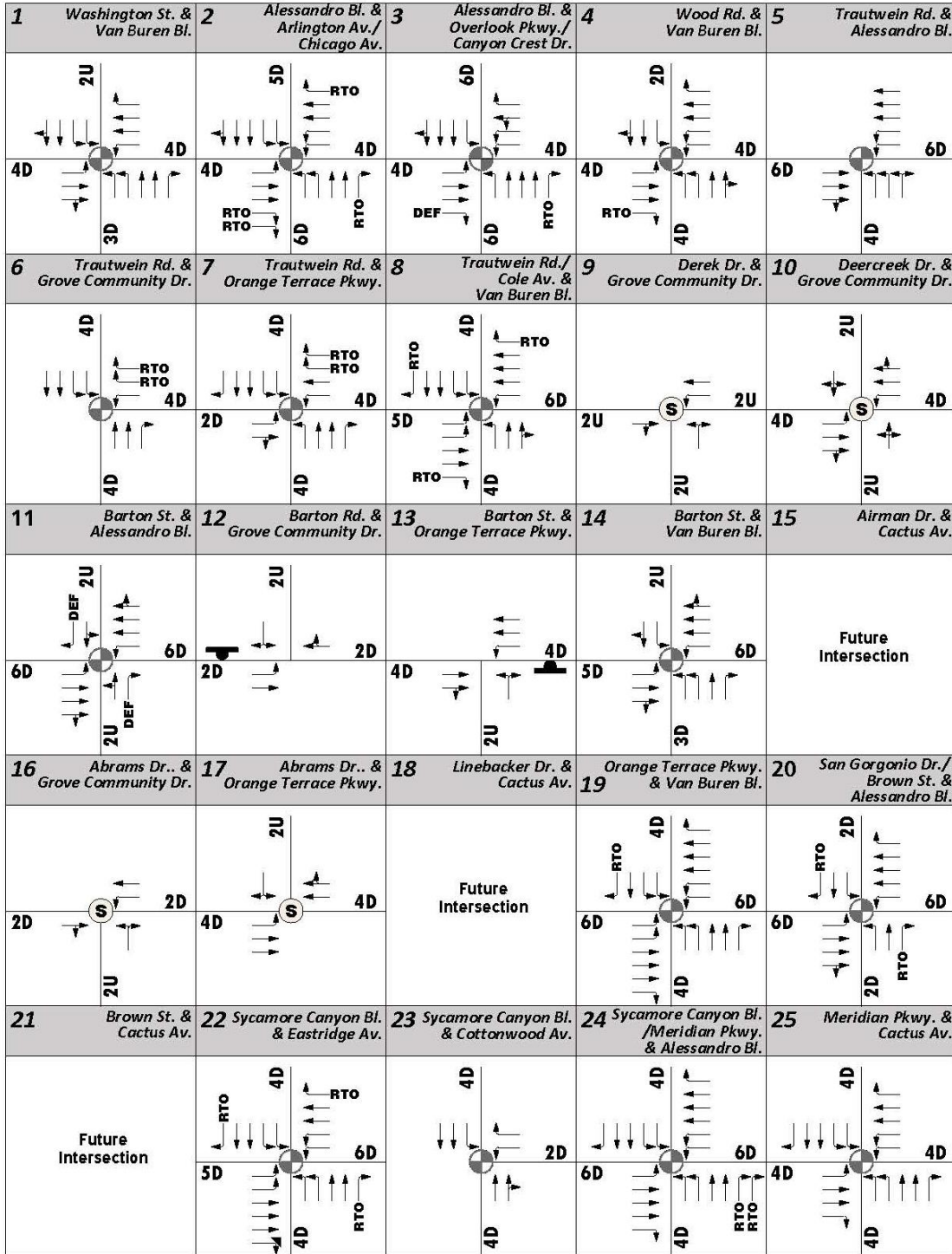

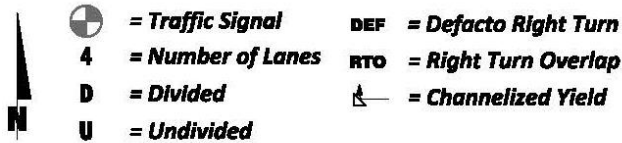
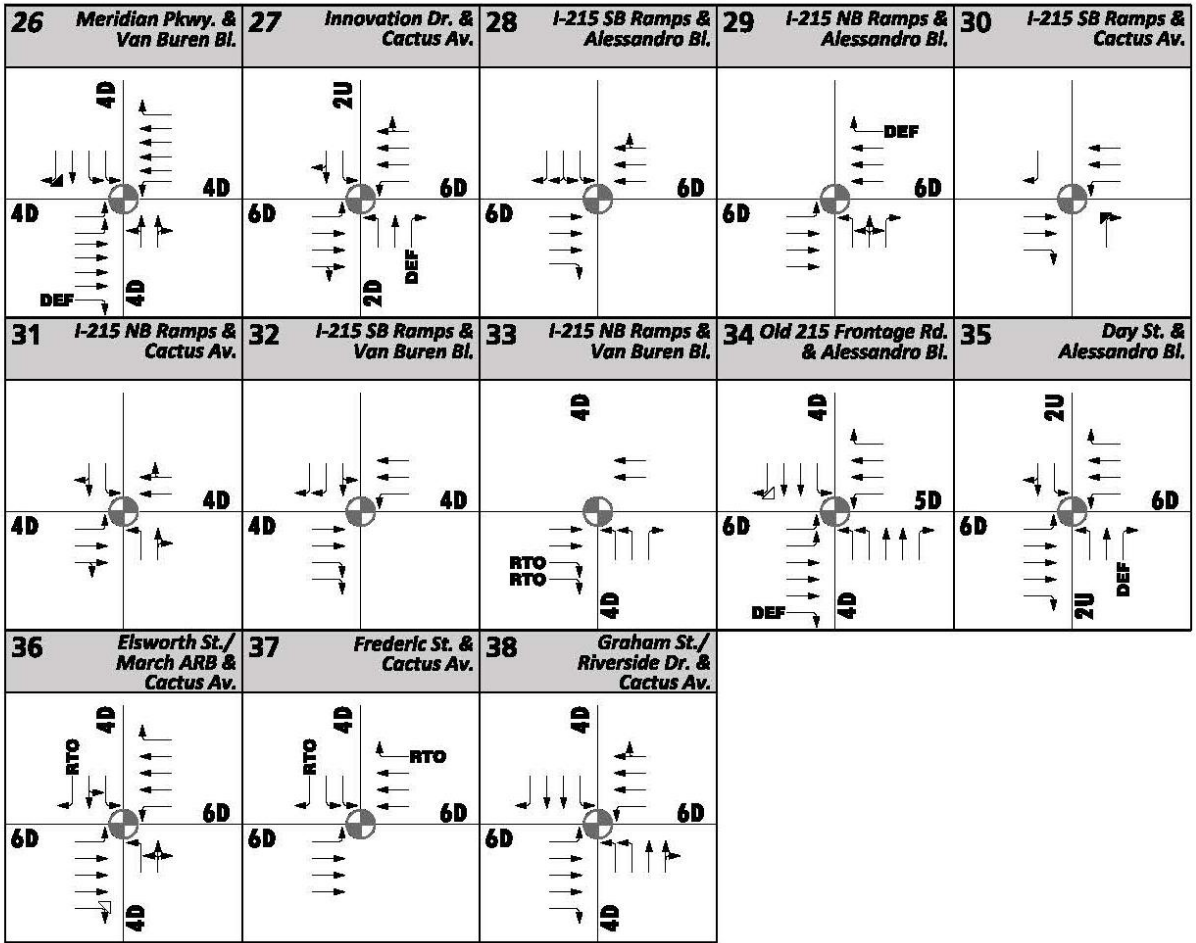

EXHIBIT 3-2: MARCH JPA GENERAL PLAN CIRCULATION ELEMENT

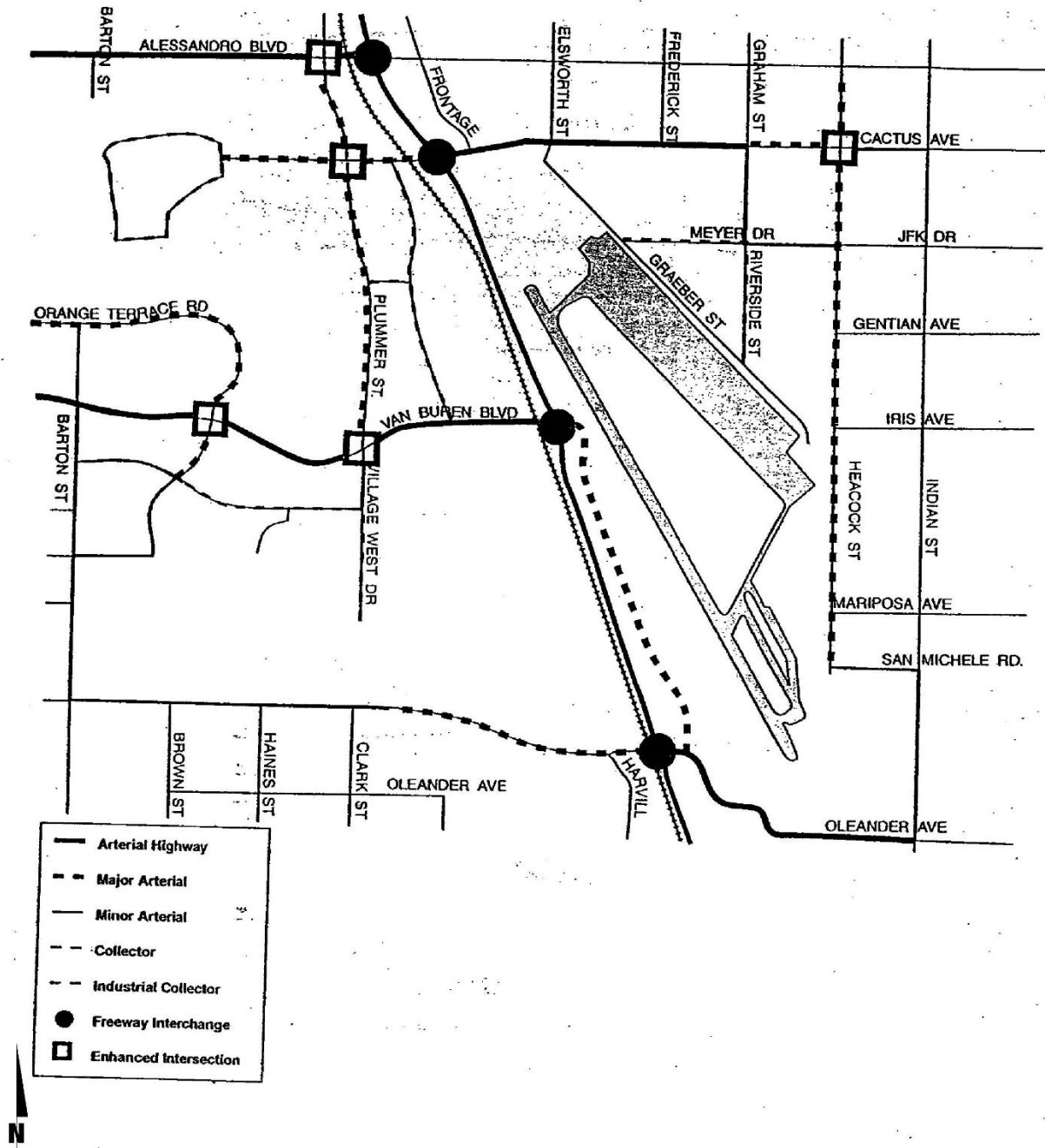
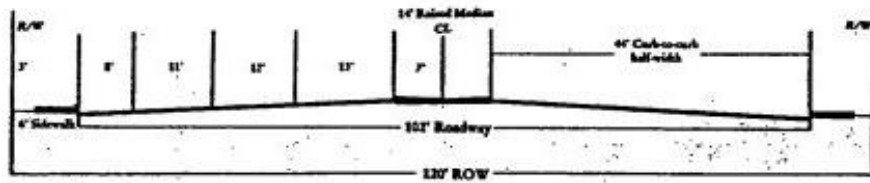
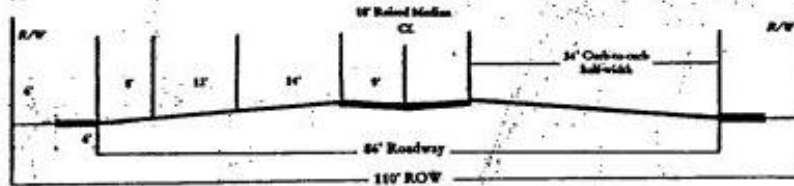

EXHIBIT 3-3: MARCH JPA GENERAL PLAN ROADWAY CROSS-SECTIONS



ARTERIAL HIGHWAY



MAJOR ARTERIAL

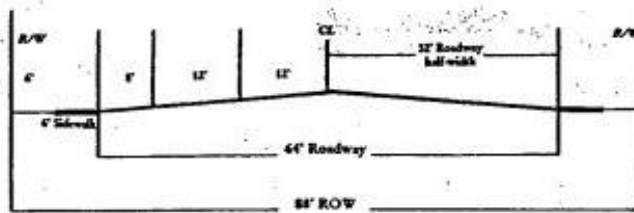

MINOR ARTERIAL

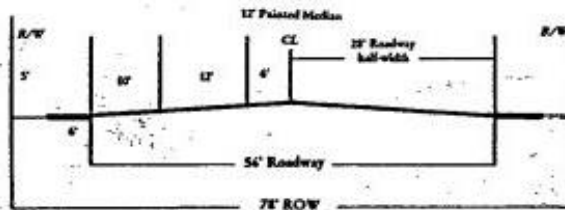

INDUSTRIAL COLLECTOR

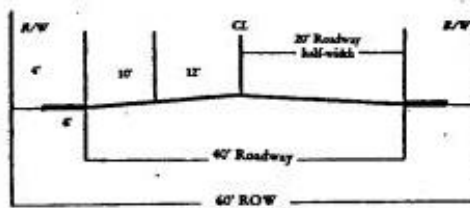

LOCAL STREET

EXHIBIT 3-4: COUNTY OF RIVERSIDE GENERAL PLAN CIRCULATION ELEMENT

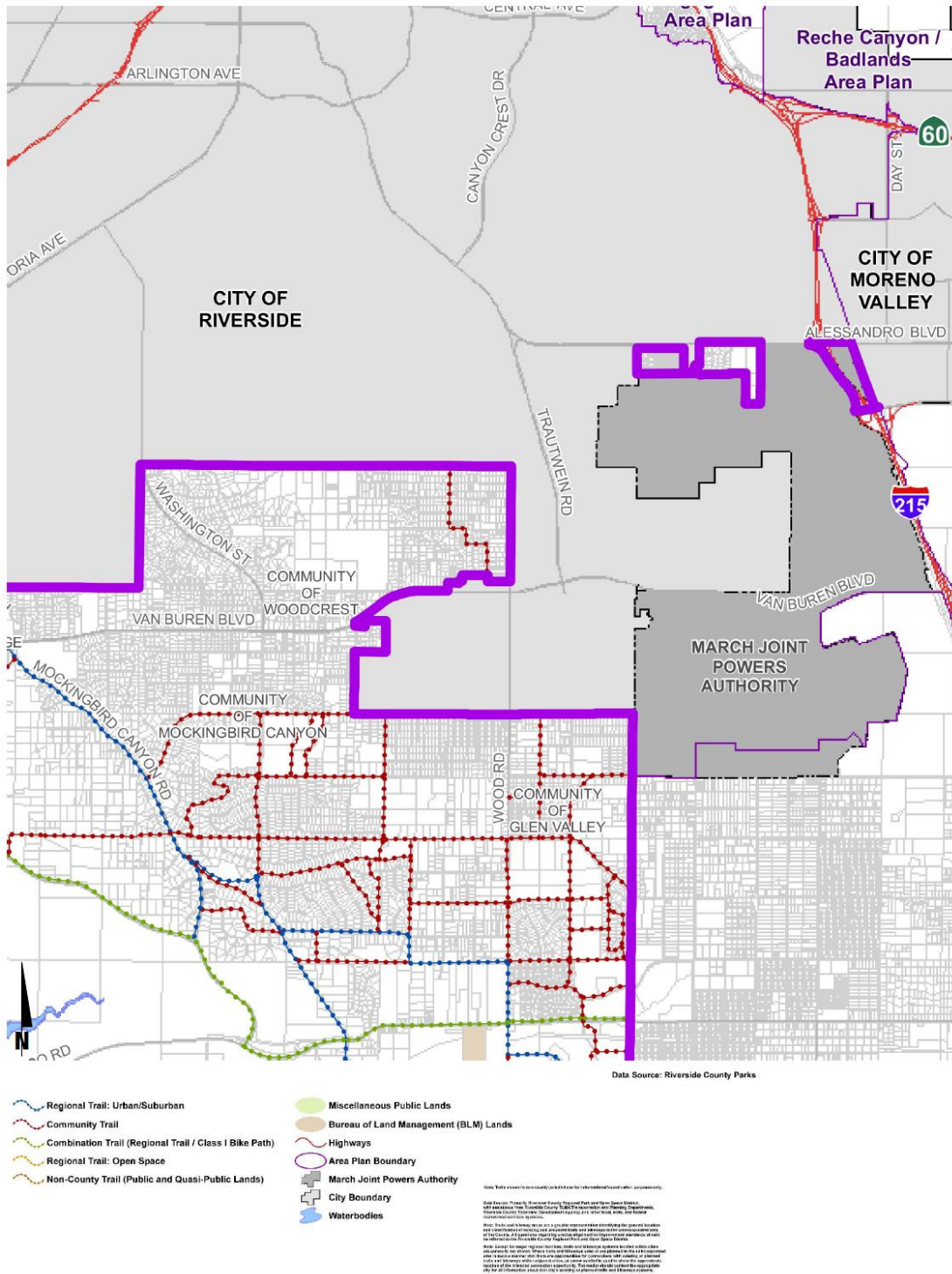
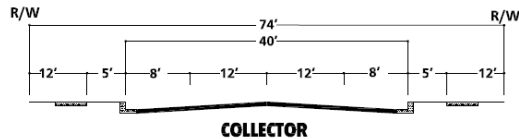
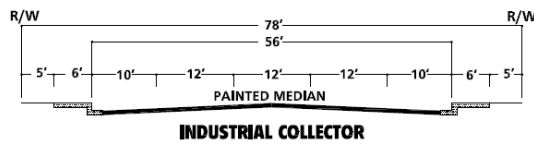
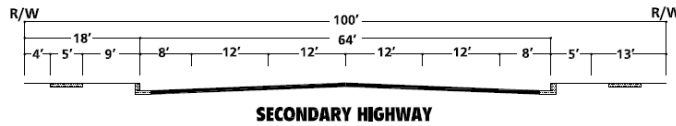
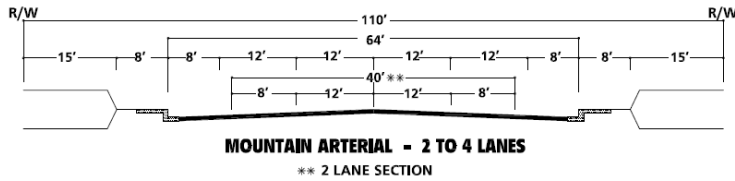
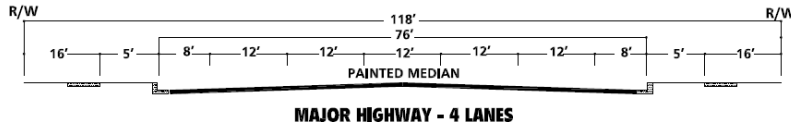
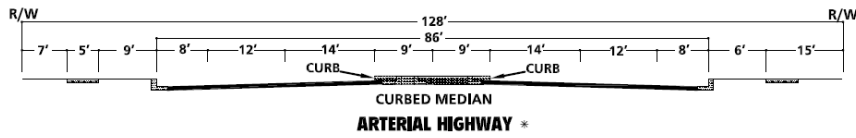
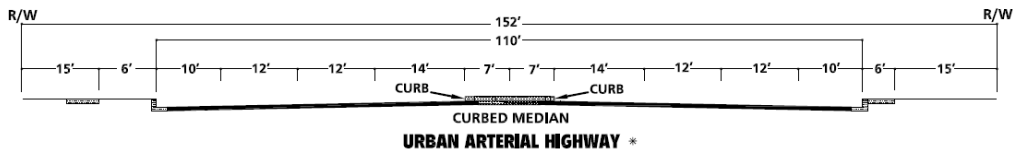
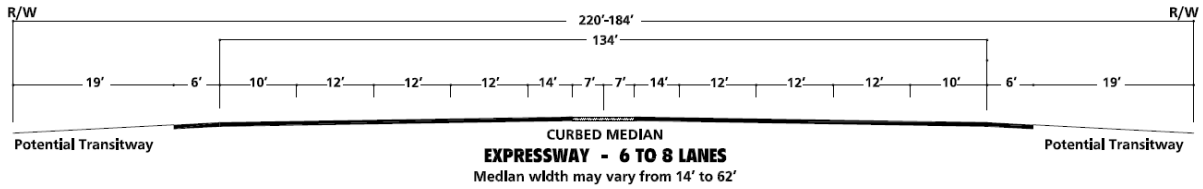

EXHIBIT 3-5: COUNTY OF RIVERSIDE GENERAL PLAN ROADWAY CROSS-SECTIONS



* IMPROVEMENTS MAY BE RECONFIGURED TO ACCOMMODATE EXCLUSIVE TRANSIT LANES OR ALTERNATIVE LANE ARRANGEMENTS ADDITIONAL RIGHT OF WAY MAY BE REQUIRED AT INTERSECTIONS TO ACCOMMODATE ULTIMATE IMPROVEMENTS FOR STATE HIGHWAYS SHALL CONFORM TO CALTRANS DESIGN STANDARDS.

EXHIBIT 3-6: CITY OF MORENO VALLEY GENERAL PLAN CIRCULATION ELEMENT

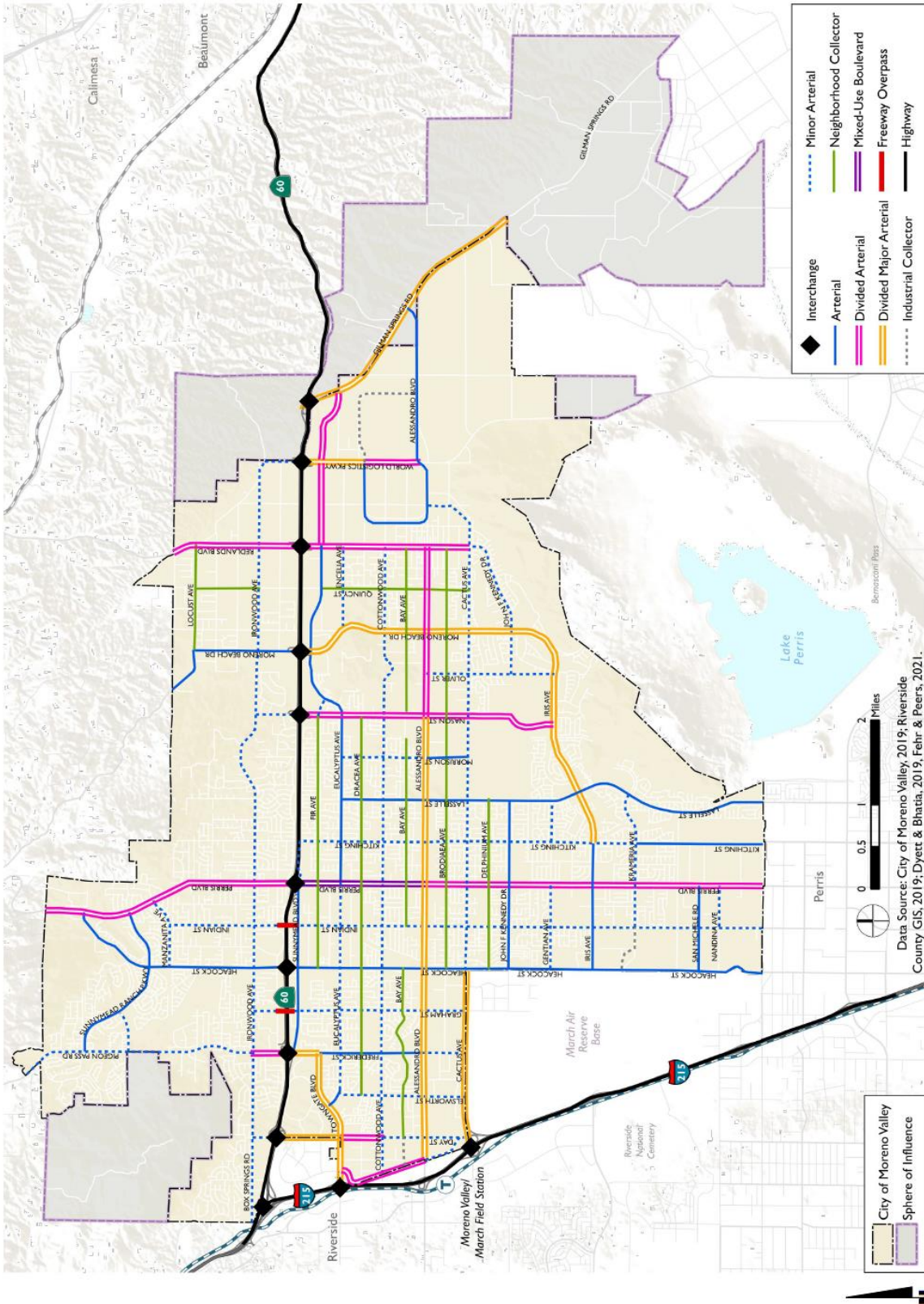

EXHIBIT 3-7: CITY OF MORENO VALLEY GENERAL PLAN ROADWAY CROSS-SECTIONS

**STREET CLASSIFICATION AND CROSS SECTION
DESIGN STANDARDS**

STANDARD PLAN NO.	STREET CLASS	ROW/ CURB TO CURB (FT)	TYPICAL SECTION (PARKING, TRAVEL LANES & MEDIAN) *** (FT)	PARKWAY WIDTH (FT)	THRU LANES	LOS C CAPACITY (ADT)	TRAFFIC INDEX ▲▲	MIN BUS BAY WIDTH (FT)	MIN THICKNESS AC OVER CAB (FT)	
MVSI-101A-0, MVSI-101B-0	DIVIDED MAJOR ARTERIAL ALT. 142/110	134/110 (RAISED MEDIAN)	8 12 12 14 18 14 12 12 8	12**	6 ▲	45,000	10	10	.50/1.00	
MVSI-102A-0, MVSI-102B-0	MODIFIED DIVIDED MAJOR ARTERIAL ALT. 130/102	120/102 (RAISED MEDIAN)	8 12 12 12 14 12 12 12 8	9**	6 ▲	45,000	10	10	.50/1.00	
MVSI-103A-0, MVSI-103B-0	4-LANE DIVIDED ARTERIAL ALT. 114/86	110/86 (RAISED MEDIAN)	8 12 14 18 14 12 8	12**	4 ▲	30,000	10	10	.50/1.00	
MVSI-103C-0	6-LANE DIVIDED ARTERIAL	110/86 (RAISED MEDIAN)	13 11 12 14 12 11 13	12	6	45,000	10	10	.50/1.00	
MVSI-104A-0, MVSI-104B-0	ARTERIAL ALT. 104/76	100/76	8 12 12 12 12 12 8 ***** 6 12 13 14 13 12 6 *****	12**	4 ▲	20,000 30,000	10	10	.50/1.00	
MVSI-105A-0, MVSI-105B-0	MINOR ARTERIAL	88/64	8 12 12 12 12 8 6 11 10 10 10 11 6 7 10 10 10 10 7	12**	4	20,000	9	10	.45/75	
MVSI-105C-0	PIGEON PASS RD.	98/74	6 13 12 12 12 13 6	12	4 ▲	20,000	9	10	.45/75	
MVSI-106A-0	INDUSTRIAL COLLECTOR	78/56	10 12 12 12 10	11	2 ▲	10,000	10	10	.50/1.00	
MVSI-106B-0	COLLECTOR	66/44	8 14 14 8	11	2	N/A	7	N/A	.30/50	
MVSI-107A-0	LOCAL STREET	56/36	7 11 11 7	10	2	N/A	6	N/A	.30/50	
MVSI-107B-0	MODIFIED LOCAL STREET	50/36	7 11 11 7	7	2	N/A	6	N/A	.30/50	
NOT TO SCALE	MVSI-104C-0, MVSI-104D-0, MVSI-104E-0	SUNNYMEAD BOULEVARD	100/72	20 12 12 12 16	12/16	4	30,000	10	10	.50/1.00
			100/68	16 12 12 12 16	16	4	30,000	10	10	.50/1.00
			100/68	16 12 12 12 16	16	4	30,000	10	10	.50/1.00
				6 11 11 12 11 11 6						

EXHIBIT 3-8: CITY OF RIVERSIDE GENERAL PLAN CIRCULATION ELEMENT

- LEGEND**
- 66 FT LOCAL 2 LANES *
 - 66 FT COLLECTOR 2 LANES
 - 80 FT COLLECTOR 2 LANES
 - 88 FT ARTERIAL 4 LANES
 - 100 FT ARTERIAL 4 LANES
 - 110 FT ARTERIAL 4 LANES
 - 120 FT ARTERIAL 6 LANES
 - 144 FT ARTERIAL 8 LANES
 - SCENIC BOULEVARD
REQUIRES SPECIAL LANDSCAPING,
ADDITIONAL RIGHT-OF-WAY MAY BE REQUIRED.
 - SPECIAL BOULEVARD
TWO-LANE DIVIDED ROADWAY OF
VARIABLE GEOMETRIC DESIGN
WITH VARIABLE WIDTHS AND DESIGN.
FOR DETAIL, SEE OBJECTIVE CCM-3 AND POLICIES CCM-3.1
THROUGH CCM-3.5.
 - PARKWAYS
FOR INFORMATION ON PARKWAYS SEE
CCAP-3.1.
 - CEJAP CORRIDOR AREA
CORRIDOR OPTIONS SUBJECT TO SPECIAL STUDY.
 - RIVERSIDE CITY BOUNDARY
 - RIVERSIDE PROPOSED SPHERE
OF INFLUENCE
- NOTE:**
- * LOCAL STREETS ARE NOT SHOWN ON THIS PLAN EXCEPT WHERE NEEDED FOR CLARITY.
 - ① MAGNOLIA AVENUE SHALL BE A SPECIAL BLVD. WITH 4 LANES EASTERLY OF HARRISON STREET.
 - ② OVERLOOK PARKWAY SHALL BE A 2-LANE PARKWAY WITH A WIDE SHOULDER PARKWAY. THE LOCATION OF OVERLOOK PARKWAY IN WASHINGTON IS NOT YET DETERMINED PENDING PREPARATION OF SPECIFIC PLAN LEVEL STUDY.
 - ③ COLUMBIA AVENUE IS SHOWN BY HUNTER BUSINESS PARK SPECIFIC PLAN AS A 134-FOOT ARTERIAL. ACTUAL STREET WIDTH DUE TO RAIL ROAD CROSSINGS, WILL BE DETERMINED BY PUBLIC WORKS.
 - ④ THESE STREETS SHALL BE 66-FOOT LOCAL ROADWAYS SERVING AS ALTERNATE ROUTES.
 - ⑤ THE STREETS IN SYCAMORE CANYON BUSINESS PARK SPECIFIC PLAN VARY IN SIZE. SEE THE SPECIFIC PLAN FOR DETAILS.
- SOURCE: CITY OF RIVERSIDE

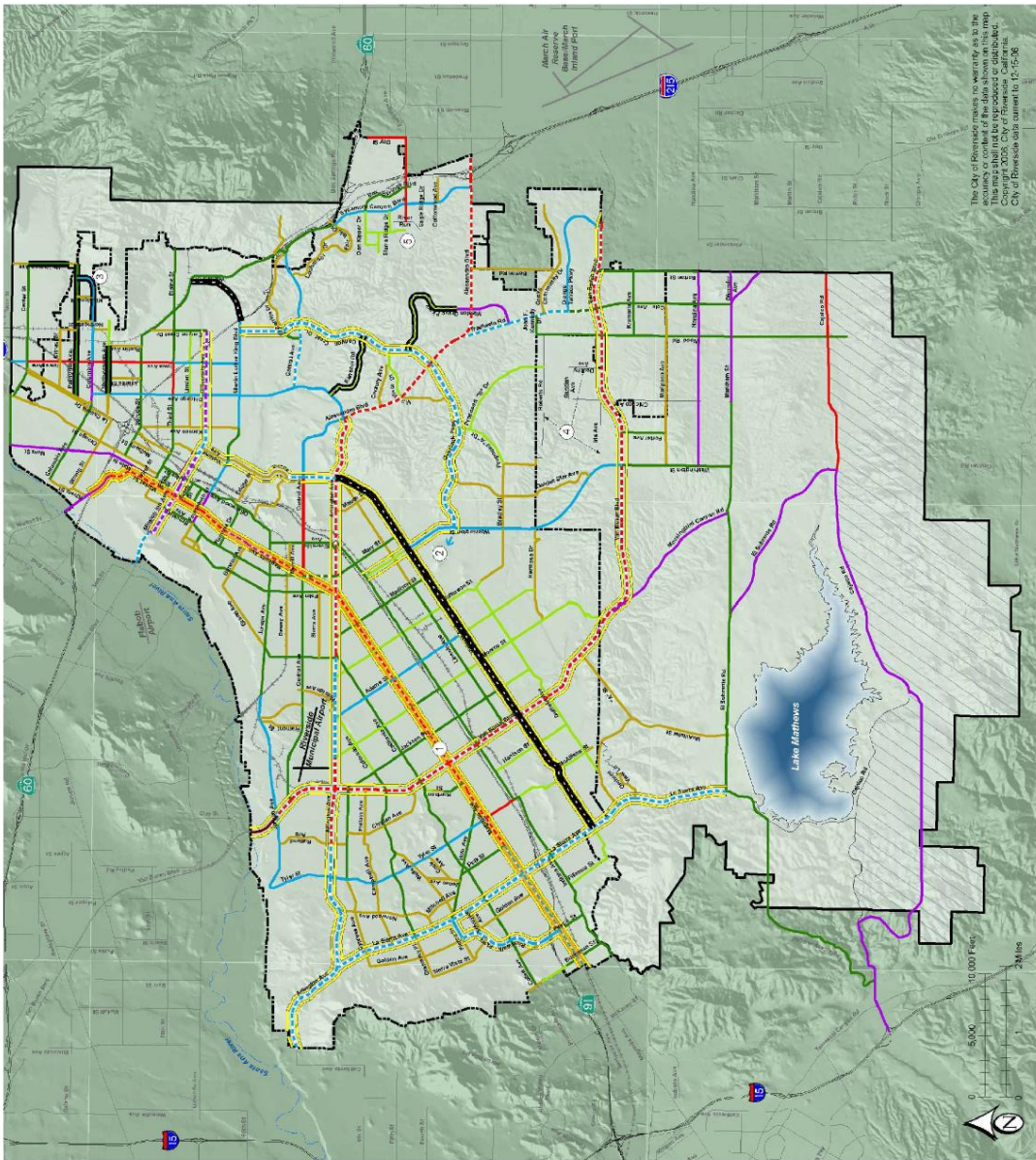

EXHIBIT 3-9: CITY OF RIVERSIDE GENERAL PLAN ROADWAY CROSS-SECTIONS

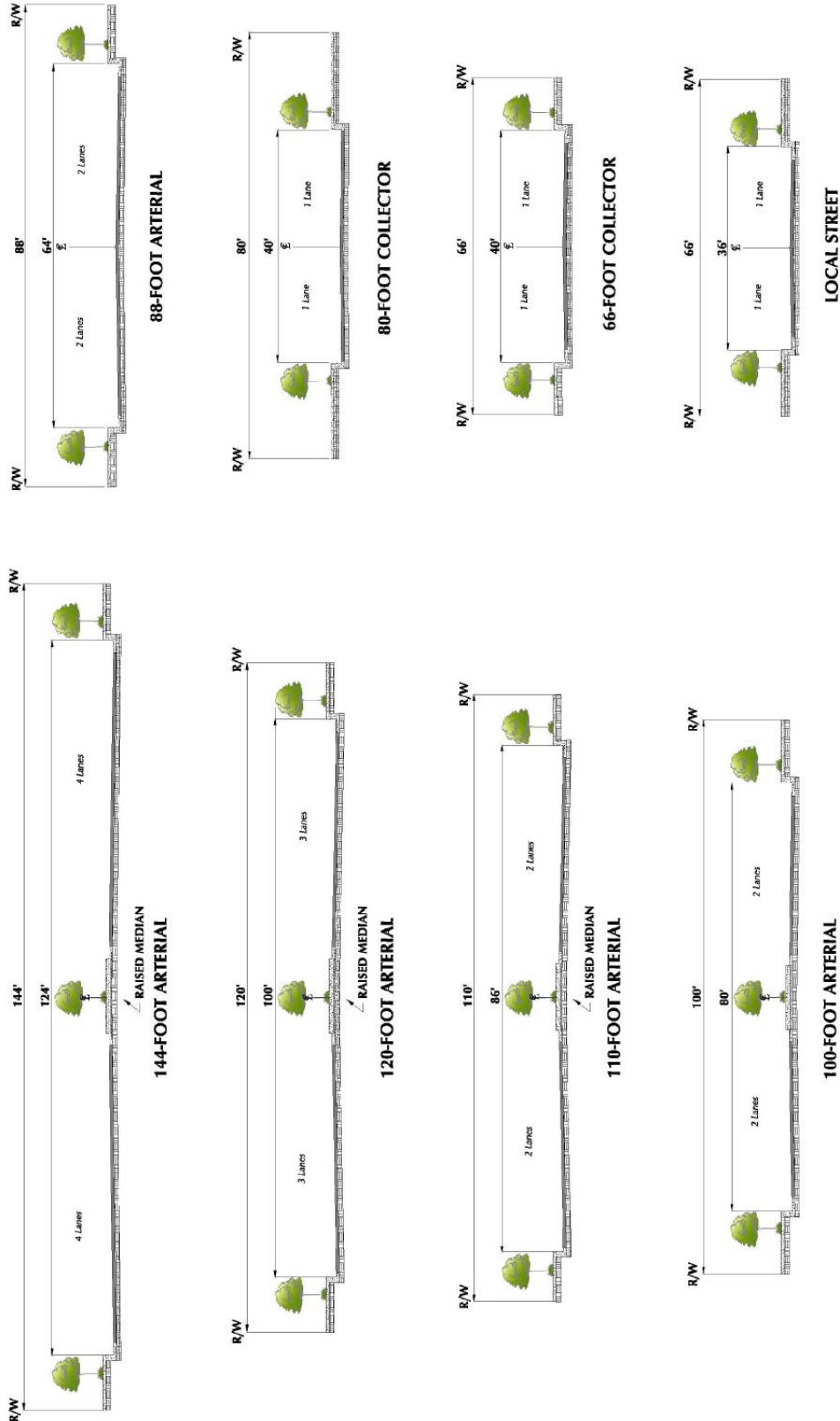

EXHIBIT 3-10: CITY OF MORENO VALLEY BIKE PLAN

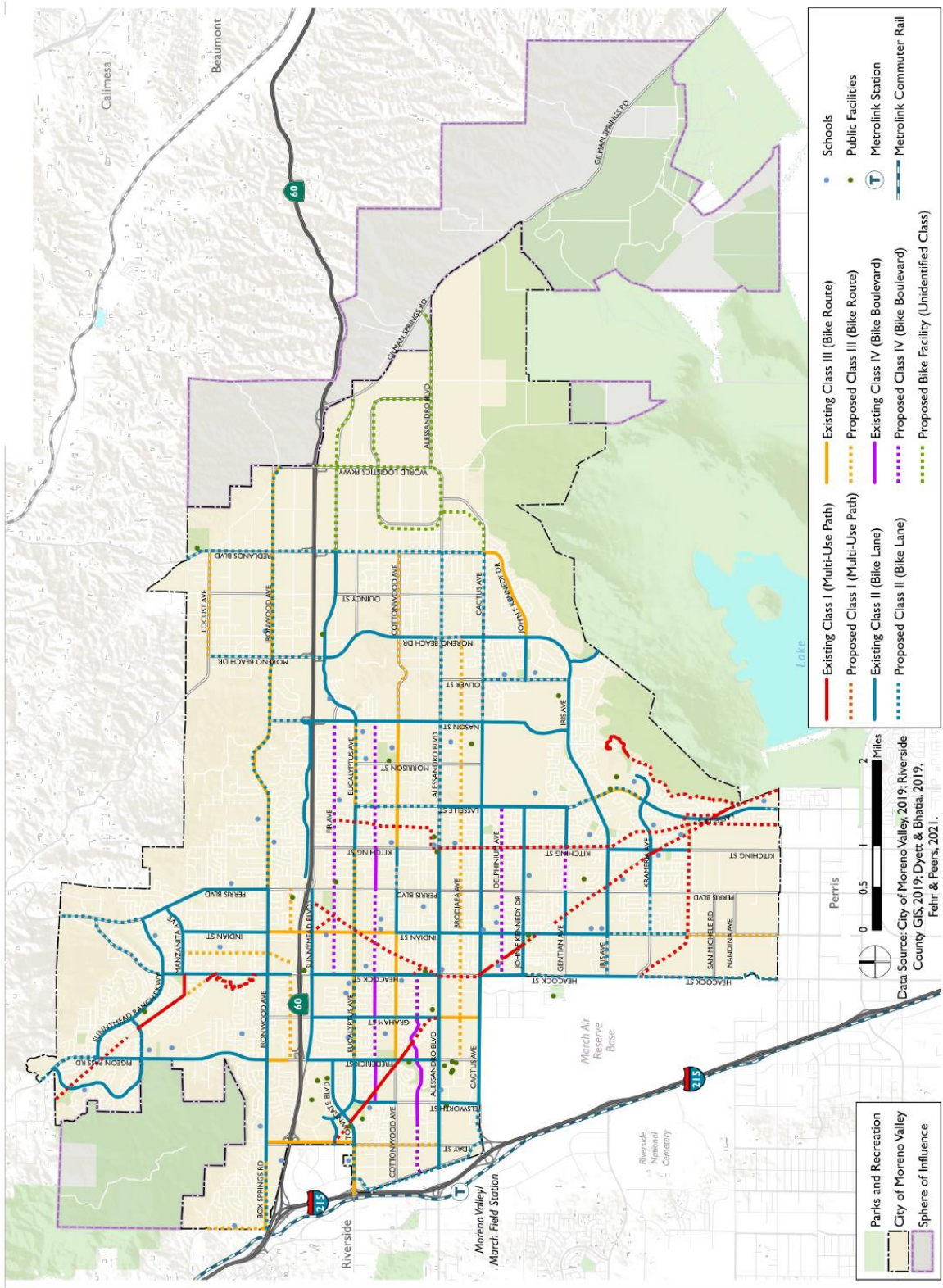

EXHIBIT 3-11: CITY OF MORENO VALLEY MASTER PLAN OF TRAILS

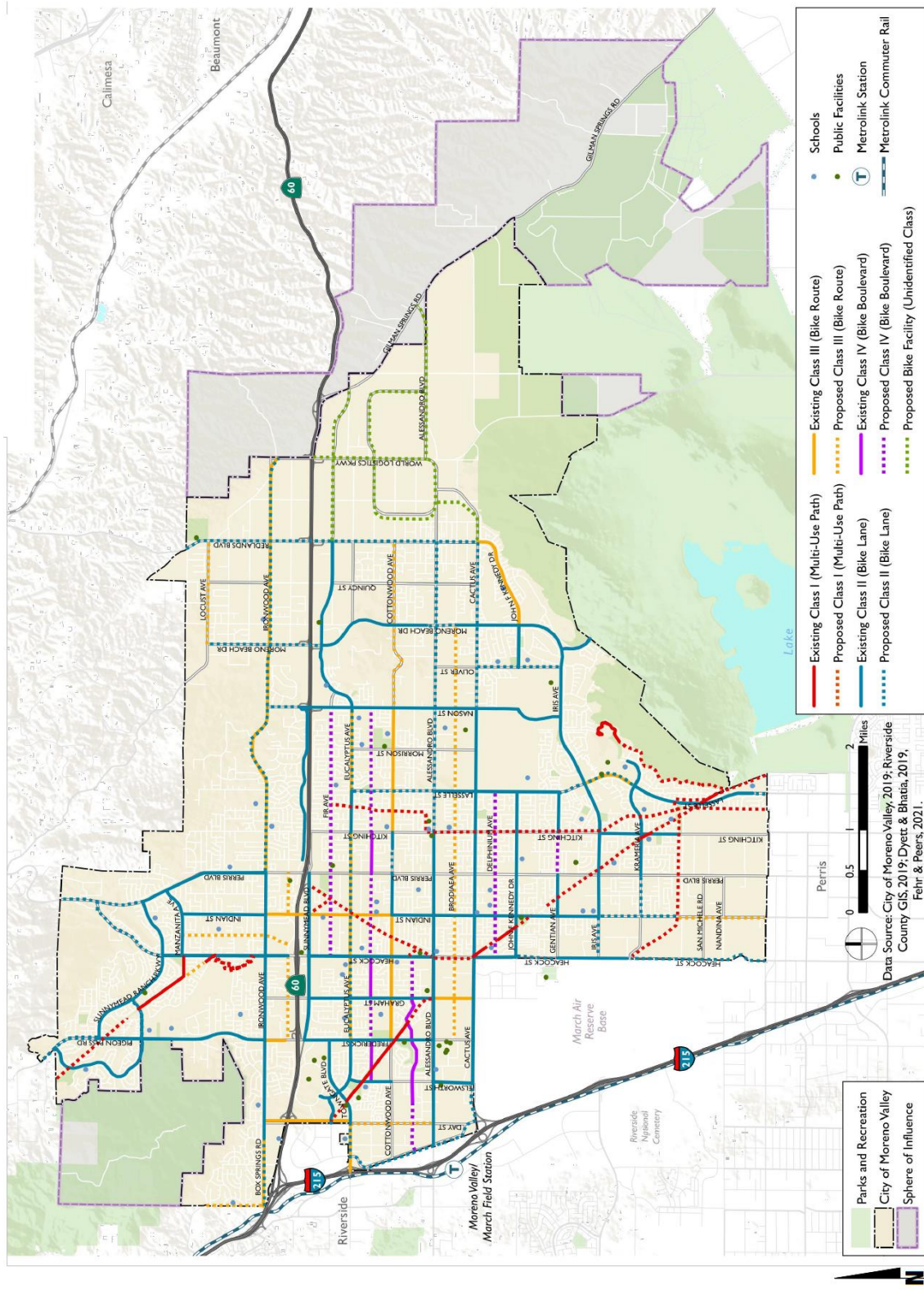

EXHIBIT 3-12: CITY OF RIVERSIDE PROPOSED BIKEWAYS AND TRAILS IMPROVEMENTS

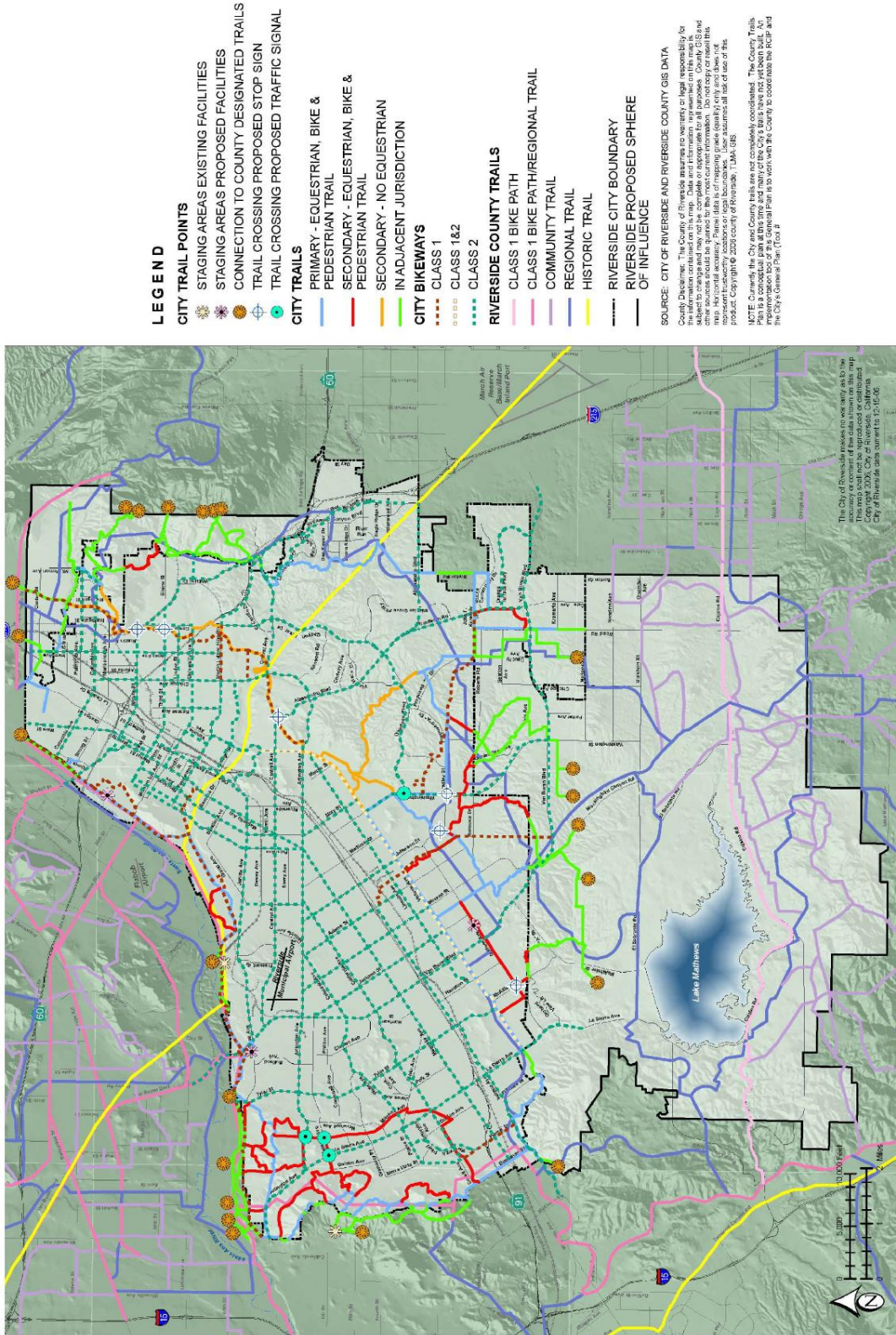
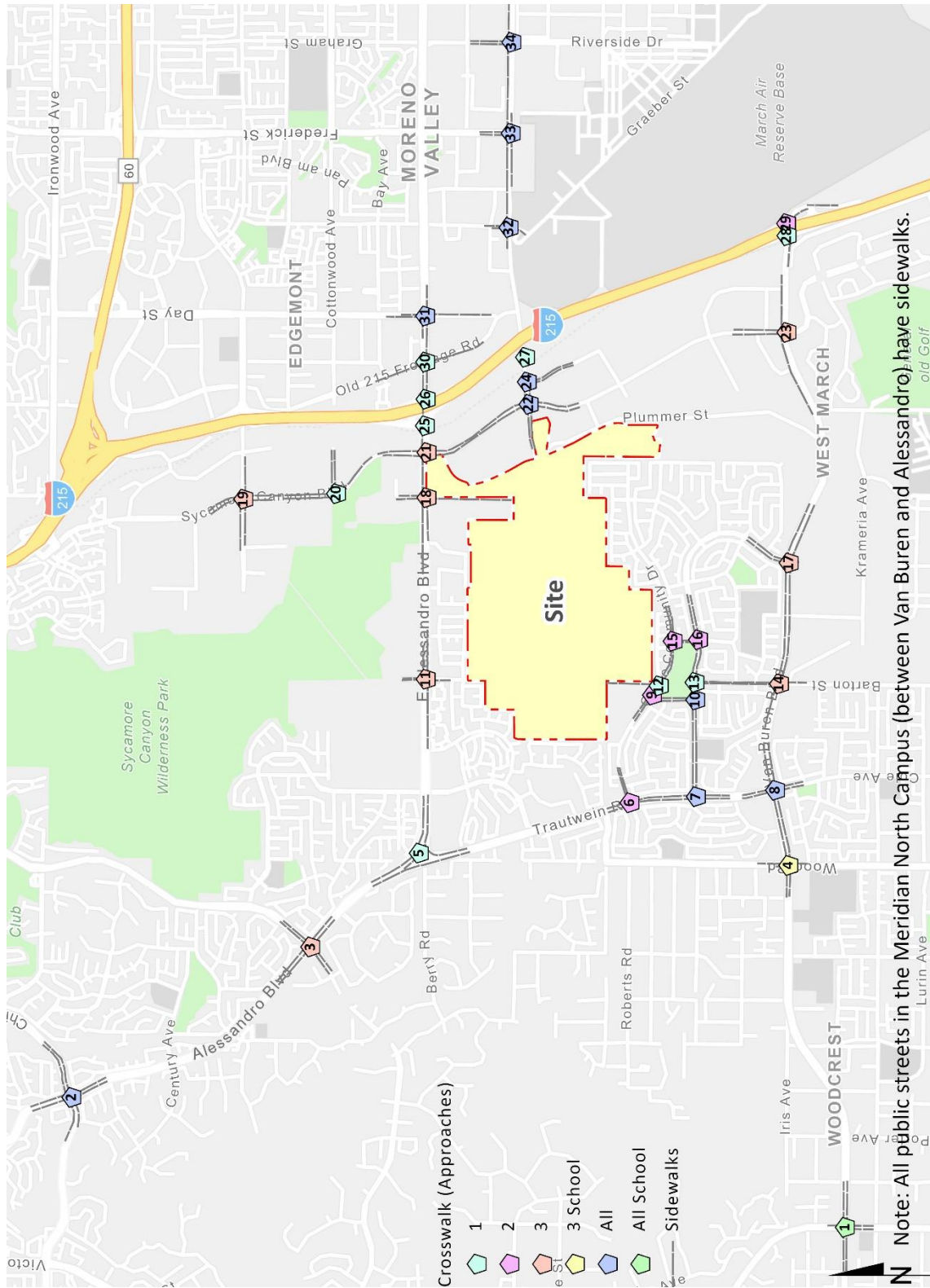

EXHIBIT 3-13: EXISTING PEDESTRIAN FACILITIES AT STUDY AREA INTERSECTIONS



3.5 TRUCK ROUTES

The March JPA designated truck route map is shown on Exhibit 3-14. Alessandro Boulevard, Meridian Parkway, Cactus Avenue, and Van Buren Boulevard are the designated March JPA truck routes within the study area. The City of Moreno Valley designated truck route map is shown on Exhibit 3-15. Alessandro Boulevard, Cactus Avenue, Elsworth Street, Frederick Street, and Graham Street are also designated truck routes within the City of Moreno Valley. The Project will extend the JPA truck routes west on Cactus Avenue and along Airman Drive, Linebacker Drive, Bunker Hill Drive, and Arclight Drive. The designated truck route maps for have been utilized to route truck traffic for the proposed Project and for future cumulative development projects throughout the study area.

3.6 TRANSIT SERVICE

The March JPA is currently served by the Riverside Transit Authority (RTA), a public transit agency serving the unincorporated Riverside County region. Existing transit routes in the vicinity of the study area are illustrated on Exhibit 3-16. As shown, the existing RTA Route 20 provides to service from Alessandro Boulevard to the Moreno Valley March Field Metrolink Station. RTA Route 27 also runs along Orange Terrace Parkway and Van Buren Boulevard to the south of the Project. There is an existing bus stop on Alessandro Boulevard near Brown Street. Transit service is reviewed and updated by RTA periodically to address ridership, budget, and community demand needs. Changes in land use can affect these periodic adjustments which may lead to either enhanced or reduced service where appropriate. As such, it is recommended that the Project Applicant work in conjunction with RTA to potentially extend the existing routes to accommodate bus service to the site.

3.7 EXISTING (2021) TRAFFIC COUNTS

The AM and PM peak hour intersection LOS analysis is based on the traffic volumes observed during the peak hour conditions using traffic data based on an adjustment of both historic (2019) traffic count data and new (2021) traffic count data collected in November 2021. The Saturday peak hour traffic counts were collected in September 2022. The following peak hours were selected for analysis:

- Weekday AM Peak Hour (peak hour between 7:00 AM and 9:00 AM)
- Weekday PM Peak Hour (peak hour between 4:00 PM and 6:00 PM)
- Weekend Saturday Peak Hour (peak hour between 11:00 AM and 2:00 PM)

Adjusted factors were calculated based on historic (2019) traffic counts in conjunction with a 2.0% per year growth rate (compounded annually) to reflect 2021 conditions and compared to new (2021) traffic count data at the same intersections for the AM and PM peak hours. No adjustments were made to the 2022 traffic counts. There were no observations made in the field that would indicate atypical traffic conditions on the count dates, such as construction activity or detour routes and near-by schools were in session and operating on normal schedules. The raw manual peak hour turning movement traffic count data sheets are included in Appendix 3.1.

EXHIBIT 3-14: MARCH JPA TRUCK ROUTES

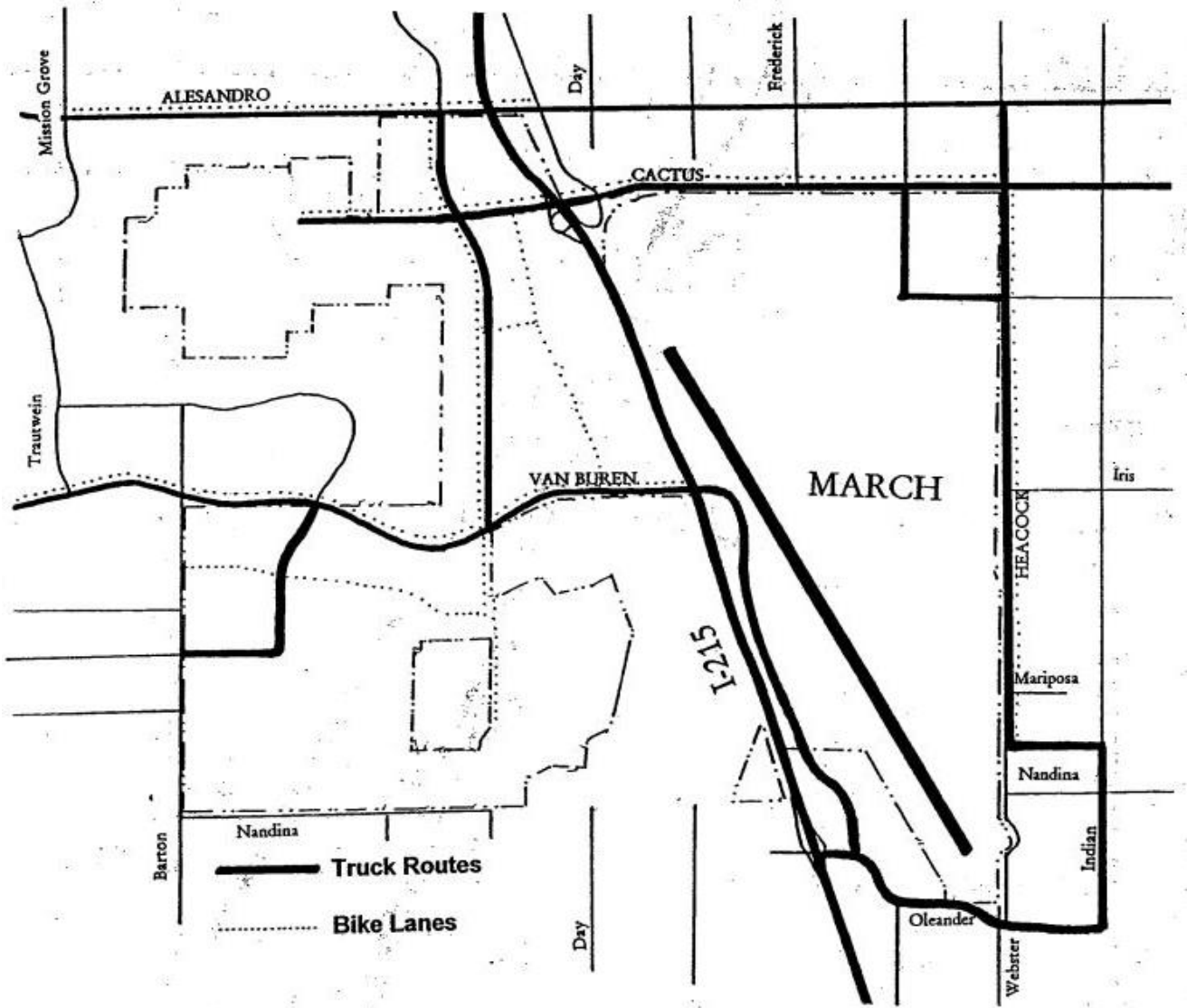
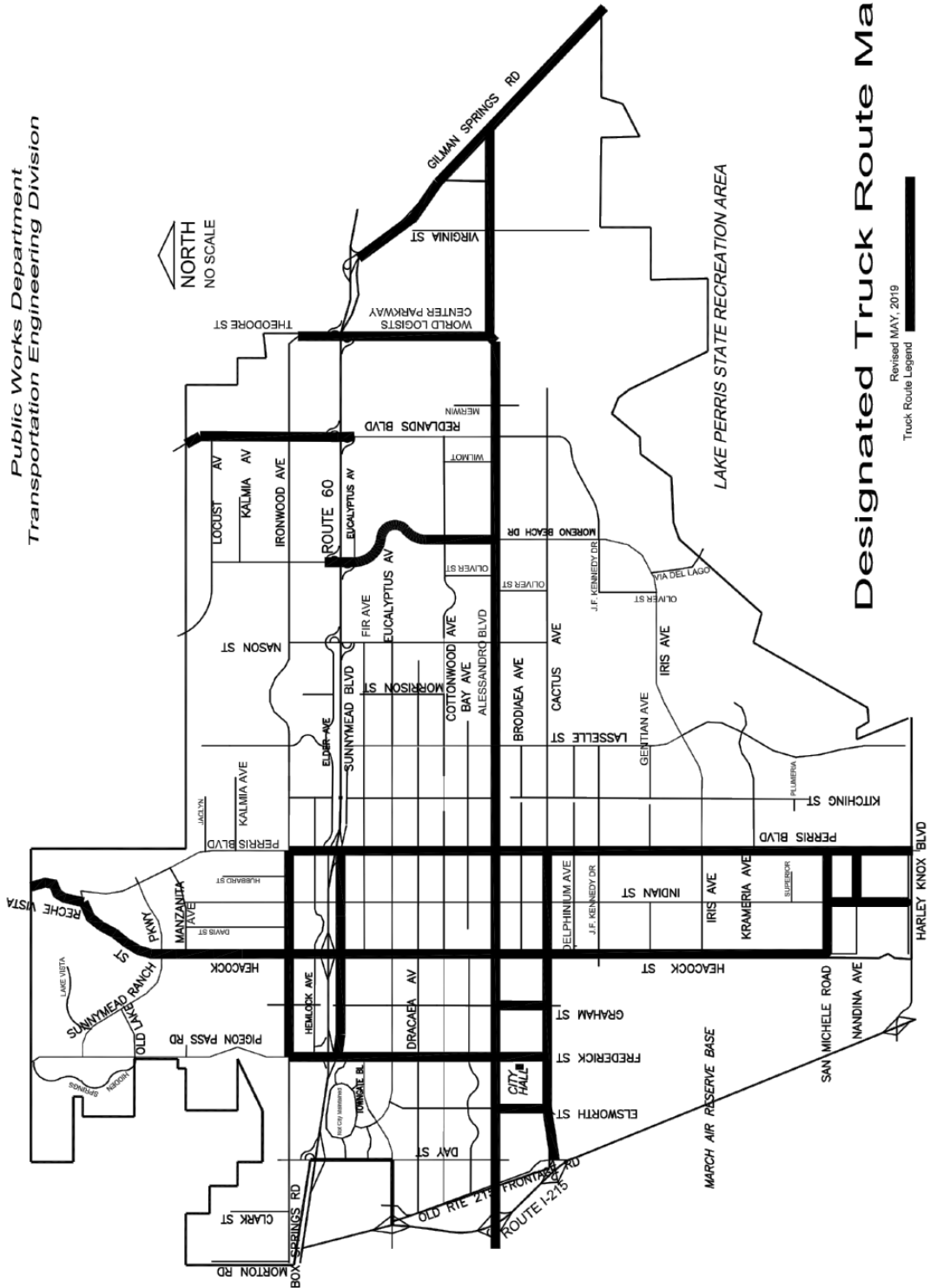

EXHIBIT 3-15: CITY OF MORENO VALLEY TRUCK ROUTES

City of Moreno Valley
Public Works Department
Transportation Engineering Division



Designated Truck Route Map

Revised MAY, 2019

Truck Route Legend

EXHIBIT 3-16: EXISTING TRANSIT ROUTES

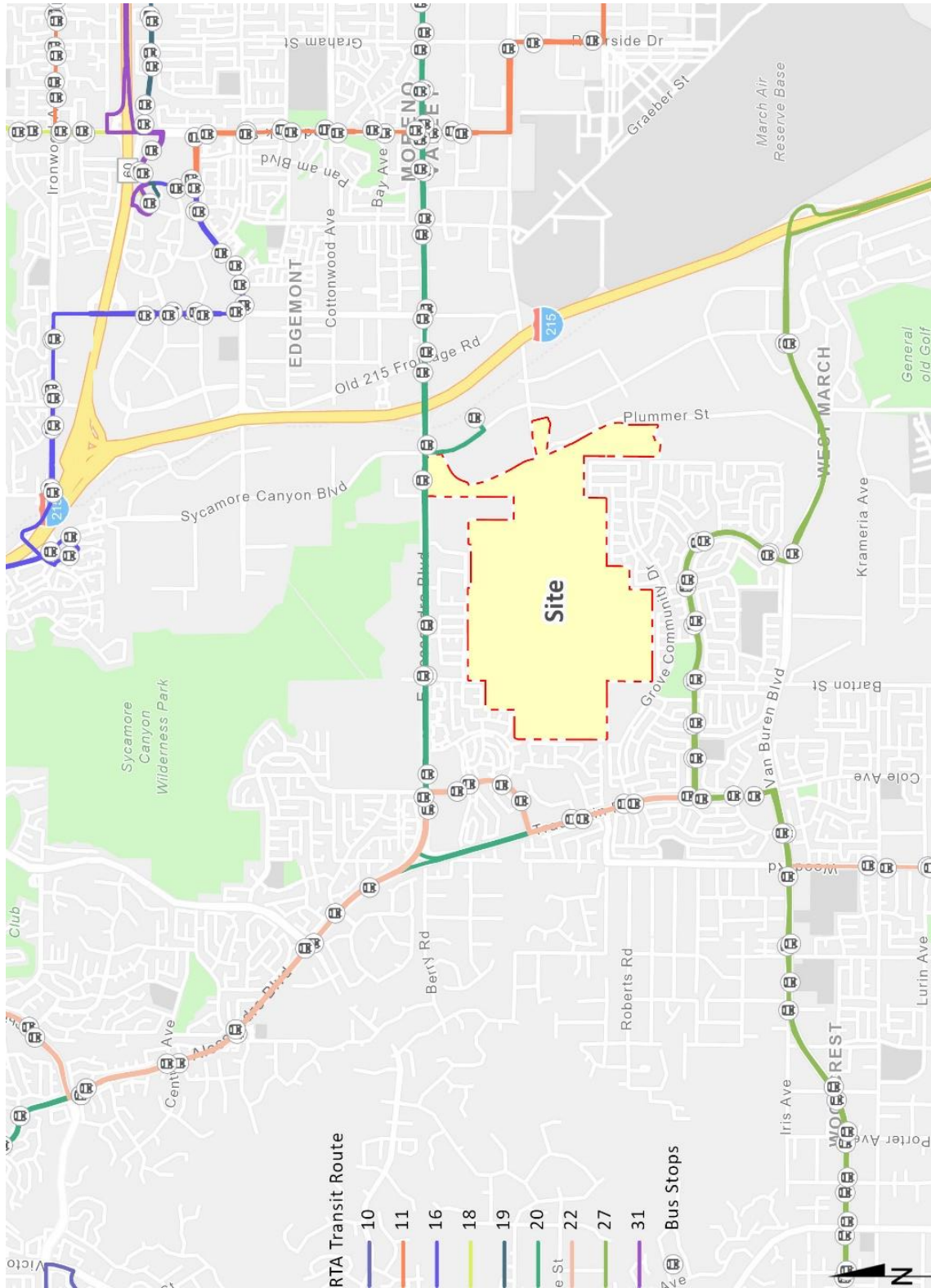

The traffic counts collected in November 2021 and September 2022 include the following vehicle classifications: Passenger Cars, 2-Axle Trucks, 3-Axle Trucks, and 4 or More Axle Trucks. To represent the effects large trucks, buses and recreational vehicles have on traffic flow, truck traffic has been accounted for in the analysis as a percentage of total traffic at the study area intersections. Where historic counts were unavailable, the AM and PM peak hour factors were applied to adjust the 2021 count data. Existing weekday ADT volumes are shown on Exhibit 3-17. Where actual 24-hour tube count data was not available, Existing ADT volumes were based upon factored intersection peak hour counts collected by Urban Crossroads, Inc. using the following formula for each intersection leg:

$$\text{Weekday PM Peak Hour (Approach Volume + Exit Volume)} \times 10.20 = \text{Leg Volume}$$

A comparison of the PM peak hour and daily traffic volumes of various roadway segments within the study area indicated that the peak-to-daily relationship is approximately 9.80 percent. As such, the above equation utilizing a factor of 10.20 estimates the ADT volumes on the study area roadway segments assuming a peak-to-daily relationship of approximately 9.8 percent (i.e., $1/0.09802 = 10.20$) and was assumed to sufficiently estimate average daily traffic (ADT) volumes for planning-level analyses. Existing weekday AM and weekday PM peak hour intersection volumes are shown on Exhibit 3-17. Existing weekend Saturday peak hour intersection volumes are shown on Exhibit 3-18.

For the purposes of this analysis, it is proposed that the actual vehicles be utilized in order to reflect the effects of heavy trucks most accurately in the analysis. Trucks will be accounted for in the analysis as a percentage of total traffic, which will be input into the analysis software (Synchro 11). As such, trip generation is reflected in actual vehicles only and not in passenger car equivalent (PCE).

3.8 INTERSECTION OPERATIONS ANALYSIS

Existing peak hour traffic operations have been evaluated for the study area intersections based on the analysis methodologies presented in Section 2.2 *Intersection Capacity Analysis* of this report. The intersection operations analysis results are summarized in Table 3-1, which indicates that the study area intersections are currently operating at an acceptable LOS during the peak hours, with the exception of the following intersections:

- Alessandro Bl. & Arlington Av./Chicago Av. (#2) – LOS E AM peak hour; LOS F PM peak hour
- Trautwein Rd. & Alessandro Bl. (#5) – LOS F AM peak hour only
- Deercreek Dr. & Orange Terrace Pkwy. (#10) – LOS F AM peak hour only
- Barton St. & Orange Terrace Pkwy. (#13) – LOS F AM and Saturday peak hours
- Barton St. & Van Buren Bl. (#14) – LOS E AM peak hour only
- Meridian Pkwy. & Alessandro Bl. (#24) – LOS F AM peak hour only
- I-215 NB Ramps & Alessandro Bl. (#29) – LOS F AM peak hour only
- I-215 NB Ramps & Cactus Av. (#31) – LOS E AM peak hour only
- Elsworth St. & Cactus Av. (#36) – LOS F AM peak hour; LOS E PM peak hour

EXHIBIT 3-17: EXISTING (2021) WEEKDAY TRAFFIC VOLUMES

<p>1 Washington St. & Van Buren Blvd.</p> <p>16,550 62(92) 176(346) 315(482) 131(133) 985(1278) 120(79) 26,750</p> <p>33,750 568(372) 1293(1007) 91(161) 136(98) 509(240) 116(92) 10,100</p>	<p>2 Alessandro Blvd. & Arlington Av./Chicago Av.</p> <p>33,600 42(20) 598(1624) 225(486) 41(25) 491(731) 595(1007) 32,050</p> <p>28,250 322(210) 812(656) 182(527) 1225(783) 1522(1013) 448(227) 51,550</p>	<p>3 Canyon Crest Dr. & Alessandro Blvd.</p> <p>13,150 49(23) 6(11) 449(547) 38(52) 1313(2826) 1(16) 53,400</p> <p>64,600 1016(599) 3114(2103) 2(5) 5(13) 10(6) 2(8) 650</p>	<p>4 Wood Rd. & Van Buren Blvd.</p> <p>9,800 162(185) 416(241) 83(82) 146(153) 823(1297) 317(197) 32,700</p> <p>30,100 102(82) 1143(1158) 439(210) 323(285) 416(237) 283(186) 13,550</p>	<p>5 Trautwein Rd. & Alessandro Blvd.</p> <p>42,850 3031(1882) 157(234) 1015(1782) 4(17) 1847(893) 7(11) 12,250</p>
<p>6 Trautwein Rd. & Grove Community Dr.</p> <p>27,250 871(1361) 206(367) 604(231) 75(49) 1428(780) 22(52) 22,300</p> <p>6,950</p>	<p>7 Trautwein Rd. & Orange Terrace Pkwy.</p> <p>22,600 20(40) 579(1050) 382(333) 67(45) 63(46) 12(12) 1,900</p> <p>8,900 485(163) 99(24) 288(148) 48(31) 974(716) 239(208) 20,850</p>	<p>8 Trautwein Rd. & Van Buren Blvd.</p> <p>19,750 226(215) 329(508) 176(287) 301(317) 884(959) 92(100) 28,350</p> <p>28,100 332(248) 1214(990) 142(118) 215(89) 535(284) 100(46) 12,150</p>	<p>9 Deercreek Dr. & Grove Community Dr.</p> <p>4,000 325(132) 49(21) 91(203) 79(18) 203(27) 31(35) 1,000</p>	<p>10 Deercreek Dr. & Orange Terrace Pkwy.</p> <p>7,550 36(19) 30(7) 82(27) 219(43) 418(422) 41(15) 7,700</p> <p>50(46) 539(237) 4(3) 156(18) 156(18) 6(2) 500</p>
<p>11 Barton St. & Alessandro Blvd.</p> <p>300 7(12) 6(5) 1320(1866) 33(40) 42,300</p> <p>42,350 5(3) 2499(2030) 36(67) 1(1) 48(33) 2,000</p>	<p>12 Barton St. & Grove Community Dr.</p> <p>750 6(27) 22(31) 100(208) 3,800</p> <p>3,500 13(20) 369(127)</p>	<p>13 Barton St. & Orange Terrace Pkwy.</p> <p>6,750 396(221) 45(41) 269(370) 238(80) 197(65) 33(39) 2,250</p>	<p>14 Barton St. & Van Buren Blvd.</p> <p>3,400 278(82) 95(27) 46(16) 135(100) 1022(1100) 104(218) 29,950</p> <p>28,950 25(32) 1233(1114) 250(255) 73(61) 345(212) 10,400</p>	<p>15 Airman Dr. & Cactus Av.</p> <p>Future Intersection</p>
<p>16 Abrams Dr. & Grove Community Dr.</p> <p>3,050 213(69) 93(35) 50(143) 52(61) 135(49) 61(58) 2,000</p>	<p>17 Abrams Dr. & Orange Terrace Pkwy.</p> <p>2,050 104(36) 73(25) 113(113) 161(278) 87(32) 301(199) 6,250</p>	<p>18 Linebacker Dr. & Cactus Av.</p> <p>Future Intersection</p>	<p>19 Orange Terrace Pkwy. & Van Buren Blvd.</p> <p>6,250 214(96) 25(30) 233(107) 135(124) 1221(1219) 41(77) 29,700</p> <p>30,050 125(200) 1212(1221) 35(47) 37(59) 15(30) 32(37) 2,950</p>	<p>20 Brown St. & Alessandro Blvd.</p> <p>41,200 16(68) 1(1) 29(108) 30(26) 1313(1967) 2(4) 0(14) 0(2) 5(23) 750</p>

##(##) AM(PM) Peak Hour Intersection Volumes
 ## Average Daily Trips

21 Brown St. & Cactus Av. <i>Future Intersection</i> 15,900 39(39) 46(46) 38(38) 16(16) 3,200	22 Sycamore Canyon Blvd. & Eastridge Av. 10,100 457(457) 176(176) 102(102) 67(67) 713(713) 84(84) 12,950	23 Sycamore Canyon Blvd. & Cottonwood Av. 13,100 233(233) 56(56) 13(13) 858(858) 20(20) 13,150	24 Meridian Pkwy. & Alessandro Blvd. 18,850 126(126) 114(114) 87(87) 535(535) 1941(1941) 87(87) 585(585) 585(585) 61(61) 23,600	25 Meridian Pkwy. & Cactus Av. 19,000 8(8) 140(140) 137(137) 885(885) 20(20) 364(364) 5(5) 366(366) 209(209) 22,200
26 Meridian Pkwy. & Van Buren Blvd. 12,900 313(313) 6(6) 48(48) 422(422) 1146(1146) 2(2) 33,400 131(131) 1322(1322) 46(46) 3(3) 1(1) 3(3) 850	27 Innovation Dr. & Cactus Av. 700 2(2) 4(4) 333(333) 15(15) 19,000	28 I-215 SB Ramps & Alessandro Blvd. 8,450 299(299) 172(172) 143(143) 2264(2264) 773(773) 338(338) 44,050	29 I-215 NB Ramps & Alessandro Blvd. 2,350 78(78) 1296(1296) 68(68) 877(877) 1111(1111) 158(158) 37,150	30 I-215 SB Ramps & Cactus Av. 2,650 195(195) 1219(1219) 579(579) 332(332) 26(26) 624(624) 22,000
31 I-215 NB Ramps & Cactus Av. 7,100 113(113) 48(48) 21(21) 1258(1258) 42(42) 32,000	32 I-215 SB Ramps & Van Buren Blvd. 3,050 719(719) 21(21) 21(21) 507(507) 657(657) 32,250	33 I-215 NB Ramps & Van Buren Blvd. 300 26(26) 32(32) 558(558) 965(965) 5(5) 13,600	34 Old 215 Frontage Rd. & Alessandro Blvd. 11,100 221(221) 43(43) 22(22) 324(324) 909(909) 42(42) 51(51) 258(258) 19(19) 30,650	35 Day St. & Alessandro Blvd. 9,900 61(61) 39(39) 77(77) 123(123) 1144(1144) 9(9) 138(138) 638(638) 9(9) 11(11) 155(155) 16(16) 26,850
36 Elsworth St. & Cactus Av. 7,150 157(157) 58(58) 82(82) 179(179) 1360(1360) 288(288) 37,750	37 Frederick St. & Cactus Av. 10,150 91(91) 149(149) 186(186) 1199(1199) 36,450	38 Graham St./Riverside Dr. & Cactus Av. 4,800 115(115) 45(45) 84(84) 62(62) 1159(1159) 160(160) 38,150	###(##) AM(PM) Peak Hour Intersection Volumes ## Average Daily Trips	

EXHIBIT 3-18: EXISTING (2021) WEEKEND TRAFFIC VOLUMES

<p>1 Washington St. & Van Buren Blvd.</p> <table border="1"> <tr> <td>← 72</td> <td>↑ 190</td> </tr> <tr> <td>← 166</td> <td>↑ 727</td> </tr> <tr> <td>← 274</td> <td>↑ 92</td> </tr> <tr> <td>110</td> <td>127</td> </tr> <tr> <td>749</td> <td>191</td> </tr> <tr> <td>68</td> <td>106</td> </tr> </table>	← 72	↑ 190	← 166	↑ 727	← 274	↑ 92	110	127	749	191	68	106	<p>2 Alessandro Blvd. & Arlington Av./Chicago Av.</p> <table border="1"> <tr> <td>← 27</td> <td>↑ 161</td> </tr> <tr> <td>← 750</td> <td>↑ 422</td> </tr> <tr> <td>← 212</td> <td>↑ 161</td> </tr> <tr> <td>21</td> <td>616</td> </tr> <tr> <td>316</td> <td>654</td> </tr> <tr> <td>500</td> <td>159</td> </tr> </table>	← 27	↑ 161	← 750	↑ 422	← 212	↑ 161	21	616	316	654	500	159	<p>3 Canyon Crest Dr. & Alessandro Blvd.</p> <table border="1"> <tr> <td>← 18</td> <td>↑ 393</td> </tr> <tr> <td>← 6</td> <td>↑ 1367</td> </tr> <tr> <td>← 304</td> <td>↑ 7</td> </tr> <tr> <td>33</td> <td>10</td> </tr> <tr> <td>1256</td> <td>6</td> </tr> <tr> <td>13</td> <td>11</td> </tr> </table>	← 18	↑ 393	← 6	↑ 1367	← 304	↑ 7	33	10	1256	6	13	11	<p>4 Wood Rd. & Van Buren Blvd.</p> <table border="1"> <tr> <td>← 135</td> <td>↑ 65</td> </tr> <tr> <td>← 142</td> <td>↑ 879</td> </tr> <tr> <td>← 114</td> <td>↑ 155</td> </tr> <tr> <td>119</td> <td>160</td> </tr> <tr> <td>912</td> <td>122</td> </tr> <tr> <td>163</td> <td>93</td> </tr> </table>	← 135	↑ 65	← 142	↑ 879	← 114	↑ 155	119	160	912	122	163	93	<p>5 Trautwein Rd. & Alessandro Blvd.</p> <table border="1"> <tr> <td>↑ 1144</td> </tr> <tr> <td>↑ 170</td> </tr> <tr> <td>961</td> </tr> <tr> <td>8</td> </tr> <tr> <td>715</td> </tr> <tr> <td>10</td> </tr> </table>	↑ 1144	↑ 170	961	8	715	10
← 72	↑ 190																																																									
← 166	↑ 727																																																									
← 274	↑ 92																																																									
110	127																																																									
749	191																																																									
68	106																																																									
← 27	↑ 161																																																									
← 750	↑ 422																																																									
← 212	↑ 161																																																									
21	616																																																									
316	654																																																									
500	159																																																									
← 18	↑ 393																																																									
← 6	↑ 1367																																																									
← 304	↑ 7																																																									
33	10																																																									
1256	6																																																									
13	11																																																									
← 135	↑ 65																																																									
← 142	↑ 879																																																									
← 114	↑ 155																																																									
119	160																																																									
912	122																																																									
163	93																																																									
↑ 1144																																																										
↑ 170																																																										
961																																																										
8																																																										
715																																																										
10																																																										
<p>6 Trautwein Rd. & Grove Community Dr.</p> <table border="1"> <tr> <td>← 611</td> <td>↑ 371</td> </tr> <tr> <td>← 333</td> <td>↑ 99</td> </tr> <tr> <td>683</td> <td>79</td> </tr> </table>	← 611	↑ 371	← 333	↑ 99	683	79	<p>7 Trautwein Rd. & Orange Terrace Pkwy.</p> <table border="1"> <tr> <td>← 19</td> <td>↑ 153</td> </tr> <tr> <td>← 588</td> <td>↑ 11</td> </tr> <tr> <td>← 190</td> <td>↑ 154</td> </tr> <tr> <td>30</td> <td>32</td> </tr> <tr> <td>17</td> <td>565</td> </tr> <tr> <td>19</td> <td>142</td> </tr> </table>	← 19	↑ 153	← 588	↑ 11	← 190	↑ 154	30	32	17	565	19	142	<p>8 Trautwein Rd. & Van Buren Blvd.</p> <table border="1"> <tr> <td>← 216</td> <td>↑ 164</td> </tr> <tr> <td>← 205</td> <td>↑ 762</td> </tr> <tr> <td>← 153</td> <td>↑ 103</td> </tr> <tr> <td>302</td> <td>92</td> </tr> <tr> <td>705</td> <td>229</td> </tr> <tr> <td>70</td> <td>43</td> </tr> </table>	← 216	↑ 164	← 205	↑ 762	← 153	↑ 103	302	92	705	229	70	43	<p>9 Deercreek Dr. & Grove Community Dr.</p> <table border="1"> <tr> <td>↑ 193</td> </tr> <tr> <td>↑ 59</td> </tr> <tr> <td>131</td> </tr> <tr> <td>14</td> </tr> <tr> <td>50</td> </tr> <tr> <td>45</td> </tr> </table>	↑ 193	↑ 59	131	14	50	45	<p>10 Deercreek Dr. & Orange Terrace Pkwy.</p> <table border="1"> <tr> <td>↑ 50</td> </tr> <tr> <td>↑ 267</td> </tr> <tr> <td>↑ 8</td> </tr> <tr> <td>51</td> </tr> <tr> <td>5</td> </tr> <tr> <td>47</td> </tr> <tr> <td>51</td> </tr> <tr> <td>204</td> </tr> <tr> <td>8</td> </tr> <tr> <td>24</td> </tr> <tr> <td>24</td> </tr> <tr> <td>4</td> </tr> </table>	↑ 50	↑ 267	↑ 8	51	5	47	51	204	8	24	24	4						
← 611	↑ 371																																																									
← 333	↑ 99																																																									
683	79																																																									
← 19	↑ 153																																																									
← 588	↑ 11																																																									
← 190	↑ 154																																																									
30	32																																																									
17	565																																																									
19	142																																																									
← 216	↑ 164																																																									
← 205	↑ 762																																																									
← 153	↑ 103																																																									
302	92																																																									
705	229																																																									
70	43																																																									
↑ 193																																																										
↑ 59																																																										
131																																																										
14																																																										
50																																																										
45																																																										
↑ 50																																																										
↑ 267																																																										
↑ 8																																																										
51																																																										
5																																																										
47																																																										
51																																																										
204																																																										
8																																																										
24																																																										
24																																																										
4																																																										
<p>11 Barton St. & Alessandro Blvd.</p> <table border="1"> <tr> <td>← 3</td> <td>↑ 4</td> </tr> <tr> <td>← 4</td> <td>↑ 1307</td> </tr> <tr> <td>← 66</td> <td>↑ 66</td> </tr> <tr> <td>1152</td> <td>46</td> </tr> <tr> <td>28</td> <td>1</td> </tr> <tr> <td></td> <td>33</td> </tr> </table>	← 3	↑ 4	← 4	↑ 1307	← 66	↑ 66	1152	46	28	1		33	<p>12 Barton St. & Grove Community Dr.</p> <table border="1"> <tr> <td>← 46</td> <td>↑ 17</td> </tr> <tr> <td>← 22</td> <td>↑ 179</td> </tr> <tr> <td>18</td> <td></td> </tr> <tr> <td>129</td> <td></td> </tr> </table>	← 46	↑ 17	← 22	↑ 179	18		129		<p>13 Barton St. & Orange Terrace Pkwy.</p> <table border="1"> <tr> <td>↑ 396</td> </tr> <tr> <td>↑ 45</td> </tr> <tr> <td>269</td> </tr> <tr> <td>238</td> </tr> <tr> <td>197</td> </tr> <tr> <td>33</td> </tr> </table>	↑ 396	↑ 45	269	238	197	33	<p>14 Barton St. & Van Buren Blvd.</p> <table border="1"> <tr> <td>← 85</td> <td>↑ 34</td> </tr> <tr> <td>← 25</td> <td>↑ 816</td> </tr> <tr> <td>← 25</td> <td>↑ 175</td> </tr> <tr> <td>80</td> <td>195</td> </tr> <tr> <td>773</td> <td>38</td> </tr> <tr> <td>162</td> <td>141</td> </tr> </table>	← 85	↑ 34	← 25	↑ 816	← 25	↑ 175	80	195	773	38	162	141	<p>15 Airman Dr. & Cactus Av.</p> <p><i>Future Intersection</i></p>																
← 3	↑ 4																																																									
← 4	↑ 1307																																																									
← 66	↑ 66																																																									
1152	46																																																									
28	1																																																									
	33																																																									
← 46	↑ 17																																																									
← 22	↑ 179																																																									
18																																																										
129																																																										
↑ 396																																																										
↑ 45																																																										
269																																																										
238																																																										
197																																																										
33																																																										
← 85	↑ 34																																																									
← 25	↑ 816																																																									
← 25	↑ 175																																																									
80	195																																																									
773	38																																																									
162	141																																																									
<p>16 Abrams Dr. & Grove Community Dr.</p> <table border="1"> <tr> <td>↑ 104</td> </tr> <tr> <td>↑ 35</td> </tr> <tr> <td>75</td> </tr> <tr> <td>69</td> </tr> <tr> <td>66</td> </tr> <tr> <td>32</td> </tr> </table>	↑ 104	↑ 35	75	69	66	32	<p>17 Abrams Dr. & Orange Terrace Pkwy.</p> <table border="1"> <tr> <td>← 54</td> <td>↑ 63</td> </tr> <tr> <td>← 52</td> <td>↑ 169</td> </tr> <tr> <td>113</td> <td></td> </tr> <tr> <td>144</td> <td></td> </tr> </table>	← 54	↑ 63	← 52	↑ 169	113		144		<p>18 Linebacker Dr. & Cactus Av.</p> <p><i>Future Intersection</i></p>	<p>19 Orange Terrace Pkwy. & Van Buren Blvd.</p> <table border="1"> <tr> <td>← 69</td> <td>↑ 241</td> </tr> <tr> <td>← 36</td> <td>↑ 959</td> </tr> <tr> <td>← 184</td> <td>↑ 32</td> </tr> <tr> <td>84</td> <td>52</td> </tr> <tr> <td>728</td> <td>46</td> </tr> <tr> <td>49</td> <td>38</td> </tr> </table>	← 69	↑ 241	← 36	↑ 959	← 184	↑ 32	84	52	728	46	49	38	<p>20 Brown St. & Alessandro Blvd.</p> <table border="1"> <tr> <td>↑ 31</td> </tr> <tr> <td>↑ 1357</td> </tr> <tr> <td>↑ 3</td> </tr> <tr> <td>33</td> </tr> <tr> <td>29</td> </tr> <tr> <td>36</td> </tr> <tr> <td>1196</td> </tr> </table>	↑ 31	↑ 1357	↑ 3	33	29	36	1196																					
↑ 104																																																										
↑ 35																																																										
75																																																										
69																																																										
66																																																										
32																																																										
← 54	↑ 63																																																									
← 52	↑ 169																																																									
113																																																										
144																																																										
← 69	↑ 241																																																									
← 36	↑ 959																																																									
← 184	↑ 32																																																									
84	52																																																									
728	46																																																									
49	38																																																									
↑ 31																																																										
↑ 1357																																																										
↑ 3																																																										
33																																																										
29																																																										
36																																																										
1196																																																										

Saturday Peak Hour Intersection Volumes

<p>21 Brown St. & Cactus Av.</p> <p><i>Future Intersection</i></p>	<p>22 Sycamore Canyon Blvd. & Eastridge Av.</p> <p>← 30 ← 119 ← 115 39 → 66 → 16 ↓</p> <p>↑ 297 ↑ 52 ↑ 183 44 ← 288 → 68 ↘</p>	<p>23 Sycamore Canyon Blvd. & Cottonwood Av.</p> <p>← 352 ← 15 4 → 343 → 6 ↘</p> <p>↑ 17</p>	<p>24 Meridian Pkwy. & Alessandro Blvd.</p> <p>← 49 ← 150 ← 54 92 → 1005 → 91 ↓</p> <p>↑ 83 ↑ 1135 ↑ 51 164 ← 133 → 15 ↘</p>	<p>25 Meridian Pkwy. & Cactus Av.</p> <p>← 5 ← 194 ← 115 15 → 28 → 4 ↓</p> <p>↑ 196 ↑ 9 ↑ 161 1 ← 149 → 122 ↘</p>
<p>26 Meridian Pkwy. & Van Buren Blvd.</p> <p>← 327 ← 9 ← 51 144 → 849 → 6 ↓</p> <p>↑ 25 ↑ 923 ↑ 33 7 ← 6 → 18 ↘</p>	<p>27 Innovation Dr. & Cactus Av.</p> <p>← 1 1 → 264 → 1 ↓</p> <p>↑ 4 ↑ 366 ↑ 22 1 ← 21 ↘</p>	<p>28 I-215 SB Ramps & Alessandro Blvd.</p> <p>← 253 ← 125 760 → 307 ↓</p> <p>↑ 111 ↑ 973</p>	<p>29 I-215 NB Ramps & Alessandro Blvd.</p> <p>167 → 723 → 427 ← 9 → 222 ↘</p> <p>↑ 137 ↑ 842</p>	<p>30 I-215 SB Ramps & Cactus Av.</p> <p>← 56 271 → 26 ↓</p> <p>↑ 338 ↑ 323 304 ↘</p>
<p>31 I-215 NB Ramps & Cactus Av.</p> <p>← 57 ← 1 ← 101 14 → 558 → 25 ↓</p> <p>↑ 109 ↑ 968 35 ← 61 → 3 ↘</p>	<p>32 I-215 SB Ramps & Van Buren Blvd.</p> <p>← 491 ← 19 419 → 524 ↓</p> <p>↑ 495 ↑ 12</p>	<p>33 I-215 NB Ramps & Van Buren Blvd.</p> <p>← 423 ← 26 486 → 15 ↓</p> <p>1 ← 37 →</p>	<p>34 Old 215 Frontage Rd. & Alessandro Blvd.</p> <p>← 191 ← 91 ← 78 285 → 716 → 11 ↓</p> <p>↑ 86 ↑ 655 ↑ 10 21 ← 72 → 12 ↘</p>	<p>35 Day St. & Alessandro Blvd.</p> <p>← 79 ← 41 ← 102 151 → 565 → 6 ↓</p> <p>↑ 121 ↑ 594 ↑ 8 9 ← 83 → 13 ↘</p>
<p>36 Elsworth St. & Cactus Av.</p> <p>← 97 ← 15 ← 139 119 → 909 → 27 ↓</p> <p>↑ 116 ↑ 906 ↑ 12 19 ← 10 → 8 ↘</p>	<p>37 Frederick St. & Cactus Av.</p> <p>← 58 ← 229 76 → 1004 → 1 ↓</p> <p>↑ 144 ↑ 906 ↑ 2</p>	<p>38 Graham St./Riverside Dr. & Cactus Av.</p> <p>← 61 ← 51 ← 56 49 → 939 → 151 ↓</p> <p>↑ 56 ↑ 975 ↑ 17 137 ← 40 → 14 ↘</p>	<p>## Saturday Peak Hour Intersection Volumes</p>	

TABLE 3-1: INTERSECTION ANALYSIS FOR EXISTING (2021) CONDITIONS

#	Intersection	Traffic Control ²	Delay ¹ (secs.)			Level of Service		
			AM	PM	SAT	AM	PM	SAT
1	Washington St. & Van Buren Blvd.	TS	40.4	39.7	22.8	D	D	C
2	Alessandro Blvd. & Arlington Av./Chicago Av.	TS	75.0	82.2	22.7	E	F	C
3	Alessandro Blvd. & Canyon Crest Dr./Overlook Pkwy.	TS	42.2	46.1	14.9	D	D	B
4	Wood Rd. & Van Buren Blvd.	TS	50.4	37.0	24.9	D	D	C
5	Trautwein Rd. & Alessandro Blvd.	TS	89.4	19.9	13.1	F	B	B
6	Trautwein Rd. & Grove Community Dr.	TS	22.1	10.4	12.4	C	B	B
7	Trautwein Rd. & Orange Terrace Pkwy.	TS	46.0	21.3	18.8	D	C	B
8	Trautwein Rd. & Van Buren Blvd.	TS	34.9	27.7	20.9	C	C	C
9	Deercreek Dr. & Grove Community Dr.	AWS	17.2	9.2	9.6	C	A	A
10	Deercreek Dr. & Orange Terrace Pkwy.	AWS	51.8	9.9	9.6	F	A	A
11	Barton St. & Alessandro Blvd.	TS	31.2	8.4	7.6	C	A	A
12	Barton St. & Grove Community Dr.	CSS	13.2	9.4	11.0	B	A	B
13	Barton St. & Orange Terrace Pkwy.	CSS	68.8	14.3	45.0	F	B	E
14	Barton St. & Van Buren Blvd.	TS	61.2	30.3	21.2	E	C	C
15	Airman Dr. & Cactus Av.	AWS	Future Intersection					
16	Abrams Dr. & Grove Community Dr.	AWS	10.9	8.5	8.4	B	A	A
17	Abrams Dr. & Orange Terrace Pkwy.	AWS	13.1	8.6	8.9	B	A	A
18	Linebacker Dr. & Cactus Av.	TS	Future Intersection					
19	Orange Terrace Pkwy. & Van Buren Blvd.	TS	18.3	17.9	17.7	B	B	B
20	Brown St. & Alessandro Blvd.	TS	9.2	13.7	5.0	A	B	A
21	Brown St. & Cactus Av.	CSS	Future Intersection					
22	Sycamore Canyon Blvd. & Eastridge Av.	TS	28.2	19.8	17.4	C	B	B
23	Sycamore Canyon Blvd. & Cottonwood Av.	TS	9.3	7.0	5.8	A	A	A
24	Meridian Pkwy. & Alessandro Blvd.	TS	89.6	41.8	19.6	F	D	B
25	Meridian Pkwy. & Cactus Av.	TS	29.5	30.8	16.6	C	C	B
26	Meridian Pkwy. & Van Buren Blvd.	TS	15.4	26.3	12.9	B	C	B
27	Innovation Dr. & Cactus Av.	TS	6.3	8.3	4.5	A	A	A
28	I-215 SB Ramps & Alessandro Blvd.	TS	8.5	9.4	6.3	A	A	A
29	I-215 NB Ramps & Alessandro Blvd.	TS	81.6	20.7	22.4	F	C	C
30	I-215 SB Ramps & Cactus Av.	TS	4.7	5.9	5.2	A	A	A
31	I-215 NB Ramps & Cactus Av.	TS	59.0	19.9	7.0	E	B	A
32	I-215 SB Ramps & Van Buren Blvd.	TS	21.5	16.9	10.9	C	B	B
33	I-215 NB Ramps & Van Buren Blvd.	TS	6.4	6.1	4.2	A	A	A
34	Old 215 Frontage Rd. & Alessandro Blvd.	TS	37.9	19.3	17.8	D	B	B
35	Day St. & Alessandro Blvd.	TS	15.0	17.1	12.5	B	B	B
36	Elsworth St. & Cactus Av.	TS	94.0	75.0	42.6	F	E	D
37	Frederick St. & Cactus Av.	TS	26.0	12.8	9.9	C	B	A
38	Graham St./Riverside Dr. & Cactus Av.	TS	14.7	15.0	16.8	B	B	B

* **BOLD** = Unacceptable LOS

¹ Per the Highway Capacity Manual (6th Edition), overall average intersection delay and level of service are shown for intersections with a traffic signal or all way stop control. For intersections with cross street stop control, the delay and level of service for the worst individual movement (or movements sharing a single lane) are shown.

² CSS = Cross-street Stop; AWS = All-Way Stop; TS = Traffic Signal

The intersection operations analysis worksheets are included in Appendix 3.2 of this TA.

3.9 EXISTING (2021) CONDITIONS ROADWAY SEGMENT CAPACITY ANALYSIS

The roadway segment capacities utilized for the purposes of this analysis are approximate figures only; and are used at the General Plan level to assist in determining the roadway functional classification (number of through lanes) needed to meet traffic demand. Table 3-2 provides a summary of the Existing (2021) conditions roadway segment capacity analysis based on the applicable roadway segment capacities. As shown in Table 3-2, the following study area roadway segment is currently operating at an unacceptable LOS based on the applicable planning level daily roadway capacities:

- Meridian Pkwy. from Alessandro Bl. to Cactus Av. (#14) – LOS E

TABLE 3-2: ROADWAY SEGMENT CAPACITY ANALYSIS FOR EXISTING (2021) CONDITIONS

#	Roadway	Segment Limits	Roadway Section	LOS Capacity ¹	Existing		Acceptable LOS	
					2021	V/C ²		LOS ³
1	Alessandro Bl.	Trautwein Rd. to Mission Grove Pkwy.	6D	57,250	42,859	0.75	C	D
2		Mission Grove Pkwy. to Barton St.	6D	57,250	42,275	0.74	C	D
3		Barton St. to Brown St.	6D	57,250	42,360	0.74	C	D
4		Brown St. to Meridian Pkwy.	6D	57,250	41,193	0.72	C	D
5		Meridian Pkwy. to I-215 Freeway	6D	57,250	44,072	0.77	C	D
6	Cactus Av.	Airman Dr. to Linebacker Dr.	2U	13,000	0	0.00	A	D
7		Linebacker Dr. to Brown St.	4D	25,900	0	0.00	A	D
8		Brown St. to Meridian Pkwy.	4D	25,900	0	0.00	A	D
9		Meridian Pkwy. to I-215 Freeway	6D	51,150	19,011	0.37	A	D
10	Barton St.	Alessandro Bl. to Cactus Av. (EVA)	2U	13,000	1,995	0.15	A	D
11		Cactus Av. (EVA) to Grove Community Dr.	2U	13,000	775	0.06	A	D
12	Brown St.	Alessandro Bl. to Cactus Av.	2D	13,000	776	0.06	A	D
13	Sycamore Canyon Bl.	Cottonwood Av. to Alessandro Bl.	4D	33,000	13,151	0.40	A	D
14	Meridian Pkwy.	Alessandro Bl. to Cactus Av.	4D	25,900	23,605	0.91	E	D
15		Cactus Av. to Van Buren Bl.	4D	25,900	22,215	0.86	D	D

BOLD = LOS does not meet the applicable jurisdictional requirements (i.e., unacceptable LOS).

¹ These maximum roadway capacities are based on the applicable agency's thresholds.

² V/C = Volume to Capacity Ratio

³ LOS = Level of Service

3.10 TRAFFIC SIGNAL WARRANTS ANALYSIS

The following unsignalized study area intersections currently meet a peak hour volume-based traffic signal warrant:

- Deercreek Dr. & Orange Terrace Pkwy. (#10)
- Barton St. & Orange Terrace Pkwy. (#13)

Existing traffic signal warrant analysis worksheets are included in Appendix 3.3.

3.11 OFF-RAMP QUEUING ANALYSIS

A queuing analysis was performed for the off-ramps at the I-215 Freeway at Alessandro Boulevard, Cactus Avenue, and Van Buren Boulevard interchanges, to assess vehicle queues for the off ramps that may potentially result in deficient peak hour operations at the ramp-to-arterial intersections and may potentially “spill back” onto the I-215 Freeway mainline. Queuing analysis findings are presented in Table 3-3. It is important to note that off-ramp lengths are consistent with the measured distance between the intersection and the freeway mainline. As shown in Table 3-3, there are no movements that are currently experiencing queuing issues during the weekday AM, weekday PM, or weekend Saturday peak 95th percentile traffic flows based on the analysis. Worksheets for Existing (2021) traffic conditions off-ramp queuing analysis are provided in Appendix 3.4.

TABLE 3-3: PEAK HOUR FREEWAY OFF-RAMP QUEUING SUMMARY FOR EXISTING (2021) CONDITIONS

Intersection	Movement	Available Stacking Distance (Feet)	95th Percentile Queue (Feet) ³			Acceptable? ¹		
			AM Peak	PM Peak	SAT Peak	AM	PM	SAT
I-215 SB Ramps & Alessandro Blvd. (#28)	SBL	525	132	191	68	Yes	Yes	Yes
	SBL/R	1,540	124	178	52	Yes	Yes	Yes
	SBR	525	118	166	48	Yes	Yes	Yes
I-215 NB Ramps & Alessandro Blvd. (#29)	NBL	450	572 ^{2 3}	342	155	Yes	Yes	Yes
	NBL/T/R	1,345	520 ²	403 ²	158	Yes	Yes	Yes
	NBR	450	41	125	64	Yes	Yes	Yes
I-215 SB Ramps & Cactus Av. (#30)	SBR	1,115	155	157	0	Yes	Yes	Yes
	NBR	1,850	18	57	0	Yes	Yes	Yes
I-215 NB Ramps & Cactus Av. (#31)	NBL	145	452 ^{2 3}	105	34	Yes	Yes	Yes
	NBT/R	1,650	432 ²	181	78	Yes	Yes	Yes
I-215 SB Ramps & Van Buren Blvd. (#32)	SBL/T	1,510	38	121 ²	24	Yes	Yes	Yes
	SBR	1,450	233	34	42	Yes	Yes	Yes
I-215 NB Ramps & Van Buren Blvd. (#33)	NBL	1,560	98	62	0	Yes	Yes	Yes
	NBR	580	2	0	0	Yes	Yes	Yes

¹ Stacking Distance is acceptable if the required stacking distance is less than or equal to the stacking distance provided. An additional 15 feet of stacking which is assumed to be provided in the transition for turn pockets is reflected in the stacking distance shown on this table, where applicable.

² 95th percentile volume exceeds capacity, queue may be longer. Queue shown is maximum after two cycles.

³ Although 95th percentile queue is anticipated to exceed the available storage for the turn lane, the adjacent through lane has sufficient storage to accommodate any spillover without spilling back and affecting the I-215 Freeway mainline.

4 PROJECTED FUTURE TRAFFIC

This section presents the traffic volumes estimated to be generated by the Project's trip assignment onto the study area roadway network. Access to the proposed Project will be provided via three roadways: Cactus Avenue, Brown Street, and Barton Street. Cactus Avenue will serve as the primary roadway, connecting with I-215 located approximately one mile east of the Project. Brown Street will serve as a secondary access to the industrial center, connecting with Alessandro Boulevard to the north. Barton Street will be completed between the existing termini to the south of Alessandro Boulevard and north of Orange Terrace Parkway. An emergency access only connection will be maintained between Cactus Avenue's terminus at Airman Drive and Barton Street. The mixed-use land use will only take access via Cactus Avenue to the east, and will not take access via Barton Street. For the purposes of this TA, the proposed Project has been evaluated in a single phase with an anticipated Opening Year of 2029. Regional access to the Project site will be available from the I-215 Freeway via the Cactus Avenue interchange although the Project could also access the I-215 Freeway via Alessandro Boulevard and Van Buren Boulevard.

4.1 TRIP GENERATION

Trip generation represents the amount of traffic that is attracted and produced by a development and is based upon the specific land uses planned for a given project.

4.1.1 DEVELOPMENT OF TRIP GENERATION RATES

Trip generation rates for the Project are shown in Table 4-1. In order to develop the traffic characteristics of the proposed Project, trip-generation statistics published in the Institute of Transportation Engineers (ITE) Trip Generation Manual (11th Edition, 2021), the High Cube Warehouse Trip Generation Study (WSP, January 2019), and the San Diego Association of Governments (SANDAG) (Not So) Brief Guide of Vehicular Traffic Generation Rates for the San Diego Region (April 2002) were used to estimate the Project's trip generation. (6) (7) (8) For purposes of the Traffic Analysis, the following ITE land use code and vehicle mix will be utilized for the Industrial Area:

- High-Cube Fulfillment Center Warehouse has been used to derive site specific trip generation estimates for up to 3,012,710 square feet of the proposed Project. The ITE Trip Generation Manual (2021) has trip generation rates for high-cube fulfillment center use for both non-sort and sort facilities (ITE land use code 155). While there is sufficient data to support use of the trip generation rates for non-sort facilities, the sort-facility rate appears to be unreliable because it is based on limited data (i.e., one to two surveyed sites). The proposed Project is speculative and whether a non-sort or sort facility end-user would occupy the buildings is not known at this time. Lastly, the ITE Trip Generation Manual recommends the use of local data sources where available. As such, the best available source for high-cube fulfillment center use would be the trip-generation statistics published in the High-Cube Warehouse Trip Generation Study (WSP, January 29, 2019) which was commissioned by the Western Riverside Council of Governments (WRCOG) in support of the Transportation Uniform Mitigation Fee (TUMF) update in the County of Riverside. The WSP trip generation rates were published in January 2019 and are based on data collected at 11 local

high-cube fulfillment center sites located throughout Southern California (specifically Riverside County and San Bernardino County). However, the WSP study does not include a split for inbound and outbound vehicles, as such, the inbound and outbound splits per the ITE Trip Generation Manual for Land Use Code 154 (high-cube transload/short-term storage) have been utilized. These rates are consistent with the rates used for other similar projects through Riverside and San Bernardino Counties. The WSP trip generation rates for high-cube fulfillment center use are slightly more conservative than the latest non-sort facility rate provided in the ITE Trip Generation Manual. It should be noted, Saturday peak hour trip generation rates are not readily available in the ITE Trip Generation Manual or the High-Cube Warehouse Trip Generation Study. As such, Saturday weekend peak hour trip generation rates were developed utilizing a ratio of the Saturday and PM peak hour trip generation rates from the Warehousing land use (ITE Land Use Code 150).

- The trip generation rates for both the Active and Public Parks are based on the trip generation rates published by SANDAG in its (Not So) Brief Guide of Vehicular Traffic Generation Rates for the San Diego Region (April 2002).
- Business Park has been utilized to derive site specific trip generation for up to 1,819,697 square feet of business park uses within the Project. For the Business Park use, a blended rate has been used based on the ITE description for Business Park that the average mix is 20 to 30 percent office/commercial and 70 to 80 percent industrial/warehousing. As such, 30% of the business park area has been designated as office related uses, while the remaining 70% of the business park area has been allocated to warehousing uses. As such, the trip generation rates for ITE Land Use Code 710 (General Office) and ITE Land Use Code 150 (Warehousing) as published in the ITE Trip Generation Manual (2021) have been utilized to calculate trip generation for up to 1,819,697 square feet of business park use.
- Shopping Plaza (ITE Land Use Code 821) is a new land use category from the ITE Trip Generation Manual (2021) for shopping centers between 40,000 to 150,000 square feet. The rates for “without grocery” have been utilized to calculate the trip generation for up to 106,858 square feet within the mixed-use area of the Project.

Internal capture is a percentage reduction that can be applied to the trip generation estimates for individual land uses to account for trips internal to the site. In other words, trips may be made between commercial retail use and employees of the business park/warehouse uses and can be made either by walking or using internal roadways without using external streets. For example, employees of the business park use may visit the commercial retail use without leaving the site and are therefore considered as vehicle trips that are internal to the site. The internal capture rate for the retail, office, and restaurant uses on-site are based on the NCHRP 684 Internal Trip Capture Estimation Tool. As the project is proposed to include commercial retail uses, pass-by percentages have been obtained from the ITE Trip Generation Handbook (3rd Edition, 2017). (9)

TABLE 4-1: CALCULATED TRIP GENERATION RATES

Land Use ¹	Units ²	ITE LU Code	AM Peak Hour			PM Peak Hour			Weekday Daily	Saturday Mid-day		
			In	Out	Total	In	Out	Total		In	Out	Total
Warehousing ³	TSF	150	0.115	0.020	0.135	0.317	0.903	1.220	12.440	0.032	0.018	0.050
Passenger Cars (AM = 87.0%; PM = 85.0%; Daily = 73.0%)			0.077	0.018	0.095	0.260	0.920	1.180	11.870	0.026	0.014	0.040
Trucks (AM = 13.0%; PM = 15.0%; Daily = 27.0%)			0.032	0.008	0.040	0.009	0.031	0.040	0.570	0.006	0.004	0.010
2-Axle Trucks (AM-2.17%; PM-2.51%; Daily-4.51%)			0.005	0.001	0.007	0.001	0.005	0.007	0.095	0.001	0.001	0.002
3-Axle Trucks (AM-2.69%; PM-3.11%; Daily-5.59%)			0.007	0.002	0.008	0.002	0.006	0.008	0.118	0.001	0.001	0.002
4-Axle+ Trucks (AM-8.14%; PM-9.39%; Daily-16.90%)			0.020	0.005	0.025	0.006	0.020	0.025	0.357	0.004	0.002	0.006
High-Cube Fulfillment Center Warehouse ^{3,6}	TSF	--	0.094	0.028	0.122	0.046	0.119	0.165	2.129	0.004	0.002	0.007
Passenger Cars (AM = 84.4%, PM = 87.3%, Daily = 82.2%)			0.079	0.024	0.103	0.040	0.104	0.144	1.750	0.004	0.002	0.006
Trucks (AM = 15.6%, PM = 12.7%, Daily = 17.8%)			0.015	0.004	0.019	0.006	0.015	0.021	0.379	0.001	0.000	0.001
2-4 Axle Trucks			0.006	0.002	0.008	0.003	0.008	0.011	0.162	0.000	0.000	0.000
5+-Axle Trucks			0.008	0.003	0.011	0.003	0.007	0.010	0.217	0.000	0.000	0.000
High-Cube Cold Storage Warehouse (With Cold Storage) ³	TSF	157	0.085	0.025	0.110	0.034	0.086	0.120	2.120	0.003	0.002	0.005
Passenger Cars (AM-73.0%; PM-77.0%; Daily-65.0%)			0.076	0.004	0.080	0.019	0.071	0.090	1.370	0.002	0.001	0.004
2-Axle Trucks (AM-9.37%; PM-7.98%; Daily-12.15%)			0.003	0.007	0.010	0.005	0.005	0.010	0.260	0.000	0.000	0.000
3-Axle Trucks (AM-2.97%; PM-2.53%; Daily-3.85%)			0.001	0.002	0.003	0.002	0.001	0.003	0.083	0.000	0.000	0.000
4-Axle+ Trucks (AM-14.66%; PM-12.49%; Daily-19.01%)			0.005	0.011	0.016	0.008	0.008	0.016	0.407	0.000	0.000	0.001
Trucks (AM = 28.0%, PM = 23.0%, Daily = 35.0%)			0.009	0.021	0.030	0.015	0.015	0.030	0.750	0.001	0.000	0.001
Active Park	AC	-- ⁴	3.25	3.25	6.50	2.25	2.25	4.50	50.00	4.44	4.81	9.26
Public Park	AC	-- ⁴	0.33	0.32	0.65	0.23	0.22	0.45	5.00	0.44	0.48	0.93
General Office ⁵	TSF	710	Based on the ITE Fitted Curve Equation									
General Office (60.000 TSF)			1.58	0.29	1.87	0.31	1.50	1.81	12.40	0.29	0.24	0.53
General Office (324.121 TSF)			1.25	0.23	1.48	0.23	1.13	1.36	9.96	0.29	0.24	0.53
General Office (144.830 TSF)			1.40	0.25	1.65	0.27	1.29	1.56	11.06	0.29	0.24	0.53
Shopping Plaza (40-150 TSF)	TSF	821	1.07	0.66	1.73	2.54	2.65	5.19	67.52	4.72	4.54	9.26

¹ Trip Generation Source: Institute of Transportation Engineers (ITE), Trip Generation Manual, Eleventh Edition (2021).

² TSF = thousand square feet; AC = Acres

³ Vehicle Mix Source: High Cube Warehouse Trip Generation Study, WSP, January 29, 2019.

Inbound and outbound split source: ITE Trip Generation Manual, Eleventh Edition (2021) for ITE Land Use Code 154.

⁴ Trip Generation Source: SANDAG (Not So) Brief Guide of Vehicular Traffic Generation Rates for the San Diego Region, April 2002. For Developed and Undeveloped Parks.

⁵ Trip generation rates based on the regression equation are not available for the Saturday peak hour, due to limitations in the ITE Trip Generation Manual for ITE Land Use Code 710. As such, the average rate has been utilized.

⁶ The ITE Trip Generation Manual, Eleventh Edition (2021), does not provide Saturday trip generation rates for industrial uses. As such, the Saturday peak hour trip generation rates are based on the breakdown of the trip rates, by vehicle type, during the PM peak hour.

4.1.2 PROPOSED PROJECT TRIP GENERATION

The trip generation summary illustrating daily, and peak hour trip generation estimates for the proposed Project are shown on Table 4-2. In order to accurately reflect the impact that heavy trucks would have on the street system, Project trips have been further broken down between passenger cars and trucks for each of the peak hours and weekday daily trip generation for the high-cube fulfillment center warehouse and business park uses. As shown on Table 4-2, the proposed land use anticipated to generate a total of 35,314 trip-ends per day with 1,761 AM peak hour trips, 3,389 PM peak hour trips, and 1,642 weekend Saturday peak hour trips.

For the purposes of this analysis, it is proposed that the actual vehicles be utilized in order to reflect the effects of heavy trucks most accurately in the analysis. Trucks will be accounted for in the analysis as a percentage of total traffic, which will be input into the analysis software (Synchro 11). As such, trip generation is reflected in actual vehicles only and not in PCE.

TABLE 4-2: PROJECT TRIP GENERATION SUMMARY

Land Use ⁵	Quantity Units ¹	AM Peak Hour			PM Peak Hour			Weekday	Saturday Peak Hour		
		In	Out	Total	In	Out	Total	Daily	In	Out	Total
Building B: High-Cube Fulfillment	1,250.000 TSF										
Passenger Cars:		99	30	129	50	130	180	2,188	5	3	8
Trucks:		18	5	23	7	19	26	474	1	0	1
Total Trips²		117	35	152	57	149	206	2,662	6	3	9
Building C: High-Cube Fulfillment	587.000 TSF										
Passenger Cars:		47	14	61	24	61	85	1,028	2	1	3
Trucks:		9	3	12	3	9	12	222	0	0	0
Total Trips²		56	17	73	27	70	97	1,250	2	1	3
High-Cube Cold Storage Warehouse	500.000 TSF										
Passenger Cars:		38	2	40	10	36	46	686	1	1	2
Trucks:		5	11	16	8	8	16	376	0	0	0
Total Trips²		43	13	56	18	44	62	1,062	1	1	2
Remaining Industrial: High-Cube Fulfillment	725.561 TSF										
Passenger Cars:		58	17	75	29	75	104	1,270	3	2	5
Trucks:		11	3	14	4	11	15	276	0	0	0
Total Trips²		69	20	89	33	86	119	1,546	3	2	5
Business Park ⁵	1,280.403 TSF										
Office Passenger Cars:	324.121 TSF	405	75	480	75	366	441	3,228	93	79	172
Office Passenger Cars:	60.000 TSF	95	17	112	19	90	109	744	17	15	32
Business Park Warehouse	896.282 TSF										
Warehouse Passenger Cars:		69	16	85	233	825	1,058	10,640	23	13	36
Warehouse Trucks:		29	7	36	8	28	36	512	6	3	9
Business Park ⁵ (Mixed-Use, 75%)	482.765 TSF										
Office Passenger Cars:	144.830 TSF	203	36	239	39	187	226	1,602	41	35	76
Business Park Warehouse	337.936 TSF										
Warehouse Passenger Cars:		26	6	32	88	311	399	4,012	9	5	14
Warehouse Trucks:		11	3	14	3	11	14	194	2	1	3
Total Business Park Trips		838	160	998	465	1,818	2,283	20,932	191	151	342
Retail (Mixed-Use, 25%)	160.921 TSF										
Passenger Cars:		173	106	279	409	426	835	10,866	760	730	1,490
Pass-by Reduction (AM: 0%; PM/Daily: 40%) ⁴		0	0	0	-164	-164	-327	-4,348	-304	-292	-596
Total Retail Trips		173	106	279	245	262	508	6,518	456	438	894
Active Park	42.20 AC	137	137	274	95	95	190	2,110	187	203	390
Public Park	18.08 AC	6	6	12	4	4	8	90	19	20	39
Total Park Trips		143	143	286	99	99	198	2,200	206	223	429
Total Passenger Cars		1,356	462	1,818	911	2,442	3,354	34,116	856	815	1,671
Internal Trip Reduction ³		-86	-86	-172	-42	-42	-84	-856	-21	-21	-42
Total Trucks		83	32	115	33	86	119	2,054	9	4	13
Project Total Trips		1,353	408	1,761	902	2,486	3,389	35,314	844	798	1,642

¹ TSF = thousand square feet; AC = Acres

² Total Trips = Passenger Cars + Truck Trips.

³ Internal trip reduction based on NCHRP 684 Internal Trip Capture Estimation Tool for the passenger car trips and commercial retail.

⁴ Pass-by reduction percentage source: ITE *Trip Generation Handbook*, 3rd Edition (2017).

⁵ 2-axle trucks have been evaluated as trucks as opposed to delivery vans or passenger cars.

4.2 PROJECT TRIP DISTRIBUTION

The Project trip distribution and assignment process represents the directional orientation of traffic to and from the Project site. The trip distribution pattern of passenger cars is heavily influenced by the geographical location of the site, the location of surrounding land uses, and the proximity to the regional freeway system. The trip distribution pattern for truck traffic is also influenced by the local truck routes approved by the March JPA, City of Moreno Valley, and City of Riverside. At the request of the March JPA, passenger car and truck trip distributions are consistent with other March JPA projects within the immediate vicinity.

Given these differences between passenger cars and trucks, separate trip distributions were generated for both passenger cars and truck trips. Exhibit 4-1 illustrates the truck trip distribution patterns. Exhibits 4-2 illustrates the trip distribution patterns for passenger cars. Each of these distribution patterns were reviewed by the March JPA, County of Riverside, City of Riverside, and City of Moreno Valley as part of the TA scoping process (see Appendix 1.1). Truck traffic will be directed to utilize Cactus Avenue to the I-215 Freeway; however, it is anticipated some trucks may use Meridian Parkway to head north or south to access the I-215 Freeway or other facilities via Alessandro Boulevard and Van Buren Boulevard. All mixed-use traffic will utilize Cactus Avenue to the east instead of utilizing Barton Street.

4.3 MODAL SPLIT

The potential for Project trips to be reduced by the use of public transit, walking or bicycling has not been included as part of the Project's estimated trip generation. Essentially, the Project's traffic projections are "conservative" in that these alternative travel modes would reduce the forecasted traffic volumes.

4.4 PROJECT TRIP ASSIGNMENT

The assignment of traffic from the Project area to the adjoining roadway system is based upon the Project trip generation, trip distribution, and the arterial highway and local street system improvements that would be in place by the time of initial occupancy of the Project. Based on the identified Project traffic generation and trip distribution patterns, the Project ADT and weekday peak hour intersection turning movement volumes are shown on Exhibit 4-3. The Project weekend peak hour intersection turning movement volumes are shown on Exhibit 4-4.

EXHIBIT 4-1: PROJECT (TRUCK) TRIP DISTRIBUTION

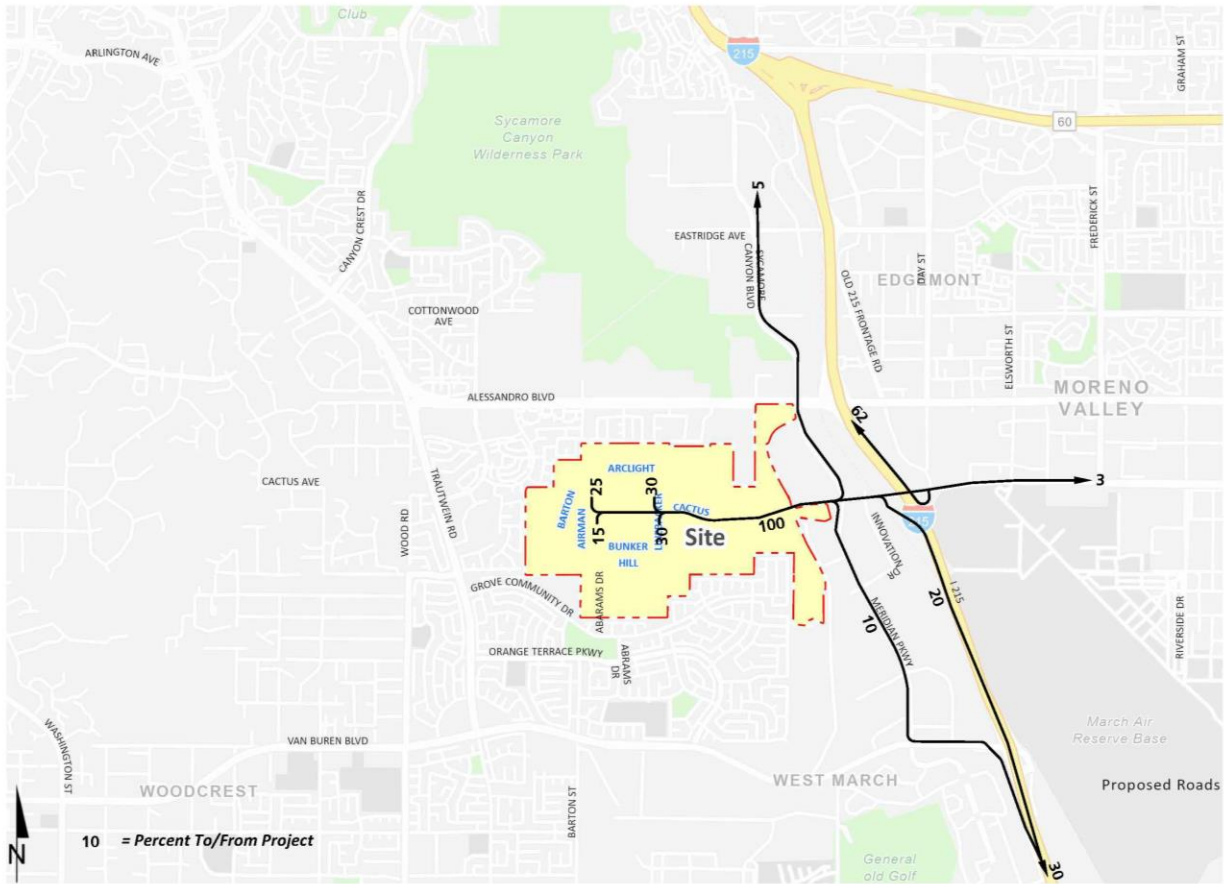

EXHIBIT 4-2: PROJECT (PASSENGER CAR) TRIP DISTRIBUTION

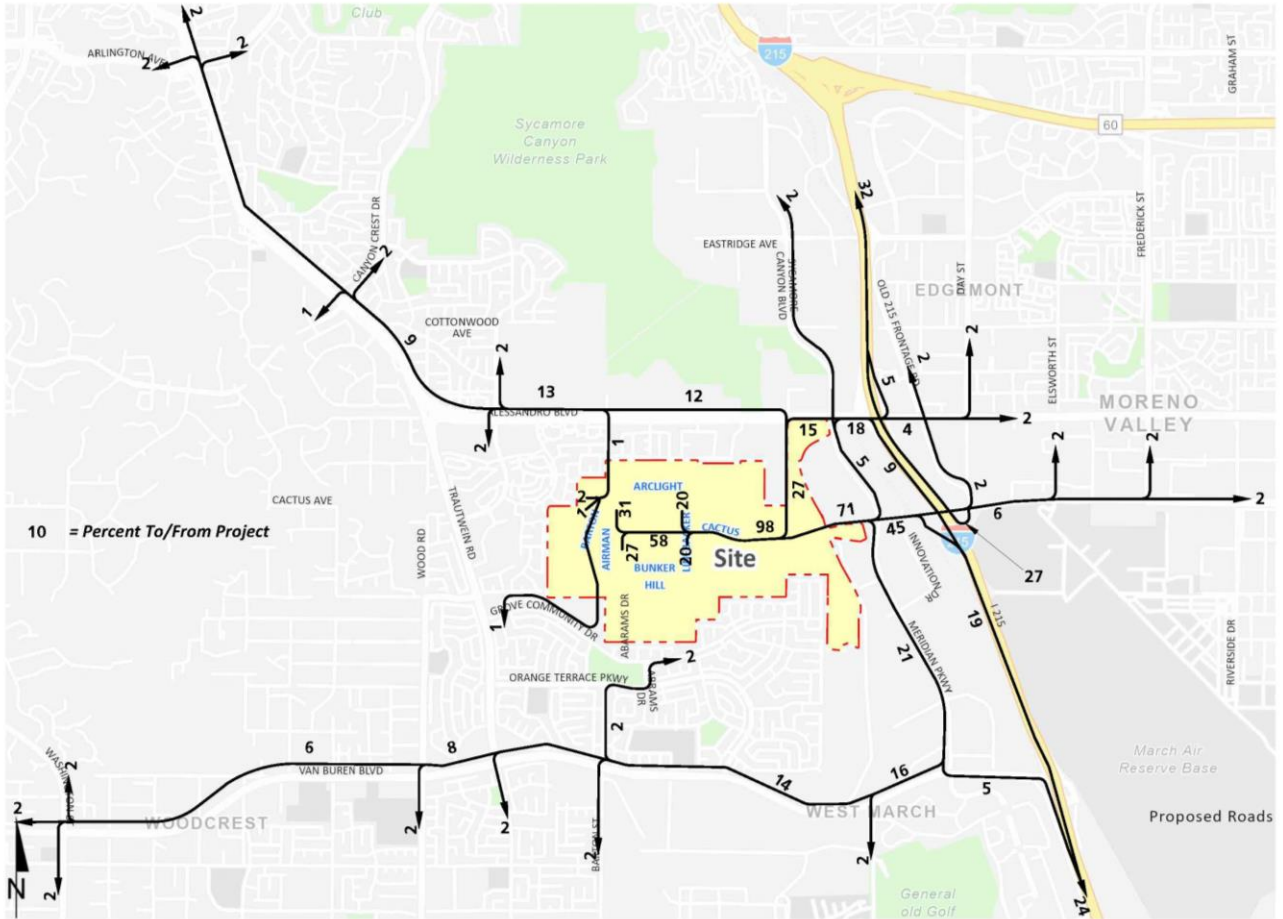

EXHIBIT 4-3: PROJECT ONLY WEEKDAY TRAFFIC VOLUMES

1	Washington St. & Van Buren Blvd.	2	Alessandro Blvd. & Arlington Av./Chicago Av.	3	Canyon Crest Dr. & Alessandro Blvd.	4	Wood Rd. & Van Buren Blvd.	5	Trautwein Rd. & Alessandro Blvd.
650	2,000	650	650	2,000	650	2,000	2,650	3,000	3,000
25(17) →	↖ 25(17) ↑ 8(48) ← 8(48) ↓ 8(48) ↘ 25(17)	25(17) →	↖ 25(17) ↓ 8(48) ↘ 8(48) ↙ 8(48)	13(9) ↓	↖ 25(17) ↓ 4(24) ↘ 23(144) ↙ 8(48)	76(52) →	↖ 23(144) ↓ 8(48) ↘ 25(17)	114(78) →	↖ 34(216)
650	650	650	2,000	350	3,000	2,000	650	3,000	3,000
6	Trautwein Rd. & Grove Community Dr.	7	Trautwein Rd. & Orange Terrace Pkwy.	8	Trautwein Rd. & Van Buren Blvd.	9	Deercreek Dr. & Grove Community Dr.	10	Deercreek Dr. & Orange Terrace Pkwy.
2,650	350	2,650	350	3,350	350	350	350	350	350
102(70) →	↖ 30(192) ↓ 8(48)	102(70) →	↖ 30(192) ↓ 8(48)	102(70) →	↖ 30(192) ↓ 8(48)	102(70) →	↖ 30(192) ↓ 8(48)	102(70) →	↖ 30(192) ↓ 8(48)
2,650	350	2,650	350	3,350	350	350	350	350	350
11	Barton St. & Alessandro Blvd.	12	Barton St. & Grove Community Dr.	13	Barton St. & Orange Terrace Pkwy.	14	Barton St. & Van Buren Blvd.	15	Airman Dr. & Cactus Av.
4,300	4,000	350	650	650	650	3,350	4,650	15,900	28,900
152(104) → 13(9) ↓	↖ 45(288) ↓ 4(24) ↘ 8(48)	13(9) →	↖ 4(24) ↓ 13(9) ↘ 25(17)	13(9) →	↖ 25(17) ↓ 8(48)	127(87) →	↖ 25(17) ↓ 8(48) ↘ 8(48)	127(87) →	↖ 133(902) ↓ 99(696)
4,300	350	350	650	650	650	3,350	650	15,900	13,000
16	Abrams Dr. & Grove Community Dr.	17	Abrams Dr. & Orange Terrace Pkwy.	18	Linebacker Dr. & Cactus Av.	19	Orange Terrace Pkwy. & Van Buren Blvd.	20	Brown St. & Alessandro Blvd.
650	650	7,200	43,350	7,200	4,650	4,650	5,050	4,000	17,700
8(48) →	↖ 25(17)	232(1598) →	↖ 84(502) ↓ 277(182) ↘ 774(684) ↙ 277(183)	232(1598) →	↖ 84(502) ↓ 277(182) ↘ 774(684) ↙ 277(183)	178(122) →	↖ 53(336)	0(-82) → 152(186) ↓	↖ 0(-82) ↓ 192(213) ↘ 45(370) ↙ 57(445)
650	650	7,200	43,350	7,200	4,650	4,650	5,050	4,000	17,700

##(##) AM(PM) Peak Hour Intersection Volumes

Average Daily Trips

21 Brown St. & Cactus Av. 17,700 129(344) ← 809(983) 32(102) → 199(299) → 43,350	22 Sycamore Canyon Blvd. & Eastridge Av. 750 ← 28(30) 7(9) → 750	23 Sycamore Canyon Blvd. & Cottonwood Av. 750 ← 28(30) 7(9) → 750	24 Meridian Pkwy. & Alessandro Blvd. 750 ← 28(30) 44(57) → 5,050 177(192) 36(40) 7(9) 9(12)	25 Meridian Pkwy. & Cactus Av. 1,800 64(69) ← 596(638) 16(21) → 147(195) → 37(82) → 150(276) 25,650 16,600 7,200
26 Meridian Pkwy. & Van Buren Blvd. 7,200 20(60) 17(22) 82(203) → 1,900 68(72) 5,300	27 Innovation Dr. & Cactus Av. 16,600 ← 596(638) 147(195) → 16,600	28 I-215 SB Ramps & Alessandro Blvd. 850 60(65) 26(34) → 26(34) → 6,050 153(167)	29 I-215 NB Ramps & Alessandro Blvd. 850 15(19) → 12(15) → 3,700 47(51) 107(116)	30 I-215 SB Ramps & Cactus Av. 5,100 368(393) ← 228(245) 114(152) → 32(43) → 16,600 9,650 1,850
31 I-215 NB Ramps & Cactus Av. 650 23(25) 6(8) → 18(24) → 90(121) → 132(141) 2,050 73(79) 9,650 6,950	32 I-215 SB Ramps & Van Buren Blvd. 950 ← 68(72) 17(22) → 950	33 I-215 NB Ramps & Van Buren Blvd. 950 0(72) → 68(0) 950	34 Old 215 Frontage Rd. & Alessandro Blvd. 650 23(25) 12(15) → 1,350 47(51) 6(8)	35 Day St. & Alessandro Blvd. 650 23(25) 6(8) → 6(8) → 1,350 23(25)
36 Elsworth St. & Cactus Av. 650 23(25) 6(8) → 12(16) → 2,050 49(53)	37 Frederick St. & Cactus Av. 650 23(25) 6(8) → 6(8) → 1,400 26(28)	38 Graham St./Riverside Dr. & Cactus Av. 750 6(8) → 750 26(28)	##(##) AM(PM) Peak Hour Intersection Volumes ## Average Daily Trips	

EXHIBIT 4-4: PROJECT ONLY WEEKEND TRAFFIC VOLUMES

1	Washington St. & Van Buren Blvd.	2	Alessandro Blvd. & Arlington Av./Chicago Av.	3	Canyon Crest Dr. & Alessandro Blvd.	4	Wood Rd. & Van Buren Blvd.	5	Trautwein Rd. & Alessandro Blvd.
6	Trautwein Rd. & Grove Community Dr.	7	Trautwein Rd. & Orange Terrace Pkwy.	8	Trautwein Rd. & Van Buren Blvd.	9	Deercreek Dr. & Grove Community Dr.	10	Deercreek Dr. & Orange Terrace Pkwy.
11	Barton St. & Alessandro Blvd.	12	Barton St. & Grove Community Dr.	13	Barton St. & Orange Terrace Pkwy.	14	Barton St. & Van Buren Blvd.	15	Airman Dr. & Cactus Av.
16	Abrams Dr. & Grove Community Dr.	17	Abrams Dr. & Orange Terrace Pkwy.	18	Linebacker Dr. & Cactus Av.	19	Orange Terrace Pkwy. & Van Buren Blvd.	20	Brown St. & Alessandro Blvd.

Saturday Peak Hour Intersection Volumes

<p>21 Brown St. & Cactus Av.</p>	<p>22 Sycamore Canyon Blvd. & Eastridge Av.</p>	<p>23 Sycamore Canyon Blvd. & Cottonwood Av.</p>	<p>24 Meridian Pkwy. & Alessandro Blvd.</p>	<p>25 Meridian Pkwy. & Cactus Av.</p>
<p>26 Meridian Pkwy. & Van Buren Blvd.</p>	<p>27 Innovation Dr. & Cactus Av.</p>	<p>28 I-215 SB Ramps & Alessandro Blvd.</p>	<p>29 I-215 NB Ramps & Alessandro Blvd.</p>	<p>30 I-215 SB Ramps & Cactus Av.</p>
<p>31 I-215 NB Ramps & Cactus Av.</p>	<p>32 I-215 SB Ramps & Van Buren Blvd.</p>	<p>33 I-215 NB Ramps & Van Buren Blvd.</p>	<p>34 Old 215 Frontage Rd. & Alessandro Blvd.</p>	<p>35 Day St. & Alessandro Blvd.</p>
<p>36 Elsworth St. & Cactus Av.</p>	<p>37 Frederick St. & Cactus Av.</p>	<p>38 Graham St./Riverside Dr. & Cactus Av.</p>	<p>## Saturday Peak Hour Intersection Volumes</p>	

4.5 BACKGROUND TRAFFIC

4.5.1 OPENING YEAR CUMULATIVE CONDITIONS

Future year traffic forecasts have been based upon background (ambient) growth at 2.0% per year. The total ambient growth is 14.87% for 2028 conditions (2.0% per year compounded over 7 years). The ambient growth factor is intended to approximate regional traffic growth. This ambient growth rate is added to existing traffic volumes to account for area-wide growth not reflected by cumulative development projects. Ambient growth has been added to daily and peak hour traffic volumes on surrounding roadways, in addition to traffic generated by the development of future projects that have been approved but not yet built and/or for which development applications have been filed and are under consideration by governing agencies. Opening Year Cumulative (2028) traffic volumes are provided in Section 7 of this report. The traffic generated by the proposed Project was then manually added to the base volume to determine Opening Year Cumulative “With Project” forecasts conditions. Conservatively, this TA estimates the area ambient traffic growth and then adds traffic generated by other known or probable related projects. These related projects are at least in part already accounted for in the assumed ambient growth rates; and some of these related projects may not be implemented and operational within the 2028 Opening Year time frame assumed for the Project (see also Section 4.6 *Cumulative Development Traffic*).

4.5.2 HORIZON YEAR (2045) CONDITIONS

The Horizon Year (2045) traffic conditions were derived from the latest County of Riverside Transportation Analysis Model (RIVCOM) using accepted procedures for model forecast refinement and smoothing. The traffic forecasts reflect the area-wide growth anticipated between Existing conditions and Horizon Year conditions. See additional discussion in Section 4.7 *Horizon Year (2045) Volume Development*.

4.6 CUMULATIVE DEVELOPMENT TRAFFIC

A cumulative project list was developed for the purposes of this analysis through consultation with planning and engineering staff from the March JPA. The cumulative projects listed are those that would generate traffic and would contribute traffic to study area intersections. Cumulative projects from the neighboring jurisdictions of County of Riverside, City of Moreno Valley, and City of Riverside have also been included.

Exhibit 4-5 illustrates the cumulative development location map. A summary of cumulative development projects and their proposed land uses are shown in Table 4-3. If applicable, the traffic generated by individual cumulative projects was manually added to the Opening Year Cumulative forecasts to ensure that traffic generated by the listed cumulative development projects in Table 4-3 are reflected as part of the background traffic. In an effort to conduct a conservative analysis, the cumulative projects are added in conjunction with the ambient growth identified in Section 4.5.1 *Background Traffic: Opening Year Cumulative Conditions*. Although it is unlikely that all of these cumulative projects would be fully built and occupied by Year 2028, they have been included in an effort to conduct a conservative analysis and overstate as opposed

to understate potential traffic deficiencies. Any other cumulative projects located beyond the cumulative study area that are not expected to contribute measurable traffic to study area intersections have not been included since the traffic would dissipate due to the distance from the Project site and study area intersections. Cumulative Only ADT and weekday peak hour intersection turning movement volumes are shown on Exhibit 4-6. Cumulative Only weekend peak hour intersection turning movement volumes are shown on Exhibit 4-7.

4.7 HORIZON YEAR (2045) VOLUME DEVELOPMENT

Traffic projections for Horizon Year (2045) without Project conditions were derived from the latest RIVCOM traffic model using accepted procedures for model forecast refinement. The post processing volume worksheets are provided in Appendix 4.1 of this TA.

In most instances the traffic model zone structure is not designed to provide accurate turning movements along arterial roadways unless refinement and reasonableness checking is performed. Therefore, the Horizon Year peak hour forecasts were refined using the model derived long-range forecasts, along with existing peak hour traffic count data collected at each analysis location in 2021 (or adjusted historic to 2021). Future estimated peak hour traffic data was used for new intersections and intersections with an anticipated change in travel patterns to further refine the Horizon Year peak hour forecasts.

The refined future peak hour approach and departure volumes obtained from the model output data are then entered into a spreadsheet program consistent with the National Cooperative Highway Research Program (NCHRP Report 765), along with initial estimates of turning movement proportions. A linear programming algorithm is used to calculate individual turning movements which match the known directional roadway segment forecast volumes computed in the previous step. This program computes a likely set of intersection turning movements from intersection approach counts and the initial turning proportions from each approach leg.

Typically, the model growth is prorated and is subsequently added to the existing (base validation) traffic volumes to represent Long Range traffic conditions. However, review of the resulting model growth indicates negative growth for several study area intersections. In an effort to conduct a conservative analysis, reductions to traffic forecasts from either Existing or Opening Year Cumulative traffic conditions were not assumed as part of this analysis. Additional growth has also been applied on a movement-by-movement basis, where applicable, to estimate reasonable Horizon Year forecasts. Horizon Year turning volumes were compared to Opening Year Cumulative volumes in order to ensure a minimum growth as a part of the refinement process. The minimum growth includes any additional growth between Opening Year Cumulative and Horizon Year traffic conditions that is not accounted for by the traffic generated by cumulative development projects and ambient growth rates assumed between Existing (2021) and Horizon Year traffic conditions. Future estimated peak hour traffic data was used for new intersections and intersections with an anticipated change in travel patterns to further refine the Horizon Year peak hour forecasts. Since the Saturday peak hour is not included within the SBTAM, future year forecast for the Saturday peak hour are based on ambient growth factors identified in the Southern California Association of Governments Demographics and Growth Forecast, May 7, 2020.

EXHIBIT 4-5: CUMULATIVE DEVELOPMENT LOCATION MAP

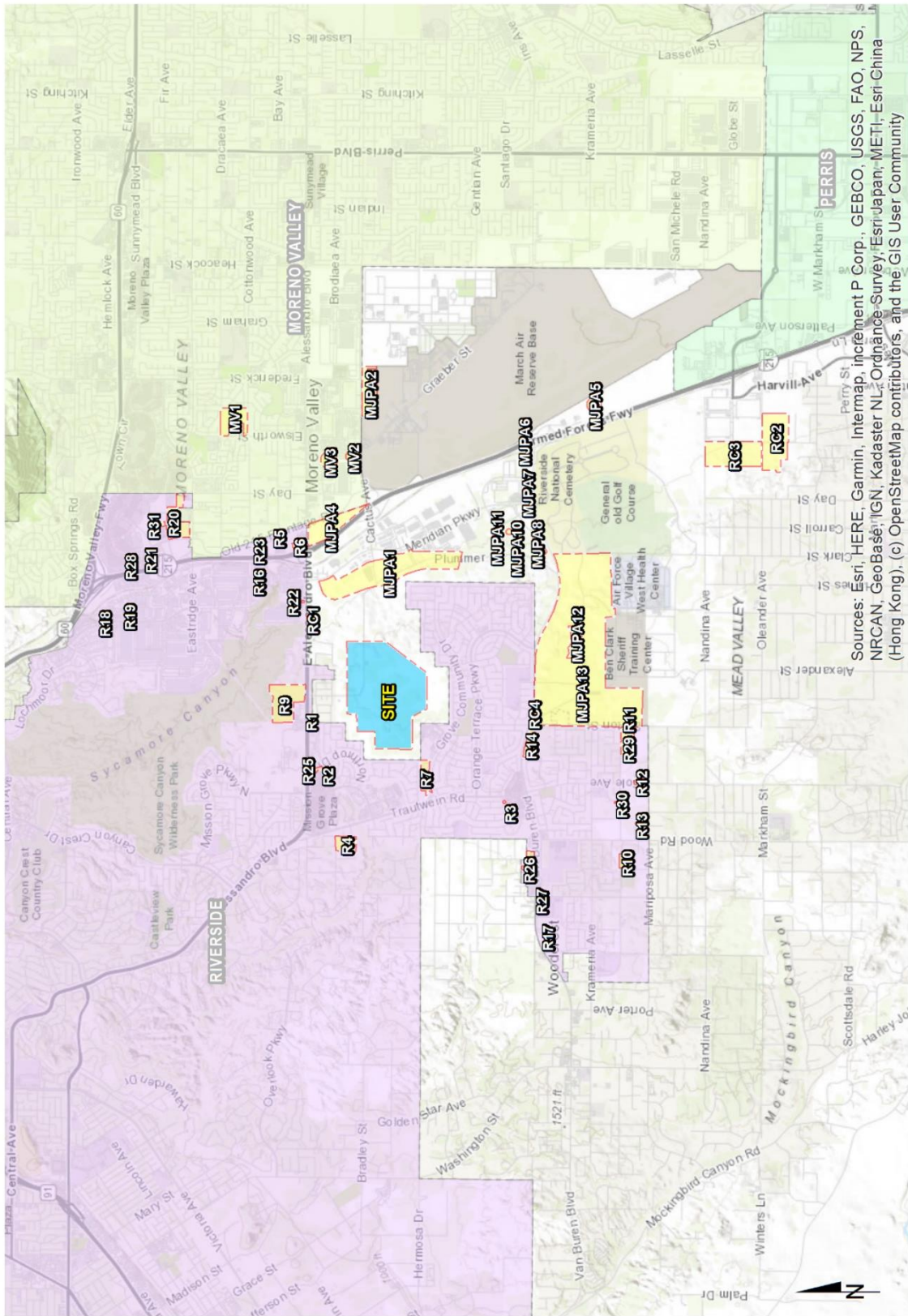

Sources: Esri, HERE, Garmin, Intermap, increment P Corp., GEBCO, USGS, FAO, NPS, NRCAN, GeoBase, IGN, Kadaster NL, Ordnance Survey, Esri/Japan, METI, Esri China (Hong Kong), (c) OpenStreetMap contributors, and the GIS User Community

EXHIBIT 4-6: CUMULATIVE ONLY WEEKDAY TRAFFIC VOLUMES

<p>1 Washington St. & Van Buren Blvd.</p> <p>4,450</p> <p>84(100)</p> <p>↑ 113(94) ↑ 222(199) ↑ 9(11)</p> <p>176(178) →</p> <p>12(10)</p> <p>3,000</p> <p>2,900</p>	<p>2 Alessandro Blvd. & Arlington Av./Chicago Av.</p> <p>1,400</p> <p>84(173)</p> <p>← 41(94)</p> <p>58(131) ↓</p> <p>77(64) → 106(81) → 67(25) →</p> <p>1,350</p> <p>2,900</p>	<p>3 Canyon Crest Dr. & Alessandro Blvd.</p> <p>5,950</p> <p>20(33) ↓ 90(211) ↓ 41(96)</p> <p>32(25) ↓ 119(149) →</p> <p>↑ 67(64) ↑ 89(166) ↑ 3(0)</p> <p>181(127) →</p> <p>4,100</p> <p>2,900</p>	<p>4 Wood Rd. & Van Buren Blvd.</p> <p>1,150</p> <p>29(47)</p> <p>16(53) ↑ 468(352) ↑ 14(43)</p> <p>327(389) → 13(15) ↓</p> <p>16(14) ↓ 21(41) →</p> <p>10,400</p> <p>8,850</p>	<p>5 Trautwein Rd. & Alessandro Blvd.</p> <p>2,600</p> <p>87(49) ↑ 81(99)</p> <p>87(68) → 225(253) ↓</p> <p>136(305) → 80(96) →</p> <p>2,600</p> <p>8,350</p>
<p>6 Trautwein Rd. & Grove Community Dr.</p> <p>10,700</p> <p>509(513) ← 4(4)</p> <p>↑ 4(4) ↑ 2(2)</p> <p>282(546) → 2(2) → 2(2) →</p> <p>Nominal</p> <p>4,800</p>	<p>7 Trautwein Rd. & Orange Terrace Pkwy.</p> <p>10,050</p> <p>497(459) ← 8(9)</p> <p>↑ 9(8) ↑ 2(2)</p> <p>13(10) ↓</p> <p>6(15) → 246(509) → 2(2) →</p> <p>Nominal</p> <p>300</p>	<p>8 Trautwein Rd. & Van Buren Blvd.</p> <p>9,350</p> <p>82(83) ↓ 150(60) ↓ 280(328)</p> <p>73(81) ↓ 328(414) →</p> <p>↑ 143(406) ↑ 426(403) ↑ 20(77)</p> <p>38(40) → 46(72) →</p> <p>19,950</p> <p>10,400</p>	<p>9 Deercreek Dr. & Grove Community Dr.</p> <p>900</p> <p>20(42) →</p> <p>900</p>	<p>10 Deercreek Dr. & Orange Terrace Pkwy.</p> <p>900</p> <p>14(42)</p> <p>900</p>
<p>11 Barton St. & Alessandro Blvd.</p> <p>100</p> <p>6(5)</p> <p>↑ 2(14) ← 141(220)</p> <p>230(162) →</p> <p>1,350</p> <p>1,550</p>	<p>12 Barton St. & Grove Community Dr.</p> <p>Nominal</p> <p>900</p>	<p>13 Barton St. & Orange Terrace Pkwy.</p> <p>Nominal</p> <p>4(4)</p> <p>4(4) → 16(37) → 10(38) →</p> <p>850</p>	<p>14 Barton St. & Van Buren Blvd.</p> <p>1,850</p> <p>32(74) ↓ 14(0) ↓ 13(10)</p> <p>20(77) ↓ 493(729) → 95(83) ↓</p> <p>↑ 6(17) ↑ 570(823) ↑ 2(26)</p> <p>58(108) ↓ 0(7) → 8(13) →</p> <p>17,400</p> <p>20,800</p>	<p>15 Airman Dr. & Cactus Av.</p> <p>2,150</p> <p>2,150</p>
<p>16 Abrams Dr. & Grove Community Dr.</p> <p>Nominal</p> <p>1,600</p>	<p>17 Abrams Dr. & Orange Terrace Pkwy.</p> <p>Nominal</p> <p>4(4)</p> <p>4(4) →</p> <p>Nominal</p>	<p>18 Linebacker Dr. & Cactus Av.</p> <p>Nominal</p>	<p>19 Orange Terrace Pkwy. & Van Buren Blvd.</p> <p>1,600</p> <p>30(49) ↓ 12(10) ↓ 8(13)</p> <p>18(54) ↓ 398(800) → 168(207) ↓</p> <p>↑ 2(12) ↑ 781(715) ↑ 93(123)</p> <p>82(245) ↓ 6(14) → 45(185) →</p> <p>20,200</p> <p>23,100</p>	<p>20 Brown St. & Alessandro Blvd.</p> <p>2,400</p> <p>125(289) ↑ 46(19)</p> <p>275(119) →</p> <p>28(0) →</p> <p>2,400</p> <p>1,950</p>

##(##) AM(PM) Peak Hour Intersection Volumes

Average Daily Trips

<p>21 Brown St. & Cactus Av.</p>	<p>22 Sycamore Canyon Blvd. & Eastridge Av.</p> <p>950</p> <p>← 52(46)</p> <p>↑ 88(29)</p> <p>↓ 33(45) → 22(88)</p> <p>6,200</p>	<p>23 Sycamore Canyon Blvd. & Cottonwood Av.</p> <p>1,650</p> <p>← 48(45)</p> <p>↓ 92(30)</p> <p>↑ 23(92)</p> <p>↓ 15(64)</p> <p>↑ 32(41) → 64(21)</p> <p>6,100</p>	<p>24 Meridian Pkwy. & Alessandro Blvd.</p> <p>1,550</p> <p>↓ 3(13)</p> <p>← 50(53)</p> <p>↓ 12(7)</p> <p>↓ 169(103)</p> <p>↓ 121(63)</p> <p>↑ 44(15)</p> <p>↑ 134(166)</p> <p>↑ 116(40)</p> <p>↑ 35(130)</p> <p>↑ 41(41)</p> <p>↑ 24(28)</p> <p>2,600</p> <p>4,650</p>	<p>25 Meridian Pkwy. & Cactus Av.</p> <p>Nominal</p> <p>↓ 2(0)</p> <p>← 151(156)</p> <p>↓ 39(171)</p> <p>↑ 39(45)</p> <p>↑ 339(165)</p> <p>↓ 32(0)</p> <p>↑ 62(162)</p> <p>↑ 61(115)</p> <p>4,450</p>
<p>26 Meridian Pkwy. & Van Buren Blvd.</p> <p>4,150</p> <p>↓ 207(196)</p> <p>↓ 216(223)</p> <p>↓ 1013(2478)</p> <p>↑ 49(87)</p> <p>↑ 7(16)</p> <p>← 1954(1762)</p> <p>43,450</p> <p>47,200</p>	<p>27 Innovation Dr. & Cactus Av.</p> <p>Nominal</p> <p>↑ 85(1)</p> <p>↑ 14(9)</p> <p>59(3) →</p> <p>5(25)</p> <p>16(70)</p> <p>750</p>	<p>28 I-215 SB Ramps & Alessandro Blvd.</p> <p>2,350</p> <p>↓ 137(48)</p> <p>↓ 169(123)</p> <p>↓ 35(75)</p> <p>↑ 85(129)</p> <p>↑ 158(173)</p> <p>5,450</p> <p>250</p>	<p>29 I-215 NB Ramps & Alessandro Blvd.</p> <p>1,300</p> <p>20(69)</p> <p>241(463)</p> <p>76(26)</p> <p>100(99)</p> <p>↑ 30(33)</p> <p>↑ 476(380)</p> <p>9,250</p> <p>900</p>	<p>30 I-215 SB Ramps & Cactus Av.</p> <p>1,250</p> <p>↑ 2(26)</p> <p>↑ 154(251)</p> <p>10(3) →</p> <p>121(127)</p> <p>Nominal</p> <p>2,400</p>
<p>31 I-215 NB Ramps & Cactus Av.</p> <p>Nominal</p> <p>↓ 8(0)</p> <p>↓ 194(232)</p> <p>↑ 2(5)</p> <p>↑ 5(2)</p> <p>↑ 387(564)</p> <p>77(2)</p> <p>3(2)</p> <p>37(84)</p> <p>8,250</p> <p>2,550</p>	<p>32 I-215 SB Ramps & Van Buren Blvd.</p> <p>10,950</p> <p>↓ 694(581)</p> <p>↓ 485(961)</p> <p>↓ 265(499)</p> <p>353(519)</p> <p>↑ 509(602)</p> <p>↑ 27(181)</p> <p>19,700</p> <p>6,700</p>	<p>33 I-215 NB Ramps & Van Buren Blvd.</p> <p>3,700</p> <p>480(710)</p> <p>358(770)</p> <p>481(419)</p> <p>132(195)</p> <p>↑ 143(864)</p> <p>10,250</p> <p>11,100</p>	<p>34 Old 215 Frontage Rd. & Alessandro Blvd.</p> <p>2,200</p> <p>↓ 34(101)</p> <p>↓ 98(46)</p> <p>↓ 189(201)</p> <p>↓ 4(4)</p> <p>7(17)</p> <p>↑ 16(7)</p> <p>↑ 199(244)</p> <p>4(6)</p> <p>0(1)</p> <p>6,200</p> <p>8,550</p>	<p>35 Day St. & Alessandro Blvd.</p> <p>1,550</p> <p>↓ 33(26)</p> <p>↓ 22(17)</p> <p>↓ 174(202)</p> <p>↑ 30(8)</p> <p>↑ 16(17)</p> <p>↑ 15(17)</p> <p>↑ 183(225)</p> <p>6(30)</p> <p>5,900</p> <p>350</p>
<p>36 Elsworth St. & Cactus Av.</p> <p>4,350</p> <p>↓ 94(90)</p> <p>↓ 90(83)</p> <p>↓ 250(356)</p> <p>↑ 75(84)</p> <p>↑ 81(86)</p> <p>↑ 299(476)</p> <p>8,650</p> <p>9,550</p>	<p>37 Frederick St. & Cactus Av.</p> <p>900</p> <p>↓ 4(1)</p> <p>↓ 4(0)</p> <p>↓ 169(332)</p> <p>← 299(476)</p> <p>8,650</p> <p>8,000</p>	<p>38 Graham St./Riverside Dr. & Cactus Av.</p> <p>1,350</p> <p>↓ 58(51)</p> <p>↓ 33(82)</p> <p>↓ 159(444)</p> <p>↓ 6(15)</p> <p>↑ 355(258)</p> <p>13(10)</p> <p>6,800</p> <p>300</p>	<p>##(##) AM(PM) Peak Hour Intersection Volumes ## Average Daily Trips</p>	

EXHIBIT 4-7: CUMULATIVE ONLY WEEKEND TRAFFIC VOLUMES

1	Washington St. & Van Buren Blvd.	2	Alessandro Blvd. & Arlington Av./Chicago Av.	3	Canyon Crest Dr. & Alessandro Blvd.	4	Wood Rd. & Van Buren Blvd.	5	Trautwein Rd. & Alessandro Blvd.																																																																														
	<table border="1"> <tr><td></td><td style="text-align: center;">← 74</td><td></td></tr> <tr><td></td><td style="text-align: center;">↑ 73</td><td></td></tr> <tr><td></td><td style="text-align: center;">↑ 112</td><td></td></tr> <tr><td></td><td style="text-align: center;">↓ 19</td><td></td></tr> <tr><td style="text-align: center;">114</td><td style="text-align: center;">→</td><td style="text-align: center;">20</td></tr> </table>		← 74			↑ 73			↑ 112			↓ 19		114	→	20		<table border="1"> <tr><td></td><td style="text-align: center;">← 94</td><td></td></tr> <tr><td></td><td style="text-align: center;">↓ 69</td><td></td></tr> <tr><td></td><td style="text-align: center;">← 26</td><td></td></tr> <tr><td></td><td style="text-align: center;">↓ 67</td><td></td></tr> <tr><td></td><td style="text-align: center;">↓ 92</td><td></td></tr> <tr><td></td><td style="text-align: center;">↓ 26</td><td></td></tr> </table>		← 94			↓ 69			← 26			↓ 67			↓ 92			↓ 26			<table border="1"> <tr><td></td><td style="text-align: center;">← 189</td><td></td></tr> <tr><td></td><td style="text-align: center;">↓ 185</td><td></td></tr> <tr><td></td><td style="text-align: center;">← 69</td><td></td></tr> <tr><td></td><td style="text-align: center;">↓ 67</td><td></td></tr> </table>		← 189			↓ 185			← 69			↓ 67			<table border="1"> <tr><td></td><td style="text-align: center;">← 43</td><td></td></tr> <tr><td></td><td style="text-align: center;">↑ 41</td><td></td></tr> <tr><td></td><td style="text-align: center;">↑ 417</td><td></td></tr> <tr><td></td><td style="text-align: center;">↓ 41</td><td></td></tr> <tr><td style="text-align: center;">424</td><td style="text-align: center;">→</td><td style="text-align: center;">43</td></tr> <tr><td style="text-align: center;">31</td><td style="text-align: center;">↓</td><td></td></tr> </table>		← 43			↑ 41			↑ 417			↓ 41		424	→	43	31	↓			<table border="1"> <tr><td></td><td style="text-align: center;">← 1</td><td></td></tr> <tr><td></td><td style="text-align: center;">↓ 256</td><td></td></tr> <tr><td></td><td style="text-align: center;">← 251</td><td></td></tr> <tr><td></td><td style="text-align: center;">↓ 2</td><td></td></tr> <tr><td></td><td style="text-align: center;">↓ 1</td><td></td></tr> </table>		← 1			↓ 256			← 251			↓ 2			↓ 1	
	← 74																																																																																						
	↑ 73																																																																																						
	↑ 112																																																																																						
	↓ 19																																																																																						
114	→	20																																																																																					
	← 94																																																																																						
	↓ 69																																																																																						
	← 26																																																																																						
	↓ 67																																																																																						
	↓ 92																																																																																						
	↓ 26																																																																																						
	← 189																																																																																						
	↓ 185																																																																																						
	← 69																																																																																						
	↓ 67																																																																																						
	← 43																																																																																						
	↑ 41																																																																																						
	↑ 417																																																																																						
	↓ 41																																																																																						
424	→	43																																																																																					
31	↓																																																																																						
	← 1																																																																																						
	↓ 256																																																																																						
	← 251																																																																																						
	↓ 2																																																																																						
	↓ 1																																																																																						
6	Trautwein Rd. & Grove Community Dr.	7	Trautwein Rd. & Orange Terrace Pkwy.	8	Trautwein Rd. & Van Buren Blvd.	9	Deercreek Dr. & Grove Community Dr.	10	Deercreek Dr. & Orange Terrace Pkwy.																																																																														
	<table border="1"> <tr><td></td><td style="text-align: center;">← 299</td><td></td></tr> <tr><td></td><td style="text-align: center;">↓ 5</td><td></td></tr> <tr><td></td><td style="text-align: center;">← 294</td><td></td></tr> <tr><td></td><td style="text-align: center;">↓ 6</td><td></td></tr> </table>		← 299			↓ 5			← 294			↓ 6			<table border="1"> <tr><td></td><td style="text-align: center;">← 304</td><td></td></tr> <tr><td></td><td style="text-align: center;">↓ 5</td><td></td></tr> <tr><td></td><td style="text-align: center;">← 300</td><td></td></tr> <tr><td></td><td style="text-align: center;">↓ 6</td><td></td></tr> </table>		← 304			↓ 5			← 300			↓ 6			<table border="1"> <tr><td></td><td style="text-align: center;">← 137</td><td></td></tr> <tr><td></td><td style="text-align: center;">↓ 140</td><td></td></tr> <tr><td></td><td style="text-align: center;">← 172</td><td></td></tr> <tr><td></td><td style="text-align: center;">↓ 370</td><td></td></tr> <tr><td></td><td style="text-align: center;">← 41</td><td></td></tr> <tr><td></td><td style="text-align: center;">↓ 43</td><td></td></tr> <tr><td></td><td style="text-align: center;">← 166</td><td></td></tr> <tr><td></td><td style="text-align: center;">↑ 362</td><td></td></tr> </table>		← 137			↓ 140			← 172			↓ 370			← 41			↓ 43			← 166			↑ 362				<table border="1"> <tr><td></td><td style="text-align: center;">← 41</td><td></td></tr> <tr><td></td><td style="text-align: center;">→ 43</td><td></td></tr> </table>		← 41			→ 43																										
	← 299																																																																																						
	↓ 5																																																																																						
	← 294																																																																																						
	↓ 6																																																																																						
	← 304																																																																																						
	↓ 5																																																																																						
	← 300																																																																																						
	↓ 6																																																																																						
	← 137																																																																																						
	↓ 140																																																																																						
	← 172																																																																																						
	↓ 370																																																																																						
	← 41																																																																																						
	↓ 43																																																																																						
	← 166																																																																																						
	↑ 362																																																																																						
	← 41																																																																																						
	→ 43																																																																																						
11	Barton St. & Alessandro Blvd.	12	Barton St. & Grove Community Dr.	13	Barton St. & Orange Terrace Pkwy.	14	Barton St. & Van Buren Blvd.	15	Airman Dr. & Cactus Av.																																																																														
	<table border="1"> <tr><td></td><td style="text-align: center;">← 1</td><td></td></tr> <tr><td style="text-align: center;">3</td><td style="text-align: center;">→</td><td></td></tr> </table>		← 1		3	→						<table border="1"> <tr><td></td><td style="text-align: center;">← 86</td><td></td></tr> <tr><td></td><td style="text-align: center;">↓ 83</td><td></td></tr> <tr><td></td><td style="text-align: center;">← 511</td><td></td></tr> <tr><td></td><td style="text-align: center;">↓ 497</td><td></td></tr> <tr><td></td><td style="text-align: center;">↓ 31</td><td></td></tr> <tr><td></td><td style="text-align: center;">← 30</td><td></td></tr> </table>		← 86			↓ 83			← 511			↓ 497			↓ 31			← 30																																																										
	← 1																																																																																						
3	→																																																																																						
	← 86																																																																																						
	↓ 83																																																																																						
	← 511																																																																																						
	↓ 497																																																																																						
	↓ 31																																																																																						
	← 30																																																																																						
16	Abrams Dr. & Grove Community Dr.	17	Abrams Dr. & Orange Terrace Pkwy.	18	Linebacker Dr. & Cactus Av.	19	Orange Terrace Pkwy. & Van Buren Blvd.	20	Brown St. & Alessandro Blvd.																																																																														
						<table border="1"> <tr><td></td><td style="text-align: center;">← 48</td><td></td></tr> <tr><td></td><td style="text-align: center;">↓ 47</td><td></td></tr> <tr><td></td><td style="text-align: center;">← 443</td><td></td></tr> <tr><td></td><td style="text-align: center;">↓ 430</td><td></td></tr> </table>		← 48			↓ 47			← 443			↓ 430			<table border="1"> <tr><td></td><td style="text-align: center;">← 6</td><td></td></tr> <tr><td style="text-align: center;">4</td><td style="text-align: center;">→</td><td></td></tr> </table>		← 6		4	→																																																														
	← 48																																																																																						
	↓ 47																																																																																						
	← 443																																																																																						
	↓ 430																																																																																						
	← 6																																																																																						
4	→																																																																																						

Saturday Peak Hour Intersection Volumes

<p>21 Brown St. & Cactus Av.</p>	<p>22 Sycamore Canyon Blvd. & Eastridge Av.</p>	<p>23 Sycamore Canyon Blvd. & Cottonwood Av.</p>	<p>24 Meridian Pkwy. & Alessandro Blvd.</p>	<p>25 Meridian Pkwy. & Cactus Av.</p>
<p>26 Meridian Pkwy. & Van Buren Blvd.</p>	<p>27 Innovation Dr. & Cactus Av.</p>	<p>28 I-215 SB Ramps & Alessandro Blvd.</p>	<p>29 I-215 NB Ramps & Alessandro Blvd.</p>	<p>30 I-215 SB Ramps & Cactus Av.</p>
<p>31 I-215 NB Ramps & Cactus Av.</p>	<p>32 I-215 SB Ramps & Van Buren Blvd.</p>	<p>33 I-215 NB Ramps & Van Buren Blvd.</p>	<p>34 Old 215 Frontage Rd. & Alessandro Blvd.</p>	<p>35 Day St. & Alessandro Blvd.</p>
<p>36 Elsworth St. & Cactus Av.</p>	<p>37 Frederick St. & Cactus Av.</p>	<p>38 Graham St./Riverside Dr. & Cactus Av.</p>	<p>## Saturday Peak Hour Intersection Volumes</p>	

The future Horizon Year peak hour turning movements were then reviewed by Urban Crossroads for reasonableness, and in some cases, were adjusted to achieve flow conservation, reasonable growth, and reasonable diversion between parallel routes. Flow conservation checks ensure that traffic flow between two closely spaced intersections, such as two freeway ramp locations, is verified in order to make certain that vehicles leaving one intersection are entering the adjacent intersection and that there is no unexplained loss of vehicles. The result of this traffic forecasting procedure is a series of traffic volumes which are suitable for traffic operations analysis.

TABLE 4-3: CUMULATIVE DEVELOPMENT LAND USE SUMMARY

ID	Project Name	Land Use ¹	Quantity Units ²
March Joint Powers Authority:			
MJPA1	Meridian Business Park (West Campus)	Industrial Park	2,278.852 TSF
MJPA2	K4 Parcel	Warehouse	718.000 TSF
MJPA3	Economic Business Center	Warehouse	124.523 TSF
MJPA4	Freeway Business Center	Warehouse	709 TSF
MJPA5	Veteran's Industrial Plaza/VIP 215	Warehouse	2,000.000 TSF
MJPA6	Veteran's Plaza	Commercial Retail	198.000 TSF
MJPA7	MS Van Buren I	Warehouse	176.396 TSF
MJPA8	MS Van Buren II	Warehouse	162.041 TSF
MJPA9	MS Prime Six	General Office	74.922 TSF
MJPA10	Meridian Distribution Center IV	Warehouse	90.000 TSF
MJPA11	Meridian Distribution Center III	Warehouse	262.269 TSF
MJPA12	Eagle Business Park	Business Park	390.480 TSF
MJPA13	South Campus	Office	388.011 TSF
		Commercial Retail	282.730 TSF
		Business Park	1,764.180 TSF
		Industrial Park	1,774.437 TSF
City of Riverside:			
R1	P17-0419/20/21	Fast Food w/ Drive Thru	1.857 TSF
R2	P16-0578	Warehouse	82.200 TSF
R3	P19-0151/P19-0152/P19-0153	Health and Fitness Club	21.706 TSF
R4	P13-0665	SFDR	8 DU
R5	P15-1035/P16-0556/P16-0567	Warehouse	176.149 TSF
R6	P14-0841 to P14-0848/P16-0472/P16-0474	Warehouse	73.200 TSF
		Commercial Retail	15.000 TSF
R7	P14-0472/P14-0473/P15-0321/P15-0322	SFDR	85 DU
R8	P19-0022/P19-0024/P19-0026/P19-0027/P19-0028	Fast Food w/ Drive Thru	4.319 TSF
R9	Sycamore Hills Distribution Center	Warehouse	603.100 TSF
R10	P06-0900, P08-0269, P08-0270	Single Family Detached Housing	20 DU
R11	P06-1355	Single Family Detached Housing	20 DU
R12	P06-1396	Single Family Detached Housing	20 DU
R13	P03-1404	Single Family Detached Housing	20 DU
R14	P10-0113, P10-0118, P10-0449	Free-Standing Discount Superstore	138.516 TSF
		Home Improvement Superstore	155.433 TSF
		Shopping Plaza	125.608 TSF
R15	P12-0360	Vocational School	11.505 TSF
R16	P12-0507 through P12-0510	Warehouse/Industrial	235.741 TSF

ID	Project Name	Land Use ¹	Quantity Units ²
R17	P13-0263, P13-0264, P13-0769	Retail	10.700 TSF
		Day Care	10.000 TSF
		Drive-Thru Restaurant	2.500 TSF
		Office	10.000 TSF
		Medical Office	8.000 TSF
R18	P13-0553, P13-0554, P13-0583, P14-0065	Multi-Family Residential	275 DU
R19	P13-0607, P13-0608, P13-0609, P13-0854	Industrial	171.616 TSF
R20	P14-0294, P14-0295, P14-0297, P16-0297 (JN:8890)		
R21	P14-0536, P14-0537	Fast Food w/ Drive Thru	3.750 TSF
R22	P14-0600, P14-0601, P14-0602, P15-044	Industrial	121.390 TSF
R23	P14-1070	Warehousing	240.080 TSF
R24	P15-0075, P15-0076, P15-0819	Auto Repair	11.738 TSF
		Fast Food w/ Drive Thru	2.200 TSF
R25	P15-0983, P15-0984	Child Care	15.000 TSF
R26	P17-0688, P17-0689	Car Wash	5.440 TSF
R27	P19-0042	Restaurant	4.300 TSF
		Office	9.920 TSF
R28	P19-0332, P19-0333	Car Wash	4.340 TSF
R29	P20-0013, P20-0014, P20-0015, P20-0016	Residential	81 DU
R30	P20-0018, P20-0019, P20-0020, P20-0021	Residential	138 DU
R31	P20-0203, P20-0281	Canyon Springs Healthcare Campus	280.800 TSF
County of Riverside:			
RC1	PP 25422	Warehouse	814.000 TSF
RC2	Knox Business Park	Warehouse	1,259.050 TSF
RC3	Oleander Business Park	Warehouse	710.736 TSF
RC4	PP25382	Commercial Office Building	10.275 TSF
City of Moreno Valley:			
MV1	Scottish Village	Multifamily	194 DU
MV2	Moreno Valley Cactus Center (PEN16-0131)	Warehouse	36.950 TSF
		Fast Food w/ Drive Thru	7.900 TSF
		Gas Station w/ Car Wash	28 VFP
MV3	PA 08-0047-0052 (Komar Cactus Plaza)	Hotel	110 Rooms
		Fast Food w/ Drive Thru	8.000 TSF
		Commercial	42.400 TSF

¹ SFDR = Single Family Detached Residential

² DU = Dwelling Units; TSF = Thousand Square Feet; SP = Spaces; VFP = Vehicle Fueling Positions

5 E+P TRAFFIC CONDITIONS

This section discusses the traffic forecasts for E+P conditions and the resulting intersection operations, roadway segment analysis, traffic signal warrant, and freeway off-ramp queuing analyses. This analysis scenario is not a “real-world” scenario in that there would be some growth that occurs between baseline conditions and implementation of the Project. However, this analysis scenario has been provided for informational purposes only to identify the deficiencies and improvement needs for study area intersections and roadway segments when Project traffic is added directly to the baseline condition.

5.1 ROADWAY IMPROVEMENTS

The lane configurations and traffic controls assumed to be in place for E+P conditions are consistent with those shown previously on Exhibit 3-1, with the exception of the following:

- Project driveways and those facilities assumed to be constructed by the Project to provide site access are also assumed to be in place for E+P conditions only (e.g., intersection and roadway improvements at the Project’s frontage and driveways).

5.2 EXISTING PLUS PROJECT TRAFFIC VOLUME FORECASTS

This scenario includes Existing traffic volumes plus Project traffic. The ADT and weekday AM and PM peak hour intersection turning movement volumes which can be expected for E+P traffic conditions are shown on Exhibit 5-1. The weekend Saturday peak hour intersection turning movement volumes for E+P conditions are shown on Exhibit 5-2.

5.3 INTERSECTION OPERATIONS ANALYSIS

E+P peak hour traffic operations have been evaluated for the study area intersections based on the analysis methodologies presented in Section 2 *Methodologies* of this TA. The intersection analysis results are summarized in Table 5-1 for E+P traffic conditions, which indicates that the following additional study area intersections are anticipated to operate at an unacceptable LOS during the peak hours, in addition to intersections previously identified under Existing (2021) conditions:

- Canyon Crest Dr./Overlook Pkwy. & Alessandro Bl. (#3) – LOS E AM peak hour; LOS F PM peak hour
- Brown St. & Alessandro Bl. (#20) – LOS F PM and Saturday peak hours
- Meridian Pkwy. & Cactus Av. (#25) – LOS F PM peak hour only

The intersection operations analysis worksheets for E+P traffic conditions are included in Appendix 5.1.

EXHIBIT 5-1: E+P WEEKDAY TRAFFIC VOLUMES

<p>1 Washington St. & Van Buren Blvd.</p> <p>17,250 62(82) ↓ 176(346) ↓ 340(499) ↓ 131(133) → 1010(1295) → 120(79) ↓</p> <p>35,750 ↑ 576(420) ↑ 1301(1055) ↑ 99(209) 136(98) → 509(240) → 141(109) →</p> <p>10,750</p> <p>27,400</p>	<p>2 Alessandro Blvd. & Arlington Av./Chicago Av.</p> <p>34,300 42(20) ↓ 623(1641) ↓ 225(486) ↓ 41(25) ↓ 491(731) → 620(1024) ↓</p> <p>28,900 ↑ 322(210) ↑ 812(656) ↑ 207(544) 1233(831) → 1530(1061) → 456(275) →</p> <p>53,550</p> <p>32,700</p>	<p>3 Canyon Crest Dr. & Alessandro Blvd.</p> <p>15,150 49(23) ↓ 82(63) ↓ 449(547) ↓ 38(52) ↓ 1313(2826) → 14(25) ↓</p> <p>65,300 ↑ 1016(599) ↑ 3114(2103) ↑ 27(22) 9(37) → 33(150) → 10(56) →</p> <p>3,600</p> <p>53,750</p>	<p>4 Wood Rd. & Van Buren Blvd.</p> <p>9,800 162(185) ↓ 416(241) ↓ 83(82) ↓ 146(153) ↓ 899(1349) → 317(197) ↓</p> <p>32,750 ↑ 102(82) ↑ 1166(1302) ↑ 447(258) 323(285) → 416(237) → 308(203) →</p> <p>14,200</p> <p>34,700</p>	<p>5 Trautwein Rd. & Alessandro Blvd.</p> <p>45,850 ← 3065(2098) ↑ 157(234) 1129(1860) → 4(17) ↓ 1847(893) → 7(11) →</p> <p>12,250</p> <p>51,550</p>
<p>6 Trautwein Rd. & Grove Community Dr.</p> <p>27,250 ← 871(1361) ↓ 206(367) ↑ 604(231) ↑ 75(49) 1428(780) → 22(52) →</p> <p>6,950</p> <p>22,300</p> <p>27,400</p>	<p>7 Trautwein Rd. & Orange Terrace Pkwy.</p> <p>22,600 20(40) ↓ 579(1050) ↓ 382(333) ↓ 67(45) ↓ 63(46) ↓ 12(12) ↓</p> <p>8,900 ↑ 485(163) ↑ 99(24) ↑ 288(148) 48(31) → 974(716) → 239(208) →</p> <p>20,850</p> <p>1,900</p> <p>31,000</p>	<p>8 Trautwein Rd. & Van Buren Blvd.</p> <p>19,750 226(215) ↓ 329(508) ↓ 176(287) ↓ 301(317) ↓ 986(1029) → 92(100) ↓</p> <p>31,450 ↑ 332(248) ↑ 1244(1182) ↑ 150(166) 213(89) → 535(284) → 123(63) →</p> <p>12,800</p> <p>4,200</p>	<p>9 Deercreek Dr. & Grove Community Dr.</p> <p>4,350 ↑ 329(156) ↑ 49(21) 104(212) → 79(18) ↓ 203(27) → 31(35) →</p> <p>1,000</p> <p>7,700</p>	<p>10 Deercreek Dr. & Orange Terrace Pkwy.</p> <p>1,450 36(19) ↓ 30(7) ↓ 82(27) ↓ 219(43) ↓ 418(422) → 41(15) ↓</p> <p>7,550 ↑ 50(46) ↑ 539(237) ↑ 4(3) 156(18) → 156(18) → 6(2) →</p> <p>500</p> <p>7,700</p>
<p>11 Barton St. & Alessandro Blvd.</p> <p>300 7(12) ↓ 4(9) ↓ 6(5) → 1472(1970) → 46(49) →</p> <p>46,350 ↑ 5(3) ↑ 2544(2318) ↑ 36(67) 76(71) → 1(1) → 48(33) →</p> <p>2,350</p> <p>46,600</p>	<p>12 Barton St. & Grove Community Dr.</p> <p>1,100 10(51) ↓ 5(2) ↓ 35(40) ↓ 100(208) →</p> <p>4,150 ↑ 13(20) ↑ 369(127) ↑ 25(17) 8(48) →</p> <p>650</p> <p>4,150</p>	<p>13 Barton St. & Orange Terrace Pkwy.</p> <p>650 25(17) ↓ 269(370) → 238(80) ↓</p> <p>6,750 ↑ 396(221) ↑ 45(41) 197(65) → 8(48) → 33(39) →</p> <p>2,950</p> <p>7,400</p>	<p>14 Barton St. & Van Buren Blvd.</p> <p>4,050 278(82) ↓ 95(27) ↓ 71(33) ↓ 135(100) ↓ 1149(1187) → 104(218) ↓</p> <p>33,600 ↑ 33(80) ↑ 1271(1354) ↑ 258(303) 358(209) → 73(61) → 370(229) →</p> <p>11,100</p> <p>33,300</p>	<p>15 Airman Dr. & Cactus Av.</p> <p>15,900 133(902) ↓ 443(379) ↑ 331(305) ↓ 99(696) →</p> <p>28,900</p> <p>13,000</p> <p>15,900</p>
<p>16 Abrams Dr. & Grove Community Dr.</p> <p>3,700 ↑ 238(86) ↑ 93(35) 58(191) → 52(61) →</p> <p>2,000</p> <p>3,850</p>	<p>17 Abrams Dr. & Orange Terrace Pkwy.</p> <p>2,050 104(36) ↓ 73(25) ↓ 113(113) ↓ 161(278) →</p> <p>5,300 ↑ 87(32) ↑ 301(199) 84(503) →</p> <p>7,200</p> <p>6,250</p>	<p>18 Linebacker Dr. & Cactus Av.</p> <p>7,200 84(502) ↓ 232(1598) →</p> <p>43,350 ↑ 277(182) ↑ 774(684) ↑ 277(183) 84(503) →</p> <p>7,200</p> <p>28,900</p>	<p>19 Orange Terrace Pkwy. & Van Buren Blvd.</p> <p>6,250 214(96) ↓ 25(30) ↓ 233(107) ↓ 135(124) ↓ 1399(1341) → 41(77) ↓</p> <p>34,700 ↑ 125(200) ↑ 1265(1557) ↑ 35(47) 37(59) → 15(30) → 32(37) →</p> <p>2,950</p> <p>34,350</p>	<p>20 Brown St. & Alessandro Blvd.</p> <p>2,400 16(68) ↓ 1(1) ↓ 29(108) ↓ 30(26) ↓ 1313(1885) → 154(190) ↓</p> <p>46,200 ↑ 50(29) ↑ 2372(1783) ↑ 205(223) 45(384) → 0(2) → 62(468) →</p> <p>18,500</p> <p>44,650</p>

##(##) AM(PM) Peak Hour Intersection Volumes

Average Daily Trips

21 Brown St. & Cactus Av. 17,700 344(400) 102(815) 299(1787) 43,350	25,650 983(649)	22 Sycamore Canyon Blvd. & Eastridge Av. 16,650 39(17) 200(342) 70(251) 46(82) 38(86) 16(46) 67(29) 722(657) 84(134) 10,100 13,700	23 Sycamore Canyon Blvd. & Cottonwood Av. 13,850 263(582) 56(31) 22(10) 13(25) 867(763) 20(22) 850 13,900	24 Meridian Pkwy. & Alessandro Blvd. 19,650 126(254) 144(509) 87(125) 140(131) 1020(1793) 244(537) 50,150 585(443) 594(446) 73(152) 535(391) 2133(1646) 127(316) 25,400	25 Meridian Pkwy. & Cactus Av. 24,750 77(51) 140(840) 137(498) 25(143) 201(1159) 83(528) 281(186) 366(328) 209(221) 35,650 29,400
26 Meridian Pkwy. & Van Buren Blvd. 20,100 373(1007) 6(13) 70(948) 625(408) 1146(1302) 2(1) 38,550	35,300 203(111) 1322(924) 46(7) 3(11) 1(14) 3(33)	27 Innovation Dr. & Cactus Av. 700 2(13) 4(3) 528(1870) 15(5) 38,400 46(13) 1899(1588) 108(49) 7(23) 20(65) 1,500	28 I-215 SB Ramps & Alessandro Blvd. 9,300 364(468) 172(310) 143(61) 2431(1885) 807(1568) 372(502) 41,000 4,550	29 I-215 NB Ramps & Alessandro Blvd. 3,200 87(217) 892(1661) 1227(913) 0(11) 158(270) 32,950 13,050	30 I-215 SB Ramps & Cactus Av. 7,800 588(506) 484(1587) 69(383) 1464(1144) 579(484) 624(546) 38,650 14,200
31 I-215 NB Ramps & Cactus Av. 7,750 138(175) 0(2) 48(166) 29(98) 1282(1521) 163(742) 41,650	33,700 138(161) 2441(1714) 422(207) 292(218) 12(3)	32 I-215 SB Ramps & Van Buren Blvd. 3,050 719(192) 21(85) 21(11) 974(844) 2(3) 507(444) 679(1734) 14,250 18,900	33 I-215 NB Ramps & Van Buren Blvd. 950 72(47) 32(4) 558(497) 965(759) 26(21) 5(4) 300 13,350	34 Old 215 Frontage Rd. & Alessandro Blvd. 11,800 221(176) 68(214) 22(110) 324(317) 924(1486) 42(97) 51(31) 266(191) 19(13) 110(105) 1301(912) 10(13) 27,950 5,900	35 Day St. & Alessandro Blvd. 10,600 86(121) 39(132) 77(201) 146(238) 646(1420) 9(21) 11(15) 155(134) 16(11) 123(173) 1169(847) 9(12) 28,250 3,450
36 Elsworth St. & Cactus Av. 7,800 182(197) 58(13) 82(201) 187(188) 1376(1962) 288(26) 39,800	37,400 120(83) 1713(1227) 69(15) 23(191) 10(64) 16(74)	37 Frederick St. & Cactus Av. 10,800 116(192) 149(432) 144(153) 1713(1227)	38 Graham St./Riverside Dr. & Cactus Av. 4,800 115(99) 45(88) 84(123) 62(101) 1167(2138) 160(353) 88(82) 1935(1296) 9(16) 9(2) 0(1) 35,650 4,500	##(##) AM(PM) Peak Hour Intersection Volumes ## Average Daily Trips	

EXHIBIT 5-2: E+P WEEKEND TRAFFIC VOLUMES

1	Washington St. & Van Buren Blvd.	2	Alessandro Blvd. & Arlington Av./Chicago Av.	3	Canyon Crest Dr. & Alessandro Blvd.	4	Wood Rd. & Van Buren Blvd.	5	Trautwein Rd. & Alessandro Blvd.																																																						
	<table border="0"> <tr><td>← 72</td><td>↑ 206</td></tr> <tr><td>← 166</td><td>↑ 743</td></tr> <tr><td>← 291</td><td>↑ 108</td></tr> <tr><td>110</td><td>127</td></tr> <tr><td>766</td><td>191</td></tr> <tr><td>68</td><td>123</td></tr> </table>	← 72	↑ 206	← 166	↑ 743	← 291	↑ 108	110	127	766	191	68	123		<table border="0"> <tr><td>← 27</td><td>↑ 161</td></tr> <tr><td>← 767</td><td>↑ 422</td></tr> <tr><td>← 212</td><td>↑ 178</td></tr> <tr><td>21</td><td>632</td></tr> <tr><td>316</td><td>670</td></tr> <tr><td>517</td><td>175</td></tr> </table>	← 27	↑ 161	← 767	↑ 422	← 212	↑ 178	21	632	316	670	517	175		<table border="0"> <tr><td>← 18</td><td>↑ 393</td></tr> <tr><td>← 56</td><td>↑ 1367</td></tr> <tr><td>← 304</td><td>↑ 24</td></tr> <tr><td>33</td><td>18</td></tr> <tr><td>1256</td><td>54</td></tr> <tr><td>21</td><td>27</td></tr> </table>	← 18	↑ 393	← 56	↑ 1367	← 304	↑ 24	33	18	1256	54	21	27		<table border="0"> <tr><td>← 135</td><td>↑ 65</td></tr> <tr><td>← 142</td><td>↑ 927</td></tr> <tr><td>← 114</td><td>↑ 171</td></tr> <tr><td>119</td><td>160</td></tr> <tr><td>962</td><td>122</td></tr> <tr><td>163</td><td>110</td></tr> </table>	← 135	↑ 65	← 142	↑ 927	← 114	↑ 171	119	160	962	122	163	110		<table border="0"> <tr><td>↑ 1215</td></tr> <tr><td>↑ 170</td></tr> <tr><td>1036</td></tr> <tr><td>8</td></tr> <tr><td>715</td></tr> <tr><td>10</td></tr> </table>	↑ 1215	↑ 170	1036	8	715	10
← 72	↑ 206																																																														
← 166	↑ 743																																																														
← 291	↑ 108																																																														
110	127																																																														
766	191																																																														
68	123																																																														
← 27	↑ 161																																																														
← 767	↑ 422																																																														
← 212	↑ 178																																																														
21	632																																																														
316	670																																																														
517	175																																																														
← 18	↑ 393																																																														
← 56	↑ 1367																																																														
← 304	↑ 24																																																														
33	18																																																														
1256	54																																																														
21	27																																																														
← 135	↑ 65																																																														
← 142	↑ 927																																																														
← 114	↑ 171																																																														
119	160																																																														
962	122																																																														
163	110																																																														
↑ 1215																																																															
↑ 170																																																															
1036																																																															
8																																																															
715																																																															
10																																																															
6	Trautwein Rd. & Grove Community Dr.	7	Trautwein Rd. & Orange Terrace Pkwy.	8	Trautwein Rd. & Van Buren Blvd.	9	Deercreek Dr. & Grove Community Dr.	10	Deercreek Dr. & Orange Terrace Pkwy.																																																						
	<table border="0"> <tr><td>← 611</td><td>↑ 371</td></tr> <tr><td>← 333</td><td>↑ 99</td></tr> <tr><td>683</td><td>79</td></tr> </table>	← 611	↑ 371	← 333	↑ 99	683	79		<table border="0"> <tr><td>← 19</td><td>↑ 153</td></tr> <tr><td>← 588</td><td>↑ 11</td></tr> <tr><td>← 190</td><td>↑ 154</td></tr> <tr><td>30</td><td>32</td></tr> <tr><td>17</td><td>565</td></tr> <tr><td>19</td><td>142</td></tr> </table>	← 19	↑ 153	← 588	↑ 11	← 190	↑ 154	30	32	17	565	19	142		<table border="0"> <tr><td>← 216</td><td>↑ 164</td></tr> <tr><td>← 205</td><td>↑ 826</td></tr> <tr><td>← 153</td><td>↑ 119</td></tr> <tr><td>302</td><td>92</td></tr> <tr><td>772</td><td>229</td></tr> <tr><td>70</td><td>60</td></tr> </table>	← 216	↑ 164	← 205	↑ 826	← 153	↑ 119	302	92	772	229	70	60		<table border="0"> <tr><td>↑ 201</td></tr> <tr><td>59</td></tr> <tr><td>139</td></tr> <tr><td>14</td></tr> <tr><td>50</td></tr> <tr><td>45</td></tr> </table>	↑ 201	59	139	14	50	45		<table border="0"> <tr><td>↑ 50</td></tr> <tr><td>↑ 267</td></tr> <tr><td>8</td></tr> <tr><td>51</td></tr> <tr><td>5</td></tr> <tr><td>47</td></tr> <tr><td>51</td></tr> <tr><td>204</td></tr> <tr><td>8</td></tr> <tr><td>24</td></tr> <tr><td>24</td></tr> <tr><td>4</td></tr> </table>	↑ 50	↑ 267	8	51	5	47	51	204	8	24	24	4						
← 611	↑ 371																																																														
← 333	↑ 99																																																														
683	79																																																														
← 19	↑ 153																																																														
← 588	↑ 11																																																														
← 190	↑ 154																																																														
30	32																																																														
17	565																																																														
19	142																																																														
← 216	↑ 164																																																														
← 205	↑ 826																																																														
← 153	↑ 119																																																														
302	92																																																														
772	229																																																														
70	60																																																														
↑ 201																																																															
59																																																															
139																																																															
14																																																															
50																																																															
45																																																															
↑ 50																																																															
↑ 267																																																															
8																																																															
51																																																															
5																																																															
47																																																															
51																																																															
204																																																															
8																																																															
24																																																															
24																																																															
4																																																															
11	Barton St. & Alessandro Blvd.	12	Barton St. & Grove Community Dr.	13	Barton St. & Orange Terrace Pkwy.	14	Barton St. & Van Buren Blvd.	15	Airman Dr. & Cactus Av.																																																						
	<table border="0"> <tr><td>← 3</td><td>↑ 4</td></tr> <tr><td>← 4</td><td>↑ 1402</td></tr> <tr><td>← 66</td><td>↑ 33</td></tr> <tr><td>1252</td><td>54</td></tr> <tr><td>36</td><td>1</td></tr> <tr><td></td><td>33</td></tr> </table>	← 3	↑ 4	← 4	↑ 1402	← 66	↑ 33	1252	54	36	1		33		<table border="0"> <tr><td>← 54</td><td>↑ 17</td></tr> <tr><td>← 22</td><td>↑ 179</td></tr> <tr><td>26</td><td>↑ 17</td></tr> <tr><td>129</td><td></td></tr> <tr><td></td><td>16</td></tr> </table>	← 54	↑ 17	← 22	↑ 179	26	↑ 17	129			16		<table border="0"> <tr><td>← 17</td><td>↑ 396</td></tr> <tr><td>← 45</td><td>↑ 45</td></tr> <tr><td>269</td><td>197</td></tr> <tr><td>238</td><td>16</td></tr> <tr><td></td><td>33</td></tr> </table>	← 17	↑ 396	← 45	↑ 45	269	197	238	16		33		<table border="0"> <tr><td>← 85</td><td>↑ 50</td></tr> <tr><td>← 25</td><td>↑ 895</td></tr> <tr><td>← 42</td><td>↑ 191</td></tr> <tr><td>80</td><td>195</td></tr> <tr><td>857</td><td>38</td></tr> <tr><td>162</td><td>158</td></tr> </table>	← 85	↑ 50	← 25	↑ 895	← 42	↑ 191	80	195	857	38	162	158		<table border="0"> <tr><td>↑ 426</td></tr> <tr><td>↑ 356</td></tr> <tr><td>411</td></tr> <tr><td></td></tr> <tr><td>345</td></tr> </table>	↑ 426	↑ 356	411		345					
← 3	↑ 4																																																														
← 4	↑ 1402																																																														
← 66	↑ 33																																																														
1252	54																																																														
36	1																																																														
	33																																																														
← 54	↑ 17																																																														
← 22	↑ 179																																																														
26	↑ 17																																																														
129																																																															
	16																																																														
← 17	↑ 396																																																														
← 45	↑ 45																																																														
269	197																																																														
238	16																																																														
	33																																																														
← 85	↑ 50																																																														
← 25	↑ 895																																																														
← 42	↑ 191																																																														
80	195																																																														
857	38																																																														
162	158																																																														
↑ 426																																																															
↑ 356																																																															
411																																																															
345																																																															
16	Abrams Dr. & Grove Community Dr.	17	Abrams Dr. & Orange Terrace Pkwy.	18	Linebacker Dr. & Cactus Av.	19	Orange Terrace Pkwy. & Van Buren Blvd.	20	Brown St. & Alessandro Blvd.																																																						
	<table border="0"> <tr><td>↑ 121</td></tr> <tr><td>↑ 35</td></tr> <tr><td>91</td></tr> <tr><td>69</td></tr> <tr><td>66</td></tr> <tr><td>32</td></tr> </table>	↑ 121	↑ 35	91	69	66	32		<table border="0"> <tr><td>↑ 63</td></tr> <tr><td>↑ 169</td></tr> <tr><td>54</td></tr> <tr><td>113</td></tr> <tr><td>144</td></tr> <tr><td>52</td></tr> </table>	↑ 63	↑ 169	54	113	144	52		<table border="0"> <tr><td>↑ 168</td></tr> <tr><td>↑ 782</td></tr> <tr><td>↑ 169</td></tr> <tr><td>159</td></tr> <tr><td>756</td></tr> <tr><td>159</td></tr> </table>	↑ 168	↑ 782	↑ 169	159	756	159		<table border="0"> <tr><td>↑ 241</td></tr> <tr><td>↑ 1070</td></tr> <tr><td>↑ 32</td></tr> <tr><td>69</td></tr> <tr><td>36</td></tr> <tr><td>184</td></tr> <tr><td>84</td></tr> <tr><td>845</td></tr> <tr><td>49</td></tr> <tr><td>52</td></tr> <tr><td>46</td></tr> <tr><td>38</td></tr> </table>	↑ 241	↑ 1070	↑ 32	69	36	184	84	845	49	52	46	38		<table border="0"> <tr><td>↑ 31</td></tr> <tr><td>↑ 1211</td></tr> <tr><td>↑ 275</td></tr> <tr><td>33</td></tr> <tr><td>29</td></tr> <tr><td>36</td></tr> <tr><td>1050</td></tr> <tr><td>246</td></tr> <tr><td>241</td></tr> <tr><td>266</td></tr> </table>	↑ 31	↑ 1211	↑ 275	33	29	36	1050	246	241	266														
↑ 121																																																															
↑ 35																																																															
91																																																															
69																																																															
66																																																															
32																																																															
↑ 63																																																															
↑ 169																																																															
54																																																															
113																																																															
144																																																															
52																																																															
↑ 168																																																															
↑ 782																																																															
↑ 169																																																															
159																																																															
756																																																															
159																																																															
↑ 241																																																															
↑ 1070																																																															
↑ 32																																																															
69																																																															
36																																																															
184																																																															
84																																																															
845																																																															
49																																																															
52																																																															
46																																																															
38																																																															
↑ 31																																																															
↑ 1211																																																															
↑ 275																																																															
33																																																															
29																																																															
36																																																															
1050																																																															
246																																																															
241																																																															
266																																																															

Saturday Peak Hour Intersection Volumes

<p>21 Brown St. & Cactus Av.</p> <table border="1"> <tr> <td>← 518</td> <td>← 601</td> </tr> <tr> <td>507 →</td> <td></td> </tr> <tr> <td>567 →</td> <td></td> </tr> </table>	← 518	← 601	507 →		567 →		<p>22 Sycamore Canyon Blvd. & Eastridge Av.</p> <table border="1"> <tr> <td>← 30</td> <td>← 136</td> <td>← 115</td> <td>↑ 297</td> </tr> <tr> <td>39 →</td> <td>44 →</td> <td>304 →</td> <td>52</td> </tr> <tr> <td>66 →</td> <td>44 →</td> <td>304 →</td> <td>183</td> </tr> <tr> <td>16 ↓</td> <td></td> <td>68 →</td> <td></td> </tr> </table>	← 30	← 136	← 115	↑ 297	39 →	44 →	304 →	52	66 →	44 →	304 →	183	16 ↓		68 →		<p>23 Sycamore Canyon Blvd. & Cottonwood Av.</p> <table border="1"> <tr> <td>← 369</td> <td>← 15</td> <td>↑ 17</td> </tr> <tr> <td></td> <td></td> <td>4</td> </tr> <tr> <td></td> <td></td> <td>359 →</td> </tr> <tr> <td></td> <td></td> <td>6 →</td> </tr> </table>	← 369	← 15	↑ 17			4			359 →			6 →	<p>24 Meridian Pkwy. & Alessandro Blvd.</p> <table border="1"> <tr> <td>← 49</td> <td>← 167</td> <td>← 54</td> <td>↑ 83</td> </tr> <tr> <td>92 →</td> <td>1125 →</td> <td>91 ↓</td> <td>1261</td> </tr> <tr> <td></td> <td></td> <td></td> <td>77</td> </tr> <tr> <td></td> <td></td> <td></td> <td>164 →</td> </tr> <tr> <td></td> <td></td> <td></td> <td>149 →</td> </tr> <tr> <td></td> <td></td> <td></td> <td>40 →</td> </tr> </table>	← 49	← 167	← 54	↑ 83	92 →	1125 →	91 ↓	1261				77				164 →				149 →				40 →	<p>25 Meridian Pkwy. & Cactus Av.</p> <table border="1"> <tr> <td>← 48</td> <td>← 194</td> <td>← 115</td> <td>↑ 196</td> </tr> <tr> <td>56 →</td> <td>386 →</td> <td>171 ↓</td> <td>390</td> </tr> <tr> <td></td> <td></td> <td></td> <td>161</td> </tr> <tr> <td></td> <td></td> <td></td> <td>178 →</td> </tr> <tr> <td></td> <td></td> <td></td> <td>149 →</td> </tr> <tr> <td></td> <td></td> <td></td> <td>122 →</td> </tr> </table>	← 48	← 194	← 115	↑ 196	56 →	386 →	171 ↓	390				161				178 →				149 →				122 →								
← 518	← 601																																																																																													
507 →																																																																																														
567 →																																																																																														
← 30	← 136	← 115	↑ 297																																																																																											
39 →	44 →	304 →	52																																																																																											
66 →	44 →	304 →	183																																																																																											
16 ↓		68 →																																																																																												
← 369	← 15	↑ 17																																																																																												
		4																																																																																												
		359 →																																																																																												
		6 →																																																																																												
← 49	← 167	← 54	↑ 83																																																																																											
92 →	1125 →	91 ↓	1261																																																																																											
			77																																																																																											
			164 →																																																																																											
			149 →																																																																																											
			40 →																																																																																											
← 48	← 194	← 115	↑ 196																																																																																											
56 →	386 →	171 ↓	390																																																																																											
			161																																																																																											
			178 →																																																																																											
			149 →																																																																																											
			122 →																																																																																											
<p>26 Meridian Pkwy. & Van Buren Blvd.</p> <table border="1"> <tr> <td>← 454</td> <td>← 9</td> <td>← 91</td> <td>↑ 68</td> </tr> <tr> <td>278 →</td> <td>849 →</td> <td>6 ↓</td> <td>923</td> </tr> <tr> <td></td> <td></td> <td></td> <td>33</td> </tr> <tr> <td></td> <td></td> <td></td> <td>7 →</td> </tr> <tr> <td></td> <td></td> <td></td> <td>6 →</td> </tr> <tr> <td></td> <td></td> <td></td> <td>18 →</td> </tr> </table>	← 454	← 9	← 91	↑ 68	278 →	849 →	6 ↓	923				33				7 →				6 →				18 →	<p>27 Innovation Dr. & Cactus Av.</p> <table border="1"> <tr> <td>← 1</td> <td>← 1</td> <td>↑ 4</td> </tr> <tr> <td>1 →</td> <td>622 →</td> <td>1 ↓</td> </tr> <tr> <td></td> <td></td> <td></td> </tr> <tr> <td></td> <td></td> <td></td> </tr> <tr> <td></td> <td></td> <td></td> </tr> <tr> <td></td> <td></td> <td></td> </tr> </table>	← 1	← 1	↑ 4	1 →	622 →	1 ↓													<p>28 I-215 SB Ramps & Alessandro Blvd.</p> <table border="1"> <tr> <td>← 296</td> <td>← 125</td> <td>↑ 111</td> </tr> <tr> <td>832 →</td> <td>379 ↓</td> <td>1083</td> </tr> </table>	← 296	← 125	↑ 111	832 →	379 ↓	1083	<p>29 I-215 NB Ramps & Alessandro Blvd.</p> <table border="1"> <tr> <td>← 208</td> <td>← 755</td> <td>↑ 137</td> </tr> <tr> <td></td> <td></td> <td>875</td> </tr> <tr> <td></td> <td></td> <td></td> </tr> <tr> <td></td> <td></td> <td></td> </tr> <tr> <td></td> <td></td> <td></td> </tr> <tr> <td></td> <td></td> <td></td> </tr> </table>	← 208	← 755	↑ 137			875													<p>30 I-215 SB Ramps & Cactus Av.</p> <table border="1"> <tr> <td>← 286</td> <td>← 551</td> <td>← 105</td> <td>↑ 489</td> </tr> <tr> <td></td> <td></td> <td></td> <td>323</td> </tr> <tr> <td></td> <td></td> <td></td> <td></td> </tr> <tr> <td></td> <td></td> <td></td> <td></td> </tr> <tr> <td></td> <td></td> <td></td> <td></td> </tr> <tr> <td></td> <td></td> <td></td> <td></td> </tr> </table>	← 286	← 551	← 105	↑ 489				323																
← 454	← 9	← 91	↑ 68																																																																																											
278 →	849 →	6 ↓	923																																																																																											
			33																																																																																											
			7 →																																																																																											
			6 →																																																																																											
			18 →																																																																																											
← 1	← 1	↑ 4																																																																																												
1 →	622 →	1 ↓																																																																																												
← 296	← 125	↑ 111																																																																																												
832 →	379 ↓	1083																																																																																												
← 208	← 755	↑ 137																																																																																												
		875																																																																																												
← 286	← 551	← 105	↑ 489																																																																																											
			323																																																																																											
<p>31 I-215 NB Ramps & Cactus Av.</p> <table border="1"> <tr> <td>← 74</td> <td>← 1</td> <td>← 101</td> <td>↑ 109</td> </tr> <tr> <td>30 →</td> <td>606 →</td> <td>241 ↓</td> <td>1018</td> </tr> <tr> <td></td> <td></td> <td></td> <td></td> </tr> <tr> <td></td> <td></td> <td></td> <td></td> </tr> <tr> <td></td> <td></td> <td></td> <td></td> </tr> <tr> <td></td> <td></td> <td></td> <td></td> </tr> </table>	← 74	← 1	← 101	↑ 109	30 →	606 →	241 ↓	1018																	<p>32 I-215 SB Ramps & Van Buren Blvd.</p> <table border="1"> <tr> <td>← 491</td> <td>← 19</td> <td>↑ 538</td> </tr> <tr> <td>419 →</td> <td>564 ↓</td> <td>12</td> </tr> </table>	← 491	← 19	↑ 538	419 →	564 ↓	12	<p>33 I-215 NB Ramps & Van Buren Blvd.</p> <table border="1"> <tr> <td>← 423</td> <td>← 26</td> <td>↑ 538</td> </tr> <tr> <td>529 →</td> <td>15 ↓</td> <td>37 →</td> </tr> </table>	← 423	← 26	↑ 538	529 →	15 ↓	37 →	<p>34 Old 215 Frontage Rd. & Alessandro Blvd.</p> <table border="1"> <tr> <td>← 191</td> <td>← 108</td> <td>← 78</td> <td>↑ 86</td> </tr> <tr> <td>285 →</td> <td>748 →</td> <td>11 ↓</td> <td>688</td> </tr> <tr> <td></td> <td></td> <td></td> <td>10</td> </tr> <tr> <td></td> <td></td> <td></td> <td>21 →</td> </tr> <tr> <td></td> <td></td> <td></td> <td>88 →</td> </tr> <tr> <td></td> <td></td> <td></td> <td>12 →</td> </tr> </table>	← 191	← 108	← 78	↑ 86	285 →	748 →	11 ↓	688				10				21 →				88 →				12 →	<p>35 Day St. & Alessandro Blvd.</p> <table border="1"> <tr> <td>← 96</td> <td>← 41</td> <td>← 102</td> <td>↑ 121</td> </tr> <tr> <td>167 →</td> <td>581 →</td> <td>6 ↓</td> <td>611</td> </tr> <tr> <td></td> <td></td> <td></td> <td>8</td> </tr> <tr> <td></td> <td></td> <td></td> <td>9 →</td> </tr> <tr> <td></td> <td></td> <td></td> <td>83 →</td> </tr> <tr> <td></td> <td></td> <td></td> <td>13 →</td> </tr> </table>	← 96	← 41	← 102	↑ 121	167 →	581 →	6 ↓	611				8				9 →				83 →				13 →						
← 74	← 1	← 101	↑ 109																																																																																											
30 →	606 →	241 ↓	1018																																																																																											
← 491	← 19	↑ 538																																																																																												
419 →	564 ↓	12																																																																																												
← 423	← 26	↑ 538																																																																																												
529 →	15 ↓	37 →																																																																																												
← 191	← 108	← 78	↑ 86																																																																																											
285 →	748 →	11 ↓	688																																																																																											
			10																																																																																											
			21 →																																																																																											
			88 →																																																																																											
			12 →																																																																																											
← 96	← 41	← 102	↑ 121																																																																																											
167 →	581 →	6 ↓	611																																																																																											
			8																																																																																											
			9 →																																																																																											
			83 →																																																																																											
			13 →																																																																																											
<p>36 Elsworth St. & Cactus Av.</p> <table border="1"> <tr> <td>← 114</td> <td>← 15</td> <td>← 139</td> <td>↑ 116</td> </tr> <tr> <td>135 →</td> <td>941 →</td> <td>27 ↓</td> <td>940</td> </tr> <tr> <td></td> <td></td> <td></td> <td>12</td> </tr> <tr> <td></td> <td></td> <td></td> <td>19 →</td> </tr> <tr> <td></td> <td></td> <td></td> <td>10 →</td> </tr> <tr> <td></td> <td></td> <td></td> <td>8 →</td> </tr> </table>	← 114	← 15	← 139	↑ 116	135 →	941 →	27 ↓	940				12				19 →				10 →				8 →	<p>37 Frederick St. & Cactus Av.</p> <table border="1"> <tr> <td>← 75</td> <td>← 229</td> <td>↑ 144</td> </tr> <tr> <td>92 →</td> <td>1020 →</td> <td>1 ↓</td> </tr> <tr> <td></td> <td></td> <td></td> </tr> <tr> <td></td> <td></td> <td></td> </tr> <tr> <td></td> <td></td> <td></td> </tr> <tr> <td></td> <td></td> <td></td> </tr> </table>	← 75	← 229	↑ 144	92 →	1020 →	1 ↓													<p>38 Graham St./Riverside Dr. & Cactus Av.</p> <table border="1"> <tr> <td>← 61</td> <td>← 51</td> <td>← 56</td> <td>↑ 56</td> </tr> <tr> <td>49 →</td> <td>955 →</td> <td>151 ↓</td> <td>992</td> </tr> <tr> <td></td> <td></td> <td></td> <td>17</td> </tr> <tr> <td></td> <td></td> <td></td> <td>137 →</td> </tr> <tr> <td></td> <td></td> <td></td> <td>40 →</td> </tr> <tr> <td></td> <td></td> <td></td> <td>14 →</td> </tr> </table>	← 61	← 51	← 56	↑ 56	49 →	955 →	151 ↓	992				17				137 →				40 →				14 →	<p>## Saturday Peak Hour Intersection Volumes</p>																									
← 114	← 15	← 139	↑ 116																																																																																											
135 →	941 →	27 ↓	940																																																																																											
			12																																																																																											
			19 →																																																																																											
			10 →																																																																																											
			8 →																																																																																											
← 75	← 229	↑ 144																																																																																												
92 →	1020 →	1 ↓																																																																																												
← 61	← 51	← 56	↑ 56																																																																																											
49 →	955 →	151 ↓	992																																																																																											
			17																																																																																											
			137 →																																																																																											
			40 →																																																																																											
			14 →																																																																																											

TABLE 5-1: INTERSECTION ANALYSIS FOR E+P CONDITIONS

#	Intersection	Traffic Control ¹	Existing (2021)						E+P					
			Delay ^{2,3,4,5} (secs.)			Level of Service			Delay ^{2,3,4,5} (secs.)			Level of Service		
			AM	PM	SAT	AM	PM	SAT	AM	PM	SAT	AM	PM	SAT
1	Washington St. & Van Buren Blvd.	TS	40.4	39.7	22.8	D	D	C	41.8	45.0	23.5	D	D	C
2	Alessandro Blvd. & Arlington Av./Chicago Av.	TS	75.0	82.2	22.7	E	F	C	76.7	87.7	23.1	E	F	C
3	Canyon Crest Dr./Overlook Pkwy. & Alessandro Blvd.	TS	42.2	46.1	14.9	D	D	B	67.3	94.7	18.9	E	F	B
4	Wood Rd. & Van Buren Blvd.	TS	50.4	37.0	24.9	D	D	C	52.0	41.9	25.6	D	D	C
5	Trautwein Rd. & Alessandro Blvd.	TS	89.4	19.9	13.1	F	B	B	91.3	20.3	13.3	F	C	B
6	Trautwein Rd. & Grove Community Dr.	TS	22.1	10.4	12.4	C	B	B	22.1	10.4	12.4	C	B	B
7	Trautwein Rd. & Orange Terrace Pkwy.	TS	46.0	21.3	18.8	D	C	B	46.1	21.3	18.8	D	C	B
8	Trautwein Rd. & Van Buren Blvd.	TS	34.9	27.7	20.9	C	C	C	38.2	31.8	21.5	D	C	C
9	Deercreek Dr. & Grove Community Dr.	AWS	17.2	9.2	9.6	C	A	A	17.7	9.4	9.8	C	A	A
10	Deercreek Dr. & Orange Terrace Pkwy.	AWS	51.8	9.9	9.6	F	A	A	51.8	9.9	9.6	F	A	A
11	Barton St. & Alessandro Blvd.	TS	31.2	8.4	7.6	C	A	A	32.8	15.0	7.9	C	B	A
12	Barton St. & Grove Community Dr.	CSS	13.2	9.4	11.0	B	A	B	13.1	9.4	11.1	C	A	B
13	Barton St. & Orange Terrace Pkwy.	CSS	68.8	14.3	45.0	F	B	E	68.8	14.3	45.0	F	B	E
14	Barton St. & Van Buren Blvd.	TS	61.2	30.3	21.2	E	C	C	72.6	34.2	22.3	E	C	C
15	Airman Dr. & Cactus Av.	TS	Future Intersection						13.9	33.6	21.5	B	C	C
16	Abrams Dr. & Grove Community Dr.	AWS	10.9	8.5	8.4	B	A	A	11.4	8.9	8.5	B	A	A
17	Abrams Dr. & Orange Terrace Pkwy.	AWS	13.1	8.6	8.9	B	A	A	13.1	8.6	8.9	B	A	A
18	Linebacker Dr. & Cactus Av.	TS	Future Intersection						22.4	54.1	23.8	C	D	C
19	Orange Terrace Pkwy. & Van Buren Blvd.	TS	18.3	17.9	17.7	B	B	B	18.3	17.6	17.6	B	B	B
20	Brown St. & Alessandro Blvd.	TS	9.2	13.7	5.0	A	B	A	40.8	>200.0	>200.0	D	F	F
21	Brown St. & Cactus Av.	TS	Future Intersection						18.7	33.5	33.4	D	C	C
22	Sycamore Canyon Blvd. & Eastridge Av.	TS	28.2	19.8	17.4	C	B	B	28.0	20.1	17.4	C	C	B
23	Sycamore Canyon Blvd. & Cottonwood Av.	TS	9.3	7.0	5.8	A	A	A	8.8	7.0	5.8	A	A	A
24	Meridian Pkwy. & Alessandro Blvd.	TS	89.6	41.8	19.6	F	D	B	89.6	46.1	19.9	F	D	B
25	Meridian Pkwy. & Cactus Av.	TS	29.5	30.8	16.6	C	C	B	49.2	176.5	19.7	C	F	B
26	Meridian Pkwy. & Van Buren Blvd.	TS	15.4	26.3	12.9	B	C	B	19.1	33.3	14.8	B	C	B
27	Innovation Dr. & Cactus Av.	TS	6.3	8.3	4.5	A	A	A	6.3	8.7	4.1	A	A	A
28	I-215 SB Ramps & Alessandro Blvd.	TS	8.5	9.4	6.3	A	A	A	9.7	10.1	6.7	A	B	A
29	I-215 NB Ramps & Alessandro Blvd.	TS	81.6	20.7	22.4	F	C	C	104.1	29.4	28.2	F	C	C
30	I-215 SB Ramps & Cactus Av.	TS	4.7	5.9	5.2	A	A	A	5.2	16.3	5.6	A	B	A
31	I-215 NB Ramps & Cactus Av.	TS	59.0	19.9	7.0	E	B	A	90.3	59.1	7.9	F	E	A
32	I-215 SB Ramps & Van Buren Blvd.	TS	21.5	16.9	10.9	C	B	B	21.8	25.3	10.8	C	C	B
33	I-215 NB Ramps & Van Buren Blvd.	TS	6.4	6.1	4.2	A	A	A	6.4	6.1	4.2	A	A	A
34	Old 215 Frontage Rd. & Alessandro Blvd.	TS	37.9	19.3	17.8	D	B	B	38.5	19.6	18.0	D	B	B
35	Day St. & Alessandro Blvd.	TS	15.0	17.1	12.5	B	B	B	15.6	18.4	12.8	B	B	B
36	Elsworth St. & Cactus Av.	TS	94.0	75.0	42.6	F	E	D	100.5	90.4	43.5	F	F	D
37	Frederick St. & Cactus Av.	TS	26.0	12.8	9.9	C	B	A	26.9	13.6	10.1	C	B	B
38	Graham St./Riverside Dr. & Cactus Av.	TS	14.7	15.0	16.8	B	B	B	14.8	15.1	16.8	B	B	B

* **BOLD** = Significant Impact

¹ CSS = Cross-street Stop; AWS = All-Way Stop; TS = Traffic Signal; **TS** = Improvement

² For intersections within the jurisdiction of March JPA, deficient occurs (improvements needed) if the pre-project condition is at or better than LOS D (or acceptable LOS) and the project-generated traffic causes deterioration below acceptable levels. However, if the pre-project condition is already below LOS D (or acceptable LOS), provide improvements if the Project contributes more than 2% of the total traffic.

³ For intersections within the jurisdiction of the City of Riverside, deficient occurs (improvements needed) when the addition of project related trips causes either peak hour LOS to degrade from acceptable (LOS A through D) to unacceptable levels (LOS E/F) or the peak hour delay to increase as follows:

- LOS A/B = By 10.0 seconds
- LOS C = By 8.0 seconds
- LOS D = By 5.0 seconds
- LOS E = By 2.0 seconds
- LOS F = By 1.0 seconds

⁴ For intersections within the jurisdiction of Caltrans, or the County of Riverside, deficient occurs (improvements needed) if the pre-project condition is at or better than LOS D (or acceptable LOS) and the project-generated traffic causes deterioration below acceptable levels.

⁵ For intersections within the City of Moreno Valley, provide improvements if the pre-project condition is at or better than LOS D (or acceptable LOS) and the project-generated traffic causes deterioration below acceptable levels. If the pre-project condition is at unacceptable LOS and Project increases delay by 5.0 or more, provide improvements to offset the increase in delay.

5.4 ROADWAY SEGMENT ANALYSIS

The roadway segment capacities are approximate figures only and are used at the General Plan level to assist in determining the roadway functional classification (number of through lanes) needed to meet traffic demand. Table 5-2 provides a summary of the E+P conditions roadway segment capacity analysis based on the applicable roadway segment capacity thresholds. As shown on Table 5-2, the following additional study area roadway segments are anticipated to operate at an unacceptable LOS based on the applicable planning level daily roadway capacity thresholds, in addition to the segment identified under Existing (2021) traffic conditions:

- Cactus Av., from Airman Dr. to Linebacker Dr. (#6) – LOS F
- Cactus Av. from Linebacker Dr. to Brown St. (#7) – LOS E
- Cactus Av., from Brown St. to Meridian Pkwy. (#8) – LOS E
- Barton Rd. from Alessandro Bl. to Cactus Av. (#10) – LOS E
- Brown St., from Alessandro Bl. to Cactus Av. (#12) – LOS F
- Meridian Pkwy. from Cactus Av. to Van Buren Bl. (#15) – LOS F

TABLE 5-2: ROADWAY SEGMENT ANALYSIS FOR E+P CONDITIONS

#	Roadway	Segment Limits	Roadway Section	LOS Capacity ¹	Existing			E+P			Acceptable LOS
					2021	V/C ²	LOS ³	2021	V/C ²	LOS ³	
1	Alessandro Bl.	Trautwein Rd. to Mission Grove Pkwy.	6D	57,250	42,859	0.75	C	45,853	0.80	C	D
2		Mission Grove Pkwy. to Barton St.	6D	57,250	42,275	0.74	C	46,599	0.81	D	D
3		Barton St. to Brown St.	6D	57,250	42,360	0.74	C	46,352	0.81	D	D
4		Brown St. to Meridian Pkwy.	6D	57,250	41,193	0.72	C	46,221	0.81	D	D
5		Meridian Pkwy. to I-215 Freeway	6D	57,250	44,072	0.77	C	50,139	0.88	D	D
6	Cactus Av.	Airman Dr. to Linebacker Dr.	2U	13,000	0	0.00	A	28,912	2.22	F	D
7		Linebacker Dr. to Brown St.	4D	25,900	0	0.00	A	43,346	1.67	F	D
8		Brown St. to Meridian Pkwy.	4D	25,900	0	0.00	A	25,630	0.99	E	D
9		Meridian Pkwy. to I-215 Freeway	6D	51,150	19,011	0.37	A	35,627	0.70	B	D
10	Barton St.	Alessandro Bl. to Cactus Av. (EVA)	2U	13,000	1,995	0.15	A	12,227	0.94	E	D
11		Cactus Av. (EVA) to Grove Community Dr.	2U	13,000	775	0.06	A	1,107	0.09	A	D
12	Brown St.	Alessandro Bl. to Cactus Av.	2D	13,000	776	0.06	A	18,492	1.42	F	D
13	Sycamore Canyon Bl.	Cottonwood Av. to Alessandro Bl.	4D	33,000	13,151	0.40	A	13,919	0.42	A	D
14	Meridian Pkwy.	Alessandro Bl. to Cactus Av.	4D	25,900	23,605	0.91	E	25,411	0.98	E	D
15		Cactus Av. to Van Buren Bl.	4D	25,900	22,215	0.86	D	29,423	1.14	F	D

BOLD = LOS does not meet the applicable jurisdictional requirements (i.e., unacceptable LOS).

¹ These maximum roadway capacities are based on the applicable agency's thresholds.

² V/C = Volume to Capacity Ratio

³ LOS = Level of Service

5.5 TRAFFIC SIGNAL WARRANTS ANALYSIS

Based on the traffic signal warrant analysis for E+P traffic conditions, the following study area intersections are anticipated to meet planning level (ADT) volume-based traffic signal warrants in addition to the locations previously warranted under Existing traffic conditions (see Appendix 5.2):

- Airman Dr. & Cactus Av. (#15)
- Linebacker Dr. & Cactus Av. (#18)

5.6 OFF-RAMP QUEUING ANALYSIS

A queuing analysis was performed for the off-ramps at the I-215 Freeway at Alessandro Boulevard, Cactus Avenue, and Van Buren Boulevard interchanges, to assess vehicle queues for the off ramps that may potentially result in deficient peak hour operations at the ramp-to-arterial intersections and may potentially “spill back” onto the I-215 Freeway mainline. Queuing analysis findings are presented in Table 5-3. It is important to note that off-ramp lengths are consistent with the measured distance between the intersection and the freeway mainline. As shown in Table 5-3, there are no movements that are anticipated to experience queuing issues during the weekday AM or weekday PM peak 95th percentile traffic flows for E+P traffic conditions, consistent with Existing (2021) traffic conditions. Worksheets for E+P traffic conditions off-ramp queuing analysis are provided in Appendix 5.3.

5.7 DEFICIENCIES AND IMPROVEMENTS

5.7.1 IMPROVEMENTS TO ADDRESS DEFICIENCIES AT INTERSECTIONS

This section provides a summary of Project deficiencies and identified improvements. Based on the deficiency criteria discussed in Section 2.7 *Deficiency Criteria*, study area intersections were found to be deficient. The effectiveness of the improvement strategies presented in Table 5-4 address the E+P deficiencies as the recommendations improve the operations back to pre-project conditions (or better) or within the allowable net change in delay per the applicable deficiency criteria for each agency. Analysis worksheets, with improvements, for E+P traffic conditions are provided in Appendix 5.4.

5.7.2 IMPROVEMENTS TO ADDRESS DEFICIENCIES AT ROADWAY SEGMENT

Additional roadway widening for the deficient roadway segments has not been recommended as acceptable or improved peak hour traffic operations can be achieved with the existing lanes or with the improvements shown on Table 5-4.

5.7.3 IMPROVEMENTS TO ADDRESS DEFICIENCIES ON OFF-RAMP QUEUES

As shown previously in Table 5-3, there are no anticipated peak hour queuing issues at the I-215 Freeway off-ramps for E+P traffic conditions, consistent with Existing (2021) traffic conditions. As such, no improvements have been recommended.

TABLE 5-3: PEAK HOUR FREEWAY OFF-RAMP QUEUING SUMMARY FOR E+P CONDITIONS

Intersection	Movement ³	Available Stacking Distance (Feet) ³	Existing (2021)						E+P					
			95th Percentile Queue (Feet)			Acceptable? ¹			95th Percentile Queue (Feet)			Acceptable? ¹		
			AM Peak Hour	PM Peak Hour	SAT Peak Hour	AM	PM	SAT	AM Peak Hour	PM Peak Hour	PM Peak Hour	AM	PM	PM
I-215 SB Ramps & Alessandro Blvd. (#28)	SBL	525	132	191	68	Yes	Yes	Yes	126	204	68	Yes	Yes	Yes
	SBL/R	1,540	124	178	52	Yes	Yes	Yes	146	191	71	Yes	Yes	Yes
	SBR	525	118	166	48	Yes	Yes	Yes	136	177	66	Yes	Yes	Yes
I-215 NB Ramps & Alessandro Blvd. (#29)	NBL	450	572 ^{2 3}	342	155	Yes	Yes	Yes	735 ^{2 3}	420 ²	180	Yes	Yes	Yes
	NBL/T/R	1,345	520 ²	403 ²	158	Yes	Yes	Yes	687 ²	457 ²	189	Yes	Yes	Yes
	NBR	450	41	125	64	Yes	Yes	Yes	47	131	70	Yes	Yes	Yes
I-215 SB Ramps & Cactus Av. (#30)	SBR	1,115	155	157	0	Yes	Yes	Yes	842 ²	617 ²	0	Yes	Yes	Yes
	NBR	1,850	18	57	0	Yes	Yes	Yes	20 ²	58	38	Yes	Yes	Yes
I-215 NB Ramps & Cactus Av. (#31)	NBL	145	452 ^{2 3}	105	34	Yes	Yes	Yes	739 ^{2 3}	229 ^{2 3}	90	Yes	Yes	Yes
	NBT/R	1,650	432 ²	181	78	Yes	Yes	Yes	417 ²	181	51	Yes	Yes	Yes
I-215 SB Ramps & Van Buren Blvd.(#32)	SBL/T	1,510	38	121 ²	24	Yes	Yes	Yes	38	121 ²	24	Yes	Yes	Yes
	SBR	1,450	233	34	42	Yes	Yes	Yes	241	34	42	Yes	Yes	Yes
I-215 NB Ramps & Van Buren Blvd. (#33)	NBL	1,560	98	62	0	Yes	Yes	Yes	97	62	0	Yes	Yes	Yes
	NBR	580	2	0	0	Yes	Yes	Yes	2	2	0	Yes	Yes	Yes

¹ Stacking Distance is acceptable if the required stacking distance is less than or equal to the stacking distance provided. An additional 15 feet of stacking which is assumed to be provided in the transition for turn pockets is reflected in the stacking distance shown on this table, where applicable.

² 95th percentile volume exceeds capacity, queue may be longer. Queue shown is maximum after two cycles.

³ Although 95th percentile queue is anticipated to exceed the available storage for the turn lane, the adjacent lane has sufficient storage to accommodate any spillover without spilling back and affecting the I-215 Freeway mainline.

TABLE 5-4: INTERSECTION ANALYSIS FOR E+P CONDITIONS WITH IMPROVEMENTS

#	Intersection	Traffic Control ³	Intersection Approach Lanes ¹												Delay ² (secs.)			Level of Service						
			Northbound			Southbound			Eastbound			Westbound			AM	PM	SAT	AM	PM	SAT				
			L	T	R	L	T	R	L	T	R	L	T	R	L	T	R							
2	Alessandro Blvd. & Arlington Av./Chicago Av. ⁵ - Without Improvements	TS	2	2	1>	2	3	0	1	2	2>	2	2	1>	76.7	87.7	23.1	E	F	C				
3	Canyon Crest Dr./Overlook Pkwy. & Alessandro Blvd. - Without Improvements	TS	1	2	1	2	1	1	1	3	0	1	3	1>	67.3	94.7	18.9	E	F	B				
	- With Improvements	TS	1	2	1	<u>3</u>	1	<u>0</u>	1	3	0	1	3	1>	52.6	40.9	18.4	D	D	B				
14	Barton St. & Van Buren Blvd. - Without Improvements	TS	2	1	1	1	1	0	1	2	0	1	3	0	72.6	34.2	22.3	E	C	C				
	- With Improvements	TS	2	1	1	1	1	0	1	2	<u>1></u>	1	3	0	52.1	30.4	21.1	D	C	C				
20	Brown St. & Alessandro Blvd. ⁷ - Without Improvements	TS	1	1	1>	1	1	1>	1	3	0	1	3	1	40.8	>200.0	>200.0	D	F	F				
25	Meridian Pkwy. & Cactus Av. - Without Improvements	TS	2	2	1	2	2	1	1	2	1	2	2	1	49.2	176.5	19.7	C	F	B				
	- With Improvements ⁶	TS	2	2	1	2	2	1	1	<u>3</u>	<u>0</u>	2	2	<u>1></u>	33.2	71.2	22.7	C	E	C				
29	I-215 NB Ramps & Alessandro Blvd. - Without Improvements	TS	1	1	1	0	0	0	1	3	0	0	3	1	104.1	29.4	28.2	F	C	C				
	- With Improvements	TS	<u>2</u>	1	0	0	0	0	1	3	0	0	3	1	23.2	25.7	23.8	C	C	C				
31	I-215 NB Ramps & Cactus Av. - Without Improvements	TS	1	1	1	1	1	0	1	2	0	0	2	0	90.3	59.1	7.9	F	E	A				
	- With Improvements	TS	<u>2</u>	1	1	1	1	0	1	2	<u>1</u>	0	<u>3</u>	0	25.8	20.8	10.5	C	C	B				
36	Elsworth St. & Cactus Av. - Without Improvements	TS	1	1	0	1	1	1>	1	3	1>>	1	3	1	100.5	90.4	43.5	F	F	D				
	- With Improvements ⁷	TS	1	1	0	1	1	1>	1	3	1>>	1	3	1	34.7	27.8	18.1	C	C	B				

* **BOLD** = LOS does not meet the applicable jurisdictional requirements (i.e., unacceptable LOS).
¹ When a right turn is designated, the lane can either be striped or unstriped. To function as a right turn lane there must be sufficient width for right turning vehicles to travel outside the through lanes.
 L = Left; T = Through; R = Right; > = Right-Turn Overlap Phasing; >> = Free Right Turn Lane; 1 = Improvement
² Per the Highway Capacity Manual 6th Edition, overall average intersection delay and level of service are shown for intersections with a traffic signal or all way stop control. For intersections with cross street stop control, the delay and level of service for the worst individual movement (or movements sharing a single lane) are shown.
³ AWS = All-Way Stop; CSS = Cross-street Stop; TS = Traffic Signal
⁴ The two intersecting roadways are built to their ultimate width as designated in the General Plan. Based on recent comments and the jurisdiction's traffic study guidelines, infeasible improvements have not been recommended.
⁵ There are no feasible intersection improvements. As such, improvements have not been identified.
⁶ Recommended improvement is for a southbound shared left-through lane which can be accommodated through restriping (no additional pavement required).
⁷ Recommended improvements can be accommodated through implementing N/S from split phasing to protected left turn phasing. Lead-lag operations should be implemented for the northbound and southbound approaches to avoid conflicting left turns. Additionally, the northbound approach should be restriped to provide one left turn lane and one shared through-right turn lane; the southbound approach should be restriped to provide one left turn lane, one through lane, and one right turn lane.

6 EAP (2028) TRAFFIC CONDITIONS

This section discusses the traffic forecasts for EAP conditions and the resulting intersection operations, roadway segment analysis, traffic signal warrant, and freeway off-ramp queuing analyses.

6.1 ROADWAY IMPROVEMENTS

The lane configurations and traffic controls assumed to be in place for EAP conditions are consistent with those shown previously on Exhibit 3-1, with the exception of the following:

- Project driveways and those facilities assumed to be constructed by the Project to provide site access are also assumed to be in place for EAP conditions only (e.g., intersection and roadway improvements at the Project's frontage and driveways).

6.2 EXISTING PLUS AMBIENT GROWTH PLUS PROJECT (EAP) TRAFFIC VOLUME FORECASTS

This scenario includes Existing traffic volumes plus ambient growth (14.87%) plus Project traffic. The ADT and weekday AM and PM peak hour intersection turning movement volumes which can be expected for EAP traffic conditions are shown on Exhibit 6-1. The weekend Saturday peak hour intersection turning movement volumes for EAP traffic conditions are shown on Exhibit 6-2.

6.3 INTERSECTION OPERATIONS ANALYSIS

EAP peak hour traffic operations have been evaluated for the study area intersections based on the analysis methodologies presented in Section 2 *Methodologies* of this TA. The intersection analysis results are summarized in Table 6-1 for EAP traffic conditions, which indicates that the following additional study area intersections are anticipated to operate at an unacceptable LOS during the peak hours, in addition to intersections previously identified under Existing (2021) conditions:

- Washington St. & Van Buren Bl. (#1) – LOS E AM and PM peak hours
- Canyon Crest Dr./Overlook Pkwy. & Alessandro Bl. (#3) – LOS E AM peak hour; LOS F PM peak hour
- Wood Rd. & Van Buren Bl. (#4) – LOS E AM and PM peak hours
- Trautwein Rd. & Orange Terrace Pkwy. (#7) – LOS E AM peak hour only
- Trautwein Rd. & Van Buren Bl. (#8) – LOS E AM peak hour only
- Brown St. & Alessandro Bl. (#20) – LOS F PM and Saturday peak hours
- Meridian Pkwy. & Cactus Av. (#25) – LOE E AM peak hour; LOS F PM peak hour

The intersection operations analysis worksheets for EAP traffic conditions are included in Appendix 6.1.

EXHIBIT 6-1: EAP (2028) WEEKDAY TRAFFIC VOLUMES

<p>1 Washington St. & Van Buren Blvd.</p> <p>19,700 71(105) ↓ 202(397) ↓ 387(571) ↓ 151(153) ↓ 1157(1485) ↓ 137(91) ↓ 156(113) ↑ 585(276) ↑ 158(122) ↑ 40,750 12,250 31,400</p>	<p>2 Alessandro Blvd. & Arlington Av./Chicago Av.</p> <p>39,300 48(23) ↓ 712(1882) ↓ 259(559) ↓ 47(28) ↓ 564(839) ↓ 708(1174) ↓ 370(241) ↑ 932(754) ↑ 234(622) ↑ 1416(947) ↑ 1756(1212) ↑ 523(309) ↑ 33,100 61,200 37,500</p>	<p>3 Canyon Crest Dr. & Alessandro Blvd.</p> <p>17,100 57(26) ↓ 83(65) ↓ 515(628) ↓ 43(60) ↓ 1508(3246) ↓ 14(27) ↓ 1167(688) ↑ 3577(2416) ↑ 28(23) ↑ 9(39) ↑ 35(151) ↑ 11(57) ↑ 74,900 3,700 61,700</p>	<p>4 Wood Rd. & Van Buren Blvd.</p> <p>11,250 186(212) ↓ 478(277) ↓ 96(94) ↓ 168(176) ↓ 1021(1542) ↓ 364(226) ↓ 117(94) ↑ 1336(1474) ↑ 512(290) ↑ 371(327) ↑ 478(272) ↑ 350(231) ↑ 37,250 16,200 39,550</p>	<p>5 Trautwein Rd. & Alessandro Blvd.</p> <p>52,250 3515(2378) ↑ 180(269) ↑ 1280(2125) ↓ 4(20) ↓ 2121(1026) ↓ 8(13) ↓ 14,100</p>
<p>6 Trautwein Rd. & Grove Community Dr.</p> <p>31,300 1001(1563) ↓ 237(422) ↓ 694(266) ↑ 86(56) ↑ 1641(896) ↑ 26(60) ↑ 8,000 25,650 25,200</p>	<p>7 Trautwein Rd. & Orange Terrace Pkwy.</p> <p>25,950 23(46) ↓ 666(1206) ↓ 439(383) ↓ 77(52) ↓ 73(53) ↓ 14(14) ↓ 557(188) ↑ 114(28) ↑ 331(170) ↑ 56(35) ↑ 1119(822) ↑ 275(239) ↑ 10,200 23,950 2,200</p>	<p>8 Trautwein Rd. & Van Buren Blvd.</p> <p>22,650 260(247) ↓ 378(584) ↓ 202(330) ↓ 346(364) ↓ 1117(1172) ↓ 106(115) ↓ 382(285) ↑ 1424(1329) ↑ 171(184) ↑ 247(102) ↑ 615(326) ↑ 140(70) ↑ 35,600 14,650 35,200</p>	<p>9 Deercreek Dr. & Grove Community Dr.</p> <p>4,950 377(176) ↑ 57(25) ↑ 118(242) ↓ 90(21) ↓ 233(31) ↓ 35(41) ↓ 1,150</p>	<p>10 Deercreek Dr. & Orange Terrace Pkwy.</p> <p>1,700 42(22) ↓ 35(9) ↓ 94(31) ↓ 252(49) ↓ 481(484) ↓ 47(17) ↓ 58(53) ↑ 620(272) ↑ 4(4) ↑ 179(21) ↑ 179(21) ↑ 7(2) ↑ 550</p>
<p>11 Barton St. & Alessandro Blvd.</p> <p>350 9(14) ↓ 4(10) ↓ 7(6) ↓ 1668(2248) ↓ 51(55) ↓ 6(3) ↑ 2915(2620) ↑ 41(77) ↑ 86(78) ↑ 1(1) ↑ 55(38) ↑ 52,650 2,600 52,900</p>	<p>12 Barton St. & Grove Community Dr.</p> <p>1,200 11(54) ↓ 5(2) ↓ 39(45) ↓ 114(239) ↓ 15(23) ↑ 423(146) ↑ 25(17) ↑ 8(48) ↑ 4,650 650 4,700</p>	<p>13 Barton St. & Orange Terrace Pkwy.</p> <p>650 25(17) ↓ 308(425) ↓ 273(92) ↓ 455(254) ↑ 51(47) ↑ 226(75) ↑ 8(48) ↑ 38(45) ↑ 7,750 3,250 8,500</p>	<p>14 Barton St. & Van Buren Blvd.</p> <p>4,550 320(94) ↓ 109(31) ↓ 77(35) ↓ 155(115) ↓ 1301(1351) ↓ 120(250) ↓ 36(85) ↑ 1454(1520) ↑ 296(341) ↑ 411(240) ↑ 83(70) ↑ 421(261) ↑ 37,950 12,650 37,750</p>	<p>15 Airman Dr. & Cactus Av.</p> <p>15,900 133(902) ↓ 443(379) ↑ 331(305) ↑ 99(696) ↑ 13,000</p>
<p>16 Abrams Dr. & Grove Community Dr.</p> <p>4,150 270(97) ↑ 106(40) ↑ 66(212) ↓ 59(70) ↓ 155(56) ↑ 70(66) ↑ 2,300</p>	<p>17 Abrams Dr. & Orange Terrace Pkwy.</p> <p>2,350 120(42) ↓ 84(28) ↓ 129(130) ↓ 185(320) ↓ 100(37) ↑ 346(229) ↑ 6,100</p>	<p>18 Linebacker Dr. & Cactus Av.</p> <p>7,200 84(502) ↓ 277(182) ↑ 774(684) ↑ 277(183) ↑ 232(1598) ↓ 84(503) ↑ 7,200</p>	<p>19 Orange Terrace Pkwy. & Van Buren Blvd.</p> <p>7,150 245(110) ↓ 29(34) ↓ 268(123) ↓ 155(142) ↓ 1580(1522) ↓ 47(88) ↓ 143(230) ↑ 1445(1739) ↑ 40(54) ↑ 43(68) ↑ 18(34) ↑ 36(43) ↑ 39,150 3,400 38,750</p>	<p>20 Brown St. & Alessandro Blvd.</p> <p>2,750 18(78) ↓ 1(1) ↓ 33(124) ↓ 35(30) ↓ 1509(2177) ↓ 155(191) ↓ 57(33) ↑ 2725(2060) ↑ 207(224) ↑ 0(2) ↑ 63(471) ↑ 18,600</p>

###(###) AM(PM) Peak Hour Intersection Volumes
 ## Average Daily Trips

21 Brown St. & Cactus Av. 17,700 344(400) 102(815) → 299(1787) → 43,350	22 Sycamore Canyon Blvd. & Eastridge Av. 25,650 983(649) 3,650	23 Sycamore Canyon Blvd. & Cottonwood Av. 15,800 298(666) 65(36) 26(11) 15(28) 995(869) 23(26) 1,000 15,850	24 Meridian Pkwy. & Alessandro Blvd. 22,450 145(292) 161(582) 100(144) 161(150) 1163(2006) → 280(617) 614(449) 2422(1871) 139(359) 672(509) 681(505) 82(163) 56,700 28,900	25 Meridian Pkwy. & Cactus Av. 28,150 79(52) 161(965) 158(572) 26(145) 202(1161) → 83(530) 1016(571) 661(433) 419(799) 282(186) 421(377) 240(254) 38,450 32,750
26 Meridian Pkwy. & Van Buren Blvd. 22,050 420(1100) 6(15) 77(1070) 687(448) → 1317(1496) 3(1) 222(121) 1519(1061) 53(8) 4(13) 1(16) 4(38) 40,250 950	27 Innovation Dr. & Cactus Av. 800 3(15) 5(3) 578(1978) 18(6) 5(40) 53(15) 2086(1762) 125(56) 8(26) 23(75) 41,650 1,750	28 I-215 SB Ramps & Alessandro Blvd. 10,550 409(531) 197(356) 164(70) 2767(2148) 922(1769) → 422(544) ↓ 46,500 5,000	29 I-215 NB Ramps & Alessandro Blvd. 3,550 97(231) → 1023(1894) → 1392(1037) 0(13) 182(310) 89(129) 1539(1181) 37,650 14,800	30 I-215 SB Ramps & Cactus Av. 8,200 618(543) 533(1690) → 73(402) ↓ 1645(1290) 665(556) 717(627) → 42,850 16,000
31 I-215 NB Ramps & Cactus Av. 8,800 155(199) 0(3) 56(191) 32(105) → 1470(1725) → 170(749) ↓ 158(185) 2792(1961) 464(224) → 335(250) → 13(4) 38,400 11,100	32 I-215 SB Ramps & Van Buren Blvd. 3,500 826(221) 25(98) 25(13) 1109(963) 3(3) 582(510) → 777(1972) → 16,250 21,550	33 I-215 NB Ramps & Van Buren Blvd. 950 72(47) ↓ 37(5) → 641(571) ↓ 1109(872) → 5(5) 30(24) 350 15,350	34 Old 215 Frontage Rd. & Alessandro Blvd. 13,450 254(202) 74(243) 26(126) 372(364) ↓ 1059(1693) → 48(111) ↓ 126(121) 1487(1042) 11(15) 59(36) 305(212) 22(15) 31,900 6,700	35 Day St. & Alessandro Blvd. 12,050 95(136) 44(152) 89(231) 167(266) ↓ 741(1624) ↓ 11(24) ↓ 142(199) 1339(970) 11(14) 12(17) 178(154) 19(13) 32,350 3,950
36 Elsworth St. & Cactus Av. 8,900 206(224) 66(15) 94(231) 213(209) → 1578(2239) → 330(30) ↓ 138(95) 1959(1405) 79(17) 26(219) 12(73) 18(85) 42,750 4,600	37 Frederick St. & Cactus Av. 12,300 130(218) 222(273) ↓ 1385(2253) → 165(176) 1959(1405) 42,750	38 Graham St./Riverside Dr. & Cactus Av. 5,500 132(114) 52(101) 96(142) 71(116) ↓ 1340(2448) ↓ 184(406) ↓ 102(94) 2218(1486) 11(19) 0(1) 40,850 5,150	###(##) AM(PM) Peak Hour Intersection Volumes ## Average Daily Trips	

EXHIBIT 6-2: EAP (2028) WEEKEND TRAFFIC VOLUMES

<p>1 Washington St. & Van Buren Blvd.</p> <table border="1"> <tr> <td>← 83</td> <td>↑ 234</td> </tr> <tr> <td>← 191</td> <td>↑ 851</td> </tr> <tr> <td>← 332</td> <td>↑ 122</td> </tr> <tr> <td>126 ↓</td> <td>146 →</td> </tr> <tr> <td>877 ↓</td> <td>219 →</td> </tr> <tr> <td>78 ↓</td> <td>139 →</td> </tr> </table>	← 83	↑ 234	← 191	↑ 851	← 332	↑ 122	126 ↓	146 →	877 ↓	219 →	78 ↓	139 →	<p>2 Alessandro Blvd. & Arlington Av./Chicago Av.</p> <table border="1"> <tr> <td>← 31</td> <td>↑ 185</td> </tr> <tr> <td>← 879</td> <td>↑ 485</td> </tr> <tr> <td>← 244</td> <td>↑ 202</td> </tr> <tr> <td>24 ↓</td> <td>724 →</td> </tr> <tr> <td>363 ↓</td> <td>767 →</td> </tr> <tr> <td>591 ↓</td> <td>199 →</td> </tr> </table>	← 31	↑ 185	← 879	↑ 485	← 244	↑ 202	24 ↓	724 →	363 ↓	767 →	591 ↓	199 →	<p>3 Canyon Crest Dr. & Alessandro Blvd.</p> <table border="1"> <tr> <td>← 21</td> <td>↑ 451</td> </tr> <tr> <td>← 57</td> <td>↑ 1570</td> </tr> <tr> <td>← 349</td> <td>↑ 25</td> </tr> <tr> <td>38 ↓</td> <td>19 →</td> </tr> <tr> <td>1443 ↓</td> <td>55 →</td> </tr> <tr> <td>23 ↓</td> <td>29 →</td> </tr> </table>	← 21	↑ 451	← 57	↑ 1570	← 349	↑ 25	38 ↓	19 →	1443 ↓	55 →	23 ↓	29 →	<p>4 Wood Rd. & Van Buren Blvd.</p> <table border="1"> <tr> <td>← 155</td> <td>↑ 75</td> </tr> <tr> <td>← 163</td> <td>↑ 1058</td> </tr> <tr> <td>← 131</td> <td>↑ 194</td> </tr> <tr> <td>137 ↓</td> <td>184 →</td> </tr> <tr> <td>1098 ↓</td> <td>140 →</td> </tr> <tr> <td>187 ↓</td> <td>124 →</td> </tr> </table>	← 155	↑ 75	← 163	↑ 1058	← 131	↑ 194	137 ↓	184 →	1098 ↓	140 →	187 ↓	124 →	<p>5 Trautwein Rd. & Alessandro Blvd.</p> <table border="1"> <tr> <td>↑ 1385</td> </tr> <tr> <td>↑ 195</td> </tr> <tr> <td>1179 ↓</td> </tr> <tr> <td>9 ↓</td> </tr> <tr> <td>821 →</td> </tr> <tr> <td>11 →</td> </tr> </table>	↑ 1385	↑ 195	1179 ↓	9 ↓	821 →	11 →
← 83	↑ 234																																																									
← 191	↑ 851																																																									
← 332	↑ 122																																																									
126 ↓	146 →																																																									
877 ↓	219 →																																																									
78 ↓	139 →																																																									
← 31	↑ 185																																																									
← 879	↑ 485																																																									
← 244	↑ 202																																																									
24 ↓	724 →																																																									
363 ↓	767 →																																																									
591 ↓	199 →																																																									
← 21	↑ 451																																																									
← 57	↑ 1570																																																									
← 349	↑ 25																																																									
38 ↓	19 →																																																									
1443 ↓	55 →																																																									
23 ↓	29 →																																																									
← 155	↑ 75																																																									
← 163	↑ 1058																																																									
← 131	↑ 194																																																									
137 ↓	184 →																																																									
1098 ↓	140 →																																																									
187 ↓	124 →																																																									
↑ 1385																																																										
↑ 195																																																										
1179 ↓																																																										
9 ↓																																																										
821 →																																																										
11 →																																																										
<p>6 Trautwein Rd. & Grove Community Dr.</p> <table border="1"> <tr> <td>← 702</td> <td>↑ 426</td> </tr> <tr> <td>← 383</td> <td>↑ 114</td> </tr> <tr> <td>785 →</td> <td>91 →</td> </tr> </table>	← 702	↑ 426	← 383	↑ 114	785 →	91 →	<p>7 Trautwein Rd. & Orange Terrace Pkwy.</p> <table border="1"> <tr> <td>← 22</td> <td>↑ 176</td> </tr> <tr> <td>← 675</td> <td>↑ 13</td> </tr> <tr> <td>← 218</td> <td>↑ 177</td> </tr> <tr> <td>34 ↓</td> <td>37 →</td> </tr> <tr> <td>20 ↓</td> <td>649 →</td> </tr> <tr> <td>22 ↓</td> <td>163 →</td> </tr> </table>	← 22	↑ 176	← 675	↑ 13	← 218	↑ 177	34 ↓	37 →	20 ↓	649 →	22 ↓	163 →	<p>8 Trautwein Rd. & Van Buren Blvd.</p> <table border="1"> <tr> <td>← 248</td> <td>↑ 188</td> </tr> <tr> <td>← 235</td> <td>↑ 939</td> </tr> <tr> <td>← 176</td> <td>↑ 134</td> </tr> <tr> <td>347 ↓</td> <td>106 →</td> </tr> <tr> <td>877 ↓</td> <td>263 →</td> </tr> <tr> <td>80 ↓</td> <td>66 →</td> </tr> </table>	← 248	↑ 188	← 235	↑ 939	← 176	↑ 134	347 ↓	106 →	877 ↓	263 →	80 ↓	66 →	<p>9 Deercreek Dr. & Grove Community Dr.</p> <table border="1"> <tr> <td>↑ 230</td> </tr> <tr> <td>↑ 68</td> </tr> <tr> <td>158 ↓</td> </tr> <tr> <td>16 ↓</td> </tr> <tr> <td>57 →</td> </tr> <tr> <td>52 →</td> </tr> </table>	↑ 230	↑ 68	158 ↓	16 ↓	57 →	52 →	<p>10 Deercreek Dr. & Orange Terrace Pkwy.</p> <table border="1"> <tr> <td>↑ 57</td> </tr> <tr> <td>↑ 307</td> </tr> <tr> <td>↑ 9</td> </tr> <tr> <td>59 ↓</td> </tr> <tr> <td>6 ↓</td> </tr> <tr> <td>54 ↓</td> </tr> <tr> <td>234 ↓</td> </tr> <tr> <td>9 ↓</td> </tr> <tr> <td>28 →</td> </tr> <tr> <td>28 →</td> </tr> <tr> <td>5 →</td> </tr> </table>	↑ 57	↑ 307	↑ 9	59 ↓	6 ↓	54 ↓	234 ↓	9 ↓	28 →	28 →	5 →							
← 702	↑ 426																																																									
← 383	↑ 114																																																									
785 →	91 →																																																									
← 22	↑ 176																																																									
← 675	↑ 13																																																									
← 218	↑ 177																																																									
34 ↓	37 →																																																									
20 ↓	649 →																																																									
22 ↓	163 →																																																									
← 248	↑ 188																																																									
← 235	↑ 939																																																									
← 176	↑ 134																																																									
347 ↓	106 →																																																									
877 ↓	263 →																																																									
80 ↓	66 →																																																									
↑ 230																																																										
↑ 68																																																										
158 ↓																																																										
16 ↓																																																										
57 →																																																										
52 →																																																										
↑ 57																																																										
↑ 307																																																										
↑ 9																																																										
59 ↓																																																										
6 ↓																																																										
54 ↓																																																										
234 ↓																																																										
9 ↓																																																										
28 →																																																										
28 →																																																										
5 →																																																										
<p>11 Barton St. & Alessandro Blvd.</p> <table border="1"> <tr> <td>← 3</td> <td>↑ 5</td> </tr> <tr> <td>← 5</td> <td>↑ 1596</td> </tr> <tr> <td>← 5</td> <td>↑ 76</td> </tr> <tr> <td>1423 ↓</td> <td>61 →</td> </tr> <tr> <td>40 ↓</td> <td>1 →</td> </tr> <tr> <td></td> <td>38 →</td> </tr> </table>	← 3	↑ 5	← 5	↑ 1596	← 5	↑ 76	1423 ↓	61 →	40 ↓	1 →		38 →	<p>12 Barton St. & Grove Community Dr.</p> <table border="1"> <tr> <td>← 61</td> <td>↑ 20</td> </tr> <tr> <td>← 25</td> <td>↑ 206</td> </tr> <tr> <td>← 17</td> <td>↑ 17</td> </tr> <tr> <td>29 ↓</td> <td></td> </tr> <tr> <td>148 ↓</td> <td></td> </tr> <tr> <td></td> <td>16 →</td> </tr> </table>	← 61	↑ 20	← 25	↑ 206	← 17	↑ 17	29 ↓		148 ↓			16 →	<p>13 Barton St. & Orange Terrace Pkwy.</p> <table border="1"> <tr> <td>← 17</td> <td>↑ 455</td> </tr> <tr> <td>← 51</td> <td>↑ 51</td> </tr> <tr> <td>308 ↓</td> <td>226 →</td> </tr> <tr> <td>273 ↓</td> <td>16 →</td> </tr> <tr> <td></td> <td>38 →</td> </tr> </table>	← 17	↑ 455	← 51	↑ 51	308 ↓	226 →	273 ↓	16 →		38 →	<p>14 Barton St. & Van Buren Blvd.</p> <table border="1"> <tr> <td>← 98</td> <td>↑ 55</td> </tr> <tr> <td>← 29</td> <td>↑ 1016</td> </tr> <tr> <td>← 46</td> <td>↑ 217</td> </tr> <tr> <td>92 ↓</td> <td>224 →</td> </tr> <tr> <td>972 ↓</td> <td>44 →</td> </tr> <tr> <td>186 ↓</td> <td>179 →</td> </tr> </table>	← 98	↑ 55	← 29	↑ 1016	← 46	↑ 217	92 ↓	224 →	972 ↓	44 →	186 ↓	179 →	<p>15 Airman Dr. & Cactus Av.</p> <table border="1"> <tr> <td>↑ 426</td> </tr> <tr> <td>↑ 356</td> </tr> <tr> <td>411 ↓</td> </tr> <tr> <td>345 →</td> </tr> </table>	↑ 426	↑ 356	411 ↓	345 →				
← 3	↑ 5																																																									
← 5	↑ 1596																																																									
← 5	↑ 76																																																									
1423 ↓	61 →																																																									
40 ↓	1 →																																																									
	38 →																																																									
← 61	↑ 20																																																									
← 25	↑ 206																																																									
← 17	↑ 17																																																									
29 ↓																																																										
148 ↓																																																										
	16 →																																																									
← 17	↑ 455																																																									
← 51	↑ 51																																																									
308 ↓	226 →																																																									
273 ↓	16 →																																																									
	38 →																																																									
← 98	↑ 55																																																									
← 29	↑ 1016																																																									
← 46	↑ 217																																																									
92 ↓	224 →																																																									
972 ↓	44 →																																																									
186 ↓	179 →																																																									
↑ 426																																																										
↑ 356																																																										
411 ↓																																																										
345 →																																																										
<p>16 Abrams Dr. & Grove Community Dr.</p> <table border="1"> <tr> <td>↑ 136</td> </tr> <tr> <td>↑ 40</td> </tr> <tr> <td>102 ↓</td> </tr> <tr> <td>79 ↓</td> </tr> <tr> <td>76 →</td> </tr> <tr> <td>37 →</td> </tr> </table>	↑ 136	↑ 40	102 ↓	79 ↓	76 →	37 →	<p>17 Abrams Dr. & Orange Terrace Pkwy.</p> <table border="1"> <tr> <td>← 62</td> <td>↑ 72</td> </tr> <tr> <td>← 60</td> <td>↑ 194</td> </tr> <tr> <td>130 ↓</td> <td></td> </tr> <tr> <td>165 ↓</td> <td></td> </tr> </table>	← 62	↑ 72	← 60	↑ 194	130 ↓		165 ↓		<p>18 Linebacker Dr. & Cactus Av.</p> <table border="1"> <tr> <td>← 159</td> <td>↑ 168</td> </tr> <tr> <td>← 782</td> <td>↑ 169</td> </tr> <tr> <td>756 ↓</td> <td></td> </tr> <tr> <td></td> <td>159 →</td> </tr> </table>	← 159	↑ 168	← 782	↑ 169	756 ↓			159 →	<p>19 Orange Terrace Pkwy. & Van Buren Blvd.</p> <table border="1"> <tr> <td>← 79</td> <td>↑ 277</td> </tr> <tr> <td>← 41</td> <td>↑ 1213</td> </tr> <tr> <td>← 211</td> <td>↑ 37</td> </tr> <tr> <td>96 ↓</td> <td>60 →</td> </tr> <tr> <td>953 ↓</td> <td>53 →</td> </tr> <tr> <td>56 ↓</td> <td>44 →</td> </tr> </table>	← 79	↑ 277	← 41	↑ 1213	← 211	↑ 37	96 ↓	60 →	953 ↓	53 →	56 ↓	44 →	<p>20 Brown St. & Alessandro Blvd.</p> <table border="1"> <tr> <td>↑ 36</td> </tr> <tr> <td>↑ 1413</td> </tr> <tr> <td>↑ 275</td> </tr> <tr> <td>38 ↓</td> </tr> <tr> <td>33 ↓</td> </tr> <tr> <td>41 ↓</td> </tr> <tr> <td>1228 ↓</td> </tr> <tr> <td>246 ↓</td> </tr> <tr> <td>241 →</td> </tr> <tr> <td>266 →</td> </tr> </table>	↑ 36	↑ 1413	↑ 275	38 ↓	33 ↓	41 ↓	1228 ↓	246 ↓	241 →	266 →										
↑ 136																																																										
↑ 40																																																										
102 ↓																																																										
79 ↓																																																										
76 →																																																										
37 →																																																										
← 62	↑ 72																																																									
← 60	↑ 194																																																									
130 ↓																																																										
165 ↓																																																										
← 159	↑ 168																																																									
← 782	↑ 169																																																									
756 ↓																																																										
	159 →																																																									
← 79	↑ 277																																																									
← 41	↑ 1213																																																									
← 211	↑ 37																																																									
96 ↓	60 →																																																									
953 ↓	53 →																																																									
56 ↓	44 →																																																									
↑ 36																																																										
↑ 1413																																																										
↑ 275																																																										
38 ↓																																																										
33 ↓																																																										
41 ↓																																																										
1228 ↓																																																										
246 ↓																																																										
241 →																																																										
266 →																																																										

Saturday Peak Hour Intersection Volumes

<p>21 Brown St. & Cactus Av.</p> <table border="1"> <tr> <td>← 518</td> <td>↑ 601</td> </tr> <tr> <td>507 ↓</td> <td></td> </tr> <tr> <td>567 →</td> <td></td> </tr> </table>	← 518	↑ 601	507 ↓		567 →		<p>22 Sycamore Canyon Blvd. & Eastridge Av.</p> <table border="1"> <tr> <td>← 34</td> <td>↑ 341</td> </tr> <tr> <td>← 154</td> <td>↑ 60</td> </tr> <tr> <td>← 132</td> <td>↑ 210</td> </tr> <tr> <td>45 ↓</td> <td>↑ 51</td> </tr> <tr> <td>76 ↓</td> <td>↑ 347</td> </tr> <tr> <td>18 ↓</td> <td>↑ 78</td> </tr> </table>	← 34	↑ 341	← 154	↑ 60	← 132	↑ 210	45 ↓	↑ 51	76 ↓	↑ 347	18 ↓	↑ 78	<p>23 Sycamore Canyon Blvd. & Cottonwood Av.</p> <table border="1"> <tr> <td>← 421</td> <td>↑ 20</td> </tr> <tr> <td>← 17</td> <td>↑ 5</td> </tr> <tr> <td></td> <td>↑ 410</td> </tr> <tr> <td></td> <td>↑ 7</td> </tr> </table>	← 421	↑ 20	← 17	↑ 5		↑ 410		↑ 7	<p>24 Meridian Pkwy. & Alessandro Blvd.</p> <table border="1"> <tr> <td>← 56</td> <td>↑ 95</td> </tr> <tr> <td>← 189</td> <td>↑ 1430</td> </tr> <tr> <td>← 62</td> <td>↑ 85</td> </tr> <tr> <td>106 ↓</td> <td>↑ 188</td> </tr> <tr> <td>1274 ↓</td> <td>↑ 169</td> </tr> <tr> <td>105 ↓</td> <td>↑ 42</td> </tr> </table>	← 56	↑ 95	← 189	↑ 1430	← 62	↑ 85	106 ↓	↑ 188	1274 ↓	↑ 169	105 ↓	↑ 42	<p>25 Meridian Pkwy. & Cactus Av.</p> <table border="1"> <tr> <td>← 49</td> <td>↑ 225</td> </tr> <tr> <td>← 223</td> <td>↑ 391</td> </tr> <tr> <td>← 132</td> <td>↑ 185</td> </tr> <tr> <td>58 ↓</td> <td>↑ 178</td> </tr> <tr> <td>390 ↓</td> <td>↑ 171</td> </tr> <tr> <td>172 ↓</td> <td>↑ 140</td> </tr> </table>	← 49	↑ 225	← 223	↑ 391	← 132	↑ 185	58 ↓	↑ 178	390 ↓	↑ 171	172 ↓	↑ 140		
← 518	↑ 601																																																							
507 ↓																																																								
567 →																																																								
← 34	↑ 341																																																							
← 154	↑ 60																																																							
← 132	↑ 210																																																							
45 ↓	↑ 51																																																							
76 ↓	↑ 347																																																							
18 ↓	↑ 78																																																							
← 421	↑ 20																																																							
← 17	↑ 5																																																							
	↑ 410																																																							
	↑ 7																																																							
← 56	↑ 95																																																							
← 189	↑ 1430																																																							
← 62	↑ 85																																																							
106 ↓	↑ 188																																																							
1274 ↓	↑ 169																																																							
105 ↓	↑ 42																																																							
← 49	↑ 225																																																							
← 223	↑ 391																																																							
← 132	↑ 185																																																							
58 ↓	↑ 178																																																							
390 ↓	↑ 171																																																							
172 ↓	↑ 140																																																							
<p>26 Meridian Pkwy. & Van Buren Blvd.</p> <table border="1"> <tr> <td>← 503</td> <td>↑ 72</td> </tr> <tr> <td>← 10</td> <td>↑ 1060</td> </tr> <tr> <td>← 99</td> <td>↑ 38</td> </tr> <tr> <td>299 ↓</td> <td>↑ 8</td> </tr> <tr> <td>975 ↓</td> <td>↑ 7</td> </tr> <tr> <td>7 ↓</td> <td>↑ 21</td> </tr> </table>	← 503	↑ 72	← 10	↑ 1060	← 99	↑ 38	299 ↓	↑ 8	975 ↓	↑ 7	7 ↓	↑ 21	<p>27 Innovation Dr. & Cactus Av.</p> <table border="1"> <tr> <td>← 1</td> <td>↑ 5</td> </tr> <tr> <td>← 1</td> <td>↑ 801</td> </tr> <tr> <td>← 1</td> <td>↑ 25</td> </tr> <tr> <td>661 ↓</td> <td>↑ 1</td> </tr> <tr> <td>1 ↓</td> <td>↑ 24</td> </tr> </table>	← 1	↑ 5	← 1	↑ 801	← 1	↑ 25	661 ↓	↑ 1	1 ↓	↑ 24	<p>28 I-215 SB Ramps & Alessandro Blvd.</p> <table border="1"> <tr> <td>← 334</td> <td>↑ 128</td> </tr> <tr> <td>← 144</td> <td>↑ 1228</td> </tr> <tr> <td>945 ↓</td> <td></td> </tr> <tr> <td>425 ↓</td> <td></td> </tr> </table>	← 334	↑ 128	← 144	↑ 1228	945 ↓		425 ↓		<p>29 I-215 NB Ramps & Alessandro Blvd.</p> <table border="1"> <tr> <td>← 233</td> <td>↑ 157</td> </tr> <tr> <td>← 862</td> <td>↑ 1000</td> </tr> <tr> <td>566 ↓</td> <td>↑ 10</td> </tr> <tr> <td>10 ↓</td> <td>↑ 255</td> </tr> </table>	← 233	↑ 157	← 862	↑ 1000	566 ↓	↑ 10	10 ↓	↑ 255	<p>30 I-215 SB Ramps & Cactus Av.</p> <table border="1"> <tr> <td>← 294</td> <td>↑ 539</td> </tr> <tr> <td>591 ↓</td> <td>↑ 371</td> </tr> <tr> <td>109 ↓</td> <td>↑ 349</td> </tr> </table>	← 294	↑ 539	591 ↓	↑ 371	109 ↓	↑ 349								
← 503	↑ 72																																																							
← 10	↑ 1060																																																							
← 99	↑ 38																																																							
299 ↓	↑ 8																																																							
975 ↓	↑ 7																																																							
7 ↓	↑ 21																																																							
← 1	↑ 5																																																							
← 1	↑ 801																																																							
← 1	↑ 25																																																							
661 ↓	↑ 1																																																							
1 ↓	↑ 24																																																							
← 334	↑ 128																																																							
← 144	↑ 1228																																																							
945 ↓																																																								
425 ↓																																																								
← 233	↑ 157																																																							
← 862	↑ 1000																																																							
566 ↓	↑ 10																																																							
10 ↓	↑ 255																																																							
← 294	↑ 539																																																							
591 ↓	↑ 371																																																							
109 ↓	↑ 349																																																							
<p>31 I-215 NB Ramps & Cactus Av.</p> <table border="1"> <tr> <td>← 82</td> <td>↑ 125</td> </tr> <tr> <td>← 1</td> <td>↑ 1162</td> </tr> <tr> <td>← 116</td> <td></td> </tr> <tr> <td>32 ↓</td> <td>↑ 124</td> </tr> <tr> <td>689 ↓</td> <td>↑ 70</td> </tr> <tr> <td>245 ↓</td> <td>↑ 3</td> </tr> </table>	← 82	↑ 125	← 1	↑ 1162	← 116		32 ↓	↑ 124	689 ↓	↑ 70	245 ↓	↑ 3	<p>32 I-215 SB Ramps & Van Buren Blvd.</p> <table border="1"> <tr> <td>← 564</td> <td>↑ 612</td> </tr> <tr> <td>← 22</td> <td>↑ 14</td> </tr> <tr> <td>481 ↓</td> <td></td> </tr> <tr> <td>642 ↓</td> <td></td> </tr> </table>	← 564	↑ 612	← 22	↑ 14	481 ↓		642 ↓		<p>33 I-215 NB Ramps & Van Buren Blvd.</p> <table border="1"> <tr> <td>← 486</td> <td>↑ 30</td> </tr> <tr> <td>← 30</td> <td>↑ 1</td> </tr> <tr> <td>601 ↓</td> <td>↑ 43</td> </tr> <tr> <td>17 ↓</td> <td>↑ 1</td> </tr> </table>	← 486	↑ 30	← 30	↑ 1	601 ↓	↑ 43	17 ↓	↑ 1	<p>34 Old 215 Frontage Rd. & Alessandro Blvd.</p> <table border="1"> <tr> <td>← 219</td> <td>↑ 99</td> </tr> <tr> <td>← 122</td> <td>↑ 785</td> </tr> <tr> <td>← 90</td> <td>↑ 11</td> </tr> <tr> <td>327 ↓</td> <td>↑ 24</td> </tr> <tr> <td>854 ↓</td> <td>↑ 99</td> </tr> <tr> <td>13 ↓</td> <td>↑ 14</td> </tr> </table>	← 219	↑ 99	← 122	↑ 785	← 90	↑ 11	327 ↓	↑ 24	854 ↓	↑ 99	13 ↓	↑ 14	<p>35 Day St. & Alessandro Blvd.</p> <table border="1"> <tr> <td>← 108</td> <td>↑ 139</td> </tr> <tr> <td>← 47</td> <td>↑ 699</td> </tr> <tr> <td>← 117</td> <td>↑ 9</td> </tr> <tr> <td>189 ↓</td> <td>↑ 10</td> </tr> <tr> <td>665 ↓</td> <td>↑ 95</td> </tr> <tr> <td>7 ↓</td> <td>↑ 15</td> </tr> </table>	← 108	↑ 139	← 47	↑ 699	← 117	↑ 9	189 ↓	↑ 10	665 ↓	↑ 95	7 ↓	↑ 15
← 82	↑ 125																																																							
← 1	↑ 1162																																																							
← 116																																																								
32 ↓	↑ 124																																																							
689 ↓	↑ 70																																																							
245 ↓	↑ 3																																																							
← 564	↑ 612																																																							
← 22	↑ 14																																																							
481 ↓																																																								
642 ↓																																																								
← 486	↑ 30																																																							
← 30	↑ 1																																																							
601 ↓	↑ 43																																																							
17 ↓	↑ 1																																																							
← 219	↑ 99																																																							
← 122	↑ 785																																																							
← 90	↑ 11																																																							
327 ↓	↑ 24																																																							
854 ↓	↑ 99																																																							
13 ↓	↑ 14																																																							
← 108	↑ 139																																																							
← 47	↑ 699																																																							
← 117	↑ 9																																																							
189 ↓	↑ 10																																																							
665 ↓	↑ 95																																																							
7 ↓	↑ 15																																																							
<p>36 Elsworth St. & Cactus Av.</p> <table border="1"> <tr> <td>← 128</td> <td>↑ 133</td> </tr> <tr> <td>← 17</td> <td>↑ 1075</td> </tr> <tr> <td>← 160</td> <td>↑ 14</td> </tr> <tr> <td>153 ↓</td> <td>↑ 22</td> </tr> <tr> <td>1076 ↓</td> <td>↑ 11</td> </tr> <tr> <td>31 ↓</td> <td>↑ 9</td> </tr> </table>	← 128	↑ 133	← 17	↑ 1075	← 160	↑ 14	153 ↓	↑ 22	1076 ↓	↑ 11	31 ↓	↑ 9	<p>37 Frederick St. & Cactus Av.</p> <table border="1"> <tr> <td>← 84</td> <td>↑ 165</td> </tr> <tr> <td>← 263</td> <td>↑ 1075</td> </tr> <tr> <td>← 2</td> <td>↑ 2</td> </tr> <tr> <td>103 ↓</td> <td></td> </tr> <tr> <td>1169 ↓</td> <td></td> </tr> <tr> <td>1 ↓</td> <td></td> </tr> </table>	← 84	↑ 165	← 263	↑ 1075	← 2	↑ 2	103 ↓		1169 ↓		1 ↓		<p>38 Graham St./Riverside Dr. & Cactus Av.</p> <table border="1"> <tr> <td>← 70</td> <td>↑ 64</td> </tr> <tr> <td>← 59</td> <td>↑ 1137</td> </tr> <tr> <td>← 64</td> <td>↑ 20</td> </tr> <tr> <td>56 ↓</td> <td>↑ 157</td> </tr> <tr> <td>1095 ↓</td> <td>↑ 46</td> </tr> <tr> <td>173 ↓</td> <td>↑ 16</td> </tr> </table>	← 70	↑ 64	← 59	↑ 1137	← 64	↑ 20	56 ↓	↑ 157	1095 ↓	↑ 46	173 ↓	↑ 16	<p>## Saturday Peak Hour Intersection Volumes</p>																	
← 128	↑ 133																																																							
← 17	↑ 1075																																																							
← 160	↑ 14																																																							
153 ↓	↑ 22																																																							
1076 ↓	↑ 11																																																							
31 ↓	↑ 9																																																							
← 84	↑ 165																																																							
← 263	↑ 1075																																																							
← 2	↑ 2																																																							
103 ↓																																																								
1169 ↓																																																								
1 ↓																																																								
← 70	↑ 64																																																							
← 59	↑ 1137																																																							
← 64	↑ 20																																																							
56 ↓	↑ 157																																																							
1095 ↓	↑ 46																																																							
173 ↓	↑ 16																																																							

TABLE 6-1: INTERSECTION ANALYSIS FOR EAP (2028) CONDITIONS

#	Intersection	Traffic Control ¹	Existing (2021)						EAP					
			Delay ^{2 3 4 5} (secs.)			Level of Service			Delay ^{2 3 4 5} (secs.)			Level of Service		
			AM	PM	SAT	AM	PM	SAT	AM	PM	SAT	AM	PM	SAT
1	Washington St. & Van Buren Blvd.	TS	40.4	39.7	22.8	D	D	C	64.6	65.7	26.1	E	E	C
2	Alessandro Blvd. & Arlington Av./Chicago Av.	TS	75.0	82.2	22.7	E	F	C	115.4	128.1	27.1	F	F	C
3	Canyon Crest Dr./Overlook Pkwy. & Alessandro Blvd.	TS	42.2	46.1	14.9	D	D	B	118.8	164.5	20.1	E	F	C
4	Wood Rd. & Van Buren Blvd.	TS	50.4	37.0	24.9	D	D	C	70.9	57.9	30.2	E	E	C
5	Trautwein Rd. & Alessandro Blvd.	TS	89.4	19.9	13.1	F	B	B	150.6	26.3	15.0	F	C	B
6	Trautwein Rd. & Grove Community Dr.	TS	22.1	10.4	12.4	C	B	B	38.0	11.6	13.1	D	B	B
7	Trautwein Rd. & Orange Terrace Pkwy.	TS	46.0	21.3	18.8	D	C	B	61.4	25.4	20.6	E	C	C
8	Trautwein Rd. & Van Buren Blvd.	TS	34.9	27.7	20.9	C	C	C	61.9	41.0	23.4	E	D	C
9	Deercreek Dr. & Grove Community Dr.	AWS	17.2	9.2	9.6	C	A	A	25.2	9.9	10.3	D	A	B
10	Deercreek Dr. & Orange Terrace Pkwy.	AWS	51.8	9.9	9.6	F	A	A	95.4	10.7	10.3	F	B	B
11	Barton St. & Alessandro Blvd.	TS	31.2	8.4	7.6	C	A	A	53.5	25.3	8.5	D	C	A
12	Barton St. & Grove Community Dr.	CSS	13.2	9.4	11.0	B	A	B	14.2	9.6	11.7	B	A	B
13	Barton St. & Orange Terrace Pkwy.	CSS	68.8	14.3	45.0	F	B	E	>100.0	16.5	>100.0	F	C	F
14	Barton St. & Van Buren Blvd.	TS	61.2	30.3	21.2	E	C	C	117.0	50.4	27.9	F	D	C
15	Airman Dr. & Cactus Av.	IS	Future Intersection						13.3	37.2	21.5	B	D	C
16	Abrams Dr. & Grove Community Dr.	AWS	10.9	8.5	8.4	B	A	A	13.0	9.3	8.8	B	A	A
17	Abrams Dr. & Orange Terrace Pkwy.	AWS	13.1	8.6	8.9	B	A	A	15.7	8.9	9.4	C	A	A
18	Linebacker Dr. & Cactus Av.	IS	Future Intersection						22.4	53.1	23.8	C	D	C
19	Orange Terrace Pkwy. & Van Buren Blvd.	TS	18.3	17.9	17.7	B	B	B	19.0	18.4	18.0	B	B	B
20	Brown St. & Alessandro Blvd.	TS	9.2	13.7	5.0	A	B	A	47.2	>200.0	184.1	D	F	F
21	Brown St. & Cactus Av.	IS	Future Intersection						18.7	36.0	33.4	B	D	C
22	Sycamore Canyon Blvd. & Eastridge Av.	TS	28.2	19.8	17.4	C	B	B	36.2	21.6	17.8	D	C	B
23	Sycamore Canyon Blvd. & Cottonwood Av.	TS	9.3	7.0	5.8	A	A	A	9.7	7.3	6.1	A	A	A
24	Meridian Pkwy. & Alessandro Blvd.	TS	89.6	41.8	19.6	F	D	B	108.1	70.2	21.2	F	E	C
25	Meridian Pkwy. & Cactus Av.	TS	29.5	30.8	16.6	C	C	B	70.6	>200.0	19.5	E	F	B
26	Meridian Pkwy. & Van Buren Blvd.	TS	15.4	26.3	12.9	B	C	B	21.7	43.5	15.7	C	D	B
27	Innovation Dr. & Cactus Av.	TS	6.3	8.3	4.5	A	A	A	6.7	9.6	4.1	A	A	A
28	I-215 SB Ramps & Alessandro Blvd.	TS	8.5	9.4	6.3	A	A	A	16.3	12.3	7.2	B	B	A
29	I-215 NB Ramps & Alessandro Blvd.	TS	81.6	20.7	22.4	F	C	C	135.6	34.2	33.8	F	C	C
30	I-215 SB Ramps & Cactus Av.	TS	4.7	5.9	5.2	A	A	A	5.9	33.6	6.0	A	C	A
31	I-215 NB Ramps & Cactus Av.	TS	59.0	19.9	7.0	E	B	A	138.8	90.6	8.5	F	E	A
32	I-215 SB Ramps & Van Buren Blvd.	TS	21.5	16.9	10.9	C	B	B	23.1	54.7	10.7	C	D	B
33	I-215 NB Ramps & Van Buren Blvd.	TS	6.4	6.1	4.2	A	A	A	6.6	6.3	4.2	A	A	A
34	Old 215 Frontage Rd. & Alessandro Blvd.	TS	37.9	19.3	17.8	D	B	B	54.9	21.5	19.0	D	C	B
35	Day St. & Alessandro Blvd.	TS	15.0	17.1	12.5	B	B	B	20.0	23.8	13.3	B	C	B
36	Elsworth St. & Cactus Av.	TS	94.0	75.0	42.6	F	E	D	146.5	132.5	47.1	F	F	D
37	Frederick St. & Cactus Av.	TS	26.0	12.8	9.9	C	B	A	41.2	16.6	10.3	D	B	B
38	Graham St./Riverside Dr. & Cactus Av.	TS	14.7	15.0	16.8	B	B	B	14.9	15.3	17.3	B	B	B

* **BOLD** = Significant Impact

¹ CSS = Cross-street Stop; AWS = All-Way Stop; TS = Traffic Signal; **IS** = Improvement

² For intersections within the jurisdiction of March JPA, deficient occurs (improvements needed) if the pre-project condition is at or better than LOS D (or acceptable LOS) and the project-generated traffic causes deterioration below acceptable levels. However, if the pre-project condition is already below LOS D (or acceptable LOS), provide improvements if the Project contributes more than 2% of the total traffic.

³ For intersections within the jurisdiction of the City of Riverside, deficient occurs (improvements needed) when the addition of project related trips causes either peak hour LOS to degrade from acceptable (LOS A through D) to unacceptable levels (LOS E/F) or the peak hour delay to increase as follows:

- LOS A/B = By 10.0 seconds
- LOS C = By 8.0 seconds
- LOS D = By 5.0 seconds
- LOS E = By 2.0 seconds
- LOS F = By 1.0 seconds

⁴ For intersections within the jurisdiction of Caltrans, or the County of Riverside, deficient occurs (improvements needed) if the pre-project condition is at or better than LOS D (or acceptable LOS) and the project-generated traffic causes deterioration below acceptable levels.

⁵ For intersections within the City of Moreno Valley, provide improvements if the pre-project condition is at or better than LOS D (or acceptable LOS) and the project-generated traffic causes deterioration below acceptable levels. If the pre-project condition is at unacceptable LOS and Project increases delay by 5.0 or more, provide improvements to offset the increase in delay.

6.4 ROADWAY SEGMENT ANALYSIS

The roadway segment capacities are approximate figures only and are used at the General Plan level to assist in determining the roadway functional classification (number of through lanes) needed to meet traffic demand. Table 6-2 provides a summary of the EAP conditions roadway segment capacity analysis based on the applicable roadway segment capacity thresholds. As shown on Table 6-2, the following additional study area roadway segments are anticipated to operate at an unacceptable LOS based on the applicable planning level daily roadway capacity thresholds, in addition to the segment identified under Existing (2021) traffic conditions:

- Cactus Av., from Airman Dr. to Linebacker Dr. (#6) – LOS F
- Cactus Av. from Linebacker Dr. to Brown St. (#7) – LOS E
- Cactus Av., from Brown St. to Meridian Pkwy. (#8) – LOS E
- Barton Rd. from Alessandro Bl. to Cactus Av. (#10) – LOS E
- Brown St., from Alessandro Bl. to Cactus Av. (#12) – LOS F
- Meridian Pkwy. from Cactus Av. to Van Buren Bl. (#15) – LOS F

TABLE 6-2: ROADWAY SEGMENT ANALYSIS FOR EAP (2028) CONDITIONS

#	Roadway	Segment Limits	Roadway Section	LOS Capacity ¹	Existing			EAP			Acceptable LOS
					2021	V/C ²	LOS ³	2025	V/C ²	LOS ³	
1	Alessandro Bl.	Trautwein Rd. to Mission Grove Pkwy.	6D	57,250	42,859	0.75	C	49,190	0.86	D	D
2		Mission Grove Pkwy. to Barton St.	6D	57,250	42,275	0.74	C	49,802	0.87	D	D
3		Barton St. to Brown St.	6D	57,250	42,360	0.74	C	50,242	0.88	D	D
4		Brown St. to Meridian Pkwy.	6D	57,250	41,193	0.72	C	49,291	0.86	D	D
5		Meridian Pkwy. to I-215 Freeway	6D	57,250	44,072	0.77	C	53,377	0.93	E	D
6	Cactus Av.	Airman Dr. to Linebacker Dr.	2U	13,000	0	0.00	A	11,066	0.85	D	D
7		Linebacker Dr. to Brown St.	4D	25,900	0	0.00	A	24,532	0.95	E	D
8		Brown St. to Meridian Pkwy.	4D	25,900	0	0.00	A	21,110	0.82	D	D
9		Meridian Pkwy. to I-215 Freeway	6D	51,150	19,011	0.37	A	36,068	0.71	B	D
10	Barton St.	Alessandro Bl. to Cactus Av. (EVA)	2U	13,000	1,995	0.15	A	12,392	0.95	E	D
11		Cactus Av. (EVA) to Grove Community Dr.	2U	13,000	775	0.06	A	3,949	0.30	A	D
12	Brown St.	Alessandro Bl. to Cactus Av.	2D	13,000	776	0.06	A	4,260	0.33	A	D
13	Sycamore Canyon Bl.	Cottonwood Av. to Alessandro Bl.	4D	33,000	13,151	0.40	A	14,951	0.45	A	D
14	Meridian Pkwy.	Alessandro Bl. to Cactus Av.	4D	25,900	23,605	0.91	E	27,237	1.05	F	D
15		Cactus Av. to Van Buren Bl.	4D	25,900	22,215	0.86	D	27,980	1.08	F	D

BOLD = LOS does not meet the applicable jurisdictional requirements (i.e., unacceptable LOS).

¹ These maximum roadway capacities are based on the applicable agency's thresholds.

² V/C = Volume to Capacity Ratio

³ LOS = Level of Service

6.5 TRAFFIC SIGNAL WARRANTS ANALYSIS

There are no additional unsignalized study area intersections anticipated to meet either peak hour volume-based or planning level (ADT) volume-based traffic signal warrants for EAP (2028) traffic conditions in addition to the intersections warranted under Existing and E+P traffic conditions (see Appendix 6.2).

6.6 OFF-RAMP QUEUING ANALYSIS

A queuing analysis was performed for the off-ramps at the I-215 Freeway at Alessandro Boulevard, Cactus Avenue, and Van Buren Boulevard interchanges, to assess vehicle queues for the off ramps that may potentially result in deficient peak hour operations at the ramp-to-arterial intersections and may potentially “spill back” onto the I-215 Freeway mainline. Queuing analysis findings are presented in Table 6-3 for EAP traffic conditions. It is important to note that off-ramp lengths are consistent with the measured distance between the intersection and the freeway mainline. As shown in Table 6-3, there are no movements that are anticipated to experience queuing issues during the weekday AM, weekday PM, or weekend Saturday peak 95th percentile traffic flows for EAP traffic conditions, consistent with Existing (2021) traffic conditions. Worksheets for EAP traffic conditions off-ramp queuing analysis are provided in Appendix 6.3.

6.7 DEFICIENCIES AND IMPROVEMENTS

6.7.1 IMPROVEMENTS TO ADDRESS DEFICIENCIES AT INTERSECTIONS

This section provides a summary of Project deficiencies and identified improvements. Based on the deficiency criteria discussed in Section 2.7 *Deficiency Criteria*, study area intersections were found to be deficient. The effectiveness of the improvement strategies presented in Table 6-4 address the EAP deficiencies as the recommendations improve the operations back to pre-project conditions (or better) or within the allowable net change in delay per the applicable deficiency criteria for each agency. Analysis worksheets, with improvements, for EAP traffic conditions are provided in Appendix 6.4.

6.7.2 IMPROVEMENTS TO ADDRESS DEFICIENCIES AT ROADWAY SEGMENT

Additional roadway widening for the deficient roadway segments has not been recommended as acceptable or improved peak hour traffic operations can be achieved with the existing lanes or with the improvements shown on Table 6-4.

6.7.3 IMPROVEMENTS TO ADDRESS DEFICIENCIES ON OFF-RAMP QUEUES

As shown previously in Table 6-3, there are no anticipated peak hour queuing issues at the I-215 Freeway off-ramps for EAP traffic conditions, consistent with Existing (2021) traffic conditions. As such, no improvements have been recommended.

TABLE 6-3: PEAK HOUR FREEWAY OFF-RAMP QUEUING SUMMARY FOR EAP (2028) CONDITIONS

Intersection	Movement ³	Available Stacking Distance (Feet) ³	Existing (2021)						EAP					
			95th Percentile Queue (Feet)			Acceptable? ¹			95th Percentile Queue (Feet)			Acceptable? ¹		
			AM Peak Hour	PM Peak Hour	PM Peak Hour	AM	PM		AM Peak Hour	PM Peak Hour	SAT Peak Hour	AM	PM	SAT
I-215 SB Ramps & Alessandro Blvd. (#28)	SBL	525	132	191	68	Yes	Yes	Yes	136	237	82	Yes	Yes	Yes
	SBL/R	1,540	124	178	52	Yes	Yes	Yes	159	224	96	Yes	Yes	Yes
	SBR	525	118	166	48	Yes	Yes	Yes	148	207	90	Yes	Yes	Yes
I-215 NB Ramps & Alessandro Blvd. (#29)	NBL	450	572 ^{2 3}	342	155	Yes	Yes	Yes	845 ^{2 3}	510 ^{2 3}	210	Yes	Yes	Yes
	NBL/T/R	1,345	520 ²	403 ²	158	Yes	Yes	Yes	806 ²	554 ²	220	Yes	Yes	Yes
	NBR	450	41	125	64	Yes	Yes	Yes	72	160	111	Yes	Yes	Yes
I-215 SB Ramps & Cactus Av. (#30)	SBR	1,115	155	157	0	Yes	Yes	Yes	894 ²	712 ²	0	Yes	Yes	Yes
	NBR	1,850	18	57	0	Yes	Yes	Yes	124	164	67	Yes	Yes	Yes
I-215 NB Ramps & Cactus Av. (#31)	NBL	145	452 ^{2 3}	105	34	Yes	Yes	Yes	830 ^{2 3}	261 ^{2 3}	100	Yes	Yes	Yes
	NBT/R	1,650	432 ²	181	78	Yes	Yes	Yes	139 ²	208	61	Yes	Yes	Yes
I-215 SB Ramps & Van Buren Blvd.(#32)	SBL/T	1,510	38	121 ²	24	Yes	Yes	Yes	44	145 ²	26	Yes	Yes	Yes
	SBR	1,450	233	34	42	Yes	Yes	Yes	334	36	44	Yes	Yes	Yes
I-215 NB Ramps & Van Buren Blvd. (#33)	NBL	1,560	98	62	0	Yes	Yes	Yes	122	75	0	Yes	Yes	Yes
	NBR	580	2	0	0	Yes	Yes	Yes	2	2	0	Yes	Yes	Yes

¹ Stacking Distance is acceptable if the required stacking distance is less than or equal to the stacking distance provided. An additional 15 feet of stacking which is assumed to be provided in the transition for turn pockets is reflected in the stacking distance shown on this table, where applicable.

² 95th percentile volume exceeds capacity, queue may be longer. Queue shown is maximum after two cycles.

³ Although 95th percentile queue is anticipated to exceed the available storage for the turn lane, the adjacent lane has sufficient storage to accommodate any spillover without spilling back and affecting the I-215 Freeway mainline.

TABLE 6-4: INTERSECTION ANALYSIS FOR EAP (2028) CONDITIONS WITH IMPROVEMENTS

#	Intersection	Traffic Control ³	Intersection Approach Lanes ¹												Delay ² (secs.)			Level of Service			
			Northbound			Southbound			Eastbound			Westbound			AM	PM	SAT	AM	PM	SAT	
			L	T	R	L	T	R	L	T	R	L	T	R	L	T	R				
1	Washington St. & Van Buren Blvd.																				
	- Without Improvements	TS	2	2	1	2	2	0	1	2	0	1	2	1	64.6	65.7	26.1	E	E	C	
	- With Improvements	TS	2	2	1	2	2	0	1	<u>3</u>	0	1	<u>3</u>	1	41.5	38.6	24.2	D	D	C	
2	Alessandro Blvd. & Arlington Av./Chicago Av. ⁴																				
	- Without Improvements	TS	2	2	1>	2	3	0	1	2	2>	2	2	1>	115.4	128.1	27.1	F	F	C	
3	Canyon Crest Dr./Overlook Pkwy. & Alessandro Blvd.																				
	- Without Improvements	TS	1	2	1	2	1	1	1	3	0	1	3	1>	118.8	164.5	20.1	E	F	C	
	- With Improvements	TS	1	2	1	<u>3</u>	1	<u>0</u>	1	3	0	1	3	1>	100.2	70.2	19.1	F	E	B	
4	Wood Rd. & Van Buren Blvd.																				
	- Without Improvements	TS	2	2	0	1	2	0	1	2	1>	2	2	1	70.9	57.9	30.2	E	E	C	
	- With Improvements	TS	2	2	0	1	2	0	1	<u>3</u>	1>	2	<u>3</u>	1	47.2	38.2	21.9	D	D	C	
5	Trautwein Rd. & Alessandro Blvd. ⁴																				
	- Without Improvements	TS	2	1	0	0	0	0	0	3	0	2	3	0	150.6	26.3	15.0	F	C	B	
7	Trautwein Rd. & Orange Terrace Pkwy.																				
	- Without Improvements	TS	1	2	1	2	2	1	1	1	0	1	1	2>	61.4	25.4	20.6	E	C	C	
	- With Improvements	TS	1	2	1	2	2	1	1	1	0	<u>2</u>	1	<u>1></u>	51.7	20.8	18.5	D	C	B	
8	Trautwein Rd. & Van Buren Blvd.																				
	- Without Improvements	TS	1	2	0	2	2	1>	2	2	1>	1	3	1>	61.9	41.0	23.4	E	D	C	
	- With Improvements	TS	1	2	0	2	2	1>	2	<u>3</u>	1>	1	3	1>	50.4	34.7	22.5	D	C	C	
10	Deercreek Dr. & Orange Terrace Pkwy.																				
	- Without Improvements	AWS	0	1	0	0	1	0	1	2	0	1	2	0	95.4	10.7	10.3	F	B	B	
	- With Improvements	<u>TS</u>	0	1	0	0	1	0	1	2	0	1	2	0	16.2	5.5	5.5	B	A	A	
13	Barton St. & Orange Terrace Pkwy.																				
	- Without Improvements	CSS	1	0	0	0	0	0	0	2	0	1	2	0	100.0	16.5	>100.0	F	C	F	
	- With Improvements	<u>TS</u>	1	0	0	0	0	0	0	2	0	1	2	0	8.1	5.9	7.9	A	A	A	
14	Barton St. & Van Buren Blvd.																				
	- Without Improvements	TS	2	1	1	1	1	0	1	2	0	1	3	0	117.0	50.4	27.9	F	D	C	
	- With Improvements	TS	2	1	1	1	1	0	1	<u>3</u>	<u>1></u>	1	3	0	60.9	25.1	20.9	E	C	C	
20	Brown St. & Alessandro Blvd. ⁴																				
	- Without Improvements	TS	1	1	1>	1	1	1>	1	3	0	1	3	1	47.2	>200.0	184.1	D	F	F	
24	Meridian Pkwy. & Alessandro Blvd. ⁴																				
	- Without Improvements	TS	2	2	2>	2	2	1	1	3	1	2	3	1	108.1	70.2	21.2	F	E	C	
25	Meridian Pkwy. & Cactus Av.																				
	- Without Improvements	TS	2	2	1	2	2	1	1	2	1	2	2	1	70.6	>200.0	19.5	E	F	B	
	- With Improvements	TS	2	2	1	2	2	1	1	2	1	2	2	<u>1></u>	39.6	148.9	23.7	D	F	C	
29	I-215 NB Ramps & Alessandro Blvd.																				
	- Without Improvements	TS	1	1	1	0	0	0	1	3	0	0	3	1	135.6	34.2	33.8	F	C	C	
	- With Improvements	TS	<u>2</u>	1	0	0	0	0	1	3	0	0	3	1	25.1	28.4	25.4	C	C	C	
31	I-215 NB Ramps & Cactus Av.																				
	- Without Improvements	TS	1	1	1	1	1	0	1	2	0	0	2	0	138.8	90.6	8.5	F	E	A	
	- With Improvements	TS	<u>2</u>	1	1	1	1	0	1	2	<u>1</u>	0	<u>3</u>	0	36.5	25.2	11.1	D	C	B	
36	Elsworth St. & Cactus Av.																				
	- Without Improvements	TS	1	1	0	1	1	1>	1	3	1>>	1	3	1	146.5	132.5	47.1	F	F	D	
	- With Improvements ⁵	TS	1	1	0	1	1	1>	1	3	1>>	1	3	1	46.6	35.6	20.5	D	D	C	

* **BOLD** = LOS does not meet the applicable jurisdictional requirements (i.e., unacceptable LOS).

¹ When a right turn is designated, the lane can either be striped or unstriped. To function as a right turn lane there must be sufficient width for right turning vehicles to travel outside the through lanes.

L = Left; T = Through; R = Right; > = Right-Turn Overlap Phasing; >> = Free Right Turn Lane; 1 = Improvement

² Per the Highway Capacity Manual 6th Edition, overall average intersection delay and level of service are shown for intersections with a traffic signal or all way stop control. For intersections with cross street stop control, the delay and level of service for the worst individual movement (or movements sharing a single lane) are shown.

³ AWS = All-Way Stop; CSS = Cross-street Stop; TS = Traffic Signal

⁴ There are no feasible intersection improvements. As such, improvements have not been identified.

⁵ Recommended improvements can be accommodated through implementing N/S from split phasing to protected left turn phasing. Lead-lag operations should be implemented for the northbound and southbound approaches to avoid conflicting left turns. Additionally, the northbound approach should be restriped to provide one left turn lane and one shared through-right turn lane; the southbound approach should be restriped to provide one left turn lane, one through lane, and one right turn lane.

7 OPENING YEAR CUMULATIVE (2028) TRAFFIC CONDITIONS

This section discusses the methods used to develop Opening Year Cumulative (2028) Without and With Project traffic forecasts, and the resulting intersection operations, roadway segment, traffic signal warrant, and freeway off-ramp queuing analyses.

7.1 ROADWAY IMPROVEMENTS

The lane configurations and traffic controls assumed to be in place for Opening Year Cumulative (2028) conditions are consistent with those shown previously on Exhibit 3-1, with the exception of the following:

- Project driveways and those facilities assumed to be constructed by the Project to provide site access are also assumed to be in place for Opening Year Cumulative conditions only (e.g., intersection and roadway improvements along the Project’s frontage and driveways).
- Driveways and those facilities assumed to be constructed by cumulative developments to provide site access are also assumed to be in place for Opening Year Cumulative conditions only.

7.2 OPENING YEAR CUMULATIVE (2028) WITHOUT PROJECT TRAFFIC VOLUME FORECASTS

This scenario includes Existing traffic volumes plus an ambient growth factor of 14.87% plus traffic from pending and approved but not yet constructed known development projects in the area. The weekday ADT and weekday AM and PM peak hour volumes which can be expected for Opening Year Cumulative (2028) Without Project traffic conditions are shown on Exhibit 7-1. The weekend Saturday peak hour volumes for Opening Year Cumulative (2028) Without Project traffic conditions are shown on Exhibit 7-2.

7.3 OPENING YEAR CUMULATIVE (2028) WITH PROJECT TRAFFIC VOLUME FORECASTS

This scenario includes Opening Year Cumulative (2028) Without Project traffic in conjunction with the addition of Project traffic. The weekday ADT and weekday AM and PM peak hour volumes which can be expected for Opening Year Cumulative (2028) With Project traffic conditions are shown on Exhibit 7-3. The weekend Saturday peak hour volumes for Opening Year Cumulative (2028) With Project traffic conditions are shown on Exhibit 7-4.

EXHIBIT 7-1: OPENING YEAR CUMULATIVE (2028) WITHOUT PROJECT WEEKDAY TRAFFIC VOLUMES

1 Washington St. & Van Buren Blvd. 23,450 71(105) ↓ 202(397) ↓ 444(653) ↓ 151(153) ↓ 1306(1645) ↓ 137(91) ↓ 33,550		2 Alessandro Blvd. & Arlington Av./Chicago Av. 41,650 ↑ 763(521) ↓ 1706(1354) ↑ 114(196) ↑ 156(113) ↓ 585(276) ↑ 145(115) 11,800		3 Canyon Crest Dr. & Alessandro Blvd. 33,700 48(23) ↓ 769(2037) ↓ 259(559) ↓ 47(28) ↓ 564(839) ↓ 739(1287) ↓ 62,100		4 Wood Rd. & Van Buren Blvd. 78,300 ↑ 1240(752) ↓ 3666(2582) ↓ -16(6) 75(85) ↓ 1627(3395) ↓ -12(9) ↓ 1(-9) ↓ 170(-10) ↓ 3(9) ↓ 1,600		5 Trautwein Rd. & Alessandro Blvd. 44,800 186(212) ↓ 478(277) ↓ 125(141) ↓ 168(176) ↓ 1266(1874) ↓ 377(241) ↓ 387(341) ↓ 478(272) ↓ 346(255) ↓ 16,650		6 Trautwein Rd. & Grove Community Dr. 8,050 ↑ 698(270) ↓ 88(58) 1923(1442) ↓ 28(62) ↓ 30,450		7 Trautwein Rd. & Orange Terrace Pkwy. 36,600 23(46) ↓ 1169(1712) ↓ 447(392) ↓ 77(52) ↓ 73(53) ↓ 27(24) ↓ 62(50) ↓ 1388(1347) ↓ 277(241) ↓ 34,850		8 Trautwein Rd. & Van Buren Blvd. 50,450 ↑ 525(691) ↓ 1804(1465) ↑ 175(165) 419(445) ↓ 1299(1485) ↓ 106(115) ↓ 247(102) ↓ 676(382) ↓ 136(108) ↓ 15,850		9 Deercreek Dr. & Grove Community Dr. 4,600 ↑ 373(152) ↓ 57(25) 105(233) ↓ 90(21) ↓ 233(31) ↓ 35(41) ↓ 1,150		10 Deercreek Dr. & Orange Terrace Pkwy. 9,550 42(22) ↓ 35(9) ↓ 94(31) ↓ 252(49) ↓ 501(526) ↓ 47(17) ↓ 179(21) ↓ 179(21) ↓ 7(2) ↓ 550	
11 Barton St. & Alessandro Blvd. 450 9(14) ↓ 10(15) ↓ 7(6) ↓ 1652(2241) ↓ 38(46) ↓ 82(54) ↓ 1(1) ↓ 55(38) ↓ 2,300		12 Barton St. & Grove Community Dr. 900 7(30) ↓ 5(2) ↓ 26(36) ↓ 114(239) ↓ 8(-48) ↓ Nominal 4,400		13 Barton St. & Orange Terrace Pkwy. 7,800 -25(-17) ↓ 312(429) ↓ 289(129) ↓ 459(258) ↓ 51(47) ↓ 236(113) ↓ -8(-48) ↓ 38(45) ↓ 3,450		14 Barton St. & Van Buren Blvd. 47,550 ↑ 26(6) ↓ 1962(1980) ↓ 282(271) 175(192) ↓ 1598(1945) ↓ 215(333) ↓ 469(348) ↓ 83(93) ↓ 379(240) ↓ 14,050		15 Airman Dr. & Cactus Av. Future Intersection											
16 Abrams Dr. & Grove Community Dr. 3,500 ↑ 245(80) ↓ 106(40) 58(164) ↓ 59(70) ↓ 155(56) ↓ 70(66) ↓ 2,300		17 Abrams Dr. & Orange Terrace Pkwy. 6,150 ↑ 100(37) ↓ 350(233) 129(130) ↓ 189(324) ↓ 84(28) ↓ 7,200		18 Linebacker Dr. & Cactus Av. Future Intersection		19 Orange Terrace Pkwy. & Van Buren Blvd. 51,600 ↑ 145(242) ↓ 2110(1883) ↑ 133(177) 173(196) ↓ 1666(2103) ↓ 215(295) ↓ 275(159) ↓ 41(44) ↓ 276(136) ↓ 125(313) ↓ 24(48) ↓ 81(228) ↓ 13,200		20 Brown St. & Alessandro Blvd. 49,400 ↑ 57(33) ↓ 2915(2573) ↓ -61(-136) 35(30) ↓ 1801(2338) ↓ 3(5) ↓ 0(16) ↓ 0(2) ↓ -6(26) ↓ 900											

##(##) AM(PM) Peak Hour Intersection Volumes
 ## Average Daily Trips

<p>21 Brown St. & Cactus Av.</p> <p><i>Future Intersection</i></p>	<p>22 Sycamore Canyon Blvd. & Eastridge Av.</p> <p>19,150</p> <p>44(20) ↓ 245(415) ↓ 81(288) ↓</p> <p>53(94) → 43(99) → 19(53) ↓</p> <p>77(33) ↓ 850(739) → 109(202) →</p> <p>12,300</p> <p>21,000</p>	<p>23 Sycamore Canyon Blvd. & Cottonwood Av.</p> <p>16,650</p> <p>314(690) ↓ 117(53) ↓</p> <p>39(63) ↑ 25(71) ↑</p> <p>1016(857) → 66(40) →</p> <p>2,400</p> <p>21,150</p>	<p>24 Meridian Pkwy. & Alessandro Blvd.</p> <p>23,150</p> <p>148(305) ↓ 179(614) ↓ 106(167) ↓</p> <p>173(157) ↓ 1253(1706) → 401(680) ↓</p> <p>637(457) ↑ 2307(1881) ↑ 211(369) ↑</p> <p>707(639) ↓ 711(493) ↓ 91(114) ↓</p> <p>52,850</p> <p>31,650</p>	<p>25 Meridian Pkwy. & Cactus Av.</p> <p>30,950</p> <p>7(6) ↓ 312(1121) ↓ 197(743) ↓</p> <p>25(46) → 7(15) → 1(16) ↓</p> <p>1055(616) ↑ 23(16) ↑ 758(964) ↑</p> <p>-88(0) ↓ 483(539) ↑ 301(369) ↑</p> <p>21,900</p> <p>26,700</p>
<p>26 Meridian Pkwy. & Van Buren Blvd.</p> <p>15,700</p> <p>527(692) ↓ 6(15) ↓ 99(1024) ↓</p> <p>579(447) → 2257(3907) → 3(1) ↓</p> <p>157(85) ↑ 3354(2746) ↑ 53(8) ↑</p> <p>4(13) ↓ 1(16) ↓ 4(38) ↓</p> <p>81,700</p> <p>950</p>	<p>27 Innovation Dr. & Cactus Av.</p> <p>800</p> <p>3(15) ↓ 5(40) ↓</p> <p>5(3) ↓ 394(835) → 18(6) ↓</p> <p>53(15) ↑ 1491(1346) ↑ 139(65) ↑</p> <p>13(51) ↓ 39(145) →</p> <p>25,100</p> <p>2,450</p>	<p>28 I-215 SB Ramps & Alessandro Blvd.</p> <p>12,000</p> <p>449(524) ↓ 254(403) ↓</p> <p>241(165) ↑ 2708(2184) ↑</p> <p>1043(1641) → 407(365) ↓</p> <p>48,000</p> <p>3,750</p>	<p>29 I-215 NB Ramps & Alessandro Blvd.</p> <p>3,950</p> <p>92(151) ↓ 1246(2259) →</p> <p>119(162) ↑ 1952(1488) ↑</p> <p>1316(973) ↓ 0(13) ↓ 248(397) ↓</p> <p>45,500</p> <p>14,050</p>	<p>30 I-215 SB Ramps & Cactus Av.</p> <p>3,050</p> <p>225(289) ↓</p> <p>353(800) → 30(149) ↓</p> <p>1402(1135) ↑ 816(805) ↑</p> <p>33,750</p> <p>16,450</p>
<p>31 I-215 NB Ramps & Cactus Av.</p> <p>8,150</p> <p>136(182) ↓ 0(3) ↓ 58(196) ↓</p> <p>22(57) ↓ 1634(1806) → 49(51) ↓</p> <p>163(187) ↑ 3094(2465) ↑</p> <p>391(124) ↓ 338(252) ↓ 48(86) ↓</p> <p>44,450</p> <p>4,150</p>	<p>32 I-215 SB Ramps & Van Buren Blvd.</p> <p>14,500</p> <p>1437(748) ↓ 25(98) ↓ 378(532) ↓</p> <p>1016(1424) → 995(2327) ↓</p> <p>1515(1493) ↑ 30(184) ↑</p> <p>34,950</p> <p>27,300</p>	<p>33 I-215 NB Ramps & Van Buren Blvd.</p> <p>2,750</p> <p>-72(-47) ↓ 517(715) → 948(1294) ↓</p> <p>173(888) ↑</p> <p>1631(1313) ↓ 137(200) →</p> <p>10,600</p> <p>27,350</p>	<p>34 Old 215 Frontage Rd. & Alessandro Blvd.</p> <p>14,950</p> <p>280(269) ↓ 49(226) ↓ 33(143) ↓</p> <p>436(398) ↓ 1230(1796) → 52(115) ↓</p> <p>142(128) ↑ 1631(1247) ↑ 11(15) ↑</p> <p>63(42) ↓ 297(164) → 22(16) ↓</p> <p>36,700</p> <p>6,000</p>	<p>35 Day St. & Alessandro Blvd.</p> <p>12,900</p> <p>101(144) ↓ 74(160) ↓ 105(248) ↓</p> <p>179(234) ↓ 905(1777) → 11(24) ↓</p> <p>157(216) ↑ 1495(1177) ↑ 11(14) ↑</p> <p>12(17) ↓ 184(184) ↑ 19(13) ↓</p> <p>37,500</p> <p>4,300</p>
<p>36 Elsworth St. & Cactus Av.</p> <p>12,500</p> <p>273(296) ↓ 66(15) ↓ 169(315) ↓</p> <p>293(243) ↓ 1807(2493) → 330(30) ↓</p> <p>219(181) ↑ 2201(1840) ↑ 79(17) ↑</p> <p>26(219) ↓ 12(73) ↓ 18(85) ↓</p> <p>49,900</p> <p>4,600</p>	<p>37 Frederick St. & Cactus Av.</p> <p>12,500</p> <p>107(201) ↓ 216(225) ↓ 1543(2532) →</p> <p>165(176) ↑ 2201(1840) ↑</p> <p>49,900</p> <p>49,800</p>	<p>38 Graham St./Riverside Dr. & Cactus Av.</p> <p>6,900</p> <p>190(165) ↓ 52(101) ↓ 96(142) ↓</p> <p>104(198) ↓ 1488(2839) → 190(421) ↓</p> <p>102(94) ↑ 2543(1723) ↑ 11(19) ↑</p> <p>24(13) ↓ 0(1) ↓</p> <p>46,850</p> <p>5,500</p>	<p>##(##) AM(PM) Peak Hour Intersection Volumes ## Average Daily Trips</p>	

EXHIBIT 7-2: OPENING YEAR CUMULATIVE (2028) WITHOUT PROJECT WEEKEND TRAFFIC VOLUMES

1	Washington St. & Van Buren Blvd.	2	Alessandro Blvd. & Arlington Av./Chicago Av.	3	Canyon Crest Dr. & Alessandro Blvd.	4	Wood Rd. & Van Buren Blvd.	5	Trautwein Rd. & Alessandro Blvd.																																																																																																																																							
<table border="0"> <tr><td>←</td><td>83</td><td></td><td></td></tr> <tr><td>←</td><td>191</td><td>↑</td><td>291</td></tr> <tr><td>←</td><td>389</td><td>↑</td><td>947</td></tr> <tr><td></td><td></td><td>↑</td><td>125</td></tr> <tr><td>→</td><td>126</td><td>↓</td><td>146</td></tr> <tr><td>→</td><td>974</td><td>↓</td><td>219</td></tr> <tr><td>↓</td><td>78</td><td>↓</td><td>142</td></tr> </table>	←	83			←	191	↑	291	←	389	↑	947			↑	125	→	126	↓	146	→	974	↓	219	↓	78	↓	142	<table border="0"> <tr><td>←</td><td>31</td><td></td><td></td></tr> <tr><td>←</td><td>956</td><td>↑</td><td>185</td></tr> <tr><td>←</td><td>244</td><td>↑</td><td>485</td></tr> <tr><td></td><td></td><td>↑</td><td>211</td></tr> <tr><td>→</td><td>24</td><td>↓</td><td>775</td></tr> <tr><td>→</td><td>363</td><td>↓</td><td>843</td></tr> <tr><td>↓</td><td>643</td><td>↓</td><td>209</td></tr> </table>	←	31			←	956	↑	185	←	244	↑	485			↑	211	→	24	↓	775	→	363	↓	843	↓	643	↓	209	<table border="0"> <tr><td>←</td><td>21</td><td></td><td></td></tr> <tr><td>←</td><td>196</td><td>↑</td><td>451</td></tr> <tr><td>←</td><td>349</td><td>↑</td><td>1570</td></tr> <tr><td></td><td></td><td>↑</td><td>77</td></tr> <tr><td>→</td><td>38</td><td>↓</td><td>11</td></tr> <tr><td>→</td><td>1443</td><td>↓</td><td>192</td></tr> <tr><td>↓</td><td>15</td><td>↓</td><td>80</td></tr> </table>	←	21			←	196	↑	451	←	349	↑	1570			↑	77	→	38	↓	11	→	1443	↓	192	↓	15	↓	80	<table border="0"> <tr><td>←</td><td>155</td><td></td><td></td></tr> <tr><td>←</td><td>163</td><td>↑</td><td>116</td></tr> <tr><td>←</td><td>174</td><td>↑</td><td>1427</td></tr> <tr><td></td><td></td><td>↑</td><td>219</td></tr> <tr><td>→</td><td>137</td><td>↓</td><td>214</td></tr> <tr><td>→</td><td>1472</td><td>↓</td><td>140</td></tr> <tr><td>↓</td><td>218</td><td>↓</td><td>150</td></tr> </table>	←	155			←	163	↑	116	←	174	↑	1427			↑	219	→	137	↓	214	→	1472	↓	140	↓	218	↓	150	<table border="0"> <tr><td>←</td><td></td><td></td><td></td></tr> <tr><td>←</td><td></td><td>↑</td><td>1315</td></tr> <tr><td>←</td><td></td><td>↑</td><td>195</td></tr> <tr><td></td><td></td><td>↑</td><td></td></tr> <tr><td>→</td><td>1106</td><td>↓</td><td></td></tr> <tr><td>↓</td><td>265</td><td>↓</td><td>1072</td></tr> <tr><td></td><td></td><td></td><td>12</td></tr> </table>	←				←		↑	1315	←		↑	195			↑		→	1106	↓		↓	265	↓	1072				12
←	83																																																																																																																																															
←	191	↑	291																																																																																																																																													
←	389	↑	947																																																																																																																																													
		↑	125																																																																																																																																													
→	126	↓	146																																																																																																																																													
→	974	↓	219																																																																																																																																													
↓	78	↓	142																																																																																																																																													
←	31																																																																																																																																															
←	956	↑	185																																																																																																																																													
←	244	↑	485																																																																																																																																													
		↑	211																																																																																																																																													
→	24	↓	775																																																																																																																																													
→	363	↓	843																																																																																																																																													
↓	643	↓	209																																																																																																																																													
←	21																																																																																																																																															
←	196	↑	451																																																																																																																																													
←	349	↑	1570																																																																																																																																													
		↑	77																																																																																																																																													
→	38	↓	11																																																																																																																																													
→	1443	↓	192																																																																																																																																													
↓	15	↓	80																																																																																																																																													
←	155																																																																																																																																															
←	163	↑	116																																																																																																																																													
←	174	↑	1427																																																																																																																																													
		↑	219																																																																																																																																													
→	137	↓	214																																																																																																																																													
→	1472	↓	140																																																																																																																																													
↓	218	↓	150																																																																																																																																													
←																																																																																																																																																
←		↑	1315																																																																																																																																													
←		↑	195																																																																																																																																													
		↑																																																																																																																																														
→	1106	↓																																																																																																																																														
↓	265	↓	1072																																																																																																																																													
			12																																																																																																																																													
6	Trautwein Rd. & Grove Community Dr.	7	Trautwein Rd. & Orange Terrace Pkwy.	8	Trautwein Rd. & Van Buren Blvd.	9	Deercreek Dr. & Grove Community Dr.	10	Deercreek Dr. & Orange Terrace Pkwy.																																																																																																																																							
<table border="0"> <tr><td>←</td><td>1001</td><td></td><td></td></tr> <tr><td>←</td><td>383</td><td>↑</td><td>426</td></tr> <tr><td></td><td></td><td>↑</td><td>119</td></tr> <tr><td>→</td><td></td><td>↑</td><td></td></tr> <tr><td>→</td><td></td><td>↑</td><td></td></tr> <tr><td>↓</td><td></td><td>↑</td><td></td></tr> <tr><td>↓</td><td></td><td>↑</td><td></td></tr> </table>	←	1001			←	383	↑	426			↑	119	→		↑		→		↑		↓		↑		↓		↑		<table border="0"> <tr><td>←</td><td>22</td><td></td><td></td></tr> <tr><td>←</td><td>979</td><td>↑</td><td>176</td></tr> <tr><td>←</td><td>218</td><td>↑</td><td>13</td></tr> <tr><td></td><td></td><td>↑</td><td>182</td></tr> <tr><td>→</td><td>34</td><td>↓</td><td>37</td></tr> <tr><td>→</td><td>20</td><td>↓</td><td>949</td></tr> <tr><td>↓</td><td>22</td><td>↓</td><td>169</td></tr> </table>	←	22			←	979	↑	176	←	218	↑	13			↑	182	→	34	↓	37	→	20	↓	949	↓	22	↓	169	<table border="0"> <tr><td>←</td><td>385</td><td></td><td></td></tr> <tr><td>←</td><td>235</td><td>↑</td><td>354</td></tr> <tr><td>←</td><td>348</td><td>↑</td><td>1237</td></tr> <tr><td></td><td></td><td>↑</td><td>159</td></tr> <tr><td>→</td><td>487</td><td>↓</td><td>106</td></tr> <tr><td>→</td><td>1180</td><td>↓</td><td>263</td></tr> <tr><td>↓</td><td>80</td><td>↓</td><td>92</td></tr> </table>	←	385			←	235	↑	354	←	348	↑	1237			↑	159	→	487	↓	106	→	1180	↓	263	↓	80	↓	92	<table border="0"> <tr><td>←</td><td></td><td></td><td></td></tr> <tr><td>←</td><td></td><td>↑</td><td>222</td></tr> <tr><td></td><td></td><td>↑</td><td>68</td></tr> <tr><td>→</td><td></td><td>↑</td><td></td></tr> <tr><td>→</td><td>150</td><td>↓</td><td>57</td></tr> <tr><td>↓</td><td>16</td><td>↓</td><td>52</td></tr> </table>	←				←		↑	222			↑	68	→		↑		→	150	↓	57	↓	16	↓	52	<table border="0"> <tr><td>←</td><td>59</td><td></td><td></td></tr> <tr><td>←</td><td>6</td><td>↑</td><td>57</td></tr> <tr><td>←</td><td>54</td><td>↑</td><td>348</td></tr> <tr><td></td><td></td><td>↑</td><td>9</td></tr> <tr><td>→</td><td>59</td><td>↓</td><td>28</td></tr> <tr><td>→</td><td>277</td><td>↓</td><td>28</td></tr> <tr><td>↓</td><td>9</td><td>↓</td><td>5</td></tr> </table>	←	59			←	6	↑	57	←	54	↑	348			↑	9	→	59	↓	28	→	277	↓	28	↓	9	↓	5				
←	1001																																																																																																																																															
←	383	↑	426																																																																																																																																													
		↑	119																																																																																																																																													
→		↑																																																																																																																																														
→		↑																																																																																																																																														
↓		↑																																																																																																																																														
↓		↑																																																																																																																																														
←	22																																																																																																																																															
←	979	↑	176																																																																																																																																													
←	218	↑	13																																																																																																																																													
		↑	182																																																																																																																																													
→	34	↓	37																																																																																																																																													
→	20	↓	949																																																																																																																																													
↓	22	↓	169																																																																																																																																													
←	385																																																																																																																																															
←	235	↑	354																																																																																																																																													
←	348	↑	1237																																																																																																																																													
		↑	159																																																																																																																																													
→	487	↓	106																																																																																																																																													
→	1180	↓	263																																																																																																																																													
↓	80	↓	92																																																																																																																																													
←																																																																																																																																																
←		↑	222																																																																																																																																													
		↑	68																																																																																																																																													
→		↑																																																																																																																																														
→	150	↓	57																																																																																																																																													
↓	16	↓	52																																																																																																																																													
←	59																																																																																																																																															
←	6	↑	57																																																																																																																																													
←	54	↑	348																																																																																																																																													
		↑	9																																																																																																																																													
→	59	↓	28																																																																																																																																													
→	277	↓	28																																																																																																																																													
↓	9	↓	5																																																																																																																																													
11	Barton St. & Alessandro Blvd.	12	Barton St. & Grove Community Dr.	13	Barton St. & Orange Terrace Pkwy.	14	Barton St. & Van Buren Blvd.	15	Airman Dr. & Cactus Av.																																																																																																																																							
<table border="0"> <tr><td>←</td><td>3</td><td></td><td></td></tr> <tr><td>←</td><td>5</td><td>↑</td><td>5</td></tr> <tr><td>←</td><td></td><td>↑</td><td>1502</td></tr> <tr><td></td><td></td><td>↑</td><td>76</td></tr> <tr><td>→</td><td>5</td><td>↓</td><td>53</td></tr> <tr><td>→</td><td>1326</td><td>↓</td><td>1</td></tr> <tr><td>↓</td><td>32</td><td>↓</td><td>38</td></tr> </table>	←	3			←	5	↑	5	←		↑	1502			↑	76	→	5	↓	53	→	1326	↓	1	↓	32	↓	38	<table border="0"> <tr><td>←</td><td>53</td><td></td><td></td></tr> <tr><td>←</td><td>25</td><td>↑</td><td>20</td></tr> <tr><td></td><td></td><td>↑</td><td>206</td></tr> <tr><td>→</td><td>21</td><td>↓</td><td></td></tr> <tr><td>↓</td><td>148</td><td>↓</td><td></td></tr> </table>	←	53			←	25	↑	20			↑	206	→	21	↓		↓	148	↓		<table border="0"> <tr><td>←</td><td></td><td></td><td></td></tr> <tr><td>←</td><td></td><td>↑</td><td>455</td></tr> <tr><td></td><td></td><td>↑</td><td>51</td></tr> <tr><td>→</td><td></td><td>↑</td><td></td></tr> <tr><td>→</td><td>308</td><td>↓</td><td>267</td></tr> <tr><td>↓</td><td>316</td><td>↓</td><td>38</td></tr> </table>	←				←		↑	455			↑	51	→		↑		→	308	↓	267	↓	316	↓	38	<table border="0"> <tr><td>←</td><td>184</td><td></td><td></td></tr> <tr><td>←</td><td>29</td><td>↑</td><td>39</td></tr> <tr><td>←</td><td>29</td><td>↑</td><td>1448</td></tr> <tr><td></td><td></td><td>↑</td><td>201</td></tr> <tr><td>→</td><td>175</td><td>↓</td><td>254</td></tr> <tr><td>→</td><td>1385</td><td>↓</td><td>44</td></tr> <tr><td>↓</td><td>217</td><td>↓</td><td>162</td></tr> </table>	←	184			←	29	↑	39	←	29	↑	1448			↑	201	→	175	↓	254	→	1385	↓	44	↓	217	↓	162	<p style="text-align: center;"><i>Future Intersection</i></p>																																								
←	3																																																																																																																																															
←	5	↑	5																																																																																																																																													
←		↑	1502																																																																																																																																													
		↑	76																																																																																																																																													
→	5	↓	53																																																																																																																																													
→	1326	↓	1																																																																																																																																													
↓	32	↓	38																																																																																																																																													
←	53																																																																																																																																															
←	25	↑	20																																																																																																																																													
		↑	206																																																																																																																																													
→	21	↓																																																																																																																																														
↓	148	↓																																																																																																																																														
←																																																																																																																																																
←		↑	455																																																																																																																																													
		↑	51																																																																																																																																													
→		↑																																																																																																																																														
→	308	↓	267																																																																																																																																													
↓	316	↓	38																																																																																																																																													
←	184																																																																																																																																															
←	29	↑	39																																																																																																																																													
←	29	↑	1448																																																																																																																																													
		↑	201																																																																																																																																													
→	175	↓	254																																																																																																																																													
→	1385	↓	44																																																																																																																																													
↓	217	↓	162																																																																																																																																													
16	Abrams Dr. & Grove Community Dr.	17	Abrams Dr. & Orange Terrace Pkwy.	18	Linebacker Dr. & Cactus Av.	19	Orange Terrace Pkwy. & Van Buren Blvd.	20	Brown St. & Alessandro Blvd.																																																																																																																																							
<table border="0"> <tr><td>←</td><td></td><td></td><td></td></tr> <tr><td>←</td><td></td><td>↑</td><td>119</td></tr> <tr><td></td><td></td><td>↑</td><td>40</td></tr> <tr><td>→</td><td></td><td>↑</td><td></td></tr> <tr><td>→</td><td>86</td><td>↓</td><td>76</td></tr> <tr><td>↓</td><td>79</td><td>↓</td><td>37</td></tr> </table>	←				←		↑	119			↑	40	→		↑		→	86	↓	76	↓	79	↓	37	<table border="0"> <tr><td>←</td><td>62</td><td></td><td></td></tr> <tr><td>←</td><td>60</td><td>↑</td><td>72</td></tr> <tr><td></td><td></td><td>↑</td><td>194</td></tr> <tr><td>→</td><td>130</td><td>↓</td><td></td></tr> <tr><td>↓</td><td>165</td><td>↓</td><td></td></tr> </table>	←	62			←	60	↑	72			↑	194	→	130	↓		↓	165	↓		<p style="text-align: center;"><i>Future Intersection</i></p>	<table border="0"> <tr><td>←</td><td>127</td><td></td><td></td></tr> <tr><td>←</td><td>41</td><td>↑</td><td>277</td></tr> <tr><td>←</td><td>211</td><td>↑</td><td>1545</td></tr> <tr><td></td><td></td><td>↑</td><td>37</td></tr> <tr><td>→</td><td>143</td><td>↓</td><td>60</td></tr> <tr><td>→</td><td>1266</td><td>↓</td><td>53</td></tr> <tr><td>↓</td><td>56</td><td>↓</td><td>44</td></tr> </table>	←	127			←	41	↑	277	←	211	↑	1545			↑	37	→	143	↓	60	→	1266	↓	53	↓	56	↓	44	<table border="0"> <tr><td>←</td><td>38</td><td></td><td></td></tr> <tr><td>←</td><td></td><td>↑</td><td>36</td></tr> <tr><td>←</td><td></td><td>↑</td><td>1565</td></tr> <tr><td></td><td></td><td>↑</td><td>3</td></tr> <tr><td>→</td><td>33</td><td>↓</td><td></td></tr> <tr><td>↓</td><td>1378</td><td>↓</td><td></td></tr> </table>	←	38			←		↑	36	←		↑	1565			↑	3	→	33	↓		↓	1378	↓																																													
←																																																																																																																																																
←		↑	119																																																																																																																																													
		↑	40																																																																																																																																													
→		↑																																																																																																																																														
→	86	↓	76																																																																																																																																													
↓	79	↓	37																																																																																																																																													
←	62																																																																																																																																															
←	60	↑	72																																																																																																																																													
		↑	194																																																																																																																																													
→	130	↓																																																																																																																																														
↓	165	↓																																																																																																																																														
←	127																																																																																																																																															
←	41	↑	277																																																																																																																																													
←	211	↑	1545																																																																																																																																													
		↑	37																																																																																																																																													
→	143	↓	60																																																																																																																																													
→	1266	↓	53																																																																																																																																													
↓	56	↓	44																																																																																																																																													
←	38																																																																																																																																															
←		↑	36																																																																																																																																													
←		↑	1565																																																																																																																																													
		↑	3																																																																																																																																													
→	33	↓																																																																																																																																														
↓	1378	↓																																																																																																																																														

Saturday Peak Hour Intersection Volumes

<p>21 Brown St. & Cactus Av.</p> <p><i>Future Intersection</i></p>	<p>22 Sycamore Canyon Blvd. & Eastridge Av.</p> <table border="1"> <tr><td>← 34</td><td>↑ 341</td></tr> <tr><td>← 138</td><td>↑ 60</td></tr> <tr><td>← 132</td><td>↑ 213</td></tr> <tr><td>↓ 45</td><td>→ 51</td></tr> <tr><td>↓ 76</td><td>→ 331</td></tr> <tr><td>↓ 18</td><td>→ 79</td></tr> </table>	← 34	↑ 341	← 138	↑ 60	← 132	↑ 213	↓ 45	→ 51	↓ 76	→ 331	↓ 18	→ 79	<p>23 Sycamore Canyon Blvd. & Cottonwood Av.</p> <table border="1"> <tr><td>← 404</td><td>↑ 22</td></tr> <tr><td>← 20</td><td>↑ 7</td></tr> <tr><td>↓ 394</td><td>→ 12</td></tr> </table>	← 404	↑ 22	← 20	↑ 7	↓ 394	→ 12	<p>24 Meridian Pkwy. & Alessandro Blvd.</p> <table border="1"> <tr><td>← 57</td><td>↑ 96</td></tr> <tr><td>← 173</td><td>↑ 1308</td></tr> <tr><td>← 63</td><td>↑ 59</td></tr> <tr><td>↓ 108</td><td>→ 188</td></tr> <tr><td>↓ 1156</td><td>→ 155</td></tr> <tr><td>↓ 105</td><td>→ 17</td></tr> </table>	← 57	↑ 96	← 173	↑ 1308	← 63	↑ 59	↓ 108	→ 188	↓ 1156	→ 155	↓ 105	→ 17	<p>25 Meridian Pkwy. & Cactus Av.</p> <table border="1"> <tr><td>← 6</td><td>↑ 225</td></tr> <tr><td>← 224</td><td>↑ 10</td></tr> <tr><td>← 132</td><td>↑ 185</td></tr> <tr><td>↓ 17</td><td>→ 1</td></tr> <tr><td>↓ 32</td><td>→ 172</td></tr> <tr><td>↓ 5</td><td>→ 140</td></tr> </table>	← 6	↑ 225	← 224	↑ 10	← 132	↑ 185	↓ 17	→ 1	↓ 32	→ 172	↓ 5	→ 140						
← 34	↑ 341																																																			
← 138	↑ 60																																																			
← 132	↑ 213																																																			
↓ 45	→ 51																																																			
↓ 76	→ 331																																																			
↓ 18	→ 79																																																			
← 404	↑ 22																																																			
← 20	↑ 7																																																			
↓ 394	→ 12																																																			
← 57	↑ 96																																																			
← 173	↑ 1308																																																			
← 63	↑ 59																																																			
↓ 108	→ 188																																																			
↓ 1156	→ 155																																																			
↓ 105	→ 17																																																			
← 6	↑ 225																																																			
← 224	↑ 10																																																			
← 132	↑ 185																																																			
↓ 17	→ 1																																																			
↓ 32	→ 172																																																			
↓ 5	→ 140																																																			
<p>26 Meridian Pkwy. & Van Buren Blvd.</p> <table border="1"> <tr><td>← 376</td><td>↑ 30</td></tr> <tr><td>← 10</td><td>↑ 1503</td></tr> <tr><td>← 60</td><td>↑ 38</td></tr> <tr><td>↓ 165</td><td>→ 8</td></tr> <tr><td>↓ 1405</td><td>→ 7</td></tr> <tr><td>↓ 7</td><td>→ 21</td></tr> </table>	← 376	↑ 30	← 10	↑ 1503	← 60	↑ 38	↓ 165	→ 8	↓ 1405	→ 7	↓ 7	→ 21	<p>27 Innovation Dr. & Cactus Av.</p> <table border="1"> <tr><td>← 1</td><td>↑ 5</td></tr> <tr><td>← 1</td><td>↑ 420</td></tr> <tr><td>← 303</td><td>↑ 25</td></tr> <tr><td>↓ 1</td><td>→ 1</td></tr> <tr><td>↓ 303</td><td>→ 24</td></tr> </table>	← 1	↑ 5	← 1	↑ 420	← 303	↑ 25	↓ 1	→ 1	↓ 303	→ 24	<p>28 I-215 SB Ramps & Alessandro Blvd.</p> <table border="1"> <tr><td>← 294</td><td>↑ 130</td></tr> <tr><td>← 144</td><td>↑ 1120</td></tr> <tr><td>↓ 875</td><td>→ 354</td></tr> </table>	← 294	↑ 130	← 144	↑ 1120	↓ 875	→ 354	<p>29 I-215 NB Ramps & Alessandro Blvd.</p> <table border="1"> <tr><td>← 193</td><td>↑ 157</td></tr> <tr><td>← 830</td><td>↑ 969</td></tr> <tr><td>↓ 492</td><td>→ 10</td></tr> <tr><td>↓ 259</td><td>→ 259</td></tr> </table>	← 193	↑ 157	← 830	↑ 969	↓ 492	→ 10	↓ 259	→ 259	<p>30 I-215 SB Ramps & Cactus Av.</p> <table border="1"> <tr><td>← 64</td><td>↑ 388</td></tr> <tr><td>← 311</td><td>↑ 371</td></tr> <tr><td>↓ 30</td><td>→ 349</td></tr> </table>	← 64	↑ 388	← 311	↑ 371	↓ 30	→ 349						
← 376	↑ 30																																																			
← 10	↑ 1503																																																			
← 60	↑ 38																																																			
↓ 165	→ 8																																																			
↓ 1405	→ 7																																																			
↓ 7	→ 21																																																			
← 1	↑ 5																																																			
← 1	↑ 420																																																			
← 303	↑ 25																																																			
↓ 1	→ 1																																																			
↓ 303	→ 24																																																			
← 294	↑ 130																																																			
← 144	↑ 1120																																																			
↓ 875	→ 354																																																			
← 193	↑ 157																																																			
← 830	↑ 969																																																			
↓ 492	→ 10																																																			
↓ 259	→ 259																																																			
← 64	↑ 388																																																			
← 311	↑ 371																																																			
↓ 30	→ 349																																																			
<p>31 I-215 NB Ramps & Cactus Av.</p> <table border="1"> <tr><td>← 65</td><td>↑ 125</td></tr> <tr><td>← 1</td><td>↑ 1112</td></tr> <tr><td>← 116</td><td>↑ 3</td></tr> <tr><td>↓ 16</td><td>→ 40</td></tr> <tr><td>↓ 641</td><td>→ 70</td></tr> <tr><td>↓ 29</td><td>→ 3</td></tr> </table>	← 65	↑ 125	← 1	↑ 1112	← 116	↑ 3	↓ 16	→ 40	↓ 641	→ 70	↓ 29	→ 3	<p>32 I-215 SB Ramps & Van Buren Blvd.</p> <table border="1"> <tr><td>← 807</td><td>↑ 770</td></tr> <tr><td>← 22</td><td>↑ 14</td></tr> <tr><td>↓ 717</td><td>→ 797</td></tr> </table>	← 807	↑ 770	← 22	↑ 14	↓ 717	→ 797	<p>33 I-215 NB Ramps & Van Buren Blvd.</p> <table border="1"> <tr><td>← 722</td><td>↑ 43</td></tr> <tr><td>← 30</td><td>↑ 1</td></tr> <tr><td>↓ 759</td><td>→ 17</td></tr> </table>	← 722	↑ 43	← 30	↑ 1	↓ 759	→ 17	<p>34 Old 215 Frontage Rd. & Alessandro Blvd.</p> <table border="1"> <tr><td>← 221</td><td>↑ 99</td></tr> <tr><td>← 105</td><td>↑ 752</td></tr> <tr><td>← 90</td><td>↑ 11</td></tr> <tr><td>↓ 331</td><td>→ 24</td></tr> <tr><td>↓ 822</td><td>→ 83</td></tr> <tr><td>↓ 13</td><td>→ 14</td></tr> </table>	← 221	↑ 99	← 105	↑ 752	← 90	↑ 11	↓ 331	→ 24	↓ 822	→ 83	↓ 13	→ 14	<p>35 Day St. & Alessandro Blvd.</p> <table border="1"> <tr><td>← 91</td><td>↑ 139</td></tr> <tr><td>← 47</td><td>↑ 682</td></tr> <tr><td>← 117</td><td>↑ 9</td></tr> <tr><td>↓ 173</td><td>→ 10</td></tr> <tr><td>↓ 649</td><td>→ 95</td></tr> <tr><td>↓ 7</td><td>→ 15</td></tr> </table>	← 91	↑ 139	← 47	↑ 682	← 117	↑ 9	↓ 173	→ 10	↓ 649	→ 95	↓ 7	→ 15
← 65	↑ 125																																																			
← 1	↑ 1112																																																			
← 116	↑ 3																																																			
↓ 16	→ 40																																																			
↓ 641	→ 70																																																			
↓ 29	→ 3																																																			
← 807	↑ 770																																																			
← 22	↑ 14																																																			
↓ 717	→ 797																																																			
← 722	↑ 43																																																			
← 30	↑ 1																																																			
↓ 759	→ 17																																																			
← 221	↑ 99																																																			
← 105	↑ 752																																																			
← 90	↑ 11																																																			
↓ 331	→ 24																																																			
↓ 822	→ 83																																																			
↓ 13	→ 14																																																			
← 91	↑ 139																																																			
← 47	↑ 682																																																			
← 117	↑ 9																																																			
↓ 173	→ 10																																																			
↓ 649	→ 95																																																			
↓ 7	→ 15																																																			
<p>36 Elsworth St. & Cactus Av.</p> <table border="1"> <tr><td>← 111</td><td>↑ 133</td></tr> <tr><td>← 17</td><td>↑ 1041</td></tr> <tr><td>← 160</td><td>↑ 14</td></tr> <tr><td>↓ 137</td><td>→ 22</td></tr> <tr><td>↓ 1044</td><td>→ 11</td></tr> <tr><td>↓ 31</td><td>→ 9</td></tr> </table>	← 111	↑ 133	← 17	↑ 1041	← 160	↑ 14	↓ 137	→ 22	↓ 1044	→ 11	↓ 31	→ 9	<p>37 Frederick St. & Cactus Av.</p> <table border="1"> <tr><td>← 67</td><td>↑ 165</td></tr> <tr><td>← 263</td><td>↑ 1041</td></tr> <tr><td>← 2</td><td>↑ 2</td></tr> <tr><td>↓ 87</td><td>→ 1153</td></tr> <tr><td>↓ 1</td><td>→ 1</td></tr> </table>	← 67	↑ 165	← 263	↑ 1041	← 2	↑ 2	↓ 87	→ 1153	↓ 1	→ 1	<p>38 Graham St./Riverside Dr. & Cactus Av.</p> <table border="1"> <tr><td>← 70</td><td>↑ 64</td></tr> <tr><td>← 59</td><td>↑ 1120</td></tr> <tr><td>← 64</td><td>↑ 20</td></tr> <tr><td>↓ 56</td><td>→ 157</td></tr> <tr><td>↓ 1079</td><td>→ 46</td></tr> <tr><td>↓ 173</td><td>→ 16</td></tr> </table>	← 70	↑ 64	← 59	↑ 1120	← 64	↑ 20	↓ 56	→ 157	↓ 1079	→ 46	↓ 173	→ 16	<p>## Saturday Peak Hour Intersection Volumes</p>															
← 111	↑ 133																																																			
← 17	↑ 1041																																																			
← 160	↑ 14																																																			
↓ 137	→ 22																																																			
↓ 1044	→ 11																																																			
↓ 31	→ 9																																																			
← 67	↑ 165																																																			
← 263	↑ 1041																																																			
← 2	↑ 2																																																			
↓ 87	→ 1153																																																			
↓ 1	→ 1																																																			
← 70	↑ 64																																																			
← 59	↑ 1120																																																			
← 64	↑ 20																																																			
↓ 56	→ 157																																																			
↓ 1079	→ 46																																																			
↓ 173	→ 16																																																			

EXHIBIT 7-3: OPENING YEAR CUMULATIVE (2028) WITH PROJECT WEEKDAY TRAFFIC VOLUMES

<p>1 Washington St. & Van Buren Blvd.</p> <p>24,100 71(105) ↓ 202(397) ↓ 469(670) ↓</p> <p>43,650 ↑ 771(569) ↑ 1714(1402) ↑ 122(244)</p> <p>151(153) → 1331(1662) → 137(91) ↓</p> <p>156(113) ↑ 585(276) ↑ 170(132) ↑</p> <p>34,250 12,500</p>	<p>2 Alessandro Blvd. & Arlington Av./Chicago Av.</p> <p>40,650 48(23) ↓ 794(2054) ↓ 259(559) ↓</p> <p>34,400 ↑ 370(241) ↑ 932(754) ↑ 272(716)</p> <p>47(28) → 564(839) → 764(1304) ↓</p> <p>1491(1011) → 1861(1292) → 588(334) →</p> <p>38,650 64,100</p>	<p>3 Canyon Crest Dr. & Alessandro Blvd.</p> <p>21,700 77(59) ↓ 97(224) ↓ 556(740) ↓</p> <p>78,950 ↑ 1240(752) ↑ 3666(2582) ↑ 9(23)</p> <p>75(85) ↓ 1627(3395) → 1(18) ↓</p> <p>5(15) ↓ 193(134) → 11(57) ↓</p> <p>21,700 4,600</p>	<p>4 Wood Rd. & Van Buren Blvd.</p> <p>12,400 186(212) ↓ 478(277) ↓ 125(141) ↓</p> <p>47,450 ↑ 133(147) ↑ 1798(1822) ↑ 524(333)</p> <p>168(176) → 1342(1926) → 377(241) ↓</p> <p>387(341) → 478(272) → 371(272) →</p> <p>48,250 17,300</p>	<p>5 Trautwein Rd. & Alessandro Blvd.</p> <p>54,650 3594(2427) ↓ 261(368) ↓</p> <p>1358(2185) → 229(273) ↓</p> <p>2257(1331) ↓ 88(109) ↓</p> <p>65,250 22,450</p>
<p>6 Trautwein Rd. & Grove Community Dr.</p> <p>42,000 1510(2076) ↓ 241(426) ↓</p> <p>8,050 ↑ 698(270) ↑ 88(58)</p> <p>1923(1442) → 28(62) ↓</p> <p>30,450</p>	<p>7 Trautwein Rd. & Orange Terrace Pkwy.</p> <p>36,600 23(46) ↓ 1169(1712) ↓ 447(392) ↓</p> <p>10,300 ↑ 566(196) ↑ 114(28) ↑ 333(172)</p> <p>77(52) → 73(53) → 27(24) ↓</p> <p>62(50) → 1388(1347) → 277(241) →</p> <p>2,500 34,850</p>	<p>8 Trautwein Rd. & Van Buren Blvd.</p> <p>33,550 342(330) ↓ 534(691) ↓ 482(658) ↓</p> <p>53,800 ↑ 525(691) ↑ 1834(1657) ↑ 183(213)</p> <p>419(445) → 1401(1555) → 106(115) ↓</p> <p>247(102) → 676(382) → 161(125) ↓</p> <p>45,450 16,500</p>	<p>9 Deercreek Dr. & Grove Community Dr.</p> <p>4,950 ↑ 377(176) ↑ 57(25)</p> <p>118(242) → 90(21) ↓</p> <p>233(31) → 35(41) ↓</p> <p>4,800 1,150</p>	<p>10 Deercreek Dr. & Orange Terrace Pkwy.</p> <p>1,700 42(22) ↓ 35(9) ↓ 94(31) ↓</p> <p>9,550 ↑ 58(53) ↑ 634(314) ↑ 4(4)</p> <p>252(49) → 501(526) → 47(17) ↓</p> <p>179(21) → 179(21) → 7(2) ↓</p> <p>9,700 550</p>
<p>11 Barton St. & Alessandro Blvd.</p> <p>450 9(14) ↓ 10(15) ↓</p> <p>54,400 ↑ 8(17) ↑ 3025(2669) ↑ 41(77)</p> <p>7(6) → 1804(2345) → 51(55) ↓</p> <p>86(78) → 1(1) ↓ 55(38) ↓</p> <p>54,150 2,600</p>	<p>12 Barton St. & Grove Community Dr.</p> <p>1,200 11(54) ↓ 5(2) ↓</p> <p>4,650 ↑ 15(23) ↑ 423(146)</p> <p>39(45) → 114(239) →</p> <p>4,700</p>	<p>13 Barton St. & Orange Terrace Pkwy.</p> <p>7,800 459(258) ↓ 51(47) ↓</p> <p>312(429) → 289(129) ↓</p> <p>236(113) → 38(45) ↓</p> <p>9,400 4,100</p>	<p>14 Barton St. & Van Buren Blvd.</p> <p>6,350 352(168) ↓ 129(31) ↓ 65(28) ↓</p> <p>52,200 ↑ 34(54) ↑ 2000(2220) ↑ 290(319)</p> <p>175(192) → 1725(2032) → 215(333) ↓</p> <p>469(348) → 83(93) → 404(257) →</p> <p>56,750 14,750</p>	<p>15 Airman Dr. & Cactus Av.</p> <p>15,900 133(902) ↓</p> <p>28,900 ↑ 443(379) ↑ 331(305)</p> <p>99(696) →</p> <p>13,000</p>
<p>16 Abrams Dr. & Grove Community Dr.</p> <p>4,150 270(97) ↓ 106(40) ↓</p> <p>66(212) → 59(70) ↓</p> <p>155(56) → 70(66) ↓</p> <p>4,350 2,300</p>	<p>17 Abrams Dr. & Orange Terrace Pkwy.</p> <p>2,350 120(42) ↓ 84(28) ↓</p> <p>6,150 ↑ 100(37) ↑ 350(233)</p> <p>129(130) → 189(324) →</p> <p>7,200</p>	<p>18 Linebacker Dr. & Cactus Av.</p> <p>7,200 84(502) ↓</p> <p>43,350 ↑ 277(182) ↑ 774(684) ↑ 277(183)</p> <p>232(1598) → 84(503) ↓</p> <p>7,200</p>	<p>19 Orange Terrace Pkwy. & Van Buren Blvd.</p> <p>8,750 275(159) ↓ 41(44) ↓ 276(136) ↓</p> <p>56,250 ↑ 145(242) ↑ 2163(2219) ↑ 133(177)</p> <p>173(196) → 1844(2225) → 215(295) ↓</p> <p>125(313) → 24(48) → 81(228) →</p> <p>58,750 13,200</p>	<p>20 Brown St. & Alessandro Blvd.</p> <p>2,750 18(78) ↓ 1(1) ↓ 33(124) ↓</p> <p>54,450 ↑ 57(33) ↑ 2915(2491) ↑ 131(77)</p> <p>35(30) → 1801(2256) → 155(191) ↓</p> <p>45(386) → 0(2) → 51(471) ↓</p> <p>53,000 18,600</p>

###(###) AM(PM) Peak Hour Intersection Volumes

Average Daily Trips

21 Brown St. & Cactus Av. 17,700 129(344) ← 809(983) 32(102) → 199(299) → 43,350	22 Sycamore Canyon Blvd. & Eastridge Av. 19,900 42(44) ↓ 264(275) ↓ 76(81) ↑ 495(525) ↑ 190(202) ↑ 158(165) 50(53) → 41(43) → 18(19) → 72(77) ↑ 812(859) ↑ 103(109) ↑ 21,800	23 Sycamore Canyon Blvd. & Cottonwood Av. 17,400 329(344) ↓ 113(117) ↑ 37(39) 24(25) ↑ 968(1025) ↑ 65(66) ↑ 21,900	24 Meridian Pkwy. & Alessandro Blvd. 23,950 139(148) ↓ 202(209) ↓ 100(106) ↑ 602(637) ↑ 2370(2499) ↑ 246(251) 164(173) → 1247(1310) → 385(401) → 668(707) ↑ 681(720) ↑ 99(103) ↑ 33,450	25 Meridian Pkwy. & Cactus Av. 32,750 75(76) ↓ 302(312) ↓ 188(197) ↑ 997(1055) ↑ 618(661) ↑ 733(758) 46(46) → 154(202) → 38(83) → 188(188) ↑ 459(483) ↑ 287(301) ↑ 33,900
26 Meridian Pkwy. & Van Buren Blvd. 22,900 566(587) ↓ 6(6) ↓ 118(121) 754(782) → 2181(2257) → 2(3) ↓ 87,500	27 Innovation Dr. & Cactus Av. 800 2(3) ↓ 5(5) 5(5) → 567(589) → 17(18) ↓ 12(13) ↑ 37(39) ↑ 2,450	28 I-215 SB Ramps & Alessandro Blvd. 12,850 494(514) ↓ 243(254) ↑ 232(241) ↑ 2725(2875) 1026(1077) → 419(441) → 58,900	29 I-215 NB Ramps & Alessandro Blvd. 4,800 102(111) → 1203(1261) → 1350(1432) ↑ 237(248) ↑ 5,300	30 I-215 SB Ramps & Cactus Av. 8,200 580(618) ↓ 1550(1647) ↑ 778(816) 483(505) → 60(73) → 796(838) ↑ 18,300
31 I-215 NB Ramps & Cactus Av. 8,850 153(161) ↓ 54(58) 28(30) → 1574(1658) → 136(170) ↓ 513(532) ↑ 319(338) ↑ 48(48) ↑ 11,100	32 I-215 SB Ramps & Van Buren Blvd. 14,500 1390(1437) ↓ 23(25) ↓ 376(378) ↑ 1527(1587) 29(30) → 983(1016) → 974(1017) ↓ 28,250	33 I-215 NB Ramps & Van Buren Blvd. 3,700 171(173) 514(517) → 911(948) ↓ 1567(1631) ↑ 137(137) ↑ 27,350	34 Old 215 Frontage Rd. & Alessandro Blvd. 15,600 265(280) ↓ 70(74) ↓ 31(33) ↑ 135(142) ↑ 1600(1682) ↑ 11(11) 414(436) → 1185(1245) → 49(52) ↓ 60(63) ↑ 286(305) ↑ 21(22) ↑ 6,700	35 Day St. & Alessandro Blvd. 13,550 122(126) ↓ 72(74) ↓ 100(105) 178(187) → 871(913) → 10(11) ↓ 11(12) ↑ 174(184) ↑ 18(19) ↑ 148(157) ↑ 1444(1520) ↑ 10(11) ↑ 4,300
36 Elsworth St. & Cactus Av. 13,200 287(298) ↓ 62(66) ↓ 163(169) 290(301) → 1733(1823) → 311(330) ↓ 211(219) ↑ 2144(2254) ↑ 75(79) ↑ 25(26) ↓ 11(12) ↑ 17(18) ↑ 4,600	37 Frederick St. & Cactus Av. 13,150 126(132) ↓ 162(172) 212(224) → 1471(1551) → 156(165) ↑ 2144(2254) ↑ 51,300	38 Graham St./Riverside Dr. & Cactus Av. 6,900 183(190) ↓ 49(52) ↓ 91(96) 100(104) → 1419(1496) → 180(190) ↓ 96(102) ↑ 2445(2571) ↑ 10(11) ↑ 23(24) ↓ 5,500	##(##) AM(PM) Peak Hour Intersection Volumes ## Average Daily Trips	

EXHIBIT 7-3: OPENING YEAR CUMULATIVE (2028) WITH PROJECT WEEKEND TRAFFIC VOLUMES

<p>1 Washington St. & Van Buren Blvd.</p> <table border="1"> <tr> <td>← 83</td> <td>↑ 307</td> </tr> <tr> <td>← 191</td> <td>↑ 963</td> </tr> <tr> <td>← 406</td> <td>↑ 141</td> </tr> <tr> <td>↓ 126</td> <td>↓ 146</td> </tr> <tr> <td>↓ 991</td> <td>↓ 219</td> </tr> <tr> <td>↓ 78</td> <td>↓ 159</td> </tr> </table>	← 83	↑ 307	← 191	↑ 963	← 406	↑ 141	↓ 126	↓ 146	↓ 991	↓ 219	↓ 78	↓ 159	<p>2 Alessandro Blvd. & Arlington Av./Chicago Av.</p> <table border="1"> <tr> <td>← 31</td> <td>↑ 185</td> </tr> <tr> <td>← 973</td> <td>↑ 485</td> </tr> <tr> <td>← 244</td> <td>↑ 228</td> </tr> <tr> <td>↓ 24</td> <td>↓ 791</td> </tr> <tr> <td>↓ 363</td> <td>↓ 859</td> </tr> <tr> <td>↓ 660</td> <td>↓ 225</td> </tr> </table>	← 31	↑ 185	← 973	↑ 485	← 244	↑ 228	↓ 24	↓ 791	↓ 363	↓ 859	↓ 660	↓ 225	<p>3 Canyon Crest Dr. & Alessandro Blvd.</p> <table border="1"> <tr> <td>← 21</td> <td>↑ 451</td> </tr> <tr> <td>← 246</td> <td>↑ 1570</td> </tr> <tr> <td>← 349</td> <td>↑ 94</td> </tr> <tr> <td>↓ 38</td> <td>↓ 19</td> </tr> <tr> <td>↓ 1443</td> <td>↓ 240</td> </tr> <tr> <td>↓ 23</td> <td>↓ 96</td> </tr> </table>	← 21	↑ 451	← 246	↑ 1570	← 349	↑ 94	↓ 38	↓ 19	↓ 1443	↓ 240	↓ 23	↓ 96	<p>4 Wood Rd. & Van Buren Blvd.</p> <table border="1"> <tr> <td>← 155</td> <td>↑ 116</td> </tr> <tr> <td>← 163</td> <td>↑ 1475</td> </tr> <tr> <td>← 174</td> <td>↑ 235</td> </tr> <tr> <td>↓ 137</td> <td>↓ 214</td> </tr> <tr> <td>↓ 1522</td> <td>↓ 140</td> </tr> <tr> <td>↓ 218</td> <td>↓ 167</td> </tr> </table>	← 155	↑ 116	← 163	↑ 1475	← 174	↑ 235	↓ 137	↓ 214	↓ 1522	↓ 140	↓ 218	↓ 167	<p>5 Trautwein Rd. & Alessandro Blvd.</p> <table border="1"> <tr> <td>↑ 1386</td> </tr> <tr> <td>↑ 195</td> </tr> <tr> <td>↓ 1181</td> </tr> <tr> <td>↓ 265</td> </tr> <tr> <td>↓ 1072</td> </tr> <tr> <td>↓ 12</td> </tr> </table>	↑ 1386	↑ 195	↓ 1181	↓ 265	↓ 1072	↓ 12
← 83	↑ 307																																																									
← 191	↑ 963																																																									
← 406	↑ 141																																																									
↓ 126	↓ 146																																																									
↓ 991	↓ 219																																																									
↓ 78	↓ 159																																																									
← 31	↑ 185																																																									
← 973	↑ 485																																																									
← 244	↑ 228																																																									
↓ 24	↓ 791																																																									
↓ 363	↓ 859																																																									
↓ 660	↓ 225																																																									
← 21	↑ 451																																																									
← 246	↑ 1570																																																									
← 349	↑ 94																																																									
↓ 38	↓ 19																																																									
↓ 1443	↓ 240																																																									
↓ 23	↓ 96																																																									
← 155	↑ 116																																																									
← 163	↑ 1475																																																									
← 174	↑ 235																																																									
↓ 137	↓ 214																																																									
↓ 1522	↓ 140																																																									
↓ 218	↓ 167																																																									
↑ 1386																																																										
↑ 195																																																										
↓ 1181																																																										
↓ 265																																																										
↓ 1072																																																										
↓ 12																																																										
<p>6 Trautwein Rd. & Grove Community Dr.</p> <table border="1"> <tr> <td>← 1001</td> <td>↑ 426</td> </tr> <tr> <td>← 383</td> <td>↑ 119</td> </tr> <tr> <td>↓ 1079</td> <td>↓ 97</td> </tr> </table>	← 1001	↑ 426	← 383	↑ 119	↓ 1079	↓ 97	<p>7 Trautwein Rd. & Orange Terrace Pkwy.</p> <table border="1"> <tr> <td>← 22</td> <td>↑ 176</td> </tr> <tr> <td>← 979</td> <td>↑ 13</td> </tr> <tr> <td>← 218</td> <td>↑ 182</td> </tr> <tr> <td>↓ 34</td> <td>↓ 37</td> </tr> <tr> <td>↓ 20</td> <td>↓ 949</td> </tr> <tr> <td>↓ 22</td> <td>↓ 169</td> </tr> </table>	← 22	↑ 176	← 979	↑ 13	← 218	↑ 182	↓ 34	↓ 37	↓ 20	↓ 949	↓ 22	↓ 169	<p>8 Trautwein Rd. & Van Buren Blvd.</p> <table border="1"> <tr> <td>← 385</td> <td>↑ 354</td> </tr> <tr> <td>← 235</td> <td>↑ 1301</td> </tr> <tr> <td>← 348</td> <td>↑ 175</td> </tr> <tr> <td>↓ 487</td> <td>↓ 106</td> </tr> <tr> <td>↓ 1247</td> <td>↓ 263</td> </tr> <tr> <td>↓ 80</td> <td>↓ 109</td> </tr> </table>	← 385	↑ 354	← 235	↑ 1301	← 348	↑ 175	↓ 487	↓ 106	↓ 1247	↓ 263	↓ 80	↓ 109	<p>9 Deercreek Dr. & Grove Community Dr.</p> <table border="1"> <tr> <td>↑ 230</td> </tr> <tr> <td>↑ 68</td> </tr> <tr> <td>↓ 158</td> </tr> <tr> <td>↓ 16</td> </tr> <tr> <td>↓ 57</td> </tr> <tr> <td>↓ 52</td> </tr> </table>	↑ 230	↑ 68	↓ 158	↓ 16	↓ 57	↓ 52	<p>10 Deercreek Dr. & Orange Terrace Pkwy.</p> <table border="1"> <tr> <td>↑ 57</td> </tr> <tr> <td>↑ 348</td> </tr> <tr> <td>↑ 9</td> </tr> <tr> <td>↓ 59</td> </tr> <tr> <td>↓ 6</td> </tr> <tr> <td>↓ 54</td> </tr> <tr> <td>↓ 277</td> </tr> <tr> <td>↓ 9</td> </tr> <tr> <td>↓ 28</td> </tr> <tr> <td>↓ 28</td> </tr> <tr> <td>↓ 5</td> </tr> </table>	↑ 57	↑ 348	↑ 9	↓ 59	↓ 6	↓ 54	↓ 277	↓ 9	↓ 28	↓ 28	↓ 5							
← 1001	↑ 426																																																									
← 383	↑ 119																																																									
↓ 1079	↓ 97																																																									
← 22	↑ 176																																																									
← 979	↑ 13																																																									
← 218	↑ 182																																																									
↓ 34	↓ 37																																																									
↓ 20	↓ 949																																																									
↓ 22	↓ 169																																																									
← 385	↑ 354																																																									
← 235	↑ 1301																																																									
← 348	↑ 175																																																									
↓ 487	↓ 106																																																									
↓ 1247	↓ 263																																																									
↓ 80	↓ 109																																																									
↑ 230																																																										
↑ 68																																																										
↓ 158																																																										
↓ 16																																																										
↓ 57																																																										
↓ 52																																																										
↑ 57																																																										
↑ 348																																																										
↑ 9																																																										
↓ 59																																																										
↓ 6																																																										
↓ 54																																																										
↓ 277																																																										
↓ 9																																																										
↓ 28																																																										
↓ 28																																																										
↓ 5																																																										
<p>11 Barton St. & Alessandro Blvd.</p> <table border="1"> <tr> <td>← 3</td> <td>↑ 5</td> </tr> <tr> <td>← 5</td> <td>↑ 1597</td> </tr> <tr> <td>← 5</td> <td>↑ 76</td> </tr> <tr> <td>↓ 1426</td> <td>↓ 61</td> </tr> <tr> <td>↓ 40</td> <td>↓ 1</td> </tr> <tr> <td></td> <td>↓ 38</td> </tr> </table>	← 3	↑ 5	← 5	↑ 1597	← 5	↑ 76	↓ 1426	↓ 61	↓ 40	↓ 1		↓ 38	<p>12 Barton St. & Grove Community Dr.</p> <table border="1"> <tr> <td>← 61</td> <td>↑ 20</td> </tr> <tr> <td>← 25</td> <td>↑ 206</td> </tr> <tr> <td>← 17</td> <td>↑ 17</td> </tr> <tr> <td>↓ 29</td> <td>↓ 16</td> </tr> <tr> <td>↓ 148</td> <td></td> </tr> </table>	← 61	↑ 20	← 25	↑ 206	← 17	↑ 17	↓ 29	↓ 16	↓ 148		<p>13 Barton St. & Orange Terrace Pkwy.</p> <table border="1"> <tr> <td>← 17</td> <td>↑ 455</td> </tr> <tr> <td>← 51</td> <td>↑ 51</td> </tr> <tr> <td>↓ 308</td> <td>↓ 267</td> </tr> <tr> <td>↓ 316</td> <td>↓ 16</td> </tr> <tr> <td></td> <td>↓ 38</td> </tr> </table>	← 17	↑ 455	← 51	↑ 51	↓ 308	↓ 267	↓ 316	↓ 16		↓ 38	<p>14 Barton St. & Van Buren Blvd.</p> <table border="1"> <tr> <td>← 184</td> <td>↑ 55</td> </tr> <tr> <td>← 29</td> <td>↑ 1527</td> </tr> <tr> <td>← 46</td> <td>↑ 217</td> </tr> <tr> <td>↓ 175</td> <td>↓ 254</td> </tr> <tr> <td>↓ 1469</td> <td>↓ 44</td> </tr> <tr> <td>↓ 217</td> <td>↓ 179</td> </tr> </table>	← 184	↑ 55	← 29	↑ 1527	← 46	↑ 217	↓ 175	↓ 254	↓ 1469	↓ 44	↓ 217	↓ 179	<p>15 Airman Dr. & Cactus Av.</p> <table border="1"> <tr> <td>↑ 426</td> </tr> <tr> <td>↑ 356</td> </tr> <tr> <td>↓ 411</td> </tr> <tr> <td>↓ 345</td> </tr> </table>	↑ 426	↑ 356	↓ 411	↓ 345						
← 3	↑ 5																																																									
← 5	↑ 1597																																																									
← 5	↑ 76																																																									
↓ 1426	↓ 61																																																									
↓ 40	↓ 1																																																									
	↓ 38																																																									
← 61	↑ 20																																																									
← 25	↑ 206																																																									
← 17	↑ 17																																																									
↓ 29	↓ 16																																																									
↓ 148																																																										
← 17	↑ 455																																																									
← 51	↑ 51																																																									
↓ 308	↓ 267																																																									
↓ 316	↓ 16																																																									
	↓ 38																																																									
← 184	↑ 55																																																									
← 29	↑ 1527																																																									
← 46	↑ 217																																																									
↓ 175	↓ 254																																																									
↓ 1469	↓ 44																																																									
↓ 217	↓ 179																																																									
↑ 426																																																										
↑ 356																																																										
↓ 411																																																										
↓ 345																																																										
<p>16 Abrams Dr. & Grove Community Dr.</p> <table border="1"> <tr> <td>↑ 136</td> </tr> <tr> <td>↑ 40</td> </tr> <tr> <td>↓ 102</td> </tr> <tr> <td>↓ 79</td> </tr> <tr> <td>↓ 76</td> </tr> <tr> <td>↓ 37</td> </tr> </table>	↑ 136	↑ 40	↓ 102	↓ 79	↓ 76	↓ 37	<p>17 Abrams Dr. & Orange Terrace Pkwy.</p> <table border="1"> <tr> <td>← 62</td> <td>↑ 72</td> </tr> <tr> <td>← 60</td> <td>↑ 194</td> </tr> <tr> <td>↓ 130</td> <td></td> </tr> <tr> <td>↓ 165</td> <td></td> </tr> </table>	← 62	↑ 72	← 60	↑ 194	↓ 130		↓ 165		<p>18 Linebacker Dr. & Cactus Av.</p> <table border="1"> <tr> <td>← 159</td> <td>↑ 168</td> </tr> <tr> <td>← 169</td> <td>↑ 782</td> </tr> <tr> <td>↓ 756</td> <td>↓ 159</td> </tr> </table>	← 159	↑ 168	← 169	↑ 782	↓ 756	↓ 159	<p>19 Orange Terrace Pkwy. & Van Buren Blvd.</p> <table border="1"> <tr> <td>← 127</td> <td>↑ 277</td> </tr> <tr> <td>← 41</td> <td>↑ 1656</td> </tr> <tr> <td>← 211</td> <td>↑ 37</td> </tr> <tr> <td>↓ 143</td> <td>↓ 60</td> </tr> <tr> <td>↓ 1383</td> <td>↓ 53</td> </tr> <tr> <td>↓ 56</td> <td>↓ 44</td> </tr> </table>	← 127	↑ 277	← 41	↑ 1656	← 211	↑ 37	↓ 143	↓ 60	↓ 1383	↓ 53	↓ 56	↓ 44	<p>20 Brown St. & Alessandro Blvd.</p> <table border="1"> <tr> <td>↑ 36</td> </tr> <tr> <td>↑ 1419</td> </tr> <tr> <td>↑ 275</td> </tr> <tr> <td>↓ 38</td> </tr> <tr> <td>↓ 33</td> </tr> <tr> <td>↓ 1232</td> </tr> <tr> <td>↓ 246</td> </tr> <tr> <td>↓ 241</td> </tr> <tr> <td>↓ 266</td> </tr> </table>	↑ 36	↑ 1419	↑ 275	↓ 38	↓ 33	↓ 1232	↓ 246	↓ 241	↓ 266													
↑ 136																																																										
↑ 40																																																										
↓ 102																																																										
↓ 79																																																										
↓ 76																																																										
↓ 37																																																										
← 62	↑ 72																																																									
← 60	↑ 194																																																									
↓ 130																																																										
↓ 165																																																										
← 159	↑ 168																																																									
← 169	↑ 782																																																									
↓ 756	↓ 159																																																									
← 127	↑ 277																																																									
← 41	↑ 1656																																																									
← 211	↑ 37																																																									
↓ 143	↓ 60																																																									
↓ 1383	↓ 53																																																									
↓ 56	↓ 44																																																									
↑ 36																																																										
↑ 1419																																																										
↑ 275																																																										
↓ 38																																																										
↓ 33																																																										
↓ 1232																																																										
↓ 246																																																										
↓ 241																																																										
↓ 266																																																										

Saturday Peak Hour Intersection Volumes

<p>21 Brown St. & Cactus Av.</p> <table border="1"> <tr> <td>← 518</td> <td>↑ 601</td> </tr> <tr> <td>507 ↓</td> <td></td> </tr> <tr> <td>567 →</td> <td></td> </tr> </table>	← 518	↑ 601	507 ↓		567 →		<p>22 Sycamore Canyon Blvd. & Eastridge Av.</p> <table border="1"> <tr> <td>← 34</td> <td>↑ 341</td> </tr> <tr> <td>← 155</td> <td>↑ 60</td> </tr> <tr> <td>← 132</td> <td>↑ 213</td> </tr> <tr> <td>45 ↓</td> <td>51 →</td> </tr> <tr> <td>76 ↓</td> <td>347 →</td> </tr> <tr> <td>18 ↓</td> <td>79 →</td> </tr> </table>	← 34	↑ 341	← 155	↑ 60	← 132	↑ 213	45 ↓	51 →	76 ↓	347 →	18 ↓	79 →	<p>23 Sycamore Canyon Blvd. & Cottonwood Av.</p> <table border="1"> <tr> <td>← 421</td> <td>↑ 22</td> </tr> <tr> <td>← 20</td> <td>↑ 7</td> </tr> <tr> <td></td> <td>410 →</td> </tr> <tr> <td></td> <td>12 →</td> </tr> </table>	← 421	↑ 22	← 20	↑ 7		410 →		12 →	<p>24 Meridian Pkwy. & Alessandro Blvd.</p> <table border="1"> <tr> <td>← 57</td> <td>↑ 96</td> </tr> <tr> <td>← 190</td> <td>↑ 1434</td> </tr> <tr> <td>← 63</td> <td>↑ 85</td> </tr> <tr> <td>108 ↓</td> <td>188 →</td> </tr> <tr> <td>1276 ↓</td> <td>171 →</td> </tr> <tr> <td>105 ↓</td> <td>42 →</td> </tr> </table>	← 57	↑ 96	← 190	↑ 1434	← 63	↑ 85	108 ↓	188 →	1276 ↓	171 →	105 ↓	42 →	<p>25 Meridian Pkwy. & Cactus Av.</p> <table border="1"> <tr> <td>← 49</td> <td>↑ 225</td> </tr> <tr> <td>← 224</td> <td>↑ 391</td> </tr> <tr> <td>← 132</td> <td>↑ 185</td> </tr> <tr> <td>58 ↓</td> <td>178 →</td> </tr> <tr> <td>390 ↓</td> <td>172 →</td> </tr> <tr> <td>172 ↓</td> <td>140 →</td> </tr> </table>	← 49	↑ 225	← 224	↑ 391	← 132	↑ 185	58 ↓	178 →	390 ↓	172 →	172 ↓	140 →										
← 518	↑ 601																																																															
507 ↓																																																																
567 →																																																																
← 34	↑ 341																																																															
← 155	↑ 60																																																															
← 132	↑ 213																																																															
45 ↓	51 →																																																															
76 ↓	347 →																																																															
18 ↓	79 →																																																															
← 421	↑ 22																																																															
← 20	↑ 7																																																															
	410 →																																																															
	12 →																																																															
← 57	↑ 96																																																															
← 190	↑ 1434																																																															
← 63	↑ 85																																																															
108 ↓	188 →																																																															
1276 ↓	171 →																																																															
105 ↓	42 →																																																															
← 49	↑ 225																																																															
← 224	↑ 391																																																															
← 132	↑ 185																																																															
58 ↓	178 →																																																															
390 ↓	172 →																																																															
172 ↓	140 →																																																															
<p>26 Meridian Pkwy. & Van Buren Blvd.</p> <table border="1"> <tr> <td>← 503</td> <td>↑ 73</td> </tr> <tr> <td>← 10</td> <td>↑ 1503</td> </tr> <tr> <td>← 100</td> <td>↑ 38</td> </tr> <tr> <td>299 ↓</td> <td>8 →</td> </tr> <tr> <td>1405 ↓</td> <td>7 →</td> </tr> <tr> <td>7 ↓</td> <td>21 →</td> </tr> </table>	← 503	↑ 73	← 10	↑ 1503	← 100	↑ 38	299 ↓	8 →	1405 ↓	7 →	7 ↓	21 →	<p>27 Innovation Dr. & Cactus Av.</p> <table border="1"> <tr> <td>← 1</td> <td>↑ 5</td> </tr> <tr> <td>← 1</td> <td>↑ 801</td> </tr> <tr> <td>← 1</td> <td>↑ 25</td> </tr> <tr> <td>661 ↓</td> <td>1 →</td> </tr> <tr> <td>1 ↓</td> <td>24 →</td> </tr> </table>	← 1	↑ 5	← 1	↑ 801	← 1	↑ 25	661 ↓	1 →	1 ↓	24 →	<p>28 I-215 SB Ramps & Alessandro Blvd.</p> <table border="1"> <tr> <td>← 337</td> <td>↑ 130</td> </tr> <tr> <td>← 144</td> <td>↑ 1230</td> </tr> <tr> <td></td> <td></td> </tr> <tr> <td>947 →</td> <td></td> </tr> <tr> <td>426 ↓</td> <td></td> </tr> </table>	← 337	↑ 130	← 144	↑ 1230			947 →		426 ↓		<p>29 I-215 NB Ramps & Alessandro Blvd.</p> <table border="1"> <tr> <td></td> <td>↑ 157</td> </tr> <tr> <td></td> <td>↑ 1002</td> </tr> <tr> <td></td> <td></td> </tr> <tr> <td>234 ↓</td> <td></td> </tr> <tr> <td>862 ↓</td> <td></td> </tr> <tr> <td></td> <td>568 →</td> </tr> <tr> <td></td> <td>10 →</td> </tr> <tr> <td></td> <td>259 →</td> </tr> </table>		↑ 157		↑ 1002			234 ↓		862 ↓			568 →		10 →		259 →	<p>30 I-215 SB Ramps & Cactus Av.</p> <table border="1"> <tr> <td>← 294</td> <td>↑ 539</td> </tr> <tr> <td></td> <td>↑ 371</td> </tr> <tr> <td></td> <td></td> </tr> <tr> <td>591 →</td> <td></td> </tr> <tr> <td>109 ↓</td> <td></td> </tr> <tr> <td></td> <td>349 →</td> </tr> </table>	← 294	↑ 539		↑ 371			591 →		109 ↓			349 →
← 503	↑ 73																																																															
← 10	↑ 1503																																																															
← 100	↑ 38																																																															
299 ↓	8 →																																																															
1405 ↓	7 →																																																															
7 ↓	21 →																																																															
← 1	↑ 5																																																															
← 1	↑ 801																																																															
← 1	↑ 25																																																															
661 ↓	1 →																																																															
1 ↓	24 →																																																															
← 337	↑ 130																																																															
← 144	↑ 1230																																																															
947 →																																																																
426 ↓																																																																
	↑ 157																																																															
	↑ 1002																																																															
234 ↓																																																																
862 ↓																																																																
	568 →																																																															
	10 →																																																															
	259 →																																																															
← 294	↑ 539																																																															
	↑ 371																																																															
591 →																																																																
109 ↓																																																																
	349 →																																																															
<p>31 I-215 NB Ramps & Cactus Av.</p> <table border="1"> <tr> <td>← 82</td> <td>↑ 125</td> </tr> <tr> <td>← 1</td> <td>↑ 1162</td> </tr> <tr> <td>← 116</td> <td></td> </tr> <tr> <td>32 ↓</td> <td>124 →</td> </tr> <tr> <td>689 ↓</td> <td>70 →</td> </tr> <tr> <td>245 ↓</td> <td>3 →</td> </tr> </table>	← 82	↑ 125	← 1	↑ 1162	← 116		32 ↓	124 →	689 ↓	70 →	245 ↓	3 →	<p>32 I-215 SB Ramps & Van Buren Blvd.</p> <table border="1"> <tr> <td>← 807</td> <td>↑ 813</td> </tr> <tr> <td>← 22</td> <td>↑ 14</td> </tr> <tr> <td></td> <td></td> </tr> <tr> <td>717 →</td> <td></td> </tr> <tr> <td>837 ↓</td> <td></td> </tr> </table>	← 807	↑ 813	← 22	↑ 14			717 →		837 ↓		<p>33 I-215 NB Ramps & Van Buren Blvd.</p> <table border="1"> <tr> <td>← 722</td> <td>↑ 30</td> </tr> <tr> <td>← 30</td> <td></td> </tr> <tr> <td></td> <td></td> </tr> <tr> <td>802 ↓</td> <td>1 →</td> </tr> <tr> <td>17 ↓</td> <td>43 →</td> </tr> </table>	← 722	↑ 30	← 30				802 ↓	1 →	17 ↓	43 →	<p>34 Old 215 Frontage Rd. & Alessandro Blvd.</p> <table border="1"> <tr> <td>← 221</td> <td>↑ 99</td> </tr> <tr> <td>← 122</td> <td>↑ 785</td> </tr> <tr> <td>← 90</td> <td>↑ 11</td> </tr> <tr> <td>331 ↓</td> <td>24 →</td> </tr> <tr> <td>854 ↓</td> <td>99 →</td> </tr> <tr> <td>13 ↓</td> <td>14 →</td> </tr> </table>	← 221	↑ 99	← 122	↑ 785	← 90	↑ 11	331 ↓	24 →	854 ↓	99 →	13 ↓	14 →	<p>35 Day St. & Alessandro Blvd.</p> <table border="1"> <tr> <td>← 108</td> <td>↑ 139</td> </tr> <tr> <td>← 47</td> <td>↑ 699</td> </tr> <tr> <td>← 117</td> <td>↑ 9</td> </tr> <tr> <td>189 ↓</td> <td>10 →</td> </tr> <tr> <td>665 ↓</td> <td>95 →</td> </tr> <tr> <td>7 ↓</td> <td>15 →</td> </tr> </table>	← 108	↑ 139	← 47	↑ 699	← 117	↑ 9	189 ↓	10 →	665 ↓	95 →	7 ↓	15 →				
← 82	↑ 125																																																															
← 1	↑ 1162																																																															
← 116																																																																
32 ↓	124 →																																																															
689 ↓	70 →																																																															
245 ↓	3 →																																																															
← 807	↑ 813																																																															
← 22	↑ 14																																																															
717 →																																																																
837 ↓																																																																
← 722	↑ 30																																																															
← 30																																																																
802 ↓	1 →																																																															
17 ↓	43 →																																																															
← 221	↑ 99																																																															
← 122	↑ 785																																																															
← 90	↑ 11																																																															
331 ↓	24 →																																																															
854 ↓	99 →																																																															
13 ↓	14 →																																																															
← 108	↑ 139																																																															
← 47	↑ 699																																																															
← 117	↑ 9																																																															
189 ↓	10 →																																																															
665 ↓	95 →																																																															
7 ↓	15 →																																																															
<p>36 Elsworth St. & Cactus Av.</p> <table border="1"> <tr> <td>← 128</td> <td>↑ 133</td> </tr> <tr> <td>← 17</td> <td>↑ 1075</td> </tr> <tr> <td>← 160</td> <td>↑ 14</td> </tr> <tr> <td>153 ↓</td> <td>22 →</td> </tr> <tr> <td>1076 ↓</td> <td>11 →</td> </tr> <tr> <td>31 ↓</td> <td>9 →</td> </tr> </table>	← 128	↑ 133	← 17	↑ 1075	← 160	↑ 14	153 ↓	22 →	1076 ↓	11 →	31 ↓	9 →	<p>37 Frederick St. & Cactus Av.</p> <table border="1"> <tr> <td>← 84</td> <td>↑ 165</td> </tr> <tr> <td>← 263</td> <td>↑ 1075</td> </tr> <tr> <td>← 2</td> <td></td> </tr> <tr> <td>103 ↓</td> <td></td> </tr> <tr> <td>1169 ↓</td> <td></td> </tr> <tr> <td>1 ↓</td> <td></td> </tr> </table>	← 84	↑ 165	← 263	↑ 1075	← 2		103 ↓		1169 ↓		1 ↓		<p>38 Graham St./Riverside Dr. & Cactus Av.</p> <table border="1"> <tr> <td>← 70</td> <td>↑ 64</td> </tr> <tr> <td>← 59</td> <td>↑ 1137</td> </tr> <tr> <td>← 64</td> <td>↑ 20</td> </tr> <tr> <td>56 ↓</td> <td>157 →</td> </tr> <tr> <td>1095 ↓</td> <td>46 →</td> </tr> <tr> <td>173 ↓</td> <td>16 →</td> </tr> </table>	← 70	↑ 64	← 59	↑ 1137	← 64	↑ 20	56 ↓	157 →	1095 ↓	46 →	173 ↓	16 →	<p>## Saturday Peak Hour Intersection Volumes</p>																									
← 128	↑ 133																																																															
← 17	↑ 1075																																																															
← 160	↑ 14																																																															
153 ↓	22 →																																																															
1076 ↓	11 →																																																															
31 ↓	9 →																																																															
← 84	↑ 165																																																															
← 263	↑ 1075																																																															
← 2																																																																
103 ↓																																																																
1169 ↓																																																																
1 ↓																																																																
← 70	↑ 64																																																															
← 59	↑ 1137																																																															
← 64	↑ 20																																																															
56 ↓	157 →																																																															
1095 ↓	46 →																																																															
173 ↓	16 →																																																															

7.4 INTERSECTION OPERATIONS ANALYSIS

7.4.1 OPENING YEAR CUMULATIVE (2028) WITHOUT PROJECT TRAFFIC CONDITIONS

Opening Year Cumulative (2028) peak hour traffic operations have been evaluated for the study area intersections based on the analysis methodologies presented in Section 2.2 *Intersection Capacity Analysis* of this report. The intersection analysis results are summarized in Table 7-1, which indicates that the following study area intersections are anticipated to continue to operate at an unacceptable LOS during the peak hours under Opening Year Cumulative (2028) Without Project traffic conditions:

- Washington St. & Van Buren Bl. (#1) – LOS F AM and PM peak hours
- Alessandro Bl. & Arlington Av./Chicago Av. (#2) – LOS F AM and PM peak hours
- Canyon Crest Dr./Overlook Pkwy. & Alessandro Bl. (#3) – LOS F AM and PM peak hours
- Wood Rd. & Van Buren Bl. (#4) – LOS F AM and PM peak hours
- Trautwein Rd. & Alessandro Bl. (#5) – LOS F AM peak hour only
- Trautwein Rd. & Grove Community Dr. (#6) – LOS E AM peak hour only
- Trautwein Rd. & Orange Terrace Pkwy. (#7) – LOS F AM peak hour only
- Trautwein Rd. & Van Buren Bl. (#8) – LOS F AM and PM peak hours
- Deercreek Dr. & Orange Terrace Pkwy. (#10) – LOS F AM peak hour only
- Barton St. & Alessandro Bl. (#11) – LOS E AM peak hour only
- Barton St. & Orange Terrace Pkwy. (#13) – LOS F AM and Saturday peak hours
- Barton St. & Van Buren Bl. (#14) – LOS F AM and PM peak hours; LOS E Saturday peak hour
- Meridian Pkwy. & Alessandro Bl. (#24) – LOS F AM and PM peak hours
- Meridian Pkwy. & Cactus Av. (#25) – LOS E AM peak hour; LOS F PM peak hour
- Meridian Pkwy. & Van Buren Bl. (#26) – LOS F AM and PM peak hours
- I-215 NB Ramps & Alessandro Bl. (#29) – LOS F AM peak hour only
- I-215 NB Ramps & Cactus Av. (#31) – LOS F AM and PM peak hours
- I-215 SB Ramps & Van Buren Bl. (#32) – LOS F PM peak hour only
- Old 215 Frontage Rd. & Alessandro Bl. (#34) – LOS E AM peak hour only
- Elsworth St. & Cactus Av. (#36) – LOS F AM and PM peak hours
- Frederick St. & Cactus Av. (#37) – LOS E AM peak hour only

The intersection operations analysis worksheets for Opening Year Cumulative (2028) Without Project traffic conditions are included in Appendix 7.1 of this TA.

TABLE 7-1: INTERSECTION ANALYSIS FOR OPENING YEAR CUMULATIVE (2028) CONDITIONS

#	Intersection	Traffic Control ¹	OY (2028) NP						OY (2028) WP					
			Delay ^{2 3 4 5} (secs.)			Level of Service			Delay ^{2 3 4 5} (secs.)			Level of Service		
			AM	PM	SAT	AM	PM	SAT	AM	PM	SAT	AM	PM	SAT
1	Washington St. & Van Buren Blvd.	TS	97.2	82.6	29.0	F	F	C	102.7	91.2	31.1	F	F	C
2	Alessandro Blvd. & Arlington Av./Chicago Av.	TS	128.9	148.3	29.3	F	F	C	131.5	156.6	30.3	F	F	C
3	Canyon Crest Dr./Overlook Pkwy. & Alessandro Blvd.	TS	129.5	133.8	24.6	F	F	C	143.0	>200.0	27.6	F	F	C
4	Wood Rd. & Van Buren Blvd.	TS	147.5	124.7	45.8	F	F	D	159.2	148.6	49.6	F	F	D
5	Trautwein Rd. & Alessandro Blvd.	TS	167.6	51.3	19.4	F	D	B	169.1	54.5	19.9	F	D	B
6	Trautwein Rd. & Grove Community Dr.	TS	65.3	13.9	13.8	E	B	B	65.3	13.9	13.8	E	B	B
7	Trautwein Rd. & Orange Terrace Pkwy.	TS	93.4	37.3	22.7	F	D	C	93.9	37.3	22.7	F	D	C
8	Trautwein Rd. & Van Buren Blvd.	TS	159.3	94.0	37.0	F	F	D	179.3	109.5	40.4	F	F	D
9	Deercreek Dr. & Grove Community Dr.	AWS	24.2	9.7	10.2	C	A	B	25.2	9.9	10.3	D	A	B
10	Deercreek Dr. & Orange Terrace Pkwy.	AWS	>100.0	11.4	10.9	F	B	B	>100.0	11.4	10.9	F	B	B
11	Barton St. & Alessandro Blvd.	TS	58.1	15.2	8.2	E	B	A	62.0	29.6	8.5	E	C	A
12	Barton St. & Grove Community Dr.	CSS	14.2	9.5	11.6	B	A	B	14.2	9.6	11.7	B	A	B
13	Barton St. & Orange Terrace Pkwy.	CSS	>100.0	20.2	>100.0	F	C	F	>100.0	20.2	>100.0	F	C	F
14	Barton St. & Van Buren Blvd.	TS	>200.0	137.1	60.1	F	F	E	>200.0	147.0	72.2	F	F	E
15	Airman Dr. & Cactus Av.	AWS	Future Intersection						14.8	52.9	21.5	B	D	C
16	Abrams Dr. & Grove Community Dr.	AWS	12.3	8.8	8.7	B	A	A	13.0	9.3	8.8	B	A	A
17	Abrams Dr. & Orange Terrace Pkwy.	AWS	15.9	8.9	9.4	C	A	A	15.9	8.9	9.4	C	A	A
18	Linebacker Dr. & Cactus Av.	TS	Future Intersection						22.4	54.4	23.8	C	D	C
19	Orange Terrace Pkwy. & Van Buren Blvd.	TS	22.9	40.6	18.5	C	D	B	23.3	44.2	18.6	C	D	B
20	Brown St. & Alessandro Blvd.	TS	11.1	19.4	5.1	B	B	A	43.7	>200.0	184.0	D	F	F
21	Brown St. & Cactus Av.	CSS	Future Intersection						9.5	33.5	33.4	A	C	C
22	Sycamore Canyon Blvd. & Eastridge Av.	TS	42.4	21.6	17.8	D	C	B	42.7	22.1	17.8	D	C	B
23	Sycamore Canyon Blvd. & Cottonwood Av.	TS	14.6	11.5	6.4	B	B	A	17.9	11.6	6.4	B	B	A
24	Meridian Pkwy. & Alessandro Blvd.	TS	120.7	86.5	20.8	F	F	C	128.2	103.3	21.3	F	F	C
25	Meridian Pkwy. & Cactus Av.	TS	73.3	102.9	16.4	E	F	B	143.2	>200.0	19.5	E	F	B
26	Meridian Pkwy. & Van Buren Blvd.	TS	123.6	>200.0	13.9	F	F	B	139.2	>200.0	16.1	F	F	B
27	Innovation Dr. & Cactus Av.	TS	7.8	10.0	4.6	A	A	A	8.5	10.8	4.1	A	B	A
28	I-215 SB Ramps & Alessandro Blvd.	TS	17.9	13.6	6.8	B	B	A	19.9	15.3	7.2	B	B	A
29	I-215 NB Ramps & Alessandro Blvd.	TS	114.4	33.4	26.2	F	C	C	137.9	53.5	34.0	F	D	C
30	I-215 SB Ramps & Cactus Av.	TS	6.0	12.4	5.4	A	B	A	7.7	52.1	6.0	A	D	A
31	I-215 NB Ramps & Cactus Av.	TS	150.0	83.1	7.7	F	F	A	194.5	151.7	8.5	F	F	A
32	I-215 SB Ramps & Van Buren Blvd.	TS	38.6	>200.0	10.6	D	F	B	44.5	>200.0	10.4	D	F	B
33	I-215 NB Ramps & Van Buren Blvd.	TS	12.4	33.7	4.2	B	C	A	12.4	33.7	4.2	B	C	A
34	Old 215 Frontage Rd. & Alessandro Blvd.	TS	82.8	24.6	18.8	E	C	B	83.4	25.3	19.0	F	C	B
35	Day St. & Alessandro Blvd.	TS	25.6	29.9	13.0	C	C	B	27.5	34.5	13.3	C	C	B
36	Elsworth St. & Cactus Av.	TS	>200.0	>200.0	44.8	F	F	D	>200.0	>200.0	47.1	F	F	D
37	Frederick St. & Cactus Av.	TS	67.7	17.5	10.1	E	B	B	68.9	19.0	10.3	E	B	B
38	Graham St./Riverside Dr. & Cactus Av.	TS	27.6	31.0	17.3	C	C	B	28.7	34.3	17.3	C	C	B

* BOLD = Significant Impact

-- = Not applicable for this jurisdiction

¹ CSS = Cross-street Stop; AWS = All-Way Stop; TS = Traffic Signal; **TS** = Improvement

² For intersections within the jurisdiction of March JPA, deficient occurs (improvements needed) if the pre-project condition is at or better than LOS D (or acceptable LOS) and the project-generated traffic causes deterioration below acceptable levels. However, if the pre-project condition is already below LOS D (or acceptable LOS), provide improvements if the Project contributes more than 2% of the total traffic.

³ For intersections within the jurisdiction of the City of Riverside, deficient occurs (improvements needed) when the addition of project related trips causes either peak hour LOS to degrade from acceptable (LOS A through D) to unacceptable levels (LOS E/F) or the peak hour delay to increase as follows:

- LOS A/B = By 10.0 seconds
- LOS C = By 8.0 seconds
- LOS D = By 5.0 seconds
- LOS E = By 2.0 seconds
- LOS F = By 1.0 seconds

⁴ For intersections within the jurisdiction of Caltrans, or the County of Riverside, deficient occurs (improvements needed) if the pre-project condition is at or better than LOS D (or acceptable LOS) and the project-generated traffic causes deterioration below acceptable levels.

⁵ For intersections within the City of Moreno Valley, provide improvements if the pre-project condition is at or better than LOS D (or acceptable LOS) and the project-generated traffic causes deterioration below acceptable levels. If the pre-project condition is at unacceptable LOS and Project increases delay by 5.0 or more, provide improvements to offset the increase in delay.

7.4.2 OPENING YEAR CUMULATIVE (2028) WITH PROJECT TRAFFIC CONDITIONS

As shown in Table 7-1, the following additional study area intersection is anticipated to operate at an unacceptable LOS during the peak hours with the addition of Project traffic, in addition to the intersections identified under Opening Year Cumulative (2028) Without Project traffic conditions:

- Brown St. & Alessandro Bl. (#20) – LOS F PM and Saturday peak hours

The intersection operations analysis worksheets for Opening Year Cumulative (2028) With Project traffic conditions are included in Appendix 7.2.

7.5 ROADWAY SEGMENT ANALYSIS

The roadway segment capacities are approximate figures only and are used at the General Plan level to assist in determining the roadway functional classification (number of through lanes) needed to meet traffic demand. Table 7-2 provides a summary of the Opening Year Cumulative (2028) Without Project conditions roadway segment capacity analysis based on the applicable roadway segment capacity thresholds. As shown on Table 7-2, the following additional study area roadway segments are anticipated to operate at an unacceptable LOS based on the applicable planning level daily roadway capacity thresholds:

- Meridian Pkwy. from Alessandro Bl. to Cactus Av. (#14) – LOS F
- Meridian Pkwy. from Cactus Av. to Van Buren Bl. (#15) – LOS F

With the addition of Project traffic, the following additional study area roadway segments are anticipated to operate at a deficient LOS for Opening Year Cumulative (2028) With Project traffic conditions:

- Alessandro Bl., from Meridian Pkwy. to I-215 Freeway (#5) – LOS E
- Cactus Av., from Airman Dr. to Linebacker Dr. (#6) – LOS F
- Cactus Av. from Linebacker Dr. to Brown St. (#7) – LOS E
- Cactus Av., from Brown St. to Meridian Pkwy. (#8) – LOS E
- Barton Rd. from Alessandro Bl. to Cactus Av. (#10) – LOS E
- Brown St., from Alessandro Bl. to Cactus Av. (#12) – LOS F

TABLE 7-2: ROADWAY SEGMENT ANALYSIS FOR OPENING YEAR CUMULATIVE (2028) CONDITIONS

#	Roadway	Segment Limits	Roadway Section	LOS Capacity ¹	2028 Without Project			2028 With Project			Acceptable LOS
					2025	V/C ²	LOS ³	2025	V/C ²	LOS ³	
1	Alessandro Bl.	Trautwein Rd. to Mission Grove Pkwy.	6D	57,250	46,634	0.81	D	49,628	0.87	D	D
2		Mission Grove Pkwy. to Barton St.	6D	57,250	44,942	0.79	C	49,266	0.86	D	D
3		Barton St. to Brown St.	6D	57,250	44,846	0.78	C	48,838	0.85	D	D
4		Brown St. to Meridian Pkwy.	6D	57,250	44,721	0.78	C	49,749	0.87	D	D
5		Meridian Pkwy. to I-215 Freeway	6D	57,250	47,865	0.84	D	53,932	0.94	E	D
6	Cactus Av.	Airman Dr. to Linebacker Dr.	2U	13,000	0	0.00	A	28,912	2.22	F	D
7		Linebacker Dr. to Brown St.	4D	25,900	0	0.00	A	43,346	1.67	F	D
8		Brown St. to Meridian Pkwy.	4D	25,900	0	0.00	A	25,630	0.99	E	D
9		Meridian Pkwy. to I-215 Freeway	6D	51,150	19,574	0.38	A	36,190	0.71	C	D
10	Barton St.	Alessandro Bl. to Cactus Av. (EVA)	2U	13,000	2,049	0.16	A	12,392	0.95	E	D
11		Cactus Av. (EVA) to Grove Community Dr.	2U	13,000	796	0.06	A	1,128	0.09	A	D
12	Brown St.	Alessandro Bl. to Cactus Av.	2D	13,000	797	0.06	A	18,513	1.42	F	D
13	Sycamore Canyon Bl.	Cottonwood Av. to Alessandro Bl.	4D	33,000	19,589	0.59	A	20,357	0.62	B	D
14	Meridian Pkwy.	Alessandro Bl. to Cactus Av.	4D	25,900	28,913	1.12	F	30,719	1.19	F	D
15		Cactus Av. to Van Buren Bl.	4D	25,900	27,252	1.05	F	34,460	1.33	F	D

BOLD = LOS does not meet the applicable jurisdictional requirements (i.e., unacceptable LOS).
¹ These maximum roadway capacities are based on the applicable agency's thresholds.
² V/C = Volume to Capacity Ratio
³ LOS = Level of Service

7.6 TRAFFIC SIGNAL WARRANTS ANALYSIS

There are no additional unsignalized study area intersections anticipated to meet either peak hour volume-based or planning level (ADT) volume-based traffic signal warrants for Opening Year Cumulative (2028) Without and With Project traffic conditions in addition to those previously warranted under Existing and E+P traffic conditions (see Appendix 7.3 and Appendix 7.4).

7.7 OFF-RAMP QUEUING ANALYSIS

A queuing analysis was performed for the off-ramps at the I-215 Freeway at Alessandro Boulevard, Cactus Avenue, and Van Buren Boulevard interchanges, to assess vehicle queues for the off ramps that may potentially result in deficient peak hour operations at the ramp-to-arterial intersections and may potentially “spill back” onto the I-215 Freeway mainline. Queuing analysis findings are presented in Table 7-3 for Opening Year Cumulative (2028) traffic conditions. It is important to note that off-ramp lengths are consistent with the measured distance between the intersection and the freeway mainline. As shown in Table 7-3, there are no movements that are anticipated to experience queuing issues during the weekday AM, weekday PM, or weekend Saturday peak 95th percentile traffic flows for Opening Year Cumulative (2028) Without and With Project traffic conditions, consistent with Existing (2021) traffic conditions. Worksheets for Opening Year Cumulative (2028) Without and With Project traffic conditions off-ramp queuing analysis are provided in Appendix 7.5 and Appendix 7.6, respectively

TABLE 7-3: PEAK HOUR FREEWAY OFF-RAMP QUEUING SUMMARY FOR OPENING YEAR CUMULATIVE (2028) CONDITIONS

Intersection	Movement ³	Available Stacking Distance (Feet) ³	OYC (2028) Without Project						OYC (2028) With Project					
			95th Percentile Queue (Feet)			Acceptable? ¹			95th Percentile Queue (Feet)			Acceptable? ¹		
			AM Peak Hour	PM Peak Hour	SAT Peak Hour	AM	PM	SAT	AM Peak Hour	PM Peak Hour	SAT Peak Hour	AM	PM	SAT
I-215 SB Ramps & Alessandro Blvd. (#28)	SBL	525	164	247	76	Yes	Yes	Yes	162	262	82	Yes	Yes	Yes
	SBL/R	1,540	170	236	72	Yes	Yes	Yes	196	252	97	Yes	Yes	Yes
	SBR	525	162	221	67	Yes	Yes	Yes	181	231	92	Yes	Yes	Yes
I-215 NB Ramps & Alessandro Blvd. (#29)	NBL	450	802 ²	485 ^{2,3}	184	Yes	Yes	Yes	877 ^{2,3}	540 ^{2,3}	211	Yes	Yes	Yes
	NBL/T/R	1,345	772 ²	517 ²	187	Yes	Yes	Yes	850 ²	569 ²	223	Yes	Yes	Yes
	NBR	450	149	231	108	Yes	Yes	Yes	149	231	112	Yes	Yes	Yes
I-215 SB Ramps & Cactus Av. (#30)	SBR	1,115	208 ²	256	0	Yes	Yes	Yes	894 ²	809 ²	0	Yes	Yes	Yes
	NBR	1,850	398 ²	407 ²	0	Yes	Yes	Yes	409 ²	612 ²	67	Yes	Yes	Yes
I-215 NB Ramps & Cactus Av. (#31)	NBL	145	674 ^{2,3}	115	37	Yes	Yes	Yes	957 ^{2,3}	251 ^{2,3}	100	Yes	Yes	Yes
	NBT/R	1,650	520 ²	217	56	Yes	Yes	Yes	520 ²	250	61	Yes	Yes	Yes
I-215 SB Ramps & Van Buren Blvd.(#32)	SBL/T	1,510	298	873 ²	26	Yes	Yes	Yes	298	873 ²	26	Yes	Yes	Yes
	SBR	1,450	790 ²	502 ²	238 ²	Yes	Yes	Yes	790 ²	502 ²	253 ²	Yes	Yes	Yes
I-215 NB Ramps & Van Buren Blvd. (#33)	NBL	1,560	284	179	0	Yes	Yes	Yes	284	179	0	Yes	Yes	Yes
	NBR	580	33	47	0	Yes	Yes	Yes	33	47	0	Yes	Yes	Yes

¹ Stacking Distance is acceptable if the required stacking distance is less than or equal to the stacking distance provided. An additional 15 feet of stacking which is assumed to be provided in the transition for turn pockets is reflected in the stacking distance shown on this table, where applicable.

² 95th percentile volume exceeds capacity, queue may be longer. Queue shown is maximum after two cycles.

³ Although 95th percentile queue is anticipated to exceed the available storage for the turn lane, the adjacent lane has sufficient storage to accommodate any spillover without spilling back and affecting the I-215 Freeway mainline.

7.8 DEFICIENCIES AND IMPROVEMENTS

7.8.1 IMPROVEMENTS TO ADDRESS DEFICIENCIES AT INTERSECTIONS

This section provides a summary of Project deficiencies and identified improvements. Based on the deficiency criteria discussed in Section 2.7 *Deficiency Criteria*, study area intersections were found to be deficient. The effectiveness of the improvement strategies presented in Table 7-4 address the Opening Year Cumulative (2028) deficiencies as the recommendations improve the operations back to pre-project conditions (or better) or within the allowable net change in delay per the applicable deficiency criteria for each agency. It should be noted, the following study area intersections fall below the applicable agency's deficiency criteria. As such, no improvements have been recommended at these locations:

- Trautwein Rd. & Grove Community Dr. (#6)
- Trautwein Rd. & Orange Terrace Pkwy. (#7)
- Old 215 Frontage Rd. at Alessandro Bl. (#34)
- Frederick St. & Cactus Av. (#37)

If not constructed by the Project, the Project Applicant should contribute to these improvements through payment of fair share or TUMF fees. Worksheets for Opening Year Cumulative (2028) with improvements HCM calculation worksheets are provided in Appendix 7.7.

7.8.2 IMPROVEMENTS TO ADDRESS DEFICIENCIES AT ROADWAY SEGMENT

Additional roadway widening for the deficient roadway segments has not been recommended as acceptable or improved peak hour traffic operations can be achieved with the existing lanes or with the improvements shown on Table 7-4.

7.8.3 IMPROVEMENTS TO ADDRESS DEFICIENCIES ON OFF-RAMP QUEUES

As shown previously in Table 7-3, there are no anticipated peak hour queuing issues at the I-215 Freeway off-ramps for Opening Year Cumulative (2028) traffic conditions, consistent with Existing (2021) traffic conditions. As such, no improvements have been recommended.

TABLE 7-4: INTERSECTION ANALYSIS FOR OPENING YEAR CUMULATIVE (2028) CONDITIONS WITH IMPROVEMENTS

#	Intersection	Traffic Control ³	Intersection Approach Lanes ¹												Delay ² (secs.)			Level of Service						
			Northbound			Southbound			Eastbound			Westbound			AM	PM	SAT	AM	PM	SAT				
			L	T	R	L	T	R	L	T	R	L	T	R	L	T	R							
1	Washington St. & Van Buren Blvd.																							
	- Without Improvements	TS	2	2	1	2	2	0	1	2	0	1	2	1	102.7	91.2	31.1	F	F	C				
	- With Improvements	TS	2	2	1	2	2	0	1	<u>3</u>	0	1	<u>3</u>	1	53.2	47.1	26.0	D	D	C				
2	Alessandro Blvd. & Arlington Av./Chicago Av. ⁷																							
	- Without Improvements	TS	2	2	1>	2	3	0	1	2	2>	2	2	1>	131.5	156.6	30.3	F	F	C				
3	Canyon Crest Dr./Overlook Pkwy. & Alessandro Blvd.																							
	- Without Improvements	TS	1	2	1	2	1	1	1	3	0	1	3	1>	143.0	>200.0	27.6	F	F	C				
	- With Improvements	TS	1	2	1	<u>3</u>	1	<u>0</u>	1	3	0	1	3	1>	132.3	190.1	27.4	F	F	C				
4	Wood Rd. & Van Buren Blvd.																							
	- Without Improvements	TS	2	2	0	1	2	0	1	2	1>	2	2	1	159.2	148.6	49.6	F	F	D				
	- With Improvements	TS	2	2	0	1	2	0	1	<u>3</u>	1>	2	<u>3</u>	1	70.2	53.7	28.9	E	D	C				
5	Trautwein Rd. & Alessandro Blvd. ⁷																							
	- Without Improvements	TS	2	1	0	0	0	0	0	3	0	2	3	0	169.1	54.5	19.9	F	D	B				
8	Trautwein Rd. & Van Buren Blvd.																							
	- Without Improvements	TS	1	2	0	2	2	1>	2	2	1>	1	3	1>	179.3	109.5	40.4	F	F	D				
	- With Improvements	TS	1	2	0	2	2	1>	2	<u>3</u>	1	1	3	1>	122.5	73.8	41.7	F	E	D				
10	Deercreek Dr. & Orange Terrace Pkwy.																							
	- Without Improvements	AWS	0	1	0	0	1	0	1	2	0	1	2	0	>100.0	11.4	10.9	F	B	B				
	- With Improvements	<u>TS</u>	0	1	0	0	1	0	1	2	0	1	2	0	16.6	5.5	5.5	B	A	A				
11	Barton St. & Alessandro Blvd.																							
	- Without Improvements	TS	0	1	1	0	1	1	1	3	0	1	3	0	62.0	29.6	8.5	E	C	A				
	- With Improvements ³	TS	<u>1</u>	<u>1</u>	<u>0</u>	<u>1</u>	<u>1</u>	<u>0</u>	1	3	0	1	3	0	56.7	12.0	8.6	E	B	A				
13	Barton St. & Orange Terrace Pkwy.																							
	- Without Improvements	CSS	1	0	0	0	0	0	0	2	0	1	2	0	>100.0	20.2	>100.0	F	C	F				
	- With Improvements	<u>TS</u>	1	0	0	0	0	0	0	2	0	1	2	0	13.8	11.9	13.6	B	B	B				
14	Barton St. & Van Buren Blvd.																							
	- Without Improvements	TS	2	1	1	1	1	0	1	2	0	1	3	0	>200.0	147.0	72.2	F	F	E				
	- With Improvements	TS	2	1	1	1	1	0	1	<u>3</u>	1>	<u>2</u>	3	0	86.5	36.2	25.0	F	D	C				
20	Brown St. & Alessandro Blvd. ⁷																							
	- Without Improvements	TS	1	1	1>	1	1	1>	1	3	0	1	3	1	43.7	>200.0	184.0	D	F	F				
24	Meridian Pkwy. & Alessandro Blvd. ⁷																							
	- Without Improvements	TS	2	2	2>	2	2	1	1	3	1	2	3	1	128.2	103.3	21.3	F	F	C				
25	Meridian Pkwy. & Cactus Av.																							
	- Without Improvements	TS	2	2	1	2	2	1	1	2	1	2	2	1	143.2	>200.0	19.5	E	F	B				
	- With Improvements ⁵	TS	2	2	1	2	2	1	1	<u>3</u>	<u>0</u>	2	2	1>	51.9	183.5	21.9	D	F	C				
26	Meridian Pkwy. & Van Buren Blvd.																							
	- Without Improvements	TS	0	2	0	2	1	1>	2	4	1	1	4	1	139.2	>200.0	16.1	F	F	B				
	- With Improvements ¹⁰	TS	0	2	0	2	<u>1</u>	1>	2	4	1	1	4	1	88.1	196.8	10.5	F	F	B				
29	I-215 NB Ramps & Alessandro Blvd.																							
	- Without Improvements	TS	1	1	1	0	0	0	1	3	0	0	3	1	137.9	53.5	34.0	F	D	C				
	- With Improvements	TS	<u>2</u>	1	0	0	0	0	1	3	0	0	3	1	37.8	38.8	26.4	D	D	C				
31	I-215 NB Ramps & Cactus Av.																							
	- Without Improvements	TS	1	1	1	1	1	0	1	2	0	0	2	0	194.5	151.7	8.5	F	F	A				
	- With Improvements	TS	<u>2</u>	1	1	1	1	0	1	2	<u>1</u>	0	<u>3</u>	0	52.4	36.1	11.1	D	D	B				
32	I-215 SB Ramps & Van Buren Blvd.																							
	- Without Improvements	TS	0	0	0	0	1	2>>	0	2	2	1	2	0	44.5	>200.0	10.4	D	F	B				
	- With Improvements	TS	0	0	0	<u>1</u>	1	1>>	0	2	1>>	1	2	0	13.0	35.3	6.7	B	D	A				

#	Intersection	Traffic Control ³	Intersection Approach Lanes ¹												Delay ² (secs.)			Level of Service					
			Northbound			Southbound			Eastbound			Westbound			AM	PM	SAT	AM	PM	SAT			
			L	T	R	L	T	R	L	T	R	L	T	R	L	T	R						
34	Old 215 Frontage Rd. & Alessandro Blvd.																						
	- Without Improvements	TS	2	2	1	1	2	1	2	3	1	1	2	1	83.4	25.3	19.0	F	C	B			
	- With Improvements	TS	2	2	1	1	2	1	2	3	1	1	3	1	21.8	22.2	18.2	C	C	B			
36	Elsworth St. & Cactus Av.																						
	- Without Improvements	TS	1	1	0	1	1	1>	1	3	1>>	1	3	1	>200.0	>200.0	47.1	F	F	D			
	- With Improvements ⁹	TS	1	1	0	1	1	1>	1	4	1>>	1	3	1	53.0	50.5	20.8	D	D	C			

* **BOLD** = LOS does not meet the applicable jurisdictional requirements (i.e., unacceptable LOS).

¹ When a right turn is designated, the lane can either be striped or unstriped. To function as a right turn lane there must be sufficient width for right turning vehicles to travel outside the through lanes.
L = Left; T = Through; R = Right; > = Right-Turn Overlap Phasing; >> = Free Right Turn Lane; **1** = Improvement

² Per the Highway Capacity Manual 6th Edition, overall average intersection delay and level of service are shown for intersections with a traffic signal or all way stop control. For intersections with cross street stop control, the delay and level of service for the worst individual movement (or movements sharing a single lane) are shown.

³ AWS = All-Way Stop; CSS = Cross-street Stop; TS = Traffic Signal

⁴ The two intersecting roadways are built to their ultimate width as designated in the General Plan. Based on recent comments and the jurisdiction's traffic study guidelines, infeasible improvements have not been recommended.

⁵ Recommended improvements shown can be accommodated through restriping (no additional pavement required).

⁶ Recommended improvement includes modifying the traffic signal from protected left turn phasing to permissive left turn phasing on the northbound and southbound

⁷ There are no feasible intersection improvements. As such, improvements have not been identified.

⁸ Recommended improvement is for a southbound shared left-through lane which can be accommodated through restriping (no additional pavement required).

⁹ Recommended improvements can be accommodated through implementing N/S from split phasing to protected left turn phasing. Lead-lag operations should be implemented for the northbound and southbound approaches to avoid conflicting left turns. Additionally, the northbound approach should be restriped to provide one left turn lane and one shared through-right turn lane; the southbound approach should be restriped to provide one left turn lane, one through lane, and one right turn lane.

¹⁰ Improvement consists of restriping the southbound through lane to provide a shared left-through-right turn lane.

This Page Intentionally Left Blank

8 HORIZON YEAR (2045) TRAFFIC CONDITIONS

This section discusses the methods used to develop Horizon Year (2045) Without and With Project traffic forecasts, and the resulting intersection operations, roadway segment, traffic signal warrant, and freeway off-ramp queuing analyses.

8.1 ROADWAY IMPROVEMENTS

The lane configurations and traffic controls assumed to be in place for Horizon Year (2045) conditions are consistent with those shown previously on Exhibit 3-1, with the exception of the following:

- Project driveways and those facilities assumed to be constructed by the Project to provide site access are also assumed to be in place for Horizon Year conditions only (e.g., intersection and roadway improvements along the Project's frontage and driveways).
- Driveways and those facilities assumed to be constructed by cumulative developments to provide site access are also assumed to be in place for Horizon Year conditions only (e.g., intersection and roadway improvements along the cumulative development's frontages and driveways).
- Other parallel facilities, that although not evaluated for the purposes of this analysis, are anticipated to be in place for Horizon Year traffic conditions and would affect the travel patterns within the study area.

8.2 HORIZON YEAR (2045) WITHOUT PROJECT TRAFFIC VOLUME FORECASTS

This scenario includes the refined post-processed volumes developed from the RIVCOM (see Section 4.7 *Horizon Year (2045) Volume Development* of this TA for a detailed discussion on the post-processing methodology). The weekday ADT and weekday AM and PM peak hour volumes which can be expected for Horizon Year (2045) Without Project traffic conditions are shown on Exhibit 8-1. The weekend Saturday peak hour volumes for Horizon Year (2045) Without Project traffic conditions are shown on Exhibit 8-2.

8.3 HORIZON YEAR (2045) WITH PROJECT TRAFFIC VOLUME FORECASTS

This scenario includes the refined post-processed volumes developed from the RIVCOM plus Project traffic. The weekday ADT and weekday AM and PM peak hour volumes which can be expected for Horizon Year (2045) With Project traffic conditions are shown on Exhibit 8-3. The weekend Saturday peak hour volumes for Horizon Year (2045) Without Project traffic conditions are shown on Exhibit 8-4.

EXHIBIT 8-1: HORIZON YEAR (2045) WITHOUT PROJECT WEEKDAY TRAFFIC VOLUMES

<p>1 Washington St. & Van Buren Blvd.</p> <p>27,350 83(122) 235(587) 521(761) 175(178) 1522(1915) 165(163) 39,100</p> <p>48,750 888(613) 1984(1582) 134(236) 328(146) 1169(323) 199(137) 18,900</p>	<p>2 Alessandro Blvd. & Arlington Av./Chicago Av.</p> <p>46,600 56(27) 898(2370) 301(649) 55(33) 656(976) 862(1499) 44,250</p> <p>39,300 431(281) 1083(876) 292(815) 1725(1128) 2155(1453) 675(340) 72,550</p>	<p>3 Canyon Crest Dr. & Alessandro Blvd.</p> <p>20,750 80(69) 25(183) 584(860) 79(89) 1891(3946) -4(102) 74,750</p> <p>91,100 1302(790) 4261(3001) 66(132) 24(63) 179(-3) 72(192) 4,450</p>	<p>4 Wood Rd. & Van Buren Blvd.</p> <p>16,550 257(240) 550(303) 133(148) 181(236) 1484(2186) 438(280) 54,100</p> <p>52,500 139(154) 2067(1973) 601(339) 450(397) 502(322) 407(299) 19,450</p>	<p>5 Trautwein Rd. & Alessandro Blvd.</p> <p>60,500 4144(2605) 303(427) 1465(2462) 266(317) 2370(1397) 103(126) 26,100</p>
<p>6 Trautwein Rd. & Grove Community Dr.</p> <p>48,800 1755(2413) 253(447) 93(61) 2235(1676) 29(65) 35,350</p> <p>8,450 733(283) 93(61) 29(65) 29(25) 2,650</p>	<p>7 Trautwein Rd. & Orange Terrace Pkwy.</p> <p>42,550 25(48) 1358(1990) 469(576) 81(55) 85(77) 29(25) 2,650</p> <p>18,350 831(322) 129(55) 350(268) 65(53) 1613(1566) 291(397) 40,500</p>	<p>8 Trautwein Rd. & Van Buren Blvd.</p> <p>39,000 397(384) 560(725) 560(764) 487(517) 1527(1737) 130(121) 50,150</p> <p>59,200 610(803) 2102(1734) 194(175) 259(107) 710(401) 144(114) 16,650</p>	<p>9 Deercreek Dr. & Grove Community Dr.</p> <p>5,350 434(177) 66(28) 122(272) 105(24) 271(36) 41(47) 5,150</p>	<p>10 Deercreek Dr. & Orange Terrace Pkwy.</p> <p>1,950 49(26) 41(10) 110(36) 293(57) 583(618) 55(20) 11,300</p> <p>11,100 67(61) 736(365) 5(4) 208(24) 208(24) 8(3) 650</p>
<p>11 Barton St. & Alessandro Blvd.</p> <p>550 10(16) 12(18) 8(7) 1945(2621) 47(55) 58,600</p> <p>59,250 9(20) 3471(2814) 48(90) 2(1) 64(44) 2,700</p>	<p>12 Barton St. & Grove Community Dr.</p> <p>1,050 8(35) 30(41) 133(278) 5,100</p> <p>4,650 17(27) 492(169) 6(3) 17(27) 492(169) 6(3) 5,100</p>	<p>13 Barton St. & Orange Terrace Pkwy.</p> <p>9,050 -25(-17) 363(499) 336(150) 275(131) -8(-48) 44(53) 10,950</p> <p>59,200 530(297) 59(54) 530(297) 59(54) 530(297) 59(54) 4,100</p>	<p>14 Barton St. & Van Buren Blvd.</p> <p>6,700 409(195) 150(36) 51(16) 203(223) 1878(2274) 261(388) 62,650</p> <p>56,050 32(14) 2287(2340) 329(323) 606(405) 97(108) 445(281) 40,750</p>	<p>15 Airman Dr. & Cactus Av.</p> <p>Future Intersection</p>
<p>16 Abrams Dr. & Grove Community Dr.</p> <p>4,050 285(93) 124(47) 67(191) 69(81) 180(66) 81(77) 2,700</p>	<p>17 Abrams Dr. & Orange Terrace Pkwy.</p> <p>2,750 139(48) 97(33) 150(151) 219(376) 8,350</p> <p>7,150 116(43) 407(271) 97(33) 116(43) 407(271) 97(33) 8,350</p>	<p>18 Linebacker Dr. & Cactus Av.</p> <p>Future Intersection</p>	<p>19 Orange Terrace Pkwy. & Van Buren Blvd.</p> <p>10,150 289(167) 43(47) 290(143) 181(206) 1965(2464) 225(310) 63,600</p> <p>60,750 153(254) 2461(2243) 140(186) 131(328) 25(51) 86(239) 15,300</p>	<p>20 Brown St. & Alessandro Blvd.</p> <p>3,200 21(91) 5(5) 39(150) 40(35) 2100(2831) 5(5) 57,000</p> <p>57,450 66(39) 3388(2991) 10(19) 5(5) 0(32) 1,000</p>

###(##) AM(PM) Peak Hour Intersection Volumes

Average Daily Trips

<p>21 Brown St. & Cactus Av.</p> <p><i>Future Intersection</i></p> <p>22,400</p> <p>52(23) ↓ 290(486) ↓ 94(335) ↓</p> <p>61(110) ↓ 50(125) ↓ 22(61) ↓</p> <p>↑ 611(426) ↑ 235(80) ↑ 192(238)</p> <p>↑ 89(38) ↑ 989(867) ↑ 127(235)</p> <p>14,300</p> <p>19,450</p> <p>4,250</p> <p>24,550</p>	<p>22 Sycamore Canyon Blvd. & Eastridge Av.</p> <p>22,400</p> <p>52(23) ↓ 290(486) ↓ 94(335) ↓</p> <p>61(110) ↓ 50(125) ↓ 22(61) ↓</p> <p>↑ 611(426) ↑ 235(80) ↑ 192(238)</p> <p>↑ 89(38) ↑ 989(867) ↑ 127(235)</p> <p>14,300</p> <p>19,450</p> <p>4,250</p> <p>24,550</p>	<p>23 Sycamore Canyon Blvd. & Cottonwood Av.</p> <p>19,450</p> <p>370(805) ↓ 136(61) ↓</p> <p>45(73) ↑ 29(83) ↑</p> <p>1182(1005) ↑ 77(46) ↑</p> <p>2,800</p> <p>24,700</p> <p>63,850</p> <p>37,100</p>	<p>24 Meridian Pkwy. & Alessandro Blvd.</p> <p>38,100</p> <p>172(354) ↓ 213(717) ↓ 123(194) ↓</p> <p>201(183) ↓ 1466(2041) ↓ 466(790) ↓</p> <p>↑ 741(531) ↑ 2713(2210) ↑ 252(433)</p> <p>822(743) ↑ 828(581) ↑ 108(145) ↑</p> <p>62,400</p> <p>37,100</p> <p>5,050</p> <p>32,200</p>	<p>25 Meridian Pkwy. & Cactus Av.</p> <p>36,300</p> <p>19(14) ↓ 362(1303) ↓ 214(757) ↓</p> <p>32(75) ↓ 28(33) ↓ 15(102) ↓</p> <p>↑ 1250(684) ↑ 145(65) ↑ 898(1070)</p> <p>↑ 561(626) ↑ 327(376)</p> <p>28,150</p> <p>32,200</p>
<p>26 Meridian Pkwy. & Van Buren Blvd.</p> <p>19,400</p> <p>622(866) ↓ 11(16) ↓ 119(1211) ↓</p> <p>706(542) ↓ 2623(4541) ↓ 31(6) ↓</p> <p>↑ 195(106) ↑ 3898(3192) ↑ 55(8)</p> <p>↑ 5(27) ↑ 4(18) ↑ 4(40)</p> <p>95,250</p> <p>1,000</p> <p>96,400</p>	<p>27 Innovation Dr. & Cactus Av.</p> <p>900</p> <p>3(16) ↓ 5(42) ↓</p> <p>5(4) ↓ 489(1156) ↓ 19(6) ↓</p> <p>↑ 56(16) ↑ 2228(1749) ↑ 146(69)</p> <p>↑ 13(54) ↑ 41(152)</p> <p>31,850</p> <p>2,850</p> <p>28,150</p>	<p>28 I-215 SB Ramps & Alessandro Blvd.</p> <p>14,100</p> <p>532(616) ↓ 453(469) ↓</p> <p>280(192) ↑ 3175(2557) ↑</p> <p>1193(1922) ↓ 479(454) ↓</p> <p>56,400</p> <p>4,650</p> <p>62,400</p>	<p>29 I-215 NB Ramps & Alessandro Blvd.</p> <p>4,750</p> <p>118(150) ↓ 1547(2256) ↓</p> <p>↑ 189(218) ↑ 2149(1730)</p> <p>1307(1022) ↑ 0(15) ↑ 496(462) ↑</p> <p>53,100</p> <p>16,600</p> <p>59,600</p>	<p>30 I-215 SB Ramps & Cactus Av.</p> <p>4,400</p> <p>325(378) ↓</p> <p>505(1124) ↓ 18(227) ↓</p> <p>↑ 2040(1359) ↑ 948(936)</p> <p>974(877) ↑</p> <p>41,300</p> <p>19,450</p>
<p>31 I-215 NB Ramps & Cactus Av.</p> <p>9,600</p> <p>162(214) ↓ 0(3) ↓ 67(227) ↓</p> <p>26(74) ↓ 2239(2123) ↓ 76(172) ↓</p> <p>↑ 190(218) ↑ 3609(2873)</p> <p>↑ 563(346) ↑ 393(298) ↑ 56(100)</p> <p>52,000</p> <p>5,950</p> <p>46,800</p>	<p>32 I-215 SB Ramps & Van Buren Blvd.</p> <p>16,850</p> <p>1670(869) ↓ 39(136) ↓ 439(618) ↓</p> <p>1181(1655) ↓ 1160(2726) ↓</p> <p>↑ 1772(1742) ↑ 34(214)</p> <p>40,750</p> <p>31,850</p> <p>77,300</p>	<p>33 I-215 NB Ramps & Van Buren Blvd.</p> <p>42,500</p> <p>0(-47) ↓ 600(831) ↓ 1265(1359) ↓</p> <p>↑ 687(1032)</p> <p>1712(1378) ↑ 160(232) ↑</p> <p>42,500</p> <p>31,800</p> <p>44,700</p>	<p>34 Old 215 Frontage Rd. & Alessandro Blvd.</p> <p>17,450</p> <p>325(313) ↓ 62(266) ↓ 53(322) ↓</p> <p>507(463) ↓ 1669(2103) ↓ 60(134) ↓</p> <p>↑ 214(299) ↑ 1945(1538) ↑ 13(17)</p> <p>73(48) ↑ 346(199) ↑ 26(19) ↑</p> <p>59,400</p> <p>7,100</p> <p>51,100</p>	<p>35 Day St. & Alessandro Blvd.</p> <p>15,100</p> <p>270(264) ↓ 87(186) ↓ 122(288) ↓</p> <p>285(280) ↓ 1583(2073) ↓ 31(79) ↓</p> <p>↑ 182(251) ↑ 1977(1636) ↑ 13(36)</p> <p>↑ 95(76) ↑ 214(214) ↑ 32(32)</p> <p>43,700</p> <p>5,000</p> <p>43,200</p>
<p>36 Elsworth St. & Cactus Av.</p> <p>18,850</p> <p>321(405) ↓ 131(73) ↓ 196(366) ↓</p> <p>437(291) ↓ 2103(2914) ↓ 683(121) ↓</p> <p>↑ 254(211) ↑ 2567(2144) ↑ 92(36)</p> <p>↑ 90(556) ↑ 49(177) ↑ 37(130)</p> <p>58,250</p> <p>12,800</p> <p>61,650</p>	<p>37 Frederick St. & Cactus Av.</p> <p>14,650</p> <p>128(236) ↓ 199(577) ↓</p> <p>252(279) ↓ 1794(2951) ↓</p> <p>↑ 192(223) ↑ 2567(2144)</p> <p>58,250</p> <p>58,100</p>	<p>38 Graham St./Riverside Dr. & Cactus Av.</p> <p>100,100</p> <p>338(192) ↓ 458(290) ↓ 355(382) ↓</p> <p>222(432) ↓ 1730(3308) ↓ 414(489) ↓</p> <p>↑ 378(558) ↑ 2961(2005) ↑ 28(27)</p> <p>50(18) ↑ 0(15) ↑</p> <p>54,550</p> <p>33,850</p> <p>60,850</p>	<p>###(##) AM(PM) Peak Hour Intersection Volumes ## Average Daily Trips</p>	

EXHIBIT 8-2: HORIZON YEAR (2045) WITHOUT PROJECT WEEKEND TRAFFIC VOLUMES

1	Washington St. & Van Buren Blvd.	2	Alessandro Blvd. & Arlington Av./Chicago Av.	3	Canyon Crest Dr. & Alessandro Blvd.	4	Wood Rd. & Van Buren Blvd.	5	Trautwein Rd. & Alessandro Blvd.																																																					
<table border="1" style="width: 100%; border-collapse: collapse;"> <tr><td style="text-align: center;">← 96</td><td style="text-align: center;">↑ 341</td></tr> <tr><td style="text-align: center;">← 222</td><td style="text-align: center;">↑ 1103</td></tr> <tr><td style="text-align: center;">← 455</td><td style="text-align: center;">↑ 148</td></tr> <tr><td style="text-align: center;">147</td><td style="text-align: center;">170</td></tr> <tr><td style="text-align: center;">1135</td><td style="text-align: center;">255</td></tr> <tr><td style="text-align: center;">91</td><td style="text-align: center;">168</td></tr> </table>	← 96	↑ 341	← 222	↑ 1103	← 455	↑ 148	147	170	1135	255	91	168		<table border="1" style="width: 100%; border-collapse: collapse;"> <tr><td style="text-align: center;">← 36</td><td style="text-align: center;">↑ 215</td></tr> <tr><td style="text-align: center;">← 1113</td><td style="text-align: center;">↑ 563</td></tr> <tr><td style="text-align: center;">← 283</td><td style="text-align: center;">↑ 248</td></tr> <tr><td style="text-align: center;">28</td><td style="text-align: center;">903</td></tr> <tr><td style="text-align: center;">422</td><td style="text-align: center;">983</td></tr> <tr><td style="text-align: center;">751</td><td style="text-align: center;">245</td></tr> </table>	← 36	↑ 215	← 1113	↑ 563	← 283	↑ 248	28	903	422	983	751	245		<table border="1" style="width: 100%; border-collapse: collapse;"> <tr><td style="text-align: center;">← 22</td><td style="text-align: center;">↑ 474</td></tr> <tr><td style="text-align: center;">← 208</td><td style="text-align: center;">↑ 1825</td></tr> <tr><td style="text-align: center;">← 367</td><td style="text-align: center;">↑ 82</td></tr> <tr><td style="text-align: center;">40</td><td style="text-align: center;">12</td></tr> <tr><td style="text-align: center;">1677</td><td style="text-align: center;">204</td></tr> <tr><td style="text-align: center;">16</td><td style="text-align: center;">84</td></tr> </table>	← 22	↑ 474	← 208	↑ 1825	← 367	↑ 82	40	12	1677	204	16	84		<table border="1" style="width: 100%; border-collapse: collapse;"> <tr><td style="text-align: center;">← 163</td><td style="text-align: center;">↑ 121</td></tr> <tr><td style="text-align: center;">← 171</td><td style="text-align: center;">↑ 1666</td></tr> <tr><td style="text-align: center;">← 183</td><td style="text-align: center;">↑ 257</td></tr> <tr><td style="text-align: center;">144</td><td style="text-align: center;">248</td></tr> <tr><td style="text-align: center;">1719</td><td style="text-align: center;">147</td></tr> <tr><td style="text-align: center;">254</td><td style="text-align: center;">177</td></tr> </table>	← 163	↑ 121	← 171	↑ 1666	← 183	↑ 257	144	248	1719	147	254	177		<table border="1" style="width: 100%; border-collapse: collapse;"> <tr><td style="text-align: center;">↑ 1540</td></tr> <tr><td style="text-align: center;">↑ 227</td></tr> <tr><td style="text-align: center;">1298</td></tr> <tr><td style="text-align: center;">308</td></tr> <tr><td style="text-align: center;">1126</td></tr> <tr><td style="text-align: center;">15</td></tr> </table>	↑ 1540	↑ 227	1298	308	1126	15
← 96	↑ 341																																																													
← 222	↑ 1103																																																													
← 455	↑ 148																																																													
147	170																																																													
1135	255																																																													
91	168																																																													
← 36	↑ 215																																																													
← 1113	↑ 563																																																													
← 283	↑ 248																																																													
28	903																																																													
422	983																																																													
751	245																																																													
← 22	↑ 474																																																													
← 208	↑ 1825																																																													
← 367	↑ 82																																																													
40	12																																																													
1677	204																																																													
16	84																																																													
← 163	↑ 121																																																													
← 171	↑ 1666																																																													
← 183	↑ 257																																																													
144	248																																																													
1719	147																																																													
254	177																																																													
↑ 1540																																																														
↑ 227																																																														
1298																																																														
308																																																														
1126																																																														
15																																																														
6	Trautwein Rd. & Grove Community Dr.	7	Trautwein Rd. & Orange Terrace Pkwy.	8	Trautwein Rd. & Van Buren Blvd.	9	Deercreek Dr. & Grove Community Dr.	10	Deercreek Dr. & Orange Terrace Pkwy.																																																					
	<table border="1" style="width: 100%; border-collapse: collapse;"> <tr><td style="text-align: center;">← 1163</td><td style="text-align: center;">↑ 447</td></tr> <tr><td style="text-align: center;">← 402</td><td style="text-align: center;">↑ 125</td></tr> <tr><td style="text-align: center;">1254</td><td style="text-align: center;">102</td></tr> </table>	← 1163	↑ 447	← 402	↑ 125	1254	102	<table border="1" style="width: 100%; border-collapse: collapse;"> <tr><td style="text-align: center;">← 23</td><td style="text-align: center;">↑ 185</td></tr> <tr><td style="text-align: center;">← 1138</td><td style="text-align: center;">↑ 13</td></tr> <tr><td style="text-align: center;">← 229</td><td style="text-align: center;">↑ 191</td></tr> <tr><td style="text-align: center;">36</td><td style="text-align: center;">39</td></tr> <tr><td style="text-align: center;">21</td><td style="text-align: center;">1103</td></tr> <tr><td style="text-align: center;">23</td><td style="text-align: center;">178</td></tr> </table>	← 23	↑ 185	← 1138	↑ 13	← 229	↑ 191	36	39	21	1103	23	178	<table border="1" style="width: 100%; border-collapse: collapse;"> <tr><td style="text-align: center;">← 448</td><td style="text-align: center;">↑ 412</td></tr> <tr><td style="text-align: center;">← 247</td><td style="text-align: center;">↑ 1448</td></tr> <tr><td style="text-align: center;">← 404</td><td style="text-align: center;">↑ 168</td></tr> <tr><td style="text-align: center;">566</td><td style="text-align: center;">111</td></tr> <tr><td style="text-align: center;">1382</td><td style="text-align: center;">276</td></tr> <tr><td style="text-align: center;">84</td><td style="text-align: center;">98</td></tr> </table>	← 448	↑ 412	← 247	↑ 1448	← 404	↑ 168	566	111	1382	276	84	98		<table border="1" style="width: 100%; border-collapse: collapse;"> <tr><td style="text-align: center;">↑ 258</td></tr> <tr><td style="text-align: center;">↑ 79</td></tr> <tr><td style="text-align: center;">175</td></tr> <tr><td style="text-align: center;">19</td></tr> <tr><td style="text-align: center;">67</td></tr> <tr><td style="text-align: center;">60</td></tr> </table>	↑ 258	↑ 79	175	19	67	60	<table border="1" style="width: 100%; border-collapse: collapse;"> <tr><td style="text-align: center;">← 68</td><td style="text-align: center;">↑ 67</td></tr> <tr><td style="text-align: center;">← 7</td><td style="text-align: center;">↑ 404</td></tr> <tr><td style="text-align: center;">← 63</td><td style="text-align: center;">↑ 11</td></tr> <tr><td style="text-align: center;">68</td><td style="text-align: center;">32</td></tr> <tr><td style="text-align: center;">323</td><td style="text-align: center;">32</td></tr> <tr><td style="text-align: center;">11</td><td style="text-align: center;">5</td></tr> </table>	← 68	↑ 67	← 7	↑ 404	← 63	↑ 11	68	32	323	32	11	5								
← 1163	↑ 447																																																													
← 402	↑ 125																																																													
1254	102																																																													
← 23	↑ 185																																																													
← 1138	↑ 13																																																													
← 229	↑ 191																																																													
36	39																																																													
21	1103																																																													
23	178																																																													
← 448	↑ 412																																																													
← 247	↑ 1448																																																													
← 404	↑ 168																																																													
566	111																																																													
1382	276																																																													
84	98																																																													
↑ 258																																																														
↑ 79																																																														
175																																																														
19																																																														
67																																																														
60																																																														
← 68	↑ 67																																																													
← 7	↑ 404																																																													
← 63	↑ 11																																																													
68	32																																																													
323	32																																																													
11	5																																																													
11	Barton St. & Alessandro Blvd.	12	Barton St. & Grove Community Dr.	13	Barton St. & Orange Terrace Pkwy.	14	Barton St. & Van Buren Blvd.	15	Airman Dr. & Cactus Av.																																																					
	<table border="1" style="width: 100%; border-collapse: collapse;"> <tr><td style="text-align: center;">← 4</td><td style="text-align: center;">↑ 5</td></tr> <tr><td style="text-align: center;">← 5</td><td style="text-align: center;">↑ 1762</td></tr> <tr><td style="text-align: center;">← 88</td><td style="text-align: center;">↑ 88</td></tr> <tr><td style="text-align: center;">1558</td><td style="text-align: center;">63</td></tr> <tr><td style="text-align: center;">39</td><td style="text-align: center;">1</td></tr> <tr><td style="text-align: center;"></td><td style="text-align: center;">44</td></tr> </table>	← 4	↑ 5	← 5	↑ 1762	← 88	↑ 88	1558	63	39	1		44	<table border="1" style="width: 100%; border-collapse: collapse;"> <tr><td style="text-align: center;">← 61</td><td style="text-align: center;">↑ 23</td></tr> <tr><td style="text-align: center;">← 29</td><td style="text-align: center;">↑ 239</td></tr> <tr><td style="text-align: center;">24</td><td style="text-align: center;"></td></tr> <tr><td style="text-align: center;">172</td><td style="text-align: center;"></td></tr> </table>	← 61	↑ 23	← 29	↑ 239	24		172		<table border="1" style="width: 100%; border-collapse: collapse;"> <tr><td style="text-align: center;">← 3</td><td style="text-align: center;">↑ 525</td></tr> <tr><td style="text-align: center;">← 59</td><td style="text-align: center;">↑ 59</td></tr> <tr><td style="text-align: center;">359</td><td style="text-align: center;">3</td></tr> <tr><td style="text-align: center;">368</td><td style="text-align: center;">44</td></tr> </table>	← 3	↑ 525	← 59	↑ 59	359	3	368	44	<table border="1" style="width: 100%; border-collapse: collapse;"> <tr><td style="text-align: center;">← 213</td><td style="text-align: center;">↑ 48</td></tr> <tr><td style="text-align: center;">← 33</td><td style="text-align: center;">↑ 1696</td></tr> <tr><td style="text-align: center;">← 36</td><td style="text-align: center;">↑ 236</td></tr> <tr><td style="text-align: center;">203</td><td style="text-align: center;">295</td></tr> <tr><td style="text-align: center;">1623</td><td style="text-align: center;">51</td></tr> <tr><td style="text-align: center;">252</td><td style="text-align: center;">191</td></tr> </table>	← 213	↑ 48	← 33	↑ 1696	← 36	↑ 236	203	295	1623	51	252	191	<p style="text-align: center;"><i>Future Intersection</i></p>																	
← 4	↑ 5																																																													
← 5	↑ 1762																																																													
← 88	↑ 88																																																													
1558	63																																																													
39	1																																																													
	44																																																													
← 61	↑ 23																																																													
← 29	↑ 239																																																													
24																																																														
172																																																														
← 3	↑ 525																																																													
← 59	↑ 59																																																													
359	3																																																													
368	44																																																													
← 213	↑ 48																																																													
← 33	↑ 1696																																																													
← 36	↑ 236																																																													
203	295																																																													
1623	51																																																													
252	191																																																													
16	Abrams Dr. & Grove Community Dr.	17	Abrams Dr. & Orange Terrace Pkwy.	18	Linebacker Dr. & Cactus Av.	19	Orange Terrace Pkwy. & Van Buren Blvd.	20	Brown St. & Alessandro Blvd.																																																					
	<table border="1" style="width: 100%; border-collapse: collapse;"> <tr><td style="text-align: center;">↑ 139</td></tr> <tr><td style="text-align: center;">↑ 47</td></tr> <tr><td style="text-align: center;">88</td></tr> <tr><td style="text-align: center;">100</td></tr> <tr><td style="text-align: center;">92</td></tr> <tr><td style="text-align: center;">43</td></tr> </table>	↑ 139	↑ 47	88	100	92	43	<table border="1" style="width: 100%; border-collapse: collapse;"> <tr><td style="text-align: center;">← 72</td><td style="text-align: center;">↑ 84</td></tr> <tr><td style="text-align: center;">← 69</td><td style="text-align: center;">↑ 226</td></tr> <tr><td style="text-align: center;">151</td><td style="text-align: center;"></td></tr> <tr><td style="text-align: center;">192</td><td style="text-align: center;"></td></tr> </table>	← 72	↑ 84	← 69	↑ 226	151		192		<p style="text-align: center;"><i>Future Intersection</i></p>	<table border="1" style="width: 100%; border-collapse: collapse;"> <tr><td style="text-align: center;">← 134</td><td style="text-align: center;">↑ 291</td></tr> <tr><td style="text-align: center;">← 43</td><td style="text-align: center;">↑ 1813</td></tr> <tr><td style="text-align: center;">← 222</td><td style="text-align: center;">↑ 39</td></tr> <tr><td style="text-align: center;">151</td><td style="text-align: center;">63</td></tr> <tr><td style="text-align: center;">1491</td><td style="text-align: center;">55</td></tr> <tr><td style="text-align: center;">59</td><td style="text-align: center;">46</td></tr> </table>	← 134	↑ 291	← 43	↑ 1813	← 222	↑ 39	151	63	1491	55	59	46	<table border="1" style="width: 100%; border-collapse: collapse;"> <tr><td style="text-align: center;">← 44</td><td style="text-align: center;">↑ 41</td></tr> <tr><td style="text-align: center;">← 5</td><td style="text-align: center;">↑ 1819</td></tr> <tr><td style="text-align: center;">← 48</td><td style="text-align: center;">↑ 4</td></tr> <tr><td style="text-align: center;">39</td><td style="text-align: center;">10</td></tr> <tr><td style="text-align: center;">1608</td><td style="text-align: center;">5</td></tr> <tr><td style="text-align: center;">5</td><td style="text-align: center;"></td></tr> </table>	← 44	↑ 41	← 5	↑ 1819	← 48	↑ 4	39	10	1608	5	5																				
↑ 139																																																														
↑ 47																																																														
88																																																														
100																																																														
92																																																														
43																																																														
← 72	↑ 84																																																													
← 69	↑ 226																																																													
151																																																														
192																																																														
← 134	↑ 291																																																													
← 43	↑ 1813																																																													
← 222	↑ 39																																																													
151	63																																																													
1491	55																																																													
59	46																																																													
← 44	↑ 41																																																													
← 5	↑ 1819																																																													
← 48	↑ 4																																																													
39	10																																																													
1608	5																																																													
5																																																														

Saturday Peak Hour Intersection Volumes

<p>21 Brown St. & Cactus Av.</p> <p><i>Future Intersection</i></p>	<p>22 Sycamore Canyon Blvd. & Eastridge Av.</p> <p>← 40 ← 163 ← 154 ↑ 397 ↑ 69 ↑ 248 → 52 → 88 → 21 ↔ 59 ↔ 387 ↔ 92</p>	<p>23 Sycamore Canyon Blvd. & Cottonwood Av.</p> <p>← 473 ← 24 ↑ 25 ↑ 8 → 461 → 14</p>	<p>24 Meridian Pkwy. & Alessandro Blvd.</p> <p>← 67 ← 204 ← 73 ↑ 112 ↑ 1541 ↑ 72 → 125 → 1364 → 121 ↔ 219 ↔ 182 ↔ 24</p>	<p>25 Meridian Pkwy. & Cactus Av.</p> <p>← 14 ← 260 ← 139 ↑ 285 ↑ 89 ↑ 232 → 27 → 83 → 32 ↔ 30 ↔ 200 ↔ 140</p>
<p>26 Meridian Pkwy. & Van Buren Blvd.</p> <p>← 457 ← 11 ← 76 ↑ 42 ↑ 1747 ↑ 40 → 214 → 1633 → 7 ↔ 8 ↔ 7 ↔ 22</p>	<p>27 Innovation Dr. & Cactus Av.</p> <p>← 1 ← 1 ← 411 ← 1 ↑ 5 ↑ 941 ↑ 27 → 1 → 25</p>	<p>28 I-215 SB Ramps & Alessandro Blvd.</p> <p>← 348 ← 167 ↑ 151 ↑ 1319 → 1004 → 411</p>	<p>29 I-215 NB Ramps & Alessandro Blvd.</p> <p>← 239 ← 1066 ↑ 183 ↑ 1004 → 440 → 12 → 301</p>	<p>30 I-215 SB Ramps & Cactus Av.</p> <p>← 112 ← 69 ← 24 ↑ 476 ↑ 431 → 406</p>
<p>31 I-215 NB Ramps & Cactus Av.</p> <p>← 79 ← 1 ← 135 ↑ 146 ↑ 1301 → 21 → 753 → 68 ↔ 60 ↔ 81 ↔ 4</p>	<p>32 I-215 SB Ramps & Van Buren Blvd.</p> <p>← 938 ← 25 ↑ 901 ↑ 16 → 834 → 933</p>	<p>33 I-215 NB Ramps & Van Buren Blvd.</p> <p>← 839 ← 35 ↑ 889 ↑ 18 → 1 → 49</p>	<p>34 Old 215 Frontage Rd. & Alessandro Blvd.</p> <p>← 257 ← 124 ← 104 ↑ 115 ↑ 880 ↑ 13 → 385 → 961 → 15 ↔ 28 ↔ 99 ↔ 16</p>	<p>35 Day St. & Alessandro Blvd.</p> <p>← 108 ← 55 ← 136 ↑ 162 ↑ 796 ↑ 11 → 204 → 757 → 8 ↔ 12 ↔ 111 ↔ 17</p>
<p>36 Elsworth St. & Cactus Av.</p> <p>← 132 ← 20 ← 186 ↑ 155 ↑ 1215 ↑ 16 → 161 → 1219 → 36 ↔ 25 ↔ 13 ↔ 11</p>	<p>37 Frederick St. & Cactus Av.</p> <p>← 80 ← 306 ↑ 192 ↑ 1215 ↑ 3 → 104 → 1343 → 1 ↔ 104 ↔ 1343 ↔ 1</p>	<p>38 Graham St./Riverside Dr. & Cactus Av.</p> <p>← 81 ← 68 ← 75 ↑ 75 ↑ 1304 ↑ 23 → 65 → 1256 → 202 ↔ 183 ↔ 53 ↔ 19</p>	<p>## Saturday Peak Hour Intersection Volumes</p>	

EXHIBIT 8-3: HORIZON YEAR (2045) WITH PROJECT WEEKDAY TRAFFIC VOLUMES

1	Washington St. & Van Buren Blvd.	2	Alessandro Blvd. & Arlington Av./Chicago Av.	3	Canyon Crest Dr. & Alessandro Blvd.	4	Wood Rd. & Van Buren Blvd.	5	Trautwein Rd. & Alessandro Blvd.
28,050	50,750	47,250	39,950	22,750	91,800	16,550	55,150		63,500
83(122) 235(587) 546(778)	896(661) 1992(1630) 142(284)	56(27) 923(2387) 301(649)	431(281) 1083(876) 317(832)	80(69) 101(235) 584(860)	1302(790) 4261(3001) 91(149)	257(240) 550(303) 133(148)	139(154) 2090(2117) 609(387)		4178(2821) 303(427)
175(178) 1547(1932) 165(163)	328(146) 1169(323) 224(154)	55(33) 656(976) 887(1516)	1733(1176) 2163(1501) 683(388)	79(89) 1891(3946) 9(111)	28(87) 202(141) 80(240)	181(236) 1560(2238) 438(280)	450(397) 502(322) 432(316)	1579(2540) 266(317)	2370(1397) 103(126)
39,800	19,600	44,950	74,500	75,100	7,450	56,100	20,150	75,850	26,100
6	Trautwein Rd. & Grove Community Dr.	7	Trautwein Rd. & Orange Terrace Pkwy.	8	Trautwein Rd. & Van Buren Blvd.	9	Deercreek Dr. & Grove Community Dr.	10	Deercreek Dr. & Orange Terrace Pkwy.
48,800	8,450	42,550	18,350	39,000	62,550		5,650	1,950	11,100
1755(2413) 253(447)	733(283) 93(61)	25(48) 1358(1990) 469(576)	831(322) 129(55) 350(268)	397(384) 560(725) 560(764)	610(803) 2132(1926) 202(223)		438(201) 66(28)	49(26) 41(10) 110(36)	67(61) 736(365) 5(4)
	2235(1676) 29(65)	81(55) 85(77) 29(25)	65(53) 1613(1566) 291(397)	487(517) 1629(1807) 130(121)	259(107) 710(401) 169(131)	135(281) 105(24)	271(36) 41(47)	293(57) 583(618) 55(20)	208(24) 208(24) 8(3)
	35,350	2,650	40,500	52,800	17,350	5,500	1,350	11,300	650
11	Barton St. & Alessandro Blvd.	12	Barton St. & Grove Community Dr.	13	Barton St. & Orange Terrace Pkwy.	14	Barton St. & Van Buren Blvd.	15	Airman Dr. & Cactus Av.
550	63,200	1,350	5,300		9,050	7,400	60,700	15,900	28,900
10(16) 12(18)	9(20) 3516(3102) 48(90)	12(59) 6(3)	17(27) 492(169) 25(17)		530(297) 59(54)	409(195) 150(36) 76(33)	40(62) 2325(2580) 337(371)		443(379) 331(305)
8(7) 2097(2725) 60(64)	101(91) 2(1) 64(44)	43(50) 133(278)	8(48)	363(499) 336(150)	275(131) 44(53)	203(223) 2005(2361) 261(388)	606(405) 97(108) 470(298)		99(696)
62,900	3,050	5,400	650	10,950	4,750	66,000	41,450		13,000
16	Abrams Dr. & Grove Community Dr.	17	Abrams Dr. & Orange Terrace Pkwy.	18	Linebacker Dr. & Cactus Av.	19	Orange Terrace Pkwy. & Van Buren Blvd.	20	Brown St. & Alessandro Blvd.
	4,700	2,750	7,150	7,200	43,350	10,150	65,400	3,200	62,450
	310(110) 124(47)	139(48) 97(33)	116(43) 407(271)		277(182) 774(684) 277(183)	289(167) 43(47) 290(143)	153(254) 2514(2579) 140(186)	21(91) 5(5) 39(150)	66(39) 3388(2909) 192(213)
75(239) 69(81)	180(66) 81(77)	150(151) 219(376)		232(1598)	84(503)	181(206) 2143(2586) 225(310)	131(328) 25(51) 86(239)	40(35) 2100(2749) 157(191)	55(389) 5(5) 57(477)
4,950	2,700	8,350		28,900	7,200	68,250	15,300	60,950	18,750

##(###) AM(PM) Peak Hour Intersection Volumes

Average Daily Trips

<p>21 Brown St. & Cactus Av.</p> <p>17,700 344(400) 102(815) 299(1787) 43,350</p> <p>25,650 ← 983(649)</p>	<p>22 Sycamore Canyon Blvd. & Eastridge Av.</p> <p>23,150 52(23) 61(110) 50(125) 22(61) 4,250</p> <p>14,300 ↑ 611(426) ↑ 235(80) ↑ 192(238) 89(38) 998(919) 127(235) 25,350</p>	<p>23 Sycamore Canyon Blvd. & Cottonwood Av.</p> <p>20,250 400(824) 136(61) 29(83) 1191(1057) 77(46) 25,450</p> <p>2,800 ↑ 45(73) ↑ 29(83)</p>	<p>24 Meridian Pkwy. & Alessandro Blvd.</p> <p>38,850 172(354) 201(183) 1523(2404) 466(790) 68,900</p> <p>68,450 ↑ 741(531) ↑ 2905(2341) ↑ 292(460) 822(743) 837(633) 120(220) 38,900</p>	<p>25 Meridian Pkwy. & Cactus Av.</p> <p>38,100 88(60) 53(202) 223(1179) 97(616) 30,650</p> <p>44,750 ↑ 1250(684) ↑ 783(482) ↑ 898(1070) 219(216) 561(626) 327(376) 39,400</p>
<p>26 Meridian Pkwy. & Van Buren Blvd.</p> <p>26,650 682(1250) 11(16) 141(1341) 909(681) 2623(4541) 31(6) 101,700</p> <p>97,150 ↑ 267(153) ↑ 3898(3192) ↑ 55(8) 5(27) 4(18) 4(40) 1,000</p>	<p>27 Innovation Dr. & Cactus Av.</p> <p>900 3(16) 5(4) 684(2302) 19(6) 44,750</p> <p>48,450 ↑ 56(16) ↑ 2866(2166) ↑ 146(69) 13(54) 41(152) 2,850</p>	<p>28 I-215 SB Ramps & Alessandro Blvd.</p> <p>14,950 597(660) 1227(2141) 513(673) 68,450</p> <p>60,100 ↑ 280(192) ↑ 3342(2671) 6,150</p>	<p>29 I-215 NB Ramps & Alessandro Blvd.</p> <p>5,600 137(273) 1562(2352) 1423(1101) 63,250</p> <p>54,400 ↑ 189(218) ↑ 2200(1765) 0(15) 496(462) 18,100</p>	<p>30 I-215 SB Ramps & Cactus Av.</p> <p>9,500 718(632) 657(2017) 61(480) 48,800</p> <p>51,000 ↑ 2285(1522) ↑ 948(936) 974(877) 21,300</p>
<p>31 I-215 NB Ramps & Cactus Av.</p> <p>10,250 187(231) 0(3) 67(227) 34(122) 2263(2270) 197(870) 56,500</p> <p>54,050 ↑ 190(218) ↑ 3688(2926) 704(438) 393(298) 56(100) 12,900</p>	<p>32 I-215 SB Ramps & Van Buren Blvd.</p> <p>16,850 1670(869) 39(136) 439(618) 1181(1655) 1182(2856) 79,200</p> <p>41,700 ↑ 1844(1789) ↑ 34(214) 32,800</p>	<p>33 I-215 NB Ramps & Van Buren Blvd.</p> <p>#DIV/0! 600(831) 1265(1359) 1712(1378) 45,650</p> <p>42,500 ↑ 687(1032) 160(232) 31,800</p>	<p>34 Old 215 Frontage Rd. & Alessandro Blvd.</p> <p>18,150 325(313) 87(283) 53(322) 507(463) 1684(2199) 60(134) 52,450</p> <p>60,700 ↑ 214(299) ↑ 1996(1573) ↑ 13(17) 73(48) 354(247) 26(19) 7,750</p>	<p>35 Day St. & Alessandro Blvd.</p> <p>15,750 295(281) 87(186) 122(288) 293(328) 1591(2121) 31(79) 44,550</p> <p>44,400 ↑ 182(251) ↑ 2002(1653) ↑ 13(36) 95(76) 214(214) 32(32) 5,000</p>
<p>36 Elsworth St. & Cactus Av.</p> <p>19,500 346(422) 131(73) 196(366) 445(339) 2119(3013) 683(121) 63,750</p> <p>59,650 ↑ 254(211) ↑ 2620(2180) ↑ 92(36) 90(556) 49(177) 37(130) 12,800</p>	<p>37 Frederick St. & Cactus Av.</p> <p>15,300 153(253) 260(327) 1802(3002) 59,500</p> <p>59,650 ↑ 192(223) ↑ 2620(2180) #DIV/0!</p>	<p>38 Graham St./Riverside Dr. & Cactus Av.</p> <p>100,100 338(192) 458(290) 355(382) 222(432) 1738(3359) 414(489) 61,550</p> <p>55,300 ↑ 378(558) ↑ 2989(2023) ↑ 28(27) 50(18) 0(15) 33,850</p>	<p>##(##) AM(PM) Peak Hour Intersection Volumes ## Average Daily Trips</p>	

EXHIBIT 8-4: HORIZON YEAR (2045) WITH PROJECT WEEKEND TRAFFIC VOLUMES

1	Washington St. & Van Buren Blvd.	2	Alessandro Blvd. & Arlington Av./Chicago Av.	3	Canyon Crest Dr. & Alessandro Blvd.	4	Wood Rd. & Van Buren Blvd.	5	Trautwein Rd. & Alessandro Blvd.																																																	
<table border="1" style="width: 100%; border-collapse: collapse;"> <tr><td style="text-align: center;">← 83</td><td style="text-align: center;">↑ 896</td></tr> <tr><td style="text-align: center;">← 235</td><td style="text-align: center;">↑ 1992</td></tr> <tr><td style="text-align: center;">← 546</td><td style="text-align: center;">↑ 142</td></tr> <tr><td style="text-align: center;">175 →</td><td style="text-align: center;">328 →</td></tr> <tr><td style="text-align: center;">1547 →</td><td style="text-align: center;">1169 →</td></tr> <tr><td style="text-align: center;">165 ↓</td><td style="text-align: center;">224 ↓</td></tr> </table>	← 83	↑ 896	← 235	↑ 1992	← 546	↑ 142	175 →	328 →	1547 →	1169 →	165 ↓	224 ↓	<table border="1" style="width: 100%; border-collapse: collapse;"> <tr><td style="text-align: center;">← 56</td><td style="text-align: center;">↑ 431</td></tr> <tr><td style="text-align: center;">← 923</td><td style="text-align: center;">↑ 1083</td></tr> <tr><td style="text-align: center;">← 301</td><td style="text-align: center;">↑ 317</td></tr> <tr><td style="text-align: center;">55 →</td><td style="text-align: center;">1733 →</td></tr> <tr><td style="text-align: center;">656 →</td><td style="text-align: center;">2163 →</td></tr> <tr><td style="text-align: center;">887 ↓</td><td style="text-align: center;">683 ↓</td></tr> </table>	← 56	↑ 431	← 923	↑ 1083	← 301	↑ 317	55 →	1733 →	656 →	2163 →	887 ↓	683 ↓	<table border="1" style="width: 100%; border-collapse: collapse;"> <tr><td style="text-align: center;">← 80</td><td style="text-align: center;">↑ 1302</td></tr> <tr><td style="text-align: center;">← 101</td><td style="text-align: center;">↑ 4261</td></tr> <tr><td style="text-align: center;">← 584</td><td style="text-align: center;">↑ 91</td></tr> <tr><td style="text-align: center;">79 →</td><td style="text-align: center;">28 →</td></tr> <tr><td style="text-align: center;">1891 →</td><td style="text-align: center;">202 →</td></tr> <tr><td style="text-align: center;">9 ↓</td><td style="text-align: center;">80 ↓</td></tr> </table>	← 80	↑ 1302	← 101	↑ 4261	← 584	↑ 91	79 →	28 →	1891 →	202 →	9 ↓	80 ↓	<table border="1" style="width: 100%; border-collapse: collapse;"> <tr><td style="text-align: center;">← 257</td><td style="text-align: center;">↑ 139</td></tr> <tr><td style="text-align: center;">← 550</td><td style="text-align: center;">↑ 2090</td></tr> <tr><td style="text-align: center;">← 133</td><td style="text-align: center;">↑ 609</td></tr> <tr><td style="text-align: center;">181 →</td><td style="text-align: center;">450 →</td></tr> <tr><td style="text-align: center;">1560 →</td><td style="text-align: center;">502 →</td></tr> <tr><td style="text-align: center;">438 ↓</td><td style="text-align: center;">432 ↓</td></tr> </table>	← 257	↑ 139	← 550	↑ 2090	← 133	↑ 609	181 →	450 →	1560 →	502 →	438 ↓	432 ↓	<table border="1" style="width: 100%; border-collapse: collapse;"> <tr><td style="text-align: center;">← 4178</td><td style="text-align: center;">↑ 303</td></tr> <tr><td style="text-align: center;">1579 →</td><td style="text-align: center;">2370 →</td></tr> <tr><td style="text-align: center;">266 ↓</td><td style="text-align: center;">103 ↓</td></tr> </table>	← 4178	↑ 303	1579 →	2370 →	266 ↓	103 ↓
← 83	↑ 896																																																									
← 235	↑ 1992																																																									
← 546	↑ 142																																																									
175 →	328 →																																																									
1547 →	1169 →																																																									
165 ↓	224 ↓																																																									
← 56	↑ 431																																																									
← 923	↑ 1083																																																									
← 301	↑ 317																																																									
55 →	1733 →																																																									
656 →	2163 →																																																									
887 ↓	683 ↓																																																									
← 80	↑ 1302																																																									
← 101	↑ 4261																																																									
← 584	↑ 91																																																									
79 →	28 →																																																									
1891 →	202 →																																																									
9 ↓	80 ↓																																																									
← 257	↑ 139																																																									
← 550	↑ 2090																																																									
← 133	↑ 609																																																									
181 →	450 →																																																									
1560 →	502 →																																																									
438 ↓	432 ↓																																																									
← 4178	↑ 303																																																									
1579 →	2370 →																																																									
266 ↓	103 ↓																																																									
6	Trautwein Rd. & Grove Community Dr.	7	Trautwein Rd. & Orange Terrace Pkwy.	8	Trautwein Rd. & Van Buren Blvd.	9	Deercreek Dr. & Grove Community Dr.	10	Deercreek Dr. & Orange Terrace Pkwy.																																																	
<table border="1" style="width: 100%; border-collapse: collapse;"> <tr><td style="text-align: center;">← 1755</td><td style="text-align: center;">↑ 733</td></tr> <tr><td style="text-align: center;">← 253</td><td style="text-align: center;">↑ 93</td></tr> <tr><td style="text-align: center;">2235 →</td><td style="text-align: center;">29 ↓</td></tr> </table>	← 1755	↑ 733	← 253	↑ 93	2235 →	29 ↓	<table border="1" style="width: 100%; border-collapse: collapse;"> <tr><td style="text-align: center;">← 25</td><td style="text-align: center;">↑ 831</td></tr> <tr><td style="text-align: center;">← 1358</td><td style="text-align: center;">↑ 129</td></tr> <tr><td style="text-align: center;">← 469</td><td style="text-align: center;">↑ 350</td></tr> <tr><td style="text-align: center;">81 →</td><td style="text-align: center;">65 →</td></tr> <tr><td style="text-align: center;">85 →</td><td style="text-align: center;">1613 →</td></tr> <tr><td style="text-align: center;">29 ↓</td><td style="text-align: center;">291 ↓</td></tr> </table>	← 25	↑ 831	← 1358	↑ 129	← 469	↑ 350	81 →	65 →	85 →	1613 →	29 ↓	291 ↓	<table border="1" style="width: 100%; border-collapse: collapse;"> <tr><td style="text-align: center;">← 397</td><td style="text-align: center;">↑ 610</td></tr> <tr><td style="text-align: center;">← 560</td><td style="text-align: center;">↑ 2132</td></tr> <tr><td style="text-align: center;">← 560</td><td style="text-align: center;">↑ 202</td></tr> <tr><td style="text-align: center;">487 →</td><td style="text-align: center;">259 →</td></tr> <tr><td style="text-align: center;">1629 →</td><td style="text-align: center;">710 →</td></tr> <tr><td style="text-align: center;">130 ↓</td><td style="text-align: center;">169 ↓</td></tr> </table>	← 397	↑ 610	← 560	↑ 2132	← 560	↑ 202	487 →	259 →	1629 →	710 →	130 ↓	169 ↓	<table border="1" style="width: 100%; border-collapse: collapse;"> <tr><td style="text-align: center;">← 438</td><td style="text-align: center;">↑ 66</td></tr> <tr><td style="text-align: center;">135 →</td><td style="text-align: center;">271 →</td></tr> <tr><td style="text-align: center;">105 ↓</td><td style="text-align: center;">41 ↓</td></tr> </table>	← 438	↑ 66	135 →	271 →	105 ↓	41 ↓	<table border="1" style="width: 100%; border-collapse: collapse;"> <tr><td style="text-align: center;">← 49</td><td style="text-align: center;">↑ 67</td></tr> <tr><td style="text-align: center;">← 41</td><td style="text-align: center;">↑ 736</td></tr> <tr><td style="text-align: center;">← 110</td><td style="text-align: center;">↑ 5</td></tr> <tr><td style="text-align: center;">293 →</td><td style="text-align: center;">208 →</td></tr> <tr><td style="text-align: center;">583 →</td><td style="text-align: center;">208 →</td></tr> <tr><td style="text-align: center;">55 ↓</td><td style="text-align: center;">8 ↓</td></tr> </table>	← 49	↑ 67	← 41	↑ 736	← 110	↑ 5	293 →	208 →	583 →	208 →	55 ↓	8 ↓						
← 1755	↑ 733																																																									
← 253	↑ 93																																																									
2235 →	29 ↓																																																									
← 25	↑ 831																																																									
← 1358	↑ 129																																																									
← 469	↑ 350																																																									
81 →	65 →																																																									
85 →	1613 →																																																									
29 ↓	291 ↓																																																									
← 397	↑ 610																																																									
← 560	↑ 2132																																																									
← 560	↑ 202																																																									
487 →	259 →																																																									
1629 →	710 →																																																									
130 ↓	169 ↓																																																									
← 438	↑ 66																																																									
135 →	271 →																																																									
105 ↓	41 ↓																																																									
← 49	↑ 67																																																									
← 41	↑ 736																																																									
← 110	↑ 5																																																									
293 →	208 →																																																									
583 →	208 →																																																									
55 ↓	8 ↓																																																									
11	Barton St. & Alessandro Blvd.	12	Barton St. & Grove Community Dr.	13	Barton St. & Orange Terrace Pkwy.	14	Barton St. & Van Buren Blvd.	15	Airman Dr. & Cactus Av.																																																	
<table border="1" style="width: 100%; border-collapse: collapse;"> <tr><td style="text-align: center;">← 10</td><td style="text-align: center;">↑ 9</td></tr> <tr><td style="text-align: center;">← 12</td><td style="text-align: center;">↑ 3516</td></tr> <tr><td style="text-align: center;">← 48</td><td style="text-align: center;">↑ 48</td></tr> <tr><td style="text-align: center;">8 →</td><td style="text-align: center;">101 →</td></tr> <tr><td style="text-align: center;">2097 →</td><td style="text-align: center;">2 →</td></tr> <tr><td style="text-align: center;">60 ↓</td><td style="text-align: center;">64 ↓</td></tr> </table>	← 10	↑ 9	← 12	↑ 3516	← 48	↑ 48	8 →	101 →	2097 →	2 →	60 ↓	64 ↓	<table border="1" style="width: 100%; border-collapse: collapse;"> <tr><td style="text-align: center;">← 12</td><td style="text-align: center;">↑ 17</td></tr> <tr><td style="text-align: center;">← 6</td><td style="text-align: center;">↑ 492</td></tr> <tr><td style="text-align: center;">← 25</td><td style="text-align: center;">↑ 8</td></tr> <tr><td style="text-align: center;">43 →</td><td style="text-align: center;">133 →</td></tr> </table>	← 12	↑ 17	← 6	↑ 492	← 25	↑ 8	43 →	133 →	<table border="1" style="width: 100%; border-collapse: collapse;"> <tr><td style="text-align: center;">← 530</td><td style="text-align: center;">↑ 59</td></tr> <tr><td style="text-align: center;">363 →</td><td style="text-align: center;">275 →</td></tr> <tr><td style="text-align: center;">336 ↓</td><td style="text-align: center;">44 ↓</td></tr> </table>	← 530	↑ 59	363 →	275 →	336 ↓	44 ↓	<table border="1" style="width: 100%; border-collapse: collapse;"> <tr><td style="text-align: center;">← 409</td><td style="text-align: center;">↑ 40</td></tr> <tr><td style="text-align: center;">← 150</td><td style="text-align: center;">↑ 2325</td></tr> <tr><td style="text-align: center;">← 76</td><td style="text-align: center;">↑ 337</td></tr> <tr><td style="text-align: center;">203 →</td><td style="text-align: center;">606 →</td></tr> <tr><td style="text-align: center;">2005 →</td><td style="text-align: center;">97 →</td></tr> <tr><td style="text-align: center;">261 ↓</td><td style="text-align: center;">470 ↓</td></tr> </table>	← 409	↑ 40	← 150	↑ 2325	← 76	↑ 337	203 →	606 →	2005 →	97 →	261 ↓	470 ↓	<table border="1" style="width: 100%; border-collapse: collapse;"> <tr><td style="text-align: center;">← 443</td><td style="text-align: center;">↑ 331</td></tr> <tr><td style="text-align: center;">133 →</td><td style="text-align: center;">99 →</td></tr> </table>	← 443	↑ 331	133 →	99 →												
← 10	↑ 9																																																									
← 12	↑ 3516																																																									
← 48	↑ 48																																																									
8 →	101 →																																																									
2097 →	2 →																																																									
60 ↓	64 ↓																																																									
← 12	↑ 17																																																									
← 6	↑ 492																																																									
← 25	↑ 8																																																									
43 →	133 →																																																									
← 530	↑ 59																																																									
363 →	275 →																																																									
336 ↓	44 ↓																																																									
← 409	↑ 40																																																									
← 150	↑ 2325																																																									
← 76	↑ 337																																																									
203 →	606 →																																																									
2005 →	97 →																																																									
261 ↓	470 ↓																																																									
← 443	↑ 331																																																									
133 →	99 →																																																									
16	Abrams Dr. & Grove Community Dr.	17	Abrams Dr. & Orange Terrace Pkwy.	18	Linebacker Dr. & Cactus Av.	19	Orange Terrace Pkwy. & Van Buren Blvd.	20	Brown St. & Alessandro Blvd.																																																	
<table border="1" style="width: 100%; border-collapse: collapse;"> <tr><td style="text-align: center;">← 310</td><td style="text-align: center;">↑ 124</td></tr> <tr><td style="text-align: center;">75 →</td><td style="text-align: center;">180 →</td></tr> <tr><td style="text-align: center;">69 ↓</td><td style="text-align: center;">81 ↓</td></tr> </table>	← 310	↑ 124	75 →	180 →	69 ↓	81 ↓	<table border="1" style="width: 100%; border-collapse: collapse;"> <tr><td style="text-align: center;">← 139</td><td style="text-align: center;">↑ 116</td></tr> <tr><td style="text-align: center;">← 97</td><td style="text-align: center;">↑ 407</td></tr> <tr><td style="text-align: center;">150 →</td><td style="text-align: center;">219 →</td></tr> </table>	← 139	↑ 116	← 97	↑ 407	150 →	219 →	<table border="1" style="width: 100%; border-collapse: collapse;"> <tr><td style="text-align: center;">← 277</td><td style="text-align: center;">↑ 774</td></tr> <tr><td style="text-align: center;">← 84</td><td style="text-align: center;">↑ 277</td></tr> <tr><td style="text-align: center;">232 →</td><td style="text-align: center;">84 →</td></tr> </table>	← 277	↑ 774	← 84	↑ 277	232 →	84 →	<table border="1" style="width: 100%; border-collapse: collapse;"> <tr><td style="text-align: center;">← 289</td><td style="text-align: center;">↑ 153</td></tr> <tr><td style="text-align: center;">← 43</td><td style="text-align: center;">↑ 2514</td></tr> <tr><td style="text-align: center;">← 290</td><td style="text-align: center;">↑ 140</td></tr> <tr><td style="text-align: center;">181 →</td><td style="text-align: center;">131 →</td></tr> <tr><td style="text-align: center;">2143 →</td><td style="text-align: center;">25 →</td></tr> <tr><td style="text-align: center;">225 ↓</td><td style="text-align: center;">86 ↓</td></tr> </table>	← 289	↑ 153	← 43	↑ 2514	← 290	↑ 140	181 →	131 →	2143 →	25 →	225 ↓	86 ↓	<table border="1" style="width: 100%; border-collapse: collapse;"> <tr><td style="text-align: center;">← 66</td><td style="text-align: center;">↑ 3388</td></tr> <tr><td style="text-align: center;">← 192</td><td style="text-align: center;">↑ 192</td></tr> <tr><td style="text-align: center;">← 5</td><td style="text-align: center;">↑ 5</td></tr> <tr><td style="text-align: center;">← 39</td><td style="text-align: center;">↑ 5</td></tr> <tr><td style="text-align: center;">40 →</td><td style="text-align: center;">55 →</td></tr> <tr><td style="text-align: center;">2100 →</td><td style="text-align: center;">5 →</td></tr> <tr><td style="text-align: center;">157 ↓</td><td style="text-align: center;">57 ↓</td></tr> </table>	← 66	↑ 3388	← 192	↑ 192	← 5	↑ 5	← 39	↑ 5	40 →	55 →	2100 →	5 →	157 ↓	57 ↓										
← 310	↑ 124																																																									
75 →	180 →																																																									
69 ↓	81 ↓																																																									
← 139	↑ 116																																																									
← 97	↑ 407																																																									
150 →	219 →																																																									
← 277	↑ 774																																																									
← 84	↑ 277																																																									
232 →	84 →																																																									
← 289	↑ 153																																																									
← 43	↑ 2514																																																									
← 290	↑ 140																																																									
181 →	131 →																																																									
2143 →	25 →																																																									
225 ↓	86 ↓																																																									
← 66	↑ 3388																																																									
← 192	↑ 192																																																									
← 5	↑ 5																																																									
← 39	↑ 5																																																									
40 →	55 →																																																									
2100 →	5 →																																																									
157 ↓	57 ↓																																																									

Saturday Peak Hour Intersection Volumes

<p>21 Brown St. & Cactus Av.</p> <table border="1"> <tr> <td>← 344</td> <td>↑ 983</td> </tr> <tr> <td>102 ↘</td> <td></td> </tr> <tr> <td>299 →</td> <td></td> </tr> </table>	← 344	↑ 983	102 ↘		299 →		<p>22 Sycamore Canyon Blvd. & Eastridge Av.</p> <table border="1"> <tr> <td>← 52</td> <td>↑ 611</td> </tr> <tr> <td>← 320</td> <td>↑ 235</td> </tr> <tr> <td>↘ 94</td> <td>↑ 192</td> </tr> <tr> <td>61 ↘</td> <td>89 ↘</td> </tr> <tr> <td>50 ↘</td> <td>998 ↘</td> </tr> <tr> <td>22 ↘</td> <td>127 ↘</td> </tr> </table>	← 52	↑ 611	← 320	↑ 235	↘ 94	↑ 192	61 ↘	89 ↘	50 ↘	998 ↘	22 ↘	127 ↘	<p>23 Sycamore Canyon Blvd. & Cottonwood Av.</p> <table border="1"> <tr> <td>← 400</td> <td>↑ 45</td> </tr> <tr> <td>↘ 136</td> <td></td> </tr> <tr> <td></td> <td>↑ 29</td> </tr> <tr> <td></td> <td>1191 →</td> </tr> <tr> <td></td> <td>77 ↘</td> </tr> </table>	← 400	↑ 45	↘ 136			↑ 29		1191 →		77 ↘	<p>24 Meridian Pkwy. & Alessandro Blvd.</p> <table border="1"> <tr> <td>← 172</td> <td>↑ 741</td> </tr> <tr> <td>← 243</td> <td>↑ 2905</td> </tr> <tr> <td>↘ 123</td> <td>↑ 292</td> </tr> <tr> <td>201 ↘</td> <td>822 ↘</td> </tr> <tr> <td>1523 ↘</td> <td>837 ↘</td> </tr> <tr> <td>466 ↘</td> <td>120 ↘</td> </tr> </table>	← 172	↑ 741	← 243	↑ 2905	↘ 123	↑ 292	201 ↘	822 ↘	1523 ↘	837 ↘	466 ↘	120 ↘	<p>25 Meridian Pkwy. & Cactus Av.</p> <table border="1"> <tr> <td>← 88</td> <td>↑ 1250</td> </tr> <tr> <td>← 362</td> <td>↑ 783</td> </tr> <tr> <td>↘ 214</td> <td>↑ 898</td> </tr> <tr> <td>53 ↘</td> <td>219 ↘</td> </tr> <tr> <td>223 ↘</td> <td>561 ↘</td> </tr> <tr> <td>97 ↘</td> <td>327 ↘</td> </tr> </table>	← 88	↑ 1250	← 362	↑ 783	↘ 214	↑ 898	53 ↘	219 ↘	223 ↘	561 ↘	97 ↘	327 ↘										
← 344	↑ 983																																																																	
102 ↘																																																																		
299 →																																																																		
← 52	↑ 611																																																																	
← 320	↑ 235																																																																	
↘ 94	↑ 192																																																																	
61 ↘	89 ↘																																																																	
50 ↘	998 ↘																																																																	
22 ↘	127 ↘																																																																	
← 400	↑ 45																																																																	
↘ 136																																																																		
	↑ 29																																																																	
	1191 →																																																																	
	77 ↘																																																																	
← 172	↑ 741																																																																	
← 243	↑ 2905																																																																	
↘ 123	↑ 292																																																																	
201 ↘	822 ↘																																																																	
1523 ↘	837 ↘																																																																	
466 ↘	120 ↘																																																																	
← 88	↑ 1250																																																																	
← 362	↑ 783																																																																	
↘ 214	↑ 898																																																																	
53 ↘	219 ↘																																																																	
223 ↘	561 ↘																																																																	
97 ↘	327 ↘																																																																	
<p>26 Meridian Pkwy. & Van Buren Blvd.</p> <table border="1"> <tr> <td>← 682</td> <td>↑ 267</td> </tr> <tr> <td>← 11</td> <td>↑ 3898</td> </tr> <tr> <td>↘ 141</td> <td>↑ 55</td> </tr> <tr> <td>909 ↘</td> <td>5 ↘</td> </tr> <tr> <td>2623 ↘</td> <td>4 ↘</td> </tr> <tr> <td>31 ↘</td> <td>4 ↘</td> </tr> </table>	← 682	↑ 267	← 11	↑ 3898	↘ 141	↑ 55	909 ↘	5 ↘	2623 ↘	4 ↘	31 ↘	4 ↘	<p>27 Innovation Dr. & Cactus Av.</p> <table border="1"> <tr> <td>← 3</td> <td>↑ 56</td> </tr> <tr> <td></td> <td>↑ 2866</td> </tr> <tr> <td></td> <td>↑ 146</td> </tr> <tr> <td>5 ↘</td> <td></td> </tr> <tr> <td>684 ↘</td> <td>13 ↘</td> </tr> <tr> <td>19 ↘</td> <td>41 ↘</td> </tr> </table>	← 3	↑ 56		↑ 2866		↑ 146	5 ↘		684 ↘	13 ↘	19 ↘	41 ↘	<p>28 I-215 SB Ramps & Alessandro Blvd.</p> <table border="1"> <tr> <td>← 597</td> <td>↑ 280</td> </tr> <tr> <td>↘ 453</td> <td>↑ 3342</td> </tr> <tr> <td></td> <td></td> </tr> <tr> <td>1227 →</td> <td></td> </tr> <tr> <td>513 ↘</td> <td></td> </tr> </table>	← 597	↑ 280	↘ 453	↑ 3342			1227 →		513 ↘		<p>29 I-215 NB Ramps & Alessandro Blvd.</p> <table border="1"> <tr> <td></td> <td>↑ 189</td> </tr> <tr> <td></td> <td>↑ 2200</td> </tr> <tr> <td></td> <td></td> </tr> <tr> <td>137 ↘</td> <td></td> </tr> <tr> <td>1562 →</td> <td></td> </tr> <tr> <td></td> <td>1423 ↘</td> </tr> <tr> <td></td> <td>496 ↘</td> </tr> </table>		↑ 189		↑ 2200			137 ↘		1562 →			1423 ↘		496 ↘	<p>30 I-215 SB Ramps & Cactus Av.</p> <table border="1"> <tr> <td>← 718</td> <td>↑ 2285</td> </tr> <tr> <td></td> <td>↑ 948</td> </tr> <tr> <td></td> <td></td> </tr> <tr> <td>657 →</td> <td></td> </tr> <tr> <td>61 ↘</td> <td></td> </tr> <tr> <td></td> <td>974 ↘</td> </tr> </table>	← 718	↑ 2285		↑ 948			657 →		61 ↘			974 ↘		
← 682	↑ 267																																																																	
← 11	↑ 3898																																																																	
↘ 141	↑ 55																																																																	
909 ↘	5 ↘																																																																	
2623 ↘	4 ↘																																																																	
31 ↘	4 ↘																																																																	
← 3	↑ 56																																																																	
	↑ 2866																																																																	
	↑ 146																																																																	
5 ↘																																																																		
684 ↘	13 ↘																																																																	
19 ↘	41 ↘																																																																	
← 597	↑ 280																																																																	
↘ 453	↑ 3342																																																																	
1227 →																																																																		
513 ↘																																																																		
	↑ 189																																																																	
	↑ 2200																																																																	
137 ↘																																																																		
1562 →																																																																		
	1423 ↘																																																																	
	496 ↘																																																																	
← 718	↑ 2285																																																																	
	↑ 948																																																																	
657 →																																																																		
61 ↘																																																																		
	974 ↘																																																																	
<p>31 I-215 NB Ramps & Cactus Av.</p> <table border="1"> <tr> <td>← 187</td> <td>↑ 190</td> </tr> <tr> <td>↘ 67</td> <td>↑ 3688</td> </tr> <tr> <td>34 ↘</td> <td></td> </tr> <tr> <td>2263 →</td> <td>704 ↘</td> </tr> <tr> <td>197 ↘</td> <td>393 ↘</td> </tr> <tr> <td></td> <td>56 ↘</td> </tr> </table>	← 187	↑ 190	↘ 67	↑ 3688	34 ↘		2263 →	704 ↘	197 ↘	393 ↘		56 ↘	<p>32 I-215 SB Ramps & Van Buren Blvd.</p> <table border="1"> <tr> <td>← 1670</td> <td>↑ 1844</td> </tr> <tr> <td>← 39</td> <td>↑ 34</td> </tr> <tr> <td>↘ 439</td> <td></td> </tr> <tr> <td></td> <td></td> </tr> <tr> <td>1181 →</td> <td></td> </tr> <tr> <td>1182 ↘</td> <td></td> </tr> </table>	← 1670	↑ 1844	← 39	↑ 34	↘ 439				1181 →		1182 ↘		<p>33 I-215 NB Ramps & Van Buren Blvd.</p> <table border="1"> <tr> <td></td> <td>↑ 687</td> </tr> <tr> <td></td> <td></td> </tr> <tr> <td></td> <td></td> </tr> <tr> <td>600 →</td> <td></td> </tr> <tr> <td>1265 ↘</td> <td></td> </tr> <tr> <td></td> <td>1712 ↘</td> </tr> <tr> <td></td> <td>160 ↘</td> </tr> </table>		↑ 687					600 →		1265 ↘			1712 ↘		160 ↘	<p>34 Old 215 Frontage Rd. & Alessandro Blvd.</p> <table border="1"> <tr> <td>← 325</td> <td>↑ 214</td> </tr> <tr> <td>← 87</td> <td>↑ 1996</td> </tr> <tr> <td>↘ 53</td> <td>↑ 13</td> </tr> <tr> <td>507 ↘</td> <td>73 ↘</td> </tr> <tr> <td>1684 →</td> <td>354 ↘</td> </tr> <tr> <td>60 ↘</td> <td>26 ↘</td> </tr> </table>	← 325	↑ 214	← 87	↑ 1996	↘ 53	↑ 13	507 ↘	73 ↘	1684 →	354 ↘	60 ↘	26 ↘	<p>35 Day St. & Alessandro Blvd.</p> <table border="1"> <tr> <td>← 295</td> <td>↑ 182</td> </tr> <tr> <td>← 87</td> <td>↑ 2002</td> </tr> <tr> <td>↘ 122</td> <td>↑ 13</td> </tr> <tr> <td>293 ↘</td> <td>95 ↘</td> </tr> <tr> <td>1591 →</td> <td>214 ↘</td> </tr> <tr> <td>31 ↘</td> <td>32 ↘</td> </tr> </table>	← 295	↑ 182	← 87	↑ 2002	↘ 122	↑ 13	293 ↘	95 ↘	1591 →	214 ↘	31 ↘	32 ↘
← 187	↑ 190																																																																	
↘ 67	↑ 3688																																																																	
34 ↘																																																																		
2263 →	704 ↘																																																																	
197 ↘	393 ↘																																																																	
	56 ↘																																																																	
← 1670	↑ 1844																																																																	
← 39	↑ 34																																																																	
↘ 439																																																																		
1181 →																																																																		
1182 ↘																																																																		
	↑ 687																																																																	
600 →																																																																		
1265 ↘																																																																		
	1712 ↘																																																																	
	160 ↘																																																																	
← 325	↑ 214																																																																	
← 87	↑ 1996																																																																	
↘ 53	↑ 13																																																																	
507 ↘	73 ↘																																																																	
1684 →	354 ↘																																																																	
60 ↘	26 ↘																																																																	
← 295	↑ 182																																																																	
← 87	↑ 2002																																																																	
↘ 122	↑ 13																																																																	
293 ↘	95 ↘																																																																	
1591 →	214 ↘																																																																	
31 ↘	32 ↘																																																																	
<p>36 Elsworth St. & Cactus Av.</p> <table border="1"> <tr> <td>← 346</td> <td>↑ 254</td> </tr> <tr> <td>← 131</td> <td>↑ 2620</td> </tr> <tr> <td>↘ 196</td> <td>↑ 92</td> </tr> <tr> <td>445 ↘</td> <td>90 ↘</td> </tr> <tr> <td>2119 →</td> <td>49 ↘</td> </tr> <tr> <td>683 ↘</td> <td>37 ↘</td> </tr> </table>	← 346	↑ 254	← 131	↑ 2620	↘ 196	↑ 92	445 ↘	90 ↘	2119 →	49 ↘	683 ↘	37 ↘	<p>37 Frederick St. & Cactus Av.</p> <table border="1"> <tr> <td>← 153</td> <td>↑ 192</td> </tr> <tr> <td></td> <td>↑ 2620</td> </tr> <tr> <td></td> <td></td> </tr> <tr> <td>260 ↘</td> <td></td> </tr> <tr> <td>1802 →</td> <td></td> </tr> </table>	← 153	↑ 192		↑ 2620			260 ↘		1802 →		<p>38 Graham St./Riverside Dr. & Cactus Av.</p> <table border="1"> <tr> <td>← 338</td> <td>↑ 378</td> </tr> <tr> <td>← 458</td> <td>↑ 2989</td> </tr> <tr> <td>↘ 355</td> <td>↑ 28</td> </tr> <tr> <td>222 ↘</td> <td></td> </tr> <tr> <td>1738 →</td> <td></td> </tr> <tr> <td>414 ↘</td> <td>50 ↘</td> </tr> </table>	← 338	↑ 378	← 458	↑ 2989	↘ 355	↑ 28	222 ↘		1738 →		414 ↘	50 ↘	<p>## Saturday Peak Hour Intersection Volumes</p>																													
← 346	↑ 254																																																																	
← 131	↑ 2620																																																																	
↘ 196	↑ 92																																																																	
445 ↘	90 ↘																																																																	
2119 →	49 ↘																																																																	
683 ↘	37 ↘																																																																	
← 153	↑ 192																																																																	
	↑ 2620																																																																	
260 ↘																																																																		
1802 →																																																																		
← 338	↑ 378																																																																	
← 458	↑ 2989																																																																	
↘ 355	↑ 28																																																																	
222 ↘																																																																		
1738 →																																																																		
414 ↘	50 ↘																																																																	

8.4 INTERSECTION OPERATIONS ANALYSIS

8.4.1 HORIZON YEAR (2045) WITHOUT PROJECT TRAFFIC CONDITIONS

Horizon Year (2045) peak hour traffic operations have been evaluated for the study area intersections based on the analysis methodologies presented in Section 2.2 *Intersection Capacity Analysis* of this report. The intersection analysis results are summarized in Table 8-1, which indicates that the following study area intersections are anticipated to operate at an unacceptable LOS during the peak hours under Horizon Year (2045) Without Project traffic conditions:

- Washington St. & Van Buren Bl. (#1) – LOS F AM and PM peak hours
- Alessandro Bl. & Arlington Av./Chicago Av. (#2) – LOS F AM and PM peak hours
- Canyon Crest Dr./Overlook Pkwy. & Alessandro Bl. (#3) – LOS F AM and PM peak hours
- Wood Rd. & Van Buren Bl. (#4) – LOS F AM and PM peak hours; LOS E Saturday peak hour
- Trautwein Rd. & Alessandro Bl. (#5) – LOS F AM and PM peak hours
- Trautwein Rd. & Grove Community Dr. (#6) – LOS E AM peak hour only
- Trautwein Rd. & Orange Terrace Pkwy. (#7) – LOS F AM and PM peak hours
- Trautwein Rd. & Van Buren Bl. (#8) – LOS F AM and PM peak hours; LOS E Saturday peak hour
- Deercreek Dr. & Orange Terrace Pkwy. (#10) – LOS F AM peak hour only
- Barton St. & Alessandro Bl. (#11) – LOS F AM and PM peak hours
- Barton St. & Orange Terrace Pkwy. (#13) – LOS F AM and Saturday peak hours
- Barton St. & Van Buren Bl. (#14) – LOS F AM, PM, and Saturday peak hours
- Brown St. & Alessandro Bl. (#20) – LOS E AM peak hour only
- Meridian Pkwy. & Alessandro Bl. (#24) – LOS F AM and PM peak hours
- Meridian Pkwy. & Cactus Av. (#25) – LOS F AM and PM peak hours
- Meridian Pkwy. & Van Buren Bl. (#26) – LOS F AM and PM peak hours
- I-215 NB Ramps & Alessandro Bl. (#29) – LOS F AM peak hour only
- I-215 NB Ramps & Cactus Av. (#31) – LOS F AM and PM peak hours
- I-215 SB Ramps & Van Buren Bl. (#32) – LOS F AM and PM peak hours
- Old 215 Frontage Rd. & Alessandro Bl. (#34) – LOS F AM peak hour only
- Day St. & Alessandro Bl. (#35) – LOS F AM peak hour; LOS E PM peak hour
- Elsworth St. & Cactus Av. (#36) – LOS F AM and PM peak hours
- Frederick St. & Cactus Av. (#37) – LOS F AM peak hour only
- Graham St./Riverside Dr. & Cactus Av. (#38) – LOS F AM and PM peak hours

The intersection operations analysis worksheets for Horizon Year (2045) Without Project traffic conditions are included in Appendix 8.1 of this TA.

TABLE 8-1: INTERSECTION ANALYSIS FOR HORIZON YEAR (2045) CONDITIONS

#	Intersection	Traffic Control ¹	HY (2045) NP						HY (2045) WP					
			Delay ^{2 3 4 5} (secs.)			Level of Service			Delay ^{2 3 4 5} (secs.)			Level of Service		
			AM	PM	SAT	AM	PM	SAT	AM	PM	SAT	AM	PM	SAT
1	Washington St. & Van Buren Blvd.	TS	>200.0	152.5	39.2	F	F	D	>200.0	164.3	43.2	F	F	D
2	Alessandro Blvd. & Arlington Av./Chicago Av.	TS	187.6	>200.0	40.5	F	F	D	190.3	>200.0	42.9	F	F	D
3	Canyon Crest Dr./Overlook Pkwy. & Alessandro Blvd.	TS	191.1	>200.0	28.2	F	F	C	>200.0	>200.0	32.4	F	F	C
4	Wood Rd. & Van Buren Blvd.	TS	196.7	>200.0	75.7	F	F	E	>200.0	>200.0	86.8	F	F	F
5	Trautwein Rd. & Alessandro Blvd.	TS	>200.0	82.5	22.6	F	F	C	>200.0	87.8	23.2	F	F	C
6	Trautwein Rd. & Grove Community Dr.	TS	74.0	17.2	14.9	E	B	B	74.7	17.2	14.9	E	B	B
7	Trautwein Rd. & Orange Terrace Pkwy.	TS	102.6	86.4	25.1	F	F	C	102.6	86.2	25.1	F	F	C
8	Trautwein Rd. & Van Buren Blvd.	TS	>200.0	155.0	61.6	F	F	E	>200.0	177.0	68.8	F	F	E
9	Deercreek Dr. & Grove Community Dr.	AWS	21.5	10.3	11.1	C	B	B	22.2	10.6	11.3	C	B	B
10	Deercreek Dr. & Orange Terrace Pkwy.	AWS	81.7	13.4	12.2	F	B	B	81.6	13.4	12.2	F	B	B
11	Barton St. & Alessandro Blvd.	TS	106.4	37.9	9.0	F	D	A	110.2	86.4	9.2	F	F	A
12	Barton St. & Grove Community Dr.	CSS	13.4	9.8	12.5	B	A	B	13.3	9.9	12.7	B	A	B
13	Barton St. & Orange Terrace Pkwy.	CSS	>100.0	28.7	>100.0	F	D	F	>100.0	28.7	>100.0	F	D	F
14	Barton St. & Van Buren Blvd.	TS	>200.0	>200.0	116.4	F	F	F	>200.0	>200.0	129.3	F	F	F
15	Airman Dr. & Cactus Av.	AWS	Future Intersection						16.9	53.8	21.5	B	D	C
16	Abrams Dr. & Grove Community Dr.	AWS	11.7	9.3	9.1	B	A	A	12.3	9.9	9.3	B	A	A
17	Abrams Dr. & Orange Terrace Pkwy.	AWS	13.6	9.4	10.1	B	A	B	13.6	9.4	10.1	B	A	B
18	Linebacker Dr. & Cactus Av.	TS	Future Intersection						22.4	54.5	23.8	C	D	C
19	Orange Terrace Pkwy. & Van Buren Blvd.	TS	28.5	54.4	19.1	C	D	B	30.4	75.0	19.5	C	E	B
20	Brown St. & Alessandro Blvd.	TS	63.8	54.0	10.6	E	D	B	98.0	>200.0	187.4	E	F	F
21	Brown St. & Cactus Av.	CSS	Future Intersection						18.7	36.5	33.4	B	D	C
22	Sycamore Canyon Blvd. & Eastridge Av.	TS	54.5	25.2	18.3	D	C	B	54.8	26.1	18.4	D	C	B
23	Sycamore Canyon Blvd. & Cottonwood Av.	TS	16.7	11.8	6.8	B	B	A	16.8	11.8	6.8	B	B	A
24	Meridian Pkwy. & Alessandro Blvd.	TS	183.3	148.6	23.0	F	F	C	198.5	180.3	23.8	F	F	C
25	Meridian Pkwy. & Cactus Av.	TS	134.8	141.0	18.5	F	F	B	146.1	>200.0	20.6	F	F	C
26	Meridian Pkwy. & Van Buren Blvd.	TS	>200.0	>200.0	15.5	F	F	B	>200.0	>200.0	17.5	F	F	B
27	Innovation Dr. & Cactus Av.	TS	8.3	9.9	3.6	A	A	A	10.4	12.0	2.7	B	B	A
28	I-215 SB Ramps & Alessandro Blvd.	TS	49.5	21.0	7.5	C	C	A	53.8	25.9	8.1	D	C	A
29	I-215 NB Ramps & Alessandro Blvd.	TS	119.9	44.1	34.4	F	D	C	140.8	65.6	44.9	F	E	D
30	I-215 SB Ramps & Cactus Av.	TS	11.0	32.7	4.5	B	C	A	15.7	149.8	5.2	B	F	A
31	I-215 NB Ramps & Cactus Av.	TS	>200.0	158.3	8.9	F	F	A	>200.0	>200.0	10.1	F	F	B
32	I-215 SB Ramps & Van Buren Blvd.	TS	80.3	>200.0	10.3	F	F	B	91.7	>200.0	10.2	F	F	B
33	I-215 NB Ramps & Van Buren Blvd.	TS	43.4	39.0	4.2	D	D	A	43.4	46.9	4.2	D	D	A
34	Old 215 Frontage Rd. & Alessandro Blvd.	TS	128.8	53.8	20.4	F	D	C	135.3	57.7	20.6	F	E	C
35	Day St. & Alessandro Blvd.	TS	114.1	79.5	14.6	F	E	B	118.9	88.2	15.2	F	F	B
36	Elsworth St. & Cactus Av.	TS	>200.0	>200.0	50.9	F	F	D	>200.0	>200.0	54.5	F	F	D
37	Frederick St. & Cactus Av.	TS	117.5	25.1	10.6	F	C	B	120.9	27.7	10.8	F	C	B
38	Graham St./Riverside Dr. & Cactus Av.	TS	>200.0	>200.0	18.3	F	F	B	>200.0	>200.0	18.3	F	F	C

* BOLD = Significant Impact

-- = Not applicable for this jurisdiction

¹ CSS = Cross-street Stop; AWS = All-Way Stop; TS = Traffic Signal; **TS** = Improvement

² For intersections within the jurisdiction of March JPA, deficient occurs (improvements needed) if the pre-project condition is at or better than LOS D (or acceptable LOS) and the project-generated traffic causes deterioration below acceptable levels. However, if the pre-project condition is already below LOS D (or acceptable LOS), provide improvements if the Project contributes more than 2% of the total traffic.

³ For intersections within the jurisdiction of the City of Riverside, deficient occurs (improvements needed) when the addition of project related trips causes either peak hour LOS to degrade from acceptable (LOS A through D) to unacceptable levels (LOS E/F) or the peak hour delay to increase as follows:

- LOS A/B = By 10.0 seconds
- LOS C = By 8.0 seconds
- LOS D = By 5.0 seconds
- LOS E = By 2.0 seconds
- LOS F = By 1.0 seconds

⁴ For intersections within the jurisdiction of Caltrans, or the County of Riverside, deficient occurs (improvements needed) if the pre-project condition is at or better than LOS D (or acceptable LOS) and the project-generated traffic causes deterioration below acceptable levels.

⁵ For intersections within the City of Moreno Valley, provide improvements if the pre-project condition is at or better than LOS D (or acceptable LOS) and the project-generated traffic causes deterioration below acceptable levels. If the pre-project condition is at an unacceptable LOS and Project increases delay by 5.0 or more, provide improvements to offset the increase in delay.

8.4.2 HORIZON YEAR (2045) WITH PROJECT TRAFFIC CONDITIONS

As shown in Table 8-1, the following additional study area intersections are anticipated to operate at a deficient LOS during one or both peak hours for Horizon Year (2045) With Project traffic conditions, in addition to the locations identified above for Horizon Year (2045) Without Project traffic conditions:

- Orange Terrace Pkwy. & Van Buren Bl. (#19) – LOS E PM peak hour only
- I-215 SB Ramps & Cactus Av. (#30) – LOS F PM peak hour only

The intersection operations analysis worksheets for Horizon Year (2045) With Project traffic conditions are included in Appendix 8.2.

8.5 ROADWAY SEGMENT ANALYSIS

The roadway segment capacities are approximate figures only and are used at the General Plan level to assist in determining the roadway functional classification (number of through lanes) needed to meet traffic demand. Table 8-2 provides a summary of the Horizon Year (2045) Without Project conditions roadway segment capacity analysis based on the applicable roadway segment capacity thresholds. As shown on Table 8-2, the following additional study area roadway segments are anticipated to operate at an unacceptable LOS based on the applicable planning level daily roadway capacity thresholds:

- Alessandro Bl. from Trautwein Rd. to Mission Grove Pkwy. (#1) – LOS F
- Alessandro Bl. from Mission Grove Pkwy. to Barton St. (#2) – LOS E
- Alessandro Bl. from Barton St. to Brown St. (#3) – LOS E
- Alessandro Bl. from Brown St. to Meridian Pkwy. (#4) – LOS E
- Alessandro Bl. from Meridian Pkwy. to I-215 Freeway (#5) – LOS F
- Meridian Pkwy. from Alessandro Bl. to Cactus Av. (#14) – LOS F
- Meridian Pkwy. from Cactus Av. to Van Buren Bl. (#15) – LOS F

With the addition of Project traffic, the following additional study area roadway segments are anticipated to operate at a deficient LOS for Horizon Year (2045) With Project traffic conditions:

- Cactus Av., from Airman Dr. to Linebacker Dr. (#6) – LOE F
- Cactus Av. from Linebacker Dr. to Brown St. (#7) – LOS E
- Cactus Av., from Brown St. to Meridian Pkwy. (#8) – LOS F
- Barton Rd. from Alessandro Bl. to Cactus Av. (#10) – LOS F
- Brown St., from Alessandro Bl. to Cactus Av. (#12) – LOS F

TABLE 8-2: ROADWAY SEGMENT ANALYSIS FOR HORIZON YEAR (2045) CONDITIONS

#	Roadway	Segment Limits	Roadway Section	LOS Capacity ¹	2040 Without Project			2040 With Project			Acceptable LOS
					2045	V/C ²	LOS ³	2045	V/C ²	LOS ³	
1	Alessandro Bl.	Trautwein Rd. to Mission Grove Pkwy.	6D	57,250	60,523	1.06	F	63,517	1.11	F	D
2		Mission Grove Pkwy. to Barton St.	6D	57,250	58,590	1.02	F	62,914	1.10	F	D
3		Barton St. to Brown St.	6D	57,250	59,226	1.03	F	63,218	1.10	F	D
4		Brown St. to Meridian Pkwy.	6D	57,250	63,866	1.12	F	68,894	1.20	F	D
5		Meridian Pkwy. to I-215 Freeway	6D	57,250	52,393	0.92	E	58,460	1.02	F	D
6	Cactus Av.	Airman Dr. to Linebacker Dr.	2U	13,000	0	0.00	A	28,912	2.22	F	D
7		Linebacker Dr. to Brown St.	4D	25,900	0	0.00	A	43,346	1.67	F	D
8		Brown St. to Meridian Pkwy.	4D	25,900	0	0.00	A	25,630	0.99	E	D
9		Meridian Pkwy. to I-215 Freeway	6D	51,150	28,137	0.55	A	44,753	0.87	D	D
10	Barton St.	Alessandro Bl. to Cactus Av. (EVA)	2U	13,000	2,718	0.21	A	14,403	1.11	F	D
11		Cactus Av. (EVA) to Grove Community Dr.	2U	13,000	1,034	0.08	A	1,366	0.11	A	D
12	Brown St.	Alessandro Bl. to Cactus Av.	2D	13,000	1,023	0.08	A	18,739	1.44	F	D
13	Sycamore Canyon Bl.	Cottonwood Av. to Alessandro Bl.	4D	33,000	24,692	0.75	C	25,460	0.77	C	D
14	Meridian Pkwy.	Alessandro Bl. to Cactus Av.	4D	25,900	37,099	1.43	F	38,905	1.50	F	D
15		Cactus Av. to Van Buren Bl.	4D	25,900	32,181	1.24	F	39,389	1.52	F	D

BOLD = LOS does not meet the applicable jurisdictional requirements (i.e., unacceptable LOS).

¹ These maximum roadway capacities are based on the applicable agency's thresholds.

² V/C = Volume to Capacity Ratio

³ LOS = Level of Service

8.6 TRAFFIC SIGNAL WARRANTS ANALYSIS

There are no additional unsignalized study area intersection anticipated to meet either peak hour volume-based or planning level (ADT) volume-based traffic signal warrants for Horizon Year (2045) Without Project traffic conditions in addition to those previously warranted under Existing and E+P conditions (see Appendix 8.3). The intersection of Deercreek Drive and Grove Community Drive (#9) is anticipated to meet a planning level (ADT) volume-based traffic signal warrant under Horizon Year (2045) With Project traffic conditions (see Appendix 8.4).

8.7 OFF-RAMP QUEUING ANALYSIS

A queuing analysis was performed for the off-ramps at the I-215 Freeway at Alessandro Boulevard, Cactus Avenue, and Van Buren Boulevard interchanges, to assess vehicle queues for the off ramps that may potentially result in deficient peak hour operations at the ramp-to-arterial intersections and may potentially “spill back” onto the I-215 Freeway mainline. Queuing analysis findings are presented in Table 8-3 for Horizon Year (2045) traffic conditions. It is important to note that off-ramp lengths are consistent with the measured distance between the intersection and the freeway mainline. As shown in Table 8-3, there are no movements that are anticipated to experience queuing issues during the weekday AM, weekday PM, or weekend Saturday peak 95th percentile traffic flows for Horizon Year (2045) Without and With Project traffic conditions, consistent with Existing (2021) traffic conditions. Worksheets for Horizon Year (2045) Without and With Project traffic conditions off-ramp queuing analysis are provided in Appendix 8.5 and Appendix 8.6, respectively.

TABLE 8-3: PEAK HOUR FREEWAY OFF-RAMP QUEUING SUMMARY FOR HORIZON YEAR (2045) CONDITIONS

Intersection	Movement ³	Available Stacking Distance (Feet) ³	HY (2045) Without Project						HY (2045) With Project					
			95th Percentile Queue (Feet)			Acceptable? ¹			95th Percentile Queue (Feet)			Acceptable? ¹		
			AM Peak Hour	PM Peak Hour	SAT Peak Hour	AM	PM	SAT	AM Peak Hour	PM Peak Hour	SAT Peak Hour	AM	PM	SAT
I-215 SB Ramps & Alessandro Blvd. (#28)	SBL	525	249	305	102	Yes	Yes	Yes	265	346 ²	113	Yes	Yes	Yes
	SBL/R	1,540	242	324 ²	116	Yes	Yes	Yes	264	345 ²	147	Yes	Yes	Yes
	SBR	525	223	298 ²	108	Yes	Yes	Yes	247	312 ²	140	Yes	Yes	Yes
I-215 NB Ramps & Alessandro Blvd. (#29)	NBL	450	814 ^{2,3}	521 ^{2,3}	180	Yes	Yes	Yes	890 ^{1,2}	578 ^{1,2}	202	Yes	Yes	Yes
	NBL/T/R	1,345	784 ²	565 ²	178	Yes	Yes	Yes	861 ²	618 ²	203	Yes	Yes	Yes
	NBR	450	458 ^{2,3}	290	121	Yes	Yes	Yes	458 ²	290	135	Yes	Yes	Yes
I-215 SB Ramps & Cactus Av. (#30)	SBR	1,115	382 ²	443 ²	0	Yes	Yes	Yes	1,035 ²	855 ²	0	Yes	Yes	Yes
	NBR	1,850	596 ²	609 ²	0	Yes	Yes	Yes	599 ²	610 ²	39	Yes	Yes	Yes
I-215 NB Ramps & Cactus Av. (#31)	NBL	145	1,010 ^{2,3}	433 ^{2,3}	61	Yes	Yes	Yes	1,166 ²	566 ²	131	Yes	Yes	Yes
	NBT/R	1,650	633 ²	265 ²	77	Yes	Yes	Yes	633 ²	265 ²	76	Yes	Yes	Yes
I-215 SB Ramps & Van Buren Blvd.(#32)	SBL/T	1,510	408 ²	1,035 ²	30	Yes	Yes	Yes	408 ²	1,035 ²	30	Yes	Yes	Yes
	SBR	1,450	958 ²	593 ²	363 ²	Yes	Yes	Yes	958 ²	593 ²	375 ²	Yes	Yes	Yes
I-215 NB Ramps & Van Buren Blvd. (#33)	NBL	1,560	324	230	0	Yes	Yes	Yes	324	218	0	Yes	Yes	Yes
	NBR	580	38	63	0	Yes	Yes	Yes	38	60	0	Yes	Yes	Yes

¹ Stacking Distance is acceptable if the required stacking distance is less than or equal to the stacking distance provided. An additional 15 feet of stacking which is assumed to be provided in the transition for turn pockets is reflected in the stacking distance shown on this table, where applicable.

² 95th percentile volume exceeds capacity, queue may be longer. Queue shown is maximum after two cycles.

³ Although 95th percentile queue is anticipated to exceed the available storage for the turn lane, the adjacent lane has sufficient storage to accommodate any spillover without spilling back and affecting the I-215 Freeway mainline.

8.8 DEFICIENCIES AND IMPROVEMENTS

8.8.1 IMPROVEMENTS TO ADDRESS DEFICIENCIES AT INTERSECTIONS

This section provides a summary of Project deficiencies and identified improvements. Based on the deficiency criteria discussed in Section 2.7 *Deficiency Criteria*, study area intersections were found to be deficient. The effectiveness of the improvement strategies presented in Table 8-5 address the Horizon Year (2045) deficiencies as the recommendations improve the operations back to pre-project conditions (or better) or within the allowable net change in delay per the applicable deficiency criteria for each agency. It should be noted the following study area intersections fall below the applicable agency's deficiency criteria. As such, no improvements have been recommended at these locations:

- Trautwein Rd. & Grove Community Rd. (#6)
- Trauwein Rd. & Orange Terrace Pkwy. (#7)
- Deercreek Rd. & Orange Terrace Pkwy. (#10)
- Frederick Street at Cactus Avenue (#37)

If not constructed by the Project, the Project Applicant should contribute to these improvements through payment of fair share or TUMF fees. Worksheets for Horizon Year (2045) With Project, with improvements, HCM calculation worksheets are provided in Appendix 8.7.

8.8.2 IMPROVEMENTS TO ADDRESS DEFICIENCIES AT ROADWAY SEGMENT

Additional roadway widening for the deficient roadway segments has not been recommended as acceptable or improved peak hour traffic operations can be achieved with the existing lanes or with the improvements shown on Table 8-4. Most roadway segments are already constructed to their ultimate or assume the ultimate lanes.

8.8.3 IMPROVEMENTS TO ADDRESS DEFICIENCIES ON OFF-RAMP QUEUES

As shown previously in Table 8-3, there are no anticipated peak hour queuing issues at the I-215 Freeway off-ramps for Horizon Year (2045) traffic conditions, consistent with Existing (2021) traffic conditions. As such, no improvements have been recommended.

TABLE 8-4: INTERSECTION ANALYSIS FOR HORIZON YEAR (2045) CONDITIONS WITH IMPROVEMENTS

#	Intersection	Traffic Control ³	Intersection Approach Lanes ¹												Delay ² (secs.)			Level of Service								
			Northbound			Southbound			Eastbound			Westbound			AM	PM	SAT	AM	PM	SAT						
			L	T	R	L	T	R	L	T	R	L	T	R	L	T	R									
1	Washington St. & Van Buren Blvd.																									
	- Without Improvements	TS	2	2	1	2	2	0	1	2	0	1	2	1	2	2	1	>200.0	164.3	43.2	F	F	D			
	- With Improvements	TS	2	2	1	2	2	0	1	<u>3</u>	0	1	<u>3</u>	1	2	2	1	123.2	76.4	31.6	F	E	C			
2	Alessandro Blvd. & Arlington Av./Chicago Av. ⁷																									
	- Without Improvements	TS	2	2	1>	2	3	0	1	2	2>	2	2	1>	2	2	1>	190.3	>200.0	42.9	F	F	D			
3	Canyon Crest Dr./Overlook Pkwy. & Alessandro Blvd.																									
	- Without Improvements	TS	1	2	1	2	1	1	1	3	0	1	3	1>	2	2	1>	>200.0	>200.0	32.4	F	F	C			
	- With Improvements	TS	1	2	1	<u>3</u>	1	<u>0</u>	1	3	0	1	3	1>	2	2	1>	193.0	>200.0	31.0	F	F	C			
4	Wood Rd. & Van Buren Blvd.																									
	- Without Improvements	TS	2	2	0	1	2	0	1	2	1>	2	2	1>	2	2	1>	>200.0	>200.0	86.8	F	F	F			
	- With Improvements	TS	2	2	0	1	2	0	1	<u>3</u>	1>	2	<u>3</u>	1	2	2	1>	101.6	106.3	34.5	F	F	C			
5	Trautwein Rd. & Alessandro Blvd. ⁴																									
	- Without Improvements	TS	2	1	0	0	0	0	0	3	0	2	3	0	2	3	0	>200.0	87.8	23.2	F	F	C			
8	Trautwein Rd. & Van Buren Blvd.																									
	- Without Improvements	TS	1	2	0	2	2	1>	2	2	1>	1	3	1>	2	2	1>	>200.0	177.0	68.8	F	F	E			
	- With Improvements	TS	1	2	0	2	2	1>	2	<u>3</u>	1	1	3	1>	2	2	1>	165.9	116.2	61.3	F	F	E			
11	Barton St. & Alessandro Blvd.																									
	- Without Improvements	TS	0	1	1	0	1	1	1	3	0	1	3	0	1	3	0	110.2	86.4	9.2	F	F	A			
	- With Improvements ⁵	TS	<u>1</u>	1	<u>0</u>	<u>1</u>	1	<u>0</u>	1	3	0	1	3	0	1	3	0	103.0	17.3	9.4	F	B	A			
13	Barton St. & Orange Terrace Pkwy.																									
	- Without Improvements	CSS	1	0	0	0	0	0	0	2	0	1	2	0	2	2	0	>100.0	28.7	>100.0	F	D	F			
	- With Improvements	<u>TS</u>	1	0	0	0	0	0	0	2	0	1	2	0	2	2	0	13.9	12.5	14.2	B	B	B			
14	Barton St. & Van Buren Blvd.																									
	- Without Improvements	TS	2	1	1	1	1	0	1	2	0	1	3	0	2	3	0	>200.0	>200.0	129.3	F	F	F			
	- With Improvements	TS	2	1	1	1	1	0	1	<u>3</u>	1>	<u>2</u>	3	0	2	3	0	128.1	64.2	33.6	F	E	C			
19	Orange Terrace Pkwy. & Van Buren Blvd.																									
	- Without Improvements	TS	2	2	1	2	1	1>	2	3	1	2	3	1	2	3	1	30.4	75.0	19.5	C	E	B			
	- With Improvements ¹⁰	TS	2	2	1>	2	1	1>	2	3	1>	2	3	1>	2	3	1>	29.2	52.8	18.9	C	C	B			
20	Brown St. & Alessandro Blvd. ⁷																									
	- Without Improvements	TS	1	1	1>	1	1	1>	1	3	0	1	3	1	1	3	1	98.0	>200.0	187.4	E	F	F			
24	Meridian Pkwy. & Alessandro Blvd. ⁷																									
	- Without Improvements	TS	2	2	2>	2	2	1	1	3	1	2	3	1	2	3	1	198.5	180.3	23.8	F	F	C			
25	Meridian Pkwy. & Cactus Av.																									
	- Without Improvements	TS	2	2	1	2	2	1	1	2	1	2	2	1	2	2	1	146.1	>200.0	20.6	F	F	C			
	- With Improvements	TS	2	2	1	2	<u>3</u>	<u>0</u>	1	<u>3</u>	<u>0</u>	2	2	1>	2	2	1>	79.5	178.6	23.1	E	F	C			
26	Meridian Pkwy. & Van Buren Blvd.																									
	- Without Improvements	TS	0	2	0	2	1	1>	2	4	1	1	4	1	2	4	1	>200.0	>200.0	17.5	F	F	B			
	- With Improvements ⁸	TS	0	2	0	2	<u>1</u>	1>	2	4	1	1	4	1	2	4	1	148.4	>200.0	16.2	F	F	B			

#	Intersection	Traffic Control ³	Intersection Approach Lanes ¹												Delay ² (secs.)			Level of Service		
			Northbound			Southbound			Eastbound			Westbound			AM	PM		AM	PM	SAT
			L	T	R	L	T	R	L	T	R	L	T	R						
29	I-215 NB Ramps & Alessandro Blvd.																			
	- Without Improvements	TS	1	1	1	0	0	0	1	3	0	0	3	1	140.8	65.6	44.9	F	E	D
	- With Improvements	TS	<u>2</u>	1	0	0	0	0	1	3	0	0	3	1	54.6	50.5	29.7	D	D	C
30	I-215 SB Ramps & Cactus Av.																			
	- Without Improvements	TS	0	0	1	0	0	1	0	2	1	1	2	0	15.7	149.8	5.2	B	F	A
	- With Improvements	TS	0	0	1	0	0	1	0	<u>3</u>	1	1	<u>3</u>	0	10.0	48.1	4.9	A	D	A
31	I-215 NB Ramps & Cactus Av.																			
	- Without Improvements	TS	1	1	1	1	1	0	1	2	0	0	2	0	>200.0	>200.0	10.1	F	F	B
	- With Improvements	TS	<u>2</u>	1	1	1	1	0	1	<u>3</u>	<u>1</u>	0	<u>4</u>	0	52.9	47.4	11.3	D	D	B
32	I-215 SB Ramps & Van Buren Blvd.																			
	- Without Improvements	TS	0	0	0	0	1	2>>	0	2	2	1	2	0	91.7	>200.0	10.2	F	F	B
	- With Improvements	TS	0	0	0	<u>1</u>	1	<u>1>></u>	0	2	<u>1>></u>	1	<u>3</u>	0	12.6	35.9	6.5	B	D	A
34	Old 215 Frontage Rd. & Alessandro Blvd.																			
	- Without Improvements	TS	2	2	1	1	2	1	2	3	1	1	2	1	135.3	57.7	20.6	F	E	C
	- With Improvements	TS	2	2	1	1	2	1	2	3	1	1	<u>3</u>	1	28.4	36.4	19.3	C	D	B
35	Day St. & Alessandro Blvd.																			
	- Without Improvements	TS	1	1	1	1	1	0	1	3	1	1	2	1	118.9	88.2	15.2	F	F	B
	- With Improvements	TS	1	1	1	1	1	<u>1</u>	1	3	1	1	<u>3</u>	1	51.1	41.8	13.9	B	D	B
36	Elsworth St. & Cactus Av.																			
	- Without Improvements	TS	1	1	0	1	1	1>	1	3	1>>	1	3	1	>200.0	>200.0	54.5	F	F	D
	- With Improvements ⁹	TS	<u>2</u>	1	0	1	1	1>	1	<u>4</u>	1>>	1	<u>4</u>	1	52.5	49.9	18.4	D	D	B
38	Graham St./Riverside Dr. & Cactus Av.																			
	- Without Improvements	TS	2	2	0	1	2	1	1	3	1	1	3	0	>200.0	>200.0	10.8	F	F	B
	- With Improvements	TS	2	2	0	<u>2</u>	2	1	1	3	1	1	3	0	174.6	149.5	18.2	F	F	B

* **BOLD** = LOS does not meet the applicable jurisdictional requirements (i.e., unacceptable LOS).

¹ When a right turn is designated, the lane can either be striped or unstriped. To function as a right turn lane there must be sufficient width for right turning vehicles to travel outside the through lanes.

L = Left; T = Through; R = Right; >= Right-Turn Overlap Phasing; >>= Free Right Turn Lane; 1 = Improvement

² Per the Highway Capacity Manual 6th Edition, overall average intersection delay and level of service are shown for intersections with a traffic signal or all way stop control. For intersections with cross street stop control, the delay and level of service for the worst individual movement (or movements sharing a single lane) are shown.

³ AWS = All-Way Stop; CSS = Cross-street Stop; TS = Traffic Signal

⁴ The two intersecting roadways are built to their ultimate width as designated in the General Plan. Based on recent comments and the jurisdiction's traffic study guidelines, infeasible improvements have not been recommended.

⁵ Recommended improvements shown can be accommodated through restriping (no additional pavement required). Improvement includes modifying the traffic signal to implement lead-lag phasing for the eastbound and westbound left turns.

⁶ Recommended improvement includes modifying the traffic signal from protected left turn phasing to permissive left turn phasing on the northbound and southbound

⁷ There are no feasible intersection improvements. As such, improvements have not been identified.

⁸ Improvement consists of restriping the southbound through lane to provide a shared left-through-right turn lane.

⁹ Recommended improvements can be accommodated through implementing N/S from split phasing to protected left turn phasing. Lead-lag operations should be implemented for the northbound and southbound approaches to avoid conflicting left turns. Additionally, the northbound approach should be restriped to provide one left turn lane and one shared through-right turn lane; the southbound approach should be restriped to provide one left turn lane, one through lane, and one right turn lane.

This Page Intentionally Left Blank

9 LOCAL AND REGIONAL FUNDING MECHANISMS

Transportation improvements within the March JPA are funded through a combination of improvements constructed by the Project, fee programs or fair share contributions. Fee programs applicable to the Project are described below.

9.1 RIVERSIDE COUNTY TRANSPORTATION UNIFORM MITIGATION FEE (TUMF)

The TUMF program is administered by the WRCOG based upon a regional Nexus Study most recently updated in 2016 to address major changes in right of way acquisition and improvement cost factors. (10) This regional program was put into place to ensure that development pays its fair share and that funding is in place for construction of facilities needed to maintain the requisite level of service and critical to mobility in the region. TUMF is a truly regional mitigation fee program and is imposed and implemented in every jurisdiction in Western Riverside County.

9.2 MEASURE A

Measure A, Riverside County's half-cent sales tax for transportation, was adopted by voters in 1988 and extended in 2002. It will continue to fund transportation improvements through 2039. Measure A funds a wide variety of transportation projects and services throughout the County. RCTC is responsible for administering the program. Measure A dollars are spent in accordance with a voter-approved expenditure plan that was adopted as part of the 1988 election.

9.3 FAIR SHARE CONTRIBUTION

Project improvements may include a combination of fee payments to established programs, construction of specific improvements, payment of a fair share contribution toward future improvements or a combination of these approaches. Improvements constructed by development may be eligible for a fee credit or reimbursement through the program where appropriate (to be determined at the JPA's discretion). When off-site improvements are identified with a minor share of responsibility assigned to proposed development, the approving jurisdiction may elect to collect a fair share contribution or require the development to construct improvements. Detailed fair share calculations, for each peak hour, for the applicable deficient study area intersection are provided in Table 9-1. These fees are collected with the proceeds solely used as part of a funding mechanism aimed at ensuring that regional highways and arterial expansions keep pace with the projected population increases. It should be noted, at the time this traffic study was prepared, the City of Riverside does not have a program to collect fair share payments.

TABLE 9-1: PROJECT FAIR SHARE CALCULATIONS FOR INTERSECTIONS

#	Intersection	Existing	Project	2045 With Project	Total New Traffic	Project % of New Traffic ¹	
1	Washington St. & Van Buren Blvd.	AM:	4,503	99	7,501	2,998	3.3%
		PM:	4,380	195	6,958	2,578	7.6%
		SAT:	2,872	99	4,428	1,556	6.4%
3	Canyon Crest Dr./Overlook Pkwy. & Alessandro Blvd.	AM:	6,005	149	8,710	2,705	5.5%
		PM:	6,209	294	9,718	3,509	8.4%
		SAT:	3,424	147	5,158	1,734	8.5%
7	Trautwein Rd. & Orange Terrace Pkwy.	AM:	3,259	0	5,326	2,067	0.0%
		PM:	2,817	0	5,432	2,615	0.0%
		SAT:	1,920	0	3,178	1,258	0.0%
10	Deercreek Dr. & Orange Terrace Pkwy.	AM:	1,622	0	2,206	584	0.0%
		PM:	843	0	1,229	386	0.0%
		SAT:	723	0	1,064	341	0.0%
11	Barton St. & Alessandro Blvd.	AM:	4,032	214	5,927	1,895	11.3%
		PM:	4,114	425	6,178	2,064	20.6%
		SAT:	2,648	211	3,785	1,137	18.6%
13	Barton St. & Orange Terrace Pkwy.	AM:	1,177	33	1,607	430	7.7%
		PM:	817	65	1,184	367	17.7%
		SAT:	637	33	1,704	1,067	3.1%
14	Barton St. & Van Buren Blvd.	AM:	3,963	231	6,978	3,015	7.7%
		PM:	3,426	457	7,060	3,634	12.6%
		SAT:	2,549	229	5,108	2,559	8.9%
19	Orange Terrace Pkwy. & Van Buren Blvd.	AM:	3,324	231	6,220	2,896	8.0%
		PM:	3,247	458	7,096	3,849	11.9%
		SAT:	2,518	228	4,634	2,116	10.8%
25	Meridian Pkwy. & Cactus Av.	AM:	2,147	1,281	5,074	2,927	43.8%
		PM:	3,142	2,436	7,571	4,429	55.0%
		SAT:	999	1,167	2,698	1,699	68.7%
26	Meridian Pkwy. & Van Buren Blvd.	AM:	3,444	357	8,630	5,186	6.9%
		PM:	4,079	700	11,273	7,194	9.7%
		SAT:	2,398	344	4,608	2,210	15.6%
29	I-215 NB Ramps & Alessandro Blvd.	AM:	3,588	201	6,006	2,418	8.3%
		PM:	3,884	333	6,185	2,301	14.5%
		SAT:	2,527	182	3,427	900	20.2%
32	I-215 SB Ramps & Van Buren Blvd.	AM:	2,831	85	94	6,390	1.3%
		PM:	3,136	177	8,138	5,002	3.5%
		SAT:	1,960	83	3,730	1,770	4.7%

#	Intersection	Existing	Project	2045 With Project	Total New Traffic	Project % of New Traffic ¹	
35	Day St. & Alessandro Blvd.	AM:	2,422	66	4,956	2,534	2.6%
		PM:	3,195	130	5,544	2,349	5.5%
		SAT:	1,772	66	2,443	671	9.8%
36	Elsworth St. & Cactus Av.	AM:	4,020	102	7,063	3,043	3.4%
		PM:	4,042	200	7,623	3,581	5.6%
		SAT:	2,377	99	3,289	912	10.9%
38	Graham St./Riverside Dr. & Cactus Av.	AM:	3,639	36	6,970	3,331	1.1%
		PM:	4,231	69	7,785	3,554	1.9%
		SAT:	2,546	33	3,438	892	3.7%

¹ **BOLD** = Highest fair share percentage is highlighted.

This Page Intentionally Left Blank

10 REFERENCES

1. **March JPA.** *Final Traffic Impact Study Preparation Guide.* March JPA : s.n., February 2020.
2. **VRPA Technologies, Inc. for Riverside County Transportation Commission.** *Riverside County Long Range Transportation Study.* County of Riverside : VRPA Technologies, Inc., December 2019.
3. **Transportation Research Board.** *Highway Capacity Manual (HCM).* 6th Edition. s.l. : National Academy of Sciences, 2016.
4. **California Department of Transportation.** California Manual on Uniform Traffic Control Devices (CA MUTCD). [book auth.] California Department of Transportation. *California Manual on Uniform Traffic Control Devices (CA MUTCD).* 2014.
5. **Institute of Transportation Engineers (ITE).** *Trip Generation Manual.* 11th Edition. September 2021.
6. **WSP.** *TUMF High-Cube Warehouse Trip Generation Study.* County of Riverside : s.n., January 29, 2019.
7. **San Diego Association of Governments (SANDAG).** *(Not So) Brief Guide of Vehicular Traffic Generation Rates for the San Diego Region.* April 2002.
8. **Institute of Transportation Engineers (ITE).** *Trip Generation Handbook.* 3rd Edition. 2017.
9. **Western Riverside Council of Governments.** *TUMF Nexus Study, 2016 Program Update.* July 2017.

This Page Intentionally Left Blank

APPENDIX 1.1:

TRAFFIC STUDY SCOPING AGREEMENT

This Page Intentionally Left Blank

December 22, 2021

Mr. Dan Fairbanks
March Joint Powers Authority
14205 Meridian Parkway, Suite 140
Riverside, California 92518

SUBJECT: SCOPING ASSUMPTIONS FOR THE WEST CAMPUS UPPER PLATEAU TRAFFIC ANALYSIS

Dear Mr. Dan Fairbanks:

The firm of Urban Crossroads, Inc. is pleased to submit this letter documenting the suggested scope of study for the West Campus Upper Plateau development (“Project”), which is located on either side of Barton Street and Cactus Avenue in the jurisdiction of the March Joint Powers Authority (March JPA) and unincorporated Riverside County (see Exhibit 1).

The proposed Project (see Exhibit 2) consists of the following uses:

- Building B – 1,330,000 square feet (SF) of high-cube fulfillment center warehouse use
- Building C – 600,000 SF of high-cube fulfillment center warehouse use
- Building E – 200,000 SF of business park use
- Industrial Area – 1,212,710 SF of high-cube fulfillment center warehouse use
- Business Park Area – 1,170,893 SF of business park use
- Mixed Use Area – 106,858 SF of retail use (25%)
- Mixed Use Area – 448,804 SF of business park use (75%)
- 10.03 Acre Active Park (with sports fields)
- 51.73 Acres of Public Park

The scope of work herein is intended to evaluate potential intersection operational deficiencies resulting from the anticipated trips to be generated by the proposed Project.

TRIP GENERATION

Trip generation represents the amount of traffic that is attracted and produced by a development and is based upon the specific land uses planned for a given project. Trip generation rates for the Project are shown in Table 1. In order to develop the traffic characteristics of the proposed project, trip-generation statistics published in the Institute of Transportation Engineers (ITE) Trip Generation Manual (11th Edition, 2021), the High Cube Warehouse Trip Generation Study (WSP, January 2019), and the San Diego Association of Governments (SANDAG) (Not So) Brief Guide of Vehicular Traffic Generation Rates for the

San Diego Region (April 2002) were used to estimate the Project's trip generation. For purposes of the Traffic Analysis, the following ITE land use code and vehicle mix will be utilized for the Industrial Area:

- High-Cube Fulfillment Center Warehouse has been used to derive site specific trip generation estimates for up to 3,142,710 square feet of the proposed Project. The ITE Trip Generation Manual (2021) has trip generation rates for high-cube fulfillment center use for both non-sort and sort facilities (ITE land use code 155). While there is sufficient data to support use of the trip generation rates for non-sort facilities, the sort-facility rate appears to be unreliable because they are based on limited data (i.e., one to two surveyed sites). The proposed Project is speculative and whether a non-sort or sort facility end-user would occupy the buildings is not known at this time. Lastly, the ITE Trip Generation Manual recommends the use of local data sources where available. As such, the best available source for high-cube fulfillment center use would be the trip-generation statistics published in the High-Cube Warehouse Trip Generation Study (WSP, January 29, 2019) which was commissioned by the Western Riverside Council of Governments (WRCOG) in support of the Transportation Uniform Mitigation Fee (TUMF) update in the County of Riverside. The WSP trip generation rates were published in January 2019 and are based on data collected at 11 local high-cube fulfillment center sites located throughout Southern California (specifically Riverside County and San Bernardino County). However, the WSP study does not include a split for inbound and outbound vehicles, as such, the inbound and outbound splits per the ITE Trip Generation Manual for Land Use Code 154 have been utilized. These rates are consistent with the rates used for other similar projects through Riverside and San Bernardino Counties. The WSP trip generation rates for high-cube fulfillment center use are slightly more conservative than the latest non-sort facility rate provided in the ITE Trip Generation Manual.
- The trip generation rates for both the Active and Public Parks are based on the trip generation rates published by SANDAG in their (Not So) Brief Guide of Vehicular Traffic Generation Rates for the San Diego Region (April 2002).
- Business Park has been utilized to derive site specific trip generation for up to 1,819,697 square feet of business park uses within the Project. For the Business Park use, a blended rate has been used based on the ITE description for Business Park that the average mix is 20 to 30 percent office/commercial and 70 to 80 percent industrial/warehousing. As such, 30% of the business park area has been designated as office related uses, while the remaining 70% of the business park area has been allocated to warehousing uses. As such, the trip generation rates for ITE Land Use Code 710 (General Office) and ITE Land Use Code 150 (Warehousing) as published in the ITE Trip Generation Manual (2021) have been utilized to calculate trip generation for up to 1,819,697 square feet of business park use.
- Shopping Plaza (ITE Land Use Code 821) is a new land use category from the ITE Trip Generation Manual (2021) for shopping centers between 40,000 to 150,000 square feet. The rates for "without grocery" have been utilized to calculate the trip generation for up to 106,858 square feet within the mixed-use area of the Project.

TABLE 1: TRIP GENERATION RATES

Land Use ¹	Units ²	ITE LU Code	AM Peak Hour			PM Peak Hour			Daily
			In	Out	Total	In	Out	Total	
Warehousing ³	TSF	150	0.115	0.020	0.135	0.317	0.903	1.220	12.440
Passenger Cars (AM = 87.0%; PM = 85.0%; Daily = 73.0%)			0.077	0.018	0.095	0.260	0.920	1.180	11.870
Trucks (AM = 13.0%; PM = 15.0%; Daily = 27.0%)			0.032	0.008	0.040	0.009	0.031	0.040	0.570
High-Cube Fulfillment Center Warehouse ³	TSF	--	0.094	0.028	0.122	0.046	0.119	0.165	2.129
Passenger Cars (AM = 84.4%, PM = 87.3%, Daily = 82.2%)			0.079	0.024	0.103	0.040	0.104	0.144	1.750
Trucks (AM = 15.6%, PM = 12.7%, Daily = 17.8%)			0.015	0.004	0.019	0.006	0.015	0.021	0.379
Active Park	AC	-- ⁴	3.25	3.25	6.50	2.25	2.25	4.50	50.00
Public Park	AC	-- ⁴	0.33	0.32	0.65	0.23	0.22	0.45	5.00
General Office	TSF	710	Based on the ITE Fitted Curve Equation						
General Office (60.000 TSF)			1.58	0.29	1.87	0.31	1.50	1.81	12.40
General Office (351.268 TSF)			1.24	0.22	1.46	0.23	1.11	1.34	9.86
General Office (134.641 TSF)			1.43	0.26	1.69	0.27	1.33	1.60	11.32
Shopping Plaza (40-150 TSF)	TSF	821	1.07	0.66	1.73	2.54	2.65	5.19	67.52

¹ Trip Generation Source: Institute of Transportation Engineers (ITE), Trip Generation Manual, Eleventh Edition (2021).

² TSF = thousand square feet; AC = Acres

³ Vehicle Mix Source: High Cube Warehouse Trip Generation Study, WSP, January 29, 2019.

Inbound and outbound split source: ITE Trip Generation Manual, Eleventh Edition (2021) for ITE Land Use Code 154.

⁴ Trip Generation Source: SANDAG (Not So) Brief Guide of Vehicular Traffic Generation Rates for the San Diego Region, April 2002. For Developed and Undeveloped Parks.

Internal capture is a percentage reduction that can be applied to the trip generation estimates for individual land uses to account for trips internal to the site. In other words, trips may be made between commercial retail use and employees of the business park/warehouse uses and can be made either by walking or using internal roadways without using external streets. For example, employees of the business park use may visit the commercial retail use without leaving the site and are therefore considered as vehicle trips that are internal to the site. The internal capture rate for the retail, office, restaurant, and residential uses on-site are based on the NCHRP 684 Internal Trip Capture Estimation Tool. As the project is proposed to include commercial retail uses, pass-by percentages have been obtained from the ITE Trip Generation Handbook (3rd Edition, 2017).

The trip generation summary illustrating daily, and peak hour trip generation estimates for the proposed Project are shown on Table 2. In order to accurately reflect the impact that heavy trucks would have on the street system, Project trips have been further broken down between passenger cars and trucks for each of the peak hours and weekday daily trip generation for the high-cube fulfillment center warehouse and business park uses. As shown on Table 2, the proposed land use anticipated to generate a total of 33,238 trip-ends per day with 1,581 AM peak hour trips and 3,251 PM peak hour trips.

For the purposes of this analysis, it is proposed that the actual vehicles be utilized in order to reflect the effects of heavy trucks most accurately in the analysis. Trucks will be accounted for in the analysis as a percentage of total traffic, which will be input into the analysis software (Synchro 11). As such, trip generation is reflected in actual vehicles only and not in passenger car equivalent (PCE).

TABLE 2: PROJECT TRIP GENERATION SUMMARY

Land Use	Quantity Units ¹	AM Peak Hour			PM Peak Hour			Daily
		In	Out	Total	In	Out	Total	
Building B: High-Cube Fulfillment	1,330.000 TSF							
Passenger Cars:		105	32	137	54	138	192	2,328
Trucks:		19	6	25	8	20	28	504
Total Trips²		124	38	162	62	158	220	2,832
Building C: High-Cube Fulfillment	600.000 TSF							
Passenger Cars:		48	14	62	24	62	86	1,050
Trucks:		9	3	12	4	9	13	228
Total Trips²		57	17	74	28	71	99	1,278
Remaining Industrial: High-Cube Fulfillment	1,212.710 TSF							
Passenger Cars:		96	29	125	49	126	175	2,122
Trucks:		18	5	23	7	18	25	460
Total Trips²		114	34	148	56	144	200	2,582
Building E: Business Park	200.000 TSF							
Office Passenger Cars:	60.000 TSF	95	17	112	19	90	109	744
Warehouse Passenger Cars:	140.000 TSF	11	3	14	36	129	165	1,662
Warehouse Trucks:		5	1	6	1	4	5	80
Business Park	1,170.893 TSF							
Office Passenger Cars:	351.268 TSF	436	77	513	81	390	471	3,464
Warehouse Passenger Cars:	819.625 TSF	63	15	78	213	754	967	9,730
Warehouse Trucks:		27	6	33	7	26	33	468
Business Park (Mixed-Use, 75%)	448.804 TSF							
Office Passenger Cars:	134.641 TSF	193	35	228	36	179	215	1,524
Warehouse Passenger Cars:	314.163 TSF	24	6	30	82	289	371	3,730
Warehouse Trucks:		10	2	12	3	10	13	180
Total Business Park Trips		864	162	1,026	478	1,871	2,349	21,582
Retail (Mixed-Use, 25%)								
Passenger Cars:	106.858 TSF	115	70	185	272	283	555	7,216
Pass-by Reduction (AM: 0%; PM/Daily: 34%) ⁴		0	0	0	-92	-92	-185	-2,454
Total Retail Trips		115	70	185	180	191	370	4,762
Active Park	10.03 AC	33	33	66	23	23	46	502
Public Park	51.73 AC	17	17	34	12	11	23	260
Total Park Trips		50	50	100	35	34	69	762
Total Passenger Cars		1,236	348	1,584	809	2,382	3,190	31,878
Internal Trip Reduction ³		-57	-57	-114	-28	-28	-56	-560
Total Trucks		88	23	111	30	87	117	1,920
Project Total Trips		1,267	314	1,581	811	2,441	3,251	33,238

¹ TSF = thousand square feet; AC = Acres

² Total Trips = Passenger Cars + Truck Trips.

³ Internal trip reduction based on NCHRP 684 Internal Trip Capture Estimation Tool for the passenger car trips and commercial retail.

⁴ Pass-by reduction percentage source: ITE [Trip Generation Handbook](#), 3rd Edition (2017).

TRIP DISTRIBUTION

The Project trip distribution and assignment process represents the directional orientation of traffic to and from the Project site. The trip distribution pattern of passenger cars is heavily influenced by the geographical location of the site, the location of surrounding land uses, and the proximity to the regional freeway system. The trip distribution pattern for truck traffic is also influenced by the local truck routes approved by the March JPA, City of Riverside, City of Moreno Valley, and Caltrans. Truck traffic will be directed to utilize Cactus Avenue to the I-215 Freeway; however, it is anticipated some trucks may use Meridian Parkway to head north or south. Given these differences, separate trip distributions were generated for both passenger cars and truck trips. Exhibit 3 illustrates the trip distribution patterns for passenger cars and Exhibit 4 illustrates the truck trip distribution patterns. Exhibits 7 and 8 show the Project only average daily traffic (ADT) and peak hour turning volumes.

STUDY AREA

INTERSECTIONS

The study area intersections (Exhibit 3) were selected based on the guidelines outlined in The March Joint Powers Authority Traffic Impact Study Preparation Guide (dated February 10, 2020). Additional study area intersections have been included at the request of City of Riverside staff.

ROADWAY SEGMENTS

The following roadway segments will be evaluated based on the applicable roadway capacities:

#	Roadway Segment	Limits
1	Alessandro Bl.	Trautwein Rd. to Mission Grove Pkwy.
2		Mission Grove Pkwy. to Barton Rd.
3		Barton Rd. to Brown St.
4		Brown St. to Meridian Pkwy.
5		Meridian Pkwy. to I-215 Freeway
6	Cactus Av.	Bandit Bl. West to Bandit Bl. East
7		Bandit Bl. East to Brown St.
8		Brown St. to Meridian Pkwy.
9		Meridian Pkwy. to I-215 Freeway
10	Barton Rd.	Alessandro Bl. to Cactus Av. (EVA)
11		Cactus Av. (EVA) to Grove Community Dr.
12	Brown St.	Alessandro Bl. to Cactus Av.
13	Sycamore Canyon Bl.	Cottonwood Av. to Alessandro Bl.
14	Meridian Pkwy.	Alessandro Bl. to Cactus Av.
15		Cactus Av. to Van Buren Bl.

ANALYSIS SCENARIOS

EXISTING CONDITIONS

Information for Existing (2021) conditions will be disclosed to represent the baseline traffic conditions. In light of the current economic conditions, it is recommended that the Existing baseline be developed based on an adjustment of both historic count data and new (2021) traffic count data. Weekday AM peak hour (7 AM – 9 AM) and PM peak hour (4 PM to 6 PM) turning movement counts have been collected at many the study area intersections shown on Exhibit 3 in August 2019. The traffic counts include the following vehicle classifications: Passenger Cars, 2-Axle Trucks, 3-Axle Trucks, and 4 or More Axle Trucks. These traffic counts were conducted while nearby schools were in session and operating on normal bell schedules. For intersections where historic traffic counts are not available, new traffic counts will be conducted and will be compared to historic count data adjusted to 2021 to determine adjustment factors.

EXISTING PLUS PROJECT (E+P)

Existing plus Project analysis will be performed to determine the impacts of the proposed Project and includes the following traffic components:

- Existing (2021) traffic
- Proposed Project traffic

EXISTING PLUS AMBIENT GROWTH PLUS PROJECT (EAP)

Existing plus Ambient Growth plus Project analysis will be performed to determine the impacts of the proposed Project and includes the following traffic components:

- Existing (2021) traffic
- Ambient growth (8.24%)
- Proposed Project traffic

OPENING YEAR CUMULATIVE (2025) ANALYSIS

To assess potential cumulative traffic impacts, Opening Year Cumulative scenarios (identified below) will be evaluated in the traffic study.

- Opening Year Cumulative (2025) Without Project
 - Existing 2021 counts
 - Ambient growth (8.24%)
 - Cumulative Development traffic
- Opening Year Cumulative (2025) With Project

- Opening Year Cumulative (2025) Without Project
- Proposed Project traffic

HORIZON YEAR (2045) ANALYSIS

The Horizon Year (2045) baseline traffic volume forecasts will be derived from the Riverside County Transportation Analysis Model (RivCOM) using accepted procedures for model forecast refinement and smoothing (uses a base year of 2018). Horizon Year scenarios (identified below) will be evaluated in the traffic study.

- Horizon Year (2045) Without Project
 - Horizon Year (2045) baseline traffic forecasts (From RivCOM)
- Horizon Year (2045) With Project
 - Horizon Year (2045) Without Project
 - Proposed Project traffic

INTERSECTION ANALYSIS METHODOLOGY

For the purposes of this analysis, signalized intersection operations analysis will be based on the methodology described in the Highway Capacity Manual (HCM 6th Edition). Intersection levels of service (LOS) operations are based on an intersection's average control delay. Unsignalized intersections will be evaluated using the methodology described in the HCM 6th Edition. At two-way or side-street stop-controlled intersections, LOS for the intersection will be the worst LOS of all the individual movements. For approaches composed of a single lane, the delay is computed as the average of all movements in that lane. For all-way stop controlled intersections, LOS is computed for the intersection as a whole.

To represent the impact large trucks, buses and recreational vehicles have on traffic flow, truck traffic will be accounted for in the analysis as a percentage of total traffic at the study area intersections. In other words, the traffic volumes utilized for intersection analyses will utilize the actual vehicle traffic flow and trucks will be reflected in the analysis as a percentage of the total traffic flow, not PCE.

TRAFFIC SIGNAL WARRANTS

Traffic signal warrant analysis will be conducted for unsignalized intersections operating at LOS E or F. Peak Hour Volume based Warrant 3 based on 2014 California Manual on Uniform Traffic Control Devices (MUTCD) will be utilized to determine whether a signal would be warranted. Planning level (ADT-based) traffic signal warrants will be run for all future intersections.

LEVEL OF SERVICE (LOS) CRITERIA

The definitions of an operational deficiency for each of the applicable jurisdictions are as follows:

MARCH JOINT POWERS AUTHORITY

Based on the March Joint Powers Authority Final Traffic Impact Study Preparation Guide (February 10, 2020), all intersections and roadway segments within the March JPA Planning Area shall operate at LOS D or better with limiting circumstances of LOS E to occur. LOS E may also be allowed to the extent that would support transit-oriented development (TOD) and walkable communities. LOS E is also acceptable during peak hours at interchange ramp intersections where ramp metering occurs. The Project is not proposed to be a TOD and neither the Alessandro Boulevard nor Cactus Avenue on-ramps are currently metered, as such, the minimum LOS utilized for the purposes of this analysis is LOS D.

CITY OF RIVERSIDE

The City of Riverside General Plan states the City will strive to maintain LOS D or better on arterial streets wherever possible. At some key locations, such as City arterial roadways, which are used as freeway bypass by regional through traffic and at heavily traveled freeway intersections, LOS E may be acceptable as determined on a case-by-case basis. Locations that may warrant the LOS E standard include portions of Arlington Avenue/Alessandro Boulevard, Van Buren Boulevard throughout the City, portions of La Sierra Avenue, and selected freeway interchanges. A higher standard, such as LOS C or better, may be adopted for Local and Collector streets in residential areas. The City recognizes that along key free-way feeder segments during peak commute hours, LOS F may be expected due to regional travel patterns.

At the City's request, the analysis for all study area intersections and roadway segments that lie within the City of Riverside will be evaluated based on the guidelines outlined in the City's Traffic Impact Analysis Guidelines for Vehicle Miles Traveled and Level of Service Assessment (July 2020).

CITY OF MORENO VALLEY

The Minimum LOS for the City of Moreno Valley is LOS D for intersections and roadway segments that are adjacent to freeway on/off ramps, and/or adjacent to employment generating land uses. LOS C is applicable to all other intersections and roadway segments. Boundary intersections are assumed to be LOS D.

COUNTY OF RIVERSIDE

County of Riverside General Plan Policy C 2.1 states that the following minimum target levels of service have been designated for the review of development proposals in the unincorporated areas of Riverside County:

- LOS C shall apply to all development proposals in any area of the Riverside County not located within the boundaries of an Area Plan, as well those areas located within the following Area Plans: REMAP, Eastern Coachella Valley, Desert Center, Palo Verde Valley, and those non- Community

Development areas of the Elsinore, Lake Mathews/Woodcrest, Mead Valley and Temescal Canyon Area Plans.

- LOS D shall apply to all development proposals located within any of the following Area Plans: Eastvale, Jurupa, Highgrove, Reche Canyon/Badlands, Lakeview/Nuevo, Sun City/Menifee Valley, Harvest Valley/Winchester, Southwest Area, The Pass, San Jacinto Valley, Western Coachella Valley and those Community Development Areas of the Elsinore, Lake Mathews/Woodcrest, Mead Valley and Temescal Canyon Area Plans. LOS E may be allowed by the Board of Supervisors within designated areas where transit-oriented development and walkable communities are proposed.

Notwithstanding the forgoing minimum LOS targets, the Board of Supervisors may, on occasion by virtue of their discretionary powers, approve a project that fails to meet these LOS targets in order to balance congestion management considerations in relation to benefits, environmental impacts and costs, provided an Environmental Impact Report, or equivalent, has been completed to fully evaluate the impacts of such approval. Any such approval must incorporate all feasible mitigation measures, make specific findings to support the decision, and adopt a statement of overriding considerations.

CALTRANS

Caltrans endeavors to maintain a target LOS at the transition between LOS C and LOS D on State highway facilities; however, Caltrans acknowledges that this may not always be feasible and recommends that the lead agency consult with Caltrans to determine the appropriate target LOS. If an existing State highway facility is operating at less than this target LOS, the existing measure of effectiveness should be maintained. In general, the region-wide goal for an acceptable LOS on all freeways, roadways segments, and intersections is D. For undeveloped or not densely developed locations, the goal may be to achieve LOS C.

CUMULATIVE DEVELOPMENT PROJECTS

Cumulative projects to be included in the analysis are listed in Table 3 and shown on Exhibit 8. It is requested that the JPA provide any new cumulative projects for inclusion in the traffic study. The same list will be shared with other agencies to obtain the latest cumulative projects for each applicable agency.

SPECIAL ISSUES

The following special issue will also be addressed as part of the Traffic Study:

- Parking Analysis: A summary of the proposed parking will be provided in the Traffic Study to demonstrate consistency with the JPA standards.
- Active Transportation: The Traffic Study will include a discussion of Active Transportation and will identify connections to the proposed parks.
- Queuing Analysis: Queuing analysis will be conducted for the I-215 Freeway off-ramp locations.

Mr. Dan Fairbanks
March Joint Powers Authority
December 22, 2021
Page 10 of 11

- Traffic Calming: Project will extend Barton Road between its existing southern and northern termini. Traffic Study will identify potential traffic calming measures for Barton Road.
- Vehicle Miles Traveled: A vehicle miles traveled (VMT) analysis will be conducted separately and will be submitted under separate cover for review.

CONCLUSION

Urban Crossroads, Inc. is pleased to submit this letter documenting the Project trip generation, trip distribution, and the recommended intersection analysis locations for the West Campus Upper Plateau Traffic Impact Study.

If you have any questions, please contact me directly at (949) 861-0177.

Respectfully submitted,

URBAN CROSSROADS, INC.



Charlene So, PE

Associate Principal

TABLE 3: CUMULATIVE DEVELOPMENT LAND USE SUMMARY

ID	Project Name	Land Use ¹	Quantity Units ²
March Joint Powers Authority:			
MJPA1	Meridian Business Park (West Campus)	Industrial Park	2,278.852 TSF
MJPA2	K4 Parcel	Warehouse	718.000 TSF
MJPA3	Economic Business Center	Warehouse	124.523 TSF
MJPA4	Freeway Business Center	Warehouse	709 TSF
MJPA5	Veteran's Industrial Plaza/VIP 215	Warehouse	2,000.000 TSF
MJPA6	Veteran's Plaza	Commercial Retail	198.000 TSF
MJPA7	MS Van Buren I	Warehouse	176.396 TSF
MJPA8	MS Van Buren II	Warehouse	162.041 TSF
MJPA9	MS Prime Six	General Office	74.922 TSF
MJPA10	Meridian Distribution Center IV	Warehouse	90.000 TSF
MJPA11	Meridian Distribution Center III	Warehouse	262.269 TSF
MJPA12	Eagle Business Park	Business Park	390.480 TSF
MJPA13	South Campus	Office	388.011 TSF
		Commercial Retail	282.730 TSF
		Business Park	1,764.180 TSF
		Industrial Park	1,774.437 TSF
City of Riverside:			
R1	P17-0419/20/21	Fast Food w/ Drive Thru	1.857 TSF
R2	P16-0578	Warehouse	82.200 TSF
R3	P19-0151/P19-0152/P19-0153	Health and Fitness Club	21.706 TSF
R4	P13-0665	SFDR	8 DU
R5	P15-1035/P16-0556/P16-0567	Warehouse	176.149 TSF
R6	P14-0841 to P14-0848/P16-0472/P16-0474	Warehouse	73.200 TSF
		Commercial Retail	15.000 TSF
R7	P14-0472/P14-0473/P15-0321/P15-0322	SFDR	85 DU
R8	P19-0022/P19-0024/P19-0026/P19-0027/P19-0028	Fast Food w/ Drive Thru	4.319 TSF
R9	Sycamore Hills Distribution Center	Warehouse	603.100 TSF
County of Riverside:			
RC1	PP 25422	Warehouse	814.000 TSF
RC2	Knox Business Park	Warehouse	1,259.050 TSF
RC3	Oleander Business Park	Warehouse	710.736 TSF
City of Moreno Valley:			
MV1	Scottish Village	Multifamily	194 DU
MV2	Moreno Valley Cactus Center (PEN16-0131)	Warehouse	36.950 TSF
		Fast Food w/ Drive Thru	7.900 TSF
		Gas Station w/ Car Wash	28 VFP
MV3	PA 08-0047-0052 (Komar Cactus Plaza)	Hotel	110 Rooms
		Fast Food w/ Drive Thru	8.000 TSF
		Commercial	42.400 TSF

¹ SFDR = Single Family Detached Residential

² DU = Dwelling Units; TSF = Thousand Square Feet; SP = Spaces; VFP = Vehicle Fueling Positions

EXHIBIT 1: LOCATION MAP

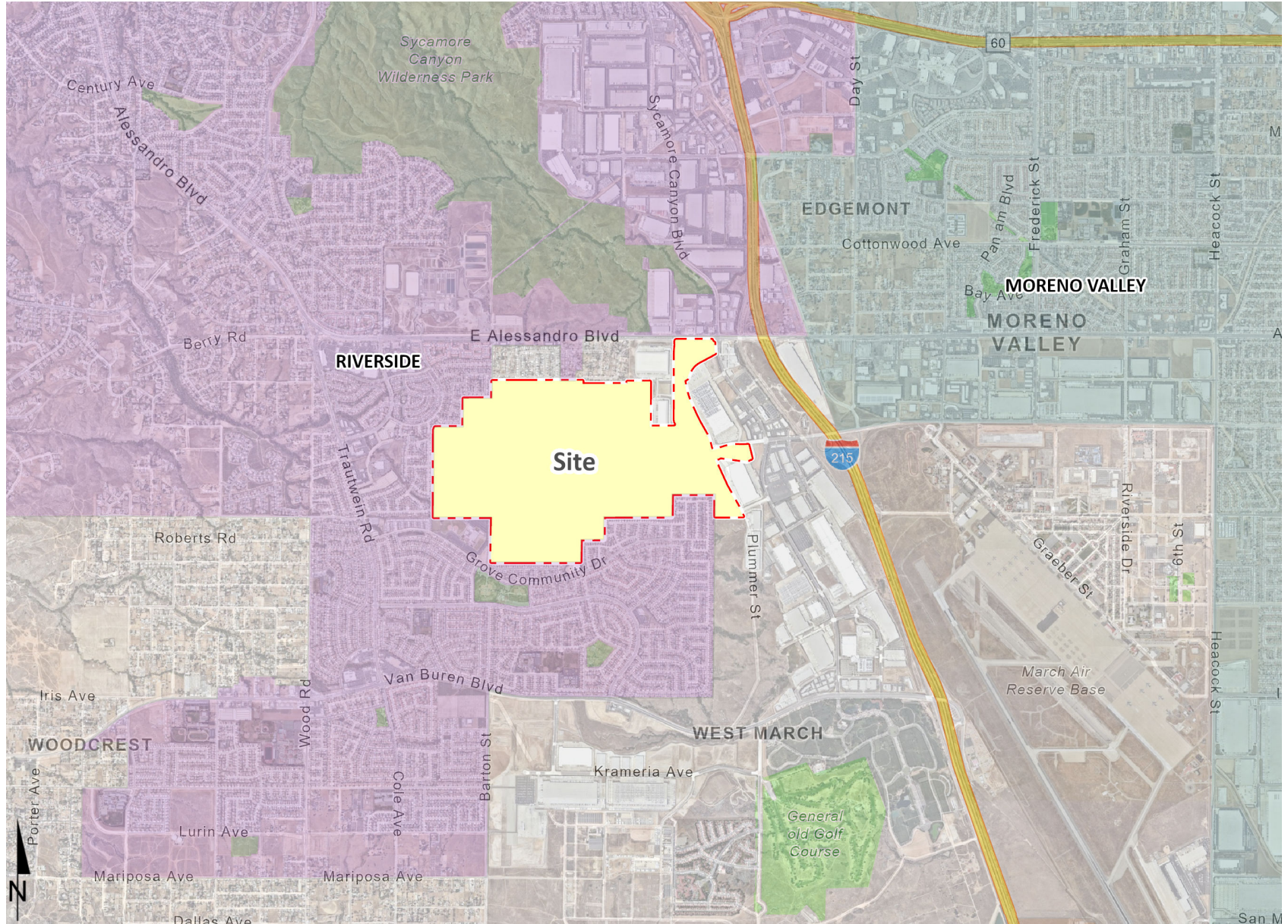

EXHIBIT 2: PRELIMINARY SITE PLAN/LAND USE PLAN

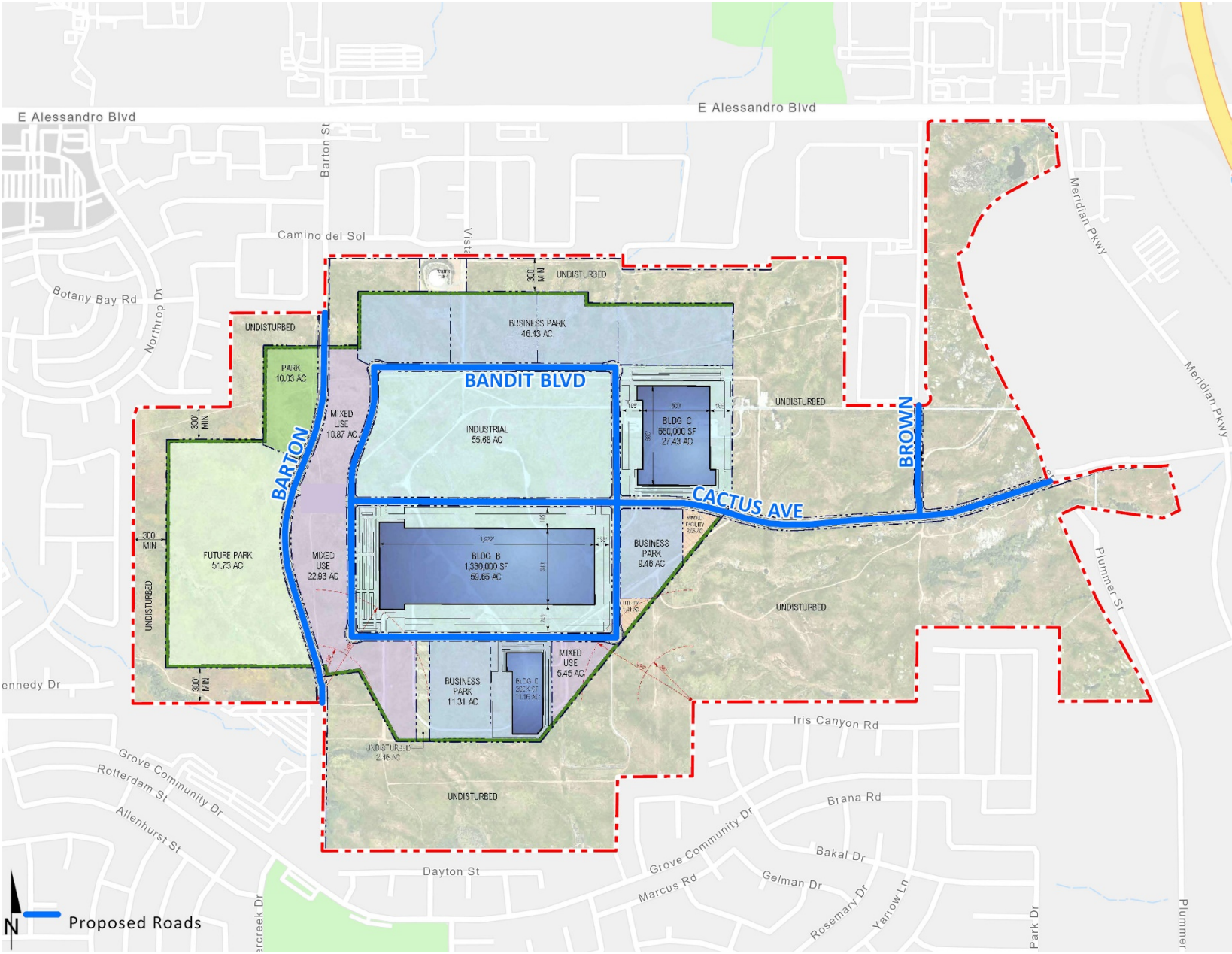

EXHIBIT 3: STUDY AREA

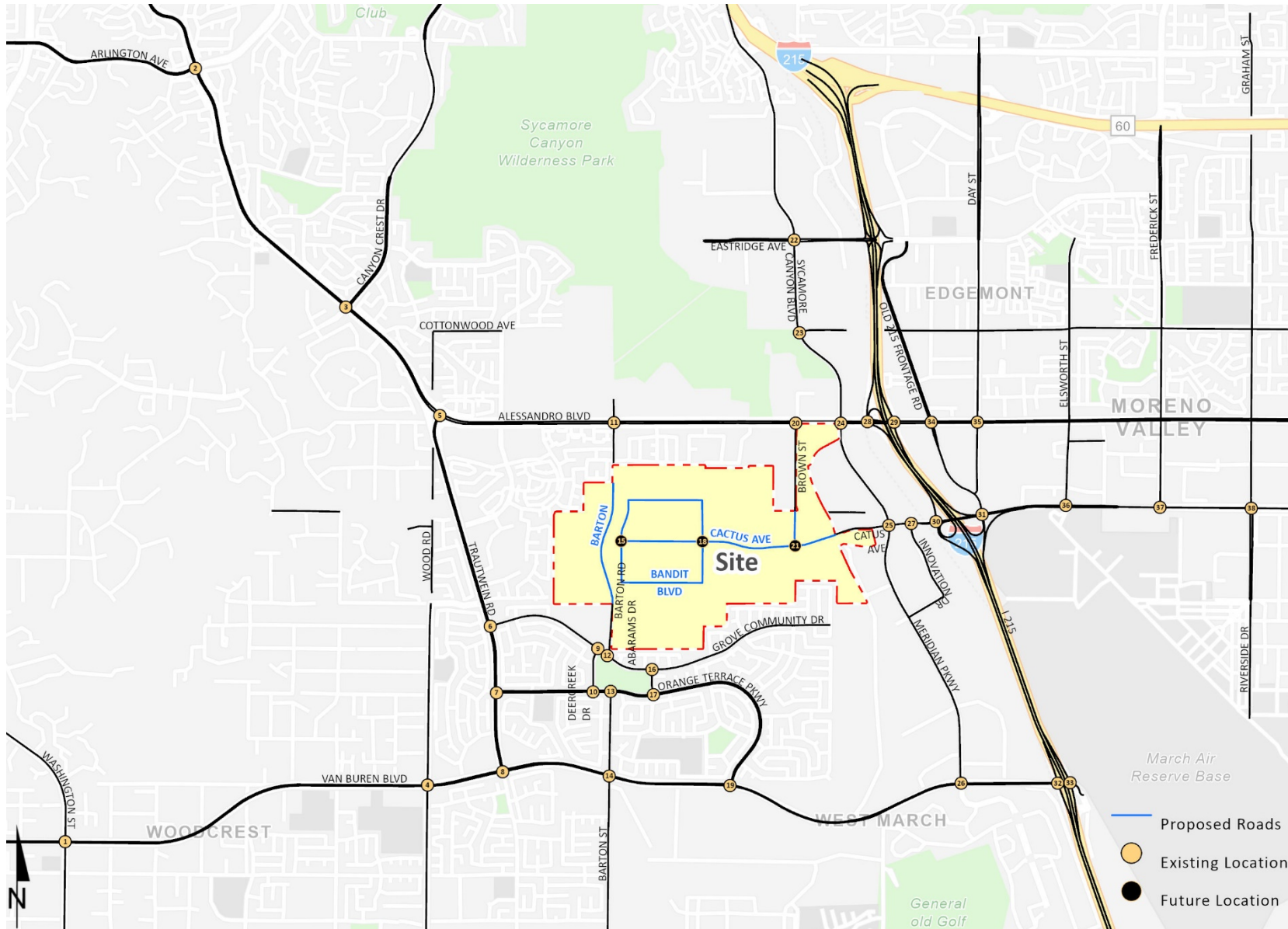

EXHIBIT 4: PROJECT (PASSENGER CAR) TRIP DISTRIBUTION

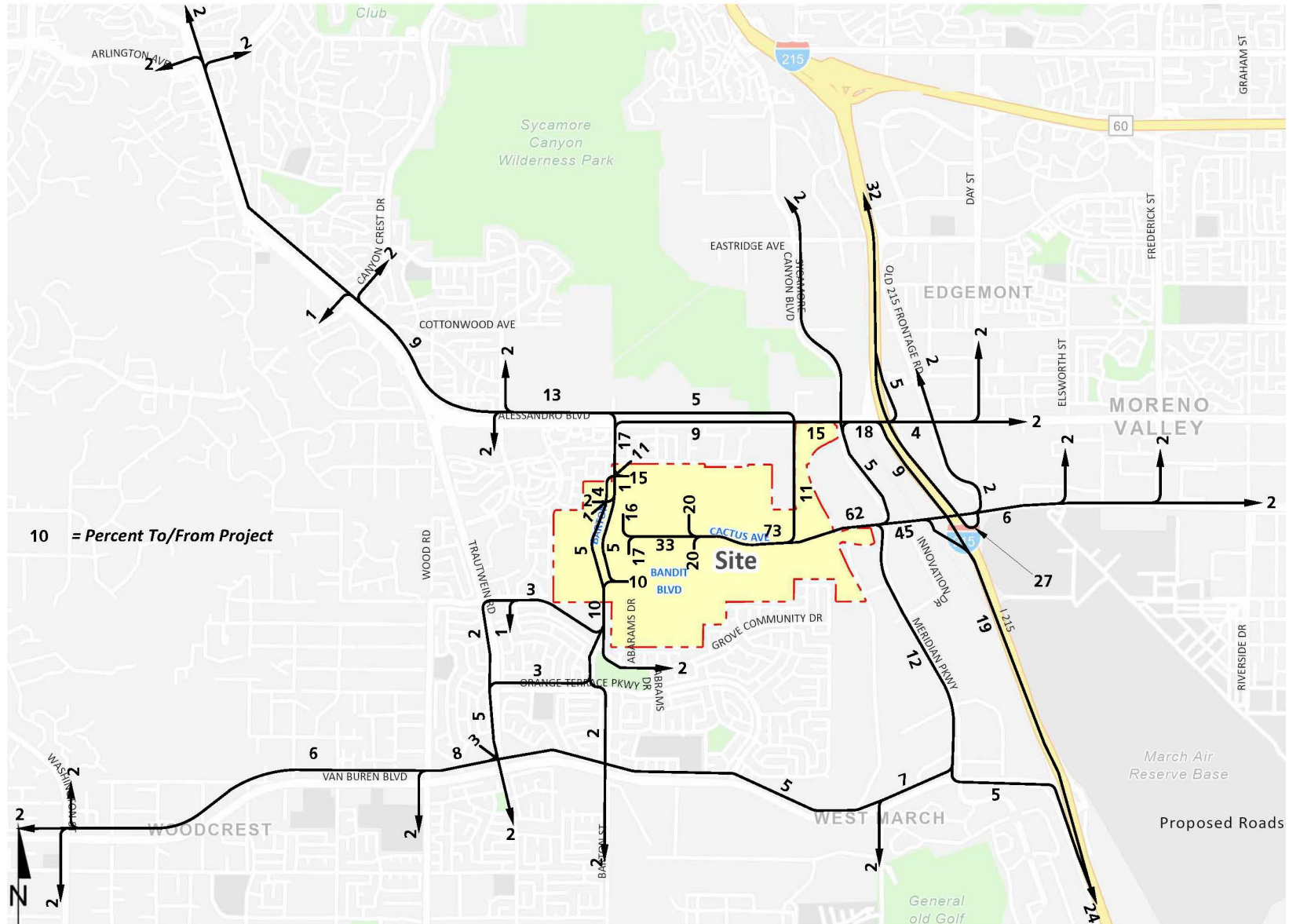
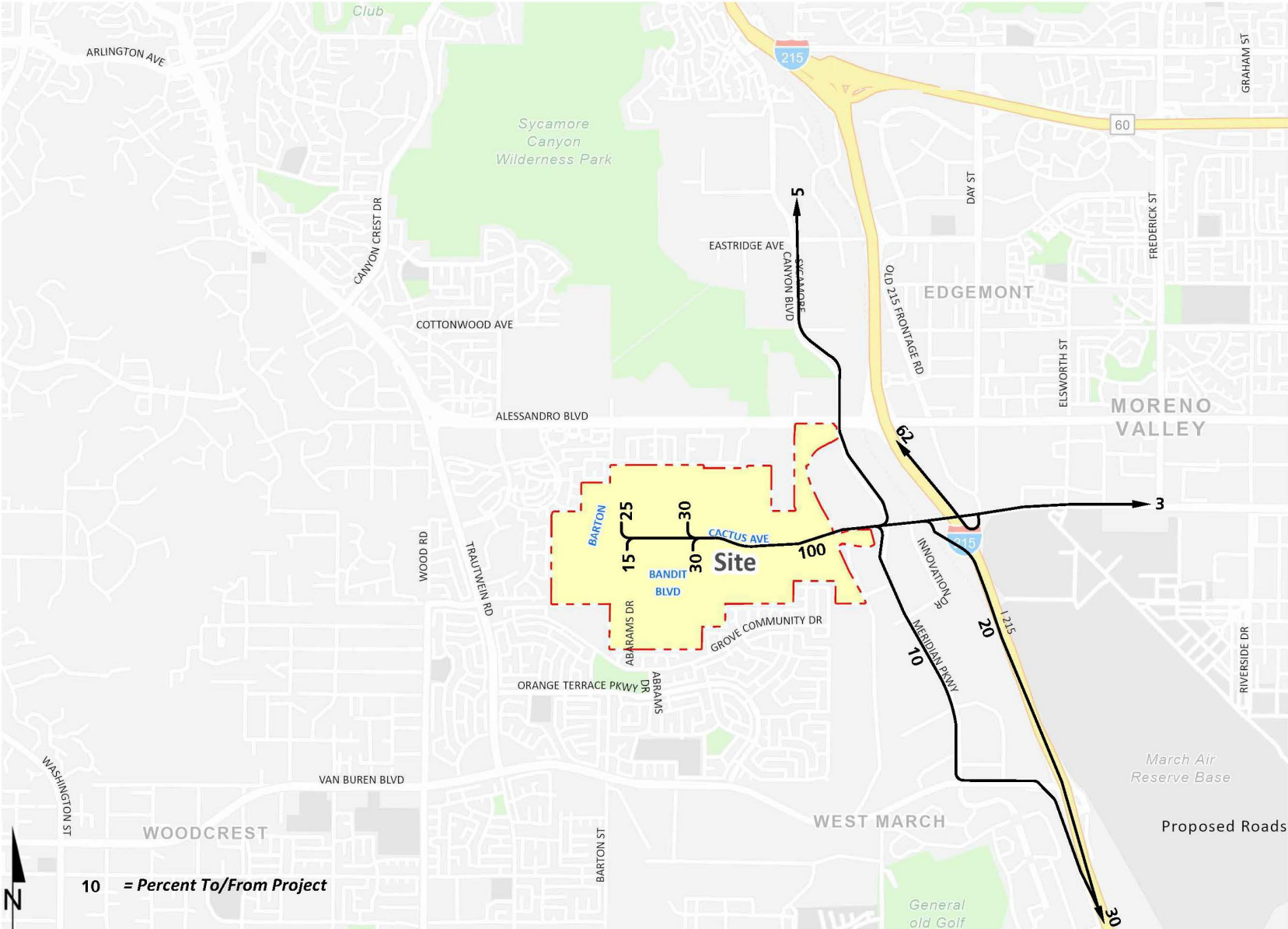
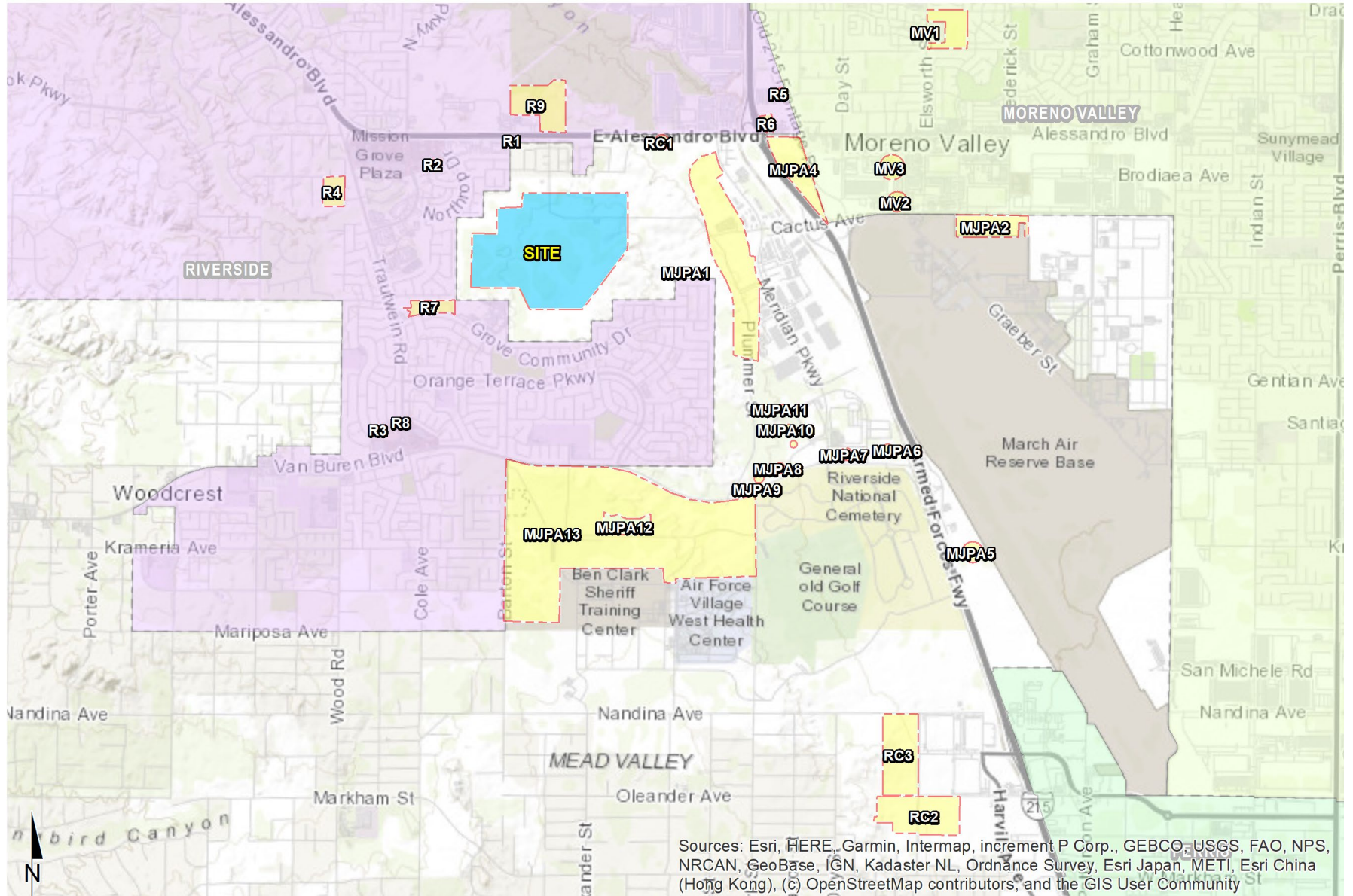

EXHIBIT 5: PROJECT (TRUCK) TRIP DISTRIBUTION



21 Brown St. & Cactus Av. 	22 Sycamore Canyon Blvd. & Eastridge Av. 	23 Sycamore Canyon Blvd. & Cottonwood Av. 	24 Meridian Pkwy. & Alessandro Blvd. 	25 Meridian Pkwy. & Cactus Av.
26 Meridian Pkwy. & Van Buren Blvd. 	27 Innovation Dr. & Cactus Av. 	28 I-215 SB Ramps & Alessandro Blvd. 	29 I-215 NB Ramps & Alessandro Blvd. 	30 I-215 SB Ramps & Cactus Av.
31 I-215 NB Ramps & Cactus Av. 	32 I-215 SB Ramps & Van Buren Blvd. 	33 I-215 NB Ramps & Van Buren Blvd. 	34 Old 215 Frontage Rd. & Alessandro Blvd. 	35 Day St. & Alessandro Blvd.
36 Elsworth St. & Cactus Av. 	37 Frederick St. & Cactus Av. 	38 Graham St./Riverside Dr. & Cactus Av. 	<p>##(##) AM(PM) Peak Hour Intersection Volumes ## Average Daily Trips</p>	

EXHIBIT 8: CUMULATIVE DEVELOPMENT PROJECT LOCATION MAP



APPENDIX 1.2:

SITE ADJACENT QUEUES

This Page Intentionally Left Blank

Intersection: 15: Airman Dr & Cactus Av.

Movement	WB	WB	NB	SB	SB
Directions Served	L	R	R	L	L
Maximum Queue (ft)	233	255	92	102	126
Average Queue (ft)	116	82	37	32	54
95th Queue (ft)	208	167	76	72	98
Link Distance (ft)	1919				
Upstream Blk Time (%)					
Queuing Penalty (veh)					
Storage Bay Dist (ft)	200		100	100	100
Storage Blk Time (%)	1	0	0	0	1
Queuing Penalty (veh)	7	0	0	0	0

Intersection: 18: Linebacker Dr & Cactus Av.

Movement	EB	EB	WB	WB	WB	NB	SB	SB
Directions Served	T	TR	L	T	R	R	L	L
Maximum Queue (ft)	146	165	250	668	219	83	61	69
Average Queue (ft)	49	61	137	228	61	31	21	31
95th Queue (ft)	101	115	248	510	143	67	52	60
Link Distance (ft)	1919	1919		2125	2125			
Upstream Blk Time (%)								
Queuing Penalty (veh)								
Storage Bay Dist (ft)			200			200	300	300
Storage Blk Time (%)	0		1	6				
Queuing Penalty (veh)	0		5	17				

Intersection: 21: Cactus Av. & Brown St

Movement	EB	EB	EB	WB	WB	SB
Directions Served	L	T	T	T	TR	R
Maximum Queue (ft)	146	76	108	254	254	218
Average Queue (ft)	64	17	44	143	135	110
95th Queue (ft)	121	53	88	220	221	176
Link Distance (ft)		2125	2125	3318	3318	1664
Upstream Blk Time (%)						
Queuing Penalty (veh)						
Storage Bay Dist (ft)	200					
Storage Blk Time (%)		0				
Queuing Penalty (veh)		0				

Network Summary

Network wide Queuing Penalty: 28

Intersection: 15: Airman Dr & Cactus Av.

Movement	WB	WB	NB	NB	SB	SB	SB
Directions Served	L	R	T	R	L	L	T
Maximum Queue (ft)	250	566	624	200	150	200	760
Average Queue (ft)	197	202	453	199	146	199	657
95th Queue (ft)	289	491	659	206	156	201	724
Link Distance (ft)		1919	990				1166
Upstream Blk Time (%)							
Queuing Penalty (veh)							
Storage Bay Dist (ft)	200			100	100	100	
Storage Blk Time (%)	20	1	0	58	60	58	
Queuing Penalty (veh)	75	2	0	0	0	0	

Intersection: 18: Linebacker Dr & Cactus Av.

Movement	EB	EB	WB	WB	WB	NB	NB	SB	SB	SB
Directions Served	T	TR	L	T	R	T	R	L	L	TR
Maximum Queue (ft)	481	483	250	674	219	951	250	302	324	315
Average Queue (ft)	295	296	164	262	45	761	250	178	184	17
95th Queue (ft)	462	459	280	579	132	919	250	285	306	146
Link Distance (ft)	1919	1919		2125	2125	1007				1132
Upstream Blk Time (%)						0				
Queuing Penalty (veh)						0				
Storage Bay Dist (ft)			200				200	300	300	
Storage Blk Time (%)	18		9	10		0	90	1	3	
Queuing Penalty (veh)	0		60	17		1	0	0	0	

Intersection: 21: Cactus Av. & Brown St

Movement	EB	EB	EB	WB	WB	SB
Directions Served	L	T	T	T	TR	R
Maximum Queue (ft)	250	735	645	328	320	274
Average Queue (ft)	247	439	303	190	183	122
95th Queue (ft)	264	689	601	289	282	217
Link Distance (ft)		2125	2125	3318	3318	1664
Upstream Blk Time (%)						
Queuing Penalty (veh)						
Storage Bay Dist (ft)	200					
Storage Blk Time (%)	37	0				2
Queuing Penalty (veh)	326	2				0

Network Summary

Network wide Queuing Penalty: 484

Intersection: 15: Airman Dr & Cactus Av.

Movement	WB	WB	NB	NB	SB	SB	SB
Directions Served	L	R	T	R	L	L	T
Maximum Queue (ft)	248	401	128	192	149	197	116
Average Queue (ft)	139	100	7	92	92	108	4
95th Queue (ft)	246	245	76	159	148	173	53
Link Distance (ft)		1919	990				1166
Upstream Blk Time (%)							
Queuing Penalty (veh)							
Storage Bay Dist (ft)	200			100	100	100	
Storage Blk Time (%)	4			5	5	10	
Queuing Penalty (veh)	17			0	0	0	

Intersection: 18: Linebacker Dr & Cactus Av.

Movement	EB	EB	WB	WB	WB	NB	SB	SB
Directions Served	T	TR	L	T	R	R	L	L
Maximum Queue (ft)	293	299	249	742	269	150	97	107
Average Queue (ft)	136	130	110	238	39	58	46	44
95th Queue (ft)	250	246	218	561	142	119	86	84
Link Distance (ft)	1919	1919		2125	2125			
Upstream Blk Time (%)								
Queuing Penalty (veh)								
Storage Bay Dist (ft)			200			200	300	300
Storage Blk Time (%)	2		1	8		0		
Queuing Penalty (veh)	0		4	13		0		

Intersection: 21: Cactus Av. & Brown St

Movement	EB	EB	EB	WB	WB	SB
Directions Served	L	T	T	T	TR	R
Maximum Queue (ft)	250	436	201	233	224	300
Average Queue (ft)	199	139	76	144	130	136
95th Queue (ft)	283	380	144	220	207	239
Link Distance (ft)		2125	2125	3318	3318	1664
Upstream Blk Time (%)						
Queuing Penalty (veh)						
Storage Bay Dist (ft)	200					
Storage Blk Time (%)	12	0				2
Queuing Penalty (veh)	34	0				0

Network Summary

Network wide Queuing Penalty: 69

This Page Intentionally Left Blank

APPENDIX 3.1:

EXISTING (2021) AND HISTORIC TRAFFIC COUNTS – 2019

This Page Intentionally Left Blank

Counts Unlimited
 PO Box 1178
 Corona, CA 92878
 (951) 268-6268

City of Riverside
 N/S: Alessandro Boulevard
 E/W: Overlook Pkwy/Canyon Crest Drive
 Weather: Clear

File Name : 01_RV_Alessandro_Overlook AM
 Site Code : 05119542
 Start Date : 8/20/2019
 Page No : 2

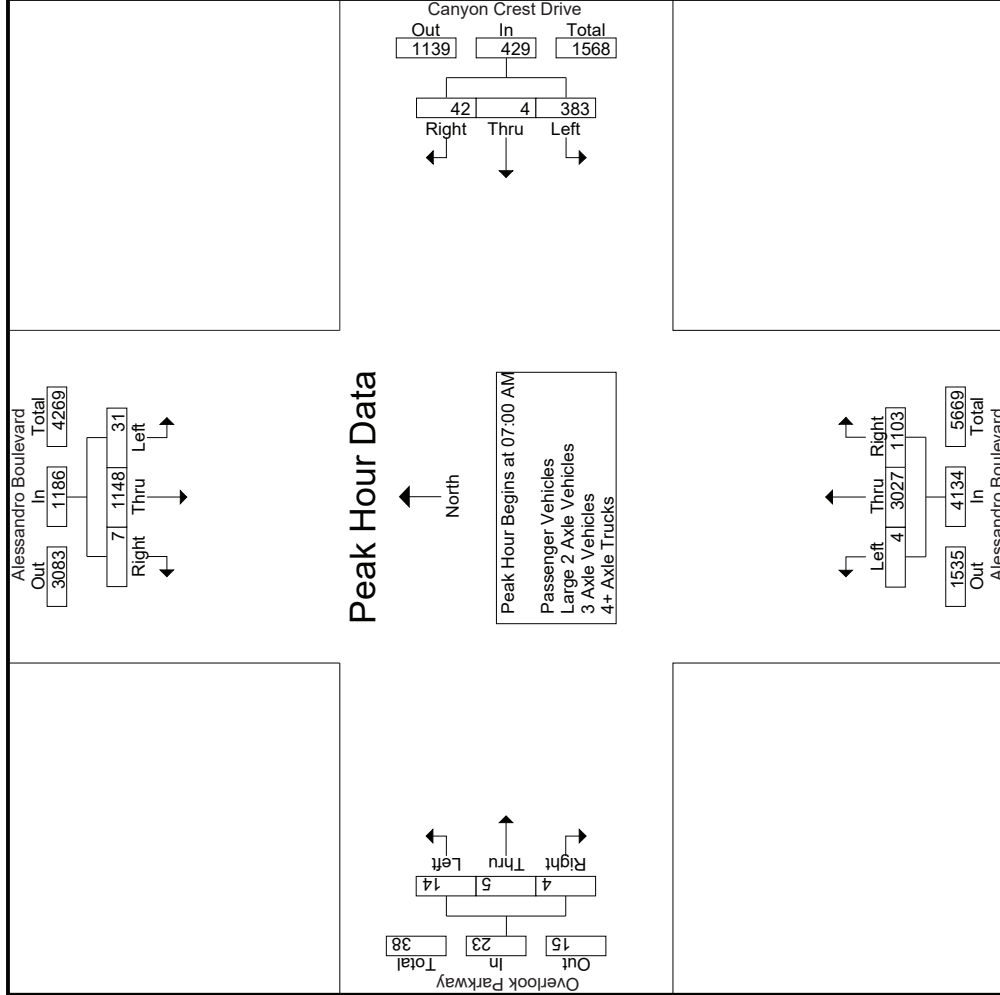

Counts Unlimited
 PO Box 1178
 Corona, CA 92878
 (951) 268-6268

City of Riverside
 N/S: Alessandro Boulevard
 E/W: Overlook Pkwy/Canyon Crest Drive
 Weather: Clear

File Name : 01_RIV_Alessandro_Overlook AM
 Site Code : 05119542
 Start Date : 8/20/2019
 Page No : 3

Start Time	Alessandro Boulevard Southbound			Canyon Crest Drive Westbound			Alessandro Boulevard Northbound			Overlook Parkway Eastbound						
	Left	Thru	Right	App. Total	Left	Thru	Right	App. Total	Left	Thru	Right	App. Total	Int. Total			
Peak Hour Analysis From 07:00 AM to 08:45 AM - Peak 1 of 1																
Peak Hour for Each Approach Begins at:																
	07:00 AM				07:00 AM				07:00 AM				08:00 AM			
+0 mins.	4	272	0	276	111	2	13	126	0	774	272	1046	4	5	2	11
+15 mins.	6	314	0	320	117	2	10	129	1	725	301	1027	2	4	1	7
+30 mins.	10	254	3	267	80	0	13	93	3	811	260	1074	1	2	0	3
+45 mins.	11	308	4	323	75	0	6	81	0	717	270	987	4	2	3	9
Total Volume	31	1148	7	1186	383	4	42	429	4	3027	1103	4134	11	13	6	30
% App. Total	2.6	96.8	0.6	89.3	89.3	0.9	9.8	831	0.1	73.2	26.7	962	36.7	43.3	20	682
PHF	.705	.914	.438	.918	.818	.500	.808	.831	.333	.933	.916	.962	.688	.650	.500	.682

Counts Unlimited
 PO Box 1178
 Corona, CA 92878
 (951) 268-6268

File Name : 01_RIV_Alessandro_Overlook AM
 Site Code : 05119542
 Start Date : 8/20/2019
 Page No : 1

City of Riverside
 N/S: Alessandro Boulevard
 EW: Overlook Pkwy/Canyon Crest Drive
 Weather: Clear

Groups Printed- Passenger Vehicles

Start Time	Alessandro Boulevard Southbound					Canyon Crest Drive Westbound					Alessandro Boulevard Northbound					Overlook Parkway Eastbound							
	Left	Thru	Right	RTOR	App. Total	Left	Thru	Right	RTOR	App. Total	Left	Thru	Right	RTOR	App. Total	Left	Thru	Right	RTOR	App. Total	Exclu. Total	Inclu. Total	Int. Total
07:00 AM	3	263	0	0	266	109	2	13	2	124	0	763	267	73	1030	4	3	2	2	9	77	1429	1506
07:15 AM	6	311	0	0	317	113	2	10	6	125	1	711	299	67	1011	5	0	1	1	6	74	1459	1533
07:30 AM	10	253	3	0	266	77	0	13	2	90	3	803	260	60	1066	3	0	0	0	3	62	1425	1487
07:45 AM	9	302	3	0	314	75	0	6	3	81	0	707	269	48	976	2	2	1	1	5	52	1376	1428
Total	28	1129	6	0	1163	374	4	42	13	420	4	2984	1095	248	4083	14	5	4	4	23	265	5689	5954
08:00 AM	5	215	0	0	220	62	0	19	9	81	0	595	220	28	815	4	4	2	2	10	39	1126	1165
08:15 AM	7	208	0	0	215	67	0	16	2	83	2	610	218	14	830	2	4	1	1	7	17	1135	1152
08:30 AM	8	228	3	1	239	56	0	20	11	76	2	538	152	18	692	1	2	0	0	3	30	1010	1040
08:45 AM	5	237	1	0	243	61	3	9	6	73	1	493	155	45	649	4	2	3	2	9	53	974	1027
Total	25	888	4	1	917	246	3	64	28	313	5	2236	745	105	2986	11	12	6	5	29	139	4245	4384
Grand Total	53	2017	10	1	2080	620	7	106	41	733	9	5220	1840	353	7069	25	17	10	9	52	404	9934	10338
Approch %	2.5	97	0.5		20.9	84.6	1	14.5		7.4	0.1	73.8	26		71.2	48.1	32.7	19.2		0.5	3.9	96.1	
Total %	0.5	20.3	0.1		20.9	6.2	0.1	1.1		7.4	0.1	52.5	18.5		71.2	0.3	0.2	0.1		0.5	3.9	96.1	

Start Time	Alessandro Boulevard Southbound					Canyon Crest Drive Westbound					Alessandro Boulevard Northbound					Overlook Parkway Eastbound							
	Left	Thru	Right	RTOR	App. Total	Left	Thru	Right	RTOR	App. Total	Left	Thru	Right	RTOR	App. Total	Left	Thru	Right	RTOR	App. Total	Exclu. Total	Inclu. Total	Int. Total
07:00 AM	3	263	0	0	266	109	2	13	2	124	0	763	267	73	1030	4	3	2	2	9	77	1429	1506
07:15 AM	6	311	0	0	317	113	2	10	6	125	1	711	299	67	1011	5	0	1	1	6	74	1459	1533
07:30 AM	10	253	3	0	266	77	0	13	2	90	3	803	260	60	1066	3	0	0	0	3	62	1425	1487
07:45 AM	9	302	3	0	314	75	0	6	3	81	0	707	269	48	976	2	2	1	1	5	52	1376	1428
Total Volume	28	1129	6	0	1163	374	4	42	13	420	4	2984	1095	248	4083	14	5	4	4	23	265	5689	5954
% App. Total	2.4	97.1	0.5		20.9	84.6	1	14.5		7.4	0.1	73.1	26.8		71.2	48.1	32.7	19.2		0.5	3.9	96.1	
PHF	.700	.908	.500		.917	.827	.500	.808		.840	.333	.929	.916		.958	.700	.417	.500		.639	.500	.639	.975

Peak Hour Analysis From 07:00 AM to 07:45 AM - Peak 1 of 1
 Peak Hour for Entire Intersection Begins at 07:00 AM

Counts Unlimited
 PO Box 1178
 Corona, CA 92878
 (951) 268-6268

City of Riverside
 N/S: Alessandro Boulevard
 E/W: Overlook Pkwy/Canyon Crest Drive
 Weather: Clear

File Name : 01_RV_Alessandro_Overlook AM
 Site Code : 05119542
 Start Date : 8/20/2019
 Page No : 2

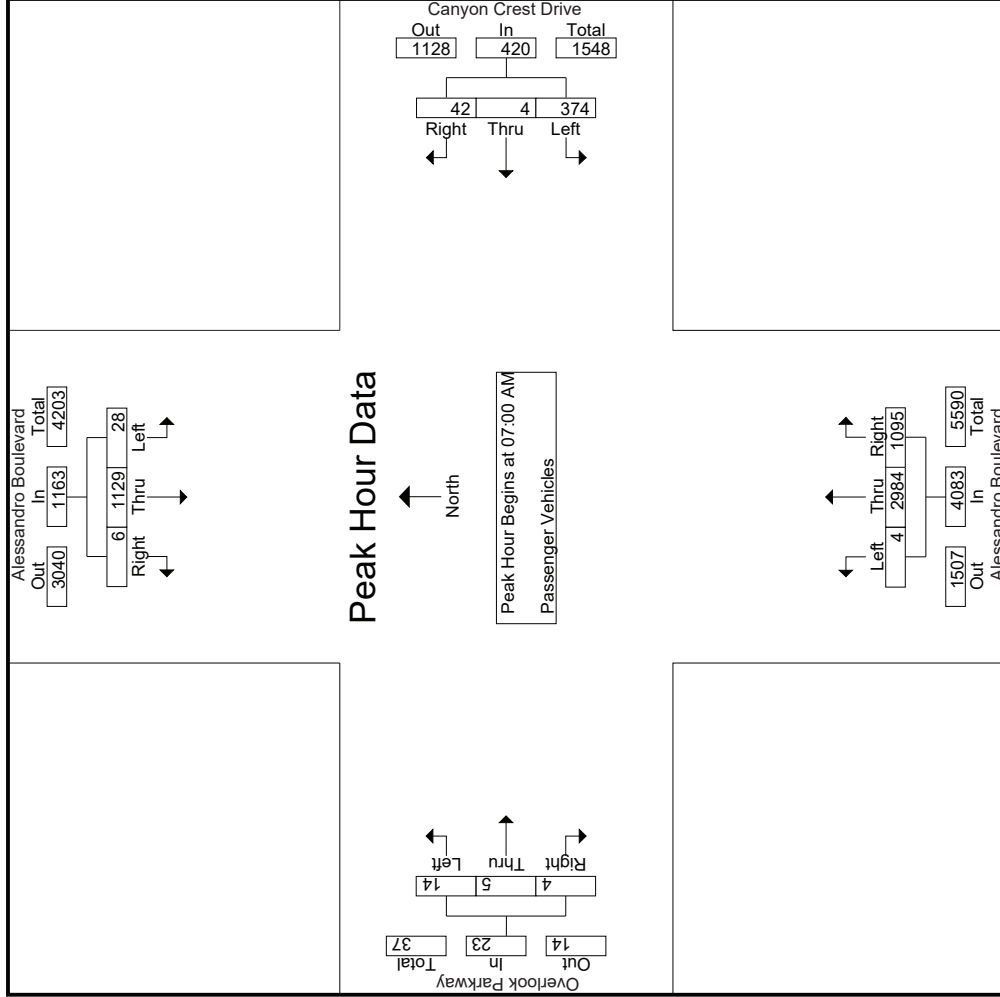

Counts Unlimited
 PO Box 1178
 Corona, CA 92878
 (951) 268-6268

City of Riverside
 N/S: Alessandro Boulevard
 E/W: Overlook Pkwy/Canyon Crest Drive
 Weather: Clear

File Name : 01_RIV_Alessandro_Overlook AM
 Site Code : 05119542
 Start Date : 8/20/2019
 Page No : 3

Start Time	Alessandro Boulevard Southbound			Canyon Crest Drive Westbound			Alessandro Boulevard Northbound			Overlook Parkway Eastbound						
	Left	Thru	Right	App. Total	Left	Thru	Right	App. Total	Left	Thru	Right	App. Total	Int. Total			
Peak Hour Analysis From 07:00 AM to 07:45 AM - Peak 1 of 1																
Peak Hour for Each Approach Begins at:																
	07:00 AM				07:00 AM				07:00 AM				07:00 AM			
+0 mins.	3	263	0	266	109	2	13	124	0	763	267	1030	4	3	2	9
+15 mins.	6	311	0	317	113	2	10	125	1	711	299	1011	5	0	1	6
+30 mins.	10	253	3	266	77	0	13	90	3	803	260	1066	3	0	0	3
+45 mins.	9	302	3	314	75	0	6	81	0	707	269	976	2	2	1	5
Total Volume	28	1129	6	1163	374	4	42	420	4	2984	1095	4083	14	5	4	23
% App. Total	2.4	97.1	0.5		89	1	10		0.1	73.1	26.8		60.9	21.7	17.4	
PHF	.700	.908	.500	.917	.827	.500	.808	.840	.333	.929	.916	.958	.700	.417	.500	.639

Counts Unlimited
 PO Box 1178
 Corona, CA 92878
 (951) 268-6268

File Name : 01_RIV_Alessandro_Overlook AM
 Site Code : 05119542
 Start Date : 8/20/2019
 Page No : 1

City of Riverside
 N/S: Alessandro Boulevard
 EW: Overlook Pkwy/Canyon Crest Drive
 Weather: Clear

Groups Printed- Large 2 Axle Vehicles

Start Time	Alessandro Boulevard Southbound					Canyon Crest Drive Westbound					Alessandro Boulevard Northbound					Overlook Parkway Eastbound								
	Left	Thru	Right	RTOR	App. Total	Left	Thru	Right	RTOR	App. Total	Left	Thru	Right	RTOR	App. Total	Left	Thru	Right	RTOR	App. Total	Exclu. Total	Inclu. Total	Int. Total	
07:00 AM	1	8	0	0	9	2	0	0	0	2	0	11	5	1	16	0	0	0	0	0	0	1	27	28
07:15 AM	0	2	0	0	2	3	0	0	0	3	0	13	2	0	15	0	0	0	0	0	0	0	20	20
07:30 AM	0	1	0	0	1	3	0	0	0	3	0	7	0	0	7	0	0	0	0	0	0	0	11	11
07:45 AM	2	6	1	0	9	0	0	0	0	0	0	10	1	1	11	0	0	0	0	0	1	20	21	
Total	3	17	1	0	21	8	0	0	0	8	0	41	8	2	49	0	0	0	0	0	2	78	80	
08:00 AM	7	7	0	0	14	0	0	3	1	3	0	7	0	0	7	0	1	0	0	1	1	25	26	
08:15 AM	1	2	0	0	3	0	0	2	0	2	0	17	2	0	19	0	0	0	0	0	0	24	24	
08:30 AM	0	5	0	0	5	2	0	2	0	4	0	12	2	1	14	0	0	0	0	0	1	23	24	
08:45 AM	0	5	0	0	5	5	0	0	0	5	1	8	2	1	11	0	0	0	0	0	1	21	22	
Total	8	19	0	0	27	7	0	7	1	14	1	44	6	2	51	0	1	0	0	1	3	93	96	
Grand Total	11	36	1	0	48	15	0	7	1	22	1	85	14	4	100	0	1	0	0	1	5	171	176	
Apprch %	22.9	75	2.1			68.2	0	31.8			1	85	14		58.5	0	100	0	0	0.6	2.8	97.2		
Total %	6.4	21.1	0.6		28.1	8.8	0	4.1		12.9	0.6	49.7	8.2			0	0.6	0						

Start Time	Alessandro Boulevard Southbound					Canyon Crest Drive Westbound					Alessandro Boulevard Northbound					Overlook Parkway Eastbound								
	Left	Thru	Right	RTOR	App. Total	Left	Thru	Right	RTOR	App. Total	Left	Thru	Right	RTOR	App. Total	Left	Thru	Right	RTOR	App. Total	Exclu. Total	Inclu. Total	Int. Total	
07:00 AM	1	8	0	0	9	2	0	0	0	2	0	11	5	1	16	0	0	0	0	0	0	1	27	28
07:15 AM	0	2	0	0	2	3	0	0	0	3	0	13	2	0	15	0	0	0	0	0	0	0	20	20
07:30 AM	0	1	0	0	1	3	0	0	0	3	0	7	0	0	7	0	0	0	0	0	0	0	11	11
07:45 AM	2	6	1	0	9	0	0	0	0	0	0	10	1	1	11	0	0	0	0	0	1	20	21	
Total Volume	3	17	1	0	21	8	0	0	0	8	0	41	8	2	49	0	0	0	0	0	2	78	80	
% App. Total	14.3	81	4.8			100	0	0		0	83.7	16.3				0	0	0	0	0	0	0	0	
PHF	.375	.531	.250		.583	.667	.000	.000		.667	.000	.788	.400		.766	.000	.000	.000		.000	.000	.000	.722	

Peak Hour Analysis From 07:00 AM to 07:45 AM - Peak 1 of 1
 Peak Hour for Entire Intersection Begins at 07:00 AM

Counts Unlimited
 PO Box 1178
 Corona, CA 92878
 (951) 268-6268

City of Riverside
 N/S: Alessandro Boulevard
 E/W: Overlook Pkwy/Canyon Crest Drive
 Weather: Clear

File Name : 01_RV_Alessandro_Overlook AM
 Site Code : 05119542
 Start Date : 8/20/2019
 Page No : 2

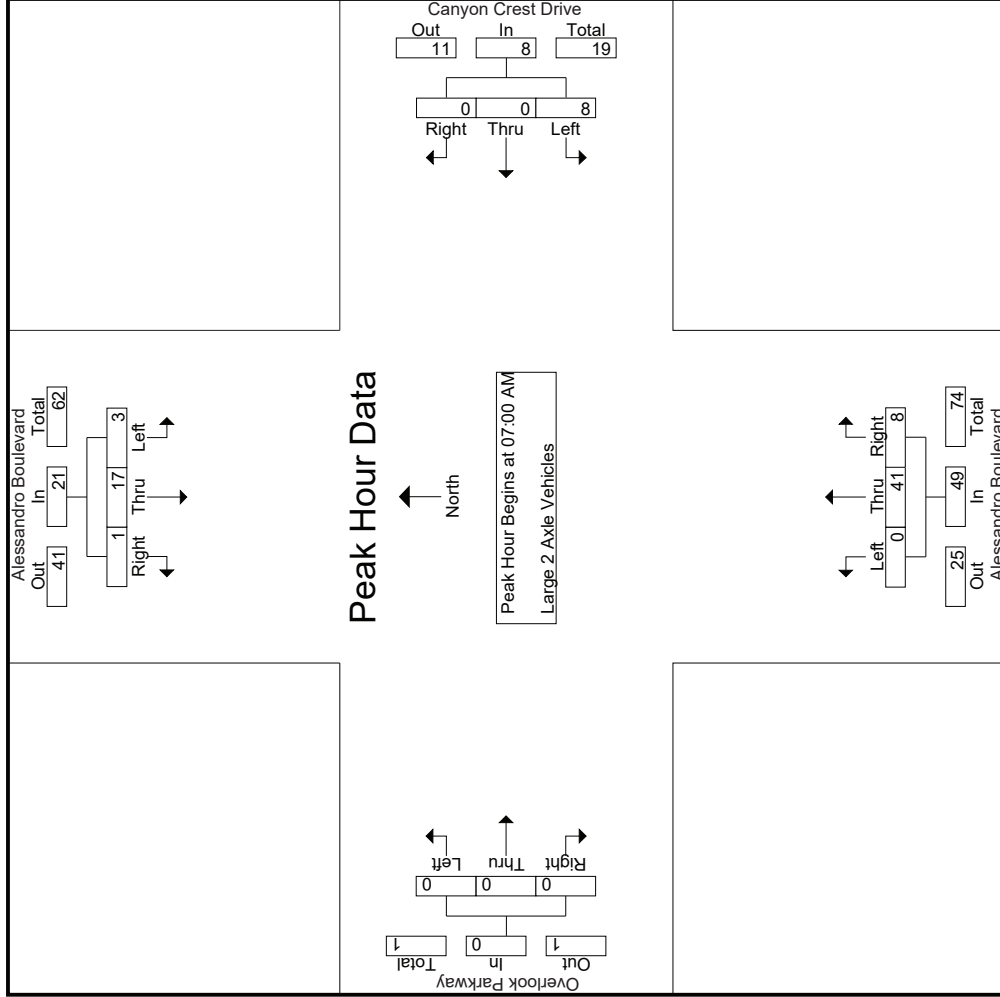

Counts Unlimited
 PO Box 1178
 Corona, CA 92878
 (951) 268-6268

City of Riverside
 N/S: Alessandro Boulevard
 E/W: Overlook Pkwy/Canyon Crest Drive
 Weather: Clear

File Name : 01_RIV_Alessandro_Overlook AM
 Site Code : 05119542
 Start Date : 8/20/2019
 Page No : 3

Start Time	Alessandro Boulevard Southbound			Canyon Crest Drive Westbound			Alessandro Boulevard Northbound			Overlook Parkway Eastbound		
	Left	Thru	Right	Left	Thru	Right	Left	Thru	Right	Left	Thru	Right
Peak Hour Analysis From 07:00 AM to 07:45 AM - Peak 1 of 1												
Peak Hour for Each Approach Begins at:												
	07:00 AM											
+0 mins.	1	8	0	2	0	0	0	11	5	0	0	0
+15 mins.	0	2	0	3	0	0	0	13	2	0	0	0
+30 mins.	0	1	0	3	0	0	0	7	0	0	0	0
+45 mins.	2	6	1	0	0	0	0	10	1	0	0	0
Total Volume	3	17	1	8	0	0	0	41	8	0	0	0
% App. Total	14.3	81	4.8	100	0	0	0	83.7	16.3	0	0	0
PHF	.375	.531	.250	.667	.000	.000	.000	.788	.400	.000	.000	.000

Counts Unlimited
 PO Box 1178
 Corona, CA 92878
 (951) 268-6268

File Name : 01_RIV_Alessandro_Overlook AM
 Site Code : 05119542
 Start Date : 8/20/2019
 Page No : 1

City of Riverside
 N/S: Alessandro Boulevard
 EW: Overlook Pkwy/Canyon Crest Drive
 Weather: Clear

Groups Printed- 3-Axle Vehicles

Start Time	Alessandro Boulevard Southbound					Canyon Crest Drive Westbound					Alessandro Boulevard Northbound					Overlook Parkway Eastbound							
	Left	Thru	Right	RTOR	App. Total	Left	Thru	Right	RTOR	App. Total	Left	Thru	Right	RTOR	App. Total	Left	Thru	Right	RTOR	App. Total	Exclu. Total	Inclu. Total	Int. Total
07:00 AM	0	1	0	0	1	0	0	0	0	0	0	0	0	0	0	0	0	0	0	0	0	0	1
07:15 AM	0	1	0	0	1	0	0	0	0	0	0	0	0	0	0	0	0	0	0	0	0	0	1
07:30 AM	0	0	0	0	0	0	0	0	0	0	0	0	0	0	0	0	0	0	0	0	0	0	0
07:45 AM	0	0	0	0	0	0	0	0	0	0	0	0	0	0	0	0	0	0	0	0	0	0	0
Total	0	2	0	0	2	0	0	0	0	0	0	0	0	0	0	0	0	0	0	0	0	2	2
08:00 AM	0	1	0	0	1	0	0	0	0	0	0	0	0	0	0	0	0	0	0	0	0	0	1
08:15 AM	0	0	0	0	0	0	0	0	0	0	0	0	1	0	1	0	0	0	0	0	0	0	1
08:30 AM	0	0	0	0	0	0	0	0	0	0	0	1	0	0	1	0	0	0	0	0	0	0	1
08:45 AM	0	0	0	0	0	0	0	0	0	0	0	1	0	0	1	0	0	0	0	0	0	0	1
Total	0	1	0	0	1	0	0	0	0	0	0	2	1	0	3	0	0	0	0	0	0	4	4
Grand Total	0	3	0	0	3	0	0	0	0	0	0	2	1	0	3	0	0	0	0	0	0	6	6
Approch %	0	100	0	0	0	0	0	0	0	0	0	66.7	33.3	0	33.3	0	0	0	0	0	0	0	100
Total %	0	50	0	0	50	0	0	0	0	0	0	33.3	16.7	0	50	0	0	0	0	0	0	0	100

Start Time	Alessandro Boulevard Southbound					Canyon Crest Drive Westbound					Alessandro Boulevard Northbound					Overlook Parkway Eastbound							
	Left	Thru	Right	RTOR	App. Total	Left	Thru	Right	RTOR	App. Total	Left	Thru	Right	RTOR	App. Total	Left	Thru	Right	RTOR	App. Total	Exclu. Total	Inclu. Total	Int. Total
07:00 AM	0	1	0	0	1	0	0	0	0	0	0	0	0	0	0	0	0	0	0	0	0	0	0
07:15 AM	0	1	0	0	1	0	0	0	0	0	0	0	0	0	0	0	0	0	0	0	0	0	0
07:30 AM	0	0	0	0	0	0	0	0	0	0	0	0	0	0	0	0	0	0	0	0	0	0	0
07:45 AM	0	0	0	0	0	0	0	0	0	0	0	0	0	0	0	0	0	0	0	0	0	0	0
Total Volume	0	2	0	0	2	0	0	0	0	0	0	0	0	0	0	0	0	0	0	0	0	0	2
% App. Total	0	100	0	0	0	0	0	0	0	0	0	0	0	0	0	0	0	0	0	0	0	0	0
PHF	.000	.500	.000	.000	.500	.000	.000	.000	.000	.000	.000	.000	.000	.000	.000	.000	.000	.000	.000	.000	.000	.000	.500

Peak Hour Analysis From 07:00 AM to 07:45 AM - Peak 1 of 1
 Peak Hour for Entire Intersection Begins at 07:00 AM

Counts Unlimited
 PO Box 1178
 Corona, CA 92878
 (951) 268-6268

City of Riverside
 N/S: Alessandro Boulevard
 E/W: Overlook Pkwy/Canyon Crest Drive
 Weather: Clear

File Name : 01_RIV_Alessandro_Overlook AM
 Site Code : 05119542
 Start Date : 8/20/2019
 Page No : 2

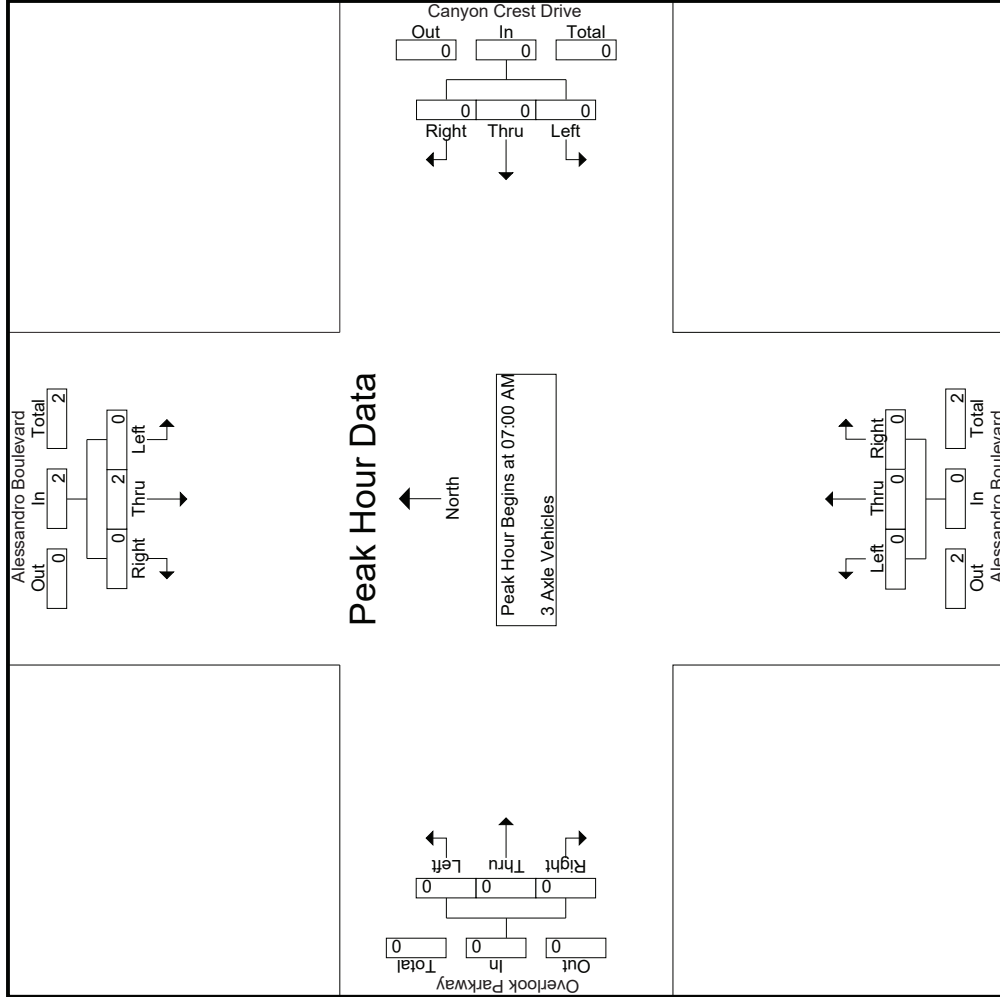

Counts Unlimited
 PO Box 1178
 Corona, CA 92878
 (951) 268-6268

City of Riverside
 N/S: Alessandro Boulevard
 E/W: Overlook Pkwy/Canyon Crest Drive
 Weather: Clear

File Name : 01_RIV_Alessandro_Overlook AM
 Site Code : 05119542
 Start Date : 8/20/2019
 Page No : 3

Start Time	Alessandro Boulevard Southbound			Canyon Crest Drive Westbound			Alessandro Boulevard Northbound			Overlook Parkway Eastbound					
	Left	Thru	Right	App. Total	Left	Thru	Right	App. Total	Left	Thru	Right	App. Total	Int. Total		
Peak Hour Analysis From 07:00 AM to 07:45 AM - Peak 1 of 1															
Peak Hour for Each Approach Begins at:															
	07:00 AM				07:00 AM				07:00 AM				07:00 AM		
+0 mins.	0	1	0	1	0	0	0	0	0	0	0	0	0	0	
+15 mins.	0	1	0	1	0	0	0	0	0	0	0	0	0	0	
+30 mins.	0	0	0	0	0	0	0	0	0	0	0	0	0	0	
+45 mins.	0	0	0	0	0	0	0	0	0	0	0	0	0	0	
Total Volume	0	2	0	2	0	0	0	0	0	0	0	0	0	0	
% App. Total	0	100	0	100	0	0	0	0	0	0	0	0	0	0	
PHF	.000	.500	.000	.500	.000	.000	.000	.000	.000	.000	.000	.000	.000	.000	

Counts Unlimited
 PO Box 1178
 Corona, CA 92878
 (951) 268-6268

File Name : 01_RIV_Alessandro_Overlook AM
 Site Code : 05119542
 Start Date : 8/20/2019
 Page No : 1

City of Riverside
 N/S: Alessandro Boulevard
 EW: Overlook Pkwy/Canyon Crest Drive
 Weather: Clear

Groups Printed- 4+ Axle Trucks

Start Time	Alessandro Boulevard Southbound				Canyon Crest Drive Westbound				Alessandro Boulevard Northbound				Overlook Parkway Eastbound					
	Left	Thru	Right	RTOR	App. Total	Left	Thru	Right	RTOR	App. Total	Left	Thru	Right	RTOR	App. Total	Exclu. Total	Inclu. Total	Int. Total
07:00 AM	0	0	0	0	0	0	0	0	0	0	0	0	0	0	0	0	0	0
07:15 AM	0	0	0	0	1	0	0	0	0	1	0	0	0	0	0	0	2	2
07:30 AM	0	0	0	0	0	0	0	0	0	1	0	0	0	0	0	0	1	1
07:45 AM	0	0	0	0	0	0	0	0	0	0	0	0	0	0	0	0	0	0
Total	0	0	0	0	1	0	0	0	0	2	0	0	0	0	0	0	3	3
08:00 AM	0	1	0	0	1	0	0	0	0	1	0	0	0	0	0	0	2	2
08:15 AM	0	0	0	0	0	0	0	0	0	0	0	0	0	0	0	0	0	0
08:30 AM	0	1	0	0	1	0	0	0	0	0	0	0	0	0	0	0	1	1
08:45 AM	0	0	0	0	0	0	0	0	0	1	0	1	1	2	0	1	2	3
Total	0	2	0	0	2	0	0	0	0	1	1	1	1	3	0	1	5	6
Grand Total	0	2	0	0	2	1	0	0	0	1	3	1	1	5	0	1	8	9
Approch %	0	100	0	0	100	0	0	0	0	20	60	20			0	0	0	0
Total %	0	25	0	0	25	12.5	0	0	0	12.5	37.5	12.5			0	11.1	88.9	

3.1-13

Start Time	Alessandro Boulevard Southbound				Canyon Crest Drive Westbound				Alessandro Boulevard Northbound				Overlook Parkway Eastbound					
	Left	Thru	Right	RTOR	App. Total	Left	Thru	Right	RTOR	App. Total	Left	Thru	Right	RTOR	App. Total	Exclu. Total	Inclu. Total	Int. Total
07:00 AM	0	0	0	0	0	0	0	0	0	0	0	0	0	0	0	0	0	0
07:15 AM	0	0	0	0	0	1	0	0	0	1	0	0	0	0	0	0	0	0
07:30 AM	0	0	0	0	0	0	0	0	0	0	0	0	0	0	0	0	0	0
07:45 AM	0	0	0	0	0	0	0	0	0	0	0	0	0	0	0	0	0	0
Total Volume	0	0	0	0	0	1	0	0	0	1	0	2	0	0	0	0	0	0
% App. Total	0	0	0	0	0	100	0	0	0	100	0	100	0	0	0	0	0	0
PHF	.000	.000	.000	.000	.000	.250	.000	.000	.000	.250	.000	.500	.000	.000	.500	.000	.000	.375

Peak Hour Analysis From 07:00 AM to 07:45 AM - Peak 1 of 1
 Peak Hour for Entire Intersection Begins at 07:00 AM

Counts Unlimited
 PO Box 1178
 Corona, CA 92878
 (951) 268-6268

City of Riverside
 N/S: Alessandro Boulevard
 E/W: Overlook Pkwy/Canyon Crest Drive
 Weather: Clear

File Name : 01_RV_Alessandro_Overlook AM
 Site Code : 05119542
 Start Date : 8/20/2019
 Page No : 2

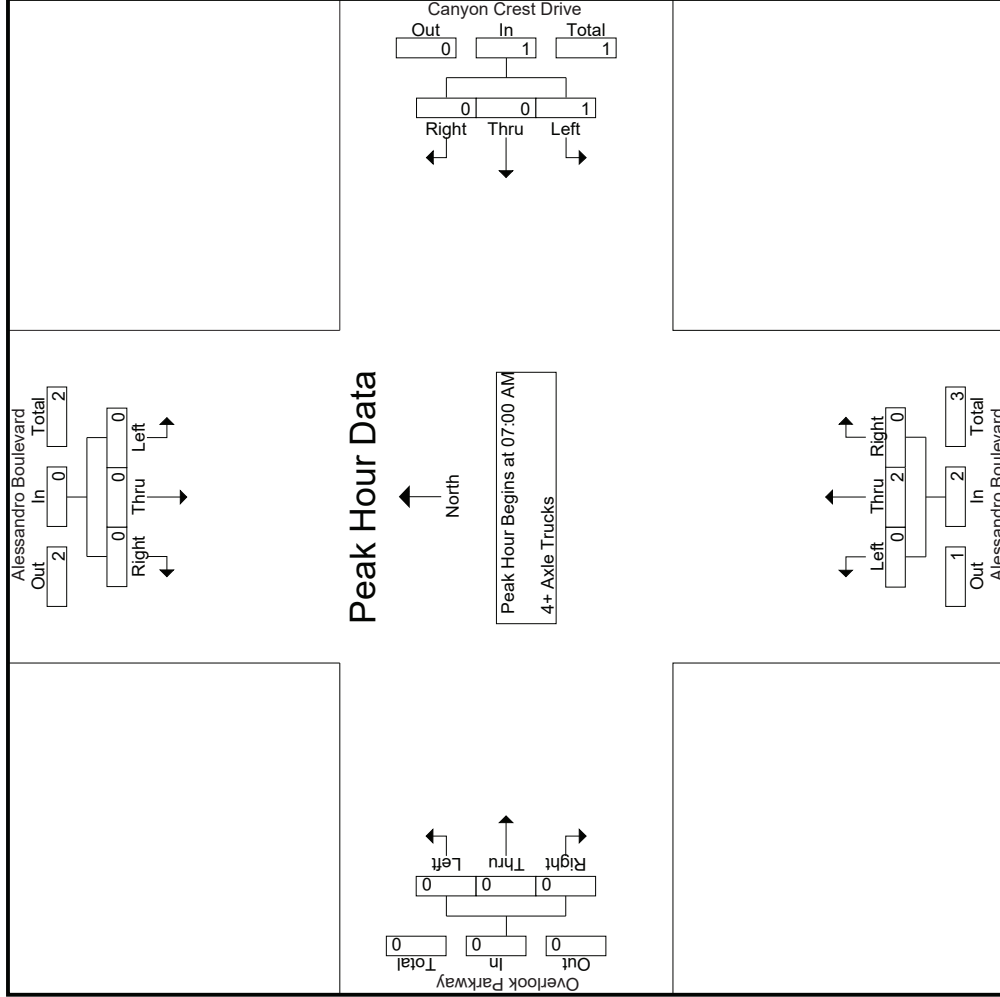

Counts Unlimited
 PO Box 1178
 Corona, CA 92878
 (951) 268-6268

City of Riverside
 N/S: Alessandro Boulevard
 E/W: Overlook Pkwy/Canyon Crest Drive
 Weather: Clear

File Name : 01_RIV_Alessandro_Overlook AM
 Site Code : 05119542
 Start Date : 8/20/2019
 Page No : 3

Start Time	Alessandro Boulevard Southbound			Canyon Crest Drive Westbound			Alessandro Boulevard Northbound			Overlook Parkway Eastbound		
	Left	Thru	Right	Left	Thru	Right	Left	Thru	Right	Left	Thru	Right
Peak Hour Analysis From 07:00 AM to 07:45 AM - Peak 1 of 1												
Peak Hour for Each Approach Begins at:												
+0 mins.	0	0	0	0	0	0	0	0	0	0	0	0
+15 mins.	0	0	0	1	0	0	0	1	0	0	0	0
+30 mins.	0	0	0	0	0	0	0	1	0	0	0	0
+45 mins.	0	0	0	0	0	0	0	0	0	0	0	0
Total Volume	0	0	0	1	0	0	1	2	0	0	0	0
% App. Total	.000	.000	.000	.250	.000	.000	.250	.500	.000	.000	.000	.000
PHF												

Counts Unlimited
 PO Box 1178
 Corona, CA 92878
 (951) 268-6268

File Name : 01_RIV_Alessandro_Overlook PM
 Site Code : 05119542
 Start Date : 8/20/2019
 Page No : 1

City of Riverside
 N/S: Alessandro Boulevard
 EW: Overlook Pkwy/Canyon Crest Drive
 Weather: Clear

Groups Printed- Passenger Vehicles - Large 2 Axle Vehicles - 3 Axle Vehicles - 4+ Axle Trucks

Start Time	Alessandro Boulevard Southbound										Alessandro Boulevard Northbound										Overlook Parkway Eastbound																		
	Left		Thru		Right		RTOR		App. Total		Left		Thru		Right		RTOR		App. Total		Left		Thru		Right		RTOR		App. Total		Exclu. Total		Inclu. Total		Int. Total				
04:00 PM	14	544	1	0	559	2	10	6	158	2	417	118	45	537	1	1	0	0	2	51	1256	1307	1	1	0	0	2	51	1256	1307	1	1	0	0	2	51	1256	1307	
04:15 PM	10	774	2	1	786	151	0	8	7	159	0	429	112	36	541	3	1	1	1	5	45	1491	1536	3	1	1	1	5	45	1491	1536	3	1	1	1	5	45	1491	1536
04:30 PM	12	704	5	0	721	140	0	7	4	147	0	418	97	20	515	2	0	0	0	2	24	1385	1409	2	0	0	0	2	24	1385	1409	2	0	0	0	2	24	1385	1409
04:45 PM	11	658	3	0	672	165	1	6	4	172	1	381	114	48	496	2	0	0	0	2	52	1342	1394	2	0	0	0	2	52	1342	1394	2	0	0	0	2	52	1342	1394
Total	47	2680	11	1	2738	602	3	31	21	636	3	1645	441	149	2089	8	2	1	1	172	5474	5646	8	2	1	1	11	172	5474	5646	8	2	1	1	11	172	5474	5646	
05:00 PM	7	725	1	0	733	167	3	8	7	178	1	367	116	24	484	3	1	1	1	5	32	1400	1432	3	1	1	1	5	32	1400	1432	3	1	1	1	5	32	1400	1432
05:15 PM	16	761	3	0	780	159	5	2	0	166	0	444	118	53	562	2	0	3	3	5	56	1513	1569	2	0	3	3	5	56	1513	1569	2	0	3	3	5	56	1513	1569
05:30 PM	12	643	2	0	657	186	2	16	11	204	0	396	100	48	496	1	0	1	1	2	60	1359	1419	1	0	1	1	2	60	1359	1419	1	0	1	1	2	60	1359	1419
05:45 PM	22	733	1	0	756	128	0	15	11	143	1	338	84	34	423	1	1	1	1	3	45	1325	1370	1	1	1	1	3	45	1325	1370	1	1	1	1	3	45	1325	1370
Total	57	2862	7	0	2926	640	10	41	29	691	2	1545	418	159	1965	7	2	6	5	193	5597	5790	7	2	6	5	15	193	5597	5790	7	2	6	5	15	193	5597	5790	
Grand Total	104	5542	18	1	5664	1242	13	72	50	1327	5	3190	859	308	4054	15	4	7	6	365	11071	11436	15	4	7	6	26	365	11071	11436	15	4	7	6	26	365	11071	11436	
Approch %	1.8	97.8	0.3			93.6	1	5.4		12	0.1	78.7	21.2		36.6	57.7	15.4	26.9		0.2	96.8		0.1	0	0.1		0.2	3.2	96.8		0.1	0	0.1		0.2	3.2	96.8		
Total %	104	5492	18	100	99.1	100	100	100	100	99.8	100	99.1	99.2	99	4323	100	100	100	100	100	99.2	99.2	100	100	100	100	100	100	99.2	99.2	100	100	100	100	100	99.2	99.2	99.2	
Passenger Vehicles	0	45	0	0	45	3	0	0	0	3	0	29	7	1	39	0	0	0	0	0	0	87	0	0	0	0	0	0	0	0	0	0	0	0	0	0	0	0	
% Large 2 Axle Vehicles	0	0.8	0	0	0.8	0.2	0	0	0	0.2	0	0.9	0.8	1	0.9	0	0	0	0	0	0	0.8	0	0	0	0	0	0	0	0	0	0	0	0	0	0	0	0	
3 Axle Vehicles	0	3	0	0	3	0	0	0	0	0	0	0	0	0	0	0	0	0	0	0	0	3	0	0	0	0	0	0	0	0	0	0	0	0	0	0	0	0	
% 3 Axle Vehicles	0	0.1	0	0	0.1	0	0	0	0	0	0	0	0	0	0	0	0	0	0	0	0	0	0	0	0	0	0	0	0	0	0	0	0	0	0	0	0	0	
4+ Axle Trucks	0	2	0	0	2	0	0	0	0	0	0	0	0	0	0	0	0	0	0	0	0	2	0	0	0	0	0	0	0	0	0	0	0	0	0	0	0	0	
% 4+ Axle Trucks	0	0	0	0	0	0	0	0	0	0	0	0	0	0	0	0	0	0	0	0	0	0	0	0	0	0	0	0	0	0	0	0	0	0	0	0	0	0	

Start Time	Alessandro Boulevard Southbound										Alessandro Boulevard Northbound										Overlook Parkway Eastbound																																																											
	Left		Thru		Right		RTOR		App. Total		Left		Thru		Right		RTOR		App. Total		Left		Thru		Right		RTOR		App. Total		Exclu. Total		Inclu. Total		Int. Total																																													
04:30 PM	12	704	5	0	704	721	0	7	147	140	0	418	97	515	2	0	0	0	2	1385	165	1	381	114	496	2	0	0	2	1342	167	3	367	116	484	3	1	1	5	1400	159	2	444	118	562	2	0	3	5	1513	631	9	1610	445	2057	9	1	4	14	5640	95.2	1.4	78.3	21.6	64.3	7.1	28.6			5640	.945	.450	.931	.943	.915	.250	.333	.700	.932	
% App. Total	1.6	98	0.4			93.1	1	3.5		95.2	0.1	78.3	21.6		64.3	7.1	28.6		5640	.945	.450	.931	.943	.915	.250	.333	.700	.932																																																				
PHF	.719	.936	.600			.931	.931	.719		.945	.450	.931	.943	.915	.250	.333	.700		5640	.945	.450	.931	.943	.915	.250	.333	.700	.932																																																				

Peak Hour Analysis From 04:00 PM to 05:45 PM - Peak 1 of 1

Peak Hour for Entire Intersection Begins at 04:30 PM

Counts Unlimited
 PO Box 1178
 Corona, CA 92878
 (951) 268-6268

City of Riverside
 N/S: Alessandro Boulevard
 E/W: Overlook Pkwy/Canyon Crest Drive
 Weather: Clear

File Name : 01_RV_Alessandro_Overlook PM
 Site Code : 05119542
 Start Date : 8/20/2019
 Page No : 2

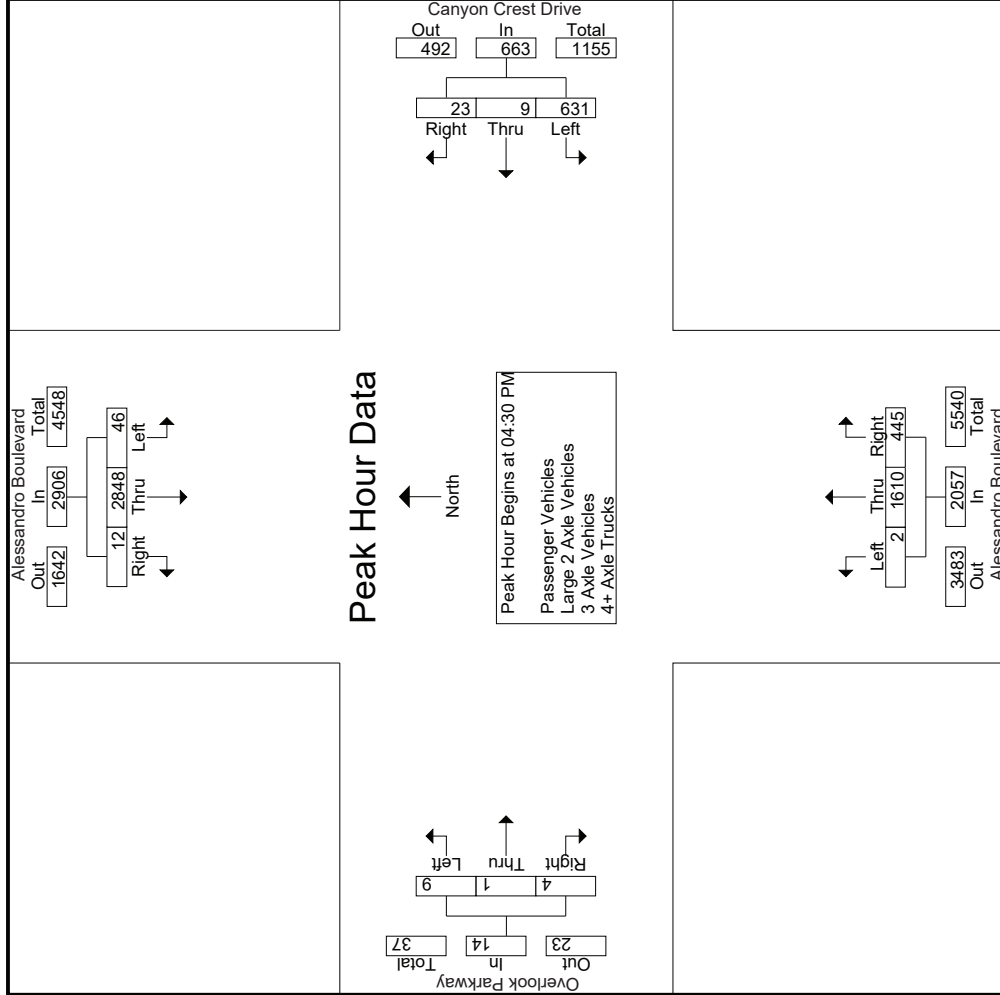

Counts Unlimited
 PO Box 1178
 Corona, CA 92878
 (951) 268-6268

City of Riverside
 N/S: Alessandro Boulevard
 E/W: Overlook Pkwy/Canyon Crest Drive
 Weather: Clear

File Name : 01_RIV_Alessandro_Overlook PM
 Site Code : 05119542
 Start Date : 8/20/2019
 Page No : 3

Start Time	Alessandro Boulevard Southbound			Canyon Crest Drive Westbound			Alessandro Boulevard Northbound			Overlook Parkway Eastbound				
	Left	Thru	Right	Left	Thru	Right	Left	Thru	Right	Left	Thru	Right	App. Total	Int. Total
Peak Hour Analysis From 04:00 PM to 05:45 PM - Peak 1 of 1														
Peak Hour for Each Approach Begins at:														
	05:00 PM			04:45 PM			04:00 PM			05:00 PM				
+0 mins.	7	725	1	165	1	6	172	2	417	118	537	3	1	5
+15 mins.	16	761	3	178	3	8	178	0	429	112	541	2	0	3
+30 mins.	12	643	2	159	5	2	166	0	418	97	515	1	0	1
+45 mins.	22	733	1	186	2	16	204	1	381	114	496	1	1	1
Total Volume	57	2862	7	677	11	32	720	3	1645	441	2089	7	2	6
% App. Total	1.9	97.8	0.2	94	1.5	4.4	882	0.1	78.7	21.1	965	46.7	13.3	40
PHF	.648	.940	.583	.910	.550	.500	.882	.375	.959	.934	.965	.583	.500	.750

Counts Unlimited
 PO Box 1178
 Corona, CA 92878
 (951) 268-6268

File Name : 01_RIV_Alessandro_Overlook PM
 Site Code : 05119542
 Start Date : 8/20/2019
 Page No : 1

City of Riverside
 N/S: Alessandro Boulevard
 EW: Overlook Pkwy/Canyon Crest Drive
 Weather: Clear

Groups Printed- Passenger Vehicles

Start Time	Alessandro Boulevard Southbound					Canyon Crest Drive Westbound					Alessandro Boulevard Northbound					Overlook Parkway Eastbound							
	Left	Thru	Right	RTOR	App. Total	Left	Thru	Right	RTOR	App. Total	Left	Thru	Right	RTOR	App. Total	Left	Thru	Right	RTOR	App. Total	Exclu. Total	Inclu. Total	Int. Total
04:00 PM	14	541	1	0	556	146	2	10	6	158	2	411	116	43	529	1	1	0	0	2	49	1245	1294
04:15 PM	10	763	2	1	775	149	0	8	7	157	0	425	111	36	536	3	1	1	1	5	45	1473	1518
04:30 PM	12	695	5	0	712	139	0	7	4	146	0	412	95	19	507	2	0	0	0	2	23	1367	1390
04:45 PM	11	652	3	0	666	165	1	6	4	172	1	377	113	48	491	2	0	0	0	2	52	1331	1383
Total	47	2651	11	1	2709	599	3	31	21	633	3	1625	435	146	2063	8	2	1	1	11	169	5416	5585
05:00 PM	7	718	1	0	726	167	3	8	7	178	1	365	115	24	481	3	1	1	1	5	32	1390	1422
05:15 PM	16	756	3	0	775	159	5	2	0	166	0	442	118	53	560	2	0	3	3	5	56	1506	1562
05:30 PM	12	638	2	0	652	186	2	16	11	204	0	393	100	48	493	1	0	1	1	2	60	1351	1411
05:45 PM	22	729	1	0	752	128	0	15	11	143	1	336	84	34	421	1	1	1	0	3	45	1319	1364
Total	57	2841	7	0	2905	640	10	41	29	691	2	1536	417	159	1955	7	2	6	5	15	193	5566	5759
Grand Total	104	5492	18	1	5614	1239	13	72	50	1324	5	3161	852	305	4018	15	4	7	6	26	362	10982	11344
Apprch %	1.9	97.8	0.3			93.6	1	5.4		12.1	0.1	78.7	21.2		36.6	57.7	15.4	26.9		0.2	3.2	96.8	
Total %	0.9	50	0.2		51.1	11.3	0.1	0.7				28.8	7.8			0.1	0	0.1					

3.1-1-19

Start Time	Alessandro Boulevard Southbound					Canyon Crest Drive Westbound					Alessandro Boulevard Northbound					Overlook Parkway Eastbound							
	Left	Thru	Right	RTOR	App. Total	Left	Thru	Right	RTOR	App. Total	Left	Thru	Right	RTOR	App. Total	Left	Thru	Right	RTOR	App. Total	Exclu. Total	Inclu. Total	Int. Total
04:30 PM	12	695	5		712	139	0	7		146	0	412	95		507	2	0	0		0	0	2	1367
04:45 PM	11	652	3		666	165	1	6		172	1	377	113		491	2	0	0		0	0	2	1331
05:00 PM	7	718	1		726	167	3	8		178	1	365	115		481	3	1	1		1	1	5	1390
05:15 PM	16	756	3		775	159	5	2		166	0	442	118		560	2	0	3		0	3	5	1506
Total Volume	46	2821	12		2879	630	9	23		662	2	1596	441		2039	9	1	4		4	14	5594	
% App. Total	1.6	98	0.4			95.2	1.4	3.5		12.1	0.1	78.3	21.6		36.6	57.7	15.4	26.9		0.2	3.2	96.8	
PHF	.719	.933	.600		.929	.943	.450	.719		.930	.500	.903	.934		.910	.750	.250	.333		.700		.929	

Peak Hour Analysis From 04:30 PM to 05:15 PM - Peak 1 of 1
 Peak Hour for Entire Intersection Begins at 04:30 PM

Counts Unlimited
 PO Box 1178
 Corona, CA 92878
 (951) 268-6268

City of Riverside
 N/S: Alessandro Boulevard
 E/W: Overlook Pkwy/Canyon Crest Drive
 Weather: Clear

File Name : 01_RV_Alessandro_Overlook PM
 Site Code : 05119542
 Start Date : 8/20/2019
 Page No : 2

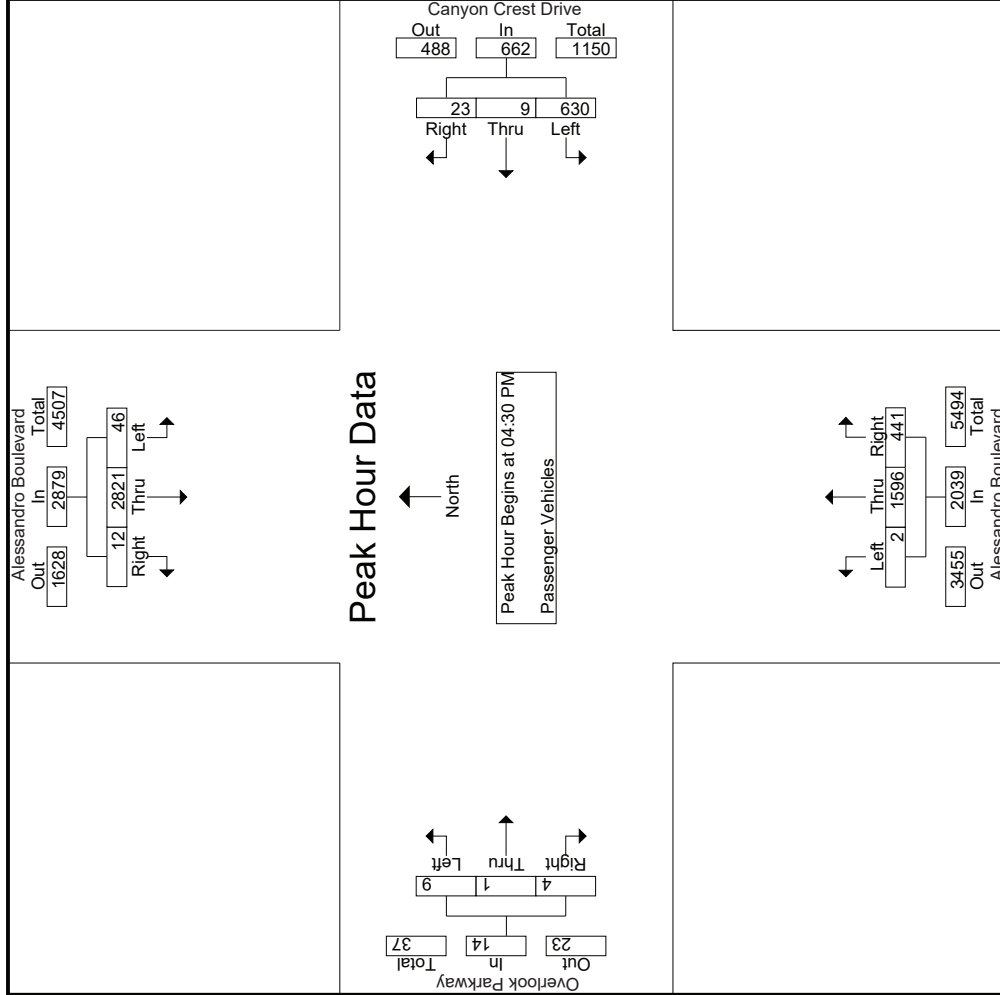

Counts Unlimited
 PO Box 1178
 Corona, CA 92878
 (951) 268-6268

City of Riverside
 N/S: Alessandro Boulevard
 E/W: Overlook Pkwy/Canyon Crest Drive
 Weather: Clear

File Name : 01_RV_Alessandro_Overlook PM
 Site Code : 05119542
 Start Date : 8/20/2019
 Page No : 3

Start Time	Alessandro Boulevard Southbound			Canyon Crest Drive Westbound			Alessandro Boulevard Northbound			Overlook Parkway Eastbound					
	Left	Thru	Right	Left	Thru	Right	Left	Thru	Right	Left	Thru	Right	App. Total	Int. Total	
Peak Hour Analysis From 04:30 PM to 05:15 PM - Peak 1 of 1															
Peak Hour for Each Approach Begins at:															
	04:30 PM			04:30 PM			04:30 PM			04:30 PM			04:30 PM		
+0 mins.	12	695	5	712	139	0	7	146	0	412	95	507	2	0	2
+15 mins.	11	652	3	666	165	1	6	172	1	377	113	491	2	0	2
+30 mins.	7	718	1	726	167	3	8	178	1	365	115	481	3	1	5
+45 mins.	16	756	3	775	159	5	2	166	0	442	118	560	2	0	5
Total Volume	46	2821	12	2879	630	9	23	662	2	1596	441	2039	9	1	14
% App. Total	1.6	98	0.4	95.2	95.2	1.4	3.5	930	0.1	78.3	21.6	64.3	7.1	28.6	700
PHF	.719	.933	.600	.929	.943	.450	.719	.930	.500	.903	.934	.910	.750	.250	.333

Counts Unlimited
 PO Box 1178
 Corona, CA 92878
 (951) 268-6268

File Name : 01_RIV_Alessandro_Overlook PM
 Site Code : 05119542
 Start Date : 8/20/2019
 Page No : 1

City of Riverside
 N/S: Alessandro Boulevard
 E/W: Overlook Pkwy/Canyon Crest Drive
 Weather: Clear

Groups Printed- Large 2 Axle Vehicles

Start Time	Alessandro Boulevard Southbound				Canyon Crest Drive Westbound				Alessandro Boulevard Northbound				Overlook Parkway Eastbound				
	Left	Thru	Right	RTOR	Left	Thru	Right	RTOR	Left	Thru	Right	RTOR	Left	Thru	Right	RTOR	
04:00 PM	0	2	0	0	0	0	0	0	0	6	2	2	8	0	0	0	0
04:15 PM	0	11	0	0	0	0	0	2	0	4	1	0	5	0	0	0	0
04:30 PM	0	8	0	0	0	0	0	1	0	6	2	1	8	0	0	0	0
04:45 PM	0	5	0	0	0	0	0	0	0	4	1	0	5	0	0	0	0
Total	0	26	0	0	0	0	0	3	0	20	6	3	26	0	0	0	0
05:00 PM	0	6	0	0	0	0	0	0	0	2	1	0	3	0	0	0	0
05:15 PM	0	5	0	0	0	0	0	0	0	2	0	0	2	0	0	0	0
05:30 PM	0	5	0	0	0	0	0	0	0	3	0	0	3	0	0	0	0
05:45 PM	0	3	0	0	0	0	0	0	0	2	0	0	2	0	0	0	0
Total	0	19	0	0	0	0	0	0	0	9	1	0	10	0	0	0	0
Grand Total	0	45	0	0	0	0	0	3	0	29	7	3	36	0	0	0	0
Approch %	0	100	0	0	0	0	0	0	0	80.6	19.4	0	42.9	0	0	0	0
Total %	0	53.6	0	0	0	0	0	3.6	0	34.5	8.3	0	42.9	0	0	0	0

3.1-22

Start Time	Alessandro Boulevard Southbound				Canyon Crest Drive Westbound				Alessandro Boulevard Northbound				Overlook Parkway Eastbound				
	Left	Thru	Right	RTOR	Left	Thru	Right	RTOR	Left	Thru	Right	RTOR	Left	Thru	Right	RTOR	
04:30 PM	0	8	0	0	1	0	0	0	1	0	0	0	8	0	0	0	
04:45 PM	0	5	0	0	0	0	0	0	0	0	4	1	5	0	0	0	
05:00 PM	0	6	0	0	0	0	0	0	0	0	2	1	3	0	0	0	
05:15 PM	0	5	0	0	0	0	0	0	0	0	2	0	2	0	0	0	
Total Volume	0	24	0	0	1	0	0	0	1	0	14	4	18	0	0	0	0
% App. Total	0	100	0	0	100	0	0	0	0	0	77.8	22.2	0	0	0	0	0
PHF	.000	.750	.000	.750	.250	.000	.000	.000	.250	.000	.583	.500	.563	.000	.000	.000	.632

Peak Hour Analysis From 04:30 PM to 05:15 PM - Peak 1 of 1
 Peak Hour for Entire Intersection Begins at 04:30 PM

Counts Unlimited
 PO Box 1178
 Corona, CA 92878
 (951) 268-6268

City of Riverside
 N/S: Alessandro Boulevard
 E/W: Overlook Pkwy/Canyon Crest Drive
 Weather: Clear

File Name : 01_RV_Alessandro_Overlook PM
 Site Code : 05119542
 Start Date : 8/20/2019
 Page No : 2

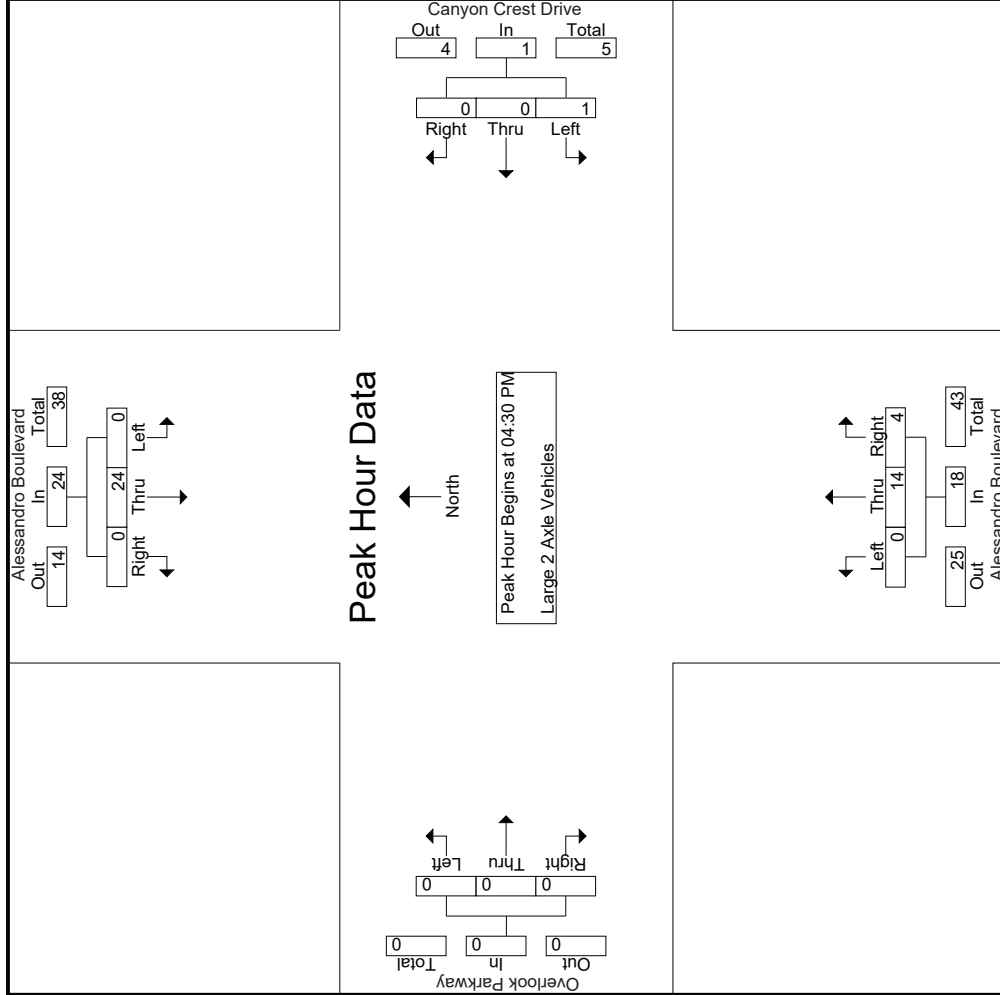

Counts Unlimited
 PO Box 1178
 Corona, CA 92878
 (951) 268-6268

City of Riverside
 N/S: Alessandro Boulevard
 E/W: Overlook Pkwy/Canyon Crest Drive
 Weather: Clear

File Name : 01_RV_Alessandro_Overlook PM
 Site Code : 05119542
 Start Date : 8/20/2019
 Page No : 3

Start Time	Alessandro Boulevard Southbound			Canyon Crest Drive Westbound			Alessandro Boulevard Northbound			Overlook Parkway Eastbound		
	Left	Thru	Right	Left	Thru	Right	Left	Thru	Right	Left	Thru	Right
Peak Hour Analysis From 04:30 PM to 05:15 PM - Peak 1 of 1	Peak Hour for Each Approach Begins at:											
	04:30 PM			04:30 PM			04:30 PM			04:30 PM		
+0 mins.	0	8	0	1	0	0	1	0	6	2	8	0
+15 mins.	0	5	0	0	0	0	0	4	1	5	0	0
+30 mins.	0	6	0	0	0	0	0	2	1	3	0	0
+45 mins.	0	5	0	0	0	0	0	2	0	2	0	0
Total Volume	0	24	0	1	0	0	1	14	4	18	0	0
% App. Total	0	100	0	100	0	0	0	77.8	22.2	.563	0	0
PHF	.000	.750	.000	.250	.000	.000	.250	.583	.500	.000	.000	.000

Counts Unlimited
 PO Box 1178
 Corona, CA 92878
 (951) 268-6268

File Name : 01_RIV_Alessandro_Overlook PM
 Site Code : 05119542
 Start Date : 8/20/2019
 Page No : 1

City of Riverside
 N/S: Alessandro Boulevard
 E/W: Overlook Pkwy/Canyon Crest Drive
 Weather: Clear

Groups Printed- 3-Axle Vehicles

Start Time	Alessandro Boulevard Southbound				Canyon Crest Drive Westbound				Alessandro Boulevard Northbound				Overlook Parkway Eastbound					
	Left	Thru	Right	RTOR	App. Total	Left	Thru	Right	RTOR	App. Total	Left	Thru	Right	RTOR	App. Total	Exclu. Total	Inclu. Total	Int. Total
04:00 PM	0	1	0	0	1	0	0	0	0	0	0	0	0	0	0	0	1	1
04:15 PM	0	0	0	0	0	0	0	0	0	0	0	0	0	0	0	0	0	0
04:30 PM	0	1	0	0	1	0	0	0	0	0	0	0	0	0	0	0	1	1
04:45 PM	0	0	0	0	0	0	0	0	0	0	0	0	0	0	0	0	0	0
Total	0	2	0	0	2	0	0	0	0	0	0	0	0	0	0	0	2	2
05:00 PM	0	1	0	0	1	0	0	0	0	0	0	0	0	0	0	0	1	1
05:15 PM	0	0	0	0	0	0	0	0	0	0	0	0	0	0	0	0	0	0
05:30 PM	0	0	0	0	0	0	0	0	0	0	0	0	0	0	0	0	0	0
05:45 PM	0	0	0	0	0	0	0	0	0	0	0	0	0	0	0	0	0	0
Total	0	1	0	0	1	0	0	0	0	0	0	0	0	0	0	0	1	1
Grand Total	0	3	0	0	3	0	0	0	0	0	0	0	0	0	0	0	3	3
Approch %	0	100	0	0	100	0	0	0	0	0	0	0	0	0	0	0	100	100
Total %	0	100	0	0	100	0	0	0	0	0	0	0	0	0	0	0	100	100

3.1-25

Start Time	Alessandro Boulevard Southbound				Canyon Crest Drive Westbound				Alessandro Boulevard Northbound				Overlook Parkway Eastbound					
	Left	Thru	Right	RTOR	App. Total	Left	Thru	Right	RTOR	App. Total	Left	Thru	Right	RTOR	App. Total	Exclu. Total	Inclu. Total	Int. Total
04:30 PM	0	1	0	0	1	0	0	0	0	0	0	0	0	0	0	0	1	1
04:45 PM	0	0	0	0	0	0	0	0	0	0	0	0	0	0	0	0	0	0
05:00 PM	0	1	0	0	1	0	0	0	0	0	0	0	0	0	0	0	1	1
05:15 PM	0	0	0	0	0	0	0	0	0	0	0	0	0	0	0	0	0	0
Total Volume	0	2	0	0	2	0	0	0	0	0	0	0	0	0	0	0	2	2
% App. Total	0	100	0	0	100	0	0	0	0	0	0	0	0	0	0	0	100	100
PHF	.000	.500	.000	.000	.500	.000	.000	.000	.000	.000	.000	.000	.000	.000	.000	.000	.500	.500

Peak Hour Analysis From 04:30 PM to 05:15 PM - Peak 1 of 1
 Peak Hour for Entire Intersection Begins at 04:30 PM

Counts Unlimited
 PO Box 1178
 Corona, CA 92878
 (951) 268-6268

City of Riverside
 N/S: Alessandro Boulevard
 E/W: Overlook Pkwy/Canyon Crest Drive
 Weather: Clear

File Name : 01_RV_Alessandro_Overlook PM
 Site Code : 05119542
 Start Date : 8/20/2019
 Page No : 2

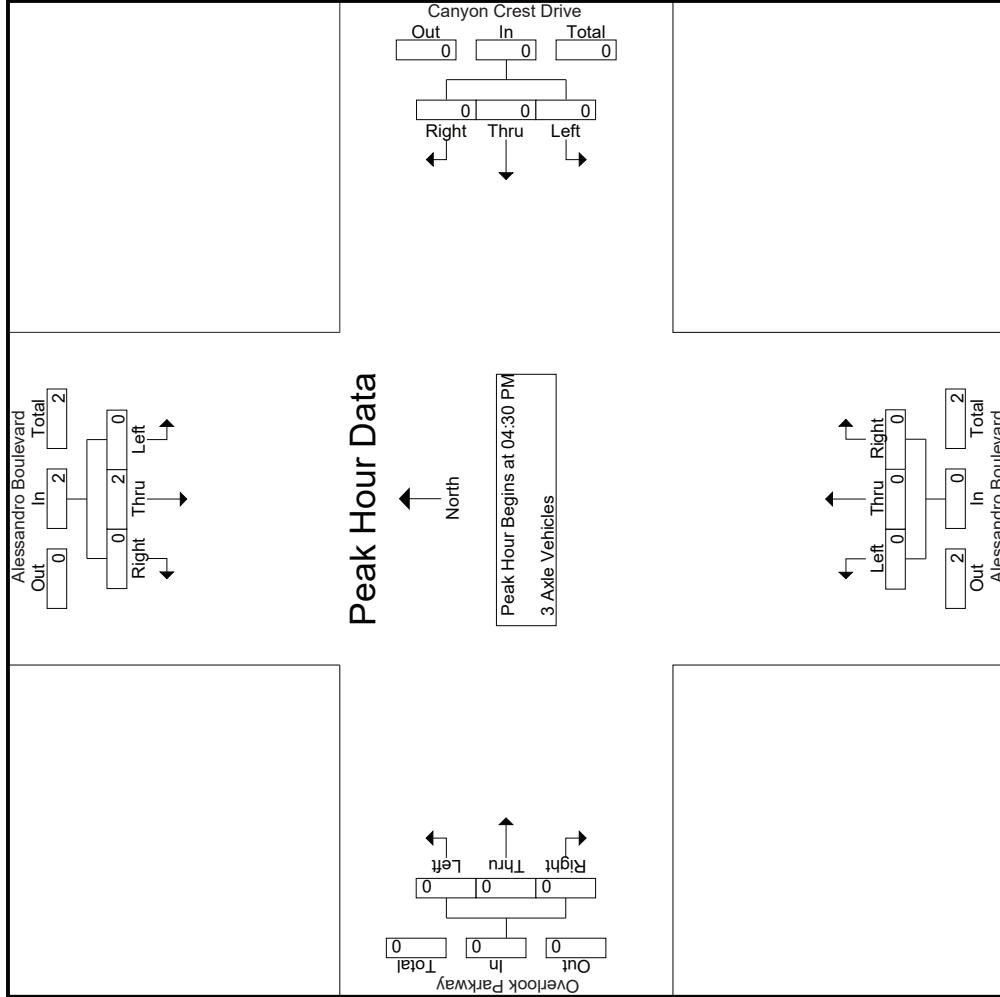

Groups Printed- 4+ Axle Trucks

Start Time	Alessandro Boulevard Southbound					Canyon Crest Drive Westbound					Alessandro Boulevard Northbound					Overlook Parkway Eastbound							
	Left	Thru	Right	RTOR	App. Total	Left	Thru	Right	RTOR	App. Total	Left	Thru	Right	RTOR	App. Total	Left	Thru	Right	RTOR	App. Total	Exclu. Total	Inclu. Total	Int. Total
04:00 PM	0	0	0	0	0	0	0	0	0	0	0	0	0	0	0	0	0	0	0	0	0	0	0
04:15 PM	0	0	0	0	0	0	0	0	0	0	0	0	0	0	0	0	0	0	0	0	0	0	0
04:30 PM	0	0	0	0	0	0	0	0	0	0	0	0	0	0	0	0	0	0	0	0	0	0	0
04:45 PM	0	1	0	0	1	0	0	0	0	0	0	0	0	0	0	0	0	0	0	0	0	1	1
Total	0	1	0	0	1	0	0	0	0	0	0	0	0	0	0	0	0	0	0	0	0	1	1
05:00 PM	0	0	0	0	0	0	0	0	0	0	0	0	0	0	0	0	0	0	0	0	0	0	0
05:15 PM	0	0	0	0	0	0	0	0	0	0	0	0	0	0	0	0	0	0	0	0	0	0	0
05:30 PM	0	0	0	0	0	0	0	0	0	0	0	0	0	0	0	0	0	0	0	0	0	0	0
05:45 PM	0	1	0	0	1	0	0	0	0	0	0	0	0	0	0	0	0	0	0	0	0	1	1
Total	0	1	0	0	1	0	0	0	0	0	0	0	0	0	0	0	0	0	0	0	0	1	1
Grand Total	0	2	0	0	2	0	0	0	0	0	0	0	0	0	0	0	0	0	0	0	0	2	2
Approch %	0	100	0			0	0	0			0	0	0			0	0	0			0	100	
Total %	0	100	0		100	0	0	0			0	0	0			0	0	0			0	100	

Start Time	Alessandro Boulevard Southbound					Canyon Crest Drive Westbound					Alessandro Boulevard Northbound					Overlook Parkway Eastbound							
	Left	Thru	Right	RTOR	App. Total	Left	Thru	Right	RTOR	App. Total	Left	Thru	Right	RTOR	App. Total	Left	Thru	Right	RTOR	App. Total	Exclu. Total	Inclu. Total	Int. Total
04:30 PM	0	0	0	0	0	0	0	0	0	0	0	0	0	0	0	0	0	0	0	0	0	0	0
04:45 PM	0	1	0	0	1	0	0	0	0	0	0	0	0	0	0	0	0	0	0	0	0	0	1
05:00 PM	0	0	0	0	0	0	0	0	0	0	0	0	0	0	0	0	0	0	0	0	0	0	0
05:15 PM	0	0	0	0	0	0	0	0	0	0	0	0	0	0	0	0	0	0	0	0	0	0	0
Total Volume	0	1	0	0	1	0	0	0	0	0	0	0	0	0	0	0	0	0	0	0	0	1	1
% App. Total	0	100	0			0	0	0			0	0	0			0	0	0			0	100	
PHF	.000	.250	.000		.250	.000	.000	.000		.000	.000	.000	.000		.000	.000	.000	.000		.000	.000	.250	

Peak Hour Analysis From 04:30 PM to 05:15 PM - Peak 1 of 1
 Peak Hour for Entire Intersection Begins at 04:30 PM

Counts Unlimited
 PO Box 1178
 Corona, CA 92878
 (951) 268-6268

City of Riverside
 N/S: Alessandro Boulevard
 E/W: Overlook Pkwy/Canyon Crest Drive
 Weather: Clear

File Name : 01_RV_Alessandro_Overlook PM
 Site Code : 05119542
 Start Date : 8/20/2019
 Page No : 2

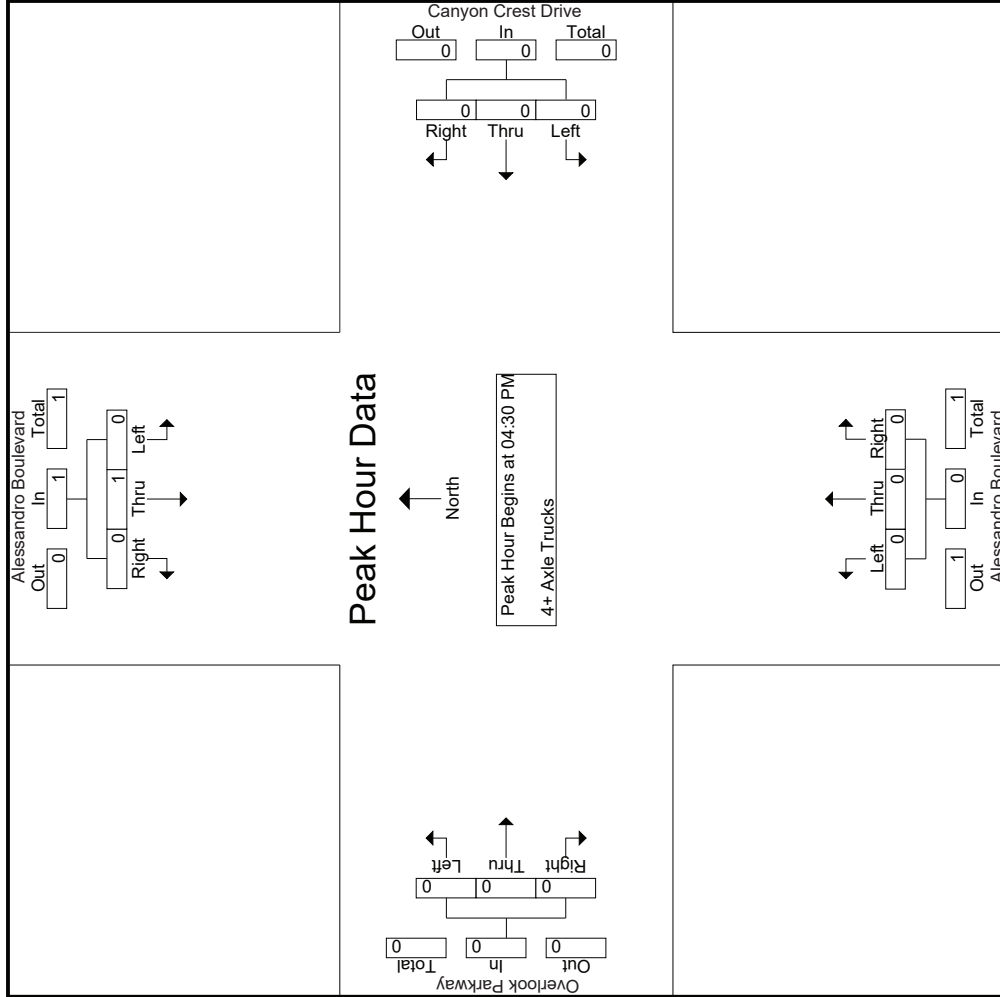

Counts Unlimited
 PO Box 1178
 Corona, CA 92878
 (951) 268-6268

City of Riverside
 N/S: Alessandro Boulevard
 E/W: Overlook Pkwy/Canyon Crest Drive
 Weather: Clear

File Name : 01_RV_Alessandro_Overlook PM
 Site Code : 05119542
 Start Date : 8/20/2019
 Page No : 3

Start Time	Alessandro Boulevard Southbound			Canyon Crest Drive Westbound			Alessandro Boulevard Northbound			Overlook Parkway Eastbound		
	Left	Thru	Right	Left	Thru	Right	Left	Thru	Right	Left	Thru	Right
Peak Hour Analysis From 04:30 PM to 05:15 PM - Peak 1 of 1												
Peak Hour for Each Approach Begins at:												
	04:30 PM			04:30 PM			04:30 PM			04:30 PM		
+0 mins.	0	0	0	0	0	0	0	0	0	0	0	0
+15 mins.	0	1	0	0	0	0	0	0	0	0	0	0
+30 mins.	0	0	0	0	0	0	0	0	0	0	0	0
+45 mins.	0	0	0	0	0	0	0	0	0	0	0	0
Total Volume	0	1	0	0	0	0	0	0	0	0	0	0
% App. Total	0	100	0	0	0	0	0	0	0	0	0	0
PHF	.000	.250	.000	.000	.000	.000	.000	.000	.000	.000	.000	.000

Location: Riverside
 N/S: Alessandro Boulevard
 E/W: Canyon Crest Dr/Overlook Pkw



Date: 8/20/2019
 Day: Tuesday

PEDESTRIANS

	North Leg Alessandro Boulevard	East Leg Canyon Crest Drive	South Leg Alessandro Boulevard	West Leg Overlook Parkway	
	Pedestrians	Pedestrians	Pedestrians	Pedestrians	
7:00 AM	1	0	0	0	1
7:15 AM	0	0	0	0	0
7:30 AM	0	0	0	0	0
7:45 AM	0	0	0	0	0
8:00 AM	0	0	0	0	0
8:15 AM	0	0	0	0	0
8:30 AM	0	0	0	0	0
8:45 AM	0	0	0	0	0
TOTAL VOLUMES:	1	0	0	0	1

	North Leg Alessandro Boulevard	East Leg Canyon Crest Drive	South Leg Alessandro Boulevard	West Leg Overlook Parkway	
	Pedestrians	Pedestrians	Pedestrians	Pedestrians	
4:00 PM	0	0	0	0	0
4:15 PM	0	0	0	0	0
4:30 PM	0	0	0	0	0
4:45 PM	0	0	0	0	0
5:00 PM	0	0	0	0	0
5:15 PM	0	0	0	0	0
5:30 PM	0	0	0	0	0
5:45 PM	1	0	0	0	1
TOTAL VOLUMES:	1	0	0	0	1

Location: Riverside
 N/S: Alessandro Boulevard
 E/W: Canyon Crest Dr/Overlook Pkwy



Date: 8/20/2019
 Day: Tuesday

BICYCLES

	Southbound Alessandro Boulevard			Westbound Canyon Crest Drive			Northbound Alessandro Boulevard			Eastbound Overlook Parkway			
	Left	Thru	Right	Left	Thru	Right	Left	Thru	Right	Left	Thru	Right	
7:00 AM	0	1	0	0	0	0	0	0	0	0	0	0	1
7:15 AM	0	0	0	0	0	0	0	0	0	0	0	0	0
7:30 AM	0	0	0	0	0	0	0	0	0	0	0	0	0
7:45 AM	0	0	0	0	0	0	0	0	0	0	0	0	0
8:00 AM	0	0	0	0	0	0	0	0	0	0	0	0	0
8:15 AM	0	1	0	0	0	0	0	0	0	0	0	0	1
8:30 AM	0	0	0	0	0	0	0	0	0	0	0	0	0
8:45 AM	0	0	0	0	0	1	0	0	0	0	0	0	1
TOTAL VOLUMES:	0	2	0	0	0	1	0	0	0	0	0	0	3

	Southbound Alessandro Boulevard			Westbound Canyon Crest Drive			Northbound Alessandro Boulevard			Eastbound Overlook Parkway			
	Left	Thru	Right	Left	Thru	Right	Left	Thru	Right	Left	Thru	Right	
4:00 PM	0	0	0	0	0	0	0	0	0	0	0	0	0
4:15 PM	0	0	0	0	0	0	0	0	0	0	0	0	0
4:30 PM	0	0	0	0	0	0	0	0	0	0	0	0	0
4:45 PM	0	0	0	0	0	0	0	0	0	0	0	0	0
5:00 PM	0	0	0	0	0	0	0	1	0	0	0	0	1
5:15 PM	0	0	0	0	0	0	0	0	0	0	0	0	0
5:30 PM	0	0	0	0	0	0	0	1	0	0	0	0	1
5:45 PM	0	0	0	0	0	0	0	0	1	0	0	0	1
TOTAL VOLUMES:	0	0	0	0	0	0	0	2	1	0	0	0	3

Groups Printed- Passenger Vehicles - Large 2 Axle Vehicles - 3 Axle Vehicles - 4+ Axle Trucks

Start Time	Wood Road Southbound						Van Buren Boulevard Westbound						Wood Road Northbound						Van Buren Boulevard Eastbound					
	Left	Thru	Right	RTOR	App. Total	Inclu. Total	Left	Thru	Right	RTOR	App. Total	Inclu. Total	Left	Thru	Right	RTOR	App. Total	Inclu. Total	Left	Thru	Right	RTOR	App. Total	Inclu. Total
07:00 AM	22	125	40	17	187	84	83	258	23	8	364	55	23	250	83	25	187	81	35	293	83	1094	1177	
07:15 AM	24	130	30	15	184	69	143	286	44	15	473	50	33	250	120	34	201	116	57	351	120	1258	1378	
07:30 AM	14	108	20	6	142	49	104	264	46	24	414	79	146	321	121	26	152	69	53	247	121	1124	1245	
07:45 AM	17	27	35	22	79	321	38	283	29	13	350	72	100	242	70	33	259	34	20	326	70	997	1067	
Total	77	390	125	60	592	321	368	1091	142	60	1601	327	465	1063	394	118	799	300	165	1217	394	4473	4867	
08:00 AM	21	23	40	23	84	84	38	275	7	5	320	55	36	40	29	24	175	18	6	217	63	752	815	
08:15 AM	24	22	23	11	69	69	33	278	6	2	317	71	31	27	20	19	162	17	5	198	38	713	751	
08:30 AM	53	28	38	15	119	119	30	250	9	5	289	67	28	32	22	127	25	150	28	203	61	738	799	
08:45 AM	13	11	25	12	49	49	33	320	7	3	360	57	33	33	19	123	25	152	27	204	43	736	779	
Total	111	84	126	61	321	321	134	1123	29	15	1286	250	128	132	90	510	93	639	90	822	205	2939	3144	
Grand Total	188	474	251	121	913	913	502	2214	171	75	2887	577	593	403	199	1573	211	1438	390	204	599	7412	8011	
Approch %	20.6	51.9	27.5				17.4	76.7	5.9			36.7	37.7	25.6		10.3	70.5	19.1						
Total %	2.5	6.4	3.4				6.8	29.9	2.3			7.8	8	5.4		2.8	19.4	5.3				7.5	92.5	
Passenger Vehicles	180	471	242		1013	1013	490	2120	169		2852	564	588	395	1744	207	1380	382		2168	0	0	7777	
% Passenger Vehicles	95.7	99.4	96.4	99.2	98	98	97.6	95.8	98.8	97.3	96.3	97.7	99.2	98	99	98.1	96	97.9	97.5	96.7	0	0	97.1	
Large 2 Axle Vehicles	8	2	7		18	18	9	47	1		58	9	5	4	19	3	38	5		49	0	0	144	
% Large 2 Axle Vehicles	4.3	0.4	2.8	0.8	1.7	1.7	1.8	2.1	0.6	1.3	2	1.6	0.8	1	0.5	1.1	1.4	2.6	1.3	1.5	2.2	0	0	1.8
3 Axle Vehicles	0	1	1		2	2	1	14	1		17	2	0	1	3	0	13	2		16	0	0	38	
% 3 Axle Vehicles	0	0.2	0.4	0	0.2	0.2	0.2	0.6	0.6	1.3	0.6	0.3	0	0.2	0	0.2	0	0.9	0.5	0.5	0.7	0	0	0.5
4+ Axle Trucks	0	0	1		1	1	2	33	0		35	2	0	3	6	1	7	1		10	0	0	52	
% 4+ Axle Trucks	0	0	0.4	0	0.1	0.1	0.4	1.5	0	0	1.2	0.3	0	0.7	0.3	0.5	0.5	0.3	0.5	0.4	0	0	0.6	
PHF	.802	.750	.781		.791	.791	.643	.954	.772		.846	.889	.796	.706	.867	.828	.647	.868		.771	.647	.867	.889	

Peak Hour Analysis From 07:00 AM to 08:45 AM - Peak 1 of 1

Peak Hour for Entire Intersection Begins at 07:00 AM

Start Time	Wood Road Southbound						Van Buren Boulevard Westbound						Wood Road Northbound						Van Buren Boulevard Eastbound					
	Left	Thru	Right	RTOR	App. Total	Inclu. Total	Left	Thru	Right	RTOR	App. Total	Inclu. Total	Left	Thru	Right	RTOR	App. Total	Inclu. Total	Left	Thru	Right	RTOR	App. Total	Inclu. Total
07:00 AM	22	125	40	17	187	84	83	258	23	8	364	55	23	250	83	25	187	81	35	293	83	1094	1177	
07:15 AM	24	130	30	15	184	69	143	286	44	15	473	50	33	250	120	34	201	116	57	351	120	1258	1378	
07:30 AM	14	108	20	6	142	49	104	264	46	24	414	79	146	321	121	26	152	69	53	247	121	1124	1245	
07:45 AM	17	27	35	22	79	321	38	283	29	13	350	72	100	242	70	33	259	34	20	326	70	997	1067	
Total	77	390	125	60	592	321	368	1091	142	60	1601	327	465	1063	394	118	799	300	165	1217	394	4473	4867	
08:00 AM	21	23	40	23	84	84	38	275	7	5	320	55	36	40	29	24	175	18	6	217	63	752	815	
08:15 AM	24	22	23	11	69	69	33	278	6	2	317	71	31	27	20	19	162	17	5	198	38	713	751	
08:30 AM	53	28	38	15	119	119	30	250	9	5	289	67	28	32	22	127	25	150	28	203	61	738	799	
08:45 AM	13	11	25	12	49	49	33	320	7	3	360	57	33	33	19	123	25	152	27	204	43	736	779	
Total	111	84	126	61	321	321	134	1123	29	15	1286	250	128	132	90	510	93	639	90	822	205	2939	3144	
Grand Total	188	474	251	121	913	913	502	2214	171	75	2887	577	593	403	199	1573	211	1438	390	204	599	7412	8011	
Approch %	20.6	51.9	27.5				17.4	76.7	5.9			36.7	37.7	25.6		10.3	70.5	19.1						
Total %	2.5	6.4	3.4				6.8	29.9	2.3			7.8	8	5.4		2.8	19.4	5.3			7.5	92.5		
Passenger Vehicles	180	471	242		1013	1013	490	2120	169		2852	564	588	395	1744	207	1380	382		2168	0	0	7777	
% Passenger Vehicles	95.7	99.4	96.4	99.2	98	98	97.6	95.8	98.8	97.3	96.3	97.7	99.2	98	99	98.1	96	97.9	97.5	96.7	0	0	97.1	
Large 2 Axle Vehicles	8	2	7		18	18	9	47	1		58	9	5	4	19	3	38	5		49	0	0	144	
% Large 2 Axle Vehicles	4.3	0.4	2.8	0.8	1.7	1.7	1.8	2.1	0.6	1.3	2	1.6	0.8	1	0.5	1.1	1.4	2.6	1.3	1.5	2.2	0	0	1.8
3 Axle Vehicles	0	1	1		2	2	1	14	1		17	2	0	1	3	0	13	2		16	0	0	38	
% 3 Axle Vehicles	0	0.2	0.4	0	0.2	0.2	0.2	0.6	0.6	1.3	0.6	0.3	0	0.2	0	0.2	0	0.9	0.5	0.5	0.7	0	0	0.5
4+ Axle Trucks	0	0	1		1	1	2	33	0		35	2	0	3	6	1	7	1		10	0	0	52	
% 4+ Axle Trucks	0	0	0.4	0	0.1	0.1	0.4	1.5	0	0	1.2	0.3	0	0.7	0.3	0.5	0.5	0.3	0.5	0.4	0	0	0.6	
PHF	.802	.750	.781		.791	.791	.643	.954	.772		.846	.889	.796	.706	.867	.828	.647	.868		.771	.647	.867	.889	

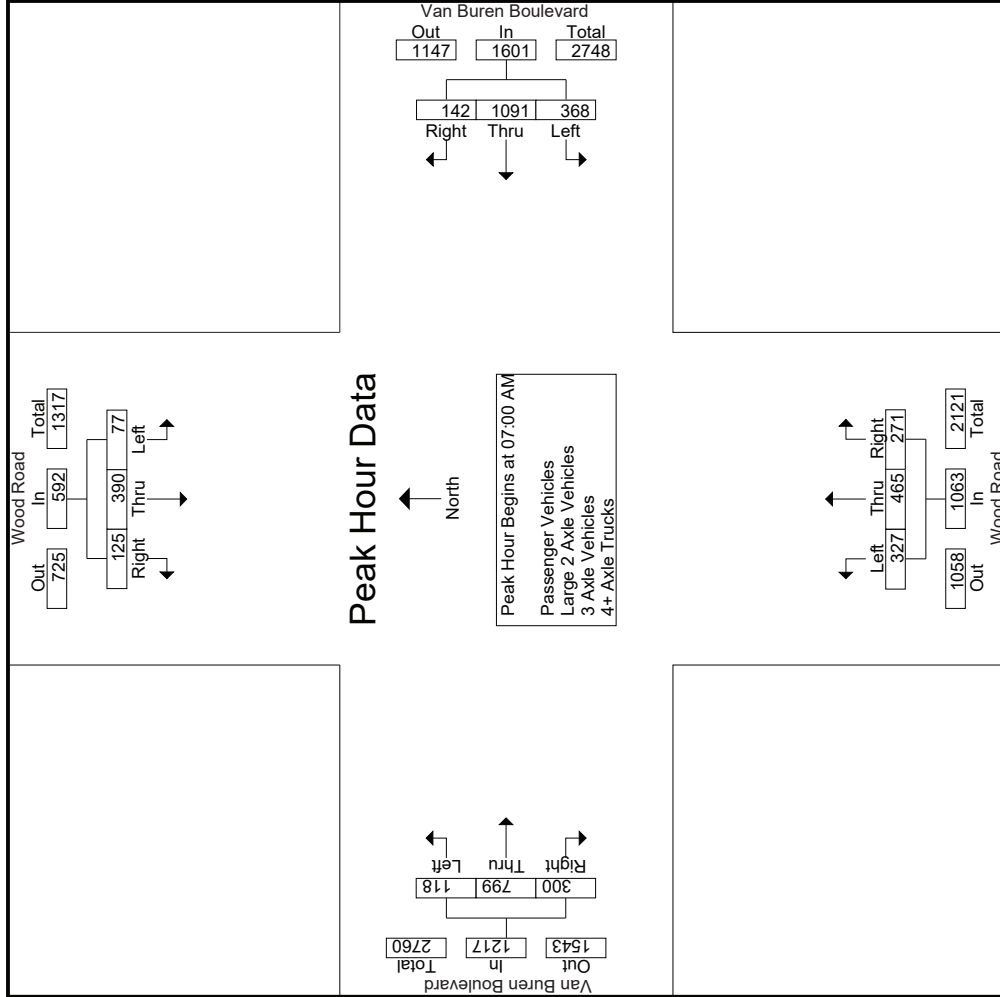

Counts Unlimited
 PO Box 1178
 Corona, CA 92878
 (951) 268-6268

City of Riverside
 N/S: Wood Road
 E/W: Van Buren Boulevard
 Weather: Clear

File Name : 02_RIV_Wood_Van Buren AM
 Site Code : 05119542
 Start Date : 8/20/2019
 Page No : 3

Start Time	Wood Road Southbound			Van Buren Boulevard Westbound			Wood Road Northbound			Van Buren Boulevard Eastbound					
	Left	Thru	Right	Left	Thru	Right	Left	Thru	Right	Left	Thru	Right	App. Total	Int. Total	
Peak Hour Analysis From 07:00 AM to 08:45 AM - Peak 1 of 1															
Peak Hour for Each Approach Begins at:															
	07:00 AM			07:00 AM			07:00 AM			07:00 AM			07:00 AM		
+0 mins.	22	125	40	187	83	258	23	364	111	55	250	187	81	293	
+15 mins.	24	130	30	184	143	286	44	473	108	50	250	201	116	351	
+30 mins.	14	108	20	142	104	264	46	414	146	96	321	152	69	247	
+45 mins.	17	27	35	79	38	283	29	350	100	70	242	259	34	326	
Total Volume	77	390	125	592	368	1091	142	1601	465	271	1063	799	300	1217	
% App. Total	13	65.9	21.1	791	23	68.1	8.9	846	43.7	25.5	828	65.7	24.7	867	
PHF	.802	.750	.781	.791	.643	.954	.772	.846	.796	.706	.828	.771	.647	.867	

Groups Printed- Passenger Vehicles

Start Time	Wood Road Southbound						Van Buren Boulevard Westbound						Wood Road Northbound						Van Buren Boulevard Eastbound					
	Left	Thru	Right	RTOR	App. Total	Inclu. Total	Left	Thru	Right	RTOR	App. Total	Inclu. Total	Left	Thru	Right	RTOR	App. Total	Inclu. Total	Left	Thru	Right	RTOR	App. Total	Inclu. Total
	07:00 AM	21	125	39	17	185	185	82	250	23	8	355	355	84	111	53	22	248	248	25	185	81	35	291
07:15 AM	23	130	29	15	182	182	141	277	44	15	462	462	91	108	49	32	248	248	34	192	116	57	342	342
07:30 AM	13	107	19	6	139	139	103	255	45	23	403	403	78	146	96	38	320	320	26	149	66	50	241	241
07:45 AM	17	26	34	22	77	77	37	270	29	13	336	336	70	98	68	15	236	236	32	248	33	20	313	313
Total	74	388	121	60	583	583	363	1052	141	59	1556	1556	323	463	266	107	1052	1052	117	774	296	162	1187	1187
08:00 AM	20	23	40	23	83	83	37	263	6	4	306	306	54	35	39	29	128	128	23	165	17	6	205	205
08:15 AM	23	22	22	11	67	67	30	262	6	2	298	298	70	29	27	20	126	126	17	151	17	5	185	185
08:30 AM	51	28	36	15	115	115	29	238	9	5	276	276	64	28	32	22	124	124	25	144	26	17	195	195
08:45 AM	12	10	23	11	45	45	31	305	7	3	343	343	53	33	31	19	117	117	25	146	26	9	197	197
Total	106	83	121	60	310	310	127	1068	28	14	1223	1223	241	125	129	90	495	495	90	606	86	37	782	782
Grand Total	180	471	242	120	893	893	490	2120	169	73	2779	2779	564	588	395	197	1547	1547	207	1380	382	199	1969	1969
Approch %	20.2	52.7	27.1				17.6	76.3	6.1		38.7	38.7	36.5	38	25.5		21.5	21.5	10.5	70.1	19.4		27.4	27.4
Total %	2.5	6.6	3.4		12.4		6.8	29.5	2.4				7.8	8.2	5.5				2.9	19.2	5.3			

Start Time	Wood Road Southbound						Van Buren Boulevard Westbound						Wood Road Northbound						Van Buren Boulevard Eastbound					
	Left	Thru	Right	RTOR	App. Total	Inclu. Total	Left	Thru	Right	RTOR	App. Total	Inclu. Total	Left	Thru	Right	RTOR	App. Total	Inclu. Total	Left	Thru	Right	RTOR	App. Total	Inclu. Total
	07:00 AM	21	125	39	17	185	185	82	250	23	8	355	355	84	111	53	22	248	248	25	185	81	35	291
07:15 AM	23	130	29	15	182	182	141	277	44	15	462	462	91	108	49	32	248	248	34	192	116	57	342	342
07:30 AM	13	107	19	6	139	139	103	255	45	23	403	403	78	146	96	38	320	320	26	149	66	50	241	241
07:45 AM	17	26	34	22	77	77	37	270	29	13	336	336	70	98	68	15	236	236	32	248	33	20	313	313
Total Volume	74	388	121	60	583	583	363	1052	141	59	1556	1556	323	463	266	107	1052	1052	117	774	296	162	1187	1187
% App. Total	12.7	66.6	20.8				23.3	67.6	9.1		38.7	38.7	36.5	38	25.5		21.5	21.5	10.5	70.1	19.4		27.4	27.4
PHF	.804	.746	.776		.788	.788	.644	.949	.783		.842	.842	.887	.793	.693		.822	.822	.860	.780	.638		.868	.868

Peak Hour Analysis From 07:00 AM to 07:45 AM - Peak 1 of 1
 Peak Hour for Entire Intersection Begins at 07:00 AM

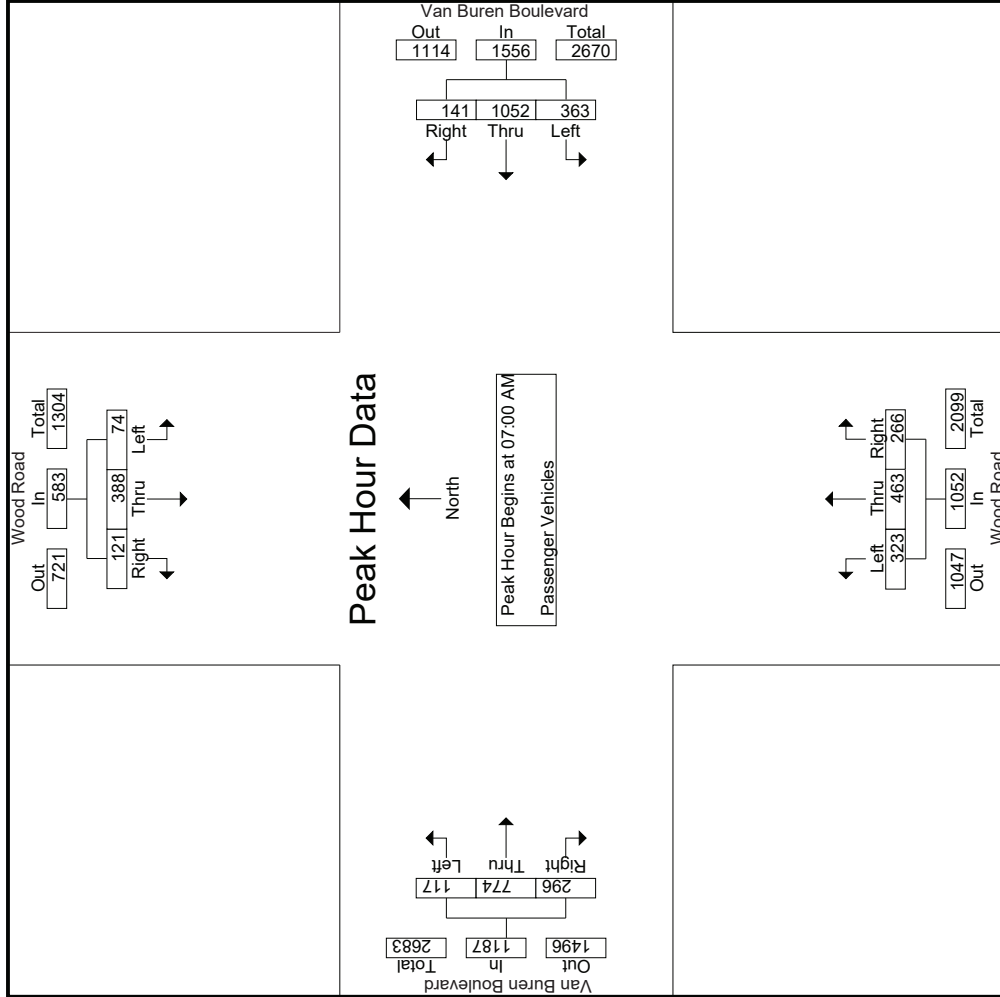

Counts Unlimited
 PO Box 1178
 Corona, CA 92878
 (951) 268-6268

City of Riverside
 N/S: Wood Road
 E/W: Van Buren Boulevard
 Weather: Clear

File Name : 02_RIV_Wood_Van Buren AM
 Site Code : 05119542
 Start Date : 8/20/2019
 Page No : 3

Start Time	Wood Road Southbound			Van Buren Boulevard Westbound			Wood Road Northbound			Van Buren Boulevard Eastbound						
	Left	Thru	Right	App. Total	Left	Thru	Right	App. Total	Left	Thru	Right	App. Total	Int. Total			
Peak Hour Analysis From 07:00 AM to 07:45 AM - Peak 1 of 1																
Peak Hour for Each Approach Begins at:																
	07:00 AM															
+0 mins.	21	125	39	185	82	250	23	355	84	111	53	248	25	185	81	291
+15 mins.	23	130	29	182	141	277	44	462	91	108	49	248	34	192	116	342
+30 mins.	13	107	19	139	103	255	45	403	78	146	96	320	26	149	66	241
+45 mins.	17	26	34	77	37	270	29	336	70	98	68	236	32	248	33	313
Total Volume	74	388	121	583	363	1052	141	1556	323	463	266	1052	117	774	296	1187
% App. Total	12.7	66.6	20.8	78.8	23.3	67.6	9.1	84.2	30.7	44	25.3	82.2	9.9	65.2	24.9	868
PHF	.804	.746	.776	.788	.644	.949	.783	.842	.887	.793	.693	.822	.860	.780	.638	.868

Groups Printed- Large 2 Axle Vehicles

Start Time	Wood Road Southbound					Van Buren Boulevard Westbound					Wood Road Northbound					Van Buren Boulevard Eastbound								
	Left	Thru	Right	RTOR	App. Total	Left	Thru	Right	RTOR	App. Total	Left	Thru	Right	RTOR	App. Total	Left	Thru	Right	RTOR	App. Total	Exclu. Total	Inclu. Total	Int. Total	
07:00 AM	1	0	1	0	2	1	2	0	0	3	0	0	0	0	0	0	2	0	0	0	2	0	7	7
07:15 AM	1	0	1	0	2	1	4	0	0	5	1	0	1	1	2	0	6	0	0	6	1	15	16	
07:30 AM	1	1	1	0	3	1	2	0	0	3	0	0	0	0	0	0	1	2	2	3	2	9	11	
07:45 AM	0	1	1	0	2	1	7	0	0	8	1	2	2	0	5	0	7	1	0	8	0	23	23	
Total	3	2	4	0	9	4	15	0	0	19	2	2	3	1	7	0	16	3	2	19	3	54	57	
08:00 AM	1	0	0	0	1	0	6	1	1	7	1	1	1	0	3	1	6	1	0	8	1	19	20	
08:15 AM	1	0	1	0	2	3	13	0	0	16	1	2	0	0	3	2	8	0	0	10	0	31	31	
08:30 AM	2	0	1	0	3	1	9	0	0	10	3	0	0	0	3	0	4	1	1	5	1	21	22	
08:45 AM	1	0	1	1	2	1	4	0	0	5	2	0	0	0	2	2	4	0	0	4	1	13	14	
Total	5	0	3	1	8	5	32	1	1	38	7	3	1	0	11	3	22	2	1	27	3	84	87	
Grand Total	8	2	7	1	17	9	47	1	1	57	9	5	4	1	18	3	38	5	3	46	6	138	144	
Approch %	47.1	11.8	41.2		15.8	82.5	1.8			41.3	6.5	27.8	22.2		13	6.5	82.6	10.9		33.3	4.2	95.8		
Total %	5.8	1.4	5.1		12.3	6.5	34.1	0.7		41.3	6.5	3.6	2.9		13	2.2	27.5	3.6		33.3	4.2	95.8		

Start Time	Wood Road Southbound					Van Buren Boulevard Westbound					Wood Road Northbound					Van Buren Boulevard Eastbound							
	Left	Thru	Right	RTOR	App. Total	Left	Thru	Right	RTOR	App. Total	Left	Thru	Right	RTOR	App. Total	Left	Thru	Right	RTOR	App. Total	Exclu. Total	Inclu. Total	Int. Total
07:00 AM	1	0	1	0	2	1	2	0	0	3	0	0	0	0	0	0	2	0	0	2	0	7	7
07:15 AM	1	0	1	0	2	1	4	0	0	5	1	0	1	1	2	0	6	0	0	6	1	15	15
07:30 AM	1	1	1	0	3	1	2	0	0	3	0	0	0	0	0	0	1	2	2	3	2	9	9
07:45 AM	0	1	1	0	2	1	7	0	0	8	1	2	2	0	5	0	7	1	0	8	0	23	23
Total Volume	3	2	4	0	9	4	15	0	0	19	2	2	3	1	7	0	16	3	2	19	3	54	54
% App. Total	33.3	22.2	44.4		33.3	21.1	78.9	0		41.3	6.5	28.6	42.9		13	6.5	84.2	15.8		33.3	4.2	95.8	
PHF	.750	.500	1.00		.750	1.00	.536	.000		.594	.500	.250	.375		.350	.000	.571	.375		.594	.587		

Peak Hour Analysis From 07:00 AM to 07:45 AM - Peak 1 of 1
 Peak Hour for Entire Intersection Begins at 07:00 AM

Counts Unlimited
 PO Box 1178
 Corona, CA 92878
 (951) 268-6268

City of Riverside
 N/S: Wood Road
 E/W: Van Buren Boulevard
 Weather: Clear

File Name : 02_RIV_Wood_Van Buren AM
 Site Code : 05119542
 Start Date : 8/20/2019
 Page No : 2

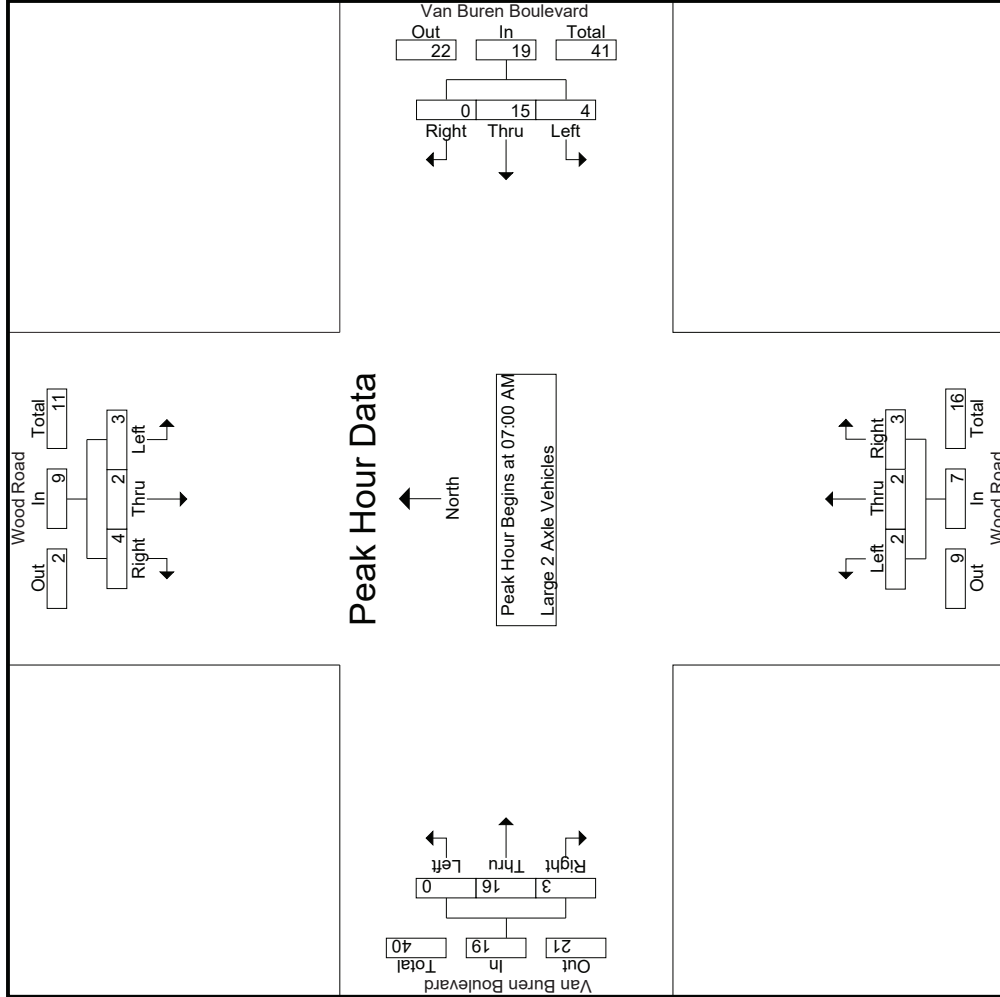

Counts Unlimited
 PO Box 1178
 Corona, CA 92878
 (951) 268-6268

City of Riverside
 N/S: Wood Road
 E/W: Van Buren Boulevard
 Weather: Clear

File Name : 02_RIV_Wood_Van Buren AM
 Site Code : 05119542
 Start Date : 8/20/2019
 Page No : 3

Start Time	Wood Road Southbound			Van Buren Boulevard Westbound			Wood Road Northbound			Van Buren Boulevard Eastbound					
	Left	Thru	Right	Left	Thru	Right	Left	Thru	Right	Left	Thru	Right			
Peak Hour Analysis From 07:00 AM to 07:45 AM - Peak 1 of 1															
Peak Hour for Each Approach Begins at:															
+0 mins.	1	0	1	2	1	0	3	0	0	0	0	0	2	0	2
+15 mins.	1	0	1	2	1	0	5	0	1	2	0	1	6	0	6
+30 mins.	1	1	1	3	1	2	3	0	0	0	0	0	1	2	3
+45 mins.	0	1	1	2	1	0	8	0	2	5	0	1	7	1	8
Total Volume	3	2	4	9	4	0	19	2	3	7	0	3	16	3	19
% App. Total	33.3	22.2	44.4	21.1	78.9	0	28.6	28.6	42.9	35.0	0	15.8	84.2	15.8	594
PHF	.750	.500	1.000	.750	1.000	.000	.594	.536	.000	.350	.000	.375	.571	.375	.594

Groups Printed- 3 Axle Vehicles

Start Time	Wood Road Southbound			Van Buren Boulevard Westbound			Wood Road Northbound			Van Buren Boulevard Eastbound			Inclu. Total	Int. Total	
	Left	Thru	Right	Left	Thru	Right	Left	Thru	Right	Left	Thru	Right			
07:00 AM	0	0	0	0	2	0	0	1	0	0	0	0	0	3	3
07:15 AM	0	0	0	1	1	0	0	0	0	2	0	0	2	0	4
07:30 AM	0	0	0	0	1	1	0	0	0	2	0	0	2	1	4
07:45 AM	0	0	0	0	0	0	0	0	0	0	0	0	2	0	2
Total	0	0	0	1	4	1	1	6	1	0	6	0	6	1	13
08:00 AM	0	0	0	0	2	0	0	2	0	0	0	0	3	0	5
08:15 AM	0	0	0	0	2	0	0	0	0	0	2	0	2	0	4
08:30 AM	0	0	0	0	1	0	0	0	0	0	1	1	2	1	3
08:45 AM	0	1	1	0	5	0	0	5	2	0	1	1	2	0	11
Total	0	1	1	0	10	0	0	10	2	0	7	2	9	1	23
Grand Total	0	1	1	0	14	1	1	16	2	0	13	2	15	2	36
Approch %	0	50	50	6.2	87.5	6.2		66.7	0	33.3	86.7	13.3	41.7	5.3	94.7
Total %	0	2.8	2.8	5.6	44.4	2.8		44.4	5.6	2.8	36.1	5.6	41.7	5.3	94.7

3.142

Start Time	Wood Road Southbound			Van Buren Boulevard Westbound			Wood Road Northbound			Van Buren Boulevard Eastbound			Inclu. Total	Int. Total	
	Left	Thru	Right	Left	Thru	Right	Left	Thru	Right	Left	Thru	Right			
07:00 AM	0	0	0	0	2	0	0	1	0	0	0	0	0	0	3
07:15 AM	0	0	0	1	1	0	0	0	0	0	0	0	2	0	4
07:30 AM	0	0	0	0	1	1	0	0	0	0	0	0	2	0	4
07:45 AM	0	0	0	0	0	0	0	0	0	0	0	0	2	0	2
Total Volume	0	0	0	1	4	1	1	6	0	0	1	0	6	0	13
% App. Total	0	0	0	16.7	66.7	16.7		100	0	100	0	0	100	0	100
PHF	.000	.000	.000	.250	.500	.250		.750	.000	.250	.250	.000	.750	.000	.813

Peak Hour Analysis From 07:00 AM to 07:45 AM - Peak 1 of 1
 Peak Hour for Entire Intersection Begins at 07:00 AM

Counts Unlimited
 PO Box 1178
 Corona, CA 92878
 (951) 268-6268

City of Riverside
 N/S: Wood Road
 E/W: Van Buren Boulevard
 Weather: Clear

File Name : 02_RIV_Wood_Van Buren AM
 Site Code : 05119542
 Start Date : 8/20/2019
 Page No : 2

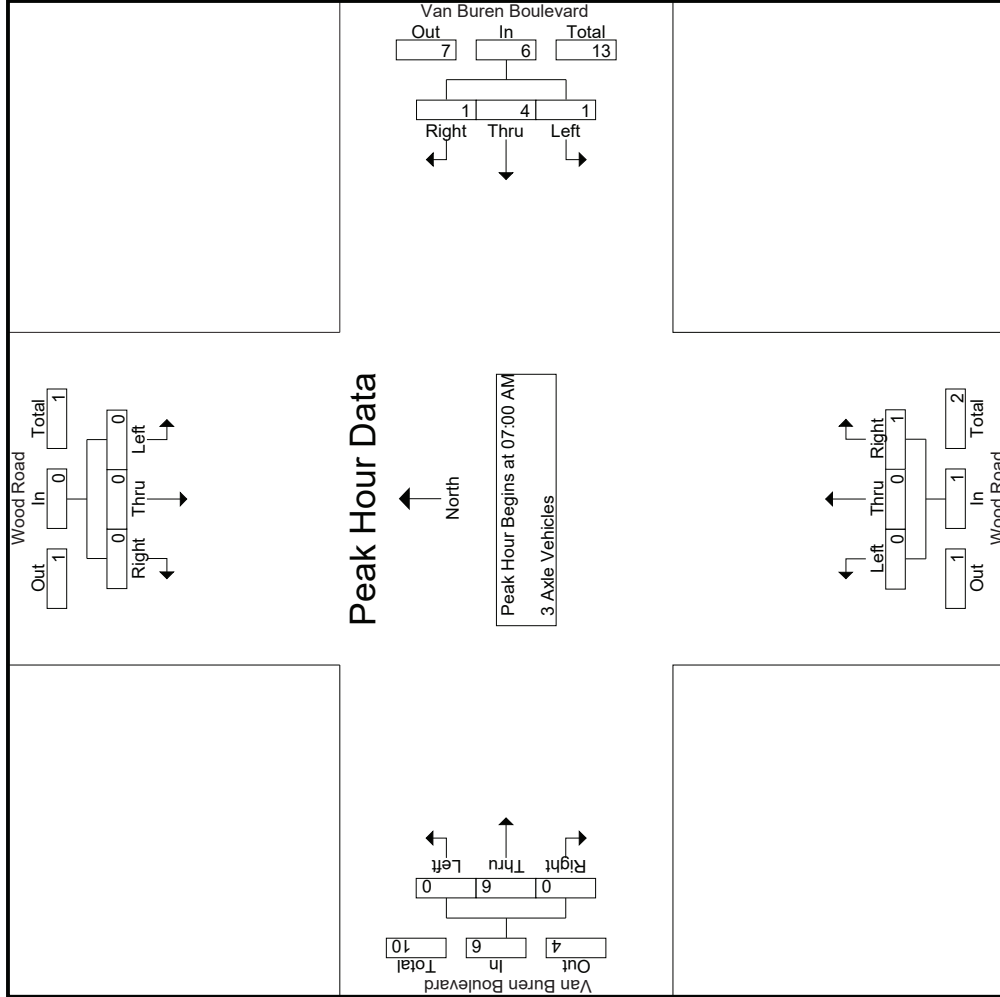

Counts Unlimited
 PO Box 1178
 Corona, CA 92878
 (951) 268-6268

City of Riverside
 N/S: Wood Road
 E/W: Van Buren Boulevard
 Weather: Clear

File Name : 02_RIV_Wood_Van Buren AM
 Site Code : 05119542
 Start Date : 8/20/2019
 Page No : 3

Start Time	Wood Road Southbound			Van Buren Boulevard Westbound			Wood Road Northbound			Van Buren Boulevard Eastbound			
	Left	Thru	Right	Left	Thru	Right	Left	Thru	Right	Left	Thru	Right	
Peak Hour Analysis From 07:00 AM to 07:45 AM - Peak 1 of 1													
Peak Hour for Each Approach Begins at:													
+0 mins.	0	0	0	0	2	0	0	0	1	0	0	0	0
+15 mins.	0	0	0	1	1	0	0	0	0	0	2	0	2
+30 mins.	0	0	0	0	1	1	0	0	0	0	2	0	0
+45 mins.	0	0	0	0	0	0	0	0	0	0	2	0	2
Total Volume	0	0	0	1	4	1	0	0	1	0	6	0	6
% App. Total	0	0	0	16.7	66.7	16.7	0	0	100	0	100	0	0
PHF	.000	.000	.000	.250	.500	.250	.000	.000	.250	.000	.750	.000	.750

Groups Printed- 4+ Axle Trucks

Start Time	Wood Road Southbound				Van Buren Boulevard Westbound				Wood Road Northbound				Van Buren Boulevard Eastbound						
	Left	Thru	Right	RTOR	App. Total	Left	Thru	Right	RTOR	App. Total	Left	Thru	Right	RTOR	App. Total	Exclu. Total	Inclu. Total	Int. Total	
07:00 AM	0	0	0	0	0	0	4	0	0	4	0	0	1	1	0	0	0	0	0
07:15 AM	0	0	0	0	0	4	0	0	0	4	0	0	0	0	0	1	0	0	0
07:30 AM	0	0	0	0	0	6	0	0	0	6	0	0	0	0	1	1	1	1	1
07:45 AM	0	0	0	0	0	6	0	0	0	6	1	0	0	0	2	0	0	0	0
Total	0	0	0	0	0	20	0	0	1	3	1	3	1	1	5	2	28	30	
08:00 AM	0	0	0	0	0	1	4	0	0	5	0	0	0	0	0	0	0	0	0
08:15 AM	0	0	0	0	0	1	0	0	0	1	0	0	0	0	1	0	0	0	0
08:30 AM	0	0	1	0	1	0	2	0	0	2	0	0	0	0	1	0	0	0	0
08:45 AM	0	0	0	0	0	1	6	0	0	7	0	0	2	0	1	0	0	0	0
Total	0	0	1	0	1	2	13	0	0	15	0	2	0	2	4	0	22	22	
Grand Total	0	0	1	0	1	2	33	0	0	35	2	0	3	1	5	1	7	1	1
Apprch %	0	0	100		5.7	94.3	0			40	0	60		11.1	77.8	11.1			2
Total %	0	0	2		4	66	0			70	4	6		2	14	2			18
																			3.8
																			96.2

3.145

Start Time	Wood Road Southbound				Van Buren Boulevard Westbound				Wood Road Northbound				Van Buren Boulevard Eastbound						
	Left	Thru	Right	RTOR	App. Total	Left	Thru	Right	RTOR	App. Total	Left	Thru	Right	RTOR	App. Total	Exclu. Total	Inclu. Total	Int. Total	
07:00 AM	0	0	0	0	0	0	4	0	0	4	0	0	1	1	0	0	0	0	0
07:15 AM	0	0	0	0	0	4	0	0	0	4	0	0	0	0	0	1	0	0	0
07:30 AM	0	0	0	0	0	6	0	0	0	6	1	0	0	0	0	1	1	1	1
07:45 AM	0	0	0	0	0	6	0	0	0	6	1	0	0	0	2	0	0	0	0
Total Volume	0	0	0	0	0	20	0	0	1	3	2	0	1	3	3	1	5	5	
% App. Total	0	0	0		0	100	0			0	66.7	0	33.3		60	20			
PHF	.000	.000	.000		.000	.833	.000	.833	.000	.750	.250	.250	.375	.250	.417	.250			.700

Peak Hour Analysis From 07:00 AM to 07:45 AM - Peak 1 of 1
 Peak Hour for Entire Intersection Begins at 07:00 AM

Counts Unlimited
 PO Box 1178
 Corona, CA 92878
 (951) 268-6268

City of Riverside
 N/S: Wood Road
 E/W: Van Buren Boulevard
 Weather: Clear

File Name : 02_RIV_Wood_Van Buren AM
 Site Code : 05119542
 Start Date : 8/20/2019
 Page No : 2

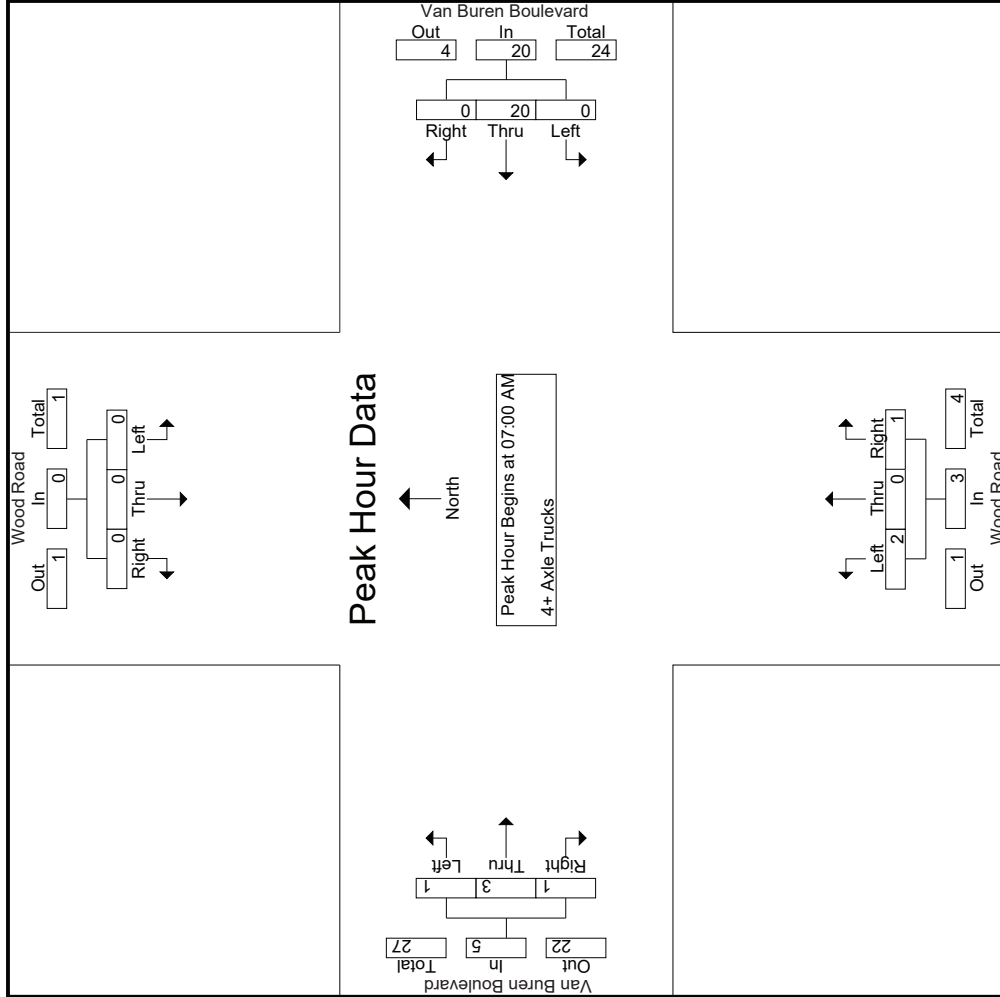

Counts Unlimited
 PO Box 1178
 Corona, CA 92878
 (951) 268-6268

City of Riverside
 N/S: Wood Road
 E/W: Van Buren Boulevard
 Weather: Clear

File Name : 02_RIV_Wood_Van Buren AM
 Site Code : 05119542
 Start Date : 8/20/2019
 Page No : 3

Start Time	Wood Road Southbound			Van Buren Boulevard Westbound			Wood Road Northbound			Van Buren Boulevard Eastbound		
	Left	Thru	Right	Left	Thru	Right	Left	Thru	Right	Left	Thru	Right
Peak Hour Analysis From 07:00 AM to 07:45 AM - Peak 1 of 1												
Peak Hour for Each Approach Begins at:												
	07:00 AM			07:00 AM			07:00 AM			07:00 AM		
+0 mins.	0	0	0	4	0	0	4	0	0	1	0	0
+15 mins.	0	0	0	4	0	0	4	0	0	0	1	0
+30 mins.	0	0	0	6	0	0	6	0	0	0	0	1
+45 mins.	0	0	0	6	0	0	6	0	0	1	2	0
Total Volume	0	0	0	20	0	0	20	0	1	3	3	1
% App. Total	0	0	0	100	0	0	100	0	33.3	75	60	20
PHF	.000	.000	.000	.833	.000	.000	.833	.000	.250	.750	.375	.250
	07:00 AM			07:00 AM			07:00 AM			07:00 AM		
	0	0	0	4	0	0	4	0	0	1	0	0
	0	0	0	4	0	0	4	0	0	0	1	0
	0	0	0	6	0	0	6	0	0	0	0	1
	0	0	0	6	0	0	6	0	0	1	2	0
	0	0	0	20	0	0	20	0	1	3	3	1
	0	0	0	100	0	0	100	0	33.3	75	60	20
	.000	.000	.000	.833	.000	.000	.833	.000	.250	.750	.375	.250
	07:00 AM			07:00 AM			07:00 AM			07:00 AM		
	0	0	0	4	0	0	4	0	0	1	0	0
	0	0	0	4	0	0	4	0	0	0	1	0
	0	0	0	6	0	0	6	0	0	0	0	1
	0	0	0	6	0	0	6	0	0	1	2	0
	0	0	0	20	0	0	20	0	1	3	3	1
	0	0	0	100	0	0	100	0	33.3	75	60	20
	.000	.000	.000	.833	.000	.000	.833	.000	.250	.750	.375	.250
	07:00 AM			07:00 AM			07:00 AM			07:00 AM		
	0	0	0	4	0	0	4	0	0	1	0	0
	0	0	0	4	0	0	4	0	0	0	1	0
	0	0	0	6	0	0	6	0	0	0	0	1
	0	0	0	6	0	0	6	0	0	1	2	0
	0	0	0	20	0	0	20	0	1	3	3	1
	0	0	0	100	0	0	100	0	33.3	75	60	20
	.000	.000	.000	.833	.000	.000	.833	.000	.250	.750	.375	.250

Counts Unlimited
 PO Box 1178
 Corona, CA 92878
 (951) 268-6268

City of Riverside
 N/S: Wood Road
 E/W: Van Buren Boulevard
 Weather: Clear

File Name : 02_RIV_Wood_Van Buren PM
 Site Code : 05119542
 Start Date : 8/20/2019
 Page No : 1

Groups Printed- Passenger Vehicles - Large 2 Axle Vehicles - 3 Axle Vehicles - 4+ Axle Trucks

Start Time	Wood Road Southbound						Van Buren Boulevard Westbound						Wood Road Northbound						Van Buren Boulevard Eastbound					
	Left	Thru	Right	RTOR	App. Total		Left	Thru	Right	RTOR	App. Total		Left	Thru	Right	RTOR	App. Total		Left	Thru	Right	RTOR	App. Total	
04:00 PM	23	50	22	9	95	66	238	15	4	319	46	49	39	10	134	42	310	65	25	417	48	965	1013	
04:15 PM	24	65	26	13	115	73	212	15	8	300	43	33	44	29	120	19	293	47	11	359	61	894	955	
04:30 PM	13	86	40	14	139	67	206	11	6	284	70	62	47	16	179	38	313	57	26	408	62	1010	1072	
04:45 PM	17	74	39	20	130	70	262	15	11	347	53	51	47	20	151	33	310	61	23	404	74	1032	1106	
Total	77	275	127	56	479	276	918	56	29	1250	212	195	177	75	584	132	1226	230	85	1588	245	3901	4146	
05:00 PM	23	77	44	26	144	61	238	16	8	315	46	62	50	12	158	34	307	56	21	397	67	1014	1081	
05:15 PM	30	76	56	17	162	43	252	16	7	311	44	60	31	10	135	46	351	68	29	465	63	1073	1136	
05:30 PM	26	59	52	24	137	90	223	14	4	327	44	49	33	22	126	33	344	59	26	436	76	1026	1102	
05:45 PM	12	74	60	25	147	72	210	8	5	290	46	41	51	27	138	29	288	42	12	359	69	933	1002	
Total	91	286	212	92	589	266	923	54	24	1243	180	212	165	71	557	142	1290	225	88	1657	275	4046	4321	
Grand Total	168	561	339	148	1068	542	1841	110	53	2493	392	407	342	146	1141	274	2516	455	173	3245	520	7947	8467	
Approch %	15.7	52.5	31.7			21.7	73.8	4.4			34.4	35.7	30			8.4	77.5	14			6.1	93.9		
Total %	2.1	7.1	4.3			6.8	23.2	1.4			4.9	5.1	4.3			3.4	31.7	5.7			40.8			
Passenger Vehicles	166	556	336		1204	538	1799	107		2496	387	403	337		1273	274	2457	449		3352	0	0	8325	
% Passenger Vehicles	98.8	99.1	99.1	98.6	99	99.3	97.7	97.3	98.1	98	98.7	99	98.5	100	98.9	100	97.7	98.7	99.4	98.1	0	0	98.3	
Large 2 Axle Vehicles	1	4	2		8	4	29	2		36	5	4	5		14	0	38	6		45	0	0	103	
% Large 2 Axle Vehicles	0.6	0.7	0.6	0.7	0.7	0.7	1.6	1.8	1.9	1.4	1.3	1	1.5	0	1.1	0	1.5	1.3	0.6	1.3	0	0	1.2	
3 Axle Vehicles	1	1	0		2	0	2	1		3	0	0	0		0	0	7	0		7	0	0	12	
% 3 Axle Vehicles	0.6	0.2	0	0	0.2	0	0.1	0.9	0	0.1	0	0	0	0	0	0	0.3	0	0	0.2	0	0	0.1	
4+ Axle Trucks	0	0	1		2	0	11	0		11	0	0	0		0	0	14	0		14	0	0	27	
% 4+ Axle Trucks	0	0	0.3	0.7	0.2	0	0.6	0	0	0.4	0	0	0	0	0	0	0.6	0	0	0.4	0	0	0.3	

Start Time	Wood Road Southbound			Van Buren Boulevard Westbound			Wood Road Northbound			Van Buren Boulevard Eastbound		
	Left	Thru	Right	Left	Thru	Right	Left	Thru	Right	Left	Thru	Right
04:45 PM	17	74	39	70	262	15	53	51	47	151	310	61
05:00 PM	23	77	44	61	238	16	46	62	50	158	307	56
05:15 PM	30	76	56	43	252	14	44	60	31	135	344	59
05:30 PM	26	59	52	90	223	14	44	49	33	126	344	59
05:45 PM	17	74	39	70	262	15	53	51	47	151	310	61
Total Volume	96	286	191	264	975	61	187	222	161	570	1312	244
% App. Total	16.8	49.9	33.3	20.3	75	4.7	32.8	38.9	28.2	8.6	77.1	14.3
PHF	.800	.929	.853	.733	.930	.953	.882	.895	.805	.902	.934	.897

Peak Hour Analysis From 04:00 PM to 05:45 PM - Peak 1 of 1

Peak Hour for Entire Intersection Begins at 04:45 PM

Counts Unlimited
 PO Box 1178
 Corona, CA 92878
 (951) 268-6268

City of Riverside
 N/S: Wood Road
 E/W: Van Buren Boulevard
 Weather: Clear

File Name : 02_RIV_Wood_Van Buren PM
 Site Code : 05119542
 Start Date : 8/20/2019
 Page No : 2

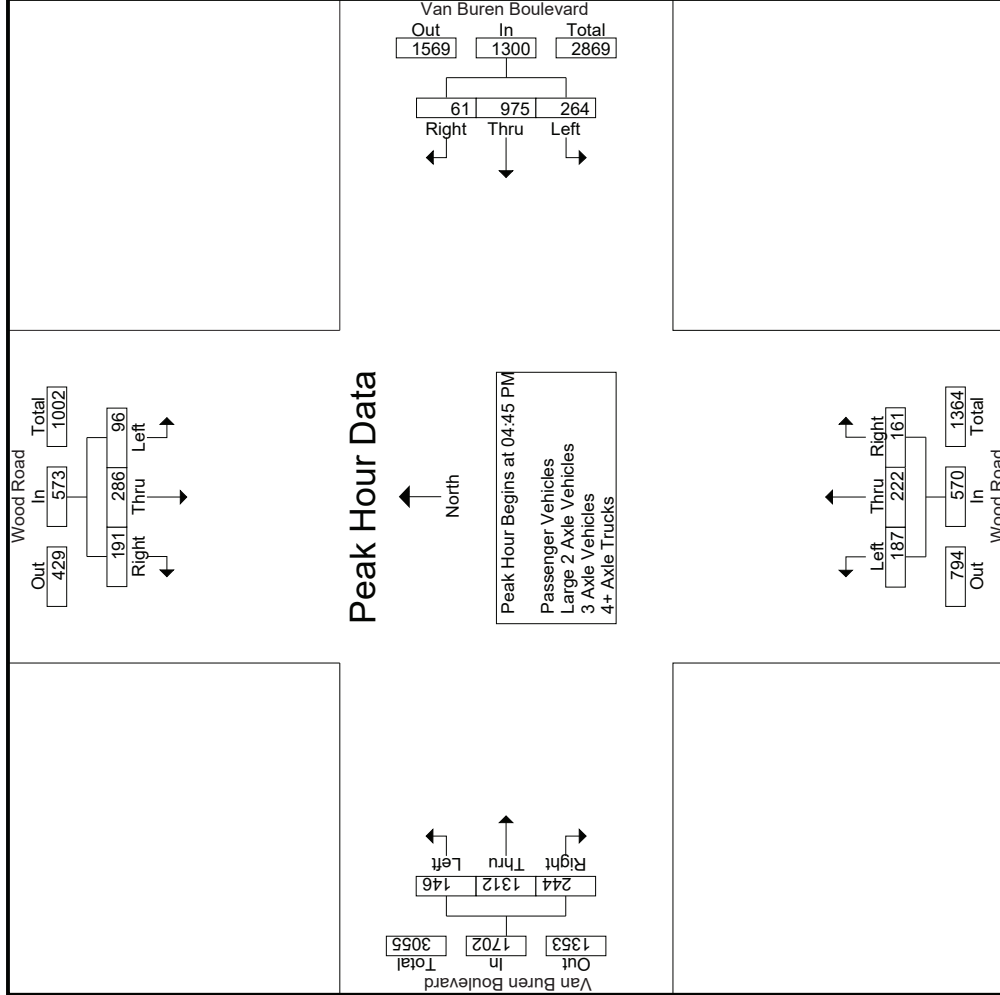

Counts Unlimited
 PO Box 1178
 Corona, CA 92878
 (951) 268-6268

City of Riverside
 N/S: Wood Road
 E/W: Van Buren Boulevard
 Weather: Clear

File Name : 02_RIV_Wood_Van Buren PM
 Site Code : 05119542
 Start Date : 8/20/2019
 Page No : 3

Start Time	Wood Road Southbound			Van Buren Boulevard Westbound			Wood Road Northbound			Van Buren Boulevard Eastbound				
	Left	Thru	Right	Left	Thru	Right	Left	Thru	Right	Left	Thru	Right	App. Total	Int. Total
Peak Hour Analysis From 04:00 PM to 05:45 PM - Peak 1 of 1														
Peak Hour for Each Approach Begins at:														
	05:00 PM			04:45 PM			04:30 PM			04:45 PM				
+0 mins.	23	77	44	70	262	15	347	70	62	47	33	310	61	404
+15 mins.	30	76	56	61	238	16	315	53	51	47	34	307	56	397
+30 mins.	26	59	52	43	252	16	311	46	62	50	46	351	68	465
+45 mins.	12	74	60	90	223	14	327	44	60	31	33	344	59	436
Total Volume	91	286	212	264	975	61	1300	213	235	175	146	1312	244	1702
% App. Total	15.4	48.6	36	20.3	75	4.7	937	34.2	37.7	28.1	8.6	77.1	14.3	
PHF	.758	.929	.883	.733	.930	.953	.937	.761	.948	.875	.793	.934	.897	.915

Groups Printed- Passenger Vehicles

Start Time	Wood Road Southbound						Van Buren Boulevard Westbound						Wood Road Northbound						Van Buren Boulevard Eastbound					
	Left	Thru	Right	RTOR	App. Total	Inclu. Total	Left	Thru	Right	RTOR	App. Total	Inclu. Total	Left	Thru	Right	RTOR	App. Total	Inclu. Total	Left	Thru	Right	RTOR	App. Total	Inclu. Total
	04:00 PM	23	49	20	8	92	66	230	15	4	311	44	47	38	10	129	42	300	65	25	407	47	939	986
04:15 PM	24	64	26	13	114	73	211	15	8	299	43	33	42	29	118	19	285	46	11	350	61	881	942	
04:30 PM	12	85	40	14	137	66	203	9	5	278	69	61	47	16	177	38	309	57	26	404	61	996	1057	
04:45 PM	17	73	39	20	129	69	253	15	11	337	52	51	47	20	150	33	296	60	23	389	74	1005	1079	
Total	76	271	125	55	472	274	897	54	28	1225	208	192	174	75	574	132	1190	228	85	1550	243	3821	4064	
05:00 PM	22	76	44	26	142	61	231	16	8	308	46	62	50	12	158	34	296	55	21	385	67	993	1060	
05:15 PM	30	76	56	17	162	43	247	16	7	306	44	59	29	10	132	46	348	67	29	461	63	1061	1124	
05:30 PM	26	59	52	24	137	89	218	13	4	320	43	49	33	22	125	33	339	58	25	430	75	1012	1087	
05:45 PM	12	74	59	24	145	71	206	8	5	285	46	41	51	27	138	29	284	41	12	354	68	922	990	
Total	90	285	211	91	586	264	902	53	24	1219	179	211	163	71	553	142	1267	221	87	1630	273	3988	4261	
Grand Total	166	556	336	146	1058	538	1799	107	52	2444	387	403	337	146	1127	274	2457	449	172	3180	516	7809	8325	
Approch %	15.7	52.6	31.8			22	73.6	4.4		34.3	35.8	29.9		14.4		8.6	77.3	14.1		40.7	6.2	93.8		
Total %	2.1	7.1	4.3		13.5	6.9	23	1.4		31.3	5	5.2	4.3		14.4	3.5	31.5	5.7						

Start Time	Wood Road Southbound						Van Buren Boulevard Westbound						Wood Road Northbound						Van Buren Boulevard Eastbound					
	Left	Thru	Right	RTOR	App. Total	Inclu. Total	Left	Thru	Right	RTOR	App. Total	Inclu. Total	Left	Thru	Right	RTOR	App. Total	Inclu. Total	Left	Thru	Right	RTOR	App. Total	Inclu. Total
	04:45 PM	17	73	39		129	69	253	15		337	52	51	47		150	33	296	60		389	60	389	1005
05:00 PM	22	76	44		142	61	231	16		308	46	62	50		158	34	296	55		385	55	385	993	
05:15 PM	30	76	56		162	43	247	16		306	44	59	29		132	46	348	67		461	63	461	1061	
05:30 PM	26	59	52		137	89	218	13		320	43	49	33		125	33	339	58		430	75	430	1012	
Total Volume	95	284	191		570	262	949	60		1271	185	221	159		565	146	1279	240		1665	240	1665	4071	
% App. Total	16.7	49.8	33.5		33.5	20.6	74.7	4.7		4.7	32.7	39.1	28.1		28.1	8.8	76.8	14.4		9.0	14.4	9.0	9.0	
PHF	.792	.934	.853		.880	.736	.938	.938		.943	.889	.891	.795		.894	.793	.919	.896		.903	.919	.903	.959	

Peak Hour Analysis From 04:45 PM to 05:30 PM - Peak 1 of 1
 Peak Hour for Entire Intersection Begins at 04:45 PM

Counts Unlimited
 PO Box 1178
 Corona, CA 92878
 (951) 268-6268

City of Riverside
 N/S: Wood Road
 E/W: Van Buren Boulevard
 Weather: Clear

File Name : 02_RIV_Wood_Van Buren PM
 Site Code : 05119542
 Start Date : 8/20/2019
 Page No : 2

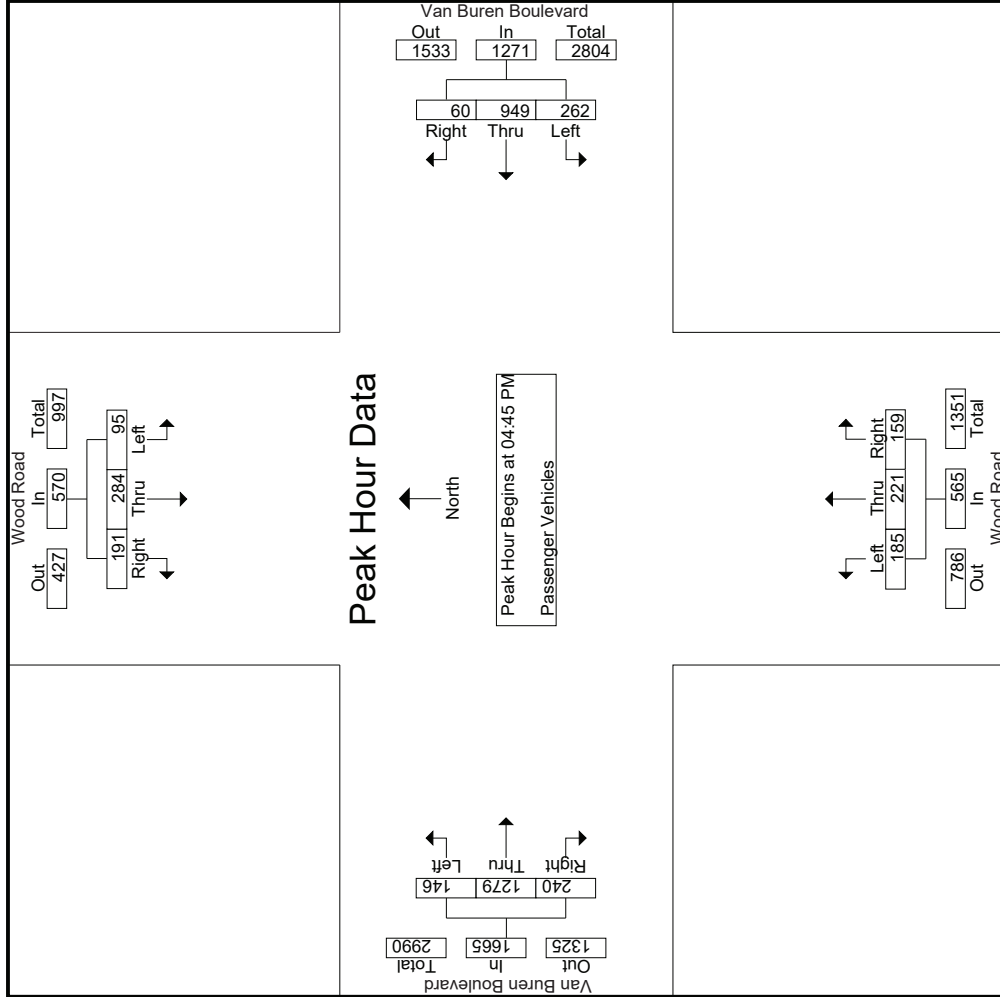

Counts Unlimited
 PO Box 1178
 Corona, CA 92878
 (951) 268-6268

City of Riverside
 N/S: Wood Road
 E/W: Van Buren Boulevard
 Weather: Clear

File Name : 02_RIV_Wood_Van Buren PM
 Site Code : 05119542
 Start Date : 8/20/2019
 Page No : 3

Start Time	Wood Road Southbound			Van Buren Boulevard Westbound			Wood Road Northbound			Van Buren Boulevard Eastbound					
	Left	Thru	Right	Left	Thru	Right	Left	Thru	Right	Left	Thru	Right	App. Total	Int. Total	
Peak Hour Analysis From 04:45 PM to 05:30 PM - Peak 1 of 1															
Peak Hour for Each Approach Begins at:															
	04:45 PM			04:45 PM			04:45 PM			04:45 PM			04:45 PM		
+0 mins.	17	73	39	69	253	15	337	51	47	150	33	296	60	389	
+15 mins.	22	76	44	61	231	16	308	62	50	158	34	296	55	385	
+30 mins.	30	76	56	43	247	16	306	59	29	132	46	348	67	461	
+45 mins.	26	59	52	89	218	13	320	49	33	125	33	339	58	430	
Total Volume	95	284	191	262	949	60	1271	221	159	565	146	1279	240	1665	
% App. Total	16.7	49.8	33.5	20.6	74.7	4.7	32.7	39.1	28.1	8.8	76.8	14.4			
PHF	.792	.934	.853	.736	.938	.938	.943	.891	.795	.894	.793	.919	.896	.903	

Groups Printed- Large 2 Axle Vehicles

Start Time	Wood Road Southbound				Van Buren Boulevard Westbound				Wood Road Northbound				Van Buren Boulevard Eastbound								
	Left	Thru	Right	RTOR	Left	Thru	Right	RTOR	Left	Thru	Right	RTOR	Left	Thru	Right	RTOR					
04:00 PM	0	1	2	1	3	0	3	0	3	2	2	1	0	5	0	6	0	6	1	17	18
04:15 PM	0	0	0	0	0	0	0	0	0	0	0	2	0	2	0	3	1	4	0	6	6
04:30 PM	0	1	0	0	1	1	1	1	3	1	1	0	0	2	0	3	0	3	1	9	10
04:45 PM	0	1	0	0	1	1	7	0	8	1	0	0	0	1	0	8	1	9	0	19	19
Total	0	3	2	1	5	2	11	1	14	4	3	3	0	10	0	20	2	0	2	51	53
05:00 PM	1	1	0	0	2	0	6	0	6	0	0	0	0	0	0	9	1	0	0	18	18
05:15 PM	0	0	0	0	0	0	4	0	4	0	1	2	0	3	0	3	1	0	0	11	11
05:30 PM	0	0	0	0	0	1	5	1	7	1	0	0	0	1	0	4	1	1	0	13	14
05:45 PM	0	0	0	0	0	1	3	0	4	0	0	0	0	0	0	2	1	0	0	7	7
Total	1	1	0	0	2	2	18	1	21	1	1	2	0	4	0	18	4	1	22	49	50
Grand Total	1	4	2	1	7	4	29	2	35	5	4	5	0	14	0	38	6	1	44	100	103
Approch %	14.3	57.1	28.6			11.4	82.9	5.7	35.7	28.6	35.7			14	0	86.4	13.6		44	2.9	97.1
Total %	1	4	2			4	29	2	35	5	4	5		14	0	38	6		44	2.9	97.1

Start Time	Wood Road Southbound				Van Buren Boulevard Westbound				Wood Road Northbound				Van Buren Boulevard Eastbound									
	Left	Thru	Right	RTOR	Left	Thru	Right	RTOR	Left	Thru	Right	RTOR	Left	Thru	Right	RTOR						
04:45 PM	0	1	0	0	1	7	0	0	8	1	0	0	0	0	8	1	0	0	8	1	9	19
05:00 PM	1	1	0	0	2	6	0	0	6	0	0	0	0	0	9	1	0	0	10	1	18	18
05:15 PM	0	0	0	0	0	4	0	0	4	0	0	1	0	2	3	1	0	0	4	1	11	11
05:30 PM	0	0	0	0	0	1	5	1	7	1	0	0	0	1	0	4	1	1	5	1	13	14
05:45 PM	0	0	0	0	0	1	3	0	4	0	0	0	0	0	2	1	0	0	3	0	7	7
Total	1	2	0	0	3	22	1	25	25	2	1	2	0	5	0	24	4	0	28	4	61	61
% App. Total	33.3	66.7	0			8	88	4	4	40	20	40		85.7	14.3							
PHF	.250	.500	.000			.500	.786	.250	.781	.500	.250	.250		.417	.000	.667	1.00		.700		.803	

Peak Hour Analysis From 04:45 PM to 05:30 PM - Peak 1 of 1
 Peak Hour for Entire Intersection Begins at 04:45 PM

Counts Unlimited
 PO Box 1178
 Corona, CA 92878
 (951) 268-6268

City of Riverside
 N/S: Wood Road
 E/W: Van Buren Boulevard
 Weather: Clear

File Name : 02_RIV_Wood_Van Buren PM
 Site Code : 05119542
 Start Date : 8/20/2019
 Page No : 2

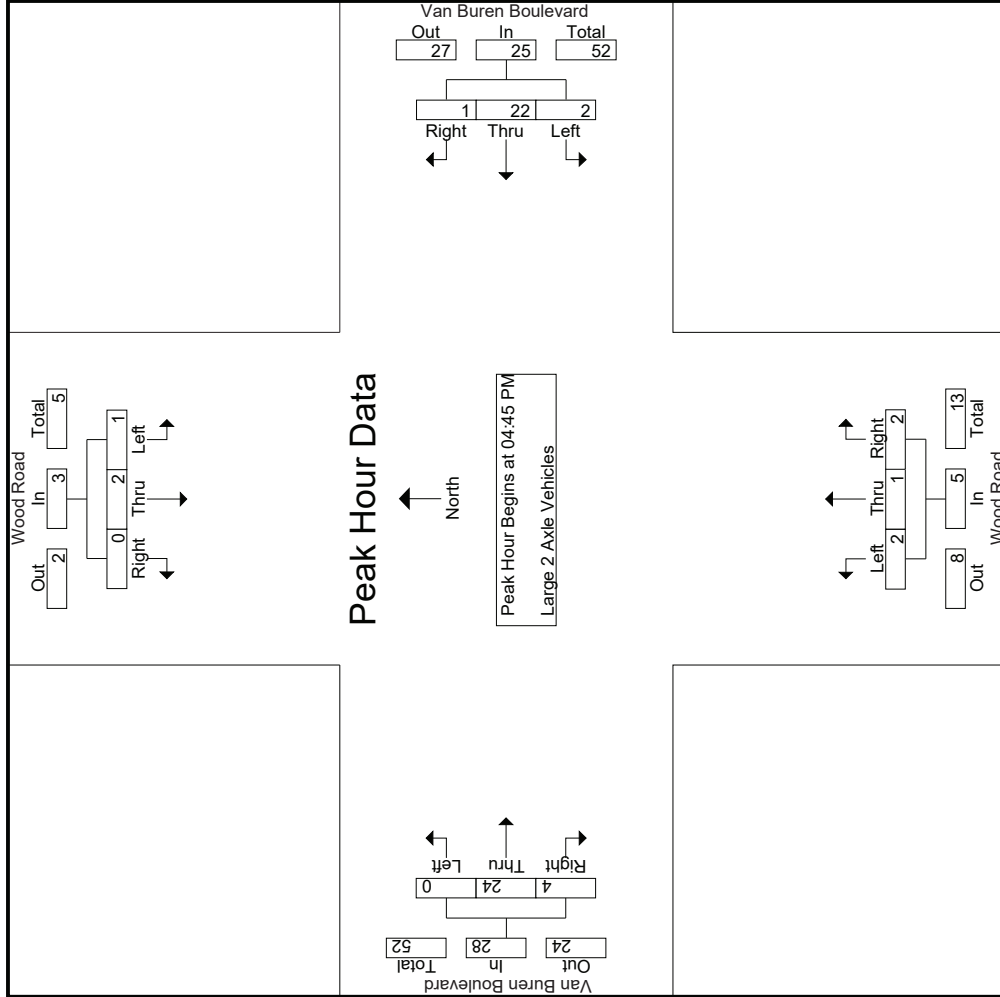

Counts Unlimited
 PO Box 1178
 Corona, CA 92878
 (951) 268-6268

City of Riverside
 N/S: Wood Road
 E/W: Van Buren Boulevard
 Weather: Clear

File Name : 02_RIV_Wood_Van Buren PM
 Site Code : 05119542
 Start Date : 8/20/2019
 Page No : 3

Start Time	Wood Road Southbound			Van Buren Boulevard Westbound			Wood Road Northbound			Van Buren Boulevard Eastbound					
	Left	Thru	Right	Left	Thru	Right	Left	Thru	Right	Left	Thru	Right			
Peak Hour Analysis From 04:45 PM to 05:30 PM - Peak 1 of 1															
Peak Hour for Each Approach Begins at:															
+0 mins.	0	1	0	1	7	0	8	1	0	0	0	0	0	8	1
+15 mins.	1	1	0	0	6	0	6	0	0	0	0	0	0	9	1
+30 mins.	0	0	0	0	4	0	4	0	0	1	2	3	0	3	1
+45 mins.	0	0	0	1	5	1	7	1	0	0	0	0	0	4	1
Total Volume	1	2	0	2	22	1	25	2	1	1	2	5	0	24	4
% App. Total	33.3	66.7	0	8	88	4	4	40	20	20	40	40	0	85.7	14.3
PHF	.250	.500	.000	.375	.786	.250	.781	.500	.250	.250	.250	.417	.000	.667	1.000
															.700

Groups Printed- 3 Axle Vehicles

Start Time	Wood Road Southbound			Van Buren Boulevard Westbound			Wood Road Northbound			Van Buren Boulevard Eastbound			Inclu. Total	Int. Total
	Left	Thru	Right	Left	Thru	Right	Left	Thru	Right	Left	Thru	Right		
04:00 PM	0	0	0	0	0	0	0	0	0	0	0	0	0	1
04:15 PM	0	1	0	0	0	0	0	0	0	0	3	0	0	4
04:30 PM	1	0	0	0	1	0	0	0	0	0	0	0	0	2
04:45 PM	0	0	0	0	0	1	0	0	0	0	2	0	0	3
Total	1	1	0	0	2	1	0	0	0	0	5	0	0	10
05:00 PM	0	0	0	0	0	0	0	0	0	0	0	0	0	0
05:15 PM	0	0	0	0	0	0	0	0	0	0	0	0	0	0
05:30 PM	0	0	0	0	0	0	0	0	0	0	0	0	0	0
05:45 PM	0	0	0	0	0	0	0	0	0	0	2	0	0	2
Total	0	0	0	0	0	0	0	0	0	0	2	0	0	2
Grand Total	1	1	0	0	2	1	0	0	0	0	7	0	0	12
Approch %	50	50	0	0	66.7	33.3	0	0	0	0	100	0	0	100
Total %	8.3	8.3	0	0	16.7	8.3	0	0	0	0	58.3	0	0	100

3.1-57

Start Time	Wood Road Southbound			Van Buren Boulevard Westbound			Wood Road Northbound			Van Buren Boulevard Eastbound			Inclu. Total	Int. Total
	Left	Thru	Right	Left	Thru	Right	Left	Thru	Right	Left	Thru	Right		
04:45 PM	0	0	0	0	0	0	0	0	0	0	0	0	0	0
05:00 PM	0	0	0	0	0	0	0	0	0	0	0	0	0	0
05:15 PM	0	0	0	0	0	0	0	0	0	0	0	0	0	0
05:30 PM	0	0	0	0	0	0	0	0	0	0	0	0	0	0
Total Volume	0	0	0	0	0	0	0	0	0	0	0	0	0	0
% App. Total	0	0	0	0	0	0	0	0	0	0	0	0	0	0
PHF	.000	.000	.000	.000	.000	.250	.000	.250	.000	.000	.250	.000	.250	.250

Peak Hour Analysis From 04:45 PM to 05:30 PM - Peak 1 of 1
 Peak Hour for Entire Intersection Begins at 04:45 PM

Counts Unlimited
 PO Box 1178
 Corona, CA 92878
 (951) 268-6268

City of Riverside
 N/S: Wood Road
 E/W: Van Buren Boulevard
 Weather: Clear

File Name : 02_RIV_Wood_Van Buren PM
 Site Code : 05119542
 Start Date : 8/20/2019
 Page No : 2

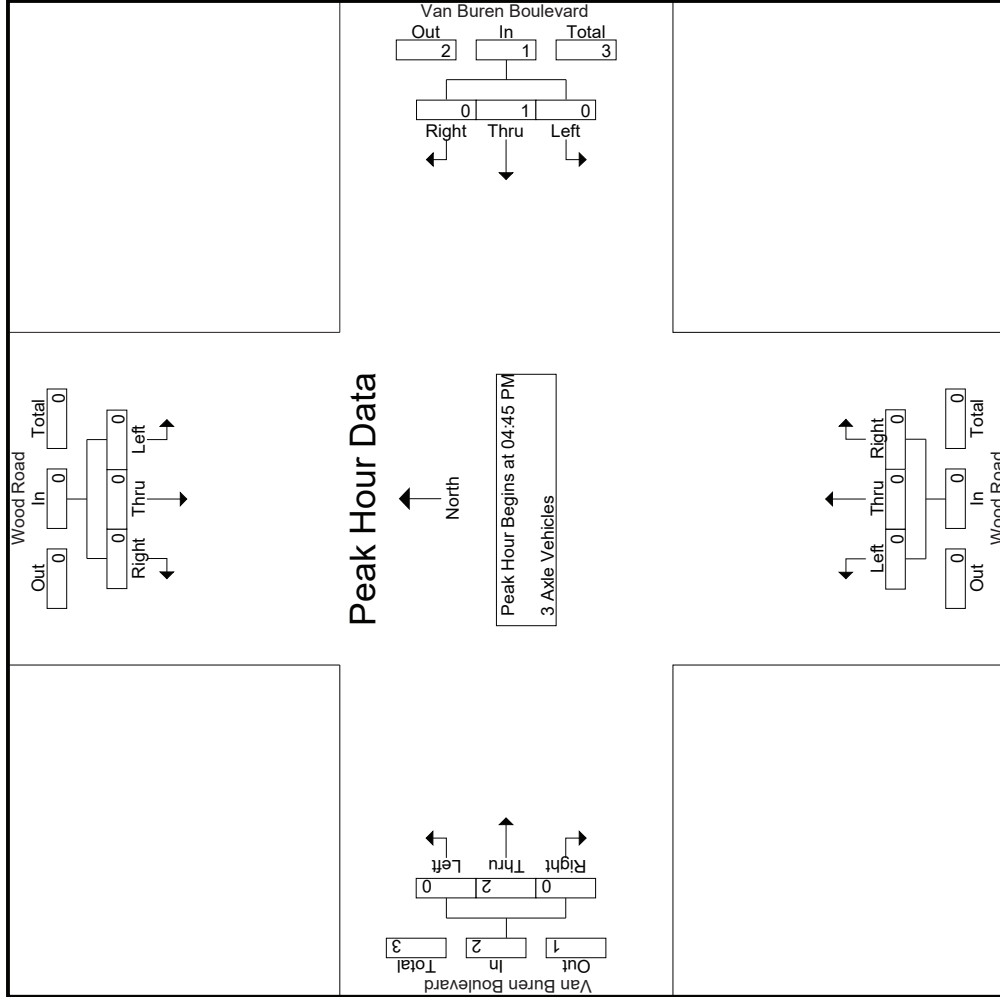

Counts Unlimited
 PO Box 1178
 Corona, CA 92878
 (951) 268-6268

City of Riverside
 N/S: Wood Road
 E/W: Van Buren Boulevard
 Weather: Clear

File Name : 02_RIV_Wood_Van Buren PM
 Site Code : 05119542
 Start Date : 8/20/2019
 Page No : 3

Start Time	Wood Road Southbound			Van Buren Boulevard Westbound			Wood Road Northbound			Van Buren Boulevard Eastbound					
	Left	Thru	Right	Left	Thru	Right	Left	Thru	Right	Left	Thru	Right	App. Total	Int. Total	
Peak Hour Analysis From 04:45 PM to 05:30 PM - Peak 1 of 1															
Peak Hour for Each Approach Begins at:															
	04:45 PM			04:45 PM			04:45 PM			04:45 PM			04:45 PM		
+0 mins.	0	0	0	0	1	0	0	0	0	0	0	0	0	2	
+15 mins.	0	0	0	0	0	0	0	0	0	0	0	0	0	0	
+30 mins.	0	0	0	0	0	0	0	0	0	0	0	0	0	0	
+45 mins.	0	0	0	0	0	0	0	0	0	0	0	0	0	0	
Total Volume	0	0	0	0	1	0	0	0	0	0	0	0	2	0	
% App. Total	0	0	0	0	100	0	0	0	0	0	0	0	100	0	
PHF	.000	.000	.000	.000	.250	.000	.000	.250	.000	.000	.000	.000	.250	.250	

Groups Printed- 4+ Axle Trucks

Start Time	Wood Road Southbound				Van Buren Boulevard Westbound				Wood Road Northbound				Van Buren Boulevard Eastbound					
	Left	Thru	Right	RTOR	App. Total	Left	Thru	Right	RTOR	App. Total	Left	Thru	Right	RTOR	App. Total	Exclu. Total	Inclu. Total	Int. Total
04:00 PM	0	0	0	0	0	0	4	0	0	4	0	0	0	0	4	0	8	8
04:15 PM	0	0	0	0	0	0	1	0	0	1	0	0	0	0	2	0	3	3
04:30 PM	0	0	0	0	0	0	2	0	0	2	0	0	0	0	1	0	3	3
04:45 PM	0	0	0	0	0	0	1	0	0	1	0	0	0	0	4	0	5	5
Total	0	0	0	0	0	0	8	0	0	8	0	0	0	0	11	0	19	19
05:00 PM	0	0	0	0	0	0	1	0	0	1	0	0	0	0	2	0	3	3
05:15 PM	0	0	0	0	0	0	1	0	0	1	0	0	0	0	0	0	1	1
05:30 PM	0	0	0	0	0	0	0	0	0	0	0	0	0	0	1	0	1	1
05:45 PM	0	0	1	1	1	0	1	0	0	1	0	0	0	0	0	1	2	3
Total	0	0	1	1	1	0	3	0	0	3	0	0	0	0	3	1	7	8
Grand Total	0	0	1	1	1	0	11	0	0	11	0	0	0	0	14	1	26	27
Approch %	0	0	100		3.8	0	100	0		42.3	0	0	0		53.8	3.7	96.3	
Total %	0	0	3.8		3.8	0	42.3	0		42.3	0	0	0		53.8		96.3	

Start Time	Wood Road Southbound				Van Buren Boulevard Westbound				Wood Road Northbound				Van Buren Boulevard Eastbound					
	Left	Thru	Right	RTOR	App. Total	Left	Thru	Right	RTOR	App. Total	Left	Thru	Right	RTOR	App. Total	Exclu. Total	Inclu. Total	Int. Total
04:45 PM	0	0	0	0	0	0	1	0	0	1	0	0	0	0	0	0	4	5
05:00 PM	0	0	0	0	0	0	1	0	0	1	0	0	0	0	2	0	2	3
05:15 PM	0	0	0	0	0	0	1	0	0	1	0	0	0	0	0	0	1	1
05:30 PM	0	0	0	0	0	0	0	0	0	0	0	0	0	0	1	0	1	1
Total Volume	0	0	0	0	0	0	3	0	0	3	0	0	0	0	7	0	7	10
% App. Total	0	0	0	0	0	0	100	0		75.0	0	0	0		100	0	438	500
PHF	.000	.000	.000	.000	.000	.000	.750	.000		.750	.000	.000	.000		.438	.000	.438	.500

Peak Hour Analysis From 04:45 PM to 05:30 PM - Peak 1 of 1
 Peak Hour for Entire Intersection Begins at 04:45 PM

Counts Unlimited
 PO Box 1178
 Corona, CA 92878
 (951) 268-6268

City of Riverside
 N/S: Wood Road
 E/W: Van Buren Boulevard
 Weather: Clear

File Name : 02_RIV_Wood_Van Buren PM
 Site Code : 05119542
 Start Date : 8/20/2019
 Page No : 2

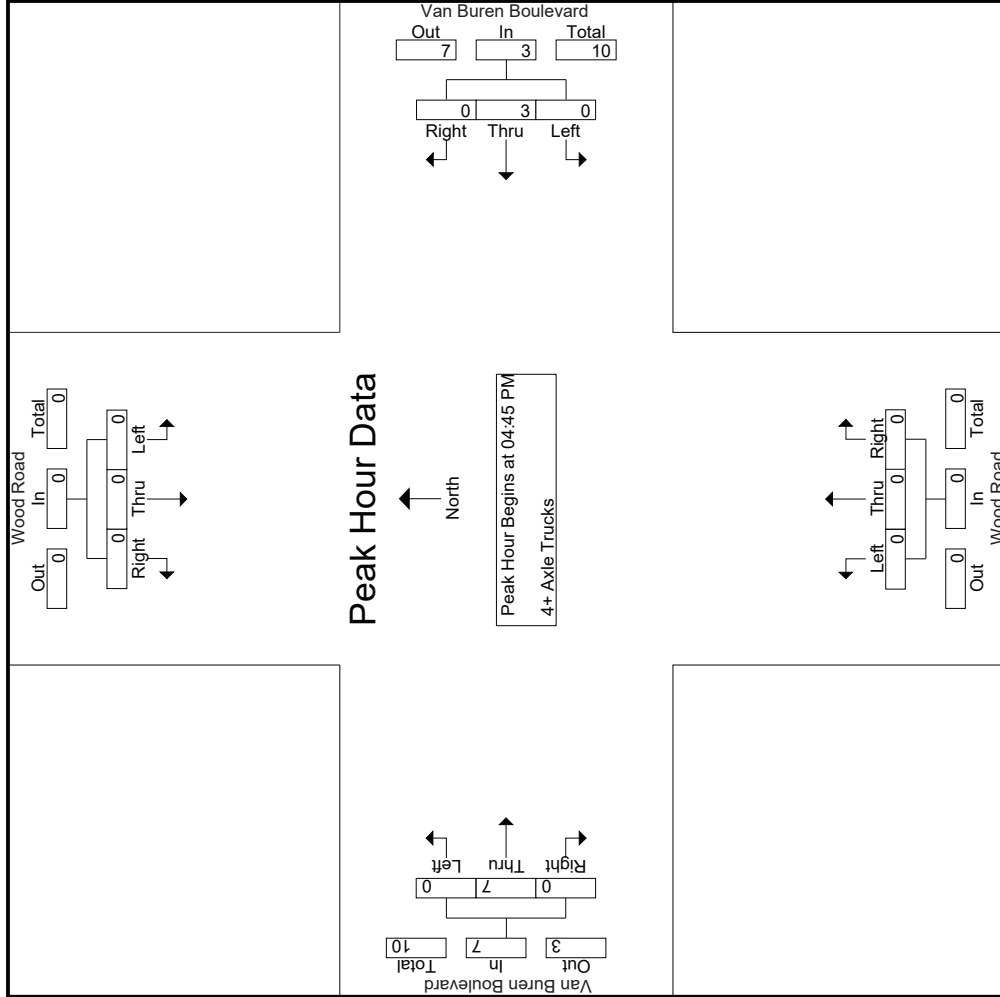

Counts Unlimited
 PO Box 1178
 Corona, CA 92878
 (951) 268-6268

City of Riverside
 N/S: Wood Road
 E/W: Van Buren Boulevard
 Weather: Clear

File Name : 02_RIV_Wood_Van Buren PM
 Site Code : 05119542
 Start Date : 8/20/2019
 Page No : 3

Start Time	Wood Road Southbound			Van Buren Boulevard Westbound			Wood Road Northbound			Van Buren Boulevard Eastbound					
	Left	Thru	Right	Left	Thru	Right	Left	Thru	Right	Left	Thru	Right	App. Total	Int. Total	
Peak Hour Analysis From 04:45 PM to 05:30 PM - Peak 1 of 1															
Peak Hour for Each Approach Begins at:															
	04:45 PM			04:45 PM			04:45 PM			04:45 PM			04:45 PM		
+0 mins.	0	0	0	0	1	0	0	0	0	0	0	0	0	4	
+15 mins.	0	0	0	0	1	0	0	0	0	0	0	0	2	2	
+30 mins.	0	0	0	0	1	0	0	0	0	0	0	0	0	0	
+45 mins.	0	0	0	0	0	0	0	0	0	0	0	1	0	1	
Total Volume	0	0	0	0	3	0	0	0	0	0	0	7	0	7	
% App. Total	0	0	0	0	100	0	0	0	0	0	0	100	0	100	
PHF	.000	.000	.000	.000	.750	.000	.000	.750	.000	.000	.000	.438	.000	.438	

Location: Riverside
 N/S: Wood Road
 E/W: Van Buren Boulevard



Date: 8/20/2019
 Day: Tuesday

PEDESTRIANS

	North Leg Wood Road	East Leg Van Buren Boulevard	South Leg Wood Road	West Leg Van Buren Boulevard	
	Pedestrians	Pedestrians	Pedestrians	Pedestrians	
7:00 AM	2	29	13	0	44
7:15 AM	3	48	7	1	59
7:30 AM	2	43	9	0	54
7:45 AM	0	2	1	0	3
8:00 AM	2	3	0	0	5
8:15 AM	1	2	4	0	7
8:30 AM	5	10	0	0	15
8:45 AM	0	0	0	0	0
TOTAL VOLUMES:	15	137	34	1	187

	North Leg Wood Road	East Leg Van Buren Boulevard	South Leg Wood Road	West Leg Van Buren Boulevard	
	Pedestrians	Pedestrians	Pedestrians	Pedestrians	
4:00 PM	4	31	34	1	70
4:15 PM	1	12	23	0	36
4:30 PM	0	7	13	0	20
4:45 PM	0	3	1	2	6
5:00 PM	0	4	0	0	4
5:15 PM	0	0	0	0	0
5:30 PM	2	4	6	0	12
5:45 PM	2	3	3	0	8
TOTAL VOLUMES:	9	64	80	3	156

Location: Riverside
 N/S: Wood Road
 E/W: Van Buren Boulevard



Date: 8/20/2019
 Day: Tuesday

BICYCLES

	Southbound Wood Road			Westbound Van Buren Boulevard			Northbound Wood Road			Eastbound Van Buren Boulevard			
	Left	Thru	Right	Left	Thru	Right	Left	Thru	Right	Left	Thru	Right	
7:00 AM	0	3	0	1	0	0	0	0	0	0	0	0	4
7:15 AM	0	1	0	1	0	0	0	0	0	0	0	0	2
7:30 AM	0	0	0	1	0	0	0	0	0	0	0	1	2
7:45 AM	0	1	0	0	0	0	0	0	0	0	0	0	1
8:00 AM	0	0	0	0	0	0	0	0	0	0	0	0	0
8:15 AM	0	0	0	0	2	0	0	0	0	0	0	0	2
8:30 AM	0	0	0	0	0	0	0	1	0	0	0	0	1
8:45 AM	0	0	0	0	0	0	0	0	0	0	1	0	1
TOTAL VOLUMES:	0	5	0	3	2	0	0	1	0	0	1	1	13

	Southbound Wood Road			Westbound Van Buren Boulevard			Northbound Wood Road			Eastbound Van Buren Boulevard			
	Left	Thru	Right	Left	Thru	Right	Left	Thru	Right	Left	Thru	Right	
4:00 PM	0	0	0	0	0	0	0	0	0	0	0	0	0
4:15 PM	0	1	0	1	0	0	0	0	1	0	0	0	3
4:30 PM	0	0	0	0	0	0	0	1	0	0	0	1	2
4:45 PM	0	0	0	0	0	0	0	0	0	0	0	0	0
5:00 PM	0	0	0	0	0	0	0	0	0	0	1	0	1
5:15 PM	0	0	0	0	0	0	0	0	0	0	0	0	0
5:30 PM	0	0	0	0	0	0	0	0	1	0	0	0	1
5:45 PM	0	0	0	0	1	0	0	0	0	0	0	1	2
TOTAL VOLUMES:	0	1	0	1	1	0	0	1	2	0	1	2	9

City of Riverside
 N/S: Trautwein Road
 E/W: Alessandro Boulevard
 Weather: Clear

File Name : 06_RIV_Trautwein_Alessandro AM
 Site Code : 05119542
 Start Date : 8/20/2019
 Page No : 1

Groups Printed- Passenger Vehicles - Large 2 Axle Vehicles - 3 Axle Vehicles - 4+ Axle Trucks

Start Time	Alessandro Boulevard Westbound				Trautwein Road Northbound				Alessandro Boulevard Eastbound				Exclu. Total	Inclu. Total	Int. Total
	Left	Thru	RTOR	App. Total	Left	Right	RTOR	App. Total	Thru	Right	RTOR	App. Total			
07:00 AM	33	658	0	691	426	2	0	428	191	0	0	191	0	1310	1310
07:15 AM	28	639	0	667	330	2	0	332	210	1	0	211	0	1210	1210
07:30 AM	27	667	0	694	399	2	0	401	219	0	0	219	0	1314	1314
07:45 AM	43	570	0	613	389	0	0	389	229	2	0	231	0	1233	1233
Total	131	2534	0	2665	1544	6	0	1550	849	3	0	852	0	5067	5067
08:00 AM	32	515	0	547	340	4	0	344	193	2	0	195	0	1086	1086
08:15 AM	20	460	0	480	376	4	0	380	179	0	0	179	0	1039	1039
08:30 AM	43	558	0	601	243	2	0	245	161	1	0	162	0	1008	1008
08:45 AM	34	484	0	518	265	6	1	271	168	3	0	171	1	960	961
Total	129	2017	0	2146	1224	16	1	1240	701	6	0	707	1	4093	4094
Grand Total	260	4551	0	4811	2768	22	1	2790	1550	9	0	1559	1	9160	9161
Apprch %	5.4	94.6			99.2	0.8			99.4	0.6					
Total %	2.8	49.7		52.5	30.2	0.2		30.5	16.9	0.1		17	0	100	
Passenger Vehicles	254	4487		4741	2717	22		2740	1522	8		1530	0	0	9011
% Passenger Vehicles	97.7	98.6	0	98.5	98.2	100	100	98.2	98.2	88.9	0	98.1	0	0	98.4
Large 2 Axle Vehicles	4	54		58	49	0		49	22	1		23	0	0	130
% Large 2 Axle Vehicles	1.5	1.2	0	1.2	1.8	0	0	1.8	1.4	11.1	0	1.5	0	0	1.4
3 Axle Vehicles	1	2		3	1	0		1	2	0		2	0	0	6
% 3 Axle Vehicles	0.4	0	0	0.1	0	0	0	0	0.1	0	0	0.1	0	0	0.1
4+ Axle Trucks	1	8		9	1	0		1	4	0		4	0	0	14
% 4+ Axle Trucks	0.4	0.2	0	0.2	0	0	0	0	0.3	0	0	0.3	0	0	0.2

Start Time	Alessandro Boulevard Westbound			Trautwein Road Northbound			Alessandro Boulevard Eastbound			Int. Total
	Left	Thru	App. Total	Left	Right	App. Total	Thru	Right	App. Total	
Peak Hour Analysis From 07:00 AM to 08:45 AM - Peak 1 of 1										
Peak Hour for Entire Intersection Begins at 07:00 AM										
07:00 AM	33	658	691	426	2	428	191	0	191	1310
07:15 AM	28	639	667	330	2	332	210	1	211	1210
07:30 AM	27	667	694	399	2	401	219	0	219	1314
07:45 AM	43	570	613	389	0	389	229	2	231	1233
Total Volume	131	2534	2665	1544	6	1550	849	3	852	5067
% App. Total	4.9	95.1		99.6	0.4		99.6	0.4		
PHF	.762	.950	.960	.906	.750	.905	.927	.375	.922	.964

City of Riverside
 N/S: Trautwein Road
 E/W: Alessandro Boulevard
 Weather: Clear

File Name : 06_RIV_Trautwein_Alessandro AM
 Site Code : 05119542
 Start Date : 8/20/2019
 Page No : 2

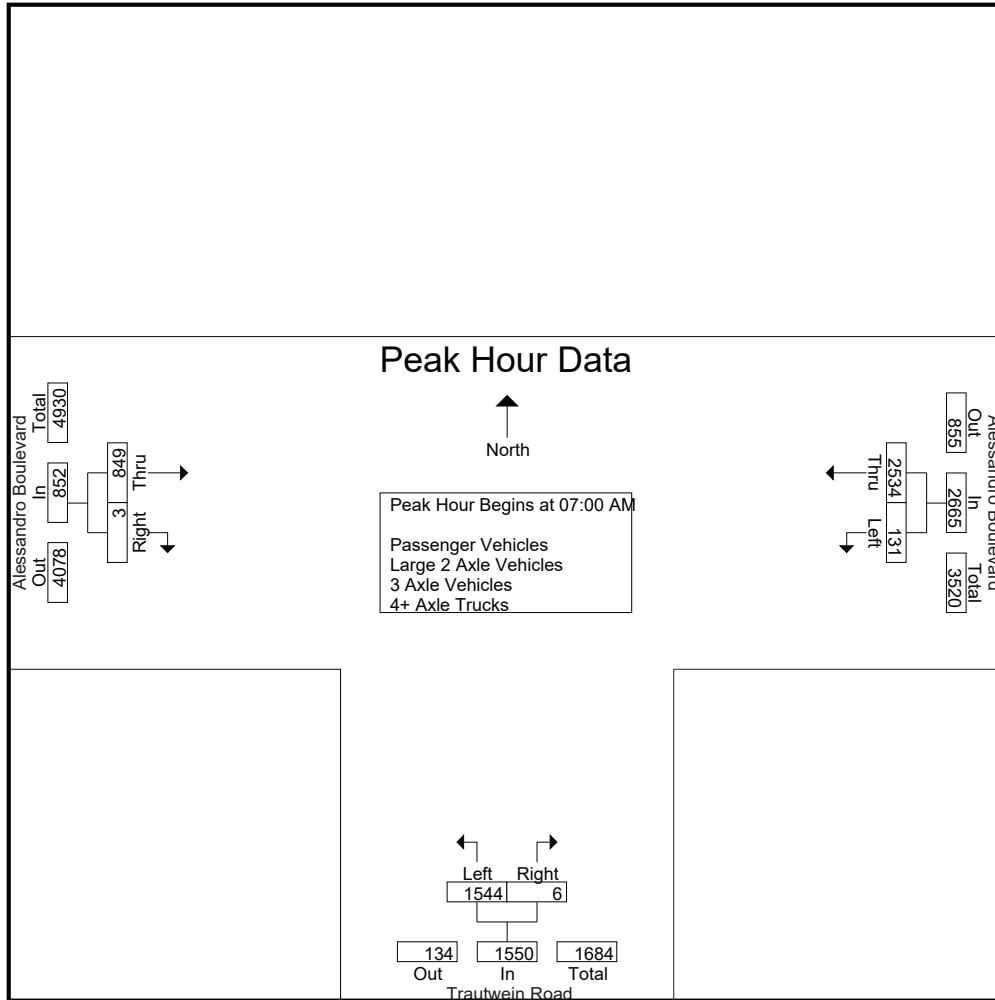

Peak Hour Analysis From 07:00 AM to 08:45 AM - Peak 1 of 1
 Peak Hour for Each Approach Begins at:

	07:00 AM			07:00 AM			07:15 AM		
+0 mins.	33	658	691	426	2	428	210	1	211
+15 mins.	28	639	667	330	2	332	219	0	219
+30 mins.	27	667	694	399	2	401	229	2	231
+45 mins.	43	570	613	389	0	389	193	2	195
Total Volume	131	2534	2665	1544	6	1550	851	5	856
% App. Total	4.9	95.1		99.6	0.4		99.4	0.6	
PHF	.762	.950	.960	.906	.750	.905	.929	.625	.926

City of Riverside
 N/S: Trautwein Road
 E/W: Alessandro Boulevard
 Weather: Clear

File Name : 06_RIV_Trautwein_Alessandro AM
 Site Code : 05119542
 Start Date : 8/20/2019
 Page No : 1

Groups Printed- Passenger Vehicles

Start Time	Alessandro Boulevard Westbound				Trautwein Road Northbound				Alessandro Boulevard Eastbound				Exclu. Total	Inclu. Total	Int. Total
	Left	Thru	RTOR	App. Total	Left	Right	RTOR	App. Total	Thru	Right	RTOR	App. Total			
07:00 AM	32	650	0	682	415	2	0	417	186	0	0	186	0	1285	1285
07:15 AM	26	632	0	658	323	2	0	325	202	1	0	203	0	1186	1186
07:30 AM	27	660	0	687	393	2	0	395	218	0	0	218	0	1300	1300
07:45 AM	40	566	0	606	382	0	0	382	227	2	0	229	0	1217	1217
Total	125	2508	0	2633	1513	6	0	1519	833	3	0	836	0	4988	4988
08:00 AM	32	510	0	542	336	4	0	340	188	2	0	190	0	1072	1072
08:15 AM	20	451	0	471	366	4	0	370	177	0	0	177	0	1018	1018
08:30 AM	43	547	0	590	238	2	0	240	161	1	0	162	0	992	992
08:45 AM	34	471	0	505	264	6	1	270	163	2	0	165	1	940	941
Total	129	1979	0	2108	1204	16	1	1220	689	5	0	694	1	4022	4023
Grand Total	254	4487	0	4741	2717	22	1	2739	1522	8	0	1530	1	9010	9011
Apprch %	5.4	94.6			99.2	0.8			99.5	0.5					
Total %	2.8	49.8		52.6	30.2	0.2		30.4	16.9	0.1		17	0	100	

Start Time	Alessandro Boulevard Westbound			Trautwein Road Northbound			Alessandro Boulevard Eastbound			Int. Total
	Left	Thru	App. Total	Left	Right	App. Total	Thru	Right	App. Total	
Peak Hour Analysis From 07:00 AM to 07:45 AM - Peak 1 of 1										
Peak Hour for Entire Intersection Begins at 07:00 AM										
07:00 AM	32	650	682	415	2	417	186	0	186	1285
07:15 AM	26	632	658	323	2	325	202	1	203	1186
07:30 AM	27	660	687	393	2	395	218	0	218	1300
07:45 AM	40	566	606	382	0	382	227	2	229	1217
Total Volume	125	2508	2633	1513	6	1519	833	3	836	4988
% App. Total	4.7	95.3		99.6	0.4		99.6	0.4		
PHF	.781	.950	.958	.911	.750	.911	.917	.375	.913	.959

City of Riverside
 N/S: Trautwein Road
 E/W: Alessandro Boulevard
 Weather: Clear

File Name : 06_RIV_Trautwein_Alessandro AM
 Site Code : 05119542
 Start Date : 8/20/2019
 Page No : 2

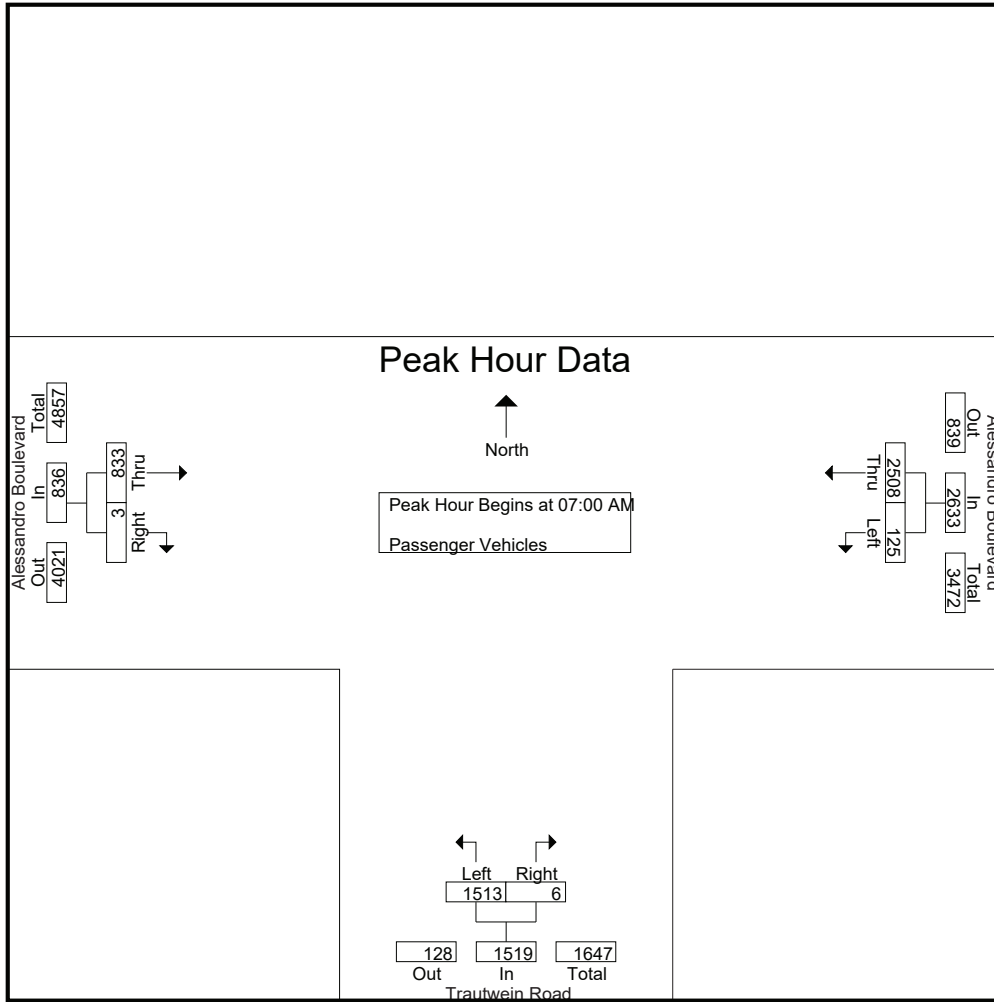

Peak Hour Analysis From 07:00 AM to 07:45 AM - Peak 1 of 1
 Peak Hour for Each Approach Begins at:

	07:00 AM			07:00 AM			07:00 AM		
+0 mins.	32	650	682	415	2	417	186	0	186
+15 mins.	26	632	658	323	2	325	202	1	203
+30 mins.	27	660	687	393	2	395	218	0	218
+45 mins.	40	566	606	382	0	382	227	2	229
Total Volume	125	2508	2633	1513	6	1519	833	3	836
% App. Total	4.7	95.3		99.6	0.4		99.6	0.4	
PHF	.781	.950	.958	.911	.750	.911	.917	.375	.913

City of Riverside
 N/S: Trautwein Road
 E/W: Alessandro Boulevard
 Weather: Clear

File Name : 06_RIV_Trautwein_Alessandro AM
 Site Code : 05119542
 Start Date : 8/20/2019
 Page No : 1

Groups Printed- Large 2 Axle Vehicles

Start Time	Alessandro Boulevard Westbound				Trautwein Road Northbound				Alessandro Boulevard Eastbound				Exclu. Total	Inclu. Total	Int. Total
	Left	Thru	RTOR	App. Total	Left	Right	RTOR	App. Total	Thru	Right	RTOR	App. Total			
07:00 AM	1	8	0	9	10	0	0	10	4	0	0	4	0	23	23
07:15 AM	2	6	0	8	7	0	0	7	6	0	0	6	0	21	21
07:30 AM	0	5	0	5	6	0	0	6	1	0	0	1	0	12	12
07:45 AM	1	3	0	4	7	0	0	7	2	0	0	2	0	13	13
Total	4	22	0	26	30	0	0	30	13	0	0	13	0	69	69
08:00 AM	0	4	0	4	4	0	0	4	4	0	0	4	0	12	12
08:15 AM	0	8	0	8	9	0	0	9	1	0	0	1	0	18	18
08:30 AM	0	10	0	10	5	0	0	5	0	0	0	0	0	15	15
08:45 AM	0	10	0	10	1	0	0	1	4	1	0	5	0	16	16
Total	0	32	0	32	19	0	0	19	9	1	0	10	0	61	61
Grand Total	4	54	0	58	49	0	0	49	22	1	0	23	0	130	130
Apprch %	6.9	93.1			100	0			95.7	4.3					
Total %	3.1	41.5		44.6	37.7	0		37.7	16.9	0.8		17.7	0	100	

Start Time	Alessandro Boulevard Westbound			Trautwein Road Northbound			Alessandro Boulevard Eastbound			Int. Total
	Left	Thru	App. Total	Left	Right	App. Total	Thru	Right	App. Total	
Peak Hour Analysis From 07:00 AM to 07:45 AM - Peak 1 of 1										
Peak Hour for Entire Intersection Begins at 07:00 AM										
07:00 AM	1	8	9	10	0	10	4	0	4	23
07:15 AM	2	6	8	7	0	7	6	0	6	21
07:30 AM	0	5	5	6	0	6	1	0	1	12
07:45 AM	1	3	4	7	0	7	2	0	2	13
Total Volume	4	22	26	30	0	30	13	0	13	69
% App. Total	15.4	84.6		100	0		100	0		
PHF	.500	.688	.722	.750	.000	.750	.542	.000	.542	.750

City of Riverside
 N/S: Trautwein Road
 E/W: Alessandro Boulevard
 Weather: Clear

File Name : 06_RIV_Trautwein_Alessandro AM
 Site Code : 05119542
 Start Date : 8/20/2019
 Page No : 2

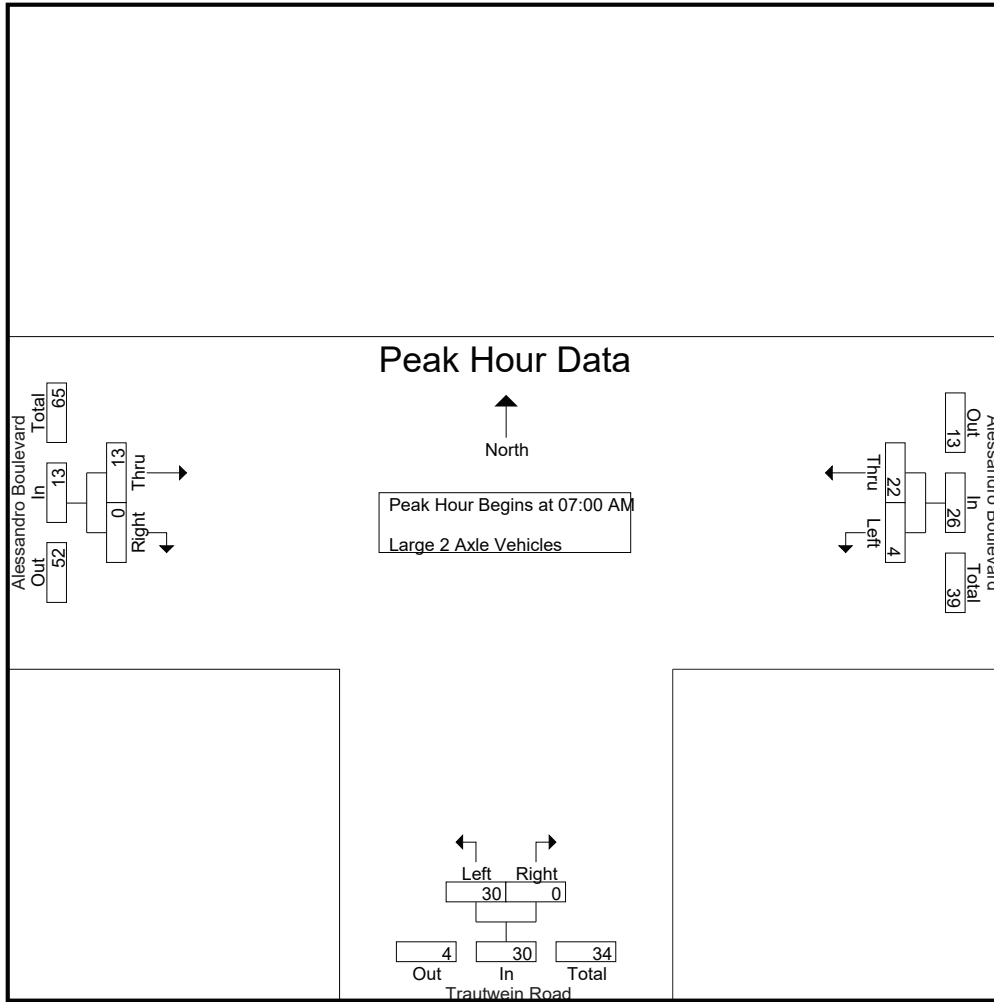

Peak Hour Analysis From 07:00 AM to 07:45 AM - Peak 1 of 1
 Peak Hour for Each Approach Begins at:

	07:00 AM			07:00 AM			07:00 AM		
+0 mins.	1	8	9	10	0	10	4	0	4
+15 mins.	2	6	8	7	0	7	6	0	6
+30 mins.	0	5	5	6	0	6	1	0	1
+45 mins.	1	3	4	7	0	7	2	0	2
Total Volume	4	22	26	30	0	30	13	0	13
% App. Total	15.4	84.6		100	0		100	0	
PHF	.500	.688	.722	.750	.000	.750	.542	.000	.542

City of Riverside
 N/S: Trautwein Road
 E/W: Alessandro Boulevard
 Weather: Clear

File Name : 06_RIV_Trautwein_Alessandro AM
 Site Code : 05119542
 Start Date : 8/20/2019
 Page No : 1

Groups Printed- 3 Axle Vehicles

Start Time	Alessandro Boulevard Westbound				Trautwein Road Northbound				Alessandro Boulevard Eastbound				Exclu. Total	Inclu. Total	Int. Total	
	Left	Thru	RTOR	App. Total	Left	Right	RTOR	App. Total	Thru	Right	RTOR	App. Total				
07:00 AM	0	0	0	0	0	0	0	0	0	0	0	0	0	0	0	0
07:15 AM	0	0	0	0	0	0	0	0	0	1	0	0	1	0	1	1
07:30 AM	0	0	0	0	0	0	0	0	0	0	0	0	0	0	0	0
07:45 AM	1	0	0	1	0	0	0	0	0	0	0	0	0	0	1	1
Total	1	0	0	1	0	0	0	0	0	1	0	0	1	0	2	2
08:00 AM	0	0	0	0	0	0	0	0	0	1	0	0	1	0	1	1
08:15 AM	0	0	0	0	1	0	0	1	0	0	0	0	0	0	1	1
08:30 AM	0	1	0	1	0	0	0	0	0	0	0	0	0	0	1	1
08:45 AM	0	1	0	1	0	0	0	0	0	0	0	0	0	0	1	1
Total	0	2	0	2	1	0	0	1	1	0	0	1	0	0	4	4
Grand Total	1	2	0	3	1	0	0	1	2	0	0	2	0	0	6	6
Apprch %	33.3	66.7			100	0			100	0						
Total %	16.7	33.3		50	16.7	0		16.7	33.3	0		33.3		0	100	

Start Time	Alessandro Boulevard Westbound			Trautwein Road Northbound			Alessandro Boulevard Eastbound			Int. Total
	Left	Thru	App. Total	Left	Right	App. Total	Thru	Right	App. Total	
Peak Hour Analysis From 07:00 AM to 07:45 AM - Peak 1 of 1										
Peak Hour for Entire Intersection Begins at 07:00 AM										
07:00 AM	0	0	0	0	0	0	0	0	0	0
07:15 AM	0	0	0	0	0	0	0	1	0	1
07:30 AM	0	0	0	0	0	0	0	0	0	0
07:45 AM	1	0	1	0	0	0	0	0	0	1
Total Volume	1	0	1	0	0	0	0	1	0	1
% App. Total	100	0		0	0			100	0	
PHF	.250	.000	.250	.000	.000	.000	.250	.000	.250	.500

City of Riverside
 N/S: Trautwein Road
 E/W: Alessandro Boulevard
 Weather: Clear

File Name : 06_RIV_Trautwein_Alessandro AM
 Site Code : 05119542
 Start Date : 8/20/2019
 Page No : 2

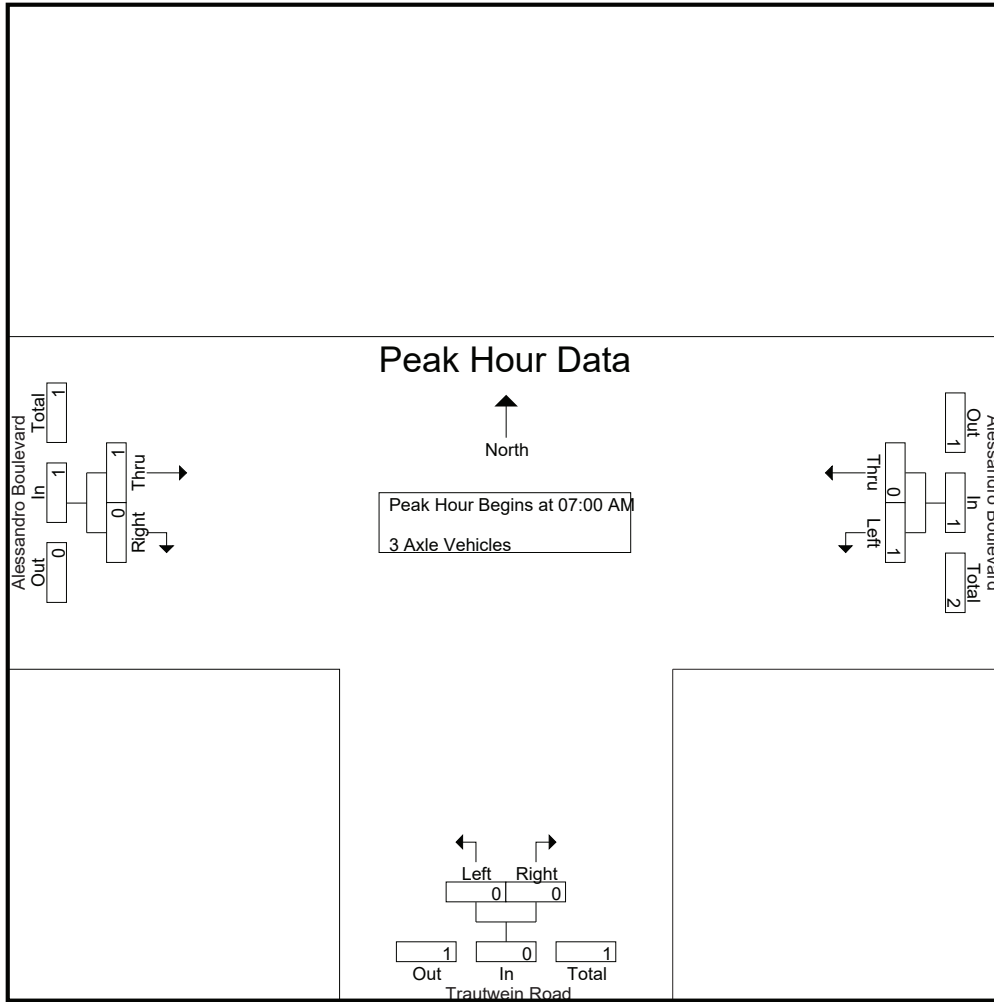

Peak Hour Analysis From 07:00 AM to 07:45 AM - Peak 1 of 1
 Peak Hour for Each Approach Begins at:

	07:00 AM			07:00 AM			07:00 AM		
+0 mins.	0	0	0	0	0	0	0	0	0
+15 mins.	0	0	0	0	0	0	1	0	1
+30 mins.	0	0	0	0	0	0	0	0	0
+45 mins.	1	0	1	0	0	0	0	0	0
Total Volume	1	0	1	0	0	0	1	0	1
% App. Total	100	0	100	0	0	0	100	0	100
PHF	.250	.000	.250	.000	.000	.000	.250	.000	.250

City of Riverside
 N/S: Trautwein Road
 E/W: Alessandro Boulevard
 Weather: Clear

File Name : 06_RIV_Trautwein_Alessandro AM
 Site Code : 05119542
 Start Date : 8/20/2019
 Page No : 1

Groups Printed- 4+ Axle Trucks

Start Time	Alessandro Boulevard Westbound				Trautwein Road Northbound				Alessandro Boulevard Eastbound				Exclu. Total	Inclu. Total	Int. Total
	Left	Thru	RTOR	App. Total	Left	Right	RTOR	App. Total	Thru	Right	RTOR	App. Total			
07:00 AM	0	0	0	0	1	0	0	1	1	0	0	1	0	2	2
07:15 AM	0	1	0	1	0	0	0	0	1	0	0	1	0	2	2
07:30 AM	0	2	0	2	0	0	0	0	0	0	0	0	0	2	2
07:45 AM	1	1	0	2	0	0	0	0	0	0	0	0	0	2	2
Total	1	4	0	5	1	0	0	1	2	0	0	2	0	8	8
08:00 AM	0	1	0	1	0	0	0	0	0	0	0	0	0	1	1
08:15 AM	0	1	0	1	0	0	0	0	1	0	0	1	0	2	2
08:30 AM	0	0	0	0	0	0	0	0	0	0	0	0	0	0	0
08:45 AM	0	2	0	2	0	0	0	0	1	0	0	1	0	3	3
Total	0	4	0	4	0	0	0	0	2	0	0	2	0	6	6
Grand Total	1	8	0	9	1	0	0	1	4	0	0	4	0	14	14
Apprch %	11.1	88.9			100	0			100	0					
Total %	7.1	57.1		64.3	7.1	0		7.1	28.6	0		28.6	0	100	

Start Time	Alessandro Boulevard Westbound			Trautwein Road Northbound			Alessandro Boulevard Eastbound			Int. Total
	Left	Thru	App. Total	Left	Right	App. Total	Thru	Right	App. Total	
Peak Hour Analysis From 07:00 AM to 07:45 AM - Peak 1 of 1										
Peak Hour for Entire Intersection Begins at 07:00 AM										
07:00 AM	0	0	0	1	0	1	1	0	1	2
07:15 AM	0	1	1	0	0	0	1	0	1	2
07:30 AM	0	2	2	0	0	0	0	0	0	2
07:45 AM	1	1	2	0	0	0	0	0	0	2
Total Volume	1	4	5	1	0	1	2	0	2	8
% App. Total	20	80		100	0		100	0		
PHF	.250	.500	.625	.250	.000	.250	.500	.000	.500	1.00

City of Riverside
 N/S: Trautwein Road
 E/W: Alessandro Boulevard
 Weather: Clear

File Name : 06_RIV_Trautwein_Alessandro AM
 Site Code : 05119542
 Start Date : 8/20/2019
 Page No : 2

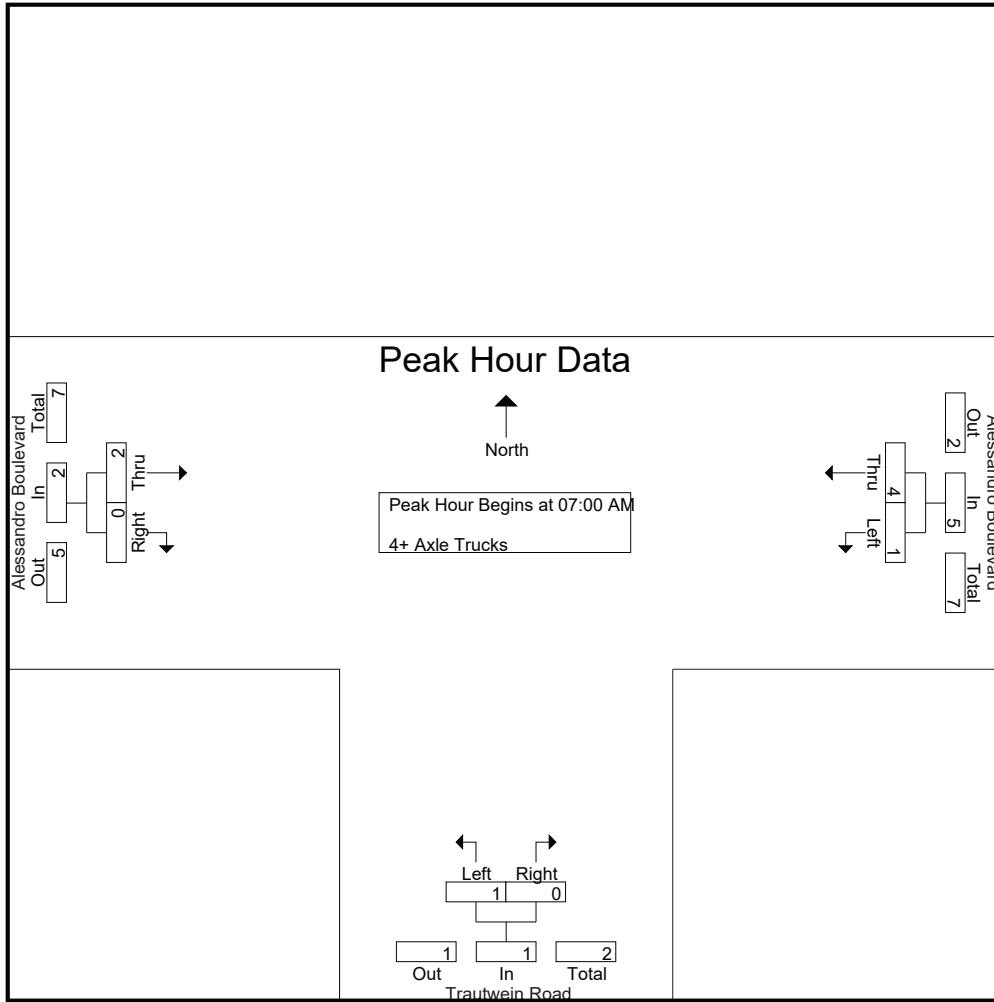

Peak Hour Analysis From 07:00 AM to 07:45 AM - Peak 1 of 1
 Peak Hour for Each Approach Begins at:

	07:00 AM			07:00 AM			07:00 AM		
+0 mins.	0	0	0	1	0	1	1	0	1
+15 mins.	0	1	1	0	0	0	1	0	1
+30 mins.	0	2	2	0	0	0	0	0	0
+45 mins.	1	1	2	0	0	0	0	0	0
Total Volume	1	4	5	1	0	1	2	0	2
% App. Total	20	80		100	0		100	0	
PHF	.250	.500	.625	.250	.000	.250	.500	.000	.500

City of Riverside
 N/S: Trautwein Road
 E/W: Alessandro Boulevard
 Weather: Clear

File Name : 06_RIV_Trautwein_Alessandro PM
 Site Code : 05119542
 Start Date : 8/20/2019
 Page No : 1

Groups Printed- Passenger Vehicles - Large 2 Axle Vehicles - 3 Axle Vehicles - 4+ Axle Trucks

Start Time	Alessandro Boulevard Westbound				Trautwein Road Northbound				Alessandro Boulevard Eastbound				Exclu. Total	Inclu. Total	Int. Total
	Left	Thru	RTOR	App. Total	Left	Right	RTOR	App. Total	Thru	Right	RTOR	App. Total			
04:00 PM	45	377	0	422	196	1	0	197	463	1	0	464	0	1083	1083
04:15 PM	64	338	0	402	181	5	1	186	521	5	1	526	2	1114	1116
04:30 PM	38	332	0	370	200	3	0	203	447	3	0	450	0	1023	1023
04:45 PM	62	332	0	394	166	3	0	169	523	9	0	532	0	1095	1095
Total	209	1379	0	1588	743	12	1	755	1954	18	1	1972	2	4315	4317
05:00 PM	59	321	0	380	201	8	1	209	455	4	0	459	1	1048	1049
05:15 PM	68	349	0	417	193	5	1	198	490	3	0	493	1	1108	1109
05:30 PM	64	326	0	390	193	1	0	194	527	4	0	531	0	1115	1115
05:45 PM	62	231	0	293	168	4	0	172	489	7	1	496	1	961	962
Total	253	1227	0	1480	755	18	2	773	1961	18	1	1979	3	4232	4235
Grand Total	462	2606	0	3068	1498	30	3	1528	3915	36	2	3951	5	8547	8552
Apprch %	15.1	84.9			98	2			99.1	0.9					
Total %	5.4	30.5		35.9	17.5	0.4		17.9	45.8	0.4		46.2	0.1	99.9	
Passenger Vehicles	460	2586		3046	1485	30		1518	3878	35		3915	0	0	8479
% Passenger Vehicles	99.6	99.2	0	99.3	99.1	100	100	99.2	99.1	97.2	100	99	0	0	99.1
Large 2 Axle Vehicles	1	20		21	13	0		13	35	0		35	0	0	69
% Large 2 Axle Vehicles	0.2	0.8	0	0.7	0.9	0	0	0.8	0.9	0	0	0.9	0	0	0.8
3 Axle Vehicles	0	0		0	0	0		0	0	1		1	0	0	1
% 3 Axle Vehicles	0	0	0	0	0	0	0	0	0	2.8	0	0	0	0	0
4+ Axle Trucks	1	0		1	0	0		0	2	0		2	0	0	3
% 4+ Axle Trucks	0.2	0	0	0	0	0	0	0	0.1	0	0	0.1	0	0	0

Start Time	Alessandro Boulevard Westbound			Trautwein Road Northbound			Alessandro Boulevard Eastbound			Int. Total
	Left	Thru	App. Total	Left	Right	App. Total	Thru	Right	App. Total	
Peak Hour Analysis From 04:00 PM to 05:45 PM - Peak 1 of 1										
Peak Hour for Entire Intersection Begins at 04:45 PM										
04:45 PM	62	332	394	166	3	169	523	9	532	1095
05:00 PM	59	321	380	201	8	209	455	4	459	1048
05:15 PM	68	349	417	193	5	198	490	3	493	1108
05:30 PM	64	326	390	193	1	194	527	4	531	1115
Total Volume	253	1328	1581	753	17	770	1995	20	2015	4366
% App. Total	16	84		97.8	2.2		99	1		
PHF	.930	.951	.948	.937	.531	.921	.946	.556	.947	.979

City of Riverside
 N/S: Trautwein Road
 E/W: Alessandro Boulevard
 Weather: Clear

File Name : 06_RIV_Trautwein_Alessandro PM
 Site Code : 05119542
 Start Date : 8/20/2019
 Page No : 2

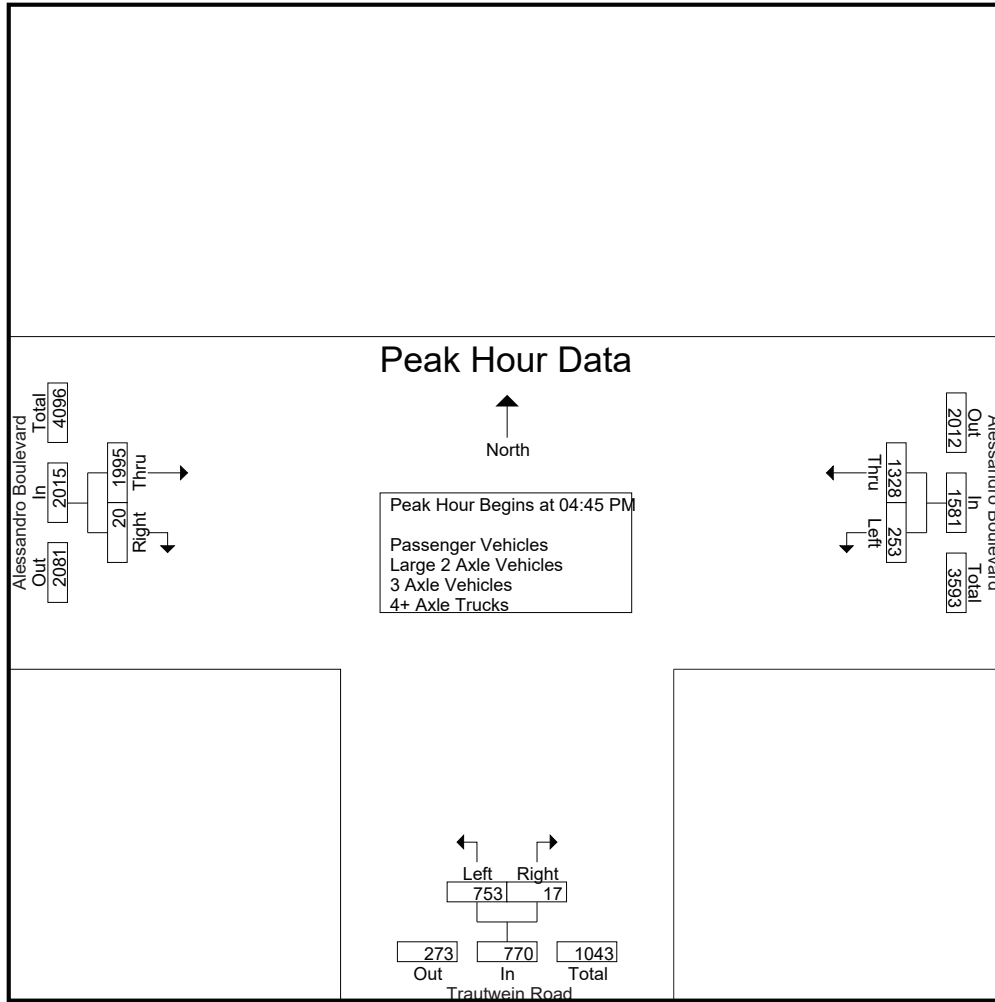

Peak Hour Analysis From 04:00 PM to 05:45 PM - Peak 1 of 1
 Peak Hour for Each Approach Begins at:

	04:00 PM			04:30 PM			04:45 PM		
+0 mins.	45	377	422	200	3	203	523	9	532
+15 mins.	64	338	402	166	3	169	455	4	459
+30 mins.	38	332	370	201	8	209	490	3	493
+45 mins.	62	332	394	193	5	198	527	4	531
Total Volume	209	1379	1588	760	19	779	1995	20	2015
% App. Total	13.2	86.8		97.6	2.4		99	1	
PHF	.816	.914	.941	.945	.594	.932	.946	.556	.947

City of Riverside
 N/S: Trautwein Road
 E/W: Alessandro Boulevard
 Weather: Clear

File Name : 06_RIV_Trautwein_Alessandro PM
 Site Code : 05119542
 Start Date : 8/20/2019
 Page No : 1

Groups Printed- Passenger Vehicles

Start Time	Alessandro Boulevard Westbound				Trautwein Road Northbound				Alessandro Boulevard Eastbound				Exclu. Total	Inclu. Total	Int. Total
	Left	Thru	RTOR	App. Total	Left	Right	RTOR	App. Total	Thru	Right	RTOR	App. Total			
04:00 PM	45	372	0	417	192	1	0	193	462	1	0	463	0	1073	1073
04:15 PM	64	337	0	401	180	5	1	185	514	5	1	519	2	1105	1107
04:30 PM	38	328	0	366	198	3	0	201	439	3	0	442	0	1009	1009
04:45 PM	62	329	0	391	163	3	0	166	519	8	0	527	0	1084	1084
Total	209	1366	0	1575	733	12	1	745	1934	17	1	1951	2	4271	4273
05:00 PM	59	318	0	377	200	8	1	208	450	4	0	454	1	1039	1040
05:15 PM	68	348	0	416	193	5	1	198	484	3	0	487	1	1101	1102
05:30 PM	63	323	0	386	192	1	0	193	525	4	0	529	0	1108	1108
05:45 PM	61	231	0	292	167	4	0	171	485	7	1	492	1	955	956
Total	251	1220	0	1471	752	18	2	770	1944	18	1	1962	3	4203	4206
Grand Total	460	2586	0	3046	1485	30	3	1515	3878	35	2	3913	5	8474	8479
Apprch %	15.1	84.9			98	2			99.1	0.9					
Total %	5.4	30.5		35.9	17.5	0.4		17.9	45.8	0.4		46.2	0.1	99.9	

Start Time	Alessandro Boulevard Westbound			Trautwein Road Northbound			Alessandro Boulevard Eastbound			Int. Total
	Left	Thru	App. Total	Left	Right	App. Total	Thru	Right	App. Total	
Peak Hour Analysis From 04:45 PM to 05:30 PM - Peak 1 of 1										
Peak Hour for Entire Intersection Begins at 04:45 PM										
04:45 PM	62	329	391	163	3	166	519	8	527	1084
05:00 PM	59	318	377	200	8	208	450	4	454	1039
05:15 PM	68	348	416	193	5	198	484	3	487	1101
05:30 PM	63	323	386	192	1	193	525	4	529	1108
Total Volume	252	1318	1570	748	17	765	1978	19	1997	4332
% App. Total	16.1	83.9		97.8	2.2		99	1		
PHF	.926	.947	.944	.935	.531	.919	.942	.594	.944	.977

City of Riverside
 N/S: Trautwein Road
 E/W: Alessandro Boulevard
 Weather: Clear

File Name : 06_RIV_Trautwein_Alessandro PM
 Site Code : 05119542
 Start Date : 8/20/2019
 Page No : 2

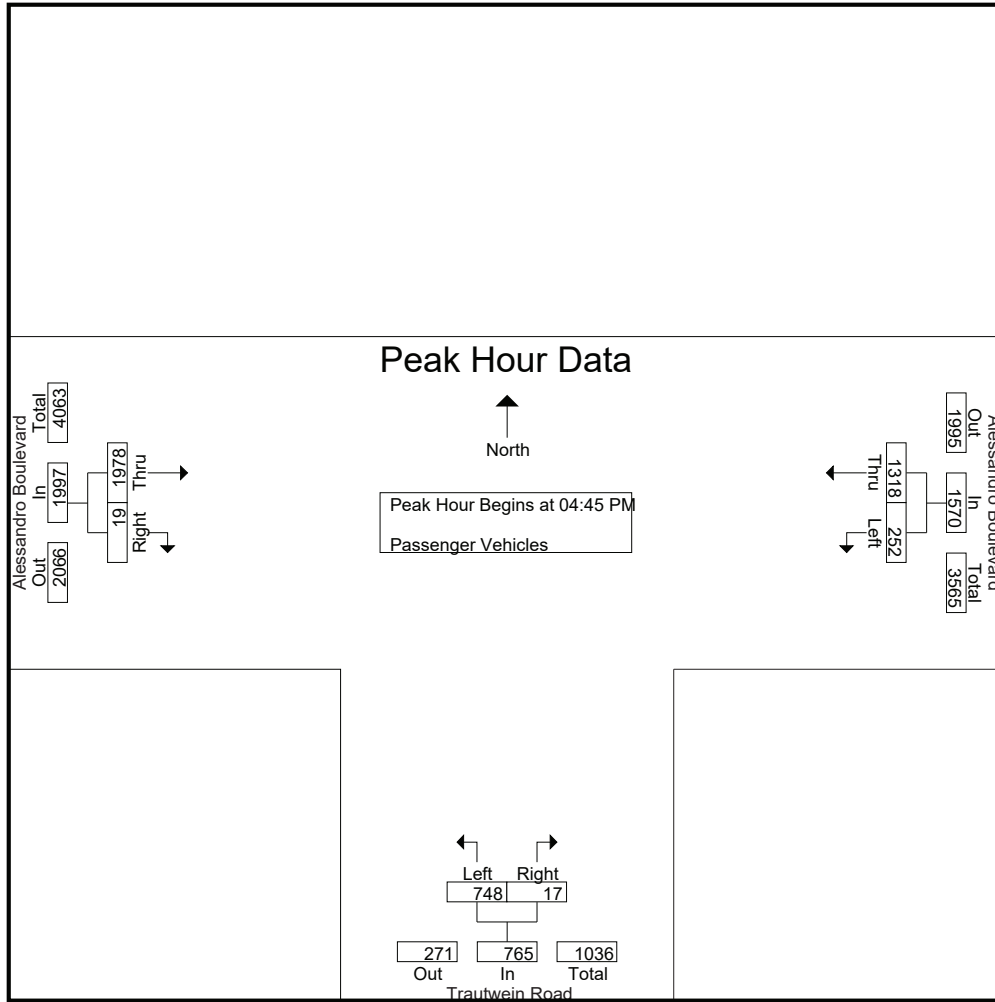

Peak Hour Analysis From 04:45 PM to 05:30 PM - Peak 1 of 1
 Peak Hour for Each Approach Begins at:

	04:45 PM			04:45 PM			04:45 PM		
+0 mins.	62	329	391	163	3	166	519	8	527
+15 mins.	59	318	377	200	8	208	450	4	454
+30 mins.	68	348	416	193	5	198	484	3	487
+45 mins.	63	323	386	192	1	193	525	4	529
Total Volume	252	1318	1570	748	17	765	1978	19	1997
% App. Total	16.1	83.9		97.8	2.2		99	1	
PHF	.926	.947	.944	.935	.531	.919	.942	.594	.944

City of Riverside
 N/S: Trautwein Road
 E/W: Alessandro Boulevard
 Weather: Clear

File Name : 06_RIV_Trautwein_Alessandro PM
 Site Code : 05119542
 Start Date : 8/20/2019
 Page No : 1

Groups Printed- Large 2 Axle Vehicles

Start Time	Alessandro Boulevard Westbound				Trautwein Road Northbound				Alessandro Boulevard Eastbound				Exclu. Total	Inclu. Total	Int. Total
	Left	Thru	RTOR	App. Total	Left	Right	RTOR	App. Total	Thru	Right	RTOR	App. Total			
04:00 PM	0	5	0	5	4	0	0	4	1	0	0	1	0	10	10
04:15 PM	0	1	0	1	1	0	0	1	7	0	0	7	0	9	9
04:30 PM	0	4	0	4	2	0	0	2	8	0	0	8	0	14	14
04:45 PM	0	3	0	3	3	0	0	3	3	0	0	3	0	9	9
Total	0	13	0	13	10	0	0	10	19	0	0	19	0	42	42
05:00 PM	0	3	0	3	1	0	0	1	5	0	0	5	0	9	9
05:15 PM	0	1	0	1	0	0	0	0	6	0	0	6	0	7	7
05:30 PM	1	3	0	4	1	0	0	1	2	0	0	2	0	7	7
05:45 PM	0	0	0	0	1	0	0	1	3	0	0	3	0	4	4
Total	1	7	0	8	3	0	0	3	16	0	0	16	0	27	27
Grand Total	1	20	0	21	13	0	0	13	35	0	0	35	0	69	69
Apprch %	4.8	95.2			100	0			100	0			0	100	
Total %	1.4	29		30.4	18.8	0		18.8	50.7	0		50.7	0	100	

Start Time	Alessandro Boulevard Westbound			Trautwein Road Northbound			Alessandro Boulevard Eastbound			Int. Total
	Left	Thru	App. Total	Left	Right	App. Total	Thru	Right	App. Total	
04:45 PM	0	3	3	3	0	3	3	0	3	9
05:00 PM	0	3	3	1	0	1	5	0	5	9
05:15 PM	0	1	1	0	0	0	6	0	6	7
05:30 PM	1	3	4	1	0	1	2	0	2	7
Total Volume	1	10	11	5	0	5	16	0	16	32
% App. Total	9.1	90.9		100	0		100	0		
PHF	.250	.833	.688	.417	.000	.417	.667	.000	.667	.889

City of Riverside
 N/S: Trautwein Road
 E/W: Alessandro Boulevard
 Weather: Clear

File Name : 06_RIV_Trautwein_Alessandro PM
 Site Code : 05119542
 Start Date : 8/20/2019
 Page No : 2

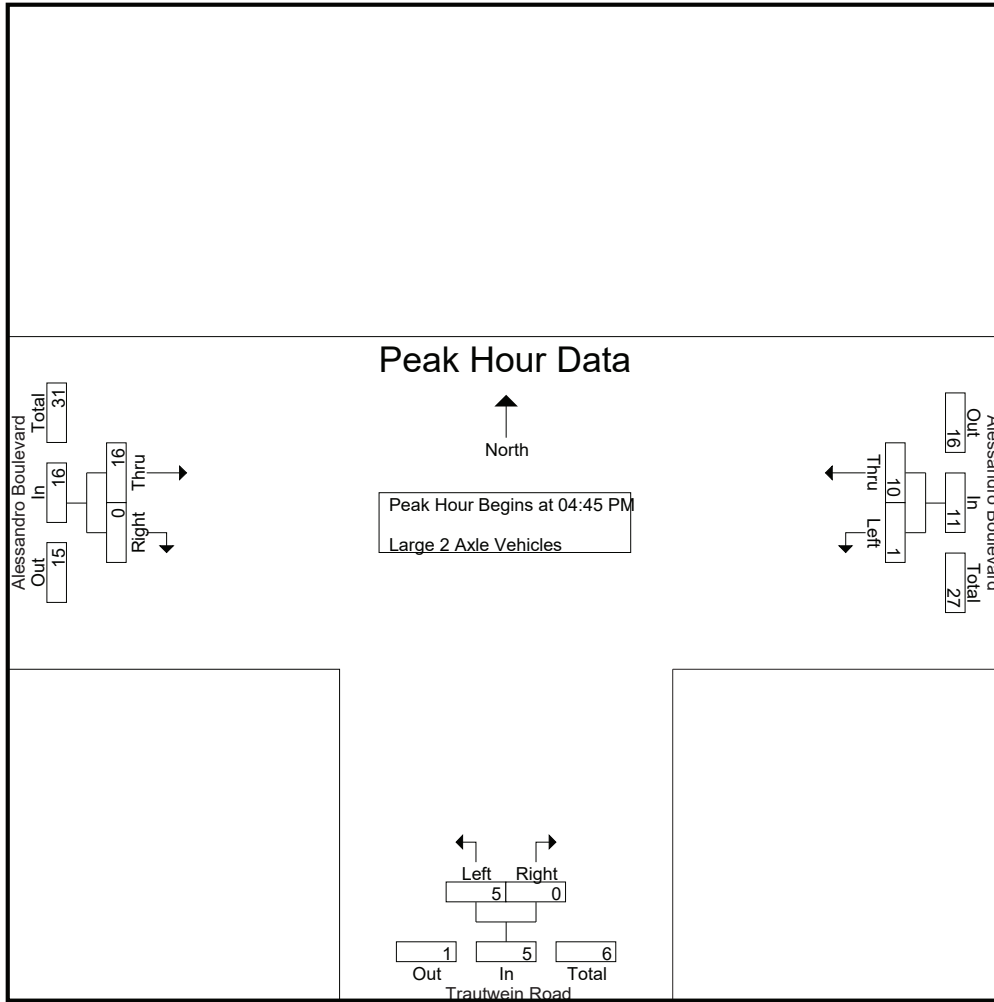

Peak Hour Analysis From 04:45 PM to 05:30 PM - Peak 1 of 1
 Peak Hour for Each Approach Begins at:

	04:45 PM			04:45 PM			04:45 PM		
+0 mins.	0	3	3	3	0	3	3	0	3
+15 mins.	0	3	3	1	0	1	5	0	5
+30 mins.	0	1	1	0	0	0	6	0	6
+45 mins.	1	3	4	1	0	1	2	0	2
Total Volume	1	10	11	5	0	5	16	0	16
% App. Total	9.1	90.9		100	0		100	0	
PHF	.250	.833	.688	.417	.000	.417	.667	.000	.667

City of Riverside
 N/S: Trautwein Road
 E/W: Alessandro Boulevard
 Weather: Clear

File Name : 06_RIV_Trautwein_Alessandro PM
 Site Code : 05119542
 Start Date : 8/20/2019
 Page No : 1

Groups Printed- 3 Axle Vehicles

Start Time	Alessandro Boulevard Westbound				Trautwein Road Northbound				Alessandro Boulevard Eastbound				Exclu. Total	Inclu. Total	Int. Total
	Left	Thru	RTOR	App. Total	Left	Right	RTOR	App. Total	Thru	Right	RTOR	App. Total			
04:00 PM	0	0	0	0	0	0	0	0	0	0	0	0	0	0	0
04:15 PM	0	0	0	0	0	0	0	0	0	0	0	0	0	0	0
04:30 PM	0	0	0	0	0	0	0	0	0	0	0	0	0	0	0
04:45 PM	0	0	0	0	0	0	0	0	0	1	0	1	0	1	1
Total	0	0	0	0	0	0	0	0	0	1	0	1	0	1	1
05:00 PM	0	0	0	0	0	0	0	0	0	0	0	0	0	0	0
05:15 PM	0	0	0	0	0	0	0	0	0	0	0	0	0	0	0
05:30 PM	0	0	0	0	0	0	0	0	0	0	0	0	0	0	0
05:45 PM	0	0	0	0	0	0	0	0	0	0	0	0	0	0	0
Total	0	0	0	0	0	0	0	0	0	0	0	0	0	0	0
Grand Total	0	0	0	0	0	0	0	0	0	1	0	1	0	1	1
Apprch %	0	0			0	0			0	100					
Total %	0	0		0	0	0		0	0	100		100	0	100	

Start Time	Alessandro Boulevard Westbound			Trautwein Road Northbound			Alessandro Boulevard Eastbound			Int. Total
	Left	Thru	App. Total	Left	Right	App. Total	Thru	Right	App. Total	
Peak Hour Analysis From 04:45 PM to 05:30 PM - Peak 1 of 1										
Peak Hour for Entire Intersection Begins at 04:45 PM										
04:45 PM	0	0	0	0	0	0	0	1	1	1
05:00 PM	0	0	0	0	0	0	0	0	0	0
05:15 PM	0	0	0	0	0	0	0	0	0	0
05:30 PM	0	0	0	0	0	0	0	0	0	0
Total Volume	0	0	0	0	0	0	0	1	1	1
% App. Total	0	0		0	0		0	100		
PHF	.000	.000	.000	.000	.000	.000	.000	.250	.250	.250

City of Riverside
 N/S: Trautwein Road
 E/W: Alessandro Boulevard
 Weather: Clear

File Name : 06_RIV_Trautwein_Alessandro PM
 Site Code : 05119542
 Start Date : 8/20/2019
 Page No : 2

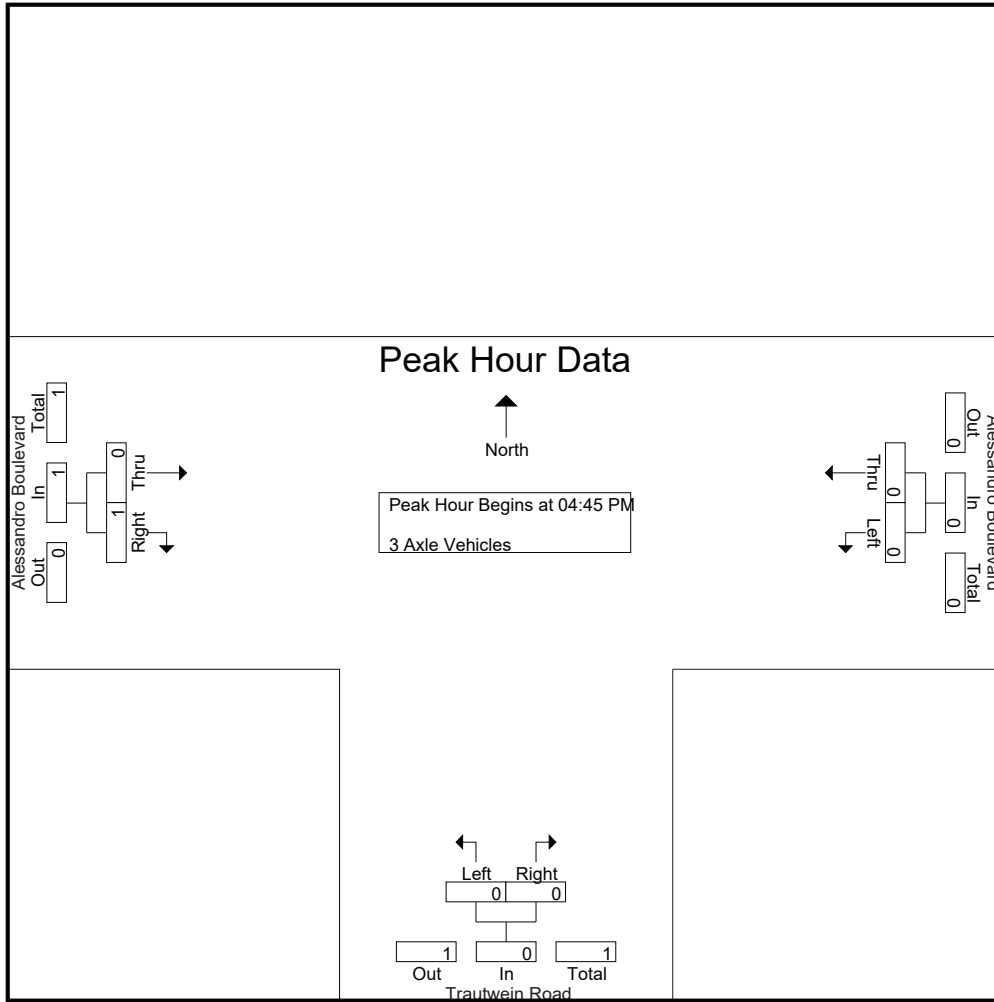

Peak Hour Analysis From 04:45 PM to 05:30 PM - Peak 1 of 1
 Peak Hour for Each Approach Begins at:

	04:45 PM			04:45 PM			04:45 PM		
+0 mins.	0	0	0	0	0	0	0	1	1
+15 mins.	0	0	0	0	0	0	0	0	0
+30 mins.	0	0	0	0	0	0	0	0	0
+45 mins.	0	0	0	0	0	0	0	0	0
Total Volume	0	0	0	0	0	0	0	1	1
% App. Total	0	0	0	0	0	0	0	100	100
PHF	.000	.000	.000	.000	.000	.000	.000	.250	.250

City of Riverside
 N/S: Trautwein Road
 E/W: Alessandro Boulevard
 Weather: Clear

File Name : 06_RIV_Trautwein_Alessandro PM
 Site Code : 05119542
 Start Date : 8/20/2019
 Page No : 1

Groups Printed- 4+ Axle Trucks

Start Time	Alessandro Boulevard Westbound				Trautwein Road Northbound				Alessandro Boulevard Eastbound				Exclu. Total	Inclu. Total	Int. Total
	Left	Thru	RTOR	App. Total	Left	Right	RTOR	App. Total	Thru	Right	RTOR	App. Total			
04:00 PM	0	0	0	0	0	0	0	0	0	0	0	0	0	0	0
04:15 PM	0	0	0	0	0	0	0	0	0	0	0	0	0	0	0
04:30 PM	0	0	0	0	0	0	0	0	0	0	0	0	0	0	0
04:45 PM	0	0	0	0	0	0	0	0	1	0	0	1	0	1	1
Total	0	0	0	0	0	0	0	0	1	0	0	1	0	1	1
05:00 PM	0	0	0	0	0	0	0	0	0	0	0	0	0	0	0
05:15 PM	0	0	0	0	0	0	0	0	0	0	0	0	0	0	0
05:30 PM	0	0	0	0	0	0	0	0	0	0	0	0	0	0	0
05:45 PM	1	0	0	1	0	0	0	0	1	0	0	1	0	2	2
Total	1	0	0	1	0	0	0	0	1	0	0	1	0	2	2
Grand Total	1	0	0	1	0	0	0	0	2	0	0	2	0	3	3
Apprch %	100	0			0	0			100	0					
Total %	33.3	0		33.3	0	0		0	66.7	0		66.7	0	100	

Start Time	Alessandro Boulevard Westbound			Trautwein Road Northbound			Alessandro Boulevard Eastbound			Int. Total
	Left	Thru	App. Total	Left	Right	App. Total	Thru	Right	App. Total	
Peak Hour Analysis From 04:45 PM to 05:30 PM - Peak 1 of 1										
Peak Hour for Entire Intersection Begins at 04:45 PM										
04:45 PM	0	0	0	0	0	0	1	0	1	1
05:00 PM	0	0	0	0	0	0	0	0	0	0
05:15 PM	0	0	0	0	0	0	0	0	0	0
05:30 PM	0	0	0	0	0	0	0	0	0	0
Total Volume	0	0	0	0	0	0	1	0	1	1
% App. Total	0	0		0	0		100	0		
PHF	.000	.000	.000	.000	.000	.000	.250	.000	.250	.250

City of Riverside
 N/S: Trautwein Road
 E/W: Alessandro Boulevard
 Weather: Clear

File Name : 06_RIV_Trautwein_Alessandro PM
 Site Code : 05119542
 Start Date : 8/20/2019
 Page No : 2

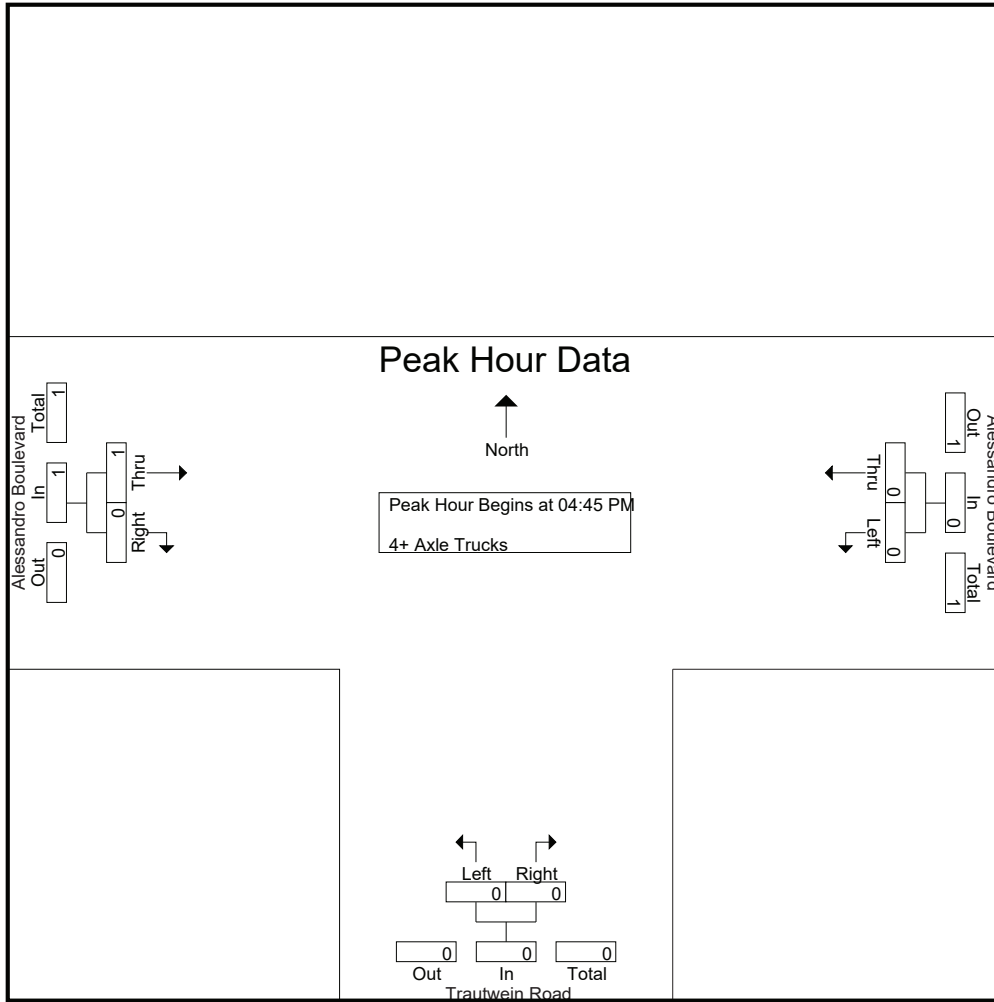

Peak Hour Analysis From 04:45 PM to 05:30 PM - Peak 1 of 1
 Peak Hour for Each Approach Begins at:

	04:45 PM			04:45 PM			04:45 PM		
+0 mins.	0	0	0	0	0	0	1	0	1
+15 mins.	0	0	0	0	0	0	0	0	0
+30 mins.	0	0	0	0	0	0	0	0	0
+45 mins.	0	0	0	0	0	0	0	0	0
Total Volume	0	0	0	0	0	0	1	0	1
% App. Total	0	0	0	0	0	0	100	0	100
PHF	.000	.000	.000	.000	.000	.000	.250	.000	.250

Location: Riverside
 N/S: Trautwein Road
 E/W: Alessandro Boulevard



Date: 8/20/2019
 Day: Tuesday

PEDESTRIANS

	North Leg Dead End	East Leg Alessandro Boulevard	South Leg Trautwein Road	West Leg Alessandro Boulevard	
	Pedestrians	Pedestrians	Pedestrians	Pedestrians	
7:00 AM	0	0	0	0	0
7:15 AM	0	0	0	0	0
7:30 AM	0	0	0	0	0
7:45 AM	0	0	0	0	0
8:00 AM	0	0	0	0	0
8:15 AM	0	0	1	0	1
8:30 AM	0	0	0	0	0
8:45 AM	0	0	0	0	0
TOTAL VOLUMES:	0	0	1	0	1

	North Leg Dead End	East Leg Alessandro Boulevard	South Leg Trautwein Road	West Leg Alessandro Boulevard	
	Pedestrians	Pedestrians	Pedestrians	Pedestrians	
4:00 PM	0	0	0	0	0
4:15 PM	0	0	0	0	0
4:30 PM	0	0	0	0	0
4:45 PM	0	0	0	0	0
5:00 PM	0	0	0	0	0
5:15 PM	0	0	0	0	0
5:30 PM	0	0	0	0	0
5:45 PM	0	0	0	0	0
TOTAL VOLUMES:	0	0	0	0	0

Location: Riverside
 N/S: Trautwein Road
 E/W: Alessandro Boulevard



Date: 8/20/2019
 Day: Tuesday

BICYCLES

	Southbound Dead End			Westbound Alessandro Boulevard			Northbound Trautwein Road			Eastbound Alessandro Boulevard			
	Left	Thru	Right	Left	Thru	Right	Left	Thru	Right	Left	Thru	Right	
7:00 AM	0	0	0	0	0	0	0	0	0	0	0	0	0
7:15 AM	0	0	0	0	0	0	0	0	0	0	0	0	0
7:30 AM	0	0	0	0	0	0	0	0	0	0	0	0	0
7:45 AM	0	0	0	0	0	0	0	0	0	0	0	0	0
8:00 AM	0	0	0	0	0	0	0	0	0	0	0	0	0
8:15 AM	0	0	0	0	0	0	0	0	0	0	1	0	1
8:30 AM	0	0	0	0	0	0	0	0	0	0	0	0	0
8:45 AM	0	0	0	0	0	0	0	0	0	0	0	0	0
TOTAL VOLUMES:	0	0	0	0	0	0	0	0	0	0	1	0	1

	Southbound Dead End			Westbound Alessandro Boulevard			Northbound Trautwein Road			Eastbound Alessandro Boulevard			
	Left	Thru	Right	Left	Thru	Right	Left	Thru	Right	Left	Thru	Right	
4:00 PM	0	0	0	0	0	0	0	0	0	0	0	0	0
4:15 PM	0	0	0	0	0	0	0	0	0	0	0	0	0
4:30 PM	0	0	0	0	0	0	0	0	0	0	0	0	0
4:45 PM	0	0	0	0	1	0	0	0	0	0	0	0	1
5:00 PM	0	0	0	0	0	0	0	0	0	0	0	0	0
5:15 PM	0	0	0	0	0	0	0	0	0	0	0	0	0
5:30 PM	0	0	0	0	0	0	1	0	0	0	0	0	1
5:45 PM	0	0	0	0	0	0	0	0	0	0	1	0	1
TOTAL VOLUMES:	0	0	0	0	1	0	1	0	0	0	1	0	3

Counts Unlimited
 PO Box 1178
 Corona, CA 92878
 (951) 268-6268

City of Riverside
 N/S: Trautwein Road
 EW: Orange Terrace Parkway
 Weather: Clear

File Name : 09_RIV_Trautwein_Orange Terrace AM
 Site Code : 05119542
 Start Date : 8/20/2019
 Page No : 1

Groups Printed- Passenger Vehicles - Large 2 Axle Vehicles - 3 Axle Vehicles - 4+ Axle Trucks

Start Time	Trautwein Road Southbound							Orange Terrace Parkway Westbound							Trautwein Road Northbound							Orange Terrace Parkway Eastbound						
	Left	Thru	Right	RTOR	App. Total	Left	Thru	Right	RTOR	App. Total	Left	Thru	Right	RTOR	App. Total	Left	Thru	Right	RTOR	App. Total	Left	Thru	Right	RTOR	App. Total	Exclu. Total	Inclu. Total	Int. Total
	Total							Total							Total							Total						
07:00 AM	103	155	1	0	259	92	28	134	78	254	8	238	38	22	284	10	15	1	1	26	101	823	924					
07:15 AM	97	177	6	5	280	101	68	138	38	307	10	249	77	36	336	16	20	2	1	38	80	961	1041					
07:30 AM	61	107	6	6	174	63	31	139	55	233	22	224	58	17	304	22	13	5	0	40	78	751	829					
07:45 AM	26	96	13	4	135	32	6	74	56	112	7	270	30	4	307	32	7	4	2	43	66	597	663					
Total	287	535	26	15	848	288	133	485	227	906	47	981	203	79	1231	80	55	12	4	147	325	3132	3457					
08:00 AM	21	90	2	0	113	19	3	77	64	99	3	242	21	5	266	42	11	2	0	55	69	533	602					
08:15 AM	25	81	1	0	107	25	0	58	56	83	1	216	17	3	234	13	0	2	2	15	61	439	500					
08:30 AM	30	85	1	0	116	32	1	66	48	99	4	220	16	8	240	12	2	0	0	14	56	469	525					
08:45 AM	28	96	1	1	125	19	3	61	33	83	3	173	17	5	193	4	8	1	0	13	39	414	453					
Total	104	352	5	1	461	95	7	262	201	364	11	851	71	21	933	71	21	5	2	97	225	1855	2080					
Grand Total	391	887	31	16	1309	383	140	747	428	1270	58	1832	274	100	2164	151	76	17	6	244	550	4987	5537					
Approch %	29.9	67.8	2.4			30.2	11	58.8			2.7	84.7	12.7			61.9	31.1	7										
Total %	7.8	17.8	0.6			7.7	2.8	15			1.2	36.7	5.5			3	1.5	0.3			9.9	90.1						
Passenger Vehicles	382	859	31		1288	375	137	735		1668	58	1781	267		2203	148	73	17		244	0	0	5403					
% Passenger Vehicles	97.7	96.8	100		97.2	97.9	97.9	98.4		98.2	100	97.2	97.4		97	98	96.1	100		97.6	0	0	97.6					
Large 2 Axle Vehicles	9	23	0		32	8	3	11		29	0	41	7		51	3	3	0		6	0	0	118					
% Large 2 Axle Vehicles	2.3	2.6	0		2.4	2.1	2.1	1.5		1.7	0	2.2	2.6		3	2	3.9	0		2.4	0	0	2.1					
3 Axle Vehicles	0	1	0		1	0	0	0		0	0	2	0		2	0	0	0		0	0	0	3					
% 3 Axle Vehicles	0	0.1	0		0.1	0	0	0		0	0	0.1	0		0.1	0	0	0		0	0	0	0.1					
4+ Axle Trucks	0	4	0		4	0	0	1		1	0	8	0		8	0	0	0		0	0	0	13					
% 4+ Axle Trucks	0	0.5	0		0.3	0	0	0.1		0.1	0	0.4	0		0.4	0	0	0		0	0	0	0.2					

Start Time	Trautwein Road Southbound							Orange Terrace Parkway Westbound							Trautwein Road Northbound							Orange Terrace Parkway Eastbound						
	Left	Thru	Right	RTOR	App. Total	Left	Thru	Right	RTOR	App. Total	Left	Thru	Right	RTOR	App. Total	Left	Thru	Right	RTOR	App. Total	Left	Thru	Right	RTOR	App. Total	Exclu. Total	Inclu. Total	Int. Total
	Total							Total							Total							Total						
07:00 AM	103	155	1	0	259	92	28	134	78	254	8	238	38	22	284	10	15	1	1	26	101	823	924					
07:15 AM	97	177	6	5	280	101	68	138	38	307	10	249	77	36	336	16	20	2	1	38	80	961	1041					
07:30 AM	61	107	6	6	174	63	31	139	55	233	22	224	58	17	304	22	13	5	0	40	78	751	829					
07:45 AM	26	96	13	4	135	32	6	74	56	112	7	270	30	4	307	32	7	4	2	43	66	597	663					
Total	287	535	26	15	848	288	133	485	227	906	47	981	203	79	1231	80	55	12	4	147	325	3132	3457					
08:00 AM	21	90	2	0	113	19	3	77	64	99	3	242	21	5	266	42	11	2	0	55	69	533	602					
08:15 AM	25	81	1	0	107	25	0	58	56	83	1	216	17	3	234	13	0	2	2	15	61	439	500					
08:30 AM	30	85	1	0	116	32	1	66	48	99	4	220	16	8	240	12	2	0	0	14	56	469	525					
08:45 AM	28	96	1	1	125	19	3	61	33	83	3	173	17	5	193	4	8	1	0	13	39	414	453					
Total	104	352	5	1	461	95	7	262	201	364	11	851	71	21	933	71	21	5	2	97	225	1855	2080					
Grand Total	391	887	31	16	1309	383	140	747	428	1270	58	1832	274	100	2164	151	76	17	6	244	550	4987	5537					
Approch %	29.9	67.8	2.4			30.2	11	58.8			2.7	84.7	12.7			61.9	31.1	7										
Total %	7.8	17.8	0.6			7.7	2.8	15			1.2	36.7	5.5			3	1.5	0.3			9.9	90.1						
Passenger Vehicles	382	859	31		1288	375	137	735		1668	58	1781	267		2203	148	73	17		244	0	0	5403					
% Passenger Vehicles	97.7	96.8	100		97.2	97.9	97.9	98.4		98.2	100	97.2	97.4		97	98	96.1	100		97.6	0	0	97.6					
Large 2 Axle Vehicles	9	23	0		32	8	3	11		29	0	41	7		51	3	3	0		6	0	0	118					
% Large 2 Axle Vehicles	2.3	2.6	0		2.4	2.1	2.1	1.5		1.7	0	2.2	2.6		3	2	3.9	0		2.4	0	0	2.1					
3 Axle Vehicles	0	1	0		1	0	0	0		0	0	2	0		2	0	0	0		0	0	0	3					
% 3 Axle Vehicles	0	0.1	0		0.1	0	0	0		0	0	0.1	0		0.1	0	0	0		0	0	0	0.1					
4+ Axle Trucks	0	4	0		4	0	0	1		1	0	8	0		8	0	0	0		0	0	0	13					
% 4+ Axle Trucks	0	0.5	0		0.3	0	0	0.1		0.1	0	0.4	0		0.4	0	0	0		0	0	0	0.2					

Start Time	Trautwein Road Southbound							Orange Terrace Parkway Westbound							Trautwein Road Northbound							Orange Terrace Parkway Eastbound						
	Left	Thru	Right	RTOR	App. Total	Left	Thru	Right	RTOR	App. Total	Left	Thru	Right	RTOR	App. Total	Left	Thru	Right	RTOR	App. Total	Left	Thru	Right	RTOR	App. Total	Exclu. Total	Inclu. Total	Int. Total
	Total							Total							Total							Total						
07:00 AM	103	155	1	0	259	92	28	134	78	254	8	238	38	22	284	10	15	1	1	26	101	823	924					
07:15 AM	97	177	6	5	280	101	68	138	38	307	10	249	77	36	336	16	20	2	1	38	80	961	1041					
07:30 AM	61	107	6	6	174	63	31	139	55	233	22	224	58	17	304	22	13	5	0	40	78	751	829					
07:45 AM	26	96	13	4	135	32	6	74	56	112	7	270	30	4	307	32	7	4	2	43	66	597	663					
Total	287	535	26	15	848	288	133	485	227	906	47	981	203	79	1231	80	55	12	4	147	325	3132	3457					
08:00 AM	21	90	2	0	113	19	3	77	64	99	3	242	21	5	266	42	11	2	0	55	69	533	602					
08:15 AM	25	81	1	0	107	25	0	58	56	83	1	216	17	3	234	13	0	2	2	15	61	439	500					
08:30 AM	30	85	1	0	116	32	1	66	48	99	4	220	16	8	240	12	2	0	0	14	56	469	525					
08:45 AM	28	96	1	1	125	19	3	61	33	83	3	173	17	5	193	4	8	1	0	13	39	414	453					
Total	104	352	5	1	461	95	7	262	201	364	11	851	71	21	933	71	21	5	2	97	225	1855	2080					
Grand Total	391	887	31	16	1309	383	140	747	428	1270	58	1832	274	100	2164	151	76	17	6	244	550	4987	5537					
Approch %	29.9	67.8	2.4			30.2	11	58.8			2.7	84.7	12.7			61.9	31.1	7										
Total %	7.8	17.8	0.6			7.7	2.8	15			1.2	36.7	5.5			3	1.5	0.3			9.9	90.1						
Passenger Vehicles	382	859	31		1288	375	137	735		1668	58	1781	267		2203	148	73	17		244	0	0	5403					
% Passenger Vehicles	97.7	96.8	100		97.2	97.9	97.9	98.4		98.2	100	97.2	97.4		97	98	96.1	100		97.6	0	0	97.6					
Large 2 Axle Vehicles	9	23	0		32	8	3	11		29	0	41	7		51	3	3	0										

Counts Unlimited
 PO Box 1178
 Corona, CA 92878
 (951) 268-6268

City of Riverside
 N/S: Trautwein Road
 E/W: Orange Terrace Parkway
 Weather: Clear

File Name : 09_RIV_Trautwein_Orange Terrace AM
 Site Code : 05119542
 Start Date : 8/20/2019
 Page No : 2

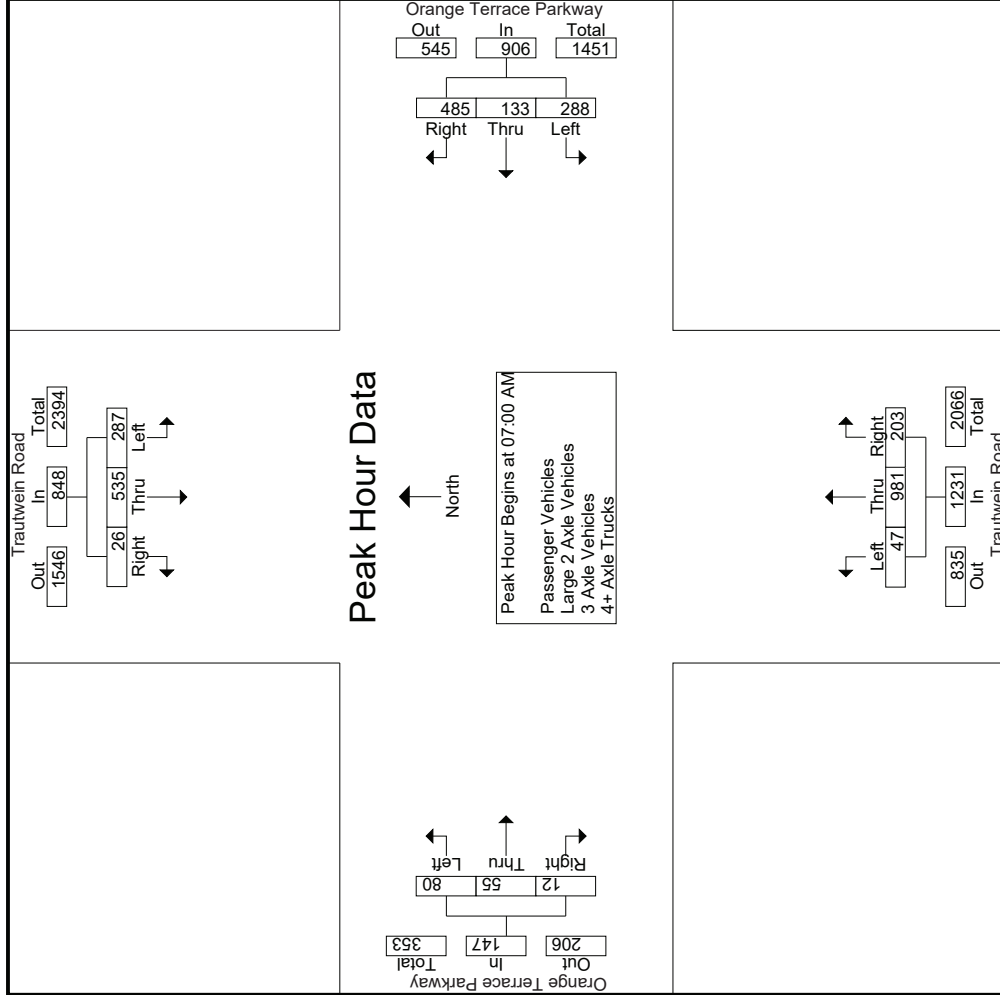

Counts Unlimited
 PO Box 1178
 Corona, CA 92878
 (951) 268-6268

City of Riverside
 N/S: Trautwein Road
 E/W: Orange Terrace Parkway
 Weather: Clear

File Name : 09_RIV_Trautwein_Orange Terrace AM
 Site Code : 05119542
 Start Date : 8/20/2019
 Page No : 3

Start Time	Trautwein Road Southbound			Orange Terrace Parkway Westbound			Trautwein Road Northbound			Orange Terrace Parkway Eastbound				
	Left	Thru	Right	App. Total	Left	Thru	Right	App. Total	Left	Thru	Right	App. Total	Int. Total	
Peak Hour Analysis From 07:00 AM to 08:45 AM - Peak 1 of 1														
Peak Hour for Each Approach Begins at:														
	07:00 AM			07:00 AM			07:00 AM			07:15 AM				
+0 mins.	103	155	1	259	28	134	254	8	238	38	20	284	38	
+15 mins.	97	177	6	280	68	138	307	10	249	77	13	336	40	
+30 mins.	61	107	6	174	31	139	233	22	224	58	7	304	43	
+45 mins.	26	96	13	135	6	74	112	7	270	30	11	307	55	
Total Volume	287	535	26	848	133	485	906	47	981	203	51	1231	176	
% App. Total	33.8	63.1	3.1		14.7	53.5		3.8	79.7	16.5	29	63.6	7.4	
PHF	.697	.756	.500	.757	.489	.872	.738	.534	.908	.659	.638	.667	.650	.800

Counts Unlimited
 PO Box 1178
 Corona, CA 92878
 (951) 268-6268

City of Riverside
 N/S: Trautwein Road
 EW: Orange Terrace Parkway
 Weather: Clear

File Name : 09_RIV_Trautwein_Orange Terrace AM
 Site Code : 05119542
 Start Date : 8/20/2019
 Page No : 1

Groups Printed- Passenger Vehicles

Start Time	Trautwein Road Southbound						Orange Terrace Parkway Westbound						Trautwein Road Northbound						Orange Terrace Parkway Eastbound					
	Left		Thru		Right		Left		Thru		Right		Left		Thru		Right		Left		Thru		Right	
	Count	%	Count	%	Count	%	Count	%	Count	%	Count	%	Count	%	Count	%	Count	%	Count	%	Count	%	Count	%
07:00 AM	101	150	1	0	252	90	28	131	77	249	8	233	38	22	279	10	15	1	1	26	100	806	906	
07:15 AM	96	171	6	5	273	101	68	136	37	305	10	240	75	35	325	16	20	2	1	38	78	941	1019	
07:30 AM	60	107	6	6	173	62	29	137	54	228	22	215	58	17	295	22	11	5	0	38	77	734	811	
07:45 AM	25	90	13	4	128	31	6	72	54	109	7	267	29	4	303	30	7	4	2	41	64	581	645	
Total	282	518	26	15	826	284	131	476	222	891	47	955	200	78	1202	78	53	12	4	143	319	3062	3381	
08:00 AM	20	89	2	0	111	18	2	77	64	97	3	235	21	5	259	42	11	2	0	55	69	522	591	
08:15 AM	24	80	1	0	105	24	0	57	55	81	1	206	15	3	222	13	0	2	2	15	60	423	483	
08:30 AM	29	83	1	0	113	31	1	65	48	97	4	212	14	6	230	11	1	0	0	12	54	452	506	
08:45 AM	27	89	1	1	117	18	3	60	32	81	3	173	17	5	193	4	8	1	0	13	38	404	442	
Total	100	341	5	1	446	91	6	259	199	356	11	826	67	19	904	70	20	5	2	95	221	1801	2022	
Grand Total	382	859	31	16	1272	375	137	735	421	1247	58	1781	267	97	2106	148	73	17	6	238	540	4863	5403	
Approch %	30	67.5	2.4		26.2	30.1	11	58.9		25.6	2.8	84.6	12.7		62.2	30.7	7.1		4.9	10	90			
Total %	7.9	17.7	0.6			7.7	2.8	15.1			1.2	36.6	5.5		43.3	3	1.5	0.3						

Start Time	Trautwein Road Southbound						Orange Terrace Parkway Westbound						Trautwein Road Northbound						Orange Terrace Parkway Eastbound					
	Left		Thru		Right		Left		Thru		Right		Left		Thru		Right		Left		Thru		Right	
	Count	%	Count	%	Count	%	Count	%	Count	%	Count	%	Count	%	Count	%	Count	%	Count	%	Count	%	Count	%
07:00 AM	101	150	1		252	90	28	131	77	249	8	233	38	22	279	10	15	1	1	26	100	806	906	
07:15 AM	96	171	6	6	273	101	68	136	37	305	10	240	75	35	325	16	20	2	2	38	78	941	1019	
07:30 AM	60	107	6	6	173	62	29	137	54	228	22	215	58	17	295	22	11	5	0	38	77	734	811	
07:45 AM	25	90	13	4	128	31	6	72	54	109	7	267	29	4	303	30	7	4	2	41	64	581	645	
Total Volume	282	518	26	15	826	284	131	476	222	891	47	955	200	78	1202	78	53	12	4	143	319	3062	3381	
% App. Total	34.1	62.7	3.1		26.2	31.9	14.7	53.4		25.6	3.9	79.5	16.6		43.3	54.5	37.1	8.4		4.9	10	90		
PHF	.698	.757	.500		.756	.703	.482	.869		.730	.534	.894	.667		.925	.650	.663	.600		.872		.813		

Peak Hour Analysis From 07:00 AM to 07:45 AM - Peak 1 of 1
 Peak Hour for Entire Intersection Begins at 07:00 AM

Counts Unlimited
 PO Box 1178
 Corona, CA 92878
 (951) 268-6268

City of Riverside
 N/S: Trautwein Road
 E/W: Orange Terrace Parkway
 Weather: Clear

File Name : 09_RIV_Trautwein_Orange Terrace AM
 Site Code : 05119542
 Start Date : 8/20/2019
 Page No : 2

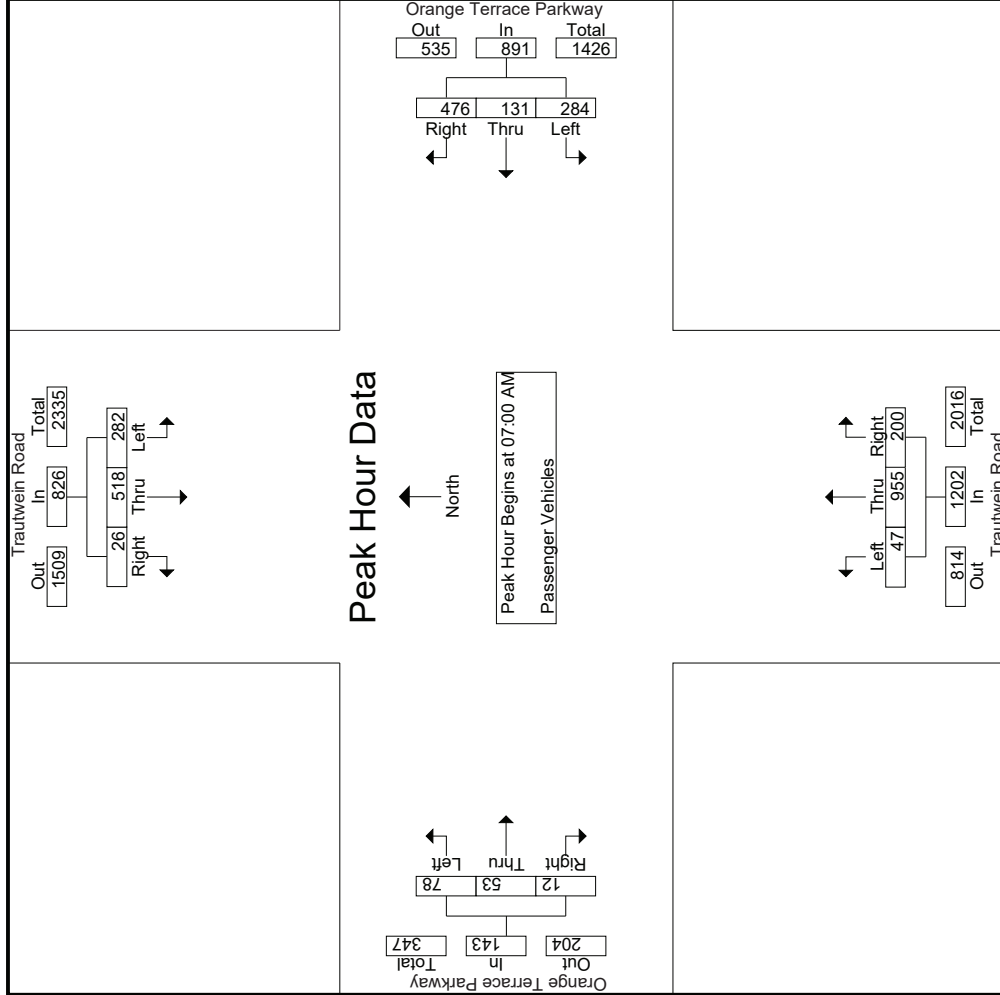

Groups Printed- Large 2 Axle Vehicles

Start Time	Trautwein Road Southbound						Orange Terrace Parkway Westbound						Trautwein Road Northbound						Orange Terrace Parkway Eastbound					
	Left		Thru		Right		Left		Thru		Right		Left		Thru		Right		Left		Thru		Right	
07:00 AM	2	5	0	0	0	7	2	0	2	1	4	0	4	0	0	4	0	0	0	0	0	0	0	
07:15 AM	1	5	0	0	6	0	0	2	1	2	6	2	1	8	0	0	0	0	0	0	0	0	2	
07:30 AM	1	0	0	0	1	2	2	2	1	5	0	8	0	8	0	2	0	0	2	1	16	17	1	
07:45 AM	1	5	0	0	6	1	0	2	2	3	2	1	0	3	2	0	0	2	2	14	16	2	2	
Total	5	15	0	0	20	4	2	8	5	14	0	20	3	23	2	2	0	0	4	61	67	6	6	
08:00 AM	1	1	0	0	2	1	1	0	0	2	0	6	0	6	0	0	0	0	0	0	10	10	0	
08:15 AM	1	1	0	0	2	1	0	1	1	2	8	2	0	10	0	0	0	0	0	1	14	15	1	
08:30 AM	1	2	0	0	3	1	0	1	0	2	7	2	2	9	1	1	0	0	2	2	16	18	2	
08:45 AM	1	4	0	0	5	1	0	1	1	2	0	0	0	0	0	0	0	0	0	1	7	8	1	
Total	4	8	0	0	12	4	1	3	2	8	0	21	4	25	1	1	0	0	2	4	47	51	4	
Grand Total	9	23	0	0	32	8	3	11	7	22	0	41	7	48	3	3	0	0	6	10	108	118	10	
Apprch %	28.1	71.9	0	0	29.6	36.4	13.6	50	20.4		0	85.4	14.6	44.4	50	50	0	0	5.6	8.5	91.5	91.5	8.5	
Total %	8.3	21.3	0	0	29.6	7.4	2.8	10.2	20.4		0	38	6.5	44.4	2.8	2.8	0	0	5.6	8.5	91.5	91.5	8.5	

Start Time	Trautwein Road Southbound						Orange Terrace Parkway Westbound						Trautwein Road Northbound						Orange Terrace Parkway Eastbound					
	Left		Thru		Right		Left		Thru		Right		Left		Thru		Right		Left		Thru		Right	
07:00 AM	2	5	0	0	7	2	0	2	1	4	0	4	0	0	4	0	0	0	0	0	0	0	0	
07:15 AM	1	5	0	0	6	0	0	2	1	2	6	2	1	8	0	0	0	0	0	0	0	0	2	
07:30 AM	1	0	0	0	1	2	2	2	1	5	0	8	0	8	0	2	0	0	2	1	16	17	1	
07:45 AM	1	5	0	0	6	1	0	2	2	3	2	1	0	3	2	0	0	2	2	14	16	2	2	
Total	5	15	0	0	20	4	2	8	5	14	0	20	3	23	2	2	0	0	4	61	67	6	6	
08:00 AM	1	1	0	0	2	1	1	0	0	2	0	6	0	6	0	0	0	0	0	0	10	10	0	
08:15 AM	1	1	0	0	2	1	0	1	1	2	8	2	0	10	0	0	0	0	0	1	14	15	1	
08:30 AM	1	2	0	0	3	1	0	1	0	2	7	2	2	9	1	1	0	0	2	2	16	18	2	
08:45 AM	1	4	0	0	5	1	0	1	1	2	0	0	0	0	0	0	0	0	0	1	7	8	1	
Total	4	8	0	0	12	4	1	3	2	8	0	21	4	25	1	1	0	0	2	4	47	51	4	
Grand Total	9	23	0	0	32	8	3	11	7	22	0	41	7	48	3	3	0	0	6	10	108	118	10	
Apprch %	28.1	71.9	0	0	29.6	36.4	13.6	50	20.4		0	85.4	14.6	44.4	50	50	0	0	5.6	8.5	91.5	91.5	8.5	
Total %	8.3	21.3	0	0	29.6	7.4	2.8	10.2	20.4		0	38	6.5	44.4	2.8	2.8	0	0	5.6	8.5	91.5	91.5	8.5	

Peak Hour Analysis From 07:00 AM to 07:45 AM - Peak 1 of 1
 Peak Hour for Entire Intersection Begins at 07:00 AM

Start Time	Trautwein Road Southbound						Orange Terrace Parkway Westbound						Trautwein Road Northbound						Orange Terrace Parkway Eastbound					
	Left		Thru		Right		Left		Thru		Right		Left		Thru		Right		Left		Thru		Right	
07:00 AM	2	5	0	0	7	2	0	2	1	4	0	4	0	0	4	0	0	0	0	0	0	0	0	
07:15 AM	1	5	0	0	6	0	0	2	1	2	6	2	1	8	0	0	0	0	0	0	0	0	2	
07:30 AM	1	0	0	0	1	2	2	2	1	5	0	8	0	8	0	2	0	0	2	1	16	17	1	
07:45 AM	1	5	0	0	6	1	0	2	2	3	2	1	0	3	2	0	0	2	2	14	16	2	2	
Total	5	15	0	0	20	4	2	8	5	14	0	20	3	23	2	2	0	0	4	61	67	6	6	
% App. Total	25	75	0	0	29.6	28.6	14.3	57.1	20.4		0	87	13	44.4	50	50	0	0	5.6	8.5	91.5	91.5	8.5	
PHF	.625	.750	.000	.000	.714	.500	.250	1.00	.700		.000	.625	.375	.375	.250	.250	.000	.000	.500	.500	.953	.953	.953	

Counts Unlimited
 PO Box 1178
 Corona, CA 92878
 (951) 268-6268

City of Riverside
 N/S: Trautwein Road
 E/W: Orange Terrace Parkway
 Weather: Clear

File Name : 09_RIV_Trautwein_Orange Terrace AM
 Site Code : 05119542
 Start Date : 8/20/2019
 Page No : 2

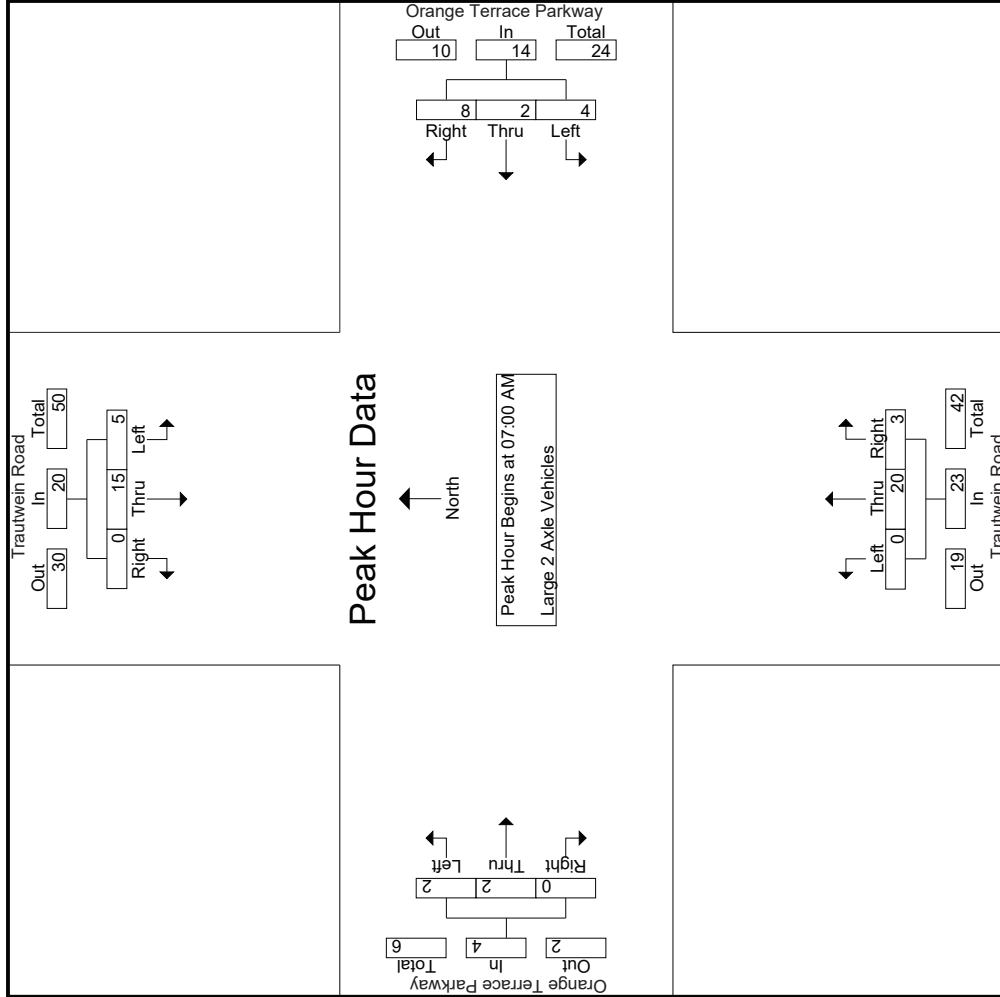

Counts Unlimited
 PO Box 1178
 Corona, CA 92878
 (951) 268-6268

City of Riverside
 N/S: Trautwein Road
 E/W: Orange Terrace Parkway
 Weather: Clear

File Name : 09_RIV_Trautwein_Orange Terrace AM
 Site Code : 05119542
 Start Date : 8/20/2019
 Page No : 3

Start Time	Trautwein Road Southbound			Orange Terrace Parkway Westbound			Trautwein Road Northbound			Orange Terrace Parkway Eastbound		
	Left	Thru	Right	Left	Thru	Right	Left	Thru	Right	Left	Thru	Right
Peak Hour Analysis From 07:00 AM to 07:45 AM - Peak 1 of 1												
Peak Hour for Each Approach Begins at:												
+0 mins.	2	5	0	2	0	2	4	4	0	0	0	0
+15 mins.	1	5	0	0	0	2	2	6	2	0	0	0
+30 mins.	1	0	0	1	2	5	8	8	0	0	2	0
+45 mins.	1	5	0	1	0	3	2	2	1	2	0	0
Total Volume	5	15	0	4	2	8	14	20	3	2	2	0
% App. Total	25	75	0	28.6	14.3	57.1	700	625	13	50	50	0
PHF	.625	.750	.000	.500	.250	1.000	.700	.625	.375	.250	.250	.000

Counts Unlimited
 PO Box 1178
 Corona, CA 92878
 (951) 268-6268

City of Riverside
 N/S: Trautwein Road
 E/W: Orange Terrace Parkway
 Weather: Clear

File Name : 09_RIV_Trautwein_Orange Terrace AM
 Site Code : 05119542
 Start Date : 8/20/2019
 Page No : 1

Groups Printed- 3 Axle Vehicles

Start Time	Trautwein Road Southbound					Orange Terrace Parkway Westbound					Trautwein Road Northbound					Orange Terrace Parkway Eastbound								
	Left	Thru	Right	RTOR	App. Total	Left	Thru	Right	RTOR	App. Total	Left	Thru	Right	RTOR	App. Total	Left	Thru	Right	RTOR	App. Total	Exclu. Total	Inclu. Total	Int. Total	
07:00 AM	0	0	0	0	0	0	0	0	0	0	0	0	0	0	0	0	0	0	0	0	0	0	0	0
07:15 AM	0	1	0	0	1	0	0	0	0	0	0	1	0	0	1	0	0	0	0	0	0	0	2	2
07:30 AM	0	0	0	0	0	0	0	0	0	0	0	0	0	0	0	0	0	0	0	0	0	0	0	0
07:45 AM	0	0	0	0	0	0	0	0	0	0	0	0	0	0	0	0	0	0	0	0	0	0	0	0
Total	0	1	0	0	1	0	0	0	0	0	0	1	0	0	1	0	0	0	0	0	0	0	2	2
08:00 AM	0	0	0	0	0	0	0	0	0	0	0	0	0	0	0	0	0	0	0	0	0	0	0	0
08:15 AM	0	0	0	0	0	0	0	0	0	0	0	0	0	0	0	0	0	0	0	0	0	0	0	0
08:30 AM	0	0	0	0	0	0	0	0	0	0	0	1	0	0	1	0	0	0	0	0	0	0	1	1
08:45 AM	0	0	0	0	0	0	0	0	0	0	0	0	0	0	0	0	0	0	0	0	0	0	0	0
Total	0	0	0	0	0	0	0	0	0	0	0	1	0	0	1	0	0	0	0	0	0	0	1	1
Grand Total	0	1	0	0	1	0	0	0	0	0	0	2	0	0	2	0	0	0	0	0	0	0	3	3
Approch %	0	100	0	0	0	0	0	0	0	0	100	0	0	0	0	0	0	0	0	0	0	0	0	0
Total %	0	33.3	0	0	33.3	0	0	0	0	0	66.7	0	0	0	66.7	0	0	0	0	0	0	0	100	100

Start Time	Trautwein Road Southbound					Orange Terrace Parkway Westbound					Trautwein Road Northbound					Orange Terrace Parkway Eastbound								
	Left	Thru	Right	RTOR	App. Total	Left	Thru	Right	RTOR	App. Total	Left	Thru	Right	RTOR	App. Total	Left	Thru	Right	RTOR	App. Total	Exclu. Total	Inclu. Total	Int. Total	
07:00 AM	0	0	0	0	0	0	0	0	0	0	0	0	0	0	0	0	0	0	0	0	0	0	0	0
07:15 AM	0	1	0	0	1	0	0	0	0	0	0	1	0	0	1	0	0	0	0	0	0	0	0	0
07:30 AM	0	0	0	0	0	0	0	0	0	0	0	0	0	0	0	0	0	0	0	0	0	0	0	0
07:45 AM	0	0	0	0	0	0	0	0	0	0	0	0	0	0	0	0	0	0	0	0	0	0	0	0
Total Volume	0	1	0	0	1	0	0	0	0	0	0	1	0	0	1	0	0	0	0	0	0	0	0	0
% App. Total	0	100	0	0	0	0	0	0	0	0	0	100	0	0	0	0	0	0	0	0	0	0	0	0
PHF	.000	.250	.000	.000	.250	.000	.000	.000	.000	.000	.250	.000	.250	.000	.250	.000	.000	.000	.000	.000	.000	.000	.250	.250

Peak Hour Analysis From 07:00 AM to 07:45 AM - Peak 1 of 1
 Peak Hour for Entire Intersection Begins at 07:00 AM

Counts Unlimited
 PO Box 1178
 Corona, CA 92878
 (951) 268-6268

City of Riverside
 N/S: Trautwein Road
 E/W: Orange Terrace Parkway
 Weather: Clear

File Name : 09_RIV_Trautwein_Orange Terrace AM
 Site Code : 05119542
 Start Date : 8/20/2019
 Page No : 2

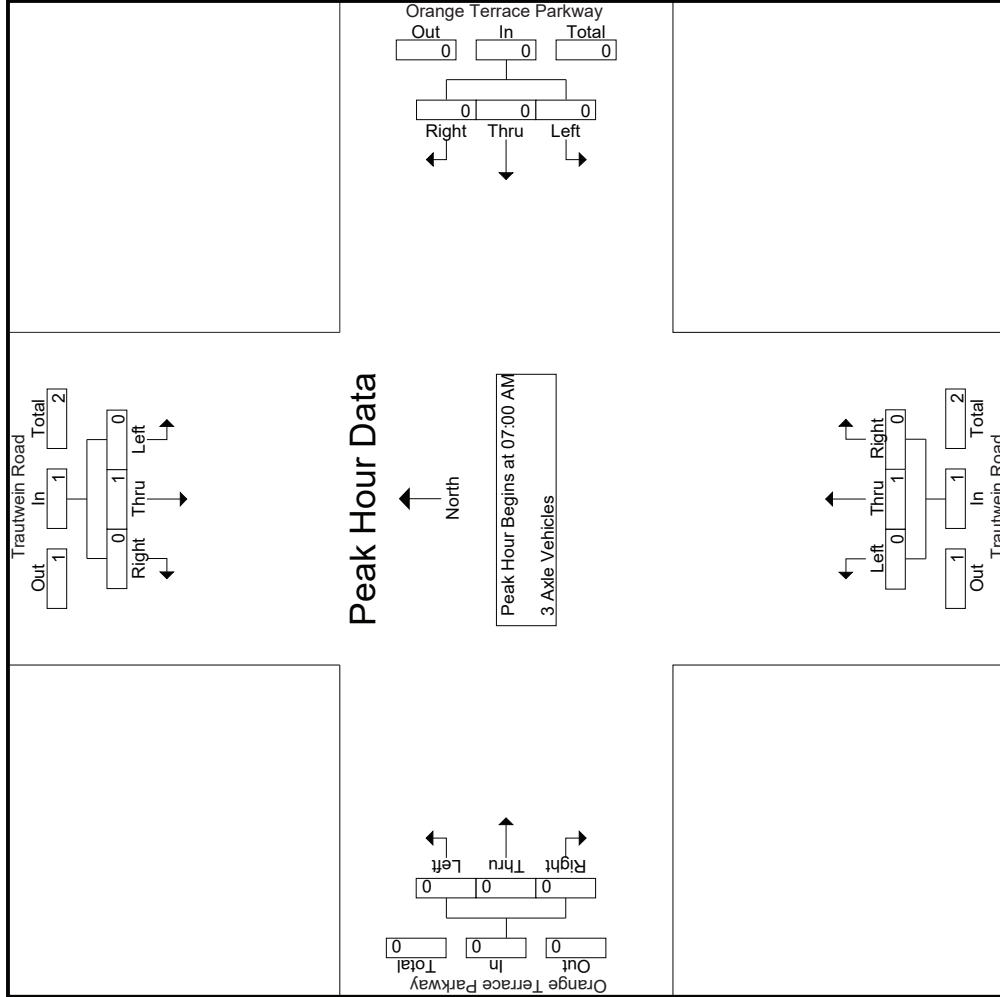

Counts Unlimited
 PO Box 1178
 Corona, CA 92878
 (951) 268-6268

City of Riverside
 N/S: Trautwein Road
 E/W: Orange Terrace Parkway
 Weather: Clear

File Name : 09_RIV_Trautwein_Orange Terrace AM
 Site Code : 05119542
 Start Date : 8/20/2019
 Page No : 3

Start Time	Trautwein Road Southbound			Orange Terrace Parkway Westbound			Trautwein Road Northbound			Orange Terrace Parkway Eastbound		
	Left	Thru	Right	Left	Thru	Right	Left	Thru	Right	Left	Thru	Right
Peak Hour Analysis From 07:00 AM to 07:45 AM - Peak 1 of 1												
Peak Hour for Each Approach Begins at:												
	07:00 AM			07:00 AM			07:00 AM			07:00 AM		
+0 mins.	0	0	0	0	0	0	0	0	0	0	0	0
+15 mins.	0	1	0	0	0	0	0	1	0	0	0	0
+30 mins.	0	0	0	0	0	0	0	0	0	0	0	0
+45 mins.	0	0	0	0	0	0	0	0	0	0	0	0
Total Volume	0	1	0	0	0	0	0	1	0	0	0	0
% App. Total	0	100	0	0	0	0	0	100	0	0	0	0
PHF	.000	.250	.000	.000	.000	.000	.000	.250	.000	.000	.000	.000
	.250			.000			.250			.000		
	.000			.000			.000			.000		
	.000			.000			.000			.000		

Groups Printed- 4+ Axle Trucks

Start Time	Trautwein Road Southbound				Orange Terrace Parkway Westbound				Trautwein Road Northbound				Orange Terrace Parkway Eastbound							
	Left	Thru	Right	RTOR	Left	Thru	Right	RTOR	Left	Thru	Right	RTOR	Left	Thru	Right	RTOR	Exclu. Total	Inclu. Total	Int. Total	
07:00 AM	0	0	0	0	0	0	1	0	0	1	0	0	0	0	0	0	0	0	2	2
07:15 AM	0	0	0	0	0	0	0	0	0	2	0	0	2	0	0	0	0	0	2	2
07:30 AM	0	0	0	0	0	0	0	0	0	1	0	0	1	0	0	0	0	0	1	1
07:45 AM	0	1	0	0	0	0	0	0	0	1	0	0	1	0	0	0	0	0	2	2
Total	0	1	0	0	0	1	0	0	0	5	0	0	5	0	0	0	0	0	7	7
08:00 AM	0	0	0	0	0	0	0	0	0	1	0	0	1	0	0	0	0	0	1	1
08:15 AM	0	0	0	0	0	0	0	0	0	2	0	0	2	0	0	0	0	0	2	2
08:30 AM	0	0	0	0	0	0	0	0	0	0	0	0	0	0	0	0	0	0	0	0
08:45 AM	0	3	0	0	0	0	0	0	0	0	0	0	0	0	0	0	0	0	3	3
Total	0	3	0	0	0	0	0	0	0	3	0	0	3	0	0	0	0	0	6	6
Grand Total	0	4	0	0	0	1	0	0	8	0	0	0	8	0	0	0	0	0	13	13
Apprch %	0	100	0	0	0	100	0	0	100	0	0	0	61.5	0	0	0	0	0	100	100
Total %	0	30.8	0	0	0	7.7	0	0	61.5	0	0	0	61.5	0	0	0	0	0	100	100

Start Time	Trautwein Road Southbound				Orange Terrace Parkway Westbound				Trautwein Road Northbound				Orange Terrace Parkway Eastbound							
	Left	Thru	Right	RTOR	Left	Thru	Right	RTOR	Left	Thru	Right	RTOR	Left	Thru	Right	RTOR	Exclu. Total	Inclu. Total	Int. Total	
07:00 AM	0	0	0	0	0	0	1	0	0	1	0	0	0	0	0	0	0	0	0	0
07:15 AM	0	0	0	0	0	0	0	0	0	2	0	0	2	0	0	0	0	0	0	0
07:30 AM	0	0	0	0	0	0	0	0	0	1	0	0	1	0	0	0	0	0	0	0
07:45 AM	0	1	0	0	0	0	0	0	0	1	0	0	1	0	0	0	0	0	0	0
Total Volume	0	1	0	0	0	1	0	0	5	0	0	0	5	0	0	0	0	0	7	7
% App. Total	0	100	0	0	0	100	0	0	100	0	0	0	100	0	0	0	0	0	100	100
PHF	.000	.250	.000	.000	.000	.250	.000	.250	.625	.000	.000	.625	.000	.000	.000	.000	.000	.000	.875	.875

Peak Hour Analysis From 07:00 AM to 07:45 AM - Peak 1 of 1
 Peak Hour for Entire Intersection Begins at 07:00 AM

Counts Unlimited
 PO Box 1178
 Corona, CA 92878
 (951) 268-6268

City of Riverside
 N/S: Trautwein Road
 E/W: Orange Terrace Parkway
 Weather: Clear

File Name : 09_RIV_Trautwein_Orange Terrace AM
 Site Code : 05119542
 Start Date : 8/20/2019
 Page No : 2

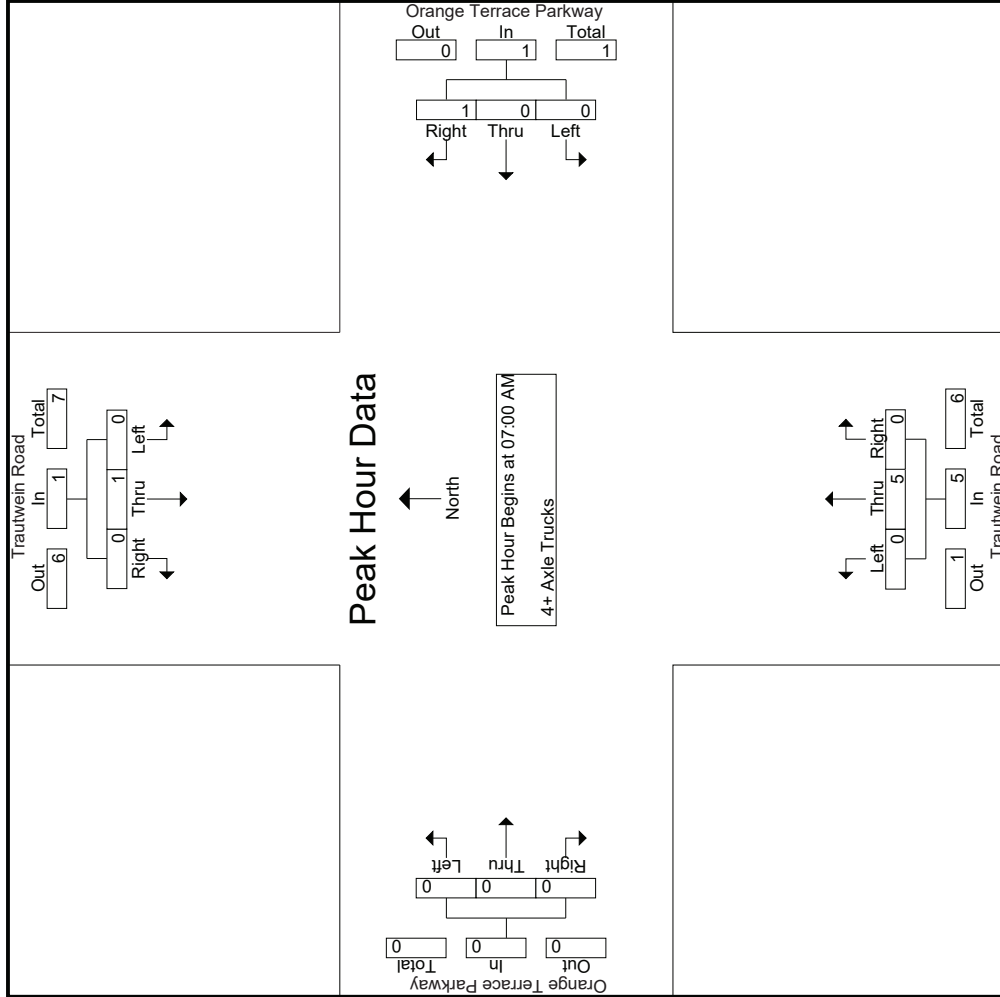

Counts Unlimited
 PO Box 1178
 Corona, CA 92878
 (951) 268-6268

City of Riverside
 N/S: Trautwein Road
 E/W: Orange Terrace Parkway
 Weather: Clear

File Name : 09_RIV_Trautwein_Orange Terrace AM
 Site Code : 05119542
 Start Date : 8/20/2019
 Page No : 3

Start Time	Trautwein Road Southbound			Orange Terrace Parkway Westbound			Trautwein Road Northbound			Orange Terrace Parkway Eastbound		
	Left	Thru	Right	Left	Thru	Right	Left	Thru	Right	Left	Thru	Right
Peak Hour Analysis From 07:00 AM to 07:45 AM - Peak 1 of 1												
Peak Hour for Each Approach Begins at:												
+0 mins.	0	0	0	0	0	1	0	0	1	0	0	1
+15 mins.	0	0	0	0	0	0	0	0	0	0	0	0
+30 mins.	0	0	0	0	0	0	0	0	1	0	0	0
+45 mins.	0	1	0	0	0	0	0	0	1	0	0	0
Total Volume	0	1	0	0	0	1	0	0	5	0	0	0
% App. Total	0	100	0	0	0	100	0	0	100	0	0	0
PHF	.000	.250	.000	.000	.000	.250	.000	.000	.625	.000	.000	.000

Counts Unlimited
 PO Box 1178
 Corona, CA 92878
 (951) 268-6268

City of Riverside
 N/S: Trautwein Road
 EW: Orange Terrace Parkway
 Weather: Clear

File Name : 09_RIV_Trautwein_Orange Terrace PM
 Site Code : 05119542
 Start Date : 8/20/2019
 Page No : 1

Groups Printed- Passenger Vehicles - Large 2 Axle Vehicles - 3 Axle Vehicles - 4+ Axle Trucks

Start Time	Trautwein Road Southbound					Orange Terrace Parkway Westbound					Trautwein Road Northbound					Orange Terrace Parkway Eastbound							
	Left	Thru	Right	RTOR	App. Total	Left	Thru	Right	RTOR	App. Total	Left	Thru	Right	RTOR	App. Total	Left	Thru	Right	RTOR	App. Total	Exclu. Total	Inclu. Total	Int. Total
	04:00 PM	63	210	4	2	277	30	4	52	40	86	8	174	45	18	227	10	9	3	1	22	61	612
04:15 PM	70	264	6	0	340	34	1	39	38	74	11	119	52	24	182	10	6	0	0	16	62	612	674
04:30 PM	86	264	7	3	357	35	5	42	32	82	6	145	45	22	196	6	9	3	3	18	60	653	713
04:45 PM	92	237	7	0	336	29	2	55	52	86	13	123	52	18	188	6	6	2	1	14	71	624	695
Total	311	975	24	5	1310	128	12	188	162	328	38	561	194	82	793	32	30	8	5	70	254	2501	2755
05:00 PM	78	247	11	2	336	39	5	47	31	91	9	143	38	10	190	6	6	4	2	16	45	633	678
05:15 PM	121	271	9	6	401	38	13	50	39	101	5	153	66	35	224	10	17	2	1	29	81	755	836
05:30 PM	105	255	8	1	368	28	3	54	43	85	7	148	68	25	223	7	11	2	0	20	69	696	765
05:45 PM	95	205	13	2	313	54	8	47	37	109	5	113	61	29	179	8	11	2	0	21	68	622	690
Total	399	978	41	11	1418	159	29	198	150	386	26	557	233	99	816	31	45	10	3	86	263	2706	2969
Grand Total	710	1953	65	16	2728	287	41	386	312	714	64	1118	427	181	1609	63	75	18	8	156	517	5207	5724
Approch %	26	71.6	2.4			40.2	5.7	54.1			4	69.5	26.5			40.4	48.1	11.5					
Total %	13.6	37.5	1.2			5.5	0.8	7.4			1.2	21.5	8.2			1.2	1.4	0.3			9	91	
% Passenger Vehicles	708	1931	65			284	41	381			64	1104	422			63	75	18			164	0	5667
% 2 Axle Vehicles	99.7	98.9	100			99	100	98.7			100	98.7	98.8			100	100	100			100	0	99
% Large 2 Axle Vehicles	2	18	0			3	0	5			0	12	5			0	0	0			0	0	51
% 3 Axle Vehicles	0.3	0.9	0			1	0	1.3			0	1.1	1.2			0	0	0			0	0	0.9
% 3 Axle Trucks	0	1	0			0	0	0			0	1	0			0	0	0			0	0	2
% 4+ Axle Trucks	0	0.1	0			0	0	0			0	0.1	0			0	0	0			0	0	0
% 4+ Axle Trucks	0	0.2	0			0	0	0			0	0.1	0			0	0	0			0	0	0.1

Start Time	Trautwein Road Southbound					Orange Terrace Parkway Westbound					Trautwein Road Northbound					Orange Terrace Parkway Eastbound							
	Left	Thru	Right	RTOR	App. Total	Left	Thru	Right	RTOR	App. Total	Left	Thru	Right	RTOR	App. Total	Left	Thru	Right	RTOR	App. Total	Exclu. Total	Inclu. Total	Int. Total
	04:45 PM	92	237	7			29	2	55			86	13	123			188	6	6			2	14
05:00 PM	78	247	11			39	5	47			91	9	143			190	6	6			4	16	633
05:15 PM	121	271	9			38	13	50			101	5	153			224	10	17			2	29	755
05:30 PM	105	255	8			28	3	54			85	7	148			223	7	11			2	20	696
05:45 PM	95	205	13			54	8	47			109	5	113			179	8	11			21	68	690
Total	396	1010	35			134	23	206			363	34	567			825	29	40			10	79	2708
% App. Total	27.5	70.1	2.4			36.9	6.3	56.7			27.2	4.1	68.7			36.7	50.6	12.7					
PHF	.818	.932	.795			.859	.442	.936			.899	.654	.926			.921	.725	.588			.625	.681	.897

Peak Hour Analysis From 04:00 PM to 05:45 PM - Peak 1 of 1
 Peak Hour for Entire Intersection Begins at 04:45 PM

Counts Unlimited
 PO Box 1178
 Corona, CA 92878
 (951) 268-6268

City of Riverside
 N/S: Trautwein Road
 E/W: Orange Terrace Parkway
 Weather: Clear

File Name : 09_RIV_Trautwein_Orange Terrace PM
 Site Code : 05119542
 Start Date : 8/20/2019
 Page No : 2

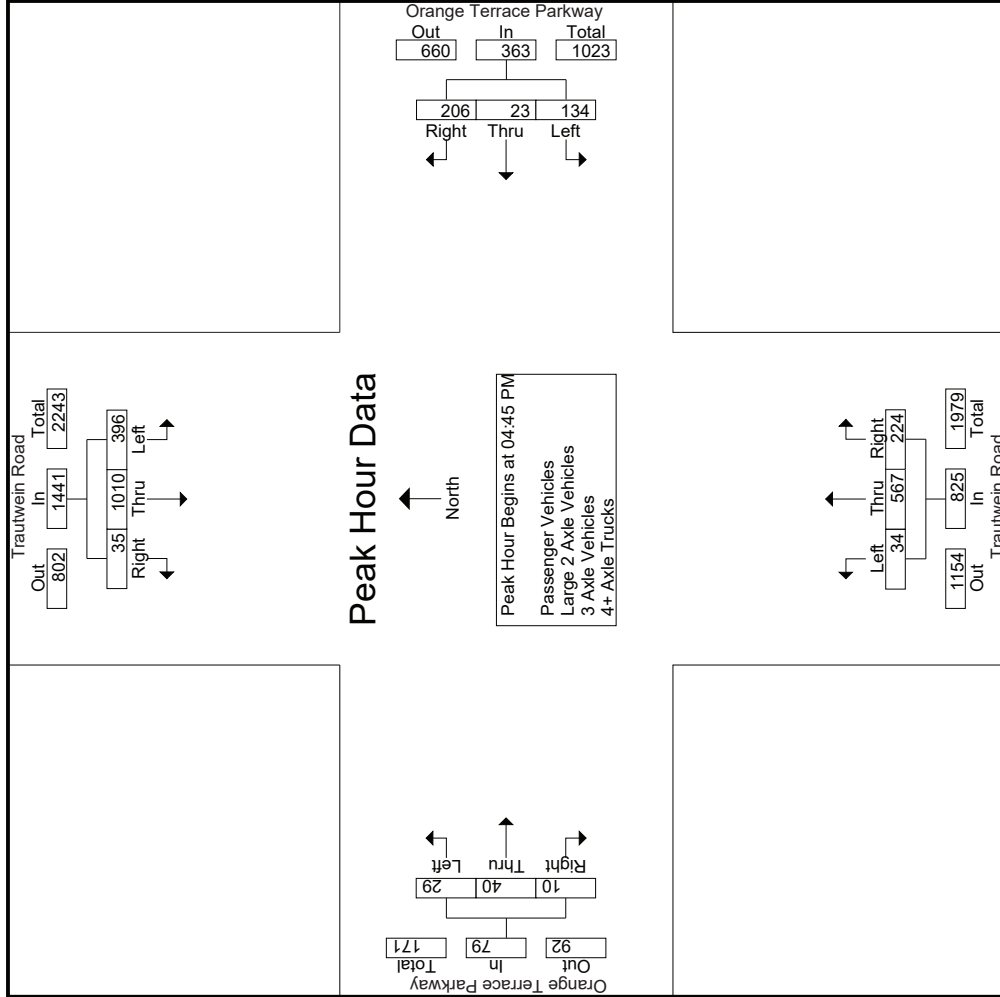

Groups Printed - Passenger Vehicles

Start Time	Trautwein Road Southbound						Orange Terrace Parkway Westbound						Trautwein Road Northbound						Orange Terrace Parkway Eastbound					
	Left	Thru	Right	RTOR	App. Total	Exclu. Total	Left	Thru	Right	RTOR	App. Total	Exclu. Total	Left	Thru	Right	RTOR	App. Total	Exclu. Total	Left	Thru	Right	RTOR	App. Total	Exclu. Total
	Inclu. Total	Int. Total	Inclu. Total	Int. Total	Inclu. Total	Int. Total	Left	Thru	Right	RTOR	App. Total	Exclu. Total	Left	Thru	Right	RTOR	App. Total	Exclu. Total	Left	Thru	Right	RTOR	App. Total	Exclu. Total
04:00 PM	63	206	4	2	273	30	4	51	39	85	171	45	18	224	10	9	3	1	22	60	604	664		
04:15 PM	69	261	6	0	336	34	1	39	38	74	117	50	24	178	10	6	0	0	16	62	604	666		
04:30 PM	86	260	7	3	353	34	5	40	31	79	6	144	45	22	195	6	9	3	3	18	59	645	704	
04:45 PM	91	232	7	0	330	28	2	55	52	85	13	120	51	17	184	6	6	2	1	14	70	613	683	
Total	309	959	24	5	1292	126	12	185	160	323	38	552	191	81	781	32	30	8	5	70	251	2466	2717	
05:00 PM	78	246	11	2	335	39	5	46	30	90	9	143	38	10	190	6	6	4	2	16	44	631	675	
05:15 PM	121	270	9	6	400	38	13	50	39	101	5	150	65	34	220	10	17	2	1	29	80	750	830	
05:30 PM	105	252	8	1	365	27	3	54	43	84	7	147	68	25	222	7	11	2	0	20	69	691	760	
05:45 PM	95	204	13	2	312	54	8	46	36	108	5	112	60	29	177	8	11	2	0	21	67	618	685	
Total	399	972	41	11	1412	158	29	196	148	383	26	552	231	98	809	31	45	10	3	86	260	2690	2950	
Grand Total	708	1931	65	16	2704	284	41	381	308	706	64	1104	422	179	1590	63	75	18	8	156	511	5156	5667	
Apprch %	26.2	71.4	2.4			40.2	5.8	54		13.7	1.2	21.4	8.2		30.8	40.4	48.1	11.5		3	9	91		
Total %	13.7	37.5	1.3		52.4	5.5	0.8	7.4								1.2	1.5	0.3						

Start Time	Trautwein Road Southbound						Orange Terrace Parkway Westbound						Trautwein Road Northbound						Orange Terrace Parkway Eastbound					
	Left	Thru	Right	RTOR	App. Total	Exclu. Total	Left	Thru	Right	RTOR	App. Total	Exclu. Total	Left	Thru	Right	RTOR	App. Total	Exclu. Total	Left	Thru	Right	RTOR	App. Total	Exclu. Total
	Inclu. Total	Int. Total	Inclu. Total	Int. Total	Inclu. Total	Int. Total	Left	Thru	Right	RTOR	App. Total	Exclu. Total	Left	Thru	Right	RTOR	App. Total	Exclu. Total	Left	Thru	Right	RTOR	App. Total	Exclu. Total
04:45 PM	91	232	7		330	28	2	55		85	13	120	51	184	6	6	2		2	14	613			
05:00 PM	78	246	11		335	39	5	46		90	9	143	38	190	6	6	4		4	16	631			
05:15 PM	121	270	9		400	38	13	50		101	5	150	65	220	10	17	2		2	29	750			
05:30 PM	105	252	8		365	27	3	54		84	7	147	68	222	7	11	2		2	20	691			
05:45 PM	95	204	13		312	54	8	46		108	5	112	60	177	8	11	2		2	21	685			
Total Volume	395	1000	35		1430	132	23	205		360	34	560	222	816	29	40	10		10	79	2685			
% App. Total	27.6	69.9	2.4			36.7	6.4	56.9		13.7	1.2	21.4	8.2		30.8	40.4	48.1	11.5		3	9	91		
PHF	.816	.926	.795		.894	.846	.442	.932		.891	.654	.933	.816	.919	.725	.588	.625			.681	.895			

Peak Hour Analysis From 04:45 PM to 05:30 PM - Peak 1 of 1
 Peak Hour for Entire Intersection Begins at 04:45 PM

Counts Unlimited
 PO Box 1178
 Corona, CA 92878
 (951) 268-6268

City of Riverside
 N/S: Trautwein Road
 E/W: Orange Terrace Parkway
 Weather: Clear

File Name : 09_RIV_Trautwein_Orange Terrace PM
 Site Code : 05119542
 Start Date : 8/20/2019
 Page No : 2

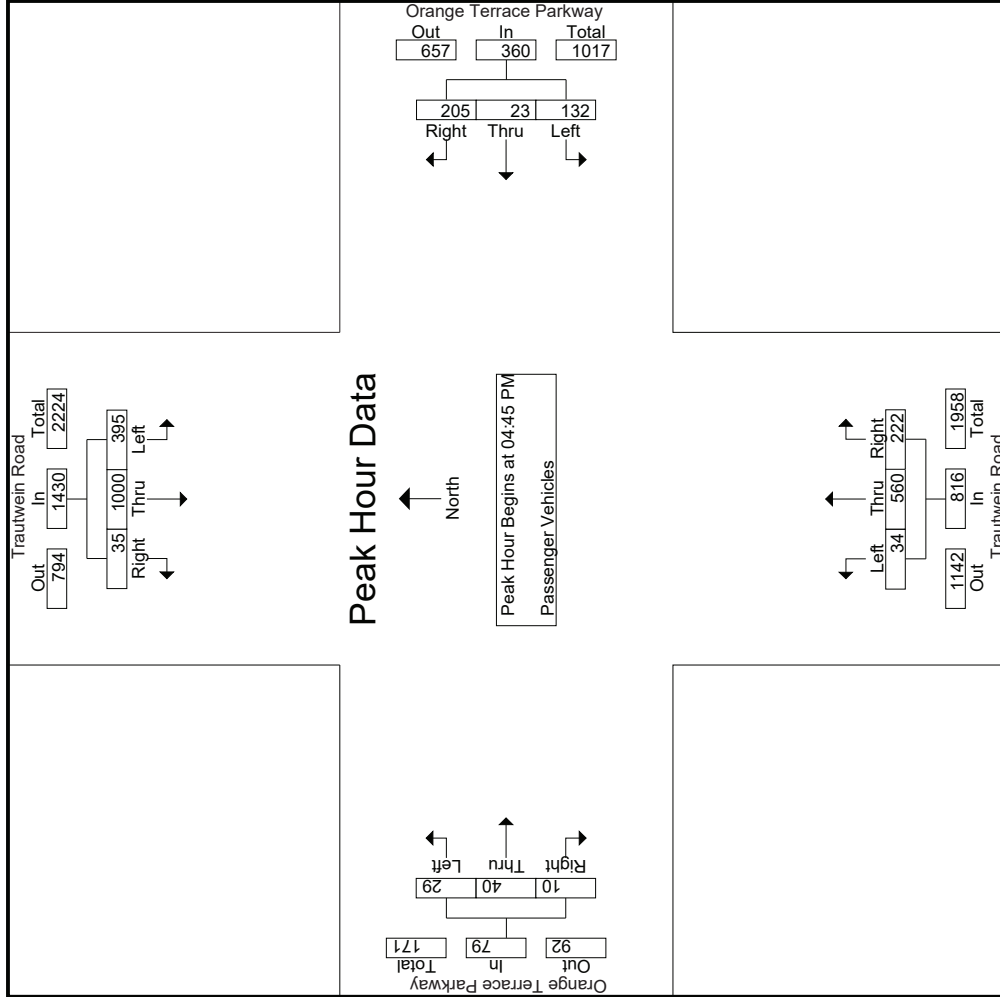

Counts Unlimited
 PO Box 1178
 Corona, CA 92878
 (951) 268-6268

City of Riverside
 N/S: Trautwein Road
 E/W: Orange Terrace Parkway
 Weather: Clear

File Name : 09_RIV_Trautwein_Orange Terrace PM
 Site Code : 05119542
 Start Date : 8/20/2019
 Page No : 3

Start Time	Trautwein Road Southbound			Orange Terrace Parkway Westbound			Trautwein Road Northbound			Orange Terrace Parkway Eastbound					
	Left	Thru	Right	Left	Thru	Right	Left	Thru	Right	Left	Thru	Right			
Peak Hour Analysis From 04:45 PM to 05:30 PM - Peak 1 of 1															
Peak Hour for Each Approach Begins at:															
	04:45 PM			04:45 PM			04:45 PM			04:45 PM					
+0 mins.	91	232	7	28	2	55	85	13	120	51	184	6	6	2	14
+15 mins.	78	246	11	39	5	46	90	9	143	38	190	6	6	4	16
+30 mins.	121	270	9	38	13	50	101	5	150	65	220	10	17	2	29
+45 mins.	105	252	8	27	3	54	84	7	147	68	222	7	11	2	20
Total Volume	395	1000	35	132	23	205	360	34	560	222	816	29	40	10	79
% App. Total	27.6	69.9	2.4	36.7	6.4	56.9	89.1	4.2	68.6	27.2	91.9	36.7	50.6	12.7	62.5
PHF	.816	.926	.795	.846	.442	.932	.891	.654	.933	.816	.919	.725	.588	.625	.681

Groups Printed- Large 2 Axle Vehicles

Start Time	Trautwein Road Southbound					Orange Terrace Parkway Westbound					Trautwein Road Northbound					Orange Terrace Parkway Eastbound								
	Left	Thru	Right	RTOR	App. Total	Left	Thru	Right	RTOR	App. Total	Left	Thru	Right	RTOR	App. Total	Left	Thru	Right	RTOR	App. Total	Exclu. Total	Inclu. Total	Int. Total	
04:00 PM	0	3	0	0	3	0	0	1	1	1	0	3	0	0	3	0	0	0	0	0	0	1	7	8
04:15 PM	1	3	0	0	4	0	0	0	0	0	0	3	0	0	3	0	0	0	0	0	0	0	7	7
04:30 PM	0	4	0	0	4	1	0	2	1	3	0	1	0	0	1	0	0	0	0	0	1	8	9	
04:45 PM	1	3	0	0	4	1	0	0	1	1	0	2	1	1	3	0	0	0	0	0	1	8	9	
Total	2	13	0	0	15	2	0	3	2	5	0	7	3	1	10	0	0	0	0	0	3	30	33	
05:00 PM	0	0	0	0	0	0	0	1	1	1	0	0	0	0	0	0	0	0	0	0	0	1	1	2
05:15 PM	0	1	0	0	1	0	0	0	0	0	0	3	1	1	4	0	0	0	0	0	0	1	5	6
05:30 PM	0	3	0	0	3	1	0	0	0	1	0	1	0	0	1	0	0	0	0	0	0	5	5	5
05:45 PM	0	1	0	0	1	0	0	1	1	1	0	1	1	0	2	0	0	0	0	0	0	1	4	5
Total	0	5	0	0	5	1	0	2	2	3	0	5	2	1	7	0	0	0	0	0	3	15	18	
Grand Total	2	18	0	0	20	3	0	5	4	8	0	12	5	2	17	0	0	0	0	0	6	45	51	
Apprch %	10	90	0	0	37.5	0	62.5	0	17.8	0	70.6	29.4	0	37.8	0	0	0	0	0	0	11.8	88.2	0	
Total %	4.4	40	0	0	44.4	6.7	11.1	0	17.8	0	26.7	11.1	0	37.8	0	0	0	0	0	0	11.8	88.2	0	

Start Time	Trautwein Road Southbound					Orange Terrace Parkway Westbound					Trautwein Road Northbound					Orange Terrace Parkway Eastbound								
	Left	Thru	Right	RTOR	App. Total	Left	Thru	Right	RTOR	App. Total	Left	Thru	Right	RTOR	App. Total	Left	Thru	Right	RTOR	App. Total	Exclu. Total	Inclu. Total	Int. Total	
04:45 PM	1	3	0	0	4	1	0	0	1	1	0	2	1	1	3	0	0	0	0	0	0	0	0	8
05:00 PM	0	0	0	0	0	0	0	0	0	0	0	0	0	0	0	0	0	0	0	0	0	0	0	1
05:15 PM	0	1	0	0	1	0	0	0	0	0	0	3	1	1	4	0	0	0	0	0	0	0	5	5
05:30 PM	0	3	0	0	3	1	0	0	1	1	0	1	0	0	1	0	0	0	0	0	0	1	8	9
Total Volume	1	7	0	0	8	2	0	0	1	3	0	6	2	8	0	0	0	0	0	0	0	0	19	
% App. Total	12.5	87.5	0	0	33.3	66.7	0	0	0	75	0	25	0	0	0	0	0	0	0	0	0	0	0	.594
PHF	.250	.583	.000	.000	.500	.750	.250	.000	.250	.750	.000	.500	.500	.500	.500	.000	.000	.000	.000	.000	.000	.000	.594	

Peak Hour Analysis From 04:45 PM to 05:30 PM - Peak 1 of 1
 Peak Hour for Entire Intersection Begins at 04:45 PM

Counts Unlimited
 PO Box 1178
 Corona, CA 92878
 (951) 268-6268

City of Riverside
 N/S: Trautwein Road
 E/W: Orange Terrace Parkway
 Weather: Clear

File Name : 09_RIV_Trautwein_Orange Terrace PM
 Site Code : 05119542
 Start Date : 8/20/2019
 Page No : 2

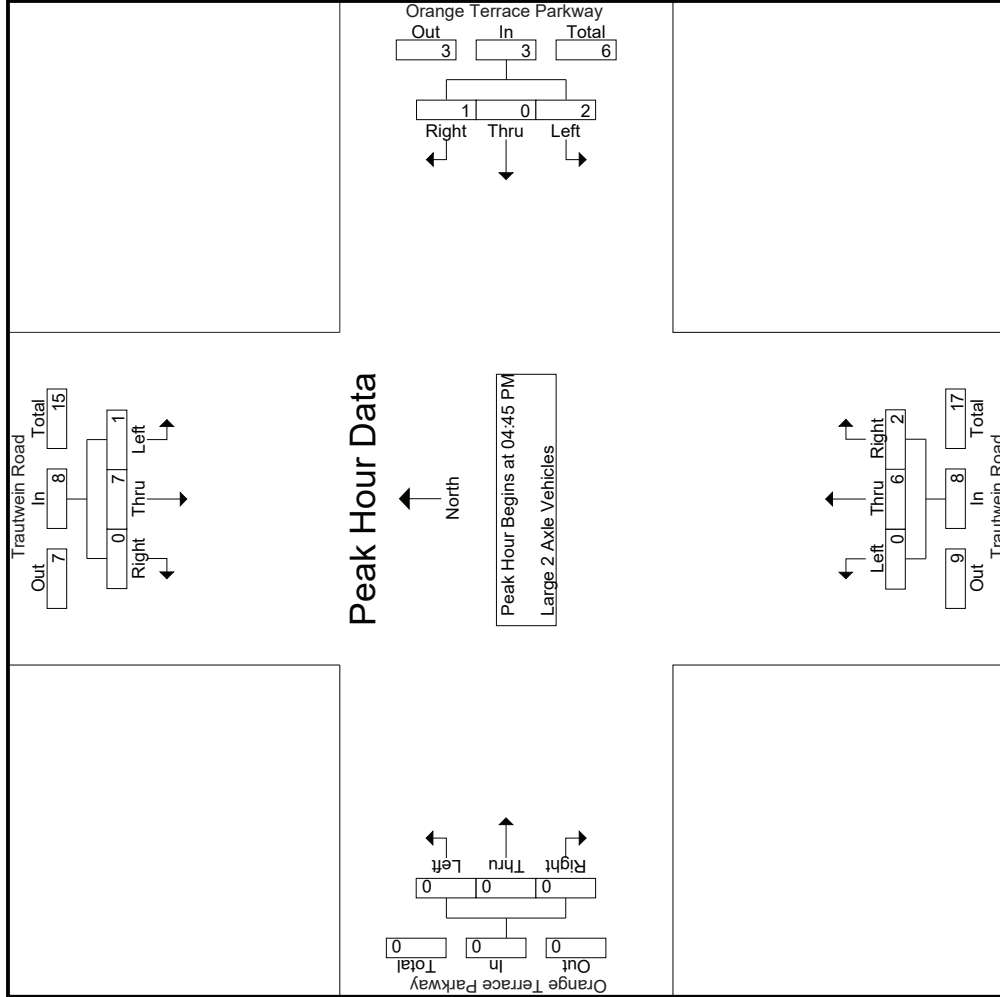

Counts Unlimited
 PO Box 1178
 Corona, CA 92878
 (951) 268-6268

City of Riverside
 N/S: Trautwein Road
 E/W: Orange Terrace Parkway
 Weather: Clear

File Name : 09_RIV_Trautwein_Orange Terrace PM
 Site Code : 05119542
 Start Date : 8/20/2019
 Page No : 3

Start Time	Trautwein Road Southbound			Orange Terrace Parkway Westbound			Trautwein Road Northbound			Orange Terrace Parkway Eastbound					
	Left	Thru	Right	Left	Thru	Right	Left	Thru	Right	Left	Thru	Right			
Peak Hour Analysis From 04:45 PM to 05:30 PM - Peak 1 of 1															
Peak Hour for Each Approach Begins at:															
+0 mins.	1	3	0	04:45 PM	1	0	0	04:45 PM	0	2	1	04:45 PM	0	0	0
+15 mins.	0	0	0	0	0	1	0	0	0	0	0	0	0	0	0
+30 mins.	0	1	0	0	0	0	0	0	3	0	3	1	0	0	0
+45 mins.	0	3	0	0	0	0	0	0	1	0	1	0	0	0	0
Total Volume	1	7	0	2	0	1	3	0	6	2	8	0	0	0	0
% App. Total	12.5	87.5	0	66.7	0	33.3	.750	.000	.750	.500	.500	.000	.000	.000	.000
PHF	.250	.583	.000	.500	.000	.250	.750	.000	.750	.500	.500	.000	.000	.000	.000

Counts Unlimited
 PO Box 1178
 Corona, CA 92878
 (951) 268-6268

File Name : 09_RIV_Trautwein_Orange Terrace PM
 Site Code : 05119542
 Start Date : 8/20/2019
 Page No : 1

City of Riverside
 N/S: Trautwein Road
 E/W: Orange Terrace Parkway
 Weather: Clear

Groups Printed- 3 Axle Vehicles

Start Time	Trautwein Road Southbound					Orange Terrace Parkway Westbound					Trautwein Road Northbound					Orange Terrace Parkway Eastbound							
	Left	Thru	Right	RTOR	App. Total	Left	Thru	Right	RTOR	App. Total	Left	Thru	Right	RTOR	App. Total	Left	Thru	Right	RTOR	App. Total	Exclu. Total	Inclu. Total	Int. Total
04:00 PM	0	0	0	0	0	0	0	0	0	0	0	0	0	0	0	0	0	0	0	0	0	0	0
04:15 PM	0	0	0	0	0	0	0	0	0	0	0	0	0	0	0	0	0	0	0	0	0	0	0
04:30 PM	0	0	0	0	0	0	0	0	0	0	0	0	0	0	0	0	0	0	0	0	0	0	0
04:45 PM	0	1	0	0	1	0	0	0	0	0	1	0	0	0	1	0	0	0	0	0	0	0	2
Total	0	1	0	0	1	0	0	0	0	0	1	0	0	0	1	0	0	0	0	0	0	0	2
05:00 PM	0	0	0	0	0	0	0	0	0	0	0	0	0	0	0	0	0	0	0	0	0	0	0
05:15 PM	0	0	0	0	0	0	0	0	0	0	0	0	0	0	0	0	0	0	0	0	0	0	0
05:30 PM	0	0	0	0	0	0	0	0	0	0	0	0	0	0	0	0	0	0	0	0	0	0	0
05:45 PM	0	0	0	0	0	0	0	0	0	0	0	0	0	0	0	0	0	0	0	0	0	0	0
Total	0	0	0	0	0	0	0	0	0	0	0	0	0	0	0	0	0	0	0	0	0	0	0
Grand Total	0	1	0	0	1	0	0	0	0	0	1	0	0	0	1	0	0	0	0	0	0	0	2
Approch %	0	100	0	0	50	0	0	0	0	0	100	0	0	50	0	0	0	0	0	0	0	0	100
Total %	0	50	0	0	50	0	0	0	0	0	50	0	0	50	0	0	0	0	0	0	0	0	100

3.1-111

Start Time	Trautwein Road Southbound					Orange Terrace Parkway Westbound					Trautwein Road Northbound					Orange Terrace Parkway Eastbound							
	Left	Thru	Right	RTOR	App. Total	Left	Thru	Right	RTOR	App. Total	Left	Thru	Right	RTOR	App. Total	Left	Thru	Right	RTOR	App. Total	Exclu. Total	Inclu. Total	Int. Total
04:45 PM	0	1	0	0	1	0	0	0	0	0	0	0	0	0	0	0	0	0	0	0	0	0	0
05:00 PM	0	0	0	0	0	0	0	0	0	0	0	0	0	0	0	0	0	0	0	0	0	0	0
05:15 PM	0	0	0	0	0	0	0	0	0	0	0	0	0	0	0	0	0	0	0	0	0	0	0
05:30 PM	0	0	0	0	0	0	0	0	0	0	0	0	0	0	0	0	0	0	0	0	0	0	0
Total Volume	0	1	0	0	1	0	0	0	0	0	0	0	0	0	1	0	0	0	0	0	0	0	2
% App. Total	0	100	0	0	100	0	0	0	0	0	100	0	0	100	0	0	0	0	0	0	0	0	100
PHF	.000	.250	.000	.000	.250	.000	.000	.000	.000	.000	.250	.000	.250	.000	.250	.000	.000	.000	.000	.000	.000	.000	.250

Peak Hour Analysis From 04:45 PM to 05:30 PM - Peak 1 of 1
 Peak Hour for Entire Intersection Begins at 04:45 PM

Counts Unlimited
 PO Box 1178
 Corona, CA 92878
 (951) 268-6268

City of Riverside
 N/S: Trautwein Road
 E/W: Orange Terrace Parkway
 Weather: Clear

File Name : 09_RIV_Trautwein_Orange Terrace PM
 Site Code : 05119542
 Start Date : 8/20/2019
 Page No : 2

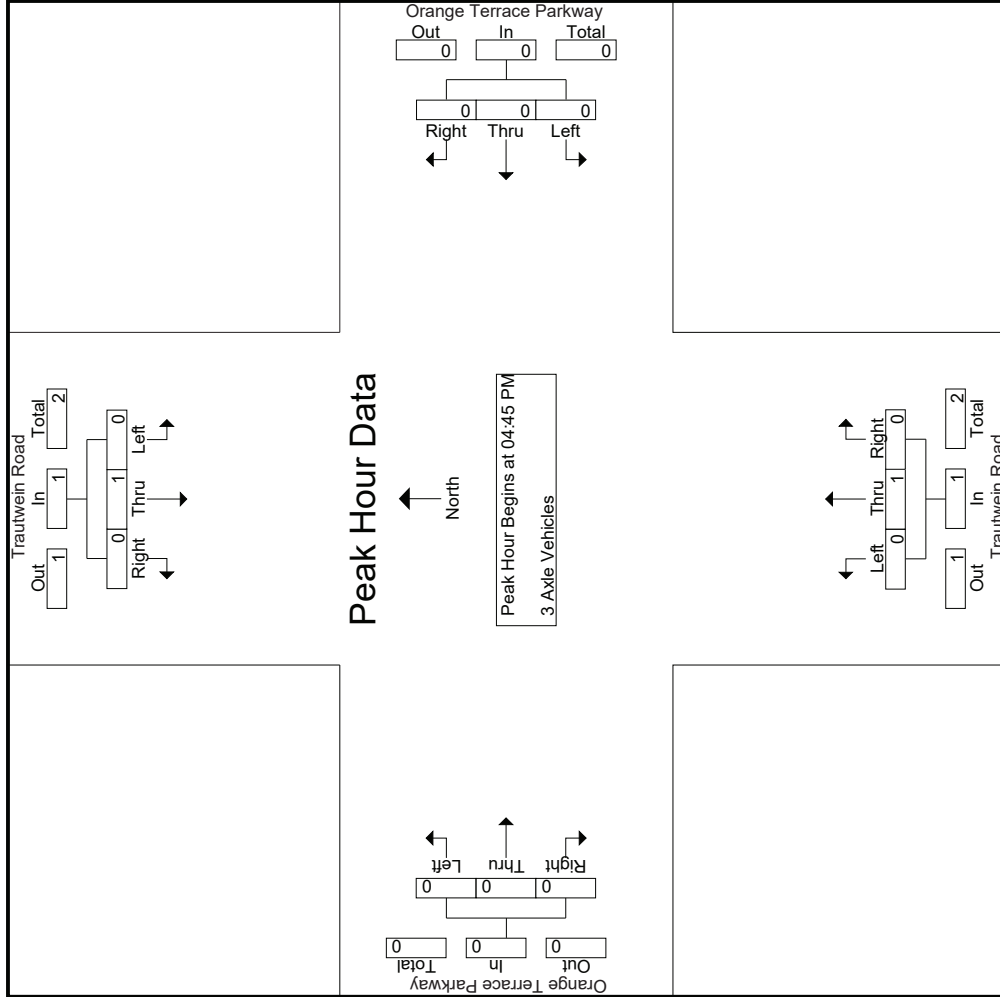

Counts Unlimited
 PO Box 1178
 Corona, CA 92878
 (951) 268-6268

City of Riverside
 N/S: Trautwein Road
 E/W: Orange Terrace Parkway
 Weather: Clear

File Name : 09_RIV_Trautwein_Orange Terrace PM
 Site Code : 05119542
 Start Date : 8/20/2019
 Page No : 3

Start Time	Trautwein Road Southbound			Orange Terrace Parkway Westbound			Trautwein Road Northbound			Orange Terrace Parkway Eastbound					
	Left	Thru	Right	Left	Thru	Right	Left	Thru	Right	Left	Thru	Right			
Peak Hour Analysis From 04:45 PM to 05:30 PM - Peak 1 of 1															
Peak Hour for Each Approach Begins at:															
+0 mins.	0	1	0	0	0	0	0	0	0	1	0	0	0	0	0
+15 mins.	0	0	0	0	0	0	0	0	0	0	0	0	0	0	0
+30 mins.	0	0	0	0	0	0	0	0	0	0	0	0	0	0	0
+45 mins.	0	0	0	0	0	0	0	0	0	0	0	0	0	0	0
Total Volume	0	1	0	0	0	0	0	0	0	1	0	0	0	0	0
% App. Total	0	100	0	0	0	0	0	0	0	100	0	0	0	0	0
PHF	.000	.250	.000	.000	.000	.000	.000	.000	.000	.250	.000	.000	.000	.000	.000

Counts Unlimited
 PO Box 1178
 Corona, CA 92878
 (951) 268-6268

City of Riverside
 N/S: Trautwein Road
 E/W: Orange Terrace Parkway
 Weather: Clear

File Name : 09_RIV_Trautwein_Orange Terrace PM
 Site Code : 05119542
 Start Date : 8/20/2019
 Page No : 1

Groups Printed- 4+ Axle Trucks

Start Time	Trautwein Road Southbound					Orange Terrace Parkway Westbound					Trautwein Road Northbound					Orange Terrace Parkway Eastbound								
	Left	Thru	Right	RTOR	App. Total	Left	Thru	Right	RTOR	App. Total	Left	Thru	Right	RTOR	App. Total	Left	Thru	Right	RTOR	App. Total	Exclu. Total	Inclu. Total	Int. Total	
04:00 PM	0	1	0	0	1	0	0	0	0	0	0	0	0	0	0	0	0	0	0	0	0	1	1	
04:15 PM	0	0	0	0	0	0	0	0	0	0	0	1	0	0	1	0	0	0	0	0	0	0	1	1
04:30 PM	0	0	0	0	0	0	0	0	0	0	0	0	0	0	0	0	0	0	0	0	0	0	0	0
04:45 PM	0	1	0	0	1	0	0	0	0	0	0	0	0	0	0	0	0	0	0	0	0	0	1	1
Total	0	2	0	0	2	0	0	0	0	0	0	1	0	0	1	0	0	0	0	0	0	0	3	3
05:00 PM	0	1	0	0	1	0	0	0	0	0	0	0	0	0	0	0	0	0	0	0	0	0	1	1
05:15 PM	0	0	0	0	0	0	0	0	0	0	0	0	0	0	0	0	0	0	0	0	0	0	0	0
05:30 PM	0	0	0	0	0	0	0	0	0	0	0	0	0	0	0	0	0	0	0	0	0	0	0	0
05:45 PM	0	0	0	0	0	0	0	0	0	0	0	0	0	0	0	0	0	0	0	0	0	0	0	0
Total	0	1	0	0	1	0	0	0	0	0	0	0	0	0	0	0	0	0	0	0	0	0	1	1
Grand Total	0	3	0	0	3	0	0	0	0	0	0	1	0	0	1	0	0	0	0	0	0	0	4	4
Approch %	0	100	0	0	75	0	0	0	0	0	0	100	0	0	25	0	0	0	0	0	0	0	100	100
Total %	0	75	0	0	75	0	0	0	0	0	0	25	0	0	25	0	0	0	0	0	0	0	100	100

3.1-114

Start Time	Trautwein Road Southbound					Orange Terrace Parkway Westbound					Trautwein Road Northbound					Orange Terrace Parkway Eastbound							
	Left	Thru	Right	RTOR	App. Total	Left	Thru	Right	RTOR	App. Total	Left	Thru	Right	RTOR	App. Total	Left	Thru	Right	RTOR	App. Total	Exclu. Total	Inclu. Total	Int. Total
04:45 PM	0	1	0	0	1	0	0	0	0	0	0	0	0	0	0	0	0	0	0	0	0	0	1
05:00 PM	0	1	0	0	1	0	0	0	0	0	0	0	0	0	0	0	0	0	0	0	0	0	1
05:15 PM	0	0	0	0	0	0	0	0	0	0	0	0	0	0	0	0	0	0	0	0	0	0	0
05:30 PM	0	0	0	0	0	0	0	0	0	0	0	0	0	0	0	0	0	0	0	0	0	0	0
Total Volume	0	2	0	0	2	0	0	0	0	0	0	0	0	0	0	0	0	0	0	0	0	0	2
% App. Total	0	100	0	0	50	0	0	0	0	0	0	0	0	0	0	0	0	0	0	0	0	0	50
PHF	.000	.500	.000	.000	.500	.000	.000	.000	.000	.000	.000	.000	.000	.000	.000	.000	.000	.000	.000	.000	.000	.000	.500

Peak Hour Analysis From 04:45 PM to 05:30 PM - Peak 1 of 1
 Peak Hour for Entire Intersection Begins at 04:45 PM

Counts Unlimited
 PO Box 1178
 Corona, CA 92878
 (951) 268-6268

City of Riverside
 N/S: Trautwein Road
 E/W: Orange Terrace Parkway
 Weather: Clear

File Name : 09_RIV_Trautwein_Orange Terrace PM
 Site Code : 05119542
 Start Date : 8/20/2019
 Page No : 2

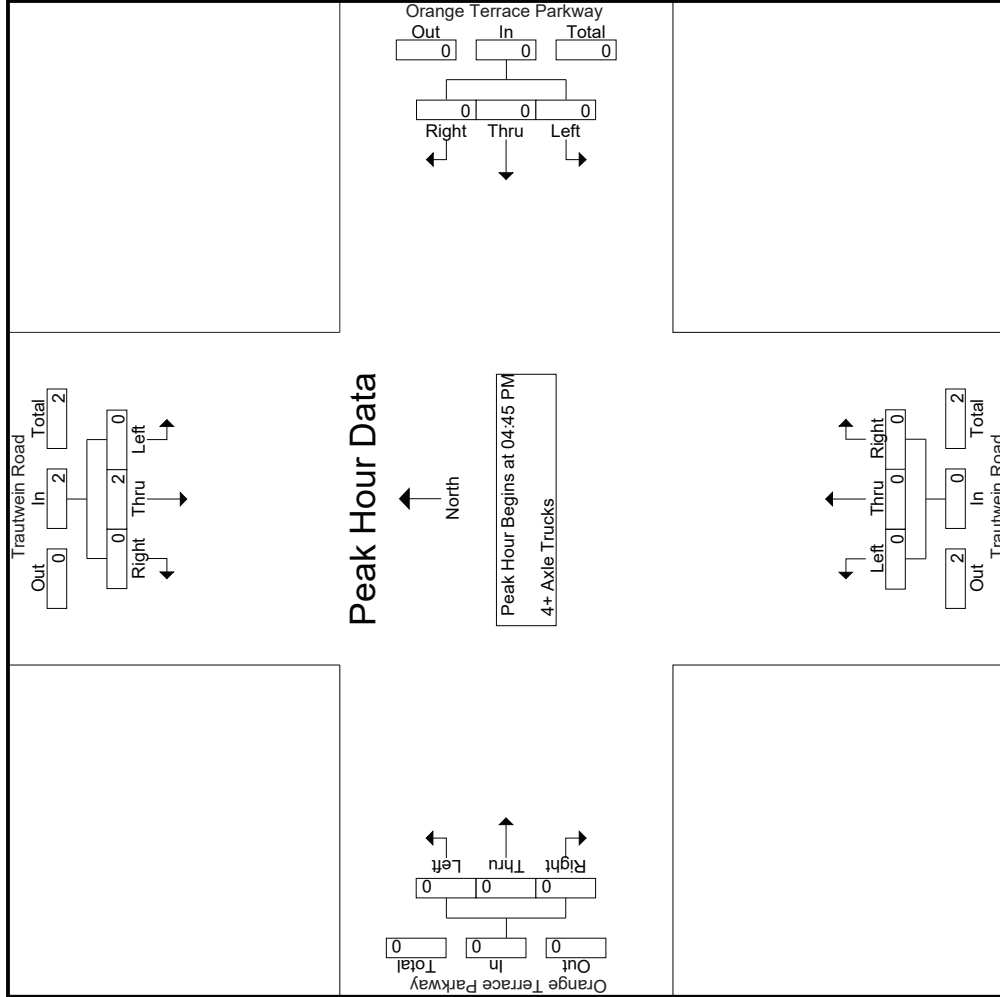

Counts Unlimited
 PO Box 1178
 Corona, CA 92878
 (951) 268-6268

City of Riverside
 N/S: Trautwein Road
 E/W: Orange Terrace Parkway
 Weather: Clear

File Name : 09_RIV_Trautwein_Orange Terrace PM
 Site Code : 05119542
 Start Date : 8/20/2019
 Page No : 3

Start Time	Trautwein Road Southbound			Orange Terrace Parkway Westbound			Trautwein Road Northbound			Orange Terrace Parkway Eastbound		
	Left	Thru	Right	Left	Thru	Right	Left	Thru	Right	Left	Thru	Right
Peak Hour Analysis From 04:45 PM to 05:30 PM - Peak 1 of 1												
Peak Hour for Each Approach Begins at:												
	04:45 PM			04:45 PM			04:45 PM			04:45 PM		
+0 mins.	0	1	0	0	0	0	0	0	0	0	0	0
+15 mins.	0	1	0	0	0	0	0	0	0	0	0	0
+30 mins.	0	0	0	0	0	0	0	0	0	0	0	0
+45 mins.	0	0	0	0	0	0	0	0	0	0	0	0
Total Volume	0	2	0	0	0	0	0	0	0	0	0	0
% App. Total	0	100	0	0	0	0	0	0	0	0	0	0
PHF	.000	.500	.000	.000	.000	.000	.000	.000	.000	.000	.000	.000

Location: Riverside
 N/S: Trautwein Road
 E/W: Orange Terrace Parkway



Date: 8/20/2019
 Day: Tuesday

PEDESTRIANS

	North Leg Trautwein Road	East Leg Orange Terrace Parkway	South Leg Trautwein Road	West Leg Orange Terrace Parkway	
	Pedestrians	Pedestrians	Pedestrians	Pedestrians	
7:00 AM	0	2	2	2	6
7:15 AM	1	0	1	0	2
7:30 AM	0	1	0	0	1
7:45 AM	0	0	0	3	3
8:00 AM	0	0	0	2	2
8:15 AM	0	2	0	2	4
8:30 AM	0	0	3	2	5
8:45 AM	1	4	0	5	10
TOTAL VOLUMES:	2	9	6	16	33

	North Leg Trautwein Road	East Leg Orange Terrace Parkway	South Leg Trautwein Road	West Leg Orange Terrace Parkway	
	Pedestrians	Pedestrians	Pedestrians	Pedestrians	
4:00 PM	0	1	3	1	5
4:15 PM	0	0	2	17	19
4:30 PM	0	0	0	6	6
4:45 PM	0	0	0	0	0
5:00 PM	0	1	0	0	1
5:15 PM	0	0	0	0	0
5:30 PM	0	1	1	2	4
5:45 PM	0	0	0	0	0
TOTAL VOLUMES:	0	3	6	26	35

Location: Riverside
 N/S: Trautwein Road
 E/W: Orange Terrace Parkway



Date: 8/20/2019
 Day: Tuesday

BICYCLES

	Southbound Trautwein Road			Westbound Orange Terrace Parkway			Northbound Trautwein Road			Eastbound Orange Terrace Parkway			
	Left	Thru	Right	Left	Thru	Right	Left	Thru	Right	Left	Thru	Right	
7:00 AM	2	0	0	0	0	0	0	0	0	0	1	0	3
7:15 AM	0	0	0	0	1	0	0	0	0	0	0	0	1
7:30 AM	0	0	0	0	0	0	0	0	0	0	0	0	0
7:45 AM	0	0	0	0	0	0	0	0	0	0	0	0	0
8:00 AM	0	1	0	0	0	0	0	0	0	0	0	0	1
8:15 AM	0	1	0	0	0	0	0	0	0	0	0	0	1
8:30 AM	0	0	0	0	0	0	0	0	0	0	0	0	0
8:45 AM	0	1	0	0	0	1	0	0	0	1	0	0	3
TOTAL VOLUMES:	2	3	0	0	1	1	0	0	0	1	1	0	9

	Southbound Trautwein Road			Westbound Orange Terrace Parkway			Northbound Trautwein Road			Eastbound Orange Terrace Parkway			
	Left	Thru	Right	Left	Thru	Right	Left	Thru	Right	Left	Thru	Right	
4:00 PM	0	0	0	0	0	0	0	0	0	0	0	0	0
4:15 PM	0	1	0	0	0	0	0	0	0	0	0	0	1
4:30 PM	0	0	0	0	0	0	0	0	0	0	0	0	0
4:45 PM	0	0	0	0	0	0	0	0	0	0	0	0	0
5:00 PM	0	0	0	0	0	0	0	1	0	0	0	0	1
5:15 PM	0	0	0	0	0	0	0	0	0	0	1	0	1
5:30 PM	0	0	0	0	0	0	0	0	0	0	0	0	0
5:45 PM	0	0	0	0	1	0	0	0	0	0	0	0	1
TOTAL VOLUMES:	0	1	0	0	1	0	0	1	0	0	1	0	4

Counts Unlimited
 PO Box 1178
 Corona, CA 92878
 (951) 268-6268

City of Riverside
 N/S: Trautwein Road/Cole Avenue
 E/W: Van Buren Boulevard
 Weather: Clear

File Name : 10_RIV_Trautwein_Van Buren AM
 Site Code : 05119542
 Start Date : 8/20/2019
 Page No : 2

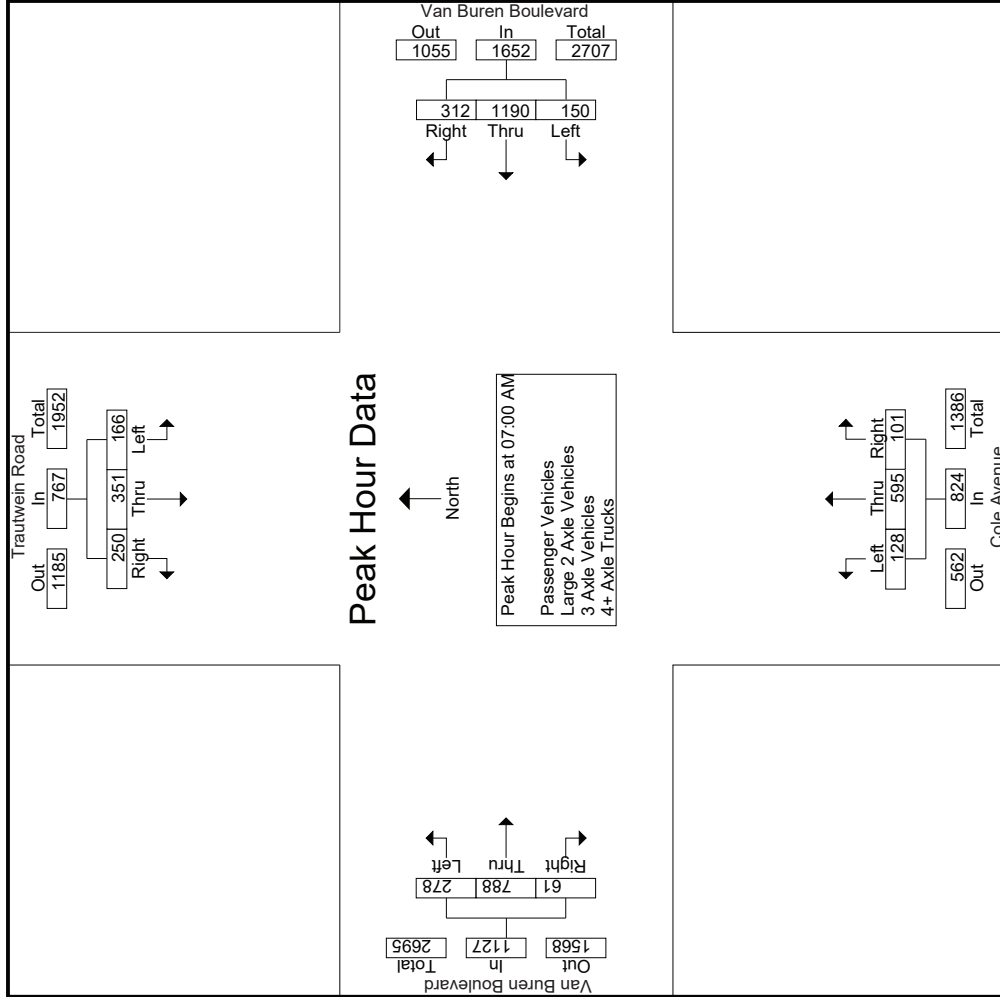

Counts Unlimited
 PO Box 1178
 Corona, CA 92878
 (951) 268-6268

City of Riverside
 N/S: Trautwein Road/Cole Avenue
 E/W: Van Buren Boulevard
 Weather: Clear

File Name : 10_RIV_Trautwein_Van Buren AM
 Site Code : 05119542
 Start Date : 8/20/2019
 Page No : 3

Start Time	Trautwein Road Southbound			Van Buren Boulevard Westbound			Cole Avenue Northbound			Van Buren Boulevard Eastbound				
	Left	Thru	Right	Left	Thru	Right	Left	Thru	Right	Left	Thru	Right	App. Total	Int. Total
Peak Hour Analysis From 07:00 AM to 08:45 AM - Peak 1 of 1														
Peak Hour for Each Approach Begins at:														
	07:00 AM			07:00 AM			07:00 AM			07:15 AM				
+0 mins.	51	74	88	32	312	72	416	28	153	19	75	196	14	285
+15 mins.	40	127	71	41	330	88	459	34	145	27	75	173	19	267
+30 mins.	37	94	53	53	273	82	408	41	165	31	83	257	20	360
+45 mins.	38	56	38	24	275	70	369	25	132	24	59	148	19	226
Total Volume	166	351	250	150	1190	312	1652	128	595	101	292	774	72	1138
% App. Total	21.6	45.8	32.6	9.1	72	18.9	900	15.5	72.2	12.3	25.7	68	6.3	790
PHF	.814	.691	.710	.708	.902	.886	.900	.780	.902	.815	.880	.753	.900	.790

Counts Unlimited
 PO Box 1178
 Corona, CA 92878
 (951) 268-6268

City of Riverside
 N/S: Trautwein Road/Cole Avenue
 EW: Van Buren Boulevard
 Weather: Clear

File Name : 10_RIV_Trautwein_Van Buren AM
 Site Code : 05119542
 Start Date : 8/20/2019
 Page No : 1

Groups Printed- Passenger Vehicles

Start Time	Trautwein Road Southbound					Van Buren Boulevard Westbound					Cole Avenue Northbound					Van Buren Boulevard Eastbound							
	Left	Thru	Right	RTOR	App. Total	Left	Thru	Right	RTOR	App. Total	Left	Thru	Right	RTOR	App. Total	Left	Thru	Right	RTOR	App. Total	Exclu. Total	Inclu. Total	Int. Total
07:00 AM	49	70	88	44	207	32	299	68	23	399	28	151	19	5	198	43	156	7	6	206	78	1010	1088
07:15 AM	40	126	69	34	235	41	323	85	11	449	33	144	26	1	203	73	185	14	13	272	59	1159	1218
07:30 AM	36	93	52	16	181	53	262	77	22	392	40	164	31	0	235	74	171	19	10	264	48	1072	1120
07:45 AM	36	52	37	26	125	23	262	70	15	355	25	130	23	1	178	80	249	18	11	347	53	1005	1058
Total	161	341	246	120	748	149	1146	300	71	1595	126	589	99	7	814	270	761	58	40	1089	238	4246	4484
08:00 AM	21	43	45	24	109	13	217	77	25	307	21	113	14	1	148	57	139	19	9	215	59	779	838
08:15 AM	18	30	34	19	82	13	221	70	27	304	22	72	7	4	101	61	113	9	4	183	54	670	724
08:30 AM	25	27	53	41	105	8	214	51	15	273	15	72	7	3	94	87	118	2	0	207	59	679	738
08:45 AM	12	27	47	22	86	7	237	66	21	310	17	59	6	4	82	64	89	6	3	159	50	637	687
Total	76	127	179	106	382	41	889	264	88	1194	75	316	34	12	425	269	459	36	16	764	222	2765	2987
Grand Total	237	468	425	226	1130	190	2035	564	159	2789	201	905	133	19	1239	539	1220	94	56	1853	460	7011	7471
Apprch %	21	41.4	37.6			6.8	73	20.2		39.8	16.2	73	10.7	17.7	29.1	65.8	5.1			26.4	6.2	93.8	
Total %	3.4	6.7	6.1		16.1	2.7	29	8		39.8	2.9	12.9	1.9		7.7	17.4	1.3						

3.1-122

Start Time	Trautwein Road Southbound					Van Buren Boulevard Westbound					Cole Avenue Northbound					Van Buren Boulevard Eastbound							
	Left	Thru	Right	RTOR	App. Total	Left	Thru	Right	RTOR	App. Total	Left	Thru	Right	RTOR	App. Total	Left	Thru	Right	RTOR	App. Total	Exclu. Total	Inclu. Total	Int. Total
07:00 AM	49	70	88		207	32	299	68		399	28	151	19		198	43	156	7		206		1010	1010
07:15 AM	40	126	69		235	41	323	85		449	33	144	26		203	73	185	14		272		1159	1159
07:30 AM	36	93	52		181	53	262	77		392	40	164	31		235	74	171	19		264		1072	1072
07:45 AM	36	52	37		125	23	262	70		355	25	130	23		178	80	249	18		347		1005	1005
Total Volume	161	341	246		748	149	1146	300		1595	126	589	99		814	270	761	58		1089		4246	4246
% App. Total	21.5	45.6	32.9		32.9	9.3	71.8	18.8		15.5	72.4	12.2			24.8	69.9	5.3						
PHF	.821	.677	.699		.796	.703	.887	.882		.888	.788	.898	.798		.866	.844	.764	.763				.785	.916

Peak Hour Analysis From 07:00 AM to 07:45 AM - Peak 1 of 1
 Peak Hour for Entire Intersection Begins at 07:00 AM

Counts Unlimited
 PO Box 1178
 Corona, CA 92878
 (951) 268-6268

City of Riverside
 N/S: Trautwein Road/Cole Avenue
 E/W: Van Buren Boulevard
 Weather: Clear

File Name : 10_RIV_Trautwein_Van Buren AM
 Site Code : 05119542
 Start Date : 8/20/2019
 Page No : 2

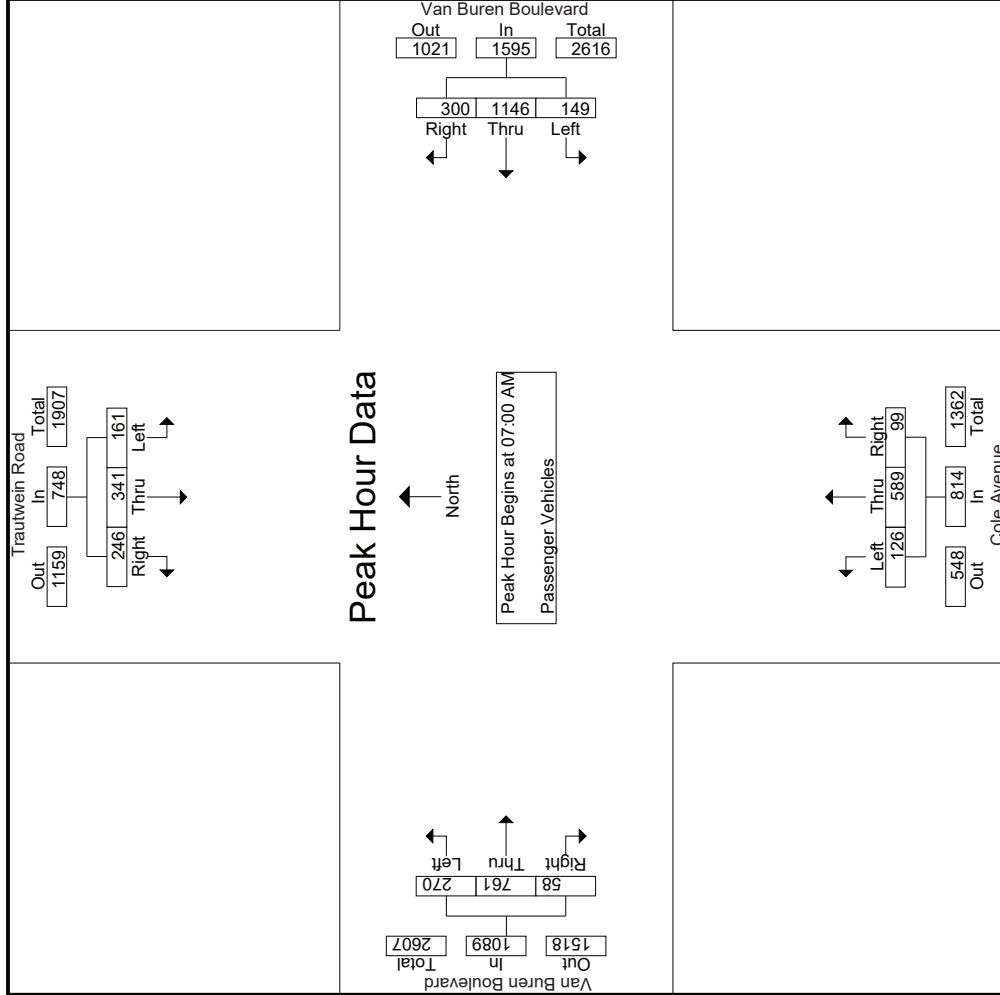

Counts Unlimited
 PO Box 1178
 Corona, CA 92878
 (951) 268-6268

City of Riverside
 N/S: Trautwein Road/Cole Avenue
 E/W: Van Buren Boulevard
 Weather: Clear

File Name : 10_RIV_Trautwein_Van Buren AM
 Site Code : 05119542
 Start Date : 8/20/2019
 Page No : 3

Start Time	Trautwein Road Southbound			Van Buren Boulevard Westbound			Cole Avenue Northbound			Van Buren Boulevard Eastbound					
	Left	Thru	Right	Left	Thru	Right	Left	Thru	Right	Left	Thru	Right	App. Total	Int. Total	
Peak Hour Analysis From 07:00 AM to 07:45 AM - Peak 1 of 1															
Peak Hour for Each Approach Begins at:															
	07:00 AM			07:00 AM			07:00 AM			07:00 AM			07:00 AM		
+0 mins.	49	70	88	32	299	68	399	28	151	19	198	43	156	7	206
+15 mins.	40	126	69	41	323	85	449	33	144	26	203	73	185	14	272
+30 mins.	36	93	52	53	262	77	392	40	164	31	235	74	171	19	264
+45 mins.	36	52	37	23	262	70	355	25	130	23	178	80	249	18	347
Total Volume	161	341	246	149	1146	300	1595	126	589	99	814	270	761	58	1089
% App. Total	21.5	45.6	32.9	9.3	71.8	18.8	15.5	72.4	12.2	12.2	24.8	69.9	69.9	5.3	785
PHF	.821	.677	.699	.703	.887	.882	.888	.788	.898	.798	.866	.844	.764	.763	.785

Groups Printed- Large 2 Axle Vehicles

Start Time	Trautwein Road Southbound				Van Buren Boulevard Westbound				Cole Avenue Northbound				Van Buren Boulevard Eastbound							
	Left	Thru	Right	RTOR	Left	Thru	Right	RTOR	Left	Thru	Right	RTOR	Left	Thru	Right	RTOR	App. Total	Exclu. Total	Inclu. Total	Int. Total
07:00 AM	2	4	0	0	0	7	4	0	0	2	0	0	2	4	1	0	7	0	26	26
07:15 AM	0	1	1	0	0	2	3	1	0	5	1	0	3	1	9	0	10	1	20	21
07:30 AM	1	1	1	0	0	6	3	0	0	9	0	0	1	1	0	0	1	0	14	14
07:45 AM	2	4	1	1	1	4	0	0	0	5	0	0	3	2	3	2	7	3	22	25
Total	5	10	3	1	18	1	19	10	1	30	1	6	9	6	16	3	25	4	82	86
08:00 AM	1	1	1	1	3	1	5	2	0	8	1	3	4	2	4	0	6	1	21	22
08:15 AM	0	1	1	0	2	0	14	2	0	16	0	1	1	4	3	1	8	1	27	28
08:30 AM	0	0	2	0	2	0	8	2	0	10	0	0	1	2	4	0	6	0	19	19
08:45 AM	0	2	3	1	5	0	4	0	0	4	0	0	0	1	5	0	6	1	15	16
Total	1	4	7	2	12	1	31	6	0	38	1	5	6	9	16	1	26	3	82	85
Grand Total	6	14	10	3	30	2	50	16	1	68	2	11	0	15	32	4	51	7	164	171
Apprch %	20	46.7	33.3		18.3	2.9	73.5	23.5		41.5	13.3	73.3	13.3	29.4	62.7	7.8	31.1	4.1	95.9	
Total %	3.7	8.5	6.1			1.2	30.5	9.8			1.2	6.7	1.2	9.1	19.5	2.4				

Start Time	Trautwein Road Southbound				Van Buren Boulevard Westbound				Cole Avenue Northbound				Van Buren Boulevard Eastbound							
	Left	Thru	Right	RTOR	Left	Thru	Right	RTOR	Left	Thru	Right	RTOR	Left	Thru	Right	RTOR	App. Total	Exclu. Total	Inclu. Total	Int. Total
07:00 AM	2	4	0	0	0	7	4	0	0	2	0	0	2	4	1	0	7	0	26	26
07:15 AM	0	1	1	0	0	2	3	1	0	5	1	0	3	1	9	0	10	1	20	21
07:30 AM	1	1	1	0	0	6	3	0	0	9	0	0	1	1	0	0	1	0	14	14
07:45 AM	2	4	1	1	1	4	0	0	0	5	0	0	3	2	3	2	7	3	22	25
Total	5	10	3	1	18	1	19	10	1	30	1	6	9	6	16	3	25	4	82	86
08:00 AM	1	1	1	1	3	1	5	2	0	8	1	3	4	2	4	0	6	1	21	22
08:15 AM	0	1	1	0	2	0	14	2	0	16	0	1	1	4	3	1	8	1	27	28
08:30 AM	0	0	2	0	2	0	8	2	0	10	0	0	1	2	4	0	6	0	19	19
08:45 AM	0	2	3	1	5	0	4	0	0	4	0	0	0	1	5	0	6	1	15	16
Total	1	4	7	2	12	1	31	6	0	38	1	5	6	9	16	1	26	3	82	85
Grand Total	6	14	10	3	30	2	50	16	1	68	2	11	0	15	32	4	51	7	164	171
Apprch %	20	46.7	33.3		18.3	2.9	73.5	23.5		41.5	13.3	73.3	13.3	29.4	62.7	7.8	31.1	4.1	95.9	
Total %	3.7	8.5	6.1			1.2	30.5	9.8			1.2	6.7	1.2	9.1	19.5	2.4				

Peak Hour Analysis From 07:00 AM to 07:45 AM - Peak 1 of 1
 Peak Hour for Entire Intersection Begins at 07:00 AM

Start Time	Trautwein Road Southbound				Van Buren Boulevard Westbound				Cole Avenue Northbound				Van Buren Boulevard Eastbound							
	Left	Thru	Right	RTOR	Left	Thru	Right	RTOR	Left	Thru	Right	RTOR	Left	Thru	Right	RTOR	App. Total	Exclu. Total	Inclu. Total	Int. Total
07:00 AM	2	4	0	0	0	7	4	0	0	2	0	0	2	4	1	0	7	0	26	26
07:15 AM	0	1	1	0	0	2	3	1	0	5	1	0	3	1	9	0	10	1	20	21
07:30 AM	1	1	1	0	0	6	3	0	0	9	0	0	1	1	0	0	1	0	14	14
07:45 AM	2	4	1	1	1	4	0	0	0	5	0	0	3	2	3	2	7	3	22	25
Total Volume	5	10	3	1	18	1	19	10	1	30	1	6	9	6	16	3	25	4	82	86
% App. Total	27.8	55.6	16.7		16.7	3.3	63.3	33.3		33.3	11.1	66.7	22.2	24	64	12	64	4.1	95.9	
PHF	.625	.625	.750		.643	.250	.679	.625		.682	.250	.750	.500	.750	.444	.375	.625		.788	

Counts Unlimited
 PO Box 1178
 Corona, CA 92878
 (951) 268-6268

City of Riverside
 N/S: Trautwein Road/Cole Avenue
 E/W: Van Buren Boulevard
 Weather: Clear

File Name : 10_RIV_Trautwein_Van Buren AM
 Site Code : 05119542
 Start Date : 8/20/2019
 Page No : 2

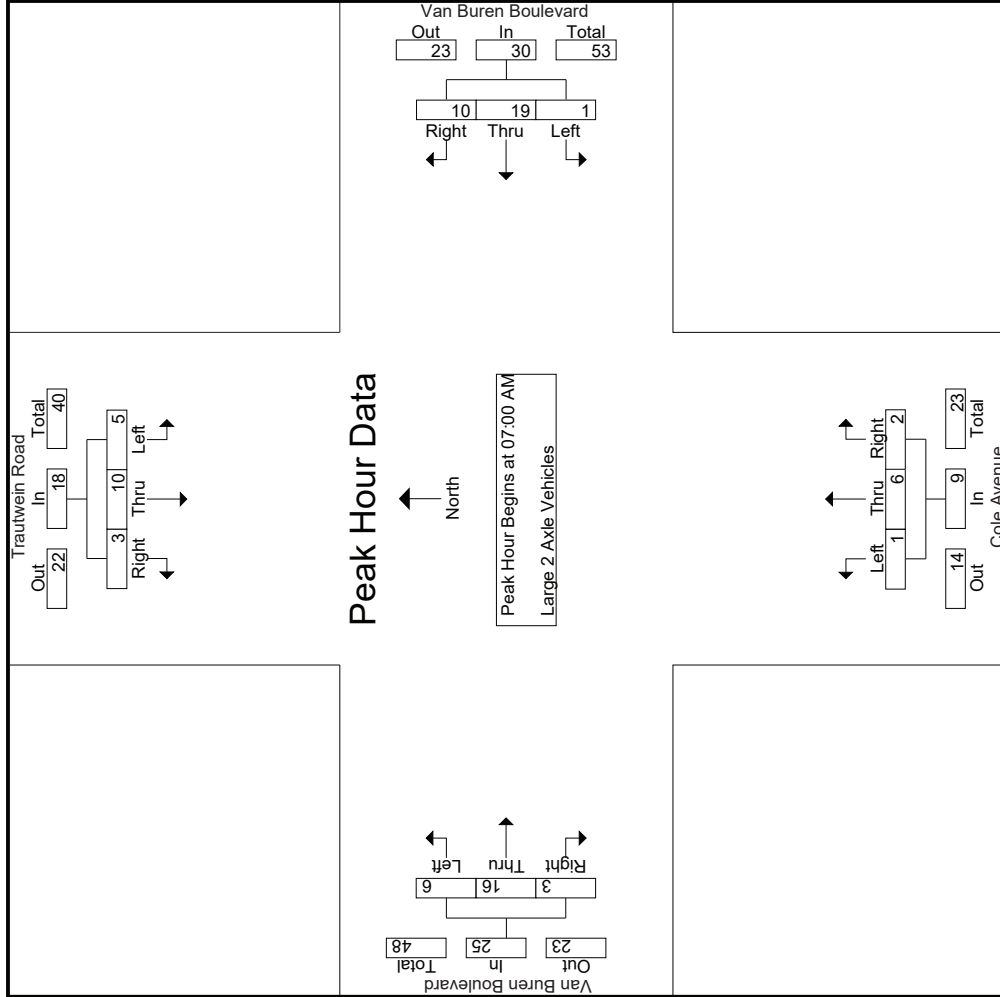

Counts Unlimited
 PO Box 1178
 Corona, CA 92878
 (951) 268-6268

City of Riverside
 N/S: Trautwein Road/Cole Avenue
 E/W: Van Buren Boulevard
 Weather: Clear

File Name : 10_RIV_Trautwein_Van Buren AM
 Site Code : 05119542
 Start Date : 8/20/2019
 Page No : 3

Start Time	Trautwein Road Southbound			Van Buren Boulevard Westbound			Cole Avenue Northbound			Van Buren Boulevard Eastbound					
	Left	Thru	Right	Left	Thru	Right	Left	Thru	Right	Left	Thru	Right	App. Total	Int. Total	
Peak Hour Analysis From 07:00 AM to 07:45 AM - Peak 1 of 1															
Peak Hour for Each Approach Begins at:															
	07:00 AM			07:00 AM			07:00 AM			07:00 AM			07:00 AM		
+0 mins.	2	4	0	7	4	11	0	2	0	2	4	1	7		
+15 mins.	0	1	1	2	3	5	1	1	1	3	9	0	10		
+30 mins.	1	1	1	6	3	9	0	1	0	1	0	0	1		
+45 mins.	2	4	1	4	0	5	0	2	1	3	3	2	7		
Total Volume	5	10	3	19	10	30	1	6	2	9	16	3	25		
% App. Total	27.8	55.6	16.7	63.3	33.3	68.2	11.1	66.7	22.2	24	64	12	625		
PHF	.625	.750	.750	.643	.625	.682	.250	.750	.500	.750	.444	.375	.625		

Groups Printed- 3 Axle Vehicles

Start Time	Trautwein Road Southbound				Van Buren Boulevard Westbound				Cole Avenue Northbound				Van Buren Boulevard Eastbound					
	Left	Thru	Right	RTOR	App. Total	Left	Thru	Right	RTOR	App. Total	Left	Thru	Right	RTOR	App. Total	Exclu. Total	Inclu. Total	Int. Total
07:00 AM	0	0	0	0	0	1	0	0	0	0	0	0	0	0	1	0	2	2
07:15 AM	0	0	1	0	1	0	0	0	0	0	0	0	0	0	2	0	4	4
07:30 AM	0	0	0	0	0	0	0	0	0	1	0	0	0	0	1	0	2	2
07:45 AM	0	0	0	0	0	0	0	0	0	0	0	0	0	0	4	0	4	4
Total	0	0	1	0	1	2	0	0	0	1	0	0	0	0	8	0	12	12
08:00 AM	0	0	0	0	0	2	0	0	0	0	0	0	0	0	4	0	6	6
08:15 AM	0	0	0	0	0	1	0	0	0	0	0	0	0	1	0	0	2	2
08:30 AM	0	0	0	0	0	0	0	0	0	0	0	0	0	0	1	0	2	2
08:45 AM	0	0	0	0	0	3	0	0	0	3	0	0	0	0	1	0	4	4
Total	0	0	0	0	0	7	0	0	0	0	1	6	0	0	7	0	14	14
Grand Total	0	0	1	0	1	9	0	0	0	1	1	14	0	0	15	0	26	26
Apprch %	0	0	100	0	0	100	0	0	0	0	6.7	93.3	0	0	57.7	0	100	100
Total %	0	0	3.8	0	34.6	3.8	0	0	0	3.8	3.8	53.8	0	0	57.7	0	100	100

Start Time	Trautwein Road Southbound				Van Buren Boulevard Westbound				Cole Avenue Northbound				Van Buren Boulevard Eastbound					
	Left	Thru	Right	RTOR	App. Total	Left	Thru	Right	RTOR	App. Total	Left	Thru	Right	RTOR	App. Total	Exclu. Total	Inclu. Total	Int. Total
07:00 AM	0	0	0	0	0	0	0	0	0	0	0	0	0	0	0	0	0	0
07:15 AM	0	0	1	0	1	0	0	0	0	0	0	0	0	0	0	0	0	0
07:30 AM	0	0	0	0	0	0	0	0	0	0	0	0	0	0	0	0	0	0
07:45 AM	0	0	0	0	0	0	0	0	0	0	0	0	0	0	0	0	0	0
Total Volume	0	0	1	0	1	2	0	0	0	2	1	0	0	0	8	0	8	12
% App. Total	0	0	100	0	0	100	0	0	0	0	100	0	0	0	100	0	100	100
PHF	.000	.000	.250	.250	.250	.000	.500	.000	.000	.250	.250	.000	.000	.000	.500	.000	.500	.750

Peak Hour Analysis From 07:00 AM to 07:45 AM - Peak 1 of 1
 Peak Hour for Entire Intersection Begins at 07:00 AM

Counts Unlimited
 PO Box 1178
 Corona, CA 92878
 (951) 268-6268

City of Riverside
 N/S: Trautwein Road/Cole Avenue
 E/W: Van Buren Boulevard
 Weather: Clear

File Name : 10_RIV_Trautwein_Van Buren AM
 Site Code : 05119542
 Start Date : 8/20/2019
 Page No : 2

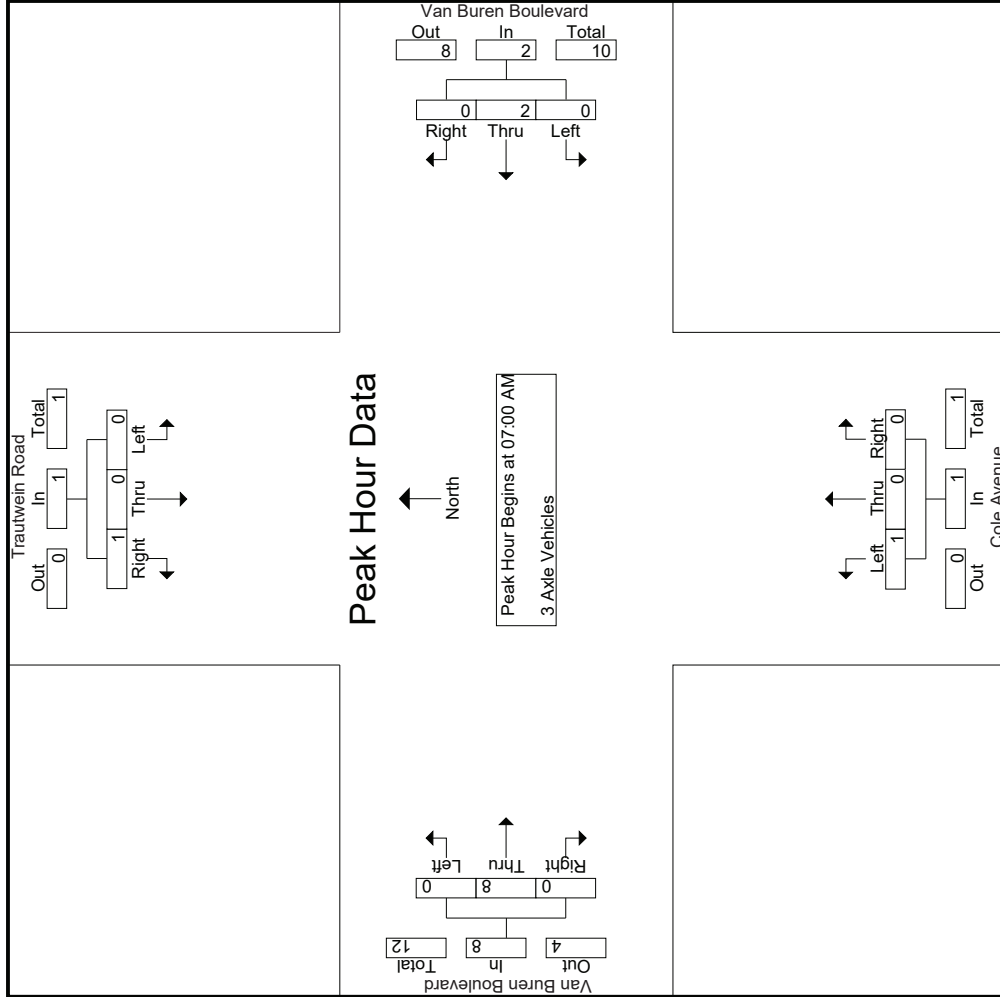

Counts Unlimited
 PO Box 1178
 Corona, CA 92878
 (951) 268-6268

City of Riverside
 N/S: Trautwein Road/Cole Avenue
 E/W: Van Buren Boulevard
 Weather: Clear

File Name : 10_RIV_Trautwein_Van Buren AM
 Site Code : 05119542
 Start Date : 8/20/2019
 Page No : 3

Start Time	Trautwein Road Southbound			Van Buren Boulevard Westbound			Cole Avenue Northbound			Van Buren Boulevard Eastbound					
	Left	Thru	Right	Left	Thru	Right	Left	Thru	Right	Left	Thru	Right	App. Total	Int. Total	
Peak Hour Analysis From 07:00 AM to 07:45 AM - Peak 1 of 1															
Peak Hour for Each Approach Begins at:															
	07:00 AM			07:00 AM			07:00 AM			07:00 AM			07:00 AM		
+0 mins.	0	0	0	1	0	0	1	0	0	0	0	0	0	1	
+15 mins.	0	0	1	1	0	0	1	0	0	0	0	0	2	2	
+30 mins.	0	0	0	0	0	0	0	0	0	1	0	0	1	1	
+45 mins.	0	0	0	0	0	0	0	0	0	0	0	0	4	4	
Total Volume	0	0	1	2	0	0	2	0	0	1	0	0	8	8	
% App. Total	0	0	100	0	100	0	100	0	0	250	0	100	0	0	
PHF	.000	.000	.250	.000	.500	.000	.500	.000	.000	.250	.000	.500	.000	.500	

Groups Printed- 4+ Axle Trucks

Start Time	Trautwein Road Southbound			Van Buren Boulevard Westbound			Cole Avenue Northbound			Van Buren Boulevard Eastbound			Inclu. Total	Int. Total	
	Left	Thru	Right	Left	Thru	Right	Left	Thru	Right	Left	Thru	Right			
07:00 AM	0	0	0	0	5	0	0	0	0	0	1	0	0	6	6
07:15 AM	0	0	0	0	4	0	0	0	0	0	1	0	1	5	5
07:30 AM	0	0	0	0	5	2	0	0	0	0	1	0	1	8	8
07:45 AM	0	0	0	0	9	0	0	0	0	0	1	1	0	11	11
Total	0	0	0	0	23	2	0	0	0	0	2	3	0	30	30
08:00 AM	0	0	1	0	1	0	0	0	0	0	0	1	0	0	3
08:15 AM	0	0	0	0	2	0	0	0	0	0	1	0	0	3	3
08:30 AM	0	0	0	0	1	0	0	0	0	0	1	0	0	2	2
08:45 AM	1	0	1	0	5	0	0	0	0	0	1	2	0	10	10
Total	1	0	2	0	9	0	0	0	0	0	2	4	0	18	18
Grand Total	1	0	2	0	32	2	0	0	0	0	4	7	0	48	48
Apprch %	33.3	0	66.7	0	94.1	5.9	0	0	0	0	36.4	63.6	0	0	100
Total %	2.1	0	4.2	0	66.7	4.2	0	0	0	0	8.3	14.6	0	0	100

Start Time	Trautwein Road Southbound			Van Buren Boulevard Westbound			Cole Avenue Northbound			Van Buren Boulevard Eastbound			Inclu. Total	Int. Total	
	Left	Thru	Right	Left	Thru	Right	Left	Thru	Right	Left	Thru	Right			
07:00 AM	0	0	0	0	5	0	0	0	0	0	1	0	0	1	6
07:15 AM	0	0	0	0	4	0	0	0	0	0	0	0	0	1	5
07:30 AM	0	0	0	0	5	2	0	0	0	0	1	0	0	8	8
07:45 AM	0	0	0	0	9	0	0	0	0	0	1	1	0	2	11
Total Volume	0	0	0	0	23	2	0	0	0	0	2	3	0	5	30
% App. Total	0	0	0	0	92	8	0	0	0	0	40	60	0	0	100
PHF	.000	.000	.000	.000	.639	.250	.694	.000	.000	.000	.500	.750	.000	.625	.682

Peak Hour Analysis From 07:00 AM to 07:45 AM - Peak 1 of 1
 Peak Hour for Entire Intersection Begins at 07:00 AM

Counts Unlimited
 PO Box 1178
 Corona, CA 92878
 (951) 268-6268

City of Riverside
 N/S: Trautwein Road/Cole Avenue
 E/W: Van Buren Boulevard
 Weather: Clear

File Name : 10_RIV_Trautwein_Van Buren AM
 Site Code : 05119542
 Start Date : 8/20/2019
 Page No : 2

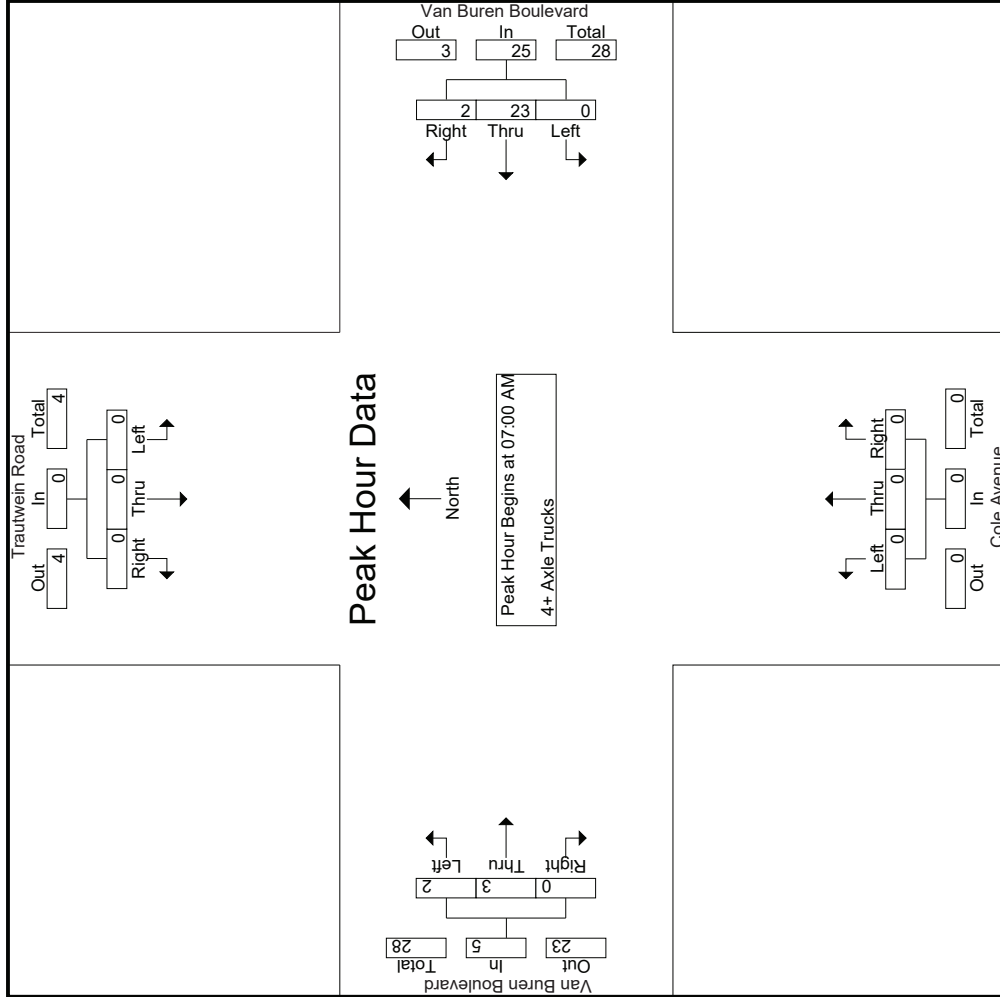

Counts Unlimited
 PO Box 1178
 Corona, CA 92878
 (951) 268-6268

City of Riverside
 N/S: Trautwein Road/Cole Avenue
 E/W: Van Buren Boulevard
 Weather: Clear

File Name : 10_RIV_Trautwein_Van Buren AM
 Site Code : 05119542
 Start Date : 8/20/2019
 Page No : 3

Start Time	Trautwein Road Southbound			Van Buren Boulevard Westbound			Cole Avenue Northbound			Van Buren Boulevard Eastbound				
	Left	Thru	Right	Left	Thru	Right	Left	Thru	Right	Left	Thru	Right		
Peak Hour Analysis From 07:00 AM to 07:45 AM - Peak 1 of 1														
Peak Hour for Each Approach Begins at:														
+0 mins.	0	0	0	07:00 AM	0	0	5	07:00 AM	0	0	0	0	0	1
+15 mins.	0	0	0	0	4	0	4	0	0	0	1	0	0	
+30 mins.	0	0	0	0	5	2	7	0	0	0	0	1	0	
+45 mins.	0	0	0	0	9	0	9	0	0	0	1	1	0	
Total Volume	0	0	0	0	23	2	25	0	0	0	2	3	0	
% App. Total	0	0	0	0	92	8	8	0	0	0	40	60	0	
PHF	.000	.000	.000	.000	.639	.250	.694	.000	.000	.000	.500	.750	.000	
													.625	

Counts Unlimited
 PO Box 1178
 Corona, CA 92878
 (951) 268-6268

City of Riverside
 N/S: Trautwein Road/Cole Avenue
 EW: Van Buren Boulevard
 Weather: Clear

File Name : 10_RIV_Trautwein_Van Buren PM
 Site Code : 05119542
 Start Date : 8/20/2019
 Page No : 1

Groups Printed- Passenger Vehicles - Large 2 Axle Vehicles - 3 Axle Vehicles - 4+ Axle Trucks

Start Time	Trautwein Road Southbound						Van Buren Boulevard Westbound						Cole Avenue Northbound						Van Buren Boulevard Eastbound					
	Left		Thru		Right		Left		Thru		Right		Left		Thru		Right		Left		Thru		Right	
		App. Total		App. Total		App. Total		App. Total		App. Total		App. Total		App. Total		App. Total		App. Total		App. Total		App. Total		App. Total
04:00 PM	57	234	57	27	218	45	15	290	23	68	11	2	102	102	87	244	22	9	353	353	53	979	1032	1032
04:15 PM	69	253	69	56	189	49	30	265	14	58	6	4	78	78	69	231	32	18	332	332	108	928	1036	1036
04:30 PM	56	252	56	45	213	39	22	265	10	71	7	0	88	88	86	271	33	11	390	390	78	995	1073	1073
04:45 PM	57	223	57	33	203	35	13	269	22	71	6	1	99	99	81	251	24	10	356	356	57	947	1004	1004
Total	239	962	239	161	823	168	80	1089	69	268	30	7	367	367	323	997	111	48	1431	1431	296	3849	4145	4145
05:00 PM	66	243	66	47	210	48	22	281	20	59	10	6	89	89	81	256	23	12	360	360	87	973	1060	1060
05:15 PM	61	235	61	55	234	58	40	319	19	73	10	0	102	102	87	304	26	17	417	417	100	1073	1173	1173
05:30 PM	71	266	71	41	193	34	18	264	16	62	12	7	90	90	96	252	31	14	379	379	80	999	1079	1079
05:45 PM	72	239	72	55	154	33	12	211	21	62	10	2	93	93	83	237	22	8	342	342	53	885	938	938
Total	270	983	270	162	791	173	92	1075	76	256	42	15	374	374	347	1049	102	51	1498	1498	320	3930	4250	4250
Grand Total	509	1945	509	323	1614	341	172	2164	145	524	72	22	741	741	670	2046	213	99	2929	2929	616	7779	8395	8395
Approch %	26.2	48.8	25	6.2	74.6	15.8	0	27.8	19.6	70.7	9.7	0.9	9.5	9.5	22.9	69.9	7.3	37.7	37.7	37.7	7.3	92.7	92.7	92.7
Total %	503	944	478	98.1	1578	339	2294	98.2	143	523	72	100	760	760	658	1994	212	100	2963	2963	0	0	8259	8259
% Passenger Vehicles	98.8	99.4	98.4	98.1	97.8	99.4	98.8	98.2	98.6	99.8	100	100	99.6	99.6	98.2	97.5	99.5	100	97.9	97.9	0	0	98.4	98.4
% Large 2 Axle Vehicles	4	5	8	1.9	24	1	28	1.2	2	1	0	0	3	0.4	11	31	1	0	43	43	0	0	97	97
% 3 Axle Vehicles	0.8	0.5	1.6	0.6	1.5	0.3	0.6	0.6	1.4	0.2	0	0	0.4	0.4	1.6	1.5	0.5	0	1.4	1.4	0	0	1.2	1.2
% 4+ Axle Trucks	0.2	0.1	0	0	0.1	0	0	0.1	0	0	0	0	0	0	0.1	0.3	0	0	0.3	0.3	0	0	0.1	0.1
% 4+ Axle Trucks	1	0	0	0	10	1	12	0.5	0	0	0	0	0	0	0	14	0	0	14	14	0	0	27	27
% 4+ Axle Trucks	0.2	0	0	0	0.6	0.3	0.6	0.5	0	0	0	0	0	0	0	0.7	0	0	0.5	0.5	0	0	0.3	0.3
Start Time	Trautwein Road Southbound						Van Buren Boulevard Westbound						Cole Avenue Northbound						Van Buren Boulevard Eastbound					
04:45 PM	57	112	54	223	31	203	35	269	22	71	6	99	81	251	24	356	947	947						
05:00 PM	66	109	68	243	23	210	48	281	20	59	10	89	81	256	23	360	1060	1060						
05:15 PM	61	119	55	235	27	234	58	319	19	73	10	102	87	304	26	417	1173	1173						
05:30 PM	71	134	61	266	37	193	34	264	16	62	12	7	90	90	96	252	31	14	379	379	80	999	1079	1079
05:45 PM	72	112	55	239	24	154	33	211	21	62	10	2	93	93	83	237	22	8	342	342	53	885	938	938
Total Volume	255	474	238	967	118	840	175	1133	77	265	38	380	345	1063	104	1512	3992	3992						
% App. Total	26.4	49	24.6	909	10.4	74.1	15.4	888	20.3	69.7	10	6.9	22.8	70.3	6.9	906	930	930						
PHF	.898	.884	.875	.909	.797	.897	.754	.888	.875	.908	.792	.931	.898	.874	.839	.906	.930	.930						

Peak Hour Analysis From 04:00 PM to 05:45 PM - Peak 1 of 1

Peak Hour for Entire Intersection Begins at 04:45 PM

Counts Unlimited
 PO Box 1178
 Corona, CA 92878
 (951) 268-6268

City of Riverside
 N/S: Trautwein Road/Cole Avenue
 E/W: Van Buren Boulevard
 Weather: Clear

File Name : 10_RIV_Trautwein_Van Buren PM
 Site Code : 05119542
 Start Date : 8/20/2019
 Page No : 2

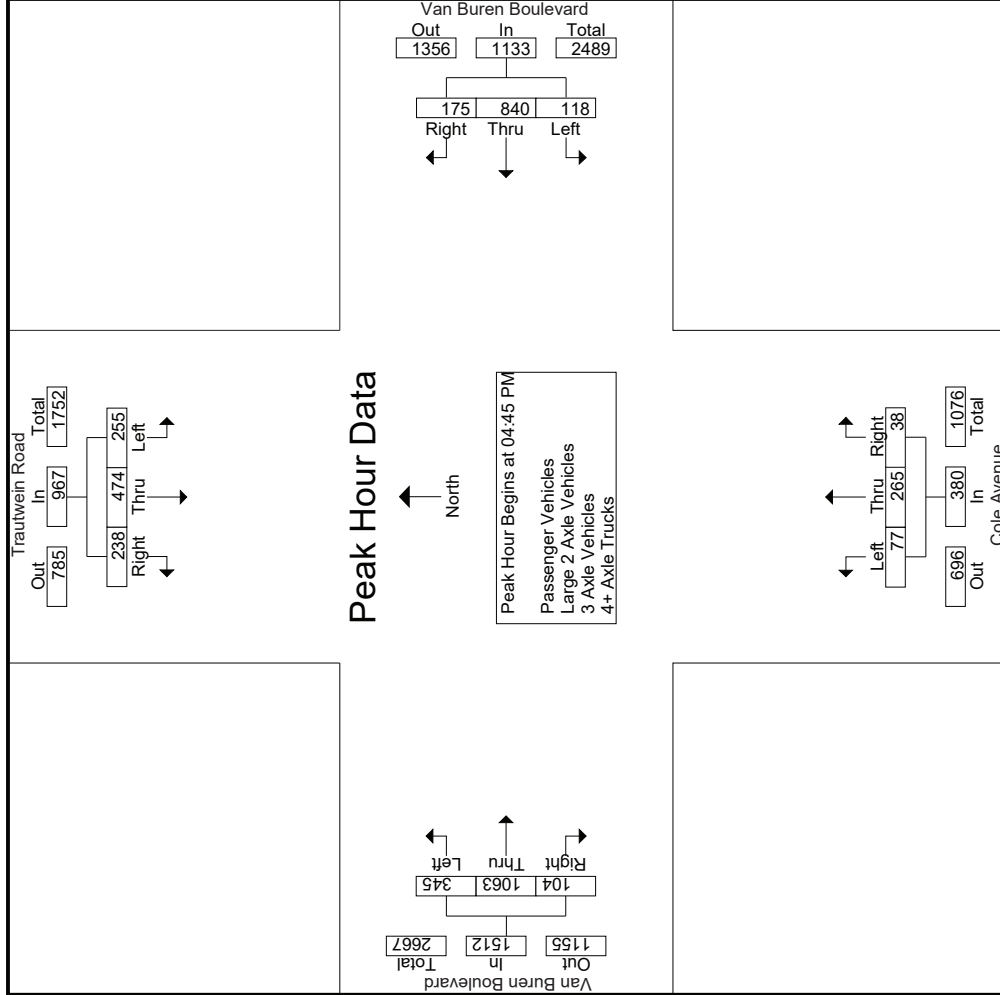

Counts Unlimited
 PO Box 1178
 Corona, CA 92878
 (951) 268-6268

City of Riverside
 N/S: Trautwein Road/Cole Avenue
 E/W: Van Buren Boulevard
 Weather: Clear

File Name : 10_RIV_Trautwein_Van Buren PM
 Site Code : 05119542
 Start Date : 8/20/2019
 Page No : 3

Start Time	Trautwein Road Southbound			Van Buren Boulevard Westbound			Cole Avenue Northbound			Van Buren Boulevard Eastbound				
	Left	Thru	Right	Left	Thru	Right	Left	Thru	Right	Left	Thru	Right	App. Total	Int. Total
Peak Hour Analysis From 04:00 PM to 05:45 PM - Peak 1 of 1														
Peak Hour for Each Approach Begins at:														
	05:00 PM			04:30 PM			04:45 PM			04:30 PM				
+0 mins.	66	109	68	243	243	243	13	213	39	265	22	71	6	99
+15 mins.	61	119	55	235	235	269	31	203	35	269	20	59	10	89
+30 mins.	71	134	61	266	281	281	23	210	48	281	19	73	10	102
+45 mins.	72	112	55	239	319	319	27	234	58	319	16	62	12	90
Total Volume	270	474	239	983	1134	1134	94	860	180	1134	77	265	38	380
% App. Total	27.5	48.2	24.3	8.3	75.8	15.9	8.3	75.8	15.9	20.3	69.7	10	7.1	22
PHF	.938	.884	.879	.924	.889	.889	.758	.919	.776	.875	.908	.792	.931	.963
														.803
														.913

Counts Unlimited
 PO Box 1178
 Corona, CA 92878
 (951) 268-6268

City of Riverside
 N/S: Trautwein Road/Cole Avenue
 E/W: Van Buren Boulevard
 Weather: Clear

File Name : 10_RIV_Trautwein_Van Buren PM
 Site Code : 05119542
 Start Date : 8/20/2019
 Page No : 1

Groups Printed- Passenger Vehicles

Start Time	Trautwein Road Southbound						Van Buren Boulevard Westbound						Cole Avenue Northbound						Van Buren Boulevard Eastbound					
	Left	Thru	Right	RTOR	App. Total	Inclu. Total	Left	Thru	Right	RTOR	App. Total	Inclu. Total	Left	Thru	Right	RTOR	App. Total	Inclu. Total	Left	Thru	Right	RTOR	App. Total	Inclu. Total
	04:00 PM	56	119	57	27	232	232	27	213	45	15	285	285	22	67	11	2	100	100	85	239	22	9	346
04:15 PM	66	114	69	56	249	249	27	188	48	29	263	263	13	58	6	4	77	77	65	222	32	18	319	319
04:30 PM	56	127	65	44	248	248	13	209	39	22	261	261	10	71	7	0	88	88	85	268	33	11	386	386
04:45 PM	56	111	51	30	218	218	31	195	35	13	261	261	22	71	6	1	99	99	79	239	24	10	342	342
Total	234	471	242	157	947	947	98	805	167	79	1070	1070	67	267	30	7	364	364	314	968	111	48	1393	1393
05:00 PM	65	109	68	47	242	242	22	202	48	22	272	272	20	59	10	6	89	89	80	247	23	12	350	350
05:15 PM	61	119	55	43	235	235	27	231	57	39	315	315	19	73	10	0	102	102	86	298	26	17	410	410
05:30 PM	71	133	59	39	263	263	36	189	34	18	259	259	16	62	12	7	90	90	95	246	31	14	372	372
05:45 PM	72	112	54	31	238	238	24	151	33	12	208	208	21	62	10	2	93	93	83	235	21	8	339	339
Total	269	473	236	160	978	978	109	773	172	91	1054	1054	76	256	42	15	374	374	344	1026	101	51	1471	1471
Grand Total	503	944	478	317	1925	1925	207	1578	339	170	2124	2124	143	523	72	22	738	738	658	1994	212	99	2864	2864
Approch %	26.1	49	24.8				9.7	74.3	16				19.4	70.9	9.8				23	69.6	7.4			
Total %	6.6	12.3	6.2		25.2		2.7	20.6	4.4		27.8		1.9	6.8	0.9		9.6		8.6	26.1	2.8		37.4	

Start Time	Trautwein Road Southbound						Van Buren Boulevard Westbound						Cole Avenue Northbound						Van Buren Boulevard Eastbound					
	Left	Thru	Right	RTOR	App. Total	Inclu. Total	Left	Thru	Right	RTOR	App. Total	Inclu. Total	Left	Thru	Right	RTOR	App. Total	Inclu. Total	Left	Thru	Right	RTOR	App. Total	Inclu. Total
	04:45 PM	56	111	51		218	218	31	195	35		261	261	22	71	6		99	99	79	239	24		342
05:00 PM	65	109	68		242	242	22	202	48		272	272	20	59	10		89	89	80	247	23		350	350
05:15 PM	61	119	55		235	235	27	231	57		315	315	19	73	10		102	102	86	298	26		410	410
05:30 PM	71	133	59		263	263	36	189	34		259	259	16	62	12		90	90	95	246	31		372	372
Total Volume	253	472	233		958	958	116	817	174		1107	1107	77	265	38		380	380	340	1030	104		1474	1474
% App. Total	26.4	49.3	24.3				10.5	73.8	15.7				20.3	69.7	10				23.1	69.9	7.1			
PHF	.891	.887	.857		.911	.911	.806	.884	.763		.879	.879	.875	.908	.792		.931	.931	.895	.864	.839		.899	.899

Peak Hour Analysis From 04:45 PM to 05:30 PM - Peak 1 of 1
 Peak Hour for Entire Intersection Begins at 04:45 PM

Counts Unlimited
 PO Box 1178
 Corona, CA 92878
 (951) 268-6268

City of Riverside
 N/S: Trautwein Road/Cole Avenue
 E/W: Van Buren Boulevard
 Weather: Clear

File Name : 10_RIV_Trautwein_Van Buren PM
 Site Code : 05119542
 Start Date : 8/20/2019
 Page No : 2

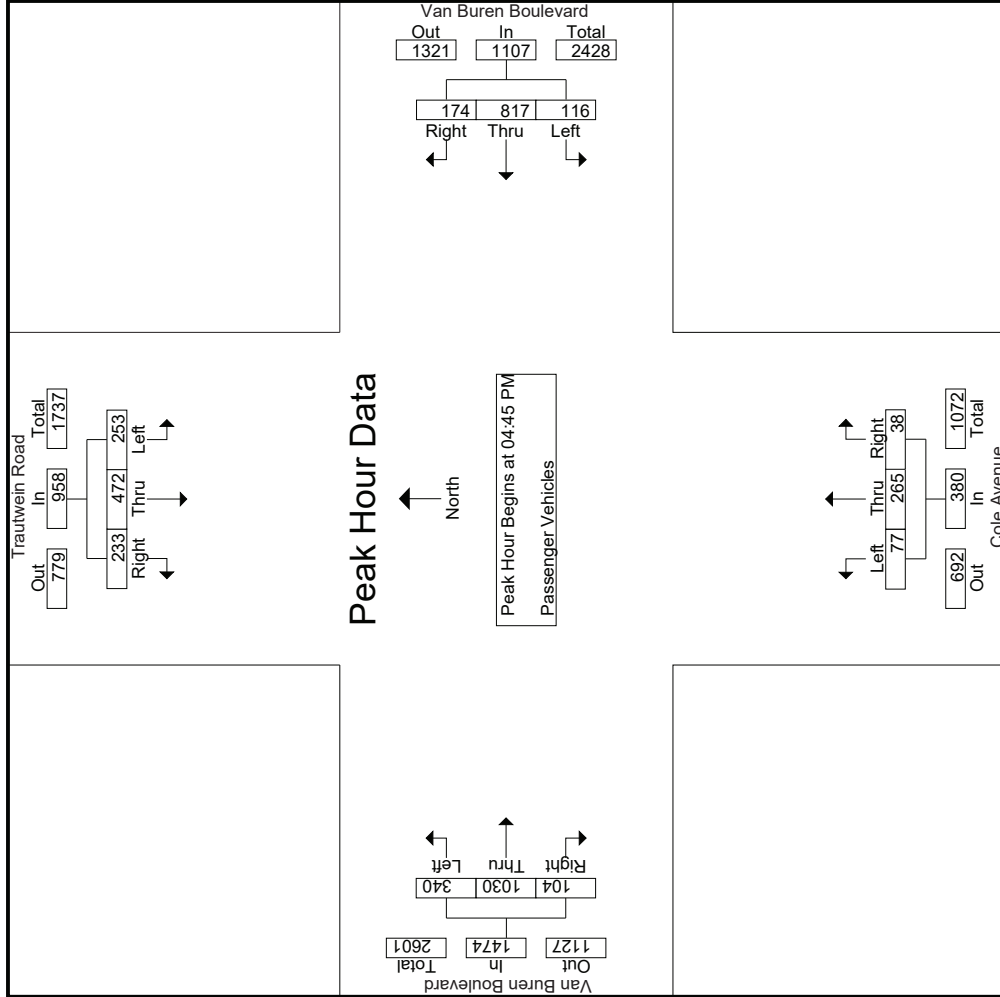

Counts Unlimited
 PO Box 1178
 Corona, CA 92878
 (951) 268-6268

City of Riverside
 N/S: Trautwein Road/Cole Avenue
 E/W: Van Buren Boulevard
 Weather: Clear

File Name : 10_RIV_Trautwein_Van Buren PM
 Site Code : 05119542
 Start Date : 8/20/2019
 Page No : 3

Start Time	Trautwein Road Southbound			Van Buren Boulevard Westbound			Cole Avenue Northbound			Van Buren Boulevard Eastbound					
	Left	Thru	Right	Left	Thru	Right	Left	Thru	Right	Left	Thru	Right	App. Total	Int. Total	
Peak Hour Analysis From 04:45 PM to 05:30 PM - Peak 1 of 1															
Peak Hour for Each Approach Begins at:															
	04:45 PM			04:45 PM			04:45 PM			04:45 PM			04:45 PM		
+0 mins.	56	111	51	195	35	261	22	71	6	79	239	24	342		
+15 mins.	65	109	68	202	48	272	20	59	10	80	247	23	350		
+30 mins.	61	119	55	231	57	315	19	73	10	86	298	26	410		
+45 mins.	71	133	59	189	34	259	16	62	12	95	246	31	372		
Total Volume	253	472	233	817	174	1107	77	265	38	340	1030	104	1474		
% App. Total	26.4	49.3	24.3	73.8	15.7	87.9	20.3	69.7	10	23.1	69.9	7.1	89.9		
PHF	.891	.887	.857	.884	.763	.879	.875	.908	.792	.895	.864	.839	.899		

Groups Printed- Large 2 Axle Vehicles

Start Time	Trautwein Road Southbound				Van Buren Boulevard Westbound				Cole Avenue Northbound				Van Buren Boulevard Eastbound							
	Left	Thru	Right	RTOR	Left	Thru	Right	RTOR	Left	Thru	Right	RTOR	Left	Thru	Right	RTOR	App. Total	Exclu. Total	Inclu. Total	Int. Total
04:00 PM	1	1	0	0	0	1	0	0	1	1	0	0	2	2	2	0	0	4	0	9
04:15 PM	3	1	0	0	0	0	0	0	1	0	0	0	1	4	3	0	0	7	0	12
04:30 PM	0	2	1	4	0	2	0	0	0	0	0	0	0	1	2	0	0	3	1	9
04:45 PM	0	0	3	3	0	6	0	0	6	0	0	0	0	1	6	0	0	7	3	16
Total	4	4	5	4	0	9	0	0	9	2	1	0	3	8	13	0	0	21	4	50
05:00 PM	0	0	0	0	1	6	0	0	7	0	0	0	0	1	7	0	0	8	0	15
05:15 PM	0	0	0	0	0	3	1	1	4	0	0	0	0	1	6	0	0	7	1	11
05:30 PM	0	1	2	2	1	4	0	0	5	0	0	0	0	1	5	0	0	6	2	14
05:45 PM	0	0	1	0	0	2	0	0	2	0	0	0	0	0	0	1	0	1	0	4
Total	0	1	3	2	2	15	1	1	18	0	0	0	0	3	18	1	0	22	3	44
Grand Total	4	5	8	6	2	24	1	1	27	2	1	0	3	11	31	1	0	43	7	90
Approch %	23.5	29.4	47.1		7.4	88.9	3.7		66.7	33.3	0		3	25.6	72.1	2.3		47.8	7.2	92.8
Total %	4.4	5.6	8.9		2.2	26.7	1.1		2.2	1.1	0		3.3	12.2	34.4	1.1				

Start Time	Trautwein Road Southbound				Van Buren Boulevard Westbound				Cole Avenue Northbound				Van Buren Boulevard Eastbound							
	Left	Thru	Right	RTOR	Left	Thru	Right	RTOR	Left	Thru	Right	RTOR	Left	Thru	Right	RTOR	App. Total	Exclu. Total	Inclu. Total	Int. Total
04:45 PM	0	0	0	3	0	6	0	0	0	6	0	0	0	0	0	0	0	0	0	7
05:00 PM	0	0	0	0	1	6	0	0	7	0	0	0	0	0	7	0	0	0	8	15
05:15 PM	0	0	0	0	0	3	1	1	4	0	0	0	0	1	6	0	0	0	7	11
05:30 PM	0	1	1	2	1	4	0	0	5	0	0	0	0	1	5	0	0	6	2	14
Total Volume	0	1	1	2	2	19	1	1	22	0	0	0	0	4	24	0	0	28	0	56
% App. Total	0	16.7	83.3		9.1	86.4	4.5		66.7	33.3	0		3	25.6	72.1	2.3		47.8	7.2	92.8
PHF	.000	.250	.417		.500	.792	.250		.786	.000	.000		.000	1.00	.857	.000		.875	.000	.875

Peak Hour Analysis From 04:45 PM to 05:30 PM - Peak 1 of 1
 Peak Hour for Entire Intersection Begins at 04:45 PM

Counts Unlimited
 PO Box 1178
 Corona, CA 92878
 (951) 268-6268

City of Riverside
 N/S: Trautwein Road/Cole Avenue
 E/W: Van Buren Boulevard
 Weather: Clear

File Name : 10_RIV_Trautwein_Van Buren PM
 Site Code : 05119542
 Start Date : 8/20/2019
 Page No : 2

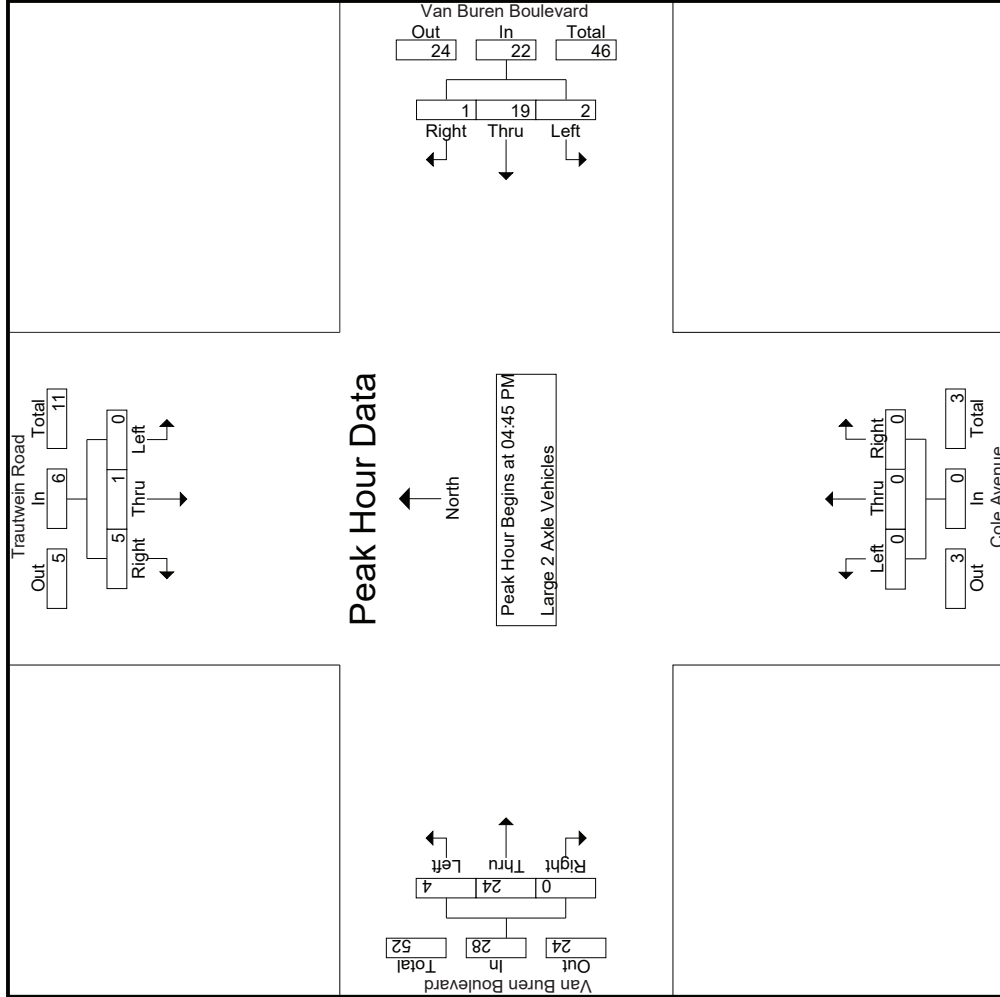

Counts Unlimited
 PO Box 1178
 Corona, CA 92878
 (951) 268-6268

City of Riverside
 N/S: Trautwein Road/Cole Avenue
 E/W: Van Buren Boulevard
 Weather: Clear

File Name : 10_RIV_Trautwein_Van Buren PM
 Site Code : 05119542
 Start Date : 8/20/2019
 Page No : 3

Start Time	Trautwein Road Southbound			Van Buren Boulevard Westbound			Cole Avenue Northbound			Van Buren Boulevard Eastbound					
	Left	Thru	Right	Left	Thru	Right	Left	Thru	Right	Left	Thru	Right	App. Total	Int. Total	
Peak Hour Analysis From 04:45 PM to 05:30 PM - Peak 1 of 1															
Peak Hour for Each Approach Begins at:															
	04:45 PM			04:45 PM			04:45 PM			04:45 PM			04:45 PM		
+0 mins.	0	0	3	0	6	0	0	6	0	0	0	0	0	0	7
+15 mins.	0	0	0	1	6	0	0	7	0	0	0	0	0	0	8
+30 mins.	0	0	0	0	3	1	0	4	0	0	0	0	0	0	7
+45 mins.	0	1	2	1	4	0	0	5	0	0	0	0	0	0	6
Total Volume	0	1	5	2	19	1	22	22	0	0	0	0	4	24	28
% App. Total	0	16.7	83.3	9.1	86.4	4.5	78.6	78.6	0	0	0	0	14.3	85.7	0
PHF	.000	.250	.417	.500	.792	.250	.786	.786	.000	.000	.000	.000	1.000	.857	.875

Counts Unlimited
 PO Box 1178
 Corona, CA 92878
 (951) 268-6268

City of Riverside
 N/S: Trautwein Road/Cole Avenue
 E/W: Van Buren Boulevard
 Weather: Clear

File Name : 10_RIV_Trautwein_Van Buren PM
 Site Code : 05119542
 Start Date : 8/20/2019
 Page No : 1

Groups Printed- 3 Axle Vehicles

Start Time	Trautwein Road Southbound				Van Buren Boulevard Westbound				Cole Avenue Northbound				Van Buren Boulevard Eastbound					
	Left	Thru	Right	RTOR	App. Total	Left	Thru	Right	RTOR	App. Total	Left	Thru	Right	RTOR	App. Total	Exclu. Total	Inclu. Total	Int. Total
04:00 PM	0	0	0	0	0	1	0	0	0	0	0	0	0	0	0	0	1	1
04:15 PM	0	0	0	0	0	0	0	0	0	0	0	3	0	0	3	0	3	3
04:30 PM	0	0	0	0	0	0	0	0	0	0	0	0	0	0	0	0	0	0
04:45 PM	1	1	0	0	2	0	1	0	0	0	1	2	0	0	3	0	6	6
Total	1	1	0	0	2	0	2	0	0	0	1	5	0	0	6	0	10	10
05:00 PM	0	0	0	0	0	0	0	0	0	0	0	0	0	0	0	0	0	0
05:15 PM	0	0	0	0	0	0	0	0	0	0	0	0	0	0	0	0	0	0
05:30 PM	0	0	0	0	0	0	0	0	0	0	0	0	0	0	0	0	0	0
05:45 PM	0	0	0	0	0	0	0	0	0	0	0	2	0	0	2	0	2	2
Total	0	0	0	0	0	0	0	0	0	0	0	2	0	0	2	0	2	2
Grand Total	1	1	0	0	2	0	2	0	0	0	1	7	0	0	8	0	12	12
Approch %	50	50	0	0	16.7	0	100	0	0	0	12.5	87.5	0	0	66.7	0	100	100
Total %	8.3	8.3	0	0	16.7	0	16.7	0	0	0	8.3	58.3	0	0	66.7	0	100	100

Start Time	Trautwein Road Southbound				Van Buren Boulevard Westbound				Cole Avenue Northbound				Van Buren Boulevard Eastbound					
	Left	Thru	Right	RTOR	App. Total	Left	Thru	Right	RTOR	App. Total	Left	Thru	Right	RTOR	App. Total	Exclu. Total	Inclu. Total	Int. Total
04:45 PM	1	1	0	0	2	0	1	0	0	0	0	0	0	0	0	0	1	1
05:00 PM	0	0	0	0	0	0	0	0	0	0	0	0	0	0	0	0	0	0
05:15 PM	0	0	0	0	0	0	0	0	0	0	0	0	0	0	0	0	0	0
05:30 PM	0	0	0	0	0	0	0	0	0	0	0	0	0	0	0	0	0	0
Total Volume	1	1	0	0	2	0	1	0	0	0	0	0	0	0	0	0	1	1
% App. Total	50	50	0	0	16.7	0	100	0	0	0	0	0	0	0	66.7	0	100	100
PHF	.250	.250	.000	.000	.250	.000	.250	.000	.000	.000	.250	.250	.000	.000	.250	.000	.250	.250

Peak Hour Analysis From 04:45 PM to 05:30 PM - Peak 1 of 1
 Peak Hour for Entire Intersection Begins at 04:45 PM

Counts Unlimited
 PO Box 1178
 Corona, CA 92878
 (951) 268-6268

City of Riverside
 N/S: Trautwein Road/Cole Avenue
 E/W: Van Buren Boulevard
 Weather: Clear

File Name : 10_RIV_Trautwein_Van Buren PM
 Site Code : 05119542
 Start Date : 8/20/2019
 Page No : 2

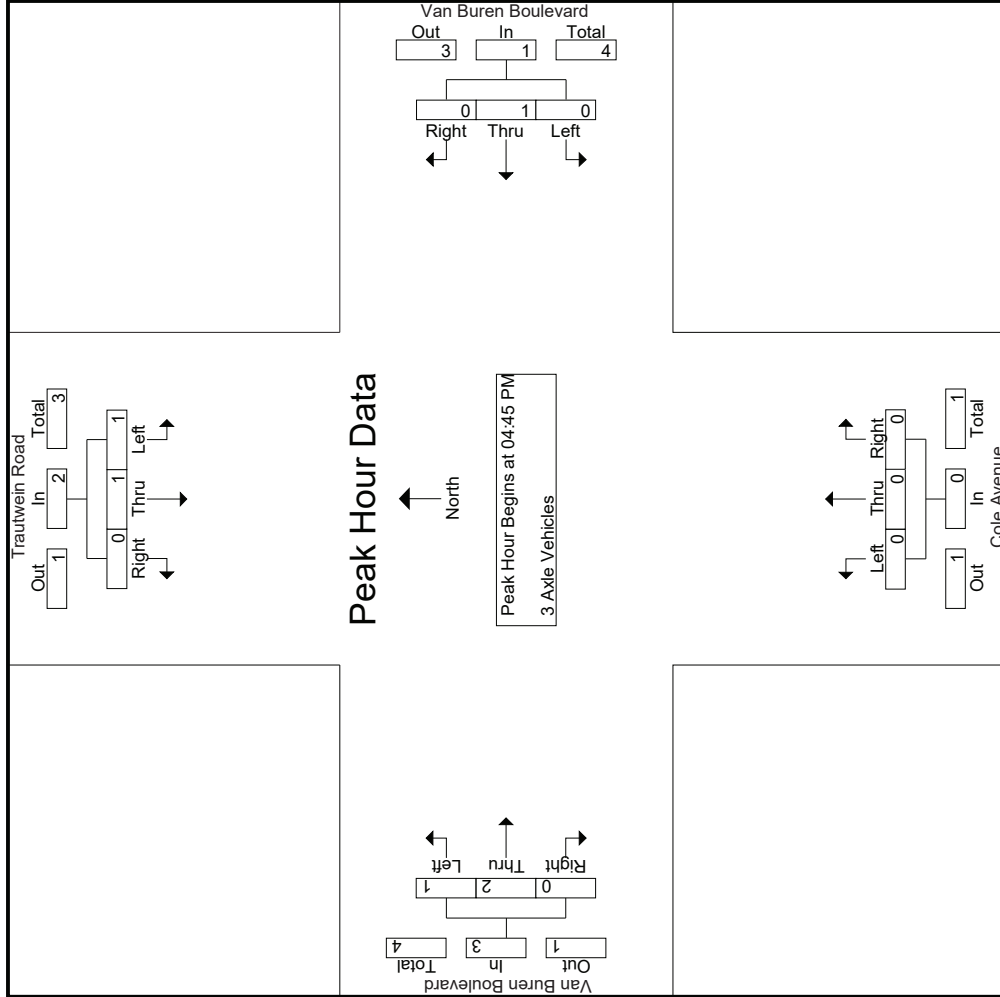

Counts Unlimited
 PO Box 1178
 Corona, CA 92878
 (951) 268-6268

City of Riverside
 N/S: Trautwein Road/Cole Avenue
 E/W: Van Buren Boulevard
 Weather: Clear

File Name : 10_RIV_Trautwein_Van Buren PM
 Site Code : 05119542
 Start Date : 8/20/2019
 Page No : 3

Start Time	Trautwein Road Southbound			Van Buren Boulevard Westbound			Cole Avenue Northbound			Van Buren Boulevard Eastbound		
	Left	Thru	Right	Left	Thru	Right	Left	Thru	Right	Left	Thru	Right
Peak Hour Analysis From 04:45 PM to 05:30 PM - Peak 1 of 1												
Peak Hour for Each Approach Begins at:												
	04:45 PM											
+0 mins.	1	1	0	0	1	0	0	1	0	0	0	0
+15 mins.	0	0	0	0	0	0	0	0	0	0	0	0
+30 mins.	0	0	0	0	0	0	0	0	0	0	0	0
+45 mins.	0	0	0	0	0	0	0	0	0	0	0	0
Total Volume	1	1	0	0	1	0	0	1	0	0	2	0
% App. Total	50	50	0	0	100	0	0	0	0	33.3	66.7	0
PHF	.250	.250	.000	.000	.250	.000	.000	.250	.000	.250	.250	.000

Counts Unlimited
 PO Box 1178
 Corona, CA 92878
 (951) 268-6268

City of Riverside
 N/S: Trautwein Road/Cole Avenue
 E/W: Van Buren Boulevard
 Weather: Clear

File Name : 10_RIV_Trautwein_Van Buren PM
 Site Code : 05119542
 Start Date : 8/20/2019
 Page No : 1

Groups Printed- 4+ Axle Trucks

Start Time	Trautwein Road Southbound				Van Buren Boulevard Westbound				Cole Avenue Northbound				Van Buren Boulevard Eastbound					
	Left	Thru	Right	RTOR	App. Total	Left	Thru	Right	RTOR	App. Total	Left	Thru	Right	RTOR	App. Total	Exclu. Total	Inclu. Total	Int. Total
04:00 PM	0	0	0	0	0	0	3	0	0	0	0	0	3	0	0	0	6	6
04:15 PM	0	0	0	0	0	1	1	1	0	2	0	0	0	0	3	1	5	6
04:30 PM	0	0	0	0	0	2	0	0	0	2	0	0	0	0	1	0	3	3
04:45 PM	0	0	0	0	0	1	0	0	0	1	0	0	0	0	4	0	5	5
Total	0	0	0	0	0	7	1	1	0	8	0	0	0	0	11	1	19	20
05:00 PM	1	0	0	0	1	0	2	0	0	2	0	0	0	0	2	0	5	5
05:15 PM	0	0	0	0	0	0	0	0	0	0	0	0	0	0	0	0	0	0
05:30 PM	0	0	0	0	0	0	0	0	0	0	0	0	0	0	1	0	1	1
05:45 PM	0	0	0	0	0	1	0	0	0	1	0	0	0	0	0	0	1	1
Total	1	0	0	0	1	3	0	0	0	3	0	0	0	0	3	0	7	7
Grand Total	1	0	0	0	1	10	1	1	0	11	0	0	0	0	14	1	26	27
Approch %	100	0	0	0	3.8	90.9	9.1	0	0	42.3	0	0	0	0	53.8	3.7	96.3	
Total %	3.8	0	0	0	3.8	38.5	3.8	0	0	42.3	0	0	0	0	53.8	3.7	96.3	

Start Time	Trautwein Road Southbound				Van Buren Boulevard Westbound				Cole Avenue Northbound				Van Buren Boulevard Eastbound					
	Left	Thru	Right	RTOR	App. Total	Left	Thru	Right	RTOR	App. Total	Left	Thru	Right	RTOR	App. Total	Exclu. Total	Inclu. Total	Int. Total
04:45 PM	0	0	0	0	0	0	1	0	0	1	0	0	0	0	0	0	4	5
05:00 PM	1	0	0	0	1	0	2	0	0	2	0	0	0	0	2	0	2	5
05:15 PM	0	0	0	0	0	0	0	0	0	0	0	0	0	0	0	0	0	0
05:30 PM	0	0	0	0	0	0	0	0	0	0	0	0	0	0	1	0	1	1
Total Volume	1	0	0	0	1	0	3	0	0	3	0	0	0	0	7	0	7	11
% App. Total	100	0	0	0	.250	0	100	0	0	.375	0	0	0	0	.438	0	.438	.550
PHF	.250	.000	.000	.000	.250	.000	.375	.000	.000	.375	.000	.000	.000	.000	.438	.000	.438	.550

Peak Hour Analysis From 04:45 PM to 05:30 PM - Peak 1 of 1
 Peak Hour for Entire Intersection Begins at 04:45 PM

Counts Unlimited
 PO Box 1178
 Corona, CA 92878
 (951) 268-6268

City of Riverside
 N/S: Trautwein Road/Cole Avenue
 E/W: Van Buren Boulevard
 Weather: Clear

File Name : 10_RIV_Trautwein_Van Buren PM
 Site Code : 05119542
 Start Date : 8/20/2019
 Page No : 2

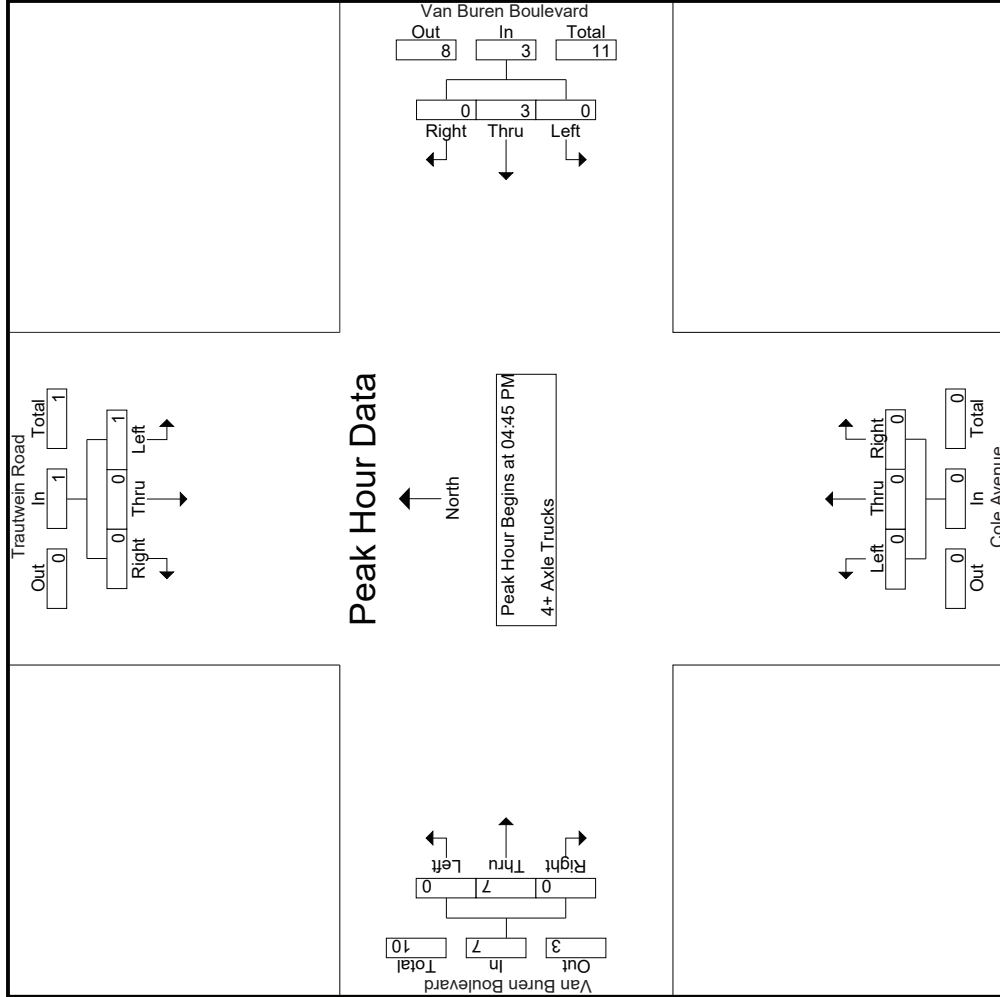

Counts Unlimited
 PO Box 1178
 Corona, CA 92878
 (951) 268-6268

City of Riverside
 N/S: Trautwein Road/Cole Avenue
 E/W: Van Buren Boulevard
 Weather: Clear

File Name : 10_RIV_Trautwein_Van Buren PM
 Site Code : 05119542
 Start Date : 8/20/2019
 Page No : 3

Start Time	Trautwein Road Southbound			Van Buren Boulevard Westbound			Cole Avenue Northbound			Van Buren Boulevard Eastbound					
	Left	Thru	Right	Left	Thru	Right	Left	Thru	Right	Left	Thru	Right	App. Total	Int. Total	
Peak Hour Analysis From 04:45 PM to 05:30 PM - Peak 1 of 1															
Peak Hour for Each Approach Begins at:															
	04:45 PM			04:45 PM			04:45 PM			04:45 PM			04:45 PM		
+0 mins.	0	0	0	0	1	0	0	0	0	0	0	0	0	0	
+15 mins.	1	0	0	2	0	0	0	0	0	0	0	0	2	4	
+30 mins.	0	0	0	0	0	0	0	0	0	0	0	0	0	2	
+45 mins.	0	0	0	0	0	0	0	0	0	0	0	0	0	0	
Total Volume	1	0	0	3	0	0	0	0	0	0	0	0	7	7	
% App. Total	100	0	0	100	0	0	0	0	0	0	0	0	100	0	
PHF	.250	.000	.000	.250	.375	.000	.375	.000	.000	.000	.000	.000	.438	.438	

Location: Riverside
 N/S: Trautwein Road
 E/W: Van Buren Boulevard



Date: 8/20/2019
 Day: Tuesday

PEDESTRIANS

	North Leg Trautwein Road	East Leg Van Buren Boulevard	South Leg Trautwein Road	West Leg Van Buren Boulevard	
	Pedestrians	Pedestrians	Pedestrians	Pedestrians	
7:00 AM	0	0	0	0	0
7:15 AM	0	0	0	0	0
7:30 AM	0	0	0	0	0
7:45 AM	0	0	0	4	4
8:00 AM	0	0	0	4	4
8:15 AM	0	0	0	1	1
8:30 AM	0	0	0	1	1
8:45 AM	0	2	0	0	2
TOTAL VOLUMES:	0	2	0	10	12

	North Leg Trautwein Road	East Leg Van Buren Boulevard	South Leg Trautwein Road	West Leg Van Buren Boulevard	
	Pedestrians	Pedestrians	Pedestrians	Pedestrians	
4:00 PM	0	1	1	0	2
4:15 PM	0	0	0	4	4
4:30 PM	0	0	1	2	3
4:45 PM	0	0	0	0	0
5:00 PM	0	0	0	0	0
5:15 PM	0	0	0	0	0
5:30 PM	0	0	0	0	0
5:45 PM	1	0	0	1	2
TOTAL VOLUMES:	1	1	2	7	11

Location: Riverside
 N/S: Trautwein Road
 E/W: Van Buren Boulevard



Date: 8/20/2019
 Day: Tuesday

BICYCLES

	Southbound Trautwein Road			Westbound Van Buren Boulevard			Northbound Trautwein Road			Eastbound Van Buren Boulevard			
	Left	Thru	Right	Left	Thru	Right	Left	Thru	Right	Left	Thru	Right	
7:00 AM	0	0	0	0	0	0	0	0	0	0	0	0	0
7:15 AM	0	0	1	0	2	1	0	0	0	0	0	0	4
7:30 AM	0	0	0	0	0	0	0	0	0	0	0	0	0
7:45 AM	0	0	0	0	0	0	0	0	0	0	0	0	0
8:00 AM	0	1	0	0	0	0	0	0	0	0	0	0	1
8:15 AM	0	0	1	0	0	0	0	0	0	0	0	0	1
8:30 AM	0	0	0	0	0	0	0	1	1	0	0	0	2
8:45 AM	0	2	0	0	1	0	0	0	0	0	0	0	3
TOTAL VOLUMES:	0	3	2	0	3	1	0	1	1	0	0	0	11

	Southbound Trautwein Road			Westbound Van Buren Boulevard			Northbound Trautwein Road			Eastbound Van Buren Boulevard			
	Left	Thru	Right	Left	Thru	Right	Left	Thru	Right	Left	Thru	Right	
4:00 PM	0	0	0	0	0	0	0	0	0	0	0	0	0
4:15 PM	0	0	0	0	0	0	0	0	0	0	0	0	0
4:30 PM	0	0	0	0	0	0	0	0	0	0	0	0	0
4:45 PM	0	1	0	1	0	0	0	0	0	0	1	1	4
5:00 PM	0	0	0	0	0	0	0	0	0	1	0	0	1
5:15 PM	0	0	0	0	0	0	0	0	0	0	0	0	0
5:30 PM	1	0	0	0	0	0	0	1	0	0	0	0	2
5:45 PM	0	0	0	0	1	0	1	0	0	0	0	0	2
TOTAL VOLUMES:	1	1	0	1	1	0	1	1	0	1	1	1	9

Counts Unlimited
 PO Box 1178
 Corona, CA 92878
 (951) 268-6268

City of Riverside
 N/S: Barton Street
 EW: Alessandro Boulevard
 Weather: Clear

File Name : 12_RIV_Barton St_Alessandro AM
 Site Code : 05119542
 Start Date : 8/20/2019
 Page No : 1

Groups Printed- Passenger Vehicles - Large 2 Axle Vehicles - 3 Axle Vehicles - 4+ Axle Trucks

Start Time	Barton Street Southbound				Alessandro Boulevard Westbound				Barton Street Northbound				Alessandro Boulevard Eastbound				Inclu. Total	Int. Total					
	Left	Thru	Right	RTOR	App. Total	Left	Thru	Right	RTOR	App. Total	Left	Thru	Right	RTOR	App. Total	Exclu. Total							
																			Left	Thru	Right	App. Total	Left
07:00 AM	1	0	0	0	1	6	705	0	0	711	19	1	7	6	27	3	247	10	3	260	9	999	1008
07:15 AM	0	0	1	1	1	7	664	0	0	671	17	0	8	7	25	2	287	6	0	295	8	992	1000
07:30 AM	0	0	1	0	1	7	649	1	0	657	17	0	5	2	22	3	276	7	2	286	4	966	970
07:45 AM	1	0	2	1	3	9	578	2	0	589	13	0	3	3	16	0	304	6	1	310	5	918	923
Total	2	0	4	2	6	29	2596	3	0	2628	66	1	23	18	90	8	1114	29	6	1151	26	3875	3901
08:00 AM	0	1	0	0	1	8	516	0	0	524	12	0	7	6	19	1	254	9	2	264	8	808	816
08:15 AM	2	0	2	1	4	13	501	1	0	515	12	0	9	7	21	0	257	2	0	259	8	799	807
08:30 AM	0	0	3	3	3	11	583	0	0	594	12	0	6	5	18	4	237	5	0	246	8	861	869
08:45 AM	2	0	0	0	2	11	529	1	0	541	17	0	9	7	26	4	219	7	1	230	8	799	807
Total	4	1	5	4	10	43	2129	2	0	2174	53	0	31	25	84	9	967	23	3	999	32	3267	3299
Grand Total	6	1	9	6	16	72	4725	5	0	4802	119	1	54	43	174	17	2081	52	9	2150	58	7142	7200
Approch %	37.5	6.2	56.2	0	0.2	1.5	98.4	0.1	0	67.2	68.4	0.6	0	0.8	2.4	0.8	96.8	2.4	0	30.1	0.8	99.2	
Total %	6	1	6	1	19	66	4650	3	4719	114	114	1	54	212	16	2044	49	2118	0	0	0	0	7068
% Passenger Vehicles	100	100	100	100	86.4	91.7	98.4	60	98.3	95.8	100	100	100	100	97.7	94.1	98.2	94.2	100	98.1	0	0	98.2
% Large 2 Axle Vehicles	0	0	33.3	0	13.6	6.9	1.2	20	1.3	2.5	3	0	0	0	1.4	5.9	1.1	5.8	0	1.2	0	0	1.3
% 3 Axle Vehicles	0	0	0	0	0	0	6	0	6	0	0	0	0	0	0	0	6	0	6	0	0	0	12
% 3 Axle Trucks	0	0	0	0	0	0	0.1	0	0.1	0	0	0	0	0	0	0	0.3	0	0	0.3	0	0	0.2
% 4+ Axle Trucks	0	0	0	0	0	1	12	1	14	2	2	0	0	2	0	9	0	0	9	0	0	0	25
% 4+ Axle Trucks	0	0	0	0	0	1.4	0.3	20	0.3	1.7	1.7	0	0	0	0.9	0	0.4	0	0	0.4	0	0	0.3

Start Time	Barton Street Southbound				Alessandro Boulevard Westbound				Barton Street Northbound				Alessandro Boulevard Eastbound				Inclu. Total	Int. Total					
	Left	Thru	Right	RTOR	App. Total	Left	Thru	Right	RTOR	App. Total	Left	Thru	Right	RTOR	App. Total	Exclu. Total							
																			Left	Thru	Right	App. Total	Left
Peak Hour Analysis From 07:00 AM to 08:45 AM - Peak 1 of 1	1	0	0	0	1	6	705	0	0	711	19	1	7	6	27	3	247	10	3	247	10	260	999
07:00 AM	1	0	0	0	1	6	705	0	0	711	19	1	7	6	27	3	247	10	3	247	10	260	999
07:15 AM	0	0	1	1	1	7	664	0	0	671	17	0	8	7	25	2	287	6	0	295	8	992	1000
07:30 AM	0	0	1	0	1	7	649	1	0	657	17	0	5	2	22	3	276	7	2	286	4	966	970
07:45 AM	1	0	2	1	3	9	578	2	0	589	13	0	3	3	16	0	304	6	1	310	5	918	923
Total Volume	2	0	4	2	6	29	2596	3	0	2628	66	1	23	18	90	8	1114	29	6	1151	26	3875	3901
% App. Total	33.3	0	66.7	0	66.7	1.1	98.8	0.1	0	92.4	73.3	1.1	25.6	0.7	96.8	2.5	96.8	2.5	0.7	96.8	2.5	928	3875
PHF	.500	.000	.500	.500	.500	.806	.921	.375	.924	.924	.868	.250	.719	.667	.833	.725	.916	.725	.667	.916	.725	.928	.970

Counts Unlimited
 PO Box 1178
 Corona, CA 92878
 (951) 268-6268

City of Riverside
 N/S: Barton Street
 E/W: Alessandro Boulevard
 Weather: Clear

File Name : 12_RIV_Barton St_Alessandro AM
 Site Code : 05119542
 Start Date : 8/20/2019
 Page No : 2

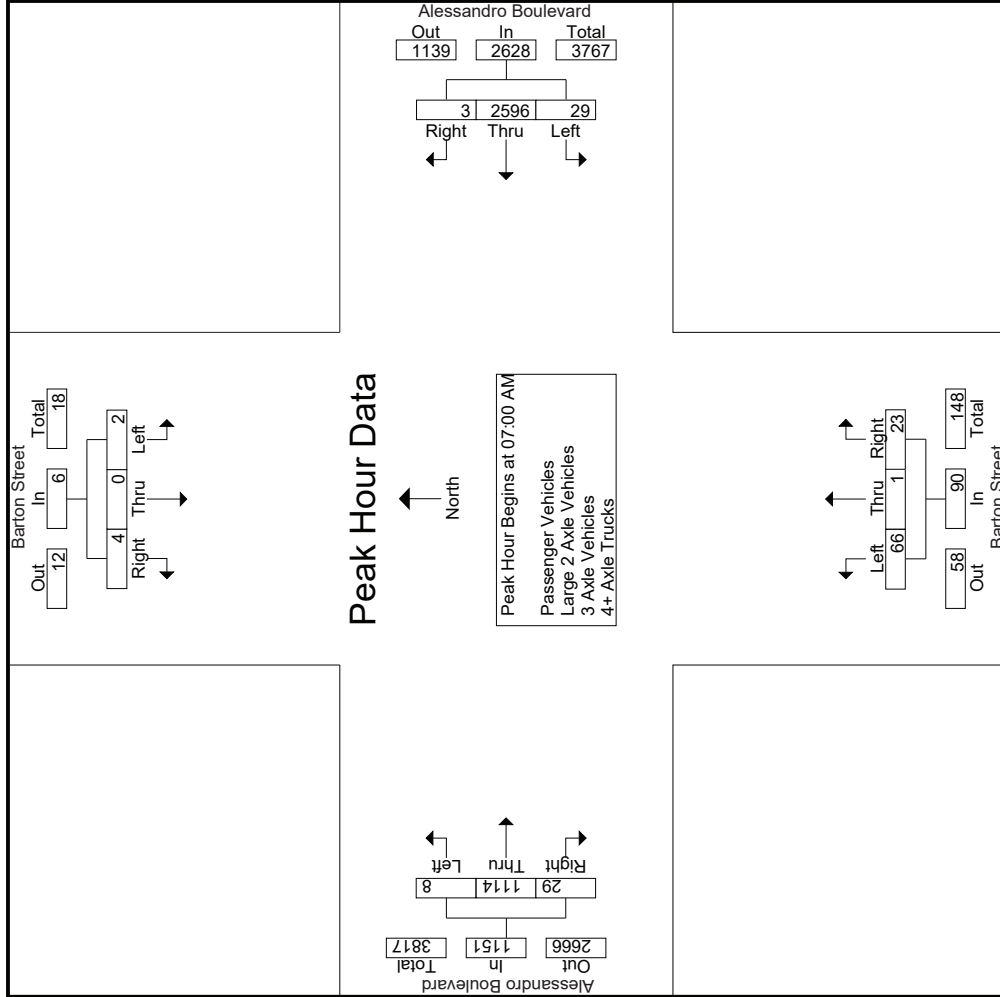

Start Time	Barton Street Southbound			Alessandro Boulevard Westbound			Barton Street Northbound			Alessandro Boulevard Eastbound				
	Left	Thru	Right	App. Total	Left	Thru	Right	App. Total	Left	Thru	Right	App. Total	Int. Total	
Peak Hour Analysis From 07:00 AM to 08:45 AM - Peak 1 of 1														
Peak Hour for Each Approach Begins at:														
	07:45 AM			07:00 AM			07:00 AM			07:15 AM				
+0 mins.	1	0	2	3	6	705	0	711	19	7	27	2	287	295
+15 mins.	0	1	0	1	7	664	0	671	17	0	25	3	276	286
+30 mins.	2	0	2	4	7	649	1	657	17	0	22	0	304	310
+45 mins.	0	0	3	3	9	578	2	589	13	0	16	1	254	264
Total Volume	3	1	7	11	29	2596	3	2628	66	1	90	6	1121	1155
% App. Total	27.3	9.1	63.6	.688	1.1	98.8	0.1	.924	73.3	1.1	25.6	0.5	97.1	2.4
PHF	.375	.250	.583	.688	.806	.921	.375	.924	.868	.250	.719	.500	.922	.778

Groups Printed- Passenger Vehicles

Start Time	Barton Street Southbound						Alessandro Boulevard Westbound						Barton Street Northbound						Alessandro Boulevard Eastbound								
	Left		Thru		Right		Left		Thru		Right		Left		Thru		Right		Left		Thru		Right				
		App. Total		RTOR		App. Total		RTOR		App. Total		RTOR		App. Total		RTOR		App. Total		App. Total		RTOR		App. Total		App. Total	
07:00 AM	1	0	0	1	6	697	0	0	703	0	0	0	19	1	7	6	27	0	27	3	243	10	3	256	9	987	996
07:15 AM	0	0	1	1	4	653	0	0	657	16	0	8	7	24	24	0	24	2	280	5	280	5	0	287	8	969	977
07:30 AM	0	0	0	0	6	641	1	0	648	16	0	5	2	21	21	0	21	3	274	7	274	7	2	284	4	953	957
07:45 AM	1	0	1	2	8	574	1	0	583	12	0	3	3	15	15	0	15	0	302	6	302	6	1	308	5	908	913
Total	2	0	2	4	24	2565	2	0	2591	63	1	23	18	87	87	8	1099	28	6	1135	1099	28	6	1135	26	3817	3843
08:00 AM	0	1	0	0	8	509	0	0	517	12	0	7	6	19	19	0	19	0	246	8	246	8	2	254	8	791	799
08:15 AM	2	0	1	3	12	491	1	0	504	11	0	9	7	20	20	0	20	0	253	2	253	2	0	255	8	782	790
08:30 AM	0	0	3	3	11	568	0	0	579	12	0	6	5	18	18	4	18	4	234	4	234	4	0	242	8	842	850
08:45 AM	2	0	0	2	11	517	0	0	528	16	0	9	7	25	25	4	25	4	212	7	212	7	1	223	8	778	786
Total	4	1	4	9	42	2085	1	0	2128	51	0	31	25	82	82	8	945	21	3	974	945	21	3	974	32	3193	3225
Grand Total	6	1	6	13	66	4650	3	0	4719	114	1	54	43	169	169	16	2044	49	9	2109	2044	49	9	2109	58	7010	7068
Approch %	46.2	7.7	46.2	0.2	1.4	98.5	0.1	0	67.3	1.6	0	0.8	2.4	0.8	0.8	0.2	29.2	0.7	0.7	30.1	29.2	0.7	0.7	30.1	0.8	99.2	99.2
Total %	0.1	0	0.1	0.2	0.9	66.3	0	0	67.3	1.6	0	0.8	2.4	0.8	0.8	0.2	29.2	0.7	0.7	30.1	29.2	0.7	0.7	30.1	0.8	99.2	99.2

Start Time	Barton Street Southbound						Alessandro Boulevard Westbound						Barton Street Northbound						Alessandro Boulevard Eastbound								
	Left		Thru		Right		Left		Thru		Right		Left		Thru		Right		Left		Thru		Right				
		App. Total		RTOR		App. Total		RTOR		App. Total		RTOR		App. Total		App. Total		RTOR		App. Total		App. Total		App. Total			
07:00 AM	1	0	0	1	6	697	0	0	703	0	0	0	19	1	7	6	27	0	27	3	243	10	3	256	9	987	996
07:15 AM	0	0	1	1	4	653	0	0	657	16	0	8	7	24	24	0	24	2	280	5	280	5	0	287	8	969	977
07:30 AM	0	0	0	0	6	641	1	0	648	16	0	5	2	21	21	0	21	3	274	7	274	7	2	284	4	953	957
07:45 AM	1	0	1	2	8	574	1	0	583	12	0	3	3	15	15	0	15	0	302	6	302	6	1	308	5	908	913
Total Volume	2	0	2	4	24	2565	2	0	2591	63	1	23	18	87	87	8	1099	28	6	1135	1099	28	6	1135	26	3817	3843
% App. Total	50	0	50	0.2	0.9	99	0.1	0	67.3	1.6	0	0.8	2.4	0.8	0.8	0.2	29.2	0.7	0.7	30.1	29.2	0.7	0.7	30.1	0.8	99.2	99.2
PHF	.500	.000	.500	.500	.750	.920	.500	.921	.921	.829	.250	.719	.806	.667	.910	.700	.921	.921	.921	.921	.921	.921	.921	.921	.921	.921	.921

Peak Hour Analysis From 07:00 AM to 07:45 AM - Peak 1 of 1
 Peak Hour for Entire Intersection Begins at 07:00 AM

Counts Unlimited
 PO Box 1178
 Corona, CA 92878
 (951) 268-6268

City of Riverside
 N/S: Barton Street
 E/W: Alessandro Boulevard
 Weather: Clear

File Name : 12_RIV_Barton St_Alessandro AM
 Site Code : 05119542
 Start Date : 8/20/2019
 Page No : 2

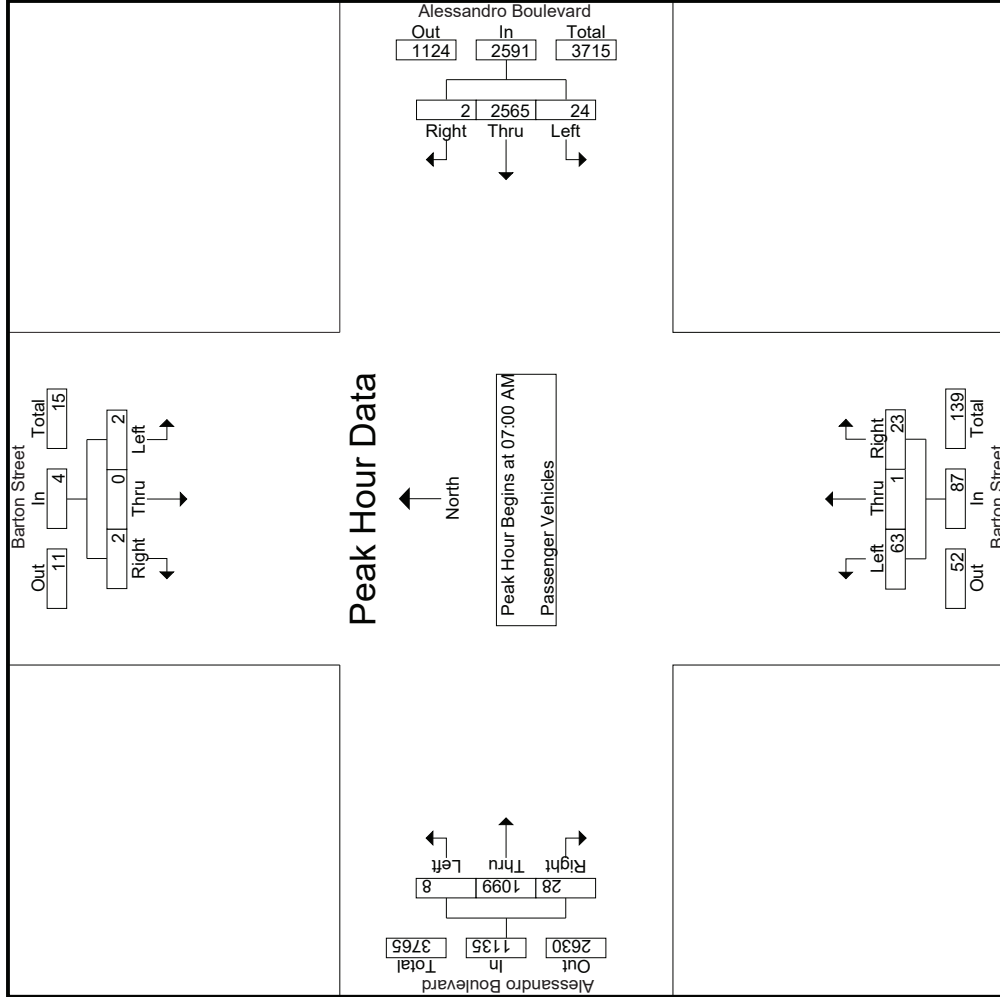

Counts Unlimited
 PO Box 1178
 Corona, CA 92878
 (951) 268-6268

City of Riverside
 N/S: Barton Street
 E/W: Alessandro Boulevard
 Weather: Clear

File Name : 12_RIV_Barton St_Alessandro AM
 Site Code : 05119542
 Start Date : 8/20/2019
 Page No : 3

Start Time	Barton Street Southbound			Alessandro Boulevard Westbound			Barton Street Northbound			Alessandro Boulevard Eastbound				
	Left	Thru	Right	Left	Thru	Right	Left	Thru	Right	Left	Thru	Right		
Peak Hour Analysis From 07:00 AM to 07:45 AM - Peak 1 of 1														
Peak Hour for Each Approach Begins at:														
	07:00 AM			07:00 AM			07:00 AM			07:00 AM				
+0 mins.	1	0	0	6	697	0	703	19	7	27	3	243	10	256
+15 mins.	0	0	1	4	653	0	657	16	8	24	2	280	5	287
+30 mins.	0	0	0	6	641	1	648	16	5	21	3	274	7	284
+45 mins.	1	0	1	8	574	1	583	12	3	15	0	302	6	308
Total Volume	2	0	2	24	2565	2	2591	63	23	87	8	1099	28	1135
% App. Total	50	0	50	0.9	99	0.1	72.4	1.1	26.4	0.7	0.7	96.8	2.5	1135
PHF	.500	.000	.500	.750	.920	.500	.921	.829	.719	.806	.667	.910	.700	.921

Groups Printed- Large 2 Axle Vehicles

Start Time	Barton Street Southbound				Alessandro Boulevard Westbound				Barton Street Northbound				Alessandro Boulevard Eastbound								
	Left	Thru	Right	RTOR	App. Total	Left	Thru	Right	RTOR	App. Total	Left	Thru	Right	RTOR	App. Total	Exclu. Total	Inclu. Total	Int. Total			
07:00 AM	0	0	0	0	0	0	8	0	0	0	0	2	0	0	2	0	10	10			
07:15 AM	0	0	0	0	0	3	5	0	0	8	1	0	0	0	1	0	14	14			
07:30 AM	0	0	1	0	1	1	5	0	0	6	1	0	0	0	2	0	10	10			
07:45 AM	0	0	1	0	1	0	4	1	0	5	0	0	0	0	0	0	6	6			
Total	0	0	2	0	2	4	22	1	0	27	2	0	0	0	2	0	40	40			
08:00 AM	0	0	0	0	0	0	4	0	0	4	0	0	0	0	0	0	13	13			
08:15 AM	0	0	1	0	1	1	9	0	0	10	0	0	0	0	2	0	13	13			
08:30 AM	0	0	0	0	0	0	13	0	0	13	0	0	1	0	2	0	15	15			
08:45 AM	0	0	0	0	0	0	9	0	0	9	1	0	0	0	4	0	14	14			
Total	0	0	1	0	1	1	35	0	0	36	1	0	0	0	17	0	55	55			
Grand Total	0	0	3	0	3	5	57	1	0	63	3	0	0	0	3	1	22	3	0	26	95
Apprch %	0	0	100		7.9	90.5	1.6			66.3	100	0	0		3.2	3.8	84.6	11.5		27.4	100
Total %	0	0	3.2		3.2	5.3	60	1.1		66.3	3.2	0	0		3.2	1.1	23.2	3.2		27.4	100

Start Time	Barton Street Southbound				Alessandro Boulevard Westbound				Barton Street Northbound				Alessandro Boulevard Eastbound								
	Left	Thru	Right	RTOR	App. Total	Left	Thru	Right	RTOR	App. Total	Left	Thru	Right	RTOR	App. Total	Exclu. Total	Inclu. Total	Int. Total			
07:00 AM	0	0	0	0	0	0	8	0	0	8	0	0	0	0	0	0	2	0	2	10	
07:15 AM	0	0	0	0	0	3	5	0	0	8	1	0	0	0	1	0	5	1	4	14	
07:30 AM	0	0	1	0	1	1	5	0	0	6	1	0	0	0	2	0	10	0	2	10	
07:45 AM	0	0	1	0	1	0	4	1	0	5	0	0	0	0	0	0	6	0	0	6	
Total Volume	0	0	2		2	4	22	1		27	2	0	0		2	0	40	1	8	40	
% App. Total	0	0	100		7.9	90.5	1.6			66.3	100	0	0		3.2	3.8	84.6	11.1		27.4	100
PHF	.000	.000	.500		.500	.333	.688	.250		.844	.500	.000	.000		.500	.000	.250	.250		.450	.714

Peak Hour Analysis From 07:00 AM to 07:45 AM - Peak 1 of 1
 Peak Hour for Entire Intersection Begins at 07:00 AM

Counts Unlimited
 PO Box 1178
 Corona, CA 92878
 (951) 268-6268

City of Riverside
 N/S: Barton Street
 E/W: Alessandro Boulevard
 Weather: Clear

File Name : 12_RIV_Barton St_Alessandro AM
 Site Code : 05119542
 Start Date : 8/20/2019
 Page No : 2

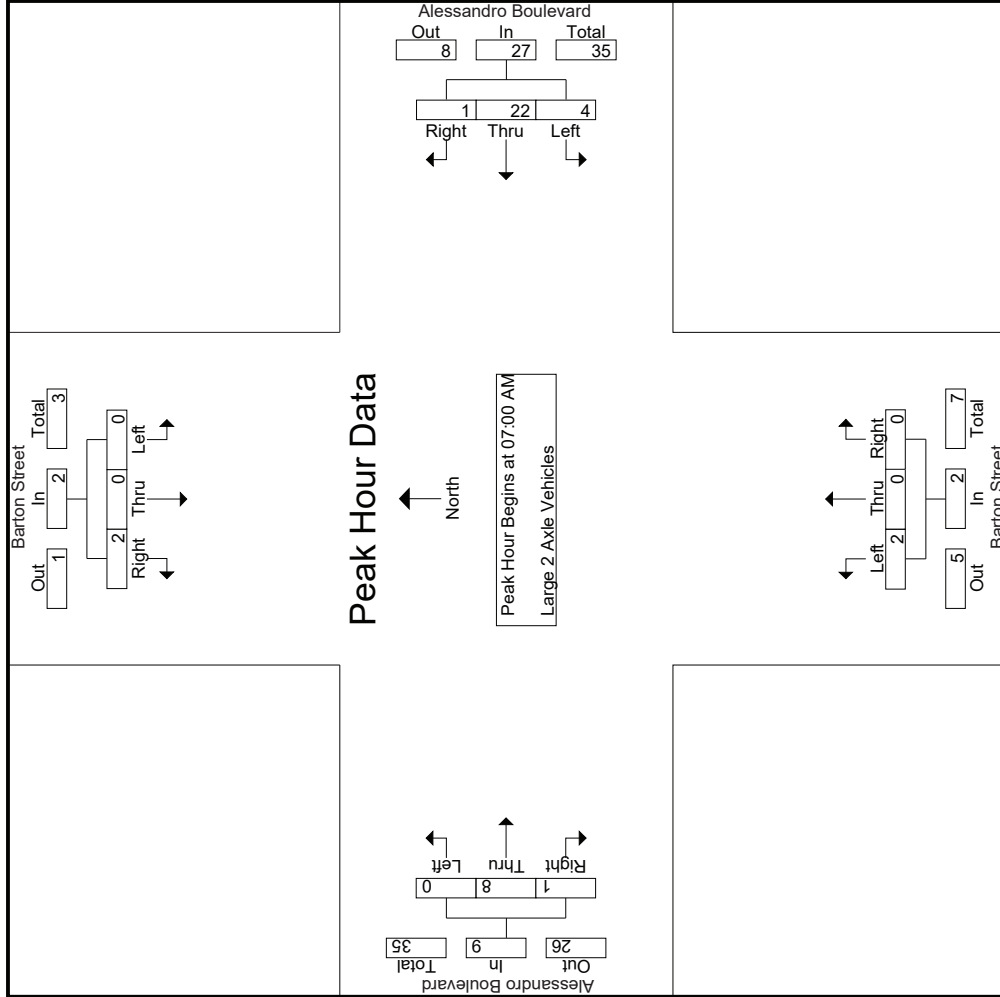

Counts Unlimited
 PO Box 1178
 Corona, CA 92878
 (951) 268-6268

City of Riverside
 N/S: Barton Street
 E/W: Alessandro Boulevard
 Weather: Clear

File Name : 12_RIV_Barton St_Alessandro AM
 Site Code : 05119542
 Start Date : 8/20/2019
 Page No : 3

Start Time	Barton Street Southbound			Alessandro Boulevard Westbound			Barton Street Northbound			Alessandro Boulevard Eastbound					
	Left	Thru	Right	Left	Thru	Right	Left	Thru	Right	Left	Thru	Right			
Peak Hour Analysis From 07:00 AM to 07:45 AM - Peak 1 of 1															
Peak Hour for Each Approach Begins at:															
+0 mins.	0	0	0	07:00 AM	0	0	0	07:00 AM	0	0	0	07:00 AM	0	0	0
+15 mins.	0	0	0	0	0	0	0	0	0	0	0	0	0	0	0
+30 mins.	0	0	1	3	5	0	1	0	0	1	0	0	4	1	5
+45 mins.	0	0	1	1	5	0	1	0	0	0	0	0	2	0	2
	0	0	1	0	4	1	0	0	0	0	0	0	0	0	0
Total Volume	0	0	2	4	22	1	2	0	0	2	0	0	8	1	9
% App. Total	0	0	100	14.8	81.5	3.7	100	0	0	0	0	0	88.9	11.1	0
PHF	.000	.000	.500	.333	.688	.250	.500	.000	.000	.500	.000	.000	.500	.250	.450

Groups Printed- 3 Axle Vehicles

Start Time	Barton Street Southbound				Alessandro Boulevard Westbound				Barton Street Northbound				Alessandro Boulevard Eastbound			
	Left	Thru	Right	RTOR	Left	Thru	Right	RTOR	Left	Thru	Right	RTOR	Left	Thru	Right	RTOR
07:00 AM	0	0	0	0	0	0	0	0	0	0	0	0	0	0	0	0
07:15 AM	0	0	0	0	0	2	0	0	0	0	0	0	0	2	0	0
07:30 AM	0	0	0	0	0	1	0	0	0	0	0	0	0	0	0	0
07:45 AM	0	0	0	0	0	0	0	0	0	0	0	0	0	0	0	0
Total	0	0	0	0	0	3	0	0	0	0	0	0	0	3	0	0
08:00 AM	0	0	0	0	0	0	0	0	0	0	0	0	0	1	0	0
08:15 AM	0	0	0	0	0	0	0	0	0	0	0	0	0	0	0	0
08:30 AM	0	0	0	0	0	1	0	0	0	0	0	0	0	1	0	0
08:45 AM	0	0	0	0	0	2	0	0	0	0	0	0	0	1	0	0
Total	0	0	0	0	0	3	0	0	0	0	0	0	0	3	0	0
Grand Total	0	0	0	0	0	6	0	0	0	0	0	0	0	6	0	0
Apprch %	0	0	0	0	0	100	0	0	0	0	0	0	0	100	0	0
Total %	0	0	0	0	0	50	0	0	0	0	0	0	0	50	0	0

Start Time	Barton Street Southbound				Alessandro Boulevard Westbound				Barton Street Northbound				Alessandro Boulevard Eastbound			
	Left	Thru	Right	RTOR	Left	Thru	Right	RTOR	Left	Thru	Right	RTOR	Left	Thru	Right	RTOR
07:00 AM	0	0	0	0	0	0	0	0	0	0	0	0	0	0	0	0
07:15 AM	0	0	0	0	0	2	0	0	0	0	0	0	0	2	0	0
07:30 AM	0	0	0	0	0	1	0	0	0	0	0	0	0	0	0	0
07:45 AM	0	0	0	0	0	0	0	0	0	0	0	0	0	0	0	0
Total Volume	0	0	0	0	0	3	0	0	0	0	0	0	0	3	0	0
% App. Total	0	0	0	0	0	100	0	0	0	0	0	0	0	100	0	0
PHF	.000	.000	.000	.000	.000	.375	.000	.000	.000	.000	.000	.000	.000	.375	.000	.375

Peak Hour Analysis From 07:00 AM to 07:45 AM - Peak 1 of 1
 Peak Hour for Entire Intersection Begins at 07:00 AM

Counts Unlimited
 PO Box 1178
 Corona, CA 92878
 (951) 268-6268

City of Riverside
 N/S: Barton Street
 E/W: Alessandro Boulevard
 Weather: Clear

File Name : 12_RIV_Barton St_Alessandro AM
 Site Code : 05119542
 Start Date : 8/20/2019
 Page No : 2

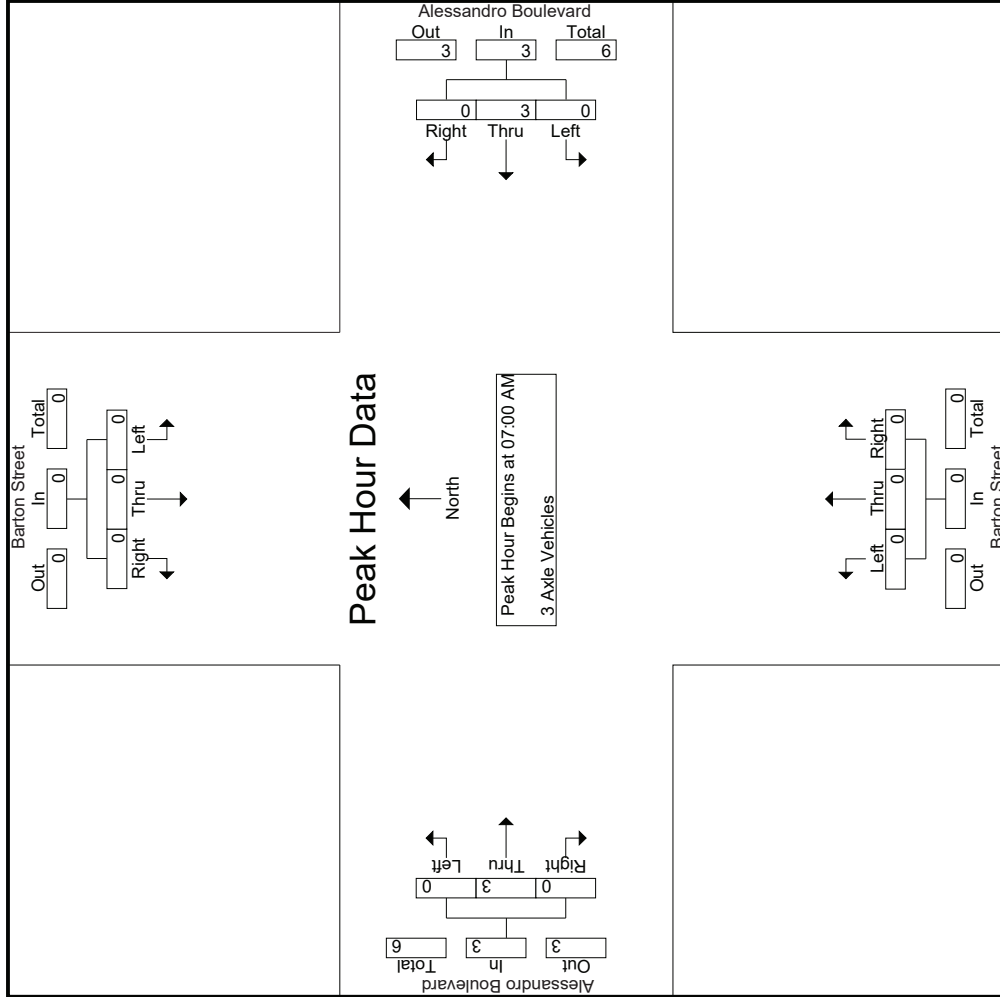

Counts Unlimited
 PO Box 1178
 Corona, CA 92878
 (951) 268-6268

City of Riverside
 N/S: Barton Street
 E/W: Alessandro Boulevard
 Weather: Clear

File Name : 12_RIV_Barton St_Alessandro AM
 Site Code : 05119542
 Start Date : 8/20/2019
 Page No : 1

Groups Printed- 4+ Axle Trucks

Start Time	Barton Street Southbound				Alessandro Boulevard Westbound				Barton Street Northbound				Alessandro Boulevard Eastbound			
	Left	Thru	Right	RTOR	Left	Thru	Right	RTOR	Left	Thru	Right	RTOR	Left	Thru	Right	RTOR
07:00 AM	0	0	0	0	0	0	0	0	0	0	0	0	0	0	0	0
07:15 AM	0	0	0	0	0	4	0	0	0	0	0	0	0	1	0	0
07:30 AM	0	0	0	0	0	2	0	0	0	0	0	0	0	0	0	0
07:45 AM	0	0	0	0	1	0	0	0	1	0	0	0	0	2	0	0
Total	0	0	0	0	1	6	0	0	1	0	0	0	0	4	0	0
08:00 AM	0	0	0	0	0	3	0	0	0	0	0	0	0	0	0	0
08:15 AM	0	0	0	0	0	1	0	0	1	0	0	0	0	2	0	0
08:30 AM	0	0	0	0	0	1	0	0	0	0	0	0	0	1	0	0
08:45 AM	0	0	0	0	0	1	1	0	0	0	0	0	0	2	0	0
Total	0	0	0	0	0	6	1	0	1	0	0	0	0	5	0	0
Grand Total	0	0	0	0	1	12	1	0	2	0	0	0	0	9	0	0
Apprch %	0	0	0	0	7.1	85.7	7.1	0	100	0	0	0	0	100	0	0
Total %	0	0	0	0	4	48	4	0	8	0	0	0	0	36	0	0

Start Time	Barton Street Southbound				Alessandro Boulevard Westbound				Barton Street Northbound				Alessandro Boulevard Eastbound			
	Left	Thru	Right	RTOR	Left	Thru	Right	RTOR	Left	Thru	Right	RTOR	Left	Thru	Right	RTOR
07:00 AM	0	0	0	0	0	0	0	0	0	0	0	0	0	0	0	0
07:15 AM	0	0	0	0	0	4	0	0	4	0	0	0	0	1	0	0
07:30 AM	0	0	0	0	0	2	0	0	2	0	0	0	0	0	0	0
07:45 AM	0	0	0	0	1	0	0	0	1	0	0	0	0	2	0	0
Total Volume	0	0	0	0	1	6	0	0	7	0	0	0	0	4	0	0
% App. Total	0	0	0	0	14.3	85.7	0	0	100	0	0	0	0	100	0	0
PHF	.000	.000	.000	.000	.250	.375	.000	.438	.250	.000	.000	.250	.000	.500	.000	.600

Peak Hour Analysis From 07:00 AM to 07:45 AM - Peak 1 of 1
 Peak Hour for Entire Intersection Begins at 07:00 AM

Counts Unlimited
 PO Box 1178
 Corona, CA 92878
 (951) 268-6268

City of Riverside
 N/S: Barton Street
 E/W: Alessandro Boulevard
 Weather: Clear

File Name : 12_RIV_Barton St_Alessandro AM
 Site Code : 05119542
 Start Date : 8/20/2019
 Page No : 2

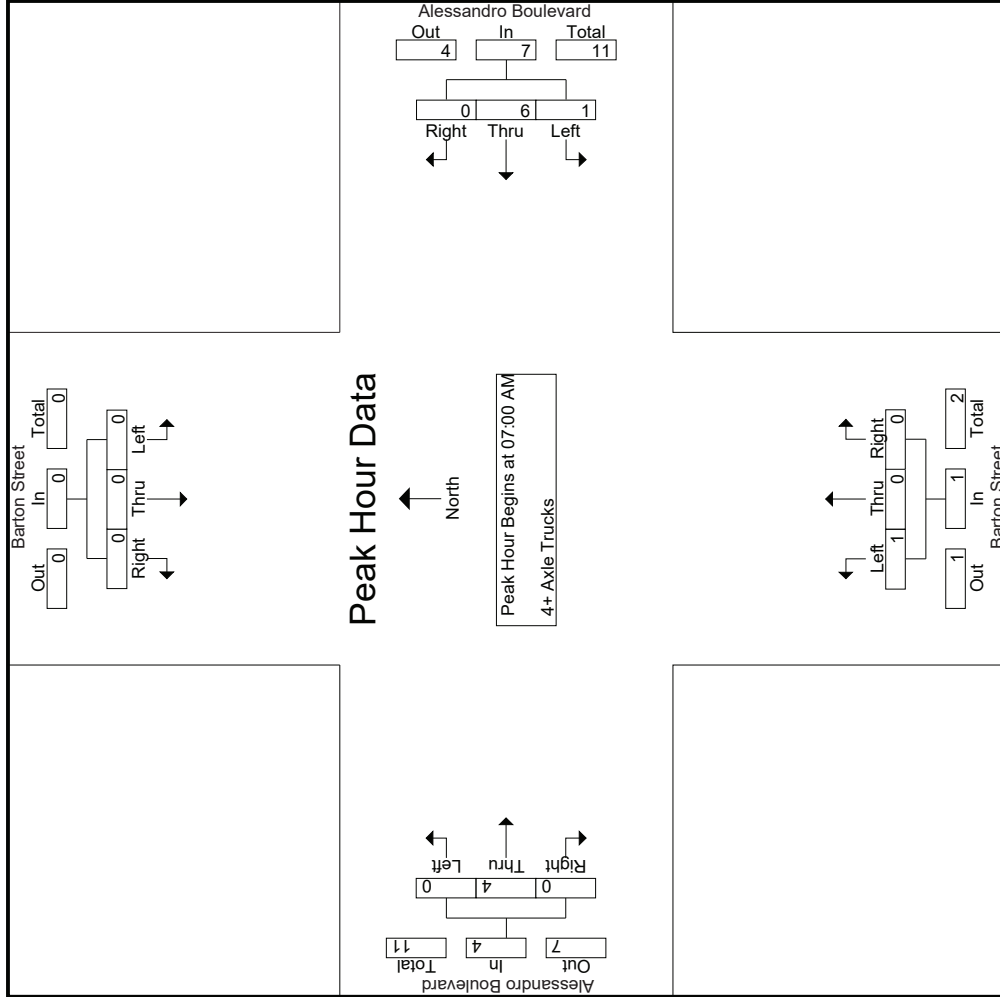

Groups Printed- Passenger Vehicles - Large 2 Axle Vehicles - 3 Axle Vehicles - 4+ Axle Trucks

Start Time	Barton Street Southbound						Alessandro Boulevard Westbound						Barton Street Northbound						Alessandro Boulevard Eastbound											
	Left		Thru		Right		Left		Thru		Right		Left		Thru		Right		Left		Thru		Right							
App. Total	RTOR	RTOR	App. Total	Left	Thru	Right	App. Total	Left	Thru	Right	App. Total	Left	Thru	Right	App. Total	Left	Thru	Right	App. Total	Left	Thru	Right	App. Total	Left	Thru	Right	App. Total	Exclu. Total	Inclu. Total	Int. Total
04:00 PM	1	0	3	2	4	0	450	18	432	0	0	7	0	7	14	7	0	7	1	474	7	1	482	10	950	960	10	950	960	
04:15 PM	2	0	5	5	7	0	411	13	398	0	0	7	0	2	9	0	2	2	0	492	12	1	504	8	931	939	8	931	939	
04:30 PM	5	0	7	7	12	0	403	8	394	1	0	10	0	3	13	0	3	3	0	513	10	1	523	11	951	962	11	951	962	
04:45 PM	1	0	1	1	2	0	408	8	400	0	0	5	0	8	13	0	8	1	0	511	14	1	525	10	948	958	10	948	958	
Total	9	0	16	15	25	1	1672	47	1624	1	0	29	0	20	49	1	1990	43	4	2034	39	4	2034	39	3780	3819	39	3780	3819	
05:00 PM	0	0	1	1	1	0	457	10	447	0	0	9	0	12	21	1	486	6	0	493	11	0	493	11	972	983	11	972	983	
05:15 PM	0	0	2	2	2	0	443	6	435	2	0	14	0	7	21	0	591	13	0	604	9	0	604	9	1070	1079	9	1070	1079	
05:30 PM	1	0	1	1	2	0	417	14	403	0	0	7	0	5	12	2	519	12	0	533	5	0	533	5	964	969	5	964	969	
05:45 PM	1	0	0	0	1	0	362	9	353	0	0	9	0	12	21	2	510	8	0	520	10	0	520	10	904	914	10	904	914	
Total	2	0	4	4	6	2	1679	39	1638	2	0	39	0	36	75	5	2106	39	0	2150	35	0	2150	35	3910	3945	35	3910	3945	
Grand Total	11	0	20	19	31	3	3351	86	3262	3	0	68	0	56	124	6	4096	82	4	4184	74	4	4184	74	7690	7764	74	7690	7764	
Approch %	35.5	0	64.5	0	0.4	0.1	43.6	2.6	97.3	0.1	0	54.8	0	45.2	1.6	0.1	97.9	2	0	54.4	1	0	54.4	1	99	0	99	0	99	
Total %	11	0	18	18	46	2	3331	85	3244	2	0	67	0	55	172	6	4053	82	0	4145	0	0	4145	0	7694	0	7694	0	7694	
% Passenger Vehicles	100	0	90	89.5	92	0	99.4	98.8	99.4	66.7	0	98.5	0	98.2	98	100	99	100	100	99	0	0	99	0	99.1	0	99.1	0	99.1	
% Large 2 Axle Vehicles	0	0	2	10.5	8	0	0.5	1	16	1	18	1	0	1.8	3	0	39	0	0	39	0	0	39	0	64	0	64	0	64	
% 3 Axle Vehicles	0	0	0	0	0	0	0	0	0	0	0	0	0	0	0	0	1	0	0	1	0	0	1	0	0	0	0	0	0	0
% 4+ Axle Trucks	0	0	0	0	0	0	0	0	0	0	0	0	0	0	0	0	0	0	0	0	0	0	0	0	0	0	0	0	0	0
% 4+ Axle Trucks	0	0	0	0	0	0	0.1	0	0.1	0	0	0	0	0	0	0	0	0	0	0.1	0	0	0.1	0	0	0	0	0	0	0.1

Start Time	Barton Street Southbound						Alessandro Boulevard Westbound						Barton Street Northbound						Alessandro Boulevard Eastbound															
	Left		Thru		Right		Left		Thru		Right		Left		Thru		Right		Left		Thru		Right		Left		Thru		Right		App. Total		Int. Total	
04:45 PM	1	0	0	1	2	8	400	0	408	0	0	5	0	8	0	8	13	0	511	14	525	948	14	511	14	525	948	14	525	948				
05:00 PM	0	0	0	1	1	10	447	0	457	0	0	9	0	12	0	12	21	1	486	6	493	972	6	486	6	493	972	6	493	972				
05:15 PM	0	0	0	2	2	6	435	2	443	2	0	14	0	7	0	7	21	0	591	13	604	1070	13	591	13	604	1070	13	604	1070				
05:30 PM	1	0	0	1	2	14	403	0	417	0	0	7	0	5	0	5	12	2	519	12	533	964	12	519	12	533	964	12	533	964				
Total Volume	2	0	0	5	7	38	1685	2	1725	2	35	35	0	32	0	32	67	3	2107	45	2155	3954	45	2107	45	2155	3954	45	2155	3954				
% App. Total	28.6	0	0	71.4	0	2.2	97.7	0.1	94.4	0.1	52.2	0	47.8	0	47.8	0	7.98	0.1	97.8	2.1	892	3954	2.1	97.8	2.1	892	3954	2.1	892	3954				
PHF	.500	.000	.000	.625	.875	.679	.942	.250	.944	.000	.625	.667	.000	.667	.000	.798	.375	.891	.891	.804	.892	.892	.804	.891	.892	.892	.892	.892	.892	.892				

Peak Hour Analysis From 04:00 PM to 05:45 PM - Peak 1 of 1

Peak Hour for Entire Intersection Begins at 04:45 PM

Counts Unlimited
 PO Box 1178
 Corona, CA 92878
 (951) 268-6268

City of Riverside
 N/S: Barton Street
 E/W: Alessandro Boulevard
 Weather: Clear

File Name : 12_RIV_Barton St_Alessandro PM
 Site Code : 05119542
 Start Date : 8/20/2019
 Page No : 2

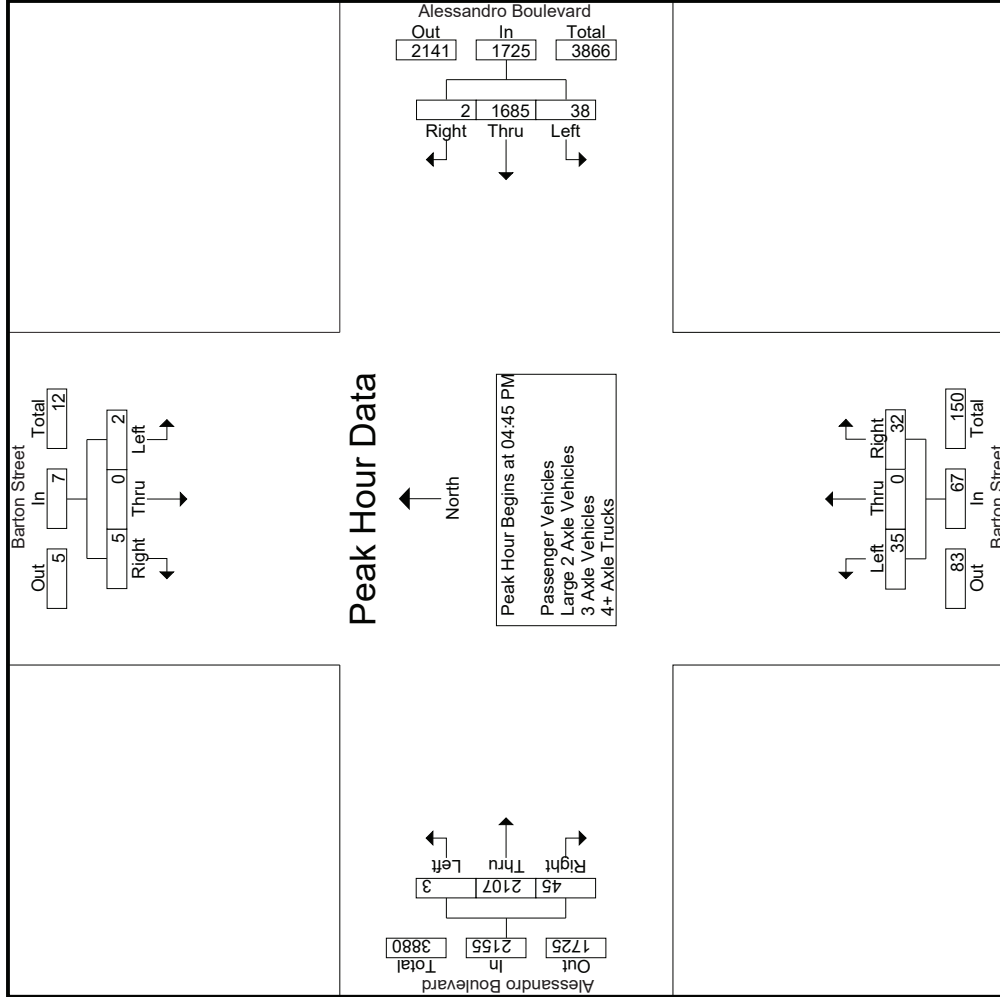

Counts Unlimited
 PO Box 1178
 Corona, CA 92878
 (951) 268-6268

City of Riverside
 N/S: Barton Street
 E/W: Alessandro Boulevard
 Weather: Clear

File Name : 12_RIV_Barton St_Alessandro PM
 Site Code : 05119542
 Start Date : 8/20/2019
 Page No : 3

Start Time	Barton Street Southbound			Alessandro Boulevard Westbound			Barton Street Northbound			Alessandro Boulevard Eastbound					
	Left	Thru	Right	Left	Thru	Right	Left	Thru	Right	Left	Thru	Right			
Peak Hour Analysis From 04:00 PM to 05:45 PM - Peak 1 of 1															
Peak Hour for Each Approach Begins at:															
	04:00 PM			04:45 PM			05:00 PM			04:45 PM					
+0 mins.	1	0	3	8	400	0	408	9	0	12	21	0	511	14	525
+15 mins.	2	0	5	10	447	0	457	14	0	7	21	1	486	6	493
+30 mins.	5	0	7	6	435	2	443	7	0	5	12	0	591	13	604
+45 mins.	1	0	1	14	403	0	417	9	0	12	21	2	519	12	533
Total Volume	9	0	16	38	1685	2	1725	39	0	36	75	3	2107	45	2155
% App. Total	36	0	64	2.2	97.7	0.1	94.4	52	0	48	893	0.1	97.8	2.1	892
PHF	.450	.000	.571	.679	.942	.250	.944	.696	.000	.750	.893	.375	.891	.804	.892

Counts Unlimited
 PO Box 1178
 Corona, CA 92878
 (951) 268-6268

City of Riverside
 N/S: Barton Street
 EW: Alessandro Boulevard
 Weather: Clear

File Name : 12_RIV_Barton St_Alessandro PM
 Site Code : 05119542
 Start Date : 8/20/2019
 Page No : 1

Groups Printed- Passenger Vehicles

Start Time	Barton Street Southbound					Alessandro Boulevard Westbound					Barton Street Northbound					Alessandro Boulevard Eastbound							
	Left	Thru	Right	RTOR	App. Total	Left	Thru	Right	RTOR	App. Total	Left	Thru	Right	RTOR	App. Total	Left	Thru	Right	RTOR	App. Total	Exclu. Total	Inclu. Total	Int. Total
04:00 PM	1	0	3	2	4	18	430	0	0	448	7	0	7	7	14	1	472	7	1	480	10	946	956
04:15 PM	2	0	5	5	7	13	396	0	0	409	7	0	2	2	9	0	484	12	1	496	8	921	929
04:30 PM	5	0	7	7	12	8	391	1	0	400	10	0	3	3	13	0	507	10	1	517	11	942	953
04:45 PM	1	0	1	1	2	7	397	0	0	404	5	0	8	8	13	0	506	14	1	520	10	939	949
Total	9	0	16	15	25	46	1614	1	0	1661	29	0	20	20	49	1	1969	43	4	2013	39	3748	3787
05:00 PM	0	0	1	1	1	10	445	0	0	455	9	0	11	9	20	1	482	6	0	489	10	965	975
05:15 PM	0	0	1	1	1	6	432	1	0	439	14	0	7	7	21	0	582	13	0	595	8	1056	1064
05:30 PM	1	0	0	0	1	14	400	0	0	414	6	0	5	4	11	2	516	12	0	530	4	956	960
05:45 PM	1	0	0	0	1	9	353	0	0	362	9	0	12	10	21	2	504	8	0	514	10	898	908
Total	2	0	2	2	4	39	1630	1	0	1670	38	0	35	30	73	5	2084	39	0	2128	32	3875	3907
Grand Total	11	0	18	17	29	85	3244	2	0	3331	67	0	55	50	122	6	4053	82	4	4141	71	7623	7694
Approch %	37.9	0	62.1	0	0.4	2.6	97.4	0.1	0	43.7	54.9	0	45.1	1.6	0.1	97.9	2	0	54.3	0.9	99.1		
Total %	0.1	0	0.2	0	0.4	1.1	42.6	0	0	43.7	0.9	0	0.7	1.1	0.1	53.2	1.1	0	54.3	0.9	99.1		

3: 1-169

Start Time	Barton Street Southbound					Alessandro Boulevard Westbound					Barton Street Northbound					Alessandro Boulevard Eastbound							
	Left	Thru	Right	RTOR	App. Total	Left	Thru	Right	RTOR	App. Total	Left	Thru	Right	RTOR	App. Total	Left	Thru	Right	RTOR	App. Total	Exclu. Total	Inclu. Total	Int. Total
04:45 PM	1	0	0	1	1	2	397	0	0	404	5	0	8	8	13	0	506	14	0	514	10	946	956
05:00 PM	0	0	1	1	1	10	445	0	0	455	9	0	11	9	20	1	482	6	0	489	8	921	929
05:15 PM	0	0	0	0	1	6	432	1	0	439	14	0	7	7	21	0	582	13	0	595	8	1056	1064
05:30 PM	1	0	0	0	1	9	353	0	0	362	9	0	12	10	21	2	504	8	0	514	10	898	908
Total Volume	2	0	3	5	15	46	1674	1	0	1712	34	0	31	31	65	3	2086	45	0	2134	32	3875	3907
% App. Total	40	0	60	0	0.4	2.2	97.8	0.1	0	43.7	52.3	0	47.7	1.6	0.1	97.8	2.1	0	54.3	0.9	99.1		
PHF	.500	.000	.750	.625	.625	.661	.940	.250	.941	.941	.607	.000	.705	.774	.774	.375	.896	.804	.897	.897			

Peak Hour Analysis From 04:45 PM to 05:30 PM - Peak 1 of 1
 Peak Hour for Entire Intersection Begins at 04:45 PM

Counts Unlimited
 PO Box 1178
 Corona, CA 92878
 (951) 268-6268

City of Riverside
 N/S: Barton Street
 E/W: Alessandro Boulevard
 Weather: Clear

File Name : 12_RIV_Barton St_Alessandro PM
 Site Code : 05119542
 Start Date : 8/20/2019
 Page No : 2

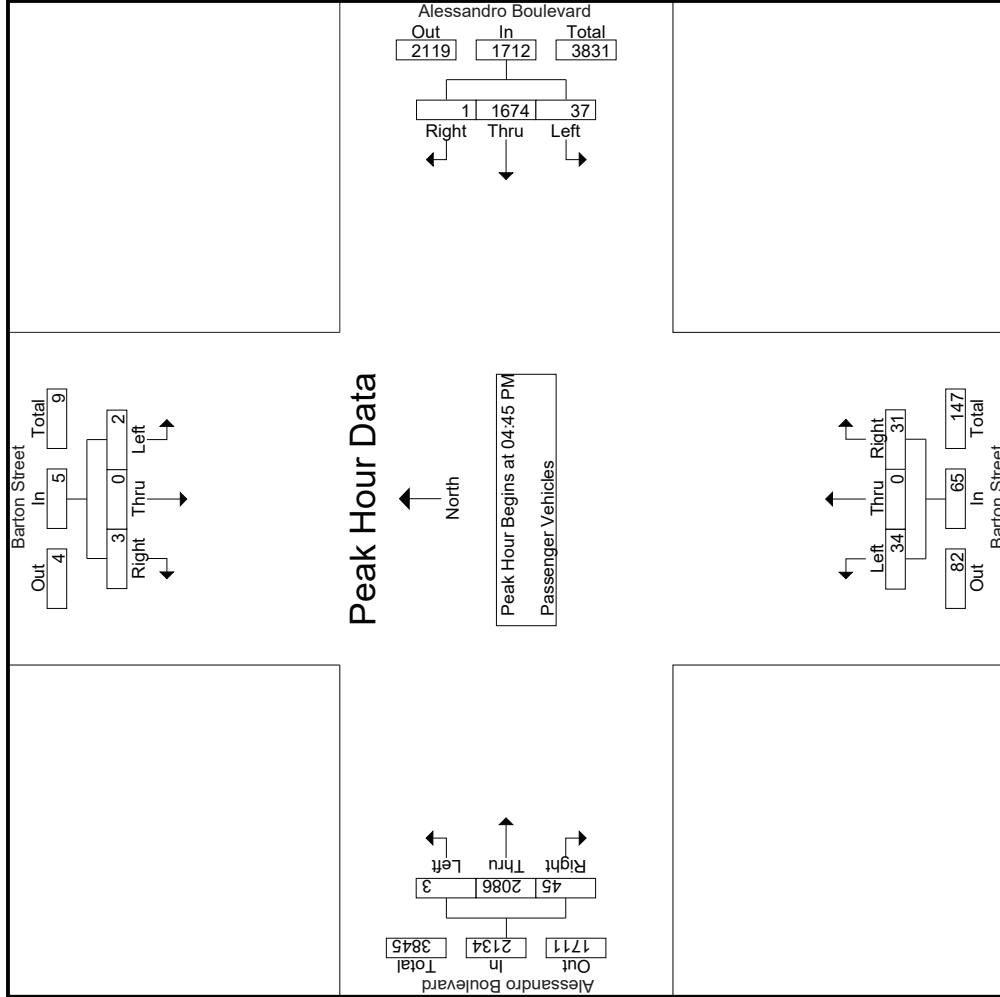

Counts Unlimited
 PO Box 1178
 Corona, CA 92878
 (951) 268-6268

City of Riverside
 N/S: Barton Street
 E/W: Alessandro Boulevard
 Weather: Clear

File Name : 12_RIV_Barton St_Alessandro PM
 Site Code : 05119542
 Start Date : 8/20/2019
 Page No : 3

Start Time	Barton Street Southbound			Alessandro Boulevard Westbound			Barton Street Northbound			Alessandro Boulevard Eastbound				
	Left	Thru	Right	Left	Thru	Right	Left	Thru	Right	Left	Thru	Right		
Peak Hour Analysis From 04:45 PM to 05:30 PM - Peak 1 of 1														
Peak Hour for Each Approach Begins at:														
	04:45 PM			04:45 PM			04:45 PM			04:45 PM				
+0 mins.	1	0	1	7	397	0	404	0	8	13	0	506	14	520
+15 mins.	0	0	1	10	445	0	455	0	11	20	1	482	6	489
+30 mins.	0	0	1	6	432	1	439	0	7	21	0	582	13	595
+45 mins.	1	0	0	14	400	0	414	0	5	11	2	516	12	530
Total Volume	2	0	3	37	1674	1	1712	0	31	65	3	2086	45	2134
% App. Total	40	0	60	2.2	97.8	0.1	52.3	0	47.7	0.1	0.1	97.8	2.1	89.7
PHF	.500	.000	.750	.661	.940	.250	.941	.000	.705	.774	.375	.896	.804	.897

Groups Printed- Large 2 Axle Vehicles

Start Time	Barton Street Southbound				Alessandro Boulevard Westbound				Barton Street Northbound				Alessandro Boulevard Eastbound							
	Left	Thru	Right	RTOR	Left	Thru	Right	RTOR	Left	Thru	Right	RTOR	Left	Thru	Right	RTOR	App. Total	Exclu. Total	Inclu. Total	Int. Total
04:00 PM	0	0	0	0	0	2	0	0	0	0	0	0	0	0	1	0	0	0	3	3
04:15 PM	0	0	0	0	0	2	0	0	0	0	0	0	0	7	0	0	7	0	9	9
04:30 PM	0	0	0	0	0	3	0	0	0	0	0	0	0	6	0	0	6	0	9	9
04:45 PM	0	0	0	0	1	3	0	0	0	0	0	0	0	4	0	0	4	0	8	8
Total	0	0	0	0	1	10	0	0	0	0	0	0	0	18	0	0	18	0	29	29
05:00 PM	0	0	0	0	0	2	0	0	1	1	1	1	0	4	0	0	4	1	7	8
05:15 PM	0	0	1	1	0	3	1	0	0	0	0	0	0	9	0	0	9	1	14	15
05:30 PM	0	0	1	1	0	1	0	0	0	1	0	0	0	3	0	0	3	1	6	7
05:45 PM	0	0	0	0	0	0	0	0	0	0	0	0	0	5	0	0	5	0	5	5
Total	0	0	2	2	0	6	1	0	1	1	1	2	0	21	0	0	21	3	32	35
Grand Total	0	0	2	2	1	16	1	0	1	1	1	2	0	39	0	0	39	3	61	64
Approch %	0	0	100		5.6	88.9	5.6		50	0	50		0	100	0		63.9	4.7	95.3	
Total %	0	0	3.3		1.6	26.2	1.6		1.6	0	1.6		0	63.9	0		63.9	4.7	95.3	

Start Time	Barton Street Southbound				Alessandro Boulevard Westbound				Barton Street Northbound				Alessandro Boulevard Eastbound							
	Left	Thru	Right	RTOR	Left	Thru	Right	RTOR	Left	Thru	Right	RTOR	Left	Thru	Right	RTOR	App. Total	Exclu. Total	Inclu. Total	Int. Total
04:45 PM	0	0	0	0	1	3	0	0	0	0	0	0	0	4	0	0	4	0	4	8
05:00 PM	0	0	0	0	0	2	0	0	0	0	1	0	0	4	0	0	4	0	4	7
05:15 PM	0	0	0	0	0	3	1	0	0	0	0	0	0	9	0	0	9	0	9	14
05:30 PM	0	0	0	0	0	1	0	0	1	0	0	0	0	3	0	0	3	0	3	6
Total Volume	0	0	0	0	1	9	1	0	1	1	1	1	0	20	0	0	20	0	20	35
% App. Total	0	0	100		9.1	81.8	9.1		50	0	50		0	100	0		55.6	0.000	55.6	.625
PHF	.000	.000	.500		.250	.750	.250		.250	.000	.250		.000	.556	.000		.556	.000	.556	.625

Peak Hour Analysis From 04:45 PM to 05:30 PM - Peak 1 of 1
 Peak Hour for Entire Intersection Begins at 04:45 PM

Counts Unlimited
 PO Box 1178
 Corona, CA 92878
 (951) 268-6268

City of Riverside
 N/S: Barton Street
 E/W: Alessandro Boulevard
 Weather: Clear

File Name : 12_RIV_Barton St_Alessandro PM
 Site Code : 05119542
 Start Date : 8/20/2019
 Page No : 2

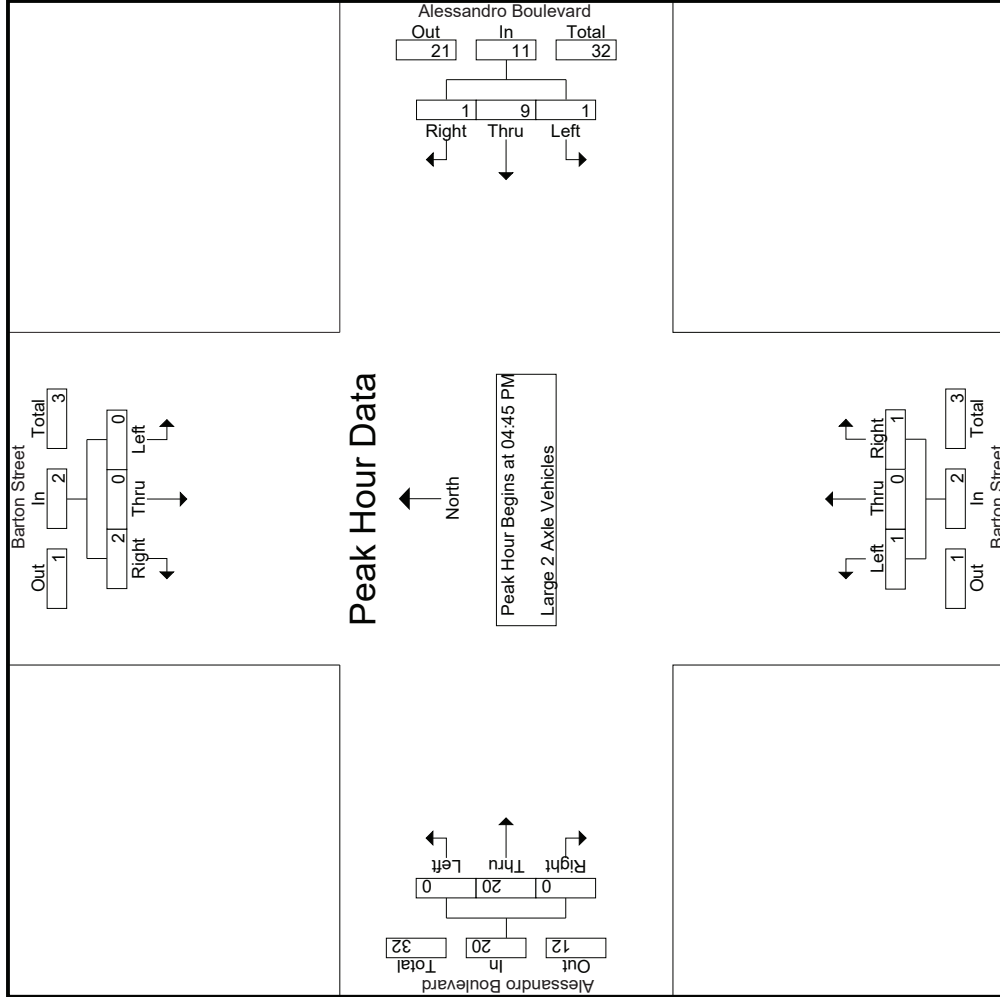

Counts Unlimited
 PO Box 1178
 Corona, CA 92878
 (951) 268-6268

City of Riverside
 N/S: Barton Street
 E/W: Alessandro Boulevard
 Weather: Clear

File Name : 12_RIV_Barton St_Alessandro PM
 Site Code : 05119542
 Start Date : 8/20/2019
 Page No : 3

Start Time	Barton Street Southbound			Alessandro Boulevard Westbound			Barton Street Northbound			Alessandro Boulevard Eastbound		
	Left	Thru	Right	Left	Thru	Right	Left	Thru	Right	Left	Thru	Right
Peak Hour Analysis From 04:45 PM to 05:30 PM - Peak 1 of 1												
Peak Hour for Each Approach Begins at:												
	04:45 PM			04:45 PM			04:45 PM			04:45 PM		
+0 mins.	0	0	0	1	3	0	4	0	0	0	4	0
+15 mins.	0	0	0	0	2	0	2	0	0	1	4	0
+30 mins.	0	0	1	0	3	1	4	0	0	0	9	0
+45 mins.	0	0	1	0	1	0	1	0	0	0	3	0
Total Volume	0	0	2	1	9	1	11	0	0	1	20	0
% App. Total	0	0	100	9.1	81.8	9.1	68.8	0	0	50	100	0
PHF	.000	.000	.500	.250	.750	.250	.688	.250	.000	.250	.556	.000

Groups Printed- 3 Axle Vehicles

Start Time	Barton Street Southbound				Alessandro Boulevard Westbound				Barton Street Northbound				Alessandro Boulevard Eastbound						
	Left	Thru	Right	RTOR	App. Total	Left	Thru	Right	RTOR	App. Total	Left	Thru	Right	RTOR	App. Total	Exclu. Total	Inclu. Total	Int. Total	
04:00 PM	0	0	0	0	0	0	0	0	0	0	0	0	0	0	0	0	1	0	1
04:15 PM	0	0	0	0	0	0	0	0	0	0	0	0	0	0	0	0	0	0	0
04:30 PM	0	0	0	0	0	0	0	0	0	0	0	0	0	0	0	0	0	0	0
04:45 PM	0	0	0	0	0	0	0	0	0	0	0	0	0	0	0	0	0	0	0
Total	0	0	0	0	0	0	0	0	0	0	0	0	0	0	0	0	1	0	1
05:00 PM	0	0	0	0	0	0	0	0	0	0	0	0	0	0	0	0	0	0	0
05:15 PM	0	0	0	0	0	0	0	0	0	0	0	0	0	0	0	0	0	0	0
05:30 PM	0	0	0	0	0	0	0	0	0	0	0	0	0	0	0	0	0	0	0
05:45 PM	0	0	0	0	0	0	0	0	0	0	0	0	0	0	0	0	0	0	0
Total	0	0	0	0	0	0	0	0	0	0	0	0	0	0	0	0	0	0	0
Grand Total	0	0	0	0	0	0	0	0	0	0	0	0	0	0	0	0	1	0	1
Approch %	0	0	0	0	0	0	0	0	0	0	0	0	0	0	0	0	0	0	0
Total %	0	0	0	0	0	0	0	0	0	0	0	0	0	0	0	0	100	0	100

Start Time	Barton Street Southbound				Alessandro Boulevard Westbound				Barton Street Northbound				Alessandro Boulevard Eastbound						
	Left	Thru	Right	RTOR	App. Total	Left	Thru	Right	RTOR	App. Total	Left	Thru	Right	RTOR	App. Total	Exclu. Total	Inclu. Total	Int. Total	
04:45 PM	0	0	0	0	0	0	0	0	0	0	0	0	0	0	0	0	0	0	0
05:00 PM	0	0	0	0	0	0	0	0	0	0	0	0	0	0	0	0	0	0	0
05:15 PM	0	0	0	0	0	0	0	0	0	0	0	0	0	0	0	0	0	0	0
05:30 PM	0	0	0	0	0	0	0	0	0	0	0	0	0	0	0	0	0	0	0
Total Volume	0	0	0	0	0	0	0	0	0	0	0	0	0	0	0	0	0	0	0
% App. Total	0	0	0	0	0	0	0	0	0	0	0	0	0	0	0	0	0	0	0
PHF	.000	.000	.000	.000	.000	.000	.000	.000	.000	.000	.000	.000	.000	.000	.000	.000	.000	.000	.000

Peak Hour Analysis From 04:45 PM to 05:30 PM - Peak 1 of 1
 Peak Hour for Entire Intersection Begins at 04:45 PM

Counts Unlimited
 PO Box 1178
 Corona, CA 92878
 (951) 268-6268

City of Riverside
 N/S: Barton Street
 E/W: Alessandro Boulevard
 Weather: Clear

File Name : 12_RIV_Barton St_Alessandro PM
 Site Code : 05119542
 Start Date : 8/20/2019
 Page No : 2

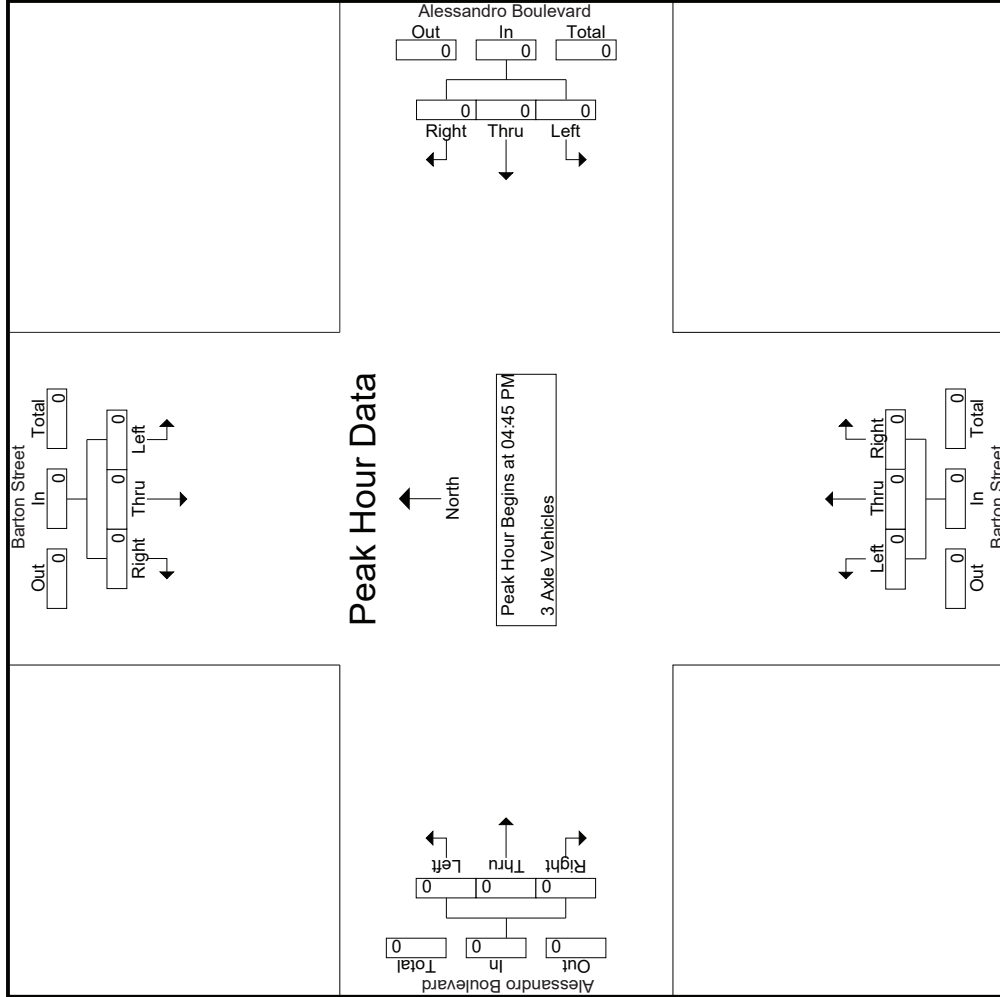

Counts Unlimited
 PO Box 1178
 Corona, CA 92878
 (951) 268-6268

City of Riverside
 N/S: Barton Street
 E/W: Alessandro Boulevard
 Weather: Clear

File Name : 12_RIV_Barton St_Alessandro PM
 Site Code : 05119542
 Start Date : 8/20/2019
 Page No : 3

Start Time	Barton Street Southbound			Alessandro Boulevard Westbound			Barton Street Northbound			Alessandro Boulevard Eastbound					
	Left	Thru	Right	Left	Thru	Right	Left	Thru	Right	Left	Thru	Right			
Peak Hour Analysis From 04:45 PM to 05:30 PM - Peak 1 of 1															
Peak Hour for Each Approach Begins at:															
+0 mins.	0	0	0	04:45 PM	0	0	0	04:45 PM	0	0	0	04:45 PM	0	0	0
+15 mins.	0	0	0	0	0	0	0	0	0	0	0	0	0	0	0
+30 mins.	0	0	0	0	0	0	0	0	0	0	0	0	0	0	0
+45 mins.	0	0	0	0	0	0	0	0	0	0	0	0	0	0	0
Total Volume	0	0	0	0	0	0	0	0	0	0	0	0	0	0	0
% App. Total	0	0	0	0	0	0	0	0	0	0	0	0	0	0	0
PHF	.000	.000	.000	.000	.000	.000	.000	.000	.000	.000	.000	.000	.000	.000	.000

Counts Unlimited
 PO Box 1178
 Corona, CA 92878
 (951) 268-6268

City of Riverside
 N/S: Barton Street
 E/W: Alessandro Boulevard
 Weather: Clear

File Name : 12_RIV_Barton St_Alessandro PM
 Site Code : 05119542
 Start Date : 8/20/2019
 Page No : 1

Groups Printed- 4+ Axle Trucks

Start Time	Barton Street Southbound				Alessandro Boulevard Westbound				Barton Street Northbound				Alessandro Boulevard Eastbound			
	Left	Thru	Right	RTOR	Left	Thru	Right	RTOR	Left	Thru	Right	RTOR	Left	Thru	Right	RTOR
04:00 PM	0	0	0	0	0	0	0	0	0	0	0	0	0	0	0	0
04:15 PM	0	0	0	0	0	0	0	0	0	0	0	0	0	1	0	0
04:30 PM	0	0	0	0	0	0	0	0	0	0	0	0	0	0	0	0
04:45 PM	0	0	0	0	0	0	0	0	0	0	0	0	0	1	0	0
Total	0	0	0	0	0	0	0	0	0	0	0	0	0	2	0	0
05:00 PM	0	0	0	0	0	0	0	0	0	0	0	0	0	0	0	0
05:15 PM	0	0	0	0	0	0	0	0	0	0	0	0	0	0	0	0
05:30 PM	0	0	0	0	2	0	0	0	0	0	0	0	0	0	0	0
05:45 PM	0	0	0	0	0	0	0	0	0	0	0	0	0	1	0	0
Total	0	0	0	0	0	2	0	0	0	0	0	0	0	1	0	0
Grand Total	0	0	0	0	0	2	0	0	0	0	0	0	0	3	0	0
Apprch %	0	0	0	0	0	100	0	0	0	0	0	0	0	100	0	0
Total %	0	0	0	0	0	40	0	0	0	0	0	0	0	60	0	100

3.1-178

Start Time	Barton Street Southbound				Alessandro Boulevard Westbound				Barton Street Northbound				Alessandro Boulevard Eastbound			
	Left	Thru	Right	RTOR	Left	Thru	Right	RTOR	Left	Thru	Right	RTOR	Left	Thru	Right	RTOR
04:45 PM	0	0	0	0	0	0	0	0	0	0	0	0	0	1	0	0
05:00 PM	0	0	0	0	0	0	0	0	0	0	0	0	0	0	0	0
05:15 PM	0	0	0	0	0	0	0	0	0	0	0	0	0	0	0	0
05:30 PM	0	0	0	0	0	0	0	0	2	0	0	0	0	0	0	0
Total Volume	0	0	0	0	0	2	0	0	2	0	0	0	0	1	0	0
% App. Total	0	0	0	0	0	100	0	0	0	0	0	0	0	100	0	0
PHF	.000	.000	.000	.000	.000	.250	.000	.000	.250	.000	.000	.000	.000	.250	.000	.375

Peak Hour Analysis From 04:45 PM to 05:30 PM - Peak 1 of 1
 Peak Hour for Entire Intersection Begins at 04:45 PM

Counts Unlimited
 PO Box 1178
 Corona, CA 92878
 (951) 268-6268

City of Riverside
 N/S: Barton Street
 E/W: Alessandro Boulevard
 Weather: Clear

File Name : 12_RIV_Barton St_Alessandro PM
 Site Code : 05119542
 Start Date : 8/20/2019
 Page No : 2

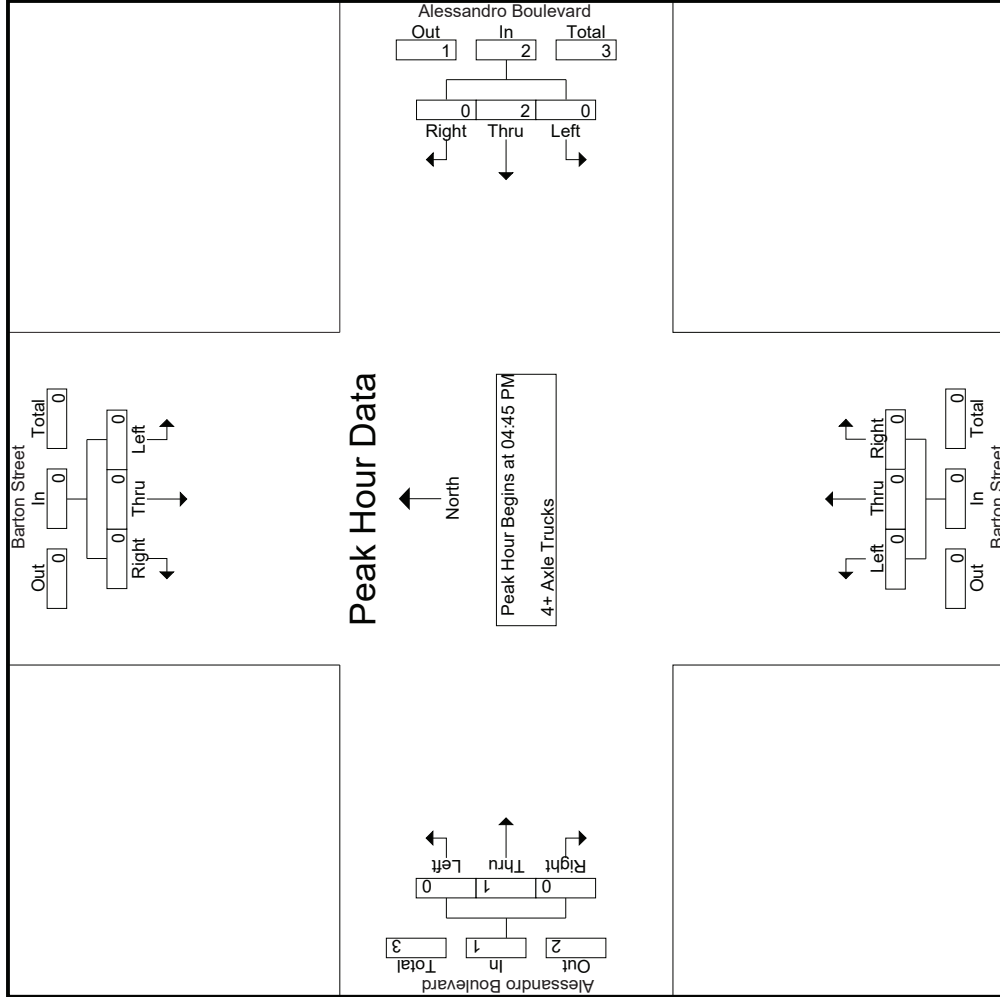

Location: Riverside
 N/S: Barton Street
 E/W: Alessandro Boulevard



Date: 8/20/2019
 Day: Tuesday

PEDESTRIANS

	North Leg Barton Street	East Leg Alessandro Boulevard	South Leg Barton Street	West Leg Alessandro Boulevard	
	Pedestrians	Pedestrians	Pedestrians	Pedestrians	
7:00 AM	0	0	0	0	0
7:15 AM	0	0	0	0	0
7:30 AM	0	2	1	0	3
7:45 AM	0	0	0	0	0
8:00 AM	0	0	0	0	0
8:15 AM	0	0	0	0	0
8:30 AM	0	0	0	0	0
8:45 AM	0	0	0	0	0
TOTAL VOLUMES:	0	2	1	0	3

	North Leg Barton Street	East Leg Alessandro Boulevard	South Leg Barton Street	West Leg Alessandro Boulevard	
	Pedestrians	Pedestrians	Pedestrians	Pedestrians	
4:00 PM	0	0	0	0	0
4:15 PM	0	0	0	0	0
4:30 PM	0	0	1	0	1
4:45 PM	0	0	0	0	0
5:00 PM	0	0	0	0	0
5:15 PM	0	0	0	0	0
5:30 PM	0	0	0	0	0
5:45 PM	0	0	0	0	0
TOTAL VOLUMES:	0	0	1	0	1

Location: Riverside
 N/S: Barton Street
 E/W: Alessandro Boulevard



Date: 8/20/2019
 Day: Tuesday

BICYCLES

	Southbound Barton Street			Westbound Alessandro Boulevard			Northbound Barton Street			Eastbound Alessandro Boulevard			
	Left	Thru	Right	Left	Thru	Right	Left	Thru	Right	Left	Thru	Right	
7:00 AM	0	0	0	0	0	0	0	0	0	0	2	0	2
7:15 AM	0	0	0	0	0	0	0	0	0	0	0	0	0
7:30 AM	0	3	0	0	0	0	0	0	0	0	0	0	3
7:45 AM	0	0	0	0	0	0	0	0	0	1	0	0	1
8:00 AM	0	0	0	0	0	0	0	0	0	0	1	0	1
8:15 AM	0	0	0	0	2	0	0	0	0	0	0	0	2
8:30 AM	0	0	0	0	0	0	0	2	0	0	1	0	3
8:45 AM	0	0	0	0	0	0	0	0	0	0	0	0	0
TOTAL VOLUMES:	0	3	0	0	2	0	0	2	0	1	4	0	12

	Southbound Barton Street			Westbound Alessandro Boulevard			Northbound Barton Street			Eastbound Alessandro Boulevard			
	Left	Thru	Right	Left	Thru	Right	Left	Thru	Right	Left	Thru	Right	
4:00 PM	0	0	0	0	0	0	0	0	0	0	0	0	0
4:15 PM	0	0	0	0	0	0	0	0	0	0	0	0	0
4:30 PM	0	1	0	0	0	0	0	0	0	0	0	0	1
4:45 PM	0	0	0	0	0	0	0	0	0	0	0	0	0
5:00 PM	0	0	0	0	0	0	0	0	0	0	0	0	0
5:15 PM	0	0	0	0	0	0	0	0	0	0	0	0	0
5:30 PM	0	0	0	0	0	0	0	0	0	0	0	2	2
5:45 PM	0	0	0	0	2	0	0	1	0	0	1	0	4
TOTAL VOLUMES:	0	1	0	0	2	0	0	1	0	0	1	2	7

Counts Unlimited
 PO Box 1178
 Corona, CA 92878
 (951) 268-6268

City of Riverside
 N/S: Barton Street
 E/W: Van Buren Boulevard
 Weather: Clear

File Name : 13_RIV_Barton St_Van Buren AM
 Site Code : 05119542
 Start Date : 8/20/2019
 Page No : 1

Groups Printed- Passenger Vehicles - Large 2 Axle Vehicles - 3 Axle Vehicles - 4+ Axle Trucks

Start Time	Barton Street Southbound						Van Buren Boulevard Westbound						Barton Street Northbound						Van Buren Boulevard Eastbound								
	Left	Thru	Right	RTOR	App. Total		Left	Thru	Right	RTOR	App. Total		Left	Thru	Right	RTOR	App. Total		Left	Thru	Right	RTOR	App. Total				
07:00 AM	7	41	78	32	126	84	375	1	0	460	31	31	66	11	128	52	175	13	0	240	43	954	43	0	240	997	
07:15 AM	10	46	120	48	176	88	377	7	1	472	31	27	96	17	154	38	229	17	4	284	70	1086	70	4	284	1156	
07:30 AM	12	25	36	16	73	77	289	3	0	369	37	16	99	39	152	26	235	20	0	281	55	875	55	0	281	930	
07:45 AM	13	20	32	13	65	48	251	7	2	306	38	14	101	19	153	28	276	22	1	326	35	850	35	1	326	885	
Total	42	132	266	109	440	297	1292	18	3	1607	137	88	362	86	587	144	915	72	5	1131	203	3765	203	5	1131	3968	
08:00 AM	6	13	36	18	55	46	264	8	2	318	50	19	48	12	117	9	168	20	3	197	35	687	35	3	197	722	
08:15 AM	3	5	12	8	20	25	248	6	0	279	46	2	32	18	80	9	159	20	0	188	26	567	26	0	188	593	
08:30 AM	5	6	19	13	30	22	248	7	0	277	51	5	40	18	96	11	137	14	2	162	33	565	33	2	162	598	
08:45 AM	5	9	12	6	26	17	244	5	0	266	53	6	31	10	90	6	110	13	0	129	16	511	16	0	129	527	
Total	19	33	79	45	131	110	1004	26	2	1140	200	32	151	58	383	35	574	67	5	676	110	2330	110	5	676	2440	
Grand Total	61	165	345	154	571	407	2296	44	5	2747	337	120	513	144	970	179	1489	139	10	1807	313	6095	313	10	1807	6408	
Approch %	10.7	28.9	60.4			14.8	83.6	1.6			34.7	12.4	52.9			9.9	82.4	7.7			9.9	82.4	7.7			4.9	95.1
Total %	1	2.7	5.7		9.4	6.7	37.7	0.7		45.1	5.5	2	8.4		15.9	2.9	24.4	2.3		29.6	4.9	95.1					
Passenger Vehicles	61	162	338	97.4	711	390	2184	42	100	2621	325	117	505	1088	1088	174	1419	135	100	1738	0	0	0	0	0	6158	
% Passenger Vehicles	100	98.2	98	97.4	98.1	95.8	95.1	95.5	100	95.2	96.4	97.5	98.4	97.9	97.7	97.2	95.3	97.1	100	95.7	0	0	0	0	0	96.1	
Large 2 Axle Vehicles	0	3	6	1.7	2.6	13	69	2	0	84	10	3	4	2.1	1.8	4	53	2	0	59	0	0	0	0	0	176	
% Large 2 Axle Vehicles	0	1.8	1.7	2.6	1.8	3.2	3	4.5	0	3.1	3	2.5	0.8	2.1	1.8	2.2	3.6	1.4	0	3.2	0	0	0	0	0	2.7	
3 Axle Vehicles	0	0	1	0	1	2	10	0	0	12	0	0	0	0	0	1	10	0	0	11	0	0	0	0	0	24	
% 3 Axle Vehicles	0	0	0.3	0	0.1	0.5	0.4	0	0	0.4	0	0	0	0	0	0.6	0.7	0	0	0.6	0	0	0	0	0	0.4	
4+ Axle Trucks	0	0	0	0	0	2	33	0	0	35	2	0	4	0	6	0	7	2	0	9	0	0	0	0	0	50	
% 4+ Axle Trucks	0	0	0	0	0	0.5	1.4	0	0	1.3	0.6	0	0.8	0	0.5	0	0.5	1.4	0	0.5	0	0	0	0	0	0.8	

Start Time	Barton Street Southbound						Van Buren Boulevard Westbound						Barton Street Northbound						Van Buren Boulevard Eastbound								
	Left	Thru	Right	RTOR	App. Total		Left	Thru	Right	RTOR	App. Total		Left	Thru	Right	RTOR	App. Total		Left	Thru	Right	RTOR	App. Total				
07:00 AM	7	41	78	32	126	84	375	1	0	460	31	31	66	11	128	52	175	13	0	240	43	954	43	0	240	997	
07:15 AM	10	46	120	48	176	88	377	7	1	472	31	27	96	17	154	38	229	17	4	284	70	1086	70	4	284	1156	
07:30 AM	12	25	36	16	73	77	289	3	0	369	37	16	99	39	152	26	235	20	0	281	55	875	55	0	281	930	
07:45 AM	13	20	32	13	65	48	251	7	2	306	38	14	101	19	153	28	276	22	1	326	35	850	35	1	326	885	
Total	42	132	266	109	440	297	1292	18	3	1607	137	88	362	86	587	144	915	72	5	1131	203	3765	203	5	1131	3968	
08:00 AM	6	13	36	18	55	46	264	8	2	318	50	19	48	12	117	9	168	20	3	197	35	687	35	3	197	722	
08:15 AM	3	5	12	8	20	25	248	6	0	279	46	2	32	18	80	9	159	20	0	188	26	567	26	0	188	593	
08:30 AM	5	6	19	13	30	22	248	7	0	277	51	5	40	18	96	11	137	14	2	162	33	565	33	2	162	598	
08:45 AM	5	9	12	6	26	17	244	5	0	266	53	6	31	10	90	6	110	13	0	129	16	511	16	0	129	527	
Total	19	33	79	45	131	110	1004	26	2	1140	200	32	151	58	383	35	574	67	5	676	110	2330	110	5	676	2440	
Grand Total	61	165	345	154	571	407	2296	44	5	2747	337	120	513	144	970	179	1489	139	10	1807	313	6095	313	10	1807	6408	
Approch %	10.7	28.9	60.4			14.8	83.6	1.6			34.7	12.4	52.9			9.9	82.4	7.7			9.9	82.4	7.7			4.9	95.1
Total %	1	2.7	5.7		9.4	6.7	37.7	0.7		45.1	5.5	2	8.4		15.9	2.9	24.4	2.3		29.6	4.9	95.1					
Passenger Vehicles	61	162	338	97.4	711	390	2184	42	100	2621	325	117	505	1088	1088	174	1419	135	100	1738	0	0	0	0	0	6158	
% Passenger Vehicles	100	98.2	98	97.4	98.1	95.8	95.1	95.5	100	95.2	96.4	97.5	98.4	97.9	97.7	97.2	95.3	97.1	100	95.7	0	0	0	0	0	96.1	
Large 2 Axle Vehicles	0	3	6	1.7	2.6	13	69	2	0	84	10	3	4	2.1	1.8	4	53	2	0	59	0	0	0	0	0	176	
% Large 2 Axle Vehicles	0	1.8	1.7	2.6	1.8	3.2	3	4.5	0	3.1	3	2.5	0.8	2.1	1.8	2.2	3.6	1.4	0	3.2	0	0	0	0	0	2.7	
3 Axle Vehicles	0	0	1	0	1	2	10	0	0	12	0	0	0	0	0	1	10	0	0	11	0	0	0	0	0	24	
% 3 Axle Vehicles	0	0	0.3	0	0.1	0.5	0.4	0	0	0.4	0	0	0	0	0	0.6	0.7	0	0	0.6	0	0	0	0	0	0.4	
4+ Axle Trucks	0	0	0	0	0	2	33	0	0	35	2	0	4	0	6	0	7	2	0	9	0	0	0	0	0	50	
% 4+ Axle Trucks	0	0	0	0	0	0.5	1.4	0	0	1.3	0.6	0	0.8	0	0.5	0	0.5	1.4	0	0.5	0	0	0	0	0	0.8	

Peak Hour Analysis From 07:00 AM to 08:45 AM - Peak 1 of 1

Peak Hour for Entire Intersection Begins at 07:00 AM

Start Time	Barton Street Southbound						Van Buren Boulevard Westbound						Barton Street Northbound						Van Buren Boulevard Eastbound							
	Left	Thru	Right	RTOR	App. Total		Left	Thru	Right	RTOR	App. Total		Left	Thru	Right	RTOR	App. Total		Left	Thru	Right	RTOR	App. Total			
07:00 AM	7	41	78	32	126	84	375	1	0	460	31	31	66	11	128	52	175	13	0	240	43	954	43	0	240	997
07:15 AM	10	46	120	48	176	88	377	7	1	472	31	27	96	17	154	38	229	17	4	284	70	1086	70	4	284	1156
07:30 AM	12	25	36	16	73	77	289	3	0	369	37	16	99	39	152	26	235	20	0	281	55	875	55	0	281	930
07:45 AM	13	20	32	13	65	48	251	7	2	306	38	14	101	19	153	28	276	22	1	326	35	850	35	1	326	885
Total Volume	42	132	266	109	440	297	1292	18	3	1607	137	88	362	86	587	144	915	72	5	1131	203	3765	203	5	1131	3968
% App. Total	9.5	30	60.5			18.5	80.4	1.1			23.3	15	61.7			12.7	80.9	6.4			6.4	28.1	6.4			24.0
PHF	.808	.717	.554		.625	.844	.857	.643		.851	.901	.710	.896		.867	.953	.829	.818		.867	.867	.867	.867		.867	.867

Counts Unlimited
 PO Box 1178
 Corona, CA 92878
 (951) 268-6268

City of Riverside
 N/S: Barton Street
 E/W: Van Buren Boulevard
 Weather: Clear

File Name : 13_RIV_Barton St_Van Buren AM
 Site Code : 05119542
 Start Date : 8/20/2019
 Page No : 2

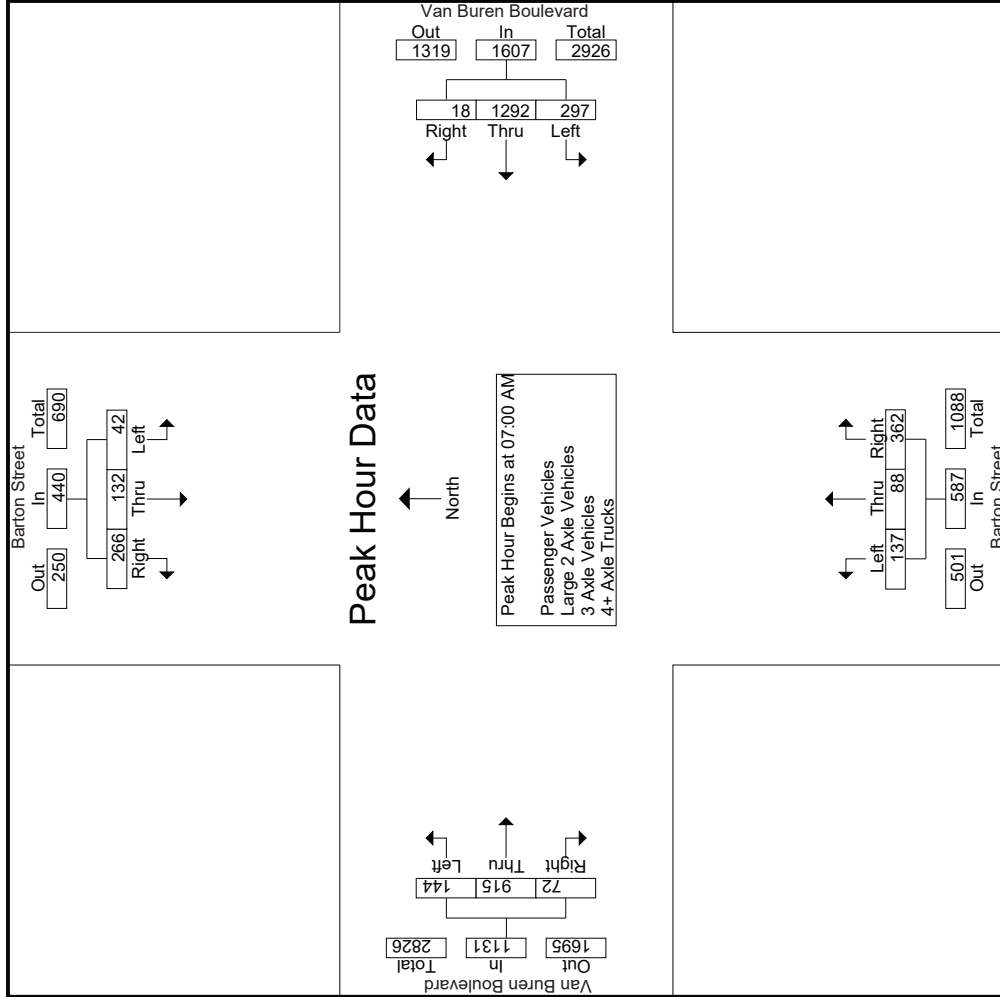

Counts Unlimited
 PO Box 1178
 Corona, CA 92878
 (951) 268-6268

City of Riverside
 N/S: Barton Street
 E/W: Van Buren Boulevard
 Weather: Clear

File Name : 13_RIV_Barton St_Van Buren AM
 Site Code : 05119542
 Start Date : 8/20/2019
 Page No : 3

Start Time	Barton Street Southbound			Van Buren Boulevard Westbound			Barton Street Northbound			Van Buren Boulevard Eastbound					
	Left	Thru	Right	Left	Thru	Right	Left	Thru	Right	Left	Thru	Right	App. Total	Int. Total	
Peak Hour Analysis From 07:00 AM to 08:45 AM - Peak 1 of 1															
Peak Hour for Each Approach Begins at:															
	07:00 AM			07:00 AM			07:00 AM			07:00 AM			07:00 AM		
+0 mins.	7	41	78	84	375	1	460	31	66	128	175	13	240		
+15 mins.	10	46	120	88	377	7	472	31	27	154	229	17	284		
+30 mins.	12	25	36	77	289	3	369	37	99	152	235	20	281		
+45 mins.	13	20	32	48	251	7	306	38	101	153	276	22	326		
Total Volume	42	132	266	297	1292	18	1607	137	362	587	915	72	1131		
% App. Total	9.5	30	60.5	18.5	80.4	1.1		23.3	15	61.7	12.7	80.9	6.4		
PHF	.808	.717	.554	.844	.857	.643	.851	.901	.710	.953	.829	.818	.867		

Groups Printed- Passenger Vehicles

Start Time	Barton Street Southbound					Van Buren Boulevard Westbound					Barton Street Northbound					Van Buren Boulevard Eastbound							
	Left	Thru	Right	RTOR	App. Total	Left	Thru	Right	RTOR	App. Total	Left	Thru	Right	RTOR	App. Total	Left	Thru	Right	RTOR	App. Total	Exclu. Total	Inclu. Total	Int. Total
07:00 AM	7	41	76	31	124	81	359	1	0	441	29	30	65	11	124	52	168	12	0	232	42	921	963
07:15 AM	10	46	120	48	176	88	365	6	1	459	30	25	94	17	149	38	215	17	4	270	70	1054	1124
07:30 AM	12	25	36	16	73	75	270	3	0	348	34	16	97	38	147	26	227	20	0	273	54	841	895
07:45 AM	13	19	32	13	64	47	242	7	2	296	38	14	101	19	153	24	268	22	1	314	35	827	862
Total	42	131	264	108	437	291	1236	17	3	1544	131	85	357	85	573	140	878	71	5	1089	201	3643	3844
08:00 AM	6	13	32	16	51	45	253	8	2	306	48	19	46	10	113	9	159	20	3	188	31	658	689
08:15 AM	3	4	11	7	18	22	231	6	0	259	45	2	32	18	79	8	151	20	0	179	25	535	560
08:30 AM	5	6	19	13	30	19	233	6	0	258	49	5	40	18	94	11	129	14	2	154	33	536	569
08:45 AM	5	8	12	6	25	13	231	5	0	249	52	6	30	10	88	6	102	10	0	118	16	480	496
Total	19	31	74	42	124	99	948	25	2	1072	194	32	148	56	374	34	541	64	5	639	105	2209	2314
Grand Total	61	162	338	150	561	390	2184	42	5	2616	325	117	505	141	947	174	1419	135	10	1728	306	5852	6158
Approch %	10.9	28.9	60.2		9.6	14.9	83.5	1.6		44.7	34.3	12.4	53.3		16.2	10.1	82.1	7.8		29.5	5	95	
Total %	1	2.8	5.8			6.7	37.3	0.7			5.6	2	8.6			3	24.2	2.3					

Start Time	Barton Street Southbound					Van Buren Boulevard Westbound					Barton Street Northbound					Van Buren Boulevard Eastbound							
	Left	Thru	Right	RTOR	App. Total	Left	Thru	Right	RTOR	App. Total	Left	Thru	Right	RTOR	App. Total	Left	Thru	Right	RTOR	App. Total	Exclu. Total	Inclu. Total	Int. Total
07:00 AM	7	41	76	31	124	81	359	1	0	441	29	30	65	11	124	52	168	12	0	232	42	921	963
07:15 AM	10	46	120	48	176	88	365	6	1	459	30	25	94	17	149	38	215	17	4	270	70	1054	1124
07:30 AM	12	25	36	16	73	75	270	3	0	348	34	16	97	38	147	26	227	20	0	273	54	841	895
07:45 AM	13	19	32	13	64	47	242	7	2	296	38	14	101	19	153	24	268	22	1	314	35	827	862
Total Volume	42	131	264	108	437	291	1236	17	3	1544	131	85	357	85	573	140	878	71	5	1089	201	3643	3844
% App. Total	9.6	30	60.4		9.6	18.8	80.1	1.1		44.7	34.3	12.4	53.3		16.2	10.1	82.1	7.8		29.5	5	95	
PHF	.808	.712	.550		.621	.827	.847	.607		.841	.862	.708	.884		.936	.673	.819	.807		.867		.867	

Peak Hour Analysis From 07:00 AM to 07:45 AM - Peak 1 of 1
 Peak Hour for Entire Intersection Begins at 07:00 AM

Counts Unlimited
 PO Box 1178
 Corona, CA 92878
 (951) 268-6268

City of Riverside
 N/S: Barton Street
 E/W: Van Buren Boulevard
 Weather: Clear

File Name : 13_RIV_Barton St_Van Buren AM
 Site Code : 05119542
 Start Date : 8/20/2019
 Page No : 2

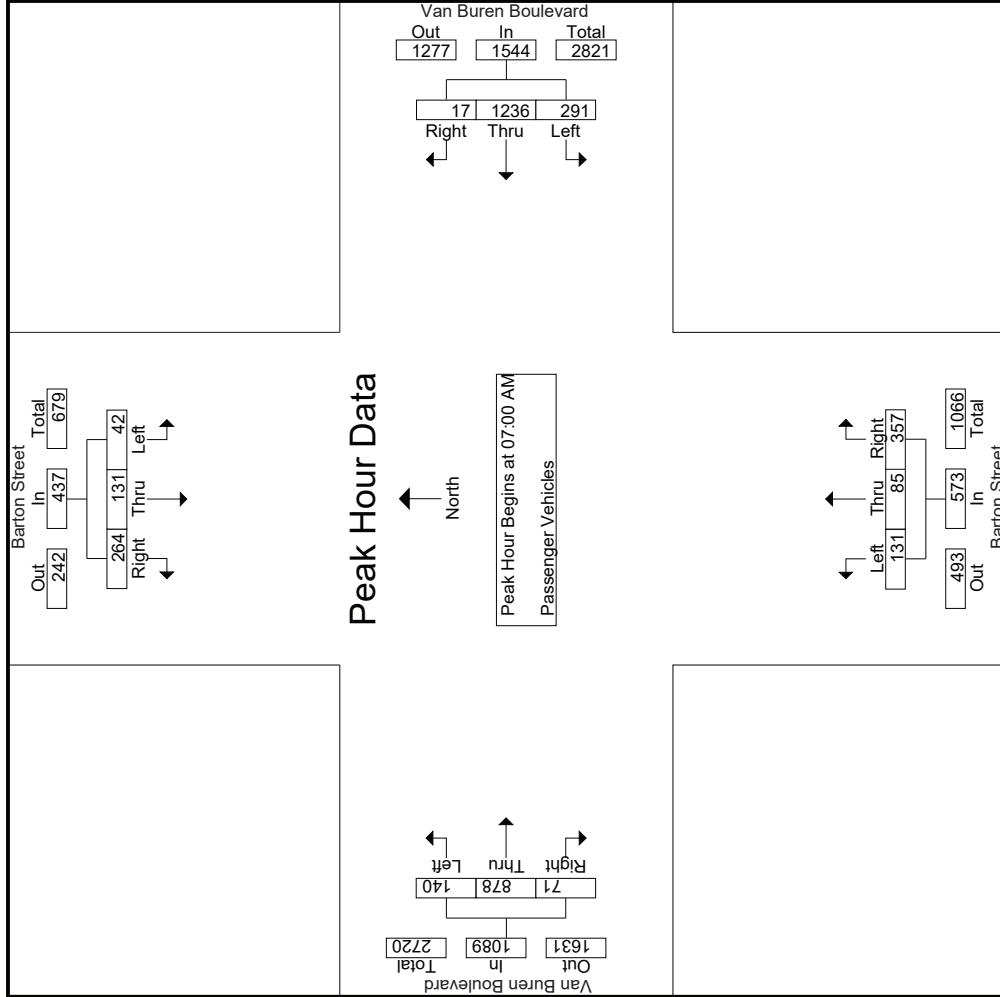

Counts Unlimited
 PO Box 1178
 Corona, CA 92878
 (951) 268-6268

City of Riverside
 N/S: Barton Street
 E/W: Van Buren Boulevard
 Weather: Clear

File Name : 13_RIV_Barton St_Van Buren AM
 Site Code : 05119542
 Start Date : 8/20/2019
 Page No : 3

Start Time	Barton Street Southbound			Van Buren Boulevard Westbound			Barton Street Northbound			Van Buren Boulevard Eastbound					
	Left	Thru	Right	Left	Thru	Right	Left	Thru	Right	Left	Thru	Right	App. Total	Int. Total	
Peak Hour Analysis From 07:00 AM to 07:45 AM - Peak 1 of 1															
Peak Hour for Each Approach Begins at:															
	07:00 AM			07:00 AM			07:00 AM			07:00 AM			07:00 AM		
+0 mins.	7	41	76	81	359	1	441	29	30	65	124	168	12	232	
+15 mins.	10	46	120	88	365	6	459	30	25	94	149	215	17	270	
+30 mins.	12	25	36	75	270	3	348	34	16	97	147	227	20	273	
+45 mins.	13	19	32	47	242	7	296	38	14	101	153	268	22	314	
Total Volume	42	131	264	291	1236	17	1544	131	85	357	573	140	878	71	
% App. Total	9.6	30	60.4	18.8	80.1	1.1	84.1	22.9	14.8	62.3	12.9	80.6	6.5	1089	
PHF	.808	.712	.550	.827	.847	.607	.841	.862	.708	.884	.936	.673	.819	.807	
														.867	

Groups Printed- Large 2 Axle Vehicles

Start Time	Barton Street Southbound				Van Buren Boulevard Westbound				Barton Street Northbound				Van Buren Boulevard Eastbound								
	Left	Thru	Right	RTOR	Left	Thru	Right	RTOR	Left	Thru	Right	RTOR	Left	Thru	Right	RTOR	App. Total	Exclu. Total	Inclu. Total	Int. Total	
07:00 AM	0	0	2	1	2	9	0	0	11	2	1	0	0	3	0	4	0	4	1	20	21
07:15 AM	0	0	0	0	0	7	1	0	8	1	2	0	0	3	0	13	0	13	0	24	24
07:30 AM	0	0	0	0	1	9	0	0	10	3	0	2	1	5	0	5	0	5	1	20	21
07:45 AM	0	1	0	0	1	4	0	0	4	0	0	0	0	0	3	5	0	8	0	13	13
Total	0	1	2	1	3	29	1	0	33	6	3	2	1	11	3	27	0	30	2	77	79
08:00 AM	0	0	3	2	3	1	8	0	9	2	0	2	2	4	0	6	0	6	4	22	26
08:15 AM	0	1	1	1	2	3	14	0	17	1	0	0	0	1	1	7	0	8	1	28	29
08:30 AM	0	0	0	0	2	12	1	0	15	1	0	0	0	1	0	7	0	7	0	23	23
08:45 AM	0	1	0	0	1	4	6	0	10	0	0	0	0	0	0	6	2	8	0	19	19
Total	0	2	4	3	6	10	40	1	51	4	0	2	2	6	1	26	2	29	5	92	97
Grand Total	0	3	6	4	9	13	69	2	84	10	3	4	3	17	4	53	2	0	7	169	176
Apprch %	0	33.3	66.7		15.5	82.1	2.4		49.7	58.8	17.6	23.5		10.1	6.8	89.8	3.4		4	96	
Total %	0	1.8	3.6		5.3	7.7	40.8	1.2		5.9	1.8	2.4			2.4	31.4	1.2		4	96	

Start Time	Barton Street Southbound				Van Buren Boulevard Westbound				Barton Street Northbound				Van Buren Boulevard Eastbound								
	Left	Thru	Right	RTOR	Left	Thru	Right	RTOR	Left	Thru	Right	RTOR	Left	Thru	Right	RTOR	App. Total	Exclu. Total	Inclu. Total	Int. Total	
07:00 AM	0	0	0	0	2	9	0	0	11	2	1	0	0	3	0	4	0	4	0	20	20
07:15 AM	0	0	0	0	0	7	1	0	8	1	2	0	0	3	0	13	0	13	0	24	24
07:30 AM	0	0	0	0	1	9	0	0	10	3	0	2	1	5	0	5	0	5	1	20	21
07:45 AM	0	1	0	0	1	4	0	0	4	0	0	0	0	0	3	5	0	8	0	13	13
Total	0	1	2	1	3	29	1	0	33	6	3	2	1	11	3	27	0	30	2	77	79
08:00 AM	0	0	3	2	3	1	8	0	9	2	0	2	2	4	0	6	0	6	4	22	26
08:15 AM	0	1	1	1	2	3	14	0	17	1	0	0	0	1	1	7	0	8	1	28	29
08:30 AM	0	0	0	0	2	12	1	0	15	1	0	0	0	1	0	7	0	7	0	23	23
08:45 AM	0	1	0	0	1	4	6	0	10	0	0	0	0	0	0	6	2	8	0	19	19
Total	0	2	4	3	6	10	40	1	51	4	0	2	2	6	1	26	2	29	5	92	97
Grand Total	0	3	6	4	9	13	69	2	84	10	3	4	3	17	4	53	2	0	7	169	176
Apprch %	0	33.3	66.7		15.5	82.1	2.4		49.7	58.8	17.6	23.5		10.1	6.8	89.8	3.4		4	96	
Total %	0	1.8	3.6		5.3	7.7	40.8	1.2		5.9	1.8	2.4			2.4	31.4	1.2		4	96	

Peak Hour Analysis From 07:00 AM to 07:45 AM - Peak 1 of 1
 Peak Hour for Entire Intersection Begins at 07:00 AM

Start Time	Barton Street Southbound				Van Buren Boulevard Westbound				Barton Street Northbound				Van Buren Boulevard Eastbound								
	Left	Thru	Right	RTOR	Left	Thru	Right	RTOR	Left	Thru	Right	RTOR	Left	Thru	Right	RTOR	App. Total	Exclu. Total	Inclu. Total	Int. Total	
07:00 AM	0	0	0	0	2	9	0	0	11	2	1	0	0	3	0	4	0	4	0	20	20
07:15 AM	0	0	0	0	0	7	1	0	8	1	2	0	0	3	0	13	0	13	0	24	24
07:30 AM	0	0	0	0	1	9	0	0	10	3	0	2	1	5	0	5	0	5	1	20	21
07:45 AM	0	1	0	0	1	4	0	0	4	0	0	0	0	0	3	5	0	8	0	13	13
Total Volume	0	1	2	1	3	29	1	0	33	6	3	2	1	11	3	27	0	30	2	77	79
% App. Total	0	33.3	66.7		9.1	87.9	3		54.5	27.3	18.2		10	90	0	0	0	0	0	0	0
PHF	.000	.250	.250	.375	.375	.806	.250	.750	.750	.500	.375	.250	.550	.519	.000	.577	.802				

Counts Unlimited
 PO Box 1178
 Corona, CA 92878
 (951) 268-6268

City of Riverside
 N/S: Barton Street
 E/W: Van Buren Boulevard
 Weather: Clear

File Name : 13_RIV_Barton St_Van Buren AM
 Site Code : 05119542
 Start Date : 8/20/2019
 Page No : 2

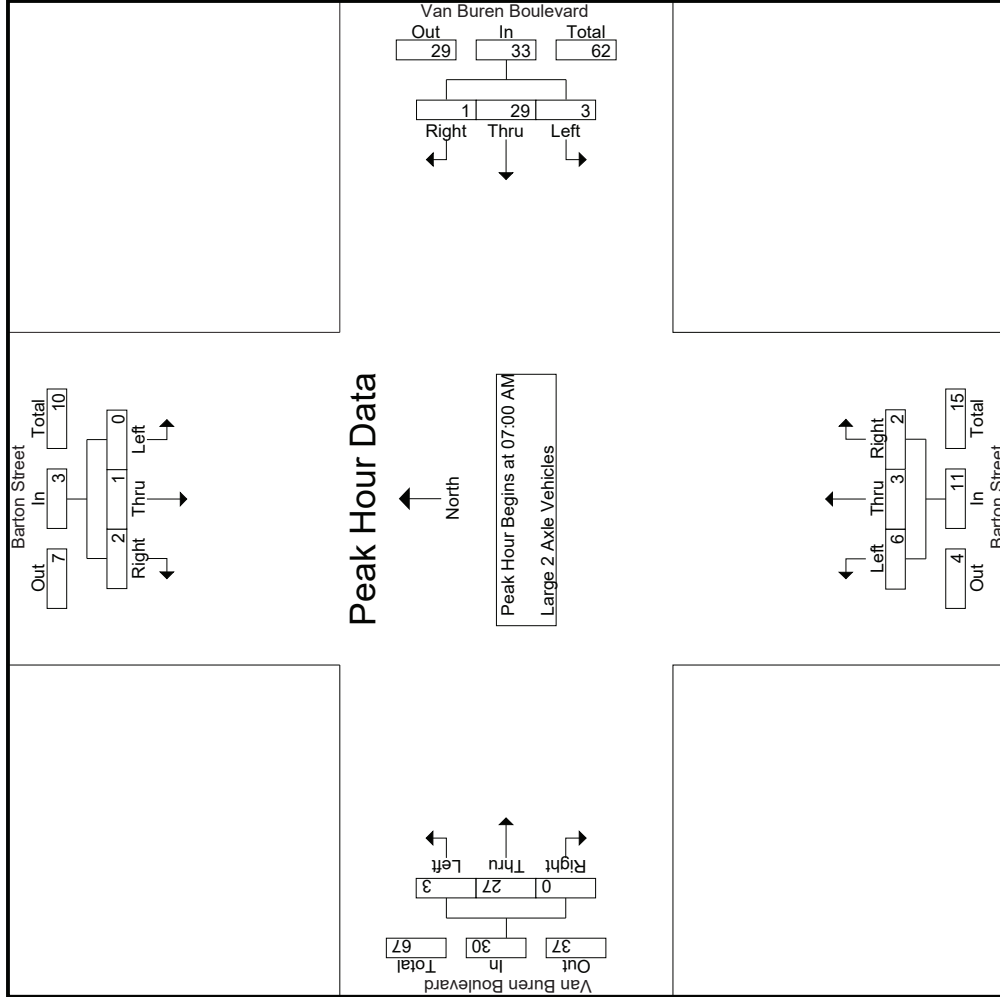

Counts Unlimited
 PO Box 1178
 Corona, CA 92878
 (951) 268-6268

City of Riverside
 N/S: Barton Street
 E/W: Van Buren Boulevard
 Weather: Clear

File Name : 13_RIV_Barton St_Van Buren AM
 Site Code : 05119542
 Start Date : 8/20/2019
 Page No : 3

Start Time	Barton Street Southbound			Van Buren Boulevard Westbound			Barton Street Northbound			Van Buren Boulevard Eastbound					
	Left	Thru	Right	Left	Thru	Right	Left	Thru	Right	Left	Thru	Right	App. Total	Int. Total	
Peak Hour Analysis From 07:00 AM to 07:45 AM - Peak 1 of 1															
Peak Hour for Each Approach Begins at:															
	07:00 AM			07:00 AM			07:00 AM			07:00 AM			07:00 AM		
+0 mins.	0	0	2	2	9	0	11	2	1	0	3	4	0	4	
+15 mins.	0	0	0	0	7	1	8	1	2	0	3	13	0	13	
+30 mins.	0	0	0	1	9	0	10	3	0	2	5	5	0	5	
+45 mins.	0	1	0	0	4	0	4	0	0	0	0	5	0	8	
Total Volume	0	1	2	3	29	1	33	6	3	2	11	27	0	30	
% App. Total	0	33.3	66.7	9.1	87.9	3	54.5	27.3	18.2	.250	.550	.90	0	.577	
PHF	.000	.250	.250	.375	.806	.250	.750	.500	.375	.250	.550	.519	.000	.577	

Groups Printed- 3 Axle Vehicles

Start Time	Barton Street Southbound				Van Buren Boulevard Westbound				Barton Street Northbound				Van Buren Boulevard Eastbound						
	Left	Thru	Right	RTOR	App. Total	Left	Thru	Right	RTOR	App. Total	Left	Thru	Right	RTOR	App. Total	Exclu. Total	Inclu. Total	Int. Total	
07:00 AM	0	0	0	0	0	1	3	0	0	4	0	0	0	0	0	0	2	0	6
07:15 AM	0	0	0	0	0	0	0	0	0	0	0	0	0	0	0	1	0	1	
07:30 AM	0	0	0	0	0	0	0	0	0	0	0	0	0	0	0	2	0	2	
07:45 AM	0	0	0	0	0	1	0	0	0	1	0	0	0	0	3	0	4	4	
Total	0	0	0	0	0	2	3	0	0	5	0	0	0	0	8	0	13	13	
08:00 AM	0	0	1	0	1	0	2	0	0	2	0	0	0	0	2	0	5	5	
08:15 AM	0	0	0	0	0	0	1	0	0	1	0	0	0	0	1	0	2	2	
08:30 AM	0	0	0	0	0	0	2	0	0	2	0	0	0	0	0	0	2	2	
08:45 AM	0	0	0	0	0	0	2	0	0	2	0	0	0	0	0	0	2	2	
Total	0	0	1	0	1	0	7	0	0	7	0	0	0	0	3	0	11	11	
Grand Total	0	0	1	0	1	2	10	0	0	12	0	0	0	0	11	0	24	24	
Apprch %	0	0	100		16.7	83.3	0			50	0	0	0		45.8	0	100		
Total %	0	0	4.2		4.2	8.3	41.7	0		50	0	0	0		45.8	0	100		

Start Time	Barton Street Southbound				Van Buren Boulevard Westbound				Barton Street Northbound				Van Buren Boulevard Eastbound						
	Left	Thru	Right	RTOR	App. Total	Left	Thru	Right	RTOR	App. Total	Left	Thru	Right	RTOR	App. Total	Exclu. Total	Inclu. Total	Int. Total	
07:00 AM	0	0	0	0	0	1	3	0	0	4	0	0	0	0	0	0	2	0	6
07:15 AM	0	0	0	0	0	0	0	0	0	0	0	0	0	0	0	1	0	1	
07:30 AM	0	0	0	0	0	0	0	0	0	0	0	0	0	0	0	2	0	2	
07:45 AM	0	0	0	0	0	1	0	0	0	1	0	0	0	0	3	0	4	4	
Total Volume	0	0	0	0	0	2	3	0	0	5	0	0	0	0	8	0	13	13	
% App. Total	0	0	0		0	40	60	0		100	0	0	0		87.5	0	100		
PHF	.000	.000	.000		.000	.500	.250	.000		.313	.000	.000	.000		.667	.000	.542		

Peak Hour Analysis From 07:00 AM to 07:45 AM - Peak 1 of 1
 Peak Hour for Entire Intersection Begins at 07:00 AM

Counts Unlimited
 PO Box 1178
 Corona, CA 92878
 (951) 268-6268

City of Riverside
 N/S: Barton Street
 E/W: Van Buren Boulevard
 Weather: Clear

File Name : 13_RIV_Barton St_Van Buren AM
 Site Code : 05119542
 Start Date : 8/20/2019
 Page No : 2

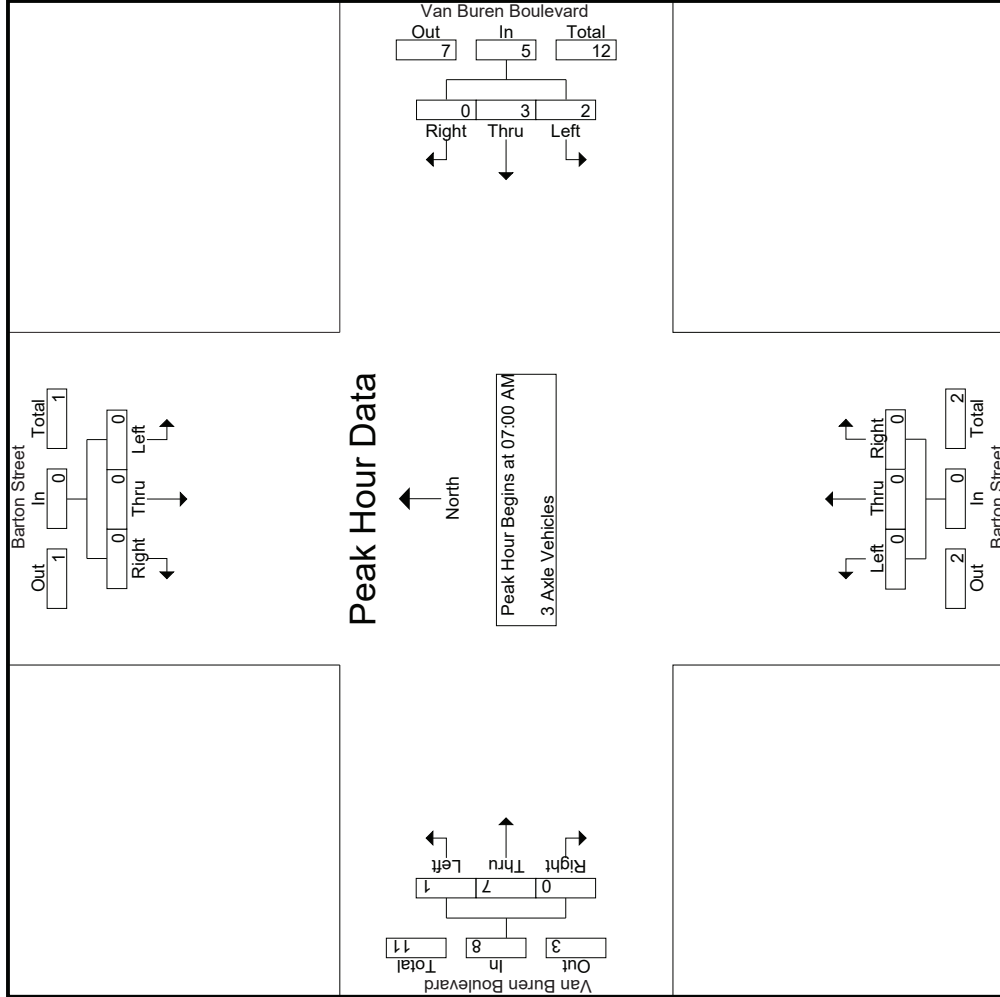

Counts Unlimited
 PO Box 1178
 Corona, CA 92878
 (951) 268-6268

City of Riverside
 N/S: Barton Street
 E/W: Van Buren Boulevard
 Weather: Clear

File Name : 13_RIV_Barton St_Van Buren AM
 Site Code : 05119542
 Start Date : 8/20/2019
 Page No : 3

Start Time	Barton Street Southbound			Van Buren Boulevard Westbound			Barton Street Northbound			Van Buren Boulevard Eastbound					
	Left	Thru	Right	Left	Thru	Right	Left	Thru	Right	Left	Thru	Right			
Peak Hour Analysis From 07:00 AM to 07:45 AM - Peak 1 of 1															
Peak Hour for Each Approach Begins at:															
+0 mins.	0	0	0	1	3	0	4	0	0	0	0	0	0	2	0
+15 mins.	0	0	0	0	0	0	0	0	0	0	0	0	0	1	0
+30 mins.	0	0	0	0	0	0	0	0	0	0	0	0	0	2	0
+45 mins.	0	0	0	1	0	0	1	0	0	0	0	0	1	2	0
Total Volume	0	0	0	2	3	0	5	0	0	0	0	0	1	7	0
% App. Total	0	0	0	40	60	0	0	0	0	0	12.5	87.5	0	0	0
PHF	.000	.000	.000	.500	.250	.000	.313	.000	.000	.000	.250	.875	.000	.000	.667

Counts Unlimited
 PO Box 1178
 Corona, CA 92878
 (951) 268-6268

City of Riverside
 N/S: Barton Street
 E/W: Van Buren Boulevard
 Weather: Clear

File Name : 13_RIV_Barton St_Van Buren AM
 Site Code : 05119542
 Start Date : 8/20/2019
 Page No : 1

Groups Printed- 4+ Axle Trucks

Start Time	Barton Street Southbound				Van Buren Boulevard Westbound				Barton Street Northbound				Van Buren Boulevard Eastbound									
	Left	Thru	Right	RTOR	Left	Thru	Right	RTOR	Left	Thru	Right	RTOR	Left	Thru	Right	RTOR						
07:00 AM	0	0	0	0	0	4	0	0	4	0	1	0	0	1	1	0	0	2	0	0	7	7
07:15 AM	0	0	0	0	0	5	0	0	5	0	2	0	0	2	0	0	0	0	0	0	7	7
07:30 AM	0	0	0	0	1	10	0	0	11	0	0	0	0	0	1	0	0	1	0	0	12	12
07:45 AM	0	0	0	0	0	5	0	0	5	0	0	0	0	0	1	0	0	1	0	0	6	6
Total	0	0	0	0	1	24	0	0	25	0	3	0	0	3	3	1	0	4	0	0	32	32
08:00 AM	0	0	0	0	0	1	0	0	1	0	0	0	0	0	1	0	0	1	0	0	2	2
08:15 AM	0	0	0	0	0	2	0	0	2	0	0	0	0	0	0	0	0	0	0	0	2	2
08:30 AM	0	0	0	0	1	1	0	0	2	1	0	0	1	0	1	0	0	1	0	0	4	4
08:45 AM	0	0	0	0	0	5	0	0	5	1	0	1	0	2	0	1	0	3	0	0	10	10
Total	0	0	0	0	1	9	0	0	10	2	0	1	0	3	0	4	1	0	0	0	18	18
Grand Total	0	0	0	0	2	33	0	0	35	2	0	4	0	6	0	7	2	0	9	0	50	50
Apprch %	0	0	0	0	5.7	94.3	0	0	33.3	0	66.7	0	0	12	0	77.8	22.2	0	18	0	100	100
Total %	0	0	0	0	4	66	0	0	70	4	0	8	0	0	0	14	4	0	0	0	0	0

Start Time	Barton Street Southbound				Van Buren Boulevard Westbound				Barton Street Northbound				Van Buren Boulevard Eastbound									
	Left	Thru	Right	RTOR	Left	Thru	Right	RTOR	Left	Thru	Right	RTOR	Left	Thru	Right	RTOR						
07:00 AM	0	0	0	0	0	4	0	0	4	0	1	0	0	1	1	0	0	1	1	0	2	7
07:15 AM	0	0	0	0	0	5	0	0	5	0	2	0	0	2	0	0	0	0	0	0	0	7
07:30 AM	0	0	0	0	1	10	0	0	11	0	0	0	0	0	1	0	0	1	0	0	12	12
07:45 AM	0	0	0	0	0	5	0	0	5	0	0	0	0	0	1	0	0	1	0	0	6	6
Total Volume	0	0	0	0	1	24	0	0	25	0	3	0	0	3	0	4	1	0	4	0	32	32
% App. Total	0	0	0	0	4	96	0	0	100	0	0	0	0	0	75	25	0	0	0	0	0	0
PHF	.000	.000	.000	.000	.250	.600	.000	.000	.568	.000	.375	.000	.375	.375	.000	.750	.250	.500	.000	.500	.667	.667

Peak Hour Analysis From 07:00 AM to 07:45 AM - Peak 1 of 1
 Peak Hour for Entire Intersection Begins at 07:00 AM

Counts Unlimited
 PO Box 1178
 Corona, CA 92878
 (951) 268-6268

City of Riverside
 N/S: Barton Street
 E/W: Van Buren Boulevard
 Weather: Clear

File Name : 13_RIV_Barton St_Van Buren AM
 Site Code : 05119542
 Start Date : 8/20/2019
 Page No : 2

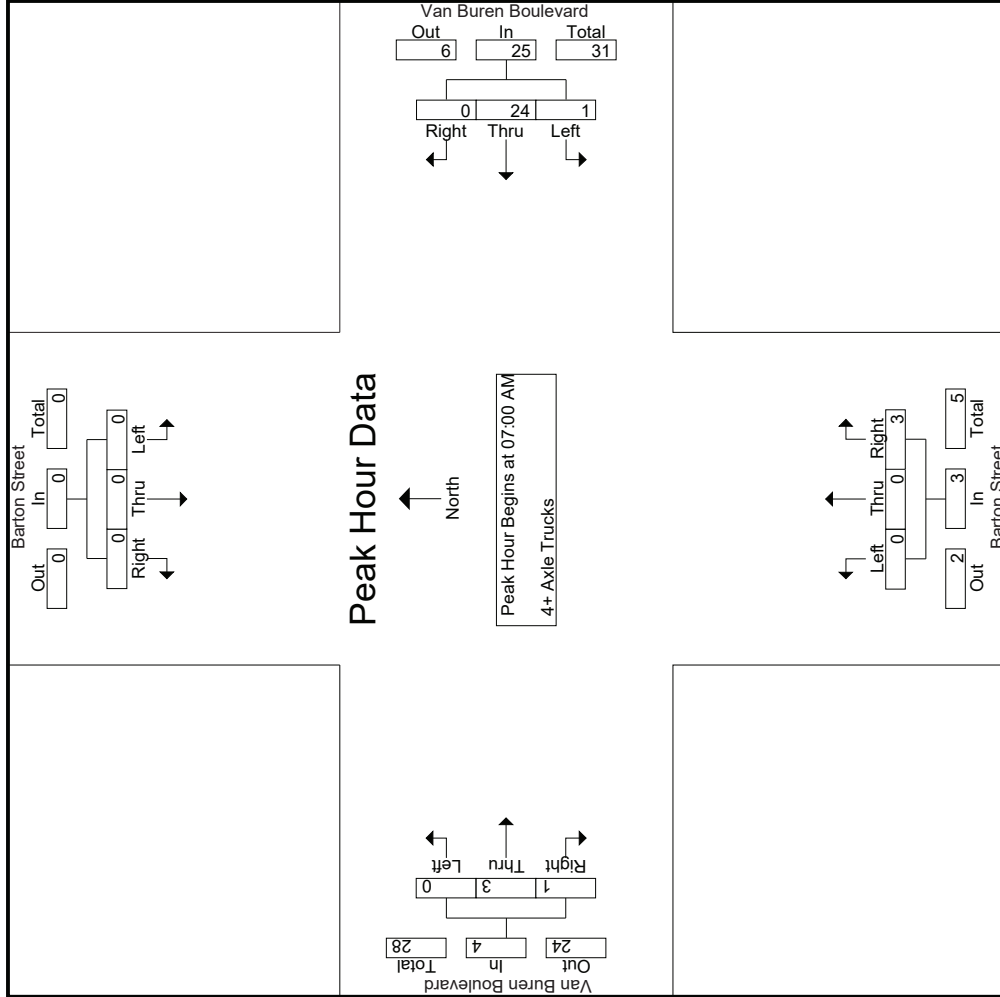

Counts Unlimited
 PO Box 1178
 Corona, CA 92878
 (951) 268-6268

City of Riverside
 N/S: Barton Street
 E/W: Van Buren Boulevard
 Weather: Clear

File Name : 13_RIV_Barton St_Van Buren AM
 Site Code : 05119542
 Start Date : 8/20/2019
 Page No : 3

Start Time	Barton Street Southbound			Van Buren Boulevard Westbound			Barton Street Northbound			Van Buren Boulevard Eastbound		
	Left	Thru	Right	Left	Thru	Right	Left	Thru	Right	Left	Thru	Right
Peak Hour Analysis From 07:00 AM to 07:45 AM - Peak 1 of 1												
Peak Hour for Each Approach Begins at:												
	07:00 AM			07:00 AM			07:00 AM			07:00 AM		
+0 mins.	0	0	0	4	0	0	4	0	1	0	1	2
+15 mins.	0	0	0	5	0	5	0	0	2	0	0	0
+30 mins.	0	0	0	10	0	11	0	0	0	0	1	0
+45 mins.	0	0	0	5	0	5	0	0	0	0	1	0
Total Volume	0	0	0	24	0	25	0	0	3	0	3	1
% App. Total	0	0	0	4	96	0	4	0	100	0	75	25
PHF	.000	.000	.000	.250	.600	.568	.000	.000	.375	.000	.750	.250
										.375		.500

Groups Printed- Passenger Vehicles - Large 2 Axle Vehicles - 3 Axle Vehicles - 4+ Axle Trucks

Start Time	Barton Street Southbound						Van Buren Boulevard Westbound						Barton Street Northbound						Van Buren Boulevard Eastbound						
	Left	Thru	Right	RTOR	App. Total	Inclu. Total	Left	Thru	Right	RTOR	App. Total	Exclu. Total	Left	Thru	Right	RTOR	App. Total	Inclu. Total	Left	Thru	Right	RTOR	App. Total	Exclu. Total	
04:00 PM	3	4	24	17	31	281	46	226	9	1	281	30	7	33	14	70	26	284	52	4	362	36	744	780	
04:15 PM	3	9	12	5	24	260	56	198	6	3	260	46	7	42	4	95	19	260	39	1	318	13	697	710	
04:30 PM	11	13	23	12	47	267	52	209	6	0	267	30	17	29	11	76	30	290	35	4	355	27	745	772	
04:45 PM	11	14	18	11	43	299	56	235	8	0	299	33	10	30	3	73	23	256	51	5	330	19	745	764	
Total	28	40	77	45	145	1107	210	868	29	4	1107	139	41	134	32	314	98	1090	177	14	1365	95	2931	3026	
05:00 PM	6	11	26	14	43	260	36	212	12	0	260	55	17	41	5	113	33	279	63	4	375	23	791	814	
05:15 PM	3	6	19	11	28	319	75	240	4	0	319	51	17	41	6	109	34	311	47	0	392	17	848	865	
05:30 PM	11	9	21	15	41	273	58	200	15	1	273	46	19	53	6	118	28	304	55	12	387	34	819	853	
05:45 PM	0	9	19	10	28	244	48	188	8	2	244	30	10	39	12	79	31	302	48	3	381	27	732	759	
Total	20	35	85	50	140	1096	182	840	39	3	1096	182	63	174	29	419	126	1196	213	19	1535	101	3190	3291	
Grand Total	48	75	162	95	285	2203	427	1708	68	7	2203	321	104	308	61	733	224	2286	390	33	2900	196	6121	6317	
Approch %	16.8	26.3	56.8				19.4	77.5	3.1			43.8	14.2	42			7.7	78.8	13.4			3.1	96.9		
Total %	0.8	1.2	2.6		4.7		7	27.9	1.1		36		5		12	3.7	37.3	6.4		47.4	0	0	0		
% Passenger Vehicles	47	75	162	100	379	2155	412	1670	67	85.7	2155	317	104	302	784	221	2210	385	97	2848	0	0	0	6166	
% 2 Axle Vehicles	97.9	100	100	100	99.7	99.7	96.5	97.8	98.5	85.7	97.5	98.8	100	98.1	100	98.7	98.7	96.7	98.7	97	97.1	0	0	0	97.6
% Large 2 Axle Vehicles	2.1	0	0	0	0.3	1.8	10	28	1	14.3	40	4	0	5	0	9	3	54	5	3	63	0	0	0	113
% 3 Axle Vehicles	0	0	0	0	0	3	1	2	0	0	3	0	0	0	0	0	0	6	0	0	6	0	0	0	9
% 3 Axle Trucks	0	0	0	0	0	0.1	0.2	0.1	0	0	0.1	0	0	0	0	0	0	0.3	0	0	0.2	0	0	0	0.1
% 4+ Axle Trucks	0	0	0	0	0	12	4	8	0	0	12	0	0	1	0	1	0	16	0	0	16	0	0	0	29
% 4+ Axle Trucks	0	0	0	0	0	0.5	0.9	0.5	0	0	0.5	0	0	0.3	0	0.1	0	0.7	0	0	0.5	0	0	0	0.5

Start Time	Barton Street Southbound						Van Buren Boulevard Westbound						Barton Street Northbound						Van Buren Boulevard Eastbound					
	Left	Thru	Right	RTOR	App. Total	Inclu. Total	Left	Thru	Right	RTOR	App. Total	Exclu. Total	Left	Thru	Right	RTOR	App. Total	Inclu. Total	Left	Thru	Right	RTOR	App. Total	Exclu. Total
04:45 PM	11	14	18		43		56	235	8		299	33	10	30		30	73	256	51		330	745		
05:00 PM	6	11	26		43		36	212	12		260	55	17	41		41	113	279	63		375	791		
05:15 PM	3	6	19		28		75	240	4		319	51	17	41		41	109	311	47		392	848		
05:30 PM	11	9	21		41		58	200	15		273	46	19	53		53	118	304	55		387	819		
05:45 PM	0	9	19		28		48	188	8		244	30	10	39		79	31	302	48		381	759		
Total Volume	31	40	84		155		225	887	39		1151	185	63	165		413	118	1150	216		1484	3203		
% App. Total	20	25.8	54.2		54.2		19.5	77.1	3.4		40	44.8	15.3	40		8	77.5	14.6	8.57		946	.944		
PHF	.705	.714	.808		.901		.750	.924	.650		.902	.841	.829	.778		.875	.875	.924	.857		.946	.944		

Peak Hour Analysis From 04:00 PM to 05:45 PM - Peak 1 of 1

Peak Hour for Entire Intersection Begins at 04:45 PM

Counts Unlimited
 PO Box 1178
 Corona, CA 92878
 (951) 268-6268

City of Riverside
 N/S: Barton Street
 E/W: Van Buren Boulevard
 Weather: Clear

File Name : 13_RIV_Barton St_Van Buren PM
 Site Code : 05119542
 Start Date : 8/20/2019
 Page No : 2

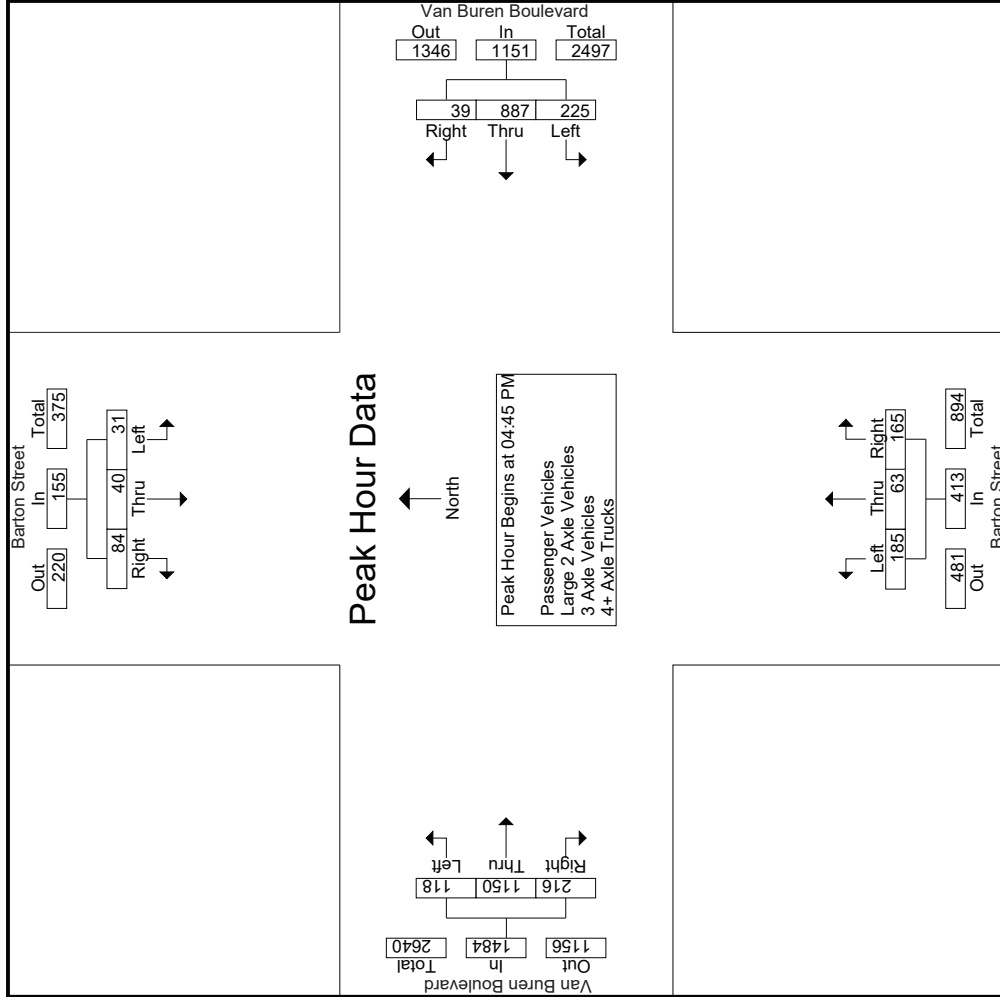

Counts Unlimited
 PO Box 1178
 Corona, CA 92878
 (951) 268-6268

City of Riverside
 N/S: Barton Street
 E/W: Van Buren Boulevard
 Weather: Clear

File Name : 13_RIV_Barton St_Van Buren PM
 Site Code : 05119542
 Start Date : 8/20/2019
 Page No : 3

Start Time	Barton Street Southbound			Van Buren Boulevard Westbound			Barton Street Northbound			Van Buren Boulevard Eastbound				
	Left	Thru	Right	App. Total	Left	Thru	Right	App. Total	Left	Thru	Right	App. Total	Int. Total	
Peak Hour Analysis From 04:00 PM to 05:45 PM - Peak 1 of 1														
Peak Hour for Each Approach Begins at:														
	04:30 PM			04:45 PM			05:00 PM			05:00 PM				
+0 mins.	11	13	23	47	56	235	8	299	17	41	113	33	279	375
+15 mins.	11	14	18	43	36	212	12	260	17	41	109	34	311	392
+30 mins.	6	11	26	43	75	240	4	319	19	53	118	28	304	387
+45 mins.	3	6	19	28	58	200	15	273	10	39	79	31	302	381
Total Volume	31	44	86	161	225	887	39	1151	63	174	419	126	1196	1535
% App. Total	19.3	27.3	53.4	.856	19.5	77.1	3.4	.902	15	41.5	8.2	77.9	13.9	.979
PHF	.705	.786	.827	.856	.750	.924	.650	.902	.829	.821	.888	.926	.961	.845

Groups Printed- Passenger Vehicles

Start Time	Barton Street Southbound					Van Buren Boulevard Westbound					Barton Street Northbound					Van Buren Boulevard Eastbound							
	Left	Thru	Right	RTOR	App. Total	Left	Thru	Right	RTOR	App. Total	Left	Thru	Right	RTOR	App. Total	Left	Thru	Right	RTOR	App. Total	Exclu. Total	Inclu. Total	Int. Total
04:00 PM	3	4	24	17	31	42	223	9	1	274	30	7	33	14	70	25	272	50	4	347	36	722	758
04:15 PM	2	9	12	5	23	52	194	6	3	252	45	7	42	4	94	19	251	38	1	308	13	677	690
04:30 PM	11	13	23	12	47	49	205	6	0	260	30	17	28	11	75	29	281	35	4	345	27	727	754
04:45 PM	11	14	18	11	43	56	227	8	0	291	33	10	28	3	71	23	242	51	5	316	19	721	740
Total	27	40	77	45	144	199	849	29	4	1077	138	41	131	32	310	96	1046	174	14	1316	95	2847	2942
05:00 PM	6	11	26	14	43	36	203	12	0	251	55	17	41	5	113	33	264	62	4	359	23	766	789
05:15 PM	3	6	19	11	28	74	238	4	0	316	50	17	40	6	107	34	303	47	0	384	17	835	852
05:30 PM	11	9	21	15	41	55	196	14	0	265	45	19	51	6	115	28	300	54	11	382	32	803	835
05:45 PM	0	9	19	10	28	48	184	8	2	240	29	10	39	12	78	30	297	48	3	375	27	721	748
Total	20	35	85	50	140	213	821	38	2	1072	179	63	171	29	413	125	1164	211	18	1500	99	3125	3224
Grand Total	47	75	162	95	284	412	1670	67	6	2149	317	104	302	61	723	221	2210	385	32	2816	194	5972	6166
Approch %	16.5	26.4	57			19.2	77.7	3.1		36	43.8	14.4	41.8		12.1	7.8	78.5	13.7		47.2	3.1	96.9	
Total %	0.8	1.3	2.7		4.8	6.9	28	1.1			5.3	1.7	5.1			3.7	37	6.4					

Start Time	Barton Street Southbound					Van Buren Boulevard Westbound					Barton Street Northbound					Van Buren Boulevard Eastbound							
	Left	Thru	Right	RTOR	App. Total	Left	Thru	Right	RTOR	App. Total	Left	Thru	Right	RTOR	App. Total	Left	Thru	Right	RTOR	App. Total	Exclu. Total	Inclu. Total	Int. Total
04:45 PM	11	14	18		43	56	227	8		291	33	10	28		71	23	242	51		316			721
05:00 PM	6	11	26		43	36	203	12		251	55	17	41		113	33	264	62		359			766
05:15 PM	3	6	19		28	74	238	4		316	50	17	40		107	34	303	47		384			835
05:30 PM	11	9	21		41	55	196	14		265	45	19	51		115	28	300	54		382			803
Total Volume	31	40	84		155	221	864	38		1123	183	63	160		406	118	1109	214		1441			3125
% App. Total	20	25.8	54.2		54.2	19.7	76.9	3.4		3.4	45.1	15.5	39.4		7.7	8.2	77	14.9		14.9			93.6
PHF	.705	.714	.808		.901	.747	.908	.679		.888	.832	.829	.784		.883	.868	.915	.863		.938			

Peak Hour Analysis From 04:45 PM to 05:30 PM - Peak 1 of 1
 Peak Hour for Entire Intersection Begins at 04:45 PM

Counts Unlimited
 PO Box 1178
 Corona, CA 92878
 (951) 268-6268

City of Riverside
 N/S: Barton Street
 E/W: Van Buren Boulevard
 Weather: Clear

File Name : 13_RIV_Barton St_Van Buren PM
 Site Code : 05119542
 Start Date : 8/20/2019
 Page No : 2

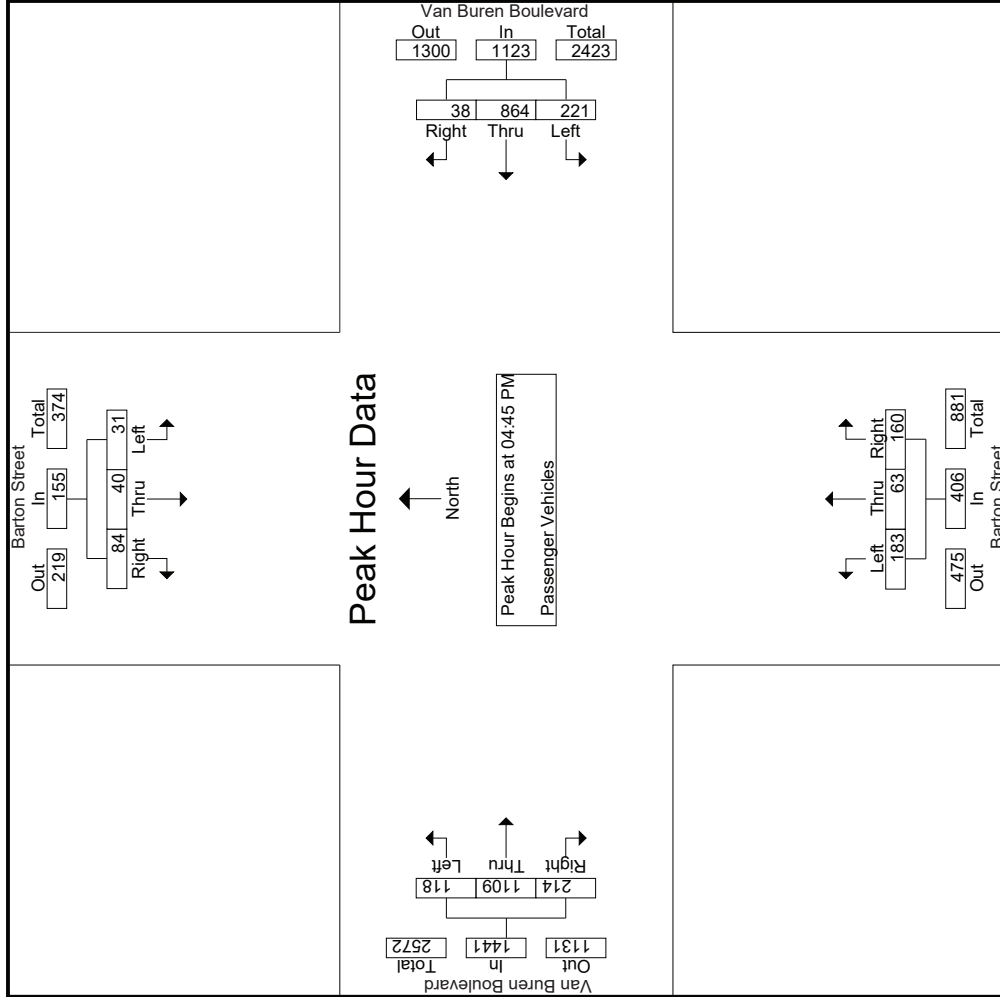

Counts Unlimited
 PO Box 1178
 Corona, CA 92878
 (951) 268-6268

City of Riverside
 N/S: Barton Street
 E/W: Van Buren Boulevard
 Weather: Clear

File Name : 13_RIV_Barton St_Van Buren PM
 Site Code : 05119542
 Start Date : 8/20/2019
 Page No : 3

Start Time	Barton Street Southbound			Van Buren Boulevard Westbound			Barton Street Northbound			Van Buren Boulevard Eastbound					
	Left	Thru	Right	Left	Thru	Right	Left	Thru	Right	Left	Thru	Right	App. Total	Int. Total	
Peak Hour Analysis From 04:45 PM to 05:30 PM - Peak 1 of 1															
Peak Hour for Each Approach Begins at:															
	04:45 PM			04:45 PM			04:45 PM			04:45 PM			04:45 PM		
+0 mins.	11	14	18	43	56	227	8	291	10	28	71	23	242	51	316
+15 mins.	6	11	26	43	36	203	12	251	17	41	113	33	264	62	359
+30 mins.	3	6	19	28	74	238	4	316	17	40	107	34	303	47	384
+45 mins.	11	9	21	41	55	196	14	265	19	51	115	28	300	54	382
Total Volume	31	40	84	155	221	864	38	1123	63	160	406	118	1109	214	1441
% App. Total	20	25.8	54.2	19.7	76.9	3.4	45.1	15.5	39.4	8.2	7.7	14.9	8.2	7.7	14.9
PHF	.705	.714	.808	.901	.747	.908	.679	.888	.829	.784	.883	.868	.915	.863	.938

Groups Printed- Large 2 Axle Vehicles

Start Time	Barton Street Southbound				Van Buren Boulevard Westbound				Barton Street Northbound				Van Buren Boulevard Eastbound							
	Left	Thru	Right	RTOR	Left	Thru	Right	RTOR	Left	Thru	Right	RTOR	Left	Thru	Right	RTOR	App. Total	Exclu. Total	Inclu. Total	Int. Total
04:00 PM	0	0	0	0	3	1	0	0	4	0	0	0	0	1	8	2	0	11	0	15
04:15 PM	1	0	0	1	3	3	0	0	6	1	0	0	1	0	5	1	0	6	0	14
04:30 PM	0	0	0	0	2	0	0	0	4	0	1	0	1	1	6	0	0	7	0	12
04:45 PM	0	0	0	0	0	6	0	0	6	0	1	0	1	0	8	0	0	8	0	15
Total	1	0	0	1	8	12	0	0	20	1	0	2	3	2	27	3	0	32	0	56
05:00 PM	0	0	0	0	0	7	0	0	7	0	0	0	0	0	11	1	0	12	0	19
05:15 PM	0	0	0	0	0	2	0	0	2	1	0	1	0	0	8	0	0	8	0	12
05:30 PM	0	0	0	0	2	4	1	1	7	1	0	2	0	3	4	1	1	5	2	15
05:45 PM	0	0	0	0	0	3	0	0	3	1	0	0	1	1	4	0	0	5	0	9
Total	0	0	0	0	2	16	1	1	19	3	0	3	0	6	1	27	2	30	2	55
Grand Total	1	0	0	1	10	28	1	1	39	4	0	5	0	9	3	54	5	62	2	111
Approch %	100	0	0	0	25.6	71.8	2.6		44.4	0	55.6			8.1	4.8	87.1	8.1	62	1.8	98.2
Total %	0.9	0	0	0.9	9	25.2	0.9		35.1	3.6	4.5			8.1	2.7	48.6	4.5	55.9	1.8	98.2

Start Time	Barton Street Southbound				Van Buren Boulevard Westbound				Barton Street Northbound				Van Buren Boulevard Eastbound							
	Left	Thru	Right	RTOR	Left	Thru	Right	RTOR	Left	Thru	Right	RTOR	Left	Thru	Right	RTOR	App. Total	Exclu. Total	Inclu. Total	Int. Total
04:45 PM	0	0	0	0	0	6	0	0	6	0	0	1	0	0	8	0	0	8	0	15
05:00 PM	0	0	0	0	0	7	0	0	7	0	0	0	0	0	11	1	0	12	0	19
05:15 PM	0	0	0	0	0	2	0	0	2	1	0	1	0	0	8	0	0	8	0	12
05:30 PM	0	0	0	0	2	4	1	1	7	1	0	2	0	3	4	1	1	5	2	15
Total	0	0	0	0	2	19	1	1	22	2	0	4	0	6	31	2	33	0	61	
% App. Total	0	0	0	0	9.1	86.4	4.5		66.7	0	66.7			93.9	6.1	6.1				
PHF	.000	.000	.000	.000	.250	.679	.250		.786	.500	.000	.500		.500	.705	.500		.688		.803

Peak Hour Analysis From 04:45 PM to 05:30 PM - Peak 1 of 1
 Peak Hour for Entire Intersection Begins at 04:45 PM

Counts Unlimited
 PO Box 1178
 Corona, CA 92878
 (951) 268-6268

City of Riverside
 N/S: Barton Street
 E/W: Van Buren Boulevard
 Weather: Clear

File Name : 13_RIV_Barton St_Van Buren PM
 Site Code : 05119542
 Start Date : 8/20/2019
 Page No : 2

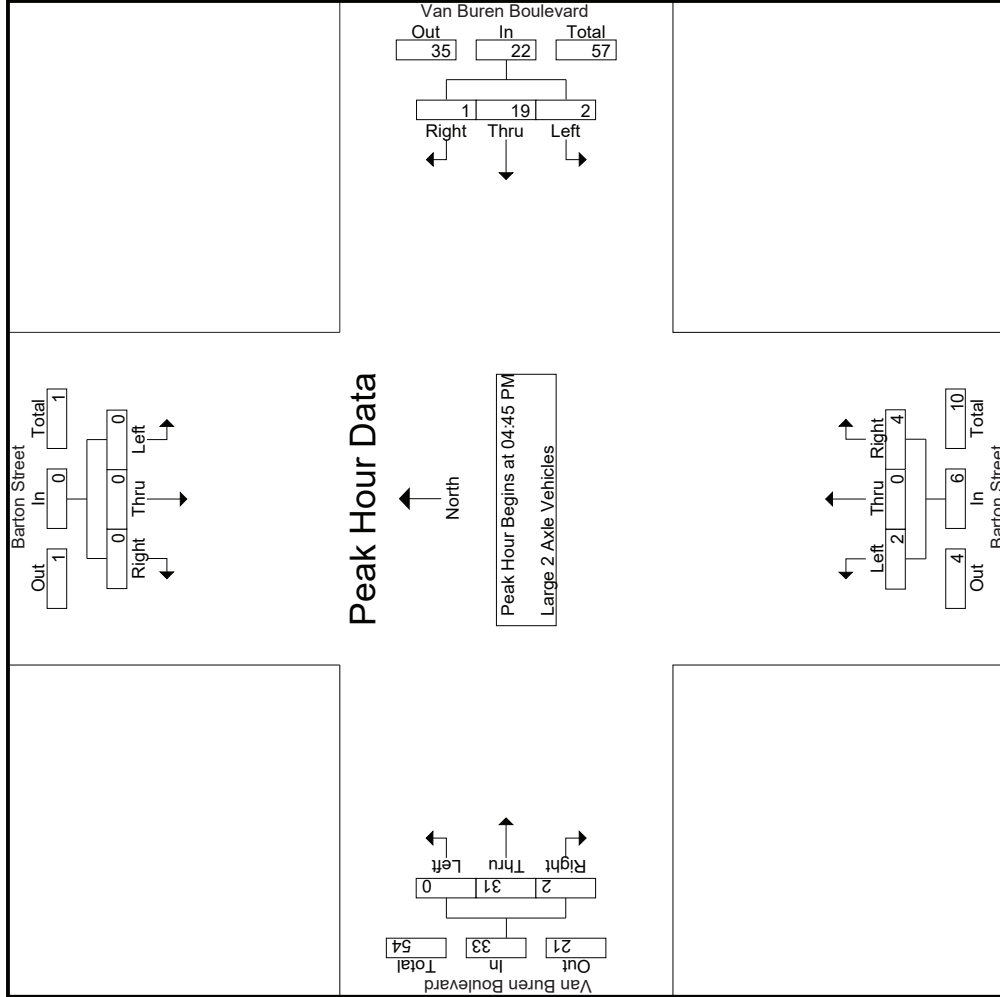

Counts Unlimited
 PO Box 1178
 Corona, CA 92878
 (951) 268-6268

City of Riverside
 N/S: Barton Street
 E/W: Van Buren Boulevard
 Weather: Clear

File Name : 13_RIV_Barton St_Van Buren PM
 Site Code : 05119542
 Start Date : 8/20/2019
 Page No : 3

Start Time	Barton Street Southbound			Van Buren Boulevard Westbound			Barton Street Northbound			Van Buren Boulevard Eastbound		
	Left	Thru	Right	Left	Thru	Right	Left	Thru	Right	Left	Thru	Right
Peak Hour Analysis From 04:45 PM to 05:30 PM - Peak 1 of 1												
Peak Hour for Each Approach Begins at:												
	04:45 PM			04:45 PM			04:45 PM			04:45 PM		
+0 mins.	0	0	0	0	6	0	6	0	1	0	8	0
+15 mins.	0	0	0	7	7	0	7	0	0	11	1	8
+30 mins.	0	0	0	2	2	0	2	1	0	8	0	12
+45 mins.	0	0	0	4	7	1	7	0	2	4	0	8
Total Volume	0	0	0	19	22	1	22	2	4	31	2	33
% App. Total	0	0	0	9.1	86.4	4.5	86.4	33.3	66.7	93.9	6.1	93.9
PHF	.000	.000	.000	.250	.786	.250	.786	.500	.500	.705	.500	.688

Groups Printed- 3 Axle Vehicles

Start Time	Barton Street Southbound			Van Buren Boulevard Westbound			Barton Street Northbound			Van Buren Boulevard Eastbound		
	Left	Thru	Right	Left	Thru	Right	Left	Thru	Right	Left	Thru	Right
04:00 PM	0	0	0	0	0	0	0	0	0	0	0	0
04:15 PM	0	0	0	1	0	0	0	0	0	0	3	0
04:30 PM	0	0	0	0	0	0	0	0	0	0	0	0
04:45 PM	0	0	0	0	1	0	0	0	0	0	2	0
Total	0	0	0	1	1	0	0	0	0	0	5	0
05:00 PM	0	0	0	0	0	0	0	0	0	0	1	0
05:15 PM	0	0	0	0	0	0	0	0	0	0	0	0
05:30 PM	0	0	0	0	0	0	0	0	0	0	0	0
05:45 PM	0	0	0	0	1	0	0	0	0	0	0	0
Total	0	0	0	0	1	0	0	0	0	0	1	0
Grand Total	0	0	0	1	2	0	0	0	0	0	6	0
Approch %	0	0	0	33.3	66.7	0	0	0	0	0	100	0
Total %	0	0	0	11.1	22.2	0	0	0	0	0	66.7	0

Start Time	Barton Street Southbound			Van Buren Boulevard Westbound			Barton Street Northbound			Van Buren Boulevard Eastbound		
	Left	Thru	Right	Left	Thru	Right	Left	Thru	Right	Left	Thru	Right
04:45 PM	0	0	0	0	1	0	0	0	0	0	2	0
05:00 PM	0	0	0	0	0	0	0	0	0	0	1	0
05:15 PM	0	0	0	0	0	0	0	0	0	0	0	0
05:30 PM	0	0	0	0	0	0	0	0	0	0	0	0
Total Volume	0	0	0	0	1	0	0	0	0	0	3	0
% App. Total	0	0	0	0	100	0	0	0	0	0	100	0
PHF	.000	.000	.000	.000	.250	.000	.000	.000	.000	.000	.375	.000

Peak Hour Analysis From 04:45 PM to 05:30 PM - Peak 1 of 1
 Peak Hour for Entire Intersection Begins at 04:45 PM

Counts Unlimited
 PO Box 1178
 Corona, CA 92878
 (951) 268-6268

City of Riverside
 N/S: Barton Street
 E/W: Van Buren Boulevard
 Weather: Clear

File Name : 13_RIV_Barton St_Van Buren PM
 Site Code : 05119542
 Start Date : 8/20/2019
 Page No : 2

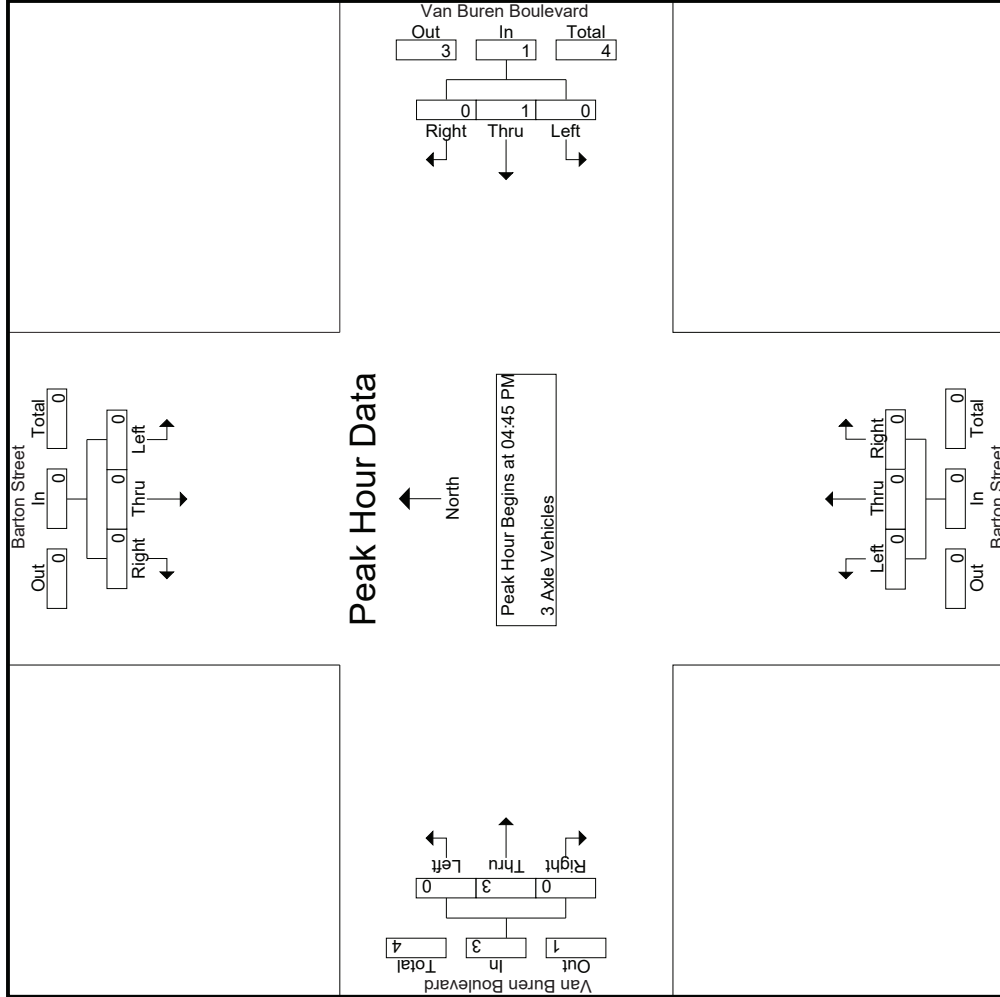

Counts Unlimited
 PO Box 1178
 Corona, CA 92878
 (951) 268-6268

City of Riverside
 N/S: Barton Street
 E/W: Van Buren Boulevard
 Weather: Clear

File Name : 13_RIV_Barton St_Van Buren PM
 Site Code : 05119542
 Start Date : 8/20/2019
 Page No : 3

Start Time	Barton Street Southbound			Van Buren Boulevard Westbound			Barton Street Northbound			Van Buren Boulevard Eastbound					
	Left	Thru	Right	Left	Thru	Right	Left	Thru	Right	Left	Thru	Right	App. Total	Int. Total	
Peak Hour Analysis From 04:45 PM to 05:30 PM - Peak 1 of 1															
Peak Hour for Each Approach Begins at:															
	04:45 PM			04:45 PM			04:45 PM			04:45 PM			04:45 PM		
+0 mins.	0	0	0	1	0	0	1	0	0	0	0	0	2	0	2
+15 mins.	0	0	0	0	0	0	0	0	0	0	0	0	1	0	1
+30 mins.	0	0	0	0	0	0	0	0	0	0	0	0	0	0	0
+45 mins.	0	0	0	0	0	0	0	0	0	0	0	0	0	0	0
Total Volume	0	0	0	1	0	0	1	0	0	0	0	0	3	0	3
% App. Total	0	0	0	100	0	0	100	0	0	0	0	0	100	0	100
PHF	.000	.000	.000	.000	.000	.000	.250	.000	.000	.000	.000	.000	.375	.000	.375

Groups Printed- 4+ Axle Trucks

Start Time	Barton Street Southbound				Van Buren Boulevard Westbound				Barton Street Northbound				Van Buren Boulevard Eastbound							
	Left	Thru	Right	RTOR	Left	Thru	Right	RTOR	Left	Thru	Right	RTOR	Left	Thru	Right	RTOR	App. Total	Exclu. Total	Inclu. Total	Int. Total
04:00 PM	0	0	0	0	1	2	0	0	3	0	0	0	0	0	4	0	4	0	7	7
04:15 PM	0	0	0	0	0	1	0	0	1	0	0	0	0	0	1	0	1	0	2	2
04:30 PM	0	0	0	0	1	2	0	0	3	0	0	0	0	3	0	3	0	6	6	6
04:45 PM	0	0	0	0	0	1	0	0	1	0	1	0	0	4	0	4	0	6	6	6
Total	0	0	0	0	2	6	0	0	8	0	0	1	0	12	0	12	0	21	21	21
05:00 PM	0	0	0	0	0	2	0	0	2	0	0	0	0	3	0	3	0	5	5	5
05:15 PM	0	0	0	0	1	0	0	0	1	0	0	0	0	0	0	0	0	1	1	1
05:30 PM	0	0	0	0	1	0	0	0	1	0	0	0	0	0	0	0	0	1	1	1
05:45 PM	0	0	0	0	0	0	0	0	0	0	0	0	0	1	0	1	0	1	1	1
Total	0	0	0	0	2	2	0	0	4	0	0	0	0	4	0	4	0	8	8	8
Grand Total	0	0	0	0	4	8	0	0	12	0	0	1	0	16	0	16	0	29	29	29
Approch %	0	0	0	0	33.3	66.7	0	0	41.4	0	0	100	0	100	0	55.2	0	100	100	100
Total %	0	0	0	0	13.8	27.6	0	0	41.4	0	0	3.4	0	55.2	0	55.2	0	100	100	100

Start Time	Barton Street Southbound				Van Buren Boulevard Westbound				Barton Street Northbound				Van Buren Boulevard Eastbound							
	Left	Thru	Right	RTOR	Left	Thru	Right	RTOR	Left	Thru	Right	RTOR	Left	Thru	Right	RTOR	App. Total	Exclu. Total	Inclu. Total	Int. Total
04:45 PM	0	0	0	0	0	0	0	0	1	0	0	0	0	1	0	0	0	0	4	6
05:00 PM	0	0	0	0	0	2	0	0	2	0	0	0	0	3	0	3	0	3	5	5
05:15 PM	0	0	0	0	1	0	0	0	1	0	0	0	0	0	0	0	0	0	1	1
05:30 PM	0	0	0	0	1	0	0	0	1	0	0	0	0	0	0	0	0	0	0	1
Total Volume	0	0	0	0	2	3	0	0	5	0	0	1	0	7	0	7	0	7	13	13
% App. Total	0	0	0	0	40	60	0	0	100	0	0	100	0	100	0	100	0	100	100	100
PHF	.000	.000	.000	.000	.500	.375	.000	.625	.250	.000	.000	.250	.000	.438	.000	.438	.000	.438	.542	.542

Peak Hour Analysis From 04:45 PM to 05:30 PM - Peak 1 of 1
 Peak Hour for Entire Intersection Begins at 04:45 PM

Counts Unlimited
 PO Box 1178
 Corona, CA 92878
 (951) 268-6268

City of Riverside
 N/S: Barton Street
 E/W: Van Buren Boulevard
 Weather: Clear

File Name : 13_RIV_Barton St_Van Buren PM
 Site Code : 05119542
 Start Date : 8/20/2019
 Page No : 2

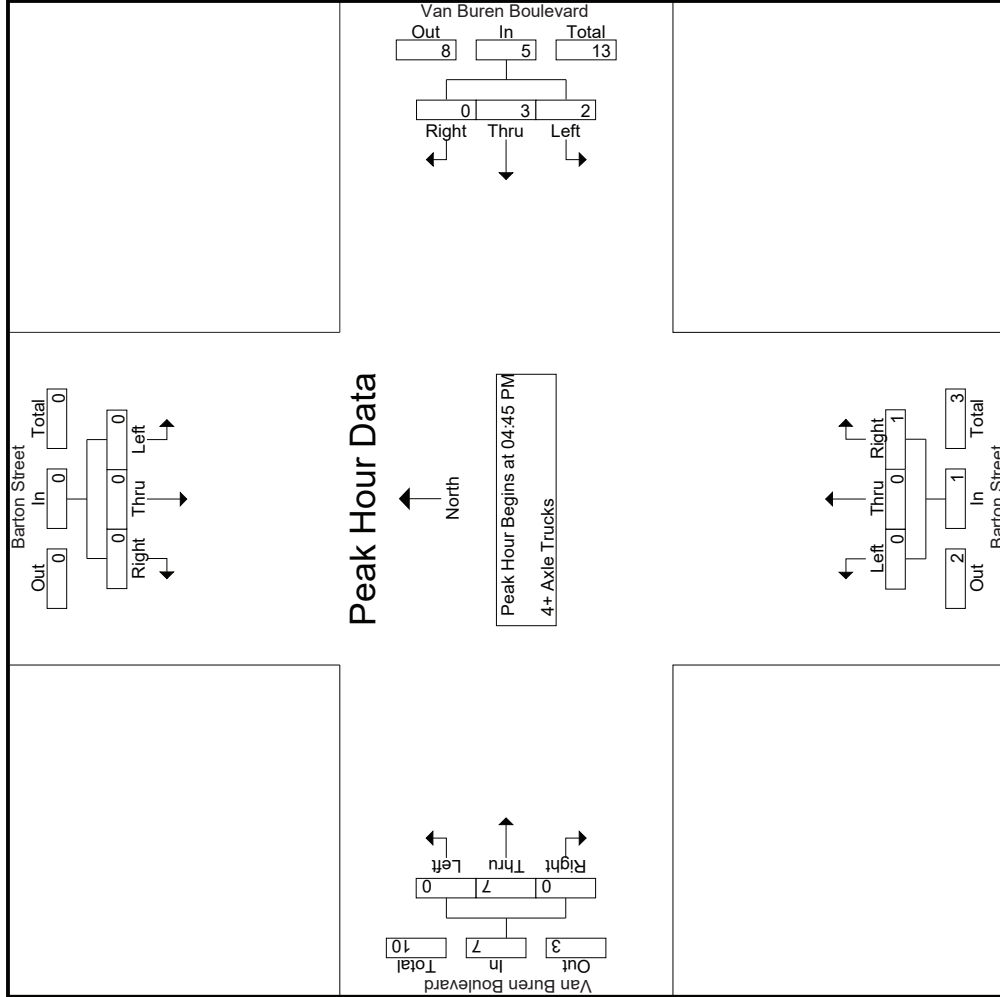

Counts Unlimited
 PO Box 1178
 Corona, CA 92878
 (951) 268-6268

City of Riverside
 N/S: Barton Street
 E/W: Van Buren Boulevard
 Weather: Clear

File Name : 13_RIV_Barton St_Van Buren PM
 Site Code : 05119542
 Start Date : 8/20/2019
 Page No : 3

Start Time	Barton Street Southbound			Van Buren Boulevard Westbound			Barton Street Northbound			Van Buren Boulevard Eastbound		
	Left	Thru	Right	Left	Thru	Right	Left	Thru	Right	Left	Thru	Right
Peak Hour Analysis From 04:45 PM to 05:30 PM - Peak 1 of 1												
Peak Hour for Each Approach Begins at:												
	04:45 PM			04:45 PM			04:45 PM			04:45 PM		
+0 mins.	0	0	0	1	0	0	1	0	0	1	0	0
+15 mins.	0	0	0	2	0	0	2	0	0	0	3	0
+30 mins.	0	0	0	0	1	0	1	0	0	0	0	0
+45 mins.	0	0	0	1	0	0	1	0	0	0	0	0
Total Volume	0	0	0	3	0	0	5	0	0	1	7	0
% App. Total	0	0	0	40	60	0	100	0	100	0	100	0
PHF	.000	.000	.000	.500	.375	.000	.625	.000	.250	.250	.000	.438

Location: Riverside
 N/S: Barton Street
 E/W: Van Buren Boulevard



Date: 8/20/2019
 Day: Tuesday

PEDESTRIANS

	North Leg Barton Street	East Leg Van Buren Boulevard	South Leg Barton Street	West Leg Van Buren Boulevard	
	Pedestrians	Pedestrians	Pedestrians	Pedestrians	
7:00 AM	1	0	0	0	1
7:15 AM	1	0	0	0	1
7:30 AM	0	0	0	0	0
7:45 AM	1	0	0	0	1
8:00 AM	0	0	0	1	1
8:15 AM	0	0	0	0	0
8:30 AM	0	0	0	0	0
8:45 AM	0	0	0	0	0
TOTAL VOLUMES:	3	0	0	1	4

	North Leg Barton Street	East Leg Van Buren Boulevard	South Leg Barton Street	West Leg Van Buren Boulevard	
	Pedestrians	Pedestrians	Pedestrians	Pedestrians	
4:00 PM	1	0	0	0	1
4:15 PM	0	0	0	0	0
4:30 PM	0	0	0	0	0
4:45 PM	0	0	0	1	1
5:00 PM	1	0	0	0	1
5:15 PM	0	0	0	0	0
5:30 PM	0	0	0	0	0
5:45 PM	0	0	0	0	0
TOTAL VOLUMES:	2	0	0	1	3

Location: Riverside
 N/S: Barton Street
 E/W: Van Buren Boulevard



Date: 8/20/2019
 Day: Tuesday

BICYCLES

	Southbound Barton Street			Westbound Van Buren Boulevard			Northbound Barton Street			Eastbound Van Buren Boulevard			
	Left	Thru	Right	Left	Thru	Right	Left	Thru	Right	Left	Thru	Right	
7:00 AM	0	0	0	0	0	0	0	0	0	0	0	0	0
7:15 AM	0	0	0	0	0	0	0	0	0	0	0	0	0
7:30 AM	0	0	0	0	0	0	0	0	0	0	0	0	0
7:45 AM	0	4	0	0	0	0	0	0	0	0	0	0	4
8:00 AM	0	0	0	0	0	0	0	0	0	0	0	0	0
8:15 AM	0	0	0	0	0	0	0	0	0	0	0	0	0
8:30 AM	0	0	0	0	0	0	0	0	0	0	0	0	0
8:45 AM	0	0	0	0	0	0	0	0	0	0	0	0	0
TOTAL VOLUMES:	0	4	0	0	0	0	0	0	0	0	0	0	4

	Southbound Barton Street			Westbound Van Buren Boulevard			Northbound Barton Street			Eastbound Van Buren Boulevard			
	Left	Thru	Right	Left	Thru	Right	Left	Thru	Right	Left	Thru	Right	
4:00 PM	0	0	0	0	0	0	0	0	0	0	0	0	0
4:15 PM	0	0	0	0	0	0	0	0	0	0	0	0	0
4:30 PM	0	0	0	0	0	0	0	0	0	0	0	0	0
4:45 PM	0	0	0	0	0	0	0	0	1	0	0	0	1
5:00 PM	0	0	0	0	0	0	0	0	0	0	0	0	0
5:15 PM	0	0	0	0	0	0	0	0	0	0	0	0	0
5:30 PM	0	0	0	0	0	0	0	0	1	0	0	0	1
5:45 PM	0	0	0	0	0	0	0	0	0	0	0	0	0
TOTAL VOLUMES:	0	0	0	0	0	0	0	0	2	0	0	0	2

City of Riverside
 N/S: Orange Terrace Parkway
 E/W: Van Buren Boulevard
 Weather: Clear

File Name : 21_RIV_Orange Terrace_Van Buren AM
 Site Code : 05119542
 Start Date : 8/20/2019
 Page No : 1

Groups Printed- Passenger Vehicles - Large 2 Axle Vehicles - 3 Axle Vehicles - 4+ Axle Trucks

Start Time	Orange Terrace Parkway Southbound				Van Buren Boulevard Westbound				Van Buren Boulevard Eastbound				Exclu. Total	Inclu. Total	Int. Total
	Left	Right	RTOR	App. Total	Thru	Right	RTOR	App. Total	Left	Thru	RTOR	App. Total			
07:00 AM	39	70	40	109	411	30	4	441	7	214	0	221	44	771	815
07:15 AM	58	75	28	133	413	26	5	439	28	255	0	283	33	855	888
07:30 AM	51	46	32	97	305	25	1	330	47	262	0	309	33	736	769
07:45 AM	37	40	29	77	299	30	3	329	30	346	0	376	32	782	814
Total	185	231	129	416	1428	111	13	1539	112	1077	0	1189	142	3144	3286
08:00 AM	55	32	24	87	242	15	1	257	36	232	0	268	25	612	637
08:15 AM	32	28	17	60	250	21	4	271	14	173	0	187	21	518	539
08:30 AM	26	22	14	48	262	18	1	280	12	163	0	175	15	503	518
08:45 AM	29	18	6	47	271	26	1	297	14	137	0	151	7	495	502
Total	142	100	61	242	1025	80	7	1105	76	705	0	781	68	2128	2196
Grand Total	327	331	190	658	2453	191	20	2644	188	1782	0	1970	210	5272	5482
Apprch %	49.7	50.3			92.8	7.2			9.5	90.5					
Total %	6.2	6.3		12.5	46.5	3.6		50.2	3.6	33.8		37.4	3.8	96.2	
Passenger Vehicles	319	326		831	2297	173		2489	181	1714		1895	0	0	5215
% Passenger Vehicles	97.6	98.5	97.9	98	93.6	90.6	95	93.4	96.3	96.2	0	96.2	0	0	95.1
Large 2 Axle Vehicles	6	5		15	69	14		84	4	41		45	0	0	144
% Large 2 Axle Vehicles	1.8	1.5	2.1	1.8	2.8	7.3	5	3.2	2.1	2.3	0	2.3	0	0	2.6
3 Axle Vehicles	2	0		2	51	3		54	0	12		12	0	0	68
% 3 Axle Vehicles	0.6	0	0	0.2	2.1	1.6	0	2	0	0.7	0	0.6	0	0	1.2
4+ Axle Trucks	0	0		0	36	1		37	3	15		18	0	0	55
% 4+ Axle Trucks	0	0	0	0	1.5	0.5	0	1.4	1.6	0.8	0	0.9	0	0	1

Start Time	Orange Terrace Parkway Southbound			Van Buren Boulevard Westbound			Van Buren Boulevard Eastbound			Int. Total
	Left	Right	App. Total	Thru	Right	App. Total	Left	Thru	App. Total	
07:00 AM	39	70	109	411	30	441	7	214	221	771
07:15 AM	58	75	133	413	26	439	28	255	283	855
07:30 AM	51	46	97	305	25	330	47	262	309	736
07:45 AM	37	40	77	299	30	329	30	346	376	782
Total Volume	185	231	416	1428	111	1539	112	1077	1189	3144
% App. Total	44.5	55.5		92.8	7.2		9.4	90.6		
PHF	.797	.770	.782	.864	.925	.872	.596	.778	.791	.919

City of Riverside
 N/S: Orange Terrace Parkway
 E/W: Van Buren Boulevard
 Weather: Clear

File Name : 21_RIV_Orange Terrace_Van Buren AM
 Site Code : 05119542
 Start Date : 8/20/2019
 Page No : 2

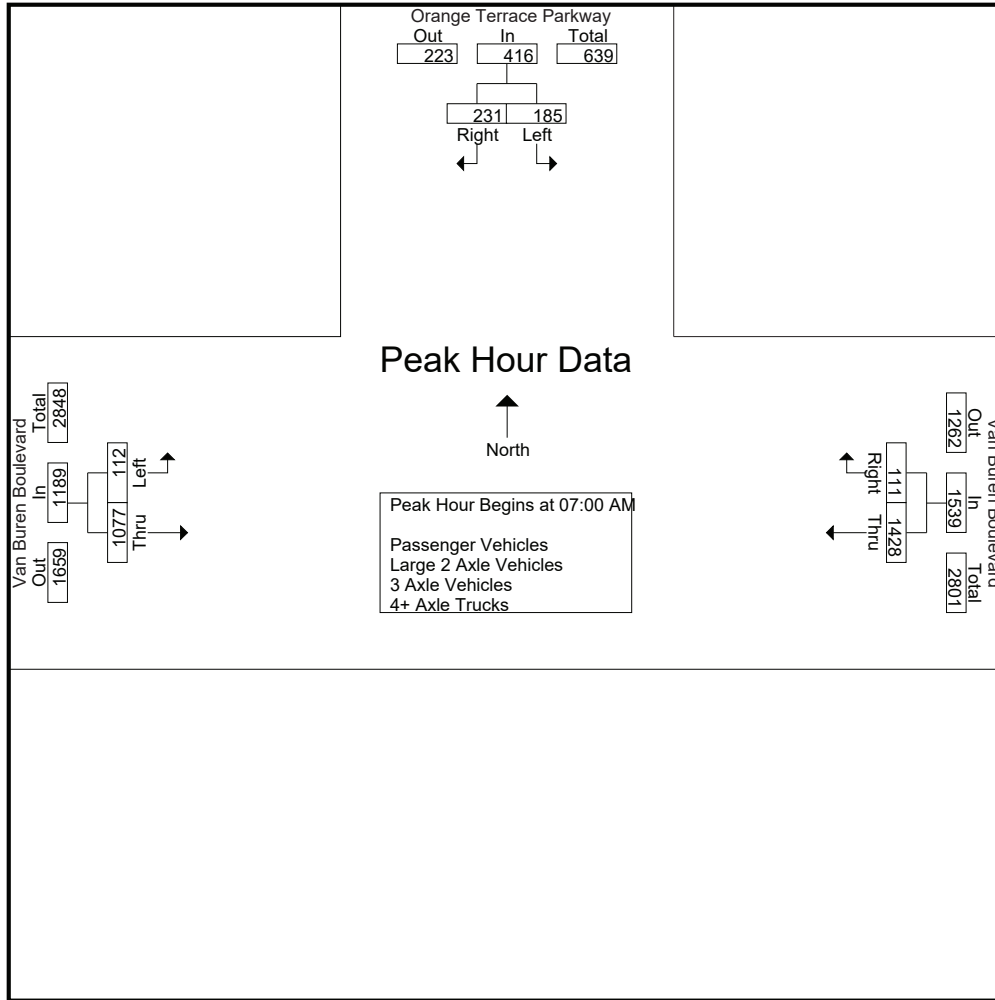

Peak Hour Analysis From 07:00 AM to 08:45 AM - Peak 1 of 1
 Peak Hour for Each Approach Begins at:

	07:00 AM			07:15 AM			07:30 AM			07:45 AM		
+0 mins.	39	70	109	411	30	441	28	255	283	141	1095	1236
+15 mins.	58	75	133	413	26	439	47	262	309	114	88.6	
+30 mins.	51	46	97	305	25	330	30	346	376			
+45 mins.	37	40	77	299	30	329	36	232	268			
Total Volume	185	231	416	1428	111	1539	141	1095	1236			
% App. Total	44.5	55.5		92.8	7.2		11.4	88.6				
PHF	.797	.770	.782	.864	.925	.872	.750	.791	.822			

City of Riverside
 N/S: Orange Terrace Parkway
 E/W: Van Buren Boulevard
 Weather: Clear

File Name : 21_RIV_Orange Terrace_Van Buren AM
 Site Code : 05119542
 Start Date : 8/20/2019
 Page No : 1

Groups Printed- Passenger Vehicles

Start Time	Orange Terrace Parkway Southbound				Van Buren Boulevard Westbound				Van Buren Boulevard Eastbound				Exclu. Total	Inclu. Total	Int. Total
	Left	Right	RTOR	App. Total	Thru	Right	RTOR	App. Total	Left	Thru	RTOR	App. Total			
07:00 AM	38	69	39	107	388	29	3	417	7	204	0	211	42	735	777
07:15 AM	56	75	28	131	398	24	5	422	24	250	0	274	33	827	860
07:30 AM	50	43	30	93	282	24	1	306	44	252	0	296	31	695	726
07:45 AM	37	40	29	77	285	27	3	312	30	339	0	369	32	758	790
Total	181	227	126	408	1353	104	12	1457	105	1045	0	1150	138	3015	3153
08:00 AM	54	32	24	86	225	12	1	237	36	220	0	256	25	579	604
08:15 AM	31	27	16	58	228	18	4	246	14	163	0	177	20	481	501
08:30 AM	25	22	14	47	239	17	1	256	12	156	0	168	15	471	486
08:45 AM	28	18	6	46	252	22	1	274	14	130	0	144	7	464	471
Total	138	99	60	237	944	69	7	1013	76	669	0	745	67	1995	2062
Grand Total	319	326	186	645	2297	173	19	2470	181	1714	0	1895	205	5010	5215
Apprch %	49.5	50.5			93	7			9.6	90.4					
Total %	6.4	6.5		12.9	45.8	3.5		49.3	3.6	34.2		37.8	3.9	96.1	

Start Time	Orange Terrace Parkway Southbound			Van Buren Boulevard Westbound			Van Buren Boulevard Eastbound			Int. Total
	Left	Right	App. Total	Thru	Right	App. Total	Left	Thru	App. Total	
Peak Hour Analysis From 07:00 AM to 07:45 AM - Peak 1 of 1										
Peak Hour for Entire Intersection Begins at 07:00 AM										
07:00 AM	38	69	107	388	29	417	7	204	211	735
07:15 AM	56	75	131	398	24	422	24	250	274	827
07:30 AM	50	43	93	282	24	306	44	252	296	695
07:45 AM	37	40	77	285	27	312	30	339	369	758
Total Volume	181	227	408	1353	104	1457	105	1045	1150	3015
% App. Total	44.4	55.6		92.9	7.1		9.1	90.9		
PHF	.808	.757	.779	.850	.897	.863	.597	.771	.779	.911

City of Riverside
 N/S: Orange Terrace Parkway
 E/W: Van Buren Boulevard
 Weather: Clear

File Name : 21_RIV_Orange Terrace_Van Buren AM
 Site Code : 05119542
 Start Date : 8/20/2019
 Page No : 2

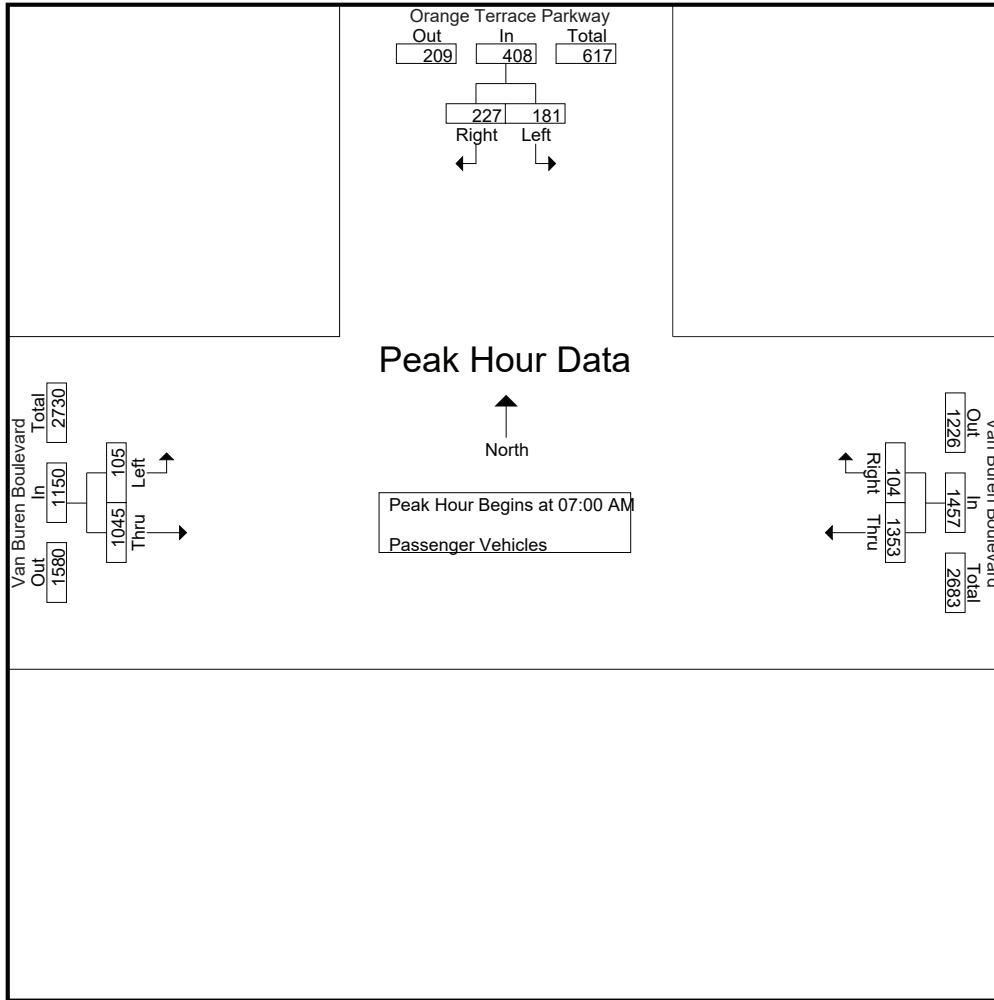

Peak Hour Analysis From 07:00 AM to 07:45 AM - Peak 1 of 1
 Peak Hour for Each Approach Begins at:

	07:00 AM			07:00 AM			07:00 AM		
+0 mins.	38	69	107	388	29	417	7	204	211
+15 mins.	56	75	131	398	24	422	24	250	274
+30 mins.	50	43	93	282	24	306	44	252	296
+45 mins.	37	40	77	285	27	312	30	339	369
Total Volume	181	227	408	1353	104	1457	105	1045	1150
% App. Total	44.4	55.6		92.9	7.1		9.1	90.9	
PHF	.808	.757	.779	.850	.897	.863	.597	.771	.779

City of Riverside
 N/S: Orange Terrace Parkway
 E/W: Van Buren Boulevard
 Weather: Clear

File Name : 21_RIV_Orange Terrace_Van Buren AM
 Site Code : 05119542
 Start Date : 8/20/2019
 Page No : 1

Groups Printed- Large 2 Axle Vehicles

Start Time	Orange Terrace Parkway Southbound				Van Buren Boulevard Westbound				Van Buren Boulevard Eastbound				Exclu. Total	Inclu. Total	Int. Total
	Left	Right	RTOR	App. Total	Thru	Right	RTOR	App. Total	Left	Thru	RTOR	App. Total			
07:00 AM	1	1	1	2	8	1	1	9	0	4	0	4	2	15	17
07:15 AM	1	0	0	1	7	1	0	8	3	4	0	7	0	16	16
07:30 AM	1	3	2	4	8	1	0	9	1	6	0	7	2	20	22
07:45 AM	0	0	0	0	3	3	0	6	0	4	0	4	0	10	10
Total	3	4	3	7	26	6	1	32	4	18	0	22	4	61	65
08:00 AM	1	0	0	1	9	3	0	12	0	8	0	8	0	21	21
08:15 AM	0	1	1	1	12	1	0	13	0	6	0	6	1	20	21
08:30 AM	1	0	0	1	13	1	0	14	0	5	0	5	0	20	20
08:45 AM	1	0	0	1	9	3	0	12	0	4	0	4	0	17	17
Total	3	1	1	4	43	8	0	51	0	23	0	23	1	78	79
Grand Total	6	5	4	11	69	14	1	83	4	41	0	45	5	139	144
Apprch %	54.5	45.5			83.1	16.9			8.9	91.1					
Total %	4.3	3.6		7.9	49.6	10.1		59.7	2.9	29.5		32.4	3.5	96.5	

Start Time	Orange Terrace Parkway Southbound			Van Buren Boulevard Westbound			Van Buren Boulevard Eastbound			Int. Total
	Left	Right	App. Total	Thru	Right	App. Total	Left	Thru	App. Total	
Peak Hour Analysis From 07:00 AM to 07:45 AM - Peak 1 of 1										
Peak Hour for Entire Intersection Begins at 07:00 AM										
07:00 AM	1	1	2	8	1	9	0	4	4	15
07:15 AM	1	0	1	7	1	8	3	4	7	16
07:30 AM	1	3	4	8	1	9	1	6	7	20
07:45 AM	0	0	0	3	3	6	0	4	4	10
Total Volume	3	4	7	26	6	32	4	18	22	61
% App. Total	42.9	57.1		81.2	18.8		18.2	81.8		
PHF	.750	.333	.438	.813	.500	.889	.333	.750	.786	.763

City of Riverside
 N/S: Orange Terrace Parkway
 E/W: Van Buren Boulevard
 Weather: Clear

File Name : 21_RIV_Orange Terrace_Van Buren AM
 Site Code : 05119542
 Start Date : 8/20/2019
 Page No : 2

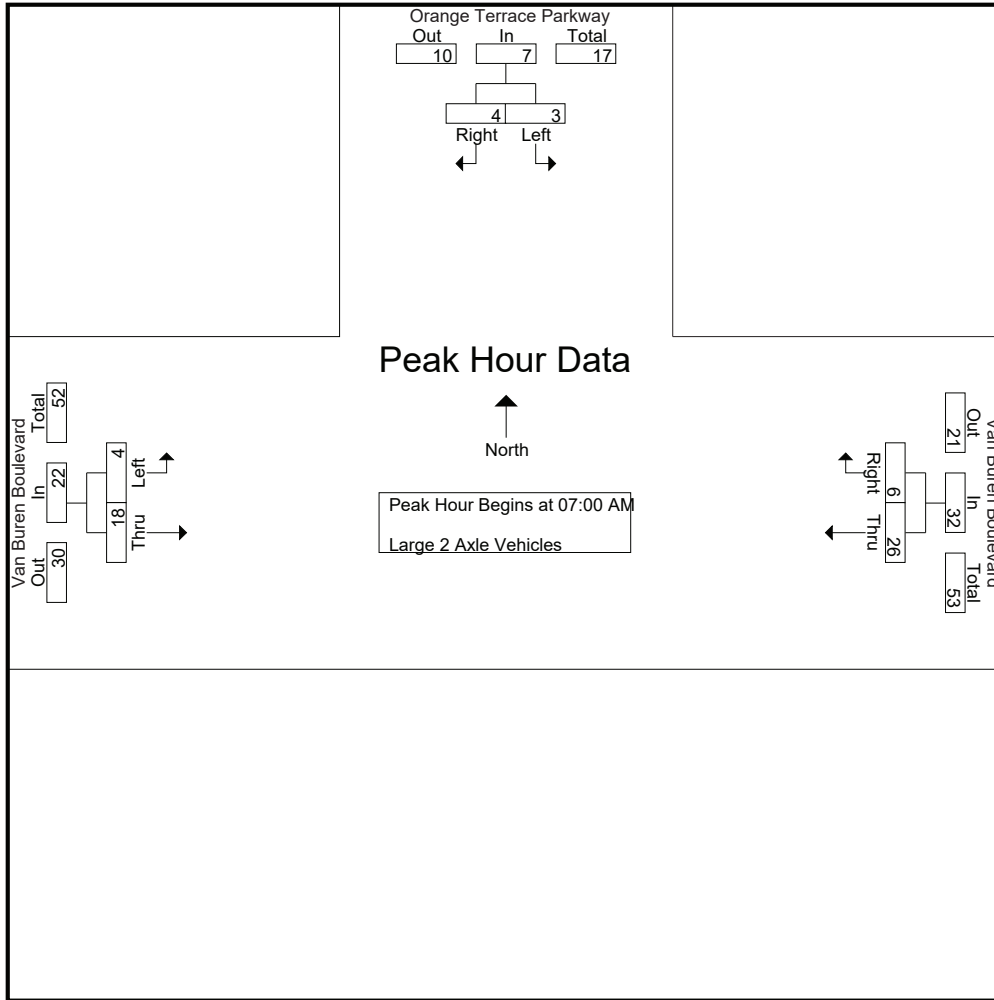

Peak Hour Analysis From 07:00 AM to 07:45 AM - Peak 1 of 1
 Peak Hour for Each Approach Begins at:

	07:00 AM			07:00 AM			07:00 AM		
+0 mins.	1	1	2	8	1	9	0	4	4
+15 mins.	1	0	1	7	1	8	3	4	7
+30 mins.	1	3	4	8	1	9	1	6	7
+45 mins.	0	0	0	3	3	6	0	4	4
Total Volume	3	4	7	26	6	32	4	18	22
% App. Total	42.9	57.1		81.2	18.8		18.2	81.8	
PHF	.750	.333	.438	.813	.500	.889	.333	.750	.786

City of Riverside
 N/S: Orange Terrace Parkway
 E/W: Van Buren Boulevard
 Weather: Clear

File Name : 21_RIV_Orange Terrace_Van Buren AM
 Site Code : 05119542
 Start Date : 8/20/2019
 Page No : 1

Groups Printed- 3 Axle Vehicles

Start Time	Orange Terrace Parkway Southbound				Van Buren Boulevard Westbound				Van Buren Boulevard Eastbound				Exclu. Total	Inclu. Total	Int. Total
	Left	Right	RTOR	App. Total	Thru	Right	RTOR	App. Total	Left	Thru	RTOR	App. Total			
07:00 AM	0	0	0	0	9	0	0	9	0	3	0	3	0	12	12
07:15 AM	1	0	0	1	6	1	0	7	0	1	0	1	0	9	9
07:30 AM	0	0	0	0	5	0	0	5	0	2	0	2	0	7	7
07:45 AM	0	0	0	0	6	0	0	6	0	2	0	2	0	8	8
Total	1	0	0	1	26	1	0	27	0	8	0	8	0	36	36
08:00 AM	0	0	0	0	7	0	0	7	0	2	0	2	0	9	9
08:15 AM	1	0	0	1	6	2	0	8	0	2	0	2	0	11	11
08:30 AM	0	0	0	0	6	0	0	6	0	0	0	0	0	6	6
08:45 AM	0	0	0	0	6	0	0	6	0	0	0	0	0	6	6
Total	1	0	0	1	25	2	0	27	0	4	0	4	0	32	32
Grand Total	2	0	0	2	51	3	0	54	0	12	0	12	0	68	68
Apprch %	100	0			94.4	5.6			0	100					
Total %	2.9	0		2.9	75	4.4		79.4	0	17.6		17.6	0	100	

Start Time	Orange Terrace Parkway Southbound			Van Buren Boulevard Westbound			Van Buren Boulevard Eastbound			Int. Total
	Left	Right	App. Total	Thru	Right	App. Total	Left	Thru	App. Total	
Peak Hour Analysis From 07:00 AM to 07:45 AM - Peak 1 of 1										
Peak Hour for Entire Intersection Begins at 07:00 AM										
07:00 AM	0	0	0	9	0	9	0	3	3	12
07:15 AM	1	0	1	6	1	7	0	1	1	9
07:30 AM	0	0	0	5	0	5	0	2	2	7
07:45 AM	0	0	0	6	0	6	0	2	2	8
Total Volume	1	0	1	26	1	27	0	8	8	36
% App. Total	100	0		96.3	3.7		0	100		
PHF	.250	.000	.250	.722	.250	.750	.000	.667	.667	.750

City of Riverside
 N/S: Orange Terrace Parkway
 E/W: Van Buren Boulevard
 Weather: Clear

File Name : 21_RIV_Orange Terrace_Van Buren AM
 Site Code : 05119542
 Start Date : 8/20/2019
 Page No : 2

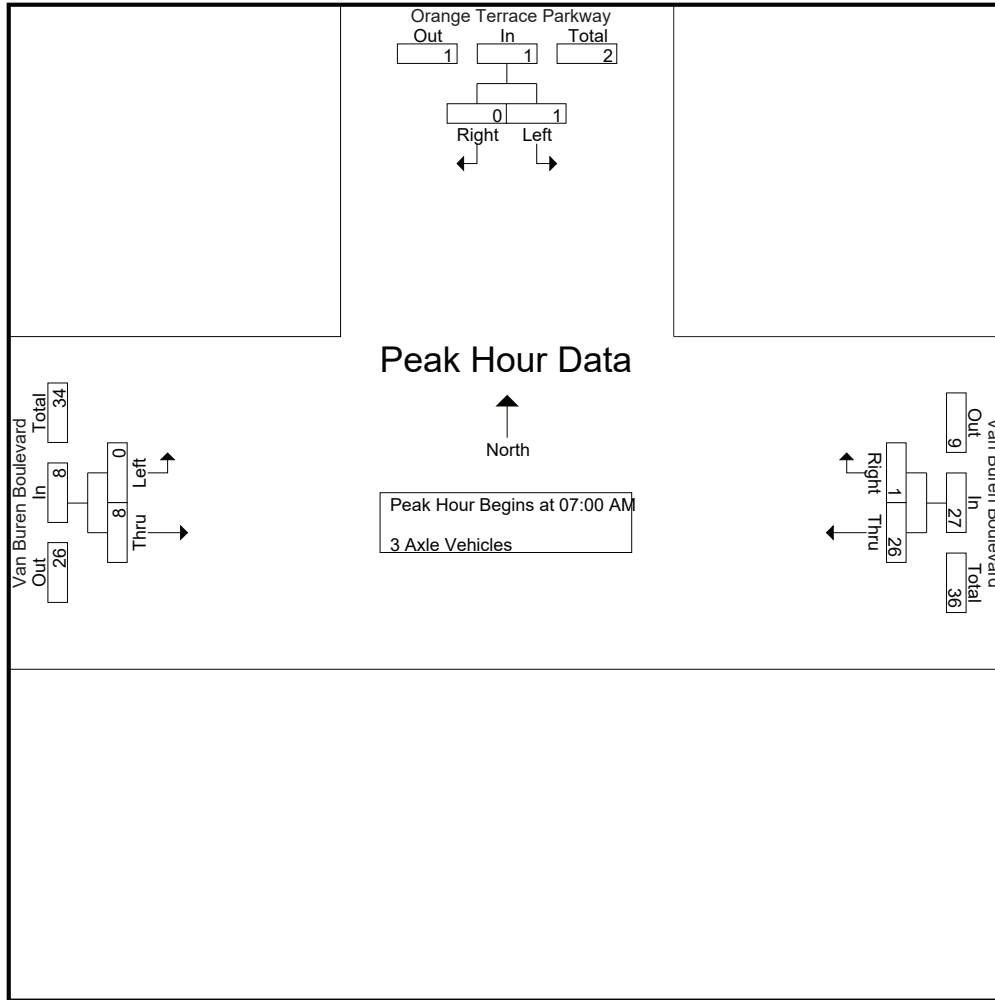

Peak Hour Analysis From 07:00 AM to 07:45 AM - Peak 1 of 1
 Peak Hour for Each Approach Begins at:

	07:00 AM			07:00 AM			07:00 AM		
+0 mins.	0	0	0	9	0	9	0	3	3
+15 mins.	1	0	1	6	1	7	0	1	1
+30 mins.	0	0	0	5	0	5	0	2	2
+45 mins.	0	0	0	6	0	6	0	2	2
Total Volume	1	0	1	26	1	27	0	8	8
% App. Total	100	0		96.3	3.7		0	100	
PHF	.250	.000	.250	.722	.250	.750	.000	.667	.667

City of Riverside
 N/S: Orange Terrace Parkway
 E/W: Van Buren Boulevard
 Weather: Clear

File Name : 21_RIV_Orange Terrace_Van Buren AM
 Site Code : 05119542
 Start Date : 8/20/2019
 Page No : 1

Groups Printed- 4+ Axle Trucks

Start Time	Orange Terrace Parkway Southbound				Van Buren Boulevard Westbound				Van Buren Boulevard Eastbound				Exclu. Total	Inclu. Total	Int. Total
	Left	Right	RTOR	App. Total	Thru	Right	RTOR	App. Total	Left	Thru	RTOR	App. Total			
07:00 AM	0	0	0	0	6	0	0	6	0	3	0	3	0	9	9
07:15 AM	0	0	0	0	2	0	0	2	1	0	0	1	0	3	3
07:30 AM	0	0	0	0	10	0	0	10	2	2	0	4	0	14	14
07:45 AM	0	0	0	0	5	0	0	5	0	1	0	1	0	6	6
Total	0	0	0	0	23	0	0	23	3	6	0	9	0	32	32
08:00 AM	0	0	0	0	1	0	0	1	0	2	0	2	0	3	3
08:15 AM	0	0	0	0	4	0	0	4	0	2	0	2	0	6	6
08:30 AM	0	0	0	0	4	0	0	4	0	2	0	2	0	6	6
08:45 AM	0	0	0	0	4	1	0	5	0	3	0	3	0	8	8
Total	0	0	0	0	13	1	0	14	0	9	0	9	0	23	23
Grand Total	0	0	0	0	36	1	0	37	3	15	0	18	0	55	55
Apprch %	0	0			97.3	2.7			16.7	83.3					
Total %	0	0			65.5	1.8		67.3	5.5	27.3		32.7	0	100	

Start Time	Orange Terrace Parkway Southbound			Van Buren Boulevard Westbound			Van Buren Boulevard Eastbound			Int. Total
	Left	Right	App. Total	Thru	Right	App. Total	Left	Thru	App. Total	
Peak Hour Analysis From 07:00 AM to 07:45 AM - Peak 1 of 1										
Peak Hour for Entire Intersection Begins at 07:00 AM										
07:00 AM	0	0	0	6	0	6	0	3	3	9
07:15 AM	0	0	0	2	0	2	1	0	1	3
07:30 AM	0	0	0	10	0	10	2	2	4	14
07:45 AM	0	0	0	5	0	5	0	1	1	6
Total Volume	0	0	0	23	0	23	3	6	9	32
% App. Total	0	0		100	0		33.3	66.7		
PHF	.000	.000	.000	.575	.000	.575	.375	.500	.563	.571

City of Riverside
 N/S: Orange Terrace Parkway
 E/W: Van Buren Boulevard
 Weather: Clear

File Name : 21_RIV_Orange Terrace_Van Buren AM
 Site Code : 05119542
 Start Date : 8/20/2019
 Page No : 2

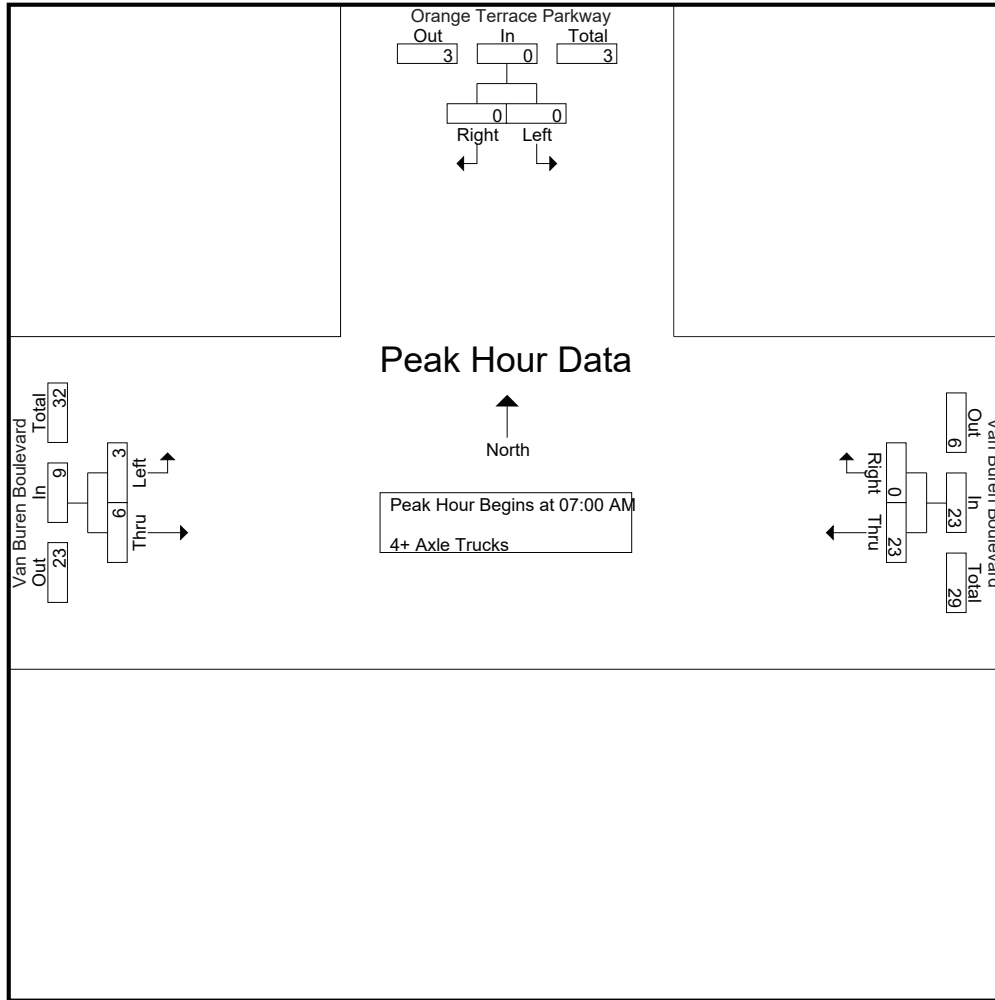

Peak Hour Analysis From 07:00 AM to 07:45 AM - Peak 1 of 1
 Peak Hour for Each Approach Begins at:

	07:00 AM			07:00 AM			07:00 AM		
+0 mins.	0	0	0	6	0	6	0	3	3
+15 mins.	0	0	0	2	0	2	1	0	1
+30 mins.	0	0	0	10	0	10	2	2	4
+45 mins.	0	0	0	5	0	5	0	1	1
Total Volume	0	0	0	23	0	23	3	6	9
% App. Total	0	0	0	100	0	100	33.3	66.7	100
PHF	.000	.000	.000	.575	.000	.575	.375	.500	.563

City of Riverside
 N/S: Orange Terrace Parkway
 E/W: Van Buren Boulevard
 Weather: Clear

File Name : 21_RIV_Orange Terrace_Van Buren PM
 Site Code : 05119542
 Start Date : 8/20/2019
 Page No : 1

Groups Printed- Passenger Vehicles - Large 2 Axle Vehicles - 3 Axle Vehicles - 4+ Axle Trucks

Start Time	Orange Terrace Parkway Southbound				Van Buren Boulevard Westbound				Van Buren Boulevard Eastbound				Exclu. Total	Inclu. Total	Int. Total
	Left	Right	RTOR	App. Total	Thru	Right	RTOR	App. Total	Left	Thru	RTOR	App. Total			
04:00 PM	39	25	21	64	230	33	8	263	31	302	0	333	29	660	689
04:15 PM	29	20	16	49	236	48	8	284	30	273	0	303	24	636	660
04:30 PM	22	22	16	44	247	65	11	312	28	313	0	341	27	697	724
04:45 PM	28	26	19	54	254	62	5	316	32	245	0	277	24	647	671
Total	118	93	72	211	967	208	32	1175	121	1133	0	1254	104	2640	2744
05:00 PM	25	14	10	39	250	52	6	302	35	282	0	317	16	658	674
05:15 PM	34	27	23	61	292	53	11	345	35	304	0	339	34	745	779
05:30 PM	27	33	28	60	236	59	6	295	32	343	0	375	34	730	764
05:45 PM	30	26	21	56	231	64	8	295	40	281	0	321	29	672	701
Total	116	100	82	216	1009	228	31	1237	142	1210	0	1352	113	2805	2918
Grand Total	234	193	154	427	1976	436	63	2412	263	2343	0	2606	217	5445	5662
Apprch %	54.8	45.2			81.9	18.1			10.1	89.9					
Total %	4.3	3.5		7.8	36.3	8		44.3	4.8	43		47.9	3.8	96.2	
Passenger Vehicles	229	186		564	1934	423		2416	261	2273		2534	0	0	5514
% Passenger Vehicles	97.9	96.4	96.8	97.1	97.9	97	93.7	97.6	99.2	97	0	97.2	0	0	97.4
Large 2 Axle Vehicles	5	4		12	23	13		40	2	48		50	0	0	102
% Large 2 Axle Vehicles	2.1	2.1	1.9	2.1	1.2	3	6.3	1.6	0.8	2	0	1.9	0	0	1.8
3 Axle Vehicles	0	0		0	3	0		3	0	6		6	0	0	9
% 3 Axle Vehicles	0	0	0	0	0.2	0	0	0.1	0	0.3	0	0.2	0	0	0.2
4+ Axle Trucks	0	3		5	16	0		16	0	16		16	0	0	37
% 4+ Axle Trucks	0	1.6	1.3	0.9	0.8	0	0	0.6	0	0.7	0	0.6	0	0	0.7

Start Time	Orange Terrace Parkway Southbound			Van Buren Boulevard Westbound			Van Buren Boulevard Eastbound			Int. Total
	Left	Right	App. Total	Thru	Right	App. Total	Left	Thru	App. Total	
Peak Hour Analysis From 04:00 PM to 05:45 PM - Peak 1 of 1										
Peak Hour for Entire Intersection Begins at 05:00 PM										
05:00 PM	25	14	39	250	52	302	35	282	317	658
05:15 PM	34	27	61	292	53	345	35	304	339	745
05:30 PM	27	33	60	236	59	295	32	343	375	730
05:45 PM	30	26	56	231	64	295	40	281	321	672
Total Volume	116	100	216	1009	228	1237	142	1210	1352	2805
% App. Total	53.7	46.3		81.6	18.4		10.5	89.5		
PHF	.853	.758	.885	.864	.891	.896	.888	.882	.901	.941

City of Riverside
 N/S: Orange Terrace Parkway
 E/W: Van Buren Boulevard
 Weather: Clear

File Name : 21_RIV_Orange Terrace_Van Buren PM
 Site Code : 05119542
 Start Date : 8/20/2019
 Page No : 2

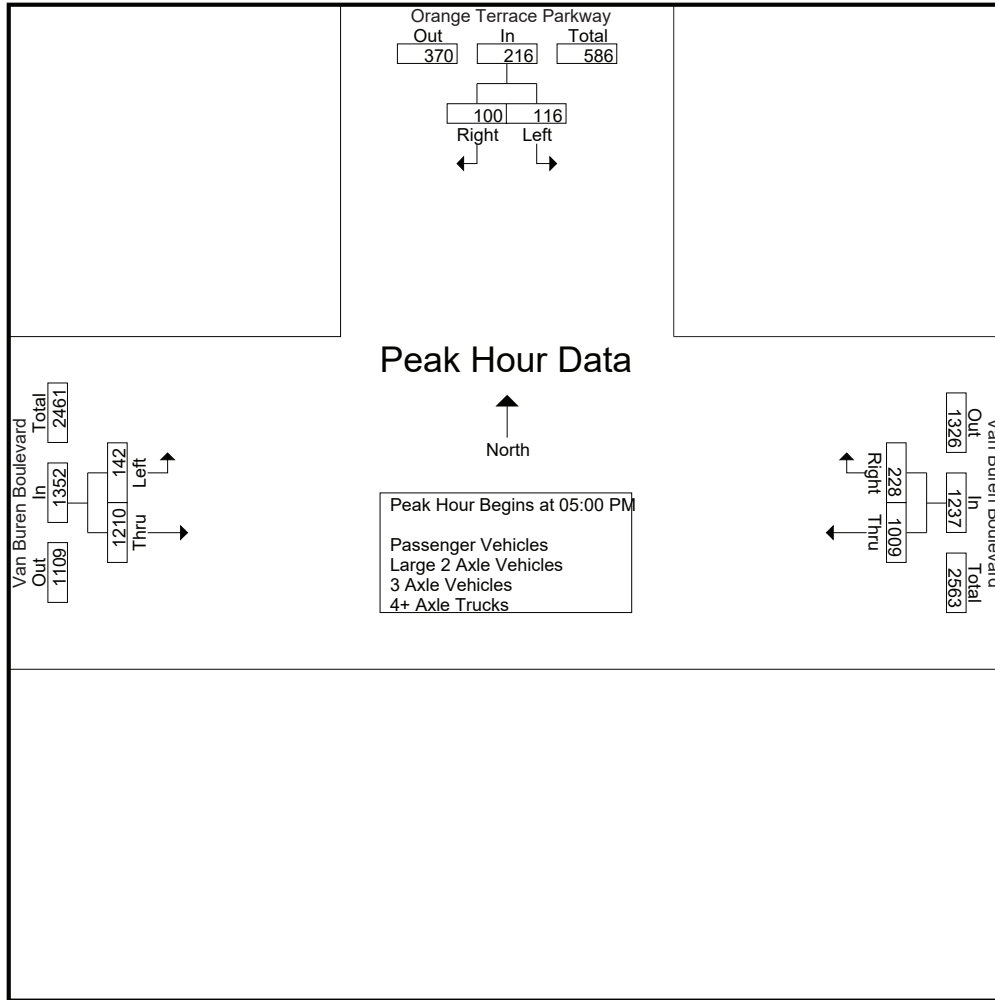

Peak Hour Analysis From 04:00 PM to 05:45 PM - Peak 1 of 1
 Peak Hour for Each Approach Begins at:

	04:30 PM			05:00 PM					
+0 mins.	25	14	39	247	65	312	35	282	317
+15 mins.	34	27	61	254	62	316	35	304	339
+30 mins.	27	33	60	250	52	302	32	343	375
+45 mins.	30	26	56	292	53	345	40	281	321
Total Volume	116	100	216	1043	232	1275	142	1210	1352
% App. Total	53.7	46.3		81.8	18.2		10.5	89.5	
PHF	.853	.758	.885	.893	.892	.924	.888	.882	.901

City of Riverside
 N/S: Orange Terrace Parkway
 E/W: Van Buren Boulevard
 Weather: Clear

File Name : 21_RIV_Orange Terrace_Van Buren PM
 Site Code : 05119542
 Start Date : 8/20/2019
 Page No : 1

Groups Printed- Passenger Vehicles

Start Time	Orange Terrace Parkway Southbound				Van Buren Boulevard Westbound				Van Buren Boulevard Eastbound				Exclu. Total	Inclu. Total	Int. Total
	Left	Right	RTOR	App. Total	Thru	Right	RTOR	App. Total	Left	Thru	RTOR	App. Total			
04:00 PM	39	25	21	64	222	32	8	254	30	291	0	321	29	639	668
04:15 PM	28	20	16	48	232	45	7	277	30	266	0	296	23	621	644
04:30 PM	22	21	15	43	243	64	10	307	27	306	0	333	25	683	708
04:45 PM	27	21	16	48	250	59	4	309	32	233	0	265	20	622	642
Total	116	87	68	203	947	200	29	1147	119	1096	0	1215	97	2565	2662
05:00 PM	24	14	10	38	241	50	6	291	35	269	0	304	16	633	649
05:15 PM	33	27	23	60	289	52	10	341	35	296	0	331	33	732	765
05:30 PM	27	32	27	59	231	58	6	289	32	336	0	368	33	716	749
05:45 PM	29	26	21	55	226	63	8	289	40	276	0	316	29	660	689
Total	113	99	81	212	987	223	30	1210	142	1177	0	1319	111	2741	2852
Grand Total	229	186	149	415	1934	423	59	2357	261	2273	0	2534	208	5306	5514
Apprch %	55.2	44.8			82.1	17.9			10.3	89.7					
Total %	4.3	3.5		7.8	36.4	8		44.4	4.9	42.8		47.8	3.8	96.2	

Start Time	Orange Terrace Parkway Southbound			Van Buren Boulevard Westbound			Van Buren Boulevard Eastbound			Int. Total
	Left	Right	App. Total	Thru	Right	App. Total	Left	Thru	App. Total	
Peak Hour Analysis From 05:00 PM to 05:45 PM - Peak 1 of 1										
Peak Hour for Entire Intersection Begins at 05:00 PM										
05:00 PM	24	14	38	241	50	291	35	269	304	633
05:15 PM	33	27	60	289	52	341	35	296	331	732
05:30 PM	27	32	59	231	58	289	32	336	368	716
05:45 PM	29	26	55	226	63	289	40	276	316	660
Total Volume	113	99	212	987	223	1210	142	1177	1319	2741
% App. Total	53.3	46.7		81.6	18.4		10.8	89.2		
PHF	.856	.773	.883	.854	.885	.887	.888	.876	.896	.936

City of Riverside
 N/S: Orange Terrace Parkway
 E/W: Van Buren Boulevard
 Weather: Clear

File Name : 21_RIV_Orange Terrace_Van Buren PM
 Site Code : 05119542
 Start Date : 8/20/2019
 Page No : 2

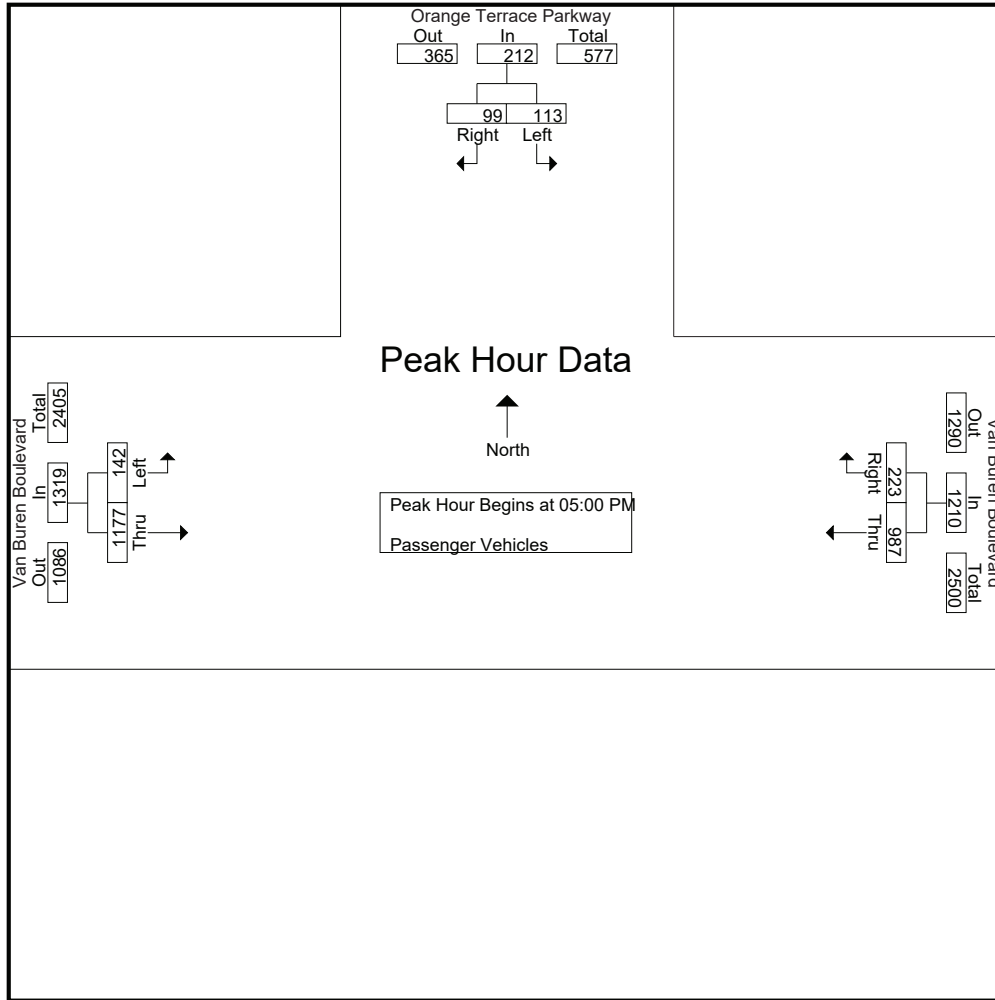

Peak Hour Analysis From 05:00 PM to 05:45 PM - Peak 1 of 1
 Peak Hour for Each Approach Begins at:

	05:00 PM			05:00 PM			05:00 PM		
+0 mins.	24	14	38	241	50	291	35	269	304
+15 mins.	33	27	60	289	52	341	35	296	331
+30 mins.	27	32	59	231	58	289	32	336	368
+45 mins.	29	26	55	226	63	289	40	276	316
Total Volume	113	99	212	987	223	1210	142	1177	1319
% App. Total	53.3	46.7		81.6	18.4		10.8	89.2	
PHF	.856	.773	.883	.854	.885	.887	.888	.876	.896

City of Riverside
 N/S: Orange Terrace Parkway
 E/W: Van Buren Boulevard
 Weather: Clear

File Name : 21_RIV_Orange Terrace_Van Buren PM
 Site Code : 05119542
 Start Date : 8/20/2019
 Page No : 1

Groups Printed- Large 2 Axle Vehicles

Start Time	Orange Terrace Parkway Southbound				Van Buren Boulevard Westbound				Van Buren Boulevard Eastbound				Exclu. Total	Inclu. Total	Int. Total
	Left	Right	RTOR	App. Total	Thru	Right	RTOR	App. Total	Left	Thru	RTOR	App. Total			
04:00 PM	0	0	0	0	3	1	0	4	1	6	0	7	0	11	11
04:15 PM	1	0	0	1	3	3	1	6	0	4	0	4	1	11	12
04:30 PM	0	1	1	1	3	1	1	4	1	3	0	4	2	9	11
04:45 PM	1	2	1	3	2	3	1	5	0	8	0	8	2	16	18
Total	2	3	2	5	11	8	3	19	2	21	0	23	5	47	52
05:00 PM	1	0	0	1	5	2	0	7	0	9	0	9	0	17	17
05:15 PM	1	0	0	1	2	1	1	3	0	8	0	8	1	12	13
05:30 PM	0	1	1	1	2	1	0	3	0	7	0	7	1	11	12
05:45 PM	1	0	0	1	3	1	0	4	0	3	0	3	0	8	8
Total	3	1	1	4	12	5	1	17	0	27	0	27	2	48	50
Grand Total	5	4	3	9	23	13	4	36	2	48	0	50	7	95	102
Apprch %	55.6	44.4			63.9	36.1			4	96					
Total %	5.3	4.2		9.5	24.2	13.7		37.9	2.1	50.5		52.6	6.9	93.1	

Start Time	Orange Terrace Parkway Southbound			Van Buren Boulevard Westbound			Van Buren Boulevard Eastbound			Int. Total
	Left	Right	App. Total	Thru	Right	App. Total	Left	Thru	App. Total	
Peak Hour Analysis From 05:00 PM to 05:45 PM - Peak 1 of 1										
Peak Hour for Entire Intersection Begins at 05:00 PM										
05:00 PM	1	0	1	5	2	7	0	9	9	17
05:15 PM	1	0	1	2	1	3	0	8	8	12
05:30 PM	0	1	1	2	1	3	0	7	7	11
05:45 PM	1	0	1	3	1	4	0	3	3	8
Total Volume	3	1	4	12	5	17	0	27	27	48
% App. Total	75	25		70.6	29.4		0	100		
PHF	.750	.250	1.00	.600	.625	.607	.000	.750	.750	.706

City of Riverside
 N/S: Orange Terrace Parkway
 E/W: Van Buren Boulevard
 Weather: Clear

File Name : 21_RIV_Orange Terrace_Van Buren PM
 Site Code : 05119542
 Start Date : 8/20/2019
 Page No : 2

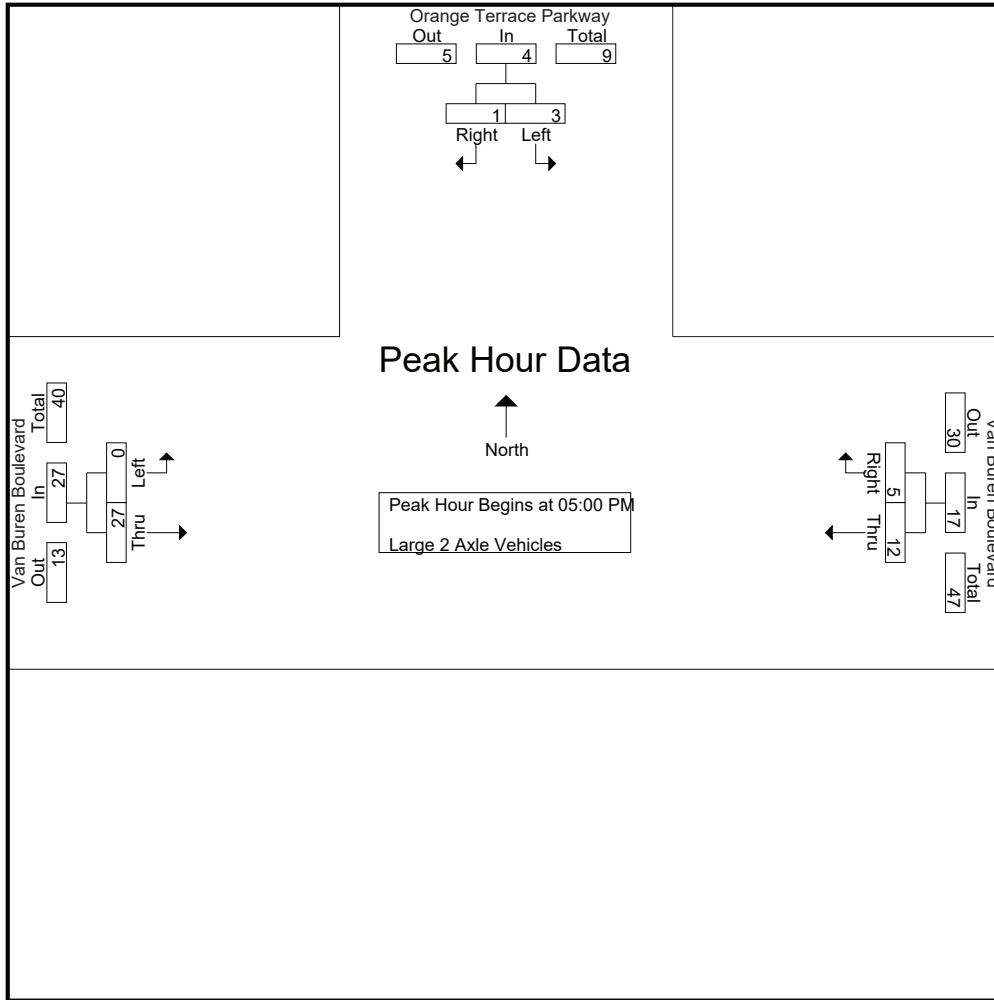

Peak Hour Analysis From 05:00 PM to 05:45 PM - Peak 1 of 1
 Peak Hour for Each Approach Begins at:

	05:00 PM			05:00 PM			05:00 PM		
+0 mins.	1	0	1	5	2	7	0	9	9
+15 mins.	1	0	1	2	1	3	0	8	8
+30 mins.	0	1	1	2	1	3	0	7	7
+45 mins.	1	0	1	3	1	4	0	3	3
Total Volume	3	1	4	12	5	17	0	27	27
% App. Total	75	25		70.6	29.4		0	100	
PHF	.750	.250	1.000	.600	.625	.607	.000	.750	.750

City of Riverside
 N/S: Orange Terrace Parkway
 E/W: Van Buren Boulevard
 Weather: Clear

File Name : 21_RIV_Orange Terrace_Van Buren PM
 Site Code : 05119542
 Start Date : 8/20/2019
 Page No : 1

Groups Printed- 3 Axle Vehicles

Start Time	Orange Terrace Parkway Southbound				Van Buren Boulevard Westbound				Van Buren Boulevard Eastbound				Exclu. Total	Inclu. Total	Int. Total
	Left	Right	RTOR	App. Total	Thru	Right	RTOR	App. Total	Left	Thru	RTOR	App. Total			
04:00 PM	0	0	0	0	2	0	0	2	0	0	0	0	0	2	2
04:15 PM	0	0	0	0	0	0	0	0	0	2	0	2	0	2	2
04:30 PM	0	0	0	0	0	0	0	0	0	1	0	1	0	1	1
04:45 PM	0	0	0	0	1	0	0	1	0	1	0	1	0	2	2
Total	0	0	0	0	3	0	0	3	0	4	0	4	0	7	7
05:00 PM	0	0	0	0	0	0	0	0	0	1	0	1	0	1	1
05:15 PM	0	0	0	0	0	0	0	0	0	0	0	0	0	0	0
05:30 PM	0	0	0	0	0	0	0	0	0	0	0	0	0	0	0
05:45 PM	0	0	0	0	0	0	0	0	0	1	0	1	0	1	1
Total	0	0	0	0	0	0	0	0	0	2	0	2	0	2	2
Grand Total	0	0	0	0	3	0	0	3	0	6	0	6	0	9	9
Apprch %	0	0			100	0			0	100					
Total %	0	0			33.3	0		33.3	0	66.7		66.7	0	100	

Start Time	Orange Terrace Parkway Southbound			Van Buren Boulevard Westbound			Van Buren Boulevard Eastbound			Int. Total
	Left	Right	App. Total	Thru	Right	App. Total	Left	Thru	App. Total	
Peak Hour Analysis From 05:00 PM to 05:45 PM - Peak 1 of 1										
Peak Hour for Entire Intersection Begins at 05:00 PM										
05:00 PM	0	0	0	0	0	0	0	1	1	1
05:15 PM	0	0	0	0	0	0	0	0	0	0
05:30 PM	0	0	0	0	0	0	0	0	0	0
05:45 PM	0	0	0	0	0	0	0	1	1	1
Total Volume	0	0	0	0	0	0	0	2	2	2
% App. Total	0	0			0	0		100		
PHF	.000	.000	.000	.000	.000	.000	.000	.500	.500	.500

City of Riverside
 N/S: Orange Terrace Parkway
 E/W: Van Buren Boulevard
 Weather: Clear

File Name : 21_RIV_Orange Terrace_Van Buren PM
 Site Code : 05119542
 Start Date : 8/20/2019
 Page No : 2

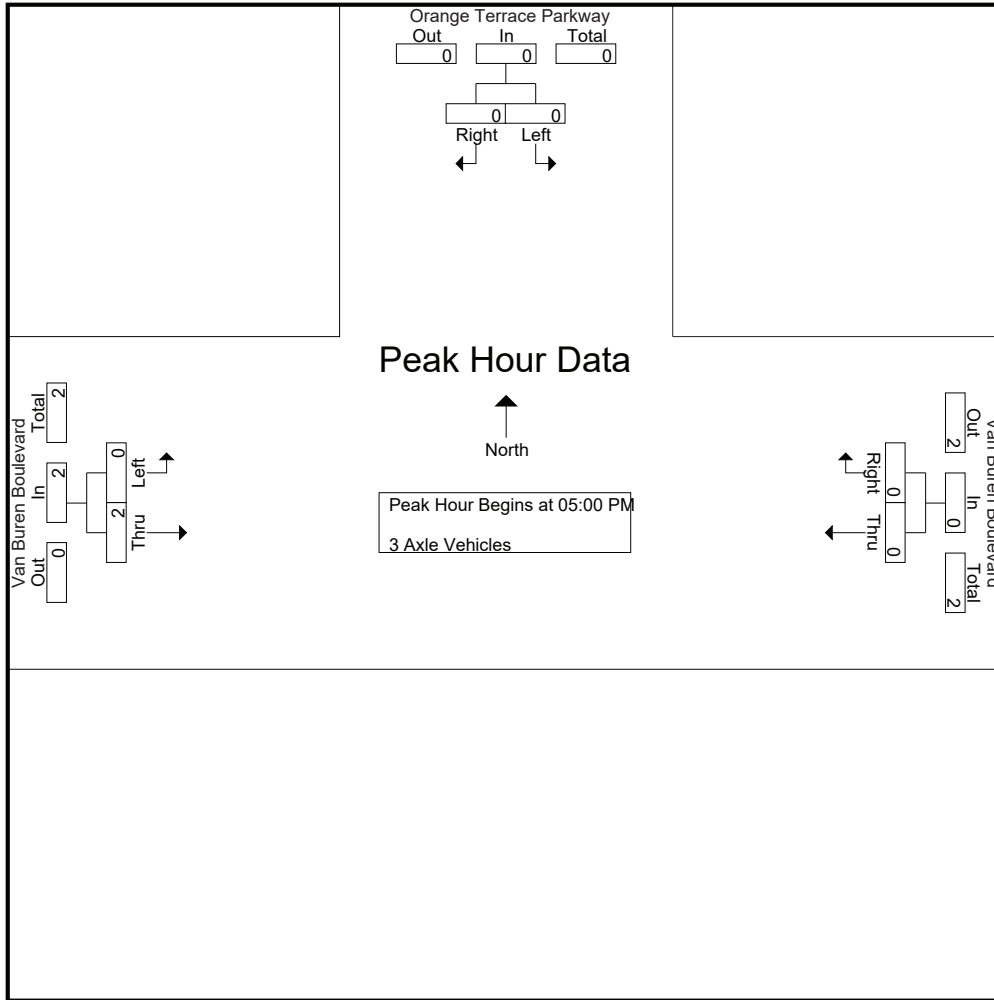

Peak Hour Analysis From 05:00 PM to 05:45 PM - Peak 1 of 1
 Peak Hour for Each Approach Begins at:

	05:00 PM			05:00 PM			05:00 PM		
+0 mins.	0	0	0	0	0	0	0	1	1
+15 mins.	0	0	0	0	0	0	0	0	0
+30 mins.	0	0	0	0	0	0	0	0	0
+45 mins.	0	0	0	0	0	0	0	1	1
Total Volume	0	0	0	0	0	0	0	2	2
% App. Total	0	0	0	0	0	0	0	100	100
PHF	.000	.000	.000	.000	.000	.000	.000	.500	.500

City of Riverside
 N/S: Orange Terrace Parkway
 E/W: Van Buren Boulevard
 Weather: Clear

File Name : 21_RIV_Orange Terrace_Van Buren PM
 Site Code : 05119542
 Start Date : 8/20/2019
 Page No : 1

Groups Printed- 4+ Axle Trucks

Start Time	Orange Terrace Parkway Southbound				Van Buren Boulevard Westbound				Van Buren Boulevard Eastbound				Exclu. Total	Inclu. Total	Int. Total
	Left	Right	RTOR	App. Total	Thru	Right	RTOR	App. Total	Left	Thru	RTOR	App. Total			
04:00 PM	0	0	0	0	3	0	0	3	0	5	0	5	0	8	8
04:15 PM	0	0	0	0	1	0	0	1	0	1	0	1	0	2	2
04:30 PM	0	0	0	0	1	0	0	1	0	3	0	3	0	4	4
04:45 PM	0	3	2	3	1	0	0	1	0	3	0	3	2	7	9
Total	0	3	2	3	6	0	0	6	0	12	0	12	2	21	23
05:00 PM	0	0	0	0	4	0	0	4	0	3	0	3	0	7	7
05:15 PM	0	0	0	0	1	0	0	1	0	0	0	0	0	1	1
05:30 PM	0	0	0	0	3	0	0	3	0	0	0	0	0	3	3
05:45 PM	0	0	0	0	2	0	0	2	0	1	0	1	0	3	3
Total	0	0	0	0	10	0	0	10	0	4	0	4	0	14	14
Grand Total	0	3	2	3	16	0	0	16	0	16	0	16	2	35	37
Apprch %	0	100			100	0			0	100					
Total %	0	8.6		8.6	45.7	0		45.7	0	45.7		45.7	5.4	94.6	

Start Time	Orange Terrace Parkway Southbound			Van Buren Boulevard Westbound			Van Buren Boulevard Eastbound			Int. Total
	Left	Right	App. Total	Thru	Right	App. Total	Left	Thru	App. Total	
Peak Hour Analysis From 05:00 PM to 05:45 PM - Peak 1 of 1										
Peak Hour for Entire Intersection Begins at 05:00 PM										
05:00 PM	0	0	0	4	0	4	0	3	3	7
05:15 PM	0	0	0	1	0	1	0	0	0	1
05:30 PM	0	0	0	3	0	3	0	0	0	3
05:45 PM	0	0	0	2	0	2	0	1	1	3
Total Volume	0	0	0	10	0	10	0	4	4	14
% App. Total	0	0		100	0		0	100		
PHF	.000	.000	.000	.625	.000	.625	.000	.333	.333	.500

City of Riverside
 N/S: Orange Terrace Parkway
 E/W: Van Buren Boulevard
 Weather: Clear

File Name : 21_RIV_Orange Terrace_Van Buren PM
 Site Code : 05119542
 Start Date : 8/20/2019
 Page No : 2

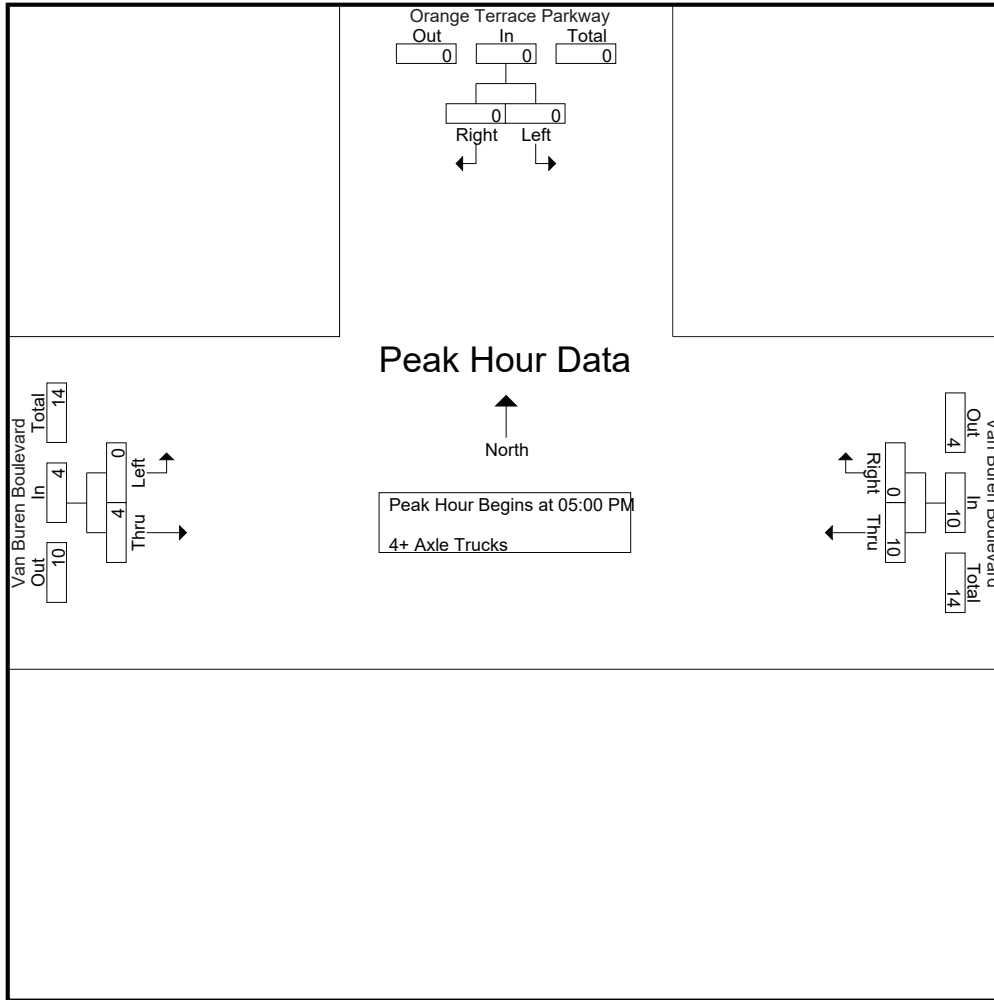

Peak Hour Analysis From 05:00 PM to 05:45 PM - Peak 1 of 1
 Peak Hour for Each Approach Begins at:

	05:00 PM			05:00 PM			05:00 PM		
+0 mins.	0	0	0	4	0	4	0	3	3
+15 mins.	0	0	0	1	0	1	0	0	0
+30 mins.	0	0	0	3	0	3	0	0	0
+45 mins.	0	0	0	2	0	2	0	1	1
Total Volume	0	0	0	10	0	10	0	4	4
% App. Total	0	0	0	100	0	100	0	100	100
PHF	.000	.000	.000	.625	.000	.625	.000	.333	.333

Location: Riverside
 N/S: Orange Terrace Parkway
 E/W: Van Buren Boulevard



Date: 8/20/2019
 Day: Tuesday

PEDESTRIANS

	North Leg Orange Terrace Parkway Pedestrians	East Leg Van Buren Boulevard Pedestrians	South Leg Dead End Pedestrians	West Leg Van Buren Boulevard Pedestrians	
7:00 AM	0	0	0	0	0
7:15 AM	1	0	0	0	1
7:30 AM	0	0	0	0	0
7:45 AM	0	0	0	0	0
8:00 AM	0	0	0	0	0
8:15 AM	0	0	0	0	0
8:30 AM	0	0	0	0	0
8:45 AM	0	0	0	0	0
TOTAL VOLUMES:	1	0	0	0	1

	North Leg Orange Terrace Parkway Pedestrians	East Leg Van Buren Boulevard Pedestrians	South Leg Dead End Pedestrians	West Leg Van Buren Boulevard Pedestrians	
4:00 PM	0	0	0	0	0
4:15 PM	0	0	0	0	0
4:30 PM	0	0	0	0	0
4:45 PM	0	0	0	0	0
5:00 PM	0	0	0	0	0
5:15 PM	0	0	0	0	0
5:30 PM	0	0	0	0	0
5:45 PM	0	0	0	0	0
TOTAL VOLUMES:	0	0	0	0	0

Location: Riverside
 N/S: Orange Terrace Parkway
 E/W: Van Buren Boulevard



Date: 8/20/2019
 Day: Tuesday

BICYCLES

	Southbound Orange Terrace Parkway			Westbound Van Buren Boulevard			Northbound Dead End			Eastbound Van Buren Boulevard			
	Left	Thru	Right	Left	Thru	Right	Left	Thru	Right	Left	Thru	Right	
7:00 AM	0	0	0	0	0	0	0	0	0	0	0	0	0
7:15 AM	0	0	0	0	0	0	0	0	0	0	0	0	0
7:30 AM	0	0	0	0	0	0	0	0	0	0	0	0	0
7:45 AM	0	0	1	0	0	0	0	0	0	0	0	0	1
8:00 AM	0	0	0	0	0	0	0	0	0	0	0	0	0
8:15 AM	0	0	0	0	0	0	0	0	0	0	0	0	0
8:30 AM	0	0	0	0	0	0	0	0	0	0	0	0	0
8:45 AM	0	0	0	0	0	0	0	0	0	0	0	0	0
TOTAL VOLUMES:	0	0	1	0	0	0	0	0	0	0	0	0	1

	Southbound Orange Terrace Parkway			Westbound Van Buren Boulevard			Northbound Dead End			Eastbound Van Buren Boulevard			
	Left	Thru	Right	Left	Thru	Right	Left	Thru	Right	Left	Thru	Right	
4:00 PM	0	0	0	0	0	0	0	0	0	0	0	0	0
4:15 PM	0	0	0	0	0	0	0	0	0	0	0	0	0
4:30 PM	0	0	0	0	0	0	0	0	0	0	0	0	0
4:45 PM	0	0	0	0	0	0	0	0	0	0	0	0	0
5:00 PM	0	0	0	0	0	0	0	0	0	0	0	0	0
5:15 PM	0	0	0	0	0	0	0	0	0	0	0	0	0
5:30 PM	0	0	0	0	0	0	0	0	0	0	0	0	0
5:45 PM	0	0	0	0	0	0	0	0	0	0	0	0	0
TOTAL VOLUMES:	0	0	0	0	0	0	0	0	0	0	0	0	0

Counts Unlimited
 PO Box 1178
 Corona, CA 92878
 (951) 268-6268

City of Riverside
 N/S: San Gorgonio Drive
 EW: Alessandro Boulevard
 Weather: Clear

File Name : 22_RIV_San Gorgonio_Alessandro AM
 Site Code : 05119542
 Start Date : 8/20/2019
 Page No : 1

Groups Printed- Passenger Vehicles - Large 2 Axle Vehicles - 3 Axle Vehicles - 4+ Axle Trucks

Start Time	San Gorgonio Drive Southbound											Alessandro Boulevard Westbound											San Gorgonio Drive Northbound											Alessandro Boulevard Eastbound																				
	Left			Thru			Right			RTOR			App. Total			Left			Thru			Right			RTOR			App. Total			Left			Thru			Right			RTOR			App. Total			Exclu. Total			Inclu. Total			Int. Total		
	Left	Thru	Right	Left	Thru	Right	Left	Thru	Right	Left	Thru	Right	Left	Thru	Right	Left	Thru	Right	Left	Thru	Right	Left	Thru	Right	Left	Thru	Right	Left	Thru	Right	Left	Thru	Right	Left	Thru	Right	Left	Thru	Right	Left	Thru	Right	Left	Thru	Right	Left	Thru	Right	Left	Thru	Right			
07:00 AM	5	1	3	0	3	0	699	12	0	711	0	0	2	0	2	0	0	0	2	0	0	0	257	1	0	258	0	0	980	0	0	257	1	0	258	0	0	980	0	0	257	1	0	258	0	0	980	0						
07:15 AM	8	2	2	0	12	0	625	7	1	632	0	0	1	1	1	0	273	1	0	274	0	0	273	1	0	274	2	2	919	0	0	273	1	0	274	0	0	919	0	0	273	1	0	274	0	0	919	0						
07:30 AM	2	2	1	0	5	0	620	10	1	630	0	0	1	0	1	0	269	0	0	272	0	3	269	0	0	272	1	1	908	0	0	269	0	0	272	1	0	908	0	0	269	0	0	908	0									
07:45 AM	8	0	3	0	11	0	553	10	1	563	0	0	1	1	1	0	263	1	0	269	0	5	263	1	0	269	2	2	844	0	0	263	1	0	269	2	0	844	0	0	263	1	0	844	0									
Total	23	5	9	0	37	0	2497	39	3	2536	0	0	5	2	5	8	1062	3	0	1073	0	0	1062	3	0	1073	5	5	3651	0	0	1062	3	0	1073	5	0	3651	0	0	1062	3	0	3651	0									
08:00 AM	4	0	3	0	7	0	503	9	0	512	0	0	0	0	0	0	262	0	0	263	0	1	262	0	0	263	0	0	782	0	0	262	0	0	263	0	0	782	0	0	262	0	0	782	0									
08:15 AM	3	0	2	0	5	0	531	6	0	537	0	0	1	0	1	0	253	0	0	254	0	1	253	0	0	254	0	0	797	0	0	253	0	0	254	0	0	797	0	0	253	0	0	797	0									
08:30 AM	6	0	4	0	10	0	570	8	0	578	0	0	0	0	0	0	243	0	0	245	0	2	243	0	0	245	0	0	833	0	0	243	0	0	245	0	0	833	0	0	243	0	0	833	0									
08:45 AM	5	0	7	0	12	0	551	9	1	560	0	0	0	0	0	6	220	0	0	226	0	6	220	0	0	226	1	1	798	0	0	220	0	0	226	1	0	798	0	0	220	0	0	798	0									
Total	18	0	16	0	34	0	2155	32	1	2187	0	0	1	0	1	10	978	0	0	988	0	0	978	0	0	988	1	1	3210	0	0	978	0	0	988	1	0	3210	0	0	978	0	0	3210	0									
Grand Total	41	5	25	0	71	0	4652	71	4	4723	0	0	6	2	6	18	2040	3	0	2061	0	0	2040	3	0	2061	6	6	6861	0	0	2040	3	0	2061	6	0	6861	0	0	2040	3	0	6861	0									
Approch %	57.7	7	35.2				98.5	1.5					100			0.9	99	0.1				0.3	29.7	0				0.1	99.9																									
Total %	0.6	0.1	0.4				67.8	1		68.8	0	0	0.1			0.3	29.7	0				0.3	29.7	0				0.1	99.9																									
% Passenger Vehicles	33	3	23	0	59	0	4554	61	75	4618	0	0	3	0	3	17	1983	3	0	2003	0	17	1983	3	0	2003	0	0	6683	0	0	1983	3	0	2003	0	0	6683	0	0	1983	3	0	6683	0									
% Large 2 Axle Vehicles	80.5	60	92	0	83.1	0	97.9	85.9	75	97.7	0	0	50	0	37.5	94.4	97.2	100	0	97.2	0	94.4	97.2	100	0	97.2	0	0	97.3	0	0	97.2	100	0	97.2	0	0	97.3	0	0	97.2	100	0	97.3	0									
% Large 3 Axle Vehicles	4	1	2	0	7	0	80	4	0	84	0	0	2	0	3	1	42	0	0	43	0	1	42	0	0	43	0	0	137	0	0	42	0	0	43	0	0	137	0	0	42	0	0	137	0									
% Large 4+ Axle Trucks	9.8	20	8	0	9.9	0	1.7	5.6	0	1.8	0	0	33.3	50	37.5	5.6	2.1	0	0	2.1	0	5.6	2.1	0	0	2.1	0	0	2	0	0	2.1	0	0	2.1	0	0	2	0	0	2	0												
% 3 Axle Vehicles	0	0	0	0	0	0	8	0	0	8	0	0	0	0	0	0	6	0	0	6	0	0	6	0	0	6	0	0	14	0	0	6	0	0	6	0	0	14	0	0	6	0												
% 4+ Axle Trucks	4	1	0	0	0	0	0.2	0	0	0.2	0	0	0	0	0	0	0.3	0	0	0.3	0	0	0.3	0	0	0.3	0	0	0.2	0	0	0.3	0	0	0.3	0	0	0.2	0	0	0.3	0												
% 4+ Axle Trucks	9.8	20	8	0	9.9	0	0.2	8.5	25	0.4	0	0	16.7	50	25	0	0.4	0	0	0.4	0	0	0.4	0	0	0.4	0	0	0.5	0	0	0.4	0	0	0.4	0	0	0.5	0	0	0.4	0												

Start Time	San Gorgonio Drive Southbound											Alessandro Boulevard Westbound											San Gorgonio Drive Northbound											Alessandro Boulevard Eastbound																				
	Left			Thru			Right			RTOR			App. Total			Left			Thru			Right			RTOR			App. Total			Left			Thru			Right			RTOR			App. Total			Exclu. Total			Inclu. Total			Int. Total		
	Left	Thru	Right	Left	Thru	Right	Left	Thru	Right	Left	Thru	Right	Left	Thru	Right	Left	Thru	Right	Left	Thru	Right	Left	Thru	Right	Left	Thru	Right	Left	Thru	Right	Left	Thru	Right	Left	Thru	Right	Left	Thru	Right	Left	Thru	Right	Left	Thru	Right	Left	Thru	Right	Left	Thru	Right	Left	Thru	Right
07:00 AM	5	1	3	0	3	0	699	12	0	711	0	0	2	0	2	0	257	1	0	258	0	0	257	1	0	258	0	0	980	0	0	257	1	0	258	0	0	980	0	0	257	1	0	980	0									
07:15 AM	8	2	2	0	12	0	625	7	1	632	0	0	1	1	1	0	273	1	0	274	0	0	273	1	0	274	2	2	919	0	0	273	1	0	274	0	0	919	0	0	273	1	0	919	0									
07:30 AM	2	2	1	0	5	0	620	10	1	630	0	0	1	0	1	0	269	0	0	272	0	3	269	0	0	272	1	1	908	0	0	269	0	0	272	1	0	908	0	0	269	0	0	908	0									
07:45 AM	8	0	3	0	11	0	553	10	1	563	0	0	1	1	1	0	263	1	0	269	0	5	263	1	0	269	2	2	844	0	0	263	1	0	269	2	0	844	0	0	263	1	0	844	0									
Total	23	5	9	0	37	0	2497	39	3	2536	0	0	5	2	5	8	1062	3	0	1073	0	0	1062	3	0	1073	5	5	3651	0	0	1062	3	0	1073	5	0	3651	0	0	1062	3	0	3651	0									
08:00 AM	4	0	3	0	7	0	503	9	0	512	0	0	0	0	0	0	262	0	0	263	0	1	262	0	0	263	0	0	782	0	0	262	0	0	263	0	0	782	0	0	262	0	0	782	0									
08:15 AM	3	0	2	0	5	0	531	6	0	537	0	0	1	0	1	0	253	0	0	254	0	1	253	0	0	254	0	0	797	0	0	253	0	0	254	0	0	797	0	0	253	0	0	797	0									
08:30 AM	6	0	4	0	10	0	570	8	0	578	0	0	0	0	0	0	243	0	0	245	0	2	243	0	0	245	0	0	833	0	0	243	0	0	245	0	0	833	0	0	243	0	0	833	0									
08:45 AM	5	0	7	0	12	0	551	9	1	560	0	0	0	0	0	6	220	0	0	226	0	6	220	0	0	226	1	1	798	0	0	220	0	0	226	1	0	798	0	0	220	0	0	798	0									
Total	18	0	16	0	34	0	2155	32	1	2187	0	0	1	0	1	10	978	0	0	988	0	0	978	0	0	988	1	1	3210	0	0	978	0	0	988	1	0	3210	0	0	978	0	0	3210	0									
Grand Total	41	5	25	0	71	0	4652	71	4	4723	0	0	6	2	6	18	2040	3	0	2061	0	0	2040	3	0	2061	6	6	6861	0	0	2040	3	0	2061	6	0	6861	0	0	2040	3	0	6861	0									
Approch %	57.7	7	35.2				98.5	1.5					100			0.9	99	0.1				0.3	29.7	0				0.1	99.9																									
Total %	0.6	0.1	0.4				67.8	1		68.8	0	0	0.1			0.3	29.7	0				0.3	29.7	0				0.1	99.9																									
% Passenger Vehicles	33	3																																																				

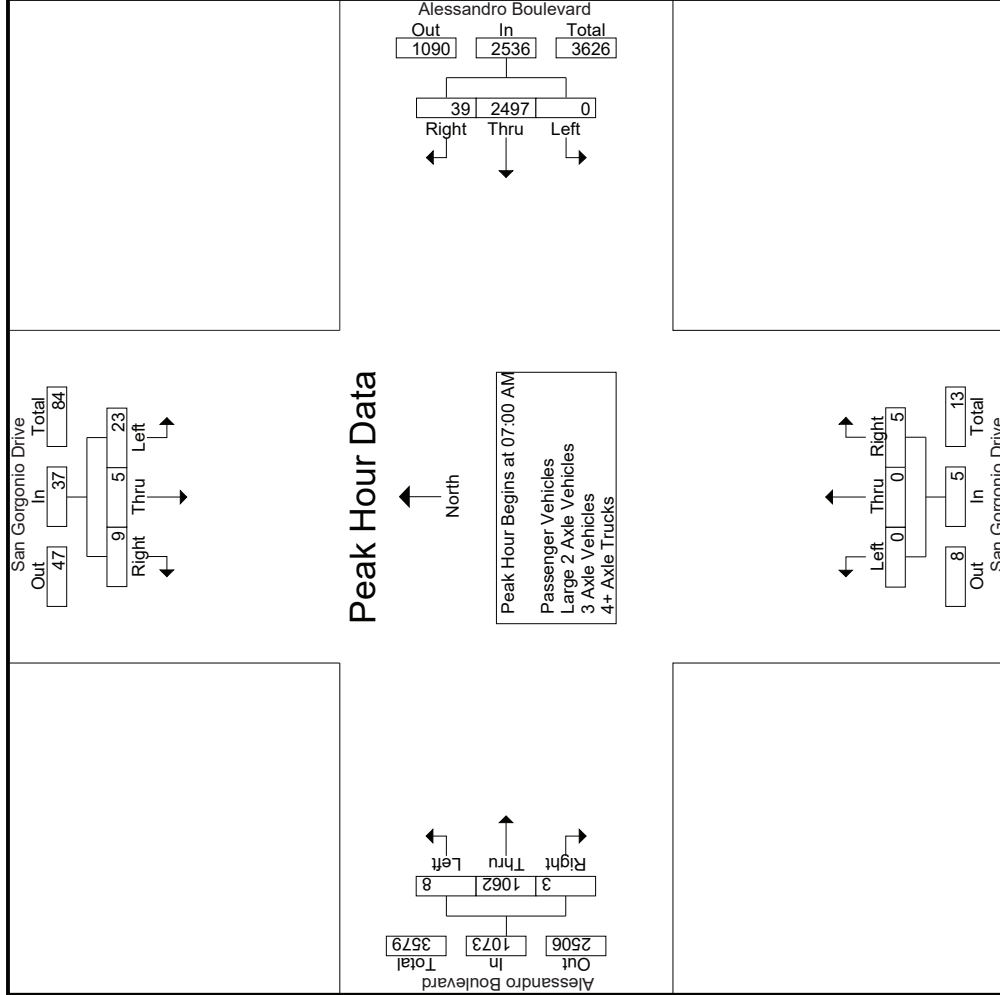

Counts Unlimited
 PO Box 1178
 Corona, CA 92878
 (951) 268-6268

City of Riverside
 N/S: San Gorgonio Drive
 E/W: Alessandro Boulevard
 Weather: Clear

File Name : 22_RIV_San Gorgonio_Alessandro AM
 Site Code : 05119542
 Start Date : 8/20/2019
 Page No : 3

Start Time	San Gorgonio Drive Southbound			Alessandro Boulevard Westbound			San Gorgonio Drive Northbound			Alessandro Boulevard Eastbound					
	Left	Thru	Right	Left	Thru	Right	Left	Thru	Right	Left	Thru	Right			
Peak Hour Analysis From 07:00 AM to 08:45 AM - Peak 1 of 1															
Peak Hour for Each Approach Begins at:															
+0 mins.	5	1	3	07:00 AM	0	12	711	07:00 AM	0	0	2	07:15 AM	0	273	1
+15 mins.	8	2	2	0	7	632	0	0	1	0	0	1	3	269	0
+30 mins.	2	2	1	0	10	630	0	0	1	0	0	1	5	263	1
+45 mins.	8	0	3	0	10	563	0	0	1	0	0	1	1	262	0
Total Volume	23	5	9	0	39	2536	0	0	5	0	0	5	9	1067	2
% App. Total	62.2	13.5	24.3	0	1.5	98.5	0	0	100	0	0	100	0.8	99	0.2
PHF	.719	.625	.750	.000	.813	.892	.000	.000	.625	.450	.977	.500	.984		

Counts Unlimited
 PO Box 1178
 Corona, CA 92878
 (951) 268-6268

File Name : 22_RIV_San Gorgonio_Alessandro AM
 Site Code : 05119542
 Start Date : 8/20/2019
 Page No : 1

City of Riverside
 N/S: San Gorgonio Drive
 E/W: Alessandro Boulevard
 Weather: Clear

Groups Printed- Passenger Vehicles

Start Time	San Gorgonio Drive Southbound						Alessandro Boulevard Westbound						San Gorgonio Drive Northbound						Alessandro Boulevard Eastbound									
	Left	Thru	Right	RTOR	App. Total		Left	Thru	Right	RTOR	App. Total		Left	Thru	Right	RTOR	App. Total		Left	Thru	Right	RTOR	App. Total		Exclu. Total	Inclu. Total	Int. Total	
07:00 AM	5	1	3	0	9	0	683	11	0	694	0	0	1	0	1	0	247	1	0	248	0	952	0	0	952	0	952	952
07:15 AM	4	1	2	0	7	0	616	5	1	621	0	0	0	0	0	0	261	1	0	262	1	890	1	0	891	1	890	891
07:30 AM	2	1	1	0	4	0	609	8	1	617	0	0	1	0	1	3	262	0	0	265	1	887	1	0	888	1	887	888
07:45 AM	8	0	2	0	10	0	542	8	1	550	0	0	0	0	0	4	261	1	0	266	1	826	1	0	827	1	826	827
Total	19	3	8	0	30	0	2450	32	3	2482	0	0	2	0	2	7	1031	3	0	1041	3	3555	3	0	3558	3	3555	3558
08:00 AM	2	0	2	0	4	0	494	9	0	503	0	0	0	0	0	1	254	0	0	255	0	762	0	0	762	0	762	762
08:15 AM	3	0	2	0	5	0	518	5	0	523	0	0	1	0	1	1	247	0	0	248	0	777	0	0	777	0	777	777
08:30 AM	5	0	4	0	9	0	554	8	0	562	0	0	0	0	0	2	239	0	0	241	0	812	0	0	812	0	812	812
08:45 AM	4	0	7	0	11	0	538	7	0	545	0	0	0	0	0	6	212	0	0	218	0	774	0	0	774	0	774	774
Total	14	0	15	0	29	0	2104	29	0	2133	0	0	1	0	1	10	952	0	0	962	0	3125	0	0	3125	0	3125	3125
Grand Total	33	3	23	0	59	0	4554	61	3	4615	0	0	3	0	3	17	1983	3	0	2003	3	6680	3	0	6683	3	6680	6683
Approch %	55.9	5.1	39			0	98.7	1.3			0	0	100			0.8	99	0.1			0	100	0			0	100	100
Total %	0.5	0	0.3		0.9	0	68.2	0.9		69.1	0	0	0		0	0.3	29.7	0		30	0	100	0			0	100	100

Start Time	San Gorgonio Drive Southbound						Alessandro Boulevard Westbound						San Gorgonio Drive Northbound						Alessandro Boulevard Eastbound									
	Left	Thru	Right	RTOR	App. Total		Left	Thru	Right	RTOR	App. Total		Left	Thru	Right	RTOR	App. Total		Left	Thru	Right	RTOR	App. Total		Exclu. Total	Inclu. Total	Int. Total	
07:00 AM	5	1	3	0	9	0	683	11	0	694	0	0	1	0	1	0	247	1	0	248	0	952	0	0	952	0	952	952
07:15 AM	4	1	2	0	7	0	616	5	1	621	0	0	0	0	0	0	261	1	0	262	1	890	1	0	891	1	890	891
07:30 AM	2	1	1	0	4	0	609	8	1	617	0	0	1	0	1	3	262	0	0	265	1	887	1	0	888	1	887	888
07:45 AM	8	0	2	0	10	0	542	8	1	550	0	0	0	0	0	4	261	1	0	266	1	826	1	0	827	1	826	827
Total	19	3	8	0	30	0	2450	32	3	2482	0	0	2	0	2	7	1031	3	0	1041	3	3555	3	0	3558	3	3555	3558
08:00 AM	2	0	2	0	4	0	494	9	0	503	0	0	0	0	0	1	254	0	0	255	0	762	0	0	762	0	762	762
08:15 AM	3	0	2	0	5	0	518	5	0	523	0	0	1	0	1	1	247	0	0	248	0	777	0	0	777	0	777	777
08:30 AM	5	0	4	0	9	0	554	8	0	562	0	0	0	0	0	2	239	0	0	241	0	812	0	0	812	0	812	812
08:45 AM	4	0	7	0	11	0	538	7	0	545	0	0	0	0	0	6	212	0	0	218	0	774	0	0	774	0	774	774
Total	14	0	15	0	29	0	2104	29	0	2133	0	0	1	0	1	10	952	0	0	962	0	3125	0	0	3125	0	3125	3125
Grand Total	33	3	23	0	59	0	4554	61	3	4615	0	0	3	0	3	17	1983	3	0	2003	3	6680	3	0	6683	3	6680	6683
Approch %	55.9	5.1	39			0	98.7	1.3			0	0	100			0.8	99	0.1			0	100	0			0	100	100
Total %	0.5	0	0.3		0.9	0	68.2	0.9		69.1	0	0	0		0	0.3	29.7	0		30	0	100	0			0	100	100

Peak Hour Analysis From 07:00 AM to 07:45 AM - Peak 1 of 1
 Peak Hour for Entire Intersection Begins at 07:00 AM

Start Time	San Gorgonio Drive Southbound						Alessandro Boulevard Westbound						San Gorgonio Drive Northbound						Alessandro Boulevard Eastbound									
	Left	Thru	Right	RTOR	App. Total		Left	Thru	Right	RTOR	App. Total		Left	Thru	Right	RTOR	App. Total		Left	Thru	Right	RTOR	App. Total		Exclu. Total	Inclu. Total	Int. Total	
07:00 AM	5	1	3	0	9	0	683	11	0	694	0	0	1	0	1	0	247	1	0	248	0	952	0	0	952	0	952	952
07:15 AM	4	1	2	0	7	0	616	5	1	621	0	0	0	0	0	0	261	1	0	262	1	890	1	0	891	1	890	891
07:30 AM	2	1	1	0	4	0	609	8	1	617	0	0	1	0	1	3	262	0	0	265	1	887	1	0	888	1	887	888
07:45 AM	8	0	2	0	10	0	542	8	1	550	0	0	0	0	0	4	261	1	0	266	1	826	1	0	827	1	826	827
Total	19	3	8	0	30	0	2450	32	3	2482	0	0	2	0	2	7	1031	3	0	1041	3	3555	3	0	3558	3	3555	3558
% App. Total	63.3	10	26.7			0	98.7	1.3			0	0	100			0.7	99	0.3			0.3	1041	0.3			0.3	3555	3555
PHF	.594	.750	.667		.750	.000	.897	.727		.894	.000	.000	.500		.500	.438	.984	.750		.978	.750	.978	.750		.978	.750	.978	.978

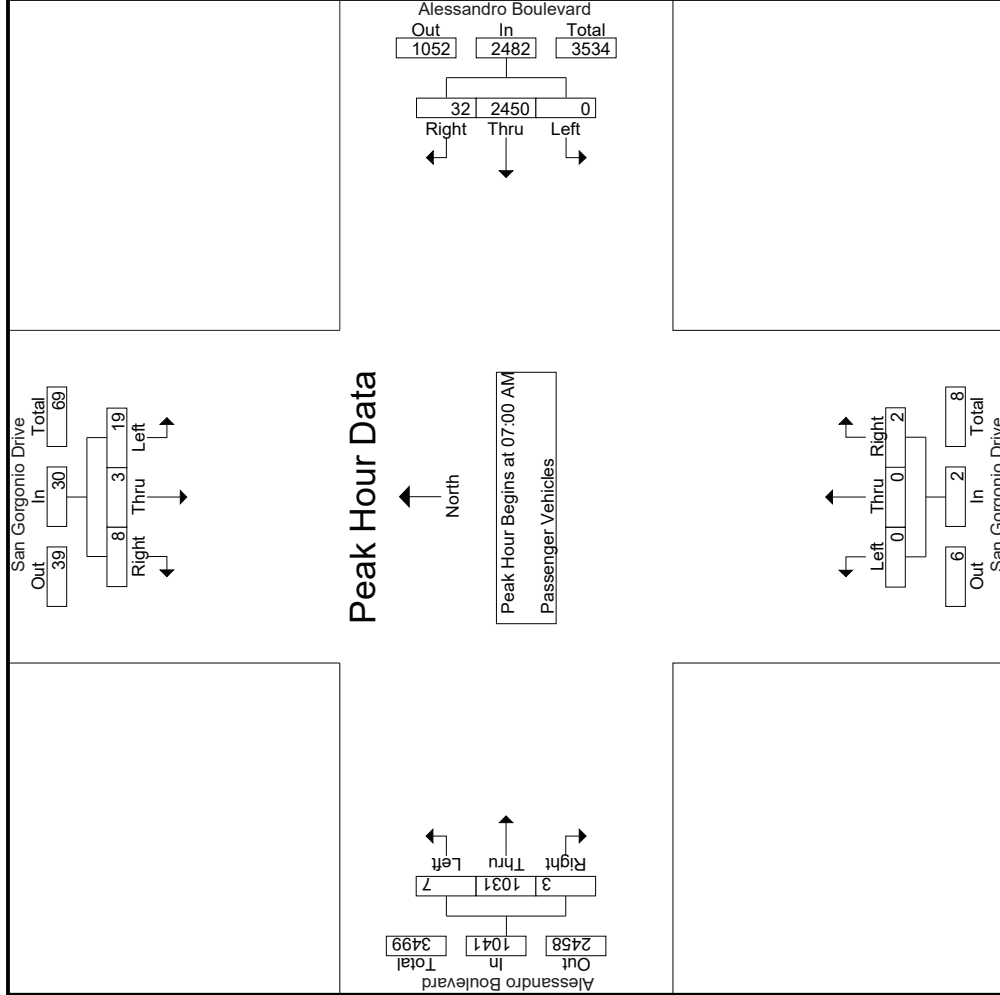

Counts Unlimited
 PO Box 1178
 Corona, CA 92878
 (951) 268-6268

City of Riverside
 N/S: San Gorgonio Drive
 E/W: Alessandro Boulevard
 Weather: Clear

File Name : 22_RIV_San Gorgonio_Alessandro AM
 Site Code : 05119542
 Start Date : 8/20/2019
 Page No : 3

Start Time	San Gorgonio Drive Southbound			Alessandro Boulevard Westbound			San Gorgonio Drive Northbound			Alessandro Boulevard Eastbound			
	Left	Thru	Right	Left	Thru	Right	Left	Thru	Right	Left	Thru	Right	
Peak Hour Analysis From 07:00 AM to 07:45 AM - Peak 1 of 1													
Peak Hour for Each Approach Begins at:													
	07:00 AM			07:00 AM			07:00 AM			07:00 AM			
+0 mins.	5	1	3	0	683	11	694	0	0	1	0	247	
+15 mins.	4	1	2	0	616	5	621	0	0	0	0	261	
+30 mins.	2	1	1	0	609	8	617	0	0	1	3	262	
+45 mins.	8	0	2	0	542	8	550	0	0	0	4	265	
Total Volume	19	3	8	0	2450	32	2482	0	0	2	7	1031	
% App. Total	63.3	10	26.7	0	98.7	1.3	98.7	0	0	100	0.7	99	
PHF	.594	.750	.667	.000	.897	.727	.894	.000	.000	.500	.438	.984	
												.750	
													.978

Groups Printed- Large 2 Axle Vehicles

Start Time	San Gorgonio Drive Southbound					Alessandro Boulevard Westbound					San Gorgonio Drive Northbound					Alessandro Boulevard Eastbound							
	Left	Thru	Right	RTOR	App. Total	Left	Thru	Right	RTOR	App. Total	Left	Thru	Right	RTOR	App. Total	Left	Thru	Right	RTOR	App. Total	Exclu. Total	Inclu. Total	Int. Total
07:00 AM	0	0	0	0	0	0	13	0	0	13	0	0	1	0	1	0	8	0	0	8	0	22	22
07:15 AM	1	1	0	0	2	0	5	1	0	6	0	0	1	1	1	0	9	0	0	9	1	18	19
07:30 AM	0	0	0	0	0	0	8	1	0	9	0	0	0	0	0	0	7	0	0	7	0	16	16
07:45 AM	0	0	1	0	1	0	11	1	0	12	0	0	0	0	0	1	0	0	0	1	0	14	14
Total	1	1	1	0	3	0	37	3	0	40	0	0	2	1	2	1	24	0	0	25	1	70	71
08:00 AM	2	0	1	0	3	0	6	0	0	6	0	0	0	0	0	0	7	0	0	7	0	16	16
08:15 AM	0	0	0	0	0	0	12	0	0	12	0	0	0	0	0	0	4	0	0	4	0	16	16
08:30 AM	1	0	0	0	1	0	15	0	0	15	0	0	0	0	0	0	2	0	0	2	0	18	18
08:45 AM	0	0	0	0	0	0	10	1	0	11	0	0	0	0	0	0	5	0	0	5	0	16	16
Total	3	0	1	0	4	0	43	1	0	44	0	0	0	0	0	0	18	0	0	18	0	66	66
Grand Total	4	1	2	0	7	0	80	4	0	84	0	0	2	1	2	1	42	0	0	43	1	136	137
Apprch %	57.1	14.3	28.6			0	95.2	4.8			0	0	100			2.3	97.7	0		31.6	0.7	99.3	
Total %	2.9	0.7	1.5		5.1	0	58.8	2.9		61.8	0	0	1.5		1.5	0.7	30.9	0					

Start Time	San Gorgonio Drive Southbound					Alessandro Boulevard Westbound					San Gorgonio Drive Northbound					Alessandro Boulevard Eastbound							
	Left	Thru	Right	RTOR	App. Total	Left	Thru	Right	RTOR	App. Total	Left	Thru	Right	RTOR	App. Total	Left	Thru	Right	RTOR	App. Total	Exclu. Total	Inclu. Total	Int. Total
07:00 AM	0	0	0	0	0	0	13	0	0	13	0	0	1	0	1	0	8	0	0	8	0	22	22
07:15 AM	1	1	0	0	2	0	5	1	0	6	0	0	1	1	1	0	9	0	0	9	1	18	19
07:30 AM	0	0	0	0	0	0	8	1	0	9	0	0	0	0	0	0	7	0	0	7	0	16	16
07:45 AM	0	0	1	0	1	0	11	1	0	12	0	0	0	0	0	1	0	0	0	1	0	14	14
Total Volume	1	1	1	0	3	0	37	3	0	40	0	0	2	1	2	1	24	0	0	25	1	70	70
% App. Total	33.3	33.3	33.3			0	92.5	7.5			0	0	100			4	96	0			0		
PHF	.250	.250	.250		.375	.000	.712	.750		.769	.000	.000	.500		.500	.250	.667	.000		.694	.000	.795	

Peak Hour Analysis From 07:00 AM to 07:45 AM - Peak 1 of 1
 Peak Hour for Entire Intersection Begins at 07:00 AM

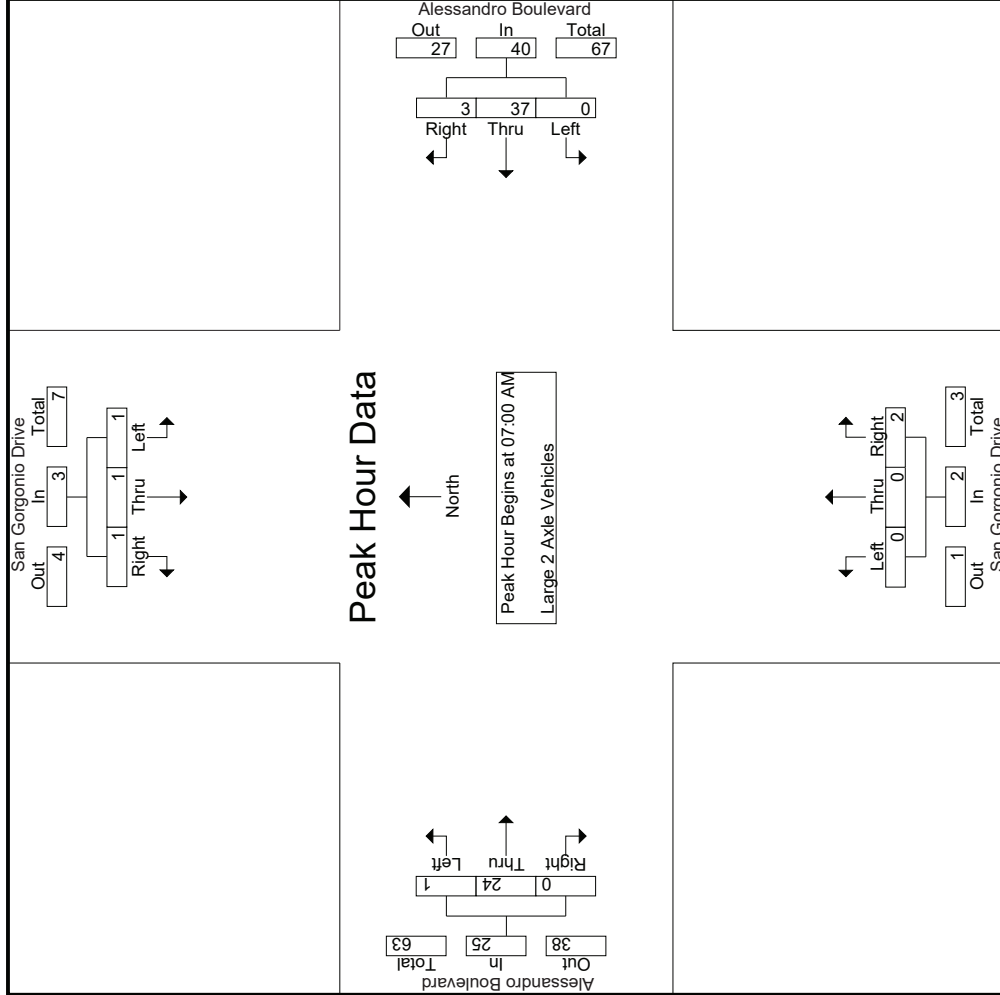

Counts Unlimited
 PO Box 1178
 Corona, CA 92878
 (951) 268-6268

City of Riverside
 N/S: San Gorgonio Drive
 E/W: Alessandro Boulevard
 Weather: Clear

File Name : 22_RIV_San Gorgonio_Alessandro AM
 Site Code : 05119542
 Start Date : 8/20/2019
 Page No : 3

Start Time	San Gorgonio Drive Southbound			Alessandro Boulevard Westbound			San Gorgonio Drive Northbound			Alessandro Boulevard Eastbound					
	Left	Thru	Right	Left	Thru	Right	Left	Thru	Right	Left	Thru	Right			
Peak Hour Analysis From 07:00 AM to 07:45 AM - Peak 1 of 1															
Peak Hour for Each Approach Begins at:															
+0 mins.	0	0	0	07:00 AM	0	0	13	07:00 AM	0	0	0	07:00 AM	0	0	8
+15 mins.	1	1	0	0	0	5	1	6	0	0	1	0	1	9	
+30 mins.	0	0	0	0	0	8	1	9	0	0	0	0	7	0	
+45 mins.	0	0	1	0	0	11	1	12	0	0	0	1	0	0	
Total Volume	1	1	1	0	0	37	3	40	0	0	2	1	24	0	
% App. Total	33.3	33.3	33.3	0	0	92.5	7.5	100	0	0	100	4	96	0	
PHF	.250	.250	.250	.000	.000	.712	.750	.769	.000	.000	.500	.250	.667	.000	
														.694	

Counts Unlimited
 PO Box 1178
 Corona, CA 92878
 (951) 268-6268

City of Riverside
 N/S: San Gorgonio Drive
 E/W: Alessandro Boulevard
 Weather: Clear

File Name : 22_RIV_San Gorgonio_Alessandro AM
 Site Code : 05119542
 Start Date : 8/20/2019
 Page No : 1

Groups Printed- 3 Axle Vehicles

Start Time	San Gorgonio Drive Southbound					Alessandro Boulevard Westbound					San Gorgonio Drive Northbound					Alessandro Boulevard Eastbound							
	Left	Thru	Right	RTOR	App. Total	Left	Thru	Right	RTOR	App. Total	Left	Thru	Right	RTOR	App. Total	Left	Thru	Right	RTOR	App. Total	Exclu. Total	Inclu. Total	Int. Total
07:00 AM	0	0	0	0	0	0	0	0	0	0	0	0	0	0	0	0	1	0	0	1	0	1	1
07:15 AM	0	0	0	0	0	0	4	0	0	4	0	0	0	0	0	0	2	0	0	2	0	6	6
07:30 AM	0	0	0	0	0	0	1	0	0	1	0	0	0	0	0	0	0	0	0	0	0	1	1
07:45 AM	0	0	0	0	0	0	0	0	0	0	0	0	0	0	0	0	0	0	0	0	0	0	0
Total	0	0	0	0	0	0	5	0	0	5	0	0	0	0	0	0	3	0	0	3	0	8	8
08:00 AM	0	0	0	0	0	0	0	0	0	0	0	0	0	0	0	0	1	0	0	1	0	1	1
08:15 AM	0	0	0	0	0	0	0	0	0	0	0	0	0	0	0	0	0	0	0	0	0	0	0
08:30 AM	0	0	0	0	0	0	1	0	0	1	0	0	0	0	0	0	1	0	0	1	0	2	2
08:45 AM	0	0	0	0	0	0	2	0	0	2	0	0	0	0	0	0	1	0	0	1	0	3	3
Total	0	0	0	0	0	0	3	0	0	3	0	0	0	0	0	0	3	0	0	3	0	6	6
Grand Total	0	0	0	0	0	0	8	0	0	8	0	0	0	0	0	0	6	0	0	6	0	14	14
Apprch %	0	0	0	0	0	0	100	0	0	100	0	0	0	0	0	0	100	0	0	100	0	100	100
Total %	0	0	0	0	0	0	57.1	0	0	57.1	0	0	0	0	0	0	42.9	0	0	42.9	0	100	100

3.1-246

Start Time	San Gorgonio Drive Southbound					Alessandro Boulevard Westbound					San Gorgonio Drive Northbound					Alessandro Boulevard Eastbound							
	Left	Thru	Right	RTOR	App. Total	Left	Thru	Right	RTOR	App. Total	Left	Thru	Right	RTOR	App. Total	Left	Thru	Right	RTOR	App. Total	Exclu. Total	Inclu. Total	Int. Total
07:00 AM	0	0	0	0	0	0	0	0	0	0	0	0	0	0	0	0	1	0	0	1	0	1	1
07:15 AM	0	0	0	0	0	0	4	0	0	4	0	0	0	0	0	0	2	0	0	2	0	6	6
07:30 AM	0	0	0	0	0	0	1	0	0	1	0	0	0	0	0	0	0	0	0	0	0	1	1
07:45 AM	0	0	0	0	0	0	0	0	0	0	0	0	0	0	0	0	0	0	0	0	0	0	0
Total Volume	0	0	0	0	0	0	5	0	0	5	0	0	0	0	0	0	3	0	0	3	0	8	8
% App. Total	0	0	0	0	0	0	100	0	0	100	0	0	0	0	0	0	100	0	0	100	0	100	100
PHF	.000	.000	.000	.000	.000	.000	.313	.000	.000	.313	.000	.000	.000	.000	.000	.000	.375	.000	.000	.375	.000	.333	.333

Peak Hour Analysis From 07:00 AM to 07:45 AM - Peak 1 of 1
 Peak Hour for Entire Intersection Begins at 07:00 AM

Counts Unlimited
 PO Box 1178
 Corona, CA 92878
 (951) 268-6268

City of Riverside
 N/S: San Gorgonio Drive
 E/W: Alessandro Boulevard
 Weather: Clear

File Name : 22_RIV_San Gorgonio_Alessandro AM
 Site Code : 05119542
 Start Date : 8/20/2019
 Page No : 2

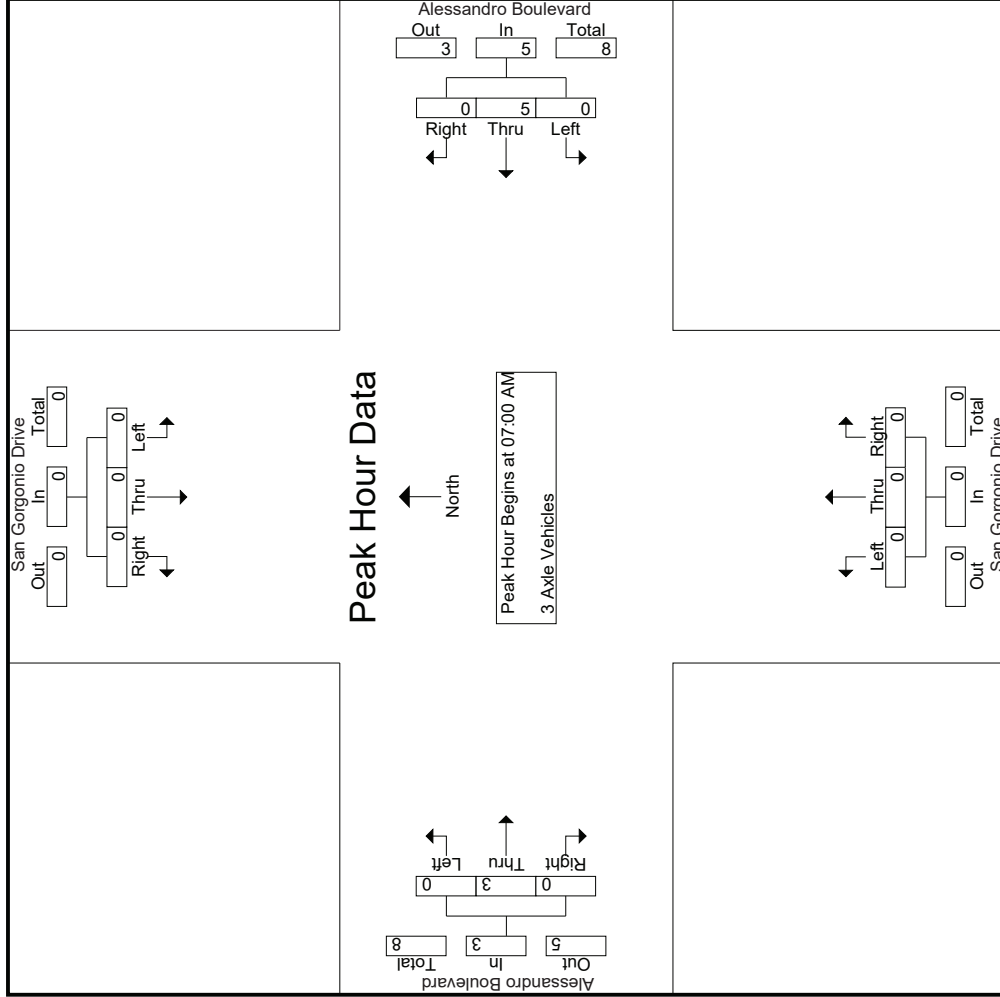

Counts Unlimited
 PO Box 1178
 Corona, CA 92878
 (951) 268-6268

City of Riverside
 N/S: San Gorgonio Drive
 E/W: Alessandro Boulevard
 Weather: Clear

File Name : 22_RIV_San Gorgonio_Alessandro AM
 Site Code : 05119542
 Start Date : 8/20/2019
 Page No : 3

Start Time	San Gorgonio Drive Southbound			Alessandro Boulevard Westbound			San Gorgonio Drive Northbound			Alessandro Boulevard Eastbound		
	Left	Thru	Right	Left	Thru	Right	Left	Thru	Right	Left	Thru	Right
Peak Hour Analysis From 07:00 AM to 07:45 AM - Peak 1 of 1	07:00 AM											
Peak Hour for Each Approach Begins at:	07:00 AM											
+0 mins.	0	0	0	0	0	0	0	0	0	0	0	0
+15 mins.	0	0	0	4	0	0	0	0	0	0	1	0
+30 mins.	0	0	0	1	0	0	0	0	0	0	0	0
+45 mins.	0	0	0	0	0	0	0	0	0	0	0	0
Total Volume	0	0	0	5	0	0	0	0	0	0	3	0
% App. Total	0	0	0	100	0	0	0	0	0	0	100	0
PHF	.000	.000	.000	.000	.313	.000	.313	.000	.000	.000	.375	.000

Counts Unlimited
 PO Box 1178
 Corona, CA 92878
 (951) 268-6268

City of Riverside
 N/S: San Gorgonio Drive
 E/W: Alessandro Boulevard
 Weather: Clear

File Name : 22_RIV_San Gorgonio_Alessandro AM
 Site Code : 05119542
 Start Date : 8/20/2019
 Page No : 1

Groups Printed- 4+ Axle Trucks

Start Time	San Gorgonio Drive Southbound					Alessandro Boulevard Westbound					San Gorgonio Drive Northbound					Alessandro Boulevard Eastbound								
	Left	Thru	Right	RTOR	App. Total	Left	Thru	Right	RTOR	App. Total	Left	Thru	Right	RTOR	App. Total	Left	Thru	Right	RTOR	App. Total	Exclu. Total	Inclu. Total	Int. Total	
07:00 AM	0	0	0	0	0	0	3	1	0	4	0	0	0	0	0	0	1	0	0	1	0	0	5	5
07:15 AM	3	0	0	0	3	0	0	1	0	1	0	0	0	0	0	0	1	0	0	1	0	0	5	5
07:30 AM	0	1	0	0	1	0	2	1	0	3	0	0	0	0	0	0	0	0	0	0	0	0	4	4
07:45 AM	0	0	0	0	0	0	0	1	0	1	0	0	1	1	1	0	2	0	0	2	1	1	4	5
Total	3	1	0	0	4	0	5	4	0	9	0	0	1	1	1	0	4	0	0	4	1	18	19	
08:00 AM	0	0	0	0	0	0	3	0	0	3	0	0	0	0	0	0	0	0	0	0	0	0	3	3
08:15 AM	0	0	0	0	0	0	1	1	0	2	0	0	0	0	0	0	2	0	0	2	0	0	4	4
08:30 AM	0	0	0	0	0	0	0	0	0	0	0	0	0	0	0	0	1	0	0	1	0	0	1	1
08:45 AM	1	0	0	0	1	0	1	1	1	2	0	0	0	0	0	0	2	0	0	2	1	1	5	6
Total	1	0	0	0	1	0	5	2	1	7	0	0	0	0	0	0	5	0	0	5	1	13	14	
Grand Total	4	1	0	0	5	0	10	6	1	16	0	0	1	1	1	0	9	0	0	9	2	31	33	
Approch %	80	20	0	0	16.1	0	62.5	37.5		51.6	0	0	100		3.2	0	100	0		29	6.1	93.9		
Total %	12.9	3.2	0	0		0	32.3	19.4			0	0	3.2			0	29	0		29				

Start Time	San Gorgonio Drive Southbound					Alessandro Boulevard Westbound					San Gorgonio Drive Northbound					Alessandro Boulevard Eastbound								
	Left	Thru	Right	RTOR	App. Total	Left	Thru	Right	RTOR	App. Total	Left	Thru	Right	RTOR	App. Total	Left	Thru	Right	RTOR	App. Total	Exclu. Total	Inclu. Total	Int. Total	
07:00 AM	0	0	0	0	0	0	0	3	1	4	0	0	0	0	0	0	1	0	0	1	0	0	1	1
07:15 AM	3	0	0	0	3	0	0	1	0	1	0	0	0	0	0	0	1	0	0	1	0	0	1	1
07:30 AM	0	1	0	0	1	0	0	2	1	3	0	0	0	0	0	0	0	0	0	0	0	0	0	0
07:45 AM	0	0	0	0	0	0	0	1	0	1	0	0	1	1	1	0	2	0	0	2	0	0	2	4
Total Volume	3	1	0	0	4	0	0	5	4	9	0	0	1	1	1	0	4	0	0	4	0	4	18	
% App. Total	.75	.25	0	0		0	55.6	44.4		100	0	0	100		.250	0	100	0		.500	0	.500	.900	
PHF	.250	.250	.000	.333		.000	.417	1.00		.563	.000	.000	.250		.250	.000	.500	.000		.500	.000	.500	.900	

Peak Hour Analysis From 07:00 AM to 07:45 AM - Peak 1 of 1
 Peak Hour for Entire Intersection Begins at 07:00 AM

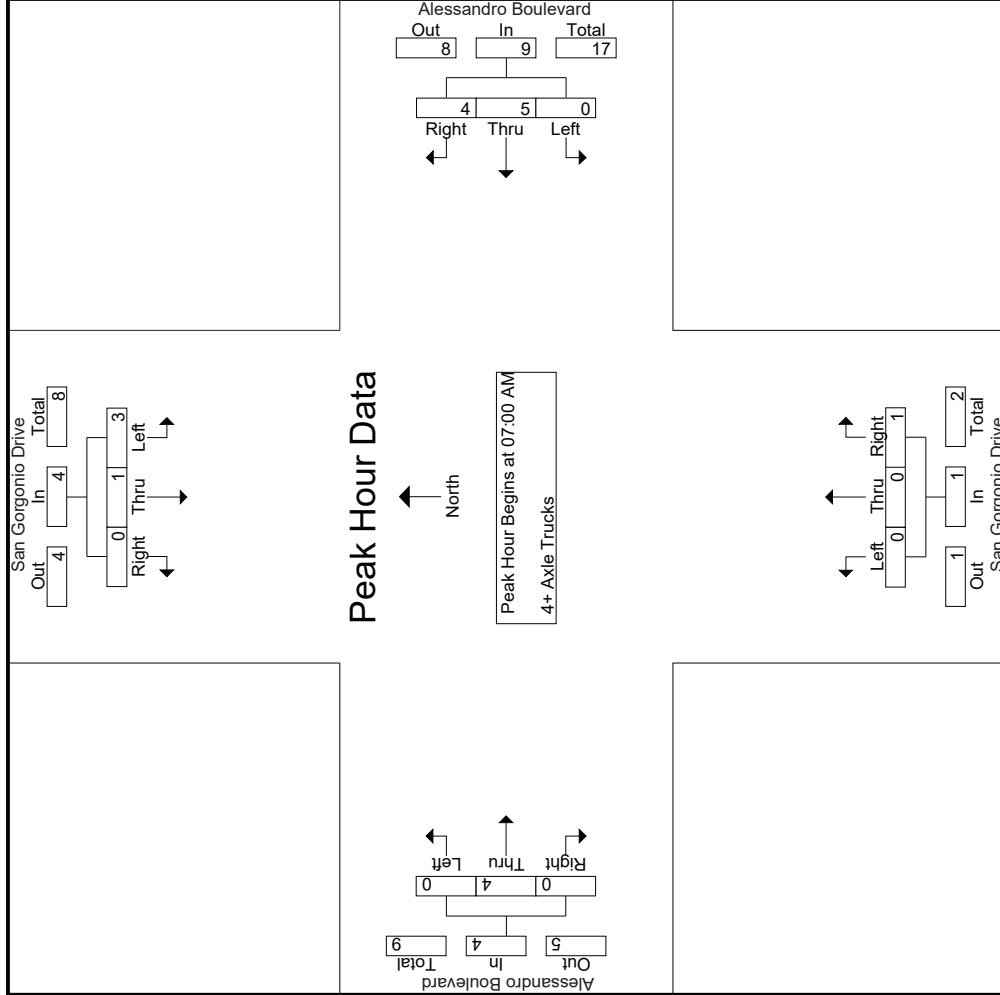

Counts Unlimited
 PO Box 1178
 Corona, CA 92878
 (951) 268-6268

City of Riverside
 N/S: San Gorgonio Drive
 E/W: Alessandro Boulevard
 Weather: Clear

File Name : 22_RIV_San Gorgonio_Alessandro AM
 Site Code : 05119542
 Start Date : 8/20/2019
 Page No : 3

Start Time	San Gorgonio Drive Southbound			Alessandro Boulevard Westbound			San Gorgonio Drive Northbound			Alessandro Boulevard Eastbound		
	Left	Thru	Right	Left	Thru	Right	Left	Thru	Right	Left	Thru	Right
Peak Hour Analysis From 07:00 AM to 07:45 AM - Peak 1 of 1												
Peak Hour for Each Approach Begins at:												
+0 mins.	0	0	0	0	0	4	0	0	0	0	0	1
+15 mins.	3	0	0	0	0	1	0	0	0	0	1	0
+30 mins.	0	1	0	0	2	1	0	0	0	0	0	0
+45 mins.	0	0	0	0	0	1	0	0	1	0	2	0
Total Volume	3	1	0	0	5	4	0	0	1	0	4	0
% App. Total	.75	.25	.00	.00	55.6	44.4	.00	.00	100	.00	100	.00
PHF	.250	.250	.000	.333	.417	1.000	.563	.000	.250	.250	.500	.000

Counts Unlimited
 PO Box 1178
 Corona, CA 92878
 (951) 268-6268

City of Riverside
 N/S: San Gorgonio Drive
 E/W: Alessandro Boulevard
 Weather: Clear

File Name : 22_RIV_San Gorgonio_Alessandro PM
 Site Code : 05119542
 Start Date : 8/20/2019
 Page No : 1

Groups Printed- Passenger Vehicles - Large 2 Axle Vehicles - 3 Axle Vehicles - 4+ Axle Trucks

Start Time	San Gorgonio Drive Southbound										Alessandro Boulevard Westbound										San Gorgonio Drive Northbound										Alessandro Boulevard Eastbound									
	Left		Thru		Right		RTOR		App. Total		Left		Thru		Right		RTOR		App. Total		Left		Thru		Right		RTOR		App. Total		Left		Thru		Right		RTOR		App. Total	
	Exclu.	Inclu.	Exclu.	Inclu.	Exclu.	Inclu.	Exclu.	Inclu.	Exclu.	Inclu.	Exclu.	Inclu.	Exclu.	Inclu.	Exclu.	Inclu.	Exclu.	Inclu.	Exclu.	Inclu.	Exclu.	Inclu.	Exclu.	Inclu.	Exclu.	Inclu.	Exclu.	Inclu.	Exclu.	Inclu.	Exclu.	Inclu.	Exclu.	Inclu.	Exclu.	Inclu.	Exclu.	Inclu.		
04:00 PM	31	0	7	0	38	0	475	7	0	482	0	0	0	1	0	0	0	1	0	500	0	0	0	0	0	502	0	1023	0	1023	0	1023	0	1023	0	1023	0	1023		
04:15 PM	14	0	6	1	20	0	354	8	0	362	0	0	0	0	0	0	0	0	0	3	495	0	0	0	0	498	1	880	881	880	881	880	881	880	881	880	881			
04:30 PM	12	0	6	0	18	0	383	8	0	391	0	0	0	0	0	0	0	0	0	3	486	0	0	0	0	489	0	898	898	898	898	898	898	898	898	898	898			
04:45 PM	6	0	4	0	10	0	370	8	2	378	0	0	0	0	0	0	0	0	0	7	493	0	0	0	0	500	2	888	890	888	890	888	890	888	890	888	890			
Total	63	0	23	1	86	0	1582	31	2	1613	0	0	0	1	0	0	0	0	1	15	1974	0	0	0	0	1989	3	3689	3692	3689	3692	3689	3692	3689	3692	3689	3692			
05:00 PM	38	0	10	1	48	0	404	10	1	414	1	0	1	1	1	1	1	1	2	9	463	1	0	0	0	473	3	937	940	937	940	937	940	937	940	937	940			
05:15 PM	20	0	10	0	30	0	358	7	2	365	0	0	0	0	0	0	0	0	0	3	538	0	0	0	0	541	2	936	938	936	938	936	938	936	938	936	938			
05:30 PM	6	1	3	0	10	0	403	1	0	404	0	0	0	0	0	0	0	0	0	10	526	0	0	0	0	536	0	950	950	950	950	950	950	950	950	950	950			
05:45 PM	8	0	5	0	13	0	315	5	0	320	0	0	0	0	0	0	0	0	0	11	487	0	0	0	0	498	0	831	831	831	831	831	831	831	831	831	831			
Total	72	1	28	1	101	0	1480	23	3	1503	1	0	1	1	1	1	1	1	2	33	2014	1	0	0	0	2048	5	3654	3659	3654	3659	3654	3659	3654	3659	3654	3659			
Grand Total	135	1	51	2	187	0	3062	54	5	3116	1	0	2	1	3	3	3	3	48	3988	1	0	0	0	4037	8	7343	7351	7343	7351	7343	7351	7343	7351	7343	7351				
Approch %	72.2	0.5	27.3			0	98.3	1.7			33.3	0	66.7	0	0	0	0	0	1.2	98.8	0	0	0	0	40.7	55	0.1	99.9												
Total %	1.8	0	0.7			2.5	0	41.7	0.7		42.4	0	0	0	0	0	0	0	0.7	54.3	0	0	0	0	5.5	0.1	99.9													
% Passenger Vehicles	118	1	50			171	0	3041	38		3084	0	0	2		3	3	3	48	3921	0	0	0	0	3969	0	0	7227												
% 2 Axle Vehicles	87.4	100	98			100	90.5	70.4	100		98.8	0	0	100		100	75	75	100	98.3	0	0	0	0	98.3	0	0	98.3												
% Large 2 Axle Vehicles	1	0	1			2	0	18	0		18	1	0	0		1	1	1	0	63	1	0	0	0	64	0	0	85												
% 3 Axle Vehicles	0.7	0	2			1.1	0	0.6	0		0.6	100	0	0		25	25	25	0	1.6	100	0	0	0	1.6	0	0	1.2												
% 4+ Axle Trucks	1	0	0			1	0	1	7		8	0	0	0		0	0	0	0	1	0	0	0	1	0	0	0	10												
% App. Total	0.7	0	0			0.5	0	0	13		0.3	0	0	0		0	0	0	0	0	0	0	0	0	0	0	0	0.1												
% 4+ Axle Trucks	15	0	0			15	0	2	9		11	0	0	0		0	0	0	0	3	0	0	0	3	0	0	0	29												
% App. Total	11.1	0	0			7.9	0	0.1	16.7		0.4	0	0	0		0	0	0	0	0.1	0	0	0	0.1	0	0	0	0.4												

Start Time	San Gorgonio Drive Southbound										Alessandro Boulevard Westbound										San Gorgonio Drive Northbound										Alessandro Boulevard Eastbound									
	Left		Thru		Right		RTOR		App. Total		Left		Thru		Right		RTOR		App. Total		Left		Thru		Right		RTOR		App. Total		Left		Thru		Right		RTOR		App. Total	
	Exclu.	Inclu.	Exclu.	Inclu.	Exclu.	Inclu.	Exclu.	Inclu.	Exclu.	Inclu.	Exclu.	Inclu.	Exclu.	Inclu.	Exclu.	Inclu.	Exclu.	Inclu.	Exclu.	Inclu.	Exclu.	Inclu.	Exclu.	Inclu.	Exclu.	Inclu.	Exclu.	Inclu.	Exclu.	Inclu.	Exclu.	Inclu.	Exclu.	Inclu.	Exclu.	Inclu.	Exclu.	Inclu.		
04:00 PM	6	0	0			4	0	10			0	0	0	0		0	0	0	0	0	0	0	0	0	0	0	0	0	0	0	0	0	0	0	0	0	0	0		
05:00 PM	38	0	10			10	0	48			40	0	0	0		0	0	0	0	2	0	0	0	0	0	0	0	0	0	0	0	0	0	0	0	0	0	0		
05:15 PM	20	0	10			10	0	30			7	0	0	0		0	0	0	0	0	0	0	0	0	0	0	0	0	0	0	0	0	0	0	0	0	0	0		
05:30 PM	6	1	3			0	0	10			1	0	0	0		0	0	0	0	0	0	0	0	0	0	0	0	0	0	0	0	0	0	0	0	0	0	0		
05:45 PM	8	0	5			0	0	13			5	0	0	0		0	0	0	0	0	0	0	0	0	0	0	0	0	0	0	0	0	0	0	0	0	0	0		
Total	70	1	27			98	0	1535			26	0	0	0		1	0	0	0	2	0	0	0	2	0	0	0	0	0	0	0	0	0	0	0	0	0	0		
% App. Total	71.4	1	27.6			27.6	0	98.3			1.7	0	0	0		50	0	0	0	1.4	0	0	0	98.5	0	0	0	0	0	0	0	0	0	0	0	0	0	0		
PHF	.461	.250	.675			.510	.000	.950			.650	.943	.250	.000		.250	.250	.250	.250	.725	.250	.250	.250	.939	.250	.947	.977													

Peak Hour Analysis From 04:00 PM to 05:45 PM - Peak 1 of 1

Peak Hour for Entire Intersection Begins at 04:45 PM

Counts Unlimited
 PO Box 1178
 Corona, CA 92878
 (951) 268-6268

City of Riverside
 N/S: San Gorgonio Drive
 E/W: Alessandro Boulevard
 Weather: Clear

File Name : 22_RIV_San Gorgonio_Alessandro PM
 Site Code : 05119542
 Start Date : 8/20/2019
 Page No : 2

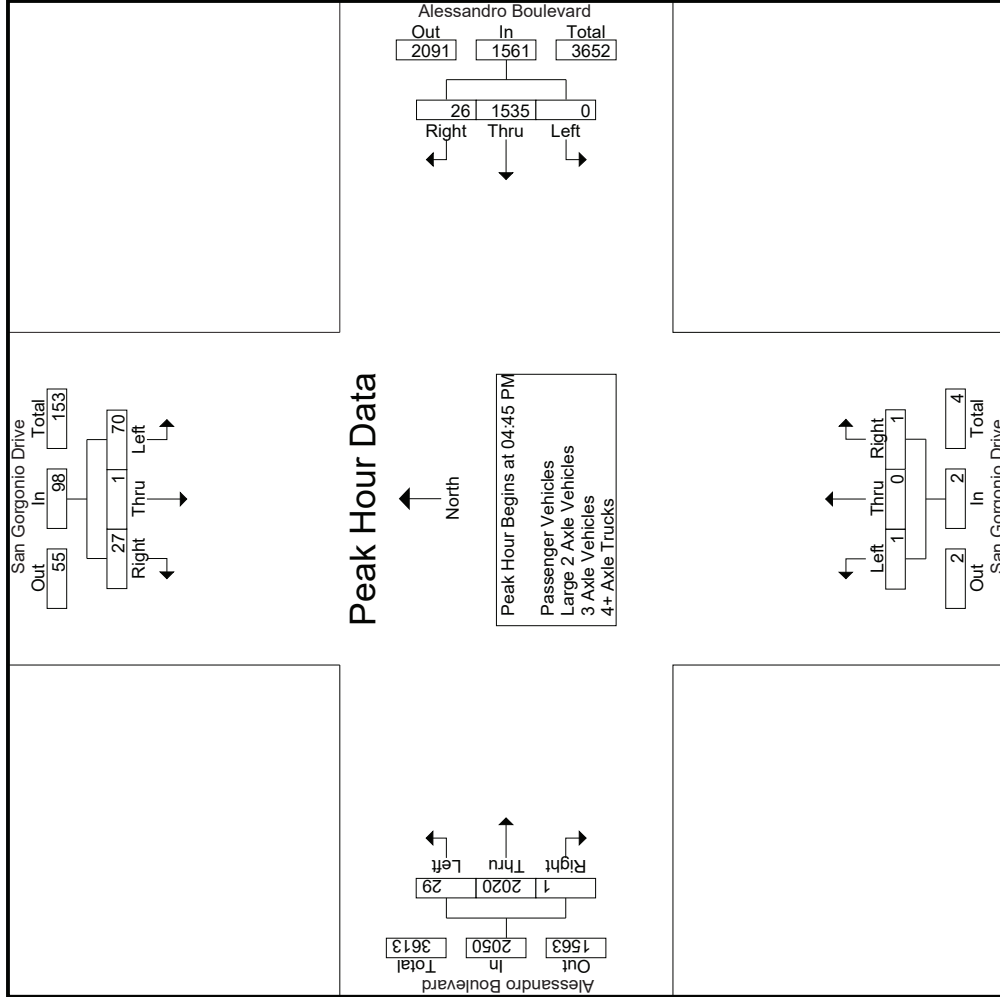

Counts Unlimited
 PO Box 1178
 Corona, CA 92878
 (951) 268-6268

City of Riverside
 N/S: San Gorgonio Drive
 E/W: Alessandro Boulevard
 Weather: Clear

File Name : 22_RIV_San Gorgonio_Alessandro PM
 Site Code : 05119542
 Start Date : 8/20/2019
 Page No : 3

Start Time	San Gorgonio Drive Southbound			Alessandro Boulevard Westbound			San Gorgonio Drive Northbound			Alessandro Boulevard Eastbound				
	Left	Thru	Right	Left	Thru	Right	Left	Thru	Right	Left	Thru	Right		
Peak Hour Analysis From 04:00 PM to 05:45 PM - Peak 1 of 1	Peak Hour for Each Approach Begins at:													
	04:30 PM			04:00 PM			04:15 PM			04:45 PM				
+0 mins.	12	0	6	0	475	7	482	0	0	0	7	493	0	500
+15 mins.	6	0	4	0	354	8	362	0	0	0	9	463	1	473
+30 mins.	38	0	10	0	383	8	391	0	0	0	3	538	0	541
+45 mins.	20	0	10	0	370	8	378	1	0	1	10	526	0	536
Total Volume	76	0	30	0	1582	31	1613	1	0	1	29	2020	1	2050
% App. Total	71.7	0	28.3	0	98.1	1.9	98.1	50	0	50	1.4	98.5	0	98.5
PHF	.500	.000	.750	.000	.833	.969	.837	.250	.000	.250	.725	.939	.250	.947

Groups Printed- Passenger Vehicles

Start Time	San Gorgonio Drive Southbound						Alessandro Boulevard Westbound						San Gorgonio Drive Northbound						Alessandro Boulevard Eastbound					
	Left	Thru	Right	RTOR	App. Total		Left	Thru	Right	RTOR	App. Total		Left	Thru	Right	RTOR	App. Total		Left	Thru	Right	RTOR	App. Total	
04:00 PM	29	0	6	0	35		0	473	5	0	478		0	0	1	0	1		2	495	0	0	497	
04:15 PM	11	0	6	1	17		0	351	5	0	356		0	0	0	0	0		3	485	0	0	488	
04:30 PM	7	0	6	0	13		0	379	7	0	386		0	0	0	0	0		3	480	0	0	483	
04:45 PM	5	0	4	0	9		0	367	6	2	373		0	0	0	0	0		7	485	0	0	492	
Total	52	0	22	1	74		0	1570	23	2	1593		0	0	1	0	1		15	1945	0	0	1960	
05:00 PM	37	0	10	1	47		0	401	5	1	406		0	0	1	1	1		9	456	0	0	465	
05:15 PM	18	0	10	0	28		0	355	6	2	361		0	0	0	0	0		3	524	0	0	527	
05:30 PM	5	1	3	0	9		0	401	1	0	402		0	0	0	0	0		10	516	0	0	526	
05:45 PM	6	0	5	0	11		0	314	3	0	317		0	0	0	0	0		11	480	0	0	491	
Total	66	1	28	1	95		0	1471	15	3	1486		0	0	1	1	1		33	1976	0	0	2009	
Grand Total	118	1	50	2	169		0	3041	38	5	3079		0	0	2	1	2		48	3921	0	0	3969	
Approch %	69.8	0.6	29.6				0	98.8	1.2				0	0	100				1.2	98.8	0			
Total %	1.6	0	0.7		2.3		0	42.1	0.5		42.7		0	0	0		0		0.7	54.3	0		55	

Start Time	San Gorgonio Drive Southbound						Alessandro Boulevard Westbound						San Gorgonio Drive Northbound						Alessandro Boulevard Eastbound					
	Left	Thru	Right	RTOR	App. Total		Left	Thru	Right	RTOR	App. Total		Left	Thru	Right	RTOR	App. Total		Left	Thru	Right	RTOR	App. Total	
04:45 PM	5	0	4		9		0	367	6		373		0	0	0		0		7	485	0		492	
05:00 PM	37	0	10		47		0	401	5		406		0	0	1		1		9	456	0		465	
05:15 PM	18	0	10		28		0	355	6		361		0	0	0		0		3	524	0		527	
05:30 PM	5	1	3		9		0	401	1		402		0	0	0		0		10	516	0		526	
Total Volume	65	1	27		93		0	1524	18		1542		0	0	1		1		29	1981	0		2010	
% App. Total	69.9	1.1	29				0	98.8	1.2				0	0	100				1.4	98.6	0			
PHF	.439	.250	.675		.495		.000	.950	.750		.950		.000	.000	.250		.250		.725	.945	.000		.954	

Peak Hour Analysis From 04:45 PM to 05:30 PM - Peak 1 of 1
 Peak Hour for Entire Intersection Begins at 04:45 PM

Counts Unlimited
 PO Box 1178
 Corona, CA 92878
 (951) 268-6268

City of Riverside
 N/S: San Gorgonio Drive
 E/W: Alessandro Boulevard
 Weather: Clear

File Name : 22_RIV_San Gorgonio_Alessandro PM
 Site Code : 05119542
 Start Date : 8/20/2019
 Page No : 2

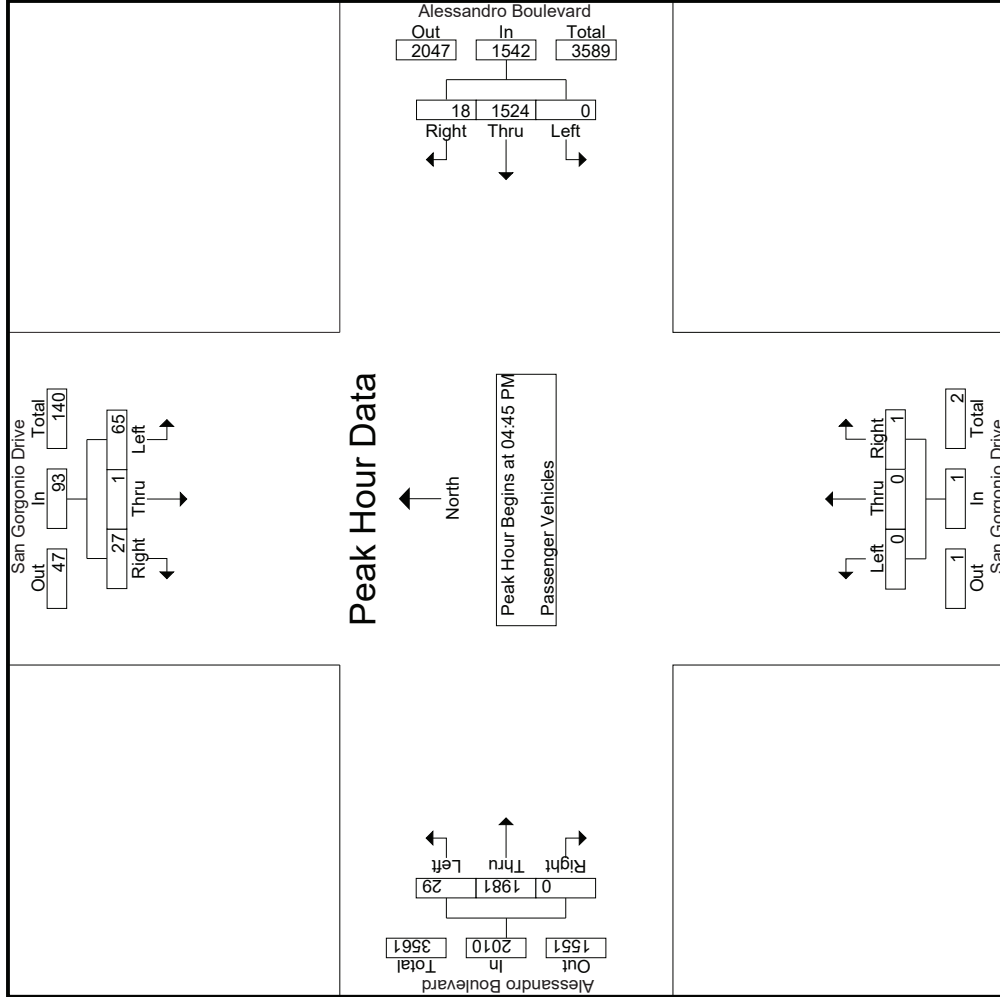

Counts Unlimited
 PO Box 1178
 Corona, CA 92878
 (951) 268-6268

City of Riverside
 N/S: San Gorgonio Drive
 E/W: Alessandro Boulevard
 Weather: Clear

File Name : 22_RIV_San Gorgonio_Alessandro PM
 Site Code : 05119542
 Start Date : 8/20/2019
 Page No : 3

Start Time	San Gorgonio Drive Southbound			Alessandro Boulevard Westbound			San Gorgonio Drive Northbound			Alessandro Boulevard Eastbound					
	Left	Thru	Right	Left	Thru	Right	Left	Thru	Right	Left	Thru	Right			
Peak Hour Analysis From 04:45 PM to 05:30 PM - Peak 1 of 1															
Peak Hour for Each Approach Begins at:															
+0 mins.	5	0	4	0	367	6	0	373	0	0	0	04:45 PM	7	485	0
+15 mins.	37	0	10	0	401	5	0	406	0	0	1	04:45 PM	9	456	0
+30 mins.	18	0	10	0	355	6	0	361	0	0	0	04:45 PM	3	524	0
+45 mins.	5	1	3	0	401	1	0	402	0	0	0	04:45 PM	10	516	0
Total Volume	65	1	27	0	1524	18	0	1542	0	0	1	04:45 PM	29	1981	0
% App. Total	69.9	1.1	29	0	98.8	1.2	0	98.8	0	0	100	04:45 PM	1.4	98.6	0
PHF	.439	.250	.675	.000	.950	.750	.000	.950	.000	.250	.250	04:45 PM	.725	.945	.000

Groups Printed- Large 2 Axle Vehicles

Start Time	San Gorgonio Drive Southbound					Alessandro Boulevard Westbound					San Gorgonio Drive Northbound					Alessandro Boulevard Eastbound							
	Left	Thru	Right	RTOR	App. Total	Left	Thru	Right	RTOR	App. Total	Left	Thru	Right	RTOR	App. Total	Left	Thru	Right	RTOR	App. Total	Exclu. Total	Inclu. Total	Int. Total
04:00 PM	0	0	1	0	1	0	2	0	0	2	0	0	0	0	0	0	5	0	0	5	0	0	8
04:15 PM	0	0	0	0	0	0	3	0	0	3	0	0	0	0	0	0	10	0	0	10	0	13	13
04:30 PM	1	0	0	0	1	0	4	0	0	4	0	0	0	0	0	0	6	0	0	6	0	11	11
04:45 PM	0	0	0	0	0	0	3	0	0	3	0	0	0	0	0	0	7	0	0	7	0	10	10
Total	1	0	1	0	2	0	12	0	0	12	0	0	0	0	0	0	28	0	0	28	0	42	42
05:00 PM	0	0	0	0	0	0	3	0	0	3	1	0	0	0	1	0	7	1	0	8	0	12	12
05:15 PM	0	0	0	0	0	0	3	0	0	3	0	0	0	0	0	0	13	0	0	13	0	16	16
05:30 PM	0	0	0	0	0	0	0	0	0	0	0	0	0	0	0	0	9	0	0	9	0	9	9
05:45 PM	0	0	0	0	0	0	0	0	0	0	0	0	0	0	0	0	6	0	0	6	0	6	6
Total	0	0	0	0	0	0	6	0	0	6	1	0	0	0	1	0	35	1	0	36	0	43	43
Grand Total	1	0	1	0	2	0	18	0	0	18	1	0	0	0	1	0	63	1	0	64	0	85	85
Approch %	50	0	50			0	100	0			100	0	0			0	98.4	1.6			0	100	
Total %	1.2	0	1.2		2.4	0	21.2	0		21.2	1.2	0	0		1.2	0	74.1	1.2		75.3	0	100	

Start Time	San Gorgonio Drive Southbound					Alessandro Boulevard Westbound					San Gorgonio Drive Northbound					Alessandro Boulevard Eastbound							
	Left	Thru	Right	RTOR	App. Total	Left	Thru	Right	RTOR	App. Total	Left	Thru	Right	RTOR	App. Total	Left	Thru	Right	RTOR	App. Total	Exclu. Total	Inclu. Total	Int. Total
04:45 PM	0	0	0	0	0	0	0	0	0	0	0	0	0	0	0	0	0	0	0	0	0	0	7
05:00 PM	0	0	0	0	0	0	3	0	0	3	1	0	0	0	1	0	7	1	0	8	0	8	10
05:15 PM	0	0	0	0	0	0	3	0	0	3	0	0	0	0	0	0	13	0	0	13	0	13	13
05:30 PM	0	0	0	0	0	0	0	0	0	0	0	0	0	0	0	0	9	0	0	9	0	9	9
05:45 PM	0	0	0	0	0	0	0	0	0	0	0	0	0	0	0	0	6	0	0	6	0	6	6
Total	0	0	0	0	0	0	6	0	0	6	1	0	0	0	1	0	35	1	0	36	0	43	43
Grand Total	0	0	0	0	0	0	18	0	0	18	1	0	0	0	1	0	63	1	0	64	0	85	85
Approch %	0	0	0			0	100	0			100	0	0			0	98.4	1.6			0	100	
Total %	0	0	0		0	0	21.2	0		21.2	1.2	0	0		1.2	0	74.1	1.2		75.3	0	100	

Start Time	San Gorgonio Drive Southbound					Alessandro Boulevard Westbound					San Gorgonio Drive Northbound					Alessandro Boulevard Eastbound							
	Left	Thru	Right	RTOR	App. Total	Left	Thru	Right	RTOR	App. Total	Left	Thru	Right	RTOR	App. Total	Left	Thru	Right	RTOR	App. Total	Exclu. Total	Inclu. Total	Int. Total
04:45 PM	0	0	0	0	0	0	0	0	0	0	0	0	0	0	0	0	0	0	0	0	0	0	7
05:00 PM	0	0	0	0	0	0	3	0	0	3	1	0	0	0	1	0	7	1	0	8	0	8	10
05:15 PM	0	0	0	0	0	0	3	0	0	3	0	0	0	0	0	0	13	0	0	13	0	13	13
05:30 PM	0	0	0	0	0	0	0	0	0	0	0	0	0	0	0	0	9	0	0	9	0	9	9
05:45 PM	0	0	0	0	0	0	0	0	0	0	0	0	0	0	0	0	6	0	0	6	0	6	6
Total	0	0	0	0	0	0	6	0	0	6	1	0	0	0	1	0	35	1	0	36	0	43	43
Grand Total	0	0	0	0	0	0	18	0	0	18	1	0	0	0	1	0	63	1	0	64	0	85	85
Approch %	0	0	0			0	100	0			100	0	0			0	98.4	1.6			0	100	
Total %	0	0	0		0	0	21.2	0		21.2	1.2	0	0		1.2	0	74.1	1.2		75.3	0	100	

Start Time	San Gorgonio Drive Southbound					Alessandro Boulevard Westbound					San Gorgonio Drive Northbound					Alessandro Boulevard Eastbound							
	Left	Thru	Right	RTOR	App. Total	Left	Thru	Right	RTOR	App. Total	Left	Thru	Right	RTOR	App. Total	Left	Thru	Right	RTOR	App. Total	Exclu. Total	Inclu. Total	Int. Total
PHF	.000	.000	.000		.000	.000	.750	.000		.750	.250	.000	.000		.000	.000	.692	.250		.712	.250	.734	.734

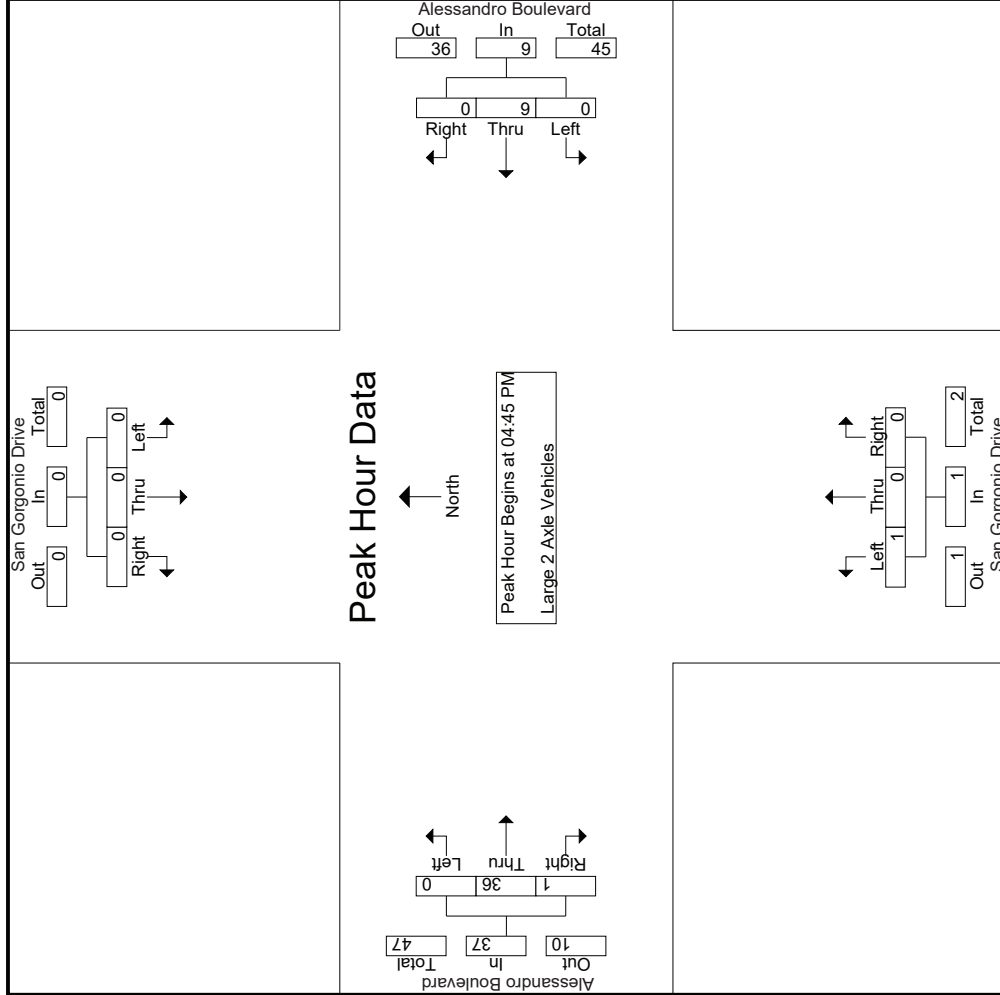

Groups Printed- 3 Axle Vehicles

Start Time	San Gorgonio Drive Southbound					Alessandro Boulevard Westbound					San Gorgonio Drive Northbound					Alessandro Boulevard Eastbound							
	Left	Thru	Right	RTOR	App. Total	Left	Thru	Right	RTOR	App. Total	Left	Thru	Right	RTOR	App. Total	Left	Thru	Right	RTOR	App. Total	Exclu. Total	Inclu. Total	Int. Total
04:00 PM	0	0	0	0	0	0	0	0	0	1	0	0	0	0	0	0	0	0	0	0	0	1	1
04:15 PM	0	0	0	0	0	0	0	2	0	2	0	0	0	0	0	0	0	0	0	0	0	2	2
04:30 PM	0	0	0	0	0	0	0	1	0	1	0	0	0	0	0	0	0	0	0	0	0	1	1
04:45 PM	0	0	0	0	0	0	0	1	0	1	0	0	0	0	0	0	0	0	0	0	0	1	1
Total	0	0	0	0	0	0	0	5	0	5	0	0	0	0	0	0	0	0	0	0	0	5	5
05:00 PM	0	0	0	0	0	0	0	1	0	1	0	0	0	0	0	0	0	0	0	0	0	1	1
05:15 PM	0	0	0	0	0	0	0	0	0	0	0	0	0	0	0	0	0	0	0	0	0	0	0
05:30 PM	1	0	0	0	1	0	0	0	0	0	0	0	0	0	0	1	0	0	0	1	0	2	2
05:45 PM	0	0	0	0	0	0	1	1	0	2	0	0	0	0	0	0	0	0	0	0	0	2	2
Total	1	0	0	0	1	0	1	2	0	3	0	0	0	0	0	0	1	0	0	1	0	5	5
Grand Total	1	0	0	0	1	0	1	7	0	8	0	0	0	0	0	0	1	0	0	1	0	10	10
Approch %	100	0	0	0	10	0	12.5	87.5		80	0	0	0	0	0	0	100	0	0	10	0	100	100
Total %	10	0	0	0	10	0	10	70		80	0	0	0	0	0	0	10	0	0	10	0	100	100

Start Time	San Gorgonio Drive Southbound					Alessandro Boulevard Westbound					San Gorgonio Drive Northbound					Alessandro Boulevard Eastbound							
	Left	Thru	Right	RTOR	App. Total	Left	Thru	Right	RTOR	App. Total	Left	Thru	Right	RTOR	App. Total	Left	Thru	Right	RTOR	App. Total	Exclu. Total	Inclu. Total	Int. Total
04:45 PM	0	0	0	0	0	0	0	0	0	1	0	0	0	0	0	0	0	0	0	0	0	0	0
05:00 PM	0	0	0	0	0	0	0	1	0	1	0	0	0	0	0	0	0	0	0	0	0	0	0
05:15 PM	0	0	0	0	0	0	0	0	0	0	0	0	0	0	0	0	0	0	0	0	0	0	0
05:30 PM	1	0	0	0	1	0	0	0	0	0	0	0	0	0	0	0	0	0	0	0	0	0	0
Total Volume	1	0	0	0	1	0	0	2	0	2	0	0	0	0	0	0	1	0	0	1	0	1	4
% App. Total	100	0	0	0	100	0	0	100		100	0	0	0	0	0	0	100	0	0	100	0	100	100
PHF	.250	.000	.000	.000	.250	.000	.000	.500		.500	.000	.000	.000	.000	.000	.000	.250	.000	.250	.000	.250	.500	.500

Peak Hour Analysis From 04:45 PM to 05:30 PM - Peak 1 of 1
 Peak Hour for Entire Intersection Begins at 04:45 PM

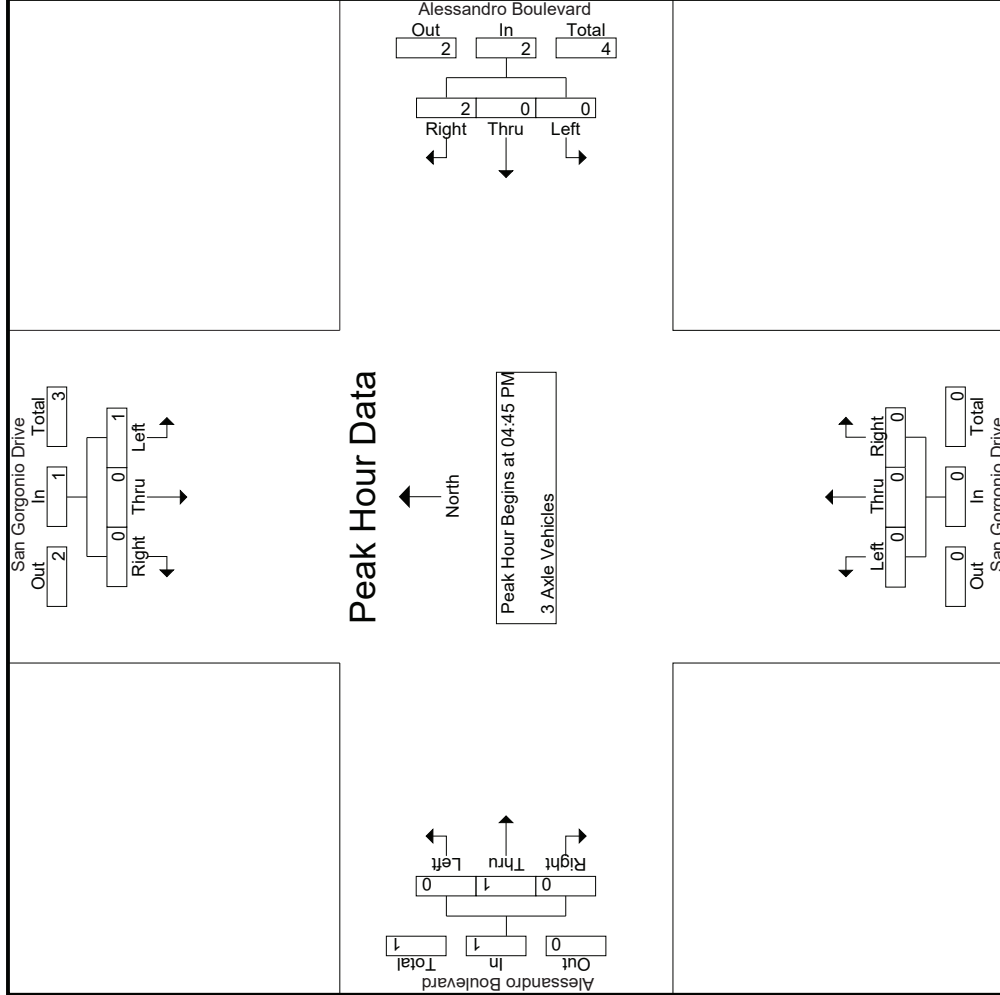

Counts Unlimited
 PO Box 1178
 Corona, CA 92878
 (951) 268-6268

City of Riverside
 N/S: San Gorgonio Drive
 E/W: Alessandro Boulevard
 Weather: Clear

File Name : 22_RIV_San Gorgonio_Alessandro PM
 Site Code : 05119542
 Start Date : 8/20/2019
 Page No : 3

Start Time	San Gorgonio Drive Southbound			Alessandro Boulevard Westbound			San Gorgonio Drive Northbound			Alessandro Boulevard Eastbound		
	Left	Thru	Right	Left	Thru	Right	Left	Thru	Right	Left	Thru	Right
Peak Hour Analysis From 04:45 PM to 05:30 PM - Peak 1 of 1												
Peak Hour for Each Approach Begins at:												
	04:45 PM			04:45 PM			04:45 PM			04:45 PM		
+0 mins.	0	0	0	0	0	1	0	0	0	0	0	0
+15 mins.	0	0	0	0	0	1	0	0	0	0	0	0
+30 mins.	0	0	0	0	0	0	0	0	0	0	0	0
+45 mins.	1	0	0	0	0	0	0	0	0	0	1	0
Total Volume	1	0	0	0	0	2	0	0	0	0	1	0
% App. Total	100	0	0	0	0	100	0	0	0	0	100	0
PHF	.250	.000	.000	.250	.000	.500	.000	.000	.000	.000	.250	.000
.000 .000 .000 .000 .000 .000 .000 .000 .000 .000 .000 .000 .000 .250												

Groups Printed- 4+ Axle Trucks

Start Time	San Gorgonio Drive Southbound					Alessandro Boulevard Westbound					San Gorgonio Drive Northbound					Alessandro Boulevard Eastbound								
	Left	Thru	Right	RTOR	App. Total	Left	Thru	Right	RTOR	App. Total	Left	Thru	Right	RTOR	App. Total	Left	Thru	Right	RTOR	App. Total	Exclu. Total	Inclu. Total	Int. Total	
04:00 PM	2	0	0	0	2	0	0	1	0	1	0	0	0	0	0	0	0	0	0	0	0	0	3	3
04:15 PM	3	0	0	0	3	0	0	1	0	1	0	0	0	0	0	0	0	0	0	0	0	0	4	4
04:30 PM	4	0	0	0	4	0	0	0	0	0	0	0	0	0	0	0	0	0	0	0	0	0	4	4
04:45 PM	1	0	0	0	1	0	0	1	0	1	0	0	0	0	0	0	1	0	0	1	0	0	3	3
Total	10	0	0	0	10	0	0	3	0	3	0	0	0	0	0	0	1	0	0	1	0	0	14	14
05:00 PM	1	0	0	0	1	0	0	4	0	4	0	0	0	0	0	0	0	0	0	0	0	0	5	5
05:15 PM	2	0	0	0	2	0	0	1	0	1	0	0	0	0	0	0	1	0	0	1	0	0	4	4
05:30 PM	0	0	0	0	0	0	0	2	0	2	0	0	0	0	0	0	0	0	0	0	0	0	2	2
05:45 PM	2	0	0	0	2	0	0	1	0	1	0	0	0	0	0	0	1	0	0	1	0	0	4	4
Total	5	0	0	0	5	0	0	8	0	8	0	0	0	0	0	0	2	0	0	2	0	0	15	15
Grand Total	15	0	0	0	15	0	2	9	0	11	0	0	0	0	0	0	3	0	0	3	0	0	29	29
Apprch %	100	0	0	0		0	18.2	81.8			0	0	0			0	100	0			0	0	100	
Total %	51.7	0	0	0	51.7	0	6.9	31		37.9	0	0	0			0	10.3	0		10.3	0	0	100	

Start Time	San Gorgonio Drive Southbound					Alessandro Boulevard Westbound					San Gorgonio Drive Northbound					Alessandro Boulevard Eastbound								
	Left	Thru	Right	RTOR	App. Total	Left	Thru	Right	RTOR	App. Total	Left	Thru	Right	RTOR	App. Total	Left	Thru	Right	RTOR	App. Total	Exclu. Total	Inclu. Total	Int. Total	
04:45 PM	1	0	0	0	1	0	0	1	0	1	0	0	0	0	0	0	1	0	0	1	0	0	1	3
05:00 PM	1	0	0	0	1	0	0	4	0	4	0	0	0	0	0	0	0	0	0	0	0	0	0	5
05:15 PM	2	0	0	0	2	0	0	1	0	1	0	0	0	0	0	0	1	0	0	1	0	0	4	4
05:30 PM	0	0	0	0	0	0	0	2	0	2	0	0	0	0	0	0	0	0	0	0	0	0	0	2
Total Volume	4	0	0	0	4	0	0	6	0	6	0	0	0	0	0	0	2	0	0	2	0	0	14	14
% App. Total	100	0	0	0		0	0	25		75	0	0	0			0	100	0			0	0	100	
PHF	.500	.000	.000	.500		.000	.250	.375		.500	.000	.000	.000		.000	.000	.500	.000		.500	.000	.500	.700	

Peak Hour Analysis From 04:45 PM to 05:30 PM - Peak 1 of 1
 Peak Hour for Entire Intersection Begins at 04:45 PM

Counts Unlimited
 PO Box 1178
 Corona, CA 92878
 (951) 268-6268

City of Riverside
 N/S: San Gorgonio Drive
 E/W: Alessandro Boulevard
 Weather: Clear

File Name : 22_RIV_San Gorgonio_Alessandro PM
 Site Code : 05119542
 Start Date : 8/20/2019
 Page No : 2

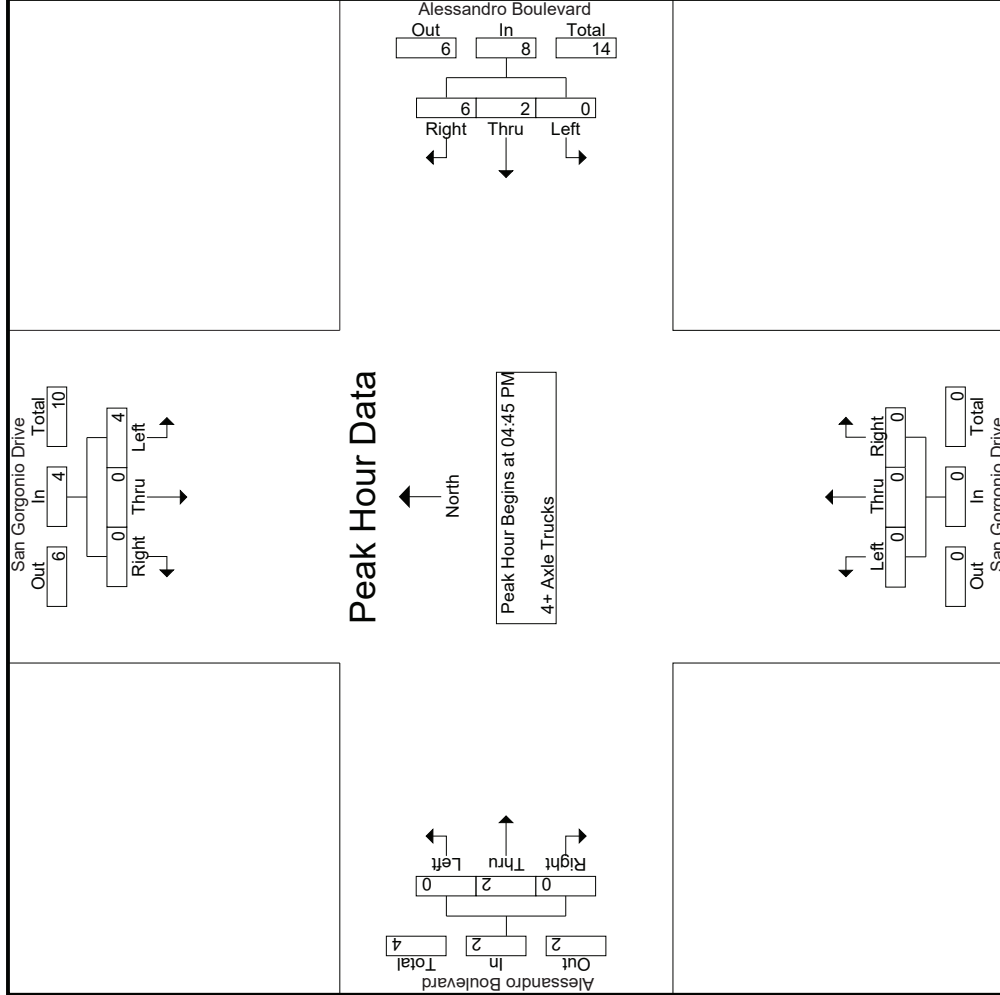

Counts Unlimited
 PO Box 1178
 Corona, CA 92878
 (951) 268-6268

City of Riverside
 N/S: San Gorgonio Drive
 E/W: Alessandro Boulevard
 Weather: Clear

File Name : 22_RIV_San Gorgonio_Alessandro PM
 Site Code : 05119542
 Start Date : 8/20/2019
 Page No : 3

Start Time	San Gorgonio Drive Southbound			Alessandro Boulevard Westbound			San Gorgonio Drive Northbound			Alessandro Boulevard Eastbound		
	Left	Thru	Right	Left	Thru	Right	Left	Thru	Right	Left	Thru	Right
Peak Hour Analysis From 04:45 PM to 05:30 PM - Peak 1 of 1												
Peak Hour for Each Approach Begins at:												
+0 mins.	1	0	0	0	0	1	1	0	0	0	0	0
+15 mins.	1	0	0	0	0	4	4	0	0	0	0	0
+30 mins.	2	0	0	0	0	1	1	0	0	0	0	0
+45 mins.	0	0	0	0	2	0	2	0	0	0	0	0
Total Volume	4	0	0	0	2	6	8	0	0	0	2	0
% App. Total	100	0	0	0	25	75	.500	0	0	.000	100	0
PHF	.500	.000	.000	.000	.250	.375	.500	.000	.000	.000	.500	.000

Location: Riverside
 N/S: San Gorgonio Drive
 E/W: Alessandro Boulevard



Date: 8/20/2019
 Day: Tuesday

PEDESTRIANS

	North Leg San Gorgonio Drive	East Leg Alessandro Boulevard	South Leg Dead End	West Leg Alessandro Boulevard	
	Pedestrians	Pedestrians	Pedestrians	Pedestrians	
7:00 AM	0	0	0	0	0
7:15 AM	0	0	0	0	0
7:30 AM	0	0	0	0	0
7:45 AM	0	0	0	0	0
8:00 AM	0	0	0	0	0
8:15 AM	0	0	0	0	0
8:30 AM	0	0	0	0	0
8:45 AM	0	0	0	0	0
TOTAL VOLUMES:	0	0	0	0	0

	North Leg San Gorgonio Drive	East Leg Alessandro Boulevard	South Leg Dead End	West Leg Alessandro Boulevard	
	Pedestrians	Pedestrians	Pedestrians	Pedestrians	
4:00 PM	0	0	0	0	0
4:15 PM	0	0	0	0	0
4:30 PM	0	0	0	0	0
4:45 PM	0	0	0	0	0
5:00 PM	0	0	0	0	0
5:15 PM	0	0	0	0	0
5:30 PM	0	0	0	0	0
5:45 PM	0	0	0	0	0
TOTAL VOLUMES:	0	0	0	0	0

Location: Riverside
 N/S: San Gorgonio Drive
 E/W: Alessandro Boulevard



Date: 8/20/2019
 Day: Tuesday

BICYCLES

	Southbound San Gorgonio Drive			Westbound Alessandro Boulevard			Northbound Dead End			Eastbound Alessandro Boulevard			
	Left	Thru	Right	Left	Thru	Right	Left	Thru	Right	Left	Thru	Right	
7:00 AM	0	0	0	0	0	0	0	0	0	0	2	0	2
7:15 AM	0	0	0	0	0	0	0	0	0	0	0	0	0
7:30 AM	0	0	0	0	0	0	0	0	0	0	0	0	0
7:45 AM	0	0	0	0	0	0	0	0	0	0	0	0	0
8:00 AM	0	0	0	0	0	0	0	0	0	0	1	0	1
8:15 AM	0	0	0	0	2	0	0	0	0	0	0	0	2
8:30 AM	0	0	0	0	0	0	0	0	0	0	1	0	1
8:45 AM	0	0	0	0	0	0	0	0	0	0	0	0	0
TOTAL VOLUMES:	0	0	0	0	2	0	0	0	0	0	4	0	6

	Southbound San Gorgonio Drive			Westbound Alessandro Boulevard			Northbound Dead End			Eastbound Alessandro Boulevard			
	Left	Thru	Right	Left	Thru	Right	Left	Thru	Right	Left	Thru	Right	
4:00 PM	0	0	0	0	0	0	0	0	0	0	0	0	0
4:15 PM	0	0	0	0	0	0	0	0	0	0	0	0	0
4:30 PM	0	0	0	0	0	0	0	0	0	0	0	0	0
4:45 PM	0	0	0	0	0	0	0	0	0	0	0	0	0
5:00 PM	0	0	0	0	0	0	0	0	0	0	0	0	0
5:15 PM	0	0	0	0	0	0	0	0	0	0	0	0	0
5:30 PM	0	0	0	0	0	0	0	0	0	0	0	0	0
5:45 PM	0	0	0	0	3	0	0	0	0	0	1	0	4
TOTAL VOLUMES:	0	0	0	0	3	0	0	0	0	0	1	0	4

Counts Unlimited
 PO Box 1178
 Corona, CA 92878
 (951) 268-6268

City of Riverside
 N/S: Sycamore Canyon Blvd/Meridian Pkwy
 E/W: Alessandro Boulevard
 Weather: Clear

File Name : 26_RIV_Meridian_Alessandro AM
 Site Code : 05119542
 Start Date : 8/20/2019
 Page No : 2

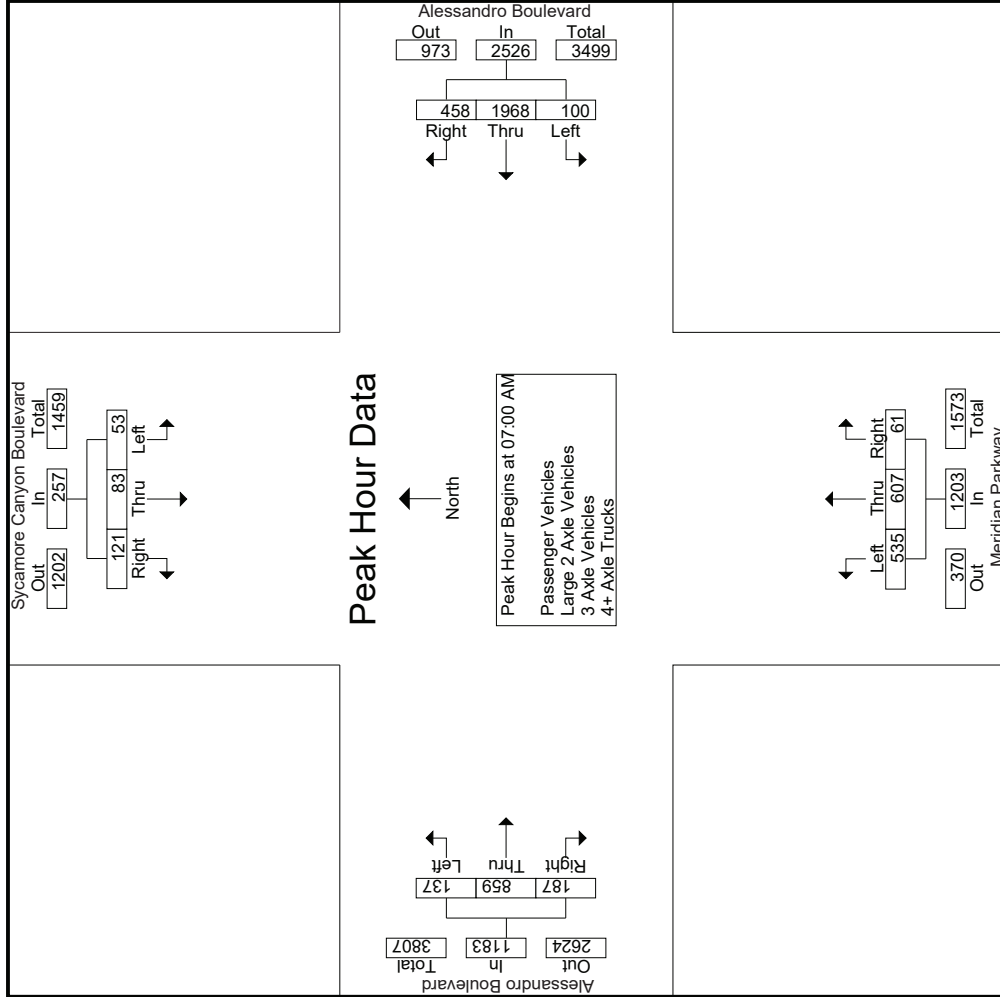

Counts Unlimited
 PO Box 1178
 Corona, CA 92878
 (951) 268-6268

City of Riverside
 N/S: Sycamore Canyon Blvd/Meridian Pkwy
 E/W: Alessandro Boulevard
 Weather: Clear

File Name : 26_RIV_Meridian_Alessandro AM
 Site Code : 05119542
 Start Date : 8/20/2019
 Page No : 3

Start Time	Sycamore Canyon Boulevard Southbound			Alessandro Boulevard Westbound			Meridian Parkway Northbound			Alessandro Boulevard Eastbound		
	Left	Thru	Right	Left	Thru	Right	Left	Thru	Right	Left	Thru	Right
Peak Hour Analysis From 07:00 AM to 08:45 AM - Peak 1 of 1												
Peak Hour for Each Approach Begins at:												
	08:00 AM			07:00 AM			07:00 AM			07:00 AM		
+0 mins.	30	20	24	74	25	100	669	144	10	286	29	200
+15 mins.	25	23	29	77	17	116	624	153	12	312	34	226
+30 mins.	25	18	31	74	10	104	598	147	20	299	39	238
+45 mins.	19	17	29	65	48	138	635	124	19	306	35	195
Total Volume	99	78	113	290	100	1968	2526	607	61	1203	137	859
% App. Total	34.1	26.9	39	4	4	77.9	18.1	44.5	5.1	11.6	11.6	72.6
PHF	.825	.848	.911	.942	.521	.904	.944	.931	.763	.964	.878	.902
						.830						.899

Counts Unlimited
 PO Box 1178
 Corona, CA 92878
 (951) 268-6268

City of Riverside
 N/S: Sycamore Canyon Blvd/Meridian Pkwy
 EW: Alessandro Boulevard
 Weather: Clear

File Name : 26_RIV_Meridian_Alessandro AM
 Site Code : 05119542
 Start Date : 8/20/2019
 Page No : 1

Groups Printed- Passenger Vehicles

Start Time	Sycamore Canyon Boulevard Southbound					Alessandro Boulevard Westbound					Meridian Parkway Northbound					Alessandro Boulevard Eastbound							
	Left	Thru	Right	RTOR	App. Total	Left	Thru	Right	RTOR	App. Total	Left	Thru	Right	RTOR	App. Total	Left	Thru	Right	RTOR	App. Total	Exclu. Total	Inclu. Total	Int. Total
07:00 AM	13	21	22	12	56	25	535	94	36	654	130	133	9	5	272	28	198	50	28	276	81	1258	1339
07:15 AM	11	24	38	24	73	17	484	110	37	611	146	147	12	12	305	31	221	34	18	286	91	1275	1366
07:30 AM	8	18	30	20	56	9	473	103	38	585	130	139	18	16	287	36	235	51	34	322	108	1250	1358
07:45 AM	15	16	25	12	56	47	442	131	23	620	123	156	18	18	297	34	193	47	20	274	73	1247	1320
Total	47	79	115	68	241	98	1934	438	134	2470	529	575	57	51	1161	129	847	182	100	1158	353	5030	5383
08:00 AM	26	18	22	8	66	31	366	147	45	544	108	121	18	16	247	38	184	53	25	275	94	1132	1226
08:15 AM	24	22	27	10	73	34	412	119	39	565	108	137	13	6	258	24	177	43	18	244	73	1140	1213
08:30 AM	24	17	28	10	69	12	399	83	29	494	123	139	18	12	280	35	174	40	22	249	73	1092	1165
08:45 AM	17	15	29	7	61	21	352	113	43	486	150	149	10	9	309	22	170	23	12	215	71	1071	1142
Total	91	72	106	35	269	98	1529	462	156	2089	489	546	59	43	1094	119	705	159	77	983	311	4435	4746
Grand Total	138	151	221	103	510	196	3463	900	290	4559	1018	1121	116	94	2255	248	1552	341	177	2141	664	9465	10129
Approch %	27.1	29.6	43.3			4.3	76	19.7		48.2	45.1	49.7	5.1	1.2	23.8	2.6	16.4	3.6		22.6	6.6	93.4	
Total %	1.5	1.6	2.3		5.4	2.1	36.6	9.5		48.2	10.8	11.8	1.2		23.8	2.6	16.4	3.6		22.6	6.6	93.4	

Start Time	Sycamore Canyon Boulevard Southbound					Alessandro Boulevard Westbound					Meridian Parkway Northbound					Alessandro Boulevard Eastbound							
	Left	Thru	Right	RTOR	App. Total	Left	Thru	Right	RTOR	App. Total	Left	Thru	Right	RTOR	App. Total	Left	Thru	Right	RTOR	App. Total	Exclu. Total	Inclu. Total	Int. Total
07:00 AM	13	21	22	12	56	25	535	94	36	654	130	133	9	5	272	28	198	50	28	276	81	1258	1339
07:15 AM	11	24	38	24	73	17	484	110	37	611	146	147	12	12	305	31	221	34	18	286	91	1275	1366
07:30 AM	8	18	30	20	56	9	473	103	38	585	130	139	18	16	287	36	235	51	34	322	108	1250	1358
07:45 AM	15	16	25	12	56	47	442	131	23	620	123	156	18	18	297	34	193	47	20	274	73	1247	1320
Total Volume	47	79	115	68	241	98	1934	438	134	2470	529	575	57	51	1161	129	847	182	100	1158	353	5030	5383
% App. Total	19.5	32.8	47.7			4	78.3	17.7		48.2	45.6	49.5	4.9	1.2	23.8	2.6	16.4	3.6		22.6	6.6	93.4	
PHF	.783	.823	.757		.825	.521	.904	.836		.944	.906	.921	.792		.952	.896	.901	.892		.899		.899	.986

Peak Hour Analysis From 07:00 AM to 07:45 AM - Peak 1 of 1
 Peak Hour for Entire Intersection Begins at 07:00 AM

Counts Unlimited
 PO Box 1178
 Corona, CA 92878
 (951) 268-6268

City of Riverside
 N/S: Sycamore Canyon Blvd/Meridian Pkwy
 E/W: Alessandro Boulevard
 Weather: Clear

File Name : 26_RIV_Meridian_Alessandro AM
 Site Code : 05119542
 Start Date : 8/20/2019
 Page No : 2

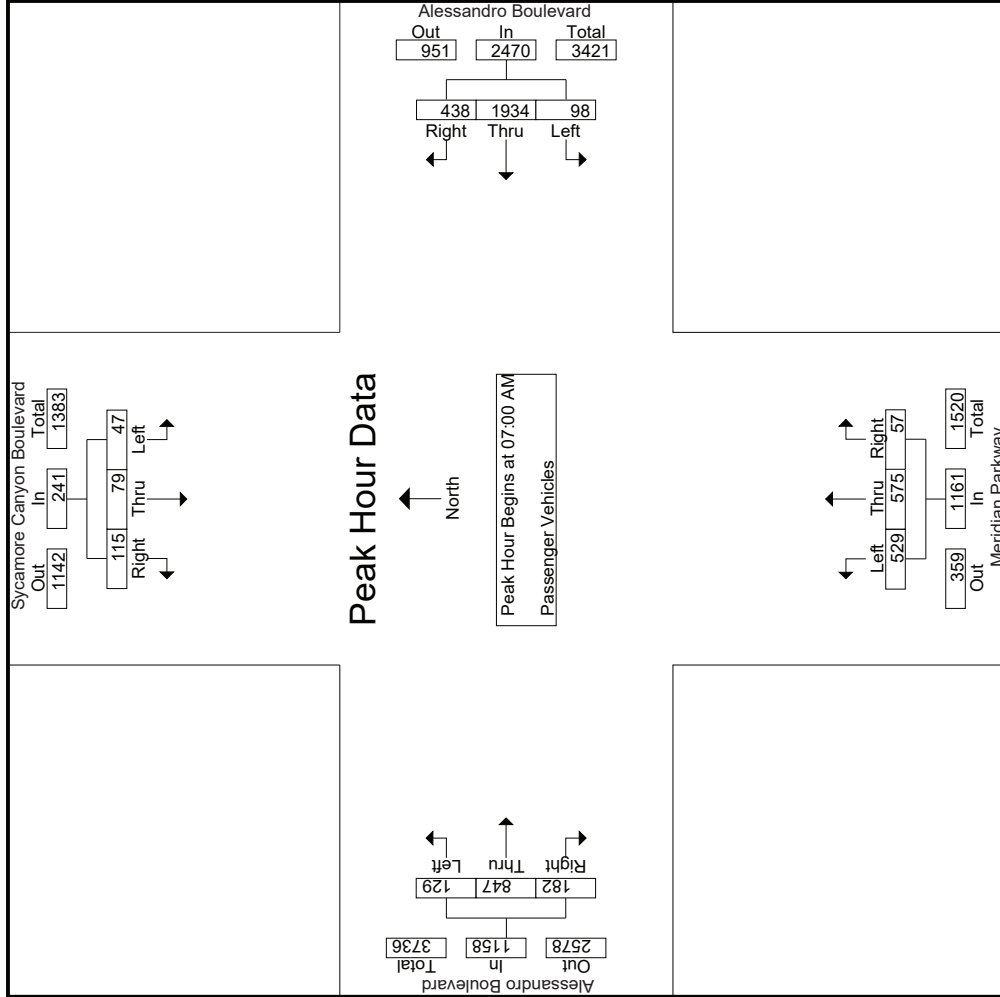

Counts Unlimited
 PO Box 1178
 Corona, CA 92878
 (951) 268-6268

City of Riverside
 N/S: Sycamore Canyon Blvd/Meridian Pkwy
 E/W: Alessandro Boulevard
 Weather: Clear

File Name : 26_RIV_Meridian_Alessandro AM
 Site Code : 05119542
 Start Date : 8/20/2019
 Page No : 3

Start Time	Sycamore Canyon Boulevard Southbound			Alessandro Boulevard Westbound			Meridian Parkway Northbound			Alessandro Boulevard Eastbound				
	Left	Thru	Right	Left	Thru	Right	Left	Thru	Right	Left	Thru	Right		
Peak Hour Analysis From 07:00 AM to 07:45 AM - Peak 1 of 1														
Peak Hour for Each Approach Begins at:														
+0 mins.	13	21	22	56	56	56	07:00 AM	130	133	9	272	28	198	50
+15 mins.	11	24	38	73	73	73	07:00 AM	146	147	12	305	31	221	34
+30 mins.	8	18	30	56	56	56	07:00 AM	130	139	18	287	36	235	51
+45 mins.	15	16	25	56	56	56	07:00 AM	123	156	18	297	34	193	47
Total Volume	47	79	115	241	241	241	07:00 AM	529	575	57	1161	129	847	182
% App. Total	19.5	32.8	47.7	.825	.825	.825	07:00 AM	45.6	49.5	4.9	.952	11.1	73.1	15.7
PHF	.783	.823	.757	.825	.825	.825	07:00 AM	.906	.921	.792	.952	.896	.901	.892

Counts Unlimited
 PO Box 1178
 Corona, CA 92878
 (951) 268-6268

City of Riverside
 N/S: Sycamore Canyon Blvd/Meridian Pkwy
 EW: Alessandro Boulevard
 Weather: Clear

File Name : 26_RIV_Meridian_Alessandro AM
 Site Code : 05119542
 Start Date : 8/20/2019
 Page No : 1

Groups Printed- Large 2 Axle Vehicles

Start Time	Sycamore Canyon Boulevard Southbound					Alessandro Boulevard Westbound					Meridian Parkway Northbound					Alessandro Boulevard Eastbound							
	Left	Thru	Right	RTOR	App. Total	Left	Thru	Right	RTOR	App. Total	Left	Thru	Right	RTOR	App. Total	Left	Thru	Right	RTOR	App. Total	Exclu. Total	Inclu. Total	Int. Total
07:00 AM	2	0	1	1	3	0	6	4	2	10	2	6	0	0	8	1	2	0	0	3	3	24	27
07:15 AM	0	0	1	0	1	0	5	3	0	8	1	1	0	0	2	1	2	2	1	5	1	16	17
07:30 AM	1	0	0	0	1	1	8	0	0	9	1	3	1	1	5	2	3	1	0	6	1	21	22
07:45 AM	1	2	0	0	3	1	7	2	0	10	1	3	0	0	4	0	0	0	0	0	0	17	17
Total	4	2	2	1	8	2	26	9	2	37	5	13	1	1	19	4	7	3	1	14	5	78	83
08:00 AM	2	1	2	2	5	2	2	1	0	5	0	3	0	0	3	0	4	1	0	5	2	18	20
08:15 AM	1	1	2	2	4	1	7	4	0	12	1	1	3	1	5	0	3	2	0	5	3	26	29
08:30 AM	1	1	3	0	5	1	4	1	0	6	3	4	0	0	7	0	2	1	1	3	1	21	22
08:45 AM	0	1	0	0	1	0	4	5	2	9	2	6	1	1	9	0	3	1	0	4	3	23	26
Total	4	4	7	4	15	4	17	11	2	32	6	14	4	2	24	0	12	5	1	17	9	88	97
Grand Total	8	6	9	5	23	6	43	20	4	69	11	27	5	3	43	4	19	8	2	31	14	166	180
Approch %	34.8	26.1	39.1			8.7	62.3	29			25.6	62.8	11.6			12.9	61.3	25.8			7.8	92.2	
Total %	4.8	3.6	5.4		13.9	3.6	25.9	12		41.6	6.6	16.3	3		25.9	2.4	11.4	4.8		18.7			

3.1-275

Start Time	Sycamore Canyon Boulevard Southbound					Alessandro Boulevard Westbound					Meridian Parkway Northbound					Alessandro Boulevard Eastbound							
	Left	Thru	Right	RTOR	App. Total	Left	Thru	Right	RTOR	App. Total	Left	Thru	Right	RTOR	App. Total	Left	Thru	Right	RTOR	App. Total	Exclu. Total	Inclu. Total	Int. Total
07:00 AM	2	0	1	1	3	0	6	4	2	10	2	6	0	0	8	1	2	0	0	3	3	24	27
07:15 AM	0	0	1	0	1	0	5	3	0	8	1	1	0	0	2	1	2	2	1	5	1	16	17
07:30 AM	1	0	0	0	1	1	8	0	0	9	1	3	1	1	5	2	3	1	0	6	1	21	22
07:45 AM	1	2	0	0	3	1	7	2	0	10	1	3	0	0	4	0	0	0	0	0	0	17	17
Total Volume	4	2	2	2	8	2	26	9	2	37	5	13	1	1	19	4	7	3	1	14	5	78	83
% App. Total	50	25	25			5.4	70.3	24.3			26.3	68.4	5.3			28.6	50	21.4					
PHF	.500	.250	.500		.667	.500	.813	.563		.925	.625	.542	.250		.594	.500	.583	.375		.583			.813

Peak Hour Analysis From 07:00 AM to 07:45 AM - Peak 1 of 1
 Peak Hour for Entire Intersection Begins at 07:00 AM

Counts Unlimited
 PO Box 1178
 Corona, CA 92878
 (951) 268-6268

City of Riverside
 N/S: Sycamore Canyon Blvd/Meridian Pkwy
 E/W: Alessandro Boulevard
 Weather: Clear

File Name : 26_RIV_Meridian_Alessandro AM
 Site Code : 05119542
 Start Date : 8/20/2019
 Page No : 2

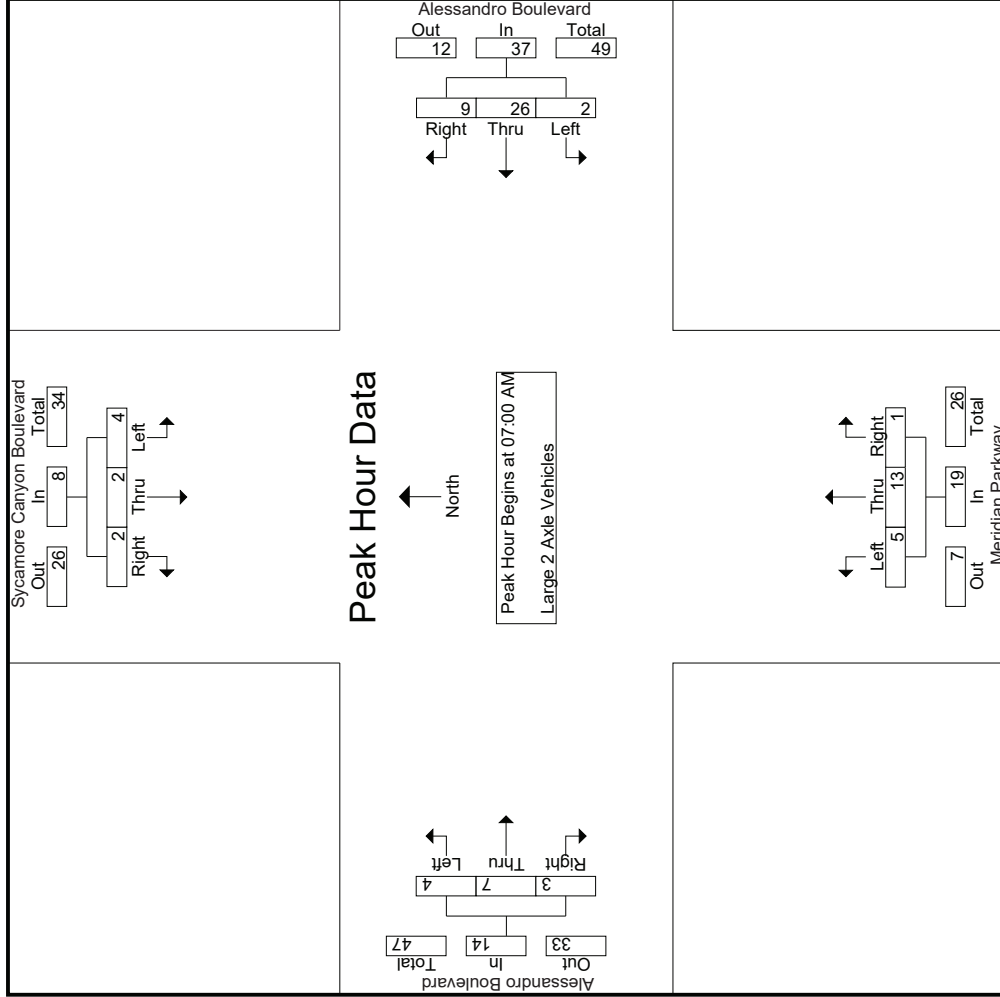

Counts Unlimited
 PO Box 1178
 Corona, CA 92878
 (951) 268-6268

City of Riverside
 N/S: Sycamore Canyon Blvd/Meridian Pkwy
 E/W: Alessandro Boulevard
 Weather: Clear

File Name : 26_RIV_Meridian_Alessandro AM
 Site Code : 05119542
 Start Date : 8/20/2019
 Page No : 3

Start Time	Sycamore Canyon Boulevard Southbound				Alessandro Boulevard Westbound				Meridian Parkway Northbound				Alessandro Boulevard Eastbound				
	Left	Thru	Right	App. Total	Left	Thru	Right	App. Total	Left	Thru	Right	App. Total	Left	Thru	Right	App. Total	Int. Total
	Peak Hour Analysis From 07:00 AM to 07:45 AM - Peak 1 of 1																
Peak Hour for Each Approach Begins at:																	
	07:00 AM				07:00 AM				07:00 AM				07:00 AM				
+0 mins.	2	0	1	3	0	6	4	10	2	6	0	8	1	2	0	3	
+15 mins.	0	0	1	1	5	3	8	1	1	0	0	2	2	2	2	5	
+30 mins.	1	0	0	1	8	0	9	1	1	1	1	5	2	3	1	6	
+45 mins.	1	2	0	3	7	2	10	1	1	0	0	4	0	0	0	0	
Total Volume	4	2	2	8	26	9	37	5	13	1	19	4	7	3	14		
% App. Total	50	25	25	66.7	5.4	70.3	24.3	26.3	68.4	5.3	28.6	50	21.4	50	21.4		
PHF	.500	.250	.500	.667	.500	.813	.563	.925	.625	.250	.594	.500	.375	.583	.375	.583	

Groups Printed- 3 Axle Vehicles

Start Time	Sycamore Canyon Boulevard Southbound				Alessandro Boulevard Westbound				Meridian Parkway Northbound				Alessandro Boulevard Eastbound					
	Left	Thru	Right	RTOR	App. Total	Left	Thru	Right	RTOR	App. Total	Left	Thru	Right	RTOR	App. Total	Exclu. Total	Inclu. Total	Int. Total
07:00 AM	0	0	0	0	0	0	0	1	1	1	0	1	0	0	1	2	3	5
07:15 AM	1	0	1	0	2	0	2	0	0	2	0	2	0	0	1	0	7	7
07:30 AM	0	0	0	0	0	1	0	0	0	2	0	0	0	0	1	0	4	4
07:45 AM	0	0	0	0	0	0	0	0	1	3	0	0	0	0	0	1	3	4
Total	1	0	1	0	2	0	3	1	1	8	1	1	1	1	3	3	17	20
08:00 AM	0	0	0	0	0	0	0	0	0	0	0	0	0	0	1	0	1	1
08:15 AM	0	0	0	0	0	0	1	0	1	2	0	0	0	0	0	1	3	4
08:30 AM	0	0	0	0	0	1	0	0	0	1	0	0	0	0	1	0	2	2
08:45 AM	1	0	0	0	1	0	2	1	0	1	0	0	0	0	1	1	7	8
Total	1	0	0	0	1	0	3	1	1	3	1	2	0	0	3	2	13	15
Grand Total	2	0	1	0	3	0	6	4	2	11	2	3	1	1	6	5	30	35
Approch %	66.7	0	33.3			0	60	40			33.3	50	16.7		14.3	85.7		
Total %	6.7	0	3.3		10	0	20	13.3		36.7	6.7	10	3.3		20			

3.1-278

Start Time	Sycamore Canyon Boulevard Southbound				Alessandro Boulevard Westbound				Meridian Parkway Northbound				Alessandro Boulevard Eastbound					
	Left	Thru	Right	RTOR	App. Total	Left	Thru	Right	RTOR	App. Total	Left	Thru	Right	RTOR	App. Total	Exclu. Total	Inclu. Total	Int. Total
07:00 AM	0	0	0	0	0	0	0	1	1	0	0	0	0	0	0	1	1	3
07:15 AM	1	0	1	0	2	0	2	0	0	2	0	2	0	0	1	0	7	7
07:30 AM	0	0	0	0	0	1	0	0	0	2	0	0	0	0	1	0	4	4
07:45 AM	0	0	0	0	0	0	0	0	1	3	0	0	0	0	0	1	3	4
Total Volume	1	0	1	0	2	0	3	1	1	8	1	1	1	1	3	3	17	20
% App. Total	50	0	50			0	75	25			33.3	33.3	33.3		.250	.250	.750	.607
PHF	.250	.000	.250		.250	.000	.375	.250		.667	.250	.250	.250		.750			

Peak Hour Analysis From 07:00 AM to 07:45 AM - Peak 1 of 1
 Peak Hour for Entire Intersection Begins at 07:00 AM

Counts Unlimited
 PO Box 1178
 Corona, CA 92878
 (951) 268-6268

City of Riverside
 N/S: Sycamore Canyon Blvd/Meridian Pkwy
 E/W: Alessandro Boulevard
 Weather: Clear

File Name : 26_RIV_Meridian_Alessandro AM
 Site Code : 05119542
 Start Date : 8/20/2019
 Page No : 2

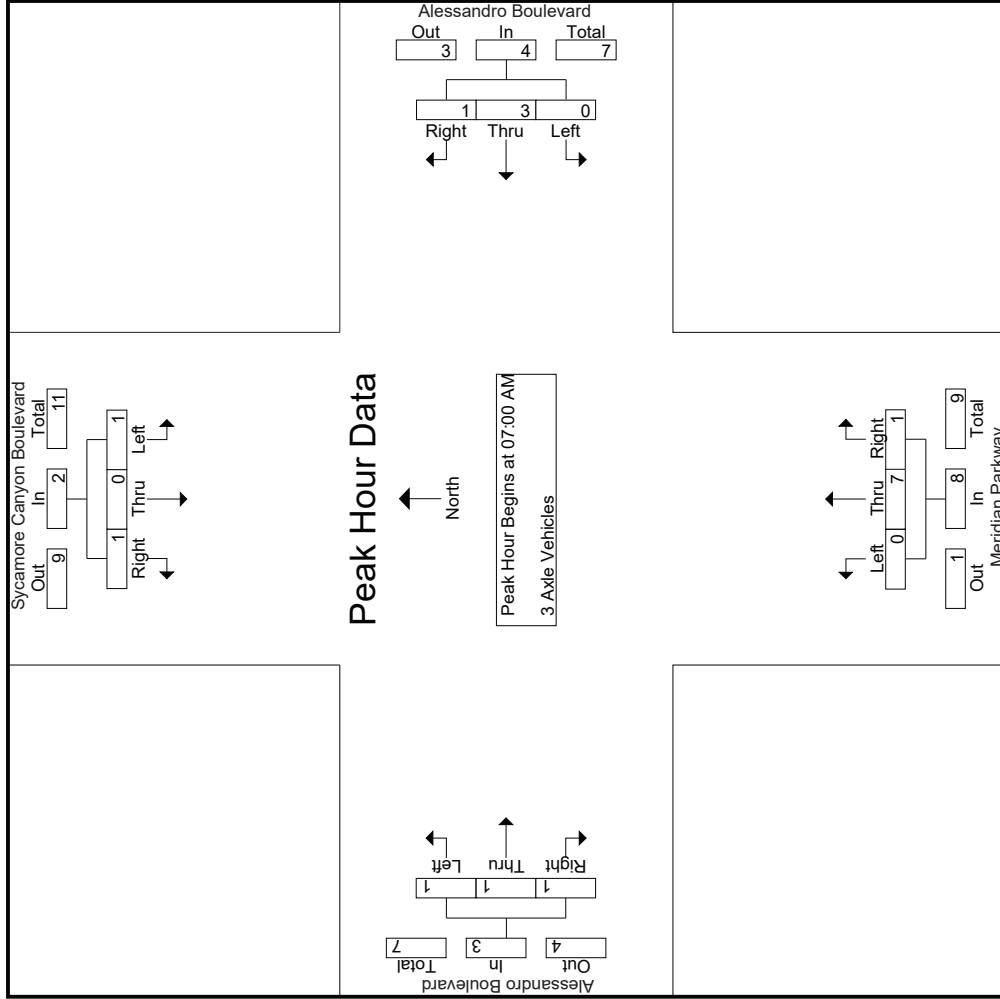

Counts Unlimited
 PO Box 1178
 Corona, CA 92878
 (951) 268-6268

City of Riverside
 N/S: Sycamore Canyon Blvd/Meridian Pkwy
 E/W: Alessandro Boulevard
 Weather: Clear

File Name : 26_RIV_Meridian_Alessandro AM
 Site Code : 05119542
 Start Date : 8/20/2019
 Page No : 3

Start Time	Sycamore Canyon Boulevard Southbound			Alessandro Boulevard Westbound			Meridian Parkway Northbound			Alessandro Boulevard Eastbound		
	Left	Thru	Right	Left	Thru	Right	Left	Thru	Right	Left	Thru	Right
Peak Hour Analysis From 07:00 AM to 07:45 AM - Peak 1 of 1												
Peak Hour for Each Approach Begins at:												
+0 mins.	0	0	0	0	0	1	0	0	1	0	0	1
+15 mins.	1	0	1	0	2	0	0	0	2	0	1	0
+30 mins.	0	0	0	0	1	0	0	0	2	1	0	0
+45 mins.	0	0	0	0	0	0	0	0	1	0	0	0
Total Volume	1	0	1	0	3	1	0	7	1	1	1	1
% App. Total	50	0	50	0	75	25	0	87.5	12.5	33.3	33.3	33.3
PHF	.250	.000	.250	.000	.375	.250	.000	.875	.250	.250	.250	.750

Counts Unlimited
 PO Box 1178
 Corona, CA 92878
 (951) 268-6268

City of Riverside
 N/S: Sycamore Canyon Blvd/Meridian Pkwy
 E/W: Alessandro Boulevard
 Weather: Clear

File Name : 26_RIV_Meridian_Alessandro AM
 Site Code : 05119542
 Start Date : 8/20/2019
 Page No : 1

Groups Printed- 4+ Axle Trucks

Start Time	Sycamore Canyon Boulevard Southbound					Alessandro Boulevard Westbound					Meridian Parkway Northbound					Alessandro Boulevard Eastbound							
	Left	Thru	Right	RTOR	App. Total	Left	Thru	Right	RTOR	App. Total	Left	Thru	Right	RTOR	App. Total	Left	Thru	Right	RTOR	App. Total	Exclu. Total	Inclu. Total	Int. Total
	07:00 AM	1	2	0	0	3	0	3	1	0	4	0	4	1	1	5	0	0	1	1	1	2	13
07:15 AM	0	0	1	0	1	0	3	2	3	3	0	3	0	0	3	2	2	0	0	4	2	11	13
07:30 AM	0	0	0	0	0	0	2	1	1	3	1	3	1	1	5	0	0	0	0	0	2	8	10
07:45 AM	0	0	2	0	2	0	0	5	1	5	0	2	0	0	2	1	2	0	0	3	1	12	13
Total	1	2	3	0	6	0	5	10	4	15	1	12	2	2	15	3	4	1	1	8	7	44	51
08:00 AM	2	1	0	0	3	0	3	3	2	6	0	5	0	0	5	0	0	0	0	0	2	14	16
08:15 AM	0	0	0	0	0	0	1	2	1	3	1	5	0	0	6	1	1	0	0	2	1	11	12
08:30 AM	0	0	0	0	0	0	2	5	2	7	0	4	0	0	4	0	1	0	0	1	2	12	14
08:45 AM	1	1	0	0	2	0	1	5	1	6	0	5	1	1	6	0	1	2	1	3	3	17	20
Total	3	2	0	0	5	0	7	15	6	22	1	19	1	1	21	1	3	2	1	6	8	54	62
Grand Total	4	4	3	0	11	0	12	25	10	37	2	31	3	3	36	4	7	3	2	14	15	98	113
Approch %	36.4	36.4	27.3			0	32.4	67.6			5.6	86.1	8.3			28.6	50	21.4		14.3	13.3	86.7	
Total %	4.1	4.1	3.1		11.2	0	12.2	25.5		37.8	2	31.6	3.1		36.7	4.1	7.1	3.1					

Start Time	Sycamore Canyon Boulevard Southbound					Alessandro Boulevard Westbound					Meridian Parkway Northbound					Alessandro Boulevard Eastbound							
	Left	Thru	Right	RTOR	App. Total	Left	Thru	Right	RTOR	App. Total	Left	Thru	Right	RTOR	App. Total	Left	Thru	Right	RTOR	App. Total	Exclu. Total	Inclu. Total	Int. Total
	07:00 AM	1	2	0	0	3	0	3	1	0	4	0	4	1	1	5	0	0	1	1	1	2	13
07:15 AM	0	0	1	0	1	0	3	2	3	3	0	3	0	0	3	2	2	0	0	4	2	11	13
07:30 AM	0	0	0	0	0	0	2	1	1	3	1	3	1	1	5	0	0	0	0	0	2	8	10
07:45 AM	0	0	2	0	2	0	0	5	1	5	0	2	0	0	2	1	2	0	0	3	1	12	13
Total	1	2	3	0	6	0	5	10	4	15	1	12	2	2	15	3	4	1	1	8	7	44	51
08:00 AM	2	1	0	0	3	0	3	3	2	6	0	5	0	0	5	0	0	0	0	0	2	14	16
08:15 AM	0	0	0	0	0	0	1	2	1	3	1	5	0	0	6	1	1	0	0	2	1	11	12
08:30 AM	0	0	0	0	0	0	2	5	2	7	0	4	0	0	4	0	1	0	0	1	2	12	14
08:45 AM	1	1	0	0	2	0	1	5	1	6	0	5	1	1	6	0	1	2	1	3	3	17	20
Total	3	2	0	0	5	0	7	15	6	22	1	19	1	1	21	1	3	2	1	6	8	54	62
Grand Total	4	4	3	0	11	0	12	25	10	37	2	31	3	3	36	4	7	3	2	14	15	98	113
Approch %	36.4	36.4	27.3			0	32.4	67.6			5.6	86.1	8.3			28.6	50	21.4		14.3	13.3	86.7	
Total %	4.1	4.1	3.1		11.2	0	12.2	25.5		37.8	2	31.6	3.1		36.7	4.1	7.1	3.1					

Peak Hour Analysis From 07:00 AM to 07:45 AM - Peak 1 of 1
 Peak Hour for Entire Intersection Begins at 07:00 AM

Start Time	Sycamore Canyon Boulevard Southbound					Alessandro Boulevard Westbound					Meridian Parkway Northbound					Alessandro Boulevard Eastbound							
	Left	Thru	Right	RTOR	App. Total	Left	Thru	Right	RTOR	App. Total	Left	Thru	Right	RTOR	App. Total	Left	Thru	Right	RTOR	App. Total	Exclu. Total	Inclu. Total	Int. Total
	07:00 AM	1	2	0	0	3	0	3	1	0	4	0	4	1	1	5	0	0	1	1	1	2	13
07:15 AM	0	0	1	0	1	0	3	2	3	3	0	3	0	0	3	2	2	0	0	4	2	11	13
07:30 AM	0	0	0	0	0	0	2	1	1	3	1	3	1	1	5	0	0	0	0	0	2	8	10
07:45 AM	0	0	2	0	2	0	0	5	1	5	0	2	0	0	2	1	2	0	0	3	1	12	13
Total Volume	1	2	3	0	6	0	5	10	4	15	1	12	2	2	15	3	4	1	1	8	7	44	51
% App. Total	16.7	33.3	50			0	33.3	66.7			6.7	80	13.3			37.5	50	12.5					
PHF	.250	.250	.375		.500	.000	.417	.500		.750	.250	.750	.500		.750	.375	.500	.250		.500	.250	.500	.846

Counts Unlimited
 PO Box 1178
 Corona, CA 92878
 (951) 268-6268

City of Riverside
 N/S: Sycamore Canyon Blvd/Meridian Pkwy
 E/W: Alessandro Boulevard
 Weather: Clear

File Name : 26_RIV_Meridian_Alessandro AM
 Site Code : 05119542
 Start Date : 8/20/2019
 Page No : 2

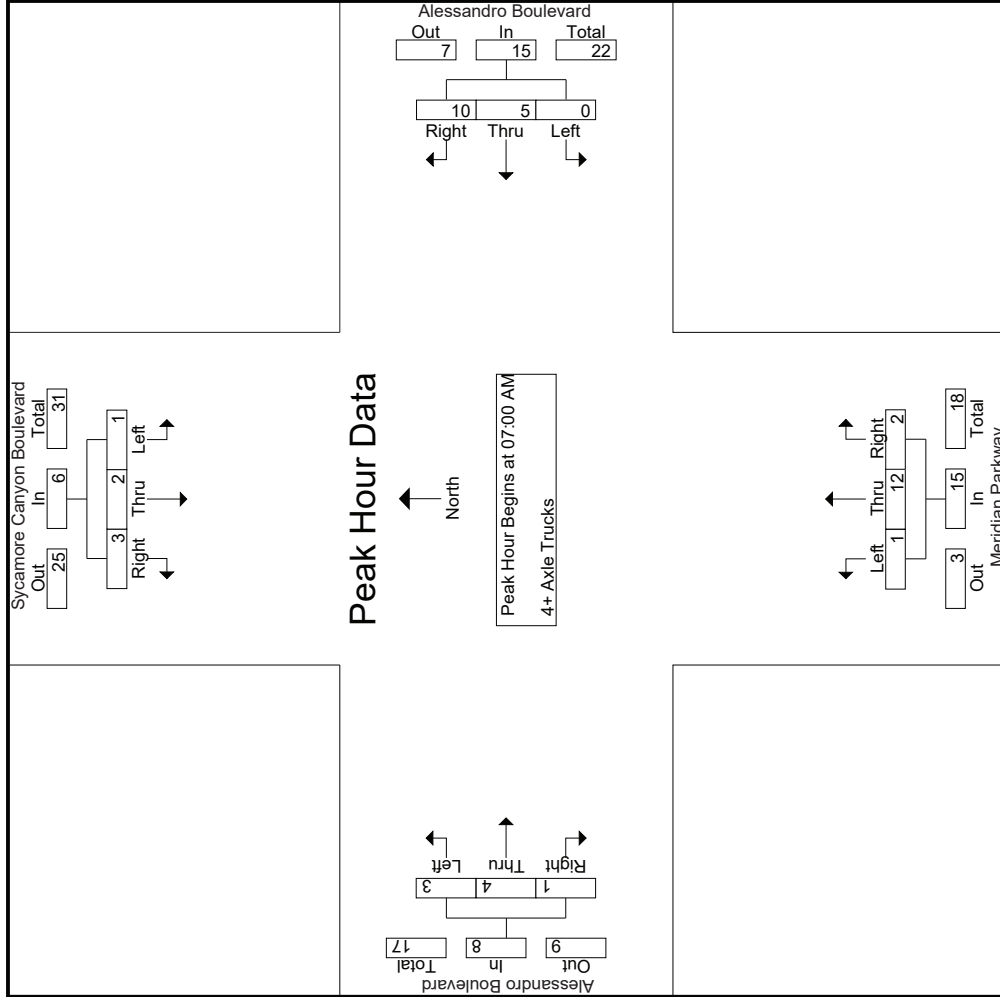

Counts Unlimited
 PO Box 1178
 Corona, CA 92878
 (951) 268-6268

City of Riverside
 N/S: Sycamore Canyon Blvd/Meridian Pkwy
 E/W: Alessandro Boulevard
 Weather: Clear

File Name : 26_RIV_Meridian_Alessandro AM
 Site Code : 05119542
 Start Date : 8/20/2019
 Page No : 3

Start Time	Sycamore Canyon Boulevard Southbound			Alessandro Boulevard Westbound			Meridian Parkway Northbound			Alessandro Boulevard Eastbound		
	Left	Thru	Right	Left	Thru	Right	Left	Thru	Right	Left	Thru	Right
Peak Hour Analysis From 07:00 AM to 07:45 AM - Peak 1 of 1												
Peak Hour for Each Approach Begins at:												
+0 mins.	1	2	0	0	0	1	4	0	1	5	0	1
+15 mins.	0	0	1	0	0	3	3	0	0	3	2	0
+30 mins.	0	0	0	0	0	1	3	1	1	5	0	0
+45 mins.	0	0	2	0	0	5	5	0	0	2	1	0
Total Volume	16.7	33.3	50	0	0	10	15	15	2	15	4	1
% App. Total	.250	.250	.375	.000	.000	.667	.750	.750	.500	.750	.500	.250
PHF												

Groups Printed- Passenger Vehicles - Large 2 Axle Vehicles - 3 Axle Vehicles - 4+ Axle Trucks

Start Time	Sycamore Canyon Boulevard Southbound										Alessandro Boulevard Westbound										Meridian Parkway Northbound										Alessandro Boulevard Eastbound																																																																																								
	Left		Thru		Right		RTOR		App. Total		Left		Thru		Right		RTOR		App. Total		Left		Thru		Right		RTOR		App. Total		Left		Thru		Right		RTOR		App. Total																																																																																
04:00 PM	40	60	61	29	161	14	354	46	12	414	70	68	20	14	158	28	423	83	9	534	64	1267	1331	04:15 PM	37	95	43	26	175	15	274	36	14	325	75	51	33	19	159	32	355	92	31	479	90	1138	1228	04:30 PM	64	94	46	24	204	18	286	27	12	331	68	73	34	16	175	23	344	110	28	477	80	1187	1267	04:45 PM	46	85	43	25	174	16	334	27	10	377	53	33	28	19	114	32	362	105	13	499	67	1164	1231	Total	187	334	193	104	714	63	1248	136	48	1447	266	225	115	68	606	115	1484	390	81	1989	301	4756	5057
05:00 PM	35	104	69	35	208	11	319	22	12	352	83	78	67	22	228	35	394	85	23	514	92	1302	1394	05:15 PM	52	82	53	27	187	12	310	22	12	344	69	51	41	18	161	37	451	103	33	591	90	1283	1373	05:30 PM	34	79	47	23	160	17	344	25	9	386	43	36	33	23	112	23	408	116	26	547	81	1205	1286	05:45 PM	41	70	45	28	156	9	248	16	5	273	63	35	25	18	123	21	349	108	34	478	85	1030	1115	Total	162	335	214	113	711	49	1221	85	38	1355	258	200	166	81	624	116	1602	412	116	2130	348	4820	5168
Grand Total	349	669	407	217	1425	112	2469	221	86	2802	524	425	281	149	1230	231	3086	802	197	4119	649	9576	10225	Approch %	24.5	46.9	28.6			4	88.1	7.9		42.6	34.6	22.8			5.6	74.9	19.5			43	6.3	93.7		Total %	3.6	7	4.3			1.2	25.8	2.3		29.3	5.5	4.4	2.9		12.8	2.4	32.2	8.4			43	6.3	93.7																																																
% Passenger Vehicles	333	649	404		1603	107	2449	200		2834	514	412	276		1350	227	3052	778		4248	0	0	10035	% 2 Axle Vehicles	95.4	97	99.3	100	97.6	95.5	99.2	90.5	90.7	98.1	98.1	96.9	98.2	99.3	97.9	98.3	98.9	97	97	98.4	0	0	98.1		% Large 2 Axle Vehicles	3	14	2		19	3	11	9		27	4	6	5		16	3	22	16		47	0	0	109																																															
% 3 Axle Vehicles	0	1	0	0	0.1	1	1	0	0	2	6	3	0	0	9	0	1	2	2	3	1.1	0	0	1.1	% 4+ Axle Trucks	0	0.1	0	0	0.1	0.9	0	0	0	0.1	1.1	0.7	0	0	0.7	0	0	0.2	0	0.1	0	0	0.1																																																																							
% 4+ Axle Trucks	13	5	1		19	1	8	12		25	0	4	0	0	4	1	11	6		18	0	0	66	% 4+ Axle Trucks	3.7	0.7	0.2	0	1.2	0.9	0.3	5.4	4.7	0.9	0	0.9	0	0	0.3	0.4	0.4	0.7	0	0.4	0	0	0.6																																																																								

Start Time	Sycamore Canyon Boulevard Southbound										Alessandro Boulevard Westbound										Meridian Parkway Northbound										Alessandro Boulevard Eastbound																																																																																																																																																
	Left		Thru		Right		RTOR		App. Total		Left		Thru		Right		RTOR		App. Total		Left		Thru		Right		RTOR		App. Total		Left		Thru		Right		RTOR		App. Total																																																																																																																																								
04:45 PM	46	85	43		174	16	334	27	10	377	53	33	28		114	32	362	105		499	1164	05:00 PM	35	104	69		208	11	319	22	12	352	83	78	67		228	35	394	85		514	1302	05:15 PM	52	82	53		187	12	310	22	12	344	69	51	41		161	37	451	103		591	1283	05:30 PM	34	79	47		160	17	344	25	9	386	43	36	33		112	23	408	116		547	1205	05:45 PM	41	70	45		156	9	248	16	5	273	63	35	25		123	21	349	108		478	85	Total Volume	167	350	212		729	56	1307	96	48	1459	248	198	169		615	127	1615	409		2151	4954	% App. Total	22.9	48	29.1		29.1	3.8	89.6	6.6		6.6	40.3	32.2	27.5		27.5	5.9	75.1	19		19	4954	PHF	.803	.841	.768		.876	.824	.950	.889		.945	.747	.635	.631		.674	.858	.895	.881		.910	.951

Peak Hour Analysis From 04:00 PM to 05:45 PM - Peak 1 of 1

Peak Hour for Entire Intersection Begins at 04:45 PM

Counts Unlimited
 PO Box 1178
 Corona, CA 92878
 (951) 268-6268

City of Riverside
 N/S: Sycamore Canyon Blvd/Meridian Pkwy
 E/W: Alessandro Boulevard
 Weather: Clear

File Name : 26_RIV_Meridian_Alessandro PM
 Site Code : 05119542
 Start Date : 8/20/2019
 Page No : 2

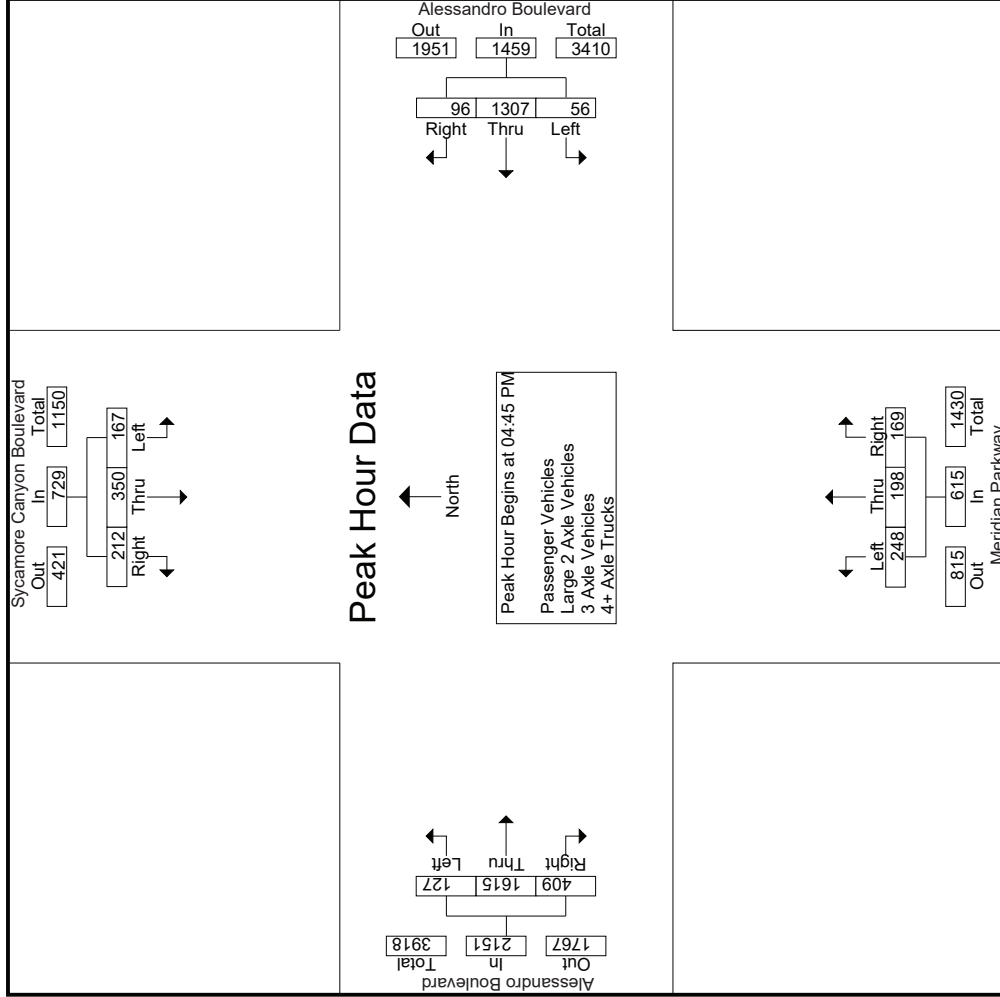

Counts Unlimited
 PO Box 1178
 Corona, CA 92878
 (951) 268-6268

City of Riverside
 N/S: Sycamore Canyon Blvd/Meridian Pkwy
 E/W: Alessandro Boulevard
 Weather: Clear

File Name : 26_RIV_Meridian_Alessandro PM
 Site Code : 05119542
 Start Date : 8/20/2019
 Page No : 3

Start Time	Sycamore Canyon Boulevard Southbound			Alessandro Boulevard Westbound			Meridian Parkway Northbound			Alessandro Boulevard Eastbound			
	Left	Thru	Right	Left	Thru	Right	Left	Thru	Right	Left	Thru	Right	
Peak Hour Analysis From 04:00 PM to 05:45 PM - Peak 1 of 1													
Peak Hour for Each Approach Begins at:													
	04:30 PM			04:45 PM			04:30 PM			04:45 PM			
+0 mins.	64	94	46	334	27	377	68	73	34	175	32	362	105
+15 mins.	46	85	43	319	22	352	53	33	28	114	35	394	85
+30 mins.	35	104	69	310	22	344	83	78	67	228	37	451	103
+45 mins.	52	82	53	344	25	386	69	51	41	161	23	408	116
Total Volume	197	365	211	1307	96	1459	273	235	170	678	127	1615	409
% App. Total	25.5	47.2	27.3	89.6	6.6	94.5	40.3	34.7	25.1	74.3	5.9	75.1	19
PHF	.770	.877	.764	.950	.889	.945	.822	.753	.634	.743	.858	.895	.881
													.910

Counts Unlimited
 PO Box 1178
 Corona, CA 92878
 (951) 268-6268

City of Riverside
 N/S: Sycamore Canyon Blvd/Meridian Pkwy
 EW: Alessandro Boulevard
 Weather: Clear

File Name : 26_RIV_Meridian_Alessandro PM
 Site Code : 05119542
 Start Date : 8/20/2019
 Page No : 1

Groups Printed- Passenger Vehicles

Start Time	Sycamore Canyon Boulevard Southbound					Alessandro Boulevard Westbound					Meridian Parkway Northbound					Alessandro Boulevard Eastbound							
	Left	Thru	Right	RTOR	App. Total	Left	Thru	Right	RTOR	App. Total	Left	Thru	Right	RTOR	App. Total	Left	Thru	Right	RTOR	App. Total	Exclu. Total	Inclu. Total	Int. Total
04:00 PM	38	57	60	29	155	11	353	40	11	404	69	67	20	14	156	28	419	82	9	529	63	1244	1307
04:15 PM	34	92	43	26	169	15	270	35	14	320	73	48	32	18	153	31	349	88	30	468	88	1110	1198
04:30 PM	62	93	45	24	200	17	284	24	10	325	66	71	34	16	171	23	339	105	25	467	75	1163	1238
04:45 PM	45	83	43	25	171	16	330	24	10	370	51	31	27	19	109	31	359	103	12	493	66	1143	1209
Total	179	325	191	104	695	59	1237	123	45	1419	259	217	113	67	589	113	1466	378	76	1957	292	4660	4952
05:00 PM	33	102	68	35	203	11	315	19	10	345	82	78	67	22	227	35	391	83	22	509	89	1284	1373
05:15 PM	49	77	53	27	179	12	309	22	12	343	68	49	38	18	155	36	444	99	33	579	90	1256	1346
05:30 PM	31	76	47	23	154	17	341	21	7	379	42	35	33	23	110	22	405	113	26	540	79	1183	1262
05:45 PM	41	69	45	28	155	8	247	15	4	270	63	33	25	18	121	21	346	105	34	472	84	1018	1102
Total	154	324	213	113	691	48	1212	77	33	1337	255	195	163	81	613	114	1586	400	115	2100	342	4741	5083
Grand Total	333	649	404	217	1386	107	2449	200	78	2756	514	412	276	148	1202	227	3052	778	191	4057	634	9401	10035
Approch %	24	46.8	29.1		14.7	3.9	88.9	7.3		29.3	42.8	34.3	23	12.8	5.6	75.2	19.2		43.2	6.3	93.7		
Total %	3.5	6.9	4.3			1.1	26.1	2.1			5.5	4.4	2.9		2.4	32.5	8.3						

Start Time	Sycamore Canyon Boulevard Southbound					Alessandro Boulevard Westbound					Meridian Parkway Northbound					Alessandro Boulevard Eastbound							
	Left	Thru	Right	RTOR	App. Total	Left	Thru	Right	RTOR	App. Total	Left	Thru	Right	RTOR	App. Total	Left	Thru	Right	RTOR	App. Total	Exclu. Total	Inclu. Total	Int. Total
04:45 PM	45	83	43		171	16	330	24		370	51	31	27		109	31	359	103		493			1143
05:00 PM	33	102	68		203	11	315	19		345	82	78	67		227	35	391	83		509			1284
05:15 PM	49	77	53		179	12	309	22		343	68	49	38		155	36	444	99		579			1256
05:30 PM	31	76	47		154	17	341	21		379	42	35	33		110	22	405	113		540			1183
Total Volume	158	338	211		707	56	1295	86		1437	243	193	165		601	124	1599	398		2121			4866
% App. Total	22.3	47.8	29.8		14.7	3.9	90.1	6		29.3	40.4	32.1	27.5		12.8	5.8	75.4	18.8		43.2			93.7
PHF	.806	.828	.776		.871	.824	.949	.896		.948	.741	.619	.616		.662	.861	.900	.881		.916			.947

Peak Hour Analysis From 04:45 PM to 05:30 PM - Peak 1 of 1
 Peak Hour for Entire Intersection Begins at 04:45 PM

Counts Unlimited
 PO Box 1178
 Corona, CA 92878
 (951) 268-6268

City of Riverside
 N/S: Sycamore Canyon Blvd/Meridian Pkwy
 E/W: Alessandro Boulevard
 Weather: Clear

File Name : 26_RIV_Meridian_Alessandro PM
 Site Code : 05119542
 Start Date : 8/20/2019
 Page No : 2

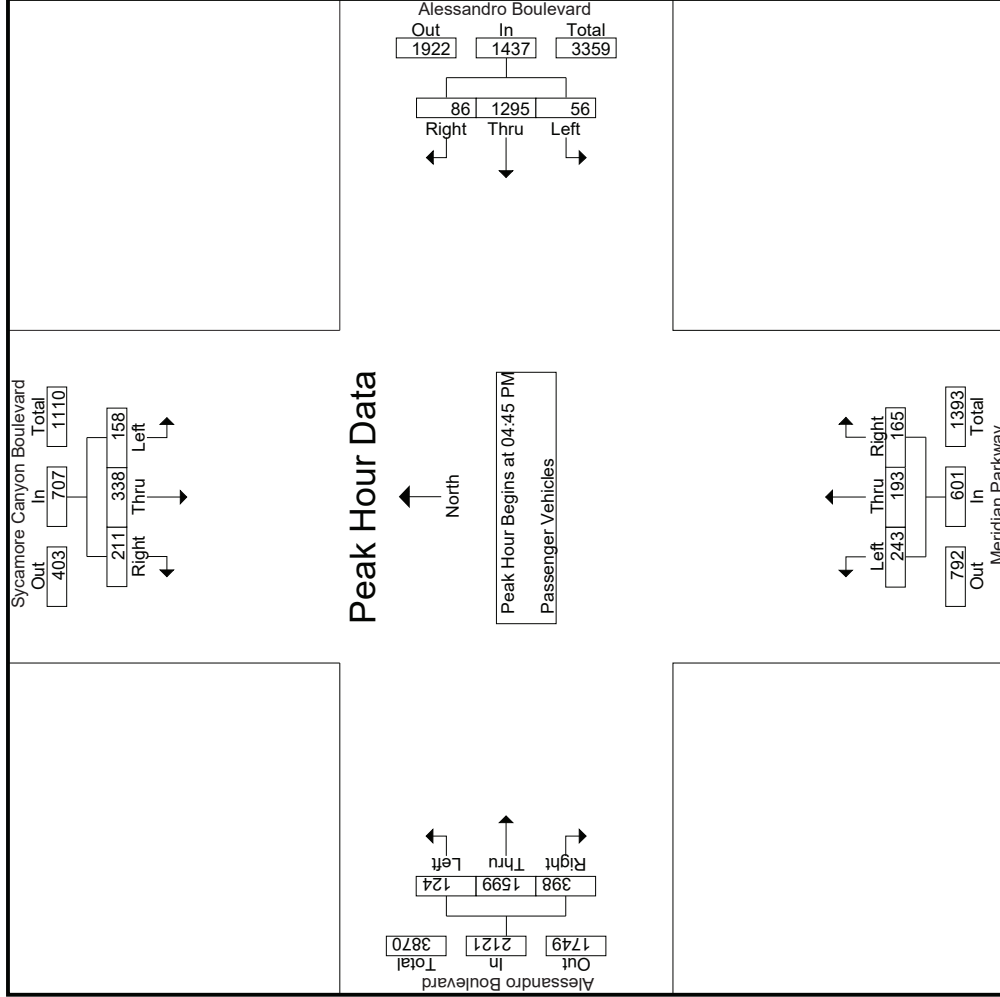

Counts Unlimited
 PO Box 1178
 Corona, CA 92878
 (951) 268-6268

City of Riverside
 N/S: Sycamore Canyon Blvd/Meridian Pkwy
 E/W: Alessandro Boulevard
 Weather: Clear

File Name : 26_RIV_Meridian_Alessandro PM
 Site Code : 05119542
 Start Date : 8/20/2019
 Page No : 3

Start Time	Sycamore Canyon Boulevard Southbound			Alessandro Boulevard Westbound			Meridian Parkway Northbound			Alessandro Boulevard Eastbound					
	Left	Thru	Right	Left	Thru	Right	Left	Thru	Right	Left	Thru	Right			
Peak Hour Analysis From 04:45 PM to 05:30 PM - Peak 1 of 1															
Peak Hour for Each Approach Begins at:															
	04:45 PM			04:45 PM			04:45 PM			04:45 PM					
+0 mins.	45	83	43	171	16	370	24	370	31	27	109	31	359	103	493
+15 mins.	33	102	68	203	11	315	19	345	78	67	227	35	391	83	509
+30 mins.	49	77	53	179	12	309	22	343	49	38	155	36	444	99	579
+45 mins.	31	76	47	154	17	341	21	379	42	33	110	22	405	113	540
Total Volume	158	338	211	707	56	1295	86	1437	193	165	601	124	1599	398	2121
% App. Total	22.3	47.8	29.8		3.9	90.1	6		32.1	27.5		5.8	75.4	18.8	
PHF	.806	.828	.776	.871	.824	.949	.896	.948	.741	.616	.662	.861	.900	.881	.916

Groups Printed- Large 2 Axle Vehicles

Start Time	Sycamore Canyon Boulevard Southbound				Alessandro Boulevard Westbound				Meridian Parkway Northbound				Alessandro Boulevard Eastbound										
	Left	Thru	Right	RTOR	App. Total	Left	Thru	Right	RTOR	App. Total	Left	Thru	Right	RTOR	App. Total	Exclu. Total	Inclu. Total	Int. Total					
04:00 PM	1	1	0	0	2	1	3	1	0	6	0	1	0	0	3	0	3	0	0				
04:15 PM	0	2	0	0	2	0	0	0	1	2	1	0	1	1	2	4	1	7	2				
04:30 PM	0	1	1	0	2	1	2	1	0	4	1	1	0	0	2	0	4	3	3				
04:45 PM	0	2	0	0	2	0	3	2	0	5	1	1	1	0	3	0	2	1	1				
Total	1	6	1	0	8	3	8	6	1	17	3	3	2	1	8	1	11	8	5	20	7	53	60
05:00 PM	1	1	1	0	3	0	1	1	1	2	0	0	0	0	0	3	1	1	1	4	2	9	11
05:15 PM	0	4	0	0	4	0	1	0	0	1	1	0	3	0	4	1	6	3	0	10	0	19	19
05:30 PM	1	2	0	0	3	0	1	1	1	2	0	1	0	0	1	1	1	2	0	4	1	10	11
05:45 PM	0	1	0	0	1	0	0	1	1	1	0	2	0	0	2	0	1	2	0	3	1	7	8
Total	2	8	1	0	11	0	3	3	3	6	1	3	3	0	7	2	11	8	1	21	4	45	49
Grand Total	3	14	2	0	19	3	11	9	4	23	4	6	5	1	15	3	22	16	6	41	11	98	109
Approch %	15.8	73.7	10.5		19.4	13	47.8	39.1		26.7	4.1	6.1	5.1		15.3	7.3	53.7	39		41.8	10.1	89.9	
Total %	3.1	14.3	2			3.1	11.2	9.2		23.5	4.1	6.1	5.1			3.1	22.4	16.3					

Start Time	Sycamore Canyon Boulevard Southbound				Alessandro Boulevard Westbound				Meridian Parkway Northbound				Alessandro Boulevard Eastbound										
	Left	Thru	Right	RTOR	App. Total	Left	Thru	Right	RTOR	App. Total	Left	Thru	Right	RTOR	App. Total	Left	Thru	Right	RTOR	App. Total	Exclu. Total	Inclu. Total	Int. Total
04:45 PM	0	2	0	0	2	0	3	2	0	5	1	1	1	1	3	0	2	1	1	3	1	3	13
05:00 PM	1	1	1	1	3	0	1	2	0	2	0	0	0	0	0	0	3	1	1	3	1	4	9
05:15 PM	0	4	0	0	4	0	1	0	0	1	1	0	3	0	4	1	6	3	0	10	0	19	19
05:30 PM	1	2	0	0	3	0	1	1	1	2	0	1	0	0	1	1	1	2	0	4	1	10	11
Total Volume	2	9	1	1	12	0	6	4	10	23	2	2	4	4	15	3	22	16	6	41	11	98	109
% App. Total	16.7	75	8.3		62.7	0	60	40		23.5	4.1	6.1	5.1		15.3	7.3	53.7	39		41.8	10.1	89.9	
PHF	.500	.563	.250		.750	.000	.500	.500		.500	.500	.333	.500		.500	.500	.500	.583		.525		.671	

Peak Hour Analysis From 04:45 PM to 05:30 PM - Peak 1 of 1
 Peak Hour for Entire Intersection Begins at 04:45 PM

Counts Unlimited
 PO Box 1178
 Corona, CA 92878
 (951) 268-6268

City of Riverside
 N/S: Sycamore Canyon Blvd/Meridian Pkwy
 E/W: Alessandro Boulevard
 Weather: Clear

File Name : 26_RIV_Meridian_Alessandro PM
 Site Code : 05119542
 Start Date : 8/20/2019
 Page No : 2

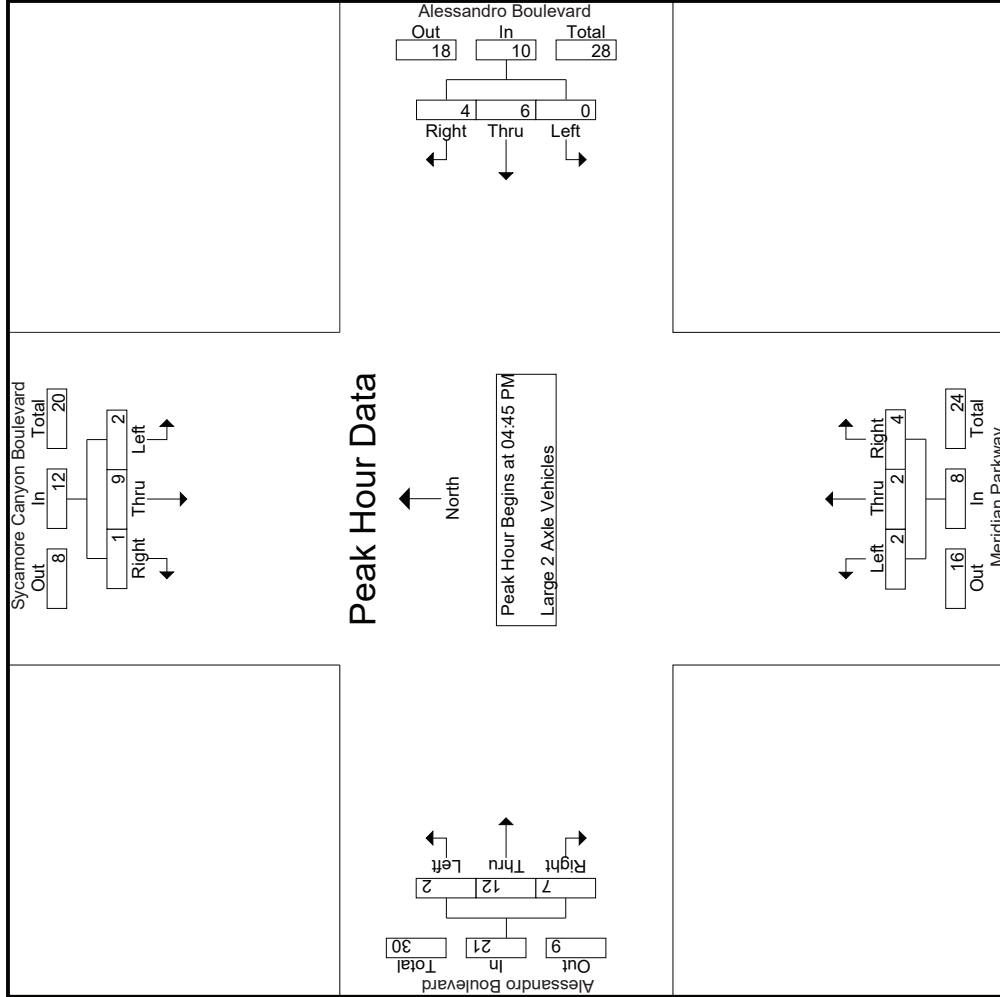

Counts Unlimited
 PO Box 1178
 Corona, CA 92878
 (951) 268-6268

City of Riverside
 N/S: Sycamore Canyon Blvd/Meridian Pkwy
 E/W: Alessandro Boulevard
 Weather: Clear

File Name : 26_RIV_Meridian_Alessandro PM
 Site Code : 05119542
 Start Date : 8/20/2019
 Page No : 3

Start Time	Sycamore Canyon Boulevard Southbound			Alessandro Boulevard Westbound			Meridian Parkway Northbound			Alessandro Boulevard Eastbound			
	Left	Thru	Right	Left	Thru	Right	Left	Thru	Right	Left	Thru	Right	
Peak Hour Analysis From 04:45 PM to 05:30 PM - Peak 1 of 1	Peak Hour for Each Approach Begins at:												
	04:45 PM			04:45 PM			04:45 PM			04:45 PM			
+0 mins.	0	2	0	2	5	1	1	1	1	3	0	2	1
+15 mins.	1	1	1	1	2	0	0	0	0	0	0	3	1
+30 mins.	0	4	0	1	1	1	1	3	4	1	1	6	3
+45 mins.	1	2	0	1	2	0	0	0	1	1	1	1	2
Total Volume	2	9	1	6	10	2	2	4	8	2	12	7	21
% App. Total	16.7	75	8.3	60	40	25	25	50	50	9.5	57.1	33.3	57.1
PHF	.500	.563	.250	.500	.500	.500	.500	.333	.500	.500	.500	.583	.525

Groups Printed- 3 Axle Vehicles

Start Time	Sycamore Canyon Boulevard Southbound				Alessandro Boulevard Westbound				Meridian Parkway Northbound				Alessandro Boulevard Eastbound					
	Left	Thru	Right	RTOR	App. Total	Left	Thru	Right	RTOR	App. Total	Left	Thru	Right	RTOR	App. Total	Exclu. Total	Inclu. Total	Int. Total
04:00 PM	0	0	0	0	0	0	0	0	0	1	0	0	0	0	0	0	1	1
04:15 PM	0	0	0	0	1	0	0	0	0	1	0	0	0	0	0	0	2	2
04:30 PM	0	0	0	0	0	0	0	0	0	2	0	0	0	0	0	0	2	2
04:45 PM	0	0	0	0	0	0	0	0	0	2	0	0	1	0	1	0	3	3
Total	0	0	0	0	1	4	2	0	0	6	0	0	1	0	1	0	8	8
05:00 PM	0	0	0	0	0	0	0	0	0	1	0	0	0	0	0	0	1	1
05:15 PM	0	0	0	0	0	0	0	0	0	1	0	0	0	0	0	0	1	1
05:30 PM	0	1	0	0	1	0	0	0	0	1	0	1	0	0	2	0	4	4
05:45 PM	0	0	0	0	1	0	0	0	0	0	0	0	0	0	0	0	1	1
Total	0	1	0	0	1	2	1	0	0	3	0	1	1	0	2	0	7	7
Grand Total	0	1	0	0	1	1	1	0	0	2	6	3	0	0	9	0	15	15
Approch %	0	100	0	0	50	50	6.7	0	0	66.7	33.3	20	0	0	33.3	66.7	0	100
Total %	0	6.7	0	0	6.7	6.7	6.7	0	0	13.3	40	20	0	0	60	6.7	13.3	20

Start Time	Sycamore Canyon Boulevard Southbound				Alessandro Boulevard Westbound				Meridian Parkway Northbound				Alessandro Boulevard Eastbound					
	Left	Thru	Right	RTOR	App. Total	Left	Thru	Right	RTOR	App. Total	Left	Thru	Right	RTOR	App. Total	Exclu. Total	Inclu. Total	Int. Total
04:45 PM	0	0	0	0	0	0	0	0	0	0	1	0	0	0	0	0	1	1
05:00 PM	0	0	0	0	0	0	0	0	0	0	0	0	0	0	0	0	0	0
05:15 PM	0	0	0	0	0	0	0	0	0	0	0	0	0	0	0	0	0	0
05:30 PM	0	1	0	0	1	0	0	0	0	0	0	0	0	0	0	0	0	0
Total Volume	0	1	0	0	1	0	0	0	0	0	3	2	0	0	5	0	3	3
% App. Total	0	100	0	0	100	0	0	0	0	0	60	40	0	0	33.3	66.7	0	100
PHF	.000	.250	.000	.000	.250	.000	.000	.000	.000	.000	.750	.500	.000	.000	.625	.500	.375	.563

Peak Hour Analysis From 04:45 PM to 05:30 PM - Peak 1 of 1
 Peak Hour for Entire Intersection Begins at 04:45 PM

Counts Unlimited
 PO Box 1178
 Corona, CA 92878
 (951) 268-6268

City of Riverside
 N/S: Sycamore Canyon Blvd/Meridian Pkwy
 E/W: Alessandro Boulevard
 Weather: Clear

File Name : 26_RIV_Meridian_Alessandro PM
 Site Code : 05119542
 Start Date : 8/20/2019
 Page No : 2

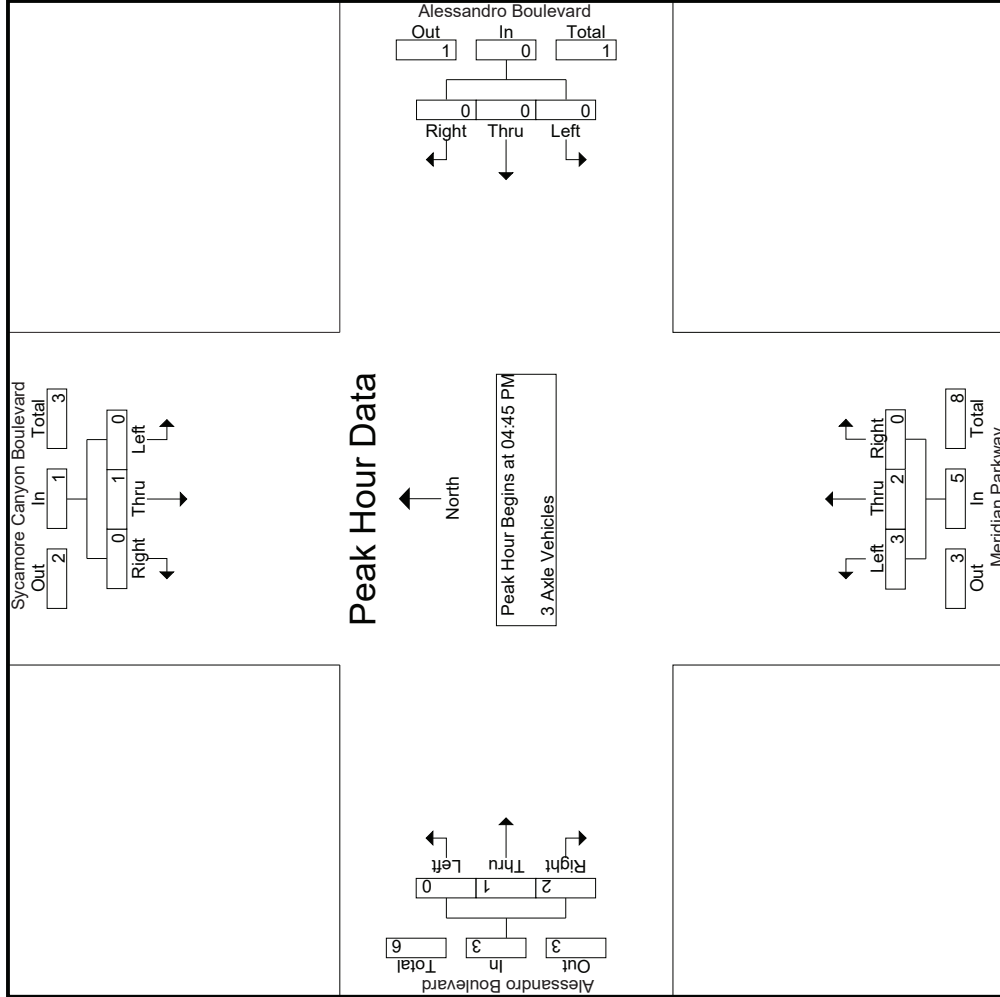

Counts Unlimited
 PO Box 1178
 Corona, CA 92878
 (951) 268-6268

City of Riverside
 N/S: Sycamore Canyon Blvd/Meridian Pkwy
 E/W: Alessandro Boulevard
 Weather: Clear

File Name : 26_RIV_Meridian_Alessandro PM
 Site Code : 05119542
 Start Date : 8/20/2019
 Page No : 3

Start Time	Sycamore Canyon Boulevard Southbound			Alessandro Boulevard Westbound			Alessandro Boulevard Eastbound			Meridian Parkway Northbound			Alessandro Boulevard Eastbound					
	Left	Thru	Right	Left	Thru	Right	Left	Thru	Right	Left	Thru	Right	Left	Thru	Right	App. Total	Int. Total	
Peak Hour Analysis From 04:45 PM to 05:30 PM - Peak 1 of 1																		
Peak Hour for Each Approach Begins at:																		
	04:45 PM			04:45 PM			04:45 PM			04:45 PM			04:45 PM					
+0 mins.	0	0	0	0	0	0	0	0	0	0	0	0	0	0	0	0	1	
+15 mins.	0	0	0	0	0	0	0	0	0	0	0	0	0	0	0	0	0	
+30 mins.	0	0	0	0	0	0	0	0	0	0	0	0	0	0	0	0	0	
+45 mins.	0	1	0	0	0	0	0	0	0	0	0	0	0	0	1	1	2	
Total Volume	0	1	0	0	0	0	0	0	0	0	0	0	0	0	1	2	3	
% App. Total	0	100	0	0	0	0	0	0	0	0	0	0	0	0	33.3	66.7	0	
PHF	.000	.250	.000	.000	.000	.000	.000	.000	.000	.750	.500	.000	.000	.250	.500	.375		

Counts Unlimited
 PO Box 1178
 Corona, CA 92878
 (951) 268-6268

City of Riverside
 N/S: Sycamore Canyon Blvd/Meridian Pkwy
 EW: Alessandro Boulevard
 Weather: Clear

File Name : 26_RIV_Meridian_Alessandro PM
 Site Code : 05119542
 Start Date : 8/20/2019
 Page No : 1

Groups Printed- 4+ Axle Trucks

Start Time	Sycamore Canyon Boulevard Southbound				Alessandro Boulevard Westbound				Meridian Parkway Northbound				Alessandro Boulevard Eastbound							
	Left	Thru	Right	RTOR	App. Total	Left	Thru	Right	RTOR	App. Total	Left	Thru	Right	RTOR	App. Total	Exclu. Total	Inclu. Total	Int. Total		
04:00 PM	1	2	1	0	4	1	0	3	0	4	0	0	0	0	0	2	0	10	10	
04:15 PM	3	1	0	0	4	0	1	1	0	2	0	3	0	0	4	4	0	13	13	
04:30 PM	2	0	0	0	2	0	0	2	0	2	0	0	0	0	3	2	7	9	9	
04:45 PM	1	0	0	0	1	0	1	1	0	2	0	0	0	0	2	0	5	5	5	
Total	7	3	1	0	11	1	2	7	2	10	0	3	0	0	11	2	35	37	37	
05:00 PM	1	1	0	0	2	0	3	2	1	5	0	0	0	0	1	1	8	9	9	
05:15 PM	3	1	0	0	4	0	0	0	0	0	0	1	0	0	2	0	7	7	7	
05:30 PM	2	0	0	0	2	0	2	3	1	5	0	0	0	0	1	1	8	9	9	
05:45 PM	0	0	0	0	0	0	1	0	0	1	0	0	0	0	3	0	4	4	4	
Total	6	2	0	0	8	0	6	5	2	11	0	1	0	0	7	2	27	29	29	
Grand Total	13	5	1	0	19	1	8	12	4	21	0	4	0	0	18	4	62	66	66	
Approch %	68.4	26.3	5.3			4.8	38.1	57.1			0	100	0		5.6	61.1	33.3			
Total %	21	8.1	1.6		30.6	1.6	12.9	19.4		33.9	0	6.5	0		1.6	17.7	9.7		6.1	93.9

Start Time	Sycamore Canyon Boulevard Southbound				Alessandro Boulevard Westbound				Meridian Parkway Northbound				Alessandro Boulevard Eastbound						
	Left	Thru	Right	RTOR	App. Total	Left	Thru	Right	RTOR	App. Total	Left	Thru	Right	RTOR	App. Total	Exclu. Total	Inclu. Total	Int. Total	
04:45 PM	1	0	0		1	0	1			2	0	0			0	0	2	5	5
05:00 PM	1	1	0		2	0	3			5	0	0			0	1	1	8	8
05:15 PM	3	1	0		4	0	0			4	0	0			1	1	2	7	7
05:30 PM	2	0	0		2	0	2			5	0	0			0	0	1	8	8
Total Volume	7	2	0		9	0	6			12	0	1			3	2	6	28	28
% App. Total	77.8	22.2	0			0	50			0	0	100			33.3	50	33.3		
PHF	.583	.500	.000		.563	.000	.500			.600	.000	.250			.750	.500	.750		.875

Peak Hour Analysis From 04:45 PM to 05:30 PM - Peak 1 of 1
 Peak Hour for Entire Intersection Begins at 04:45 PM

Counts Unlimited
 PO Box 1178
 Corona, CA 92878
 (951) 268-6268

City of Riverside
 N/S: Sycamore Canyon Blvd/Meridian Pkwy
 E/W: Alessandro Boulevard
 Weather: Clear

File Name : 26_RIV_Meridian_Alessandro PM
 Site Code : 05119542
 Start Date : 8/20/2019
 Page No : 2

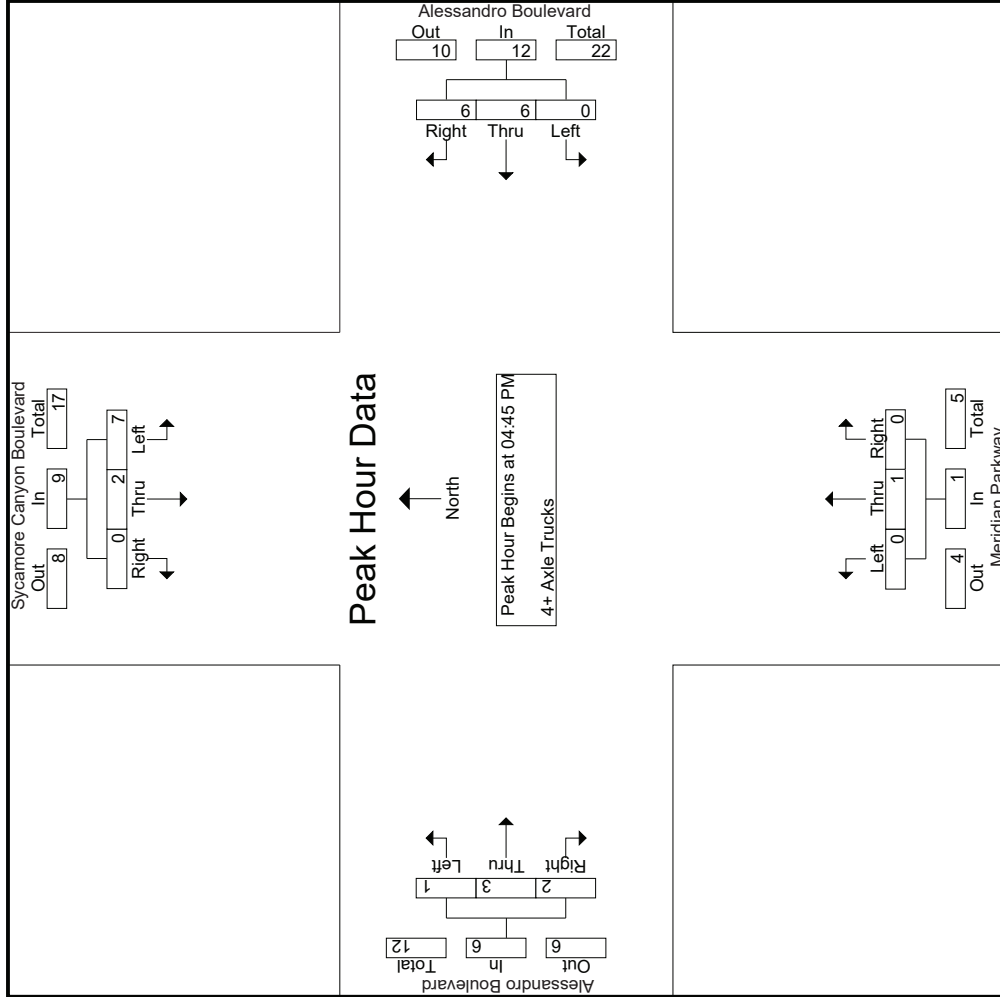

Counts Unlimited
 PO Box 1178
 Corona, CA 92878
 (951) 268-6268

City of Riverside
 N/S: Sycamore Canyon Blvd/Meridian Pkwy
 E/W: Alessandro Boulevard
 Weather: Clear

File Name : 26_RIV_Meridian_Alessandro PM
 Site Code : 05119542
 Start Date : 8/20/2019
 Page No : 3

Start Time	Sycamore Canyon Boulevard Southbound			Alessandro Boulevard Westbound			Meridian Parkway Northbound			Alessandro Boulevard Eastbound		
	Left	Thru	Right	Left	Thru	Right	Left	Thru	Right	Left	Thru	Right
Peak Hour Analysis From 04:45 PM to 05:30 PM - Peak 1 of 1												
Peak Hour for Each Approach Begins at:	04:45 PM			04:45 PM			04:45 PM			04:45 PM		
+0 mins.	1	0	0	1	1	1	0	0	0	0	0	0
+15 mins.	1	1	0	3	2	5	0	0	0	0	0	0
+30 mins.	3	1	0	0	0	0	0	1	0	0	1	1
+45 mins.	2	0	0	2	3	5	0	0	0	0	1	0
Total Volume	7	2	0	6	6	12	0	1	0	1	3	2
% App. Total	77.8	22.2	0	0	50	50	0	100	0	16.7	50	33.3
PHF	.583	.500	.000	.000	.500	.600	.000	.250	.000	.250	.750	.500

Location: Riverside
 N/S: Sycamore Cyn Blvd/Meridian Pkwy
 E/W: Alessandro Boulevard



Date: 8/20/2019
 Day: Tuesday

PEDESTRIANS

	North Leg Sycamore canon Blvd Pedestrians	East Leg Alessandro Boulevard Pedestrians	South Leg Meridian Parkway Pedestrians	West Leg Alessandro Boulevard Pedestrians	
7:00 AM	0	0	0	0	0
7:15 AM	0	0	0	0	0
7:30 AM	0	0	2	2	4
7:45 AM	0	0	0	0	0
8:00 AM	0	0	0	0	0
8:15 AM	0	0	4	4	8
8:30 AM	0	0	0	0	0
8:45 AM	0	0	0	0	0
TOTAL VOLUMES:	0	0	6	6	12

	North Leg Sycamore canon Blvd Pedestrians	East Leg Alessandro Boulevard Pedestrians	South Leg Meridian Parkway Pedestrians	West Leg Alessandro Boulevard Pedestrians	
4:00 PM	0	0	0	0	0
4:15 PM	0	0	0	0	0
4:30 PM	1	0	1	1	3
4:45 PM	0	0	0	1	1
5:00 PM	0	0	0	1	1
5:15 PM	0	0	0	0	0
5:30 PM	0	0	0	0	0
5:45 PM	0	0	0	0	0
TOTAL VOLUMES:	1	0	1	3	5

Location: Riverside
 N/S: Sycamore Cyn Blvd/Meridian Pkwy
 E/W: Alessandro Boulevard



Date: 8/20/2019
 Day: Tuesday

BICYCLES

	Southbound Sycamore canon Blvd			Westbound Alessandro Boulevard			Northbound Meridian Parkway			Eastbound Alessandro Boulevard			
	Left	Thru	Right	Left	Thru	Right	Left	Thru	Right	Left	Thru	Right	
7:00 AM	0	0	0	0	0	0	0	0	0	0	2	0	2
7:15 AM	0	0	0	0	0	0	0	0	0	0	0	0	0
7:30 AM	0	0	0	0	0	0	0	0	0	0	0	0	0
7:45 AM	0	0	0	0	0	0	0	0	0	0	0	0	0
8:00 AM	0	0	0	0	2	0	0	1	0	0	0	1	4
8:15 AM	0	0	0	0	0	0	0	0	0	0	0	0	0
8:30 AM	0	0	0	0	0	0	0	0	0	1	0	0	1
8:45 AM	0	0	0	0	0	0	0	0	0	0	0	0	0
TOTAL VOLUMES:	0	0	0	0	2	0	0	1	0	1	2	1	7

	Southbound Sycamore canon Blvd			Westbound Alessandro Boulevard			Northbound Meridian Parkway			Eastbound Alessandro Boulevard			
	Left	Thru	Right	Left	Thru	Right	Left	Thru	Right	Left	Thru	Right	
4:00 PM	0	0	0	0	0	0	0	0	0	0	0	0	0
4:15 PM	0	0	0	0	0	0	0	0	0	0	0	0	0
4:30 PM	0	0	0	0	0	0	0	0	0	0	0	0	0
4:45 PM	0	0	0	0	0	0	0	0	0	0	0	0	0
5:00 PM	0	0	0	0	0	0	0	0	0	0	0	0	0
5:15 PM	0	0	0	0	0	0	0	0	0	0	0	0	0
5:30 PM	0	1	0	0	0	0	0	0	0	0	0	0	1
5:45 PM	0	0	0	0	1	0	0	2	0	1	0	0	4
TOTAL VOLUMES:	0	1	0	0	1	0	0	2	0	1	0	0	5

Counts Unlimited
 PO Box 1178
 Corona, CA 92878
 (951) 268-6268

County of Riverside
 N/S: Meridian Parkway
 EW: Cactus Avenue
 Weather: Clear

File Name : 28_CRV_Meridian_Cactus AM
 Site Code : 05119542
 Start Date : 8/20/2019
 Page No : 1

Groups Printed- Passenger Vehicles - Large 2 Axle Vehicles - 3 Axle Vehicles - 4+ Axle Trucks

Start Time	Meridian Parkway Southbound					Cactus Avenue Westbound					Meridian Parkway Northbound					Commercial Driveway Eastbound							
	Left	Thru	Right	RTOR	App. Total	Left	Thru	Right	RTOR	App. Total	Left	Thru	Right	RTOR	App. Total	Left	Thru	Right	RTOR	App. Total	Exclu. Total	Inclu. Total	Int. Total
	07:00 AM	25	34	2	1	61	87	1	237	54	325	1	75	31	23	107	2	1	5	0	8	78	501
07:15 AM	25	33	2	0	60	85	3	231	68	319	1	115	25	14	141	2	3	2	1	7	83	527	610
07:30 AM	19	22	1	1	42	81	2	202	48	285	1	106	40	21	147	3	1	0	0	4	70	478	548
07:45 AM	22	26	0	0	48	67	0	188	55	255	2	78	40	18	120	1	0	3	3	4	76	427	503
Total	91	115	5	2	211	320	6	858	225	1184	5	374	136	76	515	8	5	10	4	23	307	1933	2240
08:00 AM	24	28	4	2	56	60	1	197	73	258	2	100	33	27	135	2	1	3	2	6	104	455	559
08:15 AM	16	35	0	0	51	56	4	259	80	319	2	78	31	18	111	2	1	0	0	3	98	484	582
08:30 AM	20	23	2	2	45	61	3	257	61	321	2	69	22	13	93	3	3	4	2	10	78	469	547
08:45 AM	15	24	2	1	41	55	0	232	85	287	1	79	36	25	116	2	1	2	2	5	113	449	562
Total	75	110	8	5	193	232	8	945	299	1185	7	326	122	83	455	9	6	9	6	24	393	1857	2250
Grand Total	166	225	13	7	404	552	14	1803	524	2369	12	700	258	159	970	17	11	19	10	47	700	3790	4490
Approch %	41.1	55.7	3.2			23.3	0.6	76.1		62.5	0.3	18.5	6.8	25.6		36.2	23.4	40.4		1.2	15.6	84.4	
Total %	4.4	5.9	0.3			10.7	0.4	47.6		62.5	0.3	18.5	6.8	25.6		36.2	23.4	40.4		1.2	15.6	84.4	
Passenger Vehicles	160	209	8		380	469	11	1747		2734	6	657	210		999	11	6	11		33	0	0	4146
% Passenger Vehicles	96.4	92.9	61.5	42.9	92.5	85	78.6	96.9	96.8	94.5	50	93.9	81.4	79.2	88.5	64.7	54.5	57.9	50	57.9	0	0	92.3
Large 2 Axle Vehicles	3	12	3		20	13	1	35		58	3	19	2		25	5	2	4		13	0	0	116
% Large 2 Axle Vehicles	1.8	5.3	23.1	28.6	4.9	2.4	7.1	1.9	1.7	2	25	2.7	0.8	0.6	2.2	29.4	18.2	21.1	20	22.8	0	0	2.6
3 Axle Vehicles	0	1	2		5	33	1	5		40	1	8	32		66	1	1	1		4	0	0	115
% 3 Axle Vehicles	0	0.4	15.4	28.6	1.2	6	7.1	0.3	0.2	1.4	8.3	1.1	12.4	15.7	5.8	5.9	9.1	5.3	10	7	0	0	2.6
4+ Axle Trucks	3	3	0		6	37	1	16		61	2	16	14		39	0	2	3		7	0	0	113
% 4+ Axle Trucks	1.8	1.3	0		1.5	6.7	7.1	0.9	1.3	2.1	16.7	2.3	5.4	4.4	3.5	0	18.2	15.8	20	12.3	0	0	2.5

Start Time	Meridian Parkway Southbound					Cactus Avenue Westbound					Meridian Parkway Northbound					Commercial Driveway Eastbound							
	Left	Thru	Right	RTOR	App. Total	Left	Thru	Right	RTOR	App. Total	Left	Thru	Right	RTOR	App. Total	Left	Thru	Right	RTOR	App. Total	Exclu. Total	Inclu. Total	Int. Total
	07:00 AM	25	34	2	1	61	87	1	237	54	325	1	75	31	23	107	2	1	5	0	8	78	501
07:15 AM	25	33	2	0	60	85	3	231	68	319	1	115	25	14	141	2	3	2	1	7	83	527	610
07:30 AM	19	22	1	1	42	81	2	202	48	285	1	106	40	21	147	3	1	0	0	4	70	478	548
07:45 AM	22	26	0	0	48	67	0	188	55	255	2	78	40	18	120	1	0	3	3	4	76	427	503
Total	91	115	5	2	211	320	6	858	225	1184	5	374	136	76	515	8	5	10	4	23	307	1933	2240
PHF	.910	.846	.625			.865	.920	.500	.905	.911	.625	.813	.850		.876	.667	.417	.500		.719	.500	.719	.917

Start Time	Meridian Parkway Southbound					Cactus Avenue Westbound					Meridian Parkway Northbound					Commercial Driveway Eastbound							
	Left	Thru	Right	RTOR	App. Total	Left	Thru	Right	RTOR	App. Total	Left	Thru	Right	RTOR	App. Total	Left	Thru	Right	RTOR	App. Total	Exclu. Total	Inclu. Total	Int. Total
	07:00 AM	25	34	2	1	61	87	1	237	54	325	1	75	31	23	107	2	1	5	0	8	78	501
07:15 AM	25	33	2	0	60	85	3	231	68	319	1	115	25	14	141	2	3	2	1	7	83	527	610
07:30 AM	19	22	1	1	42	81	2	202	48	285	1	106	40	21	147	3	1	0	0	4	70	478	548
07:45 AM	22	26	0	0	48	67	0	188	55	255	2	78	40	18	120	1	0	3	3	4	76	427	503
Total Volume	91	115	5		211	320	6	858		1184	5	374	136		515	8	5	10		23	307	1933	2240
% App. Total	43.1	54.5	2.4			27	0.5	72.5		72.5	1	72.6	26.4		43.5	34.8	21.7	43.5		43.5	0	0	1933

Peak Hour Analysis From 07:00 AM to 08:45 AM - Peak 1 of 1

Peak Hour for Entire Intersection Begins at 07:00 AM

Counts Unlimited
 PO Box 1178
 Corona, CA 92878
 (951) 268-6268

County of Riverside
 N/S: Meridian Parkway
 E/W: Cactus Avenue
 Weather: Clear

File Name : 28_CRV_Meridian_Cactus AM
 Site Code : 05119542
 Start Date : 8/20/2019
 Page No : 2

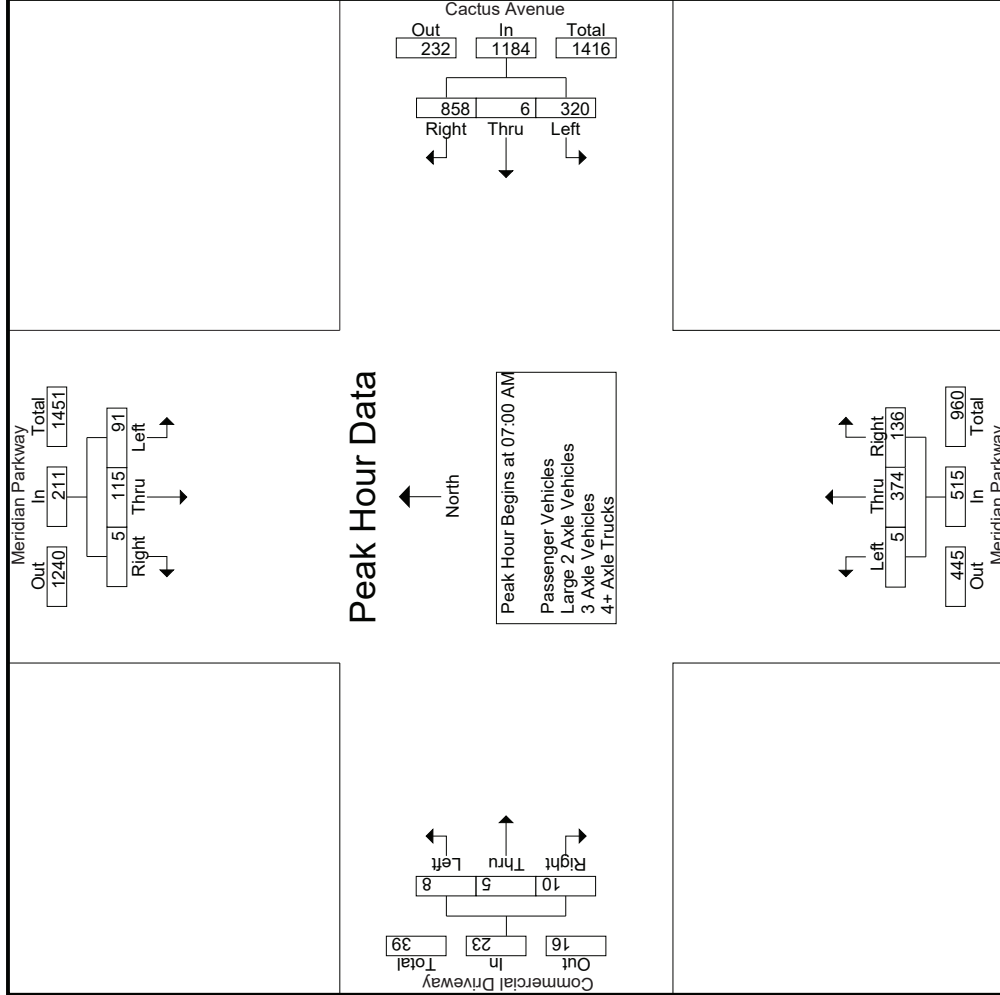

Counts Unlimited
 PO Box 1178
 Corona, CA 92878
 (951) 268-6268

County of Riverside
 N/S: Meridian Parkway
 E/W: Cactus Avenue
 Weather: Clear

File Name : 28_CRV_Meridian_Cactus AM
 Site Code : 05119542
 Start Date : 8/20/2019
 Page No : 3

Start Time	Meridian Parkway Southbound			Cactus Avenue Westbound			Meridian Parkway Northbound			Commercial Driveway Eastbound			
	Left	Thru	Right	App. Total	Left	Thru	Right	App. Total	Left	Thru	Right	App. Total	Int. Total
Peak Hour Analysis From 07:00 AM to 08:45 AM - Peak 1 of 1													
Peak Hour for Each Approach Begins at:													
	07:00 AM			08:00 AM			07:15 AM			08:00 AM			
+0 mins.	25	34	2	61	60	1	197	258	1	115	25	141	6
+15 mins.	25	33	2	60	56	4	259	319	1	106	40	147	3
+30 mins.	19	22	1	42	61	3	257	321	2	78	40	120	10
+45 mins.	22	26	0	48	55	0	232	287	2	100	33	135	5
Total Volume	91	115	5	211	232	8	945	1185	6	399	138	543	24
% App. Total	43.1	54.5	2.4	.865	19.6	0.7	79.7	.923	1.1	73.5	25.4	.923	37.5
PHF	.910	.846	.625	.865	.951	.500	.912	.923	.750	.867	.863	.923	37.5
													.500
													.563
													.600

Counts Unlimited
 PO Box 1178
 Corona, CA 92878
 (951) 268-6268

County of Riverside
 N/S: Meridian Parkway
 EW: Cactus Avenue
 Weather: Clear

File Name : 28_CRV_Meridian_Cactus AM
 Site Code : 05119542
 Start Date : 8/20/2019
 Page No : 1

Groups Printed- Passenger Vehicles

Start Time	Meridian Parkway Southbound						Cactus Avenue Westbound						Meridian Parkway Northbound						Commercial Driveway Eastbound					
	Left	Thru	Right	RTOR	App. Total	Inclu. Total	Left	Thru	Right	RTOR	App. Total	Inclu. Total	Left	Thru	Right	RTOR	App. Total	Inclu. Total	Left	Thru	Right	RTOR	App. Total	Inclu. Total
	07:00 AM	24	33	1	0	58	72	0	227	52	299	1	69	28	20	98	1	0	3	0	4	72	459	531
07:15 AM	23	31	1	0	55	71	2	227	67	300	1	110	21	10	132	1	2	2	1	5	78	492	570	
07:30 AM	19	21	0	0	40	77	1	197	48	275	1	101	32	17	134	3	0	0	0	3	65	452	517	
07:45 AM	21	26	0	0	47	62	0	185	54	247	1	73	33	16	107	1	0	1	1	2	71	403	474	
Total	87	111	2	0	200	282	3	836	221	1121	4	353	114	63	471	6	2	6	2	14	286	1806	2092	
08:00 AM	24	25	4	2	53	51	1	193	73	245	0	95	23	18	118	1	0	2	1	3	94	419	513	
08:15 AM	15	32	0	0	47	42	4	252	77	298	0	69	26	16	95	1	1	0	0	2	93	442	535	
08:30 AM	19	22	1	1	42	48	3	248	57	299	1	64	16	9	81	2	2	3	2	7	69	429	498	
08:45 AM	15	19	1	0	35	46	0	218	79	264	1	76	31	20	108	1	1	0	0	2	99	409	508	
Total	73	98	6	3	177	187	8	911	286	1106	2	304	96	63	402	5	4	5	3	14	355	1699	2054	
Grand Total	160	209	8	3	377	469	11	1747	507	2227	6	657	210	126	873	11	6	11	5	28	641	3505	4146	
Approch %	42.4	55.4	2.1			21.1	0.5	78.4		63.5	0.7	75.3	24.1		24.9	39.3	21.4	39.3		0.8	15.5	84.5		
Total %	4.6	6	0.2		10.8	13.4	0.3	49.8			0.2	18.7	6			0.3	0.2	0.3						

Start Time	Meridian Parkway Southbound						Cactus Avenue Westbound						Meridian Parkway Northbound						Commercial Driveway Eastbound					
	Left	Thru	Right	RTOR	App. Total	Inclu. Total	Left	Thru	Right	RTOR	App. Total	Inclu. Total	Left	Thru	Right	RTOR	App. Total	Inclu. Total	Left	Thru	Right	RTOR	App. Total	Inclu. Total
	07:00 AM	24	33	1	0	58	72	0	227	52	299	1	69	28	20	98	1	0	3	0	4	72	459	531
07:15 AM	23	31	1	0	55	71	2	227	67	300	1	110	21	10	132	1	2	2	1	5	78	492	570	
07:30 AM	19	21	0	0	40	77	1	197	48	275	1	101	32	17	134	3	0	0	0	3	65	452	517	
07:45 AM	21	26	0	0	47	62	0	185	54	247	1	73	33	16	107	1	0	1	1	2	71	403	474	
Total Volume	87	111	2	0	200	282	3	836	221	1121	4	353	114	63	471	6	2	6	2	14	286	1806	2092	
% App. Total	43.5	55.5	1			25.2	0.3	74.6		63.5	0.7	75.3	24.1		24.9	39.3	21.4	39.3		0.8	15.5	84.5		
PHF	.906	.841	.500		.862	.916	.375	.921		.934	1.00	.802	.864		.879	.500	.250	.500		.700	.700	.918		

Peak Hour Analysis From 07:00 AM to 07:45 AM - Peak 1 of 1
 Peak Hour for Entire Intersection Begins at 07:00 AM

Counts Unlimited
 PO Box 1178
 Corona, CA 92878
 (951) 268-6268

County of Riverside
 N/S: Meridian Parkway
 E/W: Cactus Avenue
 Weather: Clear

File Name : 28_CRV_Meridian_Cactus AM
 Site Code : 05119542
 Start Date : 8/20/2019
 Page No : 2

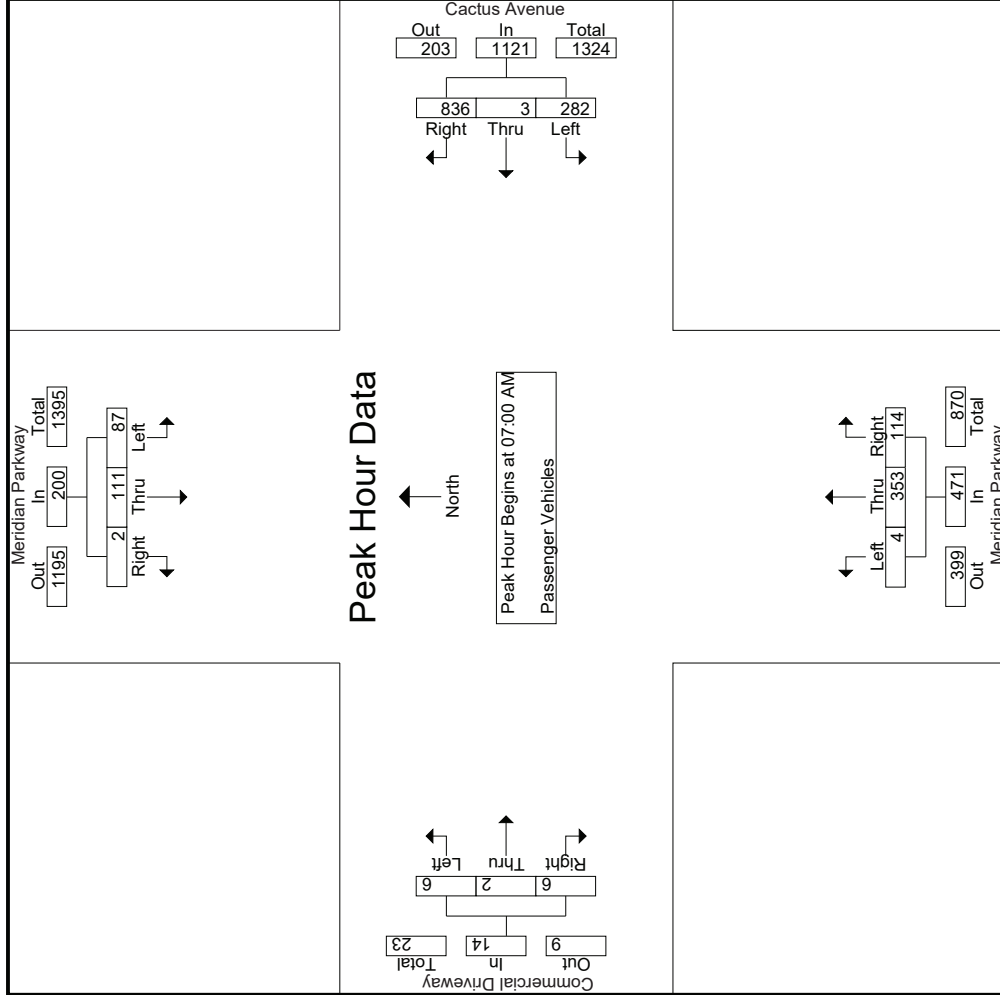

Counts Unlimited
 PO Box 1178
 Corona, CA 92878
 (951) 268-6268

County of Riverside
 N/S: Meridian Parkway
 E/W: Cactus Avenue
 Weather: Clear

File Name : 28_CRV_Meridian_Cactus AM
 Site Code : 05119542
 Start Date : 8/20/2019
 Page No : 3

Start Time	Meridian Parkway Southbound			Cactus Avenue Westbound			Meridian Parkway Northbound			Commercial Driveway Eastbound					
	Left	Thru	Right	App. Total	Left	Thru	Right	App. Total	Left	Thru	Right	App. Total	Int. Total		
Peak Hour Analysis From 07:00 AM to 07:45 AM - Peak 1 of 1															
Peak Hour for Each Approach Begins at:															
	07:00 AM				07:00 AM				07:00 AM				07:00 AM		
+0 mins.	24	33	1	58	72	0	227	299	69	28	98	1	0	3	4
+15 mins.	23	31	1	55	71	2	227	300	110	21	132	1	2	2	5
+30 mins.	19	21	0	40	77	1	197	275	101	32	134	3	0	0	3
+45 mins.	21	26	0	47	62	0	185	247	73	33	107	1	0	1	2
Total Volume	87	111	2	200	282	3	836	1121	353	114	471	6	2	6	14
% App. Total	43.5	55.5	1		25.2	0.3	74.6		74.9	24.2	42.9	42.9	14.3	42.9	
PHF	.906	.841	.500	.862	.916	.375	.921	.934	.802	.864	.879	.500	.250	.500	.700

Groups Printed- Large 2 Axle Vehicles

Start Time	Meridian Parkway Southbound					Cactus Avenue Westbound					Meridian Parkway Northbound					Commercial Driveway Eastbound							
	Left	Thru	Right	RTOR	App. Total	Left	Thru	Right	RTOR	App. Total	Left	Thru	Right	RTOR	App. Total	Left	Thru	Right	RTOR	App. Total	Exclu. Total	Inclu. Total	Int. Total
	07:00 AM	0	1	1	1	2	2	0	9	2	11	0	1	0	0	1	1	0	1	0	2	3	16
07:15 AM	0	2	1	0	3	0	0	1	0	1	0	3	0	0	3	1	0	0	0	1	0	0	8
07:30 AM	0	1	0	0	1	0	1	4	0	5	0	0	0	0	0	0	0	0	0	0	0	0	6
07:45 AM	1	0	0	0	1	1	0	0	0	1	0	2	0	0	2	0	0	1	1	1	1	5	6
Total	1	4	2	1	7	3	1	14	2	18	0	6	0	0	6	2	0	2	1	4	4	35	39
08:00 AM	0	2	0	0	2	0	0	4	0	4	1	3	1	1	5	1	1	0	0	2	1	13	14
08:15 AM	1	2	0	0	3	4	0	5	1	9	2	4	1	0	7	0	0	0	0	0	1	19	20
08:30 AM	1	1	0	0	2	3	0	6	2	9	0	4	0	0	4	1	1	1	0	3	2	18	20
08:45 AM	0	3	1	1	4	3	0	6	4	9	0	2	0	0	2	1	0	1	1	2	6	17	23
Total	2	8	1	1	11	10	0	21	7	31	3	13	2	1	18	3	2	2	1	7	10	67	77
Grand Total	3	12	3	2	18	13	1	35	9	49	3	19	2	1	24	5	2	4	2	11	14	102	116
Apprch %	16.7	66.7	16.7		26.5	26.5	2	71.4		48	12.5	79.2	8.3		23.5	45.5	18.2	36.4		10.8	12.1	87.9	
Total %	2.9	11.8	2.9		17.6	12.7	1	34.3		48	2.9	18.6	2		23.5	4.9	2	3.9					

Start Time	Meridian Parkway Southbound					Cactus Avenue Westbound					Meridian Parkway Northbound					Commercial Driveway Eastbound							
	Left	Thru	Right	RTOR	App. Total	Left	Thru	Right	RTOR	App. Total	Left	Thru	Right	RTOR	App. Total	Left	Thru	Right	RTOR	App. Total	Exclu. Total	Inclu. Total	Int. Total
	07:00 AM	0	1	1	1	2	2	0	9	2	11	0	1	0	0	1	1	0	1	0	2	3	16
07:15 AM	0	2	1	0	3	0	0	1	0	1	0	3	0	0	3	1	0	0	0	1	0	0	8
07:30 AM	0	1	0	0	1	0	1	4	0	5	0	0	0	0	0	0	0	0	0	0	0	0	6
07:45 AM	1	0	0	0	1	1	0	0	0	1	0	2	0	0	2	0	0	1	1	1	1	5	6
Total Volume	1	4	2	1	7	3	1	14	2	18	0	6	0	0	6	2	0	2	1	4	4	35	39
% App. Total	14.3	57.1	28.6		28.6	16.7	5.6	77.8		48	0	100	0		23.5	45.5	18.2	36.4		10.8	12.1	87.9	
PHF	.250	.500	.500		.583	.375	.250	.389		.409	.000	.500	.000		.500	.500	.000	.500		.500	.500	.500	.547

Peak Hour Analysis From 07:00 AM to 07:45 AM - Peak 1 of 1
 Peak Hour for Entire Intersection Begins at 07:00 AM

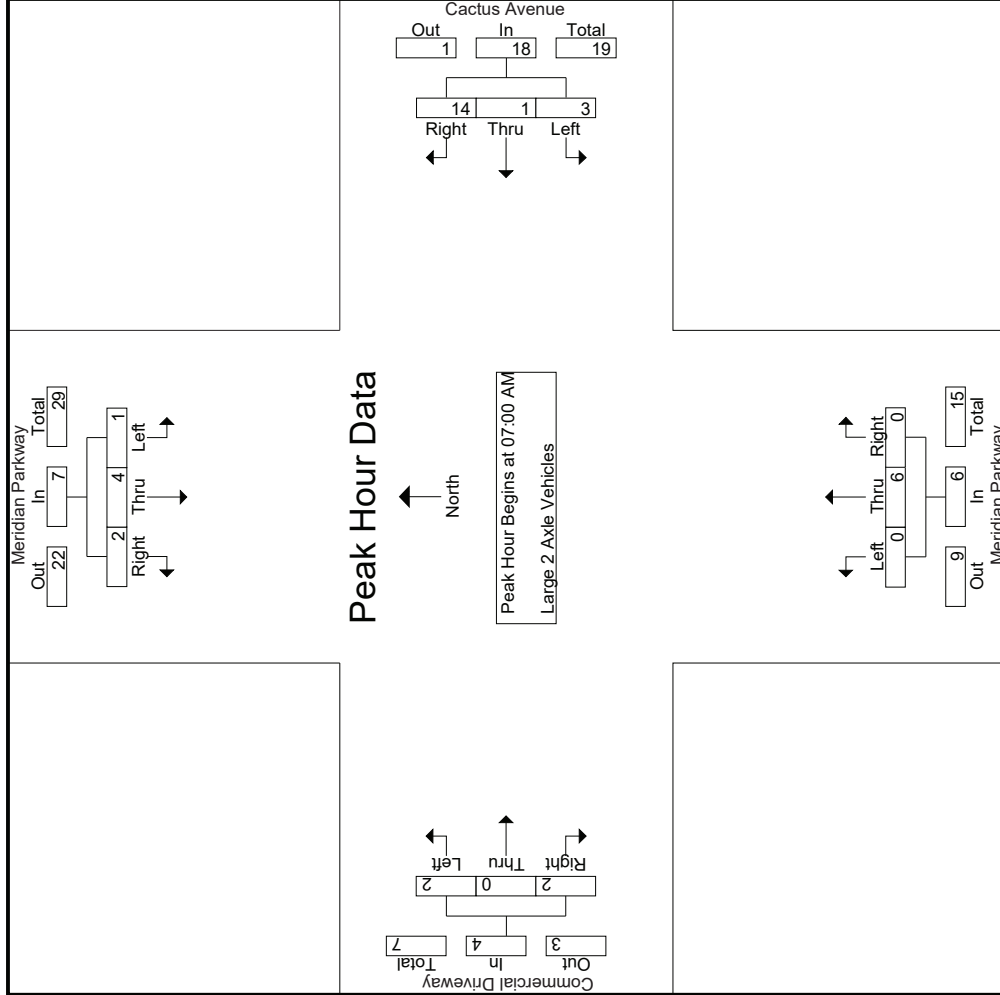

Counts Unlimited
 PO Box 1178
 Corona, CA 92878
 (951) 268-6268

County of Riverside
 N/S: Meridian Parkway
 E/W: Cactus Avenue
 Weather: Clear

File Name : 28_CRV_Meridian_Cactus AM
 Site Code : 05119542
 Start Date : 8/20/2019
 Page No : 3

Start Time	Meridian Parkway Southbound			Cactus Avenue Westbound			Meridian Parkway Northbound			Commercial Driveway Eastbound		
	Left	Thru	Right	Left	Thru	Right	Left	Thru	Right	Left	Thru	Right
Peak Hour Analysis From 07:00 AM to 07:45 AM - Peak 1 of 1												
Peak Hour for Each Approach Begins at:												
+0 mins.	0	1	1	2	0	9	11	0	1	0	0	1
+15 mins.	0	2	1	3	0	1	1	0	3	0	0	0
+30 mins.	0	1	0	1	0	4	5	0	0	0	0	0
+45 mins.	1	0	0	1	0	0	1	0	2	0	0	1
Total Volume	1	4	2	7	3	14	18	0	6	0	0	2
% App. Total	14.3	57.1	28.6	16.7	5.6	77.8	40.9	0	100	0	0	50
PHF	.250	.500	.500	.375	.250	.389	.409	.000	.500	.000	.000	.500

Counts Unlimited
 PO Box 1178
 Corona, CA 92878
 (951) 268-6268

County of Riverside
 N/S: Meridian Parkway
 E/W: Cactus Avenue
 Weather: Clear

File Name : 28_CRV_Meridian_Cactus AM
 Site Code : 05119542
 Start Date : 8/20/2019
 Page No : 1

Groups Printed- 3 Axle Vehicles

Start Time	Meridian Parkway Southbound				Cactus Avenue Westbound				Meridian Parkway Northbound				Commercial Driveway Eastbound								
	Left	Thru	Right	RTOR	App. Total	Left	Thru	Right	RTOR	App. Total	Left	Thru	Right	RTOR	App. Total	Exclu. Total	Inclu. Total	Int. Total			
07:00 AM	0	0	0	0	0	8	1	1	0	10	0	0	3	3	0	1	0	0	1		
07:15 AM	0	0	0	0	0	6	0	2	1	8	0	0	3	3	0	0	0	0	0		
07:30 AM	0	0	1	1	1	1	0	1	0	2	0	2	5	4	0	0	0	0	0		
07:45 AM	0	0	0	0	0	2	0	0	0	2	0	3	4	1	7	0	1	1	1		
Total	0	0	1	1	1	17	1	4	1	22	0	5	15	11	20	0	1	1	2		
08:00 AM	0	0	0	0	0	4	0	0	0	4	1	0	9	8	10	0	0	0	0		
08:15 AM	0	1	0	0	1	6	0	0	0	6	0	2	2	1	4	1	0	0	1		
08:30 AM	0	0	1	1	1	5	0	0	0	5	0	0	4	3	4	0	0	0	0		
08:45 AM	0	0	0	0	0	1	0	1	0	2	0	1	2	2	3	0	0	0	0		
Total	0	1	1	1	2	16	0	1	0	17	1	3	17	14	21	1	0	0	1		
Grand Total	0	1	2	2	3	33	1	5	1	39	1	8	32	25	41	1	1	1	3		
Apprch %	0	33.3	66.7			84.6	2.6	12.8		45.3	2.4	19.5	78		47.7	33.3	33.3	33.3	29		
Total %	0	1.2	2.3		3.5	38.4	1.2	5.8		45.3	1.2	9.3	37.2		47.7	1.2	1.2	1.2	3.5		
																				25.2	
																					74.8

3.1-310

Start Time	Meridian Parkway Southbound				Cactus Avenue Westbound				Meridian Parkway Northbound				Commercial Driveway Eastbound									
	Left	Thru	Right	RTOR	App. Total	Left	Thru	Right	RTOR	App. Total	Left	Thru	Right	RTOR	App. Total	Left	Thru	Right	RTOR	App. Total	Int. Total	
Peak Hour Analysis From 07:00 AM to 07:45 AM - Peak 1 of 1																						
Peak Hour for Entire Intersection Begins at 07:00 AM																						
07:00 AM	0	0	0	0	0	8	1	1	10	10	0	0	3	3	3	0	0	0	0	0	0	14
07:15 AM	0	0	0	0	0	6	0	2	8	8	0	0	3	3	3	0	0	0	0	0	0	11
07:30 AM	0	0	0	0	1	1	0	0	2	1	0	2	5	4	7	0	0	0	0	0	0	10
07:45 AM	0	0	0	0	0	2	0	0	2	0	0	3	4	7	4	0	0	1	1	1	1	10
Total Volume	0	0	1	1	1	17	1	4	22	22	0	5	15	20	20	0	1	1	1	2	2	45
% App. Total	0	0	100			77.3	4.5	18.2	.550	.550	0	25	75		.714	0	50	50		.500	.804	
PHF	.000	.000	.250		.250	.531	.250	.500	.550	.550	.000	.417	.750		.714	.000	.250	.250		.500	.804	

Counts Unlimited
 PO Box 1178
 Corona, CA 92878
 (951) 268-6268

County of Riverside
 N/S: Meridian Parkway
 E/W: Cactus Avenue
 Weather: Clear

File Name : 28_CRV_Meridian_Cactus AM
 Site Code : 05119542
 Start Date : 8/20/2019
 Page No : 2

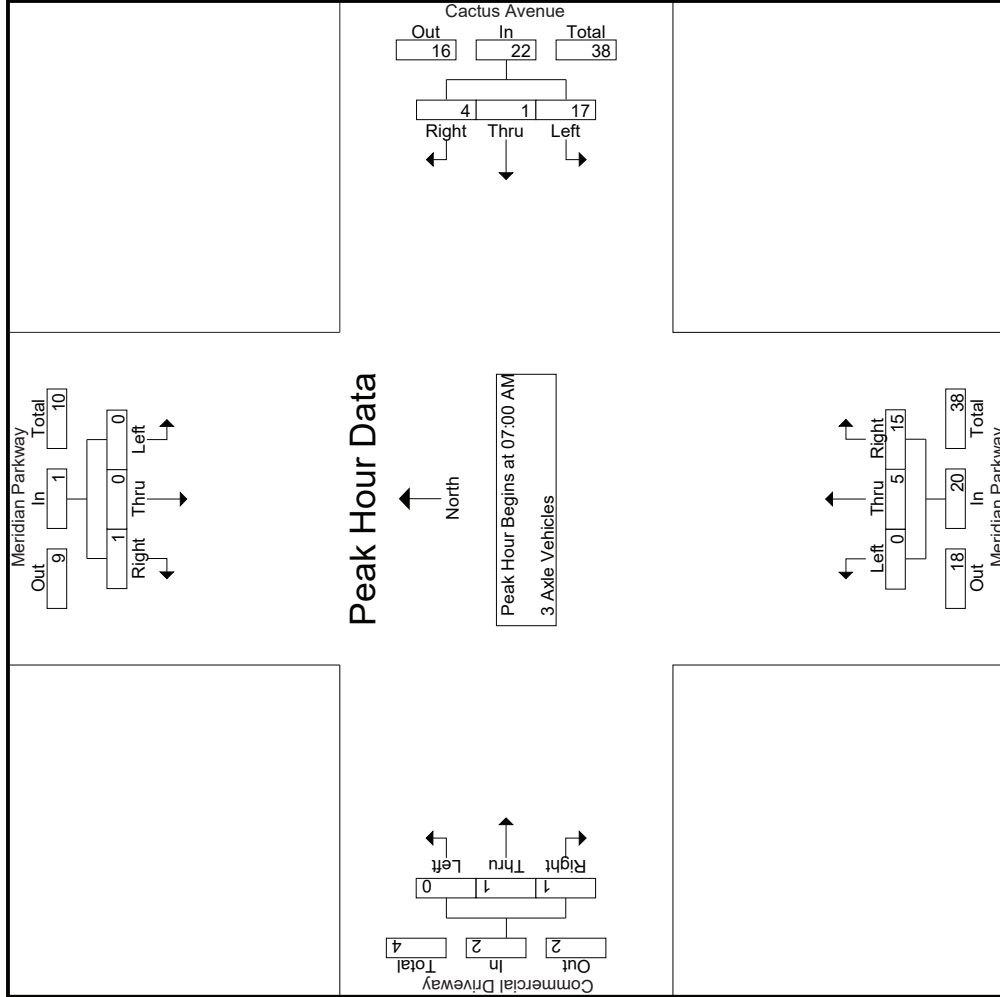

Counts Unlimited
 PO Box 1178
 Corona, CA 92878
 (951) 268-6268

County of Riverside
 N/S: Meridian Parkway
 E/W: Cactus Avenue
 Weather: Clear

File Name : 28_CRV_Meridian_Cactus AM
 Site Code : 05119542
 Start Date : 8/20/2019
 Page No : 3

Start Time	Meridian Parkway Southbound			Cactus Avenue Westbound			Meridian Parkway Northbound			Commercial Driveway Eastbound						
	Left	Thru	Right	App. Total	Left	Thru	Right	App. Total	Left	Thru	Right	App. Total	Int. Total			
Peak Hour Analysis From 07:00 AM to 07:45 AM - Peak 1 of 1																
Peak Hour for Each Approach Begins at:																
	07:00 AM				07:00 AM				07:00 AM				07:00 AM			
+0 mins.	0	0	0	0	8	1	1	10	0	0	3	3	0	1	0	1
+15 mins.	0	0	0	0	6	0	2	8	0	0	3	3	0	0	0	0
+30 mins.	0	0	1	1	1	0	1	2	2	0	5	7	0	0	0	0
+45 mins.	0	0	0	0	2	0	0	2	3	4	4	7	0	0	1	1
Total Volume	0	0	1	1	17	1	4	22	5	15	15	20	0	1	1	2
% App. Total	0	0	100	.250	77.3	4.5	18.2	.550	0	25	.75	.714	0	50	50	.500
PHF	.000	.000	.250	.250	.531	.250	.500	.550	.000	.417	.750	.714	.000	.250	.250	.500

Counts Unlimited
 PO Box 1178
 Corona, CA 92878
 (951) 268-6268

County of Riverside
 N/S: Meridian Parkway
 EW: Cactus Avenue
 Weather: Clear

File Name : 28_CRV_Meridian_Cactus AM
 Site Code : 05119542
 Start Date : 8/20/2019
 Page No : 1

Groups Printed- 4+ Axle Trucks

Start Time	Meridian Parkway Southbound				Cactus Avenue Westbound				Meridian Parkway Northbound				Commercial Driveway Eastbound					
	Left	Thru	Right	RTOR	App. Total	Left	Thru	Right	RTOR	App. Total	Left	Thru	Right	RTOR	App. Total	Exclu. Total	Inclu. Total	Int. Total
07:00 AM	1	0	0	0	1	5	0	0	0	5	0	0	1	0	1	0	12	12
07:15 AM	2	0	0	0	2	8	1	1	0	10	0	2	1	1	3	1	16	17
07:30 AM	0	0	0	0	0	3	0	0	0	3	0	3	0	0	6	0	10	10
07:45 AM	0	0	0	0	0	2	0	3	1	5	1	0	3	1	4	2	9	11
Total	3	0	0	0	3	18	1	4	1	23	1	10	7	2	18	3	47	50
08:00 AM	0	1	0	0	1	5	0	0	0	5	0	2	0	0	2	1	9	10
08:15 AM	0	0	0	0	0	4	0	2	2	6	0	3	2	1	5	3	11	14
08:30 AM	0	0	0	0	0	5	0	3	2	8	1	1	2	1	4	0	12	15
08:45 AM	0	2	0	0	2	5	0	7	2	12	0	0	3	3	3	6	18	24
Total	0	3	0	0	3	19	0	12	6	31	1	6	7	5	14	13	50	63
Grand Total	3	3	0	0	6	37	1	16	7	54	2	16	14	7	32	0	97	113
Apprch %	50	50	0	0	68.5	1.9	29.6			55.7	6.2	50	43.8		33	0	40	60
Total %	3.1	3.1	0	0	6.2	38.1	1	16.5		55.7	2.1	16.5	14.4		33	0	2.1	3.1
															5.2	14.2		85.8

3.1-313

Start Time	Meridian Parkway Southbound				Cactus Avenue Westbound				Meridian Parkway Northbound				Commercial Driveway Eastbound					
	Left	Thru	Right	RTOR	App. Total	Left	Thru	Right	RTOR	App. Total	Left	Thru	Right	RTOR	App. Total	Exclu. Total	Inclu. Total	Int. Total
07:00 AM	1	0	0	0	1	5	0	0	0	5	0	0	1	0	1	0	12	12
07:15 AM	2	0	0	0	2	8	1	1	0	10	0	2	1	1	3	1	16	17
07:30 AM	0	0	0	0	0	3	0	0	0	3	0	3	0	0	6	0	10	10
07:45 AM	0	0	0	0	0	2	0	3	1	5	1	0	3	1	4	2	9	11
Total Volume	3	0	0	0	3	18	1	4	1	23	1	10	7	2	18	3	47	50
% App. Total	100	0	0	0	6.2	78.3	4.3	17.4		55.7	6.2	50	43.8		33.3	0	40	60
PHF	.375	.000	.000	.000	.375	.563	.250	.333		.575	.250	.500	.583		.750	.250	.750	.734

Peak Hour Analysis From 07:00 AM to 07:45 AM - Peak 1 of 1
 Peak Hour for Entire Intersection Begins at 07:00 AM

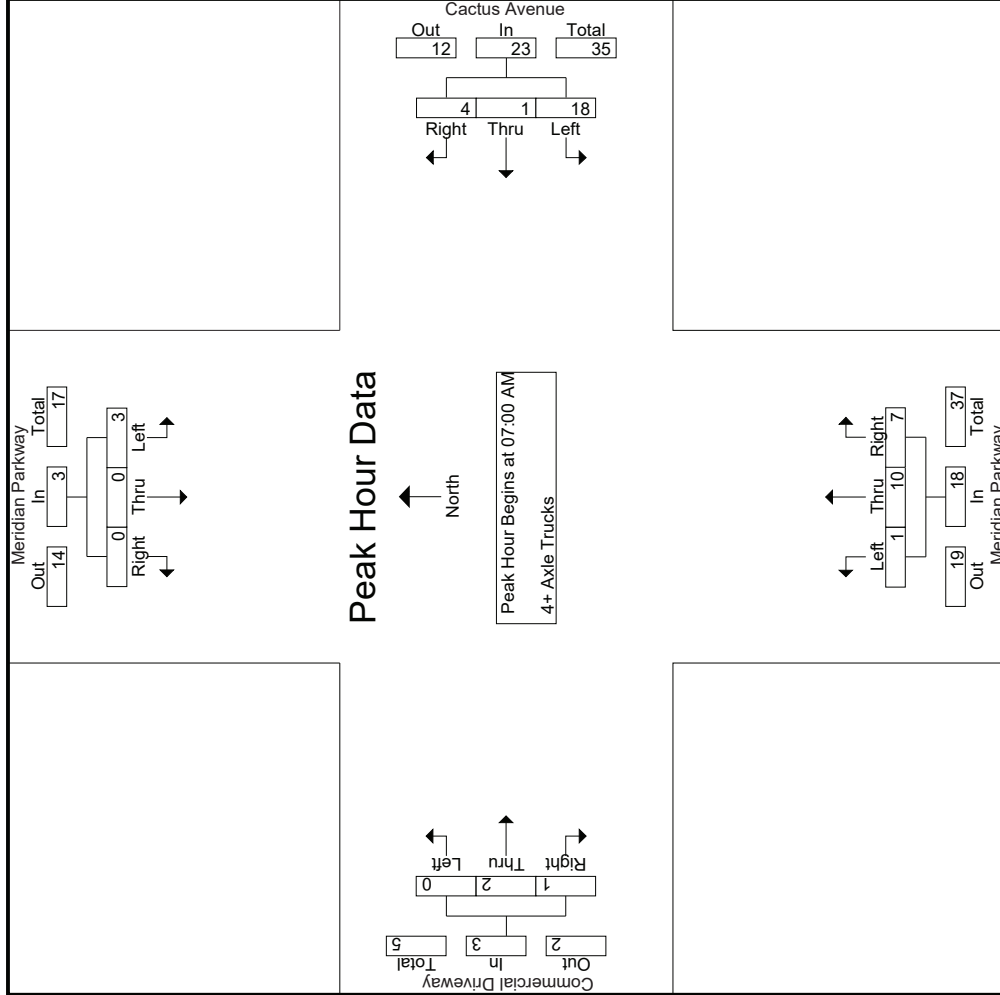

Counts Unlimited
 PO Box 1178
 Corona, CA 92878
 (951) 268-6268

County of Riverside
 N/S: Meridian Parkway
 E/W: Cactus Avenue
 Weather: Clear

File Name : 28_CRV_Meridian_Cactus AM
 Site Code : 05119542
 Start Date : 8/20/2019
 Page No : 3

Start Time	Meridian Parkway Southbound			Cactus Avenue Westbound			Meridian Parkway Northbound			Commercial Driveway Eastbound		
	Left	Thru	Right	Left	Thru	Right	Left	Thru	Right	Left	Thru	Right
Peak Hour Analysis From 07:00 AM to 07:45 AM - Peak 1 of 1												
Peak Hour for Each Approach Begins at:												
	07:00 AM											
+0 mins.	1	0	0	5	0	0	0	5	0	0	0	1
+15 mins.	2	0	0	10	1	1	1	3	2	1	1	0
+30 mins.	0	0	0	3	0	0	0	3	0	0	1	0
+45 mins.	0	0	0	5	0	3	3	5	0	0	0	0
Total Volume	3	0	0	18	1	4	4	23	10	7	2	1
% App. Total	100	0	0	78.3	4.3	17.4	17.4	56.3	55.6	38.9	66.7	33.3
PHF	.375	.000	.000	.563	.250	.333	.575	.250	.500	.583	.250	.750

Groups Printed- Passenger Vehicles - Large 2 Axle Vehicles - 3 Axle Vehicles - 4+ Axle Trucks

Start Time	Meridian Parkway Southbound					Cactus Avenue Westbound					Meridian Parkway Northbound					Commercial Driveway Eastbound						
	Left	Thru	Right	RTOR	App. Total	Left	Thru	Right	RTOR	App. Total	Left	Thru	Right	RTOR	App. Total	Left	Thru	Right	RTOR	App. Total	Exclu. Total	Inclu. Total
04:00 PM	72	97	0	0	169	70	0	69	46	139	58	47	21	105	0	0	0	0	0	67	413	480
04:15 PM	98	105	0	0	203	81	2	69	39	152	47	38	18	86	1	0	1	1	3	58	443	501
04:30 PM	90	125	3	0	218	88	1	61	32	150	56	61	38	118	1	2	1	1	4	71	490	561
04:45 PM	90	126	0	0	216	89	1	50	25	140	45	37	20	82	1	0	1	1	2	46	440	486
Total	350	453	3	0	806	328	4	249	142	581	2	206	183	391	3	2	3	3	8	242	1786	2028
05:00 PM	99	122	0	0	221	92	1	54	26	147	51	48	28	99	0	1	0	0	1	54	468	522
05:15 PM	100	111	0	0	211	134	1	52	27	187	43	33	23	76	0	0	2	0	2	50	476	526
05:30 PM	94	107	2	0	203	87	0	52	32	139	30	34	16	64	0	2	0	0	2	48	408	456
05:45 PM	112	92	0	0	204	88	2	39	18	129	40	49	30	89	0	1	1	0	2	48	424	472
Total	405	432	2	0	839	401	4	197	103	602	0	164	164	328	0	4	3	0	7	200	1776	1976
Grand Total	755	885	5	0	1645	729	8	446	245	1183	2	370	347	194	3	6	6	3	15	442	3562	4004
Approch %	45.9	53.8	0.3			61.6	0.7	37.7			0.3	51.5	48.3		20	40	40					
Total %	21.2	24.8	0.1			20.5	0.2	12.5			0.1	10.4	9.7		0.1	0.2	0.2			11	89	
Passenger Vehicles	734	854	3		1591	698	5	437		1381	2	352	329		1	5	5		14	0	0	3857
Large Passenger Vehicles	97.2	96.5	60	0	96.7	95.7	62.5	98	98.4	96.7	100	95.1	94.8	96.9	33.3	83.3	83.3	100	77.8	0	0	96.3
Large 2 Axle Vehicles	13	22	2		37	12	1	3		17	0	12	13		2	0	1		3	0	0	87
% Large 2 Axle Vehicles	1.7	2.5	40	0	2.2	1.6	12.5	0.7	0.4	1.2	0	3.2	3.7	2.6	33.3	66.7	0	16.7	0	16.7	0	2.2
3 Axle Vehicles	2	3	0		5	3	1	6		13	0	4	1		0	0	0		0	0	0	23
% 3 Axle Vehicles	0.3	0.3	0	0	0.3	0.4	12.5	1.3	1.2	0.9	0	1.1	0.3	0	0	0	0	0	0	0	0	0.6
4+ Axle Trucks	6	6	0		12	16	1	0		17	0	2	4		0	1	0		1	0	0	37
% 4+ Axle Trucks	0.8	0.7	0	0	0.7	2.2	12.5	0	0	1.2	0	0.5	1.2	0.5	0	16.7	0	0	5.6	0	0	0.9

Start Time	Meridian Parkway Southbound					Cactus Avenue Westbound					Meridian Parkway Northbound					Commercial Driveway Eastbound						
	Left	Thru	Right	RTOR	App. Total	Left	Thru	Right	RTOR	App. Total	Left	Thru	Right	RTOR	App. Total	Left	Thru	Right	RTOR	App. Total	Exclu. Total	Inclu. Total
04:30 PM	90	125	3		218	88	1	61		150	56	61		118	1	2	1		4	0	0	490
04:45 PM	90	126	0		216	89	1	50		140	45	37		82	1	0	1		2	58	443	501
05:00 PM	99	122	0		221	92	1	54		147	51	48		99	0	1	0		3	71	490	561
05:15 PM	100	111	0		211	134	1	52		187	43	33		76	0	2	0		4	46	440	486
Total Volume	379	484	3		866	403	4	217		624	1	195	179		375	2	3		9	242	1786	2028
% App. Total	43.8	55.9	0.3		43.8	64.6	0.6	34.8		43.8	0.3	52	47.7		33.3	22.2	33.3		44.4	44.2	1786	2028
PHF	.948	.960	.250		.980	.752	1.00	.889		.834	.250	.871	.734		.794	.500	.375		.500	.500	.563	.956

Peak Hour Analysis From 04:00 PM to 05:45 PM - Peak 1 of 1

Peak Hour for Entire Intersection Begins at 04:30 PM

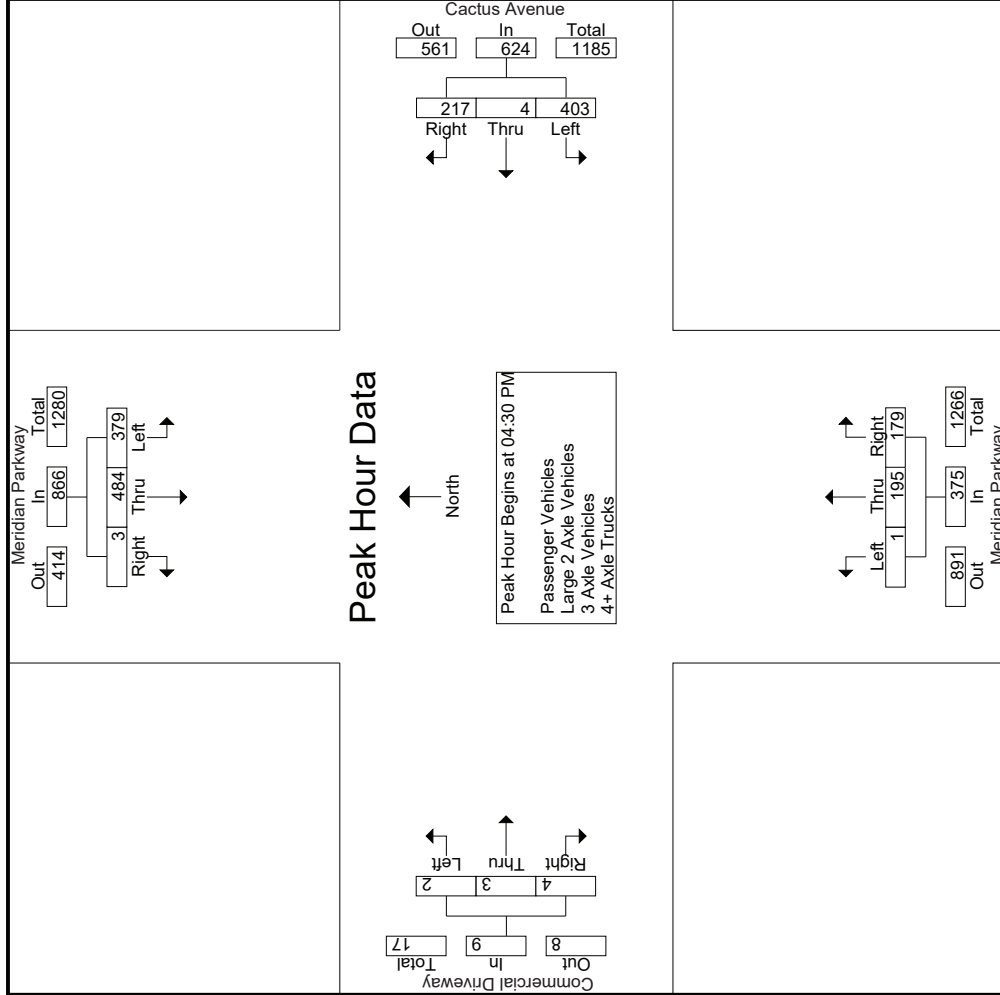

Counts Unlimited
 PO Box 1178
 Corona, CA 92878
 (951) 268-6268

County of Riverside
 N/S: Meridian Parkway
 E/W: Cactus Avenue
 Weather: Clear

File Name : 28_CRV_Meridian_Cactus PM
 Site Code : 05119542
 Start Date : 8/20/2019
 Page No : 3

Start Time	Meridian Parkway Southbound			Cactus Avenue Westbound			Meridian Parkway Northbound			Commercial Driveway Eastbound				
	Left	Thru	Right	App. Total	Left	Thru	Right	App. Total	Left	Thru	Right	App. Total	Int. Total	
Peak Hour Analysis From 04:00 PM to 05:45 PM - Peak 1 of 1														
Peak Hour for Each Approach Begins at:														
	04:30 PM			04:30 PM			04:00 PM			04:15 PM				
+0 mins.	90	125	3	218	88	150	1	61	58	47	105	1	0	1
+15 mins.	90	126	0	216	89	140	1	50	47	38	86	1	2	1
+30 mins.	99	122	0	221	92	147	1	54	56	61	118	1	0	1
+45 mins.	100	111	0	211	134	187	1	52	45	37	82	0	1	0
Total Volume	379	484	3	866	403	624	4	217	206	183	391	3	3	3
% App. Total	43.8	55.9	0.3	64.6	75.2	83.4	0.6	34.8	52.7	46.8	33.3	33.3	33.3	33.3
PHF	.948	.960	.250	.980	.752	1.000	.889	.888	.888	.750	.828	.750	.375	.750
														.563

Counts Unlimited
 PO Box 1178
 Corona, CA 92878
 (951) 268-6268

County of Riverside
 N/S: Meridian Parkway
 EW: Cactus Avenue
 Weather: Clear

File Name : 28_CRV_Meridian_Cactus PM
 Site Code : 05119542
 Start Date : 8/20/2019
 Page No : 1

Groups Printed- Passenger Vehicles

Start Time	Meridian Parkway Southbound						Cactus Avenue Westbound						Meridian Parkway Northbound						Commercial Driveway Eastbound								
	Left	Thru	Right	RTOR	App. Total		Left	Thru	Right	RTOR	App. Total		Left	Thru	Right	RTOR	App. Total		Left	Thru	Right	RTOR	App. Total		Exclu. Total	Inclu. Total	Int. Total
04:00 PM	69	93	0	0	162		67	0	68	45	135		54	41	19	95		0	0	0	0	0		64	392	456	
04:15 PM	95	101	0	0	196		78	2	66	38	146		44	35	18	80		0	1	1	1	2		57	424	481	
04:30 PM	87	123	1	0	211		83	0	60	32	143		53	60	38	114		0	2	1	1	3		71	471	542	
04:45 PM	86	121	0	0	207		86	1	48	24	135		43	35	18	78		0	0	1	1	1		43	421	464	
Total	337	438	1	0	776		314	3	242	139	559		194	171	93	367		1	2	3	3	6		235	1708	1943	
05:00 PM	97	119	0	0	216		89	0	53	25	142		50	46	27	96		0	0	0	0	0		52	454	506	
05:15 PM	98	108	0	0	206		127	1	52	27	180		40	33	23	73		0	0	1	0	1		50	460	510	
05:30 PM	91	103	2	0	196		84	0	51	32	135		30	32	16	62		0	2	0	0	2		48	395	443	
05:45 PM	111	86	0	0	197		84	1	39	18	124		38	47	29	85		0	1	1	1	0		47	408	455	
Total	397	416	2	0	815		384	2	195	102	581		158	158	95	316		0	3	2	0	5		197	1717	1914	
Grand Total	734	854	3	0	1591		698	5	437	241	1140		352	329	188	683		1	5	5	3	11		432	3425	3857	
Approch %	46.1	53.7	0.2		46.5		61.2	0.4	38.3		33.3		51.5	48.2	19.9		9.1	45.5	45.5		0.3		11.2	88.8			
Total %	21.4	24.9	0.1				20.4	0.1	12.8				10.3	9.6			0	0.1	0.1								

3.1-319

Start Time	Meridian Parkway Southbound						Cactus Avenue Westbound						Meridian Parkway Northbound						Commercial Driveway Eastbound								
	Left	Thru	Right	RTOR	App. Total		Left	Thru	Right	RTOR	App. Total		Left	Thru	Right	RTOR	App. Total		Left	Thru	Right	RTOR	App. Total		Exclu. Total	Inclu. Total	Int. Total
04:30 PM	87	123	1	0	211		83	0	60	45	143		53	60	35	114		0	2	1	1	3		64	392	456	
04:45 PM	86	121	0	0	207		86	1	48	38	135		43	35	18	78		0	0	0	0	0		57	424	481	
05:00 PM	97	119	0	0	216		89	0	53	25	142		50	46	27	96		0	0	0	0	0		52	454	506	
05:15 PM	98	108	0	0	206		127	1	52	27	180		40	33	23	73		0	0	1	0	1		50	460	510	
Total Volume	368	471	1	0	840		385	2	213	102	600		186	174	95	361		0	2	3	3	6		235	1708	1943	
% App. Total	43.8	56.1	0.1		46.5		64.2	0.3	35.5		33.3		51.5	48.2	19.9		9.1	45.5	45.5		0.3		11.2	88.8			
PHF	.939	.957	.250		.972		.758	.500	.888		.833		.877	.725		.792		.000	.250	.750		.417					

Peak Hour Analysis From 04:30 PM to 05:15 PM - Peak 1 of 1
 Peak Hour for Entire Intersection Begins at 04:30 PM

Counts Unlimited
 PO Box 1178
 Corona, CA 92878
 (951) 268-6268

County of Riverside
 N/S: Meridian Parkway
 E/W: Cactus Avenue
 Weather: Clear

File Name : 28_CRV_Meridian_Cactus PM
 Site Code : 05119542
 Start Date : 8/20/2019
 Page No : 2

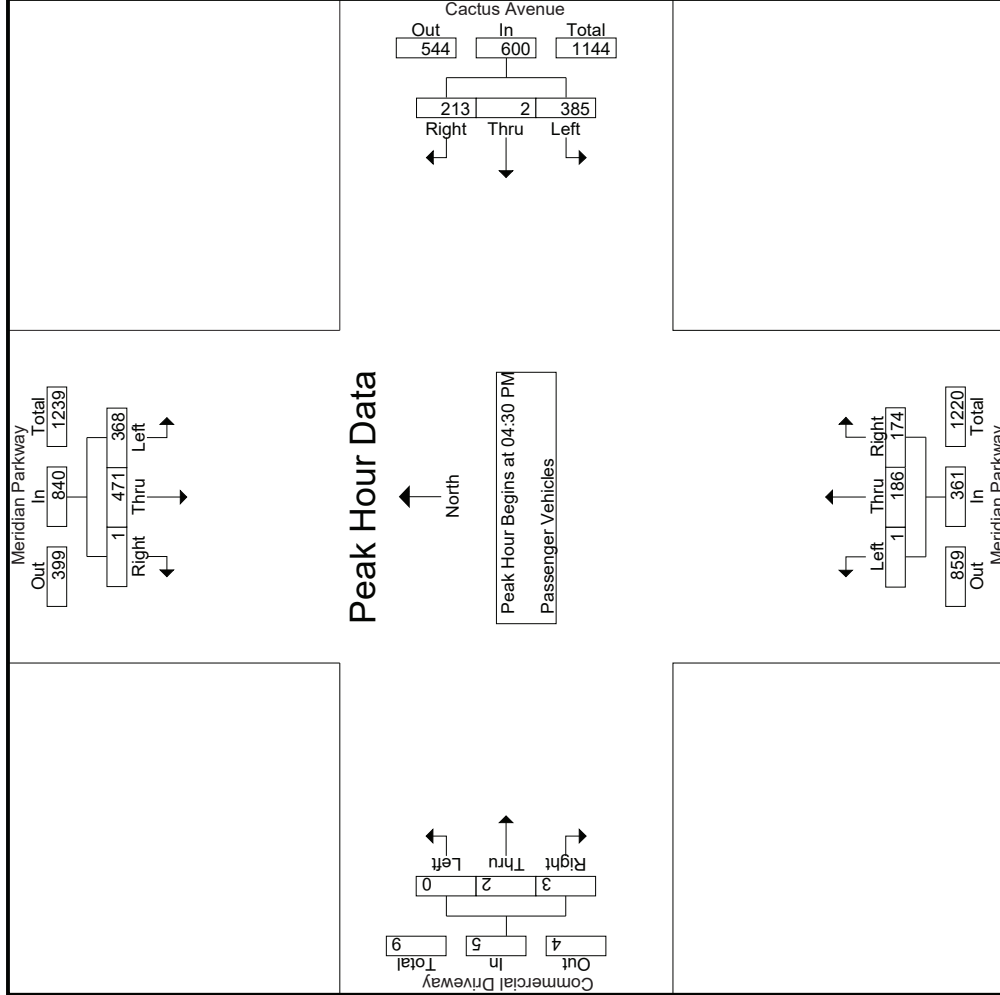

Counts Unlimited
 PO Box 1178
 Corona, CA 92878
 (951) 268-6268

County of Riverside
 N/S: Meridian Parkway
 E/W: Cactus Avenue
 Weather: Clear

File Name : 28_CRV_Meridian_Cactus PM
 Site Code : 05119542
 Start Date : 8/20/2019
 Page No : 3

Start Time	Meridian Parkway Southbound			Cactus Avenue Westbound			Meridian Parkway Northbound			Commercial Driveway Eastbound					
	Left	Thru	Right	Left	Thru	Right	Left	Thru	Right	Left	Thru	Right	App. Total	Int. Total	
Peak Hour Analysis From 04:30 PM to 05:15 PM - Peak 1 of 1															
Peak Hour for Each Approach Begins at:															
	04:30 PM			04:30 PM			04:30 PM			04:30 PM			04:30 PM		
+0 mins.	87	123	1	83	0	60	143	53	60	114	0	2	1	3	
+15 mins.	86	121	0	86	1	48	135	43	35	78	0	0	1	1	
+30 mins.	97	119	0	89	0	53	142	50	46	96	0	0	0	0	
+45 mins.	98	108	0	127	1	52	180	40	33	73	0	0	1	1	
Total Volume	368	471	1	385	2	213	600	186	174	361	0	2	3	5	
% App. Total	43.8	56.1	0.1	64.2	0.3	35.5	83.3	51.5	48.2	79.2	0	40	60		
PHF	.939	.957	.250	.758	.500	.888	.833	.877	.725	.792	.000	.250	.750	.417	

Groups Printed- Large 2 Axle Vehicles

Start Time	Meridian Parkway Southbound				Cactus Avenue Westbound				Meridian Parkway Northbound				Commercial Driveway Eastbound						
	Left	Thru	Right	RTOR	App. Total	Left	Thru	Right	RTOR	App. Total	Left	Thru	Right	RTOR	App. Total	Exclu. Total	Inclu. Total	Int. Total	
04:00 PM	1	2	0	0	3	1	0	0	0	1	0	2	5	2	7	0	0	0	0
04:15 PM	3	4	0	0	7	2	0	3	1	5	0	3	2	0	5	0	0	0	0
04:30 PM	2	1	2	0	5	3	1	0	0	4	0	2	0	0	2	1	0	0	1
04:45 PM	3	5	0	0	8	2	0	0	0	2	0	1	1	1	2	1	0	0	1
Total	9	12	2	0	23	8	1	3	1	12	0	8	8	3	16	2	0	0	2
05:00 PM	0	2	0	0	2	0	0	0	0	0	0	1	2	1	3	0	0	0	0
05:15 PM	1	2	0	0	3	2	0	0	0	2	0	1	0	0	1	0	0	1	0
05:30 PM	2	3	0	0	5	1	0	0	0	1	0	2	0	2	2	0	0	0	0
05:45 PM	1	3	0	0	4	1	0	0	0	1	0	2	1	1	3	0	0	0	0
Total	4	10	0	0	14	4	0	0	0	4	0	4	5	2	9	0	0	1	1
Grand Total	13	22	2	0	37	12	1	3	1	16	0	12	13	5	25	2	0	1	0
Approch %	35.1	59.5	5.4			75	6.2	18.8			0	48	52			66.7	0	33.3	
Total %	16	27.2	2.5		45.7	14.8	1.2	3.7		19.8	0	14.8	16		30.9	2.5	0	1.2	
																6.9		93.1	

Start Time	Meridian Parkway Southbound				Cactus Avenue Westbound				Meridian Parkway Northbound				Commercial Driveway Eastbound						
	Left	Thru	Right	RTOR	App. Total	Left	Thru	Right	RTOR	App. Total	Left	Thru	Right	RTOR	App. Total	Exclu. Total	Inclu. Total	Int. Total	
04:30 PM	2	1	2		5	3	1	0		4	0	2	0		2	0	0	1	12
04:45 PM	3	5	0		8	2	0	0		2	0	1	1		2	0	0	0	13
05:00 PM	0	2	0		2	0	0	0		0	0	1	2		3	0	0	0	5
05:15 PM	1	2	0		3	2	0	0		2	0	1	0		1	0	1	1	7
Total Volume	6	10	2		18	7	1	0		8	0	5	3		8	0	0	1	37
% App. Total	33.3	55.6	11.1			87.5	12.5	0			0	62.5	37.5			0	33.3		
PHF	.500	.500	.250		.563	.583	.250	.000		.500	.000	.625	.375		.667	.250	.750		.712

Peak Hour Analysis From 04:30 PM to 05:15 PM - Peak 1 of 1
 Peak Hour for Entire Intersection Begins at 04:30 PM

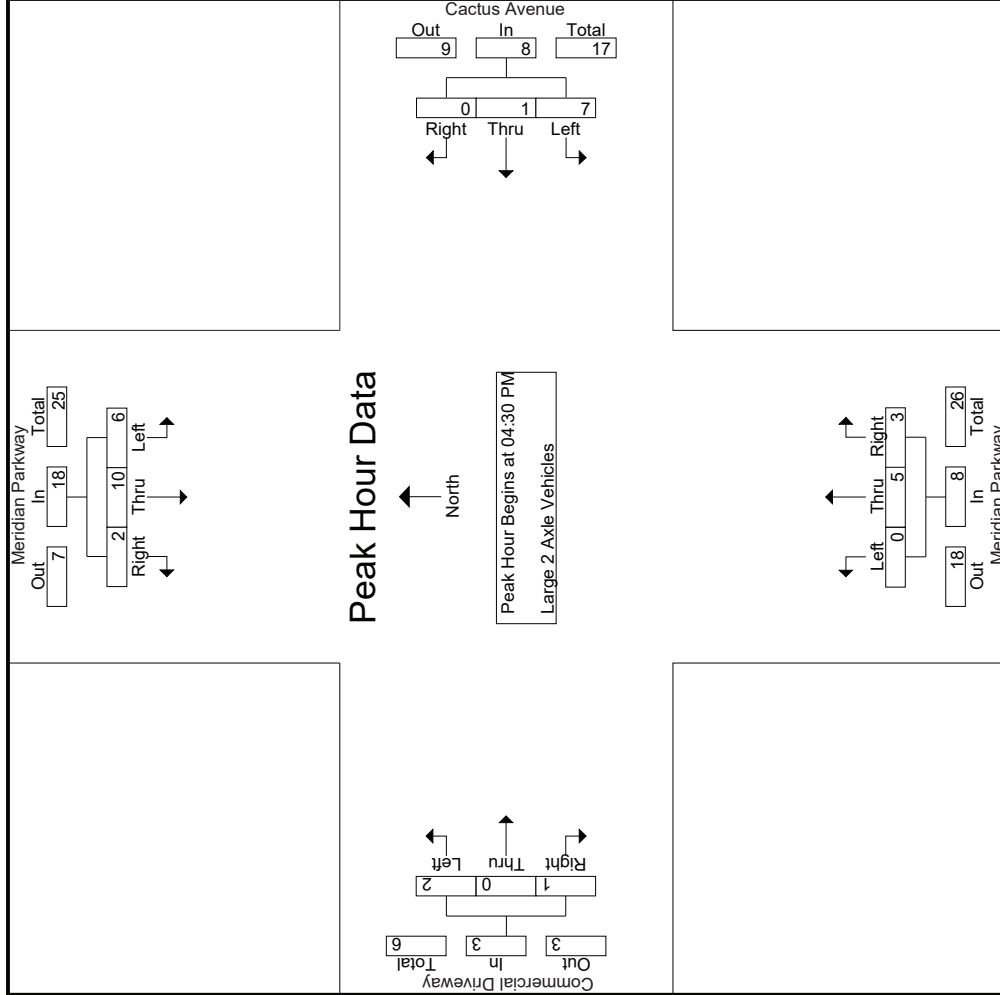

Counts Unlimited
 PO Box 1178
 Corona, CA 92878
 (951) 268-6268

County of Riverside
 N/S: Meridian Parkway
 E/W: Cactus Avenue
 Weather: Clear

File Name : 28_CRV_Meridian_Cactus PM
 Site Code : 05119542
 Start Date : 8/20/2019
 Page No : 3

Start Time	Meridian Parkway Southbound			Cactus Avenue Westbound			Meridian Parkway Northbound			Commercial Driveway Eastbound		
	Left	Thru	Right	Left	Thru	Right	Left	Thru	Right	Left	Thru	Right
Peak Hour Analysis From 04:30 PM to 05:15 PM - Peak 1 of 1												
Peak Hour for Each Approach Begins at:												
	04:30 PM			04:30 PM			04:30 PM			04:30 PM		
+0 mins.	2	1	2	3	1	0	4	0	2	0	0	1
+15 mins.	3	5	0	2	0	0	2	1	2	1	0	0
+30 mins.	0	2	0	0	0	0	0	1	3	0	0	0
+45 mins.	1	2	0	2	0	0	2	1	1	0	0	1
Total Volume	6	10	2	7	1	0	8	5	8	2	0	1
% App. Total	33.3	55.6	11.1	87.5	12.5	0	0	62.5	37.5	66.7	0	33.3
PHF	.500	.500	.250	.583	.250	.000	.500	.625	.375	.667	.000	.250
										.500	.000	.250
										.667	.000	.750

Counts Unlimited
 PO Box 1178
 Corona, CA 92878
 (951) 268-6268

County of Riverside
 N/S: Meridian Parkway
 E/W: Cactus Avenue
 Weather: Clear

File Name : 28_CRV_Meridian_Cactus PM
 Site Code : 05119542
 Start Date : 8/20/2019
 Page No : 1

Groups Printed- 3 Axle Vehicles

Start Time	Meridian Parkway Southbound					Cactus Avenue Westbound					Meridian Parkway Northbound					Commercial Driveway Eastbound							
	Left	Thru	Right	RTOR	App. Total	Left	Thru	Right	RTOR	App. Total	Left	Thru	Right	RTOR	App. Total	Left	Thru	Right	RTOR	App. Total	Exclu. Total	Inclu. Total	Int. Total
04:00 PM	0	1	0	0	1	1	0	1	1	2	0	1	0	0	1	0	0	0	0	0	1	4	5
04:15 PM	0	0	0	0	0	0	0	0	0	0	0	0	0	0	0	0	0	0	0	0	0	0	0
04:30 PM	0	0	0	0	0	0	0	1	0	1	0	1	0	0	1	0	0	0	0	0	0	2	2
04:45 PM	0	0	0	0	0	0	0	2	1	2	0	1	0	0	1	0	0	0	0	0	1	3	4
Total	0	1	0	0	1	1	0	4	2	5	0	3	0	0	3	0	0	0	0	0	2	9	11
05:00 PM	1	0	0	0	1	1	0	1	1	2	0	0	0	0	0	0	0	0	0	0	1	3	4
05:15 PM	0	0	0	0	0	1	0	0	0	1	0	1	0	0	1	0	0	0	0	0	0	2	2
05:30 PM	1	1	0	0	2	0	0	1	0	1	0	0	0	0	0	0	0	0	0	0	0	3	3
05:45 PM	0	1	0	0	1	0	1	0	0	1	0	0	1	0	1	0	0	0	0	0	0	3	3
Total	2	2	0	0	4	2	1	2	1	5	0	1	1	0	2	0	0	0	0	0	1	11	12
Grand Total	2	3	0	0	5	3	1	6	3	10	0	4	1	0	5	0	0	0	0	0	3	20	23
Approch %	40	60	0	0	25	30	10	60	30	50	0	80	20	5	25	0	0	0	0	0	13	87	
Total %	10	15	0	0	25	15	5	30	15	50	0	20	5	5	25	0	0	0	0	0	13	87	

3.1-325

Start Time	Meridian Parkway Southbound					Cactus Avenue Westbound					Meridian Parkway Northbound					Commercial Driveway Eastbound							
	Left	Thru	Right	RTOR	App. Total	Left	Thru	Right	RTOR	App. Total	Left	Thru	Right	RTOR	App. Total	Left	Thru	Right	RTOR	App. Total	Exclu. Total	Inclu. Total	Int. Total
04:30 PM	0	0	0	0	0	0	0	0	0	0	0	0	0	0	0	0	0	0	0	0	0	0	2
04:45 PM	0	0	0	0	0	0	0	0	0	0	0	0	0	0	0	0	0	0	0	0	0	0	0
05:00 PM	1	0	0	0	1	1	0	1	0	2	0	0	0	0	0	0	0	0	0	0	0	0	3
05:15 PM	0	0	0	0	0	0	0	0	0	0	0	0	0	0	0	0	0	0	0	0	0	0	2
Total Volume	1	0	0	0	1	2	0	4	0	6	0	0	3	0	3	0	0	0	0	0	0	0	10
% App. Total	100	0	0	0	25	33.3	0	66.7	0	100	0	100	0	0	100	0	0	0	0	0	0	0	0
PHF	.250	.000	.000	.000	.250	.500	.000	.500	.000	.750	.000	.750	.000	.750	.000	.000	.000	.000	.000	.000	.000	.833	

Peak Hour Analysis From 04:30 PM to 05:15 PM - Peak 1 of 1
 Peak Hour for Entire Intersection Begins at 04:30 PM

Counts Unlimited
 PO Box 1178
 Corona, CA 92878
 (951) 268-6268

County of Riverside
 N/S: Meridian Parkway
 E/W: Cactus Avenue
 Weather: Clear

File Name : 28_CRV_Meridian_Cactus PM
 Site Code : 05119542
 Start Date : 8/20/2019
 Page No : 2

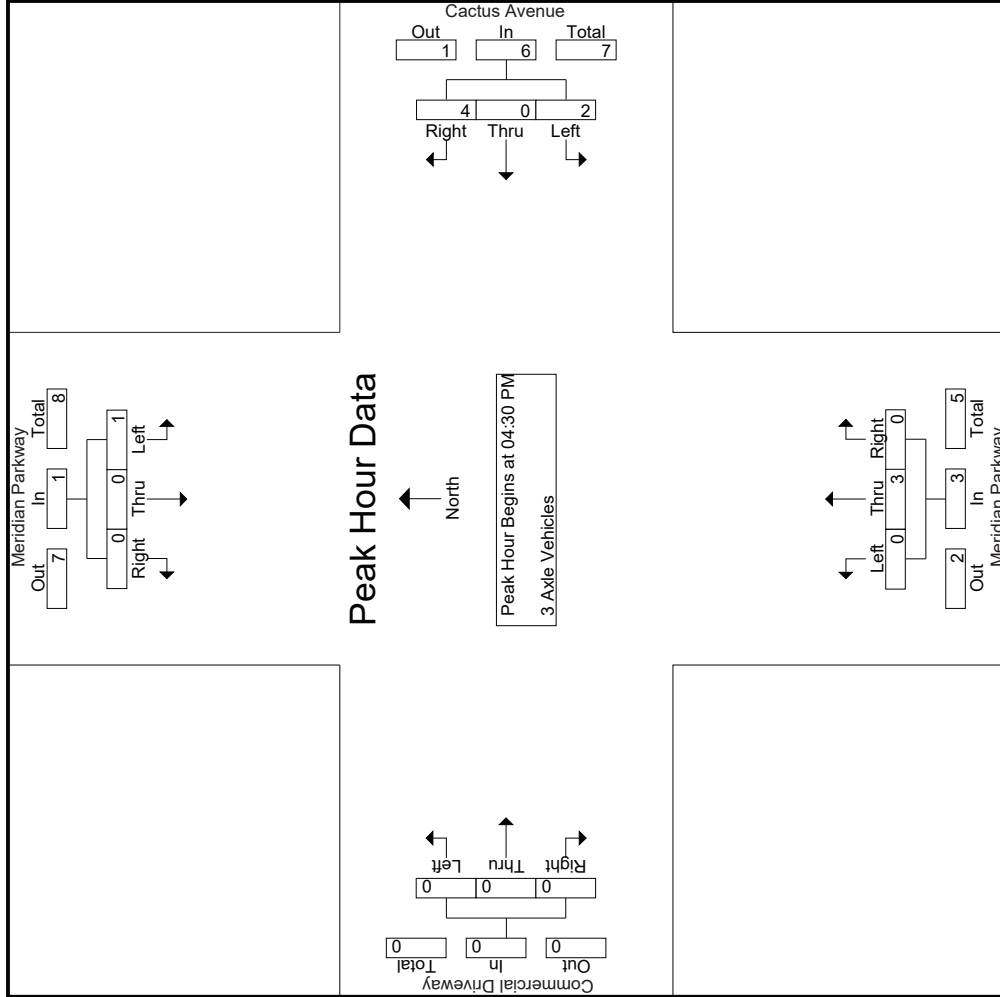

Counts Unlimited
 PO Box 1178
 Corona, CA 92878
 (951) 268-6268

County of Riverside
 N/S: Meridian Parkway
 E/W: Cactus Avenue
 Weather: Clear

File Name : 28_CRV_Meridian_Cactus PM
 Site Code : 05119542
 Start Date : 8/20/2019
 Page No : 3

Start Time	Meridian Parkway Southbound			Cactus Avenue Westbound			Meridian Parkway Northbound			Commercial Driveway Eastbound		
	Left	Thru	Right	Left	Thru	Right	Left	Thru	Right	Left	Thru	Right
Peak Hour Analysis From 04:30 PM to 05:15 PM - Peak 1 of 1												
Peak Hour for Each Approach Begins at:												
	04:30 PM			04:30 PM			04:30 PM			04:30 PM		
+0 mins.	0	0	0	0	1	1	0	0	1	0	0	0
+15 mins.	0	0	0	0	2	2	0	0	1	0	0	0
+30 mins.	1	0	0	1	1	2	0	0	0	0	0	0
+45 mins.	0	0	0	0	0	1	0	0	1	0	0	0
Total Volume	1	0	0	2	4	6	0	0	3	0	0	0
% App. Total	100	0	0	33.3	66.7	100	0	0	75	0	0	0
PHF	.250	.000	.000	.500	.500	.750	.000	.000	.750	.000	.000	.000

Counts Unlimited
 PO Box 1178
 Corona, CA 92878
 (951) 268-6268

County of Riverside
 N/S: Meridian Parkway
 E/W: Cactus Avenue
 Weather: Clear

File Name : 28_CRV_Meridian_Cactus PM
 Site Code : 05119542
 Start Date : 8/20/2019
 Page No : 1

Groups Printed- 4+ Axle Trucks

Start Time	Meridian Parkway Southbound				Cactus Avenue Westbound				Meridian Parkway Northbound				Commercial Driveway Eastbound						
	Left	Thru	Right	RTOR	App. Total	Left	Thru	Right	RTOR	App. Total	Left	Thru	Right	RTOR	App. Total	Exclu. Total	Inclu. Total	Int. Total	
04:00 PM	2	1	0	0	3	1	0	0	0	1	0	1	0	0	2	0	0	0	6
04:15 PM	0	0	0	0	0	1	0	0	0	1	0	0	0	0	1	0	0	0	2
04:30 PM	1	1	0	0	2	2	0	0	0	2	0	0	0	0	1	0	0	0	5
04:45 PM	1	0	0	0	1	1	0	0	0	1	0	0	0	0	1	0	1	3	4
Total	4	2	0	0	6	5	0	0	0	5	0	1	4	1	5	0	1	16	17
05:00 PM	1	1	0	0	2	2	1	0	0	3	0	0	0	0	0	1	0	0	6
05:15 PM	1	1	0	0	2	4	0	0	0	4	0	1	0	0	1	0	0	7	7
05:30 PM	0	0	0	0	0	2	0	0	0	2	0	0	0	0	0	0	0	2	2
05:45 PM	0	2	0	0	2	3	0	0	0	3	0	0	0	0	0	0	0	5	5
Total	2	4	0	0	6	11	1	0	0	12	0	1	0	0	1	0	1	20	20
Grand Total	6	6	0	0	12	16	1	0	0	17	0	2	4	1	6	0	1	36	37
Apprch %	50	50	0	0	94.1	5.9	0	0	0	47.2	0	33.3	66.7	0	16.7	0	100	0	2.7
Total %	16.7	16.7	0	0	33.3	44.4	2.8	0	0	47.2	0	5.6	11.1	0	16.7	0	2.8	97.3	0

3.1-328

Start Time	Meridian Parkway Southbound				Cactus Avenue Westbound				Meridian Parkway Northbound				Commercial Driveway Eastbound						
	Left	Thru	Right	RTOR	App. Total	Left	Thru	Right	RTOR	App. Total	Left	Thru	Right	RTOR	App. Total	Exclu. Total	Inclu. Total	Int. Total	
04:30 PM	1	1	0	0	2	2	0	0	0	2	0	0	0	0	1	0	0	0	5
04:45 PM	1	0	0	0	1	1	0	0	0	1	0	0	0	0	1	0	0	0	3
05:00 PM	1	1	0	0	2	2	0	0	0	3	0	0	0	0	0	0	0	1	6
05:15 PM	1	1	0	0	2	4	0	0	0	4	0	0	0	0	1	0	0	0	7
Total Volume	4	3	0	0	7	9	1	0	0	10	0	1	2	0	3	0	1	1	21
% App. Total	57.1	42.9	0	0	90	10	0	0	0	33.3	0	66.7	0	0	100	0	0	0	21
PHF	1.00	.750	.000	.875	.625	.563	.250	.000	.625	.750	.000	.250	.500	.000	.250	.000	.250	.750	.750

Peak Hour Analysis From 04:30 PM to 05:15 PM - Peak 1 of 1
 Peak Hour for Entire Intersection Begins at 04:30 PM

Counts Unlimited
 PO Box 1178
 Corona, CA 92878
 (951) 268-6268

County of Riverside
 N/S: Meridian Parkway
 E/W: Cactus Avenue
 Weather: Clear

File Name : 28_CRV_Meridian_Cactus PM
 Site Code : 05119542
 Start Date : 8/20/2019
 Page No : 2

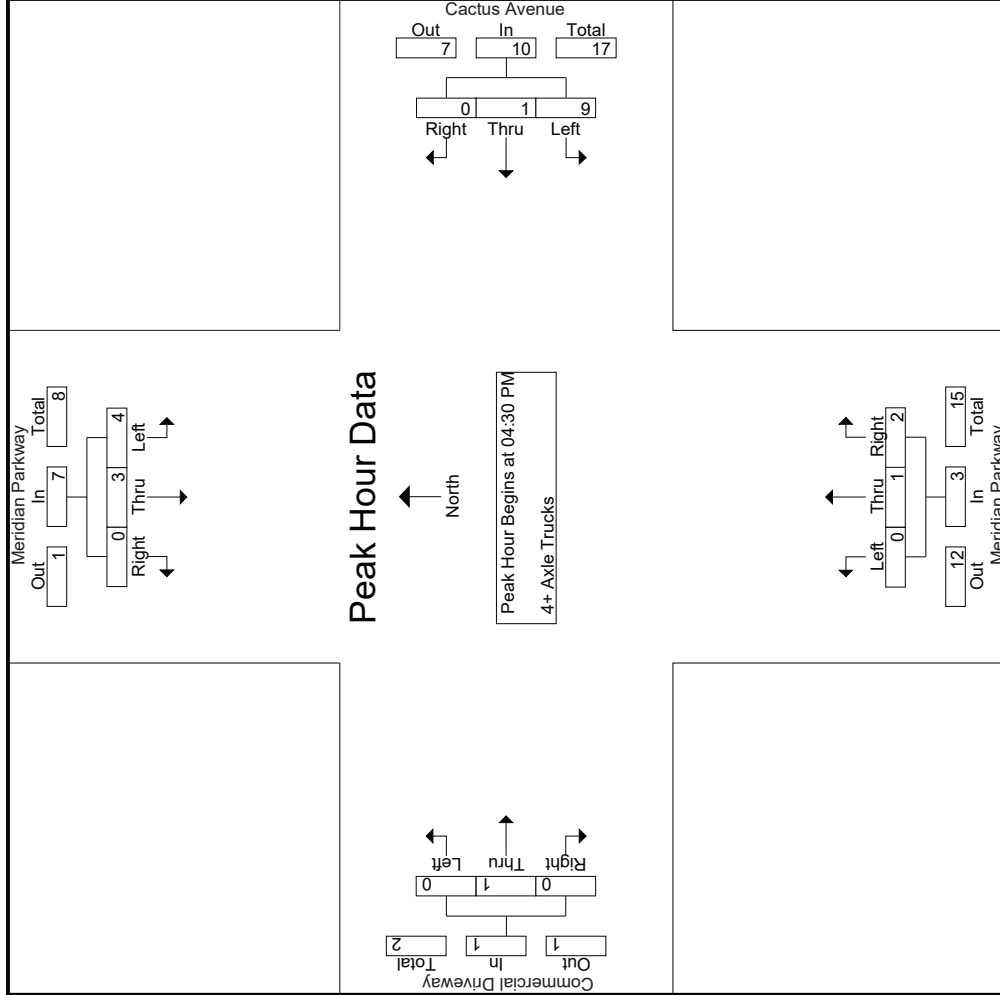

Counts Unlimited
 PO Box 1178
 Corona, CA 92878
 (951) 268-6268

County of Riverside
 N/S: Meridian Parkway
 E/W: Cactus Avenue
 Weather: Clear

File Name : 28_CRV_Meridian_Cactus PM
 Site Code : 05119542
 Start Date : 8/20/2019
 Page No : 3

Start Time	Meridian Parkway Southbound			Cactus Avenue Westbound			Meridian Parkway Northbound			Commercial Driveway Eastbound		
	Left	Thru	Right	Left	Thru	Right	Left	Thru	Right	Left	Thru	Right
Peak Hour Analysis From 04:30 PM to 05:15 PM - Peak 1 of 1	Peak Hour for Each Approach Begins at:											
	04:30 PM			04:30 PM			04:30 PM			04:30 PM		
+0 mins.	1	1	0	2	0	0	2	0	0	1	0	0
+15 mins.	1	0	0	1	0	0	1	0	0	1	0	0
+30 mins.	1	1	0	2	1	0	3	0	0	0	0	0
+45 mins.	1	1	0	4	0	0	4	0	1	0	0	0
Total Volume	4	3	0	9	1	0	10	1	1	2	1	0
% App. Total	57.1	42.9	0	90	10	0	66.7	33.3	66.7	500	100	0
PHF	1.000	.750	.000	.563	.250	.000	.625	.000	.750	.500	.250	.000

Location: County of Riverside
 N/S: Meridian Parkway
 E/W: Cactus Avenue



Date: 8/20/2019
 Day: Tuesday

PEDESTRIANS

	North Leg Meridian Parkway Pedestrians	East Leg Cactus Avenue Pedestrians	South Leg Meridian Parkway Pedestrians	West Leg Dead End Pedestrians	
7:00 AM	0	0	0	0	0
7:15 AM	0	0	0	0	0
7:30 AM	0	0	0	0	0
7:45 AM	0	0	0	0	0
8:00 AM	1	0	0	1	2
8:15 AM	0	1	0	0	1
8:30 AM	0	0	0	0	0
8:45 AM	0	0	0	0	0
TOTAL VOLUMES:	1	1	0	1	3

	North Leg Meridian Parkway Pedestrians	East Leg Cactus Avenue Pedestrians	South Leg Meridian Parkway Pedestrians	West Leg Dead End Pedestrians	
4:00 PM	0	0	0	0	0
4:15 PM	0	0	0	0	0
4:30 PM	0	0	0	0	0
4:45 PM	0	0	0	0	0
5:00 PM	0	0	0	0	0
5:15 PM	0	0	0	0	0
5:30 PM	0	0	0	1	1
5:45 PM	0	0	0	2	2
TOTAL VOLUMES:	0	0	0	3	3

Location: County of Riverside
 N/S: Meridian Parkway
 E/W: Cactus Avenue



Date: 8/20/2019
 Day: Tuesday

BICYCLES

	Southbound Meridian Parkway			Westbound Cactus Avenue			Northbound Meridian Parkway			Eastbound Dead End			
	Left	Thru	Right	Left	Thru	Right	Left	Thru	Right	Left	Thru	Right	
7:00 AM	0	0	0	0	0	0	0	0	0	0	0	0	0
7:15 AM	0	0	0	0	0	0	0	0	0	0	0	0	0
7:30 AM	0	0	0	0	0	0	0	0	0	0	0	0	0
7:45 AM	0	0	0	0	0	0	0	0	0	0	0	0	0
8:00 AM	0	0	0	0	0	0	0	0	0	0	0	0	0
8:15 AM	0	0	0	0	0	0	0	0	0	0	0	0	0
8:30 AM	0	0	0	0	0	0	0	0	0	0	0	0	0
8:45 AM	0	0	0	0	0	0	0	0	0	0	0	0	0
TOTAL VOLUMES:	0	0	0	0	0	0	0	0	0	0	0	0	0

	Southbound Meridian Parkway			Westbound Cactus Avenue			Northbound Meridian Parkway			Eastbound Dead End			
	Left	Thru	Right	Left	Thru	Right	Left	Thru	Right	Left	Thru	Right	
4:00 PM	0	0	0	0	0	0	0	0	0	0	0	0	0
4:15 PM	0	0	0	0	0	0	0	0	0	0	0	0	0
4:30 PM	0	0	0	0	0	0	0	0	0	0	0	0	0
4:45 PM	0	0	0	0	0	0	0	0	0	0	0	0	0
5:00 PM	0	0	0	0	0	0	0	0	0	0	0	0	0
5:15 PM	0	0	0	0	0	0	0	0	0	0	0	0	0
5:30 PM	0	1	0	0	0	0	0	1	0	0	0	0	2
5:45 PM	0	0	0	0	0	0	0	0	0	0	0	0	0
TOTAL VOLUMES:	0	1	0	0	0	0	0	1	0	0	0	0	2

Counts Unlimited
 PO Box 1178
 Corona, CA 92878
 (951) 268-6268

County of Riverside
 N/S: Meridian Parkway/Harrison Street
 EW: Van Buren Boulevard
 Weather: Clear

File Name : 31_CRV_Meridian_Van Buren AM
 Site Code : 05119542
 Start Date : 8/20/2019
 Page No : 1

Groups Printed- Passenger Vehicles - Large 2 Axle Vehicles - 3 Axle Vehicles - 4+ Axle Trucks

Start Time	Meridian Parkway Southbound						Van Buren Boulevard Westbound						Harrison Street Northbound						Van Buren Boulevard Eastbound						
	Left	Thru	Right	RTOR	App. Total		Left	Thru	Right	RTOR	App. Total		Left	Thru	Right	RTOR	App. Total		Left	Thru	Right	RTOR	App. Total		
07:00 AM	4	1	96	0	101	8	435	43	13	486	0	0	0	0	0	63	167	1	0	231	13	818	13	818	831
07:15 AM	9	0	91	0	100	7	388	50	8	445	0	0	0	0	0	85	199	2	2	286	10	831	10	831	841
07:30 AM	5	3	68	1	76	14	339	60	18	413	1	0	0	0	1	94	238	3	2	335	21	825	21	825	846
07:45 AM	5	3	54	2	62	15	280	50	17	345	0	0	1	1	1	118	283	2	1	403	21	811	21	811	832
Total	23	7	309	3	339	44	1442	203	56	1689	1	0	1	1	2	360	887	8	5	1255	65	3285	65	3285	3350
08:00 AM	13	1	53	2	67	5	220	38	20	263	2	0	1	0	3	97	212	1	0	310	22	643	22	643	665
08:15 AM	9	2	43	0	54	3	230	30	6	263	1	0	1	1	2	55	188	5	1	248	8	567	8	567	575
08:30 AM	13	0	46	0	59	5	226	52	12	283	0	0	0	0	0	45	130	2	0	177	12	519	12	519	531
08:45 AM	22	1	36	0	59	6	246	50	15	302	0	0	1	1	1	61	117	7	0	185	16	547	16	547	563
Total	57	4	178	2	239	19	922	170	53	1111	3	0	3	2	6	258	647	15	1	920	58	2276	58	2276	2334
Grand Total	80	11	487	5	578	63	2364	373	109	2800	4	0	4	3	8	618	1534	23	6	2175	123	5561	123	5561	5684
Approach	13.8	1.9	84.3			2.2	84.4	13.3			50	0	50			28.4	70.5	1.1			2.2	97.8	2.2		
Total %	1.4	0.2	8.8		10.4	1.1	42.5	6.7		50.4	0.1	0	0.1		0.1	11.1	27.6	0.4		39.1	2.2	97.8	2.2		
% Passenger Vehicles	46	11	467		528	61	2231	345		2743	4	0	3		9	604	1463	21		2093	0	0	0		5373
% Large 2 Axle Vehicles	57.5	100	95.9		80	96.8	94.4	92.5		97.2	100	0	75		66.7	97.7	95.4	91.3		83.3	96	0	0		94.5
% Large 3 Axle Vehicles	5	0	12		18	2	63	7		73	0	0	0		0	8	29	1		39	0	0	0		130
% Large 4+ Axle Trucks	6.2	0	2.5		20	3.2	2.7	1.9		0.9	2.5	0	0		0	1.3	1.9	4.3		16.7	1.8	0	0		2.3
% 3 Axle Vehicles	9	0	2		11	0	28	8		37	0	0	1		2	4	24	1		29	0	0	0		79
% 3 Axle Vehicles	11.2	0	0.4		1.9	0	1.2	2.1		0.9	0	0	25		33.3	0.6	1.6	4.3		1.3	0	0	0		1.4
% 4+ Axle Trucks	20	0	6		26	0	42	13		56	0	0	0		0	2	18	0		20	0	0	0		102
% 4+ Axle Trucks	25	0	1.2		4.5	0	1.8	3.5		1.9	0	0	0		0	0.3	1.2	0		0.9	0	0	0		1.8
Start Time	Meridian Parkway Southbound						Van Buren Boulevard Westbound						Harrison Street Northbound						Van Buren Boulevard Eastbound						
	Left	Thru	Right	RTOR	App. Total		Left	Thru	Right	RTOR	App. Total		Left	Thru	Right	RTOR	App. Total		Left	Thru	Right	RTOR	App. Total		
07:00 AM	4	1	96	0	101	8	435	43	13	486	0	0	0	0	0	63	167	1	0	231	13	818	13	818	831
07:15 AM	9	0	91	0	100	7	388	50	8	445	0	0	0	0	0	85	199	2	2	286	10	831	10	831	841
07:30 AM	5	3	68	1	76	14	339	60	18	413	1	0	0	0	1	94	238	3	2	335	21	825	21	825	846
07:45 AM	5	3	54	2	62	15	280	50	17	345	0	0	1	1	1	118	283	2	1	403	21	811	21	811	832
Total Volume	23	7	309	3	339	44	1442	203	56	1689	1	0	1	1	2	360	887	8	5	1255	65	3285	65	3285	3350
% App. Total	6.8	2.1	91.2		91.2	2.6	85.4	12		12	50	0	50		50	28.7	70.7	0.6		0.6	0.6	98.8	0.6		98.8
PHF	.639	.583	.805		.839	.733	.829	.846		.869	.250	.000	.250		.250	.500	.784	.667		.779	.500	.779	.667		.988

Peak Hour Analysis From 07:00 AM to 08:45 AM - Peak 1 of 1
 Peak Hour for Entire Intersection Begins at 07:00 AM

Counts Unlimited
 PO Box 1178
 Corona, CA 92878
 (951) 268-6268

County of Riverside
 N/S: Meridian Parkway/Harrison Street
 E/W: Van Buren Boulevard
 Weather: Clear

File Name : 31_CRV_Meridian_Van Buren AM
 Site Code : 05119542
 Start Date : 8/20/2019
 Page No : 2

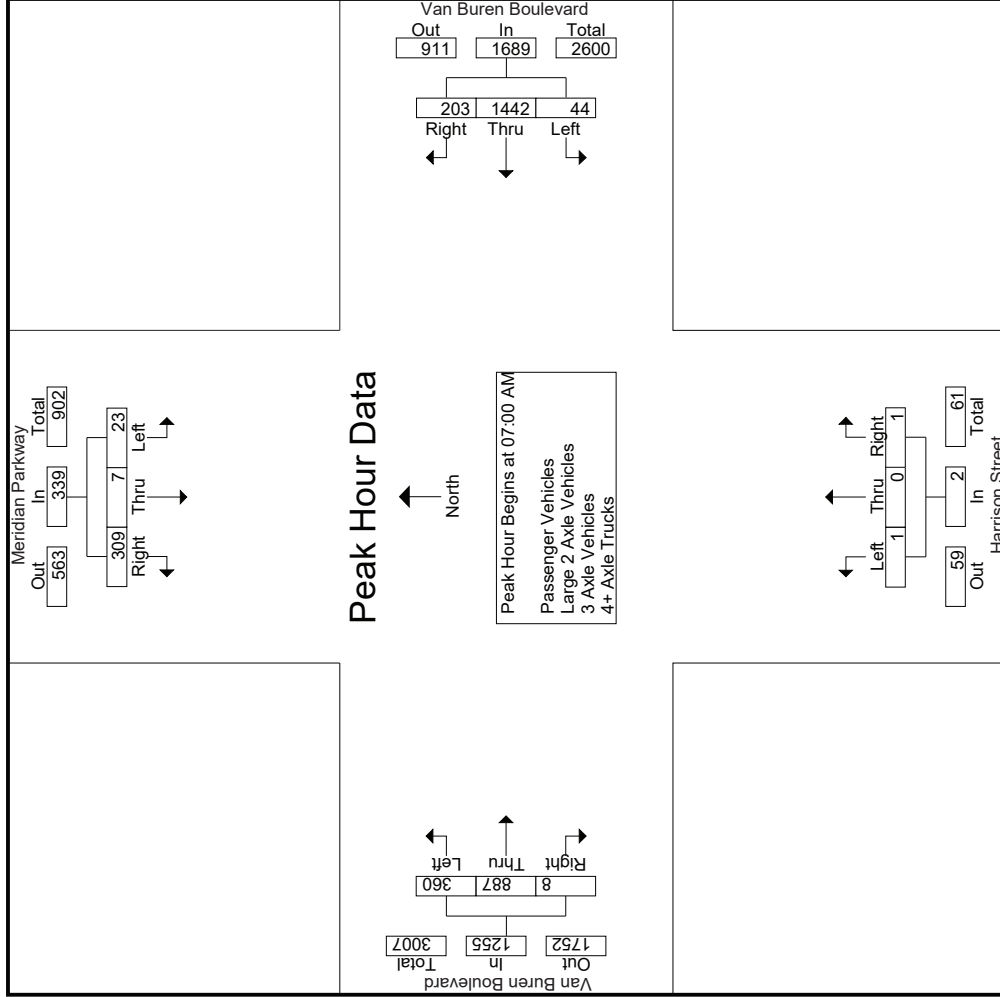

Counts Unlimited
 PO Box 1178
 Corona, CA 92878
 (951) 268-6268

County of Riverside
 N/S: Meridian Parkway/Harrison Street
 E/W: Van Buren Boulevard
 Weather: Clear

File Name : 31_CRV_Meridian_Van Buren AM
 Site Code : 05119542
 Start Date : 8/20/2019
 Page No : 3

Start Time	Meridian Parkway Southbound			Van Buren Boulevard Westbound			Harrison Street Northbound			Van Buren Boulevard Eastbound				
	Left	Thru	Right	Left	Thru	Right	Left	Thru	Right	Left	Thru	Right	App. Total	Int. Total
Peak Hour Analysis From 07:00 AM to 08:45 AM - Peak 1 of 1														
Peak Hour for Each Approach Begins at:														
	07:00 AM			07:00 AM			07:30 AM			07:15 AM				
+0 mins.	4	1	96	8	435	43	486	1	0	0	85	199	2	286
+15 mins.	9	0	91	7	388	50	445	0	0	1	94	238	3	335
+30 mins.	5	3	68	14	339	60	413	2	0	1	118	283	2	403
+45 mins.	5	3	54	15	280	50	345	1	0	1	97	212	1	310
Total Volume	23	7	309	44	1442	203	1689	4	0	3	394	932	8	1334
% App. Total	6.8	2.1	91.2	2.6	85.4	12	57.1	0	42.9	0.6	29.5	69.9	0.6	
PHF	.639	.583	.805	.733	.829	.846	.869	.500	.750	.667	.835	.823	.667	.828

Counts Unlimited
 PO Box 1178
 Corona, CA 92878
 (951) 268-6268

County of Riverside
 N/S: Meridian Parkway/Harrison Street
 EW: Van Buren Boulevard
 Weather: Clear

File Name : 31_CRV_Meridian_Van Buren AM
 Site Code : 05119542
 Start Date : 8/20/2019
 Page No : 1

Groups Printed- Passenger Vehicles

Start Time	Meridian Parkway Southbound					Van Buren Boulevard Westbound					Harrison Street Northbound					Van Buren Boulevard Eastbound							
	Left	Thru	Right	RTOR	App. Total	Left	Thru	Right	RTOR	App. Total	Left	Thru	Right	RTOR	App. Total	Left	Thru	Right	RTOR	App. Total	Exclu. Total	Inclu. Total	Int. Total
07:00 AM	2	1	96	0	99	8	416	38	12	462	0	0	0	0	0	60	163	1	0	224	12	785	797
07:15 AM	5	0	88	0	93	7	381	43	8	431	0	0	0	0	0	84	192	2	2	278	10	802	812
07:30 AM	2	3	67	1	72	14	318	58	17	390	1	0	0	0	1	93	231	2	1	326	19	789	808
07:45 AM	3	3	52	2	58	15	265	49	17	329	0	0	1	1	1	116	277	2	1	395	21	783	804
Total	12	7	303	3	322	44	1380	188	54	1612	1	0	1	1	2	353	863	7	4	1223	62	3159	3221
08:00 AM	9	1	49	1	59	4	203	36	19	243	2	0	1	0	3	94	195	1	0	290	20	595	615
08:15 AM	6	2	42	0	50	3	211	26	6	240	1	0	0	0	1	54	171	4	1	229	7	520	527
08:30 AM	7	0	42	0	49	4	208	48	12	260	0	0	0	0	0	42	124	2	0	168	12	477	489
08:45 AM	12	1	31	0	44	6	229	47	15	282	0	0	1	1	1	61	110	7	0	178	16	505	521
Total	34	4	164	1	202	17	851	157	52	1025	3	0	2	1	5	251	600	14	1	865	55	2097	2152
Grand Total	46	11	467	4	524	61	2231	345	106	2637	4	0	3	2	7	604	1463	21	5	2088	117	5256	5373
Approch %	8.8	2.1	89.1			2.3	84.6	13.1		57.1	0.1	0	42.9	0.1	28.9	70.1	1	0.4	39.7	2.2	97.8		
Total %	0.9	0.2	8.9		10	1.2	42.4	6.6		50.2	0.1	0	0.1		11.5	27.8	0.4						

3:1-336

Start Time	Meridian Parkway Southbound					Van Buren Boulevard Westbound					Harrison Street Northbound					Van Buren Boulevard Eastbound							
	Left	Thru	Right	RTOR	App. Total	Left	Thru	Right	RTOR	App. Total	Left	Thru	Right	RTOR	App. Total	Left	Thru	Right	RTOR	App. Total	Exclu. Total	Inclu. Total	Int. Total
07:00 AM	2	1	96	0	99	8	416	38	12	462	0	0	0	0	0	60	163	1	0	224	12	785	797
07:15 AM	5	0	88	0	93	7	381	43	8	431	0	0	0	0	0	84	192	2	2	278	10	802	812
07:30 AM	2	3	67	1	72	14	318	58	17	390	1	0	0	0	1	93	231	2	1	326	19	789	808
07:45 AM	3	3	52	2	58	15	265	49	17	329	0	0	1	1	1	116	277	2	1	395	21	783	804
Total Volume	12	7	303	3	322	44	1380	188	54	1612	1	0	1	1	2	353	863	7	4	1223	62	3159	3221
% App. Total	3.7	2.2	94.1			2.7	85.6	11.7		50.2	0.1	0	50	0.1	28.9	70.6	0.6		39.7	2.2	97.8		
PHF	.600	.583	.789		.813	.733	.829	.810		.872	.250	.000	.250		.500	.761	.779	.875		.774		.774	.985

Peak Hour Analysis From 07:00 AM to 07:45 AM - Peak 1 of 1
 Peak Hour for Entire Intersection Begins at 07:00 AM

Counts Unlimited
 PO Box 1178
 Corona, CA 92878
 (951) 268-6268

County of Riverside
 N/S: Meridian Parkway/Harrison Street
 E/W: Van Buren Boulevard
 Weather: Clear

File Name : 31_CRV_Meridian_Van Buren AM
 Site Code : 05119542
 Start Date : 8/20/2019
 Page No : 2

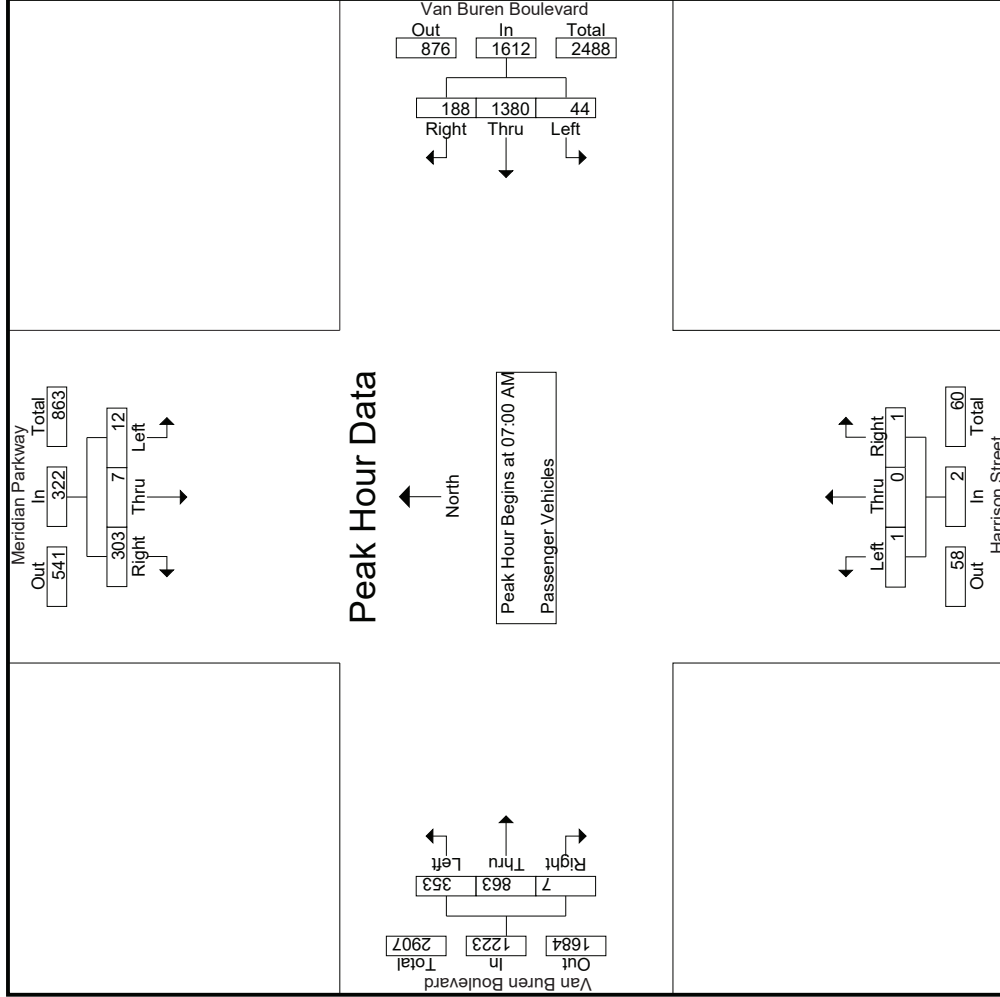

Counts Unlimited
 PO Box 1178
 Corona, CA 92878
 (951) 268-6268

County of Riverside
 N/S: Meridian Parkway/Harrison Street
 E/W: Van Buren Boulevard
 Weather: Clear

File Name : 31_CRV_Meridian_Van Buren AM
 Site Code : 05119542
 Start Date : 8/20/2019
 Page No : 3

Start Time	Meridian Parkway Southbound			Van Buren Boulevard Westbound			Harrison Street Northbound			Van Buren Boulevard Eastbound				
	Left	Thru	Right	Left	Thru	Right	Left	Thru	Right	Left	Thru	Right		
Peak Hour Analysis From 07:00 AM to 07:45 AM - Peak 1 of 1														
Peak Hour for Each Approach Begins at:														
	07:00 AM			07:00 AM			07:00 AM			07:00 AM				
+0 mins.	2	1	96	8	416	38	462	0	0	0	60	163	1	224
+15 mins.	5	0	88	7	381	43	431	0	0	0	84	192	2	278
+30 mins.	2	3	67	14	318	58	390	1	0	0	93	231	2	326
+45 mins.	3	3	52	15	265	49	329	0	0	1	116	277	2	395
Total Volume	12	7	303	44	1380	188	1612	1	0	1	353	863	7	1223
% App. Total	3.7	2.2	94.1	2.7	85.6	11.7	87.2	.250	0	.50	28.9	70.6	0.6	122.3
PHF	.600	.583	.789	.733	.829	.810	.872	.250	.000	.250	.761	.779	.875	.774

Groups Printed- Large 2 Axle Vehicles

Start Time	Meridian Parkway Southbound				Van Buren Boulevard Westbound				Harrison Street Northbound				Van Buren Boulevard Eastbound								
	Left	Thru	Right	RTOR	Left	Thru	Right	RTOR	Left	Thru	Right	RTOR	Left	Thru	Right	RTOR	App. Total	Exclu. Total	Inclu. Total	Int. Total	
07:00 AM	2	0	0	0	0	10	0	0	0	0	0	0	0	1	2	0	0	3	0	15	15
07:15 AM	1	0	2	0	0	2	3	0	0	0	0	0	0	1	5	0	0	6	0	14	14
07:30 AM	0	0	1	0	0	10	0	0	0	0	0	0	0	0	2	1	1	3	1	14	15
07:45 AM	0	0	0	0	0	8	0	0	0	0	0	0	0	1	0	0	1	0	0	9	9
Total	3	0	3	0	6	30	3	0	0	0	0	0	3	9	1	1	13	1	52	53	
08:00 AM	1	0	2	1	3	1	8	1	1	10	0	0	0	2	7	0	0	9	2	22	24
08:15 AM	0	0	1	0	1	0	11	2	0	13	0	0	0	1	8	0	0	9	0	23	23
08:30 AM	0	0	3	0	3	1	9	1	0	11	0	0	0	2	1	0	0	3	0	17	17
08:45 AM	1	0	3	0	4	0	5	0	0	5	0	0	0	0	4	0	0	4	0	13	13
Total	2	0	9	1	11	2	33	4	1	39	0	0	0	5	20	0	0	25	2	75	77
Grand Total	5	0	12	1	17	2	63	7	1	72	0	0	0	8	29	1	1	38	3	127	130
Apprch %	29.4	0	70.6		2.8	87.5	9.7			56.7	0	0	0	21.1	76.3	2.6		29.9	2.3	97.7	
Total %	3.9	0	9.4		13.4	49.6	5.5			6.3	22.8	0.8		6.3	22.8	0.8		29.9	2.3	97.7	

Start Time	Meridian Parkway Southbound				Van Buren Boulevard Westbound				Harrison Street Northbound				Van Buren Boulevard Eastbound								
	Left	Thru	Right	RTOR	Left	Thru	Right	RTOR	Left	Thru	Right	RTOR	Left	Thru	Right	RTOR	App. Total	Exclu. Total	Inclu. Total	Int. Total	
07:00 AM	2	0	0	0	0	10	0	0	0	0	0	0	0	1	2	0	0	3	0	15	15
07:15 AM	1	0	2	0	0	2	3	0	0	5	0	0	0	1	5	0	0	6	0	14	14
07:30 AM	0	0	1	0	0	10	0	0	0	10	0	0	0	0	2	1	1	3	1	14	15
07:45 AM	0	0	0	0	0	8	0	0	0	8	0	0	0	1	0	0	0	1	0	9	9
Total	3	0	3	0	6	30	3	0	0	33	0	0	0	3	9	1	1	13	1	52	53
08:00 AM	1	0	2	1	3	1	8	1	1	10	0	0	0	2	7	0	0	9	2	22	24
08:15 AM	0	0	1	0	1	0	11	2	0	13	0	0	0	1	8	0	0	9	0	23	23
08:30 AM	0	0	3	0	3	1	9	1	0	11	0	0	0	2	1	0	0	3	0	17	17
08:45 AM	1	0	3	0	4	0	5	0	0	5	0	0	0	0	4	0	0	4	0	13	13
Total	2	0	9	1	11	2	33	4	1	39	0	0	0	5	20	0	0	25	2	75	77
Grand Total	5	0	12	1	17	2	63	7	1	72	0	0	0	8	29	1	1	38	3	127	130
Apprch %	29.4	0	70.6		2.8	87.5	9.7			56.7	0	0	0	21.1	76.3	2.6		29.9	2.3	97.7	
Total %	3.9	0	9.4		13.4	49.6	5.5			6.3	22.8	0.8		6.3	22.8	0.8		29.9	2.3	97.7	

Peak Hour Analysis From 07:00 AM to 07:45 AM - Peak 1 of 1
 Peak Hour for Entire Intersection Begins at 07:00 AM

Start Time	Meridian Parkway Southbound				Van Buren Boulevard Westbound				Harrison Street Northbound				Van Buren Boulevard Eastbound								
	Left	Thru	Right	RTOR	Left	Thru	Right	RTOR	Left	Thru	Right	RTOR	Left	Thru	Right	RTOR	App. Total	Exclu. Total	Inclu. Total	Int. Total	
07:00 AM	2	0	0	0	0	10	0	0	0	0	0	0	0	1	2	0	0	3	0	15	15
07:15 AM	1	0	2	0	0	2	3	0	0	5	0	0	0	1	5	0	0	6	0	14	14
07:30 AM	0	0	1	0	0	10	0	0	0	10	0	0	0	0	2	1	1	3	1	14	15
07:45 AM	0	0	0	0	0	8	0	0	0	8	0	0	0	1	0	0	0	1	0	9	9
Total Volume	3	0	3	0	6	30	3	0	0	33	0	0	0	3	9	1	1	13	1	52	53
% App. Total	.375	0	.50	0	.50	.909	9.1	0	0	90.9	0	0	0	23.1	69.2	7.7	0	7.7	0	.542	.867
PHF	.375	.000	.375	.500	.500	.825	.250	.000	.000	.825	.000	.000	.000	.750	.450	.250	.542	.250	.542	.867	.867

Counts Unlimited
 PO Box 1178
 Corona, CA 92878
 (951) 268-6268

County of Riverside
 N/S: Meridian Parkway/Harrison Street
 E/W: Van Buren Boulevard
 Weather: Clear

File Name : 31_CRV_Meridian_Van Buren AM
 Site Code : 05119542
 Start Date : 8/20/2019
 Page No : 2

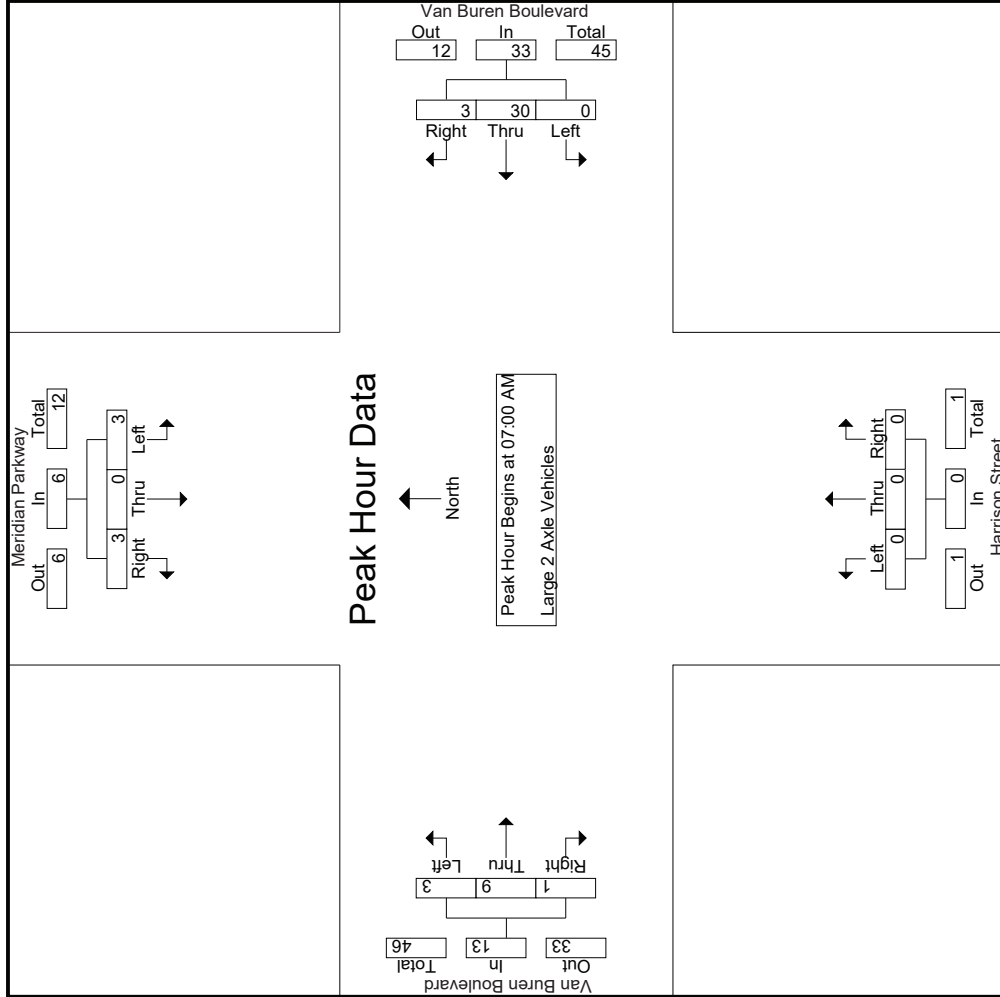

Counts Unlimited
 PO Box 1178
 Corona, CA 92878
 (951) 268-6268

County of Riverside
 N/S: Meridian Parkway/Harrison Street
 E/W: Van Buren Boulevard
 Weather: Clear

File Name : 31_CRV_Meridian_Van Buren AM
 Site Code : 05119542
 Start Date : 8/20/2019
 Page No : 3

Start Time	Meridian Parkway Southbound			Van Buren Boulevard Westbound			Harrison Street Northbound			Van Buren Boulevard Eastbound				
	Left	Thru	Right	Left	Thru	Right	Left	Thru	Right	Left	Thru	Right	App. Total	Int. Total
Peak Hour Analysis From 07:00 AM to 07:45 AM - Peak 1 of 1	07:00 AM													
Peak Hour for Each Approach Begins at:	07:00 AM													
+0 mins.	2	0	0	10	0	0	10	0	0	0	0	2	0	3
+15 mins.	1	0	2	2	3	5	0	0	0	0	0	5	0	6
+30 mins.	0	0	1	10	0	10	0	0	0	0	0	2	1	3
+45 mins.	0	0	0	8	0	8	0	0	0	0	0	0	0	1
Total Volume	3	0	3	30	3	33	0	0	0	0	0	9	1	13
% App. Total	50	0	50	90.9	9.1	82.5	0	0	0	0	0	23.1	7.7	75.0
PHF	.375	.000	.375	.750	.250	.825	.000	.000	.000	.000	.000	.450	.250	.542

Counts Unlimited
 PO Box 1178
 Corona, CA 92878
 (951) 268-6268

County of Riverside
 N/S: Meridian Parkway/Harrison Street
 EW: Van Buren Boulevard
 Weather: Clear

File Name : 31_CRV_Meridian_Van Buren AM
 Site Code : 05119542
 Start Date : 8/20/2019
 Page No : 1

Groups Printed- 3 Axle Vehicles

Start Time	Meridian Parkway Southbound				Van Buren Boulevard Westbound				Harrison Street Northbound				Van Buren Boulevard Eastbound							
	Left	Thru	Right	RTOR	App. Total	Left	Thru	Right	RTOR	App. Total	Left	Thru	Right	RTOR	App. Total	Exclu. Total	Inclu. Total	Int. Total		
07:00 AM	0	0	0	0	0	0	1	3	1	4	0	0	0	0	0	1	0	0	6	
07:15 AM	1	0	0	0	1	0	0	1	0	1	0	0	0	0	0	2	0	4	4	
07:30 AM	2	0	0	0	2	0	1	0	0	1	0	0	0	0	3	0	6	6		
07:45 AM	1	0	1	0	2	0	3	0	0	3	0	0	0	0	6	0	11	11		
Total	4	0	1	0	5	0	5	4	1	9	0	0	0	0	12	1	26	27		
08:00 AM	1	0	0	0	1	0	8	0	0	8	0	0	0	0	6	0	15	15		
08:15 AM	1	0	0	0	1	0	3	0	1	4	0	1	1	0	7	1	12	13		
08:30 AM	1	0	1	0	2	0	5	2	0	7	0	0	0	0	3	0	12	12		
08:45 AM	2	0	0	0	2	0	7	2	0	9	0	0	0	0	1	0	12	12		
Total	5	0	1	0	6	0	23	4	0	27	0	0	1	1	17	1	51	52		
Grand Total	9	0	2	0	11	0	28	8	1	36	0	0	1	1	29	2	77	79		
Approch %	81.8	0	18.2			0	77.8	22.2		46.8	0	0	100		13.8	82.8	3.4			
Total %	11.7	0	2.6		14.3	0	36.4	10.4		46.8	0	0	1.3		5.2	31.2	1.3		2.5	97.5

3.1-342

Start Time	Meridian Parkway Southbound				Van Buren Boulevard Westbound				Harrison Street Northbound				Van Buren Boulevard Eastbound							
	Left	Thru	Right	RTOR	App. Total	Left	Thru	Right	RTOR	App. Total	Left	Thru	Right	RTOR	App. Total	Exclu. Total	Inclu. Total	Int. Total		
07:00 AM	0	0	0	0	0	0	1	3	1	4	0	0	0	0	0	1	0	0	5	
07:15 AM	1	0	0	0	1	0	0	1	0	1	0	0	0	0	2	0	4	4		
07:30 AM	2	0	0	0	2	0	1	0	0	1	0	0	0	0	3	0	6	6		
07:45 AM	1	0	1	0	2	0	3	0	0	3	0	0	0	0	6	0	11	11		
Total Volume	4	0	1	0	5	0	5	4	0	9	0	0	0	0	12	1	26	27		
% App. Total	80	0	20			0	55.6	44.4		46.8	0	0	100		13.8	82.8	3.4		2.5	97.5
PHF	.500	.000	.250		.625	.000	.417	.333		.563	.000	.000	.000		.000	.450	.500		.591	

Peak Hour Analysis From 07:00 AM to 07:45 AM - Peak 1 of 1
 Peak Hour for Entire Intersection Begins at 07:00 AM

Counts Unlimited
 PO Box 1178
 Corona, CA 92878
 (951) 268-6268

County of Riverside
 N/S: Meridian Parkway/Harrison Street
 E/W: Van Buren Boulevard
 Weather: Clear

File Name : 31_CRV_Meridian_Van Buren AM
 Site Code : 05119542
 Start Date : 8/20/2019
 Page No : 2

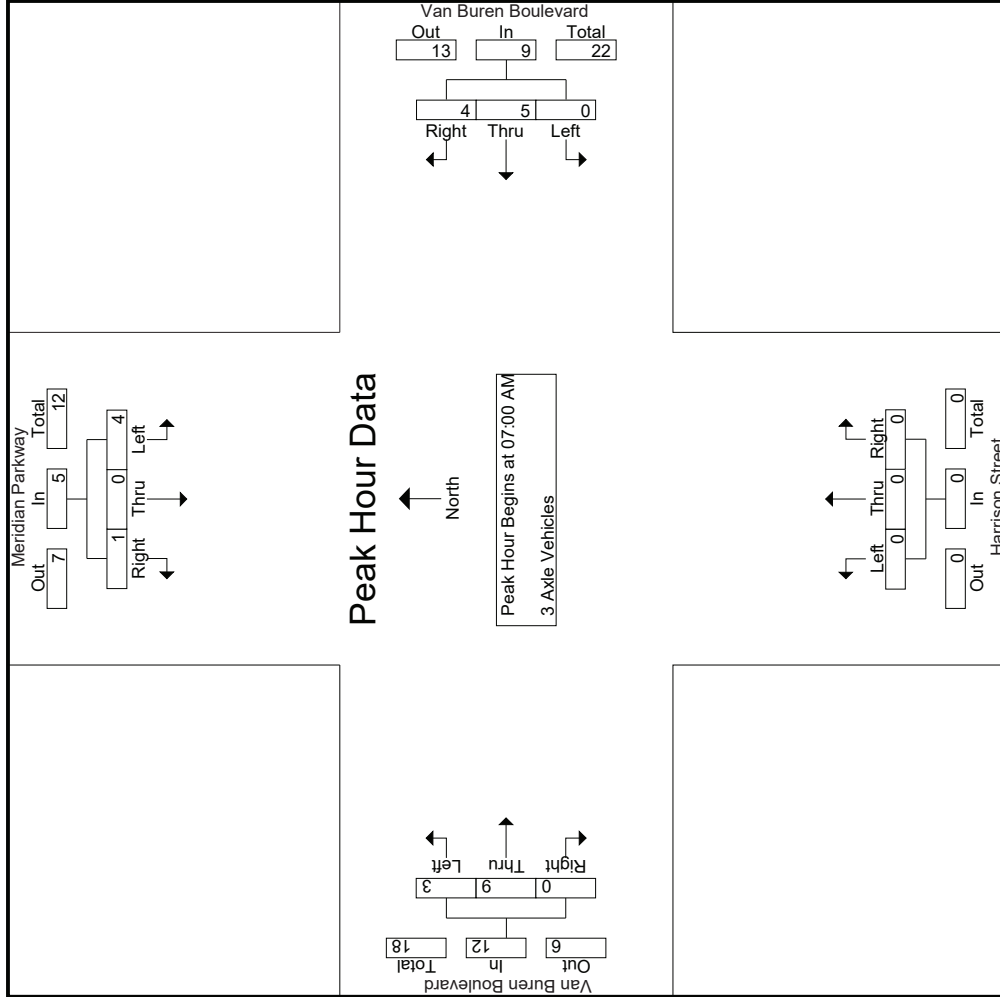

Counts Unlimited
 PO Box 1178
 Corona, CA 92878
 (951) 268-6268

County of Riverside
 N/S: Meridian Parkway/Harrison Street
 E/W: Van Buren Boulevard
 Weather: Clear

File Name : 31_CRV_Meridian_Van Buren AM
 Site Code : 05119542
 Start Date : 8/20/2019
 Page No : 3

Start Time	Meridian Parkway Southbound			Van Buren Boulevard Westbound			Harrison Street Northbound			Van Buren Boulevard Eastbound		
	Left	Thru	Right	Left	Thru	Right	Left	Thru	Right	Left	Thru	Right
Peak Hour Analysis From 07:00 AM to 07:45 AM - Peak 1 of 1												
Peak Hour for Each Approach Begins at:												
+0 mins.	0	0	0	0	0	4	0	0	0	0	0	0
+15 mins.	1	0	0	0	1	3	0	0	0	1	0	0
+30 mins.	2	0	0	0	0	1	0	0	0	0	2	0
+45 mins.	1	0	1	0	3	0	1	0	0	1	2	0
Total Volume	4	0	1	0	5	4	9	0	0	3	9	0
% App. Total	80	0	20	0	55.6	44.4	0	0	0	25	75	0
PHF	.500	.000	.250	.000	.417	.333	.563	.000	.000	.750	.450	.000

Counts Unlimited
 PO Box 1178
 Corona, CA 92878
 (951) 268-6268

County of Riverside
 N/S: Meridian Parkway/Harrison Street
 EW: Van Buren Boulevard
 Weather: Clear

File Name : 31_CRV_Meridian_Van Buren AM
 Site Code : 05119542
 Start Date : 8/20/2019
 Page No : 1

Groups Printed- 4+ Axle Trucks

Start Time	Meridian Parkway Southbound				Van Buren Boulevard Westbound				Harrison Street Northbound				Van Buren Boulevard Eastbound			
	Left	Thru	Right	RTOR	Left	Thru	Right	RTOR	Left	Thru	Right	RTOR	Left	Thru	Right	RTOR
07:00 AM	0	0	0	0	0	8	2	0	0	0	0	0	1	2	0	0
07:15 AM	2	0	1	0	0	5	3	0	0	0	0	0	0	0	0	0
07:30 AM	1	0	0	0	0	10	2	1	0	0	0	0	0	3	0	0
07:45 AM	1	0	1	0	0	4	1	0	0	0	0	0	0	1	0	0
Total	4	0	2	0	0	27	8	1	0	0	0	0	1	6	0	0
08:00 AM	2	0	2	0	0	1	1	0	0	0	0	0	0	5	0	0
08:15 AM	2	0	0	0	0	5	2	0	0	0	0	0	0	3	0	0
08:30 AM	5	0	0	0	0	4	1	0	0	0	0	0	1	2	0	0
08:45 AM	7	0	2	0	0	5	1	0	0	0	0	0	0	2	0	0
Total	16	0	4	0	0	15	5	0	0	0	0	0	1	12	0	0
Grand Total	20	0	6	0	0	42	13	1	0	0	0	0	2	18	0	0
Apprch %	76.9	0	23.1		0	76.4	23.6		0	0	0		10	90	0	
Total %	19.8	0	5.9		0	41.6	12.9		0	0	0		2	17.8	0	
						54.5								19.8		

3:1-345

Start Time	Meridian Parkway Southbound				Van Buren Boulevard Westbound				Harrison Street Northbound				Van Buren Boulevard Eastbound			
	Left	Thru	Right	RTOR	Left	Thru	Right	RTOR	Left	Thru	Right	RTOR	Left	Thru	Right	RTOR
07:00 AM	0	0	0	0	0	8	2	0	0	0	0	0	1	2	0	0
07:15 AM	2	0	1	0	0	5	3	0	0	0	0	0	0	0	0	0
07:30 AM	1	0	0	0	0	10	2	1	0	0	0	0	0	3	0	0
07:45 AM	1	0	1	0	0	4	1	0	0	0	0	0	0	1	0	0
Total Volume	4	0	2	0	0	27	8	0	0	0	0	0	1	6	0	0
% App. Total	66.7	0	33.3		0	77.1	22.9		0	0	0		14.3	85.7	0	
PHF	.500	.000	.500		.000	.675	.667		.000	.000	.000		.250	.500	.000	
						.729								.583		

Peak Hour Analysis From 07:00 AM to 07:45 AM - Peak 1 of 1
 Peak Hour for Entire Intersection Begins at 07:00 AM

Counts Unlimited
 PO Box 1178
 Corona, CA 92878
 (951) 268-6268

County of Riverside
 N/S: Meridian Parkway/Harrison Street
 E/W: Van Buren Boulevard
 Weather: Clear

File Name : 31_CRV_Meridian_Van Buren AM
 Site Code : 05119542
 Start Date : 8/20/2019
 Page No : 2

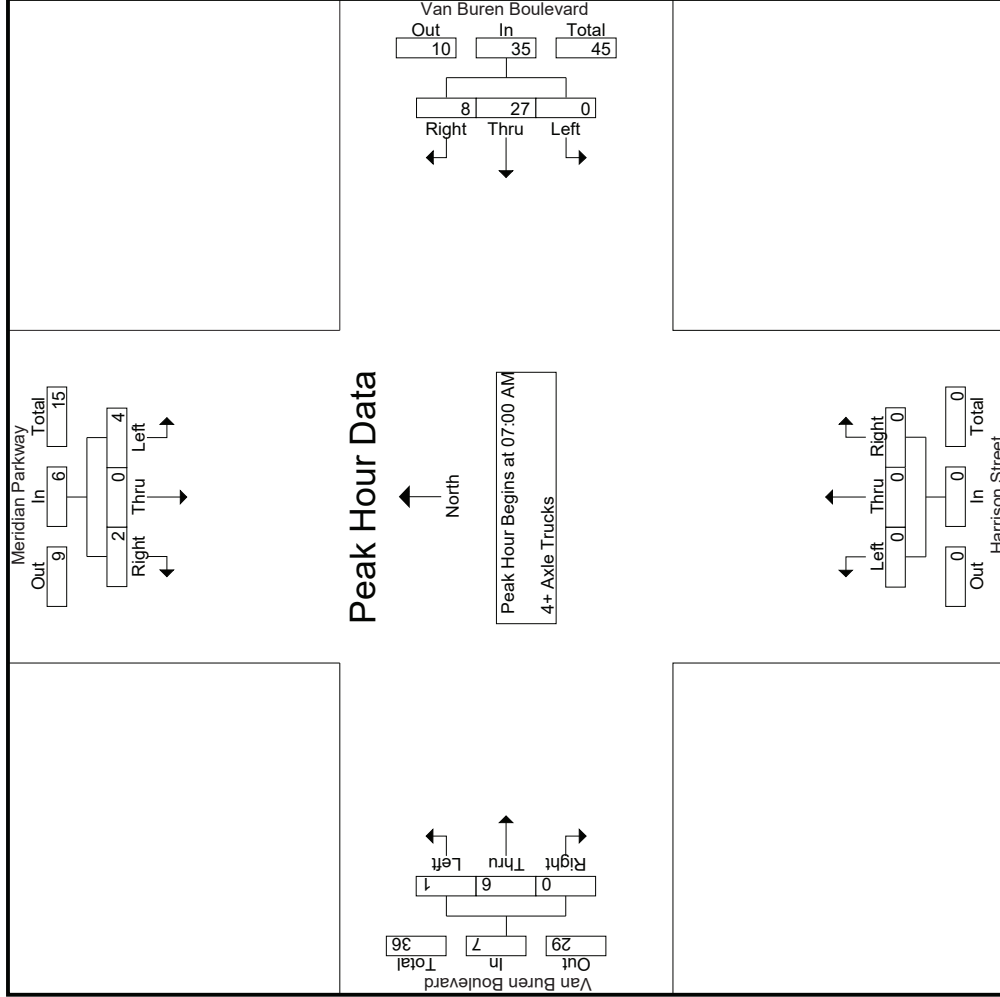

Counts Unlimited
 PO Box 1178
 Corona, CA 92878
 (951) 268-6268

County of Riverside
 N/S: Meridian Parkway/Harrison Street
 E/W: Van Buren Boulevard
 Weather: Clear

File Name : 31_CRV_Meridian_Van Buren AM
 Site Code : 05119542
 Start Date : 8/20/2019
 Page No : 3

Start Time	Meridian Parkway Southbound			Van Buren Boulevard Westbound			Harrison Street Northbound			Van Buren Boulevard Eastbound			
	Left	Thru	Right	Left	Thru	Right	Left	Thru	Right	Left	Thru	Right	
Peak Hour Analysis From 07:00 AM to 07:45 AM - Peak 1 of 1													
Peak Hour for Each Approach Begins at:													
+0 mins.	0	0	0	0	8	2	10	0	0	0	0	2	0
+15 mins.	2	0	1	0	5	3	8	0	0	0	0	0	0
+30 mins.	1	0	0	0	10	2	12	0	0	0	0	3	0
+45 mins.	1	0	1	0	4	1	5	0	0	0	0	1	0
Total Volume	4	0	2	0	27	8	35	0	0	0	1	6	0
% App. Total	66.7	0	33.3	0	77.1	22.9	72.9	0	0	0	14.3	85.7	0
PHF	.500	.000	.500	.000	.675	.667	.729	.000	.000	.000	.250	.500	.000

Counts Unlimited
PO Box 1178
Corona, CA 92878
(951) 268-6268

County of Riverside
N/S: Meridian Parkway/Harrison Street
EW: Van Buren Boulevard
Weather: Clear

File Name : 31_CRV_Meridian_Van Buren PM
Site Code : 05119542
Start Date : 8/20/2019
Page No : 1

Groups Printed- Passenger Vehicles - Large 2 Axle Vehicles - 3 Axle Vehicles - 4+ Axle Trucks

Start Time	Meridian Parkway Southbound					Van Buren Boulevard Westbound					Harrison Street Northbound					Van Buren Boulevard Eastbound							
	Left	Thru	Right	RTOR	App. Total	Left	Thru	Right	RTOR	App. Total	Left	Thru	Right	RTOR	App. Total	Left	Thru	Right	RTOR	App. Total	Exclu. Total	Inclu. Total	Int. Total
04:00 PM	74	0	75	0	149	1	217	13	4	231	2	1	3	3	6	49	298	2	0	349	7	735	742
04:15 PM	77	1	109	0	187	4	179	10	3	193	1	0	2	1	3	67	318	1	0	386	4	769	773
04:30 PM	93	4	114	0	211	5	167	8	5	180	3	7	19	16	29	61	274	1	0	336	21	756	777
04:45 PM	94	2	111	0	207	1	191	5	2	197	1	3	9	7	13	55	261	1	0	317	9	734	743
Total	338	7	409	0	754	11	754	36	14	801	7	11	33	27	51	232	1151	5	0	1388	41	2994	3035
05:00 PM	80	2	140	0	222	1	181	6	2	188	1	2	5	0	8	53	296	2	1	351	3	769	772
05:15 PM	98	1	134	0	233	2	220	3	1	225	2	0	1	1	3	44	350	0	0	394	2	855	857
05:30 PM	83	0	126	0	209	0	173	3	1	176	0	0	2	0	2	53	361	0	0	414	1	801	802
05:45 PM	63	0	120	0	183	1	210	4	2	215	0	1	1	1	2	65	267	1	1	333	4	733	737
Total	324	3	520	0	847	4	784	16	6	804	3	3	9	2	15	215	1274	3	2	1492	10	3158	3168
Grand Total	662	10	929	0	1601	15	1538	52	20	1605	10	14	42	29	66	447	2425	8	2	2880	51	6152	6203
Approch %	41.3	0.6	58			0.9	95.8	3.2		15.2	21.2	63.6			15.5	84.2	0.3		46.8	0.8	99.2		
Total %	10.8	0.2	15.1		26	0.2	25	0.8		26.1	0.2	0.7		1.1	7.3	39.4	0.1						
% Passenger Vehicles	644	10	916		1570	14	1497	41		1570	10	14	42		95	426	2371	8		2807	0	0	6042
% 2 Axle Vehicles	97.3	100	98.6		98.1	93.3	97.3	78.8		96.6	100	100	100		100	95.3	97.8	100		97.4	0	0	97.4
% Large 2 Axle Vehicles	1.4	0	0.8		1.6	1	22	6		30	0	0	0		0	13	33	0		46	0	0	92
% 3 Axle Vehicles	3	0	1		4	0	3	1		4	0	0	0		0	2.9	1.4	0		1.6	0	0	1.5
% 3 Axle Trucks	0.5	0	0.1		0.2	0	0.2	1.9		0.2	0	0	0		0	0.2	0.2	0		0.2	0	0	0.2
% 4+ Axle Trucks	6	0	5		11	0	16	4		21	0	0	0		0	7	16	0		23	0	0	55
% 4+ Axle Trucks	0.9	0	0.5		0.7	0	1	7.7		1.3	0	0	0		0	1.6	0.7	0		0.8	0	0	0.9
Start Time	Meridian Parkway Southbound					Van Buren Boulevard Westbound					Harrison Street Northbound					Van Buren Boulevard Eastbound							
04:00 PM	94	2	111		207	1	191	5		197	1	3	9		9	13	261	1		317	1	317	734
05:00 PM	80	2	140		222	1	181	6		188	1	2	5		5	8	296	2		351	2	351	769
05:15 PM	98	1	134		233	2	220	3		225	2	0	1		1	3	344	0		394	0	394	855
05:30 PM	83	0	126		209	0	173	3		176	0	0	2		2	53	361	0		414	1	414	801
05:45 PM	63	0	120		183	1	210	4		215	0	1	1		2	65	267	1		333	4	333	737
Total Volume	355	5	511		871	4	765	17		786	4	5	17		17	205	1268	3		1476	3	1476	3159
% App. Total	40.8	0.6	58.7		58.7	0.5	97.3	2.2		2.2	15.4	19.2	65.4		65.4	13.9	85.9	0.2		0.2	0.2	0.2	92.4
PHF	.906	.625	.913		.935	.500	.869	.708		.873	.500	.417	.472		.472	.500	.878	.375		.891	.375	.891	.924

Peak Hour Analysis From 04:00 PM to 05:45 PM - Peak 1 of 1
Peak Hour for Entire Intersection Begins at 04:45 PM

Counts Unlimited
 PO Box 1178
 Corona, CA 92878
 (951) 268-6268

County of Riverside
 N/S: Meridian Parkway/Harrison Street
 E/W: Van Buren Boulevard
 Weather: Clear

File Name : 31_CRV_Meridian_Van Buren PM
 Site Code : 05119542
 Start Date : 8/20/2019
 Page No : 2

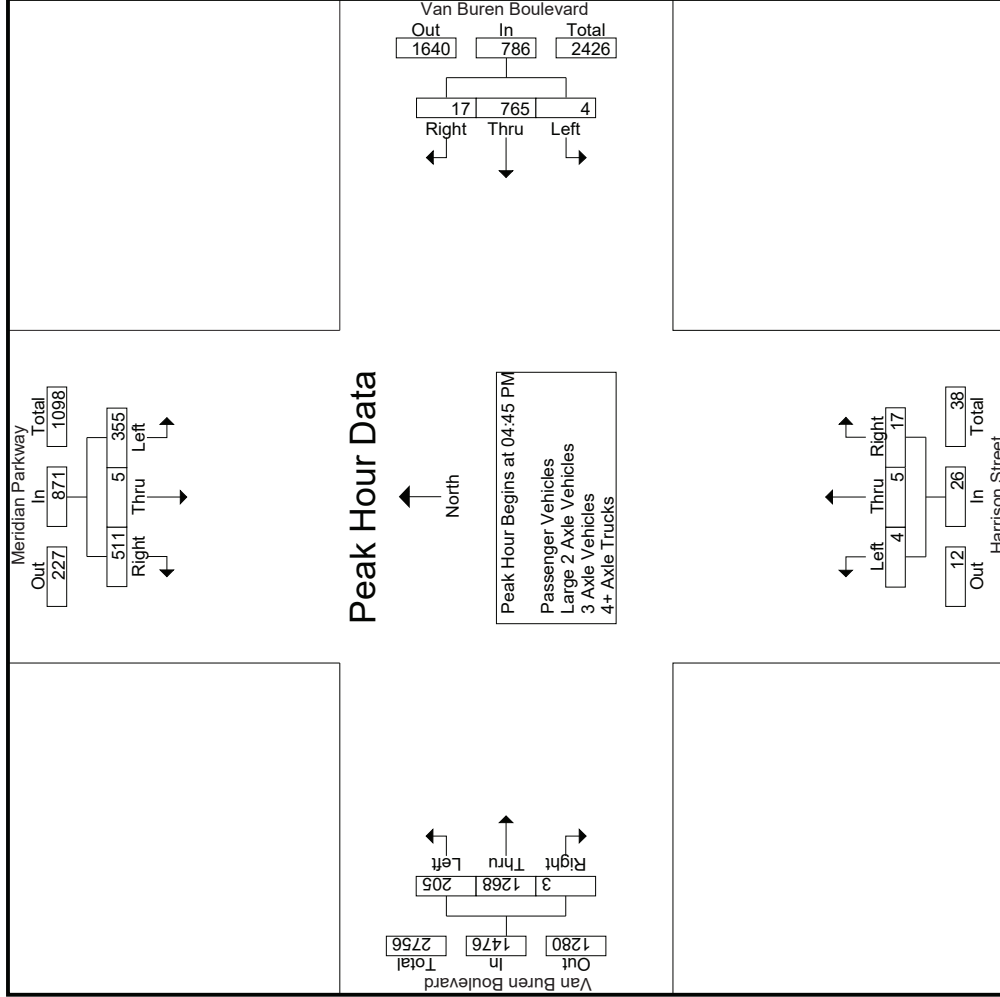

Counts Unlimited
 PO Box 1178
 Corona, CA 92878
 (951) 268-6268

County of Riverside
 N/S: Meridian Parkway/Harrison Street
 E/W: Van Buren Boulevard
 Weather: Clear

File Name : 31_CRV_Meridian_Van Buren PM
 Site Code : 05119542
 Start Date : 8/20/2019
 Page No : 3

Start Time	Meridian Parkway Southbound			Van Buren Boulevard Westbound			Harrison Street Northbound			Van Buren Boulevard Eastbound				
	Left	Thru	Right	Left	Thru	Right	Left	Thru	Right	Left	Thru	Right	App. Total	Int. Total
Peak Hour Analysis From 04:00 PM to 05:45 PM - Peak 1 of 1														
Peak Hour for Each Approach Begins at:														
	04:30 PM			05:00 PM			04:15 PM			05:00 PM				
+0 mins.	93	4	114	181	6	188	1	0	2	3	53	296	2	351
+15 mins.	94	2	111	220	3	225	3	7	19	29	44	350	0	394
+30 mins.	80	2	140	173	3	176	1	3	9	13	53	361	0	414
+45 mins.	98	1	134	210	4	215	1	2	5	8	65	267	1	333
Total Volume	365	9	499	784	16	804	6	12	35	53	215	1274	3	1492
% App. Total	41.8	1	57.2	97.5	2	99.3	11.3	22.6	66	14.4	85.4	85.4	0.2	90.1
PHF	.931	.563	.891	.891	.667	.893	.500	.429	.461	.457	.827	.882	.375	.901

Counts Unlimited
 PO Box 1178
 Corona, CA 92878
 (951) 268-6268

County of Riverside
 N/S: Meridian Parkway/Harrison Street
 EW: Van Buren Boulevard
 Weather: Clear

File Name : 31_CRV_Meridian_Van Buren PM
 Site Code : 05119542
 Start Date : 8/20/2019
 Page No : 1

Groups Printed- Passenger Vehicles

Start Time	Meridian Parkway Southbound					Van Buren Boulevard Westbound					Harrison Street Northbound					Van Buren Boulevard Eastbound							
	Left	Thru	Right	RTOR	App. Total	Left	Thru	Right	RTOR	App. Total	Left	Thru	Right	RTOR	App. Total	Left	Thru	Right	RTOR	App. Total	Exclu. Total	Inclu. Total	Int. Total
04:00 PM	71	0	74	0	145	1	207	13	4	221	2	1	3	3	6	46	290	2	0	338	7	710	717
04:15 PM	75	1	107	0	183	4	172	5	2	181	1	0	2	1	3	65	310	1	0	376	3	743	746
04:30 PM	93	4	114	0	211	5	163	6	4	174	3	7	19	16	29	57	271	1	0	329	20	743	763
04:45 PM	89	2	110	0	201	0	185	5	2	190	1	3	9	7	13	53	254	1	0	308	9	712	721
Total	328	7	405	0	740	10	727	29	12	766	7	11	33	27	51	221	1125	5	0	1351	39	2908	2947
05:00 PM	77	2	137	0	216	1	176	4	2	181	1	2	5	0	8	48	285	2	1	335	3	740	743
05:15 PM	97	1	132	0	230	2	216	3	1	221	2	0	1	1	3	42	342	0	0	384	2	838	840
05:30 PM	81	0	123	0	204	0	171	2	1	173	0	0	2	0	2	51	356	0	0	407	1	786	787
05:45 PM	61	0	119	0	180	1	207	3	2	211	0	1	1	1	2	64	263	1	1	328	4	721	725
Total	316	3	511	0	830	4	770	12	6	786	3	3	9	2	15	205	1246	3	2	1454	10	3085	3095
Grand Total	644	10	916	0	1570	14	1497	41	18	1552	10	14	42	29	66	426	2371	8	2	2805	49	5993	6042
Approch %	41	0.6	58.3		26.2	0.9	96.5	2.6		25.9	15.2	21.2	63.6		1.1	15.2	84.5	0.3		46.8	0.8	99.2	
Total %	10.7	0.2	15.3		26.2	0.2	25	0.7		25.9	0.2	0.2	0.7		1.1	7.1	39.6	0.1		46.8	0.8	99.2	

3.1-351

Start Time	Meridian Parkway Southbound					Van Buren Boulevard Westbound					Harrison Street Northbound					Van Buren Boulevard Eastbound							
	Left	Thru	Right	RTOR	App. Total	Left	Thru	Right	RTOR	App. Total	Left	Thru	Right	RTOR	App. Total	Left	Thru	Right	RTOR	App. Total	Exclu. Total	Inclu. Total	Int. Total
04:45 PM	89	2	110	0	201	0	185	5	2	190	1	3	9	7	13	53	254	1	0	308	7	710	717
05:00 PM	77	2	137	0	216	1	176	4	2	181	1	2	5	0	8	48	285	2	1	335	3	743	746
05:15 PM	97	1	132	0	230	2	216	3	1	221	2	0	1	1	3	42	342	0	0	384	2	838	840
05:30 PM	81	0	123	0	204	0	171	2	1	173	0	0	2	0	2	51	356	0	0	407	1	786	787
Total Volume	344	5	502	0	851	3	748	14	6	766	4	5	17	7	51	194	1237	3	2	1434	39	2908	2947
% App. Total	40.4	0.6	59		26.2	0.4	97.8	1.8		25.9	15.4	19.2	65.4		1.1	13.5	86.3	0.2		46.8	0.8	99.2	
PHF	.887	.625	.916		.925	.375	.866	.700		.865	.500	.417	.472		.500	.915	.869	.375		.881			

Peak Hour Analysis From 04:45 PM to 05:30 PM - Peak 1 of 1
 Peak Hour for Entire Intersection Begins at 04:45 PM

Counts Unlimited
 PO Box 1178
 Corona, CA 92878
 (951) 268-6268

County of Riverside
 N/S: Meridian Parkway/Harrison Street
 E/W: Van Buren Boulevard
 Weather: Clear

File Name : 31_CRV_Meridian_Van Buren PM
 Site Code : 05119542
 Start Date : 8/20/2019
 Page No : 2

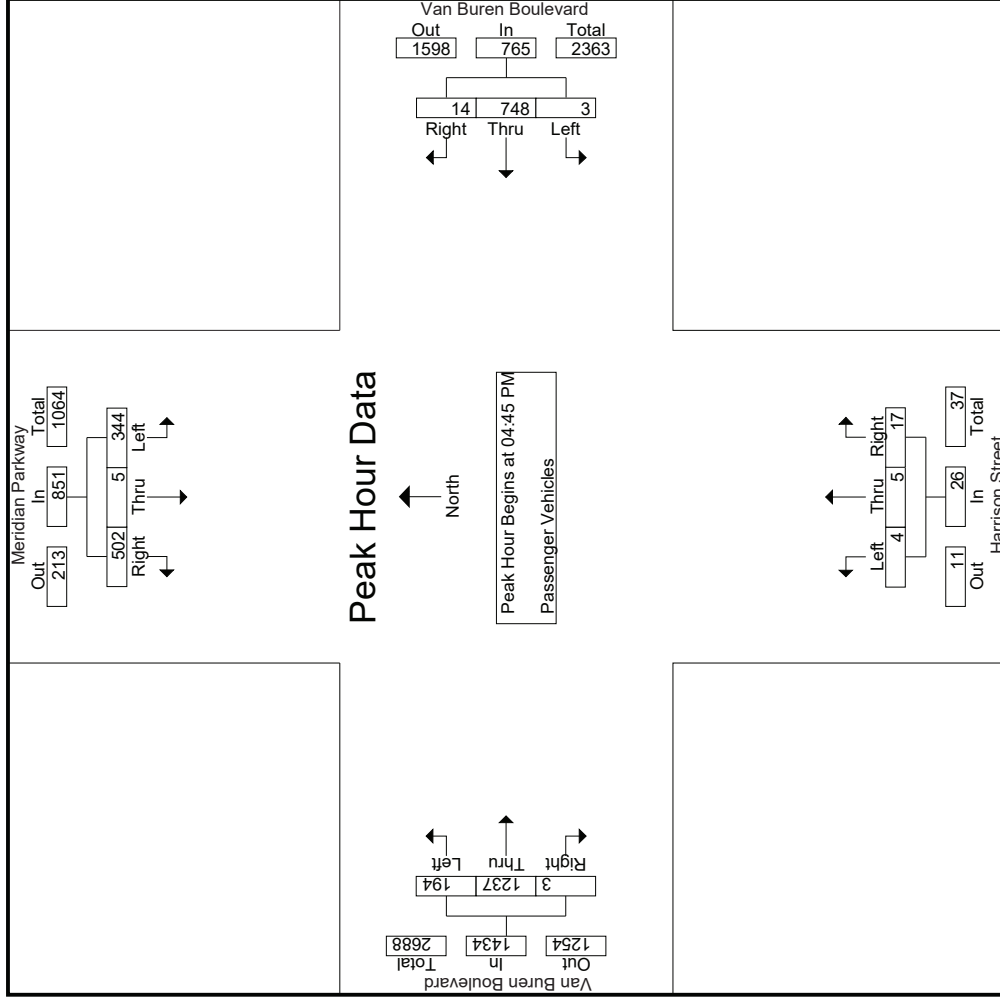

Counts Unlimited
 PO Box 1178
 Corona, CA 92878
 (951) 268-6268

County of Riverside
 N/S: Meridian Parkway/Harrison Street
 E/W: Van Buren Boulevard
 Weather: Clear

File Name : 31_CRV_Meridian_Van Buren PM
 Site Code : 05119542
 Start Date : 8/20/2019
 Page No : 3

Start Time	Meridian Parkway Southbound			Van Buren Boulevard Westbound			Harrison Street Northbound			Van Buren Boulevard Eastbound				
	Left	Thru	Right	Left	Thru	Right	Left	Thru	Right	Left	Thru	Right		
Peak Hour Analysis From 04:45 PM to 05:30 PM - Peak 1 of 1	Peak Hour for Each Approach Begins at:													
	04:45 PM			04:45 PM			04:45 PM			04:45 PM				
+0 mins.	89	2	110	0	185	5	190	1	3	9	13	254	1	308
+15 mins.	77	2	137	1	176	4	181	1	2	5	8	285	2	335
+30 mins.	97	1	132	2	216	3	221	2	0	1	3	342	0	384
+45 mins.	81	0	123	0	171	2	173	0	0	2	2	356	0	407
Total Volume	344	5	502	3	748	14	765	4	5	17	26	194	3	1434
% App. Total	40.4	0.6	59	0.4	97.8	1.8	86.5	15.4	19.2	65.4	13.5	86.3	0.2	88.1
PHF	.887	.625	.916	.375	.866	.700	.865	.500	.417	.472	.500	.915	.375	.881

Counts Unlimited
 PO Box 1178
 Corona, CA 92878
 (951) 268-6268

County of Riverside
 N/S: Meridian Parkway/Harrison Street
 EW: Van Buren Boulevard
 Weather: Clear

File Name : 31_CRV_Meridian_Van Buren PM
 Site Code : 05119542
 Start Date : 8/20/2019
 Page No : 1

Groups Printed- Large 2 Axle Vehicles

Start Time	Meridian Parkway Southbound				Van Buren Boulevard Westbound				Harrison Street Northbound				Van Buren Boulevard Eastbound						
	Left	Thru	Right	RTOR	App. Total	Left	Thru	Right	RTOR	App. Total	Left	Thru	Right	RTOR	App. Total	Exclu. Total	Inclu. Total	Int. Total	
04:00 PM	2	0	0	0	2	0	5	0	0	5	0	0	0	0	0	7	0	14	14
04:15 PM	1	0	1	0	2	0	4	1	0	5	0	0	0	0	5	0	12	12	12
04:30 PM	0	0	0	0	0	0	3	2	1	5	0	0	0	0	3	1	8	9	9
04:45 PM	2	0	1	0	3	1	4	0	0	5	0	0	0	0	6	0	14	14	14
Total	5	0	2	0	7	1	16	3	1	20	0	0	0	0	21	1	48	49	49
05:00 PM	2	0	1	0	3	0	2	1	0	3	0	0	0	0	10	0	16	16	16
05:15 PM	0	0	1	0	1	0	3	0	0	3	0	0	0	0	6	0	10	10	10
05:30 PM	1	0	3	0	4	0	0	1	0	1	0	0	0	0	7	0	12	12	12
05:45 PM	1	0	0	0	1	0	1	1	0	2	0	0	0	0	2	0	5	5	5
Total	4	0	5	0	9	0	6	3	0	9	0	0	0	0	25	0	43	43	43
Grand Total	9	0	7	0	16	1	22	6	1	29	0	0	0	0	46	1	91	92	92
Approch %	56.2	0	43.8		3.4	75.9	20.7			31.9					50.5	1.1	98.9		
Total %	9.9	0	7.7		17.6	1.1	24.2	6.6											

3:1-354

Start Time	Meridian Parkway Southbound				Van Buren Boulevard Westbound				Harrison Street Northbound				Van Buren Boulevard Eastbound						
	Left	Thru	Right	RTOR	App. Total	Left	Thru	Right	RTOR	App. Total	Left	Thru	Right	RTOR	App. Total	Exclu. Total	Inclu. Total	Int. Total	
04:45 PM	2	0	1	0	3	1	4	0	0	5	0	0	0	0	0	0	6	14	14
05:00 PM	2	0	1	0	3	0	2	1	3	3	0	0	0	0	6	0	10	16	16
05:15 PM	0	0	1	0	1	0	3	0	0	3	0	0	0	0	5	0	6	10	10
05:30 PM	1	0	3	0	4	0	0	0	1	1	0	0	0	0	7	0	7	12	12
Total Volume	5	0	6		11	1	9	2	12	12	0	0	0	0	29	0	52	52	52
% App. Total	45.5	0	54.5		6.88	8.3	75	16.7		60					72.5		81.3		
PHF	.625	.000	.500		.688	.250	.563	.500		.600	.000	.000	.000	.000	.833	.000	.725		.813

Peak Hour Analysis From 04:45 PM to 05:30 PM - Peak 1 of 1
 Peak Hour for Entire Intersection Begins at 04:45 PM

Counts Unlimited
 PO Box 1178
 Corona, CA 92878
 (951) 268-6268

County of Riverside
 N/S: Meridian Parkway/Harrison Street
 E/W: Van Buren Boulevard
 Weather: Clear

File Name : 31_CRV_Meridian_Van Buren PM
 Site Code : 05119542
 Start Date : 8/20/2019
 Page No : 2

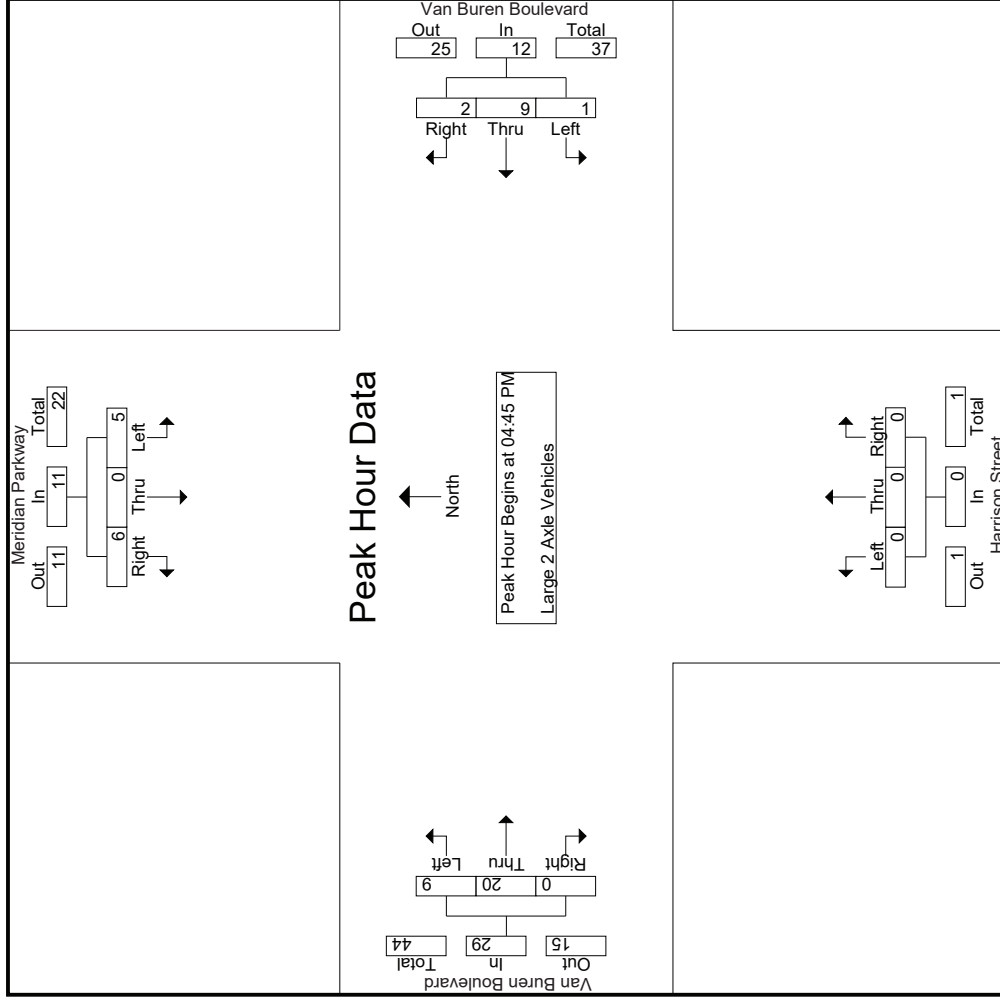

Counts Unlimited
 PO Box 1178
 Corona, CA 92878
 (951) 268-6268

County of Riverside
 N/S: Meridian Parkway/Harrison Street
 E/W: Van Buren Boulevard
 Weather: Clear

File Name : 31_CRV_Meridian_Van Buren PM
 Site Code : 05119542
 Start Date : 8/20/2019
 Page No : 3

Start Time	Meridian Parkway Southbound			Van Buren Boulevard Westbound			Harrison Street Northbound			Van Buren Boulevard Eastbound		
	Left	Thru	Right	Left	Thru	Right	Left	Thru	Right	Left	Thru	Right
Peak Hour Analysis From 04:45 PM to 05:30 PM - Peak 1 of 1												
Peak Hour for Each Approach Begins at:												
+0 mins.	2	0	1	1	4	0	5	0	0	2	4	0
+15 mins.	2	0	1	2	2	1	3	0	0	4	6	0
+30 mins.	0	0	1	3	0	0	3	0	0	1	5	0
+45 mins.	1	0	3	0	0	1	1	0	0	2	5	0
Total Volume	5	0	6	9	9	2	12	0	0	9	20	0
% App. Total	45.5	0	54.5	8.3	7.5	16.7	16.7	0	0	31	69	0
PHF	.625	.000	.500	.250	.563	.500	.600	.000	.000	.563	.833	.000

Counts Unlimited
 PO Box 1178
 Corona, CA 92878
 (951) 268-6268

County of Riverside
 N/S: Meridian Parkway/Harrison Street
 EW: Van Buren Boulevard
 Weather: Clear

File Name : 31_CRV_Meridian_Van Buren PM
 Site Code : 05119542
 Start Date : 8/20/2019
 Page No : 1

Groups Printed- 3 Axle Vehicles

Start Time	Meridian Parkway Southbound			Van Buren Boulevard Westbound			Harrison Street Northbound			Van Buren Boulevard Eastbound								
	Left	Thru	Right	RTOR	App. Total	Left	Thru	Right	RTOR	App. Total	Left	Thru	Right	RTOR	App. Total	Exclu. Total	Inclu. Total	Int. Total
04:00 PM	0	0	1	0	1	0	0	0	0	0	0	0	0	0	0	0	2	2
04:15 PM	1	0	0	0	1	0	0	0	0	0	0	2	0	0	2	0	4	4
04:30 PM	0	0	0	0	0	0	0	0	0	0	1	0	0	0	1	0	1	1
04:45 PM	1	0	0	0	1	0	0	0	0	0	0	1	0	0	1	0	3	3
Total	2	0	1	0	3	0	2	1	0	0	1	3	0	0	4	0	10	10
05:00 PM	0	0	0	0	0	0	0	0	0	0	0	1	0	0	1	0	1	1
05:15 PM	0	0	0	0	0	1	0	0	0	0	0	0	0	0	0	0	1	1
05:30 PM	1	0	0	0	1	0	0	0	0	0	0	0	0	0	0	0	1	1
05:45 PM	0	0	0	0	0	0	0	0	0	0	0	1	0	0	1	0	1	1
Total	1	0	0	0	1	0	1	0	0	0	0	2	0	0	2	0	4	4
Grand Total	3	0	1	0	4	0	3	1	0	0	1	5	0	0	6	0	14	14
Approch %	75	0	25		28.6	0	75	25		0	16.7	83.3	0		42.9	0	100	
Total %	21.4	0	7.1		28.6	0	21.4	7.1		0	7.1	35.7	0			0		

3:1-357

Start Time	Meridian Parkway Southbound			Van Buren Boulevard Westbound			Harrison Street Northbound			Van Buren Boulevard Eastbound								
	Left	Thru	Right	RTOR	App. Total	Left	Thru	Right	RTOR	App. Total	Left	Thru	Right	RTOR	App. Total	Exclu. Total	Inclu. Total	Int. Total
04:45 PM	1	0	0		1	0	0	0		0	0	0	0		0	0	1	1
05:00 PM	0	0	0		0	0	0	0		0	0	0	0		0	0	1	1
05:15 PM	0	0	0		0	0	0	0		0	0	0	0		0	0	1	1
05:30 PM	1	0	0		1	0	0	0		0	0	0	0		0	0	1	1
Total Volume	2	0	0		2	0	2	0		0	0	2	0		2	0	6	6
% App. Total	100	0	0		100	0	100	0		0	0	100	0		0	0	100	100
PHF	.500	.000	.000		.500	.000	.500	.000		.000	.000	.500	.000		.000	.000	.500	.500

Peak Hour Analysis From 04:45 PM to 05:30 PM - Peak 1 of 1
 Peak Hour for Entire Intersection Begins at 04:45 PM

Counts Unlimited
 PO Box 1178
 Corona, CA 92878
 (951) 268-6268

County of Riverside
 N/S: Meridian Parkway/Harrison Street
 E/W: Van Buren Boulevard
 Weather: Clear

File Name : 31_CRV_Meridian_Van Buren PM
 Site Code : 05119542
 Start Date : 8/20/2019
 Page No : 2

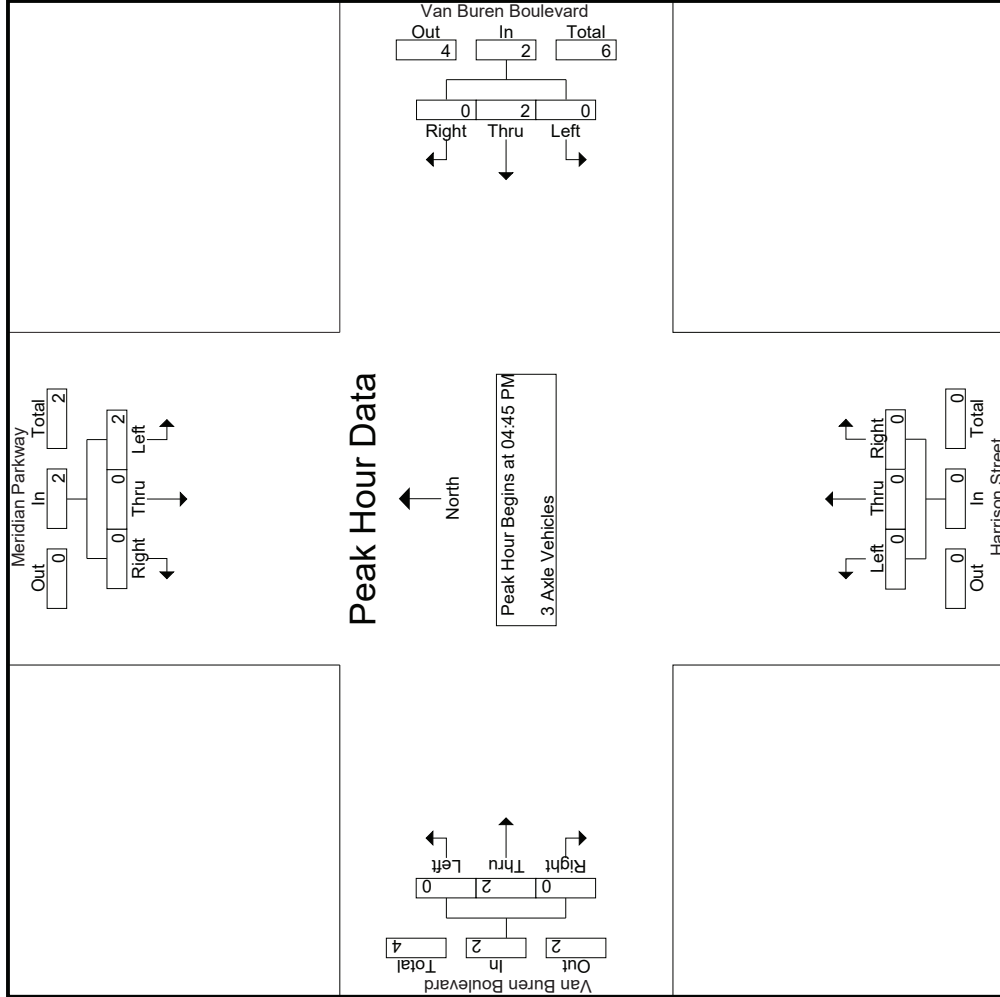

Counts Unlimited
 PO Box 1178
 Corona, CA 92878
 (951) 268-6268

County of Riverside
 N/S: Meridian Parkway/Harrison Street
 E/W: Van Buren Boulevard
 Weather: Clear

File Name : 31_CRV_Meridian_Van Buren PM
 Site Code : 05119542
 Start Date : 8/20/2019
 Page No : 3

Start Time	Meridian Parkway Southbound			Van Buren Boulevard Westbound			Harrison Street Northbound			Van Buren Boulevard Eastbound		
	Left	Thru	Right	Left	Thru	Right	Left	Thru	Right	Left	Thru	Right
Peak Hour Analysis From 04:45 PM to 05:30 PM - Peak 1 of 1	Peak Hour for Each Approach Begins at:											
	04:45 PM			04:45 PM			04:45 PM			04:45 PM		
+0 mins.	1	0	0	1	0	0	1	0	0	0	0	0
+15 mins.	0	0	0	0	0	0	0	0	0	0	1	0
+30 mins.	0	0	0	1	0	0	1	0	0	0	0	0
+45 mins.	1	0	0	0	0	0	0	0	0	0	0	0
Total Volume	2	0	0	2	0	0	2	0	0	0	2	0
% App. Total	100	0	0	100	0	0	100	0	0	0	100	0
PHF	.500	.000	.000	.500	.000	.000	.500	.000	.000	.000	.500	.000
	.000	.000	.500	.000	.000	.000	.000	.000	.000	.000	.000	.500

Counts Unlimited
 PO Box 1178
 Corona, CA 92878
 (951) 268-6268

County of Riverside
 N/S: Meridian Parkway/Harrison Street
 EW: Van Buren Boulevard
 Weather: Clear

File Name : 31_CRV_Meridian_Van Buren PM
 Site Code : 05119542
 Start Date : 8/20/2019
 Page No : 1

Groups Printed- 4+ Axle Trucks

Start Time	Meridian Parkway Southbound				Van Buren Boulevard Westbound				Harrison Street Northbound				Van Buren Boulevard Eastbound						
	Left	Thru	Right	RTOR	App. Total	Left	Thru	Right	RTOR	App. Total	Left	Thru	Right	RTOR	App. Total	Exclu. Total	Inclu. Total	Int. Total	
04:00 PM	1	0	0	0	1	0	4	0	0	4	0	0	0	0	0	4	0	9	9
04:15 PM	0	0	1	0	1	0	3	1	0	6	0	0	0	0	0	3	1	10	11
04:30 PM	0	0	0	0	0	0	1	0	0	1	0	0	0	0	0	3	0	4	4
04:45 PM	2	0	0	0	2	0	1	0	0	1	0	0	0	0	2	0	0	5	5
Total	3	0	1	0	4	0	9	3	1	12	0	0	0	0	12	1	28	29	
05:00 PM	1	0	2	0	3	0	3	1	0	4	0	0	0	0	0	5	0	12	12
05:15 PM	1	0	1	0	2	0	0	0	0	0	0	0	0	0	0	4	0	6	6
05:30 PM	0	0	0	0	0	0	2	0	0	2	0	0	0	0	0	0	0	2	2
05:45 PM	1	0	1	0	2	0	2	0	0	2	0	0	0	0	2	0	0	6	6
Total	3	0	4	0	7	0	7	1	0	8	0	0	0	0	11	0	26	26	
Grand Total	6	0	5	0	11	0	16	4	1	20	0	0	0	0	23	1	54	55	
Approch %	54.5	0	45.5			0	80	20			0	0	0		30.4	69.6	0		
Total %	11.1	0	9.3		20.4	0	29.6	7.4		37	0	0	0		13	29.6	0	1.8	98.2

3.1-360

Start Time	Meridian Parkway Southbound				Van Buren Boulevard Westbound				Harrison Street Northbound				Van Buren Boulevard Eastbound						
	Left	Thru	Right	RTOR	App. Total	Left	Thru	Right	RTOR	App. Total	Left	Thru	Right	RTOR	App. Total	Exclu. Total	Inclu. Total	Int. Total	
04:45 PM	2	0	0	0	2	0	1	0	0	1	0	0	0	0	0	0	0	2	5
05:00 PM	1	0	2	0	3	0	3	1	0	4	0	0	0	0	4	0	5	12	12
05:15 PM	1	0	0	0	2	0	0	0	0	0	0	0	0	0	0	0	4	6	6
05:30 PM	0	0	0	0	0	0	2	0	0	2	0	0	0	0	0	0	0	2	2
Total Volume	4	0	3	0	7	0	6	1	0	7	0	0	0	0	9	0	11	25	
% App. Total	57.1	0	42.9			0	85.7	14.3			0	0	0		18.2	81.8	0		
PHF	.500	.000	.375		.583	.000	.500	.250		.438	.000	.000	.000		.563	.000	.550	.521	

Peak Hour Analysis From 04:45 PM to 05:30 PM - Peak 1 of 1
 Peak Hour for Entire Intersection Begins at 04:45 PM

Counts Unlimited
 PO Box 1178
 Corona, CA 92878
 (951) 268-6268

County of Riverside
 N/S: Meridian Parkway/Harrison Street
 E/W: Van Buren Boulevard
 Weather: Clear

File Name : 31_CRV_Meridian_Van Buren PM
 Site Code : 05119542
 Start Date : 8/20/2019
 Page No : 2

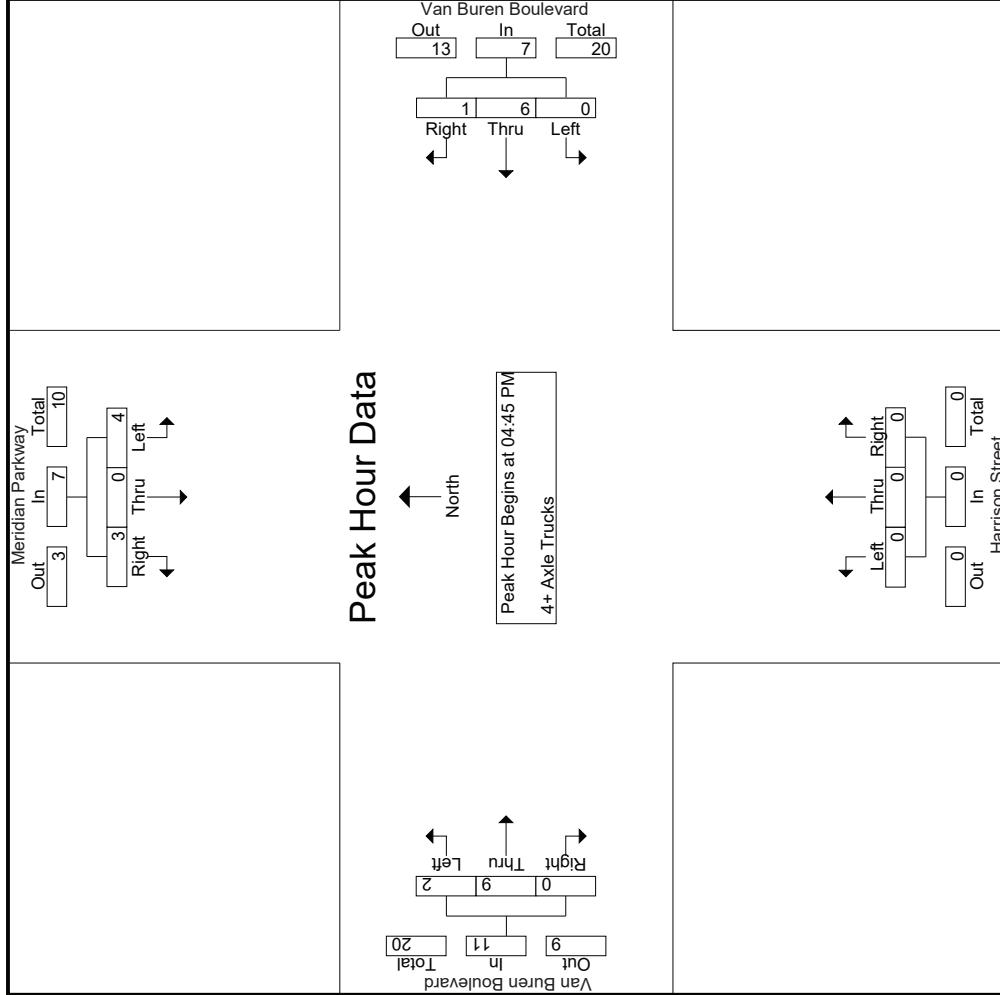

Counts Unlimited
 PO Box 1178
 Corona, CA 92878
 (951) 268-6268

County of Riverside
 N/S: Meridian Parkway/Harrison Street
 E/W: Van Buren Boulevard
 Weather: Clear

File Name : 31_CRV_Meridian_Van Buren PM
 Site Code : 05119542
 Start Date : 8/20/2019
 Page No : 3

Start Time	Meridian Parkway Southbound			Van Buren Boulevard Westbound			Harrison Street Northbound			Van Buren Boulevard Eastbound					
	Left	Thru	Right	Left	Thru	Right	Left	Thru	Right	Left	Thru	Right	App. Total	Int. Total	
Peak Hour Analysis From 04:45 PM to 05:30 PM - Peak 1 of 1															
Peak Hour for Each Approach Begins at:															
	04:45 PM			04:45 PM			04:45 PM			04:45 PM			04:45 PM		
+0 mins.	2	0	0	1	0	0	1	0	0	0	0	0	2	0	2
+15 mins.	1	0	2	3	1	4	4	0	0	0	0	0	4	0	5
+30 mins.	1	0	1	0	0	0	0	0	0	0	0	0	3	0	4
+45 mins.	0	0	0	2	0	2	2	0	0	0	0	0	0	0	0
Total Volume	4	0	3	6	1	7	7	0	0	0	0	0	9	0	11
% App. Total	57.1	0	42.9	85.7	14.3	438	438	.000	.000	.000	.000	.000	81.8	0	.550
PHF	.500	.000	.375	.500	.250	.438	.438	.000	.000	.000	.000	.000	.563	.000	.550

Location: County of Riverside
 N/S: Meridian Parkway
 E/W: Van Buren Boulevard



Date: 8/20/2019
 Day: Tuesday

PEDESTRIANS

	North Leg Meridian Parkway Pedestrians	East Leg Van Buren Boulevard Pedestrians	South Leg Harrison Street Pedestrians	West Leg Van Buren Boulevard Pedestrians	
7:00 AM	0	0	0	0	0
7:15 AM	0	0	0	0	0
7:30 AM	0	0	0	0	0
7:45 AM	0	0	0	0	0
8:00 AM	0	0	0	0	0
8:15 AM	0	0	0	0	0
8:30 AM	0	0	0	0	0
8:45 AM	0	0	0	0	0
TOTAL VOLUMES:	0	0	0	0	0

	North Leg Meridian Parkway Pedestrians	East Leg Van Buren Boulevard Pedestrians	South Leg Harrison Street Pedestrians	West Leg Van Buren Boulevard Pedestrians	
4:00 PM	0	0	0	0	0
4:15 PM	0	0	0	0	0
4:30 PM	0	0	0	0	0
4:45 PM	0	0	0	0	0
5:00 PM	0	0	0	0	0
5:15 PM	0	0	0	0	0
5:30 PM	0	0	0	0	0
5:45 PM	0	0	0	1	1
TOTAL VOLUMES:	0	0	0	1	1

Location: County of Riverside
 N/S: Meridian Parkway
 E/W: Van Buren Boulevard



Date: 8/20/2019
 Day: Tuesday

BICYCLES

	Southbound Meridian Parkway			Westbound Van Buren Boulevard			Northbound Harrison Street			Eastbound Van Buren Boulevard			
	Left	Thru	Right	Left	Thru	Right	Left	Thru	Right	Left	Thru	Right	
7:00 AM	0	0	0	0	0	0	0	0	0	0	0	0	0
7:15 AM	0	0	0	0	0	0	0	0	0	0	0	0	0
7:30 AM	0	0	0	0	0	0	0	0	0	0	0	0	0
7:45 AM	0	0	1	0	0	0	0	0	0	0	0	0	1
8:00 AM	0	0	0	0	0	0	0	0	0	1	0	0	1
8:15 AM	0	0	0	0	0	0	0	0	0	0	0	0	0
8:30 AM	0	0	0	0	0	0	0	0	0	0	1	0	1
8:45 AM	0	0	0	0	0	0	0	0	0	0	0	0	0
TOTAL VOLUMES:	0	0	1	0	0	0	0	0	0	1	1	0	3

	Southbound Meridian Parkway			Westbound Van Buren Boulevard			Northbound Harrison Street			Eastbound Van Buren Boulevard			
	Left	Thru	Right	Left	Thru	Right	Left	Thru	Right	Left	Thru	Right	
4:00 PM	0	0	0	0	0	0	0	0	0	0	0	0	0
4:15 PM	0	0	0	0	0	0	0	0	0	0	0	0	0
4:30 PM	0	0	0	0	0	0	0	0	0	0	0	0	0
4:45 PM	0	0	0	0	0	0	0	0	0	0	0	0	0
5:00 PM	0	0	0	0	0	0	0	0	0	0	0	0	0
5:15 PM	0	0	0	0	0	0	0	0	0	0	0	0	0
5:30 PM	0	0	1	0	0	0	0	0	0	0	0	0	1
5:45 PM	0	0	0	0	0	0	0	0	0	0	0	0	0
TOTAL VOLUMES:	0	0	1	0	0	0	0	0	0	0	0	0	1

Counts Unlimited
 PO Box 1178
 Corona, CA 92878
 (951) 268-6268

County of Riverside
 N/S: Innovation Drive
 EW: Cactus Avenue
 Weather: Clear

File Name : 32_CRV_Innovation_Cactus AM
 Site Code : 05119542
 Start Date : 8/20/2019
 Page No : 1

Groups Printed- Passenger Vehicles - Large 2 Axle Vehicles - 3 Axle Vehicles - 4+ Axle Trucks

Start Time	Innovation Drive Southbound						Cactus Avenue Westbound						Innovation Drive Northbound						Cactus Avenue Eastbound								
	Left	Thru	Right	RTOR	App. Total		Left	Thru	Right	RTOR	App. Total		Left	Thru	Right	RTOR	App. Total		Left	Thru	Right	RTOR	App. Total				
07:00 AM	0	0	0	0	0		34	337	16	0	387		0	0	8	7	8		2	52	0	0	54		7	449	456
07:15 AM	1	0	1	1	2		15	331	14	1	360		0	7	5	8	8		0	58	1	0	59		7	429	436
07:30 AM	1	0	0	0	1		14	304	24	0	342		0	7	6	7	7		0	62	2	0	64		6	414	420
07:45 AM	2	1	0	0	3		33	290	44	0	367		0	3	3	3	3		1	59	1	0	61		3	434	437
Total	4	1	1	1	6		96	1262	98	1	1456		1	0	25	21	26		3	231	4	0	238		23	1726	1749
08:00 AM	3	0	0	0	3		24	277	34	1	335		1	0	8	6	9		1	55	1	0	57		7	404	411
08:15 AM	3	0	2	1	5		20	321	15	0	356		1	0	8	8	9		0	51	0	0	51		9	421	430
08:30 AM	3	0	0	0	3		19	327	13	0	359		1	0	7	6	8		0	43	3	0	46		6	416	422
08:45 AM	0	2	1	0	3		24	291	5	0	320		2	0	12	9	14		2	48	2	1	52		10	389	399
Total	9	2	3	1	14		87	1216	67	1	1370		5	0	35	29	40		3	197	6	1	206		32	1630	1662
Grand Total	13	3	4	2	20		183	2478	165	2	2826		6	0	60	50	66		6	428	10	1	444		55	3356	3411
Approch %	65	15	20				6.5	87.7	5.8		90.9		9.1	0	90.9		100		1.4	96.4	2.3		100		13.2	1.6	98.4
Total %	0.4	0.1	0.1		0.6		5.5	73.8	4.9		84.2		0.2	0	1.8		2		0.2	12.8	0.3		13.2		1.6	0	91.1
Passenger Vehicles	10	2	2		15		149	2333	162		2646		2	0	32		62		6	369	10		386		0	0	3109
% Passenger Vehicles	76.9	66.7	50	50	68.2		81.4	94.1	98.2	100	93.6		33.3	0	53.3	56	53.4		100	86.2	100	100	86.7		0	0	91.1
Large 2 Axle Vehicles	3	1	2		7		12	47	3		62		2	0	5		12		0	8	0		8		0	0	89
% Large 2 Axle Vehicles	23.1	33.3	50	50	31.8		6.6	1.9	1.8	0	2.2		33.3	0	8.3	10	10.3		0	1.9	0	0	1.8		0	0	2.6
3 Axle Vehicles	0	0	0		0		4	39	0		43		0	0	3		6		0	33	0		33		0	0	82
% 3 Axle Vehicles	0	0	0		0		2.2	1.6	0	0	1.5		0	0	5	6	5.2		0	7.7	0	0	7.4		0	0	2.4
4+ Axle Trucks	0	0	0		0		18	59	0		77		2	0	20		36		0	18	0	0	18		0	0	131
% 4+ Axle Trucks	0	0	0		0		9.8	2.4	0	0	2.7		33.3	0	33.3	28	31		0	4.2	0	0	4		0	0	3.8

Start Time	Innovation Drive Southbound						Cactus Avenue Westbound						Innovation Drive Northbound						Cactus Avenue Eastbound								
	Left	Thru	Right	RTOR	App. Total		Left	Thru	Right	RTOR	App. Total		Left	Thru	Right	RTOR	App. Total		Left	Thru	Right	RTOR	App. Total				
07:00 AM	0	0	0	0	0		34	337	16	0	387		0	0	8	7	8		2	52	0	0	54		7	449	456
07:15 AM	1	0	1	1	2		15	331	14	1	360		0	7	5	8	8		0	58	1	0	59		7	429	436
07:30 AM	1	0	0	0	1		14	304	24	0	342		0	7	6	7	7		0	62	2	0	64		6	414	420
07:45 AM	2	1	0	0	3		33	290	44	0	367		0	3	3	3	3		1	59	1	0	61		3	434	437
Total Volume	4	1	1	1	6		96	1262	98	1	1456		1	0	25	21	26		3	231	4	0	238		23	1726	1749
% App. Total	66.7	16.7	16.7		16.7		6.6	86.7	6.7		96.2		3.8	0	96.2		96.2		1.3	97.1	1.7		1.7		1.7	0	91.1
PHF	.500	.250	.250		.250		.706	.936	.557	.941	.941		.250	.000	.781		.781		.813	.813	.500	.930	.930		.930	.930	.961

Peak Hour Analysis From 07:00 AM to 08:45 AM - Peak 1 of 1

Peak Hour for Entire Intersection Begins at 07:00 AM

Counts Unlimited
 PO Box 1178
 Corona, CA 92878
 (951) 268-6268

County of Riverside
 N/S: Innovation Drive
 E/W: Cactus Avenue
 Weather: Clear

File Name : 32_CRV_Innovation_Cactus AM
 Site Code : 05119542
 Start Date : 8/20/2019
 Page No : 2

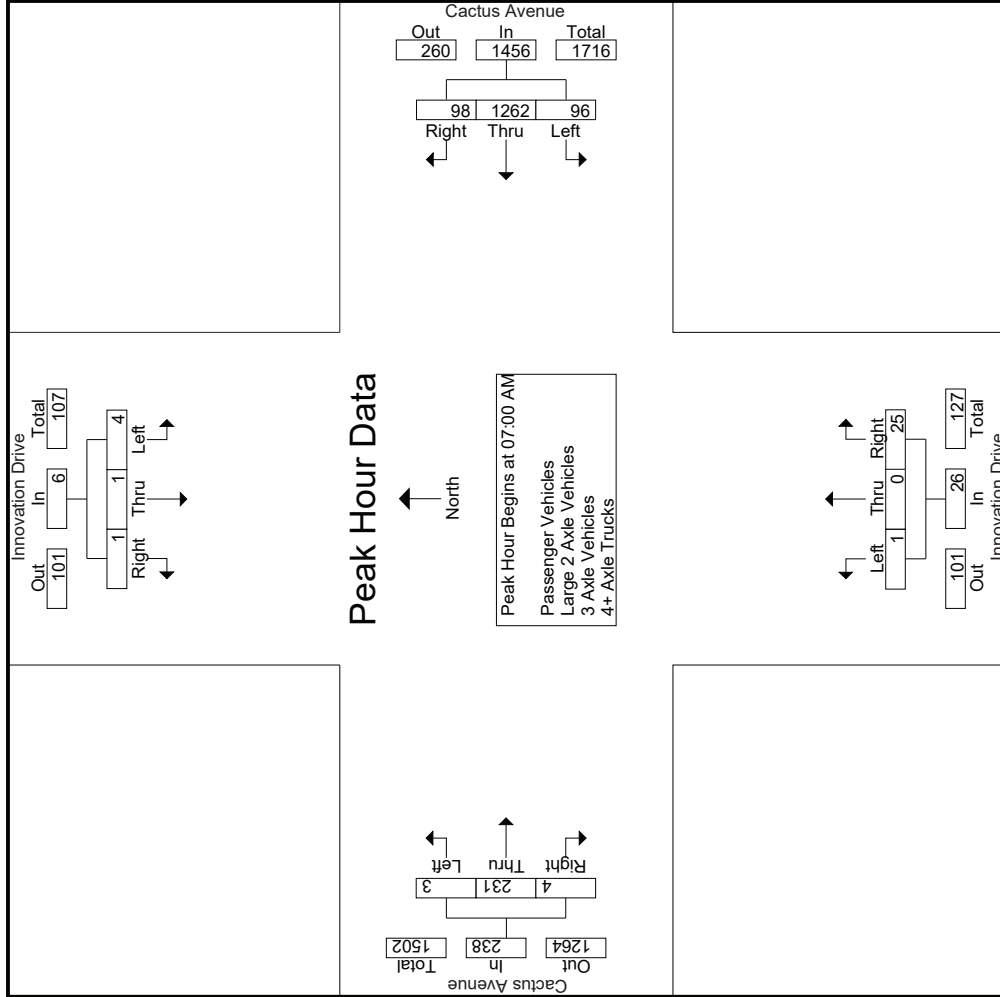

Counts Unlimited
 PO Box 1178
 Corona, CA 92878
 (951) 268-6268

County of Riverside
 N/S: Innovation Drive
 E/W: Cactus Avenue
 Weather: Clear

File Name : 32_CRV_Innovation_Cactus AM
 Site Code : 05119542
 Start Date : 8/20/2019
 Page No : 3

Start Time	Innovation Drive Southbound			Cactus Avenue Westbound			Innovation Drive Northbound			Cactus Avenue Eastbound			
	Left	Thru	Right	App. Total	Left	Thru	Right	App. Total	Left	Thru	Right	App. Total	Int. Total
Peak Hour Analysis From 07:00 AM to 08:45 AM - Peak 1 of 1													
Peak Hour for Each Approach Begins at:													
	07:45 AM			07:00 AM			08:00 AM			07:15 AM			
+0 mins.	2	1	0	3	34	16	387	0	8	9	58	1	59
+15 mins.	3	0	0	3	15	14	360	0	8	9	62	2	64
+30 mins.	3	0	2	5	14	24	342	0	7	8	59	1	61
+45 mins.	3	0	0	3	33	44	367	0	12	14	55	1	57
Total Volume	11	1	2	14	96	98	1456	0	35	40	234	5	241
% App. Total	78.6	7.1	14.3	.700	6.6	6.7	86.7	0	87.5	.714	97.1	2.1	
PHF	.917	.250	.250	.700	.706	.557	.941	.000	.729	.714	.944	.625	.941

Counts Unlimited
 PO Box 1178
 Corona, CA 92878
 (951) 268-6268

File Name : 32_CRV_Innovation_Cactus AM
 Site Code : 05119542
 Start Date : 8/20/2019
 Page No : 1

County of Riverside
 N/S: Innovation Drive
 EW: Cactus Avenue
 Weather: Clear

Groups Printed- Passenger Vehicles

Start Time	Innovation Drive Southbound				Cactus Avenue Westbound				Innovation Drive Northbound				Cactus Avenue Eastbound						
	Left	Thru	Right	RTOR	App. Total	Left	Thru	Right	RTOR	App. Total	Left	Thru	Right	RTOR	App. Total	Exclu. Total	Inclu. Total	Int. Total	
07:00 AM	0	0	0	0	0	28	311	16	0	355	0	0	3	3	3	49	3	407	410
07:15 AM	1	0	1	1	2	12	313	14	1	339	1	0	3	3	4	52	5	397	402
07:30 AM	1	0	0	0	1	11	293	24	0	328	0	0	5	5	5	55	5	389	394
07:45 AM	1	1	0	0	2	26	281	44	0	351	0	0	2	2	2	53	2	408	410
Total	3	1	1	1	5	77	1198	98	1	1373	1	0	13	13	14	209	15	1601	1616
08:00 AM	2	0	0	0	2	21	264	31	1	316	0	0	5	3	5	46	4	369	373
08:15 AM	2	0	0	0	2	16	305	15	0	336	0	0	4	4	4	45	4	387	391
08:30 AM	3	0	0	0	3	14	299	13	0	326	1	0	2	2	3	38	2	370	372
08:45 AM	0	1	1	0	2	21	267	5	0	293	0	0	8	6	8	47	7	350	357
Total	7	1	1	0	9	72	1135	64	1	1271	1	0	19	15	20	176	17	1476	1493
Grand Total	10	2	2	1	14	149	2333	162	2	2644	2	0	32	28	34	385	32	3077	3109
Approch %	71.4	14.3	0.1	0.1	0.5	5.6	88.2	6.1		85.9	5.9	0	94.1		1.1	12.5	1	99	
Total %	0.3	0.1	0.1			4.8	75.8	5.3			0.1	0	1						

3:1-368

Start Time	Innovation Drive Southbound				Cactus Avenue Westbound				Innovation Drive Northbound				Cactus Avenue Eastbound						
	Left	Thru	Right	RTOR	App. Total	Left	Thru	Right	RTOR	App. Total	Left	Thru	Right	RTOR	App. Total	Exclu. Total	Inclu. Total	Int. Total	
07:00 AM	0	0	0	0	0	28	311	16	0	355	0	0	3	3	3	49	3	407	410
07:15 AM	1	0	1	1	2	12	313	14	1	339	1	0	3	3	4	52	5	397	402
07:30 AM	1	0	0	0	1	11	293	24	0	328	0	0	5	5	5	55	5	389	394
07:45 AM	1	1	0	0	2	26	281	44	0	351	0	0	2	2	2	53	2	408	410
Total Volume	3	1	1	1	5	77	1198	98	1	1373	1	0	13	13	14	209	15	1601	1616
% App. Total	60	20	20			5.6	87.3	7.1		85.9	5.9	0	94.1		1.1	12.5	1	99	
PHF	.750	.250	.250		.625	.688	.957	.557		.967	.250	.000	.650		.700	.953	.500	.950	.981

Peak Hour Analysis From 07:00 AM to 07:45 AM - Peak 1 of 1
 Peak Hour for Entire Intersection Begins at 07:00 AM

Counts Unlimited
 PO Box 1178
 Corona, CA 92878
 (951) 268-6268

County of Riverside
 N/S: Innovation Drive
 E/W: Cactus Avenue
 Weather: Clear

File Name : 32_CRV_Innovation_Cactus AM
 Site Code : 05119542
 Start Date : 8/20/2019
 Page No : 2

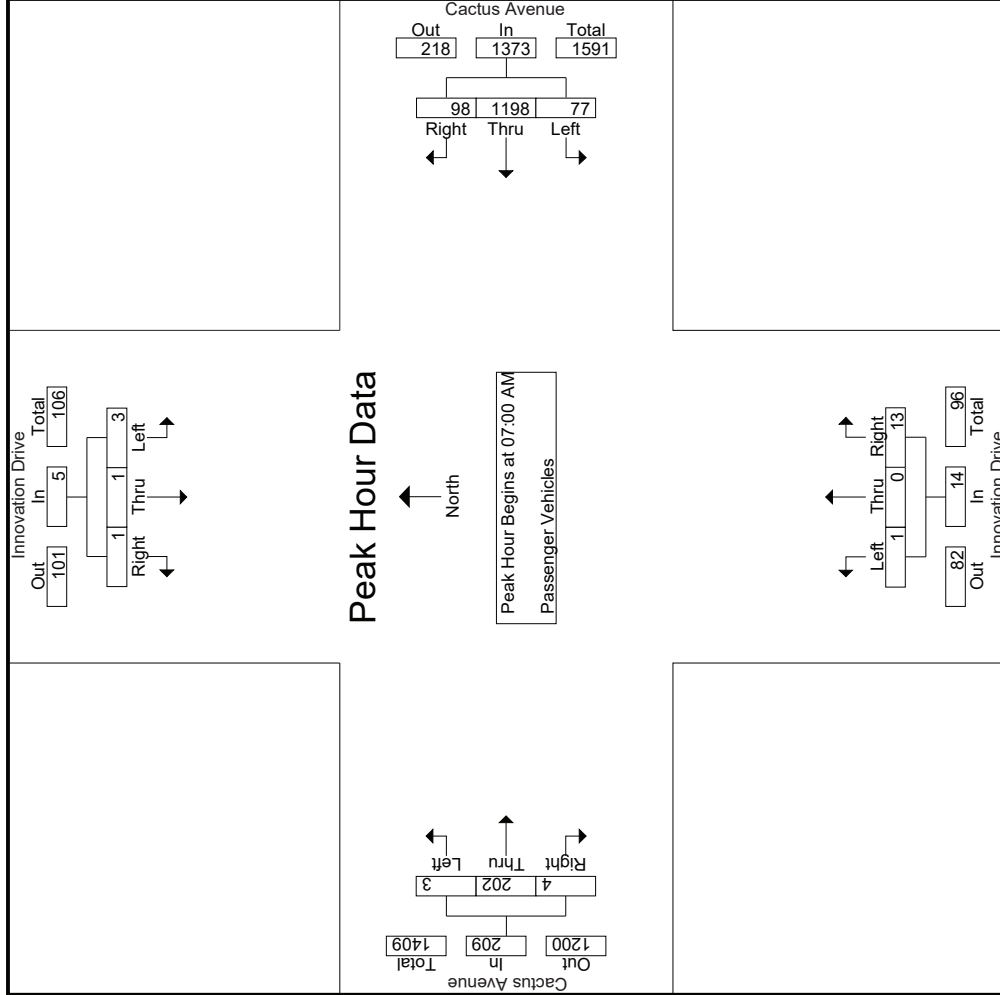

Counts Unlimited
 PO Box 1178
 Corona, CA 92878
 (951) 268-6268

County of Riverside
 N/S: Innovation Drive
 E/W: Cactus Avenue
 Weather: Clear

File Name : 32_CRV_Innovation_Cactus AM
 Site Code : 05119542
 Start Date : 8/20/2019
 Page No : 3

Start Time	Innovation Drive Southbound			Cactus Avenue Westbound			Innovation Drive Northbound			Cactus Avenue Eastbound					
	Left	Thru	Right	App. Total	Left	Thru	Right	App. Total	Left	Thru	Right	App. Total	Int. Total		
Peak Hour Analysis From 07:00 AM to 07:45 AM - Peak 1 of 1															
Peak Hour for Each Approach Begins at:															
	07:00 AM				07:00 AM				07:00 AM				07:00 AM		
+0 mins.	0	0	0		311	16		355	0	0	3		47	0	49
+15 mins.	1	0	1		313	14		339	1	0	4		51	1	52
+30 mins.	1	0	0		293	24		328	0	0	5		53	2	55
+45 mins.	1	1	0		281	44		351	0	0	2		51	1	53
Total Volume	3	1	1		1198	98		1373	1	0	13		202	4	209
% App. Total	60	20	20		5.6	87.3		7.1	7.1	0	92.9		1.4	96.7	1.9
PHF	.750	.250	.250		.688	.557		.967	.250	.000	.650		.375	.953	.950

Counts Unlimited
 PO Box 1178
 Corona, CA 92878
 (951) 268-6268

File Name : 32_CRV_Innovation_Cactus AM
 Site Code : 05119542
 Start Date : 8/20/2019
 Page No : 1

County of Riverside
 N/S: Innovation Drive
 E/W: Cactus Avenue
 Weather: Clear

Groups Printed- Large 2 Axle Vehicles

Start Time	Innovation Drive Southbound				Cactus Avenue Westbound				Innovation Drive Northbound				Cactus Avenue Eastbound						
	Left	Thru	Right	RTOR	App. Total	Left	Thru	Right	RTOR	App. Total	Left	Thru	Right	RTOR	App. Total	Exclu. Total	Inclu. Total	Int. Total	
07:00 AM	0	0	0	0	0	3	10	0	0	13	0	0	0	1	1	0	0	0	1
07:15 AM	0	0	0	0	0	1	1	0	0	2	0	0	1	1	1	0	0	0	1
07:30 AM	0	0	0	0	0	0	4	0	0	4	0	0	0	0	0	0	0	0	0
07:45 AM	1	0	0	0	1	0	1	0	0	1	0	0	0	0	1	0	0	0	0
Total	1	0	0	0	1	4	16	0	0	20	0	0	2	2	2	0	1	0	2
08:00 AM	1	0	0	0	1	0	4	3	0	7	0	0	0	0	0	0	0	0	0
08:15 AM	1	0	2	1	3	3	5	0	0	8	0	0	1	1	1	0	3	0	2
08:30 AM	0	0	0	0	0	3	13	0	0	16	0	0	2	2	2	0	2	0	3
08:45 AM	0	1	0	0	1	2	9	0	0	11	2	0	0	0	2	0	0	0	2
Total	2	1	2	1	5	8	31	3	0	42	2	0	3	3	5	0	7	0	7
Grand Total	3	1	2	1	6	12	47	3	0	62	2	0	5	5	7	0	8	0	8
Approch %	50	16.7	33.3		7.2	19.4	75.8	4.8		74.7	28.6	0	71.4	6	8.4	0	100	0	9.6
Total %	3.6	1.2	2.4			14.5	56.6	3.6			2.4	0	6			0	9.6	0	6.7
																			93.3

3:1-371

Start Time	Innovation Drive Southbound				Cactus Avenue Westbound				Innovation Drive Northbound				Cactus Avenue Eastbound						
	Left	Thru	Right	RTOR	App. Total	Left	Thru	Right	RTOR	App. Total	Left	Thru	Right	RTOR	App. Total	Exclu. Total	Inclu. Total	Int. Total	
07:00 AM	0	0	0	0	0	3	10	0	0	13	0	0	0	1	1	0	0	0	1
07:15 AM	0	0	0	0	0	1	1	0	0	2	0	0	1	1	1	0	0	0	1
07:30 AM	0	0	0	0	0	0	4	0	0	4	0	0	0	0	0	0	0	0	0
07:45 AM	1	0	0	0	1	0	1	0	0	1	0	0	0	0	1	0	0	0	0
Total Volume	1	0	0	0	1	4	16	0	0	20	0	0	2	2	2	0	1	0	2
% App. Total	100	0	0	0	0	20	80	0	0	100	0	0	100	0	0	0	100	0	0
PHF	.250	.000	.000	.000	.250	.333	.400	.000	.385	.000	.000	.000	.500	.500	.250	.000	.250	.000	.429

Peak Hour Analysis From 07:00 AM to 07:45 AM - Peak 1 of 1
 Peak Hour for Entire Intersection Begins at 07:00 AM

Counts Unlimited
 PO Box 1178
 Corona, CA 92878
 (951) 268-6268

County of Riverside
 N/S: Innovation Drive
 E/W: Cactus Avenue
 Weather: Clear

File Name : 32_CRV_Innovation_Cactus AM
 Site Code : 05119542
 Start Date : 8/20/2019
 Page No : 2

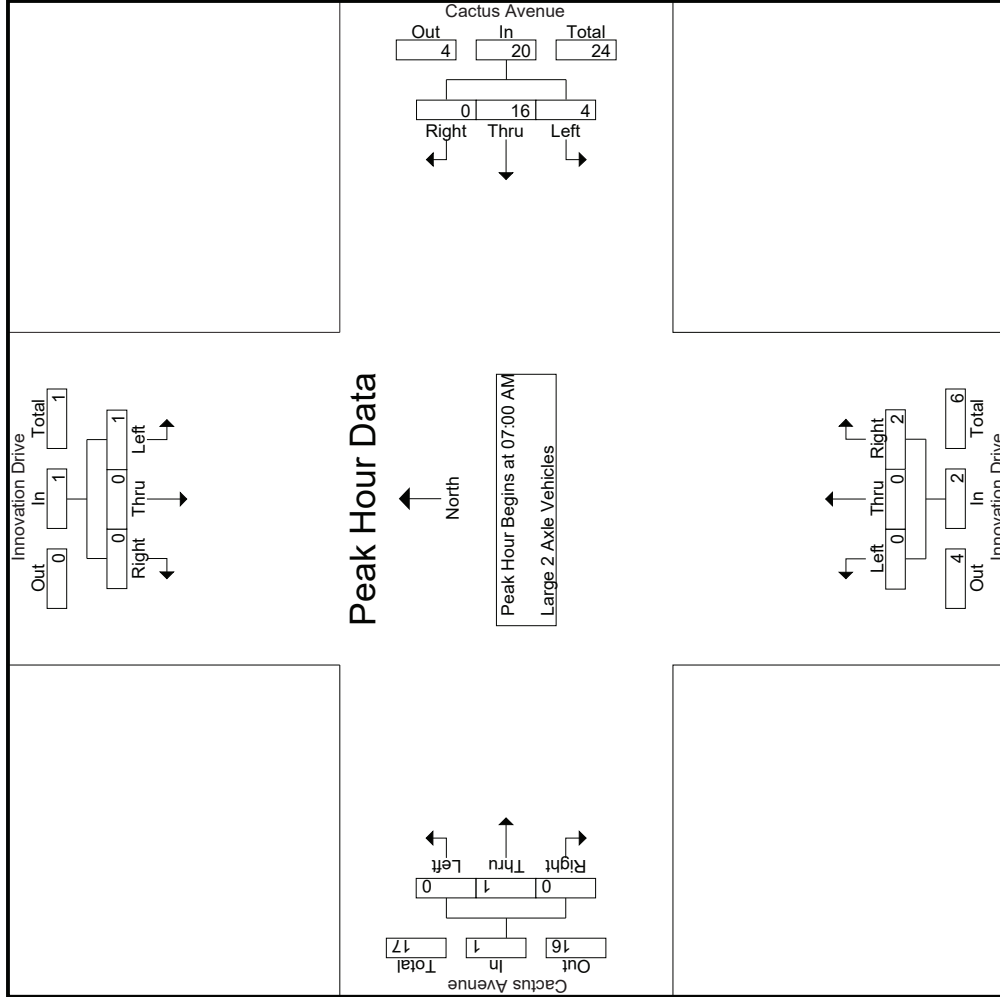

Counts Unlimited
 PO Box 1178
 Corona, CA 92878
 (951) 268-6268

County of Riverside
 N/S: Innovation Drive
 E/W: Cactus Avenue
 Weather: Clear

File Name : 32_CRV_Innovation_Cactus AM
 Site Code : 05119542
 Start Date : 8/20/2019
 Page No : 3

Start Time	Innovation Drive Southbound			Cactus Avenue Westbound			Innovation Drive Northbound			Cactus Avenue Eastbound		
	Left	Thru	Right	Left	Thru	Right	Left	Thru	Right	Left	Thru	Right
Peak Hour Analysis From 07:00 AM to 07:45 AM - Peak 1 of 1												
Peak Hour for Each Approach Begins at:												
	07:00 AM			07:00 AM			07:00 AM			07:00 AM		
+0 mins.	0	0	0	3	10	0	13	0	0	1	0	0
+15 mins.	0	0	0	1	1	0	2	0	0	1	0	0
+30 mins.	0	0	0	0	4	0	4	0	0	0	0	0
+45 mins.	1	0	0	0	1	0	1	0	0	0	1	0
Total Volume	1	0	0	4	16	0	20	0	0	2	1	0
% App. Total	100	0	0	20	80	0	100	0	0	100	0	0
PHF	.250	.000	.000	.333	.400	.000	.385	.000	.000	.500	.250	.000

Counts Unlimited
 PO Box 1178
 Corona, CA 92878
 (951) 268-6268

County of Riverside
 N/S: Innovation Drive
 E/W: Cactus Avenue
 Weather: Clear

File Name : 32_CRV_Innovation_Cactus AM
 Site Code : 05119542
 Start Date : 8/20/2019
 Page No : 1

Groups Printed- 3 Axle Vehicles

Start Time	Innovation Drive Southbound				Cactus Avenue Westbound				Innovation Drive Northbound				Cactus Avenue Eastbound								
	Left	Thru	Right	RTOR	Left	Thru	Right	RTOR	Left	Thru	Right	RTOR	Left	Thru	Right	RTOR					
07:00 AM	0	0	0	0	1	11	0	0	12	0	1	1	1	0	4	0	0	4	1	17	18
07:15 AM	0	0	0	0	0	7	0	0	7	0	0	0	0	0	3	0	0	3	0	10	10
07:30 AM	0	0	0	0	0	3	0	0	3	0	0	0	0	0	5	0	0	5	0	8	8
07:45 AM	0	0	0	0	1	2	0	0	3	0	1	1	1	0	4	0	0	4	1	8	9
Total	0	0	0	0	2	23	0	0	25	0	0	2	2	0	16	0	0	16	2	43	45
08:00 AM	0	0	0	0	0	3	0	0	3	0	0	0	0	0	9	0	0	9	0	12	12
08:15 AM	0	0	0	0	0	5	0	0	5	0	0	0	0	0	2	0	0	2	0	7	7
08:30 AM	0	0	0	0	1	5	0	0	6	0	1	1	1	0	4	0	0	4	1	11	12
08:45 AM	0	0	0	0	1	3	0	0	4	0	0	0	0	0	2	0	0	2	0	6	6
Total	0	0	0	0	2	16	0	0	18	0	0	1	1	0	17	0	0	17	1	36	37
Grand Total	0	0	0	0	4	39	0	0	43	0	0	3	3	0	33	0	0	33	3	79	82
Apprch %	0	0	0	0	9.3	90.7	0	0	54.4	0	0	100	3.8	0	100	0	0	41.8	3.7	96.3	
Total %	0	0	0	0	5.1	49.4	0	0	54.4	0	0	3.8	3.8	0	41.8	0	0	41.8	3.7	96.3	

3.1-374

Start Time	Innovation Drive Southbound				Cactus Avenue Westbound				Innovation Drive Northbound				Cactus Avenue Eastbound								
	Left	Thru	Right	RTOR	Left	Thru	Right	RTOR	Left	Thru	Right	RTOR	Left	Thru	Right	RTOR					
07:00 AM	0	0	0	0	1	11	0	0	12	0	1	1	1	0	4	0	0	4	1	17	18
07:15 AM	0	0	0	0	0	7	0	0	7	0	0	0	0	0	3	0	0	3	0	10	10
07:30 AM	0	0	0	0	0	3	0	0	3	0	0	0	0	0	5	0	0	5	0	8	8
07:45 AM	0	0	0	0	1	2	0	0	3	0	1	1	1	0	4	0	0	4	1	8	9
Total Volume	0	0	0	0	2	23	0	0	25	0	0	2	2	0	16	0	0	16	2	43	45
% App. Total	0	0	0	0	8	92	0	0	54.4	0	0	100	3.8	0	100	0	0	41.8	3.7	96.3	
PHF	.000	.000	.000	.000	.500	.523	.000	.000	.521	.000	.000	.500	.500	.000	.800	.000	.000	.800	.000	.632	

Peak Hour Analysis From 07:00 AM to 07:45 AM - Peak 1 of 1
 Peak Hour for Entire Intersection Begins at 07:00 AM

Counts Unlimited
 PO Box 1178
 Corona, CA 92878
 (951) 268-6268

County of Riverside
 N/S: Innovation Drive
 E/W: Cactus Avenue
 Weather: Clear

File Name : 32_CRV_Innovation_Cactus AM
 Site Code : 05119542
 Start Date : 8/20/2019
 Page No : 2

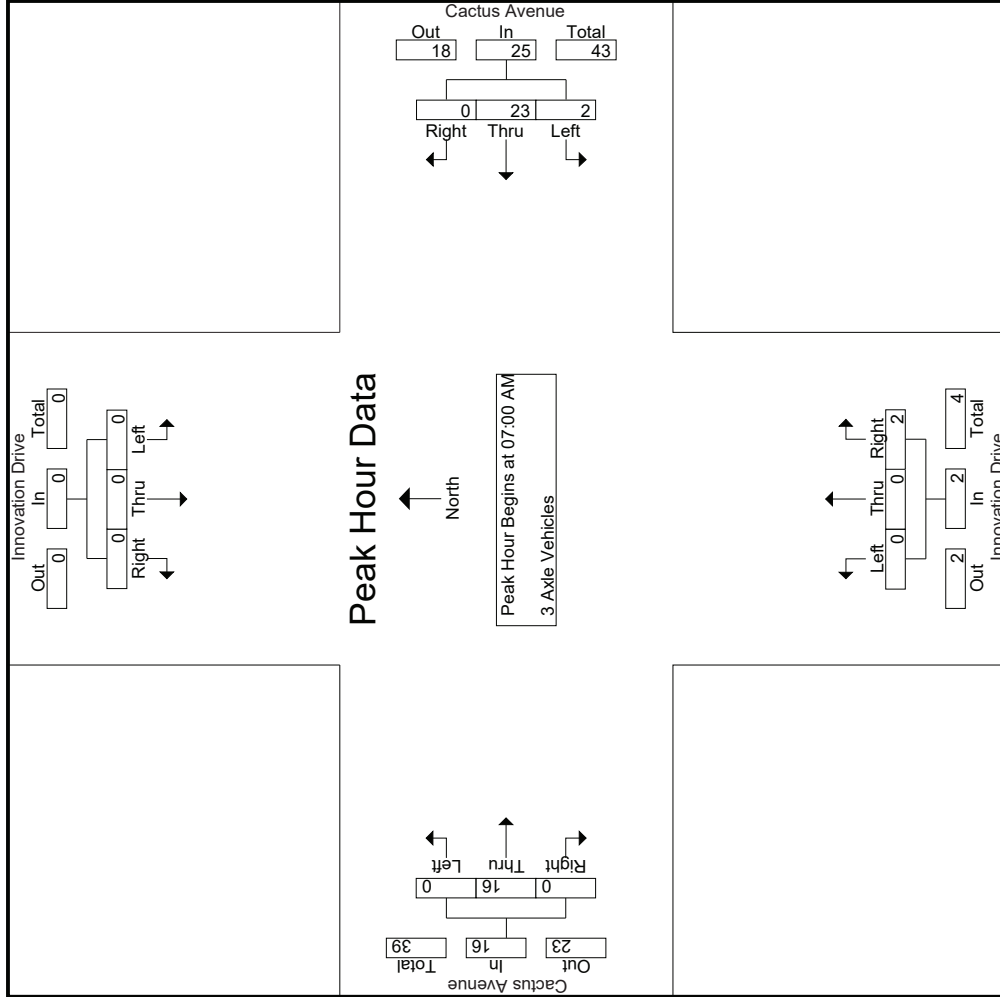

Counts Unlimited
 PO Box 1178
 Corona, CA 92878
 (951) 268-6268

County of Riverside
 N/S: Innovation Drive
 E/W: Cactus Avenue
 Weather: Clear

File Name : 32_CRV_Innovation_Cactus AM
 Site Code : 05119542
 Start Date : 8/20/2019
 Page No : 3

Start Time	Innovation Drive Southbound			Cactus Avenue Westbound			Innovation Drive Northbound			Cactus Avenue Eastbound		
	Left	Thru	Right	Left	Thru	Right	Left	Thru	Right	Left	Thru	Right
Peak Hour Analysis From 07:00 AM to 07:45 AM - Peak 1 of 1												
Peak Hour for Each Approach Begins at:												
	07:00 AM			07:00 AM			07:00 AM			07:00 AM		
+0 mins.	0	0	0	11	0	12	0	0	1	0	4	0
+15 mins.	0	0	0	7	0	7	0	0	0	0	3	0
+30 mins.	0	0	0	3	0	3	0	0	0	0	5	0
+45 mins.	0	0	0	2	0	3	0	0	1	0	4	0
Total Volume	0	0	0	23	0	25	0	0	2	0	16	0
% App. Total	0	0	0	8	92	0	0	0	100	0	100	0
PHF	.000	.000	.000	.500	.523	.521	.000	.000	.500	.000	.800	.000

Counts Unlimited
 PO Box 1178
 Corona, CA 92878
 (951) 268-6268

County of Riverside
 N/S: Innovation Drive
 E/W: Cactus Avenue
 Weather: Clear

File Name : 32_CRV_Innovation_Cactus AM
 Site Code : 05119542
 Start Date : 8/20/2019
 Page No : 1

Groups Printed- 4+ Axle Trucks

Start Time	Innovation Drive Southbound				Cactus Avenue Westbound				Innovation Drive Northbound				Cactus Avenue Eastbound						
	Left	Thru	Right	RTOR	App. Total	Left	Thru	Right	RTOR	App. Total	Left	Thru	Right	RTOR	App. Total	Exclu. Total	Inclu. Total	Int. Total	
07:00 AM	0	0	0	0	0	2	5	0	0	7	0	0	3	2	3	0	1	0	0
07:15 AM	0	0	0	0	0	2	10	0	0	12	0	0	3	1	3	0	4	0	4
07:30 AM	0	0	0	0	0	3	4	0	0	7	0	0	2	1	2	0	4	0	4
07:45 AM	0	0	0	0	0	6	6	0	0	12	0	0	0	0	0	0	3	0	3
Total	0	0	0	0	0	13	25	0	0	38	0	0	8	4	8	0	12	0	12
08:00 AM	0	0	0	0	0	3	6	0	0	9	1	0	3	3	4	0	0	0	0
08:15 AM	0	0	0	0	0	1	6	0	0	7	1	0	3	3	4	0	1	0	1
08:30 AM	0	0	0	0	0	1	10	0	0	11	0	0	2	1	2	0	2	0	2
08:45 AM	0	0	0	0	0	0	12	0	0	12	0	0	4	3	4	0	3	0	3
Total	0	0	0	0	0	5	34	0	0	39	2	0	12	10	14	0	6	0	6
Grand Total	0	0	0	0	0	18	59	0	0	77	2	0	20	14	22	0	18	0	18
Apprch %	0	0	0	0	0	23.4	76.6	0	0	65.8	9.1	0	90.9		18.8	0	100	0	15.4
Total %	0	0	0	0	0	15.4	50.4	0	0	65.8	1.7	0	17.1		18.8	0	15.4	0	10.7

3.1-377

Start Time	Innovation Drive Southbound				Cactus Avenue Westbound				Innovation Drive Northbound				Cactus Avenue Eastbound									
	Left	Thru	Right	RTOR	App. Total	Left	Thru	Right	RTOR	App. Total	Left	Thru	Right	RTOR	App. Total	Left	Thru	Right	RTOR	App. Total	Int. Total	
07:00 AM	0	0	0	0	0	2	5	0	0	7	0	0	3	2	3	0	1	0	0	1	0	11
07:15 AM	0	0	0	0	0	2	10	0	0	12	0	0	3	1	3	0	4	0	4	0	0	19
07:30 AM	0	0	0	0	0	3	4	0	0	7	0	0	2	1	2	0	4	0	4	0	0	13
07:45 AM	0	0	0	0	0	6	6	0	0	12	0	0	0	0	0	0	3	0	3	0	0	15
Total Volume	0	0	0	0	0	13	25	0	0	38	0	0	8	4	8	0	12	0	12	0	0	58
% App. Total	0	0	0	0	0	34.2	65.8	0	0	65.8	0	0	100		100	0	100	0	100	0	0	.763
PHF	.000	.000	.000	.000	.000	.542	.625	.000	.000	.792	.000	.000	.667	.000	.667	.000	.750	.000	.750	.000	.000	.763

Peak Hour Analysis From 07:00 AM to 07:45 AM - Peak 1 of 1
 Peak Hour for Entire Intersection Begins at 07:00 AM

Counts Unlimited
 PO Box 1178
 Corona, CA 92878
 (951) 268-6268

County of Riverside
 N/S: Innovation Drive
 E/W: Cactus Avenue
 Weather: Clear

File Name : 32_CRV_Innovation_Cactus AM
 Site Code : 05119542
 Start Date : 8/20/2019
 Page No : 2

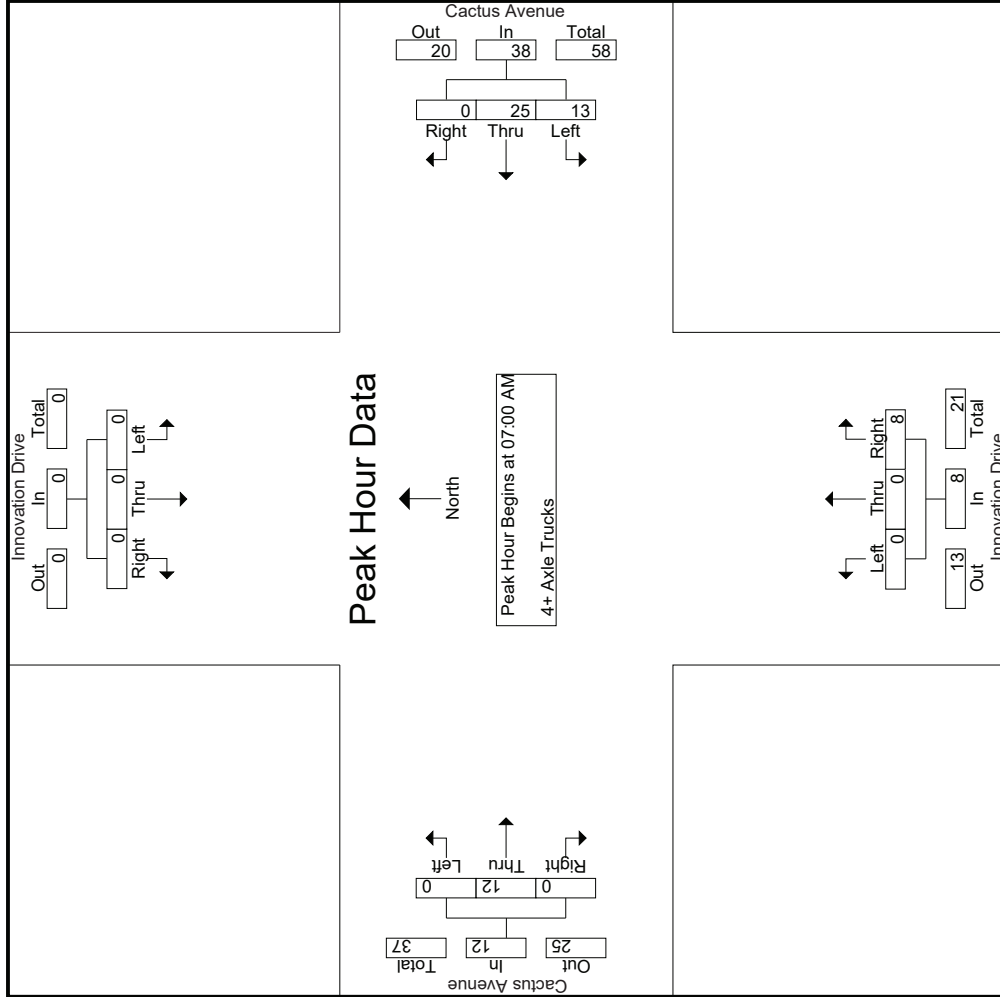

Counts Unlimited
 PO Box 1178
 Corona, CA 92878
 (951) 268-6268

County of Riverside
 N/S: Innovation Drive
 E/W: Cactus Avenue
 Weather: Clear

File Name : 32_CRV_Innovation_Cactus AM
 Site Code : 05119542
 Start Date : 8/20/2019
 Page No : 3

Start Time	Innovation Drive Southbound			Cactus Avenue Westbound			Innovation Drive Northbound			Cactus Avenue Eastbound		
	Left	Thru	Right	Left	Thru	Right	Left	Thru	Right	Left	Thru	Right
Peak Hour Analysis From 07:00 AM to 07:45 AM - Peak 1 of 1												
Peak Hour for Each Approach Begins at:												
	07:00 AM			07:00 AM			07:00 AM			07:00 AM		
+0 mins.	0	0	0	2	5	0	7	0	0	3	0	1
+15 mins.	0	0	0	2	10	0	12	0	0	3	0	4
+30 mins.	0	0	0	3	4	0	7	0	0	2	0	4
+45 mins.	0	0	0	6	6	0	12	0	0	0	0	3
Total Volume	0	0	0	13	25	0	38	0	0	8	0	12
% App. Total	0	0	0	34.2	65.8	0	100	0	0	100	0	0
PHF	.000	.000	.000	.542	.625	.000	.792	.000	.000	.667	.000	.750

Counts Unlimited
 PO Box 1178
 Corona, CA 92878
 (951) 268-6268

County of Riverside
 N/S: Innovation Drive
 E/W: Cactus Avenue
 Weather: Clear

File Name : 32_CRV_Innovation_Cactus PM
 Site Code : 05119542
 Start Date : 8/20/2019
 Page No : 1

Groups Printed- Passenger Vehicles - Large 2 Axle Vehicles - 3 Axle Vehicles - 4+ Axle Trucks

Start Time	Innovation Drive Southbound						Cactus Avenue Westbound						Innovation Drive Northbound						Cactus Avenue Eastbound												
	Left	Thru	Right	RTOR	App. Total		Left	Thru	Right	RTOR	App. Total		Left	Thru	Right	RTOR	App. Total		Left	Thru	Right	RTOR	App. Total		Left	Thru	Right	RTOR	App. Total		
	Exclu. Total	Inclu. Total	Exclu. Total	Inclu. Total	Exclu. Total	Inclu. Total	Exclu. Total	Inclu. Total	Exclu. Total	Inclu. Total	Exclu. Total	Inclu. Total	Exclu. Total	Inclu. Total	Exclu. Total	Inclu. Total	Exclu. Total	Inclu. Total	Exclu. Total	Inclu. Total	Exclu. Total	Inclu. Total	Exclu. Total	Inclu. Total	Exclu. Total	Inclu. Total	Exclu. Total	Inclu. Total	Exclu. Total	Inclu. Total	
04:00 PM	19	0	4	3	23		10	132	4	1	146		6	0	22	14	28		1	117	3	0	121		18	318	18	318	18	318	336
04:15 PM	7	0	0	0	7		7	154	1	0	162		1	0	13	10	14		0	136	6	0	142		10	325	10	325	10	325	335
04:30 PM	7	0	2	1	9		11	154	1	0	166		6	0	26	18	32		0	155	4	0	159		19	366	19	366	19	366	385
04:45 PM	5	1	0	0	6		6	120	2	0	128		4	0	18	12	22		0	123	3	0	126		12	282	12	282	12	282	294
Total	38	1	6	4	45		34	560	8	1	602		17	0	79	54	96		1	531	16	0	548		59	1291	59	1291	59	1291	1350
05:00 PM	52	0	7	3	59		11	149	4	3	164		4	0	38	25	42		0	157	1	0	158		31	423	31	423	31	423	454
05:15 PM	5	0	2	2	7		11	176	0	0	187		1	0	22	19	23		0	135	1	0	136		21	353	21	353	21	353	374
05:30 PM	11	0	0	0	11		4	151	1	0	156		3	0	11	9	14		0	143	3	0	146		9	327	9	327	9	327	336
05:45 PM	4	0	1	1	5		7	120	2	0	129		1	0	8	8	9		0	164	1	0	165		9	308	9	308	9	308	317
Total	72	0	10	6	82		33	596	7	3	636		9	0	79	61	88		0	599	6	0	605		70	1411	70	1411	70	1411	1481
Grand Total	110	1	16	10	127		67	1156	15	4	1238		26	0	158	115	184		1	1130	22	0	1153		129	2702	129	2702	129	2702	2831
Approch %	86.6	0.8	12.6	0.6	4.7		5.4	93.4	1.2	0.6	45.8		14.1	0	85.9	6.8	6.8		0.1	98	1.9	0	42.7		4.6	95.4	4.6	95.4	4.6	95.4	
Total %	110	1	15	93.8	90		53	1107	14	100	1178		20	0	136	262	262		1	1102	14	0	1117		0	0	0	0	0	0	2692
% Passenger Vehicles	100	100	93.8	90	98.5		79.1	95.8	93.3	100	94.8		76.9	0	86.1	92.2	87.6		100	97.5	63.6	0	96.9		0	0	0	0	0	0	95.1
% Large 2 Axle Vehicles	0	0	1	10	1.5		2	24	1	6.7	2.2		1	0	3	1.7	6		0	21	1	0	22		0	0	0	0	0	0	57
% 3 Axle Vehicles	0	0	0	0	0		5	5	0	0	10		5	0	3	3.3	10		0	2	1	0	3		0	0	0	0	0	0	23
% 3 Axle Trucks	0	0	0	0	0		7.5	0.4	0	0	0.8		19.2	0	1.9	1.7	3.3		0	0.2	4.5	0	0.3		0	0	0	0	0	0	0.8
% 4+ Axle Trucks	0	0	0	0	0		7	20	0	0	27		0	0	16	21	21		0	5	6	0	11		0	0	0	0	0	0	59
% 4+ Axle Trucks	0	0	0	0	0		10.4	1.7	0	0	2.2		0	0	10.1	4.3	7		0	0.4	27.3	0	1		0	0	0	0	0	0	2.1

Start Time	Innovation Drive Southbound						Cactus Avenue Westbound						Innovation Drive Northbound						Cactus Avenue Eastbound												
	Left	Thru	Right	RTOR	App. Total		Left	Thru	Right	RTOR	App. Total		Left	Thru	Right	RTOR	App. Total		Left	Thru	Right	RTOR	App. Total		Left	Thru	Right	RTOR	App. Total		
	Exclu. Total	Inclu. Total	Exclu. Total	Inclu. Total	Exclu. Total	Inclu. Total	Exclu. Total	Inclu. Total	Exclu. Total	Inclu. Total	Exclu. Total	Inclu. Total	Exclu. Total	Inclu. Total	Exclu. Total	Inclu. Total	Exclu. Total	Inclu. Total	Exclu. Total	Inclu. Total	Exclu. Total	Inclu. Total	Exclu. Total	Inclu. Total	Exclu. Total	Inclu. Total	Exclu. Total	Inclu. Total	Exclu. Total	Inclu. Total	
04:30 PM	7	0	0	2	9		11	154	1	0	166		6	0	26	14	26		0	155	4	0	159		32	366	32	366	32	366	366
04:45 PM	5	1	0	0	6		6	120	2	0	128		4	0	18	10	18		0	123	3	0	126		3	282	3	282	3	282	282
05:00 PM	52	0	7	7	59		11	149	4	0	164		4	0	38	25	42		0	135	1	0	136		158	423	158	423	158	423	423
05:15 PM	5	0	0	0	5		7	120	2	0	128		4	0	18	12	22		0	123	3	0	126		12	282	12	282	12	282	294
Total Volume	69	1	11	11	81		39	599	7	3	645		15	0	104	61	88		0	570	9	0	579		579	1424	579	1424	579	1424	1424
% App. Total	85.2	1.2	13.6	13.6	39.3		6	92.9	1.1	0	12.6		0	0	87.4	0	87.4		0	98.4	1.6	0	98.4		1.6	579	1.6	579	1.6	579	1424
PHF	.332	.250	.393	.393	.343		.886	.851	.438	.862	.862		.625	.000	.684	.000	.684		.000	.908	.563	.000	.908		.910	.842	.910	.842	.910	.842	.842

Peak Hour Analysis From 04:00 PM to 05:45 PM - Peak 1 of 1

Peak Hour for Entire Intersection Begins at 04:30 PM

Counts Unlimited
 PO Box 1178
 Corona, CA 92878
 (951) 268-6268

County of Riverside
 N/S: Innovation Drive
 E/W: Cactus Avenue
 Weather: Clear

File Name : 32_CRV_Innovation_Cactus PM
 Site Code : 05119542
 Start Date : 8/20/2019
 Page No : 2

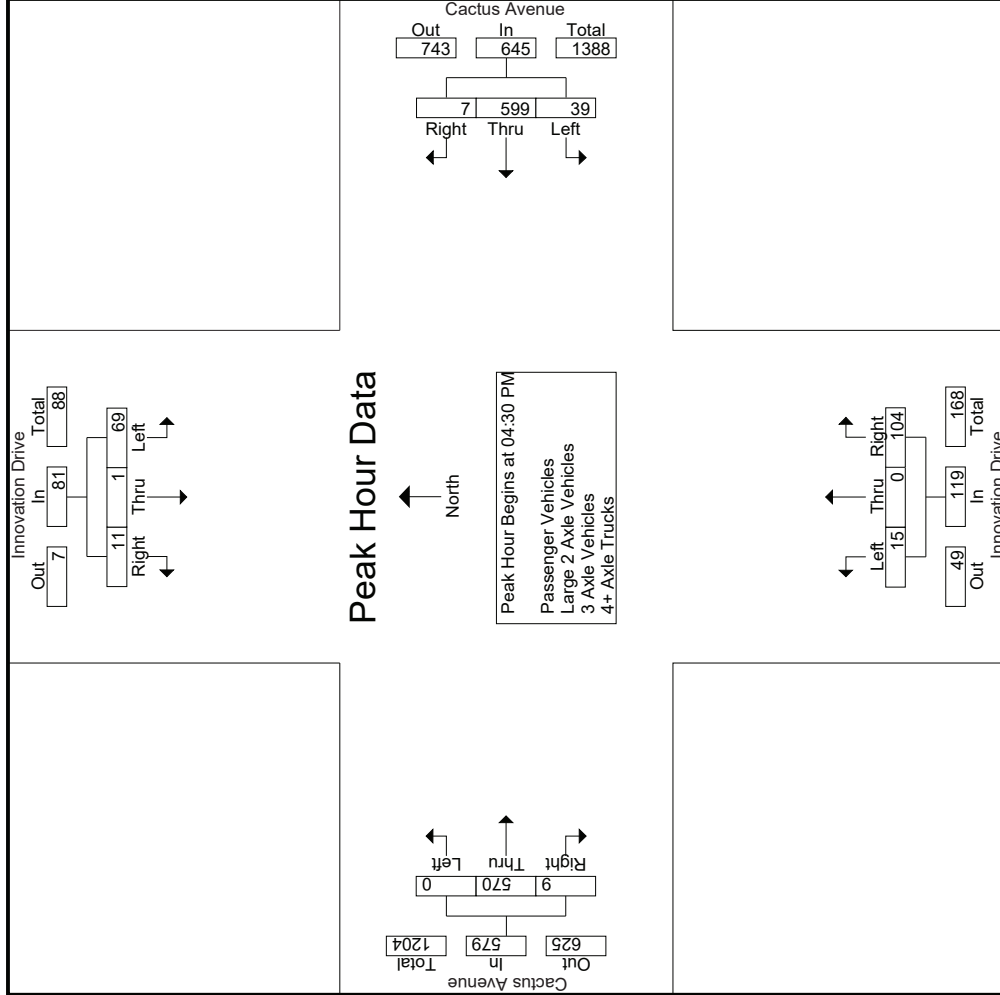

Counts Unlimited
 PO Box 1178
 Corona, CA 92878
 (951) 268-6268

County of Riverside
 N/S: Innovation Drive
 EW: Cactus Avenue
 Weather: Clear

File Name : 32_CRV_Innovation_Cactus PM
 Site Code : 05119542
 Start Date : 8/20/2019
 Page No : 1

Groups Printed- Passenger Vehicles

Start Time	Innovation Drive Southbound					Cactus Avenue Westbound					Innovation Drive Northbound					Cactus Avenue Eastbound							
	Left	Thru	Right	RTOR	App. Total	Left	Thru	Right	RTOR	App. Total	Left	Thru	Right	RTOR	App. Total	Left	Thru	Right	RTOR	App. Total	Exclu. Total	Inclu. Total	Int. Total
04:00 PM	19	0	3	2	22	8	129	3	1	140	5	0	19	14	24	1	109	1	0	111	17	297	314
04:15 PM	7	0	0	0	7	6	150	1	0	157	1	0	10	8	11	0	133	6	0	139	8	314	322
04:30 PM	7	0	2	1	9	9	148	1	0	158	5	0	24	17	29	0	153	3	0	156	18	352	370
04:45 PM	5	1	0	0	6	4	116	2	0	122	2	0	11	10	13	0	119	2	0	121	10	262	272
Total	38	1	5	3	44	27	543	7	1	577	13	0	64	49	77	1	514	12	0	527	53	1225	1278
05:00 PM	52	0	7	3	59	10	139	4	3	153	4	0	35	24	39	0	153	0	0	153	30	404	434
05:15 PM	5	0	2	2	7	9	165	0	0	174	1	0	19	17	20	0	134	0	0	134	19	335	354
05:30 PM	11	0	0	0	11	3	146	1	0	150	2	0	11	9	13	0	140	1	0	141	9	315	324
05:45 PM	4	0	1	1	5	4	114	2	0	120	0	0	7	7	7	0	161	1	0	162	8	294	302
Total	72	0	10	6	82	26	564	7	3	597	7	0	72	57	79	0	588	2	0	590	66	1348	1414
Grand Total	110	1	15	9	126	53	1107	14	4	1174	20	0	136	106	156	1	1102	14	0	1117	119	2573	2692
Approch %	87.3	0.8	11.9		4.9	4.5	94.3	1.2		45.6	12.8	0	87.2	6.1		0.1	98.7	1.3		43.4	4.4	95.6	
Total %	4.3	0	0.6		4.9	2.1	43	0.5			0.8	0	5.3			0	42.8	0.5					

3:1-383

Start Time	Innovation Drive Southbound					Cactus Avenue Westbound					Innovation Drive Northbound					Cactus Avenue Eastbound							
	Left	Thru	Right	RTOR	App. Total	Left	Thru	Right	RTOR	App. Total	Left	Thru	Right	RTOR	App. Total	Left	Thru	Right	RTOR	App. Total	Exclu. Total	Inclu. Total	Int. Total
04:30 PM	7	0	2		9	9	148	1		158	5	0	24		29	0	153	3		156			352
04:45 PM	5	1	0		6	4	116	2		122	2	0	11		13	0	119	2		121			262
05:00 PM	52	0	7		59	10	139	4		153	4	0	35		39	0	153	0		153			404
05:15 PM	5	0	2		7	9	165	0		174	1	0	19		20	0	134	0		134			335
Total Volume	69	1	11		81	32	568	7		607	12	0	89		101	0	559	5		564			1353
% App. Total	85.2	1.2	13.6		33.3	5.3	93.6	1.2		88.1	11.9	0	88.1		99.1	0	99.1	0.9		99.1			.837
PHF	.332	.250	.393		.343	.800	.861	.438		.872	.600	.000	.636		.647	.000	.913	.417		.904			.837

Peak Hour Analysis From 04:30 PM to 05:15 PM - Peak 1 of 1
 Peak Hour for Entire Intersection Begins at 04:30 PM

Counts Unlimited
 PO Box 1178
 Corona, CA 92878
 (951) 268-6268

County of Riverside
 N/S: Innovation Drive
 E/W: Cactus Avenue
 Weather: Clear

File Name : 32_CRV_Innovation_Cactus PM
 Site Code : 05119542
 Start Date : 8/20/2019
 Page No : 2

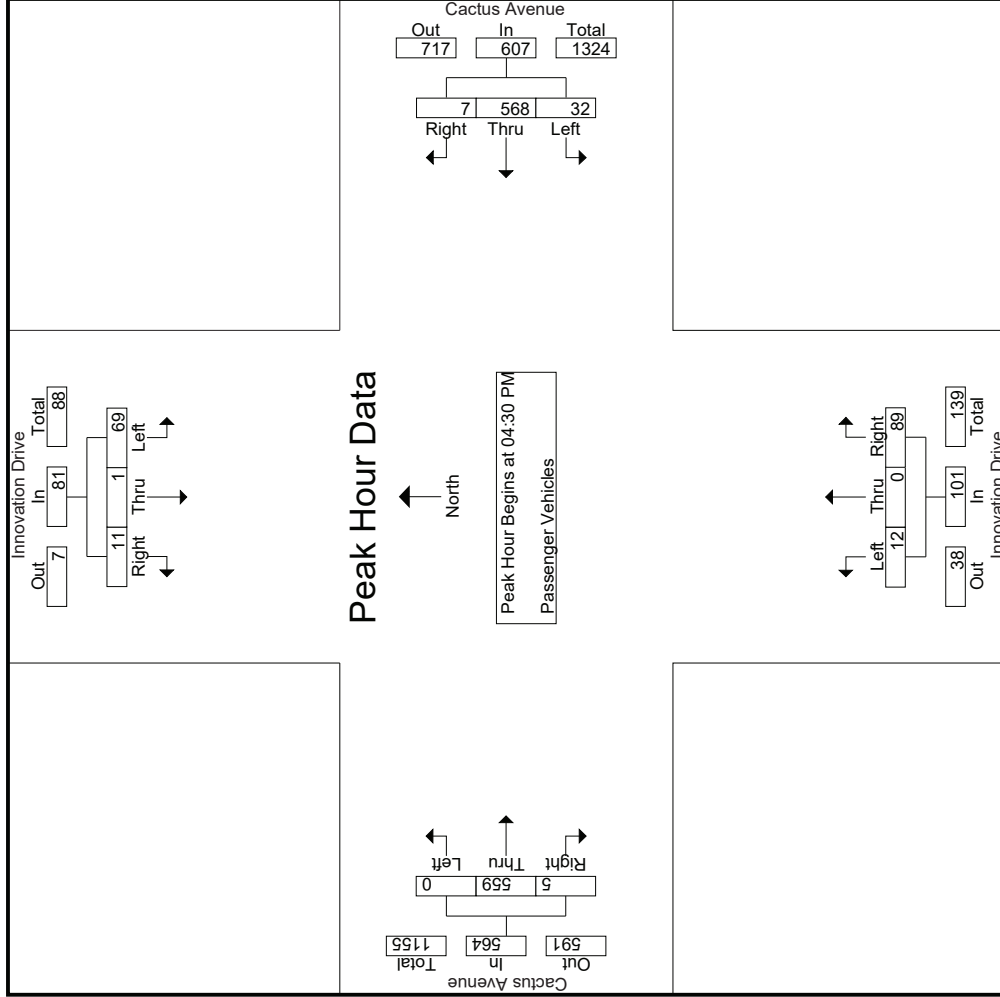

Counts Unlimited
 PO Box 1178
 Corona, CA 92878
 (951) 268-6268

County of Riverside
 N/S: Innovation Drive
 E/W: Cactus Avenue
 Weather: Clear

File Name : 32_CRV_Innovation_Cactus PM
 Site Code : 05119542
 Start Date : 8/20/2019
 Page No : 3

Start Time	Innovation Drive Southbound			Cactus Avenue Westbound			Innovation Drive Northbound			Cactus Avenue Eastbound			
	Left	Thru	Right	Left	Thru	Right	Left	Thru	Right	Left	Thru	Right	
Peak Hour Analysis From 04:30 PM to 05:15 PM - Peak 1 of 1													
Peak Hour for Each Approach Begins at:													
	04:30 PM			04:30 PM			04:30 PM			04:30 PM			
+0 mins.	7	0	2	148	1	158	0	24	29	0	153	3	156
+15 mins.	5	1	0	116	2	122	0	11	13	0	119	2	121
+30 mins.	52	0	7	139	4	153	0	35	39	0	153	0	153
+45 mins.	5	0	2	165	0	174	0	19	20	0	134	0	134
Total Volume	69	1	11	568	7	607	0	89	101	0	559	5	564
% App. Total	85.2	1.2	13.6	93.6	1.2	88.1	0	88.1	64.7	0	99.1	0.9	90.4
PHF	.332	.250	.393	.861	.438	.872	.000	.636	.647	.000	.913	.417	.904

Counts Unlimited
 PO Box 1178
 Corona, CA 92878
 (951) 268-6268

County of Riverside
 N/S: Innovation Drive
 E/W: Cactus Avenue
 Weather: Clear

File Name : 32_CRV_Innovation_Cactus PM
 Site Code : 05119542
 Start Date : 8/20/2019
 Page No : 1

Groups Printed- Large 2 Axle Vehicles

Start Time	Innovation Drive Southbound				Cactus Avenue Westbound				Innovation Drive Northbound				Cactus Avenue Eastbound										
	Left	Thru	Right	RTOR	Left	Thru	Right	RTOR	Left	Thru	Right	RTOR	Left	Thru	Right	RTOR							
04:00 PM	0	0	1	1	0	1	0	0	2	0	0	0	0	7	0	0	7						
04:15 PM	0	0	0	0	0	3	0	0	3	0	0	0	0	2	0	0	2						
04:30 PM	0	0	0	0	1	4	0	0	5	0	0	1	1	1	0	0	1						
04:45 PM	0	0	0	0	0	2	0	0	2	0	0	1	1	0	0	0	3						
Total	0	0	1	1	1	10	1	0	12	0	0	2	1	2	0	0	13						
05:00 PM	0	0	0	0	0	4	0	0	4	0	0	0	0	0	0	0	2						
05:15 PM	0	0	0	0	1	6	0	0	7	0	0	0	0	1	0	0	1						
05:30 PM	0	0	0	0	0	3	0	0	3	0	0	0	0	0	3	1	4						
05:45 PM	0	0	0	0	0	0	0	0	1	1	0	1	2	0	0	0	2						
Total	0	0	0	0	1	14	0	0	15	1	0	1	2	0	8	1	9						
Grand Total	0	0	1	1	2	24	1	0	27	1	0	3	2	4	0	21	1	0	22	3	54	57	
Apprch %	0	0	100		7.4	88.9	3.7		25	0	75		7.4	0	95.5	4.5	40.7	5.3	94.7				
Total %	0	0	1.9		3.7	44.4	1.9		50	1.9	0	5.6		7.4	38.9	1.9	40.7	5.3	94.7				

3:1-386

Start Time	Innovation Drive Southbound				Cactus Avenue Westbound				Innovation Drive Northbound				Cactus Avenue Eastbound										
	Left	Thru	Right	RTOR	Left	Thru	Right	RTOR	Left	Thru	Right	RTOR	Left	Thru	Right	RTOR							
04:30 PM	0	0	0	0	1	4	0	0	5	0	0	1	1	1	0	0	1						
04:45 PM	0	0	0	0	0	2	0	0	2	0	0	1	1	3	0	0	3						
05:00 PM	0	0	0	0	0	4	0	0	4	0	0	0	0	2	0	0	2						
05:15 PM	0	0	0	0	1	6	0	0	7	0	0	0	0	1	0	0	1						
Total Volume	0	0	0	0	2	16	0	0	18	0	0	2	2	7	0	7	0	7	0	0	7	27	
% App. Total	0	0	0	0	11.1	88.9	0		0	0	100		0	100	0	0	0	0	0	0	0	0	0
PHF	.000	.000	.000	.000	.500	.667	.000		.643	.000	.000	.500		.500	.000	.583	.000	.583	.000	.583	.000	.844	

Peak Hour Analysis From 04:30 PM to 05:15 PM - Peak 1 of 1
 Peak Hour for Entire Intersection Begins at 04:30 PM

Counts Unlimited
 PO Box 1178
 Corona, CA 92878
 (951) 268-6268

County of Riverside
 N/S: Innovation Drive
 E/W: Cactus Avenue
 Weather: Clear

File Name : 32_CRV_Innovation_Cactus PM
 Site Code : 05119542
 Start Date : 8/20/2019
 Page No : 2

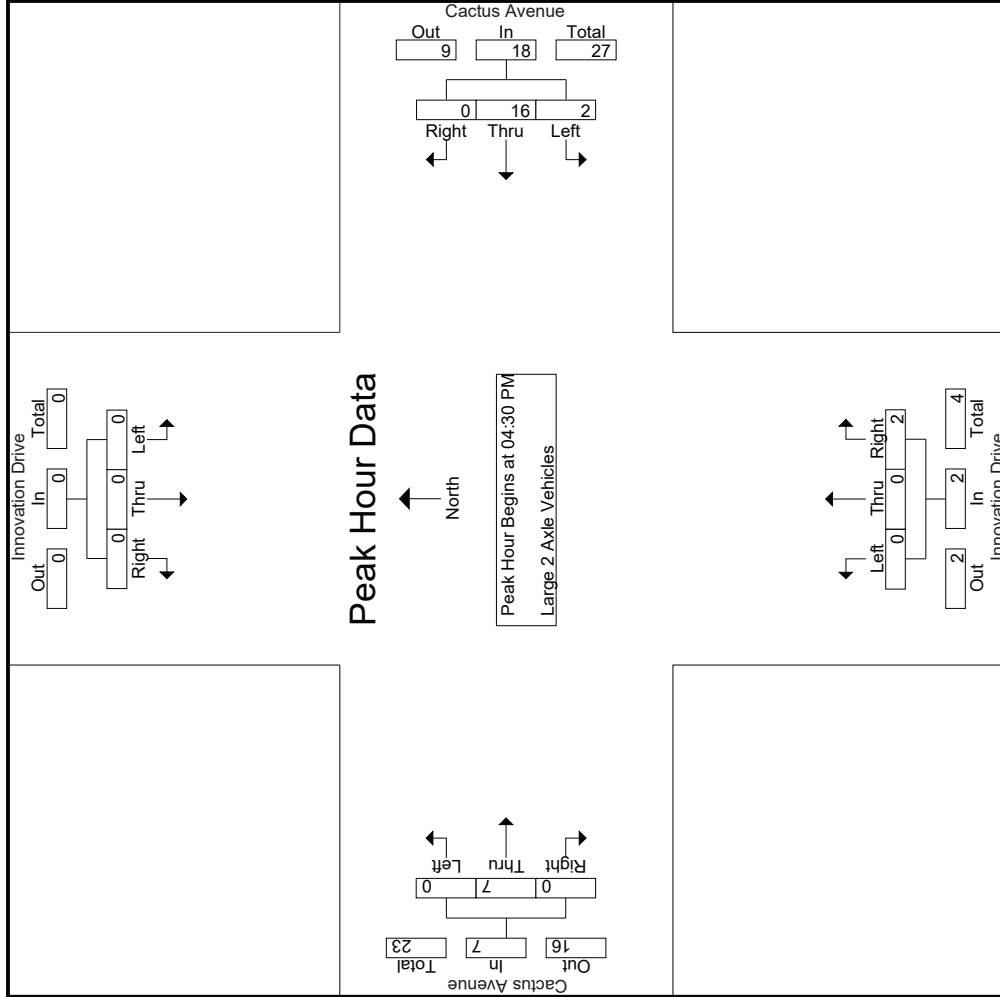

Counts Unlimited
 PO Box 1178
 Corona, CA 92878
 (951) 268-6268

County of Riverside
 N/S: Innovation Drive
 E/W: Cactus Avenue
 Weather: Clear

File Name : 32_CRV_Innovation_Cactus PM
 Site Code : 05119542
 Start Date : 8/20/2019
 Page No : 3

Start Time	Innovation Drive Southbound			Cactus Avenue Westbound			Innovation Drive Northbound			Cactus Avenue Eastbound		
	Left	Thru	Right	Left	Thru	Right	Left	Thru	Right	Left	Thru	Right
Peak Hour Analysis From 04:30 PM to 05:15 PM - Peak 1 of 1												
Peak Hour for Each Approach Begins at:												
	04:30 PM			04:30 PM			04:30 PM			04:30 PM		
+0 mins.	0	0	0	1	4	0	0	0	0	1	1	0
+15 mins.	0	0	0	0	2	0	0	1	0	1	3	0
+30 mins.	0	0	0	0	4	0	0	0	0	0	2	0
+45 mins.	0	0	0	1	6	0	0	0	0	0	1	0
Total Volume	0	0	0	2	16	0	0	0	0	2	7	0
% App. Total	0	0	0	11.1	88.9	0	0	100	0	0	100	0
PHF	.000	.000	.000	.500	.667	.000	.643	.500	.500	.000	.583	.000

Counts Unlimited
 PO Box 1178
 Corona, CA 92878
 (951) 268-6268

County of Riverside
 N/S: Innovation Drive
 E/W: Cactus Avenue
 Weather: Clear

File Name : 32_CRV_Innovation_Cactus PM
 Site Code : 05119542
 Start Date : 8/20/2019
 Page No : 2

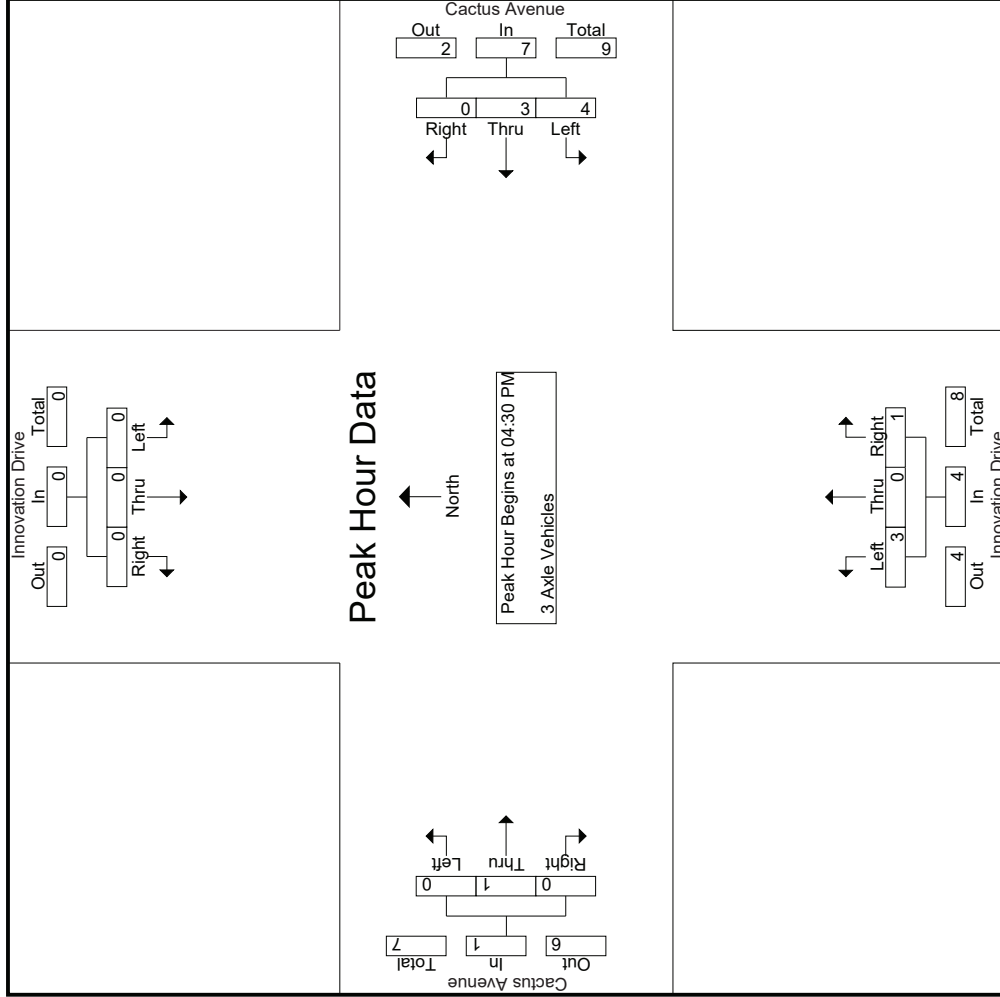

Counts Unlimited
 PO Box 1178
 Corona, CA 92878
 (951) 268-6268

County of Riverside
 N/S: Innovation Drive
 E/W: Cactus Avenue
 Weather: Clear

File Name : 32_CRV_Innovation_Cactus PM
 Site Code : 05119542
 Start Date : 8/20/2019
 Page No : 3

Start Time	Innovation Drive Southbound			Cactus Avenue Westbound			Innovation Drive Northbound			Cactus Avenue Eastbound		
	Left	Thru	Right	Left	Thru	Right	Left	Thru	Right	Left	Thru	Right
Peak Hour Analysis From 04:30 PM to 05:15 PM - Peak 1 of 1												
Peak Hour for Each Approach Begins at:												
	04:30 PM			04:30 PM			04:30 PM			04:30 PM		
+0 mins.	0	0	0	0	0	0	1	1	0	0	0	0
+15 mins.	0	0	0	2	0	0	2	2	0	0	0	0
+30 mins.	0	0	0	0	2	0	2	1	0	0	1	0
+45 mins.	0	0	0	1	1	0	2	0	0	0	0	0
Total Volume	0	0	0	4	3	0	7	3	0	1	1	0
% App. Total	0	0	0	57.1	42.9	0	75	37.5	0	25	0	100
PHF	.000	.000	.000	.500	.375	.000	.875	.375	.000	.250	.000	.250

Counts Unlimited
 PO Box 1178
 Corona, CA 92878
 (951) 268-6268

County of Riverside
 N/S: Innovation Drive
 E/W: Cactus Avenue
 Weather: Clear

File Name : 32_CRV_Innovation_Cactus PM
 Site Code : 05119542
 Start Date : 8/20/2019
 Page No : 1

Groups Printed- 4+ Axle Trucks

Start Time	Innovation Drive Southbound				Cactus Avenue Westbound				Innovation Drive Northbound				Cactus Avenue Eastbound			
	Left	Thru	Right	RTOR	Left	Thru	Right	RTOR	Left	Thru	Right	RTOR	Left	Thru	Right	RTOR
04:00 PM	0	0	0	0	2	1	0	0	3	0	3	0	0	1	2	0
04:15 PM	0	0	0	0	1	1	0	0	2	0	1	1	0	1	0	0
04:30 PM	0	0	0	0	0	2	0	0	2	0	1	0	0	1	1	0
04:45 PM	0	0	0	0	0	2	0	0	2	0	6	2	0	1	1	0
Total	0	0	0	0	3	6	0	0	9	0	11	3	0	4	4	0
05:00 PM	0	0	0	0	1	4	0	0	5	0	2	0	0	1	1	0
05:15 PM	0	0	0	0	0	4	0	0	4	0	3	2	0	0	1	0
05:30 PM	0	0	0	0	2	0	0	0	2	0	0	0	0	0	0	0
05:45 PM	0	0	0	0	3	4	0	0	7	0	0	0	0	0	0	0
Total	0	0	0	0	4	14	0	0	18	0	5	2	0	1	2	0
Grand Total	0	0	0	0	7	20	0	0	27	0	16	5	0	5	6	0
Apprch %	0	0	0	0	25.9	74.1	0	0	0	0	100	0	0	45.5	54.5	0
Total %	0	0	0	0	13	37	0	0	50	0	29.6	0	0	9.3	11.1	0

Start Time	Innovation Drive Southbound				Cactus Avenue Westbound				Innovation Drive Northbound				Cactus Avenue Eastbound			
	Left	Thru	Right	RTOR	Left	Thru	Right	RTOR	Left	Thru	Right	RTOR	Left	Thru	Right	RTOR
04:30 PM	0	0	0	0	0	0	0	0	2	0	0	0	0	0	1	0
04:45 PM	0	0	0	0	0	2	0	0	2	0	0	0	0	0	1	0
05:00 PM	0	0	0	0	1	4	0	0	5	0	2	0	0	1	1	0
05:15 PM	0	0	0	0	0	0	0	0	4	0	4	0	0	0	0	0
Total Volume	0	0	0	0	1	12	0	0	13	0	12	0	0	3	4	0
% App. Total	0	0	0	0	7.7	92.3	0	0	0	0	100	0	0	42.9	57.1	0
PHF	.000	.000	.000	.000	.250	.750	.000	.650	.000	.500	.500	.000	.000	.750	1.00	.875

Peak Hour Analysis From 04:30 PM to 05:15 PM - Peak 1 of 1
 Peak Hour for Entire Intersection Begins at 04:30 PM

Counts Unlimited
 PO Box 1178
 Corona, CA 92878
 (951) 268-6268

County of Riverside
 N/S: Innovation Drive
 E/W: Cactus Avenue
 Weather: Clear

File Name : 32_CRV_Innovation_Cactus PM
 Site Code : 05119542
 Start Date : 8/20/2019
 Page No : 2

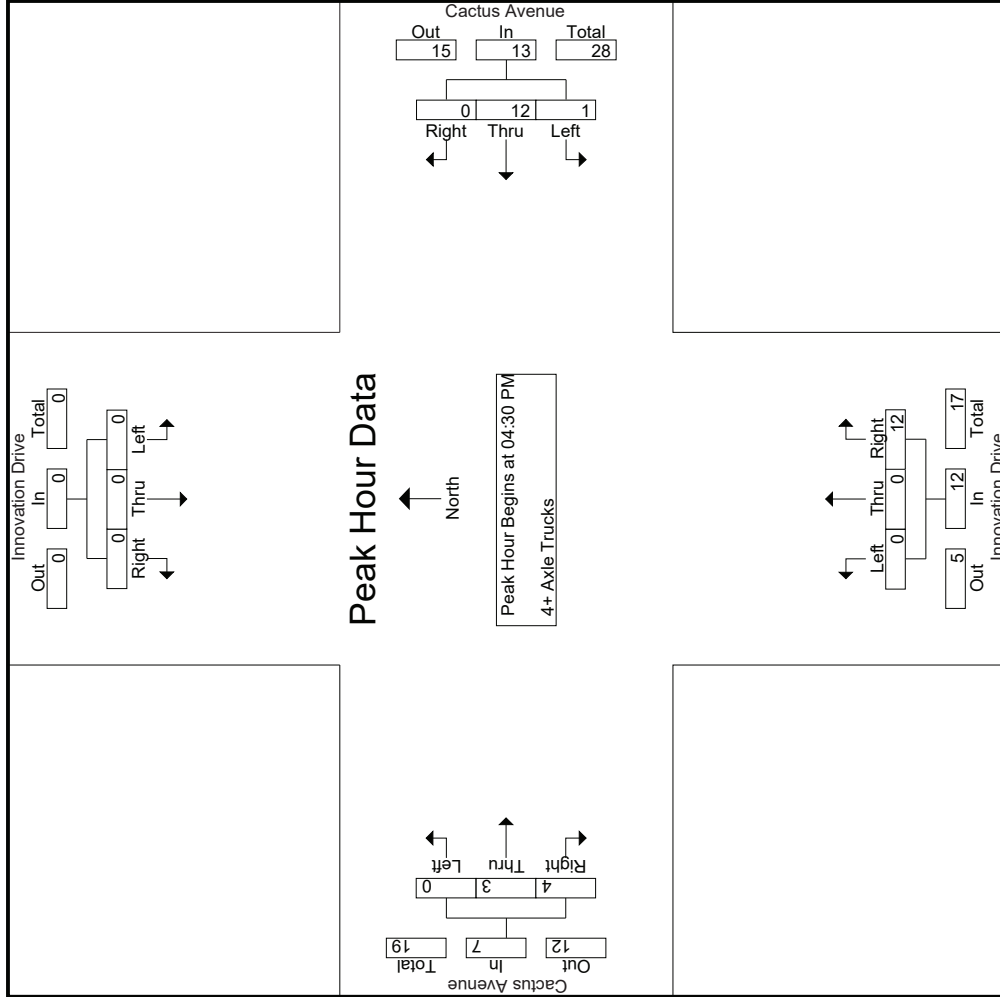

Counts Unlimited
 PO Box 1178
 Corona, CA 92878
 (951) 268-6268

County of Riverside
 N/S: Innovation Drive
 E/W: Cactus Avenue
 Weather: Clear

File Name : 32_CRV_Innovation_Cactus PM
 Site Code : 05119542
 Start Date : 8/20/2019
 Page No : 3

Start Time	Innovation Drive Southbound			Cactus Avenue Westbound			Innovation Drive Northbound			Cactus Avenue Eastbound		
	Left	Thru	Right	Left	Thru	Right	Left	Thru	Right	Left	Thru	Right
Peak Hour Analysis From 04:30 PM to 05:15 PM - Peak 1 of 1												
Peak Hour for Each Approach Begins at:												
	04:30 PM			04:30 PM			04:30 PM			04:30 PM		
+0 mins.	0	0	0	0	2	0	0	0	1	0	1	1
+15 mins.	0	0	0	0	2	0	0	0	6	0	1	1
+30 mins.	0	0	0	1	4	0	0	0	2	0	1	1
+45 mins.	0	0	0	0	4	0	0	0	3	0	0	1
Total Volume	0	0	0	1	12	0	0	0	12	0	3	4
% App. Total	0	0	0	7.7	92.3	0	0	0	100	0	42.9	57.1
PHF	.000	.000	.000	.250	.750	.000	.000	.000	.500	.000	.750	1.000
					.650				.500		.875	

Location: County of Riverside
 N/S: Innovation Drive
 E/W: Cactus Avenue



Date: 8/20/2019
 Day: Tuesday

PEDESTRIANS

	North Leg Innovation Drive	East Leg Cactus Avenue	South Leg Innovation Drive	West Leg Cactus Avenue	
	Pedestrians	Pedestrians	Pedestrians	Pedestrians	
7:00 AM	0	0	0	0	0
7:15 AM	0	0	0	0	0
7:30 AM	0	0	0	0	0
7:45 AM	0	0	0	0	0
8:00 AM	1	0	0	0	1
8:15 AM	0	0	0	0	0
8:30 AM	0	0	0	0	0
8:45 AM	1	0	0	0	1
TOTAL VOLUMES:	2	0	0	0	2

	North Leg Innovation Drive	East Leg Cactus Avenue	South Leg Innovation Drive	West Leg Cactus Avenue	
	Pedestrians	Pedestrians	Pedestrians	Pedestrians	
4:00 PM	0	0	0	0	0
4:15 PM	0	0	0	0	0
4:30 PM	0	1	0	0	1
4:45 PM	0	0	0	0	0
5:00 PM	0	0	0	0	0
5:15 PM	0	0	0	0	0
5:30 PM	0	0	0	0	0
5:45 PM	0	0	0	0	0
TOTAL VOLUMES:	0	1	0	0	1

Location: County of Riverside
 N/S: Innovation Drive
 E/W: Cactus Avenue



Date: 8/20/2019
 Day: Tuesday

BICYCLES

	Southbound Innovation Drive			Westbound Cactus Avenue			Northbound Innovation Drive			Eastbound Cactus Avenue			
	Left	Thru	Right	Left	Thru	Right	Left	Thru	Right	Left	Thru	Right	
7:00 AM	0	0	0	0	0	0	0	0	0	0	0	0	0
7:15 AM	0	0	0	0	0	0	0	0	0	0	0	0	0
7:30 AM	0	1	0	0	0	0	0	0	0	0	0	0	2
7:45 AM	0	0	0	0	0	0	0	0	0	0	0	0	0
8:00 AM	0	0	0	0	0	0	0	0	0	0	0	0	0
8:15 AM	0	0	0	0	0	0	0	0	0	0	0	0	0
8:30 AM	0	0	0	0	0	0	0	0	0	0	0	0	0
8:45 AM	0	0	0	0	0	0	0	0	0	0	1	0	1
TOTAL VOLUMES:	0	1	0	0	0	1	0	0	0	0	1	0	3

	Southbound Innovation Drive			Westbound Cactus Avenue			Northbound Innovation Drive			Eastbound Cactus Avenue			
	Left	Thru	Right	Left	Thru	Right	Left	Thru	Right	Left	Thru	Right	
4:00 PM	0	0	0	0	0	0	0	0	0	0	0	0	0
4:15 PM	0	0	0	0	0	0	0	0	0	0	0	0	0
4:30 PM	0	0	0	0	0	0	0	0	0	0	0	0	0
4:45 PM	0	0	0	0	0	0	0	0	0	0	0	0	0
5:00 PM	0	0	0	0	0	0	0	0	0	0	0	0	0
5:15 PM	0	0	0	0	0	0	0	0	0	0	0	0	0
5:30 PM	0	0	0	0	0	0	0	0	0	0	0	0	0
5:45 PM	0	0	0	0	0	0	0	0	0	0	0	0	0
TOTAL VOLUMES:	0	0	0	0	0	0	0	0	0	0	0	0	0

Counts Unlimited
 PO Box 1178
 Corona, CA 92878
 (951) 268-6268

City of Riverside
 N/S: I-215 Southbound Ramps
 E/W: Alessandro Boulevard
 Weather: Clear

File Name : 34_RIV_215S_Alessandro AM
 Site Code : 05119542
 Start Date : 8/20/2019
 Page No : 2

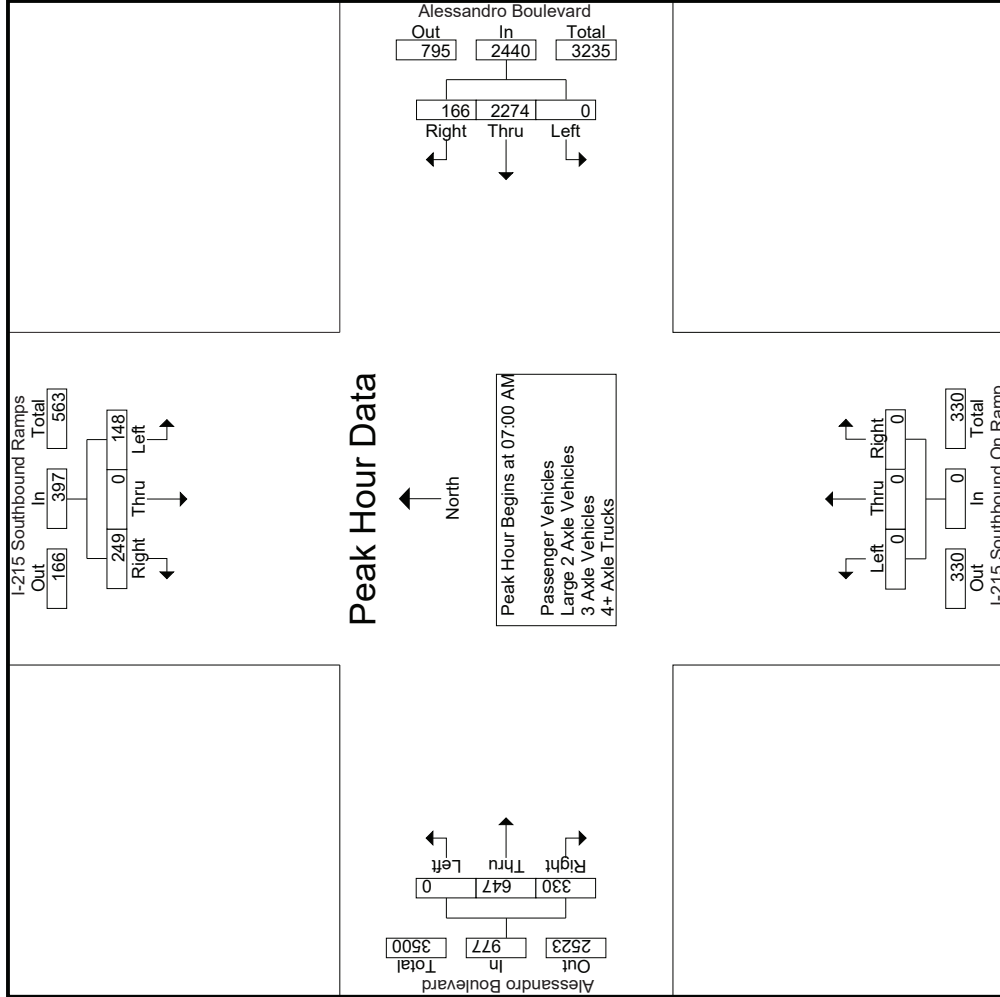

Groups Printed- Passenger Vehicles

Start Time	I-215 Southbound Ramps Southbound										Alessandro Boulevard Westbound										I-215 Southbound On Ramp Northbound										Alessandro Boulevard Eastbound																																																																																																																																																																																																																																																																																																																																
	Left		Thru		Right		RTOR		App. Total		Left		Thru		Right		RTOR		App. Total		Left		Thru		Right		RTOR		App. Total		Left		Thru		Right		RTOR		App. Total																																																																																																																																																																																																																																																																																																																								
07:00 AM	23	0	53	5	76	0	604	46	650	0	0	0	0	0	0	0	0	0	0	0	130	91	4	221	9	947	956	07:15 AM	27	0	56	0	83	0	546	30	576	0	0	0	0	0	0	0	0	0	0	161	90	7	251	7	910	917	07:30 AM	35	0	49	2	84	0	542	42	584	0	0	0	0	0	0	0	0	0	0	168	77	6	245	8	913	921	07:45 AM	37	0	70	9	107	0	541	40	581	0	0	0	0	0	0	0	0	0	0	171	68	5	239	15	927	942	Total	122	0	228	16	350	0	2233	158	2391	0	0	0	0	0	0	0	0	0	0	630	326	22	956	39	3697	3736	08:00 AM	31	0	47	7	78	0	516	39	555	0	0	0	0	0	0	0	0	0	0	142	62	1	204	8	837	845	08:15 AM	23	0	52	4	75	0	498	32	530	0	0	0	0	0	0	0	0	0	0	167	62	1	229	5	834	839	08:30 AM	24	0	64	9	88	0	441	49	490	0	0	0	0	0	0	0	0	0	0	159	54	7	213	16	791	807	08:45 AM	38	0	56	18	94	0	412	22	434	0	0	0	0	0	0	0	0	0	0	155	56	3	211	21	739	760	Total	116	0	219	38	335	0	1867	142	2009	0	0	0	0	0	0	0	0	0	0	623	234	12	857	50	3201	3251	Grand Total	238	0	447	54	685	0	4100	300	4400	0	0	0	0	0	0	0	0	0	0	1253	560	34	1813	89	6898	6987	Approch %	34.7	0	65.3			0	93.2	6.8		0	0	0	0	0	0	0	0	0	0	69.1	30.9		26.3	1.3	98.7		Total %	3.5	0	6.5			0	59.4	4.3	63.8	0	0	0	0	0	0	0	0	0	0	18.2	8.1					

Start Time	I-215 Southbound Ramps Southbound										Alessandro Boulevard Westbound										I-215 Southbound On Ramp Northbound										Alessandro Boulevard Eastbound																																																																																																																																																											
	Left		Thru		Right		App. Total		Left		Thru		Right		App. Total		Left		Thru		Right		App. Total		Left		Thru		Right		App. Total		Left		Thru		Right		App. Total																																																																																																																																																			
07:00 AM	23	0	53	5	76	0	604	46	650	0	0	0	0	0	0	0	0	0	0	0	130	91	4	221	9	947	956	07:15 AM	27	0	56	0	83	0	546	30	576	0	0	0	0	0	0	0	0	0	0	161	90	7	251	7	910	917	07:30 AM	35	0	49	2	84	0	542	42	584	0	0	0	0	0	0	0	0	0	0	168	77	6	245	8	913	921	07:45 AM	37	0	70	9	107	0	541	40	581	0	0	0	0	0	0	0	0	0	0	171	68	5	239	15	927	942	Total Volume	122	0	228	16	350	0	2233	158	2391	0	0	0	0	0	0	0	0	0	0	630	326	22	956	39	3697	% App. Total	34.9	0	65.1			0	93.4	6.6		0	0	0	0	0	0	0	0	0	0	65.9	34.1						PHF	.824	.000	.814		.818	.000	.924	.859	.920	.000	.000	.000	.000	.000	.000	.000	.000	.000	.000	.921	.896		.952	.976

Peak Hour Analysis From 07:00 AM to 07:45 AM - Peak 1 of 1
 Peak Hour for Entire Intersection Begins at 07:00 AM

Counts Unlimited
 PO Box 1178
 Corona, CA 92878
 (951) 268-6268

City of Riverside
 N/S: I-215 Southbound Ramps
 E/W: Alessandro Boulevard
 Weather: Clear

File Name : 34_RIV_215S_Alessandro AM
 Site Code : 05119542
 Start Date : 8/20/2019
 Page No : 2

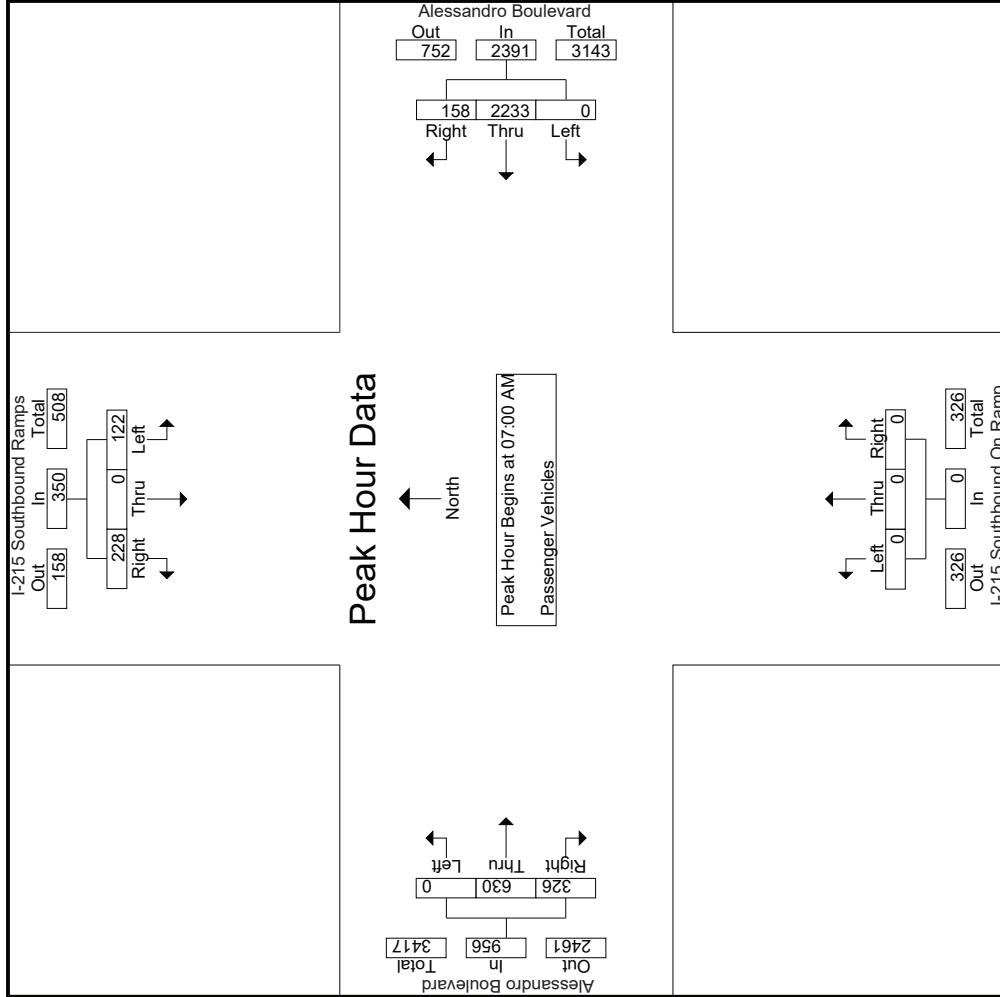

Counts Unlimited
 PO Box 1178
 Corona, CA 92878
 (951) 268-6268

City of Riverside
 N/S: I-215 Southbound Ramps
 E/W: Alessandro Boulevard
 Weather: Clear

File Name : 34_RIV_215S_Alessandro AM
 Site Code : 05119542
 Start Date : 8/20/2019
 Page No : 3

Start Time	I-215 Southbound Ramps Southbound			Alessandro Boulevard Westbound			I-215 Southbound On Ramp Northbound			Alessandro Boulevard Eastbound					
	Left	Thru	Right	Left	Thru	Right	Left	Thru	Right	Left	Thru	Right			
Peak Hour Analysis From 07:00 AM to 07:45 AM - Peak 1 of 1															
Peak Hour for Each Approach Begins at:															
	07:00 AM														
+0 mins.	23	0	53	0	0	46	0	0	0	0	0	0	0	130	91
+15 mins.	27	0	56	0	0	30	0	0	0	0	0	0	0	161	90
+30 mins.	35	0	49	0	0	42	0	0	0	0	0	0	0	168	77
+45 mins.	37	0	70	0	0	40	0	0	0	0	0	0	0	171	68
Total Volume	122	0	228	0	0	158	0	0	0	0	0	0	0	630	326
% App. Total	34.9	0	65.1	0	0	6.6	0	0	0	0	0	0	0	65.9	34.1
PHF	.824	.000	.814	.000	.000	.859	.000	.000	.000	.000	.921	.896	.000	.921	.952

Groups Printed- Large 2 Axle Vehicles

Start Time	I-215 Southbound Ramps Southbound				Alessandro Boulevard Westbound				I-215 Southbound On Ramp Northbound				Alessandro Boulevard Eastbound						
	Left	Thru	Right	RTOR	App. Total	Left	Thru	Right	RTOR	App. Total	Left	Thru	Right	RTOR	App. Total	Exclu. Total	Inclu. Total	Int. Total	
07:00 AM	1	0	2	0	3	0	9	2	0	11	0	0	0	0	0	4	1	18	19
07:15 AM	2	0	1	0	3	0	7	3	0	10	0	1	0	0	1	0	0	14	14
07:30 AM	3	0	4	0	7	0	7	1	0	8	0	0	0	0	5	0	0	20	20
07:45 AM	4	0	6	0	10	0	6	1	0	7	0	0	0	0	0	0	0	17	17
Total	10	0	13	0	23	0	29	7	0	36	0	0	0	1	10	1	69	70	
08:00 AM	1	0	0	0	1	0	4	2	0	6	0	0	0	0	5	0	0	12	12
08:15 AM	1	0	2	1	3	0	13	2	0	15	0	0	0	0	8	1	26	27	
08:30 AM	2	0	3	0	5	0	6	2	0	8	0	0	0	0	3	0	16	16	
08:45 AM	4	0	2	0	6	0	10	1	0	11	0	0	0	2	4	0	21	21	
Total	8	0	7	1	15	0	33	7	0	40	0	0	0	6	20	1	75	76	
Grand Total	18	0	20	1	38	0	62	14	0	76	0	0	0	8	30	2	144	146	
Approch %	47.4	0	52.6			0	81.6	18.4			0	0	0						
Total %	12.5	0	13.9		26.4	0	43.1	9.7		52.8	0	0	0		20.8	1.4	98.6		

3:1-403

Start Time	I-215 Southbound Ramps Southbound				Alessandro Boulevard Westbound				I-215 Southbound On Ramp Northbound				Alessandro Boulevard Eastbound						
	Left	Thru	Right	RTOR	App. Total	Left	Thru	Right	RTOR	App. Total	Left	Thru	Right	RTOR	App. Total	Exclu. Total	Inclu. Total	Int. Total	
07:00 AM	1	0	2	0	3	0	9	2	0	11	0	0	0	0	0	4	1	18	18
07:15 AM	2	0	1	0	3	0	7	3	0	10	0	1	0	0	1	0	14	14	
07:30 AM	3	0	4	0	7	0	7	1	0	8	0	0	0	0	5	0	20	20	
07:45 AM	4	0	6	0	10	0	6	1	0	7	0	0	0	0	0	0	17	17	
Total Volume	10	0	13	0	23	0	29	7	0	36	0	0	0	1	10	1	69	70	
% App. Total	43.5	0	56.5			0	80.6	19.4			0	0	0						
PHF	.625	.000	.542		.575	.000	.806	.583		.818	.000	.000	.000	.500	.500	.500	.500	.863	

Peak Hour Analysis From 07:00 AM to 07:45 AM - Peak 1 of 1
 Peak Hour for Entire Intersection Begins at 07:00 AM

Counts Unlimited
 PO Box 1178
 Corona, CA 92878
 (951) 268-6268

City of Riverside
 N/S: I-215 Southbound Ramps
 E/W: Alessandro Boulevard
 Weather: Clear

File Name : 34_RIV_215S_Alessandro AM
 Site Code : 05119542
 Start Date : 8/20/2019
 Page No : 2

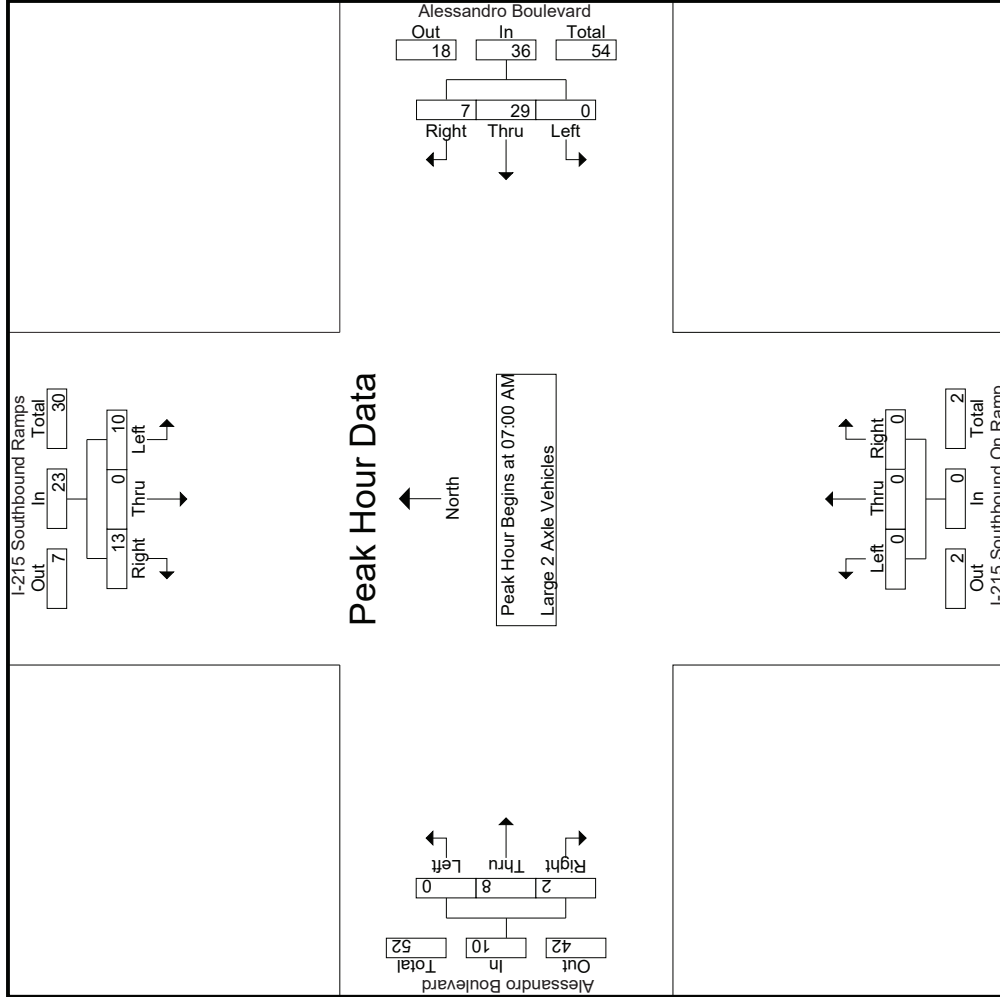

Counts Unlimited
 PO Box 1178
 Corona, CA 92878
 (951) 268-6268

City of Riverside
 N/S: I-215 Southbound Ramps
 E/W: Alessandro Boulevard
 Weather: Clear

File Name : 34_RIV_215S_Alessandro AM
 Site Code : 05119542
 Start Date : 8/20/2019
 Page No : 3

Start Time	I-215 Southbound Ramps Southbound			Alessandro Boulevard Westbound			I-215 Southbound On Ramp Northbound			Alessandro Boulevard Eastbound				
	Left	Thru	Right	Left	Thru	Right	Left	Thru	Right	Left	Thru	Right		
Peak Hour Analysis From 07:00 AM to 07:45 AM - Peak 1 of 1														
Peak Hour for Each Approach Begins at:														
	07:00 AM													
+0 mins.	1	0	2	3	0	2	11	0	0	0	0	3	1	4
+15 mins.	2	0	1	3	0	3	10	0	0	0	0	1	0	1
+30 mins.	3	0	4	7	0	7	8	0	0	0	0	4	1	5
+45 mins.	4	0	6	10	0	6	7	0	0	0	0	0	0	0
Total Volume	10	0	13	23	0	29	36	0	0	0	0	8	2	10
% App. Total	43.5	0	56.5		0	80.6	19.4	0	0	0	0	80	20	
PHF	.625	.000	.542	.575	.000	.806	.583	.818	.000	.000	.000	.500	.500	.500

Groups Printed- 3 Axle Vehicles

Start Time	I-215 Southbound Ramps Southbound				Alessandro Boulevard Westbound				I-215 Southbound On Ramp Northbound				Alessandro Boulevard Eastbound					
	Left	Thru	Right	RTOR	App. Total	Left	Thru	Right	RTOR	App. Total	Left	Thru	Right	RTOR	App. Total	Exclu. Total	Inclu. Total	Int. Total
07:00 AM	0	0	0	0	0	0	0	0	0	0	0	0	0	0	0	0	1	1
07:15 AM	2	0	0	0	2	0	1	0	0	1	0	0	0	0	2	0	5	5
07:30 AM	2	0	0	0	2	0	1	0	0	1	0	0	0	0	0	0	3	3
07:45 AM	2	0	0	0	2	0	0	0	0	0	0	0	0	0	1	0	3	3
Total	6	0	0	0	6	3	0	0	0	3	0	0	0	0	3	0	12	12
08:00 AM	0	0	0	0	0	0	0	0	0	0	0	0	0	0	0	0	1	1
08:15 AM	1	0	0	0	1	0	1	0	0	1	0	0	0	0	0	0	2	2
08:30 AM	5	0	1	0	6	0	0	0	0	0	0	0	0	0	2	0	8	8
08:45 AM	2	0	0	0	2	0	4	1	0	5	0	0	0	0	1	0	8	8
Total	8	0	1	0	9	0	5	1	0	6	0	0	0	0	4	0	19	19
Grand Total	14	0	1	0	15	0	8	1	0	9	0	0	0	0	7	0	31	31
Approch %	93.3	0	6.7			0	88.9	11.1		29	0	0	0	0	22.6	0	100	
Total %	45.2	0	3.2		48.4	0	25.8	3.2			0	0	0	0	14.3	0		

3.1-406

Start Time	I-215 Southbound Ramps Southbound				Alessandro Boulevard Westbound				I-215 Southbound On Ramp Northbound				Alessandro Boulevard Eastbound					
	Left	Thru	Right	RTOR	App. Total	Left	Thru	Right	RTOR	App. Total	Left	Thru	Right	RTOR	App. Total	Exclu. Total	Inclu. Total	Int. Total
07:00 AM	0	0	0	0	0	0	0	0	0	0	0	0	0	0	0	0	0	0
07:15 AM	2	0	0	0	2	0	1	0	0	1	0	0	0	0	1	0	2	5
07:30 AM	2	0	0	0	2	0	1	0	0	1	0	0	0	0	0	0	3	3
07:45 AM	2	0	0	0	2	0	0	0	0	0	0	0	0	0	1	0	3	3
Total Volume	6	0	0	0	6	0	3	0	0	3	0	0	0	0	2	1	3	12
% App. Total	100	0	0			0	100	0		0	0	0	0	66.7	33.3	0		
PHF	.750	.000	.000		.750	.000	.750	.000		.750	.000	.000	.000	.000	.500	.250	.375	.600

Peak Hour Analysis From 07:00 AM to 07:45 AM - Peak 1 of 1
 Peak Hour for Entire Intersection Begins at 07:00 AM

Counts Unlimited
 PO Box 1178
 Corona, CA 92878
 (951) 268-6268

City of Riverside
 N/S: I-215 Southbound Ramps
 E/W: Alessandro Boulevard
 Weather: Clear

File Name : 34_RIV_215S_Alessandro AM
 Site Code : 05119542
 Start Date : 8/20/2019
 Page No : 2

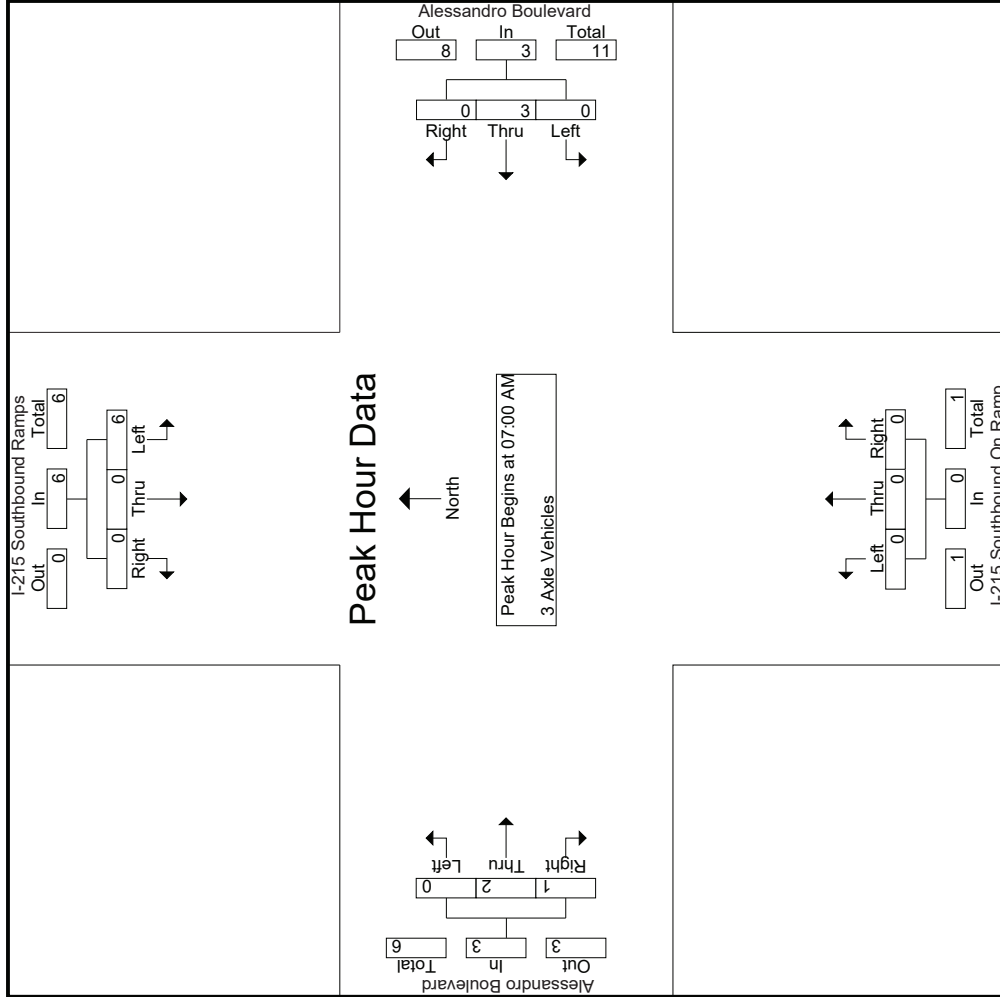

Groups Printed- 4+ Axle Trucks

Start Time	I-215 Southbound Ramps Southbound				Alessandro Boulevard Westbound				I-215 Southbound On Ramp Northbound				Alessandro Boulevard Eastbound						
	Left	Thru	Right	RTOR	App. Total	Left	Thru	Right	RTOR	App. Total	Left	Thru	Right	RTOR	App. Total	Exclu. Total	Inclu. Total	Int. Total	
07:00 AM	3	0	1	0	4	0	3	0	0	3	0	0	0	0	0	2	0	9	9
07:15 AM	1	0	4	0	5	0	1	1	0	2	0	0	0	0	3	0	10	10	10
07:30 AM	4	0	1	0	5	0	3	0	0	3	0	0	0	0	1	0	9	9	9
07:45 AM	2	0	2	0	4	0	2	0	0	2	0	0	0	0	2	0	8	8	8
Total	10	0	8	0	18	0	9	1	0	10	0	0	0	0	8	0	36	36	36
08:00 AM	5	0	2	0	7	0	5	0	0	5	0	0	0	0	2	0	14	14	14
08:15 AM	4	0	1	0	5	0	1	0	0	1	0	0	0	0	1	0	7	7	7
08:30 AM	1	0	2	0	3	0	5	0	0	5	0	0	0	0	1	0	9	9	9
08:45 AM	2	0	1	0	3	0	7	0	0	7	0	0	0	0	3	0	14	14	14
Total	12	0	6	0	18	0	18	0	0	18	0	0	0	0	8	0	44	44	44
Grand Total	22	0	14	0	36	0	27	1	0	28	0	0	0	0	16	0	80	80	80
Apprch %	61.1	0	38.9			0	96.4	3.6			0	0	0		20	0	100		
Total %	27.5	0	17.5		45	0	33.8	1.2		35	0	0	0		20	0	100		

Start Time	I-215 Southbound Ramps Southbound				Alessandro Boulevard Westbound				I-215 Southbound On Ramp Northbound				Alessandro Boulevard Eastbound						
	Left	Thru	Right	RTOR	App. Total	Left	Thru	Right	RTOR	App. Total	Left	Thru	Right	RTOR	App. Total	Exclu. Total	Inclu. Total	Int. Total	
07:00 AM	3	0	1	0	4	0	3	0	0	3	0	0	0	0	2	0	9	9	9
07:15 AM	1	0	4	0	5	0	1	1	0	2	0	0	0	0	3	0	10	10	10
07:30 AM	4	0	1	0	5	0	3	0	0	3	0	0	0	0	1	0	9	9	9
07:45 AM	2	0	2	0	4	0	2	0	0	2	0	0	0	0	2	0	8	8	8
Total Volume	10	0	8	0	18	0	9	1	0	10	0	0	0	0	8	0	36	36	36
% App. Total	55.6	0	44.4			0	90	10			0	0	0		12.5	0	100		
PHF	.625	.000	.500		.900	.000	.750	.250		.833	.000	.000	.000		.583	.250	.667		.900

Peak Hour Analysis From 07:00 AM to 07:45 AM - Peak 1 of 1
 Peak Hour for Entire Intersection Begins at 07:00 AM

Counts Unlimited
 PO Box 1178
 Corona, CA 92878
 (951) 268-6268

City of Riverside
 N/S: I-215 Southbound Ramps
 E/W: Alessandro Boulevard
 Weather: Clear

File Name : 34_RIV_215S_Alessandro AM
 Site Code : 05119542
 Start Date : 8/20/2019
 Page No : 2

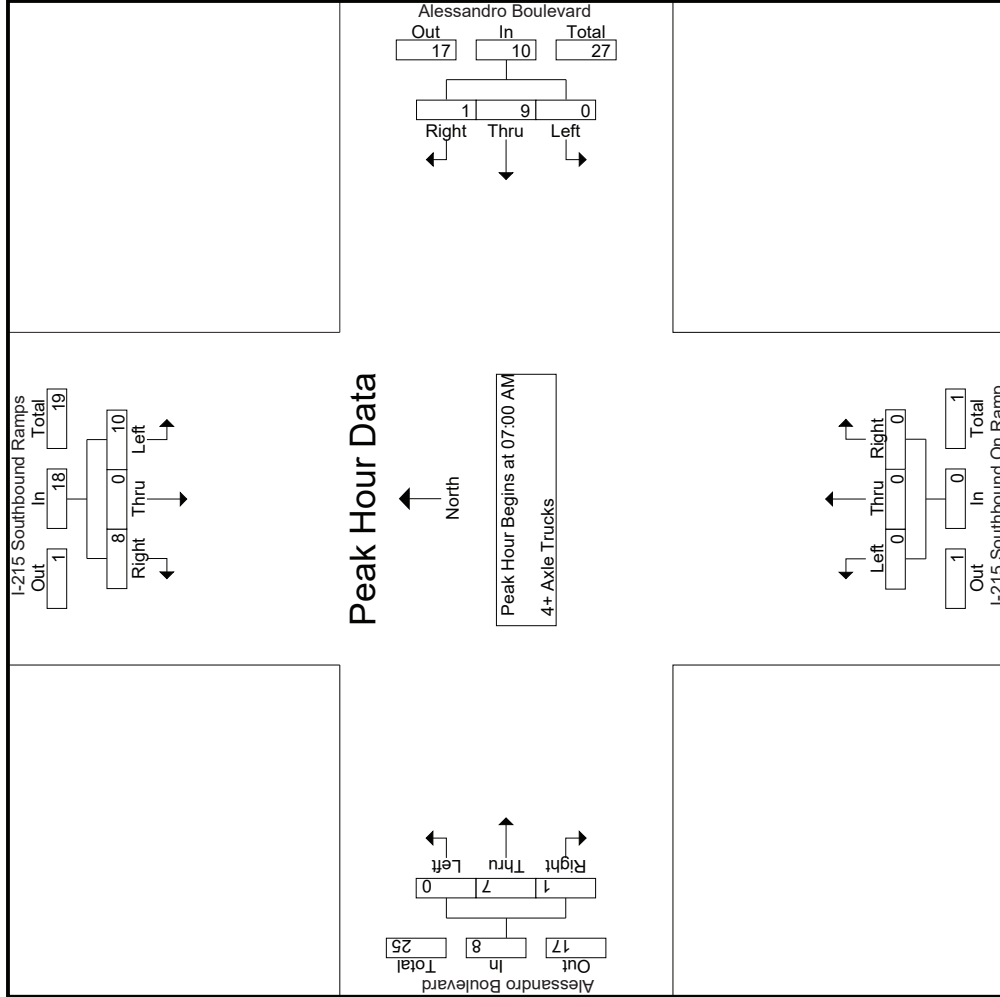

Counts Unlimited
 PO Box 1178
 Corona, CA 92878
 (951) 268-6268

City of Riverside
 N/S: I-215 Southbound Ramps
 E/W: Alessandro Boulevard
 Weather: Clear

File Name : 34_RIV_215S_Alessandro AM
 Site Code : 05119542
 Start Date : 8/20/2019
 Page No : 3

Start Time	I-215 Southbound Ramps Southbound			Alessandro Boulevard Westbound			I-215 Southbound On Ramp Northbound			Alessandro Boulevard Eastbound						
	Left	Thru	Right	Left	Thru	Right	Left	Thru	Right	Left	Thru	Right				
Peak Hour Analysis From 07:00 AM to 07:45 AM - Peak 1 of 1																
Peak Hour for Each Approach Begins at:																
+0 mins.	3	0	1	07:00 AM	0	0	3	07:00 AM	0	0	0	07:00 AM	0	2	0	
+15 mins.	1	0	4	0	0	1	2	0	0	0	0	0	3	0	0	3
+30 mins.	4	0	1	0	0	3	0	0	0	0	0	0	1	0	0	1
+45 mins.	2	0	2	0	0	2	0	0	0	0	0	0	1	0	1	2
Total Volume	10	0	8	0	0	9	10	0	0	0	0	0	7	1	1	8
% App. Total	55.6	0	44.4	0	0	90	10	0	0	0	0	0	87.5	12.5	0	66.7
PHF	.625	.000	.500	.000	.000	.750	.250	.000	.000	.000	.000	.583	.250	.000	.667	.667

		Groups Printed- Passenger Vehicles - Large 2 Axle Vehicles - 3 Axle Vehicles - 4+ Axle Trucks																				
		I-215 Southbound Ramps Southbound				Alessandro Boulevard Westbound				I-215 Southbound On Ramp Northbound				Alessandro Boulevard Eastbound								
Start Time	Left	Thru	Right	RTOR	App. Total	Left	Thru	Right	RTOR	App. Total	Left	Thru	Right	RTOR	App. Total	Exclu. Total	Inclu. Total	Int. Total				
04:00 PM	48	0	64	30	112	0	327	30	0	357	0	0	0	0	0	330	131	7	461	37	930	967
04:15 PM	64	0	54	29	118	0	294	19	0	313	0	0	0	0	0	346	92	9	438	38	869	907
04:30 PM	60	0	74	36	134	0	253	28	0	281	0	0	0	0	0	362	109	3	471	39	886	925
04:45 PM	38	0	74	37	112	0	307	21	0	328	0	0	0	0	0	328	105	4	433	41	873	914
Total	210	0	266	132	476	0	1181	98	0	1279	0	0	0	0	0	1366	437	23	1803	155	3558	3713
05:00 PM	45	0	89	39	134	0	275	17	0	292	0	0	0	0	0	426	84	3	510	42	936	978
05:15 PM	44	0	71	35	115	0	286	26	0	312	0	0	0	0	0	457	104	3	561	38	988	1026
05:30 PM	56	0	82	38	138	0	279	25	0	304	0	0	0	0	0	347	101	5	448	43	890	933
05:45 PM	50	0	69	37	119	0	218	21	0	239	0	0	0	0	0	356	89	10	445	47	803	850
Total	195	0	311	149	506	0	1058	89	0	1147	0	0	0	0	0	1586	378	21	1964	170	3617	3787
Grand Total	405	0	577	281	982	0	2239	187	0	2426	0	0	0	0	0	2952	815	44	3767	325	7175	7500
Approch %	41.2	0	58.8	0	13.7	0	31.2	2.6	0	33.8	0	0	0	0	0	41.1	21.6	0	52.5	4.3	95.7	0
Total %	348	0	553	96.4	1172	0	2209	183	0	2392	0	0	0	0	0	2899	806	100	3749	0	0	7313
% Passenger Vehicles	85.9	0	95.8	96.4	92.8	0	98.7	97.9	0	98.6	0	0	0	0	0	98.2	98.9	100	98.4	0	0	97.5
% Large 2 Axle Vehicles	6	0	9	2.1	21	0	19	3	0	22	0	0	0	0	0	30	6	0	36	0	0	79
% 3 Axle Vehicles	1.5	0	1.6	0.6	1.7	0	0.8	1.6	0	0.9	0	0	0	0	0	1	0.7	0	0.9	0	0	1.1
% 3 Axle Trucks	2	0	1	0.4	4	0	1	0	0	1	0	0	0	0	0	1	0	0	1	0	0	6
% 4+ Axle Trucks	0.5	0	0.2	0.4	0.3	0	0	0	0	0	0	0	0	0	0	0	0	0	0	0	0	0.1
% 4+ Axle Trucks	49	0	14	1.1	66	0	10	1	0	11	0	0	0	0	0	22	3	0	25	0	0	102
% 4+ Axle Trucks	12.1	0	2.4	1.1	5.2	0	0.4	0.5	0	0.5	0	0	0	0	0	0.7	0.4	0	0.7	0	0	1.4
Alessandro Boulevard																						
Westbound										Eastbound												
Start Time	Left	Thru	Right	RTOR	App. Total	Left	Thru	Right	RTOR	App. Total	Left	Thru	Right	RTOR	App. Total	Left	Thru	Right	RTOR	App. Total	Int. Total	
04:45 PM	38	0	74	0	112	0	307	21	0	328	0	0	0	0	0	0	0	0	0	0	433	873
05:00 PM	45	0	89	0	134	0	275	17	0	292	0	0	0	0	0	0	0	0	0	0	510	936
05:15 PM	44	0	71	0	115	0	286	26	0	312	0	0	0	0	0	0	0	0	0	0	561	933
05:30 PM	56	0	82	0	138	0	279	25	0	304	0	0	0	0	0	0	0	0	0	0	561	980
05:45 PM	50	0	69	0	119	0	218	21	0	239	0	0	0	0	0	0	0	0	0	0	448	890
Total Volume	183	0	316	0	499	0	1147	89	0	1236	0	0	0	0	0	0	0	0	0	0	1952	3687
% App. Total	36.7	0	63.3	0	63.3	0	92.8	7.2	0	7.2	0	0	0	0	0	0	0	0	0	0	19.52	36.87
PHF	.817	.000	.888	.904	.904	.000	.934	.856	.942	.942	.000	.000	.000	.000	.000	.000	.852	.938	.870	.870	.933	.933

Peak Hour Analysis From 04:00 PM to 05:45 PM - Peak 1 of 1

Peak Hour for Entire Intersection Begins at 04:45 PM

Counts Unlimited
 PO Box 1178
 Corona, CA 92878
 (951) 268-6268

City of Riverside
 N/S: I-215 Southbound Ramps
 E/W: Alessandro Boulevard
 Weather: Clear

File Name : 34_RIV_215S_Alessandro PM
 Site Code : 05119542
 Start Date : 8/20/2019
 Page No : 2

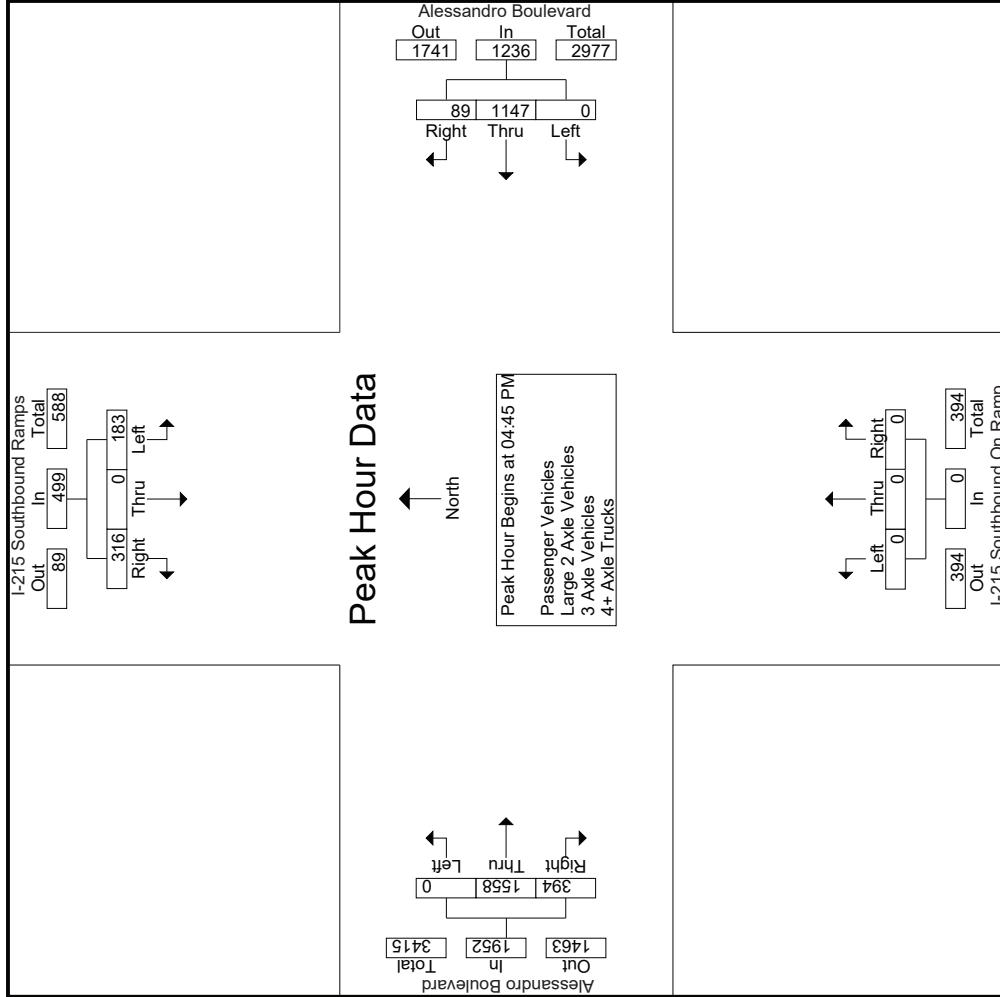

Groups Printed- Passenger Vehicles

Start Time	I-215 Southbound Ramps Southbound					Alessandro Boulevard Westbound					I-215 Southbound On Ramp Northbound					Alessandro Boulevard Eastbound							
	Left	Thru	Right	RTOR	App. Total	Left	Thru	Right	RTOR	App. Total	Left	Thru	Right	RTOR	App. Total	Left	Thru	Right	RTOR	App. Total	Exclu. Total	Inclu. Total	Int. Total
04:00 PM	42	0	62	30	104	0	319	30	0	349	0	0	0	0	0	0	326	129	7	455	37	908	945
04:15 PM	58	0	52	28	110	0	290	18	0	308	0	0	0	0	0	0	335	91	9	426	37	844	881
04:30 PM	51	0	72	35	123	0	249	28	0	277	0	0	0	0	0	0	354	107	3	461	38	861	899
04:45 PM	28	0	68	32	96	0	302	20	0	322	0	0	0	0	0	0	322	104	4	426	36	844	880
Total	179	0	254	125	433	0	1160	96	0	1256	0	0	0	0	0	0	1337	431	23	1768	148	3457	3605
05:00 PM	39	0	85	39	124	0	272	17	0	289	0	0	0	0	0	0	422	83	3	505	42	918	960
05:15 PM	37	0	69	35	106	0	285	25	0	310	0	0	0	0	0	0	446	103	3	549	38	965	1003
05:30 PM	50	0	78	36	128	0	275	24	0	299	0	0	0	0	0	0	343	100	5	443	41	870	911
05:45 PM	43	0	67	36	110	0	217	21	0	238	0	0	0	0	0	0	351	89	10	440	46	788	834
Total	169	0	299	146	468	0	1049	87	0	1136	0	0	0	0	0	0	1562	375	21	1937	167	3541	3708
Grand Total	348	0	553	271	901	0	2209	183	0	2392	0	0	0	0	0	0	2899	806	44	3705	315	6998	7313
Approch %	38.6	0	61.4			0	92.3	7.7			0	0	0			0	78.2	21.8					
Total %	5	0	7.9		12.9	0	31.6	2.6		34.2	0	0	0			0	41.4	11.5		52.9	4.3	95.7	

Start Time	I-215 Southbound Ramps Southbound					Alessandro Boulevard Westbound					I-215 Southbound On Ramp Northbound					Alessandro Boulevard Eastbound							
	Left	Thru	Right	RTOR	App. Total	Left	Thru	Right	RTOR	App. Total	Left	Thru	Right	RTOR	App. Total	Left	Thru	Right	RTOR	App. Total	Exclu. Total	Inclu. Total	Int. Total
04:45 PM	28	0	68		96	0	302	20		322	0	0	0		0	0	322	104		426			844
05:00 PM	39	0	85		124	0	272	17		289	0	0	0		0	0	422	83		505			918
05:15 PM	37	0	69		106	0	285	25		310	0	0	0		0	0	446	103		549			965
05:30 PM	50	0	78		128	0	275	24		299	0	0	0		0	0	343	100		443			870
Total Volume	154	0	300		454	0	1134	86		1220	0	0	0		0	0	1533	390		1923			3597
% App. Total	33.9	0	66.1			0	93	7			0	0	0		0	0	79.7	20.3					.932
PHF	.770	.000	.882		.887	.000	.939	.860		.947	.000	.000	.000		.000	.000	.859	.938		.876			

Peak Hour Analysis From 04:45 PM to 05:30 PM - Peak 1 of 1
 Peak Hour for Entire Intersection Begins at 04:45 PM

Counts Unlimited
 PO Box 1178
 Corona, CA 92878
 (951) 268-6268

City of Riverside
 N/S: I-215 Southbound Ramps
 E/W: Alessandro Boulevard
 Weather: Clear

File Name : 34_RIV_215S_Alessandro PM
 Site Code : 05119542
 Start Date : 8/20/2019
 Page No : 2

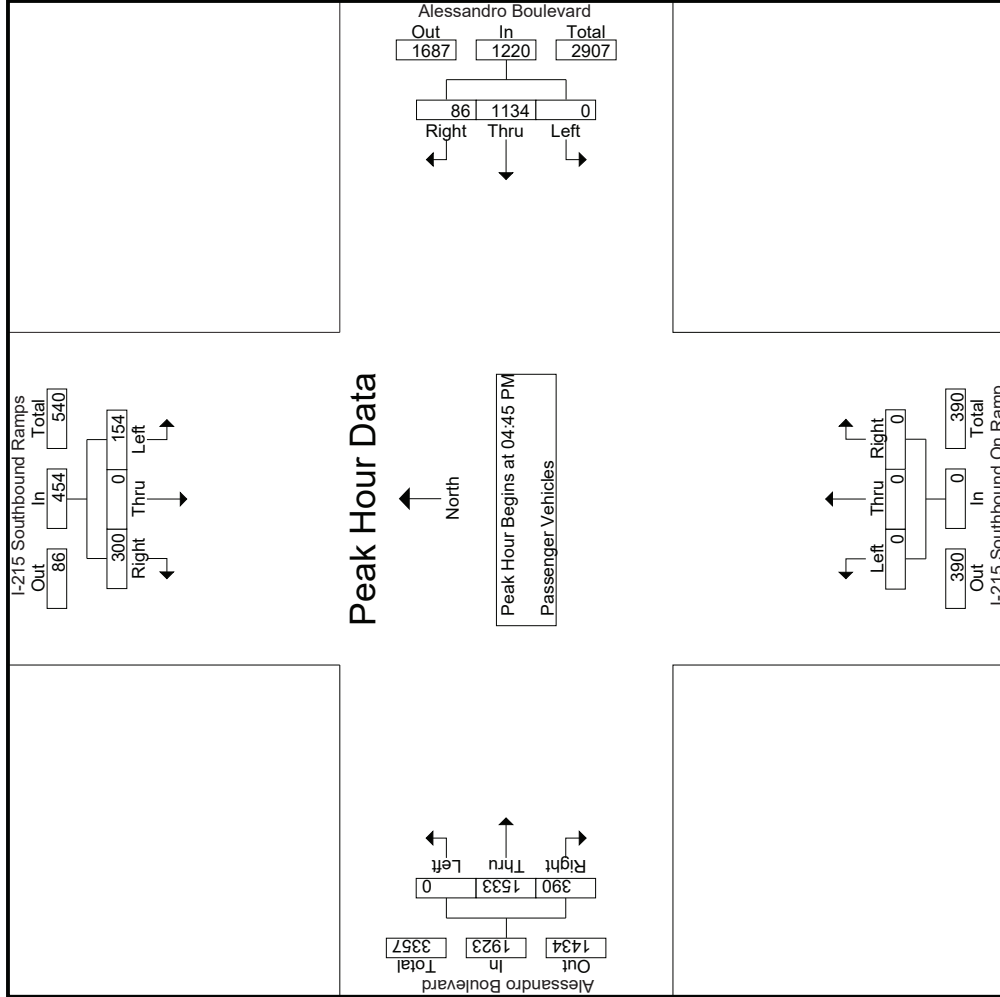

Counts Unlimited
 PO Box 1178
 Corona, CA 92878
 (951) 268-6268

City of Riverside
 N/S: I-215 Southbound Ramps
 E/W: Alessandro Boulevard
 Weather: Clear

File Name : 34_RIV_215S_Alessandro PM
 Site Code : 05119542
 Start Date : 8/20/2019
 Page No : 3

Start Time	I-215 Southbound Ramps Southbound			Alessandro Boulevard Westbound			I-215 Southbound On Ramp Northbound			Alessandro Boulevard Eastbound					
	Left	Thru	Right	Left	Thru	Right	Left	Thru	Right	Left	Thru	Right			
Peak Hour Analysis From 04:45 PM to 05:30 PM - Peak 1 of 1															
Peak Hour for Each Approach Begins at:	04:45 PM			04:45 PM			04:45 PM			04:45 PM					
+0 mins.	28	0	68	0	302	20	0	322	0	0	0	0	322	104	426
+15 mins.	39	0	85	0	272	17	0	289	0	0	0	0	422	83	505
+30 mins.	37	0	69	0	285	25	0	310	0	0	0	0	446	103	549
+45 mins.	50	0	78	0	275	24	0	299	0	0	0	0	343	100	443
Total Volume	154	0	300	0	1134	86	0	1220	0	0	0	0	1533	390	1923
% App. Total	33.9	0	66.1	0	93	7	0	947	0	0	0	0	79.7	20.3	87.6
PHF	.770	.000	.882	.000	.939	.860	.000	.947	.000	.000	.000	.000	.859	.938	.876

Groups Printed- Large 2 Axle Vehicles

Start Time	I-215 Southbound Ramps Southbound				Alessandro Boulevard Westbound				I-215 Southbound On Ramp Northbound				Alessandro Boulevard Eastbound						
	Left	Thru	Right	RTOR	App. Total	Left	Thru	Right	RTOR	App. Total	Left	Thru	Right	RTOR	App. Total	Exclu. Total	Inclu. Total	Int. Total	
04:00 PM	0	0	1	0	1	0	4	0	0	4	0	0	0	0	0	0	0	9	9
04:15 PM	0	0	0	0	0	0	3	1	0	4	0	0	0	0	5	0	0	9	9
04:30 PM	0	0	0	0	0	0	4	0	0	4	0	0	0	0	6	0	0	10	10
04:45 PM	2	0	5	4	7	0	3	0	0	3	0	0	0	0	5	4	15	19	19
Total	2	0	6	4	8	0	14	1	0	15	0	0	0	0	20	4	43	47	47
05:00 PM	1	0	0	0	1	0	2	0	0	2	0	0	0	0	4	0	7	7	7
05:15 PM	0	0	1	0	1	0	1	1	0	2	0	0	0	0	8	0	11	11	11
05:30 PM	2	0	1	1	3	0	2	1	0	3	0	0	0	0	1	1	7	8	8
05:45 PM	1	0	1	1	2	0	0	0	0	0	0	0	0	0	3	1	5	6	6
Total	4	0	3	2	7	0	5	2	0	7	0	0	0	0	16	2	30	32	32
Grand Total	6	0	9	6	15	0	19	3	0	22	0	0	0	0	36	6	73	79	79
Approch %	40	0	60			0	86.4	13.6			0	0	0						
Total %	8.2	0	12.3		20.5	0	26	4.1		30.1	0	0	0		49.3	7.6	92.4		

Start Time	I-215 Southbound Ramps Southbound				Alessandro Boulevard Westbound				I-215 Southbound On Ramp Northbound				Alessandro Boulevard Eastbound						
	Left	Thru	Right	RTOR	App. Total	Left	Thru	Right	RTOR	App. Total	Left	Thru	Right	RTOR	App. Total	Exclu. Total	Inclu. Total	Int. Total	
04:45 PM	2	0	0	5	7	0	0	0	0	0	0	0	0	0	0	0	0	5	15
05:00 PM	1	0	0	0	1	0	2	0	0	2	0	0	0	0	3	1	4	7	7
05:15 PM	0	0	0	1	1	0	0	1	0	1	0	0	0	0	1	0	8	11	11
05:30 PM	2	0	1	1	3	0	0	2	0	2	0	0	0	0	1	1	7	11	11
Total Volume	5	0	7	7	12	0	8	2	0	10	0	0	0	0	15	3	18	40	40
% App. Total	41.7	0	58.3			0	80	20		83.3	0	0	0		16.7				
PHF	.625	.000	.350		.429	.000	.667	.500		.833	.000	.000	.000		.536	.750	.563		.667

Counts Unlimited
 PO Box 1178
 Corona, CA 92878
 (951) 268-6268

City of Riverside
 N/S: I-215 Southbound Ramps
 E/W: Alessandro Boulevard
 Weather: Clear

File Name : 34_RIV_215S_Alessandro PM
 Site Code : 05119542
 Start Date : 8/20/2019
 Page No : 2

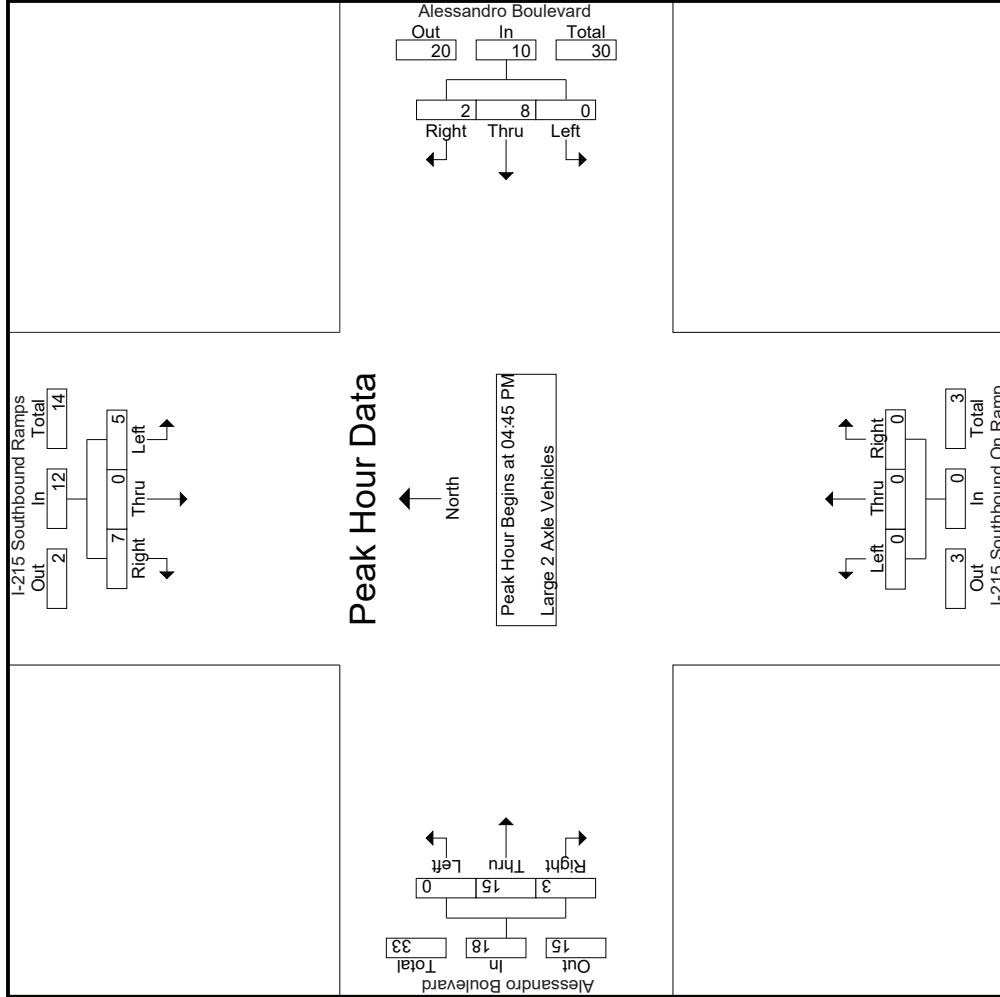

Counts Unlimited
 PO Box 1178
 Corona, CA 92878
 (951) 268-6268

City of Riverside
 N/S: I-215 Southbound Ramps
 E/W: Alessandro Boulevard
 Weather: Clear

File Name : 34_RIV_215S_Alessandro PM
 Site Code : 05119542
 Start Date : 8/20/2019
 Page No : 3

Start Time	I-215 Southbound Ramps Southbound			Alessandro Boulevard Westbound			I-215 Southbound On Ramp Northbound			Alessandro Boulevard Eastbound					
	Left	Thru	Right	Left	Thru	Right	Left	Thru	Right	Left	Thru	Right			
Peak Hour Analysis From 04:45 PM to 05:30 PM - Peak 1 of 1															
Peak Hour for Each Approach Begins at:															
+0 mins.	2	0	5	04:45 PM	0	0	3	04:45 PM	0	0	0	04:45 PM	0	4	1
+15 mins.	1	0	0	04:45 PM	0	0	2	04:45 PM	0	0	0	04:45 PM	0	3	1
+30 mins.	0	0	1	04:45 PM	0	1	1	04:45 PM	0	0	0	04:45 PM	0	7	1
+45 mins.	2	0	1	04:45 PM	0	2	1	04:45 PM	0	0	0	04:45 PM	0	1	0
Total Volume	5	0	7	04:45 PM	0	8	2	04:45 PM	0	0	0	04:45 PM	0	15	3
% App. Total	41.7	0	58.3	04:45 PM	0	80	20	04:45 PM	0	0	0	04:45 PM	0	83.3	16.7
PHF	.625	.000	.350	04:45 PM	.000	.667	.500	04:45 PM	.000	.000	.000	04:45 PM	.000	.536	.750

Groups Printed- 3 Axle Vehicles

Start Time	I-215 Southbound Ramps Southbound				Alessandro Boulevard Westbound				I-215 Southbound On Ramp Northbound				Alessandro Boulevard Eastbound					
	Left	Thru	Right	RTOR	App. Total	Left	Thru	Right	RTOR	App. Total	Left	Thru	Right	RTOR	App. Total	Exclu. Total	Inclu. Total	Int. Total
04:00 PM	0	0	0	0	0	0	0	0	0	0	0	0	0	0	0	0	0	0
04:15 PM	0	0	1	1	1	0	0	0	0	0	0	0	0	0	0	1	1	2
04:30 PM	1	0	0	0	1	0	0	0	0	0	0	0	0	0	0	0	1	1
04:45 PM	1	0	0	0	1	0	0	0	0	0	0	0	0	0	0	0	1	1
Total	2	0	1	1	3	0	0	0	0	0	0	0	0	0	0	1	3	4
05:00 PM	0	0	0	0	0	0	0	0	0	0	0	0	0	0	0	0	0	0
05:15 PM	0	0	0	0	0	0	0	0	0	0	0	0	0	0	0	0	0	0
05:30 PM	0	0	0	0	0	0	0	0	0	0	0	0	0	0	0	0	0	0
05:45 PM	0	0	0	0	0	0	1	0	0	1	0	0	0	0	0	0	1	1
Total	0	0	0	0	0	0	1	0	0	1	0	0	0	0	0	0	2	2
Grand Total	2	0	1	1	3	0	1	0	0	1	0	0	0	0	1	1	5	6
Approch %	66.7	0	33.3			0	100	0		20	0	0	0		20	16.7	83.3	
Total %	40	0	20		60	0	20	0		20	0	0	0		20			

3:1-421

Start Time	I-215 Southbound Ramps Southbound				Alessandro Boulevard Westbound				I-215 Southbound On Ramp Northbound				Alessandro Boulevard Eastbound					
	Left	Thru	Right	RTOR	App. Total	Left	Thru	Right	RTOR	App. Total	Left	Thru	Right	RTOR	App. Total	Exclu. Total	Inclu. Total	Int. Total
04:45 PM	1	0	0	0	1	0	0	0	0	0	0	0	0	0	0	0	0	1
05:00 PM	0	0	0	0	0	0	0	0	0	0	0	0	0	0	0	0	0	0
05:15 PM	0	0	0	0	0	0	0	0	0	0	0	0	0	0	0	0	0	0
05:30 PM	0	0	0	0	0	0	0	0	0	0	0	0	0	0	0	0	0	0
Total Volume	1	0	0	0	1	0	0	0	0	0	0	0	0	0	1	0	1	2
% App. Total	100	0	0			0	0	0		0	0	0	0		100	0	0	
PHF	.250	.000	.000		.250	.000	.000	.000		.000	.000	.000	.000		.250	.000	.250	.500

Peak Hour Analysis From 04:45 PM to 05:30 PM - Peak 1 of 1
 Peak Hour for Entire Intersection Begins at 04:45 PM

Counts Unlimited
 PO Box 1178
 Corona, CA 92878
 (951) 268-6268

City of Riverside
 N/S: I-215 Southbound Ramps
 E/W: Alessandro Boulevard
 Weather: Clear

File Name : 34_RIV_215S_Alessandro PM
 Site Code : 05119542
 Start Date : 8/20/2019
 Page No : 2

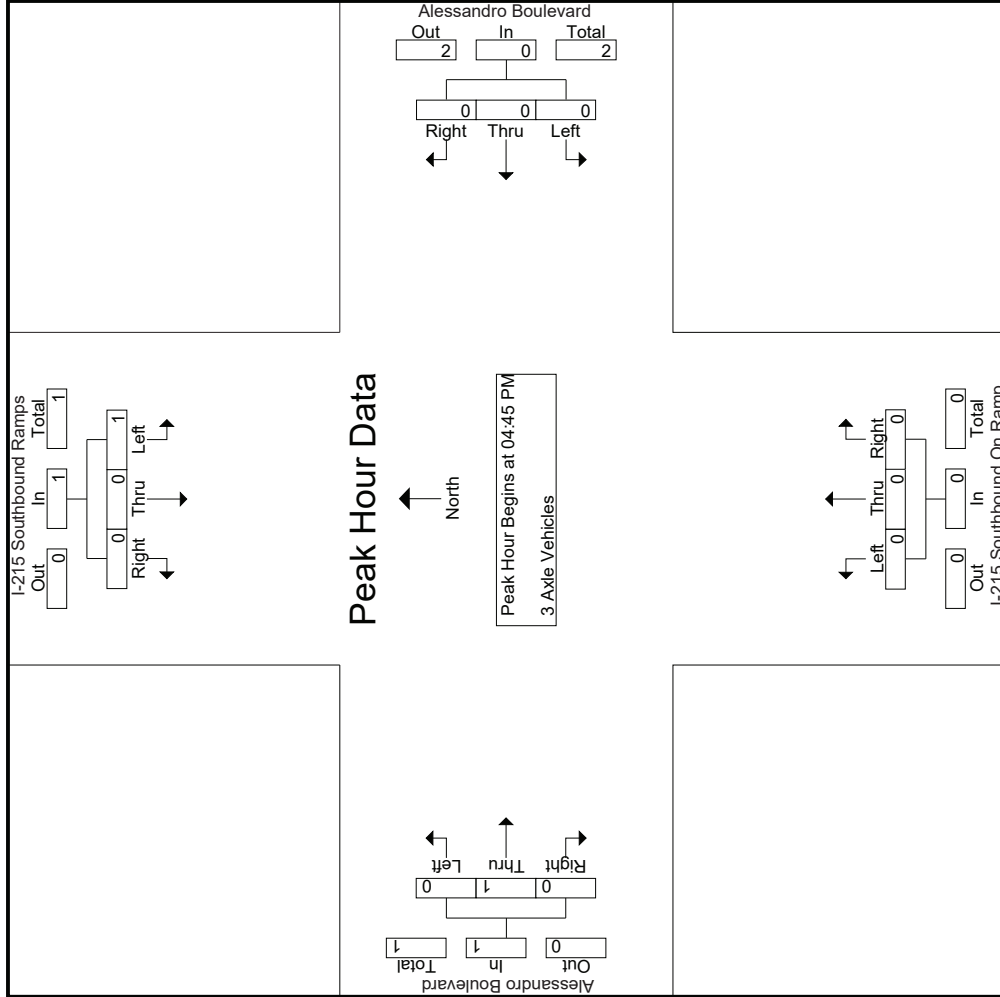

Groups Printed- 4+ Axle Trucks

Start Time	I-215 Southbound Ramps Southbound				Alessandro Boulevard Westbound				I-215 Southbound On Ramp Northbound				Alessandro Boulevard Eastbound						
	Left	Thru	Right	RTOR	App. Total	Left	Thru	Right	RTOR	App. Total	Left	Thru	Right	RTOR	App. Total	Exclu. Total	Inclu. Total	Int. Total	
04:00 PM	6	0	1	0	7	0	4	0	0	4	0	0	0	0	0	2	0	13	13
04:15 PM	6	0	1	0	7	0	1	0	0	0	0	0	0	0	7	0	15	15	
04:30 PM	8	0	2	1	10	0	0	0	0	0	0	0	0	0	4	1	14	15	
04:45 PM	7	0	1	1	8	0	2	1	0	3	0	0	0	0	2	1	13	14	
Total	27	0	5	2	32	0	7	1	0	8	0	0	0	0	15	2	55	57	
05:00 PM	5	0	4	0	9	0	1	0	0	1	0	0	0	0	1	0	11	11	
05:15 PM	7	0	1	0	8	0	0	0	0	0	0	0	0	0	4	0	12	12	
05:30 PM	4	0	3	1	7	0	2	0	0	2	0	0	1	0	3	1	12	13	
05:45 PM	6	0	1	0	7	0	0	0	0	0	0	0	0	0	2	0	9	9	
Total	22	0	9	1	31	0	3	0	0	3	0	0	0	0	10	1	44	45	
Grand Total	49	0	14	3	63	0	10	1	0	11	0	0	0	0	25	3	99	102	
Approch %	77.8	0	22.2			0	90.9	9.1			0	0	0		25.3	2.9	97.1		
Total %	49.5	0	14.1		63.6	0	10.1	1		11.1	0	0	0						

3:1-424

Start Time	I-215 Southbound Ramps Southbound				Alessandro Boulevard Westbound				I-215 Southbound On Ramp Northbound				Alessandro Boulevard Eastbound					
	Left	Thru	Right	RTOR	App. Total	Left	Thru	Right	RTOR	App. Total	Left	Thru	Right	RTOR	App. Total	Exclu. Total	Inclu. Total	Int. Total
04:45 PM	7	0	1	0	8	0	2	1	0	3	0	0	0	0	2	0	2	13
05:00 PM	5	0	4	0	9	0	1	0	0	1	0	0	0	0	1	0	11	11
05:15 PM	7	0	1	0	8	0	0	0	0	0	0	0	0	0	4	0	12	12
05:30 PM	4	0	3	1	7	0	2	0	0	2	0	0	1	0	3	1	12	13
05:45 PM	6	0	1	0	7	0	0	0	0	0	0	0	0	0	2	0	9	9
Total	23	0	9	0	32	0	5	1	0	6	0	0	0	0	9	1	48	48
% App. Total	71.9	0	28.1			0	83.3	16.7			0	0	0		10	10		
PHF	.821	.000	.563		.889	.000	.625	.250		.500	.000	.000	.000		.563	.250	.625	.923

Peak Hour Analysis From 04:45 PM to 05:30 PM - Peak 1 of 1
 Peak Hour for Entire Intersection Begins at 04:45 PM

Counts Unlimited
 PO Box 1178
 Corona, CA 92878
 (951) 268-6268

City of Riverside
 N/S: I-215 Southbound Ramps
 E/W: Alessandro Boulevard
 Weather: Clear

File Name : 34_RIV_215S_Alessandro PM
 Site Code : 05119542
 Start Date : 8/20/2019
 Page No : 2

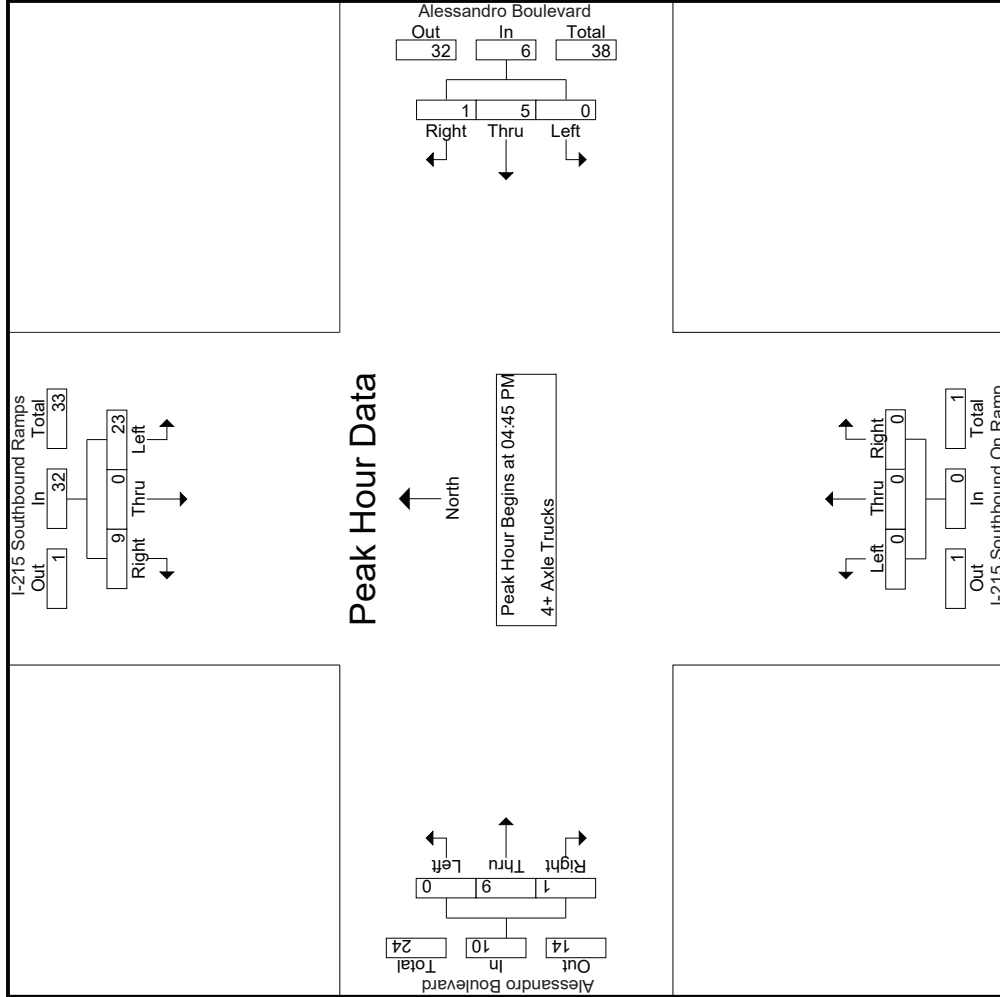

Location: Riverside
 N/S: I-215 Southbound Ramps
 E/W: Alessandro Boulevard



Date: 8/20/2019
 Day: Tuesday

PEDESTRIANS

	North Leg I-215 Southbound Ramps	East Leg Alessandro Boulevard	South Leg I-215 Southbound Ramps	West Leg Alessandro Boulevard	
	Pedestrians	Pedestrians	Pedestrians	Pedestrians	
7:00 AM	0	0	0	0	0
7:15 AM	0	0	0	0	0
7:30 AM	0	0	0	0	0
7:45 AM	0	0	0	0	0
8:00 AM	0	0	0	0	0
8:15 AM	0	0	0	0	0
8:30 AM	0	0	0	0	0
8:45 AM	0	0	0	0	0
TOTAL VOLUMES:	0	0	0	0	0

	North Leg I-215 Southbound Ramps	East Leg Alessandro Boulevard	South Leg I-215 Southbound Ramps	West Leg Alessandro Boulevard	
	Pedestrians	Pedestrians	Pedestrians	Pedestrians	
4:00 PM	0	0	0	0	0
4:15 PM	0	0	0	0	0
4:30 PM	0	0	0	0	0
4:45 PM	0	0	0	0	0
5:00 PM	0	0	0	0	0
5:15 PM	0	0	0	0	0
5:30 PM	0	0	0	0	0
5:45 PM	0	0	0	0	0
TOTAL VOLUMES:	0	0	0	0	0

Location: Riverside
 N/S: I-215 Southbound Ramps
 E/W: Alessandro Boulevard



Date: 8/20/2019
 Day: Tuesday

BICYCLES

	Southbound I-215 Southbound Ramps			Westbound Alessandro Boulevard			Northbound I-215 Southbound Ramps			Eastbound Alessandro Boulevard			
	Left	Thru	Right	Left	Thru	Right	Left	Thru	Right	Left	Thru	Right	
7:00 AM	0	0	0	0	0	0	0	0	0	0	2	0	2
7:15 AM	0	0	0	0	0	0	0	0	0	0	0	0	0
7:30 AM	0	0	0	0	0	0	0	0	0	0	0	0	0
7:45 AM	0	0	0	0	0	0	0	0	0	0	0	0	0
8:00 AM	0	0	0	0	2	0	0	0	0	0	0	0	2
8:15 AM	0	0	0	0	1	0	0	0	0	0	0	0	1
8:30 AM	0	0	0	0	0	0	0	0	0	0	0	0	0
8:45 AM	0	0	0	0	0	0	0	0	0	0	0	0	0
TOTAL VOLUMES:	0	0	0	0	3	0	0	0	0	0	2	0	5

	Southbound I-215 Southbound Ramps			Westbound Alessandro Boulevard			Northbound I-215 Southbound Ramps			Eastbound Alessandro Boulevard			
	Left	Thru	Right	Left	Thru	Right	Left	Thru	Right	Left	Thru	Right	
4:00 PM	0	0	0	0	0	0	0	0	0	0	0	0	0
4:15 PM	0	0	0	0	0	0	0	0	0	0	0	0	0
4:30 PM	0	0	0	0	0	0	0	0	0	0	0	0	0
4:45 PM	0	0	0	0	0	0	0	0	0	0	0	0	0
5:00 PM	0	0	0	0	0	0	0	0	0	0	0	0	0
5:15 PM	0	0	0	0	0	0	0	0	0	0	0	0	0
5:30 PM	0	0	0	0	0	0	0	0	0	0	0	0	0
5:45 PM	0	0	0	0	1	0	0	0	0	0	0	0	1
TOTAL VOLUMES:	0	0	0	0	1	0	0	0	0	0	0	0	1

Counts Unlimited
 PO Box 1178
 Corona, CA 92878
 (951) 268-6268

City of Moreno Valley
 N/S: I-215 Northbound Ramps
 EW: Alessandro Boulevard
 Weather: Clear

File Name : 37_MR_V_215N_Alessandro AM
 Site Code : 05119542
 Start Date : 8/20/2019
 Page No : 1

Groups Printed- Passenger Vehicles - Large 2 Axle Vehicles - 3 Axle Vehicles - 4+ Axle Trucks

Start Time	Alessandro Boulevard Westbound										Alessandro Boulevard Eastbound												
	I-215 Northbound On Ramp Southbound					Alessandro Boulevard Westbound					I-215 Northbound Off Ramp Northbound					Alessandro Boulevard Eastbound							
	Left	Thru	Right	RTOR	App. Total	Left	Thru	Right	RTOR	App. Total	Left	Thru	Right	RTOR	App. Total	Left	Thru	Right	RTOR	App. Total	Exclu. Total	Inclu. Total	Int. Total
07:00 AM	0	0	0	0	0	0	440	18	9	458	210	1	13	9	224	8	142	0	0	150	18	832	850
07:15 AM	0	0	0	0	0	0	432	18	5	450	173	0	30	15	203	4	203	0	0	207	20	860	880
07:30 AM	0	0	0	0	0	0	394	16	1	410	195	1	27	18	223	8	205	0	0	213	19	846	865
07:45 AM	0	0	0	0	0	0	396	18	8	414	177	0	50	24	227	11	206	0	0	217	32	858	890
Total	0	0	0	0	0	0	1662	70	23	1732	755	2	120	66	877	31	756	0	0	787	89	3396	3485
08:00 AM	0	0	0	0	0	0	365	22	3	387	214	0	46	23	260	7	194	0	0	201	26	848	874
08:15 AM	0	0	0	0	0	0	381	16	5	397	181	0	68	40	249	13	177	0	0	190	45	836	881
08:30 AM	0	0	0	0	0	0	322	21	2	343	168	1	73	47	242	10	198	0	0	208	49	793	842
08:45 AM	0	0	0	0	0	0	251	31	8	282	196	2	108	47	306	9	202	0	0	211	55	799	854
Total	0	0	0	0	0	0	1319	90	18	1409	759	3	295	157	1057	39	771	0	0	810	175	3276	3451
Grand Total	0	0	0	0	0	0	2981	160	41	3141	1514	5	415	223	1934	70	1527	0	0	1597	264	6672	6936
Approch %	0	0	0	0	0	0	94.9	5.1	0	78.3	0.3	21.5	0	0	4.4	95.6	0	0	23.9	3.8	96.2	0	0
Total %	0	0	0	0	0	0	44.7	2.4	0	47.1	22.7	0.1	6.2	29	1	22.9	0	0	23.9	3.8	96.2	0	0
% Passenger Vehicles	0	0	0	0	0	0	2912	117	82.9	3063	1471	3	399	96	2087	56	1447	0	0	1503	0	0	6653
% Large 2 Axle Vehicles	0	0	0	0	0	0	97.7	73.1	82.9	96.3	97.2	60	96.1	96	96.8	80	94.8	0	0	94.1	0	0	95.9
% Large 3 Axle Vehicles	0	0	0	0	0	0	1.6	6.9	2.4	1.9	1.7	0	2.4	2.2	1.9	3	3.4	0	0	3.7	0	0	1.38
% 3 Axle Vehicles	0	0	0	0	0	0	7	7	14	14	3	0	1	5	1	19	0	0	20	0	0	39	
% 4+ Axle Trucks	0	0	0	0	0	0	0.2	4.4	0	0.4	0.2	0	0.2	0.4	0.2	1.4	1.2	0	0	1.3	0	0	0.6
% 4+ Axle Trucks	0	0	0	0	0	0	14	25	45	14	2	5	24	24	10	27	0	0	37	0	0	106	
% 4+ Axle Trucks	0	0	0	0	0	0	0.5	15.6	14.6	1.4	0.9	40	1.2	1.3	1.1	14.3	1.8	0	0	2.3	0	0	1.5

Start Time	Alessandro Boulevard Westbound										Alessandro Boulevard Eastbound												
	I-215 Northbound On Ramp Southbound					Alessandro Boulevard Westbound					I-215 Northbound Off Ramp Northbound					Alessandro Boulevard Eastbound							
	Left	Thru	Right	RTOR	App. Total	Left	Thru	Right	RTOR	App. Total	Left	Thru	Right	RTOR	App. Total	Left	Thru	Right	RTOR	App. Total	Exclu. Total	Inclu. Total	Int. Total
07:15 AM	0	0	0	0	0	0	0	0	0	0	173	0	30	0	203	4	203	0	0	207	0	207	860
07:30 AM	0	0	0	0	0	0	394	16	5	410	195	1	27	18	223	8	205	0	0	213	0	213	846
07:45 AM	0	0	0	0	0	0	396	18	8	414	177	0	50	24	227	11	206	0	0	217	0	217	858
08:00 AM	0	0	0	0	0	0	365	22	3	387	214	0	46	23	260	7	194	0	0	201	0	201	874
Total Volume	0	0	0	0	0	0	1587	74	1661	1661	759	1	153	913	30	808	0	0	838	0	838	3412	
% App. Total	0	0	0	0	0	0	95.5	4.5	0	95.5	83.1	0.1	16.8	0	96.4	3.6	96.4	0	0	96.4	0	96.4	992
PHF	.000	.000	.000	.000	.000	.000	.918	.841	.923	.923	.887	.250	.765	.878	.878	.981	.000	.000	.965	.000	.965	.992	.992

Peak Hour Analysis From 07:00 AM to 08:45 AM - Peak 1 of 1
 Peak Hour for Entire Intersection Begins at 07:15 AM

Counts Unlimited
 PO Box 1178
 Corona, CA 92878
 (951) 268-6268

City of Moreno Valley
 N/S: I-215 Northbound Ramps
 E/W: Alessandro Boulevard
 Weather: Clear

File Name : 37_MRV_215N_Alessandro AM
 Site Code : 05119542
 Start Date : 8/20/2019
 Page No : 2

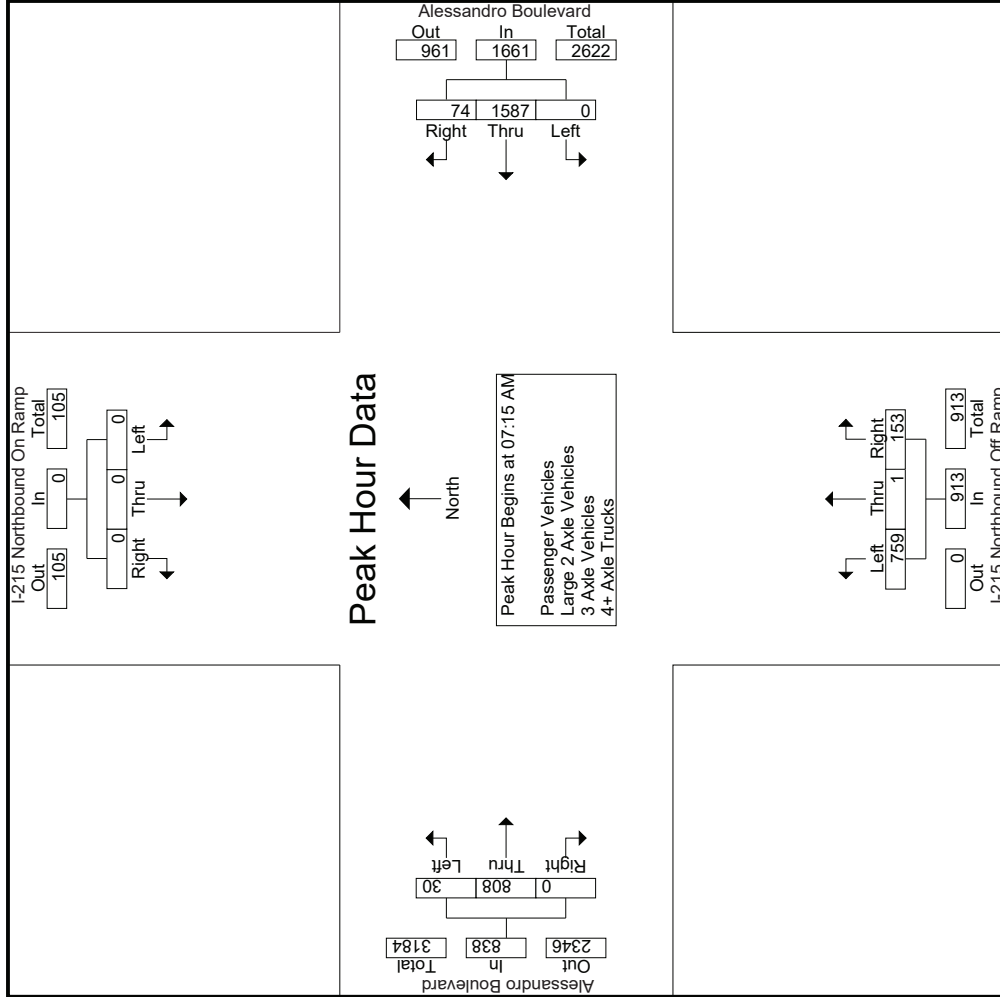

Counts Unlimited
 PO Box 1178
 Corona, CA 92878
 (951) 268-6268

City of Moreno Valley
 N/S: I-215 Northbound Ramps
 E/W: Alessandro Boulevard
 Weather: Clear

File Name : 37_MRV_215N_Alessandro AM
 Site Code : 05119542
 Start Date : 8/20/2019
 Page No : 3

Start Time	I-215 Northbound On Ramp Southbound			Alessandro Boulevard Westbound			I-215 Northbound Off Ramp Northbound			Alessandro Boulevard Eastbound		
	Left	Thru	Right	Left	Thru	Right	Left	Thru	Right	Left	Thru	Right
Peak Hour Analysis From 07:00 AM to 08:45 AM - Peak 1 of 1	Peak Hour for Each Approach Begins at:											
	07:00 AM			07:00 AM			08:00 AM			07:15 AM		
+0 mins.	0	0	0	0	0	18	458	0	46	0	203	0
+15 mins.	0	0	0	0	0	18	450	0	68	0	205	0
+30 mins.	0	0	0	0	0	16	410	1	73	0	206	0
+45 mins.	0	0	0	0	0	18	414	2	108	0	194	0
Total Volume	0	0	0	0	0	70	1732	3	295	0	808	0
% App. Total	0.000	0.000	0.000	0.000	0.000	.944	.945	0.375	.683	0.000	.981	0.000
PHF	.965											

Counts Unlimited
 PO Box 1178
 Corona, CA 92878
 (951) 268-6268

City of Moreno Valley
 N/S: I-215 Northbound Ramps
 EW: Alessandro Boulevard
 Weather: Clear

File Name : 37_MRV_215N_Alessandro AM
 Site Code : 05119542
 Start Date : 8/20/2019
 Page No : 1

Groups Printed- Passenger Vehicles

Start Time	I-215 Northbound On Ramp Southbound					Alessandro Boulevard Westbound					I-215 Northbound Off Ramp Northbound					Alessandro Boulevard Eastbound							
	Left	Thru	Right	RTOR	App. Total	Left	Thru	Right	RTOR	App. Total	Left	Thru	Right	RTOR	App. Total	Left	Thru	Right	RTOR	App. Total	Exclu. Total	Inclu. Total	Int. Total
07:00 AM	0	0	0	0	0	0	433	10	7	443	204	1	13	9	218	5	136	0	0	141	16	802	818
07:15 AM	0	0	0	0	0	0	419	15	4	434	170	0	29	14	199	3	195	0	0	198	18	831	849
07:30 AM	0	0	0	0	0	0	388	13	1	401	190	0	25	17	215	7	191	0	0	198	18	814	832
07:45 AM	0	0	0	0	0	0	392	10	6	402	171	0	50	24	221	9	198	0	0	207	30	830	860
Total	0	0	0	0	0	0	1632	48	18	1680	735	1	117	64	853	24	720	0	0	744	82	3277	3359
08:00 AM	0	0	0	0	0	0	358	18	3	376	210	0	45	23	255	5	185	0	0	190	26	821	847
08:15 AM	0	0	0	0	0	0	371	14	5	385	174	0	67	39	241	11	165	0	0	176	44	802	846
08:30 AM	0	0	0	0	0	0	311	15	2	326	167	1	68	43	236	8	188	0	0	196	45	758	803
08:45 AM	0	0	0	0	0	0	240	22	6	262	185	1	102	45	288	8	189	0	0	197	51	747	798
Total	0	0	0	0	0	0	1280	69	16	1349	736	2	282	150	1020	32	727	0	0	759	166	3128	3294
Grand Total	0	0	0	0	0	0	2912	117	34	3029	1471	3	399	214	1873	56	1447	0	0	1503	248	6405	6653
Apprch %	0	0	0	0	0	0	96.1	3.9		47.3	78.5	0.2	21.3		29.2	3.7	96.3	0	0	23.5	3.7	96.3	
Total %	0	0	0	0	0	0	45.5	1.8			23	0	6.2			0.9	22.6	0	0				96.3

3.1-432

Start Time	I-215 Northbound On Ramp Southbound					Alessandro Boulevard Westbound					I-215 Northbound Off Ramp Northbound					Alessandro Boulevard Eastbound							
	Left	Thru	Right	RTOR	App. Total	Left	Thru	Right	RTOR	App. Total	Left	Thru	Right	RTOR	App. Total	Left	Thru	Right	RTOR	App. Total	Exclu. Total	Inclu. Total	Int. Total
07:15 AM	0	0	0	0	0	0	419	15		434	170	0	29		199	3	195	0		198			831
07:30 AM	0	0	0	0	0	0	388	13		401	190	0	25		215	7	191	0		198			814
07:45 AM	0	0	0	0	0	0	392	10		402	171	0	50		221	9	198	0		207			830
08:00 AM	0	0	0	0	0	0	358	18		376	210	0	45		255	5	185	0		190			847
Total Volume	0	0	0	0	0	0	1557	56		1613	741	0	149		890	24	769	0		793			3296
% App. Total	0	0	0	0	0	0	96.5	3.5		47.3	83.3	0	16.7		29.2	3	97	0		23.5	3.7	96.3	
PHF	.000	.000	.000	.000	.000	.000	.929	.778		.929	.882	.000	.745		.873	.667	.971	.000		.958			.992

Peak Hour Analysis From 07:15 AM to 08:00 AM - Peak 1 of 1
 Peak Hour for Entire Intersection Begins at 07:15 AM

Counts Unlimited
 PO Box 1178
 Corona, CA 92878
 (951) 268-6268

City of Moreno Valley
 N/S: I-215 Northbound Ramps
 E/W: Alessandro Boulevard
 Weather: Clear

File Name : 37_MRV_215N_Alessandro AM
 Site Code : 05119542
 Start Date : 8/20/2019
 Page No : 2

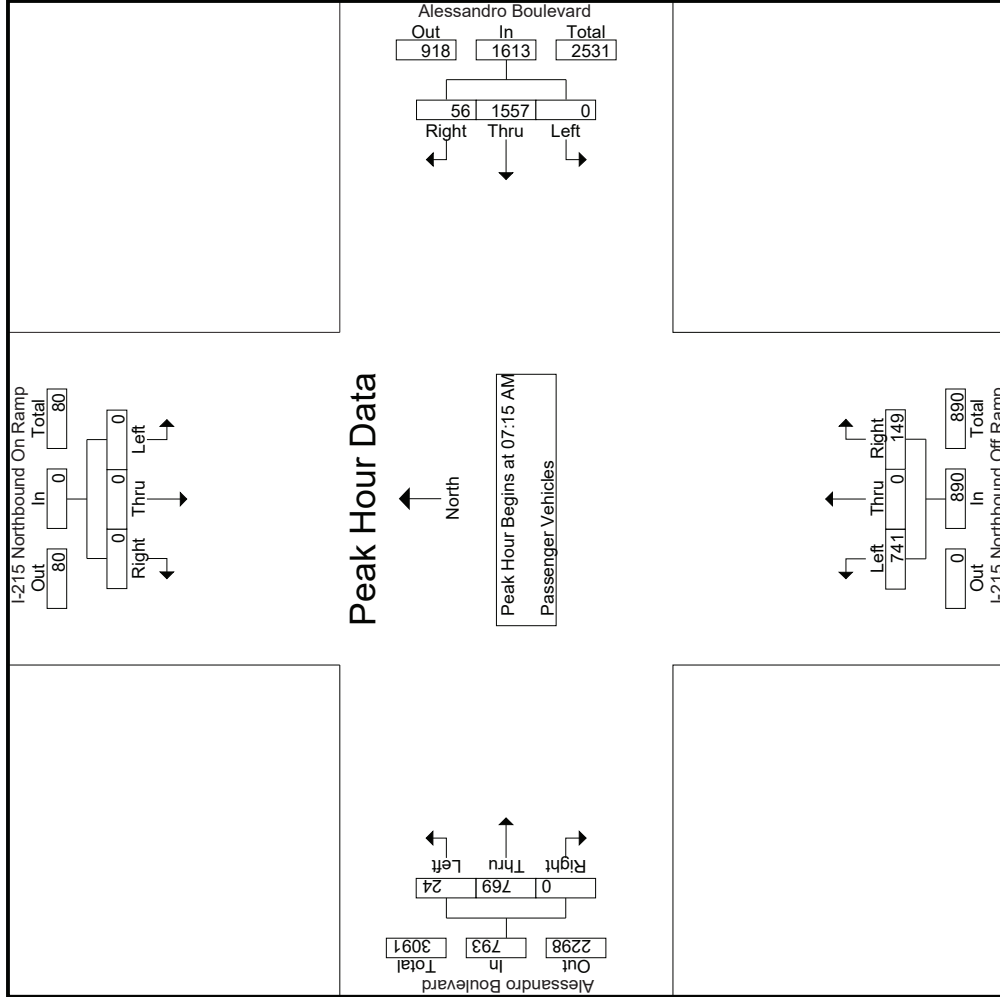

Counts Unlimited
 PO Box 1178
 Corona, CA 92878
 (951) 268-6268

City of Moreno Valley
 N/S: I-215 Northbound Ramps
 E/W: Alessandro Boulevard
 Weather: Clear

File Name : 37_MRV_215N_Alessandro AM
 Site Code : 05119542
 Start Date : 8/20/2019
 Page No : 3

Start Time	I-215 Northbound On Ramp Southbound			Alessandro Boulevard Westbound			I-215 Northbound Off Ramp Northbound			Alessandro Boulevard Eastbound					
	Left	Thru	Right	Left	Thru	Right	Left	Thru	Right	Left	Thru	Right			
Peak Hour Analysis From 07:15 AM to 08:00 AM - Peak 1 of 1	Peak Hour for Each Approach Begins at:														
	07:15 AM			07:15 AM			07:15 AM			07:15 AM					
+0 mins.	0	0	0	0	0	15	434	170	0	29	199	3	195	0	198
+15 mins.	0	0	0	0	0	13	401	190	0	25	215	7	191	0	198
+30 mins.	0	0	0	0	0	10	402	171	0	50	221	9	198	0	207
+45 mins.	0	0	0	0	0	18	376	210	0	45	255	5	185	0	190
Total Volume	0	0	0	0	0	56	1613	741	0	149	890	24	769	0	793
% App. Total	0	0	0	0	0	3.5	96.5	83.3	0	16.7	87.3	3	97	0	958
PHF	.000	.000	.000	.000	.000	.778	.929	.882	.000	.745	.873	.667	.971	.000	.958

Counts Unlimited
 PO Box 1178
 Corona, CA 92878
 (951) 268-6268

City of Moreno Valley
 N/S: I-215 Northbound Ramps
 E/W: Alessandro Boulevard
 Weather: Clear

File Name : 37_MRV_215N_Alessandro AM
 Site Code : 05119542
 Start Date : 8/20/2019
 Page No : 1

Groups Printed- Large 2 Axle Vehicles

Start Time	I-215 Northbound On Ramp Southbound				Alessandro Boulevard Westbound				I-215 Northbound Off Ramp Northbound				Alessandro Boulevard Eastbound						
	Left	Thru	Right	RTOR	Left	Thru	Right	RTOR	Left	Thru	Right	RTOR	Left	Thru	Right	RTOR			
07:00 AM	0	0	0	0	0	6	0	0	6	3	0	0	3	0	3	0	0	12	12
07:15 AM	0	0	0	0	0	10	1	0	11	2	0	0	2	0	4	0	0	17	17
07:30 AM	0	0	0	0	0	4	0	0	4	4	0	2	6	0	7	0	1	17	18
07:45 AM	0	0	0	0	0	3	4	1	7	4	0	0	4	0	3	0	1	14	15
Total	0	0	0	0	0	23	5	1	28	13	0	2	15	0	17	0	2	60	62
08:00 AM	0	0	0	0	0	4	0	0	4	2	0	1	3	1	2	0	0	10	10
08:15 AM	0	0	0	0	0	8	0	0	8	7	0	1	8	2	6	0	1	24	25
08:30 AM	0	0	0	0	0	7	2	0	9	0	0	3	3	0	3	0	3	15	18
08:45 AM	0	0	0	0	0	6	4	0	10	4	0	3	7	0	6	0	0	23	23
Total	0	0	0	0	0	25	6	0	31	13	0	8	21	3	17	0	4	72	76
Grand Total	0	0	0	0	0	48	11	1	59	26	0	10	36	3	34	0	6	132	138
Apprch %	0	0	0	0	0	81.4	18.6		72.2	0	27.8		27.3	8.1	91.9	0			
Total %	0	0	0	0	0	36.4	8.3		44.7	19.7	0	7.6		2.3	25.8	0	4.3	95.7	

3:1-435

Start Time	I-215 Northbound On Ramp Southbound				Alessandro Boulevard Westbound				I-215 Northbound Off Ramp Northbound				Alessandro Boulevard Eastbound						
	Left	Thru	Right	RTOR	Left	Thru	Right	RTOR	Left	Thru	Right	RTOR	Left	Thru	Right	RTOR			
07:15 AM	0	0	0	0	0	10	4	0	11	2	0	0	2	0	4	0	0	4	17
07:30 AM	0	0	0	0	0	4	0	0	4	4	0	2	6	0	7	0	0	7	17
07:45 AM	0	0	0	0	0	3	4	0	7	4	0	0	4	0	3	0	0	3	14
08:00 AM	0	0	0	0	0	0	4	0	4	2	0	1	3	1	2	0	0	3	10
Total Volume	0	0	0	0	0	21	5	0	26	12	0	3	15	1	16	0	0	17	58
% App. Total	0	0	0	0	0	80.8	19.2		19.2	80	0	20		5.9	94.1	0			
PHF	.000	.000	.000	.000	.000	.525	.313		.591	.750	.000	.375	.625	.250	.571	.000	.607	.853	

Peak Hour Analysis From 07:15 AM to 08:00 AM - Peak 1 of 1
 Peak Hour for Entire Intersection Begins at 07:15 AM

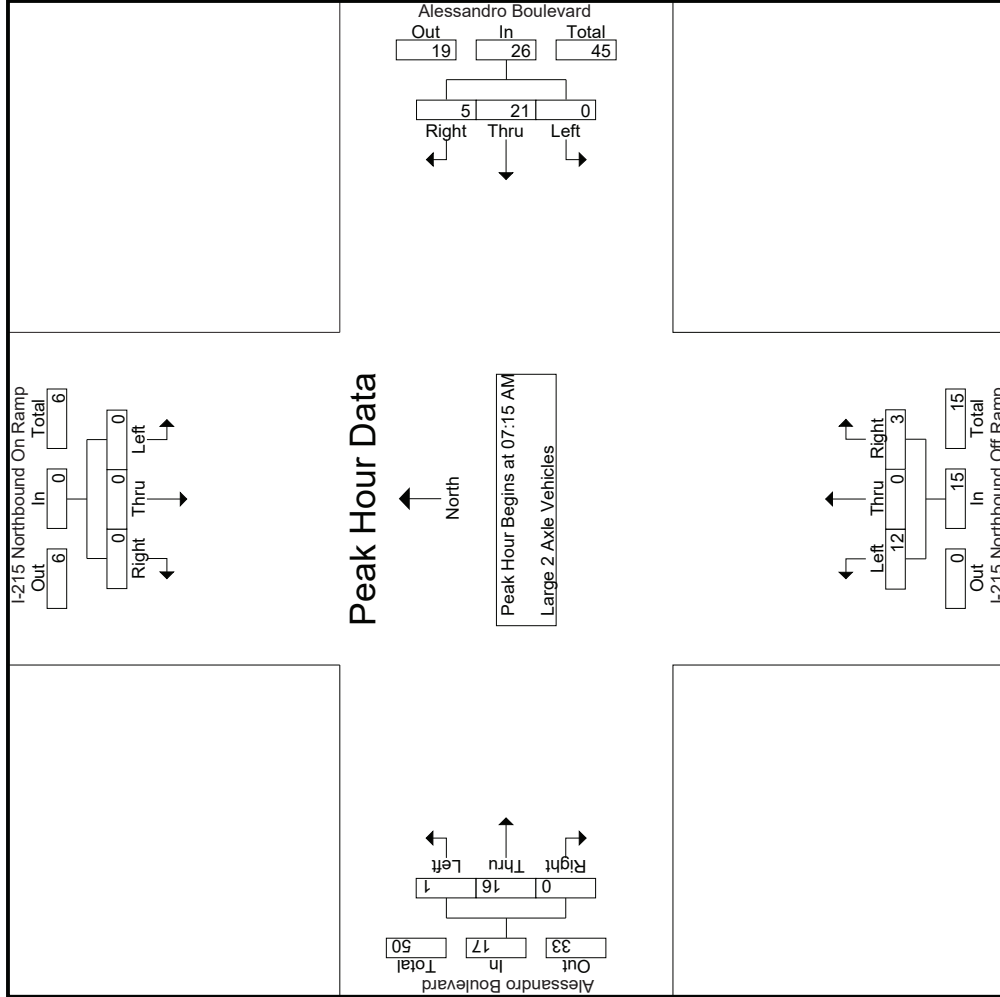

Counts Unlimited
 PO Box 1178
 Corona, CA 92878
 (951) 268-6268

File Name : 37_MRV_215N_Alessandro AM
 Site Code : 05119542
 Start Date : 8/20/2019
 Page No : 3

City of Moreno Valley
 N/S: I-215 Northbound Ramps
 E/W: Alessandro Boulevard
 Weather: Clear

Start Time	I-215 Northbound On Ramp Southbound			Alessandro Boulevard Westbound			I-215 Northbound Off Ramp Northbound			Alessandro Boulevard Eastbound					
	Left	Thru	Right	App. Total	Left	Thru	Right	App. Total	Left	Thru	Right	App. Total			
Peak Hour Analysis From 07:15 AM to 08:00 AM - Peak 1 of 1	Peak Hour for Each Approach Begins at:														
	07:15 AM			07:15 AM			07:15 AM			07:15 AM					
+0 mins.	0	0	0	0	0	0	1	11	2	0	0	0	4	2	0
+15 mins.	0	0	0	0	0	4	0	4	6	0	2	0	7	3	0
+30 mins.	0	0	0	0	0	7	4	7	4	0	0	0	3	4	0
+45 mins.	0	0	0	0	0	4	0	4	3	0	1	0	2	1	0
Total Volume	0	0	0	0	21	5	26	26	15	0	3	0	16	1	0
% App. Total	0	0	0	0	80.8	19.2	591	.591	.625	0	.20	0	94.1	5.9	0
PHF	.000	.000	.000	.000	.525	.313	.591	.591	.625	.000	.375	.000	.571	.250	.607

Counts Unlimited
 PO Box 1178
 Corona, CA 92878
 (951) 268-6268

City of Moreno Valley
 N/S: I-215 Northbound Ramps
 EW: Alessandro Boulevard
 Weather: Clear

File Name : 37_MRV_215N_Alessandro AM
 Site Code : 05119542
 Start Date : 8/20/2019
 Page No : 1

Groups Printed- 3-Axle Vehicles

Start Time	I-215 Northbound On Ramp Southbound				Alessandro Boulevard Westbound				I-215 Northbound Off Ramp Northbound				Alessandro Boulevard Eastbound			
	Left	Thru	Right	RTOR	Left	Thru	Right	RTOR	Left	Thru	Right	RTOR	Left	Thru	Right	RTOR
07:00 AM	0	0	0	0	0	0	0	0	1	0	0	0	0	0	0	0
07:15 AM	0	0	0	0	0	1	0	0	1	0	0	0	0	3	0	0
07:30 AM	0	0	0	0	0	1	0	0	0	0	0	0	0	2	0	0
07:45 AM	0	0	0	0	0	0	0	0	0	0	0	0	0	3	0	0
Total	0	0	0	0	0	2	3	0	5	1	0	0	1	0	8	0
08:00 AM	0	0	0	0	0	1	0	0	1	0	0	0	0	1	0	0
08:15 AM	0	0	0	0	0	1	0	0	1	0	0	0	0	1	0	0
08:30 AM	0	0	0	0	0	2	0	1	2	0	1	1	6	0	0	0
08:45 AM	0	0	0	0	0	3	2	0	5	2	0	0	2	0	3	0
Total	0	0	0	0	0	5	4	0	9	2	0	1	3	1	11	0
Grand Total	0	0	0	0	0	7	7	0	14	3	0	1	4	1	19	0
Apprch %	0	0	0	0	0	50	50		75	7.9	0	2.6	10.5	2.6	95	0
Total %	0	0	0	0	0	18.4	18.4		36.8	7.9	0	2.6	10.5	2.6	50	0
														52.6		
																2.6
																97.4

3:1-438

Start Time	I-215 Northbound On Ramp Southbound				Alessandro Boulevard Westbound				I-215 Northbound Off Ramp Northbound				Alessandro Boulevard Eastbound			
	Left	Thru	Right	RTOR	Left	Thru	Right	RTOR	Left	Thru	Right	RTOR	Left	Thru	Right	RTOR
07:15 AM	0	0	0	0	0	0	0	0	1	0	0	0	0	0	0	0
07:30 AM	0	0	0	0	0	1	0	0	1	0	0	0	0	2	0	0
07:45 AM	0	0	0	0	0	0	0	0	0	0	0	0	0	3	0	0
08:00 AM	0	0	0	0	0	0	1	0	1	0	0	0	0	1	0	0
Total Volume	0	0	0	0	0	0	3	0	3	0	0	0	0	9	0	0
% App. Total	0	0	0	0	0	0	100	0	100	0	0	0	0	100	0	0
PHF	.000	.000	.000	.000	.000	.000	.750	.000	.750	.000	.000	.000	.000	.750	.000	.750

Peak Hour Analysis From 07:15 AM to 08:00 AM - Peak 1 of 1
 Peak Hour for Entire Intersection Begins at 07:15 AM

Counts Unlimited
 PO Box 1178
 Corona, CA 92878
 (951) 268-6268

City of Moreno Valley
 N/S: I-215 Northbound Ramps
 E/W: Alessandro Boulevard
 Weather: Clear

File Name : 37_MRV_215N_Alessandro AM
 Site Code : 05119542
 Start Date : 8/20/2019
 Page No : 2

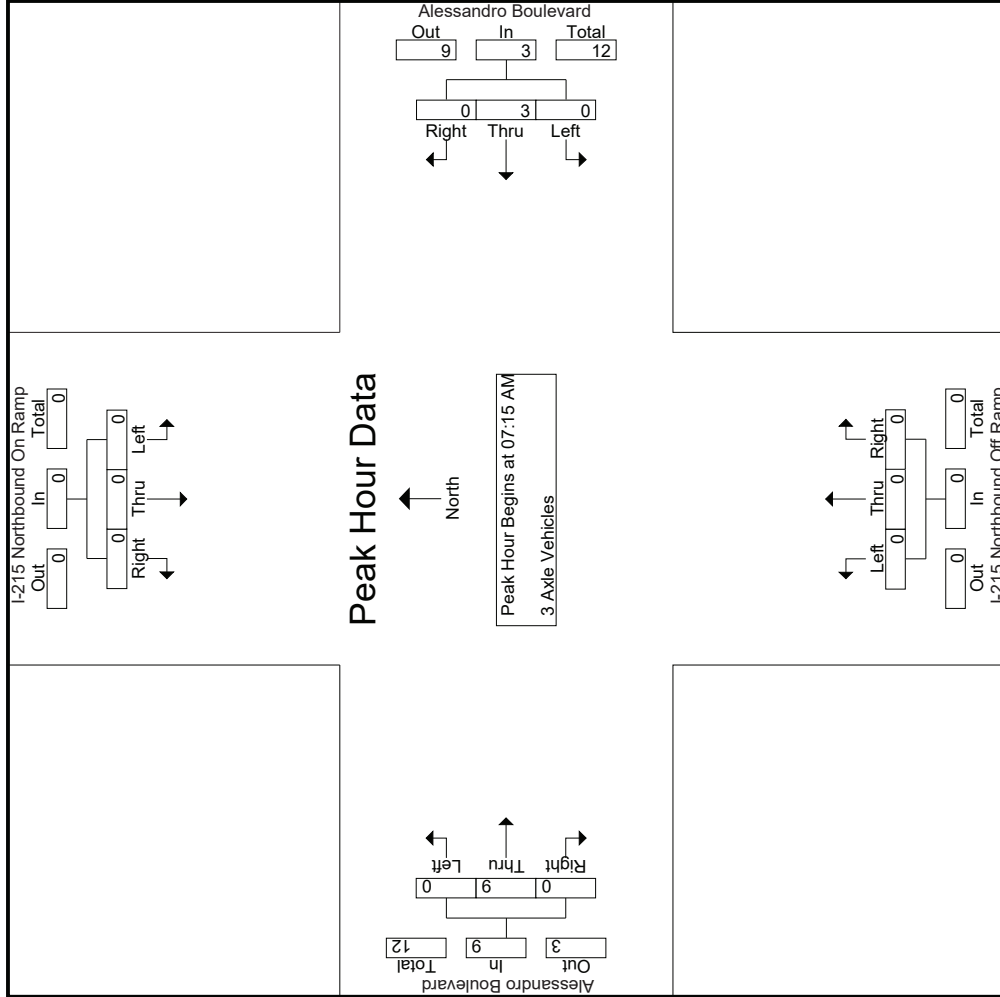

Counts Unlimited
 PO Box 1178
 Corona, CA 92878
 (951) 268-6268

City of Moreno Valley
 N/S: I-215 Northbound Ramps
 E/W: Alessandro Boulevard
 Weather: Clear

File Name : 37_MRV_215N_Alessandro AM
 Site Code : 05119542
 Start Date : 8/20/2019
 Page No : 3

Start Time	I-215 Northbound On Ramp Southbound			Alessandro Boulevard Westbound			I-215 Northbound Off Ramp Northbound			Alessandro Boulevard Eastbound		
	Left	Thru	Right	Left	Thru	Right	Left	Thru	Right	Left	Thru	Right
Peak Hour Analysis From 07:15 AM to 08:00 AM - Peak 1 of 1												
Peak Hour for Each Approach Begins at:	07:15 AM											
+0 mins.	0	0	0	0	1	0	0	0	0	0	0	0
+15 mins.	0	0	0	0	1	0	0	0	0	0	0	0
+30 mins.	0	0	0	0	0	0	0	0	0	0	0	0
+45 mins.	0	0	0	0	1	0	0	0	0	0	0	0
Total Volume	0	0	0	0	3	0	0	0	0	0	9	0
% App. Total	0	0	0	0	100	0	0	0	0	0	100	0
PHF	.000	.000	.000	.000	.750	.000	.000	.000	.000	.000	.750	.000

Counts Unlimited
 PO Box 1178
 Corona, CA 92878
 (951) 268-6268

City of Moreno Valley
 N/S: I-215 Northbound Ramps
 EW: Alessandro Boulevard
 Weather: Clear

File Name : 37_MRV_215N_Alessandro AM
 Site Code : 05119542
 Start Date : 8/20/2019
 Page No : 1

Groups Printed- 4+ Axle Trucks

Start Time	I-215 Northbound On Ramp Southbound				Alessandro Boulevard Westbound				I-215 Northbound Off Ramp Northbound				Alessandro Boulevard Eastbound								
	Left	Thru	Right	RTOR	Left	Thru	Right	RTOR	Left	Thru	Right	RTOR	Left	Thru	Right	RTOR					
07:00 AM	0	0	0	0	0	1	5	2	6	2	0	0	0	3	3	0	0	6	2	14	16
07:15 AM	0	0	0	0	0	2	1	1	4	2	0	1	2	1	1	0	0	2	2	8	10
07:30 AM	0	0	0	0	0	1	3	0	4	1	1	0	2	1	5	0	0	6	0	12	12
07:45 AM	0	0	0	0	0	1	4	1	5	2	0	0	2	2	2	0	4	1	11	12	12
Total	0	0	0	0	0	5	14	4	19	6	1	1	8	7	11	0	0	18	5	45	50
08:00 AM	0	0	0	0	0	2	4	0	6	2	0	0	2	1	6	0	0	7	0	15	15
08:15 AM	0	0	0	0	0	1	2	0	3	0	0	0	0	0	5	0	0	5	0	8	8
08:30 AM	0	0	0	0	0	4	2	0	6	1	0	1	2	1	1	0	0	2	0	10	10
08:45 AM	0	0	0	0	0	2	3	2	5	5	1	3	2	1	4	0	0	5	4	19	23
Total	0	0	0	0	0	9	11	2	20	8	1	4	2	3	16	0	0	19	4	52	56
Grand Total	0	0	0	0	0	14	25	6	39	14	2	5	3	10	27	0	0	37	9	97	106
Apprch %	0	0	0	0	0	35.9	64.1		66.7	9.5	23.8		21.6	10.3	27.8		38.1	8.5	91.5		
Total %	0	0	0	0	0	14.4	25.8		40.2	14.4	2.1	5.2		10.3	27.8		38.1	8.5	91.5		

3:1-441

Start Time	I-215 Northbound On Ramp Southbound				Alessandro Boulevard Westbound				I-215 Northbound Off Ramp Northbound				Alessandro Boulevard Eastbound								
	Left	Thru	Right	RTOR	Left	Thru	Right	RTOR	Left	Thru	Right	RTOR	Left	Thru	Right	RTOR					
07:15 AM	0	0	0	0	0	0	2	4	2	4	1	0	1	1	0	0	2	0	2	8	
07:30 AM	0	0	0	0	0	0	1	3	4	1	1	0	1	0	2	1	5	0	6	12	
07:45 AM	0	0	0	0	0	0	1	4	5	2	0	0	2	0	2	0	2	0	4	11	
08:00 AM	0	0	0	0	0	0	2	4	6	2	2	0	0	1	6	0	6	0	7	15	
Total Volume	0	0	0	0	0	0	6	13	19	6	1	1	8	5	14	0	19	0	19	46	
% App. Total	0	0	0	0	0	31.6	68.4		68.4	75	12.5	12.5		26.3	73.7		73.7	0	73.7		
PHF	.000	.000	.000	.000	.000	.750	.813		.792	.750	.250	.250		.625	.583		.000	.679	.679		.767

Peak Hour Analysis From 07:15 AM to 08:00 AM - Peak 1 of 1
 Peak Hour for Entire Intersection Begins at 07:15 AM

Counts Unlimited
 PO Box 1178
 Corona, CA 92878
 (951) 268-6268

City of Moreno Valley
 N/S: I-215 Northbound Ramps
 E/W: Alessandro Boulevard
 Weather: Clear

File Name : 37_MRV_215N_Alessandro AM
 Site Code : 05119542
 Start Date : 8/20/2019
 Page No : 2

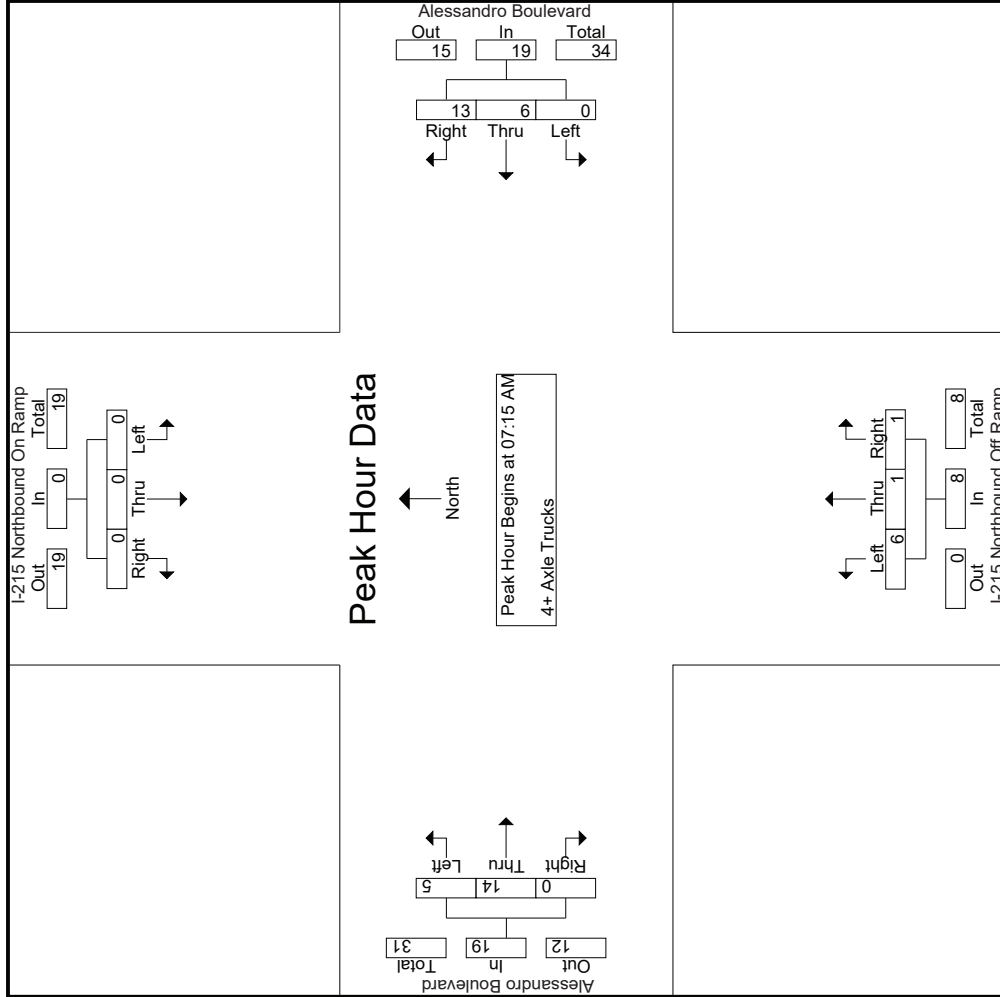

Counts Unlimited
 PO Box 1178
 Corona, CA 92878
 (951) 268-6268

City of Moreno Valley
 N/S: I-215 Northbound Ramps
 EW: Alessandro Boulevard
 Weather: Clear

File Name : 37_MRV_215N_Alessandro PM
 Site Code : 05119542
 Start Date : 8/20/2019
 Page No : 1

Groups Printed- Passenger Vehicles - Large 2 Axle Vehicles - 3 Axle Vehicles - 4+ Axle Trucks

Start Time	Alessandro Boulevard Southbound										Alessandro Boulevard Westbound										Alessandro Boulevard Eastbound									
	I-215 Northbound On Ramp					Alessandro Boulevard Southbound					Alessandro Boulevard Westbound					I-215 Northbound Off Ramp					Alessandro Boulevard Eastbound									
	Left	Thru	Right	RTOR	App. Total	Left	Thru	Right	RTOR	App. Total	Left	Thru	Right	RTOR	App. Total	Left	Thru	Right	RTOR	App. Total	Left	Thru	Right	RTOR	App. Total	Exclu. Total	Inclu. Total	Int. Total		
04:00 PM	0	0	0	0	0	0	204	44	12	248	141	1	44	21	186	46	325	0	0	371	33	805	838							
04:15 PM	0	0	0	0	0	0	219	37	11	256	95	1	45	15	141	41	377	0	0	418	26	815	841							
04:30 PM	0	0	0	0	0	0	183	56	17	239	104	2	48	16	154	54	370	0	0	424	33	817	850							
04:45 PM	0	0	0	0	0	0	213	39	11	252	114	0	38	24	152	49	309	0	0	358	35	762	797							
Total	0	0	0	0	0	0	819	176	51	995	454	4	175	76	633	190	1381	0	0	1571	127	3199	3326							
05:00 PM	0	0	0	0	0	0	198	62	12	260	96	0	25	13	121	78	394	0	0	472	25	853	878							
05:15 PM	0	0	0	0	0	0	223	43	19	266	90	0	40	13	130	69	411	0	0	480	32	876	908							
05:30 PM	0	0	0	0	0	0	212	36	16	248	99	0	25	17	124	69	350	0	0	419	33	791	824							
05:45 PM	0	0	0	0	0	0	155	52	16	207	85	1	36	22	122	60	356	0	0	416	38	745	783							
Total	0	0	0	0	0	0	788	193	63	981	370	1	126	65	497	276	1511	0	0	1787	128	3265	3393							
Grand Total	0	0	0	0	0	0	1607	369	114	1976	824	5	301	141	1130	466	2892	0	0	3358	255	6464	6719							
Approch %	0	0	0	0	0	0	81.3	18.7	0	30.6	12.7	0.1	4.7	17.5	7.2	44.7	0	0	51.9	0	3.8	96.2								
Total %	0	0	0	0	0	0	1593	323	91.2	2020	805	5	297	1246	437	2820	0	0	3257	0	0	6523								
% Passenger Vehicles	0	0	0	0	0	0	99.1	87.5	91.2	96.7	100	98.7	98.6	98	93.8	97.5	0	0	97	0	0	97.1								
% Large 2 Axle Vehicles	0	0	0	0	0	0	5	11	3.5	20	15	0	2	19	10	18	0	0	28	0	0	67								
% Large 3 Axle Vehicles	0	0	0	0	0	0	0.3	3	3.5	1	1.8	0	0.7	1.4	1.5	2.1	0.6	0	0.8	0	0	1								
% 3 Axle Vehicles	0	0	0	0	0	0	1	4	1.8	7	0	0	2	2	1	3	0	0	4	0	0	13								
% 4+ Axle Trucks	0	0	0	0	0	0	0.1	1.1	1.8	0.3	0	0	0.7	0	0.2	0.2	0.1	0	0.1	0	0	0.2								
% 4+ Axle Trucks	0	0	0	0	0	0	8	31	8.4	43	4	0	0	4	18	51	0	0	69	0	0	116								
% 4+ Axle Trucks	0	0	0	0	0	0	0.5	8.4	3.5	2.1	0.5	0	0	0.3	3.9	1.8	0	0	2.1	0	0	1.7								

Start Time	Alessandro Boulevard Southbound										Alessandro Boulevard Westbound										Alessandro Boulevard Eastbound									
	I-215 Northbound On Ramp					Alessandro Boulevard Southbound					Alessandro Boulevard Westbound					I-215 Northbound Off Ramp					Alessandro Boulevard Eastbound									
	Left	Thru	Right	RTOR	App. Total	Left	Thru	Right	RTOR	App. Total	Left	Thru	Right	RTOR	App. Total	Left	Thru	Right	RTOR	App. Total	Left	Thru	Right	RTOR	App. Total	Exclu. Total	Inclu. Total	Int. Total		
04:30 PM	0	0	0	0	0	0	0	0	0	0	0	0	0	0	0	0	0	0	0	0	0	0	0	0	0	0	0			
04:45 PM	0	0	0	0	0	0	0	0	0	0	0	0	0	0	0	0	0	0	0	0	0	0	0	0	0	0	0			
05:00 PM	0	0	0	0	0	0	0	0	0	0	0	0	0	0	0	0	0	0	0	0	0	0	0	0	0	0	0			
05:15 PM	0	0	0	0	0	0	0	0	0	0	0	0	0	0	0	0	0	0	0	0	0	0	0	0	0	0	0			
Total Volume	0	0	0	0	0	0	0	0	0	0	0	0	0	0	0	0	0	0	0	0	0	0	0	0	0	0				
% App. Total	0.000	0.000	0.000	0.000	0.000	0.000	0.000	0.000	0.000	0.000	0.000	0.000	0.000	0.000	0.000	0.000	0.000	0.000	0.000	0.000	0.000	0.000	0.000	0.000	0.000	0.000				
PHF	0.000	0.000	0.000	0.000	0.000	0.000	0.000	0.000	0.000	0.000	0.000	0.000	0.000	0.000	0.000	0.000	0.000	0.000	0.000	0.000	0.000	0.000	0.000	0.000	0.000	0.000				

Peak Hour Analysis From 04:00 PM to 05:45 PM - Peak 1 of 1

Peak Hour for Entire Intersection Begins at 04:30 PM

Counts Unlimited
 PO Box 1178
 Corona, CA 92878
 (951) 268-6268

City of Moreno Valley
 N/S: I-215 Northbound Ramps
 E/W: Alessandro Boulevard
 Weather: Clear

File Name : 37_MRV_215N_Alessandro PM
 Site Code : 05119542
 Start Date : 8/20/2019
 Page No : 2

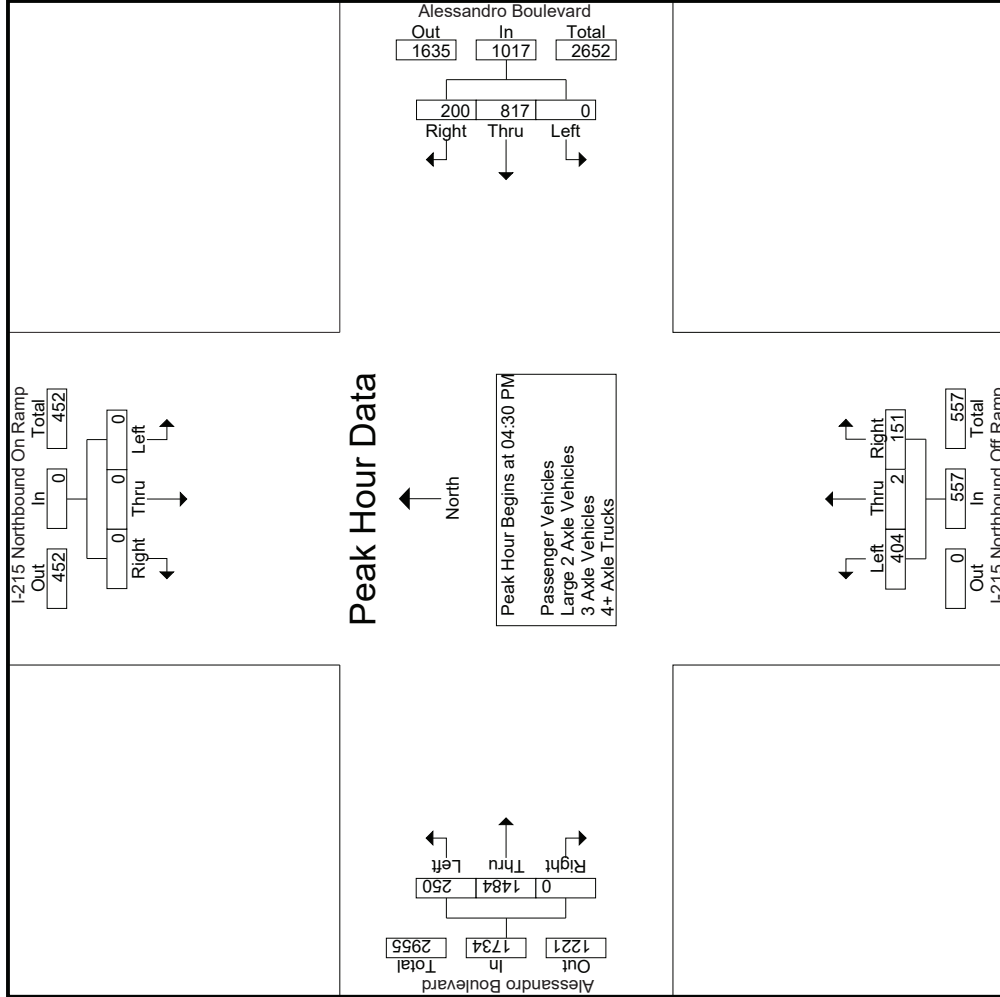

Counts Unlimited
 PO Box 1178
 Corona, CA 92878
 (951) 268-6268

City of Moreno Valley
 N/S: I-215 Northbound Ramps
 E/W: Alessandro Boulevard
 Weather: Clear

File Name : 37_MRV_215N_Alessandro PM
 Site Code : 05119542
 Start Date : 8/20/2019
 Page No : 3

Start Time	I-215 Northbound On Ramp Southbound			Alessandro Boulevard Westbound			I-215 Northbound Off Ramp Northbound			Alessandro Boulevard Eastbound		
	Left	Thru	Right	Left	Thru	Right	Left	Thru	Right	Left	Thru	Right
Peak Hour Analysis From 04:00 PM to 05:45 PM - Peak 1 of 1	Peak Hour for Each Approach Begins at:											
	04:00 PM			04:45 PM			04:00 PM			05:00 PM		
+0 mins.	0	0	0	0	213	39	252	1	44	186	394	0
+15 mins.	0	0	0	0	198	62	260	1	45	141	411	0
+30 mins.	0	0	0	0	223	43	266	2	48	154	350	0
+45 mins.	0	0	0	0	212	36	248	0	38	152	356	0
Total Volume	0	0	0	0	846	180	1026	4	175	633	1511	0
% App. Total	.000	.000	.000	.000	.948	.726	.964	.805	.911	.851	.919	.000
PHF												

Groups Printed- Passenger Vehicles

Start Time	I-215 Northbound On Ramp Southbound				Alessandro Boulevard Westbound				I-215 Northbound Off Ramp Northbound				Alessandro Boulevard Eastbound									
	Left	Thru	Right	RTOR	Left	Thru	Right	RTOR	Left	Thru	Right	RTOR	Left	Thru	Right	RTOR						
04:00 PM	0	0	0	0	0	202	39	11	241	135	1	44	21	180	45	316	0	0	361	32	782	814
04:15 PM	0	0	0	0	0	216	26	8	242	94	1	45	15	140	37	366	0	0	403	23	785	808
04:30 PM	0	0	0	0	0	182	52	16	234	99	2	48	16	149	50	360	0	0	410	32	793	825
04:45 PM	0	0	0	0	0	211	36	10	247	113	0	37	24	150	45	297	0	0	342	34	739	773
Total	0	0	0	0	0	811	153	45	964	441	4	174	76	619	177	1339	0	0	1516	121	3099	3220
05:00 PM	0	0	0	0	0	196	54	11	250	95	0	24	12	119	76	386	0	0	462	23	831	854
05:15 PM	0	0	0	0	0	221	39	17	260	89	0	39	13	128	64	402	0	0	466	30	854	884
05:30 PM	0	0	0	0	0	211	30	15	241	95	0	25	17	120	65	345	0	0	410	32	771	803
05:45 PM	0	0	0	0	0	154	47	16	201	85	1	35	21	121	55	348	0	0	403	37	725	762
Total	0	0	0	0	0	782	170	59	952	364	1	123	63	488	260	1481	0	0	1741	122	3181	3303
Grand Total	0	0	0	0	0	1593	323	104	1916	805	5	297	139	1107	437	2820	0	0	3257	243	6280	6523
Apprch %	0	0	0	0	0	83.1	16.9		30.5	72.7	0.5	26.8		17.6	13.4	86.6	0	0	51.9	3.7	96.3	
Total %	0	0	0	0	0	25.4	5.1		30.5	12.8	0.1	4.7		17.6	7	44.9	0	0	51.9	3.7	96.3	

Start Time	I-215 Northbound On Ramp Southbound				Alessandro Boulevard Westbound				I-215 Northbound Off Ramp Northbound				Alessandro Boulevard Eastbound			
	Left	Thru	Right	App. Total	Left	Thru	Right	App. Total	Left	Thru	Right	App. Total	Left	Thru	Right	App. Total
Peak Hour Analysis From 04:30 PM to 05:15 PM - Peak 1 of 1																
Peak Hour for Entire Intersection Begins at 04:30 PM																
04:30 PM	0	0	0	0	0	182	52	234	99	2	48	149	50	360	0	410
04:45 PM	0	0	0	0	0	211	36	247	113	0	37	150	45	297	0	342
05:00 PM	0	0	0	0	0	196	54	250	95	0	24	119	76	386	0	462
05:15 PM	0	0	0	0	0	221	39	260	89	0	39	128	64	402	0	466
Total Volume	0	0	0	0	0	810	181	991	396	2	148	546	235	1445	0	1680
% App. Total	0	0	0	0	0	81.7	18.3	95.3	72.5	0.4	27.1	7	14	86	0	90.1
PHF	.000	.000	.000	.000	.000	.916	.838	.953	.876	.250	.771	.910	.773	.899	.000	.901

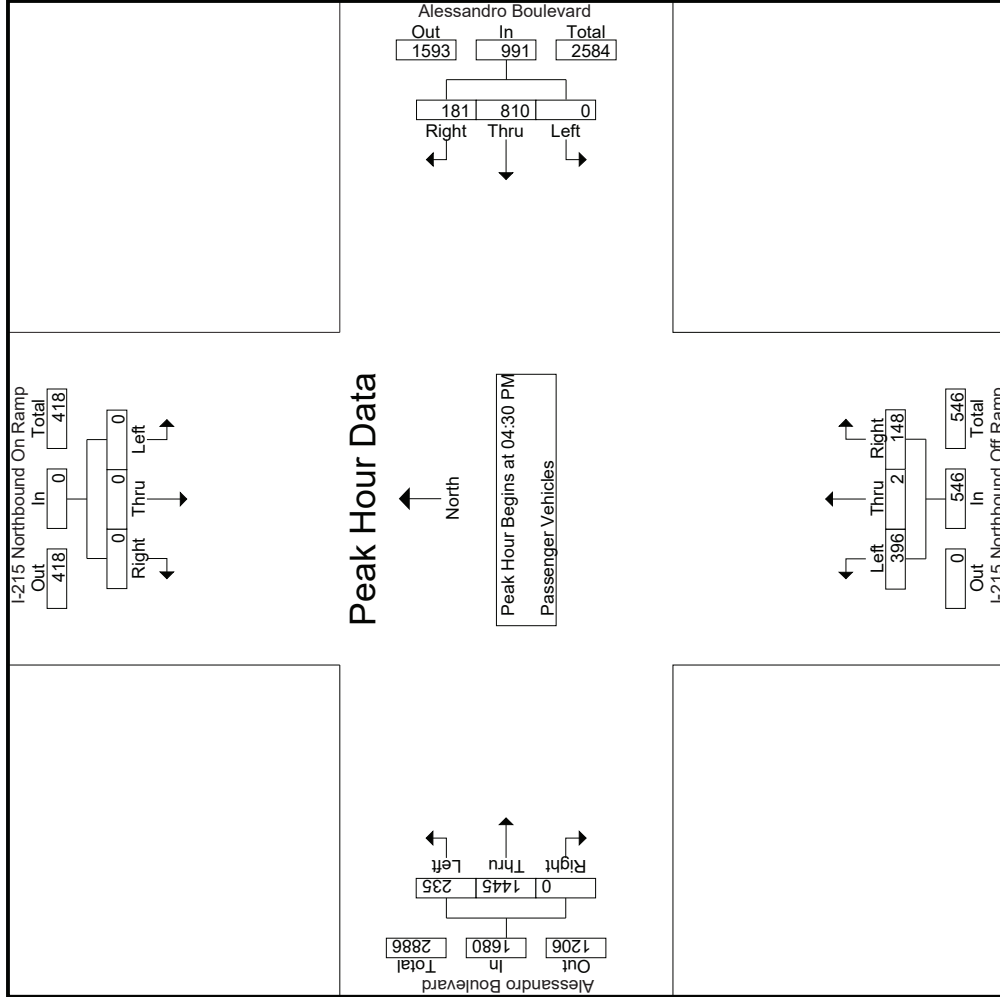

Counts Unlimited
 PO Box 1178
 Corona, CA 92878
 (951) 268-6268

City of Moreno Valley
 N/S: I-215 Northbound Ramps
 E/W: Alessandro Boulevard
 Weather: Clear

File Name : 37_MRV_215N_Alessandro PM
 Site Code : 05119542
 Start Date : 8/20/2019
 Page No : 3

Start Time	I-215 Northbound On Ramp Southbound			Alessandro Boulevard Westbound			I-215 Northbound Off Ramp Northbound			Alessandro Boulevard Eastbound					
	Left	Thru	Right	Left	Thru	Right	Left	Thru	Right	Left	Thru	Right			
Peak Hour Analysis From 04:30 PM to 05:15 PM - Peak 1 of 1	Peak Hour for Each Approach Begins at:														
	04:30 PM			04:30 PM			04:30 PM			04:30 PM					
+0 mins.	0	0	0	0	182	52	234	99	2	48	149	50	360	0	410
+15 mins.	0	0	0	0	211	36	247	113	0	37	150	45	297	0	342
+30 mins.	0	0	0	0	196	54	250	95	0	24	119	76	386	0	462
+45 mins.	0	0	0	0	221	39	260	89	0	39	128	64	402	0	466
Total Volume	0	0	0	0	810	181	991	396	2	148	546	235	1445	0	1680
% App. Total	0	0	0	0	81.7	18.3	953	72.5	0.4	27.1	910	14	86	0	1680
PHF	.000	.000	.000	.000	.916	.838	.953	.876	.250	.771	.910	.773	.899	.000	.901

Counts Unlimited
 PO Box 1178
 Corona, CA 92878
 (951) 268-6268

City of Moreno Valley
 N/S: I-215 Northbound Ramps
 EW: Alessandro Boulevard
 Weather: Clear

File Name : 37_MRV_215N_Alessandro PM
 Site Code : 05119542
 Start Date : 8/20/2019
 Page No : 1

Groups Printed- Large 2 Axle Vehicles

Start Time	I-215 Northbound On Ramp Southbound				Alessandro Boulevard Westbound				I-215 Northbound Off Ramp Northbound				Alessandro Boulevard Eastbound								
	Left	Thru	Right	RTOR	Left	Thru	Right	RTOR	Left	Thru	Right	RTOR	Left	Thru	Right	RTOR					
04:00 PM	0	0	0	0	0	0	1	1	4	0	0	0	4	0	2	0	0	2	1	7	8
04:15 PM	0	0	0	0	0	2	4	1	6	1	0	0	1	1	3	0	0	4	1	11	12
04:30 PM	0	0	0	0	0	1	2	1	3	5	0	0	5	1	2	0	0	3	1	11	12
04:45 PM	0	0	0	0	0	0	1	1	1	0	0	0	0	3	3	0	0	6	1	7	8
Total	0	0	0	0	0	3	8	4	11	10	0	0	10	5	10	0	0	15	4	36	40
05:00 PM	0	0	0	0	0	1	1	0	2	1	0	1	2	0	3	0	0	3	1	7	8
05:15 PM	0	0	0	0	0	1	1	0	2	2	1	0	1	2	2	0	0	4	0	7	7
05:30 PM	0	0	0	0	0	0	0	0	0	3	0	0	3	1	2	0	0	3	0	6	6
05:45 PM	0	0	0	0	0	0	1	0	1	0	0	1	1	2	1	0	0	3	1	5	6
Total	0	0	0	0	0	2	3	0	5	5	0	2	7	5	8	0	0	13	2	25	27
Grand Total	0	0	0	0	0	5	11	4	16	15	0	2	2	10	18	0	0	28	6	61	67
Approch %	0	0	0	0	0	31.2	68.8		88.2	0	11.8		27.9	35.7	64.3	0	0	45.9	9	91	
Total %	0	0	0	0	0	8.2	18		26.2	24.6	0	3.3		16.4	29.5	0	0				

3:1-450

Start Time	I-215 Northbound On Ramp Southbound				Alessandro Boulevard Westbound				I-215 Northbound Off Ramp Northbound				Alessandro Boulevard Eastbound								
	Left	Thru	Right	RTOR	Left	Thru	Right	RTOR	Left	Thru	Right	RTOR	Left	Thru	Right	RTOR					
04:30 PM	0	0	0	0	0	0	1	1	3	5	0	0	0	0	2	0	0	0	3	3	11
04:45 PM	0	0	0	0	0	0	0	0	1	0	0	0	0	0	3	0	0	0	0	6	7
05:00 PM	0	0	0	0	0	0	1	1	2	1	0	1	2	0	3	0	0	3	0	3	7
05:15 PM	0	0	0	0	0	0	1	1	2	1	0	0	1	2	2	0	0	2	0	4	7
Total Volume	0	0	0	0	0	0	3	5	8	7	0	1	8	6	10	0	0	16	0	32	
% App. Total	0	0	0	0	0	37.5	62.5		62.5	87.5	0	12.5		37.5	62.5	0	0				
PHF	.000	.000	.000	.000	.000	.000	.750	.625	.667	.350	.000	.250	.400	.500	.833	.000	.667	.000	.667	.727	

Counts Unlimited
 PO Box 1178
 Corona, CA 92878
 (951) 268-6268

City of Moreno Valley
 N/S: I-215 Northbound Ramps
 E/W: Alessandro Boulevard
 Weather: Clear

File Name : 37_MRV_215N_Alessandro PM
 Site Code : 05119542
 Start Date : 8/20/2019
 Page No : 2

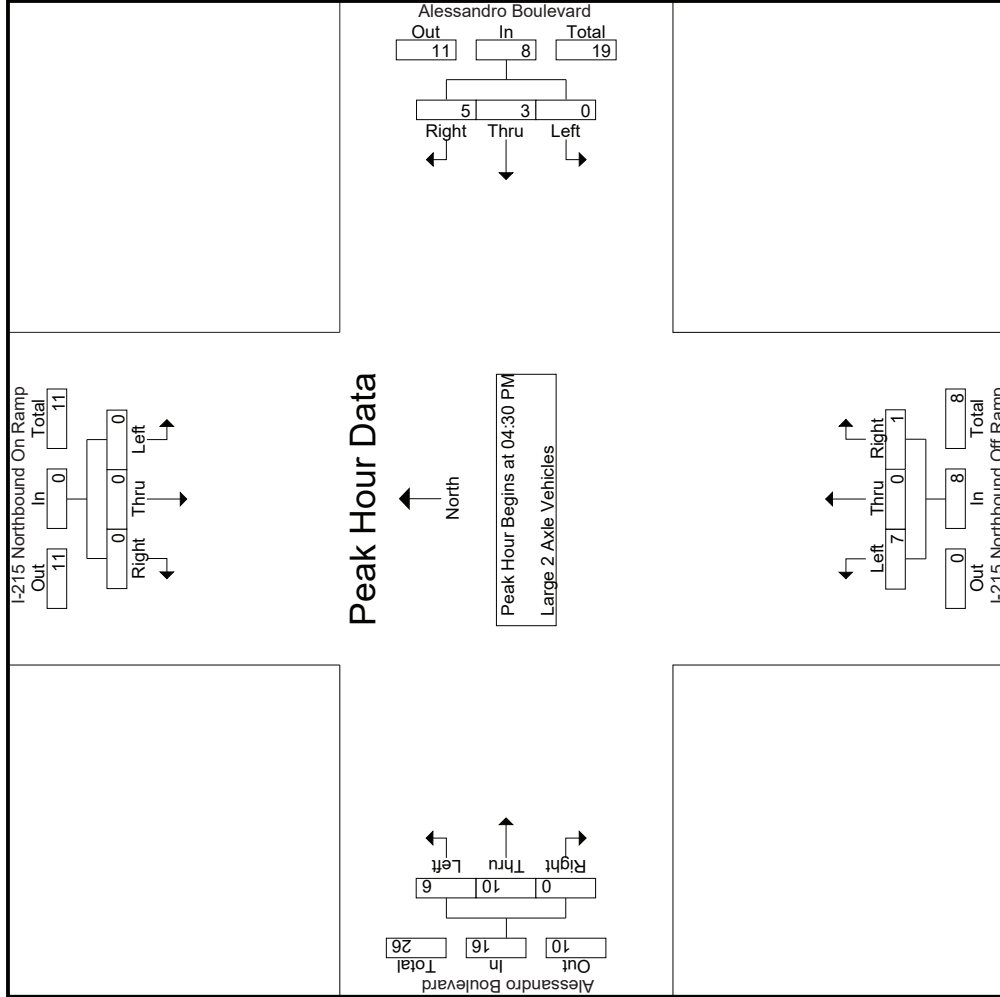

Counts Unlimited
 PO Box 1178
 Corona, CA 92878
 (951) 268-6268

City of Moreno Valley
 N/S: I-215 Northbound Ramps
 E/W: Alessandro Boulevard
 Weather: Clear

File Name : 37_MRV_215N_Alessandro PM
 Site Code : 05119542
 Start Date : 8/20/2019
 Page No : 3

Start Time	I-215 Northbound On Ramp Southbound			Alessandro Boulevard Westbound			I-215 Northbound Off Ramp Northbound			Alessandro Boulevard Eastbound		
	Left	Thru	Right	Left	Thru	Right	Left	Thru	Right	Left	Thru	Right
Peak Hour Analysis From 04:30 PM to 05:15 PM - Peak 1 of 1												
Peak Hour for Each Approach Begins at:												
+0 mins.	0	0	0	0	0	3	0	0	0	1	2	0
+15 mins.	0	0	0	0	0	1	0	0	0	0	0	0
+30 mins.	0	0	0	0	0	1	1	1	1	2	3	0
+45 mins.	0	0	0	0	0	1	1	0	0	0	2	0
Total Volume	0	0	0	0	0	3	5	7	0	6	10	0
% App. Total	0	0	0	0	0	37.5	62.5	87.5	0	37.5	62.5	0
PHF	.000	.000	.000	.000	.000	.667	.625	.350	.000	.500	.833	.000

Groups Printed- 3 Axle Vehicles

Start Time	I-215 Northbound On Ramp Southbound				Alessandro Boulevard Westbound				I-215 Northbound Off Ramp Northbound				Alessandro Boulevard Eastbound			
	Left	Thru	Right	RTOR	Left	Thru	Right	RTOR	Left	Thru	Right	RTOR	Left	Thru	Right	RTOR
04:00 PM	0	0	0	0	0	0	0	0	0	0	0	0	0	0	0	0
04:15 PM	0	0	0	0	0	0	0	0	0	0	0	0	0	0	0	0
04:30 PM	0	0	0	0	0	0	0	0	0	0	0	0	0	0	0	0
04:45 PM	0	0	0	0	0	0	0	0	0	0	0	0	0	0	0	0
Total	0	0	0	0	0	0	0	0	0	0	0	0	0	0	0	0
05:00 PM	0	0	0	0	0	0	0	0	0	0	0	0	0	0	0	0
05:15 PM	0	0	0	0	0	0	0	0	0	0	0	0	0	0	0	0
05:30 PM	0	0	0	0	0	0	0	0	0	0	0	0	0	0	0	0
05:45 PM	0	0	0	0	0	0	0	0	0	0	0	0	0	0	0	0
Total	0	0	0	0	0	0	0	0	0	0	0	0	0	0	0	0
Grand Total	0	0	0	0	0	0	0	0	0	0	0	0	0	0	0	0
Apprch %	0	0	0	0	0	20	80	0	0	0	0	0	25	75	0	0
Total %	0	0	0	0	0	9.1	36.4	0	0	0	18.2	0	9.1	27.3	0	0
								45.5			18.2				15.4	84.6

3:1-453

Start Time	I-215 Northbound On Ramp Southbound				Alessandro Boulevard Westbound				I-215 Northbound Off Ramp Northbound				Alessandro Boulevard Eastbound			
	Left	Thru	Right	App. Total	Left	Thru	Right	App. Total	Left	Thru	Right	App. Total	Left	Thru	Right	App. Total
04:30 PM	0	0	0	0	0	0	0	0	0	0	0	0	0	0	0	0
04:45 PM	0	0	0	0	0	0	0	0	0	0	0	0	0	0	0	0
05:00 PM	0	0	0	0	0	0	0	0	0	0	0	0	0	0	0	0
05:15 PM	0	0	0	0	0	0	0	0	0	0	0	0	0	0	0	0
Total Volume	0	0	0	0	0	0	0	0	0	0	0	0	0	0	0	0
% App. Total	0	0	0	0	0	0	0	0	0	0	0	0	0	0	0	0
PHF	.000	.000	.000	.000	.000	.000	.000	.750	.750	.000	.000	.500	.500	.500	.000	.875

Peak Hour Analysis From 04:30 PM to 05:15 PM - Peak 1 of 1
 Peak Hour for Entire Intersection Begins at 04:30 PM

Counts Unlimited
 PO Box 1178
 Corona, CA 92878
 (951) 268-6268

City of Moreno Valley
 N/S: I-215 Northbound Ramps
 E/W: Alessandro Boulevard
 Weather: Clear

File Name : 37_MRV_215N_Alessandro PM
 Site Code : 05119542
 Start Date : 8/20/2019
 Page No : 2

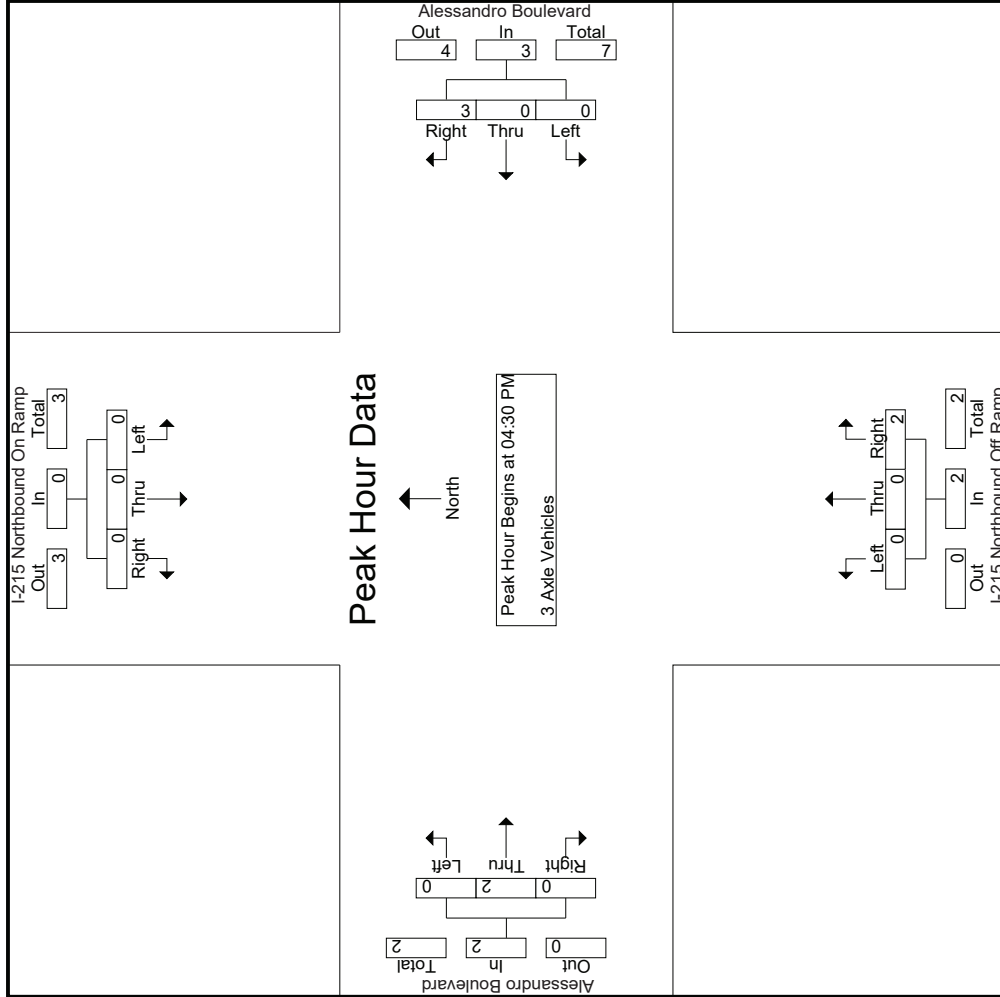

Counts Unlimited
 PO Box 1178
 Corona, CA 92878
 (951) 268-6268

City of Moreno Valley
 N/S: I-215 Northbound Ramps
 E/W: Alessandro Boulevard
 Weather: Clear

File Name : 37_MRV_215N_Alessandro PM
 Site Code : 05119542
 Start Date : 8/20/2019
 Page No : 3

Start Time	I-215 Northbound On Ramp Southbound			Alessandro Boulevard Westbound			I-215 Northbound Off Ramp Northbound			Alessandro Boulevard Eastbound		
	Left	Thru	Right	Left	Thru	Right	Left	Thru	Right	Left	Thru	Right
Peak Hour Analysis From 04:30 PM to 05:15 PM - Peak 1 of 1												
Peak Hour for Each Approach Begins at:												
+0 mins.	0	0	0	0	0	1	0	0	0	0	1	0
+15 mins.	0	0	0	0	0	1	0	0	0	0	1	0
+30 mins.	0	0	0	0	0	1	0	0	0	0	0	0
+45 mins.	0	0	0	0	0	1	0	0	0	0	0	0
Total Volume	0	0	0	0	0	3	0	0	0	0	2	0
% App. Total	0	0	0	0	0	100	0	0	0	0	100	0
PHF	.000	.000	.000	.000	.000	.750	.000	.000	.000	.500	.500	.000

Counts Unlimited
 PO Box 1178
 Corona, CA 92878
 (951) 268-6268

City of Moreno Valley
 N/S: I-215 Northbound Ramps
 EW: Alessandro Boulevard
 Weather: Clear

File Name : 37_MRV_215N_Alessandro PM
 Site Code : 05119542
 Start Date : 8/20/2019
 Page No : 1

Groups Printed- 4+ Axle Trucks

Start Time	I-215 Northbound On Ramp Southbound				Alessandro Boulevard Westbound				I-215 Northbound Off Ramp Northbound				Alessandro Boulevard Eastbound				
	Left	Thru	Right	RTOR	Left	Thru	Right	RTOR	Left	Thru	Right	RTOR	Left	Thru	Right	RTOR	
04:00 PM	0	0	0	0	0	2	4	0	6	2	0	0	2	1	7	0	8
04:15 PM	0	0	0	0	0	1	6	2	7	0	0	0	0	3	7	0	10
04:30 PM	0	0	0	0	0	0	1	0	1	0	0	0	0	3	7	0	10
04:45 PM	0	0	0	0	0	2	2	0	4	1	0	0	1	1	8	0	9
Total	0	0	0	0	0	5	13	2	18	3	0	0	3	8	29	0	37
05:00 PM	0	0	0	0	0	1	6	0	7	0	0	0	0	2	5	0	7
05:15 PM	0	0	0	0	0	1	2	1	3	0	0	0	0	3	7	0	10
05:30 PM	0	0	0	0	0	1	6	1	7	1	0	0	1	2	3	0	5
05:45 PM	0	0	0	0	0	0	4	0	4	0	0	0	0	3	7	0	10
Total	0	0	0	0	0	3	18	2	21	1	0	0	1	10	22	0	32
Grand Total	0	0	0	0	0	8	31	4	39	4	0	0	4	18	51	0	69
Apprch %	0	0	0	0	0	20.5	79.5		100					26.1	73.9		
Total %	0	0	0	0	0	7.1	27.7		34.8				3.6	16.1	45.5		61.6

3:1-456

Start Time	I-215 Northbound On Ramp Southbound				Alessandro Boulevard Westbound				I-215 Northbound Off Ramp Northbound				Alessandro Boulevard Eastbound				
	Left	Thru	Right	App. Total	Left	Thru	Right	App. Total	Left	Thru	Right	App. Total	Left	Thru	Right	App. Total	
04:30 PM	0	0	0	0	0	0	1	1	0	0	0	0	0	0	0	0	0
04:45 PM	0	0	0	0	0	2	2	4	7	1	0	0	0	1	8	0	9
05:00 PM	0	0	0	0	0	0	1	6	7	0	0	0	0	2	5	0	7
05:15 PM	0	0	0	0	0	0	2	3	5	0	0	0	0	3	7	0	10
Total Volume	0	0	0	0	0	4	11	15	21	1	0	0	1	9	27	0	36
% App. Total	0	0	0	0	0	26.7	73.3		100					25	75		
PHF	.000	.000	.000	.000	.000	.500	.458	.536	.250	.000	.000	.250	.750	.844	.000	.900	.929

Counts Unlimited
 PO Box 1178
 Corona, CA 92878
 (951) 268-6268

City of Moreno Valley
 N/S: I-215 Northbound Ramps
 E/W: Alessandro Boulevard
 Weather: Clear

File Name : 37_MRV_215N_Alessandro PM
 Site Code : 05119542
 Start Date : 8/20/2019
 Page No : 2

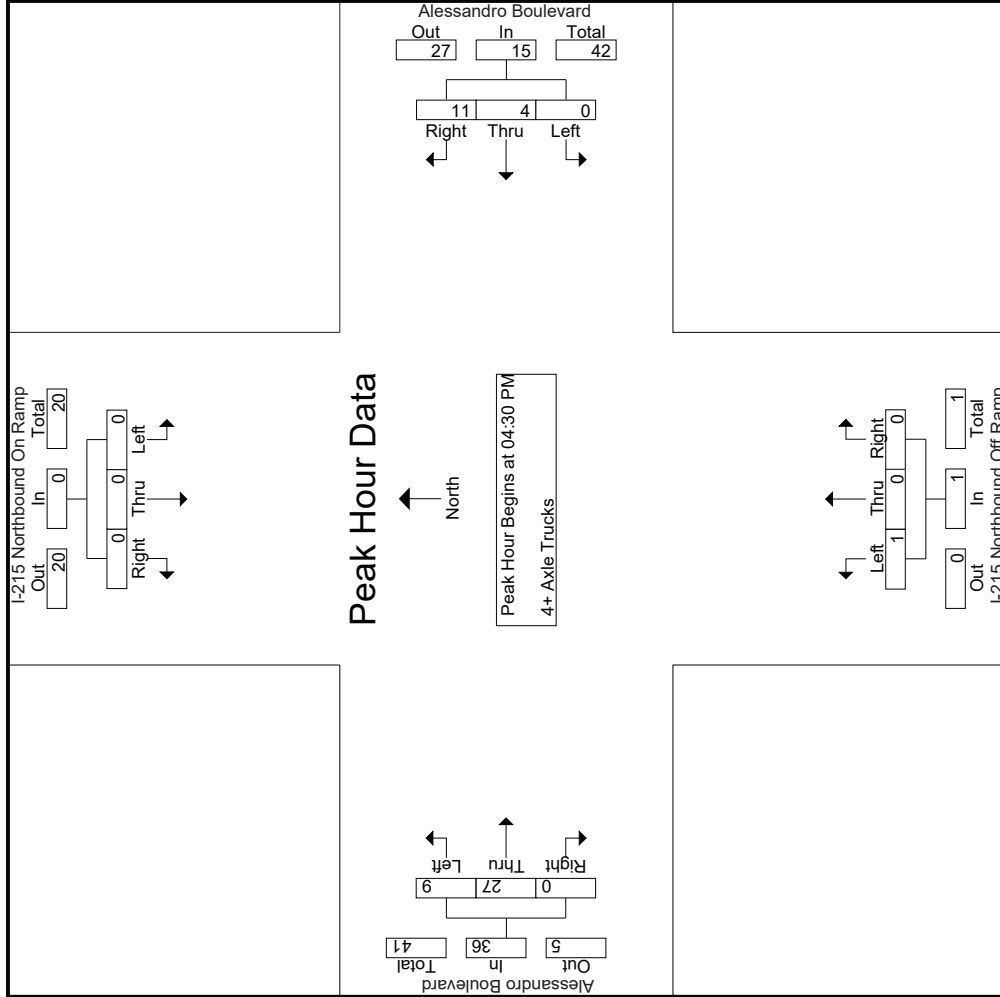

Counts Unlimited
 PO Box 1178
 Corona, CA 92878
 (951) 268-6268

City of Moreno Valley
 N/S: I-215 Northbound Ramps
 E/W: Alessandro Boulevard
 Weather: Clear

File Name : 37_MRV_215N_Alessandro PM
 Site Code : 05119542
 Start Date : 8/20/2019
 Page No : 3

Start Time	I-215 Northbound On Ramp Southbound			Alessandro Boulevard Westbound			I-215 Northbound Off Ramp Northbound			Alessandro Boulevard Eastbound					
	Left	Thru	Right	Left	Thru	Right	Left	Thru	Right	Left	Thru	Right			
Peak Hour Analysis From 04:30 PM to 05:15 PM - Peak 1 of 1	Peak Hour for Each Approach Begins at:														
+0 mins.	04:30 PM			04:30 PM			04:30 PM			04:30 PM					
+15 mins.	0	0	0	0	0	1	0	0	0	0	0	0	3	7	0
+30 mins.	0	0	0	0	2	4	1	0	0	1	0	0	1	8	0
+45 mins.	0	0	0	0	1	6	7	0	0	0	0	0	2	5	0
Total Volume	0	0	0	0	4	11	15	0	0	1	0	0	3	7	0
% App. Total	0	0	0	0	26.7	73.3	.536	.000	.000	.250	.000	.000	.250	.750	.000
PHF	.000			.000			.000			.000			.900		

Location: Moreno Valley
 N/S: I-215 Northbound Ramps
 E/W: Alessandro Boulevard



Date: 8/20/2019
 Day: Tuesday

PEDESTRIANS

	North Leg I-215 Northbound Ramps	East Leg Alessandro Boulevard	South Leg I-215 Northbound Ramps	West Leg Alessandro Boulevard	
	Pedestrians	Pedestrians	Pedestrians	Pedestrians	
7:00 AM	0	0	0	0	0
7:15 AM	0	0	0	0	0
7:30 AM	0	0	1	0	1
7:45 AM	0	0	0	0	0
8:00 AM	0	0	0	0	0
8:15 AM	0	0	0	0	0
8:30 AM	0	0	1	0	1
8:45 AM	0	0	0	0	0
TOTAL VOLUMES:	0	0	2	0	2

	North Leg I-215 Northbound Ramps	East Leg Alessandro Boulevard	South Leg I-215 Northbound Ramps	West Leg Alessandro Boulevard	
	Pedestrians	Pedestrians	Pedestrians	Pedestrians	
4:00 PM	0	0	0	0	0
4:15 PM	0	0	0	0	0
4:30 PM	0	0	0	0	0
4:45 PM	0	0	0	0	0
5:00 PM	0	0	0	0	0
5:15 PM	0	0	0	0	0
5:30 PM	0	0	0	0	0
5:45 PM	0	0	0	0	0
TOTAL VOLUMES:	0	0	0	0	0

Location: Moreno Valley
 N/S: I-215 Northbound Ramps
 E/W: Alessandro Boulevard



Date: 8/20/2019
 Day: Tuesday

BICYCLES

	Southbound I-215 Northbound Ramps			Westbound Alessandro Boulevard			Northbound I-215 Northbound Ramps			Eastbound Alessandro Boulevard			
	Left	Thru	Right	Left	Thru	Right	Left	Thru	Right	Left	Thru	Right	
7:00 AM	0	0	0	0	0	0	0	0	0	0	2	0	2
7:15 AM	0	0	0	0	0	0	0	0	0	0	0	0	0
7:30 AM	0	0	0	0	0	0	0	0	0	0	0	0	0
7:45 AM	0	0	0	0	0	0	0	0	0	0	0	0	0
8:00 AM	0	0	0	0	2	0	0	0	0	0	0	0	2
8:15 AM	0	0	0	0	0	0	0	0	0	0	0	0	0
8:30 AM	0	0	0	0	0	0	0	0	0	0	0	0	0
8:45 AM	0	0	0	0	0	0	0	0	0	0	0	0	0
TOTAL VOLUMES:	0	0	0	0	2	0	0	0	0	0	2	0	4

	Southbound I-215 Northbound Ramps			Westbound Alessandro Boulevard			Northbound I-215 Northbound Ramps			Eastbound Alessandro Boulevard			
	Left	Thru	Right	Left	Thru	Right	Left	Thru	Right	Left	Thru	Right	
4:00 PM	0	0	0	0	0	0	0	0	0	0	0	0	0
4:15 PM	0	0	0	0	0	0	0	0	0	0	0	0	0
4:30 PM	0	0	0	0	0	0	0	0	0	0	0	0	0
4:45 PM	0	0	0	0	0	0	0	0	0	0	0	0	0
5:00 PM	0	0	0	0	0	0	0	0	0	0	0	0	0
5:15 PM	0	0	0	0	0	0	0	0	0	0	0	0	0
5:30 PM	0	0	0	0	0	0	0	0	0	0	0	0	0
5:45 PM	0	0	0	0	0	0	0	0	0	0	0	0	0
TOTAL VOLUMES:	0	0	0	0	0	0	0	0	0	0	0	0	0

Counts Unlimited
 PO Box 1178
 Corona, CA 92878
 (951) 268-6268

City of Moreno Valley
 N/S: I-215 Southbound Ramps
 E/W: Cactus Avenue
 Weather: Clear

File Name : 35_MRV_215S_Cactus AM
 Site Code : 05119542
 Start Date : 8/20/2019
 Page No : 2

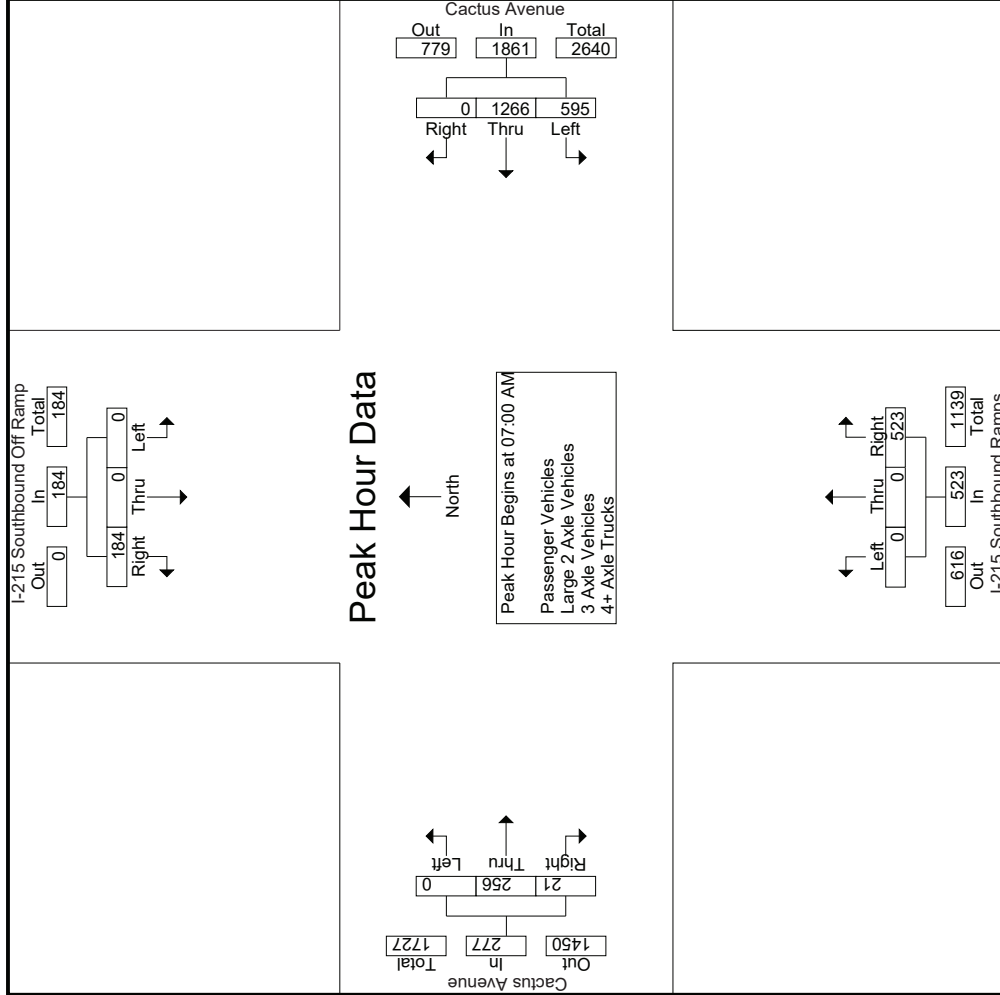

Counts Unlimited
 PO Box 1178
 Corona, CA 92878
 (951) 268-6268

City of Moreno Valley
 N/S: I-215 Southbound Ramps
 E/W: Cactus Avenue
 Weather: Clear

File Name : 35_MRV_215S_Cactus AM
 Site Code : 05119542
 Start Date : 8/20/2019
 Page No : 3

Start Time	I-215 Southbound Off Ramp Southbound			Cactus Avenue Westbound			I-215 Southbound Ramps Northbound			Cactus Avenue Eastbound			
	Left	Thru	Right	Left	Thru	Right	Left	Thru	Right	Left	Thru	Right	
Peak Hour Analysis From 07:00 AM to 08:45 AM - Peak 1 of 1													
Peak Hour for Each Approach Begins at:													
+0 mins.	0	0	64	171	343	0	514	0	138	138	0	66	73
+15 mins.	0	0	64	157	318	0	475	0	129	129	0	62	68
+30 mins.	0	0	43	137	310	0	447	0	119	119	0	71	75
+45 mins.	0	0	49	130	295	0	425	0	137	137	0	58	66
Total Volume	0	0	220	595	1266	0	1861	0	523	523	0	257	282
% App. Total	0	0	100	32	68	0	870	0	100	947	0	91.1	8.9
PHF	.000	.000	.859	.870	.923	.000	.905	.000	.947	.947	.000	.905	.781

Counts Unlimited
 PO Box 1178
 Corona, CA 92878
 (951) 268-6268

City of Moreno Valley
 N/S: I-215 Southbound Ramps
 EW: Cactus Avenue
 Weather: Clear

File Name : 35_MRV_215S_Cactus AM
 Site Code : 05119542
 Start Date : 8/20/2019
 Page No : 1

Groups Printed- Passenger Vehicles

Start Time	I-215 Southbound Off Ramp Southbound				Cactus Avenue Westbound				I-215 Southbound Ramps Northbound				Cactus Avenue Eastbound						
	Left	Thru	Right	RTOR	App. Total	Left	Thru	Right	RTOR	App. Total	Left	Thru	Right	RTOR	App. Total	Exclu. Total	Inclu. Total	Int. Total	
07:00 AM	0	0	29	2	29	167	325	0	0	492	0	0	122	2	122	0	47	2	49
07:15 AM	0	0	27	8	27	156	308	0	0	464	0	0	120	0	120	0	58	3	61
07:30 AM	0	0	35	8	35	132	301	0	0	433	0	0	109	0	109	0	54	6	60
07:45 AM	0	0	56	20	56	125	286	0	0	411	0	0	127	0	127	0	60	2	62
Total	0	0	147	38	147	580	1220	0	0	1800	0	0	478	2	478	0	219	13	232
08:00 AM	0	0	57	32	57	127	263	0	0	390	0	0	110	0	110	0	47	6	53
08:15 AM	0	0	33	30	33	76	295	0	0	371	0	0	96	0	96	0	53	3	56
08:30 AM	0	0	37	13	37	86	291	0	0	377	0	0	85	0	85	0	34	5	39
08:45 AM	0	0	34	13	34	100	263	0	0	363	0	0	81	0	81	0	47	9	56
Total	0	0	161	88	161	389	1112	0	0	1501	0	0	372	0	372	0	181	23	204
Grand Total	0	0	308	126	308	969	2332	0	0	3301	0	0	850	2	850	0	400	36	436
Apprch %	0	0	100			29.4	70.6	0	0		0	0	100			0	91.7	8.3	
Total %	0	0	6.3			19.8	47.6	0	0	67.4	0	0	17.4		17.4	0	8.2	0.7	8.9

3.1-464

Start Time	I-215 Southbound Off Ramp Southbound				Cactus Avenue Westbound				I-215 Southbound Ramps Northbound				Cactus Avenue Eastbound						
	Left	Thru	Right	RTOR	App. Total	Left	Thru	Right	RTOR	App. Total	Left	Thru	Right	RTOR	App. Total	Exclu. Total	Inclu. Total	Int. Total	
07:00 AM	0	0	29	0	29	167	325	0	0	492	0	0	122	0	122	0	47	2	49
07:15 AM	0	0	27	0	27	156	308	0	0	464	0	0	120	0	120	0	58	3	61
07:30 AM	0	0	35	0	35	132	301	0	0	433	0	0	109	0	109	0	54	6	60
07:45 AM	0	0	56	0	56	125	286	0	0	411	0	0	127	0	127	0	60	2	62
Total Volume	0	0	147	0	147	580	1220	0	0	1800	0	0	478	0	478	0	219	13	232
% App. Total	0	0	100			32.2	67.8	0	0		0	0	100			0	94.4	5.6	
PHF	.000	.000	.656			.868	.938	.000	.000	.915	.000	.000	.941		.941	.000	.913	.542	.935

Peak Hour Analysis From 07:00 AM to 07:45 AM - Peak 1 of 1
 Peak Hour for Entire Intersection Begins at 07:00 AM

Counts Unlimited
 PO Box 1178
 Corona, CA 92878
 (951) 268-6268

City of Moreno Valley
 N/S: I-215 Southbound Ramps
 E/W: Cactus Avenue
 Weather: Clear

File Name : 35_MRV_215S_Cactus AM
 Site Code : 05119542
 Start Date : 8/20/2019
 Page No : 2

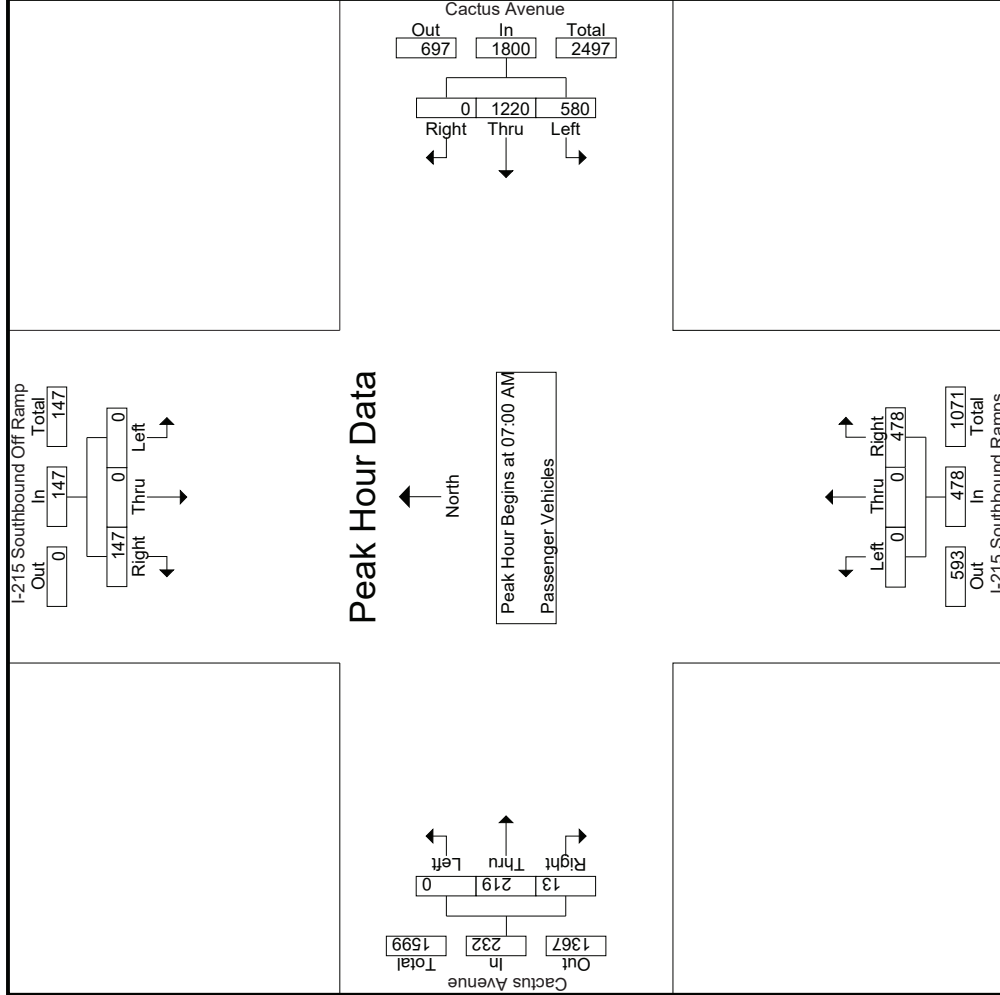

Counts Unlimited
 PO Box 1178
 Corona, CA 92878
 (951) 268-6268

City of Moreno Valley
 N/S: I-215 Southbound Ramps
 E/W: Cactus Avenue
 Weather: Clear

File Name : 35_MRV_215S_Cactus AM
 Site Code : 05119542
 Start Date : 8/20/2019
 Page No : 3

Start Time	I-215 Southbound Off Ramp Southbound			Cactus Avenue Westbound			I-215 Southbound Ramps Northbound			Cactus Avenue Eastbound					
	Left	Thru	Right	Left	Thru	Right	Left	Thru	Right	Left	Thru	Right			
Peak Hour Analysis From 07:00 AM to 07:45 AM - Peak 1 of 1															
Peak Hour for Each Approach Begins at:	07:00 AM														
+0 mins.	0	0	29	167	325	0	492	0	0	0	122	122	0	47	2
+15 mins.	0	0	27	156	308	0	464	0	0	0	120	120	0	58	3
+30 mins.	0	0	35	132	301	0	433	0	0	0	109	109	0	54	6
+45 mins.	0	0	56	125	286	0	411	0	0	0	127	127	0	60	2
Total Volume	0	0	147	580	1220	0	1800	0	0	0	478	478	0	219	13
% App. Total	0	0	100	32.2	67.8	0	91.5	0	0	0	100	94.1	0	94.4	5.6
PHF	.000	.000	.656	.868	.938	.000	.915	.000	.000	.000	.941	.941	.000	.913	.542

Groups Printed- Large 2 Axle Vehicles

Start Time	I-215 Southbound Off Ramp Southbound				Cactus Avenue Westbound				I-215 Southbound Ramps Northbound				Cactus Avenue Eastbound								
	Left	Thru	Right	RTOR	Left	Thru	Right	RTOR	Left	Thru	Right	RTOR	Left	Thru	Right	RTOR					
07:00 AM	0	0	3	0	3	9	0	0	12	0	0	3	0	2	1	0	3	0	21	21	
07:15 AM	0	0	1	0	1	1	0	0	1	0	3	0	3	0	1	1	0	2	0	7	7
07:30 AM	0	0	1	1	4	5	0	0	9	0	5	0	5	0	0	0	0	0	1	15	16
07:45 AM	0	0	2	0	4	4	0	0	4	0	3	0	3	0	2	1	0	3	0	12	12
Total	0	0	7	1	11	15	0	0	26	0	0	14	0	5	3	0	8	1	55	56	
08:00 AM	0	0	2	1	5	5	0	0	10	0	1	0	1	0	2	0	0	2	1	15	16
08:15 AM	0	0	4	4	3	3	0	0	6	0	6	0	6	0	3	1	0	4	4	20	24
08:30 AM	0	0	5	1	13	0	0	0	14	0	1	0	1	0	4	1	0	5	1	25	26
08:45 AM	0	0	4	2	7	6	0	0	13	0	2	0	2	0	0	0	0	2	19	21	
Total	0	0	15	8	16	27	0	0	43	0	0	10	0	9	2	0	11	8	79	87	
Grand Total	0	0	22	9	27	42	0	0	69	0	0	24	0	0	14	5	0	19	9	134	143
Apprch %	0	0	100		39.1	60.9	0	0	51.5	0	0	17.9	0	0	73.7	26.3	0	14.2	6.3	93.7	
Total %	0	0	16.4		20.1	31.3	0	0	51.5	0	0	17.9	0	0	10.4	3.7	0	14.2	6.3	93.7	

3:1-467

Start Time	I-215 Southbound Off Ramp Southbound				Cactus Avenue Westbound				I-215 Southbound Ramps Northbound				Cactus Avenue Eastbound								
	Left	Thru	Right	RTOR	Left	Thru	Right	RTOR	Left	Thru	Right	RTOR	Left	Thru	Right	RTOR					
07:00 AM	0	0	3	0	3	9	0	0	12	0	0	3	0	2	1	0	3	0	21	21	
07:15 AM	0	0	1	0	1	1	0	0	1	0	3	0	3	0	1	1	0	2	0	7	7
07:30 AM	0	0	1	1	4	5	0	0	9	0	5	0	5	0	0	0	0	0	1	15	16
07:45 AM	0	0	2	0	4	4	0	0	4	0	3	0	3	0	2	1	0	3	0	12	12
Total Volume	0	0	7	1	11	15	0	0	26	0	0	14	0	5	3	0	8	1	55	56	
% App. Total	0	0	100		42.3	57.7	0	0	51.5	0	0	100	0	0	62.5	37.5	0	14.2	6.3	93.7	
PHF	.000	.000	.583		.688	.417	.000	.542	.542	.000	.700	.000	.700	.000	.625	.750	.667	.667	.655		

Peak Hour Analysis From 07:00 AM to 07:45 AM - Peak 1 of 1
 Peak Hour for Entire Intersection Begins at 07:00 AM

Counts Unlimited
 PO Box 1178
 Corona, CA 92878
 (951) 268-6268

City of Moreno Valley
 N/S: I-215 Southbound Ramps
 E/W: Cactus Avenue
 Weather: Clear

File Name : 35_MRV_215S_Cactus AM
 Site Code : 05119542
 Start Date : 8/20/2019
 Page No : 2

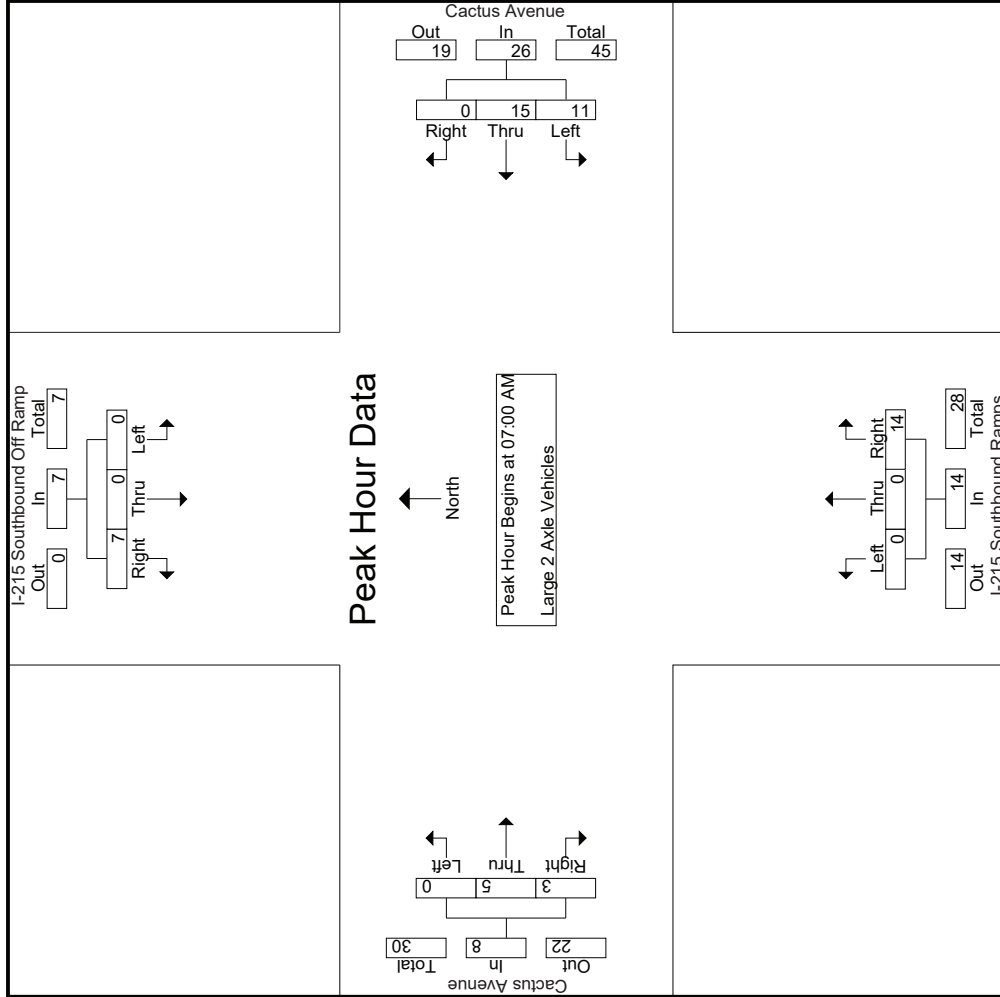

Counts Unlimited
 PO Box 1178
 Corona, CA 92878
 (951) 268-6268

City of Moreno Valley
 N/S: I-215 Southbound Ramps
 E/W: Cactus Avenue
 Weather: Clear

File Name : 35_MRV_215S_Cactus AM
 Site Code : 05119542
 Start Date : 8/20/2019
 Page No : 3

Start Time	I-215 Southbound Off Ramp			Cactus Avenue Westbound			I-215 Southbound Ramps Northbound			Cactus Avenue Eastbound			
	Left	Thru	Right	App. Total	Left	Thru	Right	App. Total	Left	Thru	Right	App. Total	Int. Total
Peak Hour Analysis From 07:00 AM to 07:45 AM - Peak 1 of 1													
Peak Hour for Each Approach Begins at:													
	07:00 AM				07:00 AM				07:00 AM				
+0 mins.	0	0	3	3	0	0	0	12	0	0	3	3	3
+15 mins.	0	0	1	1	0	1	0	1	0	0	3	3	2
+30 mins.	0	0	1	1	4	5	0	9	0	0	5	5	0
+45 mins.	0	0	2	2	4	0	0	4	0	0	3	3	0
Total Volume	0	0	7	7	11	15	0	26	0	0	14	14	8
% App. Total	0	0	100	.583	42.3	57.7	0	100	0	0	100	70.0	66.7
PHF	.000	.000	.583	.583	.688	.417	.000	.542	.000	.000	.700	.700	.667

Counts Unlimited
 PO Box 1178
 Corona, CA 92878
 (951) 268-6268

City of Moreno Valley
 N/S: I-215 Southbound Ramps
 EW: Cactus Avenue
 Weather: Clear

File Name : 35_MRV_215S_Cactus AM
 Site Code : 05119542
 Start Date : 8/20/2019
 Page No : 1

Groups Printed- 3 Axle Vehicles

Start Time	I-215 Southbound Off Ramp Southbound				Cactus Avenue Westbound				I-215 Southbound Ramps Northbound				Cactus Avenue Eastbound			
	Left	Thru	Right	RTOR	Left	Thru	Right	RTOR	Left	Thru	Right	RTOR	Left	Thru	Right	RTOR
07:00 AM	0	0	2	0	1	9	0	0	0	0	2	0	0	5	0	0
07:15 AM	0	0	0	0	1	7	0	0	0	0	1	0	0	3	0	0
07:30 AM	0	0	0	0	2	0	0	0	0	0	1	0	0	5	0	0
07:45 AM	0	0	0	0	0	3	0	0	0	0	2	0	0	5	0	0
Total	0	0	2	0	2	21	0	0	0	0	6	0	0	18	0	0
08:00 AM	0	0	0	0	2	4	0	0	0	0	0	0	0	9	0	0
08:15 AM	0	0	1	0	0	5	0	0	0	0	2	0	0	1	0	0
08:30 AM	0	0	0	0	0	6	0	0	0	0	0	0	0	5	1	0
08:45 AM	0	0	0	0	3	3	0	0	0	0	1	0	0	0	0	0
Total	0	0	1	0	5	18	0	0	0	0	3	0	0	16	1	0
Grand Total	0	0	3	0	7	39	0	0	0	0	9	0	0	34	1	0
Apprch %	0	0	100		15.2	84.8	0		0	0	100		0	97.1	2.9	
Total %	0	0	3.2		3.2	7.5	41.9		0	0	9.7		0	36.6	1.1	
App. Total																
Exclu. Total																
Inclu. Total																
Int. Total																

3:1-470

Start Time	I-215 Southbound Off Ramp Southbound				Cactus Avenue Westbound				I-215 Southbound Ramps Northbound				Cactus Avenue Eastbound			
	Left	Thru	Right	RTOR	Left	Thru	Right	RTOR	Left	Thru	Right	RTOR	Left	Thru	Right	RTOR
07:00 AM	0	0	0	0	1	9	0	0	0	0	2	0	0	5	0	0
07:15 AM	0	0	0	0	1	7	0	0	0	0	1	0	0	3	0	0
07:30 AM	0	0	0	0	2	0	0	0	0	0	1	0	0	5	0	0
07:45 AM	0	0	0	0	0	3	0	0	0	0	2	0	0	5	0	0
Total Volume	0	0	2	0	2	21	0	0	0	0	6	0	0	18	0	0
% App. Total	0	0	100		8.7	91.3	0		0	0	100		0	100	0	
PHF	.000	.000	.250		.500	.583	.000		.000	.000	.750		.000	.900	.000	

Peak Hour Analysis From 07:00 AM to 07:45 AM - Peak 1 of 1
 Peak Hour for Entire Intersection Begins at 07:00 AM

Counts Unlimited
 PO Box 1178
 Corona, CA 92878
 (951) 268-6268

City of Moreno Valley
 N/S: I-215 Southbound Ramps
 E/W: Cactus Avenue
 Weather: Clear

File Name : 35_MRV_215S_Cactus AM
 Site Code : 05119542
 Start Date : 8/20/2019
 Page No : 2

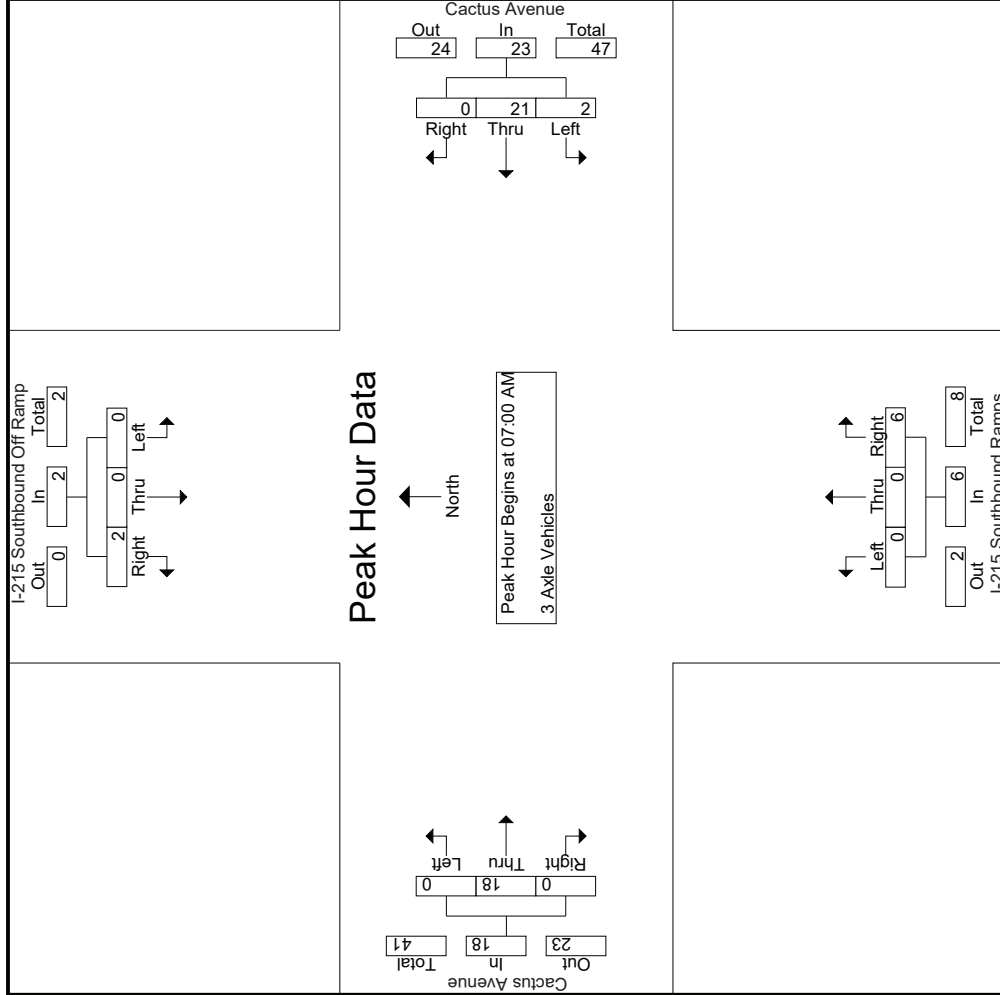

Counts Unlimited
 PO Box 1178
 Corona, CA 92878
 (951) 268-6268

City of Moreno Valley
 N/S: I-215 Southbound Ramps
 E/W: Cactus Avenue
 Weather: Clear

File Name : 35_MRV_215S_Cactus AM
 Site Code : 05119542
 Start Date : 8/20/2019
 Page No : 3

Start Time	I-215 Southbound Off Ramp			Cactus Avenue Westbound			I-215 Southbound Ramps Northbound			Cactus Avenue Eastbound			
	Left	Thru	Right	App. Total	Left	Thru	Right	App. Total	Left	Thru	Right	App. Total	Int. Total
Peak Hour Analysis From 07:00 AM to 07:45 AM - Peak 1 of 1	Peak Hour for Each Approach Begins at:												
	07:00 AM				07:00 AM				07:00 AM				
+0 mins.	0	0	2	2	1	9	0	10	0	0	2	2	5
+15 mins.	0	0	0	0	1	7	0	8	0	0	1	1	3
+30 mins.	0	0	0	0	0	2	0	2	0	0	1	1	5
+45 mins.	0	0	0	0	0	3	0	3	0	0	2	2	5
Total Volume	0	0	2	2	2	21	0	23	0	0	6	6	18
% App. Total	0	0	100	.250	8.7	91.3	0	.575	.000	.000	.100	.750	.900
PHF	.000	.000	.250	.250	.500	.583	.000	.575	.000	.000	.750	.750	.900

Counts Unlimited
 PO Box 1178
 Corona, CA 92878
 (951) 268-6268

City of Moreno Valley
 N/S: I-215 Southbound Ramps
 EW: Cactus Avenue
 Weather: Clear

File Name : 35_MRV_215S_Cactus AM
 Site Code : 05119542
 Start Date : 8/20/2019
 Page No : 1

Groups Printed- 4+ Axle Trucks

Start Time	I-215 Southbound Off Ramp Southbound				Cactus Avenue Westbound				I-215 Southbound Ramps Northbound				Cactus Avenue Eastbound								
	Left	Thru	Right	RTOR	App. Total	Left	Thru	Right	RTOR	App. Total	Left	Thru	Right	RTOR	App. Total	Exclu. Total	Inclu. Total	Int. Total			
07:00 AM	0	0	7	1	7	0	0	0	0	0	0	0	11	0	3	1	0	4	1	22	23
07:15 AM	0	0	10	0	10	0	2	0	0	2	0	5	0	0	4	3	0	7	0	24	24
07:30 AM	0	0	5	0	5	1	2	0	0	3	0	4	0	0	3	0	0	3	0	15	15
07:45 AM	0	0	6	0	6	1	6	0	0	7	0	5	0	0	4	1	0	5	0	23	23
Total	0	0	28	1	28	2	10	0	0	12	0	0	25	0	14	5	0	19	1	84	85
08:00 AM	0	0	5	1	5	3	5	0	0	8	0	4	0	0	0	2	0	2	1	19	20
08:15 AM	0	0	5	2	5	0	1	0	0	1	0	13	0	0	3	1	0	4	2	23	25
08:30 AM	0	0	7	0	7	2	4	0	0	6	0	7	0	0	3	1	0	4	0	24	24
08:45 AM	0	0	4	1	4	0	7	0	0	7	0	5	0	0	4	3	0	7	1	23	24
Total	0	0	21	4	21	5	17	0	0	22	0	0	29	0	10	7	0	17	4	89	93
Grand Total	0	0	49	5	49	7	27	0	0	34	0	0	54	0	0	24	12	0	5	173	178
Apprch %	0	0	100		20.6	79.4	0			19.7	0	0	100	0	66.7	33.3		36			
Total %	0	0	28.3		28.3	4	15.6	0		19.7	0	0	31.2	0	13.9	6.9		20.8	2.8	97.2	

3:1-473

Start Time	I-215 Southbound Off Ramp Southbound				Cactus Avenue Westbound				I-215 Southbound Ramps Northbound				Cactus Avenue Eastbound								
	Left	Thru	Right	RTOR	App. Total	Left	Thru	Right	RTOR	App. Total	Left	Thru	Right	RTOR	App. Total	Exclu. Total	Inclu. Total	Int. Total			
07:00 AM	0	0	7	0	7	0	0	0	0	0	0	0	11	0	3	1	0	4	1	22	22
07:15 AM	0	0	10	0	10	0	2	0	0	2	0	5	0	0	4	3	0	7	0	24	24
07:30 AM	0	0	5	0	5	1	2	0	0	3	0	4	0	0	3	0	0	3	0	15	15
07:45 AM	0	0	6	0	6	1	6	0	0	7	0	5	0	0	4	1	0	5	0	23	23
Total Volume	0	0	28	1	28	2	10	0	0	12	0	0	25	0	14	5	0	19	1	84	84
% App. Total	0	0	100		20.6	79.4	0			19.7	0	0	100	0	66.7	33.3		36			
PHF	.000	.000	.700		.700	.500	.417	.000		.429	.000	.000	.568	.000	.875	.417		.679		.875	

Peak Hour Analysis From 07:00 AM to 07:45 AM - Peak 1 of 1
 Peak Hour for Entire Intersection Begins at 07:00 AM

Counts Unlimited
 PO Box 1178
 Corona, CA 92878
 (951) 268-6268

City of Moreno Valley
 N/S: I-215 Southbound Ramps
 E/W: Cactus Avenue
 Weather: Clear

File Name : 35_MRV_215S_Cactus AM
 Site Code : 05119542
 Start Date : 8/20/2019
 Page No : 2

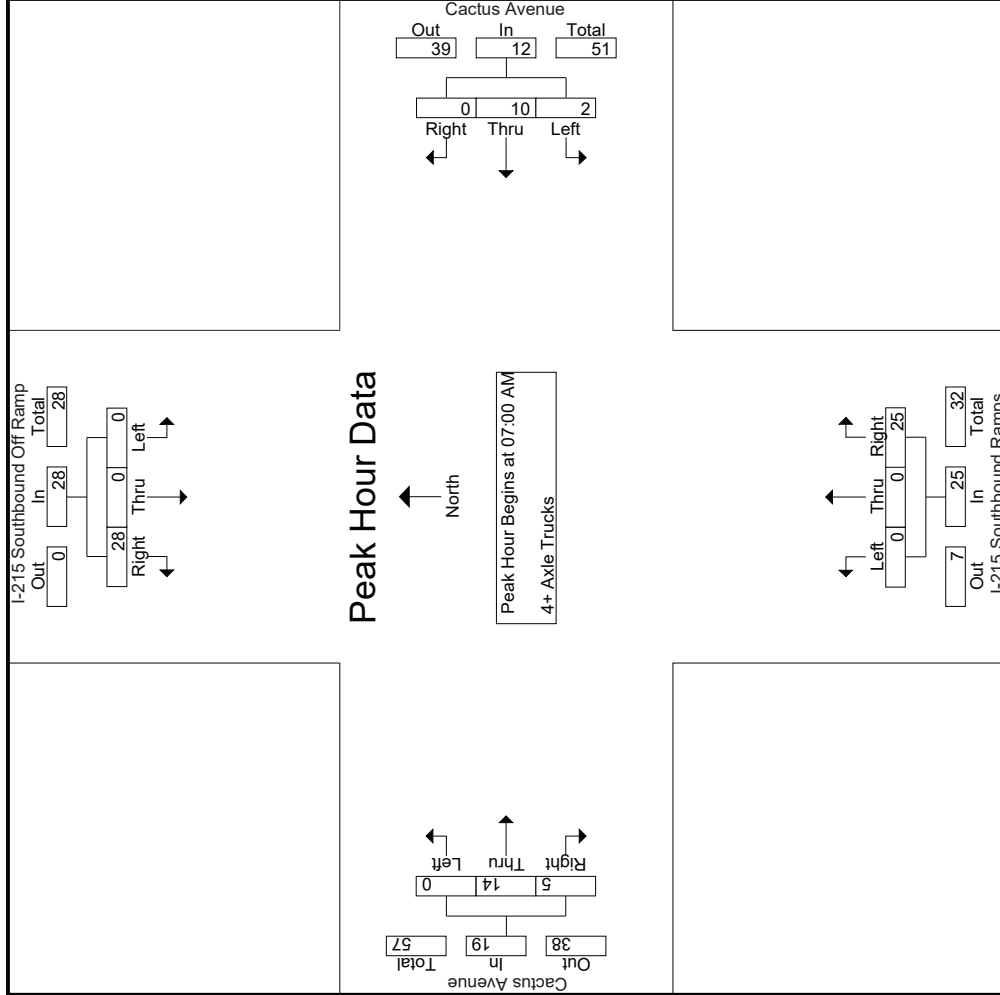

Counts Unlimited
 PO Box 1178
 Corona, CA 92878
 (951) 268-6268

City of Moreno Valley
 N/S: I-215 Southbound Ramps
 E/W: Cactus Avenue
 Weather: Clear

File Name : 35_MRV_215S_Cactus AM
 Site Code : 05119542
 Start Date : 8/20/2019
 Page No : 3

Start Time	I-215 Southbound Off Ramp			Cactus Avenue Westbound			I-215 Southbound Ramps Northbound			Cactus Avenue Eastbound						
	Left	Thru	Right	App. Total	Left	Thru	Right	App. Total	Left	Thru	Right	App. Total	Int. Total			
Peak Hour Analysis From 07:00 AM to 07:45 AM - Peak 1 of 1																
Peak Hour for Each Approach Begins at:																
	07:00 AM				07:00 AM				07:00 AM							
+0 mins.	0	0	7	7	0	0	0	0	0	0	11	11	0	3	1	4
+15 mins.	0	0	10	10	0	2	0	2	0	5	5	7	0	4	3	7
+30 mins.	0	0	5	5	1	2	0	3	0	4	4	0	0	3	0	3
+45 mins.	0	0	6	6	1	6	0	7	0	5	5	0	0	4	1	5
Total Volume	0	0	28	28	2	10	0	12	0	0	25	25	0	14	5	19
% App. Total	0	0	100	100	16.7	83.3	0	0	0	0	100	100	0	73.7	26.3	73.7
PHF	.000	.000	.700	.700	.500	.417	.000	.429	.000	.000	.568	.568	.000	.875	.417	.679

Counts Unlimited
 PO Box 1178
 Corona, CA 92878
 (951) 268-6268

City of Moreno Valley
 N/S: I-215 Southbound Ramps
 EW: Cactus Avenue
 Weather: Clear

File Name : 35_MRV_215S_Cactus PM
 Site Code : 05119542
 Start Date : 8/20/2019
 Page No : 1

Groups Printed- Passenger Vehicles - Large 2 Axle Vehicles - 3 Axle Vehicles - 4+ Axle Trucks

Start Time	I-215 Southbound Off Ramp Southbound						Cactus Avenue Westbound						I-215 Southbound Ramps Northbound						Cactus Avenue Eastbound					
	Left	Thru	Right	RTOR	App. Total		Left	Thru	Right	RTOR	App. Total		Left	Thru	Right	RTOR	App. Total		Left	Thru	Right	RTOR	App. Total	
04:00 PM	0	0	22	15	22		166	122	0	0	288		0	0	122	0	122		0	135	34	0	169	
04:15 PM	0	0	30	30	30		138	136	0	0	274		0	0	153	0	153		0	125	32	0	157	
04:30 PM	0	0	41	36	41		155	126	0	0	281		0	0	154	0	154		0	162	26	0	188	
04:45 PM	0	0	30	26	30		120	97	0	0	217		0	0	141	0	141		0	121	32	0	153	
Total	0	0	123	107	123		579	481	0	0	1060		0	0	570	0	570		0	543	124	0	667	
05:00 PM	0	0	39	29	39		155	129	0	0	284		0	0	145	0	145		0	184	54	0	238	
05:15 PM	0	0	46	35	46		143	138	0	0	281		0	0	187	0	187		0	141	31	0	172	
05:30 PM	0	0	42	37	42		119	120	0	0	239		0	0	191	0	191		0	147	28	0	175	
05:45 PM	0	0	32	24	32		99	102	0	0	201		0	0	177	0	177		0	152	27	0	179	
Total	0	0	159	125	159		516	489	0	0	1005		0	0	700	0	700		0	624	140	0	764	
Grand Total	0	0	282	232	282		1095	970	0	0	2065		0	0	1270	0	1270		0	1167	264	0	1431	
Approch %	0	0	100	100	100		53	47	0	0	100		0	0	100	0	100		0	81.6	18.4	0	100	
Total %	0	0	5.6	5.6	5.6		21.7	19.2	0	0	40.9		0	0	25.2	0	25.2		0	23.1	5.2	0	28.3	
% Passenger Vehicles	0	0	242	88.8	88.8		1076	943	0	0	2019		0	0	1162	0	1162		0	1121	256	0	1377	
% Large 2 Axle Vehicles	0	0	85.8	88.8	87.2		98.3	97.2	0	0	97.8		0	0	91.5	0	91.5		0	96.1	97	0	96.2	
% Large 3 Axle Vehicles	0	0	13	4.3	4.3		15	17	0	0	32		0	0	28	0	28		0	24	2	0	26	
% Large 4+ Axle Trucks	0	0	4	0.4	0.4		2	4	0	0	6		0	0	11	0	11		0	2.1	0.8	0	1.8	
% 3 Axle Vehicles	0	0	1.4	0.4	1		0.2	0.4	0	0	0.3		0	0	0.9	0	0.9		0	0.3	0.4	0	0.3	
% 4+ Axle Trucks	0	0	23	6.5	38		2	6	0	0	8		0	0	69	0	69		0	18	5	0	23	
% 4+ Axle Trucks	0	0	8.2	6.5	7.4		0.2	0.6	0	0	0.4		0	0	5.4	0	5.4		0	1.5	1.9	0	1.6	
PHF	.000	.000	.864	.864	.864		.832	.886	.000	.885	.000		.000	.000	.916	.000	.916		.000	.848	.648	.000	.803	

Peak Hour Analysis From 04:00 PM to 05:45 PM - Peak 1 of 1

Peak Hour for Entire Intersection Begins at 05:00 PM

Start Time	I-215 Southbound Off Ramp Southbound						Cactus Avenue Westbound						I-215 Southbound Ramps Northbound						Cactus Avenue Eastbound					
	Left	Thru	Right	RTOR	App. Total		Left	Thru	Right	RTOR	App. Total		Left	Thru	Right	RTOR	App. Total		Left	Thru	Right	RTOR	App. Total	
05:00 PM	0	0	39	0	39		155	129	0	0	284		0	0	145	0	145		0	184	54	0	238	
05:15 PM	0	0	46	0	46		143	138	0	0	281		0	0	187	0	187		0	141	31	0	172	
05:30 PM	0	0	42	0	42		119	120	0	0	239		0	0	191	0	191		0	147	28	0	175	
05:45 PM	0	0	32	0	32		99	102	0	0	201		0	0	177	0	177		0	152	27	0	179	
Total Volume	0	0	159	0	159		516	489	0	0	1005		0	0	700	0	700		0	624	140	0	764	
% App. Total	0	0	100	0	100		51.3	48.7	0	0	100		0	0	100	0	100		0	81.7	18.3	0	100	
PHF	.000	.000	.864	.864	.864		.832	.886	.000	.885	.000		.000	.000	.916	.000	.916		.000	.848	.648	.000	.803	

Counts Unlimited
 PO Box 1178
 Corona, CA 92878
 (951) 268-6268

City of Moreno Valley
 N/S: I-215 Southbound Ramps
 E/W: Cactus Avenue
 Weather: Clear

File Name : 35_MRV_215S_Cactus PM
 Site Code : 05119542
 Start Date : 8/20/2019
 Page No : 2

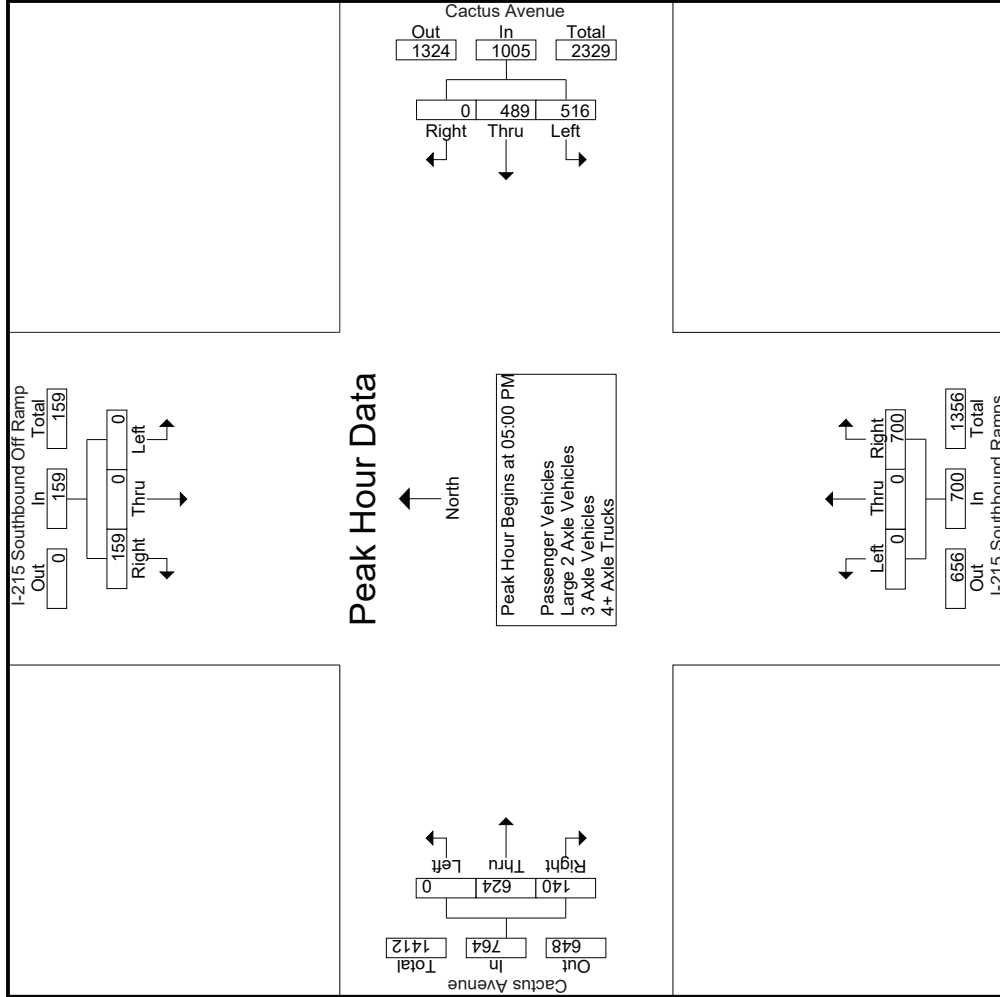

Counts Unlimited
 PO Box 1178
 Corona, CA 92878
 (951) 268-6268

City of Moreno Valley
 N/S: I-215 Southbound Ramps
 E/W: Cactus Avenue
 Weather: Clear

File Name : 35_MRV_215S_Cactus PM
 Site Code : 05119542
 Start Date : 8/20/2019
 Page No : 3

Start Time	I-215 Southbound Off Ramp			Cactus Avenue Westbound			I-215 Southbound Ramps Northbound			Cactus Avenue Eastbound				
	Left	Thru	Right	App. Total	Left	Thru	Right	App. Total	Left	Thru	Right	App. Total	Int. Total	
Peak Hour Analysis From 04:00 PM to 05:45 PM - Peak 1 of 1														
Peak Hour for Each Approach Begins at:														
	05:00 PM				04:30 PM				05:00 PM					
+0 mins.	0	0	39	39	155	126	0	281	0	0	145	145	0	238
+15 mins.	0	0	46	46	120	97	0	217	0	0	187	187	0	172
+30 mins.	0	0	42	42	155	129	0	284	0	0	191	191	0	175
+45 mins.	0	0	32	32	143	138	0	281	0	0	177	177	0	179
Total Volume	0	0	159	159	573	490	0	1063	0	0	700	700	0	764
% App. Total	0	0	100	100	53.9	46.1	0	100	0	0	100	100	0	18.3
PHF	.000	.000	.864	.864	.924	.888	.000	.936	.000	.000	.916	.916	.000	.848
														.803

Counts Unlimited
 PO Box 1178
 Corona, CA 92878
 (951) 268-6268

City of Moreno Valley
 N/S: I-215 Southbound Ramps
 EW: Cactus Avenue
 Weather: Clear

File Name : 35_MRV_215S_Cactus PM
 Site Code : 05119542
 Start Date : 8/20/2019
 Page No : 1

Groups Printed- Passenger Vehicles

Start Time	I-215 Southbound Off Ramp Southbound					Cactus Avenue Westbound					I-215 Southbound Ramps Northbound					Cactus Avenue Eastbound							
	Left	Thru	Right	RTOR	App. Total	Left	Thru	Right	RTOR	App. Total	Left	Thru	Right	RTOR	App. Total	Left	Thru	Right	RTOR	App. Total	Exclu. Total	Inclu. Total	Int. Total
04:00 PM	0	0	19	14	19	163	120	0	0	283	0	0	110	0	110	0	126	31	0	157	14	569	583
04:15 PM	0	0	27	27	27	134	132	0	0	266	0	0	137	0	137	0	118	31	0	149	27	579	606
04:30 PM	0	0	35	31	35	153	125	0	0	278	0	0	134	0	134	0	159	25	0	184	31	631	662
04:45 PM	0	0	27	25	27	115	93	0	0	208	0	0	127	0	127	0	112	31	0	143	25	505	530
Total	0	0	108	97	108	565	470	0	0	1035	0	0	508	0	508	0	515	118	0	633	97	2284	2381
05:00 PM	0	0	31	24	31	153	125	0	0	278	0	0	137	0	137	0	177	54	0	231	24	677	701
05:15 PM	0	0	40	30	40	142	132	0	0	274	0	0	178	0	178	0	137	30	0	167	30	659	689
05:30 PM	0	0	39	35	39	118	117	0	0	235	0	0	175	0	175	0	145	28	0	173	35	622	657
05:45 PM	0	0	24	20	24	98	99	0	0	197	0	0	164	0	164	0	147	26	0	173	20	558	578
Total	0	0	134	109	134	511	473	0	0	984	0	0	654	0	654	0	606	138	0	744	109	2516	2625
Grand Total	0	0	242	206	242	1076	943	0	0	2019	0	0	1162	0	1162	0	1121	256	0	1377	206	4800	5006
Approch %	0	0	100			53.3	46.7	0		42.1	0	0	100		24.2	0	81.4	18.6		28.7	4.1	95.9	
Total %	0	0	5		5	22.4	19.6	0		42.1	0	0	24.2		24.2	0	23.4	5.3		28.7			

3.1-479

Start Time	I-215 Southbound Off Ramp Southbound					Cactus Avenue Westbound					I-215 Southbound Ramps Northbound					Cactus Avenue Eastbound							
	Left	Thru	Right	RTOR	App. Total	Left	Thru	Right	RTOR	App. Total	Left	Thru	Right	RTOR	App. Total	Left	Thru	Right	RTOR	App. Total	Exclu. Total	Inclu. Total	Int. Total
05:00 PM	0	0	31		31	153	125	0		278	0	0	137		137	0	177	54		231			
05:15 PM	0	0	40		40	142	132	0		274	0	0	178		178	0	137	30		167			
05:30 PM	0	0	39		39	118	117	0		235	0	0	175		175	0	145	28		173			
05:45 PM	0	0	24		24	98	99	0		197	0	0	164		164	0	147	26		173			
Total Volume	0	0	134		134	511	473	0		984	0	0	654		654	0	606	138		744			
% App. Total	0	0	100		100	51.9	48.1	0		42.1	0	0	100		100	0	81.5	18.5		28.7			
PHF	.000	.000	.838		.838	.835	.896	.000		.885	.000	.000	.919		.919	.000	.856	.639		.805			.929

Peak Hour Analysis From 05:00 PM to 05:45 PM - Peak 1 of 1
 Peak Hour for Entire Intersection Begins at 05:00 PM

Counts Unlimited
 PO Box 1178
 Corona, CA 92878
 (951) 268-6268

City of Moreno Valley
 N/S: I-215 Southbound Ramps
 E/W: Cactus Avenue
 Weather: Clear

File Name : 35_MRV_215S_Cactus PM
 Site Code : 05119542
 Start Date : 8/20/2019
 Page No : 2

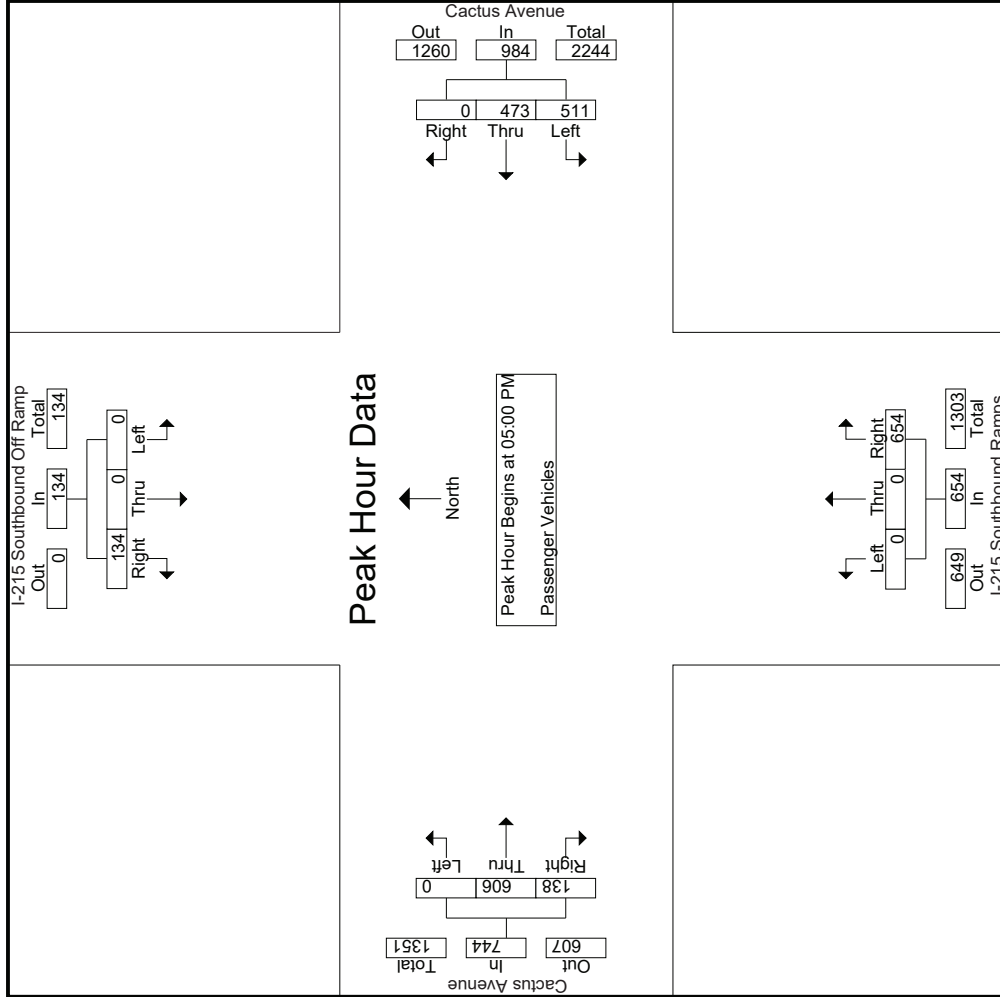

Counts Unlimited
 PO Box 1178
 Corona, CA 92878
 (951) 268-6268

City of Moreno Valley
 N/S: I-215 Southbound Ramps
 E/W: Cactus Avenue
 Weather: Clear

File Name : 35_MRV_215S_Cactus PM
 Site Code : 05119542
 Start Date : 8/20/2019
 Page No : 3

Start Time	I-215 Southbound Off Ramp Southbound			Cactus Avenue Westbound			I-215 Southbound Ramps Northbound			Cactus Avenue Eastbound					
	Left	Thru	Right	Left	Thru	Right	Left	Thru	Right	Left	Thru	Right			
Peak Hour Analysis From 05:00 PM to 05:45 PM - Peak 1 of 1	Peak Hour for Each Approach Begins at:														
	05:00 PM			05:00 PM			05:00 PM			05:00 PM					
+0 mins.	0	0	31	153	125	0	278	0	0	137	137	0	177	54	231
+15 mins.	0	0	40	142	132	0	274	0	0	178	178	0	137	30	167
+30 mins.	0	0	39	118	117	0	235	0	0	175	175	0	145	28	173
+45 mins.	0	0	24	98	99	0	197	0	0	164	164	0	147	26	173
Total Volume	0	0	134	511	473	0	984	0	0	654	654	0	606	138	744
% App. Total	0	0	100	51.9	48.1	0	100	0	0	100	91.9	0	81.5	18.5	80.5
PHF	.000	.000	.838	.835	.896	.000	.885	.000	.000	.919	.919	.000	.856	.639	.805

Groups Printed- Large 2 Axle Vehicles

Start Time	I-215 Southbound Off Ramp Southbound				Cactus Avenue Westbound				I-215 Southbound Ramps Northbound				Cactus Avenue Eastbound			
	Left	Thru	Right	RTOR	Left	Thru	Right	RTOR	Left	Thru	Right	RTOR	Left	Thru	Right	RTOR
04:00 PM	0	0	1	0	3	0	0	0	3	0	0	0	0	6	1	0
04:15 PM	0	0	1	1	3	4	0	0	7	0	4	0	0	4	0	0
04:30 PM	0	0	4	3	2	1	0	0	3	0	7	0	0	2	0	0
04:45 PM	0	0	1	0	4	2	0	0	6	0	3	0	0	4	0	0
Total	0	0	7	4	12	7	0	0	19	0	15	0	0	16	1	0
05:00 PM	0	0	2	2	1	2	0	0	3	0	1	0	0	2	0	0
05:15 PM	0	0	2	2	1	5	0	0	6	0	3	0	0	1	0	0
05:30 PM	0	0	1	1	1	3	0	0	4	0	6	0	0	2	0	0
05:45 PM	0	0	1	1	0	0	0	0	0	0	3	0	0	3	1	0
Total	0	0	6	6	3	10	0	0	13	0	13	0	0	8	1	0
Grand Total	0	0	13	10	15	17	0	0	32	0	28	0	0	24	2	0
Apprch %	0	0	100		46.9	53.1	0				100		0	92.3	7.7	
Total %	0	0	13.1		15.2	17.2	0		32.3	0	28.3		0	24.2	2	

3:1-482

Start Time	I-215 Southbound Off Ramp Southbound				Cactus Avenue Westbound				I-215 Southbound Ramps Northbound				Cactus Avenue Eastbound			
	Left	Thru	Right	App. Total	Left	Thru	Right	App. Total	Left	Thru	Right	App. Total	Left	Thru	Right	App. Total
05:00 PM	0	0	0	2	1	2	0	3	0	0	1	1	0	2	0	2
05:15 PM	0	0	2	2	1	5	0	6	0	0	3	3	0	1	0	1
05:30 PM	0	0	1	1	1	3	0	4	0	0	6	6	0	2	0	2
05:45 PM	0	0	1	1	0	0	0	0	0	0	3	3	0	3	1	4
Total Volume	0	0	6	6	3	10	0	13	0	0	13	13	0	8	1	9
% App. Total	0	0	100		23.1	76.9	0		0	0	100		0	88.9	11.1	
PHF	.000	.000	.750	.750	.750	.500	.000	.542	.000	.000	.542	.542	.000	.667	.250	.563
																.788

Peak Hour Analysis From 05:00 PM to 05:45 PM - Peak 1 of 1
 Peak Hour for Entire Intersection Begins at 05:00 PM

Counts Unlimited
 PO Box 1178
 Corona, CA 92878
 (951) 268-6268

City of Moreno Valley
 N/S: I-215 Southbound Ramps
 E/W: Cactus Avenue
 Weather: Clear

File Name : 35_MRV_215S_Cactus PM
 Site Code : 05119542
 Start Date : 8/20/2019
 Page No : 2

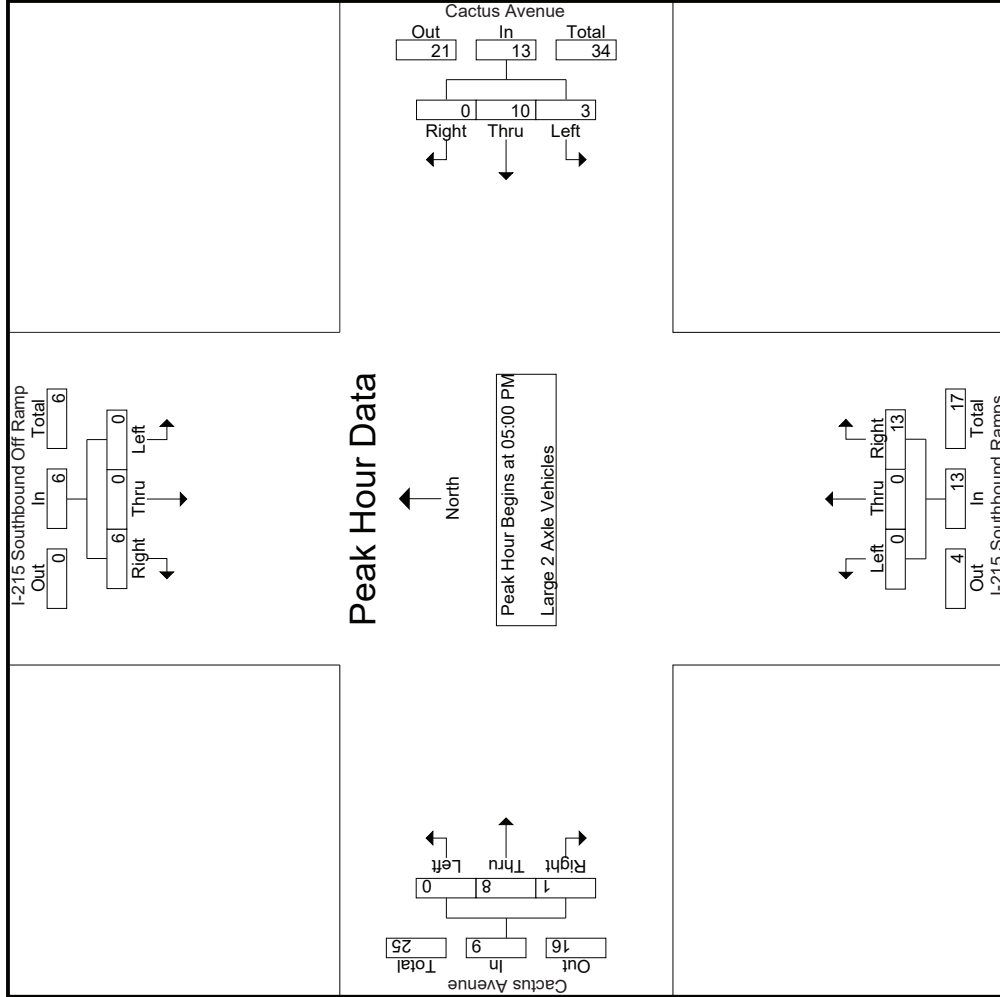

Counts Unlimited
 PO Box 1178
 Corona, CA 92878
 (951) 268-6268

City of Moreno Valley
 N/S: I-215 Southbound Ramps
 E/W: Cactus Avenue
 Weather: Clear

File Name : 35_MRV_215S_Cactus PM
 Site Code : 05119542
 Start Date : 8/20/2019
 Page No : 3

Start Time	I-215 Southbound Off Ramp			Cactus Avenue Westbound			I-215 Southbound Ramps Northbound			Cactus Avenue Eastbound		
	Left	Thru	Right	Left	Thru	Right	Left	Thru	Right	Left	Thru	Right
Peak Hour Analysis From 05:00 PM to 05:45 PM - Peak 1 of 1												
Peak Hour for Each Approach Begins at:												
	05:00 PM			05:00 PM			05:00 PM			05:00 PM		
+0 mins.	0	0	2	1	2	0	3	0	0	1	2	0
+15 mins.	0	0	2	1	5	0	6	0	0	3	1	0
+30 mins.	0	0	1	1	3	0	4	0	0	2	0	0
+45 mins.	0	0	1	0	0	0	0	0	0	3	1	4
Total Volume	0	0	6	3	10	0	13	0	0	13	8	1
% App. Total	0	0	100	23.1	76.9	0	100	0	0	100	88.9	11.1
PHF	.000	.000	.750	.750	.500	.000	.542	.000	.000	.542	.667	.250
			.750	.750	.500	.000	.542	.000	.000	.542	.667	.250

Groups Printed- 3 Axle Vehicles

Start Time	I-215 Southbound Off Ramp Southbound				Cactus Avenue Westbound				I-215 Southbound Ramps Northbound				Cactus Avenue Eastbound			
	Left	Thru	Right	RTOR	Left	Thru	Right	RTOR	Left	Thru	Right	RTOR	Left	Thru	Right	RTOR
04:00 PM	0	0	0	0	0	1	0	0	1	0	0	0	0	0	0	0
04:15 PM	0	0	0	0	0	0	0	0	0	2	0	0	1	1	0	0
04:30 PM	0	0	0	0	0	0	0	0	0	0	0	0	0	0	0	0
04:45 PM	0	0	0	0	0	2	0	0	2	0	0	4	0	0	0	0
Total	0	0	0	0	0	3	0	0	3	0	0	8	0	1	1	0
05:00 PM	0	0	2	0	1	1	0	0	2	0	0	1	0	1	0	0
05:15 PM	0	0	1	0	0	0	0	0	0	0	0	1	0	0	0	0
05:30 PM	0	0	0	0	0	0	0	0	0	0	0	0	0	0	0	0
05:45 PM	0	0	1	1	1	0	0	0	1	0	0	1	0	1	0	0
Total	0	0	4	1	2	1	0	0	3	0	0	3	0	3	0	0
Grand Total	0	0	4	1	2	4	0	0	6	0	0	11	0	0	4	1
Apprch %	0	0	100		33.3	66.7	0	0	0	0	100		0	80	20	
Total %	0	0	15.4		7.7	15.4	0	0	23.1	0	0	42.3		0	15.4	3.8
												42.3		0	19.2	3.7
														0	26	96.3

3:1-485

Start Time	I-215 Southbound Off Ramp Southbound				Cactus Avenue Westbound				I-215 Southbound Ramps Northbound				Cactus Avenue Eastbound			
	Left	Thru	Right	App. Total	Left	Thru	Right	App. Total	Left	Thru	Right	App. Total	Left	Thru	Right	App. Total
05:00 PM	0	0	2		1	0	0	0	2	0	0	0	0	1	0	0
05:15 PM	0	0	1		0	0	0	0	0	0	0	0	0	1	0	0
05:30 PM	0	0	0		0	0	0	0	0	0	0	0	0	0	0	0
05:45 PM	0	0	1		1	0	0	0	1	0	0	1	0	1	0	0
Total Volume	0	0	4		2	1	0	0	3	0	0	3	0	3	0	0
% App. Total	0	0	100		66.7	33.3	0	0	0	0	100		0	100	0	0
PHF	.000	.000	.500	.500	.500	.250	.000	.375	.000	.000	.750	.750	.000	.750	.000	.542

Peak Hour Analysis From 05:00 PM to 05:45 PM - Peak 1 of 1
 Peak Hour for Entire Intersection Begins at 05:00 PM

Counts Unlimited
 PO Box 1178
 Corona, CA 92878
 (951) 268-6268

City of Moreno Valley
 N/S: I-215 Southbound Ramps
 E/W: Cactus Avenue
 Weather: Clear

File Name : 35_MRV_215S_Cactus PM
 Site Code : 05119542
 Start Date : 8/20/2019
 Page No : 2

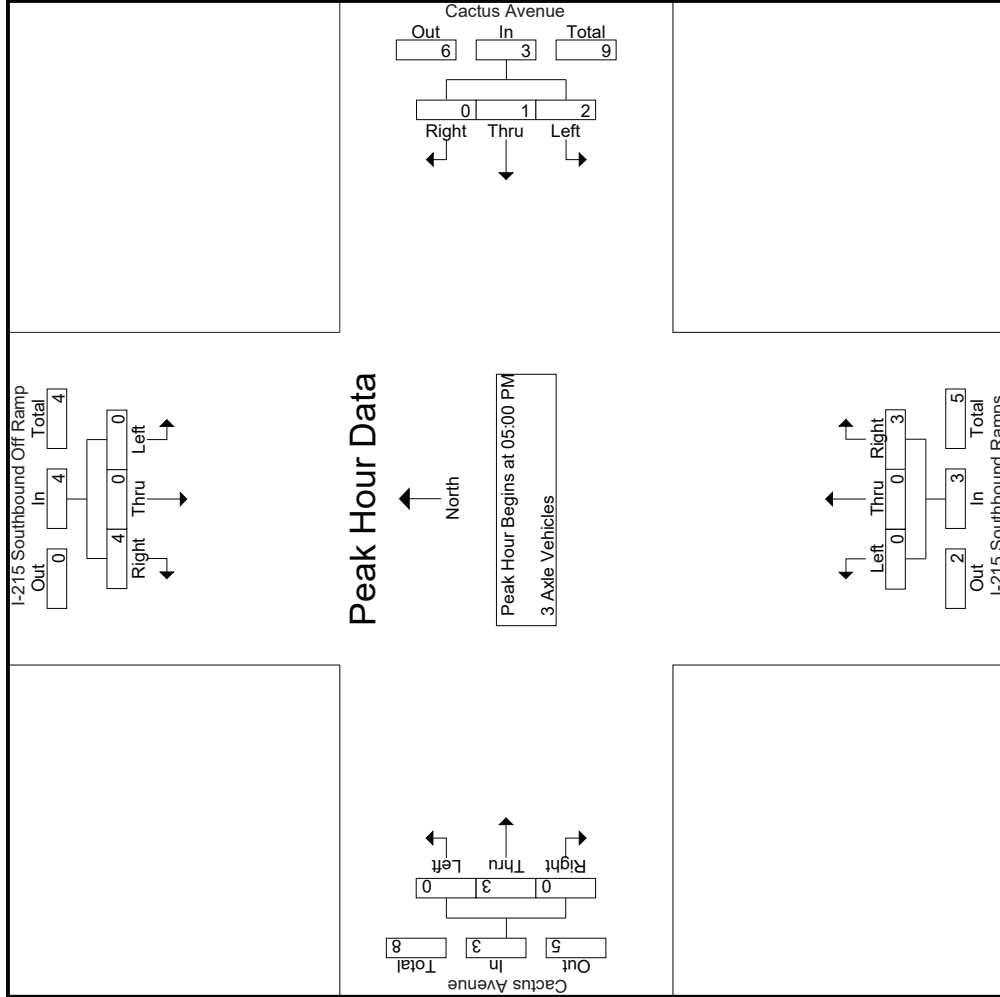

Counts Unlimited
 PO Box 1178
 Corona, CA 92878
 (951) 268-6268

City of Moreno Valley
 N/S: I-215 Southbound Ramps
 E/W: Cactus Avenue
 Weather: Clear

File Name : 35_MRV_215S_Cactus PM
 Site Code : 05119542
 Start Date : 8/20/2019
 Page No : 3

Start Time	I-215 Southbound Off Ramp			Cactus Avenue Westbound			I-215 Southbound Ramps Northbound			Cactus Avenue Eastbound				
	Left	Thru	Right	App. Total	Left	Thru	Right	App. Total	Left	Thru	Right	App. Total	Int. Total	
Peak Hour Analysis From 05:00 PM to 05:45 PM - Peak 1 of 1														
Peak Hour for Each Approach Begins at:														
	05:00 PM				05:00 PM				05:00 PM				05:00 PM	
+0 mins.	0	0	2	2	1	0	0	2	0	0	1	1	0	1
+15 mins.	0	0	1	1	0	0	0	0	0	0	1	1	0	1
+30 mins.	0	0	0	0	0	0	0	0	0	0	0	0	0	0
+45 mins.	0	0	1	1	1	0	0	1	0	0	1	1	0	1
Total Volume	0	0	4	4	2	1	0	3	0	0	3	3	0	3
% App. Total	0	0	100	100	66.7	33.3	0	75	0	0	100	75	0	100
PHF	.000	.000	.500	.500	.500	.250	.000	.375	.000	.000	.750	.750	.000	.750

Groups Printed- 4+ Axle Trucks

Start Time	I-215 Southbound Off Ramp Southbound				Cactus Avenue Westbound				I-215 Southbound Ramps Northbound				Cactus Avenue Eastbound								
	Left	Thru	Right	RTOR	App. Total	Left	Thru	Right	RTOR	App. Total	Left	Thru	Right	RTOR	App. Total	Exclu. Total	Inclu. Total	Int. Total			
04:00 PM	0	0	2	1	0	0	0	0	0	1	0	0	10	0	3	2	0	5	1	18	19
04:15 PM	0	0	2	2	2	1	0	0	0	1	0	10	0	0	2	0	0	2	2	15	17
04:30 PM	0	0	2	2	2	0	0	0	0	0	0	12	0	0	1	1	0	2	2	16	18
04:45 PM	0	0	2	1	2	1	0	0	0	1	0	7	0	0	5	1	0	6	1	16	17
Total	0	0	8	6	8	2	1	0	0	3	0	39	0	0	11	4	0	15	6	65	71
05:00 PM	0	0	4	3	4	0	1	0	0	1	0	6	0	0	4	0	0	4	3	15	18
05:15 PM	0	0	3	3	3	0	1	0	0	1	0	5	0	0	2	1	0	3	3	12	15
05:30 PM	0	0	2	1	2	0	0	0	0	0	0	10	0	0	0	0	0	0	1	12	13
05:45 PM	0	0	6	2	6	0	3	0	0	3	0	9	0	0	1	0	0	1	2	19	21
Total	0	0	15	9	15	0	5	0	0	5	0	30	0	0	7	1	0	8	9	58	67
Grand Total	0	0	23	15	23	2	6	0	0	8	0	69	0	0	18	5	0	23	15	123	138
Apprch %	0	0	100			25	75	0		6.5	0	100		0	78.3	21.7		18.7	10.9	89.1	
Total %	0	0	18.7		18.7	1.6	4.9	0		6.5	0	56.1		0	14.6	4.1		18.7	10.9	89.1	

Start Time	I-215 Southbound Off Ramp Southbound				Cactus Avenue Westbound				I-215 Southbound Ramps Northbound				Cactus Avenue Eastbound								
	Left	Thru	Right	RTOR	App. Total	Left	Thru	Right	RTOR	App. Total	Left	Thru	Right	RTOR	App. Total	Exclu. Total	Inclu. Total	Int. Total			
05:00 PM	0	0	4		4	0	1	0	0	1	0	0	6	0	4	0	0	4	0	4	15
05:15 PM	0	0	3		3	0	1	0	0	1	0	5	0	0	2	1	0	3	1	3	12
05:30 PM	0	0	2		2	0	0	0	0	0	0	10	0	0	0	0	0	0	0	0	12
05:45 PM	0	0	6		6	0	3	0	0	3	0	9	0	0	1	0	0	1	0	1	19
Total Volume	0	0	15		15	0	5	0	0	5	0	30	0	0	7	1	0	8	1	8	58
% App. Total	0	0	100		100	0	100	0	0	100	0	100	0	0	87.5	12.5		12.5	0	250	763
PHF	.000	.000	.625		.625	.000	.417	.000	.000	.417	.000	.750	.000	.000	.438	.250		.500		.763	

Peak Hour Analysis From 05:00 PM to 05:45 PM - Peak 1 of 1
 Peak Hour for Entire Intersection Begins at 05:00 PM

Counts Unlimited
 PO Box 1178
 Corona, CA 92878
 (951) 268-6268

City of Moreno Valley
 N/S: I-215 Southbound Ramps
 E/W: Cactus Avenue
 Weather: Clear

File Name : 35_MRV_215S_Cactus PM
 Site Code : 05119542
 Start Date : 8/20/2019
 Page No : 2

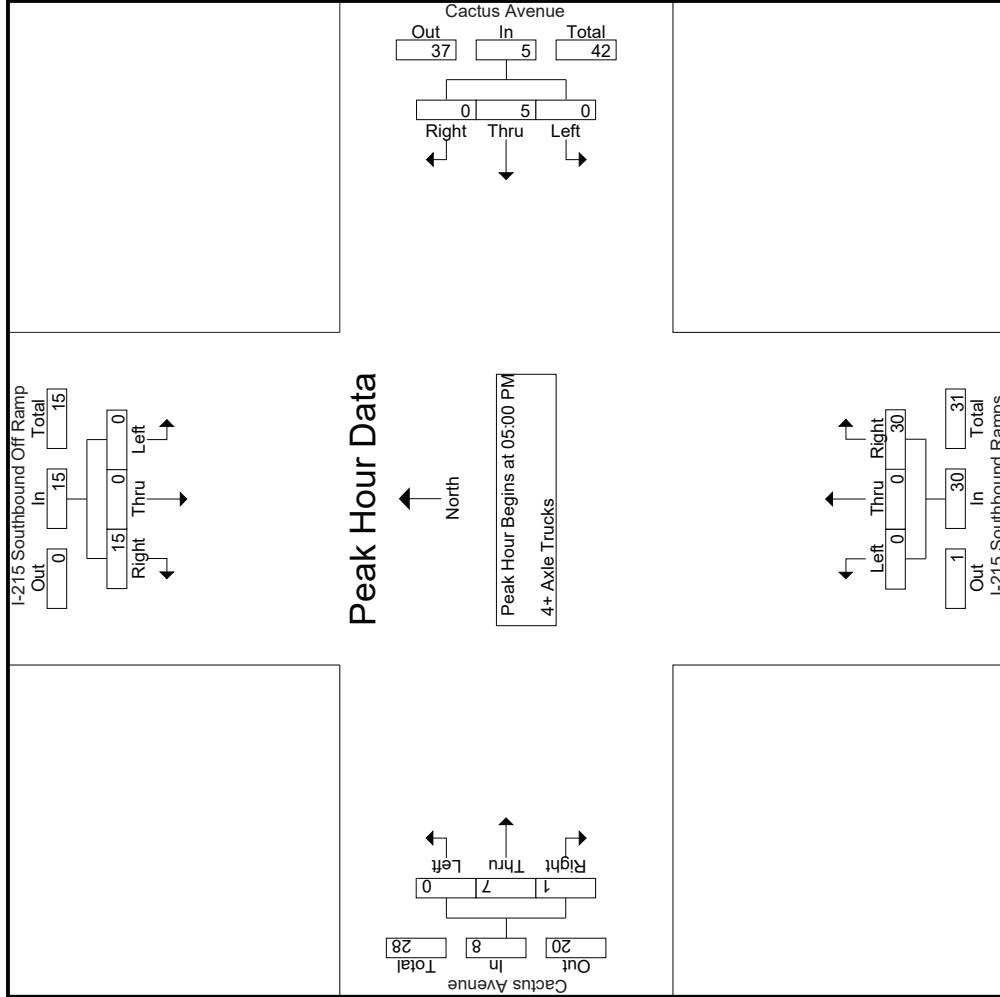

Counts Unlimited
 PO Box 1178
 Corona, CA 92878
 (951) 268-6268

City of Moreno Valley
 N/S: I-215 Southbound Ramps
 E/W: Cactus Avenue
 Weather: Clear

File Name : 35_MRV_215S_Cactus PM
 Site Code : 05119542
 Start Date : 8/20/2019
 Page No : 3

Start Time	I-215 Southbound Off Ramp			Cactus Avenue Westbound			I-215 Southbound Ramps Northbound			Cactus Avenue Eastbound				
	Left	Thru	Right	App. Total	Left	Thru	Right	App. Total	Left	Thru	Right	App. Total	Int. Total	
Peak Hour Analysis From 05:00 PM to 05:45 PM - Peak 1 of 1														
Peak Hour for Each Approach Begins at:														
	05:00 PM				05:00 PM				05:00 PM				05:00 PM	
+0 mins.	0	0	4	4	0	0	1	0	0	0	6	6	0	4
+15 mins.	0	0	3	3	0	1	0	0	0	5	5	5	2	1
+30 mins.	0	0	2	2	0	0	0	0	0	10	10	10	0	0
+45 mins.	0	0	6	6	0	3	0	0	0	9	9	9	1	0
Total Volume	0	0	15	15	0	5	0	5	0	30	30	30	7	1
% App. Total	0	0	100	100	0	100	0	100	0	100	100	100	87.5	12.5
PHF	.000	.000	.625	.625	.000	.417	.000	.417	.000	.000	.750	.750	.438	.250
									.000	.000	.750	.750	.500	.500

Location: Moreno Valley
 N/S: I-215 Southbound Ramps
 E/W: Cactus Avenue



Date: 8/20/2019
 Day: Tuesday

PEDESTRIANS

	North Leg I-215 Southbound Ramps	East Leg Cactus Avenue	South Leg I-215 Southbound Ramps	West Leg Cactus Avenue	
	Pedestrians	Pedestrians	Pedestrians	Pedestrians	
7:00 AM	0	0	0	0	0
7:15 AM	0	0	0	0	0
7:30 AM	0	0	0	0	0
7:45 AM	0	0	0	0	0
8:00 AM	1	0	0	0	1
8:15 AM	0	0	0	0	0
8:30 AM	0	0	1	0	1
8:45 AM	1	0	0	0	1
TOTAL VOLUMES:	2	0	1	0	3

	North Leg I-215 Southbound Ramps	East Leg Cactus Avenue	South Leg I-215 Southbound Ramps	West Leg Cactus Avenue	
	Pedestrians	Pedestrians	Pedestrians	Pedestrians	
4:00 PM	0	0	0	0	0
4:15 PM	0	0	0	0	0
4:30 PM	0	0	0	0	0
4:45 PM	1	0	0	0	1
5:00 PM	0	0	0	0	0
5:15 PM	0	0	0	0	0
5:30 PM	0	0	0	0	0
5:45 PM	0	0	0	0	0
TOTAL VOLUMES:	1	0	0	0	1

Location: Moreno Valley
 N/S: I-215 Southbound Ramps
 E/W: Cactus Avenue



Date: 8/20/2019
 Day: Tuesday

BICYCLES

	Southbound I-215 Southbound Ramps			Westbound Cactus Avenue			Northbound I-215 Southbound Ramps			Eastbound Cactus Avenue			
	Left	Thru	Right	Left	Thru	Right	Left	Thru	Right	Left	Thru	Right	
7:00 AM	0	0	0	0	0	0	0	0	0	0	0	0	0
7:15 AM	0	0	0	0	0	0	0	0	0	0	0	0	0
7:30 AM	0	0	0	0	1	0	0	0	0	0	0	0	1
7:45 AM	0	0	0	0	0	0	0	0	0	0	0	0	0
8:00 AM	0	0	0	0	0	0	0	0	0	0	1	0	1
8:15 AM	0	0	0	0	0	0	0	0	0	0	0	0	0
8:30 AM	0	0	0	0	0	0	0	0	0	0	0	0	0
8:45 AM	0	0	0	0	0	0	0	0	0	0	0	0	0
TOTAL VOLUMES:	0	0	0	0	1	0	0	0	0	0	1	0	2

	Southbound I-215 Southbound Ramps			Westbound Cactus Avenue			Northbound I-215 Southbound Ramps			Eastbound Cactus Avenue			
	Left	Thru	Right	Left	Thru	Right	Left	Thru	Right	Left	Thru	Right	
4:00 PM	0	0	0	0	0	0	0	0	0	0	0	0	0
4:15 PM	0	0	0	0	0	0	0	0	0	0	0	0	0
4:30 PM	0	0	0	0	0	0	0	0	0	0	0	0	0
4:45 PM	0	0	0	0	0	0	0	0	0	0	0	0	0
5:00 PM	0	0	0	0	0	0	0	0	0	0	0	0	0
5:15 PM	0	0	0	0	0	0	0	0	0	0	0	0	0
5:30 PM	0	0	0	0	0	0	0	0	0	0	0	0	0
5:45 PM	0	0	0	0	0	0	0	0	0	0	0	0	0
TOTAL VOLUMES:	0	0	0	0	0	0	0	0	0	0	0	0	0

Counts Unlimited
 PO Box 1178
 Corona, CA 92878
 (951) 268-6268

City of Moreno Valley
 N/S: Old 215 Frontage Rd/I-215 NB Ramps
 EW: Cactus Avenue
 Weather: Clear

File Name : 38_MRV_Old 215 F_215N_Cactus AM
 Site Code : 05119542
 Start Date : 8/20/2019
 Page No : 1

Groups Printed- Passenger Vehicles - Large 2 Axle Vehicles - 3 Axle Vehicles - 4+ Axle Trucks

Start Time	Old 215 Frontage Road Southbound						Cactus Avenue Westbound						I-215 Northbound Ramps Northbound						Cactus Avenue Eastbound						
	Left	Thru	Right	RTOR	App. Total		Left	Thru	Right	RTOR	App. Total		Left	Thru	Right	RTOR	App. Total		Left	Thru	Right	RTOR	App. Total		
	Exclu. Total	Inclu. Total	Int. Total				Exclu. Total	Inclu. Total	Int. Total				Exclu. Total	Inclu. Total	Int. Total				Exclu. Total	Inclu. Total	Int. Total				
07:00 AM	6	0	23	7	29	0	448	60	17	508	97	108	157	0	362	5	191	3	0	199	24	1098			
07:15 AM	12	2	22	8	36	0	412	61	15	473	84	121	199	0	404	7	185	5	1	197	24	1110			
07:30 AM	8	0	17	6	25	0	401	78	17	479	85	113	246	0	444	12	170	2	1	184	24	1132			
07:45 AM	6	1	15	2	22	0	371	65	13	436	81	94	217	0	392	5	190	4	1	199	16	1049			
Total	32	3	77	23	112	0	1632	264	62	1896	347	436	819	0	1602	29	736	14	3	779	88	4389			
08:00 AM	10	0	13	9	23	0	381	63	14	444	70	73	233	0	376	15	157	2	1	174	24	1017			
08:15 AM	8	0	9	7	17	0	298	47	11	345	116	75	144	0	335	3	172	7	2	182	20	879			
08:30 AM	8	0	10	4	18	0	293	42	10	335	149	65	130	0	344	7	137	5	1	149	15	846			
08:45 AM	6	0	10	1	16	0	310	31	8	341	99	56	144	0	299	9	135	6	2	150	11	806			
Total	32	0	42	21	74	0	1282	183	43	1465	434	269	651	0	1354	34	601	20	6	655	70	3548			
Grand Total	64	3	119	44	186	0	2914	447	105	3361	781	705	1470	0	2956	63	1337	34	9	1434	158	7937			
Approch %	34.4	1.6	64			0	86.7	13.3			26.4	23.8	49.7			4.4	93.2	2.4							
Total %	0.8	0	1.5			2.3	0	36.7	5.6	42.3	9.8	8.9	18.5		37.2	0.8	16.8	0.4		18.1	2	98			
% Passenger Vehicles	58	1	73		161	0	2782	426		3305	753	674	1441		2868	25	1239	10		1276	0	0			7610
% 2 Axle Vehicles	90.6	33.3	61.3		65.9	70	0	95.5	95.3	92.4	96.4	95.6	98	0	97	39.7	92.7	29.4		22.2	88.4	0			94
% Large 2 Axle Vehicles	1	0	6		11	0	45	6		54	12	11	11		34	3	26	3		34	0	0			133
% 3 Axle Vehicles	1.6	0	5		9.1	0	1.5	1.3		2.9	1.5	1.6	0.7		1.2	4.8	1.9	8.8		22.2	2.4	0			1.6
% 3 Axle Trucks	4	0	29		42	0	33	5		41	6	5	5		16	30	10	2		42	0	0			141
% 4+ Axle Trucks	6.2	0	24.4		20.5	0	1.1	1.1		2.9	0.8	0.7	0.3		0.5	47.6	0.7	5.9		0	2.9	0			1.7
% App. Total	1	2	11		16	0	54	10		66	10	15	13		38	5	62	19		91	0	0			211
PHF	1.6	66.7	9.2		4.5	0	1.9	2.2		1.9	1.3	2.1	0.9		1.3	7.9	4.6	55.9		6.3	0	0			2.6

Start Time	Old 215 Frontage Road Southbound						Cactus Avenue Westbound						I-215 Northbound Ramps Northbound						Cactus Avenue Eastbound						
	Left	Thru	Right	RTOR	App. Total		Left	Thru	Right	RTOR	App. Total		Left	Thru	Right	RTOR	App. Total		Left	Thru	Right	RTOR	App. Total		
	Exclu. Total	Inclu. Total	Int. Total				Exclu. Total	Inclu. Total	Int. Total				Exclu. Total	Inclu. Total	Int. Total				Exclu. Total	Inclu. Total	Int. Total				
07:00 AM	6	0	23	7	29	0	448	60	17	508	97	108	157	0	362	5	191	3	0	199	24	1098			
07:15 AM	12	2	22	8	36	0	412	61	15	473	84	121	199	0	404	7	185	5	1	197	24	1110			
07:30 AM	8	0	17	6	25	0	401	78	17	479	85	113	246	0	444	12	170	2	1	184	24	1132			
07:45 AM	6	1	15	2	22	0	371	65	13	436	81	94	217	0	392	5	190	4	1	199	16	1049			
Total	32	3	77	23	112	0	1632	264	62	1896	347	436	819	0	1602	29	736	14	3	779	88	4389			
Grand Total	64	3	119	44	186	0	2914	447	105	3361	781	705	1470	0	2956	63	1337	34	9	1434	158	7937			
Approch %	34.4	1.6	64			0	86.7	13.3			26.4	23.8	49.7			4.4	93.2	2.4							
Total %	0.8	0	1.5			2.3	0	36.7	5.6	42.3	9.8	8.9	18.5		37.2	0.8	16.8	0.4		18.1	2	98			
% Passenger Vehicles	58	1	73		161	0	2782	426		3305	753	674	1441		2868	25	1239	10		1276	0	0			7610
% 2 Axle Vehicles	90.6	33.3	61.3		65.9	70	0	95.5	95.3	92.4	96.4	95.6	98	0	97	39.7	92.7	29.4		22.2	88.4	0			94
% Large 2 Axle Vehicles	1	0	6		11	0	45	6		54	12	11	11		34	3	26	3		34	0	0			133
% 3 Axle Vehicles	1.6	0	5		9.1	0	1.5	1.3		2.9	1.5	1.6	0.7		1.2	4.8	1.9	8.8		22.2	2.4	0			1.6
% 3 Axle Trucks	4	0	29		42	0	33	5		41	6	5	5		16	30	10	2		42	0	0			141
% 4+ Axle Trucks	6.2	0	24.4		20.5	0	1.1	1.1		2.9	0.8	0.7	0.3		0.5	47.6	0.7	5.9		0	2.9	0			1.7
% App. Total	1	2	11		16	0	54	10		66	10	15	13		38	5	62	19		91	0	0			211
PHF	1.6	66.7	9.2		4.5	0	1.9	2.2		1.9	1.3	2.1	0.9		1.3	7.9	4.6	55.9		6.3	0	0			2.6

Peak Hour Analysis From 07:00 AM to 08:45 AM - Peak 1 of 1

Peak Hour for Entire Intersection Begins at 07:00 AM

Start Time	Old 215 Frontage Road Southbound						Cactus Avenue Westbound						I-215 Northbound Ramps Northbound						Cactus Avenue Eastbound						
	Left	Thru	Right	RTOR	App. Total		Left	Thru	Right	RTOR	App. Total		Left	Thru	Right	RTOR	App. Total		Left	Thru	Right	RTOR	App. Total		
07:00 AM	6	0	23	7	29	0	448	60	17	508	97	108	157	0	362	5	191	3	0	199	24	1098			
07:15 AM	12	2	22	8	36	0	412	61	15	473	84	121	199	0	404	7	185	5	1	197	24	1110			
07:30 AM	8	0	17	6	25	0	401	78	17	479	85	113	246	0	444	12	170	2	1	184	24	1132			
07:45 AM	6	1	15	2	22	0	371	65	13	436	81	94	217	0	392	5	190	4	1	199	16	1049			
Total Volume	32	3	77	23	112	0	1632	264	62	1896	347	436	819	0	1602	29	736	14	3	779	88	4389			
% App. Total	28.6	2.7	68.8			0	86.1	13.9			21.7	27.2	51.1			3.7	94.5	1.8							
PHF	.667	.375	.837		.778	.000	.911	.846		.933	.894	.901	.832		.902	.604	.963	.700		.979					.969

Counts Unlimited
 PO Box 1178
 Corona, CA 92878
 (951) 268-6268

City of Moreno Valley
 N/S: Old 215 Frontage Rd/I-215 NB Ramps
 E/W: Cactus Avenue
 Weather: Clear

File Name : 38_MRV_Old 215 F_215N_Cactus AM
 Site Code : 05119542
 Start Date : 8/20/2019
 Page No : 2

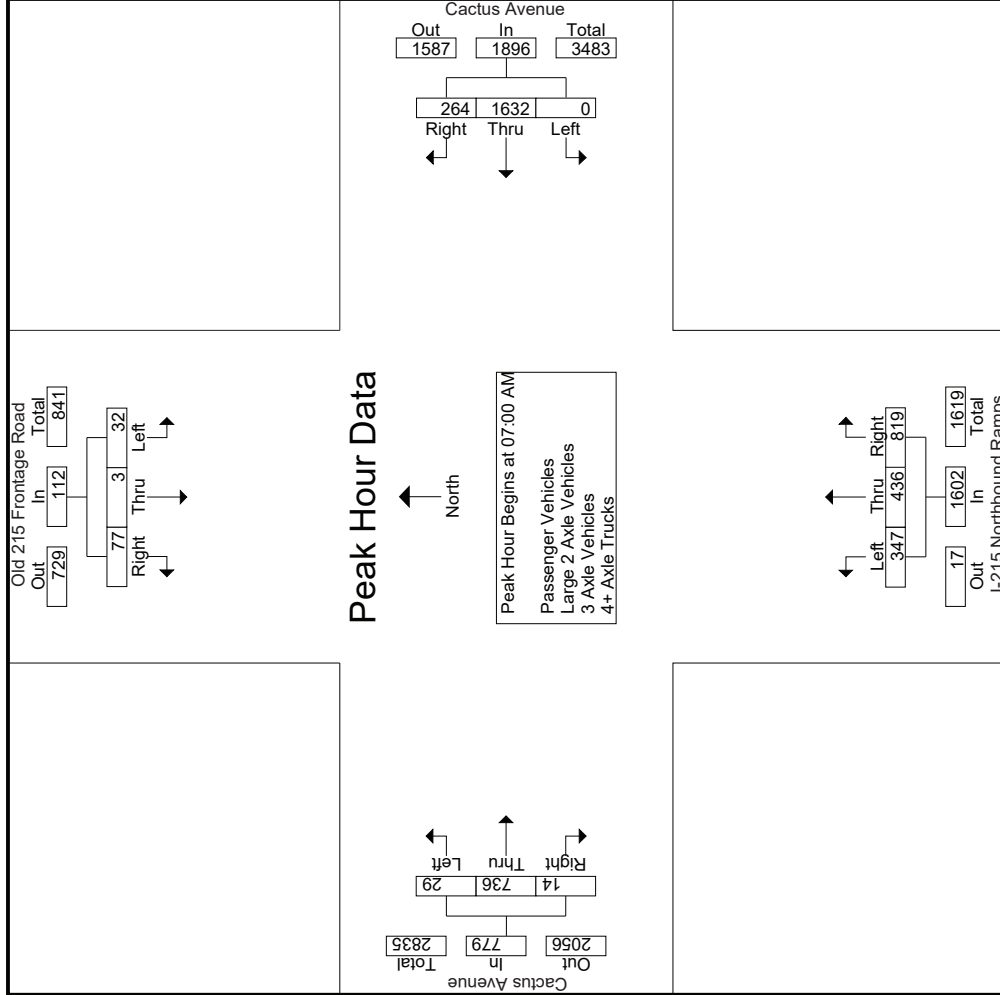

Counts Unlimited
 PO Box 1178
 Corona, CA 92878
 (951) 268-6268

City of Moreno Valley
 N/S: Old 215 Frontage Rd/I-215 NB Ramps
 EW: Cactus Avenue
 Weather: Clear

File Name : 38_MRV_Old 215 F_215N_Cactus AM
 Site Code : 05119542
 Start Date : 8/20/2019
 Page No : 3

Start Time	Old 215 Frontage Road Southbound			Cactus Avenue Westbound			I-215 Northbound Ramps Northbound			Cactus Avenue Eastbound		
	Left	Thru	Right	Left	Thru	Right	Left	Thru	Right	Left	Thru	Right
Peak Hour Analysis From 07:00 AM to 08:45 AM - Peak 1 of 1												
Peak Hour for Each Approach Begins at:												
+0 mins.	6	0	23	0	448	60	84	121	199	5	191	3
+15 mins.	12	2	22	0	412	61	85	113	246	7	185	5
+30 mins.	8	0	17	0	401	78	81	94	217	12	170	2
+45 mins.	6	1	15	0	371	65	70	73	233	5	190	4
Total Volume	32	3	77	0	1632	264	320	401	895	29	736	14
% App. Total	28.6	2.7	68.8	0	86.1	13.9	19.8	24.8	55.4	3.7	94.5	1.8
PHF	.667	.375	.837	.000	.911	.846	.941	.829	.910	.604	.963	.700

Counts Unlimited
 PO Box 1178
 Corona, CA 92878
 (951) 268-6268

City of Moreno Valley
 N/S: Old 215 Frontage Rd/I-215 NB Ramps
 EW: Cactus Avenue
 Weather: Clear

File Name : 38_MRV_Old 215 F_215N_Cactus AM
 Site Code : 05119542
 Start Date : 8/20/2019
 Page No : 1

Groups Printed- Passenger Vehicles

Start Time	Old 215 Frontage Road Southbound						Cactus Avenue Westbound						I-215 Northbound Ramps Northbound						Cactus Avenue Eastbound								
	Left	Thru	Right	RTOR	App. Total		Left	Thru	Right	RTOR	App. Total		Left	Thru	Right	RTOR	App. Total		Left	Thru	Right	RTOR	App. Total		Exclu. Total	Inclu. Total	Int. Total
07:00 AM	5	0	13	5	18		0	426	59	17	485		92	100	150	0	342		2	173	0	0	175		22	1020	1042
07:15 AM	11	0	16	8	27		0	399	60	15	459		82	115	197	0	394		3	172	3	1	178		24	1058	1082
07:30 AM	8	0	14	4	22		0	388	75	16	463		81	111	241	0	433		6	163	0	0	169		20	1087	1107
07:45 AM	4	1	12	1	17		0	360	63	12	423		79	94	213	0	386		2	178	0	0	180		13	1006	1019
Total	28	1	55	18	84		0	1573	257	60	1830		334	420	801	0	1555		13	686	3	1	702		79	4171	4250
08:00 AM	9	0	6	4	15		0	361	61	13	422		67	72	231	0	370		2	150	0	0	152		17	959	976
08:15 AM	8	0	5	4	13		0	281	44	10	325		115	70	142	0	327		0	151	4	0	155		14	820	834
08:30 AM	8	0	4	3	12		0	271	36	7	307		142	60	126	0	328		3	124	1	0	128		10	775	785
08:45 AM	5	0	3	0	8		0	296	28	7	324		95	52	141	0	288		7	128	2	1	137		8	757	765
Total	30	0	18	11	48		0	1209	169	37	1378		419	254	640	0	1313		12	553	7	1	572		49	3311	3360
Grand Total	58	1	73	29	132		0	2782	426	97	3208		753	674	1441	0	2868		25	1239	10	2	1274		128	7482	7610
Approch %	43.9	0.8	55.3				0	86.7	13.3		42.9		26.3	23.5	50.2		38.3				0.3	16.6	0.1		1.7		98.3
Total %	0.8	0	1		1.8		0	37.2	5.7		10.1	9	19.3		9				0.3	16.6	0.1		1.7		98.3		

3:1-496

Start Time	Old 215 Frontage Road Southbound						Cactus Avenue Westbound						I-215 Northbound Ramps Northbound						Cactus Avenue Eastbound								
	Left	Thru	Right	RTOR	App. Total		Left	Thru	Right	RTOR	App. Total		Left	Thru	Right	RTOR	App. Total		Left	Thru	Right	RTOR	App. Total		Exclu. Total	Inclu. Total	Int. Total
07:00 AM	5	0	13	5	18		0	426	59	17	485		92	100	150	0	342		2	173	0	0	175		22	1020	1042
07:15 AM	11	0	16	8	27		0	399	60	15	459		82	115	197	0	394		3	172	3	1	178		24	1058	1082
07:30 AM	8	0	14	4	22		0	388	75	16	463		81	111	241	0	433		6	163	0	0	169		20	1087	1107
07:45 AM	4	1	12	1	17		0	360	63	12	423		79	94	213	0	386		2	178	0	0	180		13	1006	1019
Total	28	1	55	18	84		0	1573	257	60	1830		334	420	801	0	1555		13	686	3	1	702		79	4171	4250
PHF	.636	.250	.859	.778	.778		.000	.923	.857	.943	.831		.908	.913	.831		.898	.250	.975		.542	.963	.250		.975		.959

Peak Hour Analysis From 07:00 AM to 07:45 AM - Peak 1 of 1
 Peak Hour for Entire Intersection Begins at 07:00 AM

Counts Unlimited
 PO Box 1178
 Corona, CA 92878
 (951) 268-6268

City of Moreno Valley
 N/S: Old 215 Frontage Rd/I-215 NB Ramps
 E/W: Cactus Avenue
 Weather: Clear

File Name : 38_MRV_Old 215 F_215N_Cactus AM
 Site Code : 05119542
 Start Date : 8/20/2019
 Page No : 2

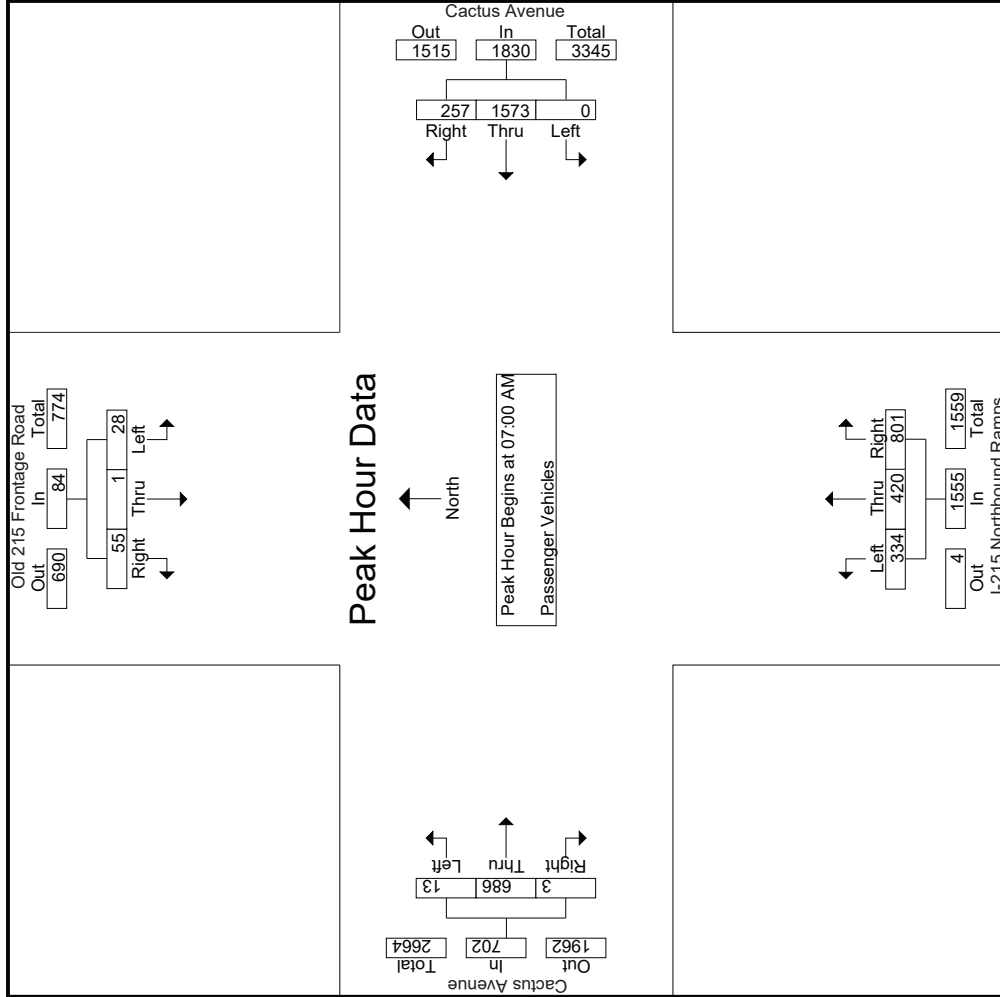

Counts Unlimited
 PO Box 1178
 Corona, CA 92878
 (951) 268-6268

City of Moreno Valley
 N/S: Old 215 Frontage Rd/I-215 NB Ramps
 EW: Cactus Avenue
 Weather: Clear

File Name : 38_MRV_Old 215 F_215N_Cactus AM
 Site Code : 05119542
 Start Date : 8/20/2019
 Page No : 3

Start Time	Old 215 Frontage Road Southbound			Cactus Avenue Westbound			I-215 Northbound Ramps Northbound			Cactus Avenue Eastbound					
	Left	Thru	Right	Left	Thru	Right	Left	Thru	Right	Left	Thru	Right	App. Total	Int. Total	
Peak Hour Analysis From 07:00 AM to 07:45 AM - Peak 1 of 1															
Peak Hour for Each Approach Begins at:															
	07:00 AM			07:00 AM			07:00 AM			07:00 AM			07:00 AM		
+0 mins.	5	0	13	0	426	59	485	100	150	342	2	173	0	175	
+15 mins.	11	0	16	0	399	60	459	115	197	394	3	172	3	178	
+30 mins.	8	0	14	0	388	75	463	111	241	433	6	163	0	169	
+45 mins.	4	1	12	0	360	63	423	94	213	386	2	178	0	180	
Total Volume	28	1	55	0	1573	257	1830	420	801	1555	13	686	3	702	
% App. Total	33.3	1.2	65.5	0	86	14	21.5	27	51.5	89.8	1.9	97.7	0.4	97.5	
PHF	.636	.250	.859	.000	.923	.857	.943	.913	.831	.898	.542	.963	.250	.975	

Groups Printed- Large 2 Axle Vehicles

Start Time	Old 215 Frontage Road Southbound				Cactus Avenue Westbound				I-215 Northbound Ramps Northbound				Cactus Avenue Eastbound							
	Left	Thru	Right	RTOR	Left	Thru	Right	RTOR	Left	Thru	Right	RTOR	Left	Thru	Right	RTOR	Exclu. Total	Inclu. Total	Int. Total	
07:00 AM	0	0	1	0	0	8	0	0	4	3	2	0	9	0	5	0	5	0	23	23
07:15 AM	1	0	0	1	0	1	0	0	1	2	1	0	4	0	2	0	2	0	8	8
07:30 AM	0	0	1	1	0	3	0	0	3	2	0	0	5	1	1	0	2	1	11	12
07:45 AM	0	0	0	0	0	4	2	1	6	0	2	0	2	0	4	1	5	2	13	15
Total	1	0	2	1	0	16	2	1	18	8	7	5	0	1	12	1	14	3	55	58
08:00 AM	0	0	2	2	0	9	1	0	10	0	2	0	3	1	2	1	4	3	19	22
08:15 AM	0	0	1	1	0	4	0	0	4	0	2	1	0	1	7	0	8	1	16	17
08:30 AM	0	0	0	0	0	10	1	1	11	2	1	2	0	0	3	1	4	1	20	21
08:45 AM	0	0	1	0	0	6	2	1	8	1	1	0	3	0	2	0	2	1	14	15
Total	0	0	4	3	0	29	4	2	33	4	4	6	0	2	14	2	18	6	69	75
Grand Total	1	0	6	4	0	45	6	3	51	12	11	11	0	3	26	3	32	9	124	133
Approch %	14.3	0	85.7		0	88.2	11.8		35.3	32.4	32.4		0	9.4	81.2	9.4	25.8	6.8	93.2	
Total %	0.8	0	4.8		0	36.3	4.8		9.7	8.9	8.9		27.4	2.4	21	2.4				

Start Time	Old 215 Frontage Road Southbound				Cactus Avenue Westbound				I-215 Northbound Ramps Northbound				Cactus Avenue Eastbound							
	Left	Thru	Right	RTOR	Left	Thru	Right	RTOR	Left	Thru	Right	RTOR	Left	Thru	Right	RTOR	Exclu. Total	Inclu. Total	Int. Total	
07:00 AM	0	0	0	1	0	8	0	0	4	3	2	0	9	0	5	0	5	0	23	23
07:15 AM	1	0	0	1	0	1	0	0	1	2	1	0	4	0	2	0	2	0	8	8
07:30 AM	0	0	1	1	0	3	0	0	3	2	0	0	5	1	1	0	2	1	11	12
07:45 AM	0	0	0	0	0	4	2	1	6	0	2	0	2	0	4	1	5	2	13	15
Total	1	0	2	1	0	16	2	1	18	8	7	5	0	1	12	1	14	3	55	58
08:00 AM	0	0	2	2	0	9	1	0	10	0	2	0	3	1	2	1	4	3	19	22
08:15 AM	0	0	1	1	0	4	0	0	4	0	2	1	0	1	7	0	8	1	16	17
08:30 AM	0	0	0	0	0	10	1	1	11	2	1	2	0	0	3	1	4	1	20	21
08:45 AM	0	0	1	0	0	6	2	1	8	1	1	0	3	0	2	0	2	1	14	15
Total	0	0	4	3	0	29	4	2	33	4	4	6	0	2	14	2	18	6	69	75
Grand Total	1	0	6	4	0	45	6	3	51	12	11	11	0	3	26	3	32	9	124	133
Approch %	14.3	0	85.7		0	88.2	11.8		35.3	32.4	32.4		0	9.4	81.2	9.4	25.8	6.8	93.2	
Total %	0.8	0	4.8		0	36.3	4.8		9.7	8.9	8.9		27.4	2.4	21	2.4				

Peak Hour Analysis From 07:00 AM to 07:45 AM - Peak 1 of 1
 Peak Hour for Entire Intersection Begins at 07:00 AM

Start Time	Old 215 Frontage Road Southbound				Cactus Avenue Westbound				I-215 Northbound Ramps Northbound				Cactus Avenue Eastbound							
	Left	Thru	Right	RTOR	Left	Thru	Right	RTOR	Left	Thru	Right	RTOR	Left	Thru	Right	RTOR	Exclu. Total	Inclu. Total	Int. Total	
07:00 AM	0	0	0	1	0	8	0	0	4	3	2	0	9	0	5	0	5	0	23	23
07:15 AM	1	0	0	1	0	1	0	0	1	2	1	0	4	0	2	0	2	0	8	8
07:30 AM	0	0	1	1	0	3	0	0	3	2	0	0	5	1	1	0	2	1	11	12
07:45 AM	0	0	0	0	0	4	2	1	6	0	2	0	2	0	4	1	5	2	13	15
Total Volume	1	0	2	3	0	16	2	1	18	8	7	5	0	1	12	1	14	3	55	58
% App. Total	33.3	0	66.7		0	88.9	11.1		35.3	32.4	32.4		0	9.4	81.2	9.4	25.8	6.8	93.2	
PHF	.250	.000	.500	.750	.000	.500	.250	.563	.563	.500	.583	.625	.556	.250	.600	.250	.700	.250	.598	

Counts Unlimited
 PO Box 1178
 Corona, CA 92878
 (951) 268-6268

City of Moreno Valley
 N/S: Old 215 Frontage Rd/I-215 NB Ramps
 E/W: Cactus Avenue
 Weather: Clear

File Name : 38_MRV_Old 215 F_215N_Cactus AM
 Site Code : 05119542
 Start Date : 8/20/2019
 Page No : 2

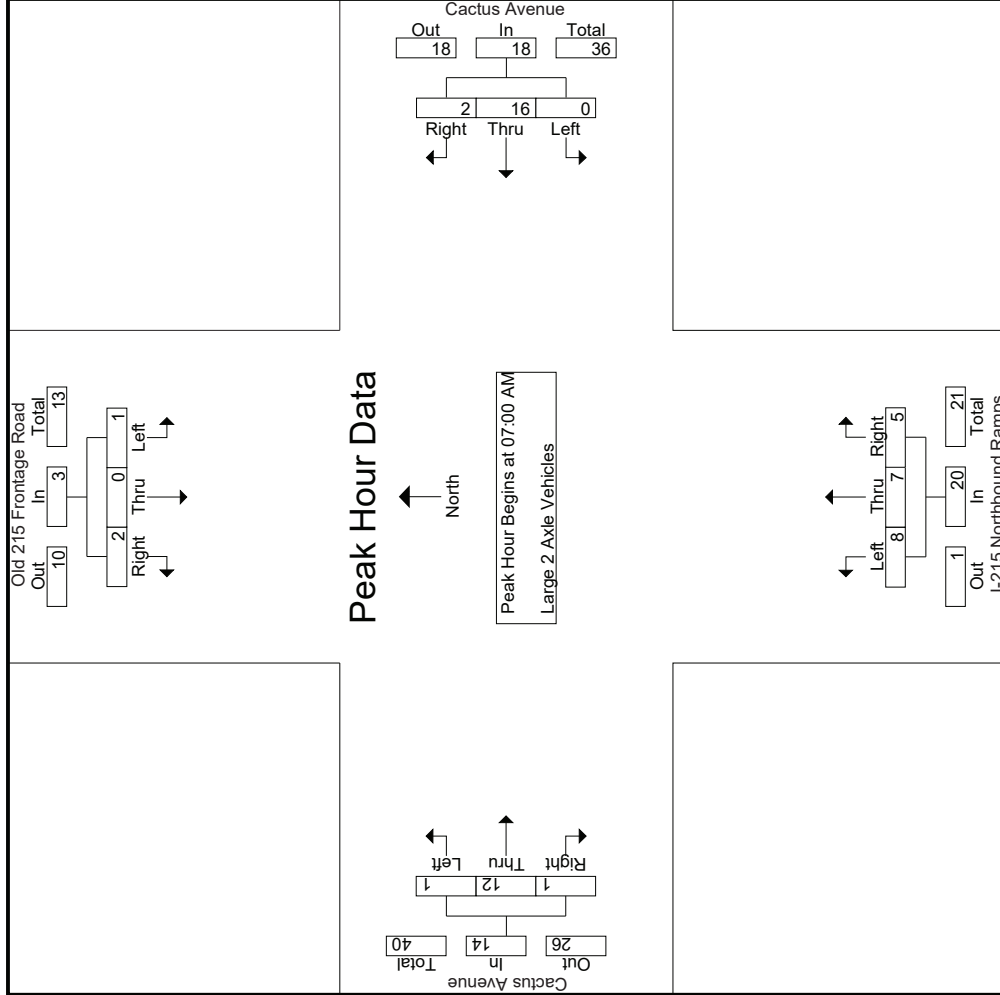

Groups Printed- 3 Axle Vehicles

Start Time	Old 215 Frontage Road Southbound					Cactus Avenue Westbound					I-215 Northbound Ramps Northbound					Cactus Avenue Eastbound							
	Left	Thru	Right	RTOR	App. Total	Left	Thru	Right	RTOR	App. Total	Left	Thru	Right	RTOR	App. Total	Left	Thru	Right	RTOR	App. Total	Exclu. Total	Inclu. Total	Int. Total
07:00 AM	0	0	8	1	8	0	8	1	0	9	1	1	3	0	5	3	1	1	0	5	1	27	28
07:15 AM	0	0	5	0	5	0	7	0	0	7	0	1	0	0	1	2	3	0	0	5	0	18	18
07:30 AM	0	0	1	1	1	0	5	2	1	7	0	0	2	0	2	4	1	0	0	5	2	15	17
07:45 AM	2	0	1	1	3	0	1	0	0	1	1	0	0	0	1	3	2	0	0	5	1	10	11
Total	2	0	15	3	17	0	21	3	1	24	2	2	5	0	9	12	7	1	0	20	4	70	74
08:00 AM	1	0	3	2	4	0	2	0	0	2	1	1	0	0	2	12	0	1	0	13	2	21	23
08:15 AM	0	0	3	2	3	0	5	1	1	6	0	0	0	0	0	1	2	0	0	3	3	12	15
08:30 AM	0	0	5	1	5	0	2	1	1	3	1	2	0	0	3	4	1	0	0	5	2	16	18
08:45 AM	1	0	3	1	4	0	3	0	0	3	2	0	0	0	2	1	0	0	0	1	1	10	11
Total	2	0	14	6	16	0	12	2	2	14	4	3	0	0	7	18	3	1	0	22	8	59	67
Grand Total	4	0	29	9	33	0	33	5	3	38	6	5	5	0	16	30	10	2	0	42	12	129	141
Approch %	12.1	0	87.9			0	86.8	13.2		37.5	31.2	31.2	31.2		12.4	71.4	23.8	4.8		32.6	8.5	91.5	
Total %	3.1	0	22.5		25.6	0	25.6	3.9		29.5	4.7	3.9	3.9		12.4	23.3	7.8	1.6					

Start Time	Old 215 Frontage Road Southbound					Cactus Avenue Westbound					I-215 Northbound Ramps Northbound					Cactus Avenue Eastbound							
	Left	Thru	Right	RTOR	App. Total	Left	Thru	Right	RTOR	App. Total	Left	Thru	Right	RTOR	App. Total	Left	Thru	Right	RTOR	App. Total	Exclu. Total	Inclu. Total	Int. Total
07:00 AM	0	0	8	0	8	0	8	1	0	9	1	1	3	0	5	3	1	1	0	5	1	27	28
07:15 AM	0	0	5	0	5	0	7	0	0	7	0	1	0	0	1	2	3	0	0	5	0	18	18
07:30 AM	0	0	1	1	1	0	5	2	1	7	0	0	2	0	2	4	1	0	0	5	2	15	17
07:45 AM	2	0	1	1	3	0	1	0	0	1	1	0	0	0	1	3	2	0	0	5	1	10	11
Total	2	0	15	3	17	0	21	3	1	24	2	2	5	0	9	12	7	1	0	20	4	70	74
08:00 AM	1	0	3	2	4	0	2	0	0	2	1	1	0	0	2	12	0	1	0	13	2	21	23
08:15 AM	0	0	3	2	3	0	5	1	1	6	0	0	0	0	0	1	2	0	0	3	3	12	15
08:30 AM	0	0	5	1	5	0	2	1	1	3	1	2	0	0	3	4	1	0	0	5	2	16	18
08:45 AM	1	0	3	1	4	0	3	0	0	3	2	0	0	0	2	1	0	0	0	1	1	10	11
Total	2	0	14	6	16	0	12	2	2	14	4	3	0	0	7	18	3	1	0	22	8	59	67
Grand Total	4	0	29	9	33	0	33	5	3	38	6	5	5	0	16	30	10	2	0	42	12	129	141
Approch %	12.1	0	87.9			0	86.8	13.2		37.5	31.2	31.2	31.2		12.4	71.4	23.8	4.8		32.6	8.5	91.5	
Total %	3.1	0	22.5		25.6	0	25.6	3.9		29.5	4.7	3.9	3.9		12.4	23.3	7.8	1.6					

Peak Hour Analysis From 07:00 AM to 07:45 AM - Peak 1 of 1
 Peak Hour for Entire Intersection Begins at 07:00 AM

Start Time	Old 215 Frontage Road Southbound					Cactus Avenue Westbound					I-215 Northbound Ramps Northbound					Cactus Avenue Eastbound							
	Left	Thru	Right	RTOR	App. Total	Left	Thru	Right	RTOR	App. Total	Left	Thru	Right	RTOR	App. Total	Left	Thru	Right	RTOR	App. Total	Exclu. Total	Inclu. Total	Int. Total
07:00 AM	0	0	8	0	8	0	8	1	0	9	1	1	3	0	5	3	1	1	0	5	1	27	28
07:15 AM	0	0	5	0	5	0	7	0	0	7	0	1	0	0	1	2	3	0	0	5	0	18	18
07:30 AM	0	0	1	1	1	0	5	2	1	7	0	0	2	0	2	4	1	0	0	5	2	15	17
07:45 AM	2	0	1	1	3	0	1	0	0	1	1	0	0	0	1	3	2	0	0	5	1	10	11
Total	2	0	15	3	17	0	21	3	1	24	2	2	5	0	9	12	7	1	0	20	4	70	74
% App. Total	11.8	0	88.2			0	87.5	12.5		37.5	31.2	31.2	31.2		12.4	71.4	23.8	4.8		32.6	8.5	91.5	
PHF	.250	.000	.469		.531	.000	.656	.375		.667	.500	.500	.417		.450	.750	.583	.250		1.00	.250	.648	

Counts Unlimited
 PO Box 1178
 Corona, CA 92878
 (951) 268-6268

City of Moreno Valley
 N/S: Old 215 Frontage Rd/I-215 NB Ramps
 E/W: Cactus Avenue
 Weather: Clear

File Name : 38_MRV_Old 215 F_215N_Cactus AM
 Site Code : 05119542
 Start Date : 8/20/2019
 Page No : 2

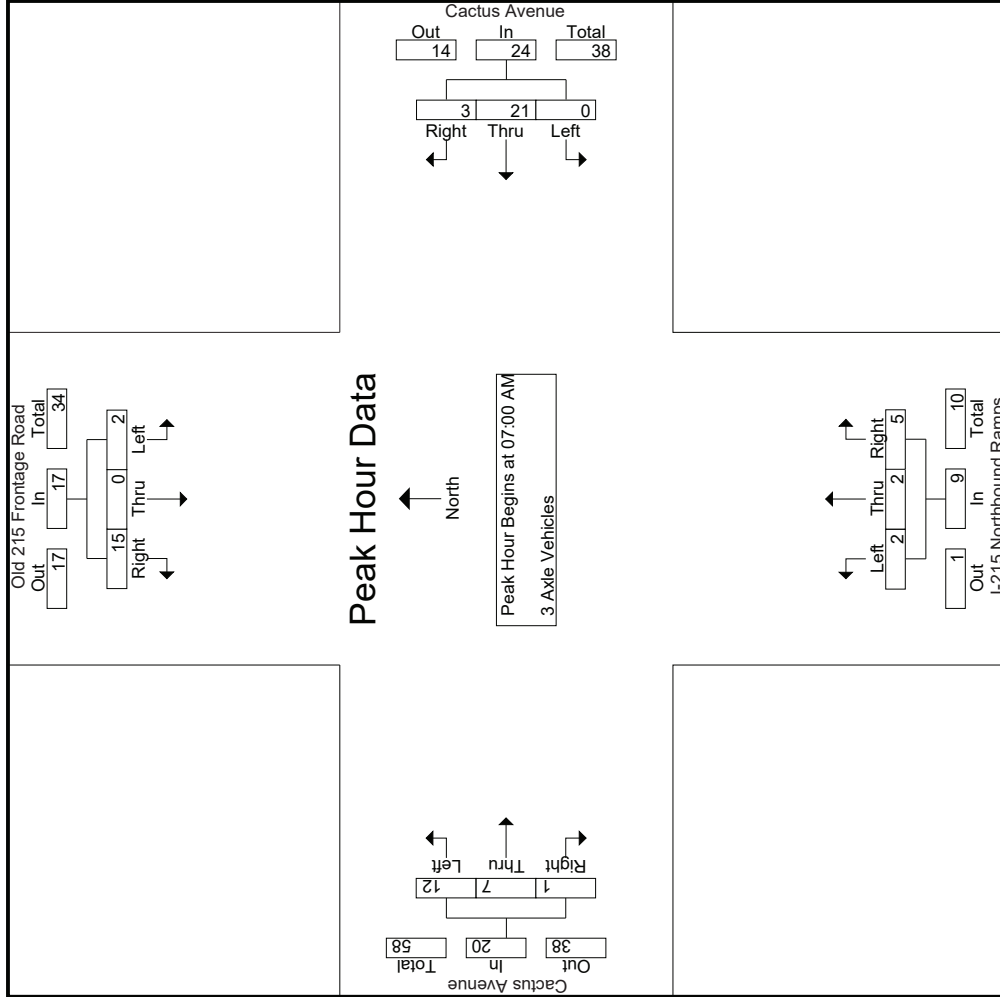

Counts Unlimited
 PO Box 1178
 Corona, CA 92878
 (951) 268-6268

City of Moreno Valley
 N/S: Old 215 Frontage Rd/I-215 NB Ramps
 EW: Cactus Avenue
 Weather: Clear

File Name : 38_MRV_Old 215 F_215N_Cactus AM
 Site Code : 05119542
 Start Date : 8/20/2019
 Page No : 3

Start Time	Old 215 Frontage Road Southbound			Cactus Avenue Westbound			I-215 Northbound Ramps Northbound			Cactus Avenue Eastbound					
	Left	Thru	Right	Left	Thru	Right	Left	Thru	Right	Left	Thru	Right			
Peak Hour Analysis From 07:00 AM to 07:45 AM - Peak 1 of 1															
Peak Hour for Each Approach Begins at:															
+0 mins.	0	0	8	0	8	1	07:00 AM	1	1	3	07:00 AM	3	1	5	
+15 mins.	0	0	5	0	7	0	07:00 AM	0	1	0	07:00 AM	2	3	0	
+30 mins.	0	0	1	0	5	2	07:00 AM	0	0	2	07:00 AM	4	1	0	
+45 mins.	2	0	1	0	1	0	07:00 AM	1	0	0	07:00 AM	3	2	0	
Total Volume	2	0	15	0	21	3	07:00 AM	2	2	5	07:00 AM	12	7	1	
% App. Total	11.8	0	88.2	0	87.5	12.5	07:00 AM	22.2	22.2	55.6	07:00 AM	60	35	5	
PHF	.250	.000	.469	.000	.656	.375	07:00 AM	.500	.500	.417	07:00 AM	.750	.583	.250	
															1.000

Counts Unlimited
 PO Box 1178
 Corona, CA 92878
 (951) 268-6268

City of Moreno Valley
 N/S: Old 215 Frontage Rd/I-215 NB Ramps
 EW: Cactus Avenue
 Weather: Clear

File Name : 38_MRV_Old 215 F_215N_Cactus AM
 Site Code : 05119542
 Start Date : 8/20/2019
 Page No : 1

Groups Printed- 4+ Axle Trucks

Start Time	Old 215 Frontage Road Southbound					Cactus Avenue Westbound					I-215 Northbound Ramps Northbound					Cactus Avenue Eastbound							
	Left	Thru	Right	RTOR	App. Total	Left	Thru	Right	RTOR	App. Total	Left	Thru	Right	RTOR	App. Total	Left	Thru	Right	RTOR	App. Total	Exclu. Total	Inclu. Total	Int. Total
	07:00 AM	1	0	1	1	2	0	6	0	0	6	0	4	2	0	6	0	12	2	0	14	1	28
07:15 AM	0	2	1	0	3	0	5	1	0	6	1	3	1	0	5	2	8	2	0	12	0	26	26
07:30 AM	0	0	1	0	1	0	5	1	0	6	1	0	3	0	4	1	5	2	1	8	1	19	20
07:45 AM	0	0	2	0	2	0	6	0	0	6	1	0	2	0	3	0	6	3	0	9	0	20	20
Total	1	2	5	1	8	0	22	2	0	24	3	7	8	0	18	3	31	9	1	43	2	93	95
08:00 AM	0	0	2	1	2	0	9	1	1	10	1	0	0	0	1	0	5	0	0	5	2	18	20
08:15 AM	0	0	0	0	0	0	8	2	0	10	1	3	1	0	5	1	12	3	2	16	2	31	33
08:30 AM	0	0	1	0	1	0	10	4	1	14	4	2	2	0	8	0	9	3	1	12	2	35	37
08:45 AM	0	0	3	0	3	0	5	1	0	6	1	3	2	0	6	1	5	4	1	10	1	25	26
Total	0	0	6	1	6	0	32	8	2	40	7	8	5	0	20	2	31	10	4	43	7	109	116
Grand Total	1	2	11	2	14	0	54	10	2	64	10	15	13	0	38	5	62	19	5	86	9	202	211
Approch %	7.1	14.3	78.6		6.9	0	84.4	15.6		31.7	26.3	39.5	34.2		18.8	5.8	72.1	22.1		42.6	4.3	95.7	
Total %	0.5	1	5.4			0	26.7	5			5	7.4	6.4			2.5	30.7	9.4					

3:1-505

Start Time	Old 215 Frontage Road Southbound					Cactus Avenue Westbound					I-215 Northbound Ramps Northbound					Cactus Avenue Eastbound							
	Left	Thru	Right	RTOR	App. Total	Left	Thru	Right	RTOR	App. Total	Left	Thru	Right	RTOR	App. Total	Left	Thru	Right	RTOR	App. Total	Exclu. Total	Inclu. Total	Int. Total
	07:00 AM	1	0	1	1	2	0	6	0	0	6	0	4	2	0	6	0	12	2	0	14	1	28
07:15 AM	0	2	1	0	3	0	5	1	0	6	1	3	1	0	5	2	8	2	0	12	0	26	26
07:30 AM	0	0	1	0	1	0	5	1	0	6	1	0	3	0	4	1	5	2	1	8	1	19	20
07:45 AM	0	0	2	0	2	0	6	0	0	6	1	0	2	0	3	0	6	3	0	9	0	20	20
Total	1	2	5	1	8	0	22	2	0	24	3	7	8	0	18	3	31	9	1	43	2	93	95
08:00 AM	0	0	2	1	2	0	9	1	1	10	1	0	0	0	1	0	5	0	0	5	2	18	20
08:15 AM	0	0	0	0	0	0	8	2	0	10	1	3	1	0	5	1	12	3	2	16	2	31	33
08:30 AM	0	0	1	0	1	0	10	4	1	14	4	2	2	0	8	0	9	3	1	12	2	35	37
08:45 AM	0	0	3	0	3	0	5	1	0	6	1	3	2	0	6	1	5	4	1	10	1	25	26
Total	0	0	6	1	6	0	32	8	2	40	7	8	5	0	20	2	31	10	4	43	7	109	116
Grand Total	1	2	11	2	14	0	54	10	2	64	10	15	13	0	38	5	62	19	5	86	9	202	211
Approch %	7.1	14.3	78.6		6.9	0	84.4	15.6		31.7	26.3	39.5	34.2		18.8	5.8	72.1	22.1		42.6	4.3	95.7	
Total %	0.5	1	5.4			0	26.7	5			5	7.4	6.4			2.5	30.7	9.4					

Peak Hour Analysis From 07:00 AM to 07:45 AM - Peak 1 of 1
 Peak Hour for Entire Intersection Begins at 07:00 AM

Start Time	Old 215 Frontage Road Southbound					Cactus Avenue Westbound					I-215 Northbound Ramps Northbound					Cactus Avenue Eastbound							
	Left	Thru	Right	RTOR	App. Total	Left	Thru	Right	RTOR	App. Total	Left	Thru	Right	RTOR	App. Total	Left	Thru	Right	RTOR	App. Total	Exclu. Total	Inclu. Total	Int. Total
07:00 AM	1	0	1	1	2	0	6	0	0	6	0	4	2	0	6	0	12	2	0	14	1	28	29
07:15 AM	0	2	1	0	3	0	5	1	0	6	1	3	1	0	5	2	8	2	0	12	0	26	26
07:30 AM	0	0	1	0	1	0	5	1	0	6	1	0	3	0	4	1	5	2	1	8	1	19	20
07:45 AM	0	0	2	0	2	0	6	0	0	6	1	0	2	0	3	0	6	3	0	9	0	20	20
Total Volume	1	2	5	1	8	0	22	2	0	24	3	7	8	0	18	3	31	9	1	43	2	93	95
% App. Total	12.5	25	62.5		66.7	0	91.7	8.3		31.7	16.7	38.9	44.4		18.8	5.8	72.1	22.1		42.6	4.3	95.7	
PHF	.250	.250	.625		.667	.000	.917	.500		1.00	.750	.438	.667		.750	.375	.646	.750		.768		.830	

Counts Unlimited
 PO Box 1178
 Corona, CA 92878
 (951) 268-6268

City of Moreno Valley
 N/S: Old 215 Frontage Rd/I-215 NB Ramps
 E/W: Cactus Avenue
 Weather: Clear

File Name : 38_MRV_Old 215 F_215N_Cactus AM
 Site Code : 05119542
 Start Date : 8/20/2019
 Page No : 2

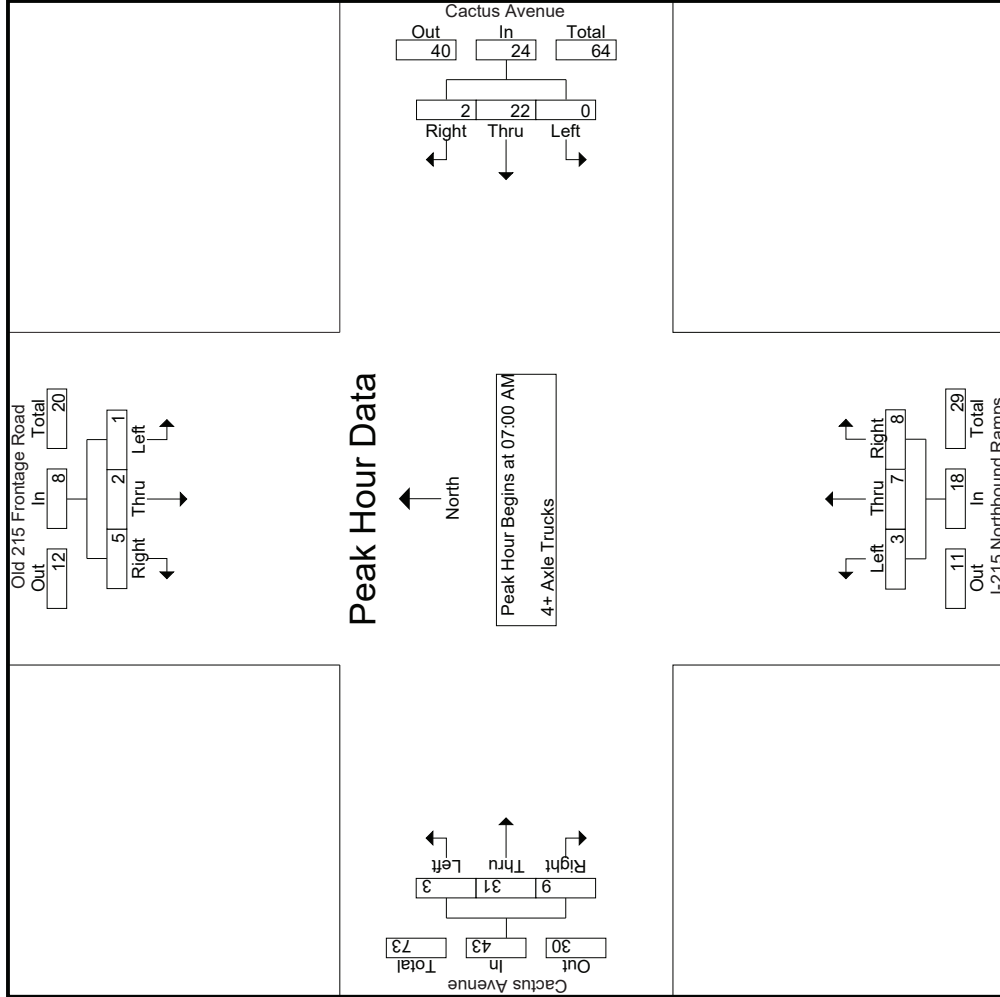

Counts Unlimited
 PO Box 1178
 Corona, CA 92878
 (951) 268-6268

City of Moreno Valley
 N/S: Old 215 Frontage Rd/I-215 NB Ramps
 EW: Cactus Avenue
 Weather: Clear

File Name : 38_MRV_Old 215 F_215N_Cactus AM
 Site Code : 05119542
 Start Date : 8/20/2019
 Page No : 3

Start Time	Old 215 Frontage Road Southbound			Cactus Avenue Westbound			I-215 Northbound Ramps Northbound			Cactus Avenue Eastbound		
	Left	Thru	Right	Left	Thru	Right	Left	Thru	Right	Left	Thru	Right
Peak Hour Analysis From 07:00 AM to 07:45 AM - Peak 1 of 1												
Peak Hour for Each Approach Begins at:												
+0 mins.	1	0	1	0	0	0	0	0	0	0	0	0
+15 mins.	0	2	1	5	1	1	1	3	1	2	8	2
+30 mins.	0	0	1	5	1	6	1	0	3	1	5	2
+45 mins.	0	0	2	6	0	6	1	0	2	0	6	3
Total Volume	1	2	5	22	2	24	3	7	8	3	31	9
% App. Total	12.5	25	62.5	91.7	8.3	100	16.7	38.9	44.4	7	72.1	20.9
PHF	.250	.250	.625	.917	.500	1.000	.750	.438	.667	.375	.646	.750

Counts Unlimited
 PO Box 1178
 Corona, CA 92878
 (951) 268-6268

City of Moreno Valley
 N/S: Old 215 Frontage Rd/I-215 NB Ramps
 EW: Cactus Avenue
 Weather: Clear

File Name : 38_MRV_Old 215 F_215N_Cactus PM
 Site Code : 05119542
 Start Date : 8/20/2019
 Page No : 1

Groups Printed- Passenger Vehicles - Large 2 Axle Vehicles - 3 Axle Vehicles - 4+ Axle Trucks

Start Time	Old 215 Frontage Road Southbound						Cactus Avenue Westbound						I-215 Northbound Ramps Northbound						Cactus Avenue Eastbound												
	Left	Thru	Right	RTOR	App. Total		Left	Thru	Right	RTOR	App. Total		Left	Thru	Right	RTOR	App. Total		Left	Thru	Right	RTOR	App. Total		Left	Thru	Right	RTOR	App. Total		
	Exclu. Total	Inclu. Total	Int. Total				Exclu. Total	Inclu. Total	Int. Total				Exclu. Total	Inclu. Total	Int. Total				Exclu. Total	Inclu. Total	Int. Total				Exclu. Total	Inclu. Total	Int. Total				
04:00 PM	20	0	21	11	41	0	379	28	5	407	7	24	142	0	173	4	213	18	1	235	17	856	873								
04:15 PM	35	0	21	9	56	0	349	21	4	370	10	15	162	0	187	7	264	7	1	278	14	891	905								
04:30 PM	36	0	31	19	67	0	363	32	6	395	8	16	173	0	197	2	313	21	10	336	35	995	1030								
04:45 PM	23	0	15	7	38	0	307	32	6	339	11	16	171	0	198	2	250	15	4	267	17	842	859								
Total	114	0	88	46	202	0	1398	113	21	1511	36	71	648	0	755	15	1040	61	16	1116	83	3584	3667								
05:00 PM	32	0	37	17	69	0	372	24	7	396	10	16	149	0	175	4	301	26	3	331	27	971	998								
05:15 PM	34	0	31	6	65	0	361	19	4	380	6	20	179	0	205	17	307	17	1	341	11	991	1002								
05:30 PM	32	0	28	13	60	0	308	14	4	322	2	20	166	0	188	4	339	16	3	359	20	929	949								
05:45 PM	24	0	17	6	41	0	278	21	3	299	8	12	174	0	194	4	306	10	0	320	9	854	863								
Total	122	0	113	42	235	0	1319	78	18	1397	26	68	668	0	762	29	1253	69	7	1351	67	3745	3812								
Grand Total	236	0	201	88	437	0	2717	191	39	2908	62	139	1316	0	1517	44	2293	130	23	2467	150	7329	7479								
Approch %	54	0	46			0	93.4	6.6			4.1	9.2	86.8			1.8	92.9	5.3			1.8	92.9	5.3								
Total %	3.2	0	2.7		6	0	37.1	2.6		39.7	0.8	1.9	18		20.7	0.6	31.3	1.8		33.7	2	98									
% Passenger Vehicles	231	0	194		508	0	2609	188		2836	50	132	1290		1472	40	2170	114		2346	0	0	7162								
% 2 Axle Vehicles	97.9	0	96.5		94.3	96.8	96.8	100		96.2	80.6	95	98		97	90.9	94.6	87.7		95.7	94.2	0	95.8								
% Large 2 Axle Vehicles	1	0	6		12	0	34	1		35	4	3	13		20	1	35	3		39	0	0	106								
% 3 Axle Vehicles	0.4	0	3		5.7	2.3	1.3	0.5		1.2	6.5	2.2	1		1.3	2.3	1.5	2.3		1.6	0	0	1.4								
% 3 Axle Trucks	1	0	0		1	0	12	0		12	5	0	4		9	0	13	2		15	0	0	37								
% 4+ Axle Trucks	0.4	0	0		0.2	0	0.4	0		0.4	8.1	0	0.3		0.6	0	0.6	1.5		0.6	0	0	0.5								
% 4+ Axle Trucks	3	0	1		4	0	62	2		64	3	4	9		16	3	75	11		90	0	0	174								
% 4+ Axle Trucks	1.3	0	0.5		0.8	0	2.3	1		2.2	4.8	2.9	0.7		1.1	6.8	3.3	8.5		4.3	3.6	0	2.3								
PHF	.868	.000	.770		.866	.000	.943	.836		.953	.795	.850	.939		.935	.945	.760	.935		.935	.935	.935	.955								

Start Time	Old 215 Frontage Road Southbound						Cactus Avenue Westbound						I-215 Northbound Ramps Northbound						Cactus Avenue Eastbound											
	Left	Thru	Right	RTOR	App. Total		Left	Thru	Right	RTOR	App. Total		Left	Thru	Right	RTOR	App. Total		Left	Thru	Right	RTOR	App. Total		Left	Thru	Right	RTOR	App. Total	
	Exclu. Total	Inclu. Total	Int. Total				Exclu. Total	Inclu. Total	Int. Total				Exclu. Total	Inclu. Total	Int. Total				Exclu. Total	Inclu. Total	Int. Total				Exclu. Total	Inclu. Total	Int. Total			
04:30 PM	36	0	31		67	0	363	32		395	8	16	173		173	197	21	313		336	21	995								
04:45 PM	23	0	15		38	0	307	32		339	11	16	171		171	198	15	250		267	15	842								
05:00 PM	32	0	37		69	0	372	24		396	10	16	149		149	175	4	301		331	26	971								
05:15 PM	34	0	31		65	0	361	19		380	6	20	179		179	198	17	307		341	17	991								
Total Volume	125	0	114		239	0	1403	107		1510	35	68	672		672	775	25	1171		1275	79	3799								
% App. Total	52.3	0	47.7			0	92.9	7.1		7.1	4.5	8.8	86.7		86.7	6.2	91.8	6.2		6.2	6.2	91.8								
PHF	.868	.000	.770		.866	.000	.943	.836		.953	.795	.850	.939		.935	.945	.760	.935		.935	.935	.935	.955							

Peak Hour Analysis From 04:00 PM to 05:45 PM - Peak 1 of 1
 Peak Hour for Entire Intersection Begins at 04:30 PM

Counts Unlimited
 PO Box 1178
 Corona, CA 92878
 (951) 268-6268

City of Moreno Valley
 N/S: Old 215 Frontage Rd/I-215 NB Ramps
 E/W: Cactus Avenue
 Weather: Clear

File Name : 38_MRV_Old 215 F_215N_Cactus PM
 Site Code : 05119542
 Start Date : 8/20/2019
 Page No : 2

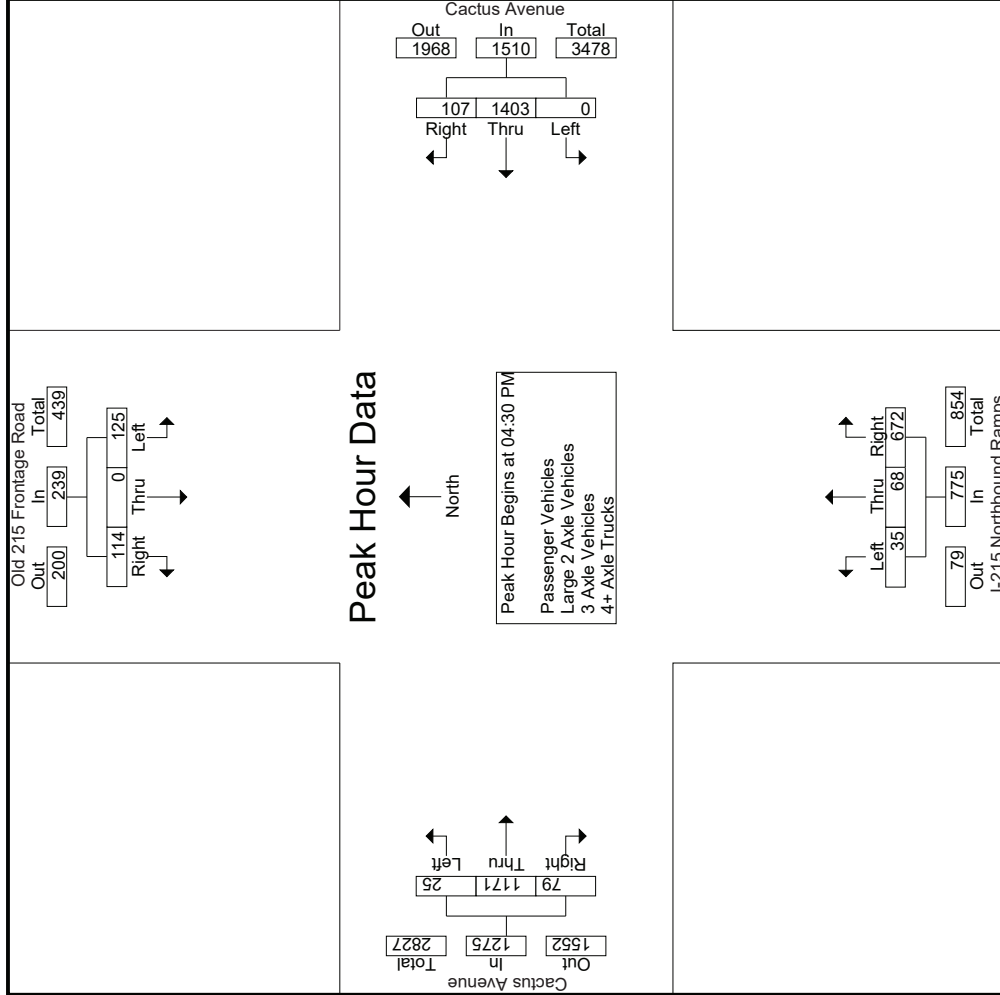

Counts Unlimited
 PO Box 1178
 Corona, CA 92878
 (951) 268-6268

City of Moreno Valley
 N/S: Old 215 Frontage Rd/I-215 NB Ramps
 EW: Cactus Avenue
 Weather: Clear

File Name : 38_MRV_Old 215 F_215N_Cactus PM
 Site Code : 05119542
 Start Date : 8/20/2019
 Page No : 3

Start Time	Old 215 Frontage Road Southbound			Cactus Avenue Westbound			I-215 Northbound Ramps Northbound			Cactus Avenue Eastbound				
	Left	Thru	Right	Left	Thru	Right	Left	Thru	Right	Left	Thru	Right	App. Total	Int. Total
Peak Hour Analysis From 04:00 PM to 05:45 PM - Peak 1 of 1														
Peak Hour for Each Approach Begins at:														
	04:30 PM			04:00 PM			04:30 PM			05:00 PM				
+0 mins.	36	0	31	0	379	28	407	8	16	173	197	4	301	331
+15 mins.	23	0	15	0	349	21	370	11	16	171	198	17	307	341
+30 mins.	32	0	37	0	363	32	395	10	16	149	175	4	339	359
+45 mins.	34	0	31	0	307	32	339	6	20	179	205	4	306	320
Total Volume	125	0	114	0	1398	113	1511	35	68	672	775	29	1253	1351
% App. Total	52.3	0	47.7	0	92.5	7.5	92.8	4.5	8.8	86.7	94.5	2.1	92.7	5.1
PHF	.868	.000	.770	.000	.922	.883	.928	.795	.850	.939	.945	.426	.924	.663

Counts Unlimited
 PO Box 1178
 Corona, CA 92878
 (951) 268-6268

City of Moreno Valley
 N/S: Old 215 Frontage Rd/I-215 NB Ramps
 EW: Cactus Avenue
 Weather: Clear

File Name : 38_MRV_Old 215 F_215N_Cactus PM
 Site Code : 05119542
 Start Date : 8/20/2019
 Page No : 1

Groups Printed- Passenger Vehicles

Start Time	Old 215 Frontage Road Southbound						Cactus Avenue Westbound						I-215 Northbound Ramps Northbound						Cactus Avenue Eastbound					
	Left	Thru	Right	RTOR	App. Total	Inclu. Total	Left	Thru	Right	RTOR	App. Total	Inclu. Total	Left	Thru	Right	RTOR	App. Total	Inclu. Total	Left	Thru	Right	RTOR	App. Total	Inclu. Total
	04:00 PM	20	0	20	10	40	40	0	363	28	5	391	391	6	21	140	0	167	167	2	200	13	1	215
04:15 PM	33	0	21	9	54	54	0	337	21	4	358	358	8	13	160	0	181	181	6	247	5	0	258	258
04:30 PM	36	0	30	18	66	66	0	348	31	6	379	379	7	16	170	0	193	193	2	295	21	10	318	318
04:45 PM	23	0	13	7	36	36	0	293	31	6	324	324	8	16	167	0	191	191	2	232	10	4	244	244
Total	112	0	84	44	196	196	0	1341	111	21	1452	1452	29	66	637	0	732	732	12	974	49	15	1035	1035
05:00 PM	31	0	36	16	67	67	0	359	24	7	383	383	8	16	140	0	164	164	4	288	25	3	317	317
05:15 PM	33	0	30	5	63	63	0	348	19	4	367	367	4	20	175	0	199	199	17	294	16	1	327	327
05:30 PM	32	0	27	12	59	59	0	298	14	4	312	312	2	20	165	0	187	187	4	323	16	3	343	343
05:45 PM	23	0	17	6	40	40	0	263	20	3	283	283	7	10	173	0	190	190	3	291	8	0	302	302
Total	119	0	110	39	229	229	0	1268	77	18	1345	1345	21	66	653	0	740	740	28	1196	65	7	1289	1289
Grand Total	231	0	194	83	425	425	0	2609	188	39	2797	2797	50	132	1290	0	1472	1472	40	2170	114	22	2324	2324
Approch %	54.4	0	45.6				0	93.3	6.7		39.9	39.9	3.4	9	87.6		21	21	1.7	93.4	4.9		33.1	33.1
Total %	3.3	0	2.8		6.1	6.1	0	37.2	2.7				0.7	1.9	18.4				0.6	30.9	1.6			

3:1-511

Start Time	Old 215 Frontage Road Southbound						Cactus Avenue Westbound						I-215 Northbound Ramps Northbound						Cactus Avenue Eastbound					
	Left	Thru	Right	RTOR	App. Total	Inclu. Total	Left	Thru	Right	RTOR	App. Total	Inclu. Total	Left	Thru	Right	RTOR	App. Total	Inclu. Total	Left	Thru	Right	RTOR	App. Total	Inclu. Total
	04:30 PM	36	0	30		66	66	0	348	31		379	379	7	16	170		193	193	2	295	21		318
04:45 PM	23	0	13		36	36	0	293	31		324	324	8	16	167		191	191	2	232	10		244	244
05:00 PM	31	0	36		67	67	0	359	24		383	383	4	20	175		199	199	17	294	16		327	327
05:15 PM	33	0	30		63	63	0	348	19		367	367	17	294	16		327	327	4	288	25		317	317
Total Volume	123	0	109	232	232	232	0	1348	105	7.2	1453	1453	27	68	652	747	747	25	1109	72	1206	1206		
% App. Total	53	0	47				0	92.8	7.2		7.2	7.2	3.6	9.1	87.3		87.3	87.3	2.1	92	6		6	6
PHF	.854	.000	.757	.866	.866	.866	.000	.939	.847	.948	.948	.948	.844	.850	.931	.938	.938	.368	.940	.720	.922	.922	.922	

Peak Hour Analysis From 04:30 PM to 05:15 PM - Peak 1 of 1
 Peak Hour for Entire Intersection Begins at 04:30 PM

Counts Unlimited
 PO Box 1178
 Corona, CA 92878
 (951) 268-6268

City of Moreno Valley
 N/S: Old 215 Frontage Rd/I-215 NB Ramps
 E/W: Cactus Avenue
 Weather: Clear

File Name : 38_MRV_Old 215 F_215N_Cactus PM
 Site Code : 05119542
 Start Date : 8/20/2019
 Page No : 2

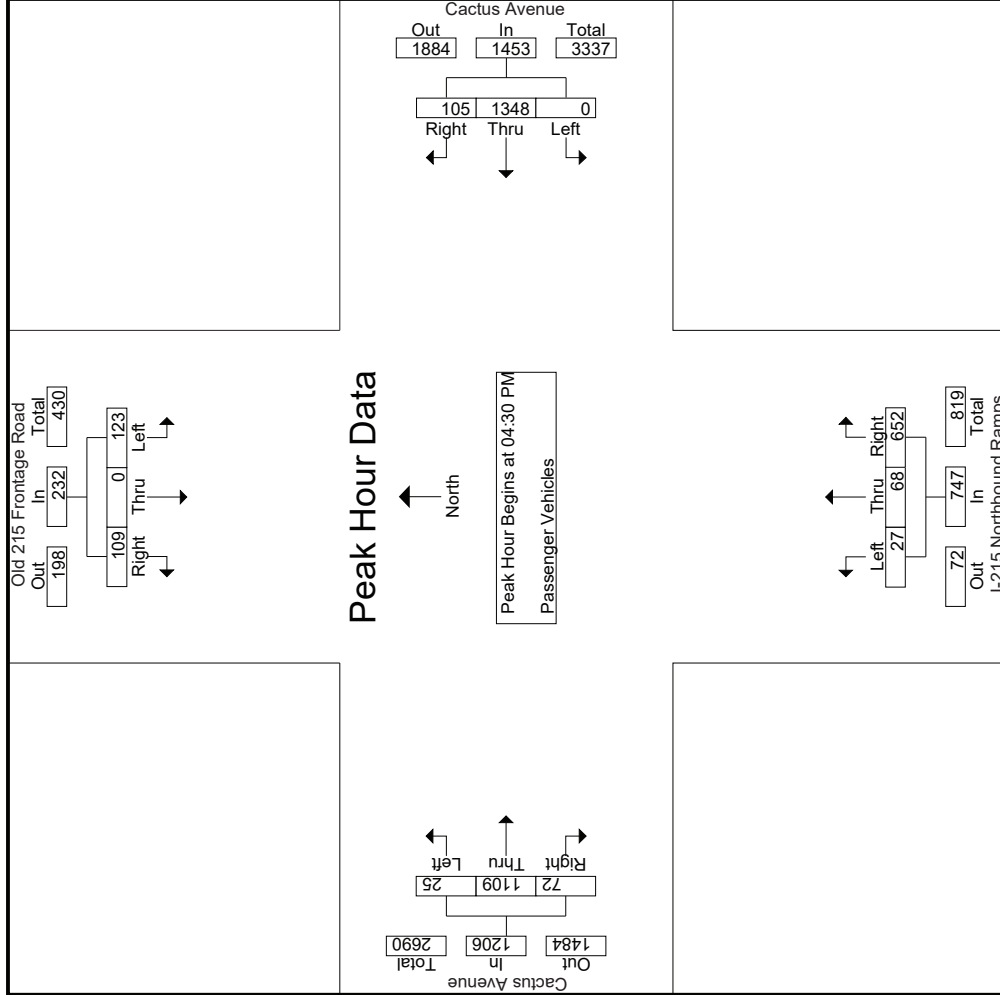

Counts Unlimited
 PO Box 1178
 Corona, CA 92878
 (951) 268-6268

City of Moreno Valley
 N/S: Old 215 Frontage Rd/I-215 NB Ramps
 EW: Cactus Avenue
 Weather: Clear

File Name : 38_MRV_Old 215 F_215N_Cactus PM
 Site Code : 05119542
 Start Date : 8/20/2019
 Page No : 3

Start Time	Old 215 Frontage Road Southbound			Cactus Avenue Westbound			I-215 Northbound Ramps Northbound			Cactus Avenue Eastbound					
	Left	Thru	Right	Left	Thru	Right	Left	Thru	Right	Left	Thru	Right	App. Total	Int. Total	
Peak Hour Analysis From 04:30 PM to 05:15 PM - Peak 1 of 1															
Peak Hour for Each Approach Begins at:															
	04:30 PM			04:30 PM			04:30 PM			04:30 PM			04:30 PM		
+0 mins.	36	0	30	0	348	31	379	7	16	170	193	2	295	21	318
+15 mins.	23	0	13	0	293	31	324	8	16	167	191	2	232	10	244
+30 mins.	31	0	36	0	359	24	383	8	16	140	164	4	288	25	317
+45 mins.	33	0	30	0	348	19	367	4	20	175	199	17	294	16	327
Total Volume	123	0	109	0	1348	105	1453	27	68	652	747	25	1109	72	1206
% App. Total	53	0	47	0	92.8	7.2	948	3.6	9.1	87.3	938	2.1	92	6	1206
PHF	.854	.000	.757	.000	.939	.847	.948	.844	.850	.931	.938	.368	.940	.720	.922

Groups Printed- Large 2 Axle Vehicles

Start Time	Old 215 Frontage Road Southbound					Cactus Avenue Westbound					I-215 Northbound Ramps Northbound					Cactus Avenue Eastbound							
	Left	Thru	Right	RTOR	App. Total	Left	Thru	Right	RTOR	App. Total	Left	Thru	Right	RTOR	App. Total	Left	Thru	Right	RTOR	App. Total	Exclu. Total	Inclu. Total	Int. Total
	04:00 PM	0	0	1	1	1	0	7	0	0	7	0	1	2	0	3	1	2	2	0	5	1	16
04:15 PM	0	0	0	0	0	0	3	0	0	3	2	1	1	0	4	0	5	0	0	5	0	12	12
04:30 PM	0	0	1	1	1	0	2	0	0	2	0	0	1	0	1	0	4	0	0	4	1	8	9
04:45 PM	0	0	1	0	1	0	4	0	0	4	1	0	2	0	3	0	6	0	0	6	0	14	14
Total	0	0	3	2	3	0	16	0	0	16	3	2	6	0	11	1	17	2	0	20	2	50	52
05:00 PM	1	0	1	1	2	0	5	0	0	5	0	0	4	0	4	0	3	0	0	3	1	14	15
05:15 PM	0	0	1	1	1	0	8	0	0	8	1	0	2	0	3	0	4	0	0	4	1	16	17
05:30 PM	0	0	1	1	1	0	3	0	0	3	0	0	1	0	1	0	6	0	0	6	0	11	12
05:45 PM	0	0	0	0	0	0	2	1	0	3	0	0	1	0	1	0	5	1	0	6	0	10	10
Total	1	0	3	3	4	0	18	1	0	19	1	1	7	0	9	0	18	1	0	19	3	51	54
Grand Total	1	0	6	5	7	0	34	1	0	35	4	3	13	0	20	1	35	3	0	39	5	101	106
Approch %	14.3	0	85.7		6.9	0	97.1	2.9		34.7	20	15	65		19.8	2.6	89.7	7.7		38.6	4.7	95.3	
Total %	1	0	5.9			0	33.7	1			4	3	12.9			1	34.7	3					

Start Time	Old 215 Frontage Road Southbound					Cactus Avenue Westbound					I-215 Northbound Ramps Northbound					Cactus Avenue Eastbound							
	Left	Thru	Right	RTOR	App. Total	Left	Thru	Right	RTOR	App. Total	Left	Thru	Right	RTOR	App. Total	Left	Thru	Right	RTOR	App. Total	Exclu. Total	Inclu. Total	Int. Total
	04:30 PM	0	0	0	1	1	0	2	0	0	2	0	0	1	0	1	0	4	0	0	4	0	4
04:45 PM	0	0	0	1	1	0	4	0	0	4	1	0	2	0	3	0	6	0	0	6	0	6	14
05:00 PM	1	0	0	1	2	0	5	0	0	5	0	0	4	0	4	0	3	0	0	3	0	3	14
05:15 PM	0	0	0	1	1	0	8	0	0	8	1	0	2	0	3	0	4	0	0	4	0	4	16
Total Volume	1	0	0	4	5	0	19	0	0	19	2	0	9	0	11	0	17	0	0	17	0	17	52
% App. Total	20	0	80		6.25	0	100	0		59.4	18.2	0	81.8		.688	0	100	0		.708	.000	.708	.813
PHF	.250	.000	1.00			.000	.594	.000		.594	.500	.000	.563		.688	.000	.708	.000		.708	.000	.708	.813

Peak Hour Analysis From 04:30 PM to 05:15 PM - Peak 1 of 1
 Peak Hour for Entire Intersection Begins at 04:30 PM

Counts Unlimited
 PO Box 1178
 Corona, CA 92878
 (951) 268-6268

City of Moreno Valley
 N/S: Old 215 Frontage Rd/I-215 NB Ramps
 E/W: Cactus Avenue
 Weather: Clear

File Name : 38_MRV_Old 215 F_215N_Cactus PM
 Site Code : 05119542
 Start Date : 8/20/2019
 Page No : 2

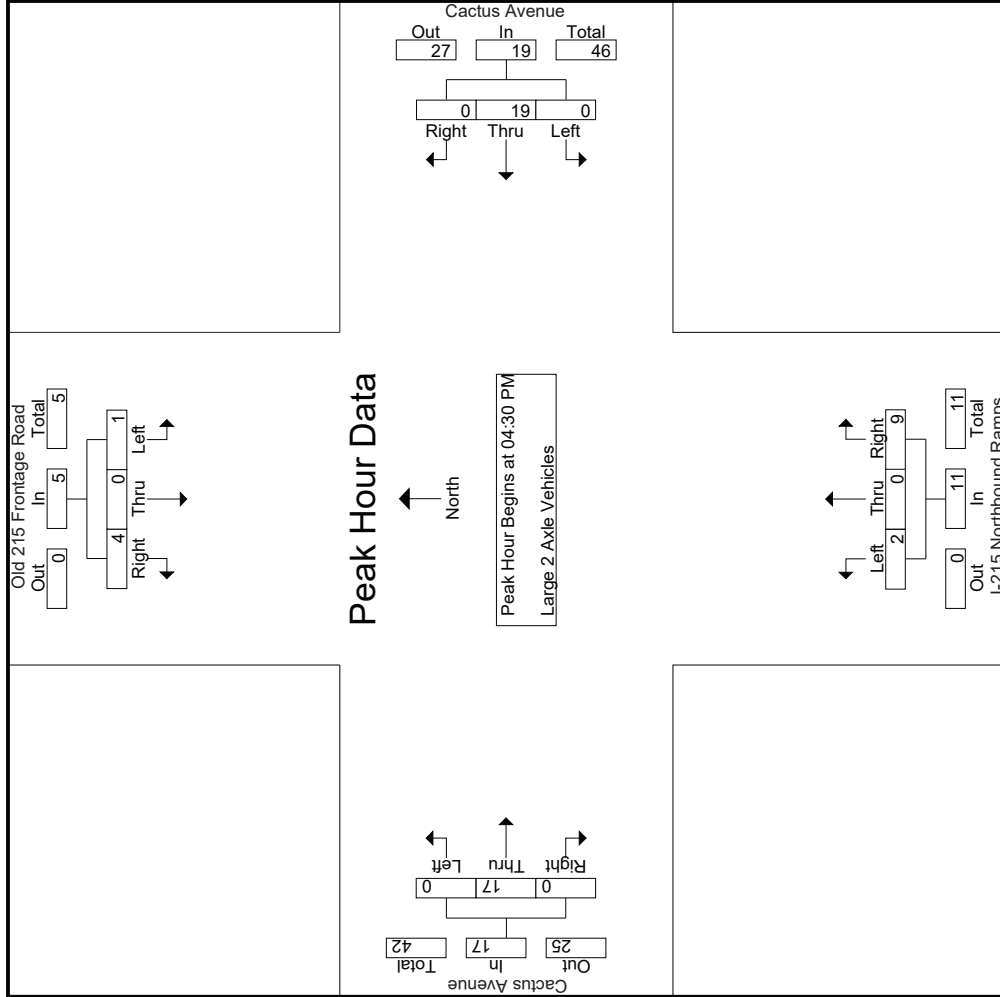

Counts Unlimited
 PO Box 1178
 Corona, CA 92878
 (951) 268-6268

City of Moreno Valley
 N/S: Old 215 Frontage Rd/I-215 NB Ramps
 EW: Cactus Avenue
 Weather: Clear

File Name : 38_MRV_Old 215 F_215N_Cactus PM
 Site Code : 05119542
 Start Date : 8/20/2019
 Page No : 3

Start Time	Old 215 Frontage Road Southbound			Cactus Avenue Westbound			I-215 Northbound Ramps Northbound			Cactus Avenue Eastbound		
	Left	Thru	Right	Left	Thru	Right	Left	Thru	Right	Left	Thru	Right
Peak Hour Analysis From 04:30 PM to 05:15 PM - Peak 1 of 1												
Peak Hour for Each Approach Begins at:												
+0 mins.	0	0	1	0	2	0	0	0	1	0	0	4
+15 mins.	0	0	1	4	4	0	1	0	2	3	0	6
+30 mins.	1	0	1	5	5	0	0	0	4	0	3	0
+45 mins.	0	0	1	8	8	0	1	0	2	0	4	0
Total Volume	1	0	4	19	19	0	2	0	9	0	17	0
% App. Total	.250	.000	1.000	.625	.594	.000	.500	.000	.563	.000	.708	.000
PHF												

Groups Printed- 3 Axle Vehicles

Start Time	Old 215 Frontage Road Southbound				Cactus Avenue Westbound				I-215 Northbound Ramps Northbound				Cactus Avenue Eastbound				
	Left	Thru	Right	RTOR	Left	Thru	Right	RTOR	Left	Thru	Right	RTOR	Left	Thru	Right	RTOR	
04:00 PM	0	0	0	0	0	5	0	0	0	0	0	0	0	1	0	0	1
04:15 PM	1	0	0	1	0	1	0	0	0	0	0	0	0	2	1	0	3
04:30 PM	0	0	0	0	0	1	0	0	1	0	0	0	2	0	1	0	1
04:45 PM	0	0	0	0	0	1	0	0	2	0	0	2	0	4	0	4	0
Total	1	0	0	1	0	8	0	0	3	0	1	0	4	0	8	1	9
05:00 PM	0	0	0	0	0	2	0	0	1	0	2	0	3	0	2	0	2
05:15 PM	0	0	0	0	0	0	0	0	1	0	1	0	2	0	2	0	2
05:30 PM	0	0	0	0	0	1	0	0	0	0	0	0	0	0	0	0	0
05:45 PM	0	0	0	0	0	1	0	0	1	0	0	0	0	1	1	0	2
Total	0	0	0	0	0	4	0	0	2	0	3	0	5	0	5	1	6
Grand Total	1	0	0	1	0	12	0	0	5	0	4	0	9	0	13	2	15
Apprch %	100	0	0	0	0	100	0	0	55.6	0	44.4	0	24.3	0	86.7	13.3	40.5
Total %	2.7	0	0	2.7	0	32.4	0	0	13.5	0	10.8	0	24.3	0	35.1	5.4	100

Start Time	Old 215 Frontage Road Southbound				Cactus Avenue Westbound				I-215 Northbound Ramps Northbound				Cactus Avenue Eastbound				
	Left	Thru	Right	RTOR	Left	Thru	Right	RTOR	Left	Thru	Right	RTOR	Left	Thru	Right	RTOR	
04:30 PM	0	0	0	0	0	1	0	0	1	0	0	0	1	0	0	0	1
04:45 PM	0	0	0	0	0	1	0	0	2	0	0	0	2	0	4	0	4
05:00 PM	0	0	0	0	0	2	0	0	1	0	1	0	3	0	2	0	7
05:15 PM	0	0	0	0	0	0	0	0	1	0	0	0	2	0	0	0	2
Total Volume	0	0	0	0	0	4	0	0	5	0	4	0	9	0	9	0	9
% App. Total	0	0	0	0	0	100	0	0	55.6	0	44.4	0	44.4	0	100	0	100
PHF	.000	.000	.000	.000	.000	.500	.000	.500	.625	.000	.500	.000	.750	.000	.563	.000	.786

Peak Hour Analysis From 04:30 PM to 05:15 PM - Peak 1 of 1
 Peak Hour for Entire Intersection Begins at 04:30 PM

Counts Unlimited
 PO Box 1178
 Corona, CA 92878
 (951) 268-6268

City of Moreno Valley
 N/S: Old 215 Frontage Rd/I-215 NB Ramps
 E/W: Cactus Avenue
 Weather: Clear

File Name : 38_MRV_Old 215 F_215N_Cactus PM
 Site Code : 05119542
 Start Date : 8/20/2019
 Page No : 2

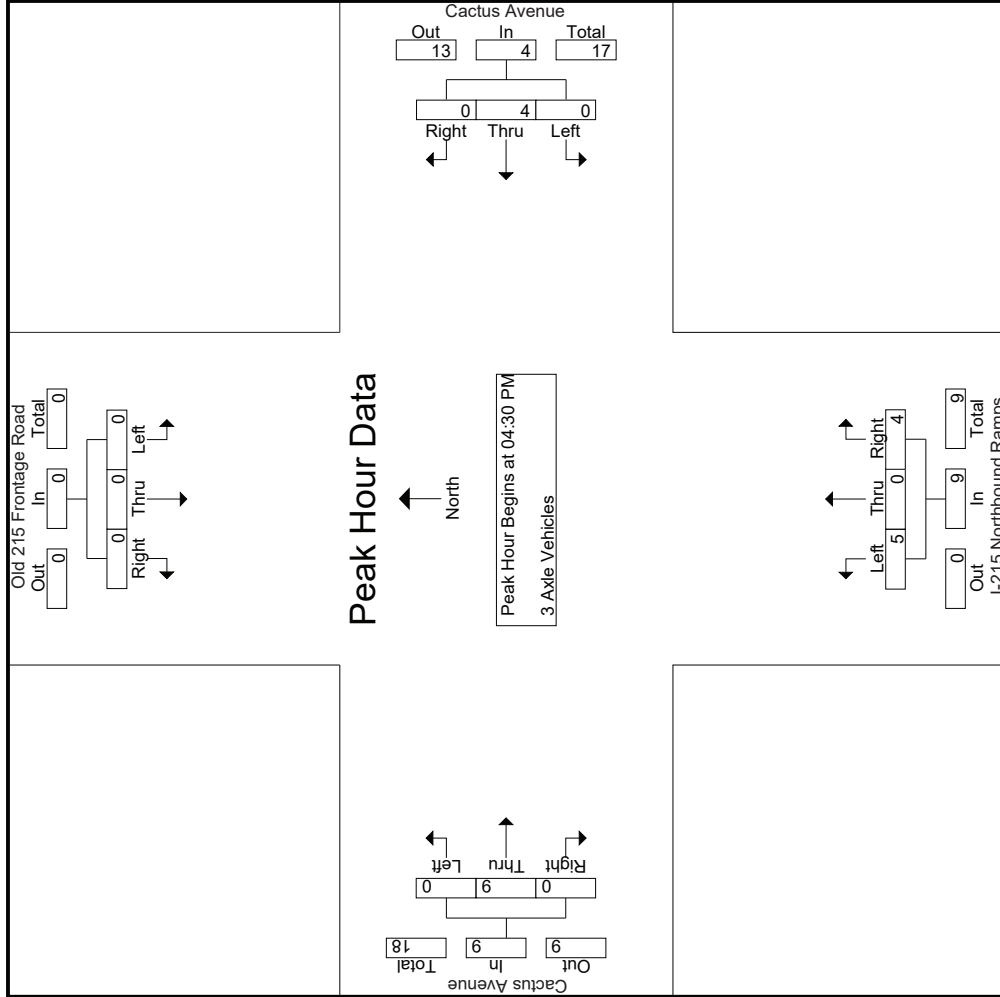

Counts Unlimited
 PO Box 1178
 Corona, CA 92878
 (951) 268-6268

City of Moreno Valley
 N/S: Old 215 Frontage Rd/I-215 NB Ramps
 EW: Cactus Avenue
 Weather: Clear

File Name : 38_MRV_Old 215 F_215N_Cactus PM
 Site Code : 05119542
 Start Date : 8/20/2019
 Page No : 3

Start Time	Old 215 Frontage Road Southbound			Cactus Avenue Westbound			I-215 Northbound Ramps Northbound			Cactus Avenue Eastbound		
	Left	Thru	Right	Left	Thru	Right	Left	Thru	Right	Left	Thru	Right
Peak Hour Analysis From 04:30 PM to 05:15 PM - Peak 1 of 1												
Peak Hour for Each Approach Begins at:												
+0 mins.	0	0	0	0	0	1	0	0	1	0	0	1
+15 mins.	0	0	0	0	0	1	0	0	0	0	4	0
+30 mins.	0	0	0	0	0	2	0	0	2	0	2	0
+45 mins.	0	0	0	0	0	0	0	0	1	0	2	0
Total Volume	0	0	0	0	4	4	0	0	4	0	9	0
% App. Total	0	0	0	0	100	0	0	55.6	44.4	0	100	0
PHF	.000	.000	.000	.000	.500	.500	.000	.625	.500	.000	.563	.000

Groups Printed- 4+ Axle Trucks

Start Time	Old 215 Frontage Road Southbound				Cactus Avenue Westbound				I-215 Northbound Ramps Northbound				Cactus Avenue Eastbound									
	Left	Thru	Right	RTOR	Left	Thru	Right	RTOR	Left	Thru	Right	RTOR	Left	Thru	Right	RTOR						
04:00 PM	0	0	0	0	0	4	0	0	1	2	0	0	3	1	10	3	0	14	0	21	21	
04:15 PM	1	0	0	1	0	8	0	0	0	1	1	0	2	1	10	1	1	12	1	23	24	
04:30 PM	0	0	0	0	0	12	1	0	0	0	1	0	1	0	13	0	0	13	0	27	27	
04:45 PM	0	0	1	0	0	9	1	0	0	0	2	0	2	0	8	5	0	13	0	26	26	
Total	1	0	1	0	0	33	2	0	35	1	3	4	8	2	41	9	1	52	1	97	98	
05:00 PM	0	0	0	0	0	6	0	0	6	1	0	3	0	4	0	8	1	0	9	0	19	19
05:15 PM	1	0	0	0	0	5	0	0	5	0	0	1	0	1	0	7	1	0	8	0	15	15
05:30 PM	0	0	0	0	0	6	0	0	6	0	0	0	0	0	10	0	0	10	0	16	16	
05:45 PM	1	0	0	1	0	12	0	0	12	1	1	1	0	3	1	9	0	10	0	26	26	
Total	2	0	0	2	0	29	0	0	29	2	1	5	8	1	34	2	0	37	0	76	76	
Grand Total	3	0	1	0	0	62	2	0	64	3	4	9	0	16	3	75	11	89	1	173	174	
Apprch %	75	0	25		0	96.9	3.1		37	18.8	25	56.2		9.2	3.4	84.3	12.4		0.6	99.4		
Total %	1.7	0	0.6		0	35.8	1.2		37	1.7	2.3	5.2		9.2	1.7	43.4	6.4		0.6	99.4		

Start Time	Old 215 Frontage Road Southbound				Cactus Avenue Westbound				I-215 Northbound Ramps Northbound				Cactus Avenue Eastbound								
	Left	Thru	Right	RTOR	Left	Thru	Right	RTOR	Left	Thru	Right	RTOR	Left	Thru	Right	RTOR					
04:30 PM	0	0	0	0	0	0	0	0	1	0	0	0	1	0	0	0	0	13	0	13	27
04:45 PM	0	0	0	1	0	9	0	0	1	0	0	2	0	2	0	8	0	8	5	13	26
05:00 PM	0	0	0	0	0	6	0	0	6	0	0	3	0	3	0	7	1	0	9	19	19
05:15 PM	1	0	0	1	0	5	0	0	5	0	0	1	0	1	0	8	0	7	1	8	15
Total Volume	1	0	0	1	0	32	2	0	34	1	0	7	0	8	0	36	7	43	7	87	87
% App. Total	50	0	50		0	94.1	5.9		37	12.5	0	87.5		16.3	0	83.7	16.3		0.6	99.4	
PHF	.250	.000	.250		.000	.667	.500		.654	.250	.000	.583		.500	.000	.692	.350		.827	.806	

Peak Hour Analysis From 04:30 PM to 05:15 PM - Peak 1 of 1
 Peak Hour for Entire Intersection Begins at 04:30 PM

Counts Unlimited
 PO Box 1178
 Corona, CA 92878
 (951) 268-6268

City of Moreno Valley
 N/S: Old 215 Frontage Rd/I-215 NB Ramps
 E/W: Cactus Avenue
 Weather: Clear

File Name : 38_MRV_Old 215 F_215N_Cactus PM
 Site Code : 05119542
 Start Date : 8/20/2019
 Page No : 2

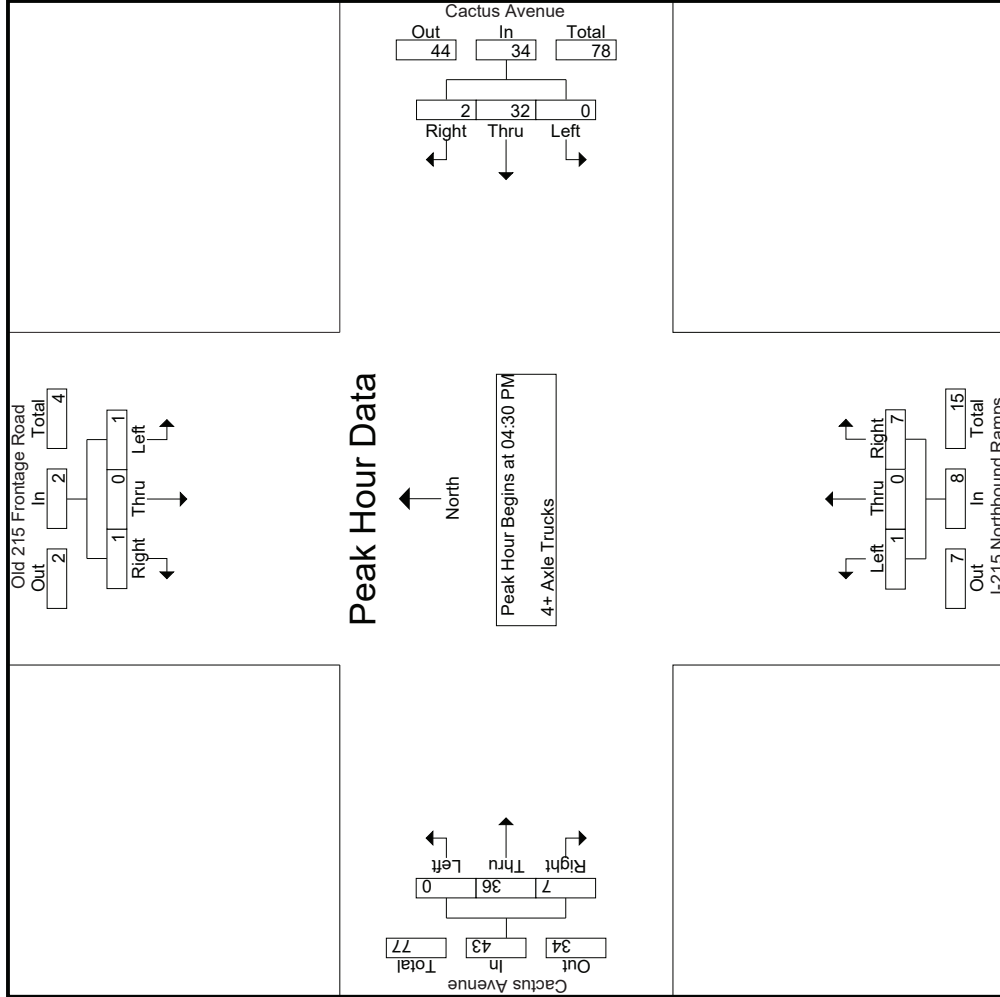

Counts Unlimited
 PO Box 1178
 Corona, CA 92878
 (951) 268-6268

City of Moreno Valley
 N/S: Old 215 Frontage Rd/I-215 NB Ramps
 EW: Cactus Avenue
 Weather: Clear

File Name : 38_MRV_Old 215 F_215N_Cactus PM
 Site Code : 05119542
 Start Date : 8/20/2019
 Page No : 3

Start Time	Old 215 Frontage Road Southbound			Cactus Avenue Westbound			I-215 Northbound Ramps Northbound			Cactus Avenue Eastbound		
	Left	Thru	Right	Left	Thru	Right	Left	Thru	Right	Left	Thru	Right
Peak Hour Analysis From 04:30 PM to 05:15 PM - Peak 1 of 1												
Peak Hour for Each Approach Begins at:												
	04:30 PM			04:30 PM			04:30 PM			04:30 PM		
+0 mins.	0	0	0	12	1	13	0	0	0	1	1	13
+15 mins.	0	0	1	9	1	10	0	0	2	2	8	5
+30 mins.	0	0	0	6	0	6	1	0	3	4	8	1
+45 mins.	1	0	0	5	0	5	0	0	1	1	7	1
Total Volume	1	0	1	32	2	34	1	0	7	8	36	7
% App. Total	50	0	50	94.1	5.9	100	12.5	0	87.5	16.3	83.7	16.3
PHF	.250	.000	.250	.667	.500	.654	.250	.000	.583	.500	.692	.350
												.827

Location: Moreno Valley
 N/S: Old 215 Frontage Rd/I-215 NB Ramps
 E/W: Cactus Avenue



Date: 8/20/2019
 Day: Tuesday

PEDESTRIANS

	North Leg Old 215 Frontage Road Pedestrians	East Leg Cactus Avenue Pedestrians	I-215 Northbound Ramps Pedestrians	West Leg Cactus Avenue Pedestrians
7:00 AM	0	0	0	0
7:15 AM	0	0	0	0
7:30 AM	0	0	0	0
7:45 AM	0	0	0	0
8:00 AM	1	0	0	0
8:15 AM	0	0	0	0
8:30 AM	1	0	0	0
8:45 AM	0	0	0	0
TOTAL VOLUMES:	2	0	0	0

	North Leg Old 215 Frontage Road Pedestrians	East Leg Cactus Avenue Pedestrians	I-215 Northbound Ramps Pedestrians	West Leg Cactus Avenue Pedestrians
4:00 PM	0	0	0	0
4:15 PM	0	0	0	0
4:30 PM	0	0	0	0
4:45 PM	1	0	0	0
5:00 PM	0	0	0	0
5:15 PM	0	0	0	0
5:30 PM	0	0	0	0
5:45 PM	0	0	0	0
TOTAL VOLUMES:	1	0	0	0

Location: Moreno Valley
 N/S: Old 215 Frontage Rd/I-215 NB Ramps
 E/W: Cactus Avenue

Date: 8/20/2019
 Day: Tuesday



BICYCLES

	Southbound Old 215 Frontage Road			Westbound Cactus Avenue			Northbound Ramps I-215 Northbound Ramps			Eastbound Cactus Avenue		
	Left	Thru	Right	Left	Thru	Right	Left	Thru	Right	Left	Thru	Right
7:00 AM	0	0	0	0	0	0	0	0	0	0	0	0
7:15 AM	0	0	0	0	0	1	0	0	0	0	0	0
7:30 AM	0	0	0	0	0	0	0	0	0	0	0	0
7:45 AM	0	0	0	0	0	0	0	0	0	0	0	0
8:00 AM	0	0	0	0	0	0	0	0	0	0	1	0
8:15 AM	0	0	0	0	0	0	0	0	0	0	0	0
8:30 AM	0	0	0	0	0	0	0	0	0	0	0	0
8:45 AM	0	0	0	0	0	0	0	0	0	0	0	0
TOTAL VOLUMES:	0	0	0	0	0	1	0	0	0	0	1	0

	Southbound Old 215 Frontage Road			Westbound Cactus Avenue			Northbound Ramps I-215 Northbound Ramps			Eastbound Cactus Avenue		
	Left	Thru	Right	Left	Thru	Right	Left	Thru	Right	Left	Thru	Right
4:00 PM	0	0	0	0	0	0	0	0	0	0	0	0
4:15 PM	0	0	0	0	0	0	0	0	0	0	0	0
4:30 PM	0	0	0	0	0	0	0	0	0	0	0	0
4:45 PM	0	0	0	0	0	0	0	0	0	0	0	0
5:00 PM	0	0	0	0	0	0	0	0	0	0	0	0
5:15 PM	0	0	0	0	0	0	0	0	0	0	0	0
5:30 PM	0	0	0	0	0	0	0	0	0	0	0	0
5:45 PM	0	0	0	0	0	0	0	0	0	0	0	0
TOTAL VOLUMES:	0	0	0	0	0	0	0	0	0	0	0	0

Groups Printed- Passenger Vehicles - Large 2 Axle Vehicles - 3 Axle Vehicles - 4+ Axle Trucks

Start Time	I-215 Southbound Off Ramp Southbound										Van Buren Boulevard Westbound										I-215 Southbound On Ramp Northbound										Van Buren Boulevard Eastbound									
	Left		Thru		Right		RTOR		App. Total		Left		Thru		Right		RTOR		App. Total		Left		Thru		Right		RTOR		App. Total		Exclu. Total		Inclu. Total		Int. Total					
07:00 AM	2	0	223	0	225	0	0	289	0	0	289	0	0	0	0	0	0	0	0	0	0	68	111	23	179	23	693	716												
07:15 AM	1	0	200	0	201	2	277	0	0	279	0	0	0	0	0	0	0	0	0	0	0	94	106	13	200	13	680	693												
07:30 AM	2	2	162	0	166	0	252	0	0	252	0	0	0	0	0	0	0	0	0	0	0	121	128	7	249	7	667	674												
07:45 AM	2	0	147	0	149	0	223	0	0	223	0	0	0	0	0	0	0	0	0	0	0	154	141	8	295	8	667	675												
Total	7	2	732	0	741	2	1041	0	0	1043	0	0	0	0	0	0	0	0	0	0	0	437	486	51	923	51	2707	2758												
08:00 AM	1	1	103	0	105	2	199	0	0	201	0	0	0	0	0	0	0	0	0	0	0	76	136	9	212	9	518	527												
08:15 AM	1	2	84	0	87	1	203	0	0	204	0	0	0	0	0	0	0	0	0	0	0	80	141	4	221	4	512	516												
08:30 AM	3	0	81	0	84	1	231	0	0	232	0	0	0	0	0	0	0	0	0	0	0	66	86	7	152	7	468	475												
08:45 AM	2	0	92	0	94	0	223	0	0	223	0	0	0	0	0	0	0	0	0	0	0	56	87	8	143	8	460	468												
Total	7	3	360	0	370	4	856	0	0	860	0	0	0	0	0	0	0	0	0	0	0	278	450	28	728	28	1958	1986												
Grand Total	14	5	1092	0	1111	6	1897	0	0	1903	0	0	0	0	0	0	0	0	0	0	0	715	936	79	1651	79	4665	4744												
Approch %	1.3	0.5	98.3			0.3	99.7				0	0	0	0	0	0	0	0	0	0	0	43.3	56.7																	
Total %	0.3	0.1	23.4			0.1	40.7				0	0	0	0	0	0	0	0	0	0	0	15.3	20.1			1.7	98.3													
% Passenger Vehicles	12	2	1020	0	1034	6	1772	0	0	1778	0	0	0	0	0	0	0	0	0	0	0	681	855	1606	0	0	4418													
% Large 2 Axle Vehicles	85.7	40	93.4	0	93.1	100	93.4	0	0	93.4	0	0	0	0	0	0	0	0	0	0	0	95.2	91.3	88.6	92.8	0	0	93.1												
% Large 3 Axle Vehicles	7.1	1	30	0	32	0	55	0	0	55	0	0	0	0	0	0	0	0	0	0	0	5	26	34	0	0	121													
% Large 4+ Axle Trucks	0	0	7	0	7	0	36	0	0	36	0	0	0	0	0	0	0	0	0	0	0	0.7	2.8	3.8	2	0	0	2.6												
% 3 Axle Vehicles	0	0	0.6	0	0.6	0	1.9	0	0	1.9	0	0	0	0	0	0	0	0	0	0	0	1.3	3.5	7.6	2.8	0	0	91												
% 4+ Axle Trucks	1	2	35	0	38	0	34	0	0	34	0	0	0	0	0	0	0	0	0	0	0	20	22	42	0	0	114													
% 4+ Axle Trucks	7.1	40	3.2	0	3.4	0	1.8	0	0	1.8	0	0	0	0	0	0	0	0	0	0	0	2.8	2.4	0	2.4	0	0	2.4												

Start Time	I-215 Southbound Off Ramp Southbound										Van Buren Boulevard Westbound										I-215 Southbound On Ramp Northbound										Van Buren Boulevard Eastbound									
	Left		Thru		Right		RTOR		App. Total		Left		Thru		Right		RTOR		App. Total		Left		Thru		Right		RTOR		App. Total		Exclu. Total		Inclu. Total		Int. Total					
07:00 AM	2	0	223	0	223	0	0	289	0	0	289	0	0	0	0	0	0	0	0	0	0	68	111	23	179	23	693	716												
07:15 AM	1	0	200	0	201	2	277	0	0	279	0	0	0	0	0	0	0	0	0	0	0	94	106	13	200	13	680	693												
07:30 AM	2	2	162	0	166	0	252	0	0	252	0	0	0	0	0	0	0	0	0	0	0	121	128	7	249	7	667	674												
07:45 AM	2	0	147	0	149	0	223	0	0	223	0	0	0	0	0	0	0	0	0	0	0	154	141	8	295	8	667	675												
Total	7	2	732	0	741	2	1041	0	0	1043	0	0	0	0	0	0	0	0	0	0	0	437	486	51	923	51	2707	2758												
08:00 AM	1	1	103	0	105	2	199	0	0	201	0	0	0	0	0	0	0	0	0	0	0	76	136	9	212	9	518	527												
08:15 AM	1	2	84	0	87	1	203	0	0	204	0	0	0	0	0	0	0	0	0	0	0	80	141	4	221	4	512	516												
08:30 AM	3	0	81	0	84	1	231	0	0	232	0	0	0	0	0	0	0	0	0	0	0	66	86	7	152	7	468	475												
08:45 AM	2	0	92	0	94	0	223	0	0	223	0	0	0	0	0	0	0	0	0	0	0	56	87	8	143	8	460	468												
Total	7	3	360	0	370	4	856	0	0	860	0	0	0	0	0	0	0	0	0	0	0	278	450	28	728	28	1958	1986												
Grand Total	14	5	1092	0	1111	6	1897	0	0	1903	0	0	0	0	0	0	0	0	0	0	0	715	936	79	1651	79	4665	4744												
Approch %	1.3	0.5	98.3			0.3	99.7				0	0	0	0	0	0	0	0	0	0	0	43.3	56.7																	
Total %	0.3	0.1	23.4			0.1	40.7				0	0	0	0	0	0	0	0	0	0	0	15.3	20.1			1.7	98.3													
% Passenger Vehicles	12	2	1020	0	1034	6	1772	0	0	1778	0	0	0	0	0	0	0	0	0	0	0	681	855	1606	0	0	4418													
% Large 2 Axle Vehicles	85.7	40	93.4	0	93.1	100	93.4	0	0	93.4	0	0	0	0	0	0	0	0	0	0	0	95.2	91.3	88.6	92.8	0	0	93.1												
% Large 3 Axle Vehicles	7.1	1	30	0	32	0	55	0	0	55	0	0	0	0	0	0	0	0	0	0	0	5	26	34	0	0	121													
% Large 4+ Axle Trucks	0	0	7	0	7	0	36	0	0	36	0	0	0	0	0	0	0	0	0	0	0	0.7	2.8	3.8	2	0	0	2.6												
% 3 Axle Vehicles	0	0	0.6	0	0.6	0	1.9	0	0	1.9	0	0	0	0	0	0	0	0	0	0	0	1.3	3.5	7.6	2.8	0	0	91												
% 4+ Axle Trucks	1	2	35	0	38	0	34	0	0	34	0	0	0	0	0	0	0	0	0	0	0	20	22	42	0	0	114													
% 4+ Axle Trucks	7.1	40	3.2	0	3.4	0	1.8	0	0	1.8	0	0	0	0	0	0	0	0	0	0	0	2.8	2.4	0	2.4	0	0	2.4												

Start Time	I-215 Southbound Off Ramp Southbound										Van Buren Boulevard Westbound										I-215 Southbound On Ramp Northbound										Van Buren Boulevard Eastbound									
	Left		Thru		Right		RTOR		App. Total		Left		Thru		Right		RTOR		App. Total		Left		Thru		Right		RTOR		App. Total		Exclu. Total		Inclu. Total		Int. Total					
07:00 AM	2	0	223	0	223	0	0	289	0	0	289	0	0	0	0	0	0	0	0	0	0	68	111	23	179	23	693	716												
07:15 AM	1	0	200	0	201	2	277	0	0	279	0	0	0	0	0	0	0	0	0	0	0	94	106	13	200	13	680	693												
07:30 AM	2	2	162	0	166	0	252	0	0	252	0	0	0	0	0	0	0	0	0	0	0	121	128	7	249	7	667	674												
07:45 AM	2	0	147	0	149	0	223	0	0	223	0	0	0	0	0	0	0	0	0	0	0	154	141	8	295	8	667	675												
Total	7	2	732	0	741	2	1041	0	0	1043	0	0	0	0	0	0	0	0	0	0	0	437	486	51	923	51	2707	2758												
08:00 AM	1	1	103	0	105	2	199	0	0	201	0	0	0	0	0	0	0	0	0	0	0	76	136	9	212	9	518	527												
08:15 AM	1	2	84	0	87	1	203	0	0	204	0	0	0	0	0	0	0	0	0	0	0	80	141	4	221	4	512	516												
08:30 AM	3	0	81	0	84	1	231	0	0	232	0	0	0	0	0	0	0	0	0	0	0	66	86	7	152	7	468	475												

Counts Unlimited
 PO Box 1178
 Corona, CA 92878
 (951) 268-6268

County of Riverside
 N/S: I-215 Southbound Ramps
 E/W: Van Buren Boulevard
 Weather: Clear

File Name : 36_CRV_215S_Van Buren AM
 Site Code : 05119542
 Start Date : 8/20/2019
 Page No : 2

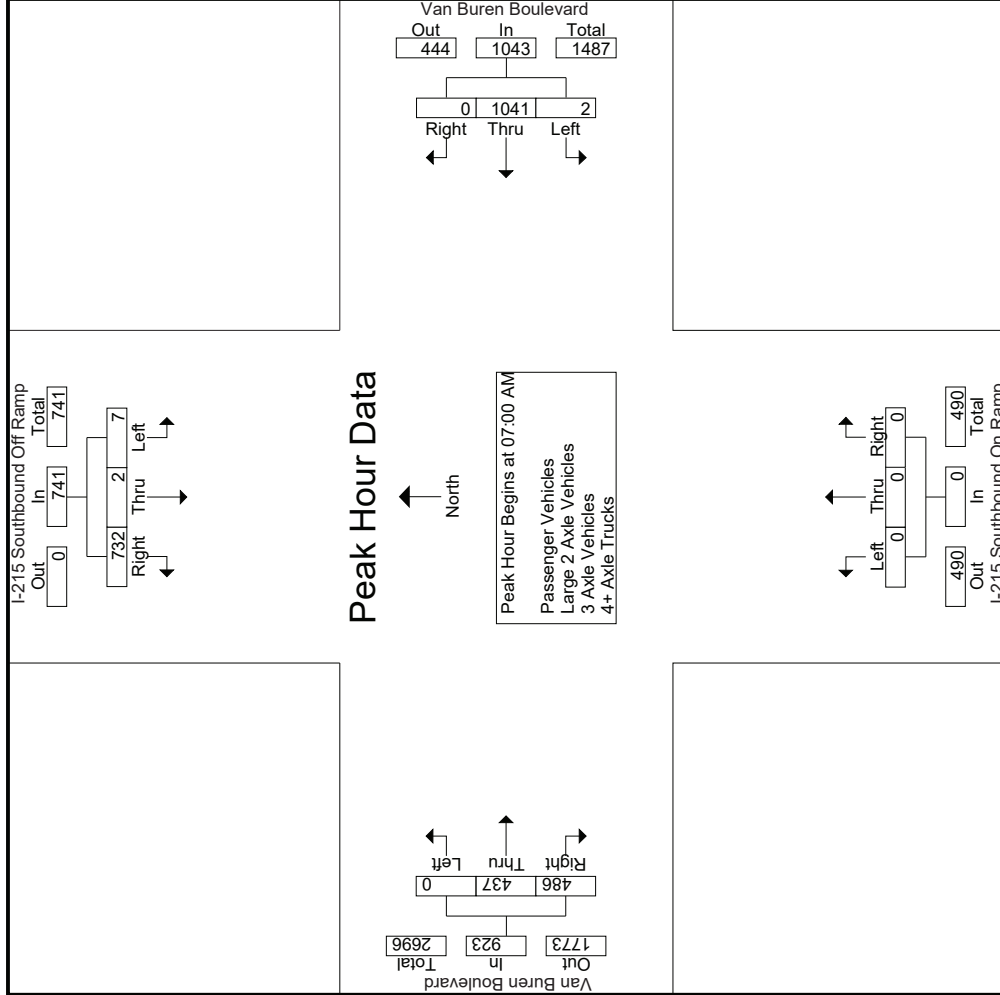

Counts Unlimited
 PO Box 1178
 Corona, CA 92878
 (951) 268-6268

County of Riverside
 N/S: I-215 Southbound Ramps
 E/W: Van Buren Boulevard
 Weather: Clear

File Name : 36_CRV_215S_Van Buren AM
 Site Code : 05119542
 Start Date : 8/20/2019
 Page No : 3

Start Time	I-215 Southbound Off Ramp Southbound			Van Buren Boulevard Westbound			I-215 Southbound On Ramp Northbound			Van Buren Boulevard Eastbound				
	Left	Thru	Right	Left	Thru	Right	Left	Thru	Right	Left	Thru	Right	App. Total	Int. Total
Peak Hour Analysis From 07:00 AM to 08:45 AM - Peak 1 of 1														
Peak Hour for Each Approach Begins at:														
	07:00 AM			07:00 AM			07:00 AM			07:30 AM				
+0 mins.	2	0	223	0	289	0	289	0	0	0	0	121	128	249
+15 mins.	1	0	200	2	277	0	279	0	0	0	0	154	141	295
+30 mins.	2	2	162	0	252	0	252	0	0	0	0	76	136	212
+45 mins.	2	0	147	0	223	0	223	0	0	0	0	80	141	221
Total Volume	7	2	732	2	1041	0	1043	0	0	0	0	431	546	977
% App. Total	0.9	0.3	98.8	0.2	99.8	0	0	0	0	0	0	44.1	55.9	828
PHF	.875	.250	.821	.250	.901	.000	.902	.000	.000	.000	.000	.700	.968	.828

Counts Unlimited
 PO Box 1178
 Corona, CA 92878
 (951) 268-6268

File Name : 36_CRV_215S_Van Buren AM
 Site Code : 05119542
 Start Date : 8/20/2019
 Page No : 1

County of Riverside
 N/S: I-215 Southbound Ramps
 EW: Van Buren Boulevard
 Weather: Clear

Groups Printed- Passenger Vehicles

Start Time	I-215 Southbound Off Ramp Southbound					Van Buren Boulevard Westbound					I-215 Southbound On Ramp Northbound					Van Buren Boulevard Eastbound							
	Left	Thru	Right	RTOR	App. Total	Left	Thru	Right	RTOR	App. Total	Left	Thru	Right	RTOR	App. Total	Left	Thru	Right	RTOR	App. Total	Exclu. Total	Inclu. Total	Int. Total
07:00 AM	1	0	212	0	213	0	269	0	0	269	0	0	0	0	0	0	67	105	20	172	20	654	674
07:15 AM	1	0	192	0	193	2	269	0	0	271	0	0	0	0	0	0	90	98	13	188	13	652	665
07:30 AM	2	1	151	0	154	0	236	0	0	236	0	0	0	0	0	0	116	123	5	239	5	629	634
07:45 AM	2	0	138	0	140	0	213	0	0	213	0	0	0	0	0	0	151	132	7	283	7	636	643
Total	6	1	693	0	700	2	987	0	0	989	0	0	0	0	0	0	424	458	45	882	45	2571	2616
08:00 AM	1	0	95	0	96	2	180	0	0	182	0	0	0	0	0	0	70	119	8	189	8	467	475
08:15 AM	0	1	75	0	76	1	189	0	0	190	0	0	0	0	0	0	71	126	4	197	4	463	467
08:30 AM	3	0	74	0	77	1	207	0	0	208	0	0	0	0	0	0	65	75	6	140	6	425	431
08:45 AM	2	0	83	0	85	0	209	0	0	209	0	0	0	0	0	0	51	77	7	128	7	422	429
Total	6	1	327	0	334	4	785	0	0	789	0	0	0	0	0	0	257	397	25	654	25	1777	1802
Grand Total	12	2	1020	0	1034	6	1772	0	0	1778	0	0	0	0	0	0	681	855	70	1536	70	4348	4418
Apprch %	1.2	0.2	98.6			0.3	99.7	0			0	0	0			0	44.3	55.7					
Total %	0.3	0	23.5			0.1	40.8	0		40.9	0	0	0			0	15.7	19.7		35.3	1.6	98.4	

3:1-528

Start Time	I-215 Southbound Off Ramp Southbound					Van Buren Boulevard Westbound					I-215 Southbound On Ramp Northbound					Van Buren Boulevard Eastbound							
	Left	Thru	Right	RTOR	App. Total	Left	Thru	Right	RTOR	App. Total	Left	Thru	Right	RTOR	App. Total	Left	Thru	Right	RTOR	App. Total	Exclu. Total	Inclu. Total	Int. Total
07:00 AM	1	0	212		213	0	269	0		269	0	0	0		0	0	67	105		172		654	674
07:15 AM	1	0	192		193	2	269	0		271	0	0	0		0	0	90	98		188		652	665
07:30 AM	2	1	151		154	0	236	0		236	0	0	0		0	0	116	123		239		629	634
07:45 AM	2	0	138		140	0	213	0		213	0	0	0		0	0	151	132		283		636	643
Total Volume	6	1	693		700	2	987	0		989	0	0	0		0	0	424	458		882		2571	2616
% App. Total	0.9	0.1	99			0.2	99.8	0			0	0	0		0	0	48.1	51.9					
PHF	.750	.250	.817		.822	.250	.917	.000		.912	.000	.000	.000		.000	.000	.702	.867		.779		.983	

Peak Hour Analysis From 07:00 AM to 07:45 AM - Peak 1 of 1
 Peak Hour for Entire Intersection Begins at 07:00 AM

Counts Unlimited
 PO Box 1178
 Corona, CA 92878
 (951) 268-6268

County of Riverside
 N/S: I-215 Southbound Ramps
 E/W: Van Buren Boulevard
 Weather: Clear

File Name : 36_CRV_215S_Van Buren AM
 Site Code : 05119542
 Start Date : 8/20/2019
 Page No : 2

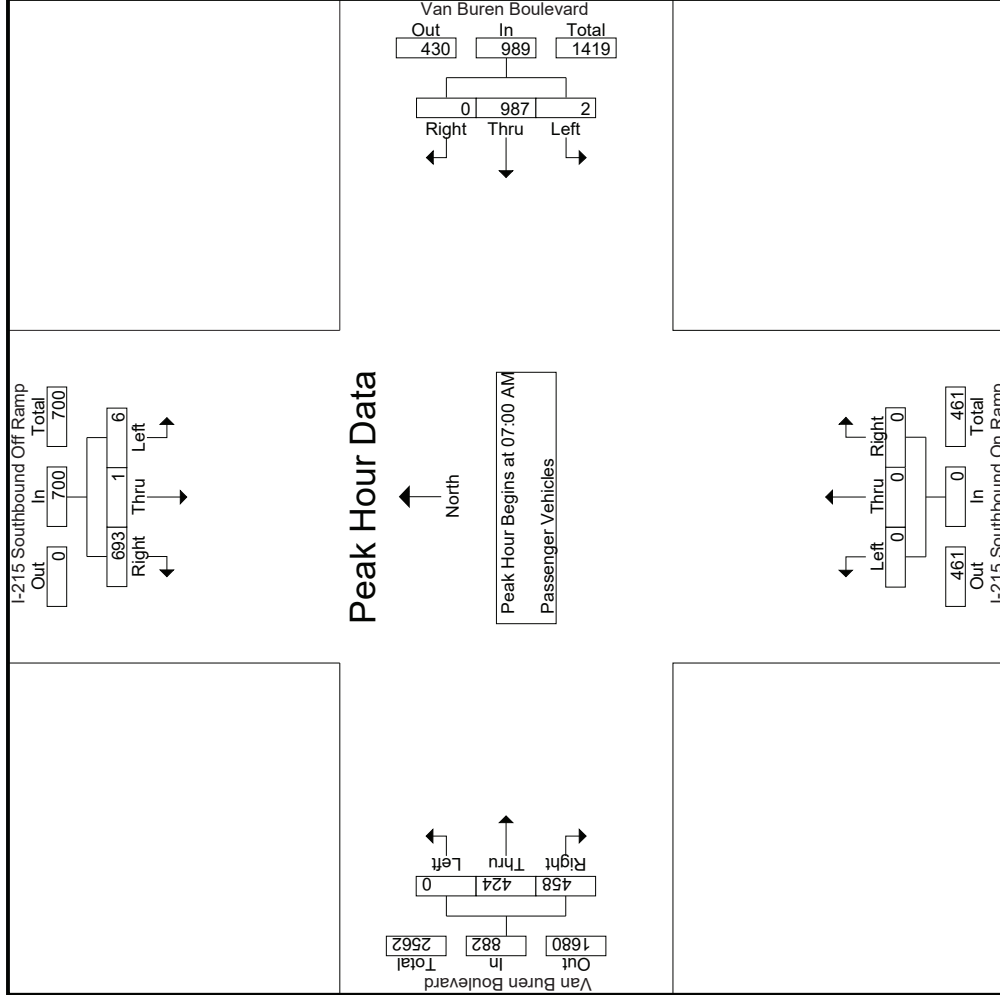

Counts Unlimited
 PO Box 1178
 Corona, CA 92878
 (951) 268-6268

County of Riverside
 N/S: I-215 Southbound Ramps
 E/W: Van Buren Boulevard
 Weather: Clear

File Name : 36_CRV_215S_Van Buren AM
 Site Code : 05119542
 Start Date : 8/20/2019
 Page No : 3

Start Time	I-215 Southbound Off Ramp Southbound			Van Buren Boulevard Westbound			I-215 Southbound On Ramp Northbound			Van Buren Boulevard Eastbound					
	Left	Thru	Right	Left	Thru	Right	Left	Thru	Right	Left	Thru	Right	App. Total	Int. Total	
Peak Hour Analysis From 07:00 AM to 07:45 AM - Peak 1 of 1															
Peak Hour for Each Approach Begins at:															
	07:00 AM			07:00 AM			07:00 AM			07:00 AM					
+0 mins.	1	0	212	0	269	0	269	0	0	0	0	67	105	172	
+15 mins.	1	0	192	2	271	0	271	0	0	0	0	90	98	188	
+30 mins.	2	1	151	0	236	0	236	0	0	0	0	116	123	239	
+45 mins.	2	0	138	0	213	0	213	0	0	0	0	151	132	283	
Total Volume	6	1	693	2	987	0	989	0	0	0	0	424	458	882	
% App. Total	0.9	0.1	99	0.2	99.8	0	912	0	0	0	0	48.1	51.9	779	
PHF	.750	.250	.817	.250	.917	.000	.912	.000	.000	.000	.000	.702	.867	.779	

Counts Unlimited
 PO Box 1178
 Corona, CA 92878
 (951) 268-6268

File Name : 36_CRV_215S_Van Buren AM
 Site Code : 05119542
 Start Date : 8/20/2019
 Page No : 1

County of Riverside
 N/S: I-215 Southbound Ramps
 EW: Van Buren Boulevard
 Weather: Clear

Groups Printed- Large 2 Axle Vehicles

Start Time	I-215 Southbound Off Ramp Southbound				Van Buren Boulevard Westbound				I-215 Southbound On Ramp Northbound				Van Buren Boulevard Eastbound					
	Left	Thru	Right	RTOR	App. Total	Left	Thru	Right	RTOR	App. Total	Left	Thru	Right	RTOR	App. Total	Exclu. Total	Inclu. Total	Int. Total
07:00 AM	1	0	4	0	5	0	10	0	0	10	0	0	0	0	0	2	19	21
07:15 AM	0	0	2	0	2	0	3	0	0	3	0	0	0	0	0	0	10	10
07:30 AM	0	0	4	0	4	0	7	0	0	7	0	0	0	0	1	0	12	12
07:45 AM	0	0	7	0	7	0	3	0	0	3	0	0	0	0	2	0	12	12
Total	1	0	17	0	18	0	23	0	0	23	0	0	0	0	12	2	53	55
08:00 AM	0	0	3	0	3	0	9	0	0	9	0	0	0	0	7	1	19	20
08:15 AM	0	1	5	0	6	0	10	0	0	10	0	0	0	0	8	0	24	24
08:30 AM	0	0	4	0	4	0	10	0	0	10	0	0	0	0	2	0	16	16
08:45 AM	0	0	1	0	1	0	3	0	0	3	0	0	0	0	2	0	6	6
Total	0	1	13	0	14	0	32	0	0	32	0	0	0	0	19	1	65	66
Grand Total	1	1	30	0	32	0	55	0	0	55	0	0	0	3	31	3	118	121
Approch %	3.1	3.1	93.8			0	100	0		46.6	0	0	0	0	26.3	2.5	97.5	
Total %	0.8	0.8	25.4		27.1	0	46.6	0		46.6	0	0	0	0	26.3	2.5	97.5	

3:1-531

Start Time	I-215 Southbound Off Ramp Southbound				Van Buren Boulevard Westbound				I-215 Southbound On Ramp Northbound				Van Buren Boulevard Eastbound					
	Left	Thru	Right	RTOR	App. Total	Left	Thru	Right	RTOR	App. Total	Left	Thru	Right	RTOR	App. Total	Exclu. Total	Inclu. Total	Int. Total
07:00 AM	1	0	4	0	5	0	10	0	0	10	0	0	0	0	0	2	19	21
07:15 AM	0	0	2	0	2	0	3	0	0	3	0	0	0	0	0	0	10	10
07:30 AM	0	0	4	0	4	0	7	0	0	7	0	0	0	0	1	0	12	12
07:45 AM	0	0	7	0	7	0	3	0	0	3	0	0	0	0	2	0	12	12
Total Volume	1	0	17	0	18	0	23	0	0	23	0	0	0	0	11	2	53	55
% App. Total	5.6	0	94.4			0	100	0		46.6	0	0	0	0	26.3	2.5	97.5	
PHF	.250	.000	.607		.643	.000	.575	.000		.575	.000	.000	.000	.000	.250	.550	.600	.697

Counts Unlimited
 PO Box 1178
 Corona, CA 92878
 (951) 268-6268

County of Riverside
 N/S: I-215 Southbound Ramps
 E/W: Van Buren Boulevard
 Weather: Clear

File Name : 36_CRV_215S_Van Buren AM
 Site Code : 05119542
 Start Date : 8/20/2019
 Page No : 2

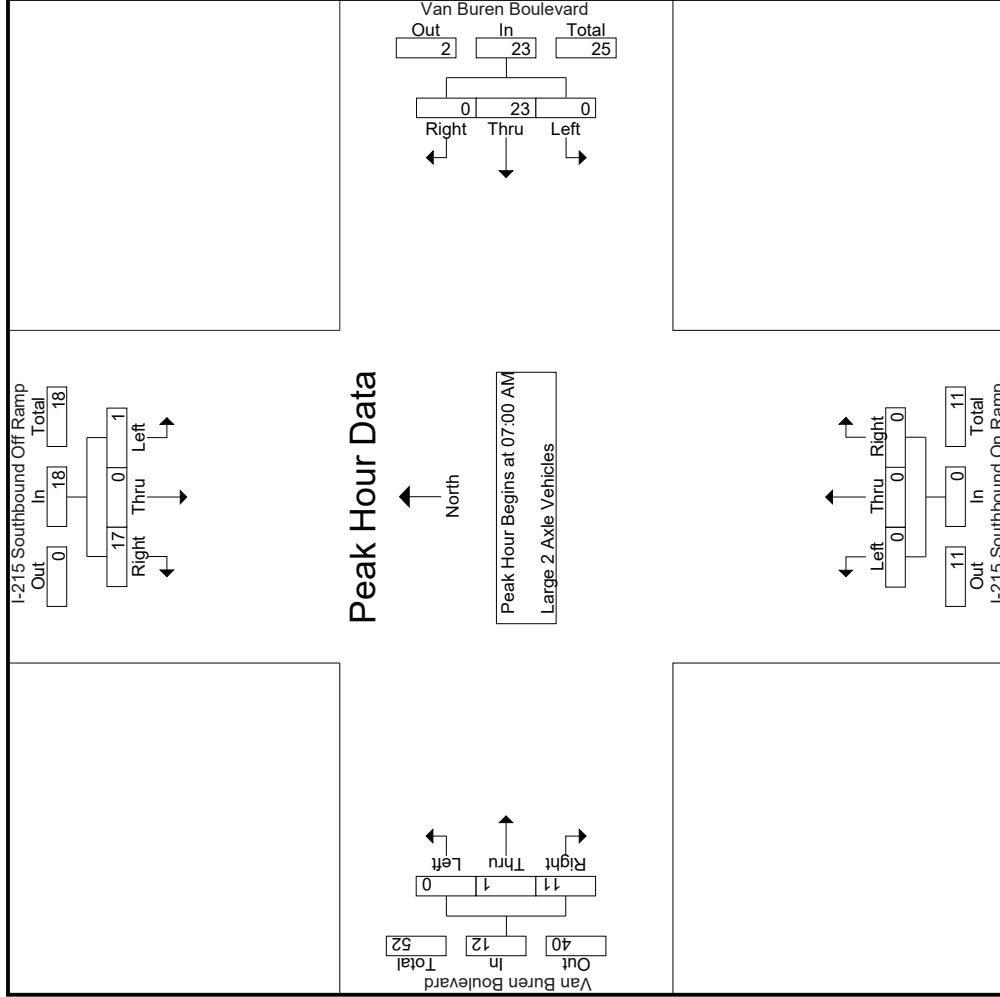

Counts Unlimited
 PO Box 1178
 Corona, CA 92878
 (951) 268-6268

County of Riverside
 N/S: I-215 Southbound Ramps
 E/W: Van Buren Boulevard
 Weather: Clear

File Name : 36_CRV_215S_Van Buren AM
 Site Code : 05119542
 Start Date : 8/20/2019
 Page No : 3

Start Time	I-215 Southbound Off Ramp Southbound			Van Buren Boulevard Westbound			I-215 Southbound On Ramp Northbound			Van Buren Boulevard Eastbound					
	Left	Thru	Right	Left	Thru	Right	Left	Thru	Right	Left	Thru	Right	App. Total	Int. Total	
Peak Hour Analysis From 07:00 AM to 07:45 AM - Peak 1 of 1															
Peak Hour for Each Approach Begins at:															
	07:00 AM			07:00 AM			07:00 AM			07:00 AM					
+0 mins.	1	0	4	10	0	0	10	0	0	0	0	0	1	3	4
+15 mins.	0	0	2	3	0	0	3	0	0	0	0	0	0	5	5
+30 mins.	0	0	4	7	0	0	7	0	0	0	0	0	0	1	1
+45 mins.	0	0	7	3	0	0	3	0	0	0	0	0	0	2	2
Total Volume	1	0	17	23	0	0	23	0	0	0	0	0	1	11	12
% App. Total	5.6	0	94.4	100	0	0	100	0	0	0	0	0	8.3	91.7	100
PHF	.250	.000	.607	.575	.000	.000	.575	.000	.000	.000	.000	.000	.250	.550	.600

Counts Unlimited
 PO Box 1178
 Corona, CA 92878
 (951) 268-6268

County of Riverside
 N/S: I-215 Southbound Ramps
 E/W: Van Buren Boulevard
 Weather: Clear

File Name : 36_CRV_215S_Van Buren AM
 Site Code : 05119542
 Start Date : 8/20/2019
 Page No : 1

Groups Printed- 3 Axle Vehicles

Start Time	I-215 Southbound Off Ramp Southbound				Van Buren Boulevard Westbound				I-215 Southbound On Ramp Northbound				Van Buren Boulevard Eastbound			
	Left	Thru	Right	RTOR	Left	Thru	Right	RTOR	Left	Thru	Right	RTOR	Left	Thru	Right	RTOR
07:00 AM	0	0	2	0	0	3	0	0	0	0	0	0	0	0	0	1
07:15 AM	0	0	1	0	0	2	0	0	0	0	0	0	0	1	3	0
07:30 AM	0	0	0	0	0	3	0	0	0	0	0	0	0	3	3	2
07:45 AM	0	0	0	0	0	3	0	0	0	0	0	0	0	0	6	1
Total	0	0	3	0	0	11	0	0	0	0	0	0	0	4	13	4
08:00 AM	0	0	1	0	0	8	0	0	0	0	0	0	0	3	6	0
08:15 AM	0	0	0	0	0	2	0	0	0	0	0	0	0	1	7	0
08:30 AM	0	0	0	0	0	8	0	0	0	0	0	0	0	1	3	1
08:45 AM	0	0	3	0	0	7	0	0	0	0	0	0	0	0	4	1
Total	0	0	4	0	0	25	0	0	0	0	0	0	0	5	20	2
Grand Total	0	0	7	0	0	36	0	0	0	0	0	0	0	9	33	6
Apprch %	0	0	100		0	100	0		0	0	0		0	21.4	78.6	
Total %	0	0	8.2		0	42.4	0		0	0	0		0	10.6	38.8	
														49.4		
														6.6	93.4	

3:1-534

Start Time	I-215 Southbound Off Ramp Southbound				Van Buren Boulevard Westbound				I-215 Southbound On Ramp Northbound				Van Buren Boulevard Eastbound			
	Left	Thru	Right	App. Total	Left	Thru	Right	App. Total	Left	Thru	Right	App. Total	Left	Thru	Right	App. Total
Peak Hour Analysis From 07:00 AM to 07:45 AM - Peak 1 of 1																
Peak Hour for Entire Intersection Begins at 07:00 AM																
07:00 AM	0	0	2		0	3	0	3	0	0	0	0	0	0	1	1
07:15 AM	0	0	1		0	2	0	2	0	0	0	0	0	1	3	4
07:30 AM	0	0	0		0	3	0	3	0	0	0	0	0	3	3	6
07:45 AM	0	0	0		0	3	0	3	0	0	0	0	0	0	6	6
Total Volume	0	0	3		0	11	0	11	0	0	0	0	0	4	13	17
% App. Total	0	0	100		0	100	0	100	0	0	0	0	0	23.5	76.5	
PHF	.000	.000	.375	.375	.000	.917	.000	.917	.000	.000	.000	.000	.000	.333	.542	.708
																.861

Counts Unlimited
 PO Box 1178
 Corona, CA 92878
 (951) 268-6268

County of Riverside
 N/S: I-215 Southbound Ramps
 E/W: Van Buren Boulevard
 Weather: Clear

File Name : 36_CRV_215S_Van Buren AM
 Site Code : 05119542
 Start Date : 8/20/2019
 Page No : 2

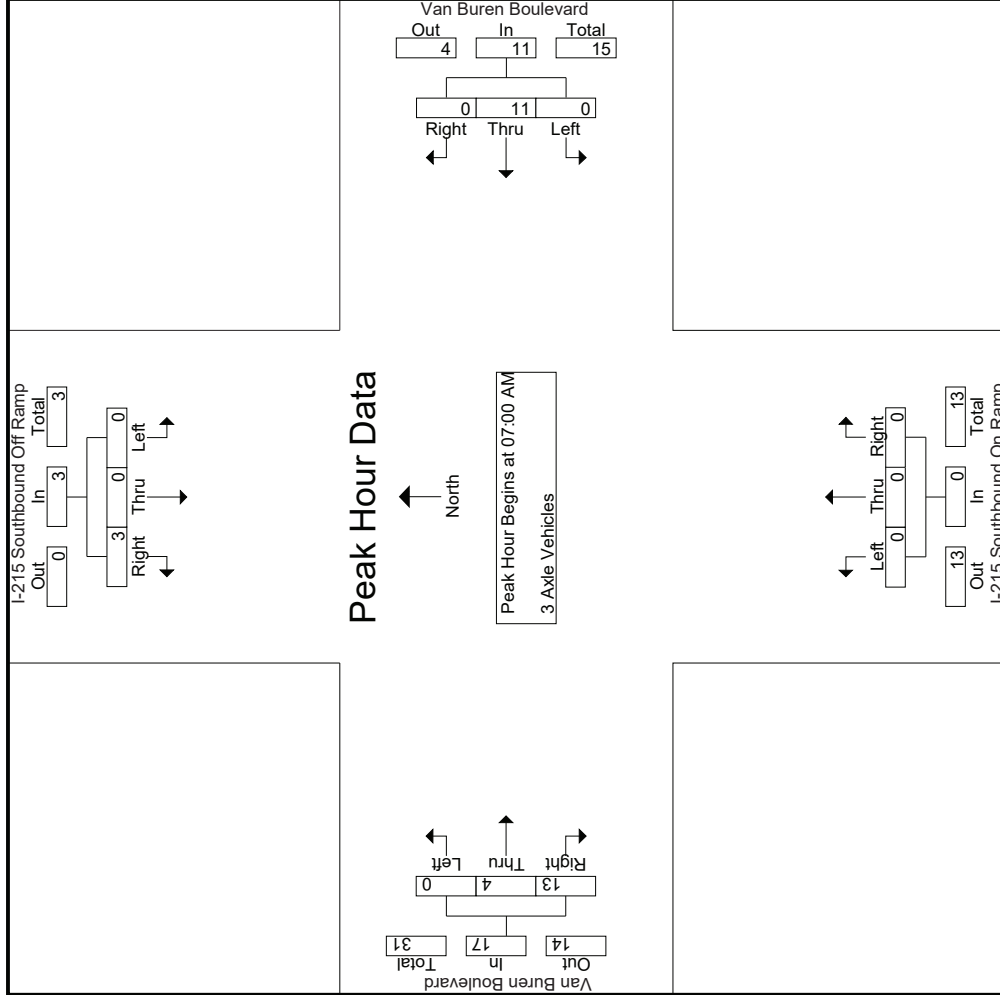

Counts Unlimited
 PO Box 1178
 Corona, CA 92878
 (951) 268-6268

County of Riverside
 N/S: I-215 Southbound Ramps
 E/W: Van Buren Boulevard
 Weather: Clear

File Name : 36_CRV_215S_Van Buren AM
 Site Code : 05119542
 Start Date : 8/20/2019
 Page No : 3

Start Time	I-215 Southbound Off Ramp Southbound			Van Buren Boulevard Westbound			I-215 Southbound On Ramp Northbound			Van Buren Boulevard Eastbound					
	Left	Thru	Right	Left	Thru	Right	Left	Thru	Right	Left	Thru	Right			
Peak Hour Analysis From 07:00 AM to 07:45 AM - Peak 1 of 1															
Peak Hour for Each Approach Begins at:															
+0 mins.	0	0	2	07:00 AM	0	0	3	07:00 AM	0	0	0	07:00 AM	0	0	1
+15 mins.	0	0	1		0	0	2		0	0	0		0	1	3
+30 mins.	0	0	0		0	0	3		0	0	0		3	3	6
+45 mins.	0	0	0		0	0	3		0	0	0		0	0	6
Total Volume	0	0	3		0	0	11		0	0	0		0	4	13
% App. Total	0	0	100		0	100	0		0	0	0		0	23.5	76.5
PHF	.000	.000	.375		.000	.917	.000		.000	.000	.000		.000	.333	.542
			.375			.917	.000		.000	.000	.000		.000	.333	.542

Groups Printed- 4+ Axle Trucks

Start Time	I-215 Southbound Off Ramp Southbound				Van Buren Boulevard Westbound				I-215 Southbound On Ramp Northbound				Van Buren Boulevard Eastbound			
	Left	Thru	Right	RTOR	Left	Thru	Right	RTOR	Left	Thru	Right	RTOR	Left	Thru	Right	RTOR
07:00 AM	0	0	5	0	0	7	0	0	0	0	0	0	0	0	2	0
07:15 AM	0	0	5	0	0	3	0	0	0	0	0	0	0	3	0	0
07:30 AM	0	1	7	0	0	6	0	0	0	0	0	0	0	2	1	0
07:45 AM	0	0	2	0	0	4	0	0	0	0	0	0	0	3	1	0
Total	0	1	19	0	0	20	0	0	0	0	0	0	0	8	4	0
08:00 AM	0	1	4	0	0	2	0	0	0	0	0	0	0	3	4	0
08:15 AM	1	0	4	0	0	2	0	0	0	0	0	0	0	4	4	0
08:30 AM	0	0	3	0	0	6	0	0	0	0	0	0	0	0	6	0
08:45 AM	0	0	5	0	0	4	0	0	0	0	0	0	0	5	4	0
Total	1	1	16	0	0	14	0	0	0	0	0	0	0	12	18	0
Grand Total	1	2	35	0	0	34	0	0	0	0	0	0	0	20	22	0
Approch %	2.6	5.3	92.1		0	100	0		0	0	0		0	47.6	52.4	
Total %	0.9	1.8	30.7		0	29.8	0		0	0	0		0	17.5	19.3	
App. Total			33.3				29.8				0			36.8		

3:1-537

Start Time	I-215 Southbound Off Ramp Southbound				Van Buren Boulevard Westbound				I-215 Southbound On Ramp Northbound				Van Buren Boulevard Eastbound			
	Left	Thru	Right	App. Total	Left	Thru	Right	App. Total	Left	Thru	Right	App. Total	Left	Thru	Right	App. Total
Peak Hour Analysis From 07:00 AM to 07:45 AM - Peak 1 of 1																
07:00 AM	0	0	5	5	0	7	0	7	0	0	0	0	0	0	2	2
07:15 AM	0	0	5	5	0	3	0	3	0	0	0	0	0	3	0	3
07:30 AM	0	1	7	8	0	6	0	6	0	0	0	0	0	2	1	3
07:45 AM	0	0	2	2	0	4	0	4	0	0	0	0	0	3	1	4
Total Volume	0	1	19	20	0	20	0	20	0	0	0	0	0	8	4	12
% App. Total	0	5	95		0	100	0		0	0	0		0	66.7	33.3	
PHF	.000	.250	.679	.625	.000	.714	.000	.714	.000	.000	.000	.000	.000	.667	.500	.750

Counts Unlimited
 PO Box 1178
 Corona, CA 92878
 (951) 268-6268

County of Riverside
 N/S: I-215 Southbound Ramps
 E/W: Van Buren Boulevard
 Weather: Clear

File Name : 36_CRV_215S_Van Buren AM
 Site Code : 05119542
 Start Date : 8/20/2019
 Page No : 2

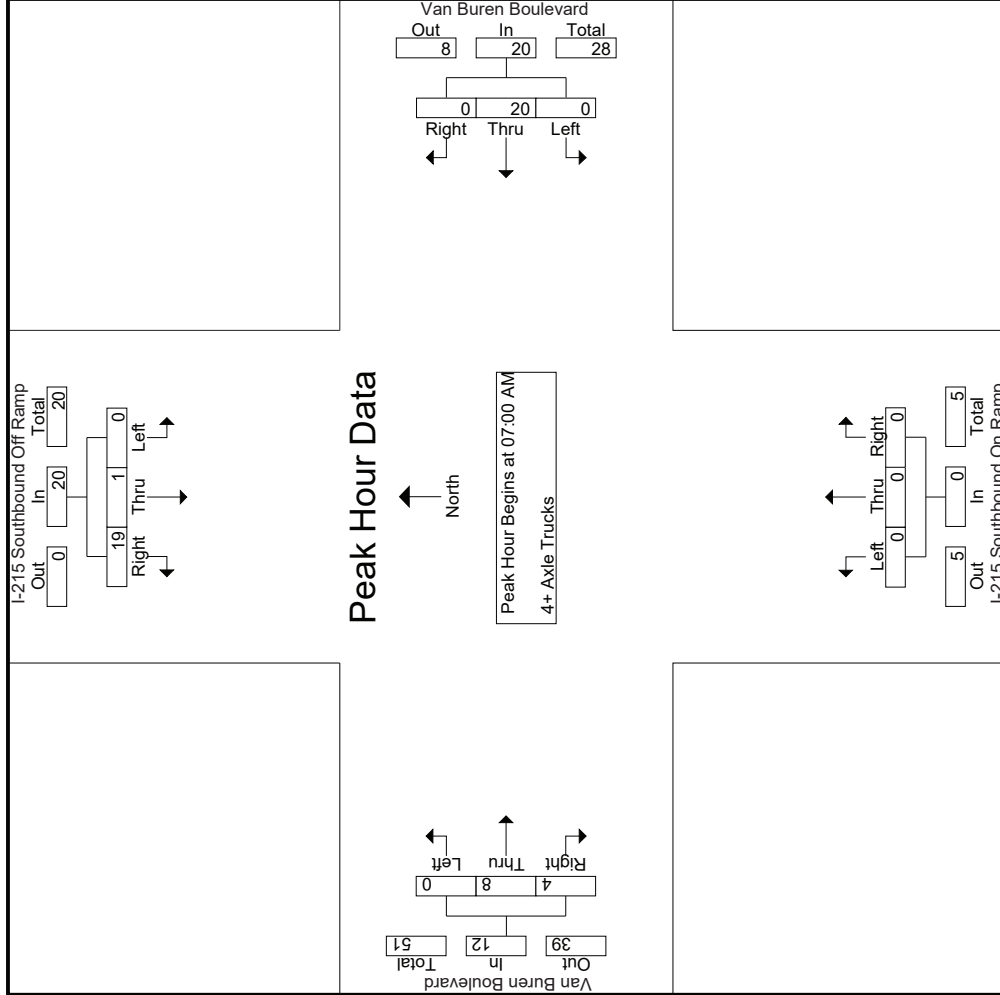

Counts Unlimited
 PO Box 1178
 Corona, CA 92878
 (951) 268-6268

County of Riverside
 N/S: I-215 Southbound Ramps
 E/W: Van Buren Boulevard
 Weather: Clear

File Name : 36_CRV_215S_Van Buren AM
 Site Code : 05119542
 Start Date : 8/20/2019
 Page No : 3

Start Time	I-215 Southbound Off Ramp			Van Buren Boulevard Westbound			I-215 Southbound On Ramp Northbound			Van Buren Boulevard Eastbound				
	Left	Thru	Right	Left	Thru	Right	Left	Thru	Right	Left	Thru	Right	App. Total	Int. Total
Peak Hour Analysis From 07:00 AM to 07:45 AM - Peak 1 of 1														
Peak Hour for Each Approach Begins at:														
	07:00 AM			07:00 AM			07:00 AM			07:00 AM				
+0 mins.	0	0	5	7	0	0	7	0	0	0	0	0	2	2
+15 mins.	0	0	5	3	0	0	3	0	0	0	3	0	0	3
+30 mins.	0	1	7	6	0	0	6	0	0	0	2	1	1	3
+45 mins.	0	0	2	4	0	0	4	0	0	0	3	1	1	4
Total Volume	0	1	19	20	0	0	20	0	0	0	8	4	12	12
% App. Total	0	5	95	100	0	0	100	0	0	0	66.7	33.3	500	750
PHF	.000	.250	.679	.625	.000	.000	.714	.000	.000	.000	.667	.500	.750	.750

Counts Unlimited
 PO Box 1178
 Corona, CA 92878
 (951) 268-6268

File Name : 36_CRV_215S_Van Buren PM
 Site Code : 05119542
 Start Date : 8/20/2019
 Page No : 1

County of Riverside
 I/S: I-215 Southbound Ramps
 EW: Van Buren Boulevard
 Weather: Clear

Groups Printed- Passenger Vehicles - Large 2 Axle Vehicles - 3 Axle Vehicles - 4+ Axle Trucks																											
Start Time	I-215 Southbound Off Ramp Southbound						Van Buren Boulevard Westbound						I-215 Southbound On Ramp Northbound						Van Buren Boulevard Eastbound								
	Left	Thru	Right	RTOR	App. Total		Left	Thru	Right	RTOR	App. Total		Left	Thru	Right	RTOR	App. Total		Left	Thru	Right	RTOR	App. Total		Exclu. Total	Inclu. Total	Int. Total
04:00 PM	2	44	72	0	118		2	152	0	0	154		0	0	0	0	0		0	118	281	43	399		43	671	714
04:15 PM	5	51	83	0	139		1	123	0	0	124		0	0	0	0	0		0	129	286	58	415		58	678	736
04:30 PM	3	42	54	0	99		0	147	0	0	147		0	0	0	0	0		0	138	284	82	422		82	668	750
04:45 PM	3	40	49	0	92		2	147	0	0	149		0	0	0	0	0		0	111	264	62	375		62	616	678
Total	13	177	258	0	448		5	569	0	0	574		0	0	0	0	0		0	496	1115	245	1611		245	2633	2878
05:00 PM	1	32	60	0	93		1	128	0	0	129		0	0	0	0	0		0	113	263	48	376		48	598	646
05:15 PM	2	49	78	0	129		3	161	0	0	164		0	0	0	0	0		0	149	315	69	464		69	757	826
05:30 PM	3	25	70	0	98		0	120	0	0	120		0	0	0	0	0		0	143	303	53	446		53	664	717
05:45 PM	5	37	87	0	129		0	137	0	0	137		0	0	0	0	0		0	102	247	57	349		57	615	672
Total	11	143	295	0	449		4	546	0	0	550		0	0	0	0	0		0	507	1128	227	1635		227	2634	2861
Grand Total	24	320	553	0	897		9	1115	0	0	1124		0	0	0	0	0		0	1003	2243	472	3246		472	5267	5739
Approch %	2.7	35.7	61.6				0.8	99.2	0	0	21.3		0	0	0	0	0		0	30.9	69.1				8.2	91.8	
Total %	0.5	6.1	10.5		17		0.2	21.2	0	0	21.3		0	0	0	0	0		0	19	42.6		61.6		0	0	
% Passenger Vehicles	21	308	517		846		9	1076	0	0	1085		0	0	0	0	0		0	974	2190		3625		0	0	5556
% Light 2 Axle Vehicles	87.5	96.2	93.5		94.3		100	96.5	0	0	96.5		0	0	0	0	0		0	97.1	97.6		97.5		0	0	96.8
% Large 2 Axle Vehicles	2	9	13		24		0	25	0	0	25		0	0	0	0	0		0	8	40		57		0	0	106
% 3 Axle Vehicles	8.3	2.8	2.4		2.7		0	2.2	0	0	2.2		0	0	0	0	0		0	0.8	1.8		1.9		0	0	1.8
% 3 Axle Trucks	0	0	2		2		0	3	0	0	3		0	0	0	0	0		0	1	6		8		0	0	13
% 4+ Axle Vehicles	0	0	0.4		0.2		0	0.3	0	0	0.3		0	0	0	0	0		0	0.1	0.3		0.2		0	0	0.2
% 4+ Axle Trucks	1	3	21		25		0	11	0	0	11		0	0	0	0	0		0	20	7		28		0	0	64
% 4+ Axle Trucks	4.2	0.9	3.8		2.8		0	1	0	0	1		0	0	0	0	0		0	2	0.3		0.2		0	0	1.1
PHF	.750	.832	.772		.800		.500	.905	.000	.898	.000		.000	.000	.000	.000	.000		.000	.000	.857		.882		.882	.872	

Peak Hour Analysis From 04:00 PM to 05:45 PM - Peak 1 of 1

Peak Hour for Entire Intersection Begins at 04:30 PM

Start Time	I-215 Southbound Off Ramp Southbound						Van Buren Boulevard Westbound						I-215 Southbound On Ramp Northbound						Van Buren Boulevard Eastbound								
	Left	Thru	Right	RTOR	App. Total		Left	Thru	Right	RTOR	App. Total		Left	Thru	Right	RTOR	App. Total		Left	Thru	Right	RTOR	App. Total		Exclu. Total	Inclu. Total	Int. Total
04:30 PM	3	42	54		99		0	147	0	0	147		0	0	0	0	0		0	138	284		422		422	668	
04:45 PM	3	40	49		92		2	147	0	0	149		0	0	0	0	0		0	111	264		375		375	616	
05:00 PM	1	32	60		93		1	128	0	0	129		0	0	0	0	0		0	113	263		376		376	598	
05:15 PM	2	49	78		129		3	161	0	0	164		0	0	0	0	0		0	149	315		464		464	757	
Total Volume	9	163	241		413		6	583	0	0	589		0	0	0	0	0		0	511	1126		1637		1637	2639	
% App. Total	2.2	39.5	58.4				1	99	0	0	31.2		0	0	0	0	0		0	31.2	68.8				68.8		
PHF	.750	.832	.772		.800		.500	.905	.000	.898	.000		.000	.000	.000	.000	.000		.000	.857	.882		.882		.882	.872	

Counts Unlimited
 PO Box 1178
 Corona, CA 92878
 (951) 268-6268

County of Riverside
 N/S: I-215 Southbound Ramps
 E/W: Van Buren Boulevard
 Weather: Clear

File Name : 36_CRV_215S_Van Buren PM
 Site Code : 05119542
 Start Date : 8/20/2019
 Page No : 2

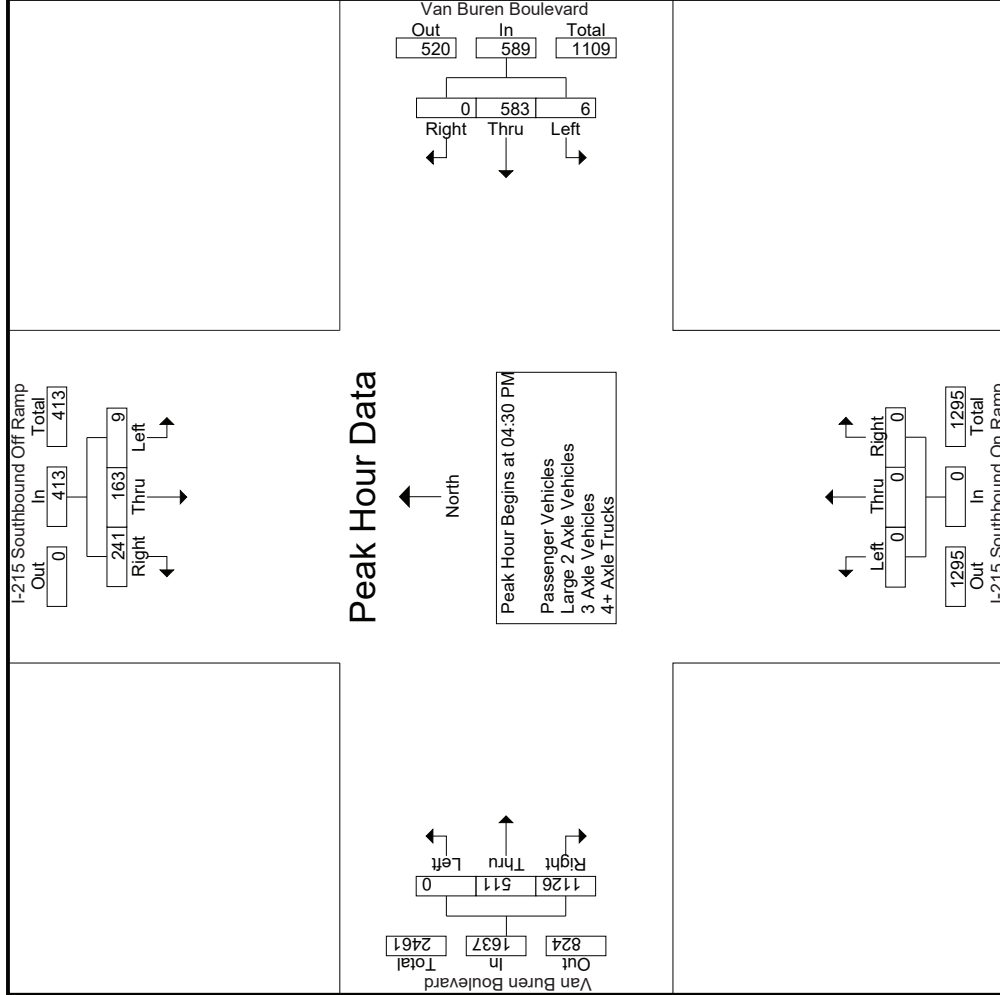

Counts Unlimited
 PO Box 1178
 Corona, CA 92878
 (951) 268-6268

County of Riverside
 N/S: I-215 Southbound Ramps
 E/W: Van Buren Boulevard
 Weather: Clear

File Name : 36_CRV_215S_Van Buren PM
 Site Code : 05119542
 Start Date : 8/20/2019
 Page No : 3

Start Time	I-215 Southbound Off Ramp Southbound			Van Buren Boulevard Westbound			I-215 Southbound On Ramp Northbound			Van Buren Boulevard Eastbound			
	Left	Thru	Right	Left	Thru	Right	Left	Thru	Right	Left	Thru	Right	
Peak Hour Analysis From 04:00 PM to 05:45 PM - Peak 1 of 1													
Peak Hour for Each Approach Begins at:													
	05:00 PM			04:30 PM			04:00 PM			04:45 PM			
+0 mins.	1	32	60	0	147	0	147	0	0	0	111	264	375
+15 mins.	2	49	78	2	147	0	149	0	0	0	113	263	376
+30 mins.	3	25	70	1	128	0	129	0	0	0	149	315	464
+45 mins.	5	37	87	3	161	0	164	0	0	0	143	303	446
Total Volume	11	143	295	6	583	0	589	0	0	0	516	1145	1661
% App. Total	2.4	31.8	65.7	1	99	0	0	0	0	0	31.1	68.9	0
PHF	.550	.730	.848	.500	.905	.000	.898	.000	.000	.000	.866	.909	.895

Groups Printed- Passenger Vehicles

Start Time	I-215 Southbound Off Ramp Southbound					Van Buren Boulevard Westbound					I-215 Southbound On Ramp Northbound					Van Buren Boulevard Eastbound							
	Left	Thru	Right	RTOR	App. Total	Left	Thru	Right	RTOR	App. Total	Left	Thru	Right	RTOR	App. Total	Left	Thru	Right	RTOR	App. Total	Exclu. Total	Inclu. Total	Int. Total
04:00 PM	2	44	65	0	111	2	149	0	0	151	0	0	0	0	0	0	112	273	43	385	43	647	690
04:15 PM	3	51	75	0	129	1	114	0	0	115	0	0	0	0	0	0	126	279	58	405	58	649	707
04:30 PM	3	39	52	0	94	0	137	0	0	137	0	0	0	0	0	0	137	282	82	419	82	650	732
04:45 PM	3	38	47	0	88	2	142	0	0	144	0	0	0	0	0	0	105	258	59	363	59	595	654
Total	11	172	239	0	422	5	542	0	0	547	0	0	0	0	0	0	480	1092	242	1572	242	2541	2783
05:00 PM	1	31	58	0	90	1	121	0	0	122	0	0	0	0	0	0	107	251	46	358	46	570	616
05:15 PM	2	47	73	0	122	3	159	0	0	162	0	0	0	0	0	0	145	307	67	452	67	736	803
05:30 PM	3	23	65	0	91	0	118	0	0	118	0	0	0	0	0	0	142	300	52	442	52	651	703
05:45 PM	4	35	82	0	121	0	136	0	0	136	0	0	0	0	0	0	100	240	54	340	54	597	651
Total	10	136	278	0	424	4	534	0	0	538	0	0	0	0	0	0	494	1098	219	1592	219	2554	2773
Grand Total	21	308	517	0	846	9	1076	0	0	1085	0	0	0	0	0	0	974	2190	461	3164	461	5095	5556
Approch %	2.5	36.4	61.1			0.8	99.2	0		21.3	0	0	0			0	30.8	69.2		62.1	8.3	91.7	
Total %	0.4	6	10.1		16.6	0.2	21.1	0			0	0	0			0	19.1	43					

3:1-543

Start Time	I-215 Southbound Off Ramp Southbound					Van Buren Boulevard Westbound					I-215 Southbound On Ramp Northbound					Van Buren Boulevard Eastbound							
	Left	Thru	Right	RTOR	App. Total	Left	Thru	Right	RTOR	App. Total	Left	Thru	Right	RTOR	App. Total	Left	Thru	Right	RTOR	App. Total	Exclu. Total	Inclu. Total	Int. Total
04:30 PM	3	39	52		94	0	137	0		137	0	0	0		0	0	137	282		419			650
04:45 PM	3	38	47		88	2	142	0		144	0	0	0		0	0	105	258		363			595
05:00 PM	1	31	58		90	1	121	0		122	0	0	0		0	0	107	251		358			570
05:15 PM	2	47	73		122	3	159	0		162	0	0	0		0	0	145	307		452			736
Total Volume	9	155	230		394	6	559	0		565	0	0	0		0	0	494	1098		1592			2551
% App. Total	2.3	39.3	58.4			1.1	98.9	0			0	0	0			0	31	69					
PHF	.750	.824	.788		.807	.500	.879	.000		.872	.000	.000	.000		.000	.000	.852	.894		.881			.867

Peak Hour Analysis From 04:30 PM to 05:15 PM - Peak 1 of 1
 Peak Hour for Entire Intersection Begins at 04:30 PM

Counts Unlimited
 PO Box 1178
 Corona, CA 92878
 (951) 268-6268

County of Riverside
 N/S: I-215 Southbound Ramps
 E/W: Van Buren Boulevard
 Weather: Clear

File Name : 36_CRV_215S_Van Buren PM
 Site Code : 05119542
 Start Date : 8/20/2019
 Page No : 2

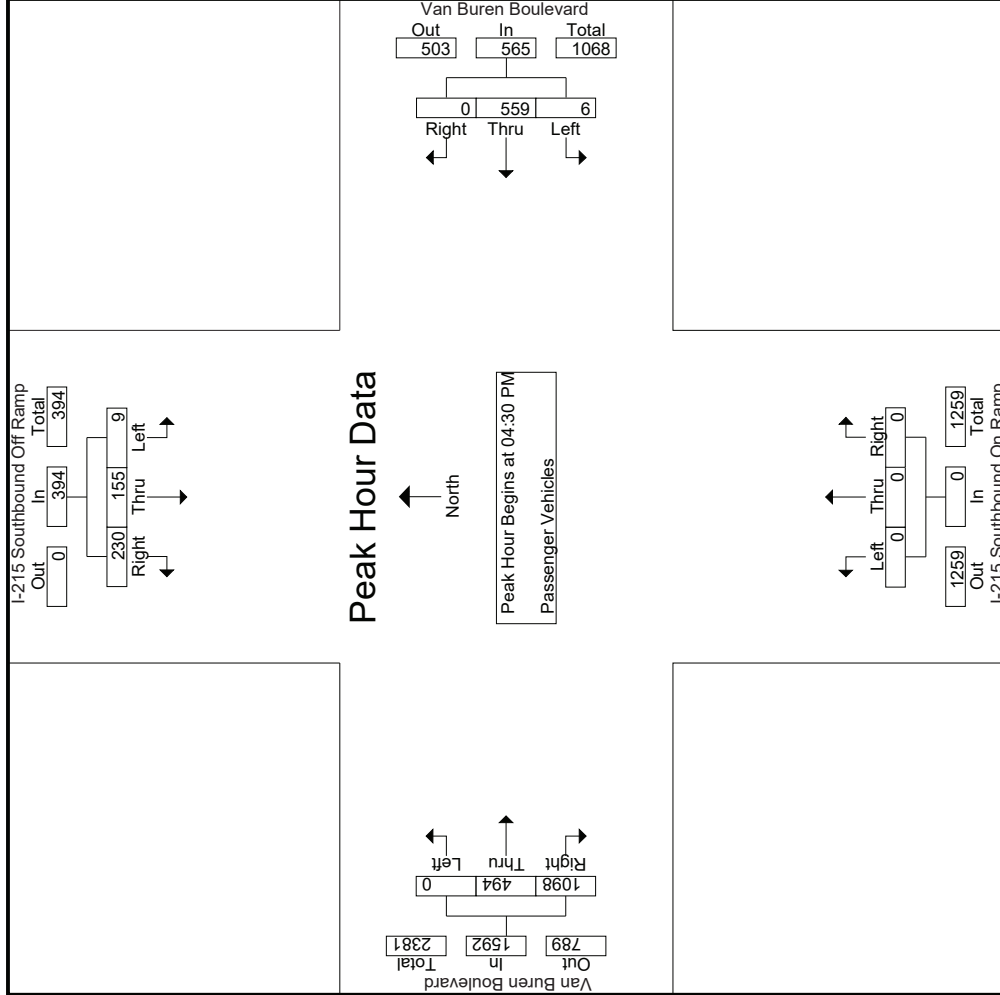

Counts Unlimited
 PO Box 1178
 Corona, CA 92878
 (951) 268-6268

County of Riverside
 N/S: I-215 Southbound Ramps
 E/W: Van Buren Boulevard
 Weather: Clear

File Name : 36_CRV_215S_Van Buren PM
 Site Code : 05119542
 Start Date : 8/20/2019
 Page No : 3

Start Time	I-215 Southbound Off Ramp Southbound			Van Buren Boulevard Westbound			I-215 Southbound On Ramp Northbound			Van Buren Boulevard Eastbound					
	Left	Thru	Right	Left	Thru	Right	Left	Thru	Right	Left	Thru	Right	App. Total	Int. Total	
Peak Hour Analysis From 04:30 PM to 05:15 PM - Peak 1 of 1															
Peak Hour for Each Approach Begins at:															
	04:30 PM			04:30 PM			04:30 PM			04:30 PM					
+0 mins.	3	39	52	0	137	0	137	0	0	0	0	0	137	282	419
+15 mins.	3	38	47	2	142	0	144	0	0	0	0	0	105	258	363
+30 mins.	1	31	58	1	121	0	122	0	0	0	0	0	107	251	358
+45 mins.	2	47	73	3	159	0	162	0	0	0	0	0	145	307	452
Total Volume	9	155	230	6	559	0	565	0	0	0	0	0	494	1098	1592
% App. Total	2.3	39.3	58.4	1.1	98.9	0	0	0	0	0	0	0	31	69	81
PHF	.750	.824	.788	.500	.879	.000	.872	.000	.000	.000	.000	.000	.852	.894	.881

Counts Unlimited
 PO Box 1178
 Corona, CA 92878
 (951) 268-6268

File Name : 36_CRV_215S_Van Buren PM
 Site Code : 05119542
 Start Date : 8/20/2019
 Page No : 1

County of Riverside
 N/S: I-215 Southbound Ramps
 EW: Van Buren Boulevard
 Weather: Clear

Groups Printed- Large 2 Axle Vehicles

Start Time	I-215 Southbound Off Ramp Southbound				Van Buren Boulevard Westbound				I-215 Southbound On Ramp Northbound				Van Buren Boulevard Eastbound				
	Left	Thru	Right	RTOR	Left	Thru	Right	RTOR	Left	Thru	Right	RTOR	Left	Thru	Right	RTOR	
04:00 PM	0	0	3	0	0	1	0	0	0	0	0	0	0	3	6	0	9
04:15 PM	2	0	2	0	5	0	0	0	0	0	0	0	0	1	5	0	6
04:30 PM	0	2	2	0	7	0	0	0	0	0	0	0	0	0	2	0	2
04:45 PM	0	1	1	0	3	0	0	0	0	0	0	0	0	1	6	3	7
Total	2	3	8	0	16	0	0	0	0	0	0	0	0	5	19	3	24
05:00 PM	0	1	0	0	0	5	0	0	0	0	0	0	0	1	8	2	9
05:15 PM	0	1	2	0	2	0	0	0	0	0	0	0	0	1	5	1	6
05:30 PM	0	2	2	0	2	0	0	0	0	0	0	0	0	1	3	1	4
05:45 PM	0	2	1	0	0	0	0	0	0	0	0	0	0	0	5	2	5
Total	0	6	5	0	9	0	0	0	0	0	0	0	0	3	21	6	24
Grand Total	2	9	13	0	25	0	0	0	0	0	0	0	0	8	40	9	48
Approch %	8.3	37.5	54.2		100	0								16.7	83.3		49.5
Total %	2.1	9.3	13.4		25.8	0								8.2	41.2		8.5
																	91.5

3:1-546

Start Time	I-215 Southbound Off Ramp Southbound				Van Buren Boulevard Westbound				I-215 Southbound On Ramp Northbound				Van Buren Boulevard Eastbound				
	Left	Thru	Right	RTOR	Left	Thru	Right	RTOR	Left	Thru	Right	RTOR	Left	Thru	Right	RTOR	
04:30 PM	0	2	2	4	0	7	0	0	0	0	0	0	0	0	2	2	13
04:45 PM	0	1	1	2	0	3	0	0	0	0	0	0	0	1	6	7	12
05:00 PM	0	1	0	1	0	5	0	0	0	0	0	0	0	1	8	9	15
05:15 PM	0	1	2	3	0	2	0	0	0	0	0	0	0	1	5	6	11
Total Volume	0	5	5	10	0	17	0	0	0	0	0	0	0	3	21	24	51
% App. Total	0	50	50		100	0								12.5	87.5		
PHF	.000	.625	.625	.625	.000	.607	.000	.000	.000	.000	.000	.000	.000	.750	.656	.667	.850

Counts Unlimited
 PO Box 1178
 Corona, CA 92878
 (951) 268-6268

County of Riverside
 N/S: I-215 Southbound Ramps
 E/W: Van Buren Boulevard
 Weather: Clear

File Name : 36_CRV_215S_Van Buren PM
 Site Code : 05119542
 Start Date : 8/20/2019
 Page No : 2

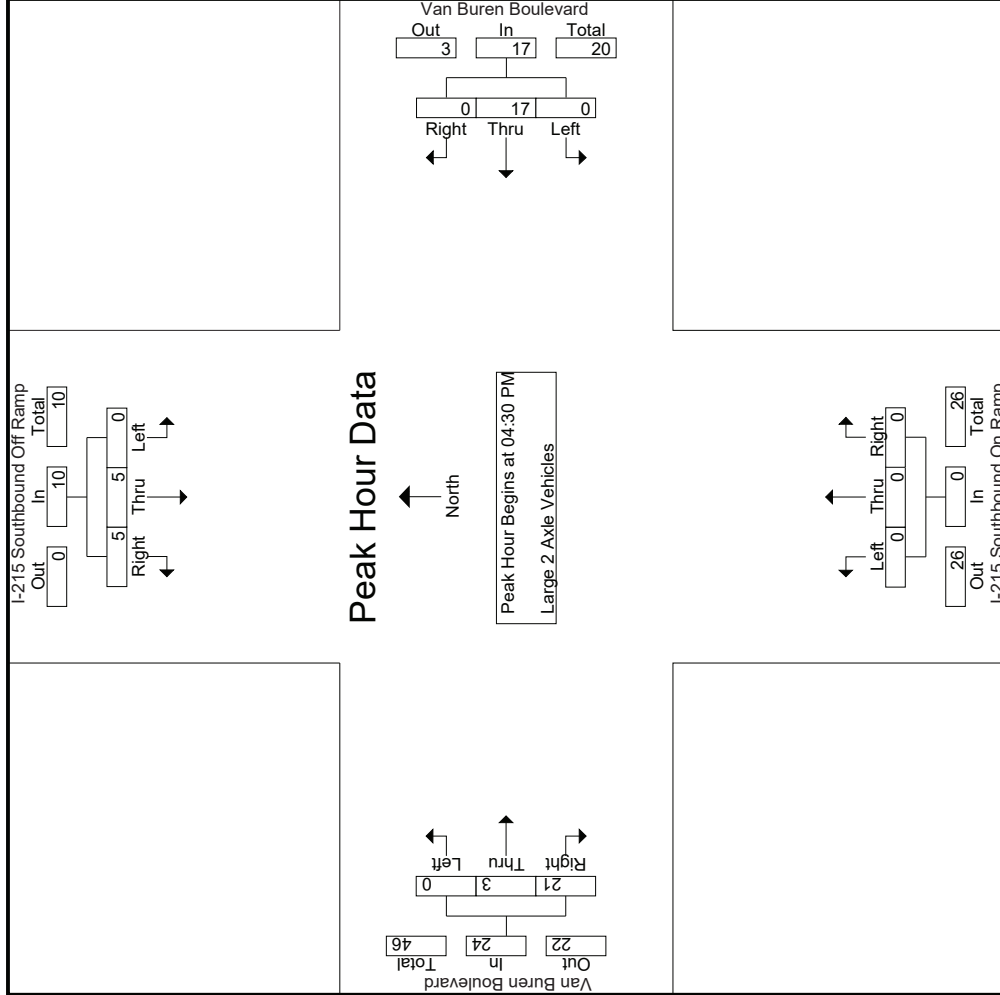

Counts Unlimited
 PO Box 1178
 Corona, CA 92878
 (951) 268-6268

County of Riverside
 N/S: I-215 Southbound Ramps
 E/W: Van Buren Boulevard
 Weather: Clear

File Name : 36_CRV_215S_Van Buren PM
 Site Code : 05119542
 Start Date : 8/20/2019
 Page No : 3

Start Time	I-215 Southbound Off Ramp Southbound			Van Buren Boulevard Westbound			I-215 Southbound On Ramp Northbound			Van Buren Boulevard Eastbound					
	Left	Thru	Right	Left	Thru	Right	Left	Thru	Right	Left	Thru	Right	App. Total	Int. Total	
Peak Hour Analysis From 04:30 PM to 05:15 PM - Peak 1 of 1	Peak Hour for Each Approach Begins at:														
	04:30 PM			04:30 PM			04:30 PM			04:30 PM					
+0 mins.	0	2	2	0	7	0	7	0	0	0	0	0	0	2	
+15 mins.	0	1	1	0	3	0	3	0	0	0	0	0	1	7	
+30 mins.	0	1	0	0	5	0	5	0	0	0	0	0	1	9	
+45 mins.	0	1	2	0	2	0	2	0	0	0	0	0	1	6	
Total Volume	0	5	5	0	17	0	17	0	0	0	0	0	3	24	
% App. Total	0	50	50	0	100	0	100	0	0	0	0	0	12.5	87.5	
PHF	.000	.625	.625	.000	.607	.000	.607	.000	.000	.000	.000	.000	.750	.667	

Groups Printed- 3-Axle Vehicles

Start Time	I-215 Southbound Off Ramp Southbound					Van Buren Boulevard Westbound					I-215 Southbound On Ramp Northbound					Van Buren Boulevard Eastbound									
	Left	Thru	Right	RTOR	App. Total	Left	Thru	Right	RTOR	App. Total	Left	Thru	Right	RTOR	App. Total	Left	Thru	Right	RTOR	App. Total	Exclu. Total	Inclu. Total	Int. Total		
04:00 PM	0	0	1	0	1	0	1	0	0	1	0	0	0	0	0	0	0	0	0	0	0	0	0	2	2
04:15 PM	0	0	0	0	0	0	1	0	0	1	0	0	0	0	0	0	0	2	0	2	0	0	3	3	3
04:30 PM	0	0	0	0	0	0	0	0	0	0	0	0	0	0	0	0	0	0	0	0	0	0	0	0	0
04:45 PM	0	0	0	0	0	0	1	0	0	1	0	0	0	0	0	0	1	0	0	1	0	0	2	2	2
Total	0	0	1	0	1	0	3	0	0	3	0	0	0	0	0	0	1	2	0	3	0	0	7	7	7
05:00 PM	0	0	0	0	0	0	0	0	0	0	0	0	0	0	0	0	0	1	0	1	0	0	1	1	1
05:15 PM	0	0	1	0	1	0	0	0	0	0	0	0	0	0	0	0	0	1	0	1	0	0	2	2	2
05:30 PM	0	0	0	0	0	0	0	0	0	0	0	0	0	0	0	0	0	0	0	0	0	0	0	0	0
05:45 PM	0	0	0	0	0	0	0	0	0	0	0	0	0	0	0	0	0	2	1	2	0	1	2	2	3
Total	0	0	1	0	1	0	0	0	0	0	0	0	0	0	0	0	0	4	1	4	0	1	5	5	6
Grand Total	0	0	2	0	2	0	3	0	0	3	0	0	0	0	0	0	1	6	1	7	0	1	12	12	13
Apprch %	0	0	100			0	100	0			0	0	0			0	14.3	85.7		58.3		7.7	92.3		
Total %	0	0	16.7		16.7	0	25	0		25	0	0	0		0	0	8.3	50		58.3		7.7	92.3		

Start Time	I-215 Southbound Off Ramp Southbound					Van Buren Boulevard Westbound					I-215 Southbound On Ramp Northbound					Van Buren Boulevard Eastbound									
	Left	Thru	Right	RTOR	App. Total	Left	Thru	Right	RTOR	App. Total	Left	Thru	Right	RTOR	App. Total	Left	Thru	Right	RTOR	App. Total	Exclu. Total	Inclu. Total	Int. Total		
04:30 PM	0	0	0	0	0	0	0	0	0	0	0	0	0	0	0	0	0	0	0	0	0	0	0	0	0
04:45 PM	0	0	0	0	0	0	0	1	0	1	0	0	0	0	0	0	0	0	0	0	0	0	0	0	0
05:00 PM	0	0	0	0	0	0	0	0	0	0	0	0	0	0	0	0	0	0	0	0	0	0	0	0	0
05:15 PM	0	0	1	0	1	0	0	0	0	0	0	0	0	0	0	0	0	0	0	0	0	0	0	0	0
Total Volume	0	0	1	0	1	0	0	1	0	1	0	0	0	0	0	0	0	0	0	0	0	0	0	0	0
% App. Total	0	0	100			0	0	100			0	0	0			0	33.3	66.7		33.3					
PHF	.000	.000	.250		.250	.000	.250	.000		.250	.000	.000	.000		.000	.000	.250	.500		.750		.750	.625		

Peak Hour Analysis From 04:30 PM to 05:15 PM - Peak 1 of 1
 Peak Hour for Entire Intersection Begins at 04:30 PM

Counts Unlimited
 PO Box 1178
 Corona, CA 92878
 (951) 268-6268

County of Riverside
 N/S: I-215 Southbound Ramps
 E/W: Van Buren Boulevard
 Weather: Clear

File Name : 36_CRV_215S_Van Buren PM
 Site Code : 05119542
 Start Date : 8/20/2019
 Page No : 2

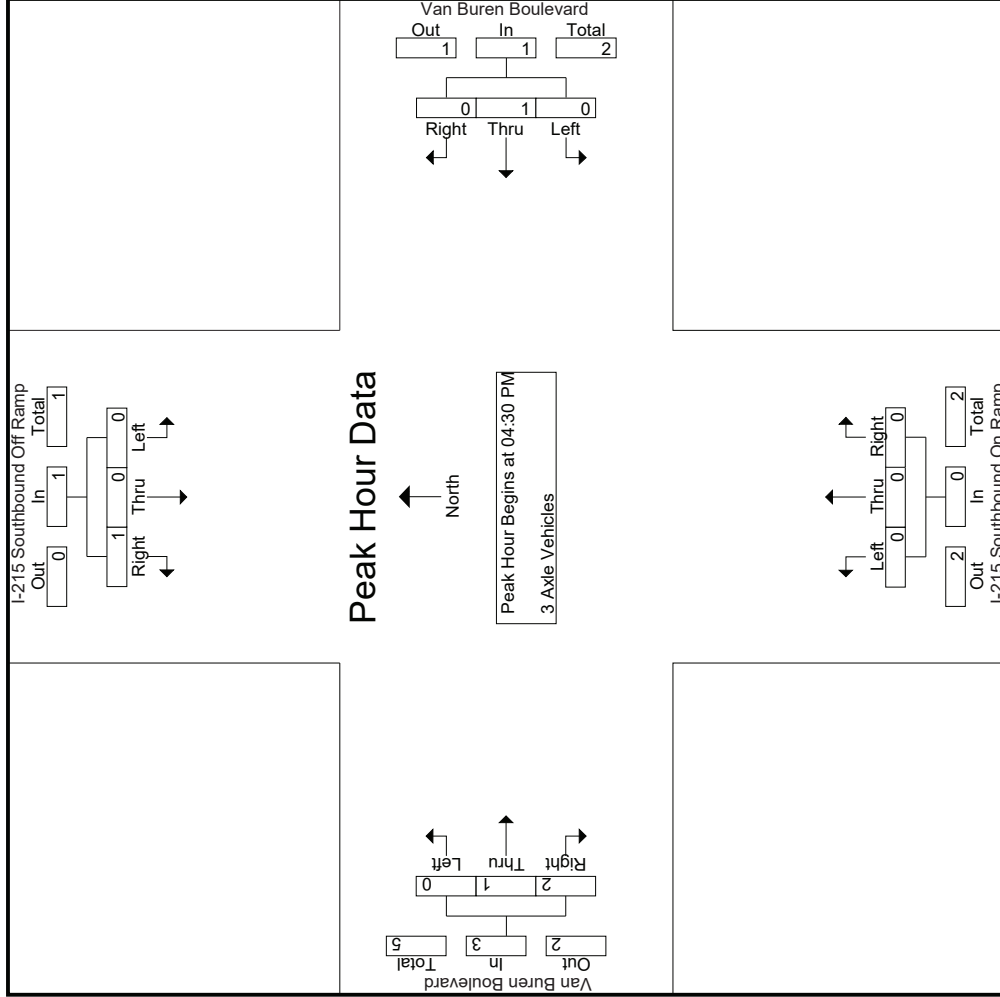

Counts Unlimited
 PO Box 1178
 Corona, CA 92878
 (951) 268-6268

County of Riverside
 N/S: I-215 Southbound Ramps
 E/W: Van Buren Boulevard
 Weather: Clear

File Name : 36_CRV_215S_Van Buren PM
 Site Code : 05119542
 Start Date : 8/20/2019
 Page No : 3

Start Time	I-215 Southbound Off Ramp			Van Buren Boulevard Westbound			I-215 Southbound On Ramp Northbound			Van Buren Boulevard Eastbound		
	Left	Thru	Right	Left	Thru	Right	Left	Thru	Right	Left	Thru	Right
Peak Hour Analysis From 04:30 PM to 05:15 PM - Peak 1 of 1												
Peak Hour for Each Approach Begins at:												
+0 mins.	0	0	0	0	0	0	0	0	0	0	0	0
+15 mins.	0	0	0	0	0	1	0	0	0	0	1	0
+30 mins.	0	0	0	0	0	0	0	0	0	0	0	1
+45 mins.	0	0	1	0	0	0	0	0	0	0	0	1
Total Volume	0	0	1	0	1	0	0	0	0	0	1	2
% App. Total	0	0	100	0	100	0	0	0	0	0	33.3	66.7
PHF	.000	.000	.250	.000	.250	.000	.000	.000	.000	.000	.250	.500

Groups Printed- 4+ Axle Trucks

Start Time	I-215 Southbound Off Ramp Southbound				Van Buren Boulevard Westbound				I-215 Southbound On Ramp Northbound				Van Buren Boulevard Eastbound						
	Left	Thru	Right	RTOR	App. Total	Left	Thru	Right	RTOR	App. Total	Left	Thru	Right	RTOR	App. Total	Exclu. Total	Inclu. Total	Int. Total	
04:00 PM	0	0	3	0	3	0	1	0	0	1	0	0	0	0	0	5	0	9	9
04:15 PM	0	0	6	0	6	0	3	0	0	3	0	0	0	0	2	2	0	11	11
04:30 PM	0	1	0	0	1	0	3	0	0	3	0	0	0	0	1	0	0	5	5
04:45 PM	0	1	1	0	2	0	1	0	0	1	0	0	0	0	4	0	0	7	7
Total	0	2	10	0	12	0	8	0	0	8	0	0	0	0	12	0	32	32	32
05:00 PM	0	0	2	0	2	0	2	0	0	2	0	0	0	0	0	8	0	12	12
05:15 PM	0	1	2	0	3	0	0	0	0	0	0	0	0	1	5	1	8	9	
05:30 PM	0	0	3	0	3	0	0	0	0	0	0	0	0	0	0	0	0	3	3
05:45 PM	1	0	4	0	5	0	1	0	0	1	0	0	0	0	2	0	8	8	
Total	1	1	11	0	13	0	3	0	0	3	0	0	0	0	15	1	31	31	32
Grand Total	1	3	21	0	25	0	11	0	0	11	0	0	0	0	27	1	63	64	
Approch %	4	12	84			0	100	0			0	0	0	0	74.1	25.9			
Total %	1.6	4.8	33.3		39.7	0	17.5	0		17.5	0	0	0	0	31.7	11.1			98.4

3:1-552

Start Time	I-215 Southbound Off Ramp Southbound				Van Buren Boulevard Westbound				I-215 Southbound On Ramp Northbound				Van Buren Boulevard Eastbound					
	Left	Thru	Right	RTOR	App. Total	Left	Thru	Right	RTOR	App. Total	Left	Thru	Right	RTOR	App. Total	Exclu. Total	Inclu. Total	Int. Total
04:30 PM	0	1	0	0	1	0	3	0	0	3	0	0	0	0	0	0	1	5
04:45 PM	0	1	1	0	2	0	1	0	0	1	0	0	0	0	4	0	4	7
05:00 PM	0	0	2	0	2	0	2	0	0	2	0	0	0	0	5	3	8	12
05:15 PM	0	1	2	0	3	0	0	0	0	0	0	0	0	0	2	2	5	8
Total Volume	0	3	5	0	8	0	6	0	0	6	0	0	0	0	13	5	18	32
% App. Total	0	37.5	62.5			0	100	0			0	0	0	0	72.2	27.8		
PHF	.000	.750	.625		.667	.000	.500	.000		.500	.000	.000	.000	.000	.650	.417		.667

Peak Hour Analysis From 04:30 PM to 05:15 PM - Peak 1 of 1
 Peak Hour for Entire Intersection Begins at 04:30 PM

Counts Unlimited
 PO Box 1178
 Corona, CA 92878
 (951) 268-6268

County of Riverside
 N/S: I-215 Southbound Ramps
 E/W: Van Buren Boulevard
 Weather: Clear

File Name : 36_CRV_215S_Van Buren PM
 Site Code : 05119542
 Start Date : 8/20/2019
 Page No : 2

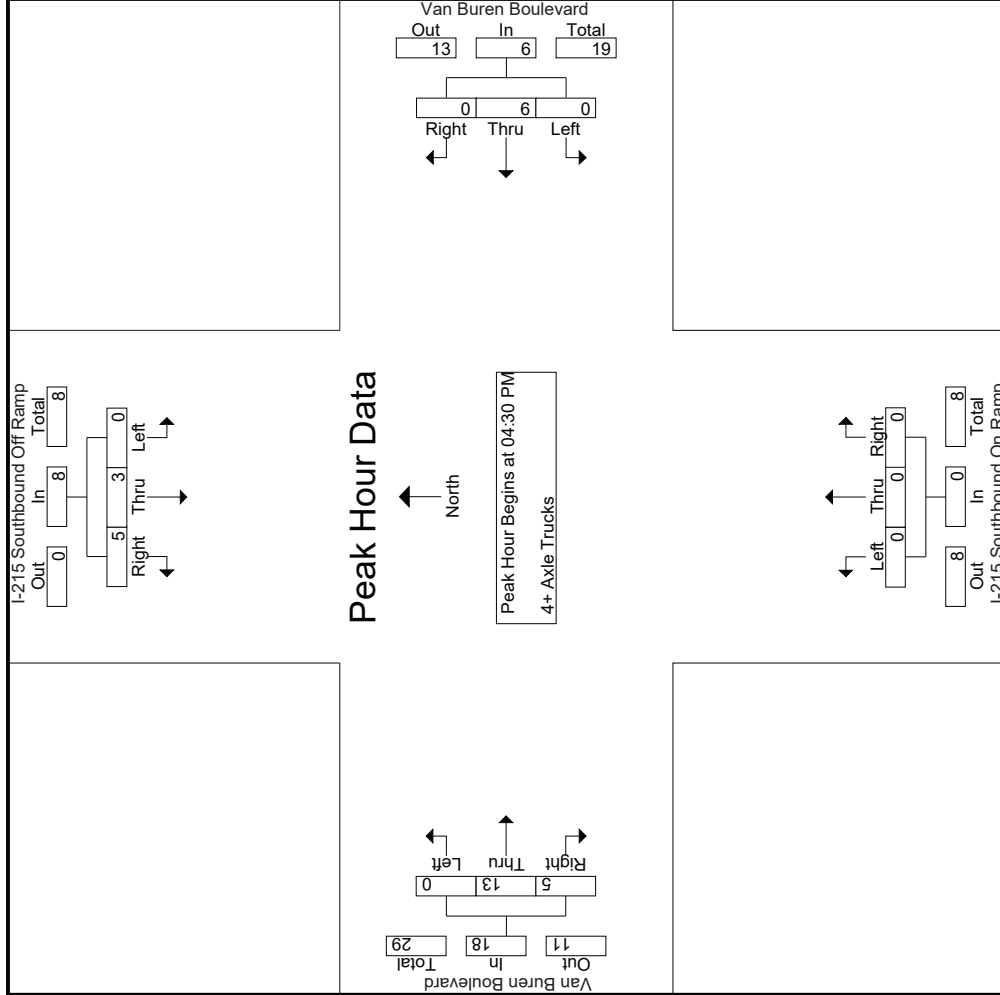

Counts Unlimited
 PO Box 1178
 Corona, CA 92878
 (951) 268-6268

County of Riverside
 N/S: I-215 Southbound Ramps
 E/W: Van Buren Boulevard
 Weather: Clear

File Name : 36_CRV_215S_Van Buren PM
 Site Code : 05119542
 Start Date : 8/20/2019
 Page No : 3

Start Time	I-215 Southbound Off Ramp			Van Buren Boulevard Westbound			I-215 Southbound On Ramp Northbound			Van Buren Boulevard Eastbound		
	Left	Thru	Right	Left	Thru	Right	Left	Thru	Right	Left	Thru	Right
Peak Hour Analysis From 04:30 PM to 05:15 PM - Peak 1 of 1												
Peak Hour for Each Approach Begins at:												
	04:30 PM											
+0 mins.	0	1	0	0	0	0	0	0	0	0	0	0
+15 mins.	0	1	1	0	1	0	0	0	0	0	1	0
+30 mins.	0	0	2	0	2	0	0	0	0	0	4	0
+45 mins.	0	1	2	0	0	0	0	0	0	0	5	3
Total Volume	0	3	5	0	6	0	0	0	0	0	13	5
% App. Total	0	37.5	62.5	0	100	0	0	0	0	0	72.2	27.8
PHF	.000	.750	.625	.000	.500	.000	.000	.000	.000	.000	.650	.417

Location: County of Riverside
 N/S: I-215 Southbound Ramps
 E/W: Van Buren Boulevard



Date: 8/20/2019
 Day: Tuesday

PEDESTRIANS

	North Leg I-215 Southbound Ramps	East Leg Van Buren Boulevard	South Leg I-215 Southbound Ramps	West Leg Van Buren Boulevard	
	Pedestrians	Pedestrians	Pedestrians	Pedestrians	
7:00 AM	0	0	0	0	0
7:15 AM	0	0	0	0	0
7:30 AM	0	0	0	0	0
7:45 AM	0	0	0	0	0
8:00 AM	0	0	0	0	0
8:15 AM	0	0	0	0	0
8:30 AM	0	0	0	0	0
8:45 AM	0	0	0	0	0
TOTAL VOLUMES:	0	0	0	0	0

	North Leg I-215 Southbound Ramps	East Leg Van Buren Boulevard	South Leg I-215 Southbound Ramps	West Leg Van Buren Boulevard	
	Pedestrians	Pedestrians	Pedestrians	Pedestrians	
4:00 PM	0	0	0	0	0
4:15 PM	0	0	0	0	0
4:30 PM	0	0	0	0	0
4:45 PM	0	0	0	0	0
5:00 PM	0	0	0	0	0
5:15 PM	0	0	0	0	0
5:30 PM	0	0	0	0	0
5:45 PM	0	0	0	0	0
TOTAL VOLUMES:	0	0	0	0	0

Location: County of Riverside
 N/S: I-215 Southbound Ramps
 E/W: Van Buren Boulevard



Date: 8/20/2019
 Day: Tuesday

BICYCLES

	Southbound I-215 Southbound Ramps			Westbound Van Buren Boulevard			Northbound I-215 Southbound Ramps			Eastbound Van Buren Boulevard			
	Left	Thru	Right	Left	Thru	Right	Left	Thru	Right	Left	Thru	Right	
7:00 AM	0	0	0	0	0	0	0	0	0	0	0	0	0
7:15 AM	0	0	0	0	0	0	0	0	0	0	0	0	0
7:30 AM	0	0	0	0	0	0	0	0	0	0	0	0	0
7:45 AM	0	0	0	0	0	0	0	0	0	0	0	0	0
8:00 AM	0	0	0	0	0	0	0	0	0	0	0	0	0
8:15 AM	0	0	0	0	0	0	0	0	0	0	0	0	0
8:30 AM	0	0	0	0	0	0	0	0	0	0	0	0	0
8:45 AM	0	0	0	0	0	0	0	0	0	0	0	0	0
TOTAL VOLUMES:	0	0	0	0	0	0	0	0	0	0	0	0	0

	Southbound I-215 Southbound Ramps			Westbound Van Buren Boulevard			Northbound I-215 Southbound Ramps			Eastbound Van Buren Boulevard			
	Left	Thru	Right	Left	Thru	Right	Left	Thru	Right	Left	Thru	Right	
4:00 PM	0	0	0	0	0	0	0	0	0	0	0	0	0
4:15 PM	0	0	0	0	0	0	0	0	0	0	0	0	0
4:30 PM	0	0	0	0	0	0	0	0	0	0	0	0	0
4:45 PM	0	0	0	0	0	0	0	0	0	0	0	0	0
5:00 PM	0	0	0	0	0	0	0	0	0	0	0	0	0
5:15 PM	0	0	0	0	0	0	0	0	0	0	0	0	0
5:30 PM	0	0	0	0	0	0	0	0	0	0	0	0	0
5:45 PM	0	0	0	0	0	0	0	0	0	0	0	0	0
TOTAL VOLUMES:	0	0	0	0	0	0	0	0	0	0	0	0	0

County of Riverside
 N/S: Van Buren Boulevard
 E/W: I-215 Northbound Ramps
 Weather: Clear

File Name : 39_CRV_Van Buren_215N AM
 Site Code : 05119542
 Start Date : 8/20/2019
 Page No : 1

Groups Printed- Passenger Vehicles - Large 2 Axle Vehicles - 3 Axle Vehicles - 4+ Axle Trucks

Start Time	Van Buren Boulevard Southbound				Van Buren Boulevard Northbound				I-215 Northbound Ramps Eastbound				Exclu. Total	Inclu. Total	Int. Total
	Thru	Right	RTOR	App. Total	Left	Thru	RTOR	App. Total	Left	Right	RTOR	App. Total			
07:00 AM	1	70	0	71	0	1	0	1	297	0	0	297	0	369	369
07:15 AM	3	98	0	101	0	3	0	3	281	1	0	282	0	386	386
07:30 AM	2	134	0	136	0	1	0	1	252	1	0	253	0	390	390
07:45 AM	4	146	0	150	0	2	0	2	226	1	0	227	0	379	379
Total	10	448	0	458	0	7	0	7	1056	3	0	1059	0	1524	1524
08:00 AM	3	85	0	88	0	1	0	1	200	2	0	202	0	291	291
08:15 AM	1	81	0	82	0	4	0	4	208	2	0	210	0	296	296
08:30 AM	1	68	0	69	0	0	0	0	230	0	0	230	0	299	299
08:45 AM	3	61	0	64	0	2	0	2	212	0	0	212	0	278	278
Total	8	295	0	303	0	7	0	7	850	4	0	854	0	1164	1164
Grand Total	18	743	0	761	0	14	0	14	1906	7	0	1913	0	2688	2688
Apprch %	2.4	97.6			0	100			99.6	0.4					
Total %	0.7	27.6		28.3	0	0.5		0.5	70.9	0.3		71.2	0	100	
Passenger Vehicles	16	694		710	0	12		12	1771	7		1778	0	0	2500
% Passenger Vehicles	88.9	93.4	0	93.3	0	85.7	0	85.7	92.9	100	0	92.9	0	0	93
Large 2 Axle Vehicles	2	18		20	0	2		2	70	0		70	0	0	92
% Large 2 Axle Vehicles	11.1	2.4	0	2.6	0	14.3	0	14.3	3.7	0	0	3.7	0	0	3.4
3 Axle Vehicles	0	10		10	0	0		0	35	0		35	0	0	45
% 3 Axle Vehicles	0	1.3	0	1.3	0	0	0	0	1.8	0	0	1.8	0	0	1.7
4+ Axle Trucks	0	21		21	0	0		0	30	0		30	0	0	51
% 4+ Axle Trucks	0	2.8	0	2.8	0	0	0	0	1.6	0	0	1.6	0	0	1.9

Start Time	Van Buren Boulevard Southbound			Van Buren Boulevard Northbound			I-215 Northbound Ramps Eastbound			Int. Total
	Thru	Right	App. Total	Left	Thru	App. Total	Left	Right	App. Total	
Peak Hour Analysis From 07:00 AM to 08:45 AM - Peak 1 of 1										
Peak Hour for Entire Intersection Begins at 07:00 AM										
07:00 AM	1	70	71	0	1	1	297	0	297	369
07:15 AM	3	98	101	0	3	3	281	1	282	386
07:30 AM	2	134	136	0	1	1	252	1	253	390
07:45 AM	4	146	150	0	2	2	226	1	227	379
Total Volume	10	448	458	0	7	7	1056	3	1059	1524
% App. Total	2.2	97.8		0	100		99.7	0.3		
PHF	.625	.767	.763	.000	.583	.583	.889	.750	.891	.977

County of Riverside
 N/S: Van Buren Boulevard
 E/W: I-215 Northbound Ramps
 Weather: Clear

File Name : 39_CRV_Van Buren_215N AM
 Site Code : 05119542
 Start Date : 8/20/2019
 Page No : 2

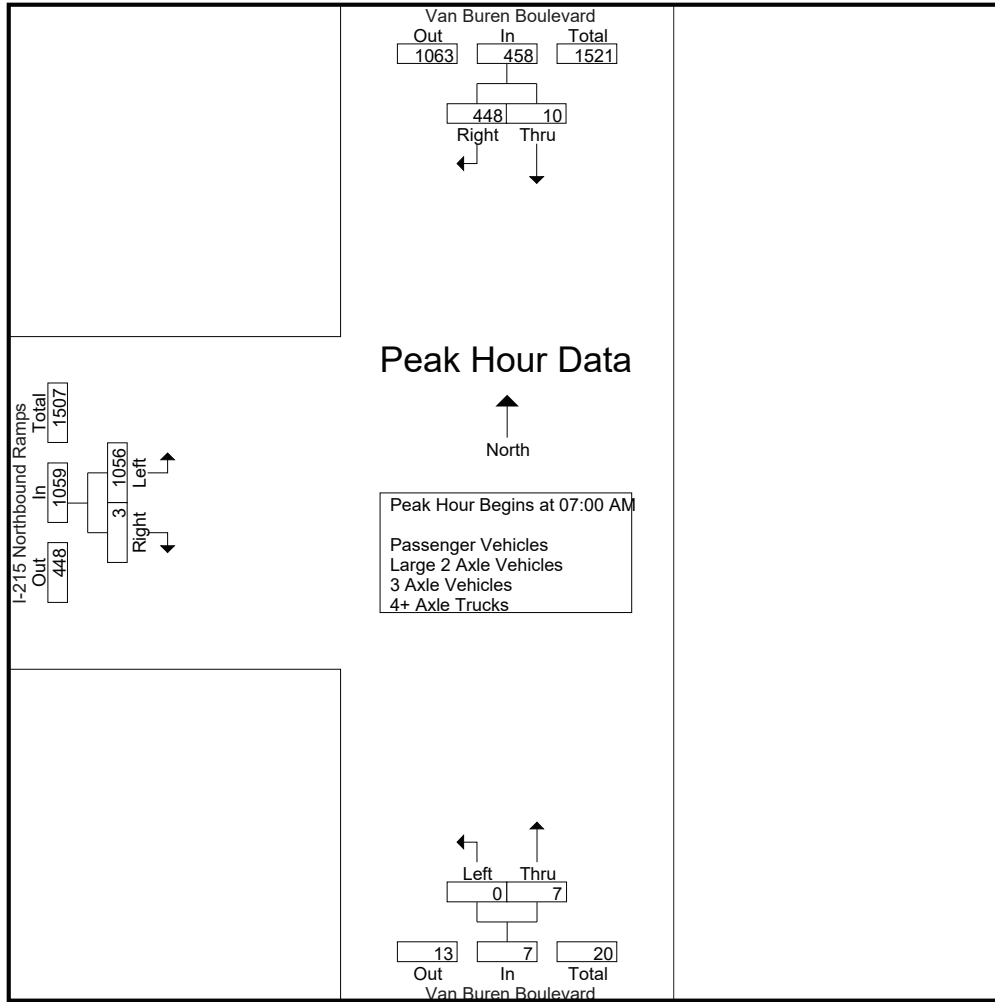

Peak Hour Analysis From 07:00 AM to 08:45 AM - Peak 1 of 1
 Peak Hour for Each Approach Begins at:

	07:15 AM			07:30 AM			07:00 AM		
+0 mins.	3	98	101	0	1	1	297	0	297
+15 mins.	2	134	136	0	2	2	281	1	282
+30 mins.	4	146	150	0	1	1	252	1	253
+45 mins.	3	85	88	0	4	4	226	1	227
Total Volume	12	463	475	0	8	8	1056	3	1059
% App. Total	2.5	97.5		0	100		99.7	0.3	
PHF	.750	.793	.792	.000	.500	.500	.889	.750	.891

County of Riverside
 N/S: Van Buren Boulevard
 E/W: I-215 Northbound Ramps
 Weather: Clear

File Name : 39_CRV_Van Buren_215N AM
 Site Code : 05119542
 Start Date : 8/20/2019
 Page No : 1

Groups Printed- Passenger Vehicles

Start Time	Van Buren Boulevard Southbound				Van Buren Boulevard Northbound				I-215 Northbound Ramps Eastbound				Exclu. Total	Inclu. Total	Int. Total
	Thru	Right	RTOR	App. Total	Left	Thru	RTOR	App. Total	Left	Right	RTOR	App. Total			
07:00 AM	0	67	0	67	0	0	0	0	277	0	0	277	0	344	344
07:15 AM	3	95	0	98	0	3	0	3	271	1	0	272	0	373	373
07:30 AM	2	126	0	128	0	1	0	1	234	1	0	235	0	364	364
07:45 AM	4	141	0	145	0	2	0	2	214	1	0	215	0	362	362
Total	9	429	0	438	0	6	0	6	996	3	0	999	0	1443	1443
08:00 AM	2	79	0	81	0	1	0	1	181	2	0	183	0	265	265
08:15 AM	1	69	0	70	0	3	0	3	190	2	0	192	0	265	265
08:30 AM	1	63	0	64	0	0	0	0	206	0	0	206	0	270	270
08:45 AM	3	54	0	57	0	2	0	2	198	0	0	198	0	257	257
Total	7	265	0	272	0	6	0	6	775	4	0	779	0	1057	1057
Grand Total	16	694	0	710	0	12	0	12	1771	7	0	1778	0	2500	2500
Apprch %	2.3	97.7			0	100			99.6	0.4					
Total %	0.6	27.8		28.4	0	0.5		0.5	70.8	0.3		71.1	0	100	

Start Time	Van Buren Boulevard Southbound			Van Buren Boulevard Northbound			I-215 Northbound Ramps Eastbound			Int. Total
	Thru	Right	App. Total	Left	Thru	App. Total	Left	Right	App. Total	
Peak Hour Analysis From 07:00 AM to 07:45 AM - Peak 1 of 1										
Peak Hour for Entire Intersection Begins at 07:00 AM										
07:00 AM	0	67	67	0	0	0	277	0	277	344
07:15 AM	3	95	98	0	3	3	271	1	272	373
07:30 AM	2	126	128	0	1	1	234	1	235	364
07:45 AM	4	141	145	0	2	2	214	1	215	362
Total Volume	9	429	438	0	6	6	996	3	999	1443
% App. Total	2.1	97.9		0	100		99.7	0.3		
PHF	.563	.761	.755	.000	.500	.500	.899	.750	.902	.967

County of Riverside
 N/S: Van Buren Boulevard
 E/W: I-215 Northbound Ramps
 Weather: Clear

File Name : 39_CRV_Van Buren_215N AM
 Site Code : 05119542
 Start Date : 8/20/2019
 Page No : 2

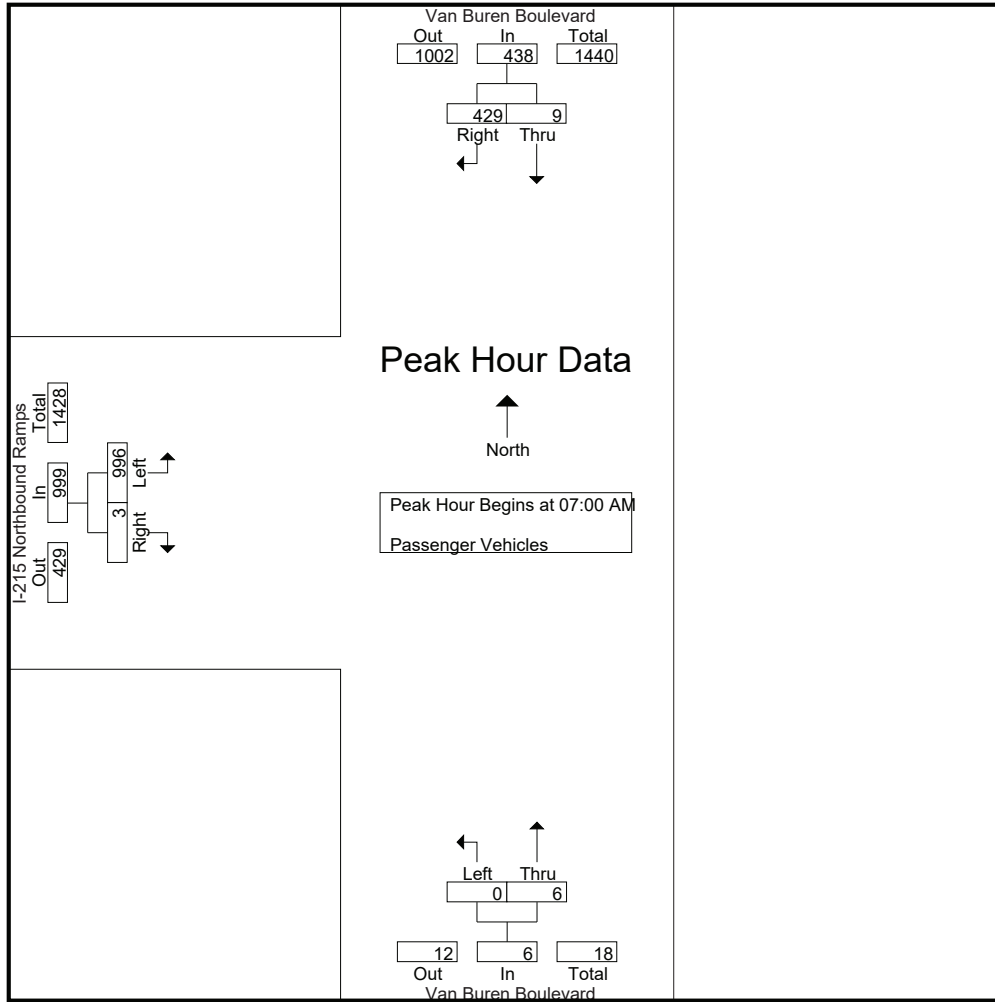

Peak Hour Analysis From 07:00 AM to 07:45 AM - Peak 1 of 1
 Peak Hour for Each Approach Begins at:

	07:00 AM			07:00 AM			07:00 AM		
+0 mins.	0	67	67	0	0	0	277	0	277
+15 mins.	3	95	98	0	3	3	271	1	272
+30 mins.	2	126	128	0	1	1	234	1	235
+45 mins.	4	141	145	0	2	2	214	1	215
Total Volume	9	429	438	0	6	6	996	3	999
% App. Total	2.1	97.9		0	100		99.7	0.3	
PHF	.563	.761	.755	.000	.500	.500	.899	.750	.902

County of Riverside
 N/S: Van Buren Boulevard
 E/W: I-215 Northbound Ramps
 Weather: Clear

File Name : 39_CRV_Van Buren_215N AM
 Site Code : 05119542
 Start Date : 8/20/2019
 Page No : 1

Groups Printed- Large 2 Axle Vehicles

Start Time	Van Buren Boulevard Southbound				Van Buren Boulevard Northbound				I-215 Northbound Ramps Eastbound				Exclu. Total	Inclu. Total	Int. Total
	Thru	Right	RTOR	App. Total	Left	Thru	RTOR	App. Total	Left	Right	RTOR	App. Total			
07:00 AM	1	3	0	4	0	1	0	1	12	0	0	12	0	17	17
07:15 AM	0	0	0	0	0	0	0	0	3	0	0	3	0	3	3
07:30 AM	0	2	0	2	0	0	0	0	9	0	0	9	0	11	11
07:45 AM	0	2	0	2	0	0	0	0	6	0	0	6	0	8	8
Total	1	7	0	8	0	1	0	1	30	0	0	30	0	39	39
08:00 AM	1	2	0	3	0	0	0	0	9	0	0	9	0	12	12
08:15 AM	0	5	0	5	0	1	0	1	14	0	0	14	0	20	20
08:30 AM	0	2	0	2	0	0	0	0	11	0	0	11	0	13	13
08:45 AM	0	2	0	2	0	0	0	0	6	0	0	6	0	8	8
Total	1	11	0	12	0	1	0	1	40	0	0	40	0	53	53
Grand Total	2	18	0	20	0	2	0	2	70	0	0	70	0	92	92
Apprch %	10	90			0	100			100	0			0	100	
Total %	2.2	19.6		21.7	0	2.2		2.2	76.1	0		76.1	0	100	

Start Time	Van Buren Boulevard Southbound			Van Buren Boulevard Northbound			I-215 Northbound Ramps Eastbound			Int. Total
	Thru	Right	App. Total	Left	Thru	App. Total	Left	Right	App. Total	
Peak Hour Analysis From 07:00 AM to 07:45 AM - Peak 1 of 1										
Peak Hour for Entire Intersection Begins at 07:00 AM										
07:00 AM	1	3	4	0	1	1	12	0	12	17
07:15 AM	0	0	0	0	0	0	3	0	3	3
07:30 AM	0	2	2	0	0	0	9	0	9	11
07:45 AM	0	2	2	0	0	0	6	0	6	8
Total Volume	1	7	8	0	1	1	30	0	30	39
% App. Total	12.5	87.5		0	100		100	0		
PHF	.250	.583	.500	.000	.250	.250	.625	.000	.625	.574

County of Riverside
 N/S: Van Buren Boulevard
 E/W: I-215 Northbound Ramps
 Weather: Clear

File Name : 39_CRV_Van Buren_215N AM
 Site Code : 05119542
 Start Date : 8/20/2019
 Page No : 2

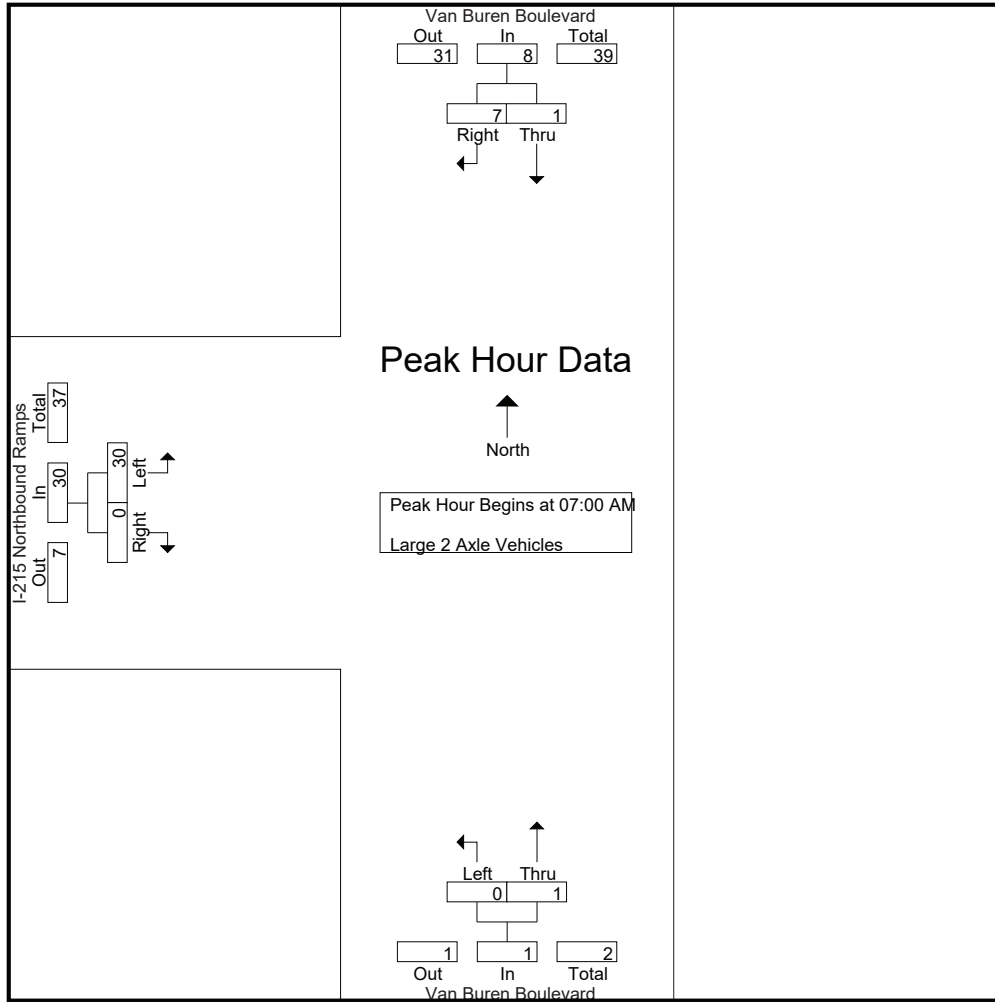

Peak Hour Analysis From 07:00 AM to 07:45 AM - Peak 1 of 1
 Peak Hour for Each Approach Begins at:

	07:00 AM			07:00 AM			07:00 AM		
+0 mins.	1	3	4	0	1	1	0	0	12
+15 mins.	0	0	0	0	0	0	3	0	3
+30 mins.	0	2	2	0	0	0	9	0	9
+45 mins.	0	2	2	0	0	0	6	0	6
Total Volume	1	7	8	0	1	1	30	0	30
% App. Total	12.5	87.5		0	100		100	0	
PHF	.250	.583	.500	.000	.250	.250	.625	.000	.625

County of Riverside
 N/S: Van Buren Boulevard
 E/W: I-215 Northbound Ramps
 Weather: Clear

File Name : 39_CRV_Van Buren_215N AM
 Site Code : 05119542
 Start Date : 8/20/2019
 Page No : 1

Groups Printed- 3 Axle Vehicles

Start Time	Van Buren Boulevard Southbound				Van Buren Boulevard Northbound				I-215 Northbound Ramps Eastbound				Exclu. Total	Inclu. Total	Int. Total
	Thru	Right	RTOR	App. Total	Left	Thru	RTOR	App. Total	Left	Right	RTOR	App. Total			
07:00 AM	0	0	0	0	0	0	0	0	3	0	0	3	0	3	3
07:15 AM	0	0	0	0	0	0	0	0	2	0	0	2	0	2	2
07:30 AM	0	4	0	4	0	0	0	0	3	0	0	3	0	7	7
07:45 AM	0	0	0	0	0	0	0	0	3	0	0	3	0	3	3
Total	0	4	0	4	0	0	0	0	11	0	0	11	0	15	15
08:00 AM	0	2	0	2	0	0	0	0	8	0	0	8	0	10	10
08:15 AM	0	3	0	3	0	0	0	0	2	0	0	2	0	5	5
08:30 AM	0	1	0	1	0	0	0	0	9	0	0	9	0	10	10
08:45 AM	0	0	0	0	0	0	0	0	5	0	0	5	0	5	5
Total	0	6	0	6	0	0	0	0	24	0	0	24	0	30	30
Grand Total	0	10	0	10	0	0	0	0	35	0	0	35	0	45	45
Apprch %	0	100			0	0			100	0					
Total %	0	22.2		22.2	0	0		0	77.8	0		77.8	0	100	

Start Time	Van Buren Boulevard Southbound			Van Buren Boulevard Northbound			I-215 Northbound Ramps Eastbound			Int. Total
	Thru	Right	App. Total	Left	Thru	App. Total	Left	Right	App. Total	
Peak Hour Analysis From 07:00 AM to 07:45 AM - Peak 1 of 1										
Peak Hour for Entire Intersection Begins at 07:00 AM										
07:00 AM	0	0	0	0	0	0	3	0	3	3
07:15 AM	0	0	0	0	0	0	2	0	2	2
07:30 AM	0	4	4	0	0	0	3	0	3	7
07:45 AM	0	0	0	0	0	0	3	0	3	3
Total Volume	0	4	4	0	0	0	11	0	11	15
% App. Total	0	100		0	0		100	0		
PHF	.000	.250	.250	.000	.000	.000	.917	.000	.917	.536

County of Riverside
 N/S: Van Buren Boulevard
 E/W: I-215 Northbound Ramps
 Weather: Clear

File Name : 39_CRV_Van Buren_215N AM
 Site Code : 05119542
 Start Date : 8/20/2019
 Page No : 2

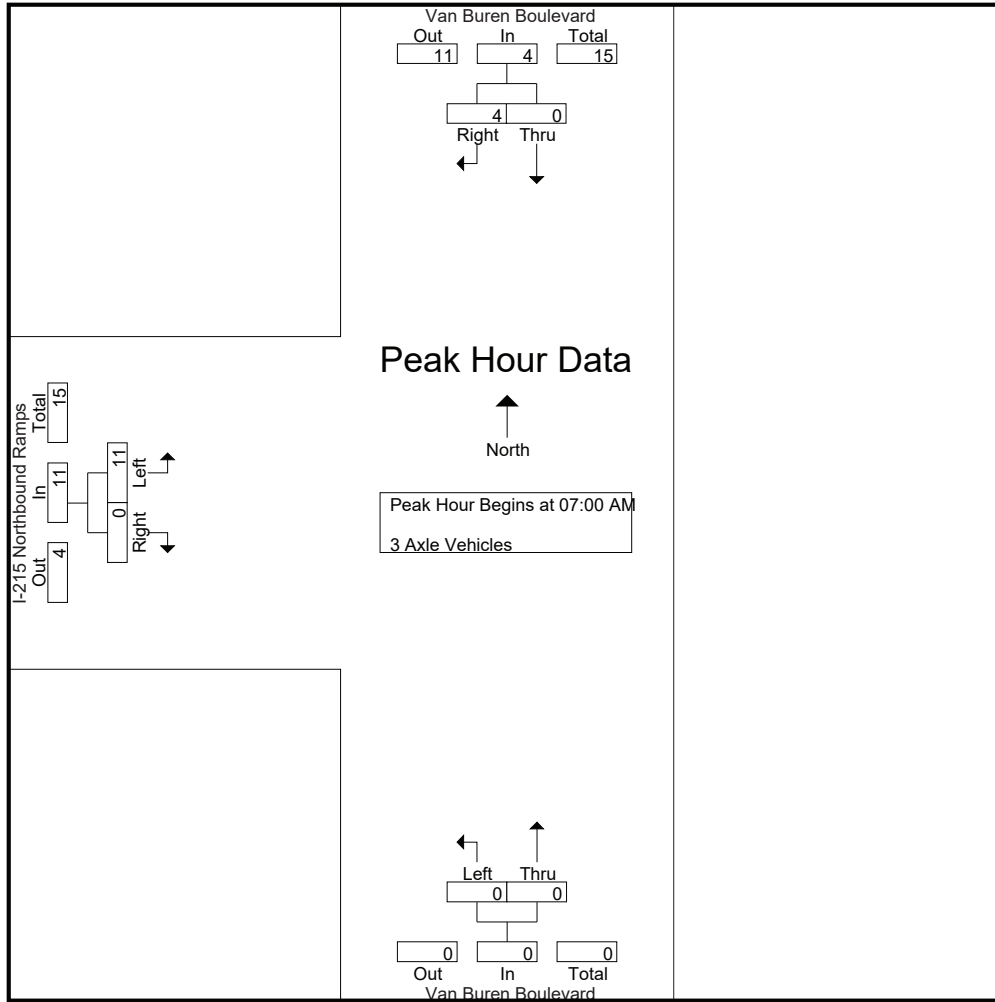

Peak Hour Analysis From 07:00 AM to 07:45 AM - Peak 1 of 1
 Peak Hour for Each Approach Begins at:

	07:00 AM			07:00 AM			07:00 AM		
+0 mins.	0	0	0	0	0	0	3	0	3
+15 mins.	0	0	0	0	0	0	2	0	2
+30 mins.	0	4	4	0	0	0	3	0	3
+45 mins.	0	0	0	0	0	0	3	0	3
Total Volume	0	4	4	0	0	0	11	0	11
% App. Total	0	100		0	0		100	0	
PHF	.000	.250	.250	.000	.000	.000	.917	.000	.917

County of Riverside
 N/S: Van Buren Boulevard
 E/W: I-215 Northbound Ramps
 Weather: Clear

File Name : 39_CRV_Van Buren_215N AM
 Site Code : 05119542
 Start Date : 8/20/2019
 Page No : 1

Groups Printed- 4+ Axle Trucks

Start Time	Van Buren Boulevard Southbound				Van Buren Boulevard Northbound				I-215 Northbound Ramps Eastbound				Exclu. Total	Inclu. Total	Int. Total
	Thru	Right	RTOR	App. Total	Left	Thru	RTOR	App. Total	Left	Right	RTOR	App. Total			
07:00 AM	0	0	0	0	0	0	0	0	5	0	0	5	0	5	5
07:15 AM	0	3	0	3	0	0	0	0	5	0	0	5	0	8	8
07:30 AM	0	2	0	2	0	0	0	0	6	0	0	6	0	8	8
07:45 AM	0	3	0	3	0	0	0	0	3	0	0	3	0	6	6
Total	0	8	0	8	0	0	0	0	19	0	0	19	0	27	27
08:00 AM	0	2	0	2	0	0	0	0	2	0	0	2	0	4	4
08:15 AM	0	4	0	4	0	0	0	0	2	0	0	2	0	6	6
08:30 AM	0	2	0	2	0	0	0	0	4	0	0	4	0	6	6
08:45 AM	0	5	0	5	0	0	0	0	3	0	0	3	0	8	8
Total	0	13	0	13	0	0	0	0	11	0	0	11	0	24	24
Grand Total	0	21	0	21	0	0	0	0	30	0	0	30	0	51	51
Apprch %	0	100			0	0			100	0			0	100	
Total %	0	41.2		41.2	0	0		0	58.8	0		58.8	0	100	

Start Time	Van Buren Boulevard Southbound			Van Buren Boulevard Northbound			I-215 Northbound Ramps Eastbound			Int. Total
	Thru	Right	App. Total	Left	Thru	App. Total	Left	Right	App. Total	
Peak Hour Analysis From 07:00 AM to 07:45 AM - Peak 1 of 1										
Peak Hour for Entire Intersection Begins at 07:00 AM										
07:00 AM	0	0	0	0	0	0	5	0	5	5
07:15 AM	0	3	3	0	0	0	5	0	5	8
07:30 AM	0	2	2	0	0	0	6	0	6	8
07:45 AM	0	3	3	0	0	0	3	0	3	6
Total Volume	0	8	8	0	0	0	19	0	19	27
% App. Total	0	100		0	0		100	0		
PHF	.000	.667	.667	.000	.000	.000	.792	.000	.792	.844

County of Riverside
 N/S: Van Buren Boulevard
 E/W: I-215 Northbound Ramps
 Weather: Clear

File Name : 39_CRV_Van Buren_215N AM
 Site Code : 05119542
 Start Date : 8/20/2019
 Page No : 2

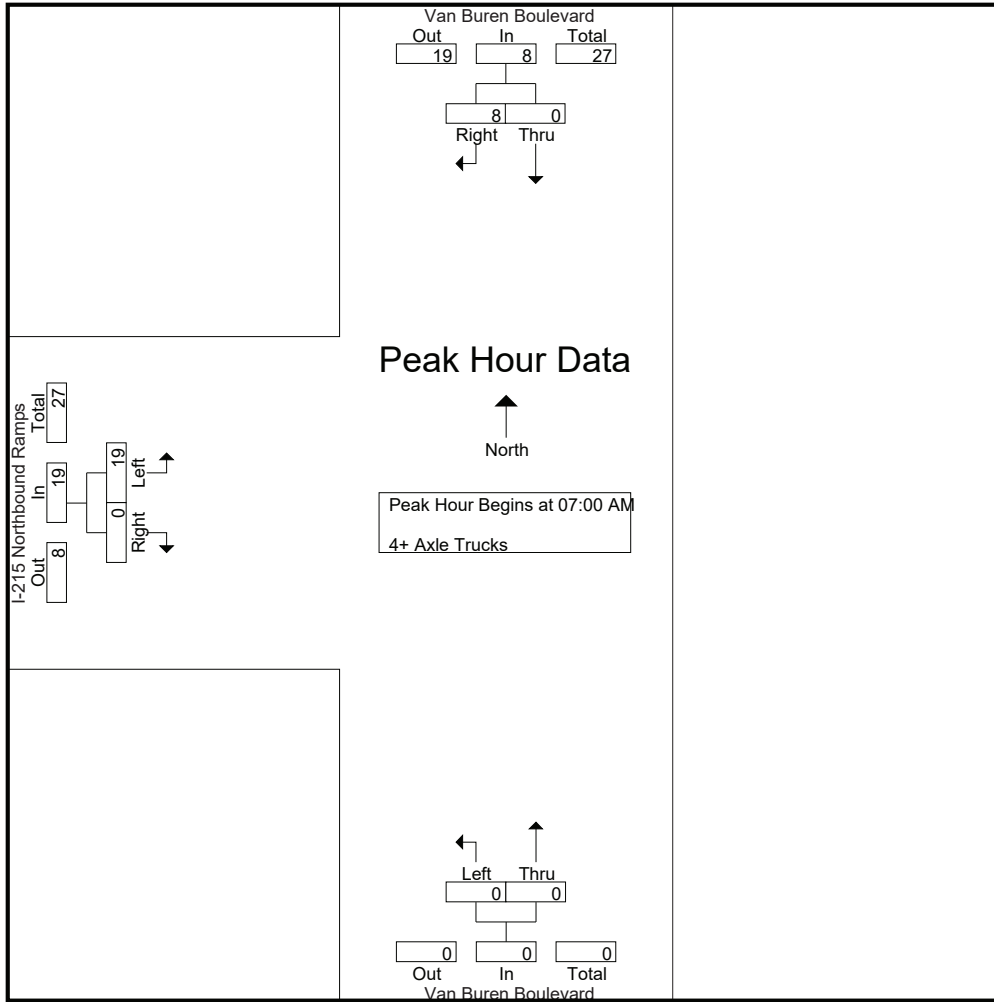

Peak Hour Analysis From 07:00 AM to 07:45 AM - Peak 1 of 1
 Peak Hour for Each Approach Begins at:

	07:00 AM			07:00 AM			07:00 AM		
+0 mins.	0	0	0	0	0	0	5	0	5
+15 mins.	0	3	3	0	0	0	5	0	5
+30 mins.	0	2	2	0	0	0	6	0	6
+45 mins.	0	3	3	0	0	0	3	0	3
Total Volume	0	8	8	0	0	0	19	0	19
% App. Total	0	100		0	0		100	0	
PHF	.000	.667	.667	.000	.000	.000	.792	.000	.792

County of Riverside
 N/S: Van Buren Boulevard
 E/W: I-215 Northbound Ramps
 Weather: Clear

File Name : 39_CRV_Van Buren_215N PM
 Site Code : 05119542
 Start Date : 8/20/2019
 Page No : 1

Groups Printed- Passenger Vehicles - Large 2 Axle Vehicles - 3 Axle Vehicles - 4+ Axle Trucks

Start Time	Van Buren Boulevard Southbound				Van Buren Boulevard Northbound				I-215 Northbound Ramps Eastbound				Exclu. Total	Inclu. Total	Int. Total
	Thru	Right	RTOR	App. Total	Left	Thru	RTOR	App. Total	Left	Right	RTOR	App. Total			
04:00 PM	4	133	0	137	0	6	0	6	148	1	0	149	0	292	292
04:15 PM	2	123	0	125	0	4	0	4	132	0	0	132	0	261	261
04:30 PM	2	145	0	147	0	4	0	4	150	0	0	150	0	301	301
04:45 PM	2	114	0	116	0	5	0	5	144	0	0	144	0	265	265
Total	10	515	0	525	0	19	0	19	574	1	0	575	0	1119	1119
05:00 PM	0	126	0	126	0	0	0	0	131	0	0	131	0	257	257
05:15 PM	2	135	0	137	0	6	0	6	159	0	0	159	0	302	302
05:30 PM	2	153	0	155	0	2	0	2	115	0	0	115	0	272	272
05:45 PM	3	107	0	110	0	2	0	2	135	0	0	135	0	247	247
Total	7	521	0	528	0	10	0	10	540	0	0	540	0	1078	1078
Grand Total	17	1036	0	1053	0	29	0	29	1114	1	0	1115	0	2197	2197
Apprch %	1.6	98.4			0	100			99.9	0.1					
Total %	0.8	47.2		47.9	0	1.3		1.3	50.7	0		50.8	0	100	
Passenger Vehicles	16	998		1014	0	28		28	1073	1		1074	0	0	2116
% Passenger Vehicles	94.1	96.3	0	96.3	0	96.6	0	96.6	96.3	100	0	96.3	0	0	96.3
Large 2 Axle Vehicles	1	16		17	0	1		1	29	0		29	0	0	47
% Large 2 Axle Vehicles	5.9	1.5	0	1.6	0	3.4	0	3.4	2.6	0	0	2.6	0	0	2.1
3 Axle Vehicles	0	2		2	0	0		0	3	0		3	0	0	5
% 3 Axle Vehicles	0	0.2	0	0.2	0	0	0	0	0.3	0	0	0.3	0	0	0.2
4+ Axle Trucks	0	20		20	0	0		0	9	0		9	0	0	29
% 4+ Axle Trucks	0	1.9	0	1.9	0	0	0	0	0.8	0	0	0.8	0	0	1.3

Start Time	Van Buren Boulevard Southbound			Van Buren Boulevard Northbound			I-215 Northbound Ramps Eastbound			Int. Total
	Thru	Right	App. Total	Left	Thru	App. Total	Left	Right	App. Total	
Peak Hour Analysis From 04:00 PM to 05:45 PM - Peak 1 of 1										
Peak Hour for Entire Intersection Begins at 04:30 PM										
04:30 PM	2	145	147	0	4	4	150	0	150	301
04:45 PM	2	114	116	0	5	5	144	0	144	265
05:00 PM	0	126	126	0	0	0	131	0	131	257
05:15 PM	2	135	137	0	6	6	159	0	159	302
Total Volume	6	520	526	0	15	15	584	0	584	1125
% App. Total	1.1	98.9		0	100		100	0		
PHF	.750	.897	.895	.000	.625	.625	.918	.000	.918	.931

County of Riverside
 N/S: Van Buren Boulevard
 E/W: I-215 Northbound Ramps
 Weather: Clear

File Name : 39_CRV_Van Buren_215N PM
 Site Code : 05119542
 Start Date : 8/20/2019
 Page No : 2

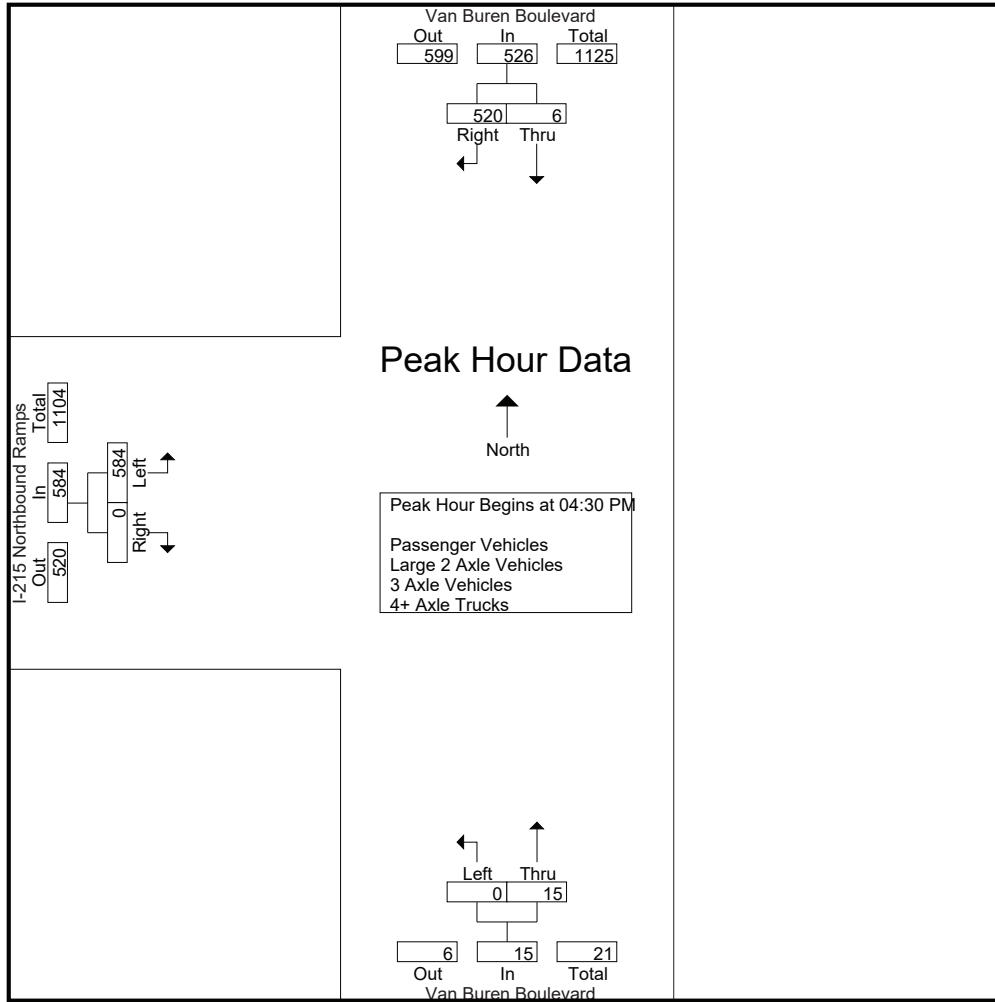

Peak Hour Analysis From 04:00 PM to 05:45 PM - Peak 1 of 1
 Peak Hour for Each Approach Begins at:

	04:45 PM			04:00 PM			04:30 PM		
+0 mins.	2	114	116	0	6	6	150	0	150
+15 mins.	0	126	126	0	4	4	144	0	144
+30 mins.	2	135	137	0	4	4	131	0	131
+45 mins.	2	153	155	0	5	5	159	0	159
Total Volume	6	528	534	0	19	19	584	0	584
% App. Total	1.1	98.9		0	100		100	0	
PHF	.750	.863	.861	.000	.792	.792	.918	.000	.918

County of Riverside
 N/S: Van Buren Boulevard
 E/W: I-215 Northbound Ramps
 Weather: Clear

File Name : 39_CRV_Van Buren_215N PM
 Site Code : 05119542
 Start Date : 8/20/2019
 Page No : 1

Groups Printed- Passenger Vehicles

Start Time	Van Buren Boulevard Southbound				Van Buren Boulevard Northbound				I-215 Northbound Ramps Eastbound				Exclu. Total	Inclu. Total	Int. Total
	Thru	Right	RTOR	App. Total	Left	Thru	RTOR	App. Total	Left	Right	RTOR	App. Total			
04:00 PM	4	125	0	129	0	6	0	6	144	1	0	145	0	280	280
04:15 PM	1	119	0	120	0	3	0	3	123	0	0	123	0	246	246
04:30 PM	2	144	0	146	0	4	0	4	140	0	0	140	0	290	290
04:45 PM	2	108	0	110	0	5	0	5	138	0	0	138	0	253	253
Total	9	496	0	505	0	18	0	18	545	1	0	546	0	1069	1069
05:00 PM	0	118	0	118	0	0	0	0	125	0	0	125	0	243	243
05:15 PM	2	130	0	132	0	6	0	6	156	0	0	156	0	294	294
05:30 PM	2	151	0	153	0	2	0	2	114	0	0	114	0	269	269
05:45 PM	3	103	0	106	0	2	0	2	133	0	0	133	0	241	241
Total	7	502	0	509	0	10	0	10	528	0	0	528	0	1047	1047
Grand Total	16	998	0	1014	0	28	0	28	1073	1	0	1074	0	2116	2116
Apprch %	1.6	98.4			0	100			99.9	0.1					
Total %	0.8	47.2		47.9	0	1.3		1.3	50.7	0		50.8	0	100	

Start Time	Van Buren Boulevard Southbound			Van Buren Boulevard Northbound			I-215 Northbound Ramps Eastbound			Int. Total
	Thru	Right	App. Total	Left	Thru	App. Total	Left	Right	App. Total	
Peak Hour Analysis From 04:30 PM to 05:15 PM - Peak 1 of 1										
Peak Hour for Entire Intersection Begins at 04:30 PM										
04:30 PM	2	144	146	0	4	4	140	0	140	290
04:45 PM	2	108	110	0	5	5	138	0	138	253
05:00 PM	0	118	118	0	0	0	125	0	125	243
05:15 PM	2	130	132	0	6	6	156	0	156	294
Total Volume	6	500	506	0	15	15	559	0	559	1080
% App. Total	1.2	98.8		0	100		100	0		
PHF	.750	.868	.866	.000	.625	.625	.896	.000	.896	.918

County of Riverside
 N/S: Van Buren Boulevard
 E/W: I-215 Northbound Ramps
 Weather: Clear

File Name : 39_CRV_Van Buren_215N PM
 Site Code : 05119542
 Start Date : 8/20/2019
 Page No : 2

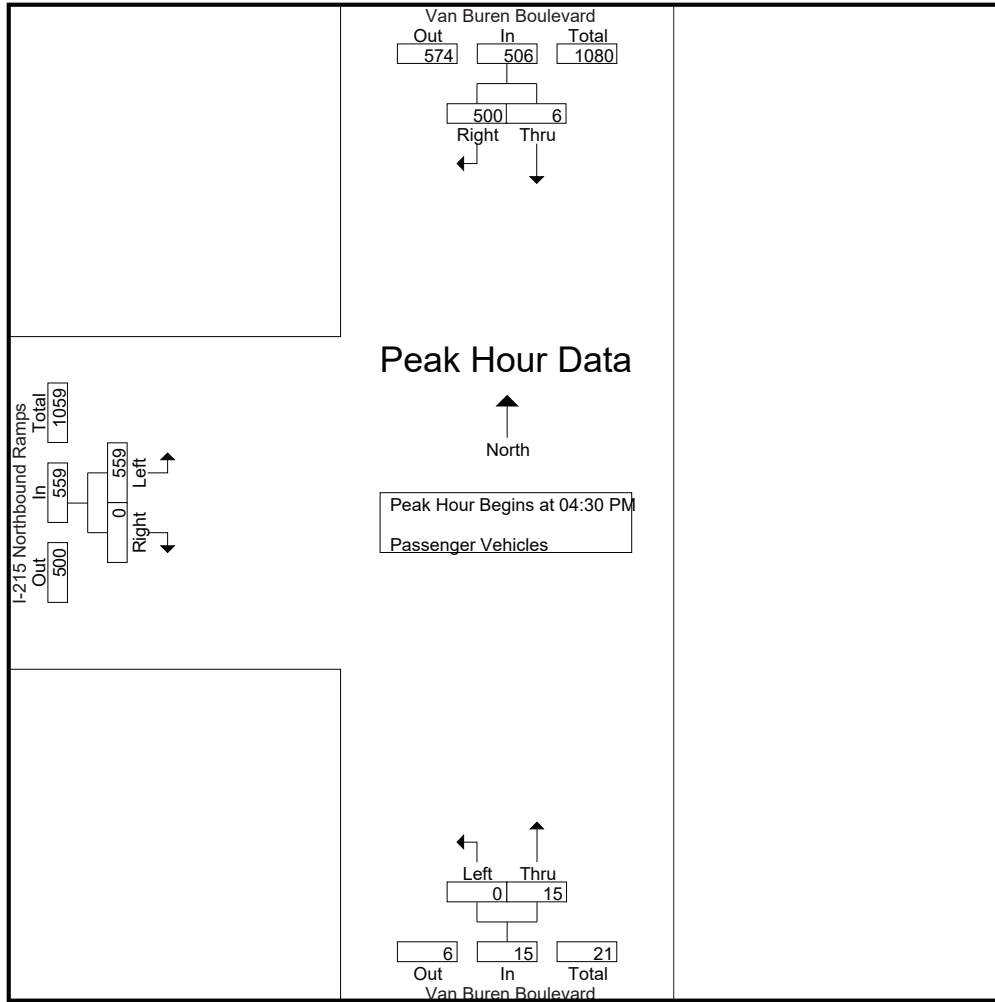

Peak Hour Analysis From 04:30 PM to 05:15 PM - Peak 1 of 1
 Peak Hour for Each Approach Begins at:

	04:30 PM			04:30 PM			04:30 PM		
+0 mins.	2	144	146	0	4	4	140	0	140
+15 mins.	2	108	110	0	5	5	138	0	138
+30 mins.	0	118	118	0	0	0	125	0	125
+45 mins.	2	130	132	0	6	6	156	0	156
Total Volume	6	500	506	0	15	15	559	0	559
% App. Total	1.2	98.8		0	100		100	0	
PHF	.750	.868	.866	.000	.625	.625	.896	.000	.896

County of Riverside
 N/S: Van Buren Boulevard
 E/W: I-215 Northbound Ramps
 Weather: Clear

File Name : 39_CRV_Van Buren_215N PM
 Site Code : 05119542
 Start Date : 8/20/2019
 Page No : 1

Groups Printed- Large 2 Axle Vehicles

Start Time	Van Buren Boulevard Southbound				Van Buren Boulevard Northbound				I-215 Northbound Ramps Eastbound				Exclu. Total	Inclu. Total	Int. Total
	Thru	Right	RTOR	App. Total	Left	Thru	RTOR	App. Total	Left	Right	RTOR	App. Total			
04:00 PM	0	5	0	5	0	0	0	0	2	0	0	2	0	7	7
04:15 PM	1	2	0	3	0	1	0	1	5	0	0	5	0	9	9
04:30 PM	0	0	0	0	0	0	0	0	8	0	0	8	0	8	8
04:45 PM	0	2	0	2	0	0	0	0	4	0	0	4	0	6	6
Total	1	9	0	10	0	1	0	1	19	0	0	19	0	30	30
05:00 PM	0	2	0	2	0	0	0	0	4	0	0	4	0	6	6
05:15 PM	0	2	0	2	0	0	0	0	3	0	0	3	0	5	5
05:30 PM	0	2	0	2	0	0	0	0	1	0	0	1	0	3	3
05:45 PM	0	1	0	1	0	0	0	0	2	0	0	2	0	3	3
Total	0	7	0	7	0	0	0	0	10	0	0	10	0	17	17
Grand Total	1	16	0	17	0	1	0	1	29	0	0	29	0	47	47
Apprch %	5.9	94.1			0	100			100	0			0		
Total %	2.1	34		36.2	0	2.1		2.1	61.7	0		61.7	0	100	

Start Time	Van Buren Boulevard Southbound			Van Buren Boulevard Northbound			I-215 Northbound Ramps Eastbound			Int. Total
	Thru	Right	App. Total	Left	Thru	App. Total	Left	Right	App. Total	
Peak Hour Analysis From 04:30 PM to 05:15 PM - Peak 1 of 1										
Peak Hour for Entire Intersection Begins at 04:30 PM										
04:30 PM	0	0	0	0	0	0	8	0	8	8
04:45 PM	0	2	2	0	0	0	4	0	4	6
05:00 PM	0	2	2	0	0	0	4	0	4	6
05:15 PM	0	2	2	0	0	0	3	0	3	5
Total Volume	0	6	6	0	0	0	19	0	19	25
% App. Total	0	100		0	0		100	0		
PHF	.000	.750	.750	.000	.000	.000	.594	.000	.594	.781

County of Riverside
 N/S: Van Buren Boulevard
 E/W: I-215 Northbound Ramps
 Weather: Clear

File Name : 39_CRV_Van Buren_215N PM
 Site Code : 05119542
 Start Date : 8/20/2019
 Page No : 2

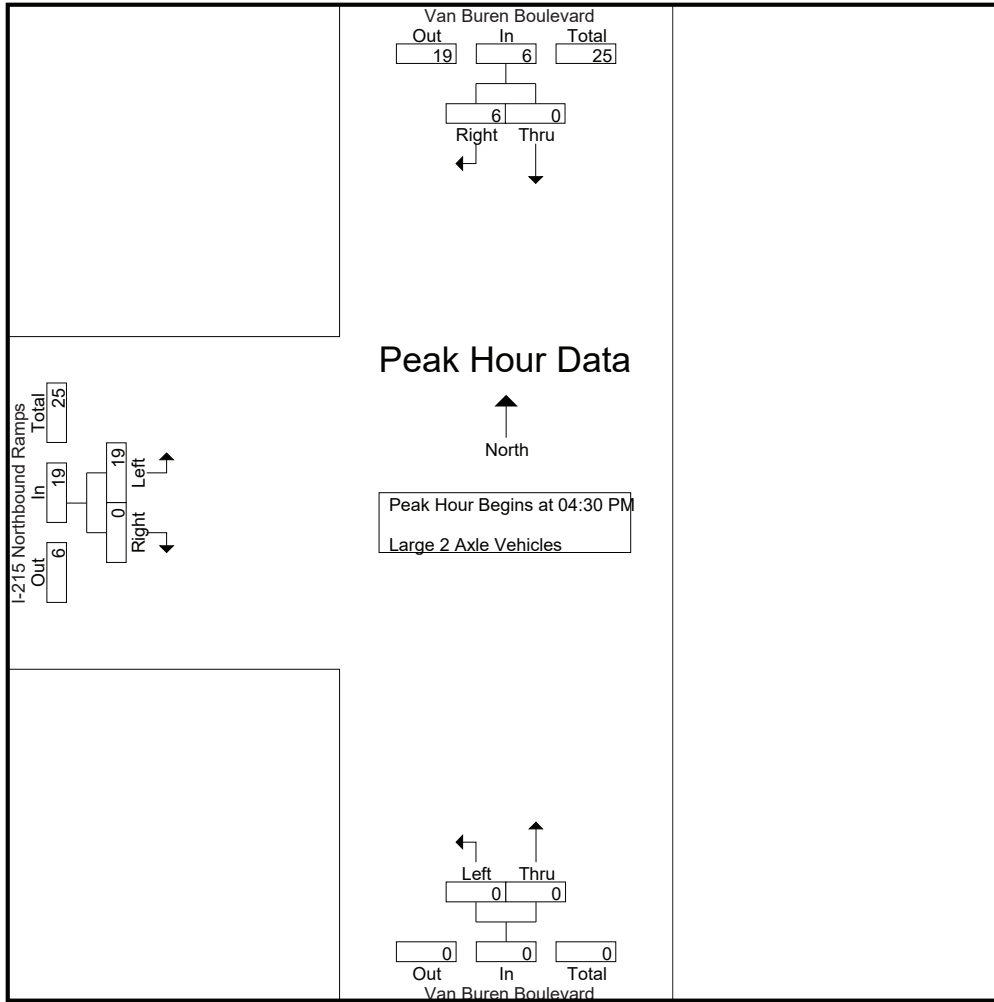

Peak Hour Analysis From 04:30 PM to 05:15 PM - Peak 1 of 1
 Peak Hour for Each Approach Begins at:

	04:30 PM			04:30 PM			04:30 PM		
+0 mins.	0	0	0	0	0	0	8	0	8
+15 mins.	0	2	2	0	0	0	4	0	4
+30 mins.	0	2	2	0	0	0	4	0	4
+45 mins.	0	2	2	0	0	0	3	0	3
Total Volume	0	6	6	0	0	0	19	0	19
% App. Total	0	100		0	0		100	0	
PHF	.000	.750	.750	.000	.000	.000	.594	.000	.594

County of Riverside
 N/S: Van Buren Boulevard
 E/W: I-215 Northbound Ramps
 Weather: Clear

File Name : 39_CRV_Van Buren_215N PM
 Site Code : 05119542
 Start Date : 8/20/2019
 Page No : 1

Groups Printed- 3 Axle Vehicles

Start Time	Van Buren Boulevard Southbound				Van Buren Boulevard Northbound				I-215 Northbound Ramps Eastbound				Exclu. Total	Inclu. Total	Int. Total
	Thru	Right	RTOR	App. Total	Left	Thru	RTOR	App. Total	Left	Right	RTOR	App. Total			
04:00 PM	0	0	0	0	0	0	0	0	1	0	0	1	0	1	1
04:15 PM	0	0	0	0	0	0	0	0	1	0	0	1	0	1	1
04:30 PM	0	0	0	0	0	0	0	0	0	0	0	0	0	0	0
04:45 PM	0	2	0	2	0	0	0	0	1	0	0	1	0	3	3
Total	0	2	0	2	0	0	0	0	3	0	0	3	0	5	5
05:00 PM	0	0	0	0	0	0	0	0	0	0	0	0	0	0	0
05:15 PM	0	0	0	0	0	0	0	0	0	0	0	0	0	0	0
05:30 PM	0	0	0	0	0	0	0	0	0	0	0	0	0	0	0
05:45 PM	0	0	0	0	0	0	0	0	0	0	0	0	0	0	0
Total	0	0	0	0	0	0	0	0	0	0	0	0	0	0	0
Grand Total	0	2	0	2	0	0	0	0	3	0	0	3	0	5	5
Apprch %	0	100			0	0			100	0			0		
Total %	0	40		40	0	0		0	60	0		60	0	100	

Start Time	Van Buren Boulevard Southbound			Van Buren Boulevard Northbound			I-215 Northbound Ramps Eastbound			Int. Total
	Thru	Right	App. Total	Left	Thru	App. Total	Left	Right	App. Total	
Peak Hour Analysis From 04:30 PM to 05:15 PM - Peak 1 of 1										
Peak Hour for Entire Intersection Begins at 04:30 PM										
04:30 PM	0	0	0	0	0	0	0	0	0	0
04:45 PM	0	2	2	0	0	0	1	0	1	3
05:00 PM	0	0	0	0	0	0	0	0	0	0
05:15 PM	0	0	0	0	0	0	0	0	0	0
Total Volume	0	2	2	0	0	0	1	0	1	3
% App. Total	0	100		0	0		100	0		
PHF	.000	.250	.250	.000	.000	.000	.250	.000	.250	.250

County of Riverside
 N/S: Van Buren Boulevard
 E/W: I-215 Northbound Ramps
 Weather: Clear

File Name : 39_CRV_Van Buren_215N PM
 Site Code : 05119542
 Start Date : 8/20/2019
 Page No : 2

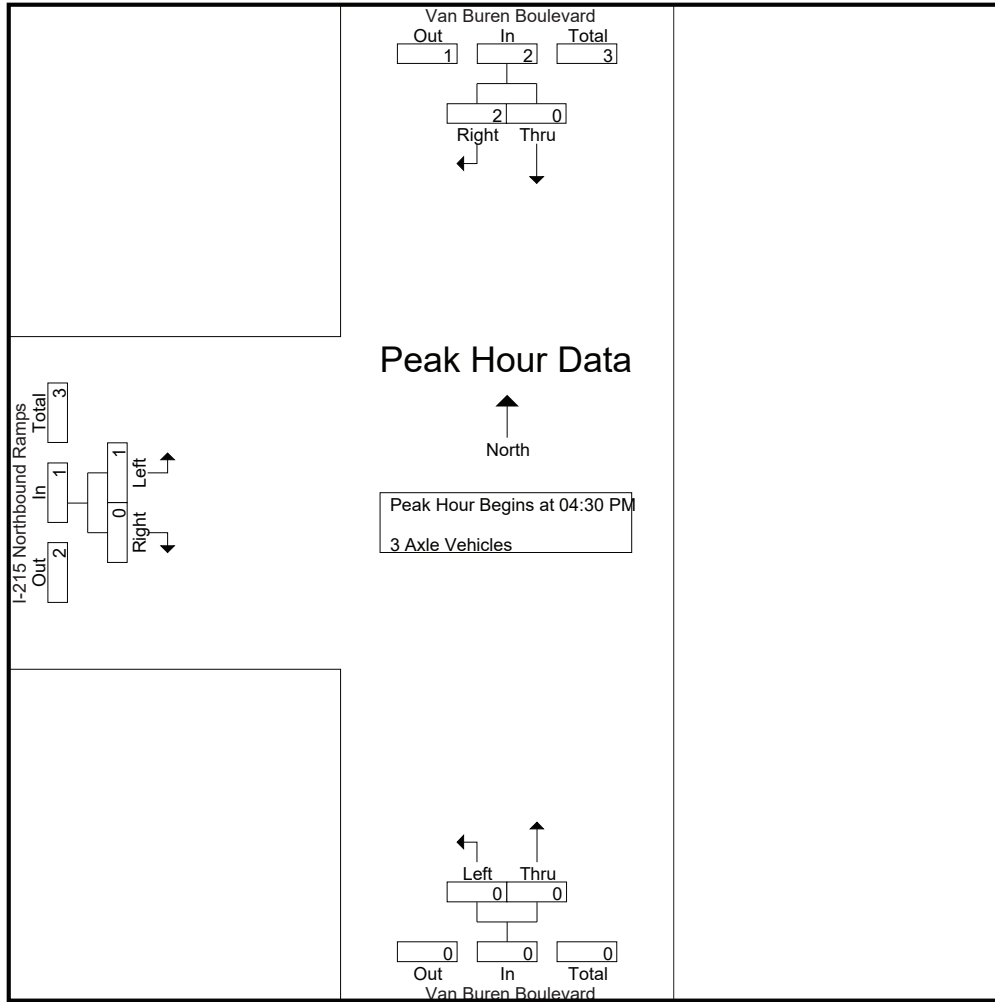

Peak Hour Analysis From 04:30 PM to 05:15 PM - Peak 1 of 1
 Peak Hour for Each Approach Begins at:

	04:30 PM			04:30 PM			04:30 PM		
+0 mins.	0	0	0	0	0	0	0	0	0
+15 mins.	0	2	2	0	0	0	1	0	1
+30 mins.	0	0	0	0	0	0	0	0	0
+45 mins.	0	0	0	0	0	0	0	0	0
Total Volume	0	2	2	0	0	0	1	0	1
% App. Total	0	100		0	0		100	0	
PHF	.000	.250	.250	.000	.000	.000	.250	.000	.250

County of Riverside
 N/S: Van Buren Boulevard
 E/W: I-215 Northbound Ramps
 Weather: Clear

File Name : 39_CRV_Van Buren_215N PM
 Site Code : 05119542
 Start Date : 8/20/2019
 Page No : 1

Groups Printed- 4+ Axle Trucks

Start Time	Van Buren Boulevard Southbound				Van Buren Boulevard Northbound				I-215 Northbound Ramps Eastbound				Exclu. Total	Inclu. Total	Int. Total
	Thru	Right	RTOR	App. Total	Left	Thru	RTOR	App. Total	Left	Right	RTOR	App. Total			
04:00 PM	0	3	0	3	0	0	0	0	1	0	0	1	0	4	4
04:15 PM	0	2	0	2	0	0	0	0	3	0	0	3	0	5	5
04:30 PM	0	1	0	1	0	0	0	0	2	0	0	2	0	3	3
04:45 PM	0	2	0	2	0	0	0	0	1	0	0	1	0	3	3
Total	0	8	0	8	0	0	0	0	7	0	0	7	0	15	15
05:00 PM	0	6	0	6	0	0	0	0	2	0	0	2	0	8	8
05:15 PM	0	3	0	3	0	0	0	0	0	0	0	0	0	3	3
05:30 PM	0	0	0	0	0	0	0	0	0	0	0	0	0	0	0
05:45 PM	0	3	0	3	0	0	0	0	0	0	0	0	0	3	3
Total	0	12	0	12	0	0	0	0	2	0	0	2	0	14	14
Grand Total	0	20	0	20	0	0	0	0	9	0	0	9	0	29	29
Apprch %	0	100			0	0			100	0			0		
Total %	0	69		69	0	0		0	31	0		31	0	100	

Start Time	Van Buren Boulevard Southbound			Van Buren Boulevard Northbound			I-215 Northbound Ramps Eastbound			Int. Total
	Thru	Right	App. Total	Left	Thru	App. Total	Left	Right	App. Total	
Peak Hour Analysis From 04:30 PM to 05:15 PM - Peak 1 of 1										
Peak Hour for Entire Intersection Begins at 04:30 PM										
04:30 PM	0	1	1	0	0	0	2	0	2	3
04:45 PM	0	2	2	0	0	0	1	0	1	3
05:00 PM	0	6	6	0	0	0	2	0	2	8
05:15 PM	0	3	3	0	0	0	0	0	0	3
Total Volume	0	12	12	0	0	0	5	0	5	17
% App. Total	0	100		0	0		100	0		
PHF	.000	.500	.500	.000	.000	.000	.625	.000	.625	.531

County of Riverside
 N/S: Van Buren Boulevard
 E/W: I-215 Northbound Ramps
 Weather: Clear

File Name : 39_CRV_Van Buren_215N PM
 Site Code : 05119542
 Start Date : 8/20/2019
 Page No : 2

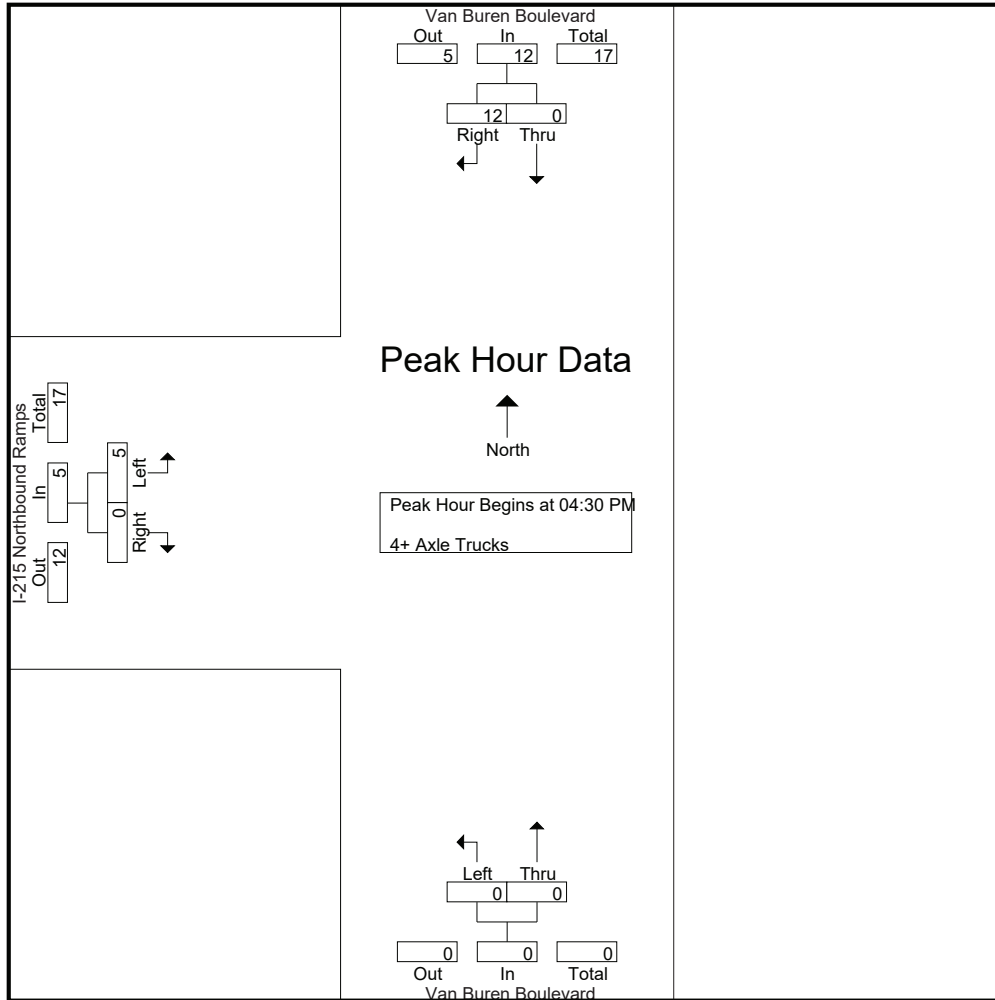

Peak Hour Analysis From 04:30 PM to 05:15 PM - Peak 1 of 1
 Peak Hour for Each Approach Begins at:

	04:30 PM			04:30 PM			04:30 PM		
+0 mins.	0	1	1	0	0	0	2	0	2
+15 mins.	0	2	2	0	0	0	1	0	1
+30 mins.	0	6	6	0	0	0	2	0	2
+45 mins.	0	3	3	0	0	0	0	0	0
Total Volume	0	12	12	0	0	0	5	0	5
% App. Total	0	100		0	0		100	0	
PHF	.000	.500	.500	.000	.000	.000	.625	.000	.625

Location: County of Riverside
 N/S: Van Buren Boulevard
 E/W: I-215 NB Ramps



Date: 8/20/2019
 Day: Tuesday

PEDESTRIANS

	North Leg Van Buren Boulevard Pedestrians	East Leg Dead End Pedestrians	South Leg Van Buren Boulevard Pedestrians	West Leg I-215 NB Ramps Pedestrians	
7:00 AM	0	0	0	0	0
7:15 AM	0	0	0	0	0
7:30 AM	0	0	0	0	0
7:45 AM	0	0	0	0	0
8:00 AM	0	0	0	0	0
8:15 AM	0	0	0	0	0
8:30 AM	0	0	0	0	0
8:45 AM	0	0	0	0	0
TOTAL VOLUMES:	0	0	0	0	0

	North Leg Van Buren Boulevard Pedestrians	East Leg Dead End Pedestrians	South Leg Van Buren Boulevard Pedestrians	West Leg I-215 NB Ramps Pedestrians	
4:00 PM	0	0	0	0	0
4:15 PM	0	0	0	0	0
4:30 PM	0	0	0	0	0
4:45 PM	0	0	0	0	0
5:00 PM	0	0	0	0	0
5:15 PM	0	0	0	0	0
5:30 PM	0	0	0	0	0
5:45 PM	0	0	0	0	0
TOTAL VOLUMES:	0	0	0	0	0

Location: County of Riverside
 N/S: Van Buren Boulevard
 E/W: I-215 NB Ramps



Date: 8/20/2019
 Day: Tuesday

BICYCLES

	Southbound Van Buren Boulevard			Westbound Dead End			Northbound Van Buren Boulevard			Eastbound I-215 NB Ramps			
	Left	Thru	Right	Left	Thru	Right	Left	Thru	Right	Left	Thru	Right	
7:00 AM	0	0	0	0	0	0	0	0	0	0	0	0	0
7:15 AM	0	0	0	0	0	0	0	0	0	0	0	0	0
7:30 AM	0	0	0	0	0	0	0	0	0	0	0	0	0
7:45 AM	0	0	0	0	0	0	0	0	0	0	0	0	0
8:00 AM	0	0	0	0	0	0	0	0	0	0	0	0	0
8:15 AM	0	0	0	0	0	0	0	0	0	0	0	0	0
8:30 AM	0	0	0	0	0	0	0	0	0	0	0	0	0
8:45 AM	0	0	0	0	0	0	0	0	0	0	0	0	0
TOTAL VOLUMES:	0	0	0	0	0	0	0	0	0	0	0	0	0

	Southbound Van Buren Boulevard			Westbound Dead End			Northbound Van Buren Boulevard			Eastbound I-215 NB Ramps			
	Left	Thru	Right	Left	Thru	Right	Left	Thru	Right	Left	Thru	Right	
4:00 PM	0	0	0	0	0	0	0	0	0	0	0	0	0
4:15 PM	0	0	0	0	0	0	0	0	0	0	0	0	0
4:30 PM	0	0	0	0	0	0	0	0	0	0	0	0	0
4:45 PM	0	0	0	0	0	0	0	0	0	0	0	0	0
5:00 PM	0	0	0	0	0	0	0	0	0	0	0	0	0
5:15 PM	0	0	0	0	0	0	0	0	0	0	0	0	0
5:30 PM	0	0	0	0	0	0	0	0	0	0	0	0	0
5:45 PM	0	0	0	0	0	0	0	0	0	0	0	0	0
TOTAL VOLUMES:	0	0	0	0	0	0	0	0	0	0	0	0	0

Counts Unlimited
PO Box 1178
Corona, CA 92878
(951) 268-6268

City of Moreno Valley
N/S: Old 215 Frontage Road
EW: Alessandro Boulevard
Weather: Clear

File Name : 40_MRV_Old 215 Frontage_Alessandro AM
Site Code : 05119542
Start Date : 8/20/2019
Page No : 1

Groups Printed- Passenger Vehicles - Large 2 Axle Vehicles - 3 Axle Vehicles - 4+ Axle Trucks

Start Time	Old 215 Frontage Road										Alessandro Boulevard												
	Southbound					Westbound					Northbound					Eastbound							
	Left	Thru	Right	RTOR	App. Total	Left	Thru	Right	RTOR	App. Total	Left	Thru	Right	RTOR	App. Total	Exclu. Total	Inclu. Total	Int. Total					
07:00 AM	2	12	34	23	48	4	361	21	11	386	71	59	4	4	134	27	116	2	1	145	39	713	752
07:15 AM	1	6	46	43	53	1	363	12	6	376	48	108	6	4	162	50	178	3	1	231	54	822	876
07:30 AM	3	10	49	36	62	1	314	14	8	329	52	92	1	1	145	39	159	5	1	203	46	739	785
07:45 AM	4	6	48	34	58	5	304	24	12	333	41	125	4	1	170	61	187	4	1	252	48	813	861
Total	10	34	177	136	221	11	1342	71	37	1424	212	384	15	10	611	177	640	14	4	831	187	3087	3274
08:00 AM	8	4	49	32	61	5	325	21	14	351	41	73	6	2	120	68	152	7	3	227	51	759	810
08:15 AM	4	6	29	19	39	3	331	16	6	350	22	67	10	5	99	59	169	3	1	231	31	719	750
08:30 AM	7	5	44	38	56	5	248	25	6	278	22	75	2	1	99	65	174	4	1	243	46	676	722
08:45 AM	6	6	30	24	42	3	261	14	2	278	16	48	9	5	73	77	206	1	1	284	32	677	709
Total	25	21	152	113	198	16	1165	76	28	1257	101	263	27	13	391	269	701	15	6	985	160	2831	2991
Grand Total	35	55	329	249	419	27	2507	147	65	2681	313	647	42	23	1002	446	1341	29	10	1816	347	5918	6265
Approch %	8.4	13.1	78.5		7.1	0.5	42.4	2.5		45.3	5.3	10.9	0.7		16.9	7.5	22.7	0.5		30.7	5.5	94.5	
Total %	33	50	315	95.6	636	10	2414	139	2622	292	616	23	54.8	52.2	943	427	1263	16	40	1710	0	0	5911
% Passenger Vehicles	94.3	90.9	95.7	95.6	95.2	37	96.3	94.6	90.8	95.5	93.3	95.2	54.8	52.2	92	95.7	94.2	55.2	40	93.6	0	0	94.3
% Large 2 Axle Vehicles	2	1	11	3.2	22	2	57	4	4.6	66	9	6	0	0	15	14	45	2	0	61	0	0	164
% Large 3 Axle Vehicles	5.7	1.8	3.3	3.2	3.3	7.4	2.3	2.7	4.6	2.4	2.9	0.9	0	0	1.5	3.1	3.4	6.9	0	3.3	0	0	2.6
% 3 Axle Vehicles	0	1	2	0.8	5	14	5	1	1.5	21	6	5	19	41	4	3	10	6	22	0	0	0	89
% 4+ Axle Trucks	0	1.8	0.6	0.8	0.7	51.9	0.2	0.7	1.5	0.8	1.9	0.8	45.2	47.8	4	0.7	0.7	20.7	30	1.2	0	0	1.4
% 4+ Axle Trucks	0	3	1	0.4	0.7	1	31	3	3.1	37	6	20	0	0	26	2	23	5	33	0	0	0	101
% 4+ Axle Trucks	0	5.5	0.3	0.4	0.7	3.7	1.2	2	3.1	1.3	1.9	3.1	0	0	2.5	0.4	1.7	17.2	30	1.8	0	0	1.6
Start Time	Old 215 Frontage Road					Alessandro Boulevard					Old 215 Frontage Road					Alessandro Boulevard							
	Southbound					Westbound					Northbound					Eastbound							
07:15 AM	1	6	46		53	1	363	12	376	48	108	6	162	231	822								
07:30 AM	3	10	49		62	1	314	14	329	52	92	1	145	203	739								
07:45 AM	4	6	48		58	5	304	24	333	41	125	4	170	813									
08:00 AM	8	4	49		61	5	325	21	351	41	73	6	120	759									
Total Volume	16	26	192		234	12	1306	71	1389	182	398	17	597	19	3133								
% App. Total	6.8	11.1	82.1		82.1	0.9	94	5.1	5.1	30.5	66.7	2.8	23.9	74	2.1								
PHF	.500	.650	.980		.944	.600	.899	.740	.740	.875	.796	.708	.878	.904	.906								

Peak Hour Analysis From 07:00 AM to 08:45 AM - Peak 1 of 1

Peak Hour for Entire Intersection Begins at 07:15 AM

Counts Unlimited
 PO Box 1178
 Corona, CA 92878
 (951) 268-6268

City of Moreno Valley
 N/S: Old 215 Frontage Road
 E/W: Alessandro Boulevard
 Weather: Clear

File Name : 40_MRV_Old 215 Frontage_Alessandro AM
 Site Code : 05119542
 Start Date : 8/20/2019
 Page No : 2

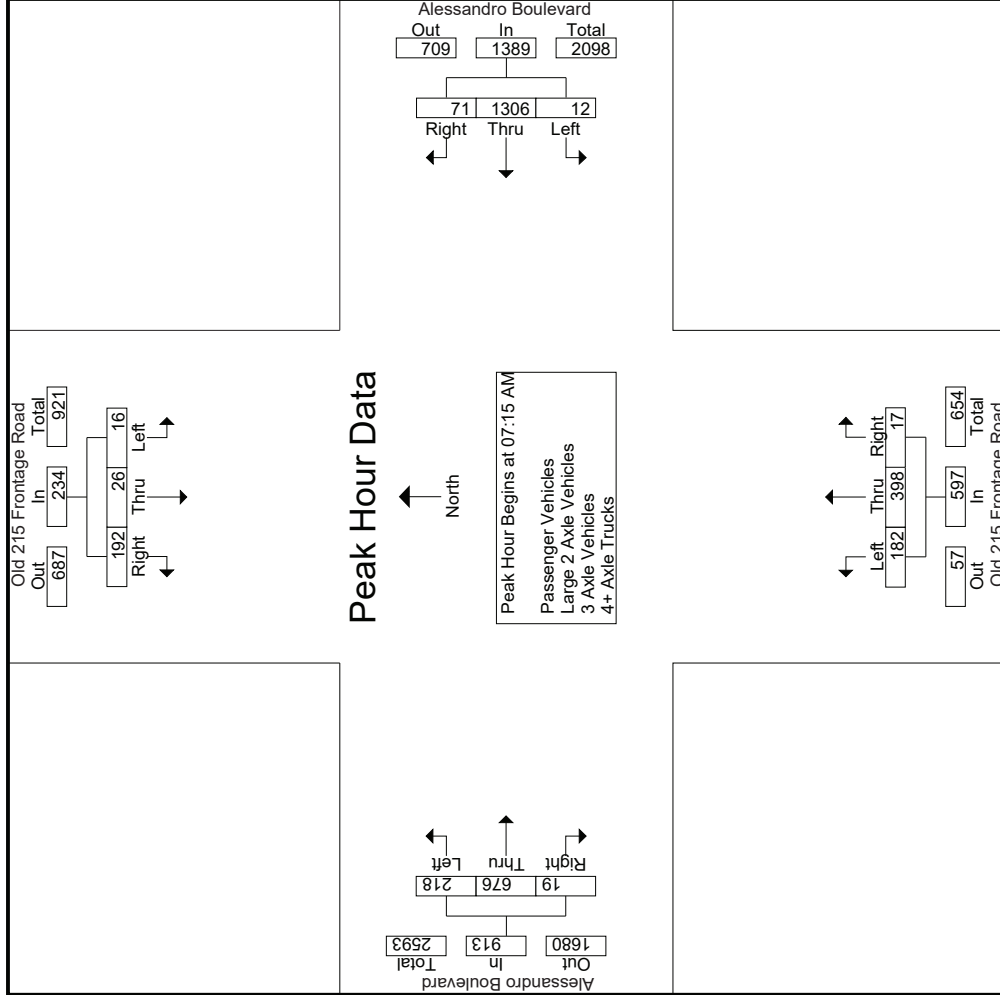

Counts Unlimited
 PO Box 1178
 Corona, CA 92878
 (951) 268-6268

City of Moreno Valley
 N/S: Old 215 Frontage Road
 E/W: Alessandro Boulevard
 Weather: Clear

File Name : 40_MRV_Old 215 Frontage_Alessandro AM
 Site Code : 05119542
 Start Date : 8/20/2019
 Page No : 3

Start Time	Old 215 Frontage Road Southbound			Alessandro Boulevard Westbound			Old 215 Frontage Road Northbound			Alessandro Boulevard Eastbound			
	Left	Thru	Right	Left	Thru	Right	Left	Thru	Right	Left	Thru	Right	
Peak Hour Analysis From 07:00 AM to 08:45 AM - Peak 1 of 1	Peak Hour for Each Approach Begins at:												
	07:15 AM			07:00 AM			07:00 AM			08:00 AM			
+0 mins.	1	6	46	4	361	21	71	59	4	134	68	7	227
+15 mins.	3	10	49	1	363	12	48	108	6	162	59	3	231
+30 mins.	4	6	48	1	314	14	52	92	1	145	65	4	243
+45 mins.	8	4	49	5	304	24	41	125	4	170	77	1	284
Total Volume	16	26	192	11	1342	71	212	384	15	611	269	15	985
% App. Total	6.8	11.1	82.1	0.8	94.2	5	34.7	62.8	2.5	27.3	71.2	1.5	
PHF	.500	.650	.980	.550	.924	.740	.746	.768	.625	.899	.873	.536	.867

Groups Printed- Passenger Vehicles

Start Time	Old 215 Frontage Road Southbound						Alessandro Boulevard Westbound						Old 215 Frontage Road Northbound						Alessandro Boulevard Eastbound					
	Left	Thru	Right	RTOR	App. Total		Left	Thru	Right	RTOR	App. Total		Left	Thru	Right	RTOR	App. Total		Left	Thru	Right	RTOR	App. Total	
07:00 AM	2	10	33	23	45		2	352	20	10	374		66	55	2	2	123		25	108	2	1	135	
07:15 AM	1	6	45	42	52		1	348	11	5	360		47	104	1	0	152		49	166	2	1	217	
07:30 AM	3	9	45	32	57		1	306	12	6	319		50	88	1	1	139		38	146	3	0	187	
07:45 AM	2	6	48	34	56		3	293	23	11	319		41	123	3	0	167		58	183	1	0	242	
Total	8	31	171	131	210		7	1299	66	32	1372		204	370	7	3	581		170	603	8	2	781	
08:00 AM	8	4	48	32	60		1	314	21	14	336		39	72	6	2	117		66	147	4	1	217	
08:15 AM	4	5	28	19	37		1	318	15	6	334		20	62	7	4	89		59	157	2	1	218	
08:30 AM	7	5	40	34	52		0	238	23	5	261		16	69	1	1	86		63	162	2	0	227	
08:45 AM	6	5	28	22	39		1	245	14	2	260		13	43	2	2	58		69	194	0	0	263	
Total	25	19	144	107	188		3	1115	73	27	1191		88	246	16	9	350		257	660	8	2	925	
Grand Total	33	50	315	238	398		10	2414	139	59	2563		292	616	23	12	931		427	1263	16	4	1706	
Approch %	8.3	12.6	79.1				0.4	94.2	5.4				31.4	66.2	2.5				25	74	0.9			
Total %	0.6	0.9	5.6		7.1		0.2	43.1	2.5		45.8		5.2	11	0.4		16.6		7.6	22.6	0.3		30.5	

3: 1-582

Start Time	Old 215 Frontage Road Southbound						Alessandro Boulevard Westbound						Old 215 Frontage Road Northbound						Alessandro Boulevard Eastbound					
	Left	Thru	Right	RTOR	App. Total		Left	Thru	Right	RTOR	App. Total		Left	Thru	Right	RTOR	App. Total		Left	Thru	Right	RTOR	App. Total	
07:15 AM	1	6	45		52		1	348	11		360		47	104	1		152		49	166	2		217	
07:30 AM	3	9	45		57		1	306	12		319		50	88	1		139		38	146	3		187	
07:45 AM	2	6	48		56		3	293	23		319		41	123	3		167		58	183	1		242	
08:00 AM	8	4	48		60		1	314	21		336		39	72	6		117		66	147	4		217	
Total Volume	14	25	186		225		6	1261	67		1334		177	387	11		575		211	642	10		863	
% App. Total	6.2	11.1	82.7				0.4	94.5	5				30.8	67.3	1.9				24.4	74.4	1.2			
PHF	.438	.694	.969		.938		.500	.906	.728		.926		.885	.787	.458		.861		.799	.877	.625		.892	

Peak Hour Analysis From 07:15 AM to 08:00 AM - Peak 1 of 1
 Peak Hour for Entire Intersection Begins at 07:15 AM

Counts Unlimited
 PO Box 1178
 Corona, CA 92878
 (951) 268-6268

City of Moreno Valley
 N/S: Old 215 Frontage Road
 E/W: Alessandro Boulevard
 Weather: Clear

File Name : 40_MRV_Old 215 Frontage_Alessandro AM
 Site Code : 05119542
 Start Date : 8/20/2019
 Page No : 2

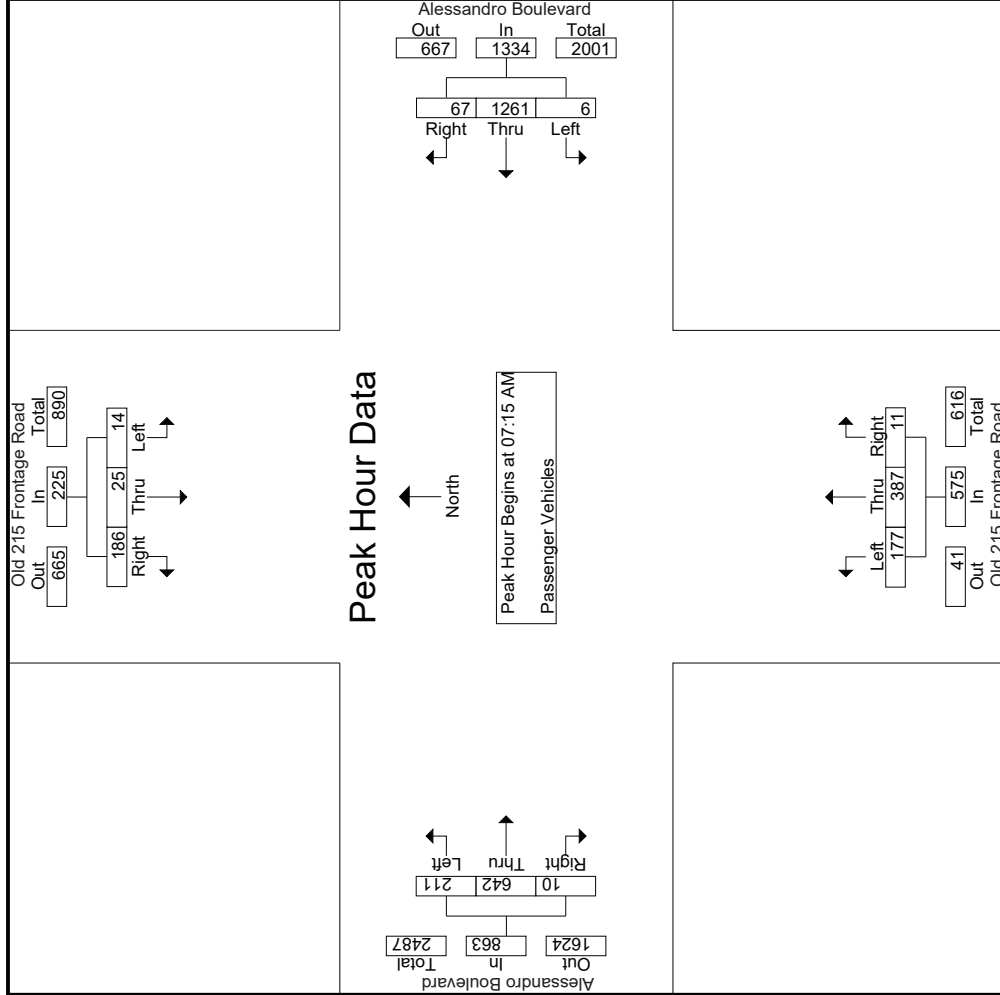

Counts Unlimited
 PO Box 1178
 Corona, CA 92878
 (951) 268-6268

City of Moreno Valley
 N/S: Old 215 Frontage Road
 E/W: Alessandro Boulevard
 Weather: Clear

File Name : 40_MRV_Old 215 Frontage_Alessandro AM
 Site Code : 05119542
 Start Date : 8/20/2019
 Page No : 3

Start Time	Old 215 Frontage Road Southbound			Alessandro Boulevard Westbound			Old 215 Frontage Road Northbound			Alessandro Boulevard Eastbound				
	Left	Thru	Right	Left	Thru	Right	Left	Thru	Right	Left	Thru	Right		
Peak Hour Analysis From 07:15 AM to 08:00 AM - Peak 1 of 1	Peak Hour for Each Approach Begins at:													
	07:15 AM			07:15 AM			07:15 AM			07:15 AM				
+0 mins.	1	6	45	1	348	11	47	104	1	152	49	166	2	217
+15 mins.	3	9	45	1	306	12	50	88	1	139	38	146	3	187
+30 mins.	2	6	48	3	293	23	41	123	3	167	58	183	1	242
+45 mins.	8	4	48	1	314	21	39	72	6	117	66	147	4	217
Total Volume	14	25	186	6	1261	67	177	387	11	575	211	642	10	863
% App. Total	6.2	11.1	82.7	0.4	94.5	5	30.8	67.3	1.9	24.4	74.4	1.2	1.2	86.3
PHF	.438	.694	.969	.500	.906	.728	.885	.787	.458	.861	.799	.877	.625	.892

Counts Unlimited
 PO Box 1178
 Corona, CA 92878
 (951) 268-6268

City of Moreno Valley
 N/S: Old 215 Frontage Road
 E/W: Alessandro Boulevard
 Weather: Clear

File Name : 40_MRV_Old 215 Frontage_Alessandro AM
 Site Code : 05119542
 Start Date : 8/20/2019
 Page No : 1

Groups Printed- Large 2 Axle Vehicles

Start Time	Old 215 Frontage Road Southbound						Alessandro Boulevard Westbound						Old 215 Frontage Road Northbound						Alessandro Boulevard Eastbound					
	Left	Thru	Right	RTOR	App. Total		Left	Thru	Right	RTOR	App. Total		Left	Thru	Right	RTOR	App. Total		Left	Thru	Right	RTOR	App. Total	
07:00 AM	0	1	1	0	2		1	4	1	1	6		2	0	0	0	2		2	5	0	0	7	
07:15 AM	0	0	1	1	1		0	11	0	0	11		1	0	0	1	1		1	9	0	0	10	
07:30 AM	0	0	4	4	4		0	4	1	1	5		1	2	0	0	3		1	7	1	0	9	
07:45 AM	2	0	0	0	2		1	6	1	1	8		0	1	0	0	1		3	1	1	0	5	
Total	2	1	6	5	9		2	25	3	3	30		4	3	0	7		7	22	2	0	31		
08:00 AM	0	0	1	0	1		0	5	0	0	5		0	0	0	0	0		1	3	0	0	4	
08:15 AM	0	0	1	0	1		0	9	1	0	10		1	0	0	1	1		0	7	0	0	7	
08:30 AM	0	0	2	2	2		0	7	0	0	7		2	2	0	0	4		1	6	0	0	7	
08:45 AM	0	0	1	1	1		0	11	0	0	11		2	1	0	0	3		5	7	0	0	12	
Total	0	0	5	3	5		0	32	1	0	33		5	3	0	8		7	23	0	0	30		
Grand Total	2	1	11	8	14		2	57	4	3	63		9	6	0	15		14	45	2	0	61		
Apprch %	14.3	7.1	78.6				3.2	90.5	6.3				60	40	0		9.8		23	73.8	3.3		39.9	
Total %	1.3	0.7	7.2		9.2		1.3	37.3	2.6		41.2		5.9	3.9	0		9.8		9.2	29.4	1.3		6.7	93.3

3:1-585

Start Time	Old 215 Frontage Road Southbound						Alessandro Boulevard Westbound						Old 215 Frontage Road Northbound						Alessandro Boulevard Eastbound					
	Left	Thru	Right	RTOR	App. Total		Left	Thru	Right	RTOR	App. Total		Left	Thru	Right	RTOR	App. Total		Left	Thru	Right	RTOR	App. Total	
07:15 AM	0	0	0	1	1		0	11	0	0	11		1	0	0	0	1		1	9	0	0	10	
07:30 AM	0	0	0	4	4		0	4	1	1	5		1	2	0	0	3		3	1	1	1	7	
07:45 AM	2	0	0	0	2		1	6	1	1	8		0	1	0	0	1		3	1	1	0	5	
08:00 AM	0	0	0	1	1		0	0	0	0	0		0	0	0	0	0		0	0	0	0	0	
Total Volume	2	0	6	6	8		1	26	2	29	29		2	3	0	5		6	20	2	0	28		
% App. Total	.250	.000	.375	.75	.500		3.4	89.7	6.9		65.9		40	60	0	.417		21.4	71.4	7.1		.700		
PHF	.250	.000	.375	.500	.500		.250	.591	.500	.659	.659		.500	.375	.000	.417		.500	.556	.500		.700	.761	

Counts Unlimited
 PO Box 1178
 Corona, CA 92878
 (951) 268-6268

City of Moreno Valley
 N/S: Old 215 Frontage Road
 E/W: Alessandro Boulevard
 Weather: Clear

File Name : 40_MRV_Old 215 Frontage_Alessandro AM
 Site Code : 05119542
 Start Date : 8/20/2019
 Page No : 2

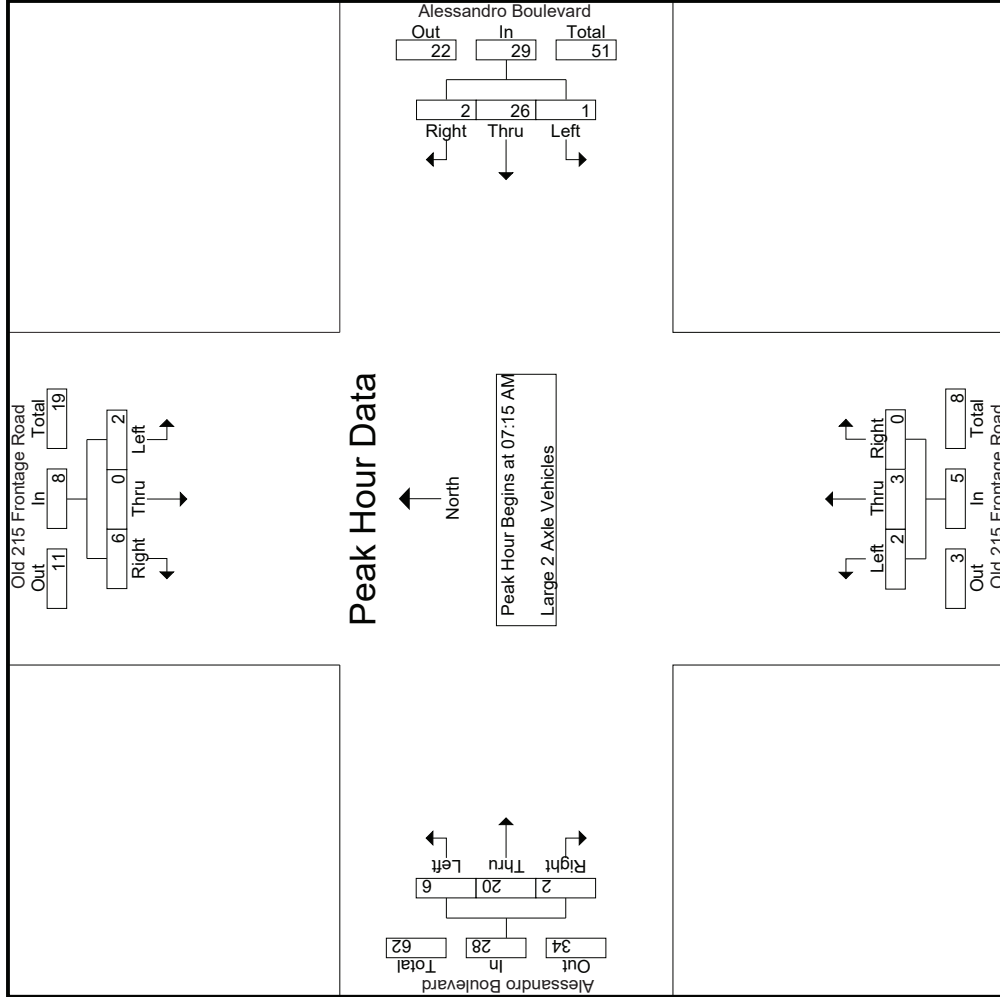

Counts Unlimited
 PO Box 1178
 Corona, CA 92878
 (951) 268-6268

City of Moreno Valley
 N/S: Old 215 Frontage Road
 E/W: Alessandro Boulevard
 Weather: Clear

File Name : 40_MRV_Old 215 Frontage_Alessandro AM
 Site Code : 05119542
 Start Date : 8/20/2019
 Page No : 3

Start Time	Old 215 Frontage Road Southbound			Alessandro Boulevard Westbound			Old 215 Frontage Road Northbound			Alessandro Boulevard Eastbound			
	Left	Thru	Right	Left	Thru	Right	Left	Thru	Right	Left	Thru	Right	
Peak Hour Analysis From 07:15 AM to 08:00 AM - Peak 1 of 1													
Peak Hour for Each Approach Begins at:													
+0 mins.	0	0	1	0	11	0	1	0	0	1	1	9	10
+15 mins.	0	0	4	0	4	1	1	2	0	3	1	7	9
+30 mins.	2	0	0	1	6	1	0	1	0	1	3	1	5
+45 mins.	0	0	1	0	5	0	0	0	0	0	1	3	4
Total Volume	2	0	6	1	26	2	2	3	0	5	6	20	28
% App. Total	.250	.000	.375	.250	.591	.500	.500	.375	.000	.417	.214	.714	.700
PHF													

Groups Printed- 3 Axle Vehicles

Start Time	Old 215 Frontage Road Southbound					Alessandro Boulevard Westbound					Old 215 Frontage Road Northbound					Alessandro Boulevard Eastbound							
	Left	Thru	Right	RTOR	App. Total	Left	Thru	Right	RTOR	App. Total	Left	Thru	Right	RTOR	App. Total	Left	Thru	Right	RTOR	App. Total	Exclu. Total	Inclu. Total	Int. Total
07:00 AM	0	0	0	0	0	1	2	0	0	3	2	1	2	2	5	0	0	0	0	0	2	8	10
07:15 AM	0	0	0	0	0	0	0	0	0	0	0	1	5	4	6	0	2	0	0	0	4	8	12
07:30 AM	0	1	0	0	1	0	0	0	0	0	1	0	0	0	1	0	2	0	0	2	0	4	4
07:45 AM	0	0	0	0	0	1	0	0	0	1	0	1	1	1	2	0	1	2	1	3	2	6	8
Total	0	1	0	0	1	2	2	0	0	4	3	3	8	7	14	0	5	2	1	7	8	26	34
08:00 AM	0	0	0	0	0	4	1	0	0	5	0	0	0	0	0	1	0	0	0	1	0	6	6
08:15 AM	0	0	0	0	0	2	1	0	0	3	0	0	3	1	3	0	0	1	0	1	1	7	8
08:30 AM	0	0	1	1	1	4	1	1	1	6	2	0	1	0	3	1	4	2	1	7	3	17	20
08:45 AM	0	0	1	1	1	2	0	0	0	2	1	2	7	3	10	1	1	1	1	3	5	16	21
Total	0	0	2	2	2	12	3	1	1	16	3	2	11	4	16	3	5	4	2	12	9	46	55
Grand Total	0	1	2	2	3	14	5	1	1	20	6	5	19	11	30	3	10	6	3	19	17	72	89
Approch %	0	33.3	66.7			70	25	5			20	16.7	63.3			15.8	52.6	31.6					
Total %	0	1.4	2.8		4.2	19.4	6.9	1.4		27.8	8.3	6.9	26.4	41.7		4.2	13.9	8.3		26.4	19.1	80.9	

3:1-588

Start Time	Old 215 Frontage Road Southbound					Alessandro Boulevard Westbound					Old 215 Frontage Road Northbound					Alessandro Boulevard Eastbound							
	Left	Thru	Right	RTOR	App. Total	Left	Thru	Right	RTOR	App. Total	Left	Thru	Right	RTOR	App. Total	Left	Thru	Right	RTOR	App. Total	Exclu. Total	Inclu. Total	Int. Total
07:15 AM	0	0	0	0	0	0	0	0	0	0	0	0	0	0	0	0	0	0	0	0	0	2	8
07:30 AM	0	1	0	0	1	0	0	0	0	0	1	0	0	0	1	0	2	0	0	2	0	4	12
07:45 AM	0	0	0	0	0	0	1	0	0	1	0	0	0	0	1	0	2	0	0	2	0	4	4
08:00 AM	0	0	0	0	0	1	0	0	0	1	0	1	1	1	2	0	1	2	1	3	2	6	8
Total Volume	0	1	0	0	1	5	1	1	1	6	1	2	6	6	9	1	5	2	1	5	2	8	24
% App. Total	0	100	0	0	0	83.3	16.7	0	0	0	11.1	22.2	66.7	0	0	12.5	62.5	25	0	0	25	66.7	75.0
PHF	.000	.250	.000	.000	.250	.313	.250	.000	.300	.300	.250	.500	.300	.375	.300	.250	.625	.250	.667	.667	.250	.667	.750

Peak Hour Analysis From 07:15 AM to 08:00 AM - Peak 1 of 1
 Peak Hour for Entire Intersection Begins at 07:15 AM

Counts Unlimited
 PO Box 1178
 Corona, CA 92878
 (951) 268-6268

City of Moreno Valley
 N/S: Old 215 Frontage Road
 E/W: Alessandro Boulevard
 Weather: Clear

File Name : 40_MRV_Old 215 Frontage_Alessandro AM
 Site Code : 05119542
 Start Date : 8/20/2019
 Page No : 2

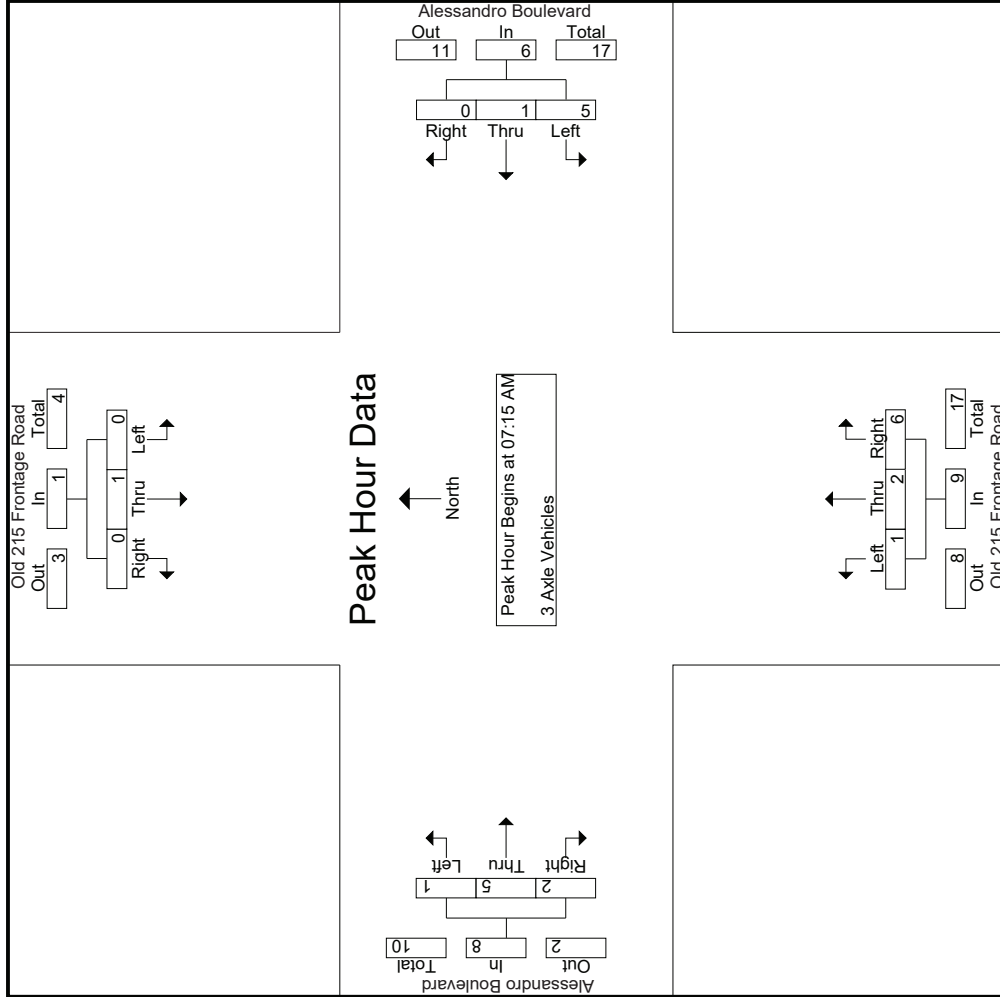

Counts Unlimited
 PO Box 1178
 Corona, CA 92878
 (951) 268-6268

City of Moreno Valley
 N/S: Old 215 Frontage Road
 E/W: Alessandro Boulevard
 Weather: Clear

File Name : 40_MRV_Old 215 Frontage_Alessandro AM
 Site Code : 05119542
 Start Date : 8/20/2019
 Page No : 3

Start Time	Old 215 Frontage Road Southbound			Alessandro Boulevard Westbound			Old 215 Frontage Road Northbound			Alessandro Boulevard Eastbound		
	Left	Thru	Right	Left	Thru	Right	Left	Thru	Right	Left	Thru	Right
Peak Hour Analysis From 07:15 AM to 08:00 AM - Peak 1 of 1												
Peak Hour for Each Approach Begins at:												
+0 mins.	0	0	0	0	0	0	0	1	5	6	0	2
+15 mins.	0	1	0	0	0	0	1	0	0	1	2	0
+30 mins.	0	0	0	1	0	1	0	1	1	2	1	3
+45 mins.	0	0	0	4	1	0	5	0	0	0	0	1
Total Volume	0	1	0	5	1	0	6	2	6	9	5	2
% App. Total	0	100	0	83.3	16.7	0	11.1	22.2	66.7	12.5	62.5	25
PHF	.000	.250	.000	.313	.250	.000	.300	.500	.300	.375	.250	.667

Counts Unlimited
 PO Box 1178
 Corona, CA 92878
 (951) 268-6268

City of Moreno Valley
 N/S: Old 215 Frontage Road
 E/W: Alessandro Boulevard
 Weather: Clear

File Name : 40_MRV_Old 215 Frontage_Alessandro AM
 Site Code : 05119542
 Start Date : 8/20/2019
 Page No : 1

Groups Printed- 4+ Axle Trucks

Start Time	Old 215 Frontage Road Southbound				Alessandro Boulevard Westbound				Old 215 Frontage Road Northbound				Alessandro Boulevard Eastbound						
	Left	Thru	Right	RTOR	Left	Thru	Right	RTOR	Left	Thru	Right	RTOR	Left	Thru	Right	RTOR	Exclu. Total	Inclu. Total	Int. Total
07:00 AM	0	1	0	0	0	3	0	0	3	0	0	0	0	3	0	0	0	11	11
07:15 AM	0	0	0	0	0	4	1	1	5	0	0	0	3	0	1	0	2	1	10
07:30 AM	0	0	0	0	0	4	1	1	5	0	0	0	2	0	4	1	5	2	12
07:45 AM	0	0	0	0	0	5	0	0	5	0	0	0	0	0	2	0	2	0	7
Total	0	1	0	0	0	16	2	2	18	1	8	0	9	0	10	2	12	3	40
08:00 AM	0	0	0	0	0	5	0	0	5	2	1	0	3	0	2	3	5	2	13
08:15 AM	0	1	0	0	0	3	0	0	3	1	5	0	6	0	5	0	5	0	15
08:30 AM	0	0	1	1	1	2	1	0	4	2	4	0	6	0	2	0	2	1	13
08:45 AM	0	1	0	0	1	5	0	0	5	0	2	0	2	2	4	0	6	0	14
Total	0	2	1	1	3	11	1	0	17	5	12	0	17	2	13	3	18	3	55
Grand Total	0	3	1	1	4	1	31	3	35	6	20	0	26	2	23	5	30	6	95
Approch %	0	75	25		2.9	88.6	8.6		23.1	76.9	0		27.4	6.7	76.7	16.7			101
Total %	0	3.2	1.1		1.1	32.6	3.2		36.8	6.3	21.1	0		2.1	24.2	5.3		5.9	94.1

3:1-591

Start Time	Old 215 Frontage Road Southbound				Alessandro Boulevard Westbound				Old 215 Frontage Road Northbound				Alessandro Boulevard Eastbound						
	Left	Thru	Right	RTOR	Left	Thru	Right	RTOR	Left	Thru	Right	RTOR	Left	Thru	Right	RTOR	Exclu. Total	Inclu. Total	Int. Total
07:15 AM	0	0	0	0	0	4	1	1	5	0	0	0	3	0	1	0	1	2	10
07:30 AM	0	0	0	0	0	4	1	1	5	0	2	0	0	2	4	1	1	5	12
07:45 AM	0	0	0	0	0	5	0	0	5	0	0	0	0	0	2	0	0	2	7
08:00 AM	0	0	0	0	0	0	0	0	0	2	1	0	0	2	3	0	3	5	13
Total Volume	0	0	0	0	0	18	2	20	20	2	6	0	8	0	9	5	14		42
% App. Total	0	0	0	0	0	90	10		25	75	0		64.3	35.7					
PHF	.000	.000	.000	.000	.000	.900	.500	1.00	.667	.250	.500	.000	.667	.000	.563	.417	.700		.808

Peak Hour Analysis From 07:15 AM to 08:00 AM - Peak 1 of 1
 Peak Hour for Entire Intersection Begins at 07:15 AM

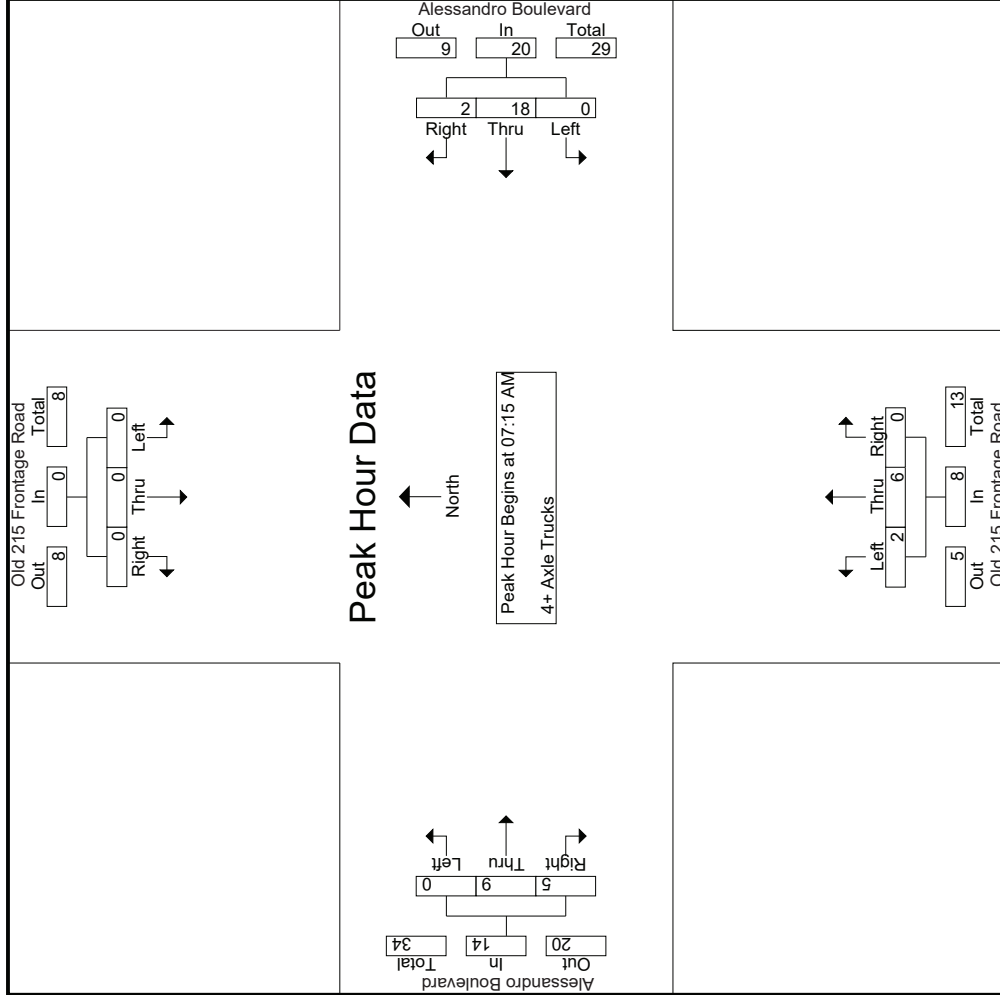

Counts Unlimited
 PO Box 1178
 Corona, CA 92878
 (951) 268-6268

City of Moreno Valley
 N/S: Old 215 Frontage Road
 E/W: Alessandro Boulevard
 Weather: Clear

File Name : 40_MRV_Old 215 Frontage_Alessandro AM
 Site Code : 05119542
 Start Date : 8/20/2019
 Page No : 3

Start Time	Old 215 Frontage Road Southbound			Alessandro Boulevard Westbound			Old 215 Frontage Road Northbound			Alessandro Boulevard Eastbound		
	Left	Thru	Right	Left	Thru	Right	Left	Thru	Right	Left	Thru	Right
Peak Hour Analysis From 07:15 AM to 08:00 AM - Peak 1 of 1												
Peak Hour for Each Approach Begins at:												
+0 mins.	0	0	0	0	0	0	0	0	0	0	0	0
+15 mins.	0	0	0	0	0	0	0	0	0	0	0	0
+30 mins.	0	0	0	0	0	0	0	0	0	0	0	0
+45 mins.	0	0	0	0	0	0	0	0	0	0	0	0
Total Volume	0	0	0	0	18	2	20	6	0	0	9	5
% App. Total	0	0	0	0	90	10	100	75	0	0	64.3	35.7
PHF	.000	.000	.000	.000	.900	.500	1.000	.500	.000	.000	.563	.417

Counts Unlimited
 PO Box 1178
 Corona, CA 92878
 (951) 268-6268

City of Moreno Valley
 N/S: Old 215 Frontage Road
 E/W: Alessandro Boulevard
 Weather: Clear

File Name : 40_MRV_Old 215 Frontage_Alessandro PM
 Site Code : 05119542
 Start Date : 8/20/2019
 Page No : 2

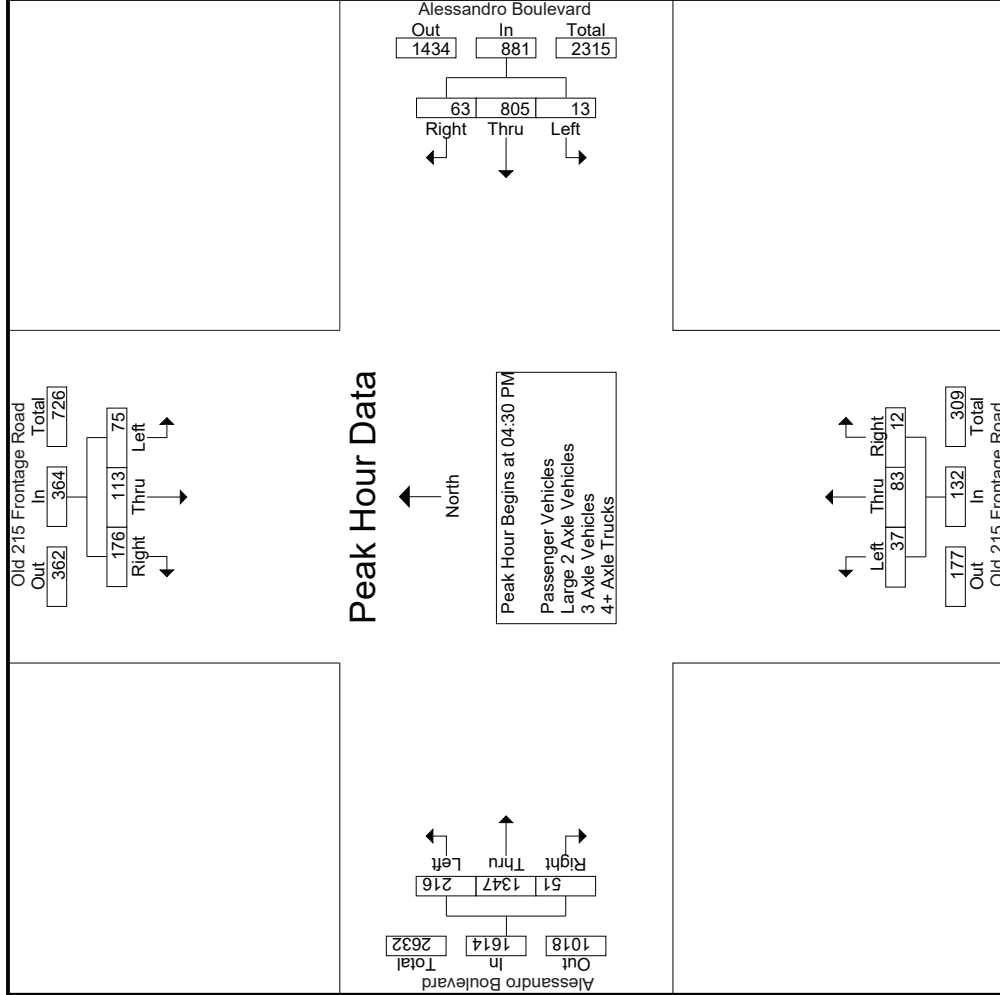

Counts Unlimited
 PO Box 1178
 Corona, CA 92878
 (951) 268-6268

City of Moreno Valley
 N/S: Old 215 Frontage Road
 E/W: Alessandro Boulevard
 Weather: Clear

File Name : 40_MRV_Old 215 Frontage_Alessandro PM
 Site Code : 05119542
 Start Date : 8/20/2019
 Page No : 3

Start Time	Old 215 Frontage Road Southbound			Alessandro Boulevard Westbound			Old 215 Frontage Road Northbound			Alessandro Boulevard Eastbound					
	Left	Thru	Right	Left	Thru	Right	Left	Thru	Right	Left	Thru	Right			
Peak Hour Analysis From 04:00 PM to 05:45 PM - Peak 1 of 1															
Peak Hour for Each Approach Begins at:															
	04:15 PM														
+0 mins.	19	29	44	92	191	15	211	9	24	2	35	48	341	13	402
+15 mins.	24	32	49	105	214	14	230	14	24	3	41	51	302	11	364
+30 mins.	12	23	39	74	190	20	211	5	23	6	34	55	333	14	402
+45 mins.	20	30	46	96	219	14	234	15	27	2	44	62	371	13	446
Total Volume	75	114	178	367	814	63	886	43	98	13	154	216	1347	51	1614
% App. Total	20.4	31.1	48.5	87.4	91.9	7.1	947	27.9	63.6	8.4	87.5	13.4	83.5	3.2	905
PHF	.781	.891	.908	.874	.929	.788	.947	.717	.907	.542	.875	.871	.908	.911	.905

Groups Printed- Passenger Vehicles

Start Time	Old 215 Frontage Road Southbound						Alessandro Boulevard Westbound						Old 215 Frontage Road Northbound						Alessandro Boulevard Eastbound					
	Left	Thru	Right	RTOR	App. Total		Left	Thru	Right	RTOR	App. Total		Left	Thru	Right	RTOR	App. Total		Left	Thru	Right	RTOR	App. Total	
04:00 PM	13	19	44	39	76		2	198	19	6	219		9	21	2	2	32		59	295	6	2	360	
04:15 PM	17	28	42	30	87		2	176	17	2	195		10	24	3	3	37		59	343	8	0	410	
04:30 PM	24	32	48	37	104		4	206	14	2	224		4	22	5	3	31		48	332	9	2	389	
04:45 PM	10	23	39	21	72		5	191	15	6	211		9	26	2	2	37		51	297	4	0	352	
Total	64	102	173	127	339		13	771	65	16	849		32	93	12	10	137		217	1267	27	4	1511	
05:00 PM	20	30	45	33	95		2	211	14	4	227		7	13	3	1	23		55	327	10	5	392	
05:15 PM	18	27	42	27	87		1	186	20	8	207		5	20	1	1	26		62	363	7	3	432	
05:30 PM	22	30	33	19	85		1	213	14	3	228		2	12	2	2	16		57	306	5	1	368	
05:45 PM	12	27	39	23	78		6	144	12	2	162		3	26	1	1	30		46	321	4	1	371	
Total	72	114	159	102	345		10	754	60	17	824		17	71	7	5	95		220	1317	26	10	1563	
Grand Total	136	216	332	229	684		23	1525	125	33	1673		49	164	19	15	232		437	2584	53	14	3074	
Approch %	19.9	31.6	48.5				1.4	91.2	7.5				21.1	70.7	8.2				14.2	84.1	1.7			
Total %	2.4	3.8	5.9		12.1		0.4	26.9	2.2		29.5		0.9	2.9	0.3		4.1		7.7	45.6	0.9		54.3	

Start Time	Old 215 Frontage Road Southbound						Alessandro Boulevard Westbound						Old 215 Frontage Road Northbound						Alessandro Boulevard Eastbound					
	Left	Thru	Right	RTOR	App. Total		Left	Thru	Right	RTOR	App. Total		Left	Thru	Right	RTOR	App. Total		Left	Thru	Right	RTOR	App. Total	
04:30 PM	24	32	48		104		4	206	14		224		4	22	5		31		48	332	9		389	
04:45 PM	10	23	39		72		5	191	15		211		9	26	2		37		51	297	4		352	
05:00 PM	20	30	45		95		2	211	14		227		7	13	3		23		55	327	10		392	
05:15 PM	18	27	39		87		1	186	20		207		5	20	1		26		62	363	7		432	
Total Volume	72	112	174		358		12	794	63		869		25	81	11		117		216	1319	30		1565	
% App. Total	20.1	31.3	48.6				1.4	91.4	7.2				21.4	69.2	9.4				13.8	84.3	1.9			
PHF	.750	.875	.906		.861		.600	.941	.788		.957		.694	.779	.550		.791		.871	.908	.750		.906	

Peak Hour Analysis From 04:30 PM to 05:15 PM - Peak 1 of 1
 Peak Hour for Entire Intersection Begins at 04:30 PM

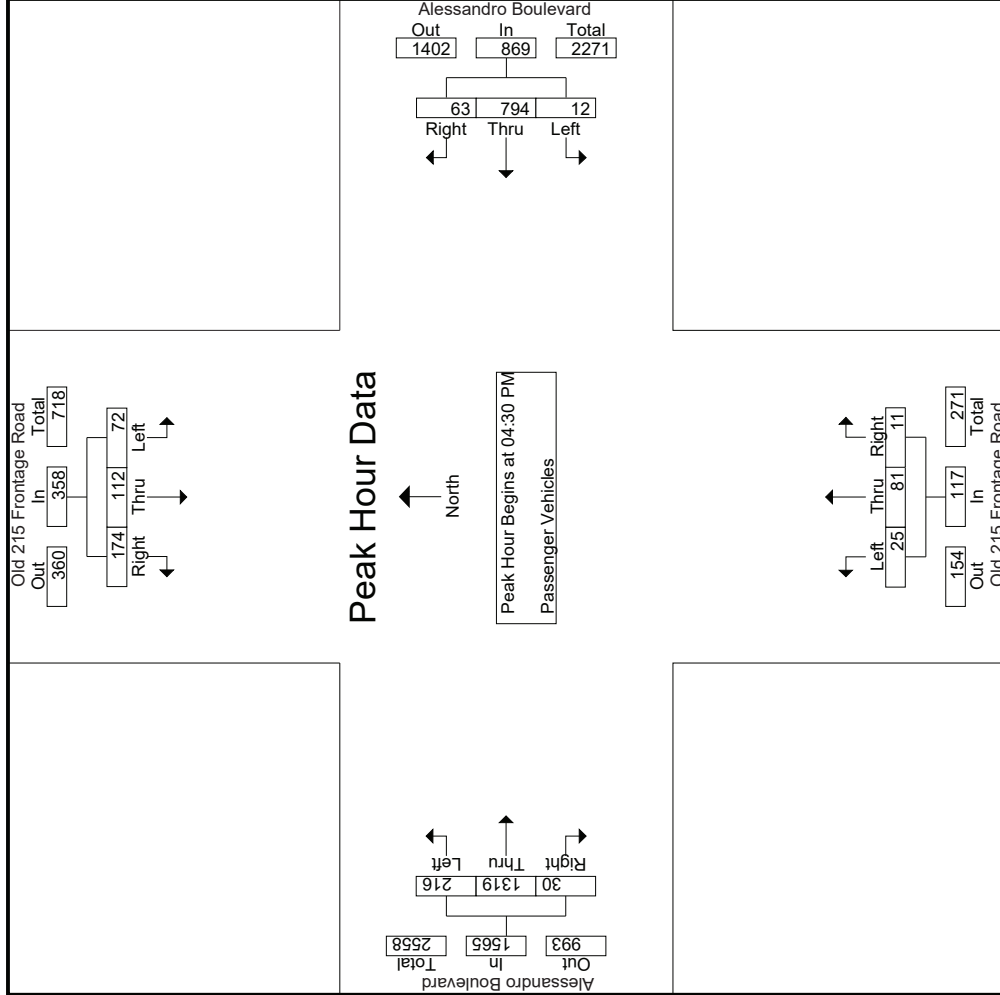

Counts Unlimited
 PO Box 1178
 Corona, CA 92878
 (951) 268-6268

City of Moreno Valley
 N/S: Old 215 Frontage Road
 E/W: Alessandro Boulevard
 Weather: Clear

File Name : 40_MRV_Old 215 Frontage_Alessandro PM
 Site Code : 05119542
 Start Date : 8/20/2019
 Page No : 3

Start Time	Old 215 Frontage Road Southbound			Alessandro Boulevard Westbound			Old 215 Frontage Road Northbound			Alessandro Boulevard Eastbound					
	Left	Thru	Right	Left	Thru	Right	Left	Thru	Right	Left	Thru	Right			
Peak Hour Analysis From 04:30 PM to 05:15 PM - Peak 1 of 1															
Peak Hour for Each Approach Begins at:															
	04:30 PM														
+0 mins.	24	32	48	4	206	14	4	224	14	4	22	5	48	332	9
+15 mins.	10	23	39	5	191	15	9	211	15	9	26	2	51	297	4
+30 mins.	20	30	45	2	211	14	7	227	14	7	13	3	55	327	10
+45 mins.	18	27	42	1	186	20	5	207	20	5	20	1	62	363	7
Total Volume	72	112	174	12	794	63	25	869	63	25	81	11	216	1319	30
% App. Total	20.1	31.3	48.6	1.4	91.4	7.2	21.4	69.2	9.4	21.4	69.2	9.4	13.8	84.3	1.9
PHF	.750	.875	.906	.600	.941	.788	.694	.957	.788	.694	.779	.550	.871	.908	.750
															.906

Groups Printed- Large 2 Axle Vehicles

Start Time	Old 215 Frontage Road Southbound						Alessandro Boulevard Westbound						Old 215 Frontage Road Northbound						Alessandro Boulevard Eastbound								
	Left	Thru	Right	RTOR	App. Total		Left	Thru	Right	RTOR	App. Total		Left	Thru	Right	RTOR	App. Total		Left	Thru	Right	RTOR	App. Total		Exclu. Total	Inclu. Total	Int. Total
04:00 PM	1	0	0	0	1		0	1	0	0	1		0	2	0	0	2		1	5	0	0	6		0	0	10
04:15 PM	0	0	0	0	0		6	0	0	0	6		1	0	0	0	1		3	0	0	0	4		0	0	11
04:30 PM	0	0	1	1	1		2	0	0	0	2		0	0	0	0	0		5	0	0	0	5		1	0	8
04:45 PM	1	0	0	0	1		0	0	0	0	0		2	0	0	0	2		0	3	0	0	3		0	0	6
Total	2	0	1	1	3		9	0	0	0	9		3	2	0	0	5		2	16	0	0	18		1	35	36
05:00 PM	0	0	0	0	0		0	2	0	0	2		0	0	0	0	0		0	4	2	1	6		1	0	8
05:15 PM	1	0	0	0	1		2	0	0	0	2		0	0	0	0	0		0	5	0	0	5		0	0	8
05:30 PM	0	0	0	0	0		2	0	0	0	2		1	0	0	0	1		0	1	0	0	1		0	0	4
05:45 PM	0	0	1	1	1		0	0	0	0	0		1	0	0	0	1		0	3	0	0	3		1	0	5
Total	1	0	1	1	2		6	0	0	0	6		2	0	0	0	2		0	13	2	1	15		2	25	27
Grand Total	3	0	2	2	5		15	0	0	0	15		3	4	0	0	7		2	29	2	1	33		3	60	63
Approch %	60	0	40				100	0					42.9	57.1	0				6.1	87.9	6.1				4.8	95.2	
Total %	5	0	3.3		8.3		25	0			25		5	6.7	0		11.7		3.3	48.3	3.3		55				

Start Time	Old 215 Frontage Road Southbound						Alessandro Boulevard Westbound						Old 215 Frontage Road Northbound						Alessandro Boulevard Eastbound								
	Left	Thru	Right	RTOR	App. Total		Left	Thru	Right	RTOR	App. Total		Left	Thru	Right	RTOR	App. Total		Left	Thru	Right	RTOR	App. Total		Exclu. Total	Inclu. Total	Int. Total
04:30 PM	0	0	0	0	0		0	0	0	0	0		0	0	0	0	0		0	0	0	0	0		0	0	5
04:45 PM	1	0	0	0	1		0	0	0	0	0		2	0	0	0	2		0	0	0	0	0		0	0	3
05:00 PM	0	0	0	0	0		0	0	0	0	0		0	0	0	0	0		0	0	0	0	0		0	0	6
05:15 PM	1	0	0	0	1		2	0	0	0	2		2	0	0	0	2		0	0	0	0	0		0	0	8
Total Volume	2	0	0	0	1		6	0	0	0	6		6	0	0	0	6		2	0	0	0	2		2	19	30
% App. Total	66.7	0	33.3				100	0			100		100	0	0		100		0	89.5	10.5		10.5		0.250	.792	.938
PHF	.500	.000	.250		.750		.000	.750	.000	.000	.750		.250	.000	.000	.000	.250		.000	.850	.250		.792		.250	.792	.938

Peak Hour Analysis From 04:30 PM to 05:15 PM - Peak 1 of 1
 Peak Hour for Entire Intersection Begins at 04:30 PM

Counts Unlimited
 PO Box 1178
 Corona, CA 92878
 (951) 268-6268

City of Moreno Valley
 N/S: Old 215 Frontage Road
 E/W: Alessandro Boulevard
 Weather: Clear

File Name : 40_MRV_Old 215 Frontage_Alessandro PM
 Site Code : 05119542
 Start Date : 8/20/2019
 Page No : 2

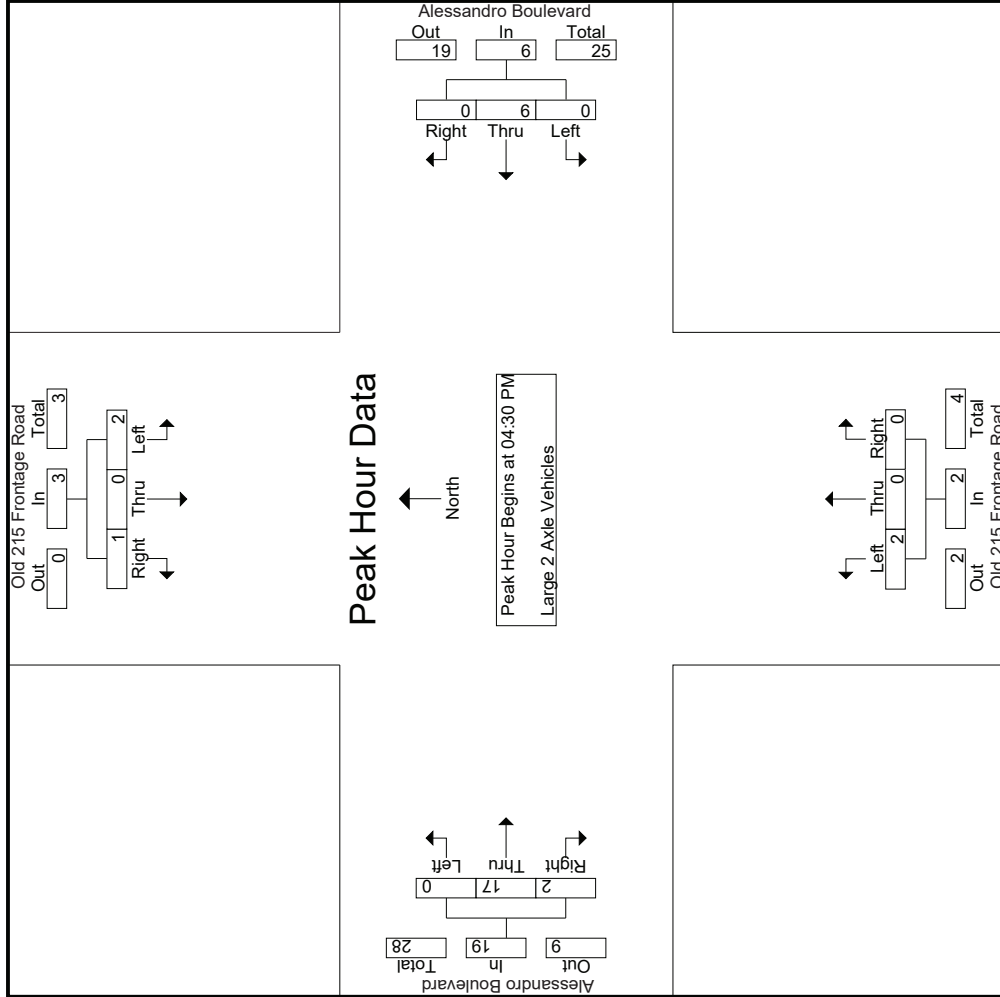

Counts Unlimited
 PO Box 1178
 Corona, CA 92878
 (951) 268-6268

City of Moreno Valley
 N/S: Old 215 Frontage Road
 E/W: Alessandro Boulevard
 Weather: Clear

File Name : 40_MRV_Old 215 Frontage_Alessandro PM
 Site Code : 05119542
 Start Date : 8/20/2019
 Page No : 3

Start Time	Old 215 Frontage Road Southbound			Alessandro Boulevard Westbound			Old 215 Frontage Road Northbound			Alessandro Boulevard Eastbound		
	Left	Thru	Right	Left	Thru	Right	Left	Thru	Right	Left	Thru	Right
Peak Hour Analysis From 04:30 PM to 05:15 PM - Peak 1 of 1												
Peak Hour for Each Approach Begins at:												
	04:30 PM											
+0 mins.	0	0	1	0	0	2	0	0	0	0	0	0
+15 mins.	1	0	0	0	0	0	2	0	0	0	0	0
+30 mins.	0	0	0	2	0	2	0	0	0	0	0	2
+45 mins.	1	0	0	0	2	2	0	0	0	0	5	0
Total Volume	2	0	1	6	6	6	2	0	0	0	17	2
% App. Total	66.7	0	33.3	0	100	0	100	0	0	0	89.5	10.5
PHF	.500	.000	.250	.000	.750	.750	.250	.000	.000	.000	.850	.250

Groups Printed- 3 Axle Vehicles

Start Time	Old 215 Frontage Road Southbound				Alessandro Boulevard Westbound				Old 215 Frontage Road Northbound				Alessandro Boulevard Eastbound					
	Left	Thru	Right	RTOR	App. Total	Left	Thru	Right	RTOR	App. Total	Left	Thru	Right	RTOR	App. Total	Exclu. Total	Inclu. Total	Int. Total
04:00 PM	0	0	0	0	0	1	0	0	0	1	0	0	0	0	0	0	1	1
04:15 PM	0	0	0	0	0	0	1	1	0	2	0	0	0	0	0	0	2	2
04:30 PM	0	0	0	0	0	1	1	0	0	2	0	0	0	0	1	0	3	3
04:45 PM	0	0	0	0	0	0	0	0	0	0	1	0	0	0	1	0	2	2
Total	0	0	0	0	0	2	2	1	0	5	1	0	0	0	2	0	8	8
05:00 PM	0	0	0	0	0	0	0	0	0	0	0	0	0	0	0	0	0	0
05:15 PM	0	0	0	0	0	0	1	0	0	1	0	0	0	0	1	0	2	2
05:30 PM	0	0	0	0	0	0	0	0	0	0	0	0	0	0	0	0	0	0
05:45 PM	0	0	1	0	1	0	0	0	0	0	0	0	0	0	0	0	1	1
Total	0	0	1	0	1	0	1	0	0	1	0	0	0	0	1	0	3	3
Grand Total	0	0	1	0	1	2	3	1	0	6	1	0	0	0	3	0	11	11
Apprch %	0	0	100		33.3	50	16.7			100	0	0		0	100	0	100	
Total %	0	0	9.1		9.1	18.2	27.3	9.1		54.5	9.1	0	0		27.3	0	100	

3.1-603

Start Time	Old 215 Frontage Road Southbound				Alessandro Boulevard Westbound				Old 215 Frontage Road Northbound				Alessandro Boulevard Eastbound					
	Left	Thru	Right	RTOR	App. Total	Left	Thru	Right	RTOR	App. Total	Left	Thru	Right	RTOR	App. Total	Exclu. Total	Inclu. Total	Int. Total
04:30 PM	0	0	0	0	0	1	0	0	0	1	0	0	0	0	0	0	1	1
04:45 PM	0	0	0	0	0	0	0	0	0	0	1	0	0	0	1	0	1	2
05:00 PM	0	0	0	0	0	0	0	0	0	0	0	0	0	0	0	0	0	0
05:15 PM	0	0	0	0	0	0	0	1	0	1	0	0	0	0	1	0	1	2
Total Volume	0	0	0	0	0	1	2	0	3	3	1	0	0	1	3	0	3	7
% App. Total	0	0	0	0	0	33.3	66.7	0	0	100	0	0	0	0	100	0	100	0
PHF	.000	.000	.000	.000	.000	.250	.500	.000	.375	.000	.250	.000	.000	.250	.750	.000	.750	.583

Peak Hour Analysis From 04:30 PM to 05:15 PM - Peak 1 of 1
 Peak Hour for Entire Intersection Begins at 04:30 PM

Counts Unlimited
 PO Box 1178
 Corona, CA 92878
 (951) 268-6268

City of Moreno Valley
 N/S: Old 215 Frontage Road
 E/W: Alessandro Boulevard
 Weather: Clear

File Name : 40_MRV_Old 215 Frontage_Alessandro PM
 Site Code : 05119542
 Start Date : 8/20/2019
 Page No : 2

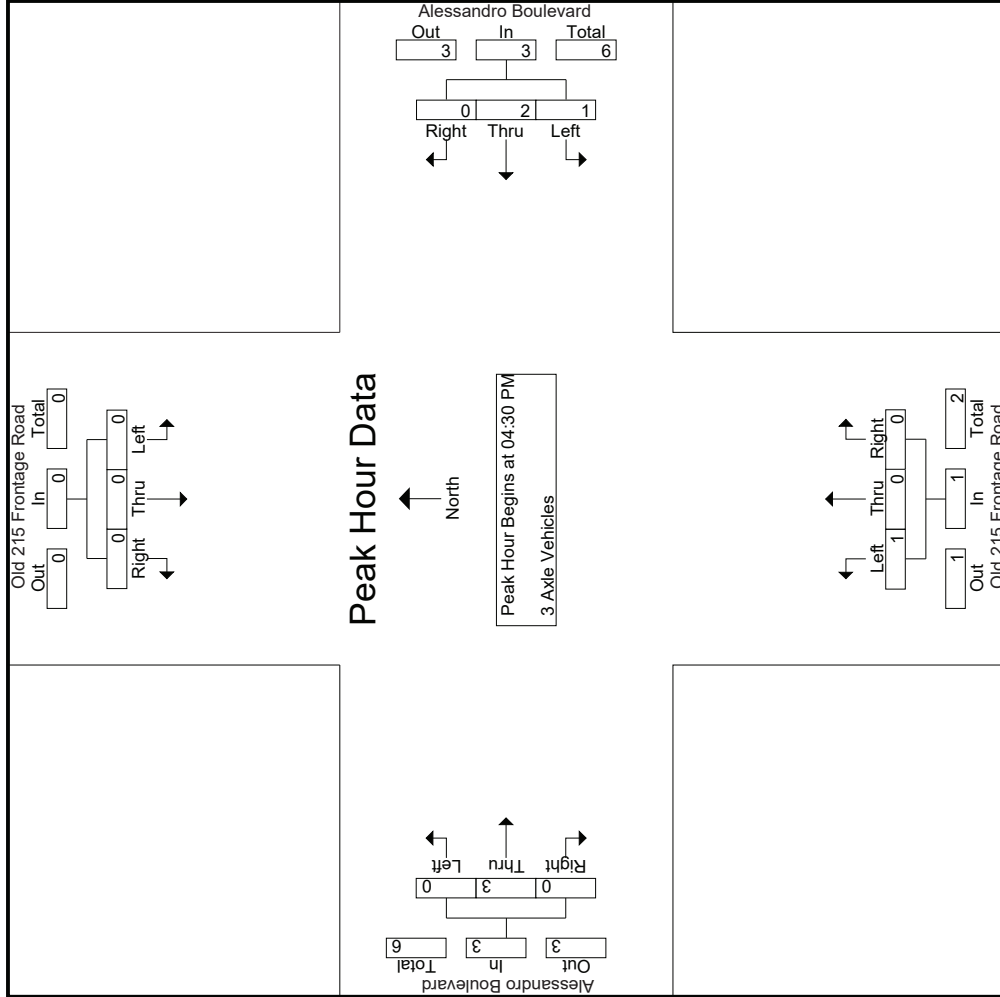

Counts Unlimited
 PO Box 1178
 Corona, CA 92878
 (951) 268-6268

City of Moreno Valley
 N/S: Old 215 Frontage Road
 E/W: Alessandro Boulevard
 Weather: Clear

File Name : 40_MRV_Old 215 Frontage_Alessandro PM
 Site Code : 05119542
 Start Date : 8/20/2019
 Page No : 3

Start Time	Old 215 Frontage Road Southbound			Alessandro Boulevard Westbound			Old 215 Frontage Road Northbound			Alessandro Boulevard Eastbound					
	Left	Thru	Right	Left	Thru	Right	Left	Thru	Right	Left	Thru	Right			
Peak Hour Analysis From 04:30 PM to 05:15 PM - Peak 1 of 1															
Peak Hour for Each Approach Begins at:															
+0 mins.	0	0	0	04:30 PM	1	0	0	04:30 PM	2	0	0	04:30 PM	0	0	0
+15 mins.	0	0	0	0	0	0	0	0	0	1	0	0	0	0	1
+30 mins.	0	0	0	0	0	0	0	0	0	0	0	0	0	0	0
+45 mins.	0	0	0	0	0	0	0	0	0	0	0	0	0	0	0
Total Volume	0	0	0	1	2	0	1	0	0	1	0	0	0	3	0
% App. Total	0	0	0	33.3	66.7	0	.250	.500	.000	.375	.000	.000	.000	.750	.000
PHF	.000	.000	.000	.250	.500	.000	.250	.375	.000	.250	.000	.000	.000	.750	.000

Groups Printed- 4+ Axle Trucks

Start Time	Old 215 Frontage Road Southbound					Alessandro Boulevard Westbound					Old 215 Frontage Road Northbound					Alessandro Boulevard Eastbound							
	Left	Thru	Right	RTOR	App. Total	Left	Thru	Right	RTOR	App. Total	Left	Thru	Right	RTOR	App. Total	Left	Thru	Right	RTOR	App. Total	Exclu. Total	Inclu. Total	Int. Total
04:00 PM	0	0	1	1	1	0	3	0	0	3	0	1	0	0	1	1	1	5	1	7	2	12	14
04:15 PM	2	1	2	1	5	0	2	0	0	2	3	0	0	0	3	0	3	5	0	8	1	18	19
04:30 PM	0	0	0	0	0	0	1	0	0	1	1	1	1	1	3	0	3	4	1	7	2	11	13
04:45 PM	1	0	0	0	1	0	0	0	0	0	3	1	0	0	4	0	1	7	4	8	4	13	17
Total	3	1	3	2	7	0	6	0	0	6	7	3	1	1	11	1	8	21	6	30	9	54	63
05:00 PM	0	0	1	1	1	0	1	0	0	1	3	0	0	0	3	0	2	2	1	4	2	9	11
05:15 PM	0	1	0	0	1	0	1	0	0	1	2	0	0	0	2	0	2	6	1	8	1	12	13
05:30 PM	0	0	0	0	0	0	4	0	0	4	3	0	0	0	3	0	2	0	0	2	0	9	9
05:45 PM	1	0	1	0	2	0	0	0	0	0	2	1	0	0	3	0	1	6	1	7	1	12	13
Total	1	1	2	1	4	0	6	0	0	6	10	1	0	0	11	0	7	14	3	21	4	42	46
Grand Total	4	2	5	3	11	0	12	0	0	12	17	4	1	1	22	1	15	35	9	51	13	96	109
Approch %	36.4	18.2	45.5			0	100	0		77.3	18.2	4.5			22.9	2	29.4	68.6		53.1	11.9	88.1	
Total %	4.2	2.1	5.2		11.5	0	12.5	0		12.5	17.7	4.2			22.9	1	15.6	36.5		53.1	11.9	88.1	

3:1-606

Start Time	Old 215 Frontage Road Southbound					Alessandro Boulevard Westbound					Old 215 Frontage Road Northbound					Alessandro Boulevard Eastbound							
	Left	Thru	Right	RTOR	App. Total	Left	Thru	Right	RTOR	App. Total	Left	Thru	Right	RTOR	App. Total	Left	Thru	Right	RTOR	App. Total	Exclu. Total	Inclu. Total	Int. Total
04:30 PM	0	0	0	0	0	0	0	0	0	0	1	1	1	1	3	0	0	0	0	3	4	7	11
04:45 PM	1	0	0	0	1	0	0	0	0	0	3	1	0	0	4	0	1	7	8	1	7	8	13
05:00 PM	0	0	0	0	0	0	0	0	0	0	3	0	0	0	3	0	2	2	2	2	2	4	9
05:15 PM	0	0	1	0	1	0	1	0	0	1	2	0	0	0	3	0	2	6	8	2	6	8	12
Total Volume	1	1	1	1	3	0	3	0	0	3	9	2	1	1	12	0	8	19	27	8	19	27	45
% App. Total	33.3	33.3	33.3		33.3	0	100	0		75	16.7	8.3			29.6	0	70.4	70.4		70.4	70.4	70.4	86.5
PHF	.250	.250	.250		.750	.000	.750	.000		.750	.750	.500	.250		.750	.000	.667	.679		.844	.844	.844	.865

Peak Hour Analysis From 04:30 PM to 05:15 PM - Peak 1 of 1
 Peak Hour for Entire Intersection Begins at 04:30 PM

Counts Unlimited
 PO Box 1178
 Corona, CA 92878
 (951) 268-6268

City of Moreno Valley
 N/S: Old 215 Frontage Road
 E/W: Alessandro Boulevard
 Weather: Clear

File Name : 40_MRV_Old 215 Frontage_Alessandro PM
 Site Code : 05119542
 Start Date : 8/20/2019
 Page No : 2

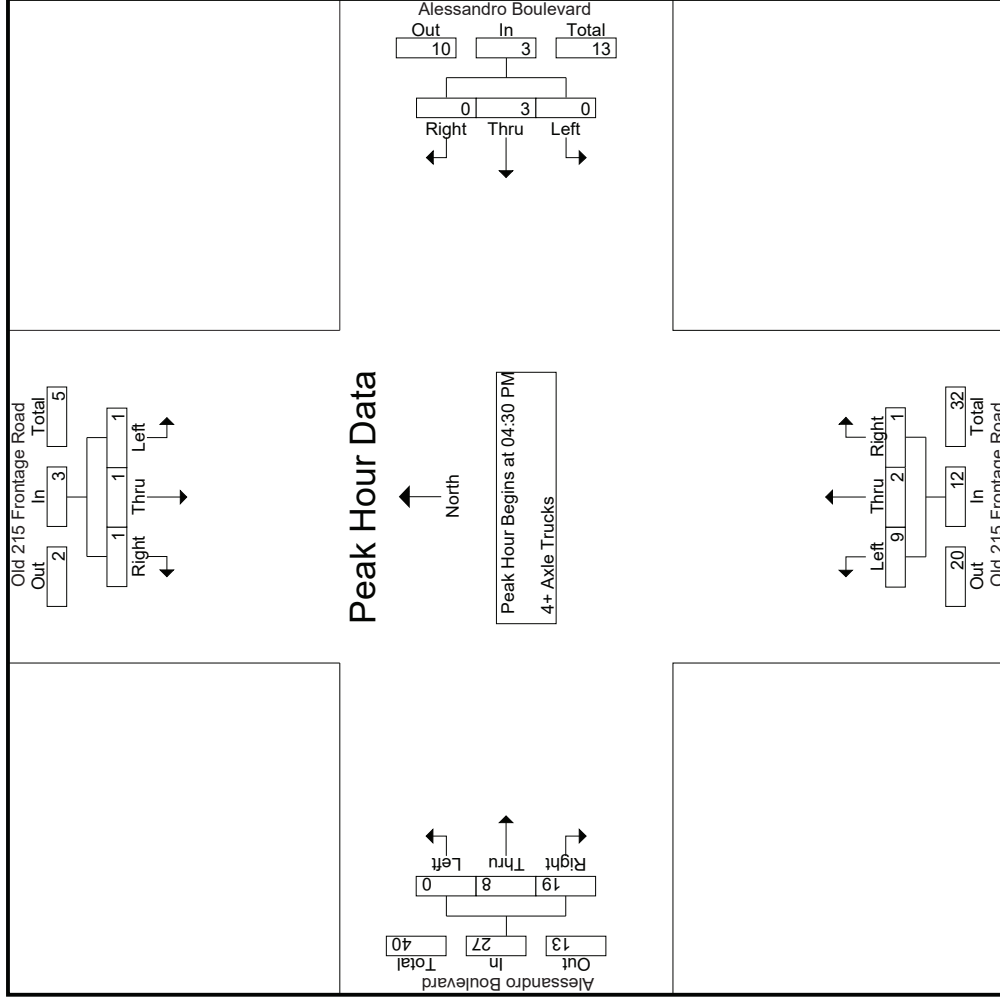

Location: Moreno Valley
 N/S: Old 215 Frontage Road
 E/W: Alessandro Boulevard



Date: 8/20/2019
 Day: Tuesday

PEDESTRIANS

	North Leg Old 215 Frontage Road Pedestrians	East Leg Alessandro Boulevard Pedestrians	South Leg Old 215 Frontage Road Pedestrians	West Leg Alessandro Boulevard Pedestrians	
7:00 AM	0	0	0	0	0
7:15 AM	0	0	0	0	0
7:30 AM	0	0	0	0	0
7:45 AM	0	0	0	0	0
8:00 AM	0	0	0	0	0
8:15 AM	0	1	0	0	1
8:30 AM	0	0	0	0	0
8:45 AM	0	0	1	0	1
TOTAL VOLUMES:	0	1	1	0	2

	North Leg Old 215 Frontage Road Pedestrians	East Leg Alessandro Boulevard Pedestrians	South Leg Old 215 Frontage Road Pedestrians	West Leg Alessandro Boulevard Pedestrians	
4:00 PM	0	0	0	0	0
4:15 PM	0	0	0	0	0
4:30 PM	0	0	0	0	0
4:45 PM	0	0	0	0	0
5:00 PM	0	0	0	0	0
5:15 PM	0	0	0	0	0
5:30 PM	0	0	0	0	0
5:45 PM	0	0	0	0	0
TOTAL VOLUMES:	0	0	0	0	0

Location: Moreno Valley
 N/S: Old 215 Frontage Road
 E/W: Alessandro Boulevard



Date: 8/20/2019
 Day: Tuesday

BICYCLES

	Southbound Old 215 Frontage Road			Westbound Alessandro Boulevard			Northbound Old 215 Frontage Road			Eastbound Alessandro Boulevard			
	Left	Thru	Right	Left	Thru	Right	Left	Thru	Right	Left	Thru	Right	
7:00 AM	0	0	0	0	0	0	0	0	0	0	2	0	2
7:15 AM	0	0	0	0	0	0	0	0	0	0	0	0	0
7:30 AM	0	0	0	0	1	0	0	0	0	0	0	0	1
7:45 AM	0	0	0	0	0	0	0	0	0	0	0	0	0
8:00 AM	0	0	0	0	1	0	0	0	0	0	0	0	1
8:15 AM	0	0	0	0	0	0	0	0	0	1	0	0	1
8:30 AM	0	0	0	0	0	0	0	0	0	0	0	0	0
8:45 AM	0	0	0	0	0	0	0	0	0	0	0	0	0
TOTAL VOLUMES:	0	0	0	0	2	0	0	0	0	1	2	0	5

	Southbound Old 215 Frontage Road			Westbound Alessandro Boulevard			Northbound Old 215 Frontage Road			Eastbound Alessandro Boulevard			
	Left	Thru	Right	Left	Thru	Right	Left	Thru	Right	Left	Thru	Right	
4:00 PM	0	0	0	0	0	0	0	0	0	0	0	0	0
4:15 PM	0	0	0	0	0	0	0	0	0	0	0	0	0
4:30 PM	0	0	0	0	0	0	0	0	0	0	0	0	0
4:45 PM	0	0	0	0	0	0	0	0	0	0	0	0	0
5:00 PM	0	0	0	0	0	0	0	0	0	0	0	0	0
5:15 PM	0	0	0	0	0	0	0	0	0	0	0	0	0
5:30 PM	0	0	0	0	0	0	0	0	0	0	0	0	0
5:45 PM	0	0	0	0	1	0	0	0	0	0	0	0	1
TOTAL VOLUMES:	0	0	0	0	1	0	0	0	0	0	0	0	1

Counts Unlimited
PO Box 1178
Corona, CA 92878
(951) 268-6268

City of Moreno Valley
N/S: Day Street
EW: Alessandro Boulevard
Weather: Clear

File Name : 07_MRV_Day_Alessandro AM
Site Code : 05119512
Start Date : 8/20/2019
Page No : 1

Groups Printed- Passenger Vehicles - Large 2 Axle Vehicles - 3 Axle Vehicles - 4+ Axle Trucks

Start Time	Day Street Southbound						Alessandro Boulevard Westbound						Day Street Northbound						Alessandro Boulevard Eastbound									
	Left	Thru	Right	RTOR	App. Total		Left	Thru	Right	RTOR	App. Total		Left	Thru	Right	RTOR	App. Total		Left	Thru	Right	RTOR	App. Total					
	Exclu. Total	Inclu. Total	Int. Total				Exclu. Total	Inclu. Total	Int. Total				Exclu. Total	Inclu. Total	Int. Total				Exclu. Total	Inclu. Total	Int. Total							
07:00 AM	6	5	33	12	44		5	383	21	6	409		3	19	8	6	30		16	93	4	0	113		24	596	620	
07:15 AM	11	7	33	22	51		8	302	16	5	326		4	22	2	1	28		33	133	3	0	169		28	574	602	
07:30 AM	9	13	20	12	42		3	293	18	3	314		4	37	7	7	48		30	134	6	0	170		22	574	596	
07:45 AM	14	5	22	10	41		7	278	29	11	314		3	36	5	5	44		40	140	5	0	185		26	584	610	
Total	40	30	108	56	178		23	1256	84	25	1363		14	114	22	19	150		119	500	18	0	637		100	2328	2428	
08:00 AM	10	5	16	8	31		1	319	37	5	357		4	28	2	2	34		19	142	4	0	165		15	587	602	
08:15 AM	17	6	28	17	51		2	284	17	7	303		5	29	5	1	39		27	143	1	0	171		25	564	589	
08:30 AM	8	5	14	5	27		3	233	19	3	255		1	11	4	2	16		29	146	3	0	178		10	476	486	
08:45 AM	13	7	22	15	42		5	218	27	3	250		7	22	2	2	31		48	164	3	2	215		22	538	560	
Total	48	23	80	45	151		11	1054	100	18	1165		17	90	13	7	120		123	595	11	2	729		72	2165	2237	
Grand Total	88	53	188	101	329		34	2310	184	43	2528		31	204	35	26	270		242	1095	29	2	1366		172	4493	4665	
Approch %	26.7	16.1	57.1				1.3	91.4	7.3				11.5	75.6	13				17.7	80.2	2.1				3.7	96.3		
Total %	2	1.2	4.2				0.8	51.4	4.1				0.7	4.5	0.8				5.4	24.4	0.6				30.4			
Passenger Vehicles	85	52	185				29	2235	177				12	202	24				237	1023	17				0	0	4438	
% Passenger Vehicles	96.6	98.1	98.4	98	97.9		85.3	96.8	96.2	93	96.5		38.7	99	68.6	76.9			97.9	93.4	58.6	50			93.4	0	0	95.1
Large 2 Axle Vehicles	2	1	3				5	35	6				48	5	2	7			4	27	2				0	0	106	
% Large 2 Axle Vehicles	2.3	1.9	1.6	2	1.9		14.7	1.5	3.3	4.7			16.1	1	20	11.5	5.7		1.7	2.5	6.9	0			2.4	0	2.3	
3 Axle Vehicles	1	0	0				0	18	1				1	0	0				1	28	3				0	0	55	
% 3 Axle Vehicles	1.1	0	0	0	0.2		0	0.8	0.5	2.3			3.2	0	0	0	0.3		0.4	2.6	10.3	50			2.4	0	1.2	
4+ Axle Trucks	0	0	0				0	0	0				13	0	4				0	17	7				0	0	66	
% 4+ Axle Trucks	0	0	0	0	0		0	0	0	0	0.9		41.9	0	11.4	11.5	6.8		0	1.6	24.1	0			1.8	0	1.4	
PHF	.714	.577	.818				.873	.719	.820	.724			.833	.875	.770	.688			.781	.744	.893	.750			.861	.977		

Peak Hour Analysis From 07:00 AM to 08:45 AM - Peak 1 of 1

Start Time	Day Street Southbound			Alessandro Boulevard Westbound			Day Street Northbound			Alessandro Boulevard Eastbound		
	Left	Thru	Right	Left	Thru	Right	Left	Thru	Right	Left	Thru	Right
07:00 AM	6	5	33	5	383	21	3	19	8	16	93	4
07:15 AM	11	7	33	8	302	16	4	22	2	33	133	3
07:30 AM	9	13	20	3	293	18	4	37	7	30	134	6
07:45 AM	14	5	22	7	278	29	3	36	5	40	140	5
Total Volume	40	30	108	23	1256	84	14	114	22	150	500	18
% App. Total	22.5	16.9	60.7	1.7	92.1	6.2	9.3	76	14.7	18.7	78.5	2.8
PHF	.714	.577	.818	.873	.719	.820	.875	.770	.688	.781	.744	.893

Counts Unlimited
 PO Box 1178
 Corona, CA 92878
 (951) 268-6268

City of Moreno Valley
 N/S: Day Street
 E/W: Alessandro Boulevard
 Weather: Clear

File Name : 07_MRV_Day_Alessandro AM
 Site Code : 05119512
 Start Date : 8/20/2019
 Page No : 2

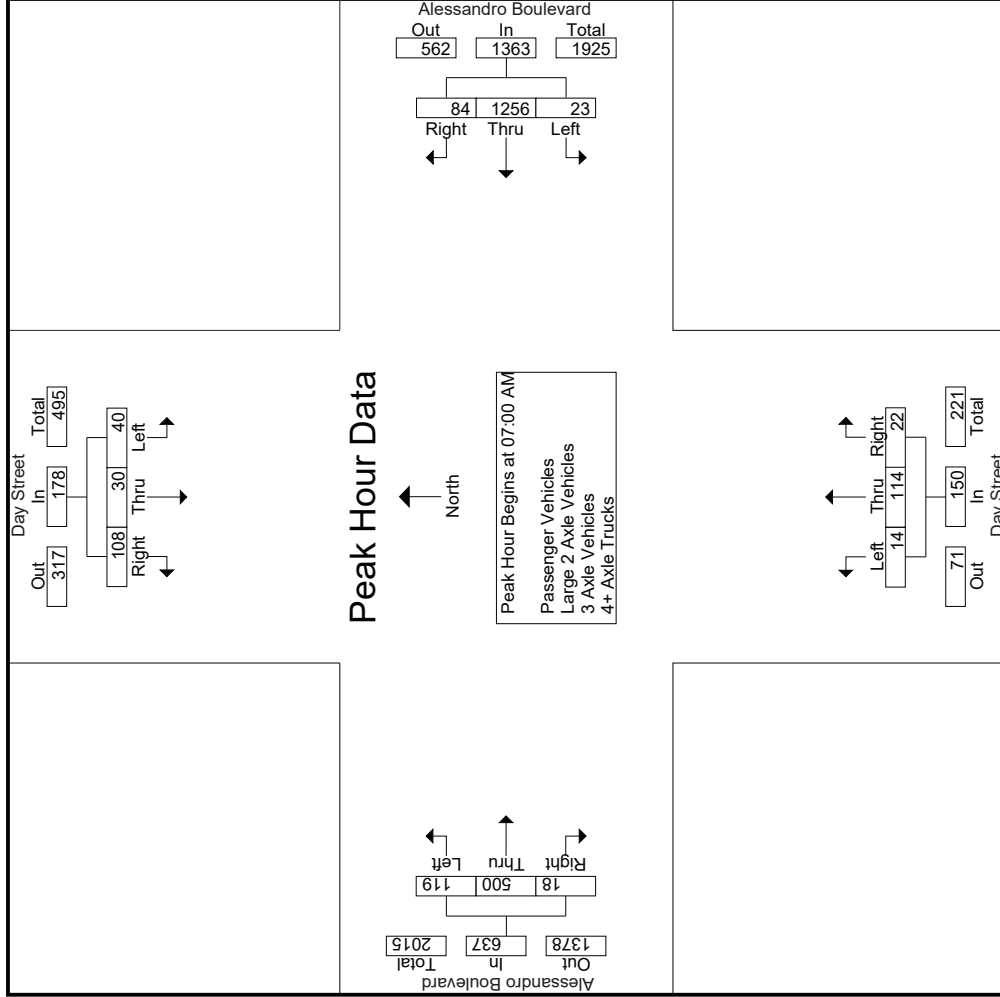

Counts Unlimited
 PO Box 1178
 Corona, CA 92878
 (951) 268-6268

City of Moreno Valley
 N/S: Day Street
 E/W: Alessandro Boulevard
 Weather: Clear

File Name : 07_MRV_Day_Alessandro AM
 Site Code : 05119512
 Start Date : 8/20/2019
 Page No : 3

Start Time	Day Street Southbound			Alessandro Boulevard Westbound			Day Street Northbound			Alessandro Boulevard Eastbound						
	Left	Thru	Right	App. Total	Left	Thru	Right	App. Total	Left	Thru	Right	App. Total	Int. Total			
Peak Hour Analysis From 07:00 AM to 08:45 AM - Peak 1 of 1																
Peak Hour for Each Approach Begins at:																
	07:00 AM			07:00 AM			07:30 AM			08:00 AM						
+0 mins.	6	5	33	44	5	383	21	409	4	37	7	48	19	142	4	165
+15 mins.	11	7	33	51	8	302	16	326	3	36	5	44	27	143	1	171
+30 mins.	9	13	20	42	3	293	18	314	4	28	2	34	29	146	3	178
+45 mins.	14	5	22	41	7	278	29	314	5	29	5	39	48	164	3	215
Total Volume	40	30	108	178	23	1256	84	1363	16	130	19	165	123	595	11	729
% App. Total	22.5	16.9	60.7	.873	1.7	92.1	6.2	.833	9.7	78.8	11.5	.859	16.9	81.6	1.5	.848
PHF	.714	.577	.818	.873	.719	.820	.724	.833	.800	.878	.679	.859	.641	.907	.688	.848

Counts Unlimited
 PO Box 1178
 Corona, CA 92878
 (951) 268-6268

City of Moreno Valley
 N/S: Day Street
 EW: Alessandro Boulevard
 Weather: Clear

File Name : 07_MRV_Day_Alessandro AM
 Site Code : 05119512
 Start Date : 8/20/2019
 Page No : 1

Groups Printed- Passenger Vehicles

Start Time	Day Street Southbound					Alessandro Boulevard Westbound					Day Street Northbound					Alessandro Boulevard Eastbound							
	Left	Thru	Right	RTOR	App. Total	Left	Thru	Right	RTOR	App. Total	Left	Thru	Right	RTOR	App. Total	Left	Thru	Right	RTOR	App. Total	Exclu. Total	Inclu. Total	Int. Total
07:00 AM	5	5	33	12	43	5	371	19	5	395	1	19	6	5	26	16	83	4	0	103	22	567	589
07:15 AM	11	7	31	21	49	8	295	16	5	319	1	22	0	0	23	32	122	2	0	156	26	547	573
07:30 AM	8	13	20	12	41	3	287	17	2	307	1	37	5	5	43	29	126	3	0	158	19	549	568
07:45 AM	14	5	22	10	41	7	268	28	11	303	1	36	4	4	41	40	136	3	0	179	25	564	589
Total	38	30	106	55	174	23	1221	80	23	1324	4	114	15	14	133	117	467	12	0	596	92	2227	2319
08:00 AM	10	5	16	8	31	1	311	35	4	347	2	28	1	1	31	18	140	2	0	160	13	569	582
08:15 AM	17	5	27	16	49	2	274	17	7	293	3	28	4	1	35	27	130	0	0	157	24	534	558
08:30 AM	7	5	14	5	26	1	221	18	3	240	1	11	2	2	14	28	137	1	0	166	10	446	456
08:45 AM	13	7	22	15	42	2	208	27	3	237	2	21	2	2	25	47	149	2	1	198	21	502	523
Total	47	22	79	44	148	6	1014	97	17	1117	8	88	9	6	105	120	556	5	1	681	68	2051	2119
Grand Total	85	52	185	99	322	29	2235	177	40	2441	12	202	24	20	238	237	1023	17	1	1277	160	4278	4438
Apprch %	26.4	16.1	57.5			1.2	91.6	7.3			5	84.9	10.1		5.6	18.6	80.1	1.3		29.9	3.6	96.4	
Total %	2	1.2	4.3		7.5	0.7	52.2	4.1		57.1	0.3	4.7	0.6		5.6	5.5	23.9	0.4		29.9	3.6	96.4	

3.1-614

Start Time	Day Street Southbound					Alessandro Boulevard Westbound					Day Street Northbound					Alessandro Boulevard Eastbound							
	Left	Thru	Right	RTOR	App. Total	Left	Thru	Right	RTOR	App. Total	Left	Thru	Right	RTOR	App. Total	Left	Thru	Right	RTOR	App. Total	Exclu. Total	Inclu. Total	Int. Total
07:00 AM	5	5	33	12	43	5	371	19	5	395	1	19	6	5	26	16	83	4	0	103	22	567	589
07:15 AM	11	7	31	21	49	8	295	16	5	319	1	22	0	0	23	32	122	2	0	156	26	547	573
07:30 AM	8	13	20	12	41	3	287	17	2	307	1	37	5	5	43	29	126	3	0	158	19	549	568
07:45 AM	14	5	22	10	41	7	268	28	11	303	1	36	4	4	41	40	136	3	0	179	25	564	589
Total Volume	38	30	106	55	174	23	1221	80	23	1324	4	114	15	14	133	117	467	12	0	596	92	2227	2319
% App. Total	21.8	17.2	60.9			1.7	92.2	6			3	85.7	11.3		11.3	19.6	78.4	2		2	3.6	96.4	
PHF	.679	.577	.803		.888	.719	.823	.714		.838	1.00	.770	.625		.773	.731	.858	.750		.832		.982	

Peak Hour Analysis From 07:00 AM to 07:45 AM - Peak 1 of 1
 Peak Hour for Entire Intersection Begins at 07:00 AM

Counts Unlimited
 PO Box 1178
 Corona, CA 92878
 (951) 268-6268

City of Moreno Valley
 N/S: Day Street
 E/W: Alessandro Boulevard
 Weather: Clear

File Name : 07_MRV_Day_Alessandro AM
 Site Code : 05119512
 Start Date : 8/20/2019
 Page No : 2

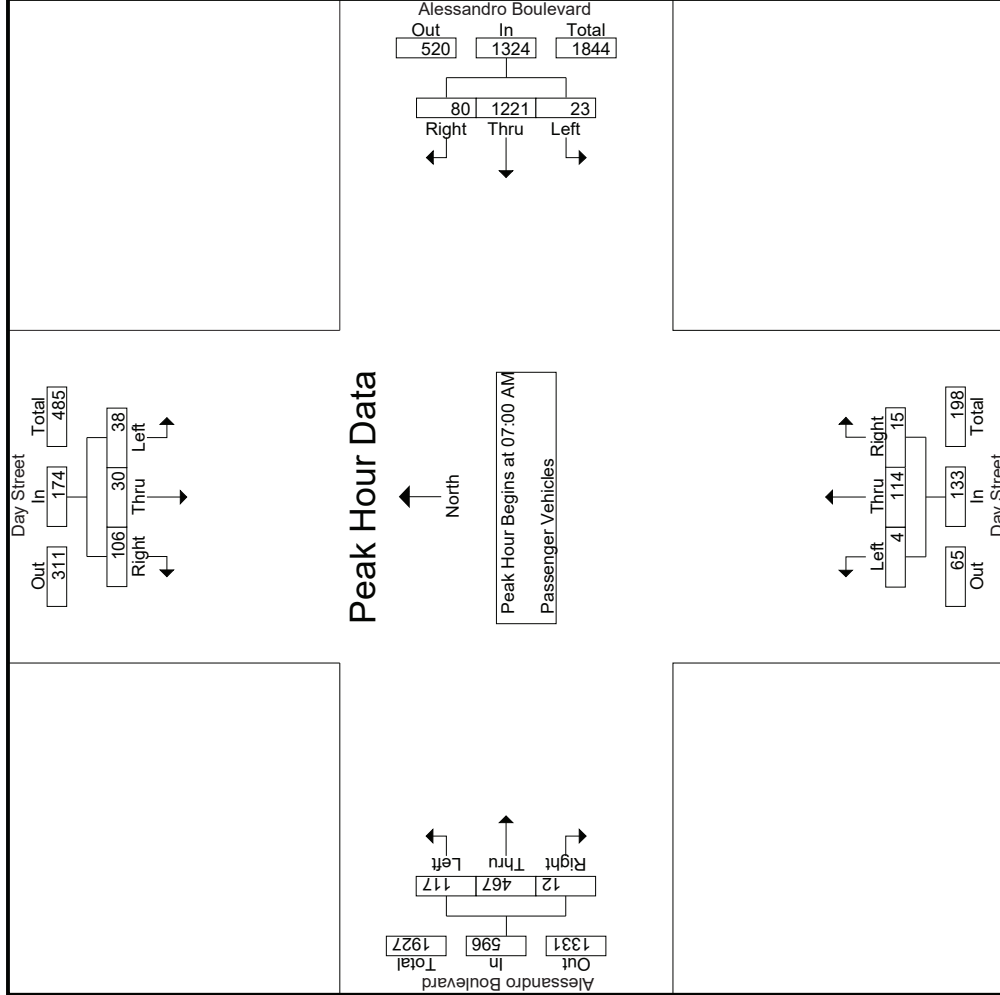

Counts Unlimited
 PO Box 1178
 Corona, CA 92878
 (951) 268-6268

City of Moreno Valley
 N/S: Day Street
 E/W: Alessandro Boulevard
 Weather: Clear

File Name : 07_MRV_Day_Alessandro AM
 Site Code : 05119512
 Start Date : 8/20/2019
 Page No : 3

Start Time	Day Street Southbound			Alessandro Boulevard Westbound			Day Street Northbound			Alessandro Boulevard Eastbound						
	Left	Thru	Right	App. Total	Left	Thru	Right	App. Total	Left	Thru	Right	App. Total	Int. Total			
Peak Hour Analysis From 07:00 AM to 07:45 AM - Peak 1 of 1																
Peak Hour for Each Approach Begins at:																
	07:00 AM			07:00 AM			07:00 AM			07:00 AM						
+0 mins.	5	5	33	43	5	371	19	395	1	19	6	26	16	83	4	103
+15 mins.	11	7	31	49	8	295	16	319	1	22	0	23	32	122	2	156
+30 mins.	8	13	20	41	3	287	17	307	1	37	5	43	29	126	3	158
+45 mins.	14	5	22	41	7	268	28	303	1	36	4	41	40	136	3	179
Total Volume	38	30	106	174	23	1221	80	1324	4	114	15	133	117	467	12	596
% App. Total	21.8	17.2	60.9	.888	1.7	92.2	6	.838	3	85.7	11.3	.773	19.6	78.4	2	.832
PHF	.679	.577	.803	.888	.719	.823	.714	.838	1.000	.770	.625	.773	.731	.858	.750	.832

Groups Printed- Large 2 Axle Vehicles

Start Time	Day Street Southbound					Alessandro Boulevard Westbound					Day Street Northbound					Alessandro Boulevard Eastbound							
	Left	Thru	Right	RTOR	App. Total	Left	Thru	Right	RTOR	App. Total	Left	Thru	Right	RTOR	App. Total	Left	Thru	Right	RTOR	App. Total	Exclu. Total	Inclu. Total	Int. Total
	07:00 AM	1	0	0	0	1	0	6	2	1	8	2	0	2	1	4	0	4	0	0	4	2	17
07:15 AM	0	0	2	1	2	0	3	0	0	3	1	0	0	0	1	1	3	0	0	4	1	10	11
07:30 AM	0	0	0	0	0	0	3	0	0	3	1	0	1	1	2	1	5	0	0	6	1	11	12
07:45 AM	0	0	0	0	0	0	4	1	0	5	0	0	0	0	0	0	0	1	0	1	0	6	6
Total	1	0	2	1	3	0	16	3	1	19	4	0	3	2	7	2	12	1	0	15	4	44	48
08:00 AM	0	0	0	0	0	0	4	2	1	6	0	0	1	1	1	1	2	0	0	3	2	10	12
08:15 AM	0	1	1	1	2	0	6	0	0	6	0	1	1	0	2	0	6	0	0	6	1	16	17
08:30 AM	1	0	0	0	1	2	3	1	0	6	0	0	2	0	2	1	3	1	0	5	0	14	14
08:45 AM	0	0	0	0	0	3	6	0	0	9	1	1	0	0	2	0	4	0	0	4	0	15	15
Total	1	1	1	1	3	5	19	3	1	27	1	2	4	1	7	2	15	1	0	18	3	55	58
Grand Total	2	1	3	2	6	5	35	6	2	46	5	2	7	3	14	4	27	2	0	33	7	99	106
Apprch %	33.3	16.7	50		6.1	10.9	76.1	13		46.5	35.7	14.3	50		14.1	12.1	81.8	6.1		33.3	6.6	93.4	
Total %	2	1	3		6.1	5.1	35.4	6.1		46.5	5.1	2	7.1		14.1	4	27.3	2		33.3	6.6	93.4	

3:1-617

Start Time	Day Street Southbound					Alessandro Boulevard Westbound					Day Street Northbound					Alessandro Boulevard Eastbound							
	Left	Thru	Right	RTOR	App. Total	Left	Thru	Right	RTOR	App. Total	Left	Thru	Right	RTOR	App. Total	Left	Thru	Right	RTOR	App. Total	Exclu. Total	Inclu. Total	Int. Total
	07:00 AM	1	0	0	0	1	0	6	2	1	8	2	0	2	1	4	0	4	0	0	4	2	17
07:15 AM	0	0	2	1	2	0	3	0	0	3	1	0	0	0	1	1	3	0	0	4	1	10	11
07:30 AM	0	0	0	0	0	0	3	0	0	3	1	0	1	1	2	1	5	0	0	6	1	11	12
07:45 AM	0	0	0	0	0	0	4	1	0	5	0	0	0	0	0	0	0	1	0	1	0	6	6
Total	1	0	2	1	3	0	16	3	1	19	4	0	3	2	7	2	12	1	0	15	4	44	48
08:00 AM	0	0	0	0	0	0	4	2	1	6	0	0	1	1	1	1	2	0	0	3	2	10	12
08:15 AM	0	1	1	1	2	0	6	0	0	6	0	1	1	0	2	0	6	0	0	6	1	16	17
08:30 AM	1	0	0	0	1	2	3	1	0	6	0	0	2	0	2	1	3	1	0	5	0	14	14
08:45 AM	0	0	0	0	0	3	6	0	0	9	1	1	0	0	2	0	4	0	0	4	0	15	15
Total	1	1	1	1	3	5	19	3	1	27	1	2	4	1	7	2	15	1	0	18	3	55	58
Grand Total	2	1	3	2	6	5	35	6	2	46	5	2	7	3	14	4	27	2	0	33	7	99	106
Apprch %	33.3	16.7	50		6.1	10.9	76.1	13		46.5	35.7	14.3	50		14.1	12.1	81.8	6.1		33.3	6.6	93.4	
Total %	2	1	3		6.1	5.1	35.4	6.1		46.5	5.1	2	7.1		14.1	4	27.3	2		33.3	6.6	93.4	

Peak Hour Analysis From 07:00 AM to 07:45 AM - Peak 1 of 1
 Peak Hour for Entire Intersection Begins at 07:00 AM

Start Time	Day Street Southbound					Alessandro Boulevard Westbound					Day Street Northbound					Alessandro Boulevard Eastbound							
	Left	Thru	Right	RTOR	App. Total	Left	Thru	Right	RTOR	App. Total	Left	Thru	Right	RTOR	App. Total	Left	Thru	Right	RTOR	App. Total	Exclu. Total	Inclu. Total	Int. Total
07:00 AM	1	0	0	0	1	0	6	2	1	8	2	0	2	1	4	0	4	0	0	4	2	17	19
07:15 AM	0	0	2	1	2	0	3	0	0	3	1	0	0	0	1	1	3	0	0	4	1	10	11
07:30 AM	0	0	0	0	0	0	3	0	0	3	1	0	1	1	2	1	5	0	0	6	1	11	12
07:45 AM	0	0	0	0	0	0	4	1	0	5	0	0	0	0	0	0	0	1	0	1	0	6	6
Total Volume	1	0	2	1	3	0	16	3	1	19	4	0	3	2	7	2	12	1	0	15	4	44	48
% App. Total	33.3	0	66.7		6.1	0	84.2	15.8		46.5	57.1	0	42.9		14.1	13.3	80	6.7		33.3	6.6	93.4	
PHF	.250	.000	.250		.375	.000	.667	.375		.594	.500	.000	.375		.438	.500	.600	.250		.625	.250	.625	.647

Counts Unlimited
 PO Box 1178
 Corona, CA 92878
 (951) 268-6268

City of Moreno Valley
 N/S: Day Street
 E/W: Alessandro Boulevard
 Weather: Clear

File Name : 07_MRV_Day_Alessandro AM
 Site Code : 05119512
 Start Date : 8/20/2019
 Page No : 2

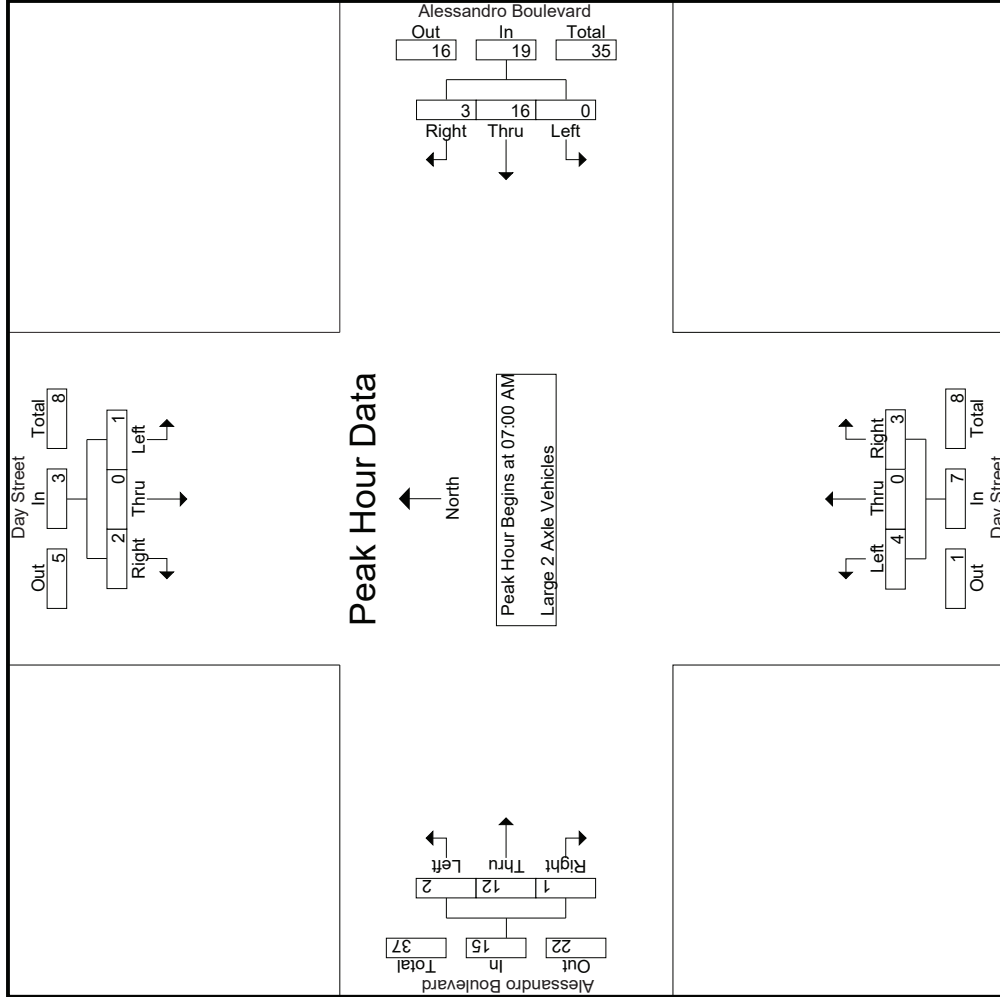

Counts Unlimited
 PO Box 1178
 Corona, CA 92878
 (951) 268-6268

City of Moreno Valley
 N/S: Day Street
 E/W: Alessandro Boulevard
 Weather: Clear

File Name : 07_MRV_Day_Alessandro AM
 Site Code : 05119512
 Start Date : 8/20/2019
 Page No : 1

Groups Printed- 3 Axle Vehicles

Start Time	Day Street Southbound				Alessandro Boulevard Westbound				Day Street Northbound				Alessandro Boulevard Eastbound							
	Left	Thru	Right	RTOR	Left	Thru	Right	RTOR	Left	Thru	Right	RTOR	Left	Thru	Right	RTOR	Exclu. Total	Inclu. Total	Int. Total	
07:00 AM	0	0	0	0	0	0	0	0	0	0	0	0	0	0	0	0	0	0	0	6
07:15 AM	0	0	0	0	0	0	0	0	0	0	0	0	0	0	0	0	0	0	0	8
07:30 AM	1	0	0	0	0	0	1	1	0	0	0	0	0	1	1	0	2	1	4	5
07:45 AM	0	0	0	0	0	0	0	0	0	0	0	0	0	0	0	0	0	0	0	4
Total	1	0	0	0	0	5	1	1	6	0	0	0	0	13	2	0	15	1	22	23
08:00 AM	0	0	0	0	0	4	0	0	4	0	0	0	0	0	0	0	0	0	0	4
08:15 AM	0	0	0	0	0	2	0	0	2	1	0	0	1	0	3	0	3	0	6	6
08:30 AM	0	0	0	0	0	4	0	0	4	0	0	0	0	5	0	0	5	0	9	9
08:45 AM	0	0	0	0	0	3	0	0	3	0	0	0	0	1	7	1	9	1	12	13
Total	0	0	0	0	0	13	0	0	13	1	0	0	1	15	1	1	17	1	31	32
Grand Total	1	0	0	0	0	18	1	1	19	1	0	0	0	1	28	3	1	32	2	53
Approch %	100	0	0	0	0	94.7	5.3		35.8	100	0	0	1.9	3.1	87.5	9.4		60.4	3.6	96.4
Total %	1.9	0	0	0	0	34	1.9		1.9	1.9	0	0	1.9	1.9	52.8	5.7		60.4	3.6	96.4

3:1-620

Start Time	Day Street Southbound				Alessandro Boulevard Westbound				Day Street Northbound				Alessandro Boulevard Eastbound							
	Left	Thru	Right	RTOR	Left	Thru	Right	RTOR	Left	Thru	Right	RTOR	Left	Thru	Right	RTOR	Exclu. Total	Inclu. Total	Int. Total	
07:00 AM	0	0	0	0	0	0	0	0	0	0	0	0	0	0	0	0	0	0	0	6
07:15 AM	0	0	0	0	0	0	0	0	0	0	0	0	0	0	0	0	0	0	0	8
07:30 AM	1	0	0	0	0	0	0	0	1	0	0	0	0	1	1	0	2	1	4	5
07:45 AM	0	0	0	0	0	0	0	0	0	0	0	0	0	0	0	0	0	0	0	4
Total Volume	1	0	0	0	0	5	1	1	6	0	0	0	0	13	2	0	15	1	22	22
% App. Total	100	0	0	0	0	83.3	16.7		16.7	100	0	0	86.7	13.3						
PHF	.250	.000	.000	.250	.000	.417	.250		.250	.000	.000	.000	.000	.464	.500	.469				.688

Peak Hour Analysis From 07:00 AM to 07:45 AM - Peak 1 of 1
 Peak Hour for Entire Intersection Begins at 07:00 AM

Counts Unlimited
 PO Box 1178
 Corona, CA 92878
 (951) 268-6268

City of Moreno Valley
 N/S: Day Street
 E/W: Alessandro Boulevard
 Weather: Clear

File Name : 07_MRV_Day_Alessandro AM
 Site Code : 05119512
 Start Date : 8/20/2019
 Page No : 2

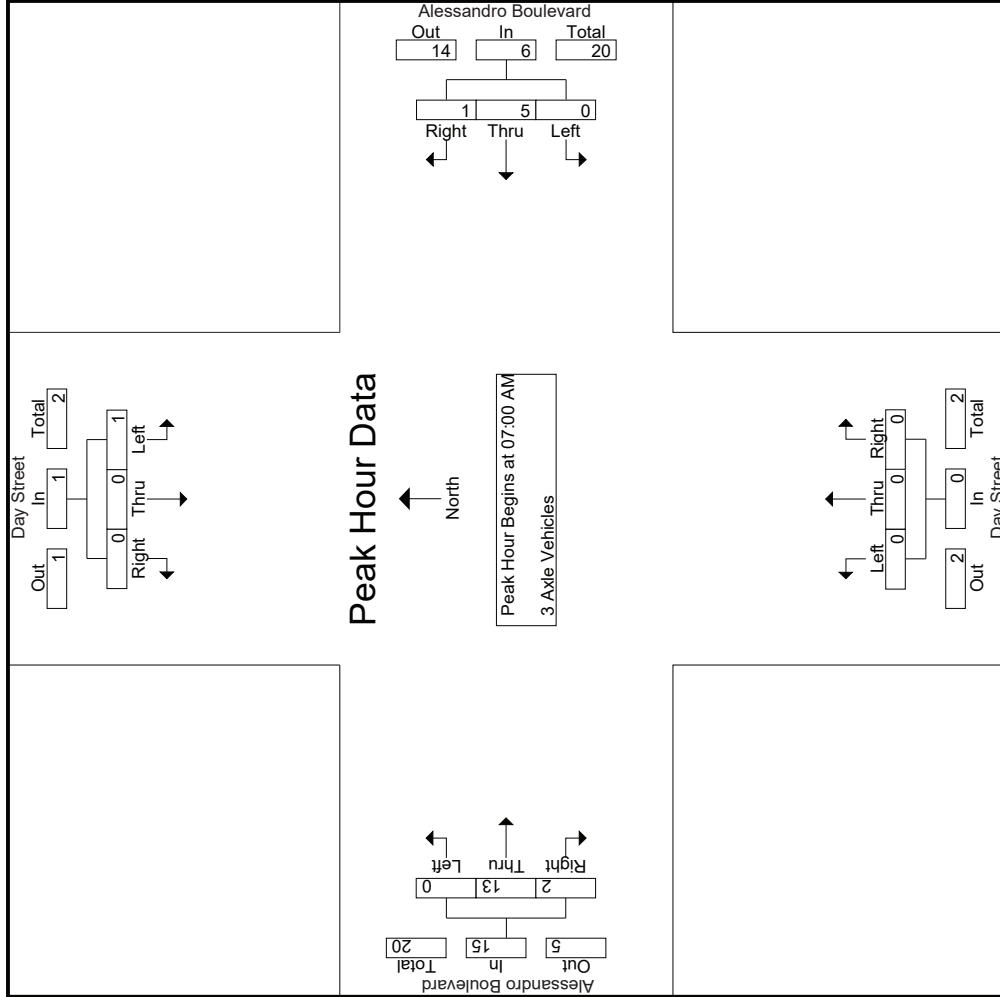

Counts Unlimited
 PO Box 1178
 Corona, CA 92878
 (951) 268-6268

City of Moreno Valley
 N/S: Day Street
 E/W: Alessandro Boulevard
 Weather: Clear

File Name : 07_MRV_Day_Alessandro AM
 Site Code : 05119512
 Start Date : 8/20/2019
 Page No : 3

Start Time	Day Street Southbound			Alessandro Boulevard Westbound			Day Street Northbound			Alessandro Boulevard Eastbound		
	Left	Thru	Right	Left	Thru	Right	Left	Thru	Right	Left	Thru	Right
Peak Hour Analysis From 07:00 AM to 07:45 AM - Peak 1 of 1												
Peak Hour for Each Approach Begins at:												
	07:00 AM			07:00 AM			07:00 AM			07:00 AM		
+0 mins.	0	0	0	0	3	0	0	0	0	0	3	0
+15 mins.	0	0	0	0	0	0	0	0	0	0	7	1
+30 mins.	1	0	0	0	0	1	0	0	0	0	1	1
+45 mins.	0	0	0	0	2	0	0	0	0	0	2	0
Total Volume	1	0	0	0	5	1	0	0	0	0	13	2
% App. Total	100	0	0	0	83.3	16.7	0	0	0	0	86.7	13.3
PHF	.250	.000	.000	.250	.417	.250	.000	.000	.000	.000	.464	.500
					.500						.000	.464
											.000	.500
											.000	.464
											.000	.464
											.000	.464

Groups Printed- 4+ Axle Trucks

Start Time	Day Street Southbound				Alessandro Boulevard Westbound				Day Street Northbound				Alessandro Boulevard Eastbound						
	Left	Thru	Right	RTOR	App. Total	Left	Thru	Right	RTOR	App. Total	Left	Thru	Right	RTOR	App. Total	Exclu. Total	Inclu. Total	Int. Total	
07:00 AM	0	0	0	0	0	0	3	0	0	3	0	0	3	0	0	3	0	6	6
07:15 AM	0	0	0	0	0	0	4	0	0	4	0	2	1	0	0	1	1	9	10
07:30 AM	0	0	0	0	0	0	3	0	0	3	0	2	0	0	0	4	1	10	11
07:45 AM	0	0	0	0	0	0	4	0	0	4	2	0	1	0	3	1	1	10	11
Total	0	0	0	0	0	14	0	0	3	14	6	0	4	3	10	3	35	38	
08:00 AM	0	0	0	0	0	0	0	0	0	0	2	0	0	0	2	0	4	4	4
08:15 AM	0	0	0	0	0	2	0	0	0	2	1	0	0	0	1	0	8	8	8
08:30 AM	0	0	0	0	0	0	5	0	0	5	0	0	0	0	0	2	0	7	7
08:45 AM	0	0	0	0	0	0	1	0	0	1	4	0	0	0	4	0	9	9	9
Total	0	0	0	0	0	8	7	0	0	8	7	0	0	4	13	0	28	28	
Grand Total	0	0	0	0	0	22	0	0	3	22	13	0	4	3	17	3	63	66	
Apprch %	0	0	0	0	0	100	0	0	0	76.5	0	23.5	0	0	70.8	29.2	0	0	
Total %	0	0	0	0	0	34.9	0	0	0	34.9	20.6	6.3	0	0	27	11.1	4.5	95.5	

3:1-623

Start Time	Day Street Southbound				Alessandro Boulevard Westbound				Day Street Northbound				Alessandro Boulevard Eastbound						
	Left	Thru	Right	RTOR	App. Total	Left	Thru	Right	RTOR	App. Total	Left	Thru	Right	RTOR	App. Total	Exclu. Total	Inclu. Total	Int. Total	
07:00 AM	0	0	0	0	0	0	3	0	0	3	0	0	0	0	0	0	3	3	6
07:15 AM	0	0	0	0	0	0	4	0	0	4	2	0	2	0	1	0	1	9	9
07:30 AM	0	0	0	0	0	0	3	0	0	3	0	2	0	0	2	0	4	10	10
07:45 AM	0	0	0	0	0	0	4	0	0	4	2	0	1	0	3	1	1	10	11
Total Volume	0	0	0	0	0	14	0	0	3	14	6	0	4	3	10	3	35	38	
% App. Total	0	0	0	0	0	100	0	0	0	72.7	0	27.3	0	0	66.7	0	68.8	68.8	
PHF	.000	.000	.000	.000	.000	.875	.000	.875	.000	.875	.750	.000	.500	.000	.667	.375	.688	.875	

Peak Hour Analysis From 07:00 AM to 07:45 AM - Peak 1 of 1
 Peak Hour for Entire Intersection Begins at 07:00 AM

Counts Unlimited
 PO Box 1178
 Corona, CA 92878
 (951) 268-6268

City of Moreno Valley
 N/S: Day Street
 E/W: Alessandro Boulevard
 Weather: Clear

File Name : 07_MRV_Day_Alessandro AM
 Site Code : 05119512
 Start Date : 8/20/2019
 Page No : 2

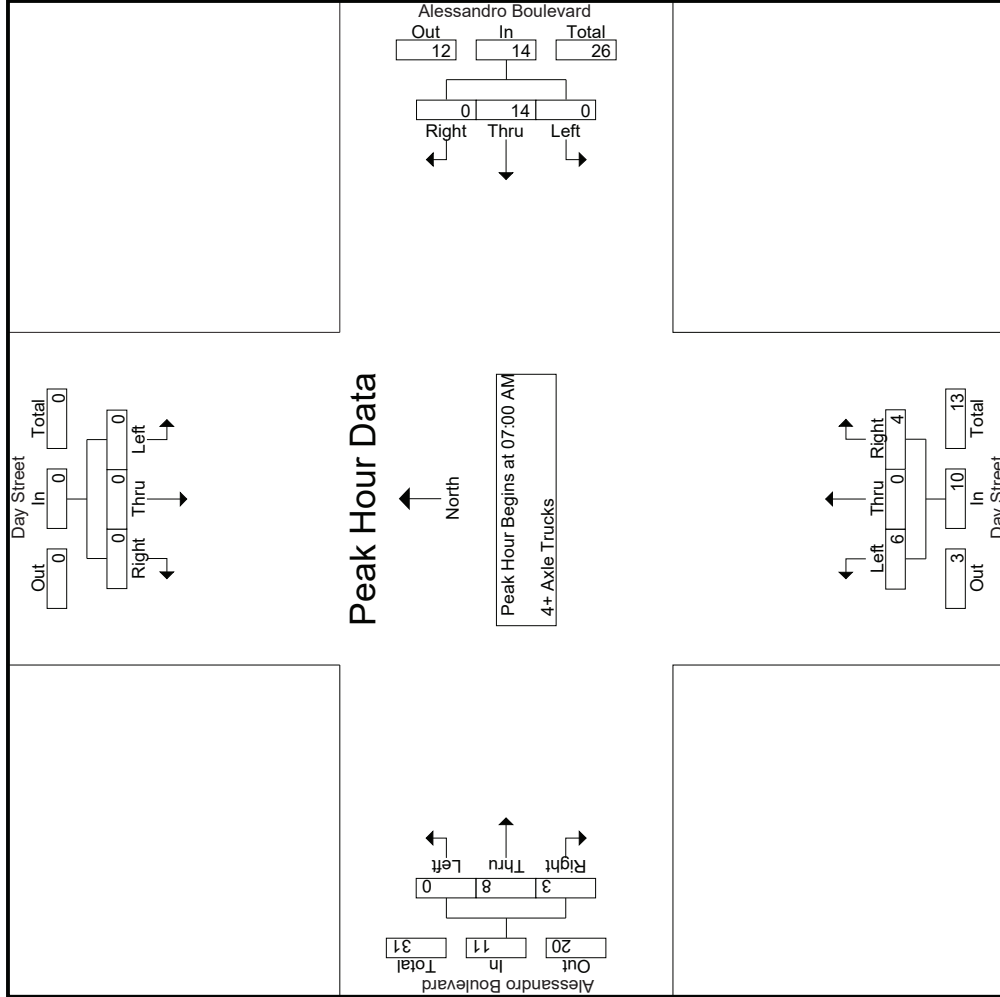

Counts Unlimited
 PO Box 1178
 Corona, CA 92878
 (951) 268-6268

City of Moreno Valley
 N/S: Day Street
 E/W: Alessandro Boulevard
 Weather: Clear

File Name : 07_MRV_Day_Alessandro AM
 Site Code : 05119512
 Start Date : 8/20/2019
 Page No : 3

Start Time	Day Street Southbound			Alessandro Boulevard Westbound			Day Street Northbound			Alessandro Boulevard Eastbound		
	Left	Thru	Right	Left	Thru	Right	Left	Thru	Right	Left	Thru	Right
Peak Hour Analysis From 07:00 AM to 07:45 AM - Peak 1 of 1												
Peak Hour for Each Approach Begins at:												
	07:00 AM			07:00 AM			07:00 AM			07:00 AM		
+0 mins.	0	0	0	0	3	0	0	0	0	0	3	0
+15 mins.	0	0	0	0	4	0	0	2	4	0	1	0
+30 mins.	0	0	0	0	3	0	0	2	3	0	2	2
+45 mins.	0	0	0	0	4	0	0	2	4	0	2	1
Total Volume	0	0	0	0	14	0	0	6	10	0	8	3
% App. Total	0	0	0	0	100	0	0	60	40	0	72.7	27.3
PHF	.000	.000	.000	.000	.875	.000	.000	.750	.500	.000	.667	.375
					.875			.625			.688	

Counts Unlimited
 PO Box 1178
 Corona, CA 92878
 (951) 268-6268

City of Moreno Valley
 N/S: Day Street
 EW: Alessandro Boulevard
 Weather: Clear

File Name : 07_MRV_Day_Alessandro PM
 Site Code : 05119512
 Start Date : 8/20/2019
 Page No : 1

Groups Printed- Passenger Vehicles - Large 2 Axle Vehicles - 3 Axle Vehicles - 4+ Axle Trucks

Start Time	Day Street Southbound						Alessandro Boulevard Westbound						Day Street Northbound						Alessandro Boulevard Eastbound							
	Left	Thru	Right	RTOR	App. Total		Left	Thru	Right	RTOR	App. Total		Left	Thru	Right	RTOR	App. Total		Left	Thru	Right	RTOR	App. Total			
	Exclu. Total	Inclu. Total	Int. Total				Exclu. Total	Inclu. Total	Int. Total				Exclu. Total	Inclu. Total	Int. Total				Exclu. Total	Inclu. Total	Int. Total					
04:00 PM	44	7	13	3	64	5	180	35	10	220	6	18	6	6	30	32	252	3	0	287	19	601	620			
04:15 PM	23	14	21	4	58	3	176	45	19	224	1	11	8	6	20	36	305	3	1	344	30	646	676			
04:30 PM	43	11	19	10	73	2	190	37	20	229	3	8	0	0	11	36	307	2	0	345	30	658	688			
04:45 PM	39	10	13	5	62	1	194	29	6	224	1	19	1	0	21	28	290	2	1	320	12	627	639			
Total	149	42	66	22	257	11	740	146	55	897	11	56	15	12	82	132	1154	10	2	1296	91	2532	2623			
05:00 PM	40	27	20	4	87	2	192	30	10	224	1	15	2	2	18	35	311	0	0	346	16	675	691			
05:15 PM	41	19	23	6	83	2	196	30	14	228	1	22	4	2	27	46	316	5	1	367	23	705	728			
05:30 PM	32	17	24	10	73	4	186	23	11	213	1	18	5	5	24	21	311	1	0	333	26	643	669			
05:45 PM	35	17	17	4	69	5	131	25	14	161	1	8	1	0	10	25	285	1	0	311	18	551	569			
Total	148	80	84	24	342	13	705	108	49	826	4	63	12	9	79	127	1223	7	1	1357	83	2574	2657			
Grand Total	297	122	150	46	569	24	1445	254	104	1723	15	119	27	21	161	259	2377	17	3	2653	174	5106	5280			
Approch %	52.2	21.4	26.4			1.4	83.9	14.7			9.3	73.9	16.8			9.8	89.6	0.6			3.3	96.7				
Total %	5.8	2.4	2.9		11.1	0.5	28.3	5		33.7	0.3	2.3	0.5		3.2	5.1	46.6	0.3		52						
Passenger Vehicles	296	121	150	100	613	21	1418	251	1792	12	119	26	178	178	2345	12	2616	0	0	5199	0	0	98.5			
% 2 Axle Vehicles	99.7	99.2	100	100	99.7	87.5	98.1	98.8	98.1	98.1	80	100	96.3	100	97.8	98.8	98.7	70.6	100	98.5	0	0	0	0	98.5	
% 3 Axle Vehicles	0.3	0.8	0	0	0.3	0	13	3	1.2	1.7	0	0	0	0	0	2	15	0	0.6	0	0	0	0	0.7		
% 4+ Axle Trucks	0	0	0	0	0	0	0.9	0	0	0.9	0	0	0	0	0.8	0.6	0	0	0.6	0	0	0	0	0		
% 3 Axle Vehicles	0	0	0	0	0	2	5	0	8	8	1	0	1	2	0	2	1	1	3	0	0	0	0	13		
% 4+ Axle Trucks	0	0	0	0	0	8.3	0.3	0	1	0.4	6.7	0	3.7	0	0	0.1	5.9	0	0.1	0	0	0	0	0.2		
% 4+ Axle Trucks	0	0	0	0	0	1	9	0	0	10	2	0	0	2	1	15	4	0	20	0	0	0	0	32		
% 4+ Axle Trucks	0	0	0	0	0	4.2	0.6	0	0	0.5	13.3	0	0	1.1	0.4	0.6	23.5	0	0.8	0	0	0	0	0.6		

Start Time	Day Street Southbound						Alessandro Boulevard Westbound						Day Street Northbound						Alessandro Boulevard Eastbound					
	Left	Thru	Right	RTOR	App. Total		Left	Thru	Right	RTOR	App. Total		Left	Thru	Right	RTOR	App. Total		Left	Thru	Right	RTOR	App. Total	
	Exclu. Total	Inclu. Total	Int. Total				Exclu. Total	Inclu. Total	Int. Total				Exclu. Total	Inclu. Total	Int. Total				Exclu. Total	Inclu. Total	Int. Total			
04:30 PM	43	11	19		73	2	190	37		229	3	8	0		11	36	307	2		345	2	320	627	
04:45 PM	39	10	13		62	1	194	29		224	1	19	1		21	28	290	2		320	2	346	675	
05:00 PM	40	27	20		87	2	192	30		222	1	15	2		18	35	311	0		311	0	658	688	
05:15 PM	41	19	23		83	2	196	30		226	1	22	4		27	46	316	5		367	5	705	728	
Total Volume	163	67	75		305	7	772	126		905	6	64	7		77	145	1224	9		1378	9	2665	2665	
% App. Total	53.4	22	24.6		24.6	0.8	85.3	13.9		13.9	7.8	83.1	9.1		9.1	10.5	88.8	0.7		0.7	0.7	939	945	
PHF	.948	.620	.815		.876	.875	.985	.851		.988	.500	.727	.438		.713	.788	.968	.450		.450				

Peak Hour Analysis From 04:00 PM to 05:45 PM - Peak 1 of 1
 Peak Hour for Entire Intersection Begins at 04:30 PM

Counts Unlimited
 PO Box 1178
 Corona, CA 92878
 (951) 268-6268

City of Moreno Valley
 N/S: Day Street
 E/W: Alessandro Boulevard
 Weather: Clear

File Name : 07_MRV_Day_Alessandro PM
 Site Code : 05119512
 Start Date : 8/20/2019
 Page No : 2

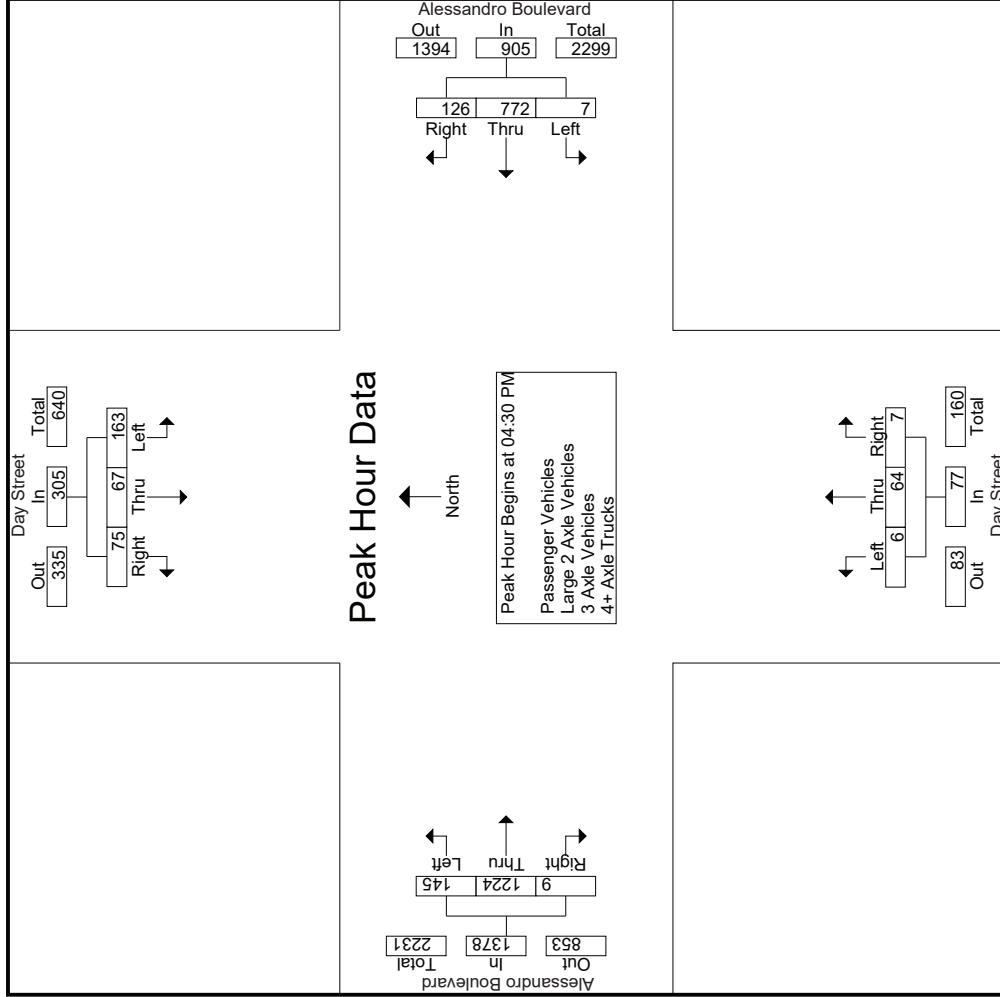

Counts Unlimited
 PO Box 1178
 Corona, CA 92878
 (951) 268-6268

City of Moreno Valley
 N/S: Day Street
 E/W: Alessandro Boulevard
 Weather: Clear

File Name : 07_MRV_Day_Alessandro PM
 Site Code : 05119512
 Start Date : 8/20/2019
 Page No : 3

Start Time	Day Street Southbound			Alessandro Boulevard Westbound			Day Street Northbound			Alessandro Boulevard Eastbound					
	Left	Thru	Right	App. Total	Left	Thru	Right	App. Total	Left	Thru	Right	App. Total	Int. Total		
Peak Hour Analysis From 04:00 PM to 05:45 PM - Peak 1 of 1															
Peak Hour for Each Approach Begins at:															
	05:00 PM				04:30 PM				04:45 PM			04:30 PM			
+0 mins.	40	27	20	87	2	190	37	229	1	19	1	36	307	2	345
+15 mins.	41	19	23	83	1	194	29	224	1	15	2	28	290	2	320
+30 mins.	32	17	24	73	2	192	30	224	1	22	4	35	311	0	346
+45 mins.	35	17	17	69	2	196	30	228	1	18	5	46	316	5	367
Total Volume	148	80	84	312	7	772	126	905	4	74	12	145	1224	9	1378
% App. Total	47.4	25.6	26.9	.897	0.8	85.3	13.9	.988	4.4	82.2	13.3	10.5	88.8	0.7	.939
PHF	.902	.741	.875	.897	.875	.985	.851	.988	1.000	.841	.600	.788	.968	.450	.939

Groups Printed- Passenger Vehicles

Start Time	Day Street Southbound					Alessandro Boulevard Westbound					Day Street Northbound					Alessandro Boulevard Eastbound							
	Left	Thru	Right	RTOR	App. Total	Left	Thru	Right	RTOR	App. Total	Left	Thru	Right	RTOR	App. Total	Left	Thru	Right	RTOR	App. Total	Exclu. Total	Inclu. Total	Int. Total
04:00 PM	44	7	13	3	64	3	178	34	10	215	5	18	6	6	29	30	251	3	0	284	19	592	611
04:15 PM	23	14	21	4	58	3	167	44	19	214	0	11	8	6	19	36	299	2	1	337	30	628	658
04:30 PM	43	11	19	10	73	2	186	37	20	225	2	8	0	0	10	36	303	0	0	339	30	647	677
04:45 PM	39	9	13	5	61	1	193	28	5	222	1	19	1	0	21	28	284	1	1	313	11	617	628
Total	149	41	66	22	256	9	724	143	54	876	8	56	15	12	79	130	1137	6	2	1273	90	2484	2574
05:00 PM	40	27	20	4	87	2	190	30	10	222	1	15	2	2	18	35	306	0	0	341	16	668	684
05:15 PM	41	19	23	6	83	2	191	30	13	223	1	22	4	2	27	46	311	4	1	361	22	694	716
05:30 PM	32	17	24	10	73	4	182	23	11	209	1	18	5	5	24	20	310	1	0	331	26	637	663
05:45 PM	34	17	17	4	68	4	131	25	14	160	1	8	0	0	9	25	281	1	0	307	18	544	562
Total	147	80	84	24	311	12	694	108	48	814	4	63	11	9	78	126	1208	6	1	1340	82	2543	2625
Grand Total	296	121	150	46	567	21	1418	251	102	1690	12	119	26	21	157	256	2345	12	3	2613	172	5027	5199
Approch %	52.2	21.3	26.5			1.2	83.9	14.9		33.6	7.6	75.8	16.6		3.1	9.8	89.7	0.5		52	3.3	96.7	
Total %	5.9	2.4	3		11.3	0.4	28.2	5			0.2	2.4	0.5			5.1	46.6	0.2					

3: 1-629

Start Time	Day Street Southbound					Alessandro Boulevard Westbound					Day Street Northbound					Alessandro Boulevard Eastbound							
	Left	Thru	Right	RTOR	App. Total	Left	Thru	Right	RTOR	App. Total	Left	Thru	Right	RTOR	App. Total	Left	Thru	Right	RTOR	App. Total	Exclu. Total	Inclu. Total	Int. Total
04:30 PM	43	11	19		73	2	186	37		225	2	8	0		10	36	303	0		339			647
04:45 PM	39	9	13		61	1	193	28		222	1	19	1		21	28	284	1		313			617
05:00 PM	40	27	20		87	2	190	30		222	1	15	2		18	35	306	0		341			668
05:15 PM	41	19	23		83	4	182	23		223	1	22	4		27	46	311	4		361			694
Total Volume	163	66	75		304	7	760	125		892	5	64	7		76	145	1204	5		1354			2626
% App. Total	53.6	21.7	24.7			0.8	85.2	14			6.6	84.2	9.2			10.7	88.9	0.4					
PHF	.948	.611	.815		.874	.875	.984	.845		.991	.625	.727	.438		.704	.788	.968	.313		.938			.946

Peak Hour Analysis From 04:30 PM to 05:15 PM - Peak 1 of 1
 Peak Hour for Entire Intersection Begins at 04:30 PM

Counts Unlimited
 PO Box 1178
 Corona, CA 92878
 (951) 268-6268

City of Moreno Valley
 N/S: Day Street
 E/W: Alessandro Boulevard
 Weather: Clear

File Name : 07_MRV_Day_Alessandro PM
 Site Code : 05119512
 Start Date : 8/20/2019
 Page No : 2

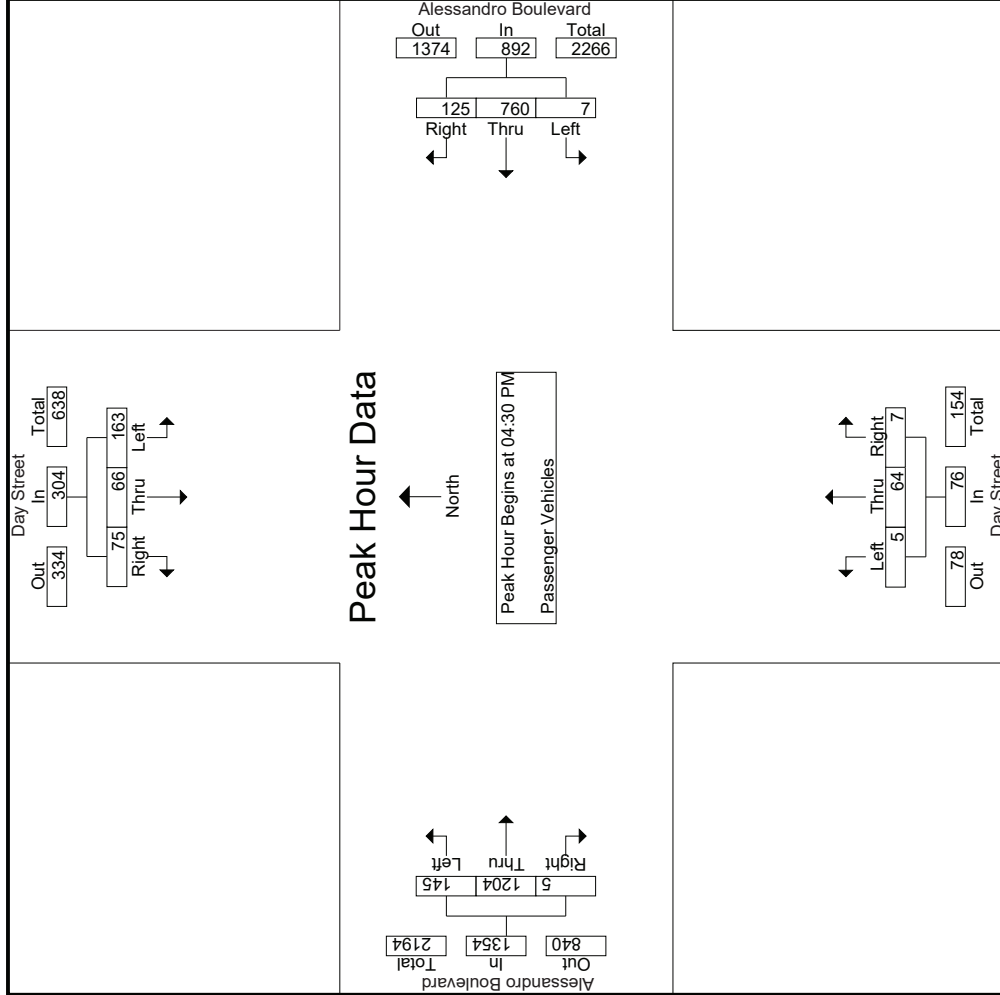

Counts Unlimited
 PO Box 1178
 Corona, CA 92878
 (951) 268-6268

City of Moreno Valley
 N/S: Day Street
 E/W: Alessandro Boulevard
 Weather: Clear

File Name : 07_MRV_Day_Alessandro PM
 Site Code : 05119512
 Start Date : 8/20/2019
 Page No : 3

Start Time	Day Street Southbound			Alessandro Boulevard Westbound			Day Street Northbound			Alessandro Boulevard Eastbound					
	Left	Thru	Right	Left	Thru	Right	Left	Thru	Right	Left	Thru	Right	App. Total	Int. Total	
Peak Hour Analysis From 04:30 PM to 05:15 PM - Peak 1 of 1															
Peak Hour for Each Approach Begins at:															
	04:30 PM			04:30 PM			04:30 PM			04:30 PM			04:30 PM		
+0 mins.	43	11	19	73	2	186	37	225	8	0	10	36	303	0	339
+15 mins.	39	9	13	61	1	193	28	222	19	1	21	28	284	1	313
+30 mins.	40	27	20	87	2	190	30	222	15	2	18	35	306	0	341
+45 mins.	41	19	23	83	2	191	30	223	22	4	27	46	311	4	361
Total Volume	163	66	75	304	7	760	125	892	64	7	76	145	1204	5	1354
% App. Total	53.6	21.7	24.7	.874	0.8	85.2	14	.991	84.2	9.2	.704	10.7	88.9	0.4	.938
PHF	.948	.611	.815	.874	.875	.984	.845	.991	.727	.438	.704	.788	.968	.313	.938

Groups Printed- Large 2 Axle Vehicles

Start Time	Day Street Southbound				Alessandro Boulevard Westbound				Day Street Northbound				Alessandro Boulevard Eastbound						
	Left	Thru	Right	RTOR	App. Total	Left	Thru	Right	RTOR	App. Total	Left	Thru	Right	RTOR	App. Total	Exclu. Total	Inclu. Total	Int. Total	
04:00 PM	0	0	0	0	0	0	0	1	0	0	0	0	0	0	0	3	0	4	4
04:15 PM	0	0	0	0	0	0	6	1	0	7	0	0	0	0	2	0	9	9	9
04:30 PM	0	0	0	0	0	0	1	0	0	1	0	0	0	0	1	0	2	2	2
04:45 PM	0	1	0	0	1	0	1	1	1	2	0	0	0	0	4	1	7	7	8
Total	0	1	0	0	1	0	8	3	1	11	0	0	0	0	10	1	22	23	23
05:00 PM	0	0	0	0	0	0	1	0	0	1	0	0	0	0	2	0	3	3	3
05:15 PM	0	0	0	0	0	0	2	0	0	2	0	0	0	0	4	0	6	6	6
05:30 PM	0	0	0	0	0	0	2	0	0	2	0	0	0	0	0	0	2	2	2
05:45 PM	1	0	0	0	1	0	0	0	0	0	0	0	0	0	1	0	2	2	2
Total	1	0	0	0	1	0	5	0	0	5	0	0	0	0	7	0	13	13	13
Grand Total	1	1	0	0	2	0	13	3	1	16	0	0	0	0	17	1	35	36	36
Approch %	50	50	0	0	5.7	0	81.2	18.8	0	45.7	0	0	0	0	11.8	88.2	0	0	0
Total %	2.9	2.9	0	0	5.7	0	37.1	8.6	0	45.7	0	0	0	0	5.7	42.9	0	0	2.8
48.6																	2.8	97.2	

3:1-632

Start Time	Day Street Southbound				Alessandro Boulevard Westbound				Day Street Northbound				Alessandro Boulevard Eastbound						
	Left	Thru	Right	RTOR	App. Total	Left	Thru	Right	RTOR	App. Total	Left	Thru	Right	RTOR	App. Total	Exclu. Total	Inclu. Total	Int. Total	
04:30 PM	0	0	0	0	0	0	0	1	0	1	0	0	0	0	0	0	1	1	2
04:45 PM	0	1	0	0	1	0	1	1	1	2	0	0	0	0	4	0	4	4	7
05:00 PM	0	0	0	0	0	0	0	1	0	1	0	0	0	0	2	0	2	2	3
05:15 PM	0	0	0	0	0	0	0	2	0	2	0	0	0	0	4	0	4	4	6
Total Volume	0	1	0	0	1	0	0	5	1	6	0	0	0	0	11	0	11	11	18
% App. Total	0	100	0	0	0	0	83.3	16.7	0	100	0	0	0	0	100	0	0	0	18
PHF	.000	.250	.000	.000	.250	.000	.625	.250	.000	.750	.000	.000	.000	.000	.688	.000	.688	.000	.643

Peak Hour Analysis From 04:30 PM to 05:15 PM - Peak 1 of 1
 Peak Hour for Entire Intersection Begins at 04:30 PM

Counts Unlimited
 PO Box 1178
 Corona, CA 92878
 (951) 268-6268

City of Moreno Valley
 N/S: Day Street
 E/W: Alessandro Boulevard
 Weather: Clear

File Name : 07_MRV_Day_Alessandro PM
 Site Code : 05119512
 Start Date : 8/20/2019
 Page No : 2

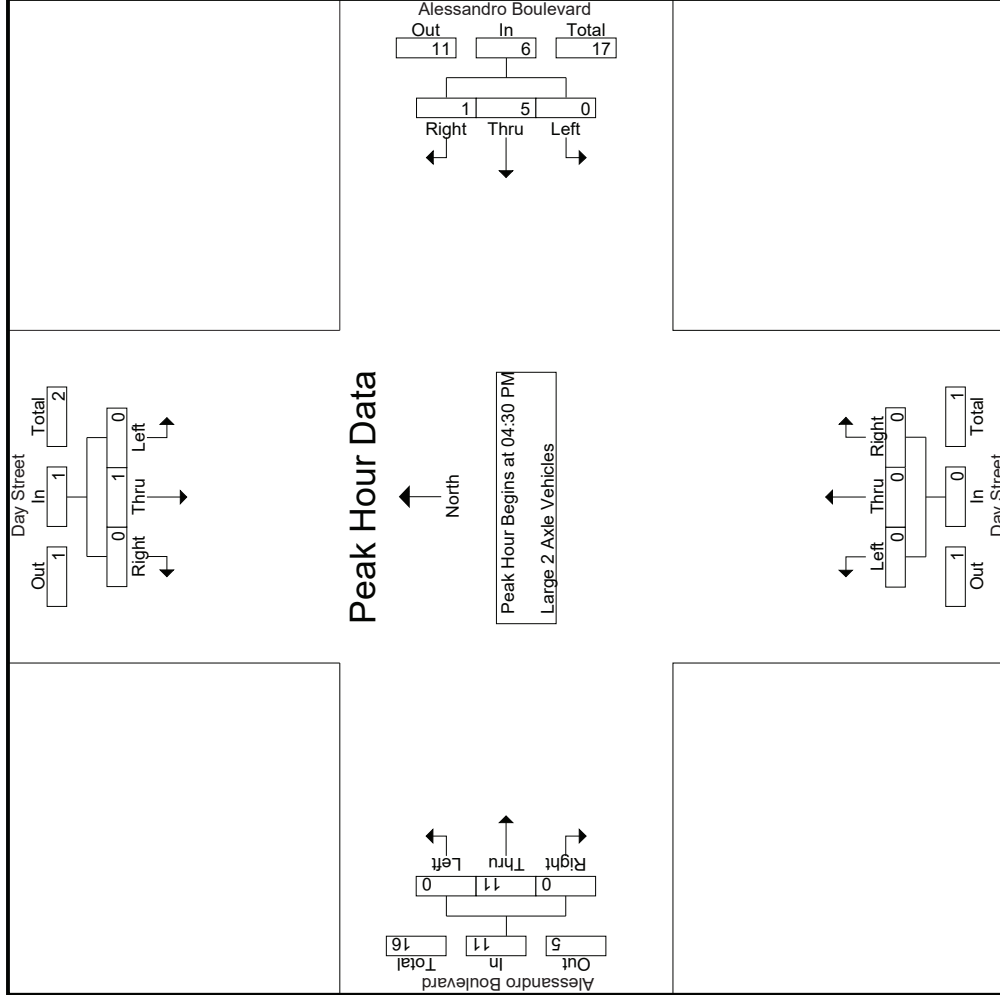

Counts Unlimited
 PO Box 1178
 Corona, CA 92878
 (951) 268-6268

City of Moreno Valley
 N/S: Day Street
 E/W: Alessandro Boulevard
 Weather: Clear

File Name : 07_MRV_Day_Alessandro PM
 Site Code : 05119512
 Start Date : 8/20/2019
 Page No : 3

Start Time	Day Street Southbound			Alessandro Boulevard Westbound			Day Street Northbound			Alessandro Boulevard Eastbound		
	Left	Thru	Right	Left	Thru	Right	Left	Thru	Right	Left	Thru	Right
Peak Hour Analysis From 04:30 PM to 05:15 PM - Peak 1 of 1												
Peak Hour for Each Approach Begins at:												
	04:30 PM			04:30 PM			04:30 PM			04:30 PM		
+0 mins.	0	0	0	1	0	0	0	0	0	0	1	0
+15 mins.	0	1	0	1	1	1	0	0	0	0	4	0
+30 mins.	0	0	0	1	0	0	0	0	0	0	2	0
+45 mins.	0	0	0	2	0	2	0	0	0	0	4	0
Total Volume	0	1	0	5	1	6	0	0	0	0	11	0
% App. Total	0	100	0	83.3	16.7	750	0	0	0	0	100	0
PHF	.000	.250	.000	.625	.250	.750	.000	.000	.000	.000	.688	.000

Groups Printed- 3 Axle Vehicles

Start Time	Day Street Southbound				Alessandro Boulevard Westbound				Day Street Northbound				Alessandro Boulevard Eastbound					
	Left	Thru	Right	RTOR	App. Total	Left	Thru	Right	RTOR	App. Total	Left	Thru	Right	RTOR	App. Total	Exclu. Total	Inclu. Total	Int. Total
04:00 PM	0	0	0	0	0	2	1	0	0	3	0	0	0	0	0	0	3	3
04:15 PM	0	0	0	0	0	0	1	0	0	1	0	0	0	0	0	0	2	2
04:30 PM	0	0	0	0	0	0	2	0	0	2	0	0	0	0	1	0	3	3
04:45 PM	0	0	0	0	0	0	0	0	0	0	0	0	0	0	1	0	1	1
Total	0	0	0	0	0	2	4	0	0	6	1	0	0	0	2	0	9	9
05:00 PM	0	0	0	0	0	0	0	0	0	0	0	0	0	0	0	0	0	0
05:15 PM	0	0	0	0	0	0	1	0	0	1	0	0	0	0	1	1	2	3
05:30 PM	0	0	0	0	0	0	0	0	0	0	0	0	0	0	0	0	0	0
05:45 PM	0	0	0	0	0	0	0	0	0	0	0	0	0	0	0	0	1	1
Total	0	0	0	0	0	0	1	0	1	1	0	0	0	0	1	1	3	4
Grand Total	0	0	0	0	0	2	5	0	1	7	1	0	1	0	2	1	12	13
Approch %	0	0	0	0	0	28.6	71.4	0	0	50	50	0	50	0	66.7	33.3	0	0
Total %	0	0	0	0	0	16.7	41.7	0	0	58.3	8.3	0	8.3	0	16.7	8.3	7.7	92.3

3:1-635

Start Time	Day Street Southbound				Alessandro Boulevard Westbound				Day Street Northbound				Alessandro Boulevard Eastbound					
	Left	Thru	Right	RTOR	App. Total	Left	Thru	Right	RTOR	App. Total	Left	Thru	Right	RTOR	App. Total	Exclu. Total	Inclu. Total	Int. Total
04:30 PM	0	0	0	0	0	0	0	0	0	0	0	0	0	0	0	0	0	0
04:45 PM	0	0	0	0	0	0	0	0	0	0	0	0	0	0	0	0	0	0
05:00 PM	0	0	0	0	0	0	0	0	0	0	0	0	0	0	0	0	0	0
05:15 PM	0	0	0	0	0	0	0	0	0	0	0	0	0	0	0	0	0	0
Total Volume	0	0	0	0	0	0	0	0	0	0	0	0	0	0	0	0	0	0
% App. Total	0	0	0	0	0	0	0	0	0	0	0	0	0	0	0	0	0	0
PHF	.000	.000	.000	.000	.000	.000	.000	.375	.000	.375	.000	.000	.000	.000	.500	.250	.750	.500

Peak Hour Analysis From 04:30 PM to 05:15 PM - Peak 1 of 1
 Peak Hour for Entire Intersection Begins at 04:30 PM

Counts Unlimited
 PO Box 1178
 Corona, CA 92878
 (951) 268-6268

City of Moreno Valley
 N/S: Day Street
 E/W: Alessandro Boulevard
 Weather: Clear

File Name : 07_MRV_Day_Alessandro PM
 Site Code : 05119512
 Start Date : 8/20/2019
 Page No : 2

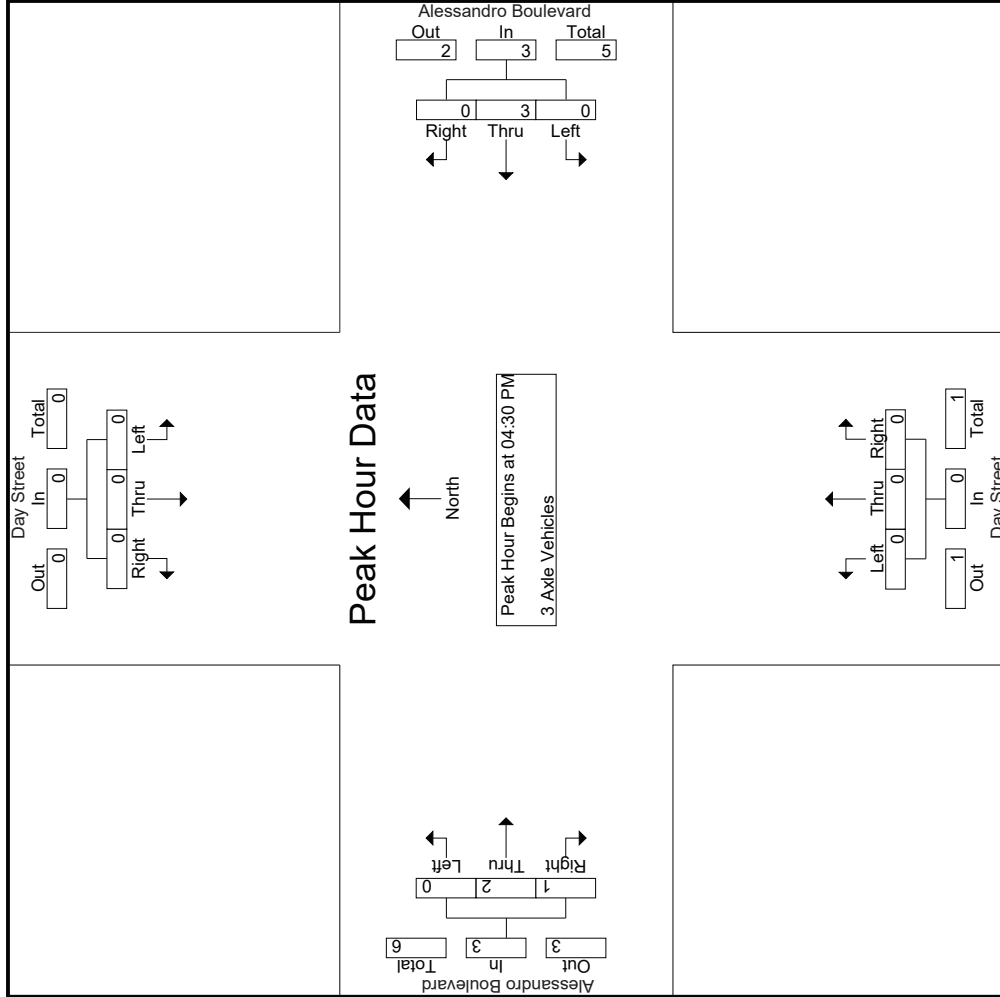

Counts Unlimited
 PO Box 1178
 Corona, CA 92878
 (951) 268-6268

City of Moreno Valley
 N/S: Day Street
 E/W: Alessandro Boulevard
 Weather: Clear

File Name : 07_MRV_Day_Alessandro PM
 Site Code : 05119512
 Start Date : 8/20/2019
 Page No : 3

Start Time	Day Street Southbound			Alessandro Boulevard Westbound			Day Street Northbound			Alessandro Boulevard Eastbound					
	Left	Thru	Right	Left	Thru	Right	Left	Thru	Right	Left	Thru	Right	App. Total	Int. Total	
Peak Hour Analysis From 04:30 PM to 05:15 PM - Peak 1 of 1															
Peak Hour for Each Approach Begins at:															
	04:30 PM			04:30 PM			04:30 PM			04:30 PM			04:30 PM		
+0 mins.	0	0	0	0	0	0	2	0	0	0	0	0	0	0	1
+15 mins.	0	0	0	0	0	0	0	0	0	0	0	0	0	0	1
+30 mins.	0	0	0	0	0	0	0	0	0	0	0	0	0	0	0
+45 mins.	0	0	0	0	0	0	1	0	0	0	0	0	0	0	0
Total Volume	0	0	0	0	0	0	3	0	0	0	0	0	0	0	3
% App. Total	0	0	0	0	100	0	.375	.000	.000	.000	.000	.000	.500	.250	.750
PHF	.000	.000	.000	.000	.000	.000	.375	.000	.000	.000	.000	.000	.500	.250	.750

Groups Printed- 4+ Axle Trucks

Start Time	Day Street Southbound				Alessandro Boulevard Westbound				Day Street Northbound				Alessandro Boulevard Eastbound							
	Left	Thru	Right	RTOR	Left	Thru	Right	RTOR	Left	Thru	Right	RTOR	Left	Thru	Right	RTOR	App. Total	Exclu. Total	Inclu. Total	Int. Total
04:00 PM	0	0	0	0	0	0	0	0	1	0	0	0	0	0	0	0	0	0	0	2
04:15 PM	0	0	0	0	0	2	0	0	2	0	0	0	0	4	1	0	5	0	7	7
04:30 PM	0	0	0	0	0	1	0	0	1	0	0	0	0	3	1	0	4	0	6	6
04:45 PM	0	0	0	0	0	0	0	0	0	0	0	0	0	1	1	0	2	0	2	2
Total	0	0	0	0	0	4	0	0	4	2	0	0	2	0	8	3	11	0	17	17
05:00 PM	0	0	0	0	0	1	0	0	1	0	0	0	0	3	0	0	3	0	4	4
05:15 PM	0	0	0	0	0	2	0	0	2	0	0	0	0	0	1	0	1	0	3	3
05:30 PM	0	0	0	0	0	2	0	0	2	0	0	0	1	1	0	0	2	0	4	4
05:45 PM	0	0	0	0	1	0	0	0	1	0	0	0	0	3	0	0	3	0	4	4
Total	0	0	0	0	1	5	0	0	6	0	0	0	0	7	1	0	9	0	15	15
Grand Total	0	0	0	0	1	9	0	0	10	2	0	0	2	1	15	4	20	0	32	32
Approch %	0	0	0	0	10	90	0	0	100	0	0	0	6.2	5	75	20	62.5	0	100	100
Total %	0	0	0	0	3.1	28.1	0	0	31.2	6.2	0	0	6.2	3.1	46.9	12.5	62.5	0	100	100

3:1-638

Start Time	Day Street Southbound				Alessandro Boulevard Westbound				Day Street Northbound				Alessandro Boulevard Eastbound							
	Left	Thru	Right	RTOR	Left	Thru	Right	RTOR	Left	Thru	Right	RTOR	Left	Thru	Right	RTOR	App. Total	Exclu. Total	Inclu. Total	Int. Total
04:30 PM	0	0	0	0	0	0	0	0	1	0	0	0	0	0	0	0	0	0	0	0
04:45 PM	0	0	0	0	0	0	0	0	0	0	0	0	0	0	0	0	0	0	0	0
05:00 PM	0	0	0	0	0	0	0	0	0	0	0	0	0	0	0	0	0	0	0	0
05:15 PM	0	0	0	0	0	0	0	0	2	0	0	0	0	0	0	0	0	0	0	0
Total Volume	0	0	0	0	0	0	0	0	4	1	0	0	1	0	7	3	10	0	15	15
% App. Total	0	0	0	0	0	100	0	0	0	100	0	0	0	70	30	30	.625	0	.625	.625
PHF	.000	.000	.000	.000	.000	.500	.000	.000	.500	.250	.000	.000	.250	.583	.750	.625	.625	.625	.625	.625

Peak Hour Analysis From 04:30 PM to 05:15 PM - Peak 1 of 1
 Peak Hour for Entire Intersection Begins at 04:30 PM

Counts Unlimited
 PO Box 1178
 Corona, CA 92878
 (951) 268-6268

City of Moreno Valley
 N/S: Day Street
 E/W: Alessandro Boulevard
 Weather: Clear

File Name : 07_MRV_Day_Alessandro PM
 Site Code : 05119512
 Start Date : 8/20/2019
 Page No : 2

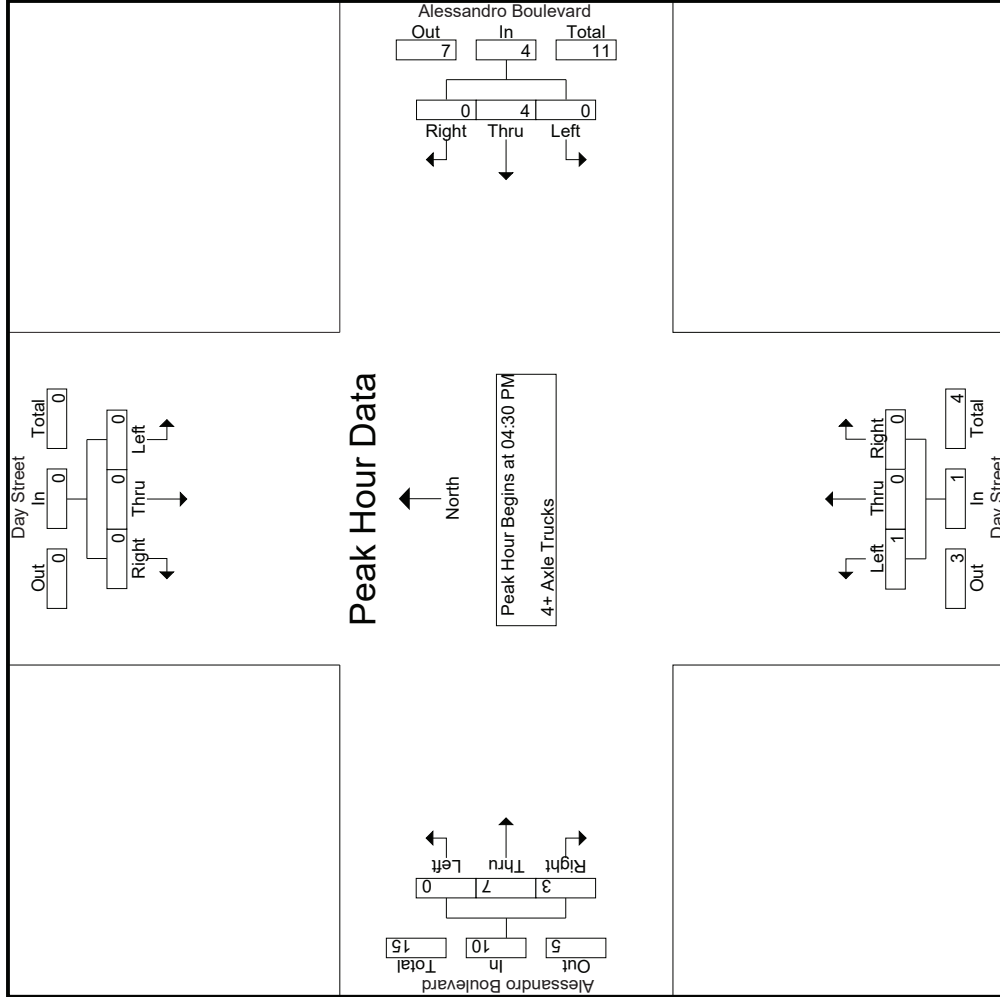

Counts Unlimited
 PO Box 1178
 Corona, CA 92878
 (951) 268-6268

City of Moreno Valley
 N/S: Day Street
 E/W: Alessandro Boulevard
 Weather: Clear

File Name : 07_MRV_Day_Alessandro PM
 Site Code : 05119512
 Start Date : 8/20/2019
 Page No : 3

Start Time	Day Street Southbound			Alessandro Boulevard Westbound			Day Street Northbound			Alessandro Boulevard Eastbound					
	Left	Thru	Right	Left	Thru	Right	Left	Thru	Right	Left	Thru	Right	App. Total	Int. Total	
Peak Hour Analysis From 04:30 PM to 05:15 PM - Peak 1 of 1															
Peak Hour for Each Approach Begins at:															
	04:30 PM			04:30 PM			04:30 PM			04:30 PM			04:30 PM		
+0 mins.	0	0	0	0	1	0	0	0	0	0	0	0	3	1	4
+15 mins.	0	0	0	0	0	0	0	0	0	0	0	0	1	1	2
+30 mins.	0	0	0	0	1	0	0	0	0	0	0	0	3	0	3
+45 mins.	0	0	0	0	2	0	0	0	0	0	0	0	0	1	1
Total Volume	0	0	0	0	4	0	0	0	0	0	0	0	7	3	10
% App. Total	0	0	0	0	100	0	0	0	0	0	0	0	70	30	100
PHF	.000	.000	.000	.000	.500	.000	.000	.000	.000	.250	.250	.583	.750	.625	.625

Location: Moreno Valley
 N/S: Day Street
 E/W: Alessandro Boulevard



Date: 8/20/2019
 Day: Tuesday

PEDESTRIANS

	North Leg Day Street	East Leg Alessandro Boulevard	South Leg Day Street	West Leg Alessandro Boulevard	
	Pedestrians	Pedestrians	Pedestrians	Pedestrians	
7:00 AM	0	0	0	0	0
7:15 AM	0	0	0	0	0
7:30 AM	0	0	0	0	0
7:45 AM	0	0	0	0	0
8:00 AM	0	0	0	0	0
8:15 AM	0	1	0	0	1
8:30 AM	0	1	0	0	1
8:45 AM	0	1	0	0	1
TOTAL VOLUMES:	0	3	0	0	3

	North Leg Day Street	East Leg Alessandro Boulevard	South Leg Day Street	West Leg Alessandro Boulevard	
	Pedestrians	Pedestrians	Pedestrians	Pedestrians	
4:00 PM	0	0	0	0	0
4:15 PM	1	0	0	0	1
4:30 PM	0	0	0	0	0
4:45 PM	0	0	0	0	0
5:00 PM	0	0	0	0	0
5:15 PM	0	0	0	0	0
5:30 PM	0	0	0	0	0
5:45 PM	1	0	0	0	1
TOTAL VOLUMES:	2	0	0	0	2

Location: Moreno Valley
 N/S: Day Street
 E/W: Alessandro Boulevard



Date: 8/20/2019
 Day: Tuesday

BICYCLES

	Southbound Day Street			Westbound Alessandro Boulevard			Northbound Day Street			Eastbound Alessandro Boulevard			
	Left	Thru	Right	Left	Thru	Right	Left	Thru	Right	Left	Thru	Right	
7:00 AM	0	0	0	0	0	0	0	0	1	0	0	0	1
7:15 AM	0	0	0	0	0	0	0	0	0	0	0	0	0
7:30 AM	0	0	0	0	0	0	0	0	0	0	0	0	0
7:45 AM	0	0	0	0	0	0	0	0	0	0	0	0	0
8:00 AM	0	0	0	0	2	0	0	0	0	0	0	0	2
8:15 AM	0	0	0	0	0	0	0	0	0	0	0	0	0
8:30 AM	0	0	0	0	0	0	0	0	0	0	0	0	0
8:45 AM	0	0	0	0	0	0	0	0	0	0	0	0	0
TOTAL VOLUMES:	0	0	0	0	2	0	0	0	1	0	0	0	3

	Southbound Day Street			Westbound Alessandro Boulevard			Northbound Day Street			Eastbound Alessandro Boulevard			
	Left	Thru	Right	Left	Thru	Right	Left	Thru	Right	Left	Thru	Right	
4:00 PM	0	0	0	0	0	0	0	0	0	0	0	0	0
4:15 PM	0	0	0	0	0	0	0	0	0	0	0	0	0
4:30 PM	0	0	0	0	0	0	0	0	0	0	1	0	1
4:45 PM	0	0	0	0	0	0	0	0	0	0	0	0	0
5:00 PM	0	0	0	0	0	0	0	0	0	0	0	0	0
5:15 PM	0	0	0	0	0	0	0	0	0	0	0	0	0
5:30 PM	0	0	0	0	0	0	0	0	0	0	0	0	0
5:45 PM	0	0	1	0	0	0	0	0	0	0	0	0	1
TOTAL VOLUMES:	0	0	1	0	0	0	0	0	0	0	1	0	2

Counts Unlimited
 PO Box 1178
 Corona, CA 92878
 (951) 268-6268

City of Moreno Valley
 N/S: Elsworth Street/March AFB
 EW: Cactus Avenue
 Weather: Clear

File Name : 44_MRV_Elsworth_Cactus AM
 Site Code : 05119542
 Start Date : 8/20/2019
 Page No : 1

Groups Printed- Passenger Vehicles - Large 2 Axle Vehicles - 3 Axle Vehicles - 4+ Axle Trucks

Start Time	Elsworth Street Southbound						Cactus Avenue Westbound						March AFB Northbound						Cactus Avenue Eastbound							
	Left	Thru	Right	RTOR	App. Total		Left	Thru	Right	RTOR	App. Total		Left	Thru	Right	RTOR	App. Total		Left	Thru	Right	RTOR	App. Total			
	Exclu. Total	Inclu. Total	Int. Total				Exclu. Total	Inclu. Total	Int. Total				Exclu. Total	Inclu. Total	Int. Total				Exclu. Total	Inclu. Total	Int. Total					
07:00 AM	15	18	38	29	71	25	460	29	5	514	8	4	10	8	22	38	257	66	1	361	43	968	1011			
07:15 AM	22	19	52	23	93	19	428	38	5	485	2	9	3	2	14	36	304	52	0	392	30	984	1014			
07:30 AM	20	26	27	22	73	25	338	40	2	403	9	7	12	8	28	29	291	56	0	376	32	880	912			
07:45 AM	29	17	37	29	83	14	413	42	8	469	9	6	7	5	22	48	360	50	1	458	43	1032	1075			
Total	86	80	154	103	320	83	1639	149	20	1871	28	26	32	23	86	151	1212	224	2	1587	148	3864	4012			
08:00 AM	22	17	24	20	63	22	364	40	4	426	7	9	7	5	23	54	286	49	1	389	30	901	931			
08:15 AM	21	18	30	19	69	14	315	29	1	358	7	3	8	8	18	35	253	30	0	318	28	763	791			
08:30 AM	35	12	30	26	77	11	289	23	1	323	6	4	13	7	23	34	222	31	0	287	34	710	744			
08:45 AM	24	17	30	23	71	18	256	28	2	302	4	4	7	5	15	36	218	24	2	278	32	666	698			
Total	102	64	114	88	280	65	1224	120	8	1409	24	20	35	25	79	159	979	134	3	1272	124	3040	3164			
Grand Total	188	144	268	191	600	148	2863	269	28	3280	52	46	67	48	165	310	2191	358	5	2859	272	6904	7176			
Approch %	31.3	24	44.7			4.5	87.3	8.2			31.5	27.9	40.6			10.8	76.6	12.5			3.8	96.2				
Total %	2.7	2.1	3.9		8.7	2.1	41.5	3.9		47.5	0.8	0.7	1		2.4	4.5	31.7	5.2		41.4						
Passenger Vehicles	180	141	250	751	147	2743	262		3180	52	45	63		206	290	2074	356		2725	0	0	0	6862			
% Passenger Vehicles	95.7	97.9	93.3	94.2	99.3	95.8	97.4		96.1	100	97.8	94		95.8	93.5	94.7	99.4		95.1	0	0	0	95.6			
Large 2 Axle Vehicles	8	3	8	3	26	0	36	2		38	0	1	1		3	11	32	1		44	0	0	0	111		
% Large 2 Axle Vehicles	4.3	2.1	3	3.7	0	1.3	0.7		1.1	0	2.2	1.5	2.1		1.4	3.5	1.5	0.3		1.5	0	0	0	0		
3 Axle Vehicles	0	0	1	1	2	1	30	1		32	0	0	1		1	5	12	0		17	0	0	0	52		
% 3 Axle Vehicles	0	0	0.4	0.5	0.3	0.7	1		0.4	0	0	1.5	0		0.5	1.6	0.5	0		0.6	0	0	0	0		
4+ Axle Trucks	0	0	9	9	12	0	54	4		58	0	0	2		3	4	73	1		78	0	0	0	151		
% 4+ Axle Trucks	0	0	3.4	1.6	1.5	0	1.9	1.5		1.8	0	0	3		1.4	1.3	3.3	0.3		2.7	0	0	0	2.1		

Start Time	Elsworth Street Southbound						Cactus Avenue Westbound						March AFB Northbound						Cactus Avenue Eastbound							
	Left	Thru	Right	RTOR	App. Total		Left	Thru	Right	RTOR	App. Total		Left	Thru	Right	RTOR	App. Total		Left	Thru	Right	RTOR	App. Total			
	Exclu. Total	Inclu. Total	Int. Total				Exclu. Total	Inclu. Total	Int. Total				Exclu. Total	Inclu. Total	Int. Total				Exclu. Total	Inclu. Total	Int. Total					
07:00 AM	15	18	38	29	71	25	460	29	5	514	8	4	10	8	22	38	257	66	1	361	43	968	1011			
07:15 AM	22	19	52	23	93	19	428	38	5	485	2	9	3	2	14	36	304	52	0	392	30	984	1014			
07:30 AM	20	26	27	22	73	25	338	40	2	403	9	7	12	8	28	29	291	56	0	376	32	880	912			
07:45 AM	29	17	37	29	83	14	413	42	8	469	9	6	7	5	22	48	360	50	1	458	43	1032	1075			
Total Volume	86	80	154	103	320	83	1639	149	20	1871	28	26	32	23	86	151	1212	224	2	1587	148	3864	4012			
% App. Total	26.9	25	48.1		48.1	4.4	87.6	8		8	32.6	30.2	37.2		9.5	76.4	14.1		14.1	0	0	0	3864			
PHF	.741	.769	.740		.860	.830	.891	.887		.910	.778	.722	.667		.786	.842	.848		.866				.866			

Peak Hour Analysis From 07:00 AM to 08:45 AM - Peak 1 of 1
 Peak Hour for Entire Intersection Begins at 07:00 AM

Counts Unlimited
 PO Box 1178
 Corona, CA 92878
 (951) 268-6268

City of Moreno Valley
 N/S: Elsworth Street/March AFB
 E/W: Cactus Avenue
 Weather: Clear

File Name : 44_MRV_Elsworth_Cactus AM
 Site Code : 05119542
 Start Date : 8/20/2019
 Page No : 2

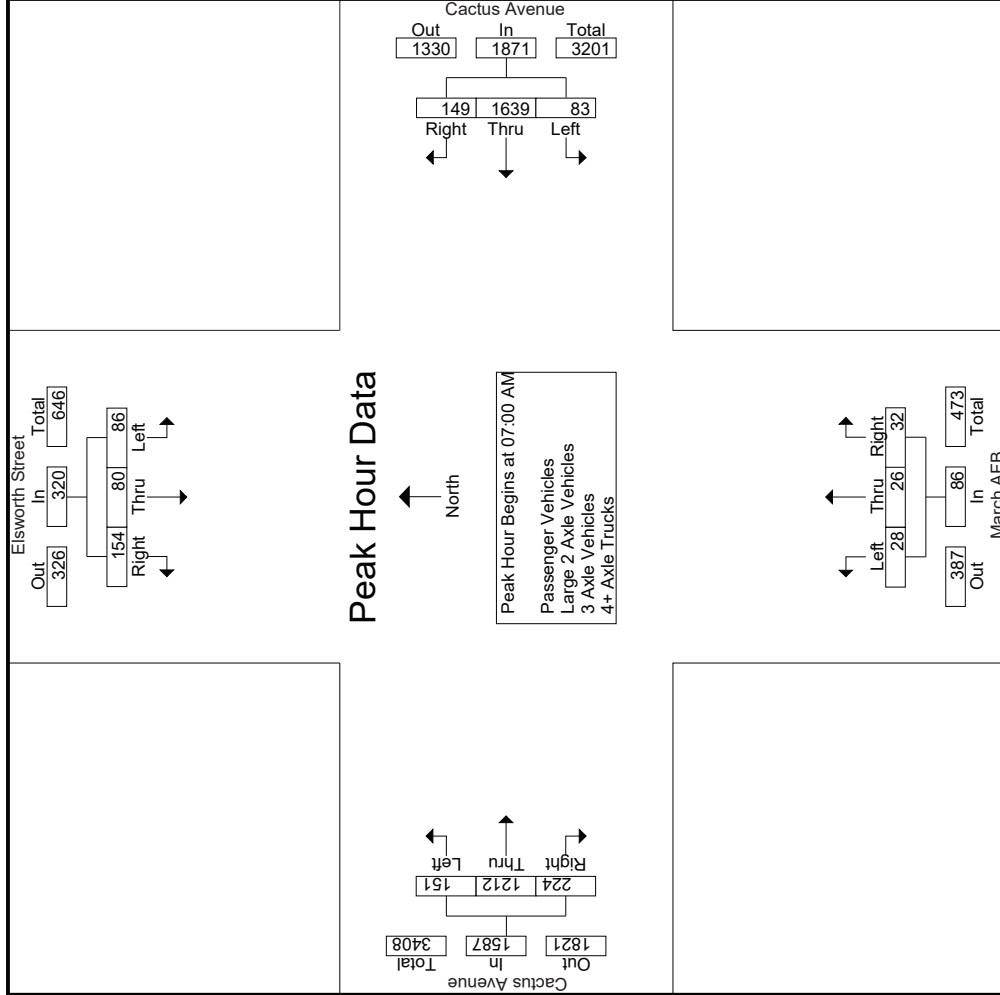

Counts Unlimited
 PO Box 1178
 Corona, CA 92878
 (951) 268-6268

City of Moreno Valley
 N/S: Elsworth Street/March AFB
 E/W: Cactus Avenue
 Weather: Clear

File Name : 44_MRV_Elsworth_Cactus AM
 Site Code : 05119542
 Start Date : 8/20/2019
 Page No : 3

Start Time	Elsworth Street Southbound			Cactus Avenue Westbound			March AFB Northbound			Cactus Avenue Eastbound		
	Left	Thru	Right	Left	Thru	Right	Left	Thru	Right	Left	Thru	Right
Peak Hour Analysis From 07:00 AM to 08:45 AM - Peak 1 of 1												
Peak Hour for Each Approach Begins at:												
	07:00 AM			07:00 AM			07:30 AM			07:15 AM		
+0 mins.	15	18	38	25	460	29	9	7	12	28	36	52
+15 mins.	22	19	52	19	428	38	9	6	7	22	29	56
+30 mins.	20	26	27	25	338	40	7	9	7	23	48	50
+45 mins.	29	17	37	14	413	42	7	3	8	18	54	49
Total Volume	86	80	154	83	1639	149	32	25	34	91	167	207
% App. Total	26.9	25	48.1	4.4	87.6	8	35.2	27.5	37.4	10.3	76.8	12.8
PHF	.741	.769	.740	.830	.891	.887	.889	.694	.708	.813	.773	.924
												.882

Counts Unlimited
 PO Box 1178
 Corona, CA 92878
 (951) 268-6268

City of Moreno Valley
 N/S: Elsworth Street/March AFB
 EW: Cactus Avenue
 Weather: Clear

File Name : 44_MRV_Elsworth_Cactus AM
 Site Code : 05119542
 Start Date : 8/20/2019
 Page No : 1

Groups Printed- Passenger Vehicles

Start Time	Elsworth Street Southbound					Cactus Avenue Westbound					March AFB Northbound					Cactus Avenue Eastbound							
	Left	Thru	Right	RTOR	App. Total	Left	Thru	Right	RTOR	App. Total	Left	Thru	Right	RTOR	App. Total	Left	Thru	Right	RTOR	App. Total	Exclu. Total	Inclu. Total	Int. Total
07:00 AM	15	18	35	27	68	25	445	28	5	498	8	4	10	8	22	33	237	66	1	336	41	924	965
07:15 AM	21	19	50	22	90	19	419	38	5	476	2	8	3	2	13	32	289	51	0	372	29	951	980
07:30 AM	18	25	25	21	68	25	328	40	2	393	9	7	12	8	28	26	279	56	0	361	31	850	881
07:45 AM	28	17	34	26	79	14	401	41	8	456	9	6	7	5	22	47	345	50	1	442	40	999	1039
Total	82	79	144	96	305	83	1593	147	20	1823	28	25	32	23	85	138	1150	223	2	1511	141	3724	3865
08:00 AM	22	15	22	18	59	21	349	38	4	408	7	9	5	4	21	52	276	49	1	377	27	865	892
08:15 AM	21	18	28	19	67	14	297	28	1	339	7	3	8	8	18	32	234	30	0	296	28	720	748
08:30 AM	31	12	27	24	70	11	266	22	1	299	6	4	12	7	22	32	205	30	0	267	32	658	690
08:45 AM	24	17	29	23	70	18	238	27	2	283	4	4	6	4	14	36	209	24	2	269	31	636	667
Total	98	62	106	84	266	64	1150	115	8	1329	24	20	31	23	75	152	924	133	3	1209	118	2879	2997
Grand Total	180	141	250	180	571	147	2743	262	28	3152	52	45	63	46	160	290	2074	356	5	2720	259	6603	6862
Approch %	31.5	24.7	43.8			4.7	87	8.3		47.7	32.5	28.1	39.4		10.7	76.2	13.1			41.2	3.8	96.2	
Total %	2.7	2.1	3.8		8.6	2.2	41.5	4			0.8	0.7	1		2.4	4.4	31.4	5.4					

3.1-646

Start Time	Elsworth Street Southbound					Cactus Avenue Westbound					March AFB Northbound					Cactus Avenue Eastbound							
	Left	Thru	Right	RTOR	App. Total	Left	Thru	Right	RTOR	App. Total	Left	Thru	Right	RTOR	App. Total	Left	Thru	Right	RTOR	App. Total	Exclu. Total	Inclu. Total	Int. Total
07:00 AM	15	18	35	27	68	25	445	28	5	498	8	4	10	8	22	33	237	66	1	336	41	924	965
07:15 AM	21	19	50	22	90	19	419	38	5	476	2	8	3	2	13	32	289	51	0	372	29	951	980
07:30 AM	18	25	25	21	68	25	328	40	2	393	9	7	12	8	28	26	279	56	0	361	31	850	881
07:45 AM	28	17	34	26	79	14	401	41	8	456	9	6	7	5	22	47	345	50	1	442	40	999	1039
Total Volume	82	79	144	96	305	83	1593	147	20	1823	28	25	32	23	85	138	1150	223	2	1511	141	3724	3865
% App. Total	26.9	25.9	47.2			4.6	87.4	8.1		47.7	32.9	29.4	37.6		10.7	76.1	14.8			41.2	3.8	96.2	
PHF	.732	.790	.720		.847	.830	.895	.896		.915	.778	.781	.667		.759	.734	.833	.845		.855		.932	

Peak Hour Analysis From 07:00 AM to 07:45 AM - Peak 1 of 1
 Peak Hour for Entire Intersection Begins at 07:00 AM

Counts Unlimited
 PO Box 1178
 Corona, CA 92878
 (951) 268-6268

City of Moreno Valley
 N/S: Elsworth Street/March AFB
 E/W: Cactus Avenue
 Weather: Clear

File Name : 44_MRV_Elsworth_Cactus AM
 Site Code : 05119542
 Start Date : 8/20/2019
 Page No : 2

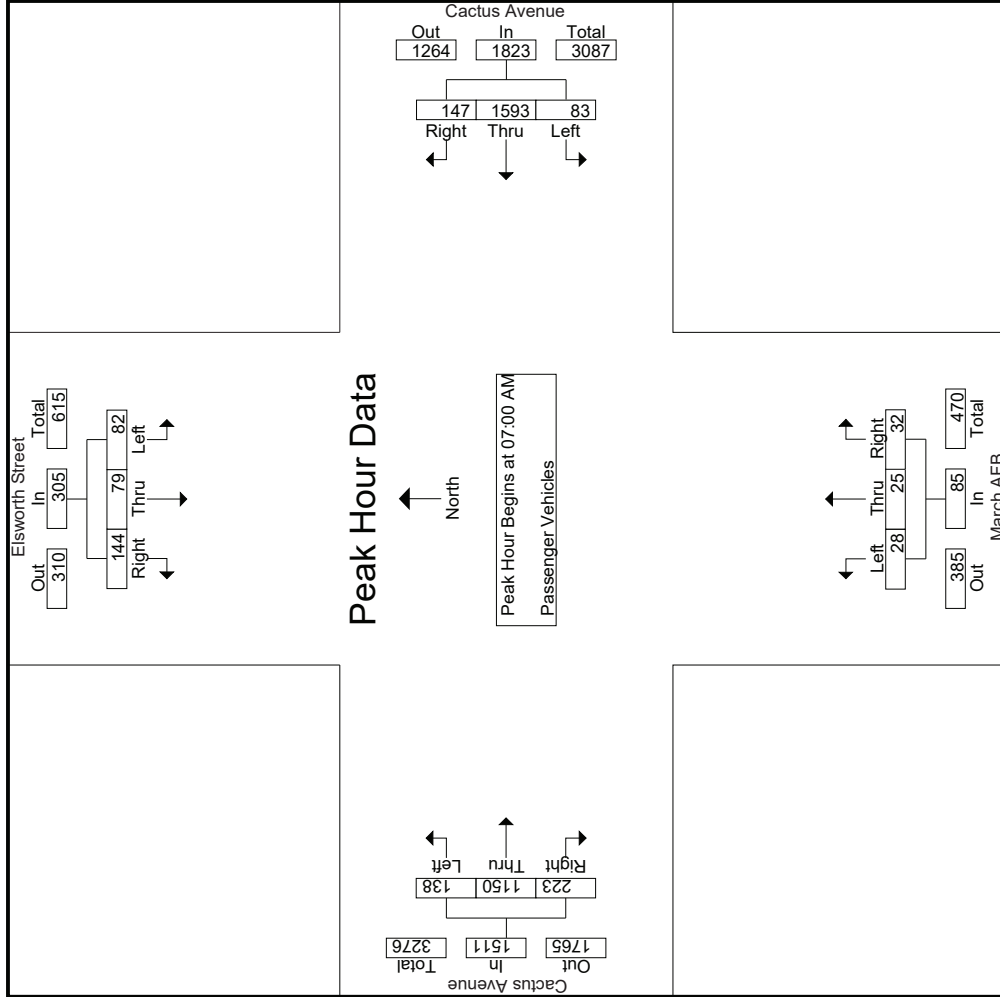

Counts Unlimited
 PO Box 1178
 Corona, CA 92878
 (951) 268-6268

City of Moreno Valley
 N/S: Elsworth Street/March AFB
 E/W: Cactus Avenue
 Weather: Clear

File Name : 44_MRV_Elsworth_Cactus AM
 Site Code : 05119542
 Start Date : 8/20/2019
 Page No : 3

Start Time	Elsworth Street Southbound			Cactus Avenue Westbound			March AFB Northbound			Cactus Avenue Eastbound					
	Left	Thru	Right	Left	Thru	Right	Left	Thru	Right	Left	Thru	Right			
Peak Hour Analysis From 07:00 AM to 07:45 AM - Peak 1 of 1															
Peak Hour for Each Approach Begins at:															
	07:00 AM			07:00 AM			07:00 AM			07:00 AM					
+0 mins.	15	18	35	25	445	28	498	8	4	10	22	33	237	66	336
+15 mins.	21	19	50	19	419	38	476	2	8	3	13	32	289	51	372
+30 mins.	18	25	68	25	328	40	393	9	7	12	28	26	279	56	361
+45 mins.	28	17	34	14	401	41	456	9	6	7	22	47	345	50	442
Total Volume	82	79	144	83	1593	147	1823	28	25	32	85	138	1150	223	1511
% App. Total	26.9	25.9	47.2	4.6	87.4	8.1	32.9	29.4	37.6	9.1	76.1	14.8	76.1	14.8	84.5
PHF	.732	.790	.720	.830	.895	.896	.915	.778	.781	.667	.759	.734	.833	.845	.855

Groups Printed- Large 2 Axle Vehicles

Start Time	Elsworth Street Southbound				Cactus Avenue Westbound				March AFB Northbound				Cactus Avenue Eastbound							
	Left	Thru	Right	RTOR	Left	Thru	Right	RTOR	Left	Thru	Right	RTOR	Left	Thru	Right	RTOR	App. Total	Exclu. Total	Inclu. Total	Int. Total
07:00 AM	0	0	2	2	0	3	0	0	3	0	0	0	3	3	0	0	6	2	11	13
07:15 AM	1	0	0	1	0	3	0	0	3	0	0	1	3	4	1	0	8	0	13	13
07:30 AM	2	1	1	4	0	1	0	0	1	0	0	0	0	4	0	0	4	1	9	10
07:45 AM	1	0	2	3	0	4	0	0	4	0	0	0	1	4	0	0	5	2	12	14
Total	4	1	5	10	0	11	0	0	11	0	1	0	7	15	1	0	23	5	45	50
08:00 AM	0	2	1	3	0	4	1	0	5	0	0	0	2	4	0	0	6	1	14	15
08:15 AM	0	0	0	0	0	4	1	0	5	0	0	0	1	8	0	0	9	0	14	14
08:30 AM	4	0	2	6	0	8	0	0	8	0	0	0	1	4	0	0	5	1	19	20
08:45 AM	0	0	0	0	0	9	0	0	9	0	1	1	0	1	0	0	1	1	11	12
Total	4	2	3	9	0	25	2	0	27	0	0	1	4	17	0	0	21	3	58	61
Grand Total	8	3	8	19	0	36	2	0	38	0	1	1	11	32	1	0	44	8	103	111
Apprch %	42.1	15.8	42.1	18.4	0	94.7	5.3		36.9	0	50	50	25	72.7	2.3		42.7	7.2	92.8	
Total %	7.8	2.9	7.8		0	35	1.9			0	1	1	10.7	31.1	1					

3:1-64

Start Time	Elsworth Street Southbound				Cactus Avenue Westbound				March AFB Northbound				Cactus Avenue Eastbound							
	Left	Thru	Right	RTOR	Left	Thru	Right	RTOR	Left	Thru	Right	RTOR	Left	Thru	Right	RTOR	App. Total	Exclu. Total	Inclu. Total	Int. Total
07:00 AM	0	0	0	2	0	3	0	0	3	0	0	0	0	0	0	0	0	0	6	11
07:15 AM	1	0	0	1	0	3	0	0	3	0	0	0	3	4	1	0	8	0	13	13
07:30 AM	2	1	1	4	0	1	0	0	1	0	0	0	0	4	0	0	4	1	9	10
07:45 AM	1	0	2	3	0	4	0	0	4	0	0	0	1	4	0	0	5	2	12	14
Total Volume	4	1	5	10	0	11	0	0	11	0	1	0	7	15	1	0	23	5	45	50
% App. Total	40	10	50	50	0	100	0		30.4	65.2	4.3		30.4	65.2	4.3		42.7	7.2	92.8	
PHF	.500	.250	.625	.625	.000	.688	.000		.688	.000	.250	.000	.583	.938	.250				.719	.865

Peak Hour Analysis From 07:00 AM to 07:45 AM - Peak 1 of 1
 Peak Hour for Entire Intersection Begins at 07:00 AM

Counts Unlimited
 PO Box 1178
 Corona, CA 92878
 (951) 268-6268

City of Moreno Valley
 N/S: Elsworth Street/March AFB
 E/W: Cactus Avenue
 Weather: Clear

File Name : 44_MRV_Elsworth_Cactus AM
 Site Code : 05119542
 Start Date : 8/20/2019
 Page No : 2

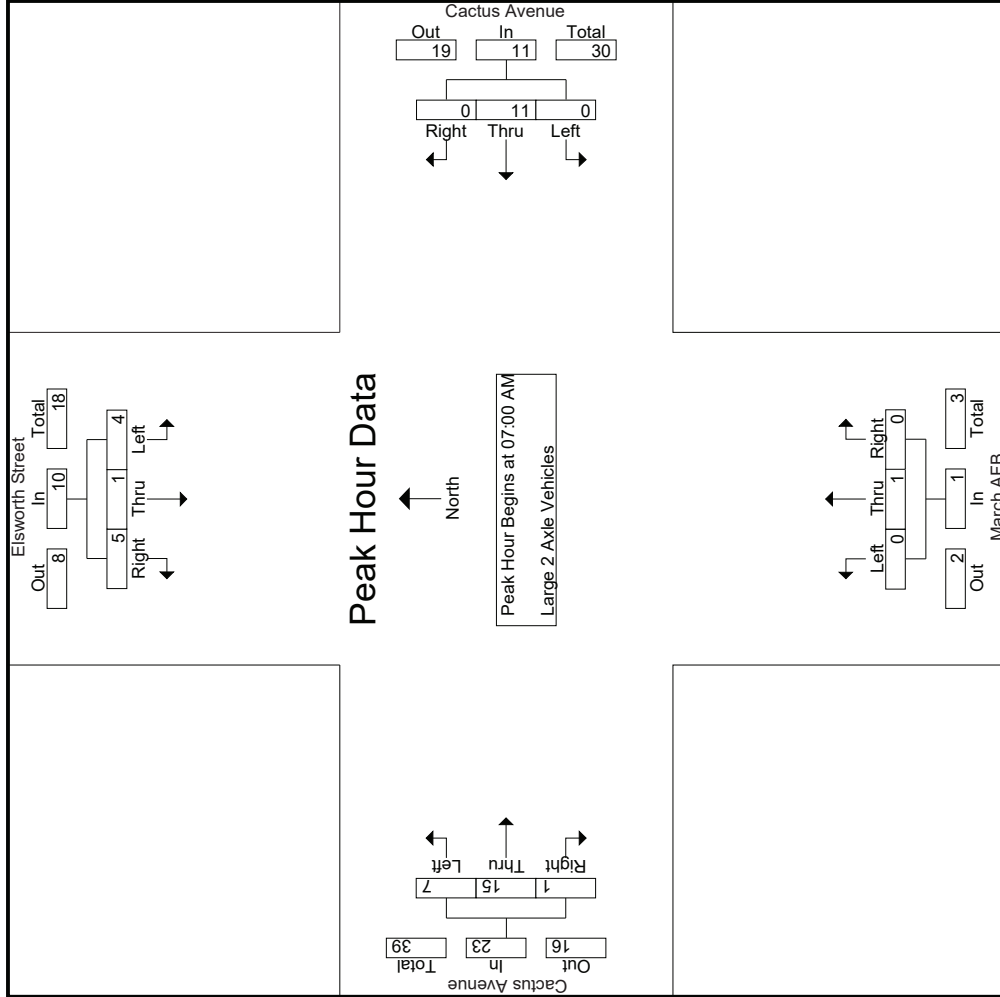

Counts Unlimited
 PO Box 1178
 Corona, CA 92878
 (951) 268-6268

City of Moreno Valley
 N/S: Elsworth Street/March AFB
 E/W: Cactus Avenue
 Weather: Clear

File Name : 44_MRV_Elsworth_Cactus AM
 Site Code : 05119542
 Start Date : 8/20/2019
 Page No : 3

Start Time	Elsworth Street Southbound			Cactus Avenue Westbound			March AFB Northbound			Cactus Avenue Eastbound		
	Left	Thru	Right	Left	Thru	Right	Left	Thru	Right	Left	Thru	Right
Peak Hour Analysis From 07:00 AM to 07:45 AM - Peak 1 of 1												
Peak Hour for Each Approach Begins at:												
+0 mins.	0	0	2	0	3	0	0	0	0	0	3	0
+15 mins.	1	0	0	0	3	0	1	0	1	3	4	1
+30 mins.	2	1	1	0	1	0	0	0	0	0	4	0
+45 mins.	1	0	2	0	4	0	0	0	0	1	4	0
Total Volume	4	1	5	0	11	0	1	1	1	7	15	1
% App. Total	40	10	50	0	100	0	0	100	0	30.4	65.2	4.3
PHF	.500	.250	.625	.000	.688	.000	.000	.250	.000	.583	.938	.250

Counts Unlimited
 PO Box 1178
 Corona, CA 92878
 (951) 268-6268

City of Moreno Valley
 N/S: Elsworth Street/March AFB
 EW: Cactus Avenue
 Weather: Clear

File Name : 44_MRV_Elsworth_Cactus AM
 Site Code : 05119542
 Start Date : 8/20/2019
 Page No : 1

Groups Printed- 3 Axle Vehicles

Start Time	Elsworth Street Southbound				Cactus Avenue Westbound				March AFB Northbound				Cactus Avenue Eastbound					
	Left	Thru	Right	RTOR	App. Total	Left	Thru	Right	RTOR	App. Total	Left	Thru	Right	RTOR	App. Total	Exclu. Total	Inclu. Total	Int. Total
07:00 AM	0	0	0	0	0	0	7	1	0	8	0	0	0	0	0	0	11	11
07:15 AM	0	0	1	1	1	0	3	0	0	3	0	0	0	0	0	1	7	8
07:30 AM	0	0	0	0	0	0	5	0	0	5	0	0	0	0	0	0	8	8
07:45 AM	0	0	0	0	0	0	1	0	0	1	0	0	0	0	0	0	4	4
Total	0	0	1	1	1	0	16	1	0	17	0	0	0	0	12	1	30	31
08:00 AM	0	0	0	0	0	1	3	0	0	4	0	0	0	0	0	0	6	6
08:15 AM	0	0	0	0	0	0	6	0	0	6	0	0	0	0	1	0	7	7
08:30 AM	0	0	0	0	0	0	3	0	0	3	0	0	1	0	0	0	5	5
08:45 AM	0	0	0	0	0	0	2	0	0	2	0	0	0	0	1	0	3	3
Total	0	0	0	0	0	1	14	0	0	15	0	0	1	0	5	0	21	21
Grand Total	0	0	1	1	1	1	30	1	0	32	0	0	1	0	17	1	51	52
Apprch %	0	0	100		3.1	93.8	3.1			62.7	0	0	100		29.4	70.6	0	
Total %	0	0	2		2	58.8	2			62.7	0	0	2		9.8	23.5	0	98.1

3:1-652

Start Time	Elsworth Street Southbound				Cactus Avenue Westbound				March AFB Northbound				Cactus Avenue Eastbound					
	Left	Thru	Right	RTOR	App. Total	Left	Thru	Right	RTOR	App. Total	Left	Thru	Right	RTOR	App. Total	Exclu. Total	Inclu. Total	Int. Total
07:00 AM	0	0	0	0	0	0	7	1	0	8	0	0	0	0	0	0	11	11
07:15 AM	0	0	1	1	1	0	3	0	0	3	0	0	0	0	0	1	7	8
07:30 AM	0	0	0	0	0	0	5	0	0	5	0	0	0	0	0	0	8	8
07:45 AM	0	0	0	0	0	0	1	0	0	1	0	0	0	0	0	0	4	4
Total Volume	0	0	1	1	1	0	16	1	0	17	0	0	0	0	12	1	30	31
% App. Total	0	0	100		3.1	94.1	5.9			62.7	0	0	100		29.4	70.6	0	
PHF	.000	.000	.250		.250	.571	.250			.531	.000	.000	.000		.667	.000	1.00	.682

Peak Hour Analysis From 07:00 AM to 07:45 AM - Peak 1 of 1
 Peak Hour for Entire Intersection Begins at 07:00 AM

Counts Unlimited
 PO Box 1178
 Corona, CA 92878
 (951) 268-6268

City of Moreno Valley
 N/S: Elsworth Street/March AFB
 E/W: Cactus Avenue
 Weather: Clear

File Name : 44_MRV_Elsworth_Cactus AM
 Site Code : 05119542
 Start Date : 8/20/2019
 Page No : 2

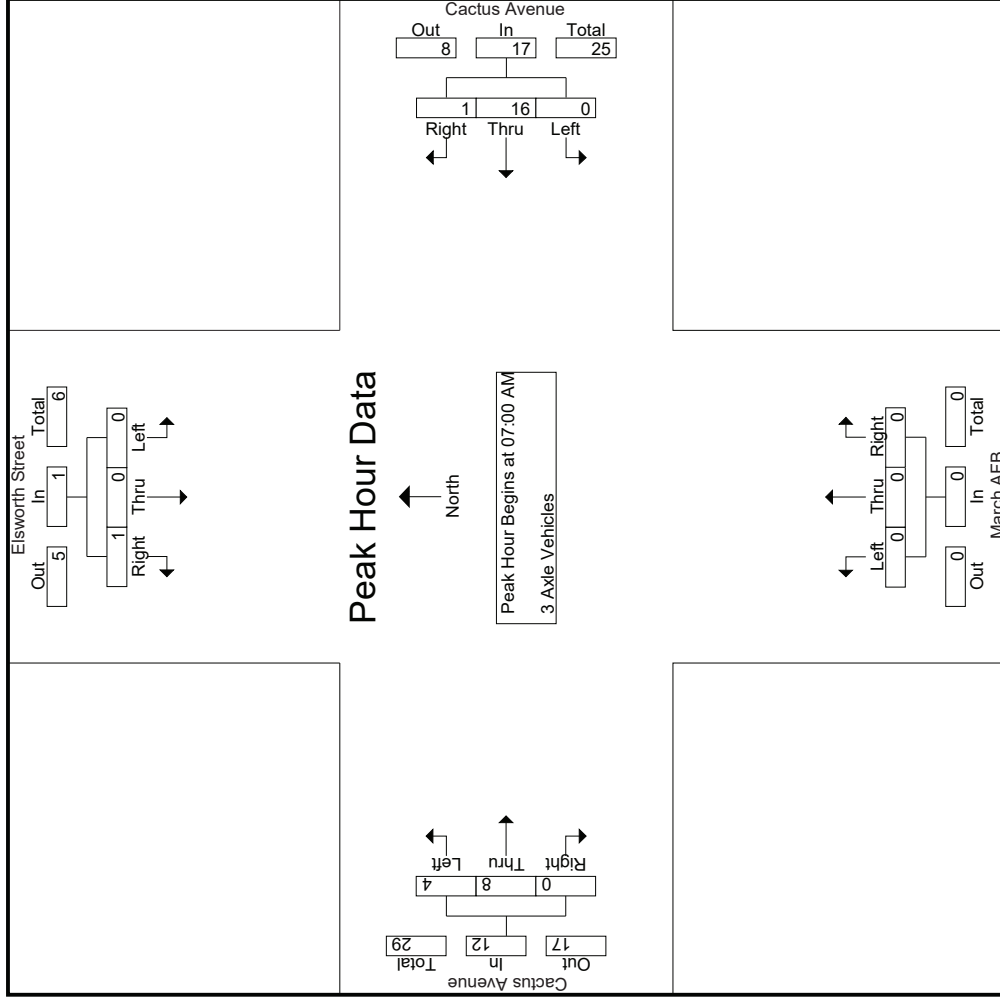

Counts Unlimited
 PO Box 1178
 Corona, CA 92878
 (951) 268-6268

City of Moreno Valley
 N/S: Elsworth Street/March AFB
 E/W: Cactus Avenue
 Weather: Clear

File Name : 44_MRV_Elsworth_Cactus AM
 Site Code : 05119542
 Start Date : 8/20/2019
 Page No : 3

Start Time	Elsworth Street Southbound			Cactus Avenue Westbound			March AFB Northbound			Cactus Avenue Eastbound		
	Left	Thru	Right	Left	Thru	Right	Left	Thru	Right	Left	Thru	Right
Peak Hour Analysis From 07:00 AM to 07:45 AM - Peak 1 of 1												
Peak Hour for Each Approach Begins at:												
+0 mins.	0	0	0	0	7	1	0	0	0	0	0	0
+15 mins.	0	0	1	0	3	0	0	0	0	1	2	0
+30 mins.	0	0	0	0	5	0	0	0	0	2	1	0
+45 mins.	0	0	0	0	1	0	0	0	0	0	3	0
Total Volume	0	0	1	0	16	1	0	0	0	4	8	0
% App. Total	0	0	100	0	94.1	5.9	0	0	0	33.3	66.7	0
PHF	.000	.000	.250	.000	.571	.250	.000	.000	.000	.500	.667	.000

Groups Printed- 4+ Axle Trucks

Start Time	Elsworth Street Southbound				Cactus Avenue Westbound				March AFB Northbound				Cactus Avenue Eastbound								
	Left	Thru	Right	RTOR	App. Total	Left	Thru	Right	RTOR	App. Total	Left	Thru	Right	RTOR	App. Total	Exclu. Total	Inclu. Total	Int. Total			
07:00 AM	0	0	1	0	1	0	5	0	0	5	0	0	0	0	0	16	0	22	22		
07:15 AM	0	0	1	0	1	0	3	0	0	3	0	0	0	0	0	9	0	13	13		
07:30 AM	0	0	1	0	1	0	4	0	0	4	0	0	0	0	0	8	0	13	13		
07:45 AM	0	0	1	1	1	0	7	1	0	8	0	0	0	0	0	8	1	17	18		
Total	0	0	4	1	4	0	19	1	0	20	0	0	0	0	0	41	1	65	66		
08:00 AM	0	0	1	1	1	0	8	1	0	9	0	0	2	1	2	4	2	16	18		
08:15 AM	0	0	2	0	2	0	8	0	0	8	0	0	0	0	0	12	0	22	22		
08:30 AM	0	0	1	1	1	0	12	1	0	13	0	0	0	0	0	14	1	28	29		
08:45 AM	0	0	1	0	1	0	7	1	0	8	0	0	0	0	0	7	0	16	16		
Total	0	0	5	2	5	0	35	3	0	38	0	0	2	1	2	37	3	82	85		
Grand Total	0	0	9	3	9	0	54	4	0	58	0	0	2	1	2	78	4	147	151		
Apprch %	0	0	100		6.1	0	93.1	6.9		39.5	0	0	100		1.4	5.1	93.6	1.3			
Total %	0	0	6.1		6.1	0	36.7	2.7		39.5	0	0	1.4		1.4	2.7	49.7	0.7		2.6	97.4

3: 1-655

Start Time	Elsworth Street Southbound				Cactus Avenue Westbound				March AFB Northbound				Cactus Avenue Eastbound						
	Left	Thru	Right	RTOR	App. Total	Left	Thru	Right	RTOR	App. Total	Left	Thru	Right	RTOR	App. Total	Exclu. Total	Inclu. Total	Int. Total	
07:00 AM	0	0	1	0	1	0	5	0	0	5	0	0	0	0	0	15	0	22	22
07:15 AM	0	0	1	1	1	0	3	0	0	3	0	0	0	0	0	9	0	13	13
07:30 AM	0	0	1	1	1	0	4	0	0	4	0	0	0	0	0	8	0	13	13
07:45 AM	0	0	1	1	1	0	7	1	0	8	0	0	0	0	0	8	1	17	18
Total Volume	0	0	4	4	4	0	19	1	0	20	0	0	0	0	0	41	0	65	65
% App. Total	0	0	100		100	0	95	5		50	0	0	0		0	95.1	0	0	0
PHF	.000	.000	1.00		1.00	.000	.679	.250		.625	.000	.000	.000		.650	.641	.739		

Peak Hour Analysis From 07:00 AM to 07:45 AM - Peak 1 of 1
 Peak Hour for Entire Intersection Begins at 07:00 AM

Counts Unlimited
 PO Box 1178
 Corona, CA 92878
 (951) 268-6268

City of Moreno Valley
 N/S: Elsworth Street/March AFB
 E/W: Cactus Avenue
 Weather: Clear

File Name : 44_MRV_Elsworth_Cactus AM
 Site Code : 05119542
 Start Date : 8/20/2019
 Page No : 2

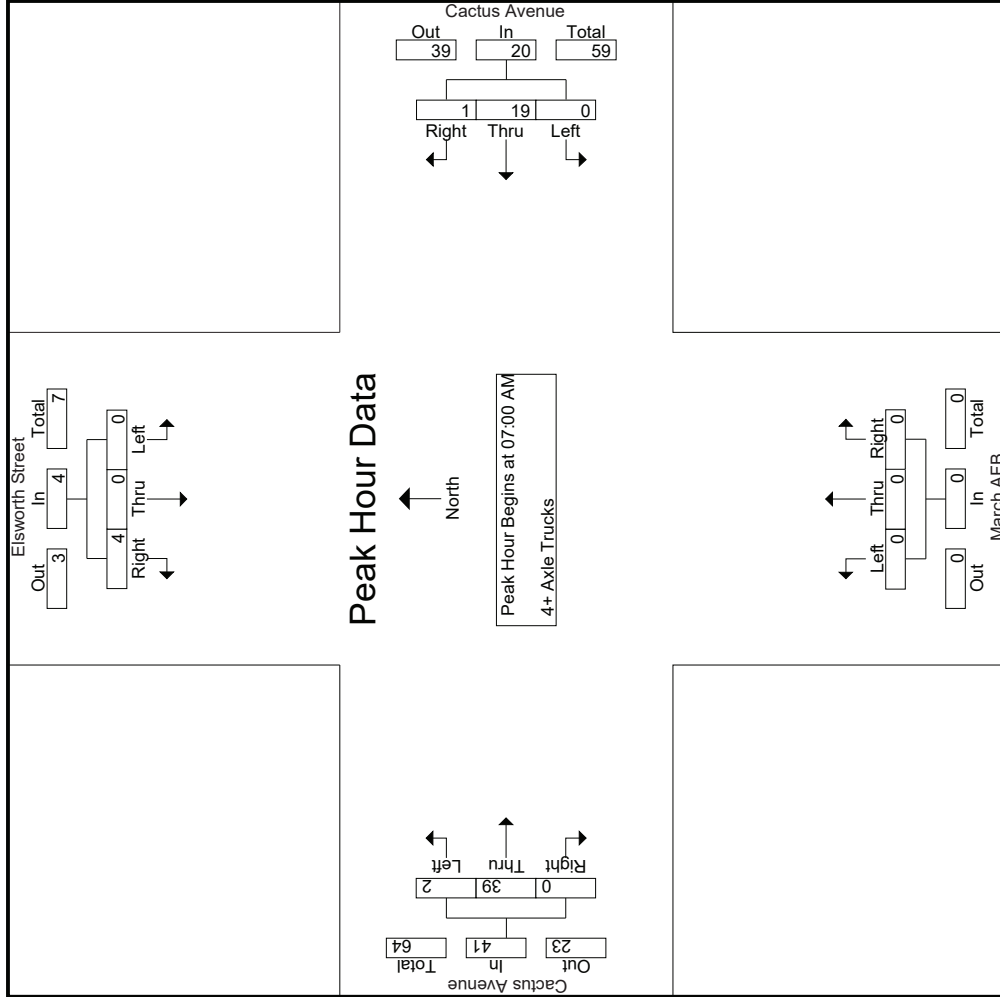

Counts Unlimited
 PO Box 1178
 Corona, CA 92878
 (951) 268-6268

City of Moreno Valley
 N/S: Elsworth Street/March AFB
 E/W: Cactus Avenue
 Weather: Clear

File Name : 44_MRV_Elsworth_Cactus AM
 Site Code : 05119542
 Start Date : 8/20/2019
 Page No : 3

Start Time	Elsworth Street Southbound			Cactus Avenue Westbound			March AFB Northbound			Cactus Avenue Eastbound					
	Left	Thru	Right	Left	Thru	Right	Left	Thru	Right	Left	Thru	Right			
Peak Hour Analysis From 07:00 AM to 07:45 AM - Peak 1 of 1															
Peak Hour for Each Approach Begins at:															
+0 mins.	0	0	1	07:00 AM	0	5	0	07:00 AM	0	0	0	07:00 AM	1	15	0
+15 mins.	0	0	1	0	3	0	0	0	0	0	0	0	0	9	0
+30 mins.	0	0	1	0	4	0	0	0	0	0	0	0	1	7	0
+45 mins.	0	0	1	0	7	1	0	8	0	0	0	0	0	8	0
Total Volume	0	0	4	0	19	1	0	20	0	0	0	2	39	0	
% App. Total	0	0	100	0	95	5	0	0	0	0	0	4.9	95.1	0	
PHF	.000	.000	1.000	.000	.679	.250	.000	.625	.000	.000	.000	.500	.650	.000	

Counts Unlimited
 PO Box 1178
 Corona, CA 92878
 (951) 268-6268

City of Moreno Valley
 N/S: Elsworth Street/March AFB
 EW: Cactus Avenue
 Weather: Clear

File Name : 44_MRV_Elsworth_Cactus PM
 Site Code : 05119542
 Start Date : 8/20/2019
 Page No : 1

Groups Printed- Passenger Vehicles - Large 2 Axle Vehicles - 3 Axle Vehicles - 4+ Axle Trucks

Start Time	Elsworth Street Southbound						Cactus Avenue Westbound						March AFB Northbound						Cactus Avenue Eastbound																
	Left	Thru	Right	RTOR	App. Total		Left	Thru	Right	RTOR	App. Total		Left	Thru	Right	RTOR	App. Total		Left	Thru	Right	RTOR	App. Total		Left	Thru	Right	RTOR	App. Total						
	Exclu. Total	Inclu. Total	Int. Total				Exclu. Total	Inclu. Total	Int. Total				Exclu. Total	Inclu. Total	Int. Total				Exclu. Total	Inclu. Total	Int. Total				Exclu. Total	Inclu. Total	Int. Total								
04:00 PM	34	2	33	23	69	9	269	24	8	302	88	25	43	11	156	26	336	3	0	365	42	892	3	0	924	42	892	3	0	924	42	892	3	0	924
04:15 PM	38	2	26	20	66	8	279	30	15	317	74	18	40	15	132	34	372	3	2	409	52	924	3	2	976	52	924	3	2	976	52	924	3	2	976
04:30 PM	53	3	46	33	102	5	280	15	3	300	66	22	35	8	123	31	432	6	0	469	44	994	6	0	1038	44	994	6	0	1038	44	994	6	0	1038
04:45 PM	50	4	36	19	90	8	272	33	10	313	53	17	25	9	95	37	393	2	0	432	38	930	2	0	968	38	930	2	0	968	38	930	2	0	968
Total	175	11	141	95	327	30	1100	102	36	1232	281	82	143	43	506	128	1533	14	2	1675	176	3740	14	2	3916	176	3740	14	2	3916	176	3740	14	2	3916
05:00 PM	47	5	42	30	94	3	315	23	2	341	41	13	24	8	78	29	429	1	0	459	40	972	1	0	1012	40	972	1	0	1012	40	972	1	0	1012
05:15 PM	47	4	52	33	103	9	283	17	1	309	32	17	10	2	59	19	497	2	0	518	36	989	2	0	1025	36	989	2	0	1025	36	989	2	0	1025
05:30 PM	65	8	27	23	100	6	253	19	7	278	25	8	12	5	45	22	477	1	0	500	35	923	1	0	958	35	923	1	0	958	35	923	1	0	958
05:45 PM	53	4	27	18	84	3	234	23	12	260	20	15	5	3	40	25	454	9	0	488	33	872	9	0	905	33	872	9	0	905	33	872	9	0	905
Total	212	21	148	104	381	21	1085	82	22	1188	118	53	51	18	222	95	1857	13	0	1965	144	3756	13	0	3900	144	3756	13	0	3900	144	3756	13	0	3900
Grand Total	387	32	289	199	708	51	2185	184	58	2420	399	135	194	61	728	223	3390	27	2	3640	320	7496	27	2	7816	320	7496	27	2	7816	320	7496	27	2	7816
Approch %	54.7	4.5	40.8			2.1	90.3	7.6			54.8	18.5	26.6			6.1	93.1	0.7			4.1	95.9	0.4			4.1	95.9	0.4			4.1	95.9	0.4		
Total %	5.2	0.4	3.9		9.4	0.7	29.1	2.5		32.3	5.3	1.8	2.6		9.7	3	45.2	0.4		48.6															
Passenger Vehicles	382	32	272		877	51	2084	180		2372	399	134	192		785	215	3255	26		3498	0	0			0	0	0			7532	0	0			96.4
Passenger Vehicles	98.7	100	94.1		96	100	95.4	97.8		98.3	100	99.3	99		98.4	96.4	96	96.3		100	96	96			96	96	96			96	96	96			96
Large 2 Axle Vehicles	2	0	9		15	0	28	2		30	0	1	2		4	7	40	0		47	0	0			0	0	0			0	0	0			0
Large 2 Axle Vehicles	0.5	0	3.1		1.7	0	1.3	1.1		1.2	0	0.7	1		1.6	3.1	1.2	0		1.3	0	0			0	0	0			0	0	0			0
3 Axle Vehicles	1	0	1		3	0	12	0		12	0	0	0		0	1	15	0		16	0	0			0	0	0			0	0	0			0
3 Axle Vehicles	0.3	0	0.3		0.3	0	0.5	0		0.5	0	0	0		0	0.4	0.4	0		0.4	0	0			0	0	0			0	0	0			0
4+ Axle Trucks	2	0	7		12	0	61	2		64	0	0	0		0	0	80	1		81	0	0			0	0	0			0	0	0			0
4+ Axle Trucks	0.5	0	2.4		1.3	0	2.8	1.1		1.7	0	0	0		0	0	2.4	3.7		2.2	0	0			0	0	0			0	0	0			0
PHF	.929	.800	.846		.944	.694	.913	.667		.926	.727	.784	.671		.722	.784	.458			.906	.722	.458			.906	.722	.458			.906	.722	.458			.906

Peak Hour Analysis From 04:00 PM to 05:45 PM - Peak 1 of 1

Start Time	Elsworth Street Southbound			Cactus Avenue Westbound			March AFB Northbound			Cactus Avenue Eastbound				
	Left	Thru	Right	Left	Thru	Right	Left	Thru	Right	Left	Thru	Right		
04:30 PM	53	3	46	5	280	15	300	22	35	123	31	432	6	469
04:45 PM	50	4	36	8	272	33	313	17	25	95	37	393	2	432
05:00 PM	47	5	42	3	315	23	341	13	24	78	29	429	1	459
05:15 PM	47	4	52	9	283	17	309	10	2	59	19	497	2	518
Total Volume	197	16	176	25	1150	88	1263	69	94	355	116	1751	11	1878
% App. Total	50.6	4.1	45.2	2	91.1	7	92.6	19.4	26.5	6.2	93.2	0.6	3885	
PHF	.929	.800	.846	.694	.913	.667	.926	.727	.784	.671	.722	.458	.906	

Counts Unlimited
 PO Box 1178
 Corona, CA 92878
 (951) 268-6268

City of Moreno Valley
 N/S: Elsworth Street/March AFB
 E/W: Cactus Avenue
 Weather: Clear

File Name : 44_MRV_Elsworth_Cactus PM
 Site Code : 05119542
 Start Date : 8/20/2019
 Page No : 2

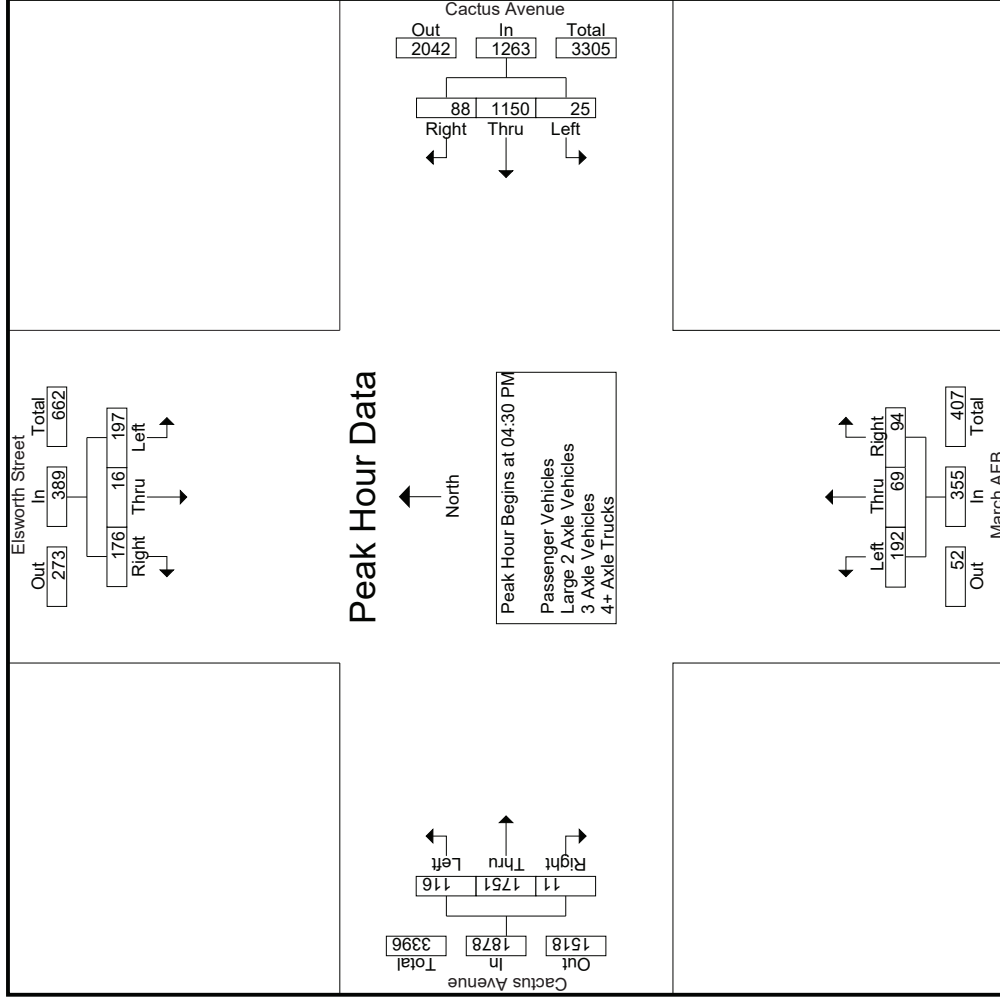

Counts Unlimited
 PO Box 1178
 Corona, CA 92878
 (951) 268-6268

City of Moreno Valley
 N/S: Elsworth Street/March AFB
 EW: Cactus Avenue
 Weather: Clear

File Name : 44_MRV_Elsworth_Cactus PM
 Site Code : 05119542
 Start Date : 8/20/2019
 Page No : 1

Groups Printed- Passenger Vehicles

Start Time	Elsworth Street Southbound					Cactus Avenue Westbound					March AFB Northbound					Cactus Avenue Eastbound							
	Left	Thru	Right	RTOR	App. Total	Left	Thru	Right	RTOR	App. Total	Left	Thru	Right	RTOR	App. Total	Left	Thru	Right	RTOR	App. Total	Exclu. Total	Inclu. Total	Int. Total
04:00 PM	34	2	33	23	69	9	254	24	8	287	88	25	43	11	156	25	322	2	0	349	42	861	903
04:15 PM	37	2	22	17	61	8	270	29	15	307	74	17	40	15	131	34	360	3	2	397	49	896	945
04:30 PM	51	3	44	31	98	5	263	14	3	282	66	22	35	8	123	30	417	6	0	453	42	956	998
04:45 PM	50	4	34	19	88	8	258	33	10	299	53	17	23	8	93	37	370	2	0	409	37	889	926
Total	172	11	133	90	316	30	1045	100	36	1175	281	81	141	42	503	126	1469	13	2	1608	170	3602	3772
05:00 PM	46	5	39	29	90	3	305	23	2	331	41	13	24	8	78	25	407	1	0	433	39	932	971
05:15 PM	47	4	50	33	101	9	270	16	1	295	32	17	10	2	59	19	484	2	0	505	36	960	996
05:30 PM	65	8	25	21	98	6	245	19	7	270	25	8	12	5	45	21	460	1	0	482	33	895	928
05:45 PM	52	4	25	18	81	3	219	22	11	244	20	15	5	3	40	24	435	9	0	468	32	833	865
Total	210	21	139	101	370	21	1039	80	21	1140	118	53	51	18	222	89	1786	13	0	1888	140	3620	3760
Grand Total	382	32	272	191	686	51	2084	180	57	2315	399	134	192	60	725	215	3255	26	2	3496	310	7222	7532
Approch %	55.7	4.7	39.7			2.2	90	7.8		32.1	55	18.5	26.5		10	6.1	93.1	0.7		48.4	4.1	95.9	
Total %	5.3	0.4	3.8		9.5	0.7	28.9	2.5			5.5	1.9	2.7			3	45.1	0.4					

3.1-661

Start Time	Elsworth Street Southbound					Cactus Avenue Westbound					March AFB Northbound					Cactus Avenue Eastbound						
	Left	Thru	Right	RTOR	App. Total	Left	Thru	Right	RTOR	App. Total	Left	Thru	Right	RTOR	App. Total	Left	Thru	Right	RTOR	App. Total	Exclu. Total	Inclu. Total
04:30 PM	51	3	44		98	5	263	14		282	66	22	35		123	30	417			6	453	956
04:45 PM	50	4	34		88	8	258	33		299	53	17	23		93	37	370			2	409	889
05:00 PM	46	5	39		90	3	305	23		331	41	13	24		78	25	407			1	433	932
05:15 PM	47	4	25		81	3	219	22		244	20	15	5		59	19	484			2	505	960
Total Volume	194	16	167		377	25	1096	86		1207	192	69	92		353	111	1678			11	1800	3737
% App. Total	51.5	4.2	44.3			2.1	90.8	7.1		32.1	54.4	19.5	26.1		10	6.2	93.2			0.6	.867	.891
PHF	.951	.800	.835		.933	.694	.898	.652		.912	.727	.784	.657		.717	.750	.867			.458		.973

Peak Hour Analysis From 04:30 PM to 05:15 PM - Peak 1 of 1
 Peak Hour for Entire Intersection Begins at 04:30 PM

Counts Unlimited
 PO Box 1178
 Corona, CA 92878
 (951) 268-6268

City of Moreno Valley
 N/S: Elsworth Street/March AFB
 E/W: Cactus Avenue
 Weather: Clear

File Name : 44_MRV_Elsworth_Cactus PM
 Site Code : 05119542
 Start Date : 8/20/2019
 Page No : 2

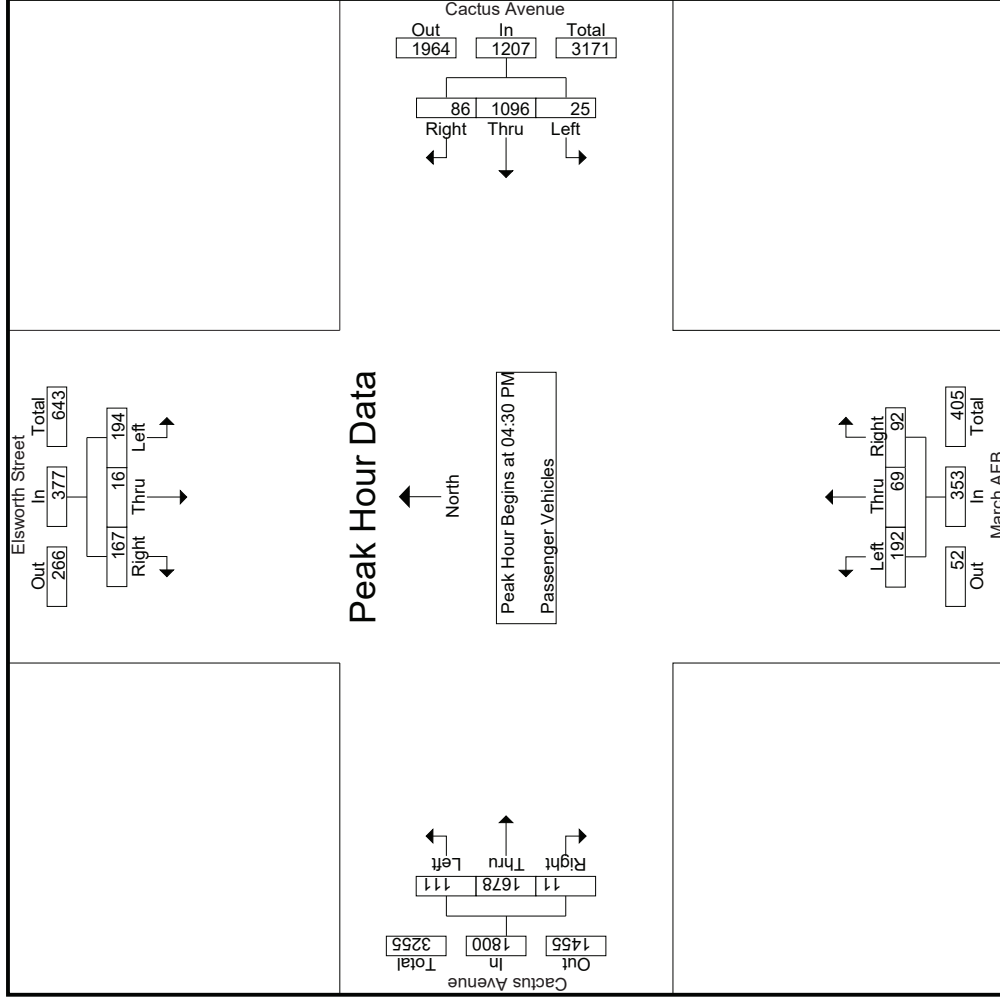

Counts Unlimited
 PO Box 1178
 Corona, CA 92878
 (951) 268-6268

City of Moreno Valley
 N/S: Elsworth Street/March AFB
 EW: Cactus Avenue
 Weather: Clear

File Name : 44_MRV_Elsworth_Cactus PM
 Site Code : 05119542
 Start Date : 8/20/2019
 Page No : 1

Groups Printed- Large 2 Axle Vehicles

Start Time	Elsworth Street Southbound				Cactus Avenue Westbound				March AFB Northbound				Cactus Avenue Eastbound					
	Left	Thru	Right	RTOR	App. Total	Left	Thru	Right	RTOR	App. Total	Left	Thru	Right	RTOR	App. Total	Exclu. Total	Inclu. Total	Int. Total
04:00 PM	0	0	0	0	0	0	6	0	0	6	0	0	0	0	0	0	10	10
04:15 PM	1	0	2	2	3	0	1	0	0	1	0	1	0	0	3	2	8	10
04:30 PM	0	0	0	0	0	0	3	1	0	4	0	0	0	0	6	0	10	10
04:45 PM	0	0	2	0	2	0	2	0	2	2	0	0	0	0	6	1	12	13
Total	1	0	4	2	5	0	12	1	0	13	0	1	2	1	3	3	40	43
05:00 PM	0	0	1	0	1	0	4	0	0	4	0	0	0	0	11	0	16	16
05:15 PM	0	0	2	0	2	0	8	1	0	9	0	0	0	0	4	0	15	15
05:30 PM	0	0	2	2	2	0	2	0	0	2	0	0	0	0	6	2	10	12
05:45 PM	1	0	0	0	1	0	2	0	0	2	0	0	0	0	7	0	10	10
Total	1	0	5	2	6	0	16	1	0	17	0	0	0	0	28	2	51	53
Grand Total	2	0	9	4	11	0	28	2	0	30	0	1	2	1	3	5	91	96
Approch %	18.2	0	81.8		12.1	0	93.3	6.7		33	0	33.3	66.7		14.9	85.1	0	0
Total %	2.2	0	9.9			0	30.8	2.2			0	1.1	2.2		7.7	44	5.2	94.8

3:1-664

Start Time	Elsworth Street Southbound				Cactus Avenue Westbound				March AFB Northbound				Cactus Avenue Eastbound					
	Left	Thru	Right	RTOR	App. Total	Left	Thru	Right	RTOR	App. Total	Left	Thru	Right	RTOR	App. Total	Exclu. Total	Inclu. Total	Int. Total
04:30 PM	0	0	0	0	0	0	3	1	4	4	0	0	0	0	6	0	6	10
04:45 PM	0	0	2	2	2	0	2	0	2	2	0	0	2	0	6	0	6	12
05:00 PM	0	0	1	1	1	0	4	0	4	4	0	0	0	0	7	0	11	16
05:15 PM	0	0	2	2	2	0	8	1	9	9	0	0	0	0	4	0	4	15
Total Volume	0	0	5	5	5	0	17	2	19	19	0	0	2	2	23	0	27	53
% App. Total	0	0	100		12.1	0	89.5	10.5		33	0	100	100		85.2	0	0	0
PHF	.000	.000	.625		.625	.000	.531	.500	.528	.528	.000	.000	.250		.821	.000	.614	.828

Peak Hour Analysis From 04:30 PM to 05:15 PM - Peak 1 of 1
 Peak Hour for Entire Intersection Begins at 04:30 PM

Counts Unlimited
 PO Box 1178
 Corona, CA 92878
 (951) 268-6268

City of Moreno Valley
 N/S: Elsworth Street/March AFB
 E/W: Cactus Avenue
 Weather: Clear

File Name : 44_MRV_Elsworth_Cactus PM
 Site Code : 05119542
 Start Date : 8/20/2019
 Page No : 2

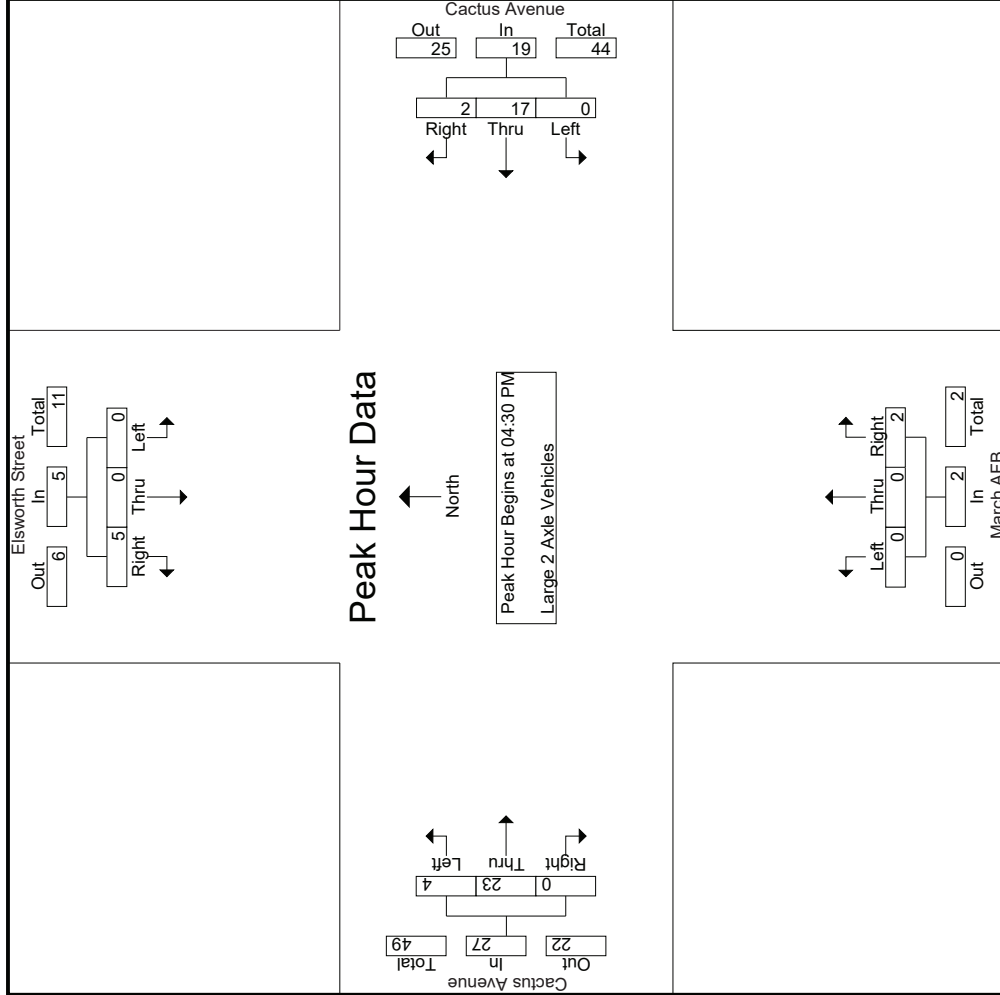

Counts Unlimited
 PO Box 1178
 Corona, CA 92878
 (951) 268-6268

City of Moreno Valley
 N/S: Elsworth Street/March AFB
 E/W: Cactus Avenue
 Weather: Clear

File Name : 44_MRV_Elsworth_Cactus PM
 Site Code : 05119542
 Start Date : 8/20/2019
 Page No : 3

Start Time	Elsworth Street Southbound			Cactus Avenue Westbound			March AFB Northbound			Cactus Avenue Eastbound		
	Left	Thru	Right	Left	Thru	Right	Left	Thru	Right	Left	Thru	Right
Peak Hour Analysis From 04:30 PM to 05:15 PM - Peak 1 of 1												
Peak Hour for Each Approach Begins at:												
	04:30 PM			04:30 PM			04:30 PM			04:30 PM		
+0 mins.	0	0	0	3	1	4	0	0	0	0	0	6
+15 mins.	0	0	2	2	0	2	0	0	2	0	6	6
+30 mins.	0	0	1	4	0	4	0	0	0	4	7	11
+45 mins.	0	0	2	8	1	9	0	0	0	0	4	4
Total Volume	0	0	5	17	2	19	0	0	2	4	23	0
% App. Total	0	0	100	89.5	10.5	.528	0	0	100	14.8	85.2	0
PHF	.000	.000	.625	.531	.500	.528	.000	.000	.250	.250	.821	.000
												.614

Counts Unlimited
 PO Box 1178
 Corona, CA 92878
 (951) 268-6268

City of Moreno Valley
 N/S: Elsworth Street/March AFB
 EW: Cactus Avenue
 Weather: Clear

File Name : 44_MRV_Elsworth_Cactus PM
 Site Code : 05119542
 Start Date : 8/20/2019
 Page No : 1

Groups Printed- 3 Axle Vehicles

Start Time	Elsworth Street Southbound				Cactus Avenue Westbound				March AFB Northbound				Cactus Avenue Eastbound						
	Left	Thru	Right	RTOR	App. Total	Left	Thru	Right	RTOR	App. Total	Left	Thru	Right	RTOR	App. Total	Exclu. Total	Inclu. Total	Int. Total	
04:00 PM	0	0	0	0	0	5	0	0	0	5	0	0	0	0	0	0	0	7	7
04:15 PM	0	0	0	0	2	2	0	0	0	2	0	0	0	0	1	0	0	3	3
04:30 PM	1	0	0	0	2	2	0	0	0	2	0	0	0	0	1	0	0	4	4
04:45 PM	0	0	0	0	2	2	0	0	0	2	0	0	0	0	4	0	0	6	6
Total	1	0	0	0	11	0	11	0	0	11	0	0	0	0	8	0	20	20	
05:00 PM	0	0	1	1	0	0	0	0	0	0	0	0	0	0	4	1	5	6	
05:15 PM	0	0	0	0	0	0	0	0	0	0	0	0	0	0	2	0	2	2	
05:30 PM	0	0	0	0	1	0	0	0	0	1	0	0	0	0	0	0	1	1	
05:45 PM	0	0	0	0	0	0	0	0	0	0	0	0	0	0	2	0	2	2	
Total	0	0	1	1	1	0	1	0	0	1	0	0	0	0	8	1	10	11	
Grand Total	1	0	1	1	2	0	12	0	0	12	0	0	0	0	16	1	30	31	
Apprch %	50	0	50		6.7	0	100	0		40	0	0	0		53.3	3.2	96.8		
Total %	3.3	0	3.3			0	40	0			3.3	50	0						

3:1-667

Start Time	Elsworth Street Southbound				Cactus Avenue Westbound				March AFB Northbound				Cactus Avenue Eastbound					
	Left	Thru	Right	RTOR	App. Total	Left	Thru	Right	RTOR	App. Total	Left	Thru	Right	RTOR	App. Total	Exclu. Total	Inclu. Total	Int. Total
04:30 PM	1	0	0	0	1	0	2	0	0	2	0	0	0	0	0	0	1	4
04:45 PM	0	0	0	0	0	0	2	0	0	2	0	0	0	0	4	0	4	6
05:00 PM	0	0	0	0	1	0	0	0	0	1	0	0	0	0	4	0	4	5
05:15 PM	0	0	0	0	0	0	0	0	0	0	0	0	0	0	2	0	2	2
Total Volume	1	0	0	0	2	0	4	0	0	4	0	0	0	0	10	0	11	17
% App. Total	50	0	50		6.7	0	100	0		40	0	0	0		53.3	3.2	96.8	
PHF	.250	.000	.250		.500	.000	.500	.000		.000	.250	.625	.000		.688		.708	

Peak Hour Analysis From 04:30 PM to 05:15 PM - Peak 1 of 1
 Peak Hour for Entire Intersection Begins at 04:30 PM

Counts Unlimited
 PO Box 1178
 Corona, CA 92878
 (951) 268-6268

City of Moreno Valley
 N/S: Elsworth Street/March AFB
 E/W: Cactus Avenue
 Weather: Clear

File Name : 44_MRV_Elsworth_Cactus PM
 Site Code : 05119542
 Start Date : 8/20/2019
 Page No : 2

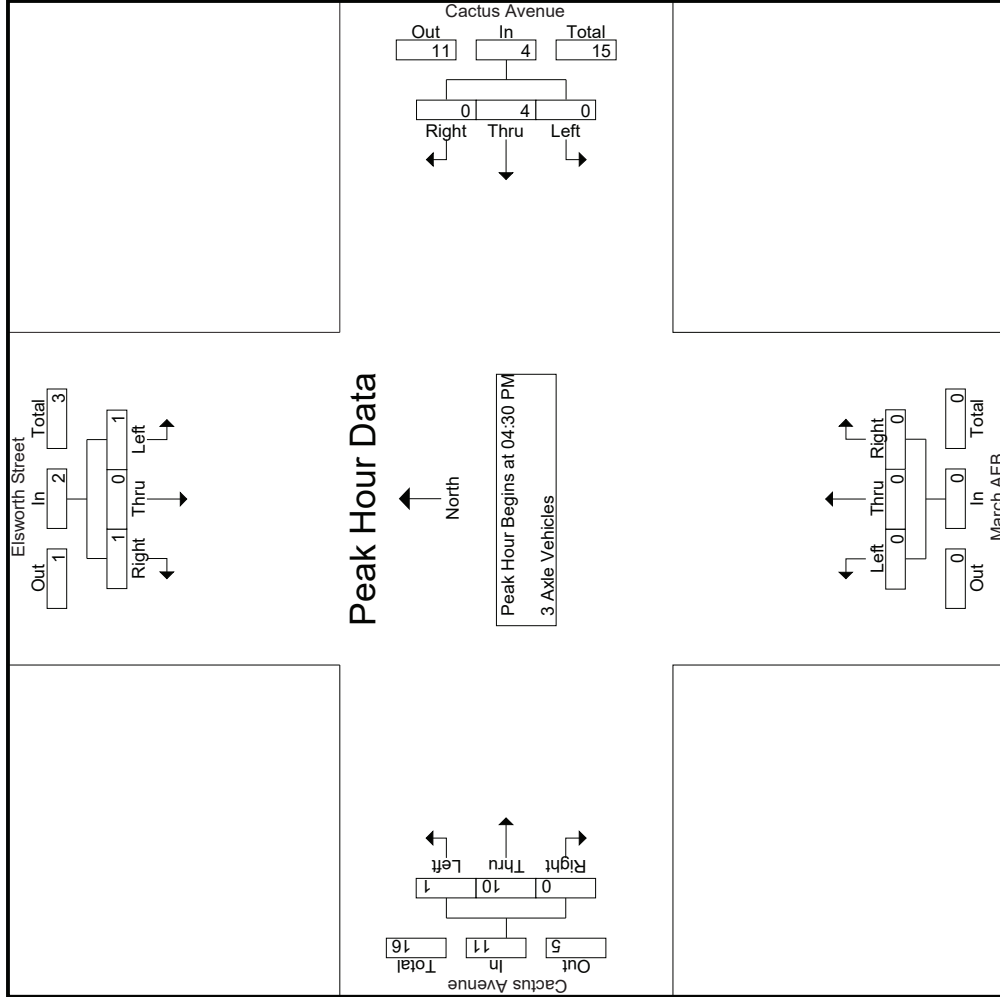

Counts Unlimited
 PO Box 1178
 Corona, CA 92878
 (951) 268-6268

City of Moreno Valley
 N/S: Elsworth Street/March AFB
 E/W: Cactus Avenue
 Weather: Clear

File Name : 44_MRV_Elsworth_Cactus PM
 Site Code : 05119542
 Start Date : 8/20/2019
 Page No : 3

Start Time	Elsworth Street Southbound			Cactus Avenue Westbound			March AFB Northbound			Cactus Avenue Eastbound		
	Left	Thru	Right	Left	Thru	Right	Left	Thru	Right	Left	Thru	Right
Peak Hour Analysis From 04:30 PM to 05:15 PM - Peak 1 of 1												
Peak Hour for Each Approach Begins at:												
	04:30 PM			04:30 PM			04:30 PM			04:30 PM		
+0 mins.	1	0	0	2	0	0	0	0	0	0	0	0
+15 mins.	0	0	0	2	0	0	0	0	0	4	0	0
+30 mins.	0	0	1	0	0	0	0	0	0	4	0	0
+45 mins.	0	0	0	0	0	0	0	0	0	2	0	0
Total Volume	1	0	1	4	0	0	4	0	0	10	0	0
% App. Total	50	0	50	100	0	0	0	0	0	90.9	0	0
PHF	.250	.000	.250	.500	.000	.000	.500	.000	.000	.250	.625	.000

Counts Unlimited
 PO Box 1178
 Corona, CA 92878
 (951) 268-6268

City of Moreno Valley
 N/S: Elsworth Street/March AFB
 EW: Cactus Avenue
 Weather: Clear

File Name : 44_MRV_Elsworth_Cactus PM
 Site Code : 05119542
 Start Date : 8/20/2019
 Page No : 1

Groups Printed- 4+ Axle Trucks

Start Time	Elsworth Street Southbound				Cactus Avenue Westbound				March AFB Northbound				Cactus Avenue Eastbound										
	Left	Thru	Right	RTOR	App. Total	Left	Thru	Right	RTOR	App. Total	Left	Thru	Right	RTOR	App. Total	Exclu. Total	Inclu. Total	Int. Total					
04:00 PM	0	0	0	0	0	4	0	0	0	4	0	0	0	0	0	0	9	1	0	10	0	14	14
04:15 PM	0	0	2	1	2	6	1	0	0	7	0	0	0	0	0	0	8	0	0	8	1	17	18
04:30 PM	1	0	2	2	3	12	0	0	0	12	0	0	0	0	0	0	9	0	0	9	2	24	26
04:45 PM	0	0	0	0	0	10	0	0	0	10	0	0	0	0	0	0	13	0	0	13	0	23	23
Total	1	0	4	3	5	32	1	0	0	33	0	0	0	0	0	3	39	1	0	40	3	78	81
05:00 PM	1	0	1	0	2	6	0	0	0	6	0	0	0	0	0	0	11	0	0	11	0	19	19
05:15 PM	0	0	0	0	0	5	0	0	0	5	0	0	0	0	0	0	7	0	0	7	0	12	12
05:30 PM	0	0	0	0	0	5	0	0	0	5	0	0	0	0	0	0	12	0	0	12	0	17	17
05:45 PM	0	0	2	0	2	13	1	1	1	14	0	0	0	0	0	1	11	0	0	11	1	27	28
Total	1	0	3	0	4	29	1	1	1	30	0	0	0	0	0	1	41	0	0	41	1	75	76
Grand Total	2	0	7	3	9	61	2	1	0	63	0	0	0	0	0	4	80	1	0	81	4	153	157
Apprch %	22.2	0	77.8		5.9	96.8	3.2			41.2	0	0	0		0	98.8	1.2			52.9	2.5	97.5	
Total %	1.3	0	4.6			39.9	1.3				0	0	0		0	52.3	0.7						

3:1-670

Start Time	Elsworth Street Southbound				Cactus Avenue Westbound				March AFB Northbound				Cactus Avenue Eastbound										
	Left	Thru	Right	RTOR	App. Total	Left	Thru	Right	RTOR	App. Total	Left	Thru	Right	RTOR	App. Total	Exclu. Total	Inclu. Total	Int. Total					
04:30 PM	1	0	0	0	2	0	0	0	0	0	0	0	0	0	0	0	0	0	0	0	0	9	9
04:45 PM	0	0	0	0	0	0	0	0	0	0	0	0	0	0	0	0	0	0	0	0	0	13	13
05:00 PM	1	0	0	0	1	0	0	0	0	0	0	0	0	0	0	0	0	0	0	0	0	11	11
05:15 PM	0	0	0	0	0	0	0	0	0	0	0	0	0	0	0	0	0	0	0	0	0	7	7
Total Volume	2	0	0	0	3	0	0	0	0	33	0	0	0	0	0	0	40	0	0	40	0	40	78
% App. Total	40	0	0	0	60	0	0	0	0	100	0	0	0	0	0	0	100	0	0	100	0	769	813
PHF	.500	.000	.375		.417	.688	.000			.688	.000	.000	.000		.769	.000	.769	.000		.769	.000	.769	.813

Peak Hour Analysis From 04:30 PM to 05:15 PM - Peak 1 of 1
 Peak Hour for Entire Intersection Begins at 04:30 PM

Counts Unlimited
 PO Box 1178
 Corona, CA 92878
 (951) 268-6268

City of Moreno Valley
 N/S: Elsworth Street/March AFB
 E/W: Cactus Avenue
 Weather: Clear

File Name : 44_MRV_Elsworth_Cactus PM
 Site Code : 05119542
 Start Date : 8/20/2019
 Page No : 2

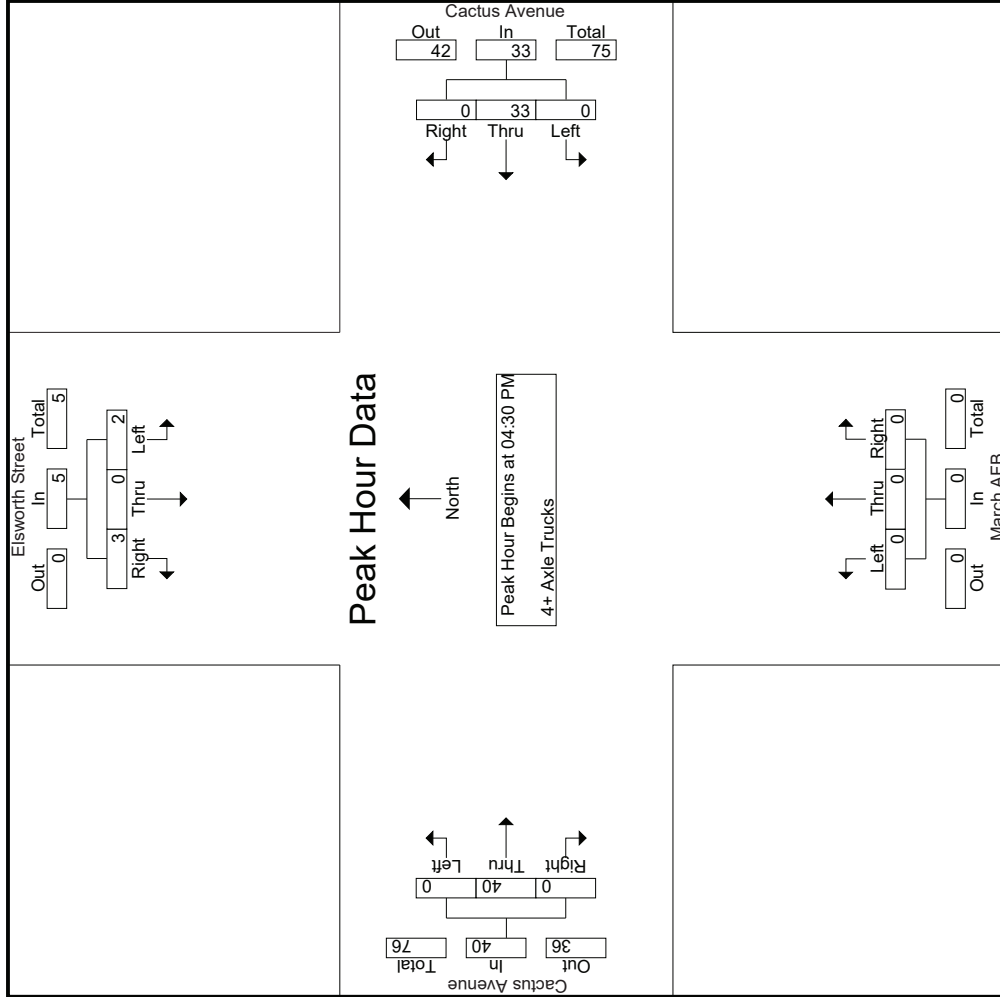

Counts Unlimited
 PO Box 1178
 Corona, CA 92878
 (951) 268-6268

City of Moreno Valley
 N/S: Elsworth Street/March AFB
 E/W: Cactus Avenue
 Weather: Clear

File Name : 44_MRV_Elsworth_Cactus PM
 Site Code : 05119542
 Start Date : 8/20/2019
 Page No : 3

Start Time	Elsworth Street Southbound			Cactus Avenue Westbound			March AFB Northbound			Cactus Avenue Eastbound		
	Left	Thru	Right	Left	Thru	Right	Left	Thru	Right	Left	Thru	Right
Peak Hour Analysis From 04:30 PM to 05:15 PM - Peak 1 of 1												
Peak Hour for Each Approach Begins at:												
	04:30 PM			04:30 PM			04:30 PM			04:30 PM		
+0 mins.	1	0	2	3	0	0	12	0	0	0	0	0
+15 mins.	0	0	0	0	0	0	10	0	0	0	0	13
+30 mins.	1	0	1	2	0	0	6	0	0	0	0	11
+45 mins.	0	0	0	0	0	0	5	0	0	0	0	7
Total Volume	2	0	3	5	0	0	33	0	0	0	0	40
% App. Total	40	0	60	417	0	0	100	0	0	0	0	100
PHF	.500	.000	.375	.417	.000	.000	.688	.000	.000	.000	.000	.769

Location: Moreno Valley
 N/S: Elsworth Street
 E/W: Cactus Avenue



Date: 8/20/2019
 Day: Tuesday

PEDESTRIANS

	North Leg Elsworth Street	East Leg Cactus Avenue	South Leg March AFB	West Leg Cactus Avenue	
	Pedestrians	Pedestrians	Pedestrians	Pedestrians	
7:00 AM	0	0	0	0	0
7:15 AM	0	1	0	0	1
7:30 AM	0	1	0	0	1
7:45 AM	0	0	0	0	0
8:00 AM	0	0	0	0	0
8:15 AM	0	0	0	0	0
8:30 AM	0	0	0	0	0
8:45 AM	0	0	0	0	0
TOTAL VOLUMES:	0	2	0	0	2

	North Leg Elsworth Street	East Leg Cactus Avenue	South Leg March AFB	West Leg Cactus Avenue	
	Pedestrians	Pedestrians	Pedestrians	Pedestrians	
4:00 PM	0	0	0	0	0
4:15 PM	0	0	2	0	2
4:30 PM	0	0	0	0	0
4:45 PM	2	0	0	0	2
5:00 PM	0	1	0	0	1
5:15 PM	0	0	0	0	0
5:30 PM	0	0	0	0	0
5:45 PM	0	0	0	0	0
TOTAL VOLUMES:	2	1	2	0	5

Location: Moreno Valley
 N/S: Elsworth Street
 E/W: Cactus Avenue



Date: 8/20/2019
 Day: Tuesday

BICYCLES

	Southbound Elsworth Street			Westbound Cactus Avenue			Northbound March AFB			Eastbound Cactus Avenue			
	Left	Thru	Right	Left	Thru	Right	Left	Thru	Right	Left	Thru	Right	
7:00 AM	0	0	0	0	0	0	0	0	0	0	0	0	0
7:15 AM	0	0	0	0	0	0	0	0	0	0	0	0	0
7:30 AM	0	0	0	0	0	0	0	0	0	0	0	0	0
7:45 AM	0	0	0	0	0	0	0	0	0	0	0	0	0
8:00 AM	0	0	0	0	0	0	0	0	0	0	0	0	0
8:15 AM	0	0	0	0	0	0	0	0	0	0	0	0	0
8:30 AM	0	0	0	0	0	0	0	0	0	0	0	0	0
8:45 AM	0	0	0	0	0	0	0	0	0	0	0	0	0
TOTAL VOLUMES:	0	0	0	0	0	0	0	0	0	0	0	0	0

	Southbound Elsworth Street			Westbound Cactus Avenue			Northbound March AFB			Eastbound Cactus Avenue			
	Left	Thru	Right	Left	Thru	Right	Left	Thru	Right	Left	Thru	Right	
4:00 PM	0	0	0	0	0	0	0	0	0	0	0	0	0
4:15 PM	0	0	0	0	0	0	0	0	0	0	0	0	0
4:30 PM	0	0	0	0	0	0	0	0	0	0	0	0	0
4:45 PM	0	0	0	0	0	0	0	0	0	0	0	0	0
5:00 PM	0	0	0	0	0	0	0	0	0	0	0	0	0
5:15 PM	0	0	0	0	0	0	0	0	0	0	0	0	0
5:30 PM	0	0	0	0	0	0	0	0	0	0	0	0	0
5:45 PM	0	0	0	0	0	0	0	0	0	0	0	0	0
TOTAL VOLUMES:	0	0	0	0	0	0	0	0	0	0	0	0	0

City of Moreno Valley
 N/S: Frederick Street
 E/W: Cactus Avenue
 Weather: Clear

File Name : 45_MRV_Frederick_Cactus AM
 Site Code : 05119542
 Start Date : 8/20/2019
 Page No : 1

Groups Printed- Passenger Vehicles - Large 2 Axle Vehicles - 3 Axle Vehicles - 4+ Axle Trucks

Start Time	Frederick Street Southbound				Cactus Avenue Westbound				Cactus Avenue Eastbound				Exclu. Total	Inclu. Total	Int. Total
	Left	Right	RTOR	App. Total	Thru	Right	RTOR	App. Total	Left	Thru	RTOR	App. Total			
07:00 AM	19	25	17	44	536	35	2	571	38	226	0	264	19	879	898
07:15 AM	29	26	20	55	453	34	1	487	49	278	0	327	21	869	890
07:30 AM	56	21	12	77	425	46	2	471	44	245	0	289	14	837	851
07:45 AM	40	37	18	77	472	63	1	535	41	276	0	317	19	929	948
Total	144	109	67	253	1886	178	6	2064	172	1025	0	1197	73	3514	3587
08:00 AM	38	21	13	59	402	34	0	436	39	245	0	284	13	779	792
08:15 AM	35	15	13	50	335	33	2	368	41	237	0	278	15	696	711
08:30 AM	30	25	15	55	310	39	0	349	41	220	0	261	15	665	680
08:45 AM	28	29	23	57	291	38	1	329	40	201	0	241	24	627	651
Total	131	90	64	221	1338	144	3	1482	161	903	0	1064	67	2767	2834
Grand Total	275	199	131	474	3224	322	9	3546	333	1928	0	2261	140	6281	6421
Apprch %	58	42			90.9	9.1			14.7	85.3					
Total %	4.4	3.2		7.5	51.3	5.1		56.5	5.3	30.7		36	2.2	97.8	
Passenger Vehicles	258	184		564	3093	300		3400	315	1805		2120	0	0	6084
% Passenger Vehicles	93.8	92.5	93.1	93.2	95.9	93.2	77.8	95.6	94.6	93.6	0	93.8	0	0	94.8
Large 2 Axle Vehicles	12	7		23	47	16		65	5	45		50	0	0	138
% Large 2 Axle Vehicles	4.4	3.5	3.1	3.8	1.5	5	22.2	1.8	1.5	2.3	0	2.2	0	0	2.1
3 Axle Vehicles	2	2		5	28	3		31	2	15		17	0	0	53
% 3 Axle Vehicles	0.7	1	0.8	0.8	0.9	0.9	0	0.9	0.6	0.8	0	0.8	0	0	0.8
4+ Axle Trucks	3	6		13	56	3		59	11	63		74	0	0	146
% 4+ Axle Trucks	1.1	3	3.1	2.1	1.7	0.9	0	1.7	3.3	3.3	0	3.3	0	0	2.3

Start Time	Frederick Street Southbound			Cactus Avenue Westbound			Cactus Avenue Eastbound			Int. Total
	Left	Right	App. Total	Thru	Right	App. Total	Left	Thru	App. Total	
Peak Hour Analysis From 07:00 AM to 08:45 AM - Peak 1 of 1										
Peak Hour for Entire Intersection Begins at 07:00 AM										
07:00 AM	19	25	44	536	35	571	38	226	264	879
07:15 AM	29	26	55	453	34	487	49	278	327	869
07:30 AM	56	21	77	425	46	471	44	245	289	837
07:45 AM	40	37	77	472	63	535	41	276	317	929
Total Volume	144	109	253	1886	178	2064	172	1025	1197	3514
% App. Total	56.9	43.1		91.4	8.6		14.4	85.6		
PHF	.643	.736	.821	.880	.706	.904	.878	.922	.915	.946

City of Moreno Valley
 N/S: Frederick Street
 E/W: Cactus Avenue
 Weather: Clear

File Name : 45_MRV_Frederick_Cactus AM
 Site Code : 05119542
 Start Date : 8/20/2019
 Page No : 2

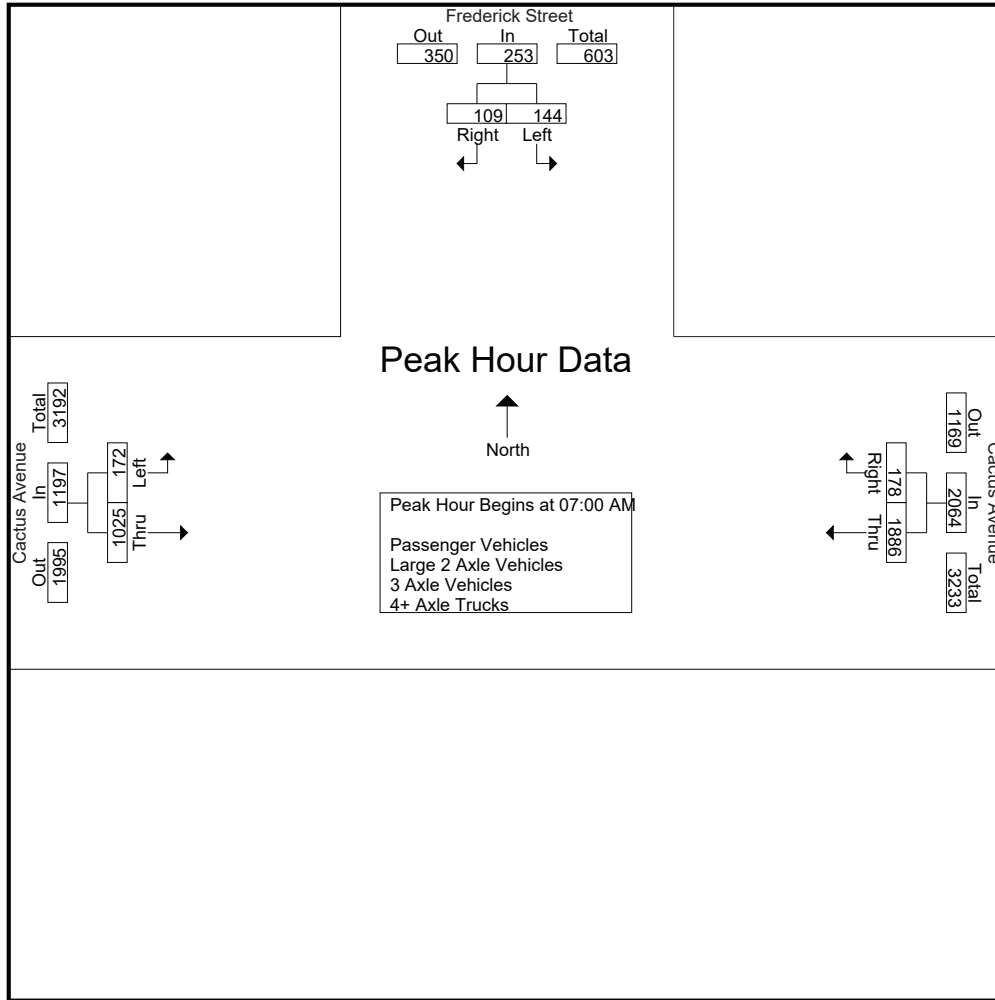

Peak Hour Analysis From 07:00 AM to 08:45 AM - Peak 1 of 1
 Peak Hour for Each Approach Begins at:

	07:15 AM			07:00 AM			07:15 AM		
+0 mins.	29	26	55	536	35	571	49	278	327
+15 mins.	56	21	77	453	34	487	44	245	289
+30 mins.	40	37	77	425	46	471	41	276	317
+45 mins.	38	21	59	472	63	535	39	245	284
Total Volume	163	105	268	1886	178	2064	173	1044	1217
% App. Total	60.8	39.2		91.4	8.6		14.2	85.8	
PHF	.728	.709	.870	.880	.706	.904	.883	.939	.930

City of Moreno Valley
 N/S: Frederick Street
 E/W: Cactus Avenue
 Weather: Clear

File Name : 45_MRV_Frederick_Cactus AM
 Site Code : 05119542
 Start Date : 8/20/2019
 Page No : 1

Groups Printed- Passenger Vehicles

Start Time	Frederick Street Southbound				Cactus Avenue Westbound				Cactus Avenue Eastbound				Exclu. Total	Inclu. Total	Int. Total
	Left	Right	RTOR	App. Total	Thru	Right	RTOR	App. Total	Left	Thru	RTOR	App. Total			
07:00 AM	18	25	17	43	515	32	2	547	37	212	0	249	19	839	858
07:15 AM	28	24	18	52	443	33	1	476	48	262	0	310	19	838	857
07:30 AM	53	21	12	74	413	45	1	458	42	228	0	270	13	802	815
07:45 AM	39	37	18	76	456	58	1	514	39	262	0	301	19	891	910
Total	138	107	65	245	1827	168	5	1995	166	964	0	1130	70	3370	3440
08:00 AM	36	19	12	55	387	31	0	418	37	230	0	267	12	740	752
08:15 AM	31	14	13	45	311	31	2	342	37	222	0	259	15	646	661
08:30 AM	27	22	14	49	292	34	0	326	38	198	0	236	14	611	625
08:45 AM	26	22	18	48	276	36	0	312	37	191	0	228	18	588	606
Total	120	77	57	197	1266	132	2	1398	149	841	0	990	59	2585	2644
Grand Total	258	184	122	442	3093	300	7	3393	315	1805	0	2120	129	5955	6084
Apprch %	58.4	41.6			91.2	8.8			14.9	85.1					
Total %	4.3	3.1		7.4	51.9	5		57	5.3	30.3		35.6	2.1	97.9	

Start Time	Frederick Street Southbound			Cactus Avenue Westbound			Cactus Avenue Eastbound			Int. Total
	Left	Right	App. Total	Thru	Right	App. Total	Left	Thru	App. Total	
Peak Hour Analysis From 07:00 AM to 07:45 AM - Peak 1 of 1										
Peak Hour for Entire Intersection Begins at 07:00 AM										
07:00 AM	18	25	43	515	32	547	37	212	249	839
07:15 AM	28	24	52	443	33	476	48	262	310	838
07:30 AM	53	21	74	413	45	458	42	228	270	802
07:45 AM	39	37	76	456	58	514	39	262	301	891
Total Volume	138	107	245	1827	168	1995	166	964	1130	3370
% App. Total	56.3	43.7		91.6	8.4		14.7	85.3		
PHF	.651	.723	.806	.887	.724	.912	.865	.920	.911	.946

City of Moreno Valley
 N/S: Frederick Street
 E/W: Cactus Avenue
 Weather: Clear

File Name : 45_MRV_Frederick_Cactus AM
 Site Code : 05119542
 Start Date : 8/20/2019
 Page No : 2

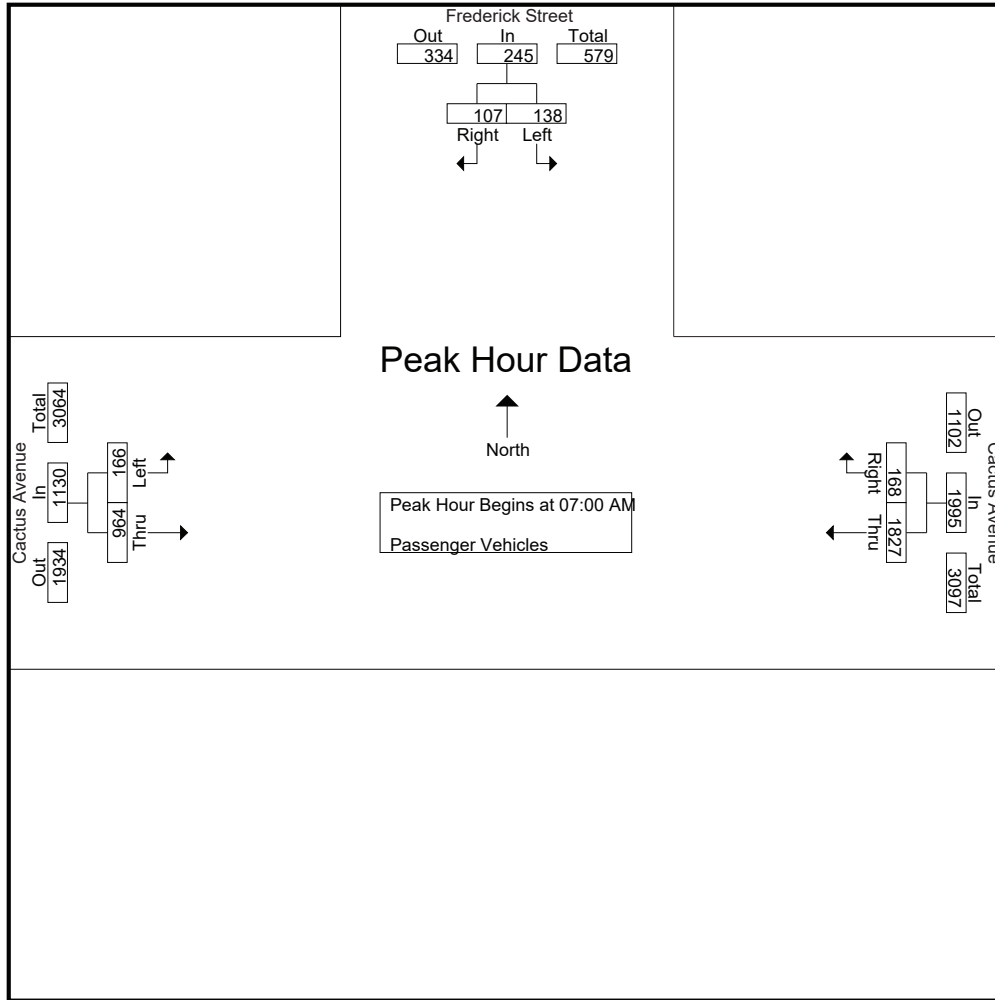

Peak Hour Analysis From 07:00 AM to 07:45 AM - Peak 1 of 1

Peak Hour for Each Approach Begins at:

	07:00 AM			07:00 AM			07:00 AM		
+0 mins.	18	25	43	515	32	547	37	212	249
+15 mins.	28	24	52	443	33	476	48	262	310
+30 mins.	53	21	74	413	45	458	42	228	270
+45 mins.	39	37	76	456	58	514	39	262	301
Total Volume	138	107	245	1827	168	1995	166	964	1130
% App. Total	56.3	43.7		91.6	8.4		14.7	85.3	
PHF	.651	.723	.806	.887	.724	.912	.865	.920	.911

City of Moreno Valley
 N/S: Frederick Street
 E/W: Cactus Avenue
 Weather: Clear

File Name : 45_MR_V_Frederick_Cactus AM
 Site Code : 05119542
 Start Date : 8/20/2019
 Page No : 1

Groups Printed- Large 2 Axle Vehicles

Start Time	Frederick Street Southbound				Cactus Avenue Westbound				Cactus Avenue Eastbound				Exclu. Total	Inclu. Total	Int. Total
	Left	Right	RTOR	App. Total	Thru	Right	RTOR	App. Total	Left	Thru	RTOR	App. Total			
07:00 AM	1	0	0	1	7	3	0	10	0	2	0	2	0	13	13
07:15 AM	1	1	1	2	3	1	0	4	0	5	0	5	1	11	12
07:30 AM	2	0	0	2	5	1	1	6	1	9	0	10	1	18	19
07:45 AM	1	0	0	1	7	4	0	11	0	6	0	6	0	18	18
Total	5	1	1	6	22	9	1	31	1	22	0	23	2	60	62
08:00 AM	1	2	1	3	4	3	0	7	1	6	0	7	1	17	18
08:15 AM	2	1	0	3	8	0	0	8	0	8	0	8	0	19	19
08:30 AM	2	0	0	2	7	3	0	10	2	7	0	9	0	21	21
08:45 AM	2	3	2	5	6	1	1	7	1	2	0	3	3	15	18
Total	7	6	3	13	25	7	1	32	4	23	0	27	4	72	76
Grand Total	12	7	4	19	47	16	2	63	5	45	0	50	6	132	138
Apprch %	63.2	36.8			74.6	25.4			10	90					
Total %	9.1	5.3		14.4	35.6	12.1		47.7	3.8	34.1		37.9	4.3	95.7	

Start Time	Frederick Street Southbound			Cactus Avenue Westbound			Cactus Avenue Eastbound			Int. Total
	Left	Right	App. Total	Thru	Right	App. Total	Left	Thru	App. Total	
Peak Hour Analysis From 07:00 AM to 07:45 AM - Peak 1 of 1										
Peak Hour for Entire Intersection Begins at 07:00 AM										
07:00 AM	1	0	1	7	3	10	0	2	2	13
07:15 AM	1	1	2	3	1	4	0	5	5	11
07:30 AM	2	0	2	5	1	6	1	9	10	18
07:45 AM	1	0	1	7	4	11	0	6	6	18
Total Volume	5	1	6	22	9	31	1	22	23	60
% App. Total	83.3	16.7		71	29		4.3	95.7		
PHF	.625	.250	.750	.786	.563	.705	.250	.611	.575	.833

City of Moreno Valley
 N/S: Frederick Street
 E/W: Cactus Avenue
 Weather: Clear

File Name : 45_MRV_Frederick_Cactus AM
 Site Code : 05119542
 Start Date : 8/20/2019
 Page No : 2

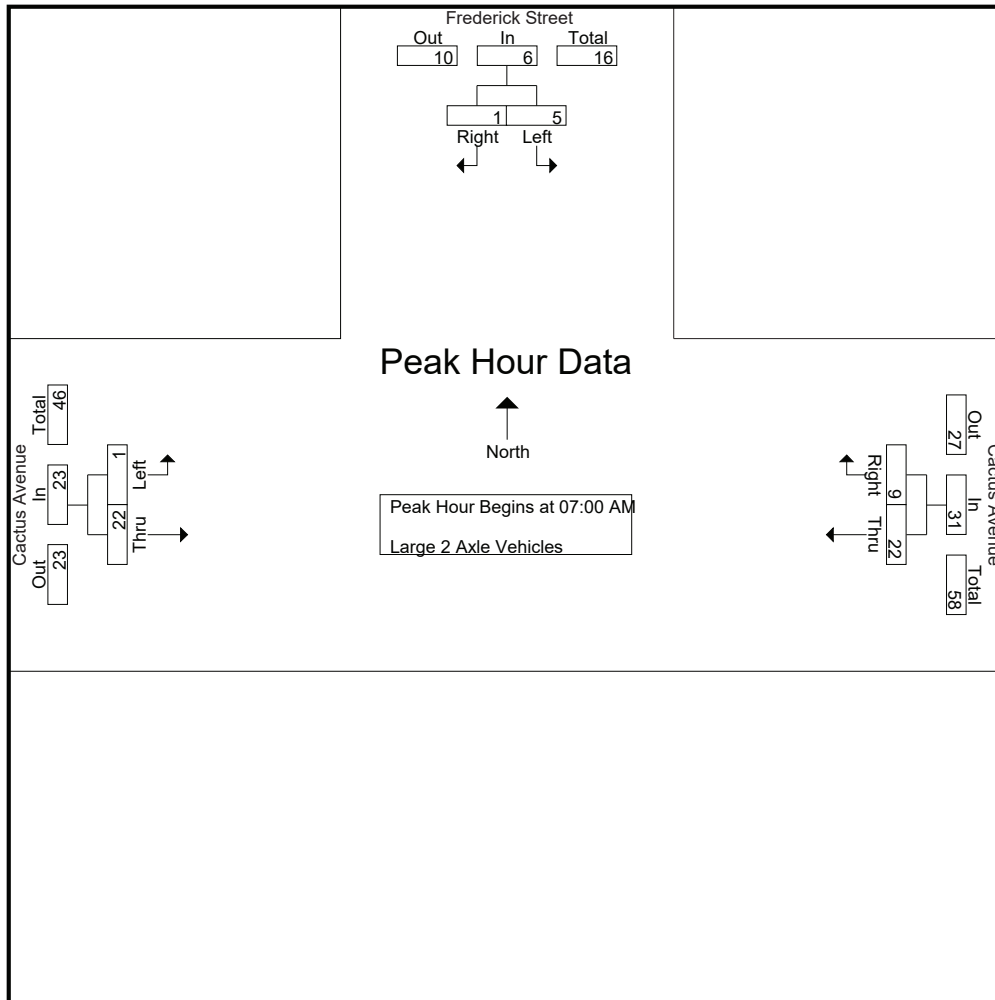

Peak Hour Analysis From 07:00 AM to 07:45 AM - Peak 1 of 1
 Peak Hour for Each Approach Begins at:

	07:00 AM			07:00 AM			07:00 AM		
+0 mins.	1	0	1	7	3	10	0	2	2
+15 mins.	1	1	2	3	1	4	0	5	5
+30 mins.	2	0	2	5	1	6	1	9	10
+45 mins.	1	0	1	7	4	11	0	6	6
Total Volume	5	1	6	22	9	31	1	22	23
% App. Total	83.3	16.7		71	29		4.3	95.7	
PHF	.625	.250	.750	.786	.563	.705	.250	.611	.575

City of Moreno Valley
 N/S: Frederick Street
 E/W: Cactus Avenue
 Weather: Clear

File Name : 45_MRV_Frederick_Cactus AM
 Site Code : 05119542
 Start Date : 8/20/2019
 Page No : 1

Groups Printed- 3 Axle Vehicles

Start Time	Frederick Street Southbound				Cactus Avenue Westbound				Cactus Avenue Eastbound				Exclu. Total	Inclu. Total	Int. Total
	Left	Right	RTOR	App. Total	Thru	Right	RTOR	App. Total	Left	Thru	RTOR	App. Total			
07:00 AM	0	0	0	0	9	0	0	9	0	2	0	2	0	11	11
07:15 AM	0	0	0	0	2	0	0	2	0	2	0	2	0	4	4
07:30 AM	1	0	0	1	4	0	0	4	0	2	0	2	0	7	7
07:45 AM	0	0	0	0	1	0	0	1	1	1	0	2	0	3	3
Total	1	0	0	1	16	0	0	16	1	7	0	8	0	25	25
08:00 AM	0	0	0	0	3	0	0	3	0	3	0	3	0	6	6
08:15 AM	1	0	0	1	8	2	0	10	1	1	0	2	0	13	13
08:30 AM	0	1	0	1	0	1	0	1	0	3	0	3	0	5	5
08:45 AM	0	1	1	1	1	0	0	1	0	1	0	1	1	3	4
Total	1	2	1	3	12	3	0	15	1	8	0	9	1	27	28
Grand Total	2	2	1	4	28	3	0	31	2	15	0	17	1	52	53
Apprch %	50	50			90.3	9.7			11.8	88.2					
Total %	3.8	3.8		7.7	53.8	5.8		59.6	3.8	28.8		32.7	1.9	98.1	

Start Time	Frederick Street Southbound			Cactus Avenue Westbound			Cactus Avenue Eastbound			Int. Total
	Left	Right	App. Total	Thru	Right	App. Total	Left	Thru	App. Total	
Peak Hour Analysis From 07:00 AM to 07:45 AM - Peak 1 of 1										
Peak Hour for Entire Intersection Begins at 07:00 AM										
07:00 AM	0	0	0	9	0	9	0	2	2	11
07:15 AM	0	0	0	2	0	2	0	2	2	4
07:30 AM	1	0	1	4	0	4	0	2	2	7
07:45 AM	0	0	0	1	0	1	1	1	2	3
Total Volume	1	0	1	16	0	16	1	7	8	25
% App. Total	100	0		100	0		12.5	87.5		
PHF	.250	.000	.250	.444	.000	.444	.250	.875	1.00	.568

City of Moreno Valley
 N/S: Frederick Street
 E/W: Cactus Avenue
 Weather: Clear

File Name : 45_MRV_Frederick_Cactus AM
 Site Code : 05119542
 Start Date : 8/20/2019
 Page No : 2

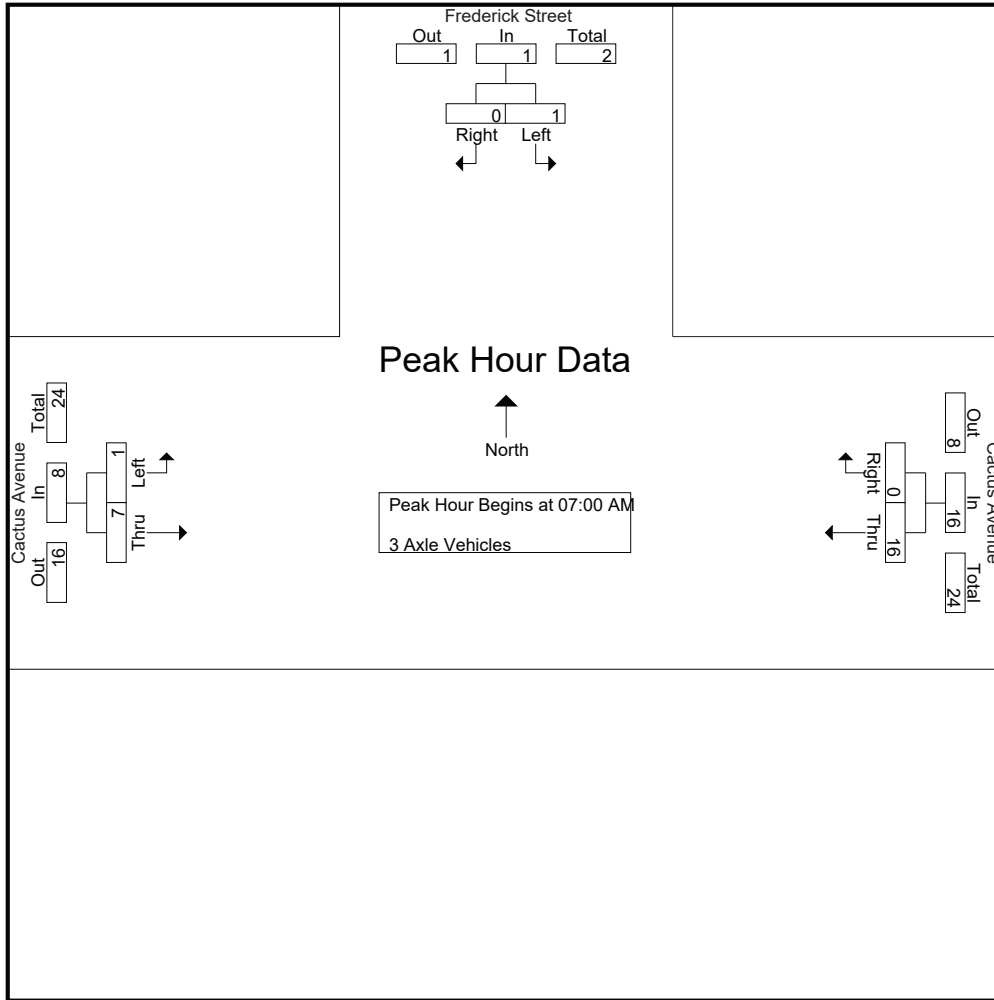

Peak Hour Analysis From 07:00 AM to 07:45 AM - Peak 1 of 1
 Peak Hour for Each Approach Begins at:

	07:00 AM			07:00 AM			07:00 AM		
+0 mins.	0	0	0	9	0	9	0	2	2
+15 mins.	0	0	0	2	0	2	0	2	2
+30 mins.	1	0	1	4	0	4	0	2	2
+45 mins.	0	0	0	1	0	1	1	1	2
Total Volume	1	0	1	16	0	16	1	7	8
% App. Total	100	0		100	0		12.5	87.5	
PHF	.250	.000	.250	.444	.000	.444	.250	.875	1.000

City of Moreno Valley
 N/S: Frederick Street
 E/W: Cactus Avenue
 Weather: Clear

File Name : 45_MRV_Frederick_Cactus AM
 Site Code : 05119542
 Start Date : 8/20/2019
 Page No : 1

Groups Printed- 4+ Axle Trucks

Start Time	Frederick Street Southbound				Cactus Avenue Westbound				Cactus Avenue Eastbound				Exclu. Total	Inclu. Total	Int. Total
	Left	Right	RTOR	App. Total	Thru	Right	RTOR	App. Total	Left	Thru	RTOR	App. Total			
07:00 AM	0	0	0	0	5	0	0	5	1	10	0	11	0	16	16
07:15 AM	0	1	1	1	5	0	0	5	1	9	0	10	1	16	17
07:30 AM	0	0	0	0	3	0	0	3	1	6	0	7	0	10	10
07:45 AM	0	0	0	0	8	1	0	9	1	7	0	8	0	17	17
Total	0	1	1	1	21	1	0	22	4	32	0	36	1	59	60
08:00 AM	1	0	0	1	8	0	0	8	1	6	0	7	0	16	16
08:15 AM	1	0	0	1	8	0	0	8	3	6	0	9	0	18	18
08:30 AM	1	2	1	3	11	1	0	12	1	12	0	13	1	28	29
08:45 AM	0	3	2	3	8	1	0	9	2	7	0	9	2	21	23
Total	3	5	3	8	35	2	0	37	7	31	0	38	3	83	86
Grand Total	3	6	4	9	56	3	0	59	11	63	0	74	4	142	146
Apprch %	33.3	66.7			94.9	5.1			14.9	85.1					
Total %	2.1	4.2		6.3	39.4	2.1		41.5	7.7	44.4		52.1	2.7	97.3	

Start Time	Frederick Street Southbound			Cactus Avenue Westbound			Cactus Avenue Eastbound			Int. Total
	Left	Right	App. Total	Thru	Right	App. Total	Left	Thru	App. Total	
Peak Hour Analysis From 07:00 AM to 07:45 AM - Peak 1 of 1										
Peak Hour for Entire Intersection Begins at 07:00 AM										
07:00 AM	0	0	0	5	0	5	1	10	11	16
07:15 AM	0	1	1	5	0	5	1	9	10	16
07:30 AM	0	0	0	3	0	3	1	6	7	10
07:45 AM	0	0	0	8	1	9	1	7	8	17
Total Volume	0	1	1	21	1	22	4	32	36	59
% App. Total	0	100		95.5	4.5		11.1	88.9		
PHF	.000	.250	.250	.656	.250	.611	1.00	.800	.818	.868

City of Moreno Valley
 N/S: Frederick Street
 E/W: Cactus Avenue
 Weather: Clear

File Name : 45_MRV_Frederick_Cactus AM
 Site Code : 05119542
 Start Date : 8/20/2019
 Page No : 2

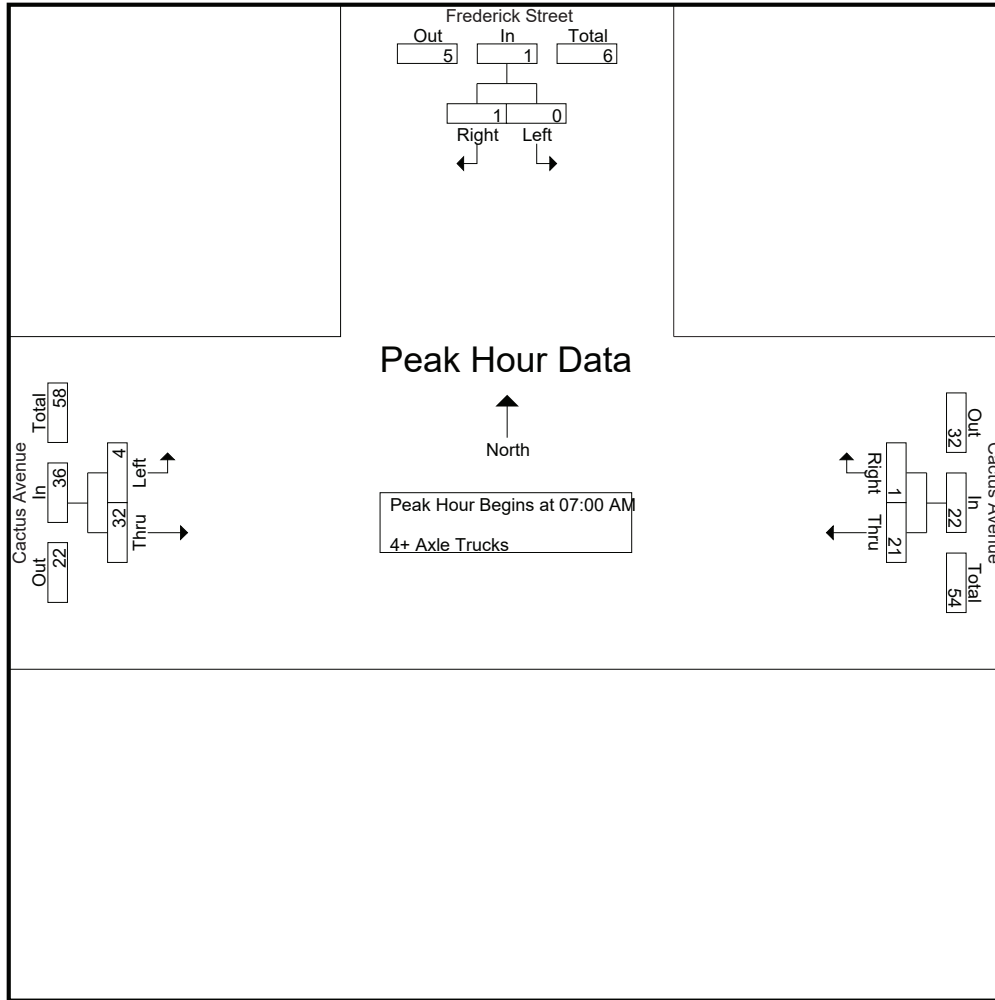

Peak Hour Analysis From 07:00 AM to 07:45 AM - Peak 1 of 1

Peak Hour for Each Approach Begins at:

	07:00 AM			07:00 AM			07:00 AM		
+0 mins.	0	0	0	5	0	5	1	10	11
+15 mins.	0	1	1	5	0	5	1	9	10
+30 mins.	0	0	0	3	0	3	1	6	7
+45 mins.	0	0	0	8	1	9	1	7	8
Total Volume	0	1	1	21	1	22	4	32	36
% App. Total	0	100		95.5	4.5		11.1	88.9	
PHF	.000	.250	.250	.656	.250	.611	1.000	.800	.818

City of Moreno Valley
 N/S: Frederick Street
 E/W: Cactus Avenue
 Weather: Clear

File Name : 45_MRV_Frederick_Cactus PM
 Site Code : 05119542
 Start Date : 8/20/2019
 Page No : 1

Groups Printed- Passenger Vehicles - Large 2 Axle Vehicles - 3 Axle Vehicles - 4+ Axle Trucks

Start Time	Frederick Street Southbound				Cactus Avenue Westbound				Cactus Avenue Eastbound				Exclu. Total	Inclu. Total	Int. Total
	Left	Right	RTOR	App. Total	Thru	Right	RTOR	App. Total	Left	Thru	RTOR	App. Total			
04:00 PM	78	28	14	106	291	27	5	318	31	430	0	461	19	885	904
04:15 PM	84	25	17	109	253	30	8	283	21	454	0	475	25	867	892
04:30 PM	86	47	23	133	253	26	14	279	31	538	0	569	37	981	1018
04:45 PM	87	22	12	109	264	63	15	327	32	448	0	480	27	916	943
Total	335	122	66	457	1061	146	42	1207	115	1870	0	1985	108	3649	3757
05:00 PM	96	47	24	143	258	46	26	304	22	505	0	527	50	974	1024
05:15 PM	75	23	18	98	257	42	15	299	24	530	0	554	33	951	984
05:30 PM	123	27	23	150	215	30	10	245	13	563	0	576	33	971	1004
05:45 PM	78	24	11	102	209	33	10	242	31	495	0	526	21	870	891
Total	372	121	76	493	939	151	61	1090	90	2093	0	2183	137	3766	3903
Grand Total	707	243	142	950	2000	297	103	2297	205	3963	0	4168	245	7415	7660
Apprch %	74.4	25.6			87.1	12.9			4.9	95.1					
Total %	9.5	3.3		12.8	27	4		31	2.8	53.4		56.2	3.2	96.8	
Passenger Vehicles	692	230		1060	1909	287		2297	188	3810		3998	0	0	7355
% Passenger Vehicles	97.9	94.7	97.2	97.1	95.4	96.6	98.1	95.7	91.7	96.1	0	95.9	0	0	96
Large 2 Axle Vehicles	6	2		8	28	5		35	7	64		71	0	0	114
% Large 2 Axle Vehicles	0.8	0.8	0	0.7	1.4	1.7	1.9	1.5	3.4	1.6	0	1.7	0	0	1.5
3 Axle Vehicles	8	3		12	10	2		12	3	12		15	0	0	39
% 3 Axle Vehicles	1.1	1.2	0.7	1.1	0.5	0.7	0	0.5	1.5	0.3	0	0.4	0	0	0.5
4+ Axle Trucks	1	8		12	53	3		56	7	77		84	0	0	152
% 4+ Axle Trucks	0.1	3.3	2.1	1.1	2.7	1	0	2.3	3.4	1.9	0	2	0	0	2

Start Time	Frederick Street Southbound			Cactus Avenue Westbound			Cactus Avenue Eastbound			Int. Total
	Left	Right	App. Total	Thru	Right	App. Total	Left	Thru	App. Total	
Peak Hour Analysis From 04:00 PM to 05:45 PM - Peak 1 of 1										
Peak Hour for Entire Intersection Begins at 04:30 PM										
04:30 PM	86	47	133	253	26	279	31	538	569	981
04:45 PM	87	22	109	264	63	327	32	448	480	916
05:00 PM	96	47	143	258	46	304	22	505	527	974
05:15 PM	75	23	98	257	42	299	24	530	554	951
Total Volume	344	139	483	1032	177	1209	109	2021	2130	3822
% App. Total	71.2	28.8		85.4	14.6		5.1	94.9		
PHF	.896	.739	.844	.977	.702	.924	.852	.939	.936	.974

City of Moreno Valley
 N/S: Frederick Street
 E/W: Cactus Avenue
 Weather: Clear

File Name : 45_MRV_Frederick_Cactus PM
 Site Code : 05119542
 Start Date : 8/20/2019
 Page No : 2

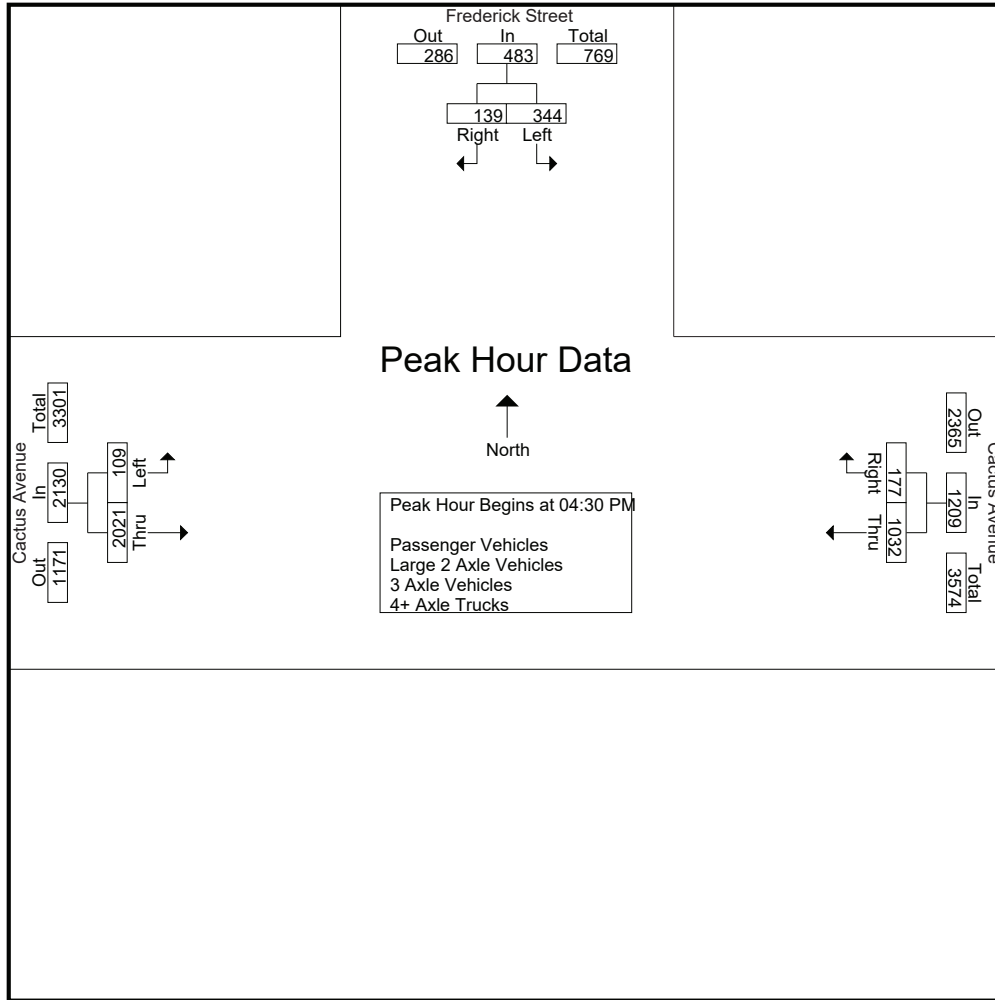

Peak Hour Analysis From 04:00 PM to 05:45 PM - Peak 1 of 1
 Peak Hour for Each Approach Begins at:

	04:45 PM			04:30 PM			05:00 PM		
+0 mins.	87	22	109	253	26	279	22	505	527
+15 mins.	96	47	143	264	63	327	24	530	554
+30 mins.	75	23	98	258	46	304	13	563	576
+45 mins.	123	27	150	257	42	299	31	495	526
Total Volume	381	119	500	1032	177	1209	90	2093	2183
% App. Total	76.2	23.8		85.4	14.6		4.1	95.9	
PHF	.774	.633	.833	.977	.702	.924	.726	.929	.947

City of Moreno Valley
 N/S: Frederick Street
 E/W: Cactus Avenue
 Weather: Clear

File Name : 45_MRV_Frederick_Cactus PM
 Site Code : 05119542
 Start Date : 8/20/2019
 Page No : 1

Groups Printed- Passenger Vehicles

Start Time	Frederick Street Southbound				Cactus Avenue Westbound				Cactus Avenue Eastbound				Exclu. Total	Inclu. Total	Int. Total
	Left	Right	RTOR	App. Total	Thru	Right	RTOR	App. Total	Left	Thru	RTOR	App. Total			
04:00 PM	76	25	13	101	276	26	5	302	27	415	0	442	18	845	863
04:15 PM	83	23	17	106	244	29	7	273	20	430	0	450	24	829	853
04:30 PM	83	45	23	128	239	26	14	265	29	518	0	547	37	940	977
04:45 PM	86	21	11	107	250	60	15	310	27	427	0	454	26	871	897
Total	328	114	64	442	1009	141	41	1150	103	1790	0	1893	105	3485	3590
05:00 PM	93	45	23	138	251	44	25	295	20	484	0	504	48	937	985
05:15 PM	74	23	18	97	245	41	15	286	24	517	0	541	33	924	957
05:30 PM	119	25	22	144	208	29	10	237	10	546	0	556	32	937	969
05:45 PM	78	23	11	101	196	32	10	228	31	473	0	504	21	833	854
Total	364	116	74	480	900	146	60	1046	85	2020	0	2105	134	3631	3765
Grand Total	692	230	138	922	1909	287	101	2196	188	3810	0	3998	239	7116	7355
Apprch %	75.1	24.9			86.9	13.1			4.7	95.3					
Total %	9.7	3.2		13	26.8	4		30.9	2.6	53.5		56.2	3.2	96.8	

Start Time	Frederick Street Southbound			Cactus Avenue Westbound			Cactus Avenue Eastbound			Int. Total
	Left	Right	App. Total	Thru	Right	App. Total	Left	Thru	App. Total	
Peak Hour Analysis From 04:30 PM to 05:15 PM - Peak 1 of 1										
Peak Hour for Entire Intersection Begins at 04:30 PM										
04:30 PM	83	45	128	239	26	265	29	518	547	940
04:45 PM	86	21	107	250	60	310	27	427	454	871
05:00 PM	93	45	138	251	44	295	20	484	504	937
05:15 PM	74	23	97	245	41	286	24	517	541	924
Total Volume	336	134	470	985	171	1156	100	1946	2046	3672
% App. Total	71.5	28.5		85.2	14.8		4.9	95.1		
PHF	.903	.744	.851	.981	.713	.932	.862	.939	.935	.977

City of Moreno Valley
 N/S: Frederick Street
 E/W: Cactus Avenue
 Weather: Clear

File Name : 45_MRV_Frederick_Cactus PM
 Site Code : 05119542
 Start Date : 8/20/2019
 Page No : 2

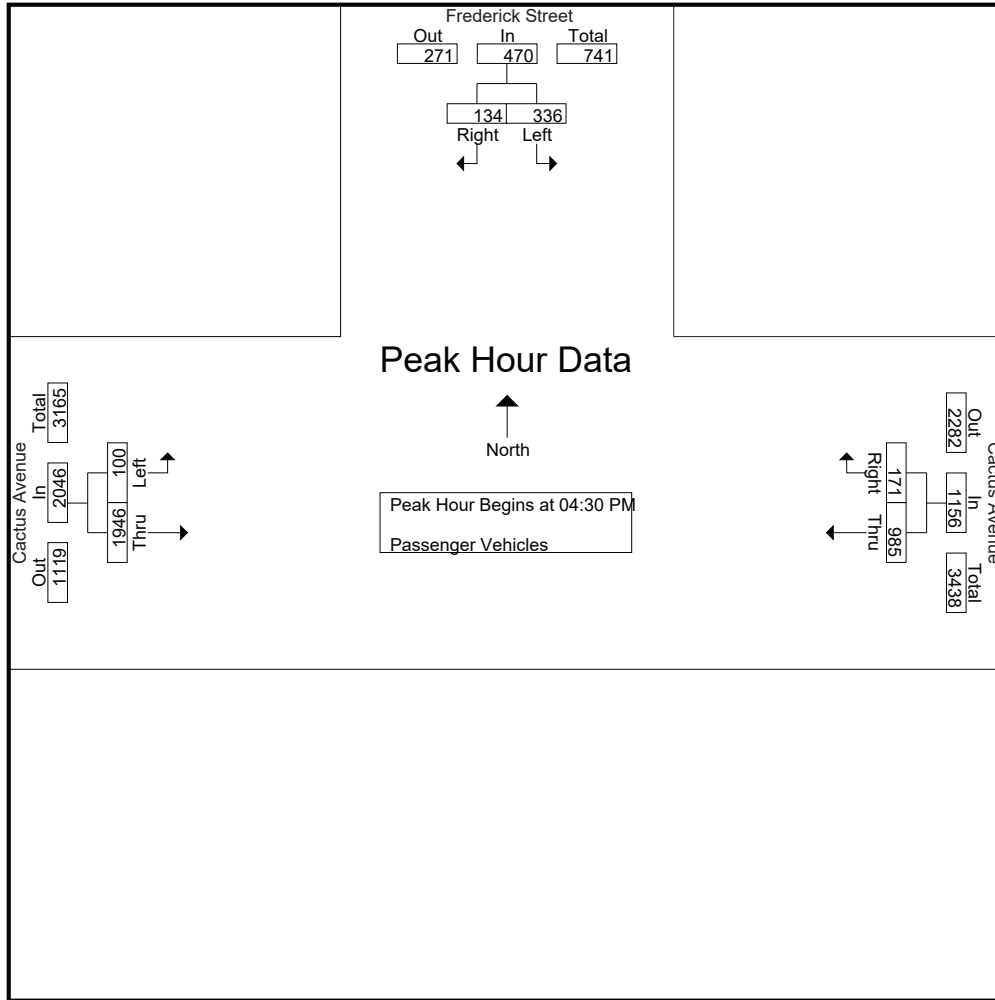

Peak Hour Analysis From 04:30 PM to 05:15 PM - Peak 1 of 1

Peak Hour for Each Approach Begins at:

	04:30 PM			04:30 PM			04:30 PM		
+0 mins.	83	45	128	239	26	265	29	518	547
+15 mins.	86	21	107	250	60	310	27	427	454
+30 mins.	93	45	138	251	44	295	20	484	504
+45 mins.	74	23	97	245	41	286	24	517	541
Total Volume	336	134	470	985	171	1156	100	1946	2046
% App. Total	71.5	28.5		85.2	14.8		4.9	95.1	
PHF	.903	.744	.851	.981	.713	.932	.862	.939	.935

City of Moreno Valley
 N/S: Frederick Street
 E/W: Cactus Avenue
 Weather: Clear

File Name : 45_MRV_Frederick_Cactus PM
 Site Code : 05119542
 Start Date : 8/20/2019
 Page No : 1

Groups Printed- Large 2 Axle Vehicles

Start Time	Frederick Street Southbound				Cactus Avenue Westbound				Cactus Avenue Eastbound				Exclu. Total	Inclu. Total	Int. Total
	Left	Right	RTOR	App. Total	Thru	Right	RTOR	App. Total	Left	Thru	RTOR	App. Total			
04:00 PM	1	1	0	2	6	1	0	7	2	6	0	8	0	17	17
04:15 PM	0	0	0	0	3	1	1	4	0	11	0	11	1	15	16
04:30 PM	2	0	0	2	4	0	0	4	0	10	0	10	0	16	16
04:45 PM	0	0	0	0	2	1	0	3	3	8	0	11	0	14	14
Total	3	1	0	4	15	3	1	18	5	35	0	40	1	62	63
05:00 PM	1	1	0	2	2	1	1	3	1	7	0	8	1	13	14
05:15 PM	0	0	0	0	6	1	0	7	0	5	0	5	0	12	12
05:30 PM	2	0	0	2	2	0	0	2	1	7	0	8	0	12	12
05:45 PM	0	0	0	0	3	0	0	3	0	10	0	10	0	13	13
Total	3	1	0	4	13	2	1	15	2	29	0	31	1	50	51
Grand Total	6	2	0	8	28	5	2	33	7	64	0	71	2	112	114
Apprch %	75	25			84.8	15.2			9.9	90.1					
Total %	5.4	1.8		7.1	25	4.5		29.5	6.2	57.1		63.4	1.8	98.2	

Start Time	Frederick Street Southbound			Cactus Avenue Westbound			Cactus Avenue Eastbound			Int. Total
	Left	Right	App. Total	Thru	Right	App. Total	Left	Thru	App. Total	
Peak Hour Analysis From 04:30 PM to 05:15 PM - Peak 1 of 1										
Peak Hour for Entire Intersection Begins at 04:30 PM										
04:30 PM	2	0	2	4	0	4	0	10	10	16
04:45 PM	0	0	0	2	1	3	3	8	11	14
05:00 PM	1	1	2	2	1	3	1	7	8	13
05:15 PM	0	0	0	6	1	7	0	5	5	12
Total Volume	3	1	4	14	3	17	4	30	34	55
% App. Total	75	25		82.4	17.6		11.8	88.2		
PHF	.375	.250	.500	.583	.750	.607	.333	.750	.773	.859

City of Moreno Valley
 N/S: Frederick Street
 E/W: Cactus Avenue
 Weather: Clear

File Name : 45_MRV_Frederick_Cactus PM
 Site Code : 05119542
 Start Date : 8/20/2019
 Page No : 2

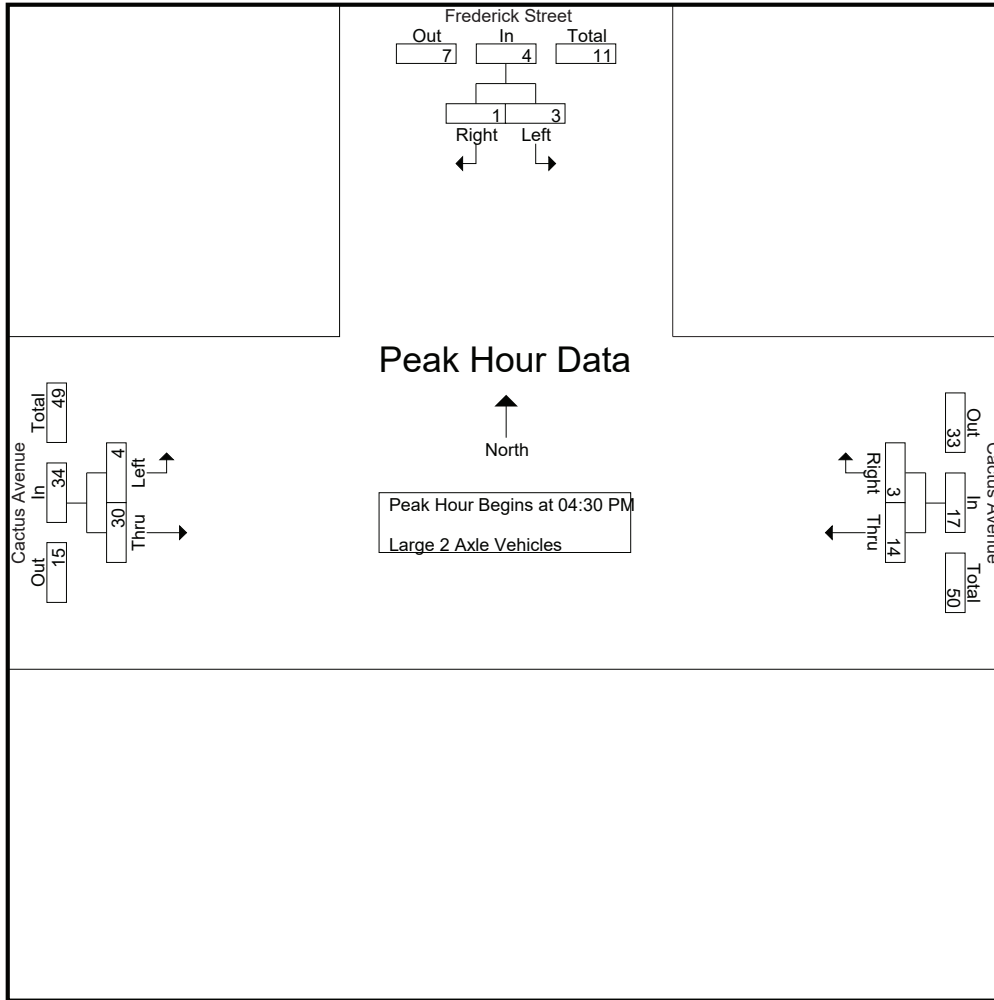

Peak Hour Analysis From 04:30 PM to 05:15 PM - Peak 1 of 1
 Peak Hour for Each Approach Begins at:

	04:30 PM			04:30 PM			04:30 PM		
+0 mins.	2	0	2	4	0	4	0	10	10
+15 mins.	0	0	0	2	1	3	3	8	11
+30 mins.	1	1	2	2	1	3	1	7	8
+45 mins.	0	0	0	6	1	7	0	5	5
Total Volume	3	1	4	14	3	17	4	30	34
% App. Total	75	25		82.4	17.6		11.8	88.2	
PHF	.375	.250	.500	.583	.750	.607	.333	.750	.773

City of Moreno Valley
 N/S: Frederick Street
 E/W: Cactus Avenue
 Weather: Clear

File Name : 45_MRV_Frederick_Cactus PM
 Site Code : 05119542
 Start Date : 8/20/2019
 Page No : 1

Groups Printed- 3 Axle Vehicles

Start Time	Frederick Street Southbound				Cactus Avenue Westbound				Cactus Avenue Eastbound				Exclu. Total	Inclu. Total	Int. Total
	Left	Right	RTOR	App. Total	Thru	Right	RTOR	App. Total	Left	Thru	RTOR	App. Total			
04:00 PM	1	1	1	2	3	0	0	3	0	1	0	1	1	6	7
04:15 PM	1	1	0	2	0	0	0	0	1	1	0	2	0	4	4
04:30 PM	1	1	0	2	1	0	0	1	1	1	0	2	0	5	5
04:45 PM	1	0	0	1	3	1	0	4	0	3	0	3	0	8	8
Total	4	3	1	7	7	1	0	8	2	6	0	8	1	23	24
05:00 PM	2	0	0	2	0	1	0	1	1	3	0	4	0	7	7
05:15 PM	0	0	0	0	1	0	0	1	0	1	0	1	0	2	2
05:30 PM	2	0	0	2	1	0	0	1	0	0	0	0	0	3	3
05:45 PM	0	0	0	0	1	0	0	1	0	2	0	2	0	3	3
Total	4	0	0	4	3	1	0	4	1	6	0	7	0	15	15
Grand Total	8	3	1	11	10	2	0	12	3	12	0	15	1	38	39
Apprch %	72.7	27.3			83.3	16.7			20	80					
Total %	21.1	7.9		28.9	26.3	5.3		31.6	7.9	31.6		39.5	2.6	97.4	

Start Time	Frederick Street Southbound			Cactus Avenue Westbound			Cactus Avenue Eastbound			Int. Total
	Left	Right	App. Total	Thru	Right	App. Total	Left	Thru	App. Total	
Peak Hour Analysis From 04:30 PM to 05:15 PM - Peak 1 of 1										
Peak Hour for Entire Intersection Begins at 04:30 PM										
04:30 PM	1	1	2	1	0	1	1	1	2	5
04:45 PM	1	0	1	3	1	4	0	3	3	8
05:00 PM	2	0	2	0	1	1	1	3	4	7
05:15 PM	0	0	0	1	0	1	0	1	1	2
Total Volume	4	1	5	5	2	7	2	8	10	22
% App. Total	80	20		71.4	28.6		20	80		
PHF	.500	.250	.625	.417	.500	.438	.500	.667	.625	.688

City of Moreno Valley
 N/S: Frederick Street
 E/W: Cactus Avenue
 Weather: Clear

File Name : 45_MRV_Frederick_Cactus PM
 Site Code : 05119542
 Start Date : 8/20/2019
 Page No : 2

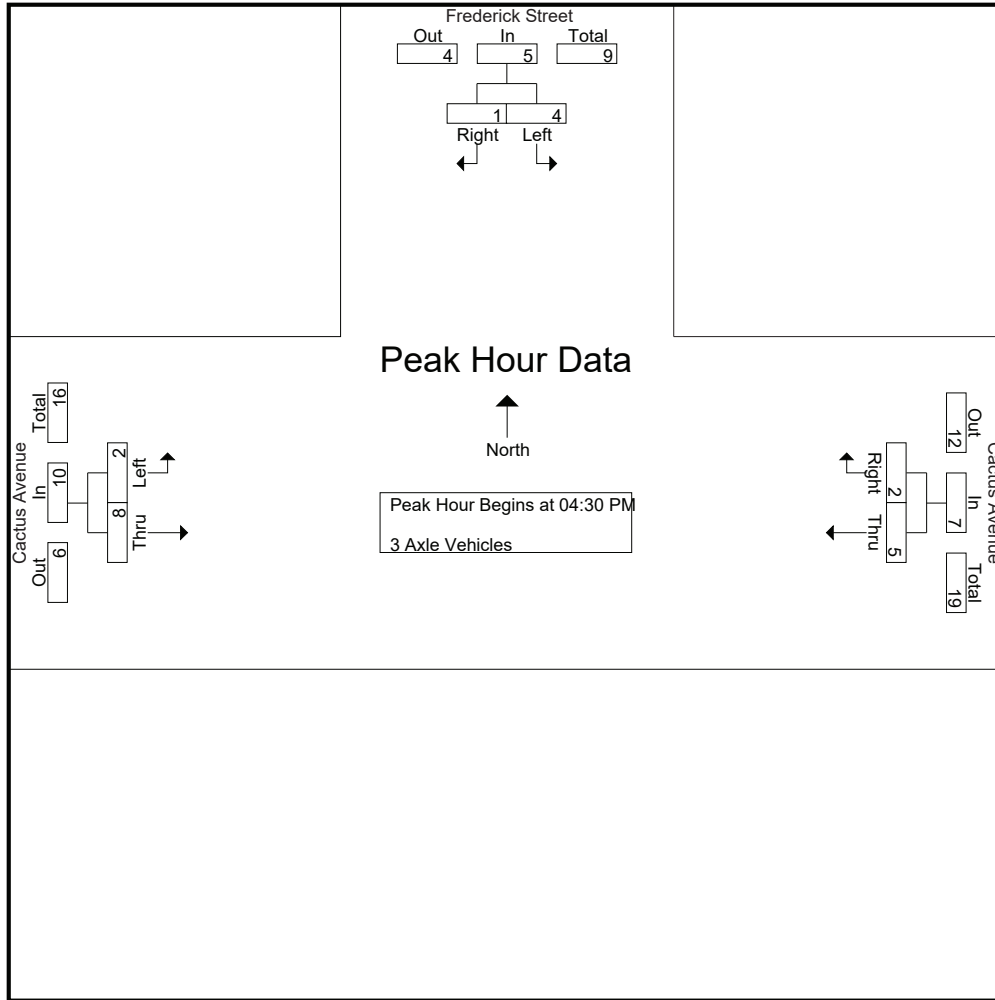

Peak Hour Analysis From 04:30 PM to 05:15 PM - Peak 1 of 1

Peak Hour for Each Approach Begins at:

	04:30 PM			04:30 PM			04:30 PM		
+0 mins.	1	1	2	1	0	1	1	1	2
+15 mins.	1	0	1	3	1	4	0	3	3
+30 mins.	2	0	2	0	1	1	1	3	4
+45 mins.	0	0	0	1	0	1	0	1	1
Total Volume	4	1	5	5	2	7	2	8	10
% App. Total	80	20		71.4	28.6		20	80	
PHF	.500	.250	.625	.417	.500	.438	.500	.667	.625

City of Moreno Valley
 N/S: Frederick Street
 E/W: Cactus Avenue
 Weather: Clear

File Name : 45_MRV_Frederick_Cactus PM
 Site Code : 05119542
 Start Date : 8/20/2019
 Page No : 1

Groups Printed- 4+ Axle Trucks

Start Time	Frederick Street Southbound				Cactus Avenue Westbound				Cactus Avenue Eastbound				Exclu. Total	Inclu. Total	Int. Total
	Left	Right	RTOR	App. Total	Thru	Right	RTOR	App. Total	Left	Thru	RTOR	App. Total			
04:00 PM	0	1	0	1	6	0	0	6	2	8	0	10	0	17	17
04:15 PM	0	1	0	1	6	0	0	6	0	12	0	12	0	19	19
04:30 PM	0	1	0	1	9	0	0	9	1	9	0	10	0	20	20
04:45 PM	0	1	1	1	9	1	0	10	2	10	0	12	1	23	24
Total	0	4	1	4	30	1	0	31	5	39	0	44	1	79	80
05:00 PM	0	1	1	1	5	0	0	5	0	11	0	11	1	17	18
05:15 PM	1	0	0	1	5	0	0	5	0	7	0	7	0	13	13
05:30 PM	0	2	1	2	4	1	0	5	2	10	0	12	1	19	20
05:45 PM	0	1	0	1	9	1	0	10	0	10	0	10	0	21	21
Total	1	4	2	5	23	2	0	25	2	38	0	40	2	70	72
Grand Total	1	8	3	9	53	3	0	56	7	77	0	84	3	149	152
Apprch %	11.1	88.9			94.6	5.4			8.3	91.7					
Total %	0.7	5.4		6	35.6	2		37.6	4.7	51.7		56.4	2	98	

Start Time	Frederick Street Southbound			Cactus Avenue Westbound			Cactus Avenue Eastbound			Int. Total
	Left	Right	App. Total	Thru	Right	App. Total	Left	Thru	App. Total	
Peak Hour Analysis From 04:30 PM to 05:15 PM - Peak 1 of 1										
Peak Hour for Entire Intersection Begins at 04:30 PM										
04:30 PM	0	1	1	9	0	9	1	9	10	20
04:45 PM	0	1	1	9	1	10	2	10	12	23
05:00 PM	0	1	1	5	0	5	0	11	11	17
05:15 PM	1	0	1	5	0	5	0	7	7	13
Total Volume	1	3	4	28	1	29	3	37	40	73
% App. Total	25	75		96.6	3.4		7.5	92.5		
PHF	.250	.750	1.00	.778	.250	.725	.375	.841	.833	.793

City of Moreno Valley
 N/S: Frederick Street
 E/W: Cactus Avenue
 Weather: Clear

File Name : 45_MRV_Frederick_Cactus PM
 Site Code : 05119542
 Start Date : 8/20/2019
 Page No : 2

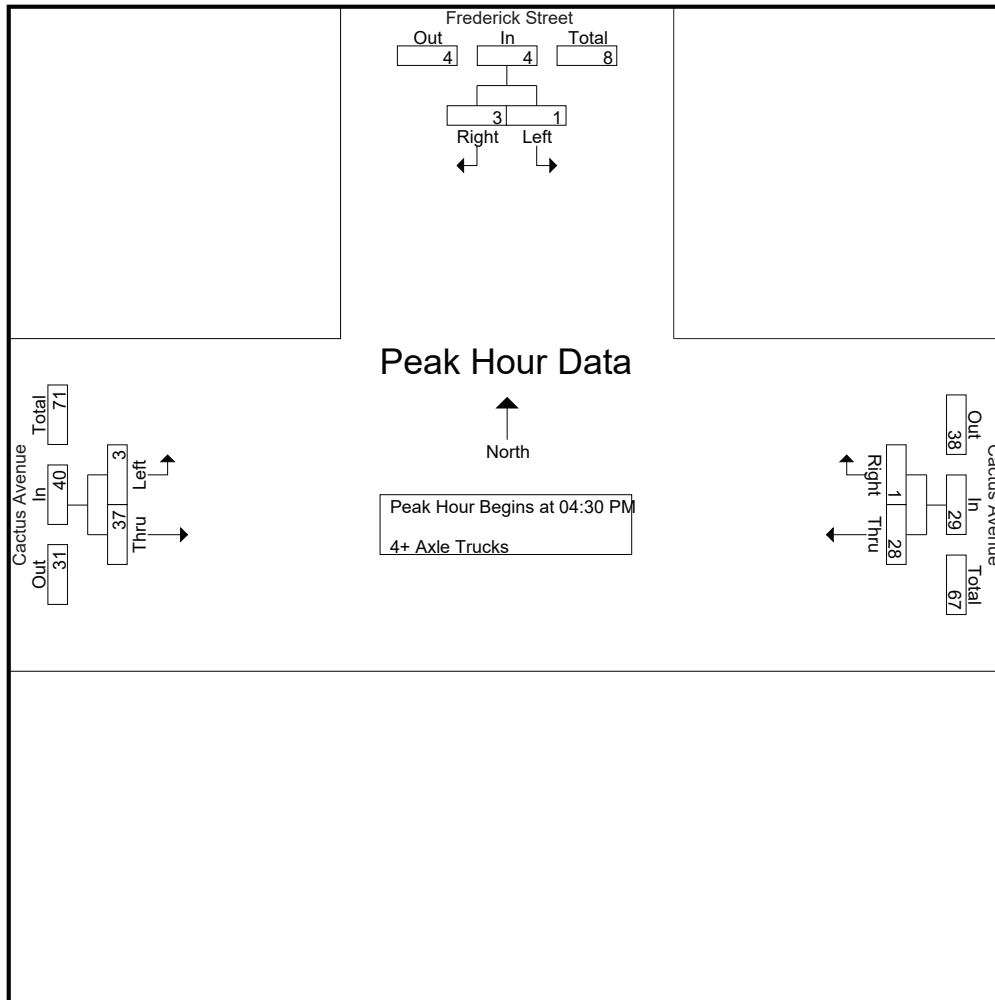

Peak Hour Analysis From 04:30 PM to 05:15 PM - Peak 1 of 1
 Peak Hour for Each Approach Begins at:

	04:30 PM			04:30 PM			04:30 PM		
+0 mins.	0	1	1	9	0	9	1	9	10
+15 mins.	0	1	1	9	1	10	2	10	12
+30 mins.	0	1	1	5	0	5	0	11	11
+45 mins.	1	0	1	5	0	5	0	7	7
Total Volume	1	3	4	28	1	29	3	37	40
% App. Total	25	75		96.6	3.4		7.5	92.5	
PHF	.250	.750	1.000	.778	.250	.725	.375	.841	.833

Location: Moreno Valley
 N/S: Frederick Street
 E/W: Cactus Avenue



Date: 8/20/2019
 Day: Tuesday

PEDESTRIANS

	North Leg Frederick Street Pedestrians	East Leg Cactus Avenue Pedestrians	South Leg Dead End Pedestrians	West Leg Cactus Avenue Pedestrians	
7:00 AM	0	0	0	0	0
7:15 AM	0	0	0	0	0
7:30 AM	0	0	0	0	0
7:45 AM	0	0	0	0	0
8:00 AM	0	0	0	0	0
8:15 AM	0	0	0	0	0
8:30 AM	0	0	0	0	0
8:45 AM	0	0	0	0	0
TOTAL VOLUMES:	0	0	0	0	0

	North Leg Frederick Street Pedestrians	East Leg Cactus Avenue Pedestrians	South Leg Dead End Pedestrians	West Leg Cactus Avenue Pedestrians	
4:00 PM	0	0	0	0	0
4:15 PM	0	0	0	0	0
4:30 PM	0	0	0	0	0
4:45 PM	1	0	0	0	1
5:00 PM	1	0	0	0	1
5:15 PM	0	0	0	0	0
5:30 PM	0	0	0	0	0
5:45 PM	1	0	0	0	1
TOTAL VOLUMES:	3	0	0	0	3

Location: Moreno Valley
 N/S: Frederick Street
 E/W: Cactus Avenue



Date: 8/20/2019
 Day: Tuesday

BICYCLES

	Southbound Frederick Street			Westbound Cactus Avenue			Northbound Dead End			Eastbound Cactus Avenue			
	Left	Thru	Right	Left	Thru	Right	Left	Thru	Right	Left	Thru	Right	
7:00 AM	0	0	0	0	0	0	0	0	0	0	0	0	0
7:15 AM	0	0	0	0	0	0	0	0	0	0	0	0	0
7:30 AM	0	0	0	0	0	0	0	0	0	0	0	0	0
7:45 AM	0	0	0	0	0	0	0	0	0	0	0	0	0
8:00 AM	0	0	0	0	0	0	0	0	0	0	0	0	0
8:15 AM	0	0	0	0	0	0	0	0	0	0	0	0	0
8:30 AM	0	0	0	0	0	0	0	0	0	0	0	0	0
8:45 AM	0	0	0	0	0	0	0	0	0	0	0	0	0
TOTAL VOLUMES:	0	0	0	0	0	0	0	0	0	0	0	0	0

	Southbound Frederick Street			Westbound Cactus Avenue			Northbound Dead End			Eastbound Cactus Avenue			
	Left	Thru	Right	Left	Thru	Right	Left	Thru	Right	Left	Thru	Right	
4:00 PM	0	0	0	0	0	0	0	0	0	0	0	0	0
4:15 PM	0	0	0	0	0	0	0	0	0	0	0	0	0
4:30 PM	0	0	0	0	0	0	0	0	0	0	1	0	1
4:45 PM	0	0	0	0	0	0	0	0	0	0	0	0	0
5:00 PM	0	0	0	0	0	0	0	0	0	0	0	0	0
5:15 PM	0	0	0	0	0	0	0	0	0	0	0	0	0
5:30 PM	0	0	0	0	0	0	0	0	0	0	0	0	0
5:45 PM	0	0	0	0	0	0	0	0	0	0	0	0	0
TOTAL VOLUMES:	0	0	0	0	0	0	0	0	0	0	1	0	1

Counts Unlimited
 PO Box 1178
 Corona, CA 92878
 (951) 268-6268

City of Moreno Valley
 N/S: Graham Street/Riverside Drive
 EW: Cactus Avenue
 Weather: Clear

File Name : 46_MRV_Graham_Cactus AM
 Site Code : 05119542
 Start Date : 8/20/2019
 Page No : 1

Groups Printed- Passenger Vehicles - Large 2 Axle Vehicles - 3 Axle Vehicles - 4+ Axle Trucks

Start Time	Graham Street Southbound						Cactus Avenue Westbound						Riverside Drive Northbound						Cactus Avenue Eastbound						
	Left	Thru	Right	RTOR	App. Total		Left	Thru	Right	RTOR	App. Total		Left	Thru	Right	RTOR	App. Total		Left	Thru	Right	RTOR	App. Total		
	Exclu. Total	Inclu. Total	Int. Total				Exclu. Total	Inclu. Total	Int. Total				Exclu. Total	Inclu. Total	Int. Total				Exclu. Total	Inclu. Total	Int. Total				
07:00 AM	7	7	35	15	49	1	452	13	1	466	60	7	0	67	9	199	31	6	239	22	821	843			
07:15 AM	18	12	22	16	52	4	437	15	1	456	52	13	2	67	15	235	44	7	294	25	869	894			
07:30 AM	13	16	21	13	50	4	391	35	1	430	53	14	0	67	26	220	48	1	294	15	841	856			
07:45 AM	23	25	31	20	79	5	430	33	1	468	57	24	1	82	29	256	50	8	335	29	964	993			
Total	61	60	109	64	230	14	1710	96	4	1820	222	58	3	283	79	910	173	22	1162	91	3495	3586			
08:00 AM	18	17	30	19	65	6	390	22	0	418	41	19	4	64	20	205	52	6	277	26	824	850			
08:15 AM	24	14	15	13	53	5	338	20	3	363	32	6	3	41	22	192	50	8	264	26	721	747			
08:30 AM	16	11	16	14	43	3	301	24	0	328	38	7	0	45	16	188	53	0	257	14	673	687			
08:45 AM	4	16	16	9	36	6	283	21	2	310	29	8	1	38	23	176	52	7	251	19	635	654			
Total	62	58	77	55	197	20	1312	87	5	1419	140	40	8	188	81	761	207	21	1049	85	2853	2938			
Grand Total	123	118	186	119	427	34	3022	183	9	3239	362	98	11	471	160	1671	380	43	2211	176	6348	6524			
Approch %	28.8	27.6	43.6			1	93.3	5.6			76.9	20.8	2.3			7.2	75.6	17.2							
Total %	1.9	1.9	2.9		6.7	0.5	47.6	2.9		51	5.7	1.5	0.2		7.4	2.5	26.3	6		34.8	2.7	97.3			
% Passenger Vehicles	121	117	179		531	33	2877	180		3099	347	94	10		455	152	1546	372		2113	0	0	6198		
% 2 Axle Vehicles	98.4	99.2	96.2		97.3	97.1	95.2	98.4		100	95.9	95.9	90.9		95.6	95	92.5	97.9		100	93.7	0	95		
% Large 2 Axle Vehicles	2	0	3		7	1	57	3		61	11	3	0		14	2	44	7		53	0	0	135		
% 3 Axle Vehicles	1.6	0	1.6		1.3	2.9	1.9	1.6		1.9	3	3.1	0		2.9	1.2	2.6	1.8		2.4	0	0	2.1		
% 3 Axle Trucks	0	0	0		0	0	17	0		17	0	1	0		1	0	14	1		15	0	0	33		
% 4+ Axle Trucks	0	0	0		0	0	0.6	0		0.5	0	1	0		0.2	0	0.8	0.3		0.7	0	0	0.5		
% 4+ Axle Trucks	0	1	4		8	0	71	0		71	4	0	1		6	6	67	0		73	0	0	158		
% 4+ Axle Trucks	0	0.8	2.2		1.5	0	2.3	0		2.2	1.1	0	9.1		1.3	3.8	4		3.2	0	0	2.4			

Start Time	Graham Street Southbound						Cactus Avenue Westbound						Riverside Drive Northbound						Cactus Avenue Eastbound					
	Left	Thru	Right	RTOR	App. Total		Left	Thru	Right	RTOR	App. Total		Left	Thru	Right	RTOR	App. Total		Left	Thru	Right	RTOR	App. Total	
	Exclu. Total	Inclu. Total	Int. Total				Exclu. Total	Inclu. Total	Int. Total				Exclu. Total	Inclu. Total	Int. Total				Exclu. Total	Inclu. Total	Int. Total			
07:15 AM	18	12	22		52	4	437	15		456	52	13	2		67	15	235	44		235	44		294	
07:30 AM	13	16	21		50	4	391	35		430	53	14	0		67	26	220	48		220	48		294	
07:45 AM	23	25	31		79	5	430	33		468	57	24	1		82	29	256	50		256	50		335	
08:00 AM	18	17	30		65	6	390	22		418	41	19	4		64	20	205	52		205	52		277	
Total Volume	72	70	104		246	19	1648	105		1772	203	70	7		280	90	916	194		916	194		1200	
% App. Total	29.3	28.5	42.3		42.3	1.1	93	5.9		5.9	72.5	25	2.5		7.5	76.3	16.2		76.3	16.2		16.2		
PHF	.783	.700	.839		.778	.792	.943	.750		.947	.890	.729	.438		.854	.776	.895	.933		.895	.933		.896	

Peak Hour Analysis From 07:00 AM to 08:45 AM - Peak 1 of 1
 Peak Hour for Entire Intersection Begins at 07:15 AM

Counts Unlimited
 PO Box 1178
 Corona, CA 92878
 (951) 268-6268

City of Moreno Valley
 N/S: Graham Street/Riverside Drive
 E/W: Cactus Avenue
 Weather: Clear

File Name : 46_MRV_Graham_Cactus AM
 Site Code : 05119542
 Start Date : 8/20/2019
 Page No : 2

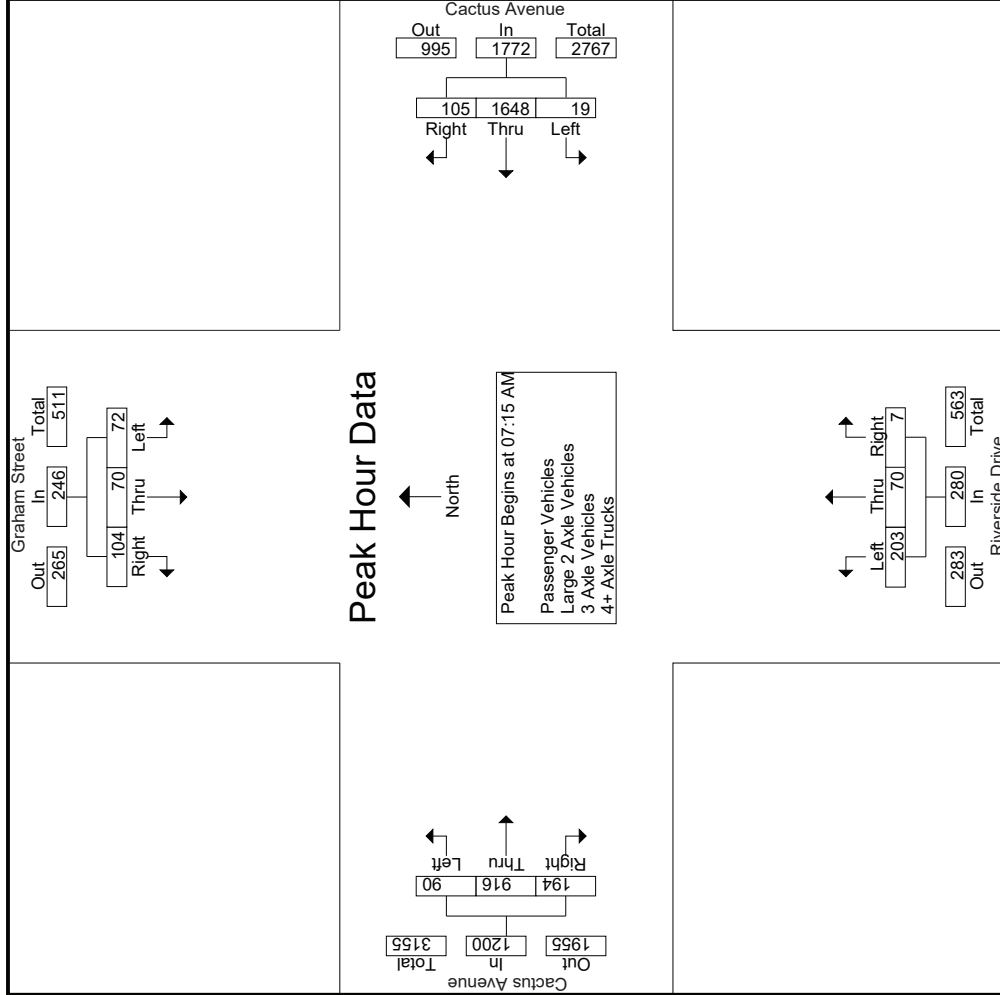

Counts Unlimited
 PO Box 1178
 Corona, CA 92878
 (951) 268-6268

City of Moreno Valley
 N/S: Graham Street/Riverside Drive
 E/W: Cactus Avenue
 Weather: Clear

File Name : 46_MRV_Graham_Cactus AM
 Site Code : 05119542
 Start Date : 8/20/2019
 Page No : 3

Start Time	Graham Street Southbound			Cactus Avenue Westbound			Riverside Drive Northbound			Cactus Avenue Eastbound				
	Left	Thru	Right	App. Total	Left	Thru	Right	App. Total	Left	Thru	Right	App. Total	Int. Total	
Peak Hour Analysis From 07:00 AM to 08:45 AM - Peak 1 of 1														
Peak Hour for Each Approach Begins at:														
	07:30 AM			07:00 AM			07:00 AM			07:15 AM				
+0 mins.	13	16	21	50	1	466	13	466	7	0	67	15	294	
+15 mins.	23	25	31	79	4	437	15	456	13	2	67	26	294	
+30 mins.	18	17	30	65	4	391	35	430	14	0	67	29	335	
+45 mins.	24	14	15	53	5	430	33	468	24	1	82	20	277	
Total Volume	78	72	97	247	14	1710	96	1820	58	3	283	90	1200	
% App. Total	31.6	29.1	39.3	.782	0.8	94	5.3	78.4	20.5	1.1	7.5	76.3	16.2	
PHF	.813	.720	.782	.782	.700	.946	.686	.972	.604	.375	.863	.776	.895	.896

Counts Unlimited
 PO Box 1178
 Corona, CA 92878
 (951) 268-6268

City of Moreno Valley
 N/S: Graham Street/Riverside Drive
 EW: Cactus Avenue
 Weather: Clear

File Name : 46_MRV_Graham_Cactus AM
 Site Code : 05119542
 Start Date : 8/20/2019
 Page No : 1

Groups Printed- Passenger Vehicles

Start Time	Graham Street Southbound					Cactus Avenue Westbound					Riverside Drive Northbound					Cactus Avenue Eastbound							
	Left	Thru	Right	RTOR	App. Total	Left	Thru	Right	RTOR	App. Total	Left	Thru	Right	RTOR	App. Total	Left	Thru	Right	RTOR	App. Total	Exclu. Total	Inclu. Total	Int. Total
07:00 AM	7	7	35	15	49	1	440	13	1	454	58	7	0	0	65	9	182	30	6	221	22	789	811
07:15 AM	18	12	22	16	52	4	423	14	1	441	50	13	2	1	65	15	219	44	7	278	25	836	861
07:30 AM	13	16	20	13	49	4	380	34	1	418	52	14	0	0	66	25	209	47	1	281	15	814	829
07:45 AM	23	24	30	19	77	5	412	33	1	450	56	24	1	0	81	29	236	50	8	315	28	923	951
Total	61	59	107	63	227	14	1655	94	4	1763	216	58	3	1	277	78	846	171	22	1095	90	3362	3452
08:00 AM	18	17	29	18	64	5	366	21	0	392	39	18	4	1	61	20	192	52	6	264	25	781	806
08:15 AM	22	14	13	11	49	5	316	20	3	341	29	4	2	1	35	21	175	47	8	243	23	668	691
08:30 AM	16	11	15	13	42	3	284	24	0	311	36	6	0	0	42	13	168	52	0	233	13	628	641
08:45 AM	4	16	15	9	35	6	256	21	2	283	27	8	1	1	36	20	165	50	7	235	19	589	608
Total	60	58	72	51	190	19	1222	86	5	1327	131	36	7	3	174	74	700	201	21	975	80	2666	2746
Grand Total	121	117	179	114	417	33	2877	180	9	3090	347	94	10	4	451	152	1546	372	43	2070	170	6028	6198
Approch %	29	28.1	42.9			1.1	93.1	5.8		51.3	76.9	20.8	2.2		7.5	7.3	74.7	18		34.3	2.7	97.3	
Total %	2	1.9	3		6.9	0.5	47.7	3			5.8	1.6	0.2			2.5	25.6	6.2					

3.1-700

Start Time	Graham Street Southbound					Cactus Avenue Westbound					Riverside Drive Northbound					Cactus Avenue Eastbound							
	Left	Thru	Right	RTOR	App. Total	Left	Thru	Right	RTOR	App. Total	Left	Thru	Right	RTOR	App. Total	Left	Thru	Right	RTOR	App. Total	Exclu. Total	Inclu. Total	Int. Total
07:15 AM	18	12	22		52	4	423	14		441	50	13	2		65	15	219	44		278			836
07:30 AM	13	16	20		49	4	380	34		418	52	14	0		66	25	209	47		281			814
07:45 AM	23	24	30		77	5	412	33		450	56	24	1		81	29	236	50		315			923
08:00 AM	18	17	29		64	5	366	21		392	39	18	4		61	20	192	52		264			806
Total Volume	72	69	101		242	18	1581	102		1701	197	69	7		273	89	856	193		1138			3354
% App. Total	29.8	28.5	41.7			1.1	92.9	6			72.2	25.3	2.6			7.8	75.2	17					
PHF	.783	.719	.842		.786	.900	.934	.750		.945	.879	.719	.438		.843	.767	.907	.928		.903			.908

Peak Hour Analysis From 07:15 AM to 08:00 AM - Peak 1 of 1
 Peak Hour for Entire Intersection Begins at 07:15 AM

Counts Unlimited
 PO Box 1178
 Corona, CA 92878
 (951) 268-6268

City of Moreno Valley
 N/S: Graham Street/Riverside Drive
 E/W: Cactus Avenue
 Weather: Clear

File Name : 46_MRV_Graham_Cactus AM
 Site Code : 05119542
 Start Date : 8/20/2019
 Page No : 2

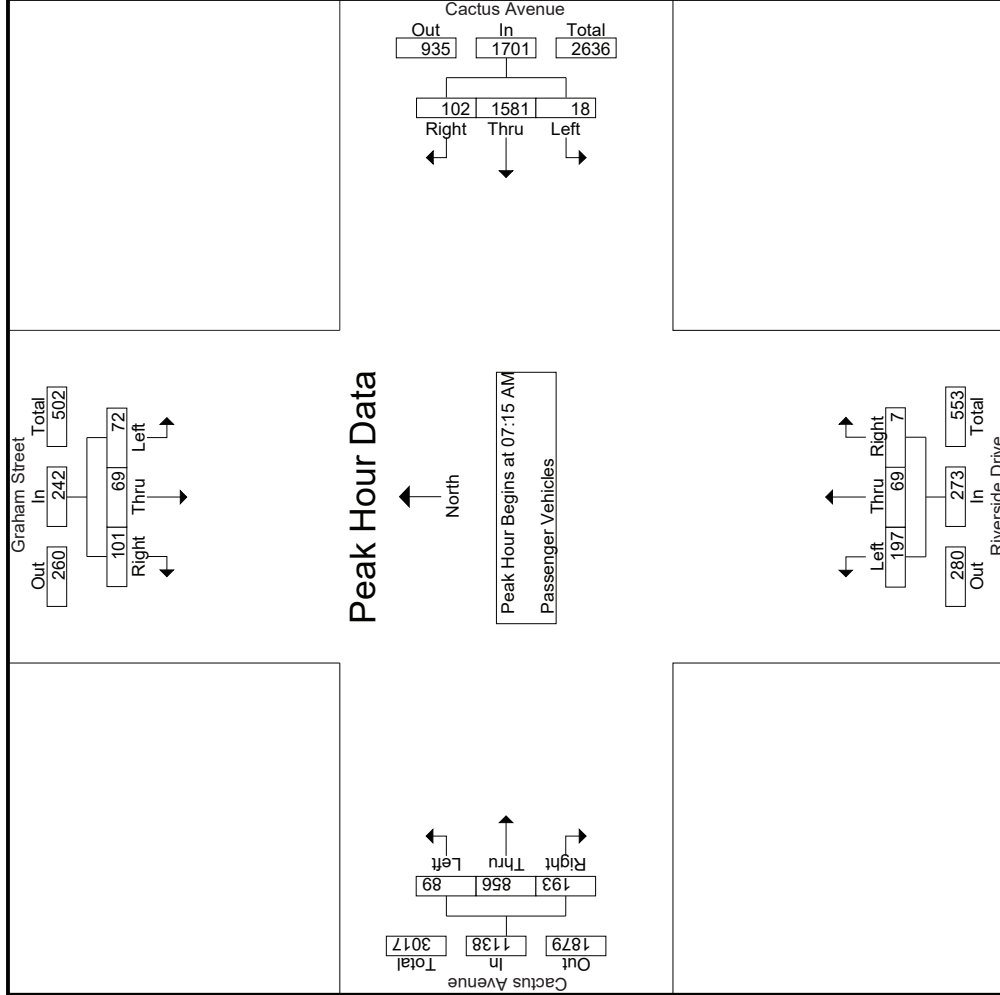

Counts Unlimited
 PO Box 1178
 Corona, CA 92878
 (951) 268-6268

City of Moreno Valley
 N/S: Graham Street/Riverside Drive
 E/W: Cactus Avenue
 Weather: Clear

File Name : 46_MRV_Graham_Cactus AM
 Site Code : 05119542
 Start Date : 8/20/2019
 Page No : 3

Start Time	Graham Street Southbound			Cactus Avenue Westbound			Riverside Drive Northbound			Cactus Avenue Eastbound					
	Left	Thru	Right	App. Total	Left	Thru	Right	App. Total	Left	Thru	Right	App. Total	Int. Total		
Peak Hour Analysis From 07:15 AM to 08:00 AM - Peak 1 of 1															
Peak Hour for Each Approach Begins at:															
	07:15 AM														
+0 mins.	18	12	22	52	4	423	14	441	13	2	65	15	219	278	
+15 mins.	13	16	20	49	4	380	34	418	14	0	66	25	209	281	
+30 mins.	23	24	30	77	5	412	33	450	24	1	81	29	236	315	
+45 mins.	18	17	29	64	5	366	21	392	18	4	61	20	192	264	
Total Volume	72	69	101	242	18	1581	102	1701	69	7	273	89	856	1138	
% App. Total	29.8	28.5	41.7		1.1	92.9	6		25.3	2.6		7.8	75.2	17	
PHF	.783	.719	.842	.786	.900	.934	.750	.945	.719	.438	.843	.767	.907	.928	.903

Counts Unlimited
 PO Box 1178
 Corona, CA 92878
 (951) 268-6268

City of Moreno Valley
 N/S: Graham Street/Riverside Drive
 EW: Cactus Avenue
 Weather: Clear

File Name : 46_MRV_Graham_Cactus AM
 Site Code : 05119542
 Start Date : 8/20/2019
 Page No : 1

Groups Printed- Large 2 Axle Vehicles

Start Time	Graham Street Southbound				Cactus Avenue Westbound				Riverside Drive Northbound				Cactus Avenue Eastbound							
	Left	Thru	Right	RTOR	Left	Thru	Right	RTOR	Left	Thru	Right	RTOR	Left	Thru	Right	RTOR	App. Total	Exclu. Total	Inclu. Total	Int. Total
07:00 AM	0	0	0	0	0	5	0	0	5	1	0	0	0	5	1	0	6	0	12	12
07:15 AM	0	0	0	0	0	4	1	0	5	1	0	0	1	0	8	0	8	0	14	14
07:30 AM	0	0	1	0	3	1	0	0	4	0	0	0	0	4	1	0	5	0	10	10
07:45 AM	0	0	1	1	0	6	0	0	6	1	0	0	1	0	7	0	7	1	15	16
Total	0	0	2	1	0	18	2	0	20	3	0	0	3	0	24	2	26	1	51	52
08:00 AM	0	0	0	0	1	11	1	0	13	2	0	0	2	0	4	0	4	0	19	19
08:15 AM	2	0	0	0	0	11	0	0	11	2	2	0	4	0	6	3	9	0	26	26
08:30 AM	0	0	1	1	0	5	0	0	5	2	1	0	3	1	7	0	8	1	17	18
08:45 AM	0	0	0	0	0	12	0	0	12	2	0	0	2	1	3	2	6	0	20	20
Total	2	0	1	1	3	39	1	0	41	8	3	0	11	2	20	5	27	1	82	83
Grand Total	2	0	3	2	1	57	3	0	61	11	3	0	14	2	44	7	53	2	133	135
Approch %	40	0	60		1.6	93.4	4.9		78.6	21.4	0		10.5	3.8	83	13.2		1.5	98.5	
Total %	1.5	0	2.3		0.8	42.9	2.3		45.9	8.3	2.3	0		1.5	33.1	5.3	39.8	1.5	98.5	

3.1-703

Start Time	Graham Street Southbound				Cactus Avenue Westbound				Riverside Drive Northbound				Cactus Avenue Eastbound							
	Left	Thru	Right	RTOR	Left	Thru	Right	RTOR	Left	Thru	Right	RTOR	Left	Thru	Right	RTOR	App. Total	Exclu. Total	Inclu. Total	Int. Total
07:15 AM	0	0	0	0	0	4	1	5	1	0	0	0	1	0	0	0	1	0	8	14
07:30 AM	0	0	1	1	0	3	1	4	1	0	0	0	0	0	4	1	4	1	5	10
07:45 AM	0	0	0	1	0	6	0	6	1	1	0	0	0	1	7	0	7	0	15	15
08:00 AM	0	0	0	0	1	11	1	13	2	2	0	0	0	2	4	0	4	0	19	19
Total Volume	0	0	2	2	1	24	3	28	4	4	0	0	4	0	23	1	24	1	58	58
% App. Total	0	0	100		3.6	85.7	10.7		100	0	0		95.8	4.2						
PHF	.000	.000	.500		.250	.545	.750		.538	.500	.000	.000	.500	.719	.250		.750		.763	

Peak Hour Analysis From 07:15 AM to 08:00 AM - Peak 1 of 1
 Peak Hour for Entire Intersection Begins at 07:15 AM

Counts Unlimited
 PO Box 1178
 Corona, CA 92878
 (951) 268-6268

City of Moreno Valley
 N/S: Graham Street/Riverside Drive
 EW: Cactus Avenue
 Weather: Clear

File Name : 46_MRV_Graham_Cactus AM
 Site Code : 05119542
 Start Date : 8/20/2019
 Page No : 2

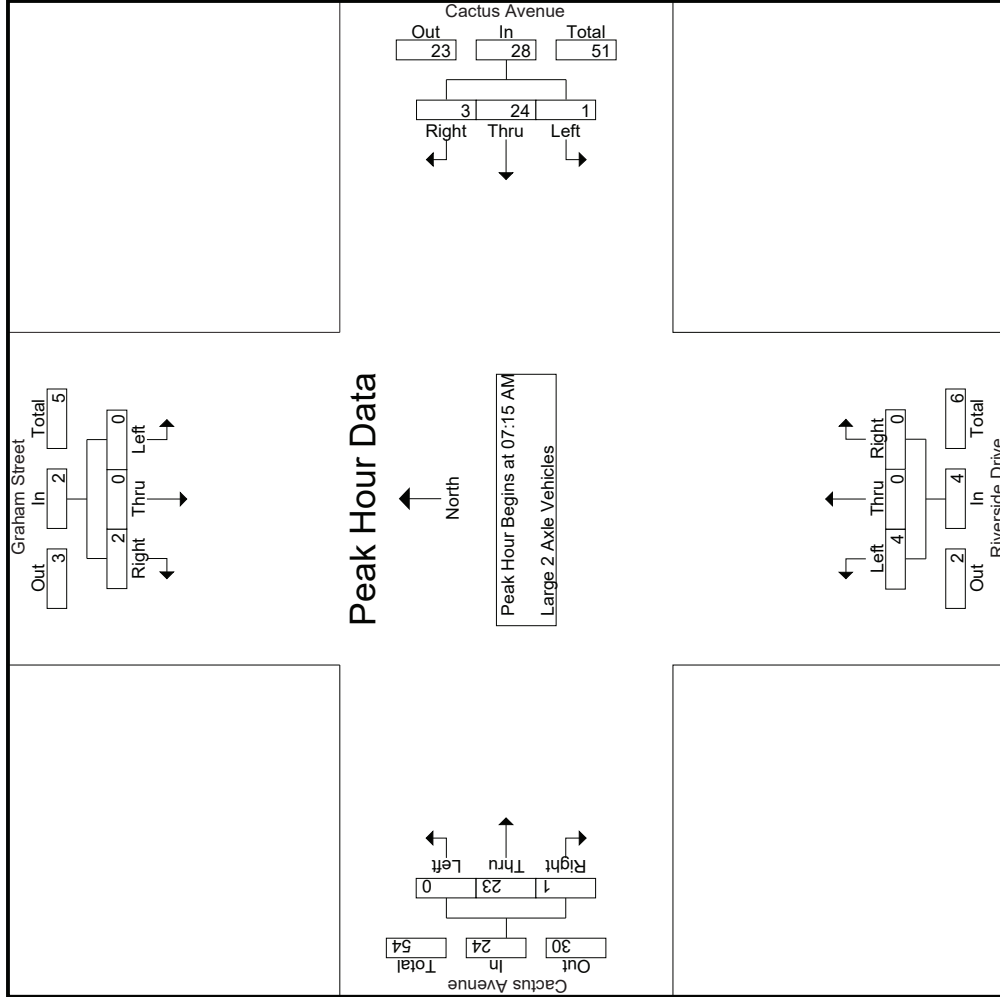

Counts Unlimited
 PO Box 1178
 Corona, CA 92878
 (951) 268-6268

City of Moreno Valley
 N/S: Graham Street/Riverside Drive
 E/W: Cactus Avenue
 Weather: Clear

File Name : 46_MRV_Graham_Cactus AM
 Site Code : 05119542
 Start Date : 8/20/2019
 Page No : 3

Start Time	Graham Street Southbound			Cactus Avenue Westbound			Riverside Drive Northbound			Cactus Avenue Eastbound				
	Left	Thru	Right	App. Total	Left	Thru	Right	App. Total	Left	Thru	Right	App. Total	Int. Total	
Peak Hour Analysis From 07:15 AM to 08:00 AM - Peak 1 of 1														
Peak Hour for Each Approach Begins at:														
	07:15 AM				07:15 AM				07:15 AM				07:15 AM	
+0 mins.	0	0	0	0	4	1	1	5	1	0	0	0	1	8
+15 mins.	0	0	1	1	3	1	4	4	0	0	0	0	0	4
+30 mins.	0	0	1	1	6	0	6	6	1	0	0	0	1	7
+45 mins.	0	0	0	0	11	1	13	13	2	0	0	0	2	4
Total Volume	0	0	2	2	24	3	28	28	4	0	0	0	4	24
% App. Total	.000	.000	.100	.500	.250	.857	10.7	.538	.500	.000	.000	.000	.500	.750
PHF	.000	.000	.500	.500	.250	.857	10.7	.538	.500	.000	.000	.000	.500	.750

Groups Printed- 3 Axle Vehicles

Start Time	Graham Street Southbound				Cactus Avenue Westbound				Riverside Drive Northbound				Cactus Avenue Eastbound			
	Left	Thru	Right	RTOR	Left	Thru	Right	RTOR	Left	Thru	Right	RTOR	Left	Thru	Right	RTOR
07:00 AM	0	0	0	0	0	1	0	0	0	0	0	0	0	3	0	0
07:15 AM	0	0	0	0	0	1	0	0	0	0	0	0	0	2	0	0
07:30 AM	0	0	0	0	0	1	0	0	0	0	0	0	0	0	0	0
07:45 AM	0	0	0	0	0	3	0	0	0	0	0	0	0	2	0	0
Total	0	0	0	0	0	6	0	0	0	0	0	0	0	7	0	0
08:00 AM	0	0	0	0	0	3	0	0	0	1	0	0	0	1	0	0
08:15 AM	0	0	0	0	0	2	0	0	0	0	0	0	0	2	0	0
08:30 AM	0	0	0	0	0	2	0	0	0	0	0	0	0	2	1	0
08:45 AM	0	0	0	0	0	4	0	0	0	0	0	0	0	2	0	0
Total	0	0	0	0	0	11	0	0	0	1	0	0	0	7	1	0
Grand Total	0	0	0	0	0	17	0	0	0	1	0	0	0	14	1	0
Apprch %	0	0	0	0	0	100	0	0	0	100	0	0	0	93.3	6.7	0
Total %	0	0	0	0	0	51.5	0	0	0	3	0	0	0	42.4	3	0

3.1-706

Start Time	Graham Street Southbound				Cactus Avenue Westbound				Riverside Drive Northbound				Cactus Avenue Eastbound			
	Left	Thru	Right	RTOR	Left	Thru	Right	RTOR	Left	Thru	Right	RTOR	Left	Thru	Right	RTOR
07:15 AM	0	0	0	0	0	1	0	0	0	0	0	0	0	0	0	0
07:30 AM	0	0	0	0	0	1	0	0	0	0	0	0	0	0	0	0
07:45 AM	0	0	0	0	0	3	0	0	0	0	0	0	0	2	0	0
08:00 AM	0	0	0	0	0	0	0	0	0	1	0	0	0	1	0	0
Total Volume	0	0	0	0	0	8	0	0	0	1	0	0	0	5	0	0
% App. Total	0	0	0	0	0	100	0	0	0	100	0	0	0	100	0	0
PHF	.000	.000	.000	.000	.000	.667	.000	.000	.000	.250	.000	.000	.000	.625	.000	.000

Peak Hour Analysis From 07:15 AM to 08:00 AM - Peak 1 of 1
 Peak Hour for Entire Intersection Begins at 07:15 AM

Counts Unlimited
 PO Box 1178
 Corona, CA 92878
 (951) 268-6268

City of Moreno Valley
 N/S: Graham Street/Riverside Drive
 EW: Cactus Avenue
 Weather: Clear

File Name : 46_MRV_Graham_Cactus AM
 Site Code : 05119542
 Start Date : 8/20/2019
 Page No : 2

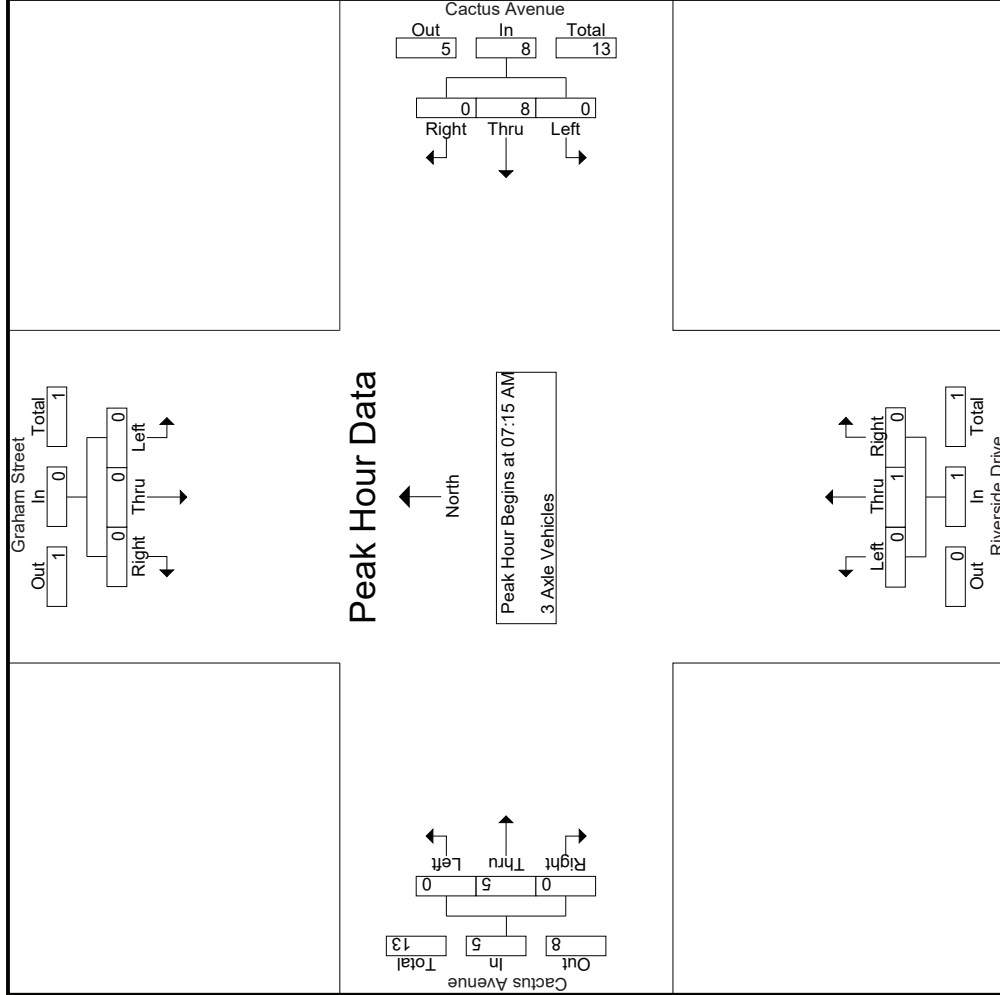

Counts Unlimited
 PO Box 1178
 Corona, CA 92878
 (951) 268-6268

City of Moreno Valley
 N/S: Graham Street/Riverside Drive
 E/W: Cactus Avenue
 Weather: Clear

File Name : 46_MRV_Graham_Cactus AM
 Site Code : 05119542
 Start Date : 8/20/2019
 Page No : 3

Start Time	Graham Street Southbound			Cactus Avenue Westbound			Riverside Drive Northbound			Cactus Avenue Eastbound		
	Left	Thru	Right	Left	Thru	Right	Left	Thru	Right	Left	Thru	Right
Peak Hour Analysis From 07:15 AM to 08:00 AM - Peak 1 of 1												
Peak Hour for Each Approach Begins at:												
	07:15 AM			07:15 AM			07:15 AM			07:15 AM		
+0 mins.	0	0	0	0	1	0	1	0	0	0	2	0
+15 mins.	0	0	0	0	1	0	1	0	0	0	0	0
+30 mins.	0	0	0	0	3	0	3	0	0	0	2	0
+45 mins.	0	0	0	0	3	0	3	0	1	0	1	0
Total Volume	0	0	0	0	8	0	8	0	1	0	5	0
% App. Total	0	0	0	0	100	0	100	0	100	0	100	0
PHF	.000	.000	.000	.000	.667	.000	.667	.000	.250	.000	.625	.000
	.000			.000			.250			.625		

Counts Unlimited
 PO Box 1178
 Corona, CA 92878
 (951) 268-6268

City of Moreno Valley
 N/S: Graham Street/Riverside Drive
 EW: Cactus Avenue
 Weather: Clear

File Name : 46_MRV_Graham_Cactus AM
 Site Code : 05119542
 Start Date : 8/20/2019
 Page No : 1

Groups Printed- 4+ Axle Trucks

Start Time	Graham Street Southbound				Cactus Avenue Westbound				Riverside Drive Northbound				Cactus Avenue Eastbound					
	Left	Thru	Right	RTOR	App. Total	Left	Thru	Right	RTOR	App. Total	Left	Thru	Right	RTOR	App. Total	Exclu. Total	Inclu. Total	Int. Total
07:00 AM	0	0	0	0	0	0	6	0	0	6	1	0	0	0	9	0	16	16
07:15 AM	0	0	0	0	0	9	9	0	0	9	1	0	0	0	6	0	16	16
07:30 AM	0	0	0	0	0	7	7	0	0	7	1	0	0	0	8	0	16	16
07:45 AM	0	1	0	0	1	9	9	0	0	9	0	0	0	0	11	0	21	21
Total	0	1	0	0	1	31	31	0	0	31	3	0	0	0	34	0	69	69
08:00 AM	0	0	1	1	1	10	10	0	0	10	0	0	0	0	8	1	19	20
08:15 AM	0	0	2	2	2	9	9	0	1	9	1	9	0	0	10	3	23	26
08:30 AM	0	0	0	0	0	10	10	0	0	10	0	11	0	0	13	0	23	23
08:45 AM	0	0	1	0	1	11	11	0	0	11	0	6	0	0	8	0	20	20
Total	0	0	4	3	4	40	40	0	1	40	1	0	1	2	39	4	85	89
Grand Total	0	1	4	3	5	71	71	0	1	71	4	0	1	1	73	4	154	158
Apprch %	0	20	80		3.2	80	100	0	20	46.1	2.6	0	0.6	3.2	8.2	91.8	0	154
Total %	0	0.6	2.6		3.2	46.1	46.1	0	0.6	46.1	2.6	0	0.6	3.2	47.4	2.5	97.5	

3.1-709

Start Time	Graham Street Southbound				Cactus Avenue Westbound				Riverside Drive Northbound				Cactus Avenue Eastbound					
	Left	Thru	Right	RTOR	App. Total	Left	Thru	Right	RTOR	App. Total	Left	Thru	Right	RTOR	App. Total	Exclu. Total	Inclu. Total	Int. Total
07:15 AM	0	0	0	0	0	0	9	0	0	9	1	0	0	0	6	0	6	16
07:30 AM	0	0	0	0	0	7	7	0	0	7	1	0	0	0	7	0	8	16
07:45 AM	0	1	0	0	1	9	9	0	0	9	0	0	0	0	11	0	11	21
08:00 AM	0	0	1	1	1	10	10	0	0	10	0	0	0	0	8	0	8	19
Total Volume	0	1	1	1	2	35	35	0	2	35	2	0	0	0	32	0	33	72
% App. Total	0	50	50		50	100	100	0	0	100	100	0	0	0	97	0	97	72
PHF	.000	.250	.250		.500	.875	.875	.000	.000	.875	.500	.000	.000	.000	.727	.000	.750	.857

Peak Hour Analysis From 07:15 AM to 08:00 AM - Peak 1 of 1
 Peak Hour for Entire Intersection Begins at 07:15 AM

Counts Unlimited
 PO Box 1178
 Corona, CA 92878
 (951) 268-6268

City of Moreno Valley
 N/S: Graham Street/Riverside Drive
 EW: Cactus Avenue
 Weather: Clear

File Name : 46_MRV_Graham_Cactus AM
 Site Code : 05119542
 Start Date : 8/20/2019
 Page No : 2

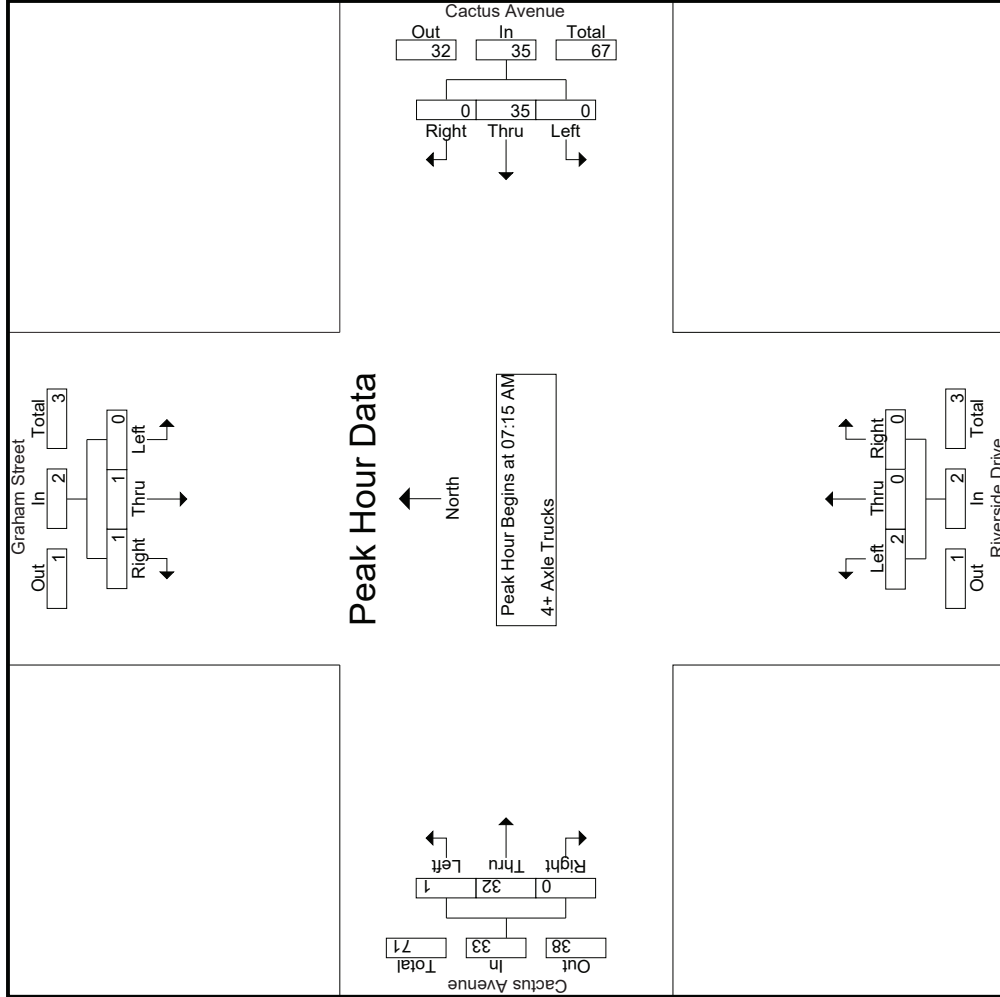

Counts Unlimited
PO Box 1178
Corona, CA 92878
(951) 268-6268

City of Moreno Valley
N/S: Graham Street/Riverside Drive
E/W: Cactus Avenue
Weather: Clear

File Name : 46_MRV_Graham_Cactus AM
Site Code : 05119542
Start Date : 8/20/2019
Page No : 3

Start Time	Graham Street Southbound			Cactus Avenue Westbound			Riverside Drive Northbound			Cactus Avenue Eastbound		
	Left	Thru	Right	Left	Thru	Right	Left	Thru	Right	Left	Thru	Right
Peak Hour Analysis From 07:15 AM to 08:00 AM - Peak 1 of 1												
Peak Hour for Each Approach Begins at:												
	07:15 AM			07:15 AM			07:15 AM			07:15 AM		
+0 mins.	0	0	0	0	9	0	9	0	0	1	0	6
+15 mins.	0	0	0	0	7	0	7	0	0	1	7	0
+30 mins.	0	1	0	0	9	0	9	0	0	0	11	0
+45 mins.	0	0	1	0	10	0	10	0	0	0	8	0
Total Volume	0	1	1	0	35	0	35	0	0	2	32	0
% App. Total	0	50	50	0	100	0	100	0	0	3	97	0
PHF	.000	.250	.250	.500	.875	.000	.875	.000	.000	.500	.727	.000
										.250	.727	.000

Counts Unlimited
 PO Box 1178
 Corona, CA 92878
 (951) 268-6268

City of Moreno Valley
 N/S: Graham Street/Riverside Drive
 EW: Cactus Avenue
 Weather: Clear

File Name : 46_MRV_Graham_Cactus PM
 Site Code : 05119542
 Start Date : 8/20/2019
 Page No : 1

Groups Printed- Passenger Vehicles - Large 2 Axle Vehicles - 3 Axle Vehicles - 4+ Axle Trucks

Start Time	Graham Street Southbound						Cactus Avenue Westbound						Riverside Drive Northbound						Cactus Avenue Eastbound							
	Left	Thru	Right	RTOR	App. Total		Left	Thru	Right	RTOR	App. Total		Left	Thru	Right	RTOR	App. Total		Left	Thru	Right	RTOR	App. Total			
	Exclu. Total	Inclu. Total	Int. Total				Exclu. Total	Inclu. Total	Int. Total				Exclu. Total	Inclu. Total	Int. Total				Exclu. Total	Inclu. Total	Int. Total					
04:00 PM	42	35	27	13	104	4	210	24	6	238	77	17	6	4	100	29	413	98	11	540	34	982	982	0	0	1016
04:15 PM	23	18	18	9	59	2	208	14	3	224	51	11	8	3	70	19	467	70	6	556	21	909	930	0	0	1032
04:30 PM	43	39	21	13	103	3	217	21	4	241	44	14	7	5	65	24	510	89	9	623	31	1032	1063	0	0	1035
04:45 PM	27	26	20	14	73	6	245	37	5	288	44	25	8	4	77	32	465	70	7	567	30	1005	1035	0	0	4044
Total	135	118	86	49	339	15	880	96	18	991	216	67	29	16	312	104	1855	327	33	2286	116	3928	4044	0	0	8155
05:00 PM	31	29	25	14	85	7	225	15	3	247	46	16	8	3	70	28	464	113	15	605	35	1007	1042	0	0	1051
05:15 PM	31	23	23	16	77	3	242	16	0	261	44	9	4	4	57	29	499	100	8	628	28	1023	1058	0	0	960
05:30 PM	34	32	21	15	87	4	202	27	4	233	32	18	1	1	51	32	514	110	11	656	28	932	960	0	0	4111
05:45 PM	29	19	20	11	68	0	197	29	5	226	32	16	2	2	50	26	485	77	10	588	28	3989	4111	0	0	8155
Total	125	103	89	56	317	14	866	87	12	967	154	59	15	10	228	115	1962	400	44	2477	122	3989	4111	0	0	8155
Grand Total	260	221	175	105	656	29	1746	183	30	1958	370	126	44	26	540	219	3817	727	77	4763	238	7917	8155	0	0	97.1
Approch %	39.6	33.7	26.7			1.5	89.2	9.3		24.7	68.5	23.3	8.1		6.8	4.6	80.1	15.3		60.2	2.9	97.1				
Total %	3.3	2.8	2.2		8.3	0.4	22.1	2.3		24.7	4.7	1.6	0.6		6.8	2.8	48.2	9.2		60.2	2.9	97.1				
Passenger Vehicles	250	221	170		745	29	1691	179		1929	363	126	44		559	213	3681	716		4686	0	0	7919			
% Passenger Vehicles	96.2	100	97.1	99	97.9	100	96.8	97.8	100	97	98.1	100	100	100	98.8	97.3	96.4	98.5	98.7	96.8	0	0	97.1			
Large 2 Axle Vehicles	9	0	2		11	0	25	4		29	7	0	0		7	2	62	11		76	0	0	123			
% Large 2 Axle Vehicles	3.5	0	1.1	0	1.4	0	1.4	2.2	0	1.5	1.9	0	0	0	1.2	0.9	1.6	1.5	1.3	1.6	0	0	1.5			
3 Axle Vehicles	1	0	0		1	0	4	0		4	0	0	0		0	0	16	0		16	0	0	21			
% 3 Axle Vehicles	0.4	0	0	0	0.1	0	0.2	0	0	0.2	0	0	0	0	0	0	0.4	0	0	0.3	0	0	0.3			
4+ Axle Trucks	0	0	3		4	0	26	0		26	0	0	0		0	4	58	0		62	0	0	92			
% 4+ Axle Trucks	0	0	1.7	1	0.5	0	1.5	0	0	1.3	0	0	0	0	0	1.8	1.5	0	0	1.3	0	0	1.1			

Start Time	Graham Street Southbound						Cactus Avenue Westbound						Riverside Drive Northbound						Cactus Avenue Eastbound						
	Left	Thru	Right	RTOR	App. Total		Left	Thru	Right	RTOR	App. Total		Left	Thru	Right	RTOR	App. Total		Left	Thru	Right	RTOR	App. Total		
	Exclu. Total	Inclu. Total	Int. Total				Exclu. Total	Inclu. Total	Int. Total				Exclu. Total	Inclu. Total	Int. Total				Exclu. Total	Inclu. Total	Int. Total				
04:30 PM	43	39	21		103	3	217	21		241	44	14	7		65	24	510	89		623	89	1032	1005		
04:45 PM	27	26	20		73	6	245	37		288	44	25	8		77	32	465	70		567	70	1007	1007		
05:00 PM	31	29	25		85	7	225	15		247	46	16	8		70	28	464	113		605	113	1007	1023		
05:15 PM	31	23	23		77	3	242	16		261	44	9	4		57	29	499	100		628	28	1023	1058		
Total Volume	132	117	89		338	19	929	89		1037	178	64	27		269	113	1938	372		2423	372	4067	4067		
% App. Total	39.1	34.6	26.3		26.3	1.8	89.6	8.6		24.7	66.2	23.8	10		80	4.7	80	15.4		15.4	15.4	965	965		
PHF	.767	.750	.890		.820	.679	.948	.601		.900	.967	.640	.844		.873	.883	.950	.823		.965	.823	.965	.965		

Peak Hour Analysis From 04:00 PM to 05:45 PM - Peak 1 of 1

Peak Hour for Entire Intersection Begins at 04:30 PM

Counts Unlimited
 PO Box 1178
 Corona, CA 92878
 (951) 268-6268

City of Moreno Valley
 N/S: Graham Street/Riverside Drive
 E/W: Cactus Avenue
 Weather: Clear

File Name : 46_MRV_Graham_Cactus PM
 Site Code : 05119542
 Start Date : 8/20/2019
 Page No : 2

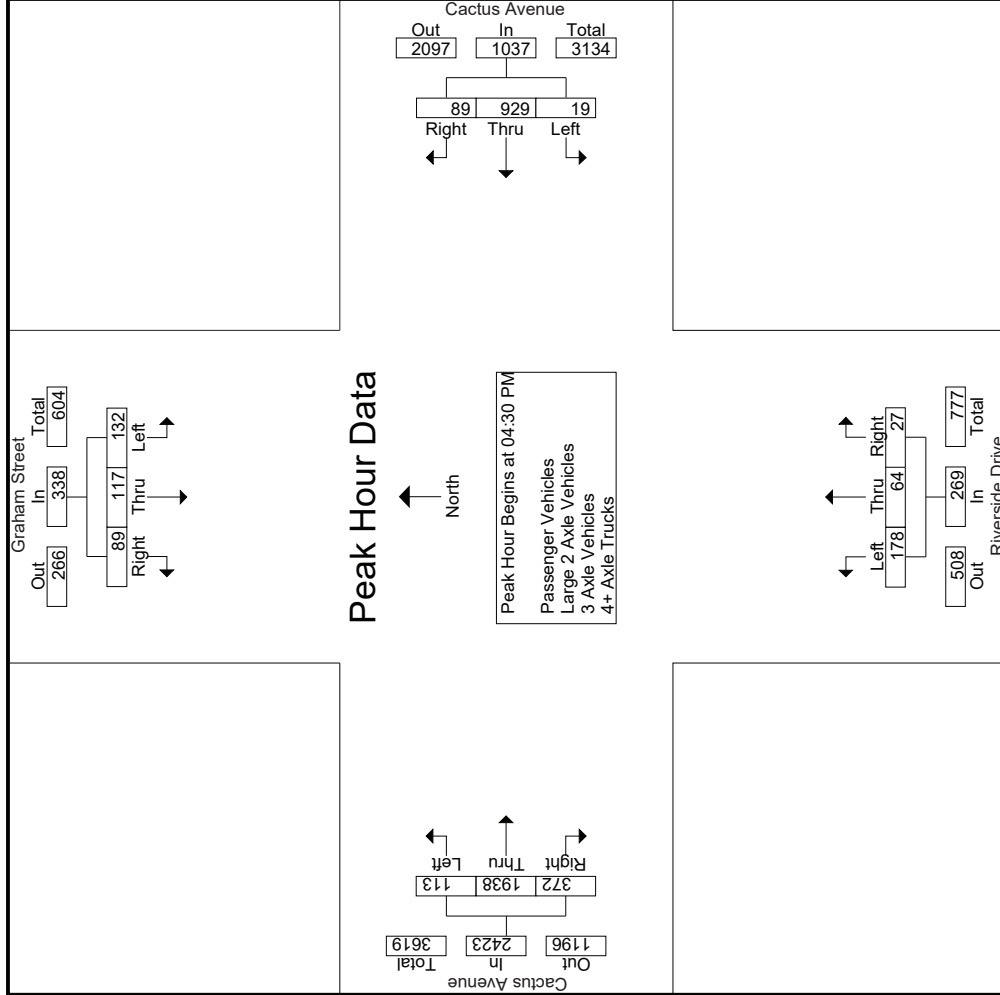

Counts Unlimited
 PO Box 1178
 Corona, CA 92878
 (951) 268-6268

City of Moreno Valley
 N/S: Graham Street/Riverside Drive
 E/W: Cactus Avenue
 Weather: Clear

File Name : 46_MRV_Graham_Cactus PM
 Site Code : 05119542
 Start Date : 8/20/2019
 Page No : 3

Start Time	Graham Street Southbound			Cactus Avenue Westbound			Riverside Drive Northbound			Cactus Avenue Eastbound			
	Left	Thru	Right	App. Total	Left	Thru	Right	App. Total	Left	Thru	Right	App. Total	Int. Total
Peak Hour Analysis From 04:00 PM to 05:45 PM - Peak 1 of 1													
Peak Hour for Each Approach Begins at:													
	04:00 PM			04:30 PM			04:00 PM			05:00 PM			
+0 mins.	42	35	27	104	3	217	21	241	17	6	464	113	605
+15 mins.	23	18	18	59	6	245	37	288	11	8	499	100	628
+30 mins.	43	39	21	103	7	225	15	247	14	7	514	110	656
+45 mins.	27	26	20	73	3	242	16	261	25	8	485	77	588
Total Volume	135	118	86	339	19	929	89	1037	67	29	1962	400	2477
% App. Total	39.8	34.8	25.4		1.8	89.6	8.6		69.2	21.5	79.2	16.1	
PHF	.785	.756	.796	.815	.679	.948	.601	.900	.701	.670	.906	.885	.944

Groups Printed- Passenger Vehicles

Start Time	Graham Street Southbound					Cactus Avenue Westbound					Riverside Drive Northbound					Cactus Avenue Eastbound							
	Left	Thru	Right	RTOR	App. Total	Left	Thru	Right	RTOR	App. Total	Left	Thru	Right	RTOR	App. Total	Left	Thru	Right	RTOR	App. Total	Exclu. Total	Inclu. Total	Int. Total
04:00 PM	39	35	27	13	101	4	204	23	6	231	72	17	6	4	95	28	387	97	11	512	34	939	973
04:15 PM	22	18	18	9	58	2	199	14	3	215	51	11	8	3	70	19	448	69	6	536	21	879	900
04:30 PM	41	39	19	12	99	3	208	19	4	230	44	14	7	5	65	24	491	86	9	601	30	995	1025
04:45 PM	27	26	19	14	72	6	238	36	5	280	43	25	8	4	76	29	445	67	7	541	30	969	999
Total	129	118	83	48	330	15	849	92	18	956	210	67	29	16	306	100	1771	319	33	2190	115	3782	3897
05:00 PM	29	29	24	14	92	7	216	15	3	238	45	16	8	3	69	28	448	112	14	588	34	977	1011
05:15 PM	30	23	23	16	76	3	235	16	0	254	44	9	4	4	57	29	488	99	8	616	28	1003	1031
05:30 PM	33	32	21	15	86	4	198	27	4	229	32	18	1	1	51	30	502	109	11	641	31	1007	1038
05:45 PM	29	19	19	11	67	0	193	29	5	222	32	16	2	2	50	26	472	77	10	575	28	914	942
Total	121	103	87	56	311	14	842	87	12	943	153	59	15	10	227	113	1910	397	43	2420	121	3901	4022
Grand Total	250	221	170	104	641	29	1691	179	30	1899	363	126	44	26	533	213	3681	716	76	4610	236	7683	7919
Approch %	39	34.5	26.5			1.5	89	9.4			68.1	23.6	8.3		6.9	4.6	79.8	15.5					
Total %	3.3	2.9	2.2		8.3	0.4	22	2.3		24.7	4.7	1.6	0.6			2.8	47.9	9.3		60	3	97	

Start Time	Graham Street Southbound					Cactus Avenue Westbound					Riverside Drive Northbound					Cactus Avenue Eastbound							
	Left	Thru	Right	RTOR	App. Total	Left	Thru	Right	RTOR	App. Total	Left	Thru	Right	RTOR	App. Total	Left	Thru	Right	RTOR	App. Total	Exclu. Total	Inclu. Total	Int. Total
04:30 PM	41	39	19		99	3	208	19		230	44	14	7		65	24	491	86		601			995
04:45 PM	27	26	19		72	6	238	36		280	43	25	8		76	29	445	67		541			969
05:00 PM	29	29	23		82	7	216	15		238	45	16	8		69	28	448	99		588			977
05:15 PM	30	23	23		76	3	235	16		254	44	9	4		57	29	488	112		616			1003
Total Volume	127	117	85		329	19	897	86		1002	176	64	27		267	110	1872	364		2346			3944
% App. Total	38.6	35.6	25.8		83.1	1.9	89.5	8.6		89.5	65.9	24	10.1		79.8	4.7	79.8	15.5		15.5			983
PHF	.774	.750	.885		.831	.679	.942	.597		.895	.978	.640	.844		.878	.948	.953	.813		.952			.983

Peak Hour Analysis From 04:30 PM to 05:15 PM - Peak 1 of 1
 Peak Hour for Entire Intersection Begins at 04:30 PM

Counts Unlimited
 PO Box 1178
 Corona, CA 92878
 (951) 268-6268

City of Moreno Valley
 N/S: Graham Street/Riverside Drive
 E/W: Cactus Avenue
 Weather: Clear

File Name : 46_MRV_Graham_Cactus PM
 Site Code : 05119542
 Start Date : 8/20/2019
 Page No : 2

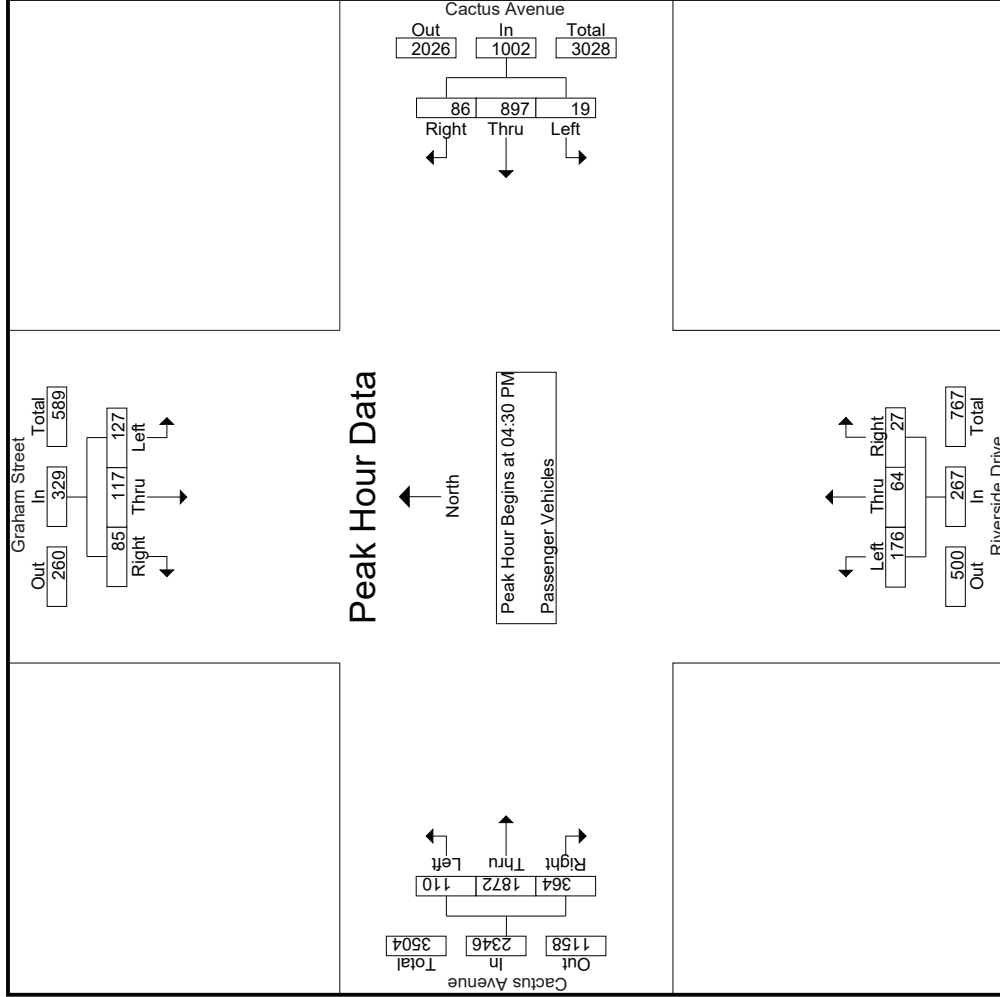

Counts Unlimited
 PO Box 1178
 Corona, CA 92878
 (951) 268-6268

City of Moreno Valley
 N/S: Graham Street/Riverside Drive
 E/W: Cactus Avenue
 Weather: Clear

File Name : 46_MRV_Graham_Cactus PM
 Site Code : 05119542
 Start Date : 8/20/2019
 Page No : 3

Start Time	Graham Street Southbound			Cactus Avenue Westbound			Riverside Drive Northbound			Cactus Avenue Eastbound					
	Left	Thru	Right	App. Total	Left	Thru	Right	App. Total	Left	Thru	Right	App. Total	Int. Total		
Peak Hour Analysis From 04:30 PM to 05:15 PM - Peak 1 of 1															
Peak Hour for Each Approach Begins at:															
	04:30 PM				04:30 PM				04:30 PM				04:30 PM		
+0 mins.	41	39	19	99	3	208	19	230	14	7	65	24	491	86	601
+15 mins.	27	26	19	72	6	238	36	280	25	8	76	29	445	67	541
+30 mins.	29	29	24	82	7	216	15	238	16	8	69	28	448	112	588
+45 mins.	30	23	23	76	3	235	16	254	9	4	57	29	488	99	616
Total Volume	127	117	85	329	19	897	86	1002	64	27	267	110	1872	364	2346
% App. Total	38.6	35.6	25.8		1.9	89.5	8.6		24	10.1		4.7	79.8	15.5	
PHF	.774	.750	.885	.831	.679	.942	.597	.895	.640	.844	.878	.948	.953	.813	.952

Groups Printed- Large 2 Axle Vehicles

Start Time	Graham Street Southbound				Cactus Avenue Westbound				Riverside Drive Northbound				Cactus Avenue Eastbound										
	Left	Thru	Right	RTOR	App. Total	Left	Thru	Right	RTOR	App. Total	Left	Thru	Right	RTOR	App. Total	Exclu. Total	Inclu. Total	Int. Total					
04:00 PM	3	0	0	0	3	0	2	1	0	3	5	0	0	0	5	1	13	1	0	15	0	26	26
04:15 PM	1	0	0	0	1	0	5	0	0	5	0	0	0	0	0	0	8	1	0	9	0	15	15
04:30 PM	1	0	0	0	1	0	5	2	0	7	0	0	0	0	0	0	8	3	0	11	0	19	19
04:45 PM	0	0	1	0	1	0	4	1	0	5	1	0	0	1	1	0	11	3	0	14	0	21	21
Total	5	0	1	0	6	0	16	4	0	20	6	0	0	0	6	1	40	8	0	49	0	81	81
05:00 PM	2	0	0	0	2	0	2	0	0	2	1	0	0	0	1	0	7	1	1	8	1	13	14
05:15 PM	1	0	0	0	1	0	4	0	0	4	0	0	0	0	0	0	3	1	0	4	0	9	9
05:30 PM	1	0	0	0	1	0	1	0	0	1	0	0	0	0	0	1	7	1	0	9	0	11	11
05:45 PM	0	0	1	0	1	0	2	0	0	2	0	0	0	0	0	0	5	0	0	5	0	8	8
Total	4	0	1	0	5	0	9	0	0	9	1	0	0	1	1	22	3	1	26	1	41	42	
Grand Total	9	0	2	0	11	0	25	4	0	29	7	0	0	0	7	2	62	11	1	75	1	122	123
Approch %	81.8	0	18.2			0	86.2	13.8			100	0	0			2.7	82.7	14.7			0.8	99.2	
Total %	7.4	0	1.6		9	0	20.5	3.3		23.8	5.7	0	0		5.7	1.6	50.8	9		61.5			

Start Time	Graham Street Southbound				Cactus Avenue Westbound				Riverside Drive Northbound				Cactus Avenue Eastbound										
	Left	Thru	Right	RTOR	App. Total	Left	Thru	Right	RTOR	App. Total	Left	Thru	Right	RTOR	App. Total	Exclu. Total	Inclu. Total	Int. Total					
04:30 PM	1	0	0	0	1	0	5	2	7	7	0	0	0	0	0	0	0	0	0	0	0	0	0
04:45 PM	0	0	1	1	1	0	4	1	5	2	1	0	0	0	1	0	1	0	11	3	3	14	21
05:00 PM	2	0	0	0	2	0	2	0	2	4	0	0	0	0	0	0	7	1	0	8	1	13	13
05:15 PM	1	0	0	0	1	0	4	0	4	4	0	0	0	0	0	0	3	1	0	4	1	8	9
Total Volume	4	0	1	1	5	0	15	3	18	18	2	0	0	0	2	0	29	8	0	29	8	37	62
% App. Total	80	0	20			0	83.3	16.7			100	0	0			0	78.4	21.6					
PHF	.500	.000	.250		.625	.000	.750	.375	.643	.500	.000	.000	.000	.000	.500	.000	.659	.667		.661		.738	

Peak Hour Analysis From 04:30 PM to 05:15 PM - Peak 1 of 1
 Peak Hour for Entire Intersection Begins at 04:30 PM

Counts Unlimited
 PO Box 1178
 Corona, CA 92878
 (951) 268-6268

City of Moreno Valley
 N/S: Graham Street/Riverside Drive
 E/W: Cactus Avenue
 Weather: Clear

File Name : 46_MRV_Graham_Cactus_PM
 Site Code : 05119542
 Start Date : 8/20/2019
 Page No : 2

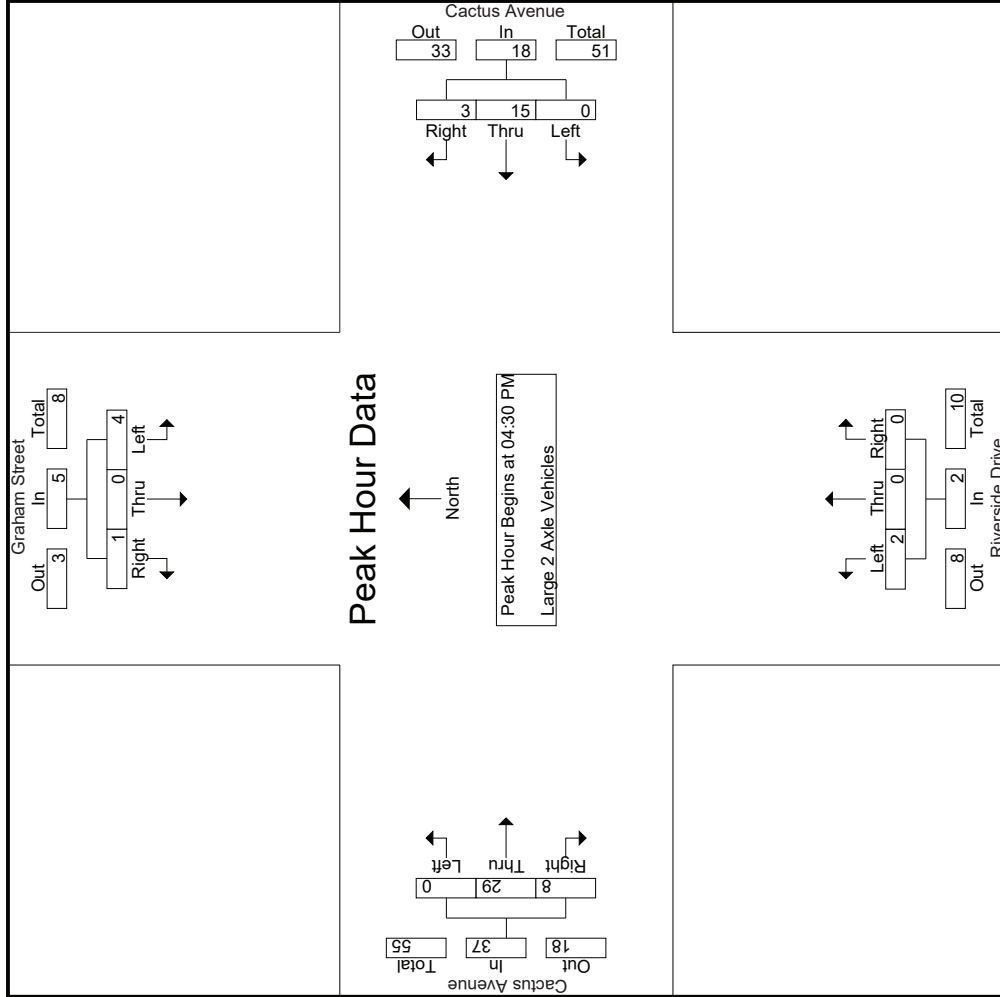

Counts Unlimited
 PO Box 1178
 Corona, CA 92878
 (951) 268-6268

City of Moreno Valley
 N/S: Graham Street/Riverside Drive
 E/W: Cactus Avenue
 Weather: Clear

File Name : 46_MRV_Graham_Cactus PM
 Site Code : 05119542
 Start Date : 8/20/2019
 Page No : 3

Start Time	Graham Street Southbound			Cactus Avenue Westbound			Riverside Drive Northbound			Cactus Avenue Eastbound		
	Left	Thru	Right	Left	Thru	Right	Left	Thru	Right	Left	Thru	Right
Peak Hour Analysis From 04:30 PM to 05:15 PM - Peak 1 of 1												
Peak Hour for Each Approach Begins at:												
	04:30 PM			04:30 PM			04:30 PM			04:30 PM		
+0 mins.	1	0	0	5	2	7	0	0	0	0	0	8
+15 mins.	0	0	1	4	1	5	1	0	0	1	0	11
+30 mins.	2	0	0	2	0	2	1	0	0	0	0	7
+45 mins.	1	0	0	4	0	4	0	0	0	0	0	3
Total Volume	4	0	1	15	3	18	2	0	0	2	0	29
% App. Total	80	0	20	83.3	16.7	64.3	100	0	0	500	0	78.4
PHF	.500	.000	.250	.750	.375	.643	.500	.000	.000	.500	.000	.659
												.667

Groups Printed- 3 Axle Vehicles

Start Time	Graham Street Southbound				Cactus Avenue Westbound				Riverside Drive Northbound				Cactus Avenue Eastbound					
	Left	Thru	Right	RTOR	App. Total	Left	Thru	Right	RTOR	App. Total	Left	Thru	Right	RTOR	App. Total	Exclu. Total	Inclu. Total	Int. Total
04:00 PM	0	0	0	0	0	0	1	0	0	0	0	0	0	0	4	0	5	5
04:15 PM	0	0	0	0	0	1	0	0	0	0	0	0	0	0	2	0	3	3
04:30 PM	1	0	0	0	1	0	0	0	0	0	0	0	0	0	1	0	2	2
04:45 PM	0	0	0	0	0	0	0	0	0	0	0	0	0	0	2	0	2	2
Total	1	0	0	0	1	2	0	0	0	0	0	0	0	0	9	0	12	12
05:00 PM	0	0	0	0	0	1	0	0	0	0	0	0	0	0	3	0	4	4
05:15 PM	0	0	0	0	0	0	0	0	0	0	0	0	0	0	2	0	2	2
05:30 PM	0	0	0	0	0	1	0	0	0	0	0	0	0	0	0	0	1	1
05:45 PM	0	0	0	0	0	0	0	0	0	0	0	0	0	0	2	0	2	2
Total	0	0	0	0	0	2	0	0	0	0	0	0	0	0	7	0	9	9
Grand Total	1	0	0	0	1	4	0	0	0	0	0	0	0	0	16	0	21	21
Apprch %	100	0	0	0	4.8	0	100	0	0	0	0	0	0	0	76.2	0	100	100
Total %	4.8	0	0	0	4.8	0	19	0	0	0	0	0	0	0	76.2	0	100	100

3.1-721

Start Time	Graham Street Southbound				Cactus Avenue Westbound				Riverside Drive Northbound				Cactus Avenue Eastbound					
	Left	Thru	Right	RTOR	App. Total	Left	Thru	Right	RTOR	App. Total	Left	Thru	Right	RTOR	App. Total	Exclu. Total	Inclu. Total	Int. Total
04:30 PM	1	0	0	0	1	0	0	0	0	0	0	0	0	0	1	0	1	2
04:45 PM	0	0	0	0	0	0	0	0	0	0	0	0	0	0	0	0	2	2
05:00 PM	0	0	0	0	0	0	0	0	0	0	0	0	0	0	3	0	3	4
05:15 PM	0	0	0	0	0	0	0	0	0	0	0	0	0	0	2	0	2	2
Total Volume	1	0	0	0	1	0	0	0	0	0	0	0	0	0	8	0	8	10
% App. Total	100	0	0	0	.250	0	100	0	0	0	0	0	0	0	100	0	.667	.625
PHF	.250	.000	.000	.000	.250	.000	.250	.000	.000	.000	.000	.000	.000	.000	.667	.000	.667	.625

Peak Hour Analysis From 04:30 PM to 05:15 PM - Peak 1 of 1
 Peak Hour for Entire Intersection Begins at 04:30 PM

Counts Unlimited
 PO Box 1178
 Corona, CA 92878
 (951) 268-6268

City of Moreno Valley
 N/S: Graham Street/Riverside Drive
 EW: Cactus Avenue
 Weather: Clear

File Name : 46_MRV_Graham_Cactus PM
 Site Code : 05119542
 Start Date : 8/20/2019
 Page No : 2

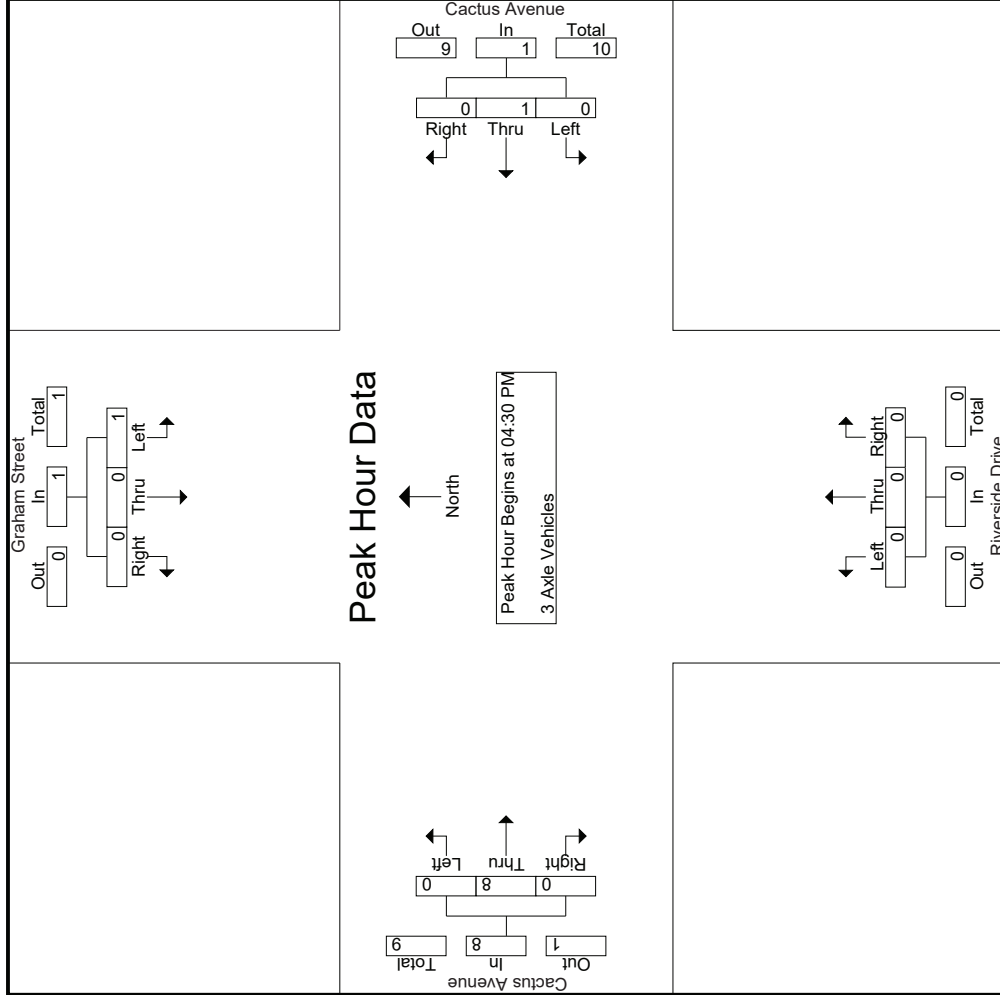

Counts Unlimited
 PO Box 1178
 Corona, CA 92878
 (951) 268-6268

City of Moreno Valley
 N/S: Graham Street/Riverside Drive
 E/W: Cactus Avenue
 Weather: Clear

File Name : 46_MRV_Graham_Cactus PM
 Site Code : 05119542
 Start Date : 8/20/2019
 Page No : 3

Start Time	Graham Street Southbound			Cactus Avenue Westbound			Riverside Drive Northbound			Cactus Avenue Eastbound		
	Left	Thru	Right	Left	Thru	Right	Left	Thru	Right	Left	Thru	Right
Peak Hour Analysis From 04:30 PM to 05:15 PM - Peak 1 of 1												
Peak Hour for Each Approach Begins at:												
	04:30 PM			04:30 PM			04:30 PM			04:30 PM		
+0 mins.	1	0	0	0	0	0	0	0	0	0	1	0
+15 mins.	0	0	0	0	0	0	0	0	0	0	2	0
+30 mins.	0	0	0	0	1	0	1	0	0	0	3	0
+45 mins.	0	0	0	0	0	0	0	0	0	0	2	0
Total Volume	1	0	0	0	1	0	1	0	0	0	8	0
% App. Total	100	0	0	0	100	0	100	0	0	0	100	0
PHF	.250	.000	.000	.250	.250	.000	.250	.000	.000	.000	.667	.000
	.000			.000			.000			.000		
	.250			.250			.000			.667		

Counts Unlimited
 PO Box 1178
 Corona, CA 92878
 (951) 268-6268

City of Moreno Valley
 N/S: Graham Street/Riverside Drive
 EW: Cactus Avenue
 Weather: Clear

File Name : 46_MRV_Graham_Cactus PM
 Site Code : 05119542
 Start Date : 8/20/2019
 Page No : 1

Groups Printed- 4+ Axle Trucks

Start Time	Graham Street Southbound			Cactus Avenue Westbound			Riverside Drive Northbound			Cactus Avenue Eastbound			Inclu. Total	Int. Total	
	Left	Thru	Right	Left	Thru	Right	Left	Thru	Right	Left	Thru	Right			Exclu. Total
04:00 PM	0	0	0	0	3	0	0	0	0	0	9	0	0	12	12
04:15 PM	0	0	0	0	3	0	0	0	0	0	9	0	0	12	12
04:30 PM	0	0	2	0	4	0	0	0	0	0	10	0	1	16	17
04:45 PM	0	0	0	0	3	0	0	0	0	3	7	0	0	13	13
Total	0	0	2	0	13	0	0	0	0	3	35	0	1	53	54
05:00 PM	0	0	1	0	6	0	0	0	0	0	6	0	0	13	13
05:15 PM	0	0	0	0	3	0	0	0	0	0	6	0	0	9	9
05:30 PM	0	0	0	0	2	0	0	0	0	1	5	0	0	8	8
05:45 PM	0	0	0	0	2	0	0	0	0	0	6	0	0	8	8
Total	0	0	1	0	13	0	0	0	0	1	23	0	0	38	38
Grand Total	0	0	3	0	26	0	0	0	0	4	58	0	1	91	92
Apprch %	0	0	100	0	100	0	0	0	0	6.5	93.5	0	0	1.1	98.9
Total %	0	0	3.3	0	28.6	0	0	0	0	4.4	63.7	0	0	68.1	71.4

3.1-724

Start Time	Graham Street Southbound			Cactus Avenue Westbound			Riverside Drive Northbound			Cactus Avenue Eastbound			Inclu. Total	Int. Total	
	Left	Thru	Right	Left	Thru	Right	Left	Thru	Right	Left	Thru	Right			Exclu. Total
04:30 PM	0	0	2	0	4	0	0	0	0	0	4	0	0	10	16
04:45 PM	0	0	0	0	3	0	0	0	0	0	3	7	0	10	13
05:00 PM	0	0	1	0	6	0	0	0	0	0	6	0	0	6	13
05:15 PM	0	0	0	0	3	0	0	0	0	0	3	0	0	6	9
Total Volume	0	0	3	0	16	0	0	0	0	3	29	0	0	32	51
% App. Total	0	0	100	0	100	0	0	0	0	9.4	90.6	0	0	1.1	98.9
PHF	.000	.000	.375	.000	.667	.000	.000	.000	.000	.250	.725	.000	.000	.800	.797

Peak Hour Analysis From 04:30 PM to 05:15 PM - Peak 1 of 1
 Peak Hour for Entire Intersection Begins at 04:30 PM

Counts Unlimited
 PO Box 1178
 Corona, CA 92878
 (951) 268-6268

City of Moreno Valley
 N/S: Graham Street/Riverside Drive
 EW: Cactus Avenue
 Weather: Clear

File Name : 46_MRV_Graham_Cactus_PM
 Site Code : 05119542
 Start Date : 8/20/2019
 Page No : 2

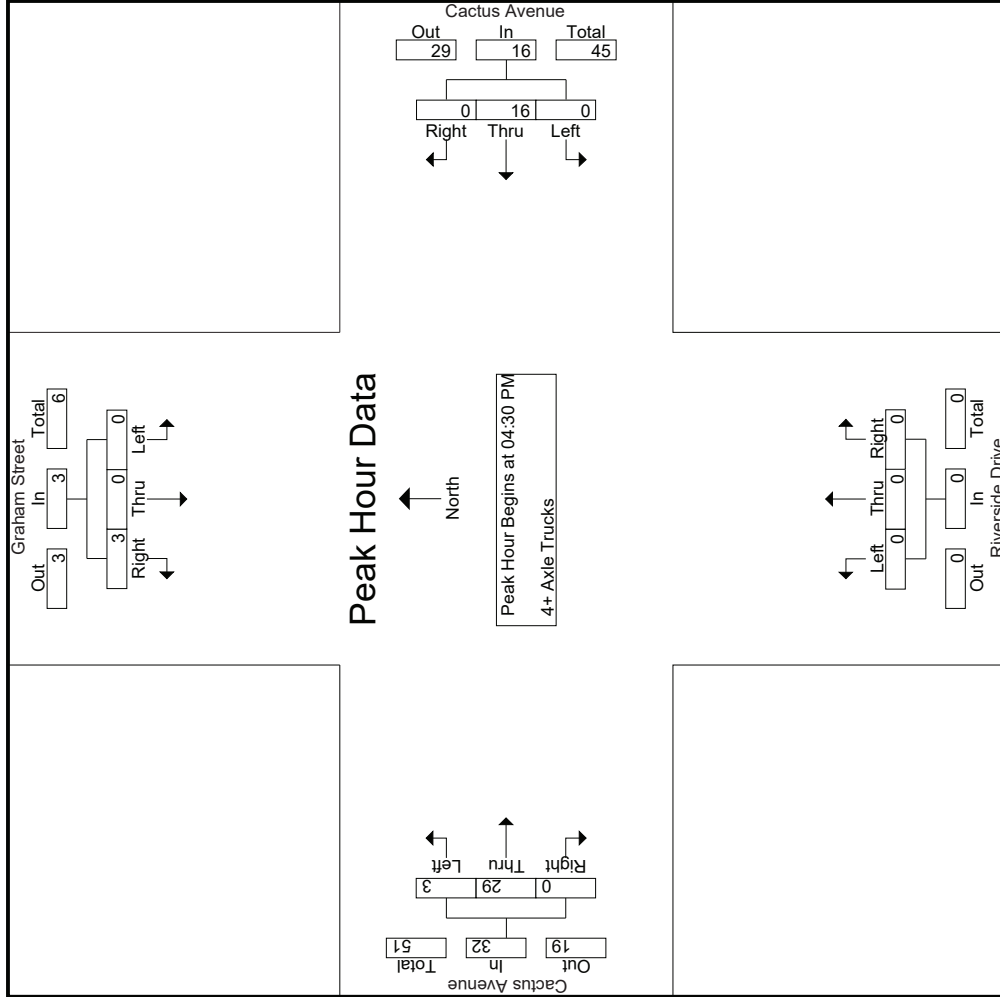

Counts Unlimited
 PO Box 1178
 Corona, CA 92878
 (951) 268-6268

City of Moreno Valley
 N/S: Graham Street/Riverside Drive
 E/W: Cactus Avenue
 Weather: Clear

File Name : 46_MRV_Graham_Cactus PM
 Site Code : 05119542
 Start Date : 8/20/2019
 Page No : 3

Start Time	Graham Street Southbound			Cactus Avenue Westbound			Riverside Drive Northbound			Cactus Avenue Eastbound						
	Left	Thru	Right	App. Total	Left	Thru	Right	App. Total	Left	Thru	Right	App. Total	Int. Total			
Peak Hour Analysis From 04:30 PM to 05:15 PM - Peak 1 of 1																
Peak Hour for Each Approach Begins at:																
	04:30 PM				04:30 PM				04:30 PM				04:30 PM			
+0 mins.	0	0	2	2	0	0	4	4	0	0	0	0	0	0	10	10
+15 mins.	0	0	0	0	0	0	3	3	0	0	0	0	0	3	7	10
+30 mins.	0	0	1	1	0	0	6	6	0	0	0	0	0	0	6	6
+45 mins.	0	0	0	0	0	0	3	3	0	0	0	0	0	0	6	6
Total Volume	0	0	3	3	0	0	16	16	0	0	0	0	0	3	29	32
% App. Total	0	0	100	.375	0	0	100	.667	0	0	0	0	0	9.4	90.6	0
PHF	.000	.000	.375	.375	.000	.000	.667	.667	.000	.000	.000	.000	.000	.250	.725	.800

Location: Moreno Valley
 N/S: Graham Street/Riverside Dr
 E/W: Cactus Avenue



Date: 8/20/2019
 Day: Tuesday

PEDESTRIANS

	North Leg Graham Street	East Leg Cactus Avenue	South Leg Riverside Drive	West Leg Cactus Avenue	
	Pedestrians	Pedestrians	Pedestrians	Pedestrians	
7:00 AM	0	0	0	1	1
7:15 AM	0	0	0	0	0
7:30 AM	0	0	0	0	0
7:45 AM	0	0	0	0	0
8:00 AM	0	0	0	0	0
8:15 AM	0	0	0	0	0
8:30 AM	1	0	0	0	1
8:45 AM	0	0	0	0	0
TOTAL VOLUMES:	1	0	0	1	2

	North Leg Graham Street	East Leg Cactus Avenue	South Leg Riverside Drive	West Leg Cactus Avenue	
	Pedestrians	Pedestrians	Pedestrians	Pedestrians	
4:00 PM	0	0	0	0	0
4:15 PM	0	0	0	0	0
4:30 PM	0	0	0	0	0
4:45 PM	0	0	0	0	0
5:00 PM	0	0	0	0	0
5:15 PM	0	0	0	0	0
5:30 PM	0	0	0	0	0
5:45 PM	0	0	0	1	1
TOTAL VOLUMES:	0	0	0	1	1

Location: Moreno Valley
 N/S: Graham Street/Riverside Dr
 E/W: Cactus Avenue



Date: 8/20/2019
 Day: Tuesday

BICYCLES

	Southbound Graham Street			Westbound Cactus Avenue			Northbound Riverside Drive			Eastbound Cactus Avenue			
	Left	Thru	Right	Left	Thru	Right	Left	Thru	Right	Left	Thru	Right	
7:00 AM	0	0	0	0	0	0	0	0	0	0	0	0	0
7:15 AM	0	0	0	0	0	0	0	0	0	0	0	0	0
7:30 AM	0	0	0	0	0	0	0	0	0	0	0	0	0
7:45 AM	0	0	0	0	0	0	0	0	0	0	0	0	0
8:00 AM	0	0	0	0	0	0	0	0	0	0	0	0	0
8:15 AM	0	0	0	0	0	0	0	0	0	0	0	0	0
8:30 AM	0	0	0	0	0	0	1	0	0	0	0	0	1
8:45 AM	0	0	0	0	0	0	0	0	0	0	0	0	0
TOTAL VOLUMES:	0	0	0	0	0	0	1	0	0	0	0	0	1

	Southbound Graham Street			Westbound Cactus Avenue			Northbound Riverside Drive			Eastbound Cactus Avenue			
	Left	Thru	Right	Left	Thru	Right	Left	Thru	Right	Left	Thru	Right	
4:00 PM	0	0	0	0	0	0	0	0	0	0	0	0	0
4:15 PM	0	0	0	0	0	0	0	0	0	0	1	0	1
4:30 PM	0	0	0	0	0	0	0	0	0	0	0	0	0
4:45 PM	0	0	0	0	0	0	0	0	0	0	0	0	0
5:00 PM	0	0	0	0	0	0	0	0	0	0	0	0	0
5:15 PM	0	0	0	0	0	0	0	0	0	0	0	0	0
5:30 PM	0	0	0	0	0	0	1	0	0	0	1	0	2
5:45 PM	0	0	0	0	0	0	0	0	0	0	0	0	0
TOTAL VOLUMES:	0	0	0	0	0	0	1	0	0	0	2	0	3

Counts Unlimited, Inc.
 PO Box 1178
 Corona, CA 92878
 (951)268-6268

County of Riverside
 N/S: Washington Street
 E/W: Van Buren Boulevard
 Weather: Clear

File Name : 01_CRV_Wash_VB AM
 Site Code : 05121716
 Start Date : 11/30/2021
 Page No : 2

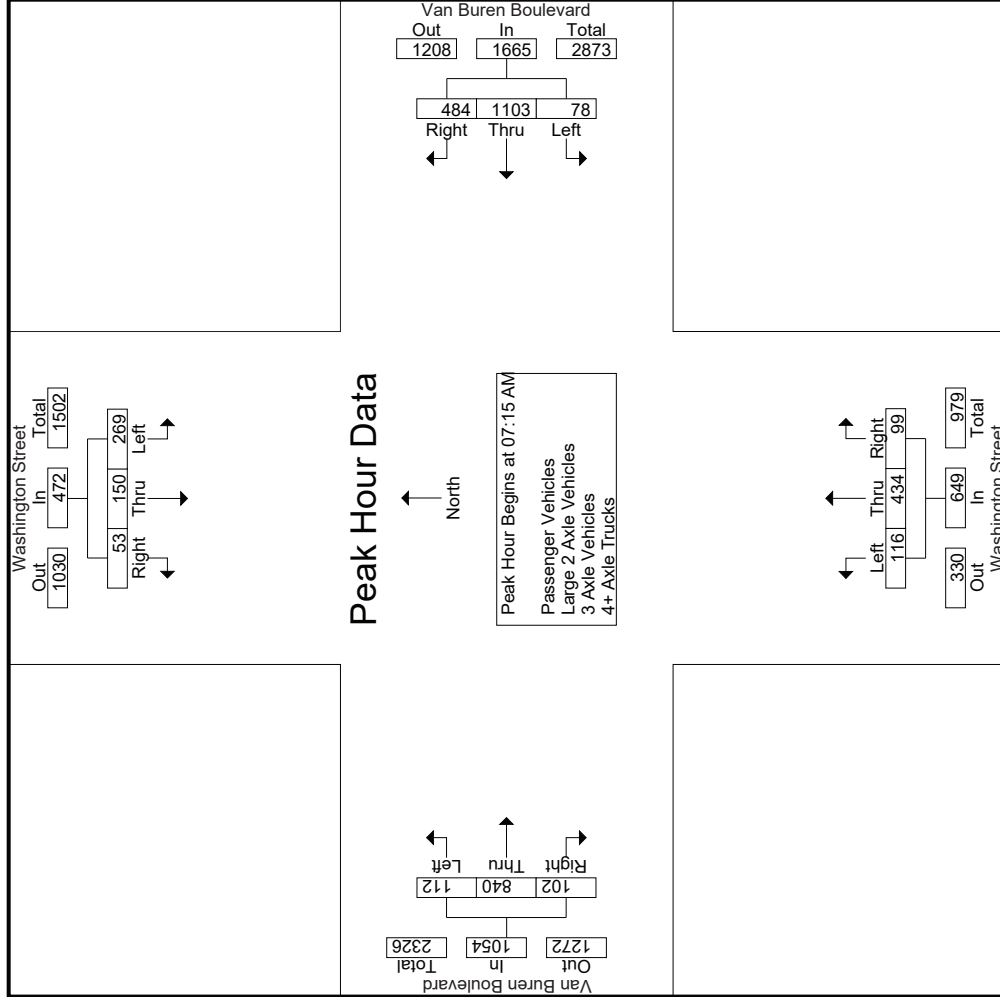

Counts Unlimited, Inc.
 PO Box 1178
 Corona, CA 92878
 (951)268-6268

County of Riverside
 N/S: Washington Street
 E/W: Van Buren Boulevard
 Weather: Clear

File Name : 01_CRV_Wash_VB AM
 Site Code : 05121716
 Start Date : 11/30/2021
 Page No : 3

Start Time	Washington Street Southbound			Van Buren Boulevard Westbound			Washington Street Northbound			Van Buren Boulevard Eastbound		
	Left	Thru	Right	Left	Thru	Right	Left	Thru	Right	Left	Thru	Right
Peak Hour Analysis From 07:00 AM to 08:45 AM - Peak 1 of 1												
Peak Hour for Each Approach Begins at:												
+0 mins.	81	31	13	13	274	97	40	85	34	26	229	15
+15 mins.	57	28	9	16	293	121	19	117	39	26	198	10
+30 mins.	51	47	13	22	303	136	30	126	22	28	200	37
+45 mins.	80	44	18	21	271	117	29	106	21	32	213	40
Total Volume	269	150	53	72	1141	471	118	434	116	112	840	102
% App. Total	57	31.8	11.2	4.3	67.8	28	17.7	65	17.4	10.6	79.7	9.7
PHF	.830	.798	.736	.818	.941	.866	.738	.861	.744	.875	.917	.638

Groups Printed- Passenger Vehicles

Start Time	Washington Street Southbound					Van Buren Boulevard Westbound					Washington Street Northbound					Van Buren Boulevard Eastbound							
	Left	Thru	Right	RTOR	App. Total	Left	Thru	Right	RTOR	App. Total	Left	Thru	Right	RTOR	App. Total	Left	Thru	Right	RTOR	App. Total	Exclu. Total	Inclu. Total	Int. Total
07:00 AM	59	25	14	8	98	13	267	92	25	372	39	82	34	20	155	23	239	9	4	271	57	896	953
07:15 AM	80	28	11	5	119	15	287	117	42	419	17	116	39	24	172	26	221	15	3	262	74	972	1046
07:30 AM	53	25	8	5	86	21	294	134	34	449	29	124	22	15	175	26	188	10	3	224	57	934	991
07:45 AM	48	43	13	6	104	20	260	115	44	395	27	105	18	11	150	27	193	35	9	255	70	904	974
Total	240	121	46	24	407	69	1108	458	145	1635	112	427	113	70	652	102	841	69	19	1012	258	3706	3964
08:00 AM	79	43	18	12	140	19	230	110	36	359	36	81	16	11	133	31	206	39	7	276	66	908	974
08:15 AM	67	36	15	7	118	18	240	107	39	365	27	102	30	17	159	24	157	11	3	192	66	834	900
08:30 AM	38	20	15	10	73	21	246	69	30	336	22	59	33	25	114	21	157	11	6	189	71	712	783
08:45 AM	42	11	13	8	66	11	213	103	37	327	22	79	28	17	129	20	142	9	4	171	66	693	759
Total	226	110	61	37	397	69	929	389	142	1387	107	321	107	70	535	96	662	70	20	828	269	3147	3416
Grand Total	466	231	107	61	804	138	2037	847	287	3022	219	748	220	140	1187	198	1503	139	39	1840	527	6853	7380
% Approach	58	28.7	13.3			4.6	67.4	28		18.4	63	18.5		17.3	10.8	81.7	7.6		26.8		7.1	92.9	
% Total	6.8	3.4	1.6		11.7	2	29.7	12.4		3.2	10.9	3.2			2.9	21.9	2						

Start Time	Washington Street Southbound					Van Buren Boulevard Westbound					Washington Street Northbound					Van Buren Boulevard Eastbound								
	Left	Thru	Right	RTOR	App. Total	Left	Thru	Right	RTOR	App. Total	Left	Thru	Right	RTOR	App. Total	Left	Thru	Right	RTOR	App. Total	Exclu. Total	Inclu. Total	Int. Total	
07:15 AM	80	28	11	11	119	15	287	117	117	419	17	116	39	26	172	26	221	15	221	15	262		262	972
07:30 AM	53	25	8	8	86	21	294	134	134	449	29	124	22	26	175	26	188	10	188	10	224		224	934
07:45 AM	48	43	13	13	104	20	260	115	115	395	27	105	18	27	150	27	193	35	193	35	255		255	904
08:00 AM	79	43	18	18	140	19	230	110	110	359	36	81	16	31	133	31	206	39	206	39	276		276	974
Total Volume	260	139	50	50	449	75	1071	476	476	1622	109	426	95	110	630	110	808	99	808	99	1017		1017	3718
% App. Total	57.9	31	11.1		11.1	4.6	66	29.3	29.3	17.3	67.6	15.1	10.8	79.4	9.7	10.8	79.4	9.7						
PHF	.813	.808	.694		.802	.893	.911	.888	.903	.900	.757	.859	.609	.887	.900	.887	.914	.635						.956

Peak Hour Analysis From 07:15 AM to 08:00 AM - Peak 1 of 1
 Peak Hour for Entire Intersection Begins at 07:15 AM

Counts Unlimited, Inc.
 PO Box 1178
 Corona, CA 92878
 (951)268-6268

County of Riverside
 N/S: Washington Street
 E/W: Van Buren Boulevard
 Weather: Clear

File Name : 01_CRV_Wash_VB AM
 Site Code : 05121716
 Start Date : 11/30/2021
 Page No : 2

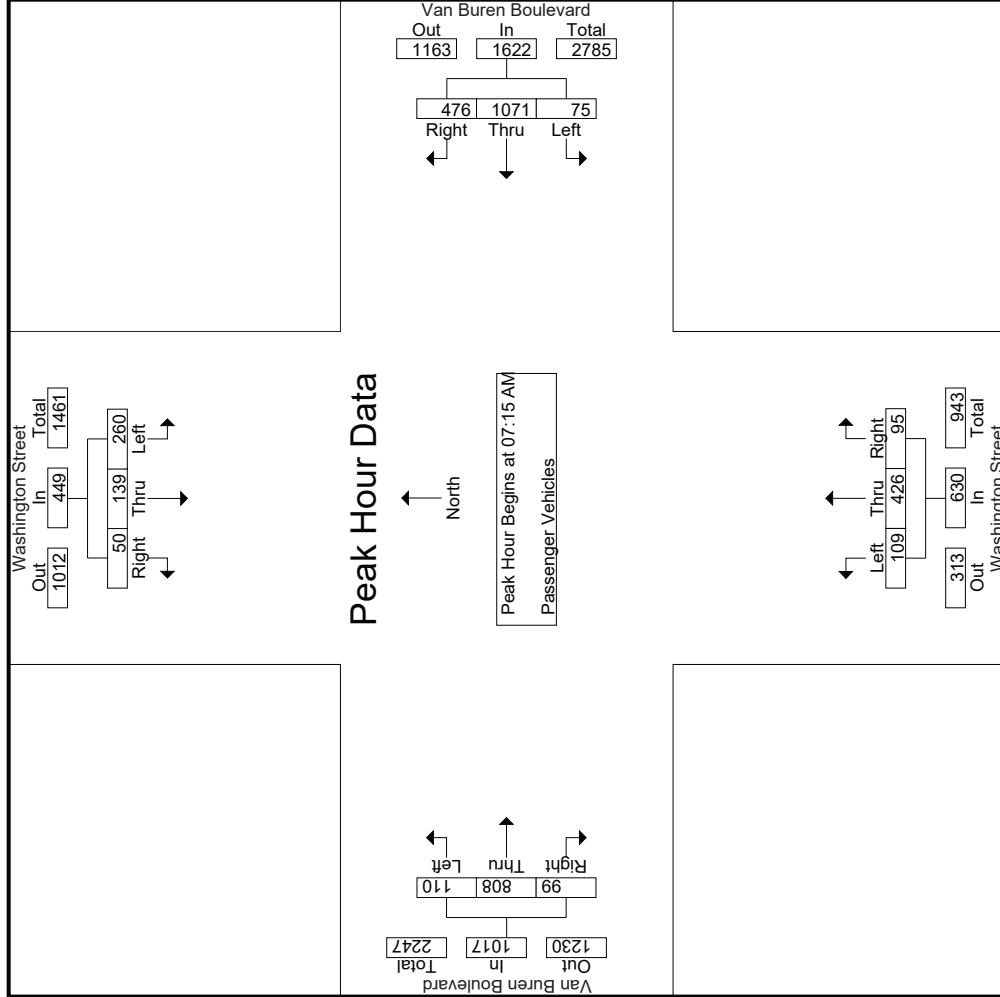

Counts Unlimited, Inc.
 PO Box 1178
 Corona, CA 92878
 (951)268-6268

County of Riverside
 N/S: Washington Street
 E/W: Van Buren Boulevard
 Weather: Clear

File Name : 01_CRV_Wash_VB AM
 Site Code : 05121716
 Start Date : 11/30/2021
 Page No : 3

Start Time	Washington Street Southbound			Van Buren Boulevard Westbound			Washington Street Northbound			Van Buren Boulevard Eastbound						
	Left	Thru	Right	App. Total	Left	Thru	Right	App. Total	Left	Thru	Right	App. Total	Int. Total			
Peak Hour Analysis From 07:15 AM to 08:00 AM - Peak 1 of 1																
Peak Hour for Each Approach Begins at:																
	07:15 AM															
+0 mins.	80	28	11	119	15	287	117	419	17	116	39	172	26	221	15	262
+15 mins.	53	25	8	86	21	294	134	449	29	124	22	175	26	188	10	224
+30 mins.	48	43	13	104	20	260	115	395	27	105	18	150	27	193	35	255
+45 mins.	79	43	18	140	19	230	110	359	36	81	16	133	31	206	39	276
Total Volume	260	139	50	449	75	1071	476	1622	109	426	95	630	110	808	99	1017
% App. Total	57.9	31	11.1		4.6	66	29.3		17.3	67.6	15.1		10.8	79.4	9.7	
PHF	.813	.808	.694	.802	.893	.911	.888	.903	.757	.859	.609	.900	.887	.914	.635	.921

Counts Unlimited, Inc.
 PO Box 1178
 Corona, CA 92878
 (951)268-6268

County of Riverside
 N/S: Washington Street
 EW: Van Buren Boulevard
 Weather: Clear

File Name : 01_CRV_Wash_VB AM
 Site Code : 05121716
 Start Date : 11/30/2021
 Page No : 1

Groups Printed- Large 2 Axle Vehicles

Start Time	Washington Street Southbound				Van Buren Boulevard Westbound				Washington Street Northbound				Van Buren Boulevard Eastbound							
	Left	Thru	Right	RTOR	Left	Thru	Right	RTOR	Left	Thru	Right	RTOR	Left	Thru	Right	RTOR	App. Total	Exclu. Total	Inclu. Total	Int. Total
07:00 AM	1	0	1	0	2	0	6	5	0	11	0	3	0	0	0	0	10	0	26	26
07:15 AM	1	2	1	0	4	0	4	4	0	8	2	1	0	0	0	0	7	0	22	22
07:30 AM	4	3	1	0	8	1	6	2	0	9	1	2	0	0	0	5	0	25	25	
07:45 AM	3	3	0	0	6	1	7	2	1	10	2	3	1	6	2	9	2	31	33	
Total	9	8	3	0	20	2	23	13	1	38	5	7	3	1	15	31	2	104	106	
08:00 AM	1	1	0	0	2	0	2	0	0	2	1	3	1	1	0	0	8	1	17	18
08:15 AM	3	1	0	0	4	0	4	4	0	8	0	1	3	1	4	0	8	1	24	25
08:30 AM	2	2	0	0	4	0	9	1	0	10	0	1	0	0	3	0	3	0	18	18
08:45 AM	0	2	0	0	2	0	5	1	0	6	0	1	0	1	4	0	5	0	14	14
Total	6	6	0	0	12	0	20	6	0	26	1	6	4	2	11	24	2	73	75	
Grand Total	15	14	3	0	32	2	43	19	1	64	6	13	7	3	26	55	4	177	181	
% Approach	46.9	43.8	9.4		3.1	67.2	29.7			23.1	50	26.9		7.3	87.3	5.5				
Total %	8.5	7.9	1.7		1.1	24.3	10.7			36.2	3.4	7.3	4	14.7	2.3	27.1	1.7	2.2	97.8	

Start Time	Washington Street Southbound				Van Buren Boulevard Westbound				Washington Street Northbound				Van Buren Boulevard Eastbound							
	Left	Thru	Right	RTOR	Left	Thru	Right	RTOR	Left	Thru	Right	RTOR	Left	Thru	Right	RTOR	App. Total	Exclu. Total	Inclu. Total	Int. Total
07:15 AM	1	2	1	0	4	0	4	4	0	8	2	1	0	0	0	0	7	0	7	22
07:30 AM	4	3	1	0	8	1	6	2	0	9	1	2	0	0	0	5	0	5	25	
07:45 AM	3	3	0	0	6	1	7	2	0	10	2	3	1	6	2	9	2	31	31	
08:00 AM	1	1	0	0	2	0	2	0	2	4	1	3	1	5	0	8	0	17	17	
Total Volume	9	9	2	0	20	2	19	8	29	36.2	6	7	4	17	25	2	29	2	95	
% App. Total	45	45	10		6.9	65.5	27.6			23.1	50	26.9		7.3	86.2	6.9				
PHF	.563	.750	.500		.625	.679	.500		.725	.750	.583	.333		.708	.893	.250	.806		.766	

Peak Hour Analysis From 07:15 AM to 08:00 AM - Peak 1 of 1
 Peak Hour for Entire Intersection Begins at 07:15 AM

Counts Unlimited, Inc.
 PO Box 1178
 Corona, CA 92878
 (951)268-6268

County of Riverside
 N/S: Washington Street
 E/W: Van Buren Boulevard
 Weather: Clear

File Name : 01_CRV_Wash_VB AM
 Site Code : 05121716
 Start Date : 11/30/2021
 Page No : 2

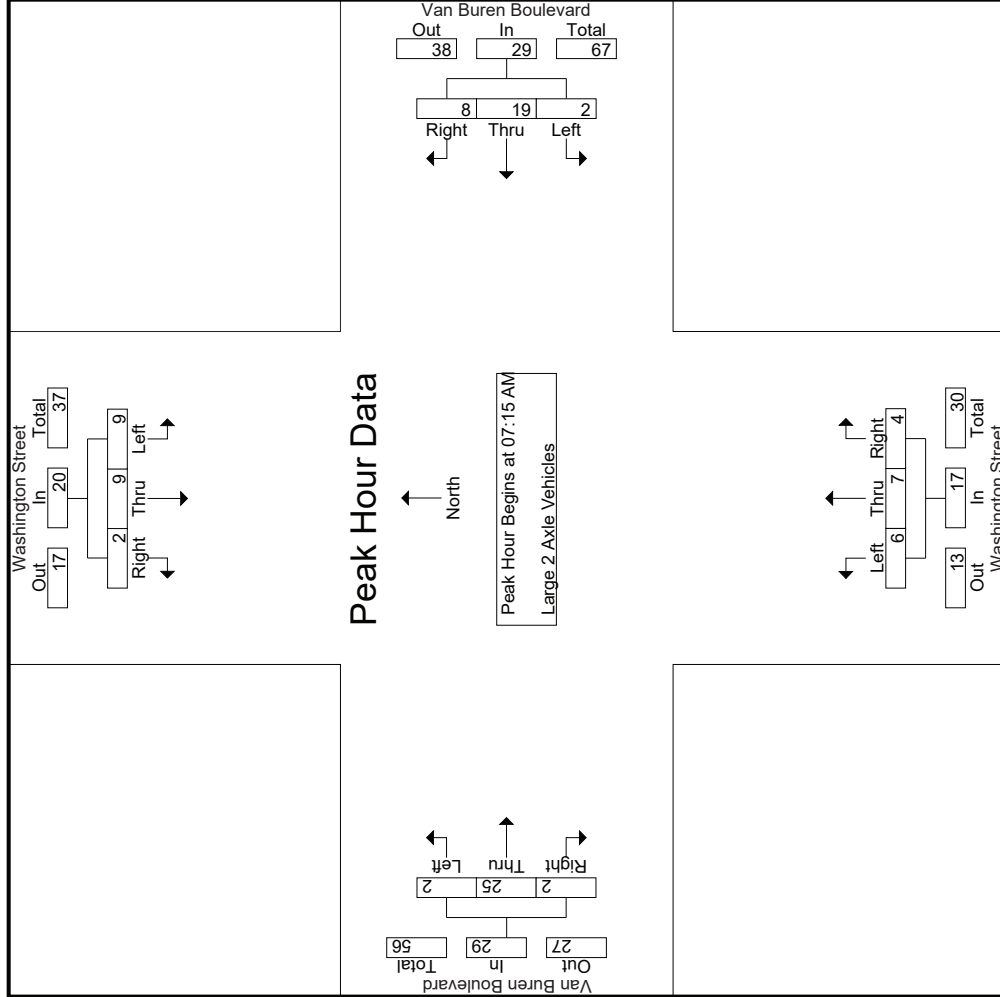

Counts Unlimited, Inc.
 PO Box 1178
 Corona, CA 92878
 (951)268-6268

County of Riverside
 N/S: Washington Street
 E/W: Van Buren Boulevard
 Weather: Clear

File Name : 01_CRV_Wash_VB AM
 Site Code : 05121716
 Start Date : 11/30/2021
 Page No : 3

Start Time	Washington Street Southbound			Van Buren Boulevard Westbound			Washington Street Northbound			Van Buren Boulevard Eastbound		
	Left	Thru	Right	Left	Thru	Right	Left	Thru	Right	Left	Thru	Right
Peak Hour Analysis From 07:15 AM to 08:00 AM - Peak 1 of 1												
Peak Hour for Each Approach Begins at:												
+0 mins.	1	2	1	0	4	4	8	2	1	0	7	0
+15 mins.	4	3	1	1	6	2	9	1	0	0	5	0
+30 mins.	3	3	0	1	7	2	10	2	3	6	2	9
+45 mins.	1	1	0	0	2	0	2	1	1	1	7	0
Total Volume	9	9	2	2	19	8	29	6	4	17	25	2
% App. Total	45	45	10	6.9	65.5	27.6	35.3	41.2	23.5	6.9	86.2	6.9
PHF	.563	.750	.500	.500	.679	.500	.725	.750	.583	.708	.893	.250

Counts Unlimited, Inc.
 PO Box 1178
 Corona, CA 92878
 (951)268-6268

County of Riverside
 N/S: Washington Street
 EW: Van Buren Boulevard
 Weather: Clear

File Name : 01_CRV_Wash_VB AM
 Site Code : 05121716
 Start Date : 11/30/2021
 Page No : 1

Groups Printed- 3 Axle Vehicles

Start Time	Washington Street Southbound				Van Buren Boulevard Westbound				Washington Street Northbound				Van Buren Boulevard Eastbound					
	Left	Thru	Right	RTOR	App. Total	Left	Thru	Right	RTOR	App. Total	Left	Thru	Right	RTOR	App. Total	Exclu. Total	Inclu. Total	Int. Total
07:00 AM	0	0	0	0	0	0	0	0	0	0	1	0	0	0	0	0	1	1
07:15 AM	0	1	0	0	1	0	0	0	0	0	0	0	0	0	1	0	2	2
07:30 AM	0	0	0	0	0	0	0	0	0	0	0	0	0	0	3	0	4	4
07:45 AM	0	1	0	0	1	0	0	0	0	0	0	0	0	0	1	0	3	3
Total	0	2	0	0	2	0	0	0	0	1	0	0	0	0	5	0	10	10
08:00 AM	0	0	0	0	0	3	0	0	0	2	1	0	0	1	0	0	6	6
08:15 AM	1	0	0	0	1	0	0	0	0	0	1	0	0	0	2	0	4	4
08:30 AM	0	0	0	0	0	0	0	0	0	0	0	0	0	0	0	0	0	0
08:45 AM	0	0	0	0	0	0	0	0	0	0	0	0	0	0	0	0	0	0
Total	1	0	0	0	1	4	0	0	0	2	1	0	0	0	6	0	13	13
Grand Total	1	2	0	0	3	0	6	0	0	3	1	1	0	0	11	0	23	23
% Approach	33.3	66.7	0	0	66.7	33.3	0	0	0	0	9.1	72.7	18.2	0	47.8	0	100	100
Total %	4.3	8.7	0	0	26.1	8.7	4.3	0	0	13	4.3	34.8	8.7	0	47.8	0	100	100

Start Time	Washington Street Southbound				Van Buren Boulevard Westbound				Washington Street Northbound				Van Buren Boulevard Eastbound					
	Left	Thru	Right	RTOR	App. Total	Left	Thru	Right	RTOR	App. Total	Left	Thru	Right	RTOR	App. Total	Exclu. Total	Inclu. Total	Int. Total
07:15 AM	0	1	0	0	1	0	0	0	0	0	0	0	0	0	0	0	1	1
07:30 AM	0	0	0	0	0	1	0	0	0	0	0	0	0	0	0	0	3	3
07:45 AM	0	1	0	0	1	0	0	0	0	0	0	0	0	0	0	0	1	1
08:00 AM	0	0	0	0	0	3	0	0	0	3	1	0	0	0	2	0	1	6
Total Volume	0	2	0	0	2	5	0	0	0	5	1	1	0	0	5	0	6	15
% App. Total	0	100	0	0	100	0	0	0	0	0	50	50	0	0	83.3	16.7	100	100
PHF	.000	.500	.000	.000	.500	.417	.000	.250	.000	.250	.000	.250	.000	.000	.417	.250	.500	.625

Peak Hour Analysis From 07:15 AM to 08:00 AM - Peak 1 of 1
 Peak Hour for Entire Intersection Begins at 07:15 AM

Counts Unlimited, Inc.
 PO Box 1178
 Corona, CA 92878
 (951)268-6268

County of Riverside
 N/S: Washington Street
 E/W: Van Buren Boulevard
 Weather: Clear

File Name : 01_CRV_Wash_VB AM
 Site Code : 05121716
 Start Date : 11/30/2021
 Page No : 2

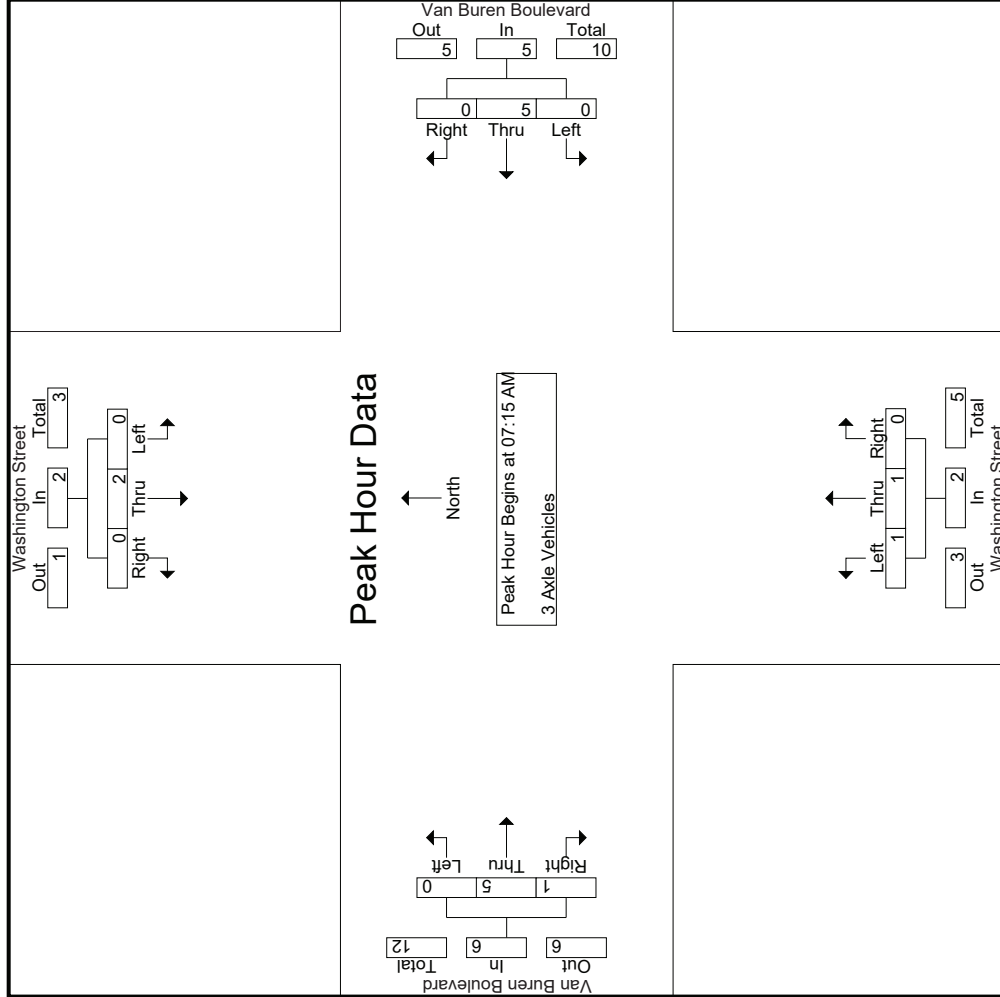

Counts Unlimited, Inc.
 PO Box 1178
 Corona, CA 92878
 (951)268-6268

County of Riverside
 N/S: Washington Street
 E/W: Van Buren Boulevard
 Weather: Clear

File Name : 01_CRV_Wash_VB AM
 Site Code : 05121716
 Start Date : 11/30/2021
 Page No : 3

Start Time	Washington Street Southbound			Van Buren Boulevard Westbound			Washington Street Northbound			Van Buren Boulevard Eastbound		
	Left	Thru	Right	Left	Thru	Right	Left	Thru	Right	Left	Thru	Right
Peak Hour Analysis From 07:15 AM to 08:00 AM - Peak 1 of 1												
Peak Hour for Each Approach Begins at:												
07:15 AM	0	1	0	0	0	0	0	0	0	0	0	0
+0 mins.	0	0	0	0	1	0	0	0	0	0	1	0
+15 mins.	0	0	0	0	0	0	0	0	0	0	3	0
+30 mins.	0	1	0	0	1	0	0	0	0	0	1	0
+45 mins.	0	0	0	0	3	0	1	1	0	0	0	1
Total Volume	0	2	0	0	5	0	1	1	0	0	5	1
% App. Total	0	100	0	0	100	0	50	50	0	0	83.3	16.7
PHF	.000	.500	.000	.000	.417	.000	.250	.250	.000	.000	.417	.250

Counts Unlimited, Inc.
 PO Box 1178
 Corona, CA 92878
 (951)268-6268

County of Riverside
 N/S: Washington Street
 EW: Van Buren Boulevard
 Weather: Clear

File Name : 01_CRV_Wash_VB AM
 Site Code : 05121716
 Start Date : 11/30/2021
 Page No : 1

Groups Printed- 4+ Axle Trucks

Start Time	Washington Street Southbound				Van Buren Boulevard Westbound				Washington Street Northbound				Van Buren Boulevard Eastbound					
	Left	Thru	Right	RTOR	App. Total	Left	Thru	Right	RTOR	App. Total	Left	Thru	Right	RTOR	App. Total	Exclu. Total	Inclu. Total	Int. Total
07:00 AM	0	0	0	0	0	0	0	0	0	0	0	0	0	0	0	0	3	3
07:15 AM	0	0	1	0	1	2	0	0	0	3	0	0	0	0	0	0	4	4
07:30 AM	0	0	0	0	0	2	0	0	0	2	0	0	0	0	2	0	4	4
07:45 AM	0	0	0	0	0	3	0	0	0	3	0	0	0	0	0	0	3	3
Total	0	0	1	0	1	8	0	0	0	9	0	0	0	0	4	0	14	14
08:00 AM	0	0	0	0	0	1	0	0	0	1	0	0	0	0	0	0	1	1
08:15 AM	0	0	0	0	0	0	0	0	0	0	0	0	1	0	4	0	4	4
08:30 AM	0	0	1	0	1	2	0	0	0	2	0	0	0	0	0	0	4	4
08:45 AM	0	0	0	0	0	2	0	0	0	2	0	0	0	0	4	0	6	6
Total	0	0	1	0	1	5	0	0	0	5	1	0	1	0	8	0	15	15
Grand Total	0	0	2	0	2	13	0	0	0	14	0	1	0	0	12	0	29	29
% Approach	0	0	100		7.1	92.9	0			48.3	0	100	0		8.3	75	16.7	
% Total	0	0	6.9		6.9	3.4	44.8	0		48.3	0	3.4	0		3.4	31	6.9	

Start Time	Washington Street Southbound				Van Buren Boulevard Westbound				Washington Street Northbound				Van Buren Boulevard Eastbound					
	Left	Thru	Right	RTOR	App. Total	Left	Thru	Right	RTOR	App. Total	Left	Thru	Right	RTOR	App. Total	Exclu. Total	Inclu. Total	Int. Total
07:15 AM	0	0	1	0	1	2	0	0	0	3	0	0	0	0	0	0	0	0
07:30 AM	0	0	0	0	0	0	2	0	0	2	0	0	0	0	2	0	2	4
07:45 AM	0	0	0	0	0	0	3	0	0	3	0	0	0	0	0	0	0	3
08:00 AM	0	0	0	0	0	0	0	0	0	0	0	0	0	0	0	0	0	1
Total Volume	0	0	1		1	8	0			9	0	0	0	0	2	0	2	12
% App. Total	0	0	100		11.1	88.9	0			0	0	100	0		0	0	0	100
PHF	.000	.000	.250		.250	.667	.000			.750	.000	.000	.000		.250	.000	.250	.750

Peak Hour Analysis From 07:15 AM to 08:00 AM - Peak 1 of 1
 Peak Hour for Entire Intersection Begins at 07:15 AM

Counts Unlimited, Inc.
 PO Box 1178
 Corona, CA 92878
 (951)268-6268

County of Riverside
 N/S: Washington Street
 E/W: Van Buren Boulevard
 Weather: Clear

File Name : 01_CRV_Wash_VB AM
 Site Code : 05121716
 Start Date : 11/30/2021
 Page No : 2

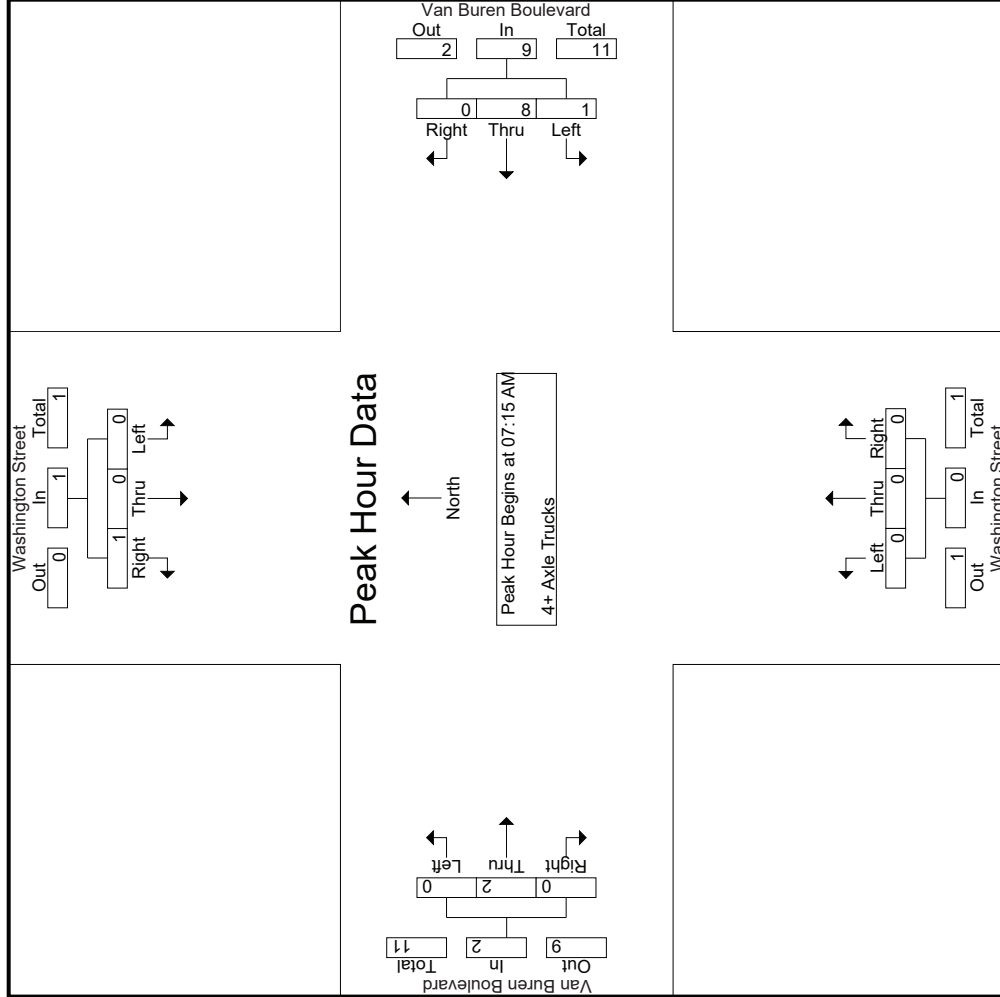

Counts Unlimited, Inc.
 PO Box 1178
 Corona, CA 92878
 (951)268-6268

County of Riverside
 N/S: Washington Street
 E/W: Van Buren Boulevard
 Weather: Clear

File Name : 01_CRV_Wash_VB AM
 Site Code : 05121716
 Start Date : 11/30/2021
 Page No : 3

Start Time	Washington Street Southbound			Van Buren Boulevard Westbound			Washington Street Northbound			Van Buren Boulevard Eastbound		
	Left	Thru	Right	Left	Thru	Right	Left	Thru	Right	Left	Thru	Right
Peak Hour Analysis From 07:15 AM to 08:00 AM - Peak 1 of 1												
Peak Hour for Each Approach Begins at:												
+0 mins.	0	0	1	1	2	0	3	0	0	0	0	0
+15 mins.	0	0	0	0	2	0	2	0	0	0	2	0
+30 mins.	0	0	0	0	3	0	3	0	0	0	0	0
+45 mins.	0	0	0	0	1	0	1	0	0	0	0	0
Total Volume	0	0	1	1	8	0	9	0	0	0	2	0
% App. Total	0	0	100	11.1	88.9	0	0	0	0	0	100	0
PHF	.000	.000	.250	.250	.667	.000	.750	.000	.000	.000	.250	.000

Counts Unlimited, Inc.
 PO Box 1178
 Corona, CA 92878
 (951)268-6268

County of Riverside
 N/S: Washington Street
 E/W: Van Buren Boulevard
 Weather: Clear

File Name : 01_CRV_Wash_VB PM
 Site Code : 05121716
 Start Date : 11/30/2021
 Page No : 1

Groups Printed- Passenger Vehicles - Large 2 Axle Vehicles - 3 Axle Vehicles - 4+ Axle Trucks

Start Time	Washington Street Southbound						Van Buren Boulevard Westbound						Washington Street Northbound						Van Buren Boulevard Eastbound					
	Left		Thru		Right		Left		Thru		Right		Left		Thru		Right		Left		Thru		Right	
	RTOR	App. Total	RTOR	App. Total	RTOR	App. Total	RTOR	App. Total	RTOR	App. Total	RTOR	App. Total	RTOR	App. Total	RTOR	App. Total	RTOR	App. Total	RTOR	App. Total	RTOR	App. Total	RTOR	App. Total
04:00 PM	117	87	10	3	214	28	233	77	19	338	20	60	17	9	97	26	288	19	6	333	37	982	1019	
04:15 PM	90	50	23	11	163	39	282	65	20	386	21	49	13	8	83	22	322	12	7	356	46	988	1034	
04:30 PM	108	70	18	9	196	35	254	69	17	358	31	62	27	16	120	28	293	17	6	338	48	1012	1060	
04:45 PM	118	72	32	15	222	36	248	81	26	365	25	68	26	17	119	22	277	17	4	316	62	1022	1084	
Total	433	279	83	38	795	138	1017	292	82	1447	97	239	83	50	419	98	1180	65	23	1343	193	4004	4197	
05:00 PM	86	72	16	11	174	38	258	102	29	398	18	46	21	14	85	45	315	12	2	372	56	1029	1085	
05:15 PM	118	95	15	10	228	42	238	86	24	366	26	56	18	12	100	27	278	21	4	326	50	1020	1070	
05:30 PM	130	85	23	13	238	35	200	80	24	315	23	55	21	13	99	31	328	24	6	383	56	1035	1091	
05:45 PM	91	63	14	8	168	33	221	77	25	331	16	34	17	9	67	36	322	23	10	381	52	947	999	
Total	425	315	68	42	808	148	917	345	102	1410	83	191	77	48	351	139	1243	80	22	1462	214	4031	4245	
Grand Total	858	594	151	80	1603	286	1934	637	184	2857	180	430	160	98	770	237	2423	145	45	2805	407	8035	8442	
% Approach	53.5	37.1	9.4			10	67.7	22.3			23.4	55.8	20.8			8.4	86.4	5.2						
% Total	10.7	7.4	1.9			3.6	24.1	7.9			2.2	5.4	2			2.9	30.2	1.8			4.8	95.2		
% Passenger Vehicles	849	587	150		1666	285	1886	620		2970	176	418	158		849	234	2338	142		2758	0	0	8243	
% Large 2 Axle Vehicles	99	98.8	99.3	100	99	99.7	97.5	97.3	97.3	97.7	97.8	97.2	98.8	99	97.8	98.7	96.5	97.9	97.8	96.8	0	0	97.6	
% 3 Axle Vehicles	7	6	0	0	13	1	32	17	2.7	1.8	3	11	2	1	17	3	62	2	0	67	0	0	152	
% 4+ Axle Trucks	0.8	1	0	0	0.8	0.3	1.7	2.7	2.7	1.8	1.7	2.6	1.2	1	2	1.3	2.6	1.4	0	2.4	0	0	1.8	
% 4+ Axle Trucks	2	0	0	0	2	0	4	0	0	4	1	1	0	0	2	0	7	0	0	7	0	0	15	
% 4+ Axle Trucks	0.2	0	0	0	0.1	0	0.2	0	0	0.1	0.6	0.2	0	0	0.2	0	0.3	0	0	0.2	0	0	0.2	
% 4+ Axle Trucks	0	1	1		2	0	12	0	0	12	0	0	0	0	0	0	16	1	18	0	0	0	32	
% 4+ Axle Trucks	0	0.2	0.7	0	0.1	0	0.6	0	0	0.4	0	0	0	0	0	0	0.7	0.7	2.2	0.6	0	0	0.4	

Start Time	Washington Street Southbound						Van Buren Boulevard Westbound						Washington Street Northbound						Van Buren Boulevard Eastbound					
	Left		Thru		Right		Left		Thru		Right		Left		Thru		Right		Left		Thru		Right	
04:45 PM	118	72	32		222	36	248	81		365	25	68	26		119	22	277	17		316	17	316	1022	
05:00 PM	86	72	16		174	38	258	102		398	18	46	21		85	45	315	12		372	12	372	1029	
05:15 PM	118	95	15		228	42	238	86		366	26	56	18		100	27	278	21		326	21	326	1020	
05:30 PM	130	85	23		238	35	200	80		315	23	55	21		99	31	328	24		383	24	383	1035	
Total Volume	452	324	86		862	151	944	349		1444	92	225	86		403	125	1198	74		1397	74	1397	4106	
% App. Total	52.4	37.6	10		10	10.5	65.4	24.2		24.2	22.8	55.8	21.3		21.3	8.9	85.8	5.3		5.3	5.3	5.3	4106	
PHF	.869	.853	.672		.905	.899	.915	.855		.907	.885	.827	.827		.847	.694	.913	.771		.912	.771	.912	.992	

Peak Hour Analysis From 04:00 PM to 05:45 PM - Peak 1 of 1
 Peak Hour for Entire Intersection Begins at 04:45 PM

Counts Unlimited, Inc.
 PO Box 1178
 Corona, CA 92878
 (951)268-6268

County of Riverside
 N/S: Washington Street
 E/W: Van Buren Boulevard
 Weather: Clear

File Name : 01_CRV_Wash_VB_PM
 Site Code : 05121716
 Start Date : 11/30/2021
 Page No : 2

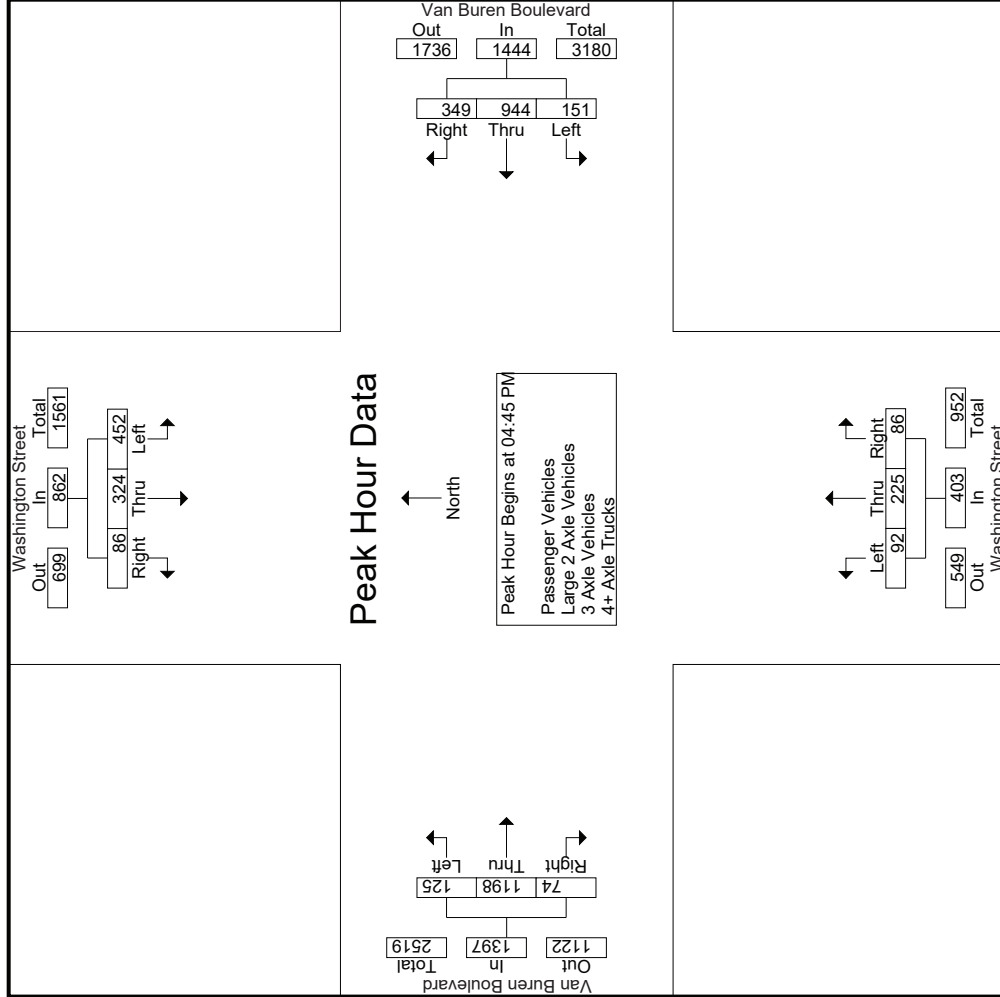

Counts Unlimited, Inc.
 PO Box 1178
 Corona, CA 92878
 (951)268-6268

County of Riverside
 N/S: Washington Street
 E/W: Van Buren Boulevard
 Weather: Clear

File Name : 01_CRV_Wash_VB PM
 Site Code : 05121716
 Start Date : 11/30/2021
 Page No : 1

Groups Printed- Passenger Vehicles

Start Time	Washington Street Southbound					Van Buren Boulevard Westbound					Washington Street Northbound					Van Buren Boulevard Eastbound							
	Left	Thru	Right	RTOR	App. Total	Left	Thru	Right	RTOR	App. Total	Left	Thru	Right	RTOR	App. Total	Left	Thru	Right	RTOR	App. Total	Exclu. Total	Inclu. Total	Int. Total
04:00 PM	115	86	9	3	210	28	226	71	18	325	20	57	17	9	94	25	275	18	5	318	35	947	982
04:15 PM	90	50	23	11	163	39	274	63	19	376	19	49	13	8	81	22	314	12	7	348	45	968	1013
04:30 PM	106	68	18	9	192	35	251	63	16	349	30	60	27	16	117	27	282	17	6	326	47	984	1031
04:45 PM	115	70	32	15	217	36	239	81	26	356	25	68	25	16	118	22	269	17	4	308	61	999	1060
Total	426	274	82	38	782	138	990	278	79	1406	94	234	82	49	410	96	1140	64	22	1300	188	3898	4086
05:00 PM	84	71	16	11	171	38	251	100	27	389	18	44	20	14	82	45	301	11	2	357	54	999	1053
05:15 PM	118	94	15	10	227	42	236	86	24	364	26	53	18	12	97	27	268	20	4	315	50	1003	1053
05:30 PM	130	85	23	13	238	34	194	80	24	308	22	53	21	13	96	31	317	24	6	372	56	1014	1070
05:45 PM	91	63	14	8	168	33	215	76	25	324	16	34	17	9	67	35	312	23	10	370	52	929	981
Total	423	313	68	42	804	147	896	342	100	1385	82	184	76	48	342	138	1198	78	22	1414	212	3945	4157
Grand Total	849	587	150	80	1586	285	1886	620	179	2791	176	418	158	97	752	234	2338	142	44	2714	400	7843	8243
% Approach	53.5	37	9.5			10.2	67.6	22.2		35.6	23.4	55.6	21		8.6	86.1	5.2			34.6	4.9	95.1	
% Total	10.8	7.5	1.9		20.2	3.6	24	7.9		2.2	5.3	2		9.6	3	29.8	1.8						

Start Time	Washington Street Southbound					Van Buren Boulevard Westbound					Washington Street Northbound					Van Buren Boulevard Eastbound							
	Left	Thru	Right	RTOR	App. Total	Left	Thru	Right	RTOR	App. Total	Left	Thru	Right	RTOR	App. Total	Left	Thru	Right	RTOR	App. Total	Exclu. Total	Inclu. Total	Int. Total
04:45 PM	115	70	32		217	36	239	81		356	25	68	25		118	22	269	17		308			999
05:00 PM	84	71	16		171	38	251	100		389	18	44	20		82	45	301	11		357			999
05:15 PM	118	94	15		227	42	236	86		364	26	53	18		97	27	268	20		315			1003
05:30 PM	130	85	23		238	34	194	80		308	22	53	21		96	31	317	24		372			1014
Total Volume	447	320	86		853	150	920	347		1417	91	218	84		393	125	1155	72		1352			4015
% App. Total	52.4	37.5	10.1			10.6	64.9	24.5		23.2	55.5	21.4		9.2	85.4	5.3							
PHF	.860	.851	.672		.896	.893	.916	.868		.911	.875	.801	.840		.833	.694	.911	.750		.909			.990

Peak Hour Analysis From 04:45 PM to 05:30 PM - Peak 1 of 1
 Peak Hour for Entire Intersection Begins at 04:45 PM

Counts Unlimited, Inc.
 PO Box 1178
 Corona, CA 92878
 (951)268-6268

County of Riverside
 N/S: Washington Street
 E/W: Van Buren Boulevard
 Weather: Clear

File Name : 01_CRV_Wash_VB PM
 Site Code : 05121716
 Start Date : 11/30/2021
 Page No : 2

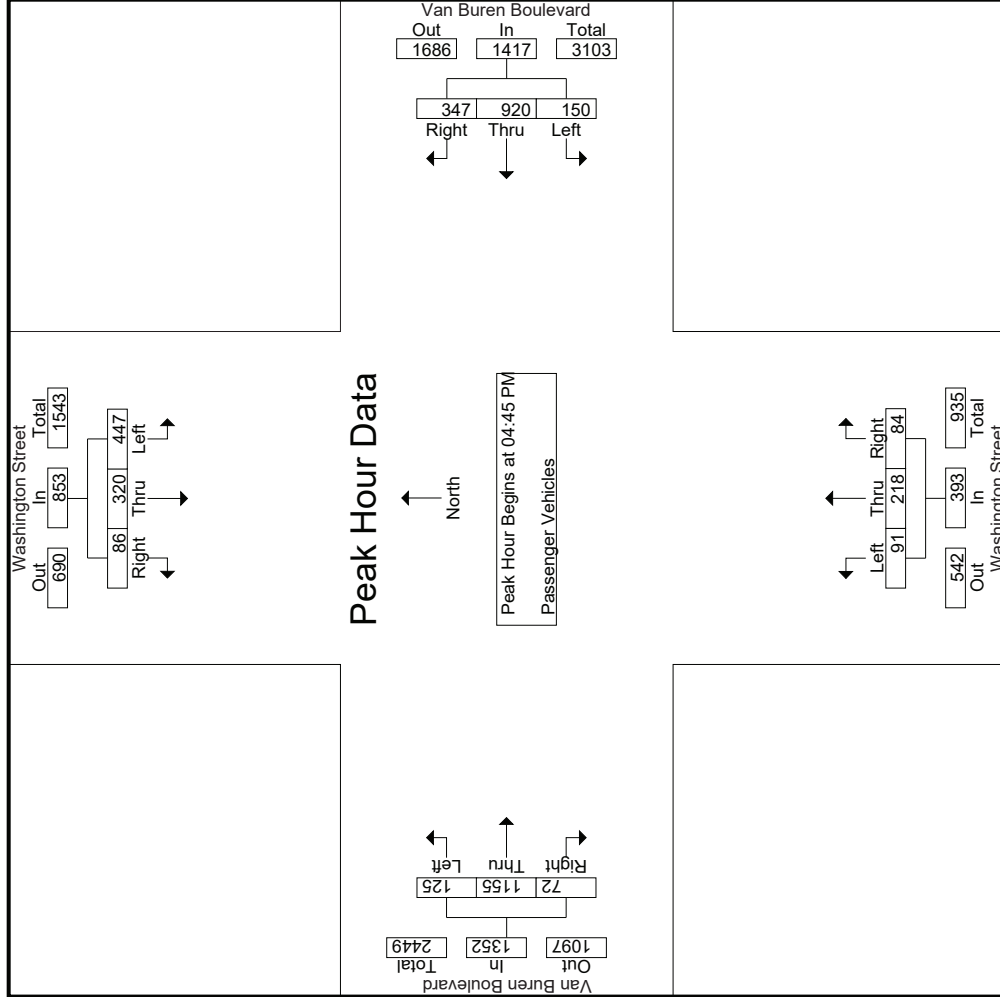

Counts Unlimited, Inc.
 PO Box 1178
 Corona, CA 92878
 (951)268-6268

County of Riverside
 N/S: Washington Street
 E/W: Van Buren Boulevard
 Weather: Clear

File Name : 01_CRV_Wash_VB PM
 Site Code : 05121716
 Start Date : 11/30/2021
 Page No : 3

Start Time	Washington Street Southbound			Van Buren Boulevard Westbound			Washington Street Northbound			Van Buren Boulevard Eastbound						
	Left	Thru	Right	Left	Thru	Right	Left	Thru	Right	Left	Thru	Right	App. Total	Int. Total		
Peak Hour Analysis From 04:45 PM to 05:30 PM - Peak 1 of 1																
Peak Hour for Each Approach Begins at:																
	04:45 PM															
+0 mins.	115	70	32	217	36	239	81	356	25	68	25	118	22	269	17	308
+15 mins.	84	71	16	171	38	251	100	389	18	44	20	82	45	301	11	357
+30 mins.	118	94	15	227	42	236	86	364	26	53	18	97	27	268	20	315
+45 mins.	130	85	23	238	34	194	80	308	22	53	21	96	31	317	24	372
Total Volume	447	320	86	853	150	920	347	1417	91	218	84	393	125	1155	72	1352
% App. Total	52.4	37.5	10.1		10.6	64.9	24.5		23.2	55.5	21.4		9.2	85.4	5.3	
PHF	.860	.851	.672	.896	.893	.916	.868	.911	.875	.801	.840	.833	.694	.911	.750	.909

Counts Unlimited, Inc.
 PO Box 1178
 Corona, CA 92878
 (951)268-6268

County of Riverside
 N/S: Washington Street
 EW: Van Buren Boulevard
 Weather: Clear

File Name : 01_CRV_Wash_VB PM
 Site Code : 05121716
 Start Date : 11/30/2021
 Page No : 1

Groups Printed- Large 2 Axle Vehicles

Start Time	Washington Street Southbound				Van Buren Boulevard Westbound				Washington Street Northbound				Van Buren Boulevard Eastbound					
	Left	Thru	Right	RTOR	Left	Thru	Right	RTOR	Left	Thru	Right	RTOR	Left	Thru	Right	RTOR		
04:00 PM	1	1	0	0	0	4	6	1	10	0	3	0	0	0	0	0	9	
04:15 PM	0	0	0	0	0	6	2	1	8	1	0	0	0	0	0	0	5	
04:30 PM	1	2	0	0	0	2	6	1	8	1	1	0	0	1	9	0	10	
04:45 PM	3	1	0	0	0	7	0	0	7	0	0	1	1	0	5	0	5	
Total	5	4	0	0	0	19	14	3	33	2	4	1	1	2	27	0	29	
05:00 PM	2	1	0	0	0	3	2	2	5	0	2	1	0	0	1	0	12	
05:15 PM	0	1	0	0	0	1	0	0	1	0	3	0	0	0	7	1	8	
05:30 PM	0	0	0	0	1	5	0	0	6	1	2	0	0	0	8	0	8	
05:45 PM	0	0	0	0	0	4	1	0	5	0	0	0	0	1	9	0	10	
Total	2	2	0	0	1	13	3	2	17	1	7	1	0	1	35	2	38	
Grand Total	7	6	0	0	1	32	17	5	50	3	11	2	1	3	62	2	67	
% Apprch %	53.8	46.2	0	0	2	64	34		18.8	68.8	12.5		16	4.5	92.5	3	45.9	
% Total %	4.8	4.1	0	0	0.7	21.9	11.6		34.2	2.1	7.5	1.4	11	2.1	42.5	1.4	3.9	
																		96.1

Start Time	Washington Street Southbound				Van Buren Boulevard Westbound				Washington Street Northbound				Van Buren Boulevard Eastbound					
	Left	Thru	Right	RTOR	Left	Thru	Right	RTOR	Left	Thru	Right	RTOR	Left	Thru	Right	RTOR		
04:45 PM	3	1	0	0	0	7	0	0	7	0	0	0	0	0	0	0	5	
05:00 PM	2	1	0	0	0	3	0	0	5	0	2	1	0	0	11	1	12	
05:15 PM	0	1	0	0	0	1	0	0	1	0	0	0	0	0	7	1	8	
05:30 PM	0	0	0	0	1	5	0	0	6	1	2	0	0	0	8	0	8	
Total Volume	5	3	0	0	1	16	2	0	19	1	7	2	0	0	31	2	33	
% App. Total	62.5	37.5	0	0	5.3	84.2	10.5		10	70	20		0	93.9	6.1		70	
PHF	.417	.750	.000	.500	.250	.571	.250	.679	.679	.250	.583	.500	.833	.000	.705	.500	.688	.761

Peak Hour Analysis From 04:45 PM to 05:30 PM - Peak 1 of 1
 Peak Hour for Entire Intersection Begins at 04:45 PM

Counts Unlimited, Inc.
 PO Box 1178
 Corona, CA 92878
 (951)268-6268

County of Riverside
 N/S: Washington Street
 E/W: Van Buren Boulevard
 Weather: Clear

File Name : 01_CRV_Wash_VB PM
 Site Code : 05121716
 Start Date : 11/30/2021
 Page No : 2

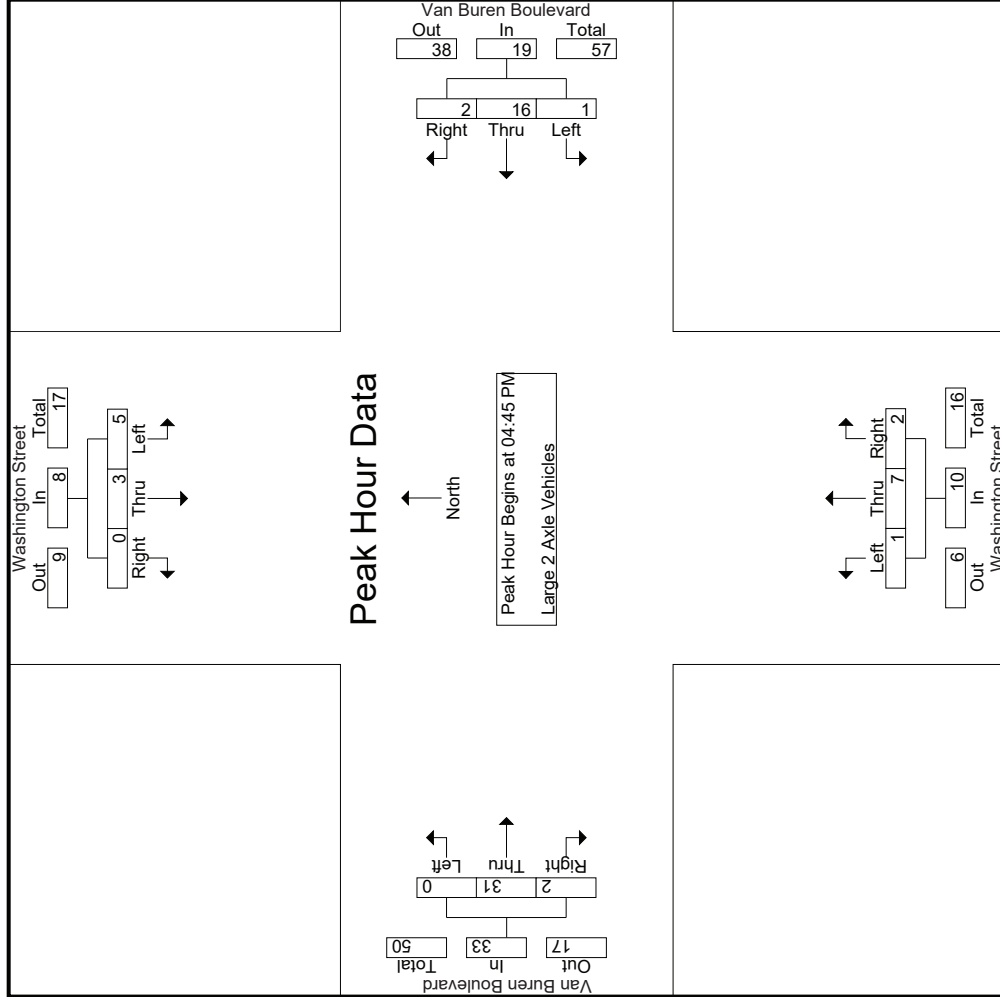

Counts Unlimited, Inc.
 PO Box 1178
 Corona, CA 92878
 (951)268-6268

File Name : 01_CRV_Wash_VB PM
 Site Code : 05121716
 Start Date : 11/30/2021
 Page No : 3

County of Riverside
 N/S: Washington Street
 E/W: Van Buren Boulevard
 Weather: Clear

Start Time	Washington Street Southbound			Van Buren Boulevard Westbound			Washington Street Northbound			Van Buren Boulevard Eastbound				
	Left	Thru	Right	App. Total	Left	Thru	Right	App. Total	Left	Thru	Right	App. Total	Int. Total	
Peak Hour Analysis From 04:45 PM to 05:30 PM - Peak 1 of 1														
Peak Hour for Each Approach Begins at:														
	04:45 PM				04:45 PM				04:45 PM				04:45 PM	
+0 mins.	3	1	0	4	0	7	0	7	0	0	1	1	0	5
+15 mins.	2	1	0	3	3	2	5	5	2	2	3	1	1	12
+30 mins.	0	1	0	1	0	1	0	1	0	3	0	0	7	8
+45 mins.	0	0	0	0	1	5	0	6	1	2	0	3	8	8
Total Volume	5	3	0	8	1	16	2	19	1	7	2	10	31	33
% App. Total	62.5	37.5	0	5.00	5.3	84.2	10.5	20.00	10	70	20	83.3	93.9	6.1
PHF	.417	.750	.000	.500	.250	.571	.250	.679	.250	.583	.500	.833	.705	.688

Counts Unlimited, Inc.
 PO Box 1178
 Corona, CA 92878
 (951)268-6268

File Name : 01_CRV_Wash_VB PM
 Site Code : 05121716
 Start Date : 11/30/2021
 Page No : 1

County of Riverside
 N/S: Washington Street
 E/W: Van Buren Boulevard
 Weather: Clear

Groups Printed- 3 Axle Vehicles

Start Time	Washington Street Southbound				Van Buren Boulevard Westbound				Washington Street Northbound				Van Buren Boulevard Eastbound			
	Left	Thru	Right	RTOR	Left	Thru	Right	RTOR	Left	Thru	Right	RTOR	Left	Thru	Right	RTOR
04:00 PM	1	0	0	0	2	0	0	0	2	0	0	0	0	2	0	0
04:15 PM	0	0	0	0	1	0	0	0	1	0	0	0	0	2	0	0
04:30 PM	1	0	0	0	0	0	0	0	0	1	0	0	0	1	0	0
04:45 PM	0	0	0	0	0	0	0	0	0	0	0	0	0	1	0	0
Total	2	0	0	0	3	0	0	0	3	1	0	0	0	6	0	0
05:00 PM	0	0	0	0	0	0	0	0	0	0	0	0	0	1	0	0
05:15 PM	0	0	0	0	0	0	0	0	0	0	0	0	0	0	0	0
05:30 PM	0	0	0	0	1	0	0	0	1	0	0	0	0	0	0	0
05:45 PM	0	0	0	0	0	0	0	0	0	0	0	0	0	0	0	0
Total	0	0	0	0	1	0	0	0	1	0	0	0	0	1	0	0
Grand Total	2	0	0	0	4	0	0	0	2	1	0	0	0	7	0	0
% Apprch %	100	0	0	0	100	0	0	0	50	50	0	0	0	100	0	0
Total %	13.3	0	0	0	26.7	0	0	0	13.3	6.7	6.7	0	0	46.7	0	0

Start Time	Washington Street Southbound				Van Buren Boulevard Westbound				Washington Street Northbound				Van Buren Boulevard Eastbound			
	Left	Thru	Right	RTOR	Left	Thru	Right	RTOR	Left	Thru	Right	RTOR	Left	Thru	Right	RTOR
04:45 PM	0	0	0	0	0	0	0	0	0	0	0	0	0	0	0	0
05:00 PM	0	0	0	0	0	0	0	0	0	0	0	0	0	0	0	0
05:15 PM	0	0	0	0	0	0	0	0	0	0	0	0	0	0	0	0
05:30 PM	0	0	0	0	0	0	0	0	0	0	0	0	0	0	0	0
Total Volume	0	0	0	0	0	0	0	0	0	0	0	0	0	0	0	0
% App. Total	.000	.000	.000	.000	.000	.250	.000	.000	.000	.000	.000	.000	.000	.500	.000	.500
PHF						.250								.500		.750

Peak Hour Analysis From 04:45 PM to 05:30 PM - Peak 1 of 1
 Peak Hour for Entire Intersection Begins at 04:45 PM

Counts Unlimited, Inc.
 PO Box 1178
 Corona, CA 92878
 (951)268-6268

County of Riverside
 N/S: Washington Street
 E/W: Van Buren Boulevard
 Weather: Clear

File Name : 01_CRV_Wash_VB PM
 Site Code : 05121716
 Start Date : 11/30/2021
 Page No : 2

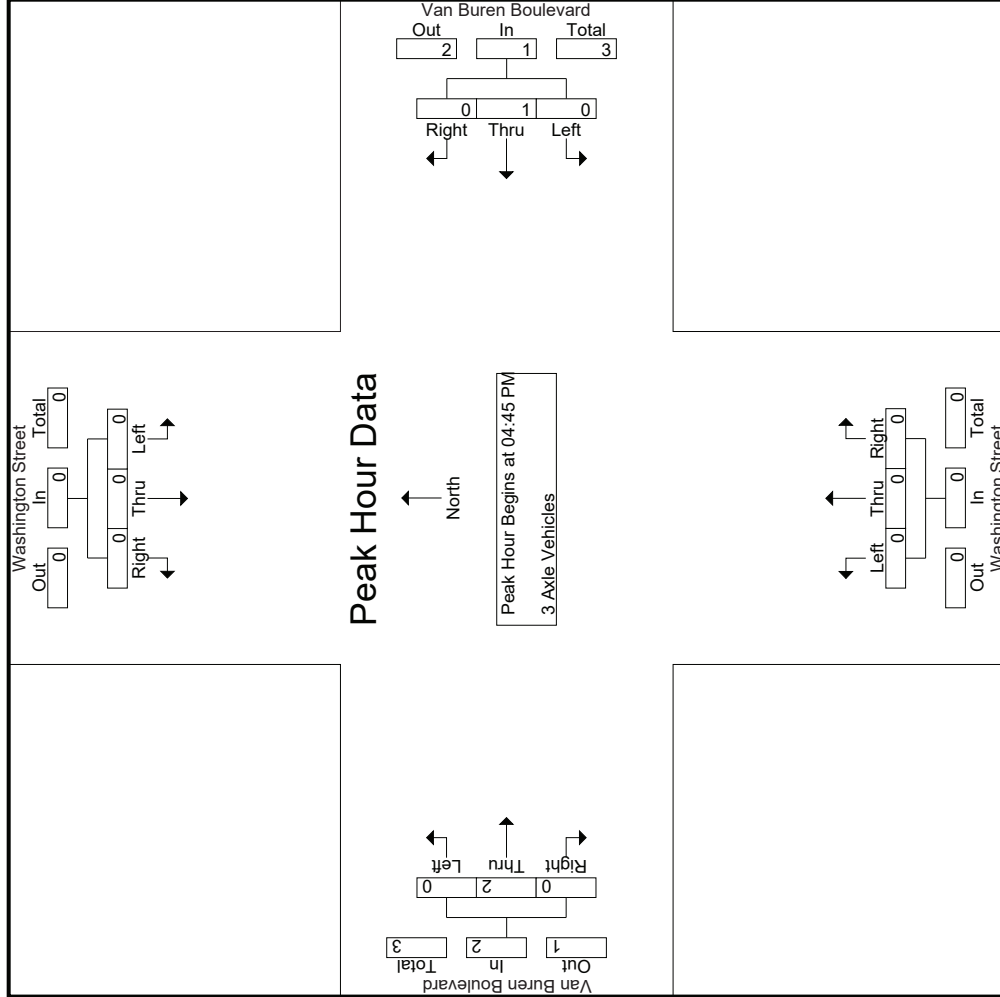

Counts Unlimited, Inc.
 PO Box 1178
 Corona, CA 92878
 (951)268-6268

County of Riverside
 N/S: Washington Street
 E/W: Van Buren Boulevard
 Weather: Clear

File Name : 01_CRV_Wash_VB PM
 Site Code : 05121716
 Start Date : 11/30/2021
 Page No : 3

Start Time	Washington Street Southbound			Van Buren Boulevard Westbound			Washington Street Northbound			Van Buren Boulevard Eastbound					
	Left	Thru	Right	App. Total	Left	Thru	Right	App. Total	Left	Thru	Right	App. Total	Int. Total		
Peak Hour Analysis From 04:45 PM to 05:30 PM - Peak 1 of 1															
Peak Hour for Each Approach Begins at:															
	04:45 PM				04:45 PM				04:45 PM				04:45 PM		
+0 mins.	0	0	0	0	0	0	0	0	0	0	0	0	0	1	
+15 mins.	0	0	0	0	0	0	0	0	0	0	0	0	0	1	
+30 mins.	0	0	0	0	0	0	0	0	0	0	0	0	0	0	
+45 mins.	0	0	0	0	0	1	0	1	0	0	0	0	0	0	
Total Volume	0	0	0	0	0	1	0	1	0	0	0	0	0	2	
% App. Total	0	0	0	0	0	100	0	100	0	0	0	0	0	0	
PHF	.000	.000	.000	.000	.000	.250	.000	.250	.000	.000	.000	.000	.000	.500	

Counts Unlimited, Inc.
 PO Box 1178
 Corona, CA 92878
 (951)268-6268

County of Riverside
 N/S: Washington Street
 E/W: Van Buren Boulevard
 Weather: Clear

File Name : 01_CRV_Wash_VB PM
 Site Code : 05121716
 Start Date : 11/30/2021
 Page No : 1

Groups Printed- 4+ Axle Trucks

Start Time	Washington Street Southbound				Van Buren Boulevard Westbound				Washington Street Northbound				Van Buren Boulevard Eastbound					
	Left	Thru	Right	RTOR	App. Total	Left	Thru	Right	RTOR	App. Total	Left	Thru	Right	RTOR	App. Total	Exclu. Total	Inclu. Total	Int. Total
04:00 PM	0	0	1	0	1	0	0	0	0	0	0	0	0	0	0	1	6	7
04:15 PM	0	0	0	0	0	1	0	0	0	1	0	0	0	0	1	0	2	2
04:30 PM	0	0	0	0	0	1	0	0	0	1	0	0	0	0	1	0	2	2
04:45 PM	0	1	0	0	1	0	2	0	0	2	0	0	0	0	2	0	5	5
Total	0	1	1	0	2	0	5	0	0	5	0	0	0	1	8	1	15	16
05:00 PM	0	0	0	0	0	4	0	0	0	4	0	0	0	0	2	0	6	6
05:15 PM	0	0	0	0	0	1	0	0	0	1	0	0	0	0	3	0	4	4
05:30 PM	0	0	0	0	0	0	0	0	0	0	0	0	0	0	3	0	3	3
05:45 PM	0	0	0	0	0	2	0	0	0	2	0	0	0	0	1	0	3	3
Total	0	0	0	0	0	7	0	0	0	7	0	0	0	0	9	0	16	16
Grand Total	0	1	1	0	2	0	12	0	0	12	0	0	0	1	17	1	31	32
% Apprch %	0	50	50			100	0	0	0	0	0	0	0	0	94.1	5.9		
Total %	0	3.2	3.2		6.5	0	38.7	0	0	38.7	0	0	0	0	54.8	3.1	96.9	

Start Time	Washington Street Southbound				Van Buren Boulevard Westbound				Washington Street Northbound				Van Buren Boulevard Eastbound					
	Left	Thru	Right	RTOR	App. Total	Left	Thru	Right	RTOR	App. Total	Left	Thru	Right	RTOR	App. Total	Exclu. Total	Inclu. Total	Int. Total
04:45 PM	0	1	0	0	1	0	2	0	0	2	0	0	0	0	0	0	2	2
05:00 PM	0	0	0	0	0	0	4	0	0	4	0	0	0	0	2	0	2	6
05:15 PM	0	0	0	0	0	1	0	0	0	1	0	0	0	0	3	0	3	4
05:30 PM	0	0	0	0	0	0	0	0	0	0	0	0	0	0	3	0	3	3
Total Volume	0	1	0	0	1	0	7	0	0	7	0	0	0	0	10	0	10	18
% App. Total	0	100	0	0	0	0	100	0	0	0	0	0	0	0	100	0	100	100
PHF	.000	.250	.000		.250	.000	.438	.000	.000	.438	.000	.000	.000	.833	.833	.000	.833	.750

Peak Hour Analysis From 04:45 PM to 05:30 PM - Peak 1 of 1
 Peak Hour for Entire Intersection Begins at 04:45 PM

Counts Unlimited, Inc.
 PO Box 1178
 Corona, CA 92878
 (951)268-6268

County of Riverside
 N/S: Washington Street
 E/W: Van Buren Boulevard
 Weather: Clear

File Name : 01_CRV_Wash_VB PM
 Site Code : 05121716
 Start Date : 11/30/2021
 Page No : 2

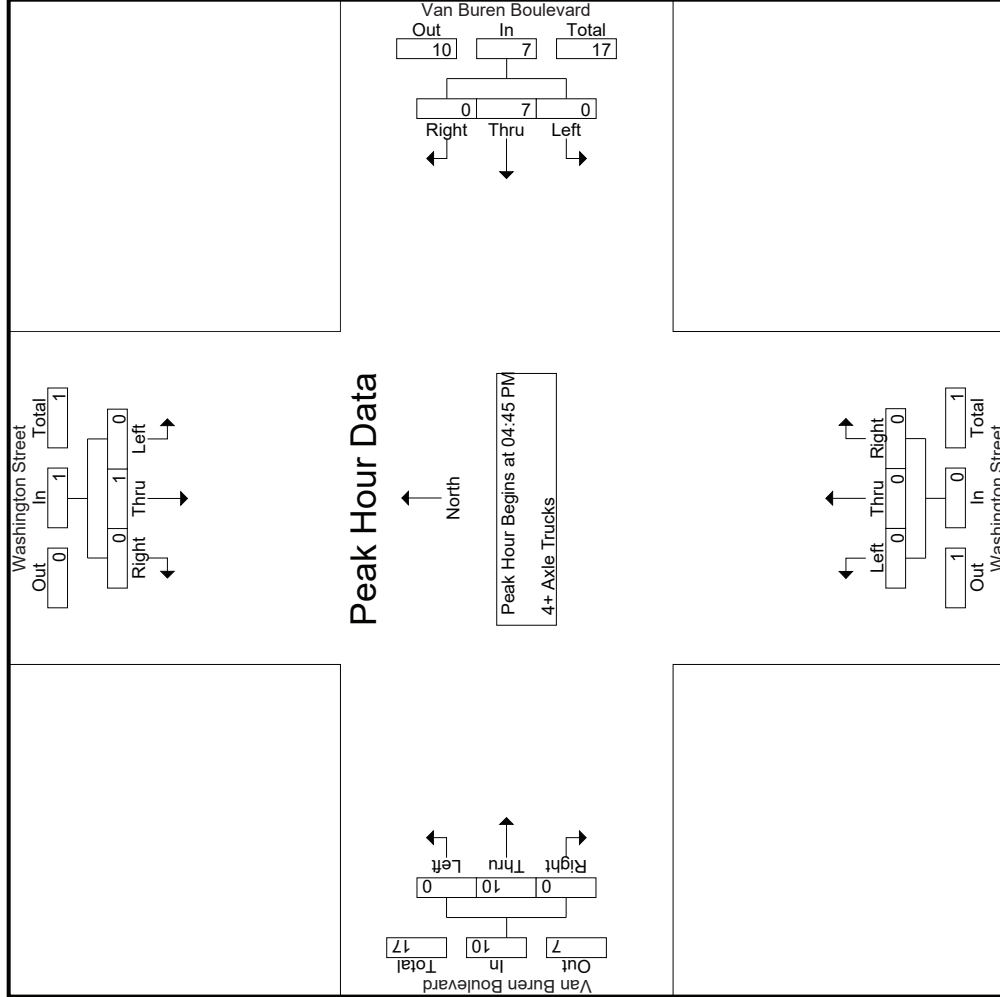

Counts Unlimited, Inc.
 PO Box 1178
 Corona, CA 92878
 (951)268-6268

County of Riverside
 N/S: Washington Street
 E/W: Van Buren Boulevard
 Weather: Clear

File Name : 01_CRV_Wash_VB PM
 Site Code : 05121716
 Start Date : 11/30/2021
 Page No : 3

Start Time	Washington Street Southbound			Van Buren Boulevard Westbound			Washington Street Northbound			Van Buren Boulevard Eastbound					
	Left	Thru	Right	Left	Thru	Right	Left	Thru	Right	Left	Thru	Right	App. Total	Int. Total	
Peak Hour Analysis From 04:45 PM to 05:30 PM - Peak 1 of 1															
Peak Hour for Each Approach Begins at:															
	04:45 PM			04:45 PM			04:45 PM			04:45 PM			04:45 PM		
+0 mins.	0	1	0	0	2	0	0	2	0	0	0	0	2	0	2
+15 mins.	0	0	0	0	4	0	0	4	0	0	0	0	2	0	2
+30 mins.	0	0	0	0	1	0	0	1	0	0	0	0	3	0	3
+45 mins.	0	0	0	0	0	0	0	0	0	0	0	0	3	0	3
Total Volume	0	1	0	0	7	0	0	7	0	0	0	0	10	0	10
% App. Total	0	100	0	0	100	0	0	100	0	0	0	0	100	0	100
PHF	.000	.250	.000	.000	.438	.000	.000	.438	.000	.000	.000	.000	.833	.000	.833

Location: County of Riverside
 N/S: Washington Street
 E/W: Van Buren Boulevard



Date: 11/30/2021
 Day: Tuesday

PEDESTRIANS

	North Leg Washington Street Pedestrians	East Leg Van Buren Boulevard Pedestrians	South Leg Washington Street Pedestrians	West Leg Van Buren Boulevard Pedestrians	
7:00 AM	2	1	0	0	3
7:15 AM	0	2	0	0	2
7:30 AM	4	0	0	1	5
7:45 AM	2	0	0	0	2
8:00 AM	1	1	0	0	2
8:15 AM	0	0	0	0	0
8:30 AM	0	0	0	0	0
8:45 AM	0	0	0	0	0
TOTAL VOLUMES:	9	4	0	1	14

	North Leg Washington Street Pedestrians	East Leg Van Buren Boulevard Pedestrians	South Leg Washington Street Pedestrians	West Leg Van Buren Boulevard Pedestrians	
4:00 PM	1	3	0	0	4
4:15 PM	0	1	0	0	1
4:30 PM	0	1	0	1	2
4:45 PM	3	1	0	2	6
5:00 PM	0	0	0	1	1
5:15 PM	0	0	0	0	0
5:30 PM	0	0	0	0	0
5:45 PM	0	0	0	0	0
TOTAL VOLUMES:	4	6	0	4	14

Location: County of Riverside
 N/S: Washington Street
 E/W: Van Buren Boulevard



Date: 11/30/2021
 Day: Tuesday

BICYCLES

	Southbound Washington Street			Westbound Van Buren Boulevard			Northbound Washington Street			Eastbound Van Buren Boulevard			
	Left	Thru	Right	Left	Thru	Right	Left	Thru	Right	Left	Thru	Right	
7:00 AM	0	0	0	0	0	0	0	0	0	0	0	0	0
7:15 AM	0	0	0	0	1	0	0	0	0	0	1	0	2
7:30 AM	0	0	0	0	0	0	0	0	0	0	0	0	0
7:45 AM	0	0	0	0	0	0	0	0	0	0	0	0	0
8:00 AM	0	0	0	0	0	0	0	0	0	0	0	0	0
8:15 AM	0	0	0	0	0	0	0	0	0	0	0	0	0
8:30 AM	0	0	0	0	0	0	0	0	0	0	0	0	0
8:45 AM	0	0	0	0	0	0	0	0	0	0	1	0	1
TOTAL VOLUMES:	0	0	0	0	1	0	0	0	0	0	2	0	3

	Southbound Washington Street			Westbound Van Buren Boulevard			Northbound Washington Street			Eastbound Van Buren Boulevard			
	Left	Thru	Right	Left	Thru	Right	Left	Thru	Right	Left	Thru	Right	
4:00 PM	0	0	0	0	0	0	0	0	0	0	1	0	1
4:15 PM	0	0	0	0	0	0	0	0	0	0	0	0	0
4:30 PM	1	0	0	0	0	1	0	0	0	0	0	0	2
4:45 PM	0	0	1	0	0	0	0	1	0	0	0	0	2
5:00 PM	0	0	0	0	0	0	0	0	0	0	0	0	0
5:15 PM	0	0	0	0	0	0	0	1	1	0	0	0	2
5:30 PM	0	0	0	0	0	0	0	0	0	0	0	0	0
5:45 PM	0	1	0	0	0	0	0	0	0	0	0	0	1
TOTAL VOLUMES:	1	1	1	0	0	1	0	2	1	0	1	0	8

Counts Unlimited, Inc.
 PO Box 1178
 Corona, CA 92878
 (951)268-6268

City of Riverside
 N/S: Alessandro Boulevard
 E/W: Arlington Avenue/Chicago Avenue
 Weather: Clear

File Name : 02_RIV_Ales_Chicago AM
 Site Code : 05121716
 Start Date : 11/30/2021
 Page No : 1

Groups Printed- Passenger Vehicles - Large 2 Axle Vehicles - 3 Axle Vehicles - 4+ Axle Trucks

Start Time	Alessandro Boulevard												Arlington Avenue											
	Southbound						Westbound						Northbound						Eastbound					
	Left	Thru	Right	RTOR	App. Total	Inclu. Total	Left	Thru	Right	RTOR	App. Total	Inclu. Total	Left	Thru	Right	RTOR	App. Total	Inclu. Total	Left	Thru	Right	RTOR	App. Total	Inclu. Total
07:00 AM	24	119	8	0	151	222	40	137	45	12	265	350	110	44	725	199	5	82	112	60	199	116	1297	1413
07:15 AM	43	122	11	2	176	285	31	202	52	7	276	327	78	37	681	224	2	90	132	53	224	99	1366	1465
07:30 AM	56	119	11	5	186	349	38	200	111	35	276	323	92	33	691	242	10	122	110	59	242	132	1468	1600
07:45 AM	69	150	6	2	225	266	46	153	67	23	228	298	102	45	628	296	18	125	153	70	296	140	1415	1555
Total	192	510	36	9	738	1122	155	692	275	77	1045	1298	382	159	2725	961	35	419	507	242	961	487	5546	6033
08:00 AM	49	126	13	4	188	195	35	109	51	17	165	286	121	27	572	291	18	134	139	70	291	118	1246	1364
08:15 AM	64	120	11	1	195	177	29	98	50	24	248	283	116	28	647	242	11	98	133	75	242	128	1261	1389
08:30 AM	47	98	10	2	155	207	31	129	47	19	240	271	84	28	595	225	8	91	126	73	225	122	1182	1304
08:45 AM	38	96	5	1	139	201	31	120	50	27	240	251	22	557	2371	966	13	80	115	79	208	129	1105	1234
Total	198	440	39	8	677	780	126	456	198	87	893	1091	387	105	2371	966	50	403	513	297	966	497	4794	5291
Grand Total	390	950	75	17	1415	1902	281	1148	473	164	1938	2389	769	264	5096	1927	85	822	1020	539	1927	984	10340	11324
% Approach	27.6	67.1	5.3			18.4	14.8	60.4	24.9		38	46.9	15.1			4.4	42.7	52.9						
% Total	3.8	9.2	0.7			13.7	2.7	11.1	4.6		18.4	23.1	7.4		49.3	0.8	7.9	9.9						8.7
Passenger Vehicles	383	926	74		1400	2034	263	1138	470		1911	2357	747		5275	84	800	1001						2414
% Passenger Vehicles	98.2	97.5	98.7	100	97.8	98.5	93.6	99.1	99.4	99.4	98.6	98.7	97.1	98.5	98.4	98.8	97.3	98.1	98.1	97.9				98.2
Large 2 Axle Vehicles	7	20	1		28	31	17	10	3	0.6	25	23	21		73	1	18	18						47
% Large 2 Axle Vehicles	1.8	2.1	1.3	0	2	1.5	6	0.9	0.6	0.6	1.3	1	2.7	1.5	1.4	1.2	2.2	1.8	1.9	1.9				1.6
3 Axle Vehicles	0	3	0		3	0	0	0	0	0	2	4	1		7	0	3	0						3
% 3 Axle Vehicles	0	0.3	0	0	0.2	0	0	0	0	0	0.1	0.2	0.1	0	0.1	0	0.4	0	0	0.1				0.1
4+ Axle Trucks	0	1	0		1	1	1	0	0	0	0	5	0		5	0	1	1						2
% 4+ Axle Trucks	0	0.1	0	0	0.1	0	0.4	0	0	0	0	0.2	0	0	0.1	0	0.1	0.1	0	0.1				0.1

Start Time	Alessandro Boulevard Southbound						Chicago Avenue Westbound						Alessandro Boulevard Northbound						Arlington Avenue Eastbound					
	Left	Thru	Right	RTOR	App. Total	Inclu. Total	Left	Thru	Right	RTOR	App. Total	Inclu. Total	Left	Thru	Right	RTOR	App. Total	Inclu. Total	Left	Thru	Right	RTOR	App. Total	Inclu. Total
	07:00 AM	24	119	8	0	151	222	40	137	45	12	265	350	110	44	725	199	5	82	112	60	199	116	1297
07:15 AM	43	122	11	2	176	285	31	202	52	7	276	327	78	37	681	224	2	90	132	53	224	99	1366	
07:30 AM	56	119	11	5	186	349	38	200	111	35	276	323	92	33	691	242	10	122	110	59	242	132	1468	
07:45 AM	69	150	6	2	225	266	46	153	67	23	228	298	102	45	628	296	18	125	153	70	296	140	1415	
Total Volume	192	510	36	9	738	1122	155	692	275	77	1045	1298	382	159	2725	961	35	419	507	242	961	487	5546	
% App. Total	26	69.1	4.9			13.8	61.7	24.5			38.3	47.6	14			3.6	43.6	52.8						8.12
PHF	.696	.850	.818			.820	.842	.856	.619		.804	.947	.927	.868	.940	.486	.838	.828						.944

Peak Hour Analysis From 07:00 AM to 08:45 AM - Peak 1 of 1
 Peak Hour for Entire Intersection Begins at 07:00 AM

Counts Unlimited, Inc.
 PO Box 1178
 Corona, CA 92878
 (951)268-6268

City of Riverside
 N/S: Alessandro Boulevard
 E/W: Arlington Avenue/Chicago Avenue
 Weather: Clear

File Name : 02_RIV_Ales_Chicago AM
 Site Code : 05121716
 Start Date : 11/30/2021
 Page No : 2

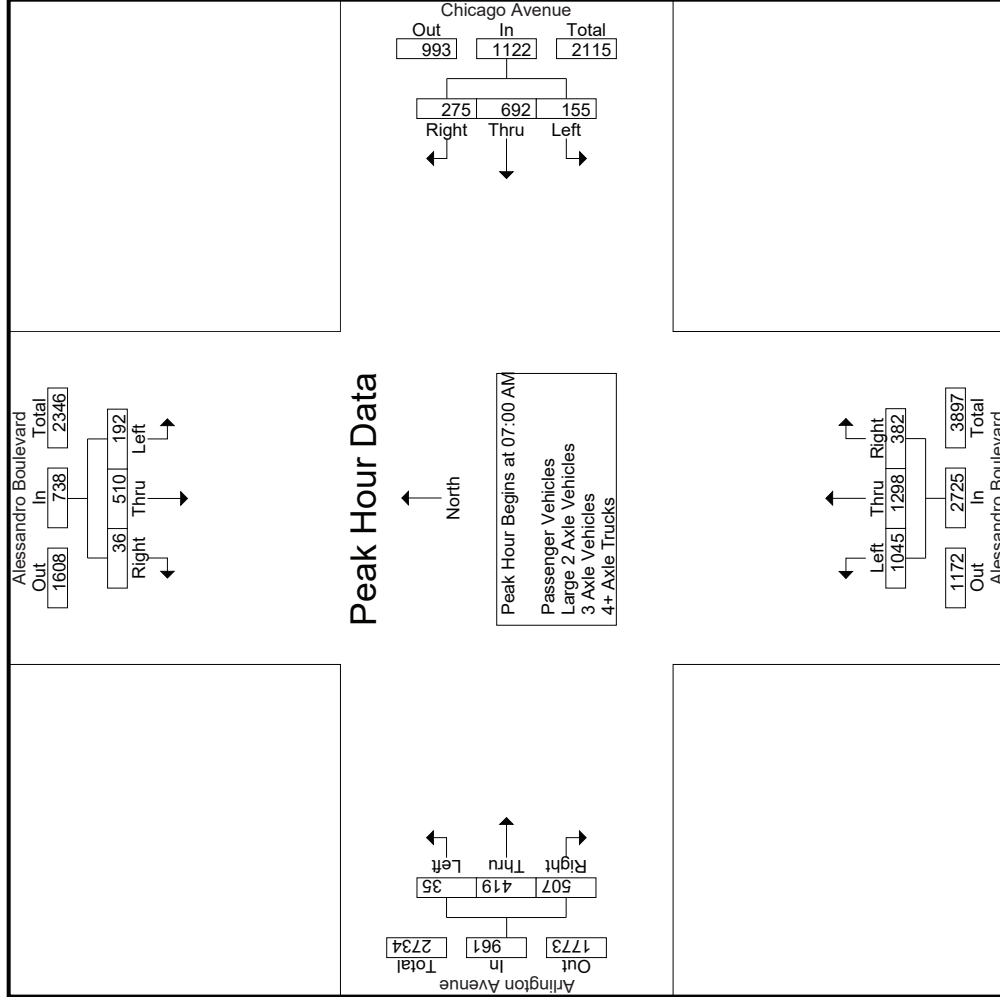

Counts Unlimited, Inc.
 PO Box 1178
 Corona, CA 92878
 (951)268-6268

City of Riverside
 N/S: Alessandro Boulevard
 E/W: Arlington Avenue/Chicago Avenue
 Weather: Clear

File Name : 02_RIV_Ales_Chicago AM
 Site Code : 05121716
 Start Date : 11/30/2021
 Page No : 3

Start Time	Alessandro Boulevard Southbound			Chicago Avenue Westbound			Alessandro Boulevard Northbound			Arlington Avenue Eastbound						
	Left	Thru	Right	App. Total	Left	Thru	Right	App. Total	Left	Thru	Right	App. Total	Int. Total			
Peak Hour Analysis From 07:00 AM to 08:45 AM - Peak 1 of 1	Peak Hour for Each Approach Begins at:															
	07:30 AM															
+0 mins.	56	119	11	186	40	137	45	222	265	350	110	725	10	122	110	242
+15 mins.	69	150	6	225	31	202	52	285	276	327	78	681	18	125	153	296
+30 mins.	49	126	13	188	38	200	111	349	276	323	92	691	18	134	139	291
+45 mins.	64	120	11	195	46	153	67	266	228	298	102	628	11	98	133	242
Total Volume	238	515	41	794	155	692	275	1122	1045	1298	382	2725	57	479	535	1071
% App. Total	30	64.9	5.2	13.8	61.7	24.5	24.5	38.3	47.6	14	14	27.25	5.3	44.7	50	107.1
PHF	.862	.858	.788	.882	.842	.856	.619	.804	.947	.927	.868	.940	.792	.894	.874	.905

Counts Unlimited, Inc.
 PO Box 1178
 Corona, CA 92878
 (951)268-6268

City of Riverside
 N/S: Alessandro Boulevard
 EW: Arlington Avenue/Chicago Avenue
 Weather: Clear

File Name : 02_RIV_Ales_Chicago AM
 Site Code : 05121716
 Start Date : 11/30/2021
 Page No : 1

Groups Printed- Passenger Vehicles

Start Time	Alessandro Boulevard Southbound					Chicago Avenue Westbound					Alessandro Boulevard Northbound					Arlington Avenue Eastbound							
	Left	Thru	Right	RTOR	App. Total	Left	Thru	Right	RTOR	App. Total	Left	Thru	Right	RTOR	App. Total	Left	Thru	Right	RTOR	App. Total	Exclu. Total	Inclu. Total	Int. Total
07:00 AM	23	115	8	0	146	34	136	45	12	215	263	350	110	44	723	5	78	111	60	194	116	1278	1394
07:15 AM	42	117	10	2	169	30	200	52	7	282	271	325	76	36	672	2	85	132	53	219	98	1342	1440
07:30 AM	54	116	11	5	181	36	199	109	34	344	272	319	90	31	681	10	121	108	59	239	129	1445	1574
07:45 AM	68	147	6	2	221	40	152	67	23	259	225	295	101	45	621	18	122	146	65	286	135	1387	1522
Total	187	495	35	9	717	140	687	273	76	1100	1031	1289	377	156	2697	35	406	497	237	938	478	5452	5930
08:00 AM	48	124	13	4	185	35	106	50	17	191	165	282	119	27	566	18	130	135	68	283	116	1225	1341
08:15 AM	64	118	11	1	193	28	98	50	24	176	243	275	108	28	626	11	94	132	75	237	128	1232	1360
08:30 AM	47	95	10	2	152	30	129	47	19	206	234	264	78	27	576	7	90	124	72	221	120	1155	1275
08:45 AM	37	94	5	1	136	30	118	50	27	198	238	247	65	22	550	13	80	113	77	206	127	1090	1217
Total	196	431	39	8	666	123	451	197	87	771	880	1068	370	104	2318	49	394	504	292	947	491	4702	5193
Grand Total	383	926	74	17	1383	263	1138	470	163	1871	1911	2357	747	260	5015	84	800	1001	529	1885	969	10154	11123
% Apprch %	27.7	67	5.4		13.6	14.1	60.8	25.1		18.4	38.1	47	14.9		49.4	4.5	42.4	53.1		18.6	8.7	91.3	
% Total %	3.8	9.1	0.7			2.6	11.2	4.6			18.8	23.2	7.4			0.8	7.9	9.9					

Start Time	Alessandro Boulevard Southbound					Chicago Avenue Westbound					Alessandro Boulevard Northbound					Arlington Avenue Eastbound							
	Left	Thru	Right	RTOR	App. Total	Left	Thru	Right	RTOR	App. Total	Left	Thru	Right	RTOR	App. Total	Left	Thru	Right	RTOR	App. Total	Exclu. Total	Inclu. Total	Int. Total
07:00 AM	23	115	8	0	146	34	136	45	12	215	263	350	110	44	723	5	78	111	60	194	116	1278	1394
07:15 AM	42	117	10	2	169	30	200	52	7	282	271	325	76	36	672	2	85	132	53	219	98	1342	1440
07:30 AM	54	116	11	5	181	36	199	109	34	344	272	319	90	31	681	10	121	108	59	239	129	1445	1574
07:45 AM	68	147	6	2	221	40	152	67	23	259	225	295	101	45	621	18	122	146	65	286	135	1387	1522
Total	187	495	35	9	717	140	687	273	76	1100	1031	1289	377	156	2697	35	406	497	237	938	478	5452	5930
08:00 AM	48	124	13	4	185	35	106	50	17	191	165	282	119	27	566	18	130	135	68	283	116	1225	1341
08:15 AM	64	118	11	1	193	28	98	50	24	176	243	275	108	28	626	11	94	132	75	237	128	1232	1360
08:30 AM	47	95	10	2	152	30	129	47	19	206	234	264	78	27	576	7	90	124	72	221	120	1155	1275
08:45 AM	37	94	5	1	136	30	118	50	27	198	238	247	65	22	550	13	80	113	77	206	127	1090	1217
Total	196	431	39	8	666	123	451	197	87	771	880	1068	370	104	2318	49	394	504	292	947	491	4702	5193
Grand Total	383	926	74	17	1383	263	1138	470	163	1871	1911	2357	747	260	5015	84	800	1001	529	1885	969	10154	11123
% Apprch %	27.7	67	5.4		13.6	14.1	60.8	25.1		18.4	38.1	47	14.9		49.4	4.5	42.4	53.1		18.6	8.7	91.3	
% Total %	3.8	9.1	0.7			2.6	11.2	4.6			18.8	23.2	7.4			0.8	7.9	9.9					

Peak Hour Analysis From 07:00 AM to 07:45 AM - Peak 1 of 1
 Peak Hour for Entire Intersection Begins at 07:00 AM

Start Time	Left	Thru	Right	RTOR	App. Total	Left	Thru	Right	RTOR	App. Total	Left	Thru	Right	RTOR	App. Total	Left	Thru	Right	RTOR	App. Total	Exclu. Total	Inclu. Total	Int. Total
07:00 AM	23	115	8	0	146	34	136	45	12	215	263	350	110	44	723	5	78	111	60	194	116	1278	1394
07:15 AM	42	117	10	2	169	30	200	52	7	282	271	325	76	36	672	2	85	132	53	219	98	1342	1440
07:30 AM	54	116	11	5	181	36	199	109	34	344	272	319	90	31	681	10	121	108	59	239	129	1445	1574
07:45 AM	68	147	6	2	221	40	152	67	23	259	225	295	101	45	621	18	122	146	65	286	135	1387	1522
Total Volume	187	495	35	9	717	140	687	273	76	1100	1031	1289	377	156	2697	35	406	497	237	938	478	5452	5930
% App. Total	26.1	69	4.9		13.6	12.7	62.5	24.8		18.4	38.2	47.8	14		49.4	4.5	42.4	53.1		18.6	8.7	91.3	
PHF	.688	.842	.795		.811	.875	.859	.626		.799	.948	.921	.857		.933	.486	.832	.851		.820		.820	.943

Counts Unlimited, Inc.
 PO Box 1178
 Corona, CA 92878
 (951)268-6268

City of Riverside
 N/S: Alessandro Boulevard
 E/W: Arlington Avenue/Chicago Avenue
 Weather: Clear

File Name : 02_RIV_Ales_Chicago AM
 Site Code : 05121716
 Start Date : 11/30/2021
 Page No : 2

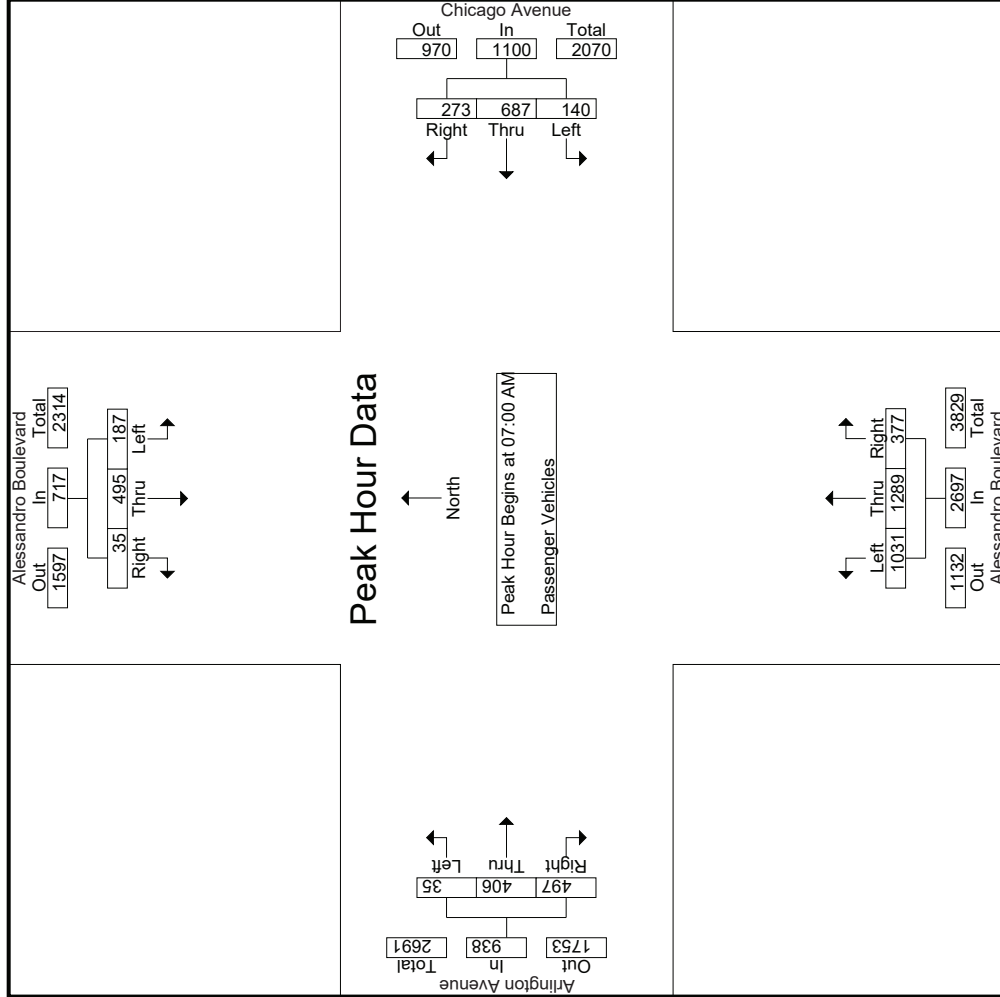

Counts Unlimited, Inc.
 PO Box 1178
 Corona, CA 92878
 (951)268-6268

City of Riverside
 N/S: Alessandro Boulevard
 E/W: Arlington Avenue/Chicago Avenue
 Weather: Clear

File Name : 02_RIV_Ales_Chicago AM
 Site Code : 05121716
 Start Date : 11/30/2021
 Page No : 3

Start Time	Alessandro Boulevard Southbound			Chicago Avenue Westbound			Alessandro Boulevard Northbound			Arlington Avenue Eastbound						
	Left	Thru	Right	App. Total	Left	Thru	Right	App. Total	Left	Thru	Right	App. Total	Int. Total			
Peak Hour Analysis From 07:00 AM to 07:45 AM - Peak 1 of 1	07:00 AM															
Peak Hour for Each Approach Begins at:	07:00 AM															
+0 mins.	23	115	8	146	34	136	45	215	263	350	110	723	5	78	111	194
+15 mins.	42	117	10	169	30	200	52	282	271	325	76	672	2	85	132	219
+30 mins.	54	116	11	181	36	199	109	344	272	319	90	681	10	121	108	239
+45 mins.	68	147	6	221	40	152	67	259	225	295	101	621	18	122	146	286
Total Volume	187	495	35	717	140	687	273	1100	1031	1289	377	2697	35	406	497	938
% App. Total	26.1	69	4.9	12.7	62.5	24.8	24.8	38.2	47.8	14	14	38.2	3.7	43.3	53	53
PHF	.688	.842	.795	.811	.875	.859	.626	.799	.948	.921	.857	.933	.486	.832	.851	.820

Counts Unlimited, Inc.
 PO Box 1178
 Corona, CA 92878
 (951)268-6268

City of Riverside
 N/S: Alessandro Boulevard
 EW: Arlington Avenue/Chicago Avenue
 Weather: Clear

File Name : 02_RIV_Ales_Chicago AM
 Site Code : 05121716
 Start Date : 11/30/2021
 Page No : 1

Groups Printed- Large 2 Axle Vehicles

Start Time	Alessandro Boulevard Southbound				Chicago Avenue Westbound				Alessandro Boulevard Northbound				Arlington Avenue Eastbound								
	Left	Thru	Right	RTOR	Left	Thru	Right	RTOR	Left	Thru	Right	RTOR	Left	Thru	Right	RTOR	App. Total	Exclu. Total	Inclu. Total	Int. Total	
07:00 AM	1	4	0	0	5	6	1	0	0	7	2	0	0	2	0	3	1	0	4	0	18
07:15 AM	1	3	1	0	5	1	2	0	0	3	5	2	2	1	9	0	3	0	0	3	20
07:30 AM	2	3	0	0	5	2	1	2	1	5	4	3	2	2	9	0	1	2	0	3	22
07:45 AM	1	3	0	0	4	5	1	0	0	6	3	1	1	0	5	0	3	7	5	10	25
Total	5	13	1	0	19	14	5	2	1	21	14	6	5	3	25	0	10	10	5	20	85
08:00 AM	1	2	0	0	3	0	3	1	0	4	0	3	1	0	4	0	3	4	2	7	18
08:15 AM	0	2	0	0	2	1	0	0	0	1	4	7	8	0	19	0	4	0	4	0	26
08:30 AM	0	1	0	0	1	1	0	0	0	1	6	5	6	1	17	1	1	2	1	4	23
08:45 AM	1	2	0	0	3	1	2	0	0	3	1	2	1	0	4	0	0	2	2	2	25
Total	2	7	0	0	9	3	5	1	0	9	11	17	16	1	44	1	8	8	5	17	85
Grand Total	7	20	1	0	28	17	10	3	1	30	25	23	21	4	69	1	18	18	10	37	179
% Apprch %	25	71.4	3.6		56.7	33.3	6.1	1.8		18.3	36.2	33.3	30.4		42.1	2.7	48.6	48.6		22.6	
% Total %	4.3	12.2	0.6		17.1	10.4	6.1	1.8		18.3	15.2	14	12.8		42.1	0.6	11	11		8.4	91.6

Start Time	Alessandro Boulevard Southbound				Chicago Avenue Westbound				Alessandro Boulevard Northbound				Arlington Avenue Eastbound								
	Left	Thru	Right	RTOR	Left	Thru	Right	RTOR	Left	Thru	Right	RTOR	Left	Thru	Right	RTOR	App. Total	Exclu. Total	Inclu. Total	Int. Total	
07:00 AM	1	4	0	0	5	6	1	0	0	7	2	0	0	2	0	3	1	0	4	0	18
07:15 AM	1	3	1	0	5	1	2	0	0	3	5	2	2	1	9	0	3	0	0	3	20
07:30 AM	2	3	0	0	5	2	1	2	1	5	4	3	2	2	9	0	1	2	0	3	22
07:45 AM	1	3	0	0	4	5	1	0	0	6	3	1	1	0	5	0	3	7	5	10	25
Total	5	13	1	0	19	14	5	2	1	21	14	6	5	3	25	0	10	10	5	20	85
08:00 AM	1	2	0	0	3	0	3	1	0	4	0	3	1	0	4	0	3	4	2	7	18
08:15 AM	0	2	0	0	2	1	0	0	0	1	4	7	8	0	19	0	4	0	4	0	26
08:30 AM	0	1	0	0	1	1	0	0	0	1	6	5	6	1	17	1	1	2	1	4	23
08:45 AM	1	2	0	0	3	1	2	0	0	3	1	2	1	0	4	0	0	2	2	2	25
Total	2	7	0	0	9	3	5	1	0	9	11	17	16	1	44	1	8	8	5	17	85
Grand Total	7	20	1	0	28	17	10	3	1	30	25	23	21	4	69	1	18	18	10	37	179
% Apprch %	25	71.4	3.6		56.7	33.3	6.1	1.8		18.3	36.2	33.3	30.4		42.1	2.7	48.6	48.6		22.6	
% Total %	4.3	12.2	0.6		17.1	10.4	6.1	1.8		18.3	15.2	14	12.8		42.1	0.6	11	11		8.4	91.6

Peak Hour Analysis From 07:00 AM to 07:45 AM - Peak 1 of 1
 Peak Hour for Entire Intersection Begins at 07:00 AM

Start Time	Left	Thru	Right	RTOR	App. Total	Exclu. Total	Inclu. Total	Int. Total
07:00 AM	1	4	0	0	5	0	5	18
07:15 AM	1	3	1	0	5	0	5	20
07:30 AM	2	3	0	0	5	0	5	22
07:45 AM	1	3	0	0	4	0	4	25
Total Volume	5	13	1	0	19	0	19	85
% App. Total	26.3	68.4	5.3		66.7	23.8	9.5	
PHF	.625	.813	.250		.950	.750	.625	.850

Counts Unlimited, Inc.
 PO Box 1178
 Corona, CA 92878
 (951)268-6268

City of Riverside
 N/S: Alessandro Boulevard
 E/W: Arlington Avenue/Chicago Avenue
 Weather: Clear

File Name : 02_RIV_Ales_Chicago AM
 Site Code : 05121716
 Start Date : 11/30/2021
 Page No : 2

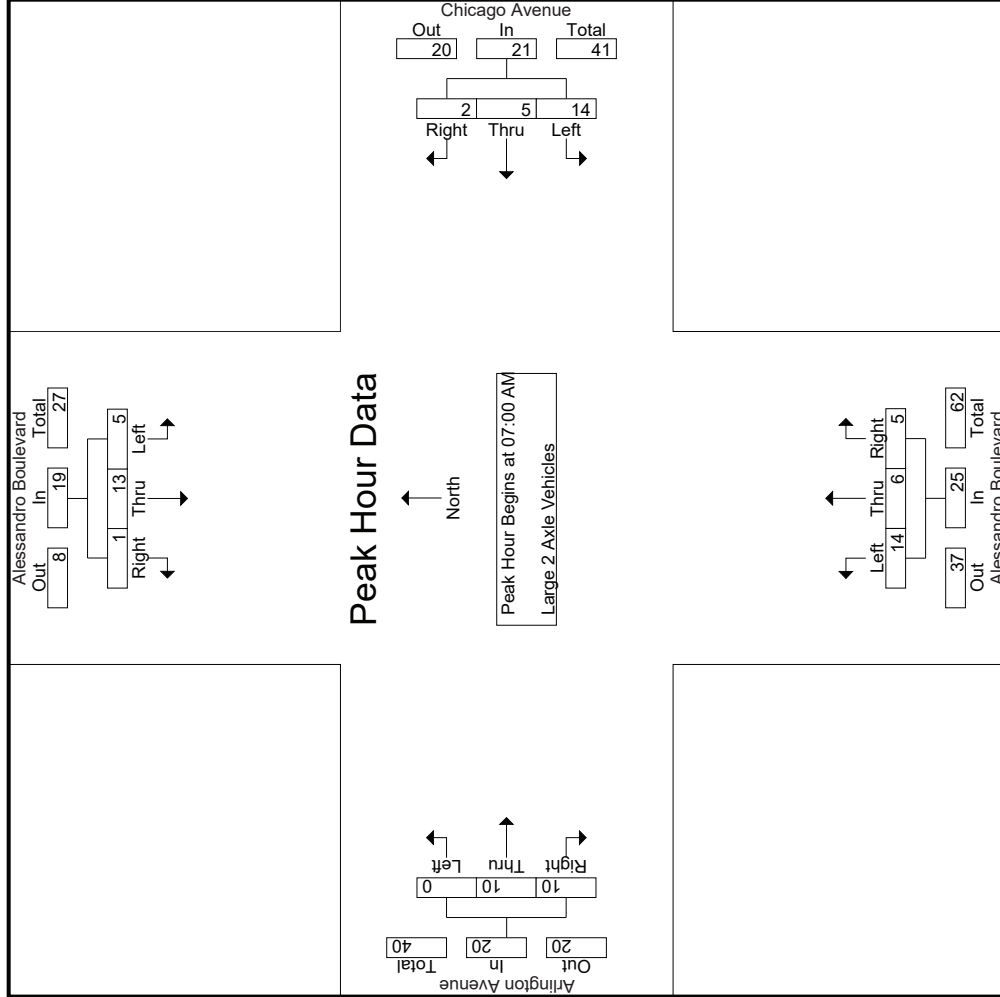

Counts Unlimited, Inc.
 PO Box 1178
 Corona, CA 92878
 (951)268-6268

City of Riverside
 N/S: Alessandro Boulevard
 EW: Arlington Avenue/Chicago Avenue
 Weather: Clear

File Name : 02_RIV_Ales_Chicago AM
 Site Code : 05121716
 Start Date : 11/30/2021
 Page No : 3

Start Time	Alessandro Boulevard Southbound			Chicago Avenue Westbound			Alessandro Boulevard Northbound			Arlington Avenue Eastbound				
	Left	Thru	Right	App. Total	Left	Thru	Right	App. Total	Left	Thru	Right	App. Total	Int. Total	
Peak Hour Analysis From 07:00 AM to 07:45 AM - Peak 1 of 1	Peak Hour for Each Approach Begins at:													
	07:00 AM													
+0 mins.	1	4	0	5	6	1	0	7	2	0	0	2	0	4
+15 mins.	1	3	1	5	1	2	0	3	5	2	2	9	0	3
+30 mins.	2	3	0	5	2	1	2	5	4	3	0	9	0	3
+45 mins.	1	3	0	4	5	1	0	6	3	1	1	5	0	10
Total Volume	5	13	1	19	14	5	2	21	14	6	5	25	0	20
% App. Total	26.3	68.4	5.3		66.7	23.8	9.5		56	24	20	69.4	0	50
PHF	.625	.813	.250	.950	.583	.625	.250	.750	.700	.500	.625	.694	.000	.357
													.833	.500

Counts Unlimited, Inc.
 PO Box 1178
 Corona, CA 92878
 (951)268-6268

City of Riverside
 N/S: Alessandro Boulevard
 E/W: Arlington Avenue/Chicago Avenue
 Weather: Clear

File Name : 02_RIV_Ales_Chicago AM
 Site Code : 05121716
 Start Date : 11/30/2021
 Page No : 1

Groups Printed- 3 Axle Vehicles

Start Time	Alessandro Boulevard Southbound				Chicago Avenue Westbound				Alessandro Boulevard Northbound				Arlington Avenue Eastbound							
	Left	Thru	Right	RTOR	Left	Thru	Right	RTOR	Left	Thru	Right	RTOR	Left	Thru	Right	RTOR	App. Total	Exclu. Total	Inclu. Total	Int. Total
07:00 AM	0	0	0	0	0	0	0	0	0	0	0	0	0	1	0	0	1	0	1	1
07:15 AM	0	1	0	0	0	0	0	0	0	0	0	0	0	0	1	0	1	0	2	2
07:30 AM	0	0	0	0	0	0	0	0	0	0	0	0	0	0	0	0	0	0	0	0
07:45 AM	0	0	0	0	0	0	0	0	0	1	0	0	1	0	0	0	0	0	1	1
Total	0	1	0	0	0	0	0	0	0	1	0	0	1	0	2	0	2	0	4	4
08:00 AM	0	0	0	0	0	0	0	0	0	0	1	0	1	0	0	0	1	0	2	2
08:15 AM	0	0	0	0	0	1	1	0	0	2	0	0	2	0	0	0	0	0	2	2
08:30 AM	0	2	0	0	0	0	2	0	0	2	0	0	2	0	0	0	0	0	4	4
08:45 AM	0	0	0	0	0	0	0	0	1	0	0	0	1	0	0	0	0	0	1	1
Total	0	2	0	0	0	2	3	1	0	6	0	0	6	0	1	0	1	0	9	9
Grand Total	0	3	0	0	0	0	0	0	2	4	1	0	7	0	3	0	3	0	13	13
% Apprch %	0	100	0	0	0	0	0	0	28.6	57.1	14.3	0	53.8	0	100	0	23.1	0	100	100
Total %	0	23.1	0	0	0	23.1	0	0	15.4	30.8	7.7	0	53.8	0	23.1	0	23.1	0	100	100

Start Time	Alessandro Boulevard Southbound				Chicago Avenue Westbound				Alessandro Boulevard Northbound				Arlington Avenue Eastbound							
	Left	Thru	Right	RTOR	Left	Thru	Right	RTOR	Left	Thru	Right	RTOR	Left	Thru	Right	RTOR	App. Total	Exclu. Total	Inclu. Total	Int. Total
07:00 AM	0	0	0	0	0	0	0	0	0	0	0	0	0	0	0	0	0	0	0	0
07:15 AM	0	1	0	0	0	0	0	0	0	0	0	0	0	0	0	0	0	0	1	1
07:30 AM	0	0	0	0	0	0	0	0	0	0	0	0	0	0	0	0	0	0	0	0
07:45 AM	0	0	0	0	0	0	0	0	0	0	0	0	1	0	0	0	1	0	0	0
Total Volume	0	1	0	0	0	0	0	0	0	0	1	0	1	0	0	0	2	0	2	4
% App. Total	0	100	0	0	0	0	0	0	0	0	100	0	100	0	0	0	100	0	100	100
PHF	.000	.250	.000	.250	.000	.000	.000	.000	.000	.000	.250	.000	.250	.000	.500	.000	.250	.000	.500	.500

Peak Hour Analysis From 07:00 AM to 07:45 AM - Peak 1 of 1
 Peak Hour for Entire Intersection Begins at 07:00 AM

Counts Unlimited, Inc.
 PO Box 1178
 Corona, CA 92878
 (951)268-6268

City of Riverside
 N/S: Alessandro Boulevard
 E/W: Arlington Avenue/Chicago Avenue
 Weather: Clear

File Name : 02_RIV_Ales_Chicago AM
 Site Code : 05121716
 Start Date : 11/30/2021
 Page No : 2

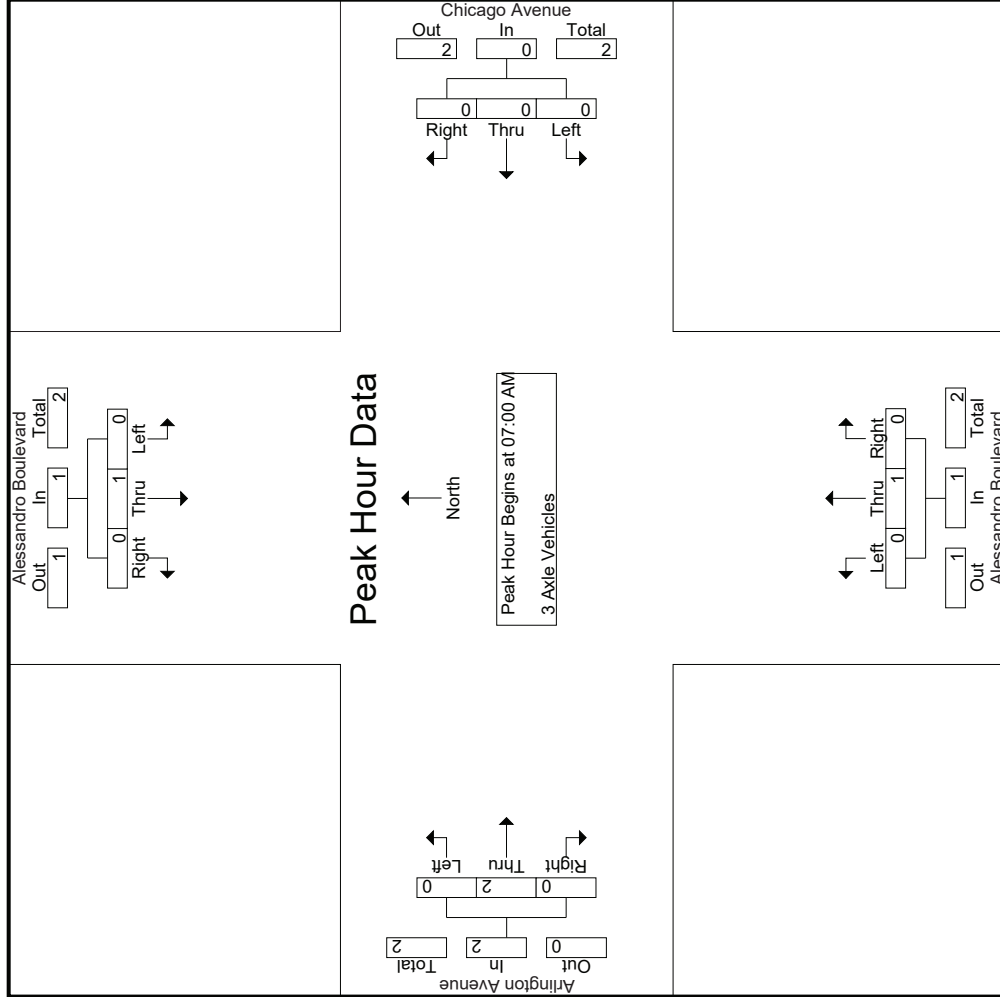

Counts Unlimited, Inc.
 PO Box 1178
 Corona, CA 92878
 (951)268-6268

City of Riverside
 N/S: Alessandro Boulevard
 E/W: Arlington Avenue/Chicago Avenue
 Weather: Clear

File Name : 02_RIV_Ales_Chicago AM
 Site Code : 05121716
 Start Date : 11/30/2021
 Page No : 3

Start Time	Alessandro Boulevard Southbound			Chicago Avenue Westbound			Alessandro Boulevard Northbound			Arlington Avenue Eastbound							
	Left	Thru	Right	App. Total	Left	Thru	Right	App. Total	Left	Thru	Right	App. Total	Int. Total				
Peak Hour Analysis From 07:00 AM to 07:45 AM - Peak 1 of 1																	
Peak Hour for Each Approach Begins at:																	
	07:00 AM																
+0 mins.	0	0	0	0	0	0	0	0	0	0	0	0	0	1	0	0	1
+15 mins.	0	1	0	1	0	0	0	0	0	0	0	0	0	1	0	0	1
+30 mins.	0	0	0	0	0	0	0	0	0	0	0	0	0	0	0	0	0
+45 mins.	0	0	0	0	0	0	0	0	0	1	0	1	0	0	0	0	
Total Volume	0	1	0	1	0	0	0	0	0	1	0	1	0	2	0	2	
% App. Total	0	100	0	0	0	0	0	0	0	100	0	0	0	100	0	0	
PHF	.000	.250	.000	.250	.000	.000	.000	.000	.000	.250	.000	.250	.000	.500	.000	.500	

Counts Unlimited, Inc.
 PO Box 1178
 Corona, CA 92878
 (951)268-6268

City of Riverside
 N/S: Alessandro Boulevard
 E/W: Arlington Avenue/Chicago Avenue
 Weather: Clear

File Name : 02_RIV_Ales_Chicago AM
 Site Code : 05121716
 Start Date : 11/30/2021
 Page No : 1

Groups Printed- 4+ Axle Trucks

Start Time	Alessandro Boulevard Southbound				Chicago Avenue Westbound				Alessandro Boulevard Northbound				Arlington Avenue Eastbound							
	Left	Thru	Right	RTOR	Left	Thru	Right	RTOR	Left	Thru	Right	RTOR	Left	Thru	Right	RTOR	App. Total	Exclu. Total	Inclu. Total	Int. Total
07:00 AM	0	0	0	0	0	0	0	0	0	0	0	0	0	0	0	0	0	0	0	0
07:15 AM	0	1	0	0	0	0	0	0	0	0	0	0	0	1	0	0	1	0	2	2
07:30 AM	0	0	0	0	0	0	0	0	0	1	0	0	0	0	0	0	0	0	1	1
07:45 AM	0	0	0	0	1	0	0	0	1	0	0	0	0	0	0	0	0	0	2	2
Total	0	1	0	0	1	0	0	0	2	0	0	0	0	1	0	0	1	0	5	5
08:00 AM	0	0	0	0	0	0	0	0	0	1	0	0	0	0	0	0	0	0	1	1
08:15 AM	0	0	0	0	0	0	0	0	0	0	0	0	0	0	1	0	1	0	1	1
08:30 AM	0	0	0	0	0	0	0	0	0	0	0	0	0	0	0	0	0	0	0	0
08:45 AM	0	0	0	0	0	0	0	0	2	0	0	0	2	0	0	0	2	0	2	2
Total	0	0	0	0	0	0	0	0	3	0	0	0	3	0	0	1	0	0	4	4
Grand Total	0	1	0	0	1	0	0	0	5	0	0	0	5	0	1	1	0	0	9	9
% Apprch %	0	100	0	0	0	0	0	0	100	0	0	0	55.6	0	50	50	22.2	0	100	100
Total %	0	11.1	0	0	11.1	0	0	0	55.6	0	0	0	11.1	0	11.1	11.1	22.2	0	100	100

Start Time	Alessandro Boulevard Southbound				Chicago Avenue Westbound				Alessandro Boulevard Northbound				Arlington Avenue Eastbound							
	Left	Thru	Right	RTOR	Left	Thru	Right	RTOR	Left	Thru	Right	RTOR	Left	Thru	Right	RTOR	App. Total	Exclu. Total	Inclu. Total	Int. Total
07:00 AM	0	0	0	0	0	0	0	0	0	0	0	0	0	0	0	0	0	0	0	0
07:15 AM	0	1	0	0	0	0	0	0	0	0	0	0	0	0	0	0	0	0	1	2
07:30 AM	0	0	0	0	0	0	0	0	0	0	0	0	0	0	0	0	0	0	0	0
07:45 AM	0	0	0	0	1	0	0	0	1	0	0	0	0	0	0	0	0	0	2	2
Total Volume	0	1	0	0	1	0	0	0	2	0	0	0	2	0	0	0	1	0	5	5
% App. Total	0	100	0	0	100	0	0	0	100	0	0	0	100	0	100	0	0	0	100	100
PHF	.000	.250	.000	.000	.250	.000	.000	.000	.500	.000	.000	.000	.500	.000	.250	.000	.250	.000	.625	.625

Peak Hour Analysis From 07:00 AM to 07:45 AM - Peak 1 of 1
 Peak Hour for Entire Intersection Begins at 07:00 AM

Counts Unlimited, Inc.
 PO Box 1178
 Corona, CA 92878
 (951)268-6268

City of Riverside
 N/S: Alessandro Boulevard
 E/W: Arlington Avenue/Chicago Avenue
 Weather: Clear

File Name : 02_RIV_Ales_Chicago AM
 Site Code : 05121716
 Start Date : 11/30/2021
 Page No : 2

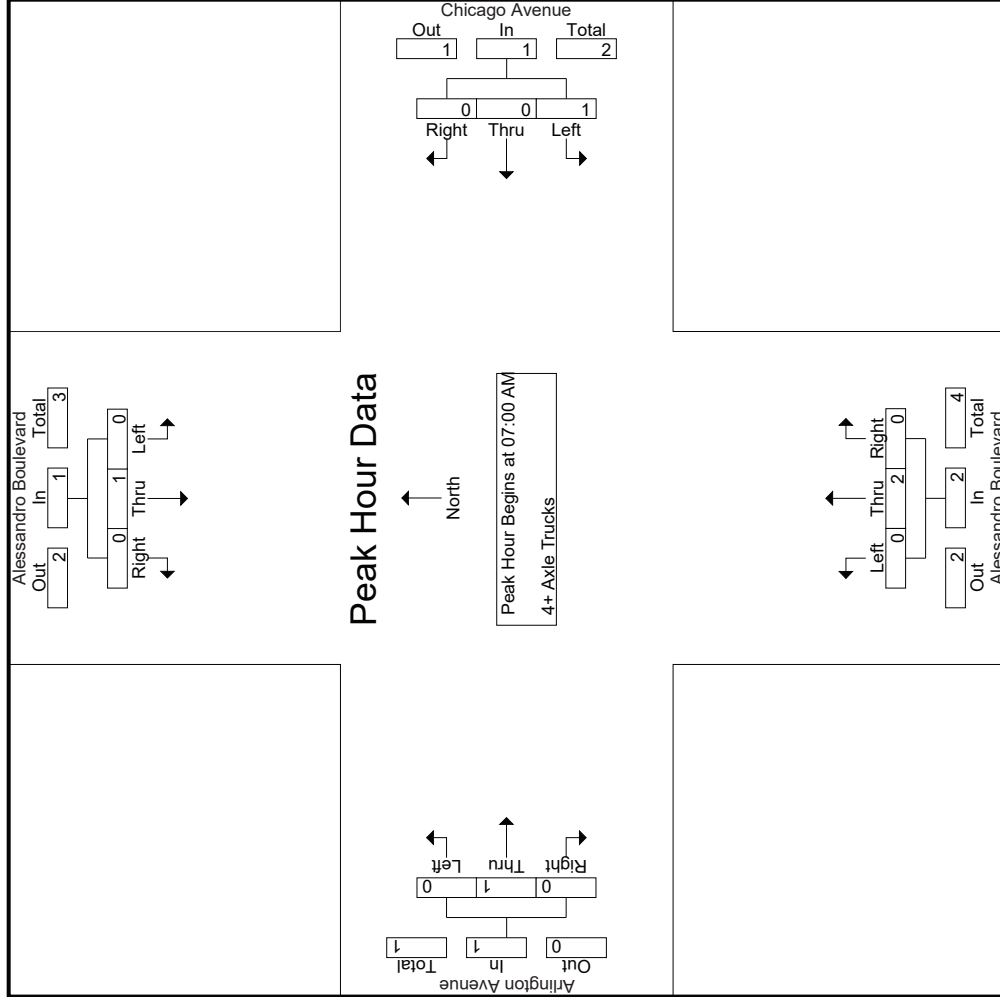

Counts Unlimited, Inc.
 PO Box 1178
 Corona, CA 92878
 (951)268-6268

City of Riverside
 N/S: Alessandro Boulevard
 E/W: Arlington Avenue/Chicago Avenue
 Weather: Clear

File Name : 02_RIV_Ales_Chicago AM
 Site Code : 05121716
 Start Date : 11/30/2021
 Page No : 3

Start Time	Alessandro Boulevard Southbound			Chicago Avenue Westbound			Alessandro Boulevard Northbound			Arlington Avenue Eastbound				
	Left	Thru	Right	App. Total	Left	Thru	Right	App. Total	Left	Thru	Right	App. Total	Int. Total	
Peak Hour Analysis From 07:00 AM to 07:45 AM - Peak 1 of 1														
Peak Hour for Each Approach Begins at:														
	07:00 AM													
+0 mins.	0	0	0	0	0	0	0	0	0	0	0	0	0	0
+15 mins.	0	1	0	1	0	0	0	0	0	0	0	1	0	1
+30 mins.	0	0	0	0	0	0	0	0	1	0	0	0	0	0
+45 mins.	0	0	0	0	1	0	0	1	0	1	0	0	0	0
Total Volume	0	1	0	1	1	0	0	1	2	0	0	1	0	1
% App. Total	0	100	0	0	100	0	0	0	100	0	0	100	0	0
PHF	.000	.250	.000	.250	.250	.000	.000	.250	.500	.000	.000	.250	.000	.250

Start Time	Alessandro Boulevard Southbound												Chicago Avenue Westbound												Alessandro Boulevard Northbound												Arlington Avenue Eastbound																													
	Left			Thru			Right			RTOR			App. Total			Left			Thru			Right			RTOR			App. Total			Left			Thru			Right			RTOR			App. Total			Exclu. Total			Inclu. Total			Int. Total														
	114			324			4			3			442			88			131			51			25			270			208			221			60			18			489			193			234			80			430			126			1631			1757		
	114			324			4			3			442			88			131			51			25			270			208			221			60			18			489			193			234			80			430			126			1631			1757		
04:00 PM	114	324	4	3	0	442	88	131	51	25	270	208	221	60	18	489	3	193	234	80	430	126	1631	1757	118	1672	1790	109	1670	1779	126	1640	1766	479	6613	7092																														
04:15 PM	87	418	7	0	512	104	140	50	21	294	164	275	67	17	506	4	143	213	80	360	118	1672	1790	4	143	213	80	360	118	109	1670	1779	126	1640	1766	479	6613	7092																												
04:30 PM	101	368	2	0	471	82	111	49	16	242	211	274	59	20	544	0	192	221	73	413	109	1670	1779	0	192	221	73	413	109	109	1670	1779	126	1640	1766	479	6613	7092																												
04:45 PM	89	448	4	2	541	92	118	57	28	267	162	237	53	12	452	8	151	221	84	380	126	1640	1766	8	151	221	84	380	126	109	1670	1779	126	1640	1766	479	6613	7092																												
Total	391	1558	17	5	1966	366	500	207	90	1073	745	1007	239	67	1991	15	679	889	317	1583	479	6613	7092	11	170	238	85	419	118	118	1679	1797	117	1719	1836	182	1787	1969	115	1667	1782	532	6852	7384																						
05:00 PM	129	322	6	1	457	105	160	50	14	315	200	231	57	18	488	11	170	238	85	419	118	1679	1797	2	165	219	83	386	117	1719	1836	182	1787	1969	115	1667	1782	532	6852	7384																										
05:15 PM	99	427	5	0	531	130	143	46	17	319	167	268	48	17	483	2	194	292	138	488	118	1672	1790	2	194	292	138	488	118	109	1670	1779	126	1640	1766	479	6613	7092																												
05:30 PM	130	353	4	1	487	114	158	47	25	319	214	223	56	18	493	8	156	221	75	359	109	1670	1779	0	192	221	73	413	109	109	1670	1779	126	1640	1766	479	6613	7092																												
05:45 PM	98	420	4	0	522	145	154	54	28	353	153	228	52	12	433	8	156	195	75	359	115	1667	1782	8	156	195	75	359	115	109	1670	1779	126	1640	1766	479	6613	7092																												
Total	456	1522	19	2	1997	494	615	197	84	1306	734	950	213	65	1897	23	685	944	381	1652	532	6852	7384	38	1364	1833	698	3235	1011	1011	13465	14476	7	93	0	0	0	0	0																											
Grand Total	847	3080	36	7	3963	860	1115	404	174	2379	1479	1957	452	132	3888	38	1364	1833	698	3235	1011	13465	14476	1.2	42.2	56.7	0.3	10.1	13.6	24	24	0	0	0	0	0																														
→ Approach %	21.4	77.7	0.9			36.1	46.9	17			38	50.3	11.6			1.2	42.2	56.7						0.3	10.1	13.6																																								
→ Total %	6.3	22.9	0.3			6.4	8.3	3			11	14.5	3.4			0.3	10.1	13.6						0.3	10.1	13.6																																								
Passenger Vehicles	843	3055	36			839	1106	402			1462	1921	438			38	1358	1819						38	1358	1819																																								
% Passenger Vehicles	99.5	99.2	100			97.6	99.2	99.5			98.9	98.2	96.9			100	99.6	99.2						100	99.6	99.2																																								
Large 2 Axle Vehicles	4	21	0			18	8	2			15	29	14			0	6	14						0	6	14																																								
% Large 2 Axle Vehicles	0.5	0.7	0			2.1	0.7	0.5			1.1	1.5	3.1			0	0.4	0.8						0	0.4	0.8																																								
3 Axle Vehicles	0	3	0			1	1	0			2	0	0			0	0	0						0	0	0																																								
% 3 Axle Vehicles	0	0.1	0			0.1	0.1	0			0	0.1	0			0	0	0						0	0	0																																								
4+ Axle Trucks	0	1	0			2	0	0			2	5	0			0	0	0						0	0	0																																								
% 4+ Axle Trucks	0	0	0			0.2	0	0			0.1	0.3	0			0	0	0						0	0	0																																								

Start Time	Alessandro Boulevard Southbound				Chicago Avenue Westbound				Alessandro Boulevard Northbound				Arlington Avenue Eastbound						
	Left	Thru	Right	App. Total	Left	Thru	Right	App. Total	Left	Thru	Right	App. Total	Left	Thru	Right	App. Total	Int. Total		
Peak Hour Analysis From 04:00 PM to 05:45 PM - Peak 1 of 1	129	322	6	457	105	160	50	315	200	231	57	488	38	1364	1833	3235			
05:00 PM	99	427	5	531	130	143	46	319	167	268	48	483	1.2	42.2	56.7	1011	13465		
05:15 PM	99	427	5	531	130	143	46	319	167	268	48	483	1.2	42.2	56.7	1011	13465		
05:30 PM	130	353	4	487	114	158	47	319	214	223	56	493	0.3	10.1	13.6	7	93		
05:45 PM	98	420	4	522	145	154	54	353	153	228	52	433	38	1358	1819	3908	0	0	14320
Total Volume	456	1522	19	1997	494	615	197	1306	734	950	213	1897	23	685	944	1652	532	6852	7384
% App. Total	22.8	76.2	1	792	852	961	912	925	857	886	934	962	523	523	883	883	846	846	846
PHF	.877	.891	.792	.940	.852	.961	.912	.925	.857	.886	.934	.962	.523	.523	.883	.883	.846	.846	.846

Counts Unlimited, Inc.
 PO Box 1178
 Corona, CA 92878
 (951)268-6268

City of Riverside
 N/S: Alessandro Boulevard
 E/W: Arlington Avenue/Chicago Avenue
 Weather: Clear

File Name : 02_RIV_Ales_Chicago PM
 Site Code : 05121716
 Start Date : 11/30/2021
 Page No : 2

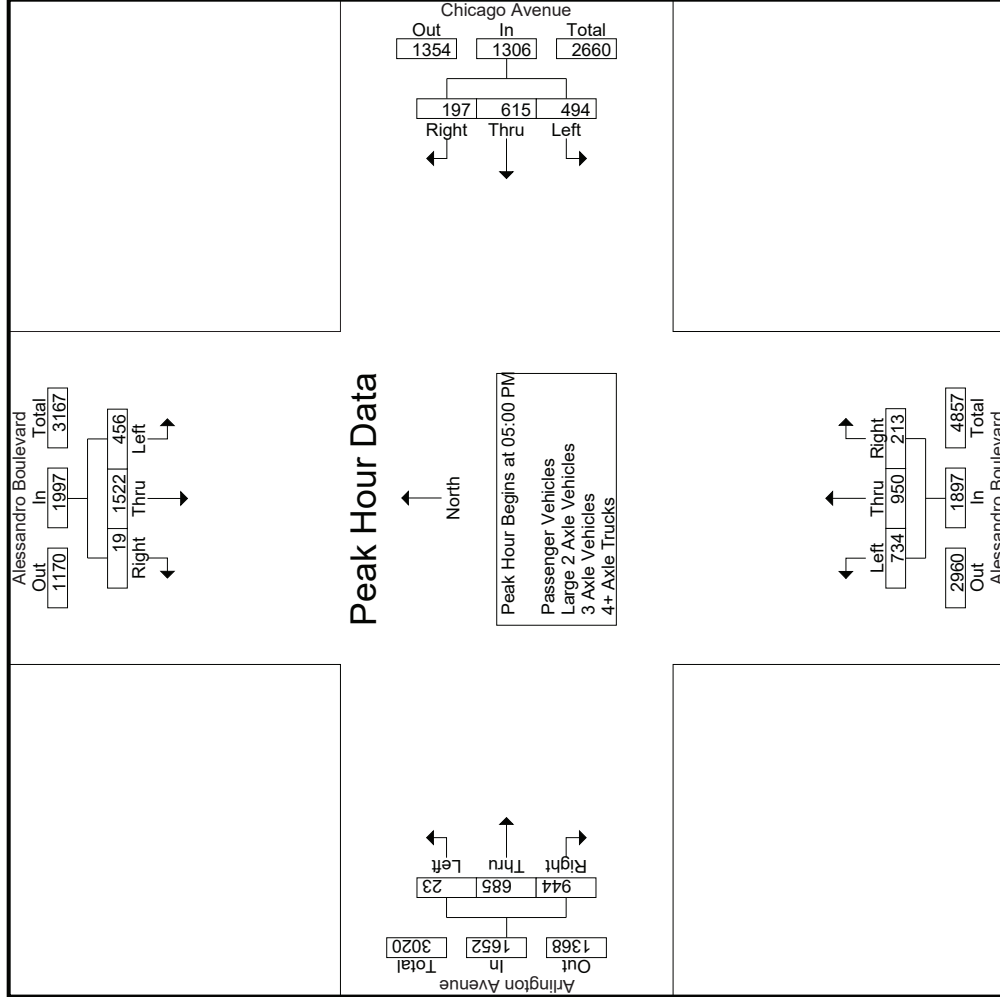

Counts Unlimited, Inc.
 PO Box 1178
 Corona, CA 92878
 (951)268-6268

City of Riverside
 N/S: Alessandro Boulevard
 E/W: Arlington Avenue/Chicago Avenue
 Weather: Clear

File Name : 02_RIV_Ales_Chicago PM
 Site Code : 05121716
 Start Date : 11/30/2021
 Page No : 3

Start Time	Alessandro Boulevard Southbound			Chicago Avenue Westbound			Alessandro Boulevard Northbound			Arlington Avenue Eastbound						
	Left	Thru	Right	App. Total	Left	Thru	Right	App. Total	Left	Thru	Right	App. Total	Int. Total			
Peak Hour Analysis From 04:00 PM to 05:45 PM - Peak 1 of 1																
Peak Hour for Each Approach Begins at:																
	04:45 PM				05:00 PM			04:00 PM			04:45 PM					
+0 mins.	89	448	4	541	105	160	50	315	208	221	60	489	8	151	221	380
+15 mins.	129	322	6	457	130	143	46	319	164	275	67	506	11	170	238	419
+30 mins.	99	427	5	531	114	158	47	319	211	274	59	544	2	165	219	386
+45 mins.	130	353	4	487	145	154	54	353	162	237	53	452	2	194	292	488
Total Volume	447	1550	19	2016	494	615	197	1306	745	1007	239	1991	23	680	970	1673
% App. Total	22.2	76.9	0.9		37.8	47.1	15.1		37.4	50.6	12		1.4	40.6	58	
PHF	.860	.865	.792	.932	.852	.961	.912	.925	.883	.915	.892	.915	.523	.876	.830	.857

Counts Unlimited, Inc.
 PO Box 1178
 Corona, CA 92878
 (951)268-6268

City of Riverside
 N/S: Alessandro Boulevard
 E/W: Arlington Avenue/Chicago Avenue
 Weather: Clear

File Name : 02_RIV_Ales_Chicago PM
 Site Code : 05121716
 Start Date : 11/30/2021
 Page No : 1

Groups Printed- Passenger Vehicles

Start Time	Alessandro Boulevard Southbound						Chicago Avenue Westbound						Alessandro Boulevard Northbound						Arlington Avenue Eastbound															
	Left		Thru		Right		Left		Thru		Right		Left		Thru		Right		Left		Thru		Right		Left		Thru		Right					
	RTOR	App. Total	RTOR	App. Total	RTOR	App. Total	RTOR	App. Total	RTOR	App. Total	RTOR	App. Total	RTOR	App. Total	RTOR	App. Total	RTOR	App. Total	RTOR	App. Total	RTOR	App. Total	RTOR	App. Total	RTOR	App. Total	RTOR	App. Total	RTOR	App. Total				
04:00 PM	113	319	4	3	436	85	128	51	25	264	203	211	60	18	474	3	193	234	80	430	126	1604	1730	1730	1730	1730	1730	1730	1730	1730	1730			
04:15 PM	86	415	7	0	508	101	139	49	21	289	161	271	65	17	497	4	141	208	78	353	116	1647	1763	1763	1763	1763	1763	1763	1763	1763	1763			
04:30 PM	101	363	2	0	466	81	110	49	16	240	209	270	57	20	536	0	191	219	72	410	108	1652	1760	1760	1760	1760	1760	1760	1760	1760	1760			
04:45 PM	89	448	4	2	541	88	117	57	28	262	159	233	49	11	441	8	150	219	84	377	125	1621	1746	1746	1746	1746	1746	1746	1746	1746	1746			
Total	389	1545	17	5	1951	355	494	206	90	1055	732	985	231	66	1948	15	675	880	314	1570	475	6524	6999	6999	6999	6999	6999	6999	6999	6999	6999	6999		
05:00 PM	129	318	6	1	453	103	159	50	14	312	200	228	55	17	483	11	169	236	84	416	116	1664	1780	1780	1780	1780	1780	1780	1780	1780	1780	1780		
05:15 PM	98	422	5	0	525	126	142	46	17	314	167	266	47	17	480	2	165	218	83	385	117	1704	1821	1821	1821	1821	1821	1821	1821	1821	1821	1821	1821	
05:30 PM	129	352	4	1	485	113	158	46	24	317	210	218	55	18	483	2	194	290	137	486	180	1771	1951	1951	1951	1951	1951	1951	1951	1951	1951	1951	1951	
05:45 PM	98	418	4	0	520	142	153	54	28	349	153	224	50	12	427	8	155	195	75	358	115	1654	1769	1769	1769	1769	1769	1769	1769	1769	1769	1769	1769	
Total	454	1510	19	2	1983	484	612	196	83	1292	730	936	207	64	1873	23	683	939	379	1645	528	6793	7321	7321	7321	7321	7321	7321	7321	7321	7321	7321	7321	
Grand Total	843	3055	36	7	3934	839	1106	402	173	2347	1462	1921	438	130	3821	38	1358	1819	693	3215	1003	13317	14320	14320	14320	14320	14320	14320	14320	14320	14320	14320	14320	
% Apprch %	21.4	77.7	0.9			35.7	47.1	17.1		17.6	38.3	50.3	11.5		28.7	1.2	42.2	56.6		24.1	7	93	93	93	93	93	93	93	93	93	93	93	93	
% Total %	6.3	22.9	0.3			6.3	8.3	3		17.6	11	14.4	3.3		28.7	0.3	10.2	13.7		24.1	7	93	93	93	93	93	93	93	93	93	93	93	93	93

Start Time	Alessandro Boulevard Southbound						Chicago Avenue Westbound						Alessandro Boulevard Northbound						Arlington Avenue Eastbound															
	Left		Thru		Right		Left		Thru		Right		Left		Thru		Right		Left		Thru		Right		Left		Thru		Right					
	RTOR	App. Total	RTOR	App. Total	RTOR	App. Total	RTOR	App. Total	RTOR	App. Total	RTOR	App. Total	RTOR	App. Total	RTOR	App. Total	RTOR	App. Total	RTOR	App. Total	RTOR	App. Total	RTOR	App. Total	RTOR	App. Total	RTOR	App. Total	RTOR	App. Total				
05:00 PM	129	318	6		453	103	159	50		312	200	228	55		483	11	169	236		416	1664	1780	1780	1780	1780	1780	1780	1780	1780	1780	1780	1780	1780	
05:15 PM	98	422	5		525	126	142	46		314	167	266	47		480	2	165	218		385	117	1704	1821	1821	1821	1821	1821	1821	1821	1821	1821	1821	1821	
05:30 PM	129	352	4		485	113	158	46		317	210	218	55		483	2	194	290		486	180	1771	1951	1951	1951	1951	1951	1951	1951	1951	1951	1951	1951	1951
05:45 PM	98	418	4		520	142	153	54		349	153	224	50		427	8	155	195		358	115	1654	1769	1769	1769	1769	1769	1769	1769	1769	1769	1769	1769	1769
Total Volume	454	1510	19		1983	484	612	196		1292	730	936	207		1873	23	683	939		1645	528	6793	7321	7321	7321	7321	7321	7321	7321	7321	7321	7321	7321	7321
% App. Total	22.9	76.1	1			37.5	47.4	15.2		17.6	11	14.4	3.3		28.7	0.3	10.2	13.7		24.1	7	93	93	93	93	93	93	93	93	93	93	93	93	93
PHF	.880	.895	.792		.944	.852	.962	.907		.926	.869	.880	.941		.969	.523	.880	.809		.846	.809	.846	.809	.846	.809	.846	.809	.846	.809	.846	.809	.846	.809	.846

Peak Hour Analysis From 05:00 PM to 05:45 PM - Peak 1 of 1
 Peak Hour for Entire Intersection Begins at 05:00 PM

Counts Unlimited, Inc.
 PO Box 1178
 Corona, CA 92878
 (951)268-6268

City of Riverside
 N/S: Alessandro Boulevard
 E/W: Arlington Avenue/Chicago Avenue
 Weather: Clear

File Name : 02_RIV_Ales_Chicago PM
 Site Code : 05121716
 Start Date : 11/30/2021
 Page No : 2

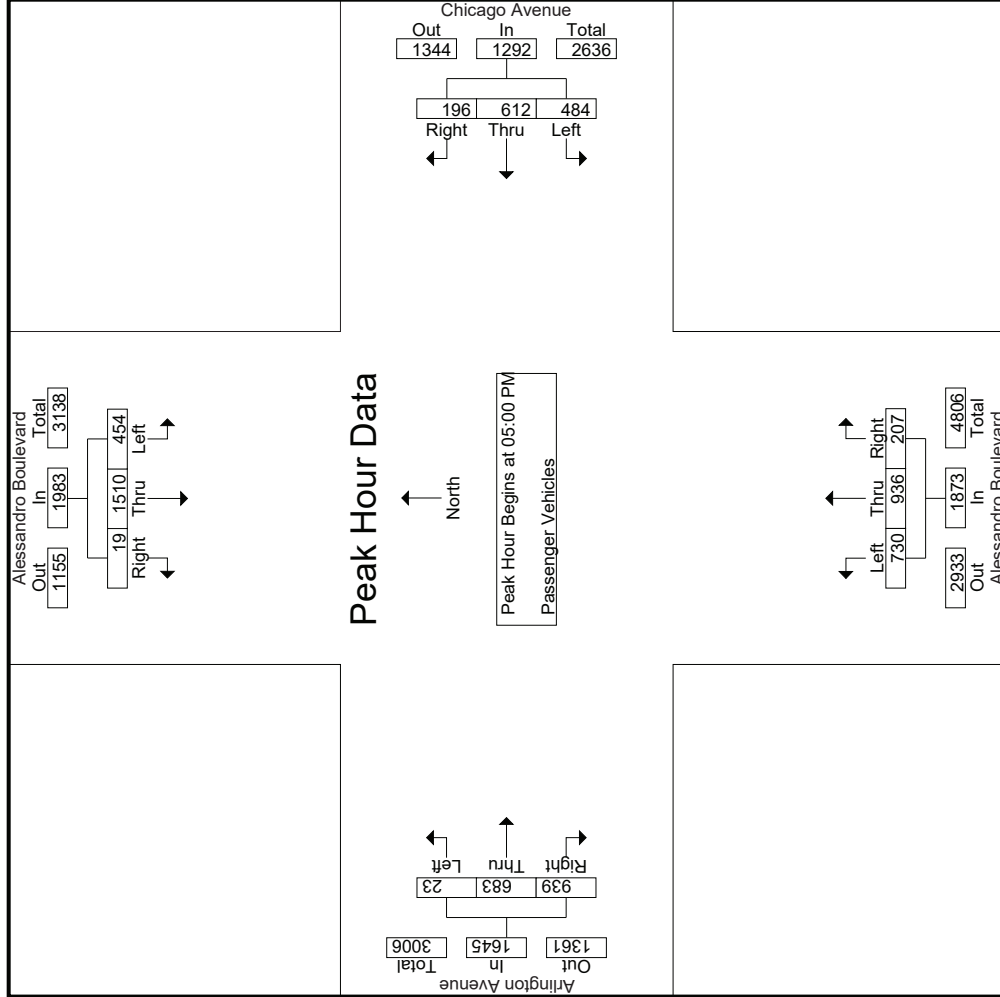

Counts Unlimited, Inc.
 PO Box 1178
 Corona, CA 92878
 (951)268-6268

City of Riverside
 N/S: Alessandro Boulevard
 E/W: Arlington Avenue/Chicago Avenue
 Weather: Clear

File Name : 02_RIV_Ales_Chicago PM
 Site Code : 05121716
 Start Date : 11/30/2021
 Page No : 3

Start Time	Alessandro Boulevard Southbound			Chicago Avenue Westbound			Alessandro Boulevard Northbound			Arlington Avenue Eastbound						
	Left	Thru	Right	App. Total	Left	Thru	Right	App. Total	Left	Thru	Right	App. Total	Int. Total			
Peak Hour Analysis From 05:00 PM to 05:45 PM - Peak 1 of 1	05:00 PM															
Peak Hour for Each Approach Begins at:	05:00 PM															
+0 mins.	129	318	6	453	103	159	50	312	200	228	55	483	11	169	236	416
+15 mins.	98	422	5	525	126	142	46	314	167	266	47	480	2	165	218	385
+30 mins.	129	352	4	485	113	158	46	317	210	218	55	483	2	194	290	486
+45 mins.	98	418	4	520	142	153	54	349	153	224	50	427	8	155	195	358
Total Volume	454	1510	19	1983	484	612	196	1292	730	936	207	1873	23	683	939	1645
% App. Total	22.9	76.1	1	94.4	37.5	47.4	15.2	92.6	39	50	11.1	96.9	1.4	41.5	57.1	84.6
PHF	.880	.895	.792	.944	.852	.962	.907	.926	.869	.880	.941	.969	.523	.880	.809	.846

Counts Unlimited, Inc.
 PO Box 1178
 Corona, CA 92878
 (951)268-6268

City of Riverside
 N/S: Alessandro Boulevard
 E/W: Arlington Avenue/Chicago Avenue
 Weather: Clear

File Name : 02_RIV_Ales_Chicago PM
 Site Code : 05121716
 Start Date : 11/30/2021
 Page No : 1

Groups Printed- Large 2 Axle Vehicles

Start Time	Alessandro Boulevard Southbound				Chicago Avenue Westbound				Alessandro Boulevard Northbound				Arlington Avenue Eastbound							
	Left	Thru	Right	RTOR	Left	Thru	Right	RTOR	Left	Thru	Right	RTOR	Left	Thru	Right	RTOR	App. Total	Exclu. Total	Inclu. Total	Int. Total
04:00 PM	1	4	0	0	3	2	0	0	5	4	8	0	0	0	0	0	0	0	22	22
04:15 PM	1	3	0	0	2	1	1	0	4	3	4	2	0	0	2	5	2	7	24	26
04:30 PM	0	2	0	0	1	1	0	0	2	2	3	2	0	0	1	2	1	3	14	15
04:45 PM	0	0	0	0	3	1	0	0	4	3	3	4	1	0	1	2	0	3	17	18
Total	2	9	0	0	9	5	1	0	15	12	18	8	1	38	0	4	9	13	4	77
05:00 PM	0	4	0	0	2	1	0	0	3	0	3	2	1	5	0	1	2	1	2	15
05:15 PM	1	5	0	0	4	1	0	0	5	0	2	1	0	3	0	0	1	0	0	15
05:30 PM	1	1	0	0	2	1	1	1	2	3	3	1	0	7	0	0	2	1	2	13
05:45 PM	0	2	0	0	2	1	0	0	3	0	3	2	0	5	0	1	0	0	0	11
Total	2	12	0	0	9	3	1	1	13	3	11	6	1	20	0	2	5	2	4	54
Grand Total	4	21	0	0	18	8	2	1	28	15	29	14	2	58	0	6	14	5	8	131
% Apprch %	16	84	0	0	64.3	28.6	7.1	1.5	21.4	25.9	50	24.1	2	44.3	0	30	70	15.3	5.8	94.2
% Total %	3.1	16	0	0	13.7	6.1	1.5		11.5	11.5	22.1	10.7		4.6	10.7					

Start Time	Alessandro Boulevard Southbound				Chicago Avenue Westbound				Alessandro Boulevard Northbound				Arlington Avenue Eastbound							
	Left	Thru	Right	RTOR	Left	Thru	Right	RTOR	Left	Thru	Right	RTOR	Left	Thru	Right	RTOR	App. Total	Exclu. Total	Inclu. Total	Int. Total
05:00 PM	0	4	0	0	2	1	0	0	3	0	3	2	1	5	0	1	2	1	2	15
05:15 PM	1	5	0	0	4	1	0	0	5	0	2	1	0	3	0	0	1	0	0	15
05:30 PM	1	1	0	0	2	1	1	1	2	3	3	1	0	7	0	0	2	1	2	13
05:45 PM	0	2	0	0	2	1	0	0	3	0	3	2	0	5	0	1	0	0	0	11
Total	2	12	0	0	9	3	1	1	13	3	11	6	1	20	0	2	5	2	4	54
Grand Total	4	21	0	0	18	8	2	1	28	15	29	14	2	58	0	6	14	5	8	131
% Apprch %	16	84	0	0	64.3	28.6	7.1	1.5	21.4	25.9	50	24.1	2	44.3	0	30	70	15.3	5.8	94.2
% Total %	3.1	16	0	0	13.7	6.1	1.5		11.5	11.5	22.1	10.7		4.6	10.7					

Peak Hour Analysis From 05:00 PM to 05:45 PM - Peak 1 of 1
 Peak Hour for Entire Intersection Begins at 05:00 PM

Start Time	Alessandro Boulevard Southbound				Chicago Avenue Westbound				Alessandro Boulevard Northbound				Arlington Avenue Eastbound							
	Left	Thru	Right	RTOR	Left	Thru	Right	RTOR	Left	Thru	Right	RTOR	Left	Thru	Right	RTOR	App. Total	Exclu. Total	Inclu. Total	Int. Total
05:00 PM	0	4	0	0	2	1	0	0	3	0	3	2	1	5	0	1	2	1	2	15
05:15 PM	1	5	0	0	4	1	0	0	5	0	2	1	0	3	0	0	1	0	0	15
05:30 PM	1	1	0	0	2	1	1	1	2	3	3	1	0	7	0	0	2	1	2	13
05:45 PM	0	2	0	0	2	1	0	0	3	0	3	2	0	5	0	1	0	0	0	11
Total Volume	2	12	0	0	9	3	1	1	13	3	11	6	1	20	0	2	5	2	4	54
% App. Total	14.3	85.7	0	0	69.2	23.1	7.7		21.4	25.9	50	24.1	2	44.3	0	30	70	15.3	5.8	94.2
PHF	.500	.600	.000	.583	.563	.750	.250	.650	.714	.250	.917	.750	.000	.500	.625	.583	.900			

Counts Unlimited, Inc.
 PO Box 1178
 Corona, CA 92878
 (951)268-6268

City of Riverside
 N/S: Alessandro Boulevard
 E/W: Arlington Avenue/Chicago Avenue
 Weather: Clear

File Name : 02_RIV_Ales_Chicago PM
 Site Code : 05121716
 Start Date : 11/30/2021
 Page No : 2

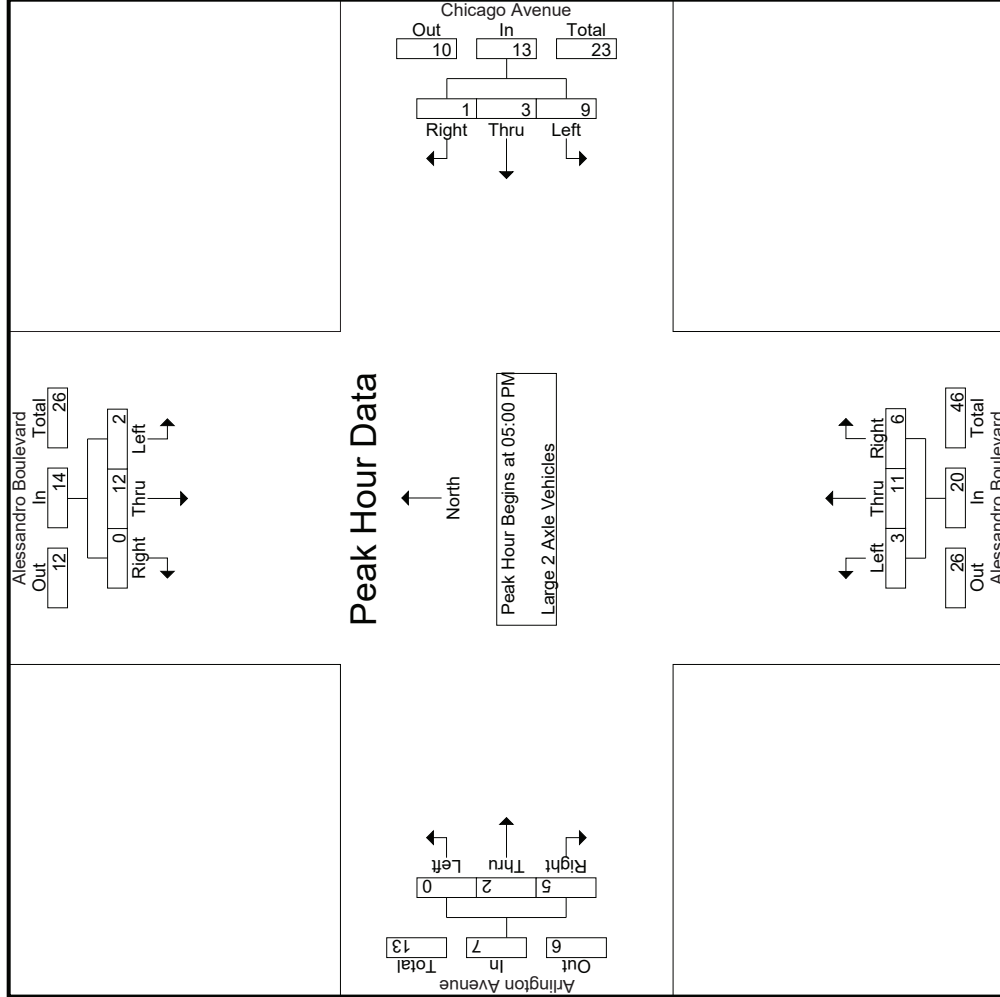

Counts Unlimited, Inc.
 PO Box 1178
 Corona, CA 92878
 (951)268-6268

City of Riverside
 N/S: Alessandro Boulevard
 E/W: Arlington Avenue/Chicago Avenue
 Weather: Clear

File Name : 02_RIV_Ales_Chicago PM
 Site Code : 05121716
 Start Date : 11/30/2021
 Page No : 3

Start Time	Alessandro Boulevard Southbound			Chicago Avenue Westbound			Alessandro Boulevard Northbound			Arlington Avenue Eastbound			
	Left	Thru	Right	App. Total	Left	Thru	Right	App. Total	Left	Thru	Right	App. Total	Int. Total
Peak Hour Analysis From 05:00 PM to 05:45 PM - Peak 1 of 1	Peak Hour for Each Approach Begins at:												
	05:00 PM												
+0 mins.	0	4	0	4	2	1	0	3	0	0	1	2	3
+15 mins.	1	5	0	6	4	1	0	5	0	2	0	1	1
+30 mins.	1	1	0	2	1	0	1	2	3	3	1	2	2
+45 mins.	0	2	0	2	2	1	0	3	0	3	2	5	1
Total Volume	2	12	0	14	9	3	1	13	3	11	6	20	7
% App. Total	14.3	85.7	0		69.2	23.1	7.7		15	55	30	28.6	71.4
PHF	.500	.600	.000	.583	.563	.750	.250	.650	.250	.917	.750	.714	.583

Counts Unlimited, Inc.
 PO Box 1178
 Corona, CA 92878
 (951)268-6268

City of Riverside
 N/S: Alessandro Boulevard
 E/W: Arlington Avenue/Chicago Avenue
 Weather: Clear

File Name : 02_RIV_Ales_Chicago PM
 Site Code : 05121716
 Start Date : 11/30/2021
 Page No : 1

Groups Printed- 3 Axle Vehicles

Start Time	Alessandro Boulevard Southbound				Chicago Avenue Westbound				Alessandro Boulevard Northbound				Arlington Avenue Eastbound					
	Left	Thru	Right	RTOR	App. Total	Left	Thru	Right	RTOR	App. Total	Left	Thru	Right	RTOR	App. Total	Exclu. Total	Inclu. Total	Int. Total
04:00 PM	0	1	0	0	1	0	1	0	0	1	0	1	0	0	0	0	3	3
04:15 PM	0	0	0	0	0	0	0	0	0	0	0	0	0	0	0	0	0	0
04:30 PM	0	2	0	0	2	0	0	0	0	0	0	0	0	0	0	0	2	2
04:45 PM	0	0	0	0	0	0	0	0	0	0	0	0	0	0	0	0	0	0
Total	0	3	0	0	3	0	1	0	0	1	0	1	0	0	0	0	5	5
05:00 PM	0	0	0	0	0	0	0	0	0	0	0	0	0	0	0	0	0	0
05:15 PM	0	0	0	0	0	0	0	0	0	0	0	0	0	0	0	0	0	0
05:30 PM	0	0	0	0	0	0	1	0	0	1	0	0	0	0	0	0	1	1
05:45 PM	0	0	0	0	0	1	0	0	0	1	0	0	0	0	0	1	1	1
Total	0	0	0	0	0	1	0	0	0	1	0	0	0	0	0	2	2	2
Grand Total	0	3	0	0	3	1	1	0	0	2	0	2	0	0	0	0	7	7
% Approach	0	100	0	0	42.9	50	50	0	0	100	0	0	0	0	0	0	100	100
Total %	0	42.9	0	0	42.9	14.3	14.3	0	0	28.6	0	28.6	0	0	0	0	100	100

Start Time	Alessandro Boulevard Southbound				Chicago Avenue Westbound				Alessandro Boulevard Northbound				Arlington Avenue Eastbound					
	Left	Thru	Right	RTOR	App. Total	Left	Thru	Right	RTOR	App. Total	Left	Thru	Right	RTOR	App. Total	Exclu. Total	Inclu. Total	Int. Total
05:00 PM	0	0	0	0	0	0	0	0	0	0	0	0	0	0	0	0	0	0
05:15 PM	0	0	0	0	0	0	0	0	0	0	0	0	0	0	0	0	0	0
05:30 PM	0	0	0	0	0	0	0	0	0	0	0	0	0	0	0	0	0	0
05:45 PM	0	0	0	0	0	1	0	0	0	1	0	0	0	0	0	0	1	1
Total Volume	0	0	0	0	0	1	0	0	0	1	0	0	0	0	0	0	1	1
% App. Total	0	0	0	0	0	100	0	0	0	100	0	0	0	0	0	0	0	2
PHF	.000	.000	.000	.000	.000	.250	.000	.000	.000	.250	.000	.000	.250	.000	.000	.000	.500	.500

Peak Hour Analysis From 05:00 PM to 05:45 PM - Peak 1 of 1
 Peak Hour for Entire Intersection Begins at 05:00 PM

Counts Unlimited, Inc.
 PO Box 1178
 Corona, CA 92878
 (951)268-6268

City of Riverside
 N/S: Alessandro Boulevard
 E/W: Arlington Avenue/Chicago Avenue
 Weather: Clear

File Name : 02_RIV_Ales_Chicago PM
 Site Code : 05121716
 Start Date : 11/30/2021
 Page No : 2

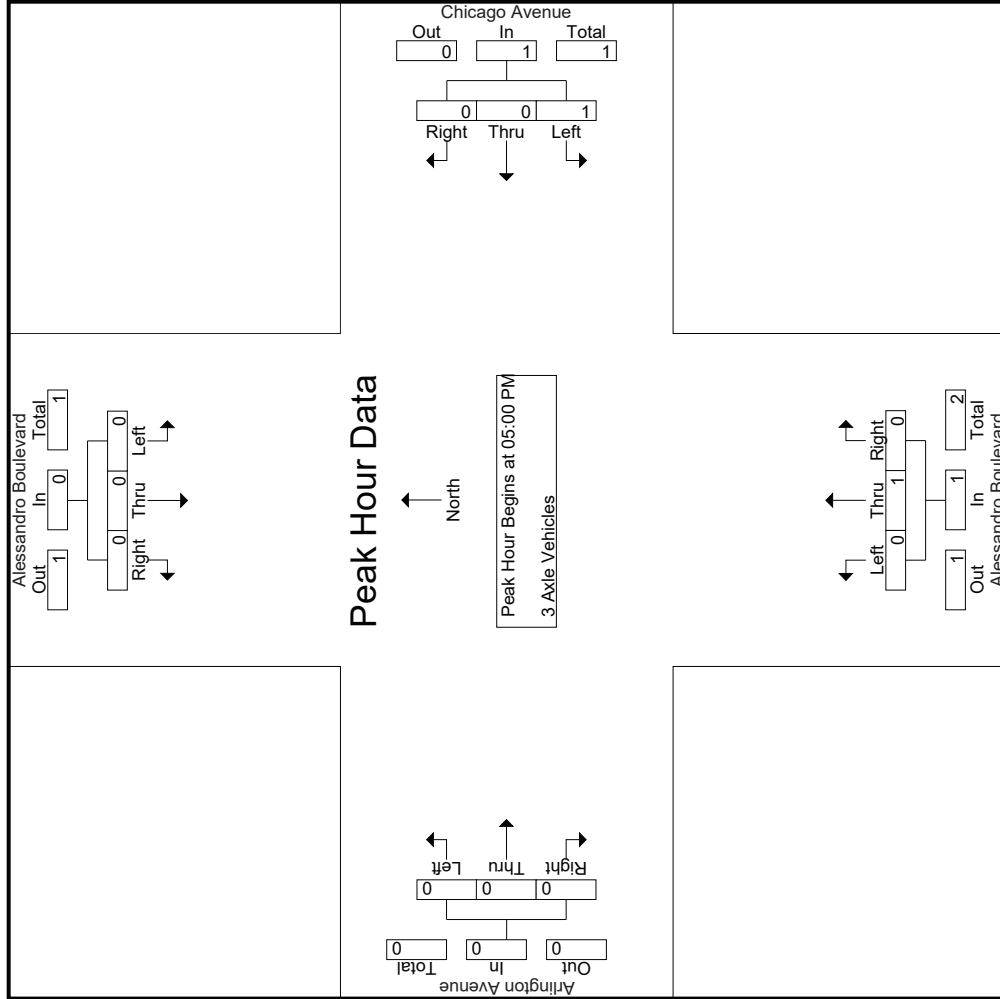

Counts Unlimited, Inc.
 PO Box 1178
 Corona, CA 92878
 (951)268-6268

City of Riverside
 N/S: Alessandro Boulevard
 E/W: Arlington Avenue/Chicago Avenue
 Weather: Clear

File Name : 02_RIV_Ales_Chicago PM
 Site Code : 05121716
 Start Date : 11/30/2021
 Page No : 3

Start Time	Alessandro Boulevard Southbound			Chicago Avenue Westbound			Alessandro Boulevard Northbound			Arlington Avenue Eastbound			
	Left	Thru	Right	App. Total	Left	Thru	Right	App. Total	Left	Thru	Right	App. Total	Int. Total
Peak Hour Analysis From 05:00 PM to 05:45 PM - Peak 1 of 1													
Peak Hour for Each Approach Begins at:													
	05:00 PM				05:00 PM				05:00 PM				
+0 mins.	0	0	0	0	0	0	0	0	0	0	0	0	0
+15 mins.	0	0	0	0	0	0	0	0	0	0	0	0	0
+30 mins.	0	0	0	0	0	0	0	0	0	0	0	0	0
+45 mins.	0	0	0	1	0	0	0	1	0	0	0	0	0
Total Volume	0	0	0	0	1	0	0	1	0	0	0	0	0
% App. Total	0	0	0	100	0	0	0	100	0	0	0	0	0
PHF	.000	.000	.000	.000	.250	.000	.000	.250	.000	.000	.000	.000	.000

Counts Unlimited, Inc.
 PO Box 1178
 Corona, CA 92878
 (951)268-6268

City of Riverside
 N/S: Alessandro Boulevard
 E/W: Arlington Avenue/Chicago Avenue
 Weather: Clear

File Name : 02_RIV_Ales_Chicago PM
 Site Code : 05121716
 Start Date : 11/30/2021
 Page No : 1

Groups Printed- 4+ Axle Trucks

Start Time	Alessandro Boulevard Southbound				Chicago Avenue Westbound				Alessandro Boulevard Northbound				Arlington Avenue Eastbound					
	Left	Thru	Right	RTOR	App. Total	Left	Thru	Right	RTOR	App. Total	Left	Thru	Right	RTOR	App. Total	Exclu. Total	Inclu. Total	Int. Total
04:00 PM	0	0	0	0	0	0	0	0	0	0	1	1	0	0	0	0	2	2
04:15 PM	0	0	0	0	0	1	0	0	0	1	0	0	0	0	0	0	0	1
04:30 PM	0	1	0	0	1	0	0	0	0	0	0	1	0	0	0	0	2	2
04:45 PM	0	0	0	0	0	1	0	0	0	1	0	0	0	0	0	0	2	2
Total	0	1	0	0	1	2	0	0	0	2	1	3	0	0	4	0	7	7
05:00 PM	0	0	0	0	0	0	0	0	0	0	0	0	0	0	0	0	0	0
05:15 PM	0	0	0	0	0	0	0	0	0	0	0	0	0	0	0	0	0	0
05:30 PM	0	0	0	0	0	0	0	0	0	0	1	1	0	0	2	0	2	2
05:45 PM	0	0	0	0	0	0	0	0	0	0	0	1	0	0	1	0	1	1
Total	0	0	0	0	0	0	0	0	0	0	1	2	0	0	3	0	3	3
Grand Total	0	1	0	0	1	2	0	0	0	2	2	5	0	0	7	0	10	10
% Approach	0	100	0	0	100	0	0	0	0	28.6	71.4	0	0	0	0	0	0	0
Total %	0	10	0	0	10	20	0	0	0	20	50	0	0	0	70	0	100	100

Start Time	Alessandro Boulevard Southbound				Chicago Avenue Westbound				Alessandro Boulevard Northbound				Arlington Avenue Eastbound					
	Left	Thru	Right	RTOR	App. Total	Left	Thru	Right	RTOR	App. Total	Left	Thru	Right	RTOR	App. Total	Exclu. Total	Inclu. Total	Int. Total
05:00 PM	0	0	0	0	0	0	0	0	0	0	0	0	0	0	0	0	0	0
05:15 PM	0	0	0	0	0	0	0	0	0	0	0	0	0	0	0	0	0	0
05:30 PM	0	0	0	0	0	0	0	0	0	0	1	1	0	0	2	0	2	2
05:45 PM	0	0	0	0	0	0	0	0	0	0	0	0	0	0	0	0	0	0
Total Volume	0	0	0	0	0	0	0	0	0	0	1	2	0	0	3	0	3	3
% App. Total	0	0	0	0	0	0	0	0	0	0	33.3	66.7	0	0	0	0	0	0
PHF	.000	.000	.000	.000	.000	.000	.250	.500	.000	.000	.375	.000	.000	.000	.000	.000	.375	.375

Peak Hour Analysis From 05:00 PM to 05:45 PM - Peak 1 of 1
 Peak Hour for Entire Intersection Begins at 05:00 PM

Counts Unlimited, Inc.
 PO Box 1178
 Corona, CA 92878
 (951)268-6268

City of Riverside
 N/S: Alessandro Boulevard
 E/W: Arlington Avenue/Chicago Avenue
 Weather: Clear

File Name : 02_RIV_Ales_Chicago PM
 Site Code : 05121716
 Start Date : 11/30/2021
 Page No : 2

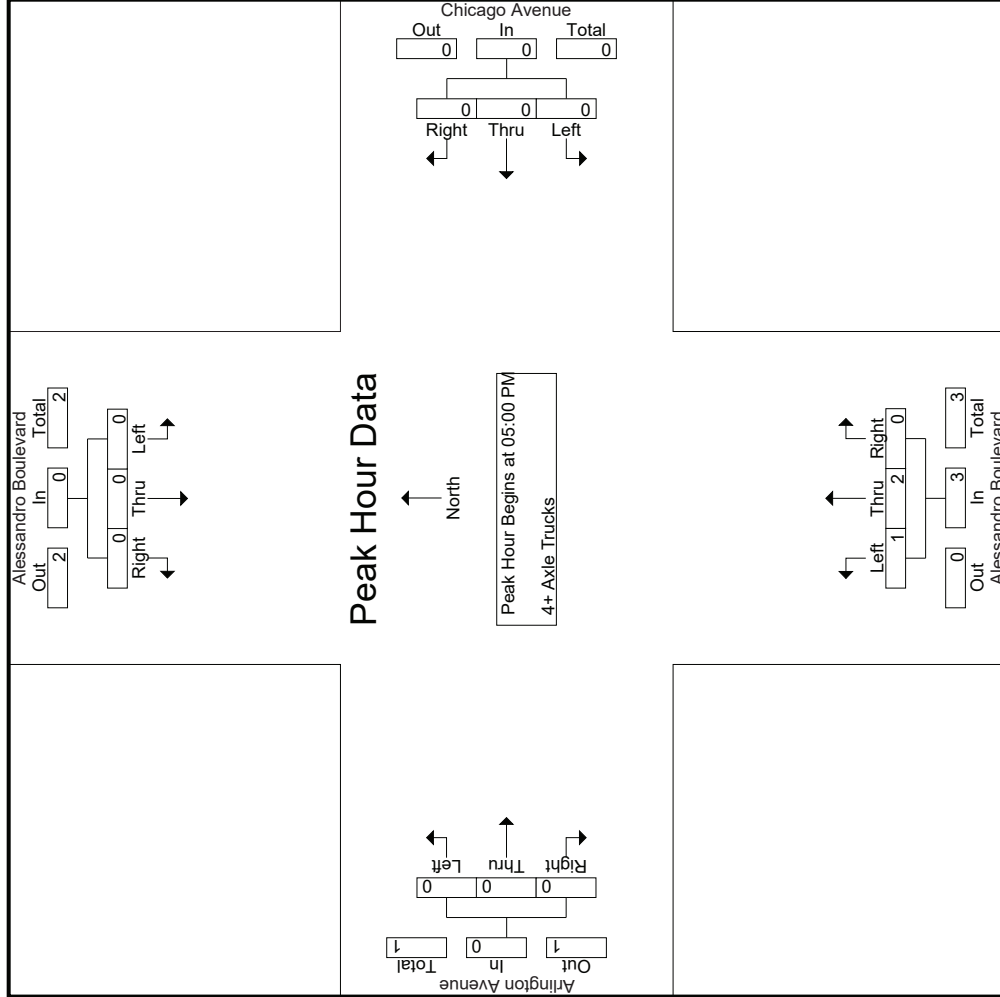

Counts Unlimited, Inc.
 PO Box 1178
 Corona, CA 92878
 (951)268-6268

City of Riverside
 N/S: Alessandro Boulevard
 E/W: Arlington Avenue/Chicago Avenue
 Weather: Clear

File Name : 02_RIV_Ales_Chicago PM
 Site Code : 05121716
 Start Date : 11/30/2021
 Page No : 3

Start Time	Alessandro Boulevard Southbound			Chicago Avenue Westbound			Alessandro Boulevard Northbound			Arlington Avenue Eastbound				
	Left	Thru	Right	App. Total	Left	Thru	Right	App. Total	Left	Thru	Right	App. Total	Int. Total	
Peak Hour Analysis From 05:00 PM to 05:45 PM - Peak 1 of 1														
Peak Hour for Each Approach Begins at:														
	05:00 PM				05:00 PM				05:00 PM				05:00 PM	
+0 mins.	0	0	0	0	0	0	0	0	0	0	0	0	0	0
+15 mins.	0	0	0	0	0	0	0	0	0	0	0	0	0	0
+30 mins.	0	0	0	0	0	0	0	1	1	0	0	0	0	0
+45 mins.	0	0	0	0	0	0	0	0	1	1	0	0	0	0
Total Volume	0	0	0	0	0	0	0	1	2	0	0	0	0	0
% App. Total	0	0	0	0	0	0	0	33.3	66.7	0	0	0	0	0
PHF	.000	.000	.000	.000	.000	.000	.000	.250	.500	.000	.000	.000	.000	.000

Location: Riverside
 N/S: Alessandro Boulevard
 E/W: Arlington Ave/Chicago Ave



Date: 11/30/2021
 Day: Tuesday

PEDESTRIANS

	North Leg Alessandro Boulevard Pedestrians	East Leg Chicago Avenue Pedestrians	South Leg Alessandro Boulevard Pedestrians	West Leg Arlington Avenue Pedestrians	
7:00 AM	0	0	0	0	0
7:15 AM	0	1	0	0	1
7:30 AM	0	0	0	0	0
7:45 AM	0	0	0	0	0
8:00 AM	0	0	0	0	0
8:15 AM	0	0	0	0	0
8:30 AM	0	0	0	0	0
8:45 AM	0	0	0	0	0
TOTAL VOLUMES:	0	1	0	0	1

	North Leg Alessandro Boulevard Pedestrians	East Leg Chicago Avenue Pedestrians	South Leg Alessandro Boulevard Pedestrians	West Leg Arlington Avenue Pedestrians	
4:00 PM	0	0	0	0	0
4:15 PM	0	0	0	0	0
4:30 PM	0	0	0	0	0
4:45 PM	0	0	0	0	0
5:00 PM	0	0	0	0	0
5:15 PM	0	0	0	0	0
5:30 PM	0	0	1	0	1
5:45 PM	0	0	0	0	0
TOTAL VOLUMES:	0	0	1	0	1

Location: Riverside
 N/S: Alessandro Boulevard
 E/W: Arlington Ave/Chicago Ave



Date: 11/30/2021
 Day: Tuesday

BICYCLES

	Southbound Alessandro Boulevard			Westbound Chicago Avenue			Northbound Alessandro Boulevard			Eastbound Arlington Avenue			
	Left	Thru	Right	Left	Thru	Right	Left	Thru	Right	Left	Thru	Right	
7:00 AM	0	0	0	0	0	0	0	0	0	0	0	0	0
7:15 AM	0	0	0	0	0	0	0	0	0	0	0	0	0
7:30 AM	0	0	0	0	0	0	0	1	0	0	0	0	1
7:45 AM	0	0	0	0	0	0	0	0	0	0	0	0	0
8:00 AM	0	0	0	0	0	0	0	1	0	0	0	0	1
8:15 AM	0	0	0	0	0	0	0	0	0	0	0	0	0
8:30 AM	0	0	0	0	0	0	0	0	0	0	0	0	0
8:45 AM	0	0	0	0	0	0	0	0	0	0	0	0	0
TOTAL VOLUMES:	0	0	0	0	0	0	0	2	0	0	0	0	2

	Southbound Alessandro Boulevard			Westbound Chicago Avenue			Northbound Alessandro Boulevard			Eastbound Arlington Avenue			
	Left	Thru	Right	Left	Thru	Right	Left	Thru	Right	Left	Thru	Right	
4:00 PM	0	0	0	0	0	0	0	1	0	0	0	0	1
4:15 PM	0	0	0	0	0	0	0	0	0	0	0	0	0
4:30 PM	0	0	0	0	0	0	0	0	0	0	0	0	0
4:45 PM	0	0	0	0	0	0	0	0	0	0	0	0	0
5:00 PM	0	0	0	0	0	0	0	1	0	0	0	0	1
5:15 PM	0	0	0	0	0	0	0	0	0	0	0	0	0
5:30 PM	0	0	0	0	0	0	0	1	0	0	0	0	1
5:45 PM	0	0	0	0	0	0	0	0	0	0	0	0	0
TOTAL VOLUMES:	0	0	0	0	0	0	0	3	0	0	0	0	3

Counts Unlimited, Inc.
 PO Box 1178
 Corona, CA 92878
 (951)268-6268

City of Riverside
 N/S: Canyon Crest Dr/Overlook Pkwy
 EW: Alessandro Boulevard
 Weather: Clear

File Name : 03_RIV_Cyn Crst_Ales AM
 Site Code : 05121716
 Start Date : 11/30/2021
 Page No : 1

Groups Printed- Passenger Vehicles - Large 2 Axle Vehicles - 3 Axle Vehicles - 4+ Axle Trucks

Start Time	Canyon Crest Drive Southbound						Alessandro Boulevard Westbound						Alessandro Boulevard Eastbound						
	Left		Thru		Right		Left		Thru		Right		Left		Thru		Right		
	RTOR	App. Total	RTOR	App. Total	RTOR	App. Total	RTOR	App. Total	RTOR	App. Total	RTOR	App. Total	RTOR	App. Total	RTOR	App. Total	RTOR	App. Total	
07:00 AM	83	0	11	4	94	21	186	754	0	1	0	0	0	0	0	258	0	0	1295
07:15 AM	107	0	15	6	122	62	240	708	2	3	0	0	5	0	0	299	0	0	1374
07:30 AM	83	2	9	4	94	35	238	694	1	2	1	1	4	0	0	301	0	0	1371
07:45 AM	119	3	8	2	130	37	224	565	1	3	1	1	5	0	0	323	0	0	1247
Total	392	5	43	16	440	155	888	2721	4	9	2	2	15	33	1147	0	1181	173	5247
08:00 AM	97	1	7	1	105	48	206	565	7	2	2	1	11	17	293	2	0	50	1199
08:15 AM	75	0	20	13	95	38	197	654	2	0	0	0	2	14	258	3	0	51	1223
08:30 AM	77	3	17	8	97	43	161	644	3	4	3	3	10	7	220	2	0	229	1143
08:45 AM	73	3	14	7	90	76	146	622	6	2	1	1	9	9	259	1	0	84	1136
Total	322	7	58	29	387	205	710	2485	18	8	6	5	32	47	1030	8	1085	239	4701
Grand Total	714	12	101	45	827	360	1598	5206	22	17	8	7	47	80	2177	9	2266	412	9948
% Approach	86.3	1.5	12.2				23.5	76.5	46.8	36.2	17			3.5	96.1	0.4			
% Total	7.2	0.1	1				16.1	52.3	0.2	0.2	0.1			0.8	21.9	0.1		4	96
% Passenger Vehicles	698	11	99		852		1571	5127	22	17	8		54	74	2125	9	2208	0	0
% Large 2 Axle Vehicles	97.8	91.7	98	97.8	97.7	99.2	98.3	98.5	100	100	100	100	100	92.5	97.6	100	97.4	0	0
% 3 Axle Vehicles	13	1	2	2.2	1.9	1.2	0.3	1.3	0	0	0	0	0	6	46	0	52	0	0
% 4+ Axle Trucks	1.8	8.3	2	2.2	1.9	1.2	0.3	1.2	0	0	0	0	0	7.5	2.1	0	2.3	0	0
% 3 Axle Vehicles	3	0	0	0	3	4		7	0	0	0	0	0	0	3	0	3	0	0
% 4+ Axle Trucks	0.4	0	0	0	0.3	0.6	0.6	0.1	0	0	0	0	0	0	0.1	0	0.1	0	0
% 4+ Axle Trucks	0	0	0	0	0	4		6	0	0	0	0	0	0	3	0	3	0	0
% 4+ Axle Trucks	0	0	0	0	0	0.3	0.3	0.1	0	0	0	0	0	0	0.1	0	0.1	0	0

Start Time	Canyon Crest Drive Southbound						Alessandro Boulevard Westbound						Alessandro Boulevard Eastbound						
	Left		Thru		Right		Left		Thru		Right		Left		Thru		Right		
	RTOR	App. Total	RTOR	App. Total	RTOR	App. Total	RTOR	App. Total	RTOR	App. Total	RTOR	App. Total	RTOR	App. Total	RTOR	App. Total	RTOR	App. Total	
07:00 AM	83	0	11	4	94	21	186	754	0	1	0	0	0	0	0	258	0	0	1295
07:15 AM	107	0	15	6	122	62	240	708	2	3	0	0	5	9	290	0	0	68	1374
07:30 AM	83	2	9	4	94	35	238	694	1	2	1	1	4	5	295	1	0	40	1371
07:45 AM	119	3	8	2	130	37	224	565	1	3	1	1	5	12	311	0	0	40	1247
Total	392	5	43	16	440	155	888	2721	4	9	2	2	15	33	1147	1	1181	173	5247
08:00 AM	97	1	7	1	105	48	206	565	7	2	2	1	11	17	293	2	0	50	1199
08:15 AM	75	0	20	13	95	38	197	654	2	0	0	0	2	14	258	3	0	51	1223
08:30 AM	77	3	17	8	97	43	161	644	3	4	3	3	10	7	220	2	0	229	1143
08:45 AM	73	3	14	7	90	76	146	622	6	2	1	1	9	9	259	1	0	84	1136
Total	322	7	58	29	387	205	710	2485	18	8	6	5	32	47	1030	8	1085	239	4701
Grand Total	714	12	101	45	827	360	1598	5206	22	17	8	7	47	80	2177	9	2266	412	9948
% Approach	86.3	1.5	12.2				23.5	76.5	46.8	36.2	17			3.5	96.1	0.4			
% Total	7.2	0.1	1				16.1	52.3	0.2	0.2	0.1			0.8	21.9	0.1		4	96
% Passenger Vehicles	698	11	99		852		1571	5127	22	17	8		54	74	2125	9	2208	0	0
% Large 2 Axle Vehicles	97.8	91.7	98	97.8	97.7	99.2	98.3	98.5	100	100	100	100	100	92.5	97.6	100	97.4	0	0
% 3 Axle Vehicles	13	1	2	2.2	1.9	1.2	0.3	1.3	0	0	0	0	0	6	46	0	52	0	0
% 4+ Axle Trucks	1.8	8.3	2	2.2	1.9	1.2	0.3	1.2	0	0	0	0	0	7.5	2.1	0	2.3	0	0
% 3 Axle Vehicles	3	0	0	0	3	4		7	0	0	0	0	0	0	3	0	3	0	0
% 4+ Axle Trucks	0.4	0	0	0	0.3	0.6	0.6	0.1	0	0	0	0	0	0	0.1	0	0.1	0	0
% 4+ Axle Trucks	0	0	0	0	0	4		6	0	0	0	0	0	0	3	0	3	0	0
% 4+ Axle Trucks	0	0	0	0	0	0.3	0.3	0.1	0	0	0	0	0	0	0.1	0	0.1	0	0

Peak Hour Analysis From 07:00 AM to 08:45 AM - Peak 1 of 1

Peak Hour for Entire Intersection Begins at 07:00 AM

Start Time	Canyon Crest Drive Southbound						Alessandro Boulevard Westbound						Alessandro Boulevard Eastbound								
	Left	Thru	Right	App. Total	Left	Thru	Right	App. Total	Left	Thru	Right	App. Total	Left	Thru	Right	App. Total	Left	Thru	Right	App. Total	Int. Total
07:00 AM	83	0	11	94	2	754	186	942	0	1	0	0	1	7	251	0	258	0	0	0	1295
07:15 AM	107	0	15	122	0	708	240	948	2	3	0	0	5	9	290	0	299	0	0	0	1374
07:30 AM	83	2	9	94	0	694	238	932	1	2	1	1	4	5	295	1	301	1	0	0	1371
07:45 AM	119	3	8	130	0	565	224	789	1	3	1	1	5	12	311	0	323	0	0	0	1247
Total Volume	392	5	43	440	2	2721	888	3611	4	9	2	2	15	33	1147	1	1181	1	0	0	5247
% App. Total	89.1	1.1	9.8	91.0	0.1	75.4	24.6	92.5	26.7	60	13.3	5.00	7.50	2.8	97.1	0.1	91.4	0.1	0	0	95.5
PHF	.824	.417	.717	.846	.250	.902	.925	.952	.500	.750	.500	.500	.750	.688	.922	.250	.914	.250	0	0	.955

Counts Unlimited, Inc.
 PO Box 1178
 Corona, CA 92878
 (951)268-6268

City of Riverside
 N/S: Canyon Crest Dr/Overlook Pkwy
 E/W: Alessandro Boulevard
 Weather: Clear

File Name : 03_RIV_Cyn Crst_Ales AM
 Site Code : 05121716
 Start Date : 11/30/2021
 Page No : 2

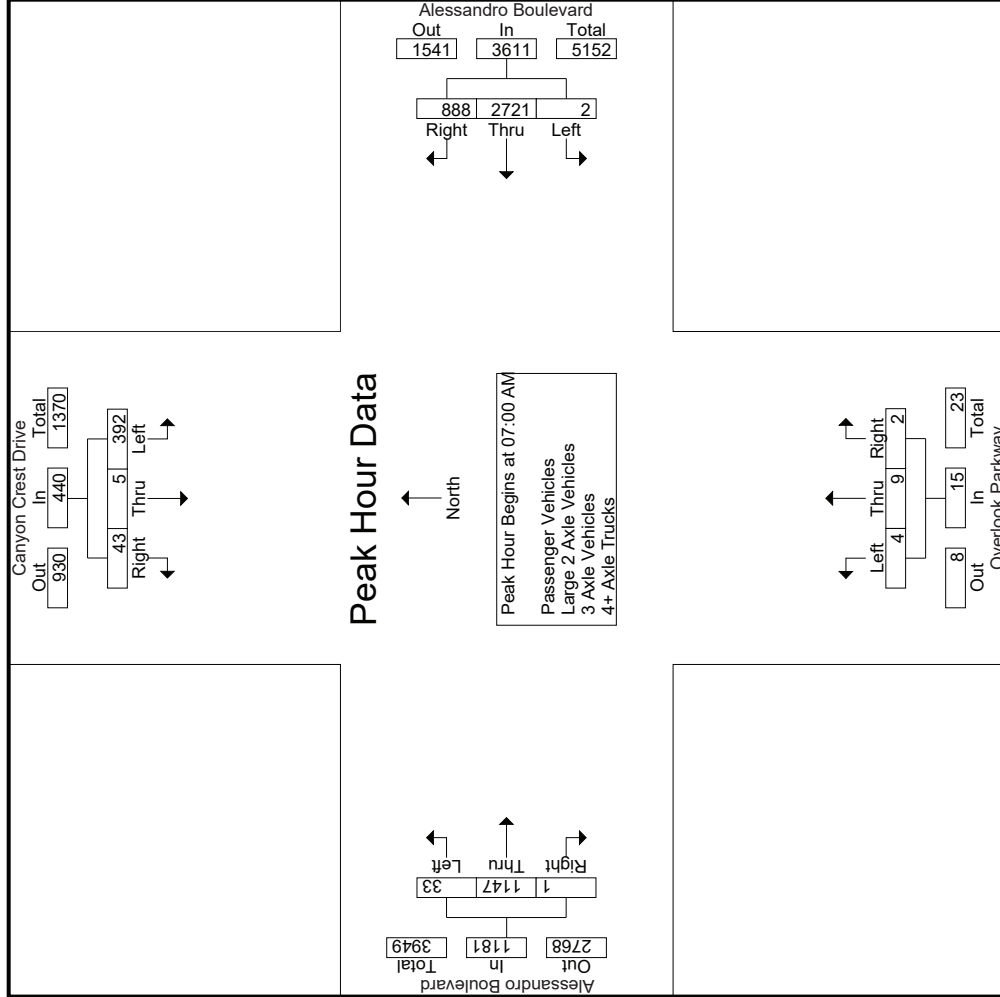

Counts Unlimited, Inc.
 PO Box 1178
 Corona, CA 92878
 (951)268-6268

File Name : 03_RIV_Cyn Crst_Ales AM
 Site Code : 05121716
 Start Date : 11/30/2021
 Page No : 3

City of Riverside
 N/S: Canyon Crest Dr/Overlook Pkwy
 E/W: Alessandro Boulevard
 Weather: Clear

Start Time	Canyon Crest Drive Southbound			Alessandro Boulevard Westbound			Overlook Parkway Northbound			Alessandro Boulevard Eastbound				
	Left	Thru	Right	Left	Thru	Right	Left	Thru	Right	Left	Thru	Right	App. Total	Int. Total
Peak Hour Analysis From 07:00 AM to 08:45 AM - Peak 1 of 1														
Peak Hour for Each Approach Begins at:														
	07:15 AM			07:00 AM			08:00 AM			07:15 AM				
+0 mins.	107	0	15	2	754	186	2	2	2	9	290	0	299	
+15 mins.	83	2	9	0	708	240	0	0	0	5	295	1	301	
+30 mins.	119	3	8	0	694	238	4	3	10	12	311	0	323	
+45 mins.	97	1	7	0	565	224	2	1	9	17	293	2	312	
Total Volume	406	6	39	2	2721	888	8	6	32	43	1189	3	1235	
% App. Total	90	1.3	8.6	0.1	75.4	24.6	25	18.8	3.5	96.3	0.2			
PHF	.853	.500	.650	.250	.902	.925	.500	.500	.727	.632	.956	.375	.956	

Counts Unlimited, Inc.
 PO Box 1178
 Corona, CA 92878
 (951)268-6268

File Name : 03_RIV_Cyn Crst_Ales AM
 Site Code : 05121716
 Start Date : 11/30/2021
 Page No : 1

City of Riverside
 N/S: Canyon Crest Dr/Overlook Pkwy
 EW: Alessandro Boulevard
 Weather: Clear

Start Time	Groups Printed- Passenger Vehicles																		
	Canyon Crest Drive Southbound				Alessandro Boulevard Westbound				Overlook Parkway Northbound				Alessandro Boulevard Eastbound						
	Left	Thru	Right	RTOR	App. Total	Left	Thru	Right	RTOR	App. Total	Left	Thru	Right	RTOR	App. Total	Exclu. Total	Inclu. Total	Int. Total	
07:00 AM	79	0	11	4	90	2	751	183	21	936	0	1	0	0	1	25	1275	1300	
07:15 AM	102	0	15	6	117	0	696	239	62	935	2	3	0	0	5	68	1349	1417	
07:30 AM	83	2	9	4	94	0	685	237	35	922	1	2	1	1	4	40	1315	1355	
07:45 AM	115	2	7	1	124	0	559	219	37	778	1	3	1	1	5	39	1219	1258	
Total	379	4	42	15	425	2	2691	878	155	3571	4	9	2	2	15	172	5158	5330	
08:00 AM	95	1	6	1	102	0	557	198	47	755	7	2	2	1	11	16	285	2	303
08:15 AM	75	0	20	13	95	0	636	192	37	828	2	0	0	0	2	13	255	3	271
08:30 AM	76	3	17	8	96	2	630	158	42	790	3	4	3	3	10	7	215	2	224
08:45 AM	73	3	14	7	90	0	613	145	76	758	6	2	1	1	9	9	253	1	263
Total	319	7	57	29	383	2	2436	693	202	3131	18	8	6	5	32	45	1008	8	1061
Grand Total	698	11	99	44	808	4	5127	1571	357	6702	22	17	8	7	47	74	2125	9	2208
% Apprch %	86.4	1.4	12.3			0.1	76.5	23.4		68.6	46.8	36.2	17		0.5	3.4	96.2	0.4	
% Total %	7.1	0.1	1		8.3	0	52.5	16.1		68.6	0.2	0.2	0.1		0.5	0.8	21.8	0.1	

Start Time	Canyon Crest Drive Southbound												Alessandro Boulevard Westbound				Overlook Parkway Northbound				Alessandro Boulevard Eastbound			
	Left	Thru	Right	RTOR	App. Total	Left	Thru	Right	RTOR	App. Total	Left	Thru	Right	RTOR	App. Total	Left	Thru	Right	RTOR	App. Total	Int. Total			
	07:00 AM	79	0	11	4	90	2	751	183	21	936	0	1	0	0	1	4	244	0	0	248	25	1275	1300
07:15 AM	102	0	15	6	117	0	696	239	62	935	2	3	0	0	5	9	283	0	0	292	68	1349	1417	
07:30 AM	83	2	9	4	94	0	685	237	35	922	1	2	1	1	4	5	289	1	0	295	40	1315	1355	
07:45 AM	115	2	7	1	124	0	559	219	37	778	1	3	1	1	5	11	301	0	0	312	39	1219	1258	
Total	379	4	42	15	425	2	2691	878	155	3571	4	9	2	2	15	29	1117	1	0	1147	172	5158	5330	
08:00 AM	95	1	6	1	102	0	557	198	47	755	7	2	2	1	11	16	285	2	0	303	49	1171	1220	
08:15 AM	75	0	20	13	95	0	636	192	37	828	2	0	0	0	2	13	255	3	0	271	50	1196	1246	
08:30 AM	76	3	17	8	96	2	630	158	42	790	3	4	3	3	10	7	215	2	0	224	53	1120	1173	
08:45 AM	73	3	14	7	90	0	613	145	76	758	6	2	1	1	9	9	253	1	0	263	84	1120	1204	
Total	319	7	57	29	383	2	2436	693	202	3131	18	8	6	5	32	45	1008	8	0	1061	236	4607	4843	
Grand Total	698	11	99	44	808	4	5127	1571	357	6702	22	17	8	7	47	74	2125	9	0	2208	408	9765	10173	
% Apprch %	86.4	1.4	12.3			0.1	76.5	23.4		68.6	46.8	36.2	17		0.5	3.4	96.2	0.4			4	96		
% Total %	7.1	0.1	1		8.3	0	52.5	16.1		68.6	0.2	0.2	0.1		0.5	0.8	21.8	0.1			4	96		

Start Time	Canyon Crest Drive Southbound												Alessandro Boulevard Westbound				Overlook Parkway Northbound				Alessandro Boulevard Eastbound			
	Left	Thru	Right	RTOR	App. Total	Left	Thru	Right	RTOR	App. Total	Left	Thru	Right	RTOR	App. Total	Left	Thru	Right	RTOR	App. Total	Int. Total			
	07:00 AM	79	0	11	4	90	2	751	183	21	936	0	1	0	0	1	4	244	0	0	248	25	1275	1300
07:15 AM	102	0	15	6	117	0	696	239	62	935	2	3	0	0	5	9	283	0	0	292	68	1349	1417	
07:30 AM	83	2	9	4	94	0	685	237	35	922	1	2	1	1	4	5	289	1	0	295	40	1315	1355	
07:45 AM	115	2	7	1	124	0	559	219	37	778	1	3	1	1	5	11	301	0	0	312	39	1219	1258	
Total	379	4	42	15	425	2	2691	878	155	3571	4	9	2	2	15	29	1117	1	0	1147	172	5158	5330	
% App. Total	89.2	0.9	9.9			0.1	75.4	24.6		68.6	46.8	36.2	17		0.5	3.4	96.2	0.4			4	96		
PHF	.824	.500	.700		.857	.250	.896	.918		.954	.500	.750	.500		.750	.659	.928	.250			.919	.956		

Peak Hour Analysis From 07:00 AM to 07:45 AM - Peak 1 of 1
 Peak Hour for Entire Intersection Begins at 07:00 AM

Counts Unlimited, Inc.
 PO Box 1178
 Corona, CA 92878
 (951)268-6268

City of Riverside
 N/S: Canyon Crest Dr/Overlook Pkwy
 EW: Alessandro Boulevard
 Weather: Clear

File Name : 03_RIV_Cyn Crst_Ales AM
 Site Code : 05121716
 Start Date : 11/30/2021
 Page No : 2

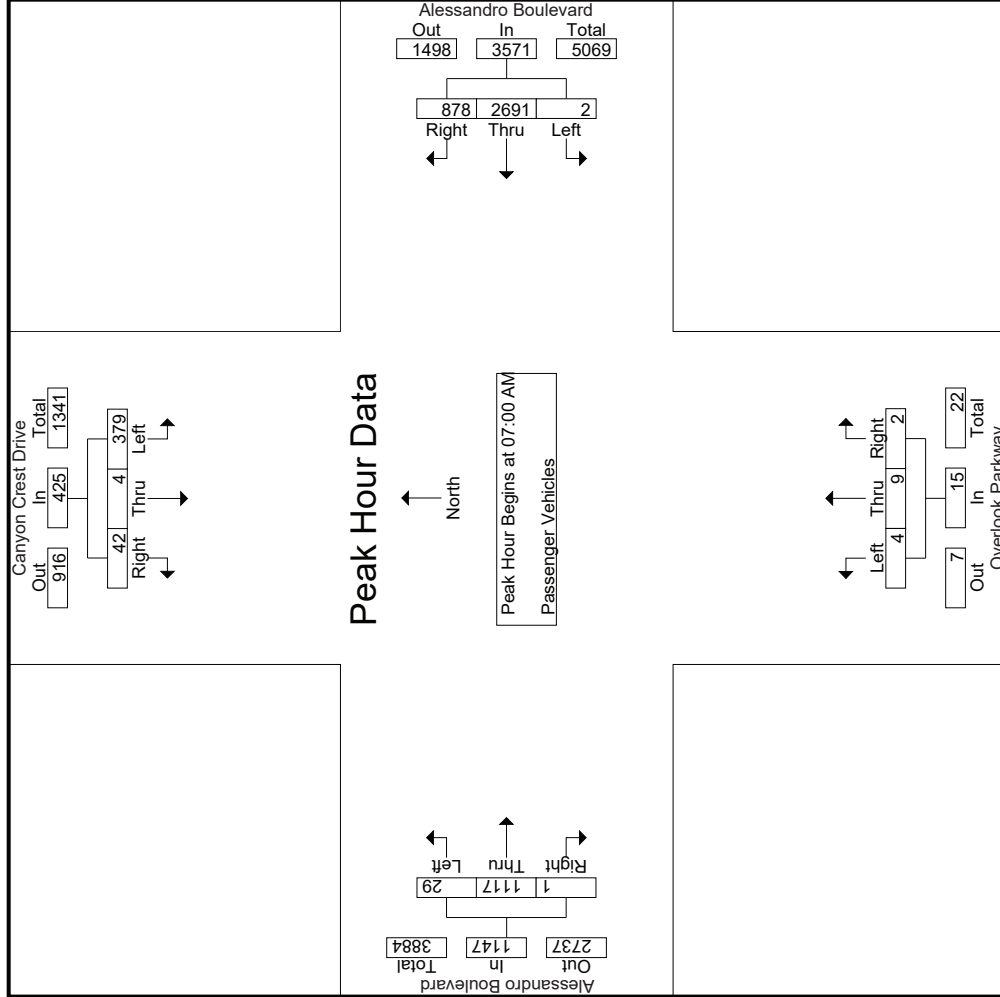

Counts Unlimited, Inc.
 PO Box 1178
 Corona, CA 92878
 (951)268-6268

File Name : 03_RIV_Cyn Crst_Ales AM
 Site Code : 05121716
 Start Date : 11/30/2021
 Page No : 3

City of Riverside
 N/S: Canyon Crest Dr/Overlook Pkwy
 EW: Alessandro Boulevard
 Weather: Clear

Start Time	Canyon Crest Drive Southbound			Alessandro Boulevard Westbound			Overlook Parkway Northbound			Alessandro Boulevard Eastbound				
	Left	Thru	Right	App. Total	Left	Thru	Right	App. Total	Left	Thru	Right	App. Total	Int. Total	
Peak Hour Analysis From 07:00 AM to 07:45 AM - Peak 1 of 1	Peak Hour for Each Approach Begins at:													
	07:00 AM													
+0 mins.	79	0	11	90	2	751	183	936	0	1	0	1	248	
+15 mins.	102	0	15	117	0	696	239	935	2	3	0	5	292	
+30 mins.	83	2	9	94	0	685	237	922	1	2	1	4	295	
+45 mins.	115	2	7	124	0	559	219	778	1	3	1	5	312	
Total Volume	379	4	42	425	2	2691	878	3571	4	9	2	15	1147	
% App. Total	89.2	0.9	9.9		0.1	75.4	24.6		26.7	60	13.3		97.4	
PHF	.824	.500	.700	.857	.250	.896	.918	.954	.500	.750	.500	.750	.928	.919

Counts Unlimited, Inc.
 PO Box 1178
 Corona, CA 92878
 (951)268-6268

File Name : 03_RIV_Cyn Crst_Ales AM
 Site Code : 05121716
 Start Date : 11/30/2021
 Page No : 1

City of Riverside
 N/S: Canyon Crest Dr/Overlook Pkwy
 EW: Alessandro Boulevard
 Weather: Clear

Groups Printed- Large 2 Axle Vehicles

Start Time	Canyon Crest Drive Southbound				Alessandro Boulevard Westbound				Overlook Parkway Northbound				Alessandro Boulevard Eastbound					
	Left	Thru	Right	RTOR	App. Total	Left	Thru	Right	RTOR	App. Total	Left	Thru	Right	RTOR	App. Total	Exclu. Total	Inclu. Total	Int. Total
07:00 AM	3	0	0	0	3	0	3	0	0	6	0	0	0	0	0	0	19	19
07:15 AM	3	0	0	0	3	0	12	1	0	13	0	0	0	0	5	0	21	21
07:30 AM	0	0	0	0	0	0	7	1	0	8	0	0	0	0	6	0	14	14
07:45 AM	4	1	1	1	6	0	5	5	0	10	0	0	0	0	10	1	26	27
Total	10	1	1	1	12	0	27	10	0	37	0	0	0	0	31	1	80	81
08:00 AM	2	0	1	0	3	0	6	6	1	12	0	0	0	0	9	1	24	25
08:15 AM	0	0	0	0	0	0	15	2	0	17	0	0	0	0	3	0	20	20
08:30 AM	1	0	0	0	1	0	12	1	0	13	0	0	0	0	4	0	18	18
08:45 AM	0	0	0	0	0	0	6	0	0	6	0	0	0	0	5	0	11	11
Total	3	0	1	0	4	0	39	9	1	48	0	0	0	0	21	1	73	74
Grand Total	13	1	2	1	16	0	66	19	1	85	0	0	0	0	52	2	153	155
% Approach	81.2	6.2	12.5			0	77.6	22.4			0	0	0	0	11.5	88.5	0	
Total %	8.5	0.7	1.3		10.5	0	43.1	12.4		55.6	0	0	0	0	3.9	30.1	0	98.7

Start Time	Canyon Crest Drive Southbound				Alessandro Boulevard Westbound				Overlook Parkway Northbound				Alessandro Boulevard Eastbound					
	Left	Thru	Right	RTOR	App. Total	Left	Thru	Right	RTOR	App. Total	Left	Thru	Right	RTOR	App. Total	Exclu. Total	Inclu. Total	Int. Total
07:00 AM	3	0	0	0	3	0	3	0	0	6	0	0	0	0	0	0	19	19
07:15 AM	3	0	0	0	3	0	12	1	0	13	0	0	0	0	5	0	21	21
07:30 AM	0	0	0	0	0	0	7	1	0	8	0	0	0	0	6	0	14	14
07:45 AM	4	1	1	1	6	0	5	5	0	10	0	0	0	0	10	1	26	27
Total	10	1	1	1	12	0	27	10	0	37	0	0	0	0	31	1	80	81
08:00 AM	2	0	1	0	3	0	6	6	1	12	0	0	0	0	9	1	24	25
08:15 AM	0	0	0	0	0	0	15	2	0	17	0	0	0	0	3	0	20	20
08:30 AM	1	0	0	0	1	0	12	1	0	13	0	0	0	0	4	0	18	18
08:45 AM	0	0	0	0	0	0	6	0	0	6	0	0	0	0	5	0	11	11
Total	3	0	1	0	4	0	39	9	1	48	0	0	0	0	21	1	73	74
Grand Total	13	1	2	1	16	0	66	19	1	85	0	0	0	0	52	2	153	155
% Approach	81.2	6.2	12.5			0	77.6	22.4			0	0	0	0	11.5	88.5	0	
Total %	8.5	0.7	1.3		10.5	0	43.1	12.4		55.6	0	0	0	0	3.9	30.1	0	98.7

Peak Hour Analysis From 07:00 AM to 07:45 AM - Peak 1 of 1
 Peak Hour for Entire Intersection Begins at 07:00 AM

Start Time	Canyon Crest Drive Southbound				Alessandro Boulevard Westbound				Overlook Parkway Northbound				Alessandro Boulevard Eastbound					
	Left	Thru	Right	RTOR	App. Total	Left	Thru	Right	RTOR	App. Total	Left	Thru	Right	RTOR	App. Total	Exclu. Total	Inclu. Total	Int. Total
07:00 AM	3	0	0	0	3	0	3	0	0	6	0	0	0	0	0	0	19	19
07:15 AM	3	0	0	0	3	0	12	1	0	13	0	0	0	0	5	0	21	21
07:30 AM	0	0	0	0	0	0	7	1	0	8	0	0	0	0	6	0	14	14
07:45 AM	4	1	1	1	6	0	5	5	0	10	0	0	0	0	10	1	26	27
Total	10	1	1	1	12	0	27	10	0	37	0	0	0	0	31	1	80	81
% App. Total	83.3	8.3	8.3			0	73	27			12.9	87.1	0	0	0	0	76.9	76.9
PHF	.625	.250	.250		.500	.000	.563	.500		.712	.000	.000	.000	.000	.000	.000	.775	.769

Counts Unlimited, Inc.
 PO Box 1178
 Corona, CA 92878
 (951)268-6268

City of Riverside
 N/S: Canyon Crest Dr/Overlook Pkwy
 E/W: Alessandro Boulevard
 Weather: Clear

File Name : 03_RIV_Cyn Crst_Ales AM
 Site Code : 05121716
 Start Date : 11/30/2021
 Page No : 2

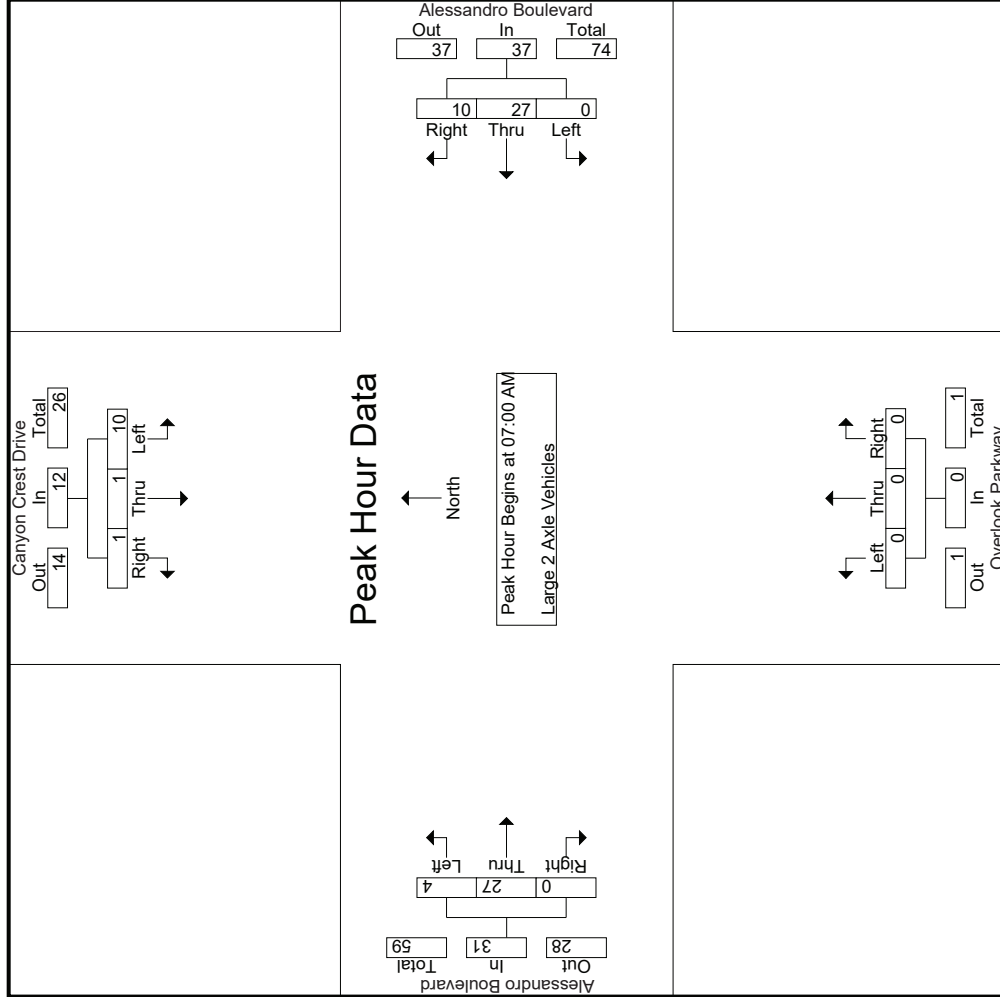

Counts Unlimited, Inc.
 PO Box 1178
 Corona, CA 92878
 (951)268-6268

File Name : 03_RIV_Cyn Crst_Ales AM
 Site Code : 05121716
 Start Date : 11/30/2021
 Page No : 3

City of Riverside
 N/S: Canyon Crest Dr/Overlook Pkwy
 E/W: Alessandro Boulevard
 Weather: Clear

Start Time	Canyon Crest Drive Southbound			Alessandro Boulevard Westbound			Overlook Parkway Northbound			Alessandro Boulevard Eastbound		
	Left	Thru	Right	Left	Thru	Right	Left	Thru	Right	Left	Thru	Right
Peak Hour Analysis From 07:00 AM to 07:45 AM - Peak 1 of 1												
Peak Hour for Each Approach Begins at:												
+0 mins.	3	0	0	0	3	3	0	0	0	0	7	0
+15 mins.	3	0	0	12	1	13	0	0	0	0	5	0
+30 mins.	0	0	0	7	1	8	0	0	0	0	6	0
+45 mins.	4	1	1	5	5	10	0	0	0	1	9	0
Total Volume	10	1	1	27	10	37	0	0	0	4	27	0
% App. Total	83.3	8.3	8.3	0	73	27	0	0	0	12.9	87.1	0
PHF	.625	.250	.250	.000	.563	.500	.000	.000	.000	.333	.750	.000

Counts Unlimited, Inc.
 PO Box 1178
 Corona, CA 92878
 (951)268-6268

City of Riverside
 N/S: Canyon Crest Dr/Overlook Pkwy
 EW: Alessandro Boulevard
 Weather: Clear

File Name : 03_RIV_Cyn Crst_Ales AM
 Site Code : 05121716
 Start Date : 11/30/2021
 Page No : 1

Groups Printed- 3 Axle Vehicles

Start Time	Canyon Crest Drive Southbound				Alessandro Boulevard Westbound				Overlook Parkway Northbound				Alessandro Boulevard Eastbound							
	Left	Thru	Right	RTOR	Left	Thru	Right	RTOR	Left	Thru	Right	RTOR	Left	Thru	Right	RTOR	App. Total	Exclu. Total	Inclu. Total	Int. Total
07:00 AM	1	0	0	0	0	0	0	0	0	0	0	0	0	0	0	0	0	0	1	1
07:15 AM	2	0	0	0	0	0	0	0	0	0	0	0	0	1	0	0	1	0	3	3
07:30 AM	0	0	0	0	0	0	0	0	0	0	0	0	0	0	0	0	0	0	0	0
07:45 AM	0	0	0	0	1	0	0	0	0	0	0	0	0	0	0	0	0	0	1	1
Total	3	0	0	0	1	0	0	0	0	0	0	0	0	1	0	0	1	0	5	5
08:00 AM	0	0	0	0	1	1	0	0	0	0	0	0	0	0	0	0	0	0	2	2
08:15 AM	0	0	0	0	3	1	1	4	0	0	0	0	0	0	0	0	1	4	5	5
08:30 AM	0	0	0	0	2	2	1	4	0	0	0	0	0	1	0	0	1	1	5	6
08:45 AM	0	0	0	0	0	0	0	0	0	0	0	0	0	1	0	0	1	0	1	1
Total	0	0	0	0	6	4	2	10	0	0	0	0	0	2	0	0	2	12	14	14
Grand Total	3	0	0	0	7	4	2	11	0	0	0	0	0	3	0	0	3	2	17	19
% Approach	100	0	0	0	63.6	36.4			0	0	0	0	0	100	0	0	17.6	10.5	89.5	
% Total	17.6	0	0	0	41.2	23.5		64.7	0	0	0	0	0	17.6	0	0	17.6	10.5	89.5	

Start Time	Canyon Crest Drive Southbound				Alessandro Boulevard Westbound				Overlook Parkway Northbound				Alessandro Boulevard Eastbound							
	Left	Thru	Right	RTOR	Left	Thru	Right	RTOR	Left	Thru	Right	RTOR	Left	Thru	Right	RTOR	App. Total	Exclu. Total	Inclu. Total	Int. Total
07:00 AM	1	0	0	0	0	0	0	0	0	0	0	0	0	0	0	0	0	0	0	0
07:15 AM	2	0	0	0	0	0	0	0	0	0	0	0	0	0	0	0	0	0	1	3
07:30 AM	0	0	0	0	0	0	0	0	0	0	0	0	0	0	0	0	0	0	0	0
07:45 AM	0	0	0	0	1	0	0	0	0	0	0	0	0	0	0	0	0	0	1	1
Total Volume	3	0	0	0	1	0	0	0	0	0	0	0	0	0	0	0	0	0	1	5
% App. Total	100	0	0	0	33.3	0	0	0	0	0	0	0	0	0	0	0	0	0	33.3	100
PHF	.375	.000	.000	.000	.375	.000	.000	.000	.250	.000	.000	.000	.000	.250	.000	.000	.000	.250	.417	.417

Peak Hour Analysis From 07:00 AM to 07:45 AM - Peak 1 of 1
 Peak Hour for Entire Intersection Begins at 07:00 AM

Counts Unlimited, Inc.
 PO Box 1178
 Corona, CA 92878
 (951)268-6268

City of Riverside
 N/S: Canyon Crest Dr/Overlook Pkwy
 E/W: Alessandro Boulevard
 Weather: Clear

File Name : 03_RIV_Cyn Crst_Ales AM
 Site Code : 05121716
 Start Date : 11/30/2021
 Page No : 2

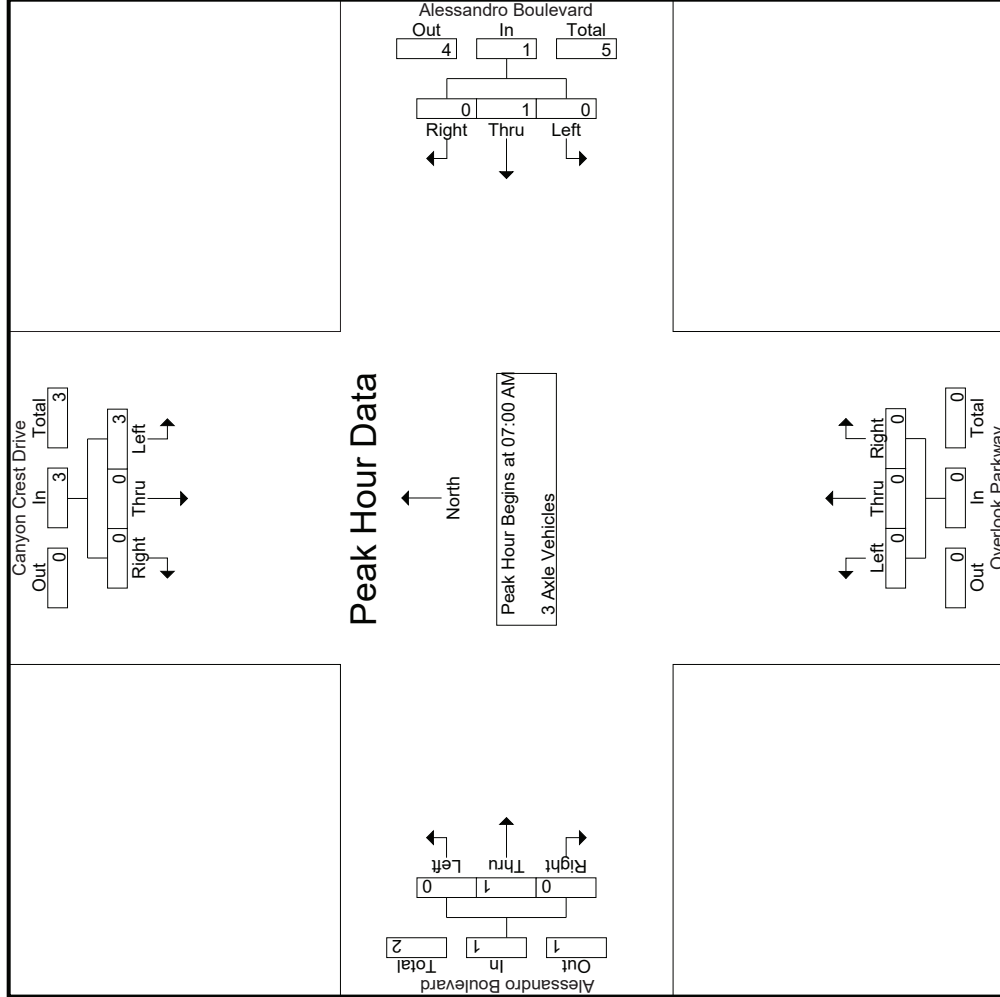

Counts Unlimited, Inc.
 PO Box 1178
 Corona, CA 92878
 (951)268-6268

City of Riverside
 N/S: Canyon Crest Dr/Overlook Pkwy
 E/W: Alessandro Boulevard
 Weather: Clear

File Name : 03_RIV_Cyn Crst_Ales AM
 Site Code : 05121716
 Start Date : 11/30/2021
 Page No : 3

Start Time	Canyon Crest Drive Southbound			Alessandro Boulevard Westbound			Overlook Parkway Northbound			Alessandro Boulevard Eastbound		
	Left	Thru	Right	Left	Thru	Right	Left	Thru	Right	Left	Thru	Right
Peak Hour Analysis From 07:00 AM to 07:45 AM - Peak 1 of 1												
Peak Hour for Each Approach Begins at:												
+0 mins.	1	0	0	0	0	0	0	0	0	0	0	0
+15 mins.	2	0	0	0	0	0	0	0	0	1	0	1
+30 mins.	0	0	0	0	0	0	0	0	0	0	0	0
+45 mins.	0	0	0	0	1	0	0	0	0	0	0	0
Total Volume	3	0	0	0	1	0	0	0	0	1	0	1
% App. Total	100	0	0	0	100	0	0	0	0	100	0	0
PHF	.375	.000	.000	.375	.000	.000	.250	.000	.000	.250	.000	.000

Counts Unlimited, Inc.
 PO Box 1178
 Corona, CA 92878
 (951)268-6268

City of Riverside
 N/S: Canyon Crest Dr/Overlook Pkwy
 EW: Alessandro Boulevard
 Weather: Clear

File Name : 03_RIV_Cyn Crst_Ales AM
 Site Code : 05121716
 Start Date : 11/30/2021
 Page No : 1

Groups Printed- 4+ Axle Trucks

Start Time	Canyon Crest Drive Southbound				Alessandro Boulevard Westbound				Overlook Parkway Northbound				Alessandro Boulevard Eastbound					
	Left	Thru	Right	RTOR	App. Total	Left	Thru	Right	RTOR	App. Total	Left	Thru	Right	RTOR	App. Total	Exclu. Total	Inclu. Total	Int. Total
07:00 AM	0	0	0	0	0	0	0	0	0	0	0	0	0	0	0	0	0	0
07:15 AM	0	0	0	0	0	0	0	0	0	0	0	0	0	0	0	0	0	0
07:30 AM	0	0	0	0	0	2	0	0	0	2	0	0	0	0	0	0	0	0
07:45 AM	0	0	0	0	0	0	0	0	0	0	0	0	0	0	0	0	0	0
Total	0	0	0	0	0	2	0	0	0	2	0	0	0	0	2	0	0	4
08:00 AM	0	0	0	0	0	1	1	0	0	2	0	0	0	0	0	0	0	2
08:15 AM	0	0	0	0	0	0	2	0	0	2	0	0	0	0	0	0	0	3
08:30 AM	0	0	0	0	0	0	0	0	0	0	0	0	0	0	0	0	0	0
08:45 AM	0	0	0	0	0	3	1	0	0	4	0	0	0	0	0	0	0	4
Total	0	0	0	0	0	4	4	0	0	8	0	0	0	0	1	0	0	9
Grand Total	0	0	0	0	0	6	4	0	0	10	0	0	0	0	3	0	0	13
% Approach	0	0	0	0	0	60	40	0	0	76.9	0	0	0	0	100	0	0	100
% Total	0	0	0	0	0	46.2	30.8	0	0	76.9	0	0	0	0	23.1	0	0	100

Start Time	Canyon Crest Drive Southbound				Alessandro Boulevard Westbound				Overlook Parkway Northbound				Alessandro Boulevard Eastbound					
	Left	Thru	Right	RTOR	App. Total	Left	Thru	Right	RTOR	App. Total	Left	Thru	Right	RTOR	App. Total	Exclu. Total	Inclu. Total	Int. Total
07:00 AM	0	0	0	0	0	0	0	0	0	0	0	0	0	0	0	0	0	0
07:15 AM	0	0	0	0	0	0	0	0	0	0	0	0	0	0	0	0	0	0
07:30 AM	0	0	0	0	0	2	0	0	0	2	0	0	0	0	0	0	0	0
07:45 AM	0	0	0	0	0	0	0	0	0	0	0	0	0	0	0	0	0	0
Total Volume	0	0	0	0	0	2	0	0	0	2	0	0	0	0	2	0	0	2
% App. Total	0	0	0	0	0	100	0	0	0	100	0	0	0	0	100	0	0	100
PHF	.000	.000	.000	.000	.000	.000	.250	.000	.000	.250	.000	.000	.000	.000	.000	.000	.500	.500

Peak Hour Analysis From 07:00 AM to 07:45 AM - Peak 1 of 1
 Peak Hour for Entire Intersection Begins at 07:00 AM

Counts Unlimited, Inc.
 PO Box 1178
 Corona, CA 92878
 (951)268-6268

City of Riverside
 N/S: Canyon Crest Dr/Overlook Pkwy
 E/W: Alessandro Boulevard
 Weather: Clear

File Name : 03_RIV_Cyn Crst_Ales AM
 Site Code : 05121716
 Start Date : 11/30/2021
 Page No : 2

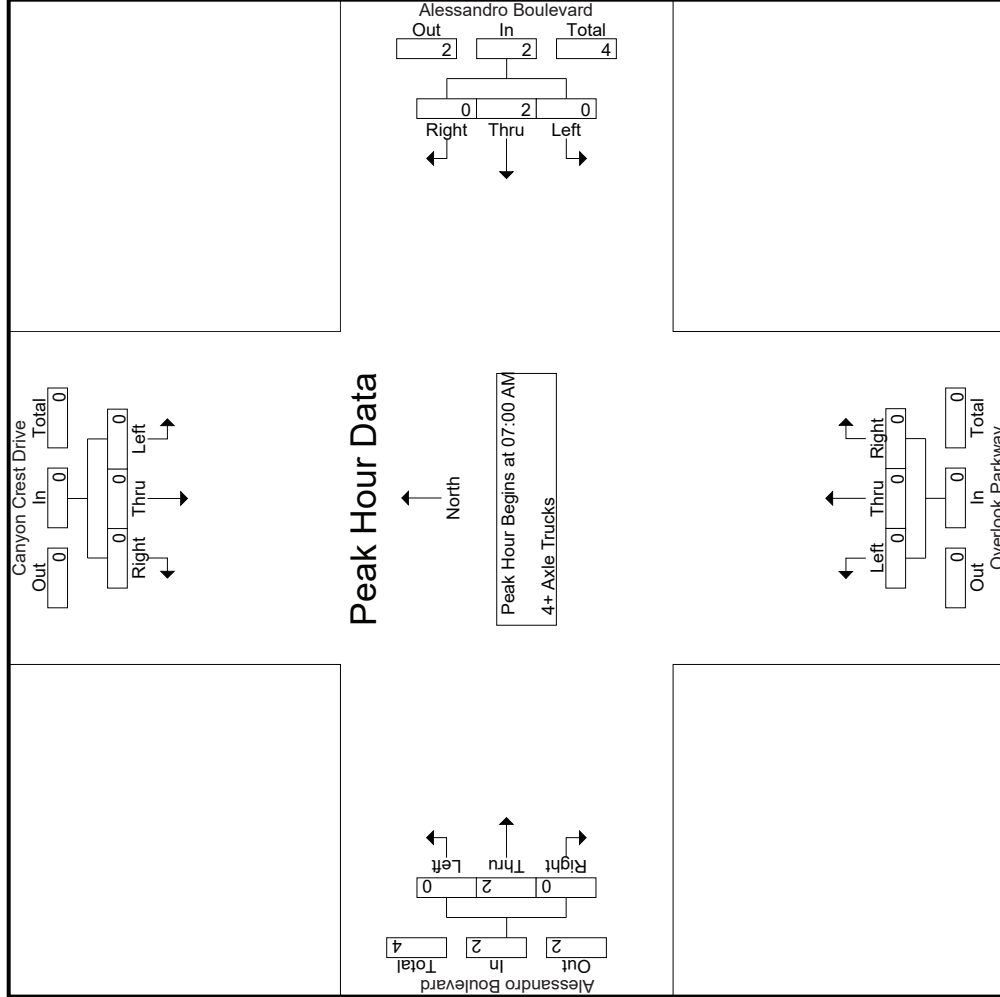

Counts Unlimited, Inc.
 PO Box 1178
 Corona, CA 92878
 (951)268-6268

City of Riverside
 N/S: Canyon Crest Dr/Overlook Pkwy
 E/W: Alessandro Boulevard
 Weather: Clear

File Name : 03_RIV_Cyn Crst_Ales AM
 Site Code : 05121716
 Start Date : 11/30/2021
 Page No : 3

Start Time	Canyon Crest Drive Southbound			Alessandro Boulevard Westbound			Overlook Parkway Northbound			Alessandro Boulevard Eastbound				
	Left	Thru	Right	Left	Thru	Right	Left	Thru	Right	Left	Thru	Right	App. Total	Int. Total
Peak Hour Analysis From 07:00 AM to 07:45 AM - Peak 1 of 1	07:00 AM													
Peak Hour for Each Approach Begins at:	07:00 AM													
+0 mins.	0	0	0	0	0	0	0	0	0	0	0	0	0	0
+15 mins.	0	0	0	0	0	0	0	0	0	0	0	1	0	1
+30 mins.	0	0	0	0	2	0	0	0	0	0	0	0	0	0
+45 mins.	0	0	0	0	0	0	0	0	0	0	0	1	0	1
Total Volume	0	0	0	0	2	0	0	0	0	0	0	2	0	2
% App. Total	0	0	0	0	100	0	0	0	0	0	0	100	0	0
PHF	.000	.000	.000	.000	.250	.000	.250	.000	.000	.000	.000	.500	.000	.500

Counts Unlimited, Inc.
 PO Box 1178
 Corona, CA 92878
 (951)268-6268

City of Riverside
 N/S: Canyon Crest Dr/Overlook Pkwy
 E/W: Alessandro Boulevard
 Weather: Clear

File Name : 03_RIV_Cyn Crst_Ales PM
 Site Code : 05121716
 Start Date : 11/30/2021
 Page No : 1

Groups Printed- Passenger Vehicles - Large 2 Axle Vehicles - 3 Axle Vehicles - 4+ Axle Trucks

Start Time	Canyon Crest Drive Southbound						Alessandro Boulevard Westbound						Alessandro Boulevard Eastbound											
	Left		Thru		Right		Left		Thru		Right		Left		Thru		Right							
	RTOR	App. Total	RTOR	App. Total	RTOR	App. Total	RTOR	App. Total	RTOR	App. Total	RTOR	App. Total	RTOR	App. Total	RTOR	App. Total	RTOR	App. Total						
04:00 PM	133	0	8	3	141	1	492	147	44	640	3	3	2	2	2	8	21	619	1	0	641	49	1430	1479
04:15 PM	111	3	6	0	120	1	543	150	51	694	5	1	3	3	9	9	9	697	3	0	709	54	1532	1586
04:30 PM	127	2	11	7	140	1	575	166	66	742	1	2	1	1	4	6	6	713	4	0	723	74	1609	1683
04:45 PM	176	2	2	1	180	2	432	149	66	583	2	3	1	1	6	19	19	672	5	0	696	68	1465	1533
Total	547	7	27	11	581	5	2042	612	227	2659	11	9	7	7	27	55	55	2701	13	0	2769	245	6036	6281
05:00 PM	133	4	4	1	141	1	553	134	37	688	5	0	3	3	8	18	18	744	4	0	766	41	1603	1644
05:15 PM	185	1	6	3	192	2	464	135	56	601	1	2	2	2	5	11	11	708	5	0	724	61	1522	1583
05:30 PM	186	2	7	2	195	3	434	121	51	558	1	2	3	3	6	9	9	670	6	1	685	57	1444	1501
05:45 PM	165	5	6	4	176	3	414	97	47	514	3	2	0	0	5	14	14	696	5	0	715	51	1410	1461
Total	669	12	23	10	704	9	1865	487	191	2361	10	6	8	8	24	52	52	2818	20	1	2890	210	5979	6189
Grand Total	1216	19	50	21	1285	14	3907	1099	418	5020	21	15	15	15	51	107	107	5519	33	1	5659	455	12015	12470
Approach %	94.6	1.5	3.9			0.3	77.8	21.9			41.2	29.4	29.4			1.9	97.5	0.6						
RTOR %	10.1	0.2	0.4			0.1	32.5	9.1			0.2	0.1	0.1			0.9	45.9	0.3				3.6	96.4	
Passenger Vehicles	1203	18	49		1291	14	3847	1080		5349	20	15	15		65	102	5465	32			5600	0	0	12305
% Passenger Vehicles	98.9	94.7	98	100	98.9	100	98.5	98.3	97.6	98.4	95.2	100	100	100	98.5	95.3	99	97	100	100	98.9	0	0	98.7
Large 2 Axle Vehicles	12	1	1		14	0	54	15		77	1	0	0		1	4	48	1			53	0	0	145
% Large 2 Axle Vehicles	1	5.3	2	0	1.1	0	1.4	1.4	1.9	1.4	4.8	0	0		1.5	3.7	0.9	3			0.9	0	0	1.2
3 Axle Vehicles	0	0	0		0	0	1	2		4	0	0	0		0	1	4	0			5	0	0	9
% 3 Axle Vehicles	0	0	0	0	0	0	0	0.2	0.2	0.1	0	0	0		0	0.9	0.1	0			0.1	0	0	0.1
4+ Axle Trucks	1	0	0		1	0	5	2		8	0	0	0		0	0	2	0			2	0	0	11
% 4+ Axle Trucks	0.1	0	0	0	0.1	0	0.1	0.2	0.2	0.1	0	0	0		0	0	0	0			0	0	0	0.1

Start Time	Canyon Crest Drive Southbound						Alessandro Boulevard Westbound						Alessandro Boulevard Eastbound											
	Left		Thru		Right		Left		Thru		Right		Left		Thru		Right							
	RTOR	App. Total	RTOR	App. Total	RTOR	App. Total	RTOR	App. Total	RTOR	App. Total	RTOR	App. Total	RTOR	App. Total	RTOR	App. Total	RTOR	App. Total						
04:15 PM	111	3	6		120	1	543	150		694	5	1	1	3	9	9	697	3			709			1532
04:30 PM	127	2	11		140	1	575	166		742	1	2	1	1	4	4	713	4			723			1609
04:45 PM	176	2	2		180	2	432	149		583	2	3	1	1	6	6	672	5			696			1465
05:00 PM	133	4	4		141	1	553	134		688	5	0	3	3	8	8	744	4			766			1603
Total Volume	547	11	23		581	5	2103	599		2707	13	6	8	8	27	27	2826	16			2894			6209
% App. Total	94.1	1.9	4		4	0.2	77.7	22.1		912	48.1	22.2	29.6		0.6	97.7	0.6				0.6			965
PHF	.777	.688	.523		.807	.625	.914	.902		.912	.650	.500	.667		.750	.684	.950	.800			.945			

Peak Hour Analysis From 04:00 PM to 05:45 PM - Peak 1 of 1
 Peak Hour for Entire Intersection Begins at 04:15 PM

Counts Unlimited, Inc.
 PO Box 1178
 Corona, CA 92878
 (951)268-6268

City of Riverside
 N/S: Canyon Crest Dr/Overlook Pkwy
 E/W: Alessandro Boulevard
 Weather: Clear

File Name : 03_RIV_Cyn Crst_Ales PM
 Site Code : 05121716
 Start Date : 11/30/2021
 Page No : 2

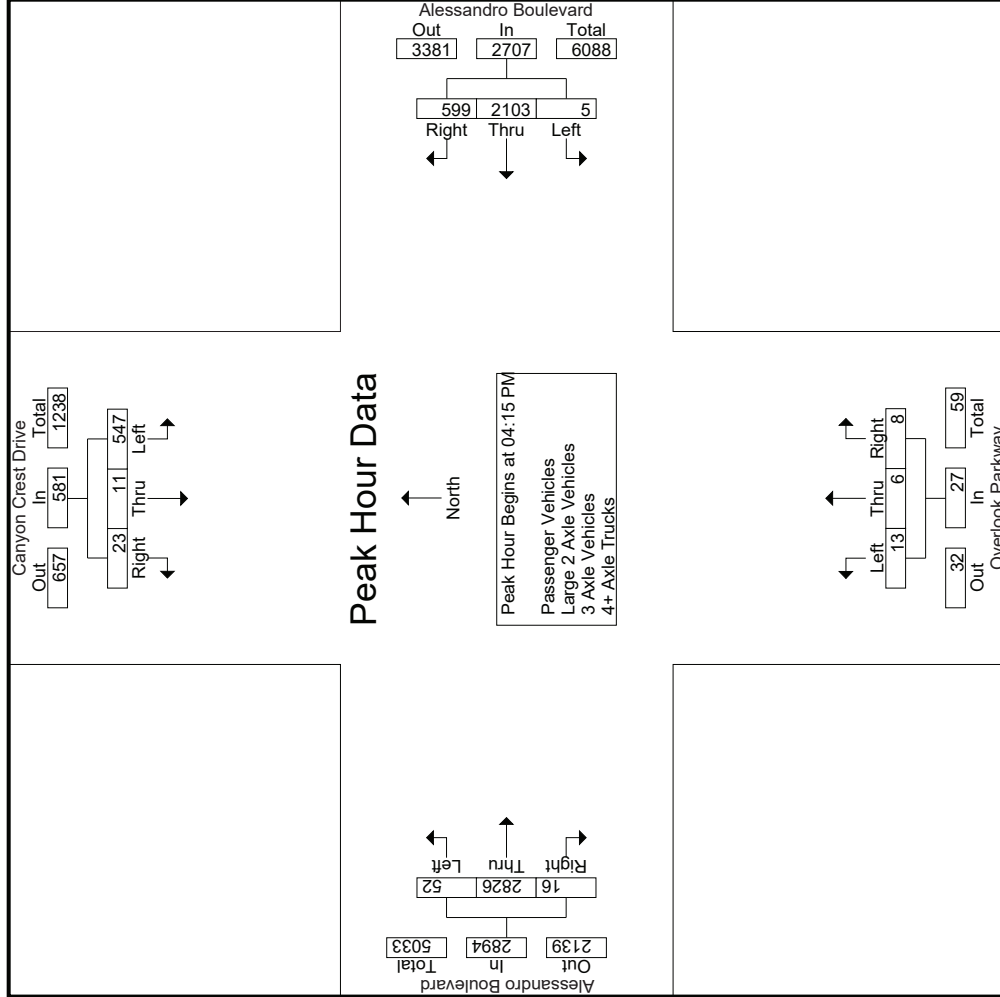

Counts Unlimited, Inc.
 PO Box 1178
 Corona, CA 92878
 (951)268-6268

File Name : 03_RIV_Cyn Crst_Ales PM
 Site Code : 05121716
 Start Date : 11/30/2021
 Page No : 3

City of Riverside
 N/S: Canyon Crest Dr/Overlook Pkwy
 EW: Alessandro Boulevard
 Weather: Clear

Start Time	Canyon Crest Drive Southbound			Alessandro Boulevard Westbound			Overlook Parkway Northbound			Alessandro Boulevard Eastbound				
	Left	Thru	Right	Left	Thru	Right	Left	Thru	Right	Left	Thru	Right		
Peak Hour Analysis From 04:00 PM to 05:45 PM - Peak 1 of 1	Peak Hour for Each Approach Begins at:													
	04:45 PM			04:15 PM			04:00 PM			04:30 PM				
+0 mins.	176	2	2	1	543	150	694	3	3	2	6	713	4	723
+15 mins.	133	4	4	1	575	166	742	5	1	3	19	672	5	696
+30 mins.	185	1	6	2	432	149	583	1	2	1	18	744	4	766
+45 mins.	186	2	7	1	553	134	688	2	3	1	11	708	5	724
Total Volume	680	9	19	5	2103	599	2707	11	9	7	54	2837	18	2909
% App. Total	96	1.3	2.7	0.2	77.7	22.1	40.7	33.3	25.9	1.9	97.5	0.6		
PHF	.914	.563	.679	.625	.914	.902	.912	.550	.583	.711	.953	.900		.949

Counts Unlimited, Inc.
 PO Box 1178
 Corona, CA 92878
 (951)268-6268

File Name : 03_RIV_Cyn Crst_Ales PM
 Site Code : 05121716
 Start Date : 11/30/2021
 Page No : 1

City of Riverside
 N/S: Canyon Crest Dr/Overlook Pkwy
 EW: Alessandro Boulevard
 Weather: Clear

Groups Printed- Passenger Vehicles																									
		Canyon Crest Drive Southbound						Alessandro Boulevard Westbound						Overlook Parkway Northbound						Alessandro Boulevard Eastbound					
Start Time	Left	Thru	Right	RTOR	App. Total	Left	Thru	Right	RTOR	App. Total	Left	Thru	Right	RTOR	App. Total	Left	Thru	Right	RTOR	App. Total	Exclu. Total	Inclu. Total	Int. Total		
04:00 PM	131	0	8	3	139	1	480	140	42	621	3	3	2	2	8	19	612	1	0	632	47	1400	1447		
04:15 PM	111	3	5	0	119	1	536	148	49	685	5	1	3	3	9	8	689	3	0	700	52	1513	1565		
04:30 PM	127	2	11	7	140	1	563	163	64	727	1	2	1	1	4	5	704	3	0	712	72	1583	1655		
04:45 PM	172	1	2	1	175	2	425	148	66	575	1	3	1	1	5	19	669	5	0	693	68	1448	1516		
Total	541	6	26	11	573	5	2004	599	221	2608	10	9	7	7	26	51	2674	12	0	2737	239	5944	6183		
05:00 PM	130	4	4	1	138	1	548	131	35	680	5	0	3	3	8	17	732	4	0	753	39	1579	1618		
05:15 PM	182	1	6	3	189	2	462	133	55	597	1	2	2	2	5	11	700	5	0	716	60	1507	1567		
05:30 PM	185	2	7	2	194	3	424	121	51	548	1	2	3	3	6	9	664	6	1	679	57	1427	1484		
05:45 PM	165	5	6	4	176	3	409	96	46	508	3	2	0	0	5	14	695	5	0	714	50	1403	1453		
Total	662	12	23	10	697	9	1843	481	187	2333	10	6	8	8	24	51	2791	20	1	2862	206	5916	6122		
Grand Total	1203	18	49	21	1270	14	3847	1080	408	4941	20	15	15	15	50	102	5465	32	1	5599	445	11860	12305		
% Approach	94.7	1.4	3.9			0.3	77.9	21.9			40	30	30			1.8	97.6	0.6							
% Total	10.1	0.2	0.4		10.7	0.1	32.4	9.1		41.7	0.2	0.1	0.1	0.1	0.4	0.9	46.1	0.3		47.2	3.6	96.4			

		Canyon Crest Drive Southbound						Alessandro Boulevard Westbound						Overlook Parkway Northbound						Alessandro Boulevard Eastbound					
Start Time	Left	Thru	Right	RTOR	App. Total	Left	Thru	Right	RTOR	App. Total	Left	Thru	Right	RTOR	App. Total	Left	Thru	Right	RTOR	App. Total	Exclu. Total	Inclu. Total	Int. Total		
04:15 PM	111	3	5		119	1	536	148		685	5	1	3		9	8	689	3		700		700	1513		
04:30 PM	127	2	11		140	1	563	148		727	1	2	1		4	5	704	3		712		712	1583		
04:45 PM	172	1	2		175	2	425	148		575	1	3	1		5	19	669	5		693		693	1448		
05:00 PM	130	4	4		138	1	548	131		680	5	0	3		8	17	732	4		753		753	1516		
Total Volume	540	10	22		572	5	2072	590		2667	12	6	8		26	49	2794	15		2858		2858	6123		
% App. Total	94.4	1.7	3.8			0.2	77.7	22.1			46.2	23.1	30.8			1.7	97.8	0.5							
PHF	.785	.625	.500		.817	.625	.920	.905		.917	.600	.500	.667		.722	.645	.954	.750		.949		.949	.967		

Peak Hour Analysis From 04:15 PM to 05:00 PM - Peak 1 of 1
 Peak Hour for Entire Intersection Begins at 04:15 PM

Counts Unlimited, Inc.
 PO Box 1178
 Corona, CA 92878
 (951)268-6268

City of Riverside
 N/S: Canyon Crest Dr/Overlook Pkwy
 E/W: Alessandro Boulevard
 Weather: Clear

File Name : 03_RIV_Cyn Crst_Ales PM
 Site Code : 05121716
 Start Date : 11/30/2021
 Page No : 2

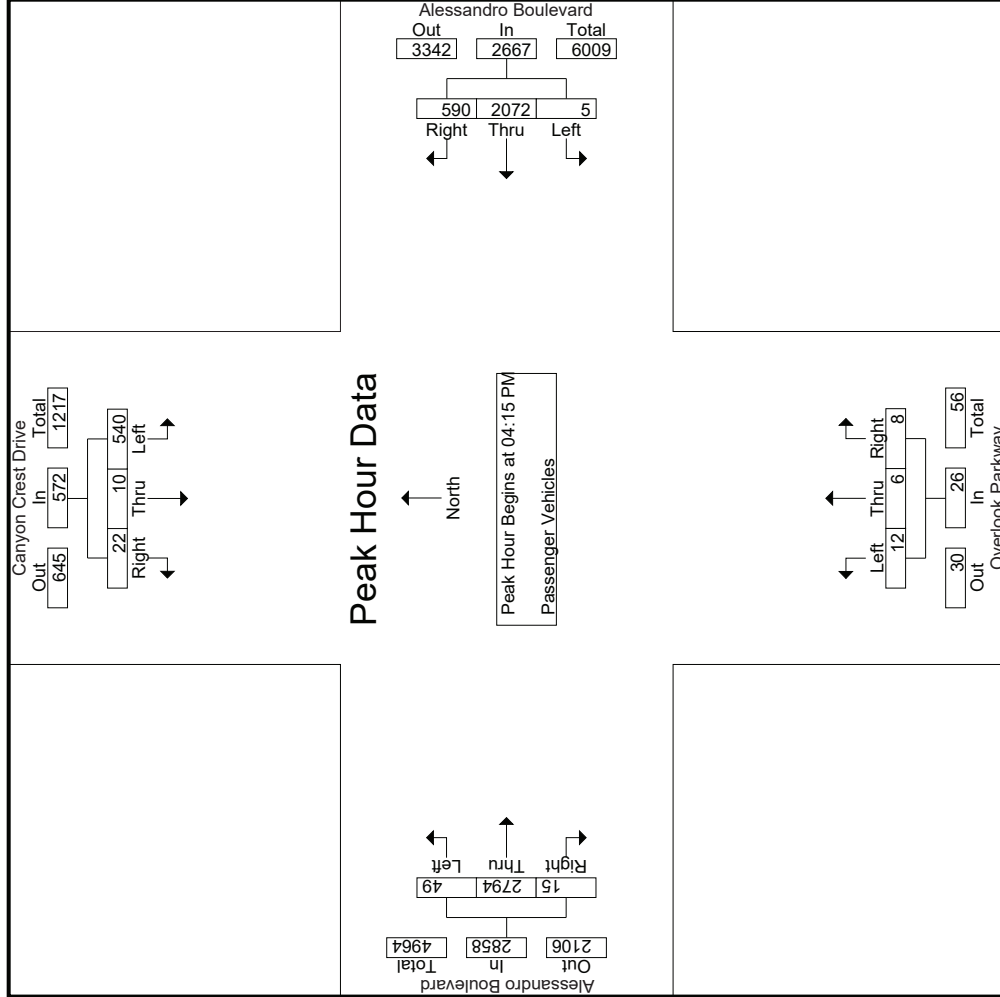

Counts Unlimited, Inc.
 PO Box 1178
 Corona, CA 92878
 (951)268-6268

File Name : 03_RIV_Cyn Crst_Ales PM
 Site Code : 05121716
 Start Date : 11/30/2021
 Page No : 3

City of Riverside
 N/S: Canyon Crest Dr/Overlook Pkwy
 E/W: Alessandro Boulevard
 Weather: Clear

Start Time	Canyon Crest Drive Southbound			Alessandro Boulevard Westbound			Overlook Parkway Northbound			Alessandro Boulevard Eastbound		
	Left	Thru	Right	Left	Thru	Right	Left	Thru	Right	Left	Thru	Right
Peak Hour Analysis From 04:15 PM to 05:00 PM - Peak 1 of 1	Peak Hour for Each Approach Begins at:											
	04:15 PM			04:15 PM			04:15 PM			04:15 PM		
+0 mins.	111	3	5	1	536	148	1	1	3	8	689	3
+15 mins.	127	2	11	1	563	163	1	2	1	5	704	3
+30 mins.	172	1	2	2	425	148	3	3	1	19	669	5
+45 mins.	130	4	4	1	548	131	0	0	3	17	732	4
Total Volume	540	10	22	5	2072	590	6	6	8	49	2794	15
% App. Total	94.4	1.7	3.8	0.2	77.7	22.1	23.1	30.8	1.7	97.8	0.5	
PHF	.785	.625	.500	.625	.920	.905	.600	.667	.645	.954	.750	.949

Counts Unlimited, Inc.
 PO Box 1178
 Corona, CA 92878
 (951)268-6268

City of Riverside
 N/S: Canyon Crest Dr/Overlook Pkwy
 E/W: Alessandro Boulevard
 Weather: Clear

File Name : 03_RIV_Cyn Crst_Ales PM
 Site Code : 05121716
 Start Date : 11/30/2021
 Page No : 1

Groups Printed- Large 2 Axle Vehicles

Start Time	Canyon Crest Drive Southbound					Alessandro Boulevard Westbound					Overlook Parkway Northbound					Alessandro Boulevard Eastbound							
	Left	Thru	Right	RTOR	App. Total	Left	Thru	Right	RTOR	App. Total	Left	Thru	Right	RTOR	App. Total	Left	Thru	Right	RTOR	App. Total	Exclu. Total	Inclu. Total	Int. Total
04:00 PM	1	0	0	0	1	0	12	5	1	17	0	0	0	0	0	2	6	0	0	8	1	26	27
04:15 PM	0	0	1	0	1	0	7	2	2	9	0	0	0	0	0	1	7	0	0	8	2	18	20
04:30 PM	0	0	0	0	0	0	11	3	2	14	0	0	0	0	0	1	7	1	0	9	2	23	25
04:45 PM	4	1	0	0	5	0	6	1	0	7	1	0	0	1	2	0	2	0	0	2	0	15	15
Total	5	1	1	0	7	0	36	11	5	47	1	0	0	1	4	22	1	0	27	5	82	87	
05:00 PM	3	0	0	0	3	0	5	1	1	6	0	0	0	0	0	0	11	0	0	11	1	20	21
05:15 PM	3	0	0	0	3	0	2	2	1	4	0	0	0	0	0	0	8	0	0	8	1	15	16
05:30 PM	1	0	0	0	1	0	6	0	0	6	0	0	0	0	0	0	6	0	0	6	0	13	13
05:45 PM	0	0	0	0	0	0	5	1	1	6	0	0	0	0	0	0	1	0	0	1	1	7	8
Total	7	0	0	0	7	0	18	4	3	22	0	0	0	0	0	0	26	0	0	26	3	55	58
Grand Total	12	1	1	0	14	0	54	15	8	69	1	0	0	0	1	4	48	1	0	53	8	137	145
% Approach	85.7	7.1	7.1	0.7	10.2	0	78.3	21.7		50.4	100	0	0	0	7.5	90.6	1.9			38.7	5.5	94.5	
% Total	8.8	0.7	0.7			0	39.4	10.9			0.7	0	0	0	2.9	35	0.7						

Start Time	Canyon Crest Drive Southbound					Alessandro Boulevard Westbound					Overlook Parkway Northbound					Alessandro Boulevard Eastbound								
	Left	Thru	Right	RTOR	App. Total	Left	Thru	Right	RTOR	App. Total	Left	Thru	Right	RTOR	App. Total	Left	Thru	Right	RTOR	App. Total	Exclu. Total	Inclu. Total	Int. Total	
04:15 PM	0	0	0	0	0	0	0	7	2	9	0	0	0	0	0	0	0	0	0	0	0	0	8	18
04:30 PM	0	0	0	0	0	0	0	11	3	14	0	0	0	0	0	0	0	0	0	0	0	0	9	23
04:45 PM	4	1	0	0	5	0	0	6	1	7	1	0	0	0	1	0	2	0	0	2	0	0	2	15
05:00 PM	3	0	0	0	3	0	0	5	1	6	0	0	0	0	0	0	11	0	0	11	0	0	11	20
Total Volume	7	1	1	1	9	0	29	7	36	36	1	0	0	0	1	2	27	1	0	30	0	0	30	76
% App. Total	77.8	11.1	11.1		11.1	0	80.6	19.4		100	0	0	0	0	6.7	90	3.3							
PHF	.438	.250	.250		.450	.000	.659	.583	.643	.000	.250	.000	.000	.000	.250	.500	.614	.250		.682				.826

Peak Hour Analysis From 04:15 PM to 05:00 PM - Peak 1 of 1
 Peak Hour for Entire Intersection Begins at 04:15 PM

Counts Unlimited, Inc.
 PO Box 1178
 Corona, CA 92878
 (951)268-6268

City of Riverside
 N/S: Canyon Crest Dr/Overlook Pkwy
 E/W: Alessandro Boulevard
 Weather: Clear

File Name : 03_RIV_Cyn Crst_Ales PM
 Site Code : 05121716
 Start Date : 11/30/2021
 Page No : 2

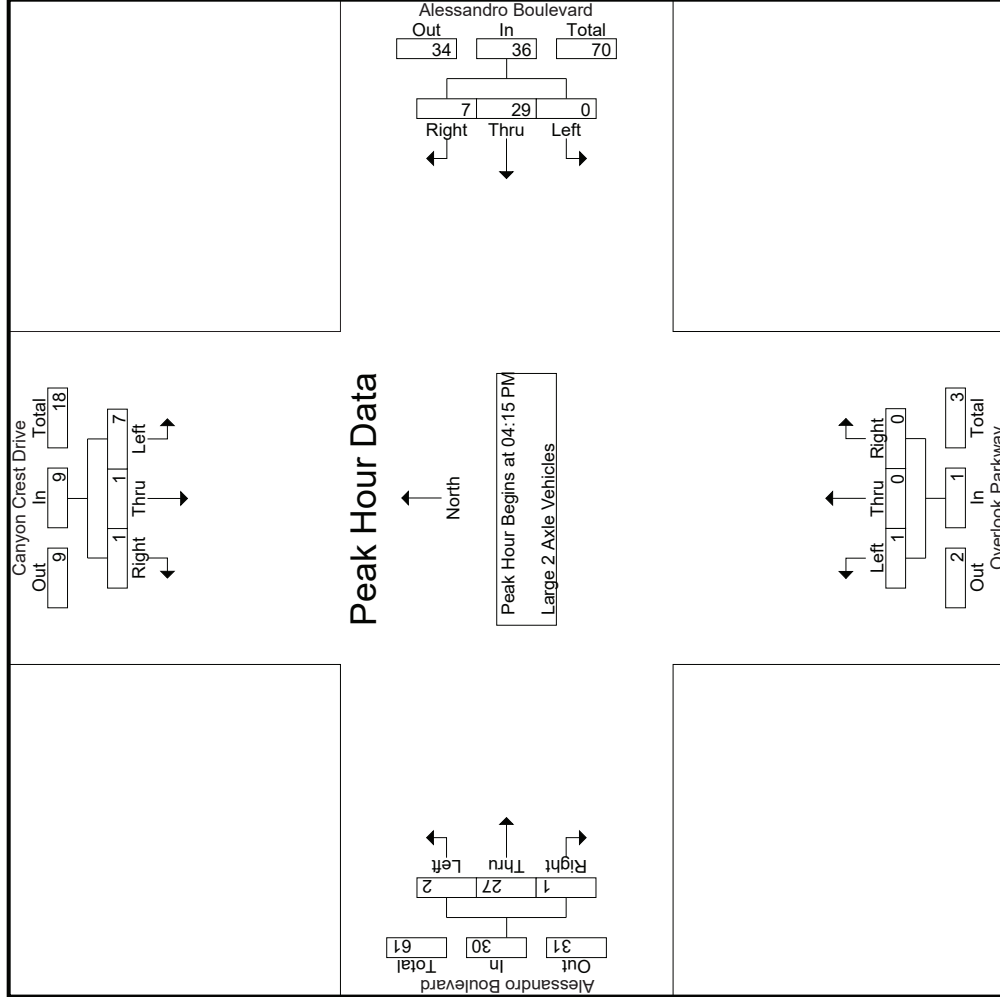

Counts Unlimited, Inc.
 PO Box 1178
 Corona, CA 92878
 (951)268-6268

File Name : 03_RIV_Cyn Crst_Ales PM
 Site Code : 05121716
 Start Date : 11/30/2021
 Page No : 3

City of Riverside
 N/S: Canyon Crest Dr/Overlook Pkwy
 E/W: Alessandro Boulevard
 Weather: Clear

Start Time	Canyon Crest Drive Southbound			Alessandro Boulevard Westbound			Overlook Parkway Northbound			Alessandro Boulevard Eastbound		
	Left	Thru	Right	Left	Thru	Right	Left	Thru	Right	Left	Thru	Right
Peak Hour Analysis From 04:15 PM to 05:00 PM - Peak 1 of 1												
Peak Hour for Each Approach Begins at:												
+0 mins.	0	0	1	0	7	2	0	0	0	0	1	7
+15 mins.	0	0	0	0	11	3	0	0	0	0	1	7
+30 mins.	4	1	0	0	6	1	1	0	0	0	2	1
+45 mins.	3	0	0	0	5	1	0	0	0	0	11	0
Total Volume	7	1	1	0	29	7	1	0	0	2	27	1
% App. Total	77.8	11.1	11.1	0	80.6	19.4	100	0	0	6.7	90	3.3
PHF	.438	.250	.250	.000	.659	.583	.250	.000	.000	.500	.614	.250
			.450		.643	.643		.250	.250		.682	.682

Counts Unlimited, Inc.
 PO Box 1178
 Corona, CA 92878
 (951)268-6268

City of Riverside
 N/S: Canyon Crest Dr/Overlook Pkwy
 E/W: Alessandro Boulevard
 Weather: Clear

File Name : 03_RIV_Cyn Crst_Ales PM
 Site Code : 05121716
 Start Date : 11/30/2021
 Page No : 1

Groups Printed- 3 Axle Vehicles

Start Time	Canyon Crest Drive Southbound				Alessandro Boulevard Westbound				Overlook Parkway Northbound				Alessandro Boulevard Eastbound											
	Left	Thru	Right	RTOR	App. Total	Left	Thru	Right	RTOR	App. Total	Left	Thru	Right	RTOR	App. Total	Left	Thru	Right	RTOR	App. Total	Exclu. Total	Inclu. Total	Int. Total	
04:00 PM	0	0	0	0	0	0	0	0	0	1	0	0	0	0	0	0	1	0	0	0	1	0	2	2
04:15 PM	0	0	0	0	0	0	0	0	0	0	0	0	0	0	0	0	0	0	0	0	0	0	0	0
04:30 PM	0	0	0	0	0	0	0	0	0	0	0	0	0	0	0	0	2	0	0	0	2	0	2	2
04:45 PM	0	0	0	0	0	0	0	0	0	0	0	0	0	0	0	0	1	0	0	0	1	0	1	1
Total	0	0	0	0	0	0	0	0	0	1	0	0	0	0	0	4	0	0	0	4	0	5	5	5
05:00 PM	0	0	0	0	0	0	0	0	0	1	0	0	0	0	0	1	0	0	0	1	1	2	3	3
05:15 PM	0	0	0	0	0	0	0	0	0	0	0	0	0	0	0	0	0	0	0	0	0	0	0	0
05:30 PM	0	0	0	0	0	1	0	0	0	1	0	0	0	0	0	0	0	0	0	0	0	0	1	1
05:45 PM	0	0	0	0	0	0	0	0	0	0	0	0	0	0	0	0	0	0	0	0	0	0	0	0
Total	0	0	0	0	0	1	1	1	1	2	0	0	0	0	0	1	0	0	0	1	1	3	4	4
Grand Total	0	0	0	0	0	1	2	1	3	3	0	0	0	0	0	1	4	0	0	5	1	8	9	9
% Apprch %	0	0	0	0	33.3	66.7	25			37.5	0	0	0	0	20	80	0	0	62.5	11.1	88.9			
% Total %	0	0	0	0	0	12.5	25			37.5	0	0	0	0	12.5	50	0	0	62.5	11.1	88.9			

Start Time	Canyon Crest Drive Southbound				Alessandro Boulevard Westbound				Overlook Parkway Northbound				Alessandro Boulevard Eastbound											
	Left	Thru	Right	RTOR	App. Total	Left	Thru	Right	RTOR	App. Total	Left	Thru	Right	RTOR	App. Total	Left	Thru	Right	RTOR	App. Total	Exclu. Total	Inclu. Total	Int. Total	
04:15 PM	0	0	0	0	0	0	0	0	0	0	0	0	0	0	0	0	0	0	0	0	0	0	0	0
04:30 PM	0	0	0	0	0	0	0	0	0	0	0	0	0	0	0	0	2	0	0	2	0	2	2	2
04:45 PM	0	0	0	0	0	0	0	0	0	0	0	0	0	0	0	0	1	0	0	1	0	1	1	1
05:00 PM	0	0	0	0	0	0	0	0	0	1	0	0	0	0	0	0	0	0	0	0	0	0	0	0
Total Volume	0	0	0	0	0	0	0	0	0	1	0	0	0	0	0	1	3	0	0	4	0	5	5	5
% App. Total	0	0	0	0	0	0	0	0	0	100	0	0	0	0	75	75	0	0	0	0	0	0	0	0
PHF	.000	.000	.000	.000	.000	.000	.250	.250	.000	.250	.000	.000	.000	.000	.000	.250	.375	.000	.500	.000	.500	.625	.625	.625

Peak Hour Analysis From 04:15 PM to 05:00 PM - Peak 1 of 1
 Peak Hour for Entire Intersection Begins at 04:15 PM

Counts Unlimited, Inc.
 PO Box 1178
 Corona, CA 92878
 (951)268-6268

City of Riverside
 N/S: Canyon Crest Dr/Overlook Pkwy
 E/W: Alessandro Boulevard
 Weather: Clear

File Name : 03_RIV_Cyn Crst_Ales PM
 Site Code : 05121716
 Start Date : 11/30/2021
 Page No : 2

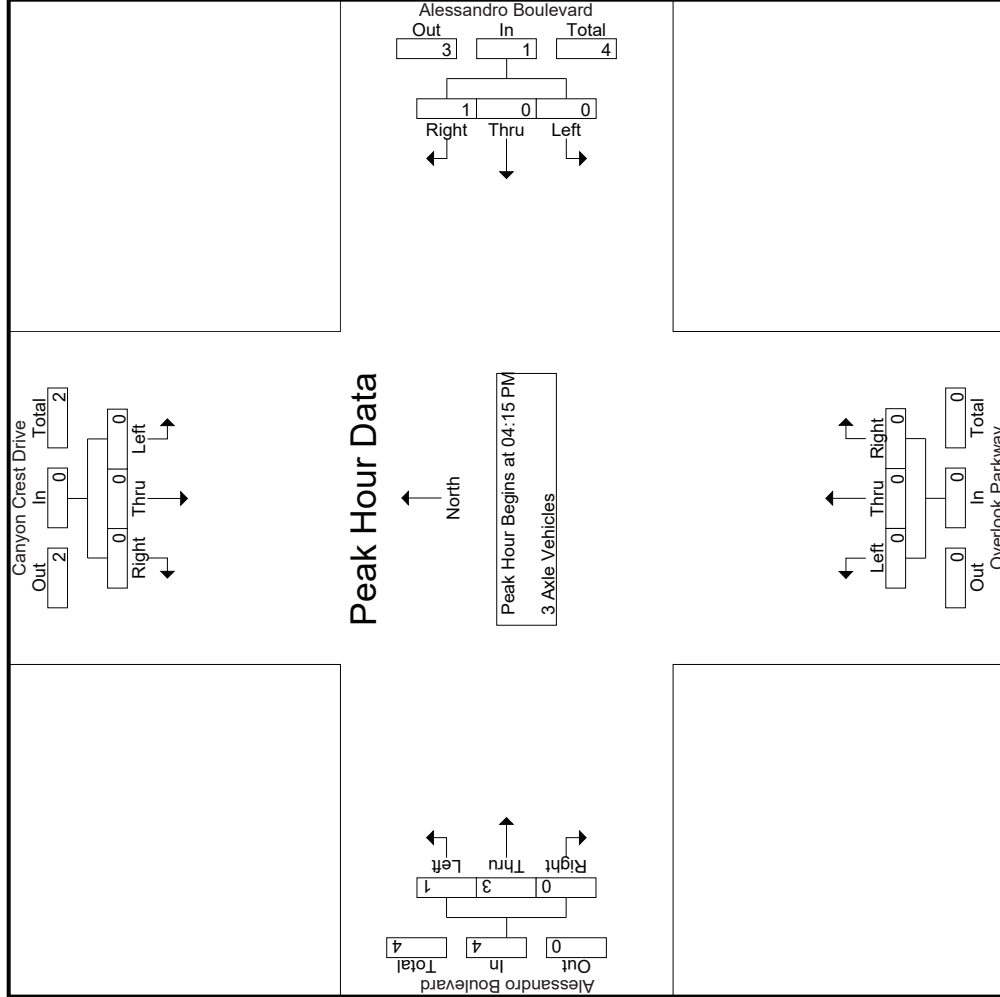

Counts Unlimited, Inc.
 PO Box 1178
 Corona, CA 92878
 (951)268-6268

File Name : 03_RIV_Cyn Crst_Ales PM
 Site Code : 05121716
 Start Date : 11/30/2021
 Page No : 3

City of Riverside
 N/S: Canyon Crest Dr/Overlook Pkwy
 E/W: Alessandro Boulevard
 Weather: Clear

Start Time	Canyon Crest Drive Southbound			Alessandro Boulevard Westbound			Overlook Parkway Northbound			Alessandro Boulevard Eastbound		
	Left	Thru	Right	Left	Thru	Right	Left	Thru	Right	Left	Thru	Right
Peak Hour Analysis From 04:15 PM to 05:00 PM - Peak 1 of 1												
Peak Hour for Each Approach Begins at:												
+0 mins.	0	0	0	0	0	0	0	0	0	0	0	0
+15 mins.	0	0	0	0	0	0	0	0	0	0	2	0
+30 mins.	0	0	0	0	0	0	0	0	0	0	1	0
+45 mins.	0	0	0	0	0	1	1	0	0	1	0	0
Total Volume	0	0	0	0	0	1	1	0	0	1	3	0
% App. Total	0	0	0	0	0	100	100	0	0	25	75	0
PHF	.000	.000	.000	.000	.000	.250	.250	.000	.000	.250	.375	.000

Counts Unlimited, Inc.
 PO Box 1178
 Corona, CA 92878
 (951)268-6268

City of Riverside
 N/S: Canyon Crest Dr/Overlook Pkwy
 EW: Alessandro Boulevard
 Weather: Clear

File Name : 03_RIV_Cyn Crst_Ales PM
 Site Code : 05121716
 Start Date : 11/30/2021
 Page No : 1

Groups Printed- 4+ Axle Trucks

Start Time	Canyon Crest Drive Southbound					Alessandro Boulevard Westbound					Overlook Parkway Northbound					Alessandro Boulevard Eastbound							
	Left	Thru	Right	RTOR	App. Total	Left	Thru	Right	RTOR	App. Total	Left	Thru	Right	RTOR	App. Total	Left	Thru	Right	RTOR	App. Total	Exclu. Total	Inclu. Total	Int. Total
04:00 PM	1	0	0	0	1	0	0	1	1	1	0	0	0	0	0	0	0	0	0	0	1	2	3
04:15 PM	0	0	0	0	0	0	0	0	0	0	0	0	0	0	0	0	1	0	0	0	0	1	1
04:30 PM	0	0	0	0	0	0	0	0	0	1	0	0	0	0	0	0	0	0	0	0	0	0	1
04:45 PM	0	0	0	0	0	0	1	0	0	1	0	0	0	0	0	0	0	0	0	0	0	0	1
Total	1	0	0	0	1	0	2	1	1	3	0	0	0	0	0	0	1	0	0	1	1	5	6
05:00 PM	0	0	0	0	0	0	0	1	0	1	0	0	0	0	0	0	1	0	0	0	0	2	2
05:15 PM	0	0	0	0	0	0	0	0	0	0	0	0	0	0	0	0	0	0	0	0	0	0	0
05:30 PM	0	0	0	0	0	3	0	0	0	3	0	0	0	0	0	0	0	0	0	0	0	3	3
05:45 PM	0	0	0	0	0	0	0	0	0	0	0	0	0	0	0	0	0	0	0	0	0	0	0
Total	0	0	0	0	0	3	1	0	0	4	0	0	0	0	0	0	1	0	0	0	0	5	5
Grand Total	1	0	0	0	1	0	5	2	1	7	0	0	0	0	0	0	2	0	0	0	1	10	11
% Approach	100	0	0	0	0	0	71.4	28.6	0	0	0	0	0	0	0	0	100	0	0	0	9.1	90.9	
% Total	10	0	0	0	10	0	50	20	0	70	0	0	0	0	0	0	20	0	0	20	9.1	90.9	

Start Time	Canyon Crest Drive Southbound					Alessandro Boulevard Westbound					Overlook Parkway Northbound					Alessandro Boulevard Eastbound							
	Left	Thru	Right	RTOR	App. Total	Left	Thru	Right	RTOR	App. Total	Left	Thru	Right	RTOR	App. Total	Left	Thru	Right	RTOR	App. Total	Exclu. Total	Inclu. Total	Int. Total
04:15 PM	0	0	0	0	0	0	0	0	0	0	0	0	0	0	0	0	0	0	0	0	0	0	1
04:30 PM	0	0	0	0	0	0	0	1	0	1	0	0	0	0	0	0	0	0	0	0	0	0	0
04:45 PM	0	0	0	0	0	0	0	1	0	1	0	0	0	0	0	0	0	0	0	0	0	0	0
05:00 PM	0	0	0	0	0	0	0	1	0	1	0	0	0	0	0	0	0	0	0	0	0	0	1
Total Volume	0	0	0	0	0	0	0	2	1	3	0	0	0	0	0	0	2	0	0	0	0	2	5
% App. Total	0	0	0	0	0	0	66.7	33.3	0	75.0	.250	.000	.000	.000	.000	.000	.500	.000	.000	.500	.000	.500	.625
PHF	.000	.000	.000	.000	.000	.000	.000	.000	.750	.000	.000	.000	.000	.000	.000	.000	.500	.000	.000	.500	.000	.500	.625

Peak Hour Analysis From 04:15 PM to 05:00 PM - Peak 1 of 1
 Peak Hour for Entire Intersection Begins at 04:15 PM

Counts Unlimited, Inc.
 PO Box 1178
 Corona, CA 92878
 (951)268-6268

City of Riverside
 N/S: Canyon Crest Dr/Overlook Pkwy
 E/W: Alessandro Boulevard
 Weather: Clear

File Name : 03_RIV_Cyn Crst_Ales PM
 Site Code : 05121716
 Start Date : 11/30/2021
 Page No : 2

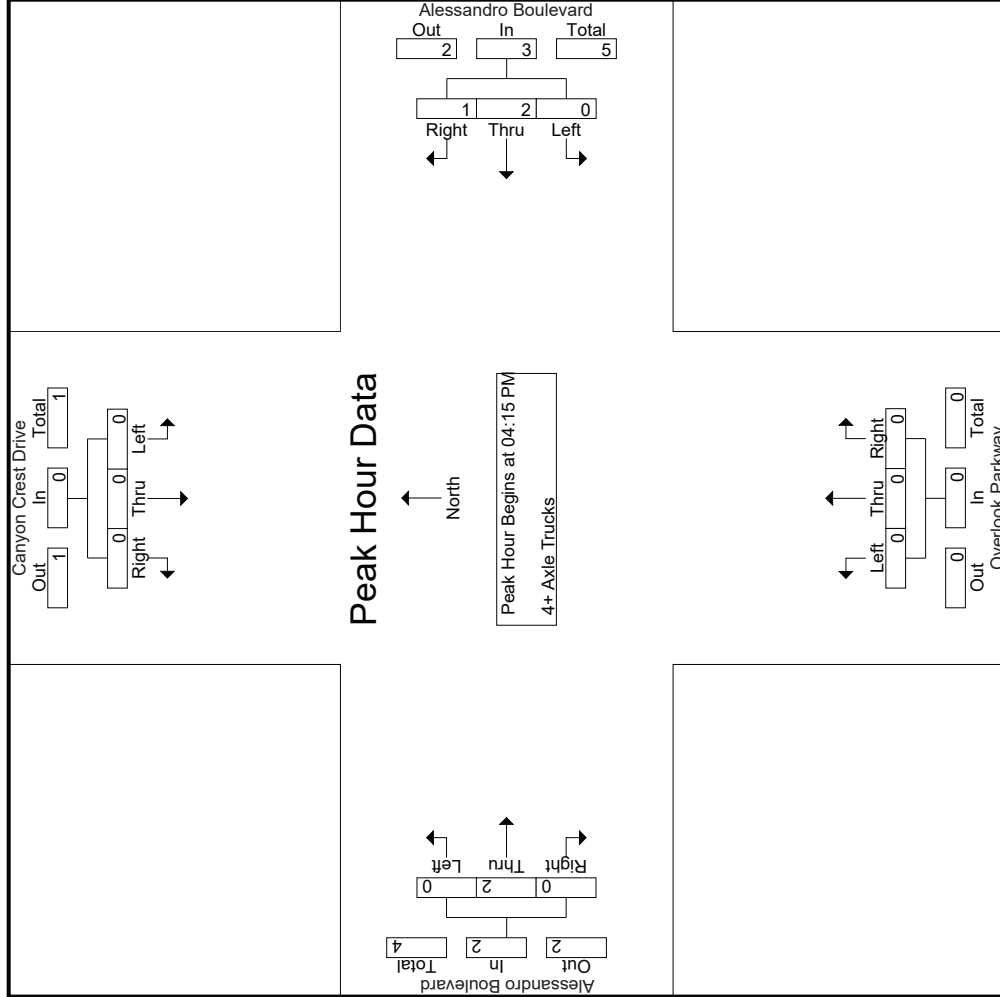

Counts Unlimited, Inc.
 PO Box 1178
 Corona, CA 92878
 (951)268-6268

City of Riverside
 N/S: Canyon Crest Dr/Overlook Pkwy
 E/W: Alessandro Boulevard
 Weather: Clear

File Name : 03_RIV_Cyn Crst_Ales PM
 Site Code : 05121716
 Start Date : 11/30/2021
 Page No : 3

Start Time	Canyon Crest Drive Southbound			Alessandro Boulevard Westbound			Overlook Parkway Northbound			Alessandro Boulevard Eastbound		
	Left	Thru	Right	Left	Thru	Right	Left	Thru	Right	Left	Thru	Right
Peak Hour Analysis From 04:15 PM to 05:00 PM - Peak 1 of 1												
Peak Hour for Each Approach Begins at:												
+0 mins.	0	0	0	0	0	0	0	0	0	0	0	0
+15 mins.	0	0	0	0	1	0	0	0	0	0	0	0
+30 mins.	0	0	0	0	1	0	0	0	0	0	0	0
+45 mins.	0	0	0	0	0	1	0	0	0	0	1	0
Total Volume	0	0	0	0	2	1	0	0	0	0	2	0
% App. Total	0	0	0	0	66.7	33.3	0	0	0	0	100	0
PHF	.000	.000	.000	.000	.500	.250	.750	.000	.000	.000	.500	.000

Location: Riverside
 N/S: Canyon Crest Dr/Overlook Pkwy
 E/W: Alessandro Boulevard



Date: 11/30/2021
 Day: Tuesday

PEDESTRIANS

	North Leg Canyon Crest Drive	East Leg Alessandro Boulevard	South Leg Overlook Parkway	West Leg Alessandro Boulevard	
	Pedestrians	Pedestrians	Pedestrians	Pedestrians	
7:00 AM	0	0	0	0	0
7:15 AM	0	0	0	0	0
7:30 AM	0	0	0	0	0
7:45 AM	0	0	0	0	0
8:00 AM	0	0	0	0	0
8:15 AM	0	0	0	0	0
8:30 AM	0	1	0	0	1
8:45 AM	0	0	0	0	0
TOTAL VOLUMES:	0	1	0	0	1

	North Leg Canyon Crest Drive	East Leg Alessandro Boulevard	South Leg Overlook Parkway	West Leg Alessandro Boulevard	
	Pedestrians	Pedestrians	Pedestrians	Pedestrians	
4:00 PM	0	0	0	0	0
4:15 PM	0	0	1	0	1
4:30 PM	0	0	0	0	0
4:45 PM	0	0	0	0	0
5:00 PM	0	0	0	0	0
5:15 PM	0	0	0	0	0
5:30 PM	0	0	0	0	0
5:45 PM	0	0	0	0	0
TOTAL VOLUMES:	0	0	1	0	1

3-1-823

Location: Riverside
 N/S: Canyon Crest Dr/Overlook Pkwy
 E/W: Alessandro Boulevard



Date: 11/30/2021
 Day: Tuesday

BICYCLES

	Southbound Canyon Crest Drive			Westbound Alessandro Boulevard			Northbound Overlook Parkway			Eastbound Alessandro Boulevard			
	Left	Thru	Right	Left	Thru	Right	Left	Thru	Right	Left	Thru	Right	
7:00 AM	0	0	0	0	0	0	0	0	0	0	0	0	0
7:15 AM	0	0	0	0	0	0	0	0	0	0	0	0	0
7:30 AM	0	0	0	0	0	0	0	0	0	0	0	0	0
7:45 AM	0	0	0	0	0	0	0	0	0	0	0	0	0
8:00 AM	0	0	0	0	0	0	0	0	0	0	0	0	0
8:15 AM	0	0	0	0	0	0	0	0	0	0	0	0	0
8:30 AM	0	0	0	0	0	0	0	0	0	0	0	0	0
8:45 AM	0	0	0	0	0	0	0	0	0	0	0	0	0
TOTAL VOLUMES:	0	0	0	0	0	0	0	0	0	0	0	0	0

	Southbound Canyon Crest Drive			Westbound Alessandro Boulevard			Northbound Overlook Parkway			Eastbound Alessandro Boulevard			
	Left	Thru	Right	Left	Thru	Right	Left	Thru	Right	Left	Thru	Right	
4:00 PM	0	0	0	0	0	0	0	0	0	0	0	0	0
4:15 PM	0	0	0	0	0	0	0	0	0	0	0	0	0
4:30 PM	0	0	0	0	0	0	0	0	0	0	0	0	0
4:45 PM	0	0	0	0	0	0	0	0	0	0	0	0	0
5:00 PM	0	0	0	0	0	0	0	0	0	0	0	0	0
5:15 PM	0	0	0	0	0	0	0	0	0	0	0	0	0
5:30 PM	1	0	0	0	1	0	0	0	0	0	0	0	2
5:45 PM	0	0	0	0	0	0	0	0	0	0	0	0	0
TOTAL VOLUMES:	1	0	0	0	1	0	0	0	0	0	0	0	2

3-1-824

Counts Unlimited, Inc.
 PO Box 1178
 Corona, CA 92878
 (951)268-6268

City of Riverside
 N/S: Wood Road
 E/W: Van Buren Boulevard
 Weather: Clear

File Name : 04_RIV_Wood_VB AM
 Site Code : 05121716
 Start Date : 11/30/2021
 Page No : 1

Groups Printed- Passenger Vehicles - Large 2 Axle Vehicles - 3 Axle Vehicles - 4+ Axle Trucks

Start Time	Wood Road Southbound						Wood Road Northbound						Van Buren Boulevard Westbound						Van Buren Boulevard Eastbound					
	Left		Thru		Right		Left		Thru		Right		Left		Thru		Right		Left		Thru		Right	
07:00 AM	21	81	37	20	139	83	246	8	6	337	79	70	41	23	190	18	151	66	28	235	77	901	978	
07:15 AM	21	117	29	21	167	127	269	26	9	422	70	98	65	31	233	49	202	96	54	347	115	1169	1284	
07:30 AM	23	146	28	11	197	155	261	36	20	452	87	120	76	46	283	33	166	87	49	286	126	1218	1344	
07:45 AM	12	41	56	32	109	41	281	24	9	346	63	97	80	26	240	35	242	44	32	321	99	1016	1115	
Total	77	385	150	84	612	406	1057	94	44	1557	299	385	262	126	946	135	761	293	163	1189	417	4304	4721	
08:00 AM	12	28	65	38	105	17	273	19	12	309	58	30	33	19	121	39	191	23	16	253	85	788	873	
08:15 AM	18	17	45	37	80	28	258	14	7	300	46	41	29	27	116	39	207	20	13	266	84	762	846	
08:30 AM	5	26	31	14	62	21	247	11	7	279	44	45	39	26	128	33	197	28	10	258	57	727	784	
08:45 AM	14	16	31	18	61	30	234	15	4	279	46	27	29	22	102	28	175	26	7	229	51	671	722	
Total	49	87	172	107	308	96	1012	59	30	1167	194	143	130	94	467	139	770	97	46	1006	277	2948	3225	
Grand Total	126	472	322	191	920	502	2069	153	74	2724	493	528	392	220	1413	274	1531	390	209	2195	694	7252	7946	
→Approch %	13.7	51.3	35			18.4	76	5.6			34.9	37.4	27.7			12.5	69.7	17.8						
8. Total %	1.7	6.5	4.4		12.7	6.9	28.5	2.1		37.6	6.8	7.3	5.4		19.5	3.8	21.1	5.4		30.3	8.7	91.3		
Passenger Vehicles	122	468	314		1094	492	1999	150		2714	487	520	385		1609	266	1464	376		2308	0	0	7725	
% Passenger Vehicles	96.8	99.2	97.5		99.5	98.5	96.6	98		98.6	98.8	98.5	98.2		98.6	97.1	95.6	96.4		96.7	96	0	97.2	
Large 2 Axle Vehicles	2	3	8		14	7	50	1		58	5	6	5		18	8	55	11		80	0	0	170	
% Large 2 Axle Vehicles	1.6	0.6	2.5		1.3	1.4	2.4	0.7		2.1	1	1.1	1.3		1.1	2.9	3.6	2.8		3.3	0	0	2.1	
3 Axle Vehicles	0	0	0		0	0	14	1		15	0	0	0		0	0	7	0		7	0	0	22	
% 3 Axle Vehicles	0	0	0		0	0	0.7	0.7		0.5	0	0	0		0	0	0.5	0		0.3	0	0	0.3	
4+ Axle Trucks	2	1	0		3	3	6	1		11	1	2	2		6	0	5	3		9	0	0	29	
% 4+ Axle Trucks	1.6	0.2	0		0.3	0.6	0.3	0.7		0.4	0.2	0.4	0.5		0.4	0	0.3	0.8		0.4	0	0	0.4	

Start Time	Wood Road Southbound						Wood Road Northbound						Van Buren Boulevard Westbound						Van Buren Boulevard Eastbound					
	Left		Thru		Right		Left		Thru		Right		Left		Thru		Right		Left		Thru		Right	
Peak Hour Analysis From 07:00 AM to 08:45 AM - Peak 1 of 1	21	81	37		139	83	246	8		337	79	70	41		190	18	151	66		235	77	901	978	
07:00 AM	21	117	29		167	127	269	26		422	70	98	65		233	49	202	96		347	115	1169	1284	
07:15 AM	23	146	28		197	155	261	36		452	87	120	76		283	33	166	87		286	126	1218	1344	
07:30 AM	12	41	56		109	41	281	24		346	63	97	80		240	35	242	44		321	99	1016	1115	
07:45 AM	77	385	150		612	406	1057	94		1557	299	385	262		946	135	761	293		1189	417	4304	4721	
Total Volume	77	385	150		612	406	1057	94		1557	299	385	262		946	135	761	293		1189	417	4304	4721	
% App. Total	12.6	62.9	24.5		67.7	26.1	67.9	6		6.53	31.6	40.7	27.7		24.6	11.4	64	24.6		786	857	2948	3225	
PHF	.837	.659	.670		.777	.655	.940	.861		.861	.859	.802	.819		.836	.689	.786	.763		.857	.857	.857	.883	

Counts Unlimited, Inc.
 PO Box 1178
 Corona, CA 92878
 (951)268-6268

City of Riverside
 N/S: Wood Road
 E/W: Van Buren Boulevard
 Weather: Clear

File Name : 04_RIV_Wood_VB AM
 Site Code : 05121716
 Start Date : 11/30/2021
 Page No : 2

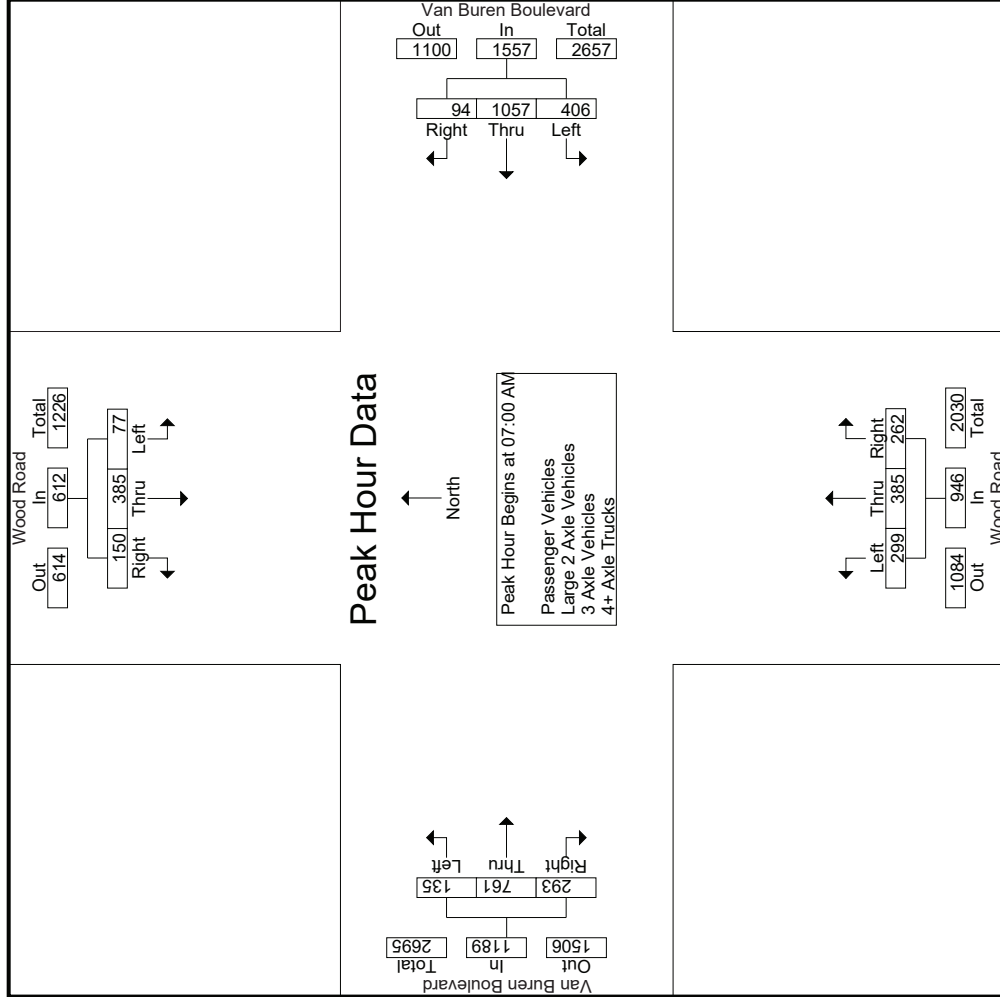

Counts Unlimited, Inc.
 PO Box 1178
 Corona, CA 92878
 (951)268-6268

City of Riverside
 N/S: Wood Road
 E/W: Van Buren Boulevard
 Weather: Clear

File Name : 04_RIV_Wood_VB AM
 Site Code : 05121716
 Start Date : 11/30/2021
 Page No : 3

Start Time	Wood Road Southbound			Van Buren Boulevard Westbound			Wood Road Northbound			Van Buren Boulevard Eastbound					
	Left	Thru	Right	Left	Thru	Right	Left	Thru	Right	Left	Thru	Right	App. Total	Int. Total	
Peak Hour Analysis From 07:00 AM to 08:45 AM - Peak 1 of 1															
Peak Hour for Each Approach Begins at:															
	07:00 AM			07:00 AM			07:00 AM			07:15 AM					
+0 mins.	21	81	37	83	246	8	337	79	70	41	190	49	202	96	347
+15 mins.	21	117	29	127	269	26	422	70	98	65	233	33	166	87	286
+30 mins.	23	146	28	155	261	36	452	87	120	76	283	35	242	44	321
+45 mins.	12	41	56	41	281	24	346	63	97	80	240	39	191	23	253
Total Volume	77	385	150	406	1057	94	1557	299	385	262	946	156	801	250	1207
% App. Total	12.6	62.9	24.5	26.1	67.9	6	31.6	40.7	27.7	27.7	12.9	12.9	66.4	20.7	80.7
PHF	.837	.659	.670	.655	.940	.653	.861	.859	.802	.819	.836	.796	.827	.651	.870

Counts Unlimited, Inc.
 PO Box 1178
 Corona, CA 92878
 (951)268-6268

City of Riverside
 N/S: Wood Road
 E/W: Van Buren Boulevard
 Weather: Clear

File Name : 04_RIV_Wood_VB AM
 Site Code : 05121716
 Start Date : 11/30/2021
 Page No : 1

Groups Printed- Passenger Vehicles

Start Time	Wood Road Southbound					Van Buren Boulevard Westbound					Wood Road Northbound					Van Buren Boulevard Eastbound							
	Left	Thru	Right	RTOR	App. Total	Left	Thru	Right	RTOR	App. Total	Left	Thru	Right	RTOR	App. Total	Left	Thru	Right	RTOR	App. Total	Exclu. Total	Inclu. Total	Int. Total
07:00 AM	20	81	36	20	137	83	240	7	5	330	78	70	41	23	189	18	146	63	27	227	75	883	958
07:15 AM	20	117	26	21	163	124	259	26	9	409	68	98	64	30	230	47	196	94	53	337	113	1139	1252
07:30 AM	23	145	27	11	195	155	248	36	20	439	87	118	76	46	281	32	157	86	49	275	126	1190	1316
07:45 AM	12	40	56	32	108	41	273	23	9	337	63	94	79	26	236	34	231	39	29	304	96	985	1081
Total	75	383	145	84	603	403	1020	92	43	1515	296	380	260	125	936	131	730	282	158	1143	410	4197	4607
08:00 AM	12	27	65	38	104	14	262	19	12	295	57	29	33	19	119	39	184	22	15	245	84	763	847
08:15 AM	17	16	45	37	78	27	250	14	7	291	46	40	28	27	114	37	193	20	13	250	84	733	817
08:30 AM	5	26	29	14	60	19	240	11	7	270	44	44	37	25	125	33	188	28	10	249	56	704	760
08:45 AM	13	16	30	17	59	29	227	14	4	270	44	27	27	21	98	26	169	24	6	219	48	646	694
Total	47	85	169	106	301	89	979	58	30	1126	191	140	125	92	456	135	734	94	44	963	272	2846	3118
Grand Total	122	468	314	190	904	492	1999	150	73	2641	487	520	385	217	1392	266	1464	376	202	2106	682	7043	7725
% Apprch %	13.5	51.8	34.7			18.6	75.7	5.7			35	37.4	27.7			12.6	69.5	17.9					
% Total %	1.7	6.6	4.5		12.8	7	28.4	2.1		37.5	6.9	7.4	5.5		19.8	3.8	20.8	5.3		29.9	8.8	91.2	

Start Time	Wood Road Southbound					Van Buren Boulevard Westbound					Wood Road Northbound					Van Buren Boulevard Eastbound							
	Left	Thru	Right	RTOR	App. Total	Left	Thru	Right	RTOR	App. Total	Left	Thru	Right	RTOR	App. Total	Left	Thru	Right	RTOR	App. Total	Exclu. Total	Inclu. Total	Int. Total
Peak Hour Analysis From 07:00 AM to 07:45 AM - Peak 1 of 1																							
Peak Hour for Entire Intersection Begins at 07:00 AM																							
07:00 AM	20	81	36		137	83	240	7	5	330	78	70	41	23	189	18	146	63	27	227			
07:15 AM	20	117	26		163	124	259	26	9	409	68	98	64	30	230	47	196	94	53	337			
07:30 AM	23	145	27		195	155	248	36	20	439	87	118	76	46	281	32	157	86	49	275			
07:45 AM	12	40	56		108	41	273	23	9	337	63	94	79	26	236	34	231	39	29	304			
Total Volume	75	383	145		603	403	1020	92	43	1515	296	380	260	125	936	131	730	282	158	1143			
% App. Total	12.4	63.5	24			26.6	67.3	6.1			31.6	40.6	27.8			11.5	63.9	24.7					
PHF	.815	.660	.647		.773	.650	.934	.639		.863	.851	.805	.823		.833	.697	.790	.750		.848			.882

Counts Unlimited, Inc.
 PO Box 1178
 Corona, CA 92878
 (951)268-6268

City of Riverside
 N/S: Wood Road
 E/W: Van Buren Boulevard
 Weather: Clear

File Name : 04_RIV_Wood_VB AM
 Site Code : 05121716
 Start Date : 11/30/2021
 Page No : 2

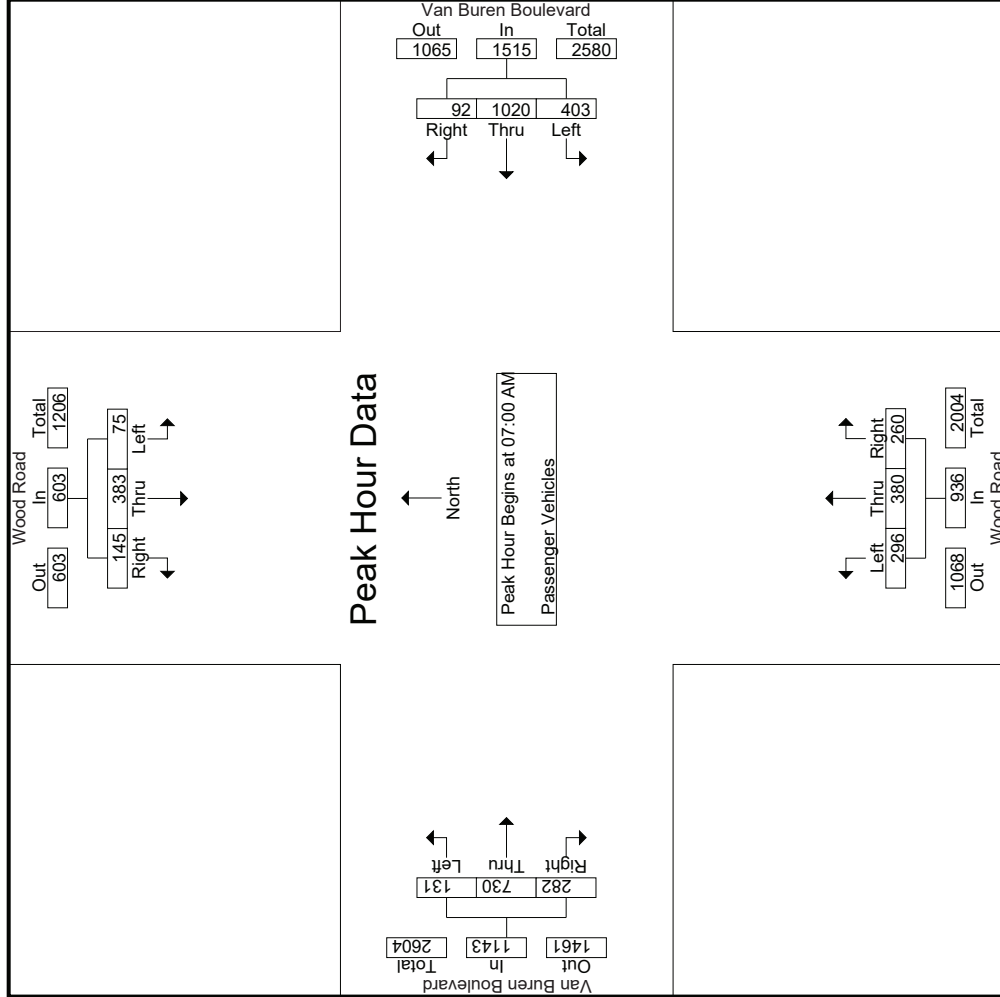

Counts Unlimited, Inc.
 PO Box 1178
 Corona, CA 92878
 (951)268-6268

City of Riverside
 N/S: Wood Road
 E/W: Van Buren Boulevard
 Weather: Clear

File Name : 04_RIV_Wood_VB AM
 Site Code : 05121716
 Start Date : 11/30/2021
 Page No : 3

Start Time	Wood Road Southbound			Van Buren Boulevard Westbound			Wood Road Northbound			Van Buren Boulevard Eastbound					
	Left	Thru	Right	Left	Thru	Right	Left	Thru	Right	Left	Thru	Right			
Peak Hour Analysis From 07:00 AM to 07:45 AM - Peak 1 of 1															
Peak Hour for Each Approach Begins at:															
	07:00 AM			07:00 AM			07:00 AM			07:00 AM					
+0 mins.	20	81	36	83	240	7	330	78	70	41	189	18	146	63	227
+15 mins.	20	117	26	124	259	26	409	68	98	64	230	47	196	94	337
+30 mins.	23	145	27	155	248	36	439	87	118	76	281	32	157	86	275
+45 mins.	12	40	56	41	273	23	337	63	94	79	236	34	231	39	304
Total Volume	75	383	145	403	1020	92	1515	296	380	260	936	131	730	282	1143
% App. Total	12.4	63.5	24	26.6	67.3	6.1	863	31.6	40.6	27.8	833	11.5	63.9	24.7	1143
PHF	.815	.660	.647	.650	.934	.639	.863	.851	.805	.823	.833	.697	.790	.750	.848

Counts Unlimited, Inc.
 PO Box 1178
 Corona, CA 92878
 (951)268-6268

File Name : 04_RIV_Wood_VB AM
 Site Code : 05121716
 Start Date : 11/30/2021
 Page No : 1

City of Riverside
 N/S: Wood Road
 EW: Van Buren Boulevard
 Weather: Clear

Groups Printed- Large 2 Axle Vehicles

Start Time	Wood Road Southbound					Van Buren Boulevard Westbound					Wood Road Northbound					Van Buren Boulevard Eastbound				
	Left	Thru	Right	RTOR	App. Total	Left	Thru	Right	RTOR	App. Total	Left	Thru	Right	RTOR	App. Total	Left	Thru	Right	RTOR	App. Total
07:00 AM	0	0	1	0	1	0	6	0	0	6	1	0	0	0	1	0	4	3	1	7
07:15 AM	1	0	3	0	4	2	4	0	0	6	2	0	1	1	3	2	6	1	1	9
07:30 AM	0	1	1	0	2	0	10	0	0	10	0	1	0	0	1	1	6	1	0	8
07:45 AM	0	0	0	0	0	0	7	0	0	7	2	2	1	0	3	1	10	5	3	16
Total	1	1	5	0	7	2	27	0	0	29	3	3	2	1	8	4	26	10	5	40
08:00 AM	0	1	0	0	1	3	7	0	0	10	0	1	0	0	1	0	7	1	1	8
08:15 AM	1	1	0	0	2	0	6	0	0	6	0	1	1	0	2	2	10	0	0	12
08:30 AM	0	0	2	0	2	1	6	0	0	7	0	1	1	1	2	0	8	0	0	8
08:45 AM	0	0	1	1	2	1	4	1	0	6	2	0	1	0	3	2	4	0	0	6
Total	1	2	3	1	6	5	23	1	0	29	2	3	3	1	8	4	29	1	1	34
Grand Total	2	3	8	1	13	7	50	1	0	58	5	6	5	2	16	8	55	11	6	74
% Apprch %	15.4	23.1	61.5		8.1	12.1	86.2	1.7		31.2	37.5	31.2	9.9		10.8	74.3	14.9			46
% Total %	1.2	1.9	5		8.1	4.3	31.1	0.6		3.1	3.7	3.1			5	34.2	6.8			5.3
																				94.7

Start Time	Wood Road Southbound					Van Buren Boulevard Westbound					Wood Road Northbound					Van Buren Boulevard Eastbound				
	Left	Thru	Right	RTOR	App. Total	Left	Thru	Right	RTOR	App. Total	Left	Thru	Right	RTOR	App. Total	Left	Thru	Right	RTOR	App. Total
07:00 AM	0	0	1	0	1	0	6	0	0	6	1	0	0	0	1	0	4	3	1	7
07:15 AM	1	0	3	0	4	2	4	0	0	6	2	0	1	1	3	2	6	1	1	9
07:30 AM	0	1	1	0	2	0	10	0	0	10	0	1	0	0	1	1	6	1	0	8
07:45 AM	0	0	0	0	0	0	7	0	0	7	2	2	1	0	3	1	10	5	3	16
Total	1	1	5	0	7	2	27	0	0	29	3	3	2	1	8	4	26	10	5	40
08:00 AM	0	1	0	0	1	3	7	0	0	10	0	1	0	0	1	0	7	1	1	8
08:15 AM	1	1	0	0	2	0	6	0	0	6	0	1	1	0	2	2	10	0	0	12
08:30 AM	0	0	2	0	2	1	6	0	0	7	0	1	1	1	2	0	8	0	0	8
08:45 AM	0	0	1	1	2	1	4	1	0	6	2	0	1	0	3	2	4	0	0	6
Total	1	2	3	1	6	5	23	1	0	29	2	3	3	1	8	4	29	1	1	34
Grand Total	2	3	8	1	13	7	50	1	0	58	5	6	5	2	16	8	55	11	6	74
% Apprch %	15.4	23.1	61.5		8.1	12.1	86.2	1.7		31.2	37.5	31.2	9.9		10.8	74.3	14.9			46
% Total %	1.2	1.9	5		8.1	4.3	31.1	0.6		3.1	3.7	3.1			5	34.2	6.8			5.3
																				94.7

Peak Hour Analysis From 07:00 AM to 07:45 AM - Peak 1 of 1
 Peak Hour for Entire Intersection Begins at 07:00 AM

Start Time	Wood Road Southbound					Van Buren Boulevard Westbound					Wood Road Northbound					Van Buren Boulevard Eastbound				
	Left	Thru	Right	RTOR	App. Total	Left	Thru	Right	RTOR	App. Total	Left	Thru	Right	RTOR	App. Total	Left	Thru	Right	RTOR	App. Total
07:00 AM	0	0	1	0	1	0	6	0	0	6	1	0	0	0	1	0	4	3	1	7
07:15 AM	1	0	3	0	4	2	4	0	0	6	2	0	1	1	3	2	6	1	1	9
07:30 AM	0	1	1	0	2	0	10	0	0	10	0	1	0	0	1	1	6	1	0	8
07:45 AM	0	0	0	0	0	0	7	0	0	7	2	2	1	0	3	1	10	5	3	16
Total	1	1	5	0	7	2	27	0	0	29	3	3	2	1	8	4	26	10	5	40
% App. Total	14.3	14.3	71.4		8.1	6.9	93.1	0		37.5	37.5	25			10	65	25			40
PHF	.250	.250	.417		.438	.250	.675	.000		.725	.375	.375	.500		.667	.500	.650	.500		.625
																				.808

Counts Unlimited, Inc.
 PO Box 1178
 Corona, CA 92878
 (951)268-6268

City of Riverside
 N/S: Wood Road
 E/W: Van Buren Boulevard
 Weather: Clear

File Name : 04_RIV_Wood_VB AM
 Site Code : 05121716
 Start Date : 11/30/2021
 Page No : 2

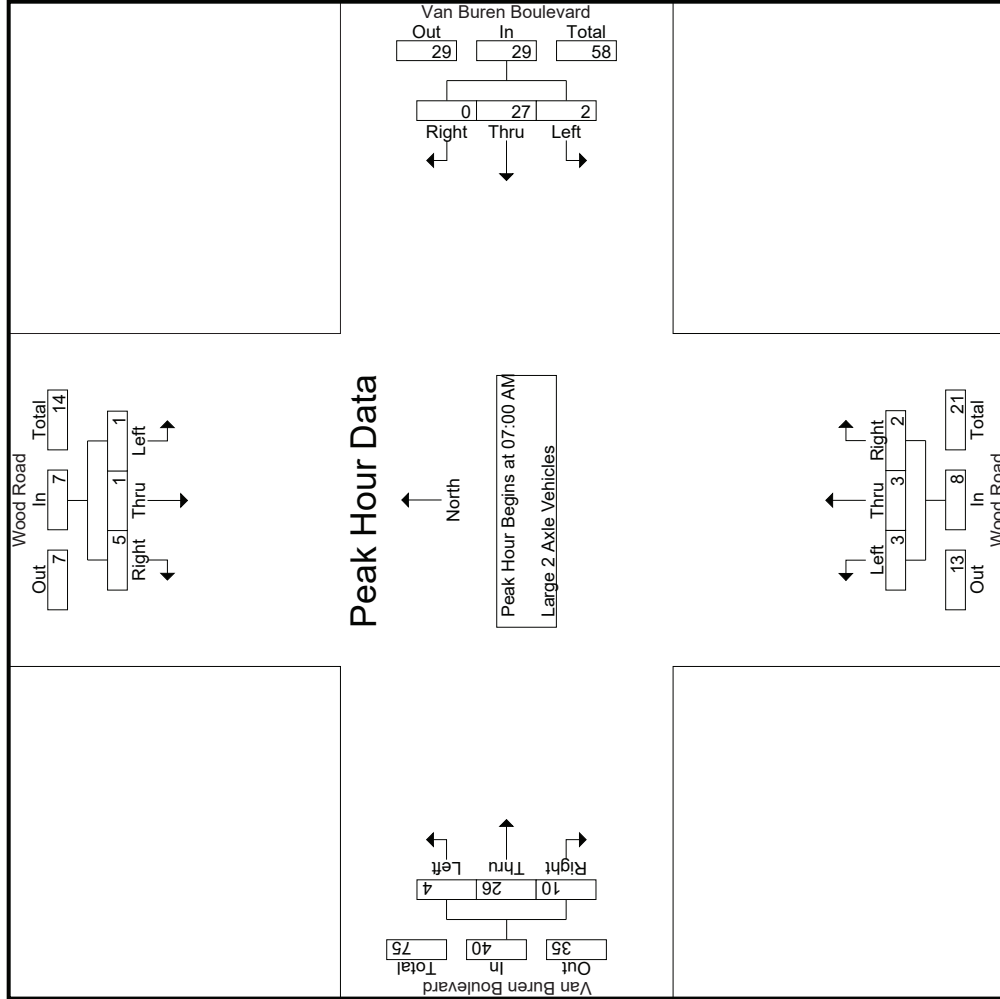

Counts Unlimited, Inc.
 PO Box 1178
 Corona, CA 92878
 (951)268-6268

City of Riverside
 N/S: Wood Road
 E/W: Van Buren Boulevard
 Weather: Clear

File Name : 04_RIV_Wood_VB AM
 Site Code : 05121716
 Start Date : 11/30/2021
 Page No : 3

Start Time	Wood Road Southbound			Van Buren Boulevard Westbound			Wood Road Northbound			Van Buren Boulevard Eastbound			Int. Total
	Left	Thru	Right	Left	Thru	Right	Left	Thru	Right	Left	Thru	Right	
Peak Hour Analysis From 07:00 AM to 07:45 AM - Peak 1 of 1													
Peak Hour for Each Approach Begins at:													
	07:00 AM			07:00 AM			07:00 AM			07:00 AM			
+0 mins.	0	0	1	0	6	0	6	0	0	0	4	3	7
+15 mins.	1	0	3	2	4	0	6	0	1	2	6	1	9
+30 mins.	0	1	1	0	10	0	10	0	0	1	6	1	8
+45 mins.	0	0	0	0	7	0	7	0	2	1	10	5	16
Total Volume	1	1	5	2	27	0	29	3	3	2	26	10	40
% App. Total	14.3	14.3	71.4	6.9	93.1	0	0	37.5	37.5	25	65	25	62.5
PHF	.250	.250	.417	.250	.675	.000	.725	.375	.375	.500	.650	.500	.625

Counts Unlimited, Inc.
 PO Box 1178
 Corona, CA 92878
 (951)268-6268

City of Riverside
 N/S: Wood Road
 E/W: Van Buren Boulevard
 Weather: Clear

File Name : 04_RIV_Wood_VB AM
 Site Code : 05121716
 Start Date : 11/30/2021
 Page No : 1

Groups Printed- 3 Axle Vehicles

Start Time	Wood Road Southbound			Van Buren Boulevard Westbound			Wood Road Northbound			Van Buren Boulevard Eastbound			Inclu. Total	Int. Total
	Left	Thru	Right	Left	Thru	Right	Left	Thru	Right	Left	Thru	Right		
07:00 AM	0	0	0	0	0	0	0	0	0	0	0	0	0	1
07:15 AM	0	0	0	0	4	0	0	0	0	0	0	0	0	4
07:30 AM	0	0	0	0	2	0	0	0	0	0	2	0	0	4
07:45 AM	0	0	0	0	0	1	0	0	0	0	0	1	0	2
Total	0	0	0	0	6	1	0	0	0	0	4	0	0	11
08:00 AM	0	0	0	0	2	0	0	0	0	0	0	0	0	2
08:15 AM	0	0	0	0	2	0	0	0	0	0	1	0	0	3
08:30 AM	0	0	0	0	1	0	0	0	0	0	0	0	0	1
08:45 AM	0	0	0	0	3	0	0	0	0	0	2	0	0	5
Total	0	0	0	0	8	0	0	0	0	0	3	0	0	11
Grand Total	0	0	0	0	14	1	0	0	0	0	7	0	0	22
% Approach	0	0	0	0	93.3	6.7	0	0	0	0	100	0	0	100
% Total	0	0	0	0	63.6	4.5	0	0	0	0	31.8	0	0	100

Start Time	Wood Road Southbound			Van Buren Boulevard Westbound			Wood Road Northbound			Van Buren Boulevard Eastbound			Inclu. Total	Int. Total
	Left	Thru	Right	Left	Thru	Right	Left	Thru	Right	Left	Thru	Right		
07:00 AM	0	0	0	0	0	0	0	0	0	0	0	0	0	1
07:15 AM	0	0	0	0	4	0	0	0	0	0	0	0	0	4
07:30 AM	0	0	0	0	2	0	0	0	0	0	2	0	0	4
07:45 AM	0	0	0	0	0	1	0	0	0	0	0	1	0	2
Total Volume	0	0	0	0	6	1	0	0	0	0	4	0	0	11
% App. Total	0	0	0	0	85.7	14.3	0	0	0	0	100	0	0	100
PHF	.000	.000	.000	.000	.375	.250	.438	.000	.000	.000	.500	.000	.500	.688

Peak Hour Analysis From 07:00 AM to 07:45 AM - Peak 1 of 1
 Peak Hour for Entire Intersection Begins at 07:00 AM

Counts Unlimited, Inc.
 PO Box 1178
 Corona, CA 92878
 (951)268-6268

City of Riverside
 N/S: Wood Road
 E/W: Van Buren Boulevard
 Weather: Clear

File Name : 04_RIV_Wood_VB AM
 Site Code : 05121716
 Start Date : 11/30/2021
 Page No : 2

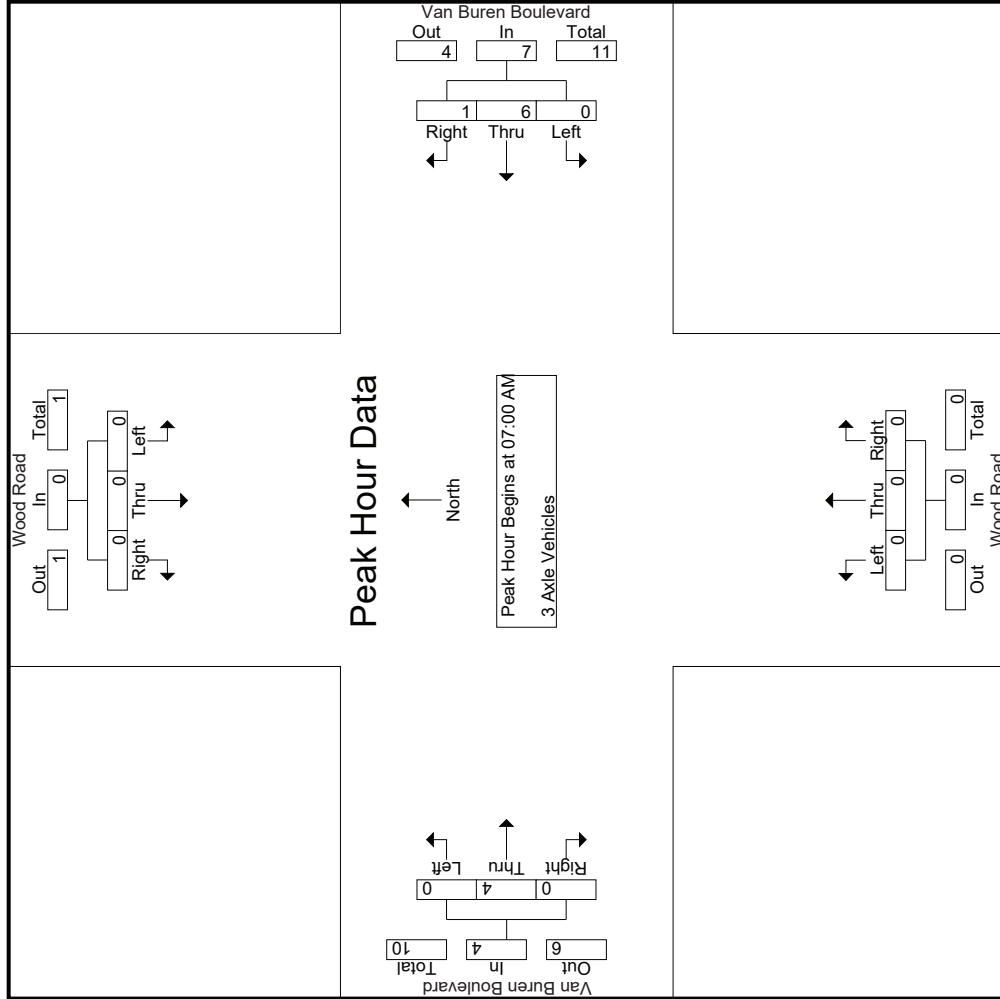

Counts Unlimited, Inc.
 PO Box 1178
 Corona, CA 92878
 (951)268-6268

City of Riverside
 N/S: Wood Road
 E/W: Van Buren Boulevard
 Weather: Clear

File Name : 04_RIV_Wood_VB AM
 Site Code : 05121716
 Start Date : 11/30/2021
 Page No : 3

Start Time	Wood Road Southbound			Van Buren Boulevard Westbound			Wood Road Northbound			Van Buren Boulevard Eastbound		
	Left	Thru	Right	Left	Thru	Right	Left	Thru	Right	Left	Thru	Right
Peak Hour Analysis From 07:00 AM to 07:45 AM - Peak 1 of 1												
Peak Hour for Each Approach Begins at:	07:00 AM											
+0 mins.	0	0	0	0	0	0	0	0	0	0	0	0
+15 mins.	0	0	0	4	0	4	0	0	0	0	0	0
+30 mins.	0	0	0	2	0	2	0	0	0	2	0	0
+45 mins.	0	0	0	0	1	1	0	0	0	0	1	0
Total Volume	0	0	0	6	1	7	0	0	0	4	0	4
% App. Total	0	0	0	85.7	14.3	0	0	0	0	0	100	0
PHF	.000	.000	.000	.375	.250	.438	.000	.000	.000	.000	.500	.000

Counts Unlimited, Inc.
 PO Box 1178
 Corona, CA 92878
 (951)268-6268

File Name : 04_RIV_Wood_VB AM
 Site Code : 05121716
 Start Date : 11/30/2021
 Page No : 1

City of Riverside
 N/S: Wood Road
 EW: Van Buren Boulevard
 Weather: Clear

Groups Printed- 4+ Axle Trucks

Start Time	Wood Road Southbound				Van Buren Boulevard Westbound				Wood Road Northbound				Van Buren Boulevard Eastbound					
	Left	Thru	Right	RTOR	Left	Thru	Right	RTOR	Left	Thru	Right	RTOR	Left	Thru	Right	RTOR		
07:00 AM	1	0	0	0	0	0	1	1	0	0	0	0	0	0	0	0		
07:15 AM	0	0	0	0	1	2	0	0	0	0	0	0	0	0	1	0		
07:30 AM	0	0	0	0	0	1	0	0	1	0	0	1	0	1	0	0		
07:45 AM	0	1	0	0	1	0	0	0	1	0	0	0	0	0	0	0		
Total	1	1	0	0	2	1	4	1	6	0	2	0	0	1	1	0		
08:00 AM	0	0	0	0	0	2	0	0	2	1	0	0	0	0	0	0		
08:15 AM	0	0	0	0	1	0	0	0	1	0	0	0	0	3	0	0		
08:30 AM	0	0	0	0	1	0	0	0	1	0	1	0	0	1	0	0		
08:45 AM	1	0	0	0	1	0	0	0	0	0	1	1	0	0	2	1		
Total	1	0	0	0	2	2	0	0	4	1	0	2	1	4	2	1		
Grand Total	2	1	0	0	3	6	1	1	10	1	2	2	1	5	3	1		
% Apprch %	66.7	33.3	0	0	30	60	10	10	20	40	40	40	0	62.5	37.5	0		
% Total %	7.7	3.8	0	0	11.5	23.1	3.8	38.5	3.8	7.7	7.7	19.2	0	19.2	11.5	30.8		
																	10.3	
																		89.7

Start Time	Wood Road Southbound				Van Buren Boulevard Westbound				Wood Road Northbound				Van Buren Boulevard Eastbound			
	Left	Thru	Right	RTOR	Left	Thru	Right	RTOR	Left	Thru	Right	RTOR	Left	Thru	Right	RTOR
07:00 AM	1	0	0	0	0	0	1	1	0	0	0	0	0	0	0	0
07:15 AM	0	0	0	0	1	2	0	0	0	0	0	0	0	0	0	0
07:30 AM	0	0	0	0	0	1	0	0	0	1	0	0	0	1	0	0
07:45 AM	0	1	0	0	1	0	0	0	1	0	0	0	0	0	0	0
Total	1	1	0	0	2	1	4	1	6	0	2	0	0	1	1	0
% App. Total	50	50	0	0	16.7	66.7	16.7	16.7	50	0	100	0	0	50	50	0
PHF	.250	.250	.000	.000	.500	.250	.500	.500	.500	.000	.500	.000	.000	.250	.250	.500

Peak Hour Analysis From 07:00 AM to 07:45 AM - Peak 1 of 1
 Peak Hour for Entire Intersection Begins at 07:00 AM

Start Time	Left	Thru	Right	App. Total
07:00 AM	1	0	0	1
07:15 AM	0	0	0	0
07:30 AM	0	0	0	0
07:45 AM	0	1	0	1
Total Volume	1	1	0	2
% App. Total	50	50	0	100

Counts Unlimited, Inc.
 PO Box 1178
 Corona, CA 92878
 (951)268-6268

City of Riverside
 N/S: Wood Road
 E/W: Van Buren Boulevard
 Weather: Clear

File Name : 04_RIV_Wood_VB AM
 Site Code : 05121716
 Start Date : 11/30/2021
 Page No : 2

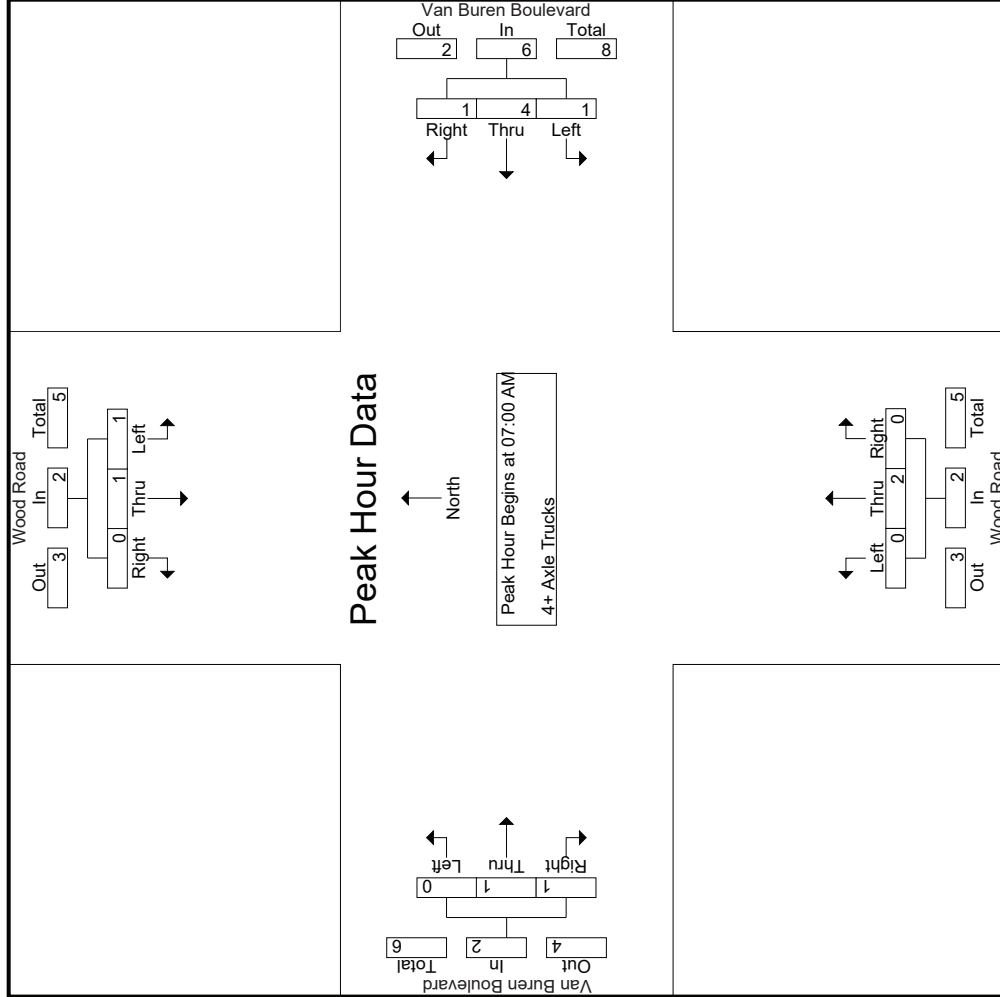

Counts Unlimited, Inc.
 PO Box 1178
 Corona, CA 92878
 (951)268-6268

City of Riverside
 N/S: Wood Road
 E/W: Van Buren Boulevard
 Weather: Clear

File Name : 04_RIV_Wood_VB AM
 Site Code : 05121716
 Start Date : 11/30/2021
 Page No : 3

Start Time	Wood Road Southbound			Van Buren Boulevard Westbound			Wood Road Northbound			Van Buren Boulevard Eastbound		
	Left	Thru	Right	Left	Thru	Right	Left	Thru	Right	Left	Thru	Right
Peak Hour Analysis From 07:00 AM to 07:45 AM - Peak 1 of 1												
Peak Hour for Each Approach Begins at:	07:00 AM											
+0 mins.	1	0	0	0	0	1	0	0	0	0	0	0
+15 mins.	0	0	0	1	2	0	0	0	0	0	0	1
+30 mins.	0	0	0	0	1	0	1	0	0	0	1	0
+45 mins.	0	1	0	0	1	0	0	1	0	0	0	0
Total Volume	1	1	0	1	4	1	0	2	0	0	1	1
% App. Total	50	50	0	16.7	66.7	16.7	0	100	0	0	50	50
PHF	.250	.250	.000	.250	.500	.250	.000	.500	.000	.000	.250	.250

Counts Unlimited, Inc.
 PO Box 1178
 Corona, CA 92878
 (951)268-6268

City of Riverside
 N/S: Wood Road
 E/W: Van Buren Boulevard
 Weather: Clear

File Name : 04_RIV_Wood_VB PM
 Site Code : 05121716
 Start Date : 11/30/2021
 Page No : 1

Groups Printed- Passenger Vehicles - Large 2 Axle Vehicles - 3 Axle Vehicles - 4+ Axle Trucks

Start Time	Wood Road Southbound						Wood Road Northbound						Van Buren Boulevard Westbound						Van Buren Boulevard Eastbound						Inclu. Total	Int. Total	
	Left	Thru	Right	RTOR	App. Total		Left	Thru	Right	RTOR	App. Total		Left	Thru	Right	RTOR	App. Total		Left	Thru	Right	RTOR	App. Total				
04:00 PM	15	44	35	20	94	59	259	20	9	338	56	59	46	26	161	31	310	49	19	390	74	983			74	983	1057
04:15 PM	18	57	34	13	109	39	285	22	7	346	62	68	48	15	178	35	287	44	22	366	57	999			57	999	1056
04:30 PM	16	65	53	13	134	60	301	21	15	382	85	54	39	17	178	40	329	53	28	422	73	1116			73	1116	1189
04:45 PM	28	61	52	22	141	40	244	14	12	298	65	42	42	16	149	38	294	39	27	371	77	959			77	959	1036
Total	77	227	174	68	478	198	1089	77	43	1364	268	223	175	74	666	144	1220	185	96	1549	281	4057			281	4057	4338
05:00 PM	13	69	40	21	122	64	259	12	8	335	72	73	51	10	196	26	250	43	19	319	58	972			58	972	1030
05:15 PM	20	62	45	20	127	32	222	19	5	273	57	49	32	14	138	48	286	36	10	370	49	908			49	908	957
05:30 PM	21	51	36	13	108	41	283	17	5	341	41	24	25	11	90	36	302	33	11	371	40	910			40	910	950
05:45 PM	13	55	25	7	93	59	232	13	4	304	54	47	28	12	129	22	289	56	21	367	44	893			44	893	937
Total	67	237	146	61	450	196	996	61	22	1253	224	193	136	47	553	132	1127	168	61	1427	191	3683			191	3683	3874
Grand Total	144	464	320	129	928	394	2085	138	65	2617	492	416	311	121	1219	276	2347	353	157	2976	472	7740			472	7740	8212
→ Approach %	15.5	50	34.5			15.1	79.7	5.3			40.4	34.1	25.5			9.3	78.9	11.9			9.3	78.9					
% Total	1.9	6	4.1		12	5.1	26.9	1.8		33.8	6.4	5.4	4		15.7	3.6	30.3	4.6		38.4	5.7	94.3					5.7
Passenger Vehicles	142	461	317		1047	389	2043	136		2633	484	411	304		1319	274	2275	349		3052	0	0					0
% Passenger Vehicles	98.6	99.4	99.1		99.1	98.7	98	98.6	100	98.2	98.4	98.8	97.7	99.2	98.4	99.3	96.9	98.9		98.1	97.4	0					0
Large 2 Axle Vehicles	2	3	2		8	5	28	1		34	7	5	6		19	2	46	2		51	0	0					0
% Large 2 Axle Vehicles	1.4	0.6	0.6		0.8	1.3	1.3	0.7	0	1.3	1.4	1.2	1.9	0.8	1.4	0.7	2	0.6		1.6	0	0					0
3 Axle Vehicles	0	0	1		2	0	4	0		4	1	1	1		2	0	10	2		14	0	0					0
% 3 Axle Vehicles	0	0	0.3		0.2	0	0.2	0	0	0.1	0.2	0	0.3	0	0.1	0	0.4	0.6		0.4	0	0					0
4+ Axle Trucks	0	0	0		0	0	10	1		11	0	0	0		0	0	16	0		16	0	0					0
% 4+ Axle Trucks	0	0	0		0	0	0.5	0.7	0	0.4	0	0	0	0	0	0	0.7	0		0.5	0	0					0

Start Time	Wood Road Southbound						Wood Road Northbound						Van Buren Boulevard Westbound						Van Buren Boulevard Eastbound						Inclu. Total	Int. Total				
	Left	Thru	Right	RTOR	App. Total		Left	Thru	Right	RTOR	App. Total		Left	Thru	Right	RTOR	App. Total		Left	Thru	Right	RTOR	App. Total							
Peak Hour Analysis From 04:00 PM to 05:45 PM - Peak 1 of 1																														
Peak Hour for Entire Intersection Begins at 04:00 PM																														
04:00 PM	15	44	35		94	59	259	20	9	338	56	59	46		161	31	310	49		390	74	983			74	983	1057			
04:15 PM	18	57	34		109	39	285	22	7	346	62	68	48		178	35	287	44		366	57	999			57	999	1056			
04:30 PM	16	65	53		134	60	301	21	15	382	85	54	39		178	40	329	53		422	73	1116			73	1116	1189			
04:45 PM	28	61	52		141	40	244	14	12	298	65	42	42		149	38	294	39		371	77	959			77	959	1036			
Total Volume	77	227	174		478	198	1089	77	43	1364	268	223	175		666	144	1220	185		1549	281	4057			281	4057	4338			
% App. Total	16.1	47.5	36.4			14.5	79.8	5.6			40.2	33.5	26.3			9.3	78.8	11.9			9.3	78.8								
PHF	.688	.873	.821			.825	.904	.875			.788	.820	.911			.900	.927	.873			.900	.918					.909			

Counts Unlimited, Inc.
 PO Box 1178
 Corona, CA 92878
 (951)268-6268

City of Riverside
 N/S: Wood Road
 E/W: Van Buren Boulevard
 Weather: Clear

File Name : 04_RIV_Wood_VB PM
 Site Code : 05121716
 Start Date : 11/30/2021
 Page No : 2

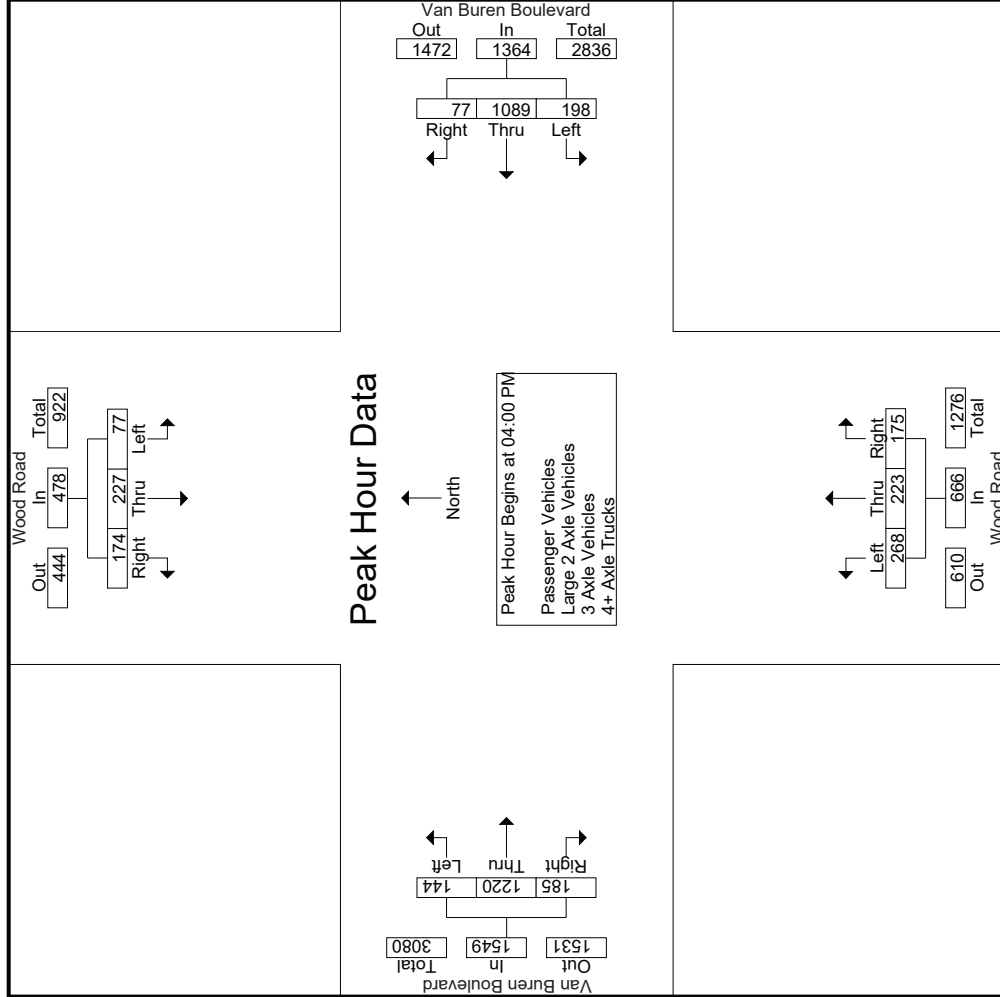

Counts Unlimited, Inc.
 PO Box 1178
 Corona, CA 92878
 (951)268-6268

City of Riverside
 N/S: Wood Road
 E/W: Van Buren Boulevard
 Weather: Clear

File Name : 04_RIV_Wood_VB PM
 Site Code : 05121716
 Start Date : 11/30/2021
 Page No : 3

Start Time	Wood Road Southbound			Van Buren Boulevard Westbound			Wood Road Northbound			Van Buren Boulevard Eastbound						
	Left	Thru	Right	Left	Thru	Right	Left	Thru	Right	Left	Thru	Right	App. Total	Int. Total		
Peak Hour Analysis From 04:00 PM to 05:45 PM - Peak 1 of 1																
Peak Hour for Each Approach Begins at:																
	04:30 PM			04:00 PM			04:15 PM			04:00 PM						
+0 mins.	16	65	53	134	59	259	20	338	62	68	48	178	31	310	49	390
+15 mins.	28	61	52	141	39	285	22	346	85	54	39	178	35	287	44	366
+30 mins.	13	69	40	122	60	301	21	382	65	42	42	149	40	329	53	422
+45 mins.	20	62	45	127	40	244	14	298	72	73	51	196	38	294	39	371
Total Volume	77	257	190	524	198	1089	77	1364	284	237	180	701	144	1220	185	1549
% App. Total	14.7	49	36.3	100	14.5	79.8	5.6	100	40.5	33.8	25.7	100	9.3	78.8	11.9	100
PHF	.688	.931	.896	.929	.825	.904	.875	.893	.835	.812	.882	.894	.900	.927	.873	.918

Counts Unlimited, Inc.
 PO Box 1178
 Corona, CA 92878
 (951)268-6268

City of Riverside
 N/S: Wood Road
 E/W: Van Buren Boulevard
 Weather: Clear

File Name : 04_RIV_Wood_VB PM
 Site Code : 05121716
 Start Date : 11/30/2021
 Page No : 1

Groups Printed- Passenger Vehicles

Start Time	Wood Road Southbound				Van Buren Boulevard Westbound				Wood Road Northbound				Van Buren Boulevard Eastbound				Exclu. Total	Inclu. Total	Int. Total				
	Left	Thru	Right	RTOR	Left	Thru	Right	RTOR	Left	Thru	Right	RTOR	Left	Thru	Right	RTOR				App. Total			
04:00 PM	14	44	35	20	93	59	253	20	9	332	56	59	45	26	160	31	305	48	19	384	74	969	1043
04:15 PM	18	57	34	13	109	39	281	21	7	341	60	65	47	15	172	35	280	43	21	358	56	980	1036
04:30 PM	16	64	53	13	133	59	295	21	15	375	83	54	37	17	174	40	316	52	27	408	72	1090	1162
04:45 PM	28	60	51	21	139	39	238	14	12	291	62	42	42	16	146	36	285	38	26	359	75	935	1010
Total	76	225	173	67	474	196	1067	76	43	1339	261	220	171	74	652	142	1186	181	93	1509	277	3974	4251
05:00 PM	12	68	40	21	120	64	252	12	8	328	71	72	50	10	193	26	238	43	19	307	58	948	1006
05:15 PM	20	62	45	20	127	31	220	19	5	270	57	49	31	14	137	48	275	36	10	359	49	893	942
05:30 PM	21	51	34	12	106	41	279	16	5	336	41	24	24	10	89	36	292	33	11	361	38	892	930
05:45 PM	13	55	25	7	93	57	225	13	4	295	54	46	28	12	128	22	284	56	21	362	44	878	922
Total	66	236	144	60	446	193	976	60	22	1229	223	191	133	46	547	132	1089	168	61	1389	189	3611	3800
Grand Total	142	461	317	127	920	389	2043	136	65	2568	484	411	304	120	1199	274	2275	349	154	2898	466	7585	8051
% Apprch %	15.4	50.1	34.5			15.1	79.6	5.3			40.4	34.3	25.4			9.5	78.5	12					
% Total %	1.9	6.1	4.2		12.1	5.1	26.9	1.8		33.9	6.4	5.4	4		15.8	3.6	30	4.6		38.2	5.8	94.2	

Start Time	Wood Road Southbound				Van Buren Boulevard Westbound				Wood Road Northbound				Van Buren Boulevard Eastbound				App. Total	Int. Total				
	Left	Thru	Right	RTOR	Left	Thru	Right	RTOR	Left	Thru	Right	RTOR	Left	Thru	Right	RTOR						
04:00 PM	14	44	35		59	253	20		56	59	45		31	305	48		160	31	305	48	384	969
04:15 PM	18	57	34		39	281	21		60	65	47		35	280	43		172	35	280	43	358	980
04:30 PM	16	64	53		59	295	21		83	54	37		40	316	52		174	40	316	52	408	1090
04:45 PM	28	60	51		39	238	14		62	42	42		36	285	38		146	36	285	38	359	935
Total Volume	76	225	173		196	1067	76		261	220	171		142	1186	181		652	142	1186	181	1509	3974
% App. Total	16	47.5	36.5		14.6	79.7	5.7		40	33.7	26.2		9.4	78.6	12		9.37	8.88	9.38	8.70	9.25	.911
PHF	.679	.879	.816		.831	.904	.905		.786	.846	.910		.888	.938	.870		.937	.888	.938	.870	.925	.911

Peak Hour Analysis From 04:00 PM to 04:45 PM - Peak 1 of 1
 Peak Hour for Entire Intersection Begins at 04:00 PM

Counts Unlimited, Inc.
 PO Box 1178
 Corona, CA 92878
 (951)268-6268

City of Riverside
 N/S: Wood Road
 E/W: Van Buren Boulevard
 Weather: Clear

File Name : 04_RIV_Wood_VB PM
 Site Code : 05121716
 Start Date : 11/30/2021
 Page No : 2

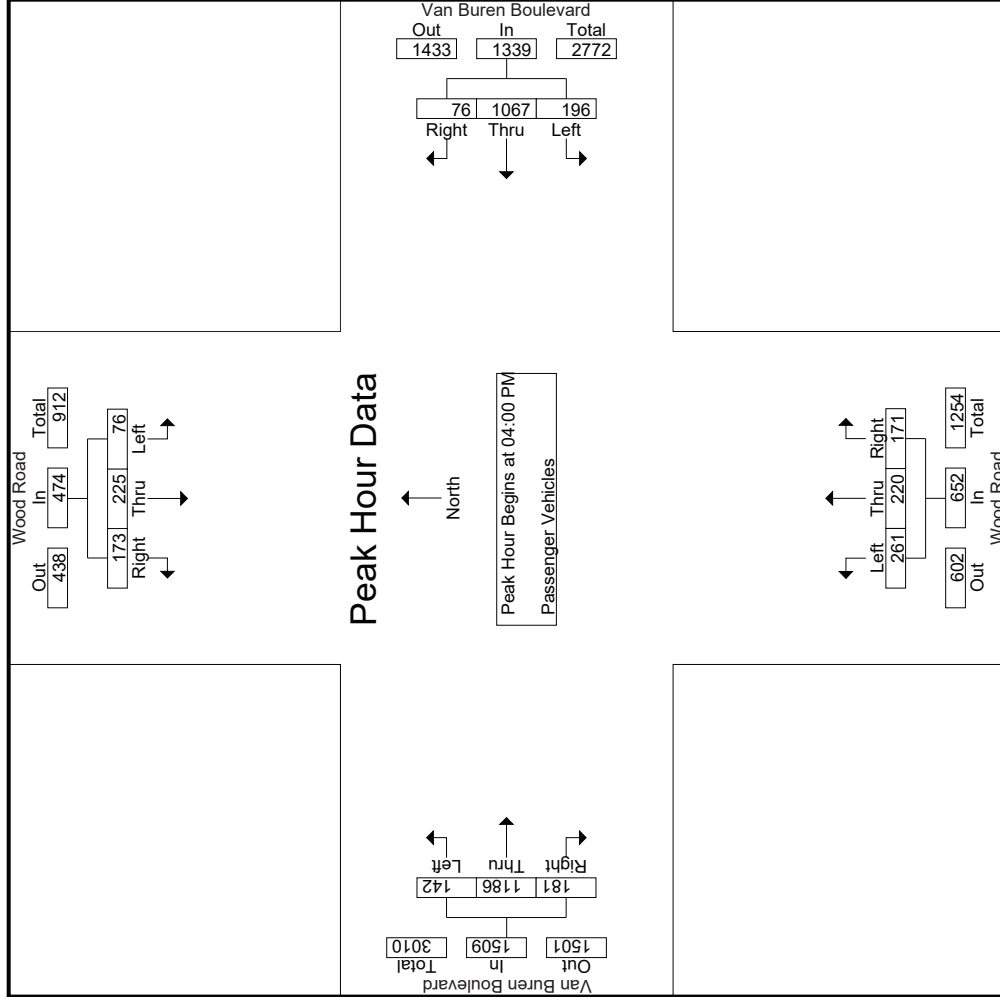

Counts Unlimited, Inc.
 PO Box 1178
 Corona, CA 92878
 (951)268-6268

City of Riverside
 N/S: Wood Road
 E/W: Van Buren Boulevard
 Weather: Clear

File Name : 04_RIV_Wood_VB PM
 Site Code : 05121716
 Start Date : 11/30/2021
 Page No : 3

Start Time	Wood Road Southbound			Van Buren Boulevard Westbound			Wood Road Northbound			Van Buren Boulevard Eastbound					
	Left	Thru	Right	Left	Thru	Right	Left	Thru	Right	Left	Thru	Right	App. Total	Int. Total	
Peak Hour Analysis From 04:00 PM to 04:45 PM - Peak 1 of 1															
Peak Hour for Each Approach Begins at:															
	04:00 PM														
+0 mins.	14	44	35	59	253	20	332	56	59	45	160	31	305	48	384
+15 mins.	18	57	34	39	281	21	341	60	65	47	172	35	280	43	358
+30 mins.	16	64	53	59	295	21	375	83	54	37	174	40	316	52	408
+45 mins.	28	60	51	39	238	14	291	62	42	42	146	36	285	38	359
Total Volume	76	225	173	196	1067	76	1339	261	220	171	652	142	1186	181	1509
% App. Total	16	47.5	36.5	14.6	79.7	5.7	40	40	33.7	26.2	9.4	9.4	78.6	12	92.5
PHF	.679	.879	.816	.831	.904	.905	.893	.786	.846	.910	.937	.888	.938	.870	.925

Counts Unlimited, Inc.
 PO Box 1178
 Corona, CA 92878
 (951)268-6268

File Name : 04_RIV_Wood_VB PM
 Site Code : 05121716
 Start Date : 11/30/2021
 Page No : 1

City of Riverside
 N/S: Wood Road
 EW: Van Buren Boulevard
 Weather: Clear

Groups Printed- Large 2 Axle Vehicles

Start Time	Wood Road Southbound				Van Buren Boulevard Westbound				Wood Road Northbound				Van Buren Boulevard Eastbound				
	Left	Thru	Right	RTOR	Left	Thru	Right	RTOR	Left	Thru	Right	RTOR	Left	Thru	Right	RTOR	
04:00 PM	1	0	0	1	0	3	0	0	3	0	1	0	0	2	1	0	3
04:15 PM	0	0	0	0	4	0	0	0	4	3	1	0	5	4	0	0	4
04:30 PM	0	1	0	1	1	5	0	0	6	2	0	3	3	9	0	0	9
04:45 PM	0	1	1	2	3	0	0	0	4	3	0	0	3	5	1	1	8
Total	1	2	1	4	2	15	0	0	17	6	3	3	12	2	20	2	24
05:00 PM	1	1	0	2	0	4	0	0	4	1	1	0	3	0	10	0	10
05:15 PM	0	0	0	0	2	0	0	0	3	0	0	1	0	6	0	0	6
05:30 PM	0	0	1	0	1	0	1	0	4	0	1	1	1	8	0	0	8
05:45 PM	0	0	0	0	2	4	0	0	6	0	1	0	1	2	0	0	2
Total	1	1	1	3	3	13	1	0	17	1	2	3	6	0	26	0	26
Grand Total	2	3	2	7	5	28	1	0	34	7	5	6	18	2	46	2	50
% Approach	28.6	42.9	28.6	6.4	14.7	82.4	2.9	0	38.9	27.8	33.3	16.5	4	92	4	45.9	
% Total	1.8	2.8	1.8	6.4	4.6	25.7	0.9	0	31.2	6.4	4.6	5.5	1.8	42.2	1.8	2.7	
																	97.3

Start Time	Wood Road Southbound				Van Buren Boulevard Westbound				Wood Road Northbound				Van Buren Boulevard Eastbound				
	Left	Thru	Right	RTOR	Left	Thru	Right	RTOR	Left	Thru	Right	RTOR	Left	Thru	Right	RTOR	
04:00 PM	1	0	0	1	0	3	0	0	3	0	1	0	0	2	1	0	3
04:15 PM	0	0	0	0	4	0	0	0	4	3	1	0	5	4	0	0	4
04:30 PM	0	1	0	1	1	5	0	0	6	2	0	3	3	9	0	0	9
04:45 PM	0	1	1	2	3	0	0	0	4	3	0	0	3	5	1	1	8
Total	1	2	1	4	2	15	0	0	17	6	3	3	12	2	20	2	24
05:00 PM	1	1	0	2	0	4	0	0	4	1	1	0	3	0	10	0	10
05:15 PM	0	0	0	0	2	0	0	0	3	0	0	1	0	6	0	0	6
05:30 PM	0	0	1	0	1	0	1	0	4	0	1	1	1	8	0	0	8
05:45 PM	0	0	0	0	2	4	0	0	6	0	1	0	1	2	0	0	2
Total	1	1	1	3	3	13	1	0	17	1	2	3	6	0	26	0	26
Grand Total	2	3	2	7	5	28	1	0	34	7	5	6	18	2	46	2	50
% Approach	28.6	42.9	28.6	6.4	14.7	82.4	2.9	0	38.9	27.8	33.3	16.5	4	92	4	45.9	
% Total	1.8	2.8	1.8	6.4	4.6	25.7	0.9	0	31.2	6.4	4.6	5.5	1.8	42.2	1.8	2.7	
																	97.3

Start Time	Wood Road Southbound				Van Buren Boulevard Westbound				Wood Road Northbound				Van Buren Boulevard Eastbound				
	Left	Thru	Right	RTOR	Left	Thru	Right	RTOR	Left	Thru	Right	RTOR	Left	Thru	Right	RTOR	
04:00 PM	1	0	0	1	0	3	0	0	3	0	1	0	0	2	1	0	3
04:15 PM	0	0	0	0	4	0	0	0	4	3	1	0	5	4	0	0	4
04:30 PM	0	1	0	1	1	5	0	0	6	2	0	3	3	9	0	0	9
04:45 PM	0	1	1	2	3	0	0	0	4	3	0	0	3	5	1	1	8
Total	1	2	1	4	2	15	0	0	17	6	3	3	12	2	20	2	24
% App. Total	25	50	25	62.5	11.8	88.2	0	0	25	50	25	25	8.3	83.3	8.3	24	
PHF	.250	.500	.250	.500	.500	.750	.000	.000	.708	.500	.250	.750	.250	.556	.500	.667	

Peak Hour Analysis From 04:00 PM to 04:45 PM - Peak 1 of 1
 Peak Hour for Entire Intersection Begins at 04:00 PM

Counts Unlimited, Inc.
 PO Box 1178
 Corona, CA 92878
 (951)268-6268

City of Riverside
 N/S: Wood Road
 E/W: Van Buren Boulevard
 Weather: Clear

File Name : 04_RIV_Wood_VB_PM
 Site Code : 05121716
 Start Date : 11/30/2021
 Page No : 2

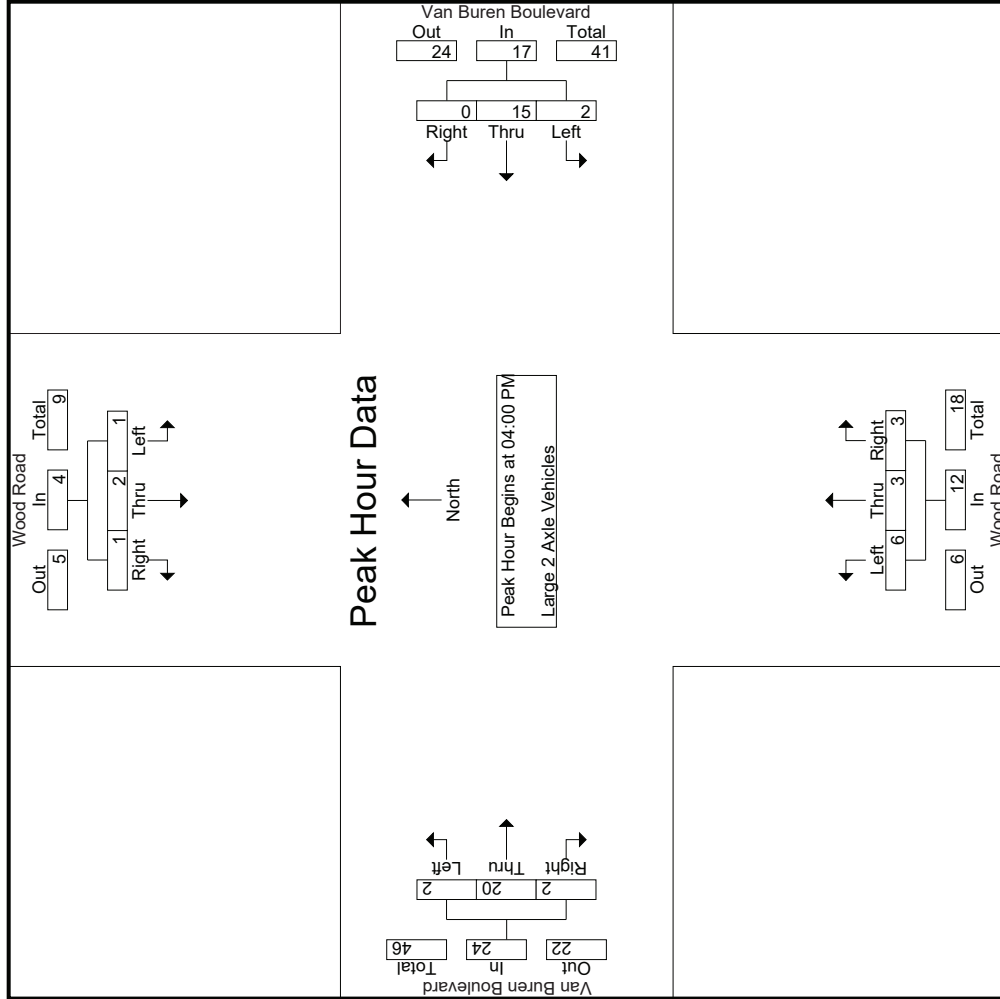

Counts Unlimited, Inc.
 PO Box 1178
 Corona, CA 92878
 (951)268-6268

City of Riverside
 N/S: Wood Road
 E/W: Van Buren Boulevard
 Weather: Clear

File Name : 04_RIV_Wood_VB PM
 Site Code : 05121716
 Start Date : 11/30/2021
 Page No : 3

Start Time	Wood Road Southbound			Van Buren Boulevard Westbound			Wood Road Northbound			Van Buren Boulevard Eastbound		
	Left	Thru	Right	Left	Thru	Right	Left	Thru	Right	Left	Thru	Right
Peak Hour Analysis From 04:00 PM to 04:45 PM - Peak 1 of 1												
Peak Hour for Each Approach Begins at:												
+0 mins.	1	0	0	0	3	0	0	0	1	0	2	1
+15 mins.	0	0	0	4	4	0	3	1	5	0	4	0
+30 mins.	0	1	0	1	5	0	0	0	3	0	9	0
+45 mins.	0	1	1	1	3	0	3	0	3	2	5	1
Total Volume	1	2	1	2	15	0	6	3	12	2	20	2
% App. Total	.250	.500	.250	.500	.750	.000	.500	.250	.600	.250	.556	.500
PHF												

Groups Printed- 3 Axle Vehicles

Start Time	Wood Road Southbound			Van Buren Boulevard Westbound			Wood Road Northbound			Van Buren Boulevard Eastbound			Inclu. Total	Int. Total
	Left	Thru	Right	Left	Thru	Right	Left	Thru	Right	Left	Thru	Right		
04:00 PM	0	0	0	0	0	0	0	0	0	0	0	0	0	3
04:15 PM	0	0	0	0	0	0	0	0	0	0	0	0	0	3
04:30 PM	0	0	0	0	0	0	0	0	0	0	0	0	0	4
04:45 PM	0	0	0	0	0	0	0	0	0	0	0	0	0	3
Total	0	0	0	0	2	0	1	0	1	0	2	7	2	13
05:00 PM	0	0	0	0	0	0	0	0	0	0	0	0	0	0
05:15 PM	0	0	0	0	0	0	0	0	0	0	0	0	0	2
05:30 PM	0	0	1	1	0	0	0	0	0	0	0	0	0	3
05:45 PM	0	0	0	0	0	0	0	0	0	0	0	0	0	1
Total	0	0	1	1	0	0	0	0	0	0	0	3	0	6
Grand Total	0	0	1	1	0	4	1	0	1	0	2	10	2	19
% Apprch %	0	0	100	0	100	0	50	0	50	0	83.3	16.7	0	13.6
% Total %	0	0	5.3	0	21.1	0	5.3	0	5.3	0	52.6	10.5	0	86.4

Start Time	Wood Road Southbound			Van Buren Boulevard Westbound			Wood Road Northbound			Van Buren Boulevard Eastbound			Inclu. Total	Int. Total
	Left	Thru	Right	Left	Thru	Right	Left	Thru	Right	Left	Thru	Right		
04:00 PM	0	0	0	0	0	0	0	0	0	0	0	0	0	1
04:15 PM	0	0	0	0	0	0	0	0	0	0	0	0	0	2
04:30 PM	0	0	0	0	0	0	0	0	0	0	0	0	0	3
04:45 PM	0	0	0	0	0	0	0	0	0	0	0	0	0	3
Total Volume	0	0	0	0	2	0	1	0	1	0	2	7	2	13
% App. Total	0	0	0	0	100	0	50	0	50	0	77.8	22.2	0	86.4
PHF	.000	.000	.000	.000	.250	.000	.250	.000	.250	.000	.500	.500	.000	.750

Peak Hour Analysis From 04:00 PM to 04:45 PM - Peak 1 of 1
 Peak Hour for Entire Intersection Begins at 04:00 PM

Counts Unlimited, Inc.
 PO Box 1178
 Corona, CA 92878
 (951)268-6268

City of Riverside
 N/S: Wood Road
 E/W: Van Buren Boulevard
 Weather: Clear

File Name : 04_RIV_Wood_VB_PM
 Site Code : 05121716
 Start Date : 11/30/2021
 Page No : 2

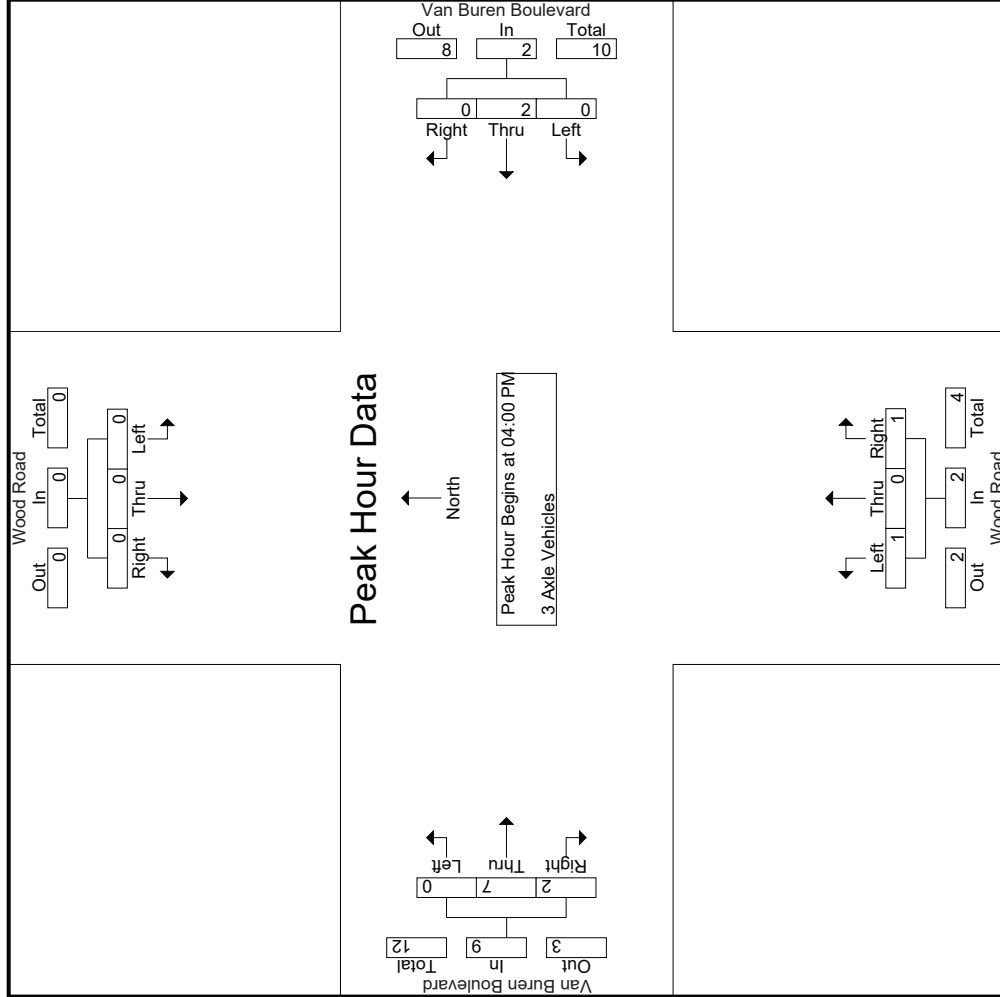

Counts Unlimited, Inc.
 PO Box 1178
 Corona, CA 92878
 (951)268-6268

City of Riverside
 N/S: Wood Road
 E/W: Van Buren Boulevard
 Weather: Clear

File Name : 04_RIV_Wood_VB PM
 Site Code : 05121716
 Start Date : 11/30/2021
 Page No : 3

Start Time	Wood Road Southbound			Van Buren Boulevard Westbound			Wood Road Northbound			Van Buren Boulevard Eastbound			Int. Total
	Left	Thru	Right	Left	Thru	Right	Left	Thru	Right	Left	Thru	Right	
Peak Hour Analysis From 04:00 PM to 04:45 PM - Peak 1 of 1													
Peak Hour for Each Approach Begins at:													
	04:00 PM			04:00 PM			04:00 PM			04:00 PM			
+0 mins.	0	0	0	0	2	0	0	0	0	0	1	0	1
+15 mins.	0	0	0	0	0	0	0	0	0	1	0	1	2
+30 mins.	0	0	0	0	0	0	0	0	0	0	2	1	3
+45 mins.	0	0	0	0	0	0	0	0	0	0	3	0	3
Total Volume	0	0	0	0	2	0	0	1	0	1	7	2	9
% App. Total	0	0	0	0	100	0	0	50	0	50	77.8	22.2	
PHF	.000	.000	.000	.000	.250	.000	.250	.250	.000	.250	.583	.500	.750

Counts Unlimited, Inc.
 PO Box 1178
 Corona, CA 92878
 (951)268-6268

File Name : 04_RIV_Wood_VB PM
 Site Code : 05121716
 Start Date : 11/30/2021
 Page No : 1

City of Riverside
 N/S: Wood Road
 EW: Van Buren Boulevard
 Weather: Clear

Groups Printed- 4+ Axle Trucks

Start Time	Wood Road Southbound				Van Buren Boulevard Westbound				Wood Road Northbound				Van Buren Boulevard Eastbound							
	Left	Thru	Right	RTOR	Left	Thru	Right	RTOR	Left	Thru	Right	RTOR	Left	Thru	Right	RTOR	App. Total	Exclu. Total	Inclu. Total	Int. Total
04:00 PM	0	0	0	0	0	1	0	0	0	0	0	0	0	2	0	0	2	0	3	3
04:15 PM	0	0	0	0	0	1	0	0	0	0	0	0	0	2	0	0	2	0	3	3
04:30 PM	0	0	0	0	0	1	0	0	0	0	0	0	0	2	0	0	2	0	3	3
04:45 PM	0	0	0	0	0	3	0	0	0	0	0	0	0	1	0	0	1	0	4	4
Total	0	0	0	0	0	5	1	0	0	0	0	0	0	7	0	0	7	0	13	13
05:00 PM	0	0	0	0	0	3	0	0	0	0	0	0	0	2	0	0	2	0	5	5
05:15 PM	0	0	0	0	0	0	0	0	0	0	0	0	0	3	0	0	3	0	3	3
05:30 PM	0	0	0	0	0	0	0	0	0	0	0	0	0	1	0	0	1	0	1	1
05:45 PM	0	0	0	0	0	2	0	0	0	0	0	0	0	3	0	0	3	0	5	5
Total	0	0	0	0	0	5	0	0	0	0	0	0	0	9	0	0	9	0	14	14
Grand Total	0	0	0	0	0	10	1	0	0	0	0	0	0	16	0	0	16	0	27	27
% Apprch	0	0	0	0	0	90.9	9.1	0	0	0	0	0	0	100	0	0	59.3	0	100	100
% Total	0	0	0	0	0	37	3.7	0	0	0	0	0	0	59.3	0	0	59.3	0	100	100

Start Time	Wood Road Southbound				Van Buren Boulevard Westbound				Wood Road Northbound				Van Buren Boulevard Eastbound							
	Left	Thru	Right	RTOR	Left	Thru	Right	RTOR	Left	Thru	Right	RTOR	Left	Thru	Right	RTOR	App. Total	Exclu. Total	Inclu. Total	Int. Total
04:00 PM	0	0	0	0	0	1	0	0	0	0	0	0	0	2	0	0	2	0	3	3
04:15 PM	0	0	0	0	0	1	0	0	0	0	0	0	0	2	0	0	2	0	3	3
04:30 PM	0	0	0	0	0	1	0	0	0	0	0	0	0	2	0	0	2	0	3	3
04:45 PM	0	0	0	0	0	3	0	0	0	0	0	0	0	1	0	0	1	0	4	4
Total	0	0	0	0	0	5	1	0	0	0	0	0	0	7	0	0	7	0	13	13
05:00 PM	0	0	0	0	0	3	0	0	0	0	0	0	0	2	0	0	2	0	5	5
05:15 PM	0	0	0	0	0	0	0	0	0	0	0	0	0	3	0	0	3	0	3	3
05:30 PM	0	0	0	0	0	0	0	0	0	0	0	0	0	1	0	0	1	0	1	1
05:45 PM	0	0	0	0	0	2	0	0	0	0	0	0	0	3	0	0	3	0	5	5
Total	0	0	0	0	0	5	0	0	0	0	0	0	0	9	0	0	9	0	14	14
Grand Total	0	0	0	0	0	10	1	0	0	0	0	0	0	16	0	0	16	0	27	27
% Apprch	0	0	0	0	0	90.9	9.1	0	0	0	0	0	0	100	0	0	59.3	0	100	100
% Total	0	0	0	0	0	37	3.7	0	0	0	0	0	0	59.3	0	0	59.3	0	100	100

Peak Hour Analysis From 04:00 PM to 04:45 PM - Peak 1 of 1
 Peak Hour for Entire Intersection Begins at 04:00 PM

Start Time	Wood Road Southbound				Van Buren Boulevard Westbound				Wood Road Northbound				Van Buren Boulevard Eastbound							
	Left	Thru	Right	RTOR	Left	Thru	Right	RTOR	Left	Thru	Right	RTOR	Left	Thru	Right	RTOR	App. Total	Exclu. Total	Inclu. Total	Int. Total
04:00 PM	0	0	0	0	0	1	0	0	0	0	0	0	0	2	0	0	2	0	3	3
04:15 PM	0	0	0	0	0	1	0	0	0	0	0	0	0	2	0	0	2	0	3	3
04:30 PM	0	0	0	0	0	1	0	0	0	0	0	0	0	2	0	0	2	0	3	3
04:45 PM	0	0	0	0	0	3	0	0	0	0	0	0	0	1	0	0	1	0	4	4
Total	0	0	0	0	0	5	1	0	0	0	0	0	0	7	0	0	7	0	13	13
% App. Total	0	0	0	0	0	83.3	16.7	0	0	0	0	0	0	100	0	0	87.5	0	100	100
PHF	.000	.000	.000	.000	.000	.417	.250	.500	.000	.000	.000	.000	.000	.875	.000	.000	.875	.000	.875	.813

Counts Unlimited, Inc.
 PO Box 1178
 Corona, CA 92878
 (951)268-6268

City of Riverside
 N/S: Wood Road
 E/W: Van Buren Boulevard
 Weather: Clear

File Name : 04_RIV_Wood_VB PM
 Site Code : 05121716
 Start Date : 11/30/2021
 Page No : 2

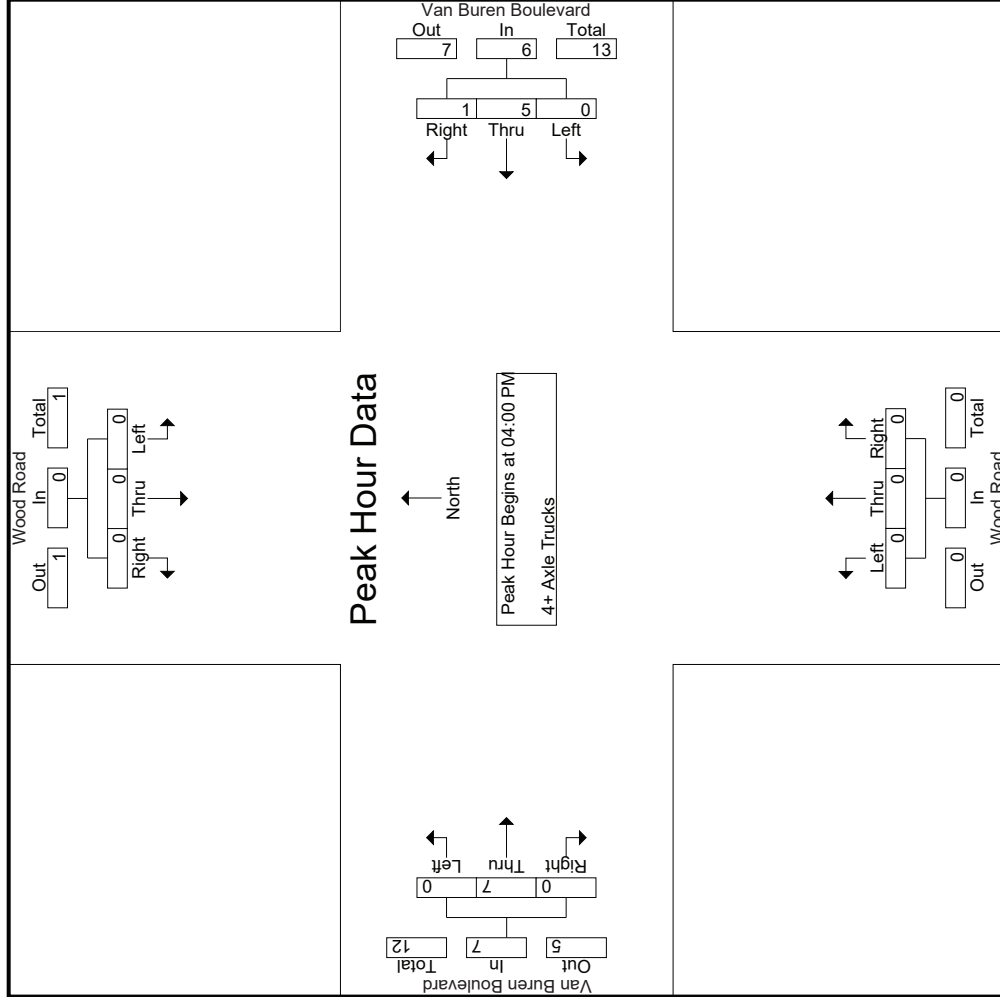

Counts Unlimited, Inc.
 PO Box 1178
 Corona, CA 92878
 (951)268-6268

City of Riverside
 N/S: Wood Road
 E/W: Van Buren Boulevard
 Weather: Clear

File Name : 04_RIV_Wood_VB PM
 Site Code : 05121716
 Start Date : 11/30/2021
 Page No : 3

Start Time	Wood Road Southbound			Van Buren Boulevard Westbound			Wood Road Northbound			Van Buren Boulevard Eastbound		
	Left	Thru	Right	Left	Thru	Right	Left	Thru	Right	Left	Thru	Right
Peak Hour Analysis From 04:00 PM to 04:45 PM - Peak 1 of 1												
Peak Hour for Each Approach Begins at:												
+0 mins.	0	0	0	0	1	0	0	0	0	0	2	0
+15 mins.	0	0	0	0	0	1	0	0	0	0	2	0
+30 mins.	0	0	0	0	1	0	0	0	0	0	2	0
+45 mins.	0	0	0	0	3	0	0	0	0	0	1	0
Total Volume	0	0	0	0	5	1	0	0	0	0	7	0
% App. Total	0	0	0	0	83.3	16.7	0	0	0	0	100	0
PHF	.000	.000	.000	.000	.417	.250	.000	.000	.000	.000	.875	.000

Location: Riverside
 N/S: Wood Road
 E/W: Van Buren Boulevard



Date: 11/30/2021
 Day: Tuesday

PEDESTRIANS

	North Leg Wood Road	East Leg Van Buren Boulevard	South Leg Wood Road	West Leg Van Buren Boulevard	
	Pedestrians	Pedestrians	Pedestrians	Pedestrians	
7:00 AM	1	20	5	0	26
7:15 AM	0	30	5	0	35
7:30 AM	0	37	5	0	42
7:45 AM	0	5	0	0	5
8:00 AM	2	2	0	0	4
8:15 AM	1	4	0	0	5
8:30 AM	0	0	0	0	0
8:45 AM	0	1	2	0	3
TOTAL VOLUMES:	4	99	17	0	120

	North Leg Wood Road	East Leg Van Buren Boulevard	South Leg Wood Road	West Leg Van Buren Boulevard	
	Pedestrians	Pedestrians	Pedestrians	Pedestrians	
4:00 PM	0	3	2	0	5
4:15 PM	1	3	2	0	6
4:30 PM	2	4	0	0	6
4:45 PM	0	2	0	0	2
5:00 PM	5	5	3	0	13
5:15 PM	2	2	0	0	4
5:30 PM	1	1	0	0	2
5:45 PM	0	2	0	0	2
TOTAL VOLUMES:	11	22	7	0	40

Location: Riverside
 N/S: Wood Road
 E/W: Van Buren Boulevard



Date: 11/30/2021
 Day: Tuesday

BICYCLES

	Southbound Wood Road			Westbound Van Buren Boulevard			Northbound Wood Road			Eastbound Van Buren Boulevard			
	Left	Thru	Right	Left	Thru	Right	Left	Thru	Right	Left	Thru	Right	
7:00 AM	0	0	0	0	1	0	0	0	0	0	0	0	1
7:15 AM	0	1	0	1	1	0	0	0	0	0	1	0	4
7:30 AM	0	0	0	2	0	0	0	0	0	0	0	0	2
7:45 AM	0	0	0	0	0	0	0	0	0	0	0	0	0
8:00 AM	0	0	0	0	1	0	0	0	0	0	0	0	1
8:15 AM	0	0	0	0	0	0	0	0	0	0	0	0	0
8:30 AM	0	0	0	0	0	0	0	0	0	0	0	0	0
8:45 AM	0	0	0	0	0	0	0	0	0	0	0	0	0
TOTAL VOLUMES:	0	1	0	3	3	0	0	0	0	0	1	0	8

	Southbound Wood Road			Westbound Van Buren Boulevard			Northbound Wood Road			Eastbound Van Buren Boulevard			
	Left	Thru	Right	Left	Thru	Right	Left	Thru	Right	Left	Thru	Right	
4:00 PM	0	0	0	0	0	0	0	0	0	1	0	0	1
4:15 PM	0	0	0	0	1	0	0	0	0	0	0	0	1
4:30 PM	0	1	0	0	0	0	0	0	0	0	0	0	1
4:45 PM	0	0	0	0	0	0	0	1	0	0	0	0	1
5:00 PM	0	0	0	0	0	0	0	0	0	0	0	0	0
5:15 PM	0	0	0	0	0	0	0	0	0	0	0	0	0
5:30 PM	0	0	0	0	0	0	0	0	0	0	0	0	0
5:45 PM	0	0	0	0	0	0	0	0	0	0	0	0	0
TOTAL VOLUMES:	0	1	0	0	1	0	0	1	0	1	0	0	4

City of Riverside
 N/S: Trautwein Road
 E/W: Alessandro Boulevard
 Weather: Clear

File Name : 05_RIV_Traut_Ales AM
 Site Code : 05121716
 Start Date : 11/30/2021
 Page No : 1

Groups Printed- Passenger Vehicles - Large 2 Axle Vehicles - 3 Axle Vehicles - 4+ Axle Trucks

Start Time	Alessandro Boulevard Westbound			Trautwein Road Northbound			Alessandro Boulevard Eastbound			Int. Total
	Left	Thru	App. Total	Left	Right	App. Total	Thru	Right	App. Total	
07:00 AM	28	531	559	385	1	386	150	1	151	1096
07:15 AM	31	544	575	445	2	447	184	1	185	1207
07:30 AM	27	582	609	427	1	428	224	0	224	1261
07:45 AM	33	409	442	342	6	348	212	2	214	1004
Total	119	2066	2185	1599	10	1609	770	4	774	4568
08:00 AM	29	499	528	362	3	365	221	0	221	1114
08:15 AM	15	510	525	294	4	298	199	0	199	1022
08:30 AM	34	514	548	249	1	250	179	0	179	977
08:45 AM	34	461	495	291	4	295	193	0	193	983
Total	112	1984	2096	1196	12	1208	792	0	792	4096
Grand Total	231	4050	4281	2795	22	2817	1562	4	1566	8664
Apprch %	5.4	94.6		99.2	0.8		99.7	0.3		
Total %	2.7	46.7	49.4	32.3	0.3	32.5	18	0	18.1	
Passenger Vehicles	222	3998	4220	2740	19	2759	1530	4	1534	8513
% Passenger Vehicles	96.1	98.7	98.6	98	86.4	97.9	98	100	98	98.3
Large 2 Axle Vehicles	5	39	44	47	2	49	30	0	30	123
% Large 2 Axle Vehicles	2.2	1	1	1.7	9.1	1.7	1.9	0	1.9	1.4
3 Axle Vehicles	3	5	8	6	1	7	0	0	0	15
% 3 Axle Vehicles	1.3	0.1	0.2	0.2	4.5	0.2	0	0	0	0.2
4+ Axle Trucks	1	8	9	2	0	2	2	0	2	13
% 4+ Axle Trucks	0.4	0.2	0.2	0.1	0	0.1	0.1	0	0.1	0.2

Start Time	Alessandro Boulevard Westbound			Trautwein Road Northbound			Alessandro Boulevard Eastbound			Int. Total
	Left	Thru	App. Total	Left	Right	App. Total	Thru	Right	App. Total	
Peak Hour Analysis From 07:00 AM to 08:45 AM - Peak 1 of 1										
Peak Hour for Entire Intersection Begins at 07:15 AM										
07:15 AM	31	544	575	445	2	447	184	1	185	1207
07:30 AM	27	582	609	427	1	428	224	0	224	1261
07:45 AM	33	409	442	342	6	348	212	2	214	1004
08:00 AM	29	499	528	362	3	365	221	0	221	1114
Total Volume	120	2034	2154	1576	12	1588	841	3	844	4586
% App. Total	5.6	94.4		99.2	0.8		99.6	0.4		
PHF	.909	.874	.884	.885	.500	.888	.939	.375	.942	.909

City of Riverside
 N/S: Trautwein Road
 E/W: Alessandro Boulevard
 Weather: Clear

File Name : 05_RIV_Traut_Ales AM
 Site Code : 05121716
 Start Date : 11/30/2021
 Page No : 2

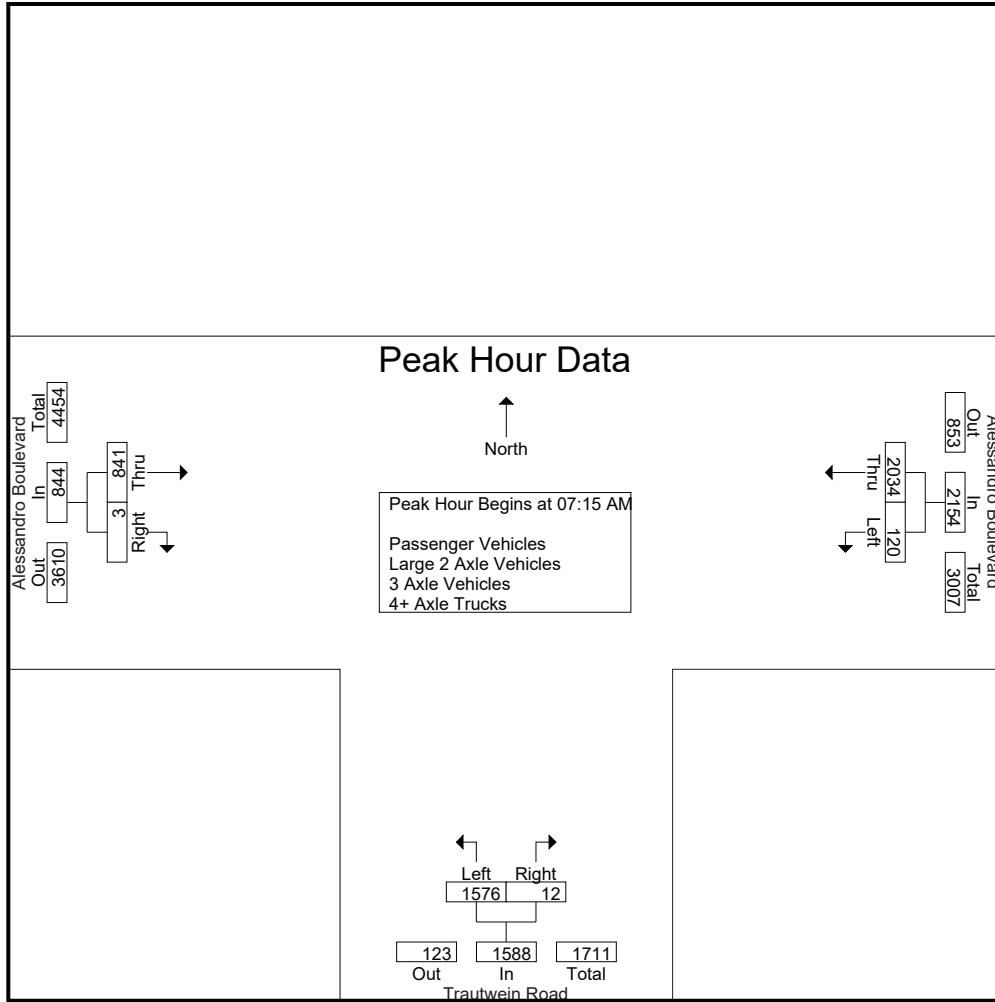

Peak Hour Analysis From 07:00 AM to 08:45 AM - Peak 1 of 1
 Peak Hour for Each Approach Begins at:

	07:00 AM			07:00 AM			07:30 AM		
+0 mins.	28	531	559	385	1	386	224	0	224
+15 mins.	31	544	575	445	2	447	212	2	214
+30 mins.	27	582	609	427	1	428	221	0	221
+45 mins.	33	409	442	342	6	348	199	0	199
Total Volume	119	2066	2185	1599	10	1609	856	2	858
% App. Total	5.4	94.6		99.4	0.6		99.8	0.2	
PHF	.902	.887	.897	.898	.417	.900	.955	.250	.958

City of Riverside
 N/S: Trautwein Road
 E/W: Alessandro Boulevard
 Weather: Clear

File Name : 05_RIV_Traut_Ales AM
 Site Code : 05121716
 Start Date : 11/30/2021
 Page No : 1

Groups Printed- Passenger Vehicles

Start Time	Alessandro Boulevard Westbound			Trautwein Road Northbound			Alessandro Boulevard Eastbound			Int. Total
	Left	Thru	App. Total	Left	Right	App. Total	Thru	Right	App. Total	
07:00 AM	25	529	554	382	1	383	147	1	148	1085
07:15 AM	30	538	568	436	2	438	181	1	182	1188
07:30 AM	26	576	602	424	1	425	218	0	218	1245
07:45 AM	31	405	436	335	5	340	209	2	211	987
Total	112	2048	2160	1577	9	1586	755	4	759	4505
08:00 AM	29	492	521	352	3	355	214	0	214	1090
08:15 AM	15	502	517	278	4	282	197	0	197	996
08:30 AM	33	503	536	243	0	243	176	0	176	955
08:45 AM	33	453	486	290	3	293	188	0	188	967
Total	110	1950	2060	1163	10	1173	775	0	775	4008
Grand Total	222	3998	4220	2740	19	2759	1530	4	1534	8513
Apprch %	5.3	94.7		99.3	0.7		99.7	0.3		
Total %	2.6	47	49.6	32.2	0.2	32.4	18	0	18	

Start Time	Alessandro Boulevard Westbound			Trautwein Road Northbound			Alessandro Boulevard Eastbound			Int. Total
	Left	Thru	App. Total	Left	Right	App. Total	Thru	Right	App. Total	
07:15 AM	30	538	568	436	2	438	181	1	182	1188
07:30 AM	26	576	602	424	1	425	218	0	218	1245
07:45 AM	31	405	436	335	5	340	209	2	211	987
08:00 AM	29	492	521	352	3	355	214	0	214	1090
Total Volume	116	2011	2127	1547	11	1558	822	3	825	4510
% App. Total	5.5	94.5		99.3	0.7		99.6	0.4		
PHF	.935	.873	.883	.887	.550	.889	.943	.375	.946	.906

Peak Hour Analysis From 07:15 AM to 08:00 AM - Peak 1 of 1
 Peak Hour for Entire Intersection Begins at 07:15 AM

City of Riverside
 N/S: Trautwein Road
 E/W: Alessandro Boulevard
 Weather: Clear

File Name : 05_RIV_Traut_Ales AM
 Site Code : 05121716
 Start Date : 11/30/2021
 Page No : 2

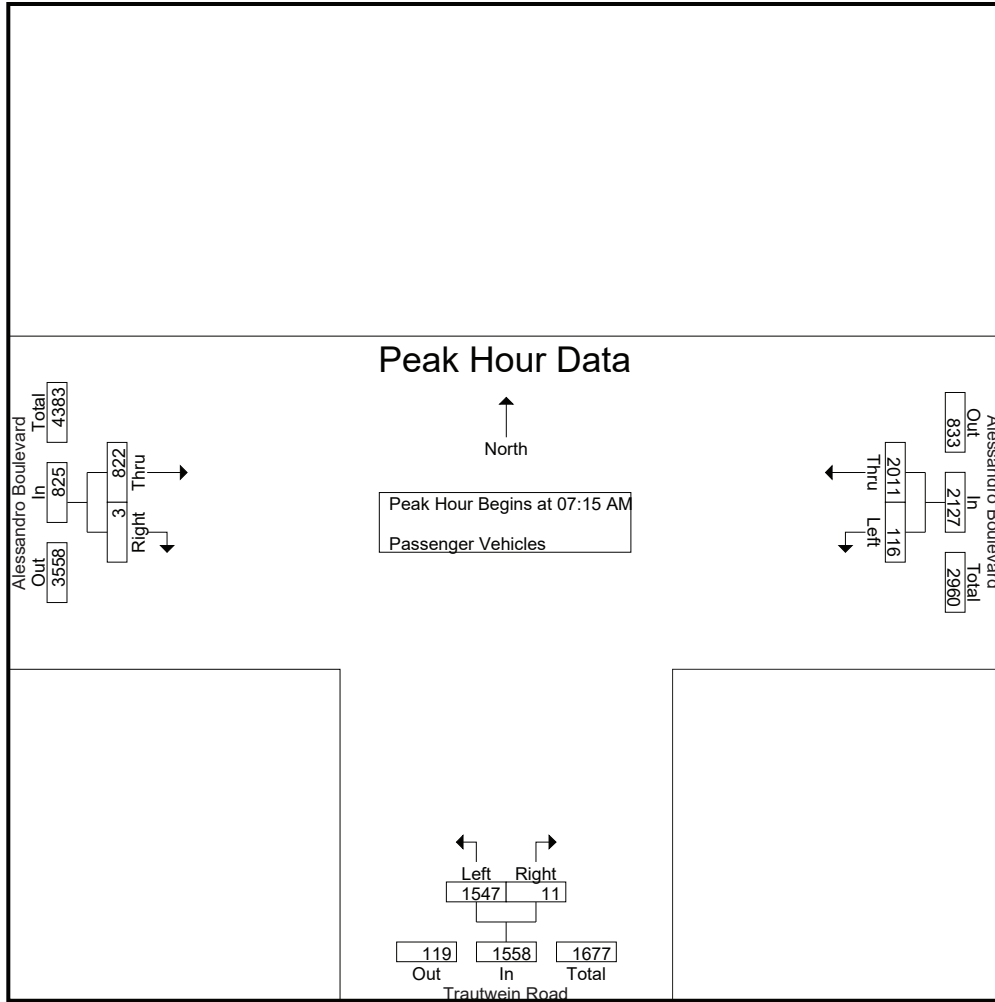

Peak Hour Analysis From 07:15 AM to 08:00 AM - Peak 1 of 1
 Peak Hour for Each Approach Begins at:

	07:15 AM			07:15 AM			07:15 AM		
+0 mins.	30	538	568	436	2	438	181	1	182
+15 mins.	26	576	602	424	1	425	218	0	218
+30 mins.	31	405	436	335	5	340	209	2	211
+45 mins.	29	492	521	352	3	355	214	0	214
Total Volume	116	2011	2127	1547	11	1558	822	3	825
% App. Total	5.5	94.5		99.3	0.7		99.6	0.4	
PHF	.935	.873	.883	.887	.550	.889	.943	.375	.946

City of Riverside
 N/S: Trautwein Road
 E/W: Alessandro Boulevard
 Weather: Clear

File Name : 05_RIV_Traut_Ales AM
 Site Code : 05121716
 Start Date : 11/30/2021
 Page No : 1

Groups Printed- Large 2 Axle Vehicles

Start Time	Alessandro Boulevard Westbound			Trautwein Road Northbound			Alessandro Boulevard Eastbound			Int. Total
	Left	Thru	App. Total	Left	Right	App. Total	Thru	Right	App. Total	
07:00 AM	3	2	5	3	0	3	3	0	3	11
07:15 AM	1	5	6	9	0	9	3	0	3	18
07:30 AM	0	5	5	3	0	3	5	0	5	13
07:45 AM	1	4	5	6	1	7	2	0	2	14
Total	5	16	21	21	1	22	13	0	13	56
08:00 AM	0	4	4	8	0	8	7	0	7	19
08:15 AM	0	6	6	13	0	13	2	0	2	21
08:30 AM	0	9	9	4	1	5	3	0	3	17
08:45 AM	0	4	4	1	0	1	5	0	5	10
Total	0	23	23	26	1	27	17	0	17	67
Grand Total	5	39	44	47	2	49	30	0	30	123
Apprch %	11.4	88.6		95.9	4.1		100	0		
Total %	4.1	31.7	35.8	38.2	1.6	39.8	24.4	0	24.4	

Start Time	Alessandro Boulevard Westbound			Trautwein Road Northbound			Alessandro Boulevard Eastbound			Int. Total
	Left	Thru	App. Total	Left	Right	App. Total	Thru	Right	App. Total	
Peak Hour Analysis From 07:15 AM to 08:00 AM - Peak 1 of 1										
Peak Hour for Entire Intersection Begins at 07:15 AM										
07:15 AM	1	5	6	9	0	9	3	0	3	18
07:30 AM	0	5	5	3	0	3	5	0	5	13
07:45 AM	1	4	5	6	1	7	2	0	2	14
08:00 AM	0	4	4	8	0	8	7	0	7	19
Total Volume	2	18	20	26	1	27	17	0	17	64
% App. Total	10	90		96.3	3.7		100	0		
PHF	.500	.900	.833	.722	.250	.750	.607	.000	.607	.842

City of Riverside
 N/S: Trautwein Road
 E/W: Alessandro Boulevard
 Weather: Clear

File Name : 05_RIV_Traut_Ales AM
 Site Code : 05121716
 Start Date : 11/30/2021
 Page No : 2

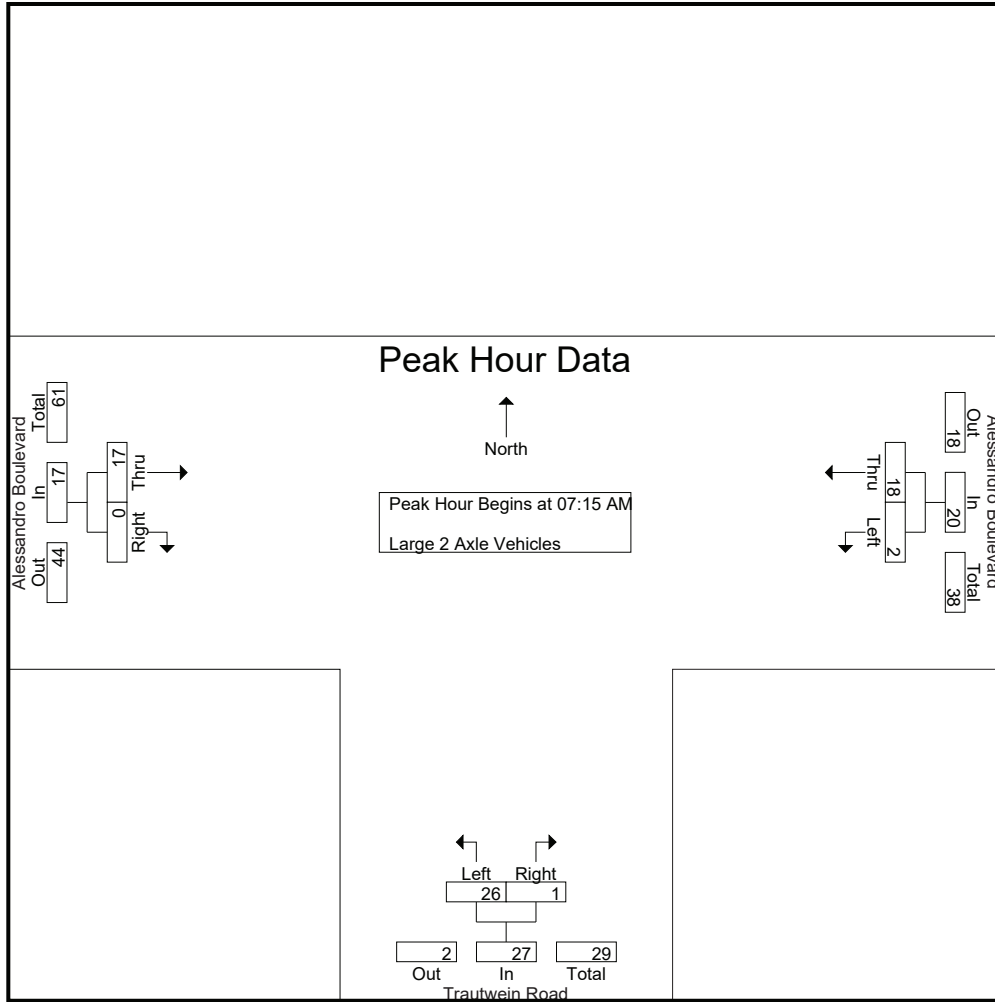

Peak Hour Analysis From 07:15 AM to 08:00 AM - Peak 1 of 1
 Peak Hour for Each Approach Begins at:

	07:15 AM			07:15 AM			07:15 AM		
+0 mins.	1	5	6	9	0	9	3	0	3
+15 mins.	0	5	5	3	0	3	5	0	5
+30 mins.	1	4	5	6	1	7	2	0	2
+45 mins.	0	4	4	8	0	8	7	0	7
Total Volume	2	18	20	26	1	27	17	0	17
% App. Total	10	90		96.3	3.7		100	0	
PHF	.500	.900	.833	.722	.250	.750	.607	.000	.607

City of Riverside
 N/S: Trautwein Road
 E/W: Alessandro Boulevard
 Weather: Clear

File Name : 05_RIV_Traut_Ales AM
 Site Code : 05121716
 Start Date : 11/30/2021
 Page No : 1

Groups Printed- 3 Axle Vehicles

Start Time	Alessandro Boulevard Westbound			Trautwein Road Northbound			Alessandro Boulevard Eastbound			Int. Total
	Left	Thru	App. Total	Left	Right	App. Total	Thru	Right	App. Total	
07:00 AM	0	0	0	0	0	0	0	0	0	0
07:15 AM	0	0	0	0	0	0	0	0	0	0
07:30 AM	0	0	0	0	0	0	0	0	0	0
07:45 AM	1	0	1	1	0	1	0	0	0	2
Total	1	0	1	1	0	1	0	0	0	2
08:00 AM	0	2	2	0	0	0	0	0	0	2
08:15 AM	0	1	1	3	0	3	0	0	0	4
08:30 AM	1	2	3	2	0	2	0	0	0	5
08:45 AM	1	0	1	0	1	1	0	0	0	2
Total	2	5	7	5	1	6	0	0	0	13
Grand Total	3	5	8	6	1	7	0	0	0	15
Apprch %	37.5	62.5		85.7	14.3		0	0		
Total %	20	33.3	53.3	40	6.7	46.7	0	0	0	

Start Time	Alessandro Boulevard Westbound			Trautwein Road Northbound			Alessandro Boulevard Eastbound			Int. Total
	Left	Thru	App. Total	Left	Right	App. Total	Thru	Right	App. Total	
07:15 AM	0	0	0	0	0	0	0	0	0	0
07:30 AM	0	0	0	0	0	0	0	0	0	0
07:45 AM	1	0	1	1	0	1	0	0	0	2
08:00 AM	0	2	2	0	0	0	0	0	0	2
Total Volume	1	2	3	1	0	1	0	0	0	4
% App. Total	33.3	66.7		100	0		0	0		
PHF	.250	.250	.375	.250	.000	.250	.000	.000	.000	.500

Peak Hour Analysis From 07:15 AM to 08:00 AM - Peak 1 of 1
 Peak Hour for Entire Intersection Begins at 07:15 AM

City of Riverside
 N/S: Trautwein Road
 E/W: Alessandro Boulevard
 Weather: Clear

File Name : 05_RIV_Traut_Ales AM
 Site Code : 05121716
 Start Date : 11/30/2021
 Page No : 2

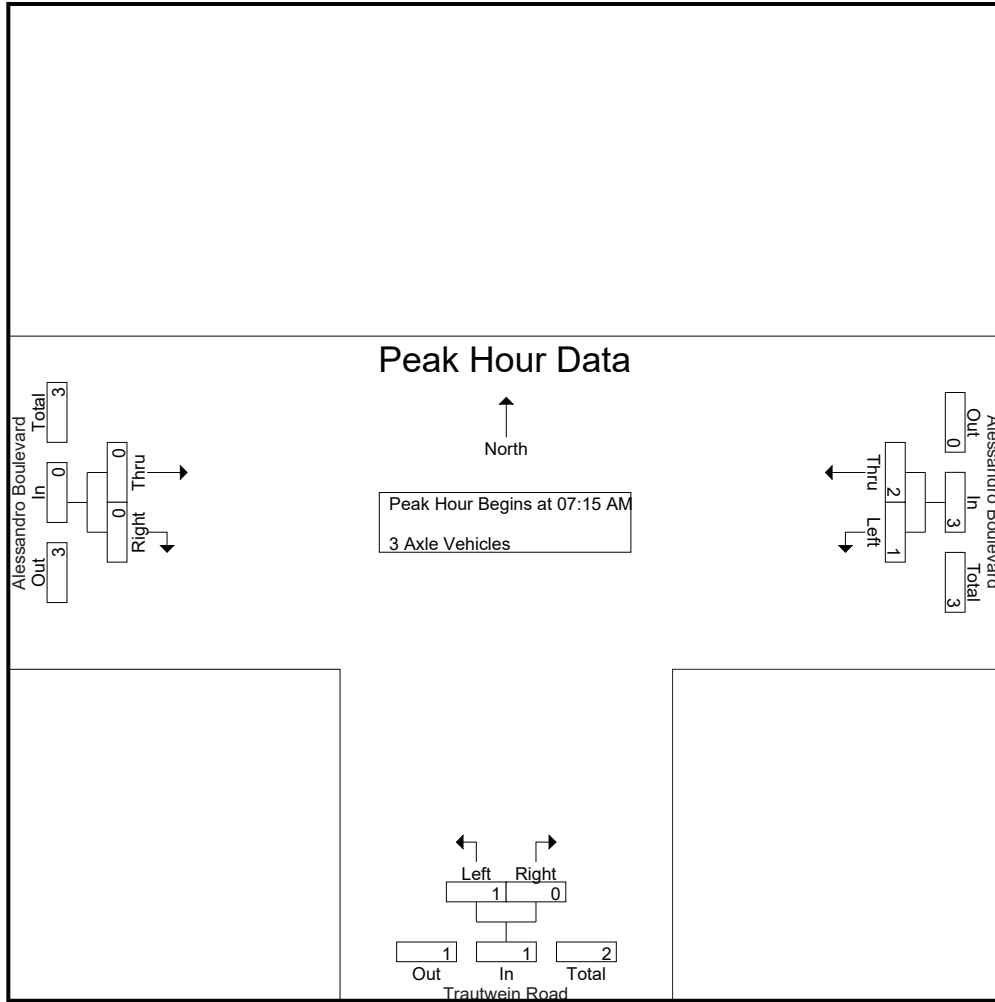

Peak Hour Analysis From 07:15 AM to 08:00 AM - Peak 1 of 1
 Peak Hour for Each Approach Begins at:

	07:15 AM			07:15 AM			07:15 AM		
+0 mins.	0	0	0	0	0	0	0	0	0
+15 mins.	0	0	0	0	0	0	0	0	0
+30 mins.	1	0	1	1	0	1	0	0	0
+45 mins.	0	2	2	0	0	0	0	0	0
Total Volume	1	2	3	1	0	1	0	0	0
% App. Total	33.3	66.7		100	0		0	0	
PHF	.250	.250	.375	.250	.000	.250	.000	.000	.000

City of Riverside
 N/S: Trautwein Road
 E/W: Alessandro Boulevard
 Weather: Clear

File Name : 05_RIV_Traut_Ales AM
 Site Code : 05121716
 Start Date : 11/30/2021
 Page No : 1

Groups Printed- 4+ Axle Trucks

Start Time	Alessandro Boulevard Westbound			Trautwein Road Northbound			Alessandro Boulevard Eastbound			Int. Total
	Left	Thru	App. Total	Left	Right	App. Total	Thru	Right	App. Total	
07:00 AM	0	0	0	0	0	0	0	0	0	0
07:15 AM	0	1	1	0	0	0	0	0	0	1
07:30 AM	1	1	2	0	0	0	1	0	1	3
07:45 AM	0	0	0	0	0	0	1	0	1	1
Total	1	2	3	0	0	0	2	0	2	5
08:00 AM	0	1	1	2	0	2	0	0	0	3
08:15 AM	0	1	1	0	0	0	0	0	0	1
08:30 AM	0	0	0	0	0	0	0	0	0	0
08:45 AM	0	4	4	0	0	0	0	0	0	4
Total	0	6	6	2	0	2	0	0	0	8
Grand Total	1	8	9	2	0	2	2	0	2	13
Apprch %	11.1	88.9		100	0		100	0		
Total %	7.7	61.5	69.2	15.4	0	15.4	15.4	0	15.4	

Start Time	Alessandro Boulevard Westbound			Trautwein Road Northbound			Alessandro Boulevard Eastbound			Int. Total
	Left	Thru	App. Total	Left	Right	App. Total	Thru	Right	App. Total	
07:15 AM	0	1	1	0	0	0	0	0	0	1
07:30 AM	1	1	2	0	0	0	1	0	1	3
07:45 AM	0	0	0	0	0	0	1	0	1	1
08:00 AM	0	1	1	2	0	2	0	0	0	3
Total Volume	1	3	4	2	0	2	2	0	2	8
% App. Total	25	75		100	0		100	0		
PHF	.250	.750	.500	.250	.000	.250	.500	.000	.500	.667

Peak Hour Analysis From 07:15 AM to 08:00 AM - Peak 1 of 1
 Peak Hour for Entire Intersection Begins at 07:15 AM

City of Riverside
 N/S: Trautwein Road
 E/W: Alessandro Boulevard
 Weather: Clear

File Name : 05_RIV_Traut_Ales AM
 Site Code : 05121716
 Start Date : 11/30/2021
 Page No : 2

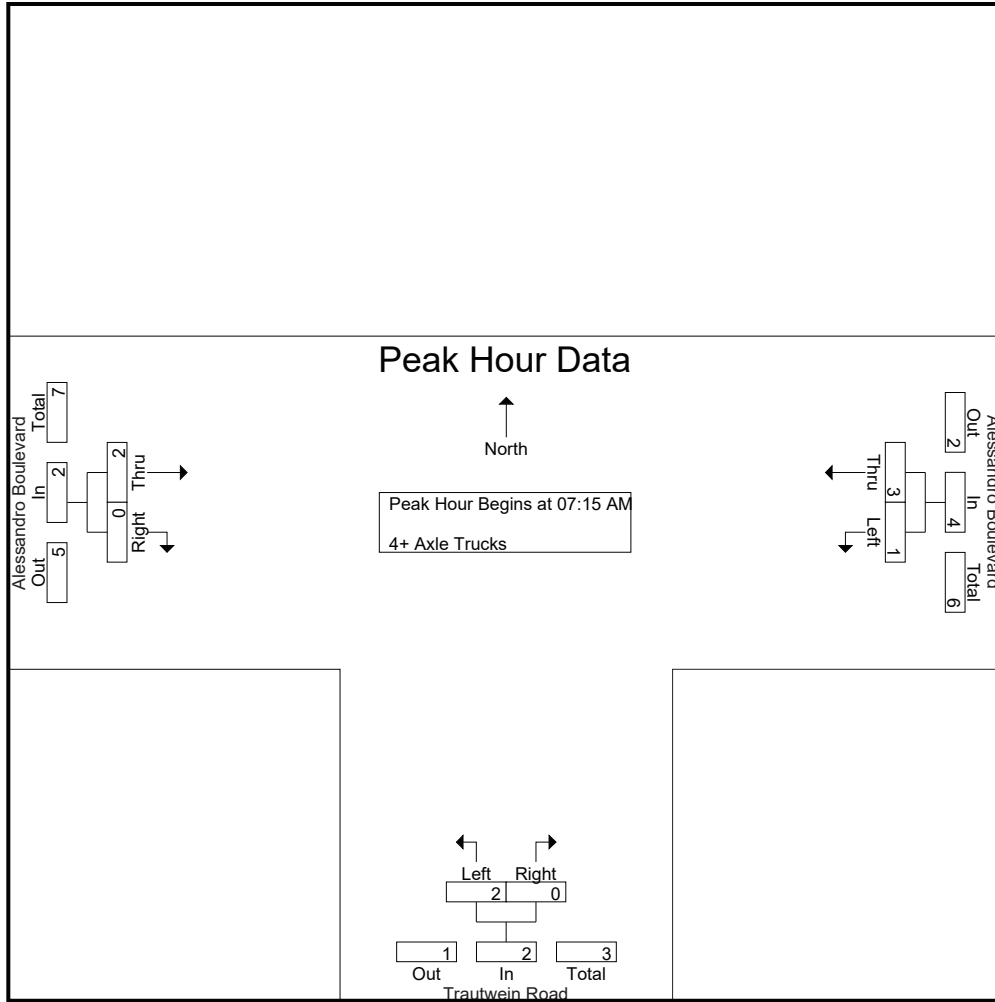

Peak Hour Analysis From 07:15 AM to 08:00 AM - Peak 1 of 1
 Peak Hour for Each Approach Begins at:

	07:15 AM			07:15 AM			07:15 AM		
+0 mins.	0	1	1	0	0	0	0	0	0
+15 mins.	1	1	2	0	0	0	1	0	1
+30 mins.	0	0	0	0	0	0	1	0	1
+45 mins.	0	1	1	2	0	2	0	0	0
Total Volume	1	3	4	2	0	2	2	0	2
% App. Total	25	75		100	0		100	0	
PHF	.250	.750	.500	.250	.000	.250	.500	.000	.500

City of Riverside
 N/S: Trautwein Road
 E/W: Alessandro Boulevard
 Weather: Clear

File Name : 05_RIV_Traut_Ales PM
 Site Code : 05121716
 Start Date : 11/30/2021
 Page No : 1

Groups Printed- Passenger Vehicles - Large 2 Axle Vehicles - 3 Axle Vehicles - 4+ Axle Trucks

Start Time	Alessandro Boulevard Westbound			Trautwein Road Northbound			Alessandro Boulevard Eastbound			Int. Total
	Left	Thru	App. Total	Left	Right	App. Total	Thru	Right	App. Total	
04:00 PM	58	494	552	178	5	183	423	5	428	1163
04:15 PM	68	478	546	232	6	238	414	4	418	1202
04:30 PM	46	478	524	207	1	208	436	9	445	1177
04:45 PM	59	435	494	185	3	188	492	1	493	1175
Total	231	1885	2116	802	15	817	1765	19	1784	4717
05:00 PM	61	491	552	269	1	270	440	3	443	1265
05:15 PM	55	438	493	183	6	189	439	8	447	1129
05:30 PM	67	392	459	194	4	198	494	2	496	1153
05:45 PM	64	355	419	165	4	169	466	4	470	1058
Total	247	1676	1923	811	15	826	1839	17	1856	4605
Grand Total	478	3561	4039	1613	30	1643	3604	36	3640	9322
Apprch %	11.8	88.2		98.2	1.8		99	1		
Total %	5.1	38.2	43.3	17.3	0.3	17.6	38.7	0.4	39	
Passenger Vehicles	474	3514	3988	1585	30	1615	3572	36	3608	9211
% Passenger Vehicles	99.2	98.7	98.7	98.3	100	98.3	99.1	100	99.1	98.8
Large 2 Axle Vehicles	2	43	45	22	0	22	28	0	28	95
% Large 2 Axle Vehicles	0.4	1.2	1.1	1.4	0	1.3	0.8	0	0.8	1
3 Axle Vehicles	1	1	2	3	0	3	3	0	3	8
% 3 Axle Vehicles	0.2	0	0	0.2	0	0.2	0.1	0	0.1	0.1
4+ Axle Trucks	1	3	4	3	0	3	1	0	1	8
% 4+ Axle Trucks	0.2	0.1	0.1	0.2	0	0.2	0	0	0	0.1

Start Time	Alessandro Boulevard Westbound			Trautwein Road Northbound			Alessandro Boulevard Eastbound			Int. Total
	Left	Thru	App. Total	Left	Right	App. Total	Thru	Right	App. Total	
Peak Hour Analysis From 04:00 PM to 05:45 PM - Peak 1 of 1										
Peak Hour for Entire Intersection Begins at 04:15 PM										
04:15 PM	68	478	546	232	6	238	414	4	418	1202
04:30 PM	46	478	524	207	1	208	436	9	445	1177
04:45 PM	59	435	494	185	3	188	492	1	493	1175
05:00 PM	61	491	552	269	1	270	440	3	443	1265
Total Volume	234	1882	2116	893	11	904	1782	17	1799	4819
% App. Total	11.1	88.9		98.8	1.2		99.1	0.9		
PHF	.860	.958	.958	.830	.458	.837	.905	.472	.912	.952

City of Riverside
 N/S: Trautwein Road
 E/W: Alessandro Boulevard
 Weather: Clear

File Name : 05_RIV_Traut_Ales PM
 Site Code : 05121716
 Start Date : 11/30/2021
 Page No : 2

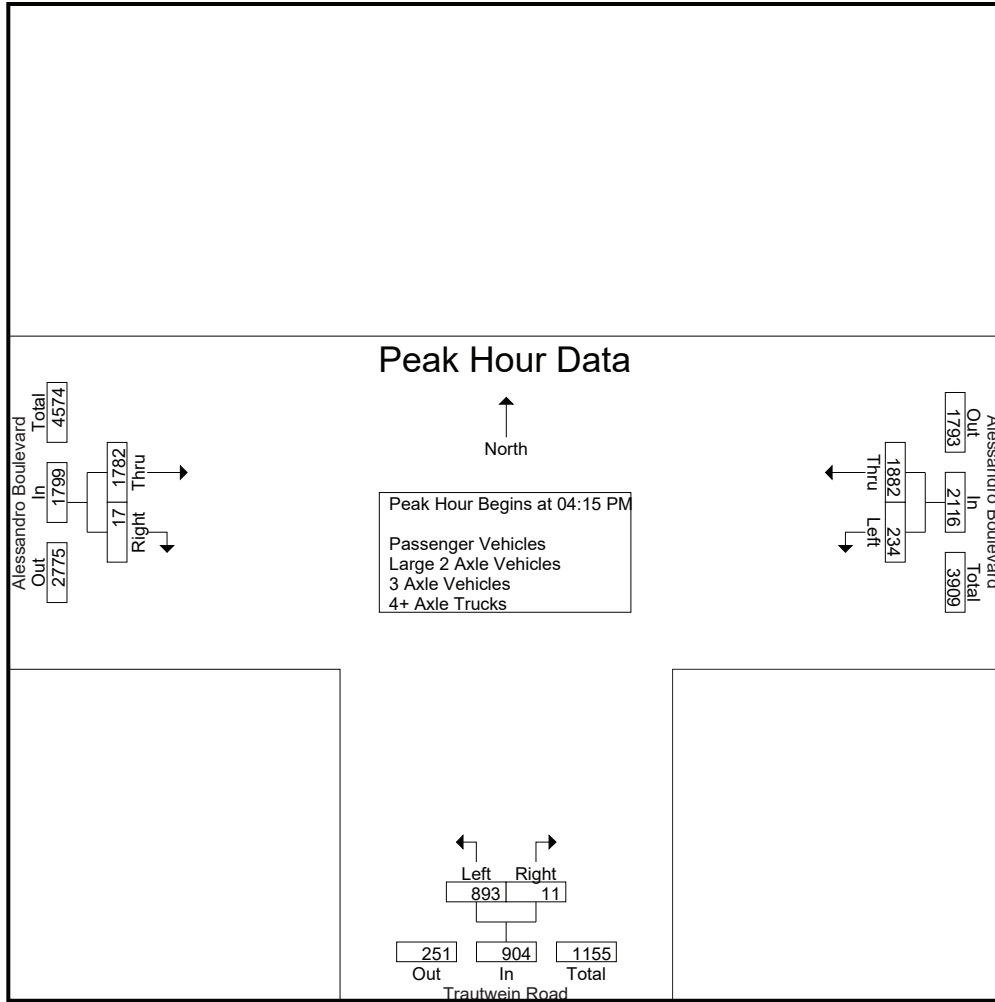

Peak Hour Analysis From 04:00 PM to 05:45 PM - Peak 1 of 1
 Peak Hour for Each Approach Begins at:

	04:00 PM			04:15 PM			04:45 PM		
+0 mins.	58	494	552	232	6	238	492	1	493
+15 mins.	68	478	546	207	1	208	440	3	443
+30 mins.	46	478	524	185	3	188	439	8	447
+45 mins.	59	435	494	269	1	270	494	2	496
Total Volume	231	1885	2116	893	11	904	1865	14	1879
% App. Total	10.9	89.1		98.8	1.2		99.3	0.7	
PHF	.849	.954	.958	.830	.458	.837	.944	.438	.947

City of Riverside
 N/S: Trautwein Road
 E/W: Alessandro Boulevard
 Weather: Clear

File Name : 05_RIV_Traut_Ales PM
 Site Code : 05121716
 Start Date : 11/30/2021
 Page No : 1

Groups Printed- Passenger Vehicles

Start Time	Alessandro Boulevard Westbound			Trautwein Road Northbound			Alessandro Boulevard Eastbound			Int. Total
	Left	Thru	App. Total	Left	Right	App. Total	Thru	Right	App. Total	
04:00 PM	57	482	539	169	5	174	419	5	424	1137
04:15 PM	67	472	539	228	6	234	405	4	409	1182
04:30 PM	45	470	515	203	1	204	429	9	438	1157
04:45 PM	59	430	489	185	3	188	491	1	492	1169
Total	228	1854	2082	785	15	800	1744	19	1763	4645
05:00 PM	61	489	550	263	1	264	434	3	437	1251
05:15 PM	54	434	488	182	6	188	438	8	446	1122
05:30 PM	67	387	454	192	4	196	490	2	492	1142
05:45 PM	64	350	414	163	4	167	466	4	470	1051
Total	246	1660	1906	800	15	815	1828	17	1845	4566
Grand Total	474	3514	3988	1585	30	1615	3572	36	3608	9211
Apprch %	11.9	88.1		98.1	1.9		99	1		
Total %	5.1	38.2	43.3	17.2	0.3	17.5	38.8	0.4	39.2	

Start Time	Alessandro Boulevard Westbound			Trautwein Road Northbound			Alessandro Boulevard Eastbound			Int. Total
	Left	Thru	App. Total	Left	Right	App. Total	Thru	Right	App. Total	
Peak Hour Analysis From 04:15 PM to 05:00 PM - Peak 1 of 1										
Peak Hour for Entire Intersection Begins at 04:15 PM										
04:15 PM	67	472	539	228	6	234	405	4	409	1182
04:30 PM	45	470	515	203	1	204	429	9	438	1157
04:45 PM	59	430	489	185	3	188	491	1	492	1169
05:00 PM	61	489	550	263	1	264	434	3	437	1251
Total Volume	232	1861	2093	879	11	890	1759	17	1776	4759
% App. Total	11.1	88.9		98.8	1.2		99	1		
PHF	.866	.951	.951	.836	.458	.843	.896	.472	.902	.951

City of Riverside
 N/S: Trautwein Road
 E/W: Alessandro Boulevard
 Weather: Clear

File Name : 05_RIV_Traut_Ales PM
 Site Code : 05121716
 Start Date : 11/30/2021
 Page No : 2

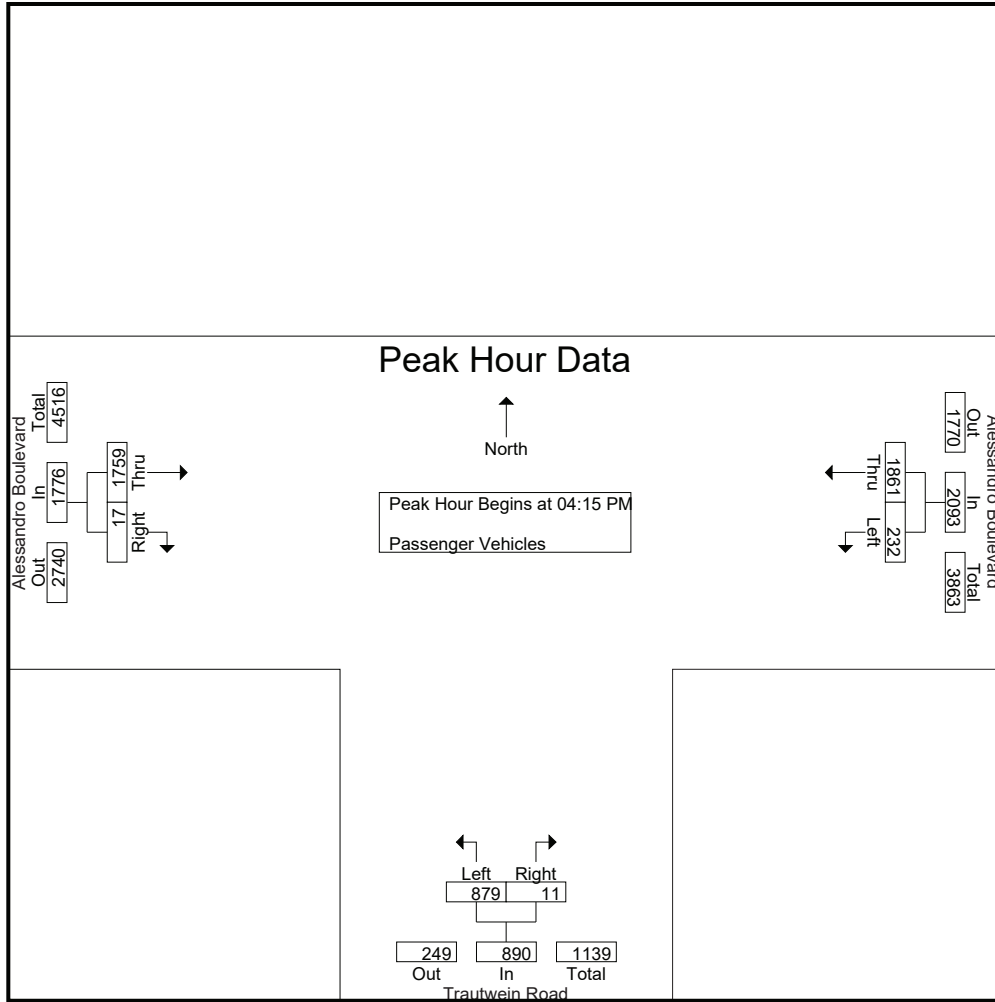

Peak Hour Analysis From 04:15 PM to 05:00 PM - Peak 1 of 1
 Peak Hour for Each Approach Begins at:

	04:15 PM			04:15 PM			04:15 PM		
+0 mins.	67	472	539	228	6	234	405	4	409
+15 mins.	45	470	515	203	1	204	429	9	438
+30 mins.	59	430	489	185	3	188	491	1	492
+45 mins.	61	489	550	263	1	264	434	3	437
Total Volume	232	1861	2093	879	11	890	1759	17	1776
% App. Total	11.1	88.9		98.8	1.2		99	1	
PHF	.866	.951	.951	.836	.458	.843	.896	.472	.902

City of Riverside
 N/S: Trautwein Road
 E/W: Alessandro Boulevard
 Weather: Clear

File Name : 05_RIV_Traut_Ales PM
 Site Code : 05121716
 Start Date : 11/30/2021
 Page No : 1

Groups Printed- Large 2 Axle Vehicles

Start Time	Alessandro Boulevard Westbound			Trautwein Road Northbound			Alessandro Boulevard Eastbound			Int. Total
	Left	Thru	App. Total	Left	Right	App. Total	Thru	Right	App. Total	
04:00 PM	0	12	12	7	0	7	3	0	3	22
04:15 PM	1	6	7	4	0	4	8	0	8	19
04:30 PM	1	8	9	3	0	3	5	0	5	17
04:45 PM	0	4	4	0	0	0	1	0	1	5
Total	2	30	32	14	0	14	17	0	17	63
05:00 PM	0	2	2	4	0	4	6	0	6	12
05:15 PM	0	3	3	1	0	1	1	0	1	5
05:30 PM	0	4	4	1	0	1	4	0	4	9
05:45 PM	0	4	4	2	0	2	0	0	0	6
Total	0	13	13	8	0	8	11	0	11	32
Grand Total	2	43	45	22	0	22	28	0	28	95
Apprch %	4.4	95.6		100	0		100	0		
Total %	2.1	45.3	47.4	23.2	0	23.2	29.5	0	29.5	

Start Time	Alessandro Boulevard Westbound			Trautwein Road Northbound			Alessandro Boulevard Eastbound			Int. Total
	Left	Thru	App. Total	Left	Right	App. Total	Thru	Right	App. Total	
Peak Hour Analysis From 04:15 PM to 05:00 PM - Peak 1 of 1										
Peak Hour for Entire Intersection Begins at 04:15 PM										
04:15 PM	1	6	7	4	0	4	8	0	8	19
04:30 PM	1	8	9	3	0	3	5	0	5	17
04:45 PM	0	4	4	0	0	0	1	0	1	5
05:00 PM	0	2	2	4	0	4	6	0	6	12
Total Volume	2	20	22	11	0	11	20	0	20	53
% App. Total	9.1	90.9		100	0		100	0		
PHF	.500	.625	.611	.688	.000	.688	.625	.000	.625	.697

City of Riverside
 N/S: Trautwein Road
 E/W: Alessandro Boulevard
 Weather: Clear

File Name : 05_RIV_Traut_Ales PM
 Site Code : 05121716
 Start Date : 11/30/2021
 Page No : 2

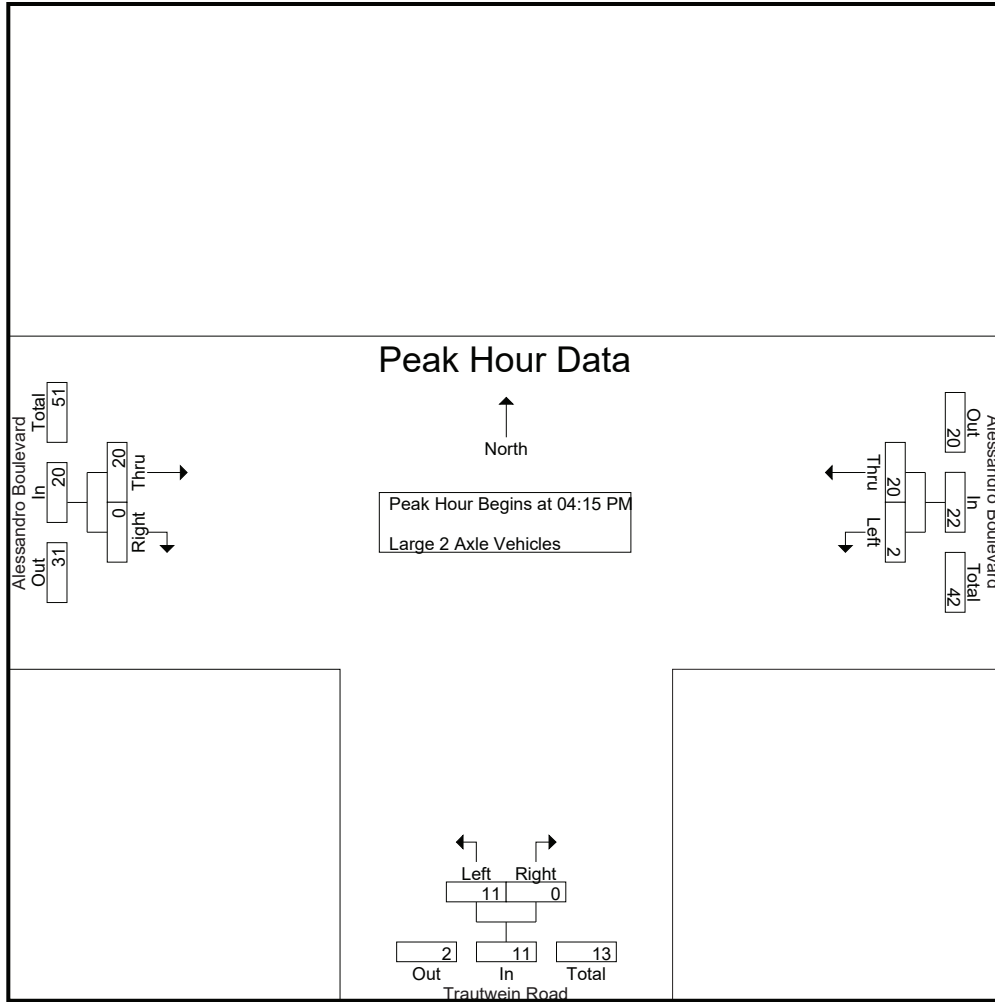

Peak Hour Analysis From 04:15 PM to 05:00 PM - Peak 1 of 1
 Peak Hour for Each Approach Begins at:

	04:15 PM			04:15 PM			04:15 PM		
+0 mins.	1	6	7	4	0	4	8	0	8
+15 mins.	1	8	9	3	0	3	5	0	5
+30 mins.	0	4	4	0	0	0	1	0	1
+45 mins.	0	2	2	4	0	4	6	0	6
Total Volume	2	20	22	11	0	11	20	0	20
% App. Total	9.1	90.9		100	0		100	0	
PHF	.500	.625	.611	.688	.000	.688	.625	.000	.625

City of Riverside
 N/S: Trautwein Road
 E/W: Alessandro Boulevard
 Weather: Clear

File Name : 05_RIV_Traut_Ales PM
 Site Code : 05121716
 Start Date : 11/30/2021
 Page No : 1

Groups Printed- 3 Axle Vehicles

Start Time	Alessandro Boulevard Westbound			Trautwein Road Northbound			Alessandro Boulevard Eastbound			Int. Total
	Left	Thru	App. Total	Left	Right	App. Total	Thru	Right	App. Total	
04:00 PM	0	0	0	1	0	1	1	0	1	2
04:15 PM	0	0	0	0	0	0	0	0	0	0
04:30 PM	0	0	0	0	0	0	2	0	2	2
04:45 PM	0	0	0	0	0	0	0	0	0	0
Total	0	0	0	1	0	1	3	0	3	4
05:00 PM	0	0	0	1	0	1	0	0	0	1
05:15 PM	1	0	1	0	0	0	0	0	0	1
05:30 PM	0	0	0	1	0	1	0	0	0	1
05:45 PM	0	1	1	0	0	0	0	0	0	1
Total	1	1	2	2	0	2	0	0	0	4
Grand Total	1	1	2	3	0	3	3	0	3	8
Apprch %	50	50		100	0		100	0		
Total %	12.5	12.5	25	37.5	0	37.5	37.5	0	37.5	

Start Time	Alessandro Boulevard Westbound			Trautwein Road Northbound			Alessandro Boulevard Eastbound			Int. Total
	Left	Thru	App. Total	Left	Right	App. Total	Thru	Right	App. Total	
04:15 PM	0	0	0	0	0	0	0	0	0	0
04:30 PM	0	0	0	0	0	0	2	0	2	2
04:45 PM	0	0	0	0	0	0	0	0	0	0
05:00 PM	0	0	0	1	0	1	0	0	0	1
Total Volume	0	0	0	1	0	1	2	0	2	3
% App. Total	0	0		100	0		100	0		
PHF	.000	.000	.000	.250	.000	.250	.250	.000	.250	.375

Peak Hour Analysis From 04:15 PM to 05:00 PM - Peak 1 of 1
 Peak Hour for Entire Intersection Begins at 04:15 PM

City of Riverside
 N/S: Trautwein Road
 E/W: Alessandro Boulevard
 Weather: Clear

File Name : 05_RIV_Traut_Ales PM
 Site Code : 05121716
 Start Date : 11/30/2021
 Page No : 2

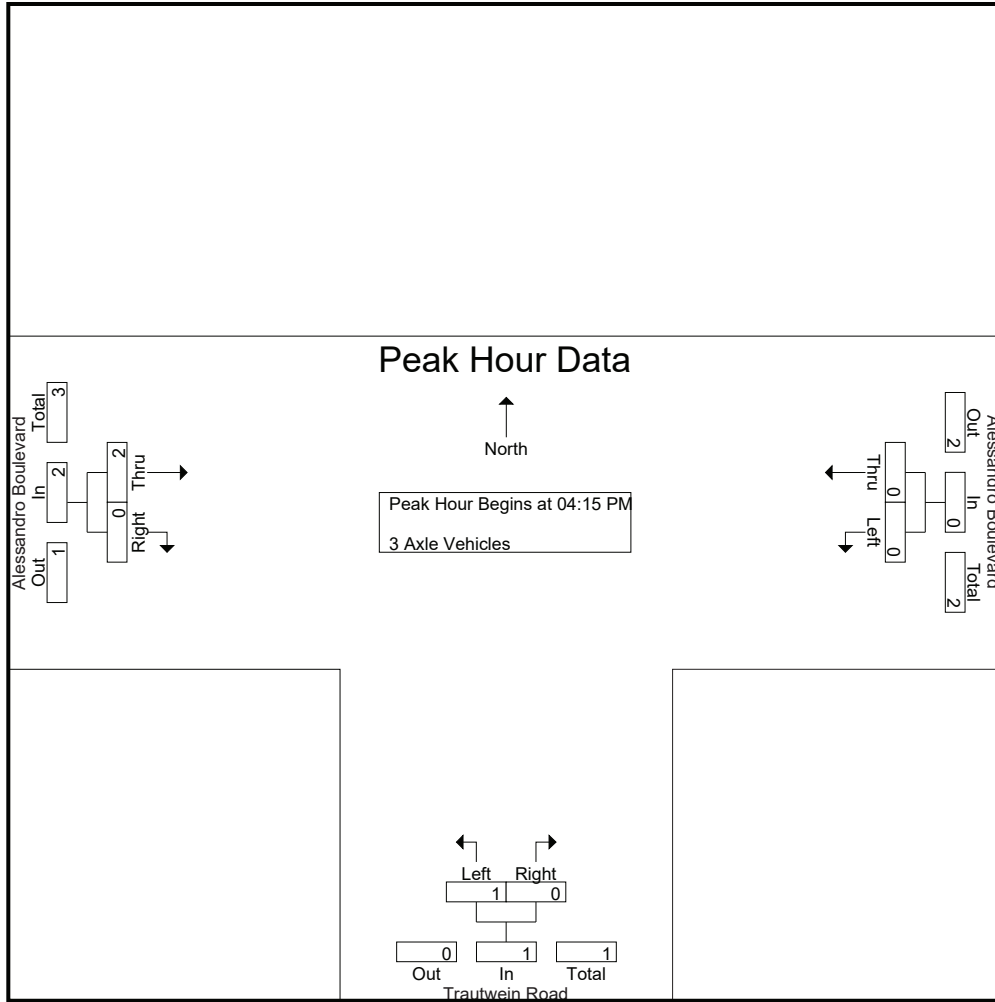

Peak Hour Analysis From 04:15 PM to 05:00 PM - Peak 1 of 1
 Peak Hour for Each Approach Begins at:

	04:15 PM			04:15 PM			04:15 PM		
+0 mins.	0	0	0	0	0	0	0	0	0
+15 mins.	0	0	0	0	0	0	2	0	2
+30 mins.	0	0	0	0	0	0	0	0	0
+45 mins.	0	0	0	1	0	1	0	0	0
Total Volume	0	0	0	1	0	1	2	0	2
% App. Total	0	0	0	100	0	100	100	0	250
PHF	.000	.000	.000	.250	.000	.250	.250	.000	.250

City of Riverside
 N/S: Trautwein Road
 E/W: Alessandro Boulevard
 Weather: Clear

File Name : 05_RIV_Traut_Ales PM
 Site Code : 05121716
 Start Date : 11/30/2021
 Page No : 1

Groups Printed- 4+ Axle Trucks

Start Time	Alessandro Boulevard Westbound			Trautwein Road Northbound			Alessandro Boulevard Eastbound			Int. Total
	Left	Thru	App. Total	Left	Right	App. Total	Thru	Right	App. Total	
04:00 PM	1	0	1	1	0	1	0	0	0	2
04:15 PM	0	0	0	0	0	0	1	0	1	1
04:30 PM	0	0	0	1	0	1	0	0	0	1
04:45 PM	0	1	1	0	0	0	0	0	0	1
Total	1	1	2	2	0	2	1	0	1	5
05:00 PM	0	0	0	1	0	1	0	0	0	1
05:15 PM	0	1	1	0	0	0	0	0	0	1
05:30 PM	0	1	1	0	0	0	0	0	0	1
05:45 PM	0	0	0	0	0	0	0	0	0	0
Total	0	2	2	1	0	1	0	0	0	3
Grand Total	1	3	4	3	0	3	1	0	1	8
Apprch %	25	75		100	0		100	0		
Total %	12.5	37.5	50	37.5	0	37.5	12.5	0	12.5	

Start Time	Alessandro Boulevard Westbound			Trautwein Road Northbound			Alessandro Boulevard Eastbound			Int. Total
	Left	Thru	App. Total	Left	Right	App. Total	Thru	Right	App. Total	
04:15 PM	0	0	0	0	0	0	1	0	1	1
04:30 PM	0	0	0	1	0	1	0	0	0	1
04:45 PM	0	1	1	0	0	0	0	0	0	1
05:00 PM	0	0	0	1	0	1	0	0	0	1
Total Volume	0	1	1	2	0	2	1	0	1	4
% App. Total	0	100		100	0		100	0		
PHF	.000	.250	.250	.500	.000	.500	.250	.000	.250	1.00

Peak Hour Analysis From 04:15 PM to 05:00 PM - Peak 1 of 1
 Peak Hour for Entire Intersection Begins at 04:15 PM

City of Riverside
 N/S: Trautwein Road
 E/W: Alessandro Boulevard
 Weather: Clear

File Name : 05_RIV_Traut_Ales PM
 Site Code : 05121716
 Start Date : 11/30/2021
 Page No : 2

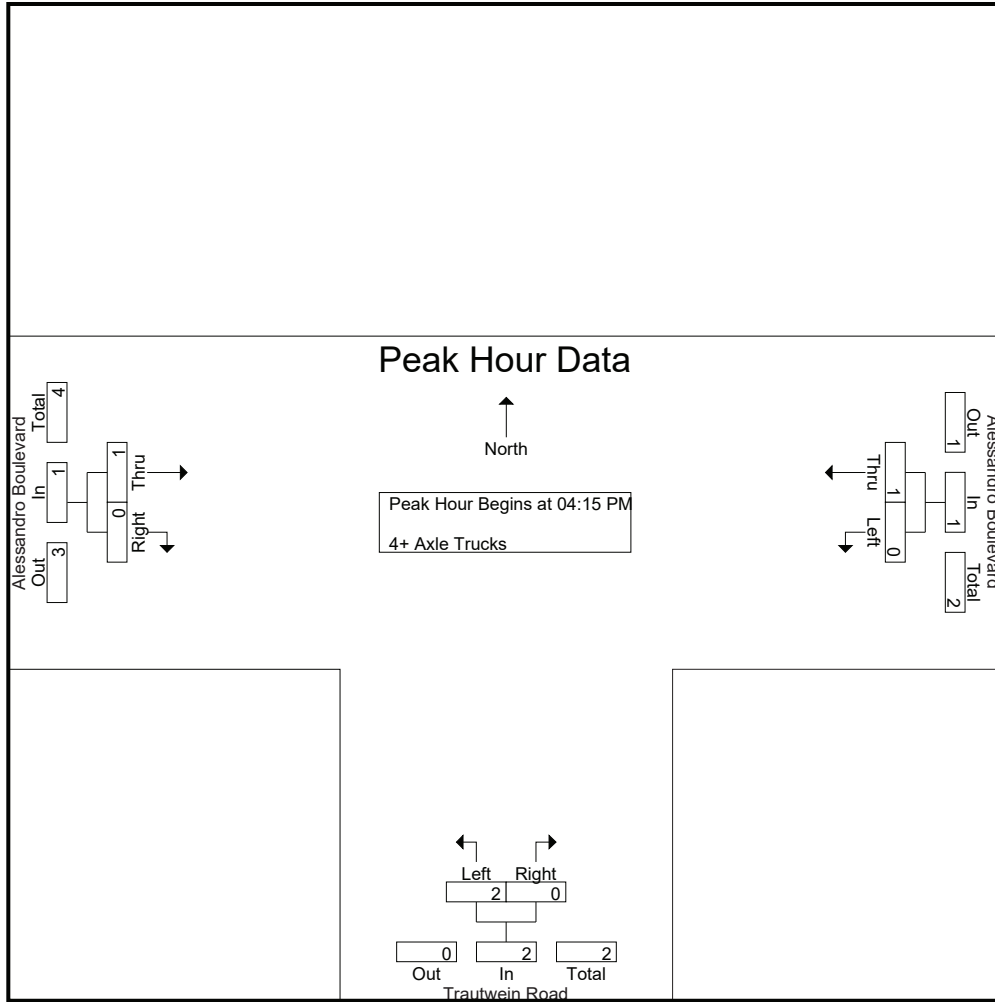

Peak Hour Analysis From 04:15 PM to 05:00 PM - Peak 1 of 1
 Peak Hour for Each Approach Begins at:

	04:15 PM			04:15 PM			04:15 PM		
+0 mins.	0	0	0	0	0	0	1	0	1
+15 mins.	0	0	0	1	0	1	0	0	0
+30 mins.	0	1	1	0	0	0	0	0	0
+45 mins.	0	0	0	1	0	1	0	0	0
Total Volume	0	1	1	2	0	2	1	0	1
% App. Total	0	100		100	0		100	0	
PHF	.000	.250	.250	.500	.000	.500	.250	.000	.250

Location: Riverside
 N/S: Trautwein Road
 E/W: Alessandro Boulevard



Date: 11/30/2021
 Day: Tuesday

PEDESTRIANS

	North Leg Dead End	East Leg Alessandro Boulevard	South Leg Trautwein Road	West Leg Alessandro Boulevard	
	Pedestrians	Pedestrians	Pedestrians	Pedestrians	
7:00 AM	0	0	0	0	0
7:15 AM	0	0	0	0	0
7:30 AM	0	0	0	0	0
7:45 AM	0	0	0	0	0
8:00 AM	0	0	0	0	0
8:15 AM	0	0	0	0	0
8:30 AM	0	0	0	0	0
8:45 AM	0	0	0	0	0
TOTAL VOLUMES:	0	0	0	0	0

	North Leg Dead End	East Leg Alessandro Boulevard	South Leg Trautwein Road	West Leg Alessandro Boulevard	
	Pedestrians	Pedestrians	Pedestrians	Pedestrians	
4:00 PM	0	0	0	0	0
4:15 PM	0	0	0	0	0
4:30 PM	0	0	0	0	0
4:45 PM	0	0	0	0	0
5:00 PM	0	0	0	0	0
5:15 PM	0	0	0	0	0
5:30 PM	0	0	0	0	0
5:45 PM	0	0	0	0	0
TOTAL VOLUMES:	0	0	0	0	0

Location: Riverside
 N/S: Trautwein Road
 E/W: Alessandro Boulevard



Date: 11/30/2021
 Day: Tuesday

BICYCLES

	Southbound Dead End			Westbound Alessandro Boulevard			Northbound Trautwein Road			Eastbound Alessandro Boulevard			
	Left	Thru	Right	Left	Thru	Right	Left	Thru	Right	Left	Thru	Right	
7:00 AM	0	0	0	0	0	0	0	0	0	0	0	0	0
7:15 AM	0	0	0	0	0	0	0	0	0	0	0	0	0
7:30 AM	0	0	0	0	0	0	0	0	0	0	0	0	0
7:45 AM	0	0	0	0	0	0	0	0	0	0	0	0	0
8:00 AM	0	0	0	0	0	0	0	0	0	0	0	0	0
8:15 AM	0	0	0	0	0	0	0	0	0	0	0	0	0
8:30 AM	0	0	0	0	0	0	0	0	0	0	0	0	0
8:45 AM	0	0	0	0	0	0	0	0	0	0	0	0	0
TOTAL VOLUMES:	0	0	0	0	0	0	0	0	0	0	0	0	0

	Southbound Dead End			Westbound Alessandro Boulevard			Northbound Trautwein Road			Eastbound Alessandro Boulevard			
	Left	Thru	Right	Left	Thru	Right	Left	Thru	Right	Left	Thru	Right	
4:00 PM	0	0	0	0	0	0	0	0	0	0	0	0	0
4:15 PM	0	0	0	0	0	0	0	0	0	0	0	0	0
4:30 PM	0	0	0	0	0	0	0	0	0	0	0	0	0
4:45 PM	0	0	0	0	0	0	0	0	0	0	0	0	0
5:00 PM	0	0	0	0	0	0	0	0	0	0	0	0	0
5:15 PM	0	0	0	0	0	0	0	0	0	0	0	0	0
5:30 PM	0	0	0	0	0	0	0	0	0	0	0	0	0
5:45 PM	0	0	0	0	0	0	0	0	0	0	0	0	0
TOTAL VOLUMES:	0	0	0	0	0	0	0	0	0	0	0	0	0

City of Riverside
 N/S: Trautwein Road
 E/W: Grove Community Drive
 Weather: Clear

File Name : 06_RIV_Traut_Grove AM
 Site Code : 05121716
 Start Date : 11/30/2021
 Page No : 1

Groups Printed- Passenger Vehicles - Large 2 Axle Vehicles - 3 Axle Vehicles - 4+ Axle Trucks

Start Time	Trautwein Road Southbound			Grove Community Drive Westbound				Trautwein Road Northbound				Exclu. Total	Inclu. Total	Int. Total
	Left	Thru	App. Total	Left	Right	RTOR	App. Total	Thru	Right	RTOR	App. Total			
07:00 AM	66	189	255	14	94	63	108	273	2	1	275	64	638	702
07:15 AM	55	251	306	24	151	41	175	332	6	2	338	43	819	862
07:30 AM	21	177	198	19	176	29	195	295	4	2	299	31	692	723
07:45 AM	34	126	160	7	94	35	101	318	7	2	325	37	586	623
Total	176	743	919	64	515	168	579	1218	19	7	1237	175	2735	2910
08:00 AM	22	115	137	9	60	44	69	303	12	5	315	49	521	570
08:15 AM	42	120	162	7	52	37	59	218	9	2	227	39	448	487
08:30 AM	46	102	148	11	73	55	84	218	14	7	232	62	464	526
08:45 AM	55	125	180	8	79	60	87	199	21	6	220	66	487	553
Total	165	462	627	35	264	196	299	938	56	20	994	216	1920	2136
Grand Total	341	1205	1546	99	779	364	878	2156	75	27	2231	391	4655	5046
Apprch %	22.1	77.9		11.3	88.7			96.6	3.4					
Total %	7.3	25.9	33.2	2.1	16.7		18.9	46.3	1.6		47.9	7.7	92.3	
Passenger Vehicles	334	1169	1503	99	768		1230	2111	74		2212	0	0	4945
% Passenger Vehicles	97.9	97	97.2	100	98.6	99.7	99	97.9	98.7	100	98	0	0	98
Large 2 Axle Vehicles	7	26	33	0	10		11	37	1		38	0	0	82
% Large 2 Axle Vehicles	2.1	2.2	2.1	0	1.3	0.3	0.9	1.7	1.3	0	1.7	0	0	1.6
3 Axle Vehicles	0	7	7	0	1		1	6	0		6	0	0	14
% 3 Axle Vehicles	0	0.6	0.5	0	0.1	0	0.1	0.3	0	0	0.3	0	0	0.3
4+ Axle Trucks	0	3	3	0	0		0	2	0		2	0	0	5
% 4+ Axle Trucks	0	0.2	0.2	0	0	0	0	0.1	0	0	0.1	0	0	0.1

Start Time	Trautwein Road Southbound			Grove Community Drive Westbound			Trautwein Road Northbound			Int. Total
	Left	Thru	App. Total	Left	Right	App. Total	Thru	Right	App. Total	
Peak Hour Analysis From 07:00 AM to 08:45 AM - Peak 1 of 1										
Peak Hour for Entire Intersection Begins at 07:00 AM										
07:00 AM	66	189	255	14	94	108	273	2	275	638
07:15 AM	55	251	306	24	151	175	332	6	338	819
07:30 AM	21	177	198	19	176	195	295	4	299	692
07:45 AM	34	126	160	7	94	101	318	7	325	586
Total Volume	176	743	919	64	515	579	1218	19	1237	2735
% App. Total	19.2	80.8		11.1	88.9		98.5	1.5		
PHF	.667	.740	.751	.667	.732	.742	.917	.679	.915	.835

City of Riverside
 N/S: Trautwein Road
 E/W: Grove Community Drive
 Weather: Clear

File Name : 06_RIV_Traut_Grove AM
 Site Code : 05121716
 Start Date : 11/30/2021
 Page No : 2

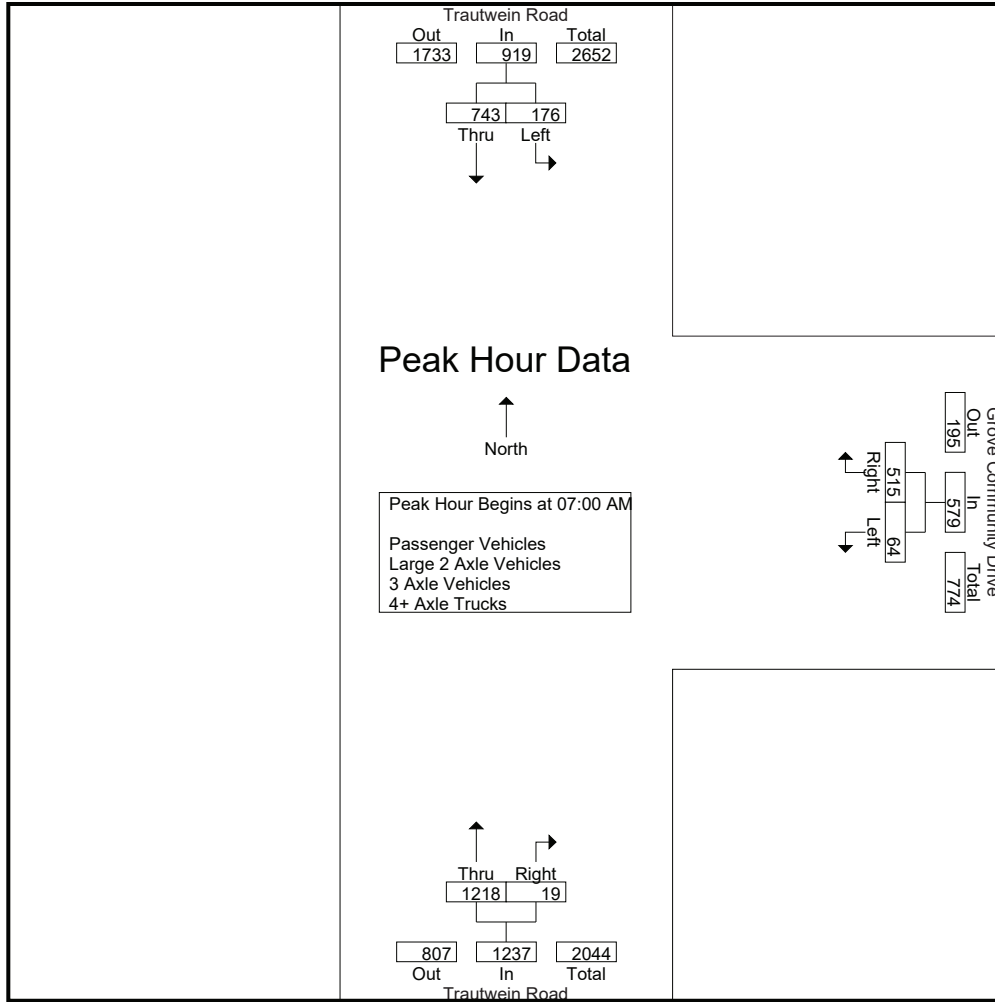

Peak Hour Analysis From 07:00 AM to 08:45 AM - Peak 1 of 1
 Peak Hour for Each Approach Begins at:

	07:00 AM			07:00 AM			07:15 AM		
+0 mins.	66	189	255	14	94	108	332	6	338
+15 mins.	55	251	306	24	151	175	295	4	299
+30 mins.	21	177	198	19	176	195	318	7	325
+45 mins.	34	126	160	7	94	101	303	12	315
Total Volume	176	743	919	64	515	579	1248	29	1277
% App. Total	19.2	80.8		11.1	88.9		97.7	2.3	
PHF	.667	.740	.751	.667	.732	.742	.940	.604	.945

City of Riverside
 N/S: Trautwein Road
 E/W: Grove Community Drive
 Weather: Clear

File Name : 06_RIV_Traut_Grove AM
 Site Code : 05121716
 Start Date : 11/30/2021
 Page No : 1

Groups Printed- Passenger Vehicles

Start Time	Trautwein Road Southbound			Grove Community Drive Westbound				Trautwein Road Northbound				Exclu. Total	Inclu. Total	Int. Total
	Left	Thru	App. Total	Left	Right	RTOR	App. Total	Thru	Right	RTOR	App. Total			
07:00 AM	65	184	249	14	94	63	108	270	2	1	272	64	629	693
07:15 AM	52	241	293	24	148	41	172	323	6	2	329	43	794	837
07:30 AM	21	173	194	19	176	29	195	289	4	2	293	31	682	713
07:45 AM	33	119	152	7	91	35	98	311	7	2	318	37	568	605
Total	171	717	888	64	509	168	573	1193	19	7	1212	175	2673	2848
08:00 AM	22	112	134	9	58	44	67	298	11	5	309	49	510	559
08:15 AM	41	117	158	7	50	36	57	210	9	2	219	38	434	472
08:30 AM	46	100	146	11	72	55	83	213	14	7	227	62	456	518
08:45 AM	54	123	177	8	79	60	87	197	21	6	218	66	482	548
Total	163	452	615	35	259	195	294	918	55	20	973	215	1882	2097
Grand Total	334	1169	1503	99	768	363	867	2111	74	27	2185	390	4555	4945
Apprch %	22.2	77.8		11.4	88.6			96.6	3.4					
Total %	7.3	25.7	33	2.2	16.9		19	46.3	1.6		48	7.9	92.1	

Start Time	Trautwein Road Southbound			Grove Community Drive Westbound			Trautwein Road Northbound			Int. Total
	Left	Thru	App. Total	Left	Right	App. Total	Thru	Right	App. Total	
07:00 AM	65	184	249	14	94	108	270	2	272	629
07:15 AM	52	241	293	24	148	172	323	6	329	794
07:30 AM	21	173	194	19	176	195	289	4	293	682
07:45 AM	33	119	152	7	91	98	311	7	318	568
Total Volume	171	717	888	64	509	573	1193	19	1212	2673
% App. Total	19.3	80.7		11.2	88.8		98.4	1.6		
PHF	.658	.744	.758	.667	.723	.735	.923	.679	.921	.842

City of Riverside
 N/S: Trautwein Road
 E/W: Grove Community Drive
 Weather: Clear

File Name : 06_RIV_Traut_Grove AM
 Site Code : 05121716
 Start Date : 11/30/2021
 Page No : 2

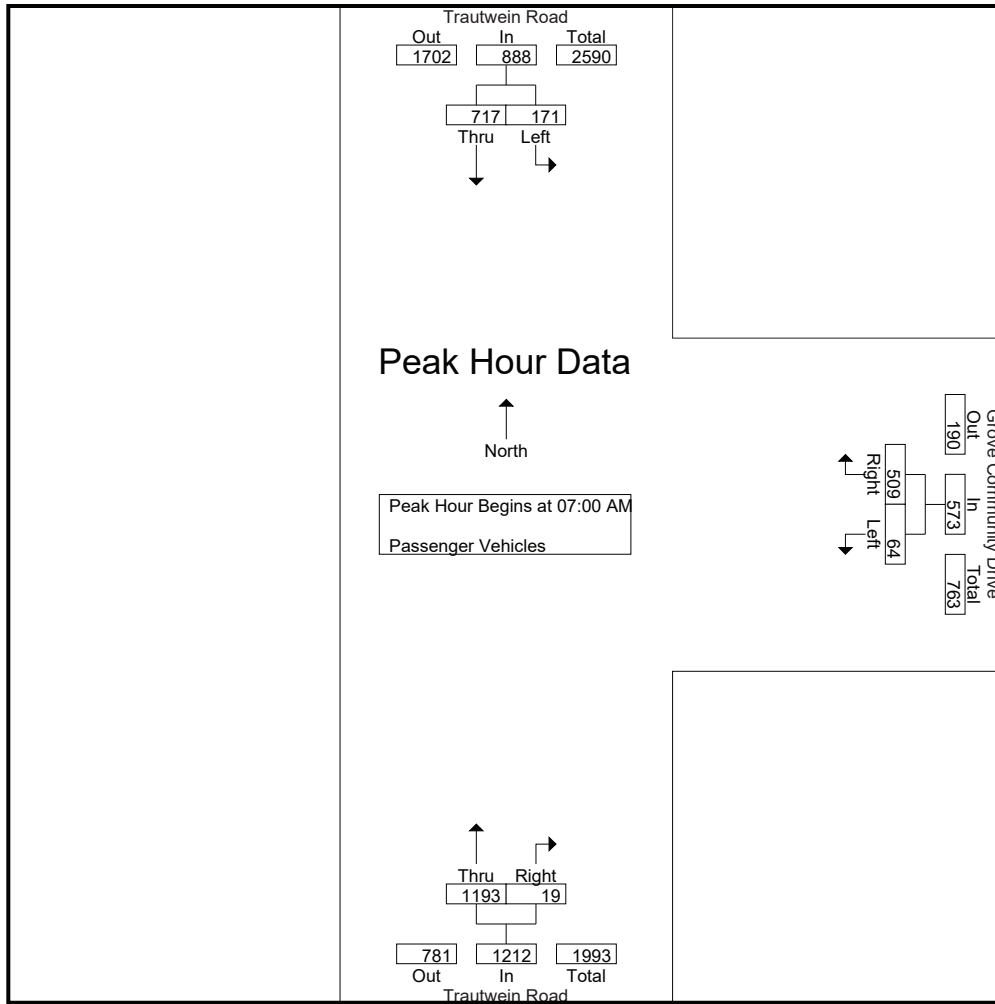

Peak Hour Analysis From 07:00 AM to 07:45 AM - Peak 1 of 1
 Peak Hour for Each Approach Begins at:

	07:00 AM			07:00 AM			07:00 AM		
+0 mins.	65	184	249	14	94	108	270	2	272
+15 mins.	52	241	293	24	148	172	323	6	329
+30 mins.	21	173	194	19	176	195	289	4	293
+45 mins.	33	119	152	7	91	98	311	7	318
Total Volume	171	717	888	64	509	573	1193	19	1212
% App. Total	19.3	80.7		11.2	88.8		98.4	1.6	
PHF	.658	.744	.758	.667	.723	.735	.923	.679	.921

City of Riverside
 N/S: Trautwein Road
 E/W: Grove Community Drive
 Weather: Clear

File Name : 06_RIV_Traut_Grove AM
 Site Code : 05121716
 Start Date : 11/30/2021
 Page No : 1

Groups Printed- Large 2 Axle Vehicles

Start Time	Trautwein Road Southbound			Grove Community Drive Westbound				Trautwein Road Northbound				Exclu. Total	Inclu. Total	Int. Total
	Left	Thru	App. Total	Left	Right	RTOR	App. Total	Thru	Right	RTOR	App. Total			
07:00 AM	1	5	6	0	0	0	0	3	0	0	3	0	9	9
07:15 AM	3	7	10	0	3	0	3	9	0	0	9	0	22	22
07:30 AM	0	2	2	0	0	0	0	5	0	0	5	0	7	7
07:45 AM	1	7	8	0	3	0	3	4	0	0	4	0	15	15
Total	5	21	26	0	6	0	6	21	0	0	21	0	53	53
08:00 AM	0	2	2	0	2	0	2	5	1	0	6	0	10	10
08:15 AM	1	1	2	0	1	1	1	6	0	0	6	1	9	10
08:30 AM	0	1	1	0	1	0	1	3	0	0	3	0	5	5
08:45 AM	1	1	2	0	0	0	0	2	0	0	2	0	4	4
Total	2	5	7	0	4	1	4	16	1	0	17	1	28	29
Grand Total	7	26	33	0	10	1	10	37	1	0	38	1	81	82
Apprch %	21.2	78.8		0	100			97.4	2.6					
Total %	8.6	32.1	40.7	0	12.3		12.3	45.7	1.2		46.9	1.2	98.8	

Start Time	Trautwein Road Southbound			Grove Community Drive Westbound			Trautwein Road Northbound			Int. Total
	Left	Thru	App. Total	Left	Right	App. Total	Thru	Right	App. Total	
07:00 AM	1	5	6	0	0	0	3	0	3	9
07:15 AM	3	7	10	0	3	3	9	0	9	22
07:30 AM	0	2	2	0	0	0	5	0	5	7
07:45 AM	1	7	8	0	3	3	4	0	4	15
Total Volume	5	21	26	0	6	6	21	0	21	53
% App. Total	19.2	80.8		0	100		100	0		
PHF	.417	.750	.650	.000	.500	.500	.583	.000	.583	.602

Peak Hour Analysis From 07:00 AM to 07:45 AM - Peak 1 of 1
 Peak Hour for Entire Intersection Begins at 07:00 AM

City of Riverside
 N/S: Trautwein Road
 E/W: Grove Community Drive
 Weather: Clear

File Name : 06_RIV_Traut_Grove AM
 Site Code : 05121716
 Start Date : 11/30/2021
 Page No : 2

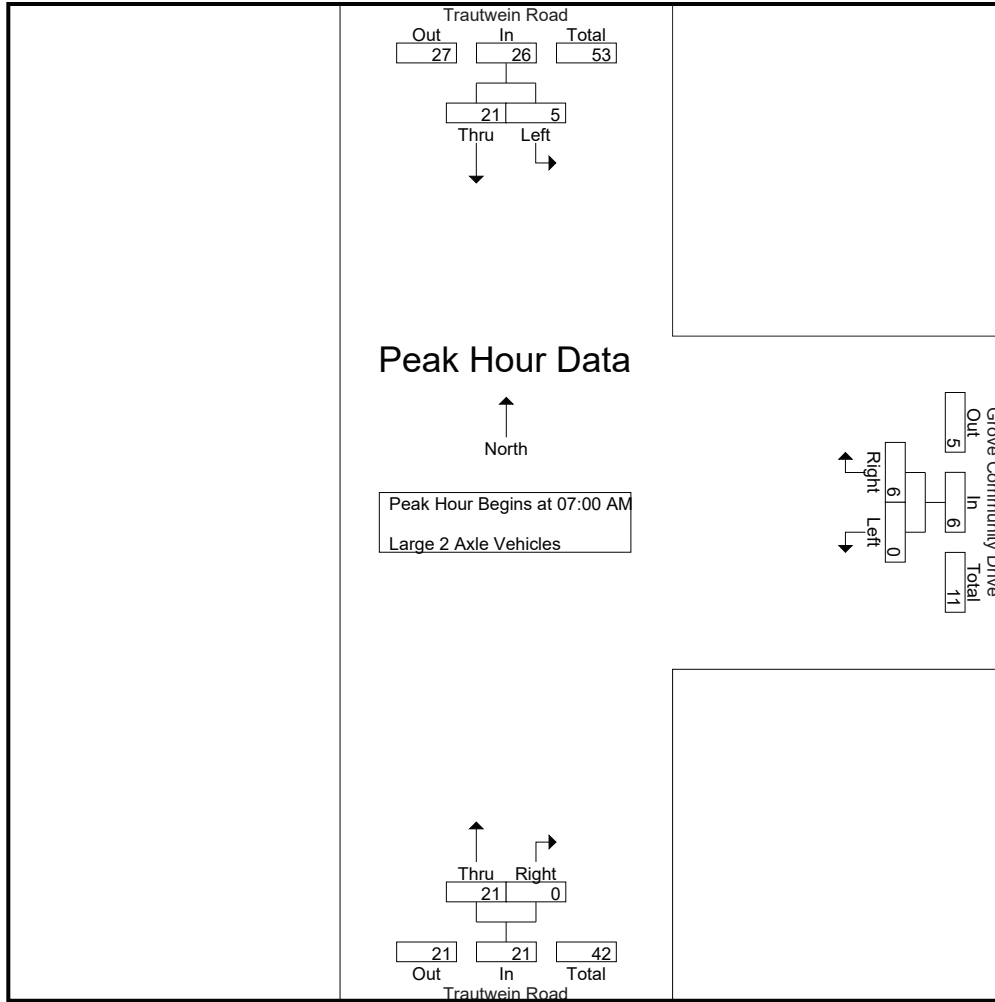

Peak Hour Analysis From 07:00 AM to 07:45 AM - Peak 1 of 1
 Peak Hour for Each Approach Begins at:

	07:00 AM			07:00 AM			07:00 AM		
+0 mins.	1	5	6	0	0	0	3	0	3
+15 mins.	3	7	10	0	3	3	9	0	9
+30 mins.	0	2	2	0	0	0	5	0	5
+45 mins.	1	7	8	0	3	3	4	0	4
Total Volume	5	21	26	0	6	6	21	0	21
% App. Total	19.2	80.8		0	100		100	0	
PHF	.417	.750	.650	.000	.500	.500	.583	.000	.583

City of Riverside
 N/S: Trautwein Road
 E/W: Grove Community Drive
 Weather: Clear

File Name : 06_RIV_Traut_Grove AM
 Site Code : 05121716
 Start Date : 11/30/2021
 Page No : 1

Groups Printed- 3 Axle Vehicles

Start Time	Trautwein Road Southbound			Grove Community Drive Westbound				Trautwein Road Northbound				Exclu. Total	Inclu. Total	Int. Total	
	Left	Thru	App. Total	Left	Right	RTOR	App. Total	Thru	Right	RTOR	App. Total				
07:00 AM	0	0	0	0	0	0	0	0	0	0	0	0	0	0	0
07:15 AM	0	3	3	0	0	0	0	0	0	0	0	0	0	3	3
07:30 AM	0	2	2	0	0	0	0	1	0	0	1	0	0	3	3
07:45 AM	0	0	0	0	0	0	0	1	0	0	1	0	0	1	1
Total	0	5	5	0	0	0	0	2	0	0	2	0	0	7	7
08:00 AM	0	1	1	0	0	0	0	0	0	0	0	0	0	1	1
08:15 AM	0	0	0	0	1	0	1	2	0	0	2	0	0	3	3
08:30 AM	0	0	0	0	0	0	0	2	0	0	2	0	0	2	2
08:45 AM	0	1	1	0	0	0	0	0	0	0	0	0	0	1	1
Total	0	2	2	0	1	0	1	4	0	0	4	0	0	7	7
Grand Total	0	7	7	0	1	0	1	6	0	0	6	0	0	14	14
Apprch %	0	100		0	100			100	0						
Total %	0	50	50	0	7.1		7.1	42.9	0		42.9	0	0	100	

Start Time	Trautwein Road Southbound			Grove Community Drive Westbound			Trautwein Road Northbound			Int. Total
	Left	Thru	App. Total	Left	Right	App. Total	Thru	Right	App. Total	
Peak Hour Analysis From 07:00 AM to 07:45 AM - Peak 1 of 1										
Peak Hour for Entire Intersection Begins at 07:00 AM										
07:00 AM	0	0	0	0	0	0	0	0	0	0
07:15 AM	0	3	3	0	0	0	0	0	0	3
07:30 AM	0	2	2	0	0	0	1	0	1	3
07:45 AM	0	0	0	0	0	0	1	0	1	1
Total Volume	0	5	5	0	0	0	2	0	2	7
% App. Total	0	100		0	0		100	0		
PHF	.000	.417	.417	.000	.000	.000	.500	.000	.500	.583

City of Riverside
 N/S: Trautwein Road
 E/W: Grove Community Drive
 Weather: Clear

File Name : 06_RIV_Traut_Grove AM
 Site Code : 05121716
 Start Date : 11/30/2021
 Page No : 2

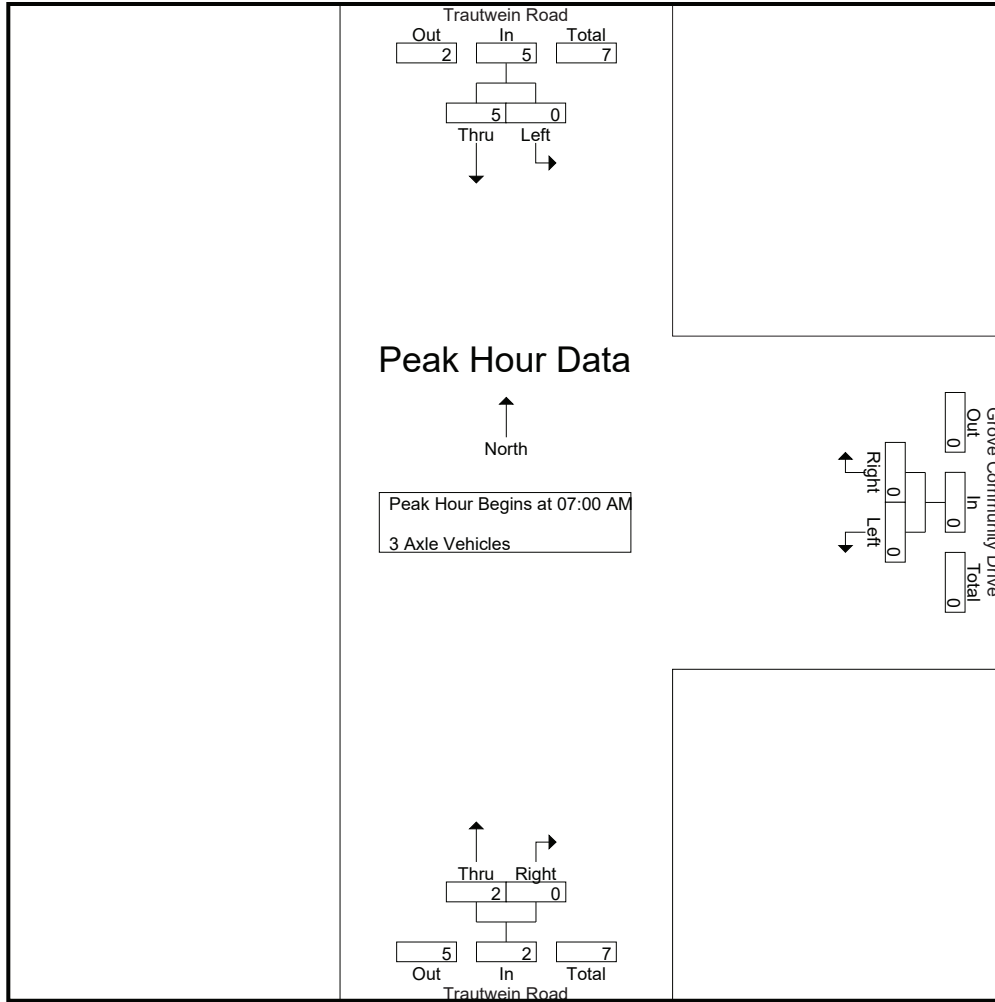

Peak Hour Analysis From 07:00 AM to 07:45 AM - Peak 1 of 1
 Peak Hour for Each Approach Begins at:

	07:00 AM			07:00 AM			07:00 AM		
+0 mins.	0	0	0	0	0	0	0	0	0
+15 mins.	0	3	3	0	0	0	0	0	0
+30 mins.	0	2	2	0	0	0	1	0	1
+45 mins.	0	0	0	0	0	0	1	0	1
Total Volume	0	5	5	0	0	0	2	0	2
% App. Total	0	100		0	0		100	0	
PHF	.000	.417	.417	.000	.000	.000	.500	.000	.500

City of Riverside
 N/S: Trautwein Road
 E/W: Grove Community Drive
 Weather: Clear

File Name : 06_RIV_Traut_Grove AM
 Site Code : 05121716
 Start Date : 11/30/2021
 Page No : 1

Groups Printed- 4+ Axle Trucks

Start Time	Trautwein Road Southbound			Grove Community Drive Westbound				Trautwein Road Northbound				Exclu. Total	Inclu. Total	Int. Total	
	Left	Thru	App. Total	Left	Right	RTOR	App. Total	Thru	Right	RTOR	App. Total				
07:00 AM	0	0	0	0	0	0	0	0	0	0	0	0	0	0	0
07:15 AM	0	0	0	0	0	0	0	0	0	0	0	0	0	0	0
07:30 AM	0	0	0	0	0	0	0	0	0	0	0	0	0	0	0
07:45 AM	0	0	0	0	0	0	0	2	0	0	2	0	2	2	2
Total	0	0	0	0	0	0	0	2	0	0	2	0	2	2	2
08:00 AM	0	0	0	0	0	0	0	0	0	0	0	0	0	0	0
08:15 AM	0	2	2	0	0	0	0	0	0	0	0	0	2	2	2
08:30 AM	0	1	1	0	0	0	0	0	0	0	0	0	1	1	1
08:45 AM	0	0	0	0	0	0	0	0	0	0	0	0	0	0	0
Total	0	3	3	0	0	0	0	0	0	0	0	0	3	3	3
Grand Total	0	3	3	0	0	0	0	2	0	0	2	0	5	5	5
Apprch %	0	100		0	0			100	0						
Total %	0	60	60	0	0		0	40	0		40	0	100		

Start Time	Trautwein Road Southbound			Grove Community Drive Westbound			Trautwein Road Northbound			Int. Total
	Left	Thru	App. Total	Left	Right	App. Total	Thru	Right	App. Total	
Peak Hour Analysis From 07:00 AM to 07:45 AM - Peak 1 of 1										
Peak Hour for Entire Intersection Begins at 07:00 AM										
07:00 AM	0	0	0	0	0	0	0	0	0	0
07:15 AM	0	0	0	0	0	0	0	0	0	0
07:30 AM	0	0	0	0	0	0	0	0	0	0
07:45 AM	0	0	0	0	0	0	2	0	2	2
Total Volume	0	0	0	0	0	0	2	0	2	2
% App. Total	0	0		0	0		100	0		
PHF	.000	.000	.000	.000	.000	.000	.250	.000	.250	.250

City of Riverside
 N/S: Trautwein Road
 E/W: Grove Community Drive
 Weather: Clear

File Name : 06_RIV_Traut_Grove AM
 Site Code : 05121716
 Start Date : 11/30/2021
 Page No : 2

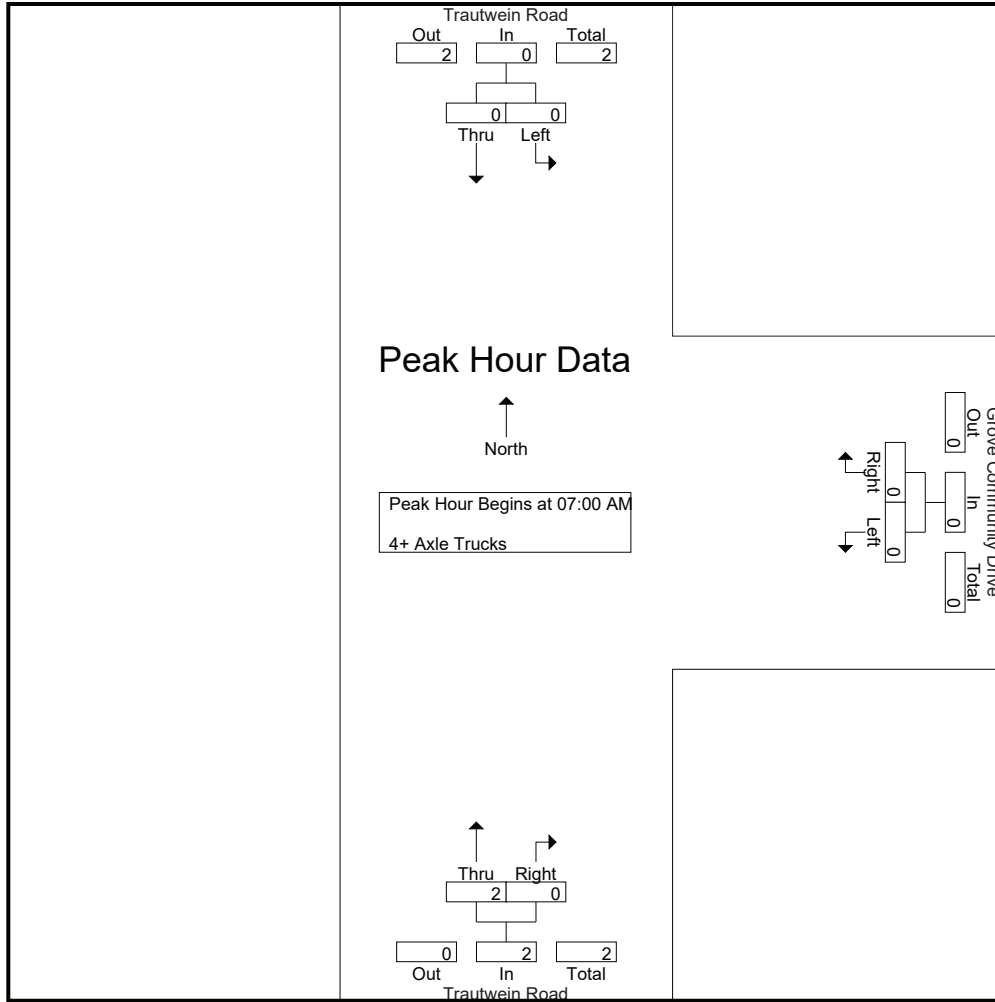

Peak Hour Analysis From 07:00 AM to 07:45 AM - Peak 1 of 1
 Peak Hour for Each Approach Begins at:

	07:00 AM			07:00 AM			07:00 AM		
+0 mins.	0	0	0	0	0	0	0	0	0
+15 mins.	0	0	0	0	0	0	0	0	0
+30 mins.	0	0	0	0	0	0	0	0	0
+45 mins.	0	0	0	0	0	0	2	0	2
Total Volume	0	0	0	0	0	0	2	0	2
% App. Total	0	0	0	0	0	0	100	0	250
PHF	.000	.000	.000	.000	.000	.000	.250	.000	.250

City of Riverside
 N/S: Trautwein Road
 E/W: Grove Community Drive
 Weather: Clear

File Name : 06_RIV_Traut_Grove PM
 Site Code : 05121716
 Start Date : 11/30/2021
 Page No : 1

Groups Printed- Passenger Vehicles - Large 2 Axle Vehicles - 3 Axle Vehicles - 4+ Axle Trucks

Start Time	Trautwein Road Southbound			Grove Community Drive Westbound				Trautwein Road Northbound				Exclu. Total	Inclu. Total	Int. Total
	Left	Thru	App. Total	Left	Right	RTOR	App. Total	Thru	Right	RTOR	App. Total			
04:00 PM	71	265	336	9	49	39	58	197	8	3	205	42	599	641
04:15 PM	75	339	414	4	43	36	47	219	6	0	225	36	686	722
04:30 PM	83	269	352	14	39	33	53	193	2	0	195	33	600	633
04:45 PM	80	307	387	10	53	42	63	209	8	0	217	42	667	709
Total	309	1180	1489	37	184	150	221	818	24	3	842	153	2552	2705
05:00 PM	75	314	389	12	58	47	70	194	12	2	206	49	665	714
05:15 PM	88	342	430	10	46	33	56	185	7	0	192	33	678	711
05:30 PM	96	307	403	8	56	51	64	162	12	1	174	52	641	693
05:45 PM	85	313	398	16	57	44	73	190	18	2	208	46	679	725
Total	344	1276	1620	46	217	175	263	731	49	5	780	180	2663	2843
Grand Total	653	2456	3109	83	401	325	484	1549	73	8	1622	333	5215	5548
Apprch %	21	79		17.1	82.9			95.5	4.5					
Total %	12.5	47.1	59.6	1.6	7.7		9.3	29.7	1.4		31.1	6	94	
Passenger Vehicles	651	2418	3069	83	399		806	1532	73		1613	0	0	5488
% Passenger Vehicles	99.7	98.5	98.7	100	99.5	99.7	99.6	98.9	100	100	99	0	0	98.9
Large 2 Axle Vehicles	2	33	35	0	2		3	12	0		12	0	0	50
% Large 2 Axle Vehicles	0.3	1.3	1.1	0	0.5	0.3	0.4	0.8	0	0	0.7	0	0	0.9
3 Axle Vehicles	0	2	2	0	0		0	2	0		2	0	0	4
% 3 Axle Vehicles	0	0.1	0.1	0	0	0	0	0.1	0	0	0.1	0	0	0.1
4+ Axle Trucks	0	3	3	0	0		0	3	0		3	0	0	6
% 4+ Axle Trucks	0	0.1	0.1	0	0	0	0	0.2	0	0	0.2	0	0	0.1

Start Time	Trautwein Road Southbound			Grove Community Drive Westbound			Trautwein Road Northbound			Int. Total
	Left	Thru	App. Total	Left	Right	App. Total	Thru	Right	App. Total	
Peak Hour Analysis From 04:00 PM to 05:45 PM - Peak 1 of 1										
Peak Hour for Entire Intersection Begins at 05:00 PM										
05:00 PM	75	314	389	12	58	70	194	12	206	665
05:15 PM	88	342	430	10	46	56	185	7	192	678
05:30 PM	96	307	403	8	56	64	162	12	174	641
05:45 PM	85	313	398	16	57	73	190	18	208	679
Total Volume	344	1276	1620	46	217	263	731	49	780	2663
% App. Total	21.2	78.8		17.5	82.5		93.7	6.3		
PHF	.896	.933	.942	.719	.935	.901	.942	.681	.938	.980

City of Riverside
 N/S: Trautwein Road
 E/W: Grove Community Drive
 Weather: Clear

File Name : 06_RIV_Traut_Grove PM
 Site Code : 05121716
 Start Date : 11/30/2021
 Page No : 2

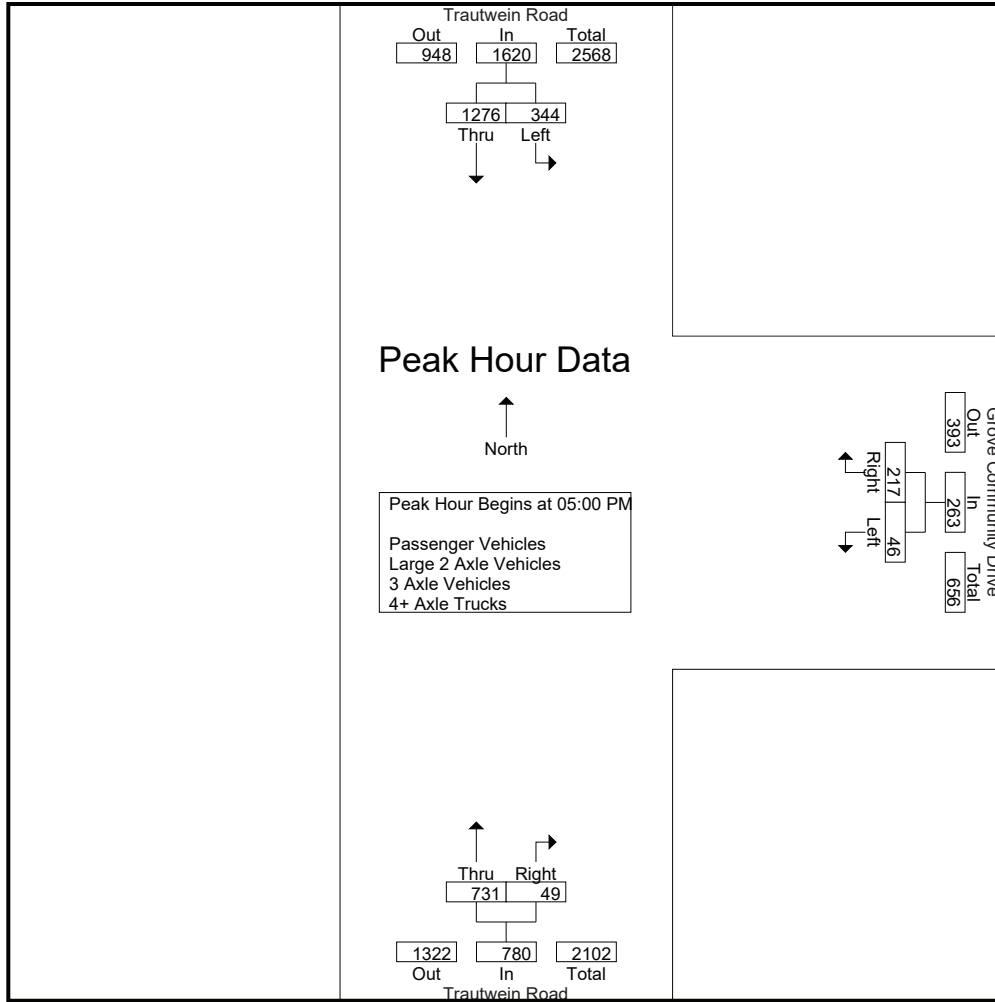

Peak Hour Analysis From 04:00 PM to 05:45 PM - Peak 1 of 1
 Peak Hour for Each Approach Begins at:

	05:00 PM			05:00 PM			04:15 PM		
+0 mins.	75	314	389	12	58	70	219	6	225
+15 mins.	88	342	430	10	46	56	193	2	195
+30 mins.	96	307	403	8	56	64	209	8	217
+45 mins.	85	313	398	16	57	73	194	12	206
Total Volume	344	1276	1620	46	217	263	815	28	843
% App. Total	21.2	78.8		17.5	82.5		96.7	3.3	
PHF	.896	.933	.942	.719	.935	.901	.930	.583	.937

City of Riverside
 N/S: Trautwein Road
 E/W: Grove Community Drive
 Weather: Clear

File Name : 06_RIV_Traut_Grove PM
 Site Code : 05121716
 Start Date : 11/30/2021
 Page No : 1

Groups Printed- Passenger Vehicles

Start Time	Trautwein Road Southbound			Grove Community Drive Westbound				Trautwein Road Northbound				Exclu. Total	Inclu. Total	Int. Total
	Left	Thru	App. Total	Left	Right	RTOR	App. Total	Thru	Right	RTOR	App. Total			
04:00 PM	70	263	333	9	48	39	57	194	8	3	202	42	592	634
04:15 PM	75	338	413	4	43	36	47	214	6	0	220	36	680	716
04:30 PM	83	267	350	14	39	33	53	193	2	0	195	33	598	631
04:45 PM	80	302	382	10	53	42	63	205	8	0	213	42	658	700
Total	308	1170	1478	37	183	150	220	806	24	3	830	153	2528	2681
05:00 PM	74	308	382	12	58	47	70	193	12	2	205	49	657	706
05:15 PM	88	331	419	10	46	33	56	184	7	0	191	33	666	699
05:30 PM	96	299	395	8	55	50	63	160	12	1	172	51	630	681
05:45 PM	85	310	395	16	57	44	73	189	18	2	207	46	675	721
Total	343	1248	1591	46	216	174	262	726	49	5	775	179	2628	2807
Grand Total	651	2418	3069	83	399	324	482	1532	73	8	1605	332	5156	5488
Apprch %	21.2	78.8		17.2	82.8			95.5	4.5					
Total %	12.6	46.9	59.5	1.6	7.7		9.3	29.7	1.4		31.1	6	94	

Start Time	Trautwein Road Southbound			Grove Community Drive Westbound			Trautwein Road Northbound			Int. Total
	Left	Thru	App. Total	Left	Right	App. Total	Thru	Right	App. Total	
Peak Hour Analysis From 05:00 PM to 05:45 PM - Peak 1 of 1										
Peak Hour for Entire Intersection Begins at 05:00 PM										
05:00 PM	74	308	382	12	58	70	193	12	205	657
05:15 PM	88	331	419	10	46	56	184	7	191	666
05:30 PM	96	299	395	8	55	63	160	12	172	630
05:45 PM	85	310	395	16	57	73	189	18	207	675
Total Volume	343	1248	1591	46	216	262	726	49	775	2628
% App. Total	21.6	78.4		17.6	82.4		93.7	6.3		
PHF	.893	.943	.949	.719	.931	.897	.940	.681	.936	.973

City of Riverside
 N/S: Trautwein Road
 E/W: Grove Community Drive
 Weather: Clear

File Name : 06_RIV_Traut_Grove PM
 Site Code : 05121716
 Start Date : 11/30/2021
 Page No : 2

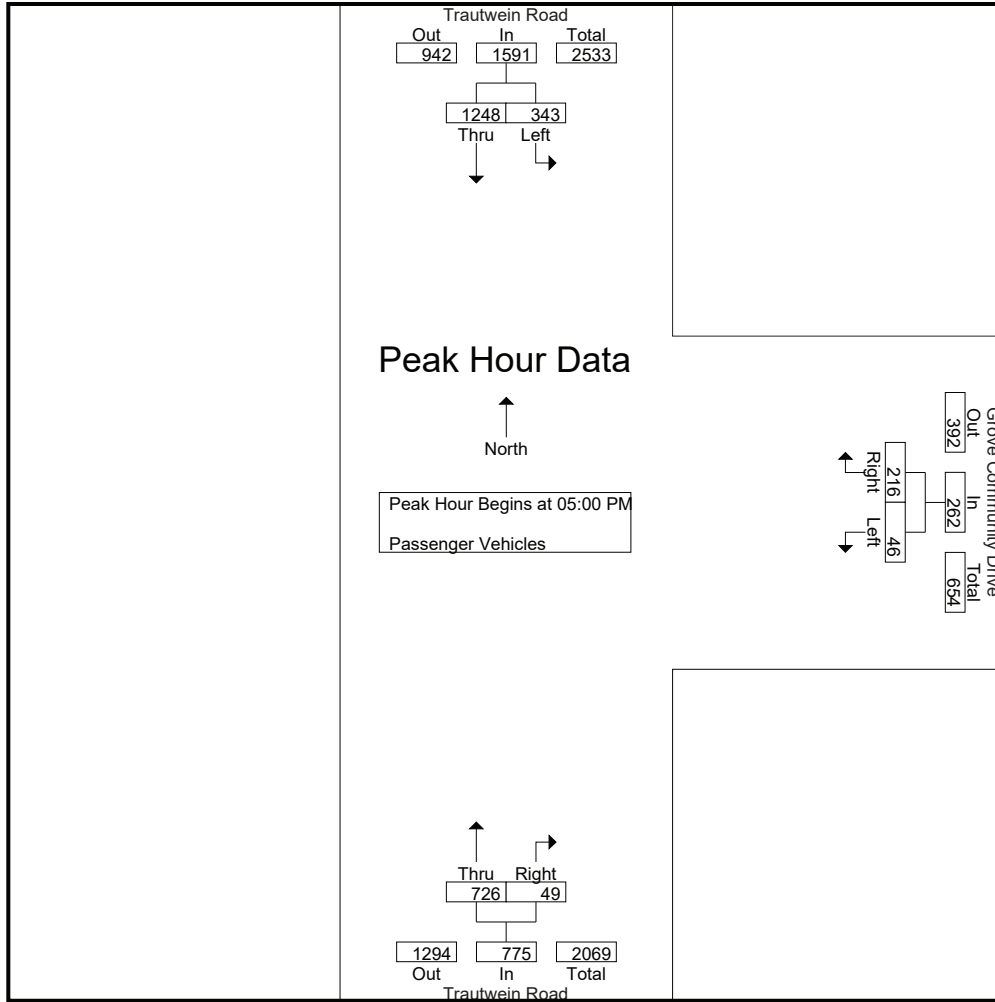

Peak Hour Analysis From 05:00 PM to 05:45 PM - Peak 1 of 1
 Peak Hour for Each Approach Begins at:

	05:00 PM			05:00 PM			05:00 PM		
+0 mins.	74	308	382	12	58	70	193	12	205
+15 mins.	88	331	419	10	46	56	184	7	191
+30 mins.	96	299	395	8	55	63	160	12	172
+45 mins.	85	310	395	16	57	73	189	18	207
Total Volume	343	1248	1591	46	216	262	726	49	775
% App. Total	21.6	78.4		17.6	82.4		93.7	6.3	
PHF	.893	.943	.949	.719	.931	.897	.940	.681	.936

City of Riverside
 N/S: Trautwein Road
 E/W: Grove Community Drive
 Weather: Clear

File Name : 06_RIV_Traut_Grove PM
 Site Code : 05121716
 Start Date : 11/30/2021
 Page No : 1

Groups Printed- Large 2 Axle Vehicles

Start Time	Trautwein Road Southbound			Grove Community Drive Westbound				Trautwein Road Northbound				Exclu. Total	Inclu. Total	Int. Total
	Left	Thru	App. Total	Left	Right	RTOR	App. Total	Thru	Right	RTOR	App. Total			
04:00 PM	1	1	2	0	1	0	1	2	0	0	2	0	5	5
04:15 PM	0	1	1	0	0	0	0	4	0	0	4	0	5	5
04:30 PM	0	1	1	0	0	0	0	0	0	0	0	0	1	1
04:45 PM	0	4	4	0	0	0	0	3	0	0	3	0	7	7
Total	1	7	8	0	1	0	1	9	0	0	9	0	18	18
05:00 PM	1	5	6	0	0	0	0	0	0	0	0	0	6	6
05:15 PM	0	10	10	0	0	0	0	1	0	0	1	0	11	11
05:30 PM	0	8	8	0	1	1	1	1	0	0	1	1	10	11
05:45 PM	0	3	3	0	0	0	0	1	0	0	1	0	4	4
Total	1	26	27	0	1	1	1	3	0	0	3	1	31	32
Grand Total	2	33	35	0	2	1	2	12	0	0	12	1	49	50
Apprch %	5.7	94.3		0	100			100	0					
Total %	4.1	67.3	71.4	0	4.1		4.1	24.5	0		24.5	2	98	

Start Time	Trautwein Road Southbound			Grove Community Drive Westbound			Trautwein Road Northbound			Int. Total
	Left	Thru	App. Total	Left	Right	App. Total	Thru	Right	App. Total	
05:00 PM	1	5	6	0	0	0	0	0	0	6
05:15 PM	0	10	10	0	0	0	1	0	1	11
05:30 PM	0	8	8	0	1	1	1	0	1	10
05:45 PM	0	3	3	0	0	0	1	0	1	4
Total Volume	1	26	27	0	1	1	3	0	3	31
% App. Total	3.7	96.3		0	100		100	0		
PHF	.250	.650	.675	.000	.250	.250	.750	.000	.750	.705

City of Riverside
 N/S: Trautwein Road
 E/W: Grove Community Drive
 Weather: Clear

File Name : 06_RIV_Traut_Grove PM
 Site Code : 05121716
 Start Date : 11/30/2021
 Page No : 2

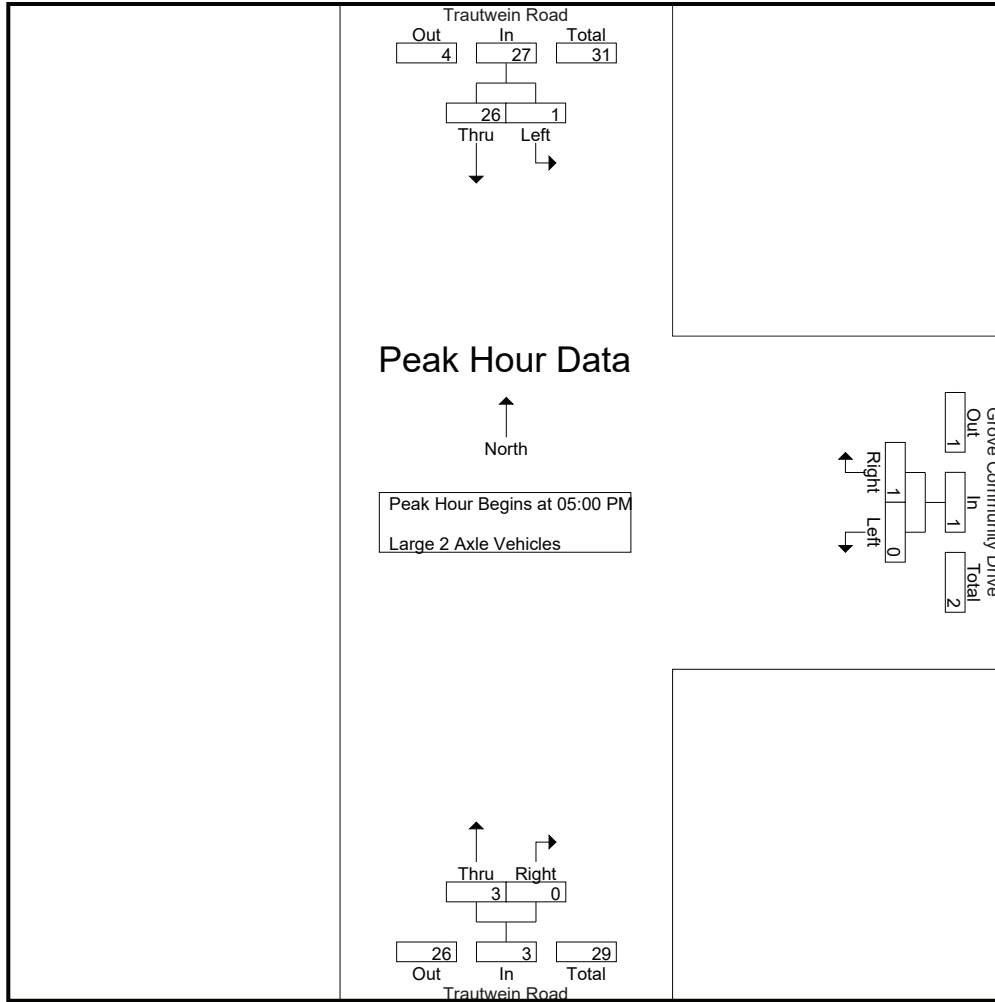

Peak Hour Analysis From 05:00 PM to 05:45 PM - Peak 1 of 1
 Peak Hour for Each Approach Begins at:

	05:00 PM			05:00 PM			05:00 PM		
+0 mins.	1	5	6	0	0	0	0	0	0
+15 mins.	0	10	10	0	0	0	1	0	1
+30 mins.	0	8	8	0	1	1	1	0	1
+45 mins.	0	3	3	0	0	0	1	0	1
Total Volume	1	26	27	0	1	1	3	0	3
% App. Total	3.7	96.3		0	100		100	0	
PHF	.250	.650	.675	.000	.250	.250	.750	.000	.750

City of Riverside
 N/S: Trautwein Road
 E/W: Grove Community Drive
 Weather: Clear

File Name : 06_RIV_Traut_Grove PM
 Site Code : 05121716
 Start Date : 11/30/2021
 Page No : 1

Groups Printed- 3 Axle Vehicles

Start Time	Trautwein Road Southbound			Grove Community Drive Westbound				Trautwein Road Northbound				Exclu. Total	Inclu. Total	Int. Total	
	Left	Thru	App. Total	Left	Right	RTOR	App. Total	Thru	Right	RTOR	App. Total				
04:00 PM	0	0	0	0	0	0	0	0	0	0	0	0	0	0	0
04:15 PM	0	0	0	0	0	0	0	0	0	0	0	0	0	0	0
04:30 PM	0	0	0	0	0	0	0	0	0	0	0	0	0	0	0
04:45 PM	0	1	1	0	0	0	0	1	0	0	1	0	2	2	
Total	0	1	1	0	0	0	0	1	0	0	1	0	2	2	
05:00 PM	0	0	0	0	0	0	0	0	0	0	0	0	0	0	
05:15 PM	0	1	1	0	0	0	0	0	0	0	0	0	1	1	
05:30 PM	0	0	0	0	0	0	0	1	0	0	1	0	1	1	
05:45 PM	0	0	0	0	0	0	0	0	0	0	0	0	0	0	
Total	0	1	1	0	0	0	0	1	0	0	1	0	2	2	
Grand Total	0	2	2	0	0	0	0	2	0	0	2	0	4	4	
Apprch %	0	100		0	0			100	0			0	100		
Total %	0	50	50	0	0		0	50	0		50	0	100		

Start Time	Trautwein Road Southbound			Grove Community Drive Westbound			Trautwein Road Northbound			Int. Total
	Left	Thru	App. Total	Left	Right	App. Total	Thru	Right	App. Total	
05:00 PM	0	0	0	0	0	0	0	0	0	0
05:15 PM	0	1	1	0	0	0	0	0	0	1
05:30 PM	0	0	0	0	0	0	0	1	0	1
05:45 PM	0	0	0	0	0	0	0	0	0	0
Total Volume	0	1	1	0	0	0	1	0	1	2
% App. Total	0	100		0	0		100	0		
PHF	.000	.250	.250	.000	.000	.000	.250	.000	.250	.500

City of Riverside
 N/S: Trautwein Road
 E/W: Grove Community Drive
 Weather: Clear

File Name : 06_RIV_Traut_Grove PM
 Site Code : 05121716
 Start Date : 11/30/2021
 Page No : 2

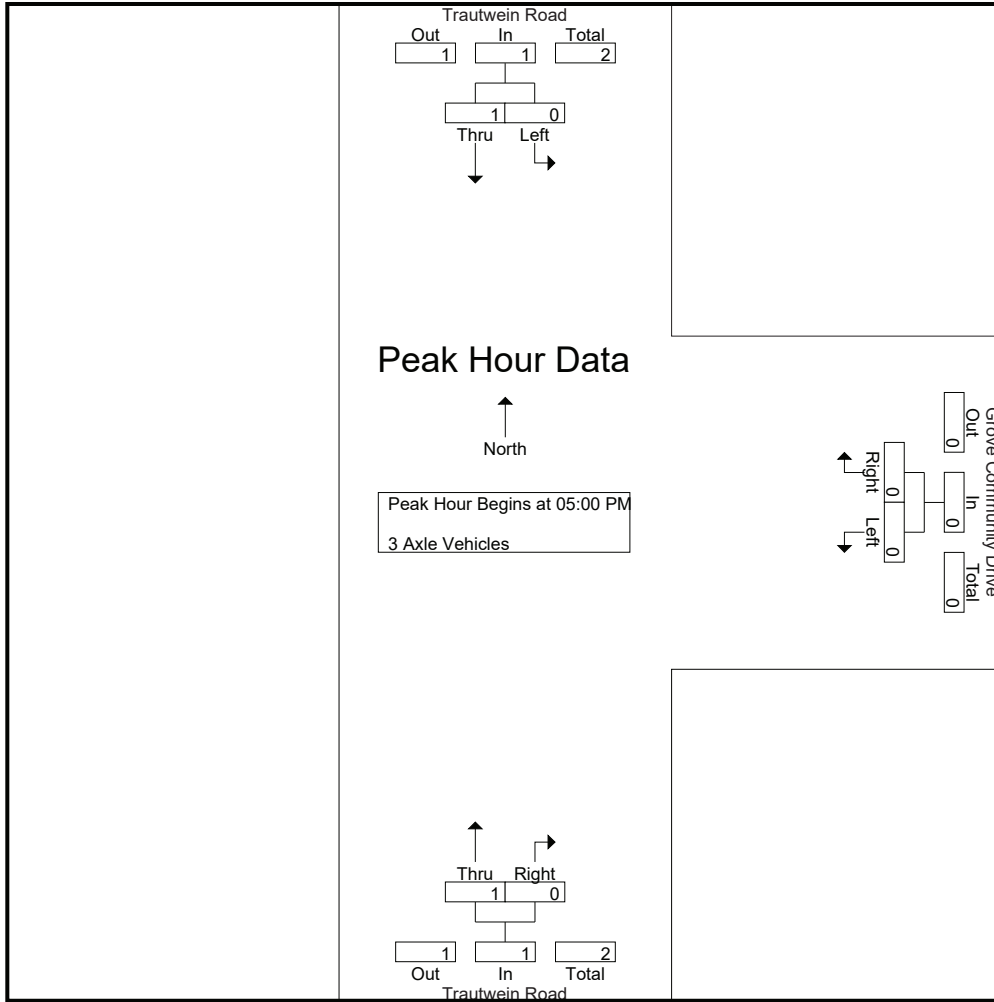

Peak Hour Analysis From 05:00 PM to 05:45 PM - Peak 1 of 1
 Peak Hour for Each Approach Begins at:

	05:00 PM			05:00 PM			05:00 PM		
+0 mins.	0	0	0	0	0	0	0	0	0
+15 mins.	0	1	1	0	0	0	0	0	0
+30 mins.	0	0	0	0	0	0	1	0	1
+45 mins.	0	0	0	0	0	0	0	0	0
Total Volume	0	1	1	0	0	0	1	0	1
% App. Total	0	100		0	0		100	0	
PHF	.000	.250	.250	.000	.000	.000	.250	.000	.250

City of Riverside
 N/S: Trautwein Road
 E/W: Grove Community Drive
 Weather: Clear

File Name : 06_RIV_Traut_Grove PM
 Site Code : 05121716
 Start Date : 11/30/2021
 Page No : 1

Groups Printed- 4+ Axle Trucks

Start Time	Trautwein Road Southbound			Grove Community Drive Westbound				Trautwein Road Northbound				Exclu. Total	Inclu. Total	Int. Total
	Left	Thru	App. Total	Left	Right	RTOR	App. Total	Thru	Right	RTOR	App. Total			
04:00 PM	0	1	1	0	0	0	0	1	0	0	1	0	2	2
04:15 PM	0	0	0	0	0	0	0	1	0	0	1	0	1	1
04:30 PM	0	1	1	0	0	0	0	0	0	0	0	0	1	1
04:45 PM	0	0	0	0	0	0	0	0	0	0	0	0	0	0
Total	0	2	2	0	0	0	0	2	0	0	2	0	4	4
05:00 PM	0	1	1	0	0	0	0	1	0	0	1	0	2	2
05:15 PM	0	0	0	0	0	0	0	0	0	0	0	0	0	0
05:30 PM	0	0	0	0	0	0	0	0	0	0	0	0	0	0
05:45 PM	0	0	0	0	0	0	0	0	0	0	0	0	0	0
Total	0	1	1	0	0	0	0	1	0	0	1	0	2	2
Grand Total	0	3	3	0	0	0	0	3	0	0	3	0	6	6
Apprch %	0	100		0	0			100	0					
Total %	0	50	50	0	0		0	50	0		50	0	100	

Start Time	Trautwein Road Southbound			Grove Community Drive Westbound			Trautwein Road Northbound			Int. Total
	Left	Thru	App. Total	Left	Right	App. Total	Thru	Right	App. Total	
05:00 PM	0	1	1	0	0	0	1	0	1	2
05:15 PM	0	0	0	0	0	0	0	0	0	0
05:30 PM	0	0	0	0	0	0	0	0	0	0
05:45 PM	0	0	0	0	0	0	0	0	0	0
Total Volume	0	1	1	0	0	0	1	0	1	2
% App. Total	0	100		0	0		100	0		
PHF	.000	.250	.250	.000	.000	.000	.250	.000	.250	.250

City of Riverside
 N/S: Trautwein Road
 E/W: Grove Community Drive
 Weather: Clear

File Name : 06_RIV_Traut_Grove PM
 Site Code : 05121716
 Start Date : 11/30/2021
 Page No : 2

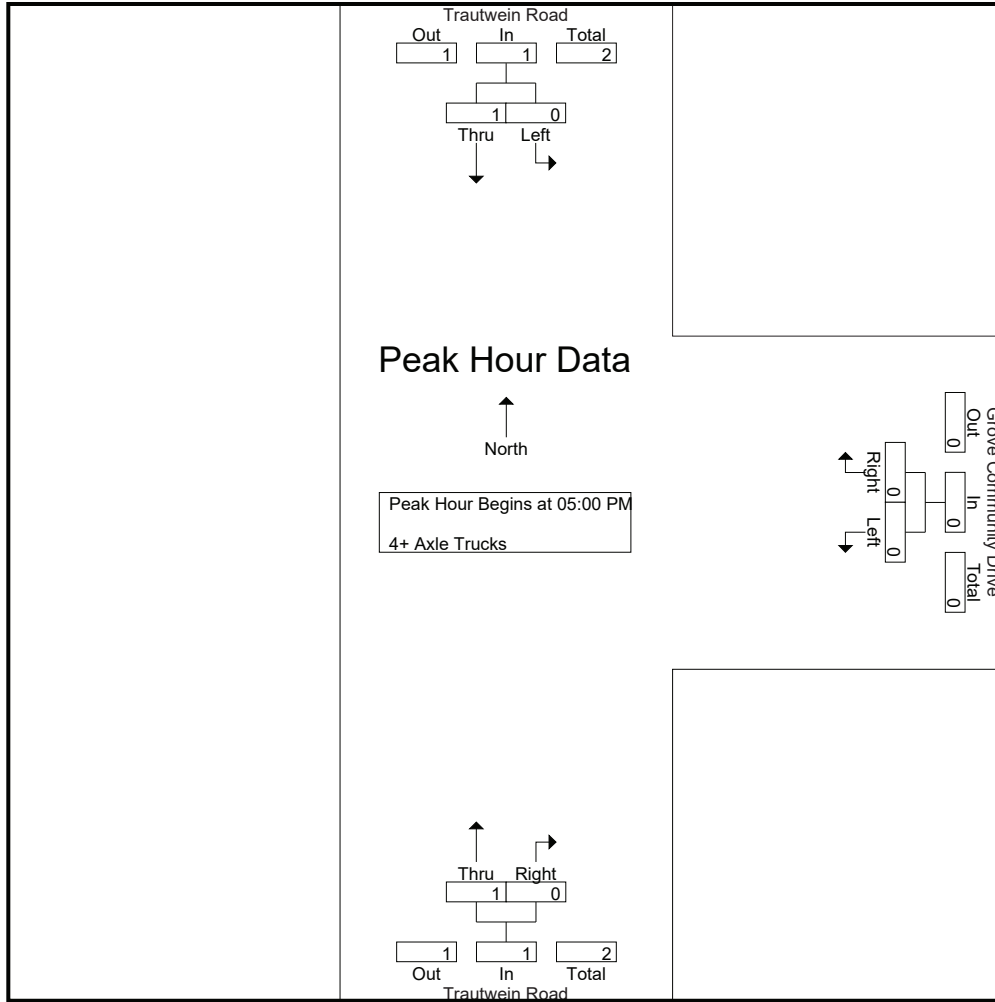

Peak Hour Analysis From 05:00 PM to 05:45 PM - Peak 1 of 1
 Peak Hour for Each Approach Begins at:

	05:00 PM			05:00 PM			05:00 PM		
+0 mins.	0	1	1	0	0	0	1	0	1
+15 mins.	0	0	0	0	0	0	0	0	0
+30 mins.	0	0	0	0	0	0	0	0	0
+45 mins.	0	0	0	0	0	0	0	0	0
Total Volume	0	1	1	0	0	0	1	0	1
% App. Total	0	100		0	0		100	0	
PHF	.000	.250	.250	.000	.000	.000	.250	.000	.250

Location: Riverside
 N/S: Trautwein Road
 E/W: Grove Community Drive



Date: 11/30/2021
 Day: Tuesday

PEDESTRIANS

	North Leg Trautwein Road	East Leg Grove Community Drive	South Leg Trautwein Road	West Leg Dead End	
	Pedestrians	Pedestrians	Pedestrians	Pedestrians	
7:00 AM	0	0	2	0	2
7:15 AM	0	4	0	0	4
7:30 AM	0	0	0	0	0
7:45 AM	0	1	0	0	1
8:00 AM	0	0	0	0	0
8:15 AM	0	0	0	0	0
8:30 AM	0	2	1	0	3
8:45 AM	0	0	0	0	0
TOTAL VOLUMES:	0	7	3	0	10

	North Leg Trautwein Road	East Leg Grove Community Drive	South Leg Trautwein Road	West Leg Dead End	
	Pedestrians	Pedestrians	Pedestrians	Pedestrians	
4:00 PM	0	0	0	0	0
4:15 PM	0	0	1	0	1
4:30 PM	0	0	0	0	0
4:45 PM	0	0	0	0	0
5:00 PM	0	0	1	0	1
5:15 PM	0	0	1	0	1
5:30 PM	0	0	0	0	0
5:45 PM	0	0	0	0	0
TOTAL VOLUMES:	0	0	3	0	3

Location: Riverside
 N/S: Trautwein Road
 E/W: Grove Community Drive



Date: 11/30/2021
 Day: Tuesday

BICYCLES

	Southbound Trautwein Road			Westbound Grove Community Drive			Northbound Trautwein Road			Eastbound Dead End			
	Left	Thru	Right	Left	Thru	Right	Left	Thru	Right	Left	Thru	Right	
7:00 AM	0	0	0	0	0	0	0	0	0	0	0	0	0
7:15 AM	0	0	0	0	0	0	0	1	0	0	0	0	1
7:30 AM	0	0	0	0	0	0	0	0	0	0	0	0	0
7:45 AM	0	0	0	0	0	0	0	0	0	0	0	0	0
8:00 AM	0	0	0	0	0	0	0	0	0	0	0	0	0
8:15 AM	0	0	0	0	0	0	0	0	0	0	0	0	0
8:30 AM	0	0	0	0	0	0	0	0	0	0	0	0	0
8:45 AM	1	1	0	0	0	0	0	0	0	0	0	0	2
TOTAL VOLUMES:	1	1	0	0	0	0	0	1	0	0	0	0	3

	Southbound Trautwein Road			Westbound Grove Community Drive			Northbound Trautwein Road			Eastbound Dead End			
	Left	Thru	Right	Left	Thru	Right	Left	Thru	Right	Left	Thru	Right	
4:00 PM	0	0	0	0	0	0	0	0	0	0	0	0	0
4:15 PM	0	0	0	0	0	0	0	0	0	0	0	0	0
4:30 PM	0	0	0	0	0	0	0	0	0	0	0	0	0
4:45 PM	0	0	0	0	0	0	0	0	0	0	0	0	0
5:00 PM	0	0	0	0	0	0	0	0	0	0	0	0	0
5:15 PM	0	0	0	0	0	0	0	0	0	0	0	0	0
5:30 PM	0	1	0	0	0	0	0	0	0	0	0	0	1
5:45 PM	1	0	0	0	0	0	0	0	0	0	0	0	1
TOTAL VOLUMES:	1	1	0	0	0	0	0	0	0	0	0	0	2

Groups Printed- Passenger Vehicles - Large 2 Axle Vehicles - 3 Axle Vehicles - 4+ Axle Trucks

Start Time	Trautwein Road Southbound						Orange Terrace Parkway Westbound						Trautwein Road Northbound						Orange Terrace Parkway Eastbound						Exclu. Total	Inclu. Total	Int. Total				
	Left	Thru	Right	RTOR	App. Total		Left	Thru	Right	RTOR	App. Total		Left	Thru	Right	RTOR	App. Total		Left	Thru	Right	RTOR	App. Total								
07:00 AM	99	101	3	1	203		50	14	99	61	163		10	178	38	18	226		5	19	3	2	27		82	619	701				
07:15 AM	98	153	4	3	255		89	32	113	56	234		6	199	56	11	261		14	11	4	2	29		72	779	851				
07:30 AM	81	132	5	1	218		67	28	93	42	188		11	204	63	28	278		15	13	0	0	28		71	712	783				
07:45 AM	30	81	4	2	115		26	6	86	47	118		12	204	36	14	252		20	8	3	0	31		63	516	579				
Total	308	467	16	7	791		232	80	391	206	703		39	785	193	71	1017		54	51	10	4	115		288	2626	2914				
08:00 AM	25	107	1	0	133		35	0	66	65	101		5	231	29	10	265		29	4	2	1	35		76	534	610				
08:15 AM	23	91	1	0	115		21	1	45	27	67		3	174	16	3	193		6	3	1	0	10		30	385	415				
08:30 AM	20	84	2	0	106		38	1	50	31	89		6	177	28	11	211		6	3	0	0	9		42	415	457				
08:45 AM	26	95	4	0	125		24	0	49	37	73		3	162	23	3	188		10	4	2	2	16		42	402	444				
Total	94	377	8	0	479		118	2	210	160	330		17	744	96	27	857		51	14	5	3	70		190	1736	1926				
Grand Total	402	844	24	7	1270		350	82	601	366	1033		56	1529	289	98	1874		105	65	15	7	185		478	4362	4840				
% Approach	31.7	66.5	1.9				33.9	7.9	58.2				3	81.6	15.4			56.8	35.1	8.1				2.4	1.5	0.3			4.2	9.9	90.1
% Total	9.2	19.3	0.6				8	1.9	13.8				1.3	35.1	6.6			2.4	1.5	0.3				9.9	90.1						
Passenger Vehicles	390	816	22		1234		344	81	592		1379		55	1467	282		1900		105	64	15		191		0	0	4704				
% Passenger Vehicles	97	96.7	91.7	85.7	96.6		98.3	98.8	98.5	98.9	98.6		98.2	95.9	97.6	98	96.3		100	98.5	100	100	99.5		0	0	97.2				
Large 2 Axle Vehicles	10	20	2		33		6	1	8		18		1	54	7		64		0	1	0		1		0	0	116				
% Large 2 Axle Vehicles	2.5	2.4	8.3	14.3	2.6		1.7	1.2	1.3	0.8	1.3		1.8	3.5	2.4	2	3.2		0	1.5	0		0.5		0	0	2.4				
3 Axle Vehicles	2	5	0		7		0	0	1		2		0	6	0		6		0	0	0		0		0	0	15				
% 3 Axle Vehicles	0.5	0.6	0		0.5		0	0	0.2	0.3	0.1		0	0.4	0	0	0.3		0	0	0		0		0	0	0.3				
4+ Axle Trucks	0	3	0		3		0	0	0		0		0	2	0		2		0	0	0		0		0	0	5				
% 4+ Axle Trucks	0	0.4	0		0.2		0	0	0	0	0		0	0.1	0	0	0.1		0	0	0		0		0	0	0.1				
Peak Hour Analysis From 07:00 AM to 08:45 AM - Peak 1 of 1																															
Peak Hour for Entire Intersection Begins at 07:00 AM																															
07:00 AM	99	101	3		203		50	14	99	61	163		10	178	38	18	226		5	19	3	2	27		82	619	701				
07:15 AM	98	153	4		255		89	32	113	56	234		6	199	56	11	261		14	11	4	2	29		72	779	851				
07:30 AM	81	132	5		218		67	28	93	42	188		11	204	63	28	278		15	13	0	0	28		71	712	783				
07:45 AM	30	81	4		115		26	6	86	47	118		12	204	36	14	252		20	8	3	0	31		63	516	579				
Total Volume	308	467	16		791		232	80	391	206	703		39	785	193	71	1017		54	51	10	4	115		288	2626	2914				
% App. Total	38.9	38.9	59		2		33	11.4	55.6				3.8	77.2	19				47	44.3	8.7				67.5	67.5	67.5				
PHF	.778	.763	.800		.775		.652	.625	.865		.751		.813	.962	.766		.915		.675	.671	.625		.927		.927	.843	.843				

Start Time	Trautwein Road Southbound						Orange Terrace Parkway Westbound						Trautwein Road Northbound						Orange Terrace Parkway Eastbound								
	Left	Thru	Right	RTOR	App. Total		Left	Thru	Right	RTOR	App. Total		Left	Thru	Right	RTOR	App. Total		Left	Thru	Right	RTOR	App. Total				
07:00 AM	99	101	3		203		50	14	99	61	163		10	178	38	18	226		5	19	3	2	27		82	619	701
07:15 AM	98	153	4		255		89	32	113	56	234		6	199	56	11	261		14	11	4	2	29		72	779	851
07:30 AM	81	132	5		218		67	28	93	42	188		11	204	63	28	278		15	13	0	0	28		71	712	783
07:45 AM	30	81	4		115		26	6	86	47	118		12	204	36	14	252		20	8	3	0	31		63	516	579
Total	308	467	16		791		232	80	391	206	703		39	785	193	71	1017		54	51	10	4	115		288	2626	2914

Counts Unlimited, Inc.
 PO Box 1178
 Corona, CA 92878
 (951)268-6268

City of Riverside
 N/S: Trautwein Road
 EW: Orange Terrace Parkway
 Weather: Clear

File Name : 07_RIV_Traut_Orange AM
 Site Code : 05121716
 Start Date : 11/30/2021
 Page No : 2

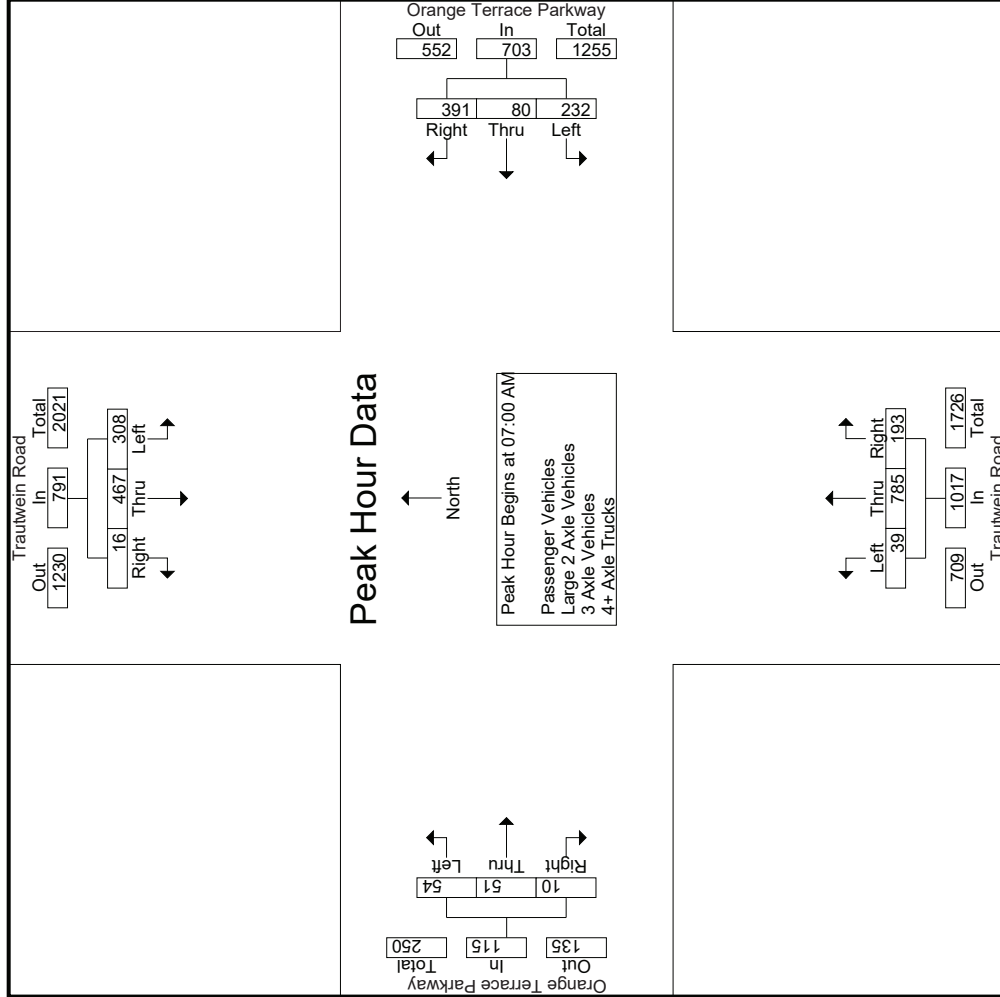

Counts Unlimited, Inc.
 PO Box 1178
 Corona, CA 92878
 (951)268-6268

File Name : 07_RIV_Traut_Orange AM
 Site Code : 05121716
 Start Date : 11/30/2021
 Page No : 3

City of Riverside
 N/S: Trautwein Road
 E/W: Orange Terrace Parkway
 Weather: Clear

Start Time	Trautwein Road Southbound			Orange Terrace Parkway Westbound			Trautwein Road Northbound			Orange Terrace Parkway Eastbound		
	Left	Thru	Right	Left	Thru	Right	Left	Thru	Right	Left	Thru	Right
Peak Hour Analysis From 07:00 AM to 08:45 AM - Peak 1 of 1												
Peak Hour for Each Approach Begins at:												
+0 mins.	99	101	3	50	14	99	163	6	199	261	14	11
+15 mins.	98	153	4	89	32	113	234	11	204	278	15	13
+30 mins.	81	132	5	67	28	93	188	12	204	252	20	8
+45 mins.	30	81	4	26	6	86	118	5	231	265	29	4
Total Volume	308	467	16	232	80	391	703	34	838	1056	78	36
% App. Total	38.9	59	2	33	11.4	55.6		3.2	79.4	63.4	29.3	7.3
PHF	.778	.763	.800	.652	.625	.865	.751	.708	.907	.672	.692	.563

Counts Unlimited, Inc.
 PO Box 1178
 Corona, CA 92878
 (951)268-6268

File Name : 07_RIV_Traut_Orange AM
 Site Code : 05121716
 Start Date : 11/30/2021
 Page No : 1

City of Riverside
 N/S: Trautwein Road
 EW: Orange Terrace Parkway
 Weather: Clear

Start Time	Orange Terrace Parkway										Trautwein Road										Groups Printed- Passenger Vehicles																										
	Westbound					Eastbound					Southbound					Northbound					Westbound					Eastbound					Southbound					Northbound											
	Left	Thru	Right	RTOR	App. Total	Left	Thru	Right	RTOR	App. Total	Left	Thru	Right	RTOR	App. Total	Left	Thru	Right	RTOR	App. Total	Left	Thru	Right	RTOR	App. Total	Left	Thru	Right	RTOR	App. Total	Left	Thru	Right	RTOR	App. Total	Exclu. Total	Inclu. Total	Int. Total									
07:00 AM	94	100	3	1	197	49	14	99	61	162	9	169	35	17	213	5	19	3	2	27	81	599	680	07:15 AM	96	149	3	2	248	88	32	110	55	230	6	192	55	11	253	14	11	4	2	29	70	760	830
07:30 AM	79	126	5	1	210	66	27	91	40	184	11	197	63	28	271	15	12	0	0	27	69	692	761	07:45 AM	29	77	4	2	110	26	6	85	47	117	12	195	35	14	242	20	8	3	0	31	63	500	563
Total	298	452	15	6	765	229	79	385	203	693	38	753	188	70	979	54	50	10	4	114	283	2551	2834	08:00 AM	25	101	1	0	127	34	0	66	65	100	5	221	28	10	254	29	4	2	1	35	76	516	592
08:15 AM	23	87	1	0	111	21	1	43	27	65	3	167	16	3	186	6	3	1	0	10	30	372	402	08:30 AM	20	83	1	0	104	37	1	49	30	87	6	166	28	11	200	6	3	0	0	9	41	400	441
08:45 AM	24	93	4	0	121	23	0	49	37	72	3	160	22	2	185	10	4	2	2	16	41	394	435	Total	92	364	7	0	463	115	2	207	159	324	17	714	94	26	825	51	14	5	3	70	188	1682	1870
Grand Total	390	816	22	6	1228	344	81	592	362	1017	55	1467	282	96	1804	105	64	15	7	184	471	4233	4704	% Approach	31.8	66.4	1.8																				
% Total	9.2	19.3	0.5			8.1	1.9	14		24	1.3	34.7	6.7		42.6	2.5	1.5	0.4		4.3	10	90																									

Start Time	Trautwein Road Southbound					Orange Terrace Parkway Westbound					Trautwein Road Northbound					Orange Terrace Parkway Eastbound																															
	Left	Thru	Right	RTOR	App. Total	Left	Thru	Right	App. Total	Left	Thru	Right	RTOR	App. Total	Left	Thru	Right	RTOR	App. Total	Left	Thru	Right	RTOR	App. Total	Left	Thru	Right	RTOR	App. Total	Left	Thru	Right	RTOR	App. Total	Int. Total												
	07:00 AM	94	100	3	1	197	49	14	99	61	162	9	169	35	17	213	5	19	3	2	27	81	599	680	07:15 AM	96	149	3	2	248	88	32	110	55	230	6	192	55	11	253	14	11	4	2	29	70	760
07:30 AM	79	126	5	1	210	66	27	91	40	184	11	197	63	28	271	15	12	0	0	27	69	692	761	07:45 AM	29	77	4	2	110	26	6	85	47	117	12	195	35	14	242	20	8	3	0	31	63	500	563
Total Volume	298	452	15	6	765	229	79	385	203	693	38	753	188	70	979	54	50	10	4	114	283	2551	2834	% App. Total	39	59.1	2																				
PHF	.776	.758	.750		.771	.651	.617	.875	.763	.753	.792	.956	.746		.903	.675	.658	.625		.919																											

Peak Hour Analysis From 07:00 AM to 07:45 AM - Peak 1 of 1
 Peak Hour for Entire Intersection Begins at 07:00 AM

Counts Unlimited, Inc.
 PO Box 1178
 Corona, CA 92878
 (951)268-6268

City of Riverside
 N/S: Trautwein Road
 E/W: Orange Terrace Parkway
 Weather: Clear

File Name : 07_RIV_Traut_Orange AM
 Site Code : 05121716
 Start Date : 11/30/2021
 Page No : 2

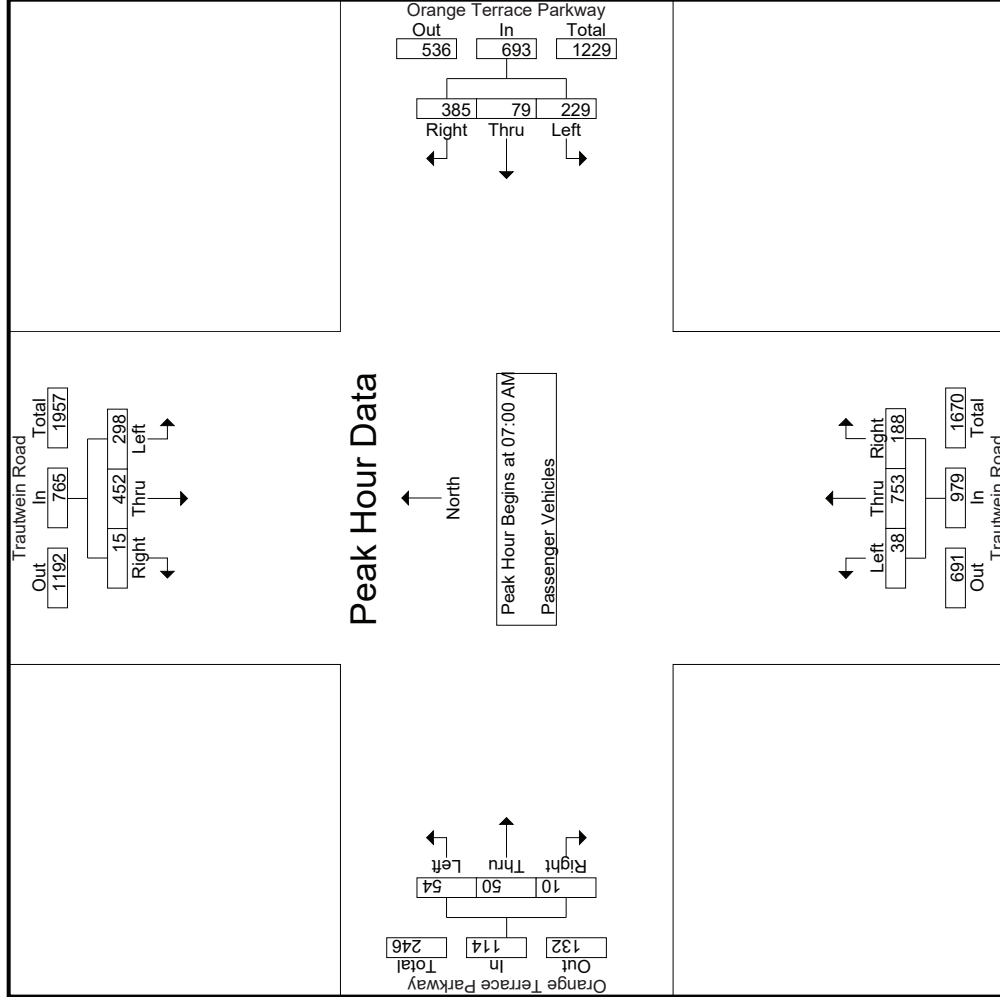

Counts Unlimited, Inc.
 PO Box 1178
 Corona, CA 92878
 (951)268-6268

File Name : 07_RIV_Traut_Orange AM
 Site Code : 05121716
 Start Date : 11/30/2021
 Page No : 3

City of Riverside
 N/S: Trautwein Road
 E/W: Orange Terrace Parkway
 Weather: Clear

Start Time	Trautwein Road Southbound			Orange Terrace Parkway Westbound			Trautwein Road Northbound			Orange Terrace Parkway Eastbound		
	Left	Thru	Right	Left	Thru	Right	Left	Thru	Right	Left	Thru	Right
Peak Hour Analysis From 07:00 AM to 07:45 AM - Peak 1 of 1												
Peak Hour for Each Approach Begins at:												
+0 mins.	94	100	3	49	14	99	9	169	35	5	19	3
+15 mins.	96	149	3	88	32	110	6	192	55	14	11	4
+30 mins.	79	126	5	66	27	91	11	197	63	15	12	0
+45 mins.	29	77	4	26	6	85	12	195	35	20	8	3
Total Volume	298	452	15	229	79	385	38	753	188	54	50	10
% App. Total	39	59.1	2	33	11.4	55.6	3.9	76.9	19.2	47.4	43.9	8.8
PHF	.776	.758	.750	.651	.617	.875	.792	.956	.746	.675	.658	.625

Counts Unlimited, Inc.
 PO Box 1178
 Corona, CA 92878
 (951)268-6268

File Name : 07_RIV_Traut_Orange AM
 Site Code : 05121716
 Start Date : 11/30/2021
 Page No : 1

City of Riverside
 N/S: Trautwein Road
 EW: Orange Terrace Parkway
 Weather: Clear

Groups Printed- Large 2 Axle Vehicles

Start Time	Trautwein Road Southbound				Orange Terrace Parkway Westbound				Trautwein Road Northbound				Orange Terrace Parkway Eastbound											
	Left	Thru	Right	RTOR	Left	Thru	Right	RTOR	Left	Thru	Right	RTOR	Left	Thru	Right	RTOR	Left	Thru	Right	RTOR	Exclu. Total	Inclu. Total	Int. Total	
07:00 AM	5	1	0	0	1	0	0	0	1	9	3	1	13	0	0	0	0	0	0	0	0	1	20	21
07:15 AM	1	2	1	1	1	0	3	1	4	0	7	1	8	0	0	0	0	0	0	0	0	2	16	18
07:30 AM	2	4	0	0	1	1	1	1	3	0	7	0	7	0	1	0	0	1	1	0	1	1	17	18
07:45 AM	1	4	0	0	0	0	1	0	1	0	6	1	7	0	0	0	0	0	0	0	0	0	13	13
Total	9	11	1	1	3	1	5	2	9	1	29	5	35	0	1	0	0	1	4	66	70			
08:00 AM	0	5	0	0	1	0	0	0	1	0	9	1	10	0	0	0	0	0	0	0	0	0	16	16
08:15 AM	0	2	0	0	2	0	2	0	2	0	6	0	6	0	0	0	0	0	0	0	0	0	10	10
08:30 AM	0	0	1	0	1	0	1	1	2	0	8	0	8	0	0	0	0	0	0	0	0	1	11	12
08:45 AM	1	2	0	0	1	0	0	0	1	0	2	1	3	0	0	0	0	0	0	0	0	1	7	8
Total	1	9	1	0	3	0	3	1	6	0	25	2	27	0	0	0	0	0	2	44	46			
Grand Total	10	20	2	1	6	1	8	3	15	1	54	7	62	0	1	0	0	1	6	110	116			
% Apprch %	31.2	62.5	6.2		40	6.7	53.3		13.6	1.6	87.1	11.3	56.4	0	100	0	0	0.9	5.2	94.8				
% Total %	9.1	18.2	1.8		5.5	0.9	7.3			0.9	49.1	6.4		0	0.9	0								

Start Time	Trautwein Road Southbound				Orange Terrace Parkway Westbound				Trautwein Road Northbound				Orange Terrace Parkway Eastbound											
	Left	Thru	Right	RTOR	Left	Thru	Right	RTOR	Left	Thru	Right	RTOR	Left	Thru	Right	RTOR	Left	Thru	Right	RTOR	Exclu. Total	Inclu. Total	Int. Total	
07:00 AM	5	1	0	0	1	0	0	0	1	9	3	1	13	0	0	0	0	0	0	0	0	1	20	21
07:15 AM	1	2	1	1	1	0	3	1	4	0	7	1	8	0	0	0	0	0	0	0	0	2	16	18
07:30 AM	2	4	0	0	1	1	1	1	3	0	7	0	7	0	1	0	0	1	1	0	1	1	17	18
07:45 AM	1	4	0	0	0	0	1	0	1	0	6	1	7	0	0	0	0	0	0	0	0	0	13	13
Total	9	11	1	1	3	1	5	2	9	1	29	5	35	0	1	0	0	1	4	66	70			
08:00 AM	0	5	0	0	1	0	0	0	1	0	9	1	10	0	0	0	0	0	0	0	0	0	16	16
08:15 AM	0	2	0	0	2	0	2	0	2	0	6	0	6	0	0	0	0	0	0	0	0	0	10	10
08:30 AM	0	0	1	0	1	0	1	1	2	0	8	0	8	0	0	0	0	0	0	0	0	1	11	12
08:45 AM	1	2	0	0	1	0	0	0	1	0	2	1	3	0	0	0	0	0	0	0	0	1	7	8
Total	1	9	1	0	3	0	3	1	6	0	25	2	27	0	0	0	0	0	2	44	46			
Grand Total	10	20	2	1	6	1	8	3	15	1	54	7	62	0	1	0	0	1	6	110	116			
% Apprch %	31.2	62.5	6.2		40	6.7	53.3		13.6	1.6	87.1	11.3	56.4	0	100	0	0	0.9	5.2	94.8				
% Total %	9.1	18.2	1.8		5.5	0.9	7.3			0.9	49.1	6.4		0	0.9	0								

Peak Hour Analysis From 07:00 AM to 07:45 AM - Peak 1 of 1
 Peak Hour for Entire Intersection Begins at 07:00 AM

Start Time	Trautwein Road Southbound				Orange Terrace Parkway Westbound				Trautwein Road Northbound				Orange Terrace Parkway Eastbound											
	Left	Thru	Right	RTOR	Left	Thru	Right	RTOR	Left	Thru	Right	RTOR	Left	Thru	Right	RTOR	Left	Thru	Right	RTOR	Exclu. Total	Inclu. Total	Int. Total	
07:00 AM	5	1	0	0	1	0	0	0	1	9	3	1	13	0	0	0	0	0	0	0	0	1	20	21
07:15 AM	1	2	1	1	1	0	3	1	4	0	7	1	8	0	0	0	0	0	0	0	0	2	16	18
07:30 AM	2	4	0	0	1	1	1	1	3	0	7	0	7	0	1	0	0	1	1	0	1	1	17	18
07:45 AM	1	4	0	0	0	0	1	0	1	0	6	1	7	0	0	0	0	0	0	0	0	0	13	13
Total Volume	9	11	1	1	3	1	5	2	9	1	29	5	35	0	1	0	0	1	4	66	70			
% App. Total	42.9	52.4	4.8		33.3	11.1	55.6		56.3	2.9	82.9	14.3		0	100	0								
PHF	.450	.688	.250		.750	.250	.417		.563	.250	.806	.417		.673	.000	.250	.000	.250	.000	.250	.825			

Counts Unlimited, Inc.
 PO Box 1178
 Corona, CA 92878
 (951)268-6268

City of Riverside
 N/S: Trautwein Road
 EW: Orange Terrace Parkway
 Weather: Clear

File Name : 07_RIV_Traut_Orange AM
 Site Code : 05121716
 Start Date : 11/30/2021
 Page No : 2

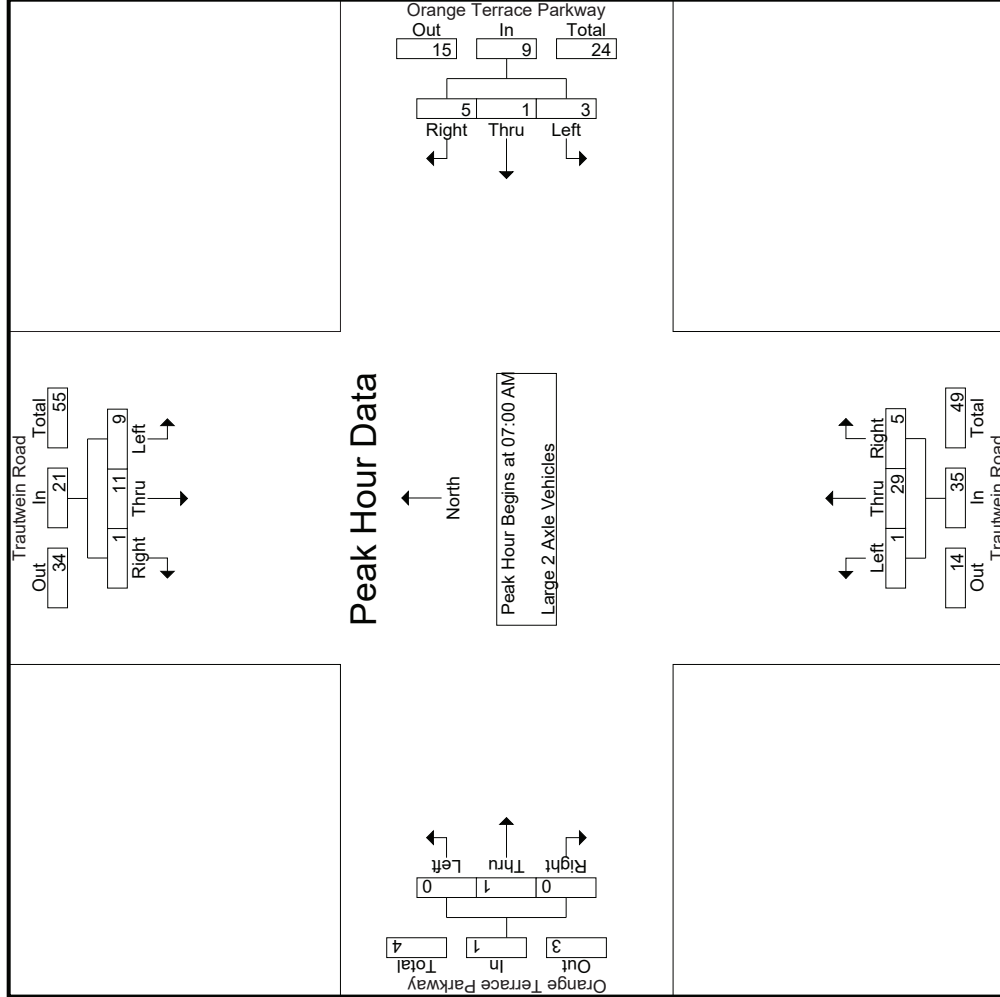

Start Time	Trautwein Road Southbound			Orange Terrace Parkway Westbound			Trautwein Road Northbound			Orange Terrace Parkway Eastbound					
	Left	Thru	Right	Left	Thru	Right	Left	Thru	Right	Left	Thru	Right			
Peak Hour Analysis From 07:00 AM to 07:45 AM - Peak 1 of 1															
Peak Hour for Each Approach Begins at:	07:00 AM			07:00 AM			07:00 AM			07:00 AM					
+0 mins.	5	1	0	1	0	0	1	1	3	9	7	1	0	0	0
+15 mins.	1	2	1	1	0	3	4	0	1	7	1	1	0	0	0
+30 mins.	2	4	0	1	1	1	3	0	0	7	0	0	1	0	1
+45 mins.	1	4	0	0	0	1	1	0	1	6	1	1	0	0	0
Total Volume	9	11	1	3	1	5	9	1	5	29	9	5	1	1	1
% App. Total	42.9	52.4	4.8	33.3	11.1	55.6	2.9	82.9	14.3	82.9	14.3	100	0	0	0
PHF	.450	.688	.250	.750	.250	.417	.563	.250	.417	.806	.417	.250	.000	.000	.250

Counts Unlimited, Inc.
 PO Box 1178
 Corona, CA 92878
 (951)268-6268

File Name : 07_RIV_Traut_Orange AM
 Site Code : 05121716
 Start Date : 11/30/2021
 Page No : 1

City of Riverside
 N/S: Trautwein Road
 EW: Orange Terrace Parkway
 Weather: Clear

Groups Printed- 3 Axle Vehicles

Start Time	Trautwein Road Southbound				Orange Terrace Parkway Westbound				Trautwein Road Northbound				Orange Terrace Parkway Eastbound											
	Left	Thru	Right	RTOR	App. Total	Left	Thru	Right	RTOR	App. Total	Left	Thru	Right	RTOR	App. Total	Left	Thru	Right	RTOR	App. Total	Exclu. Total	Inclu. Total	Int. Total	
07:00 AM	0	0	0	0	0	0	0	0	0	0	0	0	0	0	0	0	0	0	0	0	0	0	0	0
07:15 AM	1	2	0	0	3	0	0	0	0	0	0	0	0	0	0	0	0	0	0	0	0	0	3	3
07:30 AM	0	2	0	0	2	0	0	0	1	1	0	0	0	0	0	0	0	0	0	0	0	1	3	4
07:45 AM	0	0	0	0	0	0	0	0	0	0	0	1	0	0	1	0	0	0	0	0	0	0	1	1
Total	1	4	0	0	5	0	0	1	1	1	0	1	0	0	1	0	0	0	0	0	0	1	7	8
08:00 AM	0	1	0	0	1	0	0	0	0	0	0	1	0	0	1	0	0	0	0	0	0	0	2	2
08:15 AM	0	0	0	0	0	0	0	0	0	0	0	1	0	0	1	0	0	0	0	0	0	0	1	1
08:30 AM	0	0	0	0	0	0	0	0	0	0	0	3	0	0	3	0	0	0	0	0	0	0	3	3
08:45 AM	1	0	0	0	1	0	0	0	0	0	0	0	0	0	0	0	0	0	0	0	0	0	1	1
Total	1	1	0	0	2	0	0	0	0	0	0	5	0	0	5	0	0	0	0	0	0	0	7	7
Grand Total	2	5	0	0	7	0	0	1	1	1	0	6	0	0	6	0	0	0	0	0	0	1	14	15
Apprch %	28.6	71.4	0	0	100	0	0	7.1	7.1	7.1	0	100	0	0	42.9	0	0	0	0	0	0	6.7	93.3	
Total %	14.3	35.7	0	0	50	0	0	7.1	7.1	7.1	0	42.9	0	0	42.9	0	0	0	0	0	0	6.7	93.3	

Start Time	Trautwein Road Southbound				Orange Terrace Parkway Westbound				Trautwein Road Northbound				Orange Terrace Parkway Eastbound											
	Left	Thru	Right	RTOR	App. Total	Left	Thru	Right	RTOR	App. Total	Left	Thru	Right	RTOR	App. Total	Left	Thru	Right	RTOR	App. Total	Exclu. Total	Inclu. Total	Int. Total	
07:00 AM	0	0	0	0	0	0	0	0	0	0	0	0	0	0	0	0	0	0	0	0	0	0	0	0
07:15 AM	1	2	0	0	3	0	0	0	0	0	0	0	0	0	0	0	0	0	0	0	0	0	3	3
07:30 AM	0	2	0	0	2	0	0	0	1	1	0	0	0	0	0	0	0	0	0	0	0	1	3	4
07:45 AM	0	0	0	0	0	0	0	0	0	0	0	1	0	0	1	0	0	0	0	0	0	0	1	1
Total	1	4	0	0	5	0	0	1	1	1	0	1	0	0	1	0	0	0	0	0	0	1	7	8
08:00 AM	0	1	0	0	1	0	0	0	0	0	0	1	0	0	1	0	0	0	0	0	0	0	2	2
08:15 AM	0	0	0	0	0	0	0	0	0	0	0	1	0	0	1	0	0	0	0	0	0	0	1	1
08:30 AM	0	0	0	0	0	0	0	0	0	0	0	3	0	0	3	0	0	0	0	0	0	0	3	3
08:45 AM	1	0	0	0	1	0	0	0	0	0	0	0	0	0	0	0	0	0	0	0	0	0	1	1
Total	1	1	0	0	2	0	0	0	0	0	0	5	0	0	5	0	0	0	0	0	0	0	7	7
Grand Total	2	5	0	0	7	0	0	1	1	1	0	6	0	0	6	0	0	0	0	0	0	1	14	15
Apprch %	28.6	71.4	0	0	100	0	0	7.1	7.1	7.1	0	100	0	0	42.9	0	0	0	0	0	0	6.7	93.3	
Total %	14.3	35.7	0	0	50	0	0	7.1	7.1	7.1	0	42.9	0	0	42.9	0	0	0	0	0	0	6.7	93.3	

Peak Hour Analysis From 07:00 AM to 07:45 AM - Peak 1 of 1
 Peak Hour for Entire Intersection Begins at 07:00 AM

Start Time	Trautwein Road Southbound				Orange Terrace Parkway Westbound				Trautwein Road Northbound				Orange Terrace Parkway Eastbound											
	Left	Thru	Right	RTOR	App. Total	Left	Thru	Right	RTOR	App. Total	Left	Thru	Right	RTOR	App. Total	Left	Thru	Right	RTOR	App. Total	Exclu. Total	Inclu. Total	Int. Total	
07:00 AM	0	0	0	0	0	0	0	0	0	0	0	0	0	0	0	0	0	0	0	0	0	0	0	0
07:15 AM	1	2	0	0	3	0	0	0	0	0	0	0	0	0	0	0	0	0	0	0	0	0	3	3
07:30 AM	0	2	0	0	2	0	0	0	1	1	0	0	0	0	0	0	0	0	0	0	0	0	3	4
07:45 AM	0	0	0	0	0	0	0	0	0	0	0	1	0	0	1	0	0	0	0	0	0	0	1	1
Total Volume	1	4	0	0	5	0	0	1	1	1	0	1	0	0	1	0	0	0	0	0	0	0	7	7
% App. Total	20	80	0	0	100	0	0	100	0	100	0	100	0	0	100	0	0	0	0	0	0	0	100	100
PHF	.250	.500	.000	.000	.417	.000	.000	.250	.250	.250	.000	.250	.000	.000	.250	.000	.000	.000	.000	.000	.000	.000	.583	.583

Counts Unlimited, Inc.
 PO Box 1178
 Corona, CA 92878
 (951)268-6268

City of Riverside
 N/S: Trautwein Road
 E/W: Orange Terrace Parkway
 Weather: Clear

File Name : 07_RIV_Traut_Orange AM
 Site Code : 05121716
 Start Date : 11/30/2021
 Page No : 2

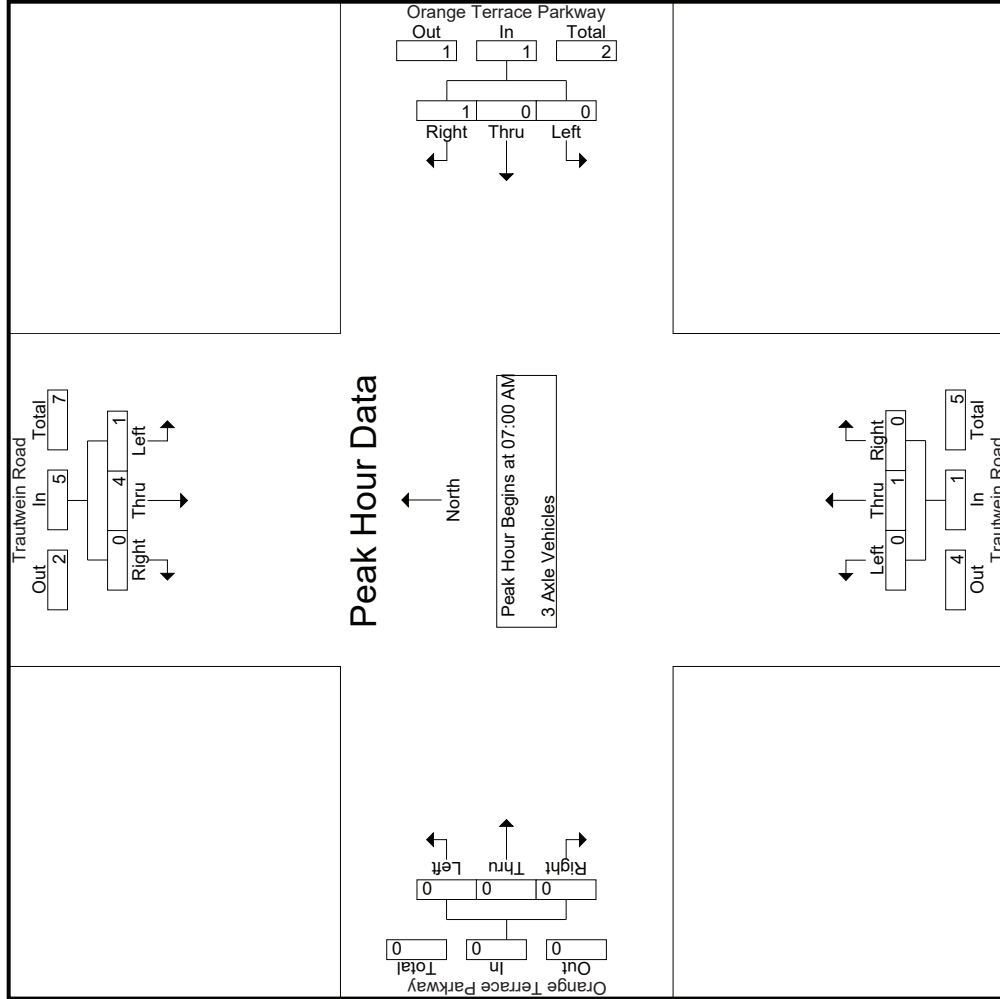

Counts Unlimited, Inc.
 PO Box 1178
 Corona, CA 92878
 (951)268-6268

File Name : 07_RIV_Traut_Orange AM
 Site Code : 05121716
 Start Date : 11/30/2021
 Page No : 3

City of Riverside
 N/S: Trautwein Road
 EW: Orange Terrace Parkway
 Weather: Clear

Start Time	Trautwein Road Southbound			Orange Terrace Parkway Westbound			Trautwein Road Northbound			Orange Terrace Parkway Eastbound		
	Left	Thru	Right	Left	Thru	Right	Left	Thru	Right	Left	Thru	Right
Peak Hour Analysis From 07:00 AM to 07:45 AM - Peak 1 of 1												
Peak Hour for Each Approach Begins at:												
	07:00 AM			07:00 AM			07:00 AM			07:00 AM		
+0 mins.	0	0	0	0	0	0	0	0	0	0	0	0
+15 mins.	1	2	0	3	0	0	0	0	0	0	0	0
+30 mins.	0	2	0	2	0	1	0	0	0	0	0	0
+45 mins.	0	0	0	0	0	0	0	1	0	0	0	0
Total Volume	1	4	0	5	0	1	0	1	0	0	0	0
% App. Total	20	80	0	100	0	100	0	100	0	0	0	0
PHF	.250	.500	.000	.417	.000	.250	.000	.250	.000	.250	.000	.000

Counts Unlimited, Inc.
 PO Box 1178
 Corona, CA 92878
 (951)268-6268

File Name : 07_RIV_Traut_Orange AM
 Site Code : 05121716
 Start Date : 11/30/2021
 Page No : 1

City of Riverside
 N/S: Trautwein Road
 EW: Orange Terrace Parkway
 Weather: Clear

Groups Printed- 4+ Axle Trucks

Start Time	Trautwein Road Southbound				Orange Terrace Parkway Westbound				Trautwein Road Northbound				Orange Terrace Parkway Eastbound											
	Left	Thru	Right	RTOR	App. Total	Left	Thru	Right	RTOR	App. Total	Left	Thru	Right	RTOR	App. Total	Left	Thru	Right	RTOR	App. Total	Exclu. Total	Inclu. Total	Int. Total	
07:00 AM	0	0	0	0	0	0	0	0	0	0	0	0	0	0	0	0	0	0	0	0	0	0	0	0
07:15 AM	0	0	0	0	0	0	0	0	0	0	0	0	0	0	0	0	0	0	0	0	0	0	0	0
07:30 AM	0	0	0	0	0	0	0	0	0	0	0	0	0	0	0	0	0	0	0	0	0	0	0	0
07:45 AM	0	0	0	0	0	0	0	0	0	0	0	2	0	0	2	0	0	0	0	0	0	0	2	2
Total	0	0	0	0	0	0	0	0	0	0	0	2	0	0	2	0	0	0	0	0	0	0	2	2
08:00 AM	0	0	0	0	0	0	0	0	0	0	0	0	0	0	0	0	0	0	0	0	0	0	0	0
08:15 AM	0	2	0	0	2	0	0	0	0	0	0	0	0	0	0	0	0	0	0	0	0	0	0	2
08:30 AM	0	1	0	0	1	0	0	0	0	0	0	0	0	0	0	0	0	0	0	0	0	0	1	1
08:45 AM	0	0	0	0	0	0	0	0	0	0	0	0	0	0	0	0	0	0	0	0	0	0	0	0
Total	0	3	0	0	3	0	0	0	0	0	0	0	0	0	0	0	0	0	0	0	0	0	3	3
Grand Total	0	3	0	0	3	0	0	0	0	0	0	2	0	0	2	0	0	0	0	0	0	0	5	5
% Apprch %	0	100	0	0	60	0	0	0	0	0	0	100	0	0	40	0	0	0	0	0	0	0	100	100
% Total %	0	60	0	0	60	0	0	0	0	0	0	40	0	0	40	0	0	0	0	0	0	0	100	100

Start Time	Trautwein Road Southbound				Orange Terrace Parkway Westbound				Trautwein Road Northbound				Orange Terrace Parkway Eastbound											
	Left	Thru	Right	RTOR	App. Total	Left	Thru	Right	RTOR	App. Total	Left	Thru	Right	RTOR	App. Total	Left	Thru	Right	RTOR	App. Total	Exclu. Total	Inclu. Total	Int. Total	
07:00 AM	0	0	0	0	0	0	0	0	0	0	0	0	0	0	0	0	0	0	0	0	0	0	0	0
07:15 AM	0	0	0	0	0	0	0	0	0	0	0	0	0	0	0	0	0	0	0	0	0	0	0	0
07:30 AM	0	0	0	0	0	0	0	0	0	0	0	0	0	0	0	0	0	0	0	0	0	0	0	0
07:45 AM	0	0	0	0	0	0	0	0	0	0	0	2	0	0	2	0	0	0	0	0	0	0	2	2
Total Volume	0	0	0	0	0	0	0	0	0	0	0	2	0	0	2	0	0	0	0	0	0	0	2	2
% App. Total	0	0	0	0	0	0	0	0	0	0	0	100	0	0	100	0	0	0	0	0	0	0	100	100
PHF	.000	.000	.000	.000	.000	.000	.000	.000	.000	.000	.000	.250	.000	.000	.250	.000	.000	.000	.000	.000	.000	.000	.250	.250

Peak Hour Analysis From 07:00 AM to 07:45 AM - Peak 1 of 1
 Peak Hour for Entire Intersection Begins at 07:00 AM

Counts Unlimited, Inc.
 PO Box 1178
 Corona, CA 92878
 (951)268-6268

City of Riverside
 N/S: Trautwein Road
 E/W: Orange Terrace Parkway
 Weather: Clear

File Name : 07_RIV_Traut_Orange AM
 Site Code : 05121716
 Start Date : 11/30/2021
 Page No : 2

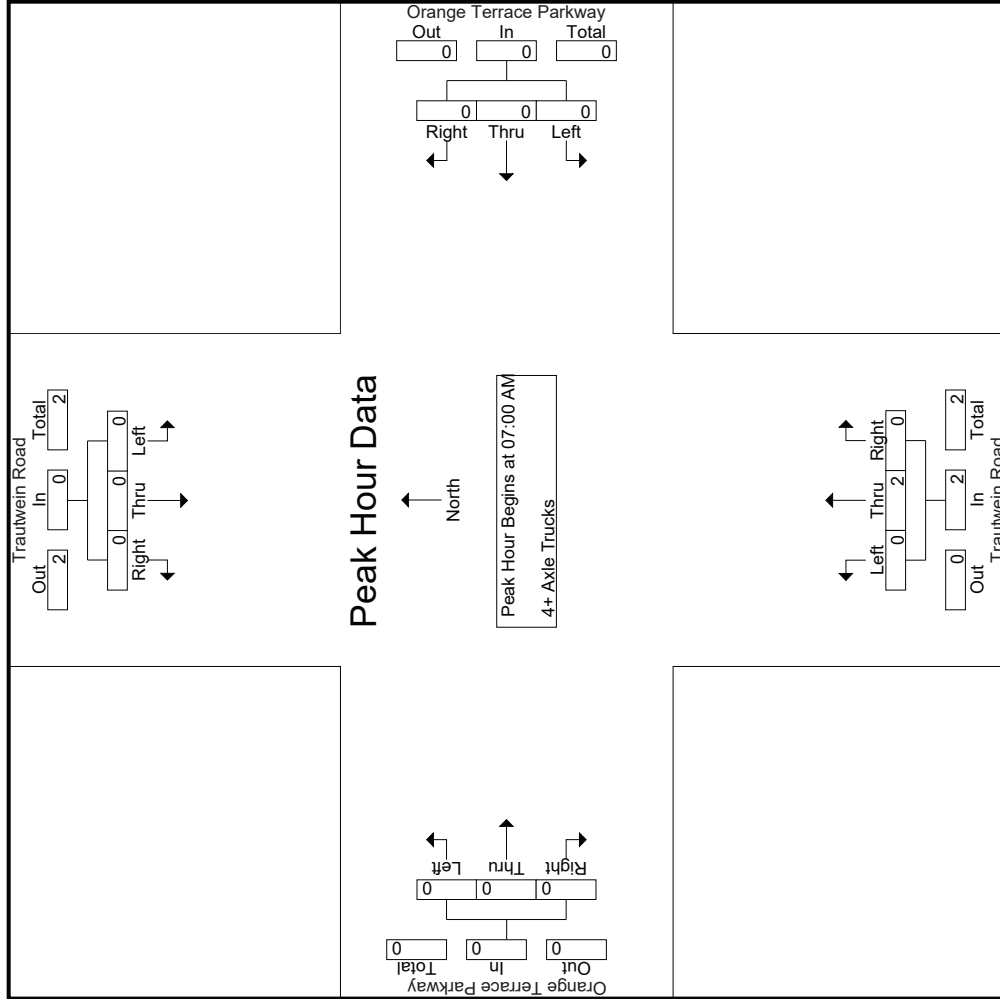

Counts Unlimited, Inc.
 PO Box 1178
 Corona, CA 92878
 (951)268-6268

File Name : 07_RIV_Traut_Orange AM
 Site Code : 05121716
 Start Date : 11/30/2021
 Page No : 3

City of Riverside
 N/S: Trautwein Road
 E/W: Orange Terrace Parkway
 Weather: Clear

Start Time	Trautwein Road Southbound			Orange Terrace Parkway Westbound			Trautwein Road Northbound			Orange Terrace Parkway Eastbound					
	Left	Thru	Right	Left	Thru	Right	Left	Thru	Right	Left	Thru	Right			
Peak Hour Analysis From 07:00 AM to 07:45 AM - Peak 1 of 1															
Peak Hour for Each Approach Begins at:															
+0 mins.	0	0	0	07:00 AM	0	0	0	07:00 AM	0	0	0	07:00 AM	0	0	0
+15 mins.	0	0	0	0	0	0	0	0	0	0	0	0	0	0	0
+30 mins.	0	0	0	0	0	0	0	0	0	0	0	0	0	0	0
+45 mins.	0	0	0	0	0	0	0	0	0	0	0	0	0	0	0
Total Volume	0	0	0	0	0	0	0	0	0	0	0	0	0	0	0
% App. Total	0	0	0	0	0	0	0	0	0	0	0	0	0	0	0
PHF	.000	.000	.000	.000	.000	.000	.000	.000	.000	.000	.000	.000	.000	.000	.000

Counts Unlimited, Inc.
 PO Box 1178
 Corona, CA 92878
 (951)268-6268

City of Riverside
 N/S: Trautwein Road
 E/W: Orange Terrace Parkway
 Weather: Clear

File Name : 07_RIV_Traut_Orange PM
 Site Code : 05121716
 Start Date : 11/30/2021
 Page No : 1

Groups Printed- Passenger Vehicles - Large 2 Axle Vehicles - 3 Axle Vehicles - 4+ Axle Trucks

Start Time	Trautwein Road Southbound						Orange Terrace Parkway Westbound						Trautwein Road Northbound						Orange Terrace Parkway Eastbound											
	Left		Thru		Right		Left		Thru		Right		Left		Thru		Right		Left		Thru		Right		Left		Thru		Right	
	Inclu.	Total	Inclu.	Total	Inclu.	Total	Inclu.	Total	Inclu.	Total	Inclu.	Total	Inclu.	Total	Inclu.	Total	Inclu.	Total	Inclu.	Total	Inclu.	Total	Inclu.	Total	Inclu.	Total	Inclu.	Total	Inclu.	Total
04:00 PM	68	202	7	1	277	33	4	60	47	97	6	131	30	15	167	5	12	4	1	21	64	562	626	64	562	626				
04:15 PM	79	257	16	3	352	25	2	46	36	73	11	171	44	19	226	8	10	2	1	20	59	671	730	59	671	730				
04:30 PM	47	239	6	2	292	36	2	30	21	68	4	166	43	19	213	5	14	4	1	23	43	596	639	43	596	639				
04:45 PM	100	214	8	3	322	36	12	41	33	89	11	160	50	16	221	16	8	3	0	27	52	659	711	52	659	711				
Total	294	912	37	9	1243	130	20	177	137	327	32	628	167	69	827	34	44	13	3	91	218	2488	2706	218	2488	2706				
05:00 PM	76	242	6	1	324	37	6	31	23	74	2	152	52	19	206	12	10	2	0	24	43	628	671	43	628	671				
05:15 PM	78	260	13	3	351	38	3	31	22	72	3	163	46	19	212	3	12	1	1	16	45	651	696	45	651	696				
05:30 PM	96	199	11	1	306	28	4	38	34	70	8	113	62	23	183	8	9	2	0	19	58	578	636	58	578	636				
05:45 PM	95	235	5	2	335	34	4	41	21	79	13	153	46	17	212	8	18	1	0	27	40	653	693	40	653	693				
Total	345	936	35	7	1316	137	17	141	100	295	26	581	206	78	813	31	49	6	1	86	186	2510	2696	186	2510	2696				
Grand Total	639	1848	72	16	2559	267	37	318	237	622	58	1209	373	147	1640	65	93	19	4	177	404	4998	5402	404	4998	5402				
Approach %	25	72.2	2.8		42.9	5.9	51.1			36.7	52.5	10.7			3.5	7.5	92.5													
Total %	12.8	37	1.4		51.2	5.3	0.7	6.4		12.4	1.2	24.2	7.5		32.8	1.3	1.9	0.4												
% Passenger Vehicles	630	1792	72		2510	265	37	312		848	58	1189	369		1762	65	93	19												
% Large 2 Axle Vehicles	98.6	97	100		97.5	99.3	100	98.1		98.7	100	98.3	98.9		99.3	100	100	100												
% 3 Axle Vehicles	1.4	2.6	0		2.2	0.7	0	1.9		1.3	0	1.2	1.1		0.7	0	0	0												
% 4+ Axle Trucks	0	0.3	0		0.2	0	0	0		0	0	0.2	0		0.1	0	0	0												

Start Time	Trautwein Road Southbound						Orange Terrace Parkway Westbound						Trautwein Road Northbound						Orange Terrace Parkway Eastbound											
	Left		Thru		Right		Left		Thru		Right		Left		Thru		Right		Left		Thru		Right		Left		Thru		Right	
	Inclu.	Total	Inclu.	Total	Inclu.	Total	Inclu.	Total	Inclu.	Total	Inclu.	Total	Inclu.	Total	Inclu.	Total	Inclu.	Total	Inclu.	Total	Inclu.	Total	Inclu.	Total	Inclu.	Total	Inclu.	Total	Inclu.	Total
04:15 PM	79	257	16		352	25	2	46	73	11	171	44		226	8	10	2		20	671										
04:30 PM	47	239	6		292	36	2	30	68	4	166	43		213	5	14	4		23	596										
04:45 PM	100	214	8		322	36	12	41	89	11	160	50		221	16	8	3		27	659										
05:00 PM	76	242	6		324	37	6	31	74	2	152	52		206	12	10	2		24	628										
Total Volume	302	952	36		1290	134	22	148	304	28	649	189		866	41	42	11		94	2554										
% App. Total	23.4	73.8	2.8		44.1	7.2	48.7		44.1	43.6	44.7	11.7		44.7	43.6	44.7	11.7		44.7	688										
PHF	.755	.926	.563		.916	.905	.458		.804	.636	.949	.909		.958	.641	.750			.870	.952										

Peak Hour Analysis From 04:00 PM to 05:45 PM - Peak 1 of 1
 Peak Hour for Entire Intersection Begins at 04:15 PM

Counts Unlimited, Inc.
 PO Box 1178
 Corona, CA 92878
 (951)268-6268

City of Riverside
 N/S: Trautwein Road
 EW: Orange Terrace Parkway
 Weather: Clear

File Name : 07_RIV_Traut_Orange PM
 Site Code : 05121716
 Start Date : 11/30/2021
 Page No : 2

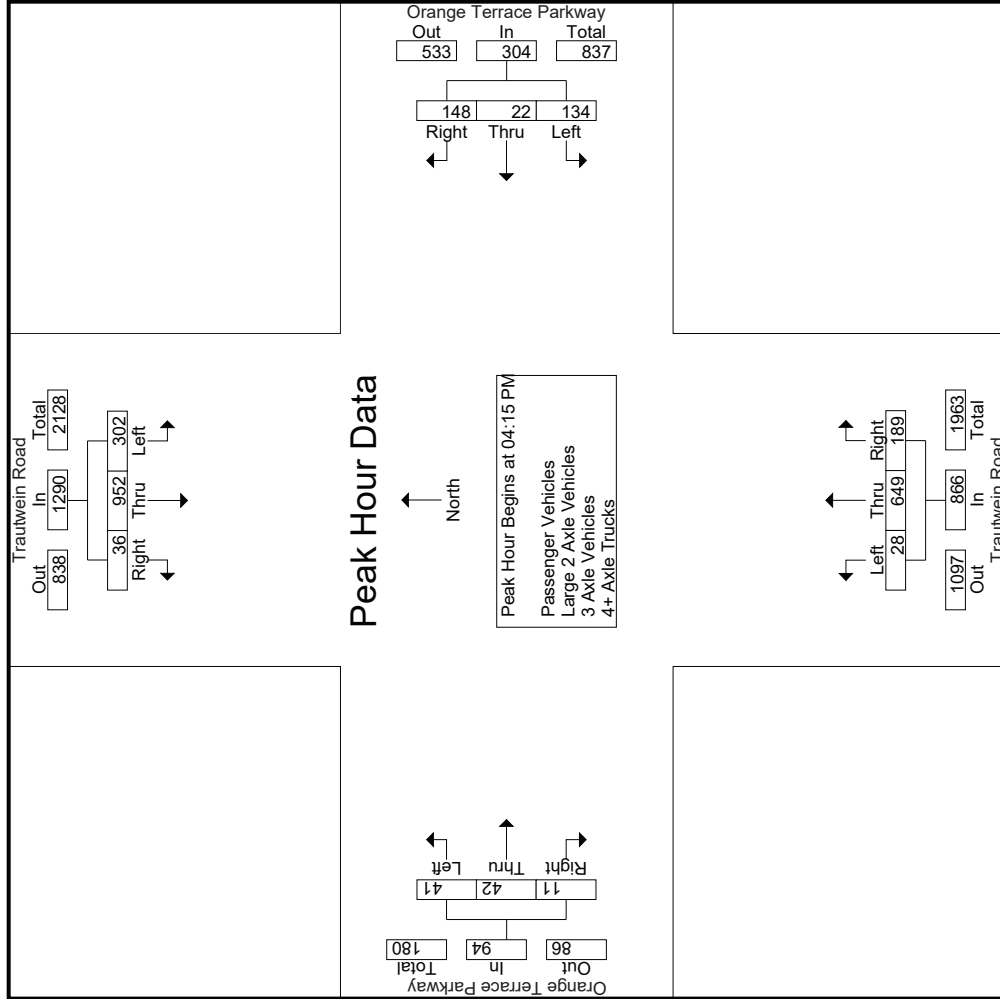

Counts Unlimited, Inc.
 PO Box 1178
 Corona, CA 92878
 (951)268-6268

File Name : 07_RIV_Traut_Orange PM
 Site Code : 05121716
 Start Date : 11/30/2021
 Page No : 3

City of Riverside
 N/S: Trautwein Road
 E/W: Orange Terrace Parkway
 Weather: Clear

Start Time	Trautwein Road Southbound			Orange Terrace Parkway Westbound			Trautwein Road Northbound			Orange Terrace Parkway Eastbound			
	Left	Thru	Right	Left	Thru	Right	Left	Thru	Right	Left	Thru	Right	
Peak Hour Analysis From 04:00 PM to 05:45 PM - Peak 1 of 1													
Peak Hour for Each Approach Begins at:													
	05:00 PM												
+0 mins.	76	242	6	33	4	60	97	11	171	44	8	10	2
+15 mins.	78	260	13	25	2	46	73	4	166	43	5	14	4
+30 mins.	96	199	11	36	2	30	68	11	160	50	16	8	3
+45 mins.	95	235	5	36	12	41	89	2	152	52	12	10	2
Total Volume	345	936	35	130	20	177	327	28	649	189	41	42	11
% App. Total	26.2	71.1	2.7	39.8	6.1	54.1	84.3	3.2	74.9	21.8	43.6	44.7	11.7
PHF	.898	.900	.673	.903	.417	.738	.843	.636	.949	.909	.641	.750	.688
			.937				.843			.958			.870

Counts Unlimited, Inc.
 PO Box 1178
 Corona, CA 92878
 (951)268-6268

File Name : 07_RIV_Traut_Orange PM
 Site Code : 05121716
 Start Date : 11/30/2021
 Page No : 1

City of Riverside
 N/S: Trautwein Road
 EW: Orange Terrace Parkway
 Weather: Clear

Groups Printed- Passenger Vehicles																				
Trautwein Road Southbound					Orange Terrace Parkway Westbound					Trautwein Road Northbound					Orange Terrace Parkway Eastbound					
Start Time	Left	Thru	Right	RTOR	App. Total	Left	Thru	Right	RTOR	App. Total	Left	Thru	Right	RTOR	App. Total	Left	Thru	Right	RTOR	App. Total
04:00 PM	68	196	7	1	271	33	4	59	47	96	6	128	30	15	164	5	12	4	1	21
04:15 PM	78	254	16	3	348	25	2	44	35	71	11	165	43	19	219	8	10	2	1	20
04:30 PM	47	235	6	2	288	35	2	30	21	67	4	165	42	18	211	5	14	4	1	23
04:45 PM	98	208	8	3	314	36	12	39	31	87	11	158	49	16	218	16	8	3	0	27
Total	291	893	37	9	1221	129	20	172	134	321	32	616	164	68	812	34	44	13	3	91
05:00 PM	74	235	6	1	315	37	6	31	23	74	2	150	52	19	204	12	10	2	0	24
05:15 PM	76	245	13	3	334	38	3	30	22	71	3	160	45	19	208	3	12	1	1	16
05:30 PM	94	190	11	1	295	27	4	38	34	69	8	112	62	23	182	8	9	2	0	19
05:45 PM	95	229	5	2	329	34	4	41	21	79	13	151	46	17	210	8	18	1	0	27
Total	339	899	35	7	1273	136	17	140	100	293	26	573	205	78	804	31	49	6	1	86
Grand Total	630	1792	72	16	2494	265	37	312	234	614	58	1189	369	146	1616	65	93	19	4	177
% Approach	25.3	71.9	2.9		43.2	43.2	6	50.8		12.5	3.6	73.6	22.8		33	36.7	52.5	10.7		3.6
% Total	12.9	36.6	1.5		50.9	5.4	0.8	6.4			1.2	24.3	7.5			1.3	1.9	0.4		7.5
Trautwein Road Southbound					Orange Terrace Parkway Westbound					Trautwein Road Northbound					Orange Terrace Parkway Eastbound					
Start Time	Left	Thru	Right	RTOR	App. Total	Left	Thru	Right	RTOR	App. Total	Left	Thru	Right	RTOR	App. Total	Left	Thru	Right	RTOR	App. Total
04:15 PM	78	254	16	3	348	25	2	44	35	71	11	165	43	19	219	8	10	2	1	20
04:30 PM	47	235	6	2	288	35	2	30	21	67	4	165	42	18	211	5	14	4	1	23
04:45 PM	98	208	8	3	314	36	12	39	31	87	11	158	49	16	218	16	8	3	0	27
05:00 PM	297	932	36	9	1265	133	22	144	299	28	638	186	852	41	42	43.6	44.7	11.7		94
Total Volume	23.5	73.7	2.8		44.5	44.5	7.4	48.2		12.5	3.3	74.9	21.8		33	36.7	52.5	10.7		3.6
% App. Total	7.58	91.7	.563		.909	.899	.458	.818		.859	.636	.967	.894		.973	.641	.750	.688		.870
PHF																				

Peak Hour Analysis From 04:15 PM to 05:00 PM - Peak 1 of 1
 Peak Hour for Entire Intersection Begins at 04:15 PM

Counts Unlimited, Inc.
 PO Box 1178
 Corona, CA 92878
 (951)268-6268

City of Riverside
 N/S: Trautwein Road
 E/W: Orange Terrace Parkway
 Weather: Clear

File Name : 07_RIV_Traut_Orange PM
 Site Code : 05121716
 Start Date : 11/30/2021
 Page No : 2

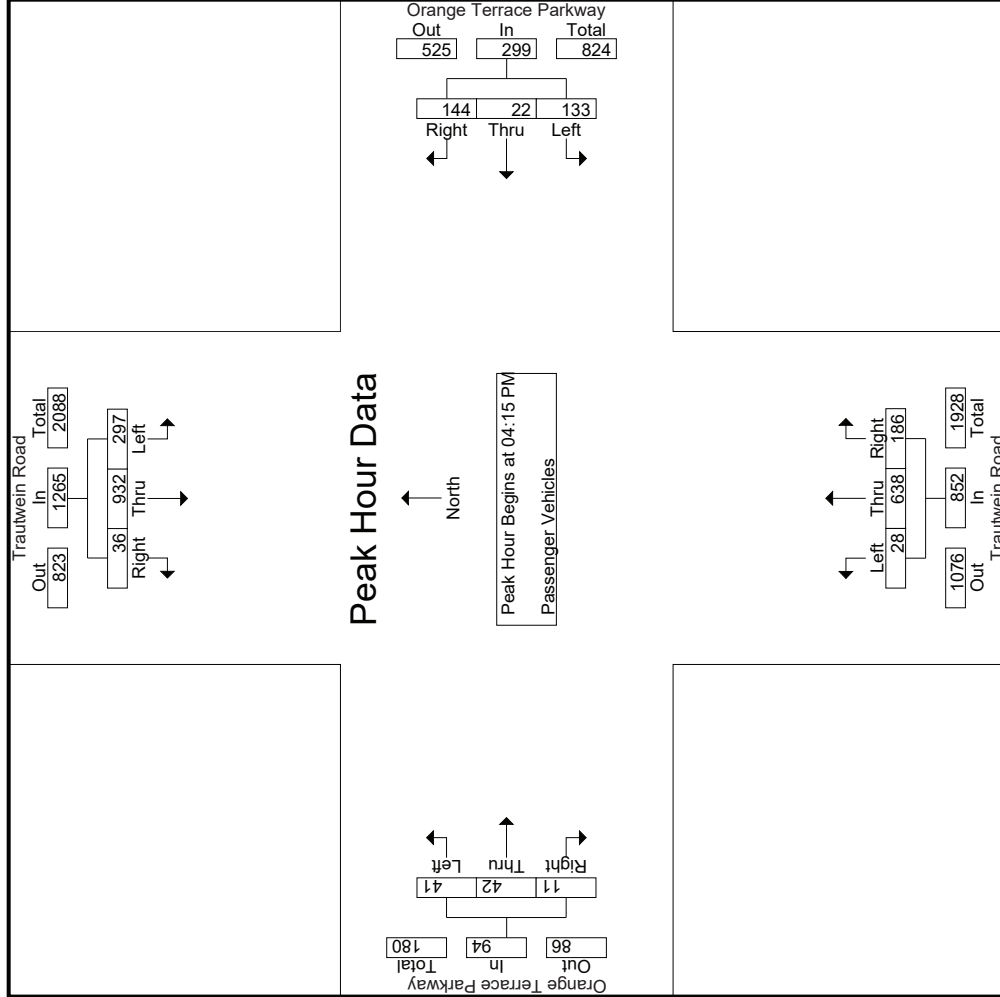

Counts Unlimited, Inc.
 PO Box 1178
 Corona, CA 92878
 (951)268-6268

File Name : 07_RIV_Traut_Orange PM
 Site Code : 05121716
 Start Date : 11/30/2021
 Page No : 3

City of Riverside
 N/S: Trautwein Road
 E/W: Orange Terrace Parkway
 Weather: Clear

Start Time	Trautwein Road Southbound			Orange Terrace Parkway Westbound			Trautwein Road Northbound			Orange Terrace Parkway Eastbound						
	Left	Thru	Right	App. Total	Left	Thru	Right	App. Total	Left	Thru	Right	App. Total	Int. Total			
Peak Hour Analysis From 04:15 PM to 05:00 PM - Peak 1 of 1																
Peak Hour for Each Approach Begins at:																
	04:15 PM															
+0 mins.	78	254	16	348	25	2	44	71	11	165	43	219	8	10	2	20
+15 mins.	47	235	6	288	35	2	30	67	4	165	42	211	5	14	4	23
+30 mins.	98	208	8	314	36	12	39	87	11	158	49	218	16	8	3	27
+45 mins.	74	235	6	315	37	6	31	74	2	150	52	204	12	10	2	24
Total Volume	297	932	36	1265	133	22	144	299	28	638	186	852	41	42	11	94
% App. Total	23.5	73.7	2.8		44.5	7.4	48.2		3.3	74.9	21.8		43.6	44.7	11.7	
PHF	.758	.917	.563	.909	.899	.458	.818	.859	.636	.967	.894	.973	.641	.750	.688	.870

Counts Unlimited, Inc.
 PO Box 1178
 Corona, CA 92878
 (951)268-6268

File Name : 07_RIV_Traut_Orange PM
 Site Code : 05121716
 Start Date : 11/30/2021
 Page No : 1

City of Riverside
 N/S: Trautwein Road
 EW: Orange Terrace Parkway
 Weather: Clear

Groups Printed- Large 2 Axle Vehicles

Start Time	Trautwein Road Southbound				Orange Terrace Parkway Westbound				Trautwein Road Northbound				Orange Terrace Parkway Eastbound					
	Left	Thru	Right	RTOR	App. Total	Left	Thru	Right	RTOR	App. Total	Left	Thru	Right	RTOR	App. Total	Exclu. Total	Inclu. Total	Int. Total
04:00 PM	0	2	0	0	2	0	0	1	0	1	0	2	0	0	0	0	5	5
04:15 PM	1	3	0	0	4	0	0	2	1	2	0	5	1	0	0	1	12	13
04:30 PM	0	3	0	0	3	1	0	1	0	1	1	1	1	0	0	1	6	7
04:45 PM	2	5	0	0	7	0	0	2	2	2	0	1	1	0	0	2	11	13
Total	3	13	0	0	16	1	0	5	3	6	0	9	3	1	12	4	34	38
05:00 PM	2	6	0	0	8	0	0	0	0	0	0	1	0	0	0	0	9	9
05:15 PM	2	14	0	0	16	0	1	0	0	1	0	3	1	0	4	0	21	21
05:30 PM	2	9	0	0	11	1	0	0	0	1	0	0	0	0	0	0	12	12
05:45 PM	0	6	0	0	6	0	0	0	0	0	2	0	0	0	0	0	8	8
Total	6	35	0	0	41	1	0	1	0	2	0	6	1	0	7	0	50	50
Grand Total	9	48	0	0	57	2	0	6	3	8	0	15	4	1	19	4	84	88
% Approach	15.8	84.2	0	0	67.9	25	0	75	0	9.5	0	78.9	21.1	0	22.6	0	95.5	95.5
% Total	10.7	57.1	0	0	67.9	2.4	0	7.1	0	9.5	0	17.9	4.8	0	22.6	0	95.5	95.5

Start Time	Trautwein Road Southbound				Orange Terrace Parkway Westbound				Trautwein Road Northbound				Orange Terrace Parkway Eastbound					
	Left	Thru	Right	RTOR	App. Total	Left	Thru	Right	RTOR	App. Total	Left	Thru	Right	RTOR	App. Total	Exclu. Total	Inclu. Total	Int. Total
04:15 PM	1	3	0	0	4	0	0	2	2	2	0	5	1	0	6	0	0	12
04:30 PM	0	3	0	0	3	1	0	0	1	1	0	1	1	0	2	0	0	6
04:45 PM	2	5	0	0	7	0	0	2	2	2	0	1	1	0	2	0	0	11
05:00 PM	2	6	0	0	8	0	0	0	0	0	0	0	0	0	1	0	0	9
Total Volume	5	17	0	0	22	1	0	4	5	5	0	8	3	0	11	0	0	38
% App. Total	22.7	77.3	0	0	80	20	0	80	0	72.7	27.3	0	0	0	0	0	0	38
PHF	.625	.708	.000	.688	.500	.250	.000	.500	.625	.400	.000	.458	.750	.000	.458	.000	.000	.792

Peak Hour Analysis From 04:15 PM to 05:00 PM - Peak 1 of 1
 Peak Hour for Entire Intersection Begins at 04:15 PM

Counts Unlimited, Inc.
 PO Box 1178
 Corona, CA 92878
 (951)268-6268

City of Riverside
 N/S: Trautwein Road
 E/W: Orange Terrace Parkway
 Weather: Clear

File Name : 07_RIV_Traut_Orange PM
 Site Code : 05121716
 Start Date : 11/30/2021
 Page No : 2

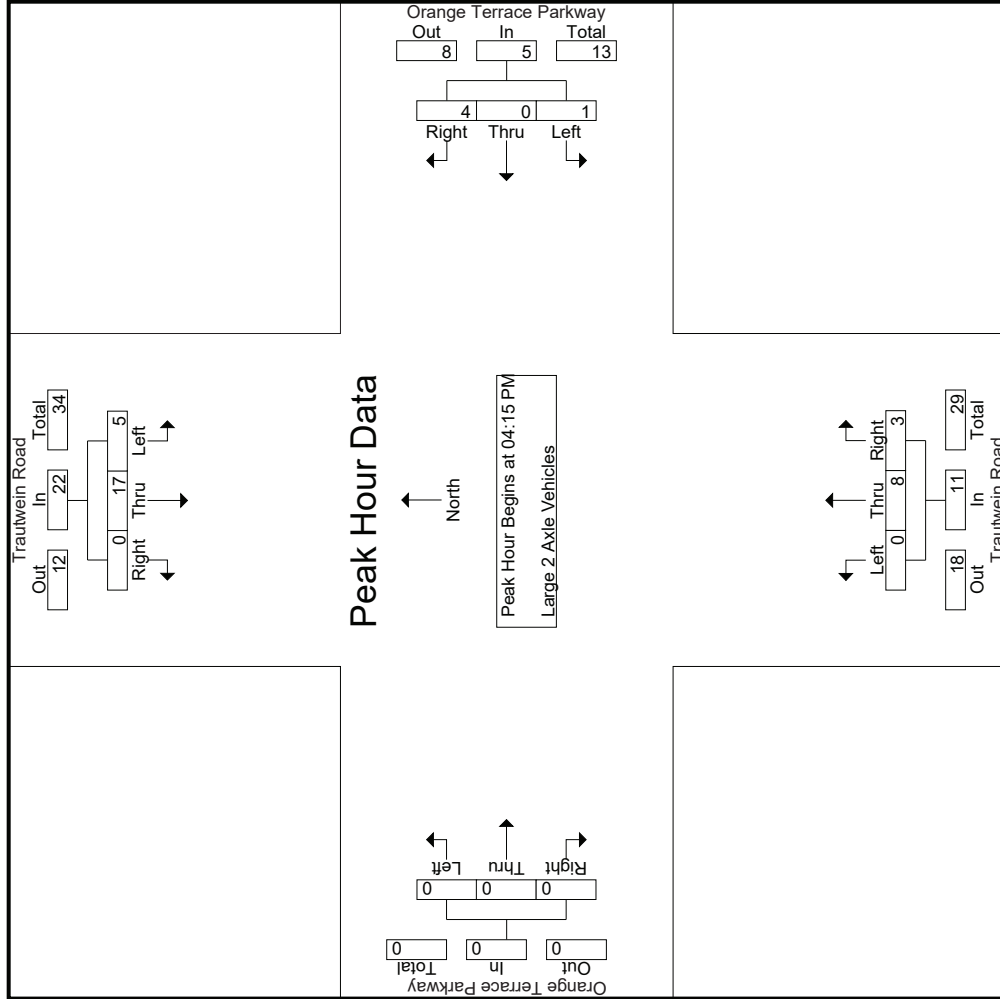

Counts Unlimited, Inc.
 PO Box 1178
 Corona, CA 92878
 (951)268-6268

File Name : 07_RIV_Traut_Orange PM
 Site Code : 05121716
 Start Date : 11/30/2021
 Page No : 3

City of Riverside
 N/S: Trautwein Road
 EW: Orange Terrace Parkway
 Weather: Clear

Start Time	Trautwein Road Southbound			Orange Terrace Parkway Westbound			Trautwein Road Northbound			Orange Terrace Parkway Eastbound		
	Left	Thru	Right	Left	Thru	Right	Left	Thru	Right	Left	Thru	Right
Peak Hour Analysis From 04:15 PM to 05:00 PM - Peak 1 of 1												
Peak Hour for Each Approach Begins at:												
	04:15 PM			04:15 PM			04:15 PM			04:15 PM		
+0 mins.	1	3	0	0	0	2	0	0	5	1	0	0
+15 mins.	0	3	0	1	0	1	0	1	1	1	0	0
+30 mins.	2	5	0	0	0	2	0	1	1	0	0	0
+45 mins.	2	6	0	0	0	0	0	1	0	0	0	0
Total Volume	5	17	0	1	0	4	0	8	3	11	0	0
% App. Total	22.7	77.3	0	20	0	80	0	72.7	27.3	0	0	0
PHF	.625	.708	.000	.250	.000	.500	.625	.400	.750	.000	.000	.000

Counts Unlimited, Inc.
 PO Box 1178
 Corona, CA 92878
 (951)268-6268

File Name : 07_RIV_Traut_Orange PM
 Site Code : 05121716
 Start Date : 11/30/2021
 Page No : 1

City of Riverside
 N/S: Trautwein Road
 EW: Orange Terrace Parkway
 Weather: Clear

Groups Printed- 3 Axle Vehicles

Start Time	Trautwein Road Southbound				Orange Terrace Parkway Westbound				Trautwein Road Northbound				Orange Terrace Parkway Eastbound											
	Left	Thru	Right	RTOR	App. Total	Left	Thru	Right	RTOR	App. Total	Left	Thru	Right	RTOR	App. Total	Left	Thru	Right	RTOR	App. Total	Exclu. Total	Inclu. Total	Int. Total	
04:00 PM	0	3	0	0	3	0	0	0	0	0	0	0	0	0	0	0	0	0	0	0	0	3	3	0
04:15 PM	0	0	0	0	0	0	0	0	0	0	0	0	0	0	0	0	0	0	0	0	0	0	0	0
04:30 PM	0	0	0	0	0	0	0	0	0	0	0	0	0	0	0	0	0	0	0	0	0	0	0	0
04:45 PM	0	1	0	0	1	0	0	0	0	0	0	1	0	0	1	0	0	0	0	0	0	0	2	2
Total	0	4	0	0	4	0	0	0	0	0	0	1	0	0	1	0	0	0	0	0	0	5	5	0
05:00 PM	0	0	0	0	0	0	0	0	0	0	0	0	0	0	0	0	0	0	0	0	0	0	0	0
05:15 PM	0	1	0	0	1	0	0	0	0	0	0	0	0	0	0	0	0	0	0	0	0	0	1	1
05:30 PM	0	0	0	0	0	0	0	0	0	0	0	1	0	0	1	0	0	0	0	0	0	0	1	1
05:45 PM	0	0	0	0	0	0	0	0	0	0	0	0	0	0	0	0	0	0	0	0	0	0	0	0
Total	0	1	0	0	1	0	0	0	0	0	0	1	0	0	1	0	0	0	0	0	0	0	2	2
Grand Total	0	5	0	0	5	0	0	0	0	0	0	2	0	0	2	0	0	0	0	0	0	7	7	0
% Approach	0	100	0	0	0	0	0	0	0	0	100	0	0	0	0	0	0	0	0	0	0	100	100	0
Total %	0	71.4	0	0	71.4	0	0	0	0	0	28.6	0	0	0	28.6	0	0	0	0	0	0	0	0	0

Start Time	Trautwein Road Southbound				Orange Terrace Parkway Westbound				Trautwein Road Northbound				Orange Terrace Parkway Eastbound											
	Left	Thru	Right	RTOR	App. Total	Left	Thru	Right	RTOR	App. Total	Left	Thru	Right	RTOR	App. Total	Left	Thru	Right	RTOR	App. Total	Exclu. Total	Inclu. Total	Int. Total	
04:15 PM	0	0	0	0	0	0	0	0	0	0	0	0	0	0	0	0	0	0	0	0	0	0	0	0
04:30 PM	0	0	0	0	0	0	0	0	0	0	0	0	0	0	0	0	0	0	0	0	0	0	0	0
04:45 PM	0	1	0	0	1	0	0	0	0	0	0	1	0	0	1	0	0	0	0	0	0	0	2	2
05:00 PM	0	0	0	0	0	0	0	0	0	0	0	0	0	0	0	0	0	0	0	0	0	0	0	0
Total Volume	0	1	0	0	1	0	0	0	0	0	0	1	0	0	1	0	0	0	0	0	0	0	2	2
% App. Total	0	100	0	0	0	0	0	0	0	0	100	0	0	0	0	0	0	0	0	0	0	0	100	100
PHF	.000	.250	.000	.000	.250	.000	.000	.000	.000	.000	.250	.000	.000	.000	.250	.000	.000	.000	.000	.000	.000	.250	.250	.250

Peak Hour Analysis From 04:15 PM to 05:00 PM - Peak 1 of 1
 Peak Hour for Entire Intersection Begins at 04:15 PM

Counts Unlimited, Inc.
 PO Box 1178
 Corona, CA 92878
 (951)268-6268

City of Riverside
 N/S: Trautwein Road
 E/W: Orange Terrace Parkway
 Weather: Clear

File Name : 07_RIV_Traut_Orange PM
 Site Code : 05121716
 Start Date : 11/30/2021
 Page No : 2

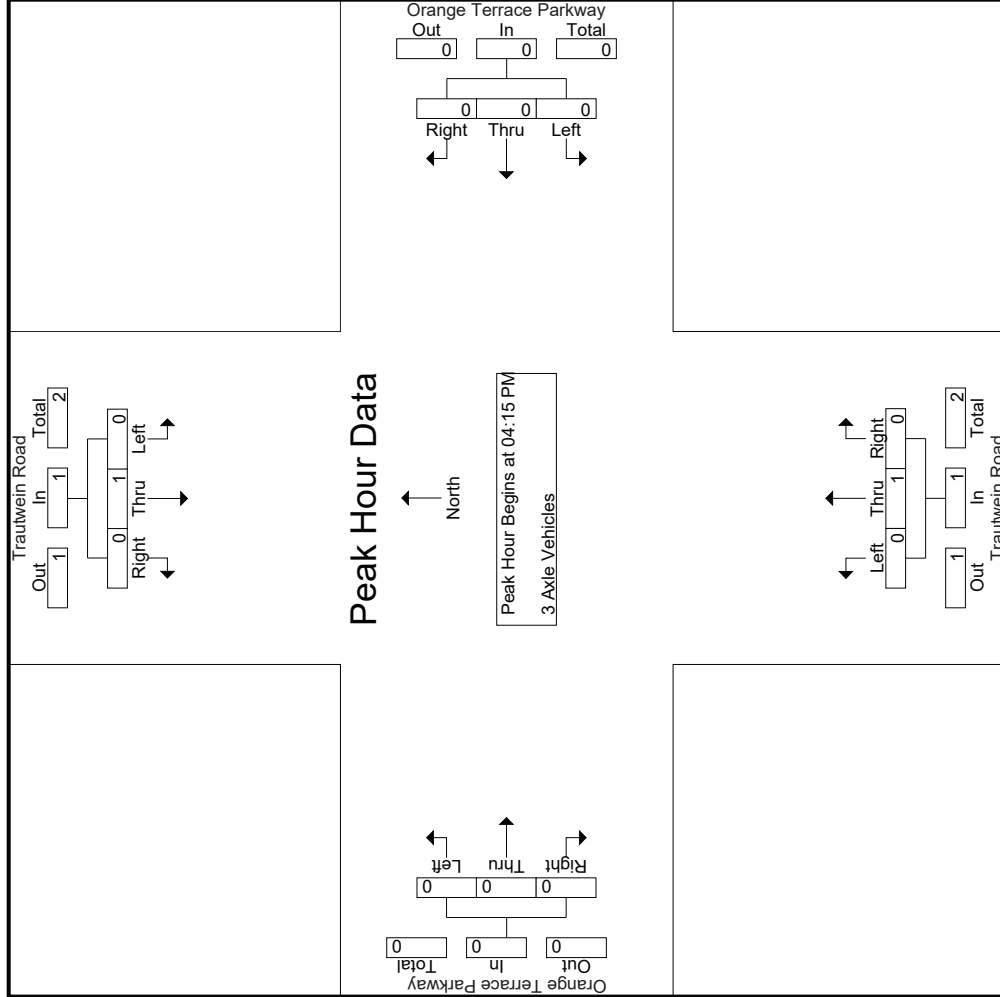

Counts Unlimited, Inc.
 PO Box 1178
 Corona, CA 92878
 (951)268-6268

File Name : 07_RIV_Traut_Orange PM
 Site Code : 05121716
 Start Date : 11/30/2021
 Page No : 3

City of Riverside
 N/S: Trautwein Road
 EW: Orange Terrace Parkway
 Weather: Clear

Start Time	Trautwein Road Southbound			Orange Terrace Parkway Westbound			Trautwein Road Northbound			Orange Terrace Parkway Eastbound		
	Left	Thru	Right	Left	Thru	Right	Left	Thru	Right	Left	Thru	Right
Peak Hour Analysis From 04:15 PM to 05:00 PM - Peak 1 of 1												
Peak Hour for Each Approach Begins at:												
	04:15 PM											
+0 mins.	0	0	0	0	0	0	0	0	0	0	0	0
+15 mins.	0	0	0	0	0	0	0	0	0	0	0	0
+30 mins.	0	1	0	0	0	0	0	1	0	0	0	0
+45 mins.	0	0	0	0	0	0	0	0	0	0	0	0
Total Volume	0	1	0	0	0	0	0	1	0	0	0	0
% App. Total	0	100	0	0	0	0	0	100	0	0	0	0
PHF	.000	.250	.000	.250	.000	.000	.000	.250	.000	.000	.000	.000

Counts Unlimited, Inc.
 PO Box 1178
 Corona, CA 92878
 (951)268-6268

File Name : 07_RIV_Traut_Orange PM
 Site Code : 05121716
 Start Date : 11/30/2021
 Page No : 1

City of Riverside
 N/S: Trautwein Road
 EW: Orange Terrace Parkway
 Weather: Clear

Groups Printed- 4+ Axle Trucks

Start Time	Trautwein Road Southbound				Orange Terrace Parkway Westbound				Trautwein Road Northbound				Orange Terrace Parkway Eastbound											
	Left	Thru	Right	RTOR	App. Total	Left	Thru	Right	RTOR	App. Total	Left	Thru	Right	RTOR	App. Total	Left	Thru	Right	RTOR	App. Total	Exclu. Total	Inclu. Total	Int. Total	
04:00 PM	0	1	0	0	1	0	0	0	0	0	0	1	0	0	1	0	0	0	0	0	0	0	2	2
04:15 PM	0	0	0	0	0	0	0	0	0	0	0	1	0	0	1	0	0	0	0	0	0	0	1	1
04:30 PM	0	1	0	0	1	0	0	0	0	0	0	0	0	0	0	0	0	0	0	0	0	0	1	1
04:45 PM	0	0	0	0	0	0	0	0	0	0	0	0	0	0	0	0	0	0	0	0	0	0	0	0
Total	0	2	0	0	2	0	0	0	0	0	2	0	2	0	2	0	0	0	0	0	0	0	4	4
05:00 PM	0	1	0	0	1	0	0	0	0	0	0	1	0	0	1	0	0	0	0	0	0	0	2	2
05:15 PM	0	0	0	0	0	0	0	0	0	0	0	0	0	0	0	0	0	0	0	0	0	0	0	0
05:30 PM	0	0	0	0	0	0	0	0	0	0	0	0	0	0	0	0	0	0	0	0	0	0	0	0
05:45 PM	0	0	0	0	0	0	0	0	0	0	0	0	0	0	0	0	0	0	0	0	0	0	0	0
Total	0	1	0	0	1	0	0	0	0	0	1	0	1	0	1	0	0	0	0	0	0	0	2	2
Grand Total	0	3	0	0	3	0	0	0	0	0	3	0	3	0	3	0	0	0	0	0	0	0	6	6
% Apprch %	0	100	0	0	0	0	0	0	0	0	100	0	0	0	0	0	0	0	0	0	0	0	6	6
% Total %	0	50	0	0	50	0	0	0	0	0	50	0	50	0	50	0	0	0	0	0	0	0	100	100

Start Time	Trautwein Road Southbound				Orange Terrace Parkway Westbound				Trautwein Road Northbound				Orange Terrace Parkway Eastbound											
	Left	Thru	Right	RTOR	App. Total	Left	Thru	Right	RTOR	App. Total	Left	Thru	Right	RTOR	App. Total	Left	Thru	Right	RTOR	App. Total	Exclu. Total	Inclu. Total	Int. Total	
04:15 PM	0	0	0	0	0	0	0	0	0	0	0	1	0	0	1	0	0	0	0	0	0	0	0	0
04:30 PM	0	1	0	0	1	0	0	0	0	0	0	0	0	0	0	0	0	0	0	0	0	0	0	0
04:45 PM	0	0	0	0	0	0	0	0	0	0	0	0	0	0	0	0	0	0	0	0	0	0	0	0
05:00 PM	0	1	0	0	1	0	0	0	0	0	0	0	0	0	0	0	0	0	0	0	0	0	0	0
Total Volume	0	2	0	0	2	0	0	0	0	0	0	2	0	2	0	0	0	0	0	0	0	0	0	0
% App. Total	0	100	0	0	0	0	0	0	0	0	100	0	0	0	0	0	0	0	0	0	0	0	0	0
PHF	.000	.500	.000	.000	.500	.000	.000	.000	.000	.000	.500	.000	.500	.000	.500	.000	.000	.000	.000	.000	.000	.000	.000	.500

Peak Hour Analysis From 04:15 PM to 05:00 PM - Peak 1 of 1
 Peak Hour for Entire Intersection Begins at 04:15 PM

Counts Unlimited, Inc.
 PO Box 1178
 Corona, CA 92878
 (951)268-6268

City of Riverside
 N/S: Trautwein Road
 EW: Orange Terrace Parkway
 Weather: Clear

File Name : 07_RIV_Traut_Orange PM
 Site Code : 05121716
 Start Date : 11/30/2021
 Page No : 2

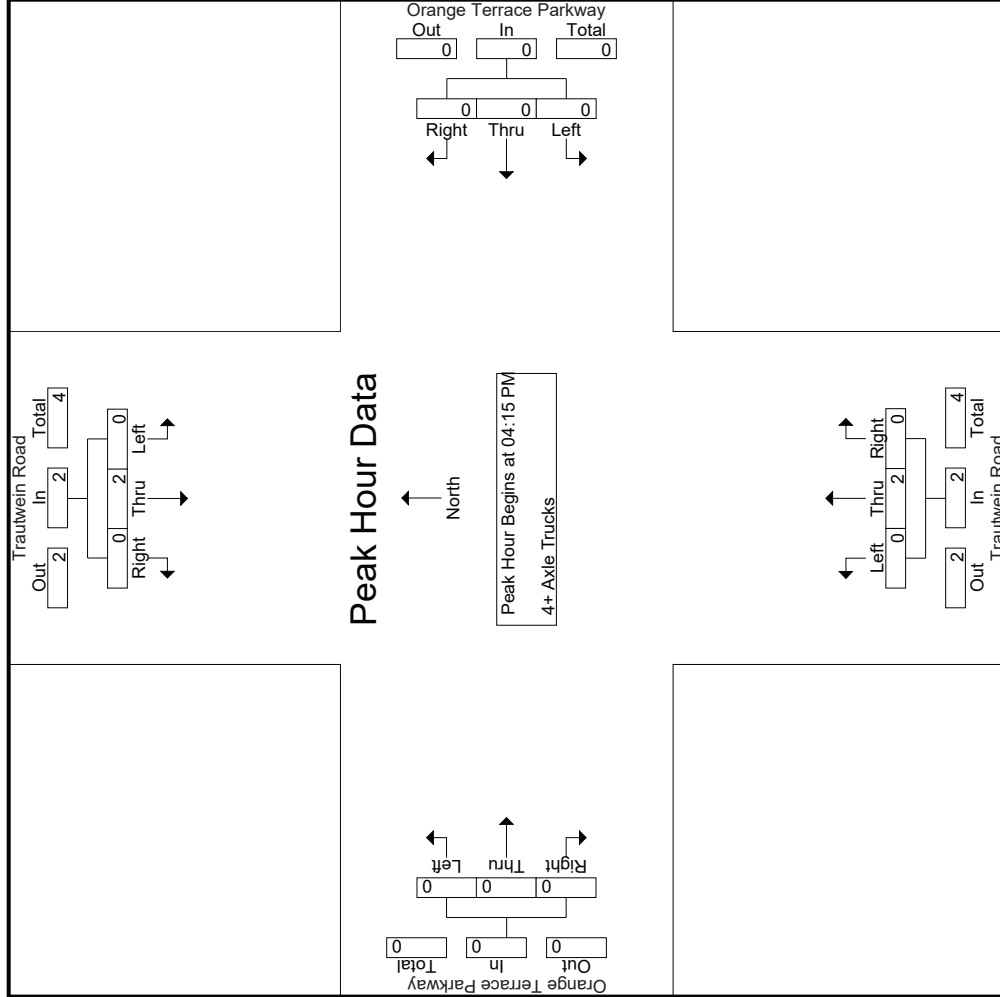

Counts Unlimited, Inc.
 PO Box 1178
 Corona, CA 92878
 (951)268-6268

File Name : 07_RIV_Traut_Orange PM
 Site Code : 05121716
 Start Date : 11/30/2021
 Page No : 3

City of Riverside
 N/S: Trautwein Road
 E/W: Orange Terrace Parkway
 Weather: Clear

Start Time	Trautwein Road Southbound			Orange Terrace Parkway Westbound			Trautwein Road Northbound			Orange Terrace Parkway Eastbound		
	Left	Thru	Right	Left	Thru	Right	Left	Thru	Right	Left	Thru	Right
Peak Hour Analysis From 04:15 PM to 05:00 PM - Peak 1 of 1												
Peak Hour for Each Approach Begins at:												
	04:15 PM			04:15 PM			04:15 PM			04:15 PM		
+0 mins.	0	0	0	0	0	0	0	0	0	0	0	0
+15 mins.	0	1	0	0	0	0	0	0	0	0	0	0
+30 mins.	0	0	0	0	0	0	0	0	0	0	0	0
+45 mins.	0	1	0	0	0	0	0	0	0	0	0	0
Total Volume	0	2	0	0	0	0	0	0	0	0	0	0
% App. Total	0	100	0	0	0	0	0	0	0	0	0	0
PHF	.000	.500	.000	.000	.000	.000	.000	.000	.000	.000	.000	.000

Location: Riverside
 N/S: Trautwein Road
 E/W: Orange Terrace Parkway



Date: 11/30/2021
 Day: Tuesday

PEDESTRIANS

	North Leg Trautwein Road	East Leg Orange Terrace Parkway	South Leg Trautwein Road	West Leg Orange Terrace Parkway	
	Pedestrians	Pedestrians	Pedestrians	Pedestrians	
7:00 AM	1	0	3	1	5
7:15 AM	0	4	0	4	8
7:30 AM	1	1	0	1	3
7:45 AM	0	0	0	0	0
8:00 AM	0	0	0	4	4
8:15 AM	0	0	0	3	3
8:30 AM	0	0	0	2	2
8:45 AM	0	0	1	3	4
TOTAL VOLUMES:	2	5	4	18	29

	North Leg Trautwein Road	East Leg Orange Terrace Parkway	South Leg Trautwein Road	West Leg Orange Terrace Parkway	
	Pedestrians	Pedestrians	Pedestrians	Pedestrians	
4:00 PM	0	1	1	1	3
4:15 PM	0	0	0	2	2
4:30 PM	0	1	1	0	2
4:45 PM	1	0	0	0	1
5:00 PM	0	0	0	0	0
5:15 PM	0	3	0	4	7
5:30 PM	0	0	0	0	0
5:45 PM	0	1	0	2	3
TOTAL VOLUMES:	1	6	2	9	18

Location: Riverside
 N/S: Trautwein Road
 E/W: Orange Terrace Parkway



Date: 11/30/2021
 Day: Tuesday

BICYCLES

	Southbound Trautwein Road			Westbound Orange Terrace Parkway			Northbound Trautwein Road			Eastbound Orange Terrace Parkway			
	Left	Thru	Right	Left	Thru	Right	Left	Thru	Right	Left	Thru	Right	
7:00 AM	0	0	0	0	1	0	0	0	0	0	0	0	1
7:15 AM	0	0	0	0	0	0	0	0	0	0	0	0	0
7:30 AM	0	1	0	0	2	0	0	0	0	0	0	0	3
7:45 AM	0	0	0	0	0	0	0	0	0	0	0	0	0
8:00 AM	0	0	0	0	0	0	0	0	0	0	0	0	0
8:15 AM	0	0	0	0	0	0	0	0	0	0	0	0	0
8:30 AM	0	0	0	0	0	0	0	0	0	0	0	0	0
8:45 AM	0	0	0	0	0	0	0	0	0	0	0	0	0
TOTAL VOLUMES:	0	1	0	0	3	0	0	0	0	0	0	0	4

	Southbound Trautwein Road			Westbound Orange Terrace Parkway			Northbound Trautwein Road			Eastbound Orange Terrace Parkway			
	Left	Thru	Right	Left	Thru	Right	Left	Thru	Right	Left	Thru	Right	
4:00 PM	0	0	0	0	0	0	0	0	0	0	0	0	0
4:15 PM	0	0	0	0	0	0	0	0	0	0	0	0	0
4:30 PM	0	0	0	0	0	0	0	0	0	0	0	0	0
4:45 PM	0	0	0	0	0	0	0	0	0	0	0	0	0
5:00 PM	0	0	0	0	0	0	0	0	0	0	0	0	0
5:15 PM	0	0	0	0	0	0	0	0	0	0	0	0	0
5:30 PM	0	1	0	0	0	0	0	0	0	0	0	0	1
5:45 PM	0	0	0	0	0	0	0	0	0	0	0	0	0
TOTAL VOLUMES:	0	1	0	0	0	0	0	0	0	0	0	0	1

Counts Unlimited, Inc.
 PO Box 1178
 Corona, CA 92878
 (951)268-6268

City of Riverside
 N/S: Trautwein Road/Cole Avenue
 E/W: Van Buren Boulevard
 Weather: Clear

File Name : 08_RIV_Traut_VB AM
 Site Code : 05121716
 Start Date : 11/30/2021
 Page No : 1

Groups Printed- Passenger Vehicles - Large 2 Axle Vehicles - 3 Axle Vehicles - 4+ Axle Trucks

Start Time	Trautwein Road Southbound					Van Buren Boulevard Westbound					Cole Avenue Northbound					Van Buren Boulevard Eastbound				
	Left	Thru	Right	RTOR	App. Total	Left	Thru	Right	RTOR	App. Total	Left	Thru	Right	RTOR	App. Total	Left	Thru	Right	RTOR	App. Total
	Exclu. Total	Inclu. Total	Int. Total	Exclu. Total	Inclu. Total	Int. Total	Exclu. Total	Inclu. Total	Int. Total	Exclu. Total	Inclu. Total	Int. Total	Exclu. Total	Inclu. Total	Int. Total	Exclu. Total	Inclu. Total	Int. Total		
07:00 AM	35	42	53	30	130	16	263	64	17	343	33	109	17	1	159	46	152	8	2	206
07:15 AM	45	96	76	27	217	41	299	83	28	423	51	112	26	2	189	59	189	16	5	264
07:30 AM	40	96	58	16	194	54	289	59	11	402	50	131	21	1	202	75	206	22	6	303
07:45 AM	38	51	24	7	113	14	234	69	17	317	39	122	27	2	188	70	209	28	17	307
Total	158	285	211	80	654	125	1085	275	73	1485	173	474	91	6	738	250	756	74	30	1080
08:00 AM	31	45	40	15	116	15	241	80	25	336	48	104	14	3	166	60	170	15	9	245
08:15 AM	28	31	35	20	94	12	207	61	23	280	43	79	7	0	129	58	165	11	1	234
08:30 AM	31	22	42	29	95	6	233	76	23	315	25	60	8	2	93	60	167	11	1	238
08:45 AM	30	33	38	21	101	12	210	55	18	277	21	73	8	0	102	69	117	11	5	197
Total	120	131	155	85	406	45	891	272	89	1208	137	316	37	5	490	247	619	48	16	914
Grand Total	278	416	366	165	1060	170	1976	547	162	2693	310	790	128	11	1228	497	1375	122	46	1994
→Approch %	26.2	39.2	34.5			6.3	73.4	20.3			25.2	64.3	10.4			24.9	69	6.1		
↳ Total %	4	6	5.2		15.2	2.4	28.3	7.8		38.6	4.4	11.3	1.8		17.6	7.1	19.7	1.7		28.6
Passenger Vehicles	269	409	349		1186	169	1903	525		2753	297	769	125		1202	472	1301	115		1931
% Large 2 Axle Vehicles	96.8	98.3	95.4	96.4	96.8	99.4	96.3	96	96.3	96.4	95.8	97.3	97.7	100	97	95	94.6	94.3	93.5	94.7
% 3 Axle Vehicles	7	6	13	3	31	0	57	19	3.1	81	11	19	3	0	33	22	61	6	0	92
% 4+ Axle Trucks	2.5	1.4	3.6	0.6	2.5	0	2.9	3.5	0.6	2.8	3.5	2.4	2.3	0	2.7	4.4	4.4	4.9	6.5	4.5
% App. Total	1	1	2	0.5	5	1	6	3	0.6	11	1	1	0	0	2	2	6	1	0	9
% Exclu. Total	0.4	0.2	0.5	0.6	0.4	0.6	0.3	0.5	0.6	0.4	0.3	0.1	0	0	0.2	0.4	0.4	0.8	0	0.4
% Int. Total	1	0	2	0	3	0	10	0	0	10	1	1	0	0	2	1	7	0	0	8
% Total	0.4	0	0.5	0	0.2	0	0.5	0	0	0.4	0.3	0.1	0	0	0.2	0.2	0.5	0	0	0.4

Start Time	Trautwein Road Southbound					Van Buren Boulevard Westbound					Cole Avenue Northbound					Van Buren Boulevard Eastbound				
	Left	Thru	Right	RTOR	App. Total	Left	Thru	Right	RTOR	App. Total	Left	Thru	Right	RTOR	App. Total	Left	Thru	Right	RTOR	App. Total
	Exclu. Total	Inclu. Total	Int. Total	Exclu. Total	Inclu. Total	Int. Total	Exclu. Total	Inclu. Total	Int. Total	Exclu. Total	Inclu. Total	Int. Total	Exclu. Total	Inclu. Total	Int. Total	Exclu. Total	Inclu. Total	Int. Total		
07:15 AM	45	96	76		217	41	299	83		423	51	112	26		189	59	189	16		264
07:30 AM	40	96	58		194	54	289	59		402	50	131	21		202	75	206	22		303
07:45 AM	38	51	24		113	14	234	69		317	39	122	27		188	70	209	28		307
08:00 AM	31	45	40		116	15	241	80		336	48	104	14		166	60	170	15		245
Total Volume	154	288	198		640	124	1063	291		1478	188	469	88		745	264	774	81		1119
% App. Total	24.1	45	30.9		737	8.4	71.9	19.7		874	25.2	63	11.8		922	23.6	69.2	7.2		926
PHF	.856	.750	.651		.737	.574	.889	.877		.874	.922	.895	.815		.922	.880	.926	.723		.911

Peak Hour Analysis From 07:00 AM to 08:45 AM - Peak 1 of 1
 Peak Hour for Entire Intersection Begins at 07:15 AM

Counts Unlimited, Inc.
 PO Box 1178
 Corona, CA 92878
 (951)268-6268

City of Riverside
 N/S: Trautwein Road/Cole Avenue
 E/W: Van Buren Boulevard
 Weather: Clear

File Name : 08_RIV_Traut_VB AM
 Site Code : 05121716
 Start Date : 11/30/2021
 Page No : 2

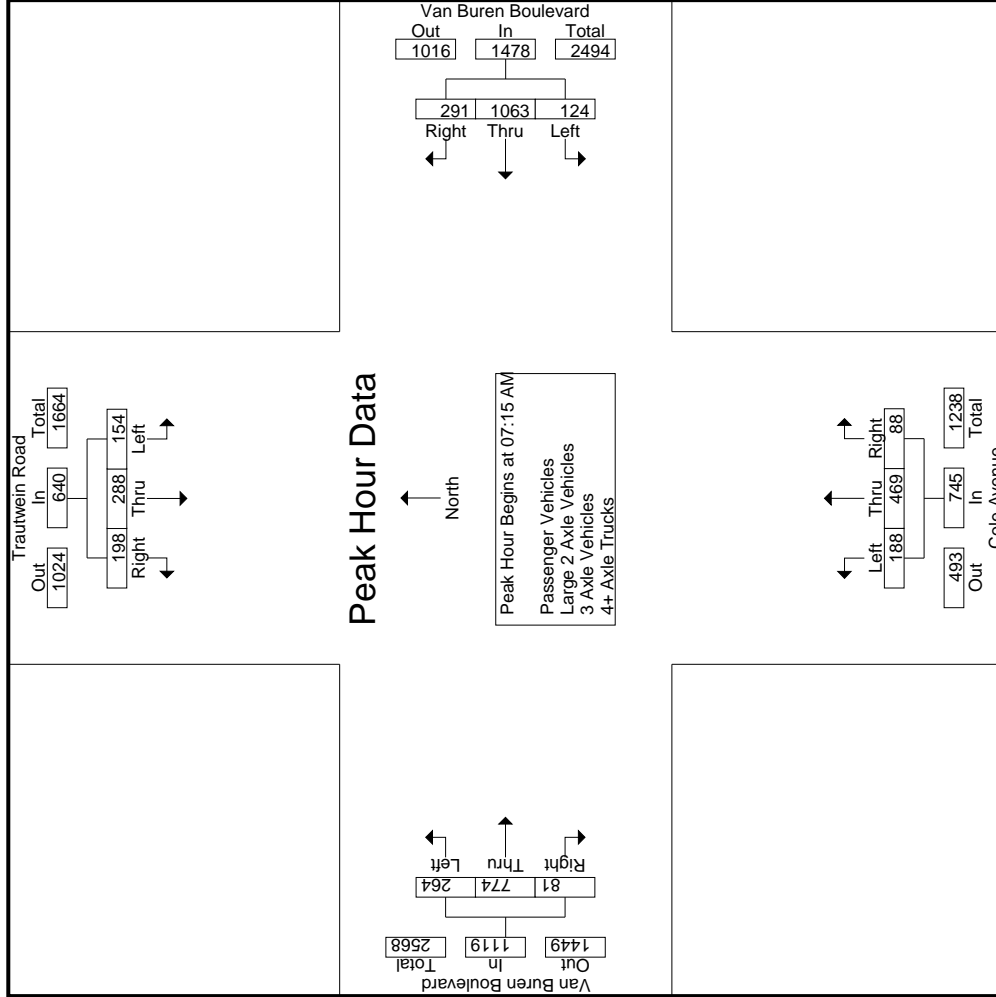

Counts Unlimited, Inc.
 PO Box 1178
 Corona, CA 92878
 (951)268-6268

City of Riverside
 N/S: Trautwein Road/Cole Avenue
 E/W: Van Buren Boulevard
 Weather: Clear

File Name : 08_RIV_Traut_VB AM
 Site Code : 05121716
 Start Date : 11/30/2021
 Page No : 3

Start Time	Trautwein Road Southbound			Van Buren Boulevard Westbound			Cole Avenue Northbound			Van Buren Boulevard Eastbound			Int. Total
	Left	Thru	Right	Left	Thru	Right	Left	Thru	Right	Left	Thru	Right	
Peak Hour Analysis From 07:00 AM to 08:45 AM - Peak 1 of 1	Peak Hour for Each Approach Begins at:												
	07:00 AM			07:00 AM			07:15 AM			07:15 AM			
+0 mins.	35	42	53	16	263	64	343	51	112	26	189	16	264
+15 mins.	45	96	76	41	299	83	423	50	131	21	206	22	303
+30 mins.	40	96	58	54	289	59	402	39	122	27	188	28	307
+45 mins.	38	51	24	14	234	69	317	48	104	14	170	15	245
Total Volume	158	285	211	125	1085	275	1485	188	469	88	774	81	1119
% App. Total	24.2	43.6	32.3	8.4	73.1	18.5	25.2	63	11.8	7.2	69.2	7.2	91.1
PHF	.878	.742	.694	.579	.907	.828	.878	.922	.895	.815	.926	.723	.911

Counts Unlimited, Inc.
 PO Box 1178
 Corona, CA 92878
 (951)268-6268

City of Riverside
 N/S: Trautwein Road/Cole Avenue
 E/W: Van Buren Boulevard
 Weather: Clear

File Name : 08_RIV_Traut_VB AM
 Site Code : 05121716
 Start Date : 11/30/2021
 Page No : 1

Groups Printed- Passenger Vehicles

Start Time	Trautwein Road Southbound				Van Buren Boulevard Westbound				Cole Avenue Northbound				Van Buren Boulevard Eastbound				Exclu. Total	Inclu. Total	Int. Total		
	Left	Thru	Right	RTOR	Left	Thru	Right	RTOR	Left	Thru	Right	RTOR	Left	Thru	Right	RTOR				App. Total	
07:00 AM	35	42	50	28	15	255	60	17	330	32	107	17	1	41	147	7	2	195	48	808	856
07:15 AM	44	93	74	26	41	289	78	25	408	49	112	25	2	57	179	16	5	252	58	1057	1115
07:30 AM	39	94	55	15	54	277	58	10	389	49	130	21	1	73	199	21	6	293	32	1070	1102
07:45 AM	37	49	24	7	14	227	67	16	308	39	117	25	2	66	201	26	15	293	40	892	932
Total	155	278	203	76	124	1048	263	68	1435	169	466	88	6	237	726	70	28	1033	178	3827	4005
08:00 AM	28	45	36	14	15	232	77	24	324	45	97	14	3	58	161	14	8	233	49	822	871
08:15 AM	27	31	34	20	12	199	58	23	269	40	75	7	0	55	151	11	1	217	44	700	744
08:30 AM	30	22	41	28	6	221	72	23	299	23	59	8	2	56	155	9	1	220	54	702	756
08:45 AM	29	33	35	21	12	203	55	18	270	20	72	8	0	66	108	11	5	185	44	652	696
Total	114	131	146	83	45	855	262	88	1162	128	303	37	5	235	575	45	15	855	191	2876	3067
Grand Total	269	409	349	159	169	1903	525	156	2597	297	769	125	11	472	1301	115	43	1888	369	6703	7072
% Apprch %	26.2	39.8	34		6.5	73.3	20.2		24.9	64.6	10.5			25	68.9	6.1		28.2			
% Total %	4	6.1	5.2		2.5	28.4	7.8		38.7	4.4	11.5	1.9		7	19.4	1.7		28.2	5.2	94.8	

Start Time	Trautwein Road Southbound				Van Buren Boulevard Westbound				Cole Avenue Northbound				Van Buren Boulevard Eastbound				App. Total	Int. Total
	Left	Thru	Right	RTOR	Left	Thru	Right	RTOR	Left	Thru	Right	RTOR	Left	Thru	Right	RTOR		
07:15 AM	44	93	74		41	289	78		49	112	25		57	179	16		252	1057
07:30 AM	39	94	55		54	277	58		49	130	21		73	199	21		293	1070
07:45 AM	37	49	24		14	227	67		39	117	25		66	201	26		293	892
08:00 AM	28	45	36		15	232	77		45	97	14		58	161	14		233	822
Total Volume	148	281	189		124	1025	280		182	456	85		254	740	77		1071	3841
% App. Total	23.9	45.5	30.6		8.7	71.7	19.6		25.2	63.1	11.8		23.7	69.1	7.2		.914	.897
PHF	.841	.747	.639		.574	.887	.897		.929	.877	.850		.870	.920	.740		.914	.897

Peak Hour Analysis From 07:15 AM to 08:00 AM - Peak 1 of 1
 Peak Hour for Entire Intersection Begins at 07:15 AM

Counts Unlimited, Inc.
 PO Box 1178
 Corona, CA 92878
 (951)268-6268

City of Riverside
 N/S: Trautwein Road/Cole Avenue
 E/W: Van Buren Boulevard
 Weather: Clear

File Name : 08_RIV_Traut_VB AM
 Site Code : 05121716
 Start Date : 11/30/2021
 Page No : 2

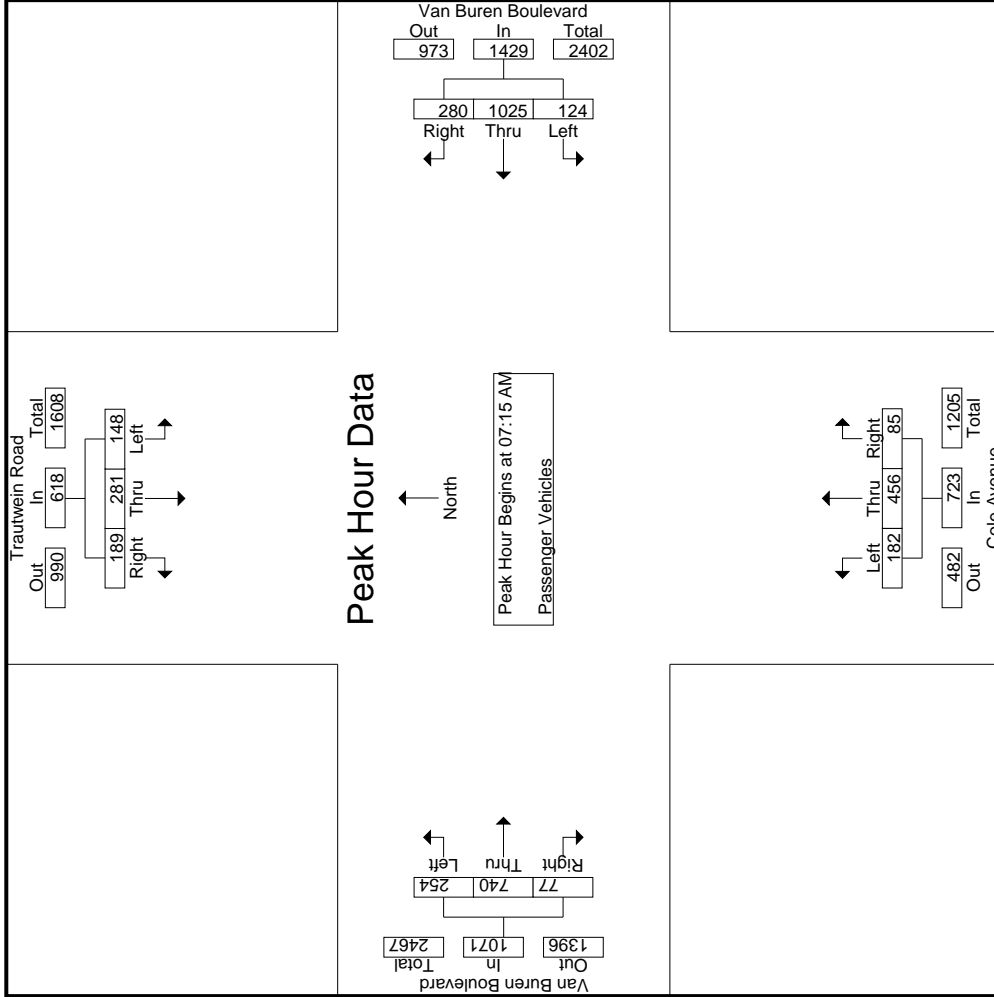

Counts Unlimited, Inc.
 PO Box 1178
 Corona, CA 92878
 (951)268-6268

City of Riverside
 N/S: Trautwein Road/Cole Avenue
 E/W: Van Buren Boulevard
 Weather: Clear

File Name : 08_RIV_Traut_VB AM
 Site Code : 05121716
 Start Date : 11/30/2021
 Page No : 3

Start Time	Trautwein Road Southbound			Van Buren Boulevard Westbound			Cole Avenue Northbound			Van Buren Boulevard Eastbound						
	Left	Thru	Right	Left	Thru	Right	Left	Thru	Right	Left	Thru	Right	App. Total	Int. Total		
Peak Hour Analysis From 07:15 AM to 08:00 AM - Peak 1 of 1	Peak Hour for Each Approach Begins at:															
	07:15 AM															
+0 mins.	44	93	74	211	41	289	78	408	49	112	25	186	57	179	16	252
+15 mins.	39	94	55	188	54	277	58	389	49	130	21	200	73	199	21	293
+30 mins.	37	49	24	110	14	227	67	308	39	117	25	181	66	201	26	293
+45 mins.	28	45	36	109	15	232	77	324	45	97	14	156	58	161	14	233
Total Volume	148	281	189	618	124	1025	280	1429	182	456	85	723	254	740	77	1071
% App. Total	23.9	45.5	30.6		8.7	71.7	19.6		25.2	63.1	11.8		23.7	69.1	7.2	
PHF	.841	.747	.639	.732	.574	.887	.897	.876	.929	.877	.850	.904	.870	.920	.740	.914

Counts Unlimited, Inc.
 PO Box 1178
 Corona, CA 92878
 (951)268-6268

City of Riverside
 N/S: Trautwein Road/Cole Avenue
 E/W: Van Buren Boulevard
 Weather: Clear

File Name : 08_RIV_Traut_VB AM
 Site Code : 05121716
 Start Date : 11/30/2021
 Page No : 1

Groups Printed- Large 2 Axle Vehicles

Start Time	Trautwein Road Southbound				Van Buren Boulevard Westbound				Cole Avenue Northbound				Van Buren Boulevard Eastbound				Exclu. Total	Inclu. Total	Int. Total			
	Left	Thru	Right	RTOR	Left	Thru	Right	RTOR	Left	Thru	Right	RTOR	Left	Thru	Right	RTOR				App. Total		
07:00 AM	0	0	3	2	3	0	8	4	0	12	1	2	0	0	3	1	0	0	9	2	27	29
07:15 AM	1	2	1	0	4	0	6	5	3	11	1	0	1	0	2	0	0	12	3	29	32	
07:30 AM	0	2	3	1	5	0	10	1	1	11	1	1	0	0	2	1	0	7	2	25	27	
07:45 AM	1	2	0	0	3	0	5	1	0	6	0	4	2	0	6	2	2	12	2	27	29	
Total	2	6	7	3	15	0	29	11	4	40	3	7	3	0	13	4	2	40	9	108	117	
08:00 AM	3	0	3	1	6	0	7	2	1	9	2	6	0	0	8	1	1	12	3	35	38	
08:15 AM	1	0	0	0	1	0	7	3	0	10	3	4	0	0	7	0	0	13	0	31	31	
08:30 AM	0	0	1	1	1	0	10	3	0	13	2	1	0	0	3	4	11	16	1	33	34	
08:45 AM	1	0	2	0	3	0	4	0	0	4	1	1	0	2	3	5	0	8	0	17	17	
Total	5	0	6	2	11	0	28	8	1	36	8	12	0	0	20	2	1	49	4	116	120	
Grand Total	7	6	13	5	26	0	57	19	5	76	11	19	3	0	33	6	3	89	13	224	237	
% Apprch %	26.9	23.1	50			0	75	25		33.9	33.3	57.6	9.1		14.7	68.5	6.7	39.7	5.5	94.5		
% Total %	3.1	2.7	5.8		11.6	0	25.4	8.5			4.9	8.5	1.3			27.2	2.7					

Start Time	Trautwein Road Southbound				Van Buren Boulevard Westbound				Cole Avenue Northbound				Van Buren Boulevard Eastbound				App. Total	Int. Total			
	Left	Thru	Right	RTOR	Left	Thru	Right	RTOR	Left	Thru	Right	RTOR	Left	Thru	Right	RTOR					
07:15 AM	1	2	1		0	6	5		1	11	1	0	1	2	0		12	0	12	7	29
07:30 AM	0	2	3		0	10	1		1	11	0	0	0	2	5		7	1	5	1	25
07:45 AM	1	2	0		0	5	1		0	6	0	4	2	6	7		12	2	12	2	27
08:00 AM	3	0	3		0	7	2		2	9	2	6	0	8	9		12	1	12	1	35
Total Volume	5	6	7		0	28	9		4	37	4	11	3	18	31		43	4	43	4	116
% App. Total	27.8	33.3	38.9		0	75.7	24.3		22.2	61.1	16.7		9.3	72.1	9.3						
PHF	.417	.750	.583		.000	.700	.450		.500	.841	.563	.375		.500	.775		.896		.829		

Peak Hour Analysis From 07:15 AM to 08:00 AM - Peak 1 of 1
 Peak Hour for Entire Intersection Begins at 07:15 AM

Counts Unlimited, Inc.
 PO Box 1178
 Corona, CA 92878
 (951)268-6268

City of Riverside
 N/S: Trautwein Road/Cole Avenue
 E/W: Van Buren Boulevard
 Weather: Clear

File Name : 08_RIV_Traut_VB AM
 Site Code : 05121716
 Start Date : 11/30/2021
 Page No : 2

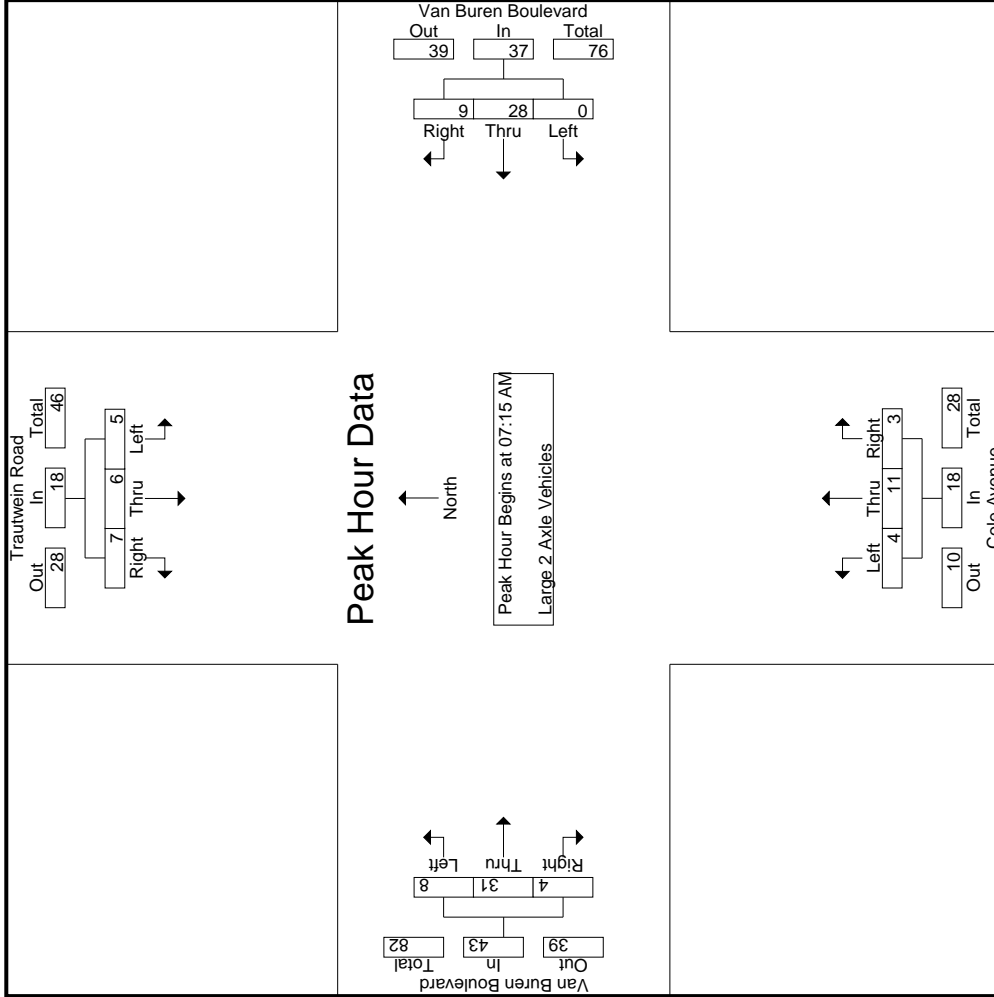

Counts Unlimited, Inc.
 PO Box 1178
 Corona, CA 92878
 (951)268-6268

File Name : 08_RIV_Traut_VB AM
 Site Code : 05121716
 Start Date : 11/30/2021
 Page No : 3

City of Riverside
 N/S: Trautwein Road/Cole Avenue
 E/W: Van Buren Boulevard
 Weather: Clear

Start Time	Trautwein Road Southbound				Van Buren Boulevard Westbound				Cole Avenue Northbound				Van Buren Boulevard Eastbound				
	Left	Thru	Right	App. Total	Left	Thru	Right	App. Total	Left	Thru	Right	App. Total	Left	Thru	Right	App. Total	Int. Total
	Peak Hour Analysis From 07:15 AM to 08:00 AM - Peak 1 of 1																
	Peak Hour for Each Approach Begins at:																
	07:15 AM				07:15 AM				07:15 AM				07:15 AM				
+0 mins.	1	2	1	4	0	6	5	11	1	0	1	2	2	10	0	12	
+15 mins.	0	2	3	5	0	10	1	11	1	1	0	2	2	5	1	7	
+30 mins.	1	2	0	3	0	5	1	6	0	4	2	6	3	7	2	12	
+45 mins.	3	0	3	6	0	7	2	9	2	6	0	8	2	9	1	12	
Total Volume	5	6	7	18	0	28	9	37	4	11	3	18	8	31	4	43	
% App. Total	27.8	33.3	38.9		0	75.7	24.3		22.2	61.1	16.7		18.6	72.1	9.3		
PHF	.417	.750	.583	.750	.000	.700	.450	.841	.500	.458	.375	.563	.667	.775	.500	.896	

Counts Unlimited, Inc.
 PO Box 1178
 Corona, CA 92878
 (951)268-6268

City of Riverside
 N/S: Trautwein Road/Cole Avenue
 E/W: Van Buren Boulevard
 Weather: Clear

File Name : 08_RIV_Traut_VB AM
 Site Code : 05121716
 Start Date : 11/30/2021
 Page No : 1

Groups Printed- 3 Axle Vehicles

Start Time	Trautwein Road Southbound					Van Buren Boulevard Westbound					Cole Avenue Northbound					Van Buren Boulevard Eastbound							
	Left	Thru	Right	RTOR	App. Total	Left	Thru	Right	RTOR	App. Total	Left	Thru	Right	RTOR	App. Total	Left	Thru	Right	RTOR	App. Total	Exclu. Total	Inclu. Total	Int. Total
07:00 AM	0	0	0	0	0	1	0	0	0	1	0	0	0	0	0	0	1	0	0	0	0	2	2
07:15 AM	0	1	1	1	2	0	2	0	0	2	0	0	0	0	0	0	0	0	0	0	1	4	5
07:30 AM	1	0	0	0	1	0	0	0	0	0	0	0	0	0	0	1	0	0	0	1	0	2	2
07:45 AM	0	0	0	0	0	0	1	1	1	2	0	0	0	0	0	0	0	0	0	0	1	2	3
Total	1	1	1	1	3	1	3	1	1	5	0	0	0	0	0	1	1	0	0	2	2	10	12
08:00 AM	0	0	1	0	1	0	0	1	0	1	1	1	0	0	2	0	0	0	0	0	0	4	4
08:15 AM	0	0	0	0	0	0	1	0	0	1	0	0	0	0	0	1	2	0	0	3	0	4	4
08:30 AM	0	0	0	0	0	0	1	1	0	2	0	0	0	0	0	1	1	1	0	2	0	4	4
08:45 AM	0	0	0	0	0	0	1	0	0	1	0	0	0	0	0	2	0	0	0	2	0	3	3
Total	0	0	1	0	1	0	3	2	0	5	1	1	0	0	2	1	5	1	0	7	0	15	15
Grand Total	1	1	2	1	4	1	6	3	1	10	1	1	0	0	2	2	6	1	0	9	2	25	27
% Approach	25	25	50			10	60	30		40	50	50	0		22.2	66.7	11.1			36	7.4	92.6	
% Total	4	4	8		16	4	24	12		40	4	4	0		8	24	4			36	7.4	92.6	

Start Time	Trautwein Road Southbound					Van Buren Boulevard Westbound					Cole Avenue Northbound					Van Buren Boulevard Eastbound								
	Left	Thru	Right	RTOR	App. Total	Left	Thru	Right	RTOR	App. Total	Left	Thru	Right	RTOR	App. Total	Left	Thru	Right	RTOR	App. Total	Exclu. Total	Inclu. Total	Int. Total	
07:15 AM	0	1	1	1	2	0	2	0	0	2	0	0	0	0	0	0	0	0	0	0	0	0	0	4
07:30 AM	1	0	0	0	1	0	0	0	0	0	0	0	0	0	0	1	0	0	0	0	0	1	2	
07:45 AM	0	0	0	0	0	0	0	0	0	0	0	0	0	0	0	0	0	0	0	0	0	0	0	2
08:00 AM	0	0	0	0	0	0	0	0	0	0	1	1	0	0	2	0	0	0	0	0	0	0	0	4
Total Volume	1	1	2		4	0	3	2		5	1	1	0		2	1	0	0		1	0	0	1	12
% App. Total	25	25	50			0	60	40		62.5	50	50	0		25	100	0	0		0	0	0	0	12
PHF	.250	.250	.500		.500	.000	.375	.500		.625	.250	.250	.000		.250	.250	.000	.000		.250	.000	.250	.750	

Peak Hour Analysis From 07:15 AM to 08:00 AM - Peak 1 of 1
 Peak Hour for Entire Intersection Begins at 07:15 AM

Counts Unlimited, Inc.
 PO Box 1178
 Corona, CA 92878
 (951)268-6268

City of Riverside
 N/S: Trautwein Road/Cole Avenue
 E/W: Van Buren Boulevard
 Weather: Clear

File Name : 08_RIV_Traut_VB AM
 Site Code : 05121716
 Start Date : 11/30/2021
 Page No : 2

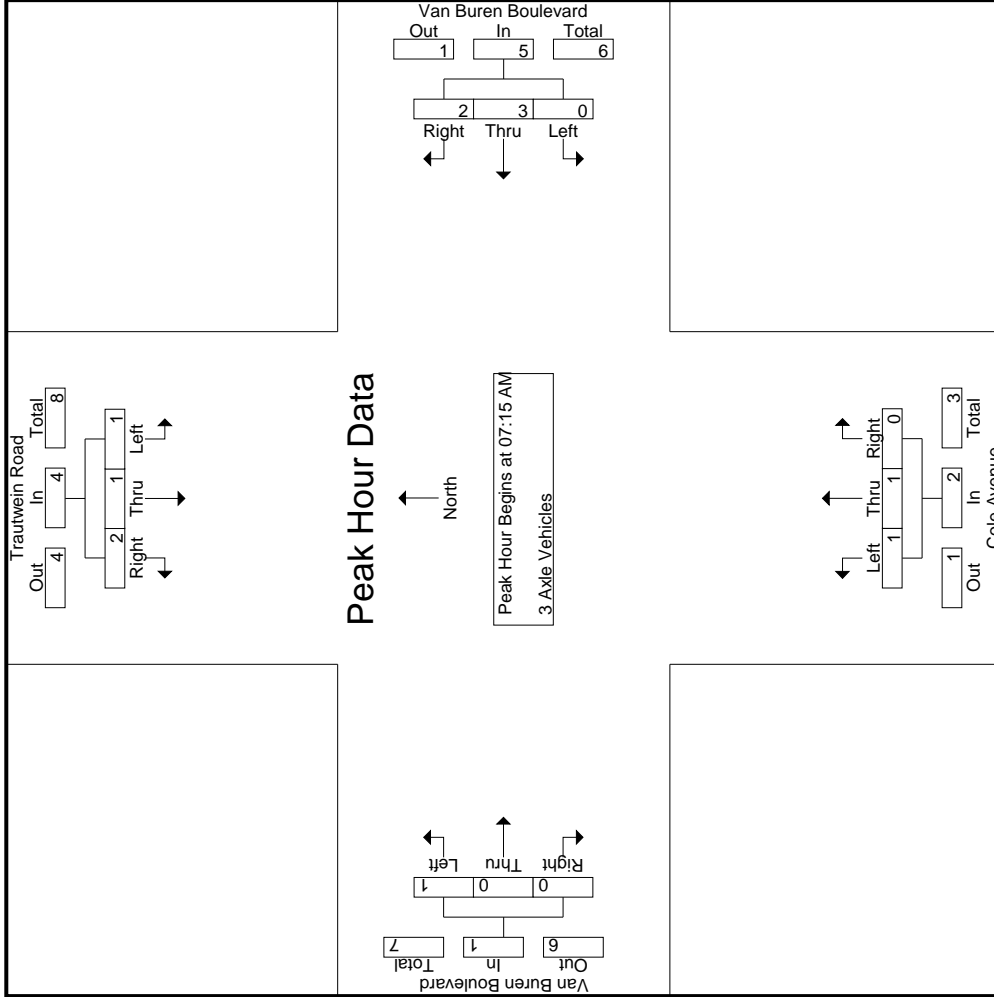

Counts Unlimited, Inc.
 PO Box 1178
 Corona, CA 92878
 (951)268-6268

City of Riverside
 N/S: Trautwein Road/Cole Avenue
 E/W: Van Buren Boulevard
 Weather: Clear

File Name : 08_RIV_Traut_VB AM
 Site Code : 05121716
 Start Date : 11/30/2021
 Page No : 3

Start Time	Trautwein Road Southbound			Van Buren Boulevard Westbound			Cole Avenue Northbound			Van Buren Boulevard Eastbound		
	Left	Thru	Right	Left	Thru	Right	Left	Thru	Right	Left	Thru	Right
Peak Hour Analysis From 07:15 AM to 08:00 AM - Peak 1 of 1												
Peak Hour for Each Approach Begins at:												
+0 mins.	0	1	1	0	2	0	0	0	0	0	0	0
+15 mins.	1	0	0	0	0	0	0	0	0	1	0	0
+30 mins.	0	0	0	0	1	1	0	0	0	0	0	0
+45 mins.	0	0	1	0	0	1	1	1	0	0	0	0
Total Volume	1	1	2	0	3	2	1	1	0	1	0	0
% App. Total	.25	.25	.50	.00	.60	.40	.50	.50	.00	.100	.00	.00
PHF	.250	.250	.500	.000	.375	.500	.250	.250	.000	.250	.000	.250

Counts Unlimited, Inc.
 PO Box 1178
 Corona, CA 92878
 (951)268-6268

City of Riverside
 N/S: Trautwein Road/Cole Avenue
 E/W: Van Buren Boulevard
 Weather: Clear

File Name : 08_RIV_Traut_VB AM
 Site Code : 05121716
 Start Date : 11/30/2021
 Page No : 1

Groups Printed- 4+ Axle Trucks

Start Time	Trautwein Road Southbound					Van Buren Boulevard Westbound					Cole Avenue Northbound					Van Buren Boulevard Eastbound								
	Left	Thru	Right	RTOR	App. Total	Left	Thru	Right	RTOR	App. Total	Left	Thru	Right	RTOR	App. Total	Left	Thru	Right	RTOR	App. Total	Exclu. Total	Inclu. Total	Int. Total	
07:00 AM	0	0	0	0	0	0	0	0	0	0	0	0	0	0	0	0	1	0	0	0	0	1	0	1
07:15 AM	0	0	0	0	0	2	0	0	0	2	1	0	0	0	1	0	0	0	0	0	0	0	3	3
07:30 AM	0	0	0	0	0	2	0	0	0	2	0	0	0	0	0	0	2	0	0	0	2	0	4	4
07:45 AM	0	0	0	0	0	1	0	0	0	1	0	1	0	0	1	1	1	0	0	0	2	0	4	4
Total	0	0	0	0	0	5	0	0	0	5	1	1	0	0	2	1	4	0	0	0	0	12	12	12
08:00 AM	0	0	0	0	0	2	0	0	0	2	0	0	0	0	0	0	0	0	0	0	0	0	2	2
08:15 AM	0	0	1	0	1	0	0	0	0	0	0	0	0	0	0	0	1	0	0	0	1	0	2	2
08:30 AM	1	0	0	0	1	1	0	0	0	1	0	0	0	0	0	0	0	0	0	0	0	0	2	2
08:45 AM	0	0	1	0	1	0	2	0	0	2	0	0	0	0	0	0	2	0	0	0	2	0	5	5
Total	1	0	2	0	3	0	5	0	0	5	0	0	0	0	0	0	3	0	0	0	0	11	11	11
Grand Total	1	0	2	0	3	0	10	0	0	10	1	1	0	0	2	1	7	0	0	0	0	23	23	23
% Apprch %	33.3	0	66.7	0	0	0	100	0	0	0	50	50	0	0	0	12.5	87.5	0	0	0	0	0	100	100
% Total %	4.3	0	8.7	0	0	43.5	0	43.5	0	4.3	4.3	0	0	8.7	4.3	30.4	0	0	0	34.8	0	0	100	100

Start Time	Trautwein Road Southbound					Van Buren Boulevard Westbound					Cole Avenue Northbound					Van Buren Boulevard Eastbound								
	Left	Thru	Right	RTOR	App. Total	Left	Thru	Right	RTOR	App. Total	Left	Thru	Right	RTOR	App. Total	Left	Thru	Right	RTOR	App. Total	Exclu. Total	Inclu. Total	Int. Total	
07:15 AM	0	0	0	0	0	0	2	0	0	2	1	0	0	0	1	0	0	0	0	0	0	0	0	0
07:30 AM	0	0	0	0	0	0	2	0	0	2	0	0	0	0	0	0	2	0	0	0	0	0	2	4
07:45 AM	0	0	0	0	0	0	1	0	0	1	0	0	0	0	1	1	1	0	0	0	0	2	2	4
08:00 AM	0	0	0	0	0	0	2	0	0	2	0	0	0	0	0	0	0	0	0	0	0	0	0	2
Total Volume	0	0	0	0	0	0	7	0	0	7	1	1	0	0	2	1	3	0	0	4	0	0	4	13
% App. Total	0	0	0	0	0	0	100	0	0	0	50	50	0	0	0	25	75	0	0	0	0	0	0	100
PHF	.000	.000	.000	.000	.000	.000	.875	.000	.875	.875	.250	.250	.000	.000	.500	.250	.375	.000	.000	.500	.75	.000	.500	.813

Peak Hour Analysis From 07:15 AM to 08:00 AM - Peak 1 of 1
 Peak Hour for Entire Intersection Begins at 07:15 AM

Counts Unlimited, Inc.
 PO Box 1178
 Corona, CA 92878
 (951)268-6268

City of Riverside
 N/S: Trautwein Road/Cole Avenue
 E/W: Van Buren Boulevard
 Weather: Clear

File Name : 08_RIV_Traut_VB AM
 Site Code : 05121716
 Start Date : 11/30/2021
 Page No : 2

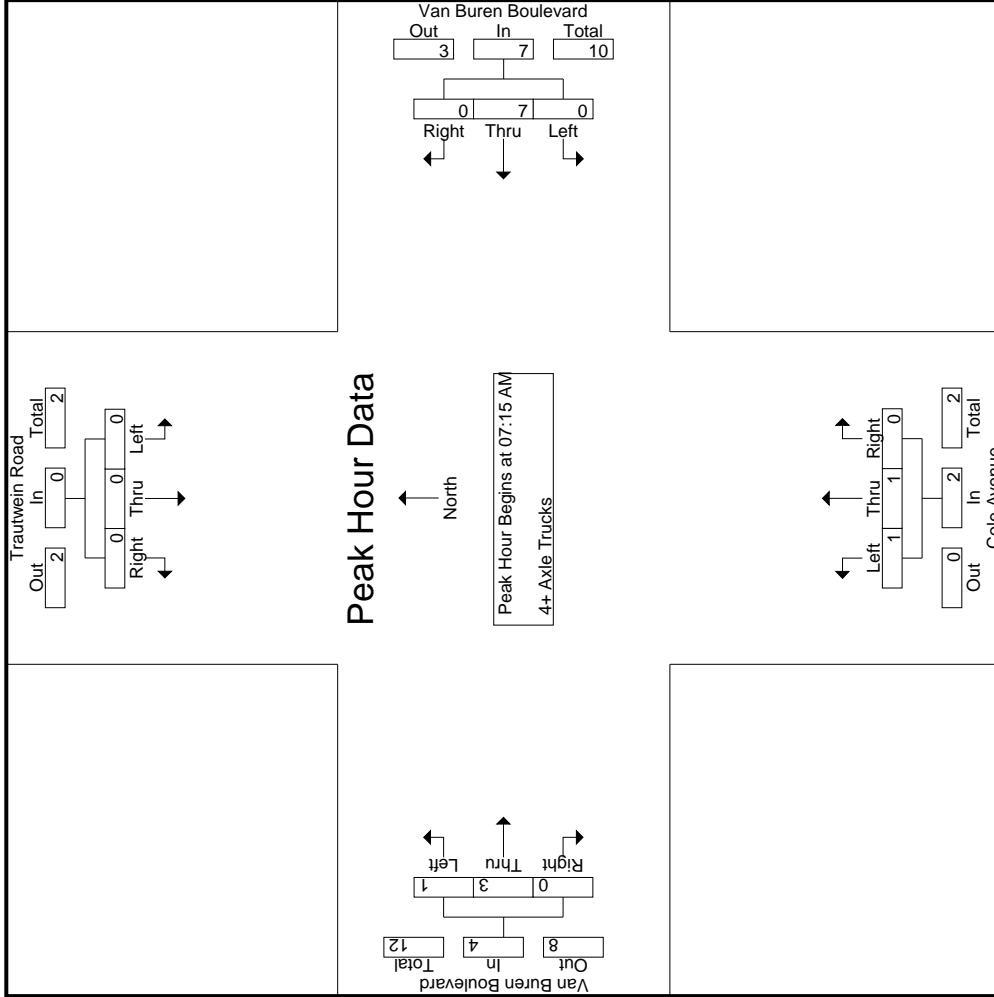

Counts Unlimited, Inc.
 PO Box 1178
 Corona, CA 92878
 (951)268-6268

City of Riverside
 N/S: Trautwein Road/Cole Avenue
 E/W: Van Buren Boulevard
 Weather: Clear

File Name : 08_RIV_Traut_VB AM
 Site Code : 05121716
 Start Date : 11/30/2021
 Page No : 3

Start Time	Trautwein Road Southbound			Van Buren Boulevard Westbound			Cole Avenue Northbound			Van Buren Boulevard Eastbound			Int. Total			
	Left	Thru	Right	Left	Thru	Right	Left	Thru	Right	Left	Thru	Right		App. Total	App. Total	App. Total
	Peak Hour Analysis From 07:15 AM to 08:00 AM - Peak 1 of 1															
Peak Hour for Each Approach Begins at:	07:15 AM															
+0 mins.	0	0	0	2	0	0	2	0	0	0	0	0	0	0	0	
+15 mins.	0	0	0	2	0	0	2	0	0	0	0	2	0	0	2	
+30 mins.	0	0	0	1	0	0	1	0	0	0	1	1	0	0	2	
+45 mins.	0	0	0	2	0	0	2	0	0	0	0	0	0	0	0	
Total Volume	0	0	0	7	0	0	7	0	0	1	1	3	0	0	4	
% App. Total	0	0	0	100	0	0	50	50	0	25	25	75	0	0	0	
PHF	.000	.000	.000	.875	.000	.000	.875	.000	.000	.250	.250	.375	.000	.000	.500	

Groups Printed- Passenger Vehicles - Large 2 Axle Vehicles - 3 Axle Vehicles - 4+ Axle Trucks

Start Time	Trautwein Road Southbound						Van Buren Boulevard Westbound						Cole Avenue Northbound						Van Buren Boulevard Eastbound												
	Left		Thru		Right		Left		Thru		Right		Left		Thru		Right		Left		Thru		Right		Left		Thru		Right		
	Exclu. Total	Inclu. Total	Exclu. Total	Inclu. Total	Exclu. Total	Inclu. Total	Exclu. Total	Inclu. Total	Exclu. Total	Inclu. Total	Exclu. Total	Inclu. Total	Exclu. Total	Inclu. Total	Exclu. Total	Inclu. Total	Exclu. Total	Inclu. Total	Exclu. Total	Inclu. Total	Exclu. Total	Inclu. Total	Exclu. Total	Inclu. Total	Exclu. Total	Inclu. Total	Exclu. Total	Inclu. Total	Exclu. Total	Inclu. Total	
04:00 PM	54	100	43	19	197	20	227	56	23	303	26	70	12	1	108	85	240	19	6	344	49	952	1001								
04:15 PM	78	135	67	31	280	38	272	69	16	379	22	76	8	0	106	78	241	27	16	346	63	1111	1174								
04:30 PM	71	131	59	27	261	19	245	61	30	325	24	65	12	5	101	67	249	21	9	337	71	1024	1095								
04:45 PM	60	105	41	17	206	36	246	59	20	341	28	78	16	0	122	86	252	30	17	368	54	1037	1091								
Total	263	471	210	94	944	113	990	245	89	1348	100	289	48	6	437	316	982	97	48	1395	237	4124	4361								
05:00 PM	78	137	48	19	263	25	227	59	19	311	15	65	10	2	90	86	217	22	13	325	53	989	1042								
05:15 PM	83	119	40	16	242	39	225	54	18	318	14	81	11	3	106	65	255	21	10	341	47	1007	1054								
05:30 PM	90	114	48	23	252	36	215	41	18	292	27	55	13	4	95	87	216	19	5	322	50	961	1011								
05:45 PM	78	89	55	23	222	31	197	42	8	270	23	84	11	1	118	82	223	27	8	332	40	942	982								
Total	329	459	191	81	979	131	864	196	63	1191	79	285	45	10	409	320	911	89	36	1320	190	3899	4089								
Grand Total	592	930	401	175	1923	244	1854	441	152	2539	179	574	93	16	846	636	1893	186	84	2715	427	8023	8450								
Approach %	30.8	48.4	20.9			9.6	73	17.4			21.2	67.8	11			23.4	69.7	6.9													
% Total %	7.4	11.6	5		24	3	23.1	5.5		31.6	2.2	7.2	1.2		10.5	7.9	23.6	2.3		33.8	5.1	94.9									
% Passenger Vehicles	561	919	395		2048	239	1799	431		2620	178	568	91		853	624	1803	182		2692	0	0	8213								
% Large 2 Axle Vehicles	94.8	98.8	98.5	98.9	97.6	98	97	97.7	99.3	97.4	99.4	99	97.8	100	99	98.1	95.2	97.8	98.8	96.2	0	0	97.2								
% 3 Axle Vehicles	26	9	4		41	4	42	5		51	1	6	2		9	11	66	4		82	0	0	183								
% 4+ Axle Trucks	4.4	1	1	1.1	2	1.6	2.3	1.1	0	1.9	0.6	1	2.2	0	1	1.7	3.5	2.2	1.2	2.9	0	0	2.2								
% 3 Axle Vehicles	5	0	0	0	5	0	4	2		6	0	0	0		0	0	8	0		8	0	0	19								
% 4+ Axle Trucks	0.8	0	0	0	0.2	0	0.2	0.5	0	0.2	0	0	0		0	0	0.4	0		0.3	0	0	0.2								
% 4+ Axle Trucks	0	2	2	0	4	1	9	3		14	0	0	0		0	1	16	0		17	0	0	35								
% 4+ Axle Trucks	0	0.2	0.5	0	0.2	0.4	0.5	0.7	0.7	0.5	0	0	0		0	0.2	0.8	0		0.6	0	0	0.4								

Start Time	Trautwein Road Southbound						Van Buren Boulevard Westbound						Cole Avenue Northbound						Van Buren Boulevard Eastbound													
	Left		Thru		Right		Left		Thru		Right		Left		Thru		Right		Left		Thru		Right		Left		Thru		Right			
	Exclu. Total	Inclu. Total	Exclu. Total	Inclu. Total	Exclu. Total	Inclu. Total	Exclu. Total	Inclu. Total	Exclu. Total	Inclu. Total	Exclu. Total	Inclu. Total	Exclu. Total	Inclu. Total	Exclu. Total	Inclu. Total	Exclu. Total	Inclu. Total	Exclu. Total	Inclu. Total	Exclu. Total	Inclu. Total	Exclu. Total	Inclu. Total	Exclu. Total	Inclu. Total	Exclu. Total	Inclu. Total	Exclu. Total	Inclu. Total		
04:15 PM	78	135	67		280	38	272	69		379	22	76	8		106	78	241	27		346	1111											
04:30 PM	71	131	59		261	19	245	61		325	24	65	12		101	67	249	21		337	1024											
04:45 PM	60	105	41		206	36	246	59		341	28	78	16		122	86	252	30		368	1037											
05:00 PM	78	89	55		263	25	227	59		311	15	65	10		90	86	217	22		325	989											
Total Volume	287	508	215		1010	118	990	248		1356	89	284	46		419	317	959	100		1376	4161											
% App. Total	28.4	50.3	21.3		21.3	8.7	7.3	18.3		11.2	21.2	67.8	11		8.59	23	69.7	7.3		8.33	936											
PHF	.920	.927	.802		.902	.776	.910	.899		.894	.795	.910	.719		.859	.922	.951	.833		.935												

Peak Hour Analysis From 04:00 PM to 05:45 PM - Peak 1 of 1
 Peak Hour for Entire Intersection Begins at 04:15 PM

Counts Unlimited, Inc.
 PO Box 1178
 Corona, CA 92878
 (951)268-6268

City of Riverside
 N/S: Trautwein Road/Cole Avenue
 E/W: Van Buren Boulevard
 Weather: Clear

File Name : 08_RIV_Traut_VB PM
 Site Code : 05121716
 Start Date : 11/30/2021
 Page No : 2

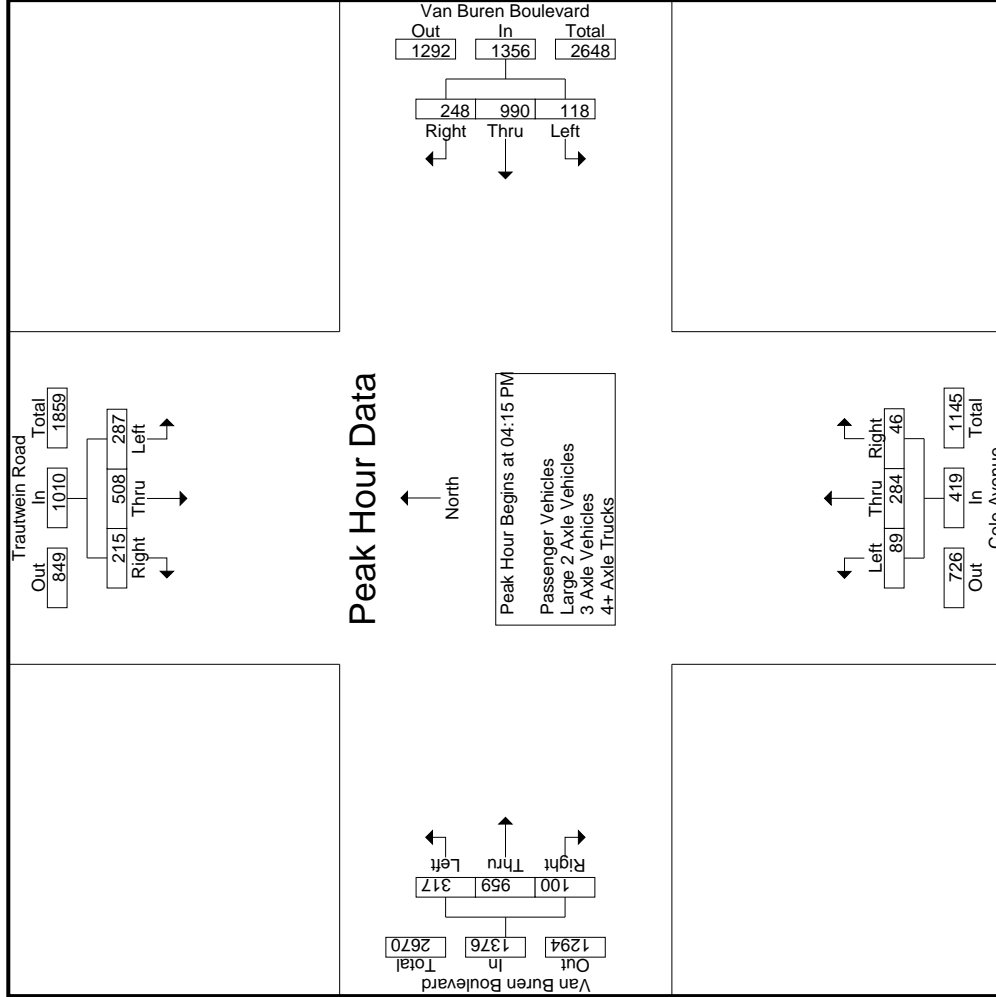

Counts Unlimited, Inc.
 PO Box 1178
 Corona, CA 92878
 (951)268-6268

City of Riverside
 N/S: Trautwein Road/Cole Avenue
 E/W: Van Buren Boulevard
 Weather: Clear

File Name : 08_RIV_Traut_VB PM
 Site Code : 05121716
 Start Date : 11/30/2021
 Page No : 3

Start Time	Trautwein Road Southbound			Van Buren Boulevard Westbound			Cole Avenue Northbound			Van Buren Boulevard Eastbound						
	Left	Thru	Right	Left	Thru	Right	Left	Thru	Right	Left	Thru	Right	App. Total	Int. Total		
Peak Hour Analysis From 04:00 PM to 05:45 PM - Peak 1 of 1																
Peak Hour for Each Approach Begins at:																
	04:15 PM			04:15 PM			04:00 PM			04:00 PM						
+0 mins.	78	135	67	280	38	272	69	379	26	70	12	108	85	240	19	344
+15 mins.	71	131	59	261	19	245	61	325	22	76	8	106	78	241	27	346
+30 mins.	60	105	41	206	36	246	59	341	24	65	12	101	67	249	21	337
+45 mins.	78	137	48	263	25	227	59	311	28	78	16	122	86	252	30	368
Total Volume	287	508	215	1010	118	990	248	1356	100	289	48	437	316	982	97	1395
% App. Total	28.4	50.3	21.3		8.7	73	18.3		22.9	66.1	11		22.7	70.4	7	
PHF	.920	.927	.802	.902	.776	.910	.899	.894	.893	.926	.750	.895	.919	.974	.808	.948

Counts Unlimited, Inc.
 PO Box 1178
 Corona, CA 92878
 (951)268-6268

City of Riverside
 N/S: Trautwein Road/Cole Avenue
 E/W: Van Buren Boulevard
 Weather: Clear

File Name : 08_RIV_Traut_VB PM
 Site Code : 05121716
 Start Date : 11/30/2021
 Page No : 1

Groups Printed- Passenger Vehicles

Start Time	Trautwein Road Southbound				Van Buren Boulevard Westbound				Cole Avenue Northbound				Van Buren Boulevard Eastbound				Exclu. Total	Inclu. Total	Int. Total
	Left	Thru	Right	RTOR	Left	Thru	Right	RTOR	Left	Thru	Right	RTOR	Left	Thru	Right	RTOR			
04:00 PM	48	100	42	19	190	23	296	1	106	84	234	19	6	337	49	929	978		
04:15 PM	77	135	67	31	279	16	362	0	105	75	234	25	16	334	63	1080	1143		
04:30 PM	68	130	56	26	254	61	322	5	99	64	233	21	9	318	70	993	1063		
04:45 PM	59	105	41	17	205	20	326	0	122	86	241	30	17	357	54	1010	1064		
Total	252	470	206	93	928	89	1306	6	432	309	942	95	48	1346	236	4012	4248		
05:00 PM	74	132	48	19	254	19	303	2	89	84	202	21	12	307	52	953	1005		
05:15 PM	74	118	40	16	232	18	313	3	104	64	239	20	10	323	47	972	1019		
05:30 PM	84	111	47	23	242	17	287	4	94	85	205	19	5	309	49	932	981		
05:45 PM	77	88	54	22	219	8	260	1	118	82	215	27	8	324	39	921	960		
Total	309	449	189	80	947	62	1163	10	405	315	861	87	35	1263	187	3778	3965		
Grand Total	561	919	395	173	1875	151	2469	16	837	624	1803	182	83	2609	423	7790	8213		
% Apprch %	29.9	49	21.1			17.5		10.9		23.9	69.1	7							
% Total %	7.2	11.8	5.1		24.1	5.5	31.7	1.2	10.7	8	23.1	2.3		33.5	5.2	94.8			

Start Time	Trautwein Road Southbound				Van Buren Boulevard Westbound				Cole Avenue Northbound				Van Buren Boulevard Eastbound				App. Total	Int. Total
	Left	Thru	Right	RTOR	Left	Thru	Right	RTOR	Left	Thru	Right	RTOR	Left	Thru	Right	RTOR		
04:15 PM	77	135	67		37	259	66		21	76	8		75	234	25		334	
04:30 PM	68	130	56		19	242	61		24	63	12		64	233	21		318	
04:45 PM	59	105	41		35	235	56		28	78	16		86	241	30		357	
05:00 PM	74	132	48		24	220	59		15	65	9		84	202	21		307	
Total Volume	278	502	212		115	956	242		88	282	45		309	910	97		1316	
% App. Total	28	50.6	21.4		8.8	72.8	18.4		21.2	68	10.8		23.5	69.1	7.4		94.8	
PHF	.903	.930	.791		.777	.923	.917		.786	.904	.703		.898	.944	.808		.922	

Peak Hour Analysis From 04:15 PM to 05:00 PM - Peak 1 of 1
 Peak Hour for Entire Intersection Begins at 04:15 PM

Counts Unlimited, Inc.
 PO Box 1178
 Corona, CA 92878
 (951)268-6268

City of Riverside
 N/S: Trautwein Road/Cole Avenue
 E/W: Van Buren Boulevard
 Weather: Clear

File Name : 08_RIV_Traut_VB PM
 Site Code : 05121716
 Start Date : 11/30/2021
 Page No : 2

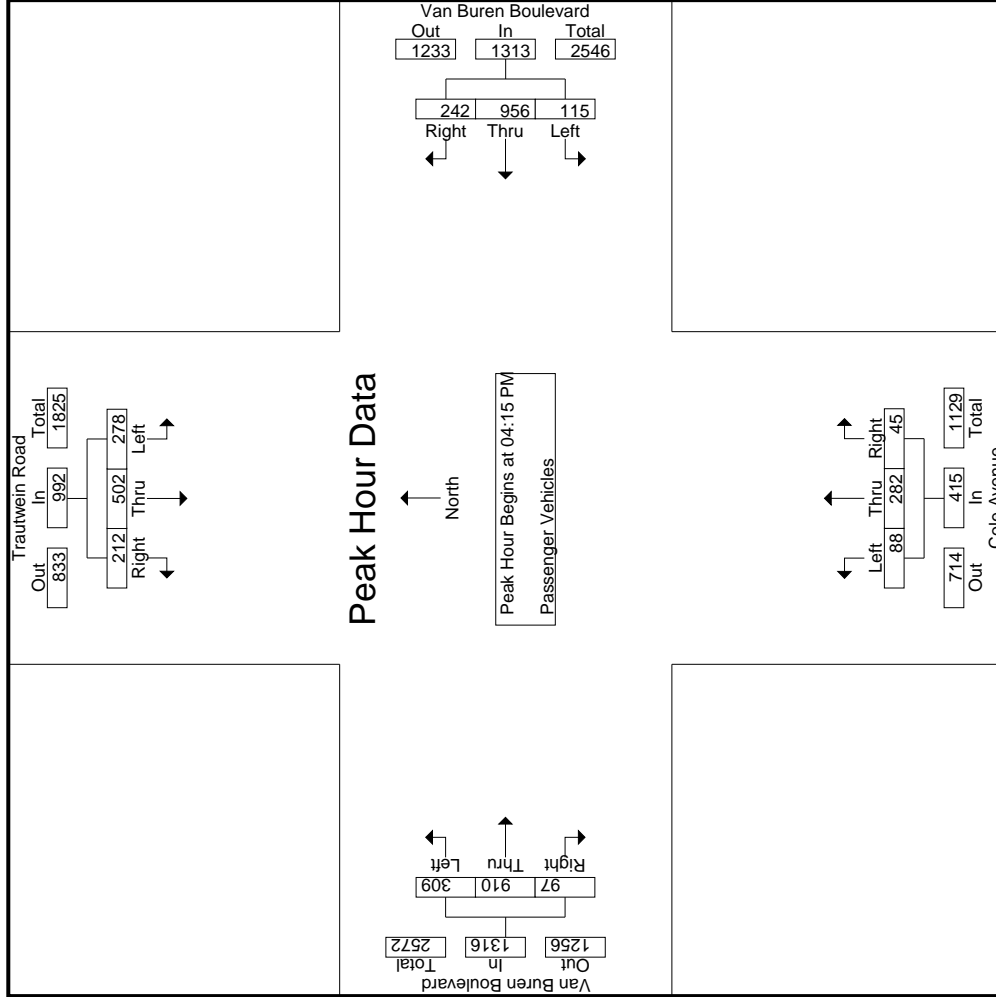

Counts Unlimited, Inc.
 PO Box 1178
 Corona, CA 92878
 (951)268-6268

City of Riverside
 N/S: Trautwein Road/Cole Avenue
 E/W: Van Buren Boulevard
 Weather: Clear

File Name : 08_RIV_Traut_VB PM
 Site Code : 05121716
 Start Date : 11/30/2021
 Page No : 3

Start Time	Trautwein Road Southbound			Van Buren Boulevard Westbound			Cole Avenue Northbound			Van Buren Boulevard Eastbound			Int. Total		
	Left	Thru	Right	Left	Thru	Right	Left	Thru	Right	Left	Thru	Right		App. Total	
Peak Hour Analysis From 04:15 PM to 05:00 PM - Peak 1 of 1	04:15 PM														
Peak Hour for Each Approach Begins at:	04:15 PM														
+0 mins.	77	135	67	37	259	66	362	21	76	8	105	75	234	25	334
+15 mins.	68	130	56	19	242	61	322	24	63	12	99	64	233	21	318
+30 mins.	59	105	41	35	235	56	326	28	78	16	122	86	241	30	357
+45 mins.	74	132	48	24	220	59	303	15	65	9	89	84	202	21	307
Total Volume	278	502	212	115	956	242	1313	88	282	45	415	309	910	97	1316
% App. Total	28	50.6	21.4	8.8	72.8	18.4	21.2	21.2	68	10.8	23.5	23.5	69.1	7.4	1316
PHF	.903	.930	.791	.777	.923	.917	.907	.786	.904	.703	.850	.898	.944	.808	.922

Counts Unlimited, Inc.
 PO Box 1178
 Corona, CA 92878
 (951)268-6268

City of Riverside
 N/S: Trautwein Road/Cole Avenue
 E/W: Van Buren Boulevard
 Weather: Clear

File Name : 08_RIV_Traut_VB PM
 Site Code : 05121716
 Start Date : 11/30/2021
 Page No : 1

Groups Printed- Large 2 Axle Vehicles

Start Time	Trautwein Road Southbound				Van Buren Boulevard Westbound				Cole Avenue Northbound				Van Buren Boulevard Eastbound											
	Left	Thru	Right	RTOR	Left	Thru	Right	RTOR	Left	Thru	Right	RTOR	Left	Thru	Right	RTOR	Left	Thru	Right	RTOR	Exclu. Total	Inclu. Total	Int. Total	
04:00 PM	3	0	0	0	3	0	0	0	4	0	2	0	0	2	0	0	0	3	0	0	4	0	13	13
04:15 PM	1	0	0	0	15	3	0	0	1	0	0	0	1	2	5	2	0	2	0	0	9	0	26	26
04:30 PM	3	0	2	1	3	0	0	0	3	0	2	0	2	3	11	0	0	14	0	0	14	1	24	25
04:45 PM	0	0	0	0	1	7	1	0	9	0	0	0	0	0	9	0	0	9	0	0	9	0	18	18
Total	7	0	2	1	9	25	4	0	31	1	4	0	0	5	28	2	0	36	1	0	36	1	81	82
05:00 PM	4	4	0	0	8	5	0	0	6	0	0	1	0	1	11	1	1	14	1	0	14	1	29	30
05:15 PM	8	1	0	0	9	4	0	0	4	0	1	0	2	1	12	1	0	14	0	0	14	0	29	29
05:30 PM	6	3	1	0	10	3	0	0	3	0	1	0	0	2	10	0	0	12	0	0	12	0	26	26
05:45 PM	1	1	1	1	3	1	5	1	7	0	0	0	0	0	5	0	0	5	0	0	5	1	15	16
Total	19	9	2	1	30	17	1	0	20	0	2	2	0	4	38	2	1	45	2	1	45	2	99	101
Grand Total	26	9	4	2	39	4	42	5	51	1	6	2	0	9	11	66	4	1	81	1	81	3	180	183
% Approach	66.7	23.1	10.3		7.8	82.4	9.8		11.1	66.7	22.2			13.6	81.5	4.9		45		45	1.6	98.4		
% Total	14.4	5	2.2		2.2	23.3	2.8		28.3	0.6	3.3	1.1		6.1	36.7	2.2		45		45	1.6	98.4		

Start Time	Trautwein Road Southbound				Van Buren Boulevard Westbound				Cole Avenue Northbound				Van Buren Boulevard Eastbound										
	Left	Thru	Right	RTOR	Left	Thru	Right	RTOR	Left	Thru	Right	RTOR	Left	Thru	Right	RTOR	Left	Thru	Right	RTOR	Exclu. Total	Inclu. Total	Int. Total
04:15 PM	1	0	0	0	12	3	0	0	15	1	0	0	0	1	2	5	2	5	9	0	2	9	26
04:30 PM	3	0	2	0	3	0	0	0	3	0	0	0	0	2	11	0	0	14	0	0	14	0	24
04:45 PM	0	0	0	0	7	1	0	0	9	0	0	0	0	9	0	0	0	9	0	0	9	0	18
05:00 PM	4	4	0	0	5	0	0	0	6	0	0	1	1	11	1	1	2	14	1	0	14	1	29
Total Volume	8	4	2	2	27	4	33	1	33	1	2	1	4	7	36	3	46	97			97		
% App. Total	57.1	28.6	14.3		6.1	81.8	12.1		25	50	25		15.2	78.3	6.5		.821				.821		
PHF	.500	.250	.250		.500	.563	.333		.550	.250	.250		.500	.818	.375		.821				.821		

Peak Hour Analysis From 04:15 PM to 05:00 PM - Peak 1 of 1
 Peak Hour for Entire Intersection Begins at 04:15 PM

Counts Unlimited, Inc.
 PO Box 1178
 Corona, CA 92878
 (951)268-6268

City of Riverside
 N/S: Trautwein Road/Cole Avenue
 E/W: Van Buren Boulevard
 Weather: Clear

File Name : 08_RIV_Traut_VB_PM
 Site Code : 05121716
 Start Date : 11/30/2021
 Page No : 2

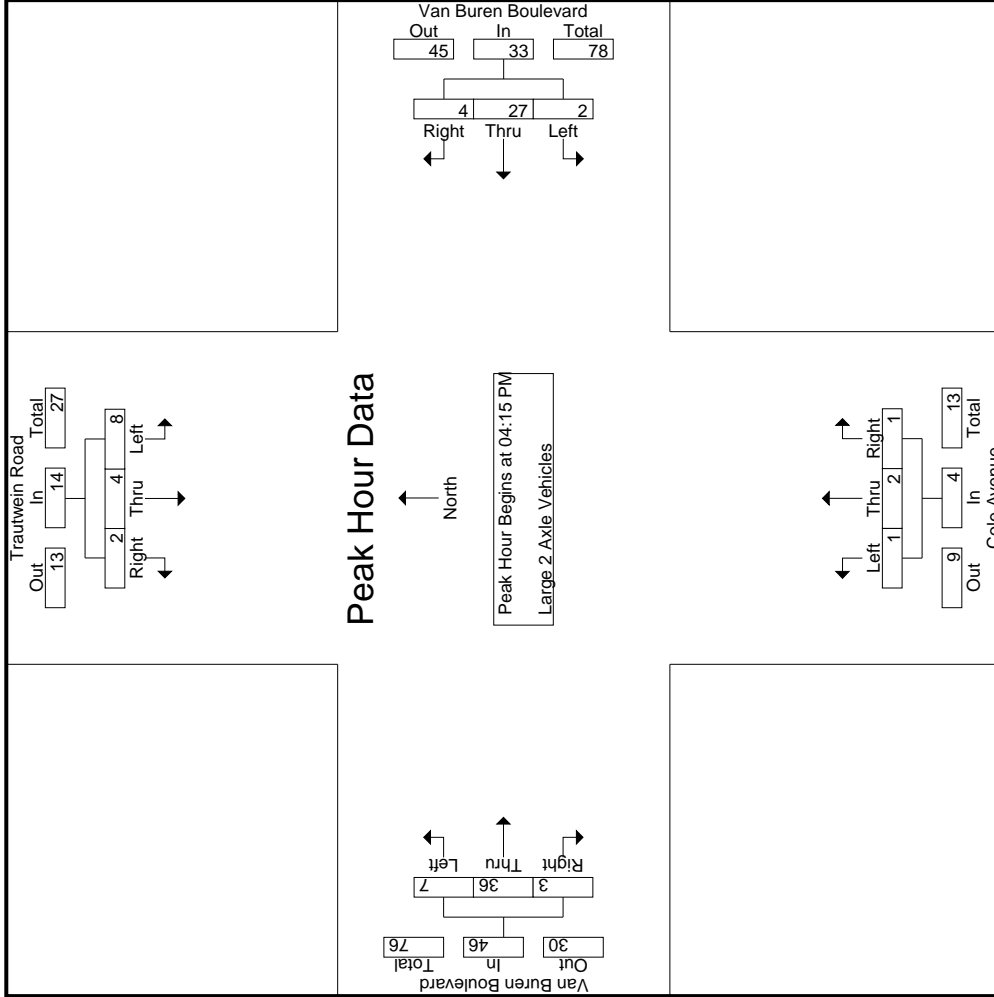

Counts Unlimited, Inc.
 PO Box 1178
 Corona, CA 92878
 (951)268-6268

City of Riverside
 N/S: Trautwein Road/Cole Avenue
 E/W: Van Buren Boulevard
 Weather: Clear

File Name : 08_RIV_Traut_VB PM
 Site Code : 05121716
 Start Date : 11/30/2021
 Page No : 3

Start Time	Trautwein Road Southbound			Van Buren Boulevard Westbound			Cole Avenue Northbound			Van Buren Boulevard Eastbound			
	Left	Thru	Right	Left	Thru	Right	Left	Thru	Right	Left	Thru	Right	
Peak Hour Analysis From 04:15 PM to 05:00 PM - Peak 1 of 1	Peak Hour for Each Approach Begins at:												
	04:15 PM			04:15 PM			04:15 PM			04:15 PM			
+0 mins.	1	0	0	1	0	3	15	1	0	0	2	5	2
+15 mins.	3	0	2	5	3	0	3	2	2	0	11	0	14
+30 mins.	0	0	0	0	1	7	9	0	0	0	9	0	9
+45 mins.	4	4	0	8	1	5	6	0	0	1	2	11	14
Total Volume	8	4	2	14	2	27	33	1	2	1	7	36	46
% App. Total	57.1	28.6	14.3	6.1	81.8	12.1	55.0	25	50	25	15.2	78.3	6.5
PHF	.500	.250	.250	.500	.563	.333	.550	.250	.250	.250	.583	.818	.375
													.821

Counts Unlimited, Inc.
 PO Box 1178
 Corona, CA 92878
 (951)268-6268

City of Riverside
 N/S: Trautwein Road/Cole Avenue
 E/W: Van Buren Boulevard
 Weather: Clear

File Name : 08_RIV_Traut_VB PM
 Site Code : 05121716
 Start Date : 11/30/2021
 Page No : 1

Groups Printed- 3 Axle Vehicles

Start Time	Trautwein Road Southbound				Van Buren Boulevard Westbound				Cole Avenue Northbound				Van Buren Boulevard Eastbound											
	Left	Thru	Right	RTOR	Left	Thru	Right	RTOR	Left	Thru	Right	RTOR	Left	Thru	Right	RTOR	Left	Thru	Right	RTOR	Exclu. Total	Inclu. Total	Int. Total	
04:00 PM	3	0	0	0	0	2	0	0	0	0	0	0	0	0	0	0	0	0	0	0	0	0	6	6
04:15 PM	0	0	0	0	0	0	0	0	0	0	0	0	0	0	0	0	0	0	0	0	0	0	1	1
04:30 PM	0	0	0	0	0	0	0	0	0	0	0	0	0	0	0	0	0	0	0	0	0	0	3	3
04:45 PM	1	0	0	0	0	0	1	0	0	0	0	0	0	0	0	0	0	0	0	0	0	0	4	4
Total	4	0	0	0	4	2	1	0	0	0	0	0	0	0	0	0	0	0	0	0	0	0	14	14
05:00 PM	0	0	0	0	0	0	0	0	0	0	0	0	0	0	0	0	0	0	0	0	0	0	0	0
05:15 PM	1	0	0	0	0	0	1	0	0	0	0	0	0	0	0	0	0	0	0	0	0	0	3	3
05:30 PM	0	0	0	0	0	0	0	0	0	0	0	0	0	0	0	0	0	0	0	0	0	0	0	0
05:45 PM	0	0	0	0	0	0	1	0	0	0	0	0	0	0	0	0	0	0	0	0	0	0	1	1
Total	1	0	0	0	1	2	1	0	0	0	0	0	0	0	0	0	0	0	0	0	0	0	5	5
Grand Total	5	0	0	0	5	4	2	0	0	0	0	0	0	0	0	0	0	0	0	0	0	0	19	19
% Approach	100	0	0	0	0	66.7	33.3	0	0	0	0	0	0	0	0	0	0	0	0	0	0	0	100	100
% Total	26.3	0	0	0	26.3	0	21.1	10.5	31.6	0	0	0	0	0	42.1	0	0	0	42.1	0	0	0	100	100

Start Time	Trautwein Road Southbound				Van Buren Boulevard Westbound				Cole Avenue Northbound				Van Buren Boulevard Eastbound											
	Left	Thru	Right	RTOR	Left	Thru	Right	RTOR	Left	Thru	Right	RTOR	Left	Thru	Right	RTOR	Left	Thru	Right	RTOR	Exclu. Total	Inclu. Total	Int. Total	
04:15 PM	0	0	0	0	0	0	0	0	0	0	0	0	0	0	0	0	0	0	0	0	0	0	1	1
04:30 PM	0	0	0	0	0	0	0	0	0	0	0	0	0	0	0	0	0	0	0	0	0	0	3	3
04:45 PM	1	0	0	0	0	0	0	0	0	0	0	0	0	0	0	0	0	0	0	0	0	0	2	4
05:00 PM	0	0	0	0	0	0	0	0	0	0	0	0	0	0	0	0	0	0	0	0	0	0	0	0
Total Volume	1	0	0	0	1	0	0	0	1	0	0	0	0	0	0	0	0	0	0	0	0	0	6	8
% App. Total	100	0	0	0	0	0	0	0	100	0	0	0	0	0	0	0	0	0	0	0	0	0	100	100
PHF	.250	.000	.000	.000	.250	.000	.000	.000	.250	.000	.000	.000	.000	.500	.000	.000	.000	.500	.000	.000	.000	.500	.500	.500

Peak Hour Analysis From 04:15 PM to 05:00 PM - Peak 1 of 1
 Peak Hour for Entire Intersection Begins at 04:15 PM

Counts Unlimited, Inc.
 PO Box 1178
 Corona, CA 92878
 (951)268-6268

City of Riverside
 N/S: Trautwein Road/Cole Avenue
 E/W: Van Buren Boulevard
 Weather: Clear

File Name : 08_RIV_Traut_VB_PM
 Site Code : 05121716
 Start Date : 11/30/2021
 Page No : 2

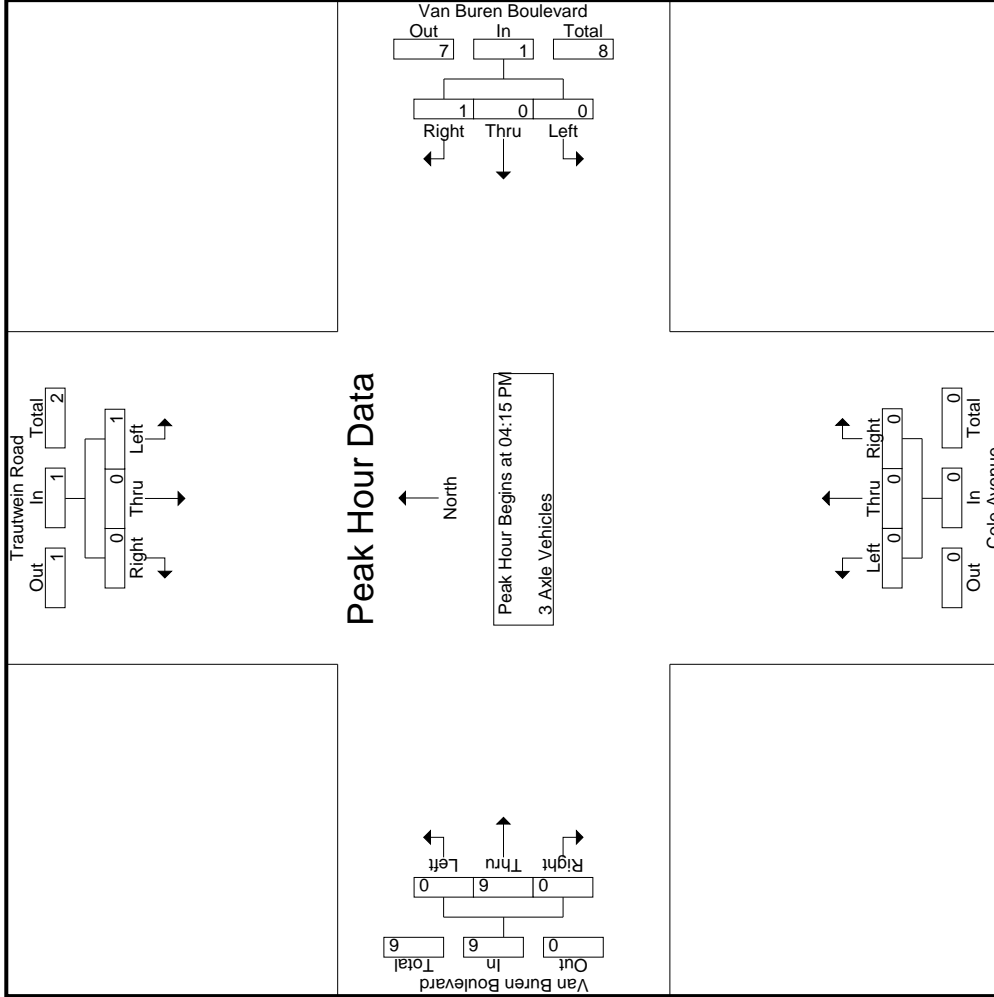

Counts Unlimited, Inc.
 PO Box 1178
 Corona, CA 92878
 (951)268-6268

City of Riverside
 N/S: Trautwein Road/Cole Avenue
 E/W: Van Buren Boulevard
 Weather: Clear

File Name : 08_RIV_Traut_VB PM
 Site Code : 05121716
 Start Date : 11/30/2021
 Page No : 3

Start Time	Trautwein Road Southbound			Van Buren Boulevard Westbound			Cole Avenue Northbound			Van Buren Boulevard Eastbound		
	Left	Thru	Right	Left	Thru	Right	Left	Thru	Right	Left	Thru	Right
Peak Hour Analysis From 04:15 PM to 05:00 PM - Peak 1 of 1												
Peak Hour for Each Approach Begins at:												
+0 mins.	0	0	0	0	0	0	0	0	0	0	1	0
+15 mins.	0	0	0	0	0	0	0	0	0	0	3	0
+30 mins.	1	0	0	0	0	1	0	0	0	0	0	0
+45 mins.	0	0	0	0	0	0	0	0	0	0	0	0
Total Volume	1	0	0	0	0	1	0	0	0	0	6	0
% App. Total	100	0	0	0	0	100	0	0	0	0	100	0
PHF	.250	.000	.000	.250	.000	.250	.000	.000	.000	.000	.500	.000

Counts Unlimited, Inc.
 PO Box 1178
 Corona, CA 92878
 (951)268-6268

City of Riverside
 N/S: Trautwein Road/Cole Avenue
 E/W: Van Buren Boulevard
 Weather: Clear

File Name : 08_RIV_Traut_VB PM
 Site Code : 05121716
 Start Date : 11/30/2021
 Page No : 1

Groups Printed- 4+ Axle Trucks

Start Time	Trautwein Road Southbound				Van Buren Boulevard Westbound				Cole Avenue Northbound				Van Buren Boulevard Eastbound											
	Left	Thru	Right	RTOR	Left	Thru	Right	RTOR	Left	Thru	Right	RTOR	Left	Thru	Right	RTOR	Left	Thru	Right	RTOR	Exclu. Total	Inclu. Total	Int. Total	
04:00 PM	0	0	1	0	0	0	1	0	1	0	0	0	0	0	0	0	0	2	0	0	0	0	4	4
04:15 PM	0	0	0	0	1	1	0	0	2	0	0	0	0	1	1	0	0	2	0	0	0	0	4	4
04:30 PM	0	1	1	0	0	0	0	0	0	0	0	0	0	0	2	0	0	2	0	0	0	0	4	4
04:45 PM	0	0	0	0	0	4	1	0	5	0	0	0	0	0	0	0	0	0	0	0	0	0	5	5
Total	0	1	2	0	3	1	5	2	8	0	0	0	0	1	5	0	0	6	0	0	0	0	17	17
05:00 PM	0	1	0	0	0	2	0	0	2	0	0	0	0	0	4	0	0	4	0	0	0	0	7	7
05:15 PM	0	0	0	0	0	0	0	0	0	0	0	0	0	0	3	0	0	3	0	0	0	0	3	3
05:30 PM	0	0	0	0	0	1	1	0	1	0	0	0	0	0	1	0	0	1	0	0	0	1	2	3
05:45 PM	0	0	0	0	0	2	0	0	2	0	0	0	0	3	0	0	0	3	0	0	0	0	5	5
Total	0	1	0	0	1	4	1	1	5	0	0	0	0	11	0	0	0	11	1	0	0	1	17	18
Grand Total	0	2	2	0	4	1	9	3	13	0	0	0	0	1	16	0	0	17	1	0	0	1	34	35
% Apprch %	0	50	50		7.7	69.2	23.1		38.2	0	0	0		5.9	94.1	0		50	2.9	97.1	0	2.9	97.1	
% Total %	0	5.9	5.9		2.9	26.5	8.8			0	0	0		2.9	47.1	0		50	2.9	97.1	0	2.9	97.1	

Start Time	Trautwein Road Southbound				Van Buren Boulevard Westbound				Cole Avenue Northbound				Van Buren Boulevard Eastbound											
	Left	Thru	Right	RTOR	Left	Thru	Right	RTOR	Left	Thru	Right	RTOR	Left	Thru	Right	RTOR	Left	Thru	Right	RTOR	Exclu. Total	Inclu. Total	Int. Total	
04:15 PM	0	0	0	0	1	1	0	0	2	0	0	0	0	0	0	0	1	1	0	0	0	0	2	4
04:30 PM	0	1	1	0	0	0	0	0	0	0	0	0	0	0	0	0	0	2	0	0	0	0	2	4
04:45 PM	0	0	0	0	0	0	4	1	5	0	0	0	0	0	0	0	0	0	0	0	0	0	0	5
05:00 PM	0	1	1	0	0	0	2	0	2	0	0	0	0	0	0	0	0	4	0	0	0	0	4	7
Total Volume	0	2	1		1	7	7		9	0	0	0		7	7	0		7	0	0	0	0	8	20
% App. Total	0	66.7	33.3		11.1	77.8	11.1		45.0	0.0	0.0	0.0		87.5	87.5	0.0		43.8	0.0	0.0	0.0	0.0	50.0	71.4
PHF	.000	.500	.250		.250	.438	.250		.450	.000	.000	.000		.438	.438	.000		.500	.000	.000	.000	.500	.714	

Peak Hour Analysis From 04:15 PM to 05:00 PM - Peak 1 of 1
 Peak Hour for Entire Intersection Begins at 04:15 PM

Counts Unlimited, Inc.
 PO Box 1178
 Corona, CA 92878
 (951)268-6268

City of Riverside
 N/S: Trautwein Road/Cole Avenue
 E/W: Van Buren Boulevard
 Weather: Clear

File Name : 08_RIV_Traut_VB PM
 Site Code : 05121716
 Start Date : 11/30/2021
 Page No : 2

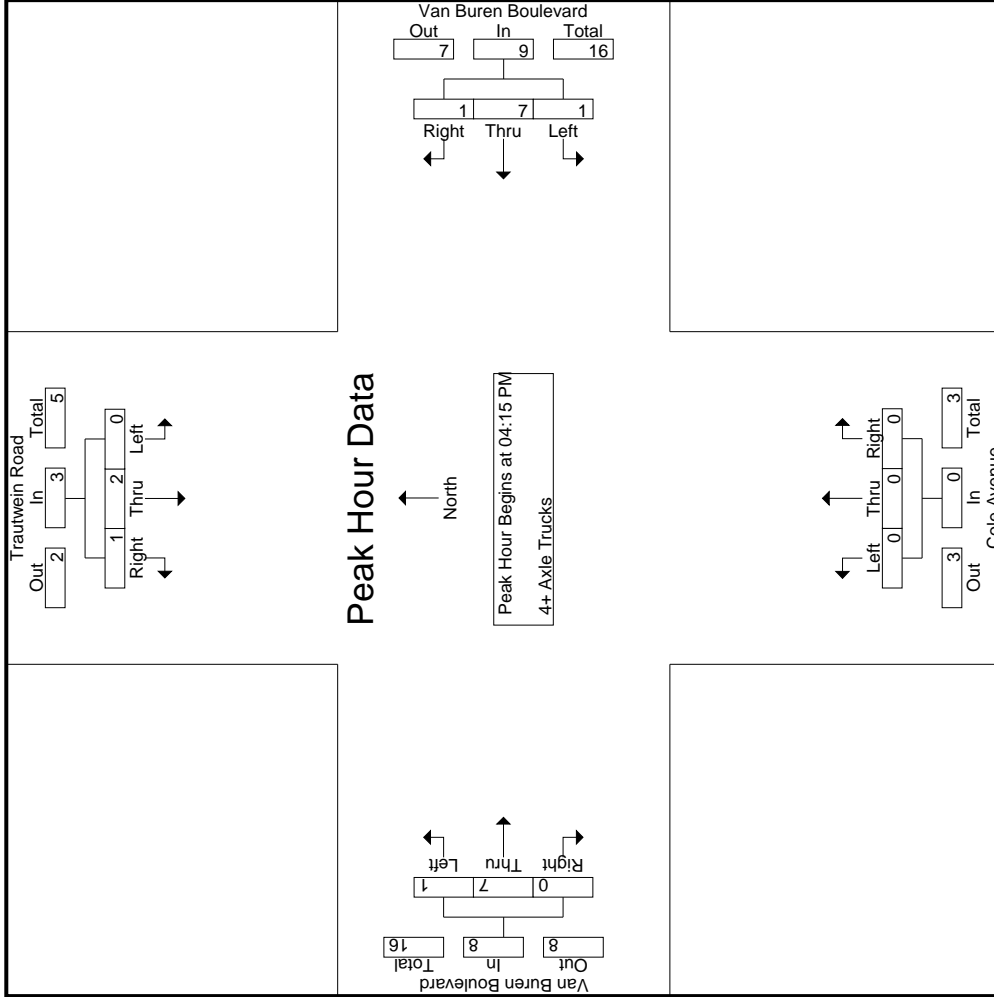

Start Time	Trautwein Road Southbound			Van Buren Boulevard Westbound			Cole Avenue Northbound			Van Buren Boulevard Eastbound		
	Left	Thru	Right	Left	Thru	Right	Left	Thru	Right	Left	Thru	Right
Peak Hour Analysis From 04:15 PM to 05:00 PM - Peak 1 of 1												
Peak Hour for Each Approach Begins at:												
+0 mins.	0	0	0	1	1	0	0	0	0	1	1	0
+15 mins.	0	1	1	0	0	0	0	0	0	0	2	0
+30 mins.	0	0	0	4	1	5	0	0	0	0	0	0
+45 mins.	0	1	0	2	0	2	0	0	0	4	0	4
Total Volume	0	2	1	7	1	9	0	0	0	7	7	0
% App. Total	0	66.7	33.3	11.1	77.8	11.1	0	0	0	12.5	87.5	0
PHF	.000	.500	.250	.250	.438	.250	.000	.000	.000	.250	.438	.000

Location: Riverside
 N/S: Trautwein Road/Cole Avenue
 E/W: Van Buren Boulevard



Date: 11/30/2021
 Day: Tuesday

PEDESTRIANS

	North Leg Trautwein Road	East Leg Van Buren Boulevard	South Leg Cole Avenue	West Leg Van Buren Boulevard	
	Pedestrians	Pedestrians	Pedestrians	Pedestrians	
7:00 AM	0	0	0	0	0
7:15 AM	0	0	0	0	0
7:30 AM	0	1	0	1	2
7:45 AM	0	0	0	0	0
8:00 AM	0	0	0	1	1
8:15 AM	0	0	0	1	1
8:30 AM	0	0	0	0	0
8:45 AM	0	0	0	0	0
TOTAL VOLUMES:	0	1	0	3	4

	North Leg Trautwein Road	East Leg Van Buren Boulevard	South Leg Cole Avenue	West Leg Van Buren Boulevard	
	Pedestrians	Pedestrians	Pedestrians	Pedestrians	
4:00 PM	0	0	0	0	0
4:15 PM	0	2	0	0	2
4:30 PM	0	0	0	0	0
4:45 PM	0	0	0	1	1
5:00 PM	0	2	0	0	2
5:15 PM	1	0	0	1	2
5:30 PM	1	0	0	0	1
5:45 PM	1	0	0	2	3
TOTAL VOLUMES:	3	4	0	4	11

Location: Riverside
 N/S: Trautwein Road/Cole Avenue
 E/W: Van Buren Boulevard



Date: 11/30/2021
 Day: Tuesday

BICYCLES

	Southbound Trautwein Road			Westbound Van Buren Boulevard			Northbound Cole Avenue			Eastbound Van Buren Boulevard			
	Left	Thru	Right	Left	Thru	Right	Left	Thru	Right	Left	Thru	Right	
7:00 AM	0	0	0	0	0	0	0	0	0	0	0	0	0
7:15 AM	0	0	0	0	0	0	0	0	0	0	0	0	0
7:30 AM	0	0	0	0	0	0	0	0	0	0	0	0	0
7:45 AM	0	0	0	0	0	0	0	0	0	0	0	0	0
8:00 AM	0	0	0	0	1	0	0	0	0	0	0	0	1
8:15 AM	0	0	0	0	0	0	0	0	0	0	0	0	0
8:30 AM	0	0	0	0	0	0	0	0	0	0	0	0	0
8:45 AM	0	0	0	0	0	0	0	0	0	0	0	0	0
TOTAL VOLUMES:	0	0	0	0	1	0	0	0	0	0	0	0	1

	Southbound Trautwein Road			Westbound Van Buren Boulevard			Northbound Cole Avenue			Eastbound Van Buren Boulevard			
	Left	Thru	Right	Left	Thru	Right	Left	Thru	Right	Left	Thru	Right	
4:00 PM	0	0	0	0	0	0	0	0	0	0	0	0	0
4:15 PM	0	0	0	0	0	0	0	0	0	0	0	0	0
4:30 PM	0	0	0	0	0	0	0	0	0	0	0	0	0
4:45 PM	0	0	0	0	0	0	0	0	0	0	0	0	0
5:00 PM	0	0	0	0	0	0	0	0	0	0	0	0	0
5:15 PM	0	0	0	0	0	0	0	0	0	0	0	0	0
5:30 PM	0	1	0	0	0	0	0	0	0	0	0	0	1
5:45 PM	0	0	0	0	0	0	0	0	0	0	0	0	0
TOTAL VOLUMES:	0	1	0	0	0	0	0	0	0	0	0	0	1

City of Riverside
 N/S: Deercreek Drive
 E/W: Grove Community Drive
 Weather: Clear

File Name : 09_RIV_Deer_Grove AM
 Site Code : 05121716
 Start Date : 11/30/2021
 Page No : 1

Groups Printed- Passenger Vehicles - Large 2 Axle Vehicles - 3 Axle Vehicles - 4+ Axle Trucks

Start Time	Grove Community Drive Westbound			Deercreek Drive Northbound			Grove Community Drive Eastbound			Int. Total
	Left	Thru	App. Total	Left	Right	App. Total	Thru	Right	App. Total	
07:00 AM	8	61	69	16	6	22	23	33	56	147
07:15 AM	20	95	115	47	8	55	20	30	50	220
07:30 AM	14	74	88	73	5	78	20	3	23	189
07:45 AM	0	47	47	37	9	46	19	1	20	113
Total	42	277	319	173	28	201	82	67	149	669
08:00 AM	3	31	34	9	9	18	16	1	17	69
08:15 AM	0	29	29	6	11	17	30	4	34	80
08:30 AM	2	30	32	7	9	16	25	1	26	74
08:45 AM	3	46	49	10	9	19	17	1	18	86
Total	8	136	144	32	38	70	88	7	95	309
Grand Total	50	413	463	205	66	271	170	74	244	978
Apprch %	10.8	89.2		75.6	24.4		69.7	30.3		
Total %	5.1	42.2	47.3	21	6.7	27.7	17.4	7.6	24.9	
Passenger Vehicles	49	405	454	204	66	270	166	73	239	963
% Passenger Vehicles	98	98.1	98.1	99.5	100	99.6	97.6	98.6	98	98.5
Large 2 Axle Vehicles	1	8	9	1	0	1	4	1	5	15
% Large 2 Axle Vehicles	2	1.9	1.9	0.5	0	0.4	2.4	1.4	2	1.5
3 Axle Vehicles	0	0	0	0	0	0	0	0	0	0
% 3 Axle Vehicles	0	0	0	0	0	0	0	0	0	0
4+ Axle Trucks	0	0	0	0	0	0	0	0	0	0
% 4+ Axle Trucks	0	0	0	0	0	0	0	0	0	0

Start Time	Grove Community Drive Westbound			Deercreek Drive Northbound			Grove Community Drive Eastbound			Int. Total
	Left	Thru	App. Total	Left	Right	App. Total	Thru	Right	App. Total	
Peak Hour Analysis From 07:00 AM to 08:45 AM - Peak 1 of 1										
Peak Hour for Entire Intersection Begins at 07:00 AM										
07:00 AM	8	61	69	16	6	22	23	33	56	147
07:15 AM	20	95	115	47	8	55	20	30	50	220
07:30 AM	14	74	88	73	5	78	20	3	23	189
07:45 AM	0	47	47	37	9	46	19	1	20	113
Total Volume	42	277	319	173	28	201	82	67	149	669
% App. Total	13.2	86.8		86.1	13.9		55	45		
PHF	.525	.729	.693	.592	.778	.644	.891	.508	.665	.760

City of Riverside
 N/S: Deercreek Drive
 E/W: Grove Community Drive
 Weather: Clear

File Name : 09_RIV_Deer_Grove AM
 Site Code : 05121716
 Start Date : 11/30/2021
 Page No : 2

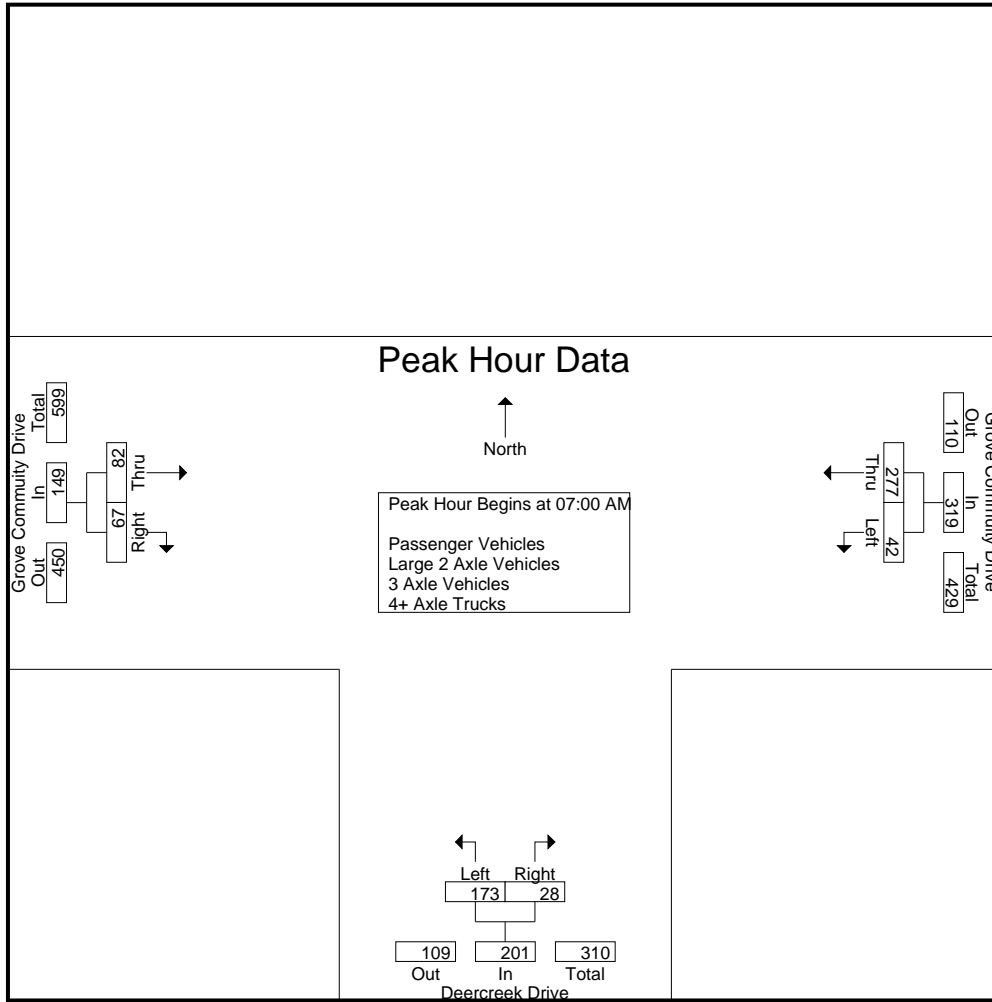

Peak Hour Analysis From 07:00 AM to 08:45 AM - Peak 1 of 1
 Peak Hour for Each Approach Begins at:

	07:00 AM			07:00 AM			07:00 AM		
+0 mins.	8	61	69	16	6	22	23	33	56
+15 mins.	20	95	115	47	8	55	20	30	50
+30 mins.	14	74	88	73	5	78	20	3	23
+45 mins.	0	47	47	37	9	46	19	1	20
Total Volume	42	277	319	173	28	201	82	67	149
% App. Total	13.2	86.8		86.1	13.9		55	45	
PHF	.525	.729	.693	.592	.778	.644	.891	.508	.665

City of Riverside
 N/S: Deercreek Drive
 E/W: Grove Community Drive
 Weather: Clear

File Name : 09_RIV_Deer_Grove AM
 Site Code : 05121716
 Start Date : 11/30/2021
 Page No : 1

Groups Printed- Passenger Vehicles

Start Time	Grove Community Drive Westbound			Deercreek Drive Northbound			Grove Community Drive Eastbound			Int. Total
	Left	Thru	App. Total	Left	Right	App. Total	Thru	Right	App. Total	
07:00 AM	8	60	68	16	6	22	23	32	55	145
07:15 AM	19	95	114	47	8	55	20	30	50	219
07:30 AM	14	72	86	73	5	78	19	3	22	186
07:45 AM	0	44	44	37	9	46	18	1	19	109
Total	41	271	312	173	28	201	80	66	146	659
08:00 AM	3	30	33	9	9	18	16	1	17	68
08:15 AM	0	29	29	6	11	17	29	4	33	79
08:30 AM	2	29	31	7	9	16	24	1	25	72
08:45 AM	3	46	49	9	9	18	17	1	18	85
Total	8	134	142	31	38	69	86	7	93	304
Grand Total	49	405	454	204	66	270	166	73	239	963
Apprch %	10.8	89.2		75.6	24.4		69.5	30.5		
Total %	5.1	42.1	47.1	21.2	6.9	28	17.2	7.6	24.8	

Start Time	Grove Community Drive Westbound			Deercreek Drive Northbound			Grove Community Drive Eastbound			Int. Total
	Left	Thru	App. Total	Left	Right	App. Total	Thru	Right	App. Total	
07:00 AM	8	60	68	16	6	22	23	32	55	145
07:15 AM	19	95	114	47	8	55	20	30	50	219
07:30 AM	14	72	86	73	5	78	19	3	22	186
07:45 AM	0	44	44	37	9	46	18	1	19	109
Total Volume	41	271	312	173	28	201	80	66	146	659
% App. Total	13.1	86.9		86.1	13.9		54.8	45.2		
PHF	.539	.713	.684	.592	.778	.644	.870	.516	.664	.752

Peak Hour Analysis From 07:00 AM to 07:45 AM - Peak 1 of 1
 Peak Hour for Entire Intersection Begins at 07:00 AM

City of Riverside
 N/S: Deercreek Drive
 E/W: Grove Community Drive
 Weather: Clear

File Name : 09_RIV_Deer_Grove AM
 Site Code : 05121716
 Start Date : 11/30/2021
 Page No : 2

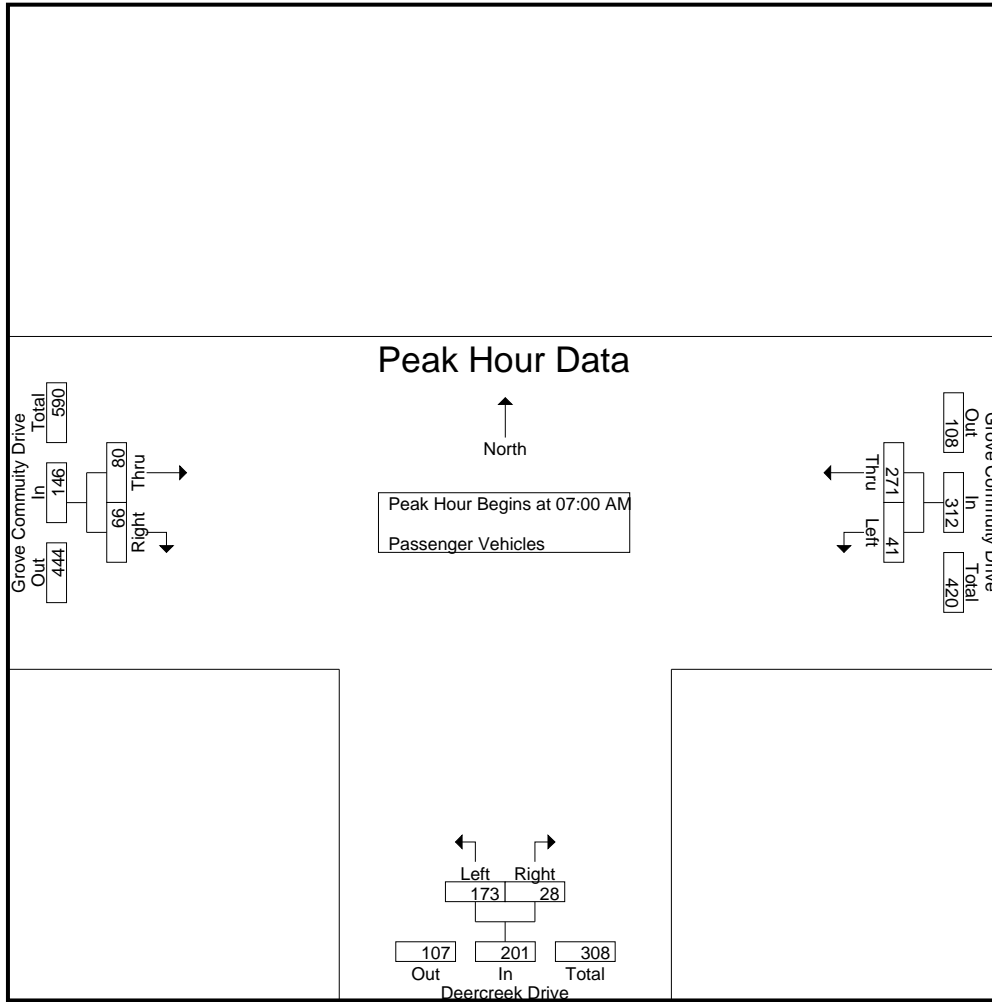

Peak Hour Analysis From 07:00 AM to 07:45 AM - Peak 1 of 1
 Peak Hour for Each Approach Begins at:

	07:00 AM			07:00 AM			07:00 AM		
+0 mins.	8	60	68	16	6	22	23	32	55
+15 mins.	19	95	114	47	8	55	20	30	50
+30 mins.	14	72	86	73	5	78	19	3	22
+45 mins.	0	44	44	37	9	46	18	1	19
Total Volume	41	271	312	173	28	201	80	66	146
% App. Total	13.1	86.9		86.1	13.9		54.8	45.2	
PHF	.539	.713	.684	.592	.778	.644	.870	.516	.664

City of Riverside
 N/S: Deercreek Drive
 E/W: Grove Community Drive
 Weather: Clear

File Name : 09_RIV_Deer_Grove AM
 Site Code : 05121716
 Start Date : 11/30/2021
 Page No : 1

Groups Printed- Large 2 Axle Vehicles

Start Time	Grove Community Drive Westbound			Deercreek Drive Northbound			Grove Community Drive Eastbound			Int. Total
	Left	Thru	App. Total	Left	Right	App. Total	Thru	Right	App. Total	
07:00 AM	0	1	1	0	0	0	0	1	1	2
07:15 AM	1	0	1	0	0	0	0	0	0	1
07:30 AM	0	2	2	0	0	0	1	0	1	3
07:45 AM	0	3	3	0	0	0	1	0	1	4
Total	1	6	7	0	0	0	2	1	3	10
08:00 AM	0	1	1	0	0	0	0	0	0	1
08:15 AM	0	0	0	0	0	0	1	0	1	1
08:30 AM	0	1	1	0	0	0	1	0	1	2
08:45 AM	0	0	0	1	0	1	0	0	0	1
Total	0	2	2	1	0	1	2	0	2	5
Grand Total	1	8	9	1	0	1	4	1	5	15
Apprch %	11.1	88.9		100	0		80	20		
Total %	6.7	53.3	60	6.7	0	6.7	26.7	6.7	33.3	

Start Time	Grove Community Drive Westbound			Deercreek Drive Northbound			Grove Community Drive Eastbound			Int. Total
	Left	Thru	App. Total	Left	Right	App. Total	Thru	Right	App. Total	
07:00 AM	0	1	1	0	0	0	0	1	1	2
07:15 AM	1	0	1	0	0	0	0	0	0	1
07:30 AM	0	2	2	0	0	0	1	0	1	3
07:45 AM	0	3	3	0	0	0	1	0	1	4
Total Volume	1	6	7	0	0	0	2	1	3	10
% App. Total	14.3	85.7		0	0		66.7	33.3		
PHF	.250	.500	.583	.000	.000	.000	.500	.250	.750	.625

Peak Hour Analysis From 07:00 AM to 07:45 AM - Peak 1 of 1

Peak Hour for Entire Intersection Begins at 07:00 AM

City of Riverside
 N/S: Deercreek Drive
 E/W: Grove Community Drive
 Weather: Clear

File Name : 09_RIV_Deer_Grove AM
 Site Code : 05121716
 Start Date : 11/30/2021
 Page No : 2

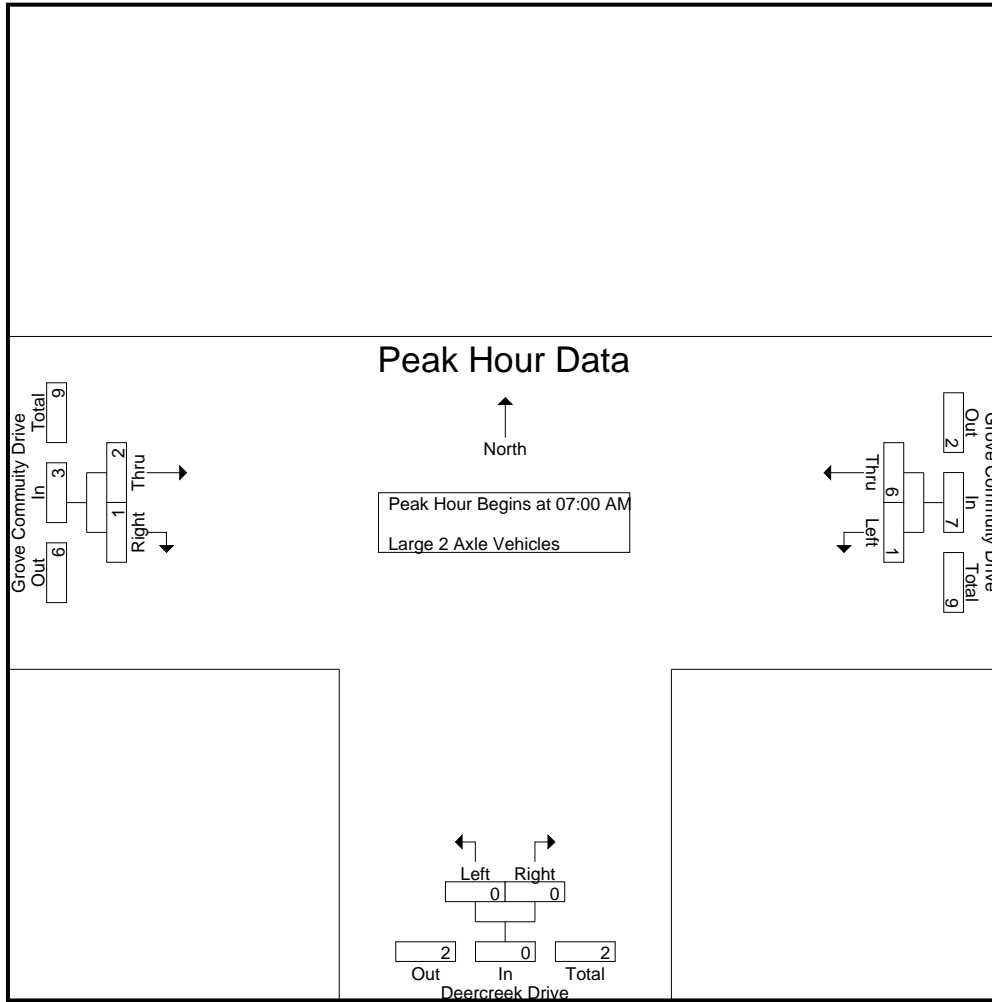

Peak Hour Analysis From 07:00 AM to 07:45 AM - Peak 1 of 1
 Peak Hour for Each Approach Begins at:

	07:00 AM			07:00 AM			07:00 AM		
+0 mins.	0	1	1	0	0	0	0	1	1
+15 mins.	1	0	1	0	0	0	0	0	0
+30 mins.	0	2	2	0	0	0	1	0	1
+45 mins.	0	3	3	0	0	0	1	0	1
Total Volume	1	6	7	0	0	0	2	1	3
% App. Total	14.3	85.7		0	0		66.7	33.3	
PHF	.250	.500	.583	.000	.000	.000	.500	.250	.750

City of Riverside
 N/S: Deercreek Drive
 E/W: Grove Community Drive
 Weather: Clear

File Name : 09_RIV_Deer_Grove AM
 Site Code : 05121716
 Start Date : 11/30/2021
 Page No : 1

Groups Printed- 3 Axle Vehicles

Start Time	Grove Community Drive Westbound			Deercreek Drive Northbound			Grove Community Drive Eastbound			Int. Total
	Left	Thru	App. Total	Left	Right	App. Total	Thru	Right	App. Total	
07:00 AM	0	0	0	0	0	0	0	0	0	0
07:15 AM	0	0	0	0	0	0	0	0	0	0
07:30 AM	0	0	0	0	0	0	0	0	0	0
07:45 AM	0	0	0	0	0	0	0	0	0	0
Total	0	0	0	0	0	0	0	0	0	0
08:00 AM	0	0	0	0	0	0	0	0	0	0
08:15 AM	0	0	0	0	0	0	0	0	0	0
08:30 AM	0	0	0	0	0	0	0	0	0	0
08:45 AM	0	0	0	0	0	0	0	0	0	0
Total	0	0	0	0	0	0	0	0	0	0
Grand Total	0	0	0	0	0	0	0	0	0	0
Apprch %	0	0		0	0		0	0		
Total %										

Start Time	Grove Community Drive Westbound			Deercreek Drive Northbound			Grove Community Drive Eastbound			Int. Total
	Left	Thru	App. Total	Left	Right	App. Total	Thru	Right	App. Total	
07:00 AM	0	0	0	0	0	0	0	0	0	0
07:15 AM	0	0	0	0	0	0	0	0	0	0
07:30 AM	0	0	0	0	0	0	0	0	0	0
07:45 AM	0	0	0	0	0	0	0	0	0	0
Total Volume	0	0	0	0	0	0	0	0	0	0
% App. Total	0	0		0	0		0	0		
PHF	.000	.000	.000	.000	.000	.000	.000	.000	.000	.000

Peak Hour Analysis From 07:00 AM to 07:45 AM - Peak 1 of 1
 Peak Hour for Entire Intersection Begins at 07:00 AM

City of Riverside
 N/S: Deercreek Drive
 E/W: Grove Community Drive
 Weather: Clear

File Name : 09_RIV_Deer_Grove AM
 Site Code : 05121716
 Start Date : 11/30/2021
 Page No : 2

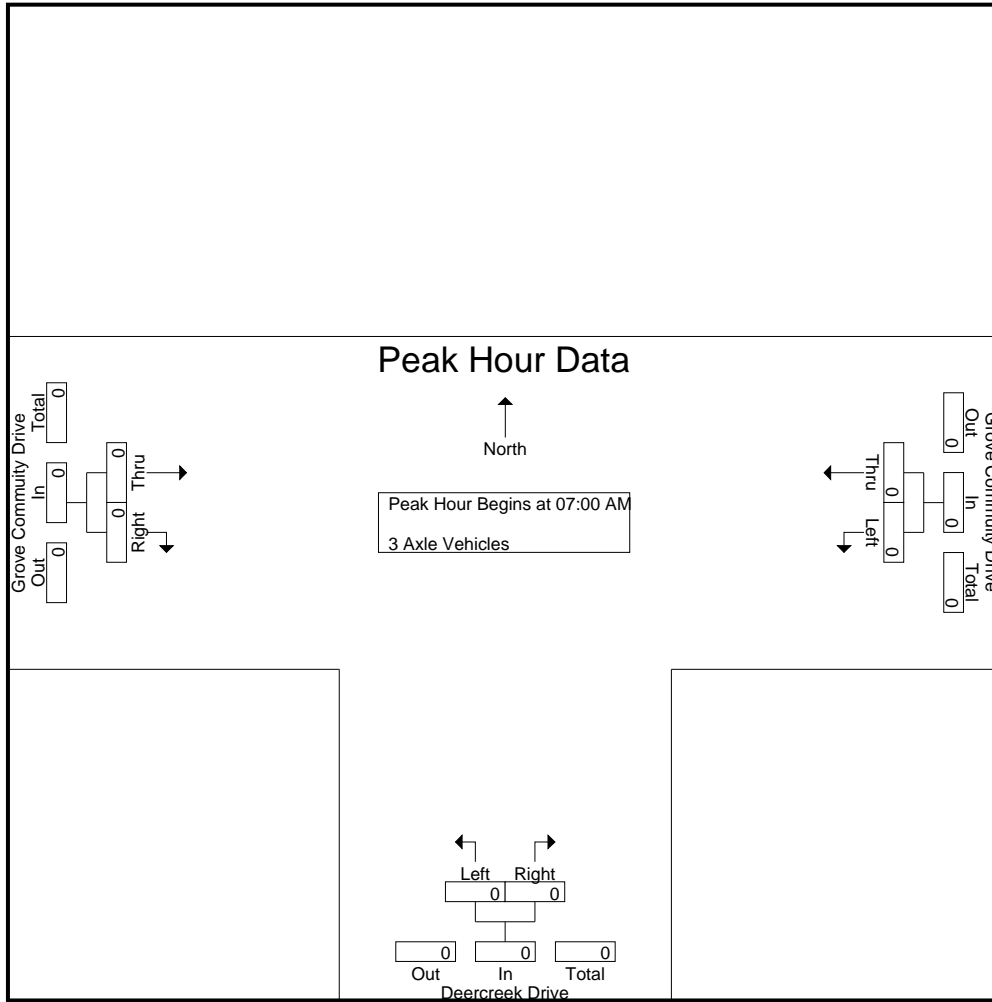

Peak Hour Analysis From 07:00 AM to 07:45 AM - Peak 1 of 1
 Peak Hour for Each Approach Begins at:

	07:00 AM			07:00 AM			07:00 AM		
+0 mins.	0	0	0	0	0	0	0	0	0
+15 mins.	0	0	0	0	0	0	0	0	0
+30 mins.	0	0	0	0	0	0	0	0	0
+45 mins.	0	0	0	0	0	0	0	0	0
Total Volume	0	0	0	0	0	0	0	0	0
% App. Total	0	0	0	0	0	0	0	0	0
PHF	.000	.000	.000	.000	.000	.000	.000	.000	.000

City of Riverside
 N/S: Deercreek Drive
 E/W: Grove Community Drive
 Weather: Clear

File Name : 09_RIV_Deer_Grove AM
 Site Code : 05121716
 Start Date : 11/30/2021
 Page No : 1

Groups Printed- 4+ Axle Trucks

Start Time	Grove Community Drive Westbound			Deercreek Drive Northbound			Grove Community Drive Eastbound			Int. Total
	Left	Thru	App. Total	Left	Right	App. Total	Thru	Right	App. Total	
07:00 AM	0	0	0	0	0	0	0	0	0	0
07:15 AM	0	0	0	0	0	0	0	0	0	0
07:30 AM	0	0	0	0	0	0	0	0	0	0
07:45 AM	0	0	0	0	0	0	0	0	0	0
Total	0	0	0	0	0	0	0	0	0	0
08:00 AM	0	0	0	0	0	0	0	0	0	0
08:15 AM	0	0	0	0	0	0	0	0	0	0
08:30 AM	0	0	0	0	0	0	0	0	0	0
08:45 AM	0	0	0	0	0	0	0	0	0	0
Total	0	0	0	0	0	0	0	0	0	0
Grand Total	0	0	0	0	0	0	0	0	0	0
Apprch %	0	0		0	0		0	0		
Total %										

Start Time	Grove Community Drive Westbound			Deercreek Drive Northbound			Grove Community Drive Eastbound			Int. Total
	Left	Thru	App. Total	Left	Right	App. Total	Thru	Right	App. Total	
07:00 AM	0	0	0	0	0	0	0	0	0	0
07:15 AM	0	0	0	0	0	0	0	0	0	0
07:30 AM	0	0	0	0	0	0	0	0	0	0
07:45 AM	0	0	0	0	0	0	0	0	0	0
Total Volume	0	0	0	0	0	0	0	0	0	0
% App. Total	0	0		0	0		0	0		
PHF	.000	.000	.000	.000	.000	.000	.000	.000	.000	.000

Peak Hour Analysis From 07:00 AM to 07:45 AM - Peak 1 of 1
 Peak Hour for Entire Intersection Begins at 07:00 AM

City of Riverside
 N/S: Deercreek Drive
 E/W: Grove Community Drive
 Weather: Clear

File Name : 09_RIV_Deer_Grove AM
 Site Code : 05121716
 Start Date : 11/30/2021
 Page No : 2

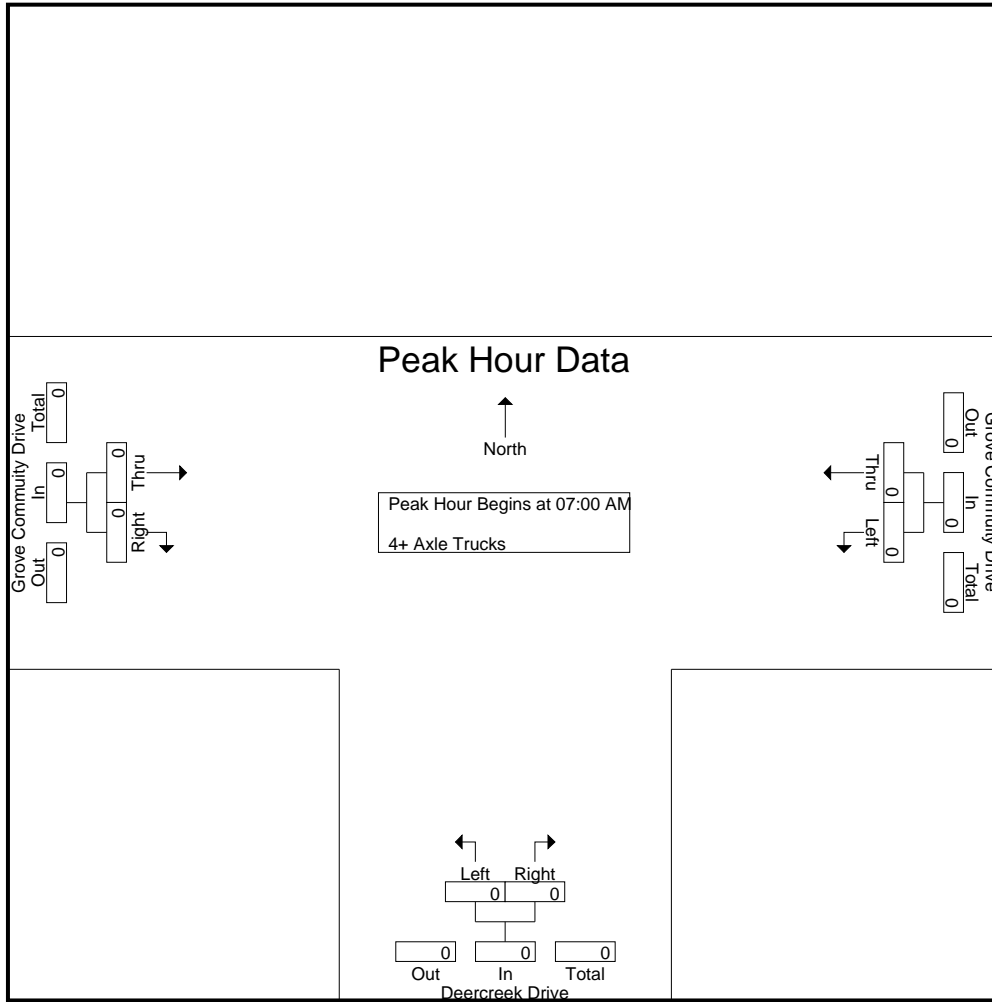

Peak Hour Analysis From 07:00 AM to 07:45 AM - Peak 1 of 1
 Peak Hour for Each Approach Begins at:

	07:00 AM			07:00 AM			07:00 AM		
+0 mins.	0	0	0	0	0	0	0	0	0
+15 mins.	0	0	0	0	0	0	0	0	0
+30 mins.	0	0	0	0	0	0	0	0	0
+45 mins.	0	0	0	0	0	0	0	0	0
Total Volume	0	0	0	0	0	0	0	0	0
% App. Total	0	0	0	0	0	0	0	0	0
PHF	.000	.000	.000	.000	.000	.000	.000	.000	.000

City of Riverside
 N/S: Deercreek Drive
 E/W: Grove Community Drive
 Weather: Clear

File Name : 09_RIV_Deer_Grove PM
 Site Code : 05121716
 Start Date : 11/30/2021
 Page No : 1

Groups Printed- Passenger Vehicles - Large 2 Axle Vehicles - 3 Axle Vehicles - 4+ Axle Trucks

Start Time	Grove Community Drive Westbound			Deercreek Drive Northbound			Grove Community Drive Eastbound			Int. Total
	Left	Thru	App. Total	Left	Right	App. Total	Thru	Right	App. Total	
04:00 PM	3	30	33	3	7	10	42	5	47	90
04:15 PM	4	20	24	6	7	13	44	1	45	82
04:30 PM	2	32	34	9	14	23	37	5	42	99
04:45 PM	6	25	31	4	9	13	47	4	51	95
Total	15	107	122	22	37	59	170	15	185	366
05:00 PM	5	31	36	6	8	14	40	3	43	93
05:15 PM	5	37	42	4	7	11	46	4	50	103
05:30 PM	4	28	32	6	5	11	61	5	66	109
05:45 PM	6	28	34	9	14	23	52	5	57	114
Total	20	124	144	25	34	59	199	17	216	419
Grand Total	35	231	266	47	71	118	369	32	401	785
Apprch %	13.2	86.8		39.8	60.2		92	8		
Total %	4.5	29.4	33.9	6	9	15	47	4.1	51.1	
Passenger Vehicles	33	228	261	47	70	117	363	32	395	773
% Passenger Vehicles	94.3	98.7	98.1	100	98.6	99.2	98.4	100	98.5	98.5
Large 2 Axle Vehicles	2	3	5	0	1	1	6	0	6	12
% Large 2 Axle Vehicles	5.7	1.3	1.9	0	1.4	0.8	1.6	0	1.5	1.5
3 Axle Vehicles	0	0	0	0	0	0	0	0	0	0
% 3 Axle Vehicles	0	0	0	0	0	0	0	0	0	0
4+ Axle Trucks	0	0	0	0	0	0	0	0	0	0
% 4+ Axle Trucks	0	0	0	0	0	0	0	0	0	0

Start Time	Grove Community Drive Westbound			Deercreek Drive Northbound			Grove Community Drive Eastbound			Int. Total
	Left	Thru	App. Total	Left	Right	App. Total	Thru	Right	App. Total	
Peak Hour Analysis From 04:00 PM to 05:45 PM - Peak 1 of 1										
Peak Hour for Entire Intersection Begins at 05:00 PM										
05:00 PM	5	31	36	6	8	14	40	3	43	93
05:15 PM	5	37	42	4	7	11	46	4	50	103
05:30 PM	4	28	32	6	5	11	61	5	66	109
05:45 PM	6	28	34	9	14	23	52	5	57	114
Total Volume	20	124	144	25	34	59	199	17	216	419
% App. Total	13.9	86.1		42.4	57.6		92.1	7.9		
PHF	.833	.838	.857	.694	.607	.641	.816	.850	.818	.919

City of Riverside
 N/S: Deercreek Drive
 E/W: Grove Community Drive
 Weather: Clear

File Name : 09_RIV_Deer_Grove PM
 Site Code : 05121716
 Start Date : 11/30/2021
 Page No : 2

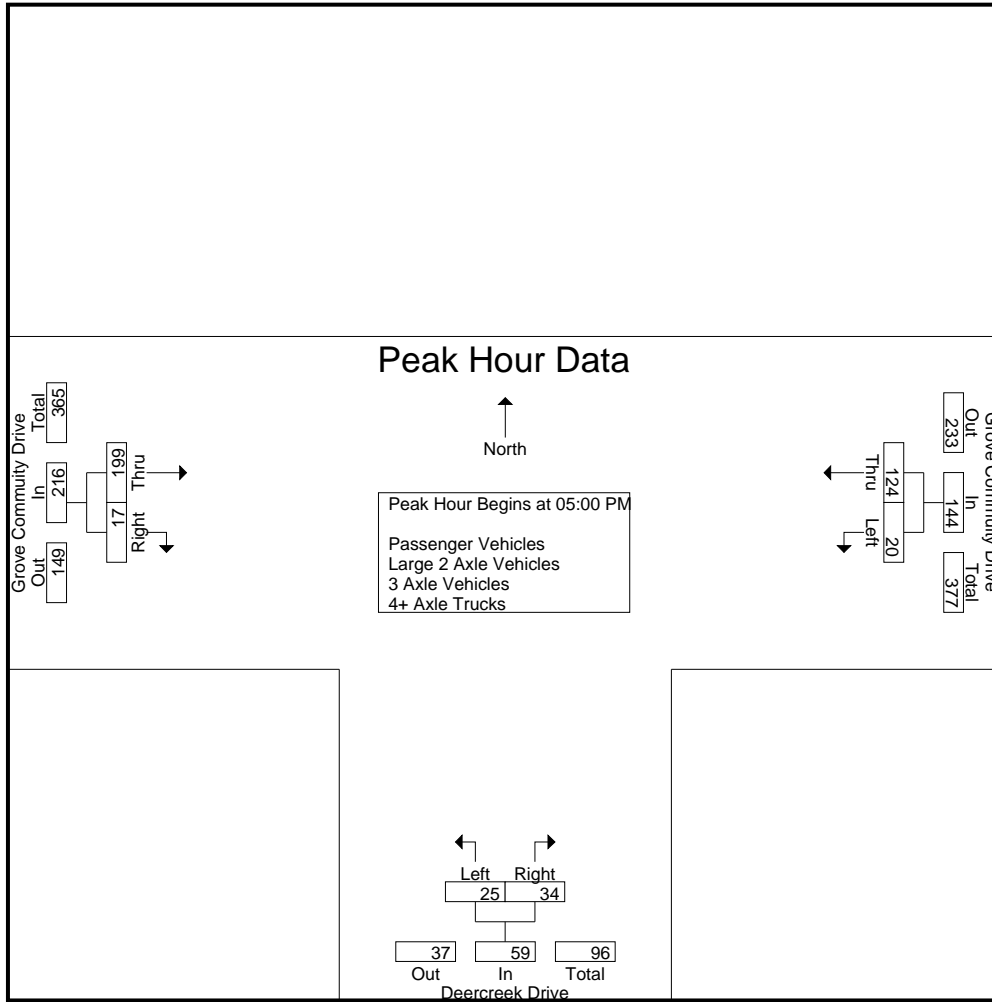

Peak Hour Analysis From 04:00 PM to 05:45 PM - Peak 1 of 1
 Peak Hour for Each Approach Begins at:

	05:00 PM			04:15 PM			05:00 PM		
+0 mins.	5	31	36	6	7	13	40	3	43
+15 mins.	5	37	42	9	14	23	46	4	50
+30 mins.	4	28	32	4	9	13	61	5	66
+45 mins.	6	28	34	6	8	14	52	5	57
Total Volume	20	124	144	25	38	63	199	17	216
% App. Total	13.9	86.1		39.7	60.3		92.1	7.9	
PHF	.833	.838	.857	.694	.679	.685	.816	.850	.818

City of Riverside
 N/S: Deercreek Drive
 E/W: Grove Community Drive
 Weather: Clear

File Name : 09_RIV_Deer_Grove PM
 Site Code : 05121716
 Start Date : 11/30/2021
 Page No : 1

Groups Printed- Passenger Vehicles

Start Time	Grove Community Drive Westbound			Deercreek Drive Northbound			Grove Community Drive Eastbound			Int. Total
	Left	Thru	App. Total	Left	Right	App. Total	Thru	Right	App. Total	
04:00 PM	3	30	33	3	6	9	42	5	47	89
04:15 PM	3	20	23	6	7	13	43	1	44	80
04:30 PM	2	32	34	9	14	23	36	5	41	98
04:45 PM	6	25	31	4	9	13	46	4	50	94
Total	14	107	121	22	36	58	167	15	182	361
05:00 PM	5	31	36	6	8	14	39	3	42	92
05:15 PM	4	35	39	4	7	11	45	4	49	99
05:30 PM	4	27	31	6	5	11	60	5	65	107
05:45 PM	6	28	34	9	14	23	52	5	57	114
Total	19	121	140	25	34	59	196	17	213	412
Grand Total	33	228	261	47	70	117	363	32	395	773
Apprch %	12.6	87.4		40.2	59.8		91.9	8.1		
Total %	4.3	29.5	33.8	6.1	9.1	15.1	47	4.1	51.1	

Start Time	Grove Community Drive Westbound			Deercreek Drive Northbound			Grove Community Drive Eastbound			Int. Total
	Left	Thru	App. Total	Left	Right	App. Total	Thru	Right	App. Total	
05:00 PM	5	31	36	6	8	14	39	3	42	92
05:15 PM	4	35	39	4	7	11	45	4	49	99
05:30 PM	4	27	31	6	5	11	60	5	65	107
05:45 PM	6	28	34	9	14	23	52	5	57	114
Total Volume	19	121	140	25	34	59	196	17	213	412
% App. Total	13.6	86.4		42.4	57.6		92	8		
PHF	.792	.864	.897	.694	.607	.641	.817	.850	.819	.904

Peak Hour Analysis From 05:00 PM to 05:45 PM - Peak 1 of 1
 Peak Hour for Entire Intersection Begins at 05:00 PM

City of Riverside
 N/S: Deercreek Drive
 E/W: Grove Community Drive
 Weather: Clear

File Name : 09_RIV_Deer_Grove PM
 Site Code : 05121716
 Start Date : 11/30/2021
 Page No : 2

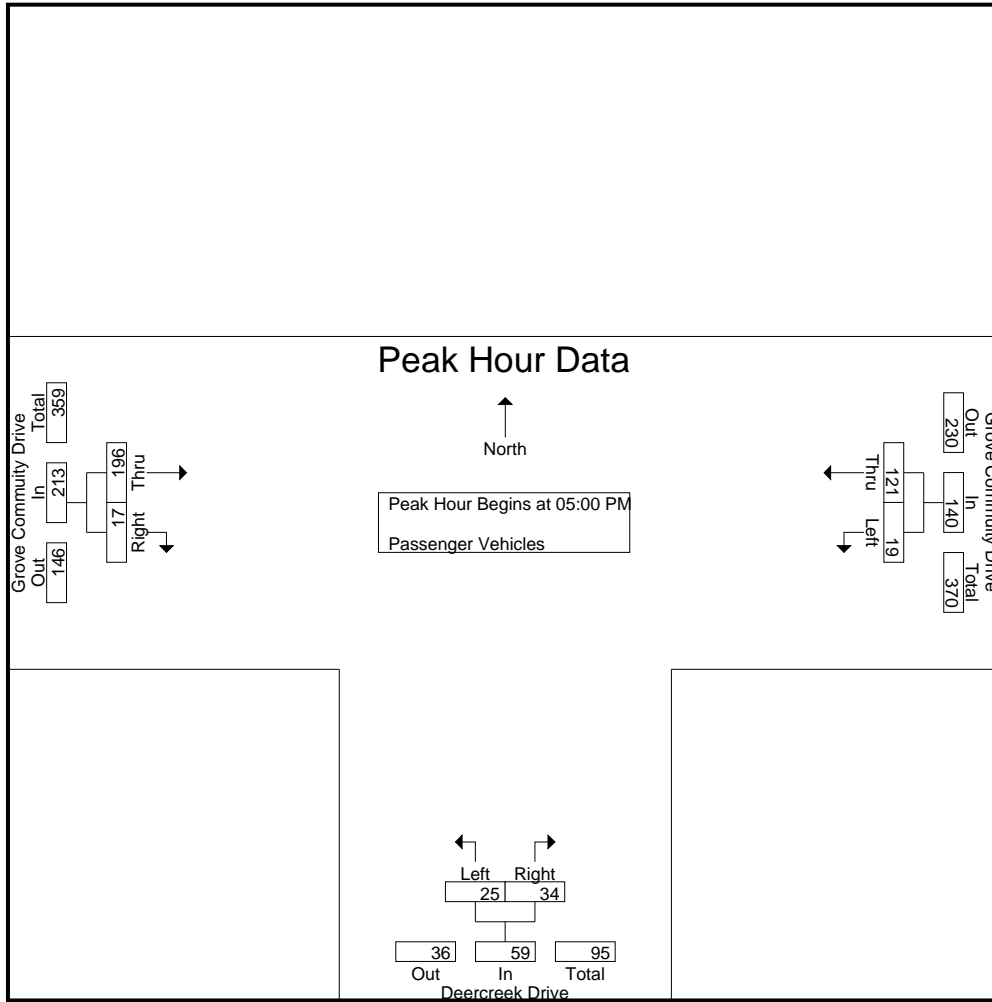

Peak Hour Analysis From 05:00 PM to 05:45 PM - Peak 1 of 1
 Peak Hour for Each Approach Begins at:

	05:00 PM			05:00 PM			05:00 PM		
+0 mins.	5	31	36	6	8	14	39	3	42
+15 mins.	4	35	39	4	7	11	45	4	49
+30 mins.	4	27	31	6	5	11	60	5	65
+45 mins.	6	28	34	9	14	23	52	5	57
Total Volume	19	121	140	25	34	59	196	17	213
% App. Total	13.6	86.4		42.4	57.6		92	8	
PHF	.792	.864	.897	.694	.607	.641	.817	.850	.819

City of Riverside
 N/S: Deercreek Drive
 E/W: Grove Community Drive
 Weather: Clear

File Name : 09_RIV_Deer_Grove PM
 Site Code : 05121716
 Start Date : 11/30/2021
 Page No : 1

Groups Printed- Large 2 Axle Vehicles

Start Time	Grove Community Drive Westbound			Deercreek Drive Northbound			Grove Community Drive Eastbound			Int. Total
	Left	Thru	App. Total	Left	Right	App. Total	Thru	Right	App. Total	
04:00 PM	0	0	0	0	1	1	0	0	0	1
04:15 PM	1	0	1	0	0	0	1	0	1	2
04:30 PM	0	0	0	0	0	0	1	0	1	1
04:45 PM	0	0	0	0	0	0	1	0	1	1
Total	1	0	1	0	1	1	3	0	3	5
05:00 PM	0	0	0	0	0	0	1	0	1	1
05:15 PM	1	2	3	0	0	0	1	0	1	4
05:30 PM	0	1	1	0	0	0	1	0	1	2
05:45 PM	0	0	0	0	0	0	0	0	0	0
Total	1	3	4	0	0	0	3	0	3	7
Grand Total	2	3	5	0	1	1	6	0	6	12
Apprch %	40	60		0	100		100	0		
Total %	16.7	25	41.7	0	8.3	8.3	50	0	50	

Start Time	Grove Community Drive Westbound			Deercreek Drive Northbound			Grove Community Drive Eastbound			Int. Total
	Left	Thru	App. Total	Left	Right	App. Total	Thru	Right	App. Total	
05:00 PM	0	0	0	0	0	0	1	0	1	1
05:15 PM	1	2	3	0	0	0	1	0	1	4
05:30 PM	0	1	1	0	0	0	1	0	1	2
05:45 PM	0	0	0	0	0	0	0	0	0	0
Total Volume	1	3	4	0	0	0	3	0	3	7
% App. Total	25	75		0	0		100	0		
PHF	.250	.375	.333	.000	.000	.000	.750	.000	.750	.438

Peak Hour Analysis From 05:00 PM to 05:45 PM - Peak 1 of 1
 Peak Hour for Entire Intersection Begins at 05:00 PM

City of Riverside
 N/S: Deercreek Drive
 E/W: Grove Community Drive
 Weather: Clear

File Name : 09_RIV_Deer_Grove PM
 Site Code : 05121716
 Start Date : 11/30/2021
 Page No : 2

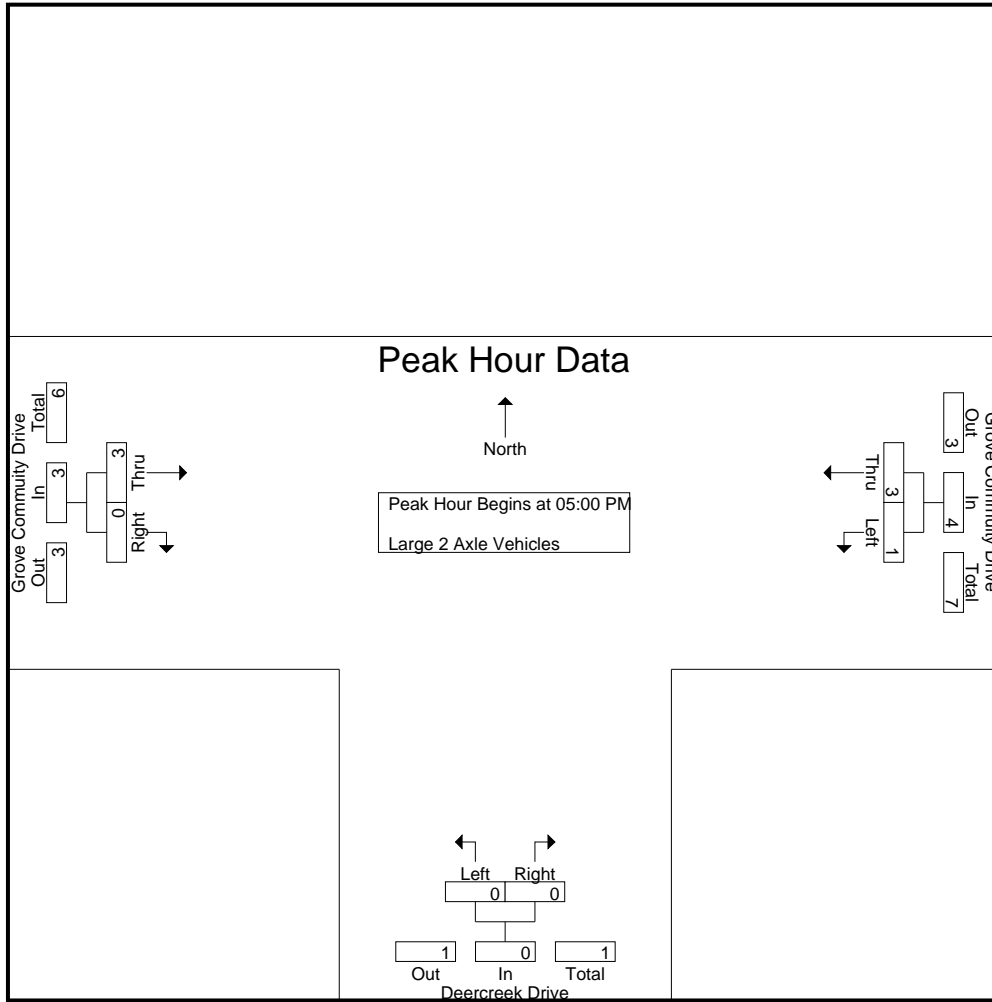

Peak Hour Analysis From 05:00 PM to 05:45 PM - Peak 1 of 1
 Peak Hour for Each Approach Begins at:

	05:00 PM			05:00 PM			05:00 PM		
+0 mins.	0	0	0	0	0	0	1	0	1
+15 mins.	1	2	3	0	0	0	1	0	1
+30 mins.	0	1	1	0	0	0	1	0	1
+45 mins.	0	0	0	0	0	0	0	0	0
Total Volume	1	3	4	0	0	0	3	0	3
% App. Total	25	75		0	0		100	0	
PHF	.250	.375	.333	.000	.000	.000	.750	.000	.750

City of Riverside
 N/S: Deercreek Drive
 E/W: Grove Community Drive
 Weather: Clear

File Name : 09_RIV_Deer_Grove PM
 Site Code : 05121716
 Start Date : 11/30/2021
 Page No : 1

Groups Printed- 3 Axle Vehicles

Start Time	Grove Community Drive Westbound			Deercreek Drive Northbound			Grove Community Drive Eastbound			Int. Total
	Left	Thru	App. Total	Left	Right	App. Total	Thru	Right	App. Total	
04:00 PM	0	0	0	0	0	0	0	0	0	0
04:15 PM	0	0	0	0	0	0	0	0	0	0
04:30 PM	0	0	0	0	0	0	0	0	0	0
04:45 PM	0	0	0	0	0	0	0	0	0	0
Total	0	0	0	0	0	0	0	0	0	0
05:00 PM	0	0	0	0	0	0	0	0	0	0
05:15 PM	0	0	0	0	0	0	0	0	0	0
05:30 PM	0	0	0	0	0	0	0	0	0	0
05:45 PM	0	0	0	0	0	0	0	0	0	0
Total	0	0	0	0	0	0	0	0	0	0
Grand Total	0	0	0	0	0	0	0	0	0	0
Apprch %	0	0		0	0		0	0		
Total %										

Start Time	Grove Community Drive Westbound			Deercreek Drive Northbound			Grove Community Drive Eastbound			Int. Total
	Left	Thru	App. Total	Left	Right	App. Total	Thru	Right	App. Total	
05:00 PM	0	0	0	0	0	0	0	0	0	0
05:15 PM	0	0	0	0	0	0	0	0	0	0
05:30 PM	0	0	0	0	0	0	0	0	0	0
05:45 PM	0	0	0	0	0	0	0	0	0	0
Total Volume	0	0	0	0	0	0	0	0	0	0
% App. Total	0	0		0	0		0	0		
PHF	.000	.000	.000	.000	.000	.000	.000	.000	.000	.000

Peak Hour Analysis From 05:00 PM to 05:45 PM - Peak 1 of 1
 Peak Hour for Entire Intersection Begins at 05:00 PM

City of Riverside
 N/S: Deercreek Drive
 E/W: Grove Community Drive
 Weather: Clear

File Name : 09_RIV_Deer_Grove PM
 Site Code : 05121716
 Start Date : 11/30/2021
 Page No : 2

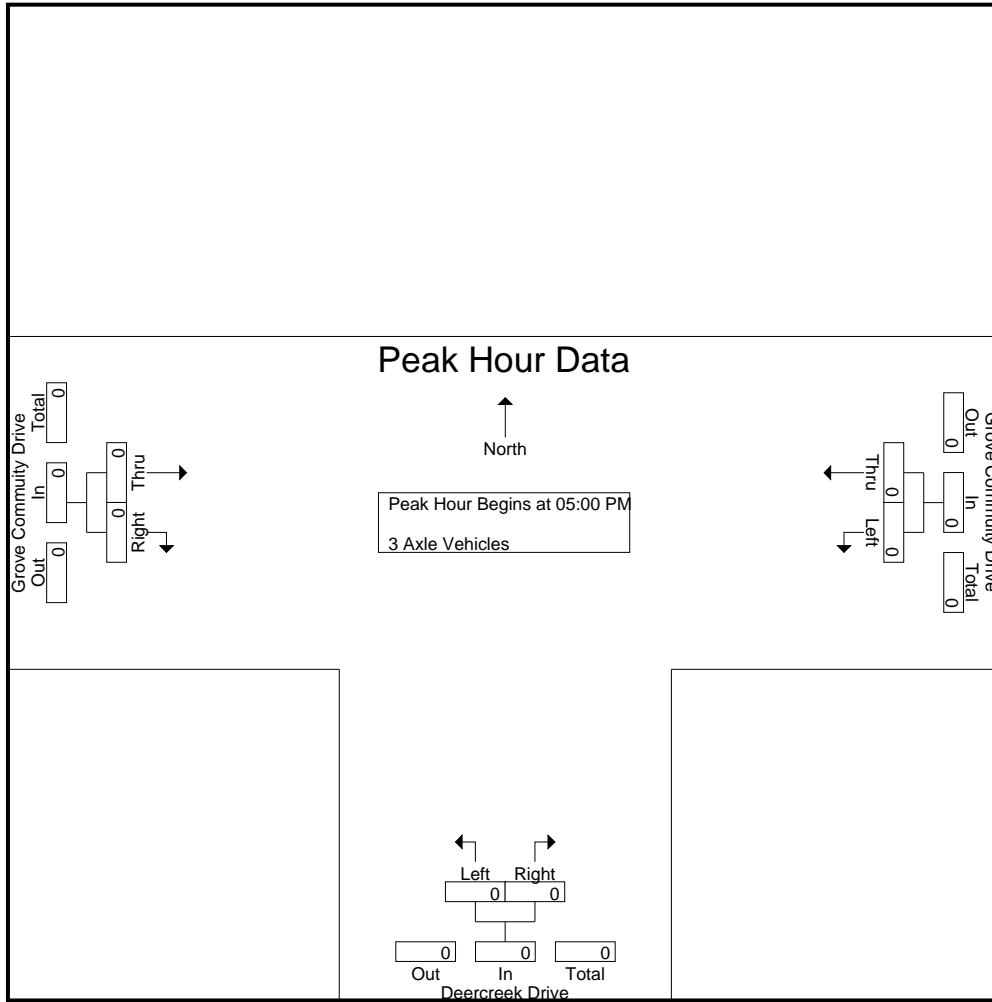

Peak Hour Analysis From 05:00 PM to 05:45 PM - Peak 1 of 1
 Peak Hour for Each Approach Begins at:

	05:00 PM			05:00 PM			05:00 PM		
+0 mins.	0	0	0	0	0	0	0	0	0
+15 mins.	0	0	0	0	0	0	0	0	0
+30 mins.	0	0	0	0	0	0	0	0	0
+45 mins.	0	0	0	0	0	0	0	0	0
Total Volume	0	0	0	0	0	0	0	0	0
% App. Total	0	0	0	0	0	0	0	0	0
PHF	.000	.000	.000	.000	.000	.000	.000	.000	.000

City of Riverside
 N/S: Deercreek Drive
 E/W: Grove Community Drive
 Weather: Clear

File Name : 09_RIV_Deer_Grove PM
 Site Code : 05121716
 Start Date : 11/30/2021
 Page No : 1

Groups Printed- 4+ Axle Trucks

Start Time	Grove Community Drive Westbound			Deercreek Drive Northbound			Grove Community Drive Eastbound			Int. Total
	Left	Thru	App. Total	Left	Right	App. Total	Thru	Right	App. Total	
04:00 PM	0	0	0	0	0	0	0	0	0	0
04:15 PM	0	0	0	0	0	0	0	0	0	0
04:30 PM	0	0	0	0	0	0	0	0	0	0
04:45 PM	0	0	0	0	0	0	0	0	0	0
Total	0	0	0	0	0	0	0	0	0	0
05:00 PM	0	0	0	0	0	0	0	0	0	0
05:15 PM	0	0	0	0	0	0	0	0	0	0
05:30 PM	0	0	0	0	0	0	0	0	0	0
05:45 PM	0	0	0	0	0	0	0	0	0	0
Total	0	0	0	0	0	0	0	0	0	0
Grand Total	0	0	0	0	0	0	0	0	0	0
Apprch %	0	0		0	0		0	0		
Total %										

Start Time	Grove Community Drive Westbound			Deercreek Drive Northbound			Grove Community Drive Eastbound			Int. Total
	Left	Thru	App. Total	Left	Right	App. Total	Thru	Right	App. Total	
05:00 PM	0	0	0	0	0	0	0	0	0	0
05:15 PM	0	0	0	0	0	0	0	0	0	0
05:30 PM	0	0	0	0	0	0	0	0	0	0
05:45 PM	0	0	0	0	0	0	0	0	0	0
Total Volume	0	0	0	0	0	0	0	0	0	0
% App. Total	0	0		0	0		0	0		
PHF	.000	.000	.000	.000	.000	.000	.000	.000	.000	.000

Peak Hour Analysis From 05:00 PM to 05:45 PM - Peak 1 of 1
 Peak Hour for Entire Intersection Begins at 05:00 PM

City of Riverside
 N/S: Deercreek Drive
 E/W: Grove Community Drive
 Weather: Clear

File Name : 09_RIV_Deer_Grove PM
 Site Code : 05121716
 Start Date : 11/30/2021
 Page No : 2

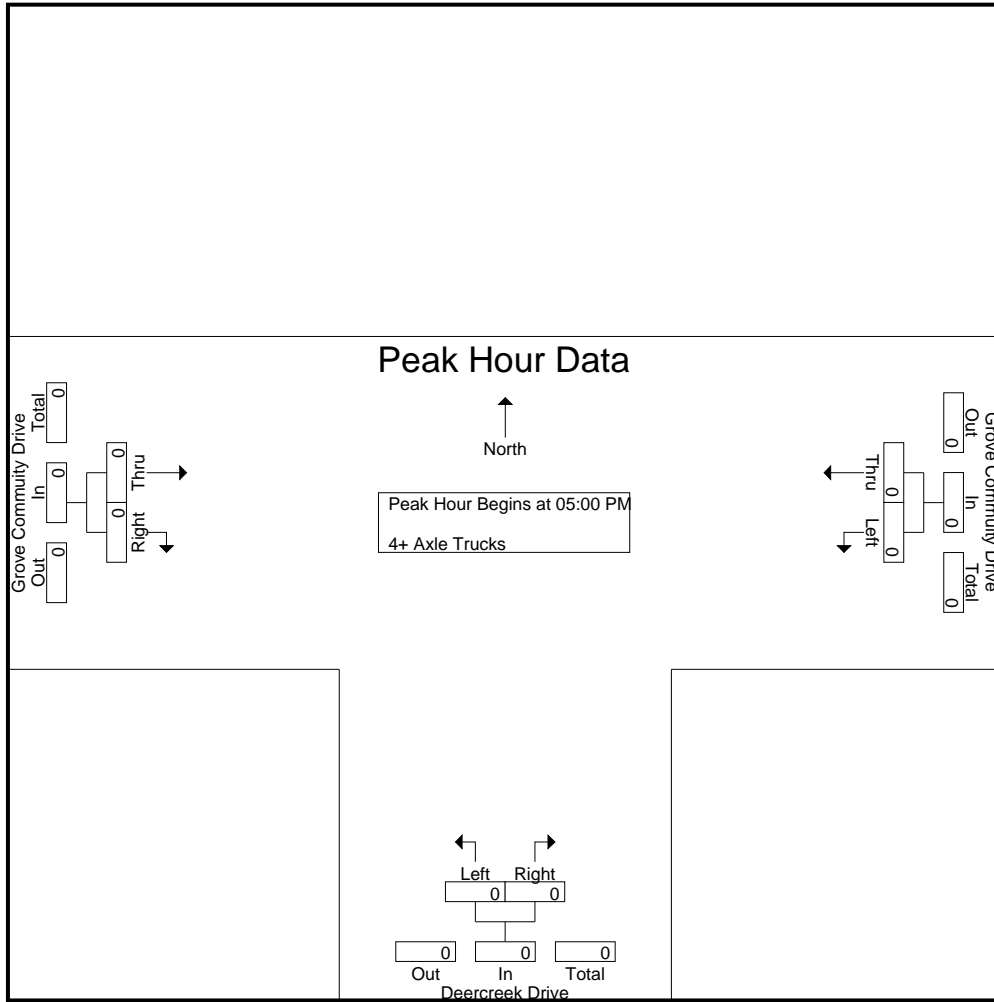

Peak Hour Analysis From 05:00 PM to 05:45 PM - Peak 1 of 1
 Peak Hour for Each Approach Begins at:

	05:00 PM			05:00 PM			05:00 PM		
+0 mins.	0	0	0	0	0	0	0	0	0
+15 mins.	0	0	0	0	0	0	0	0	0
+30 mins.	0	0	0	0	0	0	0	0	0
+45 mins.	0	0	0	0	0	0	0	0	0
Total Volume	0	0	0	0	0	0	0	0	0
% App. Total	0	0	0	0	0	0	0	0	0
PHF	.000	.000	.000	.000	.000	.000	.000	.000	.000

Location: Riverside
 N/S: Deercreek Drive
 E/W: Grove Community Drive



Date: 11/30/2021
 Day: Tuesday

PEDESTRIANS

	North Leg Dead End	East Leg Grove Community Drive	South Leg Deercreek Drive	West Leg Grove Community Drive	
	Pedestrians	Pedestrians	Pedestrians	Pedestrians	
7:00 AM	0	1	2	0	3
7:15 AM	0	2	0	0	2
7:30 AM	0	2	0	0	2
7:45 AM	0	1	0	0	1
8:00 AM	0	0	1	0	1
8:15 AM	0	0	2	1	3
8:30 AM	0	1	2	0	3
8:45 AM	0	0	1	0	1
TOTAL VOLUMES:	0	7	8	1	16

	North Leg Dead End	East Leg Grove Community Drive	South Leg Deercreek Drive	West Leg Grove Community Drive	
	Pedestrians	Pedestrians	Pedestrians	Pedestrians	
4:00 PM	0	1	0	0	1
4:15 PM	0	0	0	0	0
4:30 PM	0	0	1	0	1
4:45 PM	0	1	0	0	1
5:00 PM	0	1	0	0	1
5:15 PM	0	1	1	1	3
5:30 PM	0	0	1	1	2
5:45 PM	0	0	0	0	0
TOTAL VOLUMES:	0	4	3	2	9

Location: Riverside
 N/S: Deercreek Drive
 E/W: Grove Community Drive



Date: 11/30/2021
 Day: Tuesday

BICYCLES

	Southbound Dead End			Westbound Grove Community Drive			Northbound Deercreek Drive			Eastbound Grove Community Drive			
	Left	Thru	Right	Left	Thru	Right	Left	Thru	Right	Left	Thru	Right	
7:00 AM	0	0	0	0	0	0	0	0	0	0	0	0	0
7:15 AM	0	0	0	0	0	0	0	0	0	0	0	0	0
7:30 AM	0	0	0	0	0	0	0	0	0	0	0	0	0
7:45 AM	0	0	0	0	0	0	0	0	0	0	0	0	0
8:00 AM	0	0	0	0	0	0	0	0	0	0	0	0	0
8:15 AM	0	0	0	0	0	0	0	0	0	0	0	0	0
8:30 AM	0	0	0	0	0	0	0	0	0	0	0	0	0
8:45 AM	0	0	0	1	0	0	0	0	0	0	1	0	2
TOTAL VOLUMES:	0	0	0	1	0	0	0	0	0	0	1	0	2

	Southbound Dead End			Westbound Grove Community Drive			Northbound Deercreek Drive			Eastbound Grove Community Drive			
	Left	Thru	Right	Left	Thru	Right	Left	Thru	Right	Left	Thru	Right	
4:00 PM	0	0	0	0	0	0	0	0	0	0	0	0	0
4:15 PM	0	0	0	1	0	0	0	0	0	0	0	0	1
4:30 PM	0	0	0	0	0	0	2	0	0	0	0	0	2
4:45 PM	0	0	0	0	0	0	0	0	0	0	0	0	0
5:00 PM	0	0	0	0	0	0	0	0	0	0	1	0	1
5:15 PM	0	0	0	0	0	0	0	0	1	0	0	0	1
5:30 PM	0	0	0	0	0	0	0	0	0	0	0	0	0
5:45 PM	0	0	0	0	1	0	0	0	0	0	0	0	1
TOTAL VOLUMES:	0	0	0	1	1	0	2	0	1	0	1	0	6

City of Riverside
 N/S: Deercreek Drive
 E/W: Orange Terrace Parkway
 Weather: Clear

File Name : 10_RIV_Deer_Orange AM
 Site Code : 05121716
 Start Date : 11/30/2021
 Page No : 1

Groups Printed- Passenger Vehicles - Large 2 Axle Vehicles - 3 Axle Vehicles - 4+ Axle Trucks

Start Time	Deercreek Drive Southbound				Orange Terrace Parkway Westbound				Deercreek Drive Northbound				Orange Terrace Parkway Eastbound				Int. Total
	Left	Thru	Right	App. Total	Left	Thru	Right	App. Total	Left	Thru	Right	App. Total	Left	Thru	Right	App. Total	
07:00 AM	34	9	11	54	0	142	10	152	35	9	0	44	8	98	8	114	364
07:15 AM	28	14	12	54	2	147	9	158	63	11	2	76	54	99	19	172	460
07:30 AM	4	2	8	14	1	102	18	121	30	11	2	43	77	88	4	169	347
07:45 AM	4	1	0	5	0	69	6	75	5	2	1	8	48	71	4	123	211
Total	70	26	31	127	3	460	43	506	133	33	5	171	187	356	35	578	1382
08:00 AM	2	1	5	8	0	67	8	75	8	4	0	12	10	34	0	44	139
08:15 AM	2	2	2	6	0	45	4	49	1	2	0	3	5	33	2	40	98
08:30 AM	8	2	2	12	1	65	9	75	7	0	0	7	11	30	0	41	135
08:45 AM	4	0	5	9	0	45	10	55	8	2	1	11	10	25	3	38	113
Total	16	5	14	35	1	222	31	254	24	8	1	33	36	122	5	163	485
Grand Total	86	31	45	162	4	682	74	760	157	41	6	204	223	478	40	741	1867
Apprch %	53.1	19.1	27.8		0.5	89.7	9.7		77	20.1	2.9		30.1	64.5	5.4		
Total %	4.6	1.7	2.4	8.7	0.2	36.5	4	40.7	8.4	2.2	0.3	10.9	11.9	25.6	2.1	39.7	
Passenger Vehicles	85	30	43	158	4	678	73	755	156	41	6	203	222	467	40	729	1845
% Passenger Vehicles	98.8	96.8	95.6	97.5	100	99.4	98.6	99.3	99.4	100	100	99.5	99.6	97.7	100	98.4	98.8
Large 2 Axle Vehicles	1	1	2	4	0	4	1	5	1	0	0	1	1	11	0	12	22
% Large 2 Axle Vehicles	1.2	3.2	4.4	2.5	0	0.6	1.4	0.7	0.6	0	0	0.5	0.4	2.3	0	1.6	1.2
3 Axle Vehicles	0	0	0	0	0	0	0	0	0	0	0	0	0	0	0	0	0
% 3 Axle Vehicles	0	0	0	0	0	0	0	0	0	0	0	0	0	0	0	0	0
4+ Axle Trucks	0	0	0	0	0	0	0	0	0	0	0	0	0	0	0	0	0
% 4+ Axle Trucks	0	0	0	0	0	0	0	0	0	0	0	0	0	0	0	0	0

Start Time	Deercreek Drive Southbound				Orange Terrace Parkway Westbound				Deercreek Drive Northbound				Orange Terrace Parkway Eastbound				Int. Total
	Left	Thru	Right	App. Total	Left	Thru	Right	App. Total	Left	Thru	Right	App. Total	Left	Thru	Right	App. Total	
Peak Hour Analysis From 07:00 AM to 08:45 AM - Peak 1 of 1																	
Peak Hour for Entire Intersection Begins at 07:00 AM																	
07:00 AM	34	9	11	54	0	142	10	152	35	9	0	44	8	98	8	114	364
07:15 AM	28	14	12	54	2	147	9	158	63	11	2	76	54	99	19	172	460
07:30 AM	4	2	8	14	1	102	18	121	30	11	2	43	77	88	4	169	347
07:45 AM	4	1	0	5	0	69	6	75	5	2	1	8	48	71	4	123	211
Total Volume	70	26	31	127	3	460	43	506	133	33	5	171	187	356	35	578	1382
% App. Total	55.1	20.5	24.4		0.6	90.9	8.5		77.8	19.3	2.9		32.4	61.6	6.1		
PHF	.515	.464	.646	.588	.375	.782	.597	.801	.528	.750	.625	.563	.607	.899	.461	.840	.751

City of Riverside
 N/S: Deercreek Drive
 E/W: Orange Terrace Parkway
 Weather: Clear

File Name : 10_RIV_Deer_Orange AM
 Site Code : 05121716
 Start Date : 11/30/2021
 Page No : 2

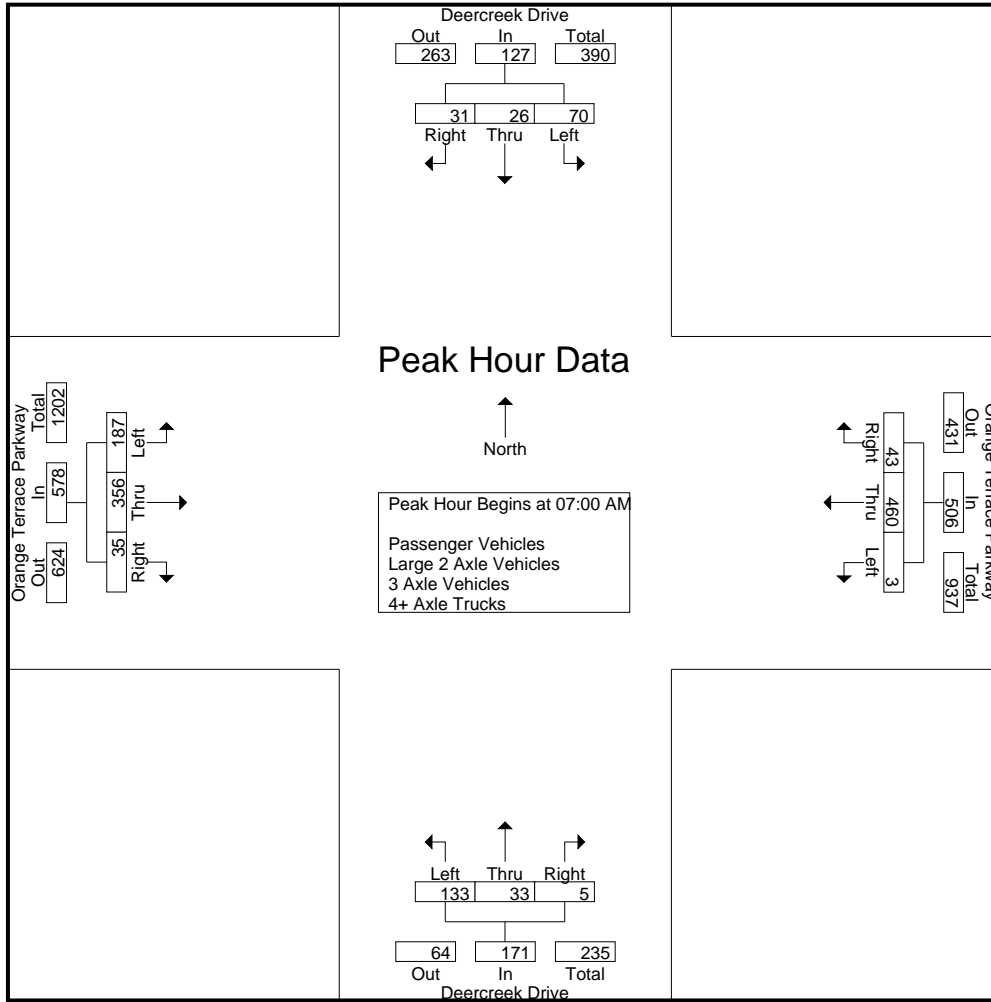

Peak Hour Analysis From 07:00 AM to 08:45 AM - Peak 1 of 1
 Peak Hour for Each Approach Begins at:

	07:00 AM				07:00 AM				07:00 AM				07:00 AM			
+0 mins.	34	9	11	54	0	142	10	152	35	9	0	44	8	98	8	114
+15 mins.	28	14	12	54	2	147	9	158	63	11	2	76	54	99	19	172
+30 mins.	4	2	8	14	1	102	18	121	30	11	2	43	77	88	4	169
+45 mins.	4	1	0	5	0	69	6	75	5	2	1	8	48	71	4	123
Total Volume	70	26	31	127	3	460	43	506	133	33	5	171	187	356	35	578
% App. Total	55.1	20.5	24.4		0.6	90.9	8.5		77.8	19.3	2.9		32.4	61.6	6.1	
PHF	.515	.464	.646	.588	.375	.782	.597	.801	.528	.750	.625	.563	.607	.899	.461	.840

City of Riverside
 N/S: Deercreek Drive
 E/W: Orange Terrace Parkway
 Weather: Clear

File Name : 10_RIV_Deer_Orange AM
 Site Code : 05121716
 Start Date : 11/30/2021
 Page No : 1

Groups Printed- Passenger Vehicles

Start Time	Deercreek Drive Southbound				Orange Terrace Parkway Westbound				Deercreek Drive Northbound				Orange Terrace Parkway Eastbound				Int. Total
	Left	Thru	Right	App. Total	Left	Thru	Right	App. Total	Left	Thru	Right	App. Total	Left	Thru	Right	App. Total	
07:00 AM	34	8	11	53	0	141	10	151	35	9	0	44	8	94	8	110	358
07:15 AM	28	14	11	53	2	147	8	157	63	11	2	76	54	97	19	170	456
07:30 AM	4	2	8	14	1	102	18	121	30	11	2	43	77	88	4	169	347
07:45 AM	4	1	0	5	0	69	6	75	4	2	1	7	48	70	4	122	209
Total	70	25	30	125	3	459	42	504	132	33	5	170	187	349	35	571	1370
08:00 AM	2	1	5	8	0	66	8	74	8	4	0	12	10	32	0	42	136
08:15 AM	2	2	2	6	0	45	4	49	1	2	0	3	5	33	2	40	98
08:30 AM	7	2	2	11	1	63	9	73	7	0	0	7	11	30	0	41	132
08:45 AM	4	0	4	8	0	45	10	55	8	2	1	11	9	23	3	35	109
Total	15	5	13	33	1	219	31	251	24	8	1	33	35	118	5	158	475
Grand Total	85	30	43	158	4	678	73	755	156	41	6	203	222	467	40	729	1845
Apprch %	53.8	19	27.2		0.5	89.8	9.7		76.8	20.2	3		30.5	64.1	5.5		
Total %	4.6	1.6	2.3	8.6	0.2	36.7	4	40.9	8.5	2.2	0.3	11	12	25.3	2.2	39.5	

Start Time	Deercreek Drive Southbound				Orange Terrace Parkway Westbound				Deercreek Drive Northbound				Orange Terrace Parkway Eastbound				Int. Total
	Left	Thru	Right	App. Total	Left	Thru	Right	App. Total	Left	Thru	Right	App. Total	Left	Thru	Right	App. Total	
07:00 AM	34	8	11	53	0	141	10	151	35	9	0	44	8	94	8	110	358
07:15 AM	28	14	11	53	2	147	8	157	63	11	2	76	54	97	19	170	456
07:30 AM	4	2	8	14	1	102	18	121	30	11	2	43	77	88	4	169	347
07:45 AM	4	1	0	5	0	69	6	75	4	2	1	7	48	70	4	122	209
Total Volume	70	25	30	125	3	459	42	504	132	33	5	170	187	349	35	571	1370
% App. Total	56	20	24		0.6	91.1	8.3		77.6	19.4	2.9		32.7	61.1	6.1		
PHF	.515	.446	.682	.590	.375	.781	.583	.803	.524	.750	.625	.559	.607	.899	.461	.840	.751

Peak Hour Analysis From 07:00 AM to 07:45 AM - Peak 1 of 1
 Peak Hour for Entire Intersection Begins at 07:00 AM

City of Riverside
 N/S: Deercreek Drive
 E/W: Orange Terrace Parkway
 Weather: Clear

File Name : 10_RIV_Deer_Orange AM
 Site Code : 05121716
 Start Date : 11/30/2021
 Page No : 2

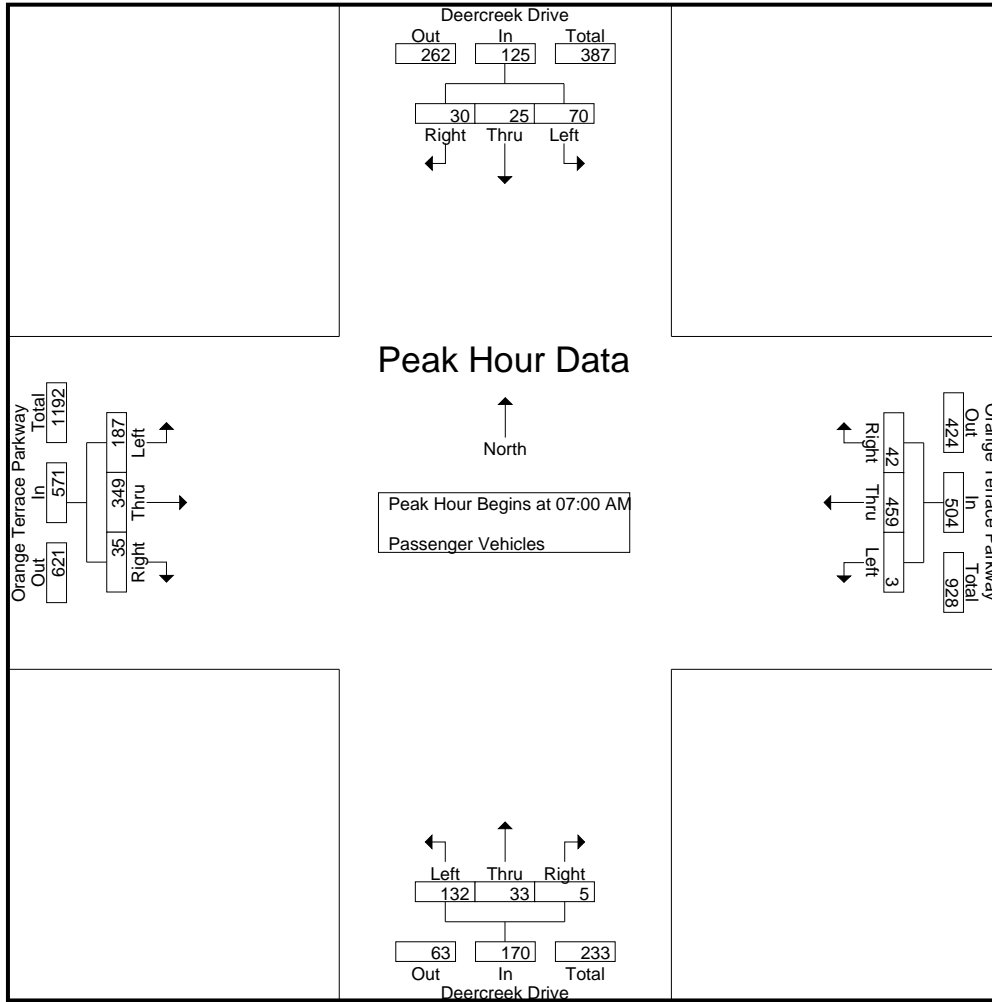

Peak Hour Analysis From 07:00 AM to 07:45 AM - Peak 1 of 1
 Peak Hour for Each Approach Begins at:

	07:00 AM				07:00 AM				07:00 AM				07:00 AM			
+0 mins.	34	8	11	53	0	141	10	151	35	9	0	44	8	94	8	110
+15 mins.	28	14	11	53	2	147	8	157	63	11	2	76	54	97	19	170
+30 mins.	4	2	8	14	1	102	18	121	30	11	2	43	77	88	4	169
+45 mins.	4	1	0	5	0	69	6	75	4	2	1	7	48	70	4	122
Total Volume	70	25	30	125	3	459	42	504	132	33	5	170	187	349	35	571
% App. Total	56	20	24		0.6	91.1	8.3		77.6	19.4	2.9		32.7	61.1	6.1	
PHF	.515	.446	.682	.590	.375	.781	.583	.803	.524	.750	.625	.559	.607	.899	.461	.840

City of Riverside
 N/S: Deercreek Drive
 E/W: Orange Terrace Parkway
 Weather: Clear

File Name : 10_RIV_Deer_Orange AM
 Site Code : 05121716
 Start Date : 11/30/2021
 Page No : 1

Groups Printed- Large 2 Axle Vehicles

Start Time	Deercreek Drive Southbound				Orange Terrace Parkway Westbound				Deercreek Drive Northbound				Orange Terrace Parkway Eastbound				Int. Total
	Left	Thru	Right	App. Total	Left	Thru	Right	App. Total	Left	Thru	Right	App. Total	Left	Thru	Right	App. Total	
07:00 AM	0	1	0	1	0	1	0	1	0	0	0	0	0	4	0	4	6
07:15 AM	0	0	1	1	0	0	1	1	0	0	0	0	0	2	0	2	4
07:30 AM	0	0	0	0	0	0	0	0	0	0	0	0	0	0	0	0	0
07:45 AM	0	0	0	0	0	0	0	0	1	0	0	1	0	1	0	1	2
Total	0	1	1	2	0	1	1	2	1	0	0	1	0	7	0	7	12
08:00 AM	0	0	0	0	0	1	0	1	0	0	0	0	0	2	0	2	3
08:15 AM	0	0	0	0	0	0	0	0	0	0	0	0	0	0	0	0	0
08:30 AM	1	0	0	1	0	2	0	2	0	0	0	0	0	0	0	0	3
08:45 AM	0	0	1	1	0	0	0	0	0	0	0	0	1	2	0	3	4
Total	1	0	1	2	0	3	0	3	0	0	0	0	1	4	0	5	10
Grand Total	1	1	2	4	0	4	1	5	1	0	0	1	1	11	0	12	22
Apprch %	25	25	50		0	80	20		100	0	0		8.3	91.7	0		
Total %	4.5	4.5	9.1	18.2	0	18.2	4.5	22.7	4.5	0	0	4.5	4.5	50	0	54.5	

Start Time	Deercreek Drive Southbound				Orange Terrace Parkway Westbound				Deercreek Drive Northbound				Orange Terrace Parkway Eastbound				Int. Total
	Left	Thru	Right	App. Total	Left	Thru	Right	App. Total	Left	Thru	Right	App. Total	Left	Thru	Right	App. Total	
07:00 AM	0	1	0	1	0	1	0	1	0	0	0	0	0	4	0	4	6
07:15 AM	0	0	1	1	0	0	1	1	0	0	0	0	0	2	0	2	4
07:30 AM	0	0	0	0	0	0	0	0	0	0	0	0	0	0	0	0	0
07:45 AM	0	0	0	0	0	0	0	0	1	0	0	1	0	1	0	1	2
Total Volume	0	1	1	2	0	1	1	2	1	0	0	1	0	7	0	7	12
% App. Total	0	50	50		0	50	50		100	0	0		0	100	0		
PHF	.000	.250	.250	.500	.000	.250	.250	.500	.250	.000	.000	.250	.000	.438	.000	.438	.500

Peak Hour Analysis From 07:00 AM to 07:45 AM - Peak 1 of 1
 Peak Hour for Entire Intersection Begins at 07:00 AM

City of Riverside
 N/S: Deercreek Drive
 E/W: Orange Terrace Parkway
 Weather: Clear

File Name : 10_RIV_Deer_Orange AM
 Site Code : 05121716
 Start Date : 11/30/2021
 Page No : 2

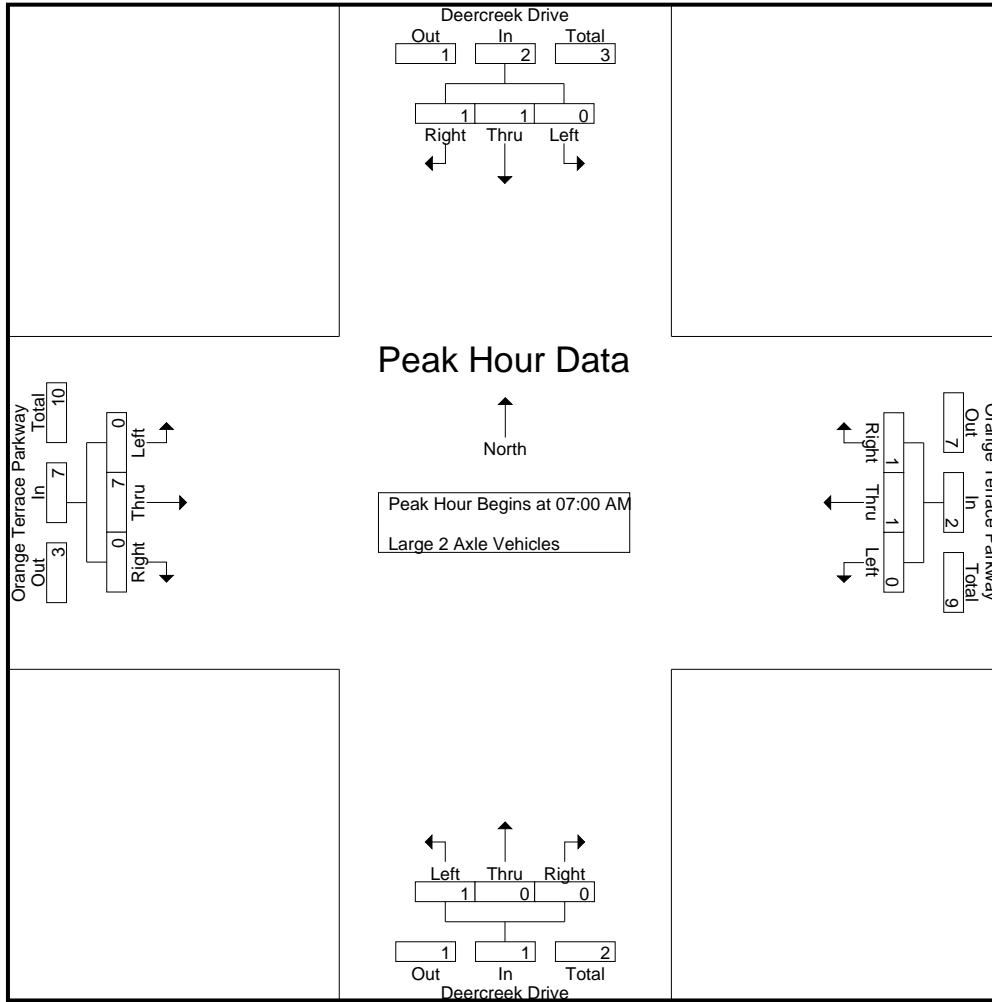

Peak Hour Analysis From 07:00 AM to 07:45 AM - Peak 1 of 1
 Peak Hour for Each Approach Begins at:

	07:00 AM				07:00 AM				07:00 AM				07:00 AM			
+0 mins.	0	1	0	1	0	1	0	1	0	0	0	0	0	4	0	4
+15 mins.	0	0	1	1	0	0	1	1	0	0	0	0	0	2	0	2
+30 mins.	0	0	0	0	0	0	0	0	0	0	0	0	0	0	0	0
+45 mins.	0	0	0	0	0	0	0	0	1	0	0	1	0	1	0	1
Total Volume	0	1	1	2	0	1	1	2	1	0	0	1	0	7	0	7
% App. Total	0	50	50		0	50	50		100	0	0		0	100	0	
PHF	.000	.250	.250	.500	.000	.250	.250	.500	.250	.000	.000	.250	.000	.438	.000	.438

City of Riverside
 N/S: Deercreek Drive
 E/W: Orange Terrace Parkway
 Weather: Clear

File Name : 10_RIV_Deer_Orange AM
 Site Code : 05121716
 Start Date : 11/30/2021
 Page No : 1

Groups Printed- 3 Axle Vehicles

Start Time	Deercreek Drive Southbound				Orange Terrace Parkway Westbound				Deercreek Drive Northbound				Orange Terrace Parkway Eastbound				Int. Total
	Left	Thru	Right	App. Total	Left	Thru	Right	App. Total	Left	Thru	Right	App. Total	Left	Thru	Right	App. Total	
07:00 AM	0	0	0	0	0	0	0	0	0	0	0	0	0	0	0	0	0
07:15 AM	0	0	0	0	0	0	0	0	0	0	0	0	0	0	0	0	0
07:30 AM	0	0	0	0	0	0	0	0	0	0	0	0	0	0	0	0	0
07:45 AM	0	0	0	0	0	0	0	0	0	0	0	0	0	0	0	0	0
Total	0	0	0	0	0	0	0	0	0	0	0	0	0	0	0	0	0
08:00 AM	0	0	0	0	0	0	0	0	0	0	0	0	0	0	0	0	0
08:15 AM	0	0	0	0	0	0	0	0	0	0	0	0	0	0	0	0	0
08:30 AM	0	0	0	0	0	0	0	0	0	0	0	0	0	0	0	0	0
08:45 AM	0	0	0	0	0	0	0	0	0	0	0	0	0	0	0	0	0
Total	0	0	0	0	0	0	0	0	0	0	0	0	0	0	0	0	0
Grand Total	0	0	0	0	0	0	0	0	0	0	0	0	0	0	0	0	0
Apprch %	0	0	0		0	0	0		0	0	0		0	0	0		
Total %																	

Start Time	Deercreek Drive Southbound				Orange Terrace Parkway Westbound				Deercreek Drive Northbound				Orange Terrace Parkway Eastbound				Int. Total
	Left	Thru	Right	App. Total	Left	Thru	Right	App. Total	Left	Thru	Right	App. Total	Left	Thru	Right	App. Total	
07:00 AM	0	0	0	0	0	0	0	0	0	0	0	0	0	0	0	0	0
07:15 AM	0	0	0	0	0	0	0	0	0	0	0	0	0	0	0	0	0
07:30 AM	0	0	0	0	0	0	0	0	0	0	0	0	0	0	0	0	0
07:45 AM	0	0	0	0	0	0	0	0	0	0	0	0	0	0	0	0	0
Total Volume	0	0	0	0	0	0	0	0	0	0	0	0	0	0	0	0	0
% App. Total	0	0	0		0	0	0		0	0	0		0	0	0		
PHF	.000	.000	.000	.000	.000	.000	.000	.000	.000	.000	.000	.000	.000	.000	.000	.000	.000

Peak Hour Analysis From 07:00 AM to 07:45 AM - Peak 1 of 1
 Peak Hour for Entire Intersection Begins at 07:00 AM

City of Riverside
 N/S: Deercreek Drive
 E/W: Orange Terrace Parkway
 Weather: Clear

File Name : 10_RIV_Deer_Orange AM
 Site Code : 05121716
 Start Date : 11/30/2021
 Page No : 2

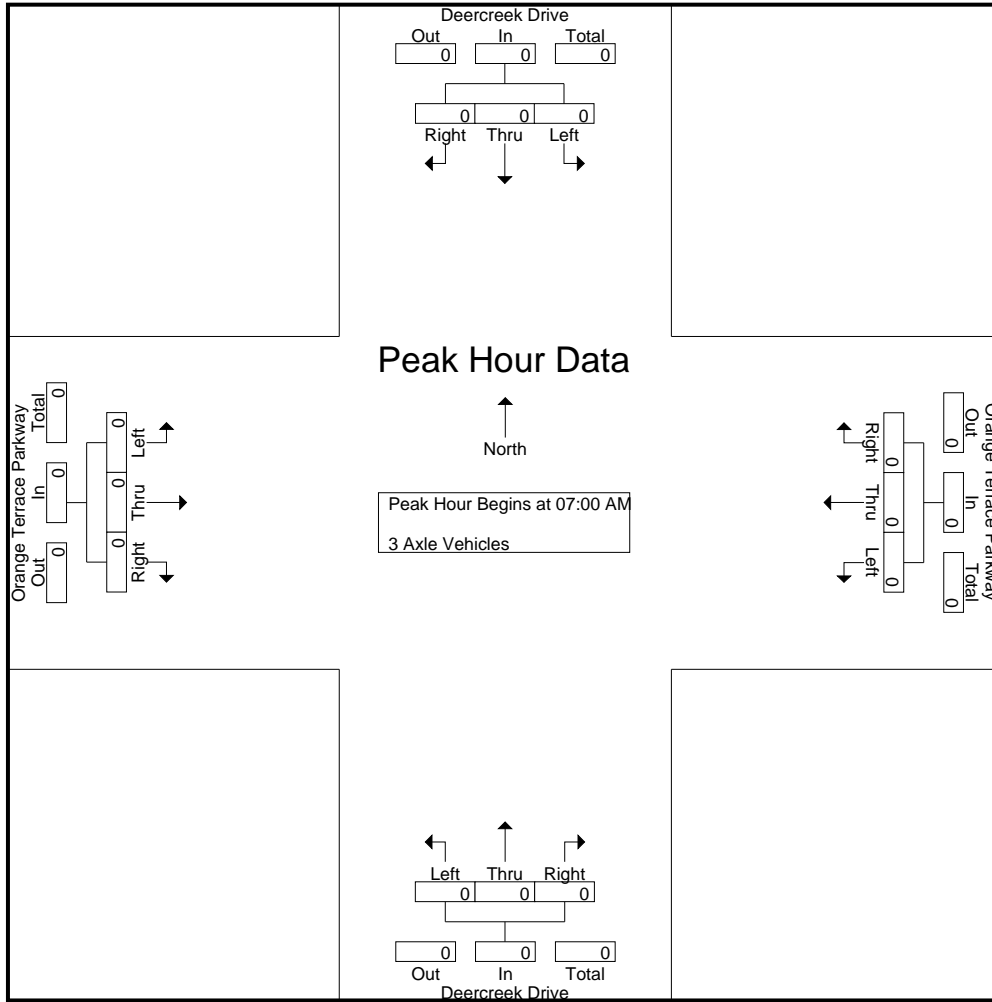

Peak Hour Analysis From 07:00 AM to 07:45 AM - Peak 1 of 1
 Peak Hour for Each Approach Begins at:

	07:00 AM				07:00 AM				07:00 AM				07:00 AM			
+0 mins.	0	0	0	0	0	0	0	0	0	0	0	0	0	0	0	0
+15 mins.	0	0	0	0	0	0	0	0	0	0	0	0	0	0	0	0
+30 mins.	0	0	0	0	0	0	0	0	0	0	0	0	0	0	0	0
+45 mins.	0	0	0	0	0	0	0	0	0	0	0	0	0	0	0	0
Total Volume	0	0	0	0	0	0	0	0	0	0	0	0	0	0	0	0
% App. Total	0	0	0	0	0	0	0	0	0	0	0	0	0	0	0	0
PHF	.000	.000	.000	.000	.000	.000	.000	.000	.000	.000	.000	.000	.000	.000	.000	.000

City of Riverside
 N/S: Deercreek Drive
 E/W: Orange Terrace Parkway
 Weather: Clear

File Name : 10_RIV_Deer_Orange AM
 Site Code : 05121716
 Start Date : 11/30/2021
 Page No : 1

Groups Printed- 4+ Axle Trucks

Start Time	Deercreek Drive Southbound				Orange Terrace Parkway Westbound				Deercreek Drive Northbound				Orange Terrace Parkway Eastbound				Int. Total
	Left	Thru	Right	App. Total	Left	Thru	Right	App. Total	Left	Thru	Right	App. Total	Left	Thru	Right	App. Total	
07:00 AM	0	0	0	0	0	0	0	0	0	0	0	0	0	0	0	0	0
07:15 AM	0	0	0	0	0	0	0	0	0	0	0	0	0	0	0	0	0
07:30 AM	0	0	0	0	0	0	0	0	0	0	0	0	0	0	0	0	0
07:45 AM	0	0	0	0	0	0	0	0	0	0	0	0	0	0	0	0	0
Total	0	0	0	0	0	0	0	0	0	0	0	0	0	0	0	0	0
08:00 AM	0	0	0	0	0	0	0	0	0	0	0	0	0	0	0	0	0
08:15 AM	0	0	0	0	0	0	0	0	0	0	0	0	0	0	0	0	0
08:30 AM	0	0	0	0	0	0	0	0	0	0	0	0	0	0	0	0	0
08:45 AM	0	0	0	0	0	0	0	0	0	0	0	0	0	0	0	0	0
Total	0	0	0	0	0	0	0	0	0	0	0	0	0	0	0	0	0
Grand Total	0	0	0	0	0	0	0	0	0	0	0	0	0	0	0	0	0
Apprch %	0	0	0		0	0	0		0	0	0		0	0	0		
Total %																	

Start Time	Deercreek Drive Southbound				Orange Terrace Parkway Westbound				Deercreek Drive Northbound				Orange Terrace Parkway Eastbound				Int. Total
	Left	Thru	Right	App. Total	Left	Thru	Right	App. Total	Left	Thru	Right	App. Total	Left	Thru	Right	App. Total	
07:00 AM	0	0	0	0	0	0	0	0	0	0	0	0	0	0	0	0	0
07:15 AM	0	0	0	0	0	0	0	0	0	0	0	0	0	0	0	0	0
07:30 AM	0	0	0	0	0	0	0	0	0	0	0	0	0	0	0	0	0
07:45 AM	0	0	0	0	0	0	0	0	0	0	0	0	0	0	0	0	0
Total Volume	0	0	0	0	0	0	0	0	0	0	0	0	0	0	0	0	0
% App. Total	0	0	0		0	0	0		0	0	0		0	0	0		
PHF	.000	.000	.000	.000	.000	.000	.000	.000	.000	.000	.000	.000	.000	.000	.000	.000	.000

Peak Hour Analysis From 07:00 AM to 07:45 AM - Peak 1 of 1
 Peak Hour for Entire Intersection Begins at 07:00 AM

City of Riverside
 N/S: Deercreek Drive
 E/W: Orange Terrace Parkway
 Weather: Clear

File Name : 10_RIV_Deer_Orange AM
 Site Code : 05121716
 Start Date : 11/30/2021
 Page No : 2

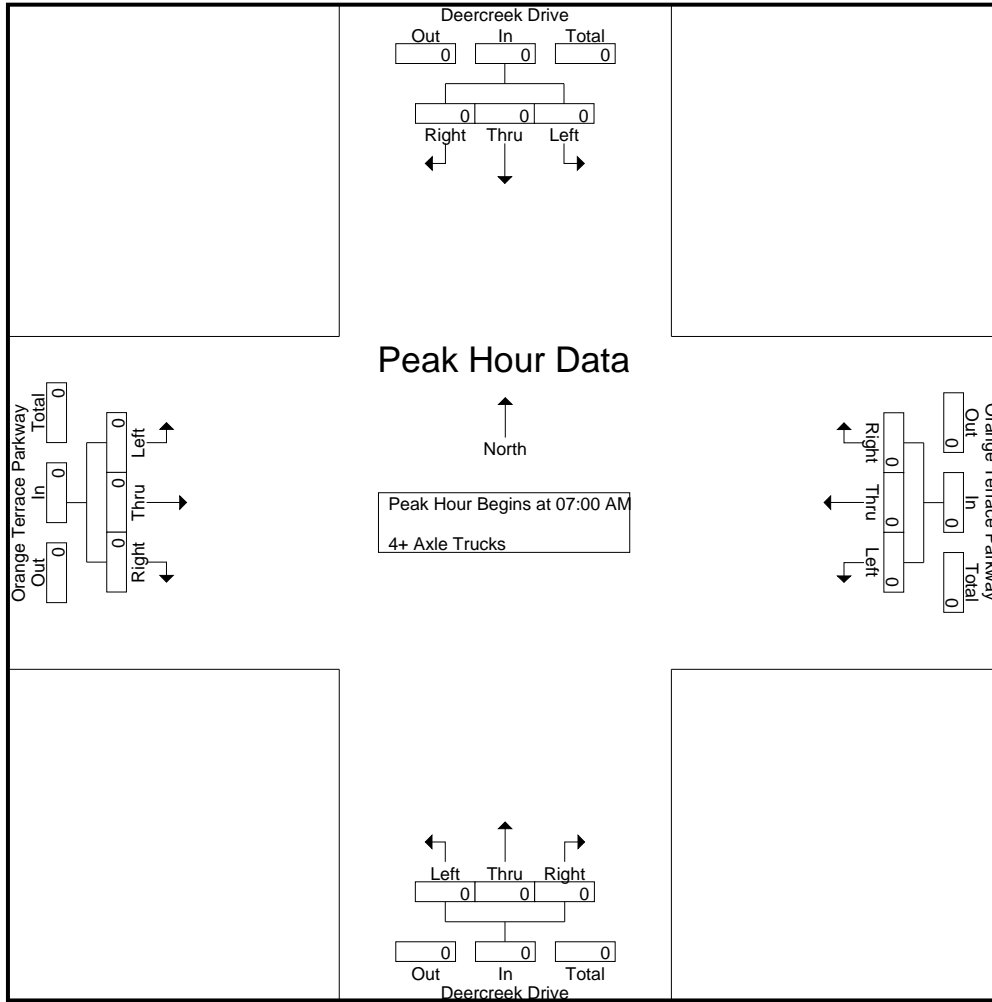

Peak Hour Analysis From 07:00 AM to 07:45 AM - Peak 1 of 1
 Peak Hour for Each Approach Begins at:

	07:00 AM				07:00 AM				07:00 AM				07:00 AM			
+0 mins.	0	0	0	0	0	0	0	0	0	0	0	0	0	0	0	0
+15 mins.	0	0	0	0	0	0	0	0	0	0	0	0	0	0	0	0
+30 mins.	0	0	0	0	0	0	0	0	0	0	0	0	0	0	0	0
+45 mins.	0	0	0	0	0	0	0	0	0	0	0	0	0	0	0	0
Total Volume	0	0	0	0	0	0	0	0	0	0	0	0	0	0	0	0
% App. Total	0	0	0	0	0	0	0	0	0	0	0	0	0	0	0	0
PHF	.000	.000	.000	.000	.000	.000	.000	.000	.000	.000	.000	.000	.000	.000	.000	.000

City of Riverside
 N/S: Deercreek Drive
 E/W: Orange Terrace Parkway
 Weather: Clear

File Name : 10_RIV_Deer_Orange PM
 Site Code : 05121716
 Start Date : 11/30/2021
 Page No : 1

Groups Printed- Passenger Vehicles - Large 2 Axle Vehicles - 3 Axle Vehicles - 4+ Axle Trucks

Start Time	Deercreek Drive Southbound				Orange Terrace Parkway Westbound				Deercreek Drive Northbound				Orange Terrace Parkway Eastbound				Int. Total
	Left	Thru	Right	App. Total	Left	Thru	Right	App. Total	Left	Thru	Right	App. Total	Left	Thru	Right	App. Total	
04:00 PM	6	1	3	10	1	52	8	61	6	2	0	8	6	64	6	76	155
04:15 PM	3	1	2	6	0	56	7	63	7	3	2	12	5	81	3	89	170
04:30 PM	3	0	3	6	0	48	7	55	6	3	0	9	15	81	5	101	171
04:45 PM	7	1	6	14	0	53	10	63	5	3	1	9	13	104	3	120	206
Total	19	3	14	36	1	209	32	242	24	11	3	38	39	330	17	386	702
05:00 PM	5	0	6	11	1	61	10	72	3	1	0	4	11	98	2	111	198
05:15 PM	11	1	5	17	0	48	11	59	4	0	0	4	6	106	3	115	195
05:30 PM	3	5	1	9	2	60	12	74	5	0	1	6	10	106	6	122	211
05:45 PM	4	2	7	13	0	54	9	63	5	4	0	9	14	98	6	118	203
Total	23	8	19	50	3	223	42	268	17	5	1	23	41	408	17	466	807
Grand Total	42	11	33	86	4	432	74	510	41	16	4	61	80	738	34	852	1509
Apprch %	48.8	12.8	38.4		0.8	84.7	14.5		67.2	26.2	6.6		9.4	86.6	4		
Total %	2.8	0.7	2.2	5.7	0.3	28.6	4.9	33.8	2.7	1.1	0.3	4	5.3	48.9	2.3	56.5	
Passenger Vehicles	41	11	33	85	4	428	73	505	40	16	4	60	78	726	33	837	1487
% Passenger Vehicles	97.6	100	100	98.8	100	99.1	98.6	99	97.6	100	100	98.4	97.5	98.4	97.1	98.2	98.5
Large 2 Axle Vehicles	1	0	0	1	0	4	1	5	1	0	0	1	2	12	1	15	22
% Large 2 Axle Vehicles	2.4	0	0	1.2	0	0.9	1.4	1	2.4	0	0	1.6	2.5	1.6	2.9	1.8	1.5
3 Axle Vehicles	0	0	0	0	0	0	0	0	0	0	0	0	0	0	0	0	0
% 3 Axle Vehicles	0	0	0	0	0	0	0	0	0	0	0	0	0	0	0	0	0
4+ Axle Trucks	0	0	0	0	0	0	0	0	0	0	0	0	0	0	0	0	0
% 4+ Axle Trucks	0	0	0	0	0	0	0	0	0	0	0	0	0	0	0	0	0

Start Time	Deercreek Drive Southbound				Orange Terrace Parkway Westbound				Deercreek Drive Northbound				Orange Terrace Parkway Eastbound				Int. Total
	Left	Thru	Right	App. Total	Left	Thru	Right	App. Total	Left	Thru	Right	App. Total	Left	Thru	Right	App. Total	
Peak Hour Analysis From 04:00 PM to 05:45 PM - Peak 1 of 1																	
Peak Hour for Entire Intersection Begins at 04:45 PM																	
04:45 PM	7	1	6	14	0	53	10	63	5	3	1	9	13	104	3	120	206
05:00 PM	5	0	6	11	1	61	10	72	3	1	0	4	11	98	2	111	198
05:15 PM	11	1	5	17	0	48	11	59	4	0	0	4	6	106	3	115	195
05:30 PM	3	5	1	9	2	60	12	74	5	0	1	6	10	106	6	122	211
Total Volume	26	7	18	51	3	222	43	268	17	4	2	23	40	414	14	468	810
% App. Total	51	13.7	35.3		1.1	82.8	16		73.9	17.4	8.7		8.5	88.5	3		
PHF	.591	.350	.750	.750	.375	.910	.896	.905	.850	.333	.500	.639	.769	.976	.583	.959	.960

City of Riverside
 N/S: Deercreek Drive
 E/W: Orange Terrace Parkway
 Weather: Clear

File Name : 10_RIV_Deer_Orange PM
 Site Code : 05121716
 Start Date : 11/30/2021
 Page No : 2

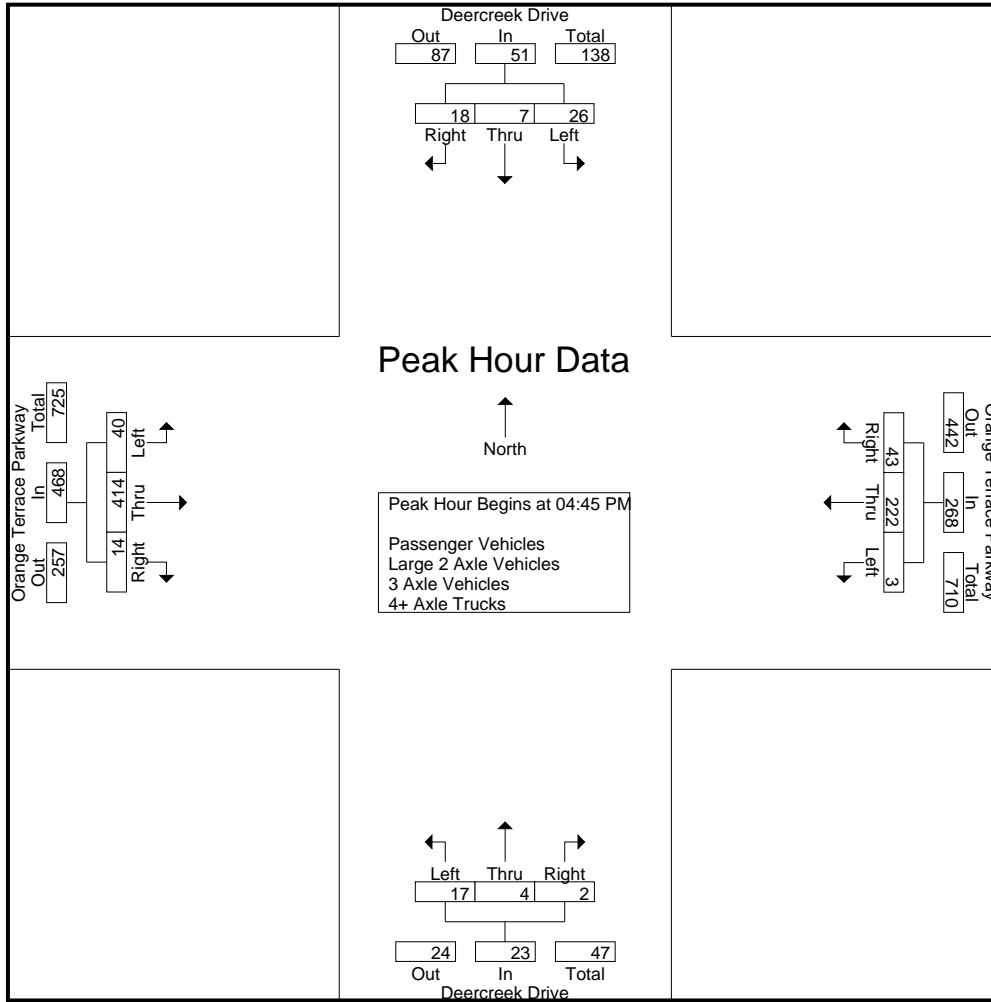

Peak Hour Analysis From 04:00 PM to 05:45 PM - Peak 1 of 1
 Peak Hour for Each Approach Begins at:

	04:45 PM				04:45 PM				04:00 PM				04:45 PM			
+0 mins.	7	1	6	14	0	53	10	63	6	2	0	8	13	104	3	120
+15 mins.	5	0	6	11	1	61	10	72	7	3	2	12	11	98	2	111
+30 mins.	11	1	5	17	0	48	11	59	6	3	0	9	6	106	3	115
+45 mins.	3	5	1	9	2	60	12	74	5	3	1	9	10	106	6	122
Total Volume	26	7	18	51	3	222	43	268	24	11	3	38	40	414	14	468
% App. Total	51	13.7	35.3		1.1	82.8	16		63.2	28.9	7.9		8.5	88.5	3	
PHF	.591	.350	.750	.750	.375	.910	.896	.905	.857	.917	.375	.792	.769	.976	.583	.959

City of Riverside
 N/S: Deercreek Drive
 E/W: Orange Terrace Parkway
 Weather: Clear

File Name : 10_RIV_Deer_Orange PM
 Site Code : 05121716
 Start Date : 11/30/2021
 Page No : 1

Groups Printed- Passenger Vehicles

Start Time	Deercreek Drive Southbound				Orange Terrace Parkway Westbound				Deercreek Drive Northbound				Orange Terrace Parkway Eastbound				Int. Total
	Left	Thru	Right	App. Total	Left	Thru	Right	App. Total	Left	Thru	Right	App. Total	Left	Thru	Right	App. Total	
04:00 PM	6	1	3	10	1	52	7	60	6	2	0	8	6	64	6	76	154
04:15 PM	3	1	2	6	0	54	7	61	7	3	2	12	5	80	3	88	167
04:30 PM	2	0	3	5	0	48	7	55	6	3	0	9	15	80	5	100	169
04:45 PM	7	1	6	14	0	53	10	63	5	3	1	9	12	101	3	116	202
Total	18	3	14	35	1	207	31	239	24	11	3	38	38	325	17	380	692
05:00 PM	5	0	6	11	1	60	10	71	3	1	0	4	11	97	1	109	195
05:15 PM	11	1	5	17	0	47	11	58	3	0	0	3	6	103	3	112	190
05:30 PM	3	5	1	9	2	60	12	74	5	0	1	6	9	106	6	121	210
05:45 PM	4	2	7	13	0	54	9	63	5	4	0	9	14	95	6	115	200
Total	23	8	19	50	3	221	42	266	16	5	1	22	40	401	16	457	795
Grand Total	41	11	33	85	4	428	73	505	40	16	4	60	78	726	33	837	1487
Apprch %	48.2	12.9	38.8		0.8	84.8	14.5		66.7	26.7	6.7		9.3	86.7	3.9		
Total %	2.8	0.7	2.2	5.7	0.3	28.8	4.9	34	2.7	1.1	0.3	4	5.2	48.8	2.2	56.3	

Start Time	Deercreek Drive Southbound				Orange Terrace Parkway Westbound				Deercreek Drive Northbound				Orange Terrace Parkway Eastbound				Int. Total
	Left	Thru	Right	App. Total	Left	Thru	Right	App. Total	Left	Thru	Right	App. Total	Left	Thru	Right	App. Total	
04:45 PM	7	1	6	14	0	53	10	63	5	3	1	9	12	101	3	116	202
05:00 PM	5	0	6	11	1	60	10	71	3	1	0	4	11	97	1	109	195
05:15 PM	11	1	5	17	0	47	11	58	3	0	0	3	6	103	3	112	190
05:30 PM	3	5	1	9	2	60	12	74	5	0	1	6	9	106	6	121	210
Total Volume	26	7	18	51	3	220	43	266	16	4	2	22	38	407	13	458	797
% App. Total	51	13.7	35.3		1.1	82.7	16.2		72.7	18.2	9.1		8.3	88.9	2.8		
PHF	.591	.350	.750	.750	.375	.917	.896	.899	.800	.333	.500	.611	.792	.960	.542	.946	.949

Peak Hour Analysis From 04:45 PM to 05:30 PM - Peak 1 of 1
 Peak Hour for Entire Intersection Begins at 04:45 PM

City of Riverside
 N/S: Deercreek Drive
 E/W: Orange Terrace Parkway
 Weather: Clear

File Name : 10_RIV_Deer_Orange PM
 Site Code : 05121716
 Start Date : 11/30/2021
 Page No : 2

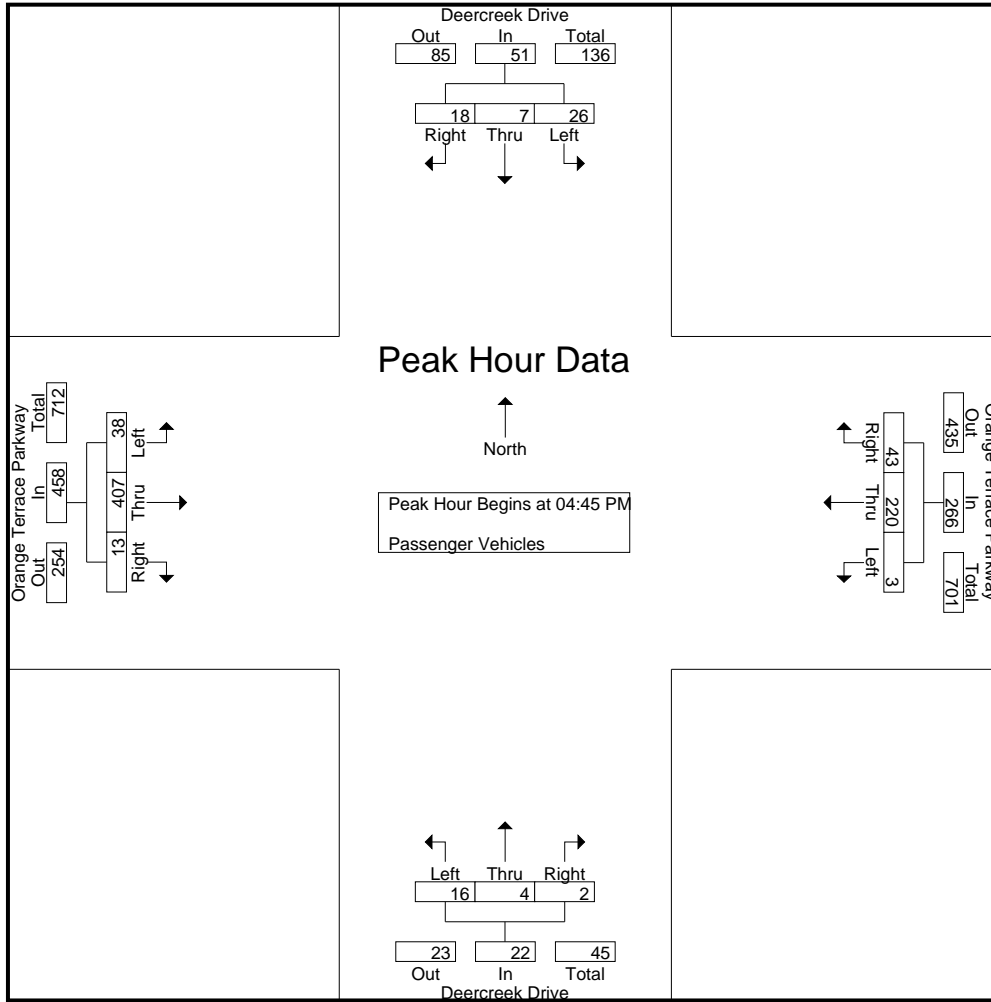

Peak Hour Analysis From 04:45 PM to 05:30 PM - Peak 1 of 1
 Peak Hour for Each Approach Begins at:

	04:45 PM				04:45 PM				04:45 PM				04:45 PM			
+0 mins.	7	1	6	14	0	53	10	63	5	3	1	9	12	101	3	116
+15 mins.	5	0	6	11	1	60	10	71	3	1	0	4	11	97	1	109
+30 mins.	11	1	5	17	0	47	11	58	3	0	0	3	6	103	3	112
+45 mins.	3	5	1	9	2	60	12	74	5	0	1	6	9	106	6	121
Total Volume	26	7	18	51	3	220	43	266	16	4	2	22	38	407	13	458
% App. Total	51	13.7	35.3		1.1	82.7	16.2		72.7	18.2	9.1		8.3	88.9	2.8	
PHF	.591	.350	.750	.750	.375	.917	.896	.899	.800	.333	.500	.611	.792	.960	.542	.946

City of Riverside
 N/S: Deercreek Drive
 E/W: Orange Terrace Parkway
 Weather: Clear

File Name : 10_RIV_Deer_Orange PM
 Site Code : 05121716
 Start Date : 11/30/2021
 Page No : 1

Groups Printed- Large 2 Axle Vehicles

Start Time	Deercreek Drive Southbound				Orange Terrace Parkway Westbound				Deercreek Drive Northbound				Orange Terrace Parkway Eastbound				Int. Total
	Left	Thru	Right	App. Total	Left	Thru	Right	App. Total	Left	Thru	Right	App. Total	Left	Thru	Right	App. Total	
04:00 PM	0	0	0	0	0	0	1	1	0	0	0	0	0	0	0	0	0
04:15 PM	0	0	0	0	0	2	0	2	0	0	0	0	0	1	0	1	3
04:30 PM	1	0	0	1	0	0	0	0	0	0	0	0	0	1	0	1	2
04:45 PM	0	0	0	0	0	0	0	0	0	0	0	0	1	3	0	4	4
Total	1	0	0	1	0	2	1	3	0	0	0	0	1	5	0	6	10
05:00 PM	0	0	0	0	0	1	0	1	0	0	0	0	0	1	1	2	3
05:15 PM	0	0	0	0	0	1	0	1	1	0	0	1	0	3	0	3	5
05:30 PM	0	0	0	0	0	0	0	0	0	0	0	0	1	0	0	1	1
05:45 PM	0	0	0	0	0	0	0	0	0	0	0	0	0	3	0	3	3
Total	0	0	0	0	0	2	0	2	1	0	0	1	1	7	1	9	12
Grand Total	1	0	0	1	0	4	1	5	1	0	0	1	2	12	1	15	22
Apprch %	100	0	0		0	80	20		100	0	0		13.3	80	6.7		
Total %	4.5	0	0	4.5	0	18.2	4.5	22.7	4.5	0	0	4.5	9.1	54.5	4.5	68.2	

Start Time	Deercreek Drive Southbound				Orange Terrace Parkway Westbound				Deercreek Drive Northbound				Orange Terrace Parkway Eastbound				Int. Total
	Left	Thru	Right	App. Total	Left	Thru	Right	App. Total	Left	Thru	Right	App. Total	Left	Thru	Right	App. Total	
04:45 PM	0	0	0	0	0	0	0	0	0	0	0	0	1	3	0	4	4
05:00 PM	0	0	0	0	0	1	0	1	0	0	0	0	0	1	1	2	3
05:15 PM	0	0	0	0	0	1	0	1	1	0	0	1	0	3	0	3	5
05:30 PM	0	0	0	0	0	0	0	0	0	0	0	0	1	0	0	1	1
Total Volume	0	0	0	0	0	2	0	2	1	0	0	1	2	7	1	10	13
% App. Total	0	0	0		0	100	0		100	0	0		20	70	10		
PHF	.000	.000	.000	.000	.000	.500	.000	.500	.250	.000	.000	.250	.500	.583	.250	.625	.650

Peak Hour Analysis From 04:45 PM to 05:30 PM - Peak 1 of 1
 Peak Hour for Entire Intersection Begins at 04:45 PM

City of Riverside
 N/S: Deercreek Drive
 E/W: Orange Terrace Parkway
 Weather: Clear

File Name : 10_RIV_Deer_Orange PM
 Site Code : 05121716
 Start Date : 11/30/2021
 Page No : 2

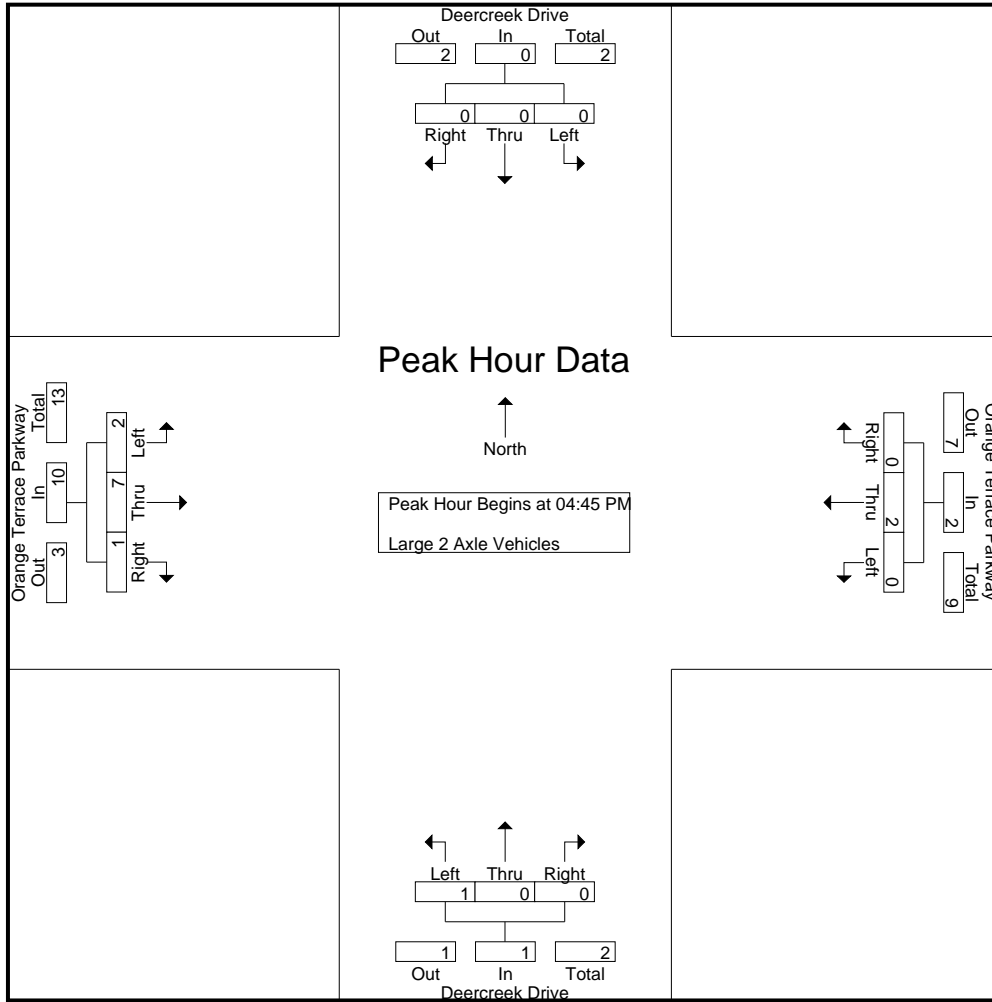

Peak Hour Analysis From 04:45 PM to 05:30 PM - Peak 1 of 1
 Peak Hour for Each Approach Begins at:

	04:45 PM				04:45 PM				04:45 PM				04:45 PM			
+0 mins.	0	0	0	0	0	0	0	0	0	0	0	0	1	3	0	4
+15 mins.	0	0	0	0	0	1	0	1	0	0	0	0	0	1	1	2
+30 mins.	0	0	0	0	0	1	0	1	1	0	0	1	0	3	0	3
+45 mins.	0	0	0	0	0	0	0	0	0	0	0	0	1	0	0	1
Total Volume	0	0	0	0	0	2	0	2	1	0	0	1	2	7	1	10
% App. Total	0	0	0	0	0	100	0	0	100	0	0	0	20	70	10	
PHF	.000	.000	.000	.000	.000	.500	.000	.500	.250	.000	.000	.250	.500	.583	.250	.625

City of Riverside
 N/S: Deercreek Drive
 E/W: Orange Terrace Parkway
 Weather: Clear

File Name : 10_RIV_Deer_Orange PM
 Site Code : 05121716
 Start Date : 11/30/2021
 Page No : 1

Groups Printed- 3 Axle Vehicles

Start Time	Deercreek Drive Southbound				Orange Terrace Parkway Westbound				Deercreek Drive Northbound				Orange Terrace Parkway Eastbound				Int. Total
	Left	Thru	Right	App. Total	Left	Thru	Right	App. Total	Left	Thru	Right	App. Total	Left	Thru	Right	App. Total	
04:00 PM	0	0	0	0	0	0	0	0	0	0	0	0	0	0	0	0	0
04:15 PM	0	0	0	0	0	0	0	0	0	0	0	0	0	0	0	0	0
04:30 PM	0	0	0	0	0	0	0	0	0	0	0	0	0	0	0	0	0
04:45 PM	0	0	0	0	0	0	0	0	0	0	0	0	0	0	0	0	0
Total	0	0	0	0	0	0	0	0	0	0	0	0	0	0	0	0	0
05:00 PM	0	0	0	0	0	0	0	0	0	0	0	0	0	0	0	0	0
05:15 PM	0	0	0	0	0	0	0	0	0	0	0	0	0	0	0	0	0
05:30 PM	0	0	0	0	0	0	0	0	0	0	0	0	0	0	0	0	0
05:45 PM	0	0	0	0	0	0	0	0	0	0	0	0	0	0	0	0	0
Total	0	0	0	0	0	0	0	0	0	0	0	0	0	0	0	0	0
Grand Total	0	0	0	0	0	0	0	0	0	0	0	0	0	0	0	0	0
Apprch %	0	0	0		0	0	0		0	0	0		0	0	0		
Total %																	

Start Time	Deercreek Drive Southbound				Orange Terrace Parkway Westbound				Deercreek Drive Northbound				Orange Terrace Parkway Eastbound				Int. Total
	Left	Thru	Right	App. Total	Left	Thru	Right	App. Total	Left	Thru	Right	App. Total	Left	Thru	Right	App. Total	
04:45 PM	0	0	0	0	0	0	0	0	0	0	0	0	0	0	0	0	0
05:00 PM	0	0	0	0	0	0	0	0	0	0	0	0	0	0	0	0	0
05:15 PM	0	0	0	0	0	0	0	0	0	0	0	0	0	0	0	0	0
05:30 PM	0	0	0	0	0	0	0	0	0	0	0	0	0	0	0	0	0
Total Volume	0	0	0	0	0	0	0	0	0	0	0	0	0	0	0	0	0
% App. Total	0	0	0		0	0	0		0	0	0		0	0	0		
PHF	.000	.000	.000	.000	.000	.000	.000	.000	.000	.000	.000	.000	.000	.000	.000	.000	.000

Peak Hour Analysis From 04:45 PM to 05:30 PM - Peak 1 of 1
 Peak Hour for Entire Intersection Begins at 04:45 PM

City of Riverside
 N/S: Deercreek Drive
 E/W: Orange Terrace Parkway
 Weather: Clear

File Name : 10_RIV_Deer_Orange PM
 Site Code : 05121716
 Start Date : 11/30/2021
 Page No : 2

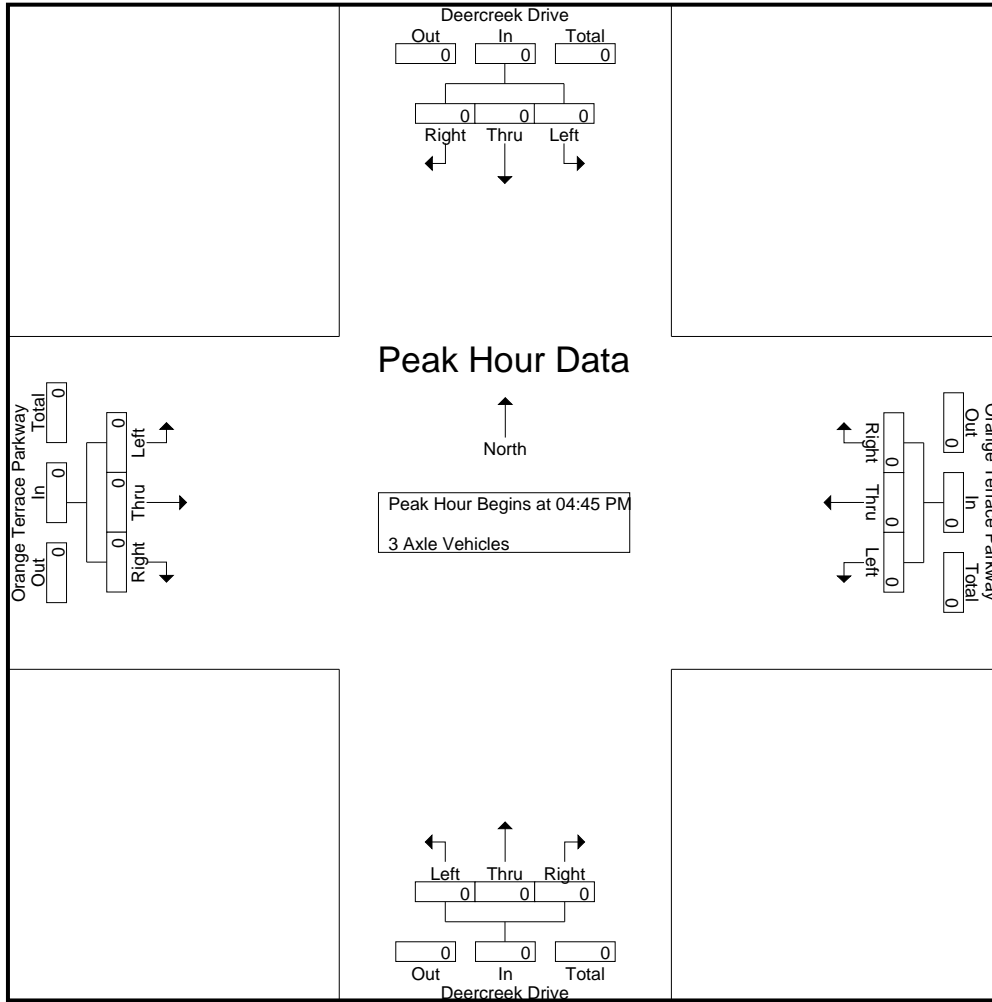

Peak Hour Analysis From 04:45 PM to 05:30 PM - Peak 1 of 1
 Peak Hour for Each Approach Begins at:

	04:45 PM				04:45 PM				04:45 PM				04:45 PM			
+0 mins.	0	0	0	0	0	0	0	0	0	0	0	0	0	0	0	0
+15 mins.	0	0	0	0	0	0	0	0	0	0	0	0	0	0	0	0
+30 mins.	0	0	0	0	0	0	0	0	0	0	0	0	0	0	0	0
+45 mins.	0	0	0	0	0	0	0	0	0	0	0	0	0	0	0	0
Total Volume	0	0	0	0	0	0	0	0	0	0	0	0	0	0	0	0
% App. Total	0	0	0	0	0	0	0	0	0	0	0	0	0	0	0	0
PHF	.000	.000	.000	.000	.000	.000	.000	.000	.000	.000	.000	.000	.000	.000	.000	.000

City of Riverside
 N/S: Deercreek Drive
 E/W: Orange Terrace Parkway
 Weather: Clear

File Name : 10_RIV_Deer_Orange PM
 Site Code : 05121716
 Start Date : 11/30/2021
 Page No : 1

Groups Printed- 4+ Axle Trucks

Start Time	Deercreek Drive Southbound				Orange Terrace Parkway Westbound				Deercreek Drive Northbound				Orange Terrace Parkway Eastbound				Int. Total
	Left	Thru	Right	App. Total	Left	Thru	Right	App. Total	Left	Thru	Right	App. Total	Left	Thru	Right	App. Total	
04:00 PM	0	0	0	0	0	0	0	0	0	0	0	0	0	0	0	0	0
04:15 PM	0	0	0	0	0	0	0	0	0	0	0	0	0	0	0	0	0
04:30 PM	0	0	0	0	0	0	0	0	0	0	0	0	0	0	0	0	0
04:45 PM	0	0	0	0	0	0	0	0	0	0	0	0	0	0	0	0	0
Total	0	0	0	0	0	0	0	0	0	0	0	0	0	0	0	0	0
05:00 PM	0	0	0	0	0	0	0	0	0	0	0	0	0	0	0	0	0
05:15 PM	0	0	0	0	0	0	0	0	0	0	0	0	0	0	0	0	0
05:30 PM	0	0	0	0	0	0	0	0	0	0	0	0	0	0	0	0	0
05:45 PM	0	0	0	0	0	0	0	0	0	0	0	0	0	0	0	0	0
Total	0	0	0	0	0	0	0	0	0	0	0	0	0	0	0	0	0
Grand Total	0	0	0	0	0	0	0	0	0	0	0	0	0	0	0	0	0
Apprch %	0	0	0		0	0	0		0	0	0		0	0	0		
Total %																	

Start Time	Deercreek Drive Southbound				Orange Terrace Parkway Westbound				Deercreek Drive Northbound				Orange Terrace Parkway Eastbound				Int. Total
	Left	Thru	Right	App. Total	Left	Thru	Right	App. Total	Left	Thru	Right	App. Total	Left	Thru	Right	App. Total	
04:45 PM	0	0	0	0	0	0	0	0	0	0	0	0	0	0	0	0	0
05:00 PM	0	0	0	0	0	0	0	0	0	0	0	0	0	0	0	0	0
05:15 PM	0	0	0	0	0	0	0	0	0	0	0	0	0	0	0	0	0
05:30 PM	0	0	0	0	0	0	0	0	0	0	0	0	0	0	0	0	0
Total Volume	0	0	0	0	0	0	0	0	0	0	0	0	0	0	0	0	0
% App. Total	0	0	0		0	0	0		0	0	0		0	0	0		
PHF	.000	.000	.000	.000	.000	.000	.000	.000	.000	.000	.000	.000	.000	.000	.000	.000	.000

Peak Hour Analysis From 04:45 PM to 05:30 PM - Peak 1 of 1
 Peak Hour for Entire Intersection Begins at 04:45 PM

City of Riverside
 N/S: Deercreek Drive
 E/W: Orange Terrace Parkway
 Weather: Clear

File Name : 10_RIV_Deer_Orange PM
 Site Code : 05121716
 Start Date : 11/30/2021
 Page No : 2

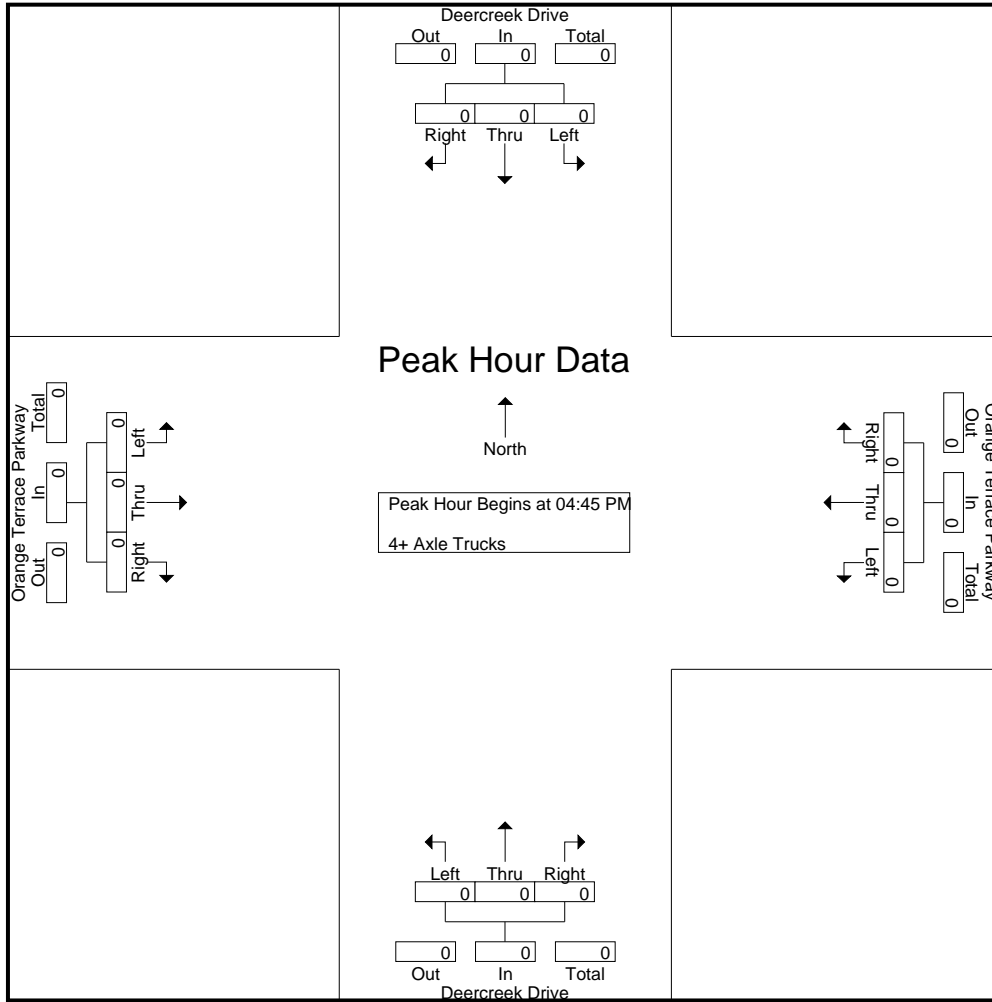

Peak Hour Analysis From 04:45 PM to 05:30 PM - Peak 1 of 1
 Peak Hour for Each Approach Begins at:

	04:45 PM				04:45 PM				04:45 PM				04:45 PM			
+0 mins.	0	0	0	0	0	0	0	0	0	0	0	0	0	0	0	0
+15 mins.	0	0	0	0	0	0	0	0	0	0	0	0	0	0	0	0
+30 mins.	0	0	0	0	0	0	0	0	0	0	0	0	0	0	0	0
+45 mins.	0	0	0	0	0	0	0	0	0	0	0	0	0	0	0	0
Total Volume	0	0	0	0	0	0	0	0	0	0	0	0	0	0	0	0
% App. Total	0	0	0	0	0	0	0	0	0	0	0	0	0	0	0	0
PHF	.000	.000	.000	.000	.000	.000	.000	.000	.000	.000	.000	.000	.000	.000	.000	.000

Location: Riverside
 N/S: Deercreek Drive
 E/W: Orange Terrace Parkway



Date: 11/30/2021
 Day: Tuesday

PEDESTRIANS

	North Leg Deercreek Drive	East Leg Orange Terrace Parkway	South Leg Deercreek Drive	West Leg Orange Terrace Parkway	
	Pedestrians	Pedestrians	Pedestrians	Pedestrians	
7:00 AM	0	0	2	2	4
7:15 AM	0	0	0	0	0
7:30 AM	0	7	6	0	13
7:45 AM	0	3	1	0	4
8:00 AM	1	1	0	0	2
8:15 AM	0	4	1	1	6
8:30 AM	0	0	1	0	1
8:45 AM	0	3	0	0	3
TOTAL VOLUMES:	1	18	11	3	33

	North Leg Deercreek Drive	East Leg Orange Terrace Parkway	South Leg Deercreek Drive	West Leg Orange Terrace Parkway	
	Pedestrians	Pedestrians	Pedestrians	Pedestrians	
4:00 PM	8	0	1	0	9
4:15 PM	1	1	2	0	4
4:30 PM	0	0	2	0	2
4:45 PM	0	0	0	0	0
5:00 PM	2	0	0	0	2
5:15 PM	0	5	0	0	5
5:30 PM	0	0	0	2	2
5:45 PM	0	5	0	0	5
TOTAL VOLUMES:	11	11	5	2	29

Location: Riverside
 N/S: Deercreek Drive
 E/W: Orange Terrace Parkway



Date: 11/30/2021
 Day: Tuesday

BICYCLES

	Southbound Deercreek Drive			Westbound Orange Terrace Parkway			Northbound Deercreek Drive			Eastbound Orange Terrace Parkway			
	Left	Thru	Right	Left	Thru	Right	Left	Thru	Right	Left	Thru	Right	
7:00 AM	0	0	0	0	0	0	0	0	0	0	0	0	0
7:15 AM	0	1	0	0	0	0	0	0	0	0	0	0	1
7:30 AM	0	0	0	0	0	0	0	0	0	1	0	0	1
7:45 AM	0	1	0	0	0	0	0	0	0	0	0	0	1
8:00 AM	0	0	0	0	0	0	0	0	0	0	0	0	0
8:15 AM	0	0	0	0	0	0	0	0	0	0	0	0	0
8:30 AM	0	0	0	0	0	0	0	0	0	0	0	0	0
8:45 AM	0	0	1	0	0	0	0	0	0	0	0	0	1
TOTAL VOLUMES:	0	2	1	0	0	0	0	0	0	1	0	0	4

	Southbound Deercreek Drive			Westbound Orange Terrace Parkway			Northbound Deercreek Drive			Eastbound Orange Terrace Parkway			
	Left	Thru	Right	Left	Thru	Right	Left	Thru	Right	Left	Thru	Right	
4:00 PM	0	1	0	0	0	0	0	0	0	1	0	0	2
4:15 PM	0	1	0	0	0	0	0	0	0	0	0	0	1
4:30 PM	0	0	0	0	0	0	0	1	0	0	0	0	1
4:45 PM	0	1	0	0	0	0	0	0	0	0	3	0	4
5:00 PM	0	0	0	0	0	0	0	0	0	0	0	0	0
5:15 PM	0	0	0	0	0	0	0	0	0	0	0	0	0
5:30 PM	0	0	0	0	0	0	0	0	0	0	0	0	0
5:45 PM	0	0	0	0	0	0	0	0	0	0	0	0	0
TOTAL VOLUMES:	0	3	0	0	0	0	0	1	0	1	3	0	8

Groups Printed- Passenger Vehicles - Large 2 Axle Vehicles - 3 Axle Vehicles - 4+ Axle Trucks

Start Time	Barton Street Southbound						Alessandro Boulevard Westbound						Barton Street Northbound						Alessandro Boulevard Eastbound						
	Left		Thru		Right		Left		Thru		Right		Left		Thru		Right		Left		Thru		Right		
	RTOR	App. Total	RTOR	App. Total	RTOR	App. Total	RTOR	App. Total	RTOR	App. Total	RTOR	App. Total	RTOR	App. Total	RTOR	App. Total	RTOR	App. Total	RTOR	App. Total	RTOR	App. Total	RTOR	App. Total	
07:00 AM	0	0	1	0	0	1	4	493	2	0	0	499	17	0	9	7	26	5	222	4	0	0	231	7	757
07:15 AM	2	1	3	0	6	527	6	520	1	0	0	527	19	0	5	3	24	4	217	3	1	1	224	4	781
07:30 AM	1	0	3	2	4	528	7	519	2	0	0	528	18	1	13	8	32	3	274	5	0	0	282	10	846
07:45 AM	1	0	1	1	2	491	5	486	0	0	0	491	13	0	11	8	24	0	271	4	0	0	275	9	792
Total	4	1	8	3	13	2045	22	2018	5	0	0	2045	67	1	38	26	106	12	984	16	1	1	1012	30	3176
08:00 AM	0	0	1	1	1	482	6	476	0	0	0	482	10	0	11	10	21	1	255	8	1	1	264	12	768
08:15 AM	1	0	1	1	2	550	11	537	2	0	3	550	17	0	4	3	21	1	266	10	2	2	270	6	850
08:30 AM	3	1	2	1	6	502	11	487	4	1	6	502	21	0	9	6	30	4	228	8	0	0	240	8	778
08:45 AM	0	0	2	2	2	457	7	449	1	0	7	457	14	0	7	6	21	1	244	8	0	0	253	8	733
Total	4	1	6	5	11	1991	35	1949	7	1	31	1991	62	0	31	25	93	7	993	34	3	3	1034	34	3129
Grand Total	8	2	14	8	24	4036	57	3967	12	1	69	4036	129	1	69	51	199	19	1977	50	4	4	2046	64	6305
% Approach	33.3	8.3	58.3	0.3	0.4	64	1.4	98.3	0.3	0.2	1.1	64	64.8	0.5	34.7	3.2	3.2	0.9	96.6	2.4	0.8	0.8	32.5	1	99
% Total	0.1	0	0.2	0	0.4	64	0.9	62.9	0.2	0.2	1.1	64	2	0	1.1	3.2	3.2	0.3	31.4	0.8	0.8	0.8	32.5	1	99
% Passenger Vehicles	4	2	9	62.5	20	3940	55	3875	9	100	98.6	98	127	1	68	246	246	18	1932	49	100	2003	0	0	6209
% Large 2 Axle Vehicles	4	0	5	12	12	75	2	70	3	0	1	75	2	0	1	4	4	1	36	1	38	38	0	0	129
% 3 Axle Vehicles	0	0	0	0	0	11	0	11	0	0	0	11	0	0	0	0	0	5.3	1.8	2	0	1.9	0	0	2
% 4+ Axle Trucks	0	0	0	0	0	0.3	0	0.3	0	0	0	0.3	0	0	0	0	0	0	0.2	0	0	0.2	0	0	0.2
% 4+ Axle Trucks	0	0	0	0	0	11	0	11	0	0	0	11	0	0	0	0	0	0	5	0	0	5	0	0	16
% 4+ Axle Trucks	0	0	0	0	0	0.3	0	0.3	0	0	0	0.3	0	0	0	0	0	0	0.3	0	0	0.2	0	0	0.3

Start Time	Barton Street Southbound						Alessandro Boulevard Westbound						Barton Street Northbound						Alessandro Boulevard Eastbound					
	Left		Thru		Right		Left		Thru		Right		Left		Thru		Right		Left		Thru		Right	
	RTOR	App. Total	RTOR	App. Total	RTOR	App. Total	RTOR	App. Total	RTOR	App. Total	RTOR	App. Total	RTOR	App. Total	RTOR	App. Total	RTOR	App. Total	RTOR	App. Total	RTOR	App. Total	RTOR	App. Total
07:30 AM	1	0	3	4	7	519	2	528	0	13	1	13	18	1	11	32	5	274	3	274	5	282	846	
07:45 AM	1	0	1	2	5	486	0	491	0	11	0	11	13	0	11	24	4	271	0	271	4	275	792	
08:00 AM	0	0	1	1	6	476	0	482	0	11	0	11	10	0	11	21	8	255	1	255	8	264	768	
08:15 AM	1	0	1	2	11	537	2	550	2	4	4	550	17	0	4	21	10	266	1	266	10	277	850	
Total Volume	3	0	6	9	29	2018	4	2051	4	39	1	39	58	1	39	98	27	1066	5	1066	27	1098	3256	
% App. Total	33.3	0	66.7	0	1.4	98.4	0.2	99.2	0.2	39.8	1	39.8	59.2	1	39.8	.766	2.5	97.1	0.5	97.1	2.5	.973	.958	
PHF	.750	.000	.500	.563	.659	.939	.500	.932	.500	.750	.250	.750	.806	.250	.750	.766	.417	.973	.675	.417	.973	.675	.973	

Peak Hour Analysis From 07:00 AM to 08:45 AM - Peak 1 of 1
 Peak Hour for Entire Intersection Begins at 07:30 AM

Counts Unlimited, Inc.
 PO Box 1178
 Corona, CA 92878
 (951)268-6268

City of Riverside
 N/S: Barton Street
 E/W: Alessandro Boulevard
 Weather: Clear

File Name : 11_RIV_Barton_Ales AM
 Site Code : 05121716
 Start Date : 11/30/2021
 Page No : 2

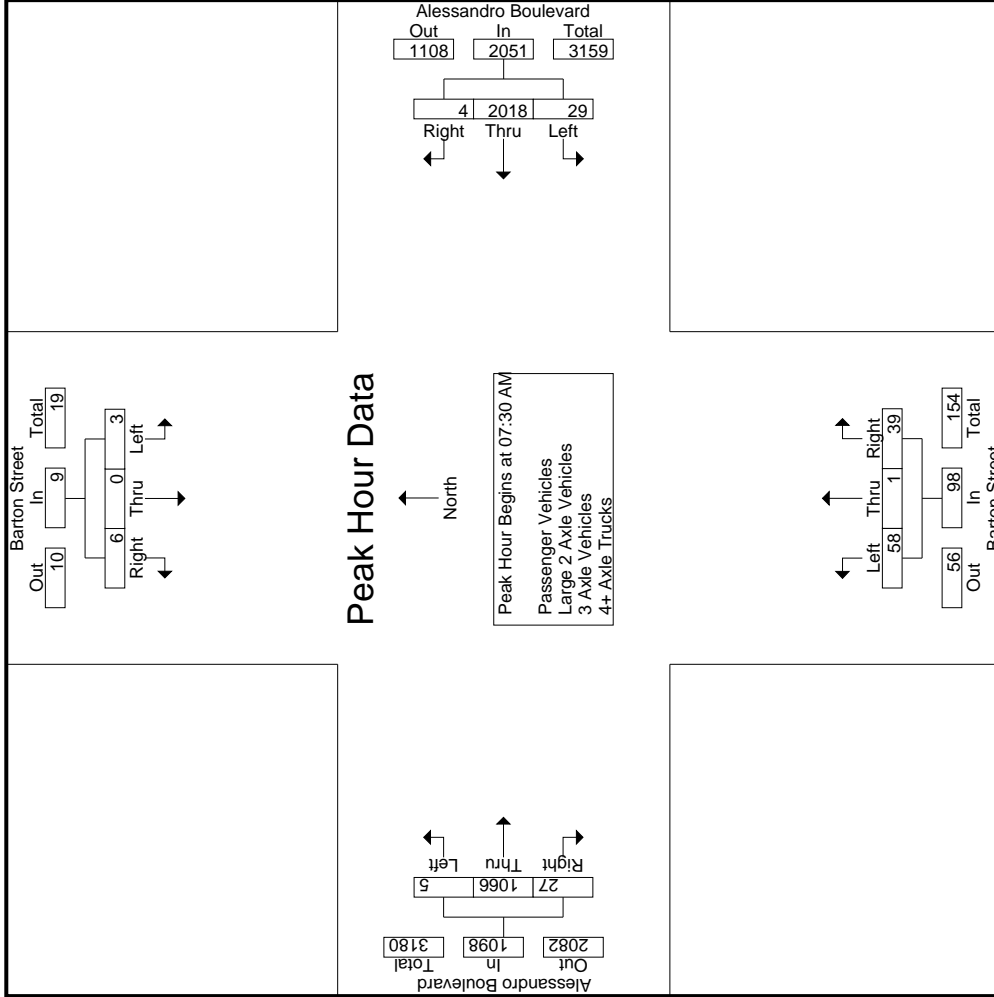

Counts Unlimited, Inc.
 PO Box 1178
 Corona, CA 92878
 (951)268-6268

City of Riverside
 N/S: Barton Street
 E/W: Alessandro Boulevard
 Weather: Clear

File Name : 11_RIV_Barton_Ales AM
 Site Code : 05121716
 Start Date : 11/30/2021
 Page No : 3

Start Time	Barton Street Southbound			Alessandro Boulevard Westbound			Barton Street Northbound			Alessandro Boulevard Eastbound			Int. Total	
	Left	Thru	Right	Left	Thru	Right	Left	Thru	Right	Left	Thru	Right		App. Total
Peak Hour Analysis From 07:00 AM to 08:45 AM - Peak 1 of 1	Peak Hour for Each Approach Begins at:													
	07:00 AM			07:30 AM			07:00 AM			07:30 AM				
+0 mins.	0	0	1	7	519	2	528	17	0	9	26	274	5	282
+15 mins.	2	1	3	5	486	0	491	19	0	5	24	271	4	275
+30 mins.	1	0	3	6	476	0	482	18	1	13	32	255	8	264
+45 mins.	1	0	1	11	537	2	550	13	0	11	24	266	10	277
Total Volume	4	1	8	29	2018	4	2051	67	1	38	106	1066	27	1098
% App. Total	30.8	7.7	61.5	1.4	98.4	0.2	93.2	63.2	0.9	35.8	0.5	97.1	2.5	
PHF	.500	.250	.667	.659	.939	.500	.932	.882	.250	.731	.828	.973	.675	.973

Counts Unlimited, Inc.
 PO Box 1178
 Corona, CA 92878
 (951)268-6268

City of Riverside
 N/S: Barton Street
 E/W: Alessandro Boulevard
 Weather: Clear

File Name : 11_RIV_Barton_Ales AM
 Site Code : 05121716
 Start Date : 11/30/2021
 Page No : 1

Groups Printed- Passenger Vehicles

Start Time	Barton Street Southbound				Alessandro Boulevard Westbound				Barton Street Northbound				Alessandro Boulevard Eastbound										
	Left	Thru	Right	RTOR	Left	Thru	Right	RTOR	Left	Thru	Right	RTOR	Left	Thru	Right	RTOR	Left	Thru	Right	RTOR	Exclu. Total	Inclu. Total	Int. Total
07:00 AM	0	0	0	0	4	482	1	0	16	0	9	7	5	216	4	0	225	7	737	744			
07:15 AM	2	1	3	0	4	513	1	0	18	0	5	3	4	215	3	1	222	4	769	773			
07:30 AM	0	0	2	2	7	505	1	0	18	1	13	8	3	270	4	0	277	10	824	834			
07:45 AM	0	0	0	0	5	478	0	0	13	0	10	7	0	264	4	0	268	7	774	781			
Total	2	1	5	2	20	1978	3	0	65	1	37	25	12	965	15	1	992	28	3104	3132			
08:00 AM	0	0	1	1	6	458	0	0	10	0	11	10	0	247	8	1	255	12	741	753			
08:15 AM	0	0	0	0	11	527	2	0	17	0	4	3	1	261	10	2	272	5	833	838			
08:30 AM	2	1	2	1	11	476	3	1	21	0	9	6	4	225	8	0	237	8	762	770			
08:45 AM	0	0	1	1	7	436	1	0	14	0	7	6	1	234	8	0	243	7	709	716			
Total	2	1	4	3	35	1897	6	1	62	0	31	25	6	967	34	3	1007	32	3045	3077			
Grand Total	4	2	9	5	55	3875	9	1	127	1	68	50	18	1932	49	4	1999	60	6149	6209			
% Approach	26.7	13.3	60		1.4	98.4	0.2		64.8	0.5	34.7		0.9	96.6	2.5		32.5						
% Total	0.1	0	0.1		0.9	63	0.1		2.1	0	1.1		0.3	31.4	0.8			1	99				

Start Time	Barton Street Southbound				Alessandro Boulevard Westbound				Barton Street Northbound				Alessandro Boulevard Eastbound										
	Left	Thru	Right	RTOR	Left	Thru	Right	RTOR	Left	Thru	Right	RTOR	Left	Thru	Right	RTOR	Left	Thru	Right	RTOR	Exclu. Total	Inclu. Total	Int. Total
07:30 AM	0	0	0	0	7	505	1	0	18	1	13	0	3	270	4	0	277	4	268	274			
07:45 AM	0	0	0	0	5	478	0	0	13	0	10	10	0	264	4	0	268	4	774	774			
08:00 AM	0	0	0	0	6	458	0	0	10	0	11	11	0	247	8	0	255	8	255	741			
08:15 AM	0	0	0	0	11	527	2	0	17	0	4	4	1	261	10	1	272	10	833	833			
Total Volume	0	0	0	0	29	1968	3	0	58	1	38	38	4	1042	26	0	1072	26	3172	3172			
% App. Total	0	0	0	0	1.5	98.4	0.2		59.8	1	39.2		0.4	97.2	2.4								
PHF	.000	.000	.000	.375	.659	.934	.375		.806	.250	.731		.333	.965	.650		.968						

Peak Hour Analysis From 07:30 AM to 08:15 AM - Peak 1 of 1
 Peak Hour for Entire Intersection Begins at 07:30 AM

Counts Unlimited, Inc.
 PO Box 1178
 Corona, CA 92878
 (951)268-6268

City of Riverside
 N/S: Barton Street
 E/W: Alessandro Boulevard
 Weather: Clear

File Name : 11_RIV_Barton_Ales AM
 Site Code : 05121716
 Start Date : 11/30/2021
 Page No : 2

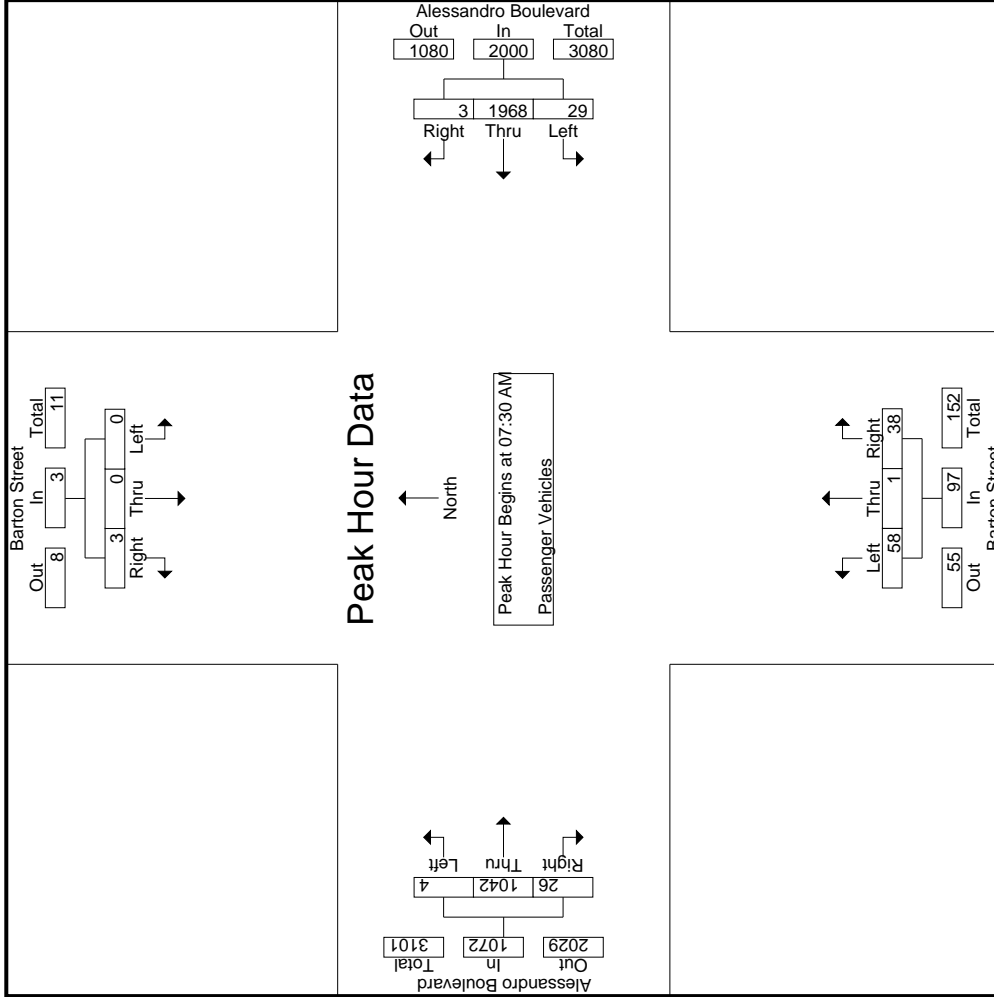

Counts Unlimited, Inc.
 PO Box 1178
 Corona, CA 92878
 (951)268-6268

City of Riverside
 N/S: Barton Street
 E/W: Alessandro Boulevard
 Weather: Clear

File Name : 11_RIV_Barton_Ales AM
 Site Code : 05121716
 Start Date : 11/30/2021
 Page No : 3

Start Time	Barton Street Southbound			Alessandro Boulevard Westbound			Barton Street Northbound			Alessandro Boulevard Eastbound			Int. Total		
	Left	Thru	Right	Left	Thru	Right	Left	Thru	Right	Left	Thru	Right		App. Total	
Peak Hour Analysis From 07:30 AM to 08:15 AM - Peak 1 of 1	07:30 AM														
Peak Hour for Each Approach Begins at:	07:30 AM														
+0 mins.	0	0	2	7	505	1	513	18	1	13	32	3	270	4	277
+15 mins.	0	0	0	5	478	0	483	13	0	10	23	0	264	4	268
+30 mins.	0	0	1	6	458	0	464	10	0	11	21	0	247	8	255
+45 mins.	0	0	0	11	527	2	540	17	0	4	21	1	261	10	272
Total Volume	0	0	3	29	1968	3	2000	58	1	38	97	4	1042	26	1072
% App. Total	0	0	100	1.5	98.4	0.2	926	59.8	1	39.2	758	0.4	97.2	2.4	968
PHF	.000	.000	.375	.659	.934	.375	.926	.806	.250	.731	.758	.333	.965	.650	.968

Counts Unlimited, Inc.
 PO Box 1178
 Corona, CA 92878
 (951)268-6268

City of Riverside
 N/S: Barton Street
 E/W: Alessandro Boulevard
 Weather: Clear

File Name : 11_RIV_Barton_Ales AM
 Site Code : 05121716
 Start Date : 11/30/2021
 Page No : 1

Groups Printed- Large 2 Axle Vehicles

Start Time	Barton Street Southbound				Alessandro Boulevard Westbound				Barton Street Northbound				Alessandro Boulevard Eastbound						
	Left	Thru	Right	RTOR	App. Total	Left	Thru	Right	RTOR	App. Total	Left	Thru	Right	RTOR	App. Total	Exclu. Total	Inclu. Total	Int. Total	
07:00 AM	0	0	1	0	1	0	10	1	0	11	1	0	0	0	1	0	5	0	18
07:15 AM	0	0	0	0	0	2	6	0	0	8	1	0	0	0	1	0	1	0	10
07:30 AM	1	0	1	0	2	0	11	1	0	12	0	0	0	0	0	4	0	18	
07:45 AM	1	0	1	1	2	0	6	0	0	6	0	0	1	1	1	4	2	13	
Total	2	0	3	1	5	2	33	2	0	37	2	0	1	1	3	0	14	2	61
08:00 AM	0	0	0	0	0	0	13	0	0	13	0	0	0	0	0	1	8	0	22
08:15 AM	1	0	1	1	2	0	9	0	0	9	0	0	0	0	0	4	1	15	
08:30 AM	1	0	0	0	1	0	8	1	0	9	0	0	0	0	0	3	0	13	
08:45 AM	0	0	1	1	1	0	7	0	0	7	0	0	0	0	0	8	1	17	
Total	2	0	2	2	4	0	37	1	0	38	0	0	0	0	0	1	23	2	68
Grand Total	4	0	5	3	9	2	70	3	0	75	2	0	1	1	3	1	36	4	129
% Apprch %	44.4	0	55.6			2.7	93.3	4		66.7	0	33.3			2.6	94.7	2.6	125	
% Total %	3.2	0	4		7.2	1.6	56	2.4		60	1.6	0	0.8		2.4	0.8	28.8	3.1	96.9

Start Time	Barton Street Southbound				Alessandro Boulevard Westbound				Barton Street Northbound				Alessandro Boulevard Eastbound						
	Left	Thru	Right	RTOR	App. Total	Left	Thru	Right	RTOR	App. Total	Left	Thru	Right	RTOR	App. Total	Exclu. Total	Inclu. Total	Int. Total	
07:30 AM	1	0	0	1	1	0	11	1	12	12	0	0	0	0	0	0	3	1	4
07:45 AM	1	0	0	1	1	0	6	0	6	6	0	0	1	1	1	0	4	0	4
08:00 AM	0	0	0	0	0	0	13	0	13	13	0	0	0	0	0	0	8	0	9
08:15 AM	1	0	1	1	2	0	9	0	9	9	0	0	0	0	0	4	0	4	15
Total Volume	3	0	3	3	6	0	39	1	40	40	0	0	1	1	1	19	19	21	68
% App. Total	50	0	50			0	97.5	2.5		100	0	100			4.8	90.5	4.8	125	
PHF	.750	.000	.750		.750	.000	.750	.250	.769	.000	.000	.250	.250	.250	.594	.250	.583	.773	

Peak Hour Analysis From 07:30 AM to 08:15 AM - Peak 1 of 1
 Peak Hour for Entire Intersection Begins at 07:30 AM

Counts Unlimited, Inc.
 PO Box 1178
 Corona, CA 92878
 (951)268-6268

City of Riverside
 N/S: Barton Street
 E/W: Alessandro Boulevard
 Weather: Clear

File Name : 11_RIV_Barton_Ales AM
 Site Code : 05121716
 Start Date : 11/30/2021
 Page No : 2

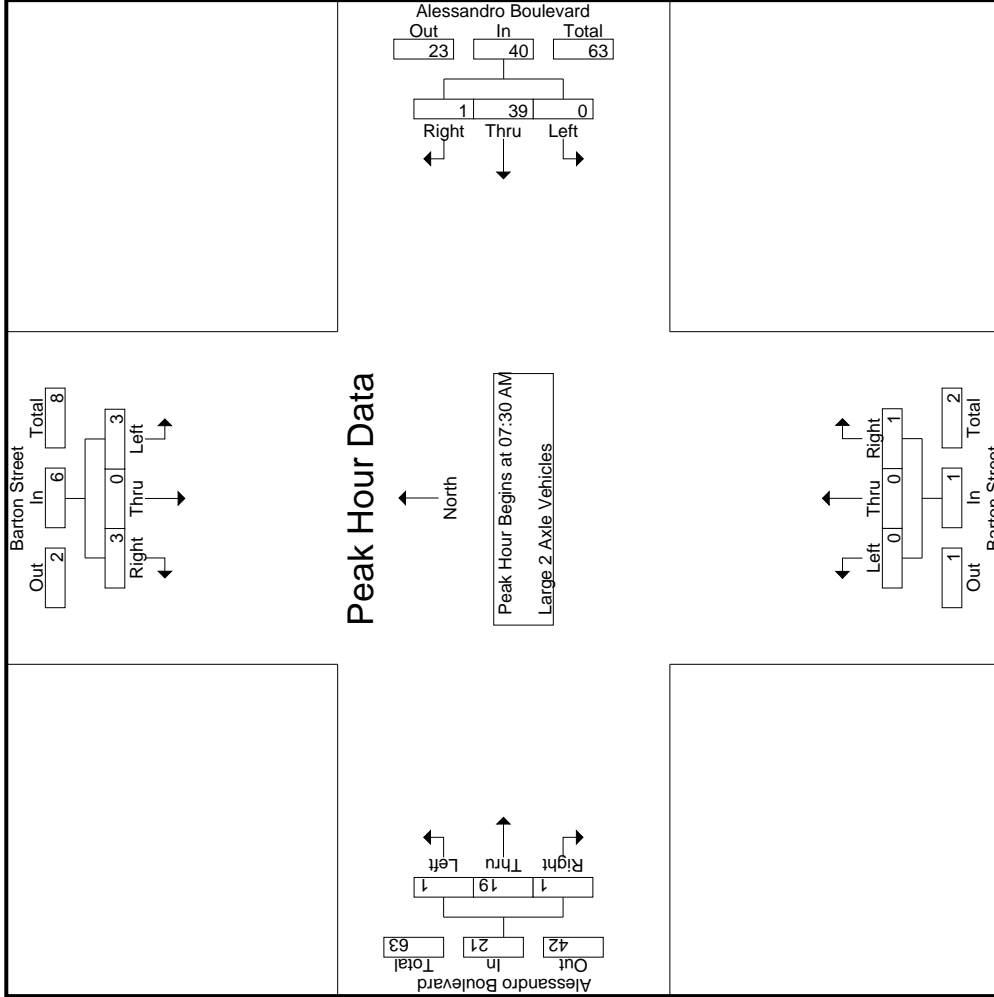

Counts Unlimited, Inc.
 PO Box 1178
 Corona, CA 92878
 (951)268-6268

City of Riverside
 N/S: Barton Street
 E/W: Alessandro Boulevard
 Weather: Clear

File Name : 11_RIV_Barton_Ales AM
 Site Code : 05121716
 Start Date : 11/30/2021
 Page No : 3

Start Time	Barton Street Southbound			Alessandro Boulevard Westbound			Barton Street Northbound			Alessandro Boulevard Eastbound			
	Left	Thru	Right	Left	Thru	Right	Left	Thru	Right	Left	Thru	Right	
Peak Hour Analysis From 07:30 AM to 08:15 AM - Peak 1 of 1													
Peak Hour for Each Approach Begins at:	07:30 AM												
+0 mins.	1	0	1	0	11	1	12	0	0	0	0	3	1
+15 mins.	1	0	1	0	6	0	6	0	0	1	0	4	0
+30 mins.	0	0	0	0	13	0	13	0	0	0	1	8	0
+45 mins.	1	0	1	0	9	0	9	0	0	0	0	4	0
Total Volume	3	0	3	0	39	1	40	0	0	1	1	19	1
% App. Total	50	0	50	0	97.5	2.5	769	0	0	100	4.8	90.5	4.8
PHF	.750	.000	.750	.000	.750	.250	.769	.000	.000	.250	.250	.594	.250

Groups Printed- 3 Axle Vehicles

Start Time	Barton Street Southbound				Alessandro Boulevard Westbound				Barton Street Northbound				Alessandro Boulevard Eastbound											
	Left	Thru	Right	RTOR	App. Total	Left	Thru	Right	RTOR	App. Total	Left	Thru	Right	RTOR	App. Total	Left	Thru	Right	RTOR	App. Total	Exclu. Total	Inclu. Total	Int. Total	
07:00 AM	0	0	0	0	0	0	0	0	0	0	0	0	0	0	0	1	0	0	0	1	0	1	1	1
07:15 AM	0	0	0	0	0	0	0	0	0	0	0	0	0	0	0	0	0	0	0	0	0	0	0	0
07:30 AM	0	0	0	0	0	1	0	0	0	1	0	0	0	0	0	0	0	0	0	0	0	0	1	1
07:45 AM	0	0	0	0	0	2	0	0	0	2	0	0	0	0	0	2	0	0	0	2	0	0	4	4
Total	0	0	0	0	0	3	0	0	0	3	0	0	0	0	0	3	0	0	0	3	0	0	6	6
08:00 AM	0	0	0	0	0	3	0	0	0	3	0	0	0	0	0	0	0	0	0	0	0	0	3	3
08:15 AM	0	0	0	0	0	1	0	0	0	1	0	0	0	0	0	0	0	0	0	0	0	0	1	1
08:30 AM	0	0	0	0	0	3	0	0	0	3	0	0	0	0	0	0	0	0	0	0	0	0	3	3
08:45 AM	0	0	0	0	0	1	0	0	0	1	0	0	0	0	0	1	0	0	0	1	0	0	2	2
Total	0	0	0	0	0	8	0	0	0	8	0	0	0	0	0	1	0	0	0	1	0	0	9	9
Grand Total	0	0	0	0	0	11	0	0	0	11	0	0	0	0	0	4	0	0	0	4	0	0	15	15
T-Approch %	0	0	0	0	0	100	0	0	0	73.3	0	0	0	0	0	100	0	0	0	26.7	0	0	100	100
Total %	0	0	0	0	0	73.3	0	0	0	73.3	0	0	0	0	0	26.7	0	0	0	26.7	0	0	100	100

Start Time	Barton Street Southbound				Alessandro Boulevard Westbound				Barton Street Northbound				Alessandro Boulevard Eastbound											
	Left	Thru	Right	RTOR	App. Total	Left	Thru	Right	RTOR	App. Total	Left	Thru	Right	RTOR	App. Total	Left	Thru	Right	RTOR	App. Total	Exclu. Total	Inclu. Total	Int. Total	
07:30 AM	0	0	0	0	0	0	1	0	0	1	0	0	0	0	0	0	0	0	0	0	0	0	0	1
07:45 AM	0	0	0	0	0	2	0	0	0	2	0	0	0	0	0	0	2	0	0	0	0	2	4	4
08:00 AM	0	0	0	0	0	3	0	0	0	3	0	0	0	0	0	0	0	0	0	0	0	0	3	3
08:15 AM	0	0	0	0	0	1	0	0	0	1	0	0	0	0	0	0	0	0	0	0	0	0	1	1
Total Volume	0	0	0	0	0	7	0	0	0	7	0	0	0	0	0	2	0	0	0	2	0	0	9	9
% App. Total	0	0	0	0	0	100	0	0	0	100	0	0	0	0	0	100	0	0	0	100	0	0	100	100
PHF	.000	.000	.000	.000	.000	.583	.000	.000	.000	.583	.000	.000	.000	.000	.000	.250	.000	.000	.250	.000	.250	.000	.563	.563

Peak Hour Analysis From 07:30 AM to 08:15 AM - Peak 1 of 1
 Peak Hour for Entire Intersection Begins at 07:30 AM

Counts Unlimited, Inc.
 PO Box 1178
 Corona, CA 92878
 (951)268-6268

City of Riverside
 N/S: Barton Street
 E/W: Alessandro Boulevard
 Weather: Clear

File Name : 11_RIV_Barton_Ales AM
 Site Code : 05121716
 Start Date : 11/30/2021
 Page No : 2

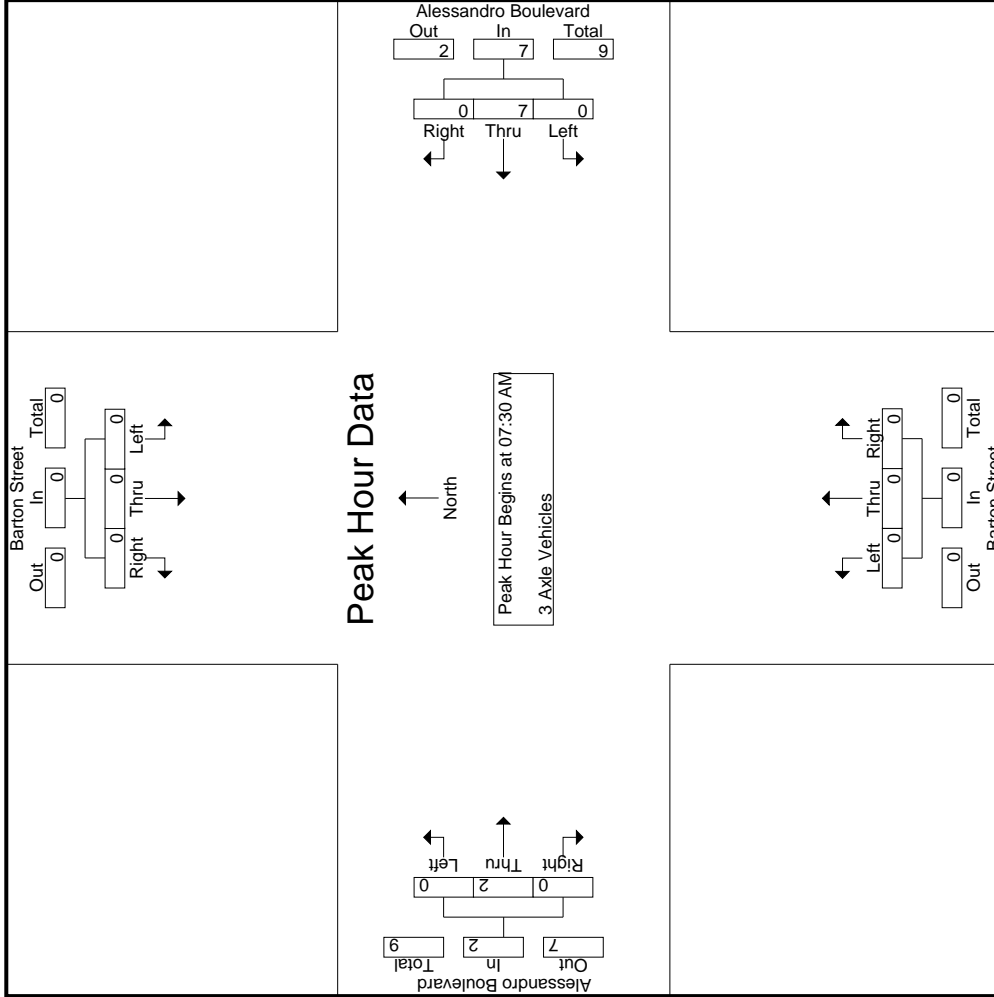

Counts Unlimited, Inc.
 PO Box 1178
 Corona, CA 92878
 (951)268-6268

City of Riverside
 N/S: Barton Street
 E/W: Alessandro Boulevard
 Weather: Clear

File Name : 11_RIV_Barton_Ales AM
 Site Code : 05121716
 Start Date : 11/30/2021
 Page No : 3

Start Time	Barton Street Southbound			Alessandro Boulevard Westbound			Barton Street Northbound			Alessandro Boulevard Eastbound			Int. Total		
	Left	Thru	Right	Left	Thru	Right	Left	Thru	Right	Left	Thru	Right		App. Total	App. Total
Peak Hour Analysis From 07:30 AM to 08:15 AM - Peak 1 of 1	07:30 AM														
Peak Hour for Each Approach Begins at:	07:30 AM														
+0 mins.	0	0	0	0	1	0	0	0	0	0	0	0	0	0	0
+15 mins.	0	0	0	0	2	0	0	0	0	0	0	2	0	0	2
+30 mins.	0	0	0	0	3	0	0	0	0	0	0	0	0	0	0
+45 mins.	0	0	0	0	1	0	0	0	0	0	0	0	0	0	0
Total Volume	0	0	0	0	7	0	0	0	0	0	0	2	0	0	2
% App. Total	0	0	0	0	100	0	0	0	0	0	0	100	0	0	0
PHF	.000	.000	.000	.000	.583	.000	.000	.583	.000	.000	.000	.250	.000	.000	.250

Groups Printed- 4+ Axle Trucks

Start Time	Barton Street Southbound				Alessandro Boulevard Westbound				Barton Street Northbound				Alessandro Boulevard Eastbound					
	Left	Thru	Right	RTOR	App. Total	Left	Thru	Right	RTOR	App. Total	Left	Thru	Right	RTOR	App. Total	Exclu. Total	Inclu. Total	Int. Total
07:00 AM	0	0	0	0	0	0	0	0	0	0	0	0	0	0	0	0	1	1
07:15 AM	0	0	0	0	0	1	0	0	0	1	0	0	0	0	1	0	2	2
07:30 AM	0	0	0	0	0	2	0	0	0	2	0	0	0	0	1	0	3	3
07:45 AM	0	0	0	0	0	0	0	0	0	0	0	0	0	0	0	0	1	1
Total	0	0	0	0	0	4	0	0	0	4	0	0	0	0	3	0	7	7
08:00 AM	0	0	0	0	0	2	0	0	0	2	0	0	0	0	0	0	2	2
08:15 AM	0	0	0	0	0	0	0	0	0	0	0	0	0	0	1	0	1	1
08:30 AM	0	0	0	0	0	0	0	0	0	0	0	0	0	0	0	0	0	0
08:45 AM	0	0	0	0	0	5	0	0	0	5	0	0	0	0	1	0	6	6
Total	0	0	0	0	0	7	0	0	0	7	0	0	0	0	2	0	9	9
Grand Total	0	0	0	0	0	11	0	0	0	11	0	0	0	0	5	0	16	16
T-Approch %	0	0	0	0	0	100	0	0	0	68.8	0	0	0	0	100	0	100	100
Total %	0	0	0	0	0	68.8	0	0	0	68.8	0	0	0	0	31.2	0	100	100

Start Time	Barton Street Southbound				Alessandro Boulevard Westbound				Barton Street Northbound				Alessandro Boulevard Eastbound					
	Left	Thru	Right	RTOR	App. Total	Left	Thru	Right	RTOR	App. Total	Left	Thru	Right	RTOR	App. Total	Exclu. Total	Inclu. Total	Int. Total
07:30 AM	0	0	0	0	0	0	2	0	0	2	0	0	0	0	0	0	1	1
07:45 AM	0	0	0	0	0	0	0	0	0	0	0	0	0	0	0	0	1	1
08:00 AM	0	0	0	0	0	2	0	0	0	2	0	0	0	0	0	0	0	0
08:15 AM	0	0	0	0	0	0	0	0	0	0	0	0	0	0	0	0	1	1
Total Volume	0	0	0	0	0	4	0	0	0	4	0	0	0	0	3	0	7	7
% App. Total	0	0	0	0	0	100	0	0	0	100	0	0	0	0	750	0	750	750
PHF	.000	.000	.000	.000	.000	.500	.000	.000	.000	.500	.000	.000	.000	.000	.750	.000	.750	.583

Peak Hour Analysis From 07:30 AM to 08:15 AM - Peak 1 of 1
 Peak Hour for Entire Intersection Begins at 07:30 AM

Counts Unlimited, Inc.
 PO Box 1178
 Corona, CA 92878
 (951)268-6268

City of Riverside
 N/S: Barton Street
 E/W: Alessandro Boulevard
 Weather: Clear

File Name : 11_RIV_Barton_Ales AM
 Site Code : 05121716
 Start Date : 11/30/2021
 Page No : 2

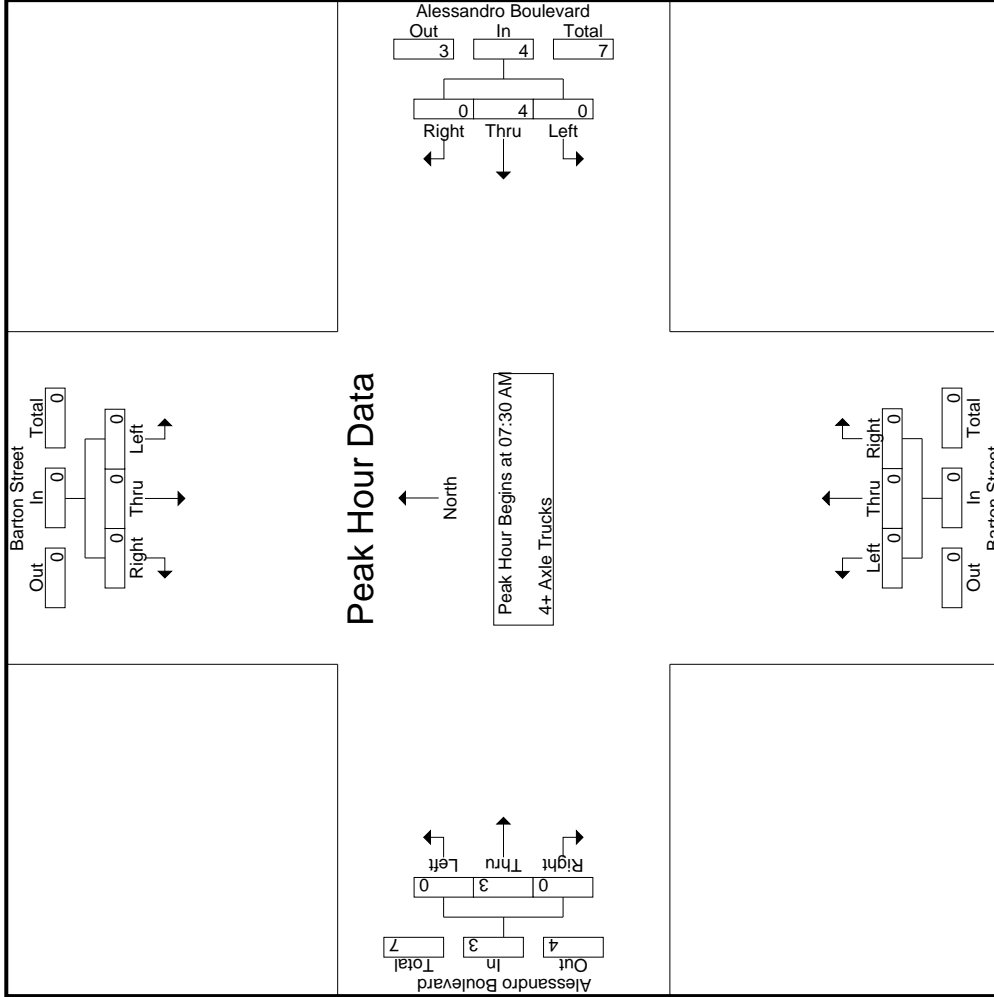

Counts Unlimited, Inc.
 PO Box 1178
 Corona, CA 92878
 (951)268-6268

City of Riverside
 N/S: Barton Street
 E/W: Alessandro Boulevard
 Weather: Clear

File Name : 11_RIV_Barton_Ales AM
 Site Code : 05121716
 Start Date : 11/30/2021
 Page No : 3

Start Time	Barton Street Southbound			Alessandro Boulevard Westbound			Barton Street Northbound			Alessandro Boulevard Eastbound			Int. Total		
	Left	Thru	Right	Left	Thru	Right	Left	Thru	Right	Left	Thru	Right		App. Total	App. Total
Peak Hour Analysis From 07:30 AM to 08:15 AM - Peak 1 of 1	07:30 AM														
Peak Hour for Each Approach Begins at:	07:30 AM														
+0 mins.	0	0	0	0	2	0	0	0	0	0	0	0	0	0	1
+15 mins.	0	0	0	0	0	0	0	0	0	0	0	0	0	0	1
+30 mins.	0	0	0	0	2	0	0	0	0	0	0	0	0	0	0
+45 mins.	0	0	0	0	0	0	0	0	0	0	0	0	0	0	1
Total Volume	0	0	0	0	4	0	0	0	0	0	0	0	0	3	3
% App. Total	0	0	0	0	100	0	0	0	0	0	0	0	100	0	0
PHF	.000	.000	.000	.000	.500	.000	.000	.500	.000	.000	.000	.000	.750	.000	.750

Groups Printed- Passenger Vehicles - Large 2 Axle Vehicles - 3 Axle Vehicles - 4+ Axle Trucks

Start Time	Barton Street Southbound						Alessandro Boulevard Westbound						Barton Street Northbound						Alessandro Boulevard Eastbound					
	Left		Thru		Right		Left		Thru		Right		Left		Thru		Right		Left		Thru		Right	
04:00 PM	0	0	2	2	11	563	0	0	0	0	12	574	12	0	8	4	20	2	448	7	1	457	7	1053
04:15 PM	3	0	2	1	28	498	1	0	0	0	527	15	0	6	5	21	1	389	6	2	396	8	949	
04:30 PM	7	0	5	5	12	519	1	0	0	0	536	14	0	6	3	20	2	491	5	0	498	8	1066	
04:45 PM	0	0	3	3	25	532	1	0	0	0	558	13	1	3	2	17	2	415	8	0	425	5	1003	
Total	10	0	12	11	80	2112	3	0	0	0	2195	54	1	23	14	78	7	1743	26	3	1776	28	4071	
05:00 PM	2	0	4	2	13	468	0	0	0	0	481	11	0	8	5	19	0	516	10	1	526	8	1032	
05:15 PM	0	0	0	0	13	502	1	0	0	0	516	9	0	16	15	25	1	436	17	1	454	16	995	
05:30 PM	0	0	1	1	21	428	1	0	0	0	450	21	0	4	1	25	1	466	6	0	473	2	949	
05:45 PM	1	0	1	1	14	400	2	0	0	0	416	12	0	10	6	22	2	488	7	0	497	7	937	
Total	3	0	6	4	61	1798	4	0	0	0	1863	53	0	38	27	91	4	1906	40	2	1950	33	3913	
Grand Total	13	0	18	15	141	3910	7	0	0	0	4058	107	1	61	41	169	11	3649	66	5	3726	61	7984	
T-Approach %	41.9	0	58.1	0	3.5	96.4	0.2	0	0	0	63.3	0.6	36.1	0.3	97.9	1.8	0.1	45.7	0.8	46.7	0.8	99.2	0.8	99.2
% Total %	0.2	0	0.2	0.4	1.8	49	0.1	0	0	0	50.8	1.3	0	0.8	2.1	0.1	45.7	0.8	0.8	46.7	0.8	99.2	0.8	99.2
Passenger Vehicles	12	0	18	18	141	3825	6	0	0	0	3972	106	1	61	61	209	9	3582	65	100	3661	0	0	
Large 2 Axle Vehicles	92.3	0	100	100	100	97.8	85.7	0	0	0	97.9	99.1	100	100	100	99.5	81.8	98.2	98.5	100	98.1	0	0	
% Large 2 Axle Vehicles	0	0	0	0	0	74	0	0	0	0	74	1	0	0	0	1	2	61	1	1	64	0	0	
% 3 Axle Vehicles	0	0	0	0	0	1.9	0	0	0	0	1.8	0.9	0	0	0	0.5	18.2	1.7	1.5	0	1.7	0	0	
3 Axle Vehicles	0	0	0	0	0	2	0	0	0	0	2	0	0	0	0	0	0	3	0	0	3	0	0	
% 3 Axle Vehicles	0	0	0	0	0	0.1	0	0	0	0	0	0	0	0	0	0	0	0.1	0	0	0.1	0	0	
4+ Axle Trucks	1	0	0	0	0	9	1	0	0	0	10	0	0	0	0	0	0	3	0	0	3	0	0	
% 4+ Axle Trucks	7.7	0	0	0	0	0.2	14.3	0	0	0	0.2	0	0	0	0	0	0	0.1	0	0	0.1	0	0	

Start Time	Barton Street Southbound						Alessandro Boulevard Westbound						Barton Street Northbound						Alessandro Boulevard Eastbound					
	Left		Thru		Right		Left		Thru		Right		Left		Thru		Right		Left		Thru		Right	
04:30 PM	7	0	0	5	12	16	1	536	14	0	6	0	6	20	2	491	5	498	1066					
04:45 PM	0	0	3	3	25	532	1	558	13	1	3	1	3	17	2	415	8	425	1003					
05:00 PM	2	0	4	4	13	468	0	481	11	0	8	0	8	19	0	516	10	526	1032					
05:15 PM	0	0	0	0	13	502	1	516	9	0	16	0	16	25	1	436	17	454	995					
Total Volume	9	0	12	12	21	67	3	2091	47	1	33	1	33	81	5	1858	40	1903	4096					
% App. Total	42.9	0	57.1	0	0	3.2	96.7	0.1	0.1	1.2	40.7	0.3	97.6	2.1	0.625	0.900	0.588	0.904	.961					
PHF	.321	.000	.600	.438	.750	.937	.950	.750	.839	.250	.516	.810	.625	.900	.588	.904	.961							

Peak Hour Analysis From 04:00 PM to 05:45 PM - Peak 1 of 1
 Peak Hour for Entire Intersection Begins at 04:30 PM

Counts Unlimited, Inc.
 PO Box 1178
 Corona, CA 92878
 (951)268-6268

City of Riverside
 N/S: Barton Street
 E/W: Alessandro Boulevard
 Weather: Clear

File Name : 11_RIV_Barton_Ales PM
 Site Code : 05121716
 Start Date : 11/30/2021
 Page No : 2

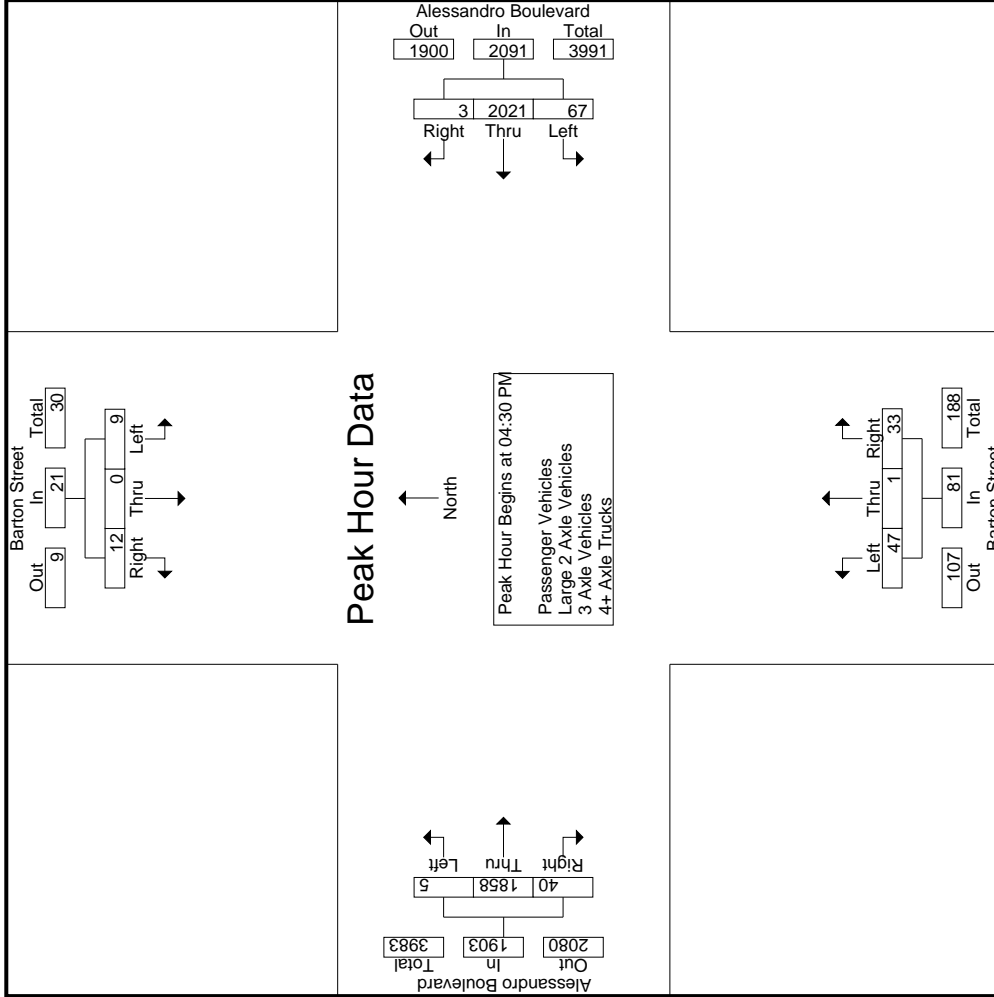

Counts Unlimited, Inc.
 PO Box 1178
 Corona, CA 92878
 (951)268-6268

City of Riverside
 N/S: Barton Street
 E/W: Alessandro Boulevard
 Weather: Clear

File Name : 11_RIV_Barton_Ales PM
 Site Code : 05121716
 Start Date : 11/30/2021
 Page No : 3

Start Time	Barton Street Southbound			Alessandro Boulevard Westbound			Barton Street Northbound			Alessandro Boulevard Eastbound			Int. Total	
	Left	Thru	Right	Left	Thru	Right	Left	Thru	Right	Left	Thru	Right		App. Total
Peak Hour Analysis From 04:00 PM to 05:45 PM - Peak 1 of 1														
Peak Hour for Each Approach Begins at:														
	04:15 PM			04:00 PM			05:00 PM			05:00 PM				
+0 mins.	3	0	2	5	0	574	11	0	8	19	0	516	10	526
+15 mins.	7	0	5	12	1	527	28	0	16	25	1	436	17	454
+30 mins.	0	0	3	3	1	536	16	0	4	25	1	466	6	473
+45 mins.	2	0	4	6	1	558	25	0	10	22	2	488	7	497
Total Volume	12	0	14	26	3	2195	80	0	38	91	4	1906	40	1950
% App. Total	46.2	0	53.8		0.1	96.2	3.6	0	41.8	58.2	0.2	97.7	2.1	
PHF	.429	.000	.700	.542	.750	.956	.714	.000	.594	.910	.500	.923	.588	.927

Groups Printed- Passenger Vehicles

Start Time	Barton Street Southbound				Alessandro Boulevard Westbound				Barton Street Northbound				Alessandro Boulevard Eastbound				Exclu. Total	Inclu. Total	Int. Total		
	Left	Thru	Right	RTOR	Left	Thru	Right	RTOR	Left	Thru	Right	RTOR	Left	Thru	Right	RTOR				App. Total	App. Total
04:00 PM	0	0	2	2	11	550	0	0	12	0	8	4	20	1	436	6	1	443	7	1026	1033
04:15 PM	3	0	2	1	28	487	0	0	15	0	6	5	21	1	375	6	2	382	8	923	931
04:30 PM	6	0	5	11	16	507	1	0	13	0	6	3	19	1	482	5	0	488	8	1042	1050
04:45 PM	0	0	3	3	25	525	1	0	13	1	3	2	17	2	410	8	0	420	5	991	996
Total	9	0	12	11	80	2069	2	0	53	1	23	14	77	5	1703	25	3	1733	28	3982	4010
05:00 PM	2	0	4	2	13	460	0	0	11	0	8	5	19	0	508	10	1	518	8	1016	1024
05:15 PM	0	0	0	0	13	491	1	0	9	0	16	15	25	1	431	17	1	449	16	979	995
05:30 PM	0	0	1	1	21	418	1	0	21	0	4	1	25	1	461	6	0	468	2	934	936
05:45 PM	1	0	1	1	14	387	2	0	12	0	10	6	22	2	479	7	0	488	7	915	922
Total	3	0	6	4	61	1756	4	0	53	0	38	27	91	4	1879	40	2	1923	33	3844	3877
Grand Total	12	0	18	15	141	3825	6	0	106	1	61	41	168	9	3582	65	5	3656	61	7826	7887
T-Approch %	40	0	60		3.5	96.3	0.2		63.1	0.6	36.3		2.1	0.2	98	1.8		46.7	0.8	99.2	
Total %	0.2	0	0.2		1.8	48.9	0.1		1.4	0	0.8		2.1	0.1	45.8	0.8		46.7	0.8	99.2	

Start Time	Barton Street Southbound				Alessandro Boulevard Westbound				Barton Street Northbound				Alessandro Boulevard Eastbound				Exclu. Total	Inclu. Total	Int. Total		
	Left	Thru	Right	RTOR	Left	Thru	Right	RTOR	Left	Thru	Right	RTOR	Left	Thru	Right	RTOR				App. Total	App. Total
04:30 PM	6	0	0	5	11	16	507	1	524	0	6	19	1	482	5	488	1042				
04:45 PM	0	0	3	3	25	525	1	551	13	1	3	17	2	410	8	420	991				
05:00 PM	2	0	4	4	13	460	0	473	11	0	8	19	0	508	10	1016	1016				
05:15 PM	0	0	0	0	13	491	1	505	9	0	16	15	25	1	431	17	1	449	16	979	995
Total Volume	8	0	12	20	67	1983	3	2053	46	1	33	80	4	1831	40	1875	4028				
% App. Total	40	0	60		3.3	96.6	0.1		57.5	1.2	41.2		2.1	0.2	97.7	2.1		46.7	0.8	99.2	
PHF	.333	.000	.600	.455	.670	.944	.750	.931	.885	.250	.516	.800	.500	.901	.588	.905					

Peak Hour Analysis From 04:30 PM to 05:15 PM - Peak 1 of 1
 Peak Hour for Entire Intersection Begins at 04:30 PM

Counts Unlimited, Inc.
 PO Box 1178
 Corona, CA 92878
 (951)268-6268

City of Riverside
 N/S: Barton Street
 E/W: Alessandro Boulevard
 Weather: Clear

File Name : 11_RIV_Barton_Ales PM
 Site Code : 05121716
 Start Date : 11/30/2021
 Page No : 2

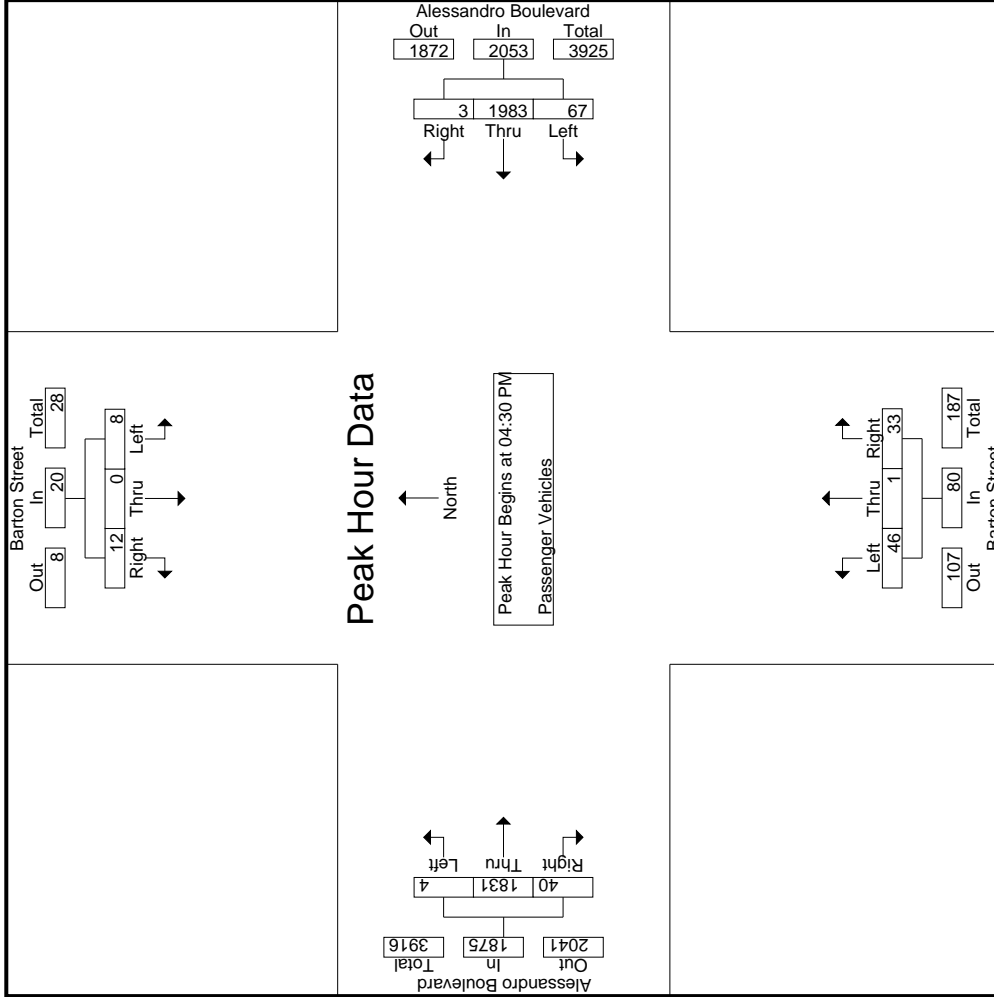

Counts Unlimited, Inc.
 PO Box 1178
 Corona, CA 92878
 (951)268-6268

City of Riverside
 N/S: Barton Street
 E/W: Alessandro Boulevard
 Weather: Clear

File Name : 11_RIV_Barton_Ales PM
 Site Code : 05121716
 Start Date : 11/30/2021
 Page No : 3

Start Time	Barton Street Southbound			Alessandro Boulevard Westbound			Barton Street Northbound			Alessandro Boulevard Eastbound			Int. Total		
	Left	Thru	Right	Left	Thru	Right	Left	Thru	Right	Left	Thru	Right		App. Total	
Peak Hour Analysis From 04:30 PM to 05:15 PM - Peak 1 of 1	04:30 PM														
Peak Hour for Each Approach Begins at:	04:30 PM														
+0 mins.	6	0	5	11	16	507	1	524	13	0	6	19	482	5	488
+15 mins.	0	0	3	3	25	525	1	551	13	1	3	17	410	8	420
+30 mins.	2	0	4	6	13	460	0	473	11	0	8	19	508	10	518
+45 mins.	0	0	0	0	13	491	1	505	9	0	16	25	431	17	449
Total Volume	8	0	12	20	67	1983	3	2053	46	1	33	80	1831	40	1875
% App. Total	40	0	60	3.3	96.6	0.1	57.5	1.2	41.2	0.2	97.7	2.1	901	588	905
PHF	.333	.000	.600	.455	.670	.944	.750	.931	.885	.250	.516	.800	.901	.588	.905

Groups Printed- Large 2 Axle Vehicles

Start Time	Barton Street Southbound				Alessandro Boulevard Westbound				Barton Street Northbound				Alessandro Boulevard Eastbound				Exclu. Total	Inclu. Total	Int. Total	
	Left	Thru	Right	RTOR	Left	Thru	Right	RTOR	Left	Thru	Right	RTOR	Left	Thru	Right	RTOR				App. Total
04:00 PM	0	0	0	0	0	11	0	0	0	0	0	0	1	10	1	0	12	0	23	23
04:15 PM	0	0	0	0	0	10	0	0	0	0	0	0	0	13	0	0	13	0	23	23
04:30 PM	0	0	0	0	0	12	0	0	0	1	0	0	1	7	0	0	8	0	21	21
04:45 PM	0	0	0	0	0	6	0	0	0	0	0	0	0	4	0	0	4	0	10	10
Total	0	0	0	0	0	39	0	0	0	1	0	0	2	34	1	0	37	0	77	77
05:00 PM	0	0	0	0	0	8	0	0	0	0	0	0	0	8	0	0	8	0	16	16
05:15 PM	0	0	0	0	0	9	0	0	0	0	0	0	0	5	0	0	5	0	14	14
05:30 PM	0	0	0	0	0	7	0	0	0	0	0	0	0	5	0	0	5	0	12	12
05:45 PM	0	0	0	0	0	11	0	0	0	0	0	0	0	9	0	0	9	0	20	20
Total	0	0	0	0	0	35	0	0	0	0	0	0	0	27	0	0	27	0	62	62
Grand Total	0	0	0	0	0	74	0	0	0	1	0	0	2	61	1	0	64	0	139	139
Approach %	0	0	0	0	0	100	0	0	0	0	0	0	3.1	95.3	1.6	0	0	0	100	100
Total %	0	0	0	0	0	53.2	0	0	0	0.7	0	0	1.4	43.9	0.7	0	46	0	100	100

Start Time	Barton Street Southbound				Alessandro Boulevard Westbound				Barton Street Northbound				Alessandro Boulevard Eastbound				Exclu. Total	Inclu. Total	Int. Total	
	Left	Thru	Right	RTOR	Left	Thru	Right	RTOR	Left	Thru	Right	RTOR	Left	Thru	Right	RTOR				App. Total
04:30 PM	0	0	0	0	0	12	0	0	0	0	0	0	1	7	0	0	8	0	21	21
04:45 PM	0	0	0	0	0	6	0	0	0	0	0	0	0	4	0	0	4	0	10	10
05:00 PM	0	0	0	0	0	8	0	0	0	0	0	0	0	8	0	0	8	0	16	16
05:15 PM	0	0	0	0	0	9	0	0	0	0	0	0	0	5	0	0	5	0	14	14
Total Volume	0	0	0	0	0	35	0	0	0	1	0	0	1	24	0	0	25	0	61	61
% App. Total	0	0	0	0	0	100	0	0	0	0	0	0	4	96	0	0	0	0	100	100
PHF	.000	.000	.000	.000	.000	.729	.000	.000	.000	.250	.000	.000	.250	.750	.000	.000	.781	.000	.726	.726

Peak Hour Analysis From 04:30 PM to 05:15 PM - Peak 1 of 1
 Peak Hour for Entire Intersection Begins at 04:30 PM

Counts Unlimited, Inc.
 PO Box 1178
 Corona, CA 92878
 (951)268-6268

City of Riverside
 N/S: Barton Street
 E/W: Alessandro Boulevard
 Weather: Clear

File Name : 11_RIV_Barton_Ales PM
 Site Code : 05121716
 Start Date : 11/30/2021
 Page No : 2

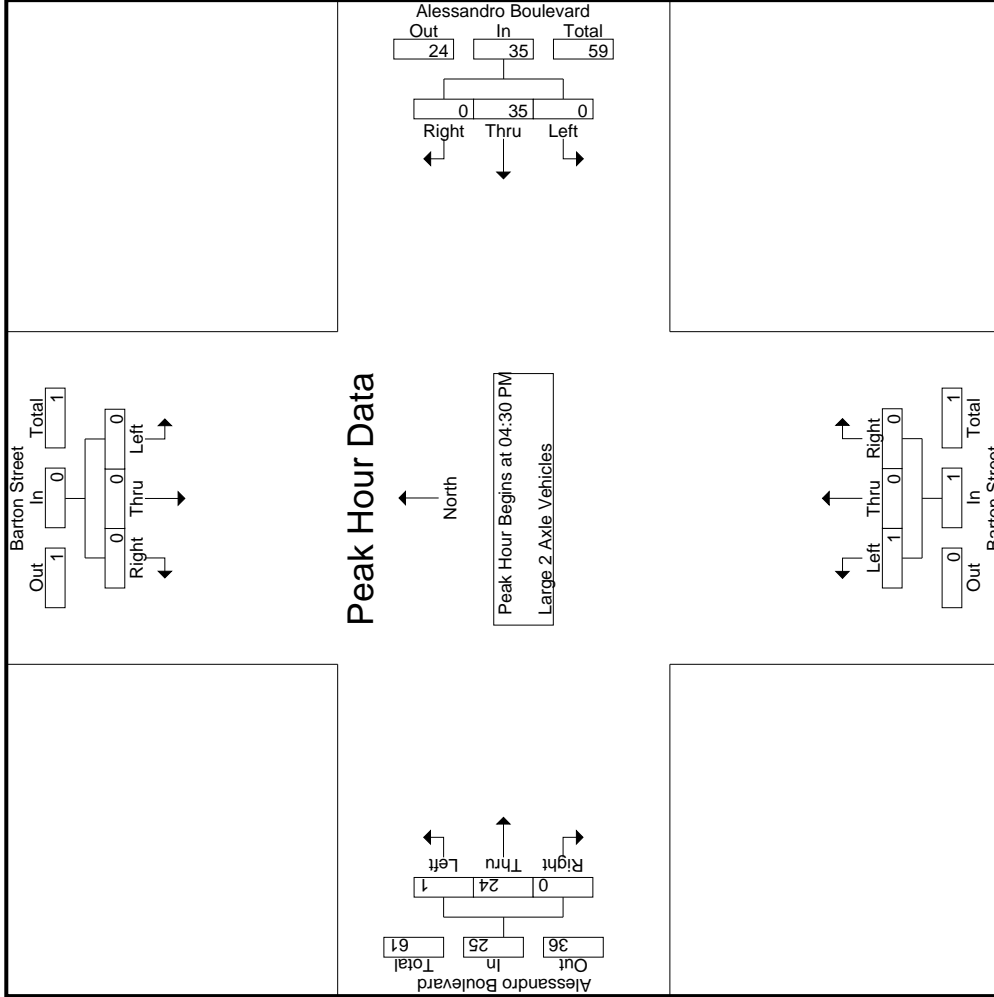

Start Time	Barton Street Southbound			Alessandro Boulevard Westbound			Barton Street Northbound			Alessandro Boulevard Eastbound			Int. Total		
	Left	Thru	Right	Left	Thru	Right	Left	Thru	Right	Left	Thru	Right		App. Total	App. Total
Peak Hour Analysis From 04:30 PM to 05:15 PM - Peak 1 of 1	04:30 PM														
Peak Hour for Each Approach Begins at:	04:30 PM														
+0 mins.	0	0	0	0	12	0	0	0	0	0	0	0	7	0	8
+15 mins.	0	0	0	0	6	0	0	0	0	0	0	4	0	0	4
+30 mins.	0	0	0	0	8	0	0	0	0	0	0	8	0	0	8
+45 mins.	0	0	0	0	9	0	0	0	0	0	0	5	0	0	5
Total Volume	0	0	0	0	35	0	0	0	0	0	0	24	0	0	25
% App. Total	0	0	0	0	100	0	0	0	0	0	0	96	0	0	100
PHF	.000	.000	.000	.000	.729	.000	.000	.000	.000	.250	.000	.750	.000	.000	.781

Groups Printed- 3 Axle Vehicles

Start Time	Barton Street Southbound				Alessandro Boulevard Westbound				Barton Street Northbound				Alessandro Boulevard Eastbound				Exclu. Total	Inclu. Total	Int. Total		
	Left	Thru	Right	RTOR	App. Total	Left	Thru	Right	RTOR	App. Total	Left	Thru	Right	RTOR	App. Total	Left				Thru	Right
04:00 PM	0	0	0	0	0	0	0	0	0	0	0	0	0	0	0	1	0	0	0	1	1
04:15 PM	0	0	0	0	0	0	0	0	0	0	0	0	0	0	0	0	0	0	0	0	0
04:30 PM	0	0	0	0	0	0	0	0	0	0	0	0	0	0	0	2	0	0	0	2	2
04:45 PM	0	0	0	0	0	0	0	0	0	0	0	0	0	0	0	0	0	0	0	0	0
Total	0	0	0	0	0	0	0	0	0	0	0	0	0	0	0	3	0	0	0	3	3
05:00 PM	0	0	0	0	0	0	0	0	0	0	0	0	0	0	0	0	0	0	0	0	0
05:15 PM	0	0	0	0	0	1	0	0	0	1	0	0	0	0	0	0	0	0	0	0	1
05:30 PM	0	0	0	0	0	0	0	0	0	0	0	0	0	0	0	0	0	0	0	0	0
05:45 PM	0	0	0	0	0	1	0	0	0	1	0	0	0	0	0	0	0	0	0	0	1
Total	0	0	0	0	0	2	0	0	0	2	0	0	0	0	0	0	0	0	0	0	2
Grand Total	0	0	0	0	0	2	0	0	0	2	0	0	0	0	0	3	0	0	0	3	5
T-Approch %	0	0	0	0	0	100	0	0	0	0	0	0	0	0	0	100	0	0	0	0	100
Total %	0	0	0	0	0	40	0	0	0	40	0	0	0	0	60	0	0	0	0	60	100

Start Time	Barton Street Southbound				Alessandro Boulevard Westbound				Barton Street Northbound				Alessandro Boulevard Eastbound				Exclu. Total	Inclu. Total	Int. Total		
	Left	Thru	Right	RTOR	App. Total	Left	Thru	Right	RTOR	App. Total	Left	Thru	Right	RTOR	App. Total	Left				Thru	Right
04:30 PM	0	0	0	0	0	0	0	0	0	0	0	0	0	0	0	0	0	0	0	0	0
04:45 PM	0	0	0	0	0	0	0	0	0	0	0	0	0	0	0	0	0	0	0	0	0
05:00 PM	0	0	0	0	0	0	0	0	0	0	0	0	0	0	0	0	0	0	0	0	0
05:15 PM	0	0	0	0	0	1	0	0	0	1	0	0	0	0	0	0	0	0	0	0	1
Total Volume	0	0	0	0	0	0	1	0	0	1	0	0	0	0	0	0	2	0	0	2	3
% App. Total	.000	.000	.000	.000	.000	.250	.000	.000	.000	.250	.000	.000	.000	.000	.000	.250	.000	.000	.250	.000	.375
PHF																					

Peak Hour Analysis From 04:30 PM to 05:15 PM - Peak 1 of 1
 Peak Hour for Entire Intersection Begins at 04:30 PM

Counts Unlimited, Inc.
 PO Box 1178
 Corona, CA 92878
 (951)268-6268

City of Riverside
 N/S: Barton Street
 E/W: Alessandro Boulevard
 Weather: Clear

File Name : 11_RIV_Barton_Ales PM
 Site Code : 05121716
 Start Date : 11/30/2021
 Page No : 2

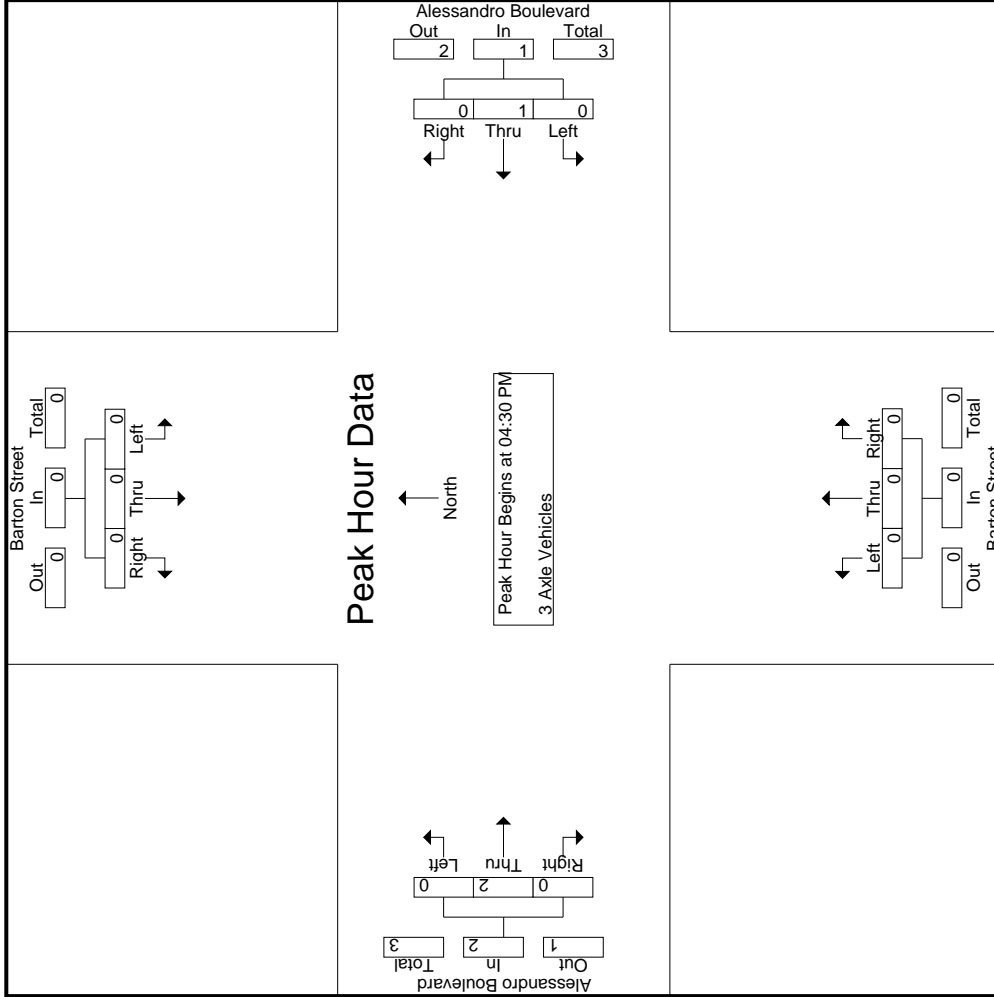

Start Time	Barton Street Southbound			Alessandro Boulevard Westbound			Barton Street Northbound			Alessandro Boulevard Eastbound			Int. Total		
	Left	Thru	Right	Left	Thru	Right	Left	Thru	Right	Left	Thru	Right		App. Total	App. Total
Peak Hour Analysis From 04:30 PM to 05:15 PM - Peak 1 of 1	04:30 PM														
Peak Hour for Each Approach Begins at:	04:30 PM														
+0 mins.	0	0	0	0	0	0	0	0	0	0	0	0	0	0	2
+15 mins.	0	0	0	0	0	0	0	0	0	0	0	0	0	0	0
+30 mins.	0	0	0	0	0	0	0	0	0	0	0	0	0	0	0
+45 mins.	0	0	0	0	1	0	0	0	0	0	0	0	0	0	0
Total Volume	0	0	0	0	1	0	0	0	0	0	0	0	0	0	2
% App. Total	0	0	0	0	100	0	0	0	0	0	0	0	0	100	0
PHF	.000	.000	.000	.000	.250	.000	.250	.000	.000	.000	.250	.000	.000	.250	.250

Groups Printed- 4+ Axle Trucks

Start Time	Barton Street Southbound				Alessandro Boulevard Westbound				Barton Street Northbound				Alessandro Boulevard Eastbound											
	Left	Thru	Right	RTOR	App. Total	Left	Thru	Right	RTOR	App. Total	Left	Thru	Right	RTOR	App. Total	Left	Thru	Right	RTOR	App. Total	Exclu. Total	Inclu. Total	Int. Total	
04:00 PM	0	0	0	0	0	2	0	0	0	2	0	0	0	0	0	0	1	0	0	0	0	0	3	3
04:15 PM	0	0	0	0	0	1	1	0	0	2	0	0	0	0	0	0	1	0	0	0	0	0	3	3
04:30 PM	1	0	0	0	1	0	0	0	0	0	0	0	0	0	0	0	0	0	0	0	0	0	1	1
04:45 PM	0	0	0	0	0	1	0	0	0	1	0	0	0	0	0	0	1	0	0	0	0	0	2	2
Total	1	0	0	0	1	4	1	0	0	5	0	0	0	0	0	3	0	0	0	0	0	0	9	9
05:00 PM	0	0	0	0	0	0	0	0	0	0	0	0	0	0	0	0	0	0	0	0	0	0	0	0
05:15 PM	0	0	0	0	0	1	0	0	0	1	0	0	0	0	0	0	0	0	0	0	0	0	1	1
05:30 PM	0	0	0	0	0	3	0	0	0	3	0	0	0	0	0	0	0	0	0	0	0	0	3	3
05:45 PM	0	0	0	0	0	1	0	0	0	1	0	0	0	0	0	0	0	0	0	0	0	0	1	1
Total	0	0	0	0	0	5	0	0	0	5	0	0	0	0	0	0	0	0	0	0	0	0	5	5
Grand Total	1	0	0	0	1	9	1	0	0	10	0	0	0	0	0	3	0	0	0	0	0	0	14	14
% Approach	100	0	0	0	7.1	90	10	0	0	71.4	0	0	0	0	0	100	0	0	0	0	0	0	100	100
Total %	7.1	0	0	0	7.1	64.3	7.1	0	0	71.4	0	0	0	0	0	21.4	0	0	0	0	0	0	100	100

Start Time	Barton Street Southbound				Alessandro Boulevard Westbound				Barton Street Northbound				Alessandro Boulevard Eastbound											
	Left	Thru	Right	RTOR	App. Total	Left	Thru	Right	RTOR	App. Total	Left	Thru	Right	RTOR	App. Total	Left	Thru	Right	RTOR	App. Total	Exclu. Total	Inclu. Total	Int. Total	
04:30 PM	1	0	0	0	1	0	0	0	0	0	0	0	0	0	0	0	0	0	0	0	0	0	0	0
04:45 PM	0	0	0	0	0	0	1	0	0	1	0	0	0	0	0	0	1	0	0	0	0	0	1	2
05:00 PM	0	0	0	0	0	0	0	0	0	0	0	0	0	0	0	0	0	0	0	0	0	0	0	0
05:15 PM	0	0	0	0	0	0	1	0	0	1	0	0	0	0	0	0	0	0	0	0	0	0	0	0
Total Volume	1	0	0	0	1	0	2	0	0	2	0	0	0	0	0	0	1	0	0	0	0	0	1	4
% App. Total	100	0	0	0	.250	0	100	0	0	.500	0	0	0	0	0	0	100	0	0	0	0	0	.250	.500
PHF	.250	.000	.000	.000	.250	.000	.500	.000	.000	.500	.000	.000	.000	.000	.000	.000	.250	.000	.000	.250	.000	.250	.500	

Peak Hour Analysis From 04:30 PM to 05:15 PM - Peak 1 of 1
 Peak Hour for Entire Intersection Begins at 04:30 PM

Counts Unlimited, Inc.
 PO Box 1178
 Corona, CA 92878
 (951)268-6268

City of Riverside
 N/S: Barton Street
 E/W: Alessandro Boulevard
 Weather: Clear

File Name : 11_RIV_Barton_Ales PM
 Site Code : 05121716
 Start Date : 11/30/2021
 Page No : 2

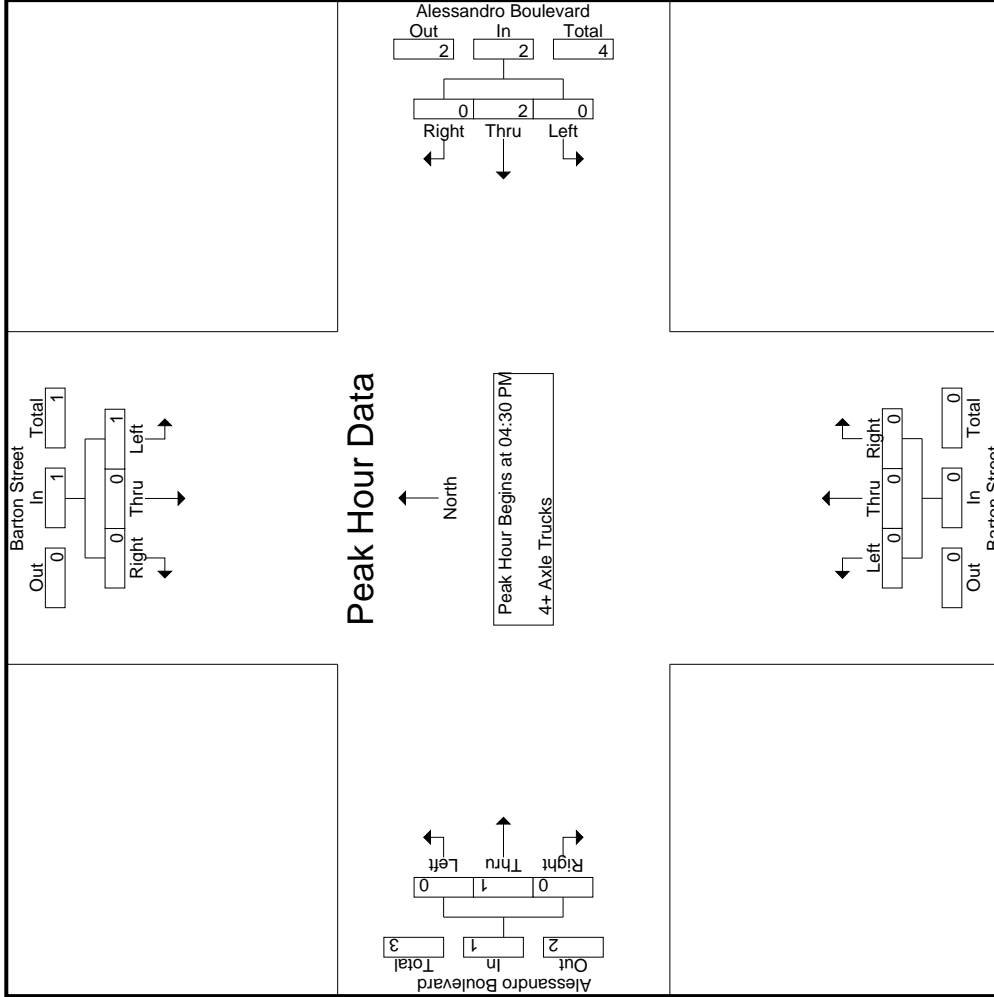

Start Time	Barton Street Southbound			Alessandro Boulevard Westbound			Barton Street Northbound			Alessandro Boulevard Eastbound			Int. Total		
	Left	Thru	Right	Left	Thru	Right	Left	Thru	Right	Left	Thru	Right		App. Total	App. Total
Peak Hour Analysis From 04:30 PM to 05:15 PM - Peak 1 of 1	04:30 PM														
Peak Hour for Each Approach Begins at:	04:30 PM														
+0 mins.	1	0	0	1	0	0	0	0	0	0	0	0	0	0	0
+15 mins.	0	0	0	0	1	0	0	0	0	0	0	1	0	0	1
+30 mins.	0	0	0	0	0	0	0	0	0	0	0	0	0	0	0
+45 mins.	0	0	0	0	1	0	1	0	0	0	0	0	0	0	0
Total Volume	1	0	0	1	2	0	2	0	0	0	0	1	0	0	1
% App. Total	100	0	0	100	0	0	100	0	0	0	0	100	0	0	100
PHF	.250	.000	.000	.250	.500	.000	.500	.000	.000	.000	.250	.000	.000	.000	.250

Location: Riverside
 N/S: Barton Street
 E/W: Alessandro Boulevard



Date: 11/30/2021
 Day: Tuesday

PEDESTRIANS

	North Leg Barton Street	East Leg Alessandro Boulevard	South Leg Barton Street	West Leg Alessandro Boulevard	
	Pedestrians	Pedestrians	Pedestrians	Pedestrians	
7:00 AM	0	0	0	0	0
7:15 AM	0	0	0	0	0
7:30 AM	0	0	1	0	1
7:45 AM	0	0	0	0	0
8:00 AM	0	1	0	0	1
8:15 AM	0	0	0	0	0
8:30 AM	0	1	0	0	1
8:45 AM	0	1	0	0	1
TOTAL VOLUMES:	0	3	1	0	4

	North Leg Barton Street	East Leg Alessandro Boulevard	South Leg Barton Street	West Leg Alessandro Boulevard	
	Pedestrians	Pedestrians	Pedestrians	Pedestrians	
4:00 PM	0	1	1	0	2
4:15 PM	0	0	0	0	0
4:30 PM	0	0	0	0	0
4:45 PM	0	0	0	0	0
5:00 PM	0	0	0	0	0
5:15 PM	0	0	1	0	1
5:30 PM	0	0	0	0	0
5:45 PM	0	0	0	0	0
TOTAL VOLUMES:	0	1	2	0	3

Location: Riverside
 N/S: Barton Street
 E/W: Alessandro Boulevard



Date: 11/30/2021
 Day: Tuesday

BICYCLES

	Southbound Barton Street			Westbound Alessandro Boulevard			Northbound Barton Street			Eastbound Alessandro Boulevard			
	Left	Thru	Right	Left	Thru	Right	Left	Thru	Right	Left	Thru	Right	
7:00 AM	0	0	0	0	0	0	0	0	0	0	0	0	0
7:15 AM	0	9	0	0	0	0	0	1	0	0	0	0	10
7:30 AM	0	0	0	0	0	0	0	0	0	0	1	0	1
7:45 AM	0	0	0	0	0	0	0	0	0	0	0	0	0
8:00 AM	0	0	0	0	0	0	0	0	0	0	0	0	0
8:15 AM	0	0	0	0	0	0	0	0	0	0	0	0	0
8:30 AM	0	0	0	0	0	0	0	0	0	0	1	0	1
8:45 AM	0	0	0	0	0	0	0	0	0	0	1	1	2
TOTAL VOLUMES:	0	9	0	0	0	0	0	1	0	0	3	1	14

	Southbound Barton Street			Westbound Alessandro Boulevard			Northbound Barton Street			Eastbound Alessandro Boulevard			
	Left	Thru	Right	Left	Thru	Right	Left	Thru	Right	Left	Thru	Right	
4:00 PM	0	0	0	0	0	0	1	0	0	0	0	0	1
4:15 PM	0	2	0	0	1	0	0	0	0	0	0	0	3
4:30 PM	0	0	0	0	0	0	0	0	0	0	0	0	0
4:45 PM	0	0	0	0	0	0	0	0	0	0	0	0	0
5:00 PM	0	0	0	0	1	0	0	0	0	0	0	0	1
5:15 PM	0	0	0	0	0	0	0	0	0	0	0	0	0
5:30 PM	0	2	0	0	0	0	2	0	0	0	0	0	4
5:45 PM	0	0	0	0	0	0	0	0	0	0	0	0	0
TOTAL VOLUMES:	0	4	0	0	2	0	3	0	0	0	0	0	9

City of Riverside
 N/S: Barton Drive
 E/W: Grove Community Drive
 Weather: Clear

File Name : 12_RIV_Barton_Grove AM
 Site Code : 05121716
 Start Date : 11/30/2021
 Page No : 1

Groups Printed- Passenger Vehicles - Large 2 Axle Vehicles - 3 Axle Vehicles - 4+ Axle Trucks

Start Time	Barton Drive Southbound			Grove Community Drive Westbound			Grove Community Drive Eastbound			Int. Total
	Left	Right	App. Total	Thru	Right	App. Total	Left	Thru	App. Total	
07:00 AM	0	2	2	65	1	66	4	22	26	94
07:15 AM	2	0	2	117	4	121	2	25	27	150
07:30 AM	1	1	2	85	2	87	8	16	24	113
07:45 AM	1	2	3	43	4	47	5	22	27	77
Total	4	5	9	310	11	321	19	85	104	434
08:00 AM	2	2	4	32	6	38	12	11	23	65
08:15 AM	3	0	3	27	0	27	12	28	40	70
08:30 AM	1	1	2	31	4	35	20	12	32	69
08:45 AM	3	3	6	46	11	57	13	13	26	89
Total	9	6	15	136	21	157	57	64	121	293
Grand Total	13	11	24	446	32	478	76	149	225	727
Apprch %	54.2	45.8		93.3	6.7		33.8	66.2		
Total %	1.8	1.5	3.3	61.3	4.4	65.7	10.5	20.5	30.9	
Passenger Vehicles	13	11	24	441	32	473	76	147	223	720
% Passenger Vehicles	100	100	100	98.9	100	99	100	98.7	99.1	99
Large 2 Axle Vehicles	0	0	0	5	0	5	0	2	2	7
% Large 2 Axle Vehicles	0	0	0	1.1	0	1	0	1.3	0.9	1
3 Axle Vehicles	0	0	0	0	0	0	0	0	0	0
% 3 Axle Vehicles	0	0	0	0	0	0	0	0	0	0
4+ Axle Trucks	0	0	0	0	0	0	0	0	0	0
% 4+ Axle Trucks	0	0	0	0	0	0	0	0	0	0

Start Time	Barton Drive Southbound			Grove Community Drive Westbound			Grove Community Drive Eastbound			Int. Total
	Left	Right	App. Total	Thru	Right	App. Total	Left	Thru	App. Total	
Peak Hour Analysis From 07:00 AM to 08:45 AM - Peak 1 of 1										
Peak Hour for Entire Intersection Begins at 07:00 AM										
07:00 AM	0	2	2	65	1	66	4	22	26	94
07:15 AM	2	0	2	117	4	121	2	25	27	150
07:30 AM	1	1	2	85	2	87	8	16	24	113
07:45 AM	1	2	3	43	4	47	5	22	27	77
Total Volume	4	5	9	310	11	321	19	85	104	434
% App. Total	44.4	55.6		96.6	3.4		18.3	81.7		
PHF	.500	.625	.750	.662	.688	.663	.594	.850	.963	.723

City of Riverside
 N/S: Barton Drive
 E/W: Grove Community Drive
 Weather: Clear

File Name : 12_RIV_Barton_Grove AM
 Site Code : 05121716
 Start Date : 11/30/2021
 Page No : 2

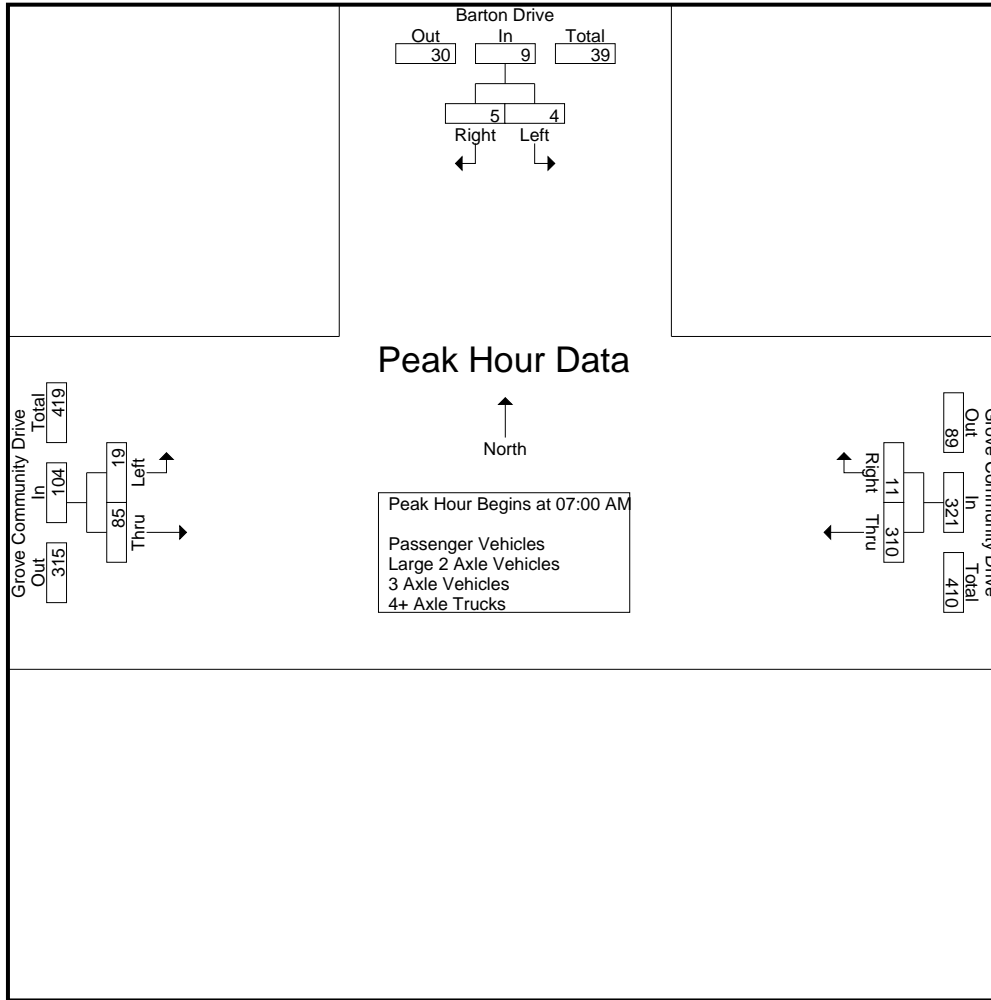

Peak Hour Analysis From 07:00 AM to 08:45 AM - Peak 1 of 1
 Peak Hour for Each Approach Begins at:

	08:00 AM			07:00 AM			07:45 AM		
+0 mins.	2	2	4	65	1	66	5	22	27
+15 mins.	3	0	3	117	4	121	12	11	23
+30 mins.	1	1	2	85	2	87	12	28	40
+45 mins.	3	3	6	43	4	47	20	12	32
Total Volume	9	6	15	310	11	321	49	73	122
% App. Total	60	40		96.6	3.4		40.2	59.8	
PHF	.750	.500	.625	.662	.688	.663	.613	.652	.763

City of Riverside
 N/S: Barton Drive
 E/W: Grove Community Drive
 Weather: Clear

File Name : 12_RIV_Barton_Grove AM
 Site Code : 05121716
 Start Date : 11/30/2021
 Page No : 1

Groups Printed- Passenger Vehicles

Start Time	Barton Drive Southbound			Grove Community Drive Westbound			Grove Community Drive Eastbound			Int. Total
	Left	Right	App. Total	Thru	Right	App. Total	Left	Thru	App. Total	
07:00 AM	0	2	2	65	1	66	4	22	26	94
07:15 AM	2	0	2	116	4	120	2	25	27	149
07:30 AM	1	1	2	85	2	87	8	15	23	112
07:45 AM	1	2	3	41	4	45	5	21	26	74
Total	4	5	9	307	11	318	19	83	102	429
08:00 AM	2	2	4	31	6	37	12	11	23	64
08:15 AM	3	0	3	27	0	27	12	28	40	70
08:30 AM	1	1	2	30	4	34	20	12	32	68
08:45 AM	3	3	6	46	11	57	13	13	26	89
Total	9	6	15	134	21	155	57	64	121	291
Grand Total	13	11	24	441	32	473	76	147	223	720
Apprch %	54.2	45.8		93.2	6.8		34.1	65.9		
Total %	1.8	1.5	3.3	61.2	4.4	65.7	10.6	20.4	31	

Start Time	Barton Drive Southbound			Grove Community Drive Westbound			Grove Community Drive Eastbound			Int. Total
	Left	Right	App. Total	Thru	Right	App. Total	Left	Thru	App. Total	
07:00 AM	0	2	2	65	1	66	4	22	26	94
07:15 AM	2	0	2	116	4	120	2	25	27	149
07:30 AM	1	1	2	85	2	87	8	15	23	112
07:45 AM	1	2	3	41	4	45	5	21	26	74
Total Volume	4	5	9	307	11	318	19	83	102	429
% App. Total	44.4	55.6		96.5	3.5		18.6	81.4		
PHF	.500	.625	.750	.662	.688	.663	.594	.830	.944	.720

Peak Hour Analysis From 07:00 AM to 07:45 AM - Peak 1 of 1
 Peak Hour for Entire Intersection Begins at 07:00 AM

City of Riverside
 N/S: Barton Drive
 E/W: Grove Community Drive
 Weather: Clear

File Name : 12_RIV_Barton_Grove AM
 Site Code : 05121716
 Start Date : 11/30/2021
 Page No : 2

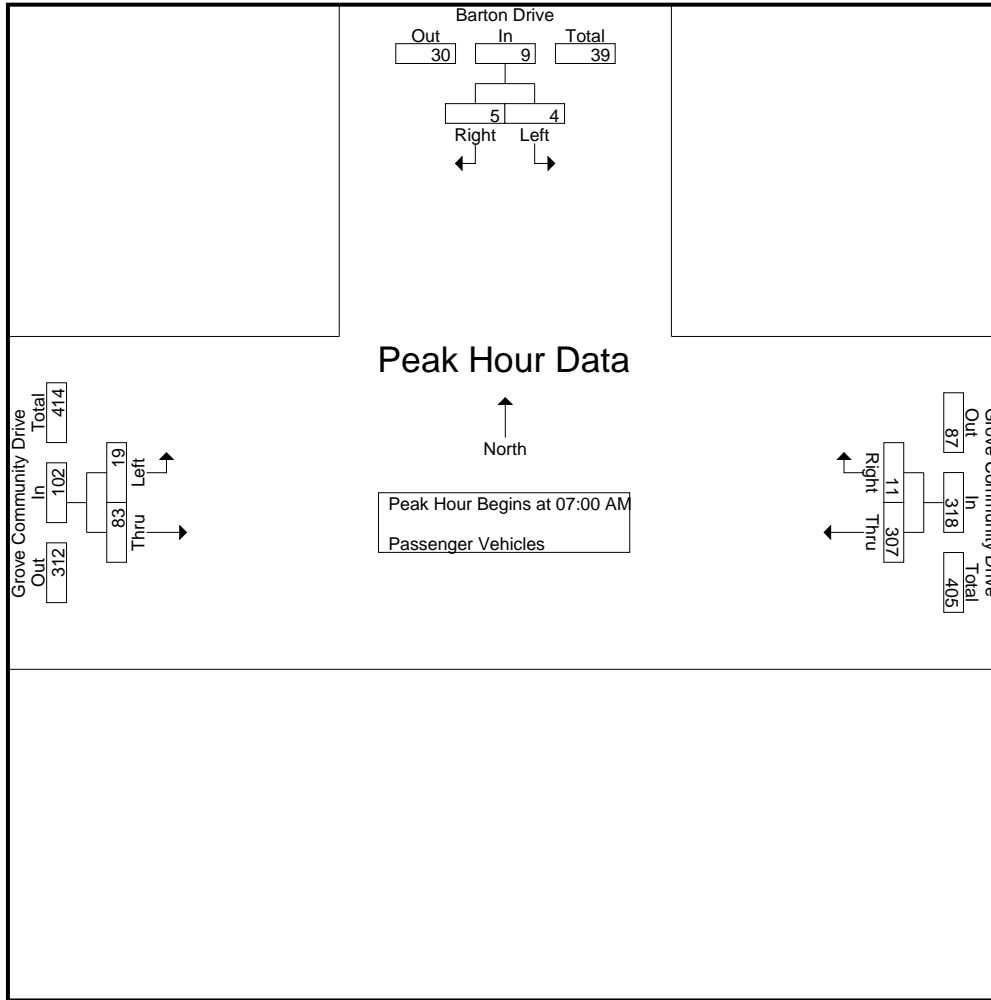

Peak Hour Analysis From 07:00 AM to 07:45 AM - Peak 1 of 1
 Peak Hour for Each Approach Begins at:

	07:00 AM			07:00 AM			07:00 AM		
+0 mins.	0	2	2	65	1	66	4	22	26
+15 mins.	2	0	2	116	4	120	2	25	27
+30 mins.	1	1	2	85	2	87	8	15	23
+45 mins.	1	2	3	41	4	45	5	21	26
Total Volume	4	5	9	307	11	318	19	83	102
% App. Total	44.4	55.6		96.5	3.5		18.6	81.4	
PHF	.500	.625	.750	.662	.688	.663	.594	.830	.944

City of Riverside
 N/S: Barton Drive
 E/W: Grove Community Drive
 Weather: Clear

File Name : 12_RIV_Barton_Grove AM
 Site Code : 05121716
 Start Date : 11/30/2021
 Page No : 1

Groups Printed- Large 2 Axle Vehicles

Start Time	Barton Drive Southbound			Grove Community Drive Westbound			Grove Community Drive Eastbound			Int. Total
	Left	Right	App. Total	Thru	Right	App. Total	Left	Thru	App. Total	
07:00 AM	0	0	0	0	0	0	0	0	0	0
07:15 AM	0	0	0	1	0	1	0	0	0	1
07:30 AM	0	0	0	0	0	0	0	1	1	1
07:45 AM	0	0	0	2	0	2	0	1	1	3
Total	0	0	0	3	0	3	0	2	2	5
08:00 AM	0	0	0	1	0	1	0	0	0	1
08:15 AM	0	0	0	0	0	0	0	0	0	0
08:30 AM	0	0	0	1	0	1	0	0	0	1
08:45 AM	0	0	0	0	0	0	0	0	0	0
Total	0	0	0	2	0	2	0	0	0	2
Grand Total	0	0	0	5	0	5	0	2	2	7
Apprch %	0	0		100	0		0	100		
Total %	0	0		71.4	0	71.4	0	28.6	28.6	

Start Time	Barton Drive Southbound			Grove Community Drive Westbound			Grove Community Drive Eastbound			Int. Total
	Left	Right	App. Total	Thru	Right	App. Total	Left	Thru	App. Total	
07:00 AM	0	0	0	0	0	0	0	0	0	0
07:15 AM	0	0	0	1	0	1	0	0	0	1
07:30 AM	0	0	0	0	0	0	0	1	1	1
07:45 AM	0	0	0	2	0	2	0	1	1	3
Total Volume	0	0	0	3	0	3	0	2	2	5
% App. Total	0	0		100	0		0	100		
PHF	.000	.000	.000	.375	.000	.375	.000	.500	.500	.417

Peak Hour Analysis From 07:00 AM to 07:45 AM - Peak 1 of 1
 Peak Hour for Entire Intersection Begins at 07:00 AM

City of Riverside
 N/S: Barton Drive
 E/W: Grove Community Drive
 Weather: Clear

File Name : 12_RIV_Barton_Grove AM
 Site Code : 05121716
 Start Date : 11/30/2021
 Page No : 2

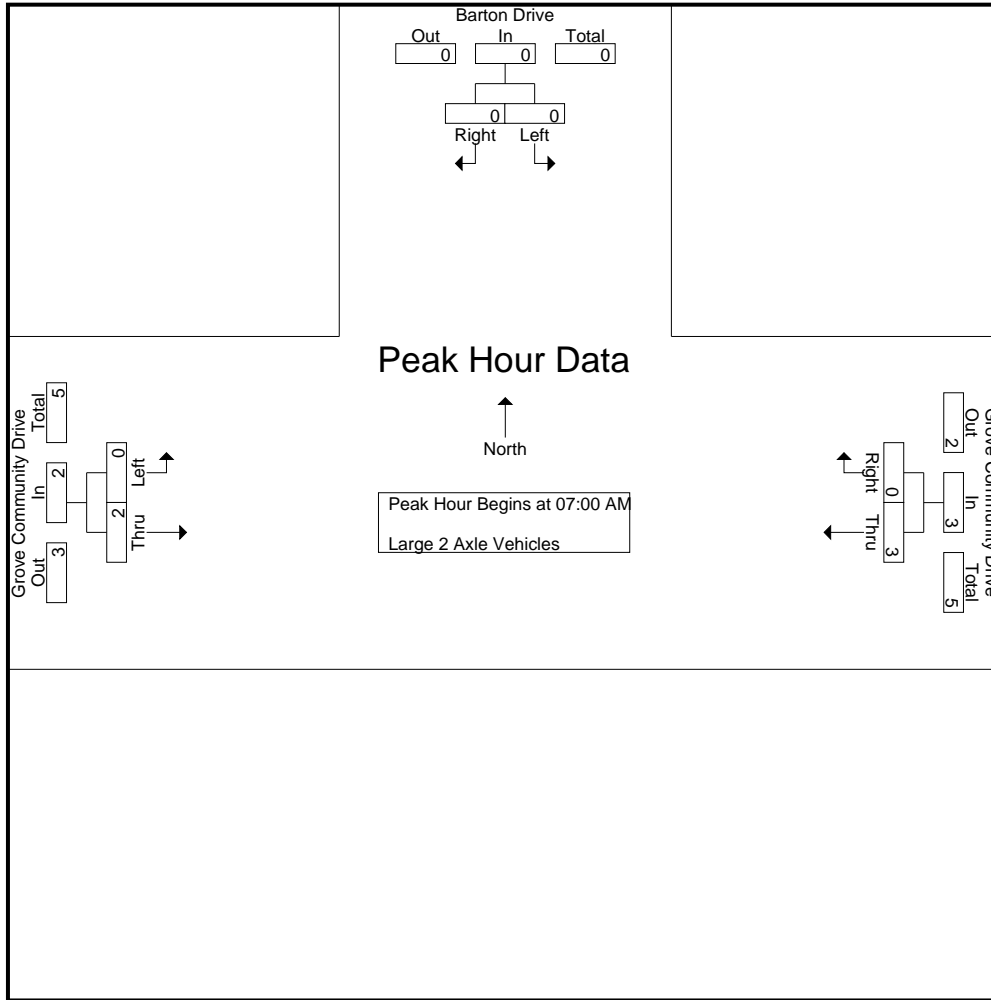

Peak Hour Analysis From 07:00 AM to 07:45 AM - Peak 1 of 1
 Peak Hour for Each Approach Begins at:

	07:00 AM			07:00 AM			07:00 AM		
+0 mins.	0	0	0	0	0	0	0	0	0
+15 mins.	0	0	0	1	0	1	0	0	0
+30 mins.	0	0	0	0	0	0	0	1	1
+45 mins.	0	0	0	2	0	2	0	1	1
Total Volume	0	0	0	3	0	3	0	2	2
% App. Total	0	0	0	100	0	100	0	100	100
PHF	.000	.000	.000	.375	.000	.375	.000	.500	.500

City of Riverside
 N/S: Barton Drive
 E/W: Grove Community Drive
 Weather: Clear

File Name : 12_RIV_Barton_Grove AM
 Site Code : 05121716
 Start Date : 11/30/2021
 Page No : 1

Groups Printed- 3 Axle Vehicles

Start Time	Barton Drive Southbound			Grove Community Drive Westbound			Grove Community Drive Eastbound			Int. Total
	Left	Right	App. Total	Thru	Right	App. Total	Left	Thru	App. Total	
07:00 AM	0	0	0	0	0	0	0	0	0	0
07:15 AM	0	0	0	0	0	0	0	0	0	0
07:30 AM	0	0	0	0	0	0	0	0	0	0
07:45 AM	0	0	0	0	0	0	0	0	0	0
Total	0	0	0	0	0	0	0	0	0	0
08:00 AM	0	0	0	0	0	0	0	0	0	0
08:15 AM	0	0	0	0	0	0	0	0	0	0
08:30 AM	0	0	0	0	0	0	0	0	0	0
08:45 AM	0	0	0	0	0	0	0	0	0	0
Total	0	0	0	0	0	0	0	0	0	0
Grand Total	0	0	0	0	0	0	0	0	0	0
Apprch %	0	0		0	0		0	0		
Total %										

Start Time	Barton Drive Southbound			Grove Community Drive Westbound			Grove Community Drive Eastbound			Int. Total
	Left	Right	App. Total	Thru	Right	App. Total	Left	Thru	App. Total	
07:00 AM	0	0	0	0	0	0	0	0	0	0
07:15 AM	0	0	0	0	0	0	0	0	0	0
07:30 AM	0	0	0	0	0	0	0	0	0	0
07:45 AM	0	0	0	0	0	0	0	0	0	0
Total Volume	0	0	0	0	0	0	0	0	0	0
% App. Total	0	0		0	0		0	0		
PHF	.000	.000	.000	.000	.000	.000	.000	.000	.000	.000

Peak Hour Analysis From 07:00 AM to 07:45 AM - Peak 1 of 1
 Peak Hour for Entire Intersection Begins at 07:00 AM

City of Riverside
 N/S: Barton Drive
 E/W: Grove Community Drive
 Weather: Clear

File Name : 12_RIV_Barton_Grove AM
 Site Code : 05121716
 Start Date : 11/30/2021
 Page No : 2

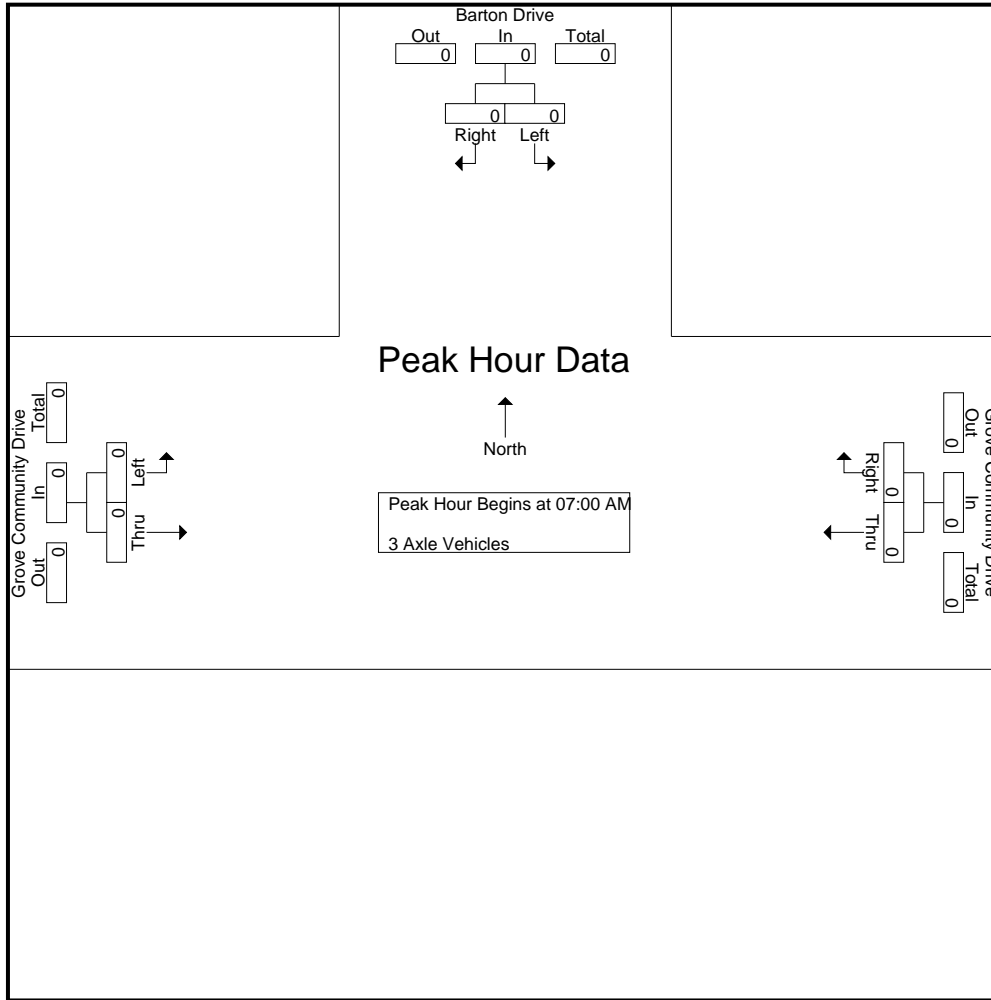

Peak Hour Analysis From 07:00 AM to 07:45 AM - Peak 1 of 1
 Peak Hour for Each Approach Begins at:

	07:00 AM			07:00 AM			07:00 AM		
+0 mins.	0	0	0	0	0	0	0	0	0
+15 mins.	0	0	0	0	0	0	0	0	0
+30 mins.	0	0	0	0	0	0	0	0	0
+45 mins.	0	0	0	0	0	0	0	0	0
Total Volume	0	0	0	0	0	0	0	0	0
% App. Total	0	0	0	0	0	0	0	0	0
PHF	.000	.000	.000	.000	.000	.000	.000	.000	.000

City of Riverside
 N/S: Barton Drive
 E/W: Grove Community Drive
 Weather: Clear

File Name : 12_RIV_Barton_Grove AM
 Site Code : 05121716
 Start Date : 11/30/2021
 Page No : 1

Groups Printed- 4+ Axle Trucks

Start Time	Barton Drive Southbound			Grove Community Drive Westbound			Grove Community Drive Eastbound			Int. Total
	Left	Right	App. Total	Thru	Right	App. Total	Left	Thru	App. Total	
07:00 AM	0	0	0	0	0	0	0	0	0	0
07:15 AM	0	0	0	0	0	0	0	0	0	0
07:30 AM	0	0	0	0	0	0	0	0	0	0
07:45 AM	0	0	0	0	0	0	0	0	0	0
Total	0	0	0	0	0	0	0	0	0	0
08:00 AM	0	0	0	0	0	0	0	0	0	0
08:15 AM	0	0	0	0	0	0	0	0	0	0
08:30 AM	0	0	0	0	0	0	0	0	0	0
08:45 AM	0	0	0	0	0	0	0	0	0	0
Total	0	0	0	0	0	0	0	0	0	0
Grand Total	0	0	0	0	0	0	0	0	0	0
Apprch %	0	0		0	0		0	0		
Total %										

Start Time	Barton Drive Southbound			Grove Community Drive Westbound			Grove Community Drive Eastbound			Int. Total
	Left	Right	App. Total	Thru	Right	App. Total	Left	Thru	App. Total	
07:00 AM	0	0	0	0	0	0	0	0	0	0
07:15 AM	0	0	0	0	0	0	0	0	0	0
07:30 AM	0	0	0	0	0	0	0	0	0	0
07:45 AM	0	0	0	0	0	0	0	0	0	0
Total Volume	0	0	0	0	0	0	0	0	0	0
% App. Total	0	0		0	0		0	0		
PHF	.000	.000	.000	.000	.000	.000	.000	.000	.000	.000

Peak Hour Analysis From 07:00 AM to 07:45 AM - Peak 1 of 1
 Peak Hour for Entire Intersection Begins at 07:00 AM

City of Riverside
 N/S: Barton Drive
 E/W: Grove Community Drive
 Weather: Clear

File Name : 12_RIV_Barton_Grove AM
 Site Code : 05121716
 Start Date : 11/30/2021
 Page No : 2

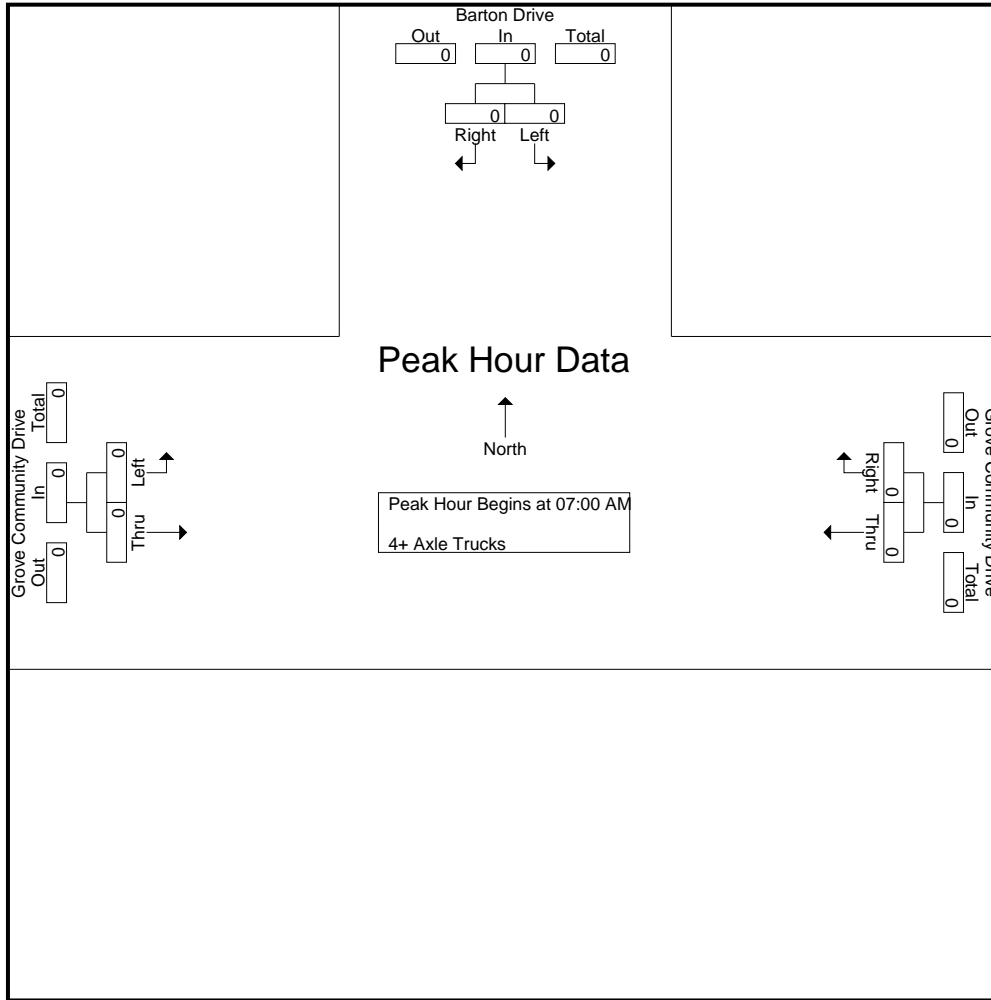

Peak Hour Analysis From 07:00 AM to 07:45 AM - Peak 1 of 1
 Peak Hour for Each Approach Begins at:

	07:00 AM			07:00 AM			07:00 AM		
+0 mins.	0	0	0	0	0	0	0	0	0
+15 mins.	0	0	0	0	0	0	0	0	0
+30 mins.	0	0	0	0	0	0	0	0	0
+45 mins.	0	0	0	0	0	0	0	0	0
Total Volume	0	0	0	0	0	0	0	0	0
% App. Total	0	0	0	0	0	0	0	0	0
PHF	.000	.000	.000	.000	.000	.000	.000	.000	.000

City of Riverside
 N/S: Barton Drive
 E/W: Grove Community Drive
 Weather: Clear

File Name : 12_RIV_Barton_Grove PM
 Site Code : 05121716
 Start Date : 11/30/2021
 Page No : 1

Groups Printed- Passenger Vehicles - Large 2 Axle Vehicles - 3 Axle Vehicles - 4+ Axle Trucks

Start Time	Barton Drive Southbound			Grove Community Drive Westbound			Grove Community Drive Eastbound			Int. Total
	Left	Right	App. Total	Thru	Right	App. Total	Left	Thru	App. Total	
04:00 PM	2	2	4	32	0	32	3	42	45	81
04:15 PM	3	3	6	21	3	24	2	49	51	81
04:30 PM	1	5	6	30	0	30	1	43	44	80
04:45 PM	1	3	4	23	0	23	2	53	55	82
Total	7	13	20	106	3	109	8	187	195	324
05:00 PM	0	9	9	24	3	27	2	45	47	83
05:15 PM	0	7	7	33	4	37	6	47	53	97
05:30 PM	1	5	6	25	6	31	7	57	64	101
05:45 PM	1	2	3	30	6	36	14	46	60	99
Total	2	23	25	112	19	131	29	195	224	380
Grand Total	9	36	45	218	22	240	37	382	419	704
Apprch %	20	80		90.8	9.2		8.8	91.2		
Total %	1.3	5.1	6.4	31	3.1	34.1	5.3	54.3	59.5	
Passenger Vehicles	9	36	45	217	22	239	37	381	418	702
% Passenger Vehicles	100	100	100	99.5	100	99.6	100	99.7	99.8	99.7
Large 2 Axle Vehicles	0	0	0	1	0	1	0	1	1	2
% Large 2 Axle Vehicles	0	0	0	0.5	0	0.4	0	0.3	0.2	0.3
3 Axle Vehicles	0	0	0	0	0	0	0	0	0	0
% 3 Axle Vehicles	0	0	0	0	0	0	0	0	0	0
4+ Axle Trucks	0	0	0	0	0	0	0	0	0	0
% 4+ Axle Trucks	0	0	0	0	0	0	0	0	0	0

Start Time	Barton Drive Southbound			Grove Community Drive Westbound			Grove Community Drive Eastbound			Int. Total
	Left	Right	App. Total	Thru	Right	App. Total	Left	Thru	App. Total	
Peak Hour Analysis From 04:00 PM to 05:45 PM - Peak 1 of 1										
Peak Hour for Entire Intersection Begins at 05:00 PM										
05:00 PM	0	9	9	24	3	27	2	45	47	83
05:15 PM	0	7	7	33	4	37	6	47	53	97
05:30 PM	1	5	6	25	6	31	7	57	64	101
05:45 PM	1	2	3	30	6	36	14	46	60	99
Total Volume	2	23	25	112	19	131	29	195	224	380
% App. Total	8	92		85.5	14.5		12.9	87.1		
PHF	.500	.639	.694	.848	.792	.885	.518	.855	.875	.941

City of Riverside
 N/S: Barton Drive
 E/W: Grove Community Drive
 Weather: Clear

File Name : 12_RIV_Barton_Grove PM
 Site Code : 05121716
 Start Date : 11/30/2021
 Page No : 2

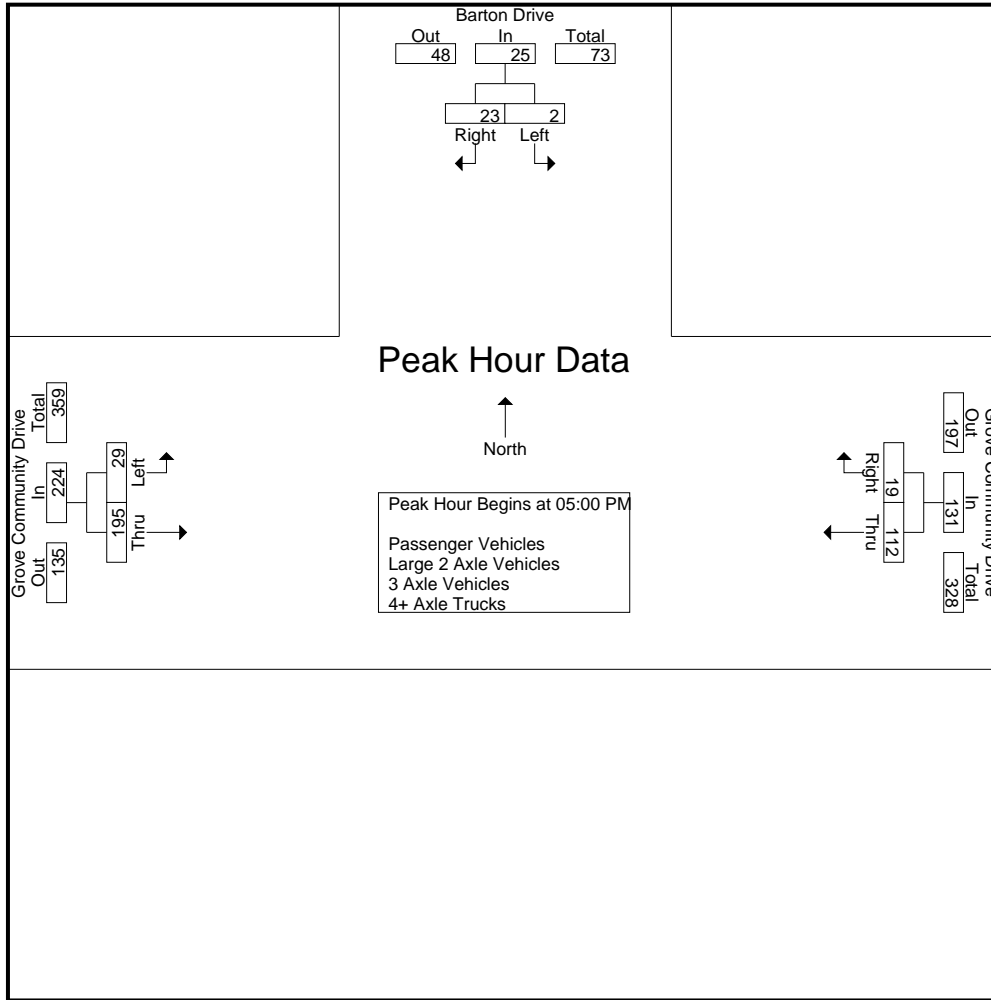

Peak Hour Analysis From 04:00 PM to 05:45 PM - Peak 1 of 1
 Peak Hour for Each Approach Begins at:

	04:30 PM			05:00 PM			05:00 PM		
+0 mins.	1	5	6	24	3	27	2	45	47
+15 mins.	1	3	4	33	4	37	6	47	53
+30 mins.	0	9	9	25	6	31	7	57	64
+45 mins.	0	7	7	30	6	36	14	46	60
Total Volume	2	24	26	112	19	131	29	195	224
% App. Total	7.7	92.3		85.5	14.5		12.9	87.1	
PHF	.500	.667	.722	.848	.792	.885	.518	.855	.875

City of Riverside
 N/S: Barton Drive
 E/W: Grove Community Drive
 Weather: Clear

File Name : 12_RIV_Barton_Grove PM
 Site Code : 05121716
 Start Date : 11/30/2021
 Page No : 1

Groups Printed- Passenger Vehicles

Start Time	Barton Drive Southbound			Grove Community Drive Westbound			Grove Community Drive Eastbound			Int. Total
	Left	Right	App. Total	Thru	Right	App. Total	Left	Thru	App. Total	
04:00 PM	2	2	4	32	0	32	3	42	45	81
04:15 PM	3	3	6	21	3	24	2	49	51	81
04:30 PM	1	5	6	30	0	30	1	43	44	80
04:45 PM	1	3	4	23	0	23	2	53	55	82
Total	7	13	20	106	3	109	8	187	195	324
05:00 PM	0	9	9	24	3	27	2	44	46	82
05:15 PM	0	7	7	33	4	37	6	47	53	97
05:30 PM	1	5	6	24	6	30	7	57	64	100
05:45 PM	1	2	3	30	6	36	14	46	60	99
Total	2	23	25	111	19	130	29	194	223	378
Grand Total	9	36	45	217	22	239	37	381	418	702
Apprch %	20	80		90.8	9.2		8.9	91.1		
Total %	1.3	5.1	6.4	30.9	3.1	34	5.3	54.3	59.5	

Start Time	Barton Drive Southbound			Grove Community Drive Westbound			Grove Community Drive Eastbound			Int. Total
	Left	Right	App. Total	Thru	Right	App. Total	Left	Thru	App. Total	
05:00 PM	0	9	9	24	3	27	2	44	46	82
05:15 PM	0	7	7	33	4	37	6	47	53	97
05:30 PM	1	5	6	24	6	30	7	57	64	100
05:45 PM	1	2	3	30	6	36	14	46	60	99
Total Volume	2	23	25	111	19	130	29	194	223	378
% App. Total	8	92		85.4	14.6		13	87		
PHF	.500	.639	.694	.841	.792	.878	.518	.851	.871	.945

Peak Hour Analysis From 05:00 PM to 05:45 PM - Peak 1 of 1
 Peak Hour for Entire Intersection Begins at 05:00 PM

City of Riverside
 N/S: Barton Drive
 E/W: Grove Community Drive
 Weather: Clear

File Name : 12_RIV_Barton_Grove PM
 Site Code : 05121716
 Start Date : 11/30/2021
 Page No : 2

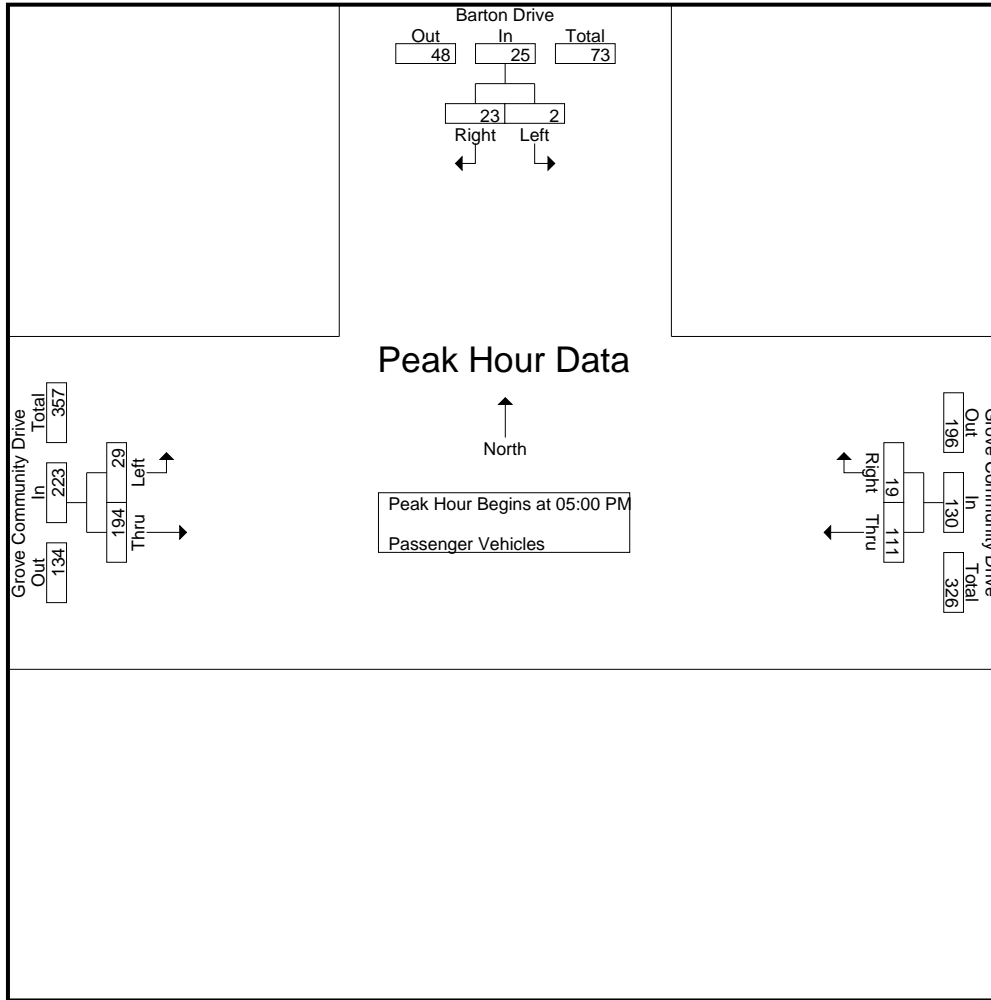

Peak Hour Analysis From 05:00 PM to 05:45 PM - Peak 1 of 1
 Peak Hour for Each Approach Begins at:

	05:00 PM			05:00 PM			05:00 PM		
+0 mins.	0	9	9	24	3	27	2	44	46
+15 mins.	0	7	7	33	4	37	6	47	53
+30 mins.	1	5	6	24	6	30	7	57	64
+45 mins.	1	2	3	30	6	36	14	46	60
Total Volume	2	23	25	111	19	130	29	194	223
% App. Total	8	92		85.4	14.6		13	87	
PHF	.500	.639	.694	.841	.792	.878	.518	.851	.871

City of Riverside
 N/S: Barton Drive
 E/W: Grove Community Drive
 Weather: Clear

File Name : 12_RIV_Barton_Grove PM
 Site Code : 05121716
 Start Date : 11/30/2021
 Page No : 1

Groups Printed- Large 2 Axle Vehicles

Start Time	Barton Drive Southbound			Grove Community Drive Westbound			Grove Community Drive Eastbound			Int. Total
	Left	Right	App. Total	Thru	Right	App. Total	Left	Thru	App. Total	
04:00 PM	0	0	0	0	0	0	0	0	0	0
04:15 PM	0	0	0	0	0	0	0	0	0	0
04:30 PM	0	0	0	0	0	0	0	0	0	0
04:45 PM	0	0	0	0	0	0	0	0	0	0
Total	0	0	0	0	0	0	0	0	0	0
05:00 PM	0	0	0	0	0	0	0	1	1	1
05:15 PM	0	0	0	0	0	0	0	0	0	0
05:30 PM	0	0	0	1	0	1	0	0	0	1
05:45 PM	0	0	0	0	0	0	0	0	0	0
Total	0	0	0	1	0	1	0	1	1	2
Grand Total	0	0	0	1	0	1	0	1	1	2
Apprch %	0	0		100	0		0	100		
Total %	0	0		50	0	50	0	50	50	

Start Time	Barton Drive Southbound			Grove Community Drive Westbound			Grove Community Drive Eastbound			Int. Total
	Left	Right	App. Total	Thru	Right	App. Total	Left	Thru	App. Total	
05:00 PM	0	0	0	0	0	0	0	1	1	1
05:15 PM	0	0	0	0	0	0	0	0	0	0
05:30 PM	0	0	0	1	0	1	0	0	0	1
05:45 PM	0	0	0	0	0	0	0	0	0	0
Total Volume	0	0	0	1	0	1	0	1	1	2
% App. Total	0	0		100	0		0	100		
PHF	.000	.000	.000	.250	.000	.250	.000	.250	.250	.500

Peak Hour Analysis From 05:00 PM to 05:45 PM - Peak 1 of 1
 Peak Hour for Entire Intersection Begins at 05:00 PM

City of Riverside
 N/S: Barton Drive
 E/W: Grove Community Drive
 Weather: Clear

File Name : 12_RIV_Barton_Grove PM
 Site Code : 05121716
 Start Date : 11/30/2021
 Page No : 2

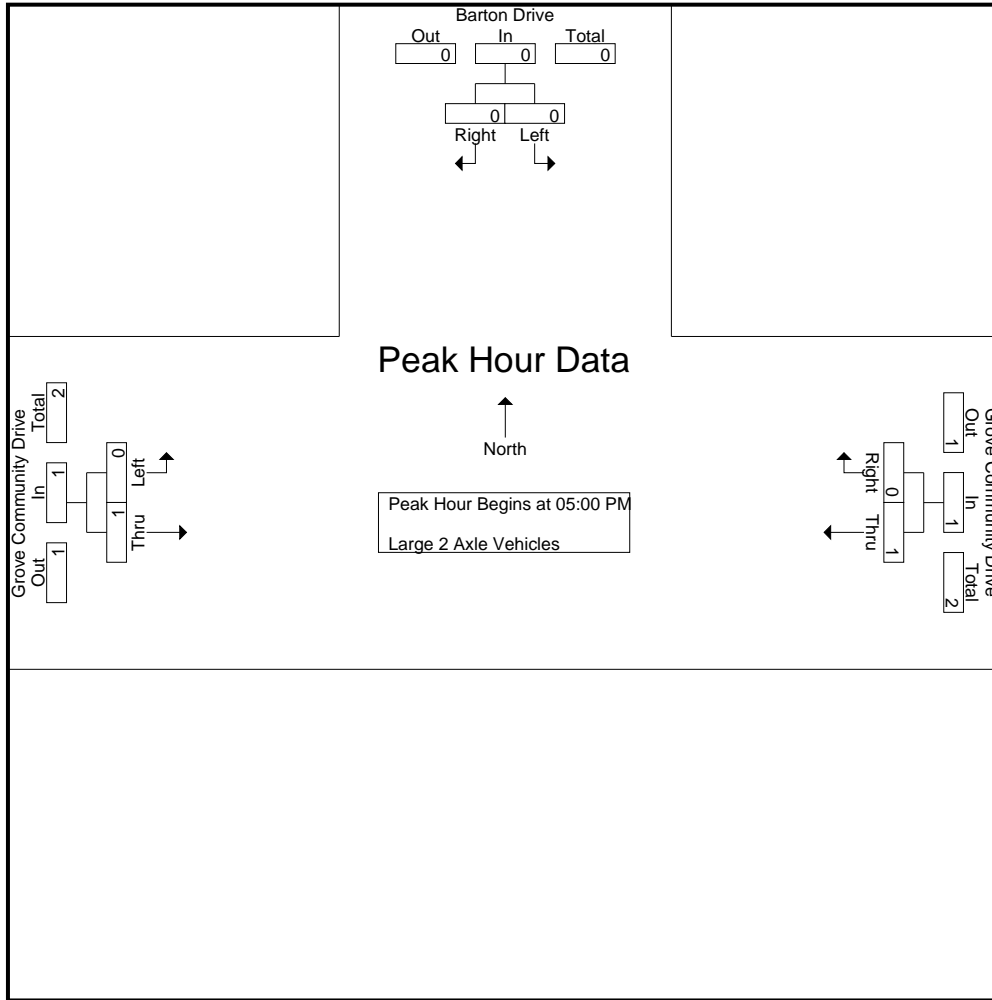

Peak Hour Analysis From 05:00 PM to 05:45 PM - Peak 1 of 1
 Peak Hour for Each Approach Begins at:

	05:00 PM			05:00 PM			05:00 PM		
+0 mins.	0	0	0	0	0	0	0	1	1
+15 mins.	0	0	0	0	0	0	0	0	0
+30 mins.	0	0	0	1	0	1	0	0	0
+45 mins.	0	0	0	0	0	0	0	0	0
Total Volume	0	0	0	1	0	1	0	1	1
% App. Total	0	0	0	100	0	100	0	100	100
PHF	.000	.000	.000	.250	.000	.250	.000	.250	.250

City of Riverside
 N/S: Barton Drive
 E/W: Grove Community Drive
 Weather: Clear

File Name : 12_RIV_Barton_Grove PM
 Site Code : 05121716
 Start Date : 11/30/2021
 Page No : 1

Groups Printed- 3 Axle Vehicles

Start Time	Barton Drive Southbound			Grove Community Drive Westbound			Grove Community Drive Eastbound			Int. Total
	Left	Right	App. Total	Thru	Right	App. Total	Left	Thru	App. Total	
04:00 PM	0	0	0	0	0	0	0	0	0	0
04:15 PM	0	0	0	0	0	0	0	0	0	0
04:30 PM	0	0	0	0	0	0	0	0	0	0
04:45 PM	0	0	0	0	0	0	0	0	0	0
Total	0	0	0	0	0	0	0	0	0	0
05:00 PM	0	0	0	0	0	0	0	0	0	0
05:15 PM	0	0	0	0	0	0	0	0	0	0
05:30 PM	0	0	0	0	0	0	0	0	0	0
05:45 PM	0	0	0	0	0	0	0	0	0	0
Total	0	0	0	0	0	0	0	0	0	0
Grand Total	0	0	0	0	0	0	0	0	0	0
Apprch %	0	0		0	0		0	0		
Total %										

Start Time	Barton Drive Southbound			Grove Community Drive Westbound			Grove Community Drive Eastbound			Int. Total
	Left	Right	App. Total	Thru	Right	App. Total	Left	Thru	App. Total	
05:00 PM	0	0	0	0	0	0	0	0	0	0
05:15 PM	0	0	0	0	0	0	0	0	0	0
05:30 PM	0	0	0	0	0	0	0	0	0	0
05:45 PM	0	0	0	0	0	0	0	0	0	0
Total Volume	0	0	0	0	0	0	0	0	0	0
% App. Total	0	0		0	0		0	0		
PHF	.000	.000	.000	.000	.000	.000	.000	.000	.000	.000

Peak Hour Analysis From 05:00 PM to 05:45 PM - Peak 1 of 1
 Peak Hour for Entire Intersection Begins at 05:00 PM

City of Riverside
 N/S: Barton Drive
 E/W: Grove Community Drive
 Weather: Clear

File Name : 12_RIV_Barton_Grove PM
 Site Code : 05121716
 Start Date : 11/30/2021
 Page No : 2

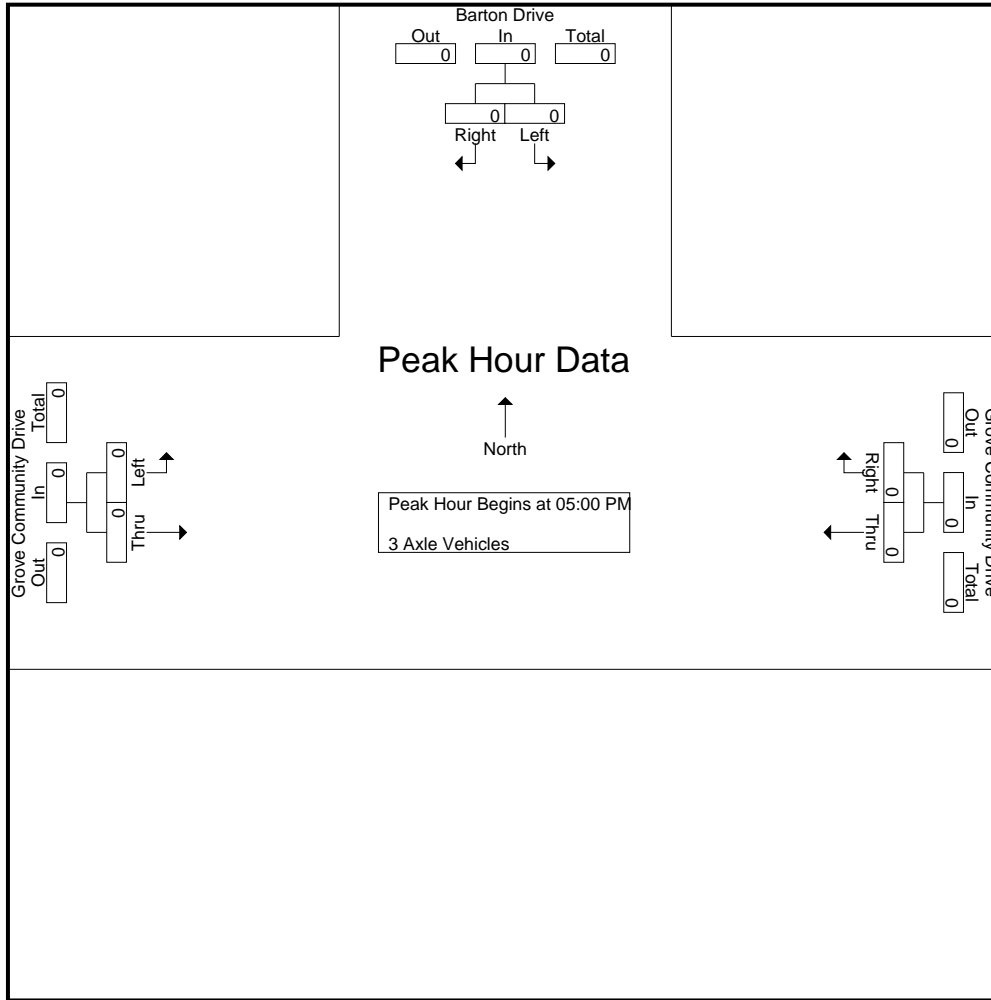

Peak Hour Analysis From 05:00 PM to 05:45 PM - Peak 1 of 1
 Peak Hour for Each Approach Begins at:

	05:00 PM			05:00 PM			05:00 PM		
+0 mins.	0	0	0	0	0	0	0	0	0
+15 mins.	0	0	0	0	0	0	0	0	0
+30 mins.	0	0	0	0	0	0	0	0	0
+45 mins.	0	0	0	0	0	0	0	0	0
Total Volume	0	0	0	0	0	0	0	0	0
% App. Total	0	0	0	0	0	0	0	0	0
PHF	.000	.000	.000	.000	.000	.000	.000	.000	.000

City of Riverside
 N/S: Barton Drive
 E/W: Grove Community Drive
 Weather: Clear

File Name : 12_RIV_Barton_Grove PM
 Site Code : 05121716
 Start Date : 11/30/2021
 Page No : 1

Groups Printed- 4+ Axle Trucks

Start Time	Barton Drive Southbound			Grove Community Drive Westbound			Grove Community Drive Eastbound			Int. Total
	Left	Right	App. Total	Thru	Right	App. Total	Left	Thru	App. Total	
04:00 PM	0	0	0	0	0	0	0	0	0	0
04:15 PM	0	0	0	0	0	0	0	0	0	0
04:30 PM	0	0	0	0	0	0	0	0	0	0
04:45 PM	0	0	0	0	0	0	0	0	0	0
Total	0	0	0	0	0	0	0	0	0	0
05:00 PM	0	0	0	0	0	0	0	0	0	0
05:15 PM	0	0	0	0	0	0	0	0	0	0
05:30 PM	0	0	0	0	0	0	0	0	0	0
05:45 PM	0	0	0	0	0	0	0	0	0	0
Total	0	0	0	0	0	0	0	0	0	0
Grand Total	0	0	0	0	0	0	0	0	0	0
Apprch %	0	0		0	0		0	0		
Total %										

Start Time	Barton Drive Southbound			Grove Community Drive Westbound			Grove Community Drive Eastbound			Int. Total
	Left	Right	App. Total	Thru	Right	App. Total	Left	Thru	App. Total	
05:00 PM	0	0	0	0	0	0	0	0	0	0
05:15 PM	0	0	0	0	0	0	0	0	0	0
05:30 PM	0	0	0	0	0	0	0	0	0	0
05:45 PM	0	0	0	0	0	0	0	0	0	0
Total Volume	0	0	0	0	0	0	0	0	0	0
% App. Total	0	0		0	0		0	0		
PHF	.000	.000	.000	.000	.000	.000	.000	.000	.000	.000

Peak Hour Analysis From 05:00 PM to 05:45 PM - Peak 1 of 1
 Peak Hour for Entire Intersection Begins at 05:00 PM

City of Riverside
 N/S: Barton Drive
 E/W: Grove Community Drive
 Weather: Clear

File Name : 12_RIV_Barton_Grove PM
 Site Code : 05121716
 Start Date : 11/30/2021
 Page No : 2

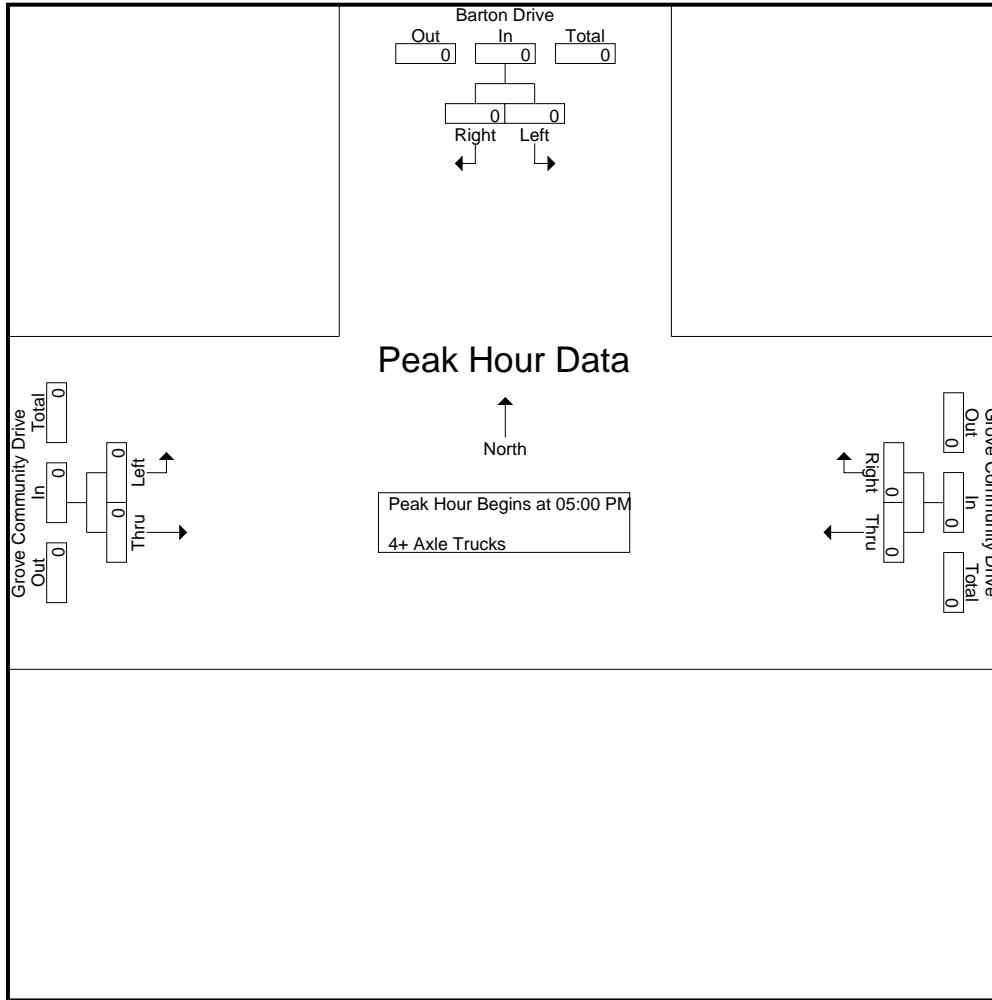

Peak Hour Analysis From 05:00 PM to 05:45 PM - Peak 1 of 1
 Peak Hour for Each Approach Begins at:

	05:00 PM			05:00 PM			05:00 PM		
+0 mins.	0	0	0	0	0	0	0	0	0
+15 mins.	0	0	0	0	0	0	0	0	0
+30 mins.	0	0	0	0	0	0	0	0	0
+45 mins.	0	0	0	0	0	0	0	0	0
Total Volume	0	0	0	0	0	0	0	0	0
% App. Total	0	0	0	0	0	0	0	0	0
PHF	.000	.000	.000	.000	.000	.000	.000	.000	.000

Location: Riverside
 N/S: Barton Drive
 E/W: Grove Community Drive



Date: 11/30/2021
 Day: Tuesday

PEDESTRIANS

	North Leg Barton Drive	East Leg Grove Community Drive	South Leg Dead End	West Leg Grove Community Drive	
	Pedestrians	Pedestrians	Pedestrians	Pedestrians	
7:00 AM	0	0	0	0	0
7:15 AM	2	0	0	0	2
7:30 AM	2	0	0	1	3
7:45 AM	1	0	0	0	1
8:00 AM	1	0	0	2	3
8:15 AM	2	0	0	0	2
8:30 AM	0	0	0	1	1
8:45 AM	1	0	0	0	1
TOTAL VOLUMES:	9	0	0	4	13

	North Leg Barton Drive	East Leg Grove Community Drive	South Leg Dead End	West Leg Grove Community Drive	
	Pedestrians	Pedestrians	Pedestrians	Pedestrians	
4:00 PM	0	0	0	0	0
4:15 PM	0	0	0	0	0
4:30 PM	0	0	0	0	0
4:45 PM	1	0	0	0	1
5:00 PM	4	0	0	0	4
5:15 PM	1	0	0	0	1
5:30 PM	1	0	0	0	1
5:45 PM	0	0	0	0	0
TOTAL VOLUMES:	7	0	0	0	7

Location: Riverside
 N/S: Barton Drive
 E/W: Grove Community Drive



Date: 11/30/2021
 Day: Tuesday

BICYCLES

	Southbound Barton Drive			Westbound Grove Community Drive			Northbound Dead End			Eastbound Grove Community Drive			
	Left	Thru	Right	Left	Thru	Right	Left	Thru	Right	Left	Thru	Right	
7:00 AM	0	0	0	0	0	0	0	0	0	0	0	0	0
7:15 AM	0	0	0	0	0	1	0	0	0	0	0	0	1
7:30 AM	1	0	0	0	0	1	0	0	0	1	0	0	3
7:45 AM	0	0	0	0	0	0	0	0	0	0	0	0	0
8:00 AM	0	0	0	0	0	0	0	0	0	0	0	0	0
8:15 AM	0	0	0	0	1	0	0	0	0	0	0	0	1
8:30 AM	0	0	0	0	0	0	0	0	0	0	0	0	0
8:45 AM	0	0	0	0	0	0	0	0	0	0	1	0	1
TOTAL VOLUMES:	1	0	0	0	1	2	0	0	0	1	1	0	6

	Southbound Barton Drive			Westbound Grove Community Drive			Northbound Dead End			Eastbound Grove Community Drive			
	Left	Thru	Right	Left	Thru	Right	Left	Thru	Right	Left	Thru	Right	
4:00 PM	0	0	0	0	0	0	0	0	0	0	0	0	0
4:15 PM	0	0	0	0	0	1	0	0	0	0	0	0	1
4:30 PM	1	0	0	0	1	0	0	0	0	0	0	0	2
4:45 PM	1	0	0	0	0	0	0	0	0	0	0	0	1
5:00 PM	1	0	1	0	0	1	0	0	0	0	1	0	4
5:15 PM	0	0	0	0	0	0	0	0	0	0	1	0	1
5:30 PM	0	0	0	0	0	0	0	0	0	0	0	0	0
5:45 PM	0	0	0	0	0	0	0	0	0	0	0	0	0
TOTAL VOLUMES:	3	0	1	0	1	2	0	0	0	0	2	0	9

City of Riverside
 N/S: Barton Street
 E/W: Orange Terrace Parkway
 Weather: Clear

File Name : 13_RIV_Barton_Orange AM
 Site Code : 05121716
 Start Date : 11/30/2021
 Page No : 1

Groups Printed- Passenger Vehicles - Large 2 Axle Vehicles - 3 Axle Vehicles - 4+ Axle Trucks

Start Time	Orange Terrace Parkway Westbound			Barton Street Northbound			Orange Terrace Parkway Eastbound			Int. Total
	Left	Thru	App. Total	Left	Right	App. Total	Thru	Right	App. Total	
07:00 AM	18	109	127	46	8	54	39	94	133	314
07:15 AM	10	100	110	61	5	66	52	78	130	306
07:30 AM	3	79	82	35	6	41	76	15	91	214
07:45 AM	7	49	56	26	9	35	62	16	78	169
Total	38	337	375	168	28	196	229	203	432	1003
08:00 AM	3	44	47	31	4	35	26	9	35	117
08:15 AM	2	47	49	5	4	9	29	7	36	94
08:30 AM	5	59	64	11	1	12	31	6	37	113
08:45 AM	5	37	42	17	0	17	26	4	30	89
Total	15	187	202	64	9	73	112	26	138	413
Grand Total	53	524	577	232	37	269	341	229	570	1416
Apprch %	9.2	90.8		86.2	13.8		59.8	40.2		
Total %	3.7	37	40.7	16.4	2.6	19	24.1	16.2	40.3	
Passenger Vehicles	51	519	570	232	37	269	331	229	560	1399
% Passenger Vehicles	96.2	99	98.8	100	100	100	97.1	100	98.2	98.8
Large 2 Axle Vehicles	2	5	7	0	0	0	10	0	10	17
% Large 2 Axle Vehicles	3.8	1	1.2	0	0	0	2.9	0	1.8	1.2
3 Axle Vehicles	0	0	0	0	0	0	0	0	0	0
% 3 Axle Vehicles	0	0	0	0	0	0	0	0	0	0
4+ Axle Trucks	0	0	0	0	0	0	0	0	0	0
% 4+ Axle Trucks	0	0	0	0	0	0	0	0	0	0

Start Time	Orange Terrace Parkway Westbound			Barton Street Northbound			Orange Terrace Parkway Eastbound			Int. Total
	Left	Thru	App. Total	Left	Right	App. Total	Thru	Right	App. Total	
Peak Hour Analysis From 07:00 AM to 08:45 AM - Peak 1 of 1										
Peak Hour for Entire Intersection Begins at 07:00 AM										
07:00 AM	18	109	127	46	8	54	39	94	133	314
07:15 AM	10	100	110	61	5	66	52	78	130	306
07:30 AM	3	79	82	35	6	41	76	15	91	214
07:45 AM	7	49	56	26	9	35	62	16	78	169
Total Volume	38	337	375	168	28	196	229	203	432	1003
% App. Total	10.1	89.9		85.7	14.3		53	47		
PHF	.528	.773	.738	.689	.778	.742	.753	.540	.812	.799

City of Riverside
 N/S: Barton Street
 E/W: Orange Terrace Parkway
 Weather: Clear

File Name : 13_RIV_Barton_Orange AM
 Site Code : 05121716
 Start Date : 11/30/2021
 Page No : 2

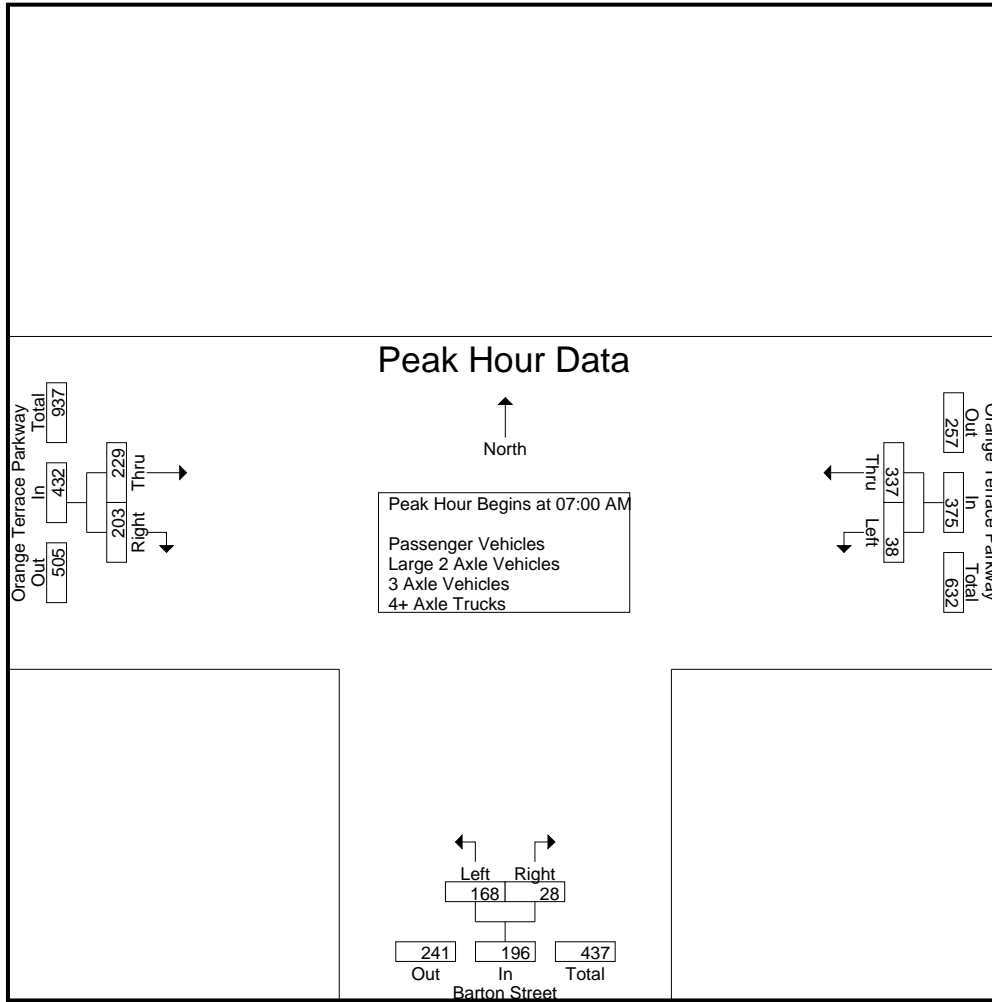

Peak Hour Analysis From 07:00 AM to 08:45 AM - Peak 1 of 1
 Peak Hour for Each Approach Begins at:

	07:00 AM			07:00 AM			07:00 AM		
+0 mins.	18	109	127	46	8	54	39	94	133
+15 mins.	10	100	110	61	5	66	52	78	130
+30 mins.	3	79	82	35	6	41	76	15	91
+45 mins.	7	49	56	26	9	35	62	16	78
Total Volume	38	337	375	168	28	196	229	203	432
% App. Total	10.1	89.9		85.7	14.3		53	47	
PHF	.528	.773	.738	.689	.778	.742	.753	.540	.812

City of Riverside
 N/S: Barton Street
 E/W: Orange Terrace Parkway
 Weather: Clear

File Name : 13_RIV_Barton_Orange AM
 Site Code : 05121716
 Start Date : 11/30/2021
 Page No : 1

Groups Printed- Passenger Vehicles

Start Time	Orange Terrace Parkway Westbound			Barton Street Northbound			Orange Terrace Parkway Eastbound			Int. Total
	Left	Thru	App. Total	Left	Right	App. Total	Thru	Right	App. Total	
07:00 AM	17	108	125	46	8	54	34	94	128	307
07:15 AM	10	99	109	61	5	66	50	78	128	303
07:30 AM	3	79	82	35	6	41	75	15	90	213
07:45 AM	7	49	56	26	9	35	62	16	78	169
Total	37	335	372	168	28	196	221	203	424	992
08:00 AM	3	43	46	31	4	35	24	9	33	114
08:15 AM	2	47	49	5	4	9	29	7	36	94
08:30 AM	5	57	62	11	1	12	31	6	37	111
08:45 AM	4	37	41	17	0	17	26	4	30	88
Total	14	184	198	64	9	73	110	26	136	407
Grand Total	51	519	570	232	37	269	331	229	560	1399
Apprch %	8.9	91.1		86.2	13.8		59.1	40.9		
Total %	3.6	37.1	40.7	16.6	2.6	19.2	23.7	16.4	40	

Start Time	Orange Terrace Parkway Westbound			Barton Street Northbound			Orange Terrace Parkway Eastbound			Int. Total
	Left	Thru	App. Total	Left	Right	App. Total	Thru	Right	App. Total	
07:00 AM	17	108	125	46	8	54	34	94	128	307
07:15 AM	10	99	109	61	5	66	50	78	128	303
07:30 AM	3	79	82	35	6	41	75	15	90	213
07:45 AM	7	49	56	26	9	35	62	16	78	169
Total Volume	37	335	372	168	28	196	221	203	424	992
% App. Total	9.9	90.1		85.7	14.3		52.1	47.9		
PHF	.544	.775	.744	.689	.778	.742	.737	.540	.828	.808

Peak Hour Analysis From 07:00 AM to 07:45 AM - Peak 1 of 1
 Peak Hour for Entire Intersection Begins at 07:00 AM

City of Riverside
 N/S: Barton Street
 E/W: Orange Terrace Parkway
 Weather: Clear

File Name : 13_RIV_Barton_Orange AM
 Site Code : 05121716
 Start Date : 11/30/2021
 Page No : 2

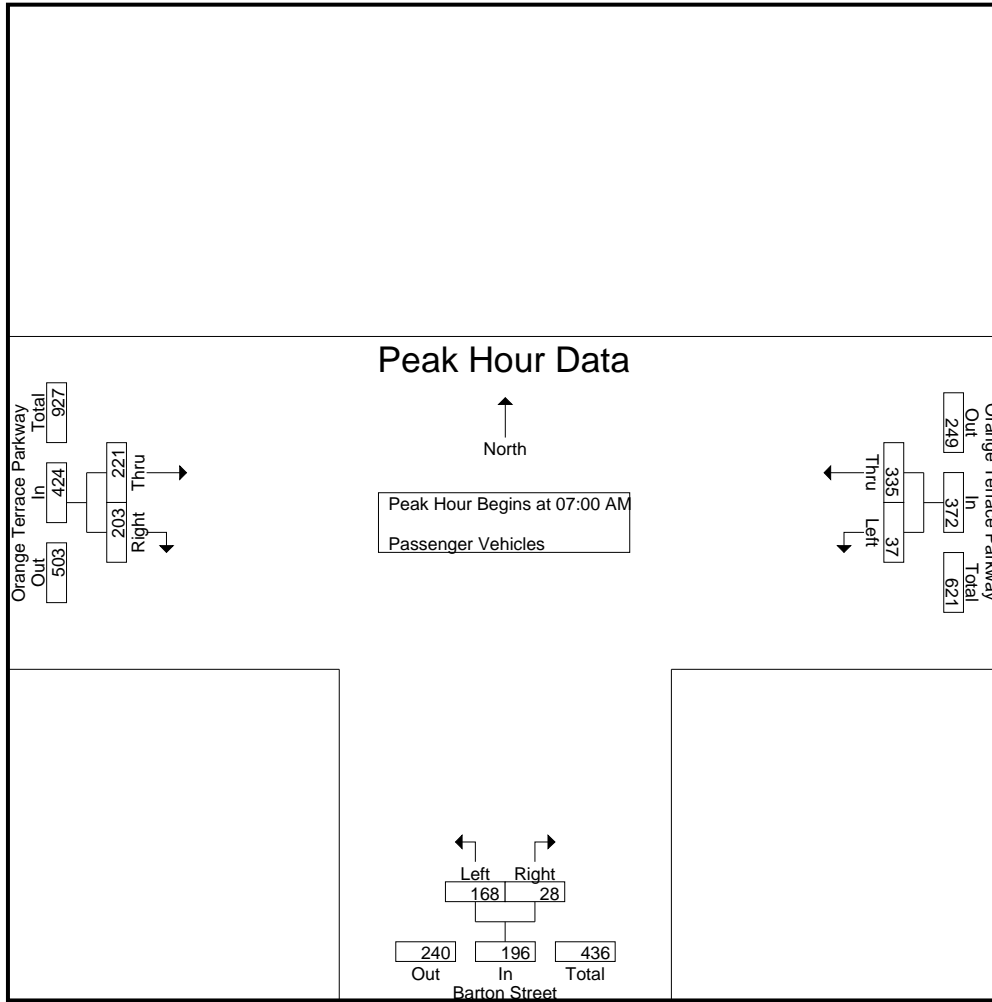

Peak Hour Analysis From 07:00 AM to 07:45 AM - Peak 1 of 1
 Peak Hour for Each Approach Begins at:

	07:00 AM			07:00 AM			07:00 AM		
+0 mins.	17	108	125	46	8	54	34	94	128
+15 mins.	10	99	109	61	5	66	50	78	128
+30 mins.	3	79	82	35	6	41	75	15	90
+45 mins.	7	49	56	26	9	35	62	16	78
Total Volume	37	335	372	168	28	196	221	203	424
% App. Total	9.9	90.1		85.7	14.3		52.1	47.9	
PHF	.544	.775	.744	.689	.778	.742	.737	.540	.828

City of Riverside
 N/S: Barton Street
 E/W: Orange Terrace Parkway
 Weather: Clear

File Name : 13_RIV_Barton_Orange AM
 Site Code : 05121716
 Start Date : 11/30/2021
 Page No : 1

Groups Printed- Large 2 Axle Vehicles

Start Time	Orange Terrace Parkway Westbound			Barton Street Northbound			Orange Terrace Parkway Eastbound			Int. Total
	Left	Thru	App. Total	Left	Right	App. Total	Thru	Right	App. Total	
07:00 AM	1	1	2	0	0	0	5	0	5	7
07:15 AM	0	1	1	0	0	0	2	0	2	3
07:30 AM	0	0	0	0	0	0	1	0	1	1
07:45 AM	0	0	0	0	0	0	0	0	0	0
Total	1	2	3	0	0	0	8	0	8	11
08:00 AM	0	1	1	0	0	0	2	0	2	3
08:15 AM	0	0	0	0	0	0	0	0	0	0
08:30 AM	0	2	2	0	0	0	0	0	0	2
08:45 AM	1	0	1	0	0	0	0	0	0	1
Total	1	3	4	0	0	0	2	0	2	6
Grand Total	2	5	7	0	0	0	10	0	10	17
Apprch %	28.6	71.4		0	0		100	0		
Total %	11.8	29.4	41.2	0	0	0	58.8	0	58.8	

Start Time	Orange Terrace Parkway Westbound			Barton Street Northbound			Orange Terrace Parkway Eastbound			Int. Total
	Left	Thru	App. Total	Left	Right	App. Total	Thru	Right	App. Total	
07:00 AM	1	1	2	0	0	0	5	0	5	7
07:15 AM	0	1	1	0	0	0	2	0	2	3
07:30 AM	0	0	0	0	0	0	1	0	1	1
07:45 AM	0	0	0	0	0	0	0	0	0	0
Total Volume	1	2	3	0	0	0	8	0	8	11
% App. Total	33.3	66.7		0	0		100	0		
PHF	.250	.500	.375	.000	.000	.000	.400	.000	.400	.393

Peak Hour Analysis From 07:00 AM to 07:45 AM - Peak 1 of 1

Peak Hour for Entire Intersection Begins at 07:00 AM

City of Riverside
 N/S: Barton Street
 E/W: Orange Terrace Parkway
 Weather: Clear

File Name : 13_RIV_Barton_Orange AM
 Site Code : 05121716
 Start Date : 11/30/2021
 Page No : 2

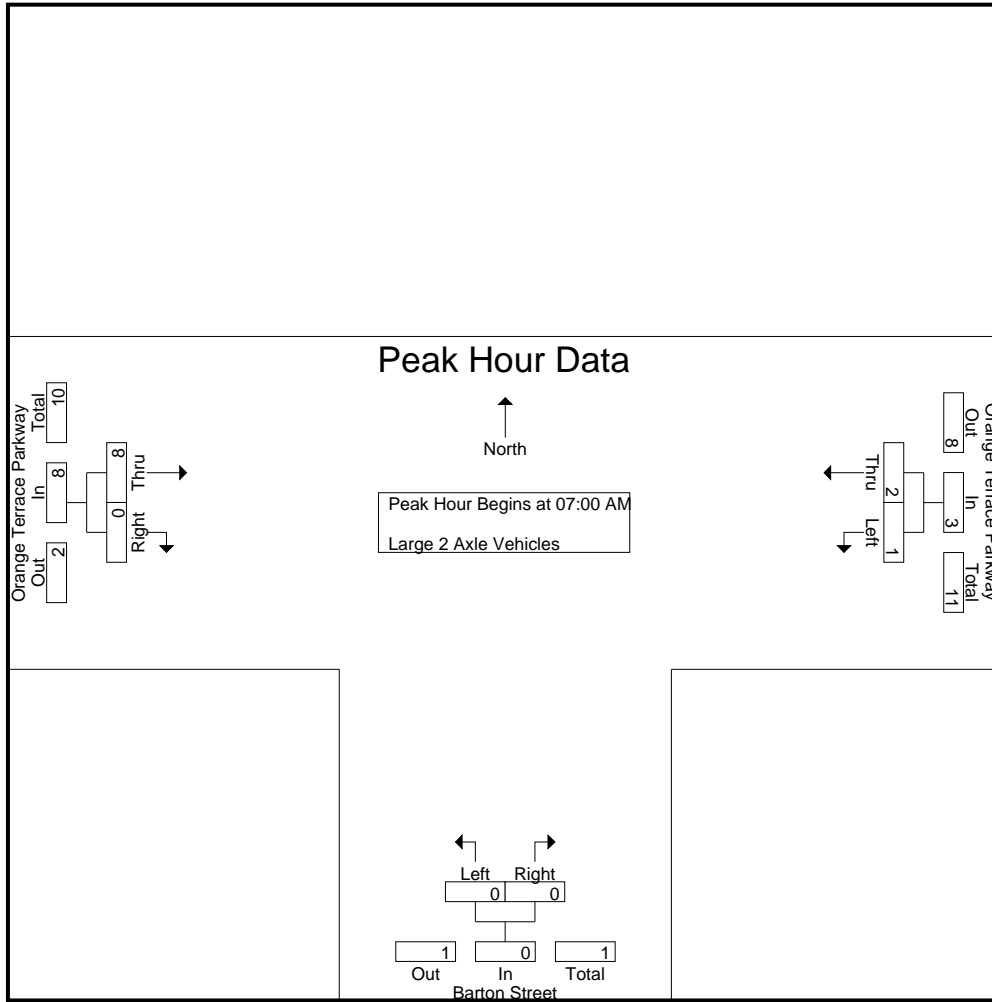

Peak Hour Analysis From 07:00 AM to 07:45 AM - Peak 1 of 1
 Peak Hour for Each Approach Begins at:

	07:00 AM			07:00 AM			07:00 AM		
+0 mins.	1	1	2	0	0	0	5	0	5
+15 mins.	0	1	1	0	0	0	2	0	2
+30 mins.	0	0	0	0	0	0	1	0	1
+45 mins.	0	0	0	0	0	0	0	0	0
Total Volume	1	2	3	0	0	0	8	0	8
% App. Total	33.3	66.7		0	0		100	0	
PHF	.250	.500	.375	.000	.000	.000	.400	.000	.400

City of Riverside
 N/S: Barton Street
 E/W: Orange Terrace Parkway
 Weather: Clear

File Name : 13_RIV_Barton_Orange AM
 Site Code : 05121716
 Start Date : 11/30/2021
 Page No : 1

Groups Printed- 3 Axle Vehicles

Start Time	Orange Terrace Parkway Westbound			Barton Street Northbound			Orange Terrace Parkway Eastbound			Int. Total
	Left	Thru	App. Total	Left	Right	App. Total	Thru	Right	App. Total	
07:00 AM	0	0	0	0	0	0	0	0	0	0
07:15 AM	0	0	0	0	0	0	0	0	0	0
07:30 AM	0	0	0	0	0	0	0	0	0	0
07:45 AM	0	0	0	0	0	0	0	0	0	0
Total	0	0	0	0	0	0	0	0	0	0
08:00 AM	0	0	0	0	0	0	0	0	0	0
08:15 AM	0	0	0	0	0	0	0	0	0	0
08:30 AM	0	0	0	0	0	0	0	0	0	0
08:45 AM	0	0	0	0	0	0	0	0	0	0
Total	0	0	0	0	0	0	0	0	0	0
Grand Total	0	0	0	0	0	0	0	0	0	0
Apprch %	0	0		0	0		0	0		
Total %										

Start Time	Orange Terrace Parkway Westbound			Barton Street Northbound			Orange Terrace Parkway Eastbound			Int. Total
	Left	Thru	App. Total	Left	Right	App. Total	Thru	Right	App. Total	
07:00 AM	0	0	0	0	0	0	0	0	0	0
07:15 AM	0	0	0	0	0	0	0	0	0	0
07:30 AM	0	0	0	0	0	0	0	0	0	0
07:45 AM	0	0	0	0	0	0	0	0	0	0
Total Volume	0	0	0	0	0	0	0	0	0	0
% App. Total	0	0		0	0		0	0		
PHF	.000	.000	.000	.000	.000	.000	.000	.000	.000	.000

Peak Hour Analysis From 07:00 AM to 07:45 AM - Peak 1 of 1
 Peak Hour for Entire Intersection Begins at 07:00 AM

City of Riverside
 N/S: Barton Street
 E/W: Orange Terrace Parkway
 Weather: Clear

File Name : 13_RIV_Barton_Orange AM
 Site Code : 05121716
 Start Date : 11/30/2021
 Page No : 2

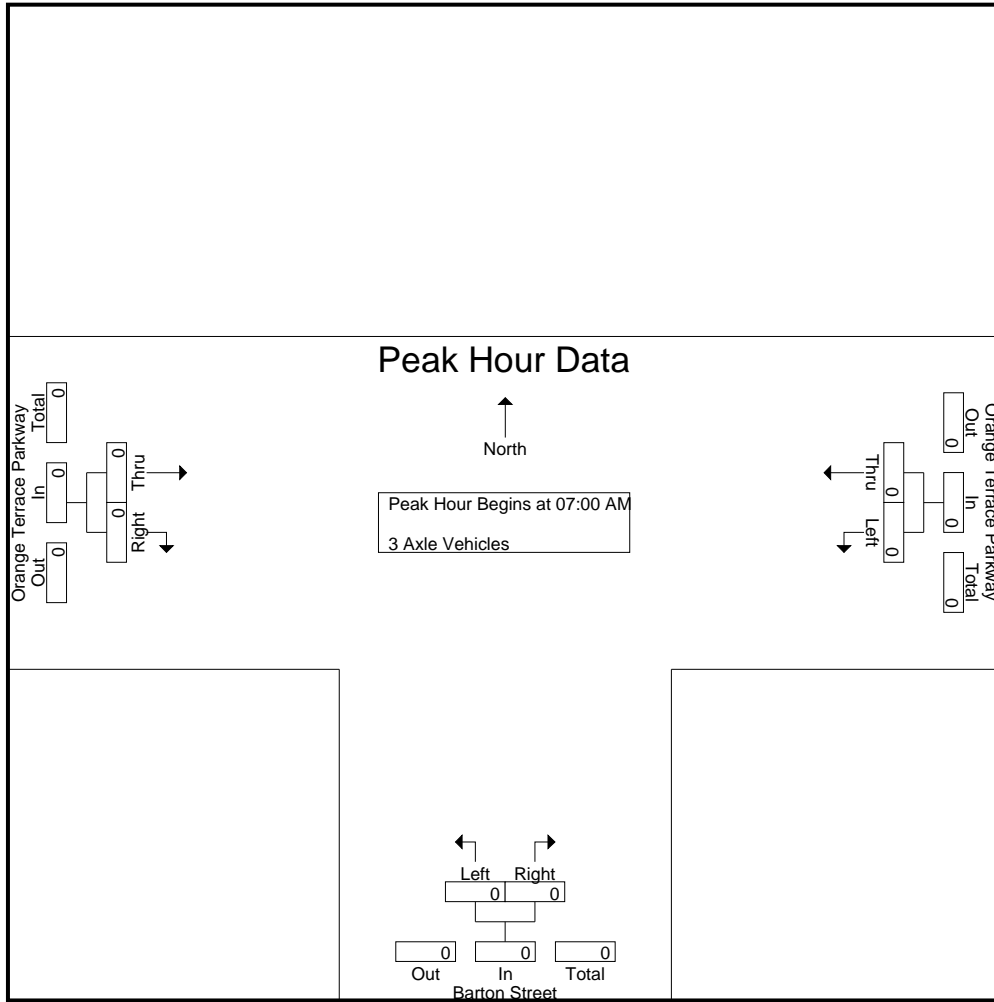

Peak Hour Analysis From 07:00 AM to 07:45 AM - Peak 1 of 1
 Peak Hour for Each Approach Begins at:

	07:00 AM			07:00 AM			07:00 AM		
+0 mins.	0	0	0	0	0	0	0	0	0
+15 mins.	0	0	0	0	0	0	0	0	0
+30 mins.	0	0	0	0	0	0	0	0	0
+45 mins.	0	0	0	0	0	0	0	0	0
Total Volume	0	0	0	0	0	0	0	0	0
% App. Total	0	0	0	0	0	0	0	0	0
PHF	.000	.000	.000	.000	.000	.000	.000	.000	.000

City of Riverside
 N/S: Barton Street
 E/W: Orange Terrace Parkway
 Weather: Clear

File Name : 13_RIV_Barton_Orange AM
 Site Code : 05121716
 Start Date : 11/30/2021
 Page No : 1

Groups Printed- 4+ Axle Trucks

Start Time	Orange Terrace Parkway Westbound			Barton Street Northbound			Orange Terrace Parkway Eastbound			Int. Total
	Left	Thru	App. Total	Left	Right	App. Total	Thru	Right	App. Total	
07:00 AM	0	0	0	0	0	0	0	0	0	0
07:15 AM	0	0	0	0	0	0	0	0	0	0
07:30 AM	0	0	0	0	0	0	0	0	0	0
07:45 AM	0	0	0	0	0	0	0	0	0	0
Total	0	0	0	0	0	0	0	0	0	0
08:00 AM	0	0	0	0	0	0	0	0	0	0
08:15 AM	0	0	0	0	0	0	0	0	0	0
08:30 AM	0	0	0	0	0	0	0	0	0	0
08:45 AM	0	0	0	0	0	0	0	0	0	0
Total	0	0	0	0	0	0	0	0	0	0
Grand Total	0	0	0	0	0	0	0	0	0	0
Apprch %	0	0		0	0		0	0		
Total %										

Start Time	Orange Terrace Parkway Westbound			Barton Street Northbound			Orange Terrace Parkway Eastbound			Int. Total
	Left	Thru	App. Total	Left	Right	App. Total	Thru	Right	App. Total	
07:00 AM	0	0	0	0	0	0	0	0	0	0
07:15 AM	0	0	0	0	0	0	0	0	0	0
07:30 AM	0	0	0	0	0	0	0	0	0	0
07:45 AM	0	0	0	0	0	0	0	0	0	0
Total Volume	0	0	0	0	0	0	0	0	0	0
% App. Total	0	0		0	0		0	0		
PHF	.000	.000	.000	.000	.000	.000	.000	.000	.000	.000

Peak Hour Analysis From 07:00 AM to 07:45 AM - Peak 1 of 1
 Peak Hour for Entire Intersection Begins at 07:00 AM

City of Riverside
 N/S: Barton Street
 E/W: Orange Terrace Parkway
 Weather: Clear

File Name : 13_RIV_Barton_Orange AM
 Site Code : 05121716
 Start Date : 11/30/2021
 Page No : 2

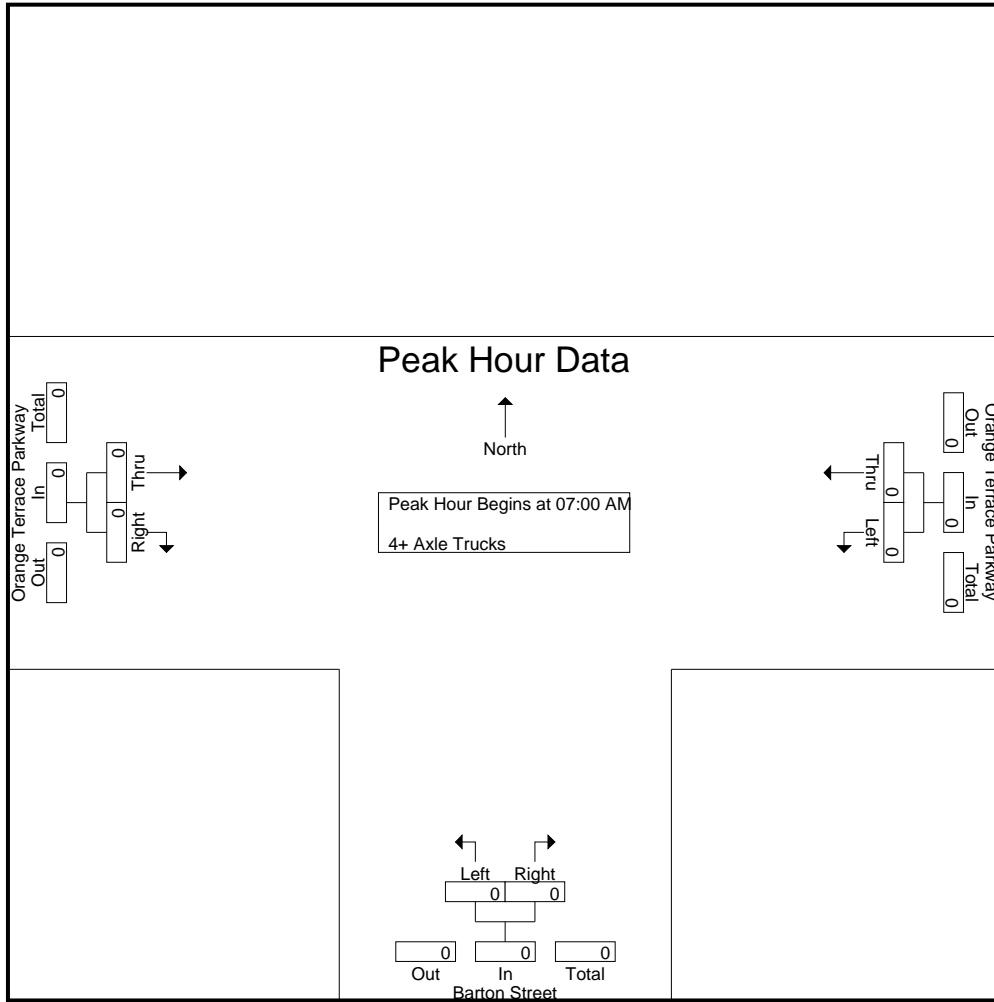

Peak Hour Analysis From 07:00 AM to 07:45 AM - Peak 1 of 1
 Peak Hour for Each Approach Begins at:

	07:00 AM			07:00 AM			07:00 AM		
+0 mins.	0	0	0	0	0	0	0	0	0
+15 mins.	0	0	0	0	0	0	0	0	0
+30 mins.	0	0	0	0	0	0	0	0	0
+45 mins.	0	0	0	0	0	0	0	0	0
Total Volume	0	0	0	0	0	0	0	0	0
% App. Total	0	0	0	0	0	0	0	0	0
PHF	.000	.000	.000	.000	.000	.000	.000	.000	.000

City of Riverside
 N/S: Barton Street
 E/W: Orange Terrace Parkway
 Weather: Clear

File Name : 13_RIV_Barton_Orange PM
 Site Code : 05121716
 Start Date : 11/30/2021
 Page No : 1

Groups Printed- Passenger Vehicles - Large 2 Axle Vehicles - 3 Axle Vehicles - 4+ Axle Trucks

Start Time	Orange Terrace Parkway Westbound			Barton Street Northbound			Orange Terrace Parkway Eastbound			Int. Total
	Left	Thru	App. Total	Left	Right	App. Total	Thru	Right	App. Total	
04:00 PM	3	53	56	7	11	18	54	11	65	139
04:15 PM	10	53	63	10	2	12	76	13	89	164
04:30 PM	4	45	49	9	9	18	71	12	83	150
04:45 PM	2	50	52	13	10	23	89	19	108	183
Total	19	201	220	39	32	71	290	55	345	636
05:00 PM	12	54	66	19	6	25	92	15	107	198
05:15 PM	7	52	59	7	11	18	89	21	110	187
05:30 PM	8	60	68	20	12	32	77	22	99	199
05:45 PM	11	48	59	17	8	25	89	17	106	190
Total	38	214	252	63	37	100	347	75	422	774
Grand Total	57	415	472	102	69	171	637	130	767	1410
Apprch %	12.1	87.9		59.6	40.4		83.1	16.9		
Total %	4	29.4	33.5	7.2	4.9	12.1	45.2	9.2	54.4	
Passenger Vehicles	57	412	469	102	69	171	632	129	761	1401
% Passenger Vehicles	100	99.3	99.4	100	100	100	99.2	99.2	99.2	99.4
Large 2 Axle Vehicles	0	3	3	0	0	0	5	1	6	9
% Large 2 Axle Vehicles	0	0.7	0.6	0	0	0	0.8	0.8	0.8	0.6
3 Axle Vehicles	0	0	0	0	0	0	0	0	0	0
% 3 Axle Vehicles	0	0	0	0	0	0	0	0	0	0
4+ Axle Trucks	0	0	0	0	0	0	0	0	0	0
% 4+ Axle Trucks	0	0	0	0	0	0	0	0	0	0

Start Time	Orange Terrace Parkway Westbound			Barton Street Northbound			Orange Terrace Parkway Eastbound			Int. Total
	Left	Thru	App. Total	Left	Right	App. Total	Thru	Right	App. Total	
Peak Hour Analysis From 04:00 PM to 05:45 PM - Peak 1 of 1										
Peak Hour for Entire Intersection Begins at 05:00 PM										
05:00 PM	12	54	66	19	6	25	92	15	107	198
05:15 PM	7	52	59	7	11	18	89	21	110	187
05:30 PM	8	60	68	20	12	32	77	22	99	199
05:45 PM	11	48	59	17	8	25	89	17	106	190
Total Volume	38	214	252	63	37	100	347	75	422	774
% App. Total	15.1	84.9		63	37		82.2	17.8		
PHF	.792	.892	.926	.788	.771	.781	.943	.852	.959	.972

City of Riverside
 N/S: Barton Street
 E/W: Orange Terrace Parkway
 Weather: Clear

File Name : 13_RIV_Barton_Orange PM
 Site Code : 05121716
 Start Date : 11/30/2021
 Page No : 2

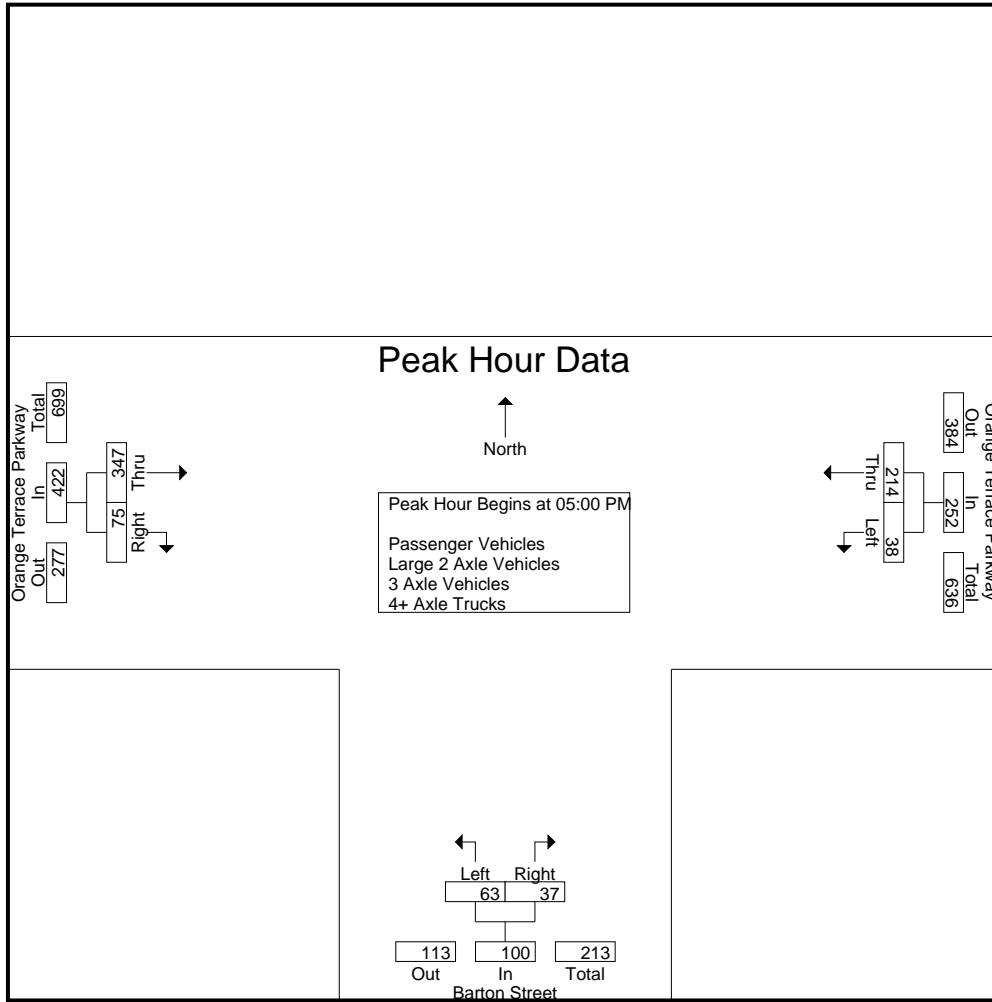

Peak Hour Analysis From 04:00 PM to 05:45 PM - Peak 1 of 1
 Peak Hour for Each Approach Begins at:

	05:00 PM			05:00 PM			04:45 PM		
+0 mins.	12	54	66	19	6	25	89	19	108
+15 mins.	7	52	59	7	11	18	92	15	107
+30 mins.	8	60	68	20	12	32	89	21	110
+45 mins.	11	48	59	17	8	25	77	22	99
Total Volume	38	214	252	63	37	100	347	77	424
% App. Total	15.1	84.9		63	37		81.8	18.2	
PHF	.792	.892	.926	.788	.771	.781	.943	.875	.964

City of Riverside
 N/S: Barton Street
 E/W: Orange Terrace Parkway
 Weather: Clear

File Name : 13_RIV_Barton_Orange PM
 Site Code : 05121716
 Start Date : 11/30/2021
 Page No : 1

Groups Printed- Passenger Vehicles

Start Time	Orange Terrace Parkway Westbound			Barton Street Northbound			Orange Terrace Parkway Eastbound			Int. Total
	Left	Thru	App. Total	Left	Right	App. Total	Thru	Right	App. Total	
04:00 PM	3	53	56	7	11	18	54	11	65	139
04:15 PM	10	51	61	10	2	12	75	13	88	161
04:30 PM	4	45	49	9	9	18	70	12	82	149
04:45 PM	2	50	52	13	10	23	89	19	108	183
Total	19	199	218	39	32	71	288	55	343	632
05:00 PM	12	54	66	19	6	25	92	15	107	198
05:15 PM	7	51	58	7	11	18	87	21	108	184
05:30 PM	8	60	68	20	12	32	77	22	99	199
05:45 PM	11	48	59	17	8	25	88	16	104	188
Total	38	213	251	63	37	100	344	74	418	769
Grand Total	57	412	469	102	69	171	632	129	761	1401
Apprch %	12.2	87.8		59.6	40.4		83	17		
Total %	4.1	29.4	33.5	7.3	4.9	12.2	45.1	9.2	54.3	

Start Time	Orange Terrace Parkway Westbound			Barton Street Northbound			Orange Terrace Parkway Eastbound			Int. Total
	Left	Thru	App. Total	Left	Right	App. Total	Thru	Right	App. Total	
05:00 PM	12	54	66	19	6	25	92	15	107	198
05:15 PM	7	51	58	7	11	18	87	21	108	184
05:30 PM	8	60	68	20	12	32	77	22	99	199
05:45 PM	11	48	59	17	8	25	88	16	104	188
Total Volume	38	213	251	63	37	100	344	74	418	769
% App. Total	15.1	84.9		63	37		82.3	17.7		
PHF	.792	.888	.923	.788	.771	.781	.935	.841	.968	.966

Peak Hour Analysis From 05:00 PM to 05:45 PM - Peak 1 of 1
 Peak Hour for Entire Intersection Begins at 05:00 PM

City of Riverside
 N/S: Barton Street
 E/W: Orange Terrace Parkway
 Weather: Clear

File Name : 13_RIV_Barton_Orange PM
 Site Code : 05121716
 Start Date : 11/30/2021
 Page No : 2

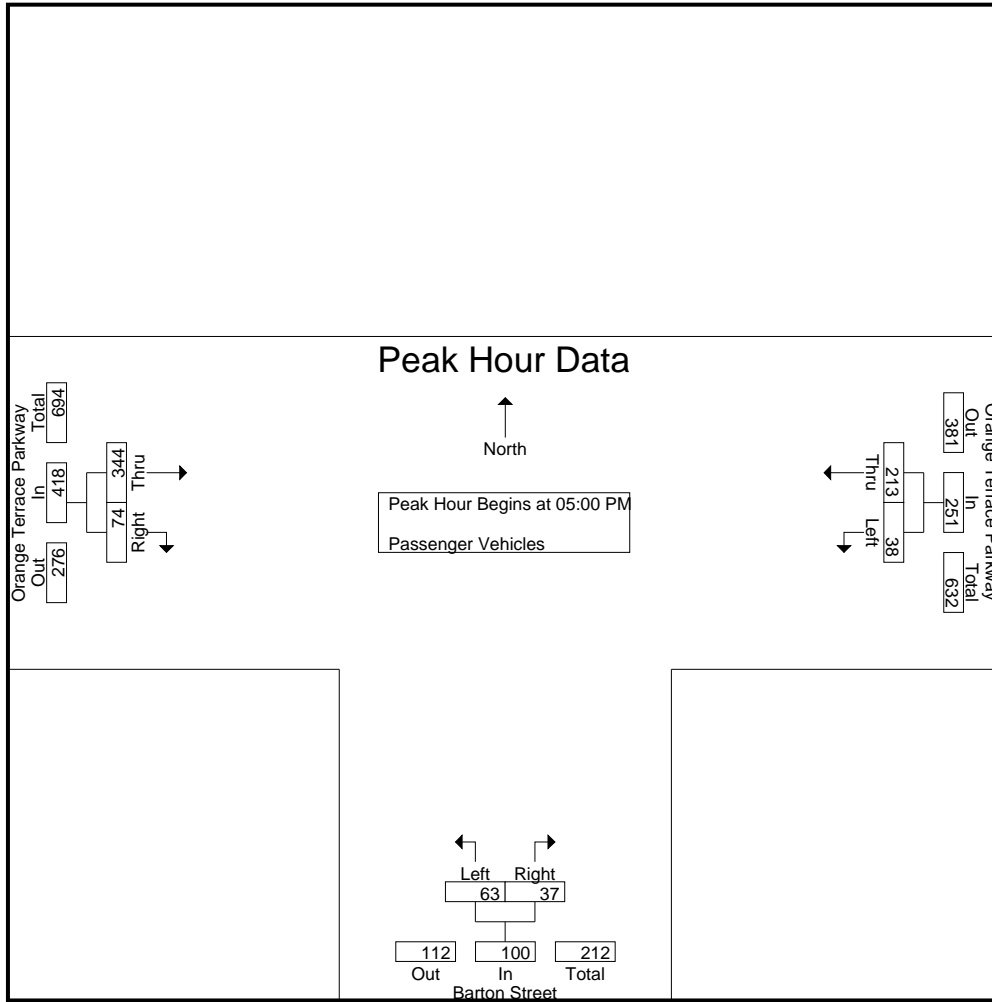

Peak Hour Analysis From 05:00 PM to 05:45 PM - Peak 1 of 1
 Peak Hour for Each Approach Begins at:

	05:00 PM			05:00 PM			05:00 PM		
+0 mins.	12	54	66	19	6	25	92	15	107
+15 mins.	7	51	58	7	11	18	87	21	108
+30 mins.	8	60	68	20	12	32	77	22	99
+45 mins.	11	48	59	17	8	25	88	16	104
Total Volume	38	213	251	63	37	100	344	74	418
% App. Total	15.1	84.9		63	37		82.3	17.7	
PHF	.792	.888	.923	.788	.771	.781	.935	.841	.968

City of Riverside
 N/S: Barton Street
 E/W: Orange Terrace Parkway
 Weather: Clear

File Name : 13_RIV_Barton_Orange PM
 Site Code : 05121716
 Start Date : 11/30/2021
 Page No : 1

Groups Printed- Large 2 Axle Vehicles

Start Time	Orange Terrace Parkway Westbound			Barton Street Northbound			Orange Terrace Parkway Eastbound			Int. Total
	Left	Thru	App. Total	Left	Right	App. Total	Thru	Right	App. Total	
04:00 PM	0	0	0	0	0	0	0	0	0	0
04:15 PM	0	2	2	0	0	0	1	0	1	3
04:30 PM	0	0	0	0	0	0	1	0	1	1
04:45 PM	0	0	0	0	0	0	0	0	0	0
Total	0	2	2	0	0	0	2	0	2	4
05:00 PM	0	0	0	0	0	0	0	0	0	0
05:15 PM	0	1	1	0	0	0	2	0	2	3
05:30 PM	0	0	0	0	0	0	0	0	0	0
05:45 PM	0	0	0	0	0	0	1	1	2	2
Total	0	1	1	0	0	0	3	1	4	5
Grand Total	0	3	3	0	0	0	5	1	6	9
Apprch %	0	100		0	0		83.3	16.7		
Total %	0	33.3	33.3	0	0	0	55.6	11.1	66.7	

Start Time	Orange Terrace Parkway Westbound			Barton Street Northbound			Orange Terrace Parkway Eastbound			Int. Total
	Left	Thru	App. Total	Left	Right	App. Total	Thru	Right	App. Total	
05:00 PM	0	0	0	0	0	0	0	0	0	0
05:15 PM	0	1	1	0	0	0	2	0	2	3
05:30 PM	0	0	0	0	0	0	0	0	0	0
05:45 PM	0	0	0	0	0	0	1	1	2	2
Total Volume	0	1	1	0	0	0	3	1	4	5
% App. Total	0	100		0	0		75	25		
PHF	.000	.250	.250	.000	.000	.000	.375	.250	.500	.417

Peak Hour Analysis From 05:00 PM to 05:45 PM - Peak 1 of 1
 Peak Hour for Entire Intersection Begins at 05:00 PM

City of Riverside
 N/S: Barton Street
 E/W: Orange Terrace Parkway
 Weather: Clear

File Name : 13_RIV_Barton_Orange PM
 Site Code : 05121716
 Start Date : 11/30/2021
 Page No : 2

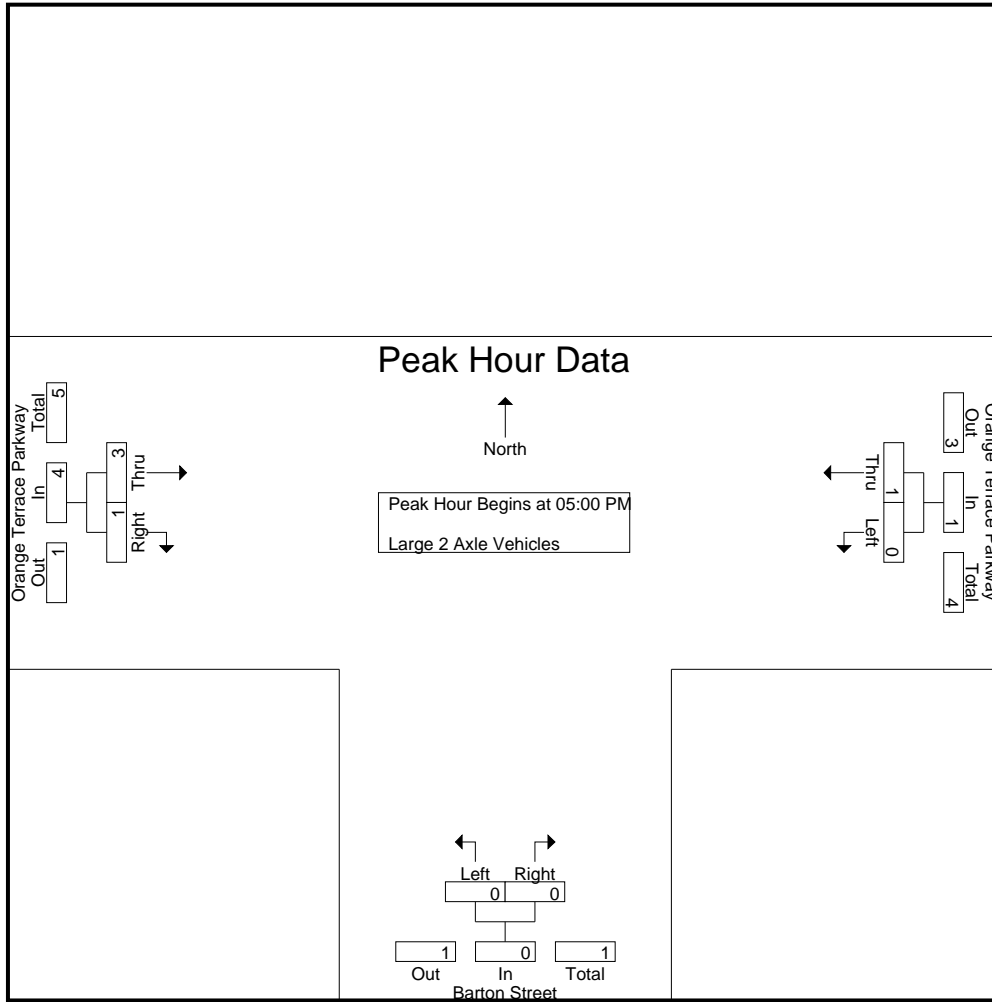

Peak Hour Analysis From 05:00 PM to 05:45 PM - Peak 1 of 1
 Peak Hour for Each Approach Begins at:

	05:00 PM			05:00 PM			05:00 PM		
+0 mins.	0	0	0	0	0	0	0	0	0
+15 mins.	0	1	1	0	0	0	2	0	2
+30 mins.	0	0	0	0	0	0	0	0	0
+45 mins.	0	0	0	0	0	0	1	1	2
Total Volume	0	1	1	0	0	0	3	1	4
% App. Total	0	100		0	0		75	25	
PHF	.000	.250	.250	.000	.000	.000	.375	.250	.500

City of Riverside
 N/S: Barton Street
 E/W: Orange Terrace Parkway
 Weather: Clear

File Name : 13_RIV_Barton_Orange PM
 Site Code : 05121716
 Start Date : 11/30/2021
 Page No : 1

Groups Printed- 3 Axle Vehicles

Start Time	Orange Terrace Parkway Westbound			Barton Street Northbound			Orange Terrace Parkway Eastbound			Int. Total
	Left	Thru	App. Total	Left	Right	App. Total	Thru	Right	App. Total	
04:00 PM	0	0	0	0	0	0	0	0	0	0
04:15 PM	0	0	0	0	0	0	0	0	0	0
04:30 PM	0	0	0	0	0	0	0	0	0	0
04:45 PM	0	0	0	0	0	0	0	0	0	0
Total	0	0	0	0	0	0	0	0	0	0
05:00 PM	0	0	0	0	0	0	0	0	0	0
05:15 PM	0	0	0	0	0	0	0	0	0	0
05:30 PM	0	0	0	0	0	0	0	0	0	0
05:45 PM	0	0	0	0	0	0	0	0	0	0
Total	0	0	0	0	0	0	0	0	0	0
Grand Total	0	0	0	0	0	0	0	0	0	0
Apprch %	0	0		0	0		0	0		
Total %										

Start Time	Orange Terrace Parkway Westbound			Barton Street Northbound			Orange Terrace Parkway Eastbound			Int. Total
	Left	Thru	App. Total	Left	Right	App. Total	Thru	Right	App. Total	
05:00 PM	0	0	0	0	0	0	0	0	0	0
05:15 PM	0	0	0	0	0	0	0	0	0	0
05:30 PM	0	0	0	0	0	0	0	0	0	0
05:45 PM	0	0	0	0	0	0	0	0	0	0
Total Volume	0	0	0	0	0	0	0	0	0	0
% App. Total	0	0		0	0		0	0		
PHF	.000	.000	.000	.000	.000	.000	.000	.000	.000	.000

Peak Hour Analysis From 05:00 PM to 05:45 PM - Peak 1 of 1
 Peak Hour for Entire Intersection Begins at 05:00 PM

City of Riverside
 N/S: Barton Street
 E/W: Orange Terrace Parkway
 Weather: Clear

File Name : 13_RIV_Barton_Orange PM
 Site Code : 05121716
 Start Date : 11/30/2021
 Page No : 2

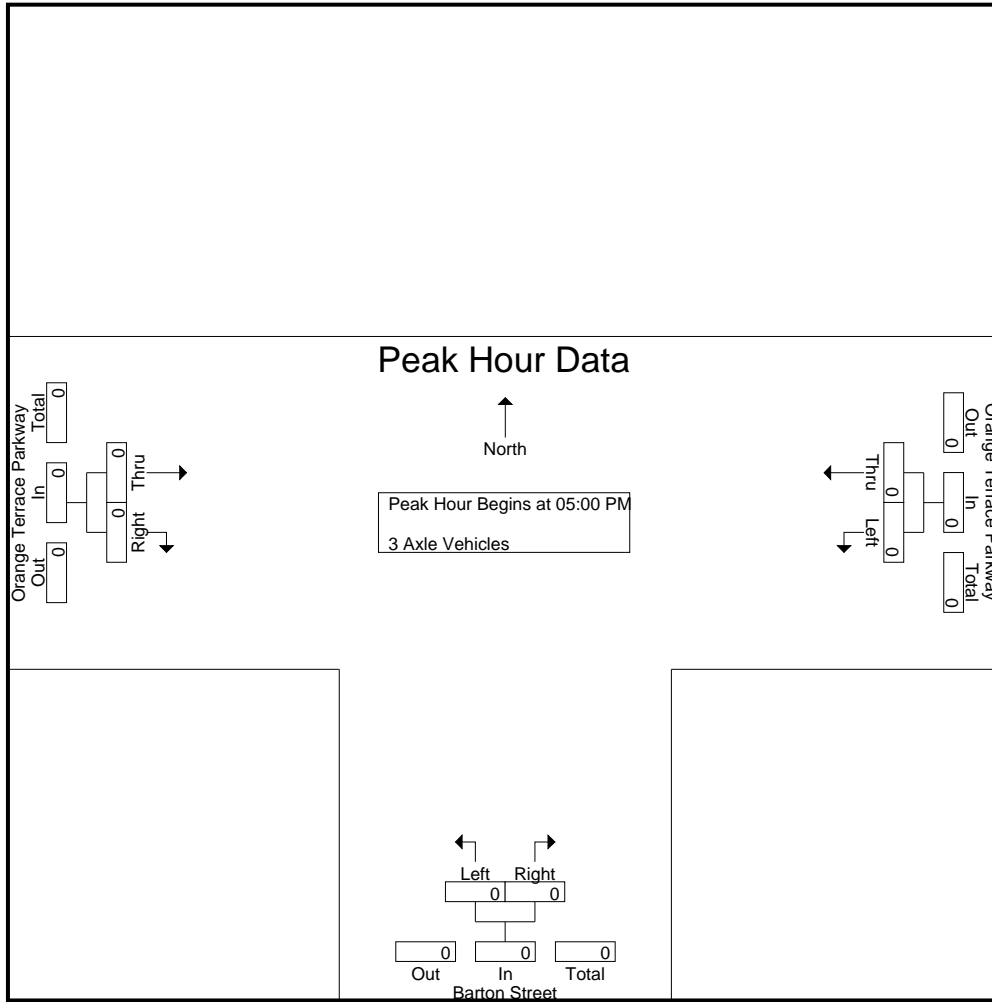

Peak Hour Analysis From 05:00 PM to 05:45 PM - Peak 1 of 1
 Peak Hour for Each Approach Begins at:

	05:00 PM			05:00 PM			05:00 PM		
+0 mins.	0	0	0	0	0	0	0	0	0
+15 mins.	0	0	0	0	0	0	0	0	0
+30 mins.	0	0	0	0	0	0	0	0	0
+45 mins.	0	0	0	0	0	0	0	0	0
Total Volume	0	0	0	0	0	0	0	0	0
% App. Total	0	0	0	0	0	0	0	0	0
PHF	.000	.000	.000	.000	.000	.000	.000	.000	.000

City of Riverside
 N/S: Barton Street
 E/W: Orange Terrace Parkway
 Weather: Clear

File Name : 13_RIV_Barton_Orange PM
 Site Code : 05121716
 Start Date : 11/30/2021
 Page No : 1

Groups Printed- 4+ Axle Trucks

Start Time	Orange Terrace Parkway Westbound			Barton Street Northbound			Orange Terrace Parkway Eastbound			Int. Total
	Left	Thru	App. Total	Left	Right	App. Total	Thru	Right	App. Total	
04:00 PM	0	0	0	0	0	0	0	0	0	0
04:15 PM	0	0	0	0	0	0	0	0	0	0
04:30 PM	0	0	0	0	0	0	0	0	0	0
04:45 PM	0	0	0	0	0	0	0	0	0	0
Total	0	0	0	0	0	0	0	0	0	0
05:00 PM	0	0	0	0	0	0	0	0	0	0
05:15 PM	0	0	0	0	0	0	0	0	0	0
05:30 PM	0	0	0	0	0	0	0	0	0	0
05:45 PM	0	0	0	0	0	0	0	0	0	0
Total	0	0	0	0	0	0	0	0	0	0
Grand Total	0	0	0	0	0	0	0	0	0	0
Apprch %	0	0		0	0		0	0		
Total %										

Start Time	Orange Terrace Parkway Westbound			Barton Street Northbound			Orange Terrace Parkway Eastbound			Int. Total
	Left	Thru	App. Total	Left	Right	App. Total	Thru	Right	App. Total	
05:00 PM	0	0	0	0	0	0	0	0	0	0
05:15 PM	0	0	0	0	0	0	0	0	0	0
05:30 PM	0	0	0	0	0	0	0	0	0	0
05:45 PM	0	0	0	0	0	0	0	0	0	0
Total Volume	0	0	0	0	0	0	0	0	0	0
% App. Total	0	0		0	0		0	0		
PHF	.000	.000	.000	.000	.000	.000	.000	.000	.000	.000

Peak Hour Analysis From 05:00 PM to 05:45 PM - Peak 1 of 1
 Peak Hour for Entire Intersection Begins at 05:00 PM

City of Riverside
 N/S: Barton Street
 E/W: Orange Terrace Parkway
 Weather: Clear

File Name : 13_RIV_Barton_Orange PM
 Site Code : 05121716
 Start Date : 11/30/2021
 Page No : 2

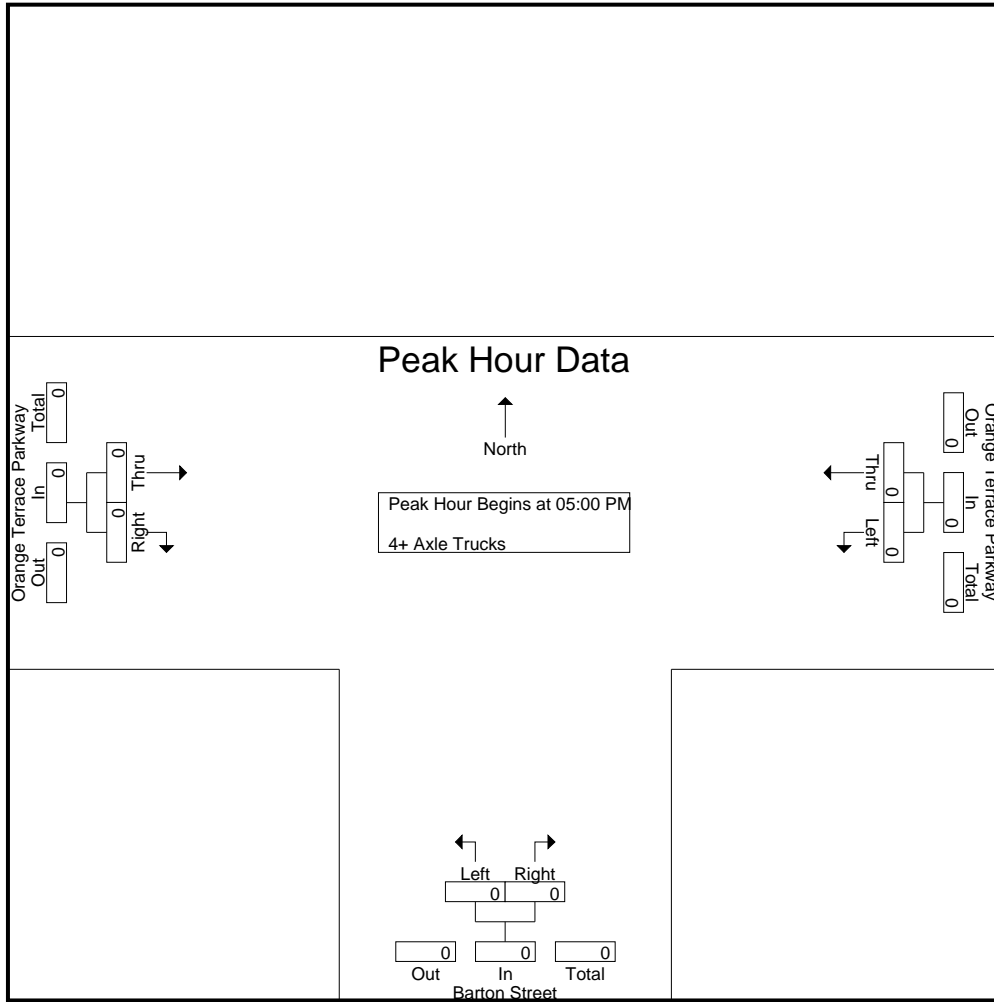

Peak Hour Analysis From 05:00 PM to 05:45 PM - Peak 1 of 1
 Peak Hour for Each Approach Begins at:

	05:00 PM			05:00 PM			05:00 PM		
+0 mins.	0	0	0	0	0	0	0	0	0
+15 mins.	0	0	0	0	0	0	0	0	0
+30 mins.	0	0	0	0	0	0	0	0	0
+45 mins.	0	0	0	0	0	0	0	0	0
Total Volume	0	0	0	0	0	0	0	0	0
% App. Total	0	0	0	0	0	0	0	0	0
PHF	.000	.000	.000	.000	.000	.000	.000	.000	.000

Location: Riverside
 N/S: Barton Street
 E/W: Orange Terrace Parkway



Date: 11/30/2021
 Day: Tuesday

PEDESTRIANS

	North Leg Dead End	East Leg Orange Terrace Parkway	South Leg Barton Street	West Leg Orange Terrace Parkway	
	Pedestrians	Pedestrians	Pedestrians	Pedestrians	
7:00 AM	0	0	0	0	0
7:15 AM	0	0	0	0	0
7:30 AM	0	0	0	0	0
7:45 AM	0	0	0	0	0
8:00 AM	0	0	0	0	0
8:15 AM	0	0	1	0	1
8:30 AM	0	0	1	0	1
8:45 AM	0	0	2	0	2
TOTAL VOLUMES:	0	0	4	0	4

	North Leg Dead End	East Leg Orange Terrace Parkway	South Leg Barton Street	West Leg Orange Terrace Parkway	
	Pedestrians	Pedestrians	Pedestrians	Pedestrians	
4:00 PM	0	0	0	0	0
4:15 PM	0	0	2	0	2
4:30 PM	0	0	2	0	2
4:45 PM	0	0	0	0	0
5:00 PM	0	0	0	0	0
5:15 PM	0	1	2	1	4
5:30 PM	0	0	0	0	0
5:45 PM	0	0	0	0	0
TOTAL VOLUMES:	0	1	6	1	8

Location: Riverside
 N/S: Barton Street
 E/W: Orange Terrace Parkway



Date: 11/30/2021
 Day: Tuesday

BICYCLES

	Southbound Dead End			Westbound Orange Terrace Parkway			Northbound Barton Street			Eastbound Orange Terrace Parkway			
	Left	Thru	Right	Left	Thru	Right	Left	Thru	Right	Left	Thru	Right	
7:00 AM	0	0	0	0	0	0	0	0	0	0	0	0	0
7:15 AM	0	0	0	0	0	0	0	0	0	0	1	0	1
7:30 AM	0	0	0	0	0	0	0	0	0	0	0	0	0
7:45 AM	0	0	0	0	0	0	0	0	0	0	0	1	1
8:00 AM	0	0	0	0	0	0	0	0	0	0	0	0	0
8:15 AM	0	0	0	0	0	0	0	0	0	0	0	0	0
8:30 AM	0	0	0	0	0	0	0	0	0	0	0	0	0
8:45 AM	0	0	0	0	0	0	0	0	0	0	0	0	0
TOTAL VOLUMES:	0	0	0	0	0	0	0	0	0	0	1	1	2

	Southbound Dead End			Westbound Orange Terrace Parkway			Northbound Barton Street			Eastbound Orange Terrace Parkway			
	Left	Thru	Right	Left	Thru	Right	Left	Thru	Right	Left	Thru	Right	
4:00 PM	0	0	0	0	0	0	0	0	0	0	0	0	0
4:15 PM	0	0	0	0	0	0	0	0	0	0	0	0	0
4:30 PM	0	0	0	0	1	0	1	0	0	0	0	0	2
4:45 PM	0	0	0	0	0	0	0	0	0	0	1	0	1
5:00 PM	0	0	0	0	2	0	0	0	0	0	2	0	4
5:15 PM	0	0	0	0	0	0	0	0	0	0	0	0	0
5:30 PM	0	0	0	0	0	0	0	0	0	0	0	0	0
5:45 PM	0	0	0	0	0	0	0	0	0	0	0	0	0
TOTAL VOLUMES:	0	0	0	0	3	0	1	0	0	0	3	0	7

Groups Printed- Passenger Vehicles - Large 2 Axle Vehicles - 3 Axle Vehicles - 4+ Axle Trucks

Start Time	Barton Street Southbound						Van Buren Boulevard Westbound						Barton Street Northbound						Van Buren Boulevard Eastbound						
	Left		Thru		Right		Left		Thru		Right		Left		Thru		Right		Left		Thru		Right		
	App. Total	RTOR	App. Total	RTOR	App. Total	RTOR	App. Total	RTOR	App. Total	RTOR	App. Total	RTOR	App. Total	RTOR	App. Total	RTOR	App. Total	RTOR	App. Total	RTOR	App. Total	RTOR	App. Total	RTOR	
07:00 AM	15	15	86	33	116	3	295	52	43	153	3	209	13	3	36	160	13	3	36	160	13	3	209	13	
07:15 AM	13	38	76	31	127	8	383	19	57	153	2	307	27	2	42	238	27	2	42	238	27	2	307	27	
07:30 AM	6	22	55	27	83	2	296	10	100	174	0	252	20	3	15	217	20	3	15	217	20	3	252	20	
07:45 AM	5	6	21	15	32	3	315	14	86	183	0	310	29	3	22	259	29	3	22	259	29	3	310	29	
Total	39	81	238	106	358	21	1289	62	295	663	5	1078	89	11	115	874	89	11	115	874	89	11	1078	89	
08:00 AM	4	11	21	7	36	3	335	16	64	139	2	249	29	2	7	213	29	2	7	213	29	2	249	29	
08:15 AM	4	6	15	10	25	4	296	11	41	122	0	210	23	1	11	176	23	1	11	176	23	1	210	23	
08:30 AM	6	2	15	14	23	3	245	6	53	127	0	212	28	7	11	173	28	7	11	173	28	7	212	28	
08:45 AM	3	5	19	16	27	11	257	8	37	113	4	173	23	4	7	143	23	4	7	143	23	4	173	23	
Total	17	24	70	47	111	21	1133	265	41	501	6	844	103	14	36	705	103	14	36	705	103	14	844	103	
Grand Total	56	105	308	153	469	42	2422	571	103	1164	11	1922	25	25	151	1579	192	25	25	151	1579	192	25	1922	25
T-Approach %	11.9	22.4	65.7			1.7		49.1	8.8	42.1				7.9	82.2	10			7.9	82.2	10				
O Total %	0.9	1.8	5.2		7.8	0.7	40.5	9.6	1.7	8.2		19.5		2.5	26.4	3.2			2.5	26.4	3.2		7.7	92.3	
% Passenger Vehicles	56	103	308		620	38	2356	555	101	1444		1444		150	1514	187			150	1514	187		0	0	
% Large 2 Axle Vehicles	100	98.1	100	100	99.7	97.6	96.8	97.2	98.1	98.6	98.7	98	96.4	100	99.3	95.9	97.4	100	99.3	95.9	97.4	100	96.4	0	
% 3 Axle Vehicles	0	2	0	0	2	4	59	14	2	6	25	56	0	1	1	50	5	0	1	50	5	0	0	142	
% 4+ Axle Trucks	0	1.9	0	0	0.3	1.9	2.4	2.5	1.9	1.2	1.7	2.9	0	0.7	0.7	3.2	2.6	0	0.7	3.2	2.6	0	0	2.2	
	0	0	0	0	0	0	8	2	0	1	4	7	0	0	0	7	0	0	0	7	0	0	0	19	
	0	0	0	0	0	0.3	0.3	0.4	0	0.2	0.3	0.3	0.4	0	0	0.4	0	0	0	0.4	0	0	0	0.3	
	0	0	0	0	0	1	9	0	0	0	0	8	0	0	0	8	0	0	0	8	0	0	0	18	
	0	0	0	0	0	0.3	0.4	0	0	0	0	0.5	0	0	0	0.5	0	0	0	0.5	0	0	0	0.3	

Start Time	Barton Street Southbound						Van Buren Boulevard Westbound						Barton Street Northbound						Van Buren Boulevard Eastbound					
	Left		Thru		Right		Left		Thru		Right		Left		Thru		Right		Left		Thru		Right	
	App. Total	RTOR	App. Total	RTOR	App. Total	RTOR	App. Total	RTOR	App. Total	RTOR	App. Total	RTOR	App. Total	RTOR	App. Total	RTOR	App. Total	RTOR	App. Total	RTOR	App. Total	RTOR	App. Total	RTOR
07:00 AM	15	15	86	33	116	3	295	52	43	153	3	209	13	3	36	160	13	3	36	160	13	3	209	13
07:15 AM	13	38	76	31	127	8	383	19	57	153	2	307	27	2	42	238	27	2	42	238	27	2	307	27
07:30 AM	6	22	55	27	83	2	296	10	100	174	0	252	20	3	15	217	20	3	15	217	20	3	252	20
07:45 AM	5	6	21	15	32	3	315	14	86	183	0	310	29	3	22	259	29	3	22	259	29	3	310	29
Total	39	81	238	106	358	21	1289	62	295	663	5	1078	89	11	115	874	89	11	115	874	89	11	1078	89
Total Volume	39	81	238	106	358	21	1289	62	295	663	5	1078	89	11	115	874	89	11	115	874	89	11	1078	89
% App. Total	10.9	22.6	66.5			1.6		46.2	9.4	44.5				10.7	81.1	8.3			10.7	81.1	8.3			
PHF	.650	.533	.692		.705	.823	.831	.656	.841	.922	.816	.738	.906	.685	.844	.767			.685	.844	.767		.869	.873

Peak Hour Analysis From 07:00 AM to 08:45 AM - Peak 1 of 1
 Peak Hour for Entire Intersection Begins at 07:00 AM

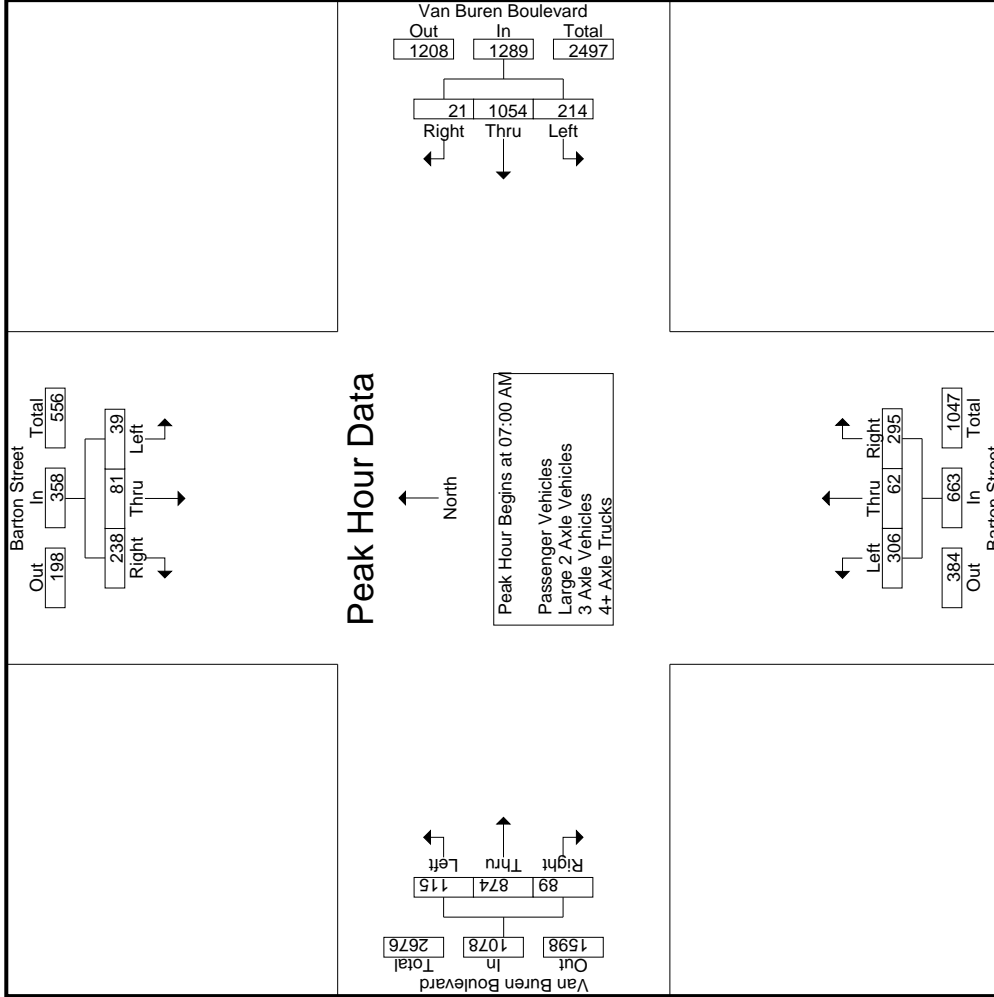

Counts Unlimited, Inc.
 PO Box 1178
 Corona, CA 92878
 (951)268-6268

City of Riverside
 N/S: Barton Street
 E/W: Van Buren Boulevard
 Weather: Clear

File Name : 14_RIV_Barton_VB AM
 Site Code : 05121716
 Start Date : 11/30/2021
 Page No : 3

Start Time	Barton Street Southbound			Van Buren Boulevard Westbound			Barton Street Northbound			Van Buren Boulevard Eastbound			Int. Total	
	Left	Thru	Right	Left	Thru	Right	Left	Thru	Right	Left	Thru	Right		App. Total
Peak Hour Analysis From 07:00 AM to 08:45 AM - Peak 1 of 1	07:00 AM													
Peak Hour for Each Approach Begins at:	07:15 AM													
+0 mins.	15	15	86	58	317	8	383	82	19	52	153	238	27	307
+15 mins.	13	38	76	65	229	2	296	77	19	57	153	217	20	252
+30 mins.	6	22	55	58	254	3	315	64	10	100	174	259	29	310
+45 mins.	5	6	21	62	270	3	335	83	14	86	183	213	29	249
Total Volume	39	81	238	243	1070	16	1329	306	62	295	663	927	105	1118
% App. Total	10.9	22.6	66.5	18.3	80.5	1.2	46.2	46.2	9.4	44.5	7.7	82.9	9.4	
PHF	.650	.533	.692	.935	.844	.500	.867	.922	.816	.738	.906	.895	.905	.902

Groups Printed- Passenger Vehicles

Start Time	Barton Street Southbound					Van Buren Boulevard Westbound					Barton Street Northbound					Van Buren Boulevard Eastbound							
	Left	Thru	Right	RTOR	App. Total	Left	Thru	Right	RTOR	App. Total	Left	Thru	Right	RTOR	App. Total	Left	Thru	Right	RTOR	App. Total	Exclu. Total	Inclu. Total	Int. Total
07:00 AM	15	15	86	33	116	32	245	5	3	282	79	19	52	43	150	36	156	13	3	205	82	753	835
07:15 AM	13	36	76	31	125	57	309	8	2	374	72	18	56	42	146	42	230	26	2	298	77	943	1020
07:30 AM	6	22	55	27	83	64	219	2	0	285	62	10	99	55	171	15	210	19	3	244	85	783	868
07:45 AM	5	6	21	15	32	55	249	3	0	307	83	14	85	46	182	22	253	27	3	302	64	823	887
Total	39	79	238	106	356	208	1022	18	5	1248	296	61	292	186	649	115	849	85	11	1049	308	3302	3610
08:00 AM	4	11	21	7	36	61	261	3	2	325	57	16	63	36	136	7	203	28	2	238	47	735	782
08:15 AM	4	6	15	10	25	46	234	4	0	284	69	10	41	23	120	10	165	23	1	198	34	627	661
08:30 AM	6	2	15	14	23	30	205	3	0	238	67	6	52	38	125	11	161	28	7	200	59	586	645
08:45 AM	3	5	19	16	27	15	225	10	4	250	66	8	35	22	109	7	136	23	4	166	46	552	598
Total	17	24	70	47	111	152	925	20	6	1097	259	40	191	119	490	35	665	102	14	802	186	2500	2686
Grand Total	56	103	308	153	467	360	1947	38	11	2345	555	101	483	305	1139	150	1514	187	25	1851	494	5802	6296
T-Approach %	12	22.1	66			15.4	83	1.6		48.7	8.9	42.4		19.6	8.1	81.8	10.1						
D-Total %	1	1.8	5.3		8	6.2	33.6	0.7		9.6	1.7	8.3			2.6	26.1	3.2		31.9	7.8	92.2		

Start Time	Barton Street Southbound					Van Buren Boulevard Westbound					Barton Street Northbound					Van Buren Boulevard Eastbound							
	Left	Thru	Right	RTOR	App. Total	Left	Thru	Right	RTOR	App. Total	Left	Thru	Right	RTOR	App. Total	Left	Thru	Right	RTOR	App. Total	Exclu. Total	Inclu. Total	Int. Total
07:00 AM	15	15	86	33	116	32	245	5	3	282	79	19	52	43	150	36	156	13	3	205	82	753	835
07:15 AM	13	36	76	31	125	57	309	8	2	374	72	18	56	42	146	42	230	26	2	298	77	943	1020
07:30 AM	6	22	55	27	83	64	219	2	0	285	62	10	99	55	171	15	210	19	3	244	85	783	868
07:45 AM	5	6	21	15	32	55	249	3	0	307	83	14	85	46	182	22	253	27	3	302	64	823	887
Total	39	79	238	106	356	208	1022	18	5	1248	296	61	292	186	649	115	849	85	11	1049	308	3302	3610
PHF	.650	.549	.692		.712	.813	.827	.563		.834	.892	.803	.737		.891	.685	.839	.787		.868			.875

Peak Hour Analysis From 07:00 AM to 07:45 AM - Peak 1 of 1
 Peak Hour for Entire Intersection Begins at 07:00 AM

Counts Unlimited, Inc.
 PO Box 1178
 Corona, CA 92878
 (951)268-6268

City of Riverside
 N/S: Barton Street
 E/W: Van Buren Boulevard
 Weather: Clear

File Name : 14_RIV_Barton_VB AM
 Site Code : 05121716
 Start Date : 11/30/2021
 Page No : 2

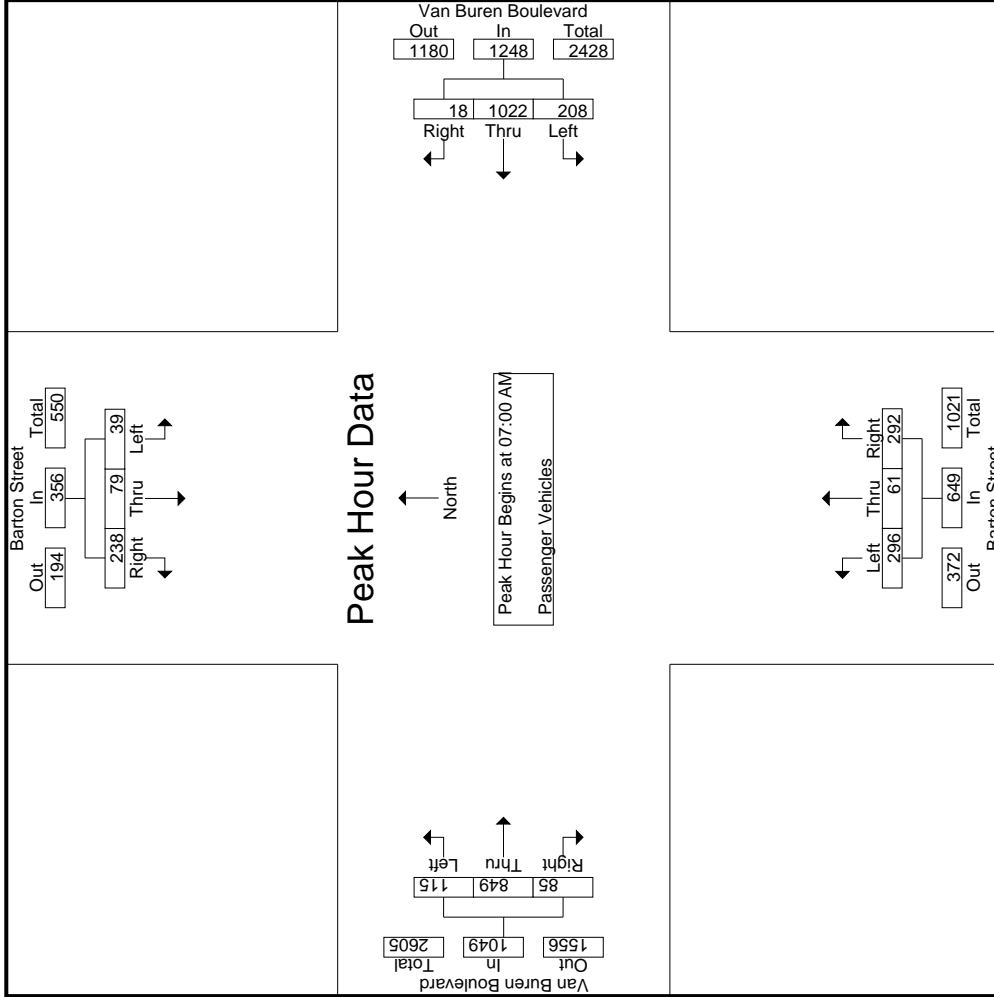

Counts Unlimited, Inc.
 PO Box 1178
 Corona, CA 92878
 (951)268-6268

City of Riverside
 N/S: Barton Street
 E/W: Van Buren Boulevard
 Weather: Clear

File Name : 14_RIV_Barton_VB AM
 Site Code : 05121716
 Start Date : 11/30/2021
 Page No : 3

Start Time	Barton Street Southbound			Van Buren Boulevard Westbound			Barton Street Northbound			Van Buren Boulevard Eastbound			Int. Total		
	Left	Thru	Right	Left	Thru	Right	Left	Thru	Right	Left	Thru	Right		App. Total	
Peak Hour Analysis From 07:00 AM to 07:45 AM - Peak 1 of 1	07:00 AM														
Peak Hour for Each Approach Begins at:	07:00 AM														
+0 mins.	15	15	86	32	245	5	282	79	19	52	150	36	156	13	205
+15 mins.	13	36	76	57	309	8	374	72	18	56	146	42	230	26	298
+30 mins.	6	22	55	64	219	2	285	62	10	99	171	15	210	19	244
+45 mins.	5	6	21	55	249	3	307	83	14	85	182	22	253	27	302
Total Volume	39	79	238	208	1022	18	1248	296	61	292	649	115	849	85	1049
% App. Total	11	22.2	66.9	16.7	81.9	1.4	45.6	45.6	9.4	45	8.1	11	80.9	8.1	1049
PHF	.650	.549	.692	.813	.827	.563	.834	.892	.803	.737	.891	.685	.839	.787	.868

Groups Printed- Large 2 Axle Vehicles

Start Time	Barton Street Southbound				Van Buren Boulevard Westbound				Barton Street Northbound				Van Buren Boulevard Eastbound											
	Left	Thru	Right	RTOR	Left	Thru	Right	RTOR	Left	Thru	Right	RTOR	Left	Thru	Right	RTOR	Left	Thru	Right	RTOR	Exclu. Total	Inclu. Total	Int. Total	
07:00 AM	0	0	0	0	1	7	3	0	11	3	0	0	0	3	0	0	0	3	0	0	0	17	17	17
07:15 AM	0	2	0	0	1	5	0	0	6	5	1	1	1	7	0	1	0	8	1	1	1	23	24	24
07:30 AM	0	0	0	0	1	9	0	0	10	2	0	1	3	3	0	4	1	5	1	1	1	18	19	19
07:45 AM	0	0	0	0	2	3	0	0	5	0	0	1	0	1	0	2	0	7	0	0	0	13	13	13
Total	0	2	0	0	5	24	3	0	32	10	1	3	2	14	0	19	4	23	2	2	2	71	71	73
08:00 AM	0	0	0	0	1	8	0	0	9	1	0	1	0	2	0	10	1	11	0	0	0	22	22	22
08:15 AM	0	0	0	0	0	10	0	0	10	1	1	0	0	2	1	7	0	8	0	0	0	20	20	20
08:30 AM	0	0	0	0	1	4	0	0	5	1	0	1	1	2	0	10	0	10	0	0	1	17	18	18
08:45 AM	0	0	0	0	0	2	1	0	3	1	0	1	0	2	0	4	0	4	0	0	0	9	9	9
Total	0	0	0	0	2	24	1	0	27	4	1	3	1	8	1	31	1	33	1	1	1	68	69	69
Grand Total	0	2	0	0	7	48	4	0	59	14	2	6	3	22	1	50	5	56	3	3	3	139	142	142
Approch %	0	100	0	0	11.9	81.4	6.8	0	42.4	63.6	9.1	27.3	0	15.8	1.8	89.3	8.9	40.3	2.1	2.1	97.9	97.9	97.9	97.9
Total %	0	1.4	0	0	5	34.5	2.9	0	42.4	10.1	1.4	4.3	0	15.8	0.7	36	3.6	40.3	2.1	2.1	97.9	97.9	97.9	97.9

Start Time	Barton Street Southbound				Van Buren Boulevard Westbound				Barton Street Northbound				Van Buren Boulevard Eastbound											
	Left	Thru	Right	RTOR	Left	Thru	Right	RTOR	Left	Thru	Right	RTOR	Left	Thru	Right	RTOR	Left	Thru	Right	RTOR	Exclu. Total	Inclu. Total	Int. Total	
07:00 AM	0	0	0	0	1	7	3	0	11	3	0	0	0	3	0	0	0	3	0	0	0	17	17	17
07:15 AM	0	2	0	0	1	5	0	0	6	5	1	1	1	7	0	1	0	8	1	1	1	23	23	23
07:30 AM	0	0	0	0	1	9	0	0	10	2	0	1	3	3	0	4	1	5	1	1	1	18	18	18
07:45 AM	0	0	0	0	2	3	0	0	5	0	0	1	0	1	0	2	0	7	0	0	0	13	13	13
Total	0	2	0	0	5	24	3	0	32	10	1	3	2	14	0	19	4	23	2	2	2	71	71	71
% App. Total	0.000	.250	.000	.000	.625	.667	.250	.727	.250	.500	.250	.750	.500	.679	.500	.679	.500	.719	.500	.500	.719	.772	.772	.772

Peak Hour Analysis From 07:00 AM to 07:45 AM - Peak 1 of 1
 Peak Hour for Entire Intersection Begins at 07:00 AM

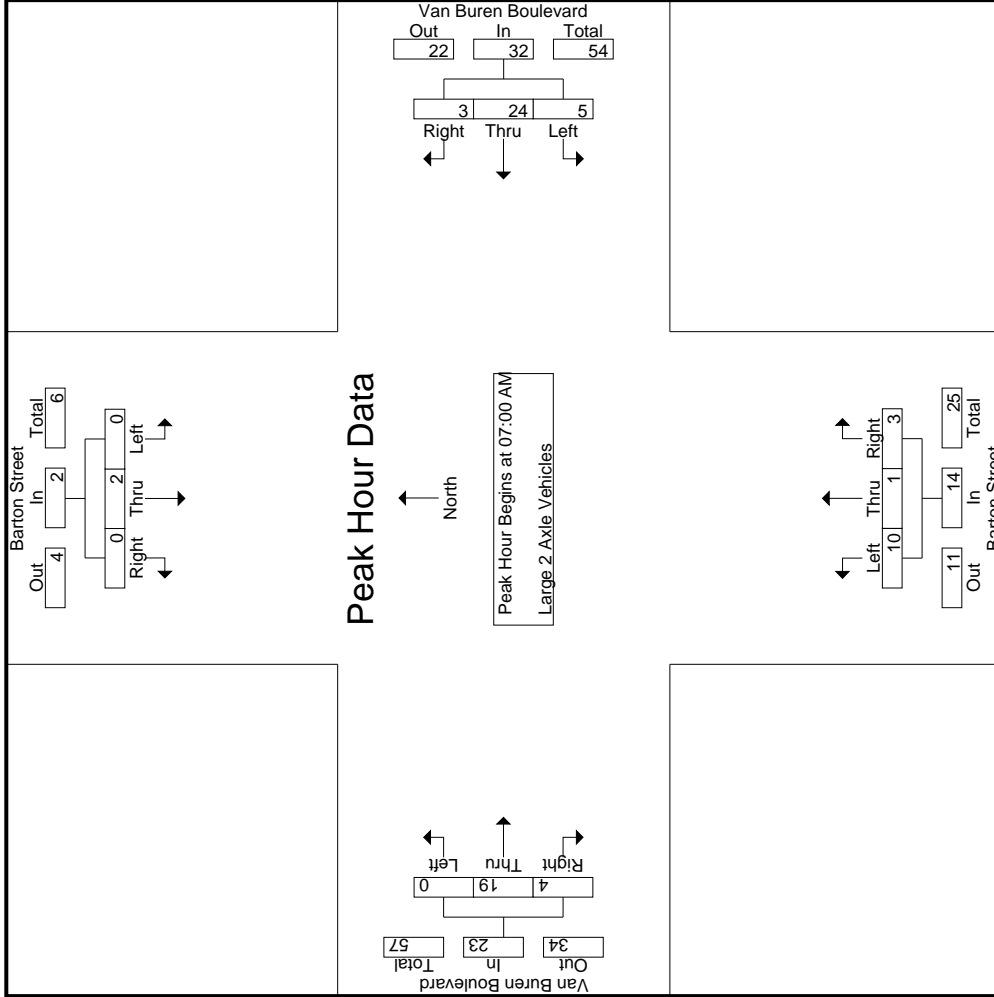

Counts Unlimited, Inc.
 PO Box 1178
 Corona, CA 92878
 (951)268-6268

City of Riverside
 N/S: Barton Street
 E/W: Van Buren Boulevard
 Weather: Clear

File Name : 14_RIV_Barton_VB AM
 Site Code : 05121716
 Start Date : 11/30/2021
 Page No : 3

Start Time	Barton Street Southbound			Van Buren Boulevard Westbound			Barton Street Northbound			Van Buren Boulevard Eastbound			Int. Total		
	Left	Thru	Right	Left	Thru	Right	Left	Thru	Right	Left	Thru	Right		App. Total	App. Total
Peak Hour Analysis From 07:00 AM to 07:45 AM - Peak 1 of 1	Peak Hour for Each Approach Begins at:														
	07:00 AM			07:00 AM			07:00 AM			07:00 AM			07:00 AM		
+0 mins.	0	0	0	1	7	3	11	3	0	0	3	0	3	0	3
+15 mins.	0	2	0	1	5	0	6	5	1	1	7	0	7	1	8
+30 mins.	0	0	0	1	9	0	10	2	0	1	3	0	4	1	5
+45 mins.	0	0	0	2	3	0	5	0	0	1	1	0	5	2	7
Total Volume	0	2	0	5	24	3	32	10	1	3	14	0	19	4	23
% App. Total	0	100	0	15.6	75	9.4	71.4	7.1	21.4	82.6	17.4	0	82.6	17.4	0
PHF	.000	.250	.000	.625	.667	.250	.727	.500	.250	.750	.500	.000	.679	.500	.719

Groups Printed- 3 Axle Vehicles

Start Time	Barton Street Southbound				Van Buren Boulevard Westbound				Barton Street Northbound				Van Buren Boulevard Eastbound				Exclu. Total	Inclu. Total	Int. Total
	Left	Thru	Right	RTOR	Left	Thru	Right	RTOR	Left	Thru	Right	RTOR	Left	Thru	Right	RTOR			
07:00 AM	0	0	0	0	0	1	0	0	1	0	0	0	0	0	1	0	0	2	
07:15 AM	0	0	0	0	0	2	0	0	2	0	0	0	0	0	0	0	0	2	
07:30 AM	0	0	0	0	0	0	0	0	0	0	0	0	0	1	0	0	1	1	
07:45 AM	0	0	0	0	0	1	0	0	1	0	0	0	0	0	0	0	0	1	
Total	0	0	0	0	0	4	0	0	4	0	0	0	0	2	0	0	2	6	
08:00 AM	0	0	0	0	0	0	0	0	0	1	0	0	1	0	0	0	0	1	
08:15 AM	0	0	0	0	0	1	0	0	1	0	0	0	3	0	0	3	0	4	
08:30 AM	0	0	0	0	2	0	0	0	2	0	0	0	1	0	0	1	0	3	
08:45 AM	0	0	0	0	1	0	0	1	1	0	1	2	0	1	0	1	1	4	
Total	0	0	0	0	1	3	0	0	4	2	0	1	3	0	5	0	1	13	
Grand Total	0	0	0	0	1	7	0	0	8	2	0	1	3	0	7	0	7	19	
T-Approch %	0	0	0	0	12.5	87.5	0	0	66.7	0	33.3	0	16.7	0	100	0	5.3	94.7	
Total %	0	0	0	0	5.6	38.9	0	0	44.4	11.1	0	5.6	16.7	0	38.9	0	5.3	94.7	

Start Time	Barton Street Southbound				Van Buren Boulevard Westbound				Barton Street Northbound				Van Buren Boulevard Eastbound				Exclu. Total	Inclu. Total	Int. Total
	Left	Thru	Right	RTOR	Left	Thru	Right	RTOR	Left	Thru	Right	RTOR	Left	Thru	Right	RTOR			
07:00 AM	0	0	0	0	0	1	0	0	1	0	0	0	0	0	1	0	0	2	
07:15 AM	0	0	0	0	0	2	0	0	2	0	0	0	0	0	0	0	0	2	
07:30 AM	0	0	0	0	0	0	0	0	0	0	0	0	0	1	0	0	1	1	
07:45 AM	0	0	0	0	0	1	0	0	1	0	0	0	0	0	0	0	0	1	
Total	0	0	0	0	0	4	0	0	4	0	0	0	0	2	0	0	2	6	
% App. Total	.000	.000	.000	.000	.000	.500	.000	.000	.000	.500	.000	.000	.000	.000	.500	.000	.500	.750	

Peak Hour Analysis From 07:00 AM to 07:45 AM - Peak 1 of 1
 Peak Hour for Entire Intersection Begins at 07:00 AM

Counts Unlimited, Inc.
 PO Box 1178
 Corona, CA 92878
 (951)268-6268

City of Riverside
 N/S: Barton Street
 E/W: Van Buren Boulevard
 Weather: Clear

File Name : 14_RIV_Barton_VB AM
 Site Code : 05121716
 Start Date : 11/30/2021
 Page No : 2

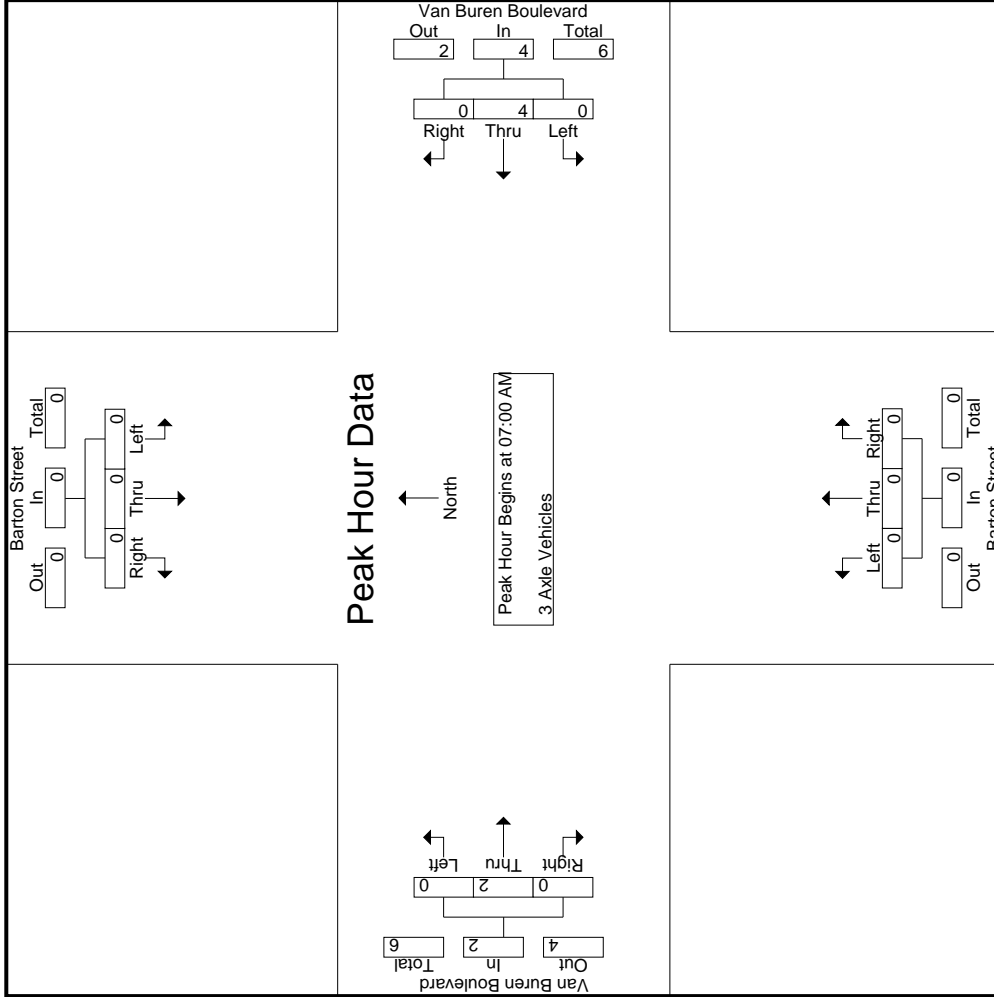

Counts Unlimited, Inc.
 PO Box 1178
 Corona, CA 92878
 (951)268-6268

City of Riverside
 N/S: Barton Street
 E/W: Van Buren Boulevard
 Weather: Clear

File Name : 14_RIV_Barton_VB AM
 Site Code : 05121716
 Start Date : 11/30/2021
 Page No : 3

Start Time	Barton Street Southbound			Van Buren Boulevard Westbound			Barton Street Northbound			Van Buren Boulevard Eastbound			Int. Total			
	Left	Thru	Right	Left	Thru	Right	Left	Thru	Right	Left	Thru	Right		App. Total	App. Total	App. Total
Peak Hour Analysis From 07:00 AM to 07:45 AM - Peak 1 of 1	07:00 AM															
Peak Hour for Each Approach Begins at:	07:00 AM															
+0 mins.	0	0	0	0	1	0	0	0	0	0	0	0	0	1	0	1
+15 mins.	0	0	0	0	2	0	0	0	0	0	0	0	0	0	0	0
+30 mins.	0	0	0	0	0	0	0	0	0	0	0	0	0	1	0	1
+45 mins.	0	0	0	0	1	0	0	0	0	0	0	0	0	0	0	0
Total Volume	0	0	0	0	4	0	0	0	0	0	0	0	0	2	0	2
% App. Total	0	0	0	0	100	0	0	0	0	0	0	0	0	100	0	0
PHF	.000	.000	.000	.000	.500	.000	.000	.000	.000	.000	.000	.000	.000	.500	.000	.500

Groups Printed- 4+ Axle Trucks

Start Time	Barton Street Southbound				Van Buren Boulevard Westbound				Barton Street Northbound				Van Buren Boulevard Eastbound				Exclu. Total	Inclu. Total	Int. Total					
	Left	Thru	Right	RTOR	App. Total	Left	Thru	Right	RTOR	App. Total	Left	Thru	Right	RTOR	App. Total	Left				Thru	Right	RTOR	App. Total	
07:00 AM	0	0	0	0	0	0	1	0	0	0	0	0	0	0	0	0	0	0	0	0	0	1	1	
07:15 AM	0	0	0	0	0	0	1	0	0	0	0	0	0	0	0	0	1	0	0	0	1	0	2	2
07:30 AM	0	0	0	0	0	0	1	0	0	0	0	0	0	0	0	0	2	0	0	0	2	0	3	3
07:45 AM	0	0	0	0	0	1	1	0	0	2	0	0	0	0	0	0	1	0	0	0	1	0	3	3
Total	0	0	0	0	0	1	4	0	0	5	0	0	0	0	0	4	4	0	0	4	0	9	9	9
08:00 AM	0	0	0	0	0	0	1	0	0	1	0	0	0	0	0	0	0	0	0	0	0	0	1	1
08:15 AM	0	0	0	0	0	0	1	0	0	1	0	0	0	0	0	0	1	0	0	0	1	0	2	2
08:30 AM	0	0	0	0	0	0	0	0	0	0	0	0	0	0	0	0	1	0	0	0	1	0	1	1
08:45 AM	0	0	0	0	0	0	3	0	0	3	0	0	0	0	0	2	0	0	0	2	0	5	5	5
Total	0	0	0	0	0	0	5	0	0	5	0	0	0	0	0	4	4	0	0	4	0	9	9	9
Grand Total	0	0	0	0	0	1	9	0	0	10	0	0	0	0	0	8	8	0	0	8	0	18	18	18
T-Approch %	0	0	0	0	0	10	90	0	0	0	0	0	0	0	0	100	0	0	0	0	0	100	100	100
Total %	0	0	0	0	0	5.6	50	0	0	55.6	0	0	0	0	0	44.4	0	0	0	44.4	0	100	100	100

Start Time	Barton Street Southbound				Van Buren Boulevard Westbound				Barton Street Northbound				Van Buren Boulevard Eastbound				Exclu. Total	Inclu. Total	Int. Total					
	Left	Thru	Right	RTOR	App. Total	Left	Thru	Right	RTOR	App. Total	Left	Thru	Right	RTOR	App. Total	Left				Thru	Right	RTOR	App. Total	
07:00 AM	0	0	0	0	0	0	1	0	0	1	0	0	0	0	0	0	0	0	0	0	0	0	0	0
07:15 AM	0	0	0	0	0	0	1	0	0	1	0	0	0	0	0	0	1	0	0	0	1	0	1	1
07:30 AM	0	0	0	0	0	0	1	0	0	1	0	0	0	0	0	0	2	0	0	0	2	0	2	3
07:45 AM	0	0	0	0	0	1	1	0	0	2	0	0	0	0	0	0	1	0	0	0	1	0	3	3
Total Volume	0	0	0	0	0	1	4	0	0	5	0	0	0	0	0	4	4	0	0	4	0	9	9	9
% App. Total	0	0	0	0	0	20	80	0	0	0	0	0	0	0	0	100	0	0	0	100	0	100	100	100
PHF	.000	.000	.000	.000	.000	.250	1.00	.000	.000	.625	.000	.000	.000	.000	.000	.000	.500	.000	.500	.000	.500	.750	.750	.750

Peak Hour Analysis From 07:00 AM to 07:45 AM - Peak 1 of 1
 Peak Hour for Entire Intersection Begins at 07:00 AM

Counts Unlimited, Inc.
 PO Box 1178
 Corona, CA 92878
 (951)268-6268

City of Riverside
 N/S: Barton Street
 E/W: Van Buren Boulevard
 Weather: Clear

File Name : 14_RIV_Barton_VB AM
 Site Code : 05121716
 Start Date : 11/30/2021
 Page No : 2

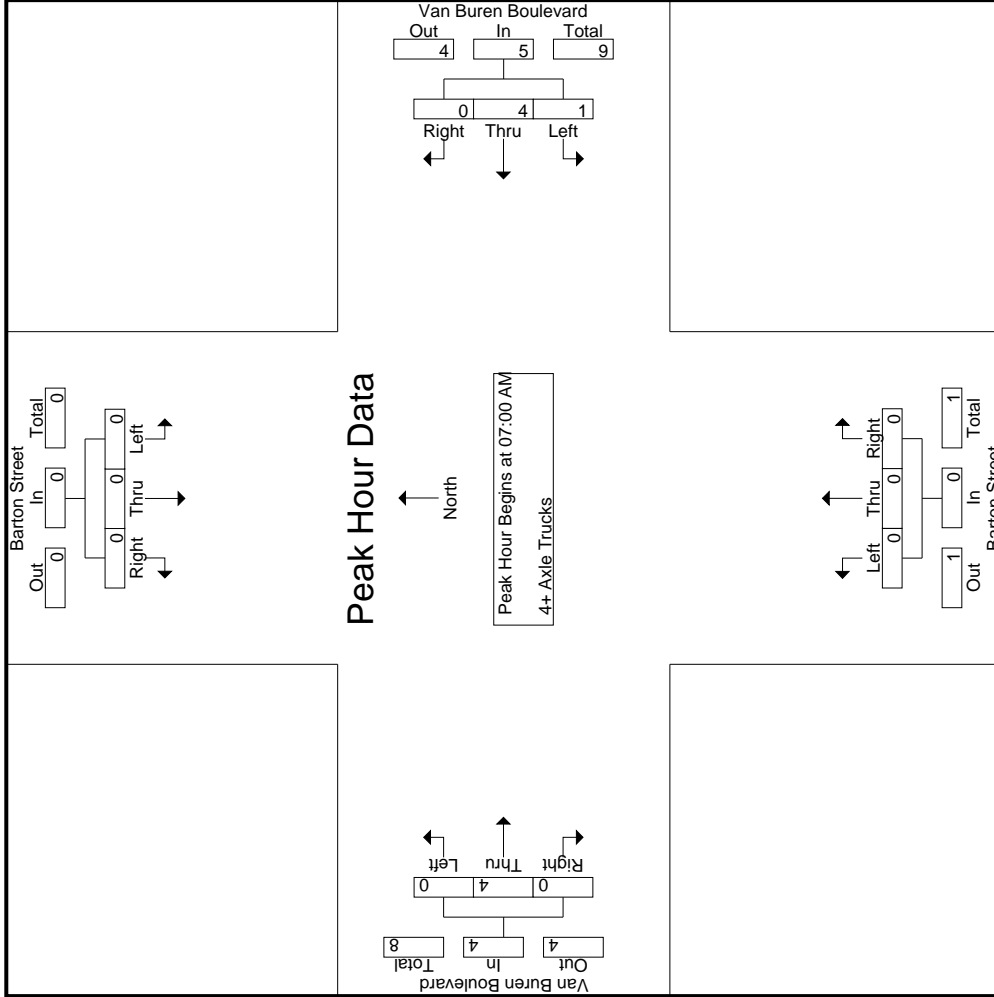

Counts Unlimited, Inc.
 PO Box 1178
 Corona, CA 92878
 (951)268-6268

City of Riverside
 N/S: Barton Street
 E/W: Van Buren Boulevard
 Weather: Clear

File Name : 14_RIV_Barton_VB AM
 Site Code : 05121716
 Start Date : 11/30/2021
 Page No : 3

Start Time	Barton Street Southbound			Van Buren Boulevard Westbound			Barton Street Northbound			Van Buren Boulevard Eastbound			Int. Total	
	Left	Thru	Right	Left	Thru	Right	Left	Thru	Right	Left	Thru	Right		App. Total
Peak Hour Analysis From 07:00 AM to 07:45 AM - Peak 1 of 1	07:00 AM													
Peak Hour for Each Approach Begins at:	07:00 AM													
+0 mins.	0	0	0	0	1	0	1	0	0	0	0	0	0	0
+15 mins.	0	0	0	0	1	0	1	0	0	0	1	0	0	1
+30 mins.	0	0	0	0	1	0	1	0	0	0	2	0	0	2
+45 mins.	0	0	0	1	1	0	2	0	0	0	1	0	0	1
Total Volume	0	0	0	1	4	0	5	0	0	0	4	0	0	4
% App. Total	0	0	0	.20	.80	0		0	0	0	100	0	0	
PHF	.000	.000	.000	.250	1.000	.000	.625	.000	.000	.000	.500	.000	.000	.500

Groups Printed- Passenger Vehicles - Large 2 Axle Vehicles - 3 Axle Vehicles - 4+ Axle Trucks

Start Time	Barton Street Southbound						Van Buren Boulevard Westbound						Barton Street Northbound						Van Buren Boulevard Eastbound					
	Left		Thru		Right		Left		Thru		Right		Left		Thru		Right		Left		Thru		Right	
	Count	%	Count	%	Count	%	Count	%	Count	%	Count	%	Count	%	Count	%	Count	%	Count	%	Count	%	Count	%
04:00 PM	4	6	23	16	33	33	68	257	5	1	330	57	20	60	32	137	18	257	54	11	329	60	829	889
04:15 PM	4	6	18	16	28	28	46	311	8	4	365	56	11	53	33	120	23	273	67	8	363	61	876	937
04:30 PM	6	9	19	13	34	34	73	241	6	2	320	57	14	57	29	128	18	267	58	3	343	47	825	872
04:45 PM	2	6	22	11	30	30	68	305	13	3	386	39	16	42	25	97	41	303	39	6	383	45	896	941
Total	16	27	82	56	125	125	255	1114	32	10	1401	209	61	212	119	482	100	1100	218	28	1418	213	3426	3639
05:00 PM	6	8	21	16	35	35	65	251	8	2	324	62	8	29	12	99	22	292	56	4	370	34	828	862
05:15 PM	9	20	24	14	53	53	77	259	9	3	345	46	16	59	32	121	38	266	34	3	338	52	857	909
05:30 PM	10	6	21	16	37	37	57	230	9	1	296	40	18	48	24	106	25	316	54	1	395	42	834	876
05:45 PM	5	7	23	15	35	35	52	223	20	4	295	68	10	49	26	127	23	284	60	3	367	48	824	872
Total	30	41	89	61	160	160	251	963	46	10	1260	216	52	185	94	453	108	1158	204	11	1470	176	3343	3519
Grand Total	46	68	171	117	285	285	506	2077	78	20	2661	425	113	397	213	935	208	2258	422	39	2888	389	6769	7158
% Approach	16.1	23.9	60	60	19	78.1	2.9	7.5	30.7	1.2	39.3	6.3	1.7	5.9	13.8	7.2	78.2	14.6	6.2	42.7	5.4	94.6	0	0
% Total	0.7	1	2.5	4.2	4.2	39.3	4.2	7.5	30.7	1.2	39.3	6.3	1.7	5.9	13.8	7.2	78.2	14.6	6.2	42.7	5.4	94.6	0	0
% Passenger Vehicles	45	67	170	99.4	398	398	497	2028	77	95	2621	422	113	392	1138	208	2155	417	2818	0	0	6975	0	0
% Large 2 Axle Vehicles	97.8	98.5	99.4	99.1	99	99	98.2	97.6	98.7	95	97.8	99.3	100	98.7	99.1	99.1	100	95.4	98.8	97.4	96.3	0	0	
% 3 Axle Vehicles	1	1	1	0.9	4	4	3	33	1	5	38	2	0	4	7	7	0	74	4	4	79	0	0	
% 4+ Axle Trucks	2.2	1.5	0.6	0	1	0.6	1.6	1.6	1.3	5	1.4	0.5	0	1	0.6	0	3.3	0.9	2.6	2.7	0	0		
% Large 2 Axle Vehicles	0	0	0	0	0	0	5	5	0	10	0	0	0	0	0	0	0	12	0	12	0	0		
% 3 Axle Vehicles	0	0	0	0	0	0	1	0.2	0	0.4	0	0	0	0	0	0	0	0.5	0	0.4	0	0		
% 4+ Axle Trucks	0	0	0	0	0	0	1	11	0	12	1	0	1	0	3	0	17	1	1	18	0	0		
% 4+ Axle Trucks	0	0	0	0	0	0	0.2	0.5	0	0.4	0.2	0	0.3	0.5	0.3	0	0.8	0.2	0	0.6	0	0		

Start Time	Barton Street Southbound						Van Buren Boulevard Westbound						Barton Street Northbound						Van Buren Boulevard Eastbound					
	Left		Thru		Right		Left		Thru		Right		Left		Thru		Right		Left		Thru		Right	
	Count	%	Count	%	Count	%	Count	%	Count	%	Count	%	Count	%	Count	%	Count	%	Count	%	Count	%	Count	%
04:00 PM	4	6	23	16	33	33	68	257	5	1	330	57	20	60	32	137	18	257	54	11	329	60	829	889
04:15 PM	4	6	18	16	28	28	46	311	8	4	365	56	11	53	33	120	23	273	67	8	363	61	876	937
04:30 PM	6	9	19	13	34	34	73	241	6	2	320	57	14	57	29	128	18	267	58	3	343	47	825	872
04:45 PM	2	6	22	11	30	30	68	305	13	3	386	39	16	42	25	97	41	303	39	6	383	45	896	941
Total	16	27	82	56	125	125	255	1114	32	10	1401	209	61	212	119	482	100	1100	218	28	1418	213	3426	3639
% App. Total	12.8	21.6	65.6	65.6	18.2	79.5	2.3	18.2	79.5	2.3	1401	1401	209	61	212	482	100	1100	218	1418	1418	1418	1418	3426
PHF	.667	.750	.891	.919	.919	.895	.615	.907	.917	.763	.883	.880	.610	.908	.813	.926	.926	.926	.926	.926	.926	.926	.926	.926

Peak Hour Analysis From 04:00 PM to 05:45 PM - Peak 1 of 1
 Peak Hour for Entire Intersection Begins at 04:00 PM

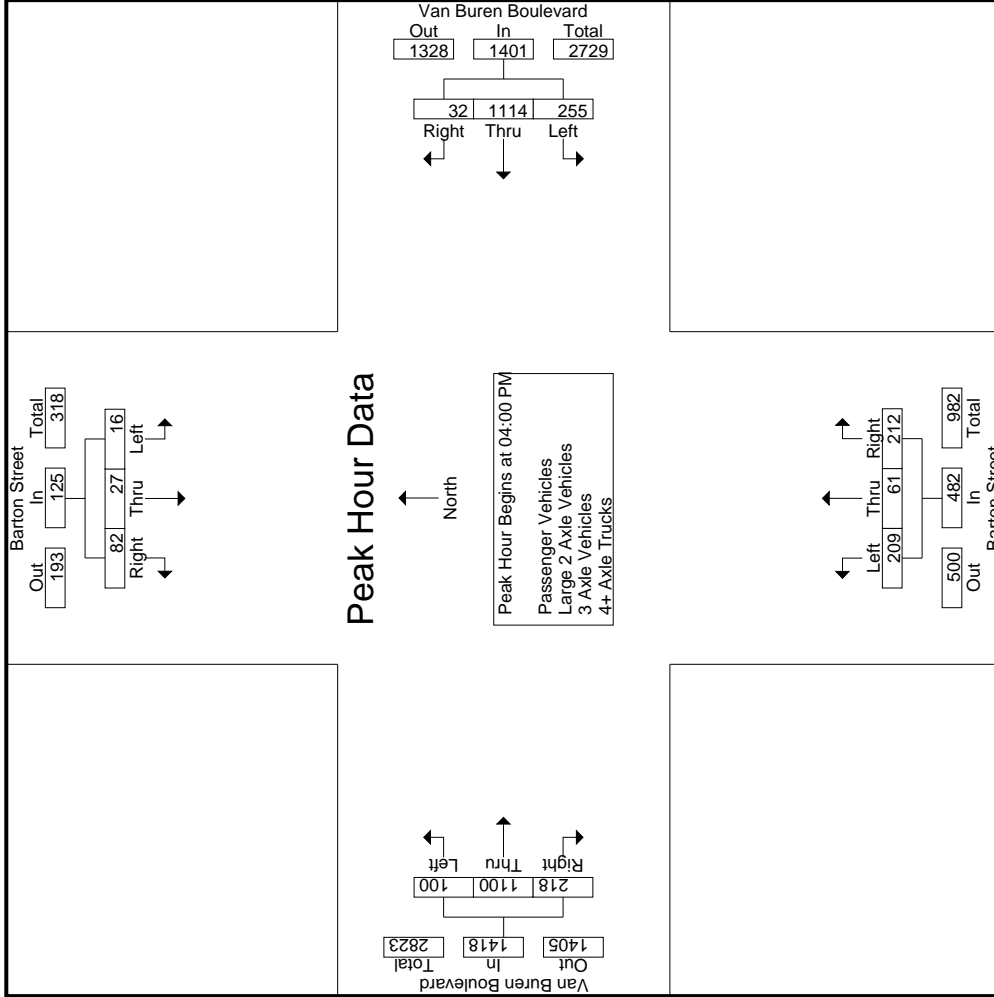

Counts Unlimited, Inc.
 PO Box 1178
 Corona, CA 92878
 (951)268-6268

City of Riverside
 N/S: Barton Street
 E/W: Van Buren Boulevard
 Weather: Clear

File Name : 14_RIV_Barton_VB PM
 Site Code : 05121716
 Start Date : 11/30/2021
 Page No : 3

Start Time	Barton Street Southbound			Van Buren Boulevard Westbound			Barton Street Northbound			Van Buren Boulevard Eastbound			Int. Total	
	Left	Thru	Right	Left	Thru	Right	Left	Thru	Right	Left	Thru	Right		App. Total
Peak Hour Analysis From 04:00 PM to 05:45 PM - Peak 1 of 1														
Peak Hour for Each Approach Begins at:														
	05:00 PM			04:00 PM			04:00 PM			04:45 PM				
+0 mins.	6	8	21	68	257	5	330	57	20	60	41	303	39	383
+15 mins.	9	20	24	46	311	8	365	56	11	53	22	292	56	370
+30 mins.	10	6	21	73	241	6	320	57	14	57	38	266	34	338
+45 mins.	5	7	23	68	305	13	386	39	16	42	25	316	54	395
Total Volume	30	41	89	255	1114	32	1401	209	61	212	126	1177	183	1486
% App. Total	18.8	25.6	55.6	18.2	79.5	2.3	43.4	12.7	44	883	8.5	79.2	12.3	
PHF	.750	.513	.927	.873	.895	.615	.907	.917	.763	.883	.768	.931	.817	.941

Groups Printed- Passenger Vehicles

Start Time	Barton Street Southbound				Van Buren Boulevard Westbound				Barton Street Northbound				Van Buren Boulevard Eastbound				Exclu. Total	Inclu. Total	Int. Total				
	Left	Thru	Right	RTOR	App. Total	Left	Thru	Right	RTOR	App. Total	Left	Thru	Right	RTOR	App. Total	Left				Thru	Right	RTOR	App. Total
04:00 PM	4	6	23	16	33	67	252	5	1	324	57	20	59	32	136	18	246	52	10	316	59	809	868
04:15 PM	4	6	18	16	28	45	299	8	4	352	56	11	53	33	120	23	266	67	8	356	61	856	917
04:30 PM	6	8	19	13	33	71	239	6	2	316	56	14	56	28	126	18	259	57	3	334	46	809	855
04:45 PM	2	6	22	11	30	68	295	12	2	375	39	16	42	25	97	41	290	38	6	369	44	871	915
Total	16	26	82	56	124	251	1085	31	9	1367	208	61	210	118	479	100	1061	214	27	1375	210	3345	3555
05:00 PM	6	8	21	16	35	62	246	8	2	316	60	8	29	12	97	22	278	55	4	355	34	803	837
05:15 PM	9	20	24	14	53	75	256	9	3	340	46	16	57	31	119	38	251	34	3	323	51	835	886
05:30 PM	10	6	20	15	36	57	223	9	1	289	40	18	47	24	105	25	297	54	1	376	41	806	847
05:45 PM	4	7	23	15	34	52	218	20	4	290	68	10	49	26	127	23	268	60	3	351	48	802	850
Total	29	41	88	60	158	246	943	46	10	1235	214	52	182	93	448	108	1094	203	11	1405	174	3246	3420
Grand Total	45	67	170	116	282	497	2028	77	19	2602	422	113	392	211	927	208	2155	417	38	2780	384	6591	6975
T-Approch %	16	23.8	60.3			19.1	77.9	3		45.5	12.2	42.3			7.5	77.5	15						
T-Total %	0.7	1	2.6		4.3	7.5	30.8	1.2		39.5	6.4	1.7	5.9		14.1	3.2	32.7	6.3		42.2	5.5	94.5	

Start Time	Barton Street Southbound				Van Buren Boulevard Westbound				Barton Street Northbound				Van Buren Boulevard Eastbound				Exclu. Total	Inclu. Total	Int. Total				
	Left	Thru	Right	RTOR	App. Total	Left	Thru	Right	RTOR	App. Total	Left	Thru	Right	RTOR	App. Total	Left				Thru	Right	RTOR	App. Total
04:00 PM	4	6	23	16	33	67	252	5	1	324	57	20	59	32	136	18	246	52	10	316	59	809	868
04:15 PM	4	6	18	16	28	45	299	8	4	352	56	11	53	33	120	23	266	67	8	356	61	856	917
04:30 PM	6	8	19	13	33	71	239	6	2	316	56	14	56	28	126	18	259	57	3	334	46	809	855
04:45 PM	2	6	22	11	30	68	295	12	2	375	39	16	42	25	97	41	290	38	6	369	44	871	915
Total	16	26	82	56	124	251	1085	31	9	1367	208	61	210	118	479	100	1061	214	27	1375	210	3345	3555
05:00 PM	6	8	21	16	35	62	246	8	2	316	60	8	29	12	97	22	278	55	4	355	34	803	837
05:15 PM	9	20	24	14	53	75	256	9	3	340	46	16	57	31	119	38	251	34	3	323	51	835	886
05:30 PM	10	6	20	15	36	57	223	9	1	289	40	18	47	24	105	25	297	54	1	376	41	806	847
05:45 PM	4	7	23	15	34	52	218	20	4	290	68	10	49	26	127	23	268	60	3	351	48	802	850
Total	29	41	88	60	158	246	943	46	10	1235	214	52	182	93	448	108	1094	203	11	1405	174	3246	3420
Grand Total	45	67	170	116	282	497	2028	77	19	2602	422	113	392	211	927	208	2155	417	38	2780	384	6591	6975
T-Approch %	16	23.8	60.3			19.1	77.9	3		45.5	12.2	42.3			7.5	77.5	15						
T-Total %	0.7	1	2.6		4.3	7.5	30.8	1.2		39.5	6.4	1.7	5.9		14.1	3.2	32.7	6.3		42.2	5.5	94.5	

Peak Hour Analysis From 04:00 PM to 04:45 PM - Peak 1 of 1
 Peak Hour for Entire Intersection Begins at 04:00 PM

Start Time	Barton Street Southbound				Van Buren Boulevard Westbound				Barton Street Northbound				Van Buren Boulevard Eastbound				Exclu. Total	Inclu. Total	Int. Total				
	Left	Thru	Right	RTOR	App. Total	Left	Thru	Right	RTOR	App. Total	Left	Thru	Right	RTOR	App. Total	Left				Thru	Right	RTOR	App. Total
04:00 PM	4	6	23	16	33	67	252	5	1	324	57	20	59	32	136	18	246	52	10	316	59	809	868
04:15 PM	4	6	18	16	28	45	299	8	4	352	56	11	53	33	120	23	266	67	8	356	61	856	917
04:30 PM	6	8	19	13	33	71	239	6	2	316	56	14	56	28	126	18	259	57	3	334	46	809	855
04:45 PM	2	6	22	11	30	68	295	12	2	375	39	16	42	25	97	41	290	38	6	369	44	871	915
Total	16	26	82	56	124	251	1085	31	9	1367	208	61	210	118	479	100	1061	214	27	1375	210	3345	3555
% App. Total	12.9	21	66.1			18.4	79.4	2.3		43.4	12.7	43.8			7.3	77.2	15.6						
PHF	.667	.813	.891		.939	.884	.907	.646		.911	.912	.763	.890		.881	.610	.799	.932		.960			

Counts Unlimited, Inc.
 PO Box 1178
 Corona, CA 92878
 (951)268-6268

City of Riverside
 N/S: Barton Street
 E/W: Van Buren Boulevard
 Weather: Clear

File Name : 14_RIV_Barton_VB PM
 Site Code : 05121716
 Start Date : 11/30/2021
 Page No : 2

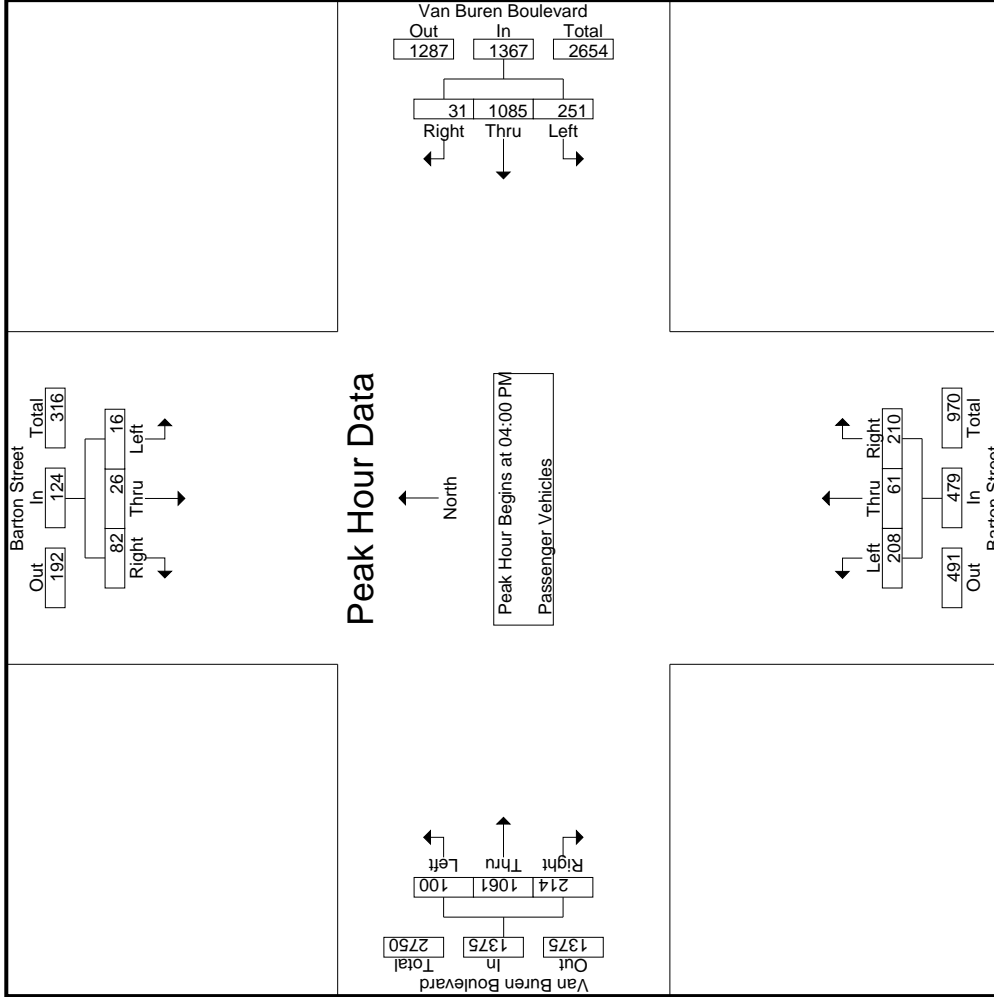

Counts Unlimited, Inc.
 PO Box 1178
 Corona, CA 92878
 (951)268-6268

City of Riverside
 N/S: Barton Street
 E/W: Van Buren Boulevard
 Weather: Clear

File Name : 14_RIV_Barton_VB PM
 Site Code : 05121716
 Start Date : 11/30/2021
 Page No : 3

Start Time	Barton Street Southbound			Van Buren Boulevard Westbound			Barton Street Northbound			Van Buren Boulevard Eastbound			Int. Total
	Left	Thru	Right	Left	Thru	Right	Left	Thru	Right	Left	Thru	Right	
Peak Hour Analysis From 04:00 PM to 04:45 PM - Peak 1 of 1	04:00 PM												
Peak Hour for Each Approach Begins at:	04:00 PM												
+0 mins.	4	6	23	67	252	5	324	57	20	59	18	246	316
+15 mins.	4	6	18	45	299	8	352	56	11	53	23	266	356
+30 mins.	6	8	19	71	239	6	316	56	14	56	18	259	334
+45 mins.	2	6	22	68	295	12	375	39	16	42	41	290	369
Total Volume	16	26	82	251	1085	31	1367	208	61	210	100	1061	1375
% App. Total	12.9	21	66.1	18.4	79.4	2.3	43.4	12.7	43.8	7.3	77.2	15.6	
PHF	.667	.813	.891	.884	.907	.646	.911	.912	.763	.890	.610	.799	.932

Counts Unlimited, Inc.
 PO Box 1178
 Corona, CA 92878
 (951)268-6268

City of Riverside
 N/S: Barton Street
 E/W: Van Buren Boulevard
 Weather: Clear

File Name : 14_RIV_Barton_VB PM
 Site Code : 05121716
 Start Date : 11/30/2021
 Page No : 1

Groups Printed- Large 2 Axle Vehicles

Start Time	Barton Street Southbound				Van Buren Boulevard Westbound				Barton Street Northbound				Van Buren Boulevard Eastbound				Exclu. Total	Inclu. Total	Int. Total	
	Left	Thru	Right	RTOR	Left	Thru	Right	RTOR	Left	Thru	Right	RTOR	Left	Thru	Right	RTOR				App. Total
04:00 PM	0	0	0	0	0	2	0	0	1	0	0	0	0	3	2	1	5	1	8	9
04:15 PM	0	0	0	0	0	10	0	0	0	0	0	0	0	6	0	0	6	0	16	16
04:30 PM	0	1	0	0	1	2	0	0	0	0	0	0	0	3	1	0	4	0	8	8
04:45 PM	0	0	0	0	0	6	1	1	0	0	0	0	0	11	0	0	11	1	18	19
Total	0	1	0	0	1	20	1	1	0	0	1	0	0	23	3	1	26	2	50	52
05:00 PM	0	0	0	0	2	2	0	0	0	0	0	0	0	10	1	0	11	0	17	17
05:15 PM	0	0	0	0	0	2	0	2	1	2	0	0	0	14	0	0	14	1	18	19
05:30 PM	0	0	1	1	0	6	0	0	1	0	0	0	0	14	0	0	14	1	22	23
05:45 PM	1	0	0	0	0	3	0	0	0	0	0	0	0	13	0	0	13	0	17	17
Total	1	0	1	1	2	13	0	0	3	1	5	0	0	51	1	0	52	2	74	76
Grand Total	1	1	1	1	3	33	1	1	4	1	6	0	0	74	4	1	78	4	124	128
T-Approch %	33.3	33.3	33.3		8.1	89.2	2.7		66.7	0	3.2		0	94.9	5.1		62.9	3.1	96.9	
Total %	0.8	0.8	0.8		2.4	26.6	0.8		3.2	0	4.8		0	59.7	3.2					

Start Time	Barton Street Southbound				Van Buren Boulevard Westbound				Barton Street Northbound				Van Buren Boulevard Eastbound				Exclu. Total	Inclu. Total	Int. Total	
	Left	Thru	Right	RTOR	Left	Thru	Right	RTOR	Left	Thru	Right	RTOR	Left	Thru	Right	RTOR				App. Total
04:00 PM	0	0	0	0	0	2	0	0	0	0	0	0	0	1	0	0	1	0	2	2
04:15 PM	0	0	0	0	0	10	0	0	0	0	0	0	0	6	0	0	6	0	16	16
04:30 PM	0	1	0	0	1	2	0	0	0	0	0	0	0	3	1	0	4	0	8	8
04:45 PM	0	0	0	0	0	6	1	1	0	0	0	0	0	11	0	0	11	1	18	19
Total	0	1	0	0	1	20	1	1	0	0	1	0	0	23	3	1	26	2	50	52
05:00 PM	0	0	0	0	2	2	0	0	0	0	0	0	0	10	1	0	11	0	17	17
05:15 PM	0	0	0	0	0	2	0	2	1	2	0	0	0	14	0	0	14	1	18	19
05:30 PM	0	0	1	1	0	6	0	0	1	0	0	0	0	14	0	0	14	1	22	23
05:45 PM	1	0	0	0	0	3	0	0	0	0	0	0	0	13	0	0	13	0	17	17
Total	1	0	1	1	2	13	0	0	3	1	5	0	0	51	1	0	52	2	74	76
Grand Total	1	1	1	1	3	33	1	1	4	1	6	0	0	74	4	1	78	4	124	128
T-Approch %	33.3	33.3	33.3		8.1	89.2	2.7		66.7	0	3.2		0	94.9	5.1		62.9	3.1	96.9	
Total %	0.8	0.8	0.8		2.4	26.6	0.8		3.2	0	4.8		0	59.7	3.2					

Peak Hour Analysis From 04:00 PM to 04:45 PM - Peak 1 of 1
 Peak Hour for Entire Intersection Begins at 04:00 PM

Start Time	Barton Street Southbound				Van Buren Boulevard Westbound				Barton Street Northbound				Van Buren Boulevard Eastbound				Exclu. Total	Inclu. Total	Int. Total	
	Left	Thru	Right	RTOR	Left	Thru	Right	RTOR	Left	Thru	Right	RTOR	Left	Thru	Right	RTOR				App. Total
04:00 PM	0	0	0	0	0	2	0	0	0	0	0	0	0	1	0	0	1	0	2	2
04:15 PM	0	0	0	0	0	10	0	0	0	0	0	0	0	6	0	0	6	0	16	16
04:30 PM	0	1	0	0	1	2	0	0	0	0	0	0	0	3	1	0	4	0	8	8
04:45 PM	0	0	0	0	0	6	1	1	0	0	0	0	0	11	0	0	11	1	18	19
Total	0	1	0	0	1	20	1	1	0	0	1	0	0	23	3	1	26	2	50	52
% App. Total	0	100	0	0	4.5	90.9	4.5		100	0	11.5		0	88.5	11.5					
PHF	.000	.250	.000		.250	.500	.250		.250	.000	.250		.000	.523	.375		.591		.694	

Counts Unlimited, Inc.
 PO Box 1178
 Corona, CA 92878
 (951)268-6268

City of Riverside
 N/S: Barton Street
 E/W: Van Buren Boulevard
 Weather: Clear

File Name : 14_RIV_Barton_VB PM
 Site Code : 05121716
 Start Date : 11/30/2021
 Page No : 2

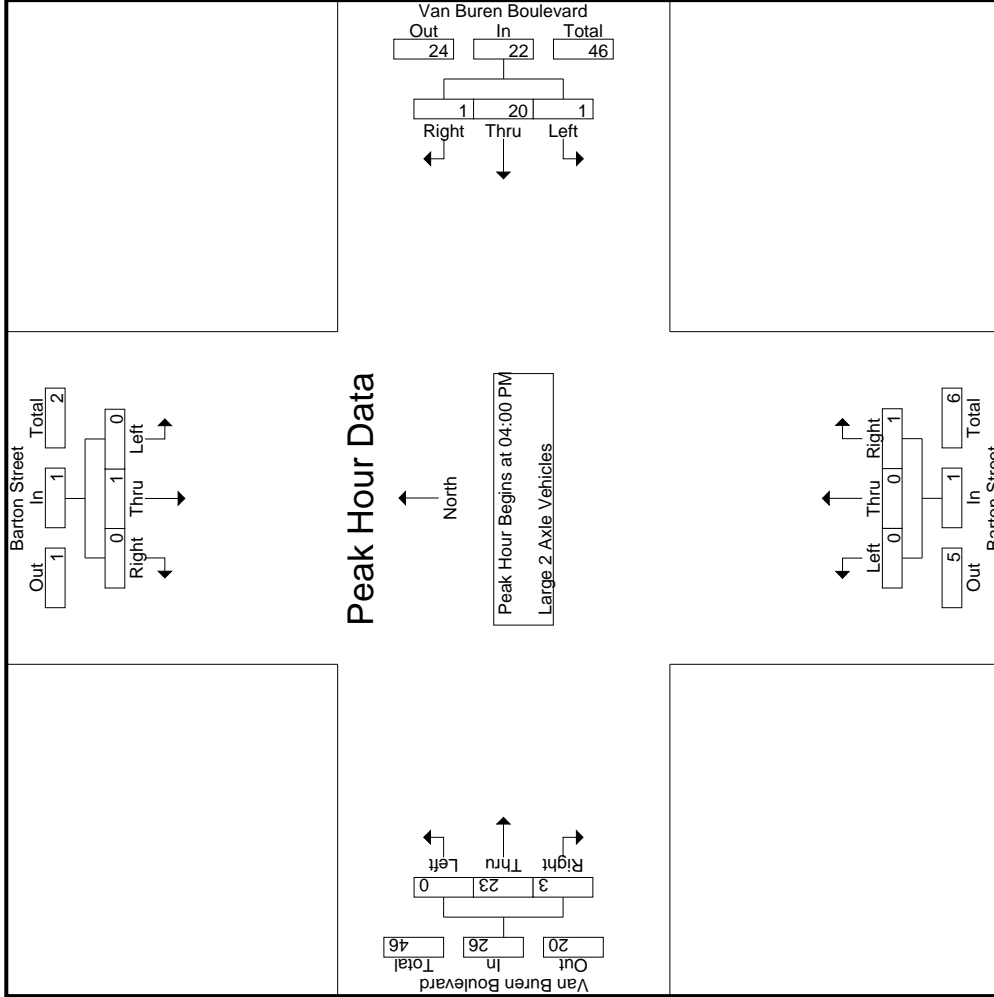

Counts Unlimited, Inc.
 PO Box 1178
 Corona, CA 92878
 (951)268-6268

City of Riverside
 N/S: Barton Street
 E/W: Van Buren Boulevard
 Weather: Clear

File Name : 14_RIV_Barton_VB PM
 Site Code : 05121716
 Start Date : 11/30/2021
 Page No : 3

Start Time	Barton Street Southbound			Van Buren Boulevard Westbound			Barton Street Northbound			Van Buren Boulevard Eastbound			Int. Total			
	Left	Thru	Right	Left	Thru	Right	Left	Thru	Right	Left	Thru	Right		App. Total	App. Total	App. Total
Peak Hour Analysis From 04:00 PM to 04:45 PM - Peak 1 of 1																
Peak Hour for Each Approach Begins at:																
	04:00 PM			04:00 PM			04:00 PM			04:00 PM			04:00 PM			
+0 mins.	0	0	0	0	2	0	0	2	0	0	0	1	0	3	2	5
+15 mins.	0	0	0	0	10	0	0	10	0	0	0	0	0	6	0	6
+30 mins.	0	1	0	1	2	0	0	3	0	0	0	0	3	1	4	4
+45 mins.	0	0	0	0	6	1	7	7	0	0	0	0	11	0	11	11
Total Volume	0	1	0	1	20	1	22	22	0	0	0	1	0	23	3	26
% App. Total	0	100	0	4.5	90.9	4.5	100	100	0	0	0	100	0	88.5	11.5	26
PHF	.000	.250	.000	.250	.500	.250	.550	.550	.000	.000	.250	.250	.000	.523	.375	.591

Groups Printed- 3 Axle Vehicles

Start Time	Barton Street Southbound				Van Buren Boulevard Westbound				Barton Street Northbound				Van Buren Boulevard Eastbound											
	Left	Thru	Right	RTOR	App. Total	Left	Thru	Right	RTOR	App. Total	Left	Thru	Right	RTOR	App. Total	Left	Thru	Right	RTOR	App. Total	Exclu. Total	Inclu. Total	Int. Total	
04:00 PM	0	0	0	0	0	1	0	0	0	2	0	0	0	0	0	0	4	0	0	0	4	0	6	6
04:15 PM	0	0	0	0	0	1	0	0	0	1	0	0	0	0	0	0	0	0	0	0	0	0	1	1
04:30 PM	0	0	0	0	0	1	0	0	0	1	0	0	0	0	0	0	3	0	0	0	3	0	4	4
04:45 PM	0	0	0	0	0	0	1	0	0	1	0	0	0	0	0	0	2	0	0	0	2	0	3	3
Total	0	0	0	0	0	3	2	0	0	5	0	0	0	0	0	0	9	0	0	0	9	0	14	14
05:00 PM	0	0	0	0	0	0	1	0	0	1	0	0	0	0	0	0	1	0	0	0	1	0	2	2
05:15 PM	0	0	0	0	0	2	1	0	0	3	0	0	0	0	0	0	1	0	0	0	1	0	4	4
05:30 PM	0	0	0	0	0	0	0	0	0	0	0	0	0	0	0	0	0	0	0	0	0	0	1	1
05:45 PM	0	0	0	0	0	0	1	0	0	1	0	0	0	0	0	0	0	0	0	0	0	0	1	1
Total	0	0	0	0	0	2	3	0	0	5	0	0	0	0	0	0	3	0	0	0	3	0	8	8
Grand Total	0	0	0	0	0	5	5	0	0	10	0	0	0	0	0	0	12	0	0	0	12	0	22	22
T-Approch %	0	0	0	0	0	50	50	0	0	45.5	0	0	0	0	0	0	100	0	0	0	54.5	0	100	100
Total %	0	0	0	0	0	22.7	22.7	0	0	45.5	0	0	0	0	0	0	54.5	0	0	0	54.5	0	100	100

Start Time	Barton Street Southbound				Van Buren Boulevard Westbound				Barton Street Northbound				Van Buren Boulevard Eastbound											
	Left	Thru	Right	RTOR	App. Total	Left	Thru	Right	RTOR	App. Total	Left	Thru	Right	RTOR	App. Total	Left	Thru	Right	RTOR	App. Total	Exclu. Total	Inclu. Total	Int. Total	
04:00 PM	0	0	0	0	0	1	1	0	0	2	0	0	0	0	0	0	4	0	0	0	4	0	6	6
04:15 PM	0	0	0	0	0	1	0	0	0	1	0	0	0	0	0	0	0	0	0	0	0	0	1	1
04:30 PM	0	0	0	0	0	1	0	0	0	1	0	0	0	0	0	0	3	0	0	0	3	0	4	4
04:45 PM	0	0	0	0	0	0	1	0	0	1	0	0	0	0	0	0	2	0	0	0	2	0	3	3
Total	0	0	0	0	0	3	2	0	0	5	0	0	0	0	0	0	9	0	0	0	9	0	14	14
05:00 PM	0	0	0	0	0	0	1	0	0	1	0	0	0	0	0	0	1	0	0	0	1	0	2	2
05:15 PM	0	0	0	0	0	2	1	0	0	3	0	0	0	0	0	0	1	0	0	0	1	0	4	4
05:30 PM	0	0	0	0	0	0	0	0	0	0	0	0	0	0	0	0	0	0	0	0	0	0	1	1
05:45 PM	0	0	0	0	0	0	1	0	0	1	0	0	0	0	0	0	0	0	0	0	0	0	1	1
Total	0	0	0	0	0	2	3	0	0	5	0	0	0	0	0	0	3	0	0	0	3	0	8	8
Grand Total	0	0	0	0	0	5	5	0	0	10	0	0	0	0	0	0	12	0	0	0	12	0	22	22
T-Approch %	0	0	0	0	0	50	50	0	0	45.5	0	0	0	0	0	0	100	0	0	0	54.5	0	100	100
Total %	0	0	0	0	0	22.7	22.7	0	0	45.5	0	0	0	0	0	0	54.5	0	0	0	54.5	0	100	100

Peak Hour Analysis From 04:00 PM to 04:45 PM - Peak 1 of 1
 Peak Hour for Entire Intersection Begins at 04:00 PM

Start Time	Barton Street Southbound				Van Buren Boulevard Westbound				Barton Street Northbound				Van Buren Boulevard Eastbound											
	Left	Thru	Right	RTOR	App. Total	Left	Thru	Right	RTOR	App. Total	Left	Thru	Right	RTOR	App. Total	Left	Thru	Right	RTOR	App. Total	Exclu. Total	Inclu. Total	Int. Total	
04:00 PM	0	0	0	0	0	1	1	0	0	2	0	0	0	0	0	0	4	0	0	0	4	0	6	6
04:15 PM	0	0	0	0	0	1	0	0	0	1	0	0	0	0	0	0	0	0	0	0	0	0	1	1
04:30 PM	0	0	0	0	0	1	0	0	0	1	0	0	0	0	0	0	3	0	0	0	3	0	4	4
04:45 PM	0	0	0	0	0	0	1	0	0	1	0	0	0	0	0	0	2	0	0	0	2	0	3	3
Total	0	0	0	0	0	3	2	0	0	5	0	0	0	0	0	0	9	0	0	0	9	0	14	14
% App. Total	0	0	0	0	0	60	40	0	0	62.5	0	0	0	0	0	0	100	0	0	0	56.3	0	58.3	58.3
PHF	.000	.000	.000	.000	.000	.750	.500	.000	.625	.000	.000	.000	.000	.000	.000	.000	.563	.000	.000	.563	.000	.563	.583	.583

Counts Unlimited, Inc.
 PO Box 1178
 Corona, CA 92878
 (951)268-6268

City of Riverside
 N/S: Barton Street
 E/W: Van Buren Boulevard
 Weather: Clear

File Name : 14_RIV_Barton_VB PM
 Site Code : 05121716
 Start Date : 11/30/2021
 Page No : 2

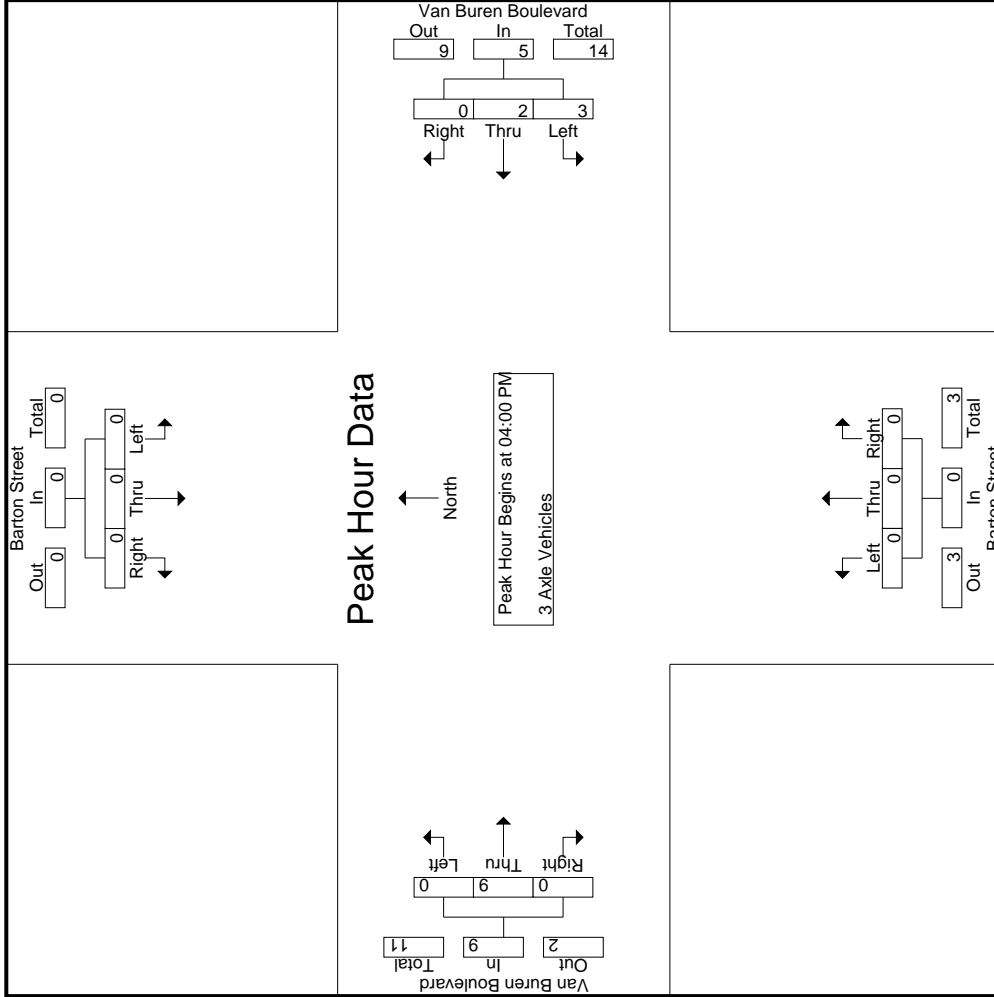

Counts Unlimited, Inc.
 PO Box 1178
 Corona, CA 92878
 (951)268-6268

City of Riverside
 N/S: Barton Street
 E/W: Van Buren Boulevard
 Weather: Clear

File Name : 14_RIV_Barton_VB PM
 Site Code : 05121716
 Start Date : 11/30/2021
 Page No : 3

Start Time	Barton Street Southbound			Van Buren Boulevard Westbound			Barton Street Northbound			Van Buren Boulevard Eastbound			Int. Total	
	Left	Thru	Right	Left	Thru	Right	Left	Thru	Right	Left	Thru	Right		App. Total
Peak Hour Analysis From 04:00 PM to 04:45 PM - Peak 1 of 1														
Peak Hour for Each Approach Begins at:														
	04:00 PM			04:00 PM			04:00 PM			04:00 PM				
+0 mins.	0	0	0	1	0	0	2	0	0	0	0	0	4	4
+15 mins.	0	0	0	0	0	0	1	0	0	0	0	0	0	0
+30 mins.	0	0	0	1	0	0	1	0	0	0	0	0	3	3
+45 mins.	0	0	0	0	1	0	1	0	0	0	0	0	2	2
Total Volume	0	0	0	3	2	0	5	0	0	0	0	9	9	9
% App. Total	0	0	0	.60	.40	0	0	0	0	0	0	100	0	0
PHF	.000	.000	.000	.750	.500	.000	.625	.000	.000	.000	.000	.563	.000	.563

Groups Printed- 4+ Axle Trucks

Start Time	Barton Street Southbound					Van Buren Boulevard Westbound					Barton Street Northbound					Van Buren Boulevard Eastbound							
	Left	Thru	Right	RTOR	App. Total	Left	Thru	Right	RTOR	App. Total	Left	Thru	Right	RTOR	App. Total	Left	Thru	Right	RTOR	App. Total	Exclu. Total	Inclu. Total	Int. Total
04:00 PM	0	0	0	0	0	0	2	0	0	2	0	0	0	0	0	0	4	0	0	4	0	6	6
04:15 PM	0	0	0	0	0	0	2	0	0	2	0	0	0	0	0	0	1	0	0	1	0	3	3
04:30 PM	0	0	0	0	0	0	0	0	0	0	1	0	1	1	2	0	2	0	0	2	1	4	5
04:45 PM	0	0	0	0	0	0	3	0	0	3	0	0	0	0	0	0	0	1	0	1	0	4	4
Total	0	0	0	0	0	0	7	0	0	7	1	0	1	1	2	0	7	1	0	8	1	17	18
05:00 PM	0	0	0	0	0	1	2	0	0	3	0	0	0	0	0	0	3	0	0	3	0	6	6
05:15 PM	0	0	0	0	0	0	0	0	0	0	0	0	0	0	0	0	0	0	0	0	0	0	0
05:30 PM	0	0	0	0	0	1	0	0	0	1	0	0	0	0	0	0	4	0	0	4	0	5	5
05:45 PM	0	0	0	0	0	0	1	0	0	1	0	0	0	0	0	0	3	0	0	3	0	4	4
Total	0	0	0	0	0	1	4	0	0	5	0	0	0	0	0	0	10	0	0	10	0	15	15
Grand Total	0	0	0	0	0	1	11	0	0	12	1	0	1	1	2	0	17	1	0	18	1	32	33
T-Approch %	0	0	0	0	0	8.3	91.7	0	0	50	50	0	50	0	6.2	0	94.4	5.6	0	56.2	3	97	
Total %	0	0	0	0	0	3.1	34.4	0	0	37.5	3.1	0	3.1	0	6.2	0	53.1	3.1	0	56.2	3	97	

Start Time	Barton Street Southbound					Van Buren Boulevard Westbound					Barton Street Northbound					Van Buren Boulevard Eastbound							
	Left	Thru	Right	RTOR	App. Total	Left	Thru	Right	RTOR	App. Total	Left	Thru	Right	RTOR	App. Total	Left	Thru	Right	RTOR	App. Total	Exclu. Total	Inclu. Total	Int. Total
04:00 PM	0	0	0	0	0	0	2	0	0	2	0	0	0	0	0	0	4	0	0	4	0	6	6
04:15 PM	0	0	0	0	0	0	2	0	0	2	0	0	0	0	0	0	1	0	0	1	0	3	3
04:30 PM	0	0	0	0	0	0	0	0	0	0	1	0	1	1	2	0	2	0	0	2	1	4	5
04:45 PM	0	0	0	0	0	0	3	0	0	3	0	0	0	0	0	0	0	1	0	1	0	4	4
Total	0	0	0	0	0	0	7	0	0	7	1	0	1	1	2	0	7	1	0	8	1	17	18
% App. Total	.000	.000	.000	.000	.000	.000	.583	.000	.000	.583	.250	.000	.250	.000	.250	.000	.438	.250	.000	.438	.250	.500	.708
PHF																							

Peak Hour Analysis From 04:00 PM to 04:45 PM - Peak 1 of 1
 Peak Hour for Entire Intersection Begins at 04:00 PM

Counts Unlimited, Inc.
 PO Box 1178
 Corona, CA 92878
 (951)268-6268

City of Riverside
 N/S: Barton Street
 E/W: Van Buren Boulevard
 Weather: Clear

File Name : 14_RIV_Barton_VB PM
 Site Code : 05121716
 Start Date : 11/30/2021
 Page No : 2

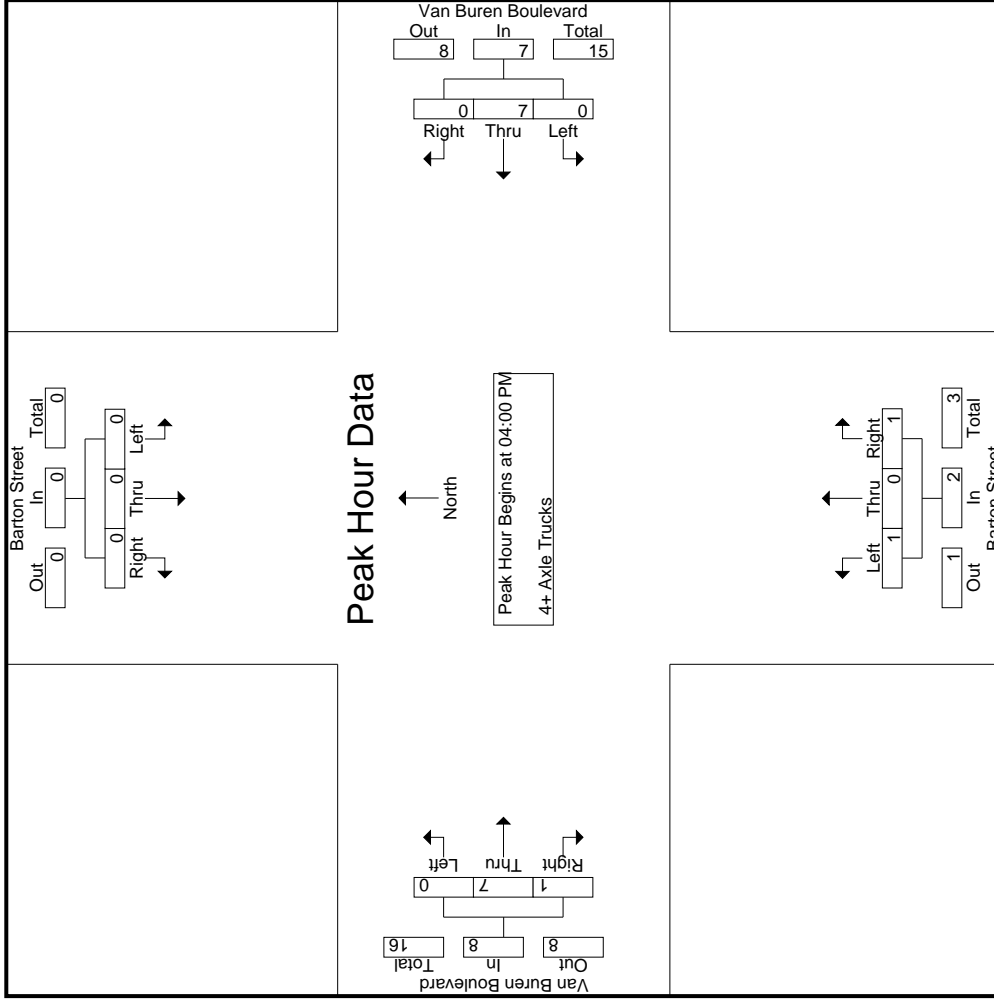

Counts Unlimited, Inc.
 PO Box 1178
 Corona, CA 92878
 (951)268-6268

City of Riverside
 N/S: Barton Street
 E/W: Van Buren Boulevard
 Weather: Clear

File Name : 14_RIV_Barton_VB PM
 Site Code : 05121716
 Start Date : 11/30/2021
 Page No : 3

Start Time	Barton Street Southbound			Van Buren Boulevard Westbound			Barton Street Northbound			Van Buren Boulevard Eastbound		
	Left	Thru	Right	Left	Thru	Right	Left	Thru	Right	Left	Thru	Right
Peak Hour Analysis From 04:00 PM to 04:45 PM - Peak 1 of 1	04:00 PM											
Peak Hour for Each Approach Begins at:	04:00 PM											
+0 mins.	0	0	0	0	2	0	0	0	0	0	4	0
+15 mins.	0	0	0	0	2	0	0	0	0	0	1	0
+30 mins.	0	0	0	0	0	0	1	0	1	0	2	0
+45 mins.	0	0	0	0	3	0	3	0	0	0	0	1
Total Volume	0	0	0	0	7	0	1	0	1	0	7	1
% App. Total	0	0	0	0	100	0	50	0	50	0	87.5	12.5
PHF	.000	.000	.000	.000	.583	.000	.250	.000	.250	.000	.438	.250
					.583	.000	.250	.000	.250	.000	.438	.250
					.583	.000	.250	.000	.250	.000	.438	.250

Location: Riverside
 N/S: Barton Street
 E/W: Van Buren Boulevard



Date: 11/30/2021
 Day: Tuesday

PEDESTRIANS

	North Leg Barton Street	East Leg Van Buren Boulevard	South Leg Barton Street	West Leg Van Buren Boulevard	
	Pedestrians	Pedestrians	Pedestrians	Pedestrians	
7:00 AM	0	0	0	0	0
7:15 AM	0	0	0	0	0
7:30 AM	0	0	0	0	0
7:45 AM	0	0	0	0	0
8:00 AM	0	0	0	0	0
8:15 AM	0	0	0	0	0
8:30 AM	0	0	0	0	0
8:45 AM	0	0	0	0	0
TOTAL VOLUMES:	0	0	0	0	0

	North Leg Barton Street	East Leg Van Buren Boulevard	South Leg Barton Street	West Leg Van Buren Boulevard	
	Pedestrians	Pedestrians	Pedestrians	Pedestrians	
4:00 PM	0	0	0	0	0
4:15 PM	0	0	0	0	0
4:30 PM	0	0	1	0	1
4:45 PM	1	0	0	0	1
5:00 PM	0	0	0	0	0
5:15 PM	0	0	0	0	0
5:30 PM	0	0	0	0	0
5:45 PM	0	0	0	0	0
TOTAL VOLUMES:	1	0	1	0	2

Location: Riverside
 N/S: Barton Street
 E/W: Van Buren Boulevard



Date: 11/30/2021
 Day: Tuesday

BICYCLES

	Southbound Barton Street			Westbound Van Buren Boulevard			Northbound Barton Street			Eastbound Van Buren Boulevard			
	Left	Thru	Right	Left	Thru	Right	Left	Thru	Right	Left	Thru	Right	
7:00 AM	0	0	0	0	0	0	0	0	0	0	0	0	0
7:15 AM	0	0	0	0	0	0	0	0	0	0	0	0	0
7:30 AM	0	0	0	0	0	0	0	0	0	0	0	0	0
7:45 AM	0	0	0	0	0	0	0	0	0	0	0	0	0
8:00 AM	0	0	0	0	0	0	0	0	0	0	0	0	0
8:15 AM	0	0	0	0	0	0	0	0	0	0	0	0	0
8:30 AM	0	0	0	0	0	0	0	0	0	0	0	0	0
8:45 AM	0	0	0	0	0	0	0	0	0	0	0	0	0
TOTAL VOLUMES:	0	0	0	0	0	0	0	0	0	0	0	0	0

	Southbound Barton Street			Westbound Van Buren Boulevard			Northbound Barton Street			Eastbound Van Buren Boulevard			
	Left	Thru	Right	Left	Thru	Right	Left	Thru	Right	Left	Thru	Right	
4:00 PM	0	0	0	0	0	0	0	0	0	0	0	0	0
4:15 PM	0	0	0	0	0	0	0	0	0	0	0	0	0
4:30 PM	0	0	0	0	0	0	0	0	0	0	0	0	0
4:45 PM	0	0	0	0	0	0	0	0	0	0	0	0	0
5:00 PM	0	0	0	0	0	1	0	0	0	0	0	0	1
5:15 PM	0	0	0	0	0	0	0	0	0	0	0	0	0
5:30 PM	0	0	0	0	0	0	0	0	0	0	0	0	0
5:45 PM	0	0	0	0	0	0	0	0	0	0	0	0	0
TOTAL VOLUMES:	0	0	0	0	0	1	0	0	0	0	0	0	1

City of Riverside
 N/S: Abrams Drive
 E/W: Grove Community Drive
 Weather: Clear

File Name : 16_RIV_Abrams_Grove AM
 Site Code : 05121716
 Start Date : 11/30/2021
 Page No : 1

Groups Printed- Passenger Vehicles - Large 2 Axle Vehicles - 3 Axle Vehicles - 4+ Axle Trucks

Start Time	Grove Community Drive Westbound			Abrams Drive Northbound			Grove Community Drive Eastbound			Int. Total
	Left	Thru	App. Total	Left	Right	App. Total	Thru	Right	App. Total	
07:00 AM	28	38	66	21	3	24	8	12	20	110
07:15 AM	24	66	90	43	9	52	9	19	28	170
07:30 AM	17	48	65	31	22	53	11	5	16	134
07:45 AM	10	30	40	20	18	38	15	8	23	101
Total	79	182	261	115	52	167	43	44	87	515
08:00 AM	5	21	26	13	5	18	9	6	15	59
08:15 AM	7	22	29	9	7	16	14	10	24	69
08:30 AM	4	28	32	6	5	11	5	8	13	56
08:45 AM	7	32	39	15	0	15	8	7	15	69
Total	23	103	126	43	17	60	36	31	67	253
Grand Total	102	285	387	158	69	227	79	75	154	768
Apprch %	26.4	73.6		69.6	30.4		51.3	48.7		
Total %	13.3	37.1	50.4	20.6	9	29.6	10.3	9.8	20.1	
Passenger Vehicles	100	280	380	155	68	223	77	75	152	755
% Passenger Vehicles	98	98.2	98.2	98.1	98.6	98.2	97.5	100	98.7	98.3
Large 2 Axle Vehicles	2	5	7	3	1	4	2	0	2	13
% Large 2 Axle Vehicles	2	1.8	1.8	1.9	1.4	1.8	2.5	0	1.3	1.7
3 Axle Vehicles	0	0	0	0	0	0	0	0	0	0
% 3 Axle Vehicles	0	0	0	0	0	0	0	0	0	0
4+ Axle Trucks	0	0	0	0	0	0	0	0	0	0
% 4+ Axle Trucks	0	0	0	0	0	0	0	0	0	0

Start Time	Grove Community Drive Westbound			Abrams Drive Northbound			Grove Community Drive Eastbound			Int. Total
	Left	Thru	App. Total	Left	Right	App. Total	Thru	Right	App. Total	
Peak Hour Analysis From 07:00 AM to 08:45 AM - Peak 1 of 1										
Peak Hour for Entire Intersection Begins at 07:00 AM										
07:00 AM	28	38	66	21	3	24	8	12	20	110
07:15 AM	24	66	90	43	9	52	9	19	28	170
07:30 AM	17	48	65	31	22	53	11	5	16	134
07:45 AM	10	30	40	20	18	38	15	8	23	101
Total Volume	79	182	261	115	52	167	43	44	87	515
% App. Total	30.3	69.7		68.9	31.1		49.4	50.6		
PHF	.705	.689	.725	.669	.591	.788	.717	.579	.777	.757

City of Riverside
 N/S: Abrams Drive
 E/W: Grove Community Drive
 Weather: Clear

File Name : 16_RIV_Abrams_Grove AM
 Site Code : 05121716
 Start Date : 11/30/2021
 Page No : 2

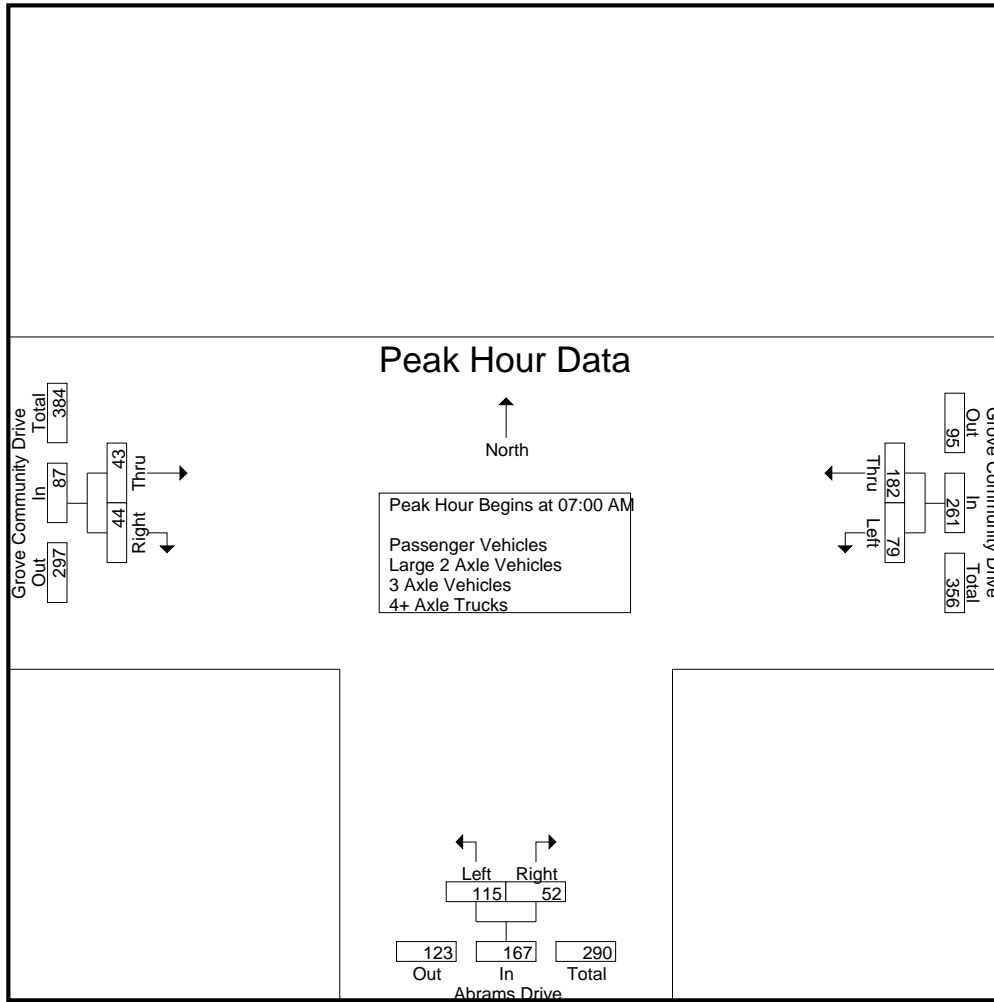

Peak Hour Analysis From 07:00 AM to 08:45 AM - Peak 1 of 1
 Peak Hour for Each Approach Begins at:

	07:00 AM			07:00 AM			07:00 AM		
+0 mins.	28	38	66	21	3	24	8	12	20
+15 mins.	24	66	90	43	9	52	9	19	28
+30 mins.	17	48	65	31	22	53	11	5	16
+45 mins.	10	30	40	20	18	38	15	8	23
Total Volume	79	182	261	115	52	167	43	44	87
% App. Total	30.3	69.7		68.9	31.1		49.4	50.6	
PHF	.705	.689	.725	.669	.591	.788	.717	.579	.777

City of Riverside
 N/S: Abrams Drive
 E/W: Grove Community Drive
 Weather: Clear

File Name : 16_RIV_Abrams_Grove AM
 Site Code : 05121716
 Start Date : 11/30/2021
 Page No : 1

Groups Printed- Passenger Vehicles

Start Time	Grove Community Drive Westbound			Abrams Drive Northbound			Grove Community Drive Eastbound			Int. Total
	Left	Thru	App. Total	Left	Right	App. Total	Thru	Right	App. Total	
07:00 AM	28	37	65	20	3	23	8	12	20	108
07:15 AM	24	66	90	42	8	50	9	19	28	168
07:30 AM	17	48	65	30	22	52	10	5	15	132
07:45 AM	10	27	37	20	18	38	14	8	22	97
Total	79	178	257	112	51	163	41	44	85	505
08:00 AM	4	20	24	13	5	18	9	6	15	57
08:15 AM	7	22	29	9	7	16	14	10	24	69
08:30 AM	4	28	32	6	5	11	5	8	13	56
08:45 AM	6	32	38	15	0	15	8	7	15	68
Total	21	102	123	43	17	60	36	31	67	250
Grand Total	100	280	380	155	68	223	77	75	152	755
Apprch %	26.3	73.7		69.5	30.5		50.7	49.3		
Total %	13.2	37.1	50.3	20.5	9	29.5	10.2	9.9	20.1	

Start Time	Grove Community Drive Westbound			Abrams Drive Northbound			Grove Community Drive Eastbound			Int. Total
	Left	Thru	App. Total	Left	Right	App. Total	Thru	Right	App. Total	
07:00 AM	28	37	65	20	3	23	8	12	20	108
07:15 AM	24	66	90	42	8	50	9	19	28	168
07:30 AM	17	48	65	30	22	52	10	5	15	132
07:45 AM	10	27	37	20	18	38	14	8	22	97
Total Volume	79	178	257	112	51	163	41	44	85	505
% App. Total	30.7	69.3		68.7	31.3		48.2	51.8		
PHF	.705	.674	.714	.667	.580	.784	.732	.579	.759	.751

Peak Hour Analysis From 07:00 AM to 07:45 AM - Peak 1 of 1
 Peak Hour for Entire Intersection Begins at 07:00 AM

City of Riverside
 N/S: Abrams Drive
 E/W: Grove Community Drive
 Weather: Clear

File Name : 16_RIV_Abrams_Grove AM
 Site Code : 05121716
 Start Date : 11/30/2021
 Page No : 2

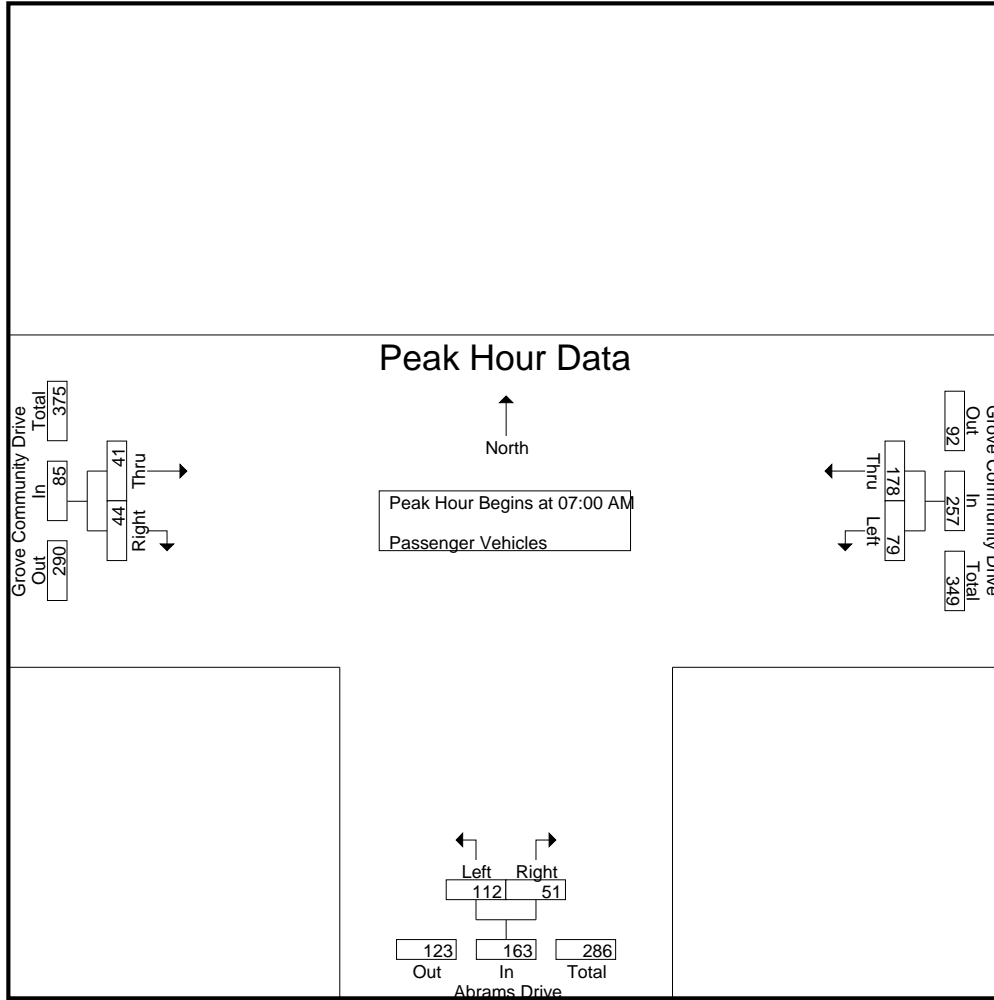

Peak Hour Analysis From 07:00 AM to 07:45 AM - Peak 1 of 1
 Peak Hour for Each Approach Begins at:

	07:00 AM			07:00 AM			07:00 AM		
+0 mins.	28	37	65	20	3	23	8	12	20
+15 mins.	24	66	90	42	8	50	9	19	28
+30 mins.	17	48	65	30	22	52	10	5	15
+45 mins.	10	27	37	20	18	38	14	8	22
Total Volume	79	178	257	112	51	163	41	44	85
% App. Total	30.7	69.3		68.7	31.3		48.2	51.8	
PHF	.705	.674	.714	.667	.580	.784	.732	.579	.759

City of Riverside
 N/S: Abrams Drive
 E/W: Grove Community Drive
 Weather: Clear

File Name : 16_RIV_Abrams_Grove AM
 Site Code : 05121716
 Start Date : 11/30/2021
 Page No : 1

Groups Printed- Large 2 Axle Vehicles

Start Time	Grove Community Drive Westbound			Abrams Drive Northbound			Grove Community Drive Eastbound			Int. Total
	Left	Thru	App. Total	Left	Right	App. Total	Thru	Right	App. Total	
07:00 AM	0	1	1	1	0	1	0	0	0	2
07:15 AM	0	0	0	1	1	2	0	0	0	2
07:30 AM	0	0	0	1	0	1	1	0	1	2
07:45 AM	0	3	3	0	0	0	1	0	1	4
Total	0	4	4	3	1	4	2	0	2	10
08:00 AM	1	1	2	0	0	0	0	0	0	2
08:15 AM	0	0	0	0	0	0	0	0	0	0
08:30 AM	0	0	0	0	0	0	0	0	0	0
08:45 AM	1	0	1	0	0	0	0	0	0	1
Total	2	1	3	0	0	0	0	0	0	3
Grand Total	2	5	7	3	1	4	2	0	2	13
Apprch %	28.6	71.4		75	25		100	0		
Total %	15.4	38.5	53.8	23.1	7.7	30.8	15.4	0	15.4	

Start Time	Grove Community Drive Westbound			Abrams Drive Northbound			Grove Community Drive Eastbound			Int. Total
	Left	Thru	App. Total	Left	Right	App. Total	Thru	Right	App. Total	
07:00 AM	0	1	1	1	0	1	0	0	0	2
07:15 AM	0	0	0	1	1	2	0	0	0	2
07:30 AM	0	0	0	1	0	1	1	0	1	2
07:45 AM	0	3	3	0	0	0	1	0	1	4
Total Volume	0	4	4	3	1	4	2	0	2	10
% App. Total	0	100		75	25		100	0		
PHF	.000	.333	.333	.750	.250	.500	.500	.000	.500	.625

Peak Hour Analysis From 07:00 AM to 07:45 AM - Peak 1 of 1
 Peak Hour for Entire Intersection Begins at 07:00 AM

City of Riverside
 N/S: Abrams Drive
 E/W: Grove Community Drive
 Weather: Clear

File Name : 16_RIV_Abrams_Grove AM
 Site Code : 05121716
 Start Date : 11/30/2021
 Page No : 2

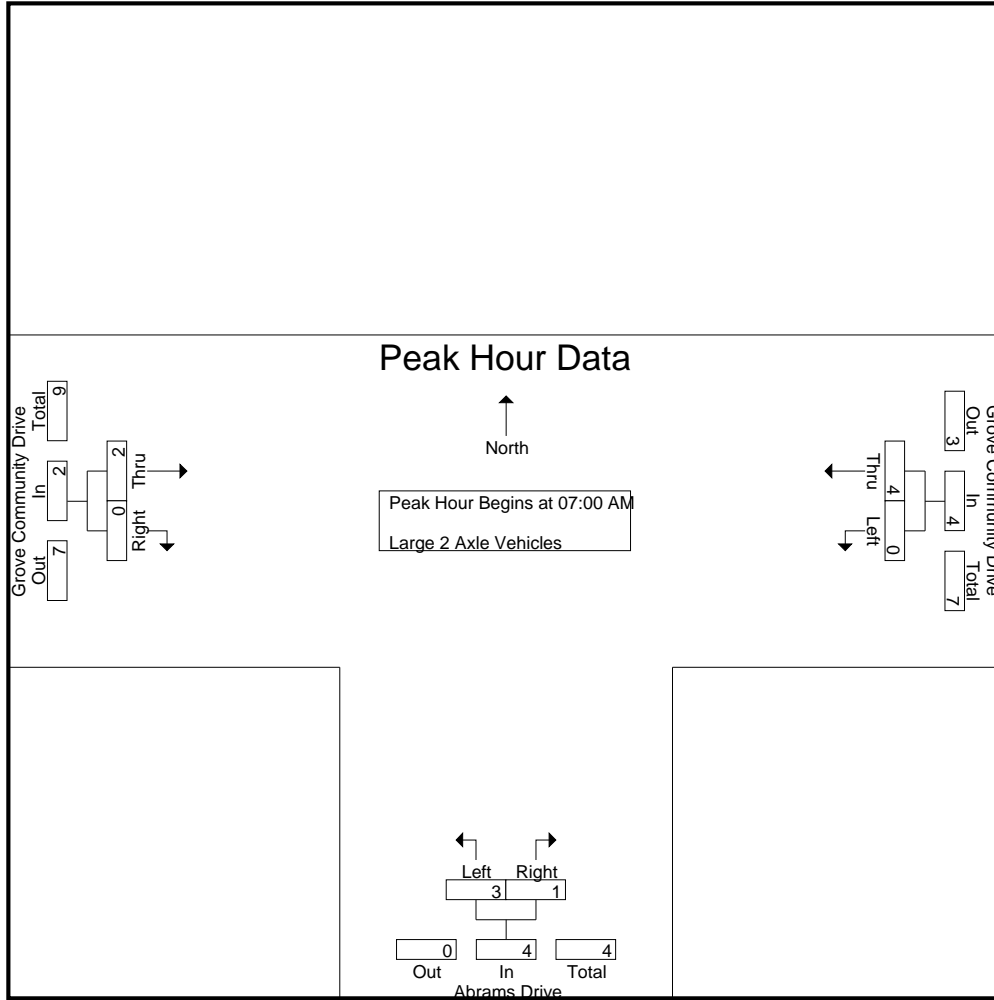

Peak Hour Analysis From 07:00 AM to 07:45 AM - Peak 1 of 1
 Peak Hour for Each Approach Begins at:

	07:00 AM			07:00 AM			07:00 AM		
+0 mins.	0	1	1	1	0	1	0	0	0
+15 mins.	0	0	0	1	1	2	0	0	0
+30 mins.	0	0	0	1	0	1	1	0	1
+45 mins.	0	3	3	0	0	0	1	0	1
Total Volume	0	4	4	3	1	4	2	0	2
% App. Total	0	100		75	25		100	0	
PHF	.000	.333	.333	.750	.250	.500	.500	.000	.500

City of Riverside
 N/S: Abrams Drive
 E/W: Grove Community Drive
 Weather: Clear

File Name : 16_RIV_Abrams_Grove AM
 Site Code : 05121716
 Start Date : 11/30/2021
 Page No : 1

Groups Printed- 3 Axle Vehicles

Start Time	Grove Community Drive Westbound			Abrams Drive Northbound			Grove Community Drive Eastbound			Int. Total
	Left	Thru	App. Total	Left	Right	App. Total	Thru	Right	App. Total	
07:00 AM	0	0	0	0	0	0	0	0	0	0
07:15 AM	0	0	0	0	0	0	0	0	0	0
07:30 AM	0	0	0	0	0	0	0	0	0	0
07:45 AM	0	0	0	0	0	0	0	0	0	0
Total	0	0	0	0	0	0	0	0	0	0
08:00 AM	0	0	0	0	0	0	0	0	0	0
08:15 AM	0	0	0	0	0	0	0	0	0	0
08:30 AM	0	0	0	0	0	0	0	0	0	0
08:45 AM	0	0	0	0	0	0	0	0	0	0
Total	0	0	0	0	0	0	0	0	0	0
Grand Total	0	0	0	0	0	0	0	0	0	0
Apprch %	0	0		0	0		0	0		
Total %										

Start Time	Grove Community Drive Westbound			Abrams Drive Northbound			Grove Community Drive Eastbound			Int. Total
	Left	Thru	App. Total	Left	Right	App. Total	Thru	Right	App. Total	
Peak Hour Analysis From 07:00 AM to 07:45 AM - Peak 1 of 1										
Peak Hour for Entire Intersection Begins at 07:00 AM										
07:00 AM	0	0	0	0	0	0	0	0	0	0
07:15 AM	0	0	0	0	0	0	0	0	0	0
07:30 AM	0	0	0	0	0	0	0	0	0	0
07:45 AM	0	0	0	0	0	0	0	0	0	0
Total Volume	0	0	0	0	0	0	0	0	0	0
% App. Total	0	0		0	0		0	0		
PHF	.000	.000	.000	.000	.000	.000	.000	.000	.000	.000

City of Riverside
 N/S: Abrams Drive
 E/W: Grove Community Drive
 Weather: Clear

File Name : 16_RIV_Abrams_Grove AM
 Site Code : 05121716
 Start Date : 11/30/2021
 Page No : 2

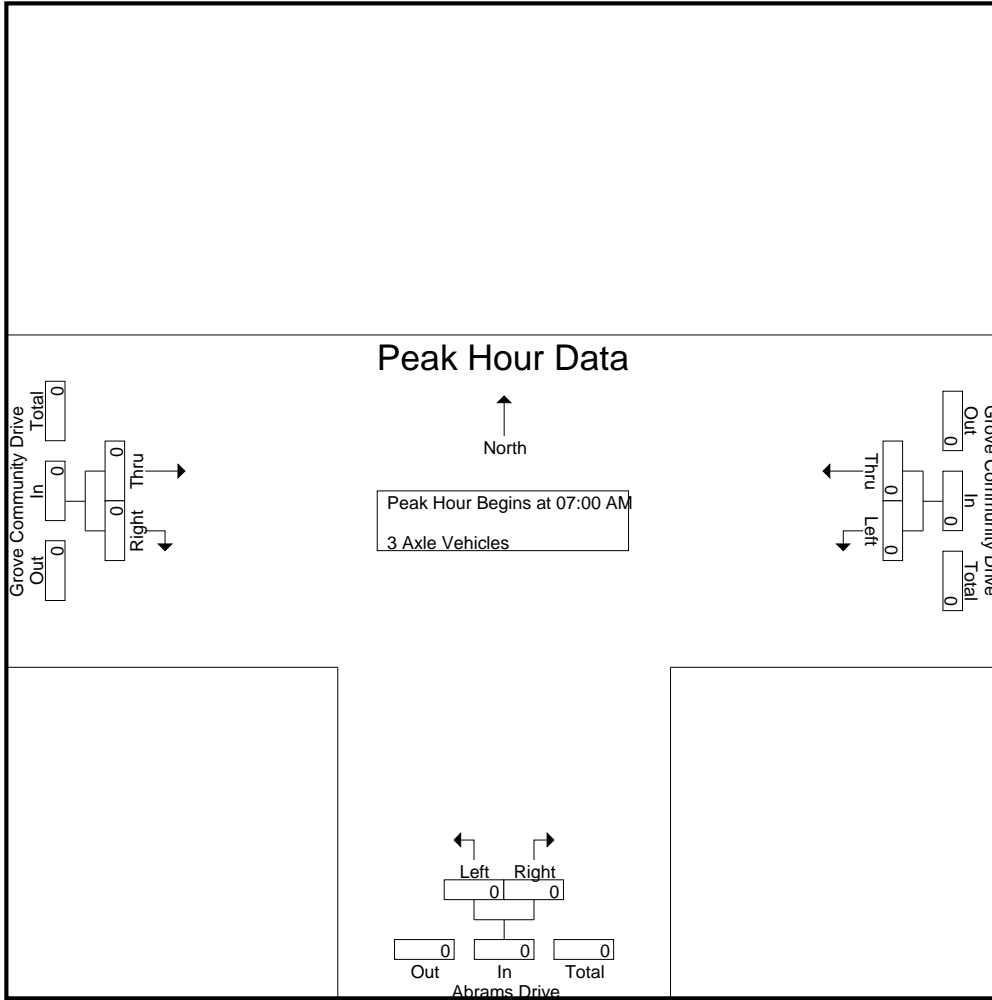

Peak Hour Analysis From 07:00 AM to 07:45 AM - Peak 1 of 1
 Peak Hour for Each Approach Begins at:

	07:00 AM			07:00 AM			07:00 AM		
+0 mins.	0	0	0	0	0	0	0	0	0
+15 mins.	0	0	0	0	0	0	0	0	0
+30 mins.	0	0	0	0	0	0	0	0	0
+45 mins.	0	0	0	0	0	0	0	0	0
Total Volume	0	0	0	0	0	0	0	0	0
% App. Total	0	0	0	0	0	0	0	0	0
PHF	.000	.000	.000	.000	.000	.000	.000	.000	.000

City of Riverside
 N/S: Abrams Drive
 E/W: Grove Community Drive
 Weather: Clear

File Name : 16_RIV_Abrams_Grove AM
 Site Code : 05121716
 Start Date : 11/30/2021
 Page No : 1

Groups Printed- 4+ Axle Trucks

Start Time	Grove Community Drive Westbound			Abrams Drive Northbound			Grove Community Drive Eastbound			Int. Total
	Left	Thru	App. Total	Left	Right	App. Total	Thru	Right	App. Total	
07:00 AM	0	0	0	0	0	0	0	0	0	0
07:15 AM	0	0	0	0	0	0	0	0	0	0
07:30 AM	0	0	0	0	0	0	0	0	0	0
07:45 AM	0	0	0	0	0	0	0	0	0	0
Total	0	0	0	0	0	0	0	0	0	0
08:00 AM	0	0	0	0	0	0	0	0	0	0
08:15 AM	0	0	0	0	0	0	0	0	0	0
08:30 AM	0	0	0	0	0	0	0	0	0	0
08:45 AM	0	0	0	0	0	0	0	0	0	0
Total	0	0	0	0	0	0	0	0	0	0
Grand Total	0	0	0	0	0	0	0	0	0	0
Apprch %	0	0		0	0		0	0		
Total %										

Start Time	Grove Community Drive Westbound			Abrams Drive Northbound			Grove Community Drive Eastbound			Int. Total
	Left	Thru	App. Total	Left	Right	App. Total	Thru	Right	App. Total	
Peak Hour Analysis From 07:00 AM to 07:45 AM - Peak 1 of 1										
Peak Hour for Entire Intersection Begins at 07:00 AM										
07:00 AM	0	0	0	0	0	0	0	0	0	0
07:15 AM	0	0	0	0	0	0	0	0	0	0
07:30 AM	0	0	0	0	0	0	0	0	0	0
07:45 AM	0	0	0	0	0	0	0	0	0	0
Total Volume	0	0	0	0	0	0	0	0	0	0
% App. Total	0	0		0	0		0	0		
PHF	.000	.000	.000	.000	.000	.000	.000	.000	.000	.000

City of Riverside
 N/S: Abrams Drive
 E/W: Grove Community Drive
 Weather: Clear

File Name : 16_RIV_Abrams_Grove AM
 Site Code : 05121716
 Start Date : 11/30/2021
 Page No : 2

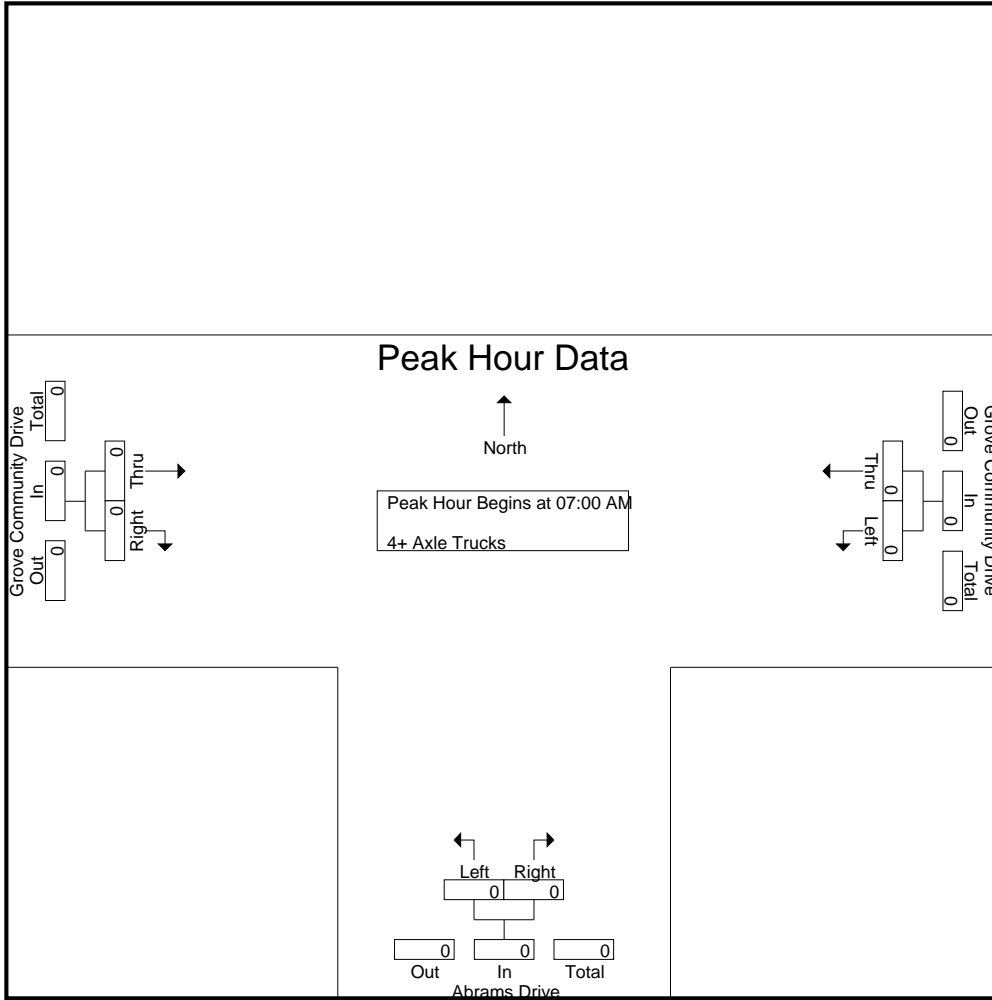

Peak Hour Analysis From 07:00 AM to 07:45 AM - Peak 1 of 1
 Peak Hour for Each Approach Begins at:

	07:00 AM			07:00 AM			07:00 AM		
+0 mins.	0	0	0	0	0	0	0	0	0
+15 mins.	0	0	0	0	0	0	0	0	0
+30 mins.	0	0	0	0	0	0	0	0	0
+45 mins.	0	0	0	0	0	0	0	0	0
Total Volume	0	0	0	0	0	0	0	0	0
% App. Total	0	0	0	0	0	0	0	0	0
PHF	.000	.000	.000	.000	.000	.000	.000	.000	.000

City of Riverside
 N/S: Abrams Drive
 E/W: Grove Community Drive
 Weather: Clear

File Name : 16_RIV_Abrams_Grove PM
 Site Code : 05121716
 Start Date : 11/30/2021
 Page No : 1

Groups Printed- Passenger Vehicles - Large 2 Axle Vehicles - 3 Axle Vehicles - 4+ Axle Trucks

Start Time	Grove Community Drive Westbound			Abrams Drive Northbound			Grove Community Drive Eastbound			Int. Total
	Left	Thru	App. Total	Left	Right	App. Total	Thru	Right	App. Total	
04:00 PM	7	21	28	5	11	16	31	8	39	83
04:15 PM	9	17	26	14	10	24	27	9	36	86
04:30 PM	6	18	24	12	8	20	25	14	39	83
04:45 PM	7	18	25	7	18	25	37	17	54	104
Total	29	74	103	38	47	85	120	48	168	356
05:00 PM	8	14	22	13	16	29	32	12	44	95
05:15 PM	11	14	25	15	10	25	28	14	42	92
05:30 PM	7	19	26	11	10	21	37	14	51	98
05:45 PM	5	22	27	15	11	26	31	12	43	96
Total	31	69	100	54	47	101	128	52	180	381
Grand Total	60	143	203	92	94	186	248	100	348	737
Apprch %	29.6	70.4		49.5	50.5		71.3	28.7		
Total %	8.1	19.4	27.5	12.5	12.8	25.2	33.6	13.6	47.2	
Passenger Vehicles	59	142	201	91	94	185	246	98	344	730
% Passenger Vehicles	98.3	99.3	99	98.9	100	99.5	99.2	98	98.9	99.1
Large 2 Axle Vehicles	1	1	2	1	0	1	2	2	4	7
% Large 2 Axle Vehicles	1.7	0.7	1	1.1	0	0.5	0.8	2	1.1	0.9
3 Axle Vehicles	0	0	0	0	0	0	0	0	0	0
% 3 Axle Vehicles	0	0	0	0	0	0	0	0	0	0
4+ Axle Trucks	0	0	0	0	0	0	0	0	0	0
% 4+ Axle Trucks	0	0	0	0	0	0	0	0	0	0

Start Time	Grove Community Drive Westbound			Abrams Drive Northbound			Grove Community Drive Eastbound			Int. Total
	Left	Thru	App. Total	Left	Right	App. Total	Thru	Right	App. Total	
Peak Hour Analysis From 04:00 PM to 05:45 PM - Peak 1 of 1										
Peak Hour for Entire Intersection Begins at 04:45 PM										
04:45 PM	7	18	25	7	18	25	37	17	54	104
05:00 PM	8	14	22	13	16	29	32	12	44	95
05:15 PM	11	14	25	15	10	25	28	14	42	92
05:30 PM	7	19	26	11	10	21	37	14	51	98
Total Volume	33	65	98	46	54	100	134	57	191	389
% App. Total	33.7	66.3		46	54		70.2	29.8		
PHF	.750	.855	.942	.767	.750	.862	.905	.838	.884	.935

City of Riverside
 N/S: Abrams Drive
 E/W: Grove Community Drive
 Weather: Clear

File Name : 16_RIV_Abrams_Grove PM
 Site Code : 05121716
 Start Date : 11/30/2021
 Page No : 2

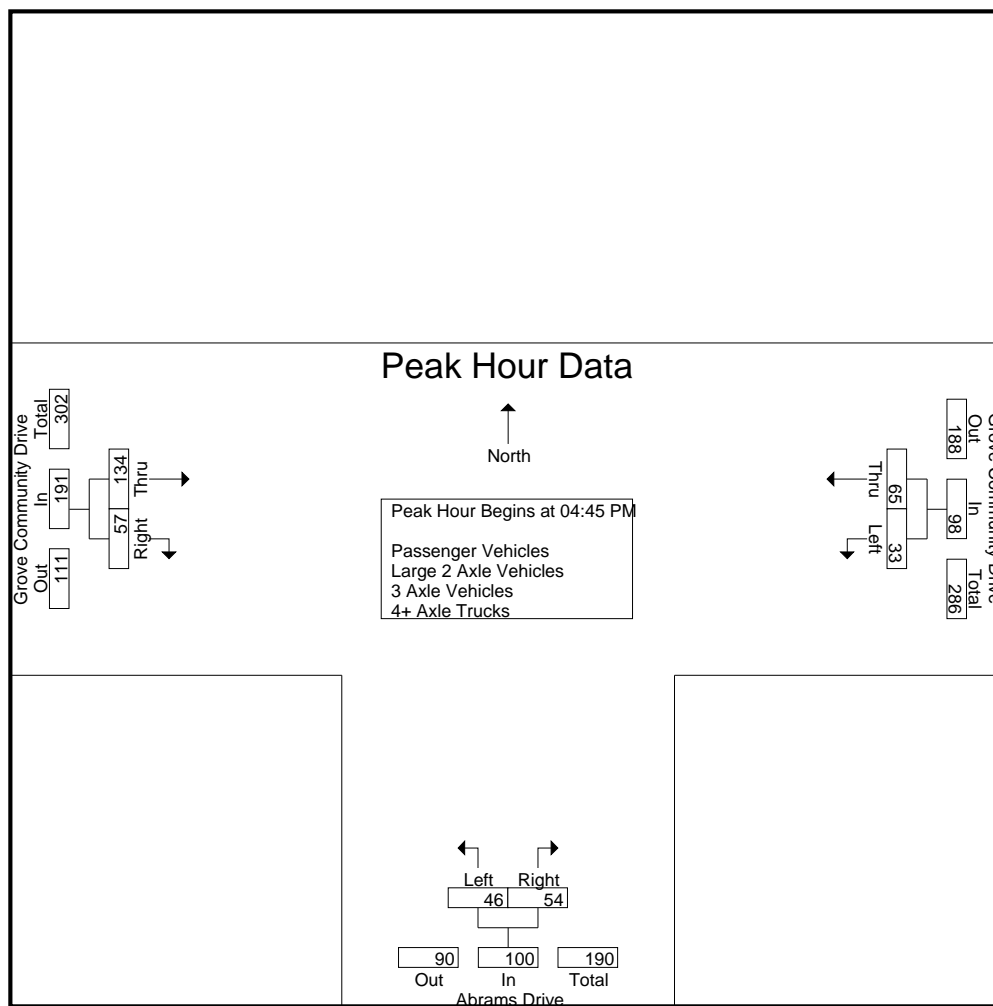

Peak Hour Analysis From 04:00 PM to 05:45 PM - Peak 1 of 1
 Peak Hour for Each Approach Begins at:

	04:00 PM			05:00 PM			04:45 PM		
+0 mins.	7	21	28	13	16	29	37	17	54
+15 mins.	9	17	26	15	10	25	32	12	44
+30 mins.	6	18	24	11	10	21	28	14	42
+45 mins.	7	18	25	15	11	26	37	14	51
Total Volume	29	74	103	54	47	101	134	57	191
% App. Total	28.2	71.8		53.5	46.5		70.2	29.8	
PHF	.806	.881	.920	.900	.734	.871	.905	.838	.884

City of Riverside
 N/S: Abrams Drive
 E/W: Grove Community Drive
 Weather: Clear

File Name : 16_RIV_Abrams_Grove PM
 Site Code : 05121716
 Start Date : 11/30/2021
 Page No : 1

Groups Printed- Passenger Vehicles

Start Time	Grove Community Drive Westbound			Abrams Drive Northbound			Grove Community Drive Eastbound			Int. Total
	Left	Thru	App. Total	Left	Right	App. Total	Thru	Right	App. Total	
04:00 PM	7	21	28	5	11	16	31	8	39	83
04:15 PM	9	17	26	14	10	24	27	8	35	85
04:30 PM	6	18	24	12	8	20	24	14	38	82
04:45 PM	7	18	25	7	18	25	37	17	54	104
Total	29	74	103	38	47	85	119	47	166	354
05:00 PM	8	14	22	13	16	29	31	11	42	93
05:15 PM	10	13	23	15	10	25	28	14	42	90
05:30 PM	7	19	26	10	10	20	37	14	51	97
05:45 PM	5	22	27	15	11	26	31	12	43	96
Total	30	68	98	53	47	100	127	51	178	376
Grand Total	59	142	201	91	94	185	246	98	344	730
Apprch %	29.4	70.6		49.2	50.8		71.5	28.5		
Total %	8.1	19.5	27.5	12.5	12.9	25.3	33.7	13.4	47.1	

Start Time	Grove Community Drive Westbound			Abrams Drive Northbound			Grove Community Drive Eastbound			Int. Total
	Left	Thru	App. Total	Left	Right	App. Total	Thru	Right	App. Total	
04:45 PM	7	18	25	7	18	25	37	17	54	104
05:00 PM	8	14	22	13	16	29	31	11	42	93
05:15 PM	10	13	23	15	10	25	28	14	42	90
05:30 PM	7	19	26	10	10	20	37	14	51	97
Total Volume	32	64	96	45	54	99	133	56	189	384
% App. Total	33.3	66.7		45.5	54.5		70.4	29.6		
PHF	.800	.842	.923	.750	.750	.853	.899	.824	.875	.923

Peak Hour Analysis From 04:45 PM to 05:30 PM - Peak 1 of 1
 Peak Hour for Entire Intersection Begins at 04:45 PM

City of Riverside
 N/S: Abrams Drive
 E/W: Grove Community Drive
 Weather: Clear

File Name : 16_RIV_Abrams_Grove PM
 Site Code : 05121716
 Start Date : 11/30/2021
 Page No : 2

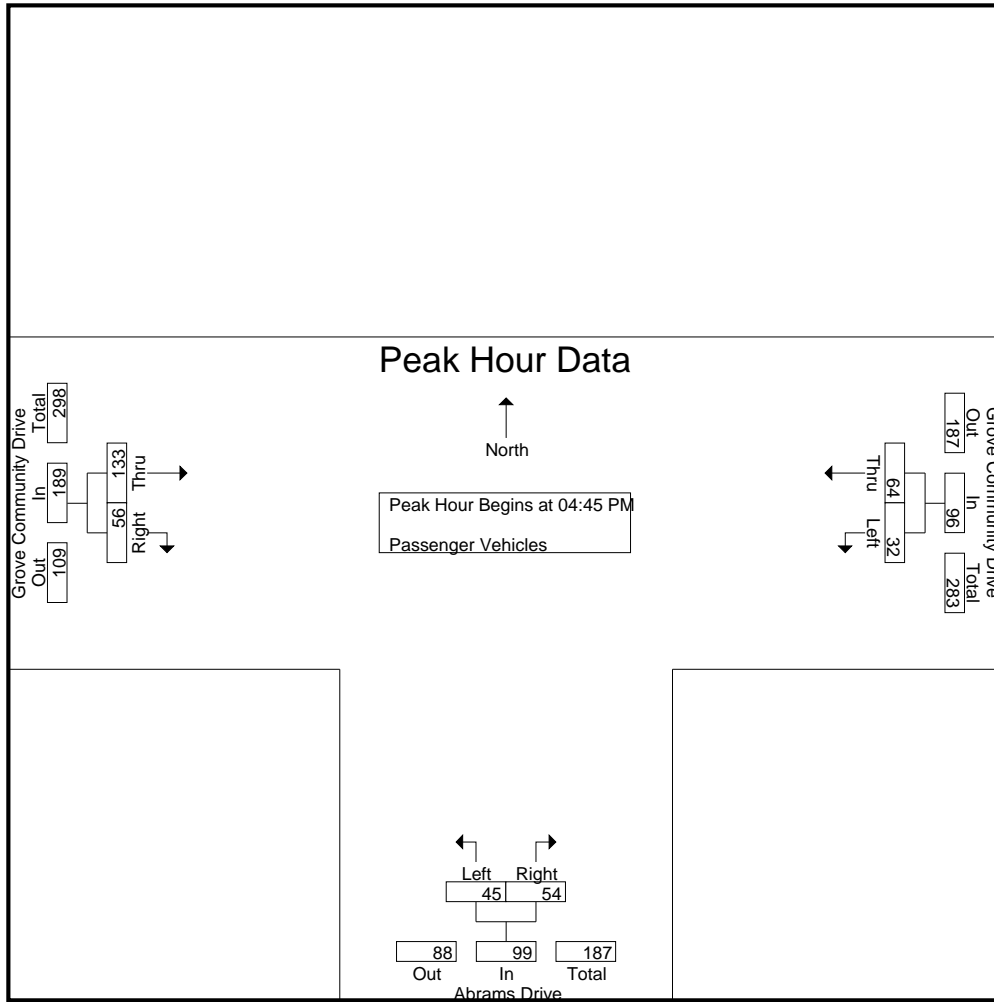

Peak Hour Analysis From 04:45 PM to 05:30 PM - Peak 1 of 1
 Peak Hour for Each Approach Begins at:

	04:45 PM			04:45 PM			04:45 PM		
+0 mins.	7	18	25	7	18	25	37	17	54
+15 mins.	8	14	22	13	16	29	31	11	42
+30 mins.	10	13	23	15	10	25	28	14	42
+45 mins.	7	19	26	10	10	20	37	14	51
Total Volume	32	64	96	45	54	99	133	56	189
% App. Total	33.3	66.7		45.5	54.5		70.4	29.6	
PHF	.800	.842	.923	.750	.750	.853	.899	.824	.875

City of Riverside
 N/S: Abrams Drive
 E/W: Grove Community Drive
 Weather: Clear

File Name : 16_RIV_Abrams_Grove PM
 Site Code : 05121716
 Start Date : 11/30/2021
 Page No : 1

Groups Printed- Large 2 Axle Vehicles

Start Time	Grove Community Drive Westbound			Abrams Drive Northbound			Grove Community Drive Eastbound			Int. Total
	Left	Thru	App. Total	Left	Right	App. Total	Thru	Right	App. Total	
04:00 PM	0	0	0	0	0	0	0	0	0	0
04:15 PM	0	0	0	0	0	0	0	1	1	1
04:30 PM	0	0	0	0	0	0	1	0	1	1
04:45 PM	0	0	0	0	0	0	0	0	0	0
Total	0	0	0	0	0	0	1	1	2	2
05:00 PM	0	0	0	0	0	0	1	1	2	2
05:15 PM	1	1	2	0	0	0	0	0	0	2
05:30 PM	0	0	0	1	0	1	0	0	0	1
05:45 PM	0	0	0	0	0	0	0	0	0	0
Total	1	1	2	1	0	1	1	1	2	5
Grand Total	1	1	2	1	0	1	2	2	4	7
Apprch %	50	50		100	0		50	50		
Total %	14.3	14.3	28.6	14.3	0	14.3	28.6	28.6	57.1	

Start Time	Grove Community Drive Westbound			Abrams Drive Northbound			Grove Community Drive Eastbound			Int. Total
	Left	Thru	App. Total	Left	Right	App. Total	Thru	Right	App. Total	
04:45 PM	0	0	0	0	0	0	0	0	0	0
05:00 PM	0	0	0	0	0	0	1	1	2	2
05:15 PM	1	1	2	0	0	0	0	0	0	2
05:30 PM	0	0	0	1	0	1	0	0	0	1
Total Volume	1	1	2	1	0	1	1	1	2	5
% App. Total	50	50		100	0		50	50		
PHF	.250	.250	.250	.250	.000	.250	.250	.250	.250	.625

Peak Hour Analysis From 04:45 PM to 05:30 PM - Peak 1 of 1
 Peak Hour for Entire Intersection Begins at 04:45 PM

City of Riverside
 N/S: Abrams Drive
 E/W: Grove Community Drive
 Weather: Clear

File Name : 16_RIV_Abrams_Grove PM
 Site Code : 05121716
 Start Date : 11/30/2021
 Page No : 2

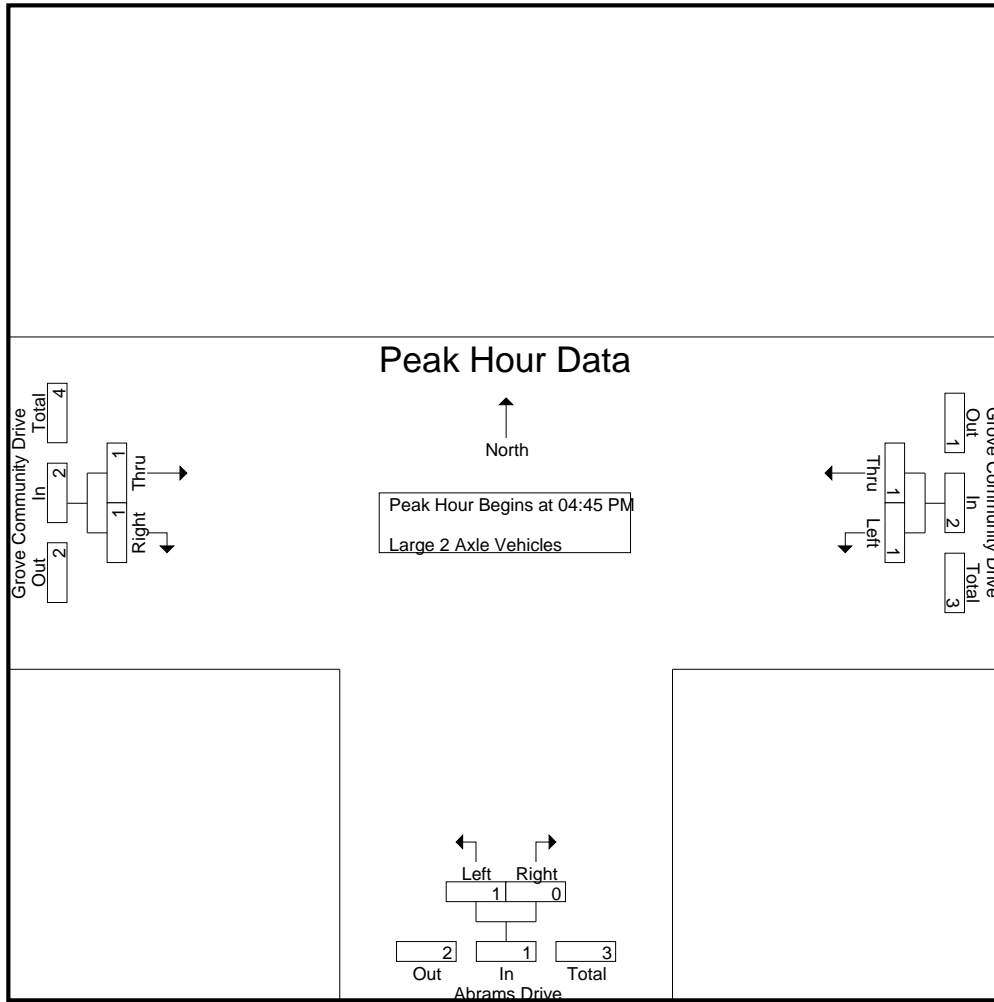

Peak Hour Analysis From 04:45 PM to 05:30 PM - Peak 1 of 1
 Peak Hour for Each Approach Begins at:

	04:45 PM			04:45 PM			04:45 PM		
+0 mins.	0	0	0	0	0	0	0	0	0
+15 mins.	0	0	0	0	0	0	1	1	2
+30 mins.	1	1	2	0	0	0	0	0	0
+45 mins.	0	0	0	1	0	1	0	0	0
Total Volume	1	1	2	1	0	1	1	1	2
% App. Total	50	50		100	0		50	50	
PHF	.250	.250	.250	.250	.000	.250	.250	.250	.250

City of Riverside
 N/S: Abrams Drive
 E/W: Grove Community Drive
 Weather: Clear

File Name : 16_RIV_Abrams_Grove PM
 Site Code : 05121716
 Start Date : 11/30/2021
 Page No : 1

Groups Printed- 3 Axle Vehicles

Start Time	Grove Community Drive Westbound			Abrams Drive Northbound			Grove Community Drive Eastbound			Int. Total
	Left	Thru	App. Total	Left	Right	App. Total	Thru	Right	App. Total	
04:00 PM	0	0	0	0	0	0	0	0	0	0
04:15 PM	0	0	0	0	0	0	0	0	0	0
04:30 PM	0	0	0	0	0	0	0	0	0	0
04:45 PM	0	0	0	0	0	0	0	0	0	0
Total	0	0	0	0	0	0	0	0	0	0
05:00 PM	0	0	0	0	0	0	0	0	0	0
05:15 PM	0	0	0	0	0	0	0	0	0	0
05:30 PM	0	0	0	0	0	0	0	0	0	0
05:45 PM	0	0	0	0	0	0	0	0	0	0
Total	0	0	0	0	0	0	0	0	0	0
Grand Total	0	0	0	0	0	0	0	0	0	0
Apprch %	0	0		0	0		0	0		
Total %										

Start Time	Grove Community Drive Westbound			Abrams Drive Northbound			Grove Community Drive Eastbound			Int. Total
	Left	Thru	App. Total	Left	Right	App. Total	Thru	Right	App. Total	
Peak Hour Analysis From 04:45 PM to 05:30 PM - Peak 1 of 1										
Peak Hour for Entire Intersection Begins at 04:45 PM										
04:45 PM	0	0	0	0	0	0	0	0	0	0
05:00 PM	0	0	0	0	0	0	0	0	0	0
05:15 PM	0	0	0	0	0	0	0	0	0	0
05:30 PM	0	0	0	0	0	0	0	0	0	0
Total Volume	0	0	0	0	0	0	0	0	0	0
% App. Total	0	0		0	0		0	0		
PHF	.000	.000	.000	.000	.000	.000	.000	.000	.000	.000

City of Riverside
 N/S: Abrams Drive
 E/W: Grove Community Drive
 Weather: Clear

File Name : 16_RIV_Abrams_Grove PM
 Site Code : 05121716
 Start Date : 11/30/2021
 Page No : 2

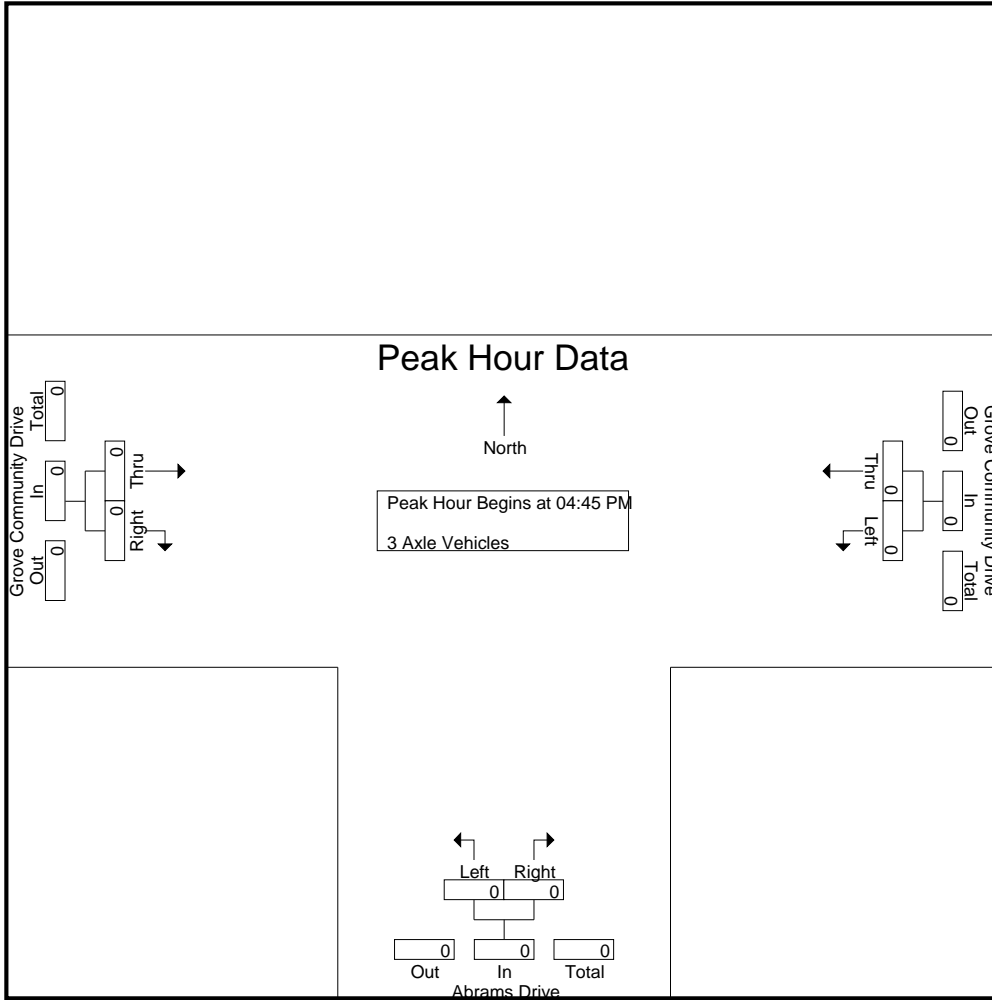

Peak Hour Analysis From 04:45 PM to 05:30 PM - Peak 1 of 1
 Peak Hour for Each Approach Begins at:

	04:45 PM			04:45 PM			04:45 PM		
+0 mins.	0	0	0	0	0	0	0	0	0
+15 mins.	0	0	0	0	0	0	0	0	0
+30 mins.	0	0	0	0	0	0	0	0	0
+45 mins.	0	0	0	0	0	0	0	0	0
Total Volume	0	0	0	0	0	0	0	0	0
% App. Total	0	0	0	0	0	0	0	0	0
PHF	.000	.000	.000	.000	.000	.000	.000	.000	.000

City of Riverside
 N/S: Abrams Drive
 E/W: Grove Community Drive
 Weather: Clear

File Name : 16_RIV_Abrams_Grove PM
 Site Code : 05121716
 Start Date : 11/30/2021
 Page No : 1

Groups Printed- 4+ Axle Trucks

Start Time	Grove Community Drive Westbound			Abrams Drive Northbound			Grove Community Drive Eastbound			Int. Total
	Left	Thru	App. Total	Left	Right	App. Total	Thru	Right	App. Total	
04:00 PM	0	0	0	0	0	0	0	0	0	0
04:15 PM	0	0	0	0	0	0	0	0	0	0
04:30 PM	0	0	0	0	0	0	0	0	0	0
04:45 PM	0	0	0	0	0	0	0	0	0	0
Total	0	0	0	0	0	0	0	0	0	0
05:00 PM	0	0	0	0	0	0	0	0	0	0
05:15 PM	0	0	0	0	0	0	0	0	0	0
05:30 PM	0	0	0	0	0	0	0	0	0	0
05:45 PM	0	0	0	0	0	0	0	0	0	0
Total	0	0	0	0	0	0	0	0	0	0
Grand Total	0	0	0	0	0	0	0	0	0	0
Apprch %	0	0		0	0		0	0		
Total %										

Start Time	Grove Community Drive Westbound			Abrams Drive Northbound			Grove Community Drive Eastbound			Int. Total
	Left	Thru	App. Total	Left	Right	App. Total	Thru	Right	App. Total	
Peak Hour Analysis From 04:45 PM to 05:30 PM - Peak 1 of 1										
Peak Hour for Entire Intersection Begins at 04:45 PM										
04:45 PM	0	0	0	0	0	0	0	0	0	0
05:00 PM	0	0	0	0	0	0	0	0	0	0
05:15 PM	0	0	0	0	0	0	0	0	0	0
05:30 PM	0	0	0	0	0	0	0	0	0	0
Total Volume	0	0	0	0	0	0	0	0	0	0
% App. Total	0	0		0	0		0	0		
PHF	.000	.000	.000	.000	.000	.000	.000	.000	.000	.000

City of Riverside
 N/S: Abrams Drive
 E/W: Grove Community Drive
 Weather: Clear

File Name : 16_RIV_Abrams_Grove PM
 Site Code : 05121716
 Start Date : 11/30/2021
 Page No : 2

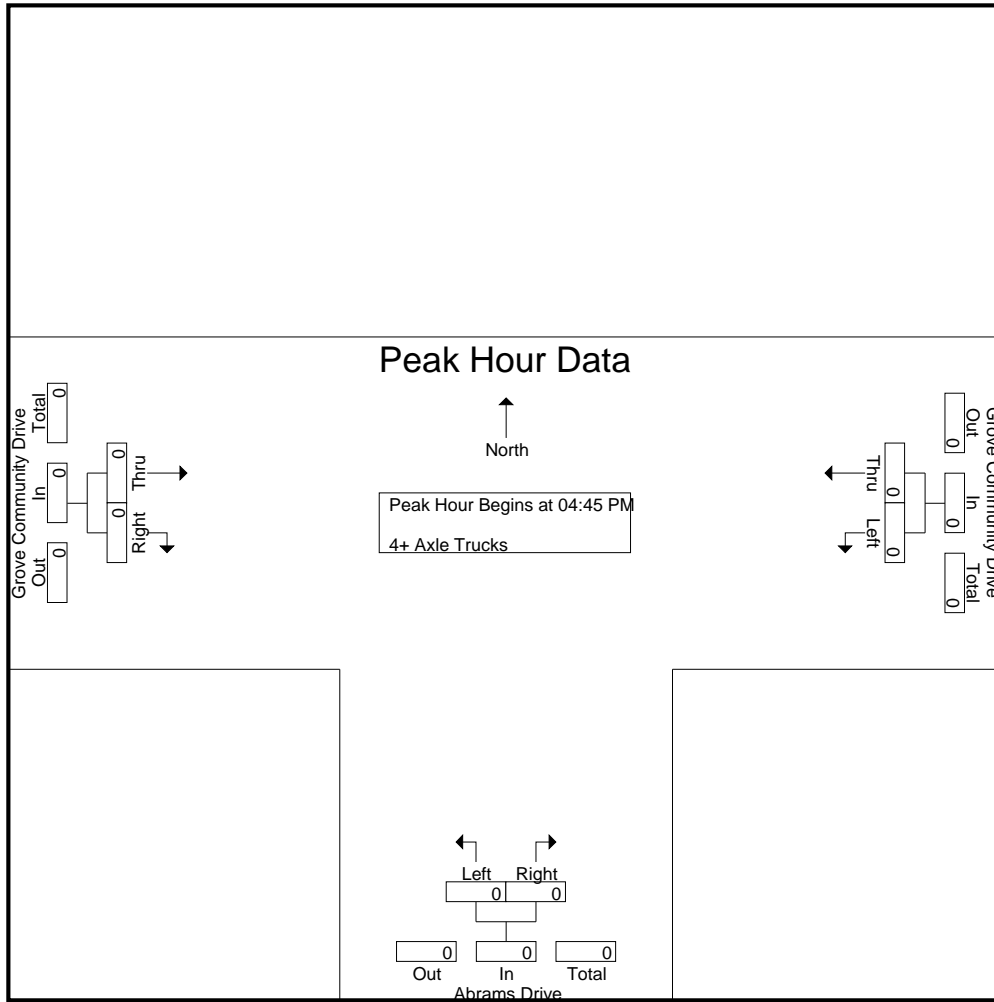

Peak Hour Analysis From 04:45 PM to 05:30 PM - Peak 1 of 1
 Peak Hour for Each Approach Begins at:

	04:45 PM			04:45 PM			04:45 PM		
+0 mins.	0	0	0	0	0	0	0	0	0
+15 mins.	0	0	0	0	0	0	0	0	0
+30 mins.	0	0	0	0	0	0	0	0	0
+45 mins.	0	0	0	0	0	0	0	0	0
Total Volume	0	0	0	0	0	0	0	0	0
% App. Total	0	0	0	0	0	0	0	0	0
PHF	.000	.000	.000	.000	.000	.000	.000	.000	.000

Location: Riverside
 N/S: Abrams Drive
 E/W: Grove Community Drive



Date: 11/30/2021
 Day: Tuesday

PEDESTRIANS

	North Leg Dead End	East Leg Grove Community Drive	South Leg Abrams Drive	West Leg Grove Community Drive	
	Pedestrians	Pedestrians	Pedestrians	Pedestrians	
7:00 AM	0	0	1	0	1
7:15 AM	0	0	4	0	4
7:30 AM	0	0	4	1	5
7:45 AM	0	0	0	0	0
8:00 AM	0	1	1	1	3
8:15 AM	0	1	2	0	3
8:30 AM	0	0	1	0	1
8:45 AM	0	0	0	0	0
TOTAL VOLUMES:	0	2	13	2	17

	North Leg Dead End	East Leg Grove Community Drive	South Leg Abrams Drive	West Leg Grove Community Drive	
	Pedestrians	Pedestrians	Pedestrians	Pedestrians	
4:00 PM	0	0	0	0	0
4:15 PM	0	0	0	0	0
4:30 PM	0	0	0	2	2
4:45 PM	0	0	0	0	0
5:00 PM	0	0	0	0	0
5:15 PM	0	0	0	1	1
5:30 PM	0	0	0	0	0
5:45 PM	0	0	0	1	1
TOTAL VOLUMES:	0	0	0	4	4

Location: Riverside
 N/S: Abrams Drive
 E/W: Grove Community Drive



Date: 11/30/2021
 Day: Tuesday

BICYCLES

	Southbound Dead End			Westbound Grove Community Drive			Northbound Abrams Drive			Eastbound Grove Community Drive			
	Left	Thru	Right	Left	Thru	Right	Left	Thru	Right	Left	Thru	Right	
7:00 AM	0	0	0	0	0	0	0	0	0	0	0	0	0
7:15 AM	0	0	0	0	1	0	0	0	0	0	0	0	1
7:30 AM	0	0	0	0	0	0	0	0	0	0	0	0	0
7:45 AM	0	0	0	0	0	0	0	0	0	0	0	1	1
8:00 AM	0	0	0	0	0	0	0	0	0	0	0	0	0
8:15 AM	0	0	0	0	0	0	1	0	0	0	0	0	1
8:30 AM	0	0	0	0	0	0	0	0	0	0	1	0	1
8:45 AM	0	0	0	0	0	0	0	0	0	0	0	0	0
TOTAL VOLUMES:	0	0	0	0	1	0	1	0	0	0	1	1	4

	Southbound Dead End			Westbound Grove Community Drive			Northbound Abrams Drive			Eastbound Grove Community Drive			
	Left	Thru	Right	Left	Thru	Right	Left	Thru	Right	Left	Thru	Right	
4:00 PM	0	0	0	0	0	0	0	0	0	0	0	0	0
4:15 PM	0	0	0	0	1	0	1	0	0	0	0	0	2
4:30 PM	0	0	0	0	1	0	0	0	0	0	0	0	1
4:45 PM	0	0	0	3	0	0	0	0	0	0	1	0	4
5:00 PM	0	0	0	0	1	0	2	0	3	0	3	0	9
5:15 PM	0	0	0	0	0	0	0	0	1	0	0	1	2
5:30 PM	0	0	0	0	0	0	0	0	0	0	0	0	0
5:45 PM	0	0	0	0	0	0	0	0	0	0	0	0	0
TOTAL VOLUMES:	0	0	0	3	3	0	3	0	4	0	4	1	18

City of Riverside
 N/S: Abrams Drive
 E/W: Orange Terrace Parkway
 Weather: Clear

File Name : 36_RIV_Abrams_Orange AM
 Site Code : 05121716
 Start Date : 11/30/2021
 Page No : 1

Groups Printed- Passenger Vehicles - Large 2 Axle Vehicles - 3 Axle Vehicles - 4+ Axle Trucks

Start Time	Abrams Drive Southbound			Orange Terrace Parkway Westbound			Orange Terrace Parkway Eastbound			Int. Total
	Left	Right	App. Total	Thru	Right	App. Total	Left	Thru	App. Total	
07:00 AM	19	26	45	80	14	94	8	18	26	165
07:15 AM	27	29	56	93	32	125	30	39	69	250
07:30 AM	10	25	35	56	14	70	35	45	80	185
07:45 AM	6	9	15	28	14	42	23	35	58	115
Total	62	89	151	257	74	331	96	137	233	715
08:00 AM	4	13	17	42	11	53	23	23	46	116
08:15 AM	4	10	14	36	6	42	14	26	40	96
08:30 AM	3	8	11	45	5	50	10	22	32	93
08:45 AM	4	8	12	26	11	37	7	16	23	72
Total	15	39	54	149	33	182	54	87	141	377
Grand Total	77	128	205	406	107	513	150	224	374	1092
Apprch %	37.6	62.4		79.1	20.9		40.1	59.9		
Total %	7.1	11.7	18.8	37.2	9.8	47	13.7	20.5	34.2	
Passenger Vehicles	76	126	202	404	105	509	150	221	371	1082
% Passenger Vehicles	98.7	98.4	98.5	99.5	98.1	99.2	100	98.7	99.2	99.1
Large 2 Axle Vehicles	1	1	2	2	2	4	0	3	3	9
% Large 2 Axle Vehicles	1.3	0.8	1	0.5	1.9	0.8	0	1.3	0.8	0.8
3 Axle Vehicles	0	1	1	0	0	0	0	0	0	1
% 3 Axle Vehicles	0	0.8	0.5	0	0	0	0	0	0	0.1
4+ Axle Trucks	0	0	0	0	0	0	0	0	0	0
% 4+ Axle Trucks	0	0	0	0	0	0	0	0	0	0

Start Time	Abrams Drive Southbound			Orange Terrace Parkway Westbound			Orange Terrace Parkway Eastbound			Int. Total
	Left	Right	App. Total	Thru	Right	App. Total	Left	Thru	App. Total	
Peak Hour Analysis From 07:00 AM to 08:45 AM - Peak 1 of 1										
Peak Hour for Entire Intersection Begins at 07:00 AM										
07:00 AM	19	26	45	80	14	94	8	18	26	165
07:15 AM	27	29	56	93	32	125	30	39	69	250
07:30 AM	10	25	35	56	14	70	35	45	80	185
07:45 AM	6	9	15	28	14	42	23	35	58	115
Total Volume	62	89	151	257	74	331	96	137	233	715
% App. Total	41.1	58.9		77.6	22.4		41.2	58.8		
PHF	.574	.767	.674	.691	.578	.662	.686	.761	.728	.715

City of Riverside
 N/S: Abrams Drive
 E/W: Orange Terrace Parkway
 Weather: Clear

File Name : 36_RIV_Abrams_Orange AM
 Site Code : 05121716
 Start Date : 11/30/2021
 Page No : 2

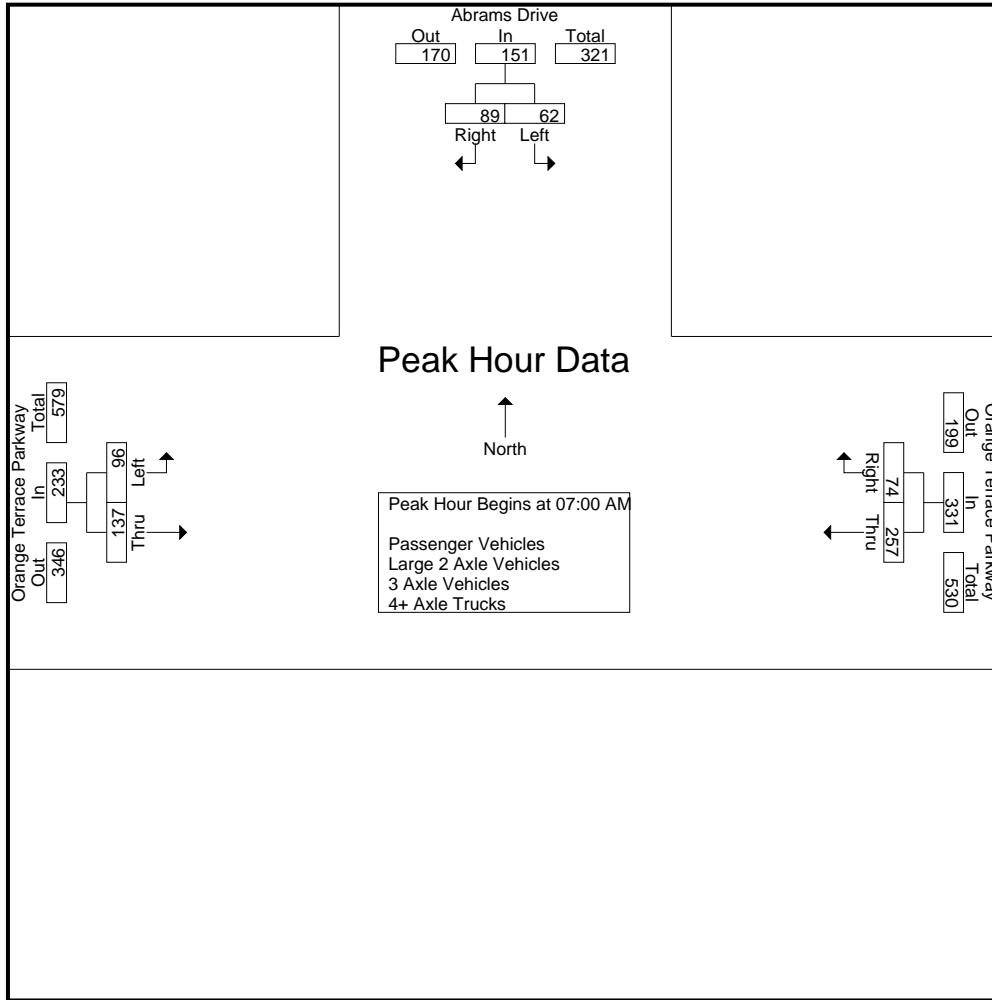

Peak Hour Analysis From 07:00 AM to 08:45 AM - Peak 1 of 1
 Peak Hour for Each Approach Begins at:

	07:00 AM			07:00 AM			07:15 AM		
+0 mins.	19	26	45	80	14	94	30	39	69
+15 mins.	27	29	56	93	32	125	35	45	80
+30 mins.	10	25	35	56	14	70	23	35	58
+45 mins.	6	9	15	28	14	42	23	23	46
Total Volume	62	89	151	257	74	331	111	142	253
% App. Total	41.1	58.9		77.6	22.4		43.9	56.1	
PHF	.574	.767	.674	.691	.578	.662	.793	.789	.791

City of Riverside
 N/S: Abrams Drive
 E/W: Orange Terrace Parkway
 Weather: Clear

File Name : 36_RIV_Abrams_Orange AM
 Site Code : 05121716
 Start Date : 11/30/2021
 Page No : 1

Groups Printed- Passenger Vehicles

Start Time	Abrams Drive Southbound			Orange Terrace Parkway Westbound			Orange Terrace Parkway Eastbound			Int. Total
	Left	Right	App. Total	Thru	Right	App. Total	Left	Thru	App. Total	
07:00 AM	19	26	45	80	14	94	8	18	26	165
07:15 AM	26	28	54	92	30	122	30	38	68	244
07:30 AM	10	25	35	56	14	70	35	43	78	183
07:45 AM	6	9	15	28	14	42	23	35	58	115
Total	61	88	149	256	72	328	96	134	230	707
08:00 AM	4	13	17	42	11	53	23	23	46	116
08:15 AM	4	10	14	35	6	41	14	26	40	95
08:30 AM	3	8	11	45	5	50	10	22	32	93
08:45 AM	4	7	11	26	11	37	7	16	23	71
Total	15	38	53	148	33	181	54	87	141	375
Grand Total	76	126	202	404	105	509	150	221	371	1082
Apprch %	37.6	62.4		79.4	20.6		40.4	59.6		
Total %	7	11.6	18.7	37.3	9.7	47	13.9	20.4	34.3	

Start Time	Abrams Drive Southbound			Orange Terrace Parkway Westbound			Orange Terrace Parkway Eastbound			Int. Total
	Left	Right	App. Total	Thru	Right	App. Total	Left	Thru	App. Total	
07:00 AM	19	26	45	80	14	94	8	18	26	165
07:15 AM	26	28	54	92	30	122	30	38	68	244
07:30 AM	10	25	35	56	14	70	35	43	78	183
07:45 AM	6	9	15	28	14	42	23	35	58	115
Total Volume	61	88	149	256	72	328	96	134	230	707
% App. Total	40.9	59.1		78	22		41.7	58.3		
PHF	.587	.786	.690	.696	.600	.672	.686	.779	.737	.724

Peak Hour Analysis From 07:00 AM to 07:45 AM - Peak 1 of 1
 Peak Hour for Entire Intersection Begins at 07:00 AM

City of Riverside
 N/S: Abrams Drive
 E/W: Orange Terrace Parkway
 Weather: Clear

File Name : 36_RIV_Abrams_Orange AM
 Site Code : 05121716
 Start Date : 11/30/2021
 Page No : 2

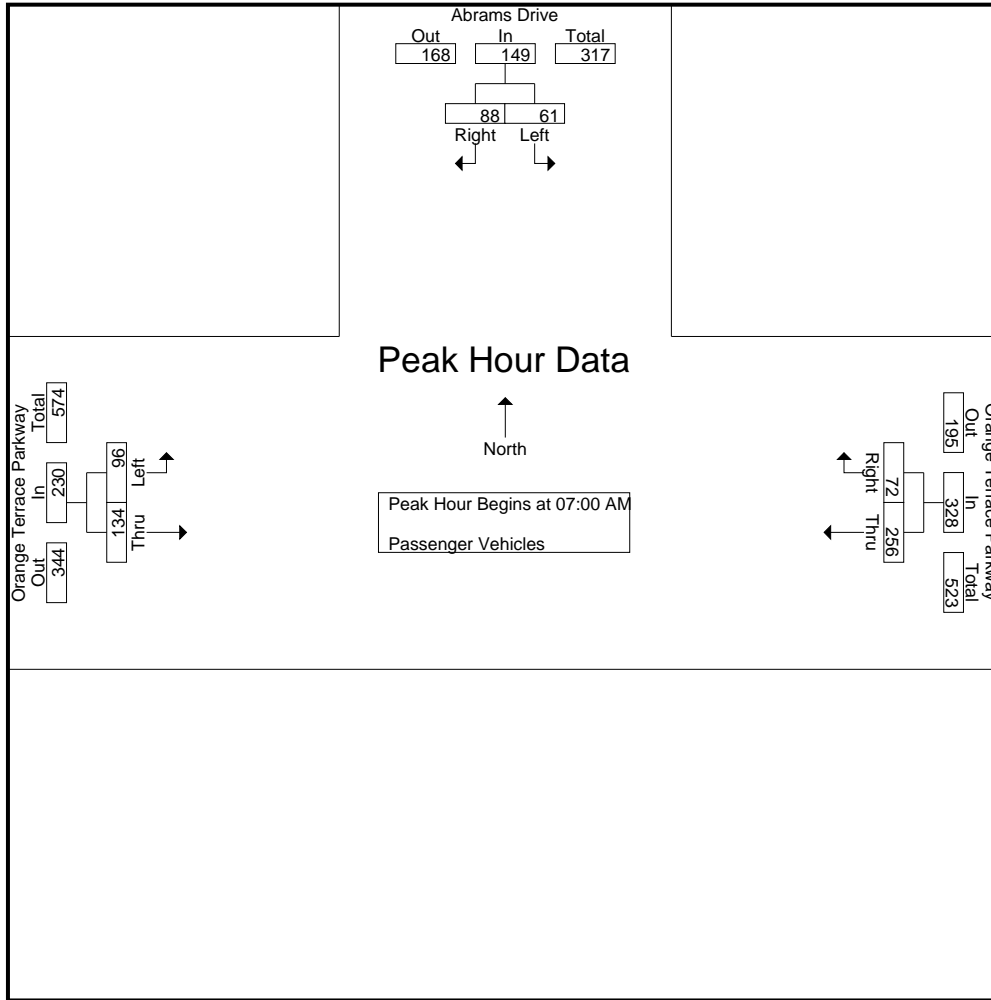

Peak Hour Analysis From 07:00 AM to 07:45 AM - Peak 1 of 1
 Peak Hour for Each Approach Begins at:

	07:00 AM			07:00 AM			07:00 AM		
+0 mins.	19	26	45	80	14	94	8	18	26
+15 mins.	26	28	54	92	30	122	30	38	68
+30 mins.	10	25	35	56	14	70	35	43	78
+45 mins.	6	9	15	28	14	42	23	35	58
Total Volume	61	88	149	256	72	328	96	134	230
% App. Total	40.9	59.1		78	22		41.7	58.3	
PHF	.587	.786	.690	.696	.600	.672	.686	.779	.737

City of Riverside
 N/S: Abrams Drive
 E/W: Orange Terrace Parkway
 Weather: Clear

File Name : 36_RIV_Abrams_Orange AM
 Site Code : 05121716
 Start Date : 11/30/2021
 Page No : 1

Groups Printed- Large 2 Axle Vehicles

Start Time	Abrams Drive Southbound			Orange Terrace Parkway Westbound			Orange Terrace Parkway Eastbound			Int. Total
	Left	Right	App. Total	Thru	Right	App. Total	Left	Thru	App. Total	
07:00 AM	0	0	0	0	0	0	0	0	0	0
07:15 AM	1	1	2	1	2	3	0	1	1	6
07:30 AM	0	0	0	0	0	0	0	2	2	2
07:45 AM	0	0	0	0	0	0	0	0	0	0
Total	1	1	2	1	2	3	0	3	3	8
08:00 AM	0	0	0	0	0	0	0	0	0	0
08:15 AM	0	0	0	1	0	1	0	0	0	1
08:30 AM	0	0	0	0	0	0	0	0	0	0
08:45 AM	0	0	0	0	0	0	0	0	0	0
Total	0	0	0	1	0	1	0	0	0	1
Grand Total	1	1	2	2	2	4	0	3	3	9
Apprch %	50	50		50	50		0	100		
Total %	11.1	11.1	22.2	22.2	22.2	44.4	0	33.3	33.3	

Start Time	Abrams Drive Southbound			Orange Terrace Parkway Westbound			Orange Terrace Parkway Eastbound			Int. Total
	Left	Right	App. Total	Thru	Right	App. Total	Left	Thru	App. Total	
07:00 AM	0	0	0	0	0	0	0	0	0	0
07:15 AM	1	1	2	1	2	3	0	1	1	6
07:30 AM	0	0	0	0	0	0	0	2	2	2
07:45 AM	0	0	0	0	0	0	0	0	0	0
Total Volume	1	1	2	1	2	3	0	3	3	8
% App. Total	50	50		33.3	66.7		0	100		
PHF	.250	.250	.250	.250	.250	.250	.000	.375	.375	.333

Peak Hour Analysis From 07:00 AM to 07:45 AM - Peak 1 of 1

Peak Hour for Entire Intersection Begins at 07:00 AM

City of Riverside
 N/S: Abrams Drive
 E/W: Orange Terrace Parkway
 Weather: Clear

File Name : 36_RIV_Abrams_Orange AM
 Site Code : 05121716
 Start Date : 11/30/2021
 Page No : 2

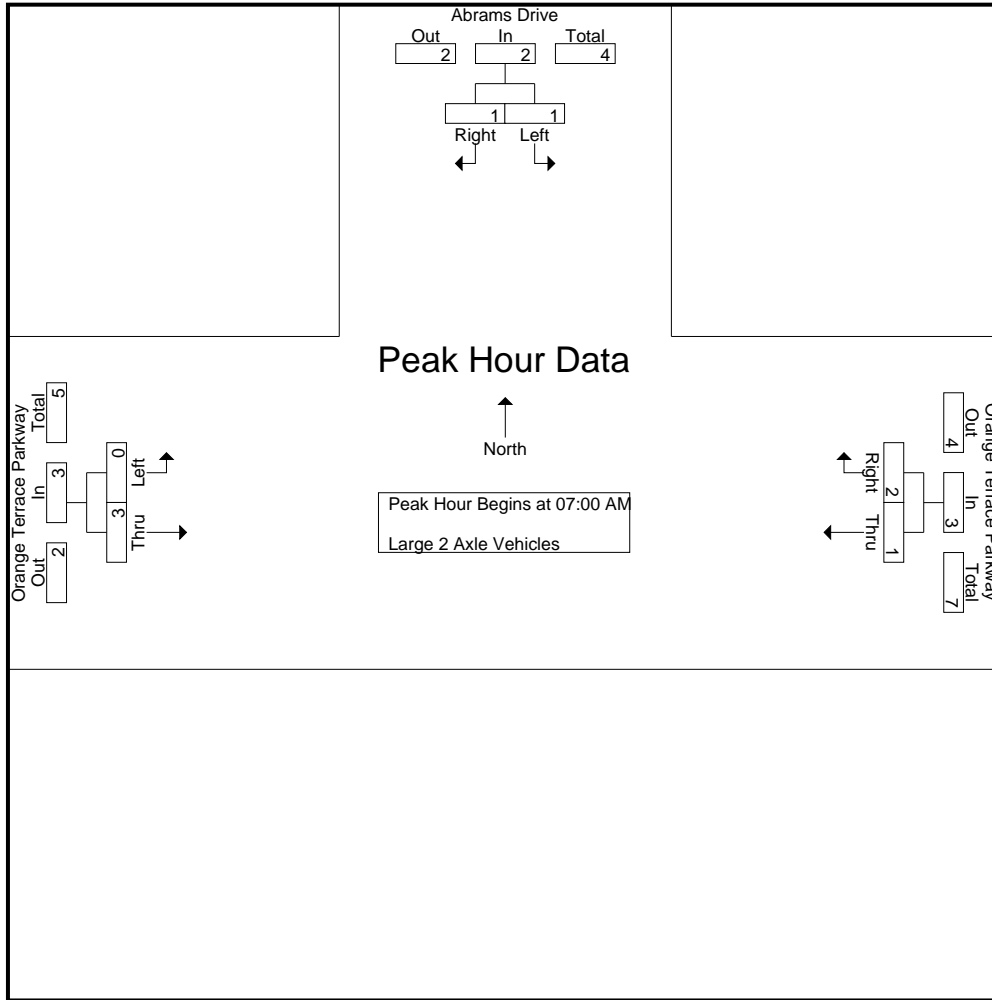

Peak Hour Analysis From 07:00 AM to 07:45 AM - Peak 1 of 1
 Peak Hour for Each Approach Begins at:

	07:00 AM			07:00 AM			07:00 AM		
+0 mins.	0	0	0	0	0	0	0	0	0
+15 mins.	1	1	2	1	2	3	0	1	1
+30 mins.	0	0	0	0	0	0	0	2	2
+45 mins.	0	0	0	0	0	0	0	0	0
Total Volume	1	1	2	1	2	3	0	3	3
% App. Total	50	50		33.3	66.7		0	100	
PHF	.250	.250	.250	.250	.250	.250	.000	.375	.375

City of Riverside
 N/S: Abrams Drive
 E/W: Orange Terrace Parkway
 Weather: Clear

File Name : 36_RIV_Abrams_Orange AM
 Site Code : 05121716
 Start Date : 11/30/2021
 Page No : 1

Groups Printed- 3 Axle Vehicles

Start Time	Abrams Drive Southbound			Orange Terrace Parkway Westbound			Orange Terrace Parkway Eastbound			Int. Total
	Left	Right	App. Total	Thru	Right	App. Total	Left	Thru	App. Total	
07:00 AM	0	0	0	0	0	0	0	0	0	0
07:15 AM	0	0	0	0	0	0	0	0	0	0
07:30 AM	0	0	0	0	0	0	0	0	0	0
07:45 AM	0	0	0	0	0	0	0	0	0	0
Total	0	0	0	0	0	0	0	0	0	0
08:00 AM	0	0	0	0	0	0	0	0	0	0
08:15 AM	0	0	0	0	0	0	0	0	0	0
08:30 AM	0	0	0	0	0	0	0	0	0	0
08:45 AM	0	1	1	0	0	0	0	0	0	1
Total	0	1	1	0	0	0	0	0	0	1
Grand Total	0	1	1	0	0	0	0	0	0	1
Apprch %	0	100		0	0		0	0		
Total %	0	100	100	0	0	0	0	0	0	

Start Time	Abrams Drive Southbound			Orange Terrace Parkway Westbound			Orange Terrace Parkway Eastbound			Int. Total
	Left	Right	App. Total	Thru	Right	App. Total	Left	Thru	App. Total	
07:00 AM	0	0	0	0	0	0	0	0	0	0
07:15 AM	0	0	0	0	0	0	0	0	0	0
07:30 AM	0	0	0	0	0	0	0	0	0	0
07:45 AM	0	0	0	0	0	0	0	0	0	0
Total Volume	0	0	0	0	0	0	0	0	0	0
% App. Total	0	0		0	0		0	0		
PHF	.000	.000	.000	.000	.000	.000	.000	.000	.000	.000

Peak Hour Analysis From 07:00 AM to 07:45 AM - Peak 1 of 1
 Peak Hour for Entire Intersection Begins at 07:00 AM

City of Riverside
 N/S: Abrams Drive
 E/W: Orange Terrace Parkway
 Weather: Clear

File Name : 36_RIV_Abrams_Orange AM
 Site Code : 05121716
 Start Date : 11/30/2021
 Page No : 2

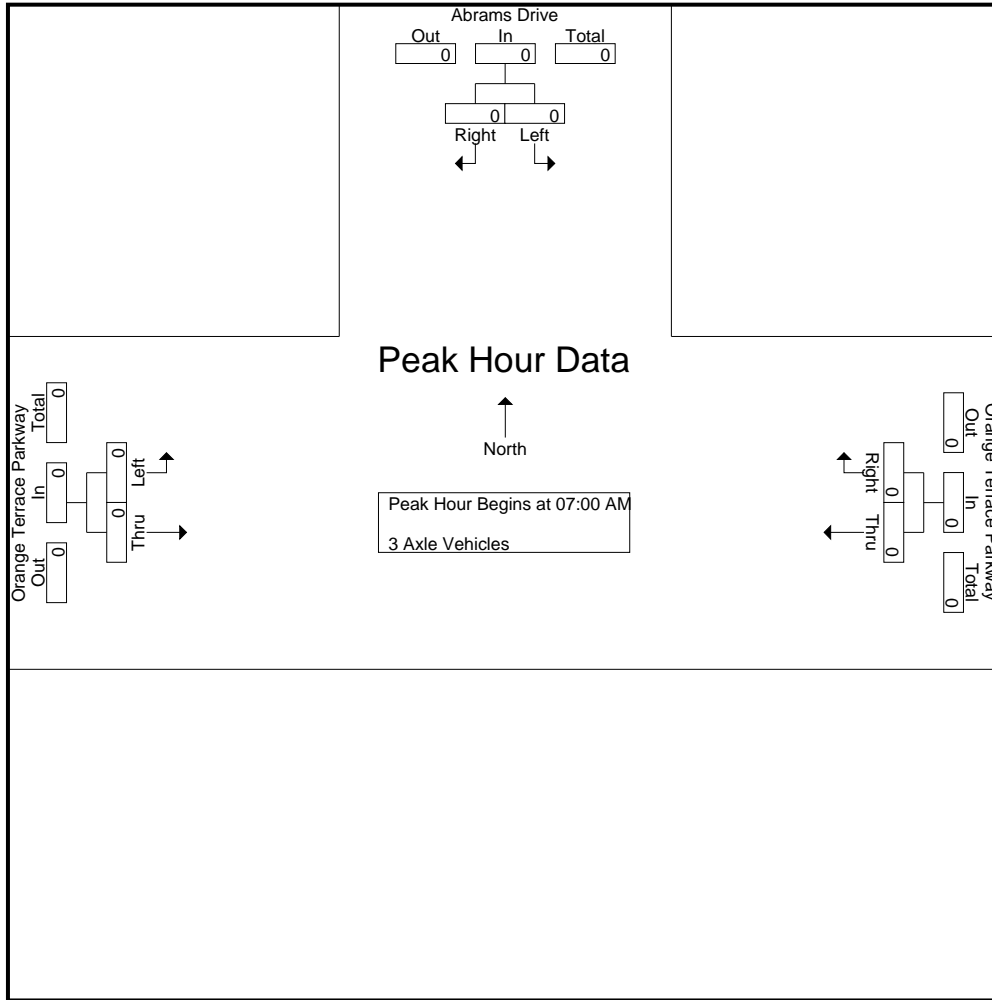

Peak Hour Analysis From 07:00 AM to 07:45 AM - Peak 1 of 1
 Peak Hour for Each Approach Begins at:

	07:00 AM			07:00 AM			07:00 AM		
+0 mins.	0	0	0	0	0	0	0	0	0
+15 mins.	0	0	0	0	0	0	0	0	0
+30 mins.	0	0	0	0	0	0	0	0	0
+45 mins.	0	0	0	0	0	0	0	0	0
Total Volume	0	0	0	0	0	0	0	0	0
% App. Total	0	0	0	0	0	0	0	0	0
PHF	.000	.000	.000	.000	.000	.000	.000	.000	.000

City of Riverside
 N/S: Abrams Drive
 E/W: Orange Terrace Parkway
 Weather: Clear

File Name : 36_RIV_Abrams_Orange AM
 Site Code : 05121716
 Start Date : 11/30/2021
 Page No : 1

Groups Printed- 4+ Axle Trucks

Start Time	Abrams Drive Southbound			Orange Terrace Parkway Westbound			Orange Terrace Parkway Eastbound			Int. Total
	Left	Right	App. Total	Thru	Right	App. Total	Left	Thru	App. Total	
07:00 AM	0	0	0	0	0	0	0	0	0	0
07:15 AM	0	0	0	0	0	0	0	0	0	0
07:30 AM	0	0	0	0	0	0	0	0	0	0
07:45 AM	0	0	0	0	0	0	0	0	0	0
Total	0	0	0	0	0	0	0	0	0	0
08:00 AM	0	0	0	0	0	0	0	0	0	0
08:15 AM	0	0	0	0	0	0	0	0	0	0
08:30 AM	0	0	0	0	0	0	0	0	0	0
08:45 AM	0	0	0	0	0	0	0	0	0	0
Total	0	0	0	0	0	0	0	0	0	0
Grand Total	0	0	0	0	0	0	0	0	0	0
Apprch %	0	0		0	0		0	0		
Total %										

Start Time	Abrams Drive Southbound			Orange Terrace Parkway Westbound			Orange Terrace Parkway Eastbound			Int. Total
	Left	Right	App. Total	Thru	Right	App. Total	Left	Thru	App. Total	
07:00 AM	0	0	0	0	0	0	0	0	0	0
07:15 AM	0	0	0	0	0	0	0	0	0	0
07:30 AM	0	0	0	0	0	0	0	0	0	0
07:45 AM	0	0	0	0	0	0	0	0	0	0
Total Volume	0	0	0	0	0	0	0	0	0	0
% App. Total	0	0		0	0		0	0		
PHF	.000	.000	.000	.000	.000	.000	.000	.000	.000	.000

Peak Hour Analysis From 07:00 AM to 07:45 AM - Peak 1 of 1
 Peak Hour for Entire Intersection Begins at 07:00 AM

City of Riverside
 N/S: Abrams Drive
 E/W: Orange Terrace Parkway
 Weather: Clear

File Name : 36_RIV_Abrams_Orange AM
 Site Code : 05121716
 Start Date : 11/30/2021
 Page No : 2

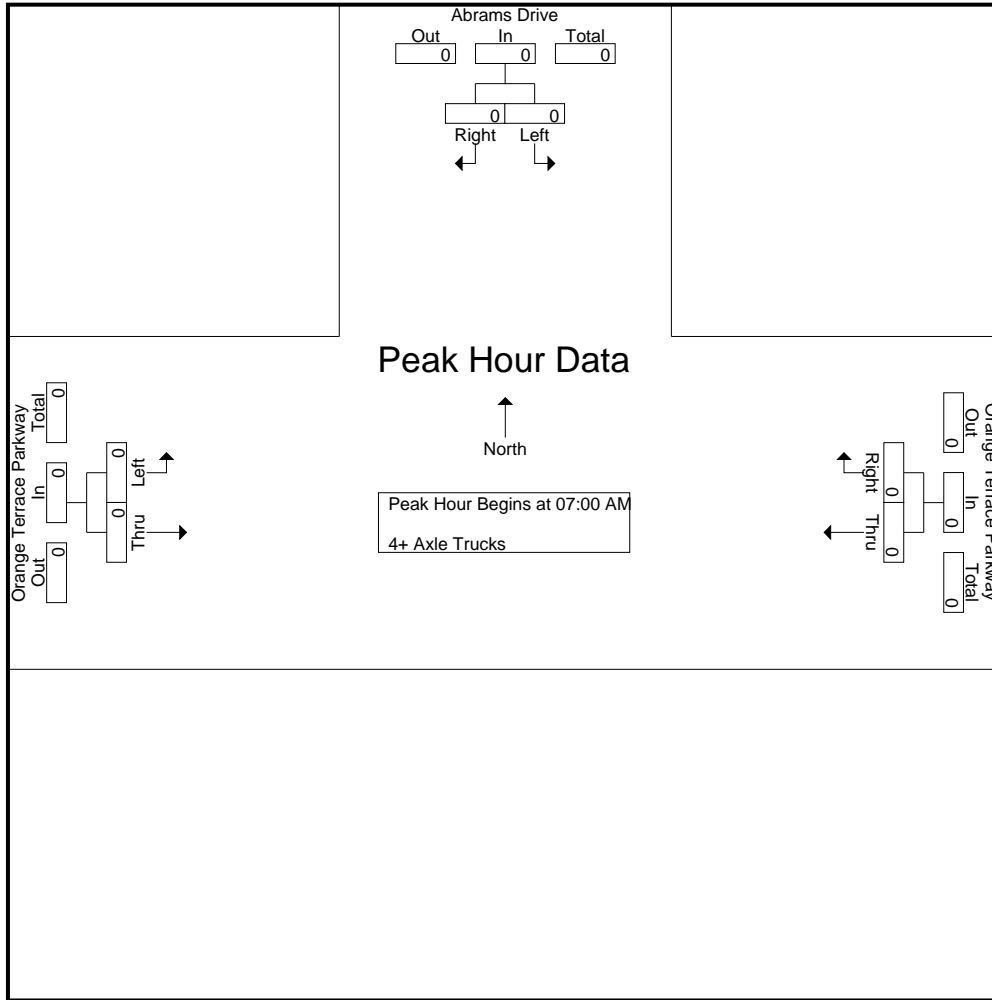

Peak Hour Analysis From 07:00 AM to 07:45 AM - Peak 1 of 1
 Peak Hour for Each Approach Begins at:

	07:00 AM			07:00 AM			07:00 AM		
+0 mins.	0	0	0	0	0	0	0	0	0
+15 mins.	0	0	0	0	0	0	0	0	0
+30 mins.	0	0	0	0	0	0	0	0	0
+45 mins.	0	0	0	0	0	0	0	0	0
Total Volume	0	0	0	0	0	0	0	0	0
% App. Total	0	0	0	0	0	0	0	0	0
PHF	.000	.000	.000	.000	.000	.000	.000	.000	.000

City of Riverside
 N/S: Abrams Drive
 E/W: Orange Terrace Parkway
 Weather: Clear

File Name : 36_RIV_Abrams_Orange PM
 Site Code : 05121716
 Start Date : 11/30/2021
 Page No : 1

Groups Printed- Passenger Vehicles - Large 2 Axle Vehicles - 3 Axle Vehicles - 4+ Axle Trucks

Start Time	Abrams Drive Southbound			Orange Terrace Parkway Westbound			Orange Terrace Parkway Eastbound			Int. Total
	Left	Right	App. Total	Thru	Right	App. Total	Left	Thru	App. Total	
04:00 PM	2	8	10	43	7	50	33	61	94	154
04:15 PM	10	7	17	52	8	60	25	60	85	162
04:30 PM	7	16	23	49	5	54	22	61	83	160
04:45 PM	4	3	7	43	10	53	26	79	105	165
Total	23	34	57	187	30	217	106	261	367	641
05:00 PM	5	9	14	51	14	65	18	55	73	152
05:15 PM	6	13	19	41	11	52	25	63	88	159
05:30 PM	6	15	21	35	13	48	19	55	74	143
05:45 PM	7	18	25	36	10	46	21	55	76	147
Total	24	55	79	163	48	211	83	228	311	601
Grand Total	47	89	136	350	78	428	189	489	678	1242
Apprch %	34.6	65.4		81.8	18.2		27.9	72.1		
Total %	3.8	7.2	11	28.2	6.3	34.5	15.2	39.4	54.6	
Passenger Vehicles	46	88	134	346	78	424	188	488	676	1234
% Passenger Vehicles	97.9	98.9	98.5	98.9	100	99.1	99.5	99.8	99.7	99.4
Large 2 Axle Vehicles	1	1	2	4	0	4	1	1	2	8
% Large 2 Axle Vehicles	2.1	1.1	1.5	1.1	0	0.9	0.5	0.2	0.3	0.6
3 Axle Vehicles	0	0	0	0	0	0	0	0	0	0
% 3 Axle Vehicles	0	0	0	0	0	0	0	0	0	0
4+ Axle Trucks	0	0	0	0	0	0	0	0	0	0
% 4+ Axle Trucks	0	0	0	0	0	0	0	0	0	0

Start Time	Abrams Drive Southbound			Orange Terrace Parkway Westbound			Orange Terrace Parkway Eastbound			Int. Total
	Left	Right	App. Total	Thru	Right	App. Total	Left	Thru	App. Total	
Peak Hour Analysis From 04:00 PM to 05:45 PM - Peak 1 of 1										
Peak Hour for Entire Intersection Begins at 04:00 PM										
04:00 PM	2	8	10	43	7	50	33	61	94	154
04:15 PM	10	7	17	52	8	60	25	60	85	162
04:30 PM	7	16	23	49	5	54	22	61	83	160
04:45 PM	4	3	7	43	10	53	26	79	105	165
Total Volume	23	34	57	187	30	217	106	261	367	641
% App. Total	40.4	59.6		86.2	13.8		28.9	71.1		
PHF	.575	.531	.620	.899	.750	.904	.803	.826	.874	.971

City of Riverside
 N/S: Abrams Drive
 E/W: Orange Terrace Parkway
 Weather: Clear

File Name : 36_RIV_Abrams_Orange PM
 Site Code : 05121716
 Start Date : 11/30/2021
 Page No : 2

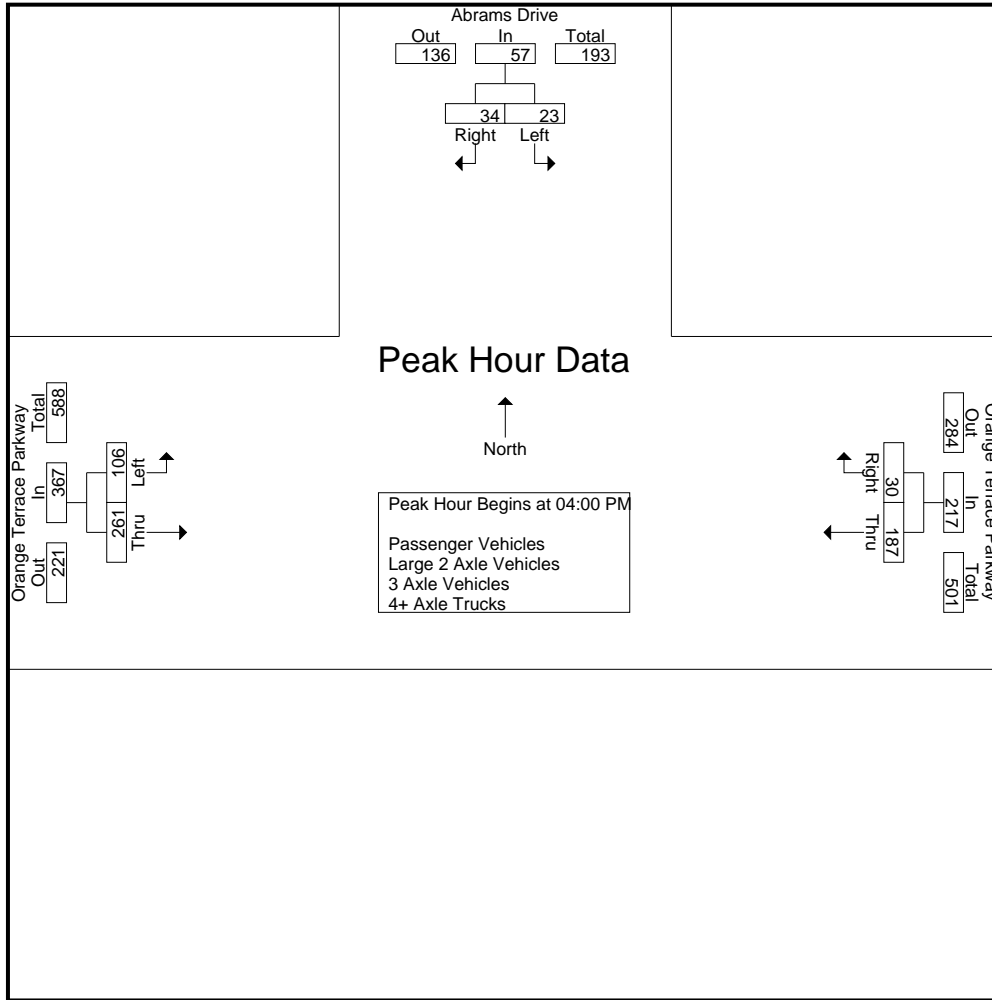

Peak Hour Analysis From 04:00 PM to 05:45 PM - Peak 1 of 1
 Peak Hour for Each Approach Begins at:

	05:00 PM			04:15 PM			04:00 PM		
+0 mins.	5	9	14	52	8	60	33	61	94
+15 mins.	6	13	19	49	5	54	25	60	85
+30 mins.	6	15	21	43	10	53	22	61	83
+45 mins.	7	18	25	51	14	65	26	79	105
Total Volume	24	55	79	195	37	232	106	261	367
% App. Total	30.4	69.6		84.1	15.9		28.9	71.1	
PHF	.857	.764	.790	.938	.661	.892	.803	.826	.874

City of Riverside
 N/S: Abrams Drive
 E/W: Orange Terrace Parkway
 Weather: Clear

File Name : 36_RIV_Abrams_Orange PM
 Site Code : 05121716
 Start Date : 11/30/2021
 Page No : 1

Groups Printed- Passenger Vehicles

Start Time	Abrams Drive Southbound			Orange Terrace Parkway Westbound			Orange Terrace Parkway Eastbound			Int. Total
	Left	Right	App. Total	Thru	Right	App. Total	Left	Thru	App. Total	
04:00 PM	2	8	10	43	7	50	33	61	94	154
04:15 PM	10	6	16	51	8	59	24	59	83	158
04:30 PM	6	16	22	47	5	52	22	61	83	157
04:45 PM	4	3	7	42	10	52	26	79	105	164
Total	22	33	55	183	30	213	105	260	365	633
05:00 PM	5	9	14	51	14	65	18	55	73	152
05:15 PM	6	13	19	41	11	52	25	63	88	159
05:30 PM	6	15	21	35	13	48	19	55	74	143
05:45 PM	7	18	25	36	10	46	21	55	76	147
Total	24	55	79	163	48	211	83	228	311	601
Grand Total	46	88	134	346	78	424	188	488	676	1234
Apprch %	34.3	65.7		81.6	18.4		27.8	72.2		
Total %	3.7	7.1	10.9	28	6.3	34.4	15.2	39.5	54.8	

Start Time	Abrams Drive Southbound			Orange Terrace Parkway Westbound			Orange Terrace Parkway Eastbound			Int. Total
	Left	Right	App. Total	Thru	Right	App. Total	Left	Thru	App. Total	
04:00 PM	2	8	10	43	7	50	33	61	94	154
04:15 PM	10	6	16	51	8	59	24	59	83	158
04:30 PM	6	16	22	47	5	52	22	61	83	157
04:45 PM	4	3	7	42	10	52	26	79	105	164
Total Volume	22	33	55	183	30	213	105	260	365	633
% App. Total	40	60		85.9	14.1		28.8	71.2		
PHF	.550	.516	.625	.897	.750	.903	.795	.823	.869	.965

Peak Hour Analysis From 04:00 PM to 04:45 PM - Peak 1 of 1
 Peak Hour for Entire Intersection Begins at 04:00 PM

City of Riverside
 N/S: Abrams Drive
 E/W: Orange Terrace Parkway
 Weather: Clear

File Name : 36_RIV_Abrams_Orange PM
 Site Code : 05121716
 Start Date : 11/30/2021
 Page No : 2

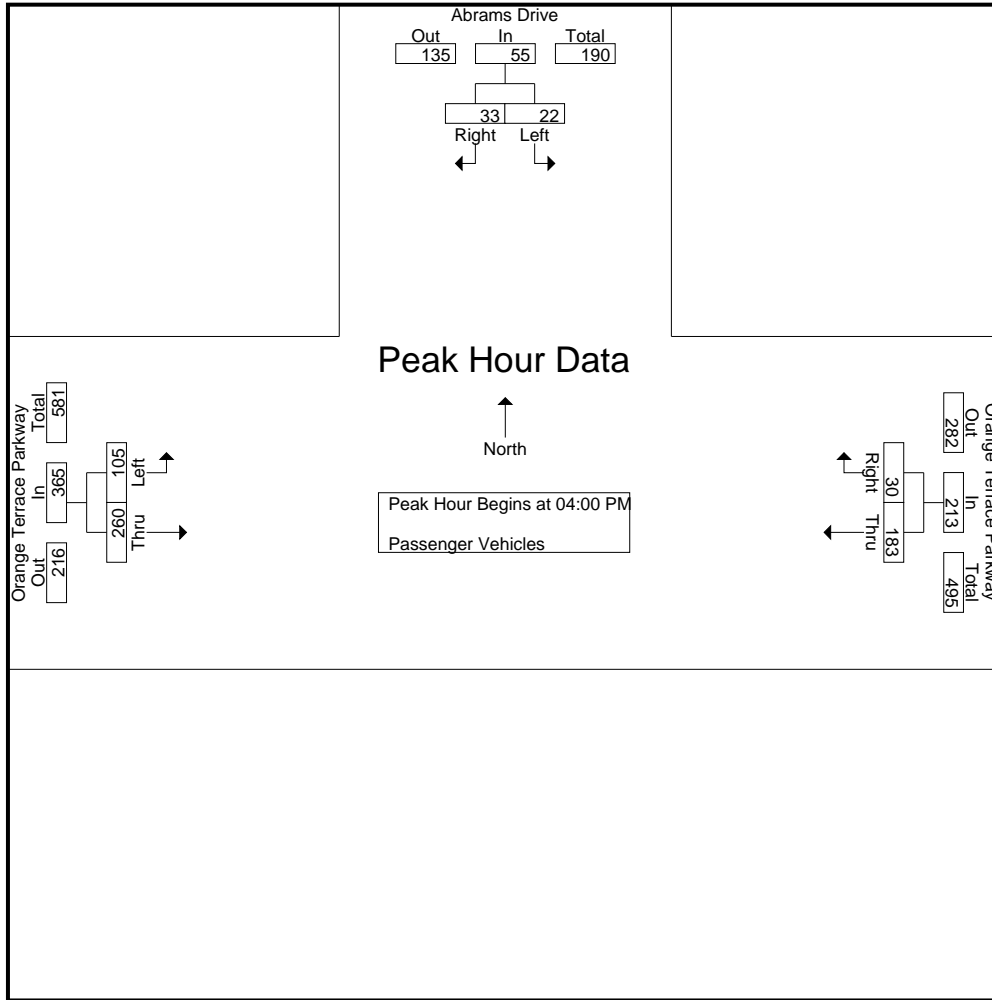

Peak Hour Analysis From 04:00 PM to 04:45 PM - Peak 1 of 1
 Peak Hour for Each Approach Begins at:

	04:00 PM			04:00 PM			04:00 PM		
+0 mins.	2	8	10	43	7	50	33	61	94
+15 mins.	10	6	16	51	8	59	24	59	83
+30 mins.	6	16	22	47	5	52	22	61	83
+45 mins.	4	3	7	42	10	52	26	79	105
Total Volume	22	33	55	183	30	213	105	260	365
% App. Total	40	60		85.9	14.1		28.8	71.2	
PHF	.550	.516	.625	.897	.750	.903	.795	.823	.869

City of Riverside
 N/S: Abrams Drive
 E/W: Orange Terrace Parkway
 Weather: Clear

File Name : 36_RIV_Abrams_Orange PM
 Site Code : 05121716
 Start Date : 11/30/2021
 Page No : 1

Groups Printed- Large 2 Axle Vehicles

Start Time	Abrams Drive Southbound			Orange Terrace Parkway Westbound			Orange Terrace Parkway Eastbound			Int. Total
	Left	Right	App. Total	Thru	Right	App. Total	Left	Thru	App. Total	
04:00 PM	0	0	0	0	0	0	0	0	0	0
04:15 PM	0	1	1	1	0	1	1	1	2	4
04:30 PM	1	0	1	2	0	2	0	0	0	3
04:45 PM	0	0	0	1	0	1	0	0	0	1
Total	1	1	2	4	0	4	1	1	2	8
05:00 PM	0	0	0	0	0	0	0	0	0	0
05:15 PM	0	0	0	0	0	0	0	0	0	0
05:30 PM	0	0	0	0	0	0	0	0	0	0
05:45 PM	0	0	0	0	0	0	0	0	0	0
Total	0	0	0	0	0	0	0	0	0	0
Grand Total	1	1	2	4	0	4	1	1	2	8
Apprch %	50	50		100	0		50	50		
Total %	12.5	12.5	25	50	0	50	12.5	12.5	25	

Start Time	Abrams Drive Southbound			Orange Terrace Parkway Westbound			Orange Terrace Parkway Eastbound			Int. Total
	Left	Right	App. Total	Thru	Right	App. Total	Left	Thru	App. Total	
04:00 PM	0	0	0	0	0	0	0	0	0	0
04:15 PM	0	1	1	1	0	1	1	1	2	4
04:30 PM	1	0	1	2	0	2	0	0	0	3
04:45 PM	0	0	0	1	0	1	0	0	0	1
Total Volume	1	1	2	4	0	4	1	1	2	8
% App. Total	50	50		100	0		50	50		
PHF	.250	.250	.500	.500	.000	.500	.250	.250	.250	.500

Peak Hour Analysis From 04:00 PM to 04:45 PM - Peak 1 of 1
 Peak Hour for Entire Intersection Begins at 04:00 PM

City of Riverside
 N/S: Abrams Drive
 E/W: Orange Terrace Parkway
 Weather: Clear

File Name : 36_RIV_Abrams_Orange PM
 Site Code : 05121716
 Start Date : 11/30/2021
 Page No : 2

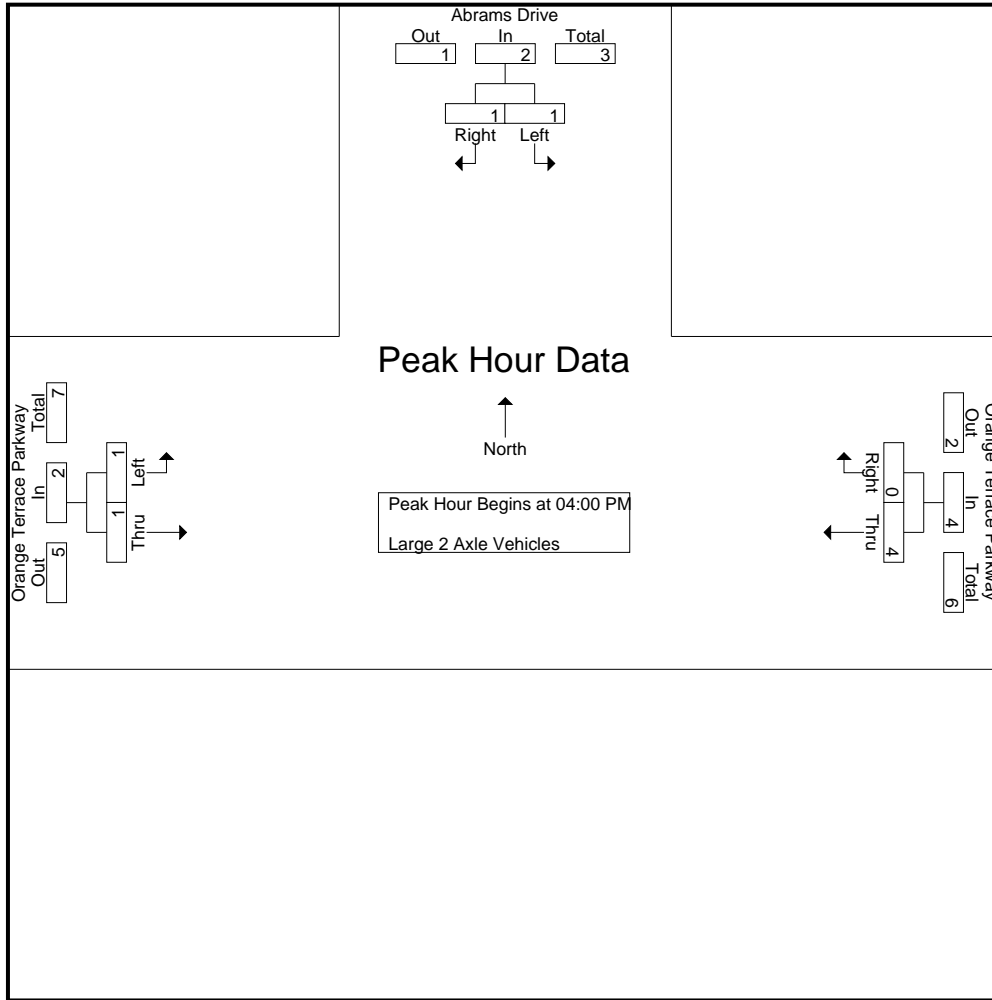

Peak Hour Analysis From 04:00 PM to 04:45 PM - Peak 1 of 1
 Peak Hour for Each Approach Begins at:

	04:00 PM			04:00 PM			04:00 PM		
+0 mins.	0	0	0	0	0	0	0	0	0
+15 mins.	0	1	1	1	0	1	1	1	2
+30 mins.	1	0	1	2	0	2	0	0	0
+45 mins.	0	0	0	1	0	1	0	0	0
Total Volume	1	1	2	4	0	4	1	1	2
% App. Total	50	50		100	0		50	50	
PHF	.250	.250	.500	.500	.000	.500	.250	.250	.250

City of Riverside
 N/S: Abrams Drive
 E/W: Orange Terrace Parkway
 Weather: Clear

File Name : 36_RIV_Abrams_Orange PM
 Site Code : 05121716
 Start Date : 11/30/2021
 Page No : 1

Groups Printed- 3 Axle Vehicles

Start Time	Abrams Drive Southbound			Orange Terrace Parkway Westbound			Orange Terrace Parkway Eastbound			Int. Total
	Left	Right	App. Total	Thru	Right	App. Total	Left	Thru	App. Total	
04:00 PM	0	0	0	0	0	0	0	0	0	0
04:15 PM	0	0	0	0	0	0	0	0	0	0
04:30 PM	0	0	0	0	0	0	0	0	0	0
04:45 PM	0	0	0	0	0	0	0	0	0	0
Total	0	0	0	0	0	0	0	0	0	0
05:00 PM	0	0	0	0	0	0	0	0	0	0
05:15 PM	0	0	0	0	0	0	0	0	0	0
05:30 PM	0	0	0	0	0	0	0	0	0	0
05:45 PM	0	0	0	0	0	0	0	0	0	0
Total	0	0	0	0	0	0	0	0	0	0
Grand Total	0	0	0	0	0	0	0	0	0	0
Apprch %	0	0		0	0		0	0		
Total %										

Start Time	Abrams Drive Southbound			Orange Terrace Parkway Westbound			Orange Terrace Parkway Eastbound			Int. Total
	Left	Right	App. Total	Thru	Right	App. Total	Left	Thru	App. Total	
04:00 PM	0	0	0	0	0	0	0	0	0	0
04:15 PM	0	0	0	0	0	0	0	0	0	0
04:30 PM	0	0	0	0	0	0	0	0	0	0
04:45 PM	0	0	0	0	0	0	0	0	0	0
Total Volume	0	0	0	0	0	0	0	0	0	0
% App. Total	0	0		0	0		0	0		
PHF	.000	.000	.000	.000	.000	.000	.000	.000	.000	.000

Peak Hour Analysis From 04:00 PM to 04:45 PM - Peak 1 of 1
 Peak Hour for Entire Intersection Begins at 04:00 PM

City of Riverside
 N/S: Abrams Drive
 E/W: Orange Terrace Parkway
 Weather: Clear

File Name : 36_RIV_Abrams_Orange PM
 Site Code : 05121716
 Start Date : 11/30/2021
 Page No : 2

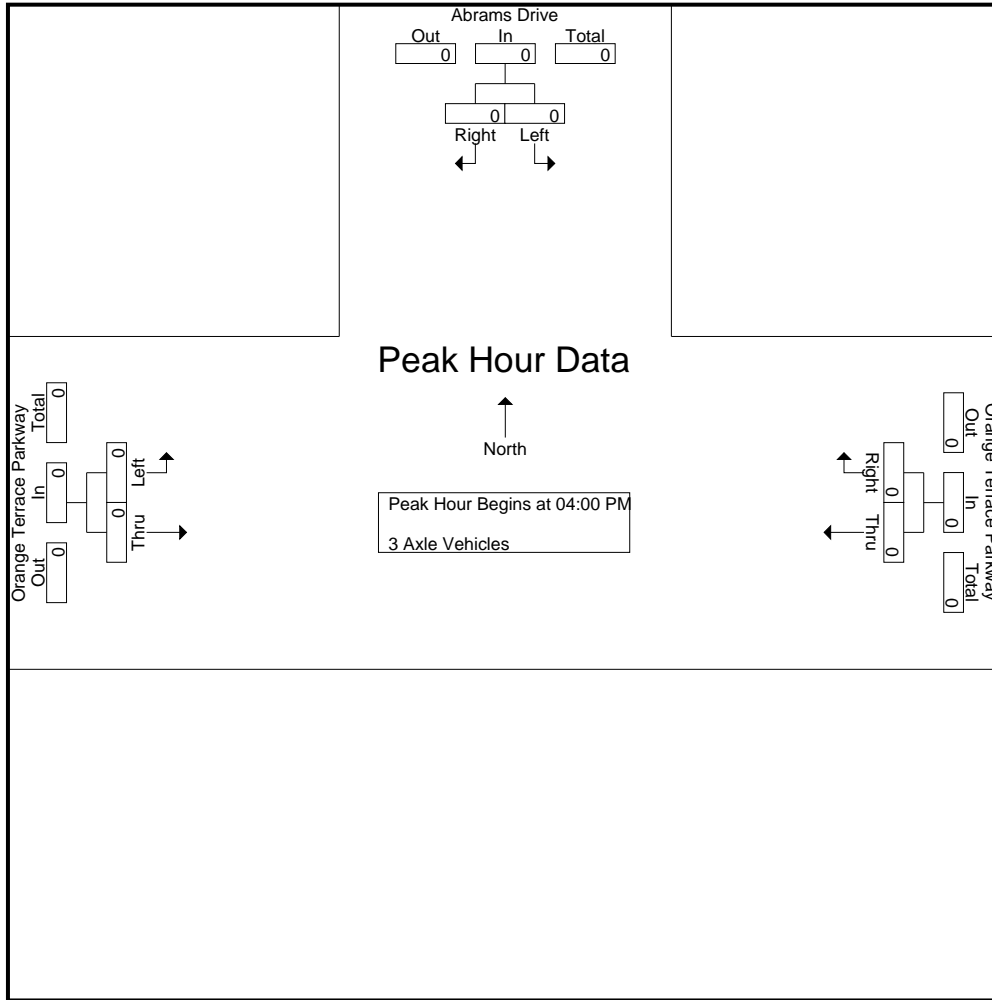

Peak Hour Analysis From 04:00 PM to 04:45 PM - Peak 1 of 1
 Peak Hour for Each Approach Begins at:

	04:00 PM			04:00 PM			04:00 PM		
+0 mins.	0	0	0	0	0	0	0	0	0
+15 mins.	0	0	0	0	0	0	0	0	0
+30 mins.	0	0	0	0	0	0	0	0	0
+45 mins.	0	0	0	0	0	0	0	0	0
Total Volume	0	0	0	0	0	0	0	0	0
% App. Total	0	0	0	0	0	0	0	0	0
PHF	.000	.000	.000	.000	.000	.000	.000	.000	.000

City of Riverside
 N/S: Abrams Drive
 E/W: Orange Terrace Parkway
 Weather: Clear

File Name : 36_RIV_Abrams_Orange PM
 Site Code : 05121716
 Start Date : 11/30/2021
 Page No : 1

Groups Printed- 4+ Axle Trucks

Start Time	Abrams Drive Southbound			Orange Terrace Parkway Westbound			Orange Terrace Parkway Eastbound			Int. Total
	Left	Right	App. Total	Thru	Right	App. Total	Left	Thru	App. Total	
04:00 PM	0	0	0	0	0	0	0	0	0	0
04:15 PM	0	0	0	0	0	0	0	0	0	0
04:30 PM	0	0	0	0	0	0	0	0	0	0
04:45 PM	0	0	0	0	0	0	0	0	0	0
Total	0	0	0	0	0	0	0	0	0	0
05:00 PM	0	0	0	0	0	0	0	0	0	0
05:15 PM	0	0	0	0	0	0	0	0	0	0
05:30 PM	0	0	0	0	0	0	0	0	0	0
05:45 PM	0	0	0	0	0	0	0	0	0	0
Total	0	0	0	0	0	0	0	0	0	0
Grand Total	0	0	0	0	0	0	0	0	0	0
Apprch %	0	0		0	0		0	0		
Total %										

Start Time	Abrams Drive Southbound			Orange Terrace Parkway Westbound			Orange Terrace Parkway Eastbound			Int. Total
	Left	Right	App. Total	Thru	Right	App. Total	Left	Thru	App. Total	
04:00 PM	0	0	0	0	0	0	0	0	0	0
04:15 PM	0	0	0	0	0	0	0	0	0	0
04:30 PM	0	0	0	0	0	0	0	0	0	0
04:45 PM	0	0	0	0	0	0	0	0	0	0
Total Volume	0	0	0	0	0	0	0	0	0	0
% App. Total	0	0		0	0		0	0		
PHF	.000	.000	.000	.000	.000	.000	.000	.000	.000	.000

Peak Hour Analysis From 04:00 PM to 04:45 PM - Peak 1 of 1
 Peak Hour for Entire Intersection Begins at 04:00 PM

City of Riverside
 N/S: Abrams Drive
 E/W: Orange Terrace Parkway
 Weather: Clear

File Name : 36_RIV_Abrams_Orange PM
 Site Code : 05121716
 Start Date : 11/30/2021
 Page No : 2

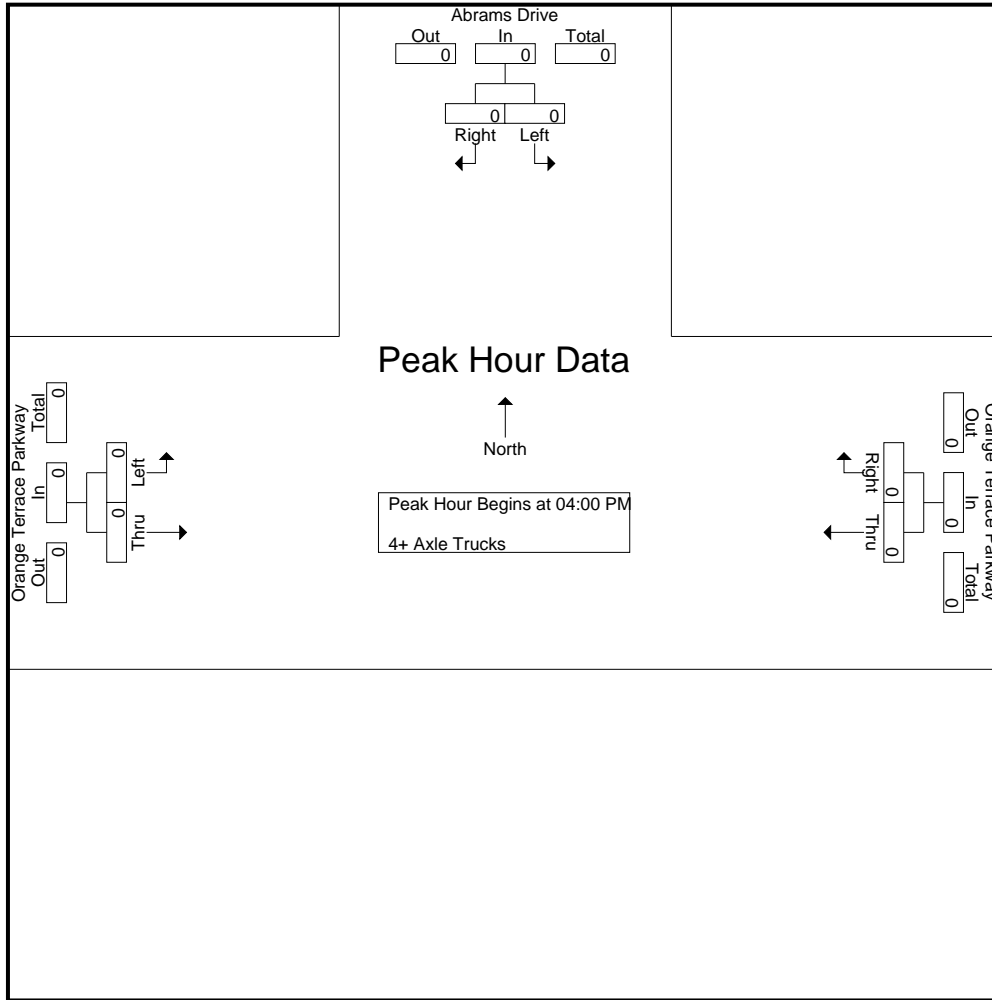

Peak Hour Analysis From 04:00 PM to 04:45 PM - Peak 1 of 1
 Peak Hour for Each Approach Begins at:

	04:00 PM			04:00 PM			04:00 PM		
+0 mins.	0	0	0	0	0	0	0	0	0
+15 mins.	0	0	0	0	0	0	0	0	0
+30 mins.	0	0	0	0	0	0	0	0	0
+45 mins.	0	0	0	0	0	0	0	0	0
Total Volume	0	0	0	0	0	0	0	0	0
% App. Total	0	0	0	0	0	0	0	0	0
PHF	.000	.000	.000	.000	.000	.000	.000	.000	.000

Location: Riverside
 N/S: Abrams Drive
 E/W: Orange Terrace Parkway



Date: 12/16/2021
 Day: Thursday

PEDESTRIANS

	North Leg Abrams Drive	East Leg Orange Terrace Parkway	South Leg Dead End	West Leg Orange Terrace Parkway	
	Pedestrians	Pedestrians	Pedestrians	Pedestrians	
7:00 AM	0	1	0	0	1
7:15 AM	1	0	0	0	1
7:30 AM	2	1	0	0	3
7:45 AM	1	0	0	1	2
8:00 AM	4	3	0	0	7
8:15 AM	0	1	0	0	1
8:30 AM	5	0	0	0	5
8:45 AM	1	1	0	0	2
TOTAL VOLUMES:	14	7	0	1	22

	North Leg Abrams Drive	East Leg Orange Terrace Parkway	South Leg Dead End	West Leg Orange Terrace Parkway	
	Pedestrians	Pedestrians	Pedestrians	Pedestrians	
4:00 PM	0	0	0	1	1
4:15 PM	2	1	0	0	3
4:30 PM	0	0	0	0	0
4:45 PM	0	0	0	0	0
5:00 PM	0	0	0	0	0
5:15 PM	0	2	0	0	2
5:30 PM	0	2	0	0	2
5:45 PM	0	0	0	0	0
TOTAL VOLUMES:	2	5	0	1	8

Location: Riverside
 N/S: Abrams Drive
 E/W: Orange Terrace Parkway

#####



Date: 12/16/2021
 Day: Thursday

BICYCLES

	Southbound Abrams Drive			Westbound Orange Terrace Parkway			Northbound Dead End			Eastbound Orange Terrace Parkway			
	Left	Thru	Right	Left	Thru	Right	Left	Thru	Right	Left	Thru	Right	
7:00 AM	0	0	0	0	0	0	0	0	0	0	0	0	0
7:15 AM	0	0	0	0	0	0	0	0	0	0	0	0	0
7:30 AM	0	0	0	0	0	0	0	0	0	0	0	0	0
7:45 AM	0	0	0	0	0	0	0	0	0	0	0	0	0
8:00 AM	0	0	0	0	0	0	0	0	0	0	0	0	0
8:15 AM	0	0	0	0	0	0	0	0	0	0	0	0	0
8:30 AM	0	0	0	0	0	0	0	0	0	0	0	0	0
8:45 AM	0	0	0	0	0	0	0	0	0	0	0	0	0
TOTAL VOLUMES:	0	0	0	0	0	0	0	0	0	0	0	0	0

	Southbound Abrams Drive			Westbound Orange Terrace Parkway			Northbound Dead End			Eastbound Orange Terrace Parkway			
	Left	Thru	Right	Left	Thru	Right	Left	Thru	Right	Left	Thru	Right	
4:00 PM	0	0	0	0	0	0	0	0	0	0	0	0	0
4:15 PM	0	0	0	0	0	0	0	0	0	0	0	0	0
4:30 PM	0	0	0	0	0	0	0	0	0	0	0	0	0
4:45 PM	0	0	0	0	0	0	0	0	0	0	1	0	1
5:00 PM	0	0	0	0	0	0	0	0	0	0	0	0	0
5:15 PM	0	0	0	0	0	0	0	0	0	0	0	0	0
5:30 PM	0	0	0	0	0	0	0	0	0	0	0	0	0
5:45 PM	0	0	0	0	0	1	0	0	0	0	0	0	1
TOTAL VOLUMES:	0	0	0	0	0	1	0	0	0	0	1	0	2

Groups Printed- Passenger Vehicles - Large 2 Axle Vehicles - 3 Axle Vehicles - 4+ Axle Trucks

Start Time	Orange Terrace Parkway Southbound						Orange Terrace Parkway Northbound						Van Buren Boulevard Eastbound											
	Left		Thru		Right		Left		Thru		Right		Left		Thru		Right		Left		Thru		Right	
	RTOR	App. Total	RTOR	App. Total	RTOR	App. Total	RTOR	App. Total	RTOR	App. Total	RTOR	App. Total	RTOR	App. Total	RTOR	App. Total	RTOR	App. Total	RTOR	App. Total	RTOR	App. Total	RTOR	App. Total
07:00 AM	43	8	44	28	95	4	351	11	19	11	19	11	19	10	225	21	4	256	47	721	4	256	47	721
07:15 AM	51	7	72	34	130	10	328	11	23	10	23	11	23	23	228	14	6	265	60	746	6	265	60	746
07:30 AM	59	3	51	38	113	7	286	5	4	5	4	20	29	304	5	0	338	52	757	5	338	52	757	
07:45 AM	62	7	44	21	113	5	306	1	5	5	14	14	48	297	5	0	350	35	783	5	350	35	783	
Total	215	25	211	121	451	28	1138	105	33	32	30	76	110	1054	45	10	1209	194	3007	194	3007	194	3007	
08:00 AM	41	6	28	17	75	11	332	6	7	8	20	20	23	285	13	4	321	39	748	13	321	39	748	
08:15 AM	31	4	20	10	55	3	321	2	4	6	25	25	14	221	7	0	242	17	643	7	242	17	643	
08:30 AM	29	7	28	21	64	7	315	0	6	6	13	13	9	237	9	2	255	35	647	9	255	35	647	
08:45 AM	33	8	26	18	67	7	294	2	12	11	14	14	21	158	10	4	189	41	571	10	189	41	571	
Total	134	25	102	66	261	29	1121	112	29	32	79	79	67	901	39	10	1007	132	2609	39	1007	132	2609	
Grand Total	349	50	313	187	712	57	2259	217	62	64	155	155	177	1955	84	20	2216	326	5616	84	2216	326	5616	
% Approach	49	7	44			2.3	89.2	8.6	46.5	12.3	41.3	41.3	8	88.2	3.8									
% Total	6.2	0.9	5.6			1.3	40.2	3.9	45.1	0.3	1.1	2.8	3.2	34.8	1.5				5.5	94.5				
% Passenger Vehicles	345	50	309			56	2194	210	2521	19	57	199	174	1883	78				2154	0	0	0	5763	
% Large 2 Axle Vehicles	98.9	100	98.7			98.2	97.1	96.8	97.1	100	89.1	93.9	98.3	96.3	92.9				96.3	0	0	0	97	
% 3 Axle Vehicles	4	0	4			0	39	7	47	0	3	6	2	47	5				55	0	0	0	118	
% 4+ Axle Trucks	1.1	0	1.3			0	1.7	3.2	1.8	0	0	2.8	1.1	2.4	6				2.5	0	0	0	2	
% Large 2 Axle Trucks	0	0	0			1	12	0	13	0	4	7	1	10	1				12	0	0	0	32	
% 3 Axle Trucks	0	0	0			1.8	0.5	0	0.5	0	0	3.3	0.6	0.5	1.2				0.5	0	0	0	0.5	
% 4+ Axle Trucks	0	0	0			0	14	0	14	0	0	0	0	15	0				15	0	0	0	29	
% 4+ Axle Trucks	0	0	0			0	0.6	0	0.5	0	0	0	0	0.8	0				0.7	0	0	0	0.5	

Start Time	Orange Terrace Parkway Southbound						Van Buren Boulevard Westbound						Orange Terrace Parkway Northbound						Van Buren Boulevard Eastbound					
	Left		Thru		Right		Left		Thru		Right		Left		Thru		Right		Left		Thru		Right	
	RTOR	App. Total	RTOR	App. Total	RTOR	App. Total	RTOR	App. Total	RTOR	App. Total	RTOR	App. Total	RTOR	App. Total	RTOR	App. Total	RTOR	App. Total	RTOR	App. Total	RTOR	App. Total	RTOR	App. Total
07:15 AM	51	7	72	130	13	294	21	328	10	2	11	23	23	228	14	265	746							
07:30 AM	59	3	51	113	7	254	25	286	10	5	5	20	29	304	5	338	757							
07:45 AM	62	7	44	113	5	267	34	306	8	1	5	14	48	297	5	350	809							
08:00 AM	41	6	28	75	7	291	34	332	6	8	7	20	23	285	13	4	321							
Total Volume	213	23	195	431	32	1106	114	1252	34	14	29	77	123	1114	37	1274	3034							
% App. Total	49.4	5.3	45.2		2.6	88.3	9.1	94.3	44.2	18.2	37.7	83.7	9.7	87.4	2.9									
PHF	.859	.821	.677	.829	.615	.940	.838	.943	.850	.583	.659	.837	.641	.916	.661	.910	.969							

Peak Hour Analysis From 07:00 AM to 08:45 AM - Peak 1 of 1
 Peak Hour for Entire Intersection Begins at 07:15 AM

Counts Unlimited, Inc.
 PO Box 1178
 Corona, CA 92878
 (951)268-6268

City of Riverside
 N/S: Orange Terrace Parkway
 E/W: Van Buren Boulevard
 Weather: Clear

File Name : 18_RIV_Orange_VB AM
 Site Code : 05121716
 Start Date : 11/30/2021
 Page No : 2

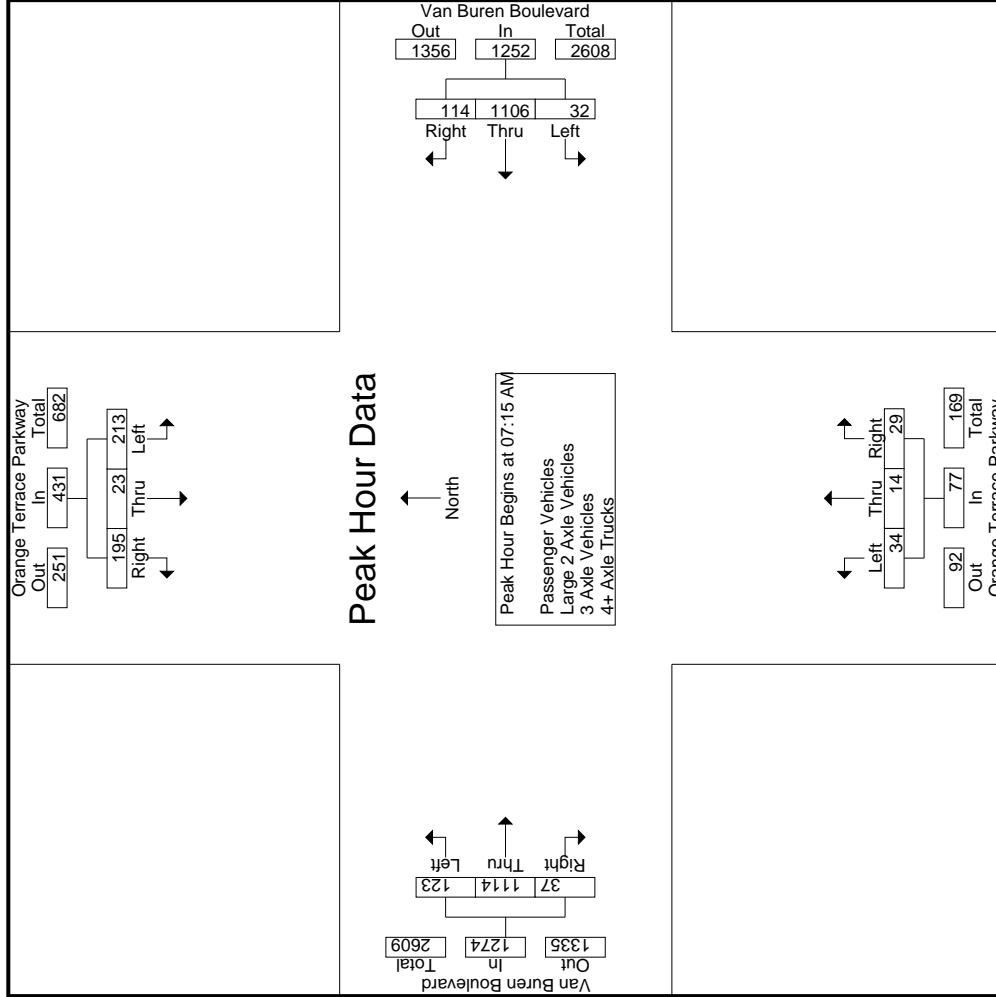

Counts Unlimited, Inc.
 PO Box 1178
 Corona, CA 92878
 (951)268-6268

City of Riverside
 N/S: Orange Terrace Parkway
 E/W: Van Buren Boulevard
 Weather: Clear

File Name : 18_RIV_Orange_VB AM
 Site Code : 05121716
 Start Date : 11/30/2021
 Page No : 3

Start Time	Orange Terrace Parkway Southbound			Van Buren Boulevard Westbound			Orange Terrace Parkway Northbound			Van Buren Boulevard Eastbound		
	Left	Thru	Right	Left	Thru	Right	Left	Thru	Right	Left	Thru	Right
Peak Hour Analysis From 07:00 AM to 08:45 AM - Peak 1 of 1												
Peak Hour for Each Approach Begins at:												
+0 mins.	43	8	44	5	267	34	10	5	5	23	228	14
+15 mins.	51	7	72	7	291	34	8	1	5	29	304	5
+30 mins.	59	3	51	7	295	19	6	6	8	48	297	5
+45 mins.	62	7	44	8	274	33	17	2	6	23	285	13
Total Volume	215	25	211	27	1127	120	41	14	24	123	1114	37
% App. Total	47.7	5.5	46.8	2.1	88.5	9.4	51.9	17.7	30.4	9.7	87.4	2.9
PHF	.867	.781	.733	.844	.955	.882	.603	.583	.750	.641	.916	.661

Groups Printed- Passenger Vehicles

Start Time	Orange Terrace Parkway Southbound					Van Buren Boulevard Westbound					Orange Terrace Parkway Northbound					Van Buren Boulevard Eastbound							
	Left	Thru	Right	RTOR	App. Total	Left	Thru	Right	RTOR	App. Total	Left	Thru	Right	RTOR	App. Total	Left	Thru	Right	RTOR	App. Total	Exclu. Total	Inclu. Total	Int. Total
07:00 AM	43	8	44	28	95	2	312	22	4	336	7	1	10	10	18	10	218	19	4	247	46	696	742
07:15 AM	50	7	70	32	127	13	285	21	10	319	10	2	10	9	22	23	218	14	6	255	57	723	780
07:30 AM	58	3	51	38	112	7	247	24	10	278	10	5	4	3	19	28	296	5	0	329	51	738	789
07:45 AM	62	7	43	21	112	5	263	33	8	301	8	1	4	4	13	48	291	4	0	343	33	769	802
Total	213	25	208	119	446	27	1107	100	32	1234	35	9	28	26	72	109	1023	42	10	1174	187	2926	3113
08:00 AM	41	6	28	17	75	7	284	34	11	325	6	6	7	7	19	22	276	11	3	309	38	728	766
08:15 AM	30	4	20	10	54	7	283	17	3	307	17	2	5	3	24	14	213	6	0	233	16	618	634
08:30 AM	28	7	27	21	62	8	265	33	7	306	7	0	5	4	12	9	222	9	2	240	34	620	654
08:45 AM	33	8	26	18	67	7	255	26	8	288	7	2	12	11	21	20	149	10	4	179	41	555	596
Total	132	25	101	66	258	29	1087	110	29	1226	37	10	29	25	76	65	860	36	9	961	129	2521	2650
Grand Total	345	50	309	185	704	56	2194	210	61	2460	72	19	57	51	148	174	1883	78	19	2135	316	5447	5763
T-Approch %	49	7.1	43.9			2.3	89.2	8.5		45.2	48.6	12.8	38.5		8.1	88.2	3.7			39.2	5.5	94.5	
T-Total %	6.3	0.9	5.7		12.9	1	40.3	3.9			1.3	0.3	1		3.2	34.6	1.4						

Start Time	Orange Terrace Parkway Southbound					Van Buren Boulevard Westbound					Orange Terrace Parkway Northbound					Van Buren Boulevard Eastbound							
	Left	Thru	Right	RTOR	App. Total	Left	Thru	Right	RTOR	App. Total	Left	Thru	Right	RTOR	App. Total	Left	Thru	Right	RTOR	App. Total	Exclu. Total	Inclu. Total	Int. Total
07:15 AM	50	7	70		127	13	285	21		319	10	2	10		22	23	218	14		255		255	723
07:30 AM	58	3	51		112	7	247	24		278	10	5	4		19	28	296	5		329		329	738
07:45 AM	62	7	43		112	5	263	33		301	8	1	4		13	48	291	4		343		343	769
08:00 AM	41	6	28		75	7	284	34		325	6	6	7		19	22	276	11		309		309	728
Total Volume	211	23	192		426	32	1079	112		1223	34	14	25		73	121	1081	34		1236		1236	2958
% App. Total	49.5	5.4	45.1		45.1	2.6	88.2	9.2		46.6	19.2	34.2			9.8	87.5	2.8						
PHF	.851	.821	.686		.839	.615	.946	.824		.941	.850	.583			.830	.630	.913			.607		.901	.962

Peak Hour Analysis From 07:15 AM to 08:00 AM - Peak 1 of 1
 Peak Hour for Entire Intersection Begins at 07:15 AM

Counts Unlimited, Inc.
 PO Box 1178
 Corona, CA 92878
 (951)268-6268

City of Riverside
 N/S: Orange Terrace Parkway
 E/W: Van Buren Boulevard
 Weather: Clear

File Name : 18_RIV_Orange_VB AM
 Site Code : 05121716
 Start Date : 11/30/2021
 Page No : 2

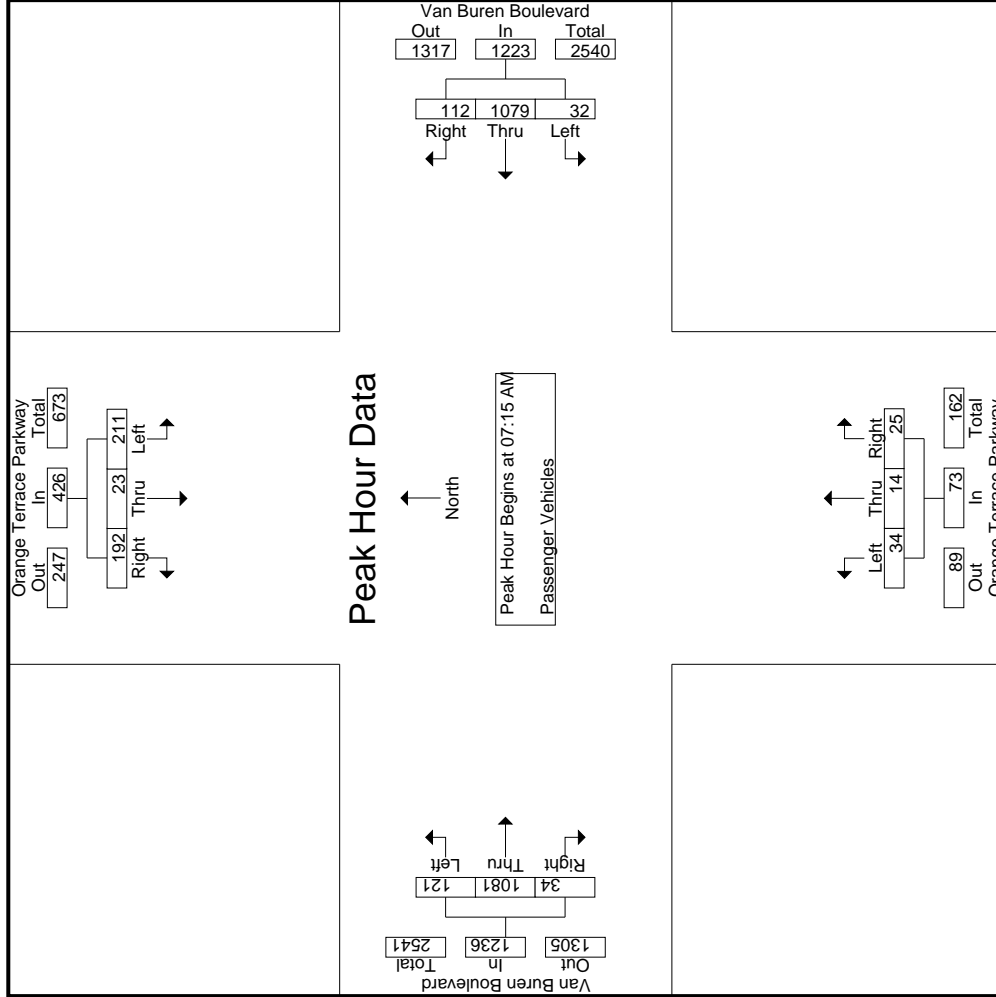

Counts Unlimited, Inc.
 PO Box 1178
 Corona, CA 92878
 (951)268-6268

City of Riverside
 N/S: Orange Terrace Parkway
 E/W: Van Buren Boulevard
 Weather: Clear

File Name : 18_RIV_Orange_VB AM
 Site Code : 05121716
 Start Date : 11/30/2021
 Page No : 3

Start Time	Orange Terrace Parkway Southbound			Van Buren Boulevard Westbound			Orange Terrace Parkway Northbound			Van Buren Boulevard Eastbound					
	Left	Thru	Right	Left	Thru	Right	Left	Thru	Right	Left	Thru	Right			
Peak Hour Analysis From 07:15 AM to 08:00 AM - Peak 1 of 1															
Peak Hour for Each Approach Begins at:	07:15 AM														
+0 mins.	50	7	70	127	13	285	21	319	2	10	22	23	218	14	255
+15 mins.	58	3	51	112	7	247	24	278	5	4	19	28	296	5	329
+30 mins.	62	7	43	112	5	263	33	301	1	4	13	48	291	4	343
+45 mins.	41	6	28	75	7	284	34	325	6	7	19	22	276	11	309
Total Volume	211	23	192	426	32	1079	112	1223	14	25	73	121	1081	34	1236
% App. Total	49.5	5.4	45.1		2.6	88.2	9.2		19.2	34.2		9.8	87.5	2.8	
PHF	.851	.821	.686	.839	.615	.946	.824	.941	.583	.625	.830	.630	.913	.607	.901

Groups Printed- Large 2 Axle Vehicles

Start Time	Orange Terrace Parkway Southbound				Van Buren Boulevard Westbound				Orange Terrace Parkway Northbound				Van Buren Boulevard Eastbound								
	Left	Thru	Right	RTOR	Left	Thru	Right	RTOR	Left	Thru	Right	RTOR	Left	Thru	Right	RTOR					
07:00 AM	0	0	0	0	0	0	0	0	10	0	0	0	1	0	3	2	0	5	1	16	17
07:15 AM	1	0	2	2	0	6	0	0	6	0	0	0	0	0	6	0	0	6	2	15	17
07:30 AM	1	0	0	1	0	3	1	0	4	0	0	0	0	1	5	0	0	6	0	11	11
07:45 AM	0	0	1	0	0	2	1	1	3	0	0	1	1	0	4	1	0	5	2	10	12
Total	2	0	3	2	0	18	5	1	23	0	0	2	2	1	18	3	0	22	5	52	57
08:00 AM	0	0	0	0	0	6	0	0	6	0	0	0	0	1	8	2	1	11	1	17	18
08:15 AM	1	0	0	1	0	9	2	0	11	0	0	1	1	0	6	0	0	6	1	19	20
08:30 AM	1	0	1	0	0	4	0	0	4	0	0	0	0	0	11	0	0	11	0	17	17
08:45 AM	0	0	0	0	0	2	0	0	2	0	0	0	0	0	4	0	0	4	0	6	6
Total	2	0	1	0	0	21	2	0	23	0	0	1	1	1	29	2	1	32	2	59	61
Grand Total	4	0	4	2	0	39	7	1	46	0	0	3	3	2	47	5	1	54	7	111	118
T-Approch %	50	0	50		0	84.8	15.2		41.4	0	0	100		3.7	87	9.3		48.6	5.9	94.1	
T-Total %	3.6	0	3.6		0	35.1	6.3		41.4	0	0	2.7		1.8	42.3	4.5		48.6			

Start Time	Orange Terrace Parkway Southbound				Van Buren Boulevard Westbound				Orange Terrace Parkway Northbound				Van Buren Boulevard Eastbound								
	Left	Thru	Right	RTOR	Left	Thru	Right	RTOR	Left	Thru	Right	RTOR	Left	Thru	Right	RTOR					
07:15 AM	1	0	2		0	6	0		0	0	0		0	0	0		0	6	0	6	15
07:30 AM	1	0	0		0	3	1		1	0	0		0	0	0		0	5	0	6	11
07:45 AM	0	0	1		0	2	1		1	0	0		0	0	1		0	4	1	5	10
08:00 AM	0	0	0		0	6	0		6	0	0		0	0	8		1	8	2	11	17
Total Volume	2	0	3		0	17	2		19	0	0		1	2	23		3	28	3	28	53
% App. Total	40	0	60		0	89.5	10.5		100	0	0		100	7.1	82.1		10.7	10.7	3.75	636	779
PHF	.500	.000	.375		.000	.708	.500		.792	.000	.000		.250	.500	.719		.375	.636			

Peak Hour Analysis From 07:15 AM to 08:00 AM - Peak 1 of 1
 Peak Hour for Entire Intersection Begins at 07:15 AM

Counts Unlimited, Inc.
 PO Box 1178
 Corona, CA 92878
 (951)268-6268

City of Riverside
 N/S: Orange Terrace Parkway
 E/W: Van Buren Boulevard
 Weather: Clear

File Name : 18_RIV_Orange_VB AM
 Site Code : 05121716
 Start Date : 11/30/2021
 Page No : 2

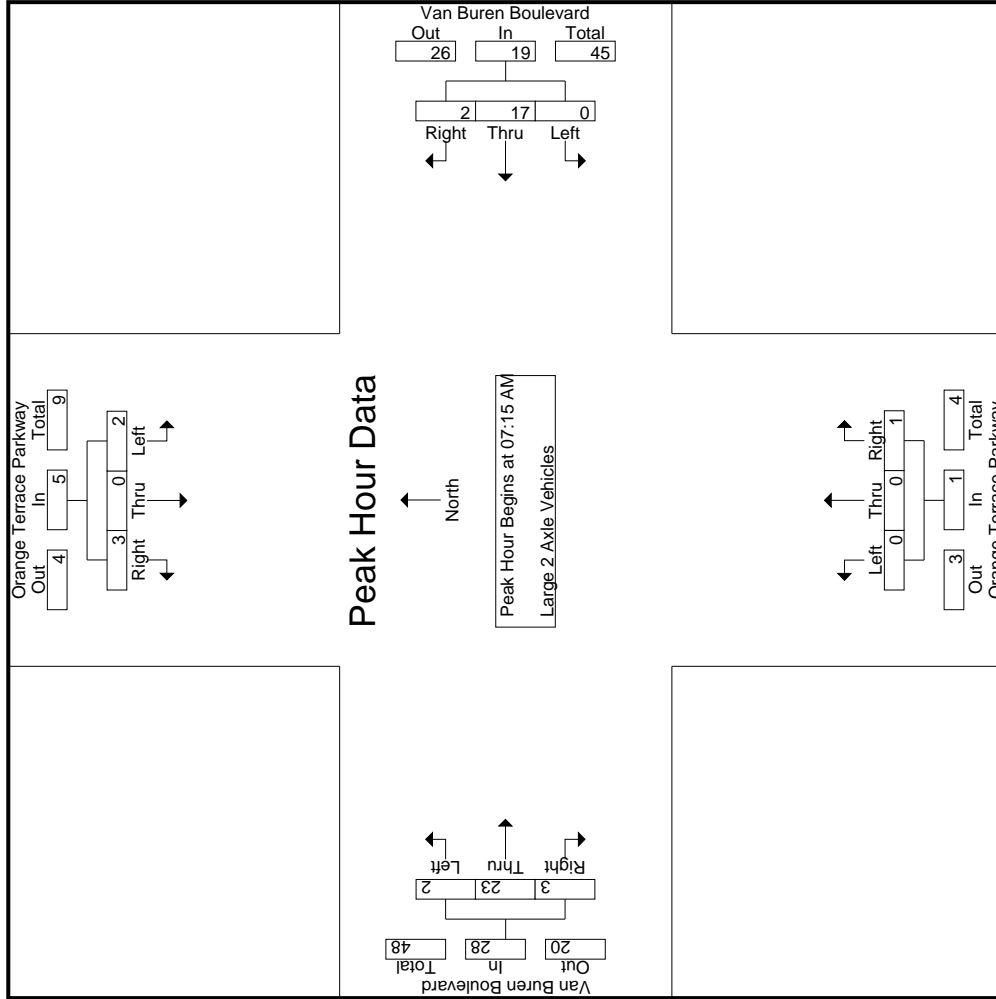

Start Time	Orange Terrace Parkway Southbound			Van Buren Boulevard Westbound			Orange Terrace Parkway Northbound			Van Buren Boulevard Eastbound			
	Left	Thru	Right	Left	Thru	Right	Left	Thru	Right	Left	Thru	Right	
Peak Hour Analysis From 07:15 AM to 08:00 AM - Peak 1 of 1													
Peak Hour for Each Approach Begins at:													
	07:15 AM												
+0 mins.	1	0	2	3	0	6	0	0	0	0	6	0	6
+15 mins.	1	0	0	1	0	3	1	0	0	1	5	0	6
+30 mins.	0	0	1	1	0	2	1	0	1	0	4	1	5
+45 mins.	0	0	0	0	0	6	0	0	0	1	8	2	11
Total Volume	2	0	3	5	0	17	2	0	1	2	23	3	28
% App. Total	40	0	60	417	0	89.5	10.5	0	100	7.1	82.1	10.7	10.7
PHF	.500	.000	.375	.417	.000	.708	.500	.000	.250	.500	.719	.375	.636

Groups Printed- 3 Axle Vehicles

Start Time	Orange Terrace Parkway Southbound				Van Buren Boulevard Westbound				Orange Terrace Parkway Northbound				Van Buren Boulevard Eastbound											
	Left	Thru	Right	RTOR	App. Total	Left	Thru	Right	RTOR	App. Total	Left	Thru	Right	RTOR	App. Total	Left	Thru	Right	RTOR	App. Total	Exclu. Total	Inclu. Total	Int. Total	
07:00 AM	0	0	0	0	0	1	0	0	0	2	0	0	0	0	0	0	2	0	0	0	2	0	4	4
07:15 AM	0	0	0	0	0	0	2	0	0	2	0	0	1	1	1	0	1	0	0	0	1	1	4	5
07:30 AM	0	0	0	0	0	0	2	0	0	2	0	0	1	1	1	0	0	0	0	0	0	1	3	4
07:45 AM	0	0	0	0	0	0	1	0	0	1	0	0	0	0	0	0	0	0	0	0	0	0	1	1
Total	0	0	0	0	0	1	6	0	0	7	0	0	2	2	2	0	3	0	0	3	2	12	14	14
08:00 AM	0	0	0	0	0	0	0	0	0	0	0	0	1	0	1	0	1	0	0	1	0	0	2	2
08:15 AM	0	0	0	0	0	0	2	0	0	2	0	0	0	0	0	0	0	1	0	0	1	0	3	3
08:30 AM	0	0	0	0	0	0	2	0	0	2	0	1	1	1	1	0	3	0	0	3	1	6	7	7
08:45 AM	0	0	0	0	0	0	2	0	0	2	0	0	0	0	0	1	3	0	0	4	0	6	6	6
Total	0	0	0	0	0	0	6	0	0	6	0	0	2	1	2	1	7	1	0	9	1	17	18	18
Grand Total	0	0	0	0	0	1	12	0	0	13	0	0	4	3	4	1	10	1	0	12	3	29	32	32
% Approach	0	0	0	0	0	7.7	92.3	0	0	100	0	0	100	8.3	83.3	8.3	41.4	0	0	41.4	9.4	90.6	90.6	90.6
Total %	0	0	0	0	0	3.4	41.4	0	0	44.8	0	0	13.8	13.8	34.5	3.4	34.5	3.4	0	41.4	9.4	90.6	90.6	90.6

Start Time	Orange Terrace Parkway Southbound				Van Buren Boulevard Westbound				Orange Terrace Parkway Northbound				Van Buren Boulevard Eastbound											
	Left	Thru	Right	RTOR	App. Total	Left	Thru	Right	RTOR	App. Total	Left	Thru	Right	RTOR	App. Total	Left	Thru	Right	RTOR	App. Total	Exclu. Total	Inclu. Total	Int. Total	
07:15 AM	0	0	0	0	0	0	2	0	0	2	0	0	1	1	1	0	1	0	0	1	0	1	4	4
07:30 AM	0	0	0	0	0	0	2	0	0	2	0	0	1	1	1	0	0	0	0	0	0	0	3	3
07:45 AM	0	0	0	0	0	0	1	0	0	1	0	0	0	0	0	0	0	0	0	0	0	0	1	1
08:00 AM	0	0	0	0	0	0	0	0	0	0	0	0	0	0	0	0	1	0	0	0	0	1	2	2
Total Volume	0	0	0	0	0	0	5	0	0	5	0	0	3	3	3	0	2	0	0	2	0	10	10	10
% App. Total	0	0	0	0	0	0	100	0	0	100	0	0	100	75.0	75.0	0	100	0	0	100	0	.625	.625	.625
PHF	.000	.000	.000	.000	.000	.000	.625	.000	.000	.625	.000	.750	.750	.750	.750	.000	.500	.000	.500	.000	.500	.500	.500	.625

Peak Hour Analysis From 07:15 AM to 08:00 AM - Peak 1 of 1
 Peak Hour for Entire Intersection Begins at 07:15 AM

Counts Unlimited, Inc.
 PO Box 1178
 Corona, CA 92878
 (951)268-6268

City of Riverside
 N/S: Orange Terrace Parkway
 E/W: Van Buren Boulevard
 Weather: Clear

File Name : 18_RIV_Orange_VB AM
 Site Code : 05121716
 Start Date : 11/30/2021
 Page No : 2

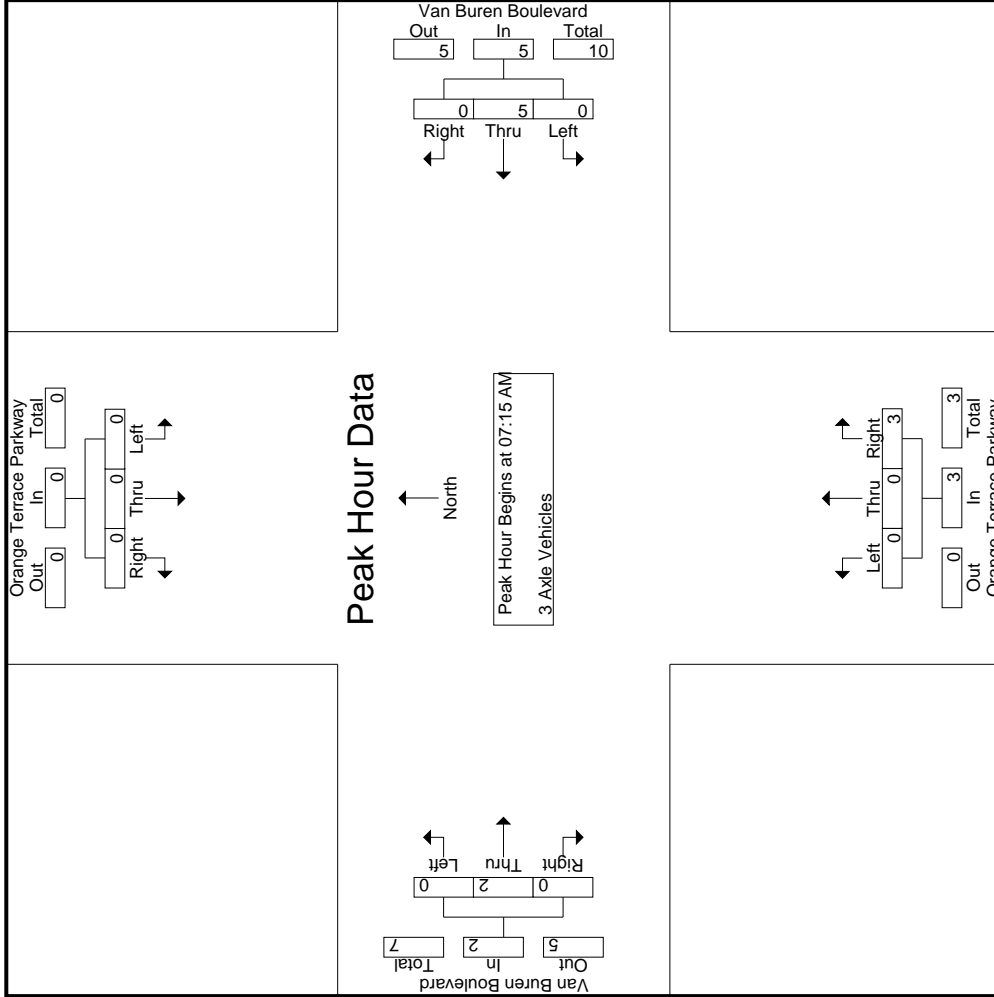

Counts Unlimited, Inc.
 PO Box 1178
 Corona, CA 92878
 (951)268-6268

City of Riverside
 N/S: Orange Terrace Parkway
 E/W: Van Buren Boulevard
 Weather: Clear

File Name : 18_RIV_Orange_VB AM
 Site Code : 05121716
 Start Date : 11/30/2021
 Page No : 3

Start Time	Orange Terrace Parkway Southbound			Van Buren Boulevard Westbound			Orange Terrace Parkway Northbound			Van Buren Boulevard Eastbound		
	Left	Thru	Right	Left	Thru	Right	Left	Thru	Right	Left	Thru	Right
Peak Hour Analysis From 07:15 AM to 08:00 AM - Peak 1 of 1	Peak Hour for Each Approach Begins at:											
	07:15 AM											
+0 mins.	0	0	0	0	2	0	0	0	1	0	1	0
+15 mins.	0	0	0	0	2	0	0	0	1	0	0	0
+30 mins.	0	0	0	0	1	0	0	0	0	0	0	0
+45 mins.	0	0	0	0	0	0	0	0	1	0	1	0
Total Volume	0	0	0	0	5	0	0	0	3	0	2	0
% App. Total	0	0	0	0	100	0	0	0	100	0	100	0
PHF	.000	.000	.000	.000	.625	.000	.625	.000	.750	.000	.500	.000

Groups Printed- 4+ Axle Trucks

Start Time	Orange Terrace Parkway Southbound				Van Buren Boulevard Westbound				Orange Terrace Parkway Northbound				Van Buren Boulevard Eastbound							
	Left	Thru	Right	RTOR	Left	Thru	Right	RTOR	Left	Thru	Right	RTOR	Left	Thru	Right	RTOR	App. Total	Exclu. Total	Inclu. Total	Int. Total
07:00 AM	0	0	0	0	0	0	0	0	0	0	0	0	0	0	0	0	2	0	5	5
07:15 AM	0	0	0	0	0	1	0	0	0	0	0	0	0	0	3	0	3	0	4	4
07:30 AM	0	0	0	0	0	2	0	0	0	0	0	0	0	0	3	0	3	0	5	5
07:45 AM	0	0	0	0	0	1	0	0	0	0	0	0	0	0	2	0	2	0	3	3
Total	0	0	0	0	0	7	0	0	0	0	0	0	0	10	0	0	10	0	17	17
08:00 AM	0	0	0	0	0	1	0	0	0	0	0	0	0	0	0	0	0	0	1	1
08:15 AM	0	0	0	0	0	1	0	0	0	0	0	0	0	2	0	0	2	0	3	3
08:30 AM	0	0	0	0	0	3	0	0	0	0	0	0	0	1	0	0	1	0	4	4
08:45 AM	0	0	0	0	0	2	0	0	0	0	0	0	0	2	0	0	2	0	4	4
Total	0	0	0	0	0	7	0	0	0	0	0	0	0	5	0	0	5	0	12	12
Grand Total	0	0	0	0	0	14	0	0	0	0	0	0	0	15	0	0	15	0	29	29
T-Approch %	0	0	0	0	0	100	0	0	0	0	0	0	0	100	0	0	100	0	100	100
Total %	0	0	0	0	0	48.3	0	0	0	0	0	0	0	51.7	0	0	51.7	0	100	100

Start Time	Orange Terrace Parkway Southbound				Van Buren Boulevard Westbound				Orange Terrace Parkway Northbound				Van Buren Boulevard Eastbound							
	Left	Thru	Right	RTOR	Left	Thru	Right	RTOR	Left	Thru	Right	RTOR	Left	Thru	Right	RTOR	App. Total	Exclu. Total	Inclu. Total	Int. Total
07:15 AM	0	0	0	0	0	1	0	0	0	0	0	0	0	0	0	0	1	0	3	4
07:30 AM	0	0	0	0	0	2	0	0	0	0	0	0	0	0	3	0	3	0	5	5
07:45 AM	0	0	0	0	0	1	0	0	0	0	0	0	0	2	0	0	2	0	3	3
08:00 AM	0	0	0	0	0	1	0	0	0	0	0	0	0	0	0	0	0	0	1	1
Total Volume	0	0	0	0	0	5	0	0	0	0	0	0	0	8	0	0	8	0	13	13
% App. Total	0	0	0	0	0	100	0	0	0	0	0	0	0	100	0	0	100	0	100	100
PHF	.000	.000	.000	.000	.000	.625	.000	.000	.000	.000	.000	.000	.000	.667	.000	.000	.667	.000	.650	.650

Peak Hour Analysis From 07:15 AM to 08:00 AM - Peak 1 of 1
 Peak Hour for Entire Intersection Begins at 07:15 AM

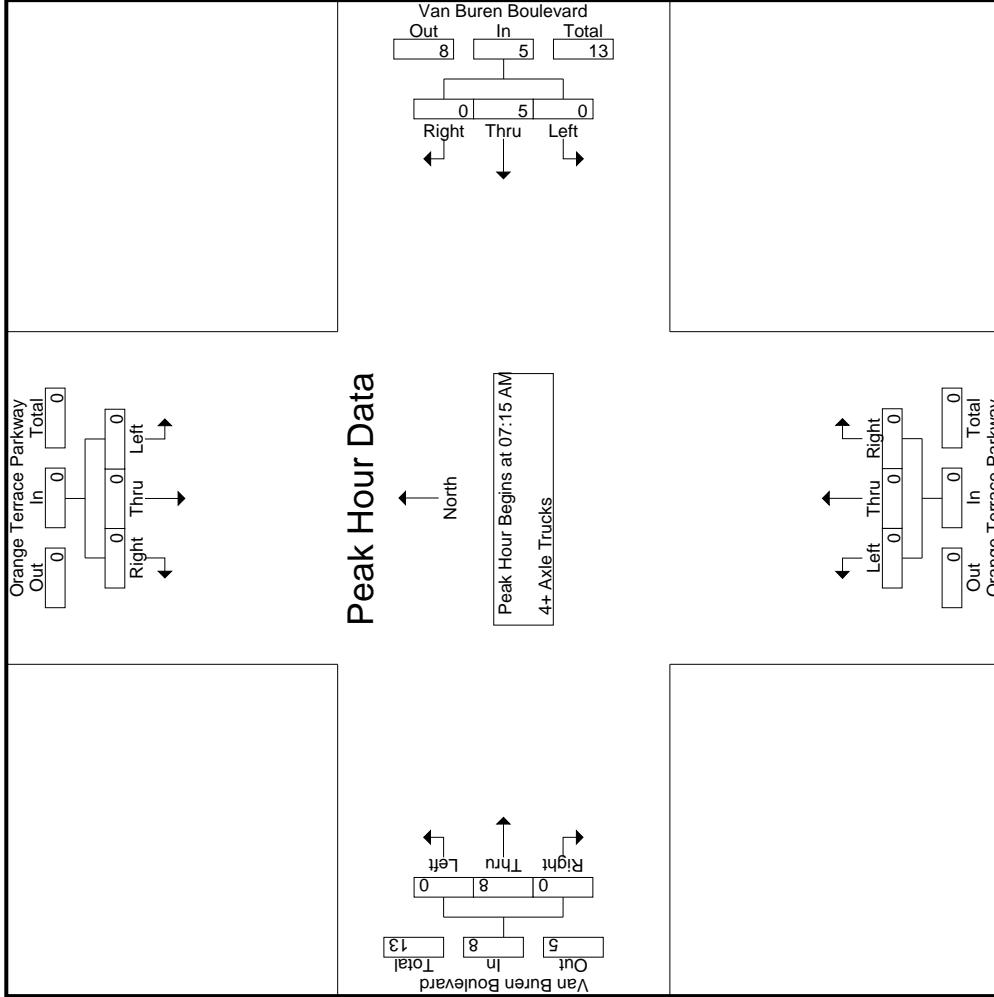

Counts Unlimited, Inc.
 PO Box 1178
 Corona, CA 92878
 (951)268-6268

City of Riverside
 N/S: Orange Terrace Parkway
 E/W: Van Buren Boulevard
 Weather: Clear

File Name : 18_RIV_Orange_VB AM
 Site Code : 05121716
 Start Date : 11/30/2021
 Page No : 3

Start Time	Orange Terrace Parkway Southbound			Van Buren Boulevard Westbound			Orange Terrace Parkway Northbound			Van Buren Boulevard Eastbound		
	Left	Thru	Right	Left	Thru	Right	Left	Thru	Right	Left	Thru	Right
Peak Hour Analysis From 07:15 AM to 08:00 AM - Peak 1 of 1												
Peak Hour for Each Approach Begins at:	07:15 AM											
+0 mins.	0	0	0	0	1	0	0	0	0	0	3	0
+15 mins.	0	0	0	0	2	0	0	0	0	0	3	0
+30 mins.	0	0	0	0	1	0	0	0	0	0	2	0
+45 mins.	0	0	0	0	1	0	0	0	0	0	0	0
Total Volume	0	0	0	0	5	0	0	0	0	0	8	0
% App. Total	0	0	0	0	100	0	0	0	0	0	100	0
PHF	.000	.000	.000	.000	.625	.000	.000	.000	.000	.000	.667	.000

Groups Printed- Passenger Vehicles - Large 2 Axle Vehicles - 3 Axle Vehicles - 4+ Axle Trucks

Start Time	Orange Terrace Parkway Southbound						Van Buren Boulevard Westbound						Orange Terrace Parkway Northbound						Van Buren Boulevard Eastbound					
	Left		Thru		Right		Left		Thru		Right		Left		Thru		Right		Left		Thru		Right	
	RTOR	App. Total	RTOR	App. Total	RTOR	App. Total	RTOR	App. Total	RTOR	App. Total	RTOR	App. Total	RTOR	App. Total	RTOR	App. Total	RTOR	App. Total	RTOR	App. Total	RTOR	App. Total	RTOR	App. Total
04:00 PM	27	5	17	13	49	7	289	53	28	349	8	4	12	8	24	21	303	19	2	343	51	765	816	
04:15 PM	25	4	32	21	61	8	339	55	20	402	9	4	8	8	21	32	299	17	4	348	53	832	885	
04:30 PM	33	5	8	4	46	13	305	58	23	376	10	7	7	7	24	33	296	12	4	341	38	787	825	
04:45 PM	16	4	19	19	39	7	336	46	10	389	10	2	6	6	18	34	336	10	3	380	38	826	864	
Total	101	18	76	57	195	35	1269	212	81	1516	37	17	33	29	87	120	1234	58	13	1412	180	3210	3390	
05:00 PM	36	2	17	10	55	15	322	58	16	395	5	4	6	4	15	26	272	19	6	317	36	782	818	
05:15 PM	36	8	26	21	70	9	313	50	13	372	17	8	12	10	37	40	312	14	4	366	48	845	893	
05:30 PM	13	10	25	18	48	7	287	46	14	340	19	10	5	4	34	22	317	22	7	361	43	783	826	
05:45 PM	22	10	28	21	60	16	299	46	14	361	18	8	14	12	40	36	318	22	8	376	55	837	892	
Total	107	30	96	70	233	47	1221	200	57	1468	59	30	37	30	126	124	1219	77	25	1420	182	3247	3429	
Grand Total	208	48	172	127	428	82	2490	412	138	2984	96	47	70	59	213	244	2453	135	38	2832	362	6457	6819	
T-Approach %	48.6	11.2	40.2			2.7	83.4	13.8			45.1	22.1	32.9			8.6	86.6	4.8						
T-Total %	3.2	0.7	2.7			1.3	38.6	6.4			1.5	0.7	1.1			3.8	38	2.1			5.3	94.7		
% Passenger Vehicles	205	47	171		549	80	2414	407		3036	90	47	65		257	242	2394	126		2797	0	0	6639	
% Large 2 Axle Vehicles	98.6	97.9	99.4	99.2	98.9	97.6	96.9	98.8	97.8	97.2	93.8	100	92.9	93.2	94.5	99.2	97.6	93.3	92.1	97.5	0	0	97.4	
% 3 Axle Vehicles	1.4	2.1	0.6	0.8	1.1	1.2	1.7	1	2.2	1.6	5	0	1.4	1.7	2.6	0.8	1.3	3.7	5.3	1.4	0	0	1.5	
% 4+ Axle Trucks	0	0	0	0	0	0	0	0.2	0	0.6	1	0	2.9	3.4	1.8	0	0.4	0.7	2.6	0.4	0	0	0.5	
% 4+ Axle Trucks	0	0	0	0	0	1	16	0	0	17	0	0	2	1.7	3	0	19	3	22	0	0	0	42	
% 4+ Axle Trucks	0	0	0	0	0	1.2	0.6	0	0	0.5	0	0	2.9	1.7	1.1	0	0.8	2.2	0	0.8	0	0	0.6	

Start Time	Orange Terrace Parkway Southbound						Van Buren Boulevard Westbound						Orange Terrace Parkway Northbound						Van Buren Boulevard Eastbound					
	Left		Thru		Right		Left		Thru		Right		Left		Thru		Right		Left		Thru		Right	
	RTOR	App. Total	RTOR	App. Total	RTOR	App. Total	RTOR	App. Total	RTOR	App. Total	RTOR	App. Total	RTOR	App. Total	RTOR	App. Total	RTOR	App. Total	RTOR	App. Total	RTOR	App. Total	RTOR	App. Total
05:00 PM	36	2	17	17	55	15	322	58		395	5	4	6	4	15	26	272	19		317	36	782		
05:15 PM	36	8	26	26	70	9	313	50		372	17	8	12	8	12	40	312	14		366	48	893		
05:30 PM	13	10	25	18	48	7	287	46		340	19	10	5	4	34	22	317	22		376	43	826		
05:45 PM	22	10	28	21	60	16	299	46		361	18	8	14	12	40	36	318	22		380	38	826		
Total Volume	107	30	96	70	233	47	1221	200		1468	59	30	37	30	126	124	1219	77		1420	180	3210		
% App. Total	45.9	12.9	41.2			3.2	83.2	13.6			46.8	23.8	29.4			8.7	85.8	5.4						
PHF	.743	.750	.857		.832	.734	.948	.862		.929	.776	.750	.661		.788	.775	.958	.875		.944				

Peak Hour Analysis From 04:00 PM to 05:45 PM - Peak 1 of 1
 Peak Hour for Entire Intersection Begins at 05:00 PM

Counts Unlimited, Inc.
 PO Box 1178
 Corona, CA 92878
 (951)268-6268

City of Riverside
 N/S: Orange Terrace Parkway
 E/W: Van Buren Boulevard
 Weather: Clear

File Name : 18_RIV_Orange_VB PM
 Site Code : 05121716
 Start Date : 11/30/2021
 Page No : 2

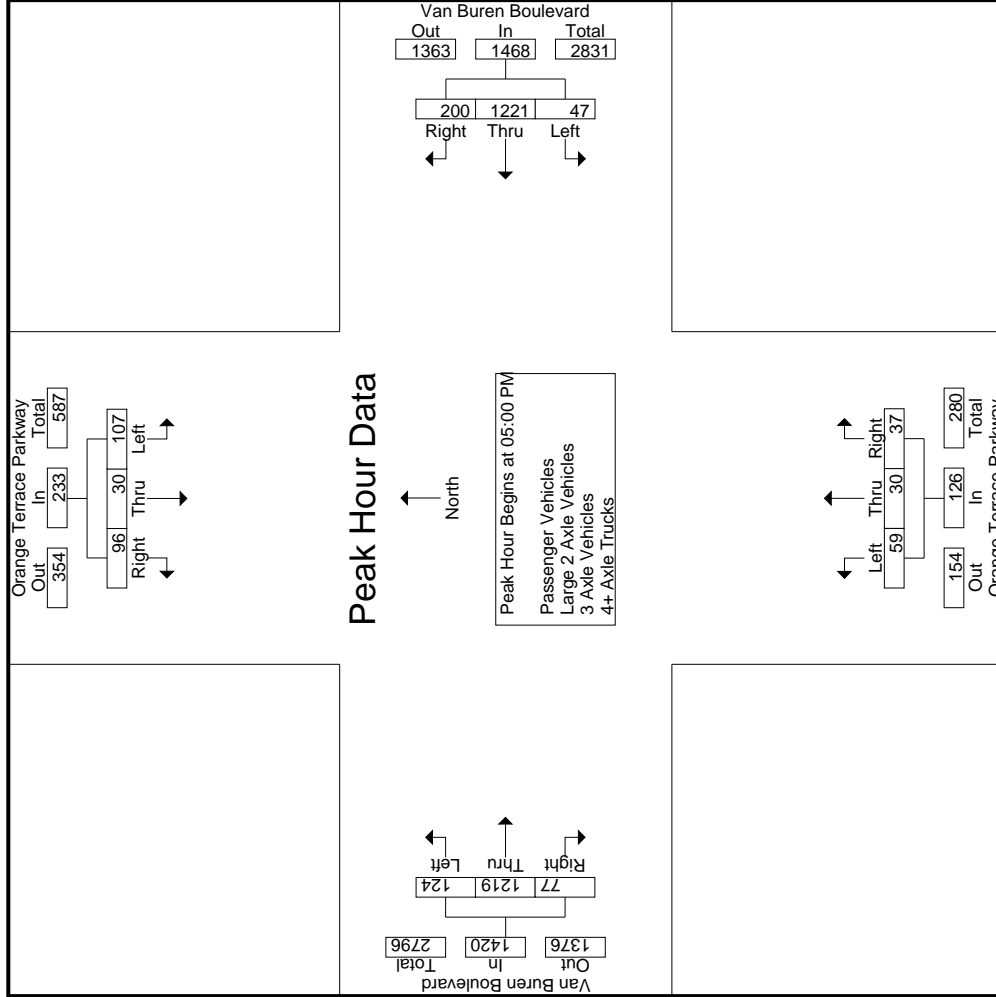

Counts Unlimited, Inc.
 PO Box 1178
 Corona, CA 92878
 (951)268-6268

City of Riverside
 N/S: Orange Terrace Parkway
 E/W: Van Buren Boulevard
 Weather: Clear

File Name : 18_RIV_Orange_VB PM
 Site Code : 05121716
 Start Date : 11/30/2021
 Page No : 3

Start Time	Orange Terrace Parkway Southbound			Van Buren Boulevard Westbound			Orange Terrace Parkway Northbound			Van Buren Boulevard Eastbound				
	Left	Thru	Right	Left	Thru	Right	Left	Thru	Right	Left	Thru	Right		
Peak Hour Analysis From 04:00 PM to 05:45 PM - Peak 1 of 1														
Peak Hour for Each Approach Begins at:														
+0 mins.	36	2	17	55	8	339	55	402	5	4	6	15	34	380
+15 mins.	36	8	26	70	13	305	58	376	17	8	12	37	26	317
+30 mins.	13	10	25	48	7	336	46	389	19	10	5	34	40	366
+45 mins.	22	10	28	60	15	322	58	395	18	8	14	40	22	361
Total Volume	107	30	96	233	43	1302	217	1562	59	30	37	126	122	1424
% App. Total	45.9	12.9	41.2	83.2	2.8	83.4	13.9	97.1	46.8	23.8	29.4	7.88	8.6	4.6
PHF	.743	.750	.857	.832	.717	.960	.935	.971	.776	.750	.661	.788	.763	.937

Groups Printed- Passenger Vehicles

Start Time	Orange Terrace Parkway Southbound					Van Buren Boulevard Westbound					Orange Terrace Parkway Northbound					Van Buren Boulevard Eastbound							
	Left	Thru	Right	RTOR	App. Total	Left	Thru	Right	RTOR	App. Total	Left	Thru	Right	RTOR	App. Total	Left	Thru	Right	RTOR	App. Total	Exclu. Total	Inclu. Total	Int. Total
04:00 PM	27	5	17	13	49	6	281	52	27	339	8	4	10	6	22	20	295	17	2	332	48	742	790
04:15 PM	24	3	32	21	59	8	328	53	19	389	8	4	8	8	20	32	293	17	4	342	52	810	862
04:30 PM	32	5	8	4	45	13	299	58	23	370	9	7	6	6	22	33	292	11	3	336	36	773	809
04:45 PM	16	4	19	19	39	7	325	46	10	378	10	2	5	5	17	34	326	9	2	369	36	803	839
Total	99	17	76	57	192	34	1233	209	79	1476	35	17	29	25	81	119	1206	54	11	1379	172	3128	3300
05:00 PM	36	2	17	10	55	14	315	58	16	387	5	4	6	4	15	25	262	19	6	306	36	763	799
05:15 PM	35	8	25	20	68	9	302	49	13	360	16	8	11	10	35	40	302	11	4	353	47	816	863
05:30 PM	13	10	25	18	48	7	275	46	14	328	18	10	5	4	33	22	310	22	7	354	43	763	806
05:45 PM	22	10	28	21	60	16	289	45	13	350	16	8	14	12	38	36	314	20	7	370	53	818	871
Total	106	30	95	69	231	46	1181	198	56	1425	55	30	36	30	121	123	1188	72	24	1383	179	3160	3339
Grand Total	205	47	171	126	423	80	2414	407	135	2901	90	47	65	55	202	242	2394	126	35	2762	351	6288	6639
T-Approch %	48.5	11.1	40.4			2.8	83.2	14		44.6	23.3	32.2			8.8	86.7	4.6						
T-Total %	3.3	0.7	2.7		6.7	1.3	38.4	6.5		46.1	1.4	0.7	1		3.8	38.1	2			43.9	5.3	94.7	

Start Time	Orange Terrace Parkway Southbound					Van Buren Boulevard Westbound					Orange Terrace Parkway Northbound					Van Buren Boulevard Eastbound							
	Left	Thru	Right	RTOR	App. Total	Left	Thru	Right	RTOR	App. Total	Left	Thru	Right	RTOR	App. Total	Left	Thru	Right	RTOR	App. Total	Exclu. Total	Inclu. Total	Int. Total
05:00 PM	36	2	17		55	14	315	58		387	5	4	6		15	25	262	19		306			763
05:15 PM	35	8	25		68	9	302	49		360	16	8	11		35	40	302	11		353			816
05:30 PM	13	10	25		48	7	275	46		328	18	10	5		33	22	310	22		354			763
05:45 PM	22	10	28		60	16	289	45		350	16	8	14		38	36	314	20		370			818
Total Volume	106	30	95		231	46	1181	198		1425	55	30	36		121	123	1188	72		1383			3160
% App. Total	45.9	13	41.1			3.2	82.9	13.9		45.5	24.8	29.8			8.9	85.9	5.2						
PHF	.736	.750	.848		.849	.719	.937	.853		.921	.764	.750	.643		.796	.769	.946	.818		.934			.966

Peak Hour Analysis From 05:00 PM to 05:45 PM - Peak 1 of 1
 Peak Hour for Entire Intersection Begins at 05:00 PM

Counts Unlimited, Inc.
 PO Box 1178
 Corona, CA 92878
 (951)268-6268

City of Riverside
 N/S: Orange Terrace Parkway
 E/W: Van Buren Boulevard
 Weather: Clear

File Name : 18_RIV_Orange_VB PM
 Site Code : 05121716
 Start Date : 11/30/2021
 Page No : 2

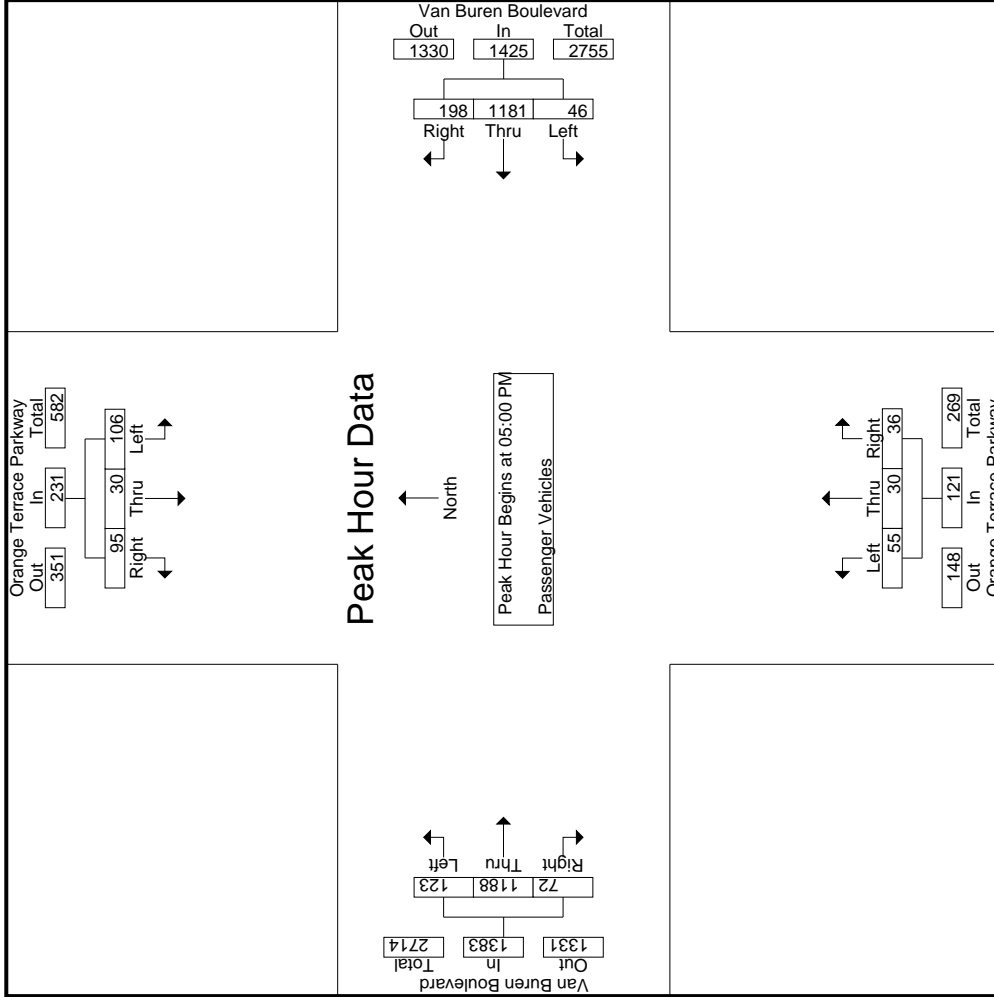

Counts Unlimited, Inc.
 PO Box 1178
 Corona, CA 92878
 (951)268-6268

File Name : 18_RIV_Orange_VB PM
 Site Code : 05121716
 Start Date : 11/30/2021
 Page No : 3

City of Riverside
 N/S: Orange Terrace Parkway
 E/W: Van Buren Boulevard
 Weather: Clear

Start Time	Orange Terrace Parkway Southbound			Van Buren Boulevard Westbound			Orange Terrace Parkway Northbound			Van Buren Boulevard Eastbound		
	Left	Thru	Right	Left	Thru	Right	Left	Thru	Right	Left	Thru	Right
Peak Hour Analysis From 05:00 PM to 05:45 PM - Peak 1 of 1												
Peak Hour for Each Approach Begins at:												
+0 mins.	36	2	17	14	315	58	5	4	6	25	262	19
+15 mins.	35	8	25	9	302	49	16	8	11	40	302	11
+30 mins.	13	10	25	7	275	46	18	10	5	22	310	22
+45 mins.	22	10	28	16	289	45	16	8	14	36	314	20
Total Volume	106	30	95	46	1181	198	55	30	36	123	1188	72
% App. Total	45.9	13	41.1	3.2	82.9	13.9	45.5	24.8	29.8	8.9	85.9	5.2
PHF	.736	.750	.848	.719	.937	.853	.764	.750	.643	.769	.946	.818

Groups Printed- Large 2 Axle Vehicles

Start Time	Orange Terrace Parkway Southbound				Van Buren Boulevard Westbound				Orange Terrace Parkway Northbound				Van Buren Boulevard Eastbound							
	Left	Thru	Right	RTOR	Left	Thru	Right	RTOR	Left	Thru	Right	RTOR	Left	Thru	Right	RTOR	App. Total	Exclu. Total	Inclu. Total	Int. Total
04:00 PM	0	0	0	0	0	0	0	0	0	0	0	0	0	0	0	0	7	1	11	12
04:15 PM	1	1	0	0	0	6	1	1	1	0	0	0	0	3	0	0	3	1	13	14
04:30 PM	1	0	0	0	0	4	0	0	0	0	0	0	0	2	0	0	2	0	7	7
04:45 PM	0	0	0	0	0	7	0	0	1	0	0	1	0	4	1	1	5	2	13	15
Total	2	1	0	0	3	0	20	2	2	1	0	1	2	1	15	1	17	4	44	48
05:00 PM	0	0	0	0	1	4	0	0	0	0	0	0	0	1	6	0	7	0	12	12
05:15 PM	1	0	1	1	2	0	5	1	0	0	0	1	0	5	3	0	8	1	17	18
05:30 PM	0	0	0	0	0	8	0	0	0	0	0	1	0	3	0	0	3	0	12	12
05:45 PM	0	0	0	0	0	5	1	1	6	2	0	2	0	2	1	1	3	2	11	13
Total	1	0	1	1	2	1	22	2	1	25	4	0	4	1	16	4	21	3	52	55
Grand Total	3	1	1	1	5	1	42	4	3	47	5	0	1	6	2	31	5	2	38	103
T-Approch %	60	20	20		2.1	89.4	8.5			83.3	0	16.7		5.3	81.6	13.2		7	96	
T-Total %	3.1	1	1		5.2	43.8	4.2			49	5.2	1		2.1	32.3	5.2		6.8	93.2	

Start Time	Orange Terrace Parkway Southbound				Van Buren Boulevard Westbound				Orange Terrace Parkway Northbound				Van Buren Boulevard Eastbound							
	Left	Thru	Right	RTOR	Left	Thru	Right	RTOR	Left	Thru	Right	RTOR	Left	Thru	Right	RTOR	App. Total	Exclu. Total	Inclu. Total	Int. Total
05:00 PM	0	0	0	0	1	4	0	0	0	0	0	0	0	0	0	0	0	0	7	12
05:15 PM	1	0	0	0	0	5	1	0	0	1	0	0	0	1	0	0	1	0	8	17
05:30 PM	0	0	0	0	0	8	0	0	0	0	0	0	0	0	0	0	0	0	3	12
05:45 PM	0	0	0	0	0	5	1	1	6	2	0	2	0	2	1	1	3	2	11	11
Total Volume	1	0	1	1	2	1	22	2	2	25	4	0	4	1	16	4	21	3	52	52
% App. Total	50	0	50		4	88	8		100	0	0	0		4.8	76.2	19		6.67	.333	.765
PHF	.250	.000	.250		.250	.688	.500		.500	.000	.000		.250	.667	.333		.500	.656		

Peak Hour Analysis From 05:00 PM to 05:45 PM - Peak 1 of 1
 Peak Hour for Entire Intersection Begins at 05:00 PM

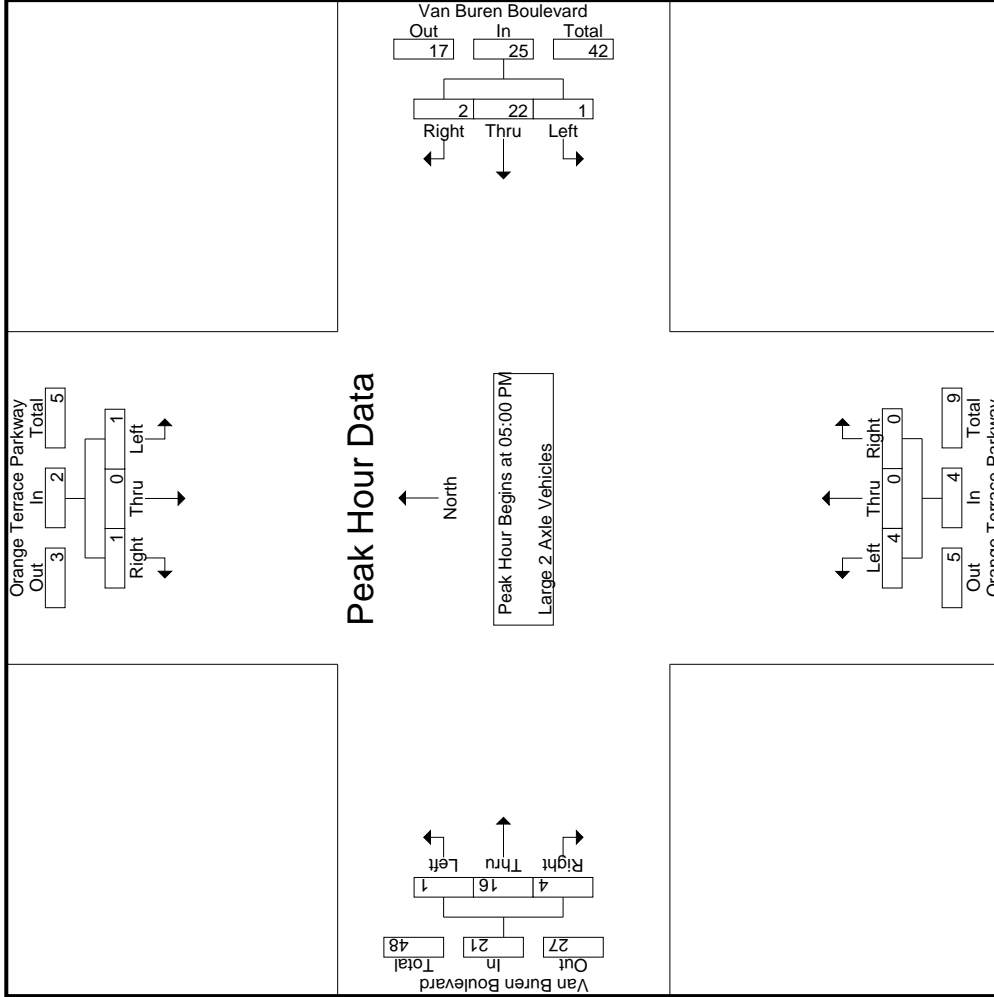

Counts Unlimited, Inc.
 PO Box 1178
 Corona, CA 92878
 (951)268-6268

File Name : 18_RIV_Orange_VB PM
 Site Code : 05121716
 Start Date : 11/30/2021
 Page No : 3

City of Riverside
 N/S: Orange Terrace Parkway
 E/W: Van Buren Boulevard
 Weather: Clear

Start Time	Orange Terrace Parkway Southbound			Van Buren Boulevard Westbound			Orange Terrace Parkway Northbound			Van Buren Boulevard Eastbound		
	Left	Thru	Right	Left	Thru	Right	Left	Thru	Right	Left	Thru	Right
Peak Hour Analysis From 05:00 PM to 05:45 PM - Peak 1 of 1												
Peak Hour for Each Approach Begins at:												
+0 mins.	0	0	0	1	4	0	0	0	0	1	6	0
+15 mins.	1	0	1	0	5	1	6	1	0	0	5	3
+30 mins.	0	0	0	0	8	0	8	1	0	0	3	0
+45 mins.	0	0	0	0	5	1	6	2	0	0	2	1
Total Volume	1	0	1	1	22	2	25	4	0	1	16	4
% App. Total	50	0	50	4	88	8	100	0	0	4.8	76.2	19
PHF	.250	.000	.250	.250	.688	.500	.781	.500	.000	.250	.667	.333

Groups Printed- 3 Axle Vehicles

Start Time	Orange Terrace Parkway Southbound				Van Buren Boulevard Westbound				Orange Terrace Parkway Northbound				Van Buren Boulevard Eastbound							
	Left	Thru	Right	RTOR	Left	Thru	Right	RTOR	Left	Thru	Right	RTOR	Left	Thru	Right	RTOR	App. Total	Exclu. Total	Inclu. Total	Int. Total
04:00 PM	0	0	0	0	0	4	0	0	4	0	0	1	0	0	0	0	0	1	5	6
04:15 PM	0	0	0	0	0	1	1	0	2	0	0	0	0	1	0	0	1	0	3	3
04:30 PM	0	0	0	0	0	2	0	0	2	1	1	1	0	1	1	1	2	2	6	8
04:45 PM	0	0	0	0	0	0	0	0	0	0	0	0	0	2	0	0	2	0	2	2
Total	0	0	0	0	0	7	1	0	8	1	0	2	3	0	4	1	5	3	16	19
05:00 PM	0	0	0	0	0	1	0	0	1	0	0	0	0	0	1	0	1	0	2	2
05:15 PM	0	0	0	0	0	5	0	0	5	0	0	0	0	3	0	0	3	0	8	8
05:30 PM	0	0	0	0	0	3	0	0	3	0	0	0	0	1	0	1	0	0	4	4
05:45 PM	0	0	0	0	0	2	0	0	2	0	0	0	0	0	0	0	0	0	2	2
Total	0	0	0	0	0	11	0	0	11	0	0	0	0	5	0	0	5	0	16	16
Grand Total	0	0	0	0	0	18	1	0	19	1	0	2	2	0	9	1	10	3	32	35
Approach %	0	0	0	0	0	94.7	5.3		33.3	0	66.7		0	90	10		31.2	8.6	91.4	
Total %	0	0	0	0	0	56.2	3.1		59.4	0	6.2		0	28.1	3.1					

Start Time	Orange Terrace Parkway Southbound				Van Buren Boulevard Westbound				Orange Terrace Parkway Northbound				Van Buren Boulevard Eastbound							
	Left	Thru	Right	RTOR	Left	Thru	Right	RTOR	Left	Thru	Right	RTOR	Left	Thru	Right	RTOR	App. Total	Exclu. Total	Inclu. Total	Int. Total
05:00 PM	0	0	0	0	0	1	0	0	1	0	0	0	0	0	0	0	0	0	1	1
05:15 PM	0	0	0	0	0	5	0	0	5	0	0	0	0	3	0	0	3	0	3	8
05:30 PM	0	0	0	0	0	3	0	0	3	0	0	0	0	1	0	1	0	0	1	4
05:45 PM	0	0	0	0	0	2	0	0	2	0	0	0	0	0	0	0	0	0	0	2
Total Volume	0	0	0	0	0	11	0	0	11	0	0	0	0	5	0	0	5	0	5	16
% App. Total	0	0	0	0	0	100	0	0	100	0	0	0	0	100	0	0	100	0	100	100
PHF	.000	.000	.000	.000	.000	.550	.000	.000	.550	.000	.000	.000	.000	.417	.000	.000	.417	.000	.417	.500

Peak Hour Analysis From 05:00 PM to 05:45 PM - Peak 1 of 1
 Peak Hour for Entire Intersection Begins at 05:00 PM

Counts Unlimited, Inc.
 PO Box 1178
 Corona, CA 92878
 (951)268-6268

City of Riverside
 N/S: Orange Terrace Parkway
 E/W: Van Buren Boulevard
 Weather: Clear

File Name : 18_RIV_Orange_VB PM
 Site Code : 05121716
 Start Date : 11/30/2021
 Page No : 2

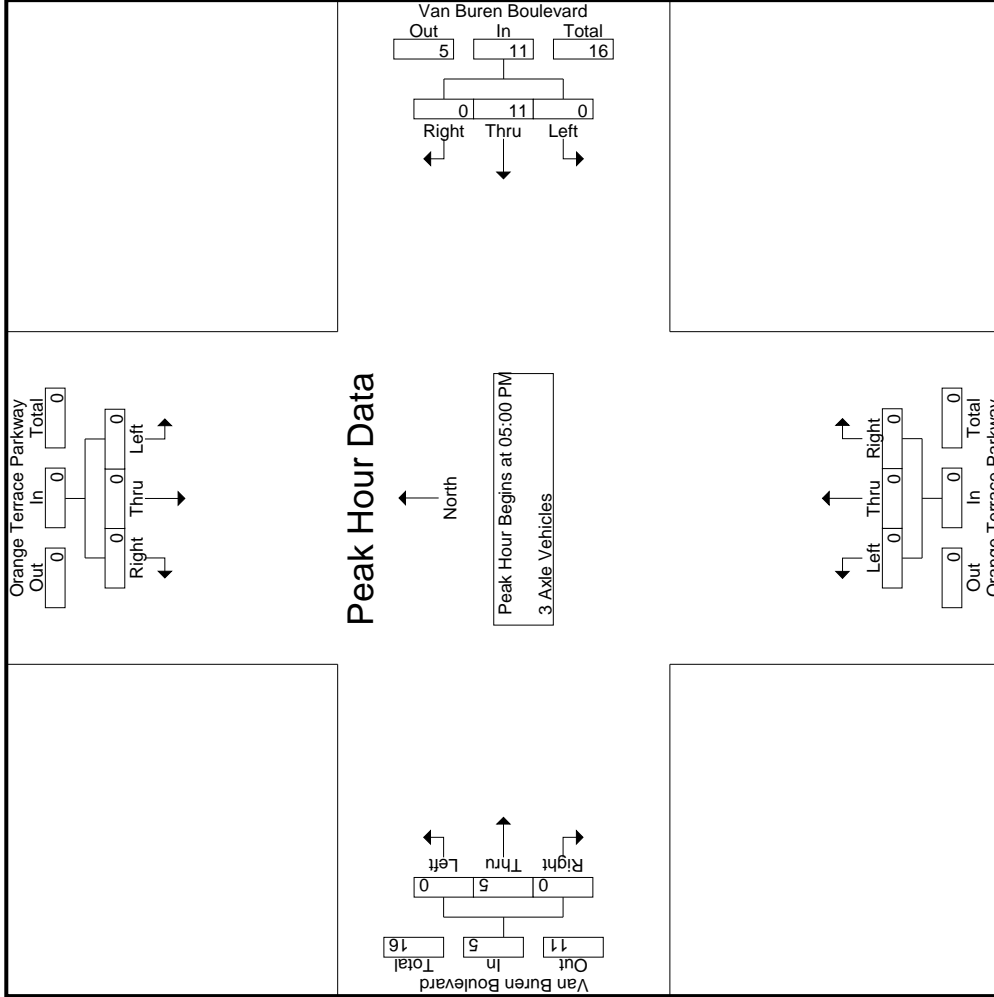

Counts Unlimited, Inc.
 PO Box 1178
 Corona, CA 92878
 (951)268-6268

File Name : 18_RIV_Orange_VB PM
 Site Code : 05121716
 Start Date : 11/30/2021
 Page No : 3

City of Riverside
 N/S: Orange Terrace Parkway
 E/W: Van Buren Boulevard
 Weather: Clear

Start Time	Orange Terrace Parkway Southbound			Van Buren Boulevard Westbound			Orange Terrace Parkway Northbound			Van Buren Boulevard Eastbound		
	Left	Thru	Right	Left	Thru	Right	Left	Thru	Right	Left	Thru	Right
Peak Hour Analysis From 05:00 PM to 05:45 PM - Peak 1 of 1	05:00 PM											
Peak Hour for Each Approach Begins at:	05:00 PM											
+0 mins.	0	0	0	0	1	0	0	0	0	0	1	0
+15 mins.	0	0	0	0	5	0	0	0	0	0	3	0
+30 mins.	0	0	0	0	3	0	0	0	0	0	1	0
+45 mins.	0	0	0	0	2	0	0	0	0	0	0	0
Total Volume	0	0	0	0	11	0	0	0	0	0	5	0
% App. Total	0	0	0	0	100	0	0	0	0	0	100	0
PHF	.000	.000	.000	.000	.550	.000	.000	.000	.000	.000	.417	.000

Counts Unlimited, Inc.
 PO Box 1178
 Corona, CA 92878
 (951)268-6268

City of Riverside
 N/S: Orange Terrace Parkway
 E/W: Van Buren Boulevard
 Weather: Clear

File Name : 18_RIV_Orange_VB PM
 Site Code : 05121716
 Start Date : 11/30/2021
 Page No : 1

Groups Printed- 4+ Axle Trucks

Start Time	Orange Terrace Parkway Southbound				Van Buren Boulevard Westbound				Orange Terrace Parkway Northbound				Van Buren Boulevard Eastbound				
	Left	Thru	Right	RTOR	Left	Thru	Right	RTOR	Left	Thru	Right	RTOR	Left	Thru	Right	RTOR	
04:00 PM	0	0	0	0	1	1	0	0	2	0	0	1	0	2	2	0	4
04:15 PM	0	0	0	0	0	4	0	0	4	0	0	0	0	2	0	0	2
04:30 PM	0	0	0	0	0	0	0	0	0	0	0	0	0	1	0	0	1
04:45 PM	0	0	0	0	0	4	0	0	4	0	0	0	0	4	0	0	4
Total	0	0	0	0	1	9	0	0	10	0	0	1	0	9	2	0	11
05:00 PM	0	0	0	0	0	2	0	0	2	0	0	0	0	3	0	0	3
05:15 PM	0	0	0	0	0	1	0	0	1	0	0	1	0	2	0	0	2
05:30 PM	0	0	0	0	0	1	0	0	1	0	0	0	0	3	0	0	3
05:45 PM	0	0	0	0	0	3	0	0	3	0	0	0	0	2	1	0	3
Total	0	0	0	0	0	7	0	0	7	0	0	1	0	10	1	0	11
Grand Total	0	0	0	0	1	16	0	0	17	0	0	2	1	0	19	3	22
% Apprch %	0	0	0	0	5.9	94.1	0	0	41.5	0	0	100	0	86.4	13.6	0	53.7
% Total %	0	0	0	0	2.4	39	0	0	41.5	0	0	4.9	0	46.3	7.3	0	53.7

Start Time	Orange Terrace Parkway Southbound				Van Buren Boulevard Westbound				Orange Terrace Parkway Northbound				Van Buren Boulevard Eastbound				
	Left	Thru	Right	RTOR	Left	Thru	Right	RTOR	Left	Thru	Right	RTOR	Left	Thru	Right	RTOR	
05:00 PM	0	0	0	0	0	2	0	0	2	0	0	0	0	3	0	0	3
05:15 PM	0	0	0	0	0	1	0	0	1	0	0	1	0	2	0	0	2
05:30 PM	0	0	0	0	0	1	0	0	1	0	0	0	0	3	0	0	3
05:45 PM	0	0	0	0	0	3	0	0	3	0	0	0	0	2	1	0	3
Total Volume	0	0	0	0	0	7	0	0	7	0	0	1	0	10	1	0	11
% App. Total	0	0	0	0	0	100	0	0	100	0	0	100	0	90.9	9.1	0	97.2
PHF	.000	.000	.000	.000	.000	.583	.000	.000	.583	.000	.250	.250	.000	.833	.250	.917	.792

Peak Hour Analysis From 05:00 PM to 05:45 PM - Peak 1 of 1
 Peak Hour for Entire Intersection Begins at 05:00 PM

Counts Unlimited, Inc.
 PO Box 1178
 Corona, CA 92878
 (951)268-6268

City of Riverside
 N/S: Orange Terrace Parkway
 E/W: Van Buren Boulevard
 Weather: Clear

File Name : 18_RIV_Orange_VB PM
 Site Code : 05121716
 Start Date : 11/30/2021
 Page No : 2

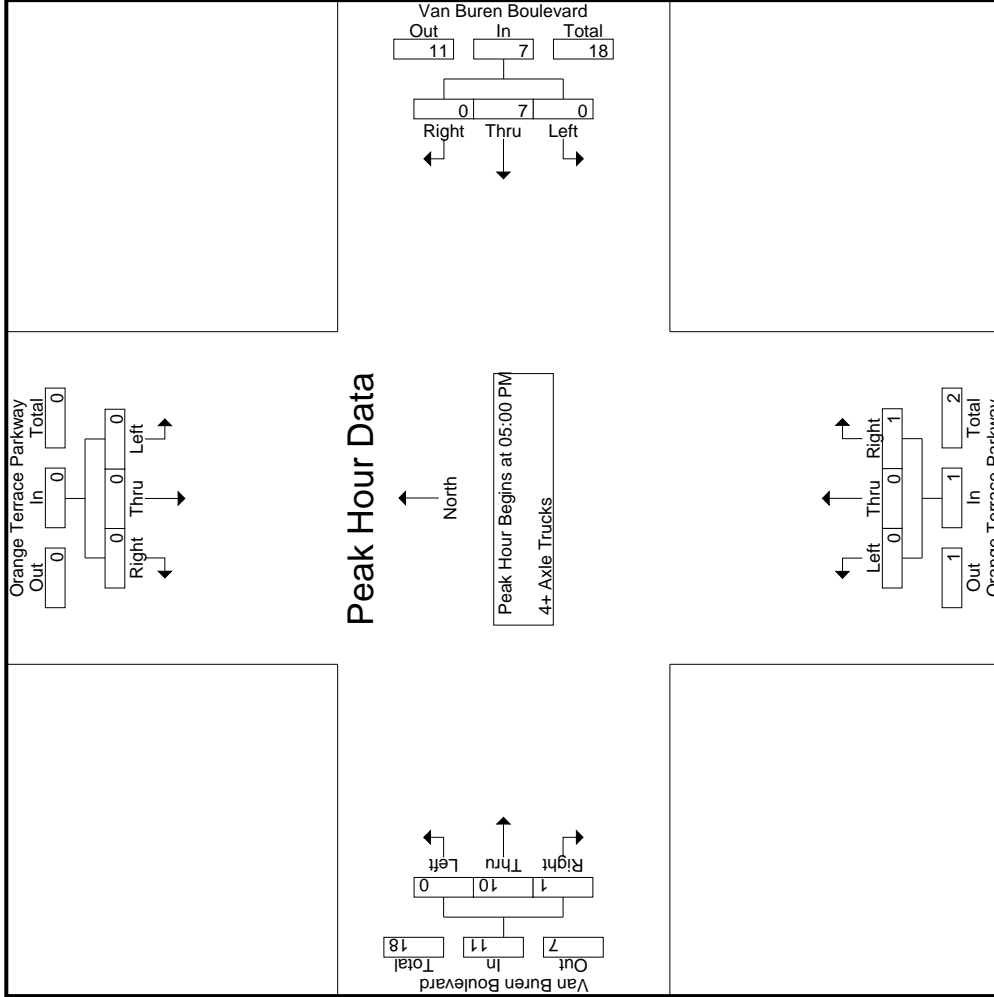

Counts Unlimited, Inc.
 PO Box 1178
 Corona, CA 92878
 (951)268-6268

File Name : 18_RIV_Orange_VB PM
 Site Code : 05121716
 Start Date : 11/30/2021
 Page No : 3

City of Riverside
 N/S: Orange Terrace Parkway
 E/W: Van Buren Boulevard
 Weather: Clear

Start Time	Orange Terrace Parkway Southbound			Van Buren Boulevard Westbound			Orange Terrace Parkway Northbound			Van Buren Boulevard Eastbound		
	Left	Thru	Right	Left	Thru	Right	Left	Thru	Right	Left	Thru	Right
Peak Hour Analysis From 05:00 PM to 05:45 PM - Peak 1 of 1	Peak Hour for Each Approach Begins at:											
+0 mins.	0	0	0	0	2	0	0	0	0	0	0	0
+15 mins.	0	0	0	0	1	0	0	0	1	0	0	0
+30 mins.	0	0	0	0	1	0	0	0	0	0	0	0
+45 mins.	0	0	0	0	3	0	0	0	0	0	0	0
Total Volume	0	0	0	0	7	0	0	0	1	0	10	1
% App. Total	0	0	0	0	100	0	0	0	100	0	90.9	9.1
PHF	.000	.000	.000	.000	.583	.000	.000	.583	.250	.000	.833	.250

Location: Riverside
 N/S: Orange Terrace Parkway
 E/W: Van Buren Boulevard



Date: 11/30/2021
 Day: Tuesday

PEDESTRIANS

	North Leg Orange Terrace Parkway Pedestrians	East Leg Van Buren Boulevard Pedestrians	South Leg Orange Terrace Parkway Pedestrians	West Leg Van Buren Boulevard Pedestrians	
7:00 AM	0	0	0	0	0
7:15 AM	0	0	0	0	0
7:30 AM	0	0	0	1	1
7:45 AM	0	0	0	0	0
8:00 AM	0	0	0	2	2
8:15 AM	0	0	0	0	0
8:30 AM	0	0	0	0	0
8:45 AM	0	0	1	1	2
TOTAL VOLUMES:	0	0	1	4	5

	North Leg Orange Terrace Parkway Pedestrians	East Leg Van Buren Boulevard Pedestrians	South Leg Orange Terrace Parkway Pedestrians	West Leg Van Buren Boulevard Pedestrians	
4:00 PM	0	0	0	3	3
4:15 PM	0	0	0	0	0
4:30 PM	0	0	0	0	0
4:45 PM	0	0	0	0	0
5:00 PM	0	0	0	0	0
5:15 PM	0	0	0	0	0
5:30 PM	0	0	0	0	0
5:45 PM	0	0	0	0	0
TOTAL VOLUMES:	0	0	0	3	3

Location: Riverside
 N/S: Orange Terrace Parkway
 E/W: Van Buren Boulevard



Date: 11/30/2021
 Day: Tuesday

BICYCLES

	Southbound Orange Terrace Parkway			Westbound Van Buren Boulevard			Northbound Orange Terrace Parkway			Eastbound Van Buren Boulevard			
	Left	Thru	Right	Left	Thru	Right	Left	Thru	Right	Left	Thru	Right	
7:00 AM	0	0	0	0	0	0	0	0	0	0	0	0	0
7:15 AM	1	0	0	0	0	0	0	0	0	0	0	0	1
7:30 AM	0	0	0	0	0	0	0	0	0	0	1	0	1
7:45 AM	0	0	0	0	0	0	0	0	0	0	0	0	0
8:00 AM	0	0	0	0	0	0	0	0	0	0	0	0	0
8:15 AM	0	0	0	0	0	0	0	0	0	0	0	0	0
8:30 AM	0	0	0	0	0	0	0	0	0	0	0	0	0
8:45 AM	0	0	0	0	0	0	0	0	0	0	0	0	0
TOTAL VOLUMES:	1	0	0	0	0	0	0	0	0	0	1	0	2

	Southbound Orange Terrace Parkway			Westbound Van Buren Boulevard			Northbound Orange Terrace Parkway			Eastbound Van Buren Boulevard			
	Left	Thru	Right	Left	Thru	Right	Left	Thru	Right	Left	Thru	Right	
4:00 PM	0	0	0	0	0	0	0	0	0	0	0	0	0
4:15 PM	0	0	0	0	0	0	0	0	0	0	1	0	1
4:30 PM	0	0	0	0	0	0	0	0	0	0	0	0	0
4:45 PM	0	0	0	0	1	0	0	0	0	0	0	0	1
5:00 PM	0	0	0	0	0	0	0	0	0	0	0	0	0
5:15 PM	0	0	0	0	0	0	0	0	0	0	0	0	0
5:30 PM	0	0	0	0	0	0	0	0	0	0	0	0	0
5:45 PM	0	0	0	0	0	0	0	0	0	0	0	0	0
TOTAL VOLUMES:	0	0	0	0	1	0	0	0	0	0	1	0	2

Counts Unlimited, Inc.
 PO Box 1178
 Corona, CA 92878
 (951)268-6268

County of Riverside
 N/S: San Geronio Drive/Brown Street
 E/W: Alessandro Boulevard
 Weather: Clear

File Name : CRV_San G_Aless AM
 Site Code : 05121648
 Start Date : 11/2/2021
 Page No : 2

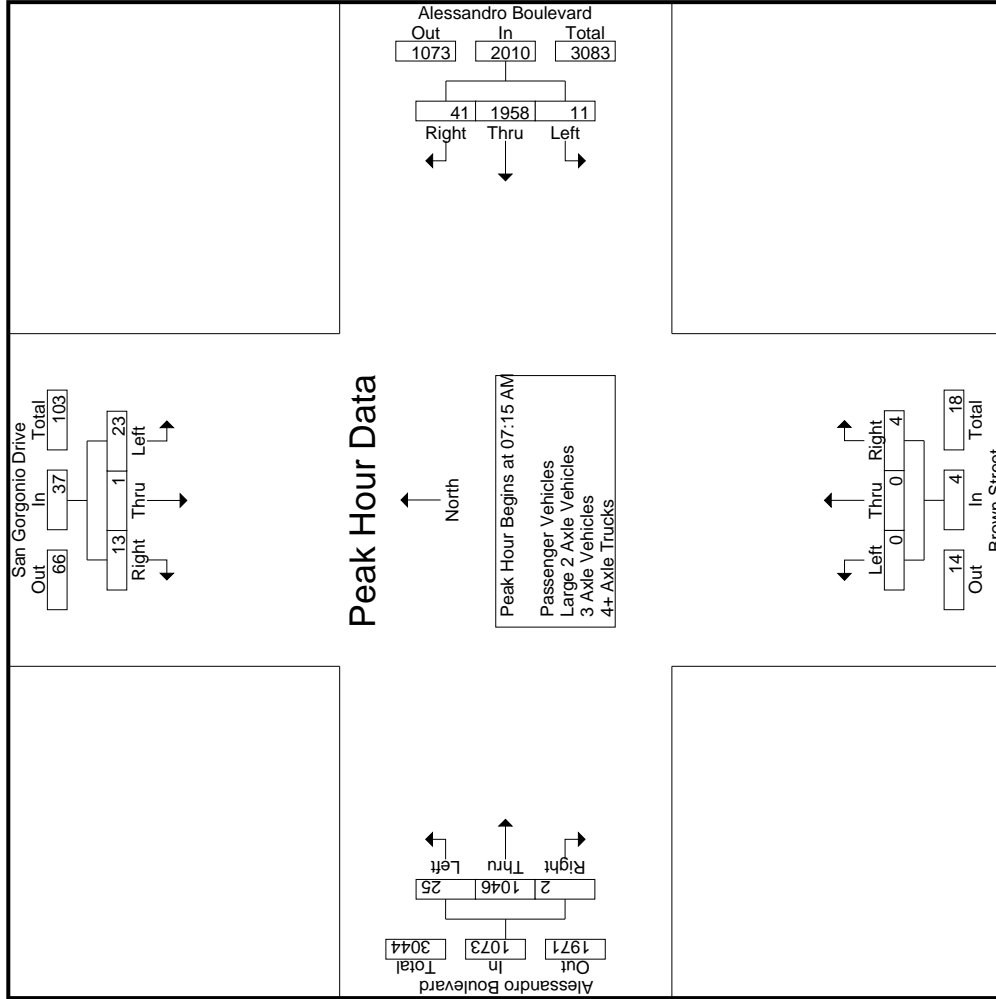

Counts Unlimited, Inc.
 PO Box 1178
 Corona, CA 92878
 (951)268-6268

County of Riverside
 N/S: San Gorgonio Drive/Brown Street
 E/W: Alessandro Boulevard
 Weather: Clear

File Name : CRV_San G_Aless PM
 Site Code : 05121648
 Start Date : 11/2/2021
 Page No : 2

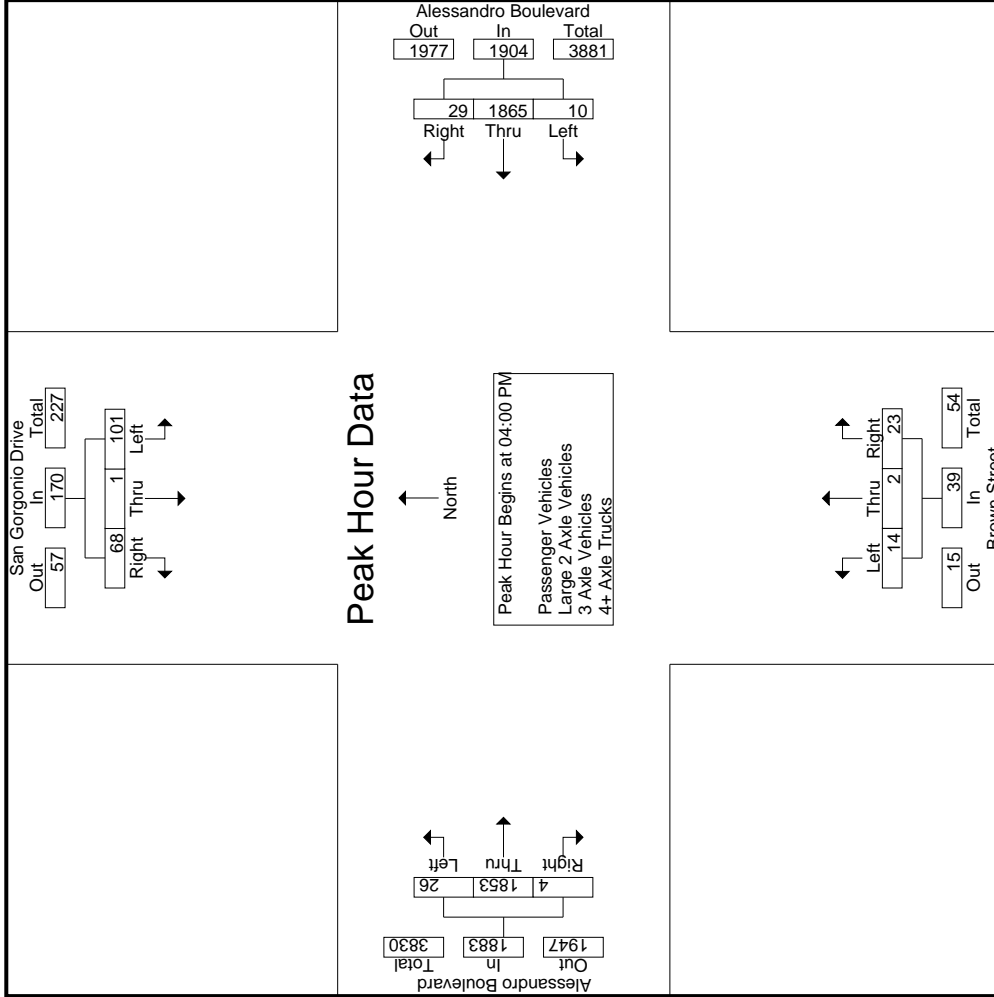

Counts Unlimited, Inc.
 PO Box 1178
 Corona, CA 92878
 (951)268-6268

File Name : 01_RIV_Syc_Eastridge AM
 Site Code : 05122021
 Start Date : 1/13/2022
 Page No : 1

City of Riverside
 N/S: Sycamore Canyon Boulevard
 E/W: Eastridge Avenue
 Weather: Clear

Groups Printed- Passenger Vehicles - Large 2 Axle Vehicles - 3 Axle Vehicles - 4+ Axle Trucks

Start Time	Sycamore Canyon Boulevard Southbound						Eastridge Avenue Westbound						Sycamore Canyon Boulevard Northbound						Eastridge Avenue Eastbound					
	Left		Thru		Right		Left		Thru		Right		Left		Thru		Right		Left		Thru		Right	
	App. Total	RTOR	App. Total	RTOR	App. Total	RTOR	App. Total	RTOR	App. Total	RTOR	App. Total	RTOR	App. Total	RTOR	App. Total	RTOR	App. Total	RTOR	App. Total	RTOR	App. Total	RTOR	App. Total	RTOR
07:00 AM	11	42	9	6	62	186	25	50	111	78	186	18	135	10	8	163	6	11	5	5	22	97	433	530
07:15 AM	16	35	8	3	59	137	13	37	87	45	137	7	143	13	11	163	6	9	3	2	18	61	377	438
07:30 AM	19	27	7	2	53	132	22	27	83	56	132	12	150	16	4	178	17	7	4	4	28	66	391	457
07:45 AM	14	41	9	1	64	172	27	36	109	69	172	20	180	33	7	233	10	5	2	1	17	78	486	564
Total	60	145	33	12	238	627	87	150	390	248	627	57	608	72	30	737	39	32	14	12	85	302	1687	1989
08:00 AM	12	36	7	3	55	124	14	20	90	64	124	13	119	11	4	143	10	9	6	4	25	75	347	422
08:15 AM	12	37	2	1	51	114	15	25	74	51	114	8	136	23	11	167	9	7	4	3	20	66	352	418
08:30 AM	23	28	5	1	56	111	20	11	80	60	111	8	95	18	7	121	6	7	3	3	16	71	304	375
08:45 AM	20	46	4	1	70	89	10	16	63	48	89	11	75	24	9	110	6	5	5	3	16	61	285	346
Total	67	147	18	6	232	438	59	72	307	223	438	40	425	76	31	541	31	28	18	13	77	273	1288	1561
Grand Total	127	292	51	18	470	1065	146	222	697	471	1065	97	1033	148	61	1278	70	60	32	25	162	575	2975	3550
T-Approach %	27	62.1	10.9			65.4	13.7	20.8	65.4		65.4	7.6	80.8	11.6		43	43.2	37	19.8		162			
T-Total %	4.3	9.8	1.7		15.8	35.8	4.9	7.5	23.4		35.8	3.3	34.7	5		43	2.4	2	1.1		5.4	16.2	83.8	
% Passenger Vehicles	115	261	33		426	1385	113	179	649		1385	84	935	123		1194	40	33	25		119	0	0	3124
% Large 2 Axle Vehicles	90.6	89.4	64.7	94.4	87.3	90.2	77.4	80.6	93.1	94.3	90.2	86.6	90.5	83.1	85.2	89.2	57.1	55	78.1	84	63.6	0	0	88
% 3 Axle Vehicles	3	8	2	0	13	34	7	8	13	1.3	34	3	33	8	4.9	47	4	7	2	4	14	0	0	108
% 4+ Axle Trucks	2.4	2.7	3.9	0	2.7	2.2	4.8	3.6	1.9	1.3	2.2	3.1	3.2	5.4	4.9	3.5	5.7	11.7	6.2	4	7.5	0	0	3
% 4+ Axle Trucks	1.6	1.7	2	0	1.6	0.7	0	0.5	1	0.6	0.7	0	10	4	3.3	1.2	1.4	3.3	0	0	1.6	0	0	1.1
% 4+ Axle Trucks	7	18	15		41	106	26	34	28	4	106	10	55	13	6.6	82	25	18	5	5	51	0	0	280
% 4+ Axle Trucks	5.5	6.2	29.4	5.6	8.4	6.9	17.8	15.3	4	3.8	6.9	10.3	5.3	8.8	6.1	6.1	35.7	30	15.6	12	27.3	0	0	7.9

Start Time	Sycamore Canyon Boulevard Southbound						Eastridge Avenue Westbound						Sycamore Canyon Boulevard Northbound						Eastridge Avenue Eastbound					
	Left		Thru		Right		Left		Thru		Right		Left		Thru		Right		Left		Thru		Right	
	App. Total	RTOR	App. Total	RTOR	App. Total	RTOR	App. Total	RTOR	App. Total	RTOR	App. Total	RTOR	App. Total	RTOR	App. Total	RTOR	App. Total	RTOR	App. Total	RTOR	App. Total	RTOR	App. Total	RTOR
07:00 AM	11	42	9	6	62	186	25	50	111	78	186	18	135	10	8	163	6	11	5	5	22	97	433	530
07:15 AM	16	35	8	3	59	137	13	37	87	45	137	7	143	13	11	163	6	9	3	2	18	61	377	438
07:30 AM	19	27	7	2	53	132	22	27	83	56	132	12	150	16	4	178	17	7	4	4	28	66	391	457
07:45 AM	14	41	9	1	64	172	27	36	109	69	172	20	180	33	7	233	10	5	2	1	17	78	486	564
Total	60	145	33	12	238	627	87	150	390	248	627	57	608	72	30	737	39	32	14	12	85	302	1687	1989
PHF	.789	.863	.917		.930	.878	.806	.750	.878		.878	.713	.844	.545		.791	.574	.727	.700		.759			.868

Peak Hour Analysis From 07:00 AM to 08:45 AM - Peak 1 of 1
 Peak Hour for Entire Intersection Begins at 07:00 AM

Counts Unlimited, Inc.
 PO Box 1178
 Corona, CA 92878
 (951)268-6268

City of Riverside
 N/S: Sycamore Canyon Boulevard
 E/W: Eastridge Avenue
 Weather: Clear

File Name : 01_RIV_Syc_Eastridge AM
 Site Code : 05122021
 Start Date : 1/13/2022
 Page No : 2

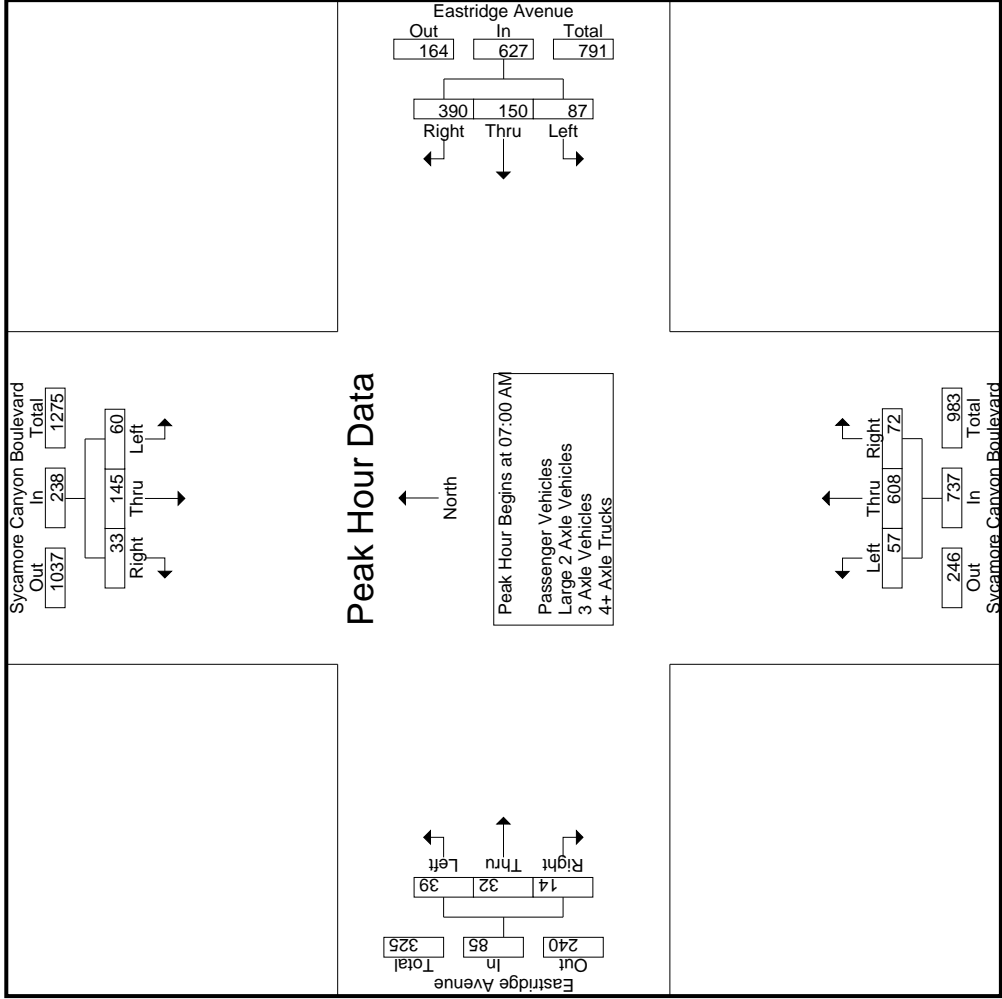

Counts Unlimited, Inc.
 PO Box 1178
 Corona, CA 92878
 (951)268-6268

City of Riverside
 N/S: Sycamore Canyon Boulevard
 E/W: Eastridge Avenue
 Weather: Clear

File Name : 01_RIV_Syc_Eastridge AM
 Site Code : 05122021
 Start Date : 1/13/2022
 Page No : 3

Start Time	Sycamore Canyon Boulevard Southbound			Eastridge Avenue Westbound			Sycamore Canyon Boulevard Northbound			Eastridge Avenue Eastbound						
	Left	Thru	Right	App. Total	Left	Thru	Right	App. Total	Left	Thru	Right	App. Total	Int. Total			
Peak Hour Analysis From 07:00 AM to 08:45 AM - Peak 1 of 1	Peak Hour for Each Approach Begins at:															
	07:00 AM															
+0 mins.	11	42	9	62	25	50	111	186	18	135	10	163	17	7	4	28
+15 mins.	16	35	8	59	13	37	87	137	7	143	13	163	10	5	2	17
+30 mins.	19	27	7	53	22	27	83	132	12	150	16	178	10	9	6	25
+45 mins.	14	41	9	64	27	36	109	172	20	180	33	233	9	7	4	20
Total Volume	60	145	33	238	87	150	390	627	57	608	72	737	46	28	16	90
% App. Total	25.2	60.9	13.9	93.0	13.9	23.9	62.2	84.3	7.7	82.5	9.8	79.1	51.1	31.1	17.8	80.4
PHF	.789	.863	.917	.930	.806	.750	.878	.843	.713	.844	.545	.791	.676	.778	.667	.804

Counts Unlimited, Inc.
 PO Box 1178
 Corona, CA 92878
 (951)268-6268

City of Riverside
 N/S: Sycamore Canyon Boulevard
 E/W: Eastridge Avenue
 Weather: Clear

File Name : 01_RIV_Syc_Eastridge AM
 Site Code : 05122021
 Start Date : 1/13/2022
 Page No : 1

Groups Printed- Passenger Vehicles

Start Time	Sycamore Canyon Boulevard Southbound					Eastridge Avenue Westbound					Sycamore Canyon Boulevard Northbound					Eastridge Avenue Eastbound							
	Left	Thru	Right	RTOR	App. Total	Left	Thru	Right	RTOR	App. Total	Left	Thru	Right	RTOR	App. Total	Left	Thru	Right	RTOR	App. Total	Exclu. Total	Inclu. Total	Int. Total
07:00 AM	11	41	8	6	60	21	46	104	74	171	16	121	9	8	146	3	6	4	4	13	92	390	482
07:15 AM	13	33	6	3	52	9	30	85	44	124	6	137	12	11	155	6	6	3	2	15	60	346	406
07:30 AM	17	22	7	2	46	15	22	77	50	114	12	137	13	4	162	12	5	4	4	21	60	343	403
07:45 AM	13	38	4	1	55	23	30	98	64	151	18	166	29	7	213	5	1	1	0	7	72	426	498
Total	54	134	25	12	213	68	128	364	232	560	52	561	63	30	676	26	18	12	10	56	284	1505	1789
08:00 AM	11	33	4	3	48	10	15	85	62	110	11	109	10	3	130	6	7	3	2	16	70	304	374
08:15 AM	11	31	1	1	43	11	18	66	49	95	6	124	15	4	145	4	3	3	3	10	57	293	350
08:30 AM	22	21	2	0	45	18	8	75	56	101	8	76	14	6	98	2	3	3	3	8	65	252	317
08:45 AM	17	42	1	1	60	6	10	59	45	75	7	65	21	9	93	2	2	4	3	8	58	236	294
Total	61	127	8	5	196	45	51	285	212	381	32	374	60	22	466	14	15	13	11	42	250	1085	1335
Grand Total	115	261	33	17	409	113	179	649	444	941	84	935	123	52	1142	40	33	25	21	98	534	2590	3124
T-Approch %	28.1	63.8	8.1			12	19	69		36.3	7.4	81.9	10.8		40.8	40.8	33.7	25.5		3.8	17.1	82.9	
T-Total %	4.4	10.1	1.3		15.8	4.4	6.9	25.1			3.2	36.1	4.7		44.1	1.5	1.3	1					

Start Time	Sycamore Canyon Boulevard Southbound					Eastridge Avenue Westbound					Sycamore Canyon Boulevard Northbound					Eastridge Avenue Eastbound							
	Left	Thru	Right	RTOR	App. Total	Left	Thru	Right	RTOR	App. Total	Left	Thru	Right	RTOR	App. Total	Left	Thru	Right	RTOR	App. Total	Exclu. Total	Inclu. Total	Int. Total
07:00 AM	11	41	8	6	60	21	46	104	74	171	16	121	9	8	146	3	6	4	4	13	92	390	482
07:15 AM	13	33	6	3	52	9	30	85	44	124	6	137	12	11	155	6	6	3	2	15	60	346	406
07:30 AM	17	22	7	2	46	15	22	77	50	114	12	137	13	4	162	12	5	4	4	21	60	343	403
07:45 AM	13	38	4	1	55	23	30	98	64	151	18	166	29	7	213	5	1	1	0	7	72	426	498
Total	54	134	25	12	213	68	128	364	232	560	52	561	63	30	676	26	18	12	10	56	284	1505	1789
08:00 AM	11	33	4	3	48	10	15	85	62	110	11	109	10	3	130	6	7	3	2	16	70	304	374
08:15 AM	11	31	1	1	43	11	18	66	49	95	6	124	15	4	145	4	3	3	3	10	57	293	350
08:30 AM	22	21	2	0	45	18	8	75	56	101	8	76	14	6	98	2	3	3	3	8	65	252	317
08:45 AM	17	42	1	1	60	6	10	59	45	75	7	65	21	9	93	2	2	4	3	8	58	236	294
Total	61	127	8	5	196	45	51	285	212	381	32	374	60	22	466	14	15	13	11	42	250	1085	1335
Grand Total	115	261	33	17	409	113	179	649	444	941	84	935	123	52	1142	40	33	25	21	98	534	2590	3124
T-Approch %	28.1	63.8	8.1			12	19	69		36.3	7.4	81.9	10.8		40.8	40.8	33.7	25.5		3.8	17.1	82.9	
T-Total %	4.4	10.1	1.3		15.8	4.4	6.9	25.1			3.2	36.1	4.7		44.1	1.5	1.3	1					

Peak Hour Analysis From 07:00 AM to 07:45 AM - Peak 1 of 1
 Peak Hour for Entire Intersection Begins at 07:00 AM

Start Time	Sycamore Canyon Boulevard Southbound					Eastridge Avenue Westbound					Sycamore Canyon Boulevard Northbound					Eastridge Avenue Eastbound							
	Left	Thru	Right	RTOR	App. Total	Left	Thru	Right	RTOR	App. Total	Left	Thru	Right	RTOR	App. Total	Left	Thru	Right	RTOR	App. Total	Exclu. Total	Inclu. Total	Int. Total
07:00 AM	11	41	8	6	60	21	46	104	74	171	16	121	9	8	146	3	6	4	4	13	92	390	482
07:15 AM	13	33	6	3	52	9	30	85	44	124	6	137	12	11	155	6	6	3	2	15	60	346	406
07:30 AM	17	22	7	2	46	15	22	77	50	114	12	137	13	4	162	12	5	4	4	21	60	343	403
07:45 AM	13	38	4	1	55	23	30	98	64	151	18	166	29	7	213	5	1	1	0	7	72	426	498
Total	54	134	25	12	213	68	128	364	232	560	52	561	63	30	676	26	18	12	10	56	284	1505	1789
% App. Total	25.4	62.9	11.7			12.1	22.9	65		36.3	7.7	83	9.3		44.1	1.5	1.3	1		3.8	17.1	82.9	
PHF	.794	.817	.781		.888	.739	.696	.875		.819	.722	.845	.543		.793	.542	.750	.750		.667			.883

Counts Unlimited, Inc.
 PO Box 1178
 Corona, CA 92878
 (951)268-6268

City of Riverside
 N/S: Sycamore Canyon Boulevard
 E/W: Eastridge Avenue
 Weather: Clear

File Name : 01_RIV_Syc_Eastridge AM
 Site Code : 05122021
 Start Date : 1/13/2022
 Page No : 2

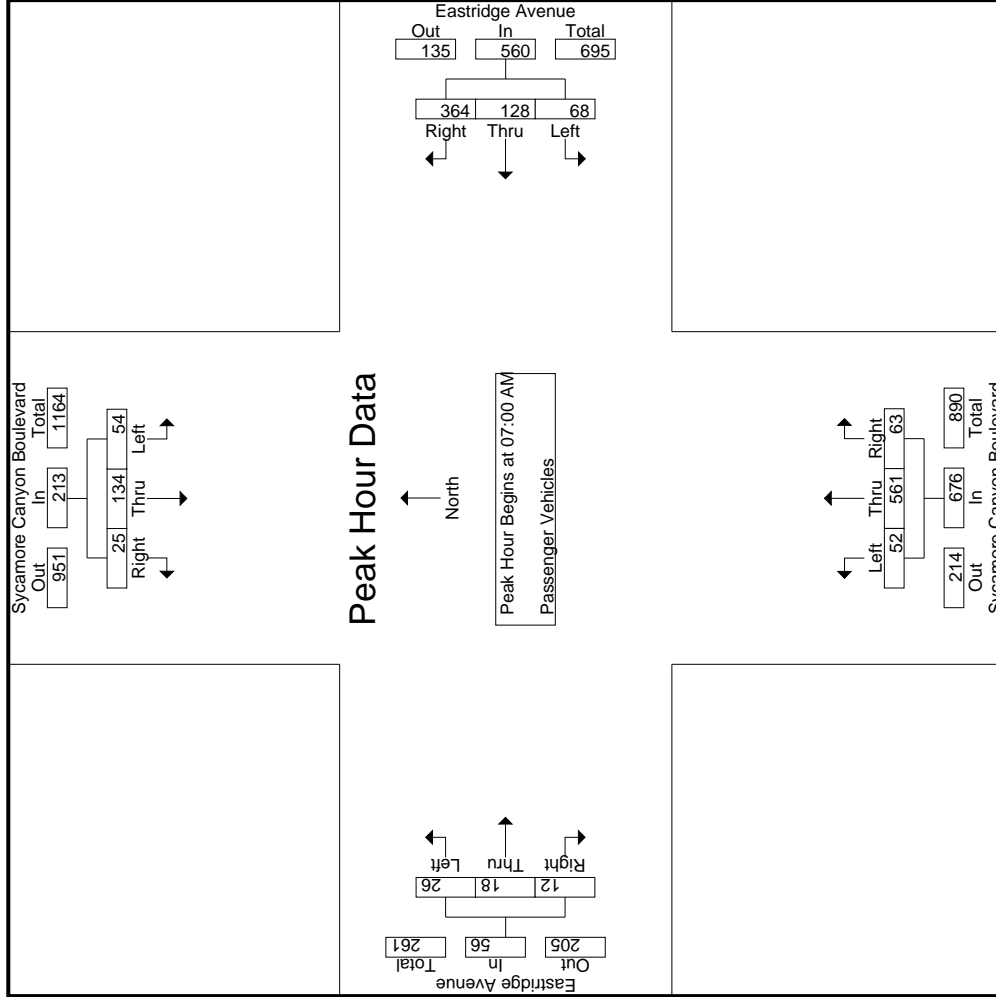

Counts Unlimited, Inc.
 PO Box 1178
 Corona, CA 92878
 (951)268-6268

File Name : 01_RIV_Syc_Eastridge AM
 Site Code : 05122021
 Start Date : 1/13/2022
 Page No : 3

City of Riverside
 N/S: Sycamore Canyon Boulevard
 E/W: Eastridge Avenue
 Weather: Clear

Start Time	Sycamore Canyon Boulevard Southbound			Eastridge Avenue Westbound			Sycamore Canyon Boulevard Northbound			Eastridge Avenue Eastbound						
	Left	Thru	Right	App. Total	Left	Thru	Right	App. Total	Left	Thru	Right	App. Total	Int. Total			
Peak Hour Analysis From 07:00 AM to 07:45 AM - Peak 1 of 1																
Peak Hour for Each Approach Begins at:																
	07:00 AM				07:00 AM				07:00 AM				07:00 AM			
+0 mins.	11	41	8	60	21	46	104	171	16	121	9	146	3	6	4	13
+15 mins.	13	33	6	52	9	30	85	124	6	137	12	155	6	6	3	15
+30 mins.	17	22	7	46	15	22	77	114	12	137	13	162	12	5	4	21
+45 mins.	13	38	4	55	23	30	98	151	18	166	29	213	5	1	1	7
Total Volume	54	134	25	213	68	128	364	560	52	561	63	676	26	18	12	56
% App. Total	25.4	62.9	11.7		12.1	22.9	65		7.7	83	9.3		46.4	32.1	21.4	
PHF	.794	.817	.781	.888	.739	.696	.875	.819	.722	.845	.543	.793	.542	.750	.750	.667

Counts Unlimited, Inc.
 PO Box 1178
 Corona, CA 92878
 (951)268-6268

City of Riverside
 N/S: Sycamore Canyon Boulevard
 E/W: Eastridge Avenue
 Weather: Clear

File Name : 01_RIV_Syc_Eastridge AM
 Site Code : 05122021
 Start Date : 1/13/2022
 Page No : 1

Groups Printed- Large 2 Axle Vehicles

Start Time	Sycamore Canyon Boulevard Southbound				Eastridge Avenue Westbound				Sycamore Canyon Boulevard Northbound				Eastridge Avenue Eastbound					
	Left	Thru	Right	RTOR	App. Total	Left	Thru	Right	RTOR	App. Total	Left	Thru	Right	RTOR	App. Total	Exclu. Total	Inclu. Total	Int. Total
07:00 AM	0	0	0	0	0	1	2	2	4	2	3	0	0	0	0	2	9	11
07:15 AM	1	0	1	0	2	1	1	0	3	0	1	1	0	0	2	0	9	9
07:30 AM	1	1	0	0	2	1	0	0	1	0	5	0	0	0	1	0	9	9
07:45 AM	0	1	1	0	2	1	5	3	7	0	5	2	0	0	0	3	16	19
Total	2	2	2	0	6	4	3	8	15	2	14	3	0	0	3	5	43	48
08:00 AM	0	2	0	0	2	2	2	1	6	1	3	1	1	1	3	3	16	19
08:15 AM	1	1	0	0	2	1	3	0	5	0	5	2	2	0	3	2	17	19
08:30 AM	0	1	0	0	1	0	0	0	1	0	8	0	0	1	0	0	11	11
08:45 AM	0	2	0	0	2	0	1	0	1	0	3	2	0	0	3	0	11	11
Total	1	6	0	0	7	3	5	5	13	1	19	5	3	2	10	5	55	60
Grand Total	3	8	2	0	13	7	8	13	28	3	33	8	3	4	13	10	98	108
% Approach	23.1	61.5	15.4	2	25	28.6	46.4	6	6.8	75	18.2	44.9	30.8	53.8	15.4	9.3	90.7	
% Total	3.1	8.2	2		13.3	7.1	8.2	13.3	28.6	3.1	33.7	8.2	4.1	7.1	2			

Start Time	Sycamore Canyon Boulevard Southbound				Eastridge Avenue Westbound				Sycamore Canyon Boulevard Northbound				Eastridge Avenue Eastbound					
	Left	Thru	Right	RTOR	App. Total	Left	Thru	Right	RTOR	App. Total	Left	Thru	Right	RTOR	App. Total	Exclu. Total	Inclu. Total	Int. Total
07:00 AM	0	0	0	0	0	1	1	2	4	2	3	0	0	0	0	2	9	11
07:15 AM	1	0	1	0	2	1	1	0	3	0	1	1	0	0	2	0	9	9
07:30 AM	1	1	0	0	2	1	0	0	1	0	5	0	0	0	1	0	9	9
07:45 AM	0	1	1	0	2	1	5	3	7	0	5	2	0	0	0	3	16	19
Total	2	2	2	0	6	4	3	8	15	2	14	3	0	0	3	5	43	48
% App. Total	33.3	33.3	33.3	2	33.3	26.7	20	53.3	10.5	73.7	15.8	33.3	66.7	0	0	0	3	43
PHF	.500	.500	.500	.750	.536	1.00	.750	.400	.679	.250	.700	.375	.250	.250	.000	.375	.672	

Peak Hour Analysis From 07:00 AM to 07:45 AM - Peak 1 of 1
 Peak Hour for Entire Intersection Begins at 07:00 AM

Counts Unlimited, Inc.
 PO Box 1178
 Corona, CA 92878
 (951)268-6268

City of Riverside
 N/S: Sycamore Canyon Boulevard
 E/W: Eastridge Avenue
 Weather: Clear

File Name : 01_RIV_Syc_Eastridge AM
 Site Code : 05122021
 Start Date : 1/13/2022
 Page No : 2

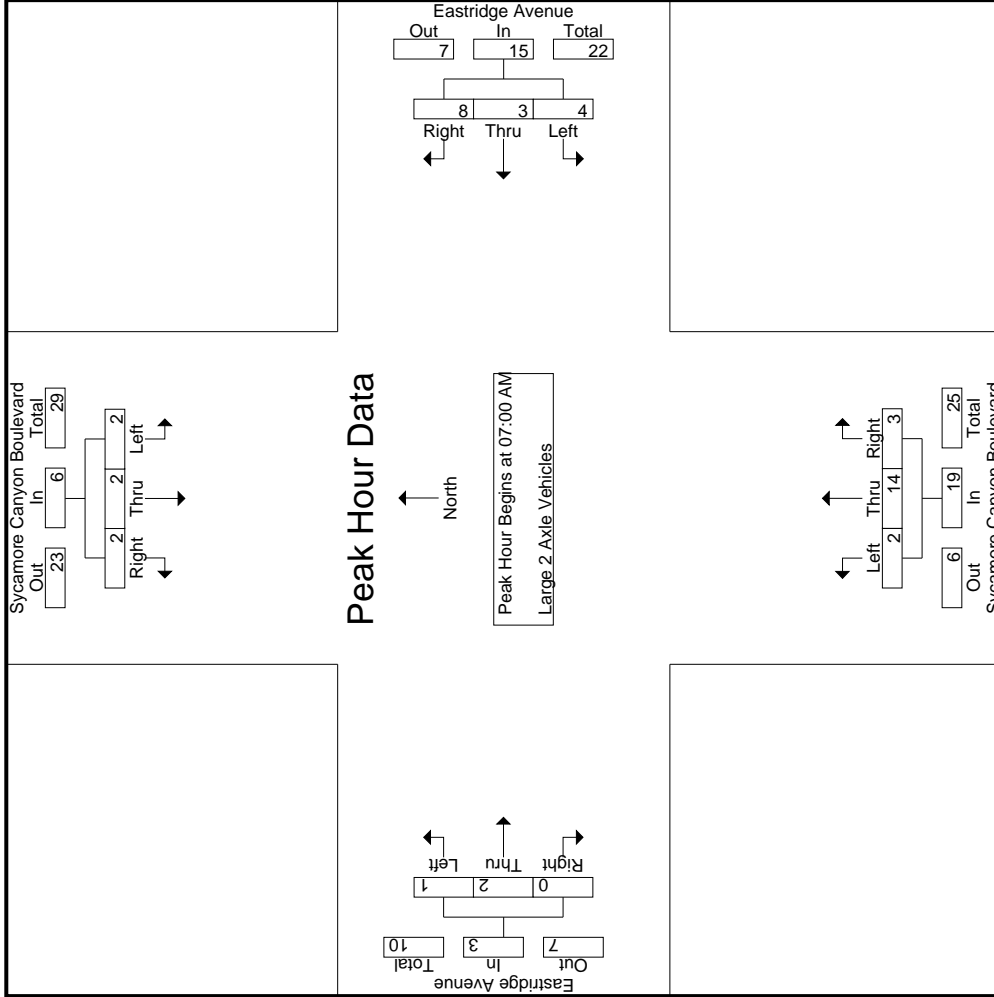

Counts Unlimited, Inc.
 PO Box 1178
 Corona, CA 92878
 (951)268-6268

City of Riverside
 N/S: Sycamore Canyon Boulevard
 E/W: Eastridge Avenue
 Weather: Clear

File Name : 01_RIV_Syc_Eastridge AM
 Site Code : 05122021
 Start Date : 1/13/2022
 Page No : 3

Start Time	Sycamore Canyon Boulevard Southbound			Eastridge Avenue Westbound			Sycamore Canyon Boulevard Northbound			Eastridge Avenue Eastbound				
	Left	Thru	Right	App. Total	Left	Thru	Right	App. Total	Left	Thru	Right	App. Total	Int. Total	
Peak Hour Analysis From 07:00 AM to 07:45 AM - Peak 1 of 1	07:00 AM													
Peak Hour for Each Approach Begins at:	07:00 AM													
+0 mins.	0	0	0	0	1	1	2	4	2	3	0	5	0	
+15 mins.	1	0	1	2	1	1	1	3	1	1	1	2	0	
+30 mins.	1	1	0	2	1	0	0	1	0	5	0	5	0	
+45 mins.	0	1	1	2	1	1	5	7	1	5	2	7	0	
Total Volume	2	2	2	6	4	3	8	15	2	14	3	19	2	
% App. Total	33.3	33.3	33.3	100.0	26.7	20	53.3	10.5	10.5	73.7	15.8	33.3	66.7	
PHF	.500	.500	.500	.750	1.000	.750	.400	.536	.250	.700	.375	.679	.250	
													.000	.375

Counts Unlimited, Inc.
 PO Box 1178
 Corona, CA 92878
 (951)268-6268

City of Riverside
 N/S: Sycamore Canyon Boulevard
 E/W: Eastridge Avenue
 Weather: Clear

File Name : 01_RIV_Syc_Eastridge AM
 Site Code : 05122021
 Start Date : 1/13/2022
 Page No : 1

Groups Printed- 3 Axle Vehicles

Start Time	Sycamore Canyon Boulevard Southbound					Eastridge Avenue Westbound					Sycamore Canyon Boulevard Northbound					Eastridge Avenue Eastbound								
	Left	Thru	Right	RTOR	App. Total	Left	Thru	Right	RTOR	App. Total	Left	Thru	Right	RTOR	App. Total	Left	Thru	Right	RTOR	App. Total	Exclu. Total	Inclu. Total	Int. Total	
07:00 AM	0	0	0	0	0	0	0	0	0	0	0	0	0	0	0	0	0	0	0	0	0	0	5	5
07:15 AM	1	0	0	0	1	0	0	0	0	0	0	0	0	0	0	0	0	0	0	0	0	0	2	2
07:30 AM	0	2	0	0	2	0	0	0	0	0	0	0	0	0	0	0	0	0	0	0	0	1	4	5
07:45 AM	1	1	0	0	2	0	0	0	0	1	0	0	0	0	2	1	0	0	0	0	1	0	6	6
Total	2	3	0	0	5	0	0	0	0	3	0	0	0	0	8	1	0	0	0	0	1	1	17	18
08:00 AM	0	0	1	0	1	0	0	0	0	0	0	0	0	0	0	0	0	0	0	0	0	0	4	4
08:15 AM	0	1	0	0	1	0	0	0	0	2	0	0	0	0	3	0	0	0	0	0	0	2	7	9
08:30 AM	0	1	0	0	1	0	0	0	0	0	0	0	0	0	0	0	0	0	0	0	0	1	4	5
08:45 AM	0	0	0	0	0	0	0	0	0	1	0	0	0	0	0	0	0	0	0	0	0	1	1	2
Total	0	2	1	0	3	0	0	0	0	3	0	0	0	0	6	0	0	0	0	0	4	16	20	
Grand Total	2	5	1	0	8	0	0	0	0	10	4	2	14	2	14	1	2	0	0	3	5	33	38	
% Apprch %	25	62.5	12.5			0	0	0	0	71.4	28.6				33.3	66.7	0	0	9.1	13.2	86.8			
% Total %	6.1	15.2	3		24.2	0	0	0	0	30.3	12.1		42.4		3	6.1	0	0						

Start Time	Sycamore Canyon Boulevard Southbound					Eastridge Avenue Westbound					Sycamore Canyon Boulevard Northbound					Eastridge Avenue Eastbound								
	Left	Thru	Right	RTOR	App. Total	Left	Thru	Right	RTOR	App. Total	Left	Thru	Right	RTOR	App. Total	Left	Thru	Right	RTOR	App. Total	Exclu. Total	Inclu. Total	Int. Total	
07:00 AM	0	0	0	0	0	0	0	0	0	0	0	0	0	0	0	0	0	0	0	0	0	0	0	0
07:15 AM	1	0	0	0	1	0	0	0	0	0	0	0	0	0	0	0	0	0	0	0	0	0	0	0
07:30 AM	0	2	0	0	2	0	0	0	0	0	0	0	0	0	0	0	0	0	0	0	0	0	0	0
07:45 AM	1	1	0	0	2	0	0	0	0	1	0	0	0	0	2	1	0	0	0	0	0	0	1	6
Total	2	3	0	0	5	0	0	0	0	3	0	0	0	0	8	1	0	0	0	1	1	17	18	
% App. Total	40	60	0	0	66.7	0	0	0	0	87.5	12.5		12.5		100	0	0	0	0	0	0	0	0	0
PHF	.500	.375	.000		.625	.000	.250	.500		.750	.000	.438	.250		.500	.250	.000	.000	.250	.000	.250	.708		

Peak Hour Analysis From 07:00 AM to 07:45 AM - Peak 1 of 1
 Peak Hour for Entire Intersection Begins at 07:00 AM

Counts Unlimited, Inc.
 PO Box 1178
 Corona, CA 92878
 (951)268-6268

City of Riverside
 N/S: Sycamore Canyon Boulevard
 E/W: Eastridge Avenue
 Weather: Clear

File Name : 01_RIV_Syc_Eastridge AM
 Site Code : 05122021
 Start Date : 1/13/2022
 Page No : 2

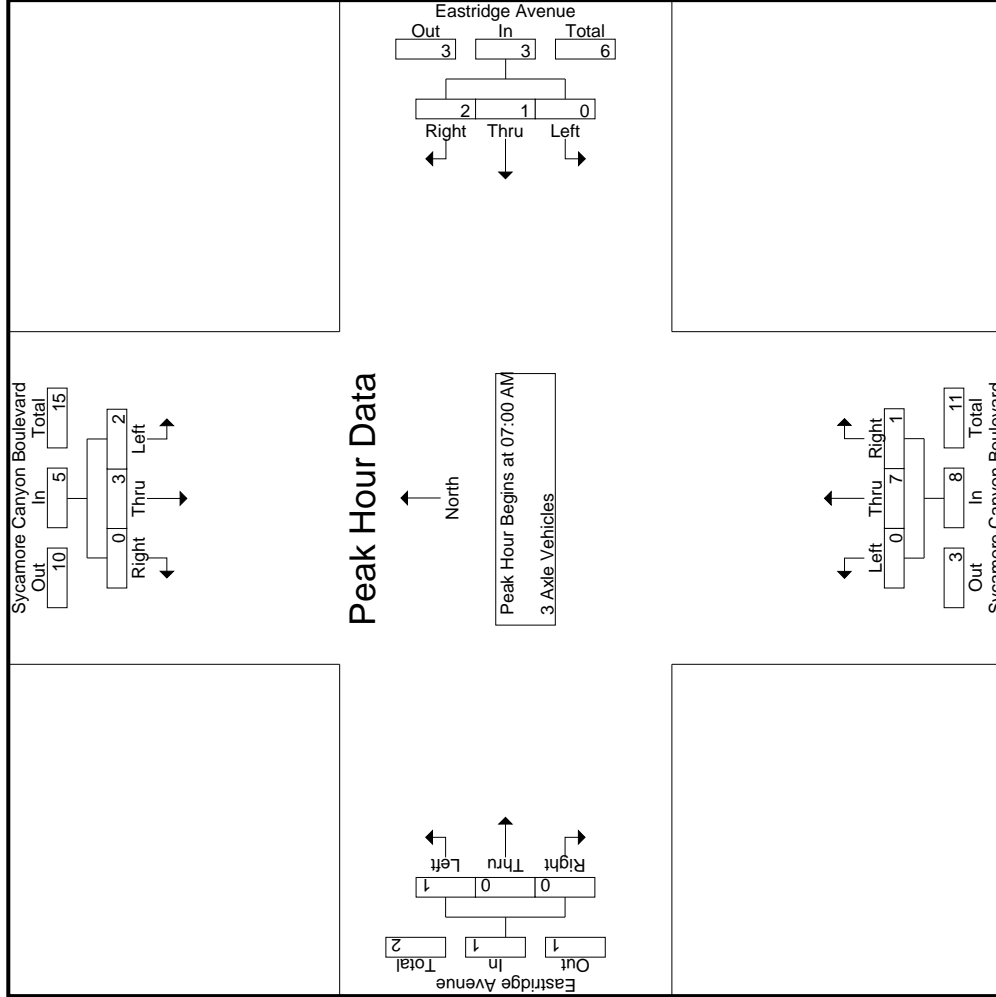

Counts Unlimited, Inc.
 PO Box 1178
 Corona, CA 92878
 (951)268-6268

City of Riverside
 N/S: Sycamore Canyon Boulevard
 E/W: Eastridge Avenue
 Weather: Clear

File Name : 01_RIV_Syc_Eastridge AM
 Site Code : 05122021
 Start Date : 1/13/2022
 Page No : 3

Start Time	Sycamore Canyon Boulevard Southbound			Eastridge Avenue Westbound			Sycamore Canyon Boulevard Northbound			Eastridge Avenue Eastbound					
	Left	Thru	Right	App. Total	Left	Thru	Right	App. Total	Left	Thru	Right	App. Total	Int. Total		
Peak Hour Analysis From 07:00 AM to 07:45 AM - Peak 1 of 1															
Peak Hour for Each Approach Begins at:															
	07:00 AM				07:00 AM				07:00 AM				07:00 AM		
+0 mins.	0	0	0	0	1	0	0	1	4	0	0	0	0	0	
+15 mins.	1	0	0	1	0	0	0	0	1	0	0	0	0	0	
+30 mins.	0	2	0	2	0	0	1	1	0	1	0	0	0	0	
+45 mins.	1	1	0	2	0	0	1	1	2	0	0	0	0	1	
Total Volume	2	3	0	5	0	1	2	3	7	1	1	8	1	1	
% App. Total	40	60	0	0	33.3	66.7	0	0	87.5	12.5	0	100	0	0	
PHF	.500	.375	.000	.625	.000	.250	.500	.750	.438	.250	.000	.500	.000	.250	

Counts Unlimited, Inc.
 PO Box 1178
 Corona, CA 92878
 (951)268-6268

City of Riverside
 N/S: Sycamore Canyon Boulevard
 E/W: Eastridge Avenue
 Weather: Clear

File Name : 01_RIV_Syc_Eastridge AM
 Site Code : 05122021
 Start Date : 1/13/2022
 Page No : 1

Groups Printed- 4+ Axle Trucks

Start Time	Sycamore Canyon Boulevard Southbound				Eastridge Avenue Westbound				Sycamore Canyon Boulevard Northbound				Eastridge Avenue Eastbound										
	Left	Thru	Right	RTOR	App. Total	Left	Thru	Right	RTOR	App. Total	Left	Thru	Right	RTOR	App. Total	Exclu. Total	Inclu. Total	Int. Total					
07:00 AM	0	1	1	0	2	3	2	5	2	10	0	7	1	0	8	3	29	32					
07:15 AM	1	2	1	0	4	3	6	1	1	10	1	4	0	0	5	1	20	21					
07:30 AM	1	2	0	0	3	6	5	5	5	16	0	8	2	0	10	5	35	40					
07:45 AM	0	1	4	0	5	3	5	2	2	13	2	7	2	0	11	3	38	41					
Total	2	6	6	0	14	15	18	16	10	49	3	26	5	0	34	12	122	134					
08:00 AM	1	1	2	0	4	2	3	1	1	6	1	7	0	0	8	2	23	25					
08:15 AM	0	4	1	0	5	3	6	3	1	12	2	5	5	4	12	5	35	40					
08:30 AM	1	5	3	1	9	2	5	4	4	9	0	10	2	0	12	5	37	42					
08:45 AM	3	2	3	0	8	4	5	3	2	12	4	7	1	0	12	2	37	39					
Total	5	12	9	1	26	11	16	12	8	39	7	29	8	4	44	14	132	146					
Grand Total	7	18	15	1	40	26	34	28	18	88	10	55	13	4	78	25	18	5	3	48	26	254	280
% Approach	17.5	45	37.5			29.5	38.6	31.8			12.8	70.5	16.7			52.1	37.5	10.4		18.9	9.3	90.7	
% Total	2.8	7.1	5.9		15.7	10.2	13.4	11		34.6	3.9	21.7	5.1		30.7	9.8	7.1	2					

Start Time	Sycamore Canyon Boulevard Southbound				Eastridge Avenue Westbound				Sycamore Canyon Boulevard Northbound				Eastridge Avenue Eastbound										
	Left	Thru	Right	RTOR	App. Total	Left	Thru	Right	RTOR	App. Total	Left	Thru	Right	RTOR	App. Total	Exclu. Total	Inclu. Total	Int. Total					
07:00 AM	0	1	1	0	2	3	2	5	2	10	0	7	1	0	8	3	29	32					
07:15 AM	1	2	1	0	4	3	6	1	1	10	1	4	0	0	5	1	20	21					
07:30 AM	1	2	0	0	3	6	5	5	5	16	0	8	2	0	10	5	35	40					
07:45 AM	0	1	4	0	5	3	5	2	2	13	2	7	2	0	11	3	38	41					
Total	2	6	6	0	14	15	18	16	10	49	3	26	5	0	34	12	122	134					
08:00 AM	1	1	2	0	4	2	3	1	1	6	1	7	0	0	8	2	23	25					
08:15 AM	0	4	1	0	5	3	6	3	1	12	2	5	5	4	12	5	35	40					
08:30 AM	1	5	3	1	9	2	5	4	4	9	0	10	2	0	12	5	37	42					
08:45 AM	3	2	3	0	8	4	5	3	2	12	4	7	1	0	12	2	37	39					
Total	5	12	9	1	26	11	16	12	8	39	7	29	8	4	44	14	132	146					
Grand Total	7	18	15	1	40	26	34	28	18	88	10	55	13	4	78	25	18	5	3	48	26	254	280
% Approach	17.5	45	37.5			29.5	38.6	31.8			12.8	70.5	16.7			52.1	37.5	10.4		18.9	9.3	90.7	
% Total	2.8	7.1	5.9		15.7	10.2	13.4	11		34.6	3.9	21.7	5.1		30.7	9.8	7.1	2					

Peak Hour Analysis From 07:00 AM to 07:45 AM - Peak 1 of 1
 Peak Hour for Entire Intersection Begins at 07:00 AM

Start Time	Sycamore Canyon Boulevard Southbound				Eastridge Avenue Westbound				Sycamore Canyon Boulevard Northbound				Eastridge Avenue Eastbound									
	Left	Thru	Right	RTOR	App. Total	Left	Thru	Right	RTOR	App. Total	Left	Thru	Right	RTOR	App. Total	Exclu. Total	Inclu. Total	Int. Total				
07:00 AM	0	1	1	0	2	3	2	5	2	10	0	7	1	0	8	3	29	32				
07:15 AM	1	2	1	0	4	3	6	1	1	10	1	4	0	0	5	1	20	21				
07:30 AM	1	2	0	0	3	6	5	5	5	16	0	8	2	0	10	5	35	40				
07:45 AM	0	1	4	0	5	3	5	2	2	13	2	7	2	0	11	3	38	41				
Total	2	6	6	0	14	15	18	16	10	49	3	26	5	0	34	12	122	134				
% App. Total	14.3	42.9	42.9			30.6	36.7	32.7			8.8	76.5	14.7			44	48	8				
PHF	.500	.750	.375		.700	.625	.750	.800		.766	.375	.813	.625		.773	.688	.600	.500		.694	.803	

Counts Unlimited, Inc.
 PO Box 1178
 Corona, CA 92878
 (951)268-6268

City of Riverside
 N/S: Sycamore Canyon Boulevard
 E/W: Eastridge Avenue
 Weather: Clear

File Name : 01_RIV_Syc_Eastridge AM
 Site Code : 05122021
 Start Date : 1/13/2022
 Page No : 2

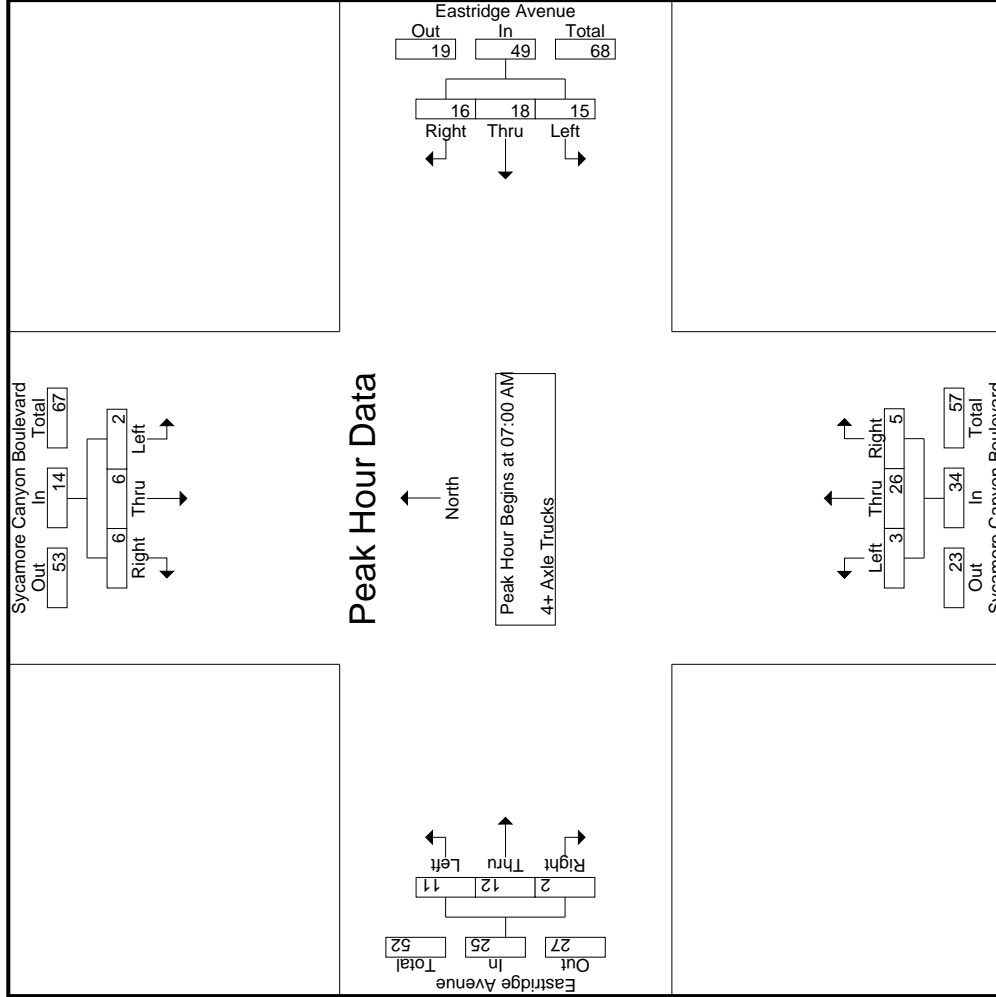

Counts Unlimited, Inc.
 PO Box 1178
 Corona, CA 92878
 (951)268-6268

City of Riverside
 N/S: Sycamore Canyon Boulevard
 E/W: Eastridge Avenue
 Weather: Clear

File Name : 01_RIV_Syc_Eastridge AM
 Site Code : 05122021
 Start Date : 1/13/2022
 Page No : 3

Start Time	Sycamore Canyon Boulevard Southbound			Eastridge Avenue Westbound			Sycamore Canyon Boulevard Northbound			Eastridge Avenue Eastbound				
	Left	Thru	Right	App. Total	Left	Thru	Right	App. Total	Left	Thru	Right	App. Total	Int. Total	
Peak Hour Analysis From 07:00 AM to 07:45 AM - Peak 1 of 1	Peak Hour for Each Approach Begins at:													
	07:00 AM													
+0 mins.	0	1	1	2	3	2	5	10	0	7	1	8	07:00 AM	
+15 mins.	1	2	1	4	3	6	1	10	1	4	0	5	3	
+30 mins.	1	2	0	3	6	5	5	16	0	8	2	10	0	
+45 mins.	0	1	4	5	3	5	5	13	2	7	2	11	4	
Total Volume	2	6	6	14	15	18	16	49	3	26	5	34	11	
% App. Total	14.3	42.9	42.9		30.6	36.7	32.7		8.8	76.5	14.7		44	
PHF	.500	.750	.375	.700	.625	.750	.800	.766	.375	.813	.625	.773	.688	
													.600	.500
														.694

Groups Printed- Passenger Vehicles - Large 2 Axle Vehicles - 3 Axle Vehicles - 4+ Axle Trucks

Start Time	Sycamore Canyon Boulevard Southbound						Eastridge Avenue Westbound						Sycamore Canyon Boulevard Northbound						Eastridge Avenue Eastbound																
	Left		Thru		Right		Left		Thru		Right		Left		Thru		Right		Left		Thru		Right		Left		Thru		Right						
	RTOR	App. Total	RTOR	App. Total	RTOR	App. Total	RTOR	App. Total	RTOR	App. Total	RTOR	App. Total	RTOR	App. Total	RTOR	App. Total	RTOR	App. Total	RTOR	App. Total	RTOR	App. Total	RTOR	App. Total	RTOR	App. Total	RTOR	App. Total	RTOR	App. Total					
04:00 PM	70	63	3	1	136	46	12	82	32	140	2	186	30	10	218	24	27	13	12	64	55	558	613	613	558	613	558	613	558	613					
04:15 PM	40	82	4	1	126	31	10	68	47	109	3	161	34	16	198	19	15	9	8	43	72	476	548	548	476	548	476	548	476	548					
04:30 PM	72	68	7	2	147	45	18	76	48	139	12	99	34	13	145	16	12	9	9	37	72	468	540	540	468	540	468	540	468	540					
04:45 PM	53	90	2	0	145	32	16	73	37	121	10	121	28	12	159	18	27	12	9	57	58	482	540	540	482	540	482	540	482	540					
Total	235	303	16	4	554	154	56	299	164	509	27	567	126	51	720	77	81	43	38	201	257	1984	2241	2241	1984	2241	257	1984	2241	257	1984				
05:00 PM	48	84	6	1	138	38	15	64	31	117	5	86	22	13	113	25	45	22	14	92	59	460	519	519	460	519	460	519	460	519					
05:15 PM	80	85	6	1	171	37	9	54	30	100	9	67	23	13	99	24	28	19	12	71	56	441	497	497	441	497	441	497	441	497					
05:30 PM	65	88	4	0	157	45	20	48	35	113	11	94	41	21	146	10	12	1	1	23	57	439	496	496	439	496	439	496	439	496					
05:45 PM	53	78	3	0	134	28	23	55	29	106	3	74	21	7	98	4	20	11	7	35	43	373	416	416	373	416	373	416	373	416					
Total	246	335	19	2	600	148	67	221	125	436	28	321	107	54	456	63	105	53	34	221	215	1713	1928	1928	1713	1928	215	1713	1928	215	1713				
Grand Total	481	638	35	6	1154	302	123	520	289	945	55	888	233	105	1176	140	186	96	72	422	472	3697	4169	4169	3697	4169	472	3697	4169	472	3697				
T-Approach %	41.7	55.3	3			32	13	55			4.7	75.5	19.8			33.2	44.1	22.7																	
N Total %	13	17.3	0.9			8.2	3.3	14.1			1.5	24	6.3			3.8	5	2.6																	
Passenger Vehicles	467	613	25			288	80	492			47	837	218			117	157	90																	
% Passenger Vehicles	97.1	96.1	71.4	50	95.5	95.4	65	94.6	95.2	92	85.5	94.3	93.6	95.2	93.8	83.6	84.4	93.8	98.6	88.1	0	0	0	0	0	0	0	0	0	0	0	0	0	0	
Large 2 Axle Vehicles	3	7	4			6	9	5			4	15	4			5	0	4																	
% Large 2 Axle Vehicles	0.6	1.1	11.4	16.7	1.3	2	7.3	1	1	1.9	7.3	1.7	1.7	1	1.9	3.6	0	4.2	0	1.8	0	0	0	0	0	0	0	0	0	0	0	0	0	0	
3 Axle Vehicles	1	1	1			4	0	3			1	11	4			0	1	0																	
% 3 Axle Vehicles	0.2	0.2	2.9	0	0.3	1.3	0	0.6	0.7	0.7	1.8	1.2	1.7	2.9	1.5	0	0.5	0	0	0.2	0	0	0	0	0	0	0	0	0	0	0	0	0	0	
4+ Axle Trucks	10	17	5			4	34	20			3	25	7			18	28	2																	
% 4+ Axle Trucks	2.1	2.7	14.3	33.3	2.9	1.3	27.6	3.8	3.1	5.4	5.5	2.8	3	1	2.8	12.9	15.1	2.1	1.4	9.9	0	0	0	0	0	0	0	0	0	0	0	0	0	0	

Start Time	Sycamore Canyon Boulevard Southbound						Eastridge Avenue Westbound						Sycamore Canyon Boulevard Northbound						Eastridge Avenue Eastbound															
	Left		Thru		Right		Left		Thru		Right		Left		Thru		Right		Left		Thru		Right		Left		Thru		Right					
	RTOR	App. Total	RTOR	App. Total	RTOR	App. Total	RTOR	App. Total	RTOR	App. Total	RTOR	App. Total	RTOR	App. Total	RTOR	App. Total	RTOR	App. Total	RTOR	App. Total	RTOR	App. Total	RTOR	App. Total	RTOR	App. Total	RTOR	App. Total	RTOR	App. Total				
04:00 PM	70	63	3	1	136	46	12	82	32	140	2	186	30	10	218	24	27	13	12	64	55	558	613	613	558	613	558	613	558	613				
04:15 PM	40	82	4	1	126	31	10	68	47	109	3	161	34	16	198	19	15	9	8	43	72	476	548	548	476	548	476	548	476	548				
04:30 PM	72	68	7	2	147	45	18	76	48	139	12	99	34	13	145	16	12	9	9	37	72	468	540	540	468	540	468	540	468	540				
04:45 PM	53	90	2	0	145	32	16	73	37	121	10	121	28	12	159	18	27	12	9	57	58	482	540	540	482	540	482	540	482	540				
Total	235	303	16	4	554	154	56	299	164	509	27	567	126	51	720	77	81	43	38	201	257	1984	2241	2241	1984	2241	257	1984	2241	257	1984			
% App. Total	.816	.842	.571			.942	.778	.912			.909	.563	.762	.926		.826	.802	.750		.785														
PHF																																		

Peak Hour Analysis From 04:00 PM to 05:45 PM - Peak 1 of 1
 Peak Hour for Entire Intersection Begins at 04:00 PM

Counts Unlimited, Inc.
 PO Box 1178
 Corona, CA 92878
 (951)268-6268

City of Riverside
 N/S: Sycamore Canyon Boulevard
 E/W: Eastridge Avenue
 Weather: Clear

File Name : 01_RIV_Syc_Eastridge PM
 Site Code : 05122021
 Start Date : 1/13/2022
 Page No : 2

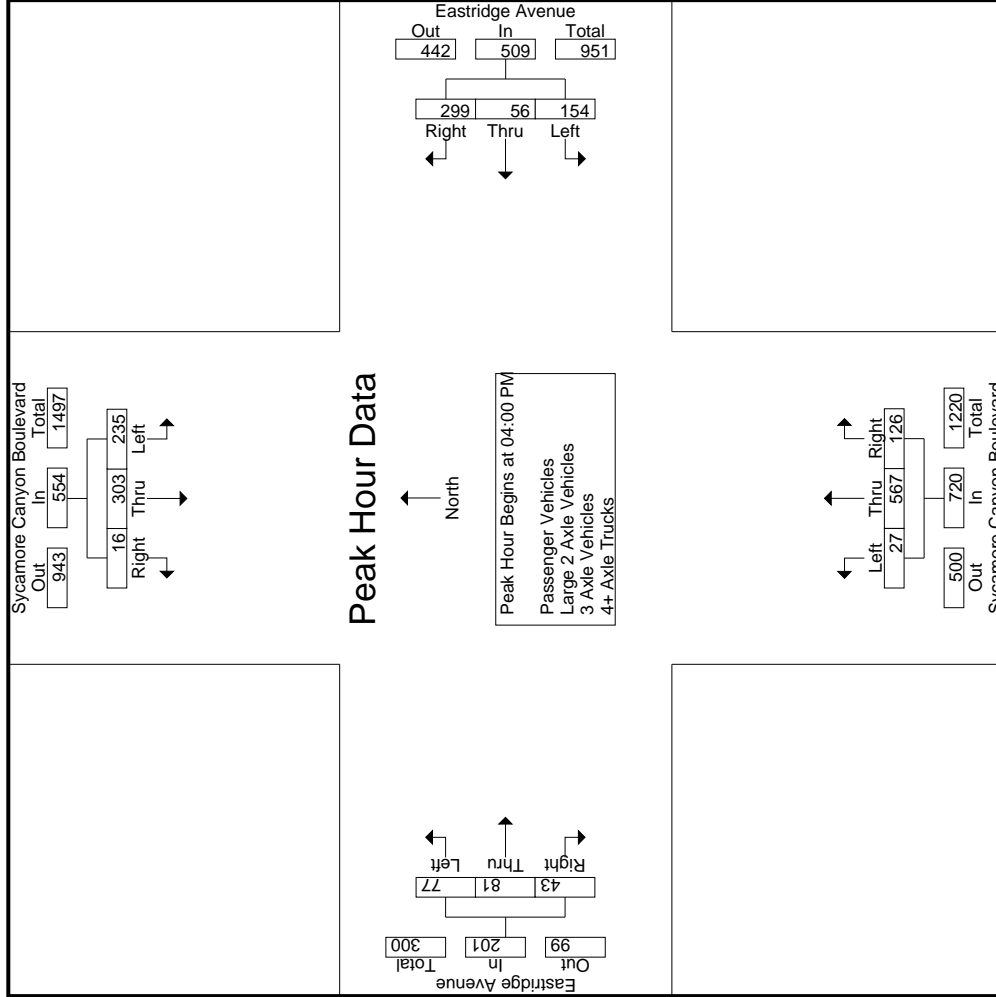

Counts Unlimited, Inc.
 PO Box 1178
 Corona, CA 92878
 (951)268-6268

City of Riverside
 N/S: Sycamore Canyon Boulevard
 E/W: Eastridge Avenue
 Weather: Clear

File Name : 01_RIV_Syc_Eastridge PM
 Site Code : 05122021
 Start Date : 1/13/2022
 Page No : 3

Start Time	Sycamore Canyon Boulevard Southbound			Eastridge Avenue Westbound			Sycamore Canyon Boulevard Northbound			Eastridge Avenue Eastbound					
	Left	Thru	Right	Left	Thru	Right	Left	Thru	Right	Left	Thru	Right			
	App. Total			App. Total			App. Total			App. Total					
Peak Hour Analysis From 04:00 PM to 05:45 PM - Peak 1 of 1	Peak Hour for Each Approach Begins at:														
	04:45 PM			04:00 PM			04:00 PM			04:30 PM					
+0 mins.	53	90	2	145	12	82	140	2	186	30	218	16	12	9	37
+15 mins.	48	84	6	138	10	68	109	3	161	34	198	18	27	12	57
+30 mins.	80	85	6	171	45	76	139	12	99	34	145	25	45	22	92
+45 mins.	65	88	4	157	32	73	121	10	121	28	159	24	28	19	71
Total Volume	246	347	18	611	56	299	509	27	567	126	720	83	112	62	257
% App. Total	40.3	56.8	2.9	30.3	11	58.7	909	3.8	78.8	17.5	826	32.3	43.6	24.1	698
PHF	.769	.964	.750	.893	.778	.912	.909	.563	.762	.926	.826	.830	.622	.705	.698

Counts Unlimited, Inc.
 PO Box 1178
 Corona, CA 92878
 (951)268-6268

City of Riverside
 N/S: Sycamore Canyon Boulevard
 E/W: Eastridge Avenue
 Weather: Clear

File Name : 01_RIV_Syc_Eastridge PM
 Site Code : 05122021
 Start Date : 1/13/2022
 Page No : 1

Groups Printed- Passenger Vehicles

Start Time	Sycamore Canyon Boulevard Southbound					Eastridge Avenue Westbound					Sycamore Canyon Boulevard Northbound					Eastridge Avenue Eastbound							
	Left	Thru	Right	RTOR	App. Total	Left	Thru	Right	RTOR	App. Total	Left	Thru	Right	RTOR	App. Total	Left	Thru	Right	RTOR	App. Total	Exclu. Total	Inclu. Total	Int. Total
04:00 PM	69	61	1	0	131	44	8	73	28	125	2	174	29	9	205	22	22	12	12	56	49	517	566
04:15 PM	39	78	3	0	120	29	8	62	45	99	2	150	32	14	184	13	12	8	7	33	66	436	502
04:30 PM	68	64	6	1	138	44	12	72	44	128	10	88	32	13	130	15	9	9	9	33	67	429	496
04:45 PM	50	85	2	0	137	32	9	71	37	112	8	116	27	12	151	14	21	12	9	47	58	447	505
Total	226	288	12	1	526	149	37	278	154	464	22	528	120	48	670	64	64	41	37	169	240	1829	2069
05:00 PM	48	82	5	1	135	36	9	63	31	108	4	80	19	12	103	22	43	22	14	87	58	433	491
05:15 PM	77	85	4	1	166	36	6	53	30	95	7	64	20	12	91	23	24	16	12	63	55	415	470
05:30 PM	65	83	3	0	151	42	13	48	35	103	11	94	39	21	144	5	11	1	1	17	57	415	472
05:45 PM	51	75	1	0	127	25	15	50	25	90	3	71	20	7	94	3	15	10	7	28	39	339	378
Total	241	325	13	2	579	139	43	214	121	396	25	309	98	52	432	53	93	49	34	195	209	1602	1811
Grand Total	467	613	25	3	1105	288	80	492	275	860	47	837	218	100	1102	117	157	90	71	364	449	3431	3880
T-Approch %	42.3	55.5	2.3			33.5	9.3	57.2		25.1	4.3	76	19.8		32.1	43.1	24.7		10.6		11.6	88.4	
N-Total %	13.6	17.9	0.7		32.2	8.4	2.3	14.3			1.4	24.4	6.4			3.4	4.6	2.6					

Start Time	Sycamore Canyon Boulevard Southbound					Eastridge Avenue Westbound					Sycamore Canyon Boulevard Northbound					Eastridge Avenue Eastbound							
	Left	Thru	Right	RTOR	App. Total	Left	Thru	Right	RTOR	App. Total	Left	Thru	Right	RTOR	App. Total	Left	Thru	Right	RTOR	App. Total	Exclu. Total	Inclu. Total	Int. Total
04:00 PM	69	61	1	0	131	44	8	73	28	125	2	174	29	9	205	22	22	12	12	56	49	517	566
04:15 PM	39	78	3	0	120	29	8	62	45	99	2	150	32	14	184	13	12	8	7	33	66	436	502
04:30 PM	68	64	6	1	138	44	12	72	44	128	10	88	32	13	130	15	9	9	9	33	67	429	496
04:45 PM	50	85	2	0	137	32	9	71	37	112	8	116	27	12	151	14	21	12	9	47	58	447	505
Total	226	288	12	1	526	149	37	278	154	464	22	528	120	48	670	64	64	41	37	169	240	1829	2069
% App. Total	43	54.8	2.3			32.1	8	59.9		25.1	4.3	76	19.8		32.1	43.1	24.7		10.6		11.6	88.4	
PHF	.819	.847	.500		.953	.847	.771	.952		.906	.550	.759	.938		.817	.727	.727	.854		.754		.884	

Peak Hour Analysis From 04:00 PM to 04:45 PM - Peak 1 of 1
 Peak Hour for Entire Intersection Begins at 04:00 PM

Counts Unlimited, Inc.
 PO Box 1178
 Corona, CA 92878
 (951)268-6268

City of Riverside
 N/S: Sycamore Canyon Boulevard
 E/W: Eastridge Avenue
 Weather: Clear

File Name : 01_RIV_Syc_Eastridge PM
 Site Code : 05122021
 Start Date : 1/13/2022
 Page No : 2

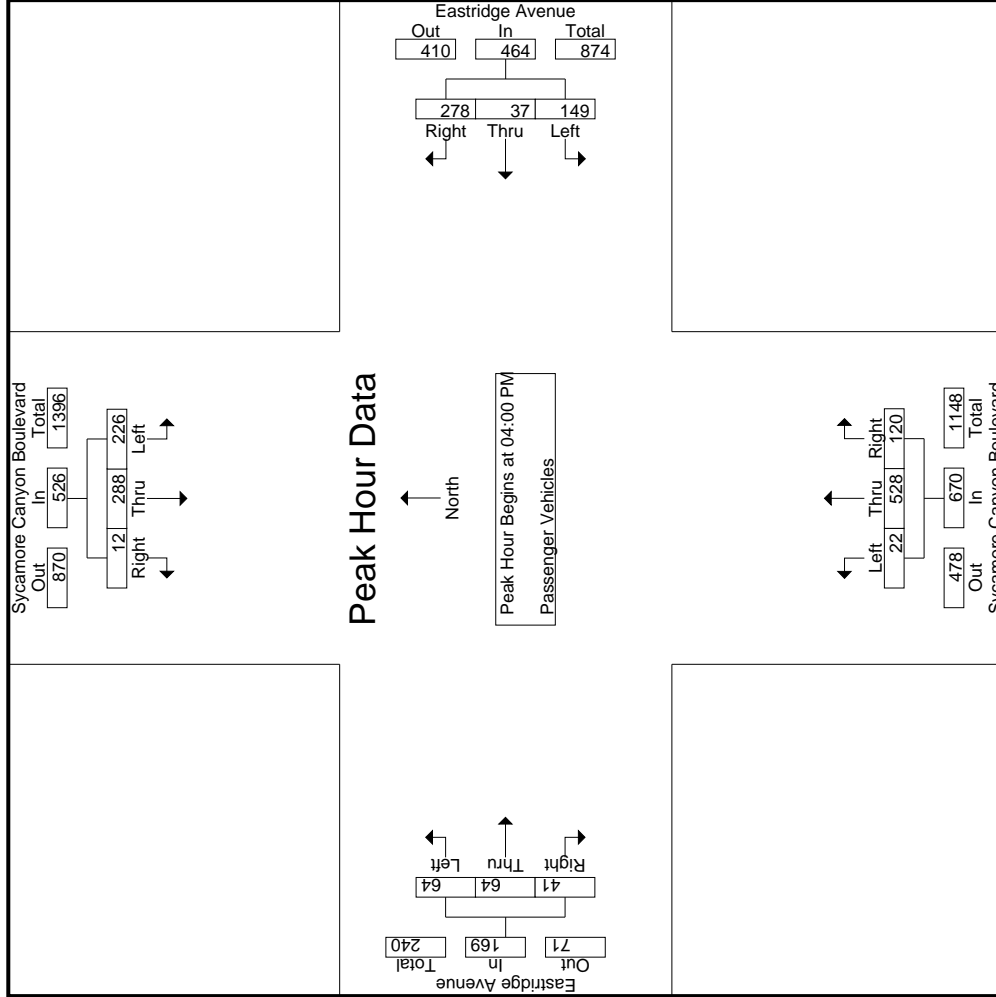

Counts Unlimited, Inc.
 PO Box 1178
 Corona, CA 92878
 (951)268-6268

City of Riverside
 N/S: Sycamore Canyon Boulevard
 E/W: Eastridge Avenue
 Weather: Clear

File Name : 01_RIV_Syc_Eastridge PM
 Site Code : 05122021
 Start Date : 1/13/2022
 Page No : 3

Start Time	Sycamore Canyon Boulevard Southbound			Eastridge Avenue Westbound			Sycamore Canyon Boulevard Northbound			Eastridge Avenue Eastbound					
	Left	Thru	Right	App. Total	Left	Thru	Right	App. Total	Left	Thru	Right	App. Total	Int. Total		
Peak Hour Analysis From 04:00 PM to 04:45 PM - Peak 1 of 1	Peak Hour for Each Approach Begins at:														
	04:00 PM			04:00 PM			04:00 PM			04:00 PM					
+0 mins.	69	61	1	131	44	8	73	125	2	174	29	205	22	12	56
+15 mins.	39	78	3	120	29	8	62	99	2	150	32	184	13	12	8
+30 mins.	68	64	6	138	44	12	72	128	10	88	32	130	15	9	33
+45 mins.	50	85	2	137	32	9	71	112	8	116	27	151	14	21	47
Total Volume	226	288	12	526	149	37	278	464	22	528	120	670	64	64	169
% App. Total	43	54.8	2.3	953	32.1	8	59.9	906	3.3	78.8	17.9	817	37.9	37.9	24.3
PHF	.819	.847	.500	.953	.847	.771	.952	.906	.550	.759	.938	.817	.727	.727	.754

Counts Unlimited, Inc.
 PO Box 1178
 Corona, CA 92878
 (951)268-6268

City of Riverside
 N/S: Sycamore Canyon Boulevard
 E/W: Eastridge Avenue
 Weather: Clear

File Name : 01_RIV_Syc_Eastridge PM
 Site Code : 05122021
 Start Date : 1/13/2022
 Page No : 1

Groups Printed- Large 2 Axle Vehicles

Start Time	Sycamore Canyon Boulevard Southbound				Eastridge Avenue Westbound				Sycamore Canyon Boulevard Northbound				Eastridge Avenue Eastbound											
	Left	Thru	Right	RTOR	App. Total	Left	Thru	Right	RTOR	App. Total	Left	Thru	Right	RTOR	App. Total	Left	Thru	Right	RTOR	App. Total	Exclu. Total	Inclu. Total	Int. Total	
04:00 PM	0	0	0	0	0	1	0	1	0	2	0	3	0	0	0	0	1	0	0	0	1	0	6	6
04:15 PM	0	1	0	0	1	0	1	1	1	2	0	4	1	1	5	1	0	0	0	1	2	9	11	11
04:30 PM	1	1	1	1	3	1	0	2	2	3	0	5	0	0	5	0	0	0	0	0	3	11	14	14
04:45 PM	1	1	0	0	2	0	1	0	0	1	2	1	0	0	3	2	0	0	0	2	0	8	8	8
Total	2	3	1	1	6	2	2	4	3	8	2	13	1	1	16	3	0	1	0	4	5	34	39	39
05:00 PM	0	2	0	0	2	1	2	1	0	4	0	1	1	0	2	2	0	0	0	2	0	10	10	10
05:15 PM	1	0	1	0	2	0	0	0	0	0	2	1	2	0	5	0	2	0	2	0	0	9	9	9
05:30 PM	0	1	1	0	2	4	0	0	0	4	0	0	0	0	0	0	0	0	0	0	0	6	6	6
05:45 PM	0	1	1	0	2	3	1	0	0	4	0	0	0	0	0	0	1	0	0	1	0	7	7	7
Total	1	4	3	0	8	4	7	1	0	12	2	2	3	0	7	2	0	3	0	5	0	32	32	32
Grand Total	3	7	4	1	14	6	9	5	3	20	4	15	4	1	23	5	0	4	0	9	5	66	71	71
T-Approch %	21.4	50	28.6			30	45	25			17.4	65.2	17.4			55.6	0	44.4			13.6			
N-Total %	4.5	10.6	6.1		21.2	9.1	13.6	7.6		30.3	6.1	22.7	6.1		34.8	7.6	0	6.1				7	93	93

Start Time	Sycamore Canyon Boulevard Southbound				Eastridge Avenue Westbound				Sycamore Canyon Boulevard Northbound				Eastridge Avenue Eastbound											
	Left	Thru	Right	RTOR	App. Total	Left	Thru	Right	RTOR	App. Total	Left	Thru	Right	RTOR	App. Total	Left	Thru	Right	RTOR	App. Total	Exclu. Total	Inclu. Total	Int. Total	
04:00 PM	0	0	0	0	0	1	0	1	0	2	0	3	0	0	3	0	0	0	0	0	0	0	6	6
04:15 PM	0	1	0	0	1	0	1	1	1	2	0	4	1	1	5	1	0	0	0	1	2	9	11	11
04:30 PM	1	1	1	1	3	1	0	2	2	3	0	5	0	0	5	0	0	0	0	0	3	11	14	14
04:45 PM	1	1	0	0	2	0	1	0	0	1	2	1	0	0	3	2	0	0	0	2	0	8	8	8
Total	2	3	1	1	6	2	2	4	3	8	2	13	1	1	16	3	0	1	0	4	5	34	39	39
05:00 PM	0	2	0	0	2	1	2	1	0	4	0	1	1	0	2	2	0	0	0	2	0	10	10	10
05:15 PM	1	0	1	0	2	0	0	0	0	0	2	1	2	0	5	0	2	0	2	0	0	9	9	9
05:30 PM	0	1	1	0	2	4	0	0	0	4	0	0	0	0	0	0	0	0	0	0	0	6	6	6
05:45 PM	0	1	1	0	2	3	1	0	0	4	0	0	0	0	0	0	1	0	0	1	0	7	7	7
Total	1	4	3	0	8	4	7	1	0	12	2	2	3	0	7	2	0	3	0	5	0	32	32	32
Grand Total	3	7	4	1	14	6	9	5	3	20	4	15	4	1	23	5	0	4	0	9	5	66	71	71
T-Approch %	21.4	50	28.6			30	45	25			17.4	65.2	17.4			55.6	0	44.4			13.6			
N-Total %	4.5	10.6	6.1		21.2	9.1	13.6	7.6		30.3	6.1	22.7	6.1		34.8	7.6	0	6.1				7	93	93

Peak Hour Analysis From 04:00 PM to 04:45 PM - Peak 1 of 1
 Peak Hour for Entire Intersection Begins at 04:00 PM

Start Time	Sycamore Canyon Boulevard Southbound				Eastridge Avenue Westbound				Sycamore Canyon Boulevard Northbound				Eastridge Avenue Eastbound											
	Left	Thru	Right	RTOR	App. Total	Left	Thru	Right	RTOR	App. Total	Left	Thru	Right	RTOR	App. Total	Left	Thru	Right	RTOR	App. Total	Exclu. Total	Inclu. Total	Int. Total	
04:00 PM	0	0	0	0	0	1	0	1	0	2	0	3	0	0	3	0	0	0	0	0	0	0	6	6
04:15 PM	0	1	0	0	1	0	1	1	1	2	0	4	1	1	5	1	0	0	0	1	2	9	11	11
04:30 PM	1	1	1	1	3	1	0	2	2	3	0	5	0	0	5	0	0	0	0	0	3	11	14	14
04:45 PM	1	1	0	0	2	0	1	0	0	1	2	1	0	0	3	2	0	0	0	2	0	8	8	8
Total	2	3	1	1	6	2	2	4	3	8	2	13	1	1	16	3	0	1	0	4	5	34	39	39
% App. Total	33.3	50	16.7			25	25	50			12.5	81.2	6.2			75	0	25				.500	.773	.773
PHF	.500	.750	.250		.500	.500	.500	.500		.667	.250	.650	.250		.800	.375	.000	.250		.500	.500	.500	.773	.773

Counts Unlimited, Inc.
 PO Box 1178
 Corona, CA 92878
 (951)268-6268

City of Riverside
 N/S: Sycamore Canyon Boulevard
 E/W: Eastridge Avenue
 Weather: Clear

File Name : 01_RIV_Syc_Eastridge PM
 Site Code : 05122021
 Start Date : 1/13/2022
 Page No : 2

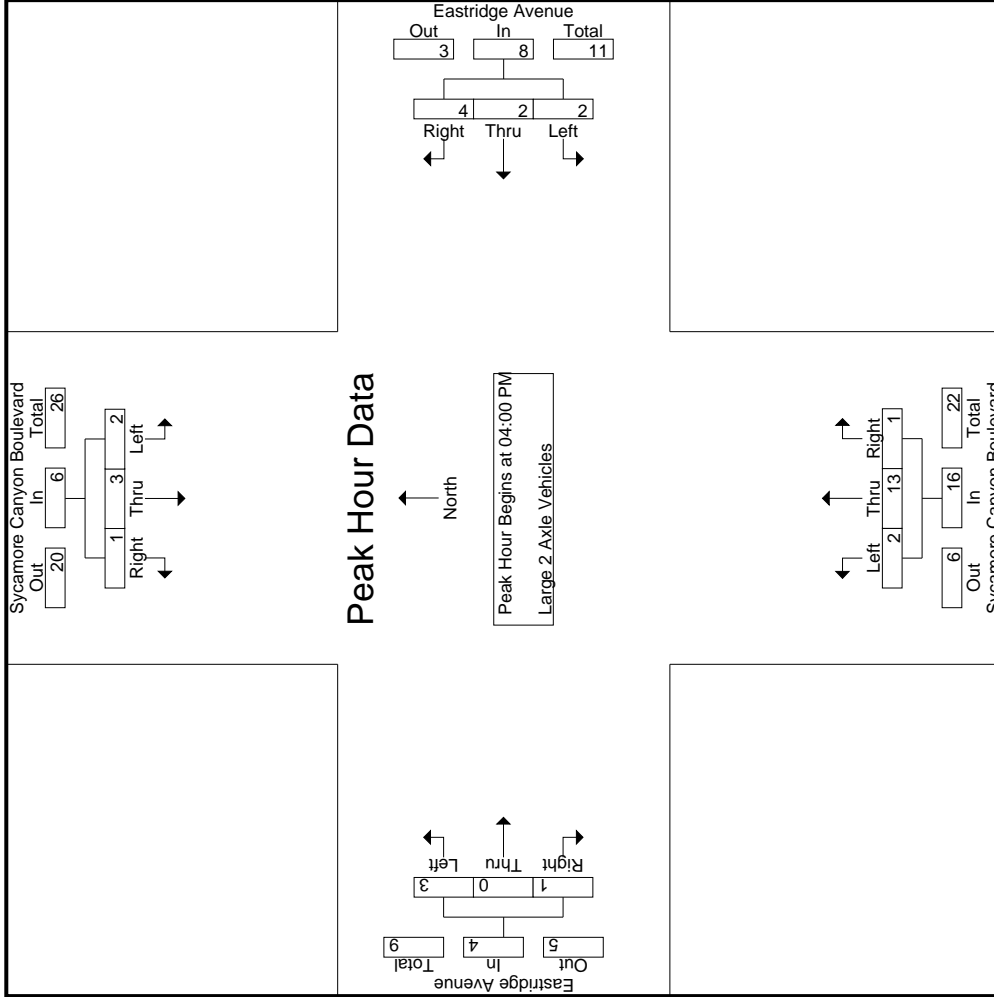

Counts Unlimited, Inc.
 PO Box 1178
 Corona, CA 92878
 (951)268-6268

City of Riverside
 N/S: Sycamore Canyon Boulevard
 E/W: Eastridge Avenue
 Weather: Clear

File Name : 01_RIV_Syc_Eastridge PM
 Site Code : 05122021
 Start Date : 1/13/2022
 Page No : 3

Start Time	Sycamore Canyon Boulevard Southbound			Eastridge Avenue Westbound			Sycamore Canyon Boulevard Northbound			Eastridge Avenue Eastbound					
	Left	Thru	Right	App. Total	Left	Thru	Right	App. Total	Left	Thru	Right	App. Total	Int. Total		
Peak Hour Analysis From 04:00 PM to 04:45 PM - Peak 1 of 1															
Peak Hour for Each Approach Begins at:															
	04:00 PM				04:00 PM				04:00 PM				04:00 PM		
+0 mins.	0	0	0	0	1	0	1	2	0	3	0	0	1	1	
+15 mins.	0	1	0	1	0	1	1	2	0	4	1	0	0	1	
+30 mins.	1	1	1	3	1	0	2	3	0	5	0	0	0	0	
+45 mins.	1	1	0	2	0	1	0	1	2	1	0	0	0	2	
Total Volume	2	3	1	6	2	2	4	8	2	13	1	16	3	4	
% App. Total	33.3	50	16.7	50	.25	.25	.50	.667	12.5	81.2	6.2	.800	.75	.25	
PHF	.500	.750	.250	.500	.500	.500	.500	.667	.250	.650	.250	.800	.375	.250	

Counts Unlimited, Inc.
 PO Box 1178
 Corona, CA 92878
 (951)268-6268

City of Riverside
 N/S: Sycamore Canyon Boulevard
 E/W: Eastridge Avenue
 Weather: Clear

File Name : 01_RIV_Syc_Eastridge PM
 Site Code : 05122021
 Start Date : 1/13/2022
 Page No : 1

Groups Printed- 3 Axle Vehicles

Start Time	Sycamore Canyon Boulevard Southbound				Eastridge Avenue Westbound				Sycamore Canyon Boulevard Northbound				Eastridge Avenue Eastbound					
	Left	Thru	Right	RTOR	App. Total	Left	Thru	Right	RTOR	App. Total	Left	Thru	Right	RTOR	App. Total	Exclu. Total	Inclu. Total	Int. Total
04:00 PM	0	0	0	0	0	0	0	1	1	0	0	0	0	0	0	1	2	3
04:15 PM	0	1	0	0	1	0	0	2	1	0	0	0	0	0	0	2	9	11
04:30 PM	0	0	0	0	0	0	0	0	0	1	1	0	0	0	0	0	3	3
04:45 PM	1	0	0	0	1	0	0	0	0	0	2	0	0	0	1	0	4	4
Total	1	1	0	0	2	0	0	3	2	3	1	9	2	1	12	3	18	21
05:00 PM	0	0	0	0	0	1	0	0	0	1	0	1	1	2	0	1	3	4
05:15 PM	0	0	0	0	0	1	0	0	1	1	0	1	1	2	0	1	3	4
05:30 PM	0	0	0	0	0	2	0	0	0	0	0	0	0	0	0	0	2	2
05:45 PM	0	0	1	0	1	0	0	0	0	0	0	0	0	0	0	0	1	1
Total	0	0	1	0	1	4	0	0	0	4	0	2	2	4	0	2	9	11
Grand Total	1	1	1	0	3	4	0	3	2	7	1	11	4	3	16	5	27	32
T-Approch %	33.3	33.3	33.3		57.1	0	42.9	0	11.1	25.9	6.2	68.8	25	0	100	0	3.7	84.4
N-Total %	3.7	3.7	3.7		14.8	0	11.1	0	11.1	3.7	3.7	40.7	14.8	0	3.7	15.6	84.4	

Start Time	Sycamore Canyon Boulevard Southbound				Eastridge Avenue Westbound				Sycamore Canyon Boulevard Northbound				Eastridge Avenue Eastbound					
	Left	Thru	Right	RTOR	App. Total	Left	Thru	Right	RTOR	App. Total	Left	Thru	Right	RTOR	App. Total	Exclu. Total	Inclu. Total	Int. Total
04:00 PM	0	0	0	0	0	0	0	1	1	0	0	0	0	0	0	0	0	0
04:15 PM	0	1	0	0	1	0	0	2	1	0	0	0	0	0	0	0	0	0
04:30 PM	0	0	0	0	0	0	0	0	0	1	1	0	0	0	0	0	0	0
04:45 PM	1	0	0	0	1	0	0	0	0	0	2	0	0	0	1	0	1	1
Total	1	1	0	0	2	0	0	3	2	3	1	9	2	2	12	0	1	18
% App. Total	.50	.50	.00		.500	.000	.000	.375	.375	.500	.250	.450	.500	.500	.250	.000	.250	.500
PHF	.250	.250	.000		.500	.000	.000	.375	.375	.500	.250	.450	.500	.500	.250	.000	.250	.500

Peak Hour Analysis From 04:00 PM to 04:45 PM - Peak 1 of 1
 Peak Hour for Entire Intersection Begins at 04:00 PM

Counts Unlimited, Inc.
 PO Box 1178
 Corona, CA 92878
 (951)268-6268

City of Riverside
 N/S: Sycamore Canyon Boulevard
 E/W: Eastridge Avenue
 Weather: Clear

File Name : 01_RIV_Syc_Eastridge PM
 Site Code : 05122021
 Start Date : 1/13/2022
 Page No : 2

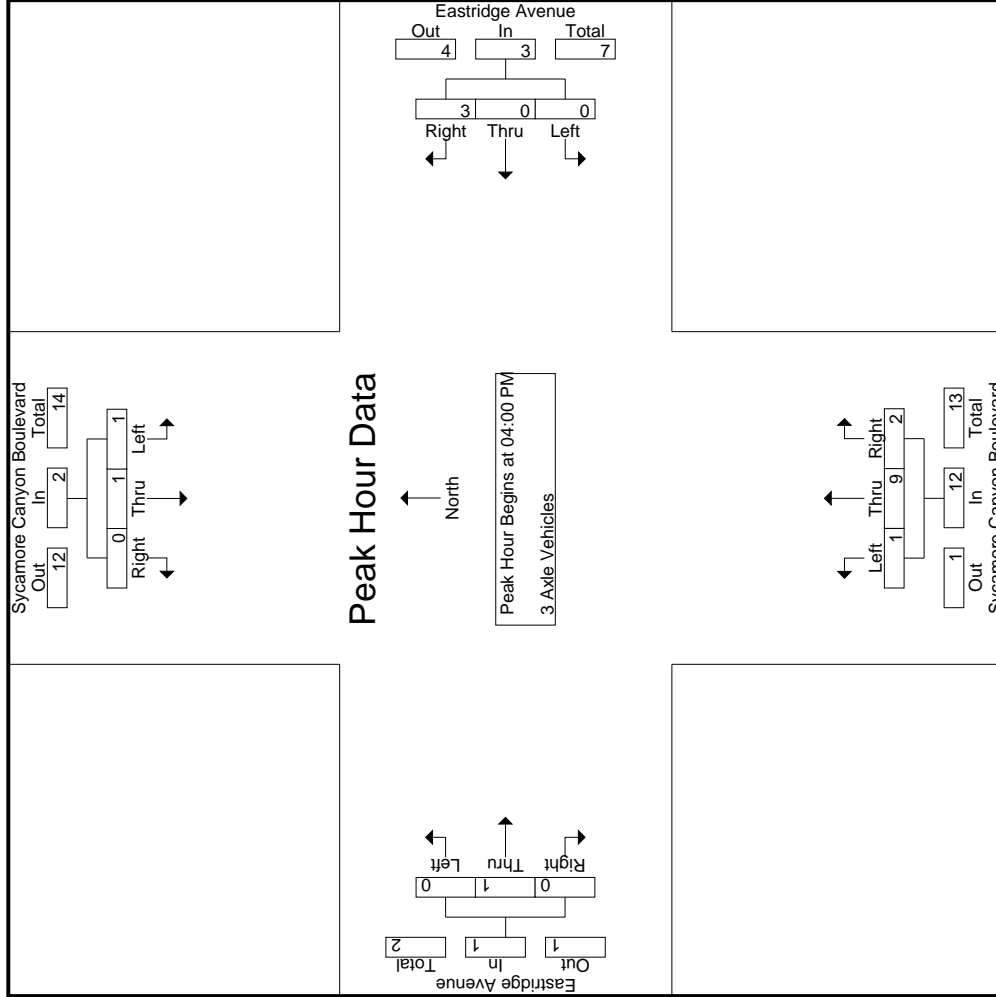

Counts Unlimited, Inc.
 PO Box 1178
 Corona, CA 92878
 (951)268-6268

City of Riverside
 N/S: Sycamore Canyon Boulevard
 E/W: Eastridge Avenue
 Weather: Clear

File Name : 01_RIV_Syc_Eastridge PM
 Site Code : 05122021
 Start Date : 1/13/2022
 Page No : 3

Start Time	Sycamore Canyon Boulevard Southbound			Eastridge Avenue Westbound			Sycamore Canyon Boulevard Northbound			Eastridge Avenue Eastbound					
	Left	Thru	Right	App. Total	Left	Thru	Right	App. Total	Left	Thru	Right	App. Total	Int. Total		
Peak Hour Analysis From 04:00 PM to 04:45 PM - Peak 1 of 1															
Peak Hour for Each Approach Begins at:															
	04:00 PM				04:00 PM				04:00 PM				04:00 PM		
+0 mins.	0	0	0	0	0	0	1	1	0	0	0	0	0	0	
+15 mins.	0	1	0	1	0	0	2	2	1	5	1	0	0	0	
+30 mins.	0	0	0	0	0	0	0	0	1	1	1	0	0	0	
+45 mins.	1	0	0	1	0	0	0	0	2	2	0	0	1	1	
Total Volume	1	1	0	2	0	0	3	3	1	9	2	12	1	1	
% App. Total	50	50	0	0	0	0	100	100	8.3	75	16.7	100	0	0	
PHF	.250	.250	.000	.500	.000	.000	.375	.375	.250	.450	.500	.500	.250	.250	

Counts Unlimited, Inc.
 PO Box 1178
 Corona, CA 92878
 (951)268-6268

File Name : 01_RIV_Syc_Eastridge PM
 Site Code : 05122021
 Start Date : 1/13/2022
 Page No : 1

City of Riverside
 N/S: Sycamore Canyon Boulevard
 E/W: Eastridge Avenue
 Weather: Clear

Groups Printed- 4+ Axle Trucks

Start Time	Sycamore Canyon Boulevard Southbound				Eastridge Avenue Westbound				Sycamore Canyon Boulevard Northbound				Eastridge Avenue Eastbound										
	Left	Thru	Right	RTOR	App. Total	Left	Thru	Right	RTOR	App. Total	Left	Thru	Right	RTOR	App. Total	Left	Thru	Right	RTOR	App. Total	Exclu. Total	Inclu. Total	Int. Total
04:00 PM	1	2	2	1	5	1	4	7	3	12	0	8	1	1	9	2	5	0	0	7	5	33	38
04:15 PM	1	2	1	1	4	2	1	3	0	6	1	2	0	0	3	5	3	1	1	9	2	22	24
04:30 PM	3	3	0	0	6	0	6	2	2	8	1	5	1	0	7	1	3	0	0	4	2	25	27
04:45 PM	1	4	0	0	5	0	6	2	0	8	0	2	1	0	3	2	5	0	0	7	0	23	23
Total	6	11	3	2	20	3	17	14	5	34	2	17	3	1	22	10	16	1	1	27	9	103	112
05:00 PM	0	0	1	0	1	0	4	0	0	4	1	4	1	0	6	1	2	0	0	3	0	14	14
05:15 PM	2	0	1	0	3	0	3	1	0	4	0	1	0	0	1	1	4	1	0	6	0	14	14
05:30 PM	0	4	0	0	4	1	3	0	0	4	0	0	2	0	2	5	1	0	0	6	0	16	16
05:45 PM	2	2	0	0	4	0	7	5	4	12	0	3	1	0	4	1	5	0	0	6	4	26	30
Total	4	6	2	0	12	1	17	6	4	24	1	8	4	0	13	8	12	1	0	21	4	70	74
Grand Total	10	17	5	2	32	4	34	20	9	58	3	25	7	1	35	18	28	2	1	48	13	173	186
T-Approch %	31.2	53.1	15.6			6.9	58.6	34.5			8.6	71.4	20			37.5	58.3	4.2		27.7			
Total %	5.8	9.8	2.9		18.5	2.3	19.7	11.6		33.5	1.7	14.5	4		20.2	10.4	16.2	1.2			7	93	

Start Time	Sycamore Canyon Boulevard Southbound				Eastridge Avenue Westbound				Sycamore Canyon Boulevard Northbound				Eastridge Avenue Eastbound										
	Left	Thru	Right	RTOR	App. Total	Left	Thru	Right	RTOR	App. Total	Left	Thru	Right	RTOR	App. Total	Left	Thru	Right	RTOR	App. Total	Exclu. Total	Inclu. Total	Int. Total
04:00 PM	1	2	2	1	5	1	4	7	3	12	0	8	1	1	9	2	5	0	0	7	5	33	38
04:15 PM	1	2	1	1	4	2	1	3	0	6	1	2	0	0	3	5	3	1	1	9	2	22	24
04:30 PM	3	3	0	0	6	0	6	2	2	8	1	5	1	0	7	1	3	0	0	4	2	25	27
04:45 PM	1	4	0	0	5	0	6	2	0	8	0	2	1	0	3	2	5	0	0	7	0	23	23
Total	6	11	3	2	20	3	17	14	5	34	2	17	3	1	22	10	16	1	1	27	9	103	112
05:00 PM	0	0	1	0	1	0	4	0	0	4	1	4	1	0	6	1	2	0	0	3	0	14	14
05:15 PM	2	0	1	0	3	0	3	1	0	4	0	1	0	0	1	1	4	1	0	6	0	14	14
05:30 PM	0	4	0	0	4	1	3	0	0	4	0	0	2	0	2	5	1	0	0	6	0	16	16
05:45 PM	2	2	0	0	4	0	7	5	4	12	0	3	1	0	4	1	5	0	0	6	4	26	30
Total	4	6	2	0	12	1	17	6	4	24	1	8	4	0	13	8	12	1	0	21	4	70	74
Grand Total	10	17	5	2	32	4	34	20	9	58	3	25	7	1	35	18	28	2	1	48	13	173	186
T-Approch %	31.2	53.1	15.6			6.9	58.6	34.5			8.6	71.4	20			37.5	58.3	4.2		27.7			
Total %	5.8	9.8	2.9		18.5	2.3	19.7	11.6		33.5	1.7	14.5	4		20.2	10.4	16.2	1.2			7	93	

Peak Hour Analysis From 04:00 PM to 04:45 PM - Peak 1 of 1
 Peak Hour for Entire Intersection Begins at 04:00 PM

Start Time	Sycamore Canyon Boulevard Southbound				Eastridge Avenue Westbound				Sycamore Canyon Boulevard Northbound				Eastridge Avenue Eastbound										
	Left	Thru	Right	RTOR	App. Total	Left	Thru	Right	RTOR	App. Total	Left	Thru	Right	RTOR	App. Total	Left	Thru	Right	RTOR	App. Total	Exclu. Total	Inclu. Total	Int. Total
04:00 PM	1	2	2	1	5	1	4	7	3	12	0	8	1	1	9	2	5	0	0	7	5	33	38
04:15 PM	1	2	1	1	4	2	1	3	0	6	1	2	0	0	3	5	3	1	1	9	2	22	24
04:30 PM	3	3	0	0	6	0	6	2	2	8	1	5	1	0	7	1	3	0	0	4	2	25	27
04:45 PM	1	4	0	0	5	0	6	2	0	8	0	2	1	0	3	2	5	0	0	7	0	23	23
Total	6	11	3	2	20	3	17	14	5	34	2	17	3	1	22	10	16	1	1	27	9	103	112
% App. Total	30	55	15			9.1	77.3	41.2			9.1	77.3	13.6			37	59.3	3.7					
PHF	.500	.688	.375		.833	.375	.708	.500		.708	.500	.531	.750		.611	.500	.800	.250				.750	.780

Counts Unlimited, Inc.
 PO Box 1178
 Corona, CA 92878
 (951)268-6268

City of Riverside
 N/S: Sycamore Canyon Boulevard
 E/W: Eastridge Avenue
 Weather: Clear

File Name : 01_RIV_Syc_Eastridge PM
 Site Code : 05122021
 Start Date : 1/13/2022
 Page No : 2

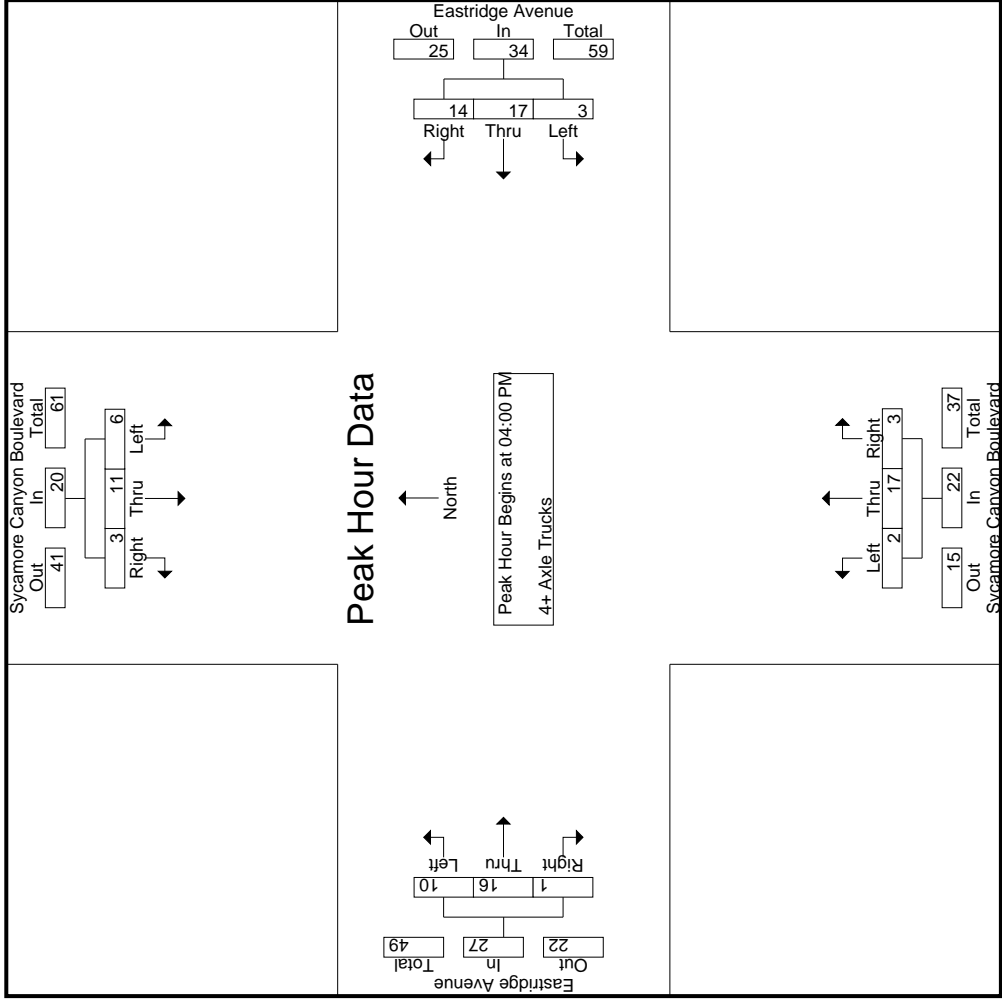

Counts Unlimited, Inc.
 PO Box 1178
 Corona, CA 92878
 (951)268-6268

City of Riverside
 N/S: Sycamore Canyon Boulevard
 E/W: Eastridge Avenue
 Weather: Clear

File Name : 01_RIV_Syc_Eastridge PM
 Site Code : 05122021
 Start Date : 1/13/2022
 Page No : 3

Start Time	Sycamore Canyon Boulevard Southbound			Eastridge Avenue Westbound			Sycamore Canyon Boulevard Northbound			Eastridge Avenue Eastbound						
	Left	Thru	Right	App. Total	Left	Thru	Right	App. Total	Left	Thru	Right	App. Total	Int. Total			
Peak Hour Analysis From 04:00 PM to 04:45 PM - Peak 1 of 1	Peak Hour for Each Approach Begins at:															
	04:00 PM				04:00 PM				04:00 PM							
+0 mins.	1	2	2	5	1	4	7	12	0	8	1	9	2	5	0	7
+15 mins.	1	2	1	4	2	1	3	6	1	2	0	3	5	3	1	9
+30 mins.	3	3	0	6	0	6	2	8	1	5	1	7	1	3	0	4
+45 mins.	1	4	0	5	0	6	2	8	0	2	1	3	2	5	0	7
Total Volume	6	11	3	20	3	17	14	34	2	17	3	22	10	16	1	27
% App. Total	30	55	15		8.8	50	41.2		9.1	77.3	13.6		37	59.3	3.7	
PHF	.500	.688	.375	.833	.375	.708	.500	.708	.500	.531	.750	.611	.500	.800	.250	.750

Location: Riverside
 N/S: Sycamore Canyon Blvd
 E/W: Eastridge Avenue



Date: 1/13/2022
 Day: Thursday

PEDESTRIANS

	North Leg Sycamore Canyon Blvd Pedestrians	East Leg Eastridge Avenue Pedestrians	South Leg Sycamore Canyon Blvd Pedestrians	West Leg Eastridge Avenue Pedestrians	
7:00 AM	0	0	0	0	0
7:15 AM	0	0	1	0	1
7:30 AM	0	0	0	0	0
7:45 AM	0	0	0	0	0
8:00 AM	0	0	0	0	0
8:15 AM	0	0	0	0	0
8:30 AM	0	0	0	0	0
8:45 AM	0	0	0	0	0
TOTAL VOLUMES:	0	0	1	0	1

	North Leg Sycamore Canyon Blvd Pedestrians	East Leg Eastridge Avenue Pedestrians	South Leg Sycamore Canyon Blvd Pedestrians	West Leg Eastridge Avenue Pedestrians	
4:00 PM	0	0	0	1	1
4:15 PM	1	0	1	0	2
4:30 PM	0	0	0	0	0
4:45 PM	0	0	0	0	0
5:00 PM	0	0	0	0	0
5:15 PM	0	0	0	0	0
5:30 PM	1	0	0	0	1
5:45 PM	0	0	0	0	0
TOTAL VOLUMES:	2	0	1	1	4

Location: Riverside
 N/S: Sycamore Canyon Blvd
 E/W: Eastridge Avenue



Date: 1/13/2022
 Day: Thursday

BICYCLES

	Southbound Sycamore Canyon Blvd			Westbound Eastridge Avenue			Northbound Sycamore Canyon Blvd			Eastbound Eastridge Avenue			
	Left	Thru	Right	Left	Thru	Right	Left	Thru	Right	Left	Thru	Right	
7:00 AM	0	1	0	0	0	0	0	0	0	0	0	0	1
7:15 AM	0	0	0	0	0	0	0	0	0	0	0	0	0
7:30 AM	0	0	0	0	0	0	0	0	0	0	0	0	0
7:45 AM	0	0	0	0	0	0	0	1	0	0	0	0	1
8:00 AM	0	0	0	0	0	0	0	0	0	0	0	0	0
8:15 AM	0	0	0	0	0	0	0	0	0	0	0	0	0
8:30 AM	0	0	0	0	0	0	0	0	0	0	0	0	0
8:45 AM	0	0	0	0	0	0	0	1	0	0	0	0	1
TOTAL VOLUMES:	0	1	0	0	0	0	0	2	0	0	0	0	3

	Southbound Sycamore Canyon Blvd			Westbound Eastridge Avenue			Northbound Sycamore Canyon Blvd			Eastbound Eastridge Avenue			
	Left	Thru	Right	Left	Thru	Right	Left	Thru	Right	Left	Thru	Right	
4:00 PM	0	0	0	0	0	0	0	0	0	0	0	0	0
4:15 PM	0	0	0	0	0	0	0	0	0	0	0	0	0
4:30 PM	0	0	0	0	0	0	0	1	0	0	0	0	1
4:45 PM	1	0	0	0	0	0	0	0	0	0	0	0	1
5:00 PM	0	0	0	0	0	0	0	1	0	0	0	0	1
5:15 PM	0	0	0	0	0	0	0	0	0	0	0	0	0
5:30 PM	0	0	0	0	0	0	0	0	0	0	0	0	0
5:45 PM	0	0	0	0	0	0	0	0	0	0	0	0	0
TOTAL VOLUMES:	1	0	0	0	0	0	0	2	0	0	0	0	3

City of Riverside
 N/S: Sycamore Canyon Boulevard
 E/W: Cottonwood Avenue
 Weather: Clear

File Name : 02_RIV_Syc_Cotton AM
 Site Code : 05122021
 Start Date : 1/13/2022
 Page No : 1

Groups Printed- Passenger Vehicles - Large 2 Axle Vehicles - 3 Axle Vehicles - 4+ Axle Trucks

Start Time	Sycamore Canyon Boulevard Southbound			Cottonwood Avenue Westbound				Sycamore Canyon Boulevard Northbound				Exclu. Total	Inclu. Total	Int. Total
	Left	Thru	App. Total	Left	Right	RTOR	App. Total	Thru	Right	RTOR	App. Total			
07:00 AM	20	56	76	4	5	3	9	163	2	0	165	3	250	253
07:15 AM	7	51	58	2	5	5	7	169	5	0	174	5	239	244
07:30 AM	13	37	50	1	4	4	5	180	4	1	184	5	239	244
07:45 AM	8	55	63	4	5	2	9	220	6	0	226	2	298	300
Total	48	199	247	11	19	14	30	732	17	1	749	15	1026	1041
08:00 AM	8	52	60	4	6	3	10	171	4	0	175	3	245	248
08:15 AM	7	48	55	6	3	1	9	155	5	0	160	1	224	225
08:30 AM	6	48	54	4	10	8	14	122	3	0	125	8	193	201
08:45 AM	13	46	59	4	4	3	8	110	5	0	115	3	182	185
Total	34	194	228	18	23	15	41	558	17	0	575	15	844	859
Grand Total	82	393	475	29	42	29	71	1290	34	1	1324	30	1870	1900
Apprch %	17.3	82.7		40.8	59.2			97.4	2.6					
Total %	4.4	21	25.4	1.6	2.2		3.8	69	1.8		70.8	1.6	98.4	
Passenger Vehicles	41	363	404	16	12		38	1193	24		1218	0	0	1660
% Passenger Vehicles	50	92.4	85.1	55.2	28.6	34.5	38	92.5	70.6	100	91.9	0	0	87.4
Large 2 Axle Vehicles	9	9	18	3	6		13	38	2		40	0	0	71
% Large 2 Axle Vehicles	11	2.3	3.8	10.3	14.3	13.8	13	2.9	5.9	0	3	0	0	3.7
3 Axle Vehicles	4	3	7	1	3		7	10	1		11	0	0	25
% 3 Axle Vehicles	4.9	0.8	1.5	3.4	7.1	10.3	7	0.8	2.9	0	0.8	0	0	1.3
4+ Axle Trucks	28	18	46	9	21		42	49	7		56	0	0	144
% 4+ Axle Trucks	34.1	4.6	9.7	31	50	41.4	42	3.8	20.6	0	4.2	0	0	7.6

Start Time	Sycamore Canyon Boulevard Southbound			Cottonwood Avenue Westbound			Sycamore Canyon Boulevard Northbound			Int. Total
	Left	Thru	App. Total	Left	Right	App. Total	Thru	Right	App. Total	
07:00 AM	20	56	76	4	5	9	163	2	165	250
07:15 AM	7	51	58	2	5	7	169	5	174	239
07:30 AM	13	37	50	1	4	5	180	4	184	239
07:45 AM	8	55	63	4	5	9	220	6	226	298
Total Volume	48	199	247	11	19	30	732	17	749	1026
% App. Total	19.4	80.6		36.7	63.3		97.7	2.3		
PHF	.600	.888	.813	.688	.950	.833	.832	.708	.829	.861

Peak Hour Analysis From 07:00 AM to 08:45 AM - Peak 1 of 1
 Peak Hour for Entire Intersection Begins at 07:00 AM

City of Riverside
 N/S: Sycamore Canyon Boulevard
 E/W: Cottonwood Avenue
 Weather: Clear

File Name : 02_RIV_Syc_Cotton AM
 Site Code : 05122021
 Start Date : 1/13/2022
 Page No : 2

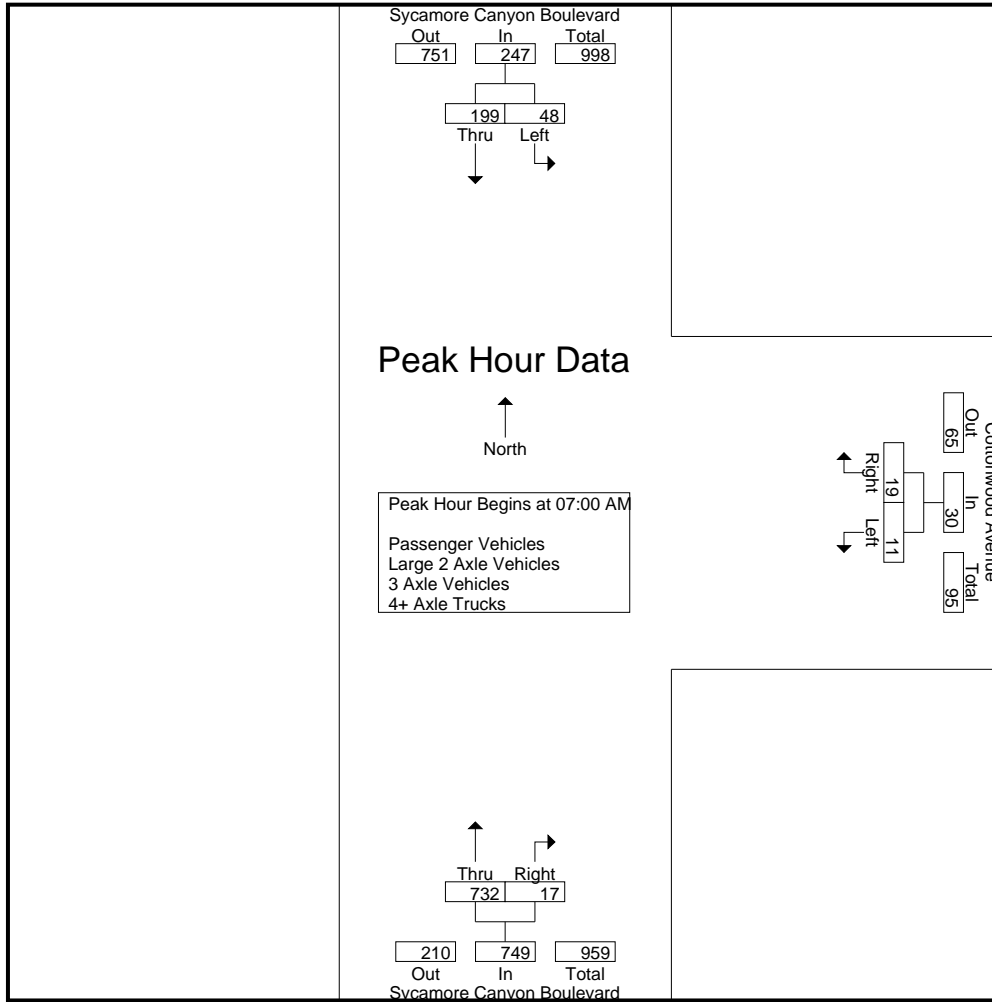

Peak Hour Analysis From 07:00 AM to 08:45 AM - Peak 1 of 1
 Peak Hour for Each Approach Begins at:

	07:00 AM			07:45 AM			07:15 AM		
+0 mins.	20	56	76	4	5	9	169	5	174
+15 mins.	7	51	58	4	6	10	180	4	184
+30 mins.	13	37	50	6	3	9	220	6	226
+45 mins.	8	55	63	4	10	14	171	4	175
Total Volume	48	199	247	18	24	42	740	19	759
% App. Total	19.4	80.6		42.9	57.1		97.5	2.5	
PHF	.600	.888	.813	.750	.600	.750	.841	.792	.840

City of Riverside
 N/S: Sycamore Canyon Boulevard
 E/W: Cottonwood Avenue
 Weather: Clear

File Name : 02_RIV_Syc_Cotton AM
 Site Code : 05122021
 Start Date : 1/13/2022
 Page No : 1

Groups Printed- Passenger Vehicles

Start Time	Sycamore Canyon Boulevard Southbound			Cottonwood Avenue Westbound				Sycamore Canyon Boulevard Northbound				Exclu. Total	Inclu. Total	Int. Total
	Left	Thru	App. Total	Left	Right	RTOR	App. Total	Thru	Right	RTOR	App. Total			
07:00 AM	14	53	67	2	2	2	4	154	2	0	156	2	227	229
07:15 AM	4	49	53	1	4	4	5	163	3	0	166	4	224	228
07:30 AM	5	34	39	1	1	1	2	167	4	1	171	2	212	214
07:45 AM	4	52	56	2	3	1	5	199	6	0	205	1	266	267
Total	27	188	215	6	10	8	16	683	15	1	698	9	929	938
08:00 AM	3	46	49	3	0	0	3	160	4	0	164	0	216	216
08:15 AM	3	42	45	4	0	0	4	137	3	0	140	0	189	189
08:30 AM	1	43	44	2	2	2	4	111	0	0	111	2	159	161
08:45 AM	7	44	51	1	0	0	1	102	2	0	104	0	156	156
Total	14	175	189	10	2	2	12	510	9	0	519	2	720	722
Grand Total	41	363	404	16	12	10	28	1193	24	1	1217	11	1649	1660
Apprch %	10.1	89.9		57.1	42.9			98	2					
Total %	2.5	22	24.5	1	0.7		1.7	72.3	1.5		73.8	0.7	99.3	

Start Time	Sycamore Canyon Boulevard Southbound			Cottonwood Avenue Westbound			Sycamore Canyon Boulevard Northbound			Int. Total
	Left	Thru	App. Total	Left	Right	App. Total	Thru	Right	App. Total	
07:00 AM	14	53	67	2	2	4	154	2	156	227
07:15 AM	4	49	53	1	4	5	163	3	166	224
07:30 AM	5	34	39	1	1	2	167	4	171	212
07:45 AM	4	52	56	2	3	5	199	6	205	266
Total Volume	27	188	215	6	10	16	683	15	698	929
% App. Total	12.6	87.4		37.5	62.5		97.9	2.1		
PHF	.482	.887	.802	.750	.625	.800	.858	.625	.851	.873

Peak Hour Analysis From 07:00 AM to 07:45 AM - Peak 1 of 1
 Peak Hour for Entire Intersection Begins at 07:00 AM

City of Riverside
 N/S: Sycamore Canyon Boulevard
 E/W: Cottonwood Avenue
 Weather: Clear

File Name : 02_RIV_Syc_Cotton AM
 Site Code : 05122021
 Start Date : 1/13/2022
 Page No : 2

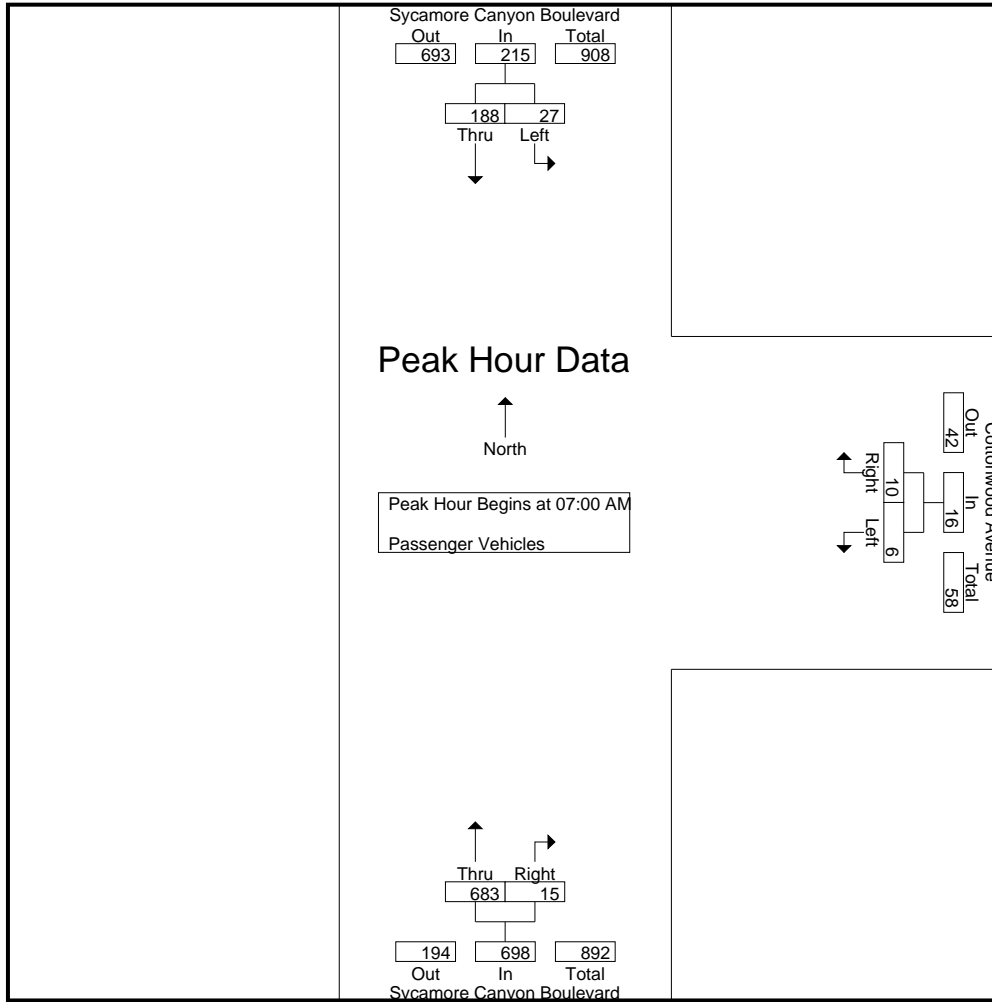

Peak Hour Analysis From 07:00 AM to 07:45 AM - Peak 1 of 1
 Peak Hour for Each Approach Begins at:

	07:00 AM			07:00 AM			07:00 AM		
+0 mins.	14	53	67	2	2	4	154	2	156
+15 mins.	4	49	53	1	4	5	163	3	166
+30 mins.	5	34	39	1	1	2	167	4	171
+45 mins.	4	52	56	2	3	5	199	6	205
Total Volume	27	188	215	6	10	16	683	15	698
% App. Total	12.6	87.4		37.5	62.5		97.9	2.1	
PHF	.482	.887	.802	.750	.625	.800	.858	.625	.851

City of Riverside
 N/S: Sycamore Canyon Boulevard
 E/W: Cottonwood Avenue
 Weather: Clear

File Name : 02_RIV_Syc_Cotton AM
 Site Code : 05122021
 Start Date : 1/13/2022
 Page No : 1

Groups Printed- Large 2 Axle Vehicles

Start Time	Sycamore Canyon Boulevard Southbound			Cottonwood Avenue Westbound				Sycamore Canyon Boulevard Northbound				Exclu. Total	Inclu. Total	Int. Total
	Left	Thru	App. Total	Left	Right	RTOR	App. Total	Thru	Right	RTOR	App. Total			
07:00 AM	3	1	4	0	0	0	0	2	0	0	2	0	6	6
07:15 AM	1	0	1	0	1	1	1	2	0	0	2	1	4	5
07:30 AM	1	1	2	0	0	0	0	5	0	0	5	0	7	7
07:45 AM	0	1	1	0	1	1	1	9	0	0	9	1	11	12
Total	5	3	8	0	2	2	2	18	0	0	18	2	28	30
08:00 AM	3	2	5	1	3	1	4	7	0	0	7	1	16	17
08:15 AM	0	3	3	0	0	0	0	4	0	0	4	0	7	7
08:30 AM	0	1	1	0	0	0	0	6	0	0	6	0	7	7
08:45 AM	1	0	1	2	1	1	3	3	2	0	5	1	9	10
Total	4	6	10	3	4	2	7	20	2	0	22	2	39	41
Grand Total	9	9	18	3	6	4	9	38	2	0	40	4	67	71
Apprch %	50	50		33.3	66.7			95	5					
Total %	13.4	13.4	26.9	4.5	9		13.4	56.7	3		59.7	5.6	94.4	

Start Time	Sycamore Canyon Boulevard Southbound			Cottonwood Avenue Westbound			Sycamore Canyon Boulevard Northbound			Int. Total
	Left	Thru	App. Total	Left	Right	App. Total	Thru	Right	App. Total	
07:00 AM	3	1	4	0	0	0	2	0	2	6
07:15 AM	1	0	1	0	1	1	2	0	2	4
07:30 AM	1	1	2	0	0	0	5	0	5	7
07:45 AM	0	1	1	0	1	1	9	0	9	11
Total Volume	5	3	8	0	2	2	18	0	18	28
% App. Total	62.5	37.5		0	100		100	0		
PHF	.417	.750	.500	.000	.500	.500	.500	.000	.500	.636

Peak Hour Analysis From 07:00 AM to 07:45 AM - Peak 1 of 1
 Peak Hour for Entire Intersection Begins at 07:00 AM

City of Riverside
 N/S: Sycamore Canyon Boulevard
 E/W: Cottonwood Avenue
 Weather: Clear

File Name : 02_RIV_Syc_Cotton AM
 Site Code : 05122021
 Start Date : 1/13/2022
 Page No : 2

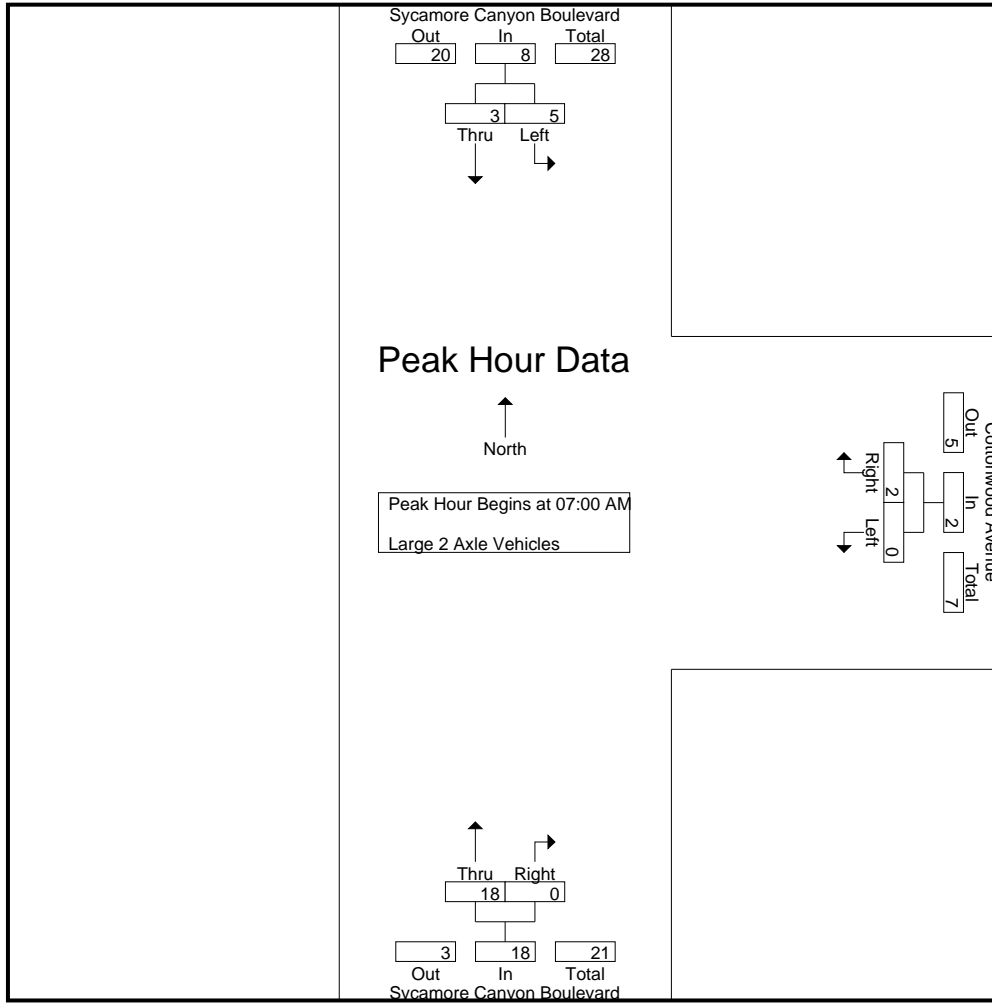

Peak Hour Analysis From 07:00 AM to 07:45 AM - Peak 1 of 1
 Peak Hour for Each Approach Begins at:

	07:00 AM			07:00 AM			07:00 AM		
+0 mins.	3	1	4	0	0	0	2	0	2
+15 mins.	1	0	1	0	1	1	2	0	2
+30 mins.	1	1	2	0	0	0	5	0	5
+45 mins.	0	1	1	0	1	1	9	0	9
Total Volume	5	3	8	0	2	2	18	0	18
% App. Total	62.5	37.5		0	100		100	0	
PHF	.417	.750	.500	.000	.500	.500	.500	.000	.500

City of Riverside
 N/S: Sycamore Canyon Boulevard
 E/W: Cottonwood Avenue
 Weather: Clear

File Name : 02_RIV_Syc_Cotton AM
 Site Code : 05122021
 Start Date : 1/13/2022
 Page No : 1

Groups Printed- 3 Axle Vehicles

Start Time	Sycamore Canyon Boulevard Southbound			Cottonwood Avenue Westbound				Sycamore Canyon Boulevard Northbound				Exclu. Total	Inclu. Total	Int. Total
	Left	Thru	App. Total	Left	Right	RTOR	App. Total	Thru	Right	RTOR	App. Total			
07:00 AM	0	0	0	0	0	0	0	2	0	0	2	0	0	2
07:15 AM	0	0	0	0	0	0	0	1	0	0	1	0	0	1
07:30 AM	2	0	2	0	0	0	0	1	0	0	1	0	0	3
07:45 AM	0	1	1	0	0	0	0	2	0	0	2	0	0	3
Total	2	1	3	0	0	0	0	6	0	0	6	0	0	9
08:00 AM	0	0	0	0	0	0	0	0	0	0	0	0	0	0
08:15 AM	1	0	1	1	1	1	2	3	1	0	4	1	0	8
08:30 AM	1	2	3	0	2	2	2	1	0	0	1	2	0	8
08:45 AM	0	0	0	0	0	0	0	0	0	0	0	0	0	0
Total	2	2	4	1	3	3	4	4	1	0	5	3	0	16
Grand Total	4	3	7	1	3	3	4	10	1	0	11	3	0	25
Apprch %	57.1	42.9		25	75			90.9	9.1					
Total %	18.2	13.6	31.8	4.5	13.6		18.2	45.5	4.5		50	12		88

Start Time	Sycamore Canyon Boulevard Southbound			Cottonwood Avenue Westbound			Sycamore Canyon Boulevard Northbound			Int. Total
	Left	Thru	App. Total	Left	Right	App. Total	Thru	Right	App. Total	
07:00 AM	0	0	0	0	0	0	2	0	2	2
07:15 AM	0	0	0	0	0	0	1	0	1	1
07:30 AM	2	0	2	0	0	0	1	0	1	3
07:45 AM	0	1	1	0	0	0	2	0	2	3
Total Volume	2	1	3	0	0	0	6	0	6	9
% App. Total	66.7	33.3		0	0	0	100	0		
PHF	.250	.250	.375	.000	.000	.000	.750	.000	.750	.750

Peak Hour Analysis From 07:00 AM to 07:45 AM - Peak 1 of 1
 Peak Hour for Entire Intersection Begins at 07:00 AM

City of Riverside
 N/S: Sycamore Canyon Boulevard
 E/W: Cottonwood Avenue
 Weather: Clear

File Name : 02_RIV_Syc_Cotton AM
 Site Code : 05122021
 Start Date : 1/13/2022
 Page No : 2

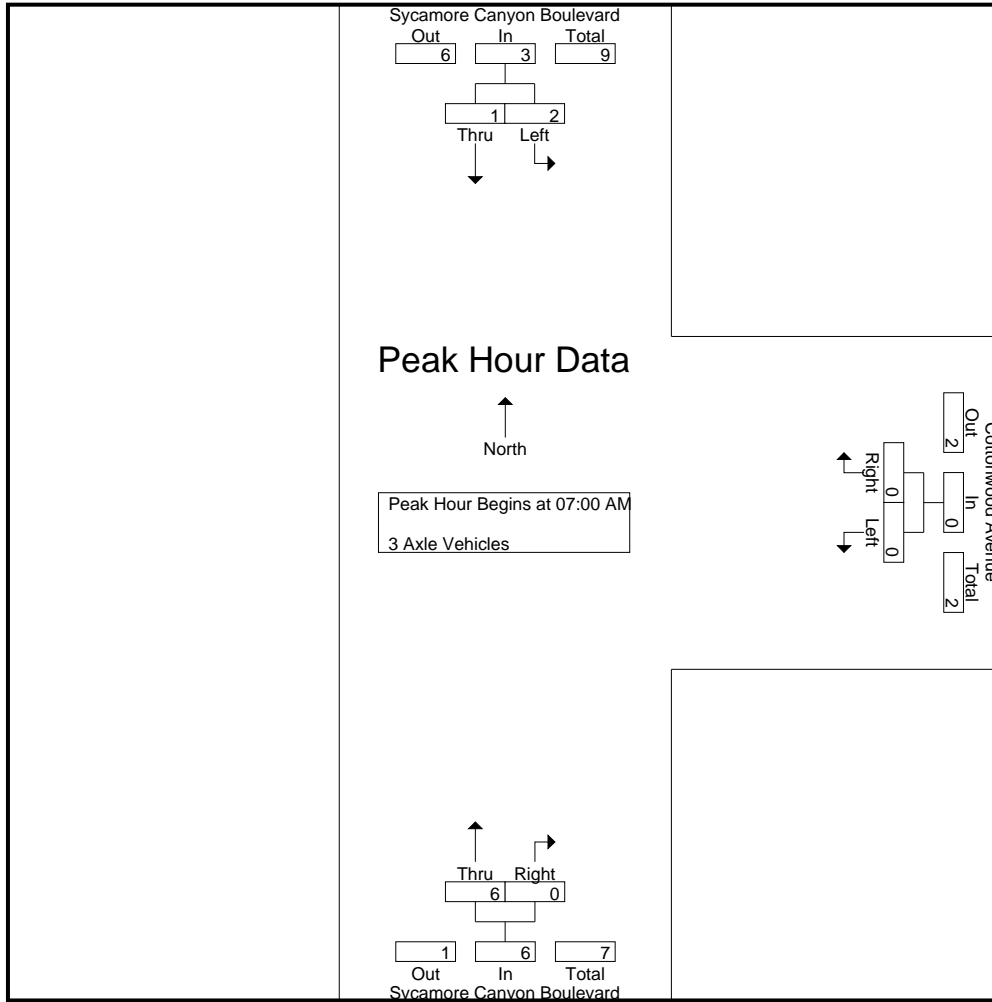

Peak Hour Analysis From 07:00 AM to 07:45 AM - Peak 1 of 1
 Peak Hour for Each Approach Begins at:

	07:00 AM			07:00 AM			07:00 AM		
+0 mins.	0	0	0	0	0	0	2	0	2
+15 mins.	0	0	0	0	0	0	1	0	1
+30 mins.	2	0	2	0	0	0	1	0	1
+45 mins.	0	1	1	0	0	0	2	0	2
Total Volume	2	1	3	0	0	0	6	0	6
% App. Total	66.7	33.3		0	0		100	0	
PHF	.250	.250	.375	.000	.000	.000	.750	.000	.750

City of Riverside
 N/S: Sycamore Canyon Boulevard
 E/W: Cottonwood Avenue
 Weather: Clear

File Name : 02_RIV_Syc_Cotton AM
 Site Code : 05122021
 Start Date : 1/13/2022
 Page No : 1

Groups Printed- 4+ Axle Trucks

Start Time	Sycamore Canyon Boulevard Southbound			Cottonwood Avenue Westbound				Sycamore Canyon Boulevard Northbound				Exclu. Total	Inclu. Total	Int. Total
	Left	Thru	App. Total	Left	Right	RTOR	App. Total	Thru	Right	RTOR	App. Total			
07:00 AM	3	2	5	2	3	1	5	5	0	0	5	1	15	16
07:15 AM	2	2	4	1	0	0	1	3	2	0	5	0	10	10
07:30 AM	5	2	7	0	3	3	3	7	0	0	7	3	17	20
07:45 AM	4	1	5	2	1	0	3	10	0	0	10	0	18	18
Total	14	7	21	5	7	4	12	25	2	0	27	4	60	64
08:00 AM	2	4	6	0	3	2	3	4	0	0	4	2	13	15
08:15 AM	3	3	6	1	2	0	3	11	1	0	12	0	21	21
08:30 AM	4	2	6	2	6	4	8	4	3	0	7	4	21	25
08:45 AM	5	2	7	1	3	2	4	5	1	0	6	2	17	19
Total	14	11	25	4	14	8	18	24	5	0	29	8	72	80
Grand Total	28	18	46	9	21	12	30	49	7	0	56	12	132	144
Apprch %	60.9	39.1		30	70			87.5	12.5					
Total %	21.2	13.6	34.8	6.8	15.9		22.7	37.1	5.3		42.4	8.3	91.7	

Start Time	Sycamore Canyon Boulevard Southbound			Cottonwood Avenue Westbound			Sycamore Canyon Boulevard Northbound			Int. Total
	Left	Thru	App. Total	Left	Right	App. Total	Thru	Right	App. Total	
07:00 AM	3	2	5	2	3	5	5	0	5	15
07:15 AM	2	2	4	1	0	1	3	2	5	10
07:30 AM	5	2	7	0	3	3	7	0	7	17
07:45 AM	4	1	5	2	1	3	10	0	10	18
Total Volume	14	7	21	5	7	12	25	2	27	60
% App. Total	66.7	33.3		41.7	58.3		92.6	7.4		
PHF	.700	.875	.750	.625	.583	.600	.625	.250	.675	.833

Peak Hour Analysis From 07:00 AM to 07:45 AM - Peak 1 of 1
 Peak Hour for Entire Intersection Begins at 07:00 AM

City of Riverside
 N/S: Sycamore Canyon Boulevard
 E/W: Cottonwood Avenue
 Weather: Clear

File Name : 02_RIV_Syc_Cotton AM
 Site Code : 05122021
 Start Date : 1/13/2022
 Page No : 2

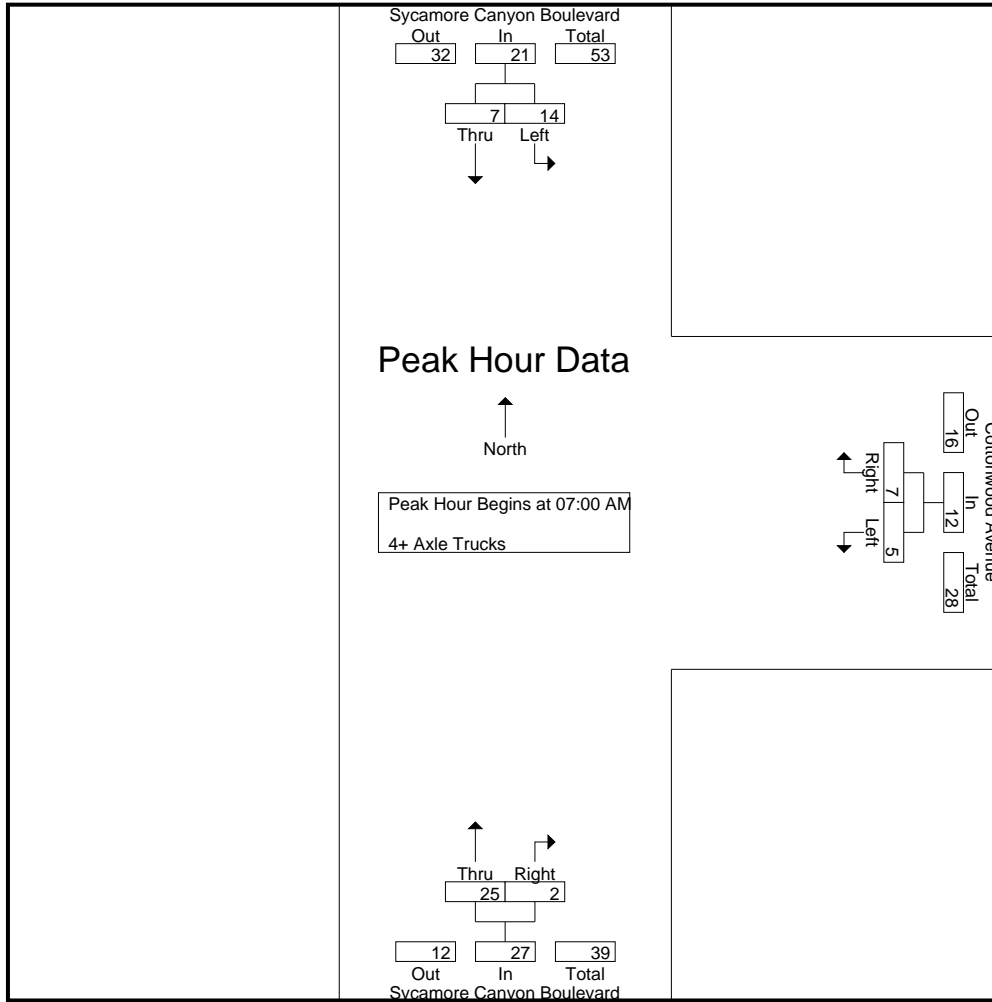

Peak Hour Analysis From 07:00 AM to 07:45 AM - Peak 1 of 1
 Peak Hour for Each Approach Begins at:

	07:00 AM			07:00 AM			07:00 AM		
+0 mins.	3	2	5	2	3	5	5	0	5
+15 mins.	2	2	4	1	0	1	3	2	5
+30 mins.	5	2	7	0	3	3	7	0	7
+45 mins.	4	1	5	2	1	3	10	0	10
Total Volume	14	7	21	5	7	12	25	2	27
% App. Total	66.7	33.3		41.7	58.3		92.6	7.4	
PHF	.700	.875	.750	.625	.583	.600	.625	.250	.675

City of Riverside
 N/S: Sycamore Canyon Boulevard
 E/W: Cottonwood Avenue
 Weather: Clear

File Name : 02_RIV_Syc_Cotton PM
 Site Code : 05122021
 Start Date : 1/13/2022
 Page No : 1

Groups Printed- Passenger Vehicles - Large 2 Axle Vehicles - 3 Axle Vehicles - 4+ Axle Trucks

Start Time	Sycamore Canyon Boulevard Southbound			Cottonwood Avenue Westbound				Sycamore Canyon Boulevard Northbound				Exclu. Total	Inclu. Total	Int. Total
	Left	Thru	App. Total	Left	Right	RTOR	App. Total	Thru	Right	RTOR	App. Total			
04:00 PM	9	126	135	10	1	1	11	216	9	0	225	1	371	372
04:15 PM	8	113	121	4	3	3	7	185	3	0	188	3	316	319
04:30 PM	2	135	137	4	3	3	7	136	3	0	139	3	283	286
04:45 PM	10	154	164	5	2	2	7	130	6	1	136	3	307	310
Total	29	528	557	23	9	9	32	667	21	1	688	10	1277	1287
05:00 PM	7	154	161	6	5	4	11	111	5	0	116	4	288	292
05:15 PM	6	146	152	3	3	1	6	88	2	0	90	1	248	249
05:30 PM	11	133	144	6	3	3	9	103	6	0	109	3	262	265
05:45 PM	3	134	137	5	2	1	7	97	5	0	102	1	246	247
Total	27	567	594	20	13	9	33	399	18	0	417	9	1044	1053
Grand Total	56	1095	1151	43	22	18	65	1066	39	1	1105	19	2321	2340
Apprch %	4.9	95.1		66.2	33.8			96.5	3.5					
Total %	2.4	47.2	49.6	1.9	0.9		2.8	45.9	1.7		47.6	0.8	99.2	
Passenger Vehicles	41	1065	1106	37	12		59	1005	36		1042	0	0	2207
% Passenger Vehicles	73.2	97.3	96.1	86	54.5	55.6	71.1	94.3	92.3	100	94.2	0	0	94.3
Large 2 Axle Vehicles	1	15	16	1	1		3	26	0		26	0	0	45
% Large 2 Axle Vehicles	1.8	1.4	1.4	2.3	4.5	5.6	3.6	2.4	0	0	2.4	0	0	1.9
3 Axle Vehicles	2	3	5	0	2		3	11	0		11	0	0	19
% 3 Axle Vehicles	3.6	0.3	0.4	0	9.1	5.6	3.6	1	0	0	1	0	0	0.8
4+ Axle Trucks	12	12	24	5	7		18	24	3		27	0	0	69
% 4+ Axle Trucks	21.4	1.1	2.1	11.6	31.8	33.3	21.7	2.3	7.7	0	2.4	0	0	2.9

Start Time	Sycamore Canyon Boulevard Southbound			Cottonwood Avenue Westbound			Sycamore Canyon Boulevard Northbound			Int. Total
	Left	Thru	App. Total	Left	Right	App. Total	Thru	Right	App. Total	
04:00 PM	9	126	135	10	1	11	216	9	225	371
04:15 PM	8	113	121	4	3	7	185	3	188	316
04:30 PM	2	135	137	4	3	7	136	3	139	283
04:45 PM	10	154	164	5	2	7	130	6	136	307
Total Volume	29	528	557	23	9	32	667	21	688	1277
% App. Total	5.2	94.8		71.9	28.1		96.9	3.1		
PHF	.725	.857	.849	.575	.750	.727	.772	.583	.764	.861

Peak Hour Analysis From 04:00 PM to 05:45 PM - Peak 1 of 1
 Peak Hour for Entire Intersection Begins at 04:00 PM

City of Riverside
 N/S: Sycamore Canyon Boulevard
 E/W: Cottonwood Avenue
 Weather: Clear

File Name : 02_RIV_Syc_Cotton PM
 Site Code : 05122021
 Start Date : 1/13/2022
 Page No : 2

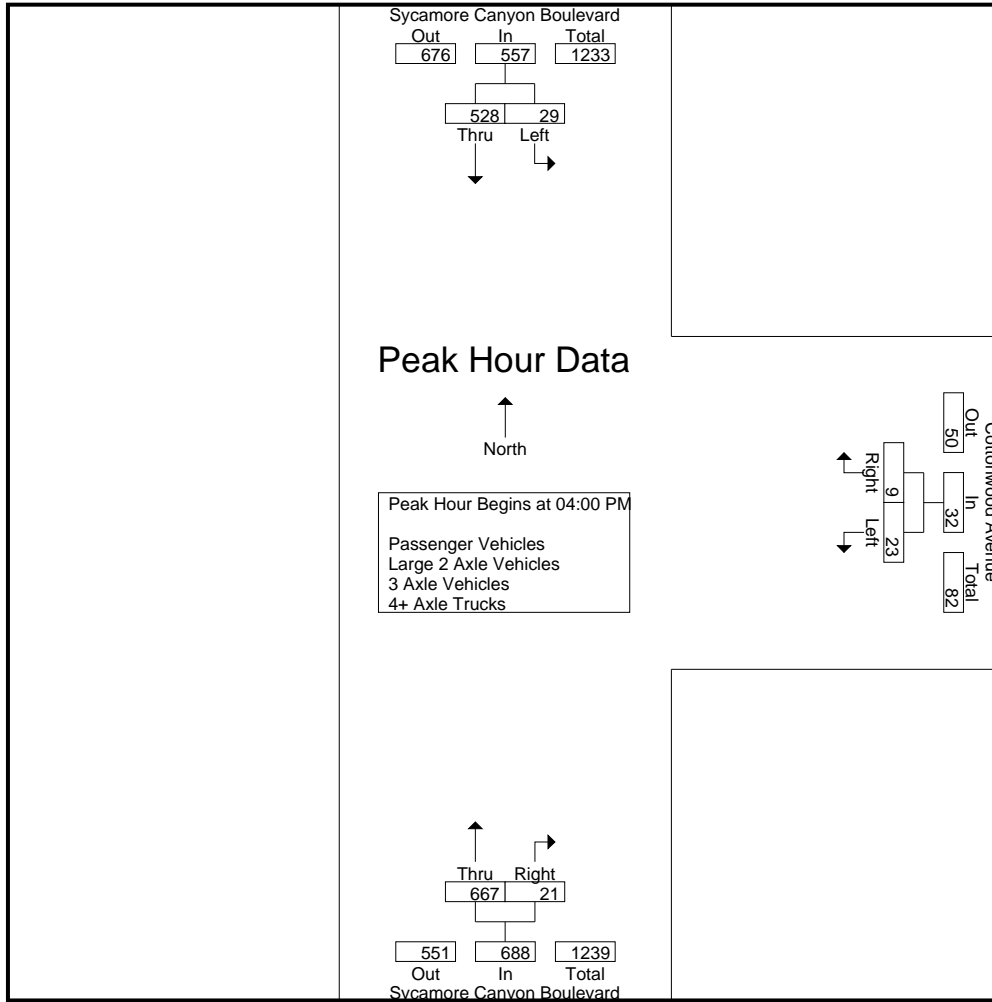

Peak Hour Analysis From 04:00 PM to 05:45 PM - Peak 1 of 1
 Peak Hour for Each Approach Begins at:

	04:45 PM			04:45 PM			04:00 PM		
+0 mins.	10	154	164	5	2	7	216	9	225
+15 mins.	7	154	161	6	5	11	185	3	188
+30 mins.	6	146	152	3	3	6	136	3	139
+45 mins.	11	133	144	6	3	9	130	6	136
Total Volume	34	587	621	20	13	33	667	21	688
% App. Total	5.5	94.5		60.6	39.4		96.9	3.1	
PHF	.773	.953	.947	.833	.650	.750	.772	.583	.764

City of Riverside
 N/S: Sycamore Canyon Boulevard
 E/W: Cottonwood Avenue
 Weather: Clear

File Name : 02_RIV_Syc_Cotton PM
 Site Code : 05122021
 Start Date : 1/13/2022
 Page No : 1

Groups Printed- Passenger Vehicles

Start Time	Sycamore Canyon Boulevard Southbound			Cottonwood Avenue Westbound				Sycamore Canyon Boulevard Northbound				Exclu. Total	Inclu. Total	Int. Total
	Left	Thru	App. Total	Left	Right	RTOR	App. Total	Thru	Right	RTOR	App. Total			
04:00 PM	8	122	130	7	1	1	8	199	8	0	207	1	345	346
04:15 PM	5	109	114	3	1	1	4	170	3	0	173	1	291	292
04:30 PM	1	133	134	4	1	1	5	128	3	0	131	1	270	271
04:45 PM	7	151	158	4	1	1	5	122	5	1	127	2	290	292
Total	21	515	536	18	4	4	22	619	19	1	638	5	1196	1201
05:00 PM	7	149	156	6	3	2	9	107	5	0	112	2	277	279
05:15 PM	3	144	147	3	1	0	4	84	2	0	86	0	237	237
05:30 PM	8	128	136	6	3	3	9	102	5	0	107	3	252	255
05:45 PM	2	129	131	4	1	1	5	93	5	0	98	1	234	235
Total	20	550	570	19	8	6	27	386	17	0	403	6	1000	1006
Grand Total	41	1065	1106	37	12	10	49	1005	36	1	1041	11	2196	2207
Apprch %	3.7	96.3		75.5	24.5			96.5	3.5					
Total %	1.9	48.5	50.4	1.7	0.5		2.2	45.8	1.6		47.4	0.5	99.5	

Start Time	Sycamore Canyon Boulevard Southbound			Cottonwood Avenue Westbound			Sycamore Canyon Boulevard Northbound			Int. Total
	Left	Thru	App. Total	Left	Right	App. Total	Thru	Right	App. Total	
04:00 PM	8	122	130	7	1	8	199	8	207	345
04:15 PM	5	109	114	3	1	4	170	3	173	291
04:30 PM	1	133	134	4	1	5	128	3	131	270
04:45 PM	7	151	158	4	1	5	122	5	127	290
Total Volume	21	515	536	18	4	22	619	19	638	1196
% App. Total	3.9	96.1		81.8	18.2		97	3		
PHF	.656	.853	.848	.643	1.00	.688	.778	.594	.771	.867

Peak Hour Analysis From 04:00 PM to 04:45 PM - Peak 1 of 1
 Peak Hour for Entire Intersection Begins at 04:00 PM

City of Riverside
 N/S: Sycamore Canyon Boulevard
 E/W: Cottonwood Avenue
 Weather: Clear

File Name : 02_RIV_Syc_Cotton PM
 Site Code : 05122021
 Start Date : 1/13/2022
 Page No : 2

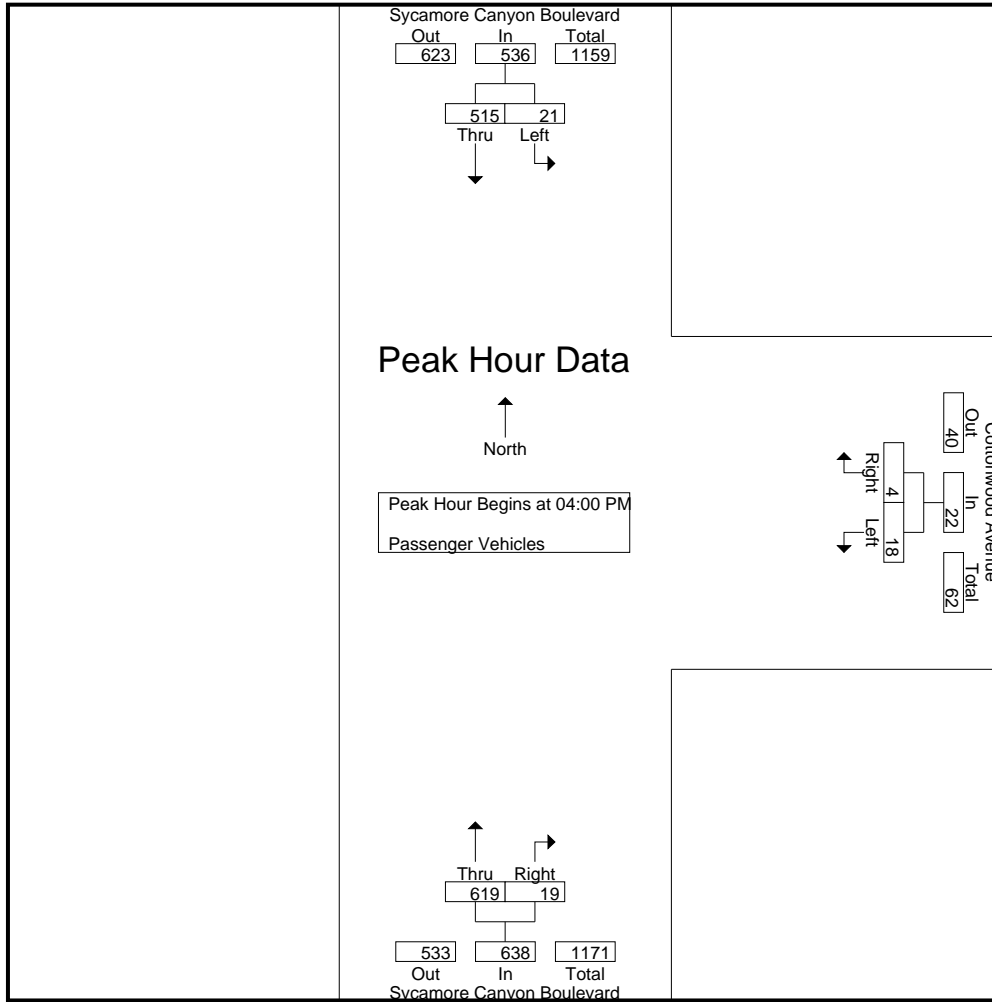

Peak Hour Analysis From 04:00 PM to 04:45 PM - Peak 1 of 1
 Peak Hour for Each Approach Begins at:

	04:00 PM			04:00 PM			04:00 PM		
+0 mins.	8	122	130	7	1	8	199	8	207
+15 mins.	5	109	114	3	1	4	170	3	173
+30 mins.	1	133	134	4	1	5	128	3	131
+45 mins.	7	151	158	4	1	5	122	5	127
Total Volume	21	515	536	18	4	22	619	19	638
% App. Total	3.9	96.1		81.8	18.2		97	3	
PHF	.656	.853	.848	.643	1.000	.688	.778	.594	.771

City of Riverside
 N/S: Sycamore Canyon Boulevard
 E/W: Cottonwood Avenue
 Weather: Clear

File Name : 02_RIV_Syc_Cotton PM
 Site Code : 05122021
 Start Date : 1/13/2022
 Page No : 1

Groups Printed- Large 2 Axle Vehicles

Start Time	Sycamore Canyon Boulevard Southbound			Cottonwood Avenue Westbound				Sycamore Canyon Boulevard Northbound				Exclu. Total	Inclu. Total	Int. Total
	Left	Thru	App. Total	Left	Right	RTOR	App. Total	Thru	Right	RTOR	App. Total			
04:00 PM	0	1	1	1	0	0	1	6	0	0	6	0	8	8
04:15 PM	0	2	2	0	1	1	1	8	0	0	8	1	11	12
04:30 PM	0	1	1	0	0	0	0	4	0	0	4	0	5	5
04:45 PM	1	2	3	0	0	0	0	2	0	0	2	0	5	5
Total	1	6	7	1	1	1	2	20	0	0	20	1	29	30
05:00 PM	0	3	3	0	0	0	0	3	0	0	3	0	6	6
05:15 PM	0	2	2	0	0	0	0	3	0	0	3	0	5	5
05:30 PM	0	1	1	0	0	0	0	0	0	0	0	0	1	1
05:45 PM	0	3	3	0	0	0	0	0	0	0	0	0	3	3
Total	0	9	9	0	0	0	0	6	0	0	6	0	15	15
Grand Total	1	15	16	1	1	1	2	26	0	0	26	1	44	45
Apprch %	6.2	93.8		50	50			100	0					
Total %	2.3	34.1	36.4	2.3	2.3		4.5	59.1	0		59.1	2.2	97.8	

Start Time	Sycamore Canyon Boulevard Southbound			Cottonwood Avenue Westbound			Sycamore Canyon Boulevard Northbound			Int. Total
	Left	Thru	App. Total	Left	Right	App. Total	Thru	Right	App. Total	
04:00 PM	0	1	1	1	0	1	6	0	6	8
04:15 PM	0	2	2	0	1	1	8	0	8	11
04:30 PM	0	1	1	0	0	0	4	0	4	5
04:45 PM	1	2	3	0	0	0	2	0	2	5
Total Volume	1	6	7	1	1	2	20	0	20	29
% App. Total	14.3	85.7		50	50		100	0		
PHF	.250	.750	.583	.250	.250	.500	.625	.000	.625	.659

Peak Hour Analysis From 04:00 PM to 04:45 PM - Peak 1 of 1
 Peak Hour for Entire Intersection Begins at 04:00 PM

City of Riverside
 N/S: Sycamore Canyon Boulevard
 E/W: Cottonwood Avenue
 Weather: Clear

File Name : 02_RIV_Syc_Cotton PM
 Site Code : 05122021
 Start Date : 1/13/2022
 Page No : 2

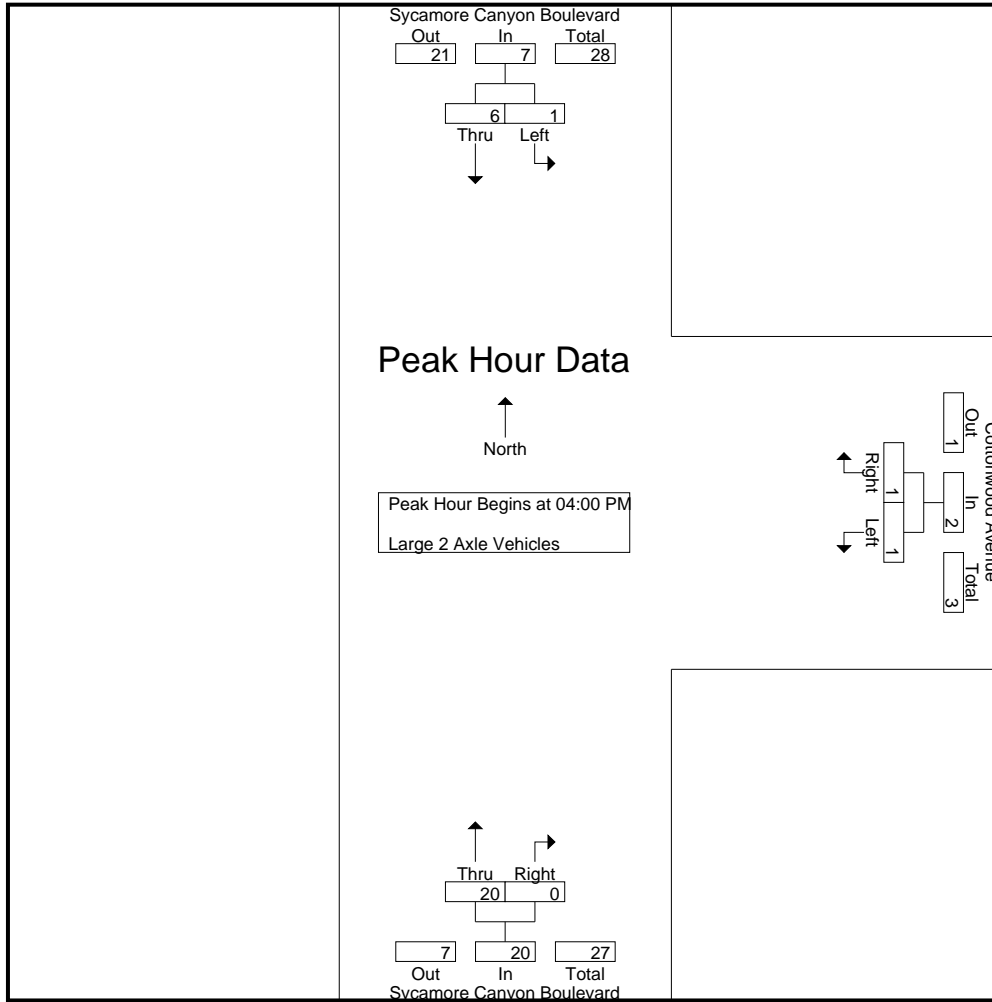

Peak Hour Analysis From 04:00 PM to 04:45 PM - Peak 1 of 1
 Peak Hour for Each Approach Begins at:

	04:00 PM			04:00 PM			04:00 PM		
+0 mins.	0	1	1	1	0	1	6	0	6
+15 mins.	0	2	2	0	1	1	8	0	8
+30 mins.	0	1	1	0	0	0	4	0	4
+45 mins.	1	2	3	0	0	0	2	0	2
Total Volume	1	6	7	1	1	2	20	0	20
% App. Total	14.3	85.7		50	50		100	0	
PHF	.250	.750	.583	.250	.250	.500	.625	.000	.625

City of Riverside
 N/S: Sycamore Canyon Boulevard
 E/W: Cottonwood Avenue
 Weather: Clear

File Name : 02_RIV_Syc_Cotton PM
 Site Code : 05122021
 Start Date : 1/13/2022
 Page No : 1

Groups Printed- 3 Axle Vehicles

Start Time	Sycamore Canyon Boulevard Southbound			Cottonwood Avenue Westbound				Sycamore Canyon Boulevard Northbound				Exclu. Total	Inclu. Total	Int. Total
	Left	Thru	App. Total	Left	Right	RTOR	App. Total	Thru	Right	RTOR	App. Total			
04:00 PM	0	0	0	0	0	0	0	2	0	0	2	0	2	2
04:15 PM	1	0	1	0	0	0	0	5	0	0	5	0	6	6
04:30 PM	0	0	0	0	1	1	1	1	0	0	1	1	2	3
04:45 PM	0	0	0	0	0	0	0	2	0	0	2	0	2	2
Total	1	0	1	0	1	1	1	10	0	0	10	1	12	13
05:00 PM	0	1	1	0	0	0	0	1	0	0	1	0	2	2
05:15 PM	1	0	1	0	1	0	1	0	0	0	0	0	2	2
05:30 PM	0	2	2	0	0	0	0	0	0	0	0	0	2	2
05:45 PM	0	0	0	0	0	0	0	0	0	0	0	0	0	0
Total	1	3	4	0	1	0	1	1	0	0	1	0	6	6
Grand Total	2	3	5	0	2	1	2	11	0	0	11	1	18	19
Apprch %	40	60		0	100			100	0					
Total %	11.1	16.7	27.8	0	11.1		11.1	61.1	0		61.1	5.3	94.7	

Start Time	Sycamore Canyon Boulevard Southbound			Cottonwood Avenue Westbound			Sycamore Canyon Boulevard Northbound			Int. Total
	Left	Thru	App. Total	Left	Right	App. Total	Thru	Right	App. Total	
04:00 PM	0	0	0	0	0	0	2	0	2	2
04:15 PM	1	0	1	0	0	0	5	0	5	6
04:30 PM	0	0	0	0	1	1	1	0	1	2
04:45 PM	0	0	0	0	0	0	2	0	2	2
Total Volume	1	0	1	0	1	1	10	0	10	12
% App. Total	100	0	100	0	100	100	100	0	100	100
PHF	.250	.000	.250	.000	.250	.250	.500	.000	.500	.500

Peak Hour Analysis From 04:00 PM to 04:45 PM - Peak 1 of 1
 Peak Hour for Entire Intersection Begins at 04:00 PM

City of Riverside
 N/S: Sycamore Canyon Boulevard
 E/W: Cottonwood Avenue
 Weather: Clear

File Name : 02_RIV_Syc_Cotton PM
 Site Code : 05122021
 Start Date : 1/13/2022
 Page No : 2

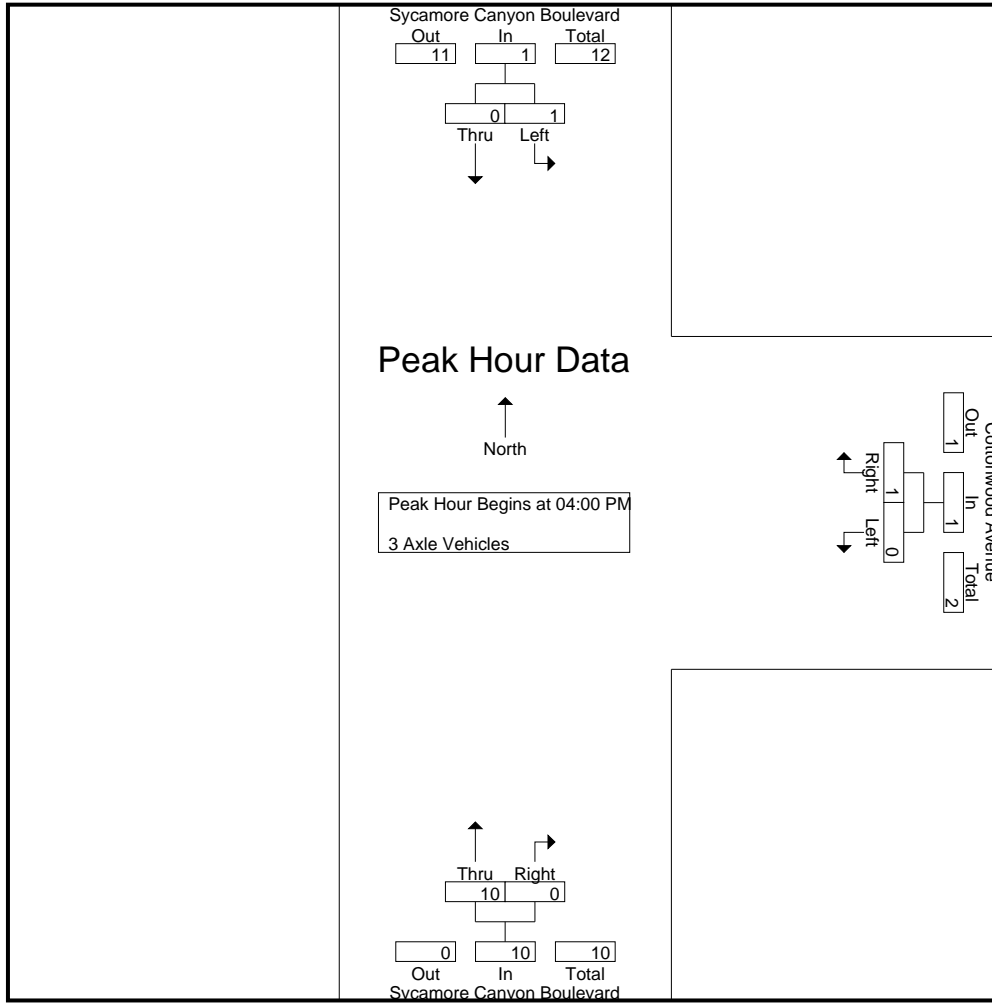

Peak Hour Analysis From 04:00 PM to 04:45 PM - Peak 1 of 1
 Peak Hour for Each Approach Begins at:

	04:00 PM			04:00 PM			04:00 PM		
+0 mins.	0	0	0	0	0	0	2	0	2
+15 mins.	1	0	1	0	0	0	5	0	5
+30 mins.	0	0	0	0	1	1	1	0	1
+45 mins.	0	0	0	0	0	0	2	0	2
Total Volume	1	0	1	0	1	1	10	0	10
% App. Total	100	0		0	100		100	0	
PHF	.250	.000	.250	.000	.250	.250	.500	.000	.500

City of Riverside
 N/S: Sycamore Canyon Boulevard
 E/W: Cottonwood Avenue
 Weather: Clear

File Name : 02_RIV_Syc_Cotton PM
 Site Code : 05122021
 Start Date : 1/13/2022
 Page No : 1

Groups Printed- 4+ Axle Trucks

Start Time	Sycamore Canyon Boulevard Southbound			Cottonwood Avenue Westbound				Sycamore Canyon Boulevard Northbound				Exclu. Total	Inclu. Total	Int. Total
	Left	Thru	App. Total	Left	Right	RTOR	App. Total	Thru	Right	RTOR	App. Total			
04:00 PM	1	3	4	2	0	0	2	9	1	0	10	0	16	16
04:15 PM	2	2	4	1	1	1	2	2	0	0	2	1	8	9
04:30 PM	1	1	2	0	1	1	1	3	0	0	3	1	6	7
04:45 PM	2	1	3	1	1	1	2	4	1	0	5	1	10	11
Total	6	7	13	4	3	3	7	18	2	0	20	3	40	43
05:00 PM	0	1	1	0	2	2	2	0	0	0	0	2	3	5
05:15 PM	2	0	2	0	1	1	1	1	0	0	1	1	4	5
05:30 PM	3	2	5	0	0	0	0	1	1	0	2	0	7	7
05:45 PM	1	2	3	1	1	0	2	4	0	0	4	0	9	9
Total	6	5	11	1	4	3	5	6	1	0	7	3	23	26
Grand Total	12	12	24	5	7	6	12	24	3	0	27	6	63	69
Apprch %	50	50		41.7	58.3			88.9	11.1					
Total %	19	19	38.1	7.9	11.1		19	38.1	4.8		42.9	8.7	91.3	

Start Time	Sycamore Canyon Boulevard Southbound			Cottonwood Avenue Westbound			Sycamore Canyon Boulevard Northbound			Int. Total
	Left	Thru	App. Total	Left	Right	App. Total	Thru	Right	App. Total	
04:00 PM	1	3	4	2	0	2	9	1	10	16
04:15 PM	2	2	4	1	1	2	2	0	2	8
04:30 PM	1	1	2	0	1	1	3	0	3	6
04:45 PM	2	1	3	1	1	2	4	1	5	10
Total Volume	6	7	13	4	3	7	18	2	20	40
% App. Total	46.2	53.8		57.1	42.9		90	10		
PHF	.750	.583	.813	.500	.750	.875	.500	.500	.500	.625

Peak Hour Analysis From 04:00 PM to 04:45 PM - Peak 1 of 1
 Peak Hour for Entire Intersection Begins at 04:00 PM

City of Riverside
 N/S: Sycamore Canyon Boulevard
 E/W: Cottonwood Avenue
 Weather: Clear

File Name : 02_RIV_Syc_Cotton PM
 Site Code : 05122021
 Start Date : 1/13/2022
 Page No : 2

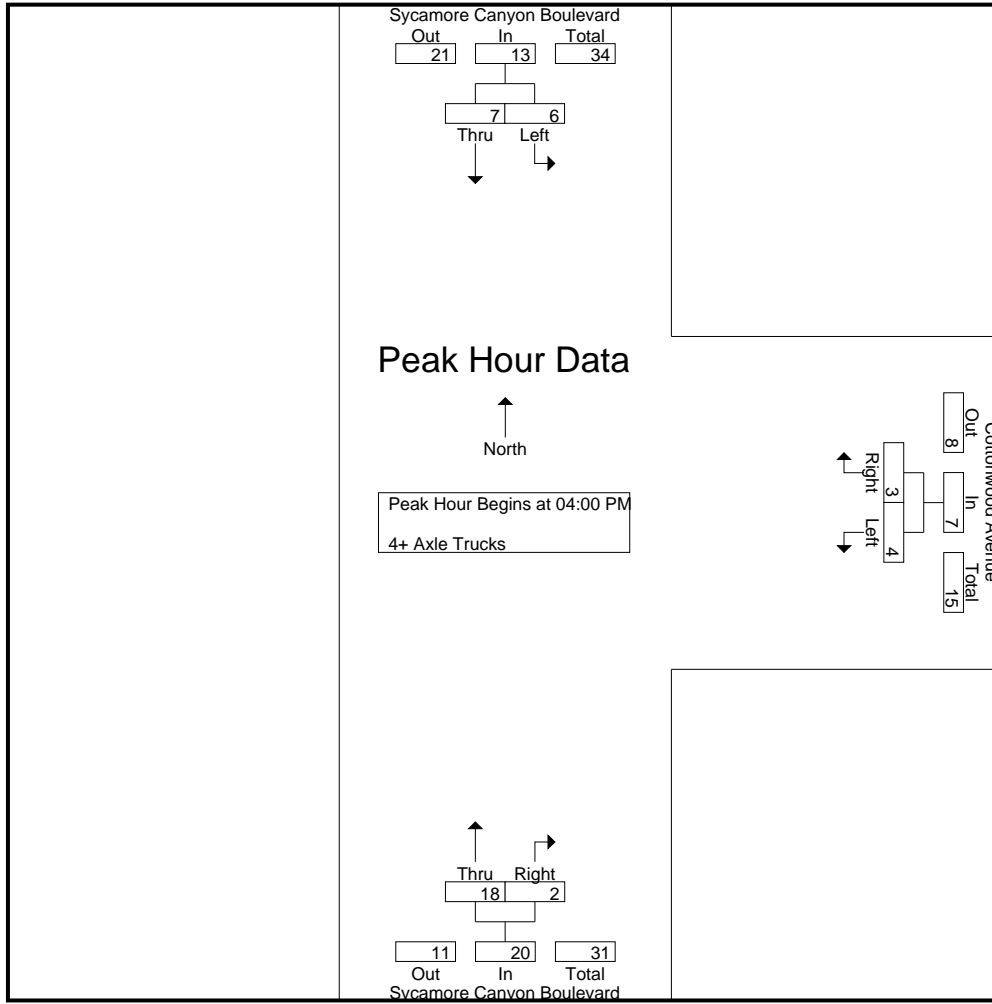

Peak Hour Analysis From 04:00 PM to 04:45 PM - Peak 1 of 1
 Peak Hour for Each Approach Begins at:

	04:00 PM			04:00 PM			04:00 PM		
+0 mins.	1	3	4	2	0	2	9	1	10
+15 mins.	2	2	4	1	1	2	2	0	2
+30 mins.	1	1	2	0	1	1	3	0	3
+45 mins.	2	1	3	1	1	2	4	1	5
Total Volume	6	7	13	4	3	7	18	2	20
% App. Total	46.2	53.8		57.1	42.9		90	10	
PHF	.750	.583	.813	.500	.750	.875	.500	.500	.500

Location: Riverside
 N/S: Sycamore Canyon Blvd
 E/W: Cottonwood Avenue



Date: 1/13/2022
 Day: Thursday

PEDESTRIANS

	North Leg Sycamore Canyon Blvd	East Leg Cottonwood Avenue	South Leg Sycamore Canyon Blvd	West Leg Dead End	
	Pedestrians	Pedestrians	Pedestrians	Pedestrians	
7:00 AM	0	0	0	0	0
7:15 AM	0	0	0	0	0
7:30 AM	0	0	0	0	0
7:45 AM	0	0	0	0	0
8:00 AM	0	1	0	0	1
8:15 AM	0	1	0	0	1
8:30 AM	0	0	0	0	0
8:45 AM	0	0	0	0	0
TOTAL VOLUMES:	0	2	0	0	2

	North Leg Sycamore Canyon Blvd	East Leg Cottonwood Avenue	South Leg Sycamore Canyon Blvd	West Leg Dead End	
	Pedestrians	Pedestrians	Pedestrians	Pedestrians	
4:00 PM	0	0	0	0	0
4:15 PM	0	1	0	0	1
4:30 PM	0	0	0	0	0
4:45 PM	0	0	0	0	0
5:00 PM	0	0	1	0	1
5:15 PM	0	0	0	0	0
5:30 PM	0	0	0	0	0
5:45 PM	0	0	0	0	0
TOTAL VOLUMES:	0	1	1	0	2

Location: Riverside
 N/S: Sycamore Canyon Blvd
 E/W: Cottonwood Avenue



Date: 1/13/2022
 Day: Thursday

BICYCLES

	Southbound Sycamore Canyon Blvd			Westbound Cottonwood Avenue			Northbound Sycamore Canyon Blvd			Eastbound Dead End			
	Left	Thru	Right	Left	Thru	Right	Left	Thru	Right	Left	Thru	Right	
7:00 AM	0	0	0	0	0	0	0	0	0	0	0	0	0
7:15 AM	0	0	0	0	0	0	0	0	0	0	0	0	0
7:30 AM	0	0	0	0	0	0	0	1	0	0	0	0	1
7:45 AM	0	0	0	0	0	0	0	0	0	0	0	0	0
8:00 AM	0	0	0	0	0	0	0	0	0	0	0	0	0
8:15 AM	0	0	0	0	0	0	0	0	0	0	0	0	0
8:30 AM	0	0	0	0	0	0	0	0	0	0	0	0	0
8:45 AM	0	0	0	0	0	0	0	1	0	0	0	0	1
TOTAL VOLUMES:	0	0	0	0	0	0	0	2	0	0	0	0	2

	Southbound Sycamore Canyon Blvd			Westbound Cottonwood Avenue			Northbound Sycamore Canyon Blvd			Eastbound Dead End			
	Left	Thru	Right	Left	Thru	Right	Left	Thru	Right	Left	Thru	Right	
4:00 PM	0	0	0	0	0	0	0	0	0	0	0	0	0
4:15 PM	0	0	0	0	0	0	0	0	0	0	0	0	0
4:30 PM	0	0	0	0	0	0	0	1	0	0	0	0	1
4:45 PM	0	0	0	0	0	0	0	0	0	0	0	0	0
5:00 PM	0	0	0	0	0	0	0	0	0	0	0	0	0
5:15 PM	0	0	0	0	0	0	0	0	0	0	0	0	0
5:30 PM	0	0	0	0	0	0	0	0	0	0	0	0	0
5:45 PM	0	0	0	0	0	0	0	0	0	0	0	0	0
TOTAL VOLUMES:	0	0	0	0	0	0	0	1	0	0	0	0	1

Groups Printed- Passenger Vehicles - Large 2 Axle Vehicles - 3 Axle Vehicles - 4+ Axle Trucks

Start Time	Sycamore Canyon Boulevard Southbound						Alessandro Boulevard Westbound						Meridian Parkway Northbound						Alessandro Boulevard Eastbound											
	Left		Thru		Right		Left		Thru		Right		Left		Thru		Right		Left		Thru		Right		Left		Thru		Right	
	App. Total	RTOR	App. Total	RTOR	App. Total	RTOR	App. Total	RTOR	App. Total	RTOR	App. Total	RTOR	App. Total	RTOR	App. Total	RTOR	App. Total	RTOR	App. Total	RTOR	App. Total	RTOR	App. Total	RTOR	Exclu. Total	Inclu. Total	Int. Total			
07:00 AM	15	26	19	6	60	38	416	82	136	82	13	6	231	23	166	59	29	248	79	1049	1128									
07:15 AM	17	19	30	10	66	38	436	79	150	99	4	2	253	28	209	54	25	291	75	1148	1223									
07:30 AM	12	23	20	12	55	35	380	106	121	140	11	2	272	24	204	72	26	300	75	1123	1198									
07:45 AM	24	29	28	17	81	27	379	137	93	124	17	9	234	35	210	48	21	293	74	1147	1221									
Total	68	97	97	45	262	138	1611	404	500	445	45	19	990	110	789	233	101	1132	303	4467	4770									
08:00 AM	21	26	29	19	76	22	394	117	133	134	20	17	287	32	195	33	9	260	67	1149	1216									
08:15 AM	19	18	21	16	58	20	413	113	131	112	10	7	253	23	203	36	12	262	55	1122	1177									
08:30 AM	13	14	19	15	46	17	376	127	104	153	6	5	263	35	205	37	18	277	70	1106	1176									
08:45 AM	11	14	22	19	47	22	337	121	86	95	9	2	190	20	170	25	11	215	54	925	979									
Total	64	72	91	69	227	96	1520	478	454	494	45	31	993	110	773	131	50	1014	246	4302	4548									
Grand Total	132	169	188	114	489	234	3131	882	954	939	90	50	1983	220	1562	364	151	2146	549	8769	9318									
% Approach	27	34.6	38.4				75.4	21.2	48.1	47.4	4.5			10.3	72.8	17														
% Total	1.5	1.9	2.1		5.6		35.7	10.1	47.3	10.9	10.7	1		2.5	17.8	4.2		24.5	5.9	94.1										
% Passenger Vehicles	117	158	180		564		3050	827	931	876	76		1926	214	1539	354		2255	0	0	8970									
% Large 2 Axle Vehicles	88.6	93.5	95.7	95.6	93.5	91.3	97.4	93.8	97.6	93.3	84.4	86	94.7	97.3	98.5	97.3	98	98.2	0	0	96.3									
% 3 Axle Vehicles	4	4	5	3.5	17	3.4	51	22	16	13	5	4	36	3	13	6	2	25	0	0	163									
% 4+ Axle Trucks	3	2.4	2.7		2.8	2.9	1.6	2.5	1.7	1.4	5.6	1.8	1.4	1.4	0.8	1.6	2	1.1	0	0	1.7									
% App. Total	0	2	0	0	2	0.3	10	9	2	10	1	14	1	1	1	3	5	5	0	0	44									
% Int. Total	0	1.2	0	0	0.3	1.4	0.3	1	0.2	1.1	1.1	2	0.7	0.5	0.1	0.8	0	0.2	0	0	0.5									
% Exclu. Total	11	5	3	1.6	20	6	20	24	5	40	8	8	57	2	9	1	1	12	0	0	141									
% App. Total	8.3	3	3	0.9	3.3	4.3	0.6	2.7	0.5	4.3	8.9	8	2.8	0.9	0.6	0.3	0	0.5	0	0	0.5									

Start Time	Sycamore Canyon Boulevard Southbound						Alessandro Boulevard Westbound						Meridian Parkway Northbound						Alessandro Boulevard Eastbound											
	Left		Thru		Right		Left		Thru		Right		Left		Thru		Right		Left		Thru		Right		Left		Thru		Right	
	App. Total	RTOR	App. Total	RTOR	App. Total	RTOR	App. Total	RTOR	App. Total	RTOR	App. Total	RTOR	App. Total	RTOR	App. Total	RTOR	App. Total	RTOR	App. Total	RTOR	App. Total	RTOR	App. Total	RTOR	Exclu. Total	Inclu. Total	Int. Total			
07:15 AM	17	19	30		66		23	436	79	538	150	99	4	253	28	209	54	291	75	1148	1223									
07:30 AM	12	23	20		55		10	380	106	496	121	140	11	272	24	204	72	300	75	1123	1198									
07:45 AM	24	29	28		81		23	379	137	539	93	124	17	234	35	210	48	293	74	1147	1221									
08:00 AM	21	26	29		76		15	394	117	526	133	134	20	287	32	195	33	260	67	1149	1216									
Total Volume	74	97	107		278		71	1589	439	2099	497	497	52	1046	119	818	207	1144	4567											
% App. Total	26.6	34.9	38.5		38.5		3.4	75.7	20.9	97.4	828	888	650	911	10.4	71.5	18.1	953	994											
PHF	.771	.836	.892		.858		.772	.911	.801	.974	.828	.888	.650	.911	.850	.974	.719	.953	.994											

Peak Hour Analysis From 07:00 AM to 08:45 AM - Peak 1 of 1
 Peak Hour for Entire Intersection Begins at 07:15 AM

Counts Unlimited, Inc.
 PO Box 1178
 Corona, CA 92878
 (951)268-6268

County of Riverside
 N/S: Sycamore Canyon Blvd/Meridian Pkwy
 E/W: Alessandro Boulevard
 Weather: Clear

File Name : 21_CRV_Meri_Ales AM
 Site Code : 05121716
 Start Date : 11/30/2021
 Page No : 2

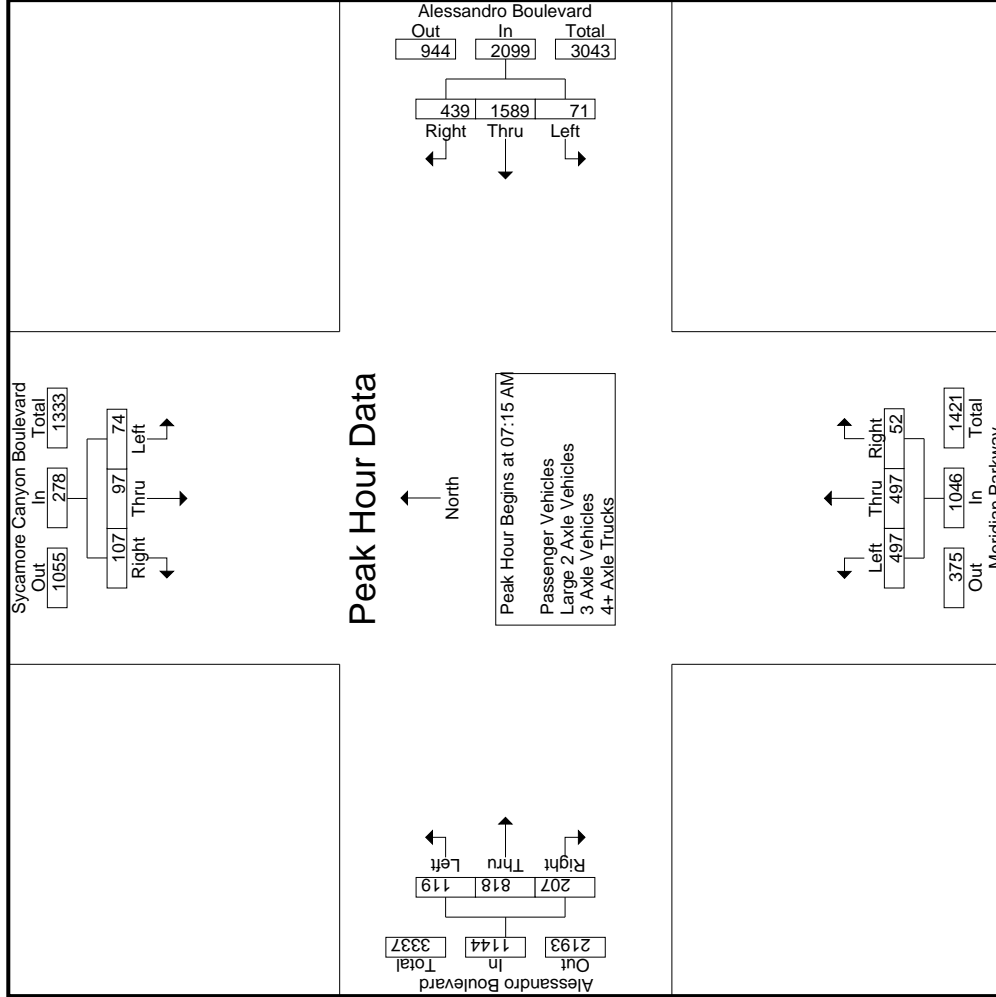

Counts Unlimited, Inc.
 PO Box 1178
 Corona, CA 92878
 (951)268-6268

File Name : 21_CRV_Meri_Ales AM
 Site Code : 05121716
 Start Date : 11/30/2021
 Page No : 3

County of Riverside
 N/S: Sycamore Canyon Blvd/Meridian Pkwy
 E/W: Alessandro Boulevard
 Weather: Clear

Start Time	Sycamore Canyon Boulevard Southbound			Alessandro Boulevard Westbound			Meridian Parkway Northbound			Alessandro Boulevard Eastbound					
	Left	Thru	Right	Left	Thru	Right	Left	Thru	Right	Left	Thru	Right	App. Total	Int. Total	
Peak Hour Analysis From 07:00 AM to 08:45 AM - Peak 1 of 1	Peak Hour for Each Approach Begins at:														
	07:15 AM			07:45 AM			07:15 AM			07:15 AM					
+0 mins.	17	19	30	23	379	137	539	150	99	4	253	28	209	54	291
+15 mins.	12	23	20	15	394	117	526	121	140	11	272	24	204	72	300
+30 mins.	24	29	28	23	413	113	549	93	124	17	234	35	210	48	293
+45 mins.	21	26	29	17	376	127	520	133	134	20	287	32	195	33	260
Total Volume	74	97	107	78	1562	494	2134	497	497	52	1046	119	818	207	1144
% App. Total	26.6	34.9	38.5	3.7	73.2	23.1		47.5	47.5	5		10.4	71.5	18.1	
PHF	.771	.836	.892	.848	.946	.901	.972	.828	.888	.650	.911	.850	.974	.719	.953

Counts Unlimited, Inc.
 PO Box 1178
 Corona, CA 92878
 (951)268-6268

County of Riverside
 N/S: Sycamore Canyon Blvd/Meridian Pkwy
 E/W: Alessandro Boulevard
 Weather: Clear

File Name : 21_CRV_Meri_Ales AM
 Site Code : 05121716
 Start Date : 11/30/2021
 Page No : 1

Groups Printed- Passenger Vehicles

Start Time	Sycamore Canyon Boulevard Southbound					Alessandro Boulevard Westbound					Meridian Parkway Northbound					Alessandro Boulevard Eastbound							
	Left	Thru	Right	RTOR	App. Total	Left	Thru	Right	RTOR	App. Total	Left	Thru	Right	RTOR	App. Total	Left	Thru	Right	RTOR	App. Total	Exclu. Total	Inclu. Total	Int. Total
07:00 AM	14	25	18	6	57	11	408	77	35	496	134	75	9	5	218	22	165	56	27	243	73	1014	1087
07:15 AM	14	17	30	10	61	23	425	79	38	527	143	98	4	2	245	28	207	54	25	289	75	1122	1197
07:30 AM	12	23	19	12	54	10	369	102	34	481	119	132	11	2	262	24	201	72	26	297	74	1094	1168
07:45 AM	21	27	26	16	74	19	372	128	27	519	93	117	14	7	224	34	207	46	20	287	70	1104	1174
Total	61	92	93	44	246	63	1574	386	134	2023	489	422	38	16	949	108	780	228	98	1116	292	4334	4626
08:00 AM	17	24	28	18	69	14	386	113	21	513	131	126	19	16	276	30	193	32	9	255	64	1113	1177
08:15 AM	17	17	20	15	54	20	397	104	18	521	127	102	7	6	236	21	200	35	12	256	51	1067	1118
08:30 AM	13	14	18	14	45	16	363	116	28	495	100	145	5	4	250	35	202	36	18	273	64	1063	1127
08:45 AM	9	11	21	18	41	13	330	108	21	451	84	81	7	1	172	20	164	23	11	207	51	871	922
Total	56	66	87	65	209	63	1476	441	88	1980	442	454	38	27	934	106	759	126	50	991	230	4114	4344
Grand Total	117	158	180	109	455	126	3050	827	222	4003	931	876	76	43	1883	214	1539	354	148	2107	522	8448	8970
T-Approch %	25.7	34.7	39.6			3.1	76.2	20.7		47.4	49.4	46.5	4		10.2	73	16.8			24.9	5.8	94.2	
N-Total %	1.4	1.9	2.1		5.4	1.5	36.1	9.8			11	10.4	0.9		22.3	2.5	18.2	4.2					

Start Time	Sycamore Canyon Boulevard Southbound					Alessandro Boulevard Westbound					Meridian Parkway Northbound					Alessandro Boulevard Eastbound							
	Left	Thru	Right	RTOR	App. Total	Left	Thru	Right	RTOR	App. Total	Left	Thru	Right	RTOR	App. Total	Left	Thru	Right	RTOR	App. Total	Exclu. Total	Inclu. Total	Int. Total
07:15 AM	14	17	30		61	23	425	79		527	143	98	4		245	28	207	54		289		289	1122
07:30 AM	12	23	19		54	10	369	102		481	119	132	11		262	24	201	72		297		297	1094
07:45 AM	21	27	26		74	19	372	128		519	93	117	14		224	34	207	46		287		287	1104
08:00 AM	17	24	28		69	14	386	113		513	131	126	19		276	30	193	32		255		255	1113
Total Volume	64	91	103		258	66	1552	422		2040	486	473	48		1007	116	808	204		1128		1128	4433
% App. Total	24.8	35.3	39.9			3.2	76.1	20.7		48.3	47	4.8			10.3	71.6	18.1						.988
PHF	.762	.843	.858		.872	.717	.913	.824		.968	.850	.896	.632		.912	.853	.976	.708					.949

Peak Hour Analysis From 07:15 AM to 08:00 AM - Peak 1 of 1
 Peak Hour for Entire Intersection Begins at 07:15 AM

Counts Unlimited, Inc.
 PO Box 1178
 Corona, CA 92878
 (951)268-6268

County of Riverside
 N/S: Sycamore Canyon Blvd/Meridian Pkwy
 E/W: Alessandro Boulevard
 Weather: Clear

File Name : 21_CRV_Meri_Ales AM
 Site Code : 05121716
 Start Date : 11/30/2021
 Page No : 2

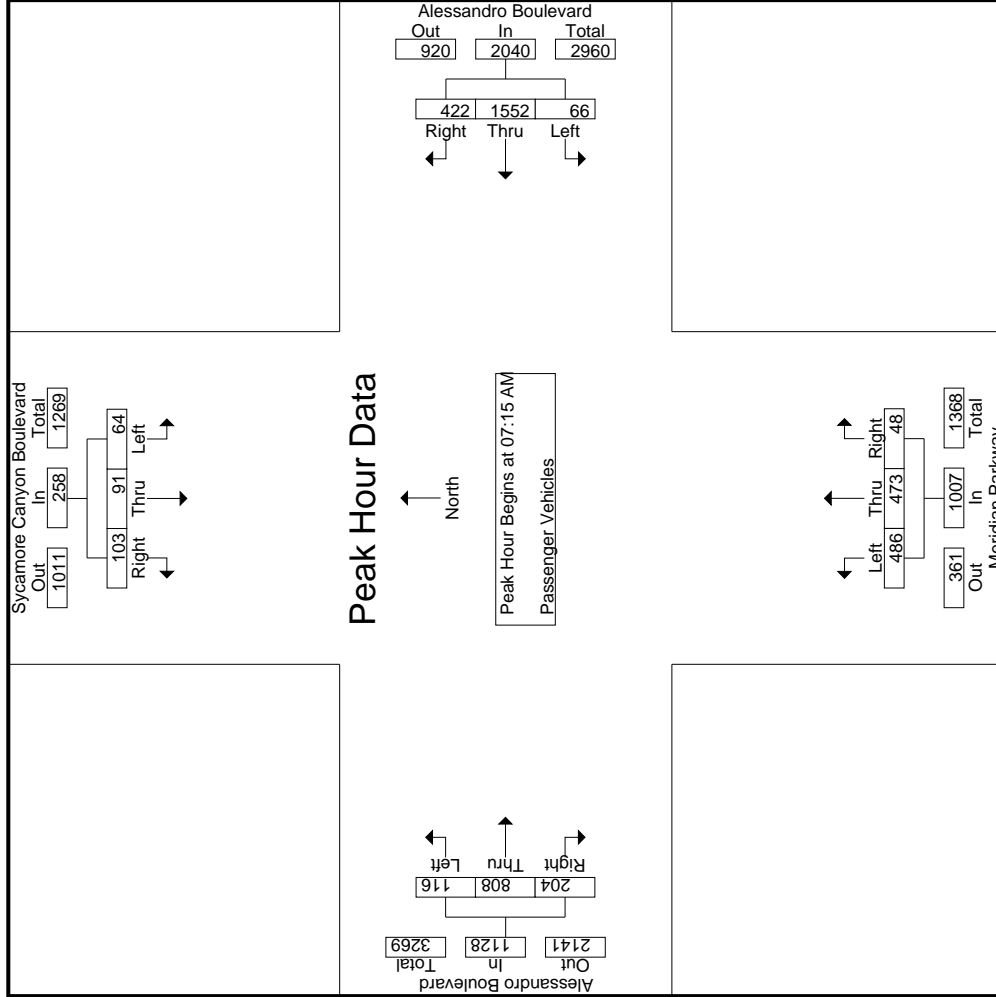

Counts Unlimited, Inc.
 PO Box 1178
 Corona, CA 92878
 (951)268-6268

File Name : 21_CRV_Meri_Ales AM
 Site Code : 05121716
 Start Date : 11/30/2021
 Page No : 3

County of Riverside
 N/S: Sycamore Canyon Blvd/Meridian Pkwy
 E/W: Alessandro Boulevard
 Weather: Clear

Start Time	Sycamore Canyon Boulevard Southbound			Alessandro Boulevard Westbound			Meridian Parkway Northbound			Alessandro Boulevard Eastbound		
	Left	Thru	Right	Left	Thru	Right	Left	Thru	Right	Left	Thru	Right
Peak Hour Analysis From 07:15 AM to 08:00 AM - Peak 1 of 1												
Peak Hour for Each Approach Begins at:												
+0 mins.	14	17	30	23	425	79	143	98	4	28	207	54
+15 mins.	12	23	19	10	369	102	119	132	11	24	201	72
+30 mins.	21	27	26	19	372	128	93	117	14	34	207	46
+45 mins.	17	24	28	14	386	113	131	126	19	30	193	32
Total Volume	64	91	103	66	1552	422	486	473	48	116	808	204
% App. Total	24.8	35.3	39.9	3.2	76.1	20.7	48.3	47	4.8	10.3	71.6	18.1
PHF	.762	.843	.858	.717	.913	.824	.850	.896	.632	.853	.976	.708

Counts Unlimited, Inc.
 PO Box 1178
 Corona, CA 92878
 (951)268-6268

County of Riverside
 N/S: Sycamore Canyon Blvd/Meridian Pkwy
 E/W: Alessandro Boulevard
 Weather: Clear

File Name : 21_CRV_Meri_Ales AM
 Site Code : 05121716
 Start Date : 11/30/2021
 Page No : 1

Groups Printed- Large 2 Axle Vehicles

Start Time	Sycamore Canyon Boulevard Southbound					Alessandro Boulevard Westbound					Meridian Parkway Northbound					Alessandro Boulevard Eastbound							
	Left	Thru	Right	RTOR	App. Total	Left	Thru	Right	RTOR	App. Total	Left	Thru	Right	RTOR	App. Total	Left	Thru	Right	RTOR	App. Total	Exclu. Total	Inclu. Total	Int. Total
07:00 AM	1	1	1	0	3	0	8	3	2	11	2	3	1	1	6	1	1	3	2	5	5	25	30
07:15 AM	0	0	0	0	0	0	5	0	0	5	4	1	0	0	5	0	1	0	0	1	0	11	11
07:30 AM	0	0	0	0	0	0	7	1	0	8	2	2	0	0	4	0	1	0	0	1	0	13	13
07:45 AM	0	0	1	1	1	2	6	4	0	12	0	3	0	0	3	1	3	2	1	6	2	22	24
Total	1	1	2	1	4	2	26	8	2	36	8	9	1	1	18	2	6	5	3	13	7	71	78
08:00 AM	1	1	1	1	3	0	4	1	1	5	2	1	0	0	3	1	2	0	0	3	2	14	16
08:15 AM	1	0	1	1	2	1	7	3	2	11	3	1	2	0	6	0	3	1	0	4	3	23	26
08:30 AM	0	0	1	1	1	0	8	4	2	12	2	0	1	1	3	0	2	0	0	2	4	18	22
08:45 AM	1	2	0	0	3	1	6	6	1	13	1	2	1	0	4	0	0	0	0	1	2	20	21
Total	3	3	3	3	9	2	25	14	6	41	8	4	4	1	16	1	7	1	0	9	10	75	85
Grand Total	4	4	5	4	13	4	51	22	8	77	16	13	5	2	34	3	13	6	3	22	17	146	163
T-Approch %	30.8	30.8	38.5			5.2	66.2	28.6		52.7	47.1	38.2	14.7		23.3	13.6	59.1	27.3		15.1	10.4	89.6	
N2 Total %	2.7	2.7	3.4		8.9	2.7	34.9	15.1			11	8.9	3.4			2.1	8.9	4.1					

Start Time	Sycamore Canyon Boulevard Southbound					Alessandro Boulevard Westbound					Meridian Parkway Northbound					Alessandro Boulevard Eastbound							
	Left	Thru	Right	RTOR	App. Total	Left	Thru	Right	RTOR	App. Total	Left	Thru	Right	RTOR	App. Total	Left	Thru	Right	RTOR	App. Total	Exclu. Total	Inclu. Total	Int. Total
07:15 AM	0	0	0	0	0	0	5	0	5	4	1	0	0	5	0	0	1	0	0	1	0	1	11
07:30 AM	0	0	0	0	0	0	7	1	8	12	2	2	0	0	4	0	1	0	0	1	0	1	13
07:45 AM	0	0	1	1	1	2	6	4	12	12	0	0	0	0	3	1	3	2	6	3	2	6	22
08:00 AM	1	1	1	1	3	0	4	1	5	5	2	1	0	0	3	1	2	0	3	14	0	3	14
Total Volume	1	1	2	2	4	2	22	6	30	30	8	7	0	0	15	2	7	2	11	60			60
% App. Total	25	25	50			6.7	73.3	20		53.3	46.7	0			18.2	63.6	18.2						.682
PHF	.250	.250	.500		.333	.250	.786	.375	.625	.625	.500	.583	.000	.750	.500	.583	.250	.458					

Peak Hour Analysis From 07:15 AM to 08:00 AM - Peak 1 of 1
 Peak Hour for Entire Intersection Begins at 07:15 AM

Counts Unlimited, Inc.
 PO Box 1178
 Corona, CA 92878
 (951)268-6268

County of Riverside
 N/S: Sycamore Canyon Blvd/Meridian Pkwy
 E/W: Alessandro Boulevard
 Weather: Clear

File Name : 21_CRV_Meri_Ales AM
 Site Code : 05121716
 Start Date : 11/30/2021
 Page No : 2

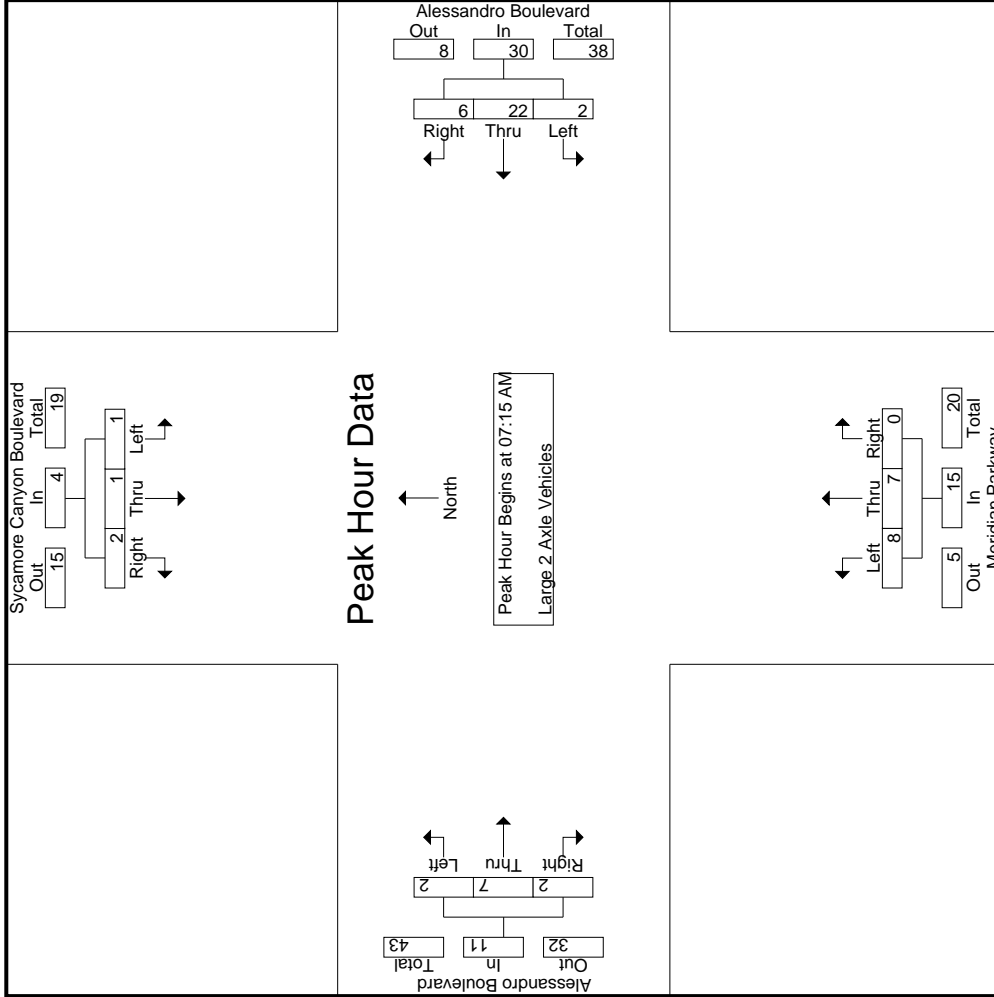

Counts Unlimited, Inc.
 PO Box 1178
 Corona, CA 92878
 (951)268-6268

County of Riverside
 N/S: Sycamore Canyon Blvd/Meridian Pkwy
 E/W: Alessandro Boulevard
 Weather: Clear

File Name : 21_CRV_Meri_Ales AM
 Site Code : 05121716
 Start Date : 11/30/2021
 Page No : 3

Start Time	Sycamore Canyon Boulevard Southbound			Alessandro Boulevard Westbound			Meridian Parkway Northbound			Alessandro Boulevard Eastbound		
	Left	Thru	Right	Left	Thru	Right	Left	Thru	Right	Left	Thru	Right
Peak Hour Analysis From 07:15 AM to 08:00 AM - Peak 1 of 1												
Peak Hour for Each Approach Begins at:												
+0 mins.	0	0	0	0	5	0	4	1	0	0	1	0
+15 mins.	0	0	0	0	7	1	2	2	0	0	1	0
+30 mins.	0	0	1	2	6	4	0	3	0	1	3	2
+45 mins.	1	1	3	0	4	1	2	1	0	1	2	0
Total Volume	1	1	2	2	22	6	8	7	0	2	7	2
% App. Total	.25	.25	.50	6.7	73.3	20	53.3	46.7	0	18.2	63.6	18.2
PHF	.250	.250	.500	.250	.786	.375	.500	.583	.000	.500	.583	.250

Counts Unlimited, Inc.
 PO Box 1178
 Corona, CA 92878
 (951)268-6268

County of Riverside
 N/S: Sycamore Canyon Blvd/Meridian Pkwy
 E/W: Alessandro Boulevard
 Weather: Clear

File Name : 21_CRV_Meri_Ales AM
 Site Code : 05121716
 Start Date : 11/30/2021
 Page No : 1

Groups Printed- 3 Axle Vehicles

Start Time	Sycamore Canyon Boulevard Southbound					Alessandro Boulevard Westbound					Meridian Parkway Northbound					Alessandro Boulevard Eastbound							
	Left	Thru	Right	RTOR	App. Total	Left	Thru	Right	RTOR	App. Total	Left	Thru	Right	RTOR	App. Total	Left	Thru	Right	RTOR	App. Total	Exclu. Total	Inclu. Total	Int. Total
07:00 AM	0	0	0	0	0	0	0	1	1	1	0	1	0	0	0	0	0	0	0	0	1	2	3
07:15 AM	0	1	0	0	1	0	0	0	0	0	0	0	0	0	0	0	0	0	0	0	0	2	2
07:30 AM	0	0	0	0	0	0	1	1	1	2	2	0	0	0	2	0	1	0	0	1	1	5	6
07:45 AM	0	0	0	0	0	1	1	2	0	4	0	3	0	0	3	0	0	0	0	0	0	7	7
Total	0	1	0	0	1	1	2	4	2	7	1	6	0	0	7	0	1	0	0	1	2	16	18
08:00 AM	0	0	0	0	0	1	2	1	0	4	0	1	0	0	1	0	0	1	0	1	0	6	6
08:15 AM	0	1	0	0	1	0	4	2	0	6	1	1	1	1	3	1	0	0	0	1	1	11	12
08:30 AM	0	0	0	0	0	0	2	1	0	3	0	2	0	0	2	0	0	1	0	1	0	6	6
08:45 AM	0	0	0	0	0	0	0	1	0	1	0	0	0	0	1	0	0	1	0	1	0	2	2
Total	0	1	0	0	1	1	8	5	0	14	1	4	1	1	6	1	0	3	0	4	1	25	26
Grand Total	0	2	0	0	2	2	10	9	2	21	2	10	1	1	13	1	1	3	0	5	3	41	44
T-Approch %	0	100	0	0	4.9	9.5	47.6	42.9	22	51.2	15.4	76.9	7.7	2.4	31.7	20	20	60	12.2	12.2	6.8	93.2	
N2 Total %	0	4.9	0	0	4.9	4.9	24.4	22			4.9	24.4	2.4			2.4	2.4	7.3					

Start Time	Sycamore Canyon Boulevard Southbound					Alessandro Boulevard Westbound					Meridian Parkway Northbound					Alessandro Boulevard Eastbound							
	Left	Thru	Right	RTOR	App. Total	Left	Thru	Right	RTOR	App. Total	Left	Thru	Right	RTOR	App. Total	Left	Thru	Right	RTOR	App. Total	Exclu. Total	Inclu. Total	Int. Total
07:15 AM	0	1	0	0	1	0	0	0	0	0	1	0	0	0	1	0	0	0	0	1	0	0	0
07:30 AM	0	0	0	0	0	0	0	1	1	2	0	2	0	0	2	0	0	1	0	1	0	1	1
07:45 AM	0	0	0	0	0	1	1	2	1	4	0	3	0	0	3	0	0	0	0	3	0	0	0
08:00 AM	0	0	0	0	0	1	1	2	1	4	0	1	0	0	1	0	0	1	0	1	0	1	1
Total Volume	0	1	0	0	1	2	4	4	10	10	1	6	0	7	7	0	1	1	1	1	1	2	20
% App. Total	0	100	0	0	.000	.250	.400	.400	.625	.625	.143	.857	0	.583	.583	.000	.250	.250	.500	.500	.250	.500	.714
PHF	.000	.250	.000	.000	.250	.500	.500	.625	.625	.625	.250	.500	.000	.583	.583	.000	.250	.250	.500	.500	.250	.500	.714

Peak Hour Analysis From 07:15 AM to 08:00 AM - Peak 1 of 1
 Peak Hour for Entire Intersection Begins at 07:15 AM

Counts Unlimited, Inc.
 PO Box 1178
 Corona, CA 92878
 (951)268-6268

County of Riverside
 N/S: Sycamore Canyon Blvd/Meridian Pkwy
 E/W: Alessandro Boulevard
 Weather: Clear

File Name : 21_CRV_Meri_Ales AM
 Site Code : 05121716
 Start Date : 11/30/2021
 Page No : 2

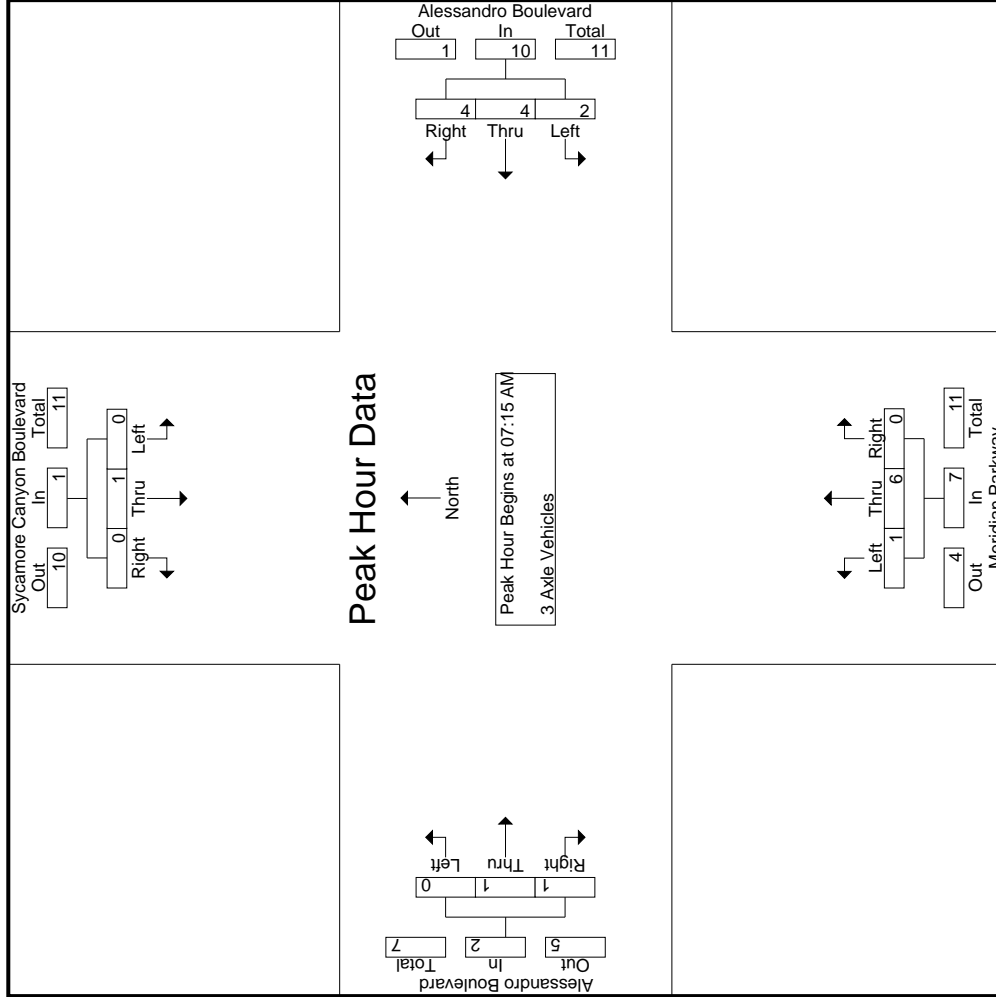

Counts Unlimited, Inc.
 PO Box 1178
 Corona, CA 92878
 (951)268-6268

File Name : 21_CRV_Meri_Ales AM
 Site Code : 05121716
 Start Date : 11/30/2021
 Page No : 3

County of Riverside
 N/S: Sycamore Canyon Blvd/Meridian Pkwy
 E/W: Alessandro Boulevard
 Weather: Clear

Start Time	Sycamore Canyon Boulevard Southbound			Alessandro Boulevard Westbound			Meridian Parkway Northbound			Alessandro Boulevard Eastbound		
	Left	Thru	Right	Left	Thru	Right	Left	Thru	Right	Left	Thru	Right
Peak Hour Analysis From 07:15 AM to 08:00 AM - Peak 1 of 1												
Peak Hour for Each Approach Begins at:												
+0 mins.	0	1	0	0	0	0	0	0	0	0	0	0
+15 mins.	0	0	0	0	1	1	2	2	0	0	1	0
+30 mins.	0	0	0	1	1	2	4	3	0	0	0	0
+45 mins.	0	0	0	1	2	1	4	1	0	0	0	1
Total Volume	0	1	0	2	4	4	10	6	0	0	1	1
% App. Total	0	100	0	20	40	40	14.3	85.7	0	0	50	50
PHF	.000	.250	.000	.500	.500	.500	.625	.250	.000	.000	.250	.250

Counts Unlimited, Inc.
 PO Box 1178
 Corona, CA 92878
 (951)268-6268

County of Riverside
 N/S: Sycamore Canyon Blvd/Meridian Pkwy
 E/W: Alessandro Boulevard
 Weather: Clear

File Name : 21_CRV_Meri_Ales AM
 Site Code : 05121716
 Start Date : 11/30/2021
 Page No : 1

Groups Printed- 4+ Axle Trucks

Start Time	Sycamore Canyon Boulevard Southbound				Alessandro Boulevard Westbound				Meridian Parkway Northbound				Alessandro Boulevard Eastbound					
	Left	Thru	Right	RTOR	App. Total	Left	Thru	Right	RTOR	App. Total	Left	Thru	Right	RTOR	App. Total	Exclu. Total	Inclu. Total	Int. Total
07:00 AM	0	0	0	0	0	1	0	1	0	2	0	3	3	0	0	0	0	8
07:15 AM	3	1	0	0	4	0	6	0	0	6	2	0	0	0	1	0	13	
07:30 AM	0	0	1	0	1	0	3	2	0	5	0	4	0	0	1	0	11	
07:45 AM	3	2	1	0	6	1	0	3	0	4	0	1	3	2	0	2	14	
Total	6	3	2	0	11	2	9	6	0	17	2	8	6	2	16	2	46	
08:00 AM	3	1	0	0	4	0	2	2	0	4	0	6	1	1	7	1	16	
08:15 AM	1	0	0	0	1	2	5	4	0	11	0	8	0	0	8	0	21	
08:30 AM	0	0	0	0	0	1	3	6	2	10	2	6	0	0	1	2	19	
08:45 AM	1	1	1	1	3	1	1	6	0	8	1	12	1	1	14	2	32	
Total	5	2	1	1	8	4	11	18	2	33	3	32	2	2	37	5	88	
Grand Total	11	5	3	1	19	6	20	24	2	50	5	40	8	4	53	7	134	
% Approach	57.9	26.3	15.8			12	40	48			9.4	75.5	15.1			16.7	75	
% Total	8.2	3.7	2.2		14.2	4.5	14.9	17.9		37.3	3.7	29.9	6		39.6	1.5	6.7	
																	0.7	

Start Time	Sycamore Canyon Boulevard Southbound				Alessandro Boulevard Westbound				Meridian Parkway Northbound				Alessandro Boulevard Eastbound				
	Left	Thru	Right	RTOR	App. Total	Left	Thru	Right	RTOR	App. Total	Left	Thru	Right	RTOR	App. Total	Exclu. Total	Inclu. Total
07:15 AM	3	1	0	0	4	0	6	0	0	6	2	0	0	0	2	0	1
07:30 AM	0	0	1	1	2	0	3	2	0	5	0	4	0	0	4	0	1
07:45 AM	3	2	1	0	6	1	0	3	0	4	0	1	3	0	4	0	0
08:00 AM	3	1	0	0	4	0	2	2	0	4	0	6	1	7	0	0	1
Total Volume	9	4	2	2	15	1	11	7	19	19	2	11	4	17	2	2	3
% App. Total	60	26.7	13.3			5.3	57.9	36.8			11.8	64.7	23.5		33.3	66.7	0
PHF	.750	.500	.500		.625	.250	.458	.583	.792	.607	.250	.458	.333	.607	.250	.500	.750

Peak Hour Analysis From 07:15 AM to 08:00 AM - Peak 1 of 1
 Peak Hour for Entire Intersection Begins at 07:15 AM

Counts Unlimited, Inc.
 PO Box 1178
 Corona, CA 92878
 (951)268-6268

County of Riverside
 N/S: Sycamore Canyon Blvd/Meridian Pkwy
 E/W: Alessandro Boulevard
 Weather: Clear

File Name : 21_CRV_Meri_Ales AM
 Site Code : 05121716
 Start Date : 11/30/2021
 Page No : 2

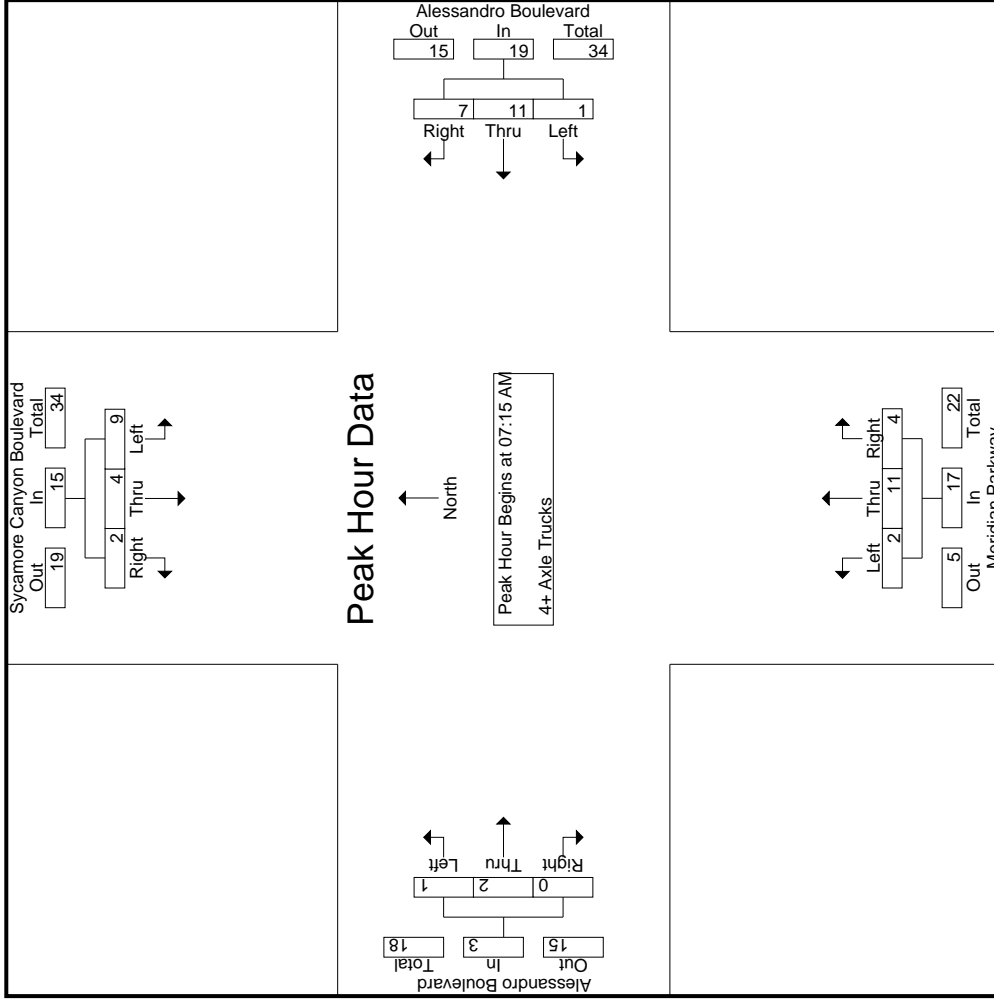

Counts Unlimited, Inc.
 PO Box 1178
 Corona, CA 92878
 (951)268-6268

County of Riverside
 N/S: Sycamore Canyon Blvd/Meridian Pkwy
 E/W: Alessandro Boulevard
 Weather: Clear

File Name : 21_CRV_Meri_Ales AM
 Site Code : 05121716
 Start Date : 11/30/2021
 Page No : 3

Start Time	Sycamore Canyon Boulevard Southbound			Alessandro Boulevard Westbound			Meridian Parkway Northbound			Alessandro Boulevard Eastbound				
	Left	Thru	Right	Left	Thru	Right	Left	Thru	Right	Left	Thru	Right	App. Total	Int. Total
Peak Hour Analysis From 07:15 AM to 08:00 AM - Peak 1 of 1														
Peak Hour for Each Approach Begins at:														
+0 mins.	3	1	0	0	6	0	6	0	0	2	0	1	0	1
+15 mins.	0	0	1	0	3	2	5	4	0	4	0	1	0	1
+30 mins.	3	2	1	1	0	3	4	0	3	4	0	0	0	0
+45 mins.	3	1	0	0	2	2	4	0	1	7	1	0	0	1
Total Volume	9	4	2	1	11	7	19	11	4	17	1	2	0	3
% App. Total	60	26.7	13.3	5.3	57.9	36.8	11.8	64.7	23.5	33.3	66.7	0	0	0
PHF	.750	.500	.500	.250	.458	.583	.792	.250	.333	.607	.250	.500	.000	.750

Counts Unlimited, Inc.
 PO Box 1178
 Corona, CA 92878
 (951)268-6268

County of Riverside
 N/S: Sycamore Canyon Blvd/Meridian Pkwy
 E/W: Alessandro Boulevard
 Weather: Clear

File Name : 21_CRV_Meri_Ales_PM
 Site Code : 05121716
 Start Date : 11/30/2021
 Page No : 1

Groups Printed- Passenger Vehicles - Large 2 Axle Vehicles - 3 Axle Vehicles - 4+ Axle Trucks

Start Time	Sycamore Canyon Boulevard Southbound					Alessandro Boulevard Westbound					Meridian Parkway Northbound					Alessandro Boulevard Eastbound							
	Left	Thru	Right	RTOR	App. Total	Left	Thru	Right	RTOR	App. Total	Left	Thru	Right	RTOR	App. Total	Left	Thru	Right	RTOR	App. Total			
	Exclu. Total	Inclu. Total	Int. Total	Exclu. Total	Inclu. Total	Int. Total	Exclu. Total	Inclu. Total	Int. Total	Exclu. Total	Inclu. Total	Int. Total	Exclu. Total	Inclu. Total	Int. Total								
04:00 PM	33	89	60	27	182	26	406	87	38	519	134	99	26	11	259	37	357	120	33	514	109	1474	1583
04:15 PM	39	97	48	16	184	36	373	96	26	505	86	115	12	6	213	32	302	102	39	436	87	1338	1425
04:30 PM	37	80	61	20	178	49	388	105	38	542	115	125	31	13	271	26	356	141	58	523	129	1514	1643
04:45 PM	31	96	48	13	175	70	394	101	38	565	113	103	13	9	229	42	332	123	44	497	104	1466	1570
Total	140	362	217	76	719	181	1561	389	140	2131	448	442	82	39	972	137	1347	486	174	1970	429	5792	6221
05:00 PM	27	145	74	30	246	80	350	88	22	518	121	97	17	11	235	29	368	141	39	538	102	1537	1639
05:15 PM	30	169	71	27	270	84	351	89	30	524	94	69	16	8	179	34	374	132	46	540	111	1513	1624
05:30 PM	44	144	59	32	247	28	356	79	43	463	99	62	20	12	181	35	382	108	46	525	133	1416	1549
05:45 PM	50	164	73	34	287	35	311	56	24	402	62	63	17	5	142	30	366	154	49	550	112	1381	1493
Total	151	622	277	123	1050	227	1368	312	119	1907	376	291	70	36	737	128	1490	535	180	2153	458	5847	6305
Grand Total	291	984	494	199	1769	408	2929	701	259	4038	824	733	152	75	1709	265	2837	1021	354	4123	887	11639	12526
% Approach	16.4	55.6	27.9			10.1	72.5	17.4			48.2	42.9	8.9			6.4	68.8	24.8					
% Total	2.5	8.5	4.2			3.5	25.2	6			7.1	6.3	1.3			2.3	24.4	8.8					
% Passenger Vehicles	275	928	486			366	2877	644			810	694	145			260	2796	1006					
% Large 2 Axle Vehicles	94.5	94.3	98.4	98.5	95.8	89.7	98.2	91.9	93.4	96.1	98.3	94.7	95.4	97.3	96.5	98.1	98.6	98.5	99.2	98.6	0	0	0
% Large 2 Axle Trucks	1.7	2.2	1.2	1	1.8	3.2	1.3	3.4	3.5	1.9	1.3	1.6	2.6	1.3	1.6	1.5	1.5	1.2	0.8	1	0	0	
% 3 Axle Vehicles	3	10	1			10	5	7			0	13	0			0	3	1		4	0	0	
% 3 Axle Trucks	1	1	0.2	0	0.7	2.5	0.2	1	1.2	0.6	0	1.8	0	0	0.7	0	0.1	0.1	0	0.1	0	0	
4+ Axle Trucks	8	24	1			19	10	26			3	14	3			1	10	2		13	0	0	
% 4+ Axle Trucks	2.7	2.4	0.2	0.5	1.7	4.7	0.3	3.7	1.9	1.4	0.4	1.9	2	1.3	1.2	0.4	0.4	0.2	0	0.3	0	0	

Start Time	Sycamore Canyon Boulevard Southbound					Alessandro Boulevard Westbound					Meridian Parkway Northbound					Alessandro Boulevard Eastbound						
	Left	Thru	Right	RTOR	App. Total	Left	Thru	Right	RTOR	App. Total	Left	Thru	Right	RTOR	App. Total	Left	Thru	Right	RTOR	App. Total		
	Exclu. Total	Inclu. Total	Int. Total	Exclu. Total	Inclu. Total	Int. Total	Exclu. Total	Inclu. Total	Int. Total	Exclu. Total	Inclu. Total	Int. Total	Exclu. Total	Inclu. Total	Int. Total							
04:30 PM	37	80	61		178	49	388	105		542	115	125	31		271	26	356	141		523		
04:45 PM	31	96	48		175	70	394	101		565	113	103	13		229	42	332	123		497		
05:00 PM	27	145	74		246	80	350	88		518	121	97	17		235	29	368	141		538		
05:15 PM	30	169	71		270	84	351	89		524	94	69	16		179	34	374	132		540		
Total Volume	125	490	254		869	283	1483	383		2149	443	394	77		914	131	1430	537		2098		
% App. Total	14.4	56.4	29.2		29.2	13.2	69	17.8		48.5	43.1	8.4		8.4	6.2	68.2	25.6			9.71		
PHF	.845	.725	.858		.805	.842	.941	.912		.951	.915	.788		.621	.843	.780	.956	.952		.971		

Peak Hour Analysis From 04:00 PM to 05:45 PM - Peak 1 of 1

Peak Hour for Entire Intersection Begins at 04:30 PM

Counts Unlimited, Inc.
 PO Box 1178
 Corona, CA 92878
 (951)268-6268

County of Riverside
 N/S: Sycamore Canyon Blvd/Meridian Pkwy
 E/W: Alessandro Boulevard
 Weather: Clear

File Name : 21_CRV_Meri_Ales PM
 Site Code : 05121716
 Start Date : 11/30/2021
 Page No : 2

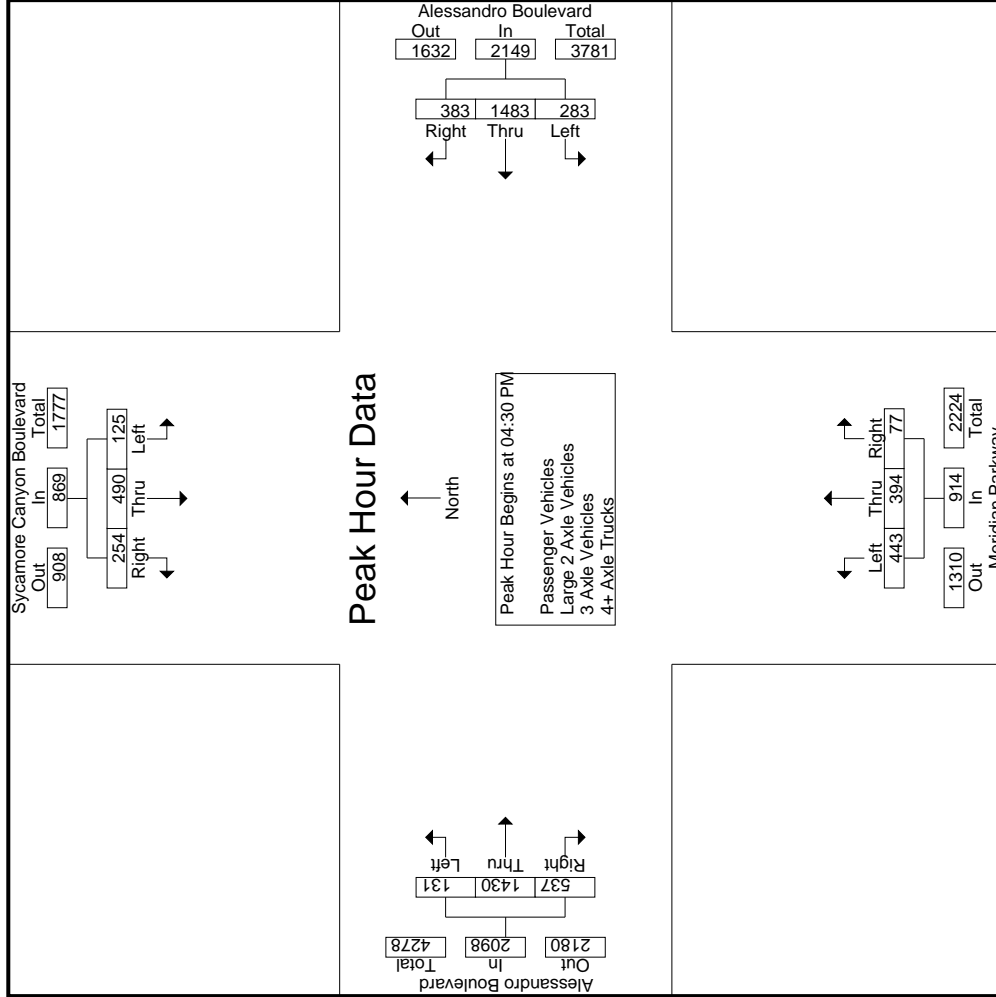

Counts Unlimited, Inc.
 PO Box 1178
 Corona, CA 92878
 (951)268-6268

File Name : 21_CRV_Meri_Ales PM
 Site Code : 05121716
 Start Date : 11/30/2021
 Page No : 3

County of Riverside
 N/S: Sycamore Canyon Blvd/Meridian Pkwy
 E/W: Alessandro Boulevard
 Weather: Clear

Start Time	Sycamore Canyon Boulevard Southbound			Alessandro Boulevard Westbound			Meridian Parkway Northbound			Alessandro Boulevard Eastbound					
	Left	Thru	Right	Left	Thru	Right	Left	Thru	Right	Left	Thru	Right	App. Total	Int. Total	
Peak Hour Analysis From 04:00 PM to 05:45 PM - Peak 1 of 1	Peak Hour for Each Approach Begins at:														
	05:00 PM			04:30 PM			04:00 PM			05:00 PM					
+0 mins.	27	145	74	49	388	105	542	134	99	26	259	29	368	141	538
+15 mins.	30	169	71	70	394	101	565	86	115	12	213	34	374	132	540
+30 mins.	44	144	59	80	350	88	518	115	125	31	271	35	382	108	525
+45 mins.	50	164	73	84	351	89	524	113	103	13	229	30	366	154	550
Total Volume	151	622	277	283	1483	383	2149	448	442	82	972	128	1490	535	2153
% App. Total	14.4	59.2	26.4	13.2	69	17.8	17.8	46.1	45.5	8.4	8.4	5.9	69.2	24.8	24.8
PHF	.755	.920	.936	.842	.941	.912	.951	.836	.884	.661	.897	.914	.975	.869	.979

Groups Printed- Passenger Vehicles

Start Time	Sycamore Canyon Boulevard Southbound					Alessandro Boulevard Westbound					Meridian Parkway Northbound					Alessandro Boulevard Eastbound							
	Left	Thru	Right	RTOR	App. Total	Left	Thru	Right	RTOR	App. Total	Left	Thru	Right	RTOR	App. Total	Left	Thru	Right	RTOR	App. Total	Exclu. Total	Inclu. Total	Int. Total
04:00 PM	31	84	59	26	174	24	396	75	36	495	131	90	25	11	246	36	348	117	33	501	106	1416	1522
04:15 PM	36	93	48	16	177	33	368	88	25	489	84	105	10	5	199	31	296	100	38	427	84	1292	1376
04:30 PM	35	76	59	20	170	44	377	96	35	517	111	121	30	13	262	26	348	139	58	513	126	1462	1588
04:45 PM	29	93	48	13	170	64	392	95	36	551	113	99	13	9	225	42	329	121	44	492	102	1438	1540
Total	131	346	214	75	691	165	1533	354	132	2052	439	415	78	38	932	135	1321	477	173	1933	418	5608	6026
05:00 PM	27	136	73	30	236	71	347	81	20	499	119	92	17	11	228	29	363	138	39	530	100	1493	1593
05:15 PM	28	161	68	25	257	73	345	82	27	500	93	68	14	8	175	34	373	131	45	538	105	1470	1575
05:30 PM	42	129	59	32	230	25	350	76	42	451	97	56	19	11	172	33	376	107	45	516	130	1369	1499
05:45 PM	47	156	72	34	275	32	302	51	21	385	62	63	17	5	142	29	363	153	49	545	109	1347	1456
Total	144	582	272	121	998	201	1344	290	110	1835	371	279	67	35	717	125	1475	529	178	2129	444	5679	6123
Grand Total	275	928	486	196	1689	366	2877	644	242	3887	810	694	145	73	1649	260	2796	1006	351	4062	862	11287	12149
T-Approch %	16.3	54.9	28.8			9.4	74	16.6		49.1	42.1	8.8			6.4	68.8	24.8			36	7.1	92.9	
N-Total %	2.4	8.2	4.3		15	3.2	25.5	5.7		7.2	6.1	1.3		14.6	2.3	24.8	8.9						

Start Time	Sycamore Canyon Boulevard Southbound					Alessandro Boulevard Westbound					Meridian Parkway Northbound					Alessandro Boulevard Eastbound							
	Left	Thru	Right	RTOR	App. Total	Left	Thru	Right	RTOR	App. Total	Left	Thru	Right	RTOR	App. Total	Left	Thru	Right	RTOR	App. Total	Exclu. Total	Inclu. Total	Int. Total
04:30 PM	35	76	59		170	44	377	96		517	111	121	30		262	26	348	139		513		1462	
04:45 PM	29	93	48		170	64	392	95		551	113	99	13		225	42	329	121		492		1438	
05:00 PM	27	136	73		236	71	347	81		499	119	92	17		228	29	363	138		530		1493	
05:15 PM	28	161	68		257	73	345	82		500	93	68	14		175	34	373	131		538		1470	
Total Volume	119	466	248		833	252	1461	354		2067	436	380	74		890	131	1413	529		2073		5863	
% App. Total	14.3	55.9	29.8			12.2	70.7	17.1		8.3	49	42.7	8.3		25.5	6.3	68.2	25.5		9.63		.982	
PHF	.850	.724	.849		.810	.863	.932	.922		.938	.916	.785	.617		.849	.780	.947	.951		.963		.982	

Peak Hour Analysis From 04:30 PM to 05:15 PM - Peak 1 of 1
 Peak Hour for Entire Intersection Begins at 04:30 PM

Counts Unlimited, Inc.
 PO Box 1178
 Corona, CA 92878
 (951)268-6268

County of Riverside
 N/S: Sycamore Canyon Blvd/Meridian Pkwy
 E/W: Alessandro Boulevard
 Weather: Clear

File Name : 21_CRV_Meri_Ales PM
 Site Code : 05121716
 Start Date : 11/30/2021
 Page No : 2

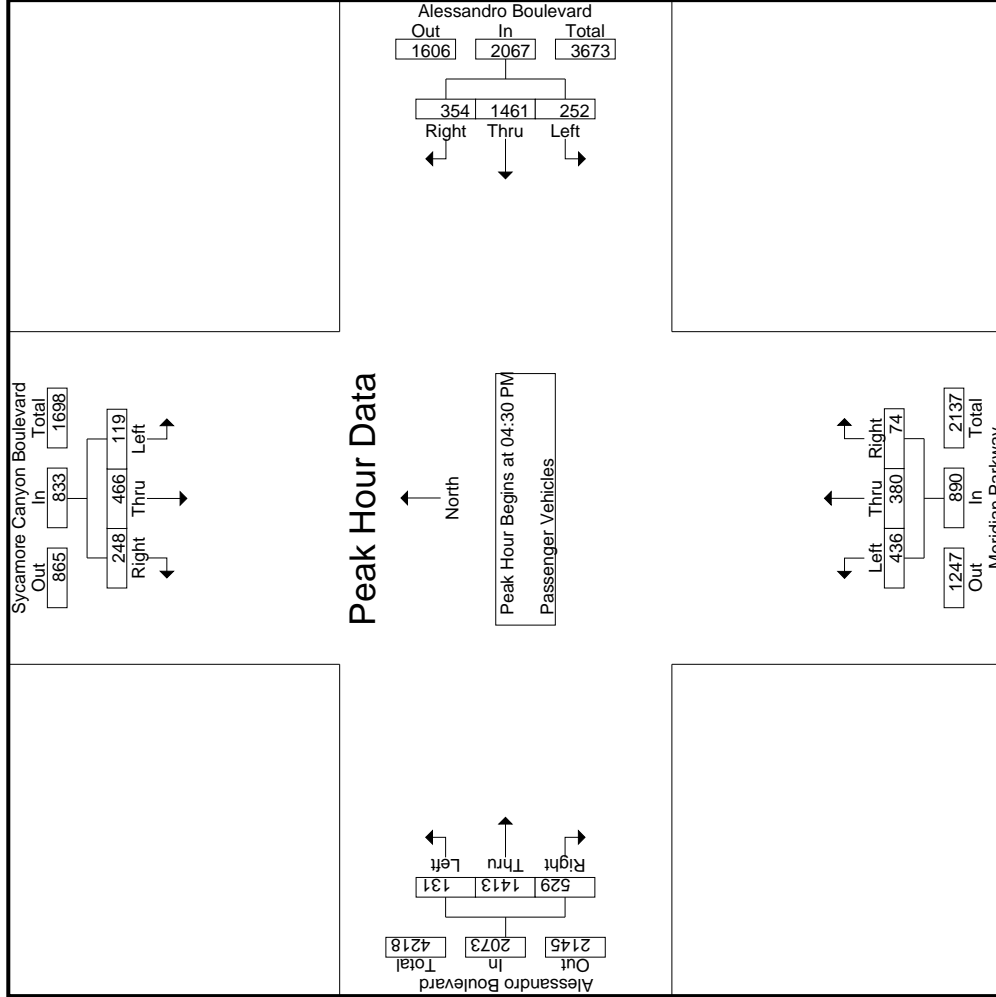

Counts Unlimited, Inc.
 PO Box 1178
 Corona, CA 92878
 (951)268-6268

County of Riverside
 N/S: Sycamore Canyon Blvd/Meridian Pkwy
 E/W: Alessandro Boulevard
 Weather: Clear

File Name : 21_CRV_Meri_Ales PM
 Site Code : 05121716
 Start Date : 11/30/2021
 Page No : 3

Start Time	Sycamore Canyon Boulevard Southbound			Alessandro Boulevard Westbound			Meridian Parkway Northbound			Alessandro Boulevard Eastbound		
	Left	Thru	Right	Left	Thru	Right	Left	Thru	Right	Left	Thru	Right
Peak Hour Analysis From 04:30 PM to 05:15 PM - Peak 1 of 1												
Peak Hour for Each Approach Begins at:												
+0 mins.	35	76	59	44	377	96	111	121	30	26	348	139
+15 mins.	29	93	48	64	392	95	113	99	13	42	329	121
+30 mins.	27	136	73	71	347	81	119	92	17	29	363	138
+45 mins.	28	161	68	73	345	82	93	68	14	34	373	131
Total Volume	119	466	248	252	1461	354	436	380	74	131	1413	529
% App. Total	14.3	55.9	29.8	12.2	70.7	17.1	49	42.7	8.3	6.3	68.2	25.5
PHF	.850	.724	.849	.863	.932	.922	.916	.785	.617	.780	.947	.951
			.810		.938							.963

Counts Unlimited, Inc.
 PO Box 1178
 Corona, CA 92878
 (951)268-6268

County of Riverside
 N/S: Sycamore Canyon Blvd/Meridian Pkwy
 E/W: Alessandro Boulevard
 Weather: Clear

File Name : 21_CRV_Meri_Ales_PM
 Site Code : 05121716
 Start Date : 11/30/2021
 Page No : 1

Groups Printed- Large 2 Axle Vehicles

Start Time	Sycamore Canyon Boulevard Southbound					Alessandro Boulevard Westbound					Meridian Parkway Northbound					Alessandro Boulevard Eastbound							
	Left	Thru	Right	RTOR	App. Total	Left	Thru	Right	RTOR	App. Total	Left	Thru	Right	RTOR	App. Total	Left	Thru	Right	RTOR	App. Total	Exclu. Total	Inclu. Total	Int. Total
04:00 PM	1	1	1	1	3	1	8	3	1	12	3	2	0	0	5	0	5	3	0	8	2	28	30
04:15 PM	0	1	0	0	1	0	4	5	1	9	2	3	1	1	6	1	3	2	1	6	3	22	25
04:30 PM	1	2	1	0	4	2	10	4	1	16	2	1	1	0	4	0	6	1	0	7	7	31	32
04:45 PM	1	2	0	0	3	4	1	3	1	8	0	2	0	0	2	0	2	1	0	3	1	16	17
Total	3	6	2	1	11	7	23	15	4	45	7	8	2	1	17	1	16	7	1	24	7	97	104
05:00 PM	0	3	1	0	4	2	2	4	2	8	2	3	0	0	5	0	5	3	0	8	2	25	27
05:15 PM	1	4	2	1	7	3	4	3	2	10	1	0	2	0	3	0	1	1	1	2	4	22	26
05:30 PM	0	5	0	0	5	0	4	0	0	4	1	1	0	0	2	2	4	1	1	7	1	18	19
05:45 PM	1	4	1	0	6	1	4	2	1	7	0	0	0	0	0	1	2	0	0	3	1	16	17
Total	2	16	4	1	22	6	14	9	5	29	4	4	2	0	10	3	12	5	2	20	8	81	89
Grand Total	5	22	6	2	33	13	37	24	9	74	11	12	4	1	27	4	28	12	3	44	15	178	193
% Approach	15.2	66.7	18.2			17.6	50	32.4		41.6	40.7	44.4	14.8		15.2	9.1	63.6	27.3		24.7	7.8	92.2	
% Total	2.8	12.4	3.4		18.5	7.3	20.8	13.5			6.2	6.7	2.2			2.2	15.7	6.7					

Start Time	Sycamore Canyon Boulevard Southbound					Alessandro Boulevard Westbound					Meridian Parkway Northbound					Alessandro Boulevard Eastbound							
	Left	Thru	Right	RTOR	App. Total	Left	Thru	Right	RTOR	App. Total	Left	Thru	Right	RTOR	App. Total	Left	Thru	Right	RTOR	App. Total	Exclu. Total	Inclu. Total	Int. Total
04:30 PM	1	2	1		4	2	10	4		16	2	1	1		4	0	6	1		7		7	31
04:45 PM	1	2	0		3	4	1	3		8	0	2	0		2	0	2	1		3		3	16
05:00 PM	0	3	1		4	2	2	4		8	2	3	0		5	0	5	3		8		8	25
05:15 PM	1	4	2		7	3	4	3		10	1	0	2		3	0	1	1		2		2	22
Total Volume	3	11	4		18	11	17	14		42	5	6	3		14	0	14	6		20		20	94
% App. Total	16.7	61.1	22.2			26.2	40.5	33.3			35.7	42.9	21.4			0	70	30					
PHF	.750	.688	.500		.643	.688	.425	.875		.656	.625	.500	.375		.700	.000	.583	.500		.625		.625	.758

Peak Hour Analysis From 04:30 PM to 05:15 PM - Peak 1 of 1
 Peak Hour for Entire Intersection Begins at 04:30 PM

Counts Unlimited, Inc.
 PO Box 1178
 Corona, CA 92878
 (951)268-6268

County of Riverside
 N/S: Sycamore Canyon Blvd/Meridian Pkwy
 E/W: Alessandro Boulevard
 Weather: Clear

File Name : 21_CRV_Meri_Ales PM
 Site Code : 05121716
 Start Date : 11/30/2021
 Page No : 2

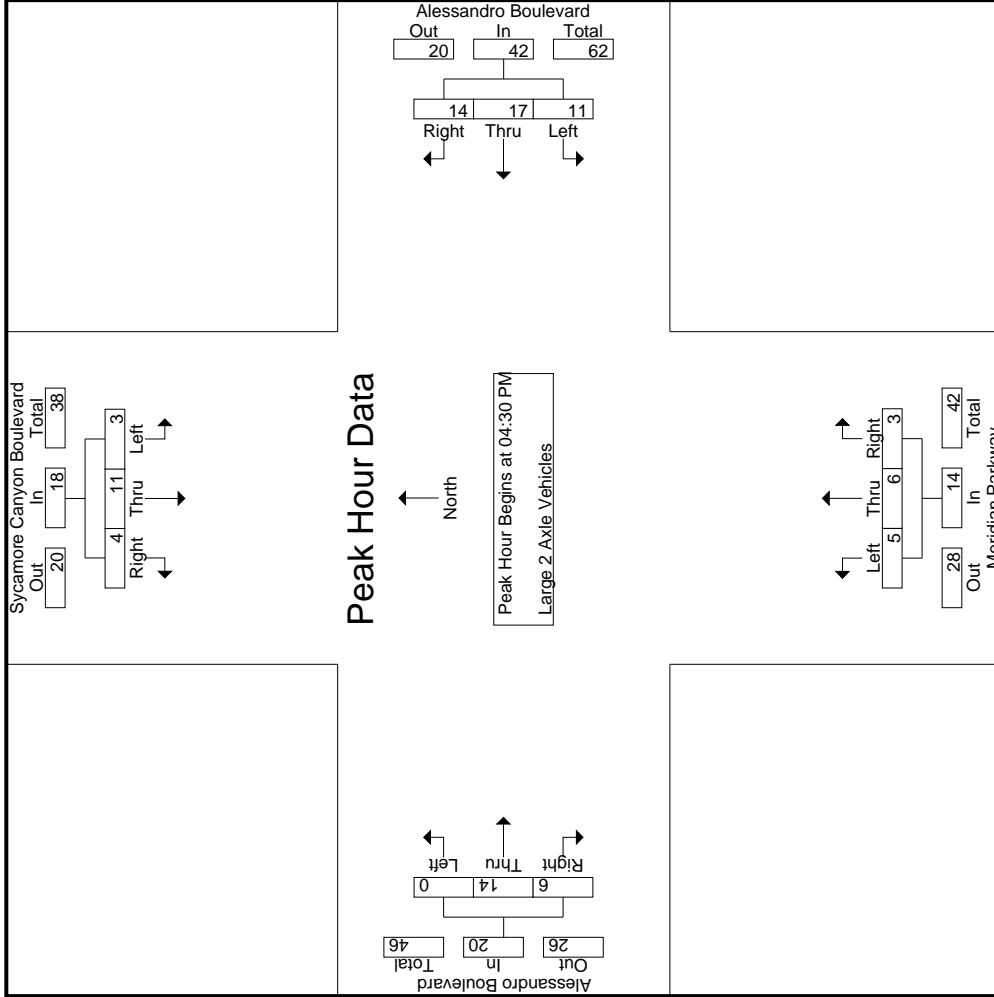

Counts Unlimited, Inc.
 PO Box 1178
 Corona, CA 92878
 (951)268-6268

File Name : 21_CRV_Meri_Ales PM
 Site Code : 05121716
 Start Date : 11/30/2021
 Page No : 3

County of Riverside
 N/S: Sycamore Canyon Blvd/Meridian Pkwy
 E/W: Alessandro Boulevard
 Weather: Clear

Start Time	Sycamore Canyon Boulevard Southbound			Alessandro Boulevard Westbound			Meridian Parkway Northbound			Alessandro Boulevard Eastbound			Int. Total		
	Left	Thru	Right	Left	Thru	Right	Left	Thru	Right	Left	Thru	Right		App. Total	
Peak Hour Analysis From 04:30 PM to 05:15 PM - Peak 1 of 1	Peak Hour for Each Approach Begins at:														
	04:30 PM			04:30 PM			04:30 PM			04:30 PM					
+0 mins.	1	2	1	4	10	4	16	2	4	1	1	1	6	1	7
+15 mins.	1	2	0	3	1	3	8	4	0	2	0	2	2	1	3
+30 mins.	0	3	1	4	2	4	8	2	2	3	0	5	5	3	8
+45 mins.	1	4	2	7	4	3	10	3	1	0	2	3	1	1	2
Total Volume	3	11	4	18	17	14	42	5	6	3	14	0	14	6	20
% App. Total	16.7	61.1	22.2	26.2	40.5	33.3	35.7	35.7	42.9	21.4	70	0	70	30	30
PHF	.750	.688	.500	.688	.425	.875	.656	.625	.500	.375	.700	.000	.583	.500	.625

Counts Unlimited, Inc.
 PO Box 1178
 Corona, CA 92878
 (951)268-6268

County of Riverside
 N/S: Sycamore Canyon Blvd/Meridian Pkwy
 E/W: Alessandro Boulevard
 Weather: Clear

File Name : 21_CRV_Meri_Ales PM
 Site Code : 05121716
 Start Date : 11/30/2021
 Page No : 1

Groups Printed- 3 Axle Vehicles

Start Time	Sycamore Canyon Boulevard Southbound				Alessandro Boulevard Westbound				Meridian Parkway Northbound				Alessandro Boulevard Eastbound							
	Left	Thru	Right	RTOR	Left	Thru	Right	RTOR	Left	Thru	Right	RTOR	Left	Thru	Right	RTOR	App. Total	Exclu. Total	Inclu. Total	Int. Total
04:00 PM	0	0	0	0	0	0	1	0	1	0	4	0	0	1	0	0	1	0	6	6
04:15 PM	1	1	0	0	0	0	1	0	1	0	2	0	0	0	1	0	1	0	6	6
04:30 PM	0	0	1	0	1	1	0	0	3	0	3	0	0	0	1	0	1	0	8	8
04:45 PM	1	1	0	0	0	0	2	1	2	0	1	0	0	1	0	0	1	1	6	7
Total	2	2	1	0	1	1	5	1	7	0	10	0	0	0	3	1	4	1	26	27
05:00 PM	0	2	0	0	2	1	0	0	3	0	1	0	0	0	0	0	0	0	6	6
05:15 PM	0	3	0	0	4	1	0	0	5	0	0	0	0	0	0	0	0	0	8	8
05:30 PM	1	2	0	0	2	0	1	1	3	0	2	0	0	0	0	0	0	1	8	9
05:45 PM	0	1	0	0	1	2	1	1	4	0	0	0	0	0	0	0	0	1	5	6
Total	1	8	0	0	9	4	2	2	15	0	3	0	0	0	0	0	2	27	29	
Grand Total	3	10	1	0	14	5	7	3	22	0	13	0	0	0	3	1	0	3	53	56
T-Approch %	21.4	71.4	7.1		45.5	22.7	31.8		41.5	0	100	0		0	75	25		7.5		
N2 Total %	5.7	18.9	1.9		26.4	9.4	13.2		41.5	0	24.5	0		0	5.7	1.9		5.4		94.6

Start Time	Sycamore Canyon Boulevard Southbound				Alessandro Boulevard Westbound				Meridian Parkway Northbound				Alessandro Boulevard Eastbound							
	Left	Thru	Right	RTOR	Left	Thru	Right	RTOR	Left	Thru	Right	RTOR	Left	Thru	Right	RTOR	App. Total	Exclu. Total	Inclu. Total	Int. Total
04:30 PM	0	0	0	0	1	1	1	0	3	0	3	0	0	0	0	0	3	0	1	1
04:45 PM	1	1	0	0	0	0	0	0	2	0	1	0	0	0	1	0	1	0	1	6
05:00 PM	0	2	0	0	2	1	0	0	3	0	3	0	0	0	0	0	1	0	0	6
05:15 PM	0	3	0	0	4	1	0	0	5	0	0	0	0	0	0	0	0	0	0	8
Total	1	6	1	0	8	3	3	13	13	0	5	0	0	1	1	2	5	0	28	
% App. Total	12.5	75	12.5		53.8	23.1	23.1		37.5	0	100	0		0	50	50		.875		
PHF	.250	.500	.250		.667	.438	.750		.375	.650	.417	.000		.250	.250	.500		.500		

Peak Hour Analysis From 04:30 PM to 05:15 PM - Peak 1 of 1
 Peak Hour for Entire Intersection Begins at 04:30 PM

Counts Unlimited, Inc.
 PO Box 1178
 Corona, CA 92878
 (951)268-6268

County of Riverside
 N/S: Sycamore Canyon Blvd/Meridian Pkwy
 E/W: Alessandro Boulevard
 Weather: Clear

File Name : 21_CRV_Meri_Ales PM
 Site Code : 05121716
 Start Date : 11/30/2021
 Page No : 2

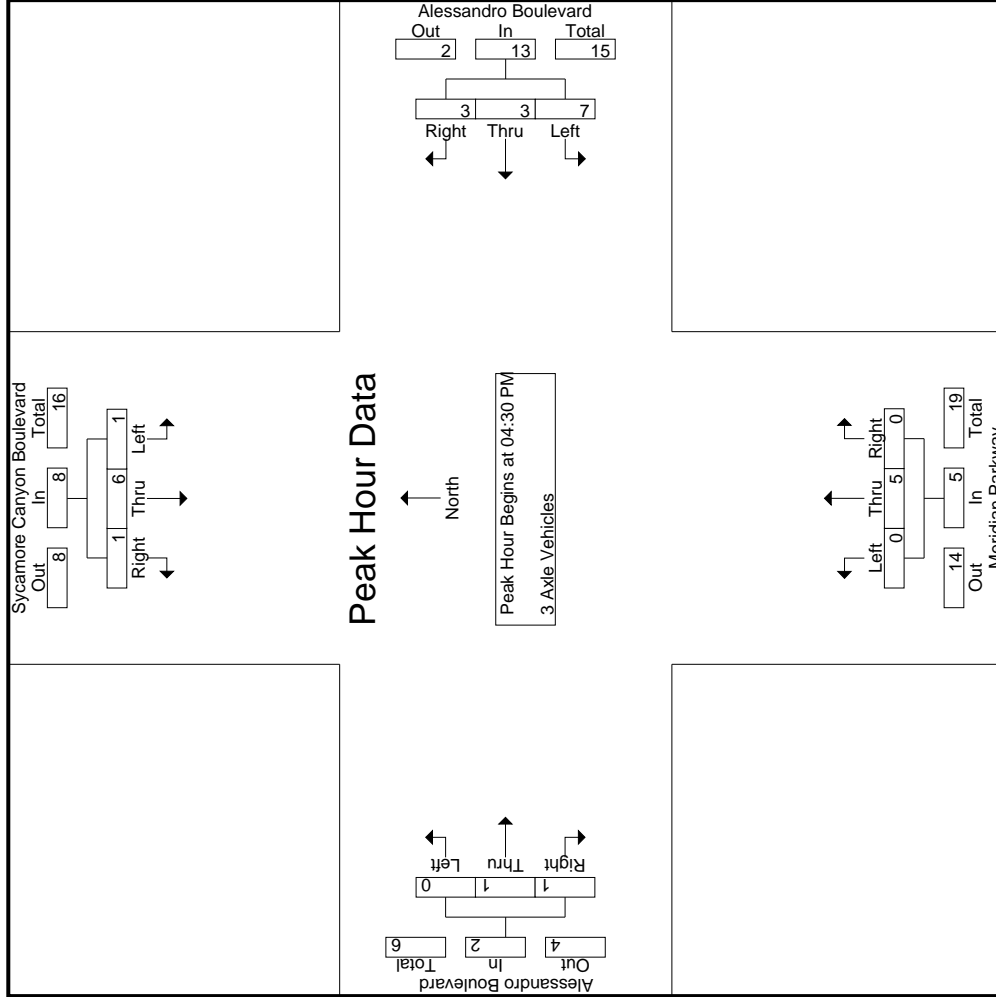

Counts Unlimited, Inc.
 PO Box 1178
 Corona, CA 92878
 (951)268-6268

File Name : 21_CRV_Meri_Ales PM
 Site Code : 05121716
 Start Date : 11/30/2021
 Page No : 3

County of Riverside
 N/S: Sycamore Canyon Blvd/Meridian Pkwy
 E/W: Alessandro Boulevard
 Weather: Clear

Start Time	Sycamore Canyon Boulevard Southbound			Alessandro Boulevard Westbound			Meridian Parkway Northbound			Alessandro Boulevard Eastbound			Int. Total	
	Left	Thru	Right	Left	Thru	Right	Left	Thru	Right	Left	Thru	Right		App. Total
Peak Hour Analysis From 04:30 PM to 05:15 PM - Peak 1 of 1	04:30 PM													
Peak Hour for Each Approach Begins at:	04:30 PM													
+0 mins.	0	0	1	1	1	1	3	0	0	3	0	0	1	1
+15 mins.	1	1	0	0	2	2	2	1	0	1	0	1	0	1
+30 mins.	0	2	0	2	1	0	3	0	0	1	0	0	0	0
+45 mins.	0	3	0	4	1	0	5	0	0	0	0	0	0	0
Total Volume	1	6	1	7	3	3	13	0	0	5	0	1	1	2
% App. Total	12.5	.75	12.5	53.8	23.1	23.1	.650	.000	.000	.417	.000	.250	.50	.500
PHF	.250	.500	.250	.438	.750	.375	.650	.000	.000	.417	.000	.250	.250	.500

Counts Unlimited, Inc.
 PO Box 1178
 Corona, CA 92878
 (951)268-6268

County of Riverside
 N/S: Sycamore Canyon Blvd/Meridian Pkwy
 E/W: Alessandro Boulevard
 Weather: Clear

File Name : 21_CRV_Meri_Ales PM
 Site Code : 05121716
 Start Date : 11/30/2021
 Page No : 1

Groups Printed- 4+ Axle Trucks

Start Time	Sycamore Canyon Boulevard Southbound				Alessandro Boulevard Westbound				Meridian Parkway Northbound				Alessandro Boulevard Eastbound										
	Left	Thru	Right	RTOR	App. Total	Left	Thru	Right	RTOR	App. Total	Left	Thru	Right	RTOR	App. Total	Left	Thru	Right	RTOR	App. Total	Exclu. Total	Inclu. Total	Int. Total
04:00 PM	1	4	0	0	5	1	2	8	1	11	0	3	1	0	4	1	3	0	0	4	1	24	25
04:15 PM	2	2	0	0	4	3	1	2	0	6	0	5	1	0	6	0	2	0	0	2	0	18	18
04:30 PM	1	2	0	0	3	2	0	4	2	6	2	0	0	2	2	0	2	0	0	2	2	13	15
04:45 PM	0	0	0	0	0	2	1	1	0	4	0	1	0	0	1	0	0	1	0	1	0	6	6
Total	4	8	0	0	12	8	4	15	3	27	2	9	2	0	13	1	7	1	0	9	3	61	64
05:00 PM	0	4	0	0	4	5	0	3	0	8	0	1	0	0	1	0	0	0	0	0	0	13	13
05:15 PM	1	1	1	1	3	4	1	4	1	9	0	1	0	0	1	0	0	0	0	0	2	13	15
05:30 PM	1	8	0	0	9	1	2	2	0	5	1	3	1	1	5	0	2	0	2	2	1	21	22
05:45 PM	2	3	0	0	5	1	3	2	1	6	0	0	0	0	0	0	1	1	0	2	1	13	14
Total	4	16	1	1	21	11	6	11	2	28	1	5	1	1	7	0	3	1	0	4	4	60	64
Grand Total	8	24	1	1	33	19	10	26	5	55	3	14	3	1	20	1	10	2	0	13	7	121	128
T-Approch %	24.2	72.7	3		34.5	18.2	47.3			45.5	15	70	15		16.5	7.7	76.9	15.4		10.7	5.5	94.5	
N2 Total %	6.6	19.8	0.8		27.3	8.3	21.5				2.5	11.6	2.5			0.8	8.3	1.7					

Start Time	Sycamore Canyon Boulevard Southbound				Alessandro Boulevard Westbound				Meridian Parkway Northbound				Alessandro Boulevard Eastbound										
	Left	Thru	Right	RTOR	App. Total	Left	Thru	Right	RTOR	App. Total	Left	Thru	Right	RTOR	App. Total	Left	Thru	Right	RTOR	App. Total	Exclu. Total	Inclu. Total	Int. Total
04:30 PM	1	2	0	0	3	2	0	4	6	6	2	0	0	2	2	0	0	0	0	2	0	2	13
04:45 PM	0	0	0	0	0	2	1	1	4	4	0	1	0	1	1	0	0	1	1	0	1	1	6
05:00 PM	0	4	0	0	4	5	0	3	8	8	0	1	0	1	1	0	0	0	0	0	0	0	13
05:15 PM	1	1	1	1	3	4	1	4	9	9	0	1	0	0	1	0	0	0	0	0	0	0	13
Total Volume	2	7	1	1	10	13	2	12	27	27	2	3	3	0	5	0	2	1	1	3	33.3	45	45
% App. Total	20	70	10		44.4	48.1	7.4	44.4			40	60	0		66.7	0	66.7	33.3			.250	.375	.865
PHF	.500	.438	.250		.625	.650	.500	.750			.250	.750	.000		.625	.000	.250	.250					

Peak Hour Analysis From 04:30 PM to 05:15 PM - Peak 1 of 1
 Peak Hour for Entire Intersection Begins at 04:30 PM

Counts Unlimited, Inc.
 PO Box 1178
 Corona, CA 92878
 (951)268-6268

County of Riverside
 N/S: Sycamore Canyon Blvd/Meridian Pkwy
 E/W: Alessandro Boulevard
 Weather: Clear

File Name : 21_CRV_Meri_Ales PM
 Site Code : 05121716
 Start Date : 11/30/2021
 Page No : 2

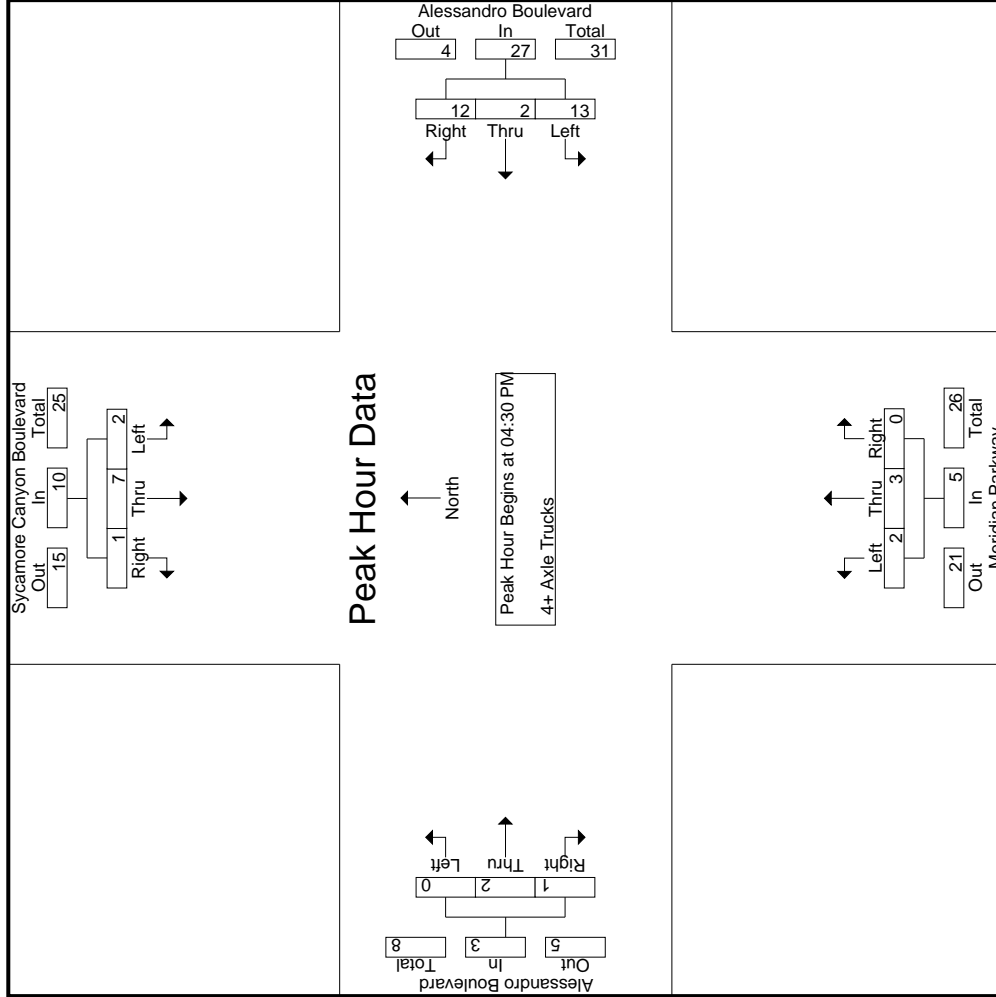

Counts Unlimited, Inc.
 PO Box 1178
 Corona, CA 92878
 (951)268-6268

File Name : 21_CRV_Meri_Ales PM
 Site Code : 05121716
 Start Date : 11/30/2021
 Page No : 3

County of Riverside
 N/S: Sycamore Canyon Blvd/Meridian Pkwy
 E/W: Alessandro Boulevard
 Weather: Clear

Start Time	Sycamore Canyon Boulevard Southbound			Alessandro Boulevard Westbound			Meridian Parkway Northbound			Alessandro Boulevard Eastbound		
	Left	Thru	Right	Left	Thru	Right	Left	Thru	Right	Left	Thru	Right
Peak Hour Analysis From 04:30 PM to 05:15 PM - Peak 1 of 1	Peak Hour for Each Approach Begins at:											
	04:30 PM			04:30 PM			04:30 PM			04:30 PM		
+0 mins.	1	2	0	0	4	6	0	0	0	2	0	2
+15 mins.	0	0	0	1	1	4	1	0	0	0	0	1
+30 mins.	0	4	0	0	3	8	0	0	1	0	0	0
+45 mins.	1	1	1	1	4	9	1	0	1	0	0	0
Total Volume	2	7	1	2	12	27	2	3	0	5	2	1
% App. Total	20	70	10	7.4	44.4	48.1	40	60	0	66.7	33.3	0
PHF	.500	.438	.250	.500	.750	.750	.250	.750	.000	.625	.250	.375

Location: County of Riverside
 N/S: Sycamore Cyn Blvd/Meridian Pkwy
 E/W: Alessandro Boulevard



Date: 11/30/2021
 Day: Tuesday

PEDESTRIANS

	North Leg Sycamore Canyon Blvd Pedestrians	East Leg Alessandro Boulevard Pedestrians	South Leg Meridian Parkway Pedestrians	West Leg Alessandro Boulevard Pedestrians	
7:00 AM	0	0	0	1	1
7:15 AM	0	0	1	1	2
7:30 AM	0	1	1	1	3
7:45 AM	0	0	0	0	0
8:00 AM	0	0	0	0	0
8:15 AM	0	0	0	0	0
8:30 AM	0	0	0	0	0
8:45 AM	0	0	0	0	0
TOTAL VOLUMES:	0	1	2	3	6

	North Leg Sycamore Canyon Blvd Pedestrians	East Leg Alessandro Boulevard Pedestrians	South Leg Meridian Parkway Pedestrians	West Leg Alessandro Boulevard Pedestrians	
4:00 PM	0	0	0	0	0
4:15 PM	0	0	0	0	0
4:30 PM	0	0	0	0	0
4:45 PM	0	0	0	0	0
5:00 PM	0	0	0	0	0
5:15 PM	0	0	0	0	0
5:30 PM	0	0	0	0	0
5:45 PM	0	0	0	0	0
TOTAL VOLUMES:	0	0	0	0	0

Location: County of Riverside
 N/S: Sycamore Cyn Blvd/Meridian Pkwy
 E/W: Alessandro Boulevard



Date: 11/30/2021
 Day: Tuesday

BICYCLES

	Southbound Sycamore Canyon Blvd			Westbound Alessandro Boulevard			Northbound Meridian Parkway			Eastbound Alessandro Boulevard			
	Left	Thru	Right	Left	Thru	Right	Left	Thru	Right	Left	Thru	Right	
7:00 AM	0	0	0	0	1	0	1	0	0	0	0	0	2
7:15 AM	0	0	0	0	0	0	0	0	0	0	0	0	0
7:30 AM	0	0	0	0	0	0	0	0	0	0	0	0	0
7:45 AM	0	0	0	0	0	0	0	0	0	0	0	0	0
8:00 AM	0	0	0	0	0	0	0	0	0	0	0	0	0
8:15 AM	0	0	0	0	0	0	0	1	0	0	0	0	1
8:30 AM	0	0	0	0	0	0	0	0	0	0	0	0	0
8:45 AM	0	0	0	0	0	0	0	0	0	0	0	2	2
TOTAL VOLUMES:	0	0	0	0	1	0	1	1	0	0	0	2	5

	Southbound Sycamore Canyon Blvd			Westbound Alessandro Boulevard			Northbound Meridian Parkway			Eastbound Alessandro Boulevard			
	Left	Thru	Right	Left	Thru	Right	Left	Thru	Right	Left	Thru	Right	
4:00 PM	0	0	0	0	0	0	0	0	0	0	0	0	0
4:15 PM	0	0	0	0	0	0	0	0	0	0	0	0	0
4:30 PM	0	0	0	0	1	0	0	0	0	0	0	0	1
4:45 PM	0	0	0	0	0	0	0	0	0	0	0	0	0
5:00 PM	0	0	0	0	0	0	0	0	0	0	0	0	0
5:15 PM	0	0	0	0	2	0	0	0	0	0	0	0	2
5:30 PM	0	0	0	0	0	0	0	0	0	0	0	0	0
5:45 PM	0	1	0	0	0	0	0	0	0	0	0	0	1
TOTAL VOLUMES:	0	1	0	0	3	0	0	0	0	0	0	0	4

Groups Printed- Passenger Vehicles - Large 2 Axle Vehicles - 3 Axle Vehicles - 4+ Axle Trucks

Start Time	Meridian Parkway Southbound					Cactus Avenue Westbound					Meridian Parkway Northbound					Cactus Avenue Eastbound							
	Left	Thru	Right	RTOR	App. Total	Left	Thru	Right	RTOR	App. Total	Left	Thru	Right	RTOR	App. Total	Left	Thru	Right	RTOR	App. Total	Exclu. Total	Inclu. Total	Int. Total
	07:00 AM	29	33	2	1	64	74	3	203	52	280	0	50	29	12	79	1	2	0	0	3	65	426
07:15 AM	34	33	5	3	72	98	6	199	33	303	1	74	36	30	111	0	1	0	0	1	66	487	553
07:30 AM	41	31	1	0	73	60	2	202	64	264	2	85	51	27	137	2	1	0	0	3	91	477	568
07:45 AM	23	39	1	0	63	78	4	182	57	264	2	96	55	19	153	1	0	0	0	1	76	481	557
Total	127	136	9	4	272	310	15	786	206	1111	4	305	171	88	480	4	4	0	0	8	298	1871	2169
08:00 AM	24	29	1	0	54	76	5	176	58	257	1	91	45	18	137	1	4	1	1	6	77	454	531
08:15 AM	23	17	1	1	41	70	3	224	68	297	1	78	29	15	108	4	1	0	0	5	84	451	535
08:30 AM	32	25	3	1	60	73	5	214	52	292	0	82	34	23	116	1	1	3	0	5	76	473	549
08:45 AM	25	21	2	0	48	38	6	150	62	194	3	59	48	23	110	2	2	5	3	9	88	361	449
Total	104	92	7	2	203	257	19	764	240	1040	5	310	156	79	471	8	8	9	4	25	325	1739	2064
Grand Total	231	228	16	6	475	567	34	1550	446	2151	9	615	327	167	951	12	12	9	4	33	623	3610	4233
% Approach	48.6	48	3.4			26.4	1.6	72.1			0.9	64.7	34.4			36.4	36.4	27.3					
% Total	6.4	6.3	0.4			13.2	0.9	42.9			0.2	17	9.1			0.3	0.3	0.2			14.7	85.3	
Passenger Vehicles	221	216	12		455	473	23	1500	2426	2426	9	548	292		999	5	8	7		23	0	0	3903
Large 2 Axle Vehicles	95.7	94.7	75	100	94.6	83.4	67.6	96.8	96.4	93.4	100	89.1	89.3	89.8	89.4	41.7	66.7	77.8	75	62.2	0	0	92.2
% Large 2 Axle Vehicles	8	8	1		17	13	4	29		54	0	19	9		33	2	0	2		5	0	0	109
% 3 Axle Vehicles	3.5	3.5	6.2	0	3.5	2.3	11.8	1.9	1.8	2.1	0	3.1	2.8	3	3	16.7	0	22.2	25	13.5	0	0	2.6
% 3 Axle Vehicles	1	1	1		3	6	2	7		19	0	7	0		7	1	1	0	2	2	0	0	31
% 4+ Axle Trucks	0.4	0.4	6.2	0	0.6	1.1	5.9	0.5	0.9	0.7	0	1.1	0	0	0.6	8.3	8.3	0	0	5.4	0	0	0.7
% 4+ Axle Trucks	1	3	2		6	75	5	14		98	0	41	26		79	4	3	0	7	7	0	0	190
% 4+ Axle Trucks	0.4	1.3	12.5	0	1.2	13.2	14.7	0.9	0.9	3.8	0	6.7	8	7.2	7.1	33.3	25	0	18.9	0	0	0	4.5

Start Time	Meridian Parkway Southbound					Cactus Avenue Westbound					Meridian Parkway Northbound					Cactus Avenue Eastbound								
	Left	Thru	Right	RTOR	App. Total	Left	Thru	Right	RTOR	App. Total	Left	Thru	Right	RTOR	App. Total	Left	Thru	Right	RTOR	App. Total	Exclu. Total	Inclu. Total	Int. Total	
	07:15 AM	34	33	5		72	98	6	199		303	1	74	36		111	0	1	0		1	0	0	1
07:30 AM	41	31	1		73	60	2	202		264	1	85	51		137	2	1	0		1	0	0	3	477
07:45 AM	23	39	1		63	78	4	182		264	2	96	55		153	1	0	0		0	0	0	1	481
08:00 AM	24	29	1		54	76	5	176		257	1	91	45		137	1	0	0		4	1	6	6	454
Total Volume	122	132	8		262	312	17	759		1088	5	346	187		538	4	6	1		6	1	11	11	1899
% App. Total	46.6	50.4	3.1			28.7	1.6	69.8			0.9	64.3	34.8			36.4	54.5	9.1						
PHF	.744	.846	.400		.897	.796	.708	.939		.898	.625	.901	.850		.879	.500	.375	.250			.458			.975

Peak Hour Analysis From 07:00 AM to 08:45 AM - Peak 1 of 1
 Peak Hour for Entire Intersection Begins at 07:15 AM

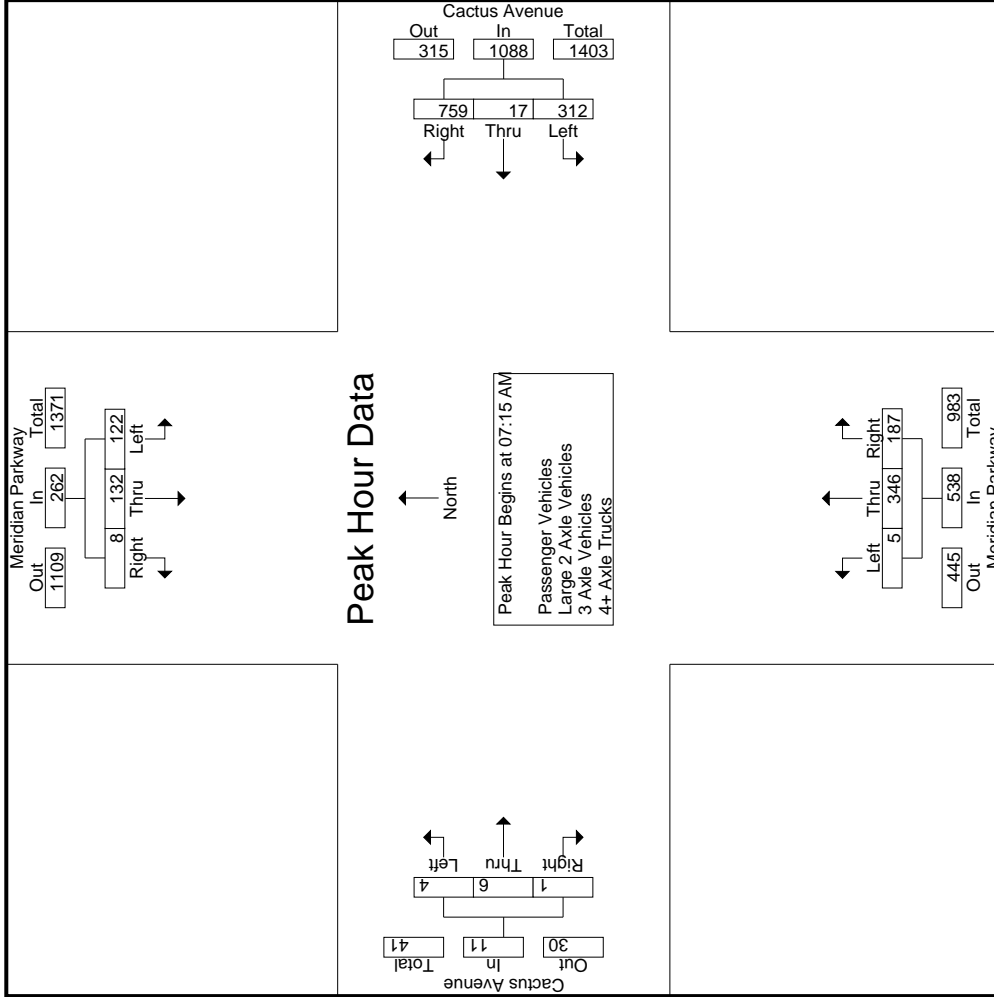

Counts Unlimited, Inc.
 PO Box 1178
 Corona, CA 92878
 (951)268-6268

County of Riverside
 N/S: Meridian Parkway
 E/W: Cactus Avenue
 Weather: Clear

File Name : 22_CRV_Meri_Cactus AM
 Site Code : 05121716
 Start Date : 11/30/2021
 Page No : 3

Start Time	Meridian Parkway Southbound			Cactus Avenue Westbound			Meridian Parkway Northbound			Cactus Avenue Eastbound						
	Left	Thru	Right	App. Total	Left	Thru	Right	App. Total	Left	Thru	Right	App. Total	Int. Total			
Peak Hour Analysis From 07:00 AM to 08:45 AM - Peak 1 of 1																
Peak Hour for Each Approach Begins at:																
	07:00 AM			07:00 AM			07:15 AM			08:00 AM						
+0 mins.	29	33	2	64	74	3	203	280	1	74	36	111	1	4	1	6
+15 mins.	34	33	5	72	98	6	199	303	1	85	51	137	4	1	0	5
+30 mins.	41	31	1	73	60	2	202	264	2	96	55	153	1	1	3	5
+45 mins.	23	39	1	63	78	4	182	264	1	91	45	137	2	2	5	9
Total Volume	127	136	9	272	310	15	786	1111	5	346	187	538	8	8	9	25
% App. Total	46.7	50	3.3	27.2	27.9	1.4	70.7	91.7	0.9	64.3	34.8	87.9	32	32	36	69.4
PHF	.774	.872	.450	.932	.791	.625	.968	.917	.625	.901	.850	.879	.500	.500	.450	.694

Groups Printed- Passenger Vehicles

Start Time	Meridian Parkway Southbound				Cactus Avenue Westbound				Meridian Parkway Northbound				Cactus Avenue Eastbound										
	Left	Thru	Right	RTOR	App. Total	Left	Thru	Right	RTOR	App. Total	Left	Thru	Right	RTOR	App. Total	Left	Thru	Right	RTOR	App. Total	Exclu. Total	Inclu. Total	Int. Total
07:00 AM	28	30	2	1	60	70	2	197	50	269	0	44	25	11	69	0	2	0	0	2	62	400	462
07:15 AM	33	32	5	3	70	82	5	193	31	280	1	70	34	28	105	0	0	0	0	0	62	455	517
07:30 AM	38	30	0	0	68	52	1	194	62	247	1	79	48	27	128	0	0	0	0	0	89	443	532
07:45 AM	22	37	1	0	60	66	3	175	55	244	2	86	52	18	140	0	0	0	0	0	73	444	517
Total	121	129	8	4	258	270	11	759	198	1040	4	279	159	84	442	0	2	0	0	2	286	1742	2028
08:00 AM	23	26	1	0	50	67	4	172	58	243	1	84	40	15	125	0	3	1	1	4	74	422	496
08:15 AM	23	17	1	1	41	59	3	215	66	277	1	63	26	13	90	3	1	0	0	4	80	412	492
08:30 AM	30	24	2	1	56	51	3	209	50	263	0	70	32	22	102	1	1	3	0	5	73	426	499
08:45 AM	24	20	0	0	44	26	2	145	58	173	3	52	35	16	90	1	1	3	2	5	76	312	388
Total	100	87	4	2	191	203	12	741	232	956	5	269	133	66	407	5	6	7	3	18	303	1572	1875
Grand Total	221	216	12	6	449	473	23	1500	430	1996	9	548	292	150	849	5	8	7	3	20	589	3314	3903
T-Approch %	49.2	48.1	2.7			23.7	1.2	75.2		60.2	1.1	64.5	34.4		25.6	25	40	35		0.6	15.1	84.9	
N-Total %	6.7	6.5	0.4		13.5	14.3	0.7	45.3			0.3	16.5	8.8			0.2	0.2	0.2					

Start Time	Meridian Parkway Southbound				Cactus Avenue Westbound				Meridian Parkway Northbound				Cactus Avenue Eastbound											
	Left	Thru	Right	RTOR	App. Total	Left	Thru	Right	RTOR	App. Total	Left	Thru	Right	RTOR	App. Total	Left	Thru	Right	RTOR	App. Total	Exclu. Total	Inclu. Total	Int. Total	
07:15 AM	33	32	3	5	70	82	5	193	31	280	1	70	34	28	105	0	0	0	0	0	0	0	0	455
07:30 AM	38	30	0	0	68	52	1	194	62	247	1	79	48	27	128	0	0	0	0	0	0	0	0	443
07:45 AM	22	37	1	0	60	66	3	175	55	244	2	86	52	18	140	0	0	0	0	0	0	0	0	444
08:00 AM	116	125	7	2.8	248	267	13	734	174	1014	5	319	174	498	498	0	3	1	4	4	0	4	4	1764
% App. Total	46.8	50.4	2.8			26.3	1.3	72.4			1	64.1	34.9		25.6	0	75	25			.250	.250	.250	.969
PHF	.763	.845	.350		.886	.814	.650	.946		.905	.625	.927	.837		.889	.000	.250	.250						

Peak Hour Analysis From 07:15 AM to 08:00 AM - Peak 1 of 1
 Peak Hour for Entire Intersection Begins at 07:15 AM

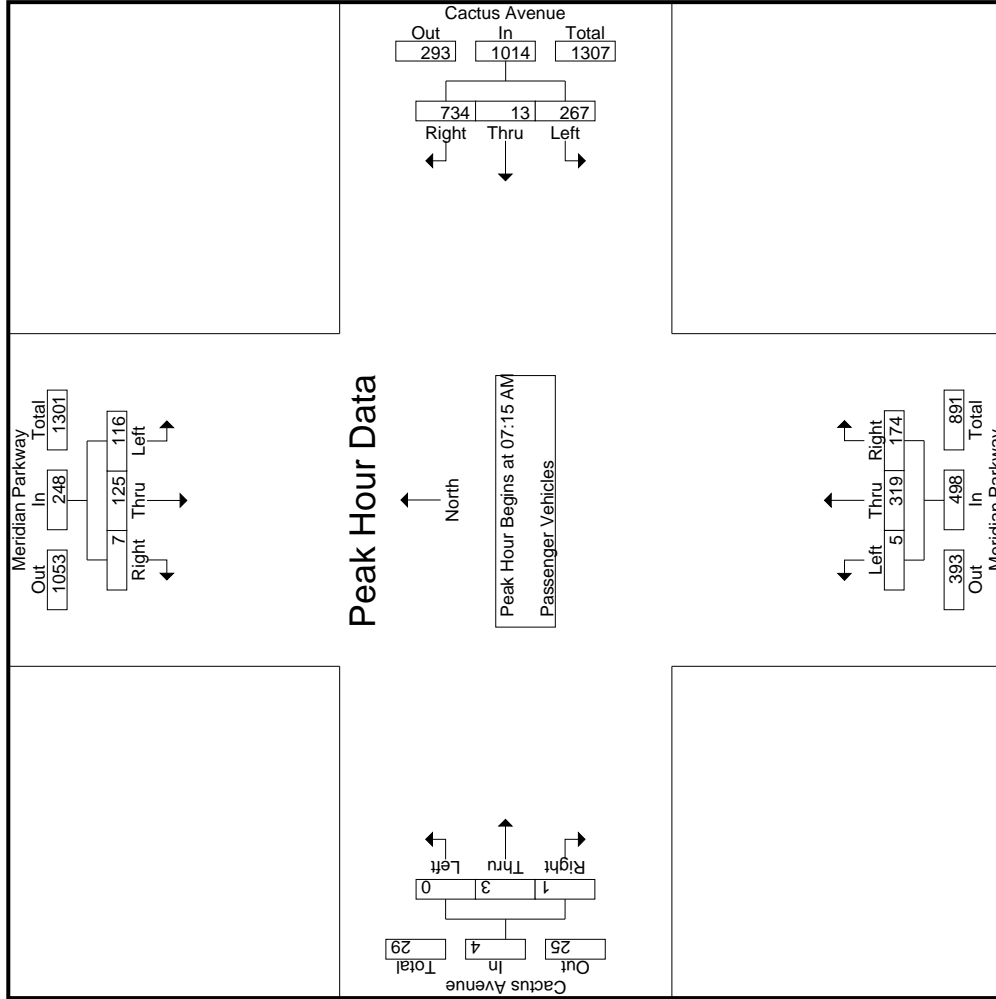

Counts Unlimited, Inc.
 PO Box 1178
 Corona, CA 92878
 (951)268-6268

File Name : 22_CRV_Meri_Cactus AM
 Site Code : 05121716
 Start Date : 11/30/2021
 Page No : 3

County of Riverside
 N/S: Meridian Parkway
 E/W: Cactus Avenue
 Weather: Clear

Start Time	Meridian Parkway Southbound				Cactus Avenue Westbound				Meridian Parkway Northbound				Cactus Avenue Eastbound				
	Left	Thru	Right	App. Total	Left	Thru	Right	App. Total	Left	Thru	Right	App. Total	Left	Thru	Right	App. Total	Int. Total
Peak Hour Analysis From 07:15 AM to 08:00 AM - Peak 1 of 1	Peak Hour for Each Approach Begins at:																
	07:15 AM				07:15 AM				07:15 AM				07:15 AM				
+0 mins.	33	32	5	70	82	5	193	280	1	70	34	105	0	0	0	0	0
+15 mins.	38	30	0	68	52	1	194	247	1	79	48	128	0	0	0	0	0
+30 mins.	22	37	1	60	66	3	175	244	2	86	52	140	0	0	0	0	0
+45 mins.	23	26	1	50	67	4	172	243	1	84	40	125	0	3	1	4	4
Total Volume	116	125	7	248	267	13	734	1014	5	319	174	498	0	3	1	1	4
% App. Total	46.8	50.4	2.8		26.3	1.3	72.4		1	64.1	34.9		0	75	25		
PHF	.763	.845	.350	.886	.814	.650	.946	.905	.625	.927	.837	.889	.000	.250	.250	.250	.250

Groups Printed- Large 2 Axle Vehicles

Start Time	Meridian Parkway Southbound				Cactus Avenue Westbound				Meridian Parkway Northbound				Cactus Avenue Eastbound											
	Left	Thru	Right	RTOR	Left	Thru	Right	RTOR	Left	Thru	Right	RTOR	Left	Thru	Right	RTOR	Left	Thru	Right	RTOR	Exclu. Total	Inclu. Total	Int. Total	
07:00 AM	0	3	0	0	3	1	0	3	1	4	0	0	0	2	0	0	0	0	0	0	0	1	9	10
07:15 AM	1	0	0	0	1	2	1	4	1	7	0	0	0	1	0	0	0	0	0	0	0	1	9	10
07:30 AM	2	1	1	0	4	1	0	6	1	7	0	0	2	0	0	0	0	0	0	0	0	1	13	14
07:45 AM	1	2	0	0	3	0	1	4	0	5	0	4	1	0	0	0	0	1	0	0	1	0	14	14
Total	4	6	1	0	11	4	2	17	3	23	0	8	2	10	1	0	0	1	0	0	1	3	45	48
08:00 AM	1	1	0	0	2	2	0	2	0	4	0	1	1	2	0	0	0	0	0	0	0	1	8	9
08:15 AM	0	0	0	0	0	3	1	4	0	4	0	4	1	5	1	0	0	0	0	0	0	2	10	12
08:30 AM	2	0	0	0	2	5	0	4	2	9	0	3	2	1	0	0	0	0	0	0	0	3	16	19
08:45 AM	1	1	0	0	2	1	2	3	2	6	0	3	3	6	0	2	1	2	0	2	2	5	16	21
Total	4	2	0	0	6	9	2	12	5	23	0	11	7	18	1	0	2	1	3	1	11	50	61	
Grand Total	8	8	1	0	17	13	4	29	8	46	0	19	9	28	2	0	2	1	4	14	14	95	109	
% Approach	47.1	47.1	5.9		28.3	8.7	63			48.4	0	67.9	32.1	29.5	50	0	50	4.2			12.8	87.2		
% Total	8.4	8.4	1.1		17.9	13.7	4.2	30.5			0	20	9.5		2.1	0	2.1							

Start Time	Meridian Parkway Southbound				Cactus Avenue Westbound				Meridian Parkway Northbound				Cactus Avenue Eastbound											
	Left	Thru	Right	RTOR	Left	Thru	Right	RTOR	Left	Thru	Right	RTOR	Left	Thru	Right	RTOR	Left	Thru	Right	RTOR	App. Total	App. Total	Int. Total	
07:15 AM	1	0	0	0	1	0	0	0	0	7	0	1	0	1	0	0	0	0	0	0	0	0	0	9
07:30 AM	2	1	1	0	4	1	0	6	1	7	0	4	1	2	0	0	0	0	0	0	2	0	0	13
07:45 AM	1	2	0	0	3	0	2	4	0	5	0	4	1	5	1	0	1	0	0	0	2	0	1	14
08:00 AM	1	1	1	0	2	2	0	2	2	4	0	1	1	2	0	0	0	0	0	0	2	0	0	8
Total Volume	5	4	4	1	10	5	2	16	3	23	0	7	3	10	1	0	1	0	0	0	10	0	0	44
% App. Total	50	40	10		21.7	8.7	69.6			69.6	0	70	30		100	0	0							
PHF	.625	.500	.250		.625	.500	.667			.821	.000	.438	.750		.500	.000	.250				.500	.000	.250	.786

Peak Hour Analysis From 07:15 AM to 08:00 AM - Peak 1 of 1
 Peak Hour for Entire Intersection Begins at 07:15 AM

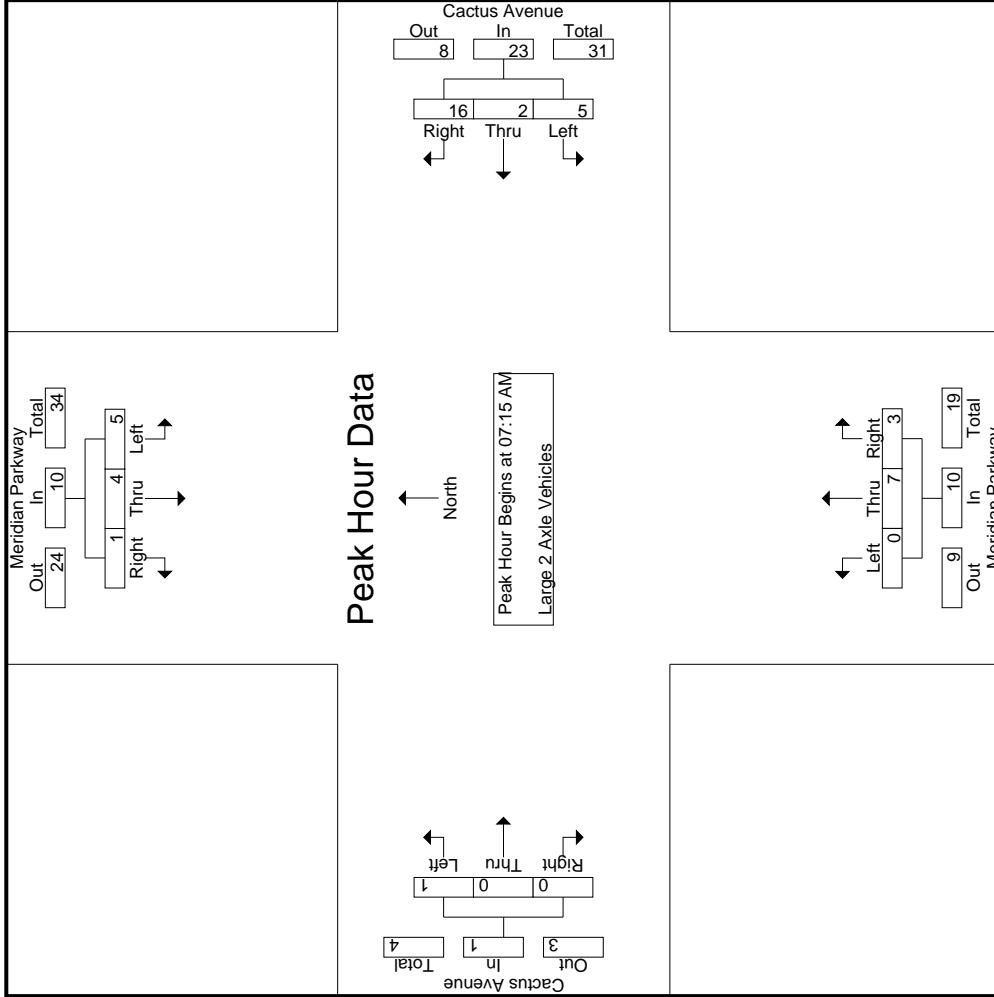

Counts Unlimited, Inc.
 PO Box 1178
 Corona, CA 92878
 (951)268-6268

File Name : 22_CRV_Meri_Cactus AM
 Site Code : 05121716
 Start Date : 11/30/2021
 Page No : 3

County of Riverside
 N/S: Meridian Parkway
 E/W: Cactus Avenue
 Weather: Clear

Start Time	Meridian Parkway Southbound			Cactus Avenue Westbound			Meridian Parkway Northbound			Cactus Avenue Eastbound			
	Left	Thru	Right	App. Total	Left	Thru	Right	App. Total	Left	Thru	Right	App. Total	Int. Total
Peak Hour Analysis From 07:15 AM to 08:00 AM - Peak 1 of 1	Peak Hour for Each Approach Begins at:												
	07:15 AM			07:15 AM			07:15 AM			07:15 AM			
+0 mins.	1	0	0	1	4	7	1	0	1	0	0	0	0
+15 mins.	2	1	1	4	6	7	0	1	2	0	0	0	0
+30 mins.	1	2	0	3	4	5	4	1	5	1	0	0	1
+45 mins.	1	1	0	2	2	4	0	1	2	0	0	0	0
Total Volume	5	4	1	10	16	23	0	3	10	1	0	0	1
% App. Total	50	40	10	62.5	8.7	69.6	0	30	100	0	0	0	0
PHF	.625	.500	.250	.625	.500	.821	.000	.750	.500	.250	.000	.000	.250

Groups Printed- 3 Axle Vehicles

Start Time	Meridian Parkway Southbound				Cactus Avenue Westbound				Meridian Parkway Northbound				Cactus Avenue Eastbound											
	Left	Thru	Right	RTOR	App. Total	Left	Thru	Right	RTOR	App. Total	Left	Thru	Right	RTOR	App. Total	Left	Thru	Right	RTOR	App. Total	Exclu. Total	Inclu. Total	Int. Total	
07:00 AM	0	0	0	0	0	0	0	0	0	3	0	0	0	0	0	1	0	0	0	0	1	1	4	5
07:15 AM	0	0	0	0	0	1	0	0	0	1	0	0	0	0	0	0	0	0	0	0	0	0	1	1
07:30 AM	1	0	0	0	1	1	0	0	0	2	0	0	0	0	0	0	0	0	0	0	0	0	3	3
07:45 AM	0	0	0	0	0	0	0	2	2	2	0	0	0	0	0	0	0	0	0	0	0	2	2	4
Total	1	0	0	0	1	2	2	4	3	8	0	0	0	0	0	1	0	0	0	0	3	10	13	
08:00 AM	0	1	0	0	1	3	0	1	0	4	0	1	0	0	1	0	0	0	0	0	0	0	6	6
08:15 AM	0	0	0	0	0	1	0	2	1	3	0	2	0	0	2	0	0	0	0	0	0	1	5	6
08:30 AM	0	0	0	0	0	0	0	0	0	0	0	4	0	0	4	0	0	0	0	0	0	0	4	4
08:45 AM	0	0	1	0	1	0	0	0	0	0	0	0	0	0	0	1	0	0	0	0	1	0	2	2
Total	0	1	1	0	2	4	0	3	1	7	0	7	0	0	7	0	1	0	0	0	1	17	18	
Grand Total	1	1	1	0	3	6	2	7	4	15	0	7	0	0	7	1	1	0	0	0	2	4	27	31
T-Approch %	33.3	33.3	33.3			40	13.3	46.7		55.6	0	100	0	0	25.9	50	50	0	0	0	7.4	12.9	87.1	
N-Total %	3.7	3.7	3.7		11.1	22.2	7.4	25.9			0	25.9	0	0	3.7	3.7	3.7	0	0	0				

Start Time	Meridian Parkway Southbound				Cactus Avenue Westbound				Meridian Parkway Northbound				Cactus Avenue Eastbound											
	Left	Thru	Right	RTOR	App. Total	Left	Thru	Right	RTOR	App. Total	Left	Thru	Right	RTOR	App. Total	Left	Thru	Right	RTOR	App. Total	Exclu. Total	Inclu. Total	Int. Total	
07:15 AM	0	0	0	0	0	0	0	0	0	1	0	0	0	0	0	0	0	0	0	0	0	0	0	1
07:30 AM	1	0	0	0	1	1	0	0	0	2	0	0	0	0	0	0	0	0	0	0	0	0	0	3
07:45 AM	0	0	0	0	0	0	0	0	0	0	0	0	0	0	0	0	0	0	0	0	0	0	0	2
08:00 AM	0	1	0	0	1	3	0	0	0	4	0	1	0	0	1	0	0	0	0	0	0	0	0	6
Total Volume	1	1	0	0	2	5	1	3	9	33.3	0	100	0	0	1	0	0	0	0	0	0	0	0	12
% App. Total	50	50	0	0	55.6	11.1	33.3				0	100	0	0		0	0	0	0	0				
PHF	.250	.250	.000	.500	.417	.250	.375	.563	.250	.000	.000	.250	.000	.250	.250	.000	.000	.000	.000	.000	.000	.000	.000	.500

Peak Hour Analysis From 07:15 AM to 08:00 AM - Peak 1 of 1
 Peak Hour for Entire Intersection Begins at 07:15 AM

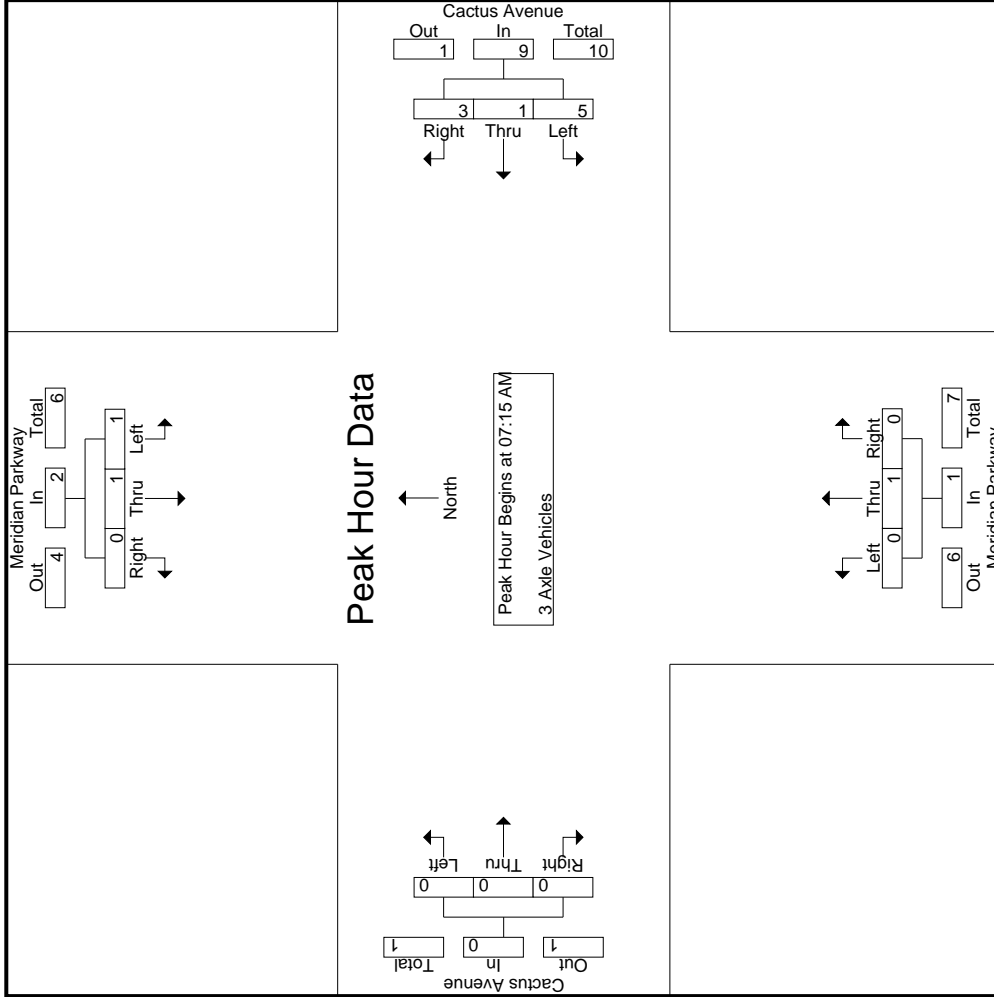

Counts Unlimited, Inc.
 PO Box 1178
 Corona, CA 92878
 (951)268-6268

File Name : 22_CRV_Meri_Cactus AM
 Site Code : 05121716
 Start Date : 11/30/2021
 Page No : 3

County of Riverside
 N/S: Meridian Parkway
 E/W: Cactus Avenue
 Weather: Clear

Start Time	Meridian Parkway Southbound			Cactus Avenue Westbound			Meridian Parkway Northbound			Cactus Avenue Eastbound			
	Left	Thru	Right	App. Total	Left	Thru	Right	App. Total	Left	Thru	Right	App. Total	Int. Total
Peak Hour Analysis From 07:15 AM to 08:00 AM - Peak 1 of 1	Peak Hour for Each Approach Begins at:												
	07:15 AM			07:15 AM			07:15 AM			07:15 AM			
+0 mins.	0	0	0	0	0	0	0	0	0	0	0	0	0
+15 mins.	1	0	0	1	1	0	2	0	0	0	0	0	0
+30 mins.	0	0	0	0	0	2	2	0	0	0	0	0	0
+45 mins.	0	1	0	1	3	0	4	0	1	0	0	1	0
Total Volume	1	1	0	2	5	1	9	0	1	0	0	1	0
% App. Total	50	50	0	55.6	11.1	33.3	0	100	0	0	0	0	0
PHF	.250	.250	.000	.500	.417	.250	.375	.563	.000	.250	.000	.250	.000

Groups Printed- 4+ Axle Trucks

Start Time	Meridian Parkway Southbound				Cactus Avenue Westbound				Meridian Parkway Northbound				Cactus Avenue Eastbound										
	Left	Thru	Right	RTOR	Left	Thru	Right	RTOR	Left	Thru	Right	RTOR	Left	Thru	Right	RTOR	Left	Thru	Right	RTOR	Exclu. Total	Inclu. Total	Int. Total
07:00 AM	1	0	0	0	1	0	1	0	4	0	4	1	8	0	0	0	0	0	0	0	1	13	14
07:15 AM	0	1	0	0	1	13	0	2	15	0	3	2	5	0	1	0	0	1	3	22	25	25	
07:30 AM	0	0	0	0	0	6	0	2	8	0	5	2	7	2	1	0	0	3	1	18	19	19	
07:45 AM	0	0	0	0	0	12	0	1	13	0	6	2	8	0	0	0	0	0	1	21	22	22	
Total	1	1	0	0	2	34	0	6	40	0	18	10	28	2	2	0	0	4	6	74	80	80	
08:00 AM	0	1	0	0	1	4	1	1	6	0	5	4	9	1	1	0	0	2	2	18	20	20	
08:15 AM	0	0	0	0	0	9	0	4	13	0	9	2	11	0	0	0	0	1	24	25	25		
08:30 AM	0	1	1	0	2	17	2	1	20	0	5	0	5	0	0	0	0	0	0	27	27	27	
08:45 AM	0	0	1	0	1	11	2	2	15	0	4	10	14	1	0	0	0	1	7	31	38	38	
Total	0	2	2	0	4	41	5	8	54	0	23	16	39	2	1	0	0	3	10	100	110	110	
Grand Total	1	3	2	0	6	75	5	14	94	0	41	26	67	4	3	0	0	7	16	174	190	190	
% Apprch %	16.7	50	33.3		79.8	5.3	14.9		54	0	61.2	38.8	38.5	57.1	42.9	0	0	4	8.4	91.6			
% Total %	0.6	1.7	1.1		43.1	2.9	8		54	0	23.6	14.9	38.5	2.3	1.7	0	0	4	8.4	91.6			

Start Time	Meridian Parkway Southbound				Cactus Avenue Westbound				Meridian Parkway Northbound				Cactus Avenue Eastbound										
	Left	Thru	Right	RTOR	Left	Thru	Right	RTOR	Left	Thru	Right	RTOR	Left	Thru	Right	RTOR	Left	Thru	Right	RTOR	Exclu. Total	Inclu. Total	Int. Total
07:15 AM	0	1	0	0	1	0	0	0	2	0	15	3	2	0	0	0	0	5	0	0	1	1	1
07:30 AM	0	0	0	0	0	6	0	2	8	0	8	0	2	0	1	0	0	7	1	0	3	3	3
07:45 AM	0	0	0	0	0	12	0	1	13	0	13	0	2	0	0	0	0	8	0	0	0	0	0
08:00 AM	0	1	0	0	1	4	1	1	6	0	6	0	4	0	1	0	0	9	1	0	2	2	2
Total Volume	0	2	0	0	2	35	1	6	42	0	19	10	29	3	3	0	0	6	0	0	6	6	79
% App. Total	0	100	0	0	83.3	2.4	14.3		700	0	65.5	34.5	.625	.375	.750	0	0	.500	.806	.750	.500	.898	.898
PHF	.000	.500	.000		.673	.250	.750		.700	.000	.792	.625	.806	.375	.750	.000	.500	.806	.750	.500	.898	.898	.898

Peak Hour Analysis From 07:15 AM to 08:00 AM - Peak 1 of 1
 Peak Hour for Entire Intersection Begins at 07:15 AM

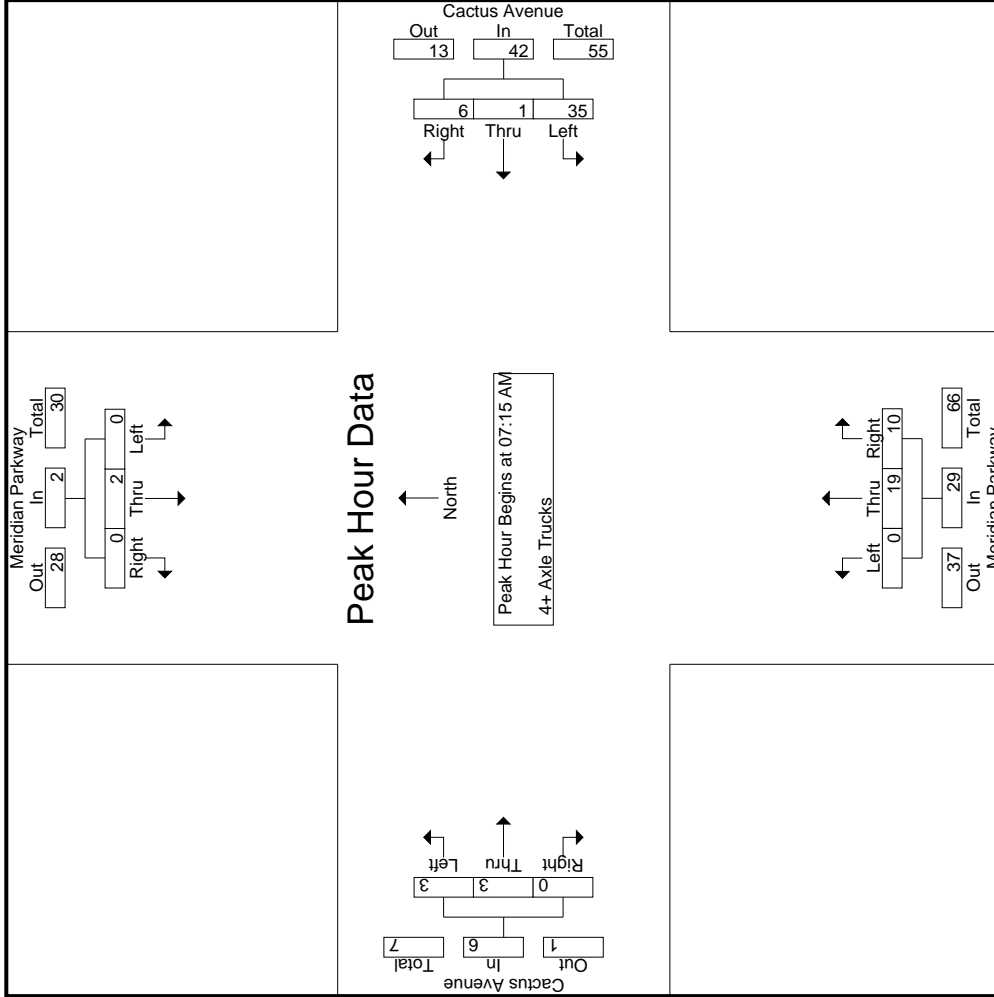

Counts Unlimited, Inc.
 PO Box 1178
 Corona, CA 92878
 (951)268-6268

County of Riverside
 N/S: Meridian Parkway
 E/W: Cactus Avenue
 Weather: Clear

File Name : 22_CRV_Meri_Cactus AM
 Site Code : 05121716
 Start Date : 11/30/2021
 Page No : 3

Start Time	Meridian Parkway Southbound			Cactus Avenue Westbound			Meridian Parkway Northbound			Cactus Avenue Eastbound					
	Left	Thru	Right	App. Total	Left	Thru	Right	App. Total	Left	Thru	Right	App. Total	Int. Total		
Peak Hour Analysis From 07:15 AM to 08:00 AM - Peak 1 of 1	Peak Hour for Each Approach Begins at:														
	07:15 AM				07:15 AM				07:15 AM				07:15 AM		
+0 mins.	0	1	0	1	13	0	2	15	3	2	5	0	1	0	1
+15 mins.	0	0	0	0	6	0	2	8	5	2	7	0	1	0	3
+30 mins.	0	0	0	0	12	0	1	13	6	2	8	0	0	0	0
+45 mins.	0	1	0	1	4	1	1	6	5	4	9	1	1	0	2
Total Volume	0	2	0	2	35	1	6	42	19	10	29	3	3	0	6
% App. Total	0	100	0	0	83.3	2.4	14.3	0	65.5	34.5	0	50	50	0	0
PHF	.000	.500	.000	.500	.673	.250	.750	.700	.792	.625	.806	.375	.750	.000	.500

Counts Unlimited, Inc.
 PO Box 1178
 Corona, CA 92878
 (951)268-6268

County of Riverside
 N/S: Meridian Parkway
 E/W: Cactus Avenue
 Weather: Clear

File Name : 22_CRV_Meri_Cactus PM
 Site Code : 05121716
 Start Date : 11/30/2021
 Page No : 1

Groups Printed- Passenger Vehicles - Large 2 Axle Vehicles - 3 Axle Vehicles - 4+ Axle Trucks

Start Time	Meridian Parkway Southbound						Cactus Avenue Westbound						Meridian Parkway Northbound						Cactus Avenue Eastbound													
	Left		Thru		Right		Left		Thru		Right		Left		Thru		Right		Left		Thru		Right		Left		Thru		Right			
	RTOR	App. Total	RTOR	App. Total	RTOR	App. Total	RTOR	App. Total	RTOR	App. Total	RTOR	App. Total	RTOR	App. Total	RTOR	App. Total	RTOR	App. Total	RTOR	App. Total	RTOR	App. Total	RTOR	App. Total	RTOR	App. Total	RTOR	App. Total	RTOR	App. Total		
04:00 PM	83	146	0	229	125	4	154	70	283	0	79	62	28	141	1	5	1	0	7	98	660	758	98	660	758	98	660	758	98	660	758	
04:15 PM	107	129	0	236	115	3	120	48	238	1	100	86	28	187	1	7	1	1	9	77	670	747	77	670	747	77	670	747	77	670	747	
04:30 PM	118	188	0	306	136	1	145	75	282	0	103	41	15	144	10	3	4	4	17	94	749	843	94	749	843	94	749	843	94	749	843	
04:45 PM	111	146	1	258	171	1	142	61	314	0	87	63	28	150	2	3	2	2	7	91	729	820	91	729	820	91	729	820	91	729	820	
Total	419	609	1	1029	547	9	561	254	1117	1	369	252	99	622	14	18	8	7	40	360	2808	3168	360	2808	3168	360	2808	3168	360	2808	3168	
05:00 PM	132	257	2	391	256	7	107	58	370	0	79	52	21	131	1	1	6	2	8	81	900	981	81	900	981	81	900	981	81	900	981	
05:15 PM	110	249	2	361	139	5	108	38	252	0	59	53	25	112	3	6	2	1	11	64	736	800	64	736	800	64	736	800	64	736	800	
05:30 PM	134	209	2	345	89	2	86	46	177	1	62	49	22	112	10	8	3	2	21	70	655	725	70	655	725	70	655	725	70	655	725	
05:45 PM	129	190	2	321	112	1	62	38	174	1	38	48	16	87	3	4	2	1	9	56	591	647	56	591	647	56	591	647	56	591	647	
Total	505	905	8	1418	596	14	363	180	973	2	238	202	84	442	17	19	13	6	49	271	2882	3153	271	2882	3153	271	2882	3153	271	2882	3153	
Grand Total	924	1514	9	2447	1143	23	924	434	2090	3	607	454	183	1064	31	37	21	13	89	631	5690	6321	631	5690	6321	631	5690	6321	631	5690	6321	
T-Approach %	37.8	61.9	0.4		54.7	1.1	44.2			0.3	57	42.7			34.8	41.6	23.6															
N Total %	16.2	26.6	0.2	43	20.1	0.4	16.2		36.7	0.1	10.7	8		18.7	0.5	0.7	0.4		1.6	10	90		10	90		10	90		10	90		
% Passenger Vehicles	900	1404	5	2310	1069	21	897		2411	3	555	417		1144	29	33	20		94	0	0	5959	0	0	5959	0	0	5959	0	0	5959	
% Large 2 Axle Vehicles	97.4	92.7	55.6	100	94.4	93.5	91.3	97.1	97.7	100	91.4	91.9	92.3	91.7	93.5	89.2	95.2	92.3	92.2	0	0	94.3	0	0	94.3	0	0	94.3	0	0	94.3	
% Large 2 Axle Vehicles	9	43	1	53	26	0	17		48	0	18	10		32	1	0	0		1	0	0	134	0	0	134	0	0	134	0	0	134	
% 3 Axle Vehicles	1	2.8	11.1	0	2.2	2.3	0	1.8	1.2	0	3	2.2	2.2	2.6	3.2	0	0	0	1	0	0	2.1	0	0	2.1	0	0	2.1	0	0	2.1	
% 3 Axle Vehicles	0.1	1.5	0	0.9	0.7	4.3	0.2	0.5	0.5	0	1.5	1.1	1.1	1.3	3.2	0	0	0	1	0	0	5.3	0	0	5.3	0	0	5.3	0	0	5.3	
4+ Axle Trucks	14	45	3	62	40	1	8		52	0	25	22		55	0	4	1		6	0	0	175	0	0	175	0	0	175	0	0	175	
% 4+ Axle Trucks	1.5	3	33.3	0	2.5	3.5	4.3	0.9	0.7	0	4.1	4.8	4.4	4.4	0	10.8	4.8	7.7	5.9	0	0	2.8	0	0	2.8	0	0	2.8	0	0	2.8	

Start Time	Meridian Parkway Southbound						Cactus Avenue Westbound						Meridian Parkway Northbound						Cactus Avenue Eastbound												
	Left		Thru		Right		Left		Thru		Right		Left		Thru		Right		Left		Thru		Right		Left		Thru		Right		
	RTOR	App. Total	RTOR	App. Total	RTOR	App. Total	RTOR	App. Total	RTOR	App. Total	RTOR	App. Total	RTOR	App. Total	RTOR	App. Total	RTOR	App. Total	RTOR	App. Total	RTOR	App. Total	RTOR	App. Total	RTOR	App. Total	RTOR	App. Total	RTOR	App. Total	
04:30 PM	118	188	0	306	136	1	145	282		0	103	41		144	3	4	17		749												
04:45 PM	111	146	1	258	171	1	142	314		0	87	63		150	3	2	7		729												
05:00 PM	132	209	2	391	256	7	107	58	370	1	100	86	28	187	10	3	4	4	17	94	749	843	94	749	843	94	749	843	94	749	843
05:15 PM	110	146	1	258	171	1	142	61	314	0	87	63	28	150	2	3	2	2	7	91	729	820	91	729	820	91	729	820	91	729	820
Total Volume	471	840	5	1316	702	14	502	1218		0	328	209		537	16	13	14		43												
% App. Total	35.8	63.8	0.4		57.6	1.1	41.2			0	61.1	38.9		37.2	30.2	32.6			.632												
PHF	.892	.817	.625	.841	.686	.500	.866	.823		.000	.796	.829		.895	.400	.542			.583												

Peak Hour Analysis From 04:00 PM to 05:45 PM - Peak 1 of 1
 Peak Hour for Entire Intersection Begins at 04:30 PM

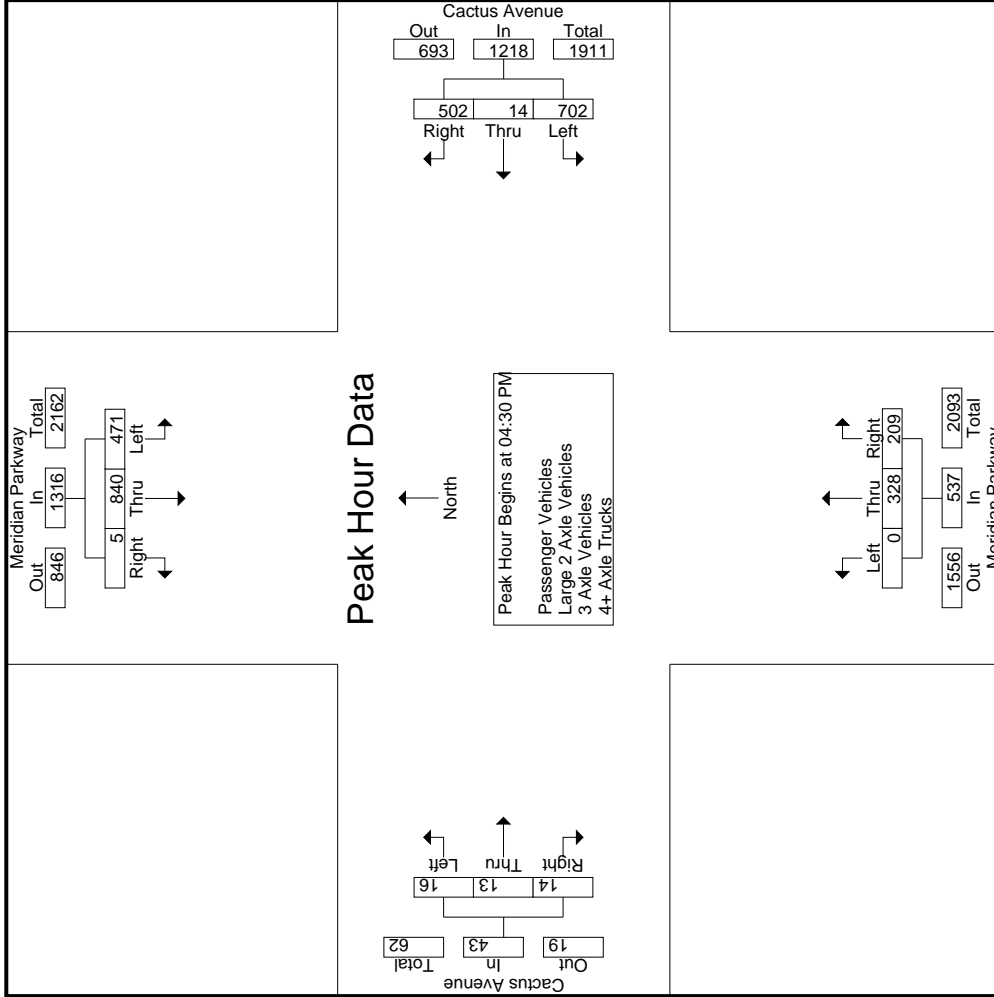

Counts Unlimited, Inc.
 PO Box 1178
 Corona, CA 92878
 (951)268-6268

County of Riverside
 N/S: Meridian Parkway
 E/W: Cactus Avenue
 Weather: Clear

File Name : 22_CRV_Meri_Cactus PM
 Site Code : 05121716
 Start Date : 11/30/2021
 Page No : 3

Start Time	Meridian Parkway Southbound				Cactus Avenue Westbound				Meridian Parkway Northbound				Cactus Avenue Eastbound				
	Left	Thru	Right	App. Total	Left	Thru	Right	App. Total	Left	Thru	Right	App. Total	Left	Thru	Right	App. Total	
	Peak Hour Analysis From 04:00 PM to 05:45 PM - Peak 1 of 1																
Peak Hour for Each Approach Begins at:	05:00 PM																
+0 mins.	132	257	2	391	136	1	145	282	0	79	62	141	05:00 PM	1	1	6	8
+15 mins.	110	249	2	361	171	1	142	314	1	100	86	187	3	6	2	11	
+30 mins.	134	209	2	345	256	7	107	370	0	103	41	144	10	8	3	21	
+45 mins.	129	190	2	321	139	5	108	252	0	87	63	150	3	4	2	9	
Total Volume	505	905	8	1418	702	14	502	1218	1	369	252	622	17	19	13	49	
% App. Total	35.6	63.8	0.6		57.6	1.1	41.2		0.2	59.3	40.5		34.7	38.8	26.5		
PHF	.942	.880	1.000	.907	.686	.500	.866	.823	.250	.896	.733	.832	.425	.594	.542	.583	

Counts Unlimited, Inc.
 PO Box 1178
 Corona, CA 92878
 (951)268-6268

County of Riverside
 N/S: Meridian Parkway
 E/W: Cactus Avenue
 Weather: Clear

File Name : 22_CRV_Meri_Cactus PM
 Site Code : 05121716
 Start Date : 11/30/2021
 Page No : 1

Groups Printed- Passenger Vehicles

Start Time	Meridian Parkway Southbound					Cactus Avenue Westbound					Meridian Parkway Northbound					Cactus Avenue Eastbound							
	Left	Thru	Right	RTOR	App. Total	Left	Thru	Right	RTOR	App. Total	Left	Thru	Right	RTOR	App. Total	Left	Thru	Right	RTOR	App. Total	Exclu. Total	Inclu. Total	Int. Total
04:00 PM	80	139	0	0	219	112	4	148	68	264	0	69	61	28	130	1	4	1	0	6	96	619	715
04:15 PM	102	122	0	0	224	104	2	112	43	218	1	90	73	23	164	1	7	1	1	9	67	615	682
04:30 PM	116	177	0	0	293	127	1	141	74	269	0	96	39	14	135	9	3	4	4	16	92	713	805
04:45 PM	111	138	1	0	250	165	1	140	60	306	0	80	56	26	136	2	2	2	2	6	88	698	786
Total	409	576	1	0	986	508	8	541	245	1057	1	335	229	91	565	13	16	8	7	37	343	2645	2988
05:00 PM	129	236	0	0	365	243	7	106	57	356	0	77	46	18	123	1	1	6	2	8	77	852	929
05:15 PM	109	230	1	0	340	132	4	104	38	240	0	54	51	24	105	3	5	1	0	9	62	694	756
05:30 PM	128	188	1	0	317	83	2	85	46	170	1	53	48	22	102	9	7	3	2	19	70	608	678
05:45 PM	125	174	2	1	301	103	0	61	38	164	1	36	43	14	80	3	4	2	1	9	54	554	608
Total	491	828	4	1	1323	561	13	356	179	930	2	220	188	78	410	16	17	12	5	45	263	2708	2971
Grand Total	900	1404	5	1	2309	1069	21	897	424	1987	3	555	417	169	975	29	33	20	12	82	606	5353	5959
T-Approch %	39	60.8	0.2			53.8	1.1	45.1		37.1	0.3	56.9	42.8		18.2	35.4	40.2	24.4		1.5	10.2	89.8	
N-Total %	16.8	26.2	0.1		43.1	20	0.4	16.8			0.1	10.4	7.8			0.5	0.6	0.4					

Start Time	Meridian Parkway Southbound					Cactus Avenue Westbound					Meridian Parkway Northbound					Cactus Avenue Eastbound							
	Left	Thru	Right	RTOR	App. Total	Left	Thru	Right	RTOR	App. Total	Left	Thru	Right	RTOR	App. Total	Left	Thru	Right	RTOR	App. Total	Exclu. Total	Inclu. Total	Int. Total
04:30 PM	116	177	0		293	127	1	141		269	0	96	39		135	9	3	4		16			713
04:45 PM	111	138	1		250	165	1	140		306	0	80	56		136	2	2	2		6			698
05:00 PM	129	236	0		365	243	7	106		356	0	77	46		123	1	1	6		8			852
05:15 PM	109	230	1		340	132	4	104		240	0	54	51		105	3	5	1		9			694
Total Volume	465	781	2		1248	667	13	491		1171	0	307	192		499	15	11	13		39			2957
% App. Total	37.3	62.6	0.2			57	1.1	41.9			0	61.5	38.5			38.5	28.2	33.3					
PHF	.901	.827	.500		.855	.686	.464	.871		.822	.000	.799	.857		.917	.417	.542	.609					.868

Peak Hour Analysis From 04:30 PM to 05:15 PM - Peak 1 of 1
 Peak Hour for Entire Intersection Begins at 04:30 PM

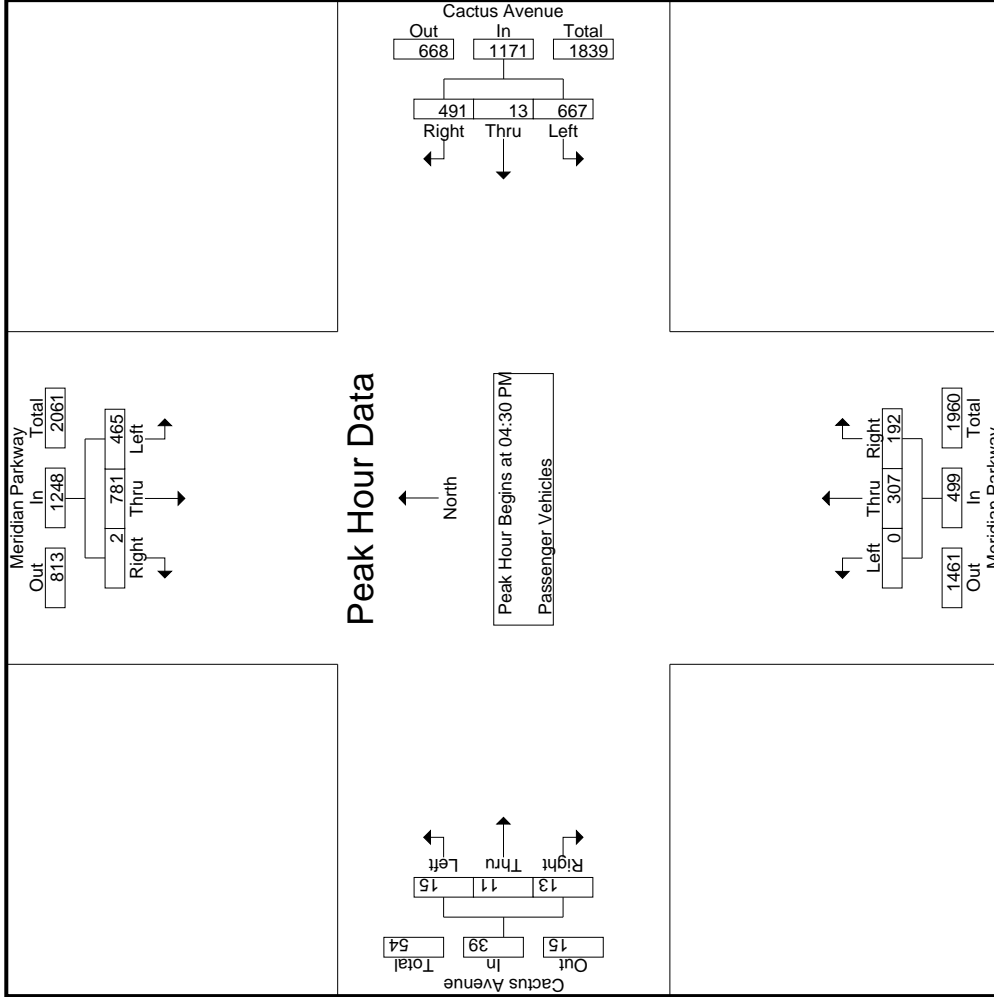

Counts Unlimited, Inc.
 PO Box 1178
 Corona, CA 92878
 (951)268-6268

County of Riverside
 N/S: Meridian Parkway
 E/W: Cactus Avenue
 Weather: Clear

File Name : 22_CRV_Meri_Cactus PM
 Site Code : 05121716
 Start Date : 11/30/2021
 Page No : 3

Start Time	Meridian Parkway Southbound				Cactus Avenue Westbound				Meridian Parkway Northbound				Cactus Avenue Eastbound				
	Left	Thru	Right	App. Total	Left	Thru	Right	App. Total	Left	Thru	Right	App. Total	Left	Thru	Right	App. Total	
	Peak Hour Analysis From 04:30 PM to 05:15 PM - Peak 1 of 1																
04:30 PM	116	177	0	293	127	1	141	269	0	96	39	135	04:30 PM	9	3	4	16
+0 mins.	111	138	1	250	165	1	140	306	0	80	56	136	04:30 PM	2	2	2	6
+15 mins.	129	236	0	365	243	7	106	356	0	77	46	123	04:30 PM	1	1	6	8
+30 mins.	109	230	1	340	132	4	104	240	0	54	51	105	04:30 PM	3	5	1	9
+45 mins.	465	781	2	1248	667	13	491	1171	0	307	192	499	04:30 PM	15	11	13	39
Total Volume	37.3	62.6	0.2		57	1.1	41.9		0	61.5	38.5		38.5	28.2	33.3		
% App. Total	.901	.827	.500	.855	.686	.464	.871	.822	.000	.799	.857	.917	.417	.550	.542		.609
PHF																	

Groups Printed- Large 2 Axle Vehicles

Start Time	Meridian Parkway Southbound				Cactus Avenue Westbound				Meridian Parkway Northbound				Cactus Avenue Eastbound								
	Left	Thru	Right	RTOR	App. Total	Left	Thru	Right	RTOR	App. Total	Left	Thru	Right	RTOR	App. Total	Exclu. Total	Inclu. Total	Int. Total			
04:00 PM	3	2	0	0	5	4	0	4	1	8	0	4	1	0	5	0	0	0	18	19	
04:15 PM	3	2	0	0	5	2	0	5	2	7	0	4	4	2	8	0	0	0	4	20	24
04:30 PM	0	7	0	0	7	3	0	4	1	7	0	3	1	0	4	0	0	0	1	18	19
04:45 PM	0	5	0	0	5	1	0	2	1	3	0	1	2	1	3	0	0	0	2	11	13
Total	6	16	0	0	22	10	0	15	5	25	0	12	8	3	20	0	0	0	8	67	75
05:00 PM	1	8	0	0	9	4	0	0	0	4	0	1	1	1	2	0	0	0	1	15	16
05:15 PM	0	4	1	0	5	5	0	2	0	7	0	2	0	0	2	0	0	0	0	14	14
05:30 PM	0	9	0	0	9	2	0	0	0	2	0	2	0	2	2	1	0	0	0	14	14
05:45 PM	2	6	0	0	8	5	0	0	0	5	0	1	1	0	2	0	0	0	0	15	15
Total	3	27	1	0	31	16	0	2	0	18	0	6	2	1	8	1	0	0	1	58	59
Grand Total	9	43	1	0	53	26	0	17	5	43	0	18	10	4	28	1	0	0	9	125	134
T-Approch %	17	81.1	1.9			60.5	0	39.5			0	64.3	35.7			100	0	0	6.7	93.3	
T-Total %	7.2	34.4	0.8		42.4	20.8	0	13.6		34.4	0	14.4	8		22.4	0.8	0	0			

Start Time	Meridian Parkway Southbound				Cactus Avenue Westbound				Meridian Parkway Northbound				Cactus Avenue Eastbound								
	Left	Thru	Right	RTOR	App. Total	Left	Thru	Right	RTOR	App. Total	Left	Thru	Right	RTOR	App. Total	Left	Thru	Right	App. Total	Int. Total	
04:30 PM	0	7	0	0	7	3	0	4	7	0	0	3	1	4	0	0	0	0	0	0	18
04:45 PM	0	5	0	0	5	1	0	2	3	0	0	1	2	3	0	0	0	0	0	0	11
05:00 PM	1	8	0	0	9	4	0	0	4	0	0	1	1	2	0	0	0	0	0	0	15
05:15 PM	0	4	1	0	5	5	0	2	0	7	0	2	0	0	2	1	0	0	0	0	14
Total Volume	1	24	1	0	26	13	0	8	21	0	0	7	4	11	0	0	0	0	0	0	58
% App. Total	3.8	92.3	3.8			61.9	0	38.1			0	63.6	36.4			0	0	0			
PHF	.250	.750	.250		.722	.650	.000	.500	.750	.500	.000	.583	.500	.688	.000	.000	.000	.000	.000	.000	.806

Peak Hour Analysis From 04:30 PM to 05:15 PM - Peak 1 of 1
 Peak Hour for Entire Intersection Begins at 04:30 PM

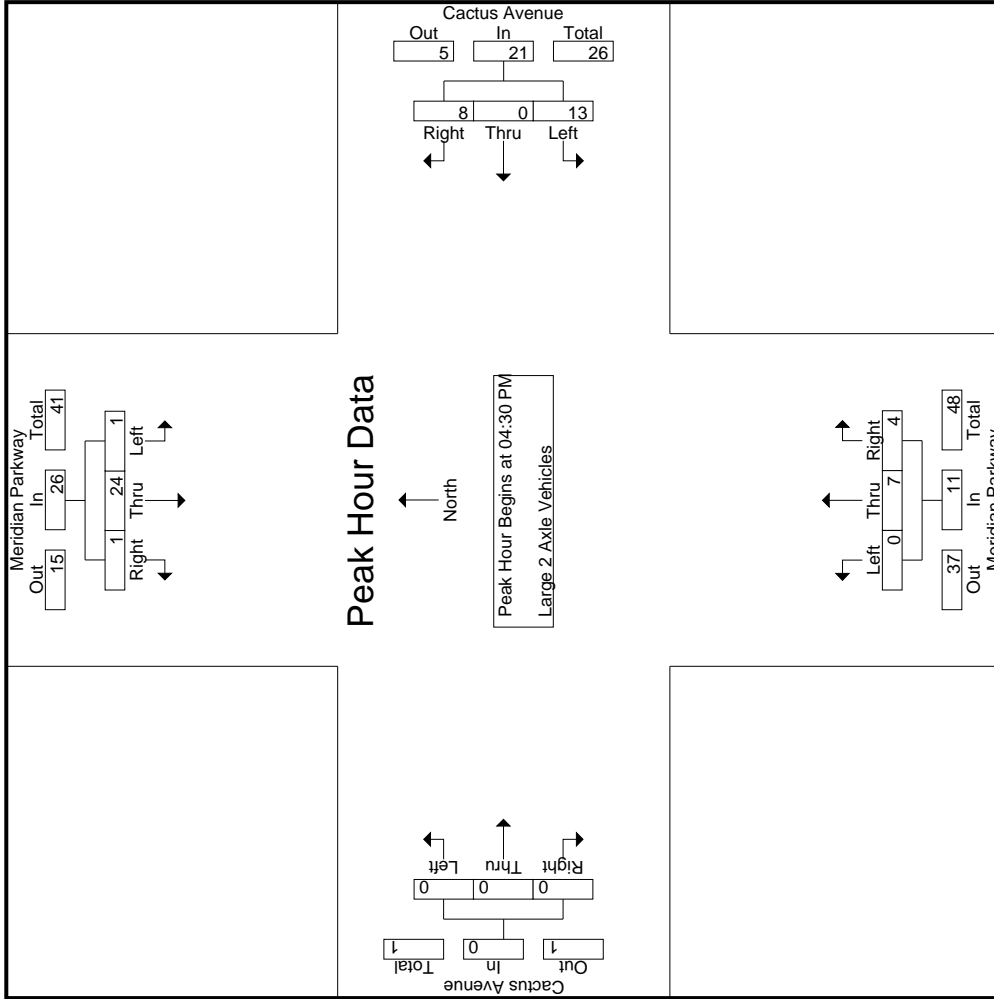

Counts Unlimited, Inc.
 PO Box 1178
 Corona, CA 92878
 (951)268-6268

File Name : 22_CRV_Meri_Cactus PM
 Site Code : 05121716
 Start Date : 11/30/2021
 Page No : 3

County of Riverside
 N/S: Meridian Parkway
 E/W: Cactus Avenue
 Weather: Clear

Start Time	Meridian Parkway Southbound			Cactus Avenue Westbound			Meridian Parkway Northbound			Cactus Avenue Eastbound						
	Left	Thru	Right	App. Total	Left	Thru	Right	App. Total	Left	Thru	Right	App. Total	Int. Total			
Peak Hour Analysis From 04:30 PM to 05:15 PM - Peak 1 of 1																
Peak Hour for Each Approach Begins at:																
	04:30 PM				04:30 PM				04:30 PM				04:30 PM			
+0 mins.	0	7	0	7	3	0	4	7	0	3	1	4	0	0	0	0
+15 mins.	0	5	0	5	1	0	2	3	0	1	2	3	0	0	0	0
+30 mins.	1	8	0	9	4	0	0	4	0	1	1	2	0	0	0	0
+45 mins.	0	4	1	5	5	0	2	7	0	2	0	2	0	0	0	0
Total Volume	1	24	1	26	13	0	8	21	0	7	4	11	0	0	0	0
% App. Total	3.8	92.3	3.8	99.9	61.9	0	38.1	63.6	0	63.6	36.4	68.8	0	0	0	0
PHF	.250	.750	.250	.722	.650	.000	.500	.750	.000	.583	.500	.688	.000	.000	.000	.000

Groups Printed- 3 Axle Vehicles

Start Time	Meridian Parkway Southbound				Cactus Avenue Westbound				Meridian Parkway Northbound				Cactus Avenue Eastbound					
	Left	Thru	Right	RTOR	App. Total	Left	Thru	Right	RTOR	App. Total	Left	Thru	Right	RTOR	App. Total	Exclu. Total	Inclu. Total	Int. Total
04:00 PM	0	0	0	0	0	3	0	1	1	4	0	2	0	0	0	1	6	7
04:15 PM	0	1	0	0	1	1	0	0	0	1	0	2	1	0	0	0	5	5
04:30 PM	0	2	0	0	2	2	0	0	0	2	0	2	0	0	1	0	7	7
04:45 PM	0	0	0	0	0	1	0	0	0	1	0	2	0	0	0	0	3	3
Total	0	3	0	0	3	7	0	1	1	8	0	7	2	0	1	1	21	22
05:00 PM	1	4	0	0	5	1	0	1	1	2	0	0	2	1	0	2	9	11
05:15 PM	0	7	0	0	7	0	1	0	0	1	0	0	0	0	0	0	8	8
05:30 PM	0	5	0	0	5	0	0	0	0	0	2	0	2	0	0	0	7	7
05:45 PM	0	3	0	0	3	0	0	0	0	0	0	1	1	0	0	1	4	5
Total	1	19	0	0	20	1	1	1	1	3	0	2	3	2	5	3	28	31
Grand Total	1	22	0	0	23	8	1	2	2	11	0	9	5	2	14	4	49	53
% Approach	4.3	95.7	0	0	0	72.7	9.1	18.2	0	64.3	35.7	100	0	0	0	7.5	92.5	0
% Total	2	44.9	0	0	46.9	16.3	2	4.1	0	18.4	10.2	28.6	2	0	2	0	0	0

Start Time	Meridian Parkway Southbound				Cactus Avenue Westbound				Meridian Parkway Northbound				Cactus Avenue Eastbound					
	Left	Thru	Right	RTOR	App. Total	Left	Thru	Right	RTOR	App. Total	Left	Thru	Right	RTOR	App. Total	Exclu. Total	Inclu. Total	Int. Total
04:30 PM	0	2	0	0	2	0	0	0	0	0	0	2	0	0	0	0	1	7
04:45 PM	0	0	0	0	0	1	0	0	0	1	0	1	1	0	0	0	0	3
05:00 PM	1	4	0	0	5	1	0	1	0	2	0	2	0	0	0	0	0	9
05:15 PM	0	7	0	0	7	0	0	0	0	0	0	0	0	0	0	0	0	8
Total Volume	1	13	0	0	14	4	1	1	0	6	0	3	3	1	0	1	1	27
% App. Total	7.1	92.9	0	0	0	66.7	16.7	16.7	0	50	50	100	0	0	0	0	0	27
PHF	.250	.464	.000	.000	.500	.250	.250	.250	.375	.750	.375	.375	.750	.250	.000	.250	.750	.750

Peak Hour Analysis From 04:30 PM to 05:15 PM - Peak 1 of 1
 Peak Hour for Entire Intersection Begins at 04:30 PM

Counts Unlimited, Inc.
 PO Box 1178
 Corona, CA 92878
 (951)268-6268

County of Riverside
 N/S: Meridian Parkway
 E/W: Cactus Avenue
 Weather: Clear

File Name : 22_CRV_Meri_Cactus PM
 Site Code : 05121716
 Start Date : 11/30/2021
 Page No : 2

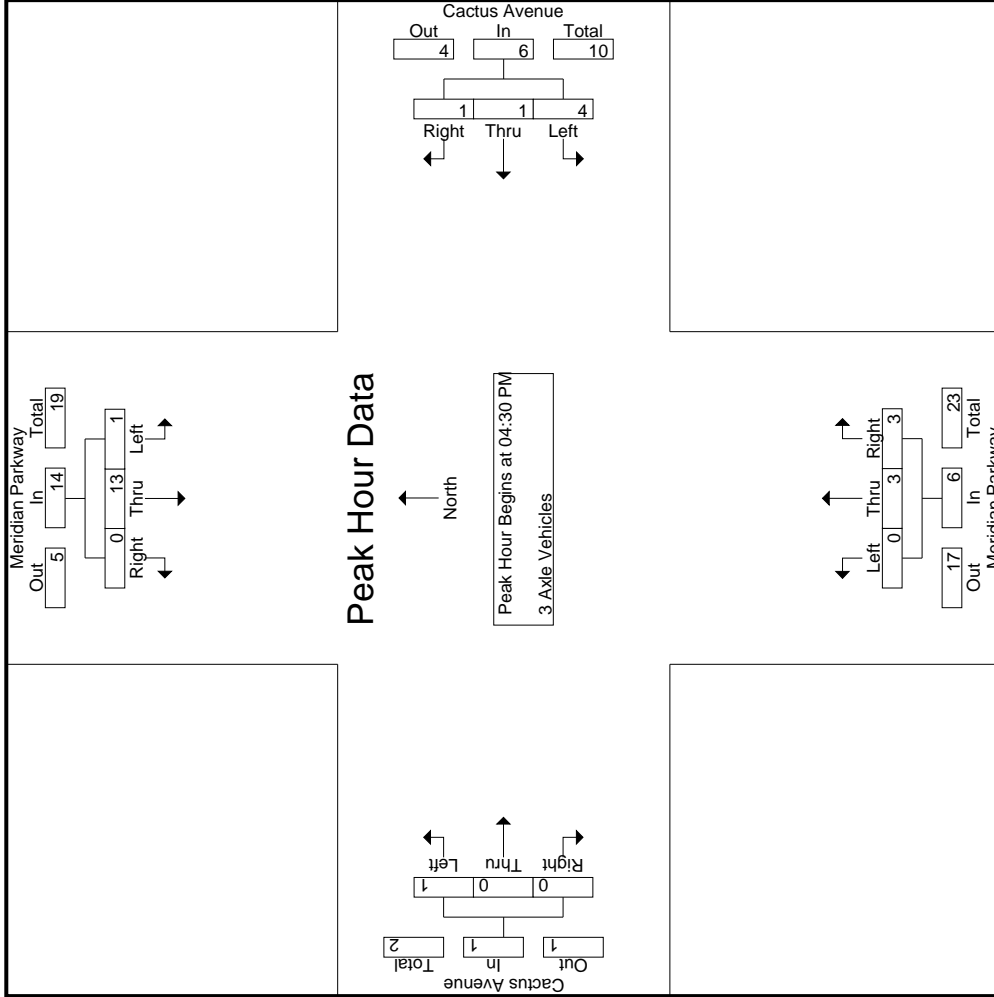

Counts Unlimited, Inc.
 PO Box 1178
 Corona, CA 92878
 (951)268-6268

File Name : 22_CRV_Meri_Cactus PM
 Site Code : 05121716
 Start Date : 11/30/2021
 Page No : 3

County of Riverside
 N/S: Meridian Parkway
 E/W: Cactus Avenue
 Weather: Clear

Start Time	Meridian Parkway Southbound			Cactus Avenue Westbound			Meridian Parkway Northbound			Cactus Avenue Eastbound					
	Left	Thru	Right	App. Total	Left	Thru	Right	App. Total	Left	Thru	Right	App. Total	Int. Total		
Peak Hour Analysis From 04:30 PM to 05:15 PM - Peak 1 of 1															
Peak Hour for Each Approach Begins at:															
	04:30 PM				04:30 PM				04:30 PM				04:30 PM		
+0 mins.	0	2	0	2	2	0	0	2	0	0	0	0	0	1	
+15 mins.	0	0	0	0	1	0	0	1	1	0	0	0	0	0	
+30 mins.	1	4	0	5	1	0	1	2	0	0	0	0	0	0	
+45 mins.	0	7	0	7	0	1	0	1	0	0	0	0	0	0	
Total Volume	1	13	0	14	4	1	1	6	0	0	3	3	1	1	
% App. Total	7.1	92.9	0		66.7	16.7	16.7		0	0	50	50	0	0	
PHF	.250	.464	.000	.500	.500	.250	.250	.750	.000	.375	.375	.750	.250	.250	

Groups Printed- 4+ Axle Trucks

Start Time	Meridian Parkway Southbound				Cactus Avenue Westbound				Meridian Parkway Northbound				Cactus Avenue Eastbound											
	Left	Thru	Right	RTOR	Left	Thru	Right	RTOR	Left	Thru	Right	RTOR	Left	Thru	Right	RTOR	Left	Thru	Right	RTOR	Exclu. Total	Inclu. Total	Int. Total	
04:00 PM	0	5	0	0	5	6	0	0	7	0	4	0	0	4	0	0	0	0	1	0	0	0	17	17
04:15 PM	2	4	0	0	6	8	1	3	12	0	4	8	3	12	0	0	0	0	0	0	0	6	30	36
04:30 PM	2	2	0	0	4	4	0	0	4	0	2	1	1	3	0	0	0	0	0	0	1	1	11	12
04:45 PM	0	3	0	0	3	4	0	0	4	0	5	4	1	9	0	1	0	0	1	0	0	1	17	18
Total	4	14	0	0	18	22	1	4	27	0	15	13	5	28	0	2	0	0	2	0	8	75	83	
05:00 PM	1	9	2	0	12	8	0	0	8	0	1	3	1	4	0	0	0	0	0	0	1	24	25	
05:15 PM	1	8	0	0	9	2	0	2	4	0	3	2	1	5	0	1	1	1	2	2	2	20	22	
05:30 PM	6	7	1	0	14	4	0	1	5	0	5	1	0	6	0	1	0	0	1	0	0	26	26	
05:45 PM	2	7	0	0	9	4	0	1	5	0	1	3	1	4	0	0	0	0	1	0	1	18	19	
Total	10	31	3	0	44	18	0	4	22	0	10	9	3	19	0	2	1	1	3	4	88	92		
Grand Total	14	45	3	0	62	40	1	8	49	0	25	22	8	47	0	4	1	1	5	12	163	175		
T-Approch %	22.6	72.6	4.8		81.6	2	16.3		30.1	0	53.2	46.8		28.8	0	2.5	0.6		3.1	6.9	93.1			
W Total %	8.6	27.6	1.8		38	24.5	0.6	4.9		0	15.3	13.5			0	2.5	0.6							

Start Time	Meridian Parkway Southbound				Cactus Avenue Westbound				Meridian Parkway Northbound				Cactus Avenue Eastbound											
	Left	Thru	Right	RTOR	Left	Thru	Right	RTOR	Left	Thru	Right	RTOR	Left	Thru	Right	RTOR	Left	Thru	Right	RTOR	App. Total	App. Total	Int. Total	
04:30 PM	2	2	0	0	4	4	0	0	4	0	2	1	3	0	0	0	0	0	0	0	0	0	0	11
04:45 PM	0	3	0	0	3	4	0	0	4	0	5	4	1	9	0	0	0	1	0	0	1	0	1	17
05:00 PM	1	9	2	0	12	8	0	0	8	0	3	2	1	6	0	0	0	0	0	0	0	0	0	24
05:15 PM	1	8	0	0	9	4	0	1	5	0	1	3	1	4	0	0	0	0	1	0	1	1	2	20
Total Volume	4	22	2	0	28	18	0	2	20	0	11	10	5	21	0	2	0	1	3	33.3	583	375	72	
% App. Total	14.3	78.6	7.1		90	0	47.6		66.7	0	52.4	47.6		66.7	0	500	.250		.583	.375		.750		
PHF	.500	.611	.250		.583	.563	.000	.250	.625	.000	.550	.625		.583	.000	.500	.250		.375	.750				

Peak Hour Analysis From 04:30 PM to 05:15 PM - Peak 1 of 1
 Peak Hour for Entire Intersection Begins at 04:30 PM

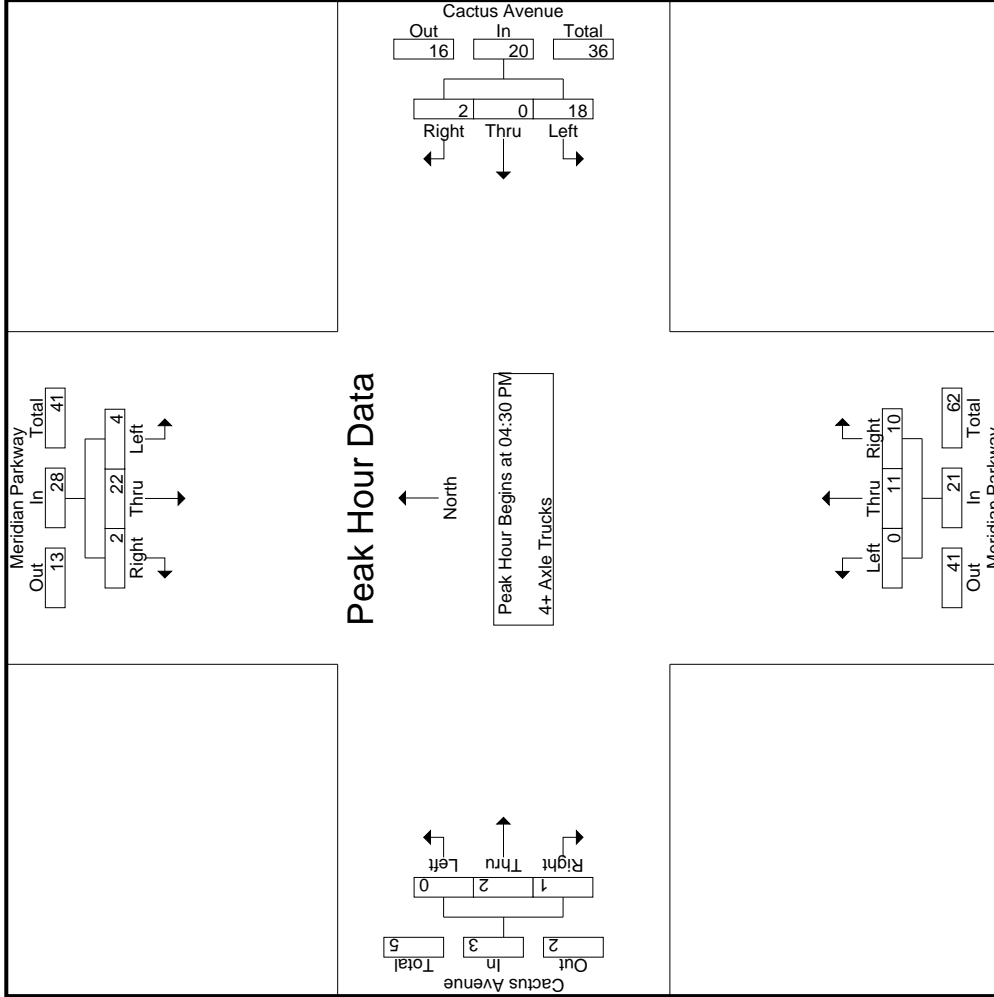

Start Time	Meridian Parkway Southbound			Cactus Avenue Westbound			Meridian Parkway Northbound			Cactus Avenue Eastbound					
	Left	Thru	Right	App. Total	Left	Thru	Right	App. Total	Left	Thru	Right	App. Total	Int. Total		
Peak Hour Analysis From 04:30 PM to 05:15 PM - Peak 1 of 1															
Peak Hour for Each Approach Begins at:															
	04:30 PM				04:30 PM				04:30 PM				04:30 PM		
+0 mins.	2	2	0	4	4	0	0	4	2	1	3	0	0	0	
+15 mins.	0	3	0	3	4	0	0	4	5	4	9	0	1	0	
+30 mins.	1	9	2	12	8	0	0	8	1	3	4	0	0	0	
+45 mins.	1	8	0	9	2	0	2	4	3	2	5	0	1	2	
Total Volume	4	22	2	28	18	0	2	20	11	10	21	0	2	1	
% App. Total	14.3	78.6	7.1	28	90	0	10	20	52.4	47.6	33.3	0	66.7	33.3	
PHF	.500	.611	.250	.583	.563	.000	.250	.625	.550	.625	.583	.000	.500	.250	

Location: County of Riverside
 N/S: Meridian Parkway
 E/W: Cactus Avenue



Date: 11/30/2021
 Day: Tuesday

PEDESTRIANS

	North Leg Meridian Parkway Pedestrians	East Leg Cactus Avenue Pedestrians	South Leg Meridian Parkway Pedestrians	West Leg Cactus Avenue Pedestrians	
7:00 AM	0	0	0	0	0
7:15 AM	0	0	0	0	0
7:30 AM	0	0	0	0	0
7:45 AM	0	0	0	0	0
8:00 AM	0	0	0	0	0
8:15 AM	0	0	0	0	0
8:30 AM	0	0	0	0	0
8:45 AM	0	0	0	0	0
TOTAL VOLUMES:	0	0	0	0	0

	North Leg Meridian Parkway Pedestrians	East Leg Cactus Avenue Pedestrians	South Leg Meridian Parkway Pedestrians	West Leg Cactus Avenue Pedestrians	
4:00 PM	0	0	0	0	0
4:15 PM	0	0	0	0	0
4:30 PM	0	0	0	0	0
4:45 PM	0	0	0	0	0
5:00 PM	0	0	0	0	0
5:15 PM	0	0	0	0	0
5:30 PM	0	0	0	0	0
5:45 PM	0	0	0	0	0
TOTAL VOLUMES:	0	0	0	0	0

Location: County of Riverside
 N/S: Meridian Parkway
 E/W: Cactus Avenue



Date: 11/30/2021
 Day: Tuesday

BICYCLES

	Southbound Meridian Parkway			Westbound Cactus Avenue			Northbound Meridian Parkway			Eastbound Cactus Avenue			
	Left	Thru	Right	Left	Thru	Right	Left	Thru	Right	Left	Thru	Right	
7:00 AM	0	0	0	0	0	0	0	0	0	0	0	0	0
7:15 AM	0	0	0	1	0	0	0	0	0	0	0	0	1
7:30 AM	0	0	0	0	0	0	0	0	0	0	0	0	0
7:45 AM	0	1	0	0	0	0	0	0	0	0	0	0	1
8:00 AM	0	0	0	0	0	0	0	0	0	0	0	0	0
8:15 AM	0	0	0	0	0	0	0	0	0	0	0	0	0
8:30 AM	0	1	0	0	0	0	0	0	0	0	0	0	1
8:45 AM	0	0	0	0	0	0	0	0	0	0	0	0	0
TOTAL VOLUMES:	0	2	0	1	0	0	0	0	0	0	0	0	3

	Southbound Meridian Parkway			Westbound Cactus Avenue			Northbound Meridian Parkway			Eastbound Cactus Avenue			
	Left	Thru	Right	Left	Thru	Right	Left	Thru	Right	Left	Thru	Right	
4:00 PM	0	0	0	0	0	0	0	0	0	0	0	0	0
4:15 PM	0	0	0	0	0	0	0	0	0	0	0	0	0
4:30 PM	0	0	0	0	0	0	0	1	0	0	0	0	1
4:45 PM	0	0	0	0	0	0	0	0	0	0	0	0	0
5:00 PM	0	0	0	0	0	0	0	0	0	0	0	0	0
5:15 PM	0	0	0	0	0	0	0	0	0	0	0	0	0
5:30 PM	0	0	0	0	0	0	0	0	0	0	0	0	0
5:45 PM	0	0	0	0	0	0	0	0	0	0	0	0	0
TOTAL VOLUMES:	0	0	0	0	0	0	0	1	0	0	0	0	1

Counts Unlimited, Inc.
 PO Box 1178
 Corona, CA 92878
 (951)268-6268

County of Riverside
 N/S: Meridian Pkwy/Harmon St
 E/W: Van Buren Boulevard
 Weather: Clear

File Name : 23_CRV_Mer_VB AM
 Site Code : 05121716
 Start Date : 11/30/2021
 Page No : 1

Groups Printed- Passenger Vehicles - Large 2 Axle Vehicles - 3 Axle Vehicles - 4+ Axle Trucks

Start Time	Meridian Parkway Southbound						Van Buren Boulevard Westbound						Harmon Street Northbound						Van Buren Boulevard Eastbound						
	Left		Thru		Right		Left		Thru		Right		Left		Thru		Right		Left		Thru		Right		
	App. Total	RTOR	App. Total	RTOR	App. Total	RTOR	App. Total	RTOR	App. Total	RTOR	App. Total	RTOR	App. Total	RTOR	App. Total	RTOR	App. Total	RTOR	App. Total	RTOR	App. Total	RTOR	App. Total	RTOR	
07:00 AM	12	1	59	0	72	6	310	31	10	347	0	0	0	0	0	0	60	224	0	284	10	703	713		
07:15 AM	8	1	95	0	104	4	321	25	3	350	0	0	1	0	0	1	84	228	0	312	3	767	770		
07:30 AM	11	2	57	0	70	16	266	30	3	312	1	0	2	2	3	73	295	0	368	5	753	758			
07:45 AM	8	2	59	0	69	18	328	31	10	377	2	0	0	2	2	126	259	2	387	11	835	846			
Total	39	6	270	0	315	44	1225	117	26	1386	3	0	3	2	6	343	1006	2	1351	29	3058	3087			
08:00 AM	16	0	69	1	85	3	267	31	7	301	0	1	0	0	1	94	243	0	337	8	724	732			
08:15 AM	15	0	55	0	70	8	285	37	10	330	0	0	2	2	2	61	217	5	283	13	685	698			
08:30 AM	16	1	49	0	66	9	276	24	7	309	0	0	2	2	2	87	210	0	297	9	674	683			
08:45 AM	15	1	27	1	43	8	279	18	2	305	0	1	1	0	2	63	173	3	239	3	589	592			
Total	62	2	200	2	264	28	1107	110	26	1245	0	2	5	4	7	305	843	8	1156	33	2672	2705			
Grand Total	101	8	470	2	579	72	2332	227	52	2631	3	2	8	6	13	648	1849	10	2507	62	5730	5792			
Approach	17.4	1.4	81.2			2.7	88.6	8.6			23.1	15.4	61.5			25.8	73.8	0.4			11.3	32.3	0.2	43.8	
Total %	1.8	0.1	8.2			1.3	40.7	4			45.9	0.1	0	0.1			11.3	32.3	0.2			1.1	98.9		
Passenger Vehicles	75	8	459			72	2221	206			2551	3	2	8			627	1738	10			2377	0	0	5491
Large 2 Axle Vehicles	74.3	100	97.7	100	93.6	100	95.2	90.7	100	95.1	100	100	100	100	100	96.8	94	100	100	94.7			0	0	94.8
% Large 2 Axle Vehicles	7	0	6	0	13	0	50	2	0	52	0	0	0	0	0	7	54	0	61	0			0	0	126
% 3 Axle Vehicles	6.9	0	1.3	0	2.2	0	2.1	0.9	0	1.9	0	0	0	0	0	1.1	2.9	0	2.4	0			0	0	2.2
% 4+ Axle Trucks	1	0	0.6	0	0.7	0	20	2	0	22	0	0	0	0	0	5	16	0	21	0			0	0	47
% 4+ Axle Trucks	18	0	2	0	20	0	41	17	0	58	0	0	0	0	0	0.8	0.9	0	0.8	0			0	0	0.8
% 4+ Axle Trucks	17.8	0	0.4	0	3.4	0	1.8	7.5	0	2.2	0	0	0	0	0	1.4	2.2	0	2	0			0	0	2.2

Start Time	Meridian Parkway Southbound						Van Buren Boulevard Westbound						Harmon Street Northbound						Van Buren Boulevard Eastbound						
	Left		Thru		Right		Left		Thru		Right		Left		Thru		Right		Left		Thru		Right		
07:15 AM	8	1	95			104	4	321	25	350	0	0	0	0	0	1	84	228	0	312	3	767	770		
07:30 AM	11	2	57			70	16	266	30	312	1	0	2	2	3	73	295	0	368	5	753	758			
07:45 AM	8	2	59			69	18	328	31	377	2	0	0	2	2	126	259	2	387	11	835	846			
08:00 AM	16	0	69			85	3	267	31	301	0	1	0	0	1	94	243	0	337	8	724	732			
Total Volume	43	5	280			328	41	1182	117	1340	3	1	3	3	7	377	1025	2	1404	29	3058	3087			
% App. Total	13.1	1.5	85.4			85.4	3.1	88.2	8.7	88.9	42.9	14.3	42.9	42.9	26.9	73	0.1	0.1	26.9	869	869	33.3	2672	2705	
PHF	.672	.625	.737			.788	.569	.901	.944	.889	.375	.250	.375	.375	.583	.748	.869	.250	.907	.907			.907		.922

Peak Hour Analysis From 07:00 AM to 08:45 AM - Peak 1 of 1
 Peak Hour for Entire Intersection Begins at 07:15 AM

Counts Unlimited, Inc.
 PO Box 1178
 Corona, CA 92878
 (951)268-6268

County of Riverside
 N/S: Meridian Pkwy/Harmon St
 E/W: Van Buren Boulevard
 Weather: Clear

File Name : 23_CRV_Mer_VB AM
 Site Code : 05121716
 Start Date : 11/30/2021
 Page No : 2

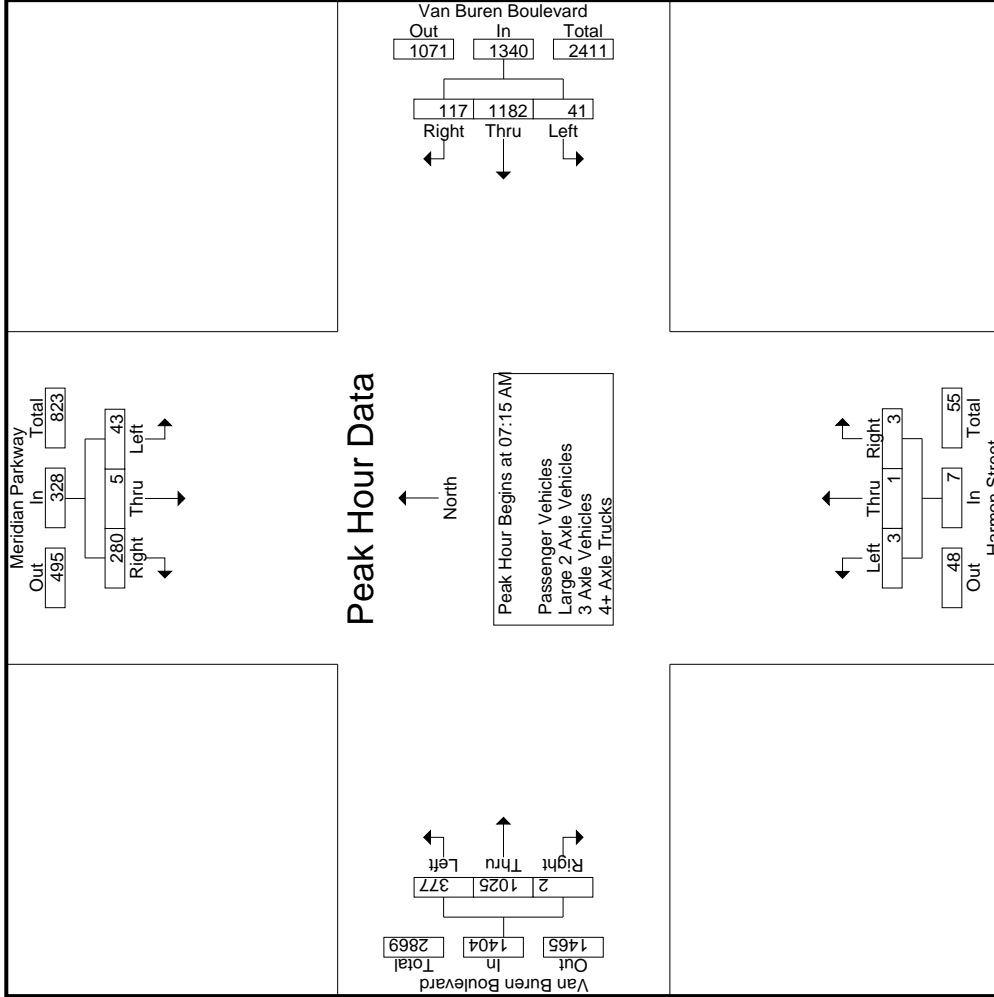

Counts Unlimited, Inc.
 PO Box 1178
 Corona, CA 92878
 (951)268-6268

County of Riverside
 N/S: Meridian Pkwy/Harmon St
 E/W: Van Buren Boulevard
 Weather: Clear

File Name : 23_CRV_Mer_VB AM
 Site Code : 05121716
 Start Date : 11/30/2021
 Page No : 3

Start Time	Meridian Parkway Southbound			Van Buren Boulevard Westbound			Harmon Street Northbound			Van Buren Boulevard Eastbound			
	Left	Thru	Right	Left	Thru	Right	Left	Thru	Right	Left	Thru	Right	
Peak Hour Analysis From 07:00 AM to 08:45 AM - Peak 1 of 1													
Peak Hour for Each Approach Begins at:													
+0 mins.	8	1	95	6	310	31	347	1	0	2	84	228	0
+15 mins.	11	2	57	4	321	25	350	2	0	0	73	295	0
+30 mins.	8	2	59	16	266	30	312	0	1	0	126	259	2
+45 mins.	16	0	69	18	328	31	377	0	0	2	94	243	0
Total Volume	43	5	280	44	1225	117	1386	3	1	4	377	1025	2
% App. Total	13.1	1.5	85.4	3.2	88.4	8.4	37.5	12.5	50	26.9	73	0.1	
PHF	.672	.625	.737	.611	.934	.944	.375	.250	.500	.748	.869	.250	

Groups Printed- Passenger Vehicles

Start Time	Meridian Parkway Southbound				Van Buren Boulevard Westbound				Harmon Street Northbound				Van Buren Boulevard Eastbound				Exclu. Total	Inclu. Total	Int. Total				
	Left	Thru	Right	RTOR	App. Total	Left	Thru	Right	RTOR	App. Total	Left	Thru	Right	RTOR	App. Total	Left				Thru	Right	RTOR	App. Total
07:00 AM	6	1	59	0	66	6	297	30	10	333	0	0	0	0	0	59	210	0	0	269	10	668	678
07:15 AM	6	1	94	0	101	4	306	22	3	332	0	0	1	0	1	83	211	0	0	294	3	728	731
07:30 AM	9	2	55	0	66	16	254	27	3	297	1	0	2	2	3	72	280	0	0	352	5	718	723
07:45 AM	6	2	58	0	66	18	313	30	10	361	2	0	0	2	2	122	251	2	1	375	11	804	815
Total	27	6	266	0	299	44	1170	109	26	1323	3	0	3	2	6	336	952	2	1	1290	29	2918	2947
08:00 AM	12	0	68	1	80	3	254	27	7	284	0	1	0	0	1	91	235	0	0	326	8	691	699
08:15 AM	11	0	52	0	63	8	267	32	10	307	0	0	2	2	2	57	204	5	1	266	13	638	651
08:30 AM	13	1	46	0	60	9	262	21	7	292	0	0	2	2	2	81	190	0	0	271	9	625	634
08:45 AM	12	1	27	1	40	8	268	17	2	293	0	1	1	0	2	62	157	3	0	222	3	557	560
Total	48	2	193	2	243	28	1051	97	26	1176	0	2	5	4	7	291	786	8	1	1085	33	2511	2544
Grand Total	75	8	459	2	542	72	2221	206	52	2499	3	2	8	6	13	627	1738	10	2	2375	62	5429	5491
T-Approch %	13.8	1.5	84.7			2.9	88.9	8.2		23.1	15.4	61.5			0.2	26.4	73.2	0.4		43.7	1.1	98.9	
W Total %	1.4	0.1	8.5		10	1.3	40.9	3.8		0.1	0	0.1			11.5	32	0.2						

Start Time	Meridian Parkway Southbound				Van Buren Boulevard Westbound				Harmon Street Northbound				Van Buren Boulevard Eastbound				App. Total	Int. Total					
	Left	Thru	Right	RTOR	App. Total	Left	Thru	Right	RTOR	App. Total	Left	Thru	Right	RTOR	App. Total	Left			Thru	Right	RTOR	App. Total	
07:15 AM	6	1	94		101	4	306	22		332	0	0	1		1	83	211	0		294	0	294	728
07:30 AM	9	2	55		66	16	254	27		297	1	0	2		3	72	280	0		352	0	352	718
07:45 AM	6	2	58		66	18	313	30		361	2	0	0		2	122	251	2		375	2	375	804
08:00 AM	12	0	68		80	3	254	27		284	0	1	0		1	91	235	0		326	0	326	691
Total Volume	33	5	275		313	41	1127	106		1274	3	1	3		7	368	977	2		1347	2	1347	2941
% App. Total	10.5	1.6	87.9		10	3.2	88.5	8.3		42.9	14.3	42.9			27.3	72.5	0.1				0.1		.914
PHF	.688	.625	.731		.775	.569	.900	.883		.882	.375	.250			.583	.754	.872	.250			.898		.914

Peak Hour Analysis From 07:15 AM to 08:00 AM - Peak 1 of 1
 Peak Hour for Entire Intersection Begins at 07:15 AM

Counts Unlimited, Inc.
 PO Box 1178
 Corona, CA 92878
 (951)268-6268

County of Riverside
 N/S: Meridian Pkwy/Harmon St
 E/W: Van Buren Boulevard
 Weather: Clear

File Name : 23_CRV_Mer_VB AM
 Site Code : 05121716
 Start Date : 11/30/2021
 Page No : 2

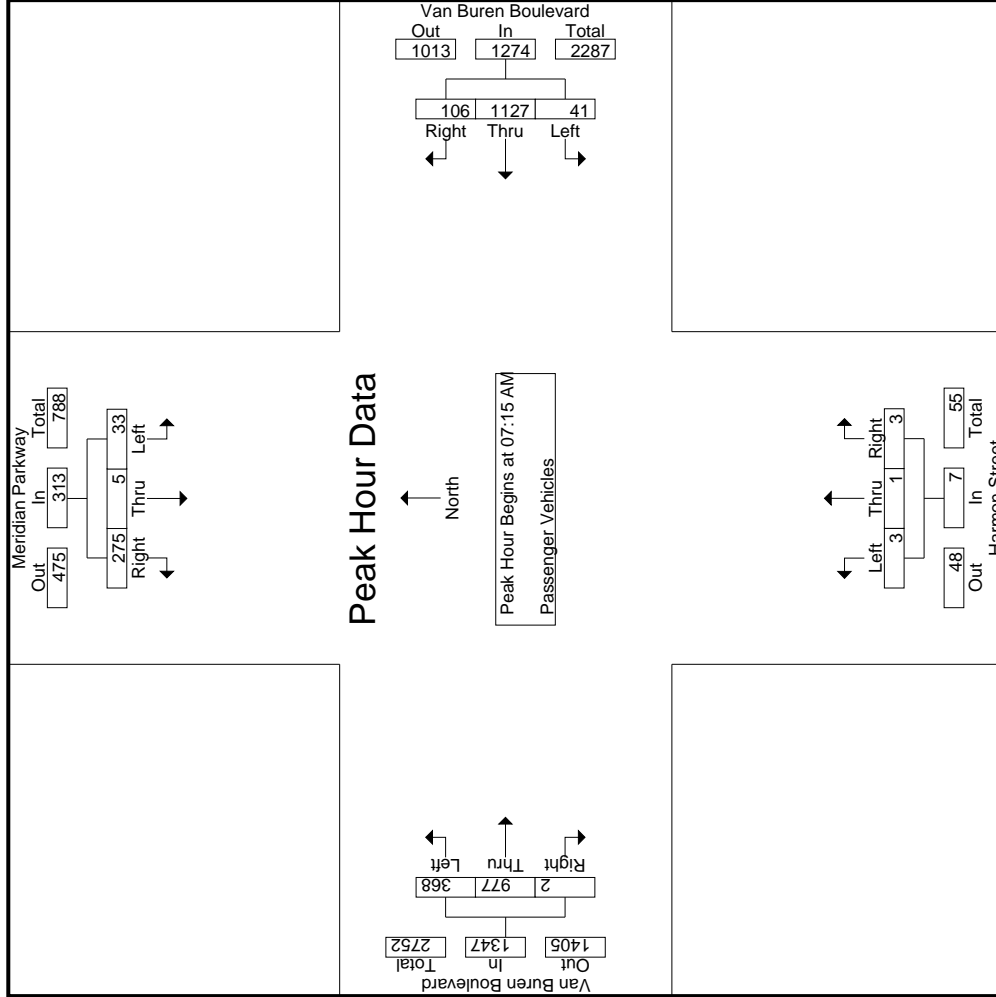

Counts Unlimited, Inc.
 PO Box 1178
 Corona, CA 92878
 (951)268-6268

County of Riverside
 N/S: Meridian Pkwy/Harmon St
 E/W: Van Buren Boulevard
 Weather: Clear

File Name : 23_CRV_Mer_VB AM
 Site Code : 05121716
 Start Date : 11/30/2021
 Page No : 3

Start Time	Meridian Parkway Southbound			Van Buren Boulevard Westbound			Harmon Street Northbound			Van Buren Boulevard Eastbound					
	Left	Thru	Right	Left	Thru	Right	Left	Thru	Right	Left	Thru	Right	App. Total	Int. Total	
Peak Hour Analysis From 07:15 AM to 08:00 AM - Peak 1 of 1	Peak Hour for Each Approach Begins at:														
	07:15 AM			07:15 AM			07:15 AM			07:15 AM			07:15 AM		
+0 mins.	6	1	94	4	306	22	332	0	0	1	83	211	0	294	
+15 mins.	9	2	55	16	254	27	297	1	0	3	72	280	0	352	
+30 mins.	6	2	58	18	313	30	361	2	0	2	122	251	2	375	
+45 mins.	12	0	68	3	254	27	284	0	1	1	91	235	0	326	
Total Volume	33	5	275	41	1127	106	1274	3	1	3	368	977	2	1347	
% App. Total	10.5	1.6	87.9	3.2	88.5	8.3	42.9	42.9	14.3	42.9	27.3	72.5	0.1		
PHF	.688	.625	.731	.569	.900	.883	.882	.375	.250	.375	.754	.872	.250	.898	

Groups Printed- Large 2-Axle Vehicles

Start Time	Meridian Parkway Southbound				Van Buren Boulevard Westbound				Harmon Street Northbound				Van Buren Boulevard Eastbound							
	Left	Thru	Right	RTOR	Left	Thru	Right	RTOR	Left	Thru	Right	RTOR	Left	Thru	Right	RTOR	App. Total	Exclu. Total	Inclu. Total	Int. Total
07:00 AM	3	0	0	0	0	7	0	0	0	0	0	0	0	0	5	0	0	0	15	15
07:15 AM	0	0	0	0	0	8	0	0	0	0	0	0	0	0	8	0	0	0	16	16
07:30 AM	0	0	1	0	0	5	1	0	0	0	0	0	1	7	0	0	0	0	15	15
07:45 AM	1	0	1	0	0	3	1	0	0	0	0	0	2	2	0	0	0	0	10	10
Total	4	0	2	0	0	23	2	0	0	0	0	0	3	22	0	0	25	0	56	56
08:00 AM	1	0	0	0	0	9	0	0	0	0	0	0	0	7	0	0	0	0	17	17
08:15 AM	0	0	1	0	0	10	0	0	0	0	0	0	2	7	0	0	0	0	20	20
08:30 AM	1	0	3	0	0	5	0	0	0	0	0	0	2	13	0	0	15	0	24	24
08:45 AM	1	0	0	0	0	3	0	0	0	0	0	0	0	5	0	0	5	0	9	9
Total	3	0	4	0	0	27	0	0	0	0	0	0	4	32	0	0	36	0	70	70
Grand Total	7	0	6	0	0	50	2	0	0	0	0	0	7	54	0	0	61	0	126	126
T-Approch %	53.8	0	46.2		0	96.2	3.8		0	0	0		11.5	88.5	0		48.4	0	100	100
W Total %	5.6	0	4.8		0	39.7	1.6		0	0	0		5.6	42.9	0			0		

Start Time	Meridian Parkway Southbound				Van Buren Boulevard Westbound				Harmon Street Northbound				Van Buren Boulevard Eastbound							
	Left	Thru	Right	RTOR	Left	Thru	Right	RTOR	Left	Thru	Right	RTOR	Left	Thru	Right	RTOR	App. Total	Exclu. Total	Inclu. Total	Int. Total
07:15 AM	0	0	0	0	0	8	0	0	0	0	0	0	0	0	0	0	0	0	8	16
07:30 AM	0	0	1	0	0	5	1	0	0	0	0	0	0	1	7	0	0	0	8	15
07:45 AM	1	0	1	0	0	3	1	0	0	0	0	0	2	2	0	0	0	0	4	10
08:00 AM	1	0	0	0	0	9	0	0	0	0	0	0	0	7	0	0	0	0	7	17
Total Volume	2	0	2	0	0	25	2	0	0	0	0	0	3	24	0	0	27	0	58	58
% App. Total	50	0	50		0	92.6	7.4		0	0	0		11.1	88.9	0			0		
PHF	.500	.000	.500		.000	.694	.500		.000	.000	.000		.375	.750	.000		.844	.000	.853	.853

Peak Hour Analysis From 07:15 AM to 08:00 AM - Peak 1 of 1
 Peak Hour for Entire Intersection Begins at 07:15 AM

Counts Unlimited, Inc.
 PO Box 1178
 Corona, CA 92878
 (951)268-6268

County of Riverside
 N/S: Meridian Pkwy/Harmon St
 E/W: Van Buren Boulevard
 Weather: Clear

File Name : 23_CRV_Mer_VB AM
 Site Code : 05121716
 Start Date : 11/30/2021
 Page No : 2

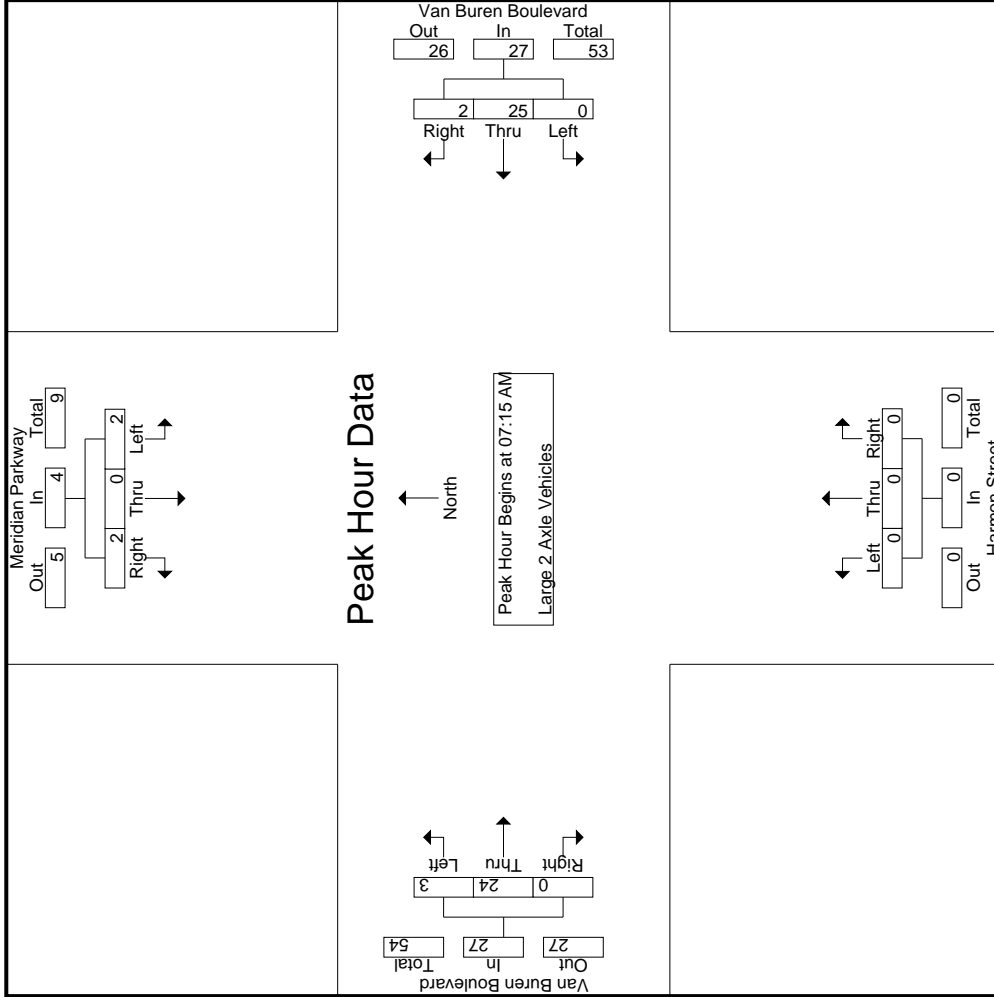

Counts Unlimited, Inc.
 PO Box 1178
 Corona, CA 92878
 (951)268-6268

County of Riverside
 N/S: Meridian Pkwy/Harmon St
 E/W: Van Buren Boulevard
 Weather: Clear

File Name : 23_CRV_Mer_VB AM
 Site Code : 05121716
 Start Date : 11/30/2021
 Page No : 3

Start Time	Meridian Parkway Southbound			Van Buren Boulevard Westbound			Harmon Street Northbound			Van Buren Boulevard Eastbound		
	Left	Thru	Right	Left	Thru	Right	Left	Thru	Right	Left	Thru	Right
Peak Hour Analysis From 07:15 AM to 08:00 AM - Peak 1 of 1												
Peak Hour for Each Approach Begins at:												
+0 mins.	0	0	0	0	8	0	0	0	0	0	8	0
+15 mins.	0	0	1	0	5	1	0	0	0	1	7	0
+30 mins.	1	0	1	0	3	1	0	0	0	2	2	0
+45 mins.	1	0	0	0	9	0	0	0	0	0	7	0
Total Volume	2	0	2	0	25	2	0	0	0	3	24	0
% App. Total	50	0	50	0	92.6	7.4	0	0	0	11.1	88.9	0
PHF	.500	.000	.500	.000	.694	.500	.000	.000	.000	.375	.750	.000

Groups Printed- 3 Axle Vehicles

Start Time	Meridian Parkway Southbound				Van Buren Boulevard Westbound				Harmon Street Northbound				Van Buren Boulevard Eastbound					
	Left	Thru	Right	RTOR	App. Total	Left	Thru	Right	RTOR	App. Total	Left	Thru	Right	RTOR	App. Total	Exclu. Total	Inclu. Total	Int. Total
07:00 AM	0	0	0	0	0	3	0	0	0	0	0	0	0	0	4	0	7	7
07:15 AM	0	0	0	0	0	4	0	0	0	0	0	0	0	0	1	0	5	5
07:30 AM	1	0	0	0	1	2	1	0	0	0	0	0	0	0	1	0	5	5
07:45 AM	0	0	0	0	0	3	0	0	0	0	0	0	0	0	1	0	4	4
Total	1	0	0	0	1	12	1	0	0	13	0	0	0	0	7	0	21	21
08:00 AM	0	0	1	0	1	0	0	0	0	0	0	0	0	0	2	0	3	3
08:15 AM	0	0	2	0	2	0	1	0	0	0	0	0	0	0	2	0	7	7
08:30 AM	0	0	0	0	0	3	0	0	0	3	0	0	0	0	6	0	9	9
08:45 AM	0	0	0	0	0	3	0	0	0	3	0	0	0	0	4	0	7	7
Total	0	0	3	0	3	8	1	0	0	9	0	0	0	0	14	0	26	26
Grand Total	1	0	3	0	4	0	20	2	0	22	0	0	0	0	21	0	47	47
T-Approch %	25	0	75			90.9	9.1			23.8	76.2			44.7		100		
33 Total %	2.1	0	6.4		8.5	0	42.6	4.3		10.6	34							

Start Time	Meridian Parkway Southbound				Van Buren Boulevard Westbound				Harmon Street Northbound				Van Buren Boulevard Eastbound					
	Left	Thru	Right	RTOR	App. Total	Left	Thru	Right	RTOR	App. Total	Left	Thru	Right	RTOR	App. Total	Exclu. Total	Inclu. Total	Int. Total
07:15 AM	0	0	0	0	0	0	4	0	0	4	0	0	0	0	0	0	1	1
07:30 AM	1	0	0	0	1	0	2	1	0	3	0	0	0	0	1	0	1	1
07:45 AM	0	0	0	0	0	0	3	0	0	3	0	0	0	0	0	0	1	1
08:00 AM	0	0	1	0	1	0	0	0	0	0	0	0	0	0	0	0	2	2
Total Volume	1	0	1		2	0	9	1		10	0	0	0	0	4	0	5	17
% App. Total	50	0	50			0	90	10		100	0	80	0		80	0	100	
PHF	.250	.000	.250		.500	.000	.563	.250		.625	.000	.250	1.00		.625	.000	.850	

Peak Hour Analysis From 07:15 AM to 08:00 AM - Peak 1 of 1
 Peak Hour for Entire Intersection Begins at 07:15 AM

Counts Unlimited, Inc.
 PO Box 1178
 Corona, CA 92878
 (951)268-6268

County of Riverside
 N/S: Meridian Pkwy/Harmon St
 E/W: Van Buren Boulevard
 Weather: Clear

File Name : 23_CRV_Mer_VB AM
 Site Code : 05121716
 Start Date : 11/30/2021
 Page No : 2

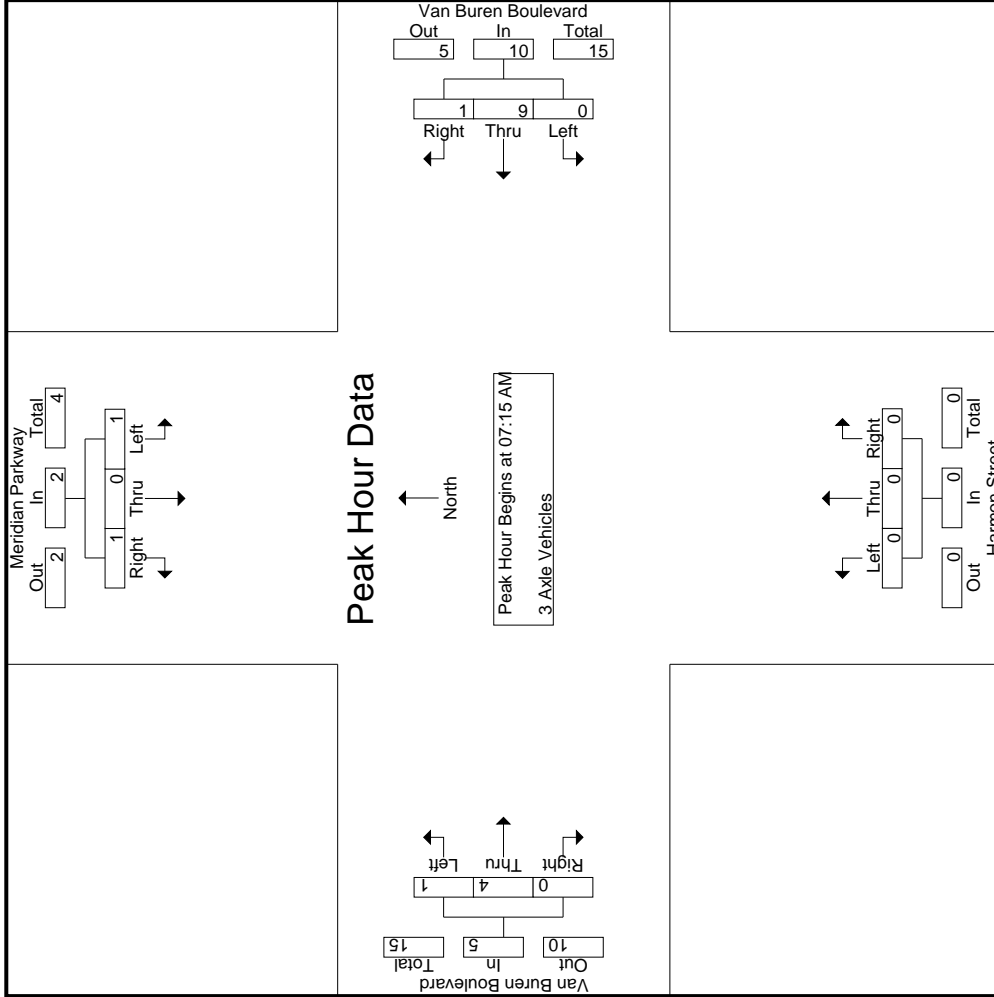

Counts Unlimited, Inc.
 PO Box 1178
 Corona, CA 92878
 (951)268-6268

County of Riverside
 N/S: Meridian Pkwy/Harmon St
 E/W: Van Buren Boulevard
 Weather: Clear

File Name : 23_CRV_Mer_VB AM
 Site Code : 05121716
 Start Date : 11/30/2021
 Page No : 3

Start Time	Meridian Parkway Southbound			Van Buren Boulevard Westbound			Harmon Street Northbound			Van Buren Boulevard Eastbound			Int. Total				
	Left	Thru	Right	Left	Thru	Right	Left	Thru	Right	Left	Thru	Right		App. Total			
Peak Hour Analysis From 07:15 AM to 08:00 AM - Peak 1 of 1	Peak Hour for Each Approach Begins at:																
	07:15 AM			07:15 AM			07:15 AM			07:15 AM							
+0 mins.	0	0	0	0	0	0	4	0	0	0	0	0	0	1	0	0	1
+15 mins.	1	0	0	1	0	1	3	1	0	0	0	0	1	1	0	0	1
+30 mins.	0	0	0	0	0	0	3	0	0	0	0	0	0	1	0	0	1
+45 mins.	0	0	1	1	0	0	0	0	0	0	0	0	1	1	1	0	2
Total Volume	1	0	1	2	0	1	10	1	0	0	0	0	1	4	0	0	5
% App. Total	.50	0	.50	.500	0	.10	.625	.250	0	0	0	0	.20	.80	0	0	.625
PHF	.250	.000	.250	.500	.000	.250	.625	.250	.000	.000	.000	.000	.250	1.000	.000	.000	.625

Counts Unlimited, Inc.
 PO Box 1178
 Corona, CA 92878
 (951)268-6268

County of Riverside
 N/S: Meridian Pkwy/Harmon St
 E/W: Van Buren Boulevard
 Weather: Clear

File Name : 23_CRV_Mer_VB AM
 Site Code : 05121716
 Start Date : 11/30/2021
 Page No : 1

Groups Printed- 4+ Axle Trucks

Start Time	Meridian Parkway Southbound				Van Buren Boulevard Westbound				Harmon Street Northbound				Van Buren Boulevard Eastbound				Exclu. Total	Inclu. Total	Int. Total
	Left	Thru	Right	RTOR	Left	Thru	Right	RTOR	Left	Thru	Right	RTOR	Left	Thru	Right	RTOR			
07:00 AM	3	0	0	3	0	3	1	0	4	0	0	0	0	0	0	0	0	6	
07:15 AM	2	0	1	3	0	3	3	0	6	0	0	0	0	0	0	0	9		
07:30 AM	1	0	1	2	0	5	1	0	6	0	0	0	0	0	0	0	7		
07:45 AM	1	0	0	1	0	9	0	0	9	0	0	0	0	0	0	0	7		
Total	7	0	2	9	0	20	5	0	25	0	0	0	0	0	0	0	29		
08:00 AM	3	0	0	3	0	4	4	0	8	0	0	0	0	0	0	0	2		
08:15 AM	4	0	0	4	0	6	4	0	10	0	0	0	0	0	0	0	6		
08:30 AM	2	0	0	2	0	6	3	0	9	0	0	0	0	0	0	0	5		
08:45 AM	2	0	0	2	0	5	1	0	6	0	0	0	0	0	0	0	8		
Total	11	0	0	11	0	21	12	0	33	0	0	0	0	0	0	0	21		
Grand Total	18	0	2	20	0	41	17	0	58	0	0	0	0	0	0	0	50		
T-Approch %	90	0	10	15.6	0	70.7	29.3	0	45.3	0	0	0	0	0	0	0	39.1		
CS Total %	14.1	0	1.6		0	32	13.3	0		0	0	0	0	0	0	0	100		

Start Time	Meridian Parkway Southbound				Van Buren Boulevard Westbound				Harmon Street Northbound				Van Buren Boulevard Eastbound				Exclu. Total	Inclu. Total	Int. Total
	Left	Thru	Right	RTOR	Left	Thru	Right	RTOR	Left	Thru	Right	RTOR	Left	Thru	Right	RTOR			
07:15 AM	2	0	1	3	0	3	3	6	0	0	0	0	0	0	0	0	0		
07:30 AM	1	0	1	2	0	5	1	6	0	0	0	0	0	0	0	0	7		
07:45 AM	1	0	0	1	0	9	0	9	0	0	0	0	0	0	0	0	7		
08:00 AM	3	0	0	3	0	4	4	8	0	0	0	0	0	0	0	0	2		
Total Volume	7	0	2	9	0	21	8	29	0	0	0	0	0	0	0	0	25		
% App. Total	77.8	0	22.2	.750	0	72.4	27.6	.806	.500	0	0	0	0	0	0	0	.875		
PHF	.583	.000	.500	.750	.000	.583	.500	.806	.000	.000	.000	.000	.625	.625	.000	.694	.875		

Peak Hour Analysis From 07:15 AM to 08:00 AM - Peak 1 of 1
 Peak Hour for Entire Intersection Begins at 07:15 AM

Counts Unlimited, Inc.
 PO Box 1178
 Corona, CA 92878
 (951)268-6268

County of Riverside
 N/S: Meridian Pkwy/Harmon St
 E/W: Van Buren Boulevard
 Weather: Clear

File Name : 23_CRV_Mer_VB AM
 Site Code : 05121716
 Start Date : 11/30/2021
 Page No : 2

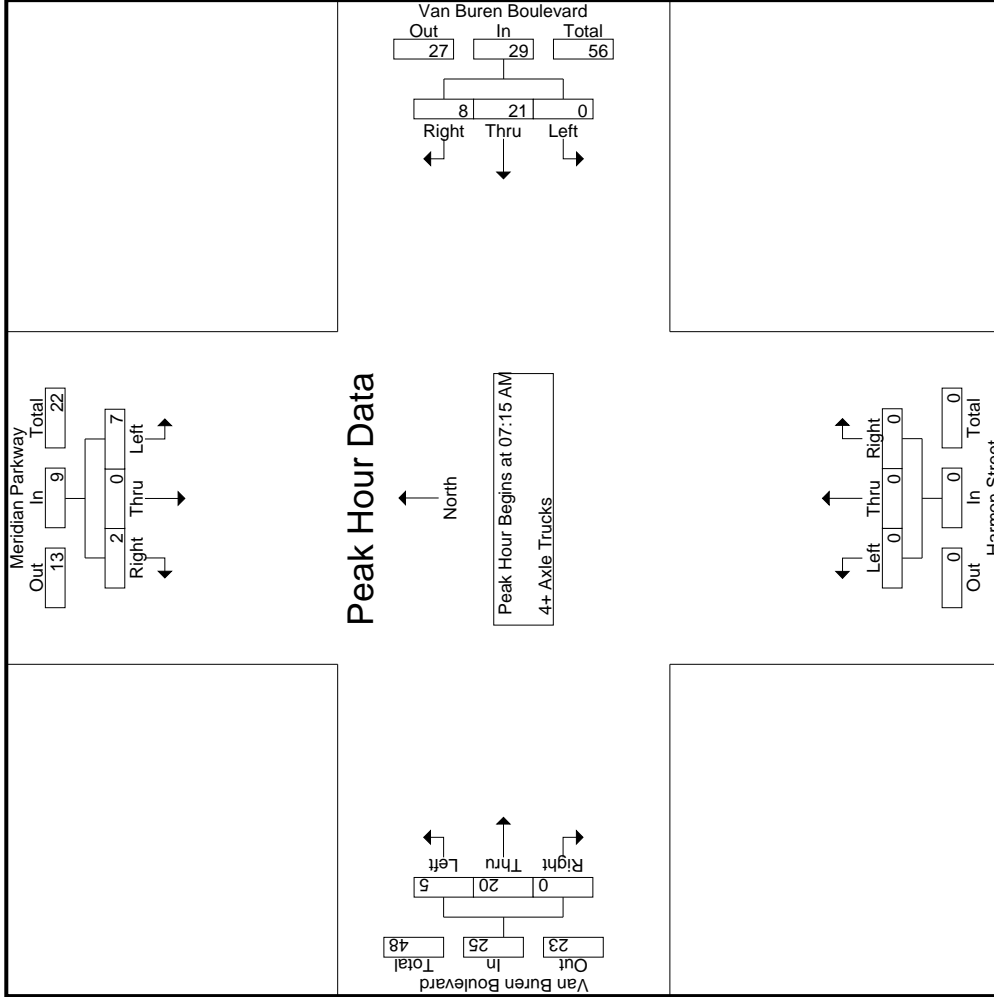

Start Time	Meridian Parkway Southbound			Van Buren Boulevard Westbound			Harmon Street Northbound			Van Buren Boulevard Eastbound		
	Left	Thru	Right	Left	Thru	Right	Left	Thru	Right	Left	Thru	Right
Peak Hour Analysis From 07:15 AM to 08:00 AM - Peak 1 of 1												
Peak Hour for Each Approach Begins at:												
+0 mins.	2	0	1	0	3	3	6	0	0	1	8	0
+15 mins.	1	0	1	0	5	1	6	0	0	0	7	0
+30 mins.	1	0	0	0	9	0	9	0	0	2	5	0
+45 mins.	3	0	0	0	4	4	8	0	0	2	0	0
Total Volume	7	0	2	0	21	8	29	0	0	5	20	0
% App. Total	77.8	0	22.2	0	72.4	27.6	806	0	0	20	80	0
PHF	.583	.000	.500	.000	.583	.500	.806	.000	.000	.625	.625	.000

Counts Unlimited, Inc.
 PO Box 1178
 Corona, CA 92878
 (951)268-6268

County of Riverside
 N/S: Meridian Pkwy/Harmon St
 E/W: Van Buren Boulevard
 Weather: Clear

File Name : 23_CRV_Mer_VB_PM
 Site Code : 05121716
 Start Date : 11/30/2021
 Page No : 1

Groups Printed- Passenger Vehicles - Large 2 Axle Vehicles - 3 Axle Vehicles - 4+ Axle Trucks

Start Time	Meridian Parkway Southbound						Van Buren Boulevard Westbound						Harmon Street Northbound						Van Buren Boulevard Eastbound						
	Left		Thru		Right		Left		Thru		Right		Left		Thru		Right		Left		Thru		Right		
	RTOR	App. Total	Left	Thru	Right	RTOR	App. Total	Left	Thru	Right	RTOR	App. Total	Left	Thru	Right	RTOR	App. Total	Left	Thru	Right	RTOR	App. Total	Exclu. Total	Inclu. Total	Int. Total
04:00 PM	2	121	0	264	4	239	1	2	2	1	5	96	319	2	1	417	6	925	931						
04:15 PM	1	125	0	246	8	296	0	3	6	3	9	91	344	1	0	436	11	987	998						
04:30 PM	4	146	0	304	8	278	4	10	21	19	35	74	327	1	0	402	27	1019	1046						
04:45 PM	2	173	0	306	8	238	5	2	9	7	16	89	361	0	0	450	15	1010	1025						
Total	9	565	0	1120	28	1051	10	17	38	30	65	350	1351	4	1	1705	59	3941	4000						
05:00 PM	2	148	0	375	8	214	1	1	2	1	4	48	300	0	0	348	2	941	943						
05:15 PM	5	156	0	469	12	265	1	1	1	1	3	58	314	0	0	372	5	1109	1114						
05:30 PM	151	0	143	0	294	8	3	297	1	0	2	73	318	0	0	391	5	985	990						
05:45 PM	2	151	0	309	4	311	0	1	0	0	1	59	316	0	0	375	1	996	997						
Total	9	598	0	1447	32	1087	3	3	5	4	11	238	1248	0	0	1486	13	4031	4044						
Grand Total	18	1163	0	2567	37	2138	13	20	43	34	76	588	2599	4	1	3191	72	7972	8044						
% Approach	0.7	45.3			5		17.1	26.3	56.6			18.4	81.4	0.1											
% Total	17.4	0.2	14.6	32.2	0.2	26.8	0.2	0.3	0.5	1		7.4	32.6	0.1	40		0.9	99.1							
% Passenger Vehicles	1336	18	1110	2464	16	1868	13	20	43	110		550	2468	4	3023		0	0	7620						
% Large 2 Axle Vehicles	96.4	100	95.4	96	94.1	92.7	97.2	97.3	93	100	100	93.5	95	100	100	94.7	0	0	94.7						
% 3 Axle Vehicles	1	0	2.5	0	1.7	3.1	0	0	0	0	0	1.7	1.7	0	0	1.7	0	0	1.7						
% 4+ Axle Trucks	0.7	0	0.4	0	0.6	1.2	0	0	0	0	0	1.7	0.8	0	0	1	0	0	0.9						
% 4+ Axle Trucks	26	0	19	45	0	57	0	0	0	0	0	18	66	0	84	0	0	0	186						
% 4+ Axle Trucks	1.9	0	1.6	1.8	0	2.6	0	0	0	0	0	3.1	2.5	0	2.6	0	0	0	2.3						

Start Time	Meridian Parkway Southbound						Van Buren Boulevard Westbound						Harmon Street Northbound						Van Buren Boulevard Eastbound						
	Left		Thru		Right		Left		Thru		Right		Left		Thru		Right		Left		Thru		Right		
	RTOR	App. Total	Left	Thru	Right	RTOR	App. Total	Left	Thru	Right	RTOR	App. Total	Left	Thru	Right	RTOR	App. Total	Left	Thru	Right	RTOR	App. Total	Exclu. Total	Inclu. Total	Int. Total
04:30 PM	4	154	0	146	304	4	256	18	278	4	10	21	74	327	1	402	1019								
04:45 PM	2	173	0	306	306	1	211	26	238	5	9	16	89	361	0	450	1010								
05:00 PM	2	148	0	375	375	0	206	8	278	1	1	2	48	300	0	348	941								
05:15 PM	5	156	0	469	469	2	251	12	265	1	2	3	58	314	0	372	1109								
Total	13	623	0	1454	1454	7	924	64	995	11	14	33	269	1302	1	1572	4079								
% App. Total	56.3	0.9	42.8			0.7	92.9	6.4		19	24.1	56.9	17.1	82.8	0.1										
PHF	.664	.650	.900	.775	.438	.902	.615	.895	.550	.350	.393	.414	.756	.902	.250	.873	.920								

Peak Hour Analysis From 04:00 PM to 05:45 PM - Peak 1 of 1
 Peak Hour for Entire Intersection Begins at 04:30 PM

Counts Unlimited, Inc.
 PO Box 1178
 Corona, CA 92878
 (951)268-6268

County of Riverside
 N/S: Meridian Pkwy/Harmon St
 E/W: Van Buren Boulevard
 Weather: Clear

File Name : 23_CRV_Mer_VB PM
 Site Code : 05121716
 Start Date : 11/30/2021
 Page No : 2

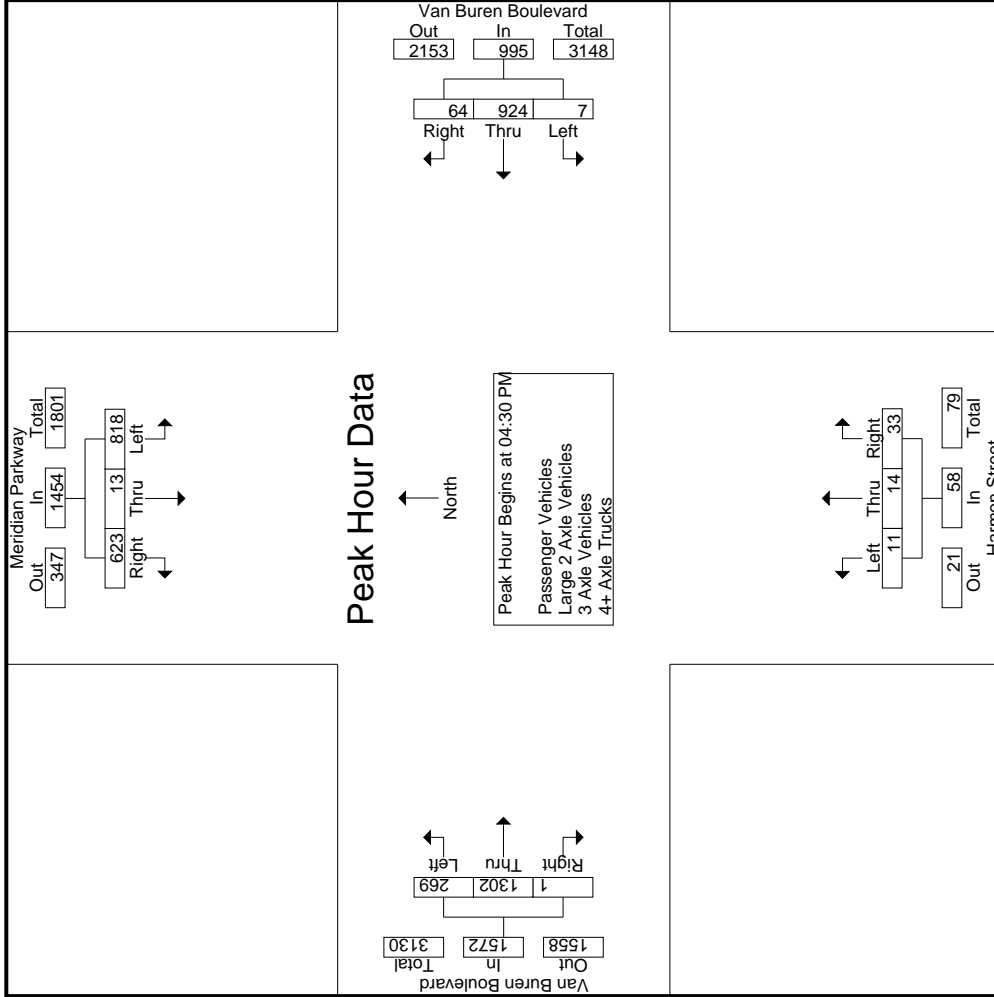

Counts Unlimited, Inc.
 PO Box 1178
 Corona, CA 92878
 (951)268-6268

County of Riverside
 N/S: Meridian Pkwy/Harmon St
 E/W: Van Buren Boulevard
 Weather: Clear

File Name : 23_CRV_Mer_VB_PM
 Site Code : 05121716
 Start Date : 11/30/2021
 Page No : 3

Start Time	Meridian Parkway Southbound			Van Buren Boulevard Westbound			Harmon Street Northbound			Van Buren Boulevard Eastbound			Int. Total
	Left	Thru	Right	Left	Thru	Right	Left	Thru	Right	Left	Thru	Right	
Peak Hour Analysis From 04:00 PM to 05:45 PM - Peak 1 of 1	Peak Hour for Each Approach Begins at:												
	04:30 PM			05:00 PM			04:00 PM			04:00 PM			
+0 mins.	154	4	146	0	206	8	214	1	2	2	319	2	417
+15 mins.	131	2	173	2	251	12	265	0	3	6	344	1	436
+30 mins.	225	2	148	5	284	8	297	4	10	21	327	1	402
+45 mins.	308	5	156	0	307	4	311	5	2	9	361	0	450
Total Volume	818	13	623	7	1048	32	1087	10	17	38	1351	4	1705
% App. Total	56.3	0.9	42.8	0.6	96.4	2.9	100.0	15.4	26.2	58.5	79.2	0.2	100.0
PHF	.664	.650	.900	.350	.853	.667	.874	.500	.425	.452	.911	.500	.947

Groups Printed- Passenger Vehicles

Start Time	Meridian Parkway Southbound				Van Buren Boulevard Westbound				Harmon Street Northbound				Van Buren Boulevard Eastbound				Exclu. Total	Inclu. Total	Int. Total				
	Left	Thru	Right	RTOR	Left	Thru	Right	RTOR	Left	Thru	Right	RTOR	Left	Thru	Right	RTOR				App. Total			
04:00 PM	139	2	117	0	258	2	210	10	4	222	1	2	2	1	5	88	305	2	1	395	6	880	886
04:15 PM	118	1	121	0	240	3	252	19	8	274	0	3	6	3	9	83	330	1	0	414	11	937	948
04:30 PM	145	4	145	0	294	3	234	18	8	255	4	10	21	19	35	71	310	1	0	382	27	966	993
04:45 PM	127	2	165	0	294	1	200	25	8	226	5	2	9	7	16	79	347	0	0	426	15	962	977
Total	529	9	548	0	1086	9	896	72	28	977	10	17	38	30	65	321	1292	4	1	1617	59	3745	3804
05:00 PM	215	2	142	0	359	0	189	8	1	197	1	1	2	1	4	45	283	0	0	328	2	888	890
05:15 PM	299	5	145	0	449	2	238	12	4	252	1	1	1	1	3	57	294	0	0	351	5	1055	1060
05:30 PM	141	0	133	0	274	5	256	7	2	268	1	0	2	2	2	70	300	0	0	370	4	915	919
05:45 PM	152	2	142	0	296	0	289	4	1	293	0	1	0	0	1	57	299	0	0	356	1	946	947
Total	807	9	562	0	1378	7	972	31	8	1010	3	3	5	4	11	229	1176	0	0	1405	12	3804	3816
Grand Total	1336	18	1110	0	2464	16	1868	103	36	1987	13	20	43	34	76	550	2468	4	1	3022	71	7549	7620
T-Approch %	54.2	0.7	45		32.6	0.8	94	5.2		26.3	17.1	26.3	56.6		1	18.2	81.7	0.1		40	0.9	99.1	
W Total %	17.7	0.2	14.7			0.2	24.7	1.4			0.2	0.3	0.6			7.3	32.7	0.1					

Start Time	Meridian Parkway Southbound				Van Buren Boulevard Westbound				Harmon Street Northbound				Van Buren Boulevard Eastbound				App. Total	Int. Total					
	Left	Thru	Right	RTOR	Left	Thru	Right	RTOR	Left	Thru	Right	RTOR	Left	Thru	Right	RTOR							
04:30 PM	145	4	145		294	3	234	18		255	4	10	21	71	310	1	382			966			
04:45 PM	127	2	165		294	1	200	25		226	5	2	9	79	347	0	426			962			
05:00 PM	215	2	142		359	0	189	8		197	1	1	2	45	283	0	328			888			
05:15 PM	299	5	145		449	2	238	12		252	1	1	1	57	294	0	351			1055			
Total Volume	786	13	597		1396	6	861	63		930	11	14	33	252	1234	1	1487			3871			
% App. Total	56.3	0.9	42.8		33	0.6	92.6	6.8		66.9	19	24.1	56.9	16.9	83	0.1	873			917			
PHF	.657	.650	.905		.777	.500	.904	.630		.912	.550	.350	.393	.797	.889	.250	.873						

Peak Hour Analysis From 04:30 PM to 05:15 PM - Peak 1 of 1
 Peak Hour for Entire Intersection Begins at 04:30 PM

Counts Unlimited, Inc.
 PO Box 1178
 Corona, CA 92878
 (951)268-6268

County of Riverside
 N/S: Meridian Pkwy/Harmon St
 E/W: Van Buren Boulevard
 Weather: Clear

File Name : 23_CRV_Mer_VB PM
 Site Code : 05121716
 Start Date : 11/30/2021
 Page No : 2

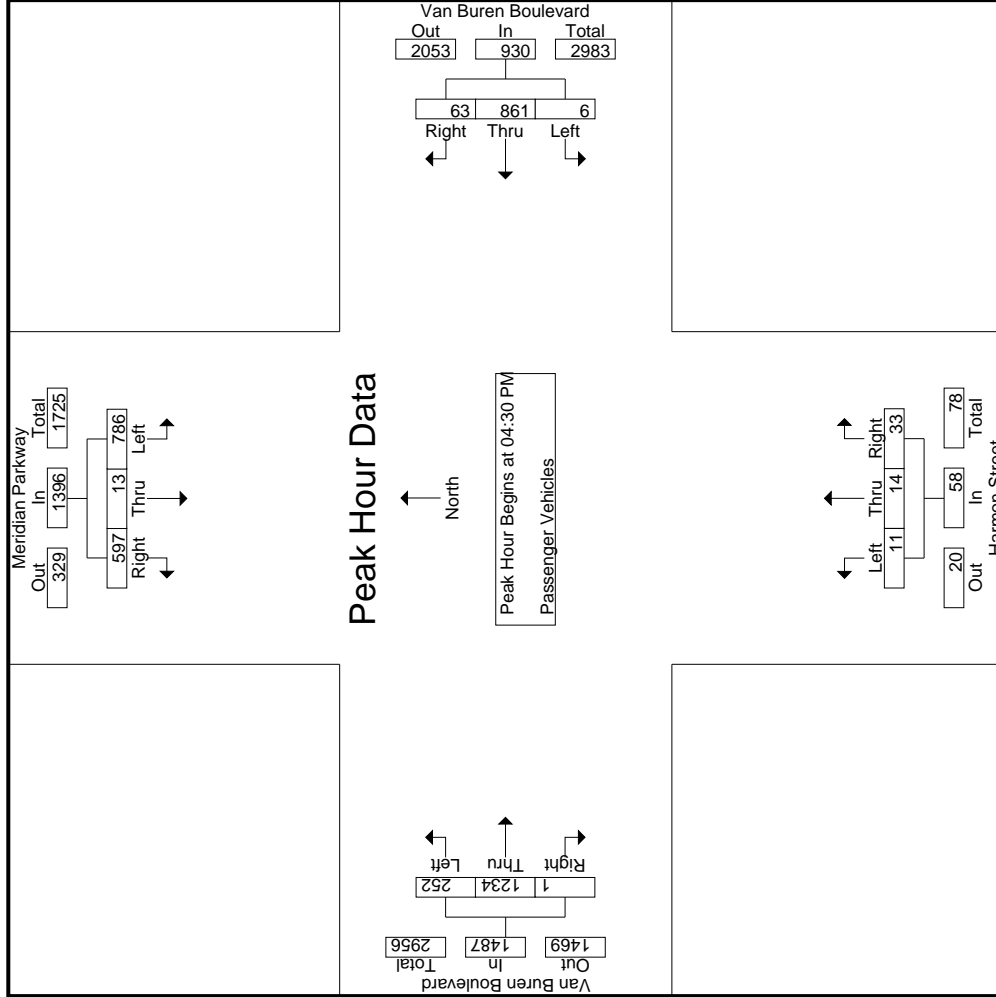

Counts Unlimited, Inc.
 PO Box 1178
 Corona, CA 92878
 (951)268-6268

County of Riverside
 N/S: Meridian Pkwy/Harmon St
 E/W: Van Buren Boulevard
 Weather: Clear

File Name : 23_CRV_Mer_VB PM
 Site Code : 05121716
 Start Date : 11/30/2021
 Page No : 3

Start Time	Meridian Parkway Southbound			Van Buren Boulevard Westbound			Harmon Street Northbound			Van Buren Boulevard Eastbound						
	Left	Thru	Right	Left	Thru	Right	Left	Thru	Right	Left	Thru	Right				
Peak Hour Analysis From 04:30 PM to 05:15 PM - Peak 1 of 1																
Peak Hour for Each Approach Begins at:																
+0 mins.	145	4	145	294	3	234	18	255	4	10	21	35	71	310	1	382
+15 mins.	127	2	165	294	1	200	25	226	5	2	9	16	79	347	0	426
+30 mins.	215	2	142	359	0	189	8	197	1	1	2	4	45	283	0	328
+45 mins.	299	5	145	449	2	238	12	252	1	1	1	3	57	294	0	351
Total Volume	786	13	597	1396	6	861	63	930	11	14	33	58	252	1234	1	1487
% App. Total	56.3	0.9	42.8	77.7	0.6	92.6	6.8	6.8	19	24.1	56.9	16.9	83	83	0.1	0.1
PHF	.657	.650	.905	.777	.500	.904	.630	.912	.550	.350	.393	.414	.797	.889	.250	.873

Groups Printed- Large 2-Axle Vehicles

Start Time	Meridian Parkway Southbound				Van Buren Boulevard Westbound				Harmon Street Northbound				Van Buren Boulevard Eastbound											
	Left	Thru	Right	RTOR	Left	Thru	Right	RTOR	Left	Thru	Right	RTOR	Left	Thru	Right	RTOR	Left	Thru	Right	RTOR	Exclu. Total	Inclu. Total	Int. Total	
04:00 PM	0	0	1	0	0	5	0	0	0	0	0	0	0	0	0	0	2	5	0	0	7	0	13	13
04:15 PM	0	0	1	0	0	9	0	0	0	0	0	0	0	0	0	0	3	5	0	0	8	0	18	18
04:30 PM	5	0	1	0	0	9	0	0	0	0	0	0	0	0	0	0	4	6	0	0	6	0	22	22
04:45 PM	0	0	6	0	0	5	0	0	0	0	0	0	0	0	0	0	4	5	0	0	9	0	20	20
Total	5	0	9	0	14	1	28	0	0	0	0	0	0	0	0	0	9	21	0	0	30	0	73	73
05:00 PM	1	0	3	0	0	8	0	0	0	0	0	0	0	0	0	0	1	7	0	0	8	0	20	20
05:15 PM	3	0	4	0	0	7	0	0	0	0	0	0	0	0	0	0	0	4	0	0	4	0	18	18
05:30 PM	4	0	8	0	12	0	18	1	1	19	0	0	0	0	0	0	0	5	0	0	5	1	36	37
05:45 PM	1	0	5	0	6	0	4	0	0	4	0	0	0	0	0	0	0	6	0	0	6	0	16	16
Total	9	0	20	0	29	0	37	1	1	38	0	0	0	0	0	0	1	22	0	0	23	1	90	91
Grand Total	14	0	29	0	43	1	65	1	1	67	0	0	0	0	0	0	10	43	0	0	53	1	163	164
% Approach	32.6	0	67.4		1.5	97	1.5			41.1							18.9	81.1			32.5			
% Total	8.6	0	17.8		26.4	0.6	39.9	0.6									6.1	26.4				0.6		99.4

Start Time	Meridian Parkway Southbound				Van Buren Boulevard Westbound				Harmon Street Northbound				Van Buren Boulevard Eastbound											
	Left	Thru	Right	RTOR	Left	Thru	Right	RTOR	Left	Thru	Right	RTOR	Left	Thru	Right	RTOR	Left	Thru	Right	RTOR	Exclu. Total	Inclu. Total	Int. Total	
04:30 PM	5	0	1	0	1	9	0	0	0	0	0	0	0	0	0	0	0	0	0	0	0	0	6	22
04:45 PM	0	0	6	0	0	5	0	0	0	0	0	0	0	0	0	0	4	5	0	0	0	0	9	20
05:00 PM	1	0	3	0	0	8	0	0	0	0	0	0	0	0	0	0	1	7	0	0	0	0	8	20
05:15 PM	3	0	4	0	0	7	0	0	0	0	0	0	0	0	0	0	0	4	0	0	0	0	4	18
Total Volume	9	0	14		1	29	0			30			5	22	0		5	22	0		27		80	80
% App. Total	39.1	0	60.9		3.3	96.7	0			18.5			18.5	81.5	0		.313	.786			.750		.909	.909
PHF	.450	.000	.583		.250	.806	.000			.750	.000		.000	.786	.000		.000	.750			.000		.750	.909

Peak Hour Analysis From 04:30 PM to 05:15 PM - Peak 1 of 1
 Peak Hour for Entire Intersection Begins at 04:30 PM

Counts Unlimited, Inc.
 PO Box 1178
 Corona, CA 92878
 (951)268-6268

County of Riverside
 N/S: Meridian Pkwy/Harmon St
 E/W: Van Buren Boulevard
 Weather: Clear

File Name : 23_CRV_Mer_VB PM
 Site Code : 05121716
 Start Date : 11/30/2021
 Page No : 2

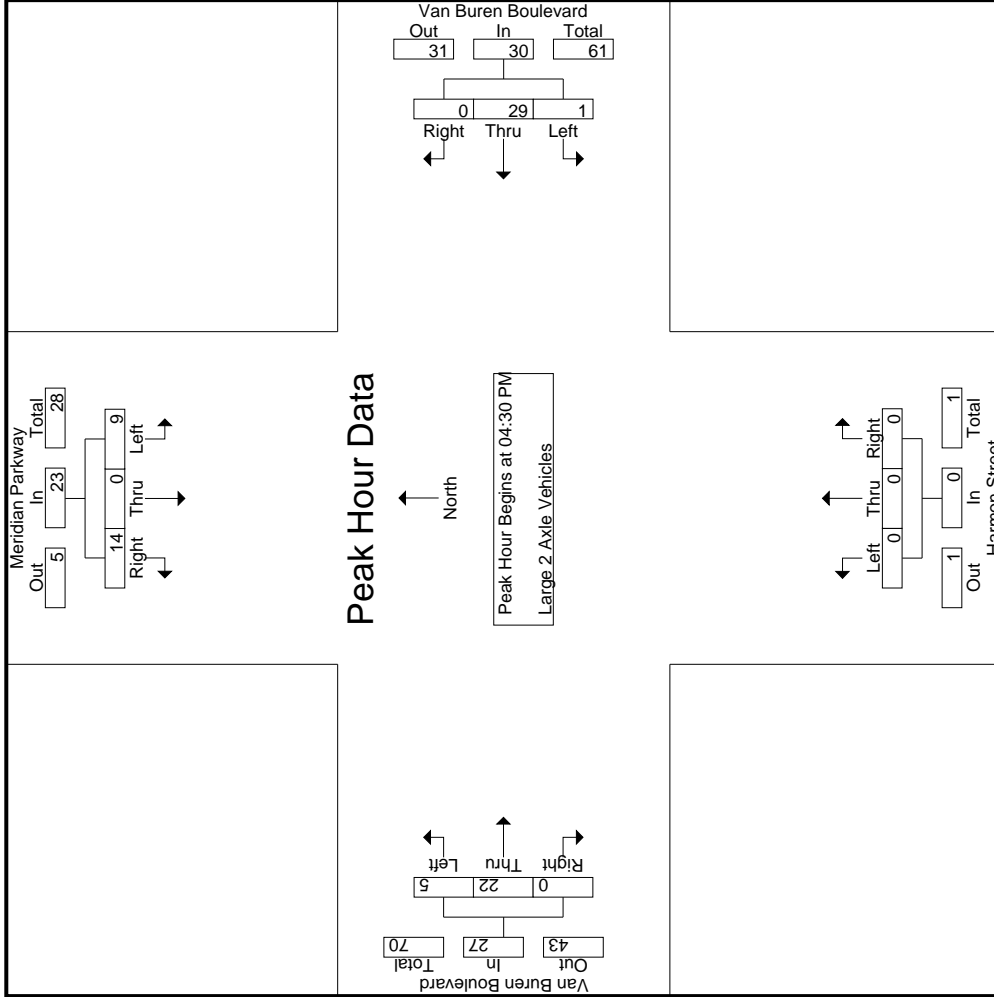

Counts Unlimited, Inc.
 PO Box 1178
 Corona, CA 92878
 (951)268-6268

County of Riverside
 N/S: Meridian Pkwy/Harmon St
 E/W: Van Buren Boulevard
 Weather: Clear

File Name : 23_CRV_Mer_VB PM
 Site Code : 05121716
 Start Date : 11/30/2021
 Page No : 3

Start Time	Meridian Parkway Southbound			Van Buren Boulevard Westbound			Harmon Street Northbound			Van Buren Boulevard Eastbound			Int. Total	
	Left	Thru	Right	Left	Thru	Right	Left	Thru	Right	Left	Thru	Right		App. Total
Peak Hour Analysis From 04:30 PM to 05:15 PM - Peak 1 of 1	04:30 PM													
Peak Hour for Each Approach Begins at:	04:30 PM													
+0 mins.	5	0	1	1	9	0	10	0	0	0	0	6	0	6
+15 mins.	0	0	6	0	5	0	5	0	0	0	4	5	0	9
+30 mins.	1	0	3	0	8	0	8	0	0	0	1	7	0	8
+45 mins.	3	0	4	0	7	0	7	0	0	0	0	4	0	4
Total Volume	9	0	14	1	29	0	30	0	0	0	5	22	0	27
% App. Total	39.1	0	60.9	3.3	96.7	0	0	0	0	0	18.5	81.5	0	0
PHF	.450	.000	.583	.250	.806	.000	.750	.000	.000	.000	.313	.786	.000	.750

Groups Printed- 3 Axle Vehicles

Start Time	Meridian Parkway Southbound				Van Buren Boulevard Westbound				Harmon Street Northbound				Van Buren Boulevard Eastbound					
	Left	Thru	Right	RTOR	App. Total	Left	Thru	Right	RTOR	App. Total	Left	Thru	Right	RTOR	App. Total	Exclu. Total	Inclu. Total	Int. Total
04:00 PM	0	0	0	0	0	4	0	0	0	0	1	2	0	0	3	0	7	7
04:15 PM	1	0	0	0	1	3	0	0	0	0	2	2	0	0	4	0	8	8
04:30 PM	1	0	0	0	1	4	0	0	0	0	1	5	0	0	6	0	11	11
04:45 PM	1	0	0	0	1	0	0	0	0	0	3	1	0	0	4	0	5	5
Total	3	0	0	0	3	11	0	0	0	0	7	10	0	0	17	0	31	31
05:00 PM	1	0	1	0	2	3	0	0	0	0	1	3	0	0	4	0	9	9
05:15 PM	2	0	3	0	5	4	0	0	0	0	1	3	0	0	4	0	13	13
05:30 PM	3	0	1	0	4	4	0	0	0	0	1	3	0	0	4	0	12	12
05:45 PM	1	0	0	0	1	5	0	0	0	0	0	3	0	0	3	0	9	9
Total	7	0	5	0	12	16	0	0	0	0	3	12	0	0	15	0	43	43
Grand Total	10	0	5	0	15	27	0	0	0	0	10	22	0	0	32	0	74	74
T-Approch %	66.7	0	33.3			0	100	0			31.2	68.8	0		43.2		100	
T-Total %	13.5	0	6.8		20.3	36.5	0	36.5			13.5	29.7	0		43.2		100	

Start Time	Meridian Parkway Southbound				Van Buren Boulevard Westbound				Harmon Street Northbound				Van Buren Boulevard Eastbound					
	Left	Thru	Right	RTOR	App. Total	Left	Thru	Right	RTOR	App. Total	Left	Thru	Right	RTOR	App. Total	Exclu. Total	Inclu. Total	Int. Total
04:30 PM	1	0	0	0	1	0	4	0	0	0	0	0	0	0	0	0	6	11
04:45 PM	1	0	0	0	1	0	0	0	0	0	3	1	0	0	4	0	4	5
05:00 PM	1	0	1	0	2	0	3	0	0	0	1	3	0	0	4	0	4	9
05:15 PM	2	0	3	0	5	0	4	0	0	0	1	3	0	0	4	0	13	13
Total Volume	5	0	4	0	9	11	11	0	0	0	6	12	0	0	18	0	38	38
% App. Total	55.6	0	44.4			0	100	0			33.3	66.7	0		75.0		100	
PHF	.625	.000	.333		.450	.688	.000	.688		.000	.500	.600	.000		.750		.731	

Peak Hour Analysis From 04:30 PM to 05:15 PM - Peak 1 of 1
 Peak Hour for Entire Intersection Begins at 04:30 PM

Counts Unlimited, Inc.
 PO Box 1178
 Corona, CA 92878
 (951)268-6268

County of Riverside
 N/S: Meridian Pkwy/Harmon St
 E/W: Van Buren Boulevard
 Weather: Clear

File Name : 23_CRV_Mer_VB PM
 Site Code : 05121716
 Start Date : 11/30/2021
 Page No : 2

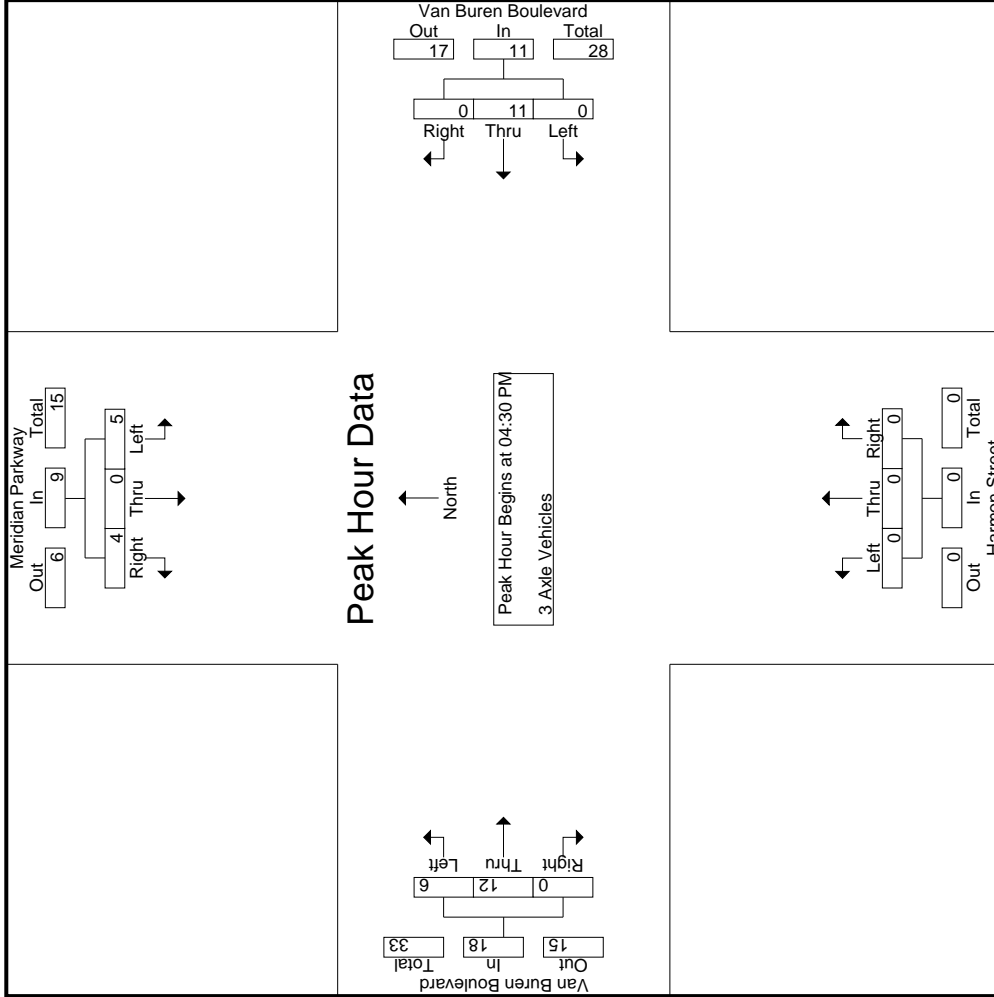

Counts Unlimited, Inc.
 PO Box 1178
 Corona, CA 92878
 (951)268-6268

County of Riverside
 N/S: Meridian Pkwy/Harmon St
 E/W: Van Buren Boulevard
 Weather: Clear

File Name : 23_CRV_Mer_VB PM
 Site Code : 05121716
 Start Date : 11/30/2021
 Page No : 3

Start Time	Meridian Parkway Southbound			Van Buren Boulevard Westbound			Harmon Street Northbound			Van Buren Boulevard Eastbound		
	Left	Thru	Right	Left	Thru	Right	Left	Thru	Right	Left	Thru	Right
Peak Hour Analysis From 04:30 PM to 05:15 PM - Peak 1 of 1												
Peak Hour for Each Approach Begins at:												
+0 mins.	1	0	0	0	4	0	0	0	0	0	1	5
+15 mins.	1	0	0	0	0	0	0	0	0	3	1	0
+30 mins.	1	0	1	0	3	0	0	0	0	1	3	0
+45 mins.	2	0	3	0	4	0	0	0	0	1	3	0
Total Volume	5	0	4	0	11	0	0	0	0	6	12	0
% App. Total	55.6	0	44.4	0	100	0	0	0	0	33.3	66.7	0
PHF	.625	.000	.333	.000	.688	.000	.000	.000	.000	.500	.600	.000
			.450		.688			.000			.750	

Counts Unlimited, Inc.
 PO Box 1178
 Corona, CA 92878
 (951)268-6268

County of Riverside
 N/S: Meridian Pkwy/Harmon St
 E/W: Van Buren Boulevard
 Weather: Clear

File Name : 23_CRV_Mer_VB_PM
 Site Code : 05121716
 Start Date : 11/30/2021
 Page No : 1

Groups Printed- 4+ Axle Trucks

Start Time	Meridian Parkway Southbound				Van Buren Boulevard Westbound				Harmon Street Northbound				Van Buren Boulevard Eastbound												
	Left	Thru	Right	RTOR	Left	Thru	Right	RTOR	Left	Thru	Right	RTOR	Left	Thru	Right	RTOR	Left	Thru	Right	RTOR	Exclu. Total	Inclu. Total	Int. Total		
04:00 PM	2	0	3	0	5	0	7	1	0	8	0	0	0	0	0	0	0	0	0	0	0	0	0	25	25
04:15 PM	1	0	3	0	4	0	10	0	0	10	0	0	0	0	0	0	0	0	0	0	0	0	0	24	24
04:30 PM	3	0	0	0	3	0	9	0	0	9	0	0	0	0	0	0	0	0	0	0	0	0	0	20	20
04:45 PM	3	0	2	0	5	0	6	1	0	7	0	0	0	0	0	0	0	0	0	0	0	0	0	23	23
Total	9	0	8	0	17	0	32	2	0	34	0	0	0	0	0	0	13	28	0	0	0	0	0	92	92
05:00 PM	8	0	2	0	10	0	6	0	0	6	0	0	0	0	0	0	1	7	0	0	0	0	0	24	24
05:15 PM	4	0	4	0	8	0	2	0	0	2	0	0	0	0	0	0	0	13	0	0	0	0	0	23	23
05:30 PM	3	0	1	0	4	0	6	0	0	6	0	0	0	0	0	0	2	10	0	0	0	0	0	22	22
05:45 PM	2	0	4	0	6	0	9	0	0	9	0	0	0	0	0	0	2	8	0	0	0	0	0	25	25
Total	17	0	11	0	28	0	23	0	0	23	0	0	0	0	0	0	5	38	0	0	0	0	0	94	94
Grand Total	26	0	19	0	45	0	55	2	0	57	0	0	0	0	0	0	18	66	0	0	0	0	0	186	186
T-Approch %	57.8	0	42.2			0	96.5	3.5			0	0	0			21.4	78.6	0						100	100
Total %	14	0	10.2		24.2	0	29.6	1.1		30.6	0	0	0			9.7	35.5	0						45.2	45.2

Start Time	Meridian Parkway Southbound				Van Buren Boulevard Westbound				Harmon Street Northbound				Van Buren Boulevard Eastbound												
	Left	Thru	Right	RTOR	Left	Thru	Right	RTOR	Left	Thru	Right	RTOR	Left	Thru	Right	RTOR	Left	Thru	Right	RTOR	Exclu. Total	Inclu. Total	Int. Total		
04:30 PM	3	0	0	0	3	0	9	0	0	9	0	0	0	0	0	0	2	6	0	0	0	0	0	20	
04:45 PM	3	0	2	0	5	0	6	1	0	7	0	0	0	0	0	0	3	8	0	0	0	0	11	23	
05:00 PM	8	0	2	0	10	0	6	0	0	6	0	0	0	0	0	0	1	7	0	0	0	0	8	24	
05:15 PM	4	0	4	0	8	0	2	0	0	2	0	0	0	0	0	0	0	13	0	0	0	0	13	23	
Total Volume	18	0	8	0	26	0	23	1	0	24	0	0	0	0	0	0	6	34	0	0	0	0	0	40	90
% App. Total	69.2	0	30.8			0	95.8	4.2			0	0	0			15	85	0						.938	
PHF	.563	.000	.500		.650	.000	.639	.250		.667	.000	.000	.000		.000	.500	.654	.000		.769				.938	

Peak Hour Analysis From 04:30 PM to 05:15 PM - Peak 1 of 1
 Peak Hour for Entire Intersection Begins at 04:30 PM

Counts Unlimited, Inc.
 PO Box 1178
 Corona, CA 92878
 (951)268-6268

County of Riverside
 N/S: Meridian Pkwy/Harmon St
 E/W: Van Buren Boulevard
 Weather: Clear

File Name : 23_CRV_Mer_VB PM
 Site Code : 05121716
 Start Date : 11/30/2021
 Page No : 2

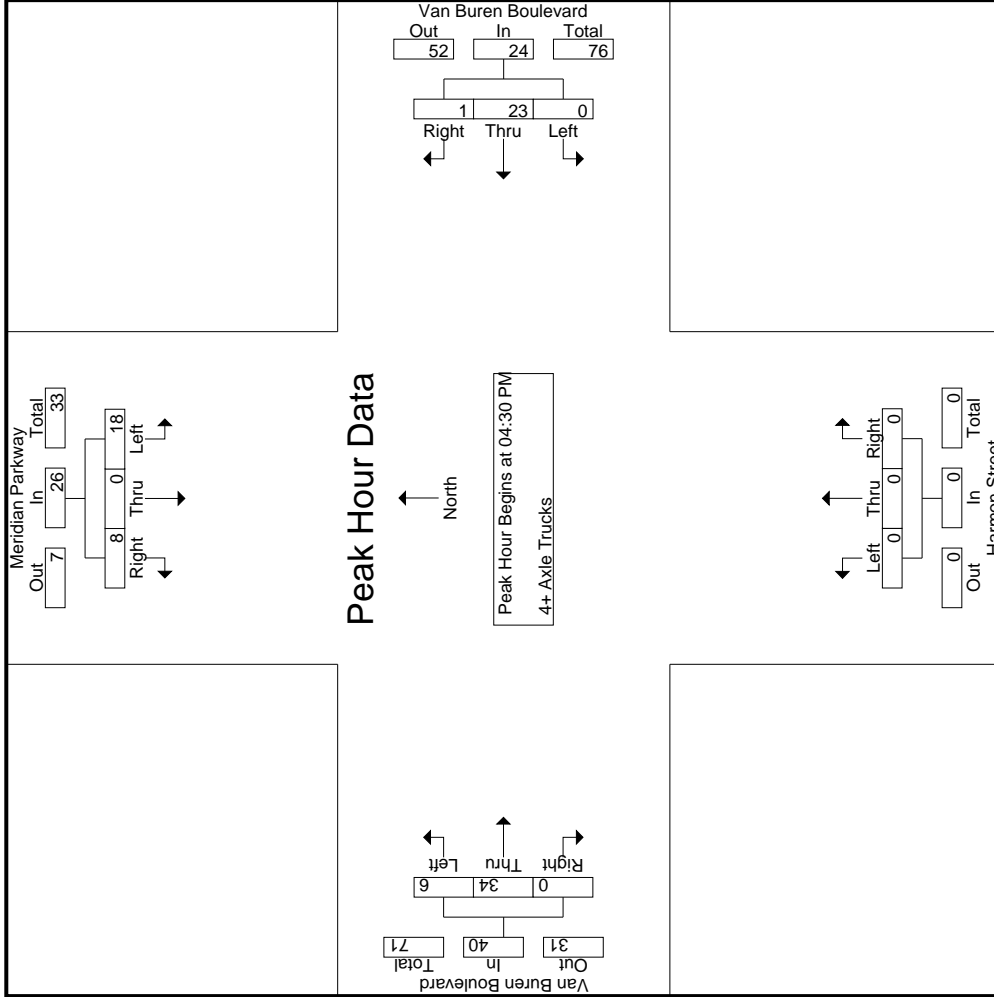

Counts Unlimited, Inc.
 PO Box 1178
 Corona, CA 92878
 (951)268-6268

County of Riverside
 N/S: Meridian Pkwy/Harmon St
 E/W: Van Buren Boulevard
 Weather: Clear

File Name : 23_CRV_Mer_VB PM
 Site Code : 05121716
 Start Date : 11/30/2021
 Page No : 3

Start Time	Meridian Parkway Southbound			Van Buren Boulevard Westbound			Harmon Street Northbound			Van Buren Boulevard Eastbound		
	Left	Thru	Right	Left	Thru	Right	Left	Thru	Right	Left	Thru	Right
Peak Hour Analysis From 04:30 PM to 05:15 PM - Peak 1 of 1												
Peak Hour for Each Approach Begins at:												
+0 mins.	3	0	0	0	9	0	9	0	0	0	2	6
+15 mins.	3	0	2	0	6	1	7	0	0	3	8	0
+30 mins.	8	0	2	0	6	0	6	0	0	1	7	0
+45 mins.	4	0	4	0	2	0	2	0	0	0	13	0
Total Volume	18	0	8	0	23	1	24	0	0	6	34	0
% App. Total	69.2	0	30.8	0	95.8	4.2	66.7	0	0	15	85	0
PHF	.563	.000	.500	.000	.639	.250	.667	.000	.000	.500	.654	.000

Location: County of Riverside
 N/S: Meridian Pkwy/Harmon St
 E/W: Van Buren Boulevard



Date: 11/30/2021
 Day: Tuesday

PEDESTRIANS

	North Leg Meridian Parkway Pedestrians	East Leg Van Buren Boulevard Pedestrians	South Leg Harmon Street Pedestrians	West Leg Van Buren Boulevard Pedestrians	
7:00 AM	0	0	0	0	0
7:15 AM	0	0	0	0	0
7:30 AM	0	0	0	0	0
7:45 AM	0	0	0	0	0
8:00 AM	0	0	0	0	0
8:15 AM	0	0	0	0	0
8:30 AM	0	0	0	0	0
8:45 AM	0	0	0	0	0
TOTAL VOLUMES:	0	0	0	0	0

	North Leg Meridian Parkway Pedestrians	East Leg Van Buren Boulevard Pedestrians	South Leg Harmon Street Pedestrians	West Leg Van Buren Boulevard Pedestrians	
4:00 PM	0	0	0	0	0
4:15 PM	0	0	0	0	0
4:30 PM	0	0	0	0	0
4:45 PM	0	0	0	0	0
5:00 PM	0	0	0	0	0
5:15 PM	0	0	0	0	0
5:30 PM	0	0	0	0	0
5:45 PM	0	0	0	0	0
TOTAL VOLUMES:	0	0	0	0	0

Location: County of Riverside
 N/S: Meridian Pkwy/Harmon St
 E/W: Van Buren Boulevard



Date: 11/30/2021
 Day: Tuesday

BICYCLES

	Southbound Meridian Parkway			Westbound Van Buren Boulevard			Northbound Harmon Street			Eastbound Van Buren Boulevard			
	Left	Thru	Right	Left	Thru	Right	Left	Thru	Right	Left	Thru	Right	
7:00 AM	0	0	0	0	0	0	0	0	0	0	0	0	0
7:15 AM	0	0	0	0	0	0	0	0	0	0	0	0	0
7:30 AM	0	0	0	0	0	0	0	0	0	0	0	0	0
7:45 AM	0	0	0	0	0	0	0	0	0	0	0	0	0
8:00 AM	0	0	0	0	0	0	0	0	0	0	0	0	0
8:15 AM	0	0	0	0	0	0	0	0	0	0	0	0	0
8:30 AM	0	0	0	0	0	0	0	0	0	0	0	0	0
8:45 AM	0	0	0	0	0	0	0	0	0	0	0	0	0
TOTAL VOLUMES:	0	0	0	0	0	0	0	0	0	0	0	0	0

	Southbound Meridian Parkway			Westbound Van Buren Boulevard			Northbound Harmon Street			Eastbound Van Buren Boulevard			
	Left	Thru	Right	Left	Thru	Right	Left	Thru	Right	Left	Thru	Right	
4:00 PM	0	0	0	0	0	0	0	0	0	0	0	0	0
4:15 PM	0	0	0	0	0	0	0	0	0	0	0	0	0
4:30 PM	0	0	0	0	0	1	0	0	1	0	0	0	2
4:45 PM	0	0	0	0	0	0	0	0	0	0	0	0	0
5:00 PM	0	0	0	0	0	0	0	0	0	0	0	0	0
5:15 PM	0	0	0	0	0	0	0	0	0	0	0	0	0
5:30 PM	0	0	0	0	0	0	0	0	0	0	0	0	0
5:45 PM	0	0	0	0	0	0	0	0	0	0	0	0	0
TOTAL VOLUMES:	0	0	0	0	0	1	0	0	1	0	0	0	2

Groups Printed- Passenger Vehicles - Large 2 Axle Vehicles - 3 Axle Vehicles - 4+ Axle Trucks

Start Time	Innovation Drive Southbound					Cactus Avenue Westbound					Innovation Drive Northbound					Cactus Avenue Eastbound							
	Left	Thru	Right	RTOR	App. Total	Left	Thru	Right	RTOR	App. Total	Left	Thru	Right	RTOR	App. Total	Left	Thru	Right	RTOR	App. Total	Exclu. Total	Inclu. Total	Int. Total
	07:00 AM	0	0	1	1	1	23	303	6	0	332	1	0	6	5	7	1	66	4	0	71	6	411
07:15 AM	1	0	0	0	1	20	298	8	0	326	1	0	4	4	5	0	69	2	1	71	5	403	408
07:30 AM	2	0	0	0	2	26	269	10	0	305	3	0	1	0	4	0	90	5	1	95	1	406	407
07:45 AM	1	0	1	0	2	30	276	18	0	324	1	0	7	4	8	3	79	3	0	85	4	419	423
Total	4	0	2	1	6	99	1146	42	0	1287	6	0	18	13	24	4	304	14	2	322	16	1639	1655
08:00 AM	4	0	0	0	4	18	273	22	1	313	0	0	9	6	9	1	58	2	2	61	9	387	396
08:15 AM	0	0	0	0	0	29	292	13	0	334	1	0	8	7	9	3	58	2	0	63	7	406	413
08:30 AM	1	0	0	0	1	13	262	15	3	290	0	0	8	8	3	1	65	4	0	70	6	369	375
08:45 AM	9	0	1	0	10	19	202	9	0	230	4	0	12	8	16	6	49	1	0	56	8	312	320
Total	14	0	1	0	15	79	1029	59	4	1167	5	0	37	24	42	11	230	9	2	250	30	1474	1504
Grand Total	18	0	3	1	21	178	2175	101	4	2454	11	0	55	37	66	15	534	23	4	572	46	3113	3159
% Approach	85.7	0	14.3			7.3	88.6	4.1		16.7	0	83.3			2.6	93.4	4						
% Total	0.6	0	0.1	0.7		5.7	69.9	3.2		78.8	0.4	0	1.8	2.1		0.5	17.2	0.7		18.4	1.5	98.5	
% Passenger Vehicles	15	0	3	19	86.4	152	2045	100	100	2301	6	0	33	61	59.2	15	494	22	75	534	0	0	2915
% Large 2 Axle Vehicles	83.3	0	100	100	100	85.4	94	99	100	93.6	54.5	0	60	59.5	59.2	100	92.5	95.7	75	92.7	0	0	92.3
% 3 Axle Vehicles	2	0	0	2	2	5	28	1	0	34	0	0	2	4	4	0	2	0	0	2	0	0	42
% 4+ Axle Trucks	11.1	0	0	9.1	9.1	2.8	1.3	1	0	1.4	0	0	3.6	5.4	3.9	0	0.4	0	0	0.3	0	0	1.3
% 3 Axle Vehicles	0	0	0	0	0	6	7	0	0	13	0	0	6	12	12	0	1	0	0	1	0	0	26
% 4+ Axle Trucks	0	0	0	0	0	3.4	0.3	0	0	0.5	0	0	10.9	16.2	11.7	0	0.2	0	0	0.2	0	0	0.8
% 4+ Axle Trucks	1	0	0	1	1	15	95	0	0	110	5	0	14	26	26	0	37	1	39	39	0	0	176
% 4+ Axle Trucks	5.6	0	0	4.5	4.5	8.4	4.4	0	0	4.5	45.5	0	25.5	18.9	25.2	0	6.9	4.3	25	6.8	0	0	5.6

Start Time	Innovation Drive Southbound					Cactus Avenue Westbound					Innovation Drive Northbound					Cactus Avenue Eastbound							
	Left	Thru	Right	RTOR	App. Total	Left	Thru	Right	RTOR	App. Total	Left	Thru	Right	RTOR	App. Total	Left	Thru	Right	RTOR	App. Total	Exclu. Total	Inclu. Total	Int. Total
	07:00 AM	0	0	1	1	1	23	303	6	0	332	1	0	6	5	7	1	66	4	0	71	6	411
07:15 AM	1	0	0	0	1	20	298	8	0	326	1	0	4	4	5	0	69	2	1	71	5	403	408
07:30 AM	2	0	0	0	2	26	269	10	0	305	3	0	1	0	4	0	90	5	1	95	1	406	407
07:45 AM	1	0	1	0	2	30	276	18	0	324	1	0	7	4	8	3	79	3	0	85	4	419	423
Total	4	0	2	1	6	99	1146	42	0	1287	6	0	18	13	24	4	304	14	2	322	16	1639	1655
08:00 AM	4	0	0	0	4	18	273	22	1	313	0	0	9	6	9	1	58	2	2	61	9	387	396
08:15 AM	0	0	0	0	0	29	292	13	0	334	1	0	8	7	9	3	58	2	0	63	7	406	413
08:30 AM	1	0	0	0	1	13	262	15	3	290	0	0	8	8	3	1	65	4	0	70	6	369	375
08:45 AM	9	0	1	0	10	19	202	9	0	230	4	0	12	8	16	6	49	1	0	56	8	312	320
Total	14	0	1	0	15	79	1029	59	4	1167	5	0	37	24	42	11	230	9	2	250	30	1474	1504
Grand Total	18	0	3	1	21	178	2175	101	4	2454	11	0	55	37	66	15	534	23	4	572	46	3113	3159
% Approach	85.7	0	14.3			7.3	88.6	4.1		16.7	0	83.3			2.6	93.4	4						
% Total	0.6	0	0.1	0.7		5.7	69.9	3.2		78.8	0.4	0	1.8	2.1		0.5	17.2	0.7		18.4	1.5	98.5	
% Passenger Vehicles	15	0	3	19	86.4	152	2045	100	100	2301	6	0	33	61	59.2	15	494	22	75	534	0	0	2915
% Large 2 Axle Vehicles	83.3	0	100	100	100	85.4	94	99	100	93.6	54.5	0	60	59.5	59.2	100	92.5	95.7	75	92.7	0	0	92.3
% 3 Axle Vehicles	2	0	0	2	2	5	28	1	0	34	0	0	2	4	4	0	2	0	0	2	0	0	42
% 4+ Axle Trucks	11.1	0	0	9.1	9.1	2.8	1.3	1	0	1.4	0	0	3.6	5.4	3.9	0	0.4	0	0	0.3	0	0	1.3
% 3 Axle Vehicles	0	0	0	0	0	6	7	0	0	13	0	0	6	12	12	0	1	0	0	1	0	0	26
% 4+ Axle Trucks	0	0	0	0	0	3.4	0.3	0	0	0.5	0	0	10.9	16.2	11.7	0	0.2	0	0	0.2	0	0	0.8
% 4+ Axle Trucks	1	0	0	1	1	15	95	0	0	110	5	0	14	26	26	0	37	1	39	39	0	0	176
% 4+ Axle Trucks	5.6	0	0	4.5	4.5	8.4	4.4	0	0	4.5	45.5	0	25.5	18.9	25.2	0	6.9	4.3	25	6.8	0	0	5.6

Peak Hour Analysis From 07:00 AM to 08:45 AM - Peak 1 of 1
 Peak Hour for Entire Intersection Begins at 07:00 AM

Start Time	Innovation Drive Southbound					Cactus Avenue Westbound					Innovation Drive Northbound					Cactus Avenue Eastbound							
	Left	Thru	Right	RTOR	App. Total	Left	Thru	Right	RTOR	App. Total	Left	Thru	Right	RTOR	App. Total	Left	Thru	Right	RTOR	App. Total	Exclu. Total	Inclu. Total	Int. Total
	07:00 AM	0	0	1	1	1	23	303	6	0	332	1	0	6	5	7	1	66	4	0	71	6	411
07:15 AM	1	0	0	0	1	20	298	8	0	326	1	0	4	4	5	0	69	2	1	71	5	403	408
07:30 AM	2	0	0	0	2	26	269	10	0	305	3	0	1	0	4	0	90	5	1	95	1	406	407
07:45 AM	1	0	1	0	2	30	276	18	0	324	1	0	7	4	8	3	79	3	0	85	4	419	423
Total	4	0	2	1	6	99	1146	42	0	1287	6	0	18	13	24	4	304	14	2	322	16	1639	1655
% App. Total	66.7	0	33.3			7.7	89	3.3		1287	6	0	18	75	75	1.2	94.4	4.3		322			1639
PHF	.500	.000	.500	.750	.750	.825	.946	.583	.969	.969	.500	.000	.643	.750	.750	.333	.844	.700	.847	.700	.847	.700	.978

Counts Unlimited, Inc.
 PO Box 1178
 Corona, CA 92878
 (951)268-6268

County of Riverside
 N/S: Innovation Drive
 E/W: Cactus Avenue
 Weather: Clear

File Name : 24_CRV_Inno_Cactus AM
 Site Code : 05121716
 Start Date : 11/30/2021
 Page No : 2

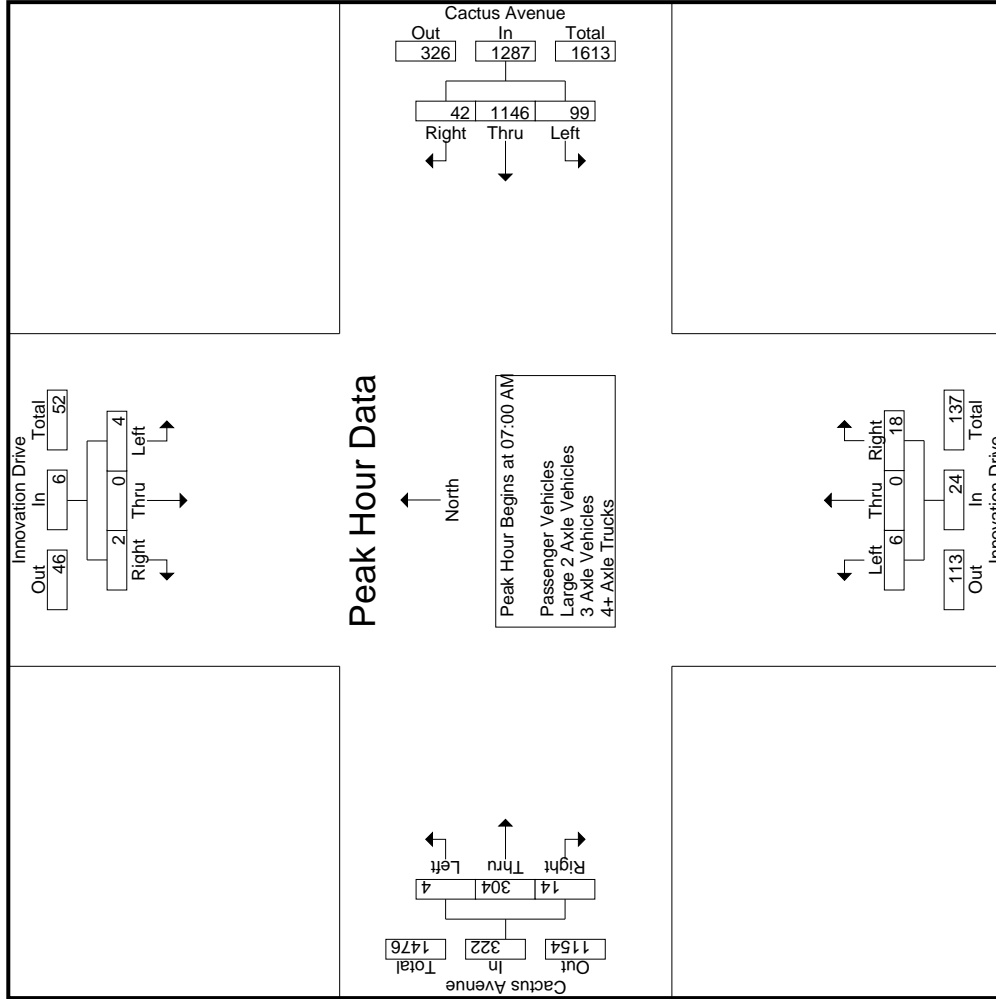

Counts Unlimited, Inc.
 PO Box 1178
 Corona, CA 92878
 (951)268-6268

File Name : 24_CRV_Inno_Cactus AM
 Site Code : 05121716
 Start Date : 11/30/2021
 Page No : 3

County of Riverside
 N/S: Innovation Drive
 E/W: Cactus Avenue
 Weather: Clear

Start Time	Innovation Drive Southbound			Cactus Avenue Westbound			Innovation Drive Northbound			Cactus Avenue Eastbound				
	Left	Thru	Right	App. Total	Left	Thru	Right	App. Total	Left	Thru	Right	App. Total	Int. Total	
Peak Hour Analysis From 07:00 AM to 08:45 AM - Peak 1 of 1														
Peak Hour for Each Approach Begins at:														
	08:00 AM			07:00 AM			08:00 AM			07:00 AM				
+0 mins.	4	0	0	4	23	6	332	0	0	9	1	66	4	71
+15 mins.	0	0	0	0	20	8	326	1	0	9	0	69	2	71
+30 mins.	1	0	0	1	26	10	305	0	0	8	0	90	5	95
+45 mins.	9	0	1	10	30	18	324	4	0	16	3	79	3	85
Total Volume	14	0	1	15	99	42	1287	5	0	42	4	304	14	322
% App. Total	93.3	0	6.7		7.7	3.3		11.9	0	88.1	1.2	94.4	4.3	
PHF	.389	.000	.250	.375	.825	.583	.969	.313	.000	.771	.333	.844	.700	.847

Groups Printed- Passenger Vehicles

Start Time	Innovation Drive Southbound				Cactus Avenue Westbound				Innovation Drive Northbound				Cactus Avenue Eastbound					
	Left	Thru	Right	RTOR	App. Total	Left	Thru	Right	RTOR	App. Total	Left	Thru	Right	RTOR	App. Total	Exclu. Total	Inclu. Total	Int. Total
07:00 AM	0	0	1	1	1	23	286	6	0	315	1	0	2	2	3	3	384	387
07:15 AM	0	0	0	0	0	18	289	8	0	315	0	0	2	2	2	3	380	383
07:30 AM	2	0	0	0	2	25	255	9	0	289	1	0	1	0	2	1	380	381
07:45 AM	1	0	1	0	2	27	258	18	0	303	1	0	5	3	6	3	389	392
Total	3	0	2	1	5	93	1088	41	0	1222	3	0	10	7	13	10	1533	1543
08:00 AM	3	0	0	0	3	12	260	22	1	294	0	0	5	4	5	6	360	366
08:15 AM	0	0	0	0	0	22	266	13	0	301	1	0	5	4	6	4	368	372
08:30 AM	1	0	0	0	1	9	245	15	3	269	0	0	6	2	6	5	343	348
08:45 AM	8	0	1	0	9	16	186	9	0	211	2	0	7	5	9	5	281	286
Total	12	0	1	0	13	59	957	59	4	1075	3	0	23	15	26	20	1352	1372
Grand Total	15	0	3	1	18	152	2045	100	4	2297	6	0	33	22	39	30	2885	2915
T-Approch %	83.3	0	16.7			6.6	89	4.4		15.4	0	84.6			2.8	93	4.1	
33 Total %	0.5	0	0.1		0.6	5.3	70.9	3.5		79.6	0.2	0	1.1		1.4	17.1	0.8	

Start Time	Innovation Drive Southbound				Cactus Avenue Westbound				Innovation Drive Northbound				Cactus Avenue Eastbound					
	Left	Thru	Right	RTOR	App. Total	Left	Thru	Right	RTOR	App. Total	Left	Thru	Right	RTOR	App. Total	Exclu. Total	Inclu. Total	Int. Total
07:00 AM	0	0	1	1	1	23	286	6	0	315	1	0	2	2	3	3	384	387
07:15 AM	0	0	0	0	0	18	289	8	0	315	0	0	2	2	2	3	380	383
07:30 AM	2	0	0	0	2	25	255	9	0	289	1	0	1	0	2	1	380	381
07:45 AM	1	0	1	0	2	27	258	18	0	303	1	0	5	3	6	3	389	392
Total	3	0	2	1	5	93	1088	41	0	1222	3	0	10	7	13	10	1533	1543
%App. Total	60	0	40			23.1	89	3.4		76.9	0	76.9			1.4	93.9	4.8	
PHF	.375	.000	.500		.625	.861	.941	.569		.970	.750	.000	.500		.542	.838	.700	.842

Peak Hour Analysis From 07:00 AM to 07:45 AM - Peak 1 of 1
 Peak Hour for Entire Intersection Begins at 07:00 AM

Counts Unlimited, Inc.
 PO Box 1178
 Corona, CA 92878
 (951)268-6268

County of Riverside
 N/S: Innovation Drive
 E/W: Cactus Avenue
 Weather: Clear

File Name : 24_CRV_Inno_Cactus AM
 Site Code : 05121716
 Start Date : 11/30/2021
 Page No : 2

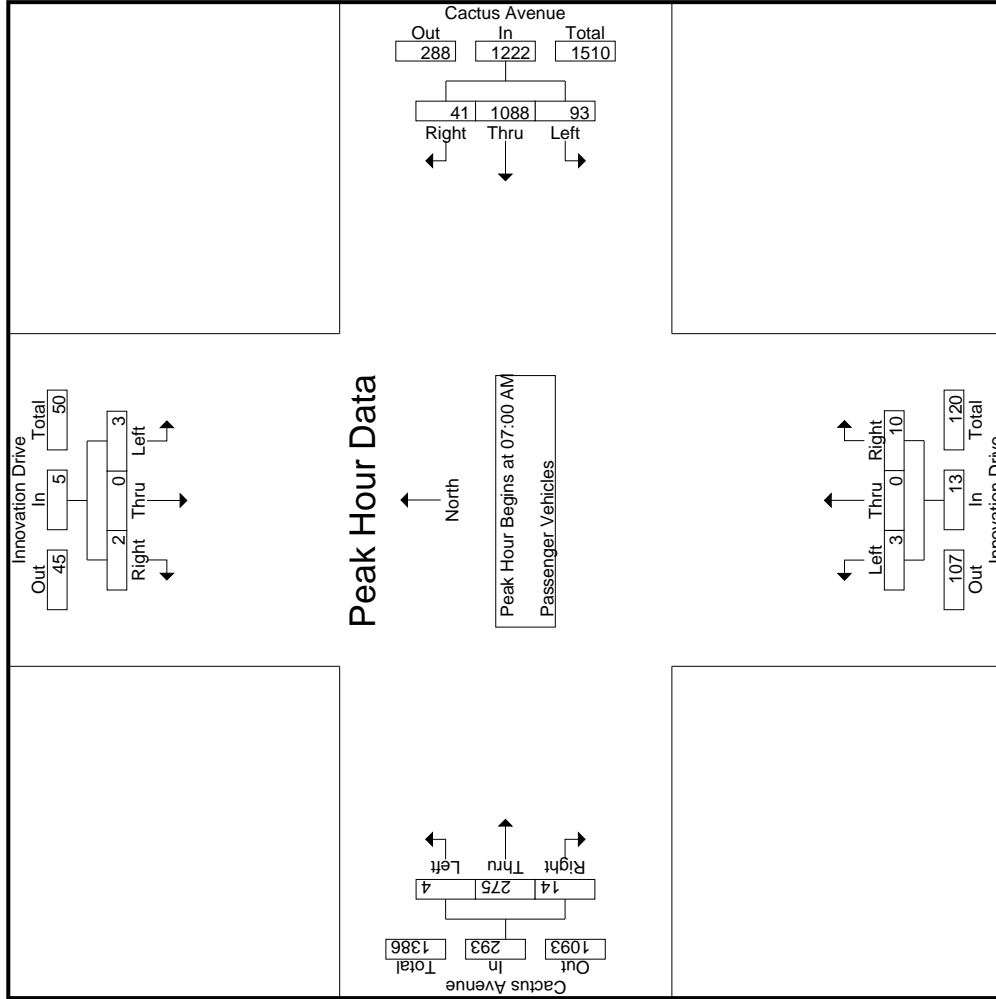

Counts Unlimited, Inc.
 PO Box 1178
 Corona, CA 92878
 (951)268-6268

File Name : 24_CRV_Inno_Cactus AM
 Site Code : 05121716
 Start Date : 11/30/2021
 Page No : 3

County of Riverside
 N/S: Innovation Drive
 E/W: Cactus Avenue
 Weather: Clear

Start Time	Innovation Drive Southbound			Cactus Avenue Westbound			Innovation Drive Northbound			Cactus Avenue Eastbound			
	Left	Thru	Right	Left	Thru	Right	Left	Thru	Right	Left	Thru	Right	
Peak Hour Analysis From 07:00 AM to 07:45 AM - Peak 1 of 1													
Peak Hour for Each Approach Begins at:													
+0 mins.	0	0	1	23	286	6	1	0	2	07:00 AM	1	60	4
+15 mins.	0	0	0	18	289	8	0	0	2	07:00 AM	0	61	2
+30 mins.	2	0	2	25	255	9	1	0	1	07:00 AM	0	82	5
+45 mins.	1	0	1	27	258	18	1	0	5	07:00 AM	3	72	3
Total Volume	3	0	2	93	1088	41	3	0	10	07:00 AM	4	275	14
% App. Total	60	0	40	7.6	89	3.4	23.1	0	76.9	07:00 AM	1.4	93.9	4.8
PHF	.375	.000	.500	.861	.941	.569	.970	.750	.500	07:00 AM	.333	.838	.700
			.625						.542				.842

Groups Printed- Large 2 Axle Vehicles

Start Time	Innovation Drive Southbound				Cactus Avenue Westbound				Innovation Drive Northbound				Cactus Avenue Eastbound						
	Left	Thru	Right	RTOR	App. Total	Left	Thru	Right	RTOR	App. Total	Left	Thru	Right	RTOR	App. Total	Exclu. Total	Inclu. Total	Int. Total	
07:00 AM	0	0	0	0	0	0	4	0	0	4	0	0	0	1	0	0	0	0	6
07:15 AM	0	0	0	0	0	1	0	0	0	1	0	0	0	0	0	0	0	0	1
07:30 AM	0	0	0	0	0	4	1	0	0	5	0	0	0	0	0	0	0	0	5
07:45 AM	0	0	0	0	0	1	7	0	0	8	0	0	1	1	0	1	1	10	11
Total	0	0	0	0	0	16	1	0	0	18	0	0	2	2	0	1	0	2	23
08:00 AM	1	0	0	0	1	0	1	0	0	1	0	0	0	0	0	0	0	0	2
08:15 AM	0	0	0	0	0	2	4	0	0	6	0	0	0	0	0	0	0	0	6
08:30 AM	0	0	0	0	0	1	0	0	0	2	0	0	0	0	0	1	0	0	3
08:45 AM	1	0	0	0	1	1	6	0	0	7	0	0	0	0	0	0	0	0	8
Total	2	0	0	0	2	4	12	0	0	16	0	0	0	0	0	1	0	0	19
Grand Total	2	0	0	0	2	5	28	1	0	34	0	0	2	2	0	2	0	2	42
% Approach	100	0	0	0	0	14.7	82.4	2.9	0	100	0	0	100	0	0	4.8	95.2	0	0
% Total	5	0	0	0	5	12.5	70	2.5	0	5	0	0	5	0	5	4.8	95.2	0	0

Start Time	Innovation Drive Southbound				Cactus Avenue Westbound				Innovation Drive Northbound				Cactus Avenue Eastbound						
	Left	Thru	Right	RTOR	App. Total	Left	Thru	Right	RTOR	App. Total	Left	Thru	Right	RTOR	App. Total	Exclu. Total	Inclu. Total	Int. Total	
07:00 AM	0	0	0	0	0	0	4	0	0	4	0	0	0	1	0	0	0	0	5
07:15 AM	0	0	0	0	0	0	1	0	0	1	0	0	0	0	0	0	0	0	1
07:30 AM	0	0	0	0	0	4	1	0	0	5	0	0	0	0	0	0	0	0	5
07:45 AM	0	0	0	0	0	1	7	0	0	8	0	0	1	1	0	1	1	10	11
Total	0	0	0	0	0	16	1	0	0	18	0	0	2	2	0	1	0	2	23
% App. Total	0	0	0	0	0	5.6	88.9	5.6	0	100	0	0	100	0	0	0	0	0	21
PHF	.000	.000	.000	.000	.000	.250	.571	.250	.563	.500	.000	.500	.250	.000	.250	.000	.250	.525	.525

Peak Hour Analysis From 07:00 AM to 07:45 AM - Peak 1 of 1
 Peak Hour for Entire Intersection Begins at 07:00 AM

Counts Unlimited, Inc.
 PO Box 1178
 Corona, CA 92878
 (951)268-6268

County of Riverside
 N/S: Innovation Drive
 E/W: Cactus Avenue
 Weather: Clear

File Name : 24_CRV_Inno_Cactus AM
 Site Code : 05121716
 Start Date : 11/30/2021
 Page No : 2

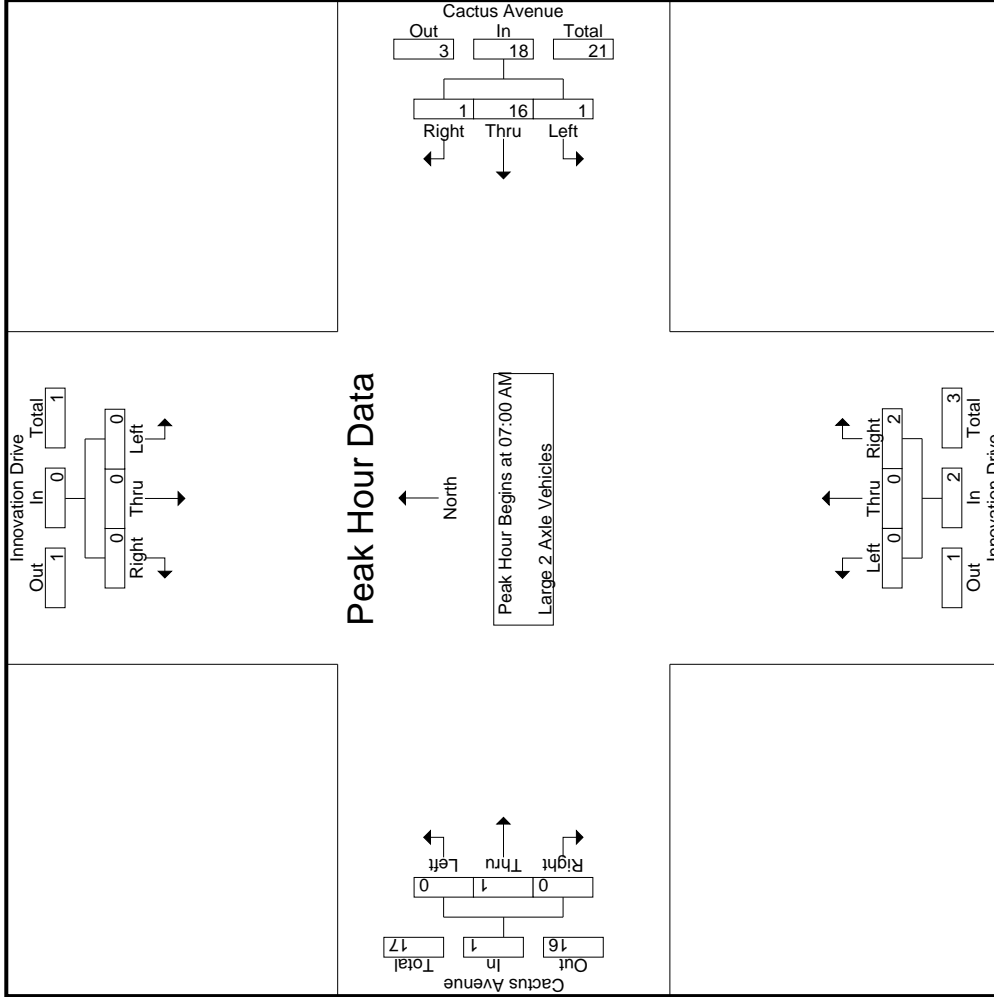

Counts Unlimited, Inc.
 PO Box 1178
 Corona, CA 92878
 (951)268-6268

File Name : 24_CRV_Inno_Cactus AM
 Site Code : 05121716
 Start Date : 11/30/2021
 Page No : 3

County of Riverside
 N/S: Innovation Drive
 E/W: Cactus Avenue
 Weather: Clear

Start Time	Innovation Drive Southbound			Cactus Avenue Westbound			Innovation Drive Northbound			Cactus Avenue Eastbound					
	Left	Thru	Right	App. Total	Left	Thru	Right	App. Total	Left	Thru	Right	App. Total	Int. Total		
Peak Hour Analysis From 07:00 AM to 07:45 AM - Peak 1 of 1															
Peak Hour for Each Approach Begins at:															
	07:00 AM				07:00 AM				07:00 AM				07:00 AM		
+0 mins.	0	0	0	0	4	0	0	4	0	0	1	0	0	0	
+15 mins.	0	0	0	0	1	0	0	1	0	0	0	0	0	0	
+30 mins.	0	0	0	0	4	1	0	5	0	0	0	0	0	0	
+45 mins.	0	0	0	1	7	0	0	8	0	0	1	0	0	1	
Total Volume	0	0	0	0	16	1	18	18	0	0	2	1	0	1	
% App. Total	0	0	0	0	88.9	5.6	5.6	5.6	0	0	100	0	0	0	
PHF	.000	.000	.000	.000	.250	.571	.250	.563	.000	.000	.500	.000	.250	.250	

Counts Unlimited, Inc.
 PO Box 1178
 Corona, CA 92878
 (951)268-6268

File Name : 24_CRV_Inno_Cactus AM
 Site Code : 05121716
 Start Date : 11/30/2021
 Page No : 1

County of Riverside
 N/S: Innovation Drive
 E/W: Cactus Avenue
 Weather: Clear

Groups Printed- 3 Axle Vehicles

Start Time	Innovation Drive Southbound				Cactus Avenue Westbound				Innovation Drive Northbound				Cactus Avenue Eastbound					
	Left	Thru	Right	RTOR	App. Total	Left	Thru	Right	RTOR	App. Total	Left	Thru	Right	RTOR	App. Total	Exclu. Total	Inclu. Total	Int. Total
07:00 AM	0	0	0	0	0	0	0	0	0	1	0	0	0	0	0	1	2	3
07:15 AM	0	0	0	0	0	1	0	0	0	1	0	0	0	0	0	1	2	3
07:30 AM	0	0	0	0	0	1	0	0	0	0	0	0	0	0	1	0	2	2
07:45 AM	0	0	0	0	0	1	0	0	0	1	0	0	0	0	0	0	1	1
Total	0	0	0	0	0	3	0	0	0	4	0	0	2	2	1	2	7	9
08:00 AM	0	0	0	0	0	0	0	0	0	2	0	0	0	0	0	0	2	2
08:15 AM	0	0	0	0	0	1	0	0	1	1	0	0	0	0	0	1	2	3
08:30 AM	0	0	0	0	0	3	0	0	0	4	0	0	1	1	0	1	5	6
08:45 AM	0	0	0	0	0	1	1	0	0	2	0	2	2	0	0	2	4	6
Total	0	0	0	0	0	5	4	0	0	9	0	0	4	4	0	4	13	17
Grand Total	0	0	0	0	0	6	7	0	0	13	0	0	6	6	1	6	20	26
T-Approch %	0	0	0	0	0	46.2	53.8	0	0	65	0	0	100	0	100	0	23.1	76.9
33 Total %	0	0	0	0	0	30	35	0	0	30	0	0	30	0	5	0	0	0

Start Time	Innovation Drive Southbound				Cactus Avenue Westbound				Innovation Drive Northbound				Cactus Avenue Eastbound					
	Left	Thru	Right	RTOR	App. Total	Left	Thru	Right	RTOR	App. Total	Left	Thru	Right	RTOR	App. Total	Exclu. Total	Inclu. Total	Int. Total
07:00 AM	0	0	0	0	0	0	0	0	0	1	0	0	0	0	0	0	0	0
07:15 AM	0	0	0	0	0	0	0	0	0	1	0	0	0	0	0	0	0	0
07:30 AM	0	0	0	0	0	0	0	0	0	0	0	0	0	0	0	0	0	0
07:45 AM	0	0	0	0	0	1	0	0	0	1	0	0	0	0	0	0	0	0
Total Volume	0	0	0	0	0	1	3	0	0	4	0	0	2	2	1	1	0	1
% App. Total	0	0	0	0	0	25	75	0	0	100	0	0	100	0	100	0	0	0
PHF	.000	.000	.000	.000	.000	.250	.750	.000	1.00	.500	.000	.000	.500	.000	.250	.000	.250	.875

Peak Hour Analysis From 07:00 AM to 07:45 AM - Peak 1 of 1
 Peak Hour for Entire Intersection Begins at 07:00 AM

Counts Unlimited, Inc.
 PO Box 1178
 Corona, CA 92878
 (951)268-6268

County of Riverside
 N/S: Innovation Drive
 E/W: Cactus Avenue
 Weather: Clear

File Name : 24_CRV_Inno_Cactus AM
 Site Code : 05121716
 Start Date : 11/30/2021
 Page No : 2

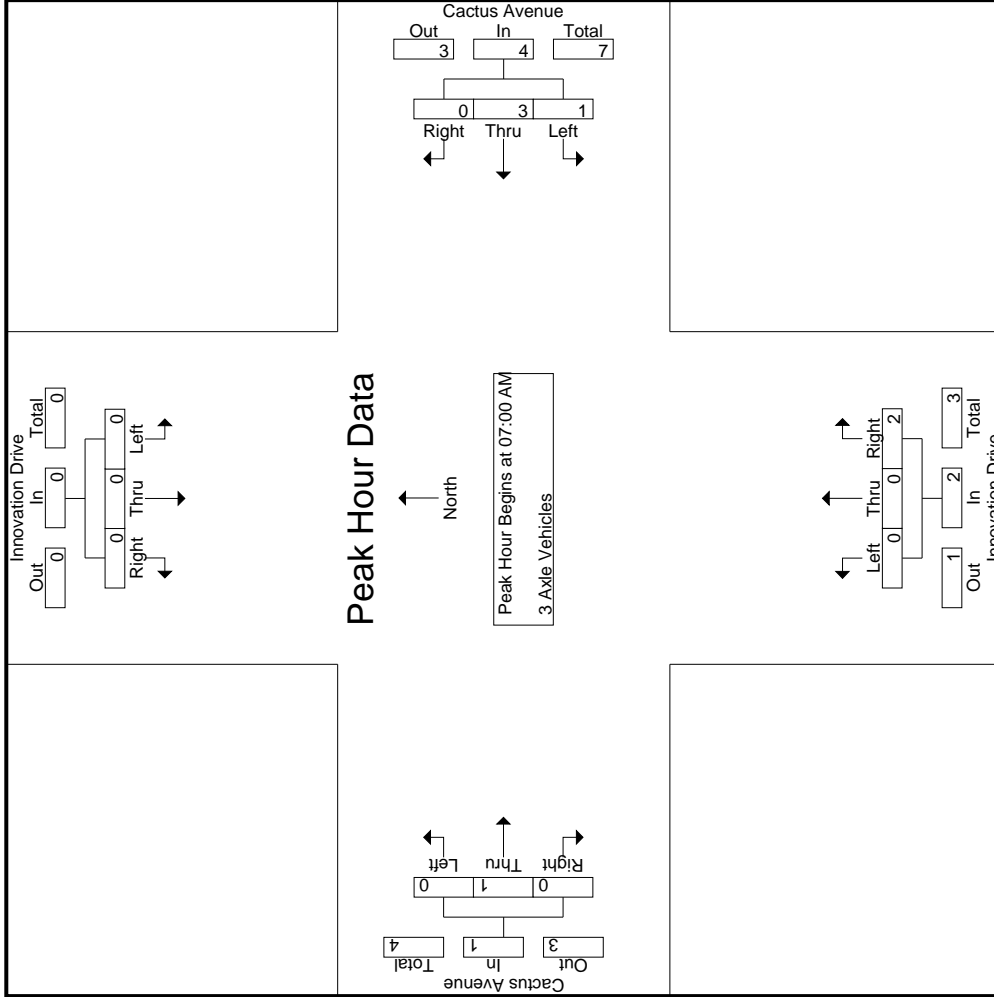

Counts Unlimited, Inc.
 PO Box 1178
 Corona, CA 92878
 (951)268-6268

File Name : 24_CRV_Inno_Cactus AM
 Site Code : 05121716
 Start Date : 11/30/2021
 Page No : 3

County of Riverside
 N/S: Innovation Drive
 E/W: Cactus Avenue
 Weather: Clear

Start Time	Innovation Drive Southbound			Cactus Avenue Westbound			Innovation Drive Northbound			Cactus Avenue Eastbound			Int. Total	
	Left	Thru	Right	Left	Thru	Right	Left	Thru	Right	Left	Thru	Right		App. Total
Peak Hour Analysis From 07:00 AM to 07:45 AM - Peak 1 of 1	07:00 AM													
Peak Hour for Each Approach Begins at:	07:00 AM													
+0 mins.	0	0	0	0	1	0	1	0	1	0	0	0	0	0
+15 mins.	0	0	0	0	1	0	1	0	1	0	0	0	0	0
+30 mins.	0	0	0	0	1	0	1	0	0	0	0	1	0	1
+45 mins.	0	0	0	1	0	0	1	0	0	0	0	0	0	0
Total Volume	0	0	0	1	3	0	4	0	2	0	1	0	0	1
% App. Total	0	0	0	.25	.75	0	1.000	.000	.500	.000	.250	.000	.250	.250
PHF	.000	.000	.000	.000	.000	.000	1.000	.000	.500	.000	.250	.000	.250	.250

Counts Unlimited, Inc.
 PO Box 1178
 Corona, CA 92878
 (951)268-6268

File Name : 24_CRV_Inno_Cactus AM
 Site Code : 05121716
 Start Date : 11/30/2021
 Page No : 1

County of Riverside
 N/S: Innovation Drive
 E/W: Cactus Avenue
 Weather: Clear

Groups Printed- 4+ Axle Trucks

Start Time	Innovation Drive Southbound					Cactus Avenue Westbound					Innovation Drive Northbound					Cactus Avenue Eastbound							
	Left	Thru	Right	RTOR	App. Total	Left	Thru	Right	RTOR	App. Total	Left	Thru	Right	RTOR	App. Total	Left	Thru	Right	RTOR	App. Total	Exclu. Total	Inclu. Total	Int. Total
07:00 AM	0	0	0	0	0	0	12	0	0	12	0	0	2	1	2	0	6	0	0	6	1	20	21
07:15 AM	1	0	0	0	1	2	7	0	0	9	1	0	1	1	2	0	8	0	0	8	1	20	21
07:30 AM	0	0	0	0	0	1	9	0	0	10	2	0	0	0	2	0	7	0	0	7	0	19	19
07:45 AM	0	0	0	0	0	1	11	0	0	12	0	0	1	0	1	0	6	0	0	6	0	19	19
Total	1	0	0	0	1	4	39	0	0	43	3	0	4	2	7	0	27	0	0	27	2	78	80
08:00 AM	0	0	0	0	0	4	12	0	0	16	0	0	4	2	4	0	2	1	1	3	3	23	26
08:15 AM	0	0	0	0	0	4	22	0	0	26	0	0	2	2	2	0	2	0	0	2	2	30	32
08:30 AM	0	0	0	0	0	2	13	0	0	15	0	0	1	0	1	0	2	0	0	2	0	18	18
08:45 AM	0	0	0	0	0	1	9	0	0	10	2	0	3	1	5	0	4	0	0	4	1	19	20
Total	0	0	0	0	0	11	56	0	0	67	2	0	10	5	12	0	10	1	1	11	6	90	96
Grand Total	1	0	0	0	1	15	95	0	0	110	5	0	14	7	19	0	37	1	1	38	8	168	176
T-Approch %	100	0	0	0	0.6	13.6	86.4	0	0	65.5	26.3	0	73.7	0	11.3	0	97.4	2.6	0.6	22.6	4.5	95.5	
33 Total %	0.6	0	0	0	0.6	8.9	56.5	0	0	65.5	3	0	8.3	0	11.3	0	22	0.6	0.6	22.6	4.5	95.5	

Start Time	Innovation Drive Southbound					Cactus Avenue Westbound					Innovation Drive Northbound					Cactus Avenue Eastbound							
	Left	Thru	Right	RTOR	App. Total	Left	Thru	Right	RTOR	App. Total	Left	Thru	Right	RTOR	App. Total	Left	Thru	Right	RTOR	App. Total	Exclu. Total	Inclu. Total	Int. Total
07:00 AM	0	0	0	0	0	0	12	0	0	12	0	0	2	1	2	0	6	0	0	6	1	20	21
07:15 AM	1	0	0	0	1	2	7	0	0	9	1	0	1	1	2	0	8	0	0	8	1	20	21
07:30 AM	0	0	0	0	0	1	9	0	0	10	2	0	0	0	2	0	7	0	0	7	0	19	19
07:45 AM	0	0	0	0	0	1	11	0	0	12	0	0	1	0	1	0	6	0	0	6	0	19	19
Total	1	0	0	0	1	4	39	0	0	43	3	0	4	2	7	0	27	0	0	27	2	78	80
08:00 AM	0	0	0	0	0	4	12	0	0	16	0	0	4	2	4	0	2	1	1	3	3	23	26
08:15 AM	0	0	0	0	0	4	22	0	0	26	0	0	2	2	2	0	2	0	0	2	2	30	32
08:30 AM	0	0	0	0	0	2	13	0	0	15	0	0	1	0	1	0	2	0	0	2	0	18	18
08:45 AM	0	0	0	0	0	1	9	0	0	10	2	0	3	1	5	0	4	0	0	4	1	19	20
Total	0	0	0	0	0	11	56	0	0	67	2	0	10	5	12	0	10	1	1	11	6	90	96
Grand Total	1	0	0	0	1	15	95	0	0	110	5	0	14	7	19	0	37	1	1	38	8	168	176
T-Approch %	100	0	0	0	0.6	13.6	86.4	0	0	65.5	26.3	0	73.7	0	11.3	0	97.4	2.6	0.6	22.6	4.5	95.5	
33 Total %	0.6	0	0	0	0.6	8.9	56.5	0	0	65.5	3	0	8.3	0	11.3	0	22	0.6	0.6	22.6	4.5	95.5	

Peak Hour Analysis From 07:00 AM to 07:45 AM - Peak 1 of 1
 Peak Hour for Entire Intersection Begins at 07:00 AM

Start Time	Innovation Drive Southbound					Cactus Avenue Westbound					Innovation Drive Northbound					Cactus Avenue Eastbound							
	Left	Thru	Right	RTOR	App. Total	Left	Thru	Right	RTOR	App. Total	Left	Thru	Right	RTOR	App. Total	Left	Thru	Right	RTOR	App. Total	Exclu. Total	Inclu. Total	Int. Total
07:00 AM	0	0	0	0	0	0	12	0	0	12	0	0	2	1	2	0	6	0	0	6	1	20	21
07:15 AM	1	0	0	0	1	2	7	0	0	9	1	0	1	1	2	0	8	0	0	8	1	20	21
07:30 AM	0	0	0	0	0	1	9	0	0	10	2	0	0	0	2	0	7	0	0	7	0	19	19
07:45 AM	0	0	0	0	0	1	11	0	0	12	0	0	1	0	1	0	6	0	0	6	0	19	19
Total	1	0	0	0	1	4	39	0	0	43	3	0	4	2	7	0	27	0	0	27	2	78	80
% App. Total	100	0	0	0	0.6	13.6	86.4	0	0	65.5	26.3	0	73.7	0	11.3	0	97.4	2.6	0.6	22.6	4.5	95.5	
PHF	.250	.000	.000	.000	.250	.500	.813	.000	.896	.875	.375	.000	.500	.000	.844	.000	.844	.000	.844	.000	.844	.000	.975

Counts Unlimited, Inc.
 PO Box 1178
 Corona, CA 92878
 (951)268-6268

County of Riverside
 N/S: Innovation Drive
 E/W: Cactus Avenue
 Weather: Clear

File Name : 24_CRV_Inno_Cactus AM
 Site Code : 05121716
 Start Date : 11/30/2021
 Page No : 2

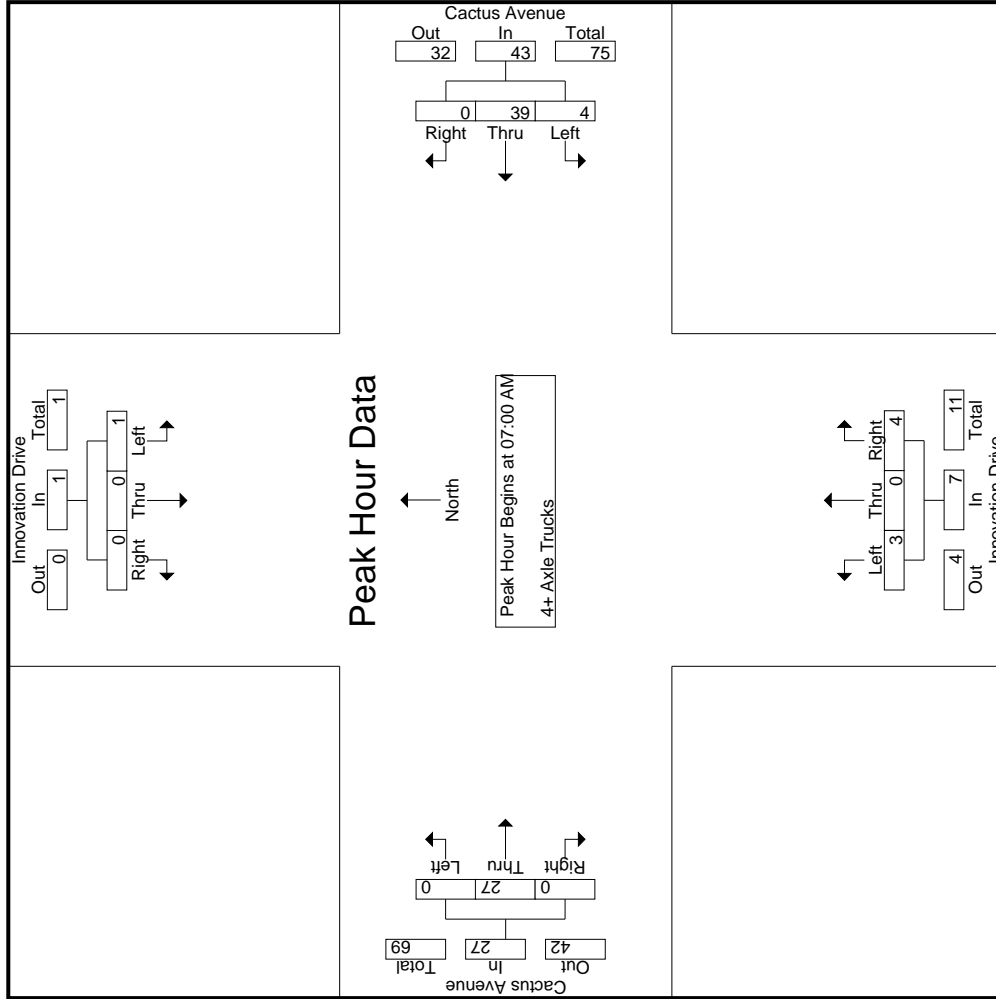

Counts Unlimited, Inc.
 PO Box 1178
 Corona, CA 92878
 (951)268-6268

File Name : 24_CRV_Inno_Cactus AM
 Site Code : 05121716
 Start Date : 11/30/2021
 Page No : 3

County of Riverside
 N/S: Innovation Drive
 E/W: Cactus Avenue
 Weather: Clear

Start Time	Innovation Drive Southbound			Cactus Avenue Westbound			Innovation Drive Northbound			Cactus Avenue Eastbound			Int. Total
	Left	Thru	Right	Left	Thru	Right	Left	Thru	Right	Left	Thru	Right	
Peak Hour Analysis From 07:00 AM to 07:45 AM - Peak 1 of 1	07:00 AM												
Peak Hour for Each Approach Begins at:	07:00 AM												
+0 mins.	0	0	0	0	12	0	0	0	2	0	6	0	6
+15 mins.	1	0	0	2	7	0	1	0	1	0	8	0	8
+30 mins.	0	0	0	1	9	0	0	0	0	0	7	0	7
+45 mins.	0	0	0	1	11	0	0	0	1	0	6	0	6
Total Volume	1	0	0	4	39	0	0	3	4	0	27	0	27
% App. Total	100	0	0	9.3	90.7	0	0	42.9	57.1	0	100	0	100
PHF	.250	.000	.000	.500	.813	.000	.000	.375	.500	.000	.844	.000	.844

Counts Unlimited, Inc.
 PO Box 1178
 Corona, CA 92878
 (951)268-6268

File Name : 24_CRV_Inno_Cactus PM
 Site Code : 05121716
 Start Date : 11/30/2021
 Page No : 1

County of Riverside
 N/S: Innovation Drive
 E/W: Cactus Avenue
 Weather: Clear

Groups Printed- Passenger Vehicles - Large 2 Axle Vehicles - 3 Axle Vehicles - 4+ Axle Trucks

Start Time	Innovation Drive Southbound						Cactus Avenue Westbound						Innovation Drive Northbound						Cactus Avenue Eastbound					
	Left		Thru		Right		Left		Thru		Right		Left		Thru		Right		Left		Thru		Right	
		App. Total		App. Total		App. Total		App. Total		App. Total		App. Total		App. Total		App. Total		App. Total		App. Total		App. Total		App. Total
04:00 PM	8	12	0	2	4	2	6	278	0	0	17	13	23	23	3	143	3	0	149	149	15	462	477	477
04:15 PM	7	11	0	2	4	2	10	246	0	0	9	7	14	14	0	190	3	0	193	193	9	464	473	473
04:30 PM	7	10	0	2	3	2	9	283	0	0	19	12	26	26	1	169	0	0	170	170	14	489	503	503
04:45 PM	9	11	0	2	0	1	13	336	0	0	18	18	23	23	1	181	0	0	182	182	18	552	570	570
Total	31	44	0	6	13	6	38	1092	0	0	63	50	86	86	5	683	6	0	694	694	56	1967	2023	2023
05:00 PM	12	16	0	4	4	4	17	341	0	0	19	10	25	25	1	184	2	0	187	187	14	592	606	606
05:15 PM	2	2	0	0	0	0	12	254	0	0	8	5	11	11	1	174	0	0	175	175	5	454	459	459
05:30 PM	7	7	0	0	0	0	7	186	0	0	17	10	21	21	0	185	1	0	186	186	10	407	417	417
05:45 PM	2	5	0	2	3	2	8	181	0	0	9	8	10	10	0	191	0	0	191	191	10	397	407	407
Total	23	30	0	6	7	6	44	962	0	0	53	33	67	67	2	734	3	0	739	739	39	1850	1889	1889
Grand Total	54	74	0	12	20	12	82	2054	0	0	116	83	153	153	7	1417	9	0	1433	1433	95	3817	3912	3912
% Approach	73	0	0	27	0	0	3.8	95.2	1	0	75.8	0	0	0	0.5	98.9	0.6	0	0	0	0	0	0	0
% Total	14	0	0	0.5	0	0	2.1	53.8	0.6	0	3	4	4	4	0.2	37.1	0.2	0	37.5	37.5	2.4	97.6	97.6	97.6
% Passenger Vehicles	54	0	0	19	0	0	68	1965	20	0	108	95.2	220	220	7	1360	6	0	1373	1373	0	0	3730	3730
% Large 2 Axle Vehicles	100	0	0	95	0	0	82.9	95.7	95.2	0	93.1	95.2	93.2	93.2	100	96	66.7	0	95.8	95.8	0	0	95.3	95.3
% 3 Axle Vehicles	0	0	0	5	0	0	4.9	1.5	4.8	0	1.7	2.4	2.5	2.5	0	0.9	22.2	0	1	1	0	0	1.5	1.5
% 4+ Axle Trucks	0	0	0	0	0	0	4.9	0.5	0	0	1.7	1.2	1.7	1.7	0	0.4	0	0	0.4	0.4	0	0	0.6	0.6
% 4+ Axle Trucks	0	0	0	0	0	0	7.3	2.3	0	0	3.4	1.2	2.5	2.5	0	2.7	11.1	0	2.7	2.7	0	0	2.5	2.5

Start Time	Innovation Drive Southbound						Cactus Avenue Westbound						Innovation Drive Northbound						Cactus Avenue Eastbound					
	Left		Thru		Right		Left		Thru		Right		Left		Thru		Right		Left		Thru		Right	
		App. Total		App. Total		App. Total		App. Total		App. Total		App. Total		App. Total		App. Total		App. Total		App. Total		App. Total		App. Total
04:15 PM	7	4	0	0	0	0	10	234	2	246	5	0	9	9	0	14	0	0	190	190	3	193	464	464
04:30 PM	7	3	0	2	10	10	9	269	5	283	7	0	19	19	1	26	1	169	0	0	170	170	489	489
04:45 PM	9	2	0	2	11	11	13	323	0	336	5	0	18	18	23	23	1	181	0	0	182	182	552	552
05:00 PM	12	4	0	4	16	16	17	341	6	364	6	0	19	19	25	25	1	184	2	2	187	187	592	592
Total Volume	35	13	0	13	48	48	49	1167	13	1229	23	0	65	65	88	88	3	724	5	5	732	732	2097	2097
% App. Total	72.9	0	0	27.1	0	0	4	95	1.1	8.44	26.1	0	73.9	0	0.4	98.9	0.7	0	95.3	95.3	0.7	0	.886	.886
PHF	.729	.000	.000	.813	.750	.750	.721	.856	.542	.844	.821	.000	.855	.000	.846	.846	.750	.750	.953	.953	.417	.417	.948	.948

Peak Hour Analysis From 04:00 PM to 05:45 PM - Peak 1 of 1
 Peak Hour for Entire Intersection Begins at 04:15 PM

Counts Unlimited, Inc.
 PO Box 1178
 Corona, CA 92878
 (951)268-6268

County of Riverside
 N/S: Innovation Drive
 E/W: Cactus Avenue
 Weather: Clear

File Name : 24_CRV_Inno_Cactus PM
 Site Code : 05121716
 Start Date : 11/30/2021
 Page No : 2

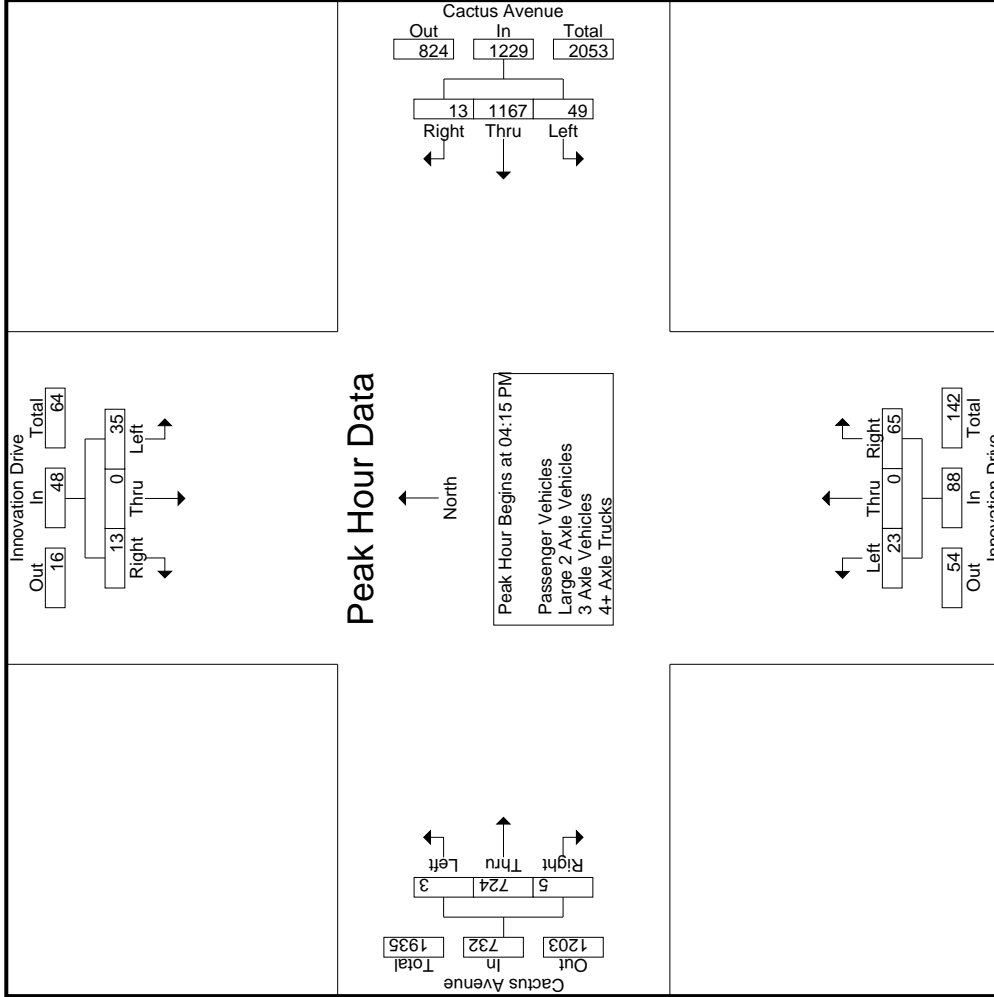

Counts Unlimited, Inc.
 PO Box 1178
 Corona, CA 92878
 (951)268-6268

File Name : 24_CRV_Inno_Cactus PM
 Site Code : 05121716
 Start Date : 11/30/2021
 Page No : 3

County of Riverside
 N/S: Innovation Drive
 E/W: Cactus Avenue
 Weather: Clear

Start Time	Innovation Drive Southbound				Cactus Avenue Westbound				Innovation Drive Northbound				Cactus Avenue Eastbound				
	Left	Thru	Right	App. Total	Left	Thru	Right	App. Total	Left	Thru	Right	App. Total	Left	Thru	Right	App. Total	Int. Total
	Peak Hour Analysis From 04:00 PM to 05:45 PM - Peak 1 of 1																
Peak Hour for Each Approach Begins at:	04:15 PM																
+0 mins.	7	0	4	11	9	269	5	283	5	0	9	14	1	184	2	187	
+15 mins.	7	0	3	10	13	323	0	336	0	0	19	26	1	174	0	175	
+30 mins.	9	0	2	11	17	341	6	364	5	0	18	23	0	185	1	186	
+45 mins.	12	0	4	16	12	254	0	266	6	0	19	25	0	191	0	191	
Total Volume	35	0	13	48	51	1187	11	1249	23	0	65	88	2	734	3	739	
% App. Total	72.9	0	27.1		4.1	95	0.9		26.1	0	73.9		0.3	99.3	0.4		
PHF	.729	.000	.813	.750	.750	.870	.458	.858	.821	.000	.855	.846	.500	.961	.375	.967	

Groups Printed- Passenger Vehicles

Start Time	Innovation Drive Southbound				Cactus Avenue Westbound				Innovation Drive Northbound				Cactus Avenue Eastbound										
	Left	Thru	Right	RTOR	App. Total	Left	Thru	Right	RTOR	App. Total	Left	Thru	Right	RTOR	App. Total	Left	Thru	Right	RTOR	App. Total	Exclu. Total	Inclu. Total	Int. Total
04:00 PM	8	0	4	2	12	5	251	5	0	261	5	0	15	13	20	3	140	2	0	145	15	438	453
04:15 PM	7	0	3	1	10	8	217	2	0	227	4	0	8	6	12	0	177	1	0	178	7	427	434
04:30 PM	7	0	3	2	10	5	257	5	0	267	7	0	15	9	22	1	163	0	0	164	11	463	474
04:45 PM	9	0	2	0	11	12	315	0	0	327	5	0	18	18	23	1	173	0	0	174	18	535	553
Total	31	0	12	5	43	30	1040	12	0	1082	21	0	56	46	77	5	653	3	0	661	51	1863	1914
05:00 PM	12	0	4	4	16	16	328	6	0	350	6	0	19	10	25	1	175	2	0	178	14	569	583
05:15 PM	2	0	0	0	2	10	247	0	0	257	2	0	8	5	10	1	170	0	0	171	5	440	445
05:30 PM	7	0	0	0	7	6	179	0	0	185	4	0	16	10	20	0	179	1	0	180	10	392	402
05:45 PM	2	0	3	2	5	6	171	2	0	179	0	0	9	8	9	0	183	0	0	183	10	376	386
Total	23	0	7	6	30	38	925	8	0	971	12	0	52	33	64	2	707	3	0	712	39	1777	1816
Grand Total	54	0	19	11	73	68	1965	20	0	2053	33	0	108	79	141	7	1360	6	0	1373	90	3640	3730
T-Approch %	74	0	26			3.3	95.7	1		23.4	0	76.6			0.5	99.1	0.4			37.7	2.4	97.6	
33 Total %	1.5	0	0.5			1.9	54	0.5		56.4	0.9	3			0.2	37.4	0.2						

Start Time	Innovation Drive Southbound				Cactus Avenue Westbound				Innovation Drive Northbound				Cactus Avenue Eastbound										
	Left	Thru	Right	RTOR	App. Total	Left	Thru	Right	RTOR	App. Total	Left	Thru	Right	RTOR	App. Total	Left	Thru	Right	RTOR	App. Total	Exclu. Total	Inclu. Total	Int. Total
04:15 PM	7	0	3		10	8	217	2		227	4	0	8		12	0	177	1		178	1	178	427
04:30 PM	7	0	3		10	5	257	5		267	7	0	15		22	1	163	0		164	0	164	463
04:45 PM	9	0	2		11	12	315	0		327	5	0	18		23	1	173	0		174	0	174	535
05:00 PM	12	0	4		16	16	328	6		350	6	0	19		25	2	175	2		178	2	178	569
Total Volume	35	0	12		47	41	1117	13		1171	22	0	60		82	3	688	3		694	3	694	1994
% App. Total	74.5	0	25.5			3.5	95.4	1.1		26.8	0	73.2			0.4	99.1	0.4				0.4	99.1	1994
PHF	.729	.000	.750		.734	.641	.851	.542		.836	.786	.000	.789		.820	.750	.972	.375		.975	.975	.876	.876

Peak Hour Analysis From 04:15 PM to 05:00 PM - Peak 1 of 1
 Peak Hour for Entire Intersection Begins at 04:15 PM

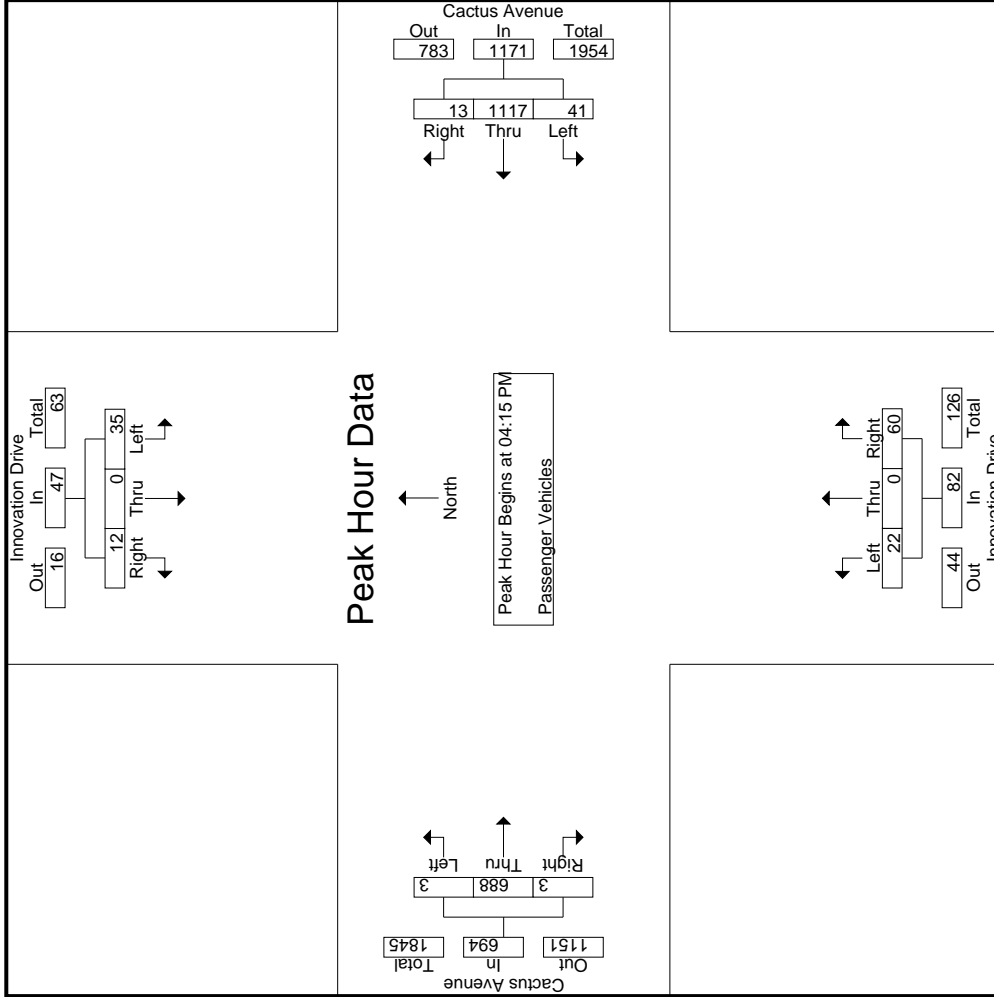

Counts Unlimited, Inc.
 PO Box 1178
 Corona, CA 92878
 (951)268-6268

File Name : 24_CRV_Inno_Cactus PM
 Site Code : 05121716
 Start Date : 11/30/2021
 Page No : 3

County of Riverside
 N/S: Innovation Drive
 E/W: Cactus Avenue
 Weather: Clear

Start Time	Innovation Drive Southbound			Cactus Avenue Westbound			Innovation Drive Northbound			Cactus Avenue Eastbound			Int. Total	
	Left	Thru	Right	Left	Thru	Right	Left	Thru	Right	Left	Thru	Right		App. Total
Peak Hour Analysis From 04:15 PM to 05:00 PM - Peak 1 of 1														
Peak Hour for Each Approach Begins at:														
	04:15 PM			04:15 PM			04:15 PM			04:15 PM				
+0 mins.	7	0	3	8	217	2	227	4	0	8	12	177	1	178
+15 mins.	7	0	3	5	257	5	267	7	0	15	22	163	0	164
+30 mins.	9	0	2	12	315	0	327	5	0	18	23	173	0	174
+45 mins.	12	0	4	16	328	6	350	6	0	19	25	175	2	178
Total Volume	35	0	12	41	1117	13	1171	22	0	60	82	688	3	694
% App. Total	74.5	0	25.5	3.5	95.4	1.1	117.1	26.8	0	73.2	0.4	99.1	0.4	99.5
PHF	.729	.000	.750	.641	.851	.542	.836	.786	.000	.789	.820	.972	.375	.975

Counts Unlimited, Inc.
 PO Box 1178
 Corona, CA 92878
 (951)268-6268

File Name : 24_CRV_Inno_Cactus PM
 Site Code : 05121716
 Start Date : 11/30/2021
 Page No : 1

County of Riverside
 N/S: Innovation Drive
 E/W: Cactus Avenue
 Weather: Clear

Groups Printed- Large 2 Axle Vehicles

Start Time	Innovation Drive Southbound				Cactus Avenue Westbound				Innovation Drive Northbound				Cactus Avenue Eastbound					
	Left	Thru	Right	RTOR	App. Total	Left	Thru	Right	RTOR	App. Total	Left	Thru	Right	RTOR	App. Total	Exclu. Total	Inclu. Total	Int. Total
04:00 PM	0	0	0	0	0	1	6	1	0	8	0	0	0	0	0	0	11	11
04:15 PM	0	0	1	1	1	4	0	0	0	4	1	0	0	1	0	1	11	12
04:30 PM	0	0	0	0	0	1	6	0	0	7	0	2	2	0	2	2	11	13
04:45 PM	0	0	0	0	0	1	3	0	0	4	0	0	0	0	2	0	6	6
Total	0	0	1	1	1	3	19	1	0	23	1	0	2	2	3	3	39	42
05:00 PM	0	0	0	0	0	0	3	0	0	3	0	0	0	0	2	0	5	5
05:15 PM	0	0	0	0	0	2	0	0	0	2	1	0	0	1	0	0	3	3
05:30 PM	0	0	0	0	0	1	2	0	0	3	0	0	0	0	0	0	3	3
05:45 PM	0	0	0	0	0	0	5	0	0	5	0	0	0	0	1	0	6	6
Total	0	0	0	0	0	1	12	0	0	13	1	0	0	0	3	0	17	17
Grand Total	0	0	1	1	1	4	31	1	0	36	2	0	2	2	4	3	56	59
% Approach	0	0	100			11.1	86.1	2.8		64.3	50	0	50		7.1	5.1	94.9	
Total %	0	0	1.8		1.8	7.1	55.4	1.8		64.3	3.6	0	3.6		7.1	5.1	94.9	

Start Time	Innovation Drive Southbound				Cactus Avenue Westbound				Innovation Drive Northbound				Cactus Avenue Eastbound					
	Left	Thru	Right	RTOR	App. Total	Left	Thru	Right	RTOR	App. Total	Left	Thru	Right	RTOR	App. Total	Exclu. Total	Inclu. Total	Int. Total
04:15 PM	0	0	1	1	1	0	4	0	0	4	1	0	0	0	1	0	5	11
04:30 PM	0	0	0	0	0	1	6	0	0	7	0	0	2	0	2	0	2	11
04:45 PM	0	0	0	0	0	1	3	0	0	4	0	0	0	0	0	0	2	6
05:00 PM	0	0	0	0	0	0	3	0	0	3	0	0	0	0	0	0	2	5
Total Volume	0	0	1	1	1	2	16	0	0	18	1	0	2	3	10	1	11	33
% App. Total	0	0	100			11.1	88.9	0		33.3	0	66.7	9.1		90.9	9.1	94.9	
PHF	.000	.000	.250		.250	.500	.667	.000		.643	.250	.000	.250		.375	.250	.550	.750

Peak Hour Analysis From 04:15 PM to 05:00 PM - Peak 1 of 1
 Peak Hour for Entire Intersection Begins at 04:15 PM

Counts Unlimited, Inc.
 PO Box 1178
 Corona, CA 92878
 (951)268-6268

County of Riverside
 N/S: Innovation Drive
 E/W: Cactus Avenue
 Weather: Clear

File Name : 24_CRV_Inno_Cactus PM
 Site Code : 05121716
 Start Date : 11/30/2021
 Page No : 2

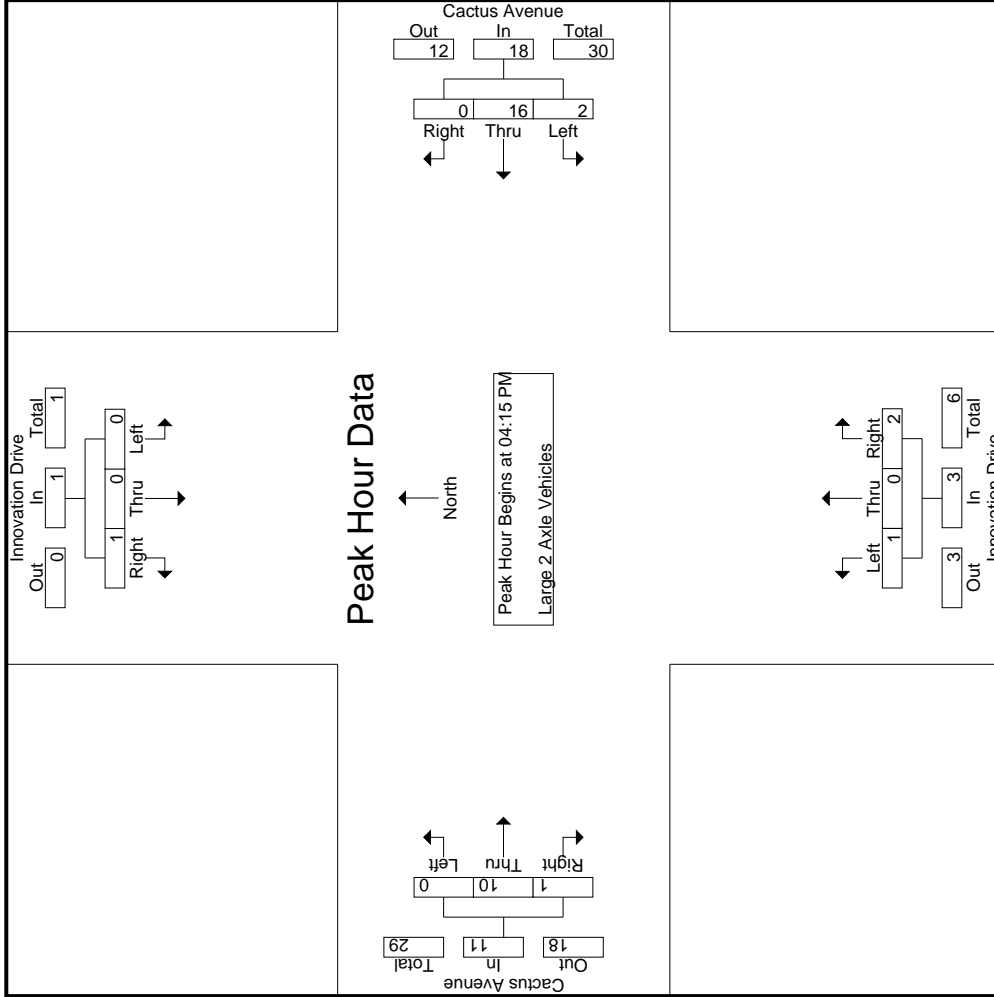

Counts Unlimited, Inc.
 PO Box 1178
 Corona, CA 92878
 (951)268-6268

File Name : 24_CRV_Inno_Cactus PM
 Site Code : 05121716
 Start Date : 11/30/2021
 Page No : 3

County of Riverside
 N/S: Innovation Drive
 E/W: Cactus Avenue
 Weather: Clear

Start Time	Innovation Drive Southbound			Cactus Avenue Westbound			Innovation Drive Northbound			Cactus Avenue Eastbound		
	Left	Thru	Right	Left	Thru	Right	Left	Thru	Right	Left	Thru	Right
Peak Hour Analysis From 04:15 PM to 05:00 PM - Peak 1 of 1												
Peak Hour for Each Approach Begins at:												
+0 mins.	0	0	1	0	4	0	0	4	0	0	0	0
+15 mins.	0	0	0	1	6	0	0	7	2	0	2	0
+30 mins.	0	0	0	1	3	0	0	4	0	0	2	0
+45 mins.	0	0	0	0	3	0	0	3	0	0	2	0
Total Volume	0	0	1	2	16	0	1	18	2	0	10	1
% App. Total	0	0	100	11.1	88.9	0	33.3	66.7	66.7	0	90.9	9.1
PHF	.000	.000	.250	.500	.667	.000	.250	.643	.250	.000	.625	.250

Groups Printed- 3 Axle Vehicles

Start Time	Innovation Drive Southbound				Cactus Avenue Westbound				Innovation Drive Northbound				Cactus Avenue Eastbound											
	Left	Thru	Right	RTOR	App. Total	Left	Thru	Right	RTOR	App. Total	Left	Thru	Right	RTOR	App. Total	Left	Thru	Right	RTOR	App. Total	Exclu. Total	Inclu. Total	Int. Total	
04:00 PM	0	0	0	0	0	0	0	0	0	3	1	0	1	0	0	0	0	0	0	0	0	0	5	5
04:15 PM	0	0	0	0	0	1	1	0	0	2	0	0	1	1	1	0	1	0	0	0	1	1	4	5
04:30 PM	0	0	0	0	0	2	2	0	0	4	0	0	0	0	0	0	0	0	0	0	0	0	4	4
04:45 PM	0	0	0	0	0	0	1	0	0	1	0	0	0	0	0	1	0	0	0	0	1	0	2	2
Total	0	0	0	0	0	3	7	0	0	10	1	0	2	1	3	0	2	0	0	2	1	15	15	16
05:00 PM	0	0	0	0	0	0	2	0	0	2	0	0	0	0	0	0	3	0	0	0	0	0	5	5
05:15 PM	0	0	0	0	0	1	1	0	0	2	0	0	0	0	0	0	0	0	0	0	0	0	2	2
05:30 PM	0	0	0	0	0	0	0	0	0	0	0	0	0	0	0	0	0	0	0	0	0	0	0	0
05:45 PM	0	0	0	0	0	0	0	0	0	0	0	0	0	0	0	1	0	0	0	1	0	0	1	1
Total	0	0	0	0	0	1	3	0	0	4	0	0	0	0	0	4	0	0	0	4	0	8	8	8
Grand Total	0	0	0	0	0	4	10	0	0	14	1	0	2	1	3	0	6	0	0	6	1	23	23	24
% Approach	0	0	0	0	0	28.6	71.4	0	0	33.3	0	66.7	0	0	100	0	100	0	0	26.1	4.2	95.8	95.8	99
% Total	0	0	0	0	0	17.4	43.5	0	0	60.9	4.3	8.7	0	0	26.1	0	26.1	0	0	26.1	0	95.8	95.8	99

Start Time	Innovation Drive Southbound				Cactus Avenue Westbound				Innovation Drive Northbound				Cactus Avenue Eastbound											
	Left	Thru	Right	RTOR	App. Total	Left	Thru	Right	RTOR	App. Total	Left	Thru	Right	RTOR	App. Total	Left	Thru	Right	RTOR	App. Total	Exclu. Total	Inclu. Total	Int. Total	
04:15 PM	0	0	0	0	0	1	1	0	0	2	0	0	1	0	1	0	0	0	0	0	0	0	1	1
04:30 PM	0	0	0	0	0	2	2	0	0	4	0	0	0	0	0	0	0	0	0	0	0	0	0	0
04:45 PM	0	0	0	0	0	0	1	0	0	1	0	0	0	0	0	0	1	0	0	0	0	0	1	1
05:00 PM	0	0	0	0	0	0	0	2	0	2	0	0	0	0	0	0	3	0	0	0	0	0	3	5
Total Volume	0	0	0	0	0	3	6	0	0	9	0	0	1	1	1	0	5	0	0	5	0	0	5	15
% App. Total	0	0	0	0	0	33.3	66.7	0	0	100	0	0	100	0	100	0	100	0	0	100	0	0	100	100
PHF	.000	.000	.000	.000	.000	.375	.750	.000	.000	.563	.000	.250	.250	.000	.417	.000	.417	.000	.000	.417	.000	.417	.750	.750

Peak Hour Analysis From 04:15 PM to 05:00 PM - Peak 1 of 1
 Peak Hour for Entire Intersection Begins at 04:15 PM

Counts Unlimited, Inc.
 PO Box 1178
 Corona, CA 92878
 (951)268-6268

County of Riverside
 N/S: Innovation Drive
 E/W: Cactus Avenue
 Weather: Clear

File Name : 24_CRV_Inno_Cactus PM
 Site Code : 05121716
 Start Date : 11/30/2021
 Page No : 2

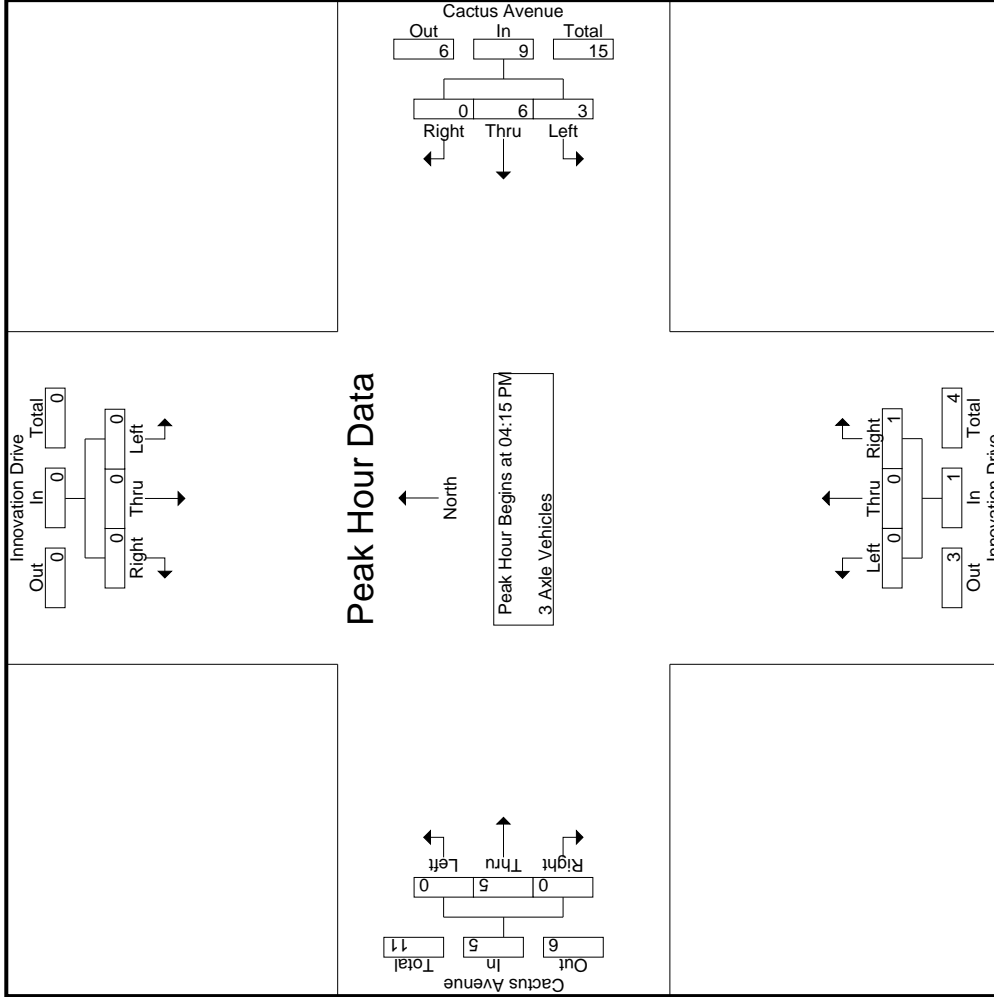

Counts Unlimited, Inc.
 PO Box 1178
 Corona, CA 92878
 (951)268-6268

File Name : 24_CRV_Inno_Cactus PM
 Site Code : 05121716
 Start Date : 11/30/2021
 Page No : 3

County of Riverside
 N/S: Innovation Drive
 E/W: Cactus Avenue
 Weather: Clear

Start Time	Innovation Drive Southbound			Cactus Avenue Westbound			Innovation Drive Northbound			Cactus Avenue Eastbound			
	Left	Thru	Right	App. Total	Left	Thru	Right	App. Total	Left	Thru	Right	App. Total	Int. Total
Peak Hour Analysis From 04:15 PM to 05:00 PM - Peak 1 of 1													
Peak Hour for Each Approach Begins at:													
	04:15 PM			04:15 PM			04:15 PM			04:15 PM			
+0 mins.	0	0	0	0	1	0	0	2	0	0	1	0	1
+15 mins.	0	0	0	2	2	0	4	0	0	0	0	0	0
+30 mins.	0	0	0	0	1	0	1	0	0	0	1	0	1
+45 mins.	0	0	0	0	2	0	2	0	0	0	3	0	3
Total Volume	0	0	0	3	6	0	9	0	0	1	5	0	5
% App. Total	0	0	0	33.3	66.7	0	0	0	0	100	0	0	0
PHF	.000	.000	.000	.375	.750	.000	.563	.000	.250	.250	.000	.417	.417

Groups Printed- 4+ Axle Trucks

Start Time	Innovation Drive Southbound					Cactus Avenue Westbound					Innovation Drive Northbound					Cactus Avenue Eastbound								
	Left	Thru	Right	RTOR	App. Total	Left	Thru	Right	RTOR	App. Total	Left	Thru	Right	RTOR	App. Total	Left	Thru	Right	RTOR	App. Total	Exclu. Total	Inclu. Total	Int. Total	
04:00 PM	0	0	0	0	0	0	6	0	0	6	0	0	1	0	1	0	1	0	0	0	0	8	8	8
04:15 PM	0	0	0	0	0	1	12	0	0	13	0	0	0	0	0	0	8	1	0	0	0	22	22	22
04:30 PM	0	0	0	0	0	1	4	0	0	5	0	0	2	1	2	0	4	0	0	0	1	11	12	12
04:45 PM	0	0	0	0	0	0	4	0	0	4	0	0	0	0	0	0	5	0	0	0	0	9	9	9
Total	0	0	0	0	0	2	26	0	0	28	0	0	3	1	3	0	18	1	0	0	1	50	51	51
05:00 PM	0	0	0	0	0	1	8	0	0	9	0	0	0	0	0	0	4	0	0	0	0	13	13	13
05:15 PM	0	0	0	0	0	1	4	0	0	5	0	0	0	0	0	0	4	0	0	0	0	9	9	9
05:30 PM	0	0	0	0	0	0	5	0	0	5	0	0	1	0	1	0	6	0	0	0	0	12	12	12
05:45 PM	0	0	0	0	0	2	5	0	0	7	1	0	0	0	1	0	6	0	0	0	0	14	14	14
Total	0	0	0	0	0	4	22	0	0	26	1	0	1	0	2	0	20	0	0	0	0	48	48	48
Grand Total	0	0	0	0	0	6	48	0	0	54	1	0	4	1	5	0	38	1	0	0	1	98	99	99
% Approach	0	0	0	0	0	11.1	88.9	0	0	55.1	20	0	80	0	5.1	0	97.4	2.6	0	0	39.8	1	99	99
% Total	0	0	0	0	0	6.1	49	0	0	55.1	1	0	4.1	0	5.1	0	38.8	1	0	0	39.8	1	99	99

Start Time	Innovation Drive Southbound					Cactus Avenue Westbound					Innovation Drive Northbound					Cactus Avenue Eastbound								
	Left	Thru	Right	RTOR	App. Total	Left	Thru	Right	RTOR	App. Total	Left	Thru	Right	RTOR	App. Total	Left	Thru	Right	RTOR	App. Total	Exclu. Total	Inclu. Total	Int. Total	
04:15 PM	0	0	0	0	0	1	12	0	0	13	0	0	0	0	0	0	8	1	0	0	0	9	9	9
04:30 PM	0	0	0	0	0	1	4	0	0	5	0	0	2	1	2	0	4	0	0	0	0	4	4	4
04:45 PM	0	0	0	0	0	0	4	0	0	4	0	0	0	0	0	0	5	0	0	0	0	5	5	5
05:00 PM	0	0	0	0	0	0	1	8	0	9	0	0	0	0	0	0	4	0	0	0	0	4	4	4
Total Volume	0	0	0	0	0	3	28	0	0	31	0	0	2	0	2	0	21	1	0	0	1	22	22	22
% App. Total	0	0	0	0	0	9.7	90.3	0	0	100	0	0	100	0	95.5	0	95.5	4.5	0	0	4.5	.611	.625	.625
PHF	.000	.000	.000	.000	.000	.750	.583	.000	.000	.596	.000	.000	.250	.000	.656	.000	.250	.250	.000	.656	.250	.611	.625	.625

Peak Hour Analysis From 04:15 PM to 05:00 PM - Peak 1 of 1
 Peak Hour for Entire Intersection Begins at 04:15 PM

Counts Unlimited, Inc.
 PO Box 1178
 Corona, CA 92878
 (951)268-6268

County of Riverside
 N/S: Innovation Drive
 E/W: Cactus Avenue
 Weather: Clear

File Name : 24_CRV_Inno_Cactus PM
 Site Code : 05121716
 Start Date : 11/30/2021
 Page No : 2

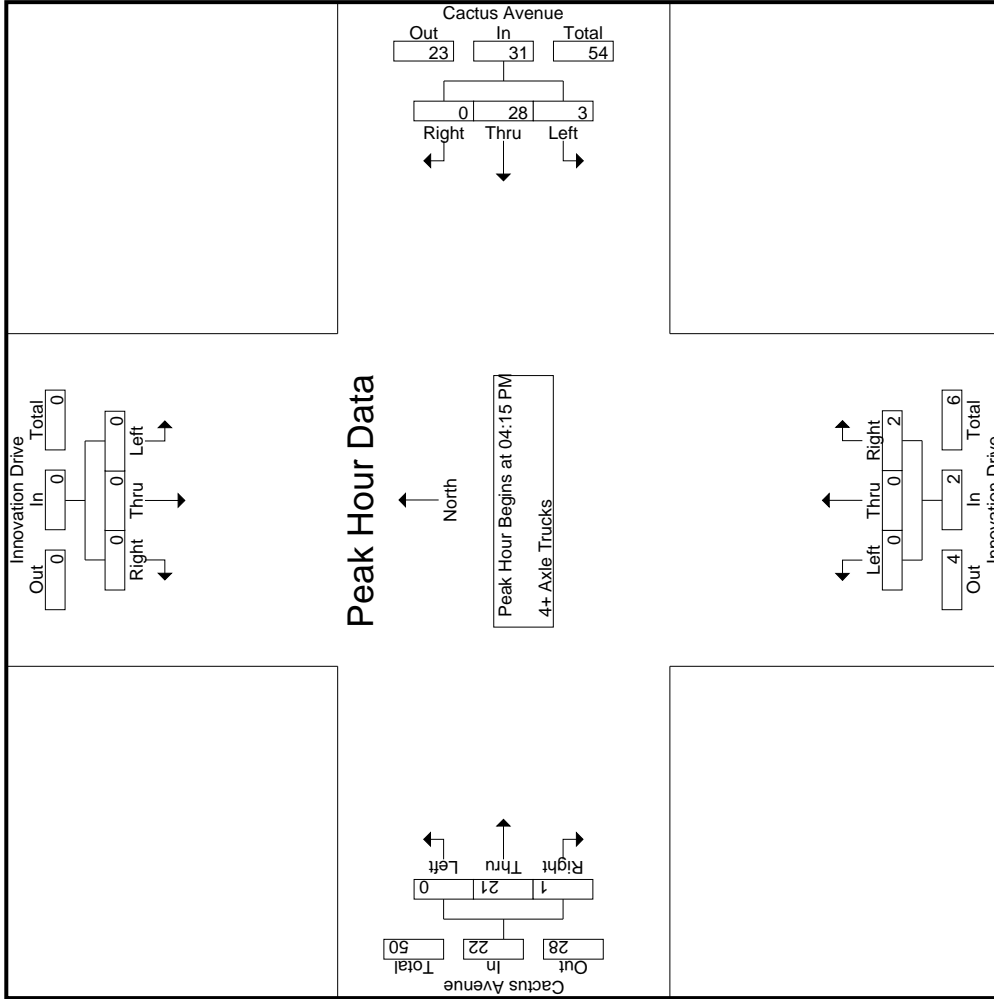

Counts Unlimited, Inc.
 PO Box 1178
 Corona, CA 92878
 (951)268-6268

File Name : 24_CRV_Inno_Cactus PM
 Site Code : 05121716
 Start Date : 11/30/2021
 Page No : 3

County of Riverside
 N/S: Innovation Drive
 E/W: Cactus Avenue
 Weather: Clear

Start Time	Innovation Drive Southbound			Cactus Avenue Westbound			Innovation Drive Northbound			Cactus Avenue Eastbound					
	Left	Thru	Right	App. Total	Left	Thru	Right	App. Total	Left	Thru	Right	App. Total	Int. Total		
Peak Hour Analysis From 04:15 PM to 05:00 PM - Peak 1 of 1															
Peak Hour for Each Approach Begins at:															
	04:15 PM			04:15 PM			04:15 PM			04:15 PM					
+0 mins.	0	0	0	0	12	0	0	13	0	0	0	0	8	1	9
+15 mins.	0	0	0	0	4	0	0	5	0	0	2	0	4	0	4
+30 mins.	0	0	0	0	4	0	0	4	0	0	0	0	5	0	5
+45 mins.	0	0	0	0	8	0	0	9	0	0	0	0	4	0	4
Total Volume	0	0	0	0	28	0	0	31	0	0	2	0	21	1	22
% App. Total	0	0	0	0	90.3	0	0	100	0	0	100	0	95.5	4.5	100
PHF	.000	.000	.000	.000	.750	.583	.000	.596	.000	.000	.250	.000	.656	.250	.611

Location: County of Riverside
 N/S: Innovation Drive
 E/W: Cactus Avenue



Date: 11/30/2021
 Day: Tuesday

PEDESTRIANS

	North Leg Innovation Drive	East Leg Cactus Avenue	South Leg Innovation Drive	West Leg Cactus Avenue	
	Pedestrians	Pedestrians	Pedestrians	Pedestrians	
7:00 AM	0	0	0	0	0
7:15 AM	0	0	0	0	0
7:30 AM	0	0	0	0	0
7:45 AM	0	0	0	0	0
8:00 AM	0	0	0	0	0
8:15 AM	0	0	0	0	0
8:30 AM	0	0	0	0	0
8:45 AM	0	0	0	0	0
TOTAL VOLUMES:	0	0	0	0	0

	North Leg Innovation Drive	East Leg Cactus Avenue	South Leg Innovation Drive	West Leg Cactus Avenue	
	Pedestrians	Pedestrians	Pedestrians	Pedestrians	
4:00 PM	0	0	0	0	0
4:15 PM	0	0	0	0	0
4:30 PM	0	0	0	0	0
4:45 PM	0	0	0	0	0
5:00 PM	0	0	0	0	0
5:15 PM	0	0	0	0	0
5:30 PM	0	0	0	0	0
5:45 PM	0	0	0	0	0
TOTAL VOLUMES:	0	0	0	0	0

Location: County of Riverside
 N/S: Innovation Drive
 E/W: Cactus Avenue



Date: 11/30/2021
 Day: Tuesday

BICYCLES

	Southbound Innovation Drive			Westbound Cactus Avenue			Northbound Innovation Drive			Eastbound Cactus Avenue			
	Left	Thru	Right	Left	Thru	Right	Left	Thru	Right	Left	Thru	Right	
7:00 AM	0	0	0	0	0	0	0	0	0	0	0	0	0
7:15 AM	0	0	0	0	0	0	0	0	0	0	0	0	0
7:30 AM	0	0	0	0	0	0	0	0	0	0	0	0	0
7:45 AM	0	0	0	0	0	0	0	0	0	0	0	0	0
8:00 AM	0	0	0	0	0	0	0	0	0	0	0	0	0
8:15 AM	0	0	0	0	0	0	0	0	0	0	0	0	0
8:30 AM	0	0	0	0	0	0	0	0	0	0	0	0	0
8:45 AM	0	0	0	0	0	0	0	0	0	0	0	0	0
TOTAL VOLUMES:	0	0	0	0	0	0	0	0	0	0	0	0	0

	Southbound Innovation Drive			Westbound Cactus Avenue			Northbound Innovation Drive			Eastbound Cactus Avenue			
	Left	Thru	Right	Left	Thru	Right	Left	Thru	Right	Left	Thru	Right	
4:00 PM	0	0	0	0	0	0	0	0	0	0	0	0	0
4:15 PM	0	0	0	0	0	0	0	0	0	0	0	0	0
4:30 PM	0	0	0	0	0	0	0	0	0	0	0	0	0
4:45 PM	0	0	0	0	0	0	0	0	0	0	0	0	0
5:00 PM	0	0	0	0	1	0	0	0	0	0	0	0	1
5:15 PM	0	0	0	0	0	0	0	0	0	0	0	0	0
5:30 PM	0	0	0	0	0	0	0	0	0	0	0	0	0
5:45 PM	0	0	0	0	0	0	0	0	0	0	0	0	0
TOTAL VOLUMES:	0	0	0	0	1	0	0	0	0	0	0	0	1

Groups Printed- Passenger Vehicles - Large 2 Axle Vehicles - 3 Axle Vehicles - 4+ Axle Trucks

Start Time	I-215 Southbound Off Ramp Southbound					Alessandro Boulevard Westbound					I-215 Southbound On Ramp Northbound					Alessandro Boulevard Eastbound							
	Left	Thru	Right	RTOR	App. Total	Left	Thru	Right	RTOR	App. Total	Left	Thru	Right	RTOR	App. Total	Left	Thru	Right	RTOR	App. Total	Exclu. Total	Inclu. Total	Int. Total
07:00 AM	36	0	45	22	81	0	457	21	4	478	0	0	0	0	0	0	129	69	0	198	26	757	783
07:15 AM	30	0	74	21	104	0	481	32	2	513	0	0	0	0	0	0	148	73	0	221	23	838	861
07:30 AM	39	0	51	14	90	0	452	30	0	482	0	0	0	0	0	0	162	91	0	253	14	825	839
07:45 AM	40	0	75	19	115	0	452	31	4	483	0	0	0	0	0	0	176	68	0	244	23	842	865
Total	145	0	245	76	390	0	1842	114	10	1956	0	0	0	0	0	0	615	301	0	916	86	3262	3348
08:00 AM	34	0	49	27	83	0	499	26	0	525	0	0	0	0	0	0	171	56	0	227	27	835	862
08:15 AM	35	0	64	14	99	0	476	23	0	499	0	0	0	0	0	0	192	47	0	239	14	837	851
08:30 AM	27	0	74	25	101	0	459	19	1	478	0	0	0	0	0	0	181	60	0	241	26	820	846
08:45 AM	44	0	54	20	98	0	421	26	2	447	0	0	0	0	0	0	144	53	0	197	22	742	764
Total	140	0	241	86	381	0	1855	94	3	1949	0	0	0	0	0	0	688	216	0	904	89	3234	3323
Grand Total	285	0	486	162	771	0	3697	208	13	3905	0	0	0	0	0	0	1303	517	0	1820	175	6496	6671
T-Approch %	37	0	63			0	94.7	5.3			0	0	0			0	71.6	28.4					
W Total %	4.4	0	7.5		11.9	0	56.9	3.2		60.1	0	0	0			0	20.1	8		28	2.6	97.4	
% Passenger Vehicles	229	0	435		812	0	3622	192		3825	0	0	0			0	1239	494		1733	0	0	6370
% Large 2 Axle Vehicles	80.4	0	89.5		91.4	0	98	92.3		84.6	0	0	0			0	95.1	95.6		95.2	0	0	95.5
% 3 Axle Vehicles	11	0	20		39	0	44	14		60	0	0	0			0	23	13		36	0	0	135
% 4+ Axle Trucks	3.9	0	4.1		4.9	0	1.2	6.7		15.4	0	0	0			0	1.8	2.5		2	0	0	2
% 4+ Axle Trucks	1.1	0	1		1.9	0	0.3	0		0.3	0	0	0			0	0.4	0.6		0.4	0	0	0.4
% 4+ Axle Trucks	42	0	26		71	0	21	2		23	0	0	0			0	36	7		43	0	0	137
% 4+ Axle Trucks	14.7	0	5.3		1.9	0	0.6	1		0.6	0	0	0			0	2.8	1.4		2.4	0	0	2.1

Start Time	I-215 Southbound Off Ramp Southbound					Alessandro Boulevard Westbound					I-215 Southbound On Ramp Northbound					Alessandro Boulevard Eastbound							
	Left	Thru	Right	RTOR	App. Total	Left	Thru	Right	RTOR	App. Total	Left	Thru	Right	RTOR	App. Total	Left	Thru	Right	RTOR	App. Total	Exclu. Total	Inclu. Total	Int. Total
07:15 AM	30	0	74		104	0	481	32		513	0	0	0			0	148	73		221			838
07:30 AM	39	0	51		90	0	452	30		482	0	0	0			0	162	91		253			825
07:45 AM	40	0	75		115	0	452	31		483	0	0	0			0	176	68		244			842
08:00 AM	34	0	49		83	0	499	26		525	0	0	0			0	171	56		227			835
Total Volume	143	0	249		392	0	1884	119		2003	0	0	0			0	657	288		945			3340
% App. Total	36.5	0	63.5		83.0	0	94.1	5.9		93.0	0	0	0			0	69.5	30.5		93.3			99.2
PHF	.894	.000	.852		.852	.000	.944	.930		.954	.000	.000	.000		.000	.000	.933	.791		.934			.992

Peak Hour Analysis From 07:00 AM to 08:45 AM - Peak 1 of 1
 Peak Hour for Entire Intersection Begins at 07:15 AM

Counts Unlimited, Inc.
 PO Box 1178
 Corona, CA 92878
 (951)268-6268

County of Riverside
 N/S: I-215 Southbound Ramps
 E/W: Alessandro Boulevard
 Weather: Clear

File Name : 25_CRV_215S_Ales AM
 Site Code : 05121716
 Start Date : 11/30/2021
 Page No : 2

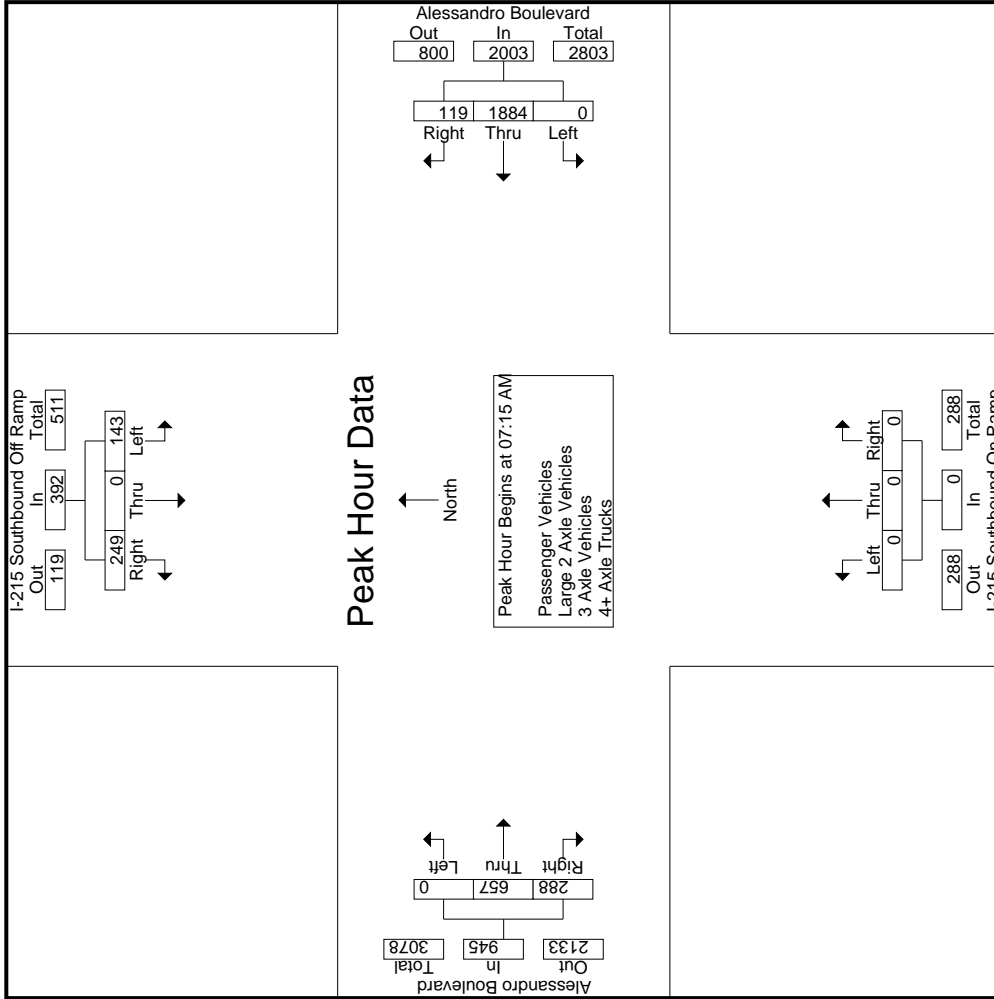

Counts Unlimited, Inc.
 PO Box 1178
 Corona, CA 92878
 (951)268-6268

County of Riverside
 N/S: I-215 Southbound Ramps
 E/W: Alessandro Boulevard
 Weather: Clear

File Name : 25_CRV_215S_Ales AM
 Site Code : 05121716
 Start Date : 11/30/2021
 Page No : 3

Start Time	I-215 Southbound Off Ramp Southbound			Alessandro Boulevard Westbound			I-215 Southbound On Ramp Northbound			Alessandro Boulevard Eastbound			Int. Total	
	Left	Thru	Right	Left	Thru	Right	Left	Thru	Right	Left	Thru	Right		App. Total
Peak Hour Analysis From 07:00 AM to 08:45 AM - Peak 1 of 1	Peak Hour for Each Approach Begins at:													
	07:45 AM			07:15 AM			07:00 AM			07:30 AM				
+0 mins.	40	0	75	0	481	32	513	0	0	0	0	162	91	253
+15 mins.	34	0	49	0	452	30	482	0	0	0	0	176	68	244
+30 mins.	35	0	64	0	452	31	483	0	0	0	0	171	56	227
+45 mins.	27	0	74	0	499	26	525	0	0	0	0	192	47	239
Total Volume	136	0	262	0	1884	119	2003	0	0	0	0	701	262	963
% App. Total	34.2	0	65.8	0	94.1	5.9	95.4	0	0	0	0	72.8	27.2	95.2
PHF	.850	.000	.873	.000	.944	.930	.954	.000	.000	.000	.000	.913	.720	.952

Counts Unlimited, Inc.
 PO Box 1178
 Corona, CA 92878
 (951)268-6268

County of Riverside
 N/S: I-215 Southbound Ramps
 E/W: Alessandro Boulevard
 Weather: Clear

File Name : 25_CRV_215S_Ales AM
 Site Code : 05121716
 Start Date : 11/30/2021
 Page No : 1

Groups Printed- Passenger Vehicles

Start Time	I-215 Southbound Off Ramp Southbound				Alessandro Boulevard Westbound				I-215 Southbound On Ramp Northbound				Alessandro Boulevard Eastbound										
	Left	Thru	Right	RTOR	App. Total	Left	Thru	Right	RTOR	App. Total	Left	Thru	Right	RTOR	App. Total	Left	Thru	Right	RTOR	App. Total	Exclu. Total	Inclu. Total	Int. Total
07:00 AM	27	0	40	20	67	0	451	18	3	469	0	0	0	0	0	0	125	69	0	194	23	730	753
07:15 AM	25	0	68	18	93	0	472	31	2	503	0	0	0	0	0	0	139	71	0	210	20	806	826
07:30 AM	33	0	43	13	76	0	447	27	0	474	0	0	0	0	0	0	153	88	0	241	13	791	804
07:45 AM	34	0	68	17	102	0	446	29	4	475	0	0	0	0	0	0	169	63	0	232	21	809	830
Total	119	0	219	68	338	0	1816	105	9	1921	0	0	0	0	0	0	586	291	0	877	77	3136	3213
08:00 AM	27	0	40	25	67	0	491	25	0	516	0	0	0	0	0	0	162	53	0	215	25	798	823
08:15 AM	29	0	61	14	90	0	465	22	0	487	0	0	0	0	0	0	183	40	0	223	14	800	814
08:30 AM	25	0	65	21	90	0	442	15	0	457	0	0	0	0	0	0	173	60	0	233	21	780	801
08:45 AM	29	0	50	20	79	0	408	25	2	433	0	0	0	0	0	0	135	50	0	185	22	697	719
Total	110	0	216	80	326	0	1806	87	2	1893	0	0	0	0	0	0	653	203	0	856	82	3075	3157
Grand Total	229	0	435	148	664	0	3622	192	11	3814	0	0	0	0	0	0	1239	494	0	1733	159	6211	6370
T-Approch %	34.5	0	65.5			0	95	5			0	0	0			0	71.5	28.5					
33 Total %	3.7	0	7		10.7	0	58.3	3.1		61.4	0	0	0			0	19.9	8		27.9	2.5	97.5	

Start Time	I-215 Southbound Off Ramp Southbound				Alessandro Boulevard Westbound				I-215 Southbound On Ramp Northbound				Alessandro Boulevard Eastbound										
	Left	Thru	Right	App. Total	Left	Thru	Right	App. Total	Left	Thru	Right	App. Total	Left	Thru	Right	App. Total	Left	Thru	Right	App. Total	Exclu. Total	Inclu. Total	Int. Total
07:15 AM	25	0	68	93	0	472	31	503	0	0	0	0	0	0	0	0	0	139	71	210			806
07:30 AM	33	0	43	76	0	447	27	474	0	0	0	0	0	0	0	0	0	153	88	241			791
07:45 AM	34	0	68	102	0	446	29	475	0	0	0	0	0	0	0	0	0	169	63	232			809
08:00 AM	27	0	40	67	0	491	25	516	0	0	0	0	0	0	0	0	0	162	53	215			798
Total Volume	119	0	219	338	0	1856	112	1968	0	0	0	0	0	0	0	0	0	623	275	898			3204
% App. Total	35.2	0	64.8			0	94.3	5.7			0	0	0	0	0	0	0	69.4	30.6				.990
PHF	.875	.000	.805	.828	.903	.945	.903	.953	.000	.000	.000	.000	.000	.000	.000	.000	.000	.922	.781	.932			

Peak Hour Analysis From 07:15 AM to 08:00 AM - Peak 1 of 1
 Peak Hour for Entire Intersection Begins at 07:15 AM

Counts Unlimited, Inc.
 PO Box 1178
 Corona, CA 92878
 (951)268-6268

County of Riverside
 N/S: I-215 Southbound Ramps
 E/W: Alessandro Boulevard
 Weather: Clear

File Name : 25_CRV_215S_Ales AM
 Site Code : 05121716
 Start Date : 11/30/2021
 Page No : 2

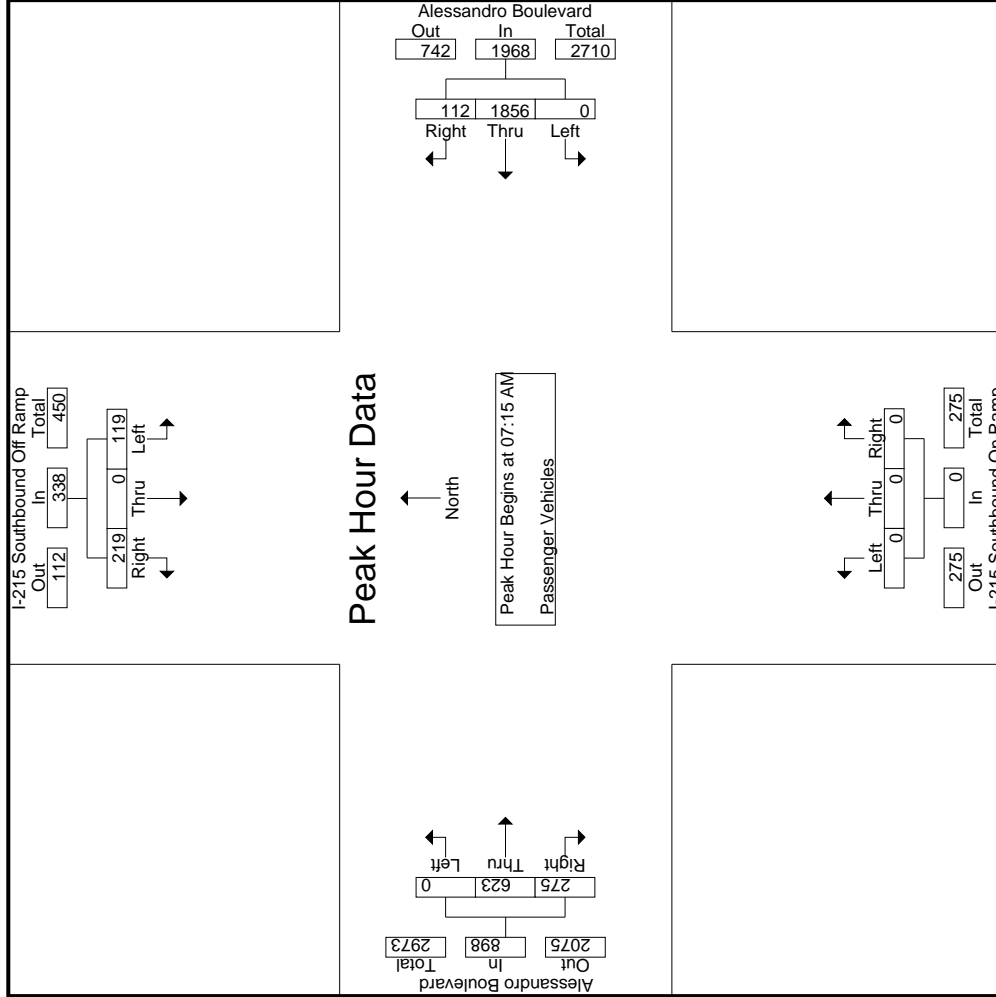

Counts Unlimited, Inc.
 PO Box 1178
 Corona, CA 92878
 (951)268-6268

County of Riverside
 N/S: I-215 Southbound Ramps
 E/W: Alessandro Boulevard
 Weather: Clear

File Name : 25_CRV_215S_Ales AM
 Site Code : 05121716
 Start Date : 11/30/2021
 Page No : 3

Start Time	I-215 Southbound Off Ramp Southbound			Alessandro Boulevard Westbound			I-215 Southbound On Ramp Northbound			Alessandro Boulevard Eastbound			Int. Total	
	Left	Thru	Right	Left	Thru	Right	Left	Thru	Right	Left	Thru	Right		App. Total
Peak Hour Analysis From 07:15 AM to 08:00 AM - Peak 1 of 1	Peak Hour for Each Approach Begins at:													
	07:15 AM													
+0 mins.	25	0	68	0	472	31	503	0	0	0	0	139	71	210
+15 mins.	33	0	43	0	447	27	474	0	0	0	0	153	88	241
+30 mins.	34	0	68	0	446	29	475	0	0	0	0	169	63	232
+45 mins.	27	0	40	0	491	25	516	0	0	0	0	162	53	215
Total Volume	119	0	219	0	1856	112	1968	0	0	0	0	623	275	898
% App. Total	35.2	0	64.8	0	94.3	5.7	953	0	0	0	0	69.4	30.6	932
PHF	.875	.000	.805	.000	.945	.903	.953	.000	.000	.000	.000	.922	.781	.932

Counts Unlimited, Inc.
 PO Box 1178
 Corona, CA 92878
 (951)268-6268

County of Riverside
 N/S: I-215 Southbound Ramps
 E/W: Alessandro Boulevard
 Weather: Clear

File Name : 25_CRV_215S_Ales AM
 Site Code : 05121716
 Start Date : 11/30/2021
 Page No : 1

Groups Printed- Large 2 Axle Vehicles

Start Time	I-215 Southbound Off Ramp Southbound				Alessandro Boulevard Westbound				I-215 Southbound On Ramp Northbound				Alessandro Boulevard Eastbound											
	Left	Thru	Right	RTOR	Left	Thru	Right	RTOR	Left	Thru	Right	RTOR	Left	Thru	Right	RTOR	Left	Thru	Right	RTOR	Exclu. Total	Inclu. Total	Int. Total	
07:00 AM	2	0	3	2	5	0	5	2	1	7	0	0	0	0	0	0	0	0	0	0	1	3	13	16
07:15 AM	2	0	3	2	5	0	6	1	0	7	0	0	0	0	0	0	0	0	0	0	5	2	17	19
07:30 AM	0	0	3	0	3	0	1	3	0	4	0	0	0	0	0	0	0	0	0	0	3	0	10	10
07:45 AM	1	0	3	1	4	0	3	2	0	5	0	0	0	0	0	0	0	0	0	0	6	1	15	16
Total	5	0	12	5	17	0	15	8	1	23	0	0	0	0	0	0	0	0	0	0	15	6	55	61
08:00 AM	3	0	4	1	7	0	7	1	0	8	0	0	0	0	0	0	0	0	0	0	6	1	21	22
08:15 AM	1	0	0	0	1	0	9	1	0	10	0	0	0	0	0	0	0	0	0	0	7	0	18	18
08:30 AM	1	0	3	2	4	0	8	3	1	11	0	0	0	0	0	0	0	0	0	0	4	3	19	22
08:45 AM	1	0	1	0	2	0	5	1	0	6	0	0	0	0	0	0	0	0	0	0	4	0	12	12
Total	6	0	8	3	14	0	29	6	1	35	0	0	0	0	0	0	0	0	0	0	21	4	70	74
Grand Total	11	0	20	8	31	0	44	14	2	58	0	0	0	0	0	0	0	0	0	0	36	10	125	135
T-Approch %	35.5	0	64.5			0	75.9	24.1		46.4	0	0	0	0	0	0	0	0	0	0	63.9	36.1		
33 Total %	8.8	0	16		24.8	0	35.2	11.2			0	0	0	0	0	0	0	0	0	0	18.4	10.4		
83																					28.8	7.4	92.6	

Start Time	I-215 Southbound Off Ramp Southbound				Alessandro Boulevard Westbound				I-215 Southbound On Ramp Northbound				Alessandro Boulevard Eastbound										
	Left	Thru	Right	App. Total	Left	Thru	Right	App. Total	Left	Thru	Right	App. Total	Left	Thru	Right	App. Total	Left	Thru	Right	App. Total	Int. Total		
07:15 AM	2	0	3	5	0	6	1	7	0	0	0	0	0	0	0	0	0	0	0	0	5	0	5
07:30 AM	0	0	3	3	0	1	3	4	0	3	0	0	0	0	0	0	0	0	0	0	3	0	3
07:45 AM	1	0	3	4	0	3	2	5	0	2	0	0	0	0	0	0	0	0	0	0	2	4	6
08:00 AM	3	0	4	7	0	7	1	8	0	7	0	0	0	0	0	0	0	0	0	0	4	2	6
Total Volume	6	0	13	19	0	17	7	24	0	24	0	0	0	0	0	0	0	0	0	0	14	6	20
% App. Total	31.6	0	68.4		0	70.8	29.2		0	75.0	0	0	0	0	0	0	0	0	0	0	70	30	
PHF	.500	.000	.813	.679	.000	.607	.583	.750	.000	.000	.000	.000	.000	.000	.000	.000	.000	.000	.000	.700	.375	.833	.750

Peak Hour Analysis From 07:15 AM to 08:00 AM - Peak 1 of 1
 Peak Hour for Entire Intersection Begins at 07:15 AM

Counts Unlimited, Inc.
 PO Box 1178
 Corona, CA 92878
 (951)268-6268

County of Riverside
 N/S: I-215 Southbound Ramps
 E/W: Alessandro Boulevard
 Weather: Clear

File Name : 25_CRV_215S_Ales AM
 Site Code : 05121716
 Start Date : 11/30/2021
 Page No : 2

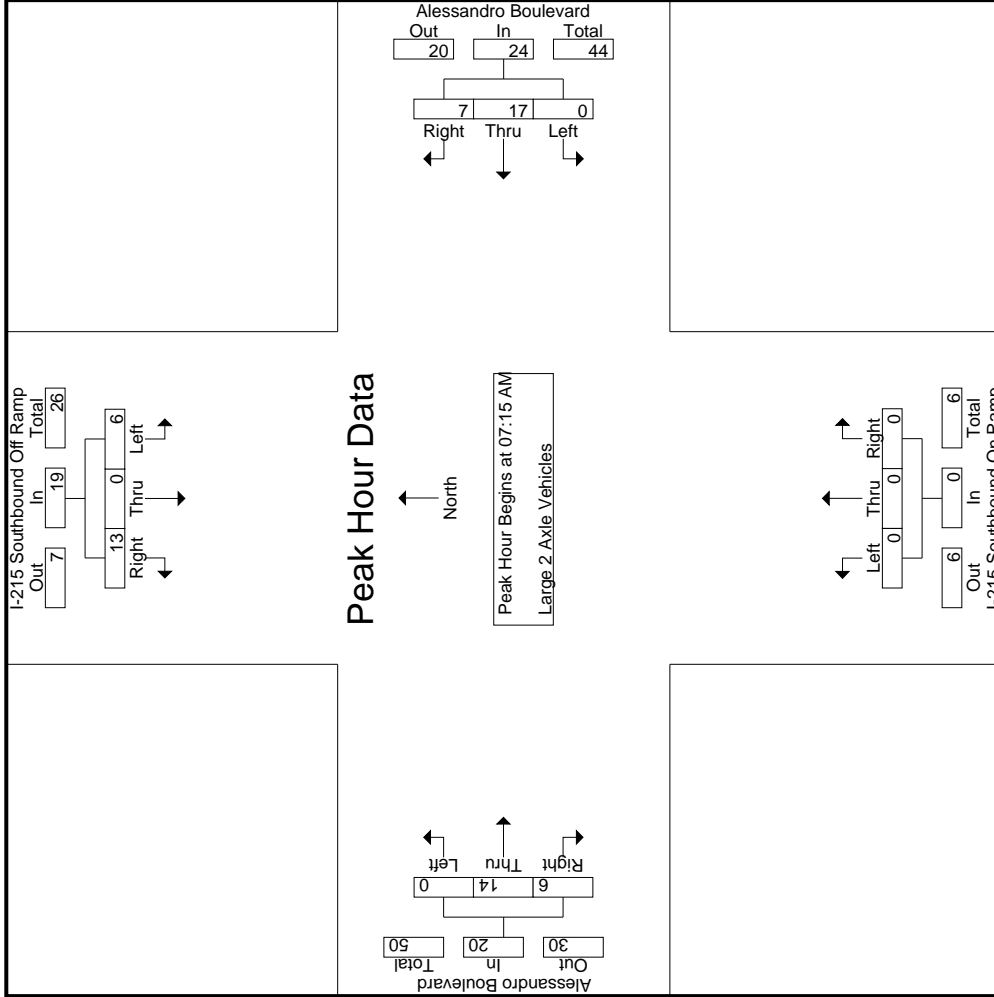

Counts Unlimited, Inc.
 PO Box 1178
 Corona, CA 92878
 (951)268-6268

County of Riverside
 N/S: I-215 Southbound Ramps
 E/W: Alessandro Boulevard
 Weather: Clear

File Name : 25_CRV_215S_Ales AM
 Site Code : 05121716
 Start Date : 11/30/2021
 Page No : 3

Start Time	I-215 Southbound Off Ramp Southbound			Alessandro Boulevard Westbound			I-215 Southbound On Ramp Northbound			Alessandro Boulevard Eastbound			Int. Total	
	Left	Thru	Right	Left	Thru	Right	Left	Thru	Right	Left	Thru	Right		App. Total
Peak Hour Analysis From 07:15 AM to 08:00 AM - Peak 1 of 1														
Peak Hour for Each Approach Begins at:	07:15 AM													
+0 mins.	2	0	3	0	6	1	7	0	0	0	0	5	0	5
+15 mins.	0	0	3	0	1	3	4	0	0	0	0	0	3	0
+30 mins.	1	0	3	0	3	2	5	0	0	0	0	0	2	4
+45 mins.	3	0	4	0	7	1	8	0	0	0	0	0	4	6
Total Volume	6	0	13	0	17	7	24	0	0	0	0	14	6	20
% App. Total	31.6	0	68.4	0	70.8	29.2	75	0	0	0	0	70	30	83.3
PHF	.500	.000	.813	.000	.607	.583	.750	.000	.000	.000	.000	.700	.375	.833

Groups Printed- 3 Axle Vehicles

Start Time	I-215 Southbound Off Ramp Southbound					Alessandro Boulevard Westbound					I-215 Southbound On Ramp Northbound					Alessandro Boulevard Eastbound							
	Left	Thru	Right	RTOR	App. Total	Left	Thru	Right	RTOR	App. Total	Left	Thru	Right	RTOR	App. Total	Left	Thru	Right	RTOR	App. Total	Exclu. Total	Inclu. Total	Int. Total
07:00 AM	0	0	0	0	0	0	0	0	0	1	0	0	0	0	0	0	2	0	0	0	0	3	3
07:15 AM	1	0	0	0	1	0	0	0	0	0	0	0	0	0	0	0	0	1	0	0	0	2	2
07:30 AM	0	0	1	1	1	0	0	0	0	0	0	0	0	0	0	0	0	0	0	0	1	1	2
07:45 AM	0	0	1	0	1	0	3	0	0	3	0	0	0	0	0	0	0	1	0	0	0	5	5
Total	1	0	2	1	3	0	4	0	0	4	0	0	0	0	0	0	2	2	0	4	1	11	12
08:00 AM	1	0	0	0	1	0	0	0	0	0	0	0	0	0	0	0	1	1	0	2	0	3	3
08:15 AM	1	0	1	0	2	0	0	0	0	0	0	0	0	0	0	0	0	0	0	0	0	2	2
08:30 AM	0	0	2	2	2	0	5	0	0	5	0	0	0	0	0	2	2	0	2	2	2	9	11
08:45 AM	0	0	0	0	0	0	1	0	0	1	0	0	0	0	0	0	0	0	0	0	0	1	1
Total	2	0	3	2	5	0	6	0	0	6	0	0	0	0	0	3	1	0	4	2	15	17	17
Grand Total	3	0	5	3	8	0	10	0	0	10	0	0	0	0	0	5	3	0	8	3	26	29	29
T-Approch %	37.5	0	62.5			0	100	0		38.5					62.5	37.5			30.8	10.3	89.7		
33 Total %	11.5	0	19.2		30.8	0	38.5	0			0	0	0	0	0	19.2	11.5						

Start Time	I-215 Southbound Off Ramp Southbound					Alessandro Boulevard Westbound					I-215 Southbound On Ramp Northbound					Alessandro Boulevard Eastbound							
	Left	Thru	Right	RTOR	App. Total	Left	Thru	Right	RTOR	App. Total	Left	Thru	Right	RTOR	App. Total	Left	Thru	Right	RTOR	App. Total	Exclu. Total	Inclu. Total	Int. Total
07:15 AM	1	0	0	0	1	0	0	0	0	0	0	0	0	0	0	0	0	0	0	0	1	1	2
07:30 AM	0	0	1	1	1	0	0	0	0	0	0	0	0	0	0	0	0	0	0	0	0	0	1
07:45 AM	0	0	1	1	1	0	3	0	0	3	0	0	0	0	0	0	0	0	0	0	1	1	5
08:00 AM	1	0	0	1	1	0	0	0	0	0	0	0	0	0	0	0	1	1	1	2	2	3	3
Total Volume	2	0	2	4	4	0	3	0	3	3	0	0	0	0	0	0	1	3	4	4	11	11	11
% App. Total	.500	.000	.500	1.00	1.00	.000	.250	.000	.250	.250	.000	.000	.000	.000	.000	.000	.250	.750	.500	.500	.550	.550	.550
PHF																							

Peak Hour Analysis From 07:15 AM to 08:00 AM - Peak 1 of 1
 Peak Hour for Entire Intersection Begins at 07:15 AM

Counts Unlimited, Inc.
 PO Box 1178
 Corona, CA 92878
 (951)268-6268

File Name : 25_CRV_215S_Ales AM
 Site Code : 05121716
 Start Date : 11/30/2021
 Page No : 2

County of Riverside
 N/S: I-215 Southbound Ramps
 E/W: Alessandro Boulevard
 Weather: Clear

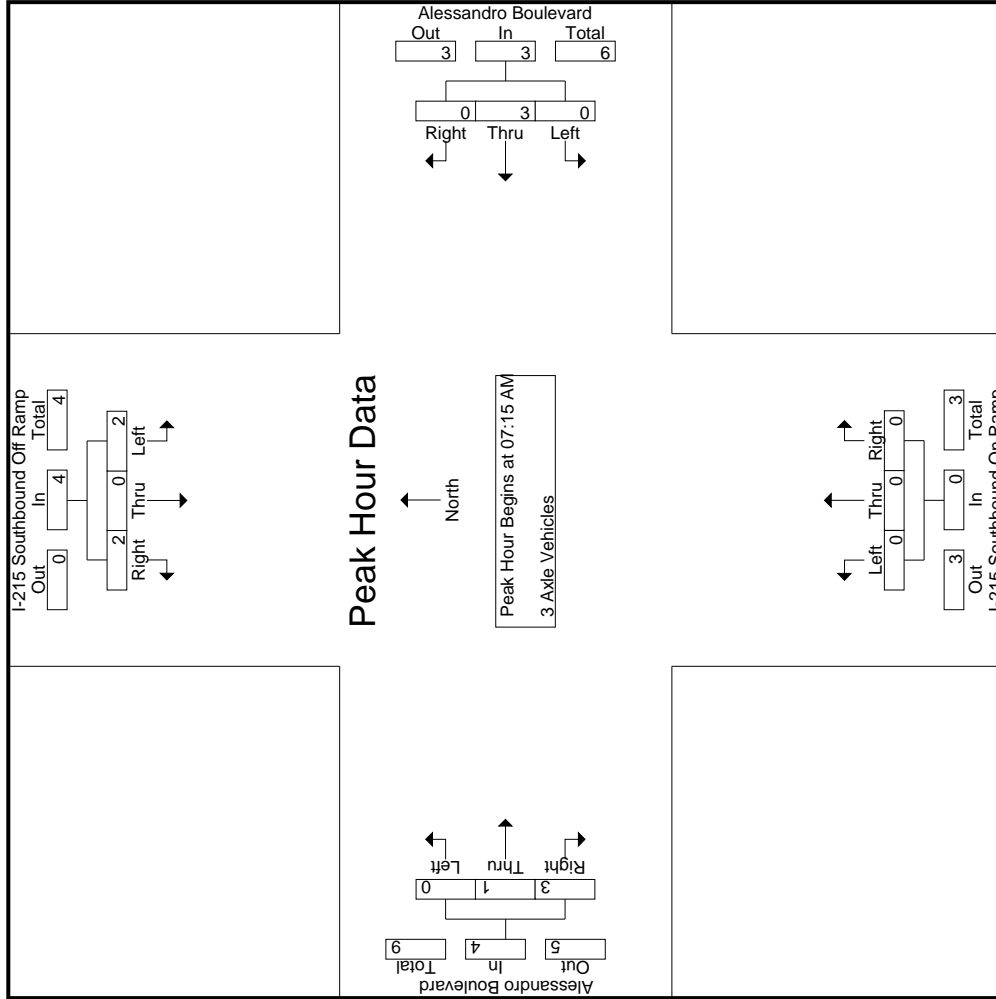

Start Time	I-215 Southbound Off Ramp Southbound			Alessandro Boulevard Westbound			I-215 Southbound On Ramp Northbound			Alessandro Boulevard Eastbound			Int. Total
	Left	Thru	Right	Left	Thru	Right	Left	Thru	Right	Left	Thru	Right	
Peak Hour Analysis From 07:15 AM to 08:00 AM - Peak 1 of 1	Peak Hour for Each Approach Begins at:												
	07:15 AM												
+0 mins.	1	0	0	0	0	0	0	0	0	0	0	1	1
+15 mins.	0	0	1	0	0	0	0	0	0	0	0	0	0
+30 mins.	0	0	1	0	3	0	3	0	0	0	0	0	1
+45 mins.	1	0	0	0	0	0	0	0	0	0	1	1	2
Total Volume	2	0	2	0	3	0	3	0	0	0	1	3	4
% App. Total	50	0	50	0	100	0	0	0	0	0	25	75	
PHF	.500	.000	.500	.000	.250	.000	.250	.000	.000	.000	.250	.750	.500

Counts Unlimited, Inc.
 PO Box 1178
 Corona, CA 92878
 (951)268-6268

County of Riverside
 N/S: I-215 Southbound Ramps
 E/W: Alessandro Boulevard
 Weather: Clear

File Name : 25_CRV_215S_Ales AM
 Site Code : 05121716
 Start Date : 11/30/2021
 Page No : 1

Groups Printed- 4+ Axle Trucks

Start Time	I-215 Southbound Off Ramp Southbound					Alessandro Boulevard Westbound					I-215 Southbound On Ramp Northbound					Alessandro Boulevard Eastbound								
	Left	Thru	Right	RTOR	App. Total	Left	Thru	Right	RTOR	App. Total	Left	Thru	Right	RTOR	App. Total	Left	Thru	Right	RTOR	App. Total	Exclu. Total	Inclu. Total	Int. Total	
07:00 AM	7	0	2	0	9	0	0	1	0	1	0	0	0	0	0	0	1	0	0	1	0	11	11	11
07:15 AM	2	0	3	1	5	0	3	0	0	3	0	0	0	0	0	0	4	1	0	5	1	13	14	14
07:30 AM	6	0	4	0	10	0	4	0	0	4	0	0	0	0	0	0	6	3	0	9	0	23	23	23
07:45 AM	5	0	3	1	8	0	0	0	0	0	0	0	0	0	0	0	5	0	0	5	1	13	14	14
Total	20	0	12	2	32	0	7	1	0	8	0	0	0	0	0	0	16	4	0	20	2	60	62	62
08:00 AM	3	0	5	1	8	0	1	0	0	1	0	0	0	0	0	0	4	0	0	4	1	13	14	14
08:15 AM	4	0	2	0	6	0	2	0	0	2	0	0	0	0	0	0	7	2	0	9	0	17	17	17
08:30 AM	1	0	4	0	5	0	4	1	0	5	0	0	0	0	0	0	2	0	0	2	0	12	12	12
08:45 AM	14	0	3	0	17	0	7	0	0	7	0	0	0	0	0	0	7	1	0	8	0	32	32	32
Total	22	0	14	1	36	0	14	1	0	15	0	0	0	0	0	0	20	3	0	23	1	74	75	75
Grand Total	42	0	26	3	68	0	21	2	0	23	0	0	0	0	0	0	36	7	0	43	3	134	137	137
T-Approch %	61.8	0	38.2			0	91.3	8.7		17.2	0	0	0			0	83.7	16.3		32.1	2.2	97.8		
CS Total %	31.3	0	19.4		50.7	0	15.7	1.5			0	0	0			0	26.9	5.2						

Start Time	I-215 Southbound Off Ramp Southbound					Alessandro Boulevard Westbound					I-215 Southbound On Ramp Northbound					Alessandro Boulevard Eastbound								
	Left	Thru	Right	RTOR	App. Total	Left	Thru	Right	RTOR	App. Total	Left	Thru	Right	RTOR	App. Total	Left	Thru	Right	RTOR	App. Total	Exclu. Total	Inclu. Total	Int. Total	
07:15 AM	2	0	3		5	0	3	0		3	0	0	0		0	0	4	1		5	1	5	13	13
07:30 AM	6	0	4		10	0	4	0		4	0	0	0		0	0	6	3		9	3	9	23	23
07:45 AM	5	0	3		8	0	0	0		0	0	0	0		0	0	5	0		5	0	5	13	13
08:00 AM	3	0	5		8	0	1	0		1	0	0	0		0	0	4	0		4	0	4	13	13
Total Volume	16	0	15		31	0	8	0		8	0	0	0		0	0	19	4		23	4	23	62	62
% App. Total	51.6	0	48.4			0	100	0		0	0	0	0		0	0	82.6	17.4						
PHF	.667	.000	.750		.775	.000	.500	.000		.500	.000	.000	.000		.000	.000	.792	.333		.639		.674		

Peak Hour Analysis From 07:15 AM to 08:00 AM - Peak 1 of 1
 Peak Hour for Entire Intersection Begins at 07:15 AM

Counts Unlimited, Inc.
 PO Box 1178
 Corona, CA 92878
 (951)268-6268

County of Riverside
 N/S: I-215 Southbound Ramps
 E/W: Alessandro Boulevard
 Weather: Clear

File Name : 25_CRV_215S_Ales AM
 Site Code : 05121716
 Start Date : 11/30/2021
 Page No : 2

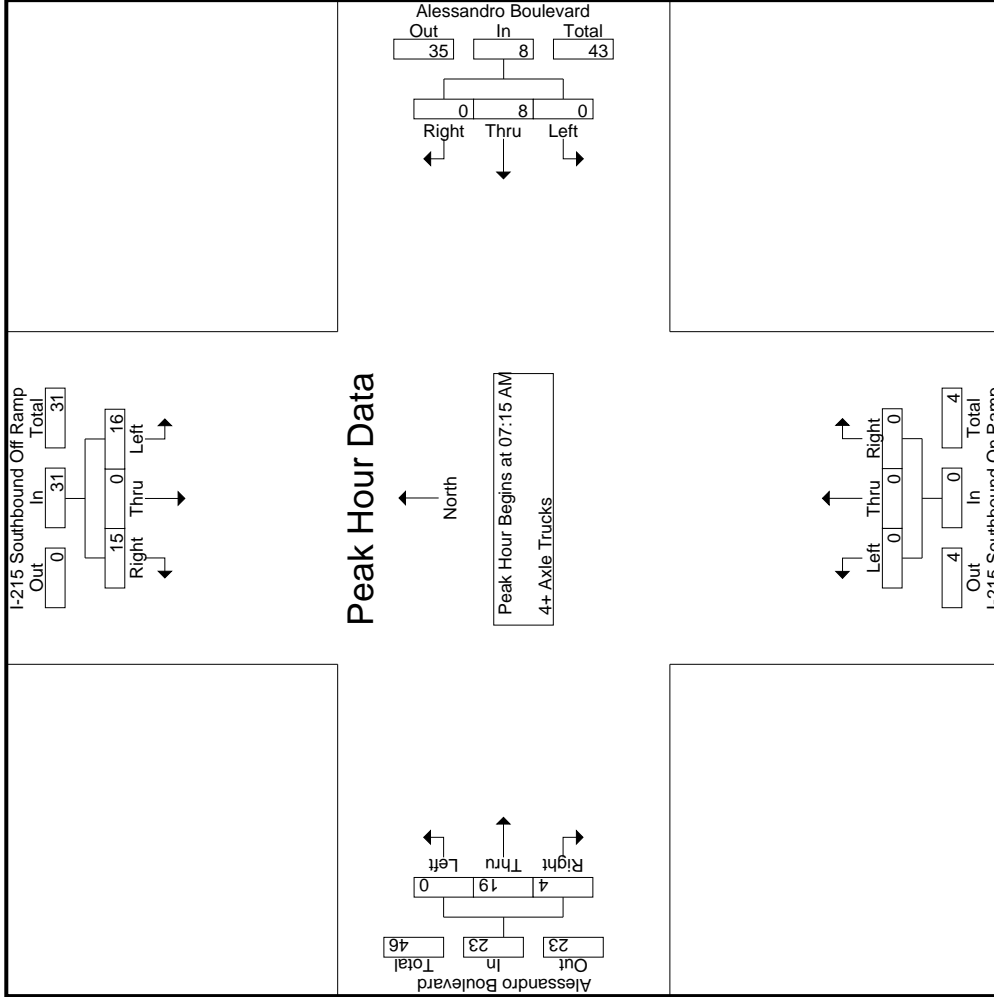

Counts Unlimited, Inc.
 PO Box 1178
 Corona, CA 92878
 (951)268-6268

County of Riverside
 N/S: I-215 Southbound Ramps
 E/W: Alessandro Boulevard
 Weather: Clear

File Name : 25_CRV_215S_Ales AM
 Site Code : 05121716
 Start Date : 11/30/2021
 Page No : 3

Start Time	I-215 Southbound Off Ramp Southbound			Alessandro Boulevard Westbound			I-215 Southbound On Ramp Northbound			Alessandro Boulevard Eastbound			Int. Total	
	Left	Thru	Right	Left	Thru	Right	Left	Thru	Right	Left	Thru	Right		App. Total
Peak Hour Analysis From 07:15 AM to 08:00 AM - Peak 1 of 1														
Peak Hour for Each Approach Begins at:	07:15 AM													
+0 mins.	2	0	3	0	3	0	0	0	0	0	0	4	1	5
+15 mins.	6	0	4	0	4	0	0	0	0	0	6	3	9	5
+30 mins.	5	0	3	0	0	0	0	0	0	0	5	0	5	5
+45 mins.	3	0	5	0	1	0	0	0	0	0	4	0	4	4
Total Volume	16	0	15	0	8	0	0	0	0	0	19	4	23	23
% App. Total	51.6	0	48.4	0	100	0	0	0	0	0	82.6	17.4		
PHF	.667	.000	.750	.000	.500	.000	.000	.500	.000	.000	.792	.333	.639	.639

Groups Printed- Passenger Vehicles - Large 2 Axle Vehicles - 3 Axle Vehicles - 4+ Axle Trucks

	I-215 Southbound Off Ramp								Alessandro Boulevard								Alessandro Boulevard							
	Southbound				Westbound				Northbound				Eastbound				Northbound				Eastbound			
	Start Time	Left	Thru	Right	RTOR	App. Total	Left	Thru	Right	RTOR	App. Total	Left	Thru	Right	RTOR	App. Total	Left	Thru	Right	RTOR	App. Total	Exclu. Total	Inclu. Total	Int. Total
04:00 PM	48	0	60	9	108	0	447	18	1	465	0	0	0	0	0	0	0	327	82	0	409	10	982	992
04:15 PM	56	0	91	27	147	0	406	20	1	426	0	0	0	0	0	0	0	291	67	0	358	28	931	959
04:30 PM	54	0	97	9	151	0	454	22	1	476	0	0	0	0	0	0	0	338	90	0	428	10	1055	1065
04:45 PM	96	0	124	12	220	0	459	17	4	476	0	0	0	0	0	0	0	313	62	0	375	16	1071	1087
Total	254	0	372	57	626	0	1766	77	7	1843	0	0	0	0	0	0	0	1269	301	0	1570	64	4039	4103
05:00 PM	73	0	113	18	186	0	412	17	3	429	0	0	0	0	0	0	0	359	68	0	427	21	1042	1063
05:15 PM	87	0	90	5	177	0	446	5	0	451	0	0	0	0	0	0	0	360	67	0	427	5	1055	1060
05:30 PM	61	0	63	14	124	0	387	18	2	405	0	0	0	0	0	0	0	358	107	0	465	16	994	1010
05:45 PM	69	0	57	26	126	0	344	14	0	358	0	0	0	0	0	0	0	331	115	0	446	26	930	956
Total	290	0	323	63	613	0	1589	54	5	1643	0	0	0	0	0	0	0	1408	357	0	1765	68	4021	4089
Grand Total	544	0	695	120	1239	0	3355	131	12	3486	0	0	0	0	0	0	0	2677	658	0	3335	132	8060	8192
T-Approch %	43.9	0	56.1			0	96.2	3.8			0	0	0	0	0	0	0	80.3	19.7					
CS Total %	6.7	0	8.6		15.4	0	41.6	1.6		43.3	0	0	0	0	0	0	0	33.2	8.2		41.4	1.6	98.4	
% Passenger Vehicles	487	0	638		1240	0	3269	123		3402	0	0	0	0	0	0	0	2629	641		3270	0	0	7912
% Large 2 Axle Vehicles	89.5	0	91.8		95.8	0	97.4	93.9	83.3	97.3	0	0	0	0	0	0	0	98.2	97.4		98.1	0	0	96.6
% 3 Axle Vehicles	12	0	17		31	0	50	5		57	0	0	0	0	0	0	0	22	12		34	0	0	122
% 4+ Axle Trucks	2.2	0	2.4		2.3	0	1.5	3.8	16.7	1.6	0	0	0	0	0	0	0	0.8	1.8		1	0	0	1.5
Total %	7	0	12		20	0	7	1		8	0	0	0	0	0	0	0	5	2		7	0	0	35
% 3 Axle Trucks	1.3	0	1.7		0.8	1.5	0	0.2	0.8	0	0.2	0	0	0	0	0	0	0.2	0.3		0.2	0	0	0.4
% 4+ Axle Trucks	38	0	28		68	0	29	2		31	0	0	0	0	0	0	0	21	3		24	0	0	123
% 4+ Axle Trucks	7	0	4		1.7	5	0	0.9	1.5	0	0.9	0	0	0	0	0	0	0.8	0.5		0.7	0	0	1.5

	I-215 Southbound Off Ramp								Alessandro Boulevard								I-215 Southbound On Ramp								Alessandro Boulevard							
	Southbound				Westbound				Northbound				Eastbound				Northbound				Eastbound											
	Start Time	Left	Thru	Right	RTOR	App. Total	Left	Thru	Right	RTOR	App. Total	Left	Thru	Right	RTOR	App. Total	Left	Thru	Right	RTOR	App. Total	Left	Thru	Right	RTOR	App. Total	Exclu. Total	Inclu. Total	Int. Total			
04:30 PM	54	0	97		151	0	454	22		476	0	0	0	0	0	0	0	338	90		428	0	0	0	0	0	0	0	1055			
04:45 PM	96	0	124		220	0	459	17		476	0	0	0	0	0	0	0	313	62		375	0	0	0	0	0	0	0	1071			
05:00 PM	73	0	113		186	0	412	17		429	0	0	0	0	0	0	0	359	68		427	0	0	0	0	0	0	0	1042			
05:15 PM	87	0	90		177	0	446	5		451	0	0	0	0	0	0	0	360	67		427	0	0	0	0	0	0	0	1060			
Total Volume	310	0	424		734	0	1771	61		1832	0	0	0	0	0	0	0	1370	287		1657	0	0	0	0	0	0	0	4223			
% App. Total	42.2	0	57.8			0	96.7	3.3			0	0	0	0	0	0	0	82.7	17.3			0	0	0	0	0	0	.968				
PHF	.807	.000	.855		.834	.000	.965	.693		.962	.000	.000	.000	.000	.000	.000	.000	.951	.797		.968											

Peak Hour Analysis From 04:00 PM to 05:45 PM - Peak 1 of 1
 Peak Hour for Entire Intersection Begins at 04:30 PM

Counts Unlimited, Inc.
 PO Box 1178
 Corona, CA 92878
 (951)268-6268

County of Riverside
 N/S: I-215 Southbound Ramps
 E/W: Alessandro Boulevard
 Weather: Clear

File Name : 25_CRV_215S_Ales PM
 Site Code : 05121716
 Start Date : 11/30/2021
 Page No : 2

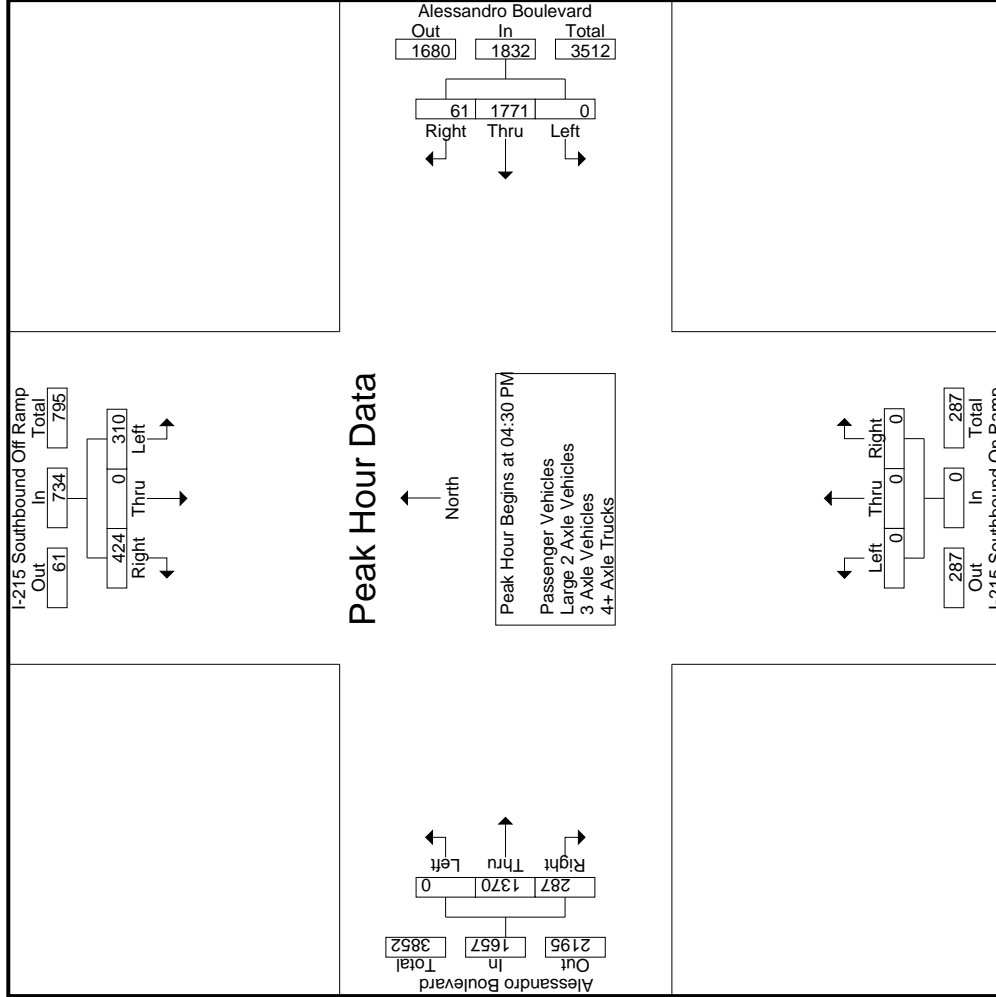

Counts Unlimited, Inc.
 PO Box 1178
 Corona, CA 92878
 (951)268-6268

File Name : 25_CRV_215S_Ales PM
 Site Code : 05121716
 Start Date : 11/30/2021
 Page No : 3

County of Riverside
 N/S: I-215 Southbound Ramps
 E/W: Alessandro Boulevard
 Weather: Clear

Start Time	I-215 Southbound Off Ramp Southbound			Alessandro Boulevard Westbound			I-215 Southbound On Ramp Northbound			Alessandro Boulevard Eastbound			Int. Total	
	Left	Thru	Right	Left	Thru	Right	Left	Thru	Right	Left	Thru	Right		App. Total
Peak Hour Analysis From 04:00 PM to 05:45 PM - Peak 1 of 1	Peak Hour for Each Approach Begins at:													
	04:30 PM			04:00 PM			04:00 PM			05:00 PM				
+0 mins.	54	0	97	0	447	18	465	0	0	0	0	359	68	427
+15 mins.	96	0	124	0	406	20	426	0	0	0	0	360	67	427
+30 mins.	73	0	113	0	454	22	476	0	0	0	0	358	107	465
+45 mins.	87	0	90	0	459	17	476	0	0	0	0	331	115	446
Total Volume	310	0	424	0	1766	77	1843	0	0	0	0	1408	357	1765
% App. Total	42.2	0	57.8	0	95.8	4.2		0	0	0	0	79.8	20.2	
PHF	.807	.000	.855	.000	.962	.875	.968	.000	.000	.000	.000	.978	.776	.949

Counts Unlimited, Inc.
 PO Box 1178
 Corona, CA 92878
 (951)268-6268

County of Riverside
 N/S: I-215 Southbound Ramps
 E/W: Alessandro Boulevard
 Weather: Clear

File Name : 25_CRV_215S_Ales PM
 Site Code : 05121716
 Start Date : 11/30/2021
 Page No : 1

Groups Printed- Passenger Vehicles

Start Time	I-215 Southbound Off Ramp Southbound				Alessandro Boulevard Westbound				I-215 Southbound On Ramp Northbound				Alessandro Boulevard Eastbound					
	Left	Thru	Right	RTOR	App. Total	Left	Thru	Right	RTOR	App. Total	Left	Thru	Right	RTOR	App. Total	Exclu. Total	Inclu. Total	Int. Total
04:00 PM	40	0	59	9	99	0	426	17	1	443	0	0	0	0	0	10	939	949
04:15 PM	50	0	87	27	137	0	396	19	1	415	0	0	0	0	0	28	900	928
04:30 PM	46	0	89	8	135	0	440	21	1	461	0	0	0	0	9	1011	1020	
04:45 PM	86	0	116	11	202	0	452	14	2	466	0	0	0	0	13	1039	1052	
Total	222	0	351	55	573	0	1714	71	5	1785	0	0	0	0	60	3889	3949	
05:00 PM	65	0	98	17	163	0	405	17	3	422	0	0	0	0	0	20	1009	1029
05:15 PM	80	0	78	4	158	0	437	4	0	441	0	0	0	0	4	1018	1022	
05:30 PM	59	0	58	14	117	0	378	18	2	396	0	0	0	0	16	968	984	
05:45 PM	61	0	53	25	114	0	335	13	0	348	0	0	0	0	25	903	928	
Total	265	0	287	60	552	0	1555	52	5	1607	0	0	0	0	65	3898	3963	
Grand Total	487	0	638	115	1125	0	3269	123	10	3392	0	0	0	0	125	7787	7912	
T-Approch %	43.3	0	56.7			0	96.4	3.6			0	0	0	0	80.4	19.6		
W Total %	6.3	0	8.2		14.4	0	42	1.6		43.6	0	0	0	0	33.8	8.2		98.4

Start Time	I-215 Southbound Off Ramp Southbound				Alessandro Boulevard Westbound				I-215 Southbound On Ramp Northbound				Alessandro Boulevard Eastbound					
	Left	Thru	Right	RTOR	App. Total	Left	Thru	Right	RTOR	App. Total	Left	Thru	Right	RTOR	App. Total	Exclu. Total	Inclu. Total	Int. Total
04:30 PM	46	0	89		135	0	440	21		461	0	0	0	0	0	86	415	1011
04:45 PM	86	0	116		202	0	452	14		466	0	0	0	0	0	61	371	1039
05:00 PM	65	0	98		163	0	405	17		422	0	0	0	0	0	67	424	1009
05:15 PM	80	0	78		158	0	437	4		441	0	0	0	0	0	66	419	1018
Total Volume	277	0	381		658	0	1734	56		1790	0	0	0	0	0	1349	280	4077
% App. Total	42.1	0	57.9		3.1	0	96.9	3.1		3.1	0	0	0	0	82.8	17.2		
PHF	.805	.000	.821		.814	.000	.959	.667		.960	.000	.000	.000	.000	.945	.814	.960	.981

Peak Hour Analysis From 04:30 PM to 05:15 PM - Peak 1 of 1
 Peak Hour for Entire Intersection Begins at 04:30 PM

Counts Unlimited, Inc.
 PO Box 1178
 Corona, CA 92878
 (951)268-6268

File Name : 25_CRV_215S_Ales PM
 Site Code : 05121716
 Start Date : 11/30/2021
 Page No : 2

County of Riverside
 N/S: I-215 Southbound Ramps
 E/W: Alessandro Boulevard
 Weather: Clear

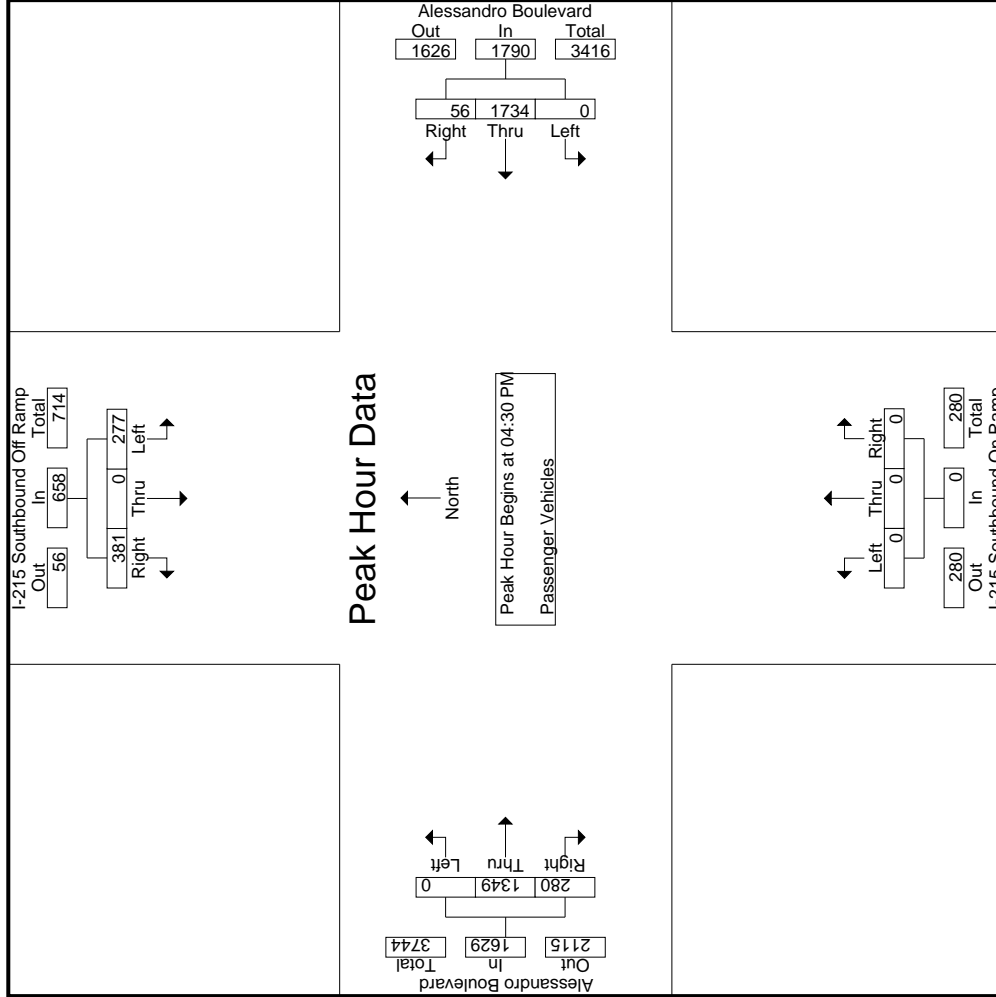

Counts Unlimited, Inc.
 PO Box 1178
 Corona, CA 92878
 (951)268-6268

File Name : 25_CRV_215S_Ales PM
 Site Code : 05121716
 Start Date : 11/30/2021
 Page No : 3

County of Riverside
 N/S: I-215 Southbound Ramps
 E/W: Alessandro Boulevard
 Weather: Clear

Start Time	I-215 Southbound Off Ramp Southbound			Alessandro Boulevard Westbound			I-215 Southbound On Ramp Northbound			Alessandro Boulevard Eastbound			Int. Total	
	Left	Thru	Right	Left	Thru	Right	Left	Thru	Right	Left	Thru	Right		App. Total
Peak Hour Analysis From 04:30 PM to 05:15 PM - Peak 1 of 1	04:30 PM													
Peak Hour for Each Approach Begins at:	04:30 PM													
+0 mins.	46	0	89	0	440	21	461	0	0	0	0	329	86	415
+15 mins.	86	0	116	0	452	14	466	0	0	0	0	310	61	371
+30 mins.	65	0	98	0	405	17	422	0	0	0	0	357	67	424
+45 mins.	80	0	78	0	437	4	441	0	0	0	0	353	66	419
Total Volume	277	0	381	0	1734	56	1790	0	0	0	0	1349	280	1629
% App. Total	42.1	0	57.9	0	96.9	3.1	96.0	0	0	0	0	82.8	17.2	96.0
PHF	.805	.000	.821	.000	.959	.667	.960	.000	.000	.000	.000	.945	.814	.960

Counts Unlimited, Inc.
 PO Box 1178
 Corona, CA 92878
 (951)268-6268

County of Riverside
 N/S: I-215 Southbound Ramps
 E/W: Alessandro Boulevard
 Weather: Clear

File Name : 25_CRV_215S_Ales PM
 Site Code : 05121716
 Start Date : 11/30/2021
 Page No : 1

Groups Printed- Large 2 Axle Vehicles

Start Time	I-215 Southbound Off Ramp Southbound					Alessandro Boulevard Westbound					I-215 Southbound On Ramp Northbound					Alessandro Boulevard Eastbound							
	Left	Thru	Right	RTOR	App. Total	Left	Thru	Right	RTOR	App. Total	Left	Thru	Right	RTOR	App. Total	Left	Thru	Right	RTOR	App. Total	Exclu. Total	Inclu. Total	Int. Total
04:00 PM	2	0	0	0	2	0	11	0	0	11	0	0	0	0	0	0	4	3	0	7	0	20	20
04:15 PM	2	0	0	0	2	0	6	1	0	7	0	0	0	0	0	0	2	1	0	3	0	12	12
04:30 PM	1	0	4	0	5	0	11	1	0	12	0	0	0	0	0	0	6	2	0	8	0	25	25
04:45 PM	1	0	4	0	5	0	5	2	2	7	0	0	0	0	0	0	1	1	0	2	2	14	16
Total	6	0	8	0	14	0	33	4	2	37	0	0	0	0	0	0	13	7	0	20	2	71	73
05:00 PM	2	0	2	0	4	0	3	0	0	3	0	0	0	0	0	0	0	1	0	1	0	8	8
05:15 PM	2	0	5	1	7	0	5	0	0	5	0	0	0	0	0	0	6	1	0	7	1	19	20
05:30 PM	0	0	1	0	1	0	5	0	0	5	0	0	0	0	0	0	1	3	0	4	0	10	10
05:45 PM	2	0	1	1	3	0	4	1	0	5	0	0	0	0	0	0	2	0	0	2	1	10	11
Total	6	0	9	2	15	0	17	1	0	18	0	0	0	0	0	0	9	5	0	14	2	47	49
Grand Total	12	0	17	2	29	0	50	5	2	55	0	0	0	0	0	0	22	12	0	34	4	118	122
T-Approch %	41.4	0	58.6			0	90.9	9.1		46.6	0	0	0			0	64.7	35.3		28.8	3.3	96.7	
W Total %	10.2	0	14.4		24.6	0	42.4	4.2			0	0	0			0	18.6	10.2					

Start Time	I-215 Southbound Off Ramp Southbound					Alessandro Boulevard Westbound					I-215 Southbound On Ramp Northbound					Alessandro Boulevard Eastbound							
	Left	Thru	Right	RTOR	App. Total	Left	Thru	Right	RTOR	App. Total	Left	Thru	Right	RTOR	App. Total	Left	Thru	Right	RTOR	App. Total	Exclu. Total	Inclu. Total	Int. Total
04:30 PM	1	0	4		5	0	11	1		12	0	0	0		0	0	6	2		8		25	
04:45 PM	1	0	4		5	0	5	2		7	0	0	0		0	0	1	1		2		14	
05:00 PM	2	0	2		4	0	3	0		3	0	0	0		0	0	0	1		1		8	
05:15 PM	2	0	5		7	0	5	0		5	0	0	0		0	0	6	1		7		19	
Total Volume	6	0	15		21	0	24	3		27	0	0	0		0	0	13	5		18		66	
% App. Total	28.6	0	71.4			0	88.9	11.1			0	0	0		0	0	72.2	27.8				.660	
PHF	.750	.000	.750		.750	.000	.545	.375		.563	.000	.000	.000		.000	.000	.542	.625		.563			

Peak Hour Analysis From 04:30 PM to 05:15 PM - Peak 1 of 1
 Peak Hour for Entire Intersection Begins at 04:30 PM

Counts Unlimited, Inc.
 PO Box 1178
 Corona, CA 92878
 (951)268-6268

File Name : 25_CRV_215S_Ales PM
 Site Code : 05121716
 Start Date : 11/30/2021
 Page No : 2

County of Riverside
 N/S: I-215 Southbound Ramps
 E/W: Alessandro Boulevard
 Weather: Clear

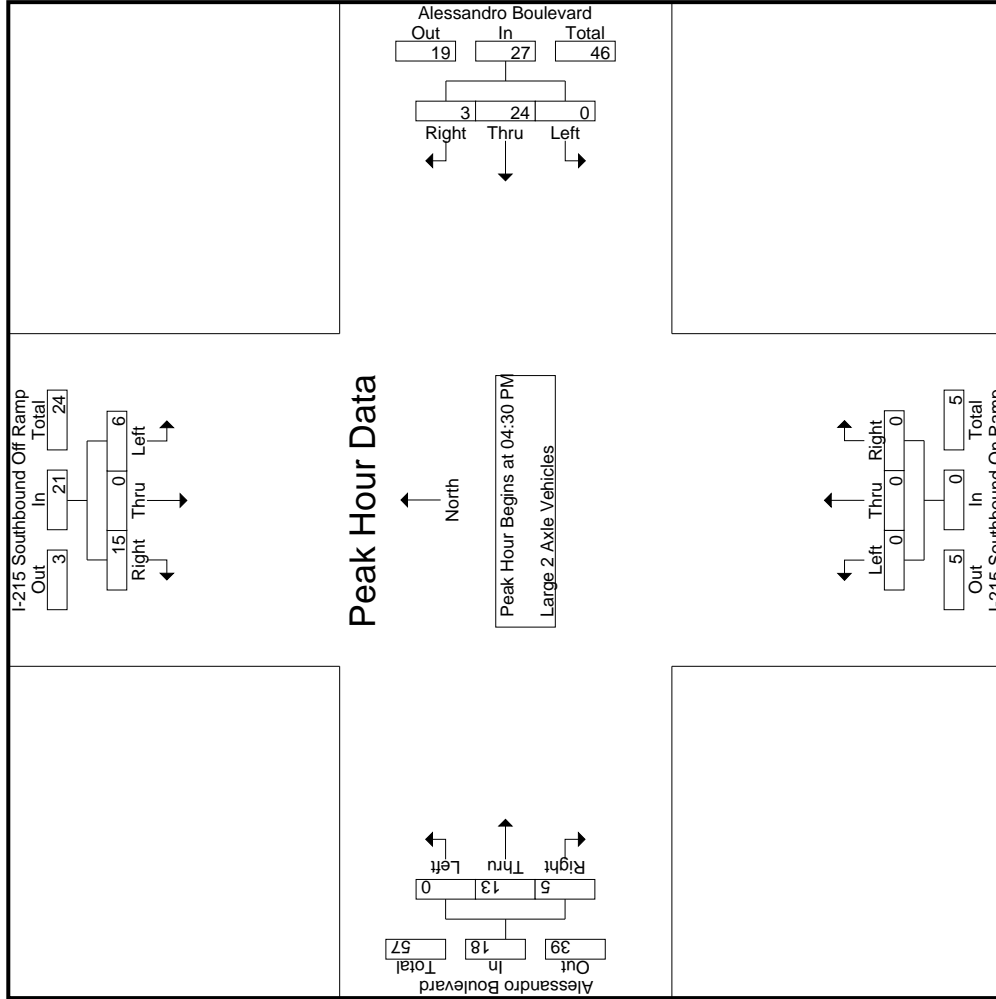

Counts Unlimited, Inc.
 PO Box 1178
 Corona, CA 92878
 (951)268-6268

County of Riverside
 N/S: I-215 Southbound Ramps
 E/W: Alessandro Boulevard
 Weather: Clear

File Name : 25_CRV_215S_Ales PM
 Site Code : 05121716
 Start Date : 11/30/2021
 Page No : 3

Start Time	I-215 Southbound Off Ramp Southbound			Alessandro Boulevard Westbound			I-215 Southbound On Ramp Northbound			Alessandro Boulevard Eastbound					
	Left	Thru	Right	Left	Thru	Right	Left	Thru	Right	Left	Thru	Right			
Peak Hour Analysis From 04:30 PM to 05:15 PM - Peak 1 of 1															
Peak Hour for Each Approach Begins at:	04:30 PM														
+0 mins.	1	0	4	11	1	12	0	0	0	0	0	0	6	2	8
+15 mins.	1	0	4	5	2	7	0	0	0	0	0	0	1	1	2
+30 mins.	2	0	2	3	0	3	0	0	0	0	0	0	0	1	1
+45 mins.	2	0	5	5	0	5	0	0	0	0	0	0	6	1	7
Total Volume	6	0	15	24	3	27	0	0	0	0	0	0	13	5	18
% App. Total	28.6	0	71.4	88.9	11.1	27	0	0	0	0	0	0	72.2	27.8	100
PHF	.750	.000	.750	.545	.375	.563	.000	.000	.000	.000	.542	.625	.563		

Groups Printed- 3 Axle Vehicles

Start Time	I-215 Southbound Off Ramp Southbound					Alessandro Boulevard Westbound					I-215 Southbound On Ramp Northbound					Alessandro Boulevard Eastbound								
	Left	Thru	Right	RTOR	App. Total	Left	Thru	Right	RTOR	App. Total	Left	Thru	Right	RTOR	App. Total	Left	Thru	Right	RTOR	App. Total	Exclu. Total	Inclu. Total	Int. Total	
04:00 PM	0	0	0	0	0	0	1	0	0	1	0	0	0	0	0	0	1	0	0	0	0	2	2	2
04:15 PM	0	0	0	0	0	0	1	0	0	1	0	0	0	0	0	0	1	0	0	0	0	2	2	2
04:30 PM	0	0	2	1	2	0	0	0	0	0	0	0	0	0	0	0	0	1	0	0	1	3	4	4
04:45 PM	3	0	0	0	3	0	1	1	0	2	0	0	0	0	0	0	2	0	0	0	0	7	7	7
Total	3	0	2	1	5	0	3	1	0	4	0	0	0	0	0	0	4	1	0	5	1	14	15	15
05:00 PM	1	0	5	0	6	0	2	0	0	2	0	0	0	0	0	0	1	0	0	1	0	9	9	9
05:15 PM	2	0	2	0	4	0	0	0	0	0	0	0	0	0	0	0	0	0	0	0	0	4	4	4
05:30 PM	0	0	2	0	2	0	0	0	0	0	0	0	0	0	0	0	0	1	0	1	0	3	3	3
05:45 PM	1	0	1	0	2	0	2	0	0	2	0	0	0	0	0	0	0	0	0	0	0	4	4	4
Total	4	0	10	0	14	0	4	0	0	4	0	0	0	0	0	0	1	1	0	2	0	20	20	20
Grand Total	7	0	12	1	19	0	7	1	0	8	0	0	0	0	0	0	5	2	0	7	1	34	35	35
Approch %	36.8	0	63.2			0	87.5	12.5			0	0	0			0	71.4	28.6		20.6				
Total %	20.6	0	35.3		55.9	0	20.6	2.9		23.5	0	0	0		0	0	14.7	5.9		2.9		97.1		

Start Time	I-215 Southbound Off Ramp Southbound					Alessandro Boulevard Westbound					I-215 Southbound On Ramp Northbound					Alessandro Boulevard Eastbound								
	Left	Thru	Right	RTOR	App. Total	Left	Thru	Right	RTOR	App. Total	Left	Thru	Right	RTOR	App. Total	Left	Thru	Right	RTOR	App. Total	Exclu. Total	Inclu. Total	Int. Total	
04:30 PM	0	0	2		2	0	0	0		0	0	0	0		0	0	0	0		0	0	1	1	3
04:45 PM	3	0	0		3	0	1	1		2	0	0	0		0	0	2	0		0	0	2	7	7
05:00 PM	1	0	5		6	0	2	0		2	0	0	0		0	0	1	0		0	0	1	9	9
05:15 PM	2	0	2		4	0	0	0		0	0	0	0		0	0	0	0		0	0	0	4	4
Total Volume	6	0	9		15	0	3	1		4	0	0	0		0	0	3	1		4	1	14	15	
% App. Total	.500	.000	.450		.625	.000	.375	.250		.500	.000	.000	.000		.000	.000	.375	.250		.500	.000	.500	.639	
PHF																								

Peak Hour Analysis From 04:30 PM to 05:15 PM - Peak 1 of 1
 Peak Hour for Entire Intersection Begins at 04:30 PM

Counts Unlimited, Inc.
 PO Box 1178
 Corona, CA 92878
 (951)268-6268

File Name : 25_CRV_215S_Ales PM
 Site Code : 05121716
 Start Date : 11/30/2021
 Page No : 2

County of Riverside
 N/S: I-215 Southbound Ramps
 E/W: Alessandro Boulevard
 Weather: Clear

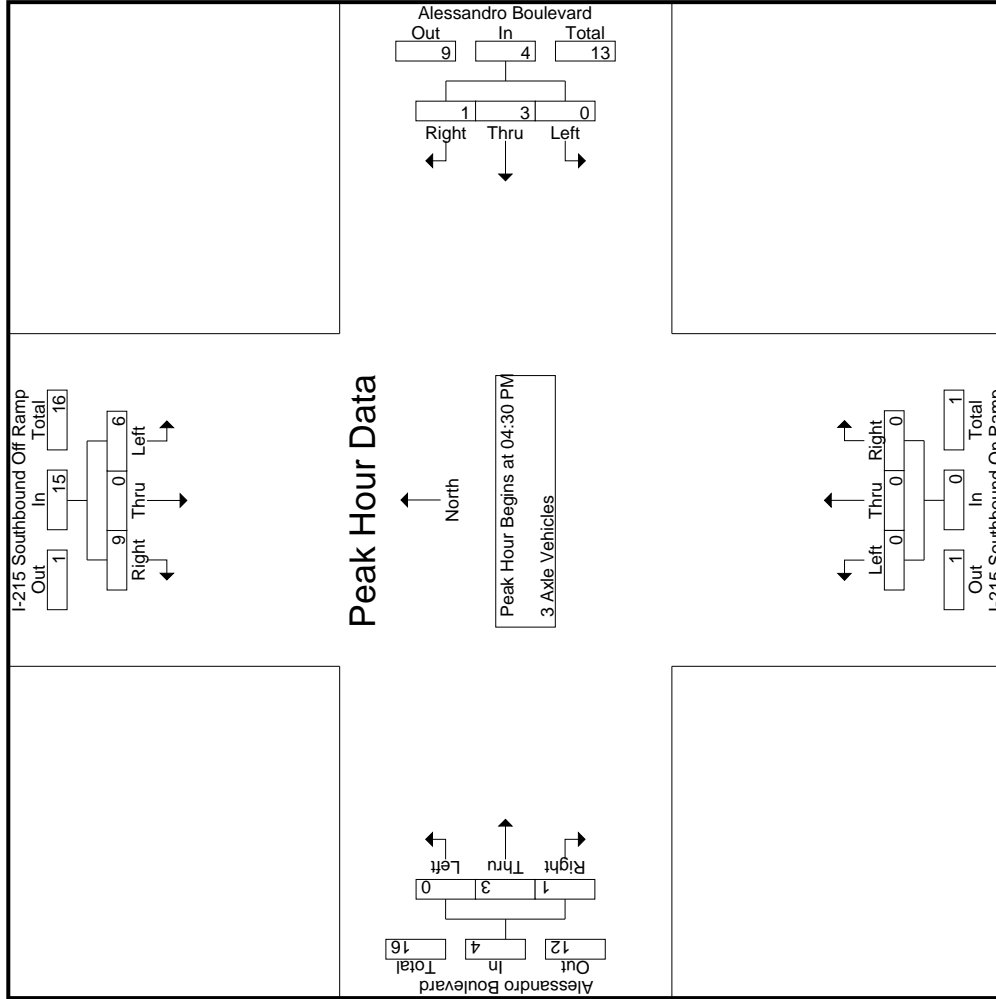

Counts Unlimited, Inc.
 PO Box 1178
 Corona, CA 92878
 (951)268-6268

File Name : 25_CRV_215S_Ales PM
 Site Code : 05121716
 Start Date : 11/30/2021
 Page No : 3

County of Riverside
 N/S: I-215 Southbound Ramps
 E/W: Alessandro Boulevard
 Weather: Clear

Start Time	I-215 Southbound Off Ramp Southbound			Alessandro Boulevard Westbound			I-215 Southbound On Ramp Northbound			Alessandro Boulevard Eastbound			Int. Total
	Left	Thru	Right	Left	Thru	Right	Left	Thru	Right	Left	Thru	Right	
Peak Hour Analysis From 04:30 PM to 05:15 PM - Peak 1 of 1	04:30 PM												
Peak Hour for Each Approach Begins at:	04:30 PM												
+0 mins.	0	0	2	0	0	0	0	0	0	0	0	1	1
+15 mins.	3	0	0	0	1	1	2	0	0	0	2	0	2
+30 mins.	1	0	5	0	2	0	2	0	0	0	1	0	1
+45 mins.	2	0	2	0	0	0	0	0	0	0	0	0	0
Total Volume	6	0	9	0	3	1	4	0	0	0	3	1	4
% App. Total	40	0	60	0	75	25	500	0	0	0	75	25	500
PHF	.500	.000	.450	.000	.375	.250	.500	.000	.000	.000	.375	.250	.500

Counts Unlimited, Inc.
 PO Box 1178
 Corona, CA 92878
 (951)268-6268

County of Riverside
 N/S: I-215 Southbound Ramps
 E/W: Alessandro Boulevard
 Weather: Clear

File Name : 25_CRV_215S_Ales PM
 Site Code : 05121716
 Start Date : 11/30/2021
 Page No : 1

Groups Printed- 4+ Axle Trucks

Start Time	I-215 Southbound Off Ramp Southbound				Alessandro Boulevard Westbound				I-215 Southbound On Ramp Northbound				Alessandro Boulevard Eastbound											
	Left	Thru	Right	RTOR	Left	Thru	Right	RTOR	Left	Thru	Right	RTOR	Left	Thru	Right	RTOR	Left	Thru	Right	RTOR	Exclu. Total	Inclu. Total	Int. Total	
04:00 PM	6	0	1	0	0	9	1	0	10	0	0	0	0	0	4	0	0	0	4	0	0	21	21	21
04:15 PM	4	0	4	0	0	3	0	0	3	0	0	0	0	0	5	1	0	0	6	0	0	17	17	17
04:30 PM	7	0	2	0	0	3	0	0	3	0	0	0	0	0	3	1	0	0	4	0	0	16	16	16
04:45 PM	6	0	4	1	0	1	0	0	1	0	0	0	0	0	0	0	0	0	0	1	1	11	11	12
Total	23	0	11	1	0	16	1	0	17	0	0	0	0	0	12	2	0	0	14	1	1	65	65	66
05:00 PM	5	0	8	1	0	2	0	0	2	0	0	0	0	0	1	0	0	0	1	1	0	16	16	17
05:15 PM	3	0	5	0	0	4	1	0	5	0	0	0	0	0	1	0	0	1	0	0	0	14	14	14
05:30 PM	2	0	2	0	0	4	0	0	4	0	0	0	0	0	5	0	0	5	0	0	0	13	13	13
05:45 PM	5	0	2	0	0	3	0	0	3	0	0	0	0	0	2	1	0	3	0	0	0	13	13	13
Total	15	0	17	1	0	13	1	0	14	0	0	0	0	0	9	1	0	10	1	1	56	56	57	57
Grand Total	38	0	28	2	0	29	2	0	31	0	0	0	0	0	21	3	0	24	2	2	121	121	123	123
% Apprch %	57.6	0	42.4			93.5	6.5		25.6	0	0	0	0	0	87.5	12.5		19.8	1.6	1.6	98.4	98.4	98.4	98.4
Total %	31.4	0	23.1			24	1.7		54.5	0	0	0	0	0	17.4	2.5		19.8	1.6	1.6	98.4	98.4	98.4	98.4

Start Time	I-215 Southbound Off Ramp Southbound				Alessandro Boulevard Westbound				I-215 Southbound On Ramp Northbound				Alessandro Boulevard Eastbound										
	Left	Thru	Right	RTOR	Left	Thru	Right	RTOR	Left	Thru	Right	RTOR	Left	Thru	Right	RTOR	Left	Thru	Right	RTOR	Exclu. Total	Inclu. Total	Int. Total
04:30 PM	7	0	2		0	3	0		0	0	0		0	0	0		0	3	1		4	4	16
04:45 PM	6	0	4		0	1	0		0	0	0		0	0	0		0	0	0		0	0	11
05:00 PM	5	0	8		0	2	0		0	0	0		0	1	0		0	1	0		1	1	16
05:15 PM	3	0	5		0	4	1		1	0	0		0	0	1		0	0	0		0	1	14
Total Volume	21	0	19		0	10	1		11	0	0		0	5	1		0	5	1		6	6	57
% App. Total	52.5	0	47.5		0	90.9	9.1		25.6	0	0		0	83.3	16.7		0	16.7	1.6		1.6	98.4	98.4
PHF	.750	.000	.594		.000	.625	.250		.550	.000	.000		.000	.417	.250		.000	.417	.250		.375	.375	.891

Peak Hour Analysis From 04:30 PM to 05:15 PM - Peak 1 of 1
 Peak Hour for Entire Intersection Begins at 04:30 PM

Counts Unlimited, Inc.
 PO Box 1178
 Corona, CA 92878
 (951)268-6268

File Name : 25_CRV_215S_Ales PM
 Site Code : 05121716
 Start Date : 11/30/2021
 Page No : 2

County of Riverside
 N/S: I-215 Southbound Ramps
 E/W: Alessandro Boulevard
 Weather: Clear

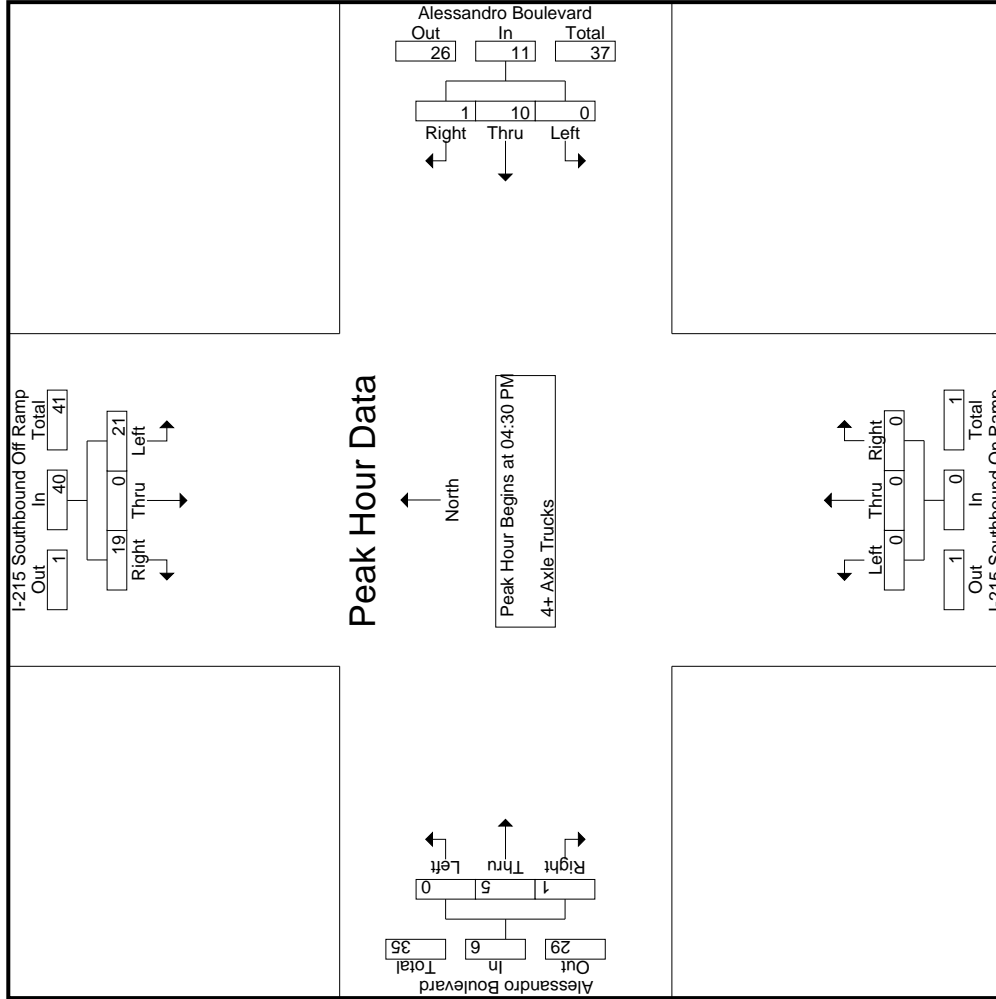

Counts Unlimited, Inc.
 PO Box 1178
 Corona, CA 92878
 (951)268-6268

File Name : 25_CRV_215S_Ales PM
 Site Code : 05121716
 Start Date : 11/30/2021
 Page No : 3

County of Riverside
 N/S: I-215 Southbound Ramps
 E/W: Alessandro Boulevard
 Weather: Clear

Start Time	I-215 Southbound Off Ramp Southbound			Alessandro Boulevard Westbound			I-215 Southbound On Ramp Northbound			Alessandro Boulevard Eastbound					
	Left	Thru	Right	Left	Thru	Right	Left	Thru	Right	Left	Thru	Right			
Peak Hour Analysis From 04:30 PM to 05:15 PM - Peak 1 of 1															
Peak Hour for Each Approach Begins at:	04:30 PM														
+0 mins.	7	0	2	0	3	0	0	3	0	0	0	0	0	3	1
+15 mins.	6	0	4	0	1	0	0	1	0	0	0	0	0	0	0
+30 mins.	5	0	8	0	2	0	0	2	0	0	0	0	0	1	0
+45 mins.	3	0	5	0	4	1	0	5	0	0	0	0	0	1	1
Total Volume	21	0	19	0	10	1	0	11	0	0	0	0	0	5	1
% App. Total	52.5	0	47.5	0	90.9	9.1	0	11	0	0	0	0	0	83.3	16.7
PHF	.750	.000	.594	.000	.625	.250	.000	.550	.000	.000	.417	.250	.000	.417	.375

Location: County of Riverside
 N/S: I-215 SB Ramps
 E/W: Alessandro Boulevard



Date: 11/30/2021
 Day: Tuesday

PEDESTRIANS

	North Leg I-215 SB Ramps	East Leg Alessandro Boulevard	South Leg I-215 SB Ramps	West Leg Alessandro Boulevard	
	Pedestrians	Pedestrians	Pedestrians	Pedestrians	
7:00 AM	0	0	0	0	0
7:15 AM	0	0	0	0	0
7:30 AM	0	0	0	0	0
7:45 AM	0	0	1	0	1
8:00 AM	0	0	0	0	0
8:15 AM	0	0	0	0	0
8:30 AM	0	0	0	0	0
8:45 AM	0	0	0	0	0
TOTAL VOLUMES:	0	0	1	0	1

	North Leg I-215 SB Ramps	East Leg Alessandro Boulevard	South Leg I-215 SB Ramps	West Leg Alessandro Boulevard	
	Pedestrians	Pedestrians	Pedestrians	Pedestrians	
4:00 PM	0	0	0	0	0
4:15 PM	0	0	0	0	0
4:30 PM	0	0	0	0	0
4:45 PM	0	0	0	0	0
5:00 PM	0	0	0	0	0
5:15 PM	0	0	0	0	0
5:30 PM	0	0	0	0	0
5:45 PM	0	0	0	0	0
TOTAL VOLUMES:	0	0	0	0	0

Location: County of Riverside
 N/S: I-215 SB Ramps
 E/W: Alessandro Boulevard



Date: 11/30/2021
 Day: Tuesday

BICYCLES

	Southbound I-215 SB Ramps			Westbound Alessandro Boulevard			Northbound I-215 SB Ramps			Eastbound Alessandro Boulevard			
	Left	Thru	Right	Left	Thru	Right	Left	Thru	Right	Left	Thru	Right	
7:00 AM	0	0	0	0	0	0	0	0	0	0	0	0	0
7:15 AM	0	0	0	0	0	0	0	0	0	0	0	0	0
7:30 AM	0	0	0	0	0	0	0	0	0	0	0	0	0
7:45 AM	0	0	0	0	0	0	0	0	0	0	0	0	0
8:00 AM	0	0	0	0	0	0	0	0	0	0	0	0	0
8:15 AM	0	0	0	0	0	0	0	0	0	0	0	0	0
8:30 AM	0	0	0	0	0	0	0	0	0	0	0	0	0
8:45 AM	0	0	0	0	0	0	0	0	0	0	0	0	0
TOTAL VOLUMES:	0	0	0	0	0	0	0	0	0	0	0	0	0

	Southbound I-215 SB Ramps			Westbound Alessandro Boulevard			Northbound I-215 SB Ramps			Eastbound Alessandro Boulevard			
	Left	Thru	Right	Left	Thru	Right	Left	Thru	Right	Left	Thru	Right	
4:00 PM	0	0	0	0	0	0	0	0	0	0	0	0	0
4:15 PM	0	0	0	0	0	0	0	0	0	0	0	0	0
4:30 PM	0	0	0	0	1	0	0	0	0	0	0	0	1
4:45 PM	0	0	0	0	0	0	0	0	0	0	0	0	0
5:00 PM	0	0	0	0	0	0	0	0	0	0	0	0	0
5:15 PM	0	0	0	0	0	0	0	0	0	0	0	0	0
5:30 PM	0	0	0	0	0	0	0	0	0	0	0	0	0
5:45 PM	0	0	0	0	0	0	0	0	0	0	0	0	0
TOTAL VOLUMES:	0	0	0	0	1	0	0	0	0	0	0	0	1

Counts Unlimited, Inc.
 PO Box 1178
 Corona, CA 92878
 (951)268-6268

County of Riverside
 N/S: I-215 Northbound Ramps
 E/W: Alessandro Boulevard
 Weather: Clear

File Name : 26_CRV_215N_Ales AM
 Site Code : 05121716
 Start Date : 11/30/2021
 Page No : 1

Groups Printed- Passenger Vehicles - Large 2 Axle Vehicles - 3 Axle Vehicles - 4+ Axle Trucks

Start Time	I-215 Northbound On Ramp Southbound						Alessandro Boulevard Westbound						I-215 Northbound Off Ramp Northbound						Alessandro Boulevard Eastbound					
	Left		Thru		Right		Left		Thru		Right		Left		Thru		Right		Left		Thru		Right	
07:00 AM	0	0	0	0	0	0	0	263	24	5	287	202	0	11	6	213	24	145	0	0	169	11	669	680
07:15 AM	0	0	0	0	0	0	0	299	25	7	324	226	0	20	12	246	10	156	0	0	166	19	736	755
07:30 AM	0	0	0	0	0	0	0	265	17	2	282	222	0	18	10	240	12	196	0	0	208	12	730	742
07:45 AM	0	0	0	0	0	0	0	265	17	0	282	232	0	33	18	265	10	225	0	0	235	18	782	800
Total	0	0	0	0	0	0	0	1092	83	14	1175	882	0	82	46	964	56	722	0	0	778	60	2917	2977
08:00 AM	0	0	0	0	0	0	0	279	14	0	293	241	0	25	16	266	13	187	0	0	200	16	759	775
08:15 AM	0	0	0	0	0	0	0	286	14	3	300	220	0	34	17	254	18	218	0	0	236	20	790	810
08:30 AM	0	0	0	0	0	0	0	245	21	4	266	229	0	42	26	271	23	200	0	0	223	30	760	790
08:45 AM	0	0	0	0	0	0	0	243	21	4	264	209	0	57	31	266	13	187	0	0	200	35	730	765
Total	0	0	0	0	0	0	0	1053	70	11	1123	899	0	158	90	1057	67	792	0	0	859	101	3039	3140
Grand Total	0	0	0	0	0	0	0	2145	153	25	2298	1781	0	240	136	2021	123	1514	0	0	1637	161	5956	6117
% Approach %	0	0	0	0	0	0	0	93.3	6.7	0	88.1	0	0	11.9	0	33.9	7.5	92.5	0	0	27.5	2.6	97.4	0
% Total %	0	0	0	0	0	0	0	36	2.6	0	38.6	29.9	0	4	0	0	2.1	25.4	0	0	0	0	0	0
Passenger Vehicles	0	0	0	0	0	0	0	2093	120	68	2230	1740	0	221	2087	87	1431	0	0	1518	0	0	5835	
% Large 2 Axle Vehicles	0	0	0	0	0	0	0	37	6	45	25	0	16	50	6	29	0	0	35	0	0	130		
% 3 Axle Vehicles	0	0	0	0	0	0	0	1.7	3.9	8	1.4	0	6.7	2.3	4.9	1.9	0	0	2.1	0	0	0		
% 4+ Axle Trucks	0	0	0	0	0	0	0	4	6	11	5	0	2	8	1	7	0	0	8	0	0	27		
% 4+ Axle Trucks	0	0	0	0	0	0	0	0.2	3.9	4	0.3	0	0.8	0.4	0.8	0.5	0	0	0.5	0	0	0.4		
% 4+ Axle Trucks	0	0	0	0	0	0	0	11	21	37	11	0	1	12	29	47	0	0	76	0	0	125		
% 4+ Axle Trucks	0	0	0	0	0	0	0	0.5	13.7	20	0.6	0	0.4	0.6	23.6	3.1	0	0	4.6	0	0	2		

Start Time	I-215 Northbound On Ramp Southbound						Alessandro Boulevard Westbound						I-215 Northbound Off Ramp Northbound						Alessandro Boulevard Eastbound					
	Left		Thru		Right		Left		Thru		Right		Left		Thru		Right		Left		Thru		Right	
07:45 AM	0	0	0	0	0	0	0	265	17	0	282	232	0	33	0	265	10	225	0	0	235	0	235	782
08:00 AM	0	0	0	0	0	0	0	279	14	0	293	241	0	25	0	266	13	187	0	0	200	0	200	759
08:15 AM	0	0	0	0	0	0	0	286	14	0	300	220	0	34	0	254	18	218	0	0	236	0	236	790
08:30 AM	0	0	0	0	0	0	0	245	21	0	266	229	0	42	0	271	23	200	0	0	223	0	223	760
Total Volume	0	0	0	0	0	0	0	1075	66	0	1141	922	0	134	0	1056	64	830	0	0	894	0	894	3091
% App. Total	0	0	0	0	0	0	0	94.2	5.8	0	94.2	87.3	0	12.7	0	92.8	7.2	92.8	0	0	94.7	0	94.7	.978
PHF	.000	.000	.000	.000	.000	.000	.000	.940	.786	.951	.956	.000	.798	.000	.974	.696	.922	.000	.000	.947	.000	.947	.978	

Peak Hour Analysis From 07:00 AM to 08:45 AM - Peak 1 of 1
 Peak Hour for Entire Intersection Begins at 07:45 AM

Counts Unlimited, Inc.
 PO Box 1178
 Corona, CA 92878
 (951)268-6268

County of Riverside
 N/S: I-215 Northbound Ramps
 E/W: Alessandro Boulevard
 Weather: Clear

File Name : 26_CRV_215N_Ales AM
 Site Code : 05121716
 Start Date : 11/30/2021
 Page No : 2

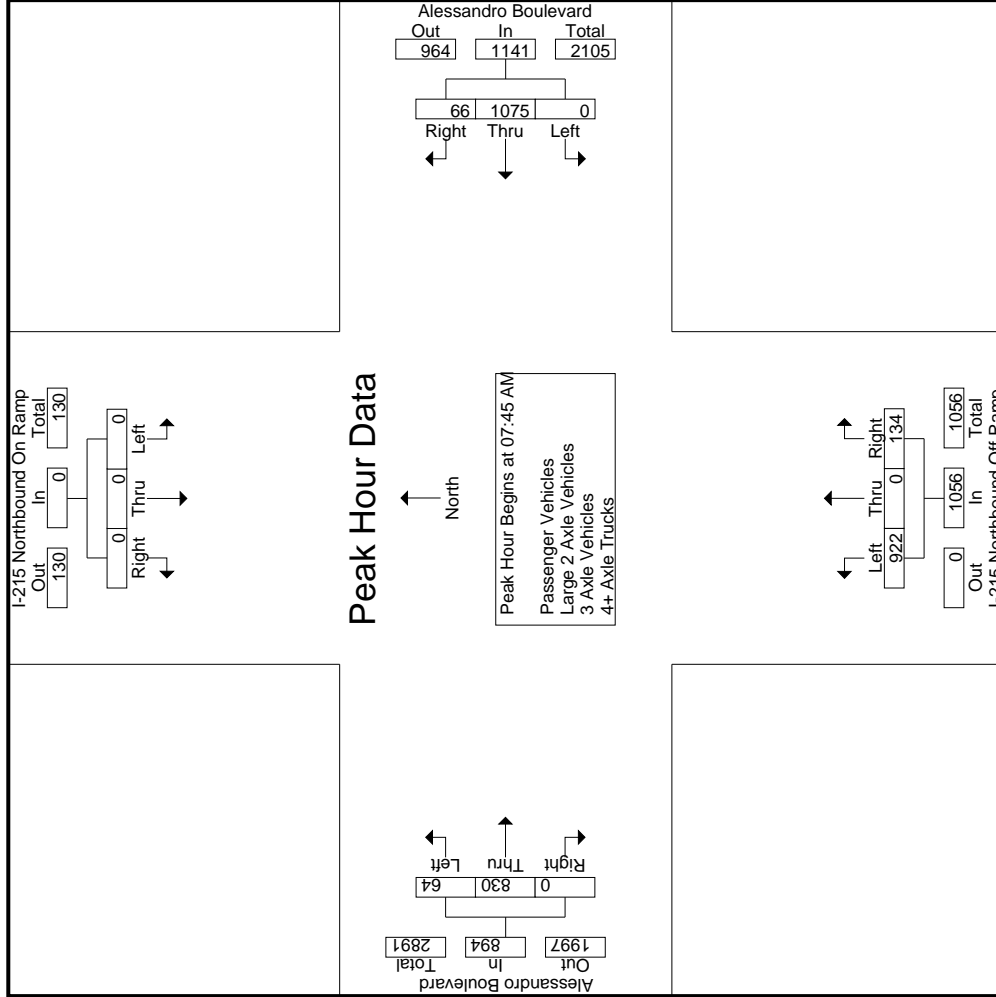

Counts Unlimited, Inc.
 PO Box 1178
 Corona, CA 92878
 (951)268-6268

File Name : 26_CRV_215N_Ales AM
 Site Code : 05121716
 Start Date : 11/30/2021
 Page No : 3

County of Riverside
 N/S: I-215 Northbound Ramps
 E/W: Alessandro Boulevard
 Weather: Clear

Start Time	I-215 Northbound On Ramp Southbound			Alessandro Boulevard Westbound			I-215 Northbound Off Ramp Northbound			Alessandro Boulevard Eastbound			Int. Total	
	Left	Thru	Right	Left	Thru	Right	Left	Thru	Right	Left	Thru	Right		App. Total
Peak Hour Analysis From 07:00 AM to 08:45 AM - Peak 1 of 1	Peak Hour for Each Approach Begins at:													
	07:00 AM			07:15 AM			08:00 AM			07:45 AM				
+0 mins.	0	0	0	0	299	25	324	0	25	266	10	225	0	235
+15 mins.	0	0	0	0	265	17	282	0	34	254	13	187	0	200
+30 mins.	0	0	0	0	265	17	282	0	42	271	18	218	0	236
+45 mins.	0	0	0	0	279	14	293	0	57	266	23	200	0	223
Total Volume	0	0	0	0	1108	73	1181	0	158	1057	64	830	0	894
% App. Total	0	0	0	0	93.8	6.2	91.1	0	14.9	97.5	7.2	92.8	0	94.7
PHF	.000	.000	.000	.000	.926	.730	.911	.000	.693	.975	.696	.922	.000	.947

Groups Printed- Passenger Vehicles

Start Time	I-215 Northbound On Ramp Southbound					Alessandro Boulevard Westbound					I-215 Northbound Off Ramp Northbound					Alessandro Boulevard Eastbound							
	Left	Thru	Right	RTOR	App. Total	Left	Thru	Right	RTOR	App. Total	Left	Thru	Right	RTOR	App. Total	Left	Thru	Right	RTOR	App. Total	Exclu. Total	Inclu. Total	Int. Total
07:00 AM	0	0	0	0	0	0	259	16	3	275	198	0	10	5	208	22	135	0	0	157	8	640	648
07:15 AM	0	0	0	0	0	0	294	20	3	314	221	0	17	10	238	7	146	0	0	153	13	705	718
07:30 AM	0	0	0	0	0	0	261	13	1	274	219	0	17	10	236	6	187	0	0	193	11	703	714
07:45 AM	0	0	0	0	0	0	260	13	0	273	228	0	30	15	258	6	215	0	0	221	15	752	767
Total	0	0	0	0	0	0	1074	62	7	1136	866	0	74	40	940	41	683	0	0	724	47	2800	2847
08:00 AM	0	0	0	0	0	0	276	13	0	289	235	0	23	15	258	8	175	0	0	183	15	730	745
08:15 AM	0	0	0	0	0	0	279	10	3	289	211	0	30	15	241	14	208	0	0	222	18	752	770
08:30 AM	0	0	0	0	0	0	233	20	4	253	223	0	40	25	263	18	195	0	0	213	29	729	758
08:45 AM	0	0	0	0	0	0	231	15	3	246	205	0	54	31	259	6	170	0	0	176	34	681	715
Total	0	0	0	0	0	0	1019	58	10	1077	874	0	147	86	1021	46	748	0	0	794	96	2892	2988
Grand Total	0	0	0	0	0	0	2093	120	17	2213	1740	0	221	126	1961	87	1431	0	0	1518	143	5692	5835
% Approach	0	0	0	0	0	0	94.6	5.4		88.7	0	11.3			34.5	5.7	94.3	0	0	26.7	2.5	97.5	
Total %	0	0	0	0	0	0	36.8	2.1		38.9	30.6	0	3.9			1.5	25.1	0	0				

Start Time	I-215 Northbound On Ramp Southbound					Alessandro Boulevard Westbound					I-215 Northbound Off Ramp Northbound					Alessandro Boulevard Eastbound							
	Left	Thru	Right	RTOR	App. Total	Left	Thru	Right	RTOR	App. Total	Left	Thru	Right	RTOR	App. Total	Left	Thru	Right	RTOR	App. Total	Exclu. Total	Inclu. Total	Int. Total
07:45 AM	0	0	0	0	0	0	260	13		273	228	0	30		258	6	215	0		221	0	221	752
08:00 AM	0	0	0	0	0	0	276	13		289	235	0	23		258	8	175	0		183	0	183	730
08:15 AM	0	0	0	0	0	0	279	10		289	211	0	30		241	14	208	0		222	0	222	752
08:30 AM	0	0	0	0	0	0	233	20		253	223	0	40		263	18	195	0		213	0	213	729
Total Volume	0	0	0	0	0	0	1048	56		1104	897	0	123		1020	46	793	0		839	0	839	2963
% App. Total	0	0	0	0	0	0	94.9	5.1		87.9	0	12.1			34.5	5.5	94.5	0		26.7	2.5	97.5	
PHF	.000	.000	.000	.000	.000	.000	.939	.700		.955	.954	.000	.769		.970	.639	.922	.000		.945	.000	.945	.985

Peak Hour Analysis From 07:45 AM to 08:30 AM - Peak 1 of 1
 Peak Hour for Entire Intersection Begins at 07:45 AM

Counts Unlimited, Inc.
 PO Box 1178
 Corona, CA 92878
 (951)268-6268

File Name : 26_CRV_215N_Ales AM
 Site Code : 05121716
 Start Date : 11/30/2021
 Page No : 2

County of Riverside
 N/S: I-215 Northbound Ramps
 E/W: Alessandro Boulevard
 Weather: Clear

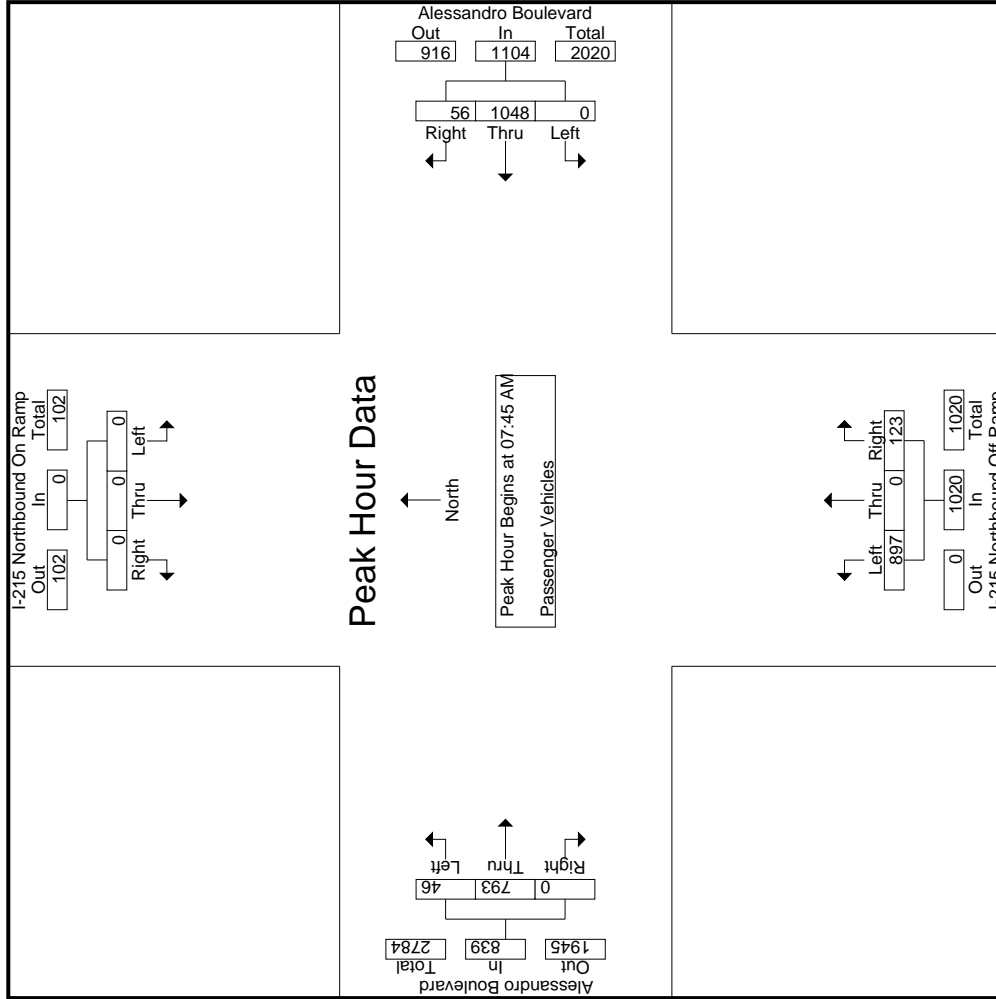

Counts Unlimited, Inc.
 PO Box 1178
 Corona, CA 92878
 (951)268-6268

File Name : 26_CRV_215N_Ales AM
 Site Code : 05121716
 Start Date : 11/30/2021
 Page No : 3

County of Riverside
 N/S: I-215 Northbound Ramps
 E/W: Alessandro Boulevard
 Weather: Clear

Start Time	I-215 Northbound On Ramp Southbound			Alessandro Boulevard Westbound			I-215 Northbound Off Ramp Northbound			Alessandro Boulevard Eastbound			Int. Total	
	Left	Thru	Right	Left	Thru	Right	Left	Thru	Right	Left	Thru	Right		App. Total
Peak Hour Analysis From 07:45 AM to 08:30 AM - Peak 1 of 1	07:45 AM													
Peak Hour for Each Approach Begins at:	07:45 AM													
+0 mins.	0	0	0	0	260	13	273	0	30	258	6	215	0	221
+15 mins.	0	0	0	0	276	13	289	0	23	258	8	175	0	183
+30 mins.	0	0	0	0	279	10	289	0	30	241	14	208	0	222
+45 mins.	0	0	0	0	233	20	253	0	40	263	18	195	0	213
Total Volume	0	0	0	0	1048	56	1104	0	123	1020	46	793	0	839
% App. Total	0	0	0	0	94.9	5.1	95.5	0	12.1	97.0	5.5	94.5	0	94.5
PHF	.000	.000	.000	.000	.939	.700	.955	.000	.769	.970	.639	.922	.000	.945

Groups Printed- Large 2 Axle Vehicles

Start Time	I-215 Northbound On Ramp Southbound				Alessandro Boulevard Westbound				I-215 Northbound Off Ramp Northbound				Alessandro Boulevard Eastbound			
	Left	Thru	Right	RTOR	Left	Thru	Right	RTOR	Left	Thru	Right	RTOR	Left	Thru	Right	RTOR
07:00 AM	0	0	0	0	0	3	1	0	4	3	0	1	4	1	2	0
07:15 AM	0	0	0	0	0	5	1	1	6	2	0	2	4	0	7	0
07:30 AM	0	0	0	0	0	2	0	0	2	1	0	1	2	1	2	0
07:45 AM	0	0	0	0	0	4	1	0	5	3	0	3	6	0	3	0
Total	0	0	0	0	0	14	3	1	17	9	0	7	16	2	14	0
08:00 AM	0	0	0	0	0	3	0	0	3	5	0	2	7	1	7	0
08:15 AM	0	0	0	0	0	6	0	0	6	7	0	3	10	3	3	0
08:30 AM	0	0	0	0	0	6	0	0	6	3	0	1	4	2	3	0
08:45 AM	0	0	0	0	0	8	3	1	11	1	0	3	4	1	2	0
Total	0	0	0	0	0	23	3	1	26	16	0	9	25	4	15	0
Grand Total	0	0	0	0	0	37	6	2	43	25	0	16	41	6	29	0
% Apprch %	0	0	0	0	0	86	14		36.1	61	0	39	34.5	17.1	82.9	0
Total %	0	0	0	0	0	31.1	5			21	0	13.4		5	24.4	0

Start Time	I-215 Northbound On Ramp Southbound				Alessandro Boulevard Westbound				I-215 Northbound Off Ramp Northbound				Alessandro Boulevard Eastbound			
	Left	Thru	Right	RTOR	Left	Thru	Right	RTOR	Left	Thru	Right	RTOR	Left	Thru	Right	RTOR
07:45 AM	0	0	0	0	0	4	1	5	5	3	0	3	6	0	3	0
08:00 AM	0	0	0	0	0	3	0	3	3	5	0	2	7	1	7	0
08:15 AM	0	0	0	0	0	6	0	6	6	7	0	3	10	0	3	0
08:30 AM	0	0	0	0	0	6	0	6	6	3	0	1	4	3	3	0
Total Volume	0	0	0	0	0	19	1	20	20	18	0	9	27	3	16	0
% App. Total	0	0	0	0	0	95	5	66.7	0	66.7	0	33.3	0	15.8	84.2	0
PHF	.000	.000	.000	.000	.000	.792	.250	.833	.000	.643	.000	.750	.675	.375	.571	.000

Peak Hour Analysis From 07:45 AM to 08:30 AM - Peak 1 of 1
 Peak Hour for Entire Intersection Begins at 07:45 AM

Counts Unlimited, Inc.
 PO Box 1178
 Corona, CA 92878
 (951)268-6268

File Name : 26_CRV_215N_Ales AM
 Site Code : 05121716
 Start Date : 11/30/2021
 Page No : 2

County of Riverside
 N/S: I-215 Northbound Ramps
 E/W: Alessandro Boulevard
 Weather: Clear

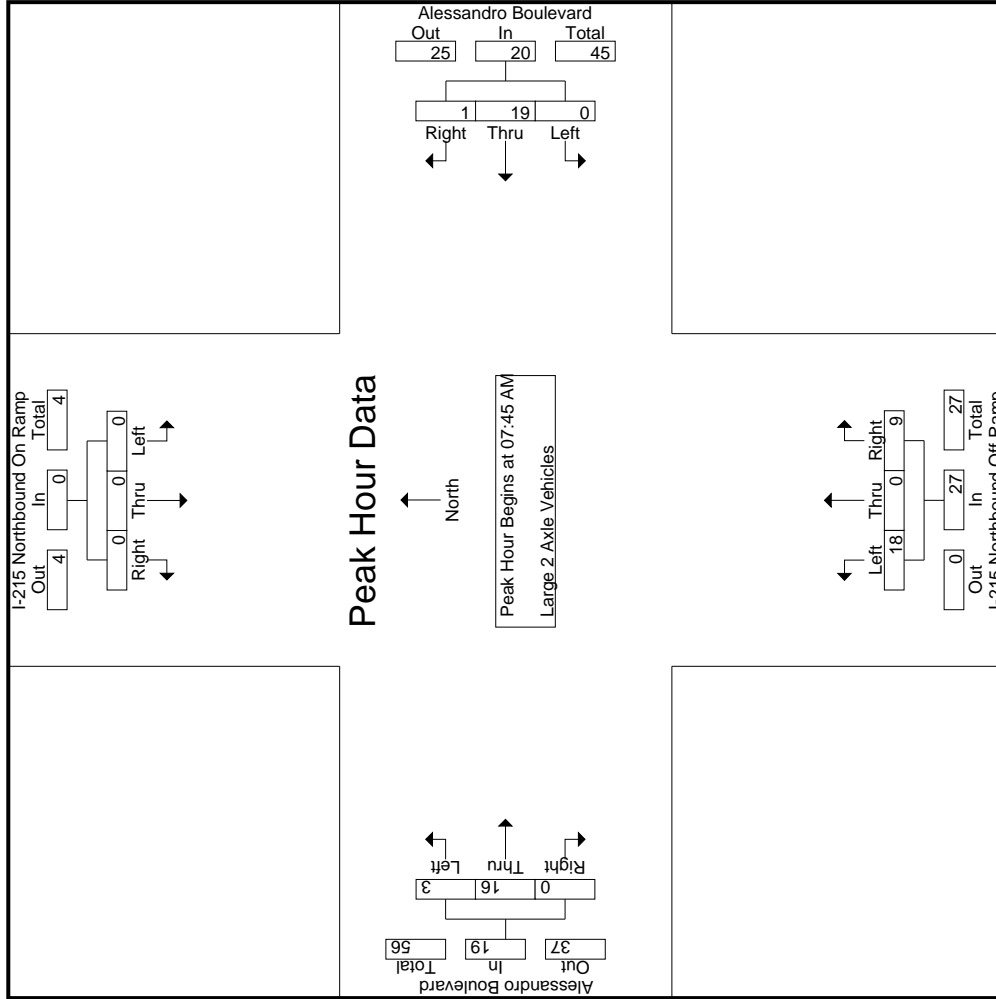

Counts Unlimited, Inc.
 PO Box 1178
 Corona, CA 92878
 (951)268-6268

County of Riverside
 N/S: I-215 Northbound Ramps
 E/W: Alessandro Boulevard
 Weather: Clear

File Name : 26_CRV_215N_Ales AM
 Site Code : 05121716
 Start Date : 11/30/2021
 Page No : 3

Start Time	I-215 Northbound On Ramp Southbound			Alessandro Boulevard Westbound			I-215 Northbound Off Ramp Northbound			Alessandro Boulevard Eastbound			Int. Total
	Left	Thru	Right	Left	Thru	Right	Left	Thru	Right	Left	Thru	Right	
Peak Hour Analysis From 07:45 AM to 08:30 AM - Peak 1 of 1	Peak Hour for Each Approach Begins at:												
	07:45 AM			07:45 AM			07:45 AM			07:45 AM			
+0 mins.	0	0	0	0	4	1	5	3	0	3	0	0	3
+15 mins.	0	0	0	0	3	0	3	5	0	2	0	0	8
+30 mins.	0	0	0	0	6	0	6	7	0	3	0	0	3
+45 mins.	0	0	0	0	6	0	6	3	0	1	4	0	5
Total Volume	0	0	0	0	19	1	20	18	0	9	27	0	19
% App. Total	0	0	0	0	95	5	33.3	66.7	0	33.3	84.2	0	0
PHF	.000	.000	.000	.000	.792	.250	.833	.643	.000	.750	.675	.375	.594

Counts Unlimited, Inc.
 PO Box 1178
 Corona, CA 92878
 (951)268-6268

County of Riverside
 N/S: I-215 Northbound Ramps
 E/W: Alessandro Boulevard
 Weather: Clear

File Name : 26_CRV_215N_Ales AM
 Site Code : 05121716
 Start Date : 11/30/2021
 Page No : 1

Groups Printed- 3 Axle Vehicles

Start Time	I-215 Northbound On Ramp Southbound					Alessandro Boulevard Westbound					I-215 Northbound Off Ramp Northbound					Alessandro Boulevard Eastbound							
	Left	Thru	Right	RTOR	App. Total	Left	Thru	Right	RTOR	App. Total	Left	Thru	Right	RTOR	App. Total	Left	Thru	Right	RTOR	App. Total	Exclu. Total	Inclu. Total	Int. Total
07:00 AM	0	0	0	0	0	0	0	2	1	2	1	0	0	0	1	0	2	0	0	2	1	5	6
07:15 AM	0	0	0	0	0	0	0	1	0	1	0	0	0	0	0	0	1	0	0	1	0	2	2
07:30 AM	0	0	0	0	0	0	0	1	0	1	0	0	0	0	0	0	0	0	0	0	0	1	1
07:45 AM	0	0	0	0	0	0	1	1	0	2	1	0	0	0	1	0	0	0	0	0	0	3	3
Total	0	0	0	0	0	0	1	5	1	6	2	0	0	0	2	0	3	0	0	3	1	11	12
08:00 AM	0	0	0	0	0	0	0	0	0	0	0	0	0	0	0	0	2	0	0	2	0	2	2
08:15 AM	0	0	0	0	0	0	0	1	0	1	0	0	1	0	2	0	1	0	0	1	0	4	4
08:30 AM	0	0	0	0	0	0	3	0	0	3	1	0	1	1	2	0	1	0	0	1	1	6	7
08:45 AM	0	0	0	0	0	0	0	0	0	0	0	0	0	0	1	1	0	0	0	1	0	2	2
Total	0	0	0	0	0	0	3	1	0	4	3	0	2	1	5	1	4	0	0	5	1	14	15
Grand Total	0	0	0	0	0	0	4	6	1	10	5	0	2	1	7	1	7	0	0	8	2	25	27
% Approach	0	0	0	0	0	0	40	60		71.4	0	28.6			12.5	4	87.5	0		32	7.4	92.6	
Total %	0	0	0	0	0	0	16	24		40	0	8			28	4	28	0		32			

Start Time	I-215 Northbound On Ramp Southbound					Alessandro Boulevard Westbound					I-215 Northbound Off Ramp Northbound					Alessandro Boulevard Eastbound							
	Left	Thru	Right	RTOR	App. Total	Left	Thru	Right	RTOR	App. Total	Left	Thru	Right	RTOR	App. Total	Left	Thru	Right	RTOR	App. Total	Exclu. Total	Inclu. Total	Int. Total
07:45 AM	0	0	0	0	0	0	0	1	0	1	1	0	0	0	1	0	0	0	0	0	0	0	0
08:00 AM	0	0	0	0	0	0	0	0	0	0	0	0	0	0	0	0	0	0	0	0	0	0	0
08:15 AM	0	0	0	0	0	0	0	1	0	1	1	0	1	0	2	0	1	0	0	1	0	1	1
08:30 AM	0	0	0	0	0	0	0	0	0	0	0	0	0	0	0	0	0	0	0	0	0	0	0
Total Volume	0	0	0	0	0	0	0	2	0	2	3	0	2	0	5	0	4	0	0	4	0	4	4
% App. Total	0	0	0	0	0	0	66.7	33.3		33.3	.500	.500	.000	.500	.625	.000	.500	.000	.500	.625	.000	.500	.625
PHF	.000	.000	.000	.000	.000	.000	.333	.500		.500	.750	.000	.500	.000	.625	.000	.500	.000	.500	.625	.000	.500	.625

Peak Hour Analysis From 07:45 AM to 08:30 AM - Peak 1 of 1
 Peak Hour for Entire Intersection Begins at 07:45 AM

Counts Unlimited, Inc.
 PO Box 1178
 Corona, CA 92878
 (951)268-6268

County of Riverside
 N/S: I-215 Northbound Ramps
 E/W: Alessandro Boulevard
 Weather: Clear

File Name : 26_CRV_215N_Ales AM
 Site Code : 05121716
 Start Date : 11/30/2021
 Page No : 2

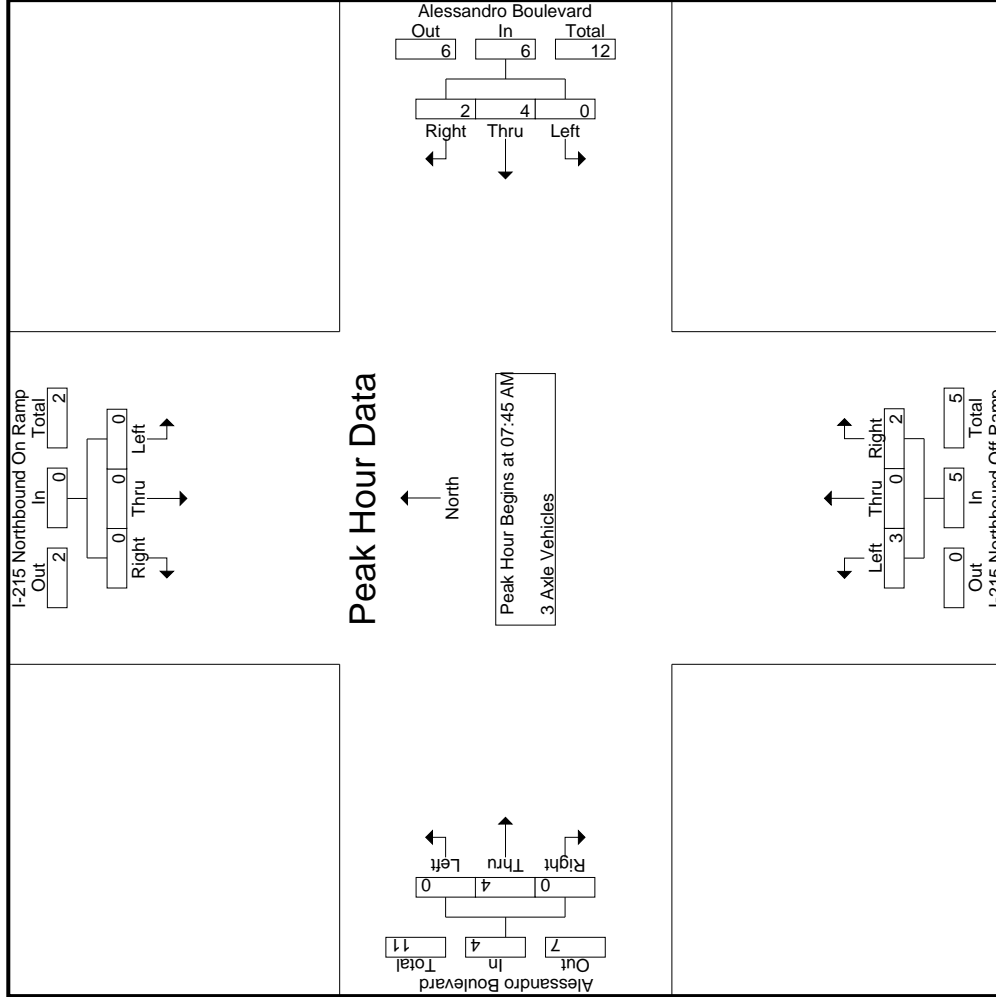

Counts Unlimited, Inc.
 PO Box 1178
 Corona, CA 92878
 (951)268-6268

File Name : 26_CRV_215N_Ales AM
 Site Code : 05121716
 Start Date : 11/30/2021
 Page No : 3

County of Riverside
 N/S: I-215 Northbound Ramps
 E/W: Alessandro Boulevard
 Weather: Clear

Start Time	I-215 Northbound On Ramp Southbound			Alessandro Boulevard Westbound			I-215 Northbound Off Ramp Northbound			Alessandro Boulevard Eastbound			Int. Total	
	Left	Thru	Right	Left	Thru	Right	Left	Thru	Right	Left	Thru	Right		App. Total
Peak Hour Analysis From 07:45 AM to 08:30 AM - Peak 1 of 1	Peak Hour for Each Approach Begins at:													
	07:45 AM			07:45 AM			07:45 AM			07:45 AM				
+0 mins.	0	0	0	1	1	1	2	0	0	0	0	0	0	0
+15 mins.	0	0	0	0	0	0	0	0	0	0	2	0	0	2
+30 mins.	0	0	0	0	1	1	1	1	0	1	1	0	0	1
+45 mins.	0	0	0	3	0	0	3	0	1	1	0	1	0	1
Total Volume	0	0	0	4	2	2	6	0	0	2	4	0	0	4
% App. Total	0	0	0	66.7	33.3	33.3	500	0	0	40	100	0	0	4
PHF	.000	.000	.000	.333	.500	.500	.500	.000	.000	.500	.500	.000	.000	.500

Counts Unlimited, Inc.
 PO Box 1178
 Corona, CA 92878
 (951)268-6268

County of Riverside
 N/S: I-215 Northbound Ramps
 E/W: Alessandro Boulevard
 Weather: Clear

File Name : 26_CRV_215N_Ales AM
 Site Code : 05121716
 Start Date : 11/30/2021
 Page No : 1

Groups Printed- 4+ Axle Trucks

Start Time	I-215 Northbound On Ramp Southbound				Alessandro Boulevard Westbound				I-215 Northbound Off Ramp Northbound				Alessandro Boulevard Eastbound					
	Left	Thru	Right	RTOR	App. Total	Left	Thru	Right	RTOR	App. Total	Left	Thru	Right	RTOR	App. Total	Exclu. Total	Inclu. Total	Int. Total
07:00 AM	0	0	0	0	0	0	0	0	0	6	0	0	0	0	7	1	13	14
07:15 AM	0	0	0	0	3	0	3	3	0	3	0	1	0	0	5	3	12	15
07:30 AM	0	0	0	0	5	2	3	1	0	2	0	0	0	0	12	1	19	20
07:45 AM	0	0	0	0	2	0	0	0	0	2	0	0	0	0	11	0	13	13
Total	0	0	0	0	16	3	13	5	0	6	5	0	1	0	35	5	57	62
08:00 AM	0	0	0	0	1	0	1	0	0	1	0	0	0	0	7	0	9	9
08:15 AM	0	0	0	0	4	1	3	0	0	4	1	0	0	0	10	0	15	15
08:30 AM	0	0	0	0	4	3	1	0	0	2	3	1	0	0	4	0	10	10
08:45 AM	0	0	0	0	7	4	3	0	0	2	5	15	0	0	20	0	29	29
Total	0	0	0	0	16	8	8	0	0	6	16	25	0	0	41	0	63	63
Grand Total	0	0	0	0	32	11	21	5	0	12	29	47	0	0	76	5	120	125
T-Approch %	0	0	0	0	34.4	65.6			0	91.7	0	8.3		0	38.2	61.8		
Total %	0	0	0	0	9.2	17.5			0	9.2	24.2	39.2	0	0	63.3	4	96	

Start Time	I-215 Northbound On Ramp Southbound				Alessandro Boulevard Westbound				I-215 Northbound Off Ramp Northbound				Alessandro Boulevard Eastbound					
	Left	Thru	Right	RTOR	App. Total	Left	Thru	Right	RTOR	App. Total	Left	Thru	Right	RTOR	App. Total	Exclu. Total	Inclu. Total	Int. Total
07:45 AM	0	0	0	0	0	0	0	0	0	2	0	0	0	0	0	0	11	13
08:00 AM	0	0	0	0	1	0	1	0	0	1	1	0	0	0	1	0	7	9
08:15 AM	0	0	0	0	3	0	3	0	0	4	1	0	0	0	1	0	10	15
08:30 AM	0	0	0	0	1	3	1	0	0	4	2	1	0	0	2	0	4	10
Total Volume	0	0	0	0	7	4	7	0	0	11	4	0	0	0	4	15	17	47
% App. Total	0	0	0	0	36.4	63.6			0	100	0	0	0	0	46.9	53.1		
PHF	.000	.000	.000	.000	.000	.333	.583	.688	.500	.000	.500	.938	.000	.000	.727	.000	.783	

Peak Hour Analysis From 07:45 AM to 08:30 AM - Peak 1 of 1
 Peak Hour for Entire Intersection Begins at 07:45 AM

Counts Unlimited, Inc.
 PO Box 1178
 Corona, CA 92878
 (951)268-6268

File Name : 26_CRV_215N_Ales AM
 Site Code : 05121716
 Start Date : 11/30/2021
 Page No : 2

County of Riverside
 N/S: I-215 Northbound Ramps
 E/W: Alessandro Boulevard
 Weather: Clear

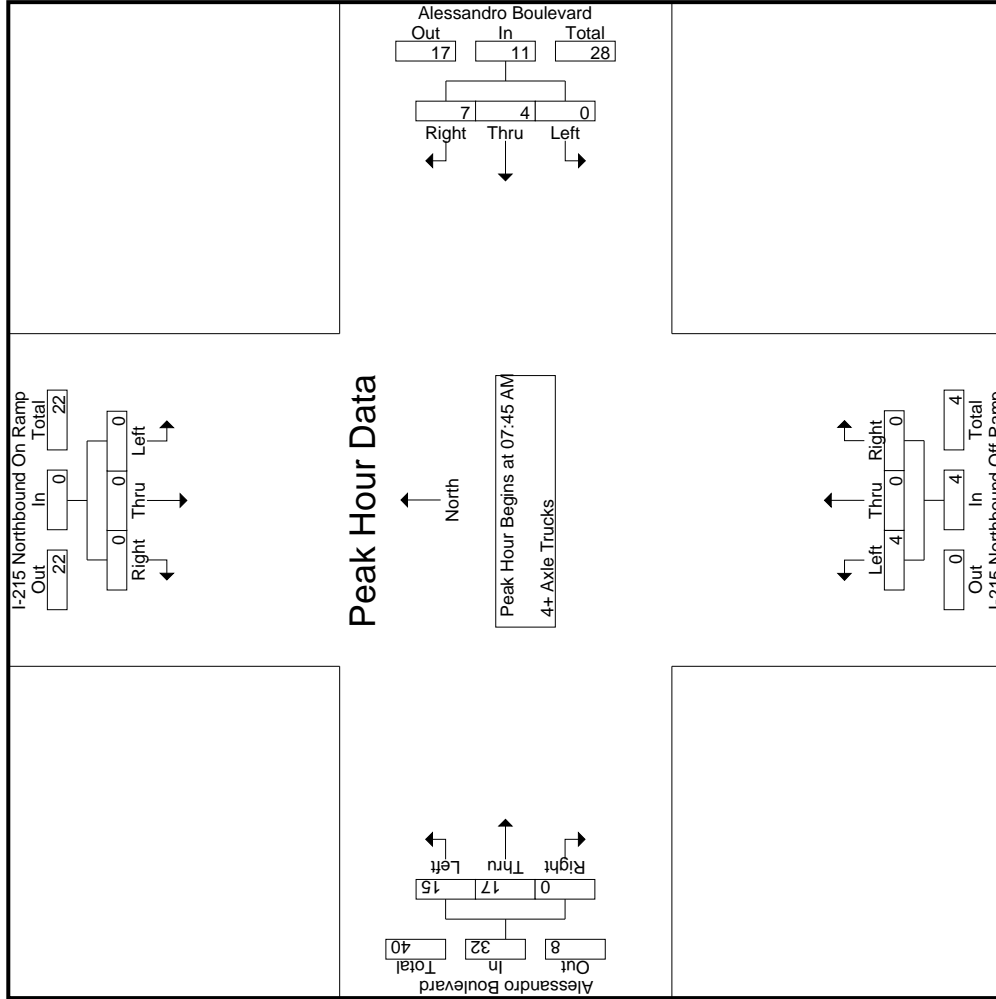

Counts Unlimited, Inc.
 PO Box 1178
 Corona, CA 92878
 (951)268-6268

File Name : 26_CRV_215N_Ales AM
 Site Code : 05121716
 Start Date : 11/30/2021
 Page No : 3

County of Riverside
 N/S: I-215 Northbound Ramps
 E/W: Alessandro Boulevard
 Weather: Clear

Start Time	I-215 Northbound On Ramp Southbound			Alessandro Boulevard Westbound			I-215 Northbound Off Ramp Northbound			Alessandro Boulevard Eastbound			Int. Total	
	Left	Thru	Right	Left	Thru	Right	Left	Thru	Right	Left	Thru	Right		App. Total
Peak Hour Analysis From 07:45 AM to 08:30 AM - Peak 1 of 1	Peak Hour for Each Approach Begins at:													
	07:45 AM			07:45 AM			07:45 AM			07:45 AM				
+0 mins.	0	0	0	0	0	2	0	0	0	0	0	0	0	11
+15 mins.	0	0	0	0	0	1	0	0	0	0	0	0	0	7
+30 mins.	0	0	0	0	0	4	1	0	0	1	4	3	0	10
+45 mins.	0	0	0	0	3	1	4	2	0	0	3	1	0	4
Total Volume	0	0	0	0	4	7	11	4	0	0	15	17	0	32
% App. Total	0	0	0	0	36.4	63.6	100	0	0	0	46.9	53.1	0	0
PHF	.000	.000	.000	.000	.333	.583	.688	.500	.000	.000	.938	.607	.000	.727

Counts Unlimited, Inc.
 PO Box 1178
 Corona, CA 92878
 (951)268-6268

County of Riverside
 N/S: I-215 Northbound Ramps
 E/W: Alessandro Boulevard
 Weather: Clear

File Name : 26_CRV_215N_Ales PM
 Site Code : 05121716
 Start Date : 11/30/2021
 Page No : 1

Groups Printed- Passenger Vehicles - Large 2 Axle Vehicles - 3 Axle Vehicles - 4+ Axle Trucks

Start Time	I-215 Northbound On Ramp Southbound						Alessandro Boulevard Westbound						I-215 Northbound Off Ramp Northbound						Alessandro Boulevard Eastbound											
	Left		Thru		Right		Left		Thru		Right		Left		Thru		Right		Left		Thru		Right		Left		Thru		Right	
	RTOR	App. Total	RTOR	App. Total	RTOR	App. Total	RTOR	App. Total	RTOR	App. Total	RTOR	App. Total	RTOR	App. Total	RTOR	App. Total	RTOR	App. Total	RTOR	App. Total	RTOR	App. Total	RTOR	App. Total	RTOR	App. Total	RTOR	App. Total	RTOR	App. Total
04:00 PM	0	0	0	0	0	0	0	282	21	3	73	28	251	21	364	0	0	385	21	364	0	0	385	31	939	970				
04:15 PM	0	0	0	0	0	0	0	223	22	6	81	27	282	19	341	0	0	360	19	341	0	0	360	33	887	920				
04:30 PM	0	0	0	0	0	0	0	278	24	5	46	16	240	20	363	0	0	383	20	363	0	0	383	21	925	946				
04:45 PM	0	0	0	0	0	0	0	255	26	6	57	17	284	15	402	0	0	417	15	402	0	0	417	23	982	1005				
Total	0	0	0	0	0	0	0	1038	93	20	257	88	1057	75	1470	0	0	1545	75	1470	0	0	1545	108	3733	3841				
05:00 PM	0	0	0	0	0	0	0	231	29	10	38	18	232	22	408	0	0	430	22	408	0	0	430	28	922	950				
05:15 PM	0	0	0	0	0	0	0	258	33	3	87	23	288	25	426	0	0	451	25	426	0	0	451	26	1030	1056				
05:30 PM	0	0	0	0	0	0	0	222	24	6	88	23	284	36	394	0	0	430	36	394	0	0	430	29	960	989				
05:45 PM	0	0	0	0	0	0	0	207	19	2	70	19	223	14	392	0	0	406	14	392	0	0	406	22	855	877				
Total	0	0	0	0	0	0	0	918	105	22	283	83	1027	97	1620	0	0	1717	97	1620	0	0	1717	105	3767	3872				
Grand Total	0	0	0	0	0	0	0	1956	198	42	540	171	2084	172	3090	0	0	3262	172	3090	0	0	3262	213	7500	7713				
T-Approch %	0	0	0	0	0	0	0	90.8	9.2	0	25.9	0	0	5.3	94.7	0	0	43.5	5.3	94.7	0	0	43.5	2.8	97.2	0				
T-Total %	0	0	0	0	0	0	0	26.1	2.6	0	7.2	0	0	2.3	41.2	0	0	0	2.3	41.2	0	0	0	0	0	0				
% Passenger Vehicles	0	0	0	0	0	0	0	1920	172	0	531	97.7	2185	151	3006	0	0	3157	151	3006	0	0	3157	0	0	7473				
% Large 2 Axle Vehicles	0	0	0	0	0	0	0	98.2	86.9	92.9	98.3	96.9	87.8	97.3	0	0	96.8	87.8	97.3	0	0	96.8	0	0	96.9					
% 3 Axle Vehicles	0	0	0	0	0	0	0	1.1	2	0	1.1	1.8	2.3	0.9	0	0	1	4	29	0	0	33	0	0	101					
% 4+ Axle Trucks	0	0	0	0	0	0	0	0.2	3	4.8	0.4	0.6	0.6	0.3	0	0	0.3	1	10	0	0	11	0	0	1.3					
% 4+ Axle Trucks	0	0	0	0	0	0	0	11	16	1	1	21	16	45	0	0	61	16	45	0	0	61	0	0	110					
% 4+ Axle Trucks	0	0	0	0	0	0	0	0.6	8.1	2.4	0.2	0.9	9.3	1.5	0	0	1.9	9.3	1.5	0	0	1.9	0	0	1.4					

Start Time	I-215 Northbound On Ramp Southbound						Alessandro Boulevard Westbound						I-215 Northbound Off Ramp Northbound						Alessandro Boulevard Eastbound											
	Left		Thru		Right		Left		Thru		Right		Left		Thru		Right		Left		Thru		Right		Left		Thru		Right	
	RTOR	App. Total	RTOR	App. Total	RTOR	App. Total	RTOR	App. Total	RTOR	App. Total	RTOR	App. Total	RTOR	App. Total	RTOR	App. Total	RTOR	App. Total	RTOR	App. Total	RTOR	App. Total	RTOR	App. Total	RTOR	App. Total	RTOR	App. Total	RTOR	App. Total
04:45 PM	0	0	0	0	0	0	0	255	26	0	281	1	57	284	15	402	0	0	417	284	15	402	0	0	417	0	0	417		
05:00 PM	0	0	0	0	0	0	0	231	29	0	260	1	38	232	22	408	0	0	922	232	22	408	0	0	922	0	0	922		
05:15 PM	0	0	0	0	0	0	0	258	33	0	291	6	87	288	25	426	0	0	1030	288	25	426	0	0	1030	0	0	1030		
05:30 PM	0	0	0	0	0	0	0	222	24	0	246	3	88	284	36	394	0	0	989	284	36	394	0	0	989	0	0	989		
Total	0	0	0	0	0	0	0	966	112	0	1078	11	270	1088	98	1630	0	0	3894	1088	98	1630	0	0	3894	0	0	3894		
% App. Total	.000	.000	.000	.000	.000	.000	.936	.848	.926	.893	.458	.767	.944	.957	.000	.958	.944	.957	.000	.958	.944	.957	.000	.958	.944	.957	.000	.958		
PHF																														

Peak Hour Analysis From 04:00 PM to 05:45 PM - Peak 1 of 1
 Peak Hour for Entire Intersection Begins at 04:45 PM

Counts Unlimited, Inc.
 PO Box 1178
 Corona, CA 92878
 (951)268-6268

File Name : 26_CRV_215N_Ales PM
 Site Code : 05121716
 Start Date : 11/30/2021
 Page No : 2

County of Riverside
 N/S: I-215 Northbound Ramps
 E/W: Alessandro Boulevard
 Weather: Clear

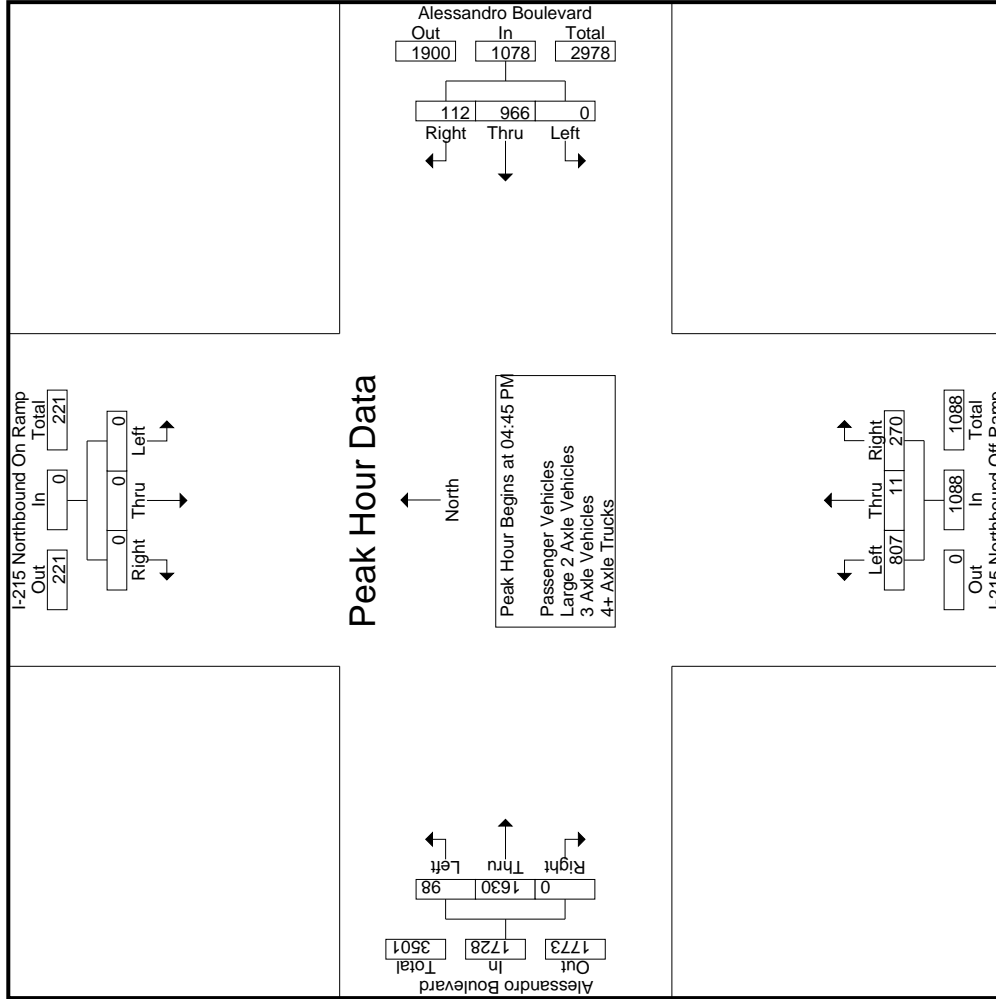

Counts Unlimited, Inc.
 PO Box 1178
 Corona, CA 92878
 (951)268-6268

File Name : 26_CRV_215N_Ales PM
 Site Code : 05121716
 Start Date : 11/30/2021
 Page No : 3

County of Riverside
 N/S: I-215 Northbound Ramps
 E/W: Alessandro Boulevard
 Weather: Clear

Start Time	I-215 Northbound On Ramp Southbound			Alessandro Boulevard Westbound			I-215 Northbound Off Ramp Northbound			Alessandro Boulevard Eastbound			Int. Total			
	Left	Thru	Right	Left	Thru	Right	Left	Thru	Right	Left	Thru	Right		App. Total		
Peak Hour Analysis From 04:00 PM to 05:45 PM - Peak 1 of 1	Peak Hour for Each Approach Begins at:															
	04:00 PM			04:30 PM			04:45 PM			04:45 PM						
+0 mins.	0	0	0	0	0	0	24	278	24	302	1	57	15	402	0	417
+15 mins.	0	0	0	0	0	0	26	255	26	281	1	38	22	408	0	430
+30 mins.	0	0	0	0	0	0	29	231	29	260	6	87	25	426	0	451
+45 mins.	0	0	0	0	0	0	33	258	33	291	3	88	36	394	0	430
Total Volume	0	0	0	0	0	0	112	1022	112	1134	11	270	98	1630	0	1728
% App. Total	0	0	0	0	0	0	9.9	90.1	9.9	74.2	1	24.8	5.7	94.3	0	100.0
PHF	.000	.000	.000	.000	.000	.000	.848	.919	.848	.939	.458	.767	.681	.957	.000	.958

Groups Printed- Passenger Vehicles

Start Time	I-215 Northbound On Ramp Southbound					Alessandro Boulevard Westbound					I-215 Northbound Off Ramp Northbound					Alessandro Boulevard Eastbound							
	Left	Thru	Right	RTOR	App. Total	Left	Thru	Right	RTOR	App. Total	Left	Thru	Right	RTOR	App. Total	Left	Thru	Right	RTOR	App. Total	Exclu. Total	Inclu. Total	Int. Total
04:00 PM	0	0	0	0	0	0	275	19	3	294	164	3	72	27	239	16	354	0	0	370	30	903	933
04:15 PM	0	0	0	0	0	0	221	21	6	242	186	4	81	27	271	16	328	0	0	344	33	857	890
04:30 PM	0	0	0	0	0	0	274	20	5	294	186	0	45	15	231	17	350	0	0	367	20	892	912
04:45 PM	0	0	0	0	0	0	249	24	5	273	222	1	55	16	278	13	391	0	0	404	21	955	976
Total	0	0	0	0	0	0	1019	84	19	1103	758	8	253	85	1019	62	1423	0	0	1485	104	3607	3711
05:00 PM	0	0	0	0	0	0	227	26	9	253	187	1	37	17	225	21	397	0	0	418	26	896	922
05:15 PM	0	0	0	0	0	0	254	28	3	282	190	6	87	23	283	23	415	0	0	438	26	1003	1029
05:30 PM	0	0	0	0	0	0	218	20	5	238	187	3	86	23	276	32	389	0	0	421	28	935	963
05:45 PM	0	0	0	0	0	0	202	14	3	216	147	0	68	19	215	13	382	0	0	395	22	826	848
Total	0	0	0	0	0	0	901	88	20	989	711	10	278	82	999	89	1583	0	0	1672	102	3660	3762
Grand Total	0	0	0	0	0	0	1920	172	39	2092	1469	18	531	167	2018	151	3006	0	0	3157	206	7267	7473
T-Approch %	0	0	0	0	0	0	91.8	8.2		72.8	20.2	0.9	26.3		27.8	4.8	95.2	0	0	43.4	2.8	97.2	
Total %	0	0	0	0	0	0	26.4	2.4		28.8	20.2	0.2	7.3		27.8	2.1	41.4	0	0	43.4	2.8	97.2	

Start Time	I-215 Northbound On Ramp Southbound					Alessandro Boulevard Westbound					I-215 Northbound Off Ramp Northbound					Alessandro Boulevard Eastbound							
	Left	Thru	Right	RTOR	App. Total	Left	Thru	Right	RTOR	App. Total	Left	Thru	Right	RTOR	App. Total	Left	Thru	Right	RTOR	App. Total	Exclu. Total	Inclu. Total	Int. Total
04:45 PM	0	0	0	0	0	0	0	0	0	0	273	24	249	1	55	278	13	391	0	0	404	0	955
05:00 PM	0	0	0	0	0	0	0	0	0	0	253	26	227	1	37	225	21	397	0	0	418	0	896
05:15 PM	0	0	0	0	0	0	0	0	0	0	282	28	254	6	87	283	23	415	0	0	438	0	1003
05:30 PM	0	0	0	0	0	0	0	0	0	0	238	20	187	3	86	276	32	389	0	0	421	0	935
Total Volume	0	0	0	0	0	0	0	0	0	0	1046	98	948	11	265	1062	89	1592	0	0	1681	0	3789
% App. Total	.000	.000	.000	.000	.000	.000	.000	.000	.000	.000	.927	.875	.933	.458	.761	.938	.695	.959	.000	.000	.959	.000	.944
PHF	.000	.000	.000	.000	.000	.000	.000	.000	.000	.000	.927	.875	.933	.458	.761	.938	.695	.959	.000	.000	.959	.000	.944

Peak Hour Analysis From 04:45 PM to 05:30 PM - Peak 1 of 1
 Peak Hour for Entire Intersection Begins at 04:45 PM

Counts Unlimited, Inc.
 PO Box 1178
 Corona, CA 92878
 (951)268-6268

County of Riverside
 N/S: I-215 Northbound Ramps
 E/W: Alessandro Boulevard
 Weather: Clear

File Name : 26_CRV_215N_Ales PM
 Site Code : 05121716
 Start Date : 11/30/2021
 Page No : 2

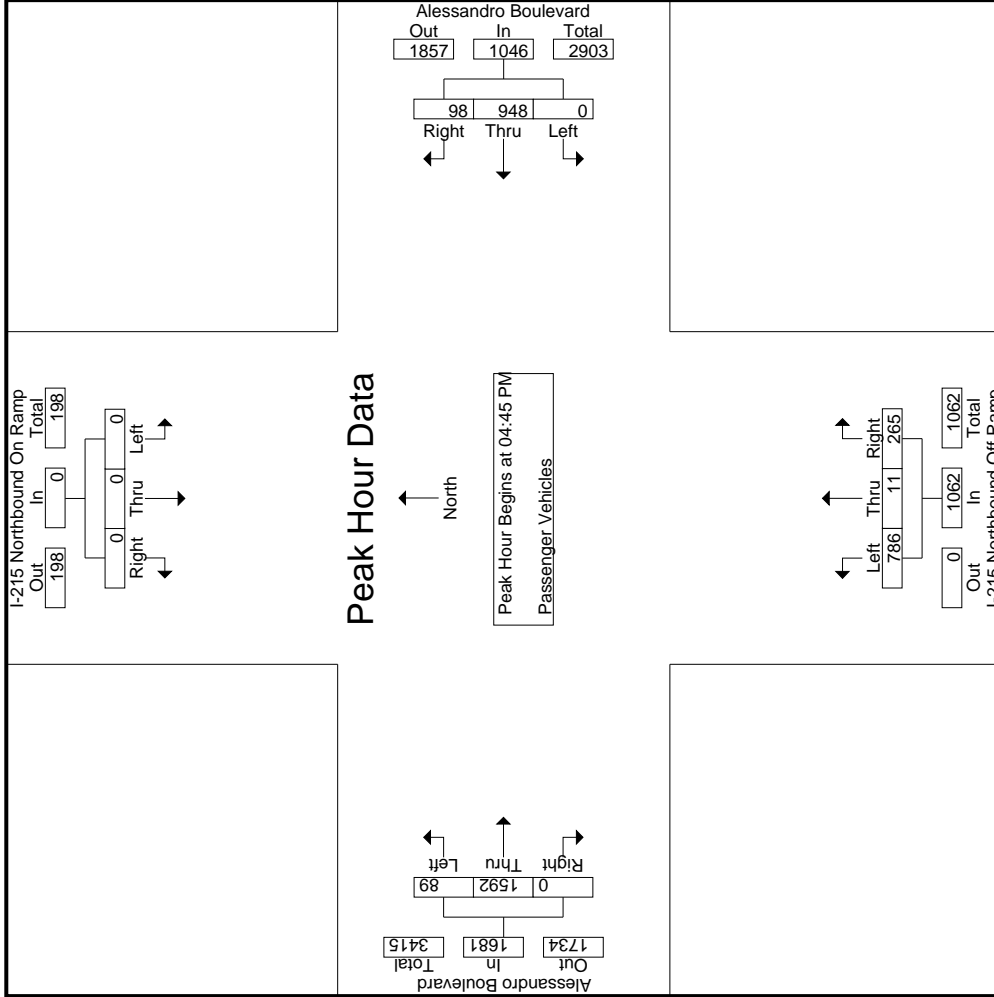

Counts Unlimited, Inc.
 PO Box 1178
 Corona, CA 92878
 (951)268-6268

File Name : 26_CRV_215N_Ales PM
 Site Code : 05121716
 Start Date : 11/30/2021
 Page No : 3

County of Riverside
 N/S: I-215 Northbound Ramps
 E/W: Alessandro Boulevard
 Weather: Clear

Start Time	I-215 Northbound On Ramp Southbound			Alessandro Boulevard Westbound			I-215 Northbound Off Ramp Northbound			Alessandro Boulevard Eastbound				
	Left	Thru	Right	Left	Thru	Right	Left	Thru	Right	Left	Thru	Right		
Peak Hour Analysis From 04:45 PM to 05:30 PM - Peak 1 of 1	Peak Hour for Each Approach Begins at:													
	04:45 PM													
+0 mins.	0	0	0	0	249	24	273	1	55	278	13	391	0	404
+15 mins.	0	0	0	0	227	26	253	1	37	225	21	397	0	418
+30 mins.	0	0	0	0	254	28	282	6	87	283	23	415	0	438
+45 mins.	0	0	0	0	218	20	238	3	86	276	32	389	0	421
Total Volume	0	0	0	0	948	98	1046	11	265	1062	89	1592	0	1681
% App. Total	0	0	0	0	90.6	9.4	92.7	1	25	93.8	5.3	94.7	0	95.9
PHF	.000	.000	.000	.000	.933	.875	.927	.885	.761	.938	.695	.959	.000	.959

Groups Printed- Large 2 Axle Vehicles

Start Time	I-215 Northbound On Ramp Southbound				Alessandro Boulevard Westbound				I-215 Northbound Off Ramp Northbound				Alessandro Boulevard Eastbound									
	Left	Thru	Right	RTOR	Left	Thru	Right	RTOR	Left	Thru	Right	RTOR	Left	Thru	Right	RTOR						
04:00 PM	0	0	0	0	0	4	1	0	5	6	0	1	1	7	3	0	0	5	1	17	18	
04:15 PM	0	0	0	0	0	2	0	0	2	7	0	0	0	7	0	5	0	0	5	0	14	14
04:30 PM	0	0	0	0	0	4	1	0	5	5	0	1	1	6	1	6	0	0	7	1	18	19
04:45 PM	0	0	0	0	0	5	0	0	5	3	0	1	0	4	0	2	0	0	2	0	11	11
Total	0	0	0	0	0	15	2	0	17	21	0	3	2	24	3	16	0	0	19	2	60	62
05:00 PM	0	0	0	0	0	2	0	0	2	2	0	1	1	3	0	2	0	0	2	1	7	8
05:15 PM	0	0	0	0	0	2	1	0	3	4	0	0	0	4	1	7	0	0	8	0	15	15
05:30 PM	0	0	0	0	0	1	0	0	1	4	0	1	0	5	0	1	0	0	1	0	7	7
05:45 PM	0	0	0	0	0	3	0	0	3	2	0	1	0	3	0	3	0	0	3	0	9	9
Total	0	0	0	0	0	7	2	0	9	12	0	3	1	15	1	13	0	0	14	1	38	39
Grand Total	0	0	0	0	0	22	4	0	26	33	0	6	3	39	4	29	0	0	33	3	98	101
% Apprch %	0	0	0	0	0	84.6	15.4		84.6	84.6	0	15.4		39.8	12.1	87.9	0		33.7	3	97	
Total %	0	0	0	0	0	22.4	4.1		26.5	33.7	0	6.1		39.8	4.1	29.6	0		33.7	3	97	

Start Time	I-215 Northbound On Ramp Southbound				Alessandro Boulevard Westbound				I-215 Northbound Off Ramp Northbound				Alessandro Boulevard Eastbound								
	Left	Thru	Right	RTOR	Left	Thru	Right	RTOR	Left	Thru	Right	RTOR	Left	Thru	Right	RTOR					
04:45 PM	0	0	0	0	0	0	0	0	0	5	0	0	0	0	2	0	0	0	0	2	2
05:00 PM	0	0	0	0	0	0	0	0	0	2	0	0	0	0	2	0	0	0	0	2	2
05:15 PM	0	0	0	0	0	0	0	0	1	3	0	0	0	0	4	0	0	0	7	0	8
05:30 PM	0	0	0	0	0	0	0	0	1	1	0	0	0	0	5	0	0	0	1	0	7
Total Volume	0	0	0	0	0	0	0	0	11	13	0	0	3	16	1	12	0	0	13	0	40
% App. Total	0	0	0	0	0	81.8	18.2		81.2	81.2	0	18.8		7.7	92.3	0		0	0	0	.667
PHF	.000	.000	.000	.000	.000	.000	.000	.000	.550	.813	.000	.750		.800	.250	.429	.000	.406	.000	.406	.667

Peak Hour Analysis From 04:45 PM to 05:30 PM - Peak 1 of 1
 Peak Hour for Entire Intersection Begins at 04:45 PM

Counts Unlimited, Inc.
 PO Box 1178
 Corona, CA 92878
 (951)268-6268

File Name : 26_CRV_215N_Ales PM
 Site Code : 05121716
 Start Date : 11/30/2021
 Page No : 2

County of Riverside
 N/S: I-215 Northbound Ramps
 E/W: Alessandro Boulevard
 Weather: Clear

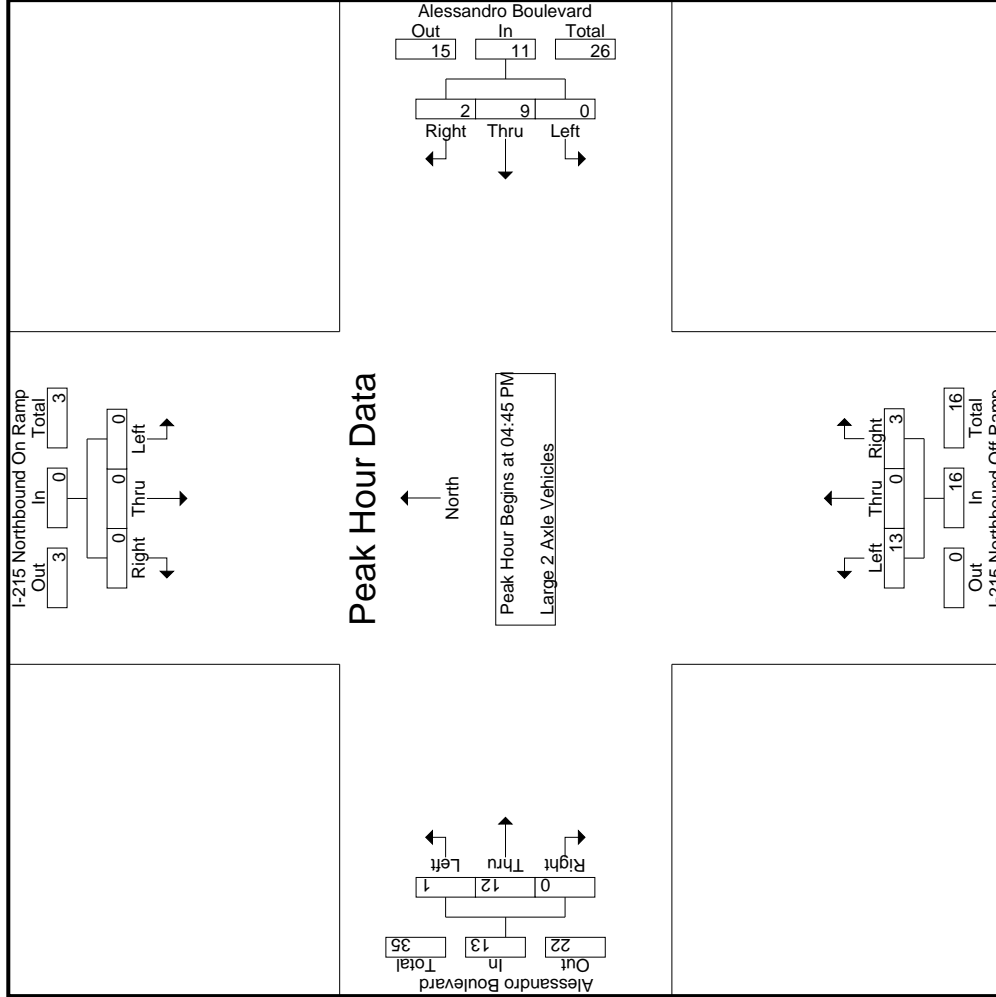

Counts Unlimited, Inc.
 PO Box 1178
 Corona, CA 92878
 (951)268-6268

File Name : 26_CRV_215N_Ales PM
 Site Code : 05121716
 Start Date : 11/30/2021
 Page No : 3

County of Riverside
 N/S: I-215 Northbound Ramps
 E/W: Alessandro Boulevard
 Weather: Clear

Start Time	I-215 Northbound On Ramp Southbound			Alessandro Boulevard Westbound			I-215 Northbound Off Ramp Northbound			Alessandro Boulevard Eastbound			Int. Total
	Left	Thru	Right	Left	Thru	Right	Left	Thru	Right	Left	Thru	Right	
Peak Hour Analysis From 04:45 PM to 05:30 PM - Peak 1 of 1	04:45 PM												
Peak Hour for Each Approach Begins at:	04:45 PM												
+0 mins.	0	0	0	0	5	0	5	0	1	0	2	0	2
+15 mins.	0	0	0	0	2	0	2	0	1	0	2	0	2
+30 mins.	0	0	0	0	2	1	3	4	0	0	7	0	8
+45 mins.	0	0	0	0	0	1	1	4	1	0	1	0	1
Total Volume	0	0	0	0	9	2	11	13	0	3	12	0	13
% App. Total	0	0	0	0	81.8	18.2	18.8	81.2	0	18.8	7.7	92.3	0
PHF	.000	.000	.000	.000	.450	.500	.550	.813	.000	.750	.250	.429	.000

Counts Unlimited, Inc.
 PO Box 1178
 Corona, CA 92878
 (951)268-6268

County of Riverside
 N/S: I-215 Northbound Ramps
 E/W: Alessandro Boulevard
 Weather: Clear

File Name : 26_CRV_215N_Ales PM
 Site Code : 05121716
 Start Date : 11/30/2021
 Page No : 1

Groups Printed- 3 Axle Vehicles

Start Time	I-215 Northbound On Ramp Southbound					Alessandro Boulevard Westbound					I-215 Northbound Off Ramp Northbound					Alessandro Boulevard Eastbound										
	Left	Thru	Right	RTOR	App. Total	Left	Thru	Right	RTOR	App. Total	Left	Thru	Right	RTOR	App. Total	Left	Thru	Right	RTOR	App. Total	Exclu. Total	Inclu. Total	Int. Total			
04:00 PM	0	0	0	0	0	0	0	0	0	0	1	0	0	0	1	0	0	0	0	0	0	0	1	0	1	1
04:15 PM	0	0	0	0	0	0	0	0	0	0	1	0	0	0	1	0	2	0	0	2	0	0	3	0	3	3
04:30 PM	0	0	0	0	0	0	0	1	0	1	0	0	0	0	0	0	0	0	0	0	0	0	1	0	1	1
04:45 PM	0	0	0	0	0	0	1	0	0	1	0	0	1	1	1	1	3	0	0	4	1	1	6	1	6	7
Total	0	0	0	0	0	0	1	1	0	2	2	0	1	1	3	1	5	0	0	6	1	11	12			
05:00 PM	0	0	0	0	0	0	1	1	1	2	1	0	0	0	1	0	3	0	0	3	1	6	7			
05:15 PM	0	0	0	0	0	0	0	3	0	3	0	0	0	0	0	0	1	0	0	1	0	4	4			
05:30 PM	0	0	0	0	0	0	0	1	1	1	0	0	1	0	1	0	0	0	0	0	1	2	3			
05:45 PM	0	0	0	0	0	0	0	1	0	1	1	0	0	0	1	0	1	0	0	1	0	3	3			
Total	0	0	0	0	0	0	2	5	2	7	2	0	1	0	3	0	5	0	0	5	2	15	17			
Grand Total	0	0	0	0	0	0	3	6	2	9	4	0	2	1	6	1	10	0	0	11	3	26	29			
% Apprch %	0	0	0	0	0	0	33.3	66.7		66.7	0	33.3	0	7.7	23.1	9.1	90.9	0	0	42.3	10.3	89.7				
Total %	0	0	0	0	0	0	11.5	23.1		34.6	15.4	0	7.7		23.1	3.8	38.5	0	0	42.3						

Start Time	I-215 Northbound On Ramp Southbound					Alessandro Boulevard Westbound					I-215 Northbound Off Ramp Northbound					Alessandro Boulevard Eastbound										
	Left	Thru	Right	RTOR	App. Total	Left	Thru	Right	RTOR	App. Total	Left	Thru	Right	RTOR	App. Total	Left	Thru	Right	RTOR	App. Total	Exclu. Total	Inclu. Total	Int. Total			
04:45 PM	0	0	0	0	0	0	0	0	0	0	0	0	0	0	0	0	0	0	0	0	0	0	0	0	0	0
05:00 PM	0	0	0	0	0	0	0	1	1	2	1	0	0	0	1	0	3	0	0	3	0	0	3	0	3	3
05:15 PM	0	0	0	0	0	0	0	3	0	3	0	0	0	0	0	0	1	0	0	1	0	0	1	0	1	1
05:30 PM	0	0	0	0	0	0	0	1	1	1	0	0	1	0	1	0	0	0	0	0	1	2	3			
05:45 PM	0	0	0	0	0	0	0	1	0	1	1	0	0	0	1	0	1	0	0	1	0	3	3			
Total	0	0	0	0	0	0	2	5	2	7	2	0	1	0	3	0	5	0	0	5	2	15	17			
Grand Total	0	0	0	0	0	0	3	6	2	9	4	0	2	1	6	1	10	0	0	11	3	26	29			
% Apprch %	0	0	0	0	0	0	33.3	66.7		66.7	0	33.3	0	7.7	23.1	9.1	90.9	0	0	42.3	10.3	89.7				
Total %	0	0	0	0	0	0	11.5	23.1		34.6	15.4	0	7.7		23.1	3.8	38.5	0	0	42.3						

Peak Hour Analysis From 04:45 PM to 05:30 PM - Peak 1 of 1
 Peak Hour for Entire Intersection Begins at 04:45 PM

Start Time	I-215 Northbound On Ramp Southbound					Alessandro Boulevard Westbound					I-215 Northbound Off Ramp Northbound					Alessandro Boulevard Eastbound										
	Left	Thru	Right	RTOR	App. Total	Left	Thru	Right	RTOR	App. Total	Left	Thru	Right	RTOR	App. Total	Left	Thru	Right	RTOR	App. Total	Exclu. Total	Inclu. Total	Int. Total			
04:45 PM	0	0	0	0	0	0	0	0	0	0	0	0	0	0	0	0	0	0	0	0	0	0	0	0	0	0
05:00 PM	0	0	0	0	0	0	0	1	1	2	1	0	0	0	1	0	3	0	0	3	0	0	3	0	3	3
05:15 PM	0	0	0	0	0	0	0	3	0	3	0	0	0	0	0	0	1	0	0	1	0	0	1	0	1	1
05:30 PM	0	0	0	0	0	0	0	1	1	1	0	0	1	0	1	0	0	0	0	0	1	2	3			
Total Volume	0	0	0	0	0	0	0	5	2	7	2	0	1	0	3	0	5	0	0	5	2	15	17			
% App. Total	0	0	0	0	0	0	28.6	71.4		71.4	33.3	0	66.7		66.7	12.5	87.5	0	0	87.5	0	0	0	0	0	0
PHF	.000	.000	.000	.000	.000	.000	.500	.417		.583	.250	.000	.500		.750	.250	.583	.000	.000	.500	.000	.500	.750			

Counts Unlimited, Inc.
 PO Box 1178
 Corona, CA 92878
 (951)268-6268

File Name : 26_CRV_215N_Ales PM
 Site Code : 05121716
 Start Date : 11/30/2021
 Page No : 2

County of Riverside
 N/S: I-215 Northbound Ramps
 E/W: Alessandro Boulevard
 Weather: Clear

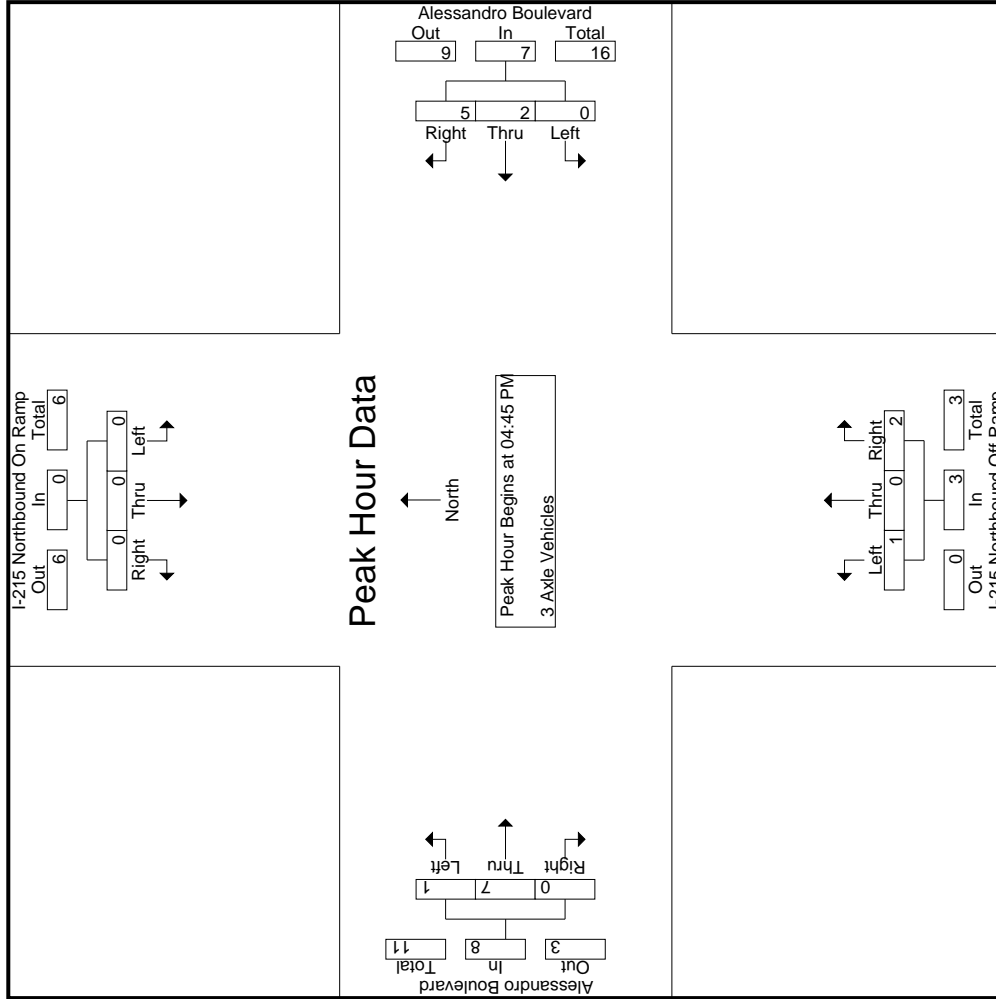

Counts Unlimited, Inc.
 PO Box 1178
 Corona, CA 92878
 (951)268-6268

File Name : 26_CRV_215N_Ales PM
 Site Code : 05121716
 Start Date : 11/30/2021
 Page No : 3

County of Riverside
 N/S: I-215 Northbound Ramps
 E/W: Alessandro Boulevard
 Weather: Clear

Start Time	I-215 Northbound On Ramp Southbound			Alessandro Boulevard Westbound			I-215 Northbound Off Ramp Northbound			Alessandro Boulevard Eastbound			Int. Total		
	Left	Thru	Right	Left	Thru	Right	Left	Thru	Right	Left	Thru	Right		App. Total	
Peak Hour Analysis From 04:45 PM to 05:30 PM - Peak 1 of 1	04:45 PM														
Peak Hour for Each Approach Begins at:	04:45 PM														
+0 mins.	0	0	0	0	1	0	1	0	1	0	0	0	0	4	
+15 mins.	0	0	0	0	1	1	2	0	1	0	0	3	0	3	
+30 mins.	0	0	0	0	0	3	3	0	0	0	1	0	0	1	
+45 mins.	0	0	0	0	0	1	1	0	1	0	0	0	0	0	
Total Volume	0	0	0	0	2	5	7	1	0	2	3	1	7	8	
% App. Total	0	0	0	0	28.6	71.4	7	33.3	0	66.7	3	12.5	87.5	0	
PHF	.000	.000	.000	.000	.500	.417	.583	.250	.000	.500	.750	.250	.583	.000	.500

Counts Unlimited, Inc.
 PO Box 1178
 Corona, CA 92878
 (951)268-6268

County of Riverside
 N/S: I-215 Northbound Ramps
 E/W: Alessandro Boulevard
 Weather: Clear

File Name : 26_CRV_215N_Ales PM
 Site Code : 05121716
 Start Date : 11/30/2021
 Page No : 1

Groups Printed- 4+ Axle Trucks

Start Time	I-215 Northbound On Ramp Southbound				Alessandro Boulevard Westbound				I-215 Northbound Off Ramp Northbound				Alessandro Boulevard Eastbound							
	Left	Thru	Right	RTOR	App. Total	Left	Thru	Right	RTOR	App. Total	Left	Thru	Right	RTOR	App. Total	Exclu. Total	Inclu. Total	Int. Total		
04:00 PM	0	0	0	0	0	3	1	0	0	4	4	0	0	0	4	3	7	0	10	
04:15 PM	0	0	0	0	0	0	1	0	0	1	3	0	0	0	3	3	6	0	9	
04:30 PM	0	0	0	0	0	0	2	0	0	2	3	0	0	0	3	2	7	0	9	
04:45 PM	0	0	0	0	0	0	2	1	0	1	1	0	0	0	1	1	6	0	7	
Total	0	0	0	0	0	3	6	1	0	9	11	0	0	0	11	9	26	0	35	
05:00 PM	0	0	0	0	0	1	2	0	0	3	3	0	0	0	3	1	6	0	7	
05:15 PM	0	0	0	0	0	2	1	0	0	3	1	0	0	0	1	1	3	0	4	
05:30 PM	0	0	0	0	0	4	2	0	0	6	2	0	0	2	2	4	4	0	8	
05:45 PM	0	0	0	0	0	0	5	0	0	2	2	1	1	0	4	1	6	0	7	
Total	0	0	0	0	0	8	10	0	0	18	8	1	1	0	10	7	19	0	26	
Grand Total	0	0	0	0	0	11	16	1	0	27	19	1	1	0	21	16	45	0	61	
% Apprch %	0	0	0	0	0	40.7	59.3			90.5	4.8	4.8			26.2	73.8	0	0	109	
% Total %	0	0	0	0	0	10.1	14.7			17.4	0.9	0.9			14.7	41.3	0	56	0.9	99.1

Start Time	I-215 Northbound On Ramp Southbound				Alessandro Boulevard Westbound				I-215 Northbound Off Ramp Northbound				Alessandro Boulevard Eastbound											
	Left	Thru	Right	RTOR	App. Total	Left	Thru	Right	RTOR	App. Total	Left	Thru	Right	RTOR	App. Total	Left	Thru	Right	RTOR	App. Total	Exclu. Total	Inclu. Total	Int. Total	
04:45 PM	0	0	0	0	0	0	0	0	0	2	1	0	0	0	0	1	6	0	0	0	0	0	0	7
05:00 PM	0	0	0	0	0	0	1	0	0	3	3	0	0	0	0	3	6	0	0	0	0	0	0	7
05:15 PM	0	0	0	0	0	0	2	0	0	1	1	0	0	0	0	1	1	0	0	0	0	0	0	4
05:30 PM	0	0	0	0	0	0	4	0	0	6	2	0	0	0	2	4	4	0	0	0	0	0	0	8
Total Volume	0	0	0	0	0	0	7	0	0	14	7	0	0	0	7	7	19	0	0	0	0	0	0	26
% App. Total	0.000	0.000	0.000	0.000	0.000	.438	.875	.583	.000	.583	.000	.000	.000	.000	.583	.438	.792	.000	.813	.000	.000	.000	.000	.734

Peak Hour Analysis From 04:45 PM to 05:30 PM - Peak 1 of 1
 Peak Hour for Entire Intersection Begins at 04:45 PM

Counts Unlimited, Inc.
 PO Box 1178
 Corona, CA 92878
 (951)268-6268

File Name : 26_CRV_215N_Ales PM
 Site Code : 05121716
 Start Date : 11/30/2021
 Page No : 2

County of Riverside
 N/S: I-215 Northbound Ramps
 E/W: Alessandro Boulevard
 Weather: Clear

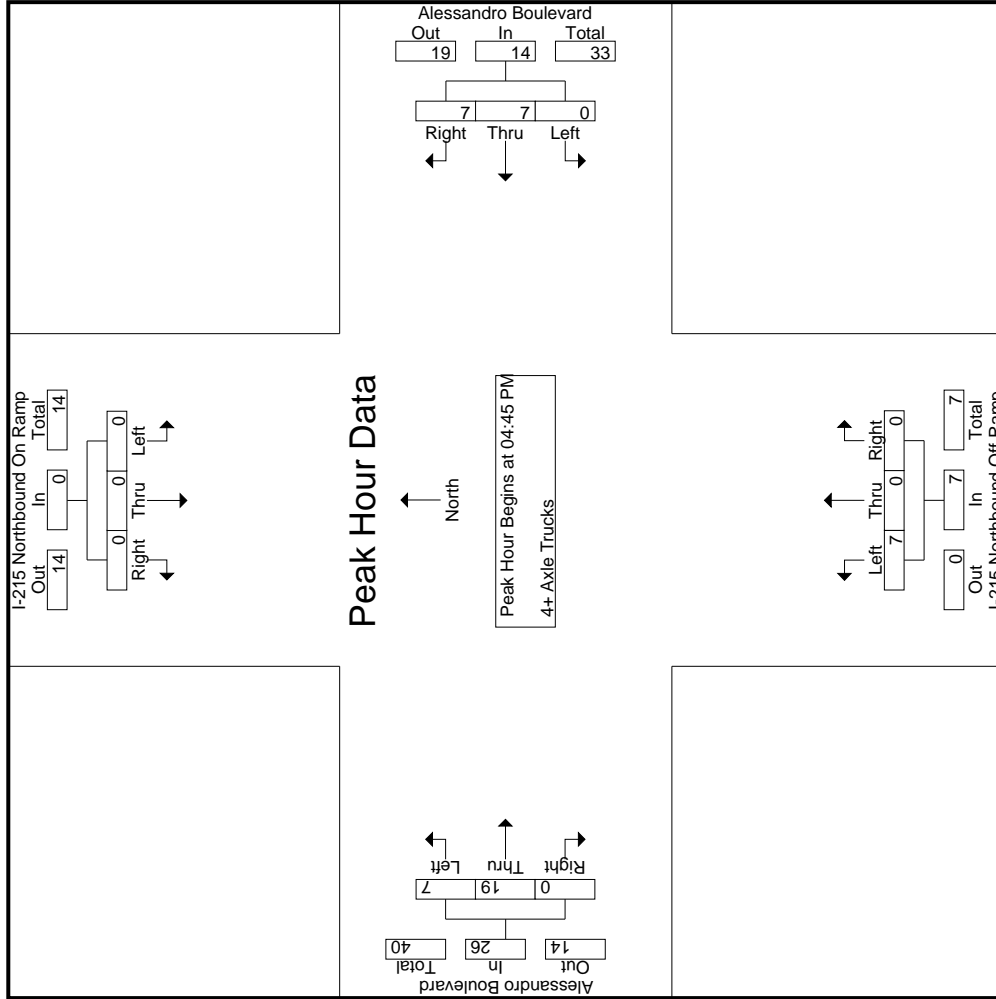

Counts Unlimited, Inc.
 PO Box 1178
 Corona, CA 92878
 (951)268-6268

File Name : 26_CRV_215N_Ales PM
 Site Code : 05121716
 Start Date : 11/30/2021
 Page No : 3

County of Riverside
 N/S: I-215 Northbound Ramps
 E/W: Alessandro Boulevard
 Weather: Clear

Start Time	I-215 Northbound On Ramp Southbound			Alessandro Boulevard Westbound			I-215 Northbound Off Ramp Northbound			Alessandro Boulevard Eastbound			Int. Total
	Left	Thru	Right	Left	Thru	Right	Left	Thru	Right	Left	Thru	Right	
Peak Hour Analysis From 04:45 PM to 05:30 PM - Peak 1 of 1	04:45 PM												
Peak Hour for Each Approach Begins at:	04:45 PM												
+0 mins.	0	0	0	0	2	2	2	1	0	1	6	0	7
+15 mins.	0	0	0	0	2	3	3	3	0	3	6	0	7
+30 mins.	0	0	0	0	2	1	1	1	0	1	3	0	4
+45 mins.	0	0	0	0	4	2	6	2	0	4	4	0	8
Total Volume	0	0	0	0	7	7	14	7	0	7	19	0	26
% App. Total	0	0	0	0	50	50	100	100	0	26.9	73.1	0	0
PHF	.000	.000	.000	.000	.438	.875	.583	.583	.000	.438	.792	.000	.813

Location: County of Riverside
 N/S: I-215 NB Ramps
 E/W: Alessandro Boulevard



Date: 11/30/2021
 Day: Tuesday

PEDESTRIANS

	North Leg I-215 NB Ramps	East Leg Alessandro Boulevard	South Leg I-215 NB Ramps	West Leg Alessandro Boulevard	
	Pedestrians	Pedestrians	Pedestrians	Pedestrians	
7:00 AM	0	0	0	0	0
7:15 AM	0	0	0	0	0
7:30 AM	0	0	0	0	0
7:45 AM	0	0	0	0	0
8:00 AM	0	0	0	0	0
8:15 AM	0	0	0	0	0
8:30 AM	0	0	0	0	0
8:45 AM	0	0	0	0	0
TOTAL VOLUMES:	0	0	0	0	0

	North Leg I-215 NB Ramps	East Leg Alessandro Boulevard	South Leg I-215 NB Ramps	West Leg Alessandro Boulevard	
	Pedestrians	Pedestrians	Pedestrians	Pedestrians	
4:00 PM	0	0	0	0	0
4:15 PM	0	0	0	0	0
4:30 PM	0	0	0	0	0
4:45 PM	0	0	0	0	0
5:00 PM	0	0	0	0	0
5:15 PM	0	0	0	0	0
5:30 PM	0	0	0	0	0
5:45 PM	0	0	0	0	0
TOTAL VOLUMES:	0	0	0	0	0

Location: County of Riverside
 N/S: I-215 NB Ramps
 E/W: Alessandro Boulevard



Date: 11/30/2021
 Day: Tuesday

BICYCLES

	Southbound I-215 NB Ramps			Westbound Alessandro Boulevard			Northbound I-215 NB Ramps			Eastbound Alessandro Boulevard			
	Left	Thru	Right	Left	Thru	Right	Left	Thru	Right	Left	Thru	Right	
7:00 AM	0	0	0	0	0	0	0	0	0	0	0	0	0
7:15 AM	0	0	0	0	0	0	0	0	0	0	0	0	0
7:30 AM	0	0	0	0	0	0	0	0	0	0	0	0	0
7:45 AM	0	0	0	0	0	0	0	0	0	0	0	0	0
8:00 AM	0	0	0	0	0	0	0	0	0	0	0	0	0
8:15 AM	0	0	0	0	0	0	0	0	0	0	0	0	0
8:30 AM	0	0	0	0	0	0	0	0	0	0	0	0	0
8:45 AM	0	0	0	0	0	0	0	0	0	0	0	0	0
TOTAL VOLUMES:	0	0	0	0	0	0	0	0	0	0	0	0	0

	Southbound I-215 NB Ramps			Westbound Alessandro Boulevard			Northbound I-215 NB Ramps			Eastbound Alessandro Boulevard			
	Left	Thru	Right	Left	Thru	Right	Left	Thru	Right	Left	Thru	Right	
4:00 PM	0	0	0	0	0	0	0	0	0	0	0	0	0
4:15 PM	0	0	0	0	0	0	0	0	0	0	0	0	0
4:30 PM	0	0	0	0	0	0	0	0	0	0	1	0	1
4:45 PM	0	0	0	0	0	0	0	0	0	0	0	0	0
5:00 PM	0	0	0	0	1	0	0	0	0	0	0	0	1
5:15 PM	0	0	0	0	0	0	0	0	0	0	0	0	0
5:30 PM	0	0	0	0	0	0	0	0	0	0	0	0	0
5:45 PM	0	0	0	0	1	0	0	0	0	0	0	0	1
TOTAL VOLUMES:	0	0	0	0	2	0	0	0	0	0	1	0	3

Groups Printed- Passenger Vehicles - Large 2 Axle Vehicles - 3 Axle Vehicles - 4+ Axle Trucks

Start Time	I-215 Southbound Off Ramp Southbound						Cactus Avenue Westbound						I-215 Southbound Ramps Northbound						Cactus Avenue Eastbound													
	Left		Thru		Right		Left		Thru		Right		Left		Thru		Right		Left		Thru		Right		Left		Thru		Right			
	RTOR	App. Total	RTOR	App. Total	RTOR	App. Total	RTOR	App. Total	RTOR	App. Total	RTOR	App. Total	RTOR	App. Total	RTOR	App. Total	RTOR	App. Total	RTOR	App. Total	RTOR	App. Total	RTOR	App. Total	RTOR	App. Total	RTOR	App. Total	RTOR	App. Total		
07:00 AM	0	0	34	20	34	34	126	279	0	0	114	0	114	0	114	0	114	0	114	0	52	4	1	56	0	52	4	1	56	21	609	630
07:15 AM	0	0	47	13	47	47	143	302	0	0	124	0	124	0	124	0	124	0	124	0	70	5	2	75	0	70	5	2	75	15	691	706
07:30 AM	0	0	40	21	40	40	112	248	0	0	158	0	158	0	158	0	158	0	158	0	78	6	4	84	0	78	6	4	84	25	642	667
07:45 AM	0	0	57	37	57	57	146	281	0	0	172	0	172	0	172	0	172	0	172	0	90	7	0	97	0	90	7	0	97	37	753	790
Total	0	0	178	91	178	178	527	1110	0	0	568	0	568	0	568	0	568	0	568	0	290	22	7	312	0	290	22	7	312	98	2695	2793
08:00 AM	0	0	35	12	35	35	101	268	0	0	109	0	109	0	109	0	109	0	109	0	62	10	0	72	0	62	10	0	72	12	585	597
08:15 AM	0	0	31	14	31	31	104	305	0	0	97	0	97	0	97	0	97	0	97	0	74	7	3	81	0	74	7	3	81	17	618	635
08:30 AM	0	0	57	16	57	57	88	249	0	0	114	0	114	0	114	0	114	0	114	0	66	9	1	75	0	66	9	1	75	17	583	600
08:45 AM	0	0	44	16	44	44	78	191	0	0	91	0	91	0	91	0	91	0	91	0	76	7	1	83	0	76	7	1	83	17	487	504
Total	0	0	167	58	167	167	371	1013	0	0	411	0	411	0	411	0	411	0	411	0	278	33	5	311	0	278	33	5	311	63	2273	2336
Grand Total	0	0	345	149	345	345	898	2123	0	0	979	0	979	0	979	0	979	0	979	0	568	55	12	623	0	568	55	12	623	161	4968	5129
% Approach	0	0	100		100		29.7	70.3	0	0	100	0	100	0	100	0	100	0	100	0	91.2	8.8			0	91.2	8.8					
% Total	0	0	6.9		6.9		18.1	42.7	0	0	19.7	0	19.7	0	19.7	0	19.7	0	19.7	0	11.4	1.1		12.5	0	11.4	1.1		12.5	3.1	96.9	
% Passenger Vehicles	0	0	234		350		810	2071	0	0	849	0	849	0	849	0	849	0	849	0	522	45		578	0	522	45		578	0	0	4658
% Large 2 Axle Vehicles	0	0	67.8		77.9		90.2	97.6	0	0	86.7	0	86.7	0	86.7	0	86.7	0	86.7	0	91.9	81.8		91.7	0	91.9	81.8		91.7	0	0	90.8
% 3 Axle Vehicles	0	0	18		27		22	23	0	0	15	0	15	0	15	0	15	0	15	0	13	5		19	0	13	5		19	0	0	106
% 4+ Axle Trucks	0	0	5.2		6		2.4	1.1	0	0	1.5	0	1.5	0	1.5	0	1.5	0	1.5	0	2.3	9.1		8.3	0	2.3	9.1		8.3	3	0	2.1
% 4+ Axle Trucks	0	0	2		2		5.5	0.5	0	0	1	0	1	0	1	0	1	0	1	0	0.2	1.8		0.3	0	0.2	1.8		0.3	0	0	1.6
% 4+ Axle Trucks	0	0	86		107		17	19	0	0	105	0	105	0	105	0	105	0	105	0	32	4		36	0	32	4		36	0	0	284
% 4+ Axle Trucks	0	0	24.9		14.1		1.9	0.9	0	0	10.7	0	10.7	0	10.7	0	10.7	0	10.7	0	5.6	7.3		5.7	0	5.6	7.3		5.7	0	0	5.5

Start Time	I-215 Southbound Off Ramp Southbound						Cactus Avenue Westbound						I-215 Southbound Ramps Northbound						Cactus Avenue Eastbound													
	Left		Thru		Right		Left		Thru		Right		Left		Thru		Right		Left		Thru		Right		Left		Thru		Right			
	RTOR	App. Total	RTOR	App. Total	RTOR	App. Total	RTOR	App. Total	RTOR	App. Total	RTOR	App. Total	RTOR	App. Total	RTOR	App. Total	RTOR	App. Total	RTOR	App. Total	RTOR	App. Total	RTOR	App. Total	RTOR	App. Total	RTOR	App. Total	RTOR	App. Total		
07:00 AM	0	0	34	0	34	34	126	279	0	0	114	0	114	0	114	0	114	0	114	0	114	0	114	0	114	0	114	0	114	0	114	114
07:15 AM	0	0	47	0	47	47	143	302	0	0	124	0	124	0	124	0	124	0	124	0	124	0	124	0	124	0	124	0	124	0	124	124
07:30 AM	0	0	40	0	40	40	112	248	0	0	158	0	158	0	158	0	158	0	158	0	158	0	158	0	158	0	158	0	158	0	158	158
07:45 AM	0	0	57	0	57	57	146	281	0	0	172	0	172	0	172	0	172	0	172	0	172	0	172	0	172	0	172	0	172	0	172	172
Total	0	0	178	0	178	178	527	1110	0	0	568	0	568	0	568	0	568	0	568	0	568	0	568	0	568	0	568	0	568	0	568	568
% App. Total	0.000	0.000	.781		.781		.902	.919	.000	.000	.920	.000	.920	.000	.920	.000	.920	.000	.920	.000	.826	.806		.786	0.000	.826	.804					
PHF																																

Peak Hour Analysis From 07:00 AM to 08:45 AM - Peak 1 of 1
 Peak Hour for Entire Intersection Begins at 07:00 AM

Counts Unlimited, Inc.
 PO Box 1178
 Corona, CA 92878
 (951)268-6268

County of Riverside
 N/S: I-215 Southbound Ramps
 E/W: Cactus Avenue
 Weather: Clear

File Name : 27_CRV_215S_Cactus AM
 Site Code : 05121716
 Start Date : 11/30/2021
 Page No : 2

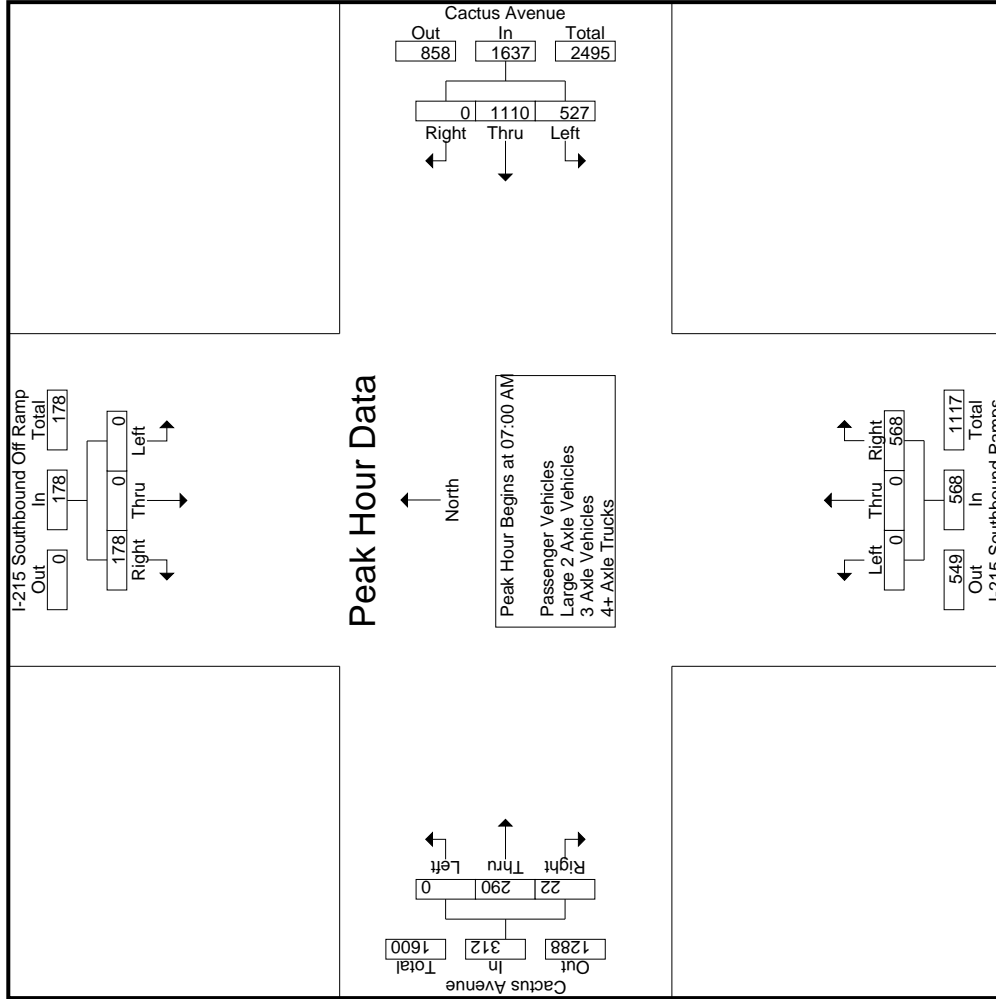

Counts Unlimited, Inc.
 PO Box 1178
 Corona, CA 92878
 (951)268-6268

County of Riverside
 N/S: I-215 Southbound Ramps
 E/W: Cactus Avenue
 Weather: Clear

File Name : 27_CRV_215S_Cactus AM
 Site Code : 05121716
 Start Date : 11/30/2021
 Page No : 3

Start Time	I-215 Southbound Off Ramp Southbound			Cactus Avenue Westbound			I-215 Southbound Ramps Northbound			Cactus Avenue Eastbound		
	Left	Thru	Right	Left	Thru	Right	Left	Thru	Right	Left	Thru	Right
Peak Hour Analysis From 07:00 AM to 08:45 AM - Peak 1 of 1												
Peak Hour for Each Approach Begins at:												
+0 mins.	0	0	57	126	279	0	0	0	114	0	78	6
+15 mins.	0	0	35	143	302	0	0	0	124	0	90	7
+30 mins.	0	0	31	112	248	0	0	0	158	0	62	10
+45 mins.	0	0	57	146	281	0	0	0	172	0	74	7
Total Volume	0	0	180	527	1110	0	0	0	568	0	304	30
% App. Total	0	0	100	32.2	67.8	0	0	0	100	0	91	9
PHF	.000	.000	.789	.902	.919	.000	.000	.000	.826	.000	.844	.750

Counts Unlimited, Inc.
 PO Box 1178
 Corona, CA 92878
 (951)268-6268

County of Riverside
 N/S: I-215 Southbound Ramps
 E/W: Cactus Avenue
 Weather: Clear

File Name : 27_CRV_215S_Cactus AM
 Site Code : 05121716
 Start Date : 11/30/2021
 Page No : 1

Groups Printed- Passenger Vehicles

Start Time	I-215 Southbound Off Ramp Southbound				Cactus Avenue Westbound				I-215 Southbound Ramps Northbound				Cactus Avenue Eastbound					
	Left	Thru	Right	RTOR	App. Total	Left	Thru	Right	RTOR	App. Total	Left	Thru	Right	RTOR	App. Total	Exclu. Total	Inclu. Total	Int. Total
07:00 AM	0	0	26	18	26	110	278	0	0	388	0	0	103	0	103	19	566	585
07:15 AM	0	0	29	9	29	129	294	0	0	423	0	0	115	0	115	11	637	648
07:30 AM	0	0	30	18	30	102	243	0	0	345	0	0	139	0	139	22	592	614
07:45 AM	0	0	45	28	45	134	275	0	0	409	0	0	149	0	149	28	695	723
Total	0	0	130	73	130	475	1090	0	0	1565	0	0	506	0	506	80	2490	2570
08:00 AM	0	0	27	11	27	91	257	0	0	348	0	0	94	0	94	11	532	543
08:15 AM	0	0	18	11	18	97	296	0	0	393	0	0	77	0	77	13	563	576
08:30 AM	0	0	34	11	34	80	243	0	0	323	0	0	95	0	95	12	523	535
08:45 AM	0	0	25	10	25	67	185	0	0	252	0	0	77	0	77	11	423	434
Total	0	0	104	43	104	335	981	0	0	1316	0	0	343	0	343	47	2041	2088
Grand Total	0	0	234	116	234	810	2071	0	0	2881	0	0	849	0	849	127	4531	4658
% Approach	0	0	100			28.1	71.9	0	0	63.6	0	0	18.7	0	18.7	2.7	97.3	
Total %	0	0	5.2			17.9	45.7	0	0	18.7	0	0	11.5	1	12.5			

Start Time	I-215 Southbound Off Ramp Southbound				Cactus Avenue Westbound				I-215 Southbound Ramps Northbound				Cactus Avenue Eastbound					
	Left	Thru	Right	RTOR	App. Total	Left	Thru	Right	RTOR	App. Total	Left	Thru	Right	RTOR	App. Total	Exclu. Total	Inclu. Total	Int. Total
07:00 AM	0	0	26		26	110	278	0	0	388	0	0	103		103	19	566	585
07:15 AM	0	0	29		29	129	294	0	0	423	0	0	115		115	11	637	648
07:30 AM	0	0	30		30	102	243	0	0	345	0	0	139		139	22	592	614
07:45 AM	0	0	45		45	134	275	0	0	409	0	0	149		149	28	695	723
Total Volume	0	0	130		130	475	1090	0	0	1565	0	0	506		506	80	2490	2570
% App. Total	0	0	100		100	30.4	69.6	0	0	63.6	0	0	100		100	2.7	97.3	
PHF	.000	.000	.722		.722	.886	.927	.000	.925	.849	.000	.849	.750		.788		.896	

Peak Hour Analysis From 07:00 AM to 07:45 AM - Peak 1 of 1
 Peak Hour for Entire Intersection Begins at 07:00 AM

Counts Unlimited, Inc.
 PO Box 1178
 Corona, CA 92878
 (951)268-6268

County of Riverside
 N/S: I-215 Southbound Ramps
 E/W: Cactus Avenue
 Weather: Clear

File Name : 27_CRV_215S_Cactus AM
 Site Code : 05121716
 Start Date : 11/30/2021
 Page No : 2

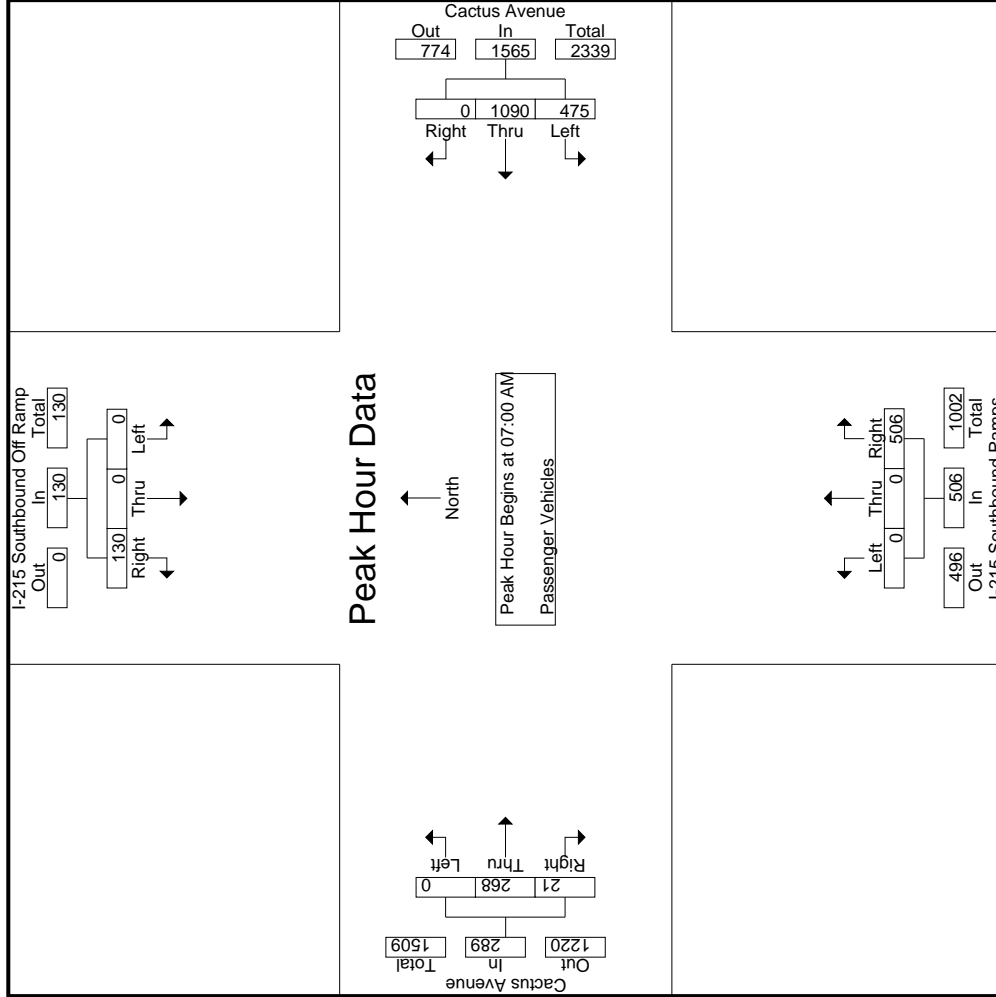

Counts Unlimited, Inc.
 PO Box 1178
 Corona, CA 92878
 (951)268-6268

File Name : 27_CRV_215S_Cactus AM
 Site Code : 05121716
 Start Date : 11/30/2021
 Page No : 3

County of Riverside
 N/S: I-215 Southbound Ramps
 E/W: Cactus Avenue
 Weather: Clear

Start Time	I-215 Southbound Off Ramp Southbound			Cactus Avenue Westbound			I-215 Southbound Ramps Northbound			Cactus Avenue Eastbound		
	Left	Thru	Right	Left	Thru	Right	Left	Thru	Right	Left	Thru	Right
Peak Hour Analysis From 07:00 AM to 07:45 AM - Peak 1 of 1												
Peak Hour for Each Approach Begins at:												
+0 mins.	0	0	26	110	278	0	0	0	103	0	45	4
+15 mins.	0	0	29	129	294	0	0	0	115	0	66	4
+30 mins.	0	0	30	102	243	0	0	0	139	0	72	6
+45 mins.	0	0	45	134	275	0	0	0	149	0	85	7
Total Volume	0	0	130	475	1090	0	0	0	506	0	268	21
% App. Total	0	0	100	30.4	69.6	0	0	0	100	0	92.7	7.3
PHF	.000	.000	.722	.886	.927	.000	.000	.000	.849	.000	.788	.785

Groups Printed- Large 2 Axle Vehicles

Start Time	I-215 Southbound Off Ramp Southbound				Cactus Avenue Westbound				I-215 Southbound Ramps Northbound				Cactus Avenue Eastbound					
	Left	Thru	Right	RTOR	App. Total	Left	Thru	Right	RTOR	App. Total	Left	Thru	Right	RTOR	App. Total	Exclu. Total	Inclu. Total	Int. Total
07:00 AM	0	0	1	1	1	4	0	0	0	4	0	0	0	0	0	1	9	10
07:15 AM	0	0	2	1	2	4	5	0	0	9	0	0	1	0	1	1	13	14
07:30 AM	0	0	4	2	4	1	2	0	0	3	0	0	0	0	2	2	9	11
07:45 AM	0	0	1	1	1	3	4	0	0	7	0	4	0	0	3	1	15	16
Total	0	0	8	5	8	12	11	0	0	23	0	0	9	0	6	5	46	51
08:00 AM	0	0	2	1	2	4	3	0	0	7	0	0	1	0	2	1	12	13
08:15 AM	0	0	2	0	2	1	4	0	0	5	0	1	0	1	4	1	12	13
08:30 AM	0	0	3	2	3	2	4	0	0	6	0	2	0	1	2	2	13	15
08:45 AM	0	0	3	1	3	3	1	0	0	4	0	2	0	2	4	1	13	14
Total	0	0	10	4	10	10	12	0	0	22	0	0	6	0	12	5	50	55
Grand Total	0	0	18	9	18	22	23	0	0	45	0	0	15	0	18	10	96	106
% Apprch %	0	0	100		18.8	48.9	51.1	0	0	46.9	0	0	15.6	0	18.8	9.4	90.6	
Total %	0	0	18.8		18.8	22.9	24	0	0	46.9	0	0	15.6	0	18.8	9.4	90.6	

Start Time	I-215 Southbound Off Ramp Southbound				Cactus Avenue Westbound				I-215 Southbound Ramps Northbound				Cactus Avenue Eastbound					
	Left	Thru	Right	RTOR	App. Total	Left	Thru	Right	RTOR	App. Total	Left	Thru	Right	RTOR	App. Total	Exclu. Total	Inclu. Total	Int. Total
07:00 AM	0	0	1	1	1	4	0	0	0	4	0	0	0	0	0	1	9	10
07:15 AM	0	0	2	1	2	4	5	0	0	9	0	0	1	0	1	1	13	14
07:30 AM	0	0	4	2	4	1	2	0	0	3	0	0	0	0	2	2	9	11
07:45 AM	0	0	1	1	1	3	4	0	0	7	0	4	0	0	3	1	15	16
Total	0	0	8	5	8	12	11	0	0	23	0	0	9	0	6	5	46	51
% App. Total	0	0	100		18.8	48.9	51.1	0	0	46.9	0	0	15.6	0	18.8	9.4	90.6	
PHF	.000	.000	.500		.500	.750	.550	.000	.639	.563	.000	.563	.000	.500	.500	.000	.500	.767

Peak Hour Analysis From 07:00 AM to 07:45 AM - Peak 1 of 1
 Peak Hour for Entire Intersection Begins at 07:00 AM

Counts Unlimited, Inc.
 PO Box 1178
 Corona, CA 92878
 (951)268-6268

County of Riverside
 N/S: I-215 Southbound Ramps
 E/W: Cactus Avenue
 Weather: Clear

File Name : 27_CRV_215S_Cactus AM
 Site Code : 05121716
 Start Date : 11/30/2021
 Page No : 2

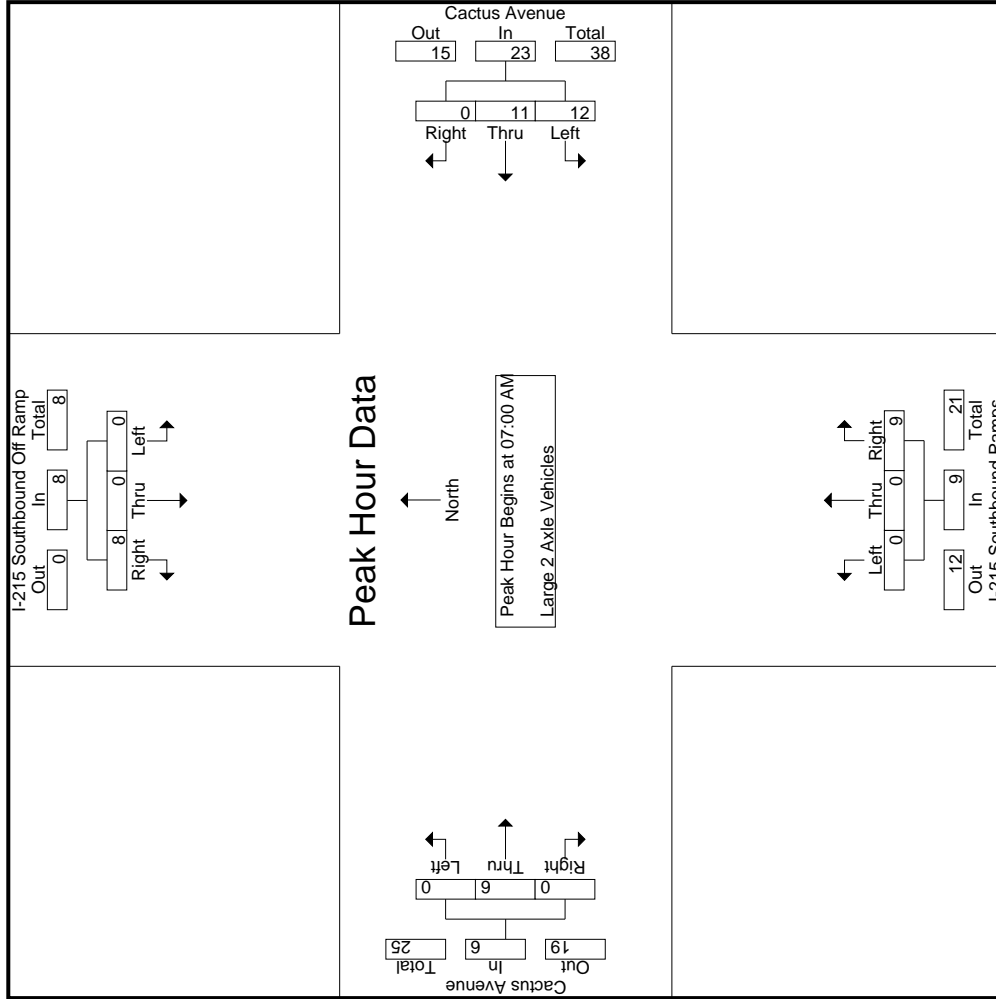

Counts Unlimited, Inc.
 PO Box 1178
 Corona, CA 92878
 (951)268-6268

File Name : 27_CRV_215S_Cactus AM
 Site Code : 05121716
 Start Date : 11/30/2021
 Page No : 3

County of Riverside
 N/S: I-215 Southbound Ramps
 E/W: Cactus Avenue
 Weather: Clear

Start Time	I-215 Southbound Off Ramp Southbound			Cactus Avenue Westbound			I-215 Southbound Ramps Northbound			Cactus Avenue Eastbound		
	Left	Thru	Right	Left	Thru	Right	Left	Thru	Right	Left	Thru	Right
Peak Hour Analysis From 07:00 AM to 07:45 AM - Peak 1 of 1												
Peak Hour for Each Approach Begins at:												
+0 mins.	0	0	1	4	0	0	0	0	4	0	0	0
+15 mins.	0	0	2	4	5	0	0	0	9	0	1	0
+30 mins.	0	0	4	1	2	0	0	0	3	0	0	0
+45 mins.	0	0	1	3	4	0	0	0	7	0	4	0
Total Volume	0	0	8	12	11	0	0	0	23	0	9	0
% App. Total	0	0	100	52.2	47.8	0	0	0	100	0	100	0
PHF	.000	.000	.500	.750	.550	.000	.000	.639	.563	.000	.500	.000

Counts Unlimited, Inc.
 PO Box 1178
 Corona, CA 92878
 (951)268-6268

County of Riverside
 N/S: I-215 Southbound Ramps
 E/W: Cactus Avenue
 Weather: Clear

File Name : 27_CRV_215S_Cactus AM
 Site Code : 05121716
 Start Date : 11/30/2021
 Page No : 1

Groups Printed- 3 Axle Vehicles

Start Time	I-215 Southbound Off Ramp Southbound				Cactus Avenue Westbound				I-215 Southbound Ramps Northbound				Cactus Avenue Eastbound					
	Left	Thru	Right	RTOR	App. Total	Left	Thru	Right	RTOR	App. Total	Left	Thru	Right	RTOR	App. Total	Exclu. Total	Inclu. Total	Int. Total
07:00 AM	0	0	2	1	2	10	0	0	0	10	0	0	0	0	0	1	12	13
07:15 AM	0	0	2	2	2	8	0	0	0	8	0	0	1	0	0	2	11	13
07:30 AM	0	0	2	0	2	7	0	0	0	7	0	0	3	0	0	0	12	12
07:45 AM	0	0	0	0	0	6	1	0	0	7	0	0	0	0	0	0	10	10
Total	0	0	6	3	6	31	1	0	0	32	0	0	7	0	0	3	45	48
08:00 AM	0	0	0	0	0	4	5	0	0	9	0	0	1	0	0	0	10	10
08:15 AM	0	0	0	0	0	4	2	0	0	6	0	0	2	0	0	0	8	8
08:30 AM	0	0	1	0	1	5	1	0	0	6	0	0	0	0	1	0	8	8
08:45 AM	0	0	0	0	0	5	1	0	0	6	0	0	0	0	1	0	8	8
Total	0	0	1	0	1	18	9	0	0	27	0	0	3	0	2	0	33	33
Grand Total	0	0	7	3	7	49	10	0	0	59	0	0	10	0	2	3	78	81
% Approach	0	0	100			83.1	16.9	0		75.6	0	0	100		2.6	3.7	96.3	
Total %	0	0	9			62.8	12.8	0			0	0	12.8					

Start Time	I-215 Southbound Off Ramp Southbound				Cactus Avenue Westbound				I-215 Southbound Ramps Northbound				Cactus Avenue Eastbound					
	Left	Thru	Right	RTOR	App. Total	Left	Thru	Right	RTOR	App. Total	Left	Thru	Right	RTOR	App. Total	Exclu. Total	Inclu. Total	Int. Total
07:00 AM	0	0	2	0	2	10	0	0	0	10	0	0	0	0	0	1	12	13
07:15 AM	0	0	2	2	2	8	0	0	0	8	0	0	1	0	0	2	11	13
07:30 AM	0	0	2	0	2	7	0	0	0	7	0	0	3	0	0	0	12	12
07:45 AM	0	0	0	0	0	6	1	0	0	7	0	0	0	0	0	0	10	10
Total	0	0	6	3	6	31	1	0	0	32	0	0	7	0	0	3	45	48
08:00 AM	0	0	0	0	0	4	5	0	0	9	0	0	1	0	0	0	10	10
08:15 AM	0	0	0	0	0	4	2	0	0	6	0	0	2	0	0	0	8	8
08:30 AM	0	0	1	0	1	5	1	0	0	6	0	0	0	0	1	0	8	8
08:45 AM	0	0	0	0	0	5	1	0	0	6	0	0	0	0	1	0	8	8
Total	0	0	1	0	1	18	9	0	0	27	0	0	3	0	2	0	33	33
Grand Total	0	0	7	3	7	49	10	0	0	59	0	0	10	0	2	3	78	81
% Approach	0	0	100			83.1	16.9	0		75.6	0	0	100		2.6	3.7	96.3	
Total %	0	0	9			62.8	12.8	0			0	0	12.8					

Peak Hour Analysis From 07:00 AM to 07:45 AM - Peak 1 of 1
 Peak Hour for Entire Intersection Begins at 07:00 AM

Start Time	I-215 Southbound Off Ramp Southbound				Cactus Avenue Westbound				I-215 Southbound Ramps Northbound				Cactus Avenue Eastbound					
	Left	Thru	Right	RTOR	App. Total	Left	Thru	Right	RTOR	App. Total	Left	Thru	Right	RTOR	App. Total	Exclu. Total	Inclu. Total	Int. Total
07:00 AM	0	0	2	0	2	10	0	0	0	10	0	0	0	0	0	1	12	13
07:15 AM	0	0	2	2	2	8	0	0	0	8	0	0	1	0	0	2	11	13
07:30 AM	0	0	2	0	2	7	0	0	0	7	0	0	3	0	0	0	12	12
07:45 AM	0	0	0	0	0	6	1	0	0	7	0	0	0	0	0	0	10	10
Total	0	0	6	3	6	31	1	0	0	32	0	0	7	0	0	3	45	48
% App. Total	0	0	100			83.1	16.9	0		75.6	0	0	100		2.6	3.7	96.3	
PHF	.000	.000	.750		.750	.775	.250	.000		.800	.000	.000	.583		.583	.000	.000	.938

Counts Unlimited, Inc.
 PO Box 1178
 Corona, CA 92878
 (951)268-6268

County of Riverside
 N/S: I-215 Southbound Ramps
 E/W: Cactus Avenue
 Weather: Clear

File Name : 27_CRV_215S_Cactus AM
 Site Code : 05121716
 Start Date : 11/30/2021
 Page No : 2

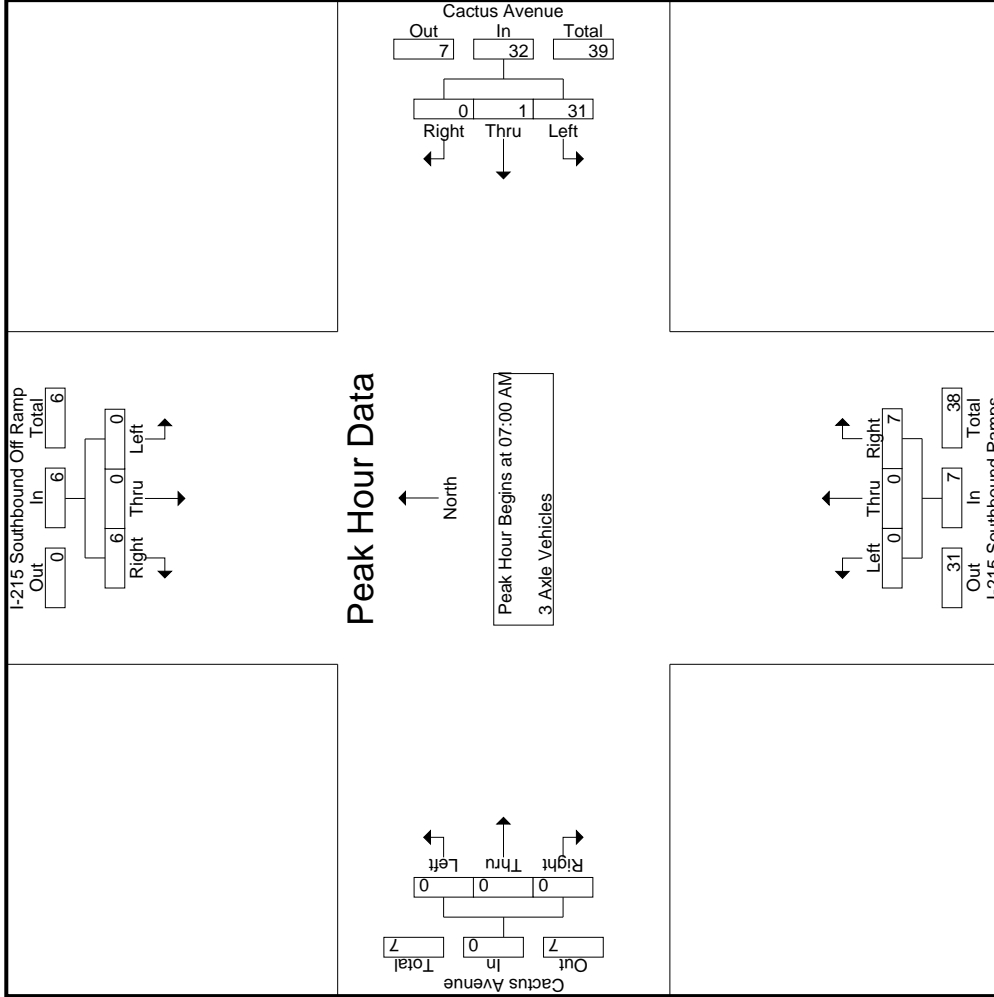

Counts Unlimited, Inc.
 PO Box 1178
 Corona, CA 92878
 (951)268-6268

File Name : 27_CRV_215S_Cactus AM
 Site Code : 05121716
 Start Date : 11/30/2021
 Page No : 3

County of Riverside
 N/S: I-215 Southbound Ramps
 E/W: Cactus Avenue
 Weather: Clear

Start Time	I-215 Southbound Off Ramp Southbound			Cactus Avenue Westbound			I-215 Southbound Ramps Northbound			Cactus Avenue Eastbound		
	Left	Thru	Right	Left	Thru	Right	Left	Thru	Right	Left	Thru	Right
Peak Hour Analysis From 07:00 AM to 07:45 AM - Peak 1 of 1												
Peak Hour for Each Approach Begins at:	07:00 AM											
+0 mins.	0	0	2	10	0	0	0	0	0	0	0	0
+15 mins.	0	0	2	8	0	0	0	0	1	0	0	0
+30 mins.	0	0	2	7	0	0	0	0	3	0	0	0
+45 mins.	0	0	0	6	1	0	0	0	3	0	0	0
Total Volume	0	0	6	31	1	0	0	0	7	0	0	0
% App. Total	0	0	100	96.9	3.1	0	0	0	100	0	0	0
PHF	.000	.000	.750	.775	.250	.000	.800	.000	.583	.000	.000	.000

Counts Unlimited, Inc.
 PO Box 1178
 Corona, CA 92878
 (951)268-6268

File Name : 27_CRV_215S_Cactus AM
 Site Code : 05121716
 Start Date : 11/30/2021
 Page No : 1

County of Riverside
 N/S: I-215 Southbound Ramps
 E/W: Cactus Avenue
 Weather: Clear

Groups Printed- 4+ Axle Trucks

Start Time	I-215 Southbound Off Ramp Southbound				Cactus Avenue Westbound				I-215 Southbound Ramps Northbound				Cactus Avenue Eastbound					
	Left	Thru	Right	RTOR	App. Total	Left	Thru	Right	RTOR	App. Total	Left	Thru	Right	RTOR	App. Total	Exclu. Total	Inclu. Total	Int. Total
07:00 AM	0	0	5	0	5	2	1	0	0	3	0	0	7	0	7	0	22	22
07:15 AM	0	0	14	1	14	2	3	0	0	5	0	0	7	0	4	1	30	31
07:30 AM	0	0	4	1	4	2	3	0	0	5	0	0	16	0	4	1	29	30
07:45 AM	0	0	11	8	11	3	1	0	0	4	0	0	16	0	2	8	33	41
Total	0	0	34	10	34	9	8	0	0	17	0	0	46	0	17	10	114	124
08:00 AM	0	0	6	0	6	2	3	0	0	5	0	0	13	0	7	0	31	31
08:15 AM	0	0	11	3	11	2	3	0	0	5	0	0	17	0	2	3	35	38
08:30 AM	0	0	19	3	19	1	1	0	0	2	0	0	17	0	1	3	39	42
08:45 AM	0	0	16	5	16	3	4	0	0	7	0	0	12	0	9	5	44	49
Total	0	0	52	11	52	8	11	0	0	19	0	0	59	0	19	11	149	160
Grand Total	0	0	86	21	86	17	19	0	0	36	0	0	105	0	36	21	263	284
% Apprch %	0	0	100		47.2	52.8	0			13.7	0	0	100		88.9	11.1		
% Total %	0	0	32.7		32.7	6.5	7.2	0		13.7	0	0	39.9		12.2	1.5		92.6

Start Time	I-215 Southbound Off Ramp Southbound				Cactus Avenue Westbound				I-215 Southbound Ramps Northbound				Cactus Avenue Eastbound					
	Left	Thru	Right	RTOR	App. Total	Left	Thru	Right	RTOR	App. Total	Left	Thru	Right	RTOR	App. Total	Exclu. Total	Inclu. Total	Int. Total
07:00 AM	0	0	5	0	5	2	1	0	0	3	0	0	7	0	7	0	22	22
07:15 AM	0	0	14	1	14	2	3	0	0	5	0	0	7	0	4	1	30	31
07:30 AM	0	0	4	1	4	2	3	0	0	5	0	0	16	0	4	1	29	30
07:45 AM	0	0	11	8	11	3	1	0	0	4	0	0	16	0	2	8	33	41
Total	0	0	34	10	34	9	8	0	0	17	0	0	46	0	17	10	114	124
08:00 AM	0	0	6	0	6	2	3	0	0	5	0	0	13	0	7	0	31	31
08:15 AM	0	0	11	3	11	2	3	0	0	5	0	0	17	0	2	3	35	38
08:30 AM	0	0	19	3	19	1	1	0	0	2	0	0	17	0	1	3	39	42
08:45 AM	0	0	16	5	16	3	4	0	0	7	0	0	12	0	9	5	44	49
Total	0	0	52	11	52	8	11	0	0	19	0	0	59	0	19	11	149	160
Grand Total	0	0	86	21	86	17	19	0	0	36	0	0	105	0	36	21	263	284
% Apprch %	0	0	100		47.2	52.8	0			13.7	0	0	100		88.9	11.1		
% Total %	0	0	32.7		32.7	6.5	7.2	0		13.7	0	0	39.9		12.2	1.5		92.6

Peak Hour Analysis From 07:00 AM to 07:45 AM - Peak 1 of 1
 Peak Hour for Entire Intersection Begins at 07:00 AM

Start Time	I-215 Southbound Off Ramp Southbound				Cactus Avenue Westbound				I-215 Southbound Ramps Northbound				Cactus Avenue Eastbound					
	Left	Thru	Right	RTOR	App. Total	Left	Thru	Right	RTOR	App. Total	Left	Thru	Right	RTOR	App. Total	Exclu. Total	Inclu. Total	Int. Total
07:00 AM	0	0	5	0	5	2	1	0	0	3	0	0	7	0	7	0	22	22
07:15 AM	0	0	14	1	14	2	3	0	0	5	0	0	7	0	4	1	30	31
07:30 AM	0	0	4	1	4	2	3	0	0	5	0	0	16	0	4	1	29	30
07:45 AM	0	0	11	8	11	3	1	0	0	4	0	0	16	0	2	8	33	41
Total	0	0	34	10	34	9	8	0	0	17	0	0	46	0	17	10	114	124
% App. Total	0	0	100		47.2	52.8	0			13.7	0	0	100		88.9	11.1		
PHF	.000	.000	.607		.607	.750	.667	.000		.850	.000	.000	.719		.719	.250	.607	.864

Counts Unlimited, Inc.
 PO Box 1178
 Corona, CA 92878
 (951)268-6268

County of Riverside
 N/S: I-215 Southbound Ramps
 E/W: Cactus Avenue
 Weather: Clear

File Name : 27_CRV_215S_Cactus AM
 Site Code : 05121716
 Start Date : 11/30/2021
 Page No : 2

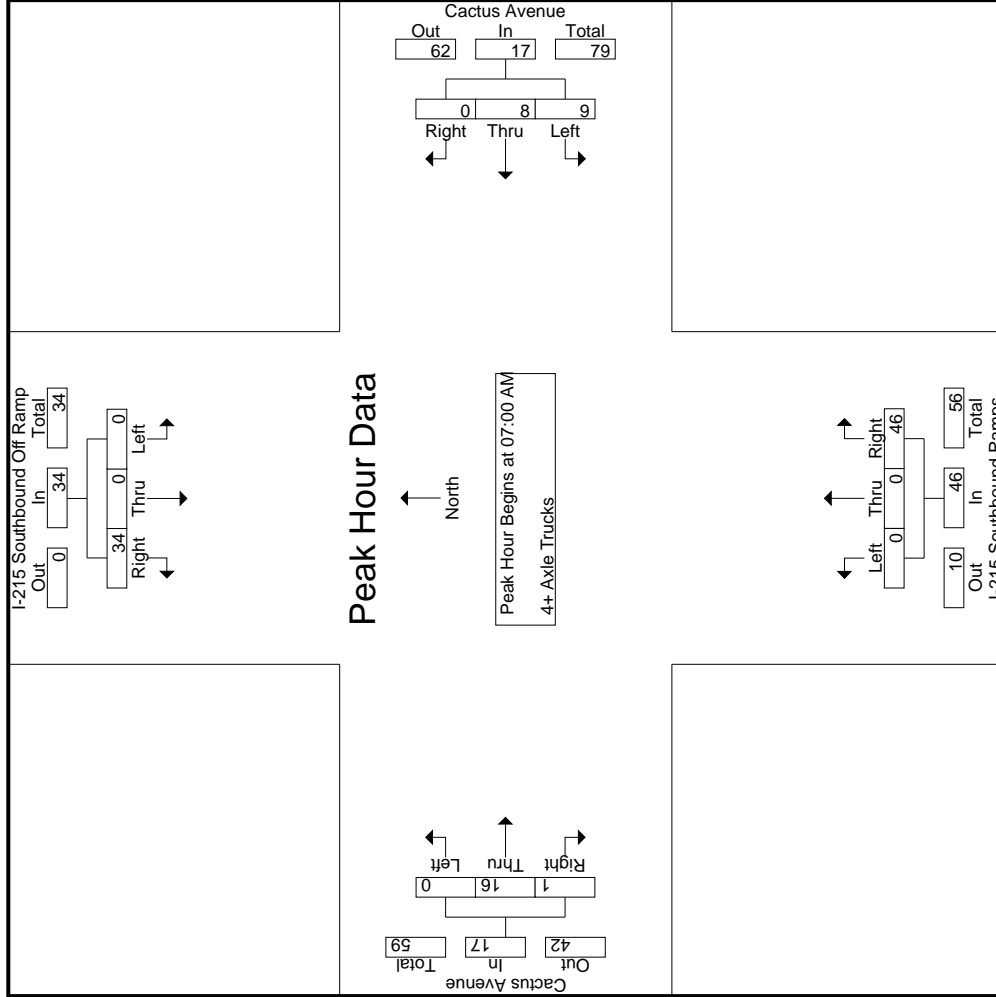

Counts Unlimited, Inc.
 PO Box 1178
 Corona, CA 92878
 (951)268-6268

File Name : 27_CRV_215S_Cactus AM
 Site Code : 05121716
 Start Date : 11/30/2021
 Page No : 3

County of Riverside
 N/S: I-215 Southbound Ramps
 E/W: Cactus Avenue
 Weather: Clear

Start Time	I-215 Southbound Off Ramp Southbound			Cactus Avenue Westbound			I-215 Southbound Ramps Northbound			Cactus Avenue Eastbound		
	Left	Thru	Right	Left	Thru	Right	Left	Thru	Right	Left	Thru	Right
Peak Hour Analysis From 07:00 AM to 07:45 AM - Peak 1 of 1												
Peak Hour for Each Approach Begins at:												
+0 mins.	0	0	5	2	1	0	0	0	7	0	7	0
+15 mins.	0	0	14	2	3	0	0	0	7	0	3	1
+30 mins.	0	0	4	2	3	0	0	0	16	0	4	0
+45 mins.	0	0	11	3	1	0	0	0	16	0	2	0
Total Volume	0	0	34	9	8	0	0	0	46	0	16	1
% App. Total	0	0	100	52.9	47.1	0	0	0	100	0	94.1	5.9
PHF	.000	.000	.607	.750	.667	.000	.000	.000	.719	.000	.571	.250
			.607		.850				.719		.607	

Groups Printed- Passenger Vehicles - Large 2 Axle Vehicles - 3 Axle Vehicles - 4+ Axle Trucks

Start Time	I-215 Southbound Off Ramp						Cactus Avenue Westbound						I-215 Southbound On Ramp						Cactus Avenue Eastbound									
	Southbound			Southbound			Westbound		Westbound		Westbound		Northbound		Northbound		Eastbound		Eastbound		Eastbound		Eastbound					
	Left	Thru	Right	RTOR	App. Total	Left	Thru	Right	RTOR	App. Total	Left	Thru	Right	RTOR	App. Total	Left	Thru	Right	RTOR	App. Total	Left	Thru	Right	RTOR	App. Total	Exclu. Total	Inclu. Total	Int. Total
04:00 PM	0	1	53	23	54	122	227	0	0	349	0	0	160	0	160	0	132	33	7	165	0	132	33	7	165	30	728	758
04:15 PM	0	0	55	31	55	131	208	0	0	339	0	0	137	0	137	0	187	30	4	217	0	187	30	4	217	35	748	783
04:30 PM	1	2	36	19	39	134	229	0	0	363	0	0	149	0	149	0	153	38	1	191	0	153	38	1	191	20	742	762
04:45 PM	1	4	71	17	76	96	268	0	0	364	0	0	157	0	157	0	185	21	7	206	0	185	21	7	206	24	803	827
Total	2	7	215	90	224	483	932	0	0	1415	0	0	603	0	603	0	657	122	19	779	0	657	122	19	779	109	3021	3130
05:00 PM	1	0	90	33	91	123	276	0	0	399	0	0	103	0	103	0	184	44	15	228	0	184	44	15	228	48	821	869
05:15 PM	0	4	36	13	40	160	237	0	0	397	0	0	62	0	62	0	146	56	3	202	0	146	56	3	202	16	701	717
05:30 PM	0	0	16	14	16	191	169	0	0	360	0	0	94	0	94	0	165	50	4	215	0	165	50	4	215	18	685	703
05:45 PM	0	0	29	20	29	122	165	0	0	287	0	0	168	0	168	0	165	35	7	200	0	165	35	7	200	27	684	711
Total	1	4	171	80	176	596	847	0	0	1443	0	0	427	0	427	0	660	185	29	845	0	660	185	29	845	109	2891	3000
Grand Total	3	11	386	170	400	1079	1779	0	0	2858	0	0	1030	0	1030	0	1317	307	48	1624	0	1317	307	48	1624	218	5912	6130
T-Approch %	0.8	2.8	96.5			37.8	62.2	0	0	100	0	0	100	0	100	0	81.1	18.9			0	81.1	18.9					
T-Total %	0.1	0.2	6.5			18.3	30.1	0	0	48.3	0	0	17.4		17.4	0	22.3	5.2		27.5	0	22.3	5.2		3.6	96.4		
% Passenger Vehicles	3	9	327		489	1056	1737	0	0	2793	0	0	943		943	0	1270	294		1610	0	1270	294		0	0	5835	
% Large 2 Axle Vehicles	100	81.8	84.7	88.2	85.8	97.9	97.6	0	0	97.7	0	0	91.6		91.6	0	96.4	95.8		96.3	0	96.4	95.8		0	0	0	95.2
% 3 Axle Vehicles	0	0	10	3.5	2.8	1.3	1.1	0	0	1.2	0	0	1.9		1.9	0	0.9	0.3		0.8	0	0.9	0.3		0	0	82	
% 4+ Axle Trucks	0	0	7	2.4	1.9	3	7	0	0	10	0	0	10		10	0	5	4		10	0	5	4		0	0	41	
% 4+ Axle Trucks	0	2	42	5.9	5.4	6	16	0	0	0.3	0	0	5.5		5.5	0	30	8		39	0	30	8		0	0	172	
% 4+ Axle Trucks	0	18.2	10.9	5.9	9.5	0.6	0.9	0	0	0.8	0	0	5.5		5.5	0	2.3	2.6		2.3	0	2.3	2.6		0	0	2.8	

Start Time	I-215 Southbound Off Ramp						Cactus Avenue Westbound						I-215 Southbound On Ramp						Cactus Avenue Eastbound									
	Southbound			Southbound			Westbound		Westbound		Westbound		Northbound		Northbound		Eastbound		Eastbound		Eastbound		Eastbound		Eastbound			
	Left	Thru	Right	RTOR	App. Total	Left	Thru	Right	RTOR	App. Total	Left	Thru	Right	RTOR	App. Total	Left	Thru	Right	RTOR	App. Total	Left	Thru	Right	RTOR	App. Total	Exclu. Total	Inclu. Total	Int. Total
04:15 PM	0	0	55		55	131	208	0	0	339	0	0	137		137	0	187	30		217	0	187	30		0	217	748	
04:30 PM	1	2	36		39	134	229	0	0	363	0	0	149		149	0	153	38		191	0	153	38		0	191	742	
04:45 PM	1	4	71		76	96	268	0	0	364	0	0	157		157	0	185	21		206	0	185	21		0	206	803	
05:00 PM	1	0	90		91	123	276	0	0	399	0	0	103		103	0	184	44		228	0	184	44		0	228	821	
Total Volume	3	6	252		261	484	981	0	0	1465	0	0	546		546	0	709	133		842	0	709	133		0	842	3114	
% App. Total	1.1	2.3	96.6		96.6	33	67	0	0	100	0	0	100		100	0	84.2	15.8		.948	0	84.2	15.8		0	.948		
PHF	.750	.375	.700		.717	.903	.889	.000	.918	.869	.000	.869	.000	.869	.869	.000	.948	.756		.923	.000	.948	.756		0	.923	.948	

Peak Hour Analysis From 04:00 PM to 05:45 PM - Peak 1 of 1
 Peak Hour for Entire Intersection Begins at 04:15 PM

Counts Unlimited, Inc.
 PO Box 1178
 Corona, CA 92878
 (951)268-6268

County of Riverside
 N/S: I-215 Southbound Ramps
 E/W: Cactus Avenue
 Weather: Clear

File Name : 27_CRV_215S_Cactus PM
 Site Code : 05121716
 Start Date : 11/30/2021
 Page No : 2

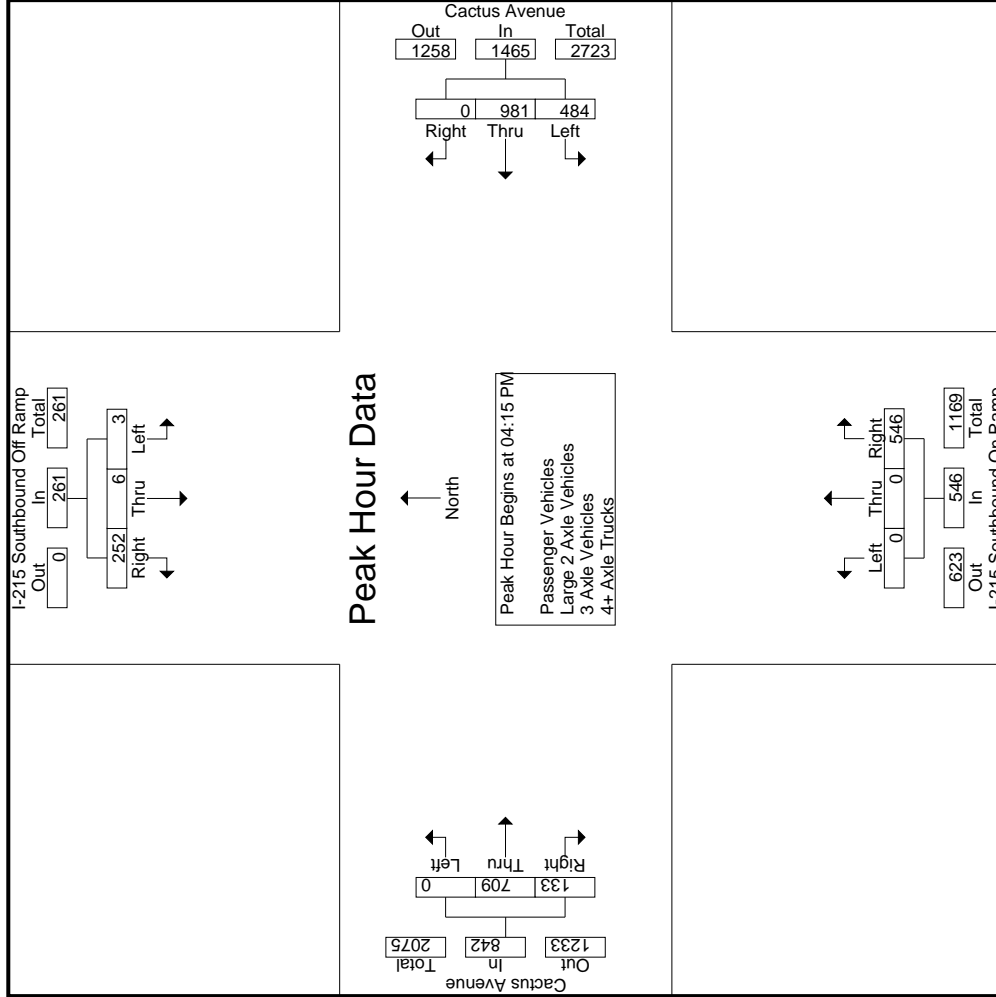

Counts Unlimited, Inc.
 PO Box 1178
 Corona, CA 92878
 (951)268-6268

File Name : 27_CRV_215S_Cactus PM
 Site Code : 05121716
 Start Date : 11/30/2021
 Page No : 3

County of Riverside
 N/S: I-215 Southbound Ramps
 E/W: Cactus Avenue
 Weather: Clear

Start Time	I-215 Southbound Off Ramp Southbound					Cactus Avenue Westbound					I-215 Southbound On Ramp Northbound					Cactus Avenue Eastbound				
	Left	Thru	Right	App. Total	Int. Total	Left	Thru	Right	App. Total	Int. Total	Left	Thru	Right	App. Total	Int. Total	Left	Thru	Right	App. Total	Int. Total
	04:15 PM					04:30 PM					04:00 PM					04:45 PM				
+0 mins.	0	0	55	55		134	229	0	363		0	0	160		0	0	185	21	206	
+15 mins.	1	2	36	39		96	268	0	364		0	0	137		0	0	184	44	228	
+30 mins.	1	4	71	76		123	276	0	399		0	0	149		0	0	146	56	202	
+45 mins.	1	0	90	91		160	237	0	397		0	0	157		0	0	165	50	215	
Total Volume	3	6	252	261		513	1010	0	1523		0	0	603		0	0	680	171	851	
% App. Total	1.1	2.3	96.6			33.7	66.3	0	100		0	0	100		0	0	79.9	20.1		
PHF	.750	.375	.700	.717		.802	.915	.000	.954		.000	.000	.942		.000	.919	.763		.933	

Peak Hour Analysis From 04:00 PM to 05:45 PM - Peak 1 of 1
 Peak Hour for Each Approach Begins at:

Counts Unlimited, Inc.
 PO Box 1178
 Corona, CA 92878
 (951)268-6268

County of Riverside
 N/S: I-215 Southbound Ramps
 E/W: Cactus Avenue
 Weather: Clear

File Name : 27_CRV_215S_Cactus PM
 Site Code : 05121716
 Start Date : 11/30/2021
 Page No : 1

Groups Printed- Passenger Vehicles

Start Time	I-215 Southbound Off Ramp Southbound				Cactus Avenue Westbound				I-215 Southbound On Ramp Northbound				Cactus Avenue Eastbound										
	Left	Thru	Right	RTOR	App. Total	Left	Thru	Right	RTOR	App. Total	Left	Thru	Right	RTOR	App. Total	Left	Thru	Right	RTOR	App. Total	Exclu. Total	Inclu. Total	Int. Total
04:00 PM	0	1	40	18	41	120	220	0	0	340	0	0	143	0	143	0	128	32	7	160	25	684	709
04:15 PM	0	0	44	28	44	130	201	0	0	331	0	0	125	0	125	0	178	28	3	206	31	706	737
04:30 PM	1	2	28	16	31	134	225	0	0	359	0	0	134	0	134	0	146	36	1	182	17	706	723
04:45 PM	1	4	64	16	69	95	265	0	0	360	0	0	148	0	148	0	177	21	7	198	23	775	798
Total	2	7	176	78	185	479	911	0	0	1390	0	0	550	0	550	0	629	117	18	746	96	2871	2967
05:00 PM	1	0	83	32	84	117	271	0	0	388	0	0	99	0	99	0	179	41	15	220	47	791	838
05:15 PM	0	2	34	13	36	156	229	0	0	385	0	0	53	0	53	0	142	55	3	197	16	671	687
05:30 PM	0	0	11	11	11	185	165	0	0	350	0	0	85	0	85	0	162	47	3	209	14	655	669
05:45 PM	0	0	23	16	23	119	161	0	0	280	0	0	156	0	156	0	158	34	7	192	23	651	674
Total	1	2	151	72	154	577	826	0	0	1403	0	0	393	0	393	0	641	177	28	818	100	2768	2868
Grand Total	3	9	327	150	339	1056	1737	0	0	2793	0	0	943	0	943	0	1270	294	46	1564	196	5639	5835
T-Approch %	0.9	2.7	96.5			37.8	62.2	0	0	49.5	0	0	16.7	0	16.7	0	81.2	18.8		27.7	3.4	96.6	
T-Total %	0.1	0.2	5.8		6	18.7	30.8	0	0							0	22.5	5.2					

Start Time	I-215 Southbound Off Ramp Southbound				Cactus Avenue Westbound				I-215 Southbound On Ramp Northbound				Cactus Avenue Eastbound													
	Left	Thru	Right	RTOR	App. Total	Left	Thru	Right	RTOR	App. Total	Left	Thru	Right	RTOR	App. Total	Left	Thru	Right	RTOR	App. Total	Left	Thru	Right	RTOR	App. Total	Int. Total
04:15 PM	0	0	44		44	130	201	0	0	331	0	0	125	0	125	0	178	28		206	0	178	28		206	706
04:30 PM	1	2	28		31	134	225	0	0	359	0	0	134	0	134	0	146	36		182	0	146	36		182	706
04:45 PM	1	4	64		69	95	265	0	0	360	0	0	148	0	148	0	177	21		198	0	177	21		198	775
05:00 PM	1	0	83		84	117	271	0	0	388	0	0	99	0	99	0	179	41		220	0	179	41		220	791
Total Volume	3	6	219		228	476	962	0	0	1438	0	0	506	0	506	0	680	126		806	0	680	126		806	2978
% App. Total	1.3	2.6	96.1		96.1	33.1	66.9	0	0	100	0	0	100	0	100	0	84.4	15.6		91.6	0	84.4	15.6		91.6	.941
PHF	.750	.375	.660		.679	.888	.887	.000	.927	.855	.000	.000	.855	.000	.855	.000	.950	.768		.916		.950	.768		.916	

Peak Hour Analysis From 04:15 PM to 05:00 PM - Peak 1 of 1
 Peak Hour for Entire Intersection Begins at 04:15 PM

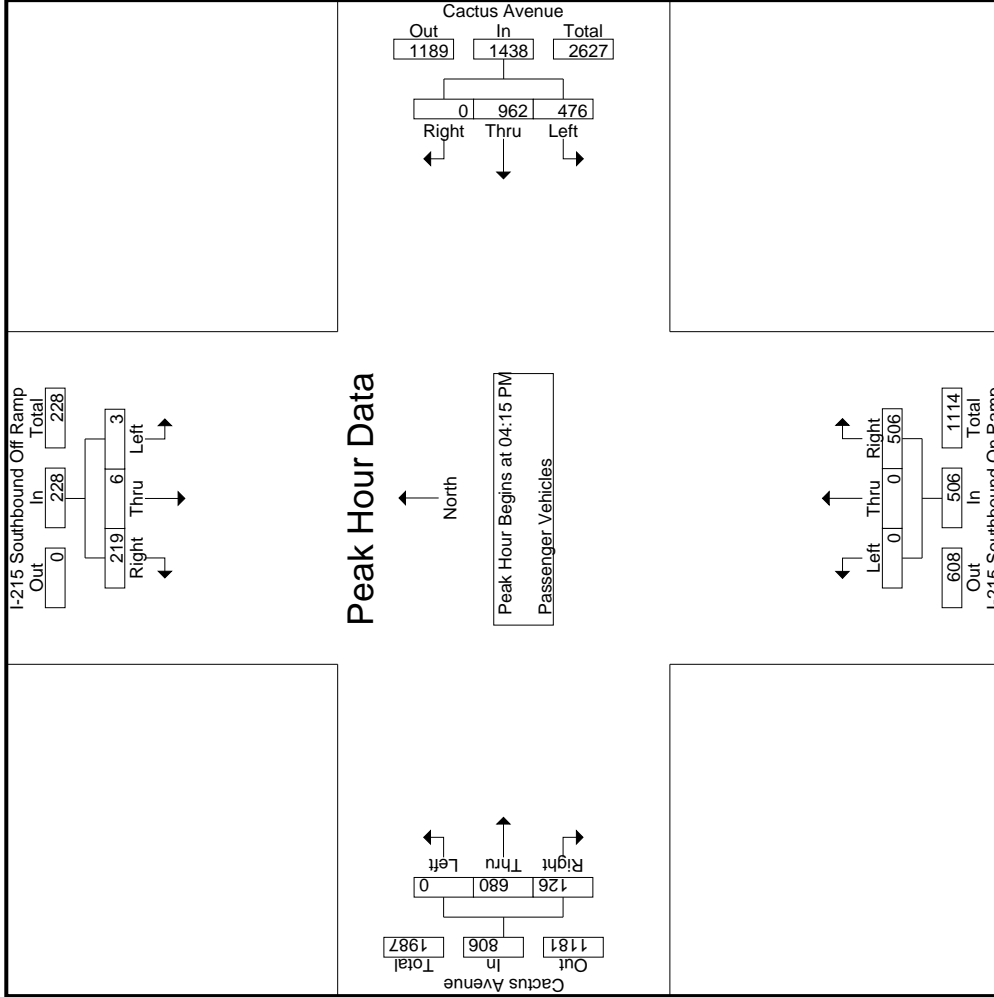

Counts Unlimited, Inc.
 PO Box 1178
 Corona, CA 92878
 (951)268-6268

File Name : 27_CRV_215S_Cactus PM
 Site Code : 05121716
 Start Date : 11/30/2021
 Page No : 3

County of Riverside
 N/S: I-215 Southbound Ramps
 E/W: Cactus Avenue
 Weather: Clear

Start Time	I-215 Southbound Off Ramp Southbound			Cactus Avenue Westbound			I-215 Southbound On Ramp Northbound			Cactus Avenue Eastbound		
	Left	Thru	Right	Left	Thru	Right	Left	Thru	Right	Left	Thru	Right
Peak Hour Analysis From 04:15 PM to 05:00 PM - Peak 1 of 1												
Peak Hour for Each Approach Begins at:	04:15 PM											
+0 mins.	0	0	44	130	201	0	331	0	125	0	178	28
+15 mins.	1	2	28	134	225	0	359	0	134	0	146	36
+30 mins.	1	4	64	95	265	0	360	0	148	0	177	21
+45 mins.	1	0	83	117	271	0	388	0	99	0	179	41
Total Volume	3	6	219	476	962	0	1438	0	506	0	680	126
% App. Total	1.3	2.6	96.1	33.1	66.9	0	100	0	100	0	84.4	15.6
PHF	.750	.375	.660	.888	.887	.000	.927	.000	.855	.000	.950	.768
			.679						.855			.916

Counts Unlimited, Inc.
 PO Box 1178
 Corona, CA 92878
 (951)268-6268

County of Riverside
 N/S: I-215 Southbound Ramps
 E/W: Cactus Avenue
 Weather: Clear

File Name : 27_CRV_215S_Cactus PM
 Site Code : 05121716
 Start Date : 11/30/2021
 Page No : 1

Groups Printed- Large 2-Axle Vehicles

Start Time	I-215 Southbound Off Ramp Southbound				Cactus Avenue Westbound				I-215 Southbound On Ramp Northbound				Cactus Avenue Eastbound											
	Left	Thru	Right	RTOR	Left	Thru	Right	RTOR	Left	Thru	Right	RTOR	Left	Thru	Right	RTOR	Left	Thru	Right	RTOR	Exclu. Total	Inclu. Total	Int. Total	
04:00 PM	0	0	3	2	0	6	0	0	6	0	0	6	0	0	0	0	0	2	0	0	2	2	17	19
04:15 PM	0	0	2	1	0	1	0	0	1	0	3	0	0	2	0	0	0	2	0	0	2	1	8	9
04:30 PM	0	0	1	1	0	2	0	0	2	0	3	0	0	2	1	0	0	3	1	0	3	1	9	10
04:45 PM	0	0	1	0	1	2	0	0	3	0	3	0	0	4	0	0	0	4	0	0	4	0	11	11
Total	0	0	7	4	1	11	0	0	12	0	15	0	0	10	1	0	0	11	4	0	11	4	45	49
05:00 PM	0	0	1	0	4	2	0	0	6	0	0	0	0	1	0	0	0	1	0	0	1	0	8	8
05:15 PM	0	0	0	0	3	1	0	0	4	0	1	0	0	0	0	0	0	0	0	0	0	0	5	5
05:30 PM	0	0	1	1	5	2	0	0	7	0	3	0	0	0	0	0	0	0	0	0	0	1	11	12
05:45 PM	0	0	1	1	1	3	0	0	4	0	1	0	0	1	0	0	0	1	0	0	1	1	7	8
Total	0	0	3	2	13	8	0	0	21	0	5	0	0	2	0	0	0	2	0	0	2	2	31	33
Grand Total	0	0	10	6	14	19	0	0	33	0	20	0	0	12	1	0	0	13	6	0	13	6	76	82
% Approach	0	0	100		42.4	57.6	0		43.4	0	100		0	92.3	7.7		17.1	7.3		17.1	7.3	92.7		
Total %	0	0	13.2		13.2	18.4	25	0	43.4	0	26.3		0	15.8	1.3		17.1	7.3		17.1	7.3	92.7		

Start Time	I-215 Southbound Off Ramp Southbound				Cactus Avenue Westbound				I-215 Southbound On Ramp Northbound				Cactus Avenue Eastbound											
	Left	Thru	Right	RTOR	Left	Thru	Right	RTOR	Left	Thru	Right	RTOR	Left	Thru	Right	RTOR	Left	Thru	Right	RTOR	Exclu. Total	Inclu. Total	Int. Total	
04:15 PM	0	0	2		0	1	0		1	0	3		0	2	0		0	2	0		2	0	2	8
04:30 PM	0	0	1		0	2	0		2	0	3		0	2	0		0	2	0		2	1	3	9
04:45 PM	0	0	1		1	2	0		3	0	3		0	4	0		0	4	0		4	0	4	11
05:00 PM	0	0	1		4	2	0		6	0	6		0	1	0		0	1	0		1	0	1	8
Total Volume	0	0	5		5	7	0		12	0	9		0	9	0		0	9	0		9	1	10	36
% App. Total	0	0	100		41.7	58.3	0		58.3	0	100		0	90	10		0	90	10		90	10	10	36
PHF	.000	.000	.625		.313	.875	.000		.500	.000	.750		.000	.563	.250		.000	.563	.250		.625	.250	.818	

Peak Hour Analysis From 04:15 PM to 05:00 PM - Peak 1 of 1
 Peak Hour for Entire Intersection Begins at 04:15 PM

Counts Unlimited, Inc.
 PO Box 1178
 Corona, CA 92878
 (951)268-6268

County of Riverside
 N/S: I-215 Southbound Ramps
 E/W: Cactus Avenue
 Weather: Clear

File Name : 27_CRV_215S_Cactus PM
 Site Code : 05121716
 Start Date : 11/30/2021
 Page No : 2

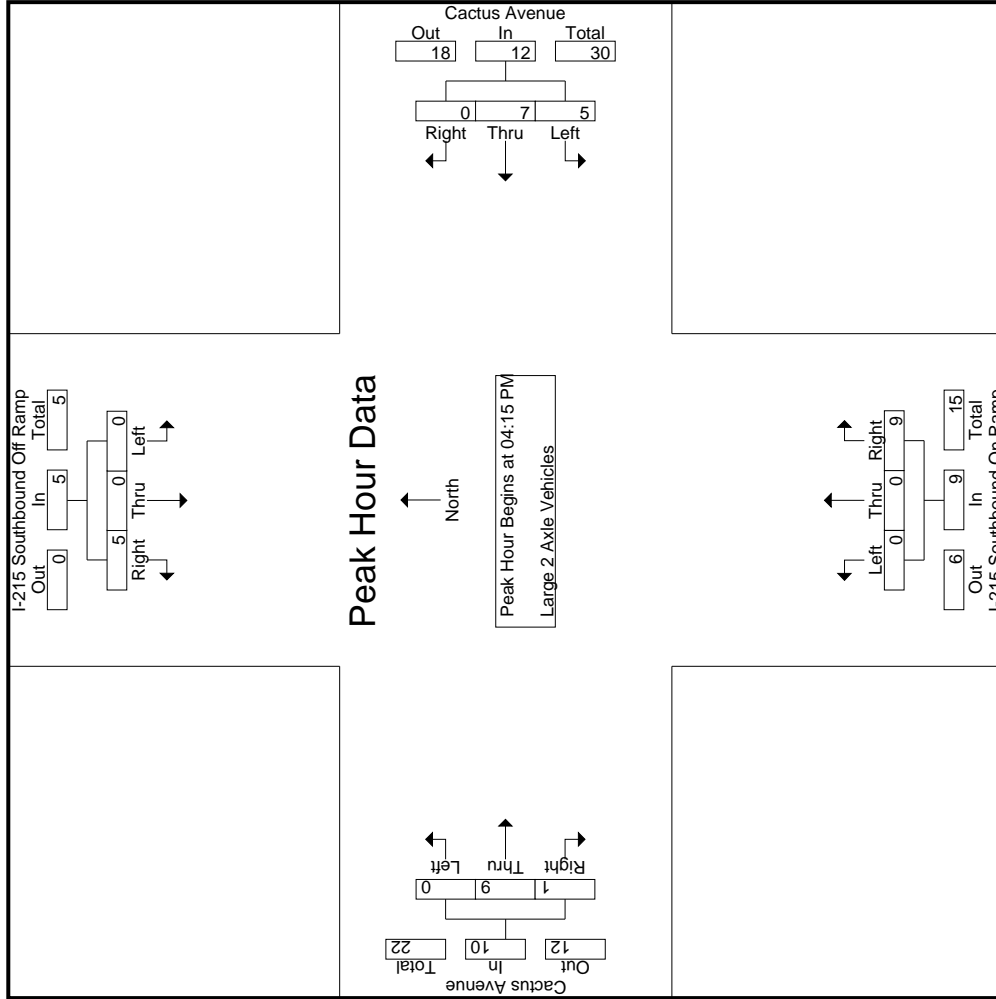

Counts Unlimited, Inc.
 PO Box 1178
 Corona, CA 92878
 (951)268-6268

File Name : 27_CRV_215S_Cactus PM
 Site Code : 05121716
 Start Date : 11/30/2021
 Page No : 3

County of Riverside
 N/S: I-215 Southbound Ramps
 E/W: Cactus Avenue
 Weather: Clear

Start Time	I-215 Southbound Off Ramp Southbound			Cactus Avenue Westbound			I-215 Southbound On Ramp Northbound			Cactus Avenue Eastbound				
	Left	Thru	Right	App. Total	Left	Thru	Right	App. Total	Left	Thru	Right	App. Total	Int. Total	
Peak Hour Analysis From 04:15 PM to 05:00 PM - Peak 1 of 1	Peak Hour for Each Approach Begins at:													
	04:15 PM													
+0 mins.	0	0	2	2	0	1	0	1	0	0	3	3	0	2
+15 mins.	0	0	1	1	0	2	0	2	0	0	3	3	0	2
+30 mins.	0	0	1	1	1	2	0	3	0	0	3	3	0	2
+45 mins.	0	0	1	1	4	2	0	6	0	0	0	0	0	4
Total Volume	0	0	5	5	5	7	0	12	0	0	9	9	0	9
% App. Total	0	0	100	100	41.7	58.3	0	100	0	0	100	100	0	90
PHF	.000	.000	.625	.625	.313	.875	.000	.500	.000	.000	.750	.750	.000	.563
														.250
														.625

Counts Unlimited, Inc.
 PO Box 1178
 Corona, CA 92878
 (951)268-6268

County of Riverside
 N/S: I-215 Southbound Ramps
 E/W: Cactus Avenue
 Weather: Clear

File Name : 27_CRV_215S_Cactus PM
 Site Code : 05121716
 Start Date : 11/30/2021
 Page No : 1

Groups Printed- 3 Axle Vehicles

Start Time	I-215 Southbound Off Ramp Southbound				Cactus Avenue Westbound				I-215 Southbound On Ramp Northbound				Cactus Avenue Eastbound					
	Left	Thru	Right	RTOR	App. Total	Left	Thru	Right	RTOR	App. Total	Left	Thru	Right	RTOR	App. Total	Exclu. Total	Inclu. Total	Int. Total
04:00 PM	0	0	2	1	2	1	1	0	0	2	0	0	0	1	0	1	7	8
04:15 PM	0	0	1	1	1	0	1	0	0	1	0	0	2	0	1	2	6	8
04:30 PM	0	0	2	1	2	0	2	0	0	2	0	0	2	0	1	1	7	8
04:45 PM	0	0	1	1	1	0	0	0	0	1	0	0	1	0	1	1	3	4
Total	0	0	6	4	6	1	4	0	0	5	0	0	7	0	3	5	23	28
05:00 PM	0	0	1	0	1	0	1	0	0	1	0	0	0	0	1	0	5	5
05:15 PM	0	0	0	0	0	0	2	0	0	2	0	0	1	0	0	0	3	3
05:30 PM	0	0	0	0	0	0	0	0	0	0	0	2	0	0	0	0	2	2
05:45 PM	0	0	0	0	0	2	0	0	0	2	0	0	0	0	1	0	3	3
Total	0	0	1	0	1	2	3	0	0	5	0	0	3	0	2	0	13	13
Grand Total	0	0	7	4	7	3	7	0	0	10	0	0	10	0	5	4	36	41
% Approach	0	0	100			30	70	0		27.8	0	0	100		55.6	44.4		
Total %	0	0	19.4		19.4	8.3	19.4	0		27.8	0	0	27.8		13.9	11.1	12.2	87.8

Start Time	I-215 Southbound Off Ramp Southbound				Cactus Avenue Westbound				I-215 Southbound On Ramp Northbound				Cactus Avenue Eastbound					
	Left	Thru	Right	RTOR	App. Total	Left	Thru	Right	RTOR	App. Total	Left	Thru	Right	RTOR	App. Total	Exclu. Total	Inclu. Total	Int. Total
04:15 PM	0	0	1	1	1	0	1	0	0	1	0	0	0	0	1	1	2	6
04:30 PM	0	0	2	1	2	0	2	0	0	2	0	0	2	0	2	0	1	7
04:45 PM	0	0	1	1	1	0	0	0	0	1	0	0	1	0	1	0	1	3
05:00 PM	0	0	1	1	1	0	1	0	0	1	0	0	0	0	1	2	3	5
Total Volume	0	0	5	5	5	0	4	0	0	4	0	0	5	0	4	3	7	21
% App. Total	0	0	100			0	100	0		100	0	0	100		57.1	42.9		
PHF	.000	.000	.625		.625	.000	.500	.000		.500	.000	.625	.625		1.00	.375	.583	.750

Peak Hour Analysis From 04:15 PM to 05:00 PM - Peak 1 of 1
 Peak Hour for Entire Intersection Begins at 04:15 PM

Counts Unlimited, Inc.
 PO Box 1178
 Corona, CA 92878
 (951)268-6268

County of Riverside
 N/S: I-215 Southbound Ramps
 E/W: Cactus Avenue
 Weather: Clear

File Name : 27_CRV_215S_Cactus PM
 Site Code : 05121716
 Start Date : 11/30/2021
 Page No : 2

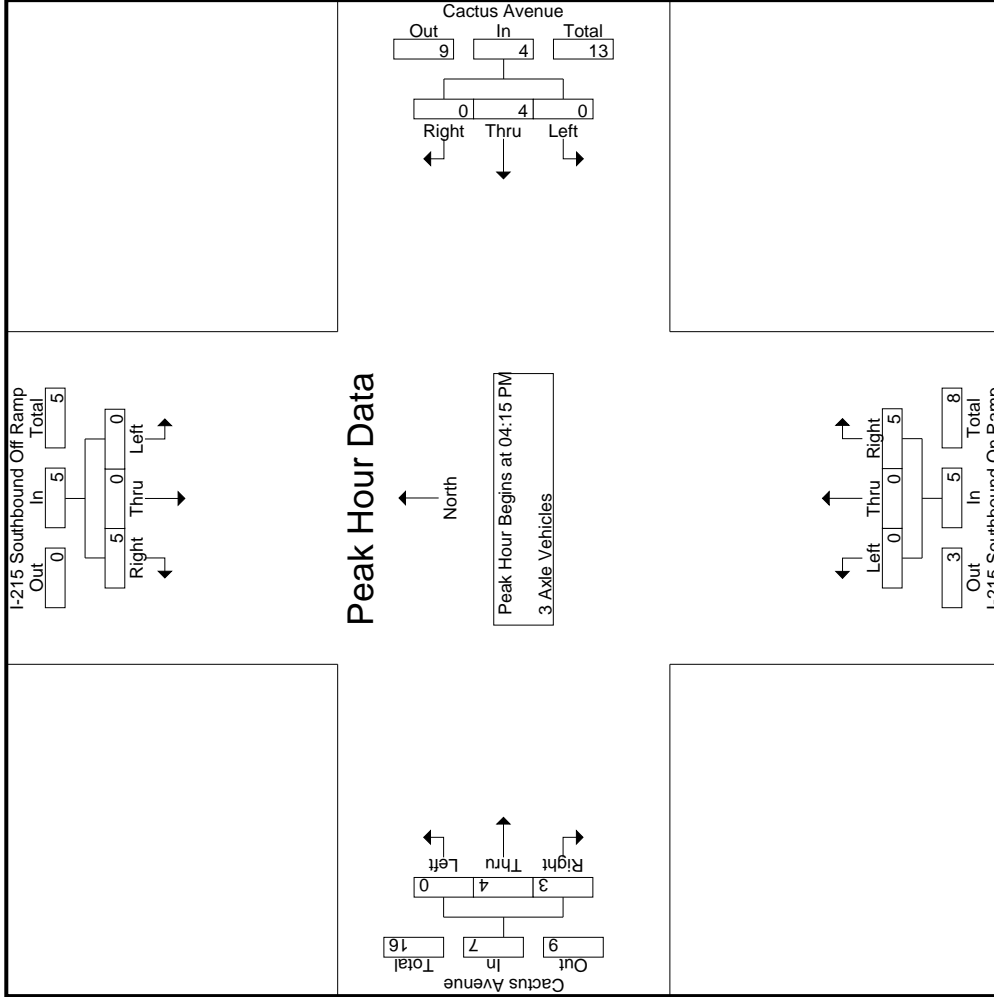

Counts Unlimited, Inc.
 PO Box 1178
 Corona, CA 92878
 (951)268-6268

File Name : 27_CRV_215S_Cactus PM
 Site Code : 05121716
 Start Date : 11/30/2021
 Page No : 3

County of Riverside
 N/S: I-215 Southbound Ramps
 E/W: Cactus Avenue
 Weather: Clear

Start Time	I-215 Southbound Off Ramp Southbound			Cactus Avenue Westbound			I-215 Southbound On Ramp Northbound			Cactus Avenue Eastbound					
	Left	Thru	Right	Left	Thru	Right	Left	Thru	Right	Left	Thru	Right			
Peak Hour Analysis From 04:15 PM to 05:00 PM - Peak 1 of 1															
Peak Hour for Each Approach Begins at:	04:15 PM														
+0 mins.	0	0	1	0	1	0	0	0	1	0	0	2	0	0	1
+15 mins.	0	0	2	0	2	0	0	0	2	0	0	2	0	0	1
+30 mins.	0	0	1	0	0	0	0	0	1	0	0	1	0	0	0
+45 mins.	0	0	1	0	1	1	0	0	1	0	0	0	0	0	2
Total Volume	0	0	5	0	4	0	0	0	4	0	0	5	0	0	3
% App. Total	0	0	100	0	100	0	0	0	100	0	0	100	0	0	42.9
PHF	.000	.000	.625	.000	.500	.000	.000	.500	.500	.000	.000	.625	.000	1.000	.375
															.583

Groups Printed- 4+ Axle Trucks

Start Time	I-215 Southbound Off Ramp Southbound				Cactus Avenue Westbound				I-215 Southbound On Ramp Northbound				Cactus Avenue Eastbound											
	Left	Thru	Right	RTOR	App. Total	Left	Thru	Right	RTOR	App. Total	Left	Thru	Right	RTOR	App. Total	Left	Thru	Right	RTOR	App. Total	Exclu. Total	Inclu. Total	Int. Total	
04:00 PM	0	0	8	2	8	1	0	0	0	1	0	0	9	0	0	2	0	0	0	0	2	2	20	22
04:15 PM	0	0	8	1	8	1	5	0	0	6	0	0	7	0	0	6	1	0	0	7	1	28	29	
04:30 PM	0	0	5	1	5	0	0	0	0	0	0	10	0	0	10	0	4	1	0	5	1	20	21	
04:45 PM	0	0	5	0	5	0	1	0	0	1	0	0	5	0	0	3	0	0	0	3	0	14	14	
Total	0	0	26	4	26	2	6	0	0	8	0	0	31	0	0	15	2	0	0	17	4	82	86	
05:00 PM	0	0	5	1	5	2	2	0	0	4	0	0	4	0	0	3	1	0	0	4	1	17	18	
05:15 PM	0	2	2	0	4	1	5	0	0	6	0	7	0	0	7	0	4	1	0	5	0	22	22	
05:30 PM	0	0	4	2	4	1	2	0	0	3	0	4	0	0	4	0	3	3	1	6	3	17	20	
05:45 PM	0	0	5	3	5	0	1	0	0	1	0	11	0	0	11	0	5	1	0	6	3	23	26	
Total	0	2	16	6	18	4	10	0	0	14	0	0	26	0	0	15	6	1	1	21	7	79	86	
Grand Total	0	2	42	10	44	6	16	0	0	22	0	0	57	0	0	30	8	1	38	11	11	161	172	
% Approach	0	4.5	95.5			27.3	72.7	0	0	13.7	0	0	100	0	0	78.9	21.1	5	23.6	6.4	93.6			
Total %	0	1.2	26.1		27.3	3.7	9.9	0	0	13.7	0	0	35.4	0	0	18.6	5	5	23.6	6.4	93.6			

Start Time	I-215 Southbound Off Ramp Southbound				Cactus Avenue Westbound				I-215 Southbound On Ramp Northbound				Cactus Avenue Eastbound										
	Left	Thru	Right	RTOR	App. Total	Left	Thru	Right	RTOR	App. Total	Left	Thru	Right	RTOR	App. Total	Left	Thru	Right	RTOR	App. Total	Exclu. Total	Inclu. Total	Int. Total
04:15 PM	0	0	8	0	8	1	5	0	0	6	0	0	7	0	0	0	0	0	0	7	1	7	28
04:30 PM	0	0	5	0	5	0	0	0	0	0	0	0	10	0	0	0	0	0	0	4	1	5	20
04:45 PM	0	0	5	0	5	0	0	0	0	1	0	0	5	0	0	0	0	0	0	3	0	3	14
05:00 PM	0	0	5	0	5	2	2	0	0	4	0	0	4	0	0	4	0	0	0	3	1	4	17
Total Volume	0	0	23	0	23	3	8	0	0	11	0	0	26	0	0	16	3	3	19	79	15.8	19	79
% App. Total	0	0	100			27.3	72.7	0	0	100	0	0	100	0	0	84.2	15.8	3	15.8	66.7	7.50	.679	.705
PHF	.000	.000	.719		.719	.375	.400	.000	.000	.458	.000	.000	.650	.000	.000	.650	.000	.667	.750	.679	.679		

Peak Hour Analysis From 04:15 PM to 05:00 PM - Peak 1 of 1
 Peak Hour for Entire Intersection Begins at 04:15 PM

Counts Unlimited, Inc.
 PO Box 1178
 Corona, CA 92878
 (951)268-6268

County of Riverside
 N/S: I-215 Southbound Ramps
 E/W: Cactus Avenue
 Weather: Clear

File Name : 27_CRV_215S_Cactus PM
 Site Code : 05121716
 Start Date : 11/30/2021
 Page No : 2

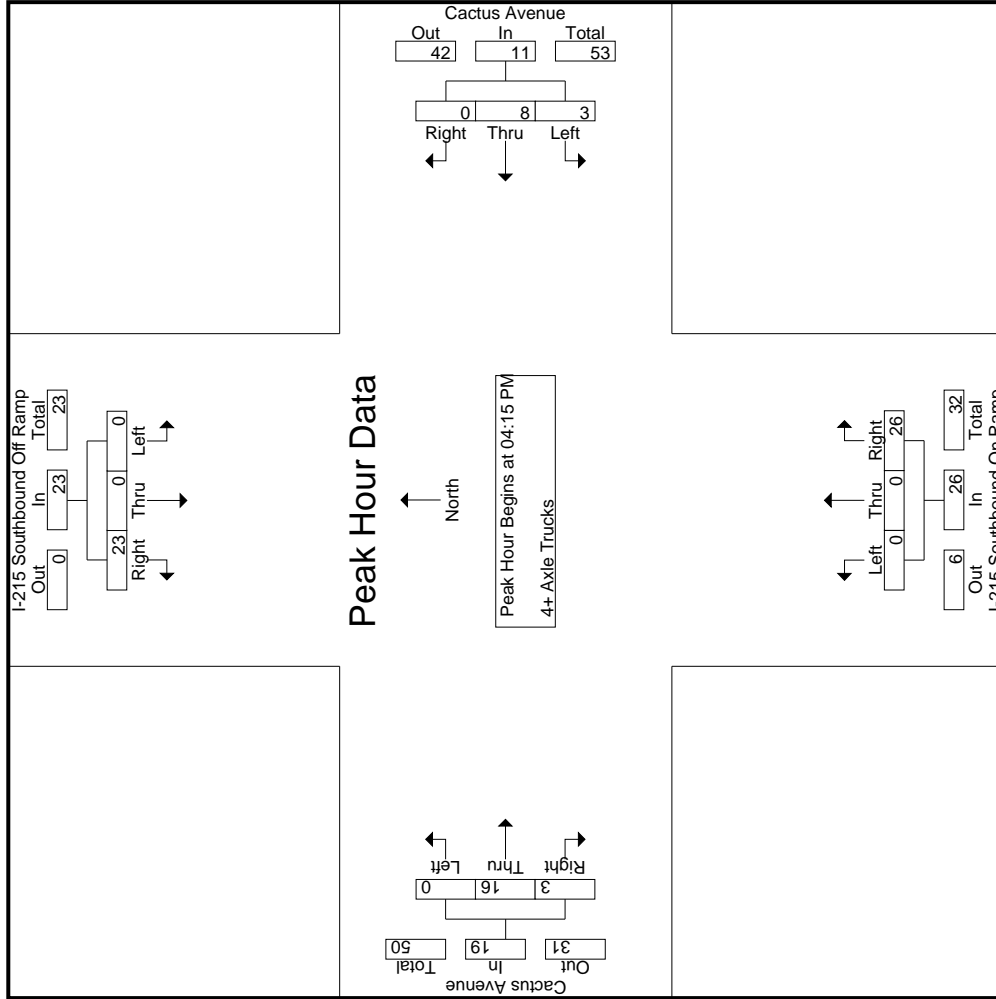

Counts Unlimited, Inc.
 PO Box 1178
 Corona, CA 92878
 (951)268-6268

File Name : 27_CRV_215S_Cactus PM
 Site Code : 05121716
 Start Date : 11/30/2021
 Page No : 3

County of Riverside
 N/S: I-215 Southbound Ramps
 E/W: Cactus Avenue
 Weather: Clear

Start Time	I-215 Southbound Off Ramp Southbound			Cactus Avenue Westbound			I-215 Southbound On Ramp Northbound			Cactus Avenue Eastbound				
	Left	Thru	Right	Left	Thru	Right	Left	Thru	Right	Left	Thru	Right		
Peak Hour Analysis From 04:15 PM to 05:00 PM - Peak 1 of 1														
Peak Hour for Each Approach Begins at:	04:15 PM													
+0 mins.	0	0	8	1	5	0	0	0	7	0	0	6	1	7
+15 mins.	0	0	5	0	0	0	0	0	10	0	0	4	1	5
+30 mins.	0	0	5	0	1	0	0	0	5	0	0	3	0	3
+45 mins.	0	0	5	2	2	0	0	0	4	0	0	3	1	4
Total Volume	0	0	23	3	8	0	0	0	26	0	0	16	3	19
% App. Total	0	0	100	27.3	72.7	0	0	0	100	0	0	84.2	15.8	
PHF	.000	.000	.719	.375	.400	.000	.000	.000	.650	.000	.000	.667	.750	.679

Location: County of Riverside
 N/S: I-215 SB Ramps
 E/W: Cactus Avenue



Date: 11/30/2021
 Day: Tuesday

PEDESTRIANS

	North Leg I-215 SB Ramps	East Leg Cactus Avenue	South Leg I-215 SB Ramps	West Leg Cactus Avenue	
	Pedestrians	Pedestrians	Pedestrians	Pedestrians	
7:00 AM	0	0	0	0	0
7:15 AM	0	0	0	0	0
7:30 AM	0	0	0	0	0
7:45 AM	0	0	0	0	0
8:00 AM	0	0	0	0	0
8:15 AM	0	0	0	0	0
8:30 AM	0	0	0	0	0
8:45 AM	0	0	0	0	0
TOTAL VOLUMES:	0	0	0	0	0

	North Leg I-215 SB Ramps	East Leg Cactus Avenue	South Leg I-215 SB Ramps	West Leg Cactus Avenue	
	Pedestrians	Pedestrians	Pedestrians	Pedestrians	
4:00 PM	0	0	0	0	0
4:15 PM	0	0	0	0	0
4:30 PM	0	0	0	0	0
4:45 PM	0	0	0	0	0
5:00 PM	0	0	0	0	0
5:15 PM	0	0	0	0	0
5:30 PM	0	0	0	0	0
5:45 PM	0	0	0	0	0
TOTAL VOLUMES:	0	0	0	0	0

Location: County of Riverside
 N/S: I-215 SB Ramps
 E/W: Cactus Avenue



Date: 11/30/2021
 Day: Tuesday

BICYCLES

	Southbound I-215 SB Ramps			Westbound Cactus Avenue			Northbound I-215 SB Ramps			Eastbound Cactus Avenue			
	Left	Thru	Right	Left	Thru	Right	Left	Thru	Right	Left	Thru	Right	
7:00 AM	0	0	0	0	0	0	0	0	0	0	0	0	0
7:15 AM	0	0	0	0	1	0	0	0	0	0	0	0	1
7:30 AM	0	0	0	0	0	0	0	0	0	0	0	0	0
7:45 AM	0	0	0	0	0	0	0	0	0	0	0	0	0
8:00 AM	0	0	0	0	0	0	0	0	0	0	0	0	0
8:15 AM	0	0	0	0	0	0	0	0	0	0	0	0	0
8:30 AM	0	0	0	0	0	0	0	0	0	0	0	0	0
8:45 AM	0	0	0	0	0	0	0	0	0	0	0	0	0
TOTAL VOLUMES:	0	0	0	0	1	0	0	0	0	0	0	0	1

	Southbound I-215 SB Ramps			Westbound Cactus Avenue			Northbound I-215 SB Ramps			Eastbound Cactus Avenue			
	Left	Thru	Right	Left	Thru	Right	Left	Thru	Right	Left	Thru	Right	
4:00 PM	0	0	0	0	0	0	0	0	0	0	0	0	0
4:15 PM	0	0	0	0	0	0	0	0	0	0	0	0	0
4:30 PM	0	0	0	0	0	0	0	0	0	0	0	0	0
4:45 PM	0	0	0	0	0	0	0	0	0	0	0	0	0
5:00 PM	0	0	0	0	2	0	0	0	0	0	0	0	2
5:15 PM	0	0	0	0	0	0	0	0	0	0	0	0	0
5:30 PM	0	0	0	0	0	0	0	0	0	0	0	0	0
5:45 PM	0	0	0	0	0	0	0	0	0	0	0	0	0
TOTAL VOLUMES:	0	0	0	0	2	0	0	0	0	0	0	0	2

Counts Unlimited, Inc.
 PO Box 1178
 Corona, CA 92878
 (951)268-6268

County of Riverside
 N/S: Old 215 Frontage Rd/I-215 NB Ramps
 E/W: Cactus Avenue
 Weather: Clear

File Name : 28_CRV_215N_Cactus AM
 Site Code : 05121716
 Start Date : 11/30/2021
 Page No : 2

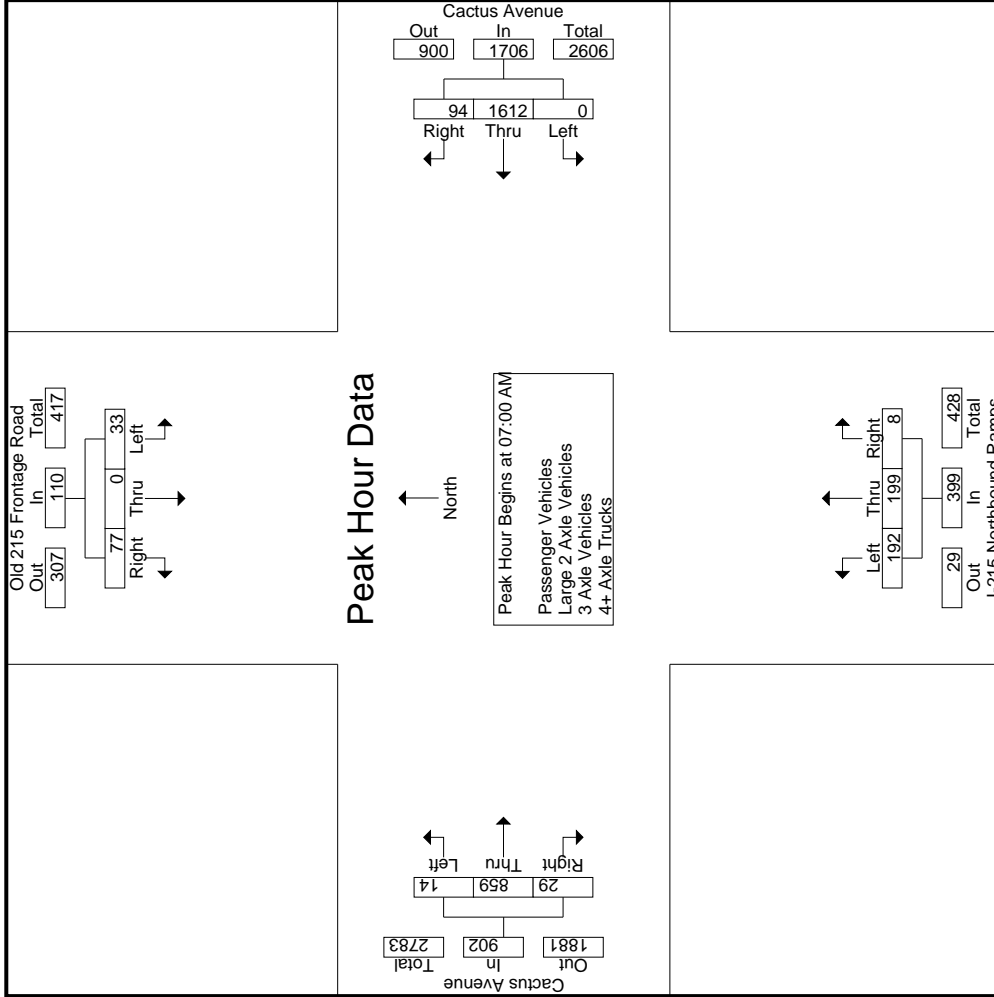

Counts Unlimited, Inc.
 PO Box 1178
 Corona, CA 92878
 (951)268-6268

File Name : 28_CRV_215N_Cactus AM
 Site Code : 05121716
 Start Date : 11/30/2021
 Page No : 3

County of Riverside
 N/S: Old 215 Frontage Rd/I-215 NB Ramps
 E/W: Cactus Avenue
 Weather: Clear

Start Time	Old 215 Frontage Road Southbound			Cactus Avenue Westbound			I-215 Northbound Ramps Northbound			Cactus Avenue Eastbound		
	Left	Thru	Right	Left	Thru	Right	Left	Thru	Right	Left	Thru	Right
Peak Hour Analysis From 07:00 AM to 08:45 AM - Peak 1 of 1												
Peak Hour for Each Approach Begins at:												
+0 mins.	9	0	21	0	378	19	59	79	4	1	215	7
+15 mins.	7	0	19	0	425	25	61	63	0	4	200	8
+30 mins.	9	0	24	0	418	22	65	57	1	2	223	7
+45 mins.	15	0	15	0	391	28	65	47	3	7	221	7
Total Volume	40	0	79	0	1612	94	250	246	8	14	859	29
% App. Total	33.6	0	66.4	0	94.5	5.5	49.6	48.8	1.6	1.6	95.2	3.2
PHF	.667	.000	.823	.000	.948	.839	.962	.778	.500	.500	.963	.906

Counts Unlimited, Inc.
 PO Box 1178
 Corona, CA 92878
 (951)268-6268

County of Riverside
 N/S: Old 215 Frontage Rd/I-215 NB Ramps
 E/W: Cactus Avenue
 Weather: Clear

File Name : 28_CRV_215N_Cactus AM
 Site Code : 05121716
 Start Date : 11/30/2021
 Page No : 1

Groups Printed- Passenger Vehicles

Start Time	Old 215 Frontage Road Southbound					Cactus Avenue Westbound					I-215 Northbound Ramps Northbound					Cactus Avenue Eastbound							
	Left	Thru	Right	RTOR	App. Total	Left	Thru	Right	RTOR	App. Total	Left	Thru	Right	RTOR	App. Total	Left	Thru	Right	RTOR	App. Total	Exclu. Total	Inclu. Total	Int. Total
07:00 AM	5	0	13	1	18	0	358	17	1	375	43	22	1	0	66	1	203	1	1	205	3	664	667
07:15 AM	8	0	7	1	15	0	410	24	2	434	45	26	1	1	72	3	188	3	1	194	5	715	720
07:30 AM	9	0	8	0	17	0	400	19	7	419	40	50	2	1	92	1	209	2	0	212	8	740	748
07:45 AM	9	0	11	3	20	0	371	28	8	399	55	65	4	1	124	5	204	2	0	211	12	754	766
Total	31	0	39	5	70	0	1539	88	18	1627	183	163	8	3	354	10	804	8	2	822	28	2873	2901
08:00 AM	7	0	9	1	16	0	299	30	5	329	55	57	0	0	112	4	156	3	1	163	7	620	627
08:15 AM	7	0	15	5	22	0	299	40	12	339	61	52	1	0	114	2	118	4	1	124	18	599	617
08:30 AM	14	0	10	3	24	0	249	20	7	269	59	39	3	0	101	6	118	1	0	125	10	519	529
08:45 AM	11	0	11	2	22	0	264	12	2	276	54	45	0	0	99	2	123	6	1	131	5	528	533
Total	39	0	45	11	84	0	1111	102	26	1213	229	193	4	0	426	14	515	14	3	543	40	2266	2306
Grand Total	70	0	84	16	154	0	2650	190	44	2840	412	356	12	3	780	24	1319	22	5	1365	68	5139	5207
T-Approch %	45.5	0	54.5			0	93.3	6.7		52.8	45.6	1.5		15.2	1.8	96.6	1.6		26.6				
14 Total %	1.4	0	1.6		3	0	51.6	3.7		8	6.9	0.2			0.5	25.7	0.4				1.3	98.7	

Start Time	Old 215 Frontage Road Southbound					Cactus Avenue Westbound					I-215 Northbound Ramps Northbound					Cactus Avenue Eastbound							
	Left	Thru	Right	RTOR	App. Total	Left	Thru	Right	RTOR	App. Total	Left	Thru	Right	RTOR	App. Total	Left	Thru	Right	RTOR	App. Total	Exclu. Total	Inclu. Total	Int. Total
07:00 AM	5	0	13	1	18	0	358	17	1	375	43	22	1	0	66	1	203	1	1	205	3	664	667
07:15 AM	8	0	7	1	15	0	410	24	2	434	45	26	1	1	72	3	188	3	1	194	5	715	720
07:30 AM	9	0	8	0	17	0	400	19	7	419	40	50	2	1	92	1	209	2	0	212	8	740	748
07:45 AM	9	0	11	3	20	0	371	28	8	399	55	65	4	1	124	5	204	2	0	211	12	754	766
Total	31	0	39	5	70	0	1539	88	18	1627	183	163	8	3	354	10	804	8	2	822	28	2873	2901
PHF	.861	.000	.750		.875	.000	.938	.786		.937	.832	.627	.500		.714	.500	.962	.667		.969			.953

Peak Hour Analysis From 07:00 AM to 07:45 AM - Peak 1 of 1
 Peak Hour for Entire Intersection Begins at 07:00 AM

Counts Unlimited, Inc.
 PO Box 1178
 Corona, CA 92878
 (951)268-6268

County of Riverside
 N/S: Old 215 Frontage Rd/I-215 NB Ramps
 E/W: Cactus Avenue
 Weather: Clear

File Name : 28_CRV_215N_Cactus AM
 Site Code : 05121716
 Start Date : 11/30/2021
 Page No : 2

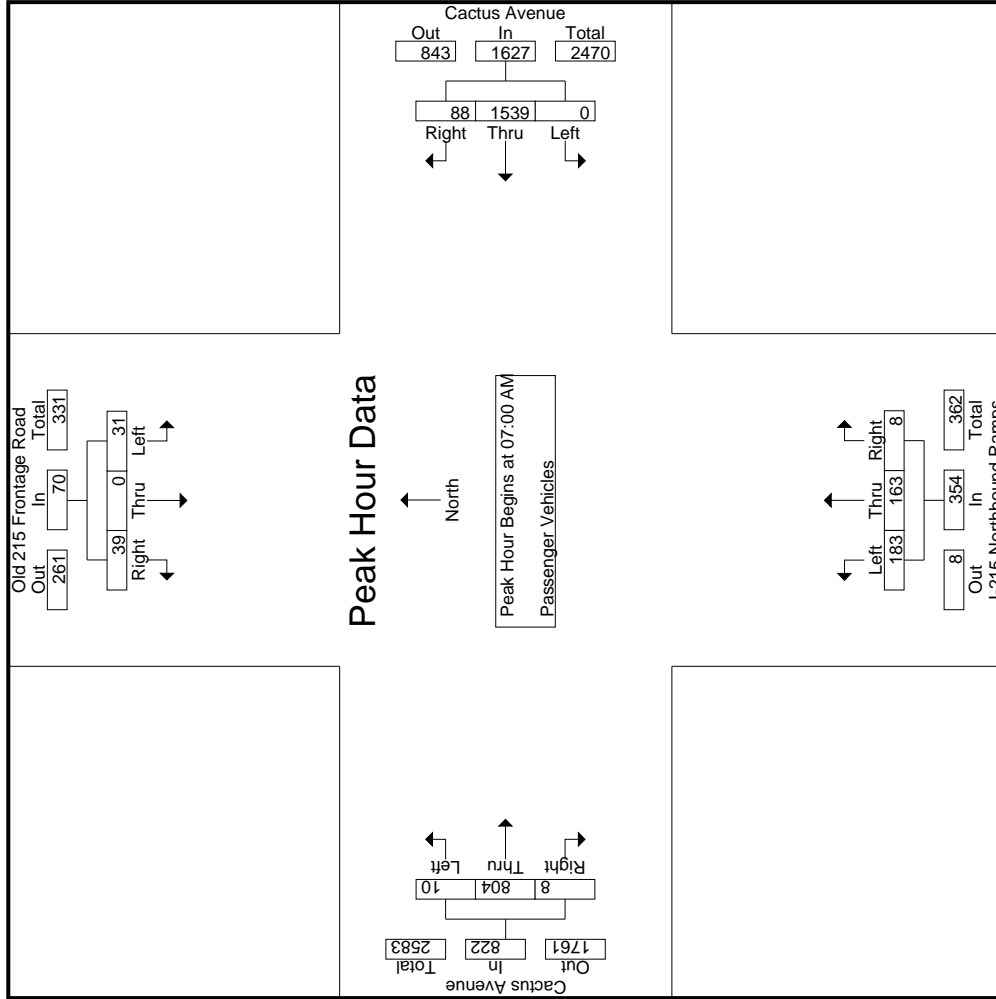

Start Time	Old 215 Frontage Road Southbound				Cactus Avenue Westbound				I-215 Northbound Ramps Northbound				Cactus Avenue Eastbound				
	Left	Thru	Right	App. Total	Left	Thru	Right	App. Total	Left	Thru	Right	App. Total	Left	Thru	Right	App. Total	Int. Total
	Peak Hour Analysis From 07:00 AM to 07:45 AM - Peak 1 of 1																
	Peak Hour for Each Approach Begins at:																
	07:00 AM																
+0 mins.	5	0	13	18	0	358	17	375	43	22	1	66	1	203	1	205	
+15 mins.	8	0	7	15	0	410	24	434	45	26	1	72	3	188	3	194	
+30 mins.	9	0	8	17	0	400	19	419	40	50	2	92	1	209	2	212	
+45 mins.	9	0	11	20	0	371	28	399	55	65	4	124	5	204	2	211	
Total Volume	31	0	39	70	0	1539	88	1627	183	163	8	354	10	804	8	822	
% App. Total	44.3	0	55.7	87.5	0	94.6	5.4	937	51.7	46	2.3	714	1.2	97.8	1	969	
PHF	.861	.000	.750	.875	.000	.938	.786	.937	.832	.627	.500	.714	.500	.962	.667	.969	

Counts Unlimited, Inc.
 PO Box 1178
 Corona, CA 92878
 (951)268-6268

County of Riverside
 N/S: Old 215 Frontage Rd/I-215 NB Ramps
 E/W: Cactus Avenue
 Weather: Clear

File Name : 28_CRV_215N_Cactus AM
 Site Code : 05121716
 Start Date : 11/30/2021
 Page No : 1

Groups Printed- Large 2 Axle Vehicles

Start Time	Old 215 Frontage Road Southbound				Cactus Avenue Westbound				I-215 Northbound Ramps Northbound				Cactus Avenue Eastbound											
	Left	Thru	Right	RTOR	App. Total	Left	Thru	Right	RTOR	App. Total	Left	Thru	Right	RTOR	App. Total	Left	Thru	Right	RTOR	App. Total	Exclu. Total	Inclu. Total	Int. Total	
07:00 AM	2	0	3	0	5	0	8	0	0	8	0	0	0	0	0	0	1	0	0	0	0	0	14	14
07:15 AM	0	0	0	0	0	4	1	0	0	5	0	1	0	0	1	0	2	0	0	0	0	0	8	8
07:30 AM	0	0	1	0	1	3	3	0	0	6	2	4	0	0	6	0	1	0	0	0	0	0	14	14
07:45 AM	0	0	1	0	1	10	0	0	0	10	2	1	0	0	3	1	5	0	0	0	0	0	20	20
Total	2	0	5	0	7	0	25	4	0	29	4	6	0	0	10	1	9	0	0	0	0	0	56	56
08:00 AM	0	0	2	0	2	0	3	0	0	3	1	2	0	0	3	1	3	0	0	0	0	0	12	12
08:15 AM	1	0	0	0	1	0	7	0	0	7	1	1	0	0	2	0	1	0	0	0	0	0	11	11
08:30 AM	0	0	0	0	0	11	2	1	0	13	1	1	0	0	2	0	1	0	0	0	1	1	16	17
08:45 AM	0	0	0	0	0	0	7	0	0	7	0	4	0	0	4	0	4	0	0	0	0	0	15	15
Total	1	0	2	0	3	0	28	2	1	30	3	8	0	0	11	1	9	0	0	0	10	1	54	55
Grand Total	3	0	7	0	10	0	53	6	1	59	7	14	0	0	21	2	18	0	0	0	20	1	110	111
% Apprch %	30	0	70			0	89.8	10.2		53.6	33.3	66.7	0	0	19.1	10	90	0	0	0	18.2	0.9	99.1	
14 Total %	2.7	0	6.4		9.1	0	48.2	5.5		53.6	6.4	12.7	0	0	19.1	1.8	16.4	0	0	0	18.2	0.9	99.1	

Start Time	Old 215 Frontage Road Southbound				Cactus Avenue Westbound				I-215 Northbound Ramps Northbound				Cactus Avenue Eastbound											
	Left	Thru	Right	RTOR	App. Total	Left	Thru	Right	RTOR	App. Total	Left	Thru	Right	RTOR	App. Total	Left	Thru	Right	RTOR	App. Total	Exclu. Total	Inclu. Total	Int. Total	
07:00 AM	2	0	3	0	5	0	8	0	0	8	0	0	0	0	0	0	1	0	0	0	0	0	14	14
07:15 AM	0	0	0	0	0	4	1	0	0	5	0	1	0	0	1	0	2	0	0	0	0	0	8	8
07:30 AM	0	0	1	0	1	3	3	0	0	6	2	4	0	0	6	0	1	0	0	0	0	0	14	14
07:45 AM	0	0	1	0	1	10	0	0	0	10	2	1	0	0	3	1	5	0	0	0	0	0	20	20
Total	2	0	5	0	7	0	25	4	0	29	4	6	0	0	10	1	9	0	0	0	10	0	56	56
% App. Total	28.6	0	71.4			0	86.2	13.8		53.6	33.3	66.7	0	0	19.1	10	90	0	0	0	18.2	0.9	99.1	
PHF	.250	.000	.417		.350	.000	.625	.333		.725	.500	.375	.000	.417	.417	.250	.450	.000	.000	.417	.000	.417	.700	

Peak Hour Analysis From 07:00 AM to 07:45 AM - Peak 1 of 1
 Peak Hour for Entire Intersection Begins at 07:00 AM

Counts Unlimited, Inc.
 PO Box 1178
 Corona, CA 92878
 (951)268-6268

County of Riverside
 N/S: Old 215 Frontage Rd/I-215 NB Ramps
 E/W: Cactus Avenue
 Weather: Clear

File Name : 28_CRV_215N_Cactus AM
 Site Code : 05121716
 Start Date : 11/30/2021
 Page No : 2

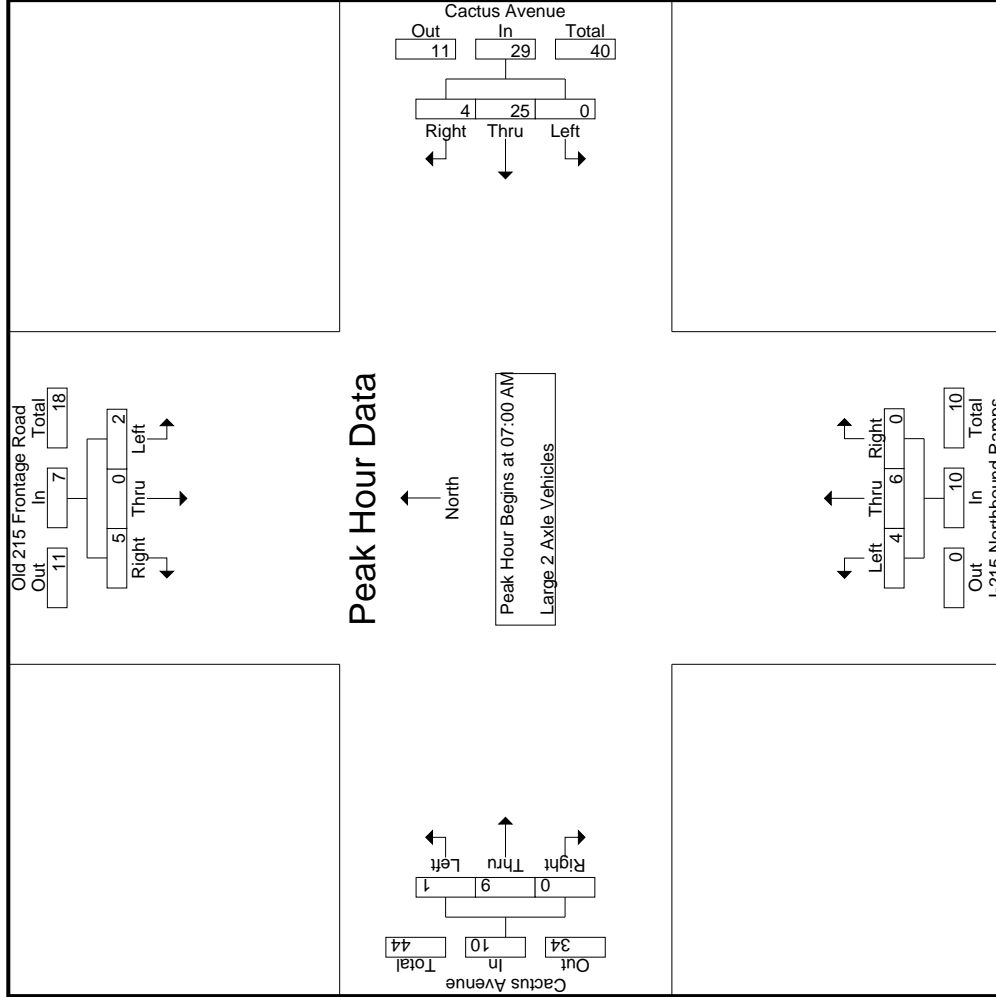

Counts Unlimited, Inc.
 PO Box 1178
 Corona, CA 92878
 (951)268-6268

File Name : 28_CRV_215N_Cactus AM
 Site Code : 05121716
 Start Date : 11/30/2021
 Page No : 3

County of Riverside
 N/S: Old 215 Frontage Rd/I-215 NB Ramps
 E/W: Cactus Avenue
 Weather: Clear

Start Time	Old 215 Frontage Road Southbound			Cactus Avenue Westbound			I-215 Northbound Ramps Northbound			Cactus Avenue Eastbound		
	Left	Thru	Right	Left	Thru	Right	Left	Thru	Right	Left	Thru	Right
Peak Hour Analysis From 07:00 AM to 07:45 AM - Peak 1 of 1												
Peak Hour for Each Approach Begins at:												
+0 mins.	2	0	3	0	8	0	0	0	0	0	0	0
+15 mins.	0	0	0	0	4	1	0	1	0	0	2	0
+30 mins.	0	0	1	0	3	3	2	4	0	0	1	0
+45 mins.	0	0	1	0	10	0	2	1	0	1	5	0
Total Volume	2	0	5	0	25	4	4	6	0	1	9	0
% App. Total	28.6	0	71.4	0	86.2	13.8	40	60	0	10	90	0
PHF	.250	.000	.417	.000	.625	.333	.500	.375	.000	.250	.450	.000

Counts Unlimited, Inc.
 PO Box 1178
 Corona, CA 92878
 (951)268-6268

County of Riverside
 N/S: Old 215 Frontage Rd/I-215 NB Ramps
 E/W: Cactus Avenue
 Weather: Clear

File Name : 28_CRV_215N_Cactus AM
 Site Code : 05121716
 Start Date : 11/30/2021
 Page No : 1

Groups Printed- 3 Axle Vehicles

Start Time	Old 215 Frontage Road Southbound				Cactus Avenue Westbound				I-215 Northbound Ramps Northbound				Cactus Avenue Eastbound										
	Left	Thru	Right	RTOR	App. Total	Left	Thru	Right	RTOR	App. Total	Left	Thru	Right	RTOR	App. Total	Exclu. Total	Inclu. Total	Int. Total					
07:00 AM	0	0	8	1	8	0	1	2	1	3	1	5	0	0	6	0	4	1	0	5	2	22	24
07:15 AM	0	0	7	1	7	0	2	0	0	2	0	6	0	0	6	0	5	1	1	6	2	21	23
07:30 AM	0	0	8	0	8	0	3	0	0	3	1	5	0	0	6	0	1	0	0	1	0	18	18
07:45 AM	0	0	9	2	9	0	2	0	0	2	0	10	0	0	10	0	1	1	0	2	2	23	25
Total	0	0	32	4	32	0	8	2	1	10	2	26	0	0	28	0	11	3	1	14	6	84	90
08:00 AM	0	0	7	0	7	0	3	2	1	5	2	4	0	0	6	0	2	0	0	2	1	20	21
08:15 AM	0	0	7	2	7	0	3	1	1	4	0	3	0	0	3	1	2	0	0	3	3	17	20
08:30 AM	1	0	5	1	6	0	4	2	0	6	1	4	0	0	5	0	6	0	0	6	1	23	24
08:45 AM	1	0	7	2	8	0	2	0	0	2	2	11	0	0	13	0	3	1	0	4	2	27	29
Total	2	0	26	5	28	0	12	5	2	17	5	22	0	0	27	1	13	1	0	15	7	87	94
Grand Total	2	0	58	9	60	0	20	7	3	27	7	48	0	0	55	1	24	4	1	29	13	171	184
% Apprch %	3.3	0	96.7			0	74.1	25.9		15.8	12.7	87.3	0	0	32.2	3.4	82.8	13.8		17	7.1	92.9	
% Total %	1.2	0	33.9		35.1	0	11.7	4.1			4.1	28.1	0	0		0.6	14	2.3					

Start Time	Old 215 Frontage Road Southbound				Cactus Avenue Westbound				I-215 Northbound Ramps Northbound				Cactus Avenue Eastbound										
	Left	Thru	Right	RTOR	App. Total	Left	Thru	Right	RTOR	App. Total	Left	Thru	Right	RTOR	App. Total	Exclu. Total	Inclu. Total	Int. Total					
07:00 AM	0	0	8	0	8	0	1	2	1	3	1	5	0	0	6	0	4	1	0	5	2	22	24
07:15 AM	0	0	7	1	7	0	2	0	0	2	0	6	0	0	6	0	5	1	1	6	2	21	23
07:30 AM	0	0	8	0	8	0	3	0	0	3	1	5	0	0	6	0	1	0	0	1	0	18	18
07:45 AM	0	0	9	2	9	0	2	0	0	2	0	10	0	0	10	0	1	1	0	2	2	23	25
Total	0	0	32	4	32	0	8	2	1	10	2	26	0	0	28	0	11	3	1	14	6	84	90
08:00 AM	0	0	7	0	7	0	3	2	1	5	2	4	0	0	6	0	2	0	0	2	1	20	21
08:15 AM	0	0	7	2	7	0	3	1	1	4	0	3	0	0	3	1	2	0	0	3	3	17	20
08:30 AM	1	0	5	1	6	0	4	2	0	6	1	4	0	0	5	0	6	0	0	6	1	23	24
08:45 AM	1	0	7	2	8	0	2	0	0	2	2	11	0	0	13	0	3	1	0	4	2	27	29
Total	2	0	26	5	28	0	12	5	2	17	5	22	0	0	27	1	13	1	0	15	7	87	94
Grand Total	2	0	58	9	60	0	20	7	3	27	7	48	0	0	55	1	24	4	1	29	13	171	184
% Apprch %	3.3	0	96.7			0	74.1	25.9		15.8	12.7	87.3	0	0	32.2	3.4	82.8	13.8		17	7.1	92.9	
% Total %	1.2	0	33.9		35.1	0	11.7	4.1			4.1	28.1	0	0		0.6	14	2.3					

Peak Hour Analysis From 07:00 AM to 07:45 AM - Peak 1 of 1
 Peak Hour for Entire Intersection Begins at 07:00 AM

Start Time	Old 215 Frontage Road Southbound				Cactus Avenue Westbound				I-215 Northbound Ramps Northbound				Cactus Avenue Eastbound										
	Left	Thru	Right	RTOR	App. Total	Left	Thru	Right	RTOR	App. Total	Left	Thru	Right	RTOR	App. Total	Exclu. Total	Inclu. Total	Int. Total					
07:00 AM	0	0	8	0	8	0	1	2	1	3	1	5	0	0	6	0	4	1	0	5	2	22	24
07:15 AM	0	0	7	1	7	0	2	0	0	2	0	6	0	0	6	0	5	1	1	6	2	21	23
07:30 AM	0	0	8	0	8	0	3	0	0	3	1	5	0	0	6	0	1	0	0	1	0	18	18
07:45 AM	0	0	9	2	9	0	2	0	0	2	0	10	0	0	10	0	1	1	0	2	2	23	25
Total	0	0	32	4	32	0	8	2	1	10	2	26	0	0	28	0	11	3	1	14	6	84	90
% App. Total	0	0	100			0	80	20		20	7.1	92.9	0	0	78.6	21.4	550	14		3	14	84	94
PHF	.000	.000	.889		.889	.000	.667	.250		.833	.500	.650	.000	.000	.700	.000	.750	.583		.583	.583	.913	.913

Counts Unlimited, Inc.
 PO Box 1178
 Corona, CA 92878
 (951)268-6268

County of Riverside
 N/S: Old 215 Frontage Rd/I-215 NB Ramps
 E/W: Cactus Avenue
 Weather: Clear

File Name : 28_CRV_215N_Cactus AM
 Site Code : 05121716
 Start Date : 11/30/2021
 Page No : 2

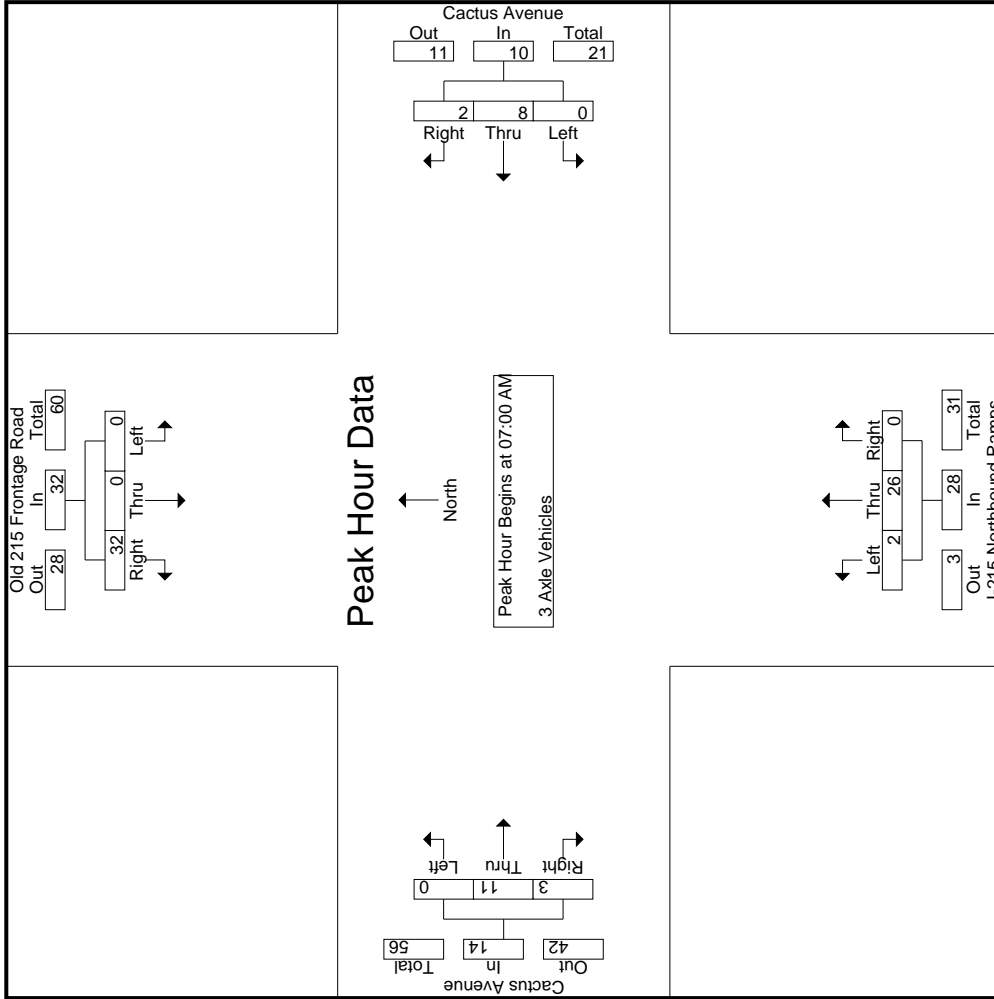

Counts Unlimited, Inc.
 PO Box 1178
 Corona, CA 92878
 (951)268-6268

File Name : 28_CRV_215N_Cactus AM
 Site Code : 05121716
 Start Date : 11/30/2021
 Page No : 3

County of Riverside
 N/S: Old 215 Frontage Rd/I-215 NB Ramps
 E/W: Cactus Avenue
 Weather: Clear

Start Time	Old 215 Frontage Road Southbound			Cactus Avenue Westbound			I-215 Northbound Ramps Northbound			Cactus Avenue Eastbound		
	Left	Thru	Right	Left	Thru	Right	Left	Thru	Right	Left	Thru	Right
Peak Hour Analysis From 07:00 AM to 07:45 AM - Peak 1 of 1												
Peak Hour for Each Approach Begins at:												
+0 mins.	0	0	8	0	1	2	3	0	5	0	4	1
+15 mins.	0	0	7	0	2	0	2	0	6	0	5	1
+30 mins.	0	0	8	0	3	0	3	0	6	0	1	0
+45 mins.	0	0	9	0	2	0	2	0	10	0	1	1
Total Volume	0	0	32	8	8	2	10	0	26	0	11	3
% App. Total	0	0	100	80	20	20	7.1	92.9	0	0	78.6	21.4
PHF	.000	.000	.889	.667	.250	.833	.500	.650	.000	.700	.550	.750

Counts Unlimited, Inc.
 PO Box 1178
 Corona, CA 92878
 (951)268-6268

County of Riverside
 N/S: Old 215 Frontage Rd/I-215 NB Ramps
 E/W: Cactus Avenue
 Weather: Clear

File Name : 28_CRV_215N_Cactus AM
 Site Code : 05121716
 Start Date : 11/30/2021
 Page No : 1

Groups Printed- 4+ Axle Trucks

Start Time	Old 215 Frontage Road Southbound				Cactus Avenue Westbound				I-215 Northbound Ramps Northbound				Cactus Avenue Eastbound										
	Left	Thru	Right	RTOR	Left	Thru	Right	RTOR	Left	Thru	Right	RTOR	Left	Thru	Right	RTOR	Left	Thru	Right	RTOR	Exclu. Total	Inclu. Total	Int. Total
07:00 AM	0	0	0	0	0	11	0	0	1	1	0	0	2	0	7	5	1	12	0	0	1	25	26
07:15 AM	0	0	1	0	9	0	0	0	0	0	0	0	0	1	5	4	0	10	0	0	0	20	20
07:30 AM	0	0	0	0	12	0	0	0	0	0	0	0	0	1	12	5	0	18	0	0	0	30	30
07:45 AM	0	0	0	0	8	0	0	0	2	3	0	0	5	1	11	4	1	16	1	1	1	29	30
Total	0	0	1	0	40	0	0	0	3	4	0	0	7	3	35	18	2	56	2	2	2	104	106
08:00 AM	0	0	1	0	12	1	0	0	3	0	0	0	3	0	7	1	0	8	0	0	0	25	25
08:15 AM	1	0	2	0	8	0	0	0	3	1	0	0	4	0	17	3	0	20	0	0	0	35	35
08:30 AM	0	0	0	0	14	1	0	0	4	3	0	0	7	1	26	2	0	29	0	0	0	51	51
08:45 AM	0	0	0	0	13	0	0	0	2	0	0	0	2	0	10	5	0	15	0	0	0	30	30
Total	1	0	3	0	49	2	0	0	12	4	0	0	16	1	60	11	0	72	0	0	0	141	141
Grand Total	1	0	4	0	89	2	0	0	15	8	0	0	23	4	95	29	2	128	2	2	2	245	247
% Apprch %	20	0	80		97.8	2.2			65.2	34.8	0		9.4	3.1	74.2	22.7		52.2			0.8	99.2	
% Total %	0.4	0	1.6		35.5	0.8			6.1	3.3	0		9.4	1.6	38.8	11.8		52.2			0.8	99.2	

Start Time	Old 215 Frontage Road Southbound				Cactus Avenue Westbound				I-215 Northbound Ramps Northbound				Cactus Avenue Eastbound										
	Left	Thru	Right	RTOR	Left	Thru	Right	RTOR	Left	Thru	Right	RTOR	Left	Thru	Right	RTOR	Left	Thru	Right	RTOR	Exclu. Total	Inclu. Total	Int. Total
07:00 AM	0	0	0	0	0	11	0	0	1	1	0	0	2	0	7	5	1	12	0	0	1	25	26
07:15 AM	0	0	1	0	9	0	0	0	0	0	0	0	0	1	5	4	0	10	0	0	0	20	20
07:30 AM	0	0	0	0	12	0	0	0	0	0	0	0	0	1	12	5	0	18	0	0	0	30	30
07:45 AM	0	0	0	0	8	0	0	0	2	3	0	0	5	1	11	4	1	16	1	1	1	29	30
Total	0	0	1	0	40	0	0	0	3	4	0	0	7	3	35	18	2	56	2	2	2	104	106
08:00 AM	0	0	1	0	12	1	0	0	3	0	0	0	3	0	7	1	0	8	0	0	0	25	25
08:15 AM	1	0	2	0	8	0	0	0	3	1	0	0	4	0	17	3	0	20	0	0	0	35	35
08:30 AM	0	0	0	0	14	1	0	0	4	3	0	0	7	1	26	2	0	29	0	0	0	51	51
08:45 AM	0	0	0	0	13	0	0	0	2	0	0	0	2	0	10	5	0	15	0	0	0	30	30
Total	1	0	3	0	49	2	0	0	12	4	0	0	16	1	60	11	0	72	0	0	0	141	141
Grand Total	1	0	4	0	89	2	0	0	15	8	0	0	23	4	95	29	2	128	2	2	2	245	247
% Apprch %	20	0	80		97.8	2.2			65.2	34.8	0		9.4	3.1	74.2	22.7		52.2			0.8	99.2	
% Total %	0.4	0	1.6		35.5	0.8			6.1	3.3	0		9.4	1.6	38.8	11.8		52.2			0.8	99.2	

Peak Hour Analysis From 07:00 AM to 07:45 AM - Peak 1 of 1
 Peak Hour for Entire Intersection Begins at 07:00 AM

Start Time	Old 215 Frontage Road Southbound				Cactus Avenue Westbound				I-215 Northbound Ramps Northbound				Cactus Avenue Eastbound										
	Left	Thru	Right	RTOR	Left	Thru	Right	RTOR	Left	Thru	Right	RTOR	Left	Thru	Right	RTOR	Left	Thru	Right	RTOR	Exclu. Total	Inclu. Total	Int. Total
07:00 AM	0	0	0	0	0	11	0	0	1	1	0	0	2	0	7	5	1	12	0	0	1	25	26
07:15 AM	0	0	1	0	9	0	0	0	0	0	0	0	0	1	5	4	0	10	0	0	0	20	20
07:30 AM	0	0	0	0	12	0	0	0	0	0	0	0	0	1	12	5	0	18	0	0	0	30	30
07:45 AM	0	0	0	0	8	0	0	0	2	3	0	0	5	1	11	4	1	16	1	1	1	29	30
Total	0	0	1	0	40	0	0	0	3	4	0	0	7	3	35	18	2	56	2	2	2	104	106
% App. Total	0	0	100		833	0			42.9	57.1	0		0.000	5.4	62.5	32.1		32.1			0.8	99.2	
PHF	.000	.000	.250		.833	.000			.375	.333	.000		.350	.750	.729	.900		.778			0.8	99.2	

Counts Unlimited, Inc.
 PO Box 1178
 Corona, CA 92878
 (951)268-6268

County of Riverside
 N/S: Old 215 Frontage Rd/I-215 NB Ramps
 E/W: Cactus Avenue
 Weather: Clear

File Name : 28_CRV_215N_Cactus AM
 Site Code : 05121716
 Start Date : 11/30/2021
 Page No : 2

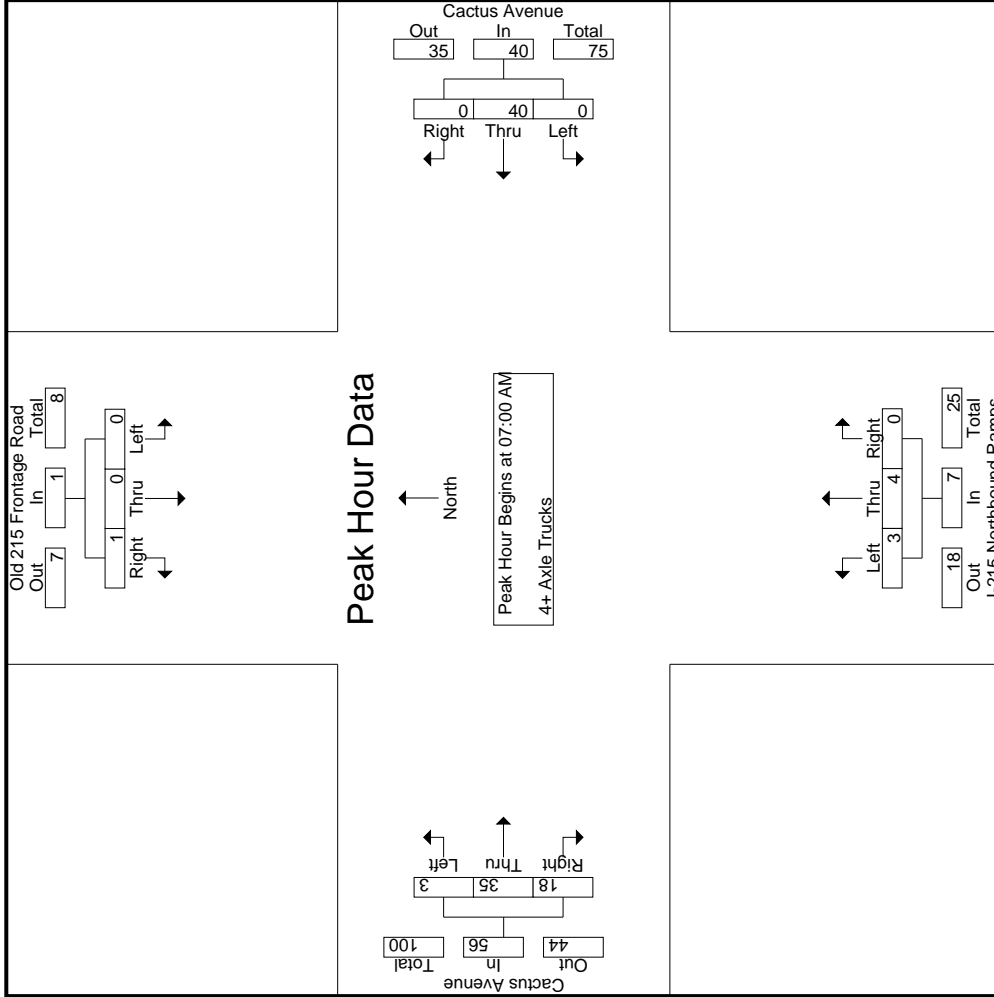

Counts Unlimited, Inc.
 PO Box 1178
 Corona, CA 92878
 (951)268-6268

County of Riverside
 N/S: Old 215 Frontage Rd/I-215 NB Ramps
 E/W: Cactus Avenue
 Weather: Clear

File Name : 28_CRV_215N_Cactus AM
 Site Code : 05121716
 Start Date : 11/30/2021
 Page No : 3

Start Time	Old 215 Frontage Road Southbound			Cactus Avenue Westbound			I-215 Northbound Ramps Northbound			Cactus Avenue Eastbound		
	Left	Thru	Right	Left	Thru	Right	Left	Thru	Right	Left	Thru	Right
Peak Hour Analysis From 07:00 AM to 07:45 AM - Peak 1 of 1												
Peak Hour for Each Approach Begins at:												
	07:00 AM											
+0 mins.	0	0	0	0	11	0	1	1	0	2	0	7
+15 mins.	0	0	1	0	9	0	0	0	0	0	1	5
+30 mins.	0	0	0	12	0	0	0	0	0	1	12	4
+45 mins.	0	0	0	8	0	8	2	3	0	1	11	5
Total Volume	0	0	1	40	40	40	3	4	0	3	35	18
% App. Total	0	0	100	100	100	100	42.9	57.1	0	5.4	62.5	32.1
PHF	.000	.000	.250	.833	.833	.833	.375	.333	.000	.750	.729	.900
	.250											
	.350											
	.778											

Groups Printed- Passenger Vehicles - Large 2 Axle Vehicles - 3 Axle Vehicles - 4+ Axle Trucks

Start Time	Old 215 Frontage Road Southbound						Cactus Avenue Westbound						I-215 Northbound Ramps						Cactus Avenue Eastbound					
	Left	Thru	Right	RTOR	App. Total	Inclu. Total	Left	Thru	Right	RTOR	App. Total	Inclu. Total	Left	Thru	Right	RTOR	App. Total	Inclu. Total	Left	Thru	Right	RTOR	App. Total	Inclu. Total
	04:00 PM	27	0	25	16	52	52	0	315	29	9	344	344	52	54	2	0	108	108	6	282	8	0	296
04:15 PM	24	1	24	13	49	49	0	338	34	8	372	372	29	60	0	0	89	89	12	313	9	0	334	334
04:30 PM	24	0	26	6	50	50	0	369	33	11	402	402	22	44	3	1	69	69	7	296	12	2	315	315
04:45 PM	43	1	39	4	83	83	0	386	34	13	420	420	29	52	0	0	81	81	18	303	7	0	328	328
Total	118	2	114	39	234	234	0	1408	130	41	1538	1538	132	210	5	1	347	347	43	1194	36	2	1273	1273
05:00 PM	56	0	51	2	107	107	0	378	42	14	420	420	22	37	0	0	59	59	7	305	11	2	323	323
05:15 PM	61	1	56	8	118	118	0	371	29	7	400	400	22	31	1	0	54	54	5	198	7	1	210	210
05:30 PM	43	0	92	21	135	135	0	321	32	4	353	353	13	32	1	0	46	46	6	232	14	1	252	252
05:45 PM	50	0	37	9	87	87	0	286	24	3	310	310	13	18	0	0	31	31	9	302	8	1	319	319
Total	210	1	236	40	447	447	0	1356	127	28	1483	1483	70	118	2	0	190	190	27	1037	40	5	1104	1104
Grand Total	328	3	350	79	681	681	0	2764	257	69	3021	3021	202	328	7	1	537	537	70	2231	76	7	2377	2377
% Approach	48.2	0.4	51.4				0	91.5	8.5				37.6	61.1	1.3				2.9	93.9	3.2			
% Total	5	0	5.3				0	41.8	3.9				3.1	5	0.1				1.1	33.7	1.1			
% Passenger Vehicles	313	3	339				0	2668	253				179	319					67	2115	50			
% Large 2 Axle Vehicles	95.4	100	96.9	96.2	96.2	96.2	0	96.5	98.4	98.6	98.6	98.6	88.6	97.3	100	100	94.1	94.1	95.7	94.8	65.8	57.1	93.8	93.8
% 3 Axle Vehicles	0.9	0	1.4	2.5	1.3	1.3	0	1.3	0	0	1.1	1.1	6.4	1.2	0	0	3.2	3.2	0	1.7	2.6	0	1.7	1.7
% 4+ Axle Trucks	2.7	0	1.4	1.3	2	2	0	1.9	1.6	1.4	1.9	1.9	5	4	0	0	1.1	1.1	2	66	23	0	94	94
% 4+ Axle Trucks	2.7	0	1.4	1.3	2	2	0	1.9	1.6	1.4	1.9	1.9	5	4	0	0	1.1	1.1	2	66	23	0	94	94

Start Time	Old 215 Frontage Road Southbound						Cactus Avenue Westbound						I-215 Northbound Ramps						Cactus Avenue Eastbound					
	Left	Thru	Right	RTOR	App. Total	Inclu. Total	Left	Thru	Right	RTOR	App. Total	Inclu. Total	Left	Thru	Right	RTOR	App. Total	Inclu. Total	Left	Thru	Right	RTOR	App. Total	Inclu. Total
	04:15 PM	24	1	24		49	49	0	338	34		372	372	29	60	3				69	296	12		
04:30 PM	24	0	26		50	50	0	369	33		402	402	22	44	0				81	303	7			
04:45 PM	43	1	39		83	83	0	386	34		420	420	22	37	0				59	305	11			
05:00 PM	56	0	51		107	107	0	378	42		420	420	22	37	0				59	305	11			
Total Volume	147	2	140		289	289	0	1471	143		1614	1614	102	193	3				298	1217	39			
% App. Total	50.9	0.7	48.4				0	91.1	8.9				34.2	64.8	1				3	93.6	3			
PHF	.656	.500	.686		.675	.675	.000	.953	.851		.961	.961	.879	.804	.250				.837	.611	.972		.813	.973

Peak Hour Analysis From 04:00 PM to 05:45 PM - Peak 1 of 1
 Peak Hour for Entire Intersection Begins at 04:15 PM

Counts Unlimited, Inc.
 PO Box 1178
 Corona, CA 92878
 (951)268-6268

County of Riverside
 N/S: Old 215 Frontage Rd/I-215 NB Ramps
 E/W: Cactus Avenue
 Weather: Clear

File Name : 28_CRV_215N_Cactus PM
 Site Code : 05121716
 Start Date : 11/30/2021
 Page No : 2

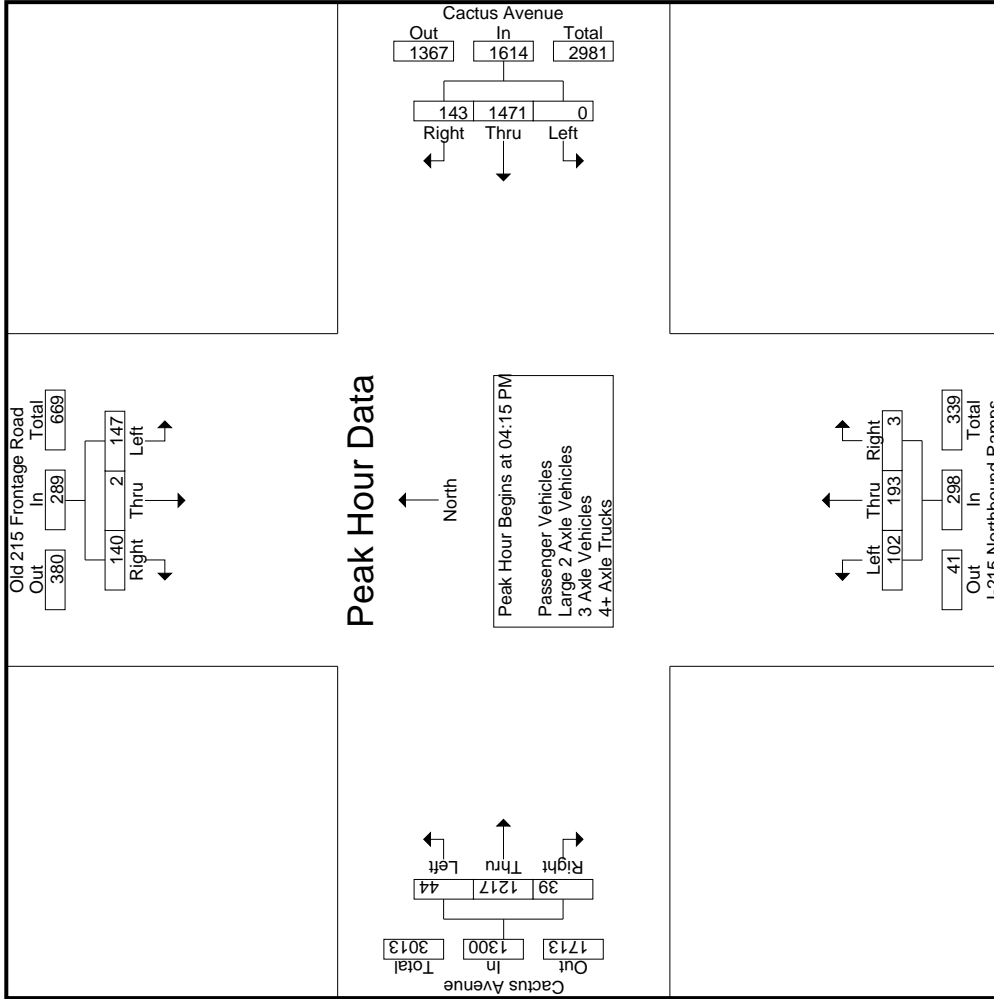

Counts Unlimited, Inc.
 PO Box 1178
 Corona, CA 92878
 (951)268-6268

File Name : 28_CRV_215N_Cactus PM
 Site Code : 05121716
 Start Date : 11/30/2021
 Page No : 3

County of Riverside
 N/S: Old 215 Frontage Rd/I-215 NB Ramps
 E/W: Cactus Avenue
 Weather: Clear

Start Time	Old 215 Frontage Road Southbound				Cactus Avenue Westbound				I-215 Northbound Ramps Northbound				Cactus Avenue Eastbound				
	Left	Thru	Right	App. Total	Left	Thru	Right	App. Total	Left	Thru	Right	App. Total	Left	Thru	Right	App. Total	Int. Total
	Peak Hour Analysis From 04:00 PM to 05:45 PM - Peak 1 of 1																
	Peak Hour for Each Approach Begins at:																
	05:00 PM				04:30 PM				04:00 PM				04:15 PM				
+0 mins.	56	0	51	107	0	369	33	402	52	54	2	108	12	313	9	334	
+15 mins.	61	1	56	118	0	386	34	420	29	60	0	89	7	296	12	315	
+30 mins.	43	0	92	135	0	378	42	420	22	44	3	69	18	303	7	328	
+45 mins.	50	0	37	87	0	371	29	400	29	52	0	81	7	305	11	323	
Total Volume	210	1	236	447	0	1504	138	1642	132	210	5	347	44	1217	39	1300	
% App. Total	47	0.2	52.8	828	0	91.6	8.4	977	38	60.5	1.4	803	3.4	93.6	3	973	
PHF	.861	.250	.641	.828	.000	.974	.821	.977	.635	.875	.417	.803	.611	.972	.813	.973	

Counts Unlimited, Inc.
 PO Box 1178
 Corona, CA 92878
 (951)268-6268

County of Riverside
 N/S: Old 215 Frontage Rd/I-215 NB Ramps
 E/W: Cactus Avenue
 Weather: Clear

File Name : 28_CRV_215N_Cactus PM
 Site Code : 05121716
 Start Date : 11/30/2021
 Page No : 1

Groups Printed- Passenger Vehicles

Start Time	Old 215 Frontage Road Southbound				Cactus Avenue Westbound				I-215 Northbound Ramps Northbound				Cactus Avenue Eastbound										
	Left	Thru	Right	RTOR	App. Total	Left	Thru	Right	RTOR	App. Total	Left	Thru	Right	RTOR	App. Total	Left	Thru	Right	RTOR	App. Total	Exclu. Total	Inclu. Total	Int. Total
04:00 PM	26	0	25	16	51	0	302	29	9	331	46	51	2	0	99	6	265	6	0	277	25	758	783
04:15 PM	23	1	24	13	48	0	322	34	8	356	24	56	0	0	80	11	292	4	0	307	21	791	812
04:30 PM	23	0	26	6	49	0	359	31	10	390	18	44	3	1	65	7	279	8	1	294	18	798	816
04:45 PM	41	1	38	4	80	0	377	34	13	411	27	51	0	0	78	17	285	5	0	307	17	876	893
Total	113	2	113	39	228	0	1360	128	40	1488	115	202	5	1	322	41	1121	23	1	1185	81	3223	3304
05:00 PM	54	0	50	2	104	0	358	42	14	400	21	36	0	0	57	6	297	8	1	311	17	872	889
05:15 PM	58	1	54	8	113	0	360	28	7	388	20	31	1	0	52	5	188	4	0	197	15	750	765
05:30 PM	41	0	88	19	129	0	312	32	4	344	12	32	1	0	45	6	221	12	1	239	24	757	781
05:45 PM	47	0	34	8	81	0	278	23	3	301	11	18	0	0	29	9	288	3	1	300	12	711	723
Total	200	1	226	37	427	0	1308	125	28	1433	64	117	2	0	183	26	994	27	3	1047	68	3090	3158
Grand Total	313	3	339	76	655	0	2668	253	68	2921	179	319	7	1	505	67	2115	50	4	2232	149	6313	6462
T-Approch %	47.8	0.5	51.8			0	91.3	8.7		46.3	35.4	63.2	1.4		8	3	94.8	2.2		35.4	2.3	97.7	
T-Total %	5	0	5.4		10.4	0	42.3	4			2.8	5.1	0.1			1.1	33.5	0.8					

Start Time	Old 215 Frontage Road Southbound				Cactus Avenue Westbound				I-215 Northbound Ramps Northbound				Cactus Avenue Eastbound												
	Left	Thru	Right	RTOR	App. Total	Left	Thru	Right	RTOR	App. Total	Left	Thru	Right	RTOR	App. Total	Left	Thru	Right	RTOR	App. Total	Left	Thru	Right	RTOR	App. Total
04:15 PM	23	1	24		48	0	322	34		356	24	56	0		80	11	292	4		307	4	307			791
04:30 PM	23	0	26		49	0	359	31		390	18	44	3		65	7	279	8		294	8	294			798
04:45 PM	41	1	38		80	0	377	34		411	27	51	0		78	17	285	5		307	5	307			876
05:00 PM	54	0	50		104	0	358	42		400	21	36	0		57	6	297	8		311	8	311			872
Total Volume	141	2	138		281	0	1416	141		1557	90	187	3		280	41	1153	25		1219	25	1219			3337
% App. Total	50.2	0.7	49.1		49.1	0	90.9	9.1		46.3	32.1	66.8	1.1		8	3.4	94.6	2.1		35.4	2.1	98.0			.952
PHF	.653	.500	.690		.675	.000	.939	.839		.947	.833	.835	.250		.875	.603	.971	.781			.980				

Peak Hour Analysis From 04:15 PM to 05:00 PM - Peak 1 of 1
 Peak Hour for Entire Intersection Begins at 04:15 PM

Counts Unlimited, Inc.
 PO Box 1178
 Corona, CA 92878
 (951)268-6268

County of Riverside
 N/S: Old 215 Frontage Rd/I-215 NB Ramps
 E/W: Cactus Avenue
 Weather: Clear

File Name : 28_CRV_215N_Cactus PM
 Site Code : 05121716
 Start Date : 11/30/2021
 Page No : 2

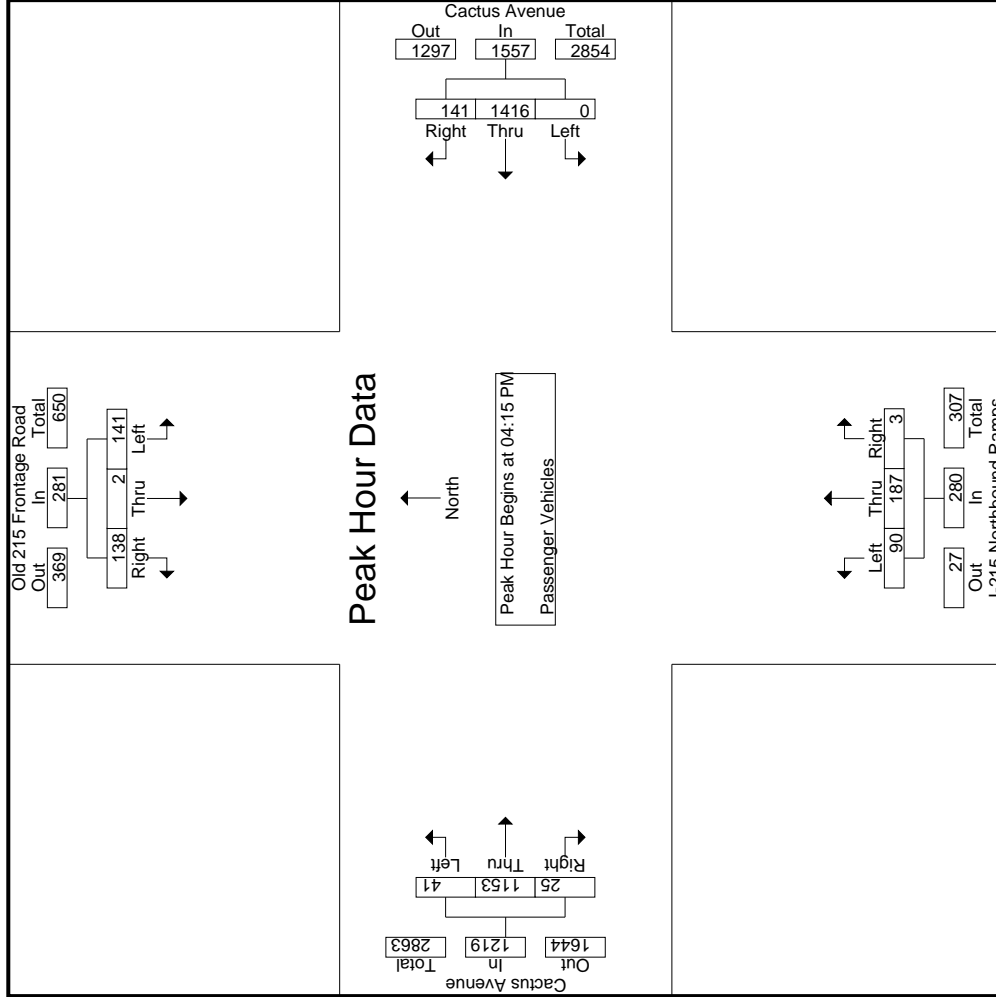

Counts Unlimited, Inc.
 PO Box 1178
 Corona, CA 92878
 (951)268-6268

File Name : 28_CRV_215N_Cactus PM
 Site Code : 05121716
 Start Date : 11/30/2021
 Page No : 3

County of Riverside
 N/S: Old 215 Frontage Rd/I-215 NB Ramps
 E/W: Cactus Avenue
 Weather: Clear

Start Time	Old 215 Frontage Road Southbound			Cactus Avenue Westbound			I-215 Northbound Ramps Northbound			Cactus Avenue Eastbound				
	Left	Thru	Right	Left	Thru	Right	Left	Thru	Right	Left	Thru	Right		
Peak Hour Analysis From 04:15 PM to 05:00 PM - Peak 1 of 1														
Peak Hour for Each Approach Begins at:														
	04:15 PM													
+0 mins.	23	1	24	0	322	34	24	56	0	80	11	292	4	307
+15 mins.	23	0	26	0	359	31	18	44	3	65	7	279	8	294
+30 mins.	41	1	38	0	377	34	27	51	0	78	17	285	5	307
+45 mins.	54	0	50	0	358	42	21	36	0	57	6	297	8	311
Total Volume	141	2	138	0	1416	141	90	187	3	280	41	1153	25	1219
% App. Total	50.2	0.7	49.1	0	90.9	9.1	32.1	66.8	1.1	87.5	3.4	94.6	2.1	980
PHF	.653	.500	.690	.000	.939	.839	.833	.835	.250	.875	.603	.971	.781	.980

Groups Printed- Large 2 Axle Vehicles

Start Time	Old 215 Frontage Road Southbound				Cactus Avenue Westbound				I-215 Northbound Ramps Northbound				Cactus Avenue Eastbound						
	Left	Thru	Right	RTOR	App. Total	Left	Thru	Right	RTOR	App. Total	Left	Thru	Right	RTOR	App. Total	Exclu. Total	Inclu. Total	Int. Total	
04:00 PM	1	0	0	0	1	0	6	0	0	6	6	2	0	0	8	0	9	0	24
04:15 PM	1	0	0	0	1	0	1	0	0	1	1	2	0	0	3	0	6	1	12
04:30 PM	0	0	0	0	0	0	7	0	0	7	2	0	0	0	2	0	4	0	13
04:45 PM	1	0	0	0	1	0	4	0	0	4	2	0	0	0	2	0	11	0	18
Total	3	0	0	0	3	0	18	0	0	18	11	4	0	0	15	0	30	1	67
05:00 PM	0	0	1	0	1	0	7	0	0	7	0	0	0	0	0	0	3	0	11
05:15 PM	0	0	1	0	1	0	5	0	0	5	0	0	0	0	0	0	1	0	7
05:30 PM	0	0	1	1	1	0	4	0	0	4	0	0	0	0	0	0	3	0	8
05:45 PM	0	0	2	1	2	0	1	0	0	1	2	0	0	0	2	0	1	1	9
Total	0	0	5	2	5	0	17	0	0	17	2	0	0	0	2	0	8	1	35
Grand Total	3	0	5	2	8	0	35	0	0	35	13	4	0	0	17	0	38	2	102
T-Approch %	37.5	0	62.5			0	100	0		76.5	23.5	0			0	95	5		100
Total %	3	0	5		8	0	35	0		13	4	0		17	0	38	2		98

Start Time	Old 215 Frontage Road Southbound				Cactus Avenue Westbound				I-215 Northbound Ramps Northbound				Cactus Avenue Eastbound						
	Left	Thru	Right	RTOR	App. Total	Left	Thru	Right	RTOR	App. Total	Left	Thru	Right	RTOR	App. Total	Exclu. Total	Inclu. Total	Int. Total	
04:15 PM	1	0	0	0	1	0	1	0	0	1	1	2	0	0	3	0	6	1	12
04:30 PM	0	0	0	0	0	0	7	0	0	7	2	0	0	0	2	0	4	0	13
04:45 PM	1	0	0	0	1	0	4	0	0	4	2	0	0	0	2	0	11	0	18
05:00 PM	0	0	1	1	1	0	7	0	0	7	0	0	0	0	0	0	3	0	11
Total Volume	2	0	1	1	3	0	19	0	0	19	5	2	0	0	7	0	24	1	54
% App. Total	66.7	0	33.3			0	100	0		71.4	28.6	0			96	4			100
PHF	.500	.000	.250		.750	.000	.679	.000		.679	.625	.250	.000		.583	.250	.568		.750

Peak Hour Analysis From 04:15 PM to 05:00 PM - Peak 1 of 1
 Peak Hour for Entire Intersection Begins at 04:15 PM

Counts Unlimited, Inc.
 PO Box 1178
 Corona, CA 92878
 (951)268-6268

County of Riverside
 N/S: Old 215 Frontage Rd/I-215 NB Ramps
 E/W: Cactus Avenue
 Weather: Clear

File Name : 28_CRV_215N_Cactus PM
 Site Code : 05121716
 Start Date : 11/30/2021
 Page No : 2

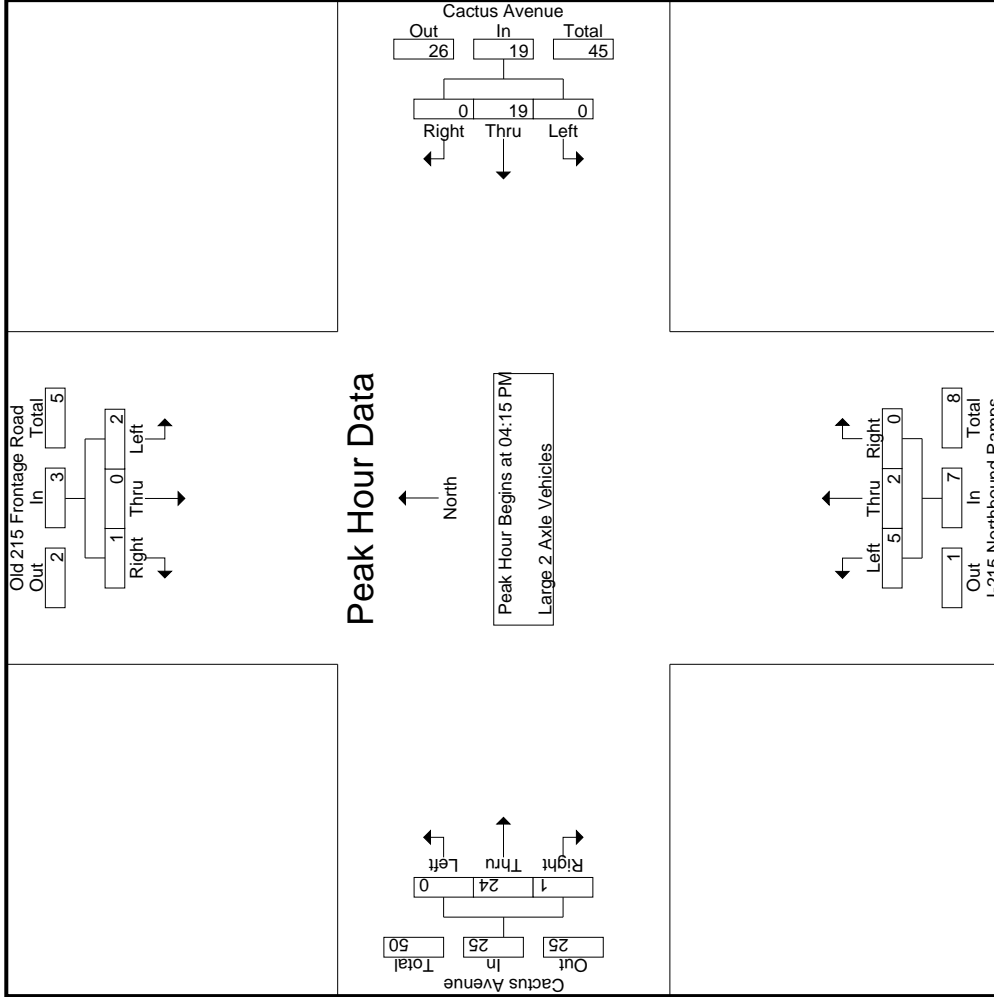

Counts Unlimited, Inc.
 PO Box 1178
 Corona, CA 92878
 (951)268-6268

File Name : 28_CRV_215N_Cactus PM
 Site Code : 05121716
 Start Date : 11/30/2021
 Page No : 3

County of Riverside
 N/S: Old 215 Frontage Rd/I-215 NB Ramps
 E/W: Cactus Avenue
 Weather: Clear

Start Time	Old 215 Frontage Road Southbound			Cactus Avenue Westbound			I-215 Northbound Ramps Northbound			Cactus Avenue Eastbound							
	Left	Thru	Right	App. Total	Left	Thru	Right	App. Total	Left	Thru	Right	App. Total	Int. Total				
Peak Hour Analysis From 04:15 PM to 05:00 PM - Peak 1 of 1	Peak Hour for Each Approach Begins at:																
	04:15 PM																
+0 mins.	1	0	0	1	0	1	0	0	1	2	0	0	3	0	6	1	7
+15 mins.	0	0	0	0	0	7	0	0	7	0	0	0	2	0	4	0	4
+30 mins.	1	0	0	1	0	4	0	0	4	0	0	0	2	0	11	0	11
+45 mins.	0	0	1	1	0	7	0	0	7	0	0	0	0	0	3	0	3
Total Volume	2	0	1	3	0	19	0	0	19	5	2	0	7	0	24	1	25
% App. Total	66.7	0	33.3	.750	0	100	0	0	100	71.4	28.6	0	.583	0	96	4	.568
PHF	.500	.000	.250	.750	.000	.679	.000	.679	.000	.625	.250	.000	.583	.000	.545	.250	.568

Groups Printed- 3 Axle Vehicles

Start Time	Old 215 Frontage Road Southbound				Cactus Avenue Westbound				I-215 Northbound Ramps Northbound				Cactus Avenue Eastbound								
	Left	Thru	Right	RTOR	App. Total	Left	Thru	Right	RTOR	App. Total	Left	Thru	Right	RTOR	App. Total	Exclu. Total	Inclu. Total	Int. Total			
04:00 PM	0	0	0	0	0	2	0	0	0	0	0	0	0	0	0	0	3	3			
04:15 PM	0	0	0	0	0	0	0	0	0	0	1	0	0	0	0	0	4	4			
04:30 PM	0	0	0	0	0	0	0	0	0	0	2	0	0	0	2	0	4	4			
04:45 PM	1	0	0	0	1	1	0	0	0	1	0	1	0	0	2	0	5	5			
Total	1	0	0	0	1	3	0	0	0	3	3	1	0	0	4	0	16	16			
05:00 PM	1	0	0	0	1	1	0	0	0	1	1	0	0	0	1	0	4	4			
05:15 PM	0	0	0	0	0	0	0	0	0	0	1	0	0	0	1	0	2	2			
05:30 PM	0	0	1	0	1	0	0	0	0	0	0	0	0	0	2	0	4	4			
05:45 PM	1	0	0	0	1	3	0	0	0	3	0	0	1	0	2	0	6	6			
Total	2	0	1	0	3	5	0	0	0	5	2	0	0	0	2	0	16	16			
Grand Total	3	0	1	0	4	8	0	0	0	8	5	1	0	0	6	1	12	1	0	14	32
% Apprch %	75	0	25			100	0	0	0	83.3	16.7	0	0	0	7.1	85.7	7.1	0	0	43.8	100
% Total %	9.4	0	3.1		12.5	25	0	0	0	15.6	3.1	0	0	0	18.8	3.1	37.5	3.1	0	43.8	100

Start Time	Old 215 Frontage Road Southbound				Cactus Avenue Westbound				I-215 Northbound Ramps Northbound				Cactus Avenue Eastbound								
	Left	Thru	Right	RTOR	App. Total	Left	Thru	Right	RTOR	App. Total	Left	Thru	Right	RTOR	App. Total	Exclu. Total	Inclu. Total	Int. Total			
04:15 PM	0	0	0	0	0	0	0	0	0	0	1	0	0	0	1	0	3	3	0	0	4
04:30 PM	0	0	0	0	0	0	0	0	0	0	2	0	0	0	2	0	2	0	0	0	4
04:45 PM	1	0	0	0	1	0	0	0	0	1	0	0	0	0	1	0	2	0	0	0	5
05:00 PM	1	0	0	0	1	0	0	0	0	1	1	0	0	0	1	0	1	0	0	0	4
Total Volume	2	0	0	0	2	0	2	0	0	2	4	1	0	0	5	1	7	0	0	8	17
% App. Total	100	0	0	0	100	0	100	0	0	80	20	0	0	0	12.5	87.5	0	0	0	0	17
PHF	.500	.000	.000	.500	.000	.500	.500	.000	.250	.000	.500	.250	.000	.625	.250	.583	.000	.667	.000	.850	.850

Peak Hour Analysis From 04:15 PM to 05:00 PM - Peak 1 of 1
 Peak Hour for Entire Intersection Begins at 04:15 PM

Counts Unlimited, Inc.
 PO Box 1178
 Corona, CA 92878
 (951)268-6268

County of Riverside
 N/S: Old 215 Frontage Rd/I-215 NB Ramps
 E/W: Cactus Avenue
 Weather: Clear

File Name : 28_CRV_215N_Cactus PM
 Site Code : 05121716
 Start Date : 11/30/2021
 Page No : 2

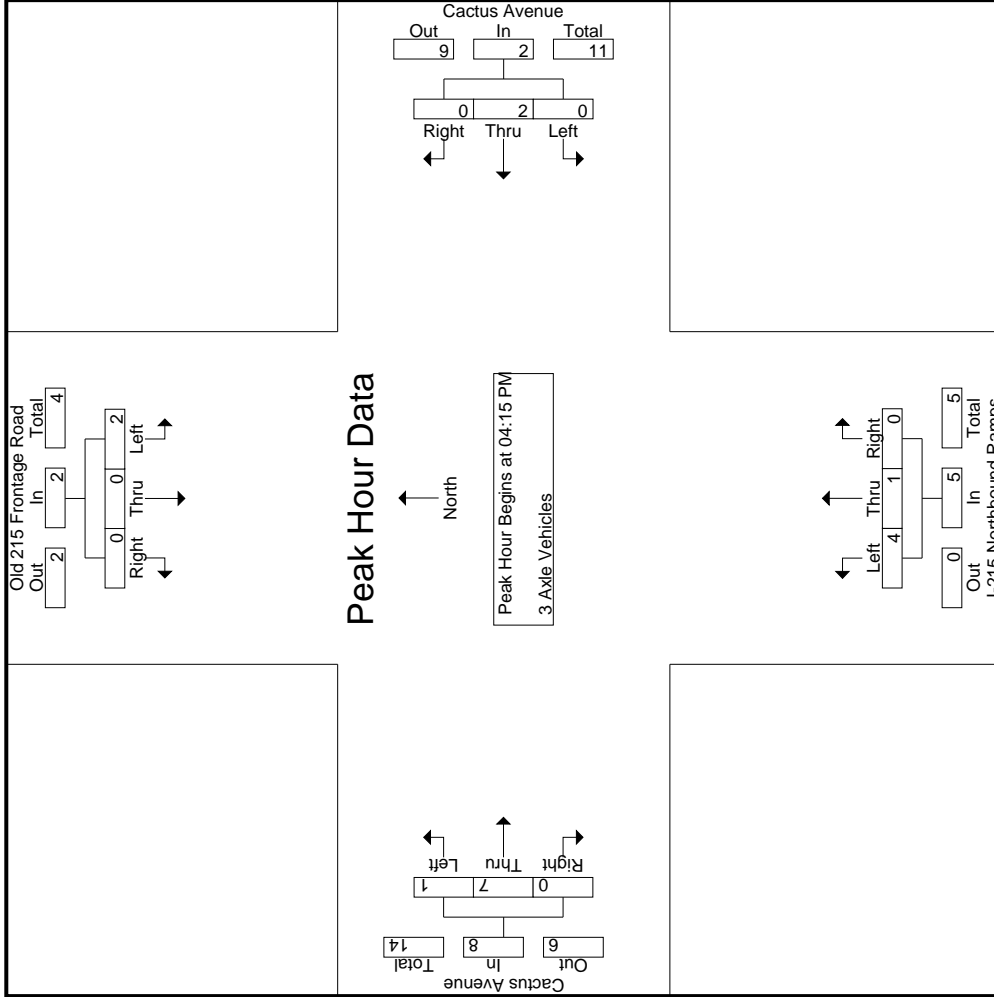

Start Time	Old 215 Frontage Road Southbound			Cactus Avenue Westbound			I-215 Northbound Ramps Northbound			Cactus Avenue Eastbound		
	Left	Thru	Right	Left	Thru	Right	Left	Thru	Right	Left	Thru	Right
Peak Hour Analysis From 04:15 PM to 05:00 PM - Peak 1 of 1												
Peak Hour for Each Approach Begins at:												
+0 mins.	0	0	0	0	0	0	1	0	0	0	3	0
+15 mins.	0	0	0	0	0	0	2	0	0	0	2	0
+30 mins.	1	0	0	1	0	1	0	1	0	0	2	0
+45 mins.	1	0	0	1	0	1	1	0	0	1	0	0
Total Volume	2	0	0	2	0	2	4	1	0	1	7	0
% App. Total	100	0	0	100	0	0	80	20	0	12.5	87.5	0
PHF	.500	.000	.000	.500	.000	.000	.500	.250	.000	.250	.583	.000

Counts Unlimited, Inc.
 PO Box 1178
 Corona, CA 92878
 (951)268-6268

County of Riverside
 N/S: Old 215 Frontage Rd/I-215 NB Ramps
 E/W: Cactus Avenue
 Weather: Clear

File Name : 28_CRV_215N_Cactus PM
 Site Code : 05121716
 Start Date : 11/30/2021
 Page No : 1

Groups Printed- 4+ Axle Trucks

Start Time	Old 215 Frontage Road Southbound				Cactus Avenue Westbound				I-215 Northbound Ramps Northbound				Cactus Avenue Eastbound					
	Left	Thru	Right	RTOR	App. Total	Left	Thru	Right	RTOR	App. Total	Left	Thru	Right	RTOR	App. Total	Exclu. Total	Inclu. Total	Int. Total
04:00 PM	0	0	0	0	0	5	0	1	0	0	0	0	0	0	9	0	15	15
04:15 PM	0	0	0	0	15	0	0	0	0	5	1	12	4	0	17	0	37	37
04:30 PM	1	0	0	1	5	0	0	0	0	0	0	11	4	1	15	2	21	23
04:45 PM	0	0	1	0	4	0	0	0	0	0	1	5	2	0	8	0	13	13
Total	1	0	1	0	29	27	2	3	0	6	2	35	12	1	49	2	86	88
05:00 PM	1	0	0	0	12	0	1	0	0	1	0	5	3	1	8	1	22	23
05:15 PM	3	0	1	0	7	6	1	0	0	1	0	8	3	1	11	1	23	24
05:30 PM	2	0	1	0	4	4	0	0	0	1	0	6	2	0	8	1	17	18
05:45 PM	2	0	1	0	5	4	1	0	0	0	0	12	3	0	15	0	23	23
Total	8	0	4	1	28	26	2	1	0	3	0	31	11	2	42	3	85	88
Grand Total	9	0	5	1	57	53	4	1	0	9	2	66	23	3	91	5	171	176
T-Approch %	64.3	0	35.7			55.6	44.4	0		5.3	2.2	72.5	25.3		53.2	2.8	97.2	
T-Total %	5.3	0	2.9		8.2	31	2.3				1.2	38.6	13.5					

Start Time	Old 215 Frontage Road Southbound				Cactus Avenue Westbound				I-215 Northbound Ramps Northbound				Cactus Avenue Eastbound					
	Left	Thru	Right	RTOR	App. Total	Left	Thru	Right	RTOR	App. Total	Left	Thru	Right	RTOR	App. Total	Exclu. Total	Inclu. Total	Int. Total
04:15 PM	0	0	0	0	0	15	0	15	0	0	3	2	0	0	5	0	17	17
04:30 PM	1	0	0	0	1	3	0	5	0	0	0	0	0	0	0	0	15	15
04:45 PM	0	0	0	1	0	4	0	4	0	0	0	0	0	0	0	0	8	8
05:00 PM	1	0	0	1	0	12	0	12	0	0	1	5	3	0	1	0	22	22
Total Volume	2	0	0	1	3	34	2	36	3	3	3	33	13	2	48	13	93	93
% App. Total	66.7	0	33.3			94.4	5.6				4.2	68.8	27.1					
PHF	.500	.000	.250	.750	.250	.567	.250	.600	.375	.000	.250	.688	.813	.706	.628			

Peak Hour Analysis From 04:15 PM to 05:00 PM - Peak 1 of 1
 Peak Hour for Entire Intersection Begins at 04:15 PM

Counts Unlimited, Inc.
 PO Box 1178
 Corona, CA 92878
 (951)268-6268

County of Riverside
 N/S: Old 215 Frontage Rd/I-215 NB Ramps
 E/W: Cactus Avenue
 Weather: Clear

File Name : 28_CRV_215N_Cactus PM
 Site Code : 05121716
 Start Date : 11/30/2021
 Page No : 2

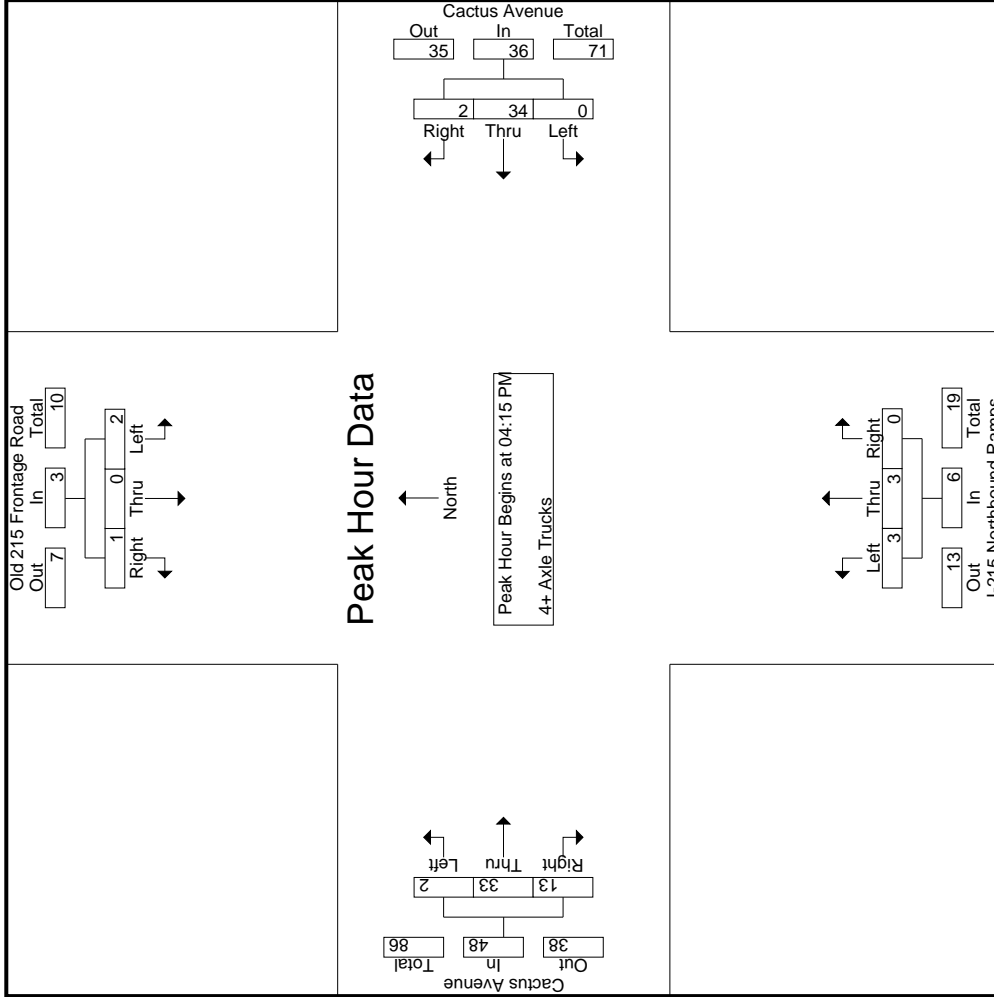

Counts Unlimited, Inc.
 PO Box 1178
 Corona, CA 92878
 (951)268-6268

File Name : 28_CRV_215N_Cactus PM
 Site Code : 05121716
 Start Date : 11/30/2021
 Page No : 3

County of Riverside
 N/S: Old 215 Frontage Rd/I-215 NB Ramps
 E/W: Cactus Avenue
 Weather: Clear

Start Time	Old 215 Frontage Road Southbound			Cactus Avenue Westbound			I-215 Northbound Ramps Northbound			Cactus Avenue Eastbound					
	Left	Thru	Right	Left	Thru	Right	Left	Thru	Right	Left	Thru	Right			
Peak Hour Analysis From 04:15 PM to 05:00 PM - Peak 1 of 1															
Peak Hour for Each Approach Begins at:															
+0 mins.	0	0	0	0	0	0	0	0	0	0	0	0			
+15 mins.	1	0	0	0	3	2	0	0	0	0	11	4			
+30 mins.	0	0	1	0	4	0	0	0	0	1	5	2			
+45 mins.	1	0	0	0	12	0	0	0	0	0	5	3			
Total Volume	2	0	1	0	34	2	0	3	0	2	33	13			
% App. Total	66.7	0	33.3	0	94.4	5.6	0	50	0	4.2	68.8	27.1			
PHF	.500	.000	.250	.000	.567	.250	.000	.375	.000	.500	.688	.813			
				04:15 PM				04:15 PM				04:15 PM			
				0	15	0	15	3	2	0	5	1	12	4	17
				0	3	2	5	0	0	0	0	0	11	4	15
				0	4	0	4	0	0	0	0	1	5	2	8
				0	12	0	12	0	1	0	1	0	5	3	8
				0	34	2	36	3	3	0	6	2	33	13	48
				0	94.4	5.6	0	50	50	0	0	4.2	68.8	27.1	0
				.000	.567	.250	.600	.250	.375	.000	.300	.500	.688	.813	.706

Location: County of Riverside
 N/S: Old 215 Frontage Rd/I-215 NB Ramps
 E/W: Cactus Avenue



Date: 11/30/2021
 Day: Tuesday

PEDESTRIANS

	North Leg Old 215 Frontage Road	East Leg Cactus Avenue	South Leg I-215 NB Ramps	West Leg Cactus Avenue	
	Pedestrians	Pedestrians	Pedestrians	Pedestrians	
7:00 AM	0	0	0	0	0
7:15 AM	0	0	0	0	0
7:30 AM	0	0	0	0	0
7:45 AM	0	0	0	0	0
8:00 AM	0	0	0	0	0
8:15 AM	0	0	0	0	0
8:30 AM	0	0	0	0	0
8:45 AM	0	0	0	0	0
TOTAL VOLUMES:	0	0	0	0	0

	North Leg Old 215 Frontage Road	East Leg Cactus Avenue	South Leg I-215 NB Ramps	West Leg Cactus Avenue	
	Pedestrians	Pedestrians	Pedestrians	Pedestrians	
4:00 PM	0	0	0	0	0
4:15 PM	0	0	0	0	0
4:30 PM	0	0	0	0	0
4:45 PM	0	0	0	0	0
5:00 PM	2	0	0	0	2
5:15 PM	0	0	0	0	0
5:30 PM	0	0	0	0	0
5:45 PM	0	0	0	0	0
TOTAL VOLUMES:	2	0	0	0	2

Location: County of Riverside
 N/S: Old 215 Frontage Rd/I-215 NB Ramps
 E/W: Cactus Avenue



Date: 11/30/2021
 Day: Tuesday

BICYCLES

	Southbound Old 215 Frontage Road			Westbound Cactus Avenue			Northbound I-215 NB Ramps			Eastbound Cactus Avenue			
	Left	Thru	Right	Left	Thru	Right	Left	Thru	Right	Left	Thru	Right	
7:00 AM	0	0	0	0	0	0	0	0	0	0	0	0	0
7:15 AM	0	0	0	0	0	0	0	0	0	0	0	0	0
7:30 AM	0	0	0	0	0	0	0	0	0	0	0	0	0
7:45 AM	0	0	0	0	0	0	0	0	0	0	0	0	0
8:00 AM	0	0	0	0	0	0	0	0	0	0	0	0	0
8:15 AM	0	0	0	0	0	0	0	0	0	0	0	0	0
8:30 AM	0	0	0	0	0	0	0	0	0	0	0	0	0
8:45 AM	0	0	0	0	0	0	0	0	0	0	0	0	0
TOTAL VOLUMES:	0	0	0	0	0	0	0	0	0	0	0	0	0

	Southbound Old 215 Frontage Road			Westbound Cactus Avenue			Northbound I-215 NB Ramps			Eastbound Cactus Avenue			
	Left	Thru	Right	Left	Thru	Right	Left	Thru	Right	Left	Thru	Right	
4:00 PM	0	0	0	0	0	0	0	0	0	0	0	0	0
4:15 PM	0	0	0	0	0	0	0	0	0	0	0	0	0
4:30 PM	0	0	0	0	0	0	0	0	0	0	0	0	0
4:45 PM	0	0	0	0	0	0	0	0	0	0	0	0	0
5:00 PM	0	0	0	0	0	0	0	0	0	0	0	0	0
5:15 PM	0	0	0	0	0	0	0	0	0	0	0	0	0
5:30 PM	0	0	0	0	0	0	0	0	0	0	0	0	0
5:45 PM	0	0	0	0	0	0	0	0	0	0	0	0	0
TOTAL VOLUMES:	0	0	0	0	0	0	0	0	0	0	0	0	0

Counts Unlimited, Inc.
PO Box 1178
Corona, CA 92878
(951)268-6268

File Name : 29_CRV_215S_VB AM
Site Code : 05121716
Start Date : 11/30/2021
Page No : 1

County of Riverside
N/S: I-215 Southbound Ramps
E/W: Van Buren Boulevard
Weather: Clear

	Groups Printed- Passenger Vehicles - Large 2 Axle Vehicles - 3 Axle Vehicles - 4+ Axle Trucks																							
	I-215 Southbound Off Ramp Southbound				Van Buren Boulevard Westbound				I-215 Southbound On Ramp Northbound				Van Buren Boulevard Eastbound											
	Start Time	Left	Thru	Right	RTOR	App. Total	Left	Thru	Right	RTOR	App. Total	Left	Thru	Right	RTOR	App. Total	Left	Thru	Right	RTOR	App. Total	Exclu. Total	Inclu. Total	Int. Total
07:00 AM	3	0	183	0	186	0	220	0	0	0	220	0	0	0	0	0	94	138	20	232	20	638	658	
07:15 AM	5	0	154	0	159	0	178	0	0	0	178	0	0	0	0	0	115	144	38	259	38	596	634	
07:30 AM	4	1	135	0	140	0	194	0	0	0	195	0	0	0	0	0	116	155	13	271	13	606	619	
07:45 AM	7	18	168	0	193	0	211	0	0	0	212	0	0	0	0	0	126	148	16	274	16	679	695	
Total	19	19	640	0	678	0	803	0	0	0	805	0	0	0	0	0	451	585	87	1036	87	2519	2606	
08:00 AM	8	18	142	0	168	0	191	0	0	0	193	0	0	0	0	0	116	140	15	256	15	617	632	
08:15 AM	7	3	135	0	145	0	203	0	0	0	207	0	0	0	0	0	100	146	17	246	17	598	615	
08:30 AM	3	0	108	0	111	0	196	0	0	0	196	0	0	0	0	0	91	134	3	225	3	532	538	
08:45 AM	6	0	136	0	142	0	195	0	0	0	197	0	0	0	0	0	83	103	13	186	13	525	538	
Total	24	21	521	0	566	0	785	0	0	0	793	0	0	0	0	0	390	523	48	913	48	2272	2320	
Grand Total	43	40	1161	0	1244	0	1588	0	0	0	1598	0	0	0	0	0	841	1108	135	1949	135	4791	4926	
Approach %	3.5	3.2	93.3				0.6	99.4									43.2	56.8						
5 Total %	0.9	0.8	24.2		26		0.2	33.1		0	33.4		0	0	0	0	17.6	23.1		40.7		2.7	97.3	
Passenger Vehicles	23	35	1073	0	1131	0	1507	0	0	0	1511	0	0	0	0	0	779	1021	0	1924	0	0	4566	
Large 2 Axle Vehicles	3	2	25	0	30	0	39	0	0	0	42	0	0	0	0	0	16	48	71	71	0	0	143	
3 Axle Vehicles	7	5	2.2	0	2.4	0	30	2.5	0	0	2.6	0	0	0	0	0	1.9	4.3	5.2	3.4	0	0	2.9	
4+ Axle Trucks	6	2	46	0	54	0	30	0	0	0	33	0	0	0	0	0	33	28	63	63	0	0	150	
% 4+ Axle Trucks	14	5	4	0	4.3	0	1.9	0	0	0	2.1	0	0	0	0	0	3.9	2.5	1.5	3	0	0	3	

	I-215 Southbound Off Ramp Southbound												I-215 Southbound On Ramp Northbound												Van Buren Boulevard Westbound												Van Buren Boulevard Eastbound											
	Start Time	Left	Thru	Right	RTOR	App. Total	Left	Thru	Right	RTOR	App. Total	Left	Thru	Right	RTOR	App. Total	Left	Thru	Right	RTOR	App. Total	Left	Thru	Right	RTOR	App. Total	Left	Thru	Right	RTOR	App. Total	Left	Thru	Right	RTOR	App. Total	Left	Thru	Right	RTOR	App. Total	Exclu. Total	Inclu. Total	Int. Total				
	07:00 AM	3	0	183	0	186	0	220	0	0	0	220	0	0	0	0	0	94	138	20	232	20	638	658																								
07:15 AM	5	0	154	0	159	0	178	0	0	0	178	0	0	0	0	0	115	144	38	259	38	596	634																									
07:30 AM	4	1	135	0	140	0	194	0	0	0	195	0	0	0	0	0	116	155	13	271	13	606	619																									
07:45 AM	7	18	168	0	193	0	211	0	0	0	212	0	0	0	0	0	126	148	16	274	16	679	695																									
Total Volume	19	19	640	0	678	0	803	0	0	0	805	0	0	0	0	0	451	585	87	1036	87	2519	2606																									
% App. Total	2.8	2.8	94.4		94.4		0.2	99.8		0	99.8		0	0	0	0	0	43.5	56.5		43.5		92.7																									
PHF	.679	.264	.874		.874		.500	.913		.000	.915		.000	.000	.000	.000	.000	.895	.944		.000	.945	.927																									

Peak Hour Analysis From 07:00 AM to 08:45 AM - Peak 1 of 1
Peak Hour for Entire Intersection Begins at 07:00 AM

Counts Unlimited, Inc.
 PO Box 1178
 Corona, CA 92878
 (951)268-6268

County of Riverside
 N/S: I-215 Southbound Ramps
 E/W: Van Buren Boulevard
 Weather: Clear

File Name : 29_CRV_215S_VB AM
 Site Code : 05121716
 Start Date : 11/30/2021
 Page No : 2

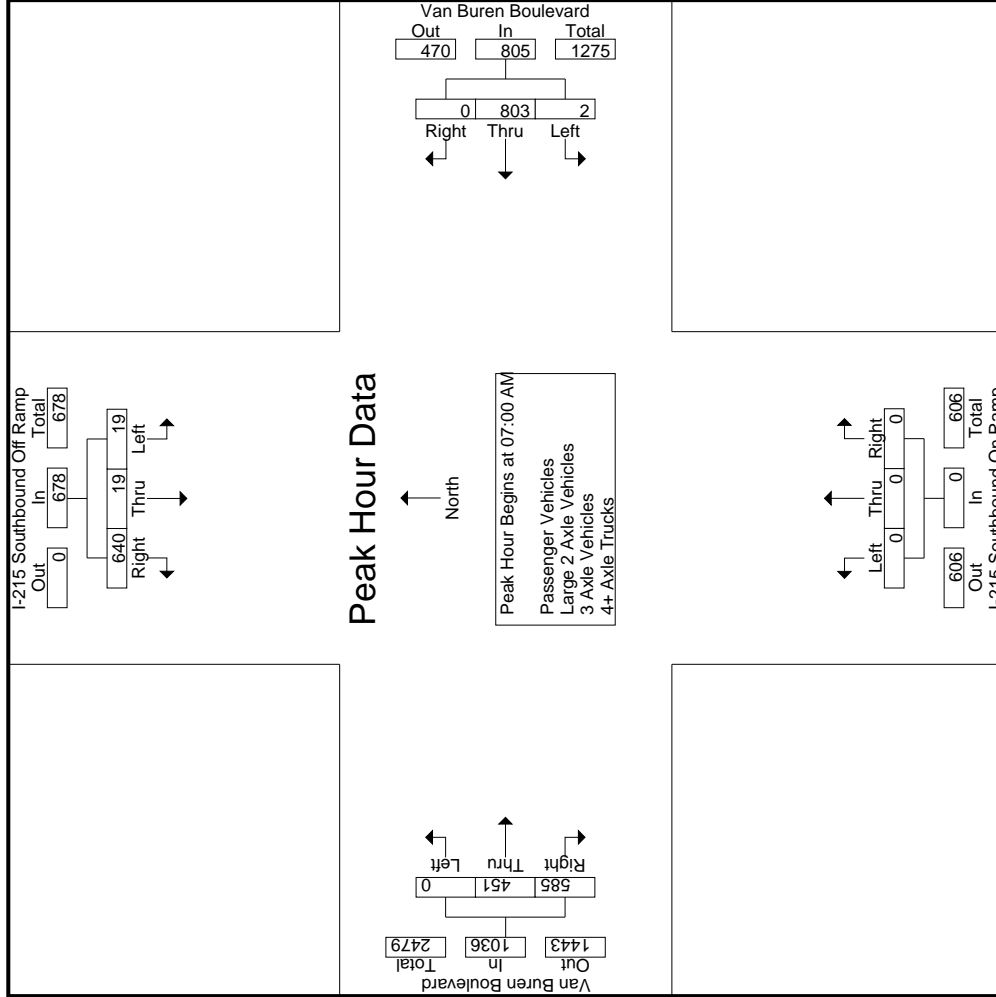

Counts Unlimited, Inc.
 PO Box 1178
 Corona, CA 92878
 (951)268-6268

File Name : 29_CRV_215S_VB AM
 Site Code : 05121716
 Start Date : 11/30/2021
 Page No : 3

County of Riverside
 N/S: I-215 Southbound Ramps
 E/W: Van Buren Boulevard
 Weather: Clear

Start Time	I-215 Southbound Off Ramp Southbound			Van Buren Boulevard Westbound			I-215 Southbound On Ramp Northbound			Van Buren Boulevard Eastbound			
	Left	Thru	Right	Left	Thru	Right	Left	Thru	Right	Left	Thru	Right	
Peak Hour Analysis From 07:00 AM to 08:45 AM - Peak 1 of 1	Peak Hour for Each Approach Begins at:												
	07:00 AM			07:45 AM			07:00 AM			07:15 AM			
+0 mins.	3	0	183	1	211	0	212	0	0	0	115	144	259
+15 mins.	5	0	154	2	191	0	193	0	0	0	116	155	271
+30 mins.	4	1	135	4	203	0	207	0	0	0	126	148	274
+45 mins.	7	18	168	0	196	0	196	0	0	0	116	140	256
Total Volume	19	19	640	7	801	0	808	0	0	0	473	587	1060
% App. Total	2.8	2.8	94.4	0.9	99.1	0	0	0	0	0	44.6	55.4	
PHF	.679	.264	.874	.438	.949	.000	.953	.000	.000	.000	.938	.947	.967

Counts Unlimited, Inc.
 PO Box 1178
 Corona, CA 92878
 (951)268-6268

County of Riverside
 N/S: I-215 Southbound Ramps
 E/W: Van Buren Boulevard
 Weather: Clear

File Name : 29_CRV_215S_VB AM
 Site Code : 05121716
 Start Date : 11/30/2021
 Page No : 1

Groups Printed- Passenger Vehicles

Start Time	I-215 Southbound Off Ramp Southbound				Van Buren Boulevard Westbound				I-215 Southbound On Ramp Northbound				Van Buren Boulevard Eastbound					
	Left	Thru	Right	RTOR	App. Total	Left	Thru	Right	RTOR	App. Total	Left	Thru	Right	RTOR	App. Total	Exclu. Total	Inclu. Total	Int. Total
07:00 AM	3	0	168	0	171	0	209	0	0	209	0	0	0	0	0	18	594	612
07:15 AM	1	0	149	0	150	0	169	0	0	169	0	0	0	0	0	34	555	589
07:30 AM	1	0	128	0	129	1	184	0	0	185	0	0	0	0	0	11	560	571
07:45 AM	4	14	154	0	172	1	207	0	0	208	0	0	0	0	0	16	637	653
Total	9	14	599	0	622	2	769	0	0	771	0	0	0	0	0	79	2346	2425
08:00 AM	4	18	127	0	149	1	177	0	0	178	0	0	0	0	0	15	571	586
08:15 AM	5	3	126	0	134	0	188	0	0	188	0	0	0	0	0	15	548	563
08:30 AM	1	0	98	0	99	0	182	0	0	182	0	0	0	0	2	491	493	
08:45 AM	4	0	123	0	127	1	191	0	0	192	0	0	0	0	13	486	499	
Total	14	21	474	0	509	2	738	0	0	740	0	0	0	0	0	45	2096	2141
Grand Total	23	35	1073	0	1131	4	1507	0	0	1511	0	0	0	0	0	124	4442	4566
T-Approch %	2	3.1	94.9			0.3	99.7	0			0	0						
Total %	0.5	0.8	24.2		25.5	0.1	33.9	0		34	0	0		23	40.5	2.7	97.3	

Start Time	I-215 Southbound Off Ramp Southbound				Van Buren Boulevard Westbound				I-215 Southbound On Ramp Northbound				Van Buren Boulevard Eastbound					
	Left	Thru	Right	RTOR	App. Total	Left	Thru	Right	RTOR	App. Total	Left	Thru	Right	RTOR	App. Total	Exclu. Total	Inclu. Total	Int. Total
07:00 AM	3	0	168	0	171	0	209	0	0	209	0	0	0	0	0	18	594	612
07:15 AM	1	0	149	0	150	0	169	0	0	169	0	0	0	0	0	34	555	589
07:30 AM	1	0	128	0	129	1	184	0	0	185	0	0	0	0	0	11	560	571
07:45 AM	4	14	154	0	172	1	207	0	0	208	0	0	0	0	0	16	637	653
Total	9	14	599	0	622	2	769	0	0	771	0	0	0	0	0	79	2346	2425
08:00 AM	4	18	127	0	149	1	177	0	0	178	0	0	0	0	0	15	571	586
08:15 AM	5	3	126	0	134	0	188	0	0	188	0	0	0	0	0	15	548	563
08:30 AM	1	0	98	0	99	0	182	0	0	182	0	0	0	0	2	491	493	
08:45 AM	4	0	123	0	127	1	191	0	0	192	0	0	0	0	13	486	499	
Total	14	21	474	0	509	2	738	0	0	740	0	0	0	0	0	45	2096	2141
Grand Total	23	35	1073	0	1131	4	1507	0	0	1511	0	0	0	0	0	124	4442	4566
T-Approch %	2	3.1	94.9			0.3	99.7	0			0	0						
Total %	0.5	0.8	24.2		25.5	0.1	33.9	0		34	0	0		23	40.5	2.7	97.3	

Peak Hour Analysis From 07:00 AM to 07:45 AM - Peak 1 of 1
 Peak Hour for Entire Intersection Begins at 07:00 AM

Start Time	I-215 Southbound Off Ramp Southbound				Van Buren Boulevard Westbound				I-215 Southbound On Ramp Northbound				Van Buren Boulevard Eastbound					
	Left	Thru	Right	RTOR	App. Total	Left	Thru	Right	RTOR	App. Total	Left	Thru	Right	RTOR	App. Total	Exclu. Total	Inclu. Total	Int. Total
07:00 AM	3	0	168	0	171	0	209	0	0	209	0	0	0	0	0	18	594	612
07:15 AM	1	0	149	0	150	0	169	0	0	169	0	0	0	0	0	34	555	589
07:30 AM	1	0	128	0	129	1	184	0	0	185	0	0	0	0	0	11	560	571
07:45 AM	4	14	154	0	172	1	207	0	0	208	0	0	0	0	0	16	637	653
Total	9	14	599	0	622	2	769	0	0	771	0	0	0	0	0	79	2346	2425
% App. Total	1.4	2.3	96.3			0.3	99.7	0			0	0						
PHF	.563	.250	.891		.904	.500	.920	.000		.922	.000	.000		.893	.955	.927	.921	

Counts Unlimited, Inc.
 PO Box 1178
 Corona, CA 92878
 (951)268-6268

County of Riverside
 N/S: I-215 Southbound Ramps
 E/W: Van Buren Boulevard
 Weather: Clear

File Name : 29_CRV_215S_VB AM
 Site Code : 05121716
 Start Date : 11/30/2021
 Page No : 2

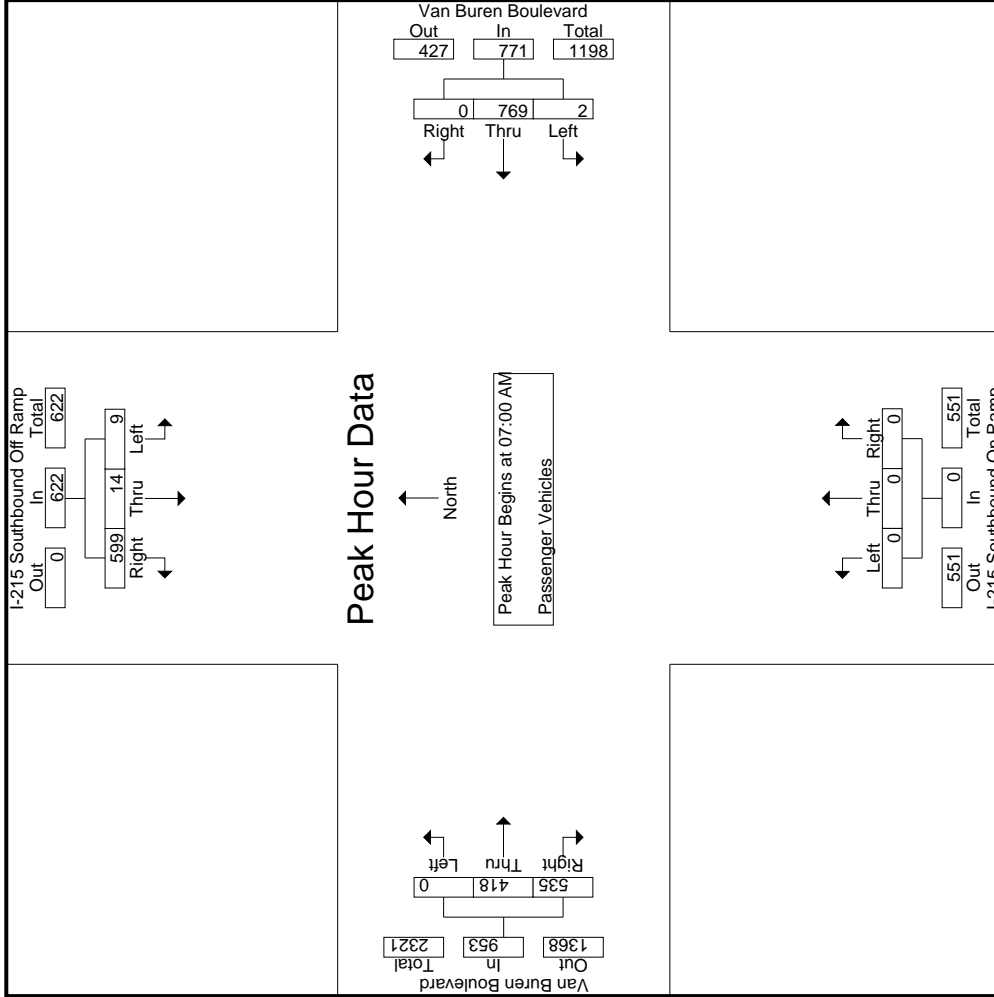

Counts Unlimited, Inc.
 PO Box 1178
 Corona, CA 92878
 (951)268-6268

County of Riverside
 N/S: I-215 Southbound Ramps
 E/W: Van Buren Boulevard
 Weather: Clear

File Name : 29_CRV_215S_VB AM
 Site Code : 05121716
 Start Date : 11/30/2021
 Page No : 3

Start Time	I-215 Southbound Off Ramp Southbound			Van Buren Boulevard Westbound			I-215 Southbound On Ramp Northbound			Van Buren Boulevard Eastbound					
	Left	Thru	Right	Left	Thru	Right	Left	Thru	Right	Left	Thru	Right			
Peak Hour Analysis From 07:00 AM to 07:45 AM - Peak 1 of 1															
Peak Hour for Each Approach Begins at:	07:00 AM														
+0 mins.	3	0	168	0	209	0	209	0	0	0	0	0	0	85	129
+15 mins.	1	0	149	0	169	0	169	0	0	0	0	0	0	108	128
+30 mins.	1	0	128	1	184	0	185	0	0	0	0	0	0	108	138
+45 mins.	4	14	154	1	207	0	208	0	0	0	0	0	0	117	140
Total Volume	9	14	599	2	769	0	771	0	0	0	0	0	0	418	535
% App. Total	1.4	2.3	96.3	0.3	99.7	0	0	0	0	0	0	0	0	43.9	56.1
PHF	.563	.250	.891	.500	.920	.000	.922	.000	.000	.000	.000	.000	.000	.893	.955
			.904												.927

Groups Printed- Large 2 Axle Vehicles

Start Time	I-215 Southbound Off Ramp Southbound					Van Buren Boulevard Westbound					I-215 Southbound On Ramp Northbound					Van Buren Boulevard Eastbound							
	Left	Thru	Right	RTOR	App. Total	Left	Thru	Right	RTOR	App. Total	Left	Thru	Right	RTOR	App. Total	Left	Thru	Right	RTOR	App. Total	Exclu. Total	Inclu. Total	Int. Total
07:00 AM	0	0	9	0	9	0	6	0	0	6	0	0	0	0	0	0	0	4	1	4	1	19	20
07:15 AM	1	0	0	0	1	0	4	0	0	4	0	0	0	0	0	0	2	10	3	12	3	17	20
07:30 AM	0	0	2	0	2	0	3	0	0	3	0	0	0	0	0	0	3	8	2	11	2	16	18
07:45 AM	0	2	2	0	4	0	1	0	0	1	0	0	0	0	0	0	3	5	0	8	0	13	13
Total	1	2	13	0	16	0	14	0	0	14	0	0	0	0	0	0	8	27	6	35	6	65	71
08:00 AM	1	0	4	0	5	1	7	0	0	8	0	0	0	0	0	0	1	7	0	8	0	21	21
08:15 AM	1	0	3	0	4	1	12	0	0	13	0	0	0	0	0	0	1	6	0	7	0	24	24
08:30 AM	0	0	2	0	2	0	5	0	0	5	0	0	0	0	0	0	3	3	1	6	1	13	14
08:45 AM	0	0	3	0	3	1	1	0	0	2	0	0	0	0	0	0	3	5	0	8	0	13	13
Total	2	0	12	0	14	3	25	0	0	28	0	0	0	0	0	0	8	21	1	29	1	71	72
Grand Total	3	2	25	0	30	3	39	0	0	42	0	0	0	0	0	0	16	48	7	64	7	136	143
% Approach	10	6.7	83.3			7.1	92.9	0			0	0	0			0	25	75		47.1	4.9	95.1	
% Total	2.2	1.5	18.4		22.1	2.2	28.7	0		30.9	0	0	0			0	11.8	35.3		47.1			

Start Time	I-215 Southbound Off Ramp Southbound					Van Buren Boulevard Westbound					I-215 Southbound On Ramp Northbound					Van Buren Boulevard Eastbound							
	Left	Thru	Right	RTOR	App. Total	Left	Thru	Right	RTOR	App. Total	Left	Thru	Right	RTOR	App. Total	Left	Thru	Right	RTOR	App. Total	Exclu. Total	Inclu. Total	Int. Total
07:00 AM	0	0	9	0	9	0	6	0	0	6	0	0	0	0	0	0	0	4	1	4	1	19	20
07:15 AM	1	0	0	0	1	0	4	0	0	4	0	0	0	0	0	0	2	10	3	12	3	17	20
07:30 AM	0	0	2	0	2	0	3	0	0	3	0	0	0	0	0	0	3	8	2	11	2	16	18
07:45 AM	0	2	2	0	4	0	1	0	0	1	0	0	0	0	0	0	3	5	0	8	0	13	13
Total	1	2	13	0	16	0	14	0	0	14	0	0	0	0	0	0	8	27	6	35	6	65	71
08:00 AM	1	0	4	0	5	1	7	0	0	8	0	0	0	0	0	0	1	7	0	8	0	21	21
08:15 AM	1	0	3	0	4	1	12	0	0	13	0	0	0	0	0	0	1	6	0	7	0	24	24
08:30 AM	0	0	2	0	2	0	5	0	0	5	0	0	0	0	0	0	3	3	1	6	1	13	14
08:45 AM	0	0	3	0	3	1	1	0	0	2	0	0	0	0	0	0	3	5	0	8	0	13	13
Total	2	0	12	0	14	3	25	0	0	28	0	0	0	0	0	0	8	21	1	29	1	71	72
Grand Total	3	2	25	0	30	3	39	0	0	42	0	0	0	0	0	0	16	48	7	64	7	136	143
% Approach	10	6.7	83.3			7.1	92.9	0			0	0	0			0	25	75		47.1	4.9	95.1	
% Total	2.2	1.5	18.4		22.1	2.2	28.7	0		30.9	0	0	0			0	11.8	35.3		47.1			

Peak Hour Analysis From 07:00 AM to 07:45 AM - Peak 1 of 1
 Peak Hour for Entire Intersection Begins at 07:00 AM

Start Time	I-215 Southbound Off Ramp Southbound					Van Buren Boulevard Westbound					I-215 Southbound On Ramp Northbound					Van Buren Boulevard Eastbound							
	Left	Thru	Right	RTOR	App. Total	Left	Thru	Right	RTOR	App. Total	Left	Thru	Right	RTOR	App. Total	Left	Thru	Right	RTOR	App. Total	Exclu. Total	Inclu. Total	Int. Total
07:00 AM	0	0	9	0	9	0	6	0	0	6	0	0	0	0	0	0	0	4	1	4	1	19	20
07:15 AM	1	0	0	0	1	0	4	0	0	4	0	0	0	0	0	0	2	10	3	12	3	17	20
07:30 AM	0	0	2	0	2	0	3	0	0	3	0	0	0	0	0	0	3	8	2	11	2	16	18
07:45 AM	0	2	2	0	4	0	1	0	0	1	0	0	0	0	0	0	3	5	0	8	0	13	13
Total	1	2	13	0	16	0	14	0	0	14	0	0	0	0	0	0	8	27	6	35	6	65	71
% App. Total	6.2	12.5	81.2			0	100	0			0	0	0			0	22.9	77.1		47.1			
PHF	.250	.250	.361		.444	.000	.583	.000		.583	.000	.000	.000		.000	.000	.667	.675		.729			.855

Counts Unlimited, Inc.
 PO Box 1178
 Corona, CA 92878
 (951)268-6268

County of Riverside
 N/S: I-215 Southbound Ramps
 E/W: Van Buren Boulevard
 Weather: Clear

File Name : 29_CRV_215S_VB AM
 Site Code : 05121716
 Start Date : 11/30/2021
 Page No : 2

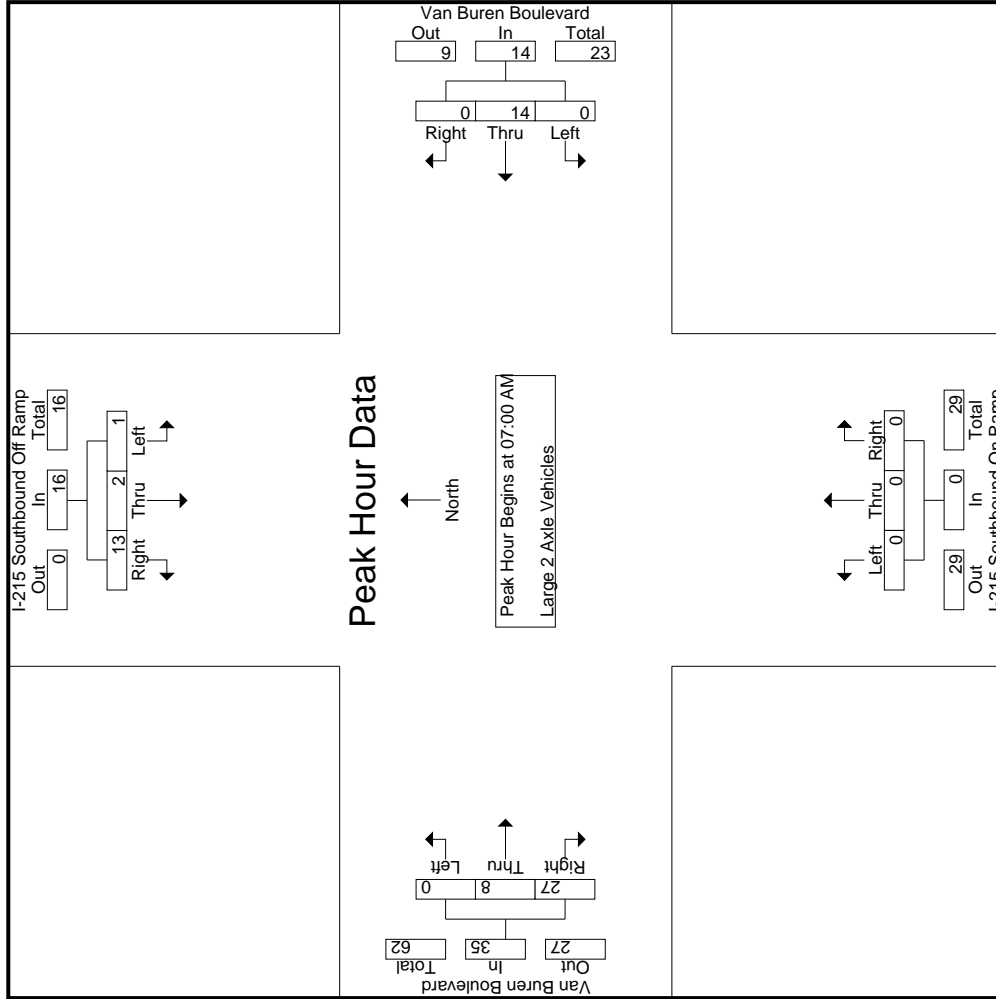

Counts Unlimited, Inc.
 PO Box 1178
 Corona, CA 92878
 (951)268-6268

County of Riverside
 N/S: I-215 Southbound Ramps
 E/W: Van Buren Boulevard
 Weather: Clear

File Name : 29_CRV_215S_VB AM
 Site Code : 05121716
 Start Date : 11/30/2021
 Page No : 3

Start Time	I-215 Southbound Off Ramp Southbound			Van Buren Boulevard Westbound			I-215 Southbound On Ramp Northbound			Van Buren Boulevard Eastbound		
	Left	Thru	Right	Left	Thru	Right	Left	Thru	Right	Left	Thru	Right
Peak Hour Analysis From 07:00 AM to 07:45 AM - Peak 1 of 1												
Peak Hour for Each Approach Begins at:												
+0 mins.	0	0	9	0	6	0	0	0	0	0	0	4
+15 mins.	1	0	0	0	4	0	0	0	0	0	2	10
+30 mins.	0	0	2	0	3	0	0	0	0	0	3	8
+45 mins.	0	2	4	0	1	0	0	0	0	0	3	5
Total Volume	1	2	13	0	14	0	0	0	0	0	8	27
% App. Total	6.2	12.5	81.2	0	100	0	0	0	0	0	22.9	77.1
PHF	.250	.250	.361	.000	.583	.000	.000	.000	.000	.000	.667	.675

Groups Printed- 3 Axle Vehicles

Start Time	I-215 Southbound Off Ramp Southbound				Van Buren Boulevard Westbound				I-215 Southbound On Ramp Northbound				Van Buren Boulevard Eastbound						
	Left	Thru	Right	RTOR	App. Total	Left	Thru	Right	RTOR	App. Total	Left	Thru	Right	RTOR	App. Total	Exclu. Total	Inclu. Total	Int. Total	
07:00 AM	0	0	2	0	2	0	1	0	0	1	0	0	0	0	0	5	1	1	6
07:15 AM	2	0	2	0	4	0	2	0	0	2	0	0	0	0	0	0	0	1	1
07:30 AM	3	0	2	0	5	0	1	0	0	1	0	0	0	0	0	0	0	4	0
07:45 AM	1	1	3	0	5	0	1	0	0	1	0	0	0	0	0	2	0	3	3
Total	6	1	9	0	16	0	5	0	0	5	0	0	0	0	0	7	7	1	14
08:00 AM	1	0	1	0	2	0	2	0	0	2	0	0	0	0	0	1	1	0	2
08:15 AM	1	0	2	0	3	0	0	0	0	0	0	0	0	0	0	0	2	1	2
08:30 AM	2	0	2	0	4	0	3	0	0	3	0	0	0	0	0	2	0	2	2
08:45 AM	1	0	3	0	4	0	2	0	0	2	0	0	0	0	0	3	1	0	4
Total	5	0	8	0	13	0	7	0	0	7	0	0	0	0	0	6	4	1	10
Grand Total	11	1	17	0	29	0	12	0	0	12	0	0	0	0	0	13	11	2	24
T-Approch %	37.9	3.4	58.6			0	100	0		0	0	0	0		0	54.2	45.8		65
ch Total %	16.9	1.5	26.2		44.6	0	18.5	0		18.5	0	0	0		0	20	16.9		97

Start Time	I-215 Southbound Off Ramp Southbound				Van Buren Boulevard Westbound				I-215 Southbound On Ramp Northbound				Van Buren Boulevard Eastbound						
	Left	Thru	Right	App. Total	Left	Thru	Right	App. Total	Left	Thru	Right	App. Total	Left	Thru	Right	App. Total	Int. Total		
07:00 AM	0	0	2	2	0	1	0	1	0	0	0	0	0	0	0	0	0	0	0
07:15 AM	2	0	2	4	0	2	0	2	0	0	0	0	0	0	0	0	0	0	1
07:30 AM	3	0	2	5	0	1	0	1	0	0	0	0	0	0	0	0	0	0	4
07:45 AM	1	1	3	5	0	1	0	1	0	0	0	0	0	0	0	2	1	0	3
Total	6	1	9	16	0	5	0	5	0	0	0	0	0	0	0	7	7	1	14
% App. Total	37.5	6.2	56.2		0	100	0		0	0	0	0	0	0	0	50	50		35
PHF	.500	.250	.750	.800	.000	.625	.000	.625	.000	.000	.000	.000	.000	.000	.350	.438	.583		.875

Peak Hour Analysis From 07:00 AM to 07:45 AM - Peak 1 of 1
 Peak Hour for Entire Intersection Begins at 07:00 AM

Counts Unlimited, Inc.
 PO Box 1178
 Corona, CA 92878
 (951)268-6268

County of Riverside
 N/S: I-215 Southbound Ramps
 E/W: Van Buren Boulevard
 Weather: Clear

File Name : 29_CRV_215S_VB AM
 Site Code : 05121716
 Start Date : 11/30/2021
 Page No : 2

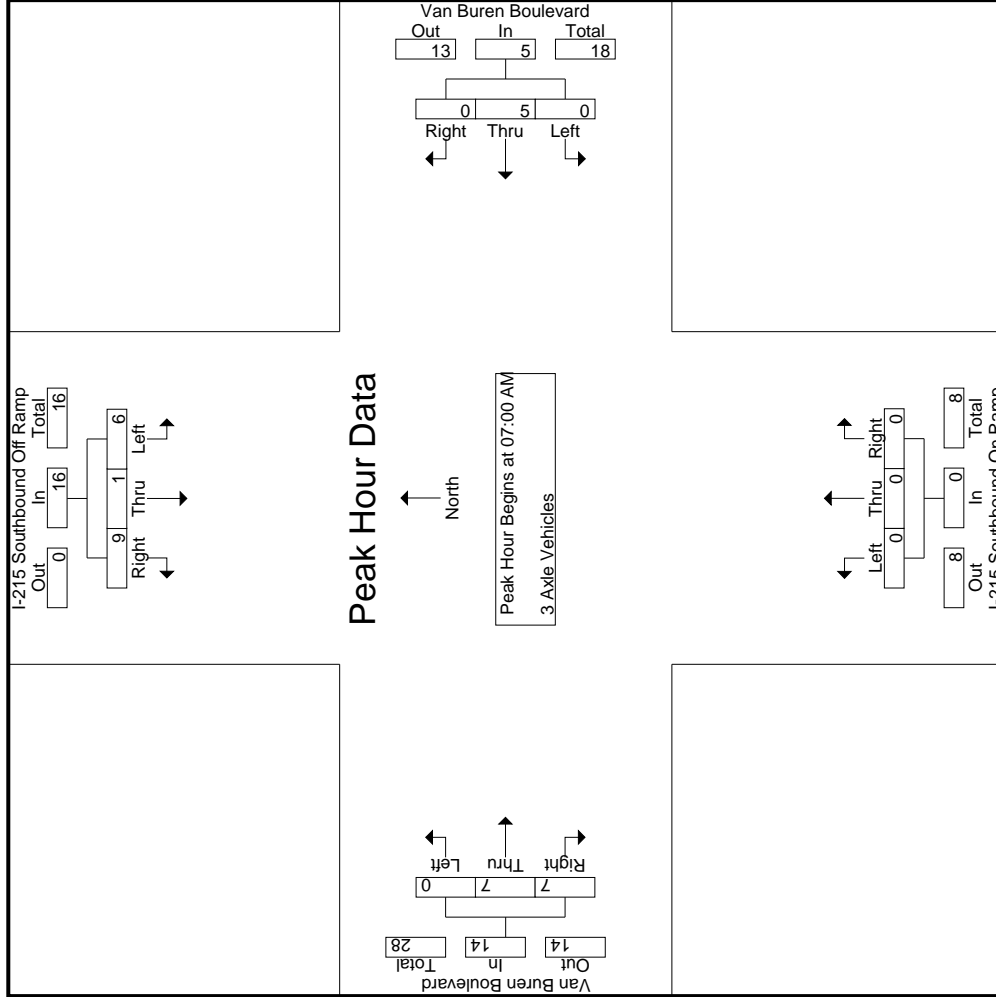

Counts Unlimited, Inc.
 PO Box 1178
 Corona, CA 92878
 (951)268-6268

File Name : 29_CRV_215S_VB AM
 Site Code : 05121716
 Start Date : 11/30/2021
 Page No : 3

County of Riverside
 N/S: I-215 Southbound Ramps
 E/W: Van Buren Boulevard
 Weather: Clear

Start Time	I-215 Southbound Off Ramp Southbound			Van Buren Boulevard Westbound			I-215 Southbound On Ramp Northbound			Van Buren Boulevard Eastbound		
	Left	Thru	Right	Left	Thru	Right	Left	Thru	Right	Left	Thru	Right
Peak Hour Analysis From 07:00 AM to 07:45 AM - Peak 1 of 1												
Peak Hour for Each Approach Begins at:	07:00 AM											
+0 mins.	0	0	2	0	1	0	0	0	0	0	5	1
+15 mins.	2	0	2	0	2	0	0	0	0	0	0	1
+30 mins.	3	0	2	0	1	0	0	0	0	0	0	4
+45 mins.	1	1	3	0	1	0	0	0	0	0	2	1
Total Volume	6	1	9	0	5	0	0	0	0	0	7	7
% App. Total	37.5	6.2	56.2	0	100	0	0	0	0	0	50	50
PHF	.500	.250	.750	.000	.625	.000	.000	.000	.000	.000	.350	.438
			.800		.625	.000		.000	.000		.350	.438

Groups Printed- 4+ Axle Trucks

Start Time	I-215 Southbound Off Ramp Southbound				Van Buren Boulevard Westbound				I-215 Southbound On Ramp Northbound				Van Buren Boulevard Eastbound					
	Left	Thru	Right	RTOR	App. Total	Left	Thru	Right	RTOR	App. Total	Left	Thru	Right	RTOR	App. Total	Exclu. Total	Inclu. Total	Int. Total
07:00 AM	0	0	4	0	4	0	4	0	0	4	0	0	0	0	8	0	16	16
07:15 AM	1	0	3	0	4	0	3	0	0	3	0	0	0	0	10	1	17	18
07:30 AM	0	1	3	0	4	0	6	0	0	6	0	0	0	0	10	0	20	20
07:45 AM	2	1	9	0	12	0	2	0	0	2	0	0	0	0	6	0	20	20
Total	3	2	19	0	24	0	15	0	0	15	0	0	0	1	34	1	73	74
08:00 AM	2	0	10	0	12	0	5	0	0	5	0	0	0	0	2	0	19	19
08:15 AM	0	0	4	0	4	3	3	0	0	6	0	0	0	1	11	1	21	22
08:30 AM	0	0	6	0	6	0	6	0	0	6	0	0	0	4	7	0	19	19
08:45 AM	1	0	7	0	8	0	1	0	0	1	0	0	0	3	7	0	16	16
Total	3	0	27	0	30	3	15	0	0	18	0	0	0	12	27	1	75	76
Grand Total	6	2	46	0	54	3	30	0	0	33	0	0	0	2	61	2	148	150
% Approach	11.1	3.7	85.2			9.1	90.9	0	0	0	0	0	0	54.1	45.9			
% Total	4.1	1.4	31.1		36.5	2	20.3	0	0	22.3	0	0	0	22.3	18.9	1.3	98.7	

Start Time	I-215 Southbound Off Ramp Southbound				Van Buren Boulevard Westbound				I-215 Southbound On Ramp Northbound				Van Buren Boulevard Eastbound					
	Left	Thru	Right	RTOR	App. Total	Left	Thru	Right	RTOR	App. Total	Left	Thru	Right	RTOR	App. Total	Exclu. Total	Inclu. Total	Int. Total
07:00 AM	0	0	4	0	4	0	4	0	0	4	0	0	0	0	8	0	16	16
07:15 AM	1	0	3	0	4	0	3	0	0	3	0	0	0	0	10	1	17	17
07:30 AM	0	1	3	0	4	0	6	0	0	6	0	0	0	0	10	0	20	20
07:45 AM	2	1	9	0	12	0	2	0	0	2	0	0	0	0	6	0	20	20
Total	3	2	19	0	24	0	15	0	0	15	0	0	0	1	34	1	73	74
% App. Total	12.5	8.3	79.2			0	100	0	0	0	0	0	0	52.9	47.1			
PHF	.375	.500	.528		.500	.000	.625	.000	.000	.625	.000	.000	.000	.000	.800	.850	.913	

Peak Hour Analysis From 07:00 AM to 07:45 AM - Peak 1 of 1
 Peak Hour for Entire Intersection Begins at 07:00 AM

Counts Unlimited, Inc.
 PO Box 1178
 Corona, CA 92878
 (951)268-6268

County of Riverside
 N/S: I-215 Southbound Ramps
 E/W: Van Buren Boulevard
 Weather: Clear

File Name : 29_CRV_215S_VB AM
 Site Code : 05121716
 Start Date : 11/30/2021
 Page No : 2

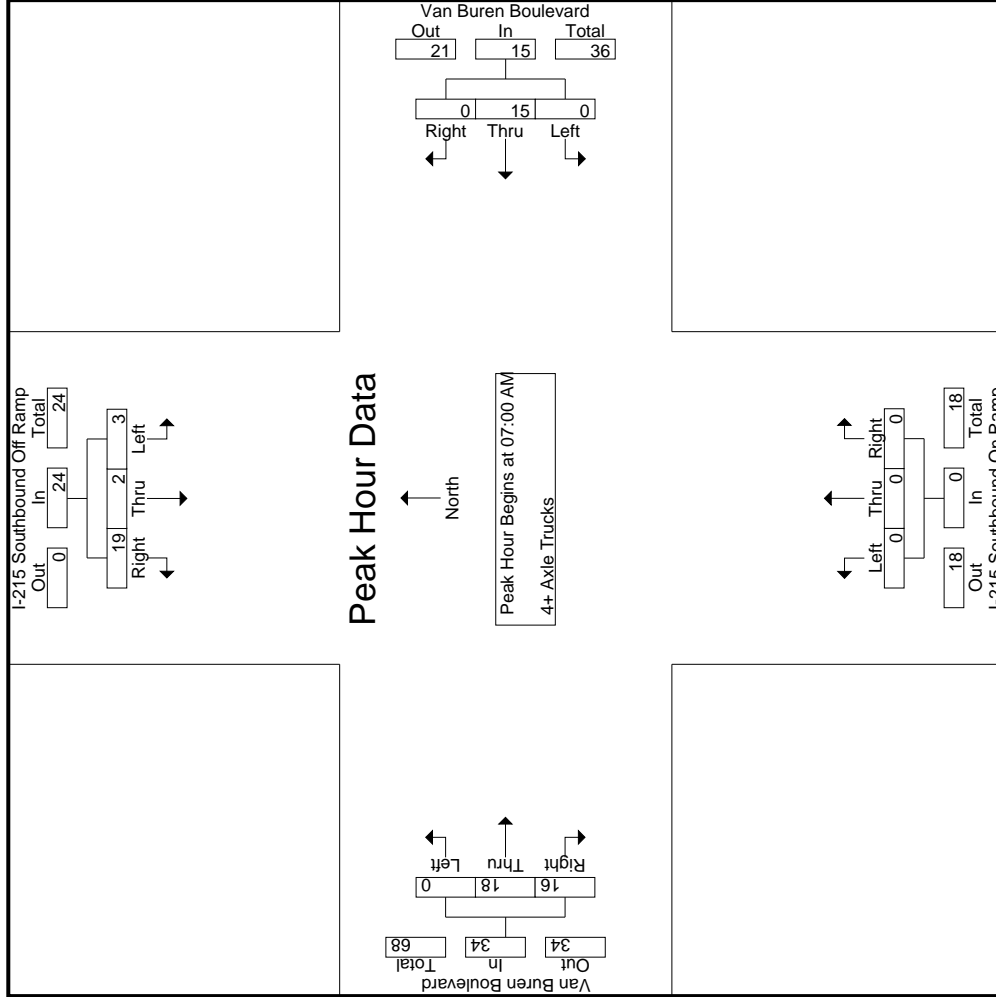

Counts Unlimited, Inc.
 PO Box 1178
 Corona, CA 92878
 (951)268-6268

File Name : 29_CRV_215S_VB AM
 Site Code : 05121716
 Start Date : 11/30/2021
 Page No : 3

County of Riverside
 N/S: I-215 Southbound Ramps
 E/W: Van Buren Boulevard
 Weather: Clear

Start Time	I-215 Southbound Off Ramp Southbound			Van Buren Boulevard Westbound			I-215 Southbound On Ramp Northbound			Van Buren Boulevard Eastbound		
	Left	Thru	Right	Left	Thru	Right	Left	Thru	Right	Left	Thru	Right
Peak Hour Analysis From 07:00 AM to 07:45 AM - Peak 1 of 1												
Peak Hour for Each Approach Begins at:												
+0 mins.	0	0	4	0	4	0	0	4	0	0	0	4
+15 mins.	1	0	3	0	3	0	0	3	0	0	5	5
+30 mins.	0	1	3	0	6	0	0	6	0	0	5	5
+45 mins.	2	1	9	0	2	0	0	2	0	0	4	2
Total Volume	3	2	19	0	15	0	0	15	0	0	18	16
% App. Total	12.5	8.3	79.2	0	100	0	0	100	0	0	52.9	47.1
PHF	.375	.500	.528	.000	.625	.000	.000	.625	.000	.000	.900	.800

Groups Printed- Passenger Vehicles - Large 2 Axle Vehicles - 3 Axle Vehicles - 4+ Axle Trucks

Start Time	I-215 Southbound Off Ramp Southbound						Van Buren Boulevard Westbound						I-215 Southbound On Ramp Northbound						Van Buren Boulevard Eastbound								
	Left	Thru	Right	RTOR	App. Total		Left	Thru	Right	RTOR	App. Total		Left	Thru	Right	RTOR	App. Total		Left	Thru	Right	RTOR	App. Total		Exclu. Total	Inclu. Total	Int. Total
04:00 PM	2	53	64	0	119		0	194	0	0	194		0	0	0	0	0		0	127	327	33	454		33	767	800
04:15 PM	4	49	73	0	126		0	194	0	0	194		0	0	0	0	0		0	107	330	64	437		64	757	821
04:30 PM	3	60	54	0	117		1	186	0	0	187		0	0	0	0	0		0	133	361	48	494		48	798	846
04:45 PM	0	10	27	0	37		0	201	0	0	201		0	0	0	0	0		0	114	373	22	487		22	725	747
Total	9	172	218	0	399		1	775	0	0	776		0	0	0	0	0		0	481	1391	167	1872		167	3047	3214
05:00 PM	1	0	24	0	25		1	182	0	0	183		0	0	0	0	0		0	121	428	4	549		4	757	761
05:15 PM	7	0	27	0	34		0	202	0	0	202		0	0	0	0	0		0	114	494	27	608		27	844	871
05:30 PM	2	33	79	0	114		2	186	0	0	188		0	0	0	0	0		0	107	391	28	498		28	800	828
05:45 PM	1	52	62	0	115		0	227	0	0	227		0	0	0	0	0		0	102	291	33	393		33	735	768
Total	11	85	192	0	288		3	797	0	0	800		0	0	0	0	0		0	444	1604	92	2048		92	3136	3228
Grand Total	20	257	410	0	687		4	1572	0	0	1576		0	0	0	0	0		0	925	2995	259	3920		259	6183	6442
T-Approach %	2.9	37.4	59.7				0.3	99.7	0	0	0		0	0	0	0	0		0	23.6	76.4	0	0		0	0	0
on Total %	0.3	4.2	6.6		11.1		0.1	25.4	0	0	25.5		0	0	0	0	0		0	15	48.4	0	63.4		4	96	96
% Passenger Vehicles	17	250	337		604		3	1472	0	0	1475		0	0	0	0	0		0	843	2895	97.7	3991		0	0	6070
% Large 2 Axle Vehicles	85	97.3	82.2		87.9		75	93.6	0	0	93.6		0	0	0	0	0		0	91.1	96.7	97.7	95.5		0	0	94.2
% 3 Axle Vehicles	3	2	20		25		1	54	0	0	55		0	0	0	0	0		0	16	36	0	56		0	0	136
% 4+ Axle Trucks	15	0.8	4.9		3.6		25	3.4	0	0	3.5		0	0	0	0	0		0	1.7	1.2	1.5	1.3		0	0	2.1
% 3 Axle Vehicles	0	2	17		19		0	14	0	0	14		0	0	0	0	0		0	11	21	0	32		0	0	65
% 4+ Axle Trucks	0	0.8	4.1		2.8		0	0.9	0	0	0.9		0	0	0	0	0		0	1.2	0.7	0	0.8		0	0	1
% 4+ Axle Trucks	0	3	36		39		0	32	0	0	32		0	0	0	0	0		0	55	43	0	100		0	0	171
% 4+ Axle Trucks	0	1.2	8.8		5.7		0	2	0	0	2		0	0	0	0	0		0	5.9	1.4	0.8	2.4		0	0	2.7

Start Time	I-215 Southbound Off Ramp Southbound						Van Buren Boulevard Westbound						I-215 Southbound On Ramp Northbound						Van Buren Boulevard Eastbound								
	Left	Thru	Right	RTOR	App. Total		Left	Thru	Right	RTOR	App. Total		Left	Thru	Right	RTOR	App. Total		Left	Thru	Right	RTOR	App. Total		Exclu. Total	Inclu. Total	Int. Total
05:00 PM	1	0	24		25		1	182	0	0	183		0	0	0	0	0		0	121	428	4	549		4	757	761
05:15 PM	7	0	27		34		0	202	0	0	202		0	0	0	0	0		0	114	494	27	608		27	844	871
05:30 PM	2	33	79		114		2	186	0	0	188		0	0	0	0	0		0	107	391	28	498		28	800	828
05:45 PM	1	52	62		115		0	227	0	0	227		0	0	0	0	0		0	102	291	33	393		33	735	768
Total Volume	11	85	192		288		3	797	0	0	800		0	0	0	0	0		0	444	1604	92	2048		92	3136	3228
% App. Total	3.8	29.5	66.7		66.7		0.4	99.6	0	0	99.6		0	0	0	0	0		0	21.7	78.3	0	0		0	0	0
PHF	.393	.409	.608		.626		.375	.878	.000	.881	.000		.000	.000	.000	.812	.842		.000	.917	.812	.842	.929		.842	.929	.929

Peak Hour Analysis From 04:00 PM to 05:45 PM - Peak 1 of 1
 Peak Hour for Entire Intersection Begins at 05:00 PM

Counts Unlimited, Inc.
 PO Box 1178
 Corona, CA 92878
 (951)268-6268

County of Riverside
 N/S: I-215 Southbound Ramps
 E/W: Van Buren Boulevard
 Weather: Clear

File Name : 29_CRV_215S_VB_PM
 Site Code : 05121716
 Start Date : 11/30/2021
 Page No : 2

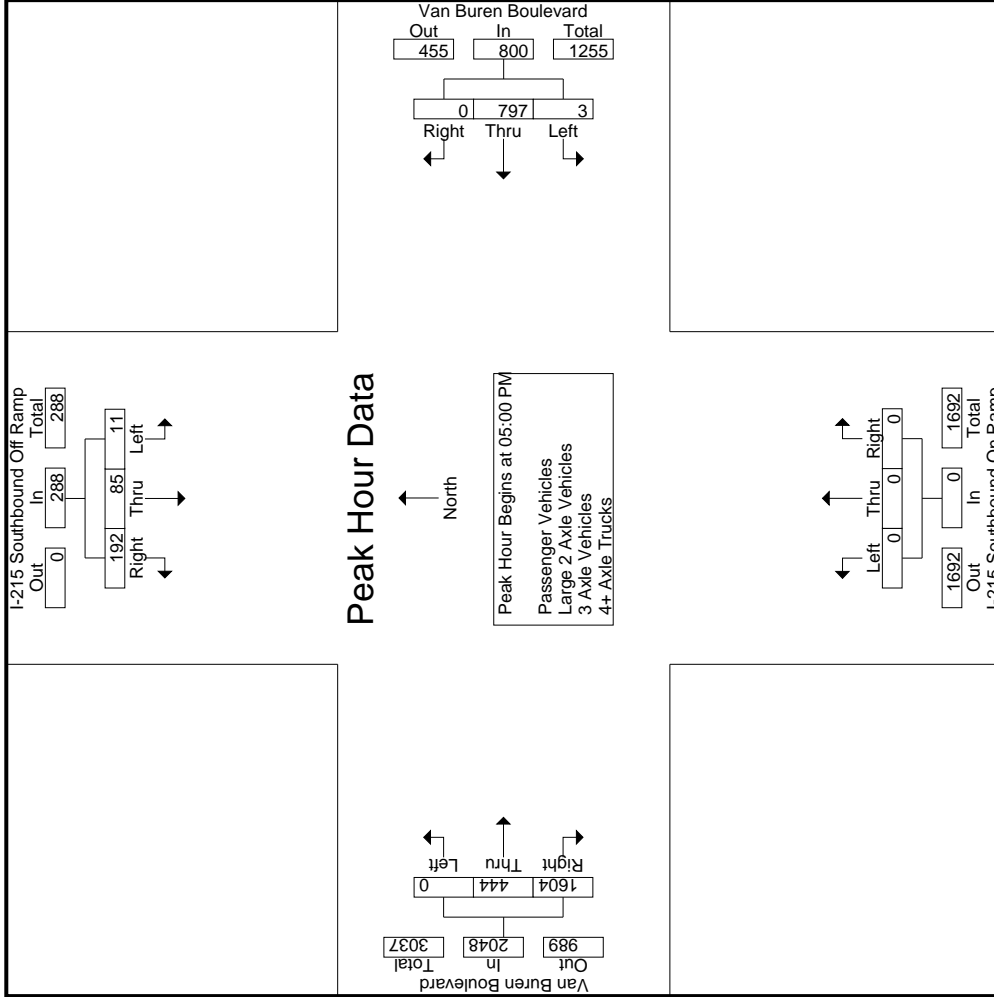

Counts Unlimited, Inc.
 PO Box 1178
 Corona, CA 92878
 (951)268-6268

File Name : 29_CRV_215S_VB_PM
 Site Code : 05121716
 Start Date : 11/30/2021
 Page No : 3

County of Riverside
 N/S: I-215 Southbound Ramps
 E/W: Van Buren Boulevard
 Weather: Clear

Start Time	I-215 Southbound Off Ramp Southbound			Van Buren Boulevard Westbound			I-215 Southbound On Ramp Northbound			Van Buren Boulevard Eastbound			
	Left	Thru	Right	Left	Thru	Right	Left	Thru	Right	Left	Thru	Right	
Peak Hour Analysis From 04:00 PM to 05:45 PM - Peak 1 of 1	Peak Hour for Each Approach Begins at:												
	04:00 PM			05:00 PM			04:00 PM			04:45 PM			
+0 mins.	2	53	64	1	182	0	183	0	0	0	114	373	487
+15 mins.	4	49	73	0	202	0	202	0	0	0	121	428	549
+30 mins.	3	60	54	2	186	0	188	0	0	0	114	494	608
+45 mins.	0	10	27	0	227	0	227	0	0	0	107	391	498
Total Volume	9	172	218	3	797	0	800	0	0	0	456	1686	2142
% App. Total	2.3	43.1	54.6	0.4	99.6	0	0	0	0	0	21.3	78.7	0
PHF	.563	.717	.747	.375	.878	.000	.881	.000	.000	.000	.942	.853	.881

Groups Printed- Passenger Vehicles

Start Time	I-215 Southbound Off Ramp Southbound				Van Buren Boulevard Westbound				I-215 Southbound On Ramp Northbound				Van Buren Boulevard Eastbound				Exclu. Total	Inclu. Total	Int. Total				
	Left	Thru	Right	RTOR	App. Total	Left	Thru	Right	RTOR	App. Total	Left	Thru	Right	RTOR	App. Total	Left				Thru	Right	RTOR	App. Total
04:00 PM	2	53	51	0	106	0	176	0	0	176	0	0	0	0	0	0	115	321	32	436	32	718	750
04:15 PM	4	46	60	0	110	0	182	0	0	182	0	0	0	0	0	0	97	324	64	421	64	713	777
04:30 PM	3	59	42	0	104	1	169	0	0	170	0	0	0	0	0	0	123	342	45	465	45	739	784
04:45 PM	0	10	23	0	33	0	192	0	0	192	0	0	0	0	0	0	105	360	22	465	22	690	712
Total	9	168	176	0	353	1	719	0	0	720	0	0	0	0	0	0	440	1347	163	1787	163	2860	3023
05:00 PM	1	0	16	0	17	1	171	0	0	172	0	0	0	0	0	0	116	409	4	525	4	714	718
05:15 PM	4	0	23	0	27	0	191	0	0	191	0	0	0	0	0	0	97	481	27	578	27	796	823
05:30 PM	2	32	68	0	102	1	174	0	0	175	0	0	0	0	0	0	96	376	26	472	26	749	775
05:45 PM	1	50	54	0	105	0	217	0	0	217	0	0	0	0	0	0	94	282	33	376	33	698	731
Total	8	82	161	0	251	2	753	0	0	755	0	0	0	0	0	0	403	1548	90	1951	90	2957	3047
Grand Total	17	250	337	0	604	3	1472	0	0	1475	0	0	0	0	0	0	843	2895	253	3738	253	5817	6070
T-Approch %	2.8	41.4	55.8			0.2	99.8	0		0	0	0				0	22.6	77.4					
T-Total %	0.3	4.3	5.8		10.4	0.1	25.3	0		25.4	0	0				0	14.5	49.8		64.3	4.2	95.8	

Start Time	I-215 Southbound Off Ramp Southbound				Van Buren Boulevard Westbound				I-215 Southbound On Ramp Northbound				Van Buren Boulevard Eastbound				Exclu. Total	Inclu. Total	Int. Total				
	Left	Thru	Right	RTOR	App. Total	Left	Thru	Right	RTOR	App. Total	Left	Thru	Right	RTOR	App. Total	Left				Thru	Right	RTOR	App. Total
05:00 PM	1	0	16		17	1	171	0		0	0	0				0	116	409		4	525	4	714
05:15 PM	4	0	23		27	0	191	0		0	0	0				0	97	481		27	578	27	796
05:30 PM	2	32	68		102	1	174	0		0	0	0				0	96	376		26	472	26	749
05:45 PM	1	50	54		105	0	217	0		0	0	0				0	94	282		33	376	33	698
Total Volume	8	82	161		251	2	753	0		0	0	0				0	403	1548		90	1951	90	2957
% App. Total	3.2	32.7	64.1		64.1	0.3	99.7	0		0	0	0				0	20.7	79.3					
PHF	.500	.410	.592		.598	.500	.868	.000		.870	.000	.000				.000	.869	.805		.844	.844	.929	

Peak Hour Analysis From 05:00 PM to 05:45 PM - Peak 1 of 1
 Peak Hour for Entire Intersection Begins at 05:00 PM

Counts Unlimited, Inc.
 PO Box 1178
 Corona, CA 92878
 (951)268-6268

County of Riverside
 N/S: I-215 Southbound Ramps
 E/W: Van Buren Boulevard
 Weather: Clear

File Name : 29_CRV_215S_VB PM
 Site Code : 05121716
 Start Date : 11/30/2021
 Page No : 2

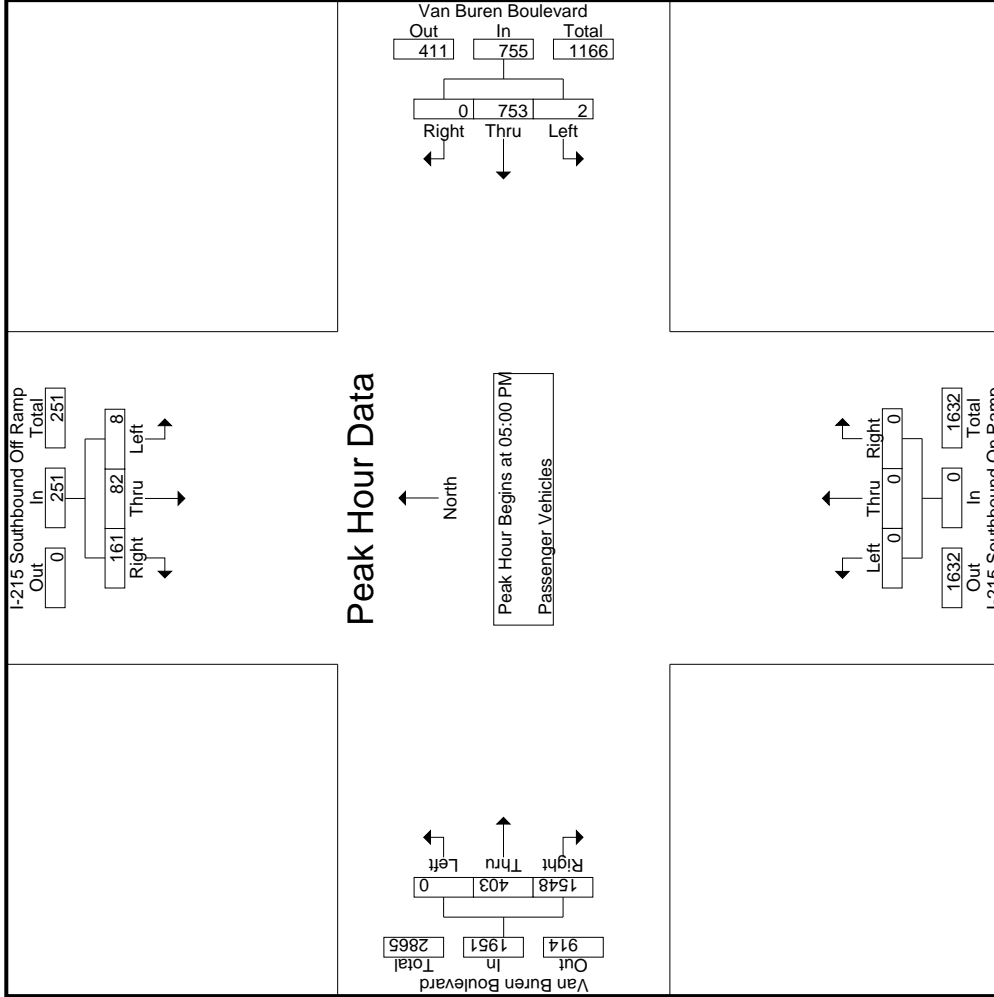

Counts Unlimited, Inc.
 PO Box 1178
 Corona, CA 92878
 (951)268-6268

File Name : 29_CRV_215S_VB_PM
 Site Code : 05121716
 Start Date : 11/30/2021
 Page No : 3

County of Riverside
 N/S: I-215 Southbound Ramps
 E/W: Van Buren Boulevard
 Weather: Clear

Start Time	I-215 Southbound Off Ramp Southbound			Van Buren Boulevard Westbound			I-215 Southbound On Ramp Northbound			Van Buren Boulevard Eastbound		
	Left	Thru	Right	Left	Thru	Right	Left	Thru	Right	Left	Thru	Right
Peak Hour Analysis From 05:00 PM to 05:45 PM - Peak 1 of 1												
Peak Hour for Each Approach Begins at:												
+0 mins.	1	0	16	171	0	0	0	0	0	0	116	409
+15 mins.	4	0	23	191	0	0	0	0	0	0	97	481
+30 mins.	2	32	68	174	0	0	0	0	0	0	96	376
+45 mins.	1	50	54	217	0	217	0	0	0	0	94	282
Total Volume	8	82	161	753	0	755	0	0	0	0	403	1548
% App. Total	3.2	32.7	64.1	99.7	0	0	0	0	0	0	20.7	79.3
PHF	.500	.410	.592	.500	.868	.000	.000	.000	.000	.000	.869	.805

Groups Printed- Large 2-Axle Vehicles

Start Time	I-215 Southbound Off Ramp Southbound				Van Buren Boulevard Westbound				I-215 Southbound On Ramp Northbound				Van Buren Boulevard Eastbound											
	Left	Thru	Right	RTOR	App. Total	Left	Thru	Right	RTOR	App. Total	Left	Thru	Right	RTOR	App. Total	Left	Thru	Right	RTOR	App. Total	Exclu. Total	Inclu. Total	Int. Total	
04:00 PM	0	0	4	0	4	0	5	0	0	5	0	0	0	0	0	0	4	1	0	5	0	14	14	14
04:15 PM	0	1	1	0	2	0	10	0	0	10	0	0	0	0	0	0	0	4	0	4	0	16	16	16
04:30 PM	0	0	4	0	4	0	10	0	0	10	0	0	0	0	0	0	4	12	3	16	3	30	33	33
04:45 PM	0	0	1	0	1	0	4	0	0	4	0	0	0	0	0	0	2	3	0	5	0	10	10	10
Total	0	1	10	0	11	0	29	0	0	29	0	0	0	0	0	0	10	20	3	30	3	70	73	73
05:00 PM	0	0	2	0	2	0	7	0	0	7	0	0	0	0	0	0	1	4	0	5	0	14	14	14
05:15 PM	3	0	2	0	5	0	6	0	0	6	0	0	0	0	0	0	4	5	0	9	0	20	20	20
05:30 PM	0	1	6	0	7	1	9	0	0	10	0	0	0	0	0	0	1	5	1	6	1	23	24	24
05:45 PM	0	0	0	0	0	0	3	0	0	3	0	0	0	0	0	0	0	2	0	2	0	5	5	5
Total	3	1	10	0	14	1	25	0	0	26	0	0	0	0	0	0	6	16	1	22	1	62	63	63
Grand Total	3	2	20	0	25	1	54	0	0	55	0	0	0	0	0	0	16	36	4	52	4	132	136	136
T-Approch %	12	8	80			1.8	98.2	0		41.7	0	0	0			0	30.8	69.2			2.9	97.1		
Total %	2.3	1.5	15.2		18.9	0.8	40.9	0			0	0	0			0	12.1	27.3		39.4	2.9	97.1		

Start Time	I-215 Southbound Off Ramp Southbound				Van Buren Boulevard Westbound				I-215 Southbound On Ramp Northbound				Van Buren Boulevard Eastbound											
	Left	Thru	Right	App. Total	Left	Thru	Right	App. Total	Left	Thru	Right	App. Total	Left	Thru	Right	App. Total	Left	Thru	Right	App. Total	Exclu. Total	Inclu. Total	Int. Total	
05:00 PM	0	0	2	2	0	7	0	7	0	0	0	0	0	0	0	0	0	1	4	5	0	14	14	14
05:15 PM	3	0	2	5	0	6	0	6	0	0	0	0	0	0	0	0	0	4	5	9	0	16	20	20
05:30 PM	0	1	6	7	1	9	0	10	0	0	0	0	0	0	0	0	0	1	5	6	1	23	23	23
05:45 PM	0	0	0	0	0	3	0	3	0	0	0	0	0	0	0	0	0	0	2	2	0	5	5	5
Total Volume	3	1	10	14	1	25	0	26	0	0	0	0	0	0	0	0	6	16	1	22	1	62	62	62
% App. Total	21.4	7.1	71.4		3.8	96.2	0		0	0	0	0	0	0	0	0	27.3	72.7			2.9	97.1		
PHF	.250	.250	.417	.500	.250	.694	.000	.650	.000	.000	.000	.000	.000	.000	.000	.375	.800	.611			.611			.674

Peak Hour Analysis From 05:00 PM to 05:45 PM - Peak 1 of 1
 Peak Hour for Entire Intersection Begins at 05:00 PM

Counts Unlimited, Inc.
 PO Box 1178
 Corona, CA 92878
 (951)268-6268

County of Riverside
 N/S: I-215 Southbound Ramps
 E/W: Van Buren Boulevard
 Weather: Clear

File Name : 29_CRV_215S_VB PM
 Site Code : 05121716
 Start Date : 11/30/2021
 Page No : 2

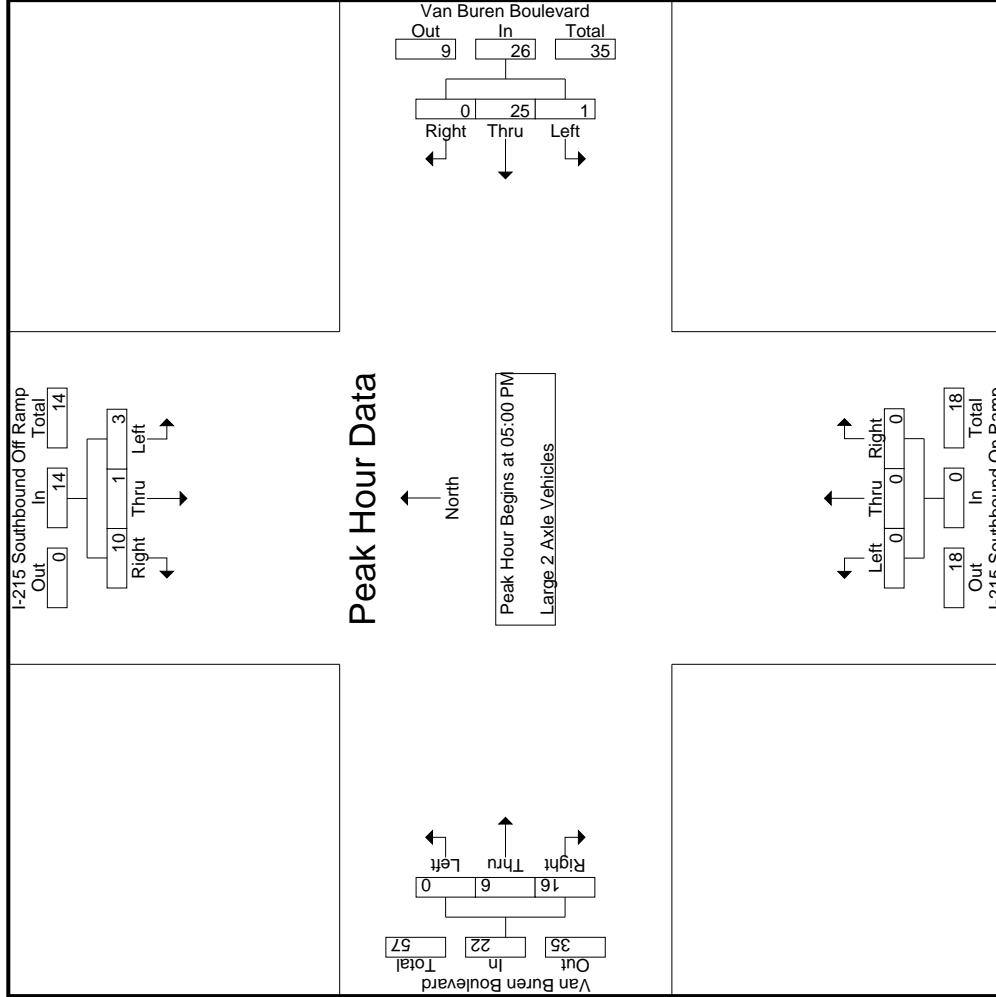

Counts Unlimited, Inc.
 PO Box 1178
 Corona, CA 92878
 (951)268-6268

County of Riverside
 N/S: I-215 Southbound Ramps
 E/W: Van Buren Boulevard
 Weather: Clear

File Name : 29_CRV_215S_VB_PM
 Site Code : 05121716
 Start Date : 11/30/2021
 Page No : 3

Start Time	I-215 Southbound Off Ramp Southbound			Van Buren Boulevard Westbound			I-215 Southbound On Ramp Northbound			Van Buren Boulevard Eastbound		
	Left	Thru	Right	Left	Thru	Right	Left	Thru	Right	Left	Thru	Right
Peak Hour Analysis From 05:00 PM to 05:45 PM - Peak 1 of 1												
Peak Hour for Each Approach Begins at:	05:00 PM											
+0 mins.	0	0	2	0	7	0	0	0	0	0	0	1
+15 mins.	3	0	2	0	6	0	0	0	0	0	4	4
+30 mins.	0	1	6	1	9	0	0	0	0	0	1	5
+45 mins.	0	0	0	0	3	0	0	0	0	0	0	2
Total Volume	3	1	10	1	25	0	0	0	0	0	6	16
% App. Total	21.4	7.1	71.4	3.8	96.2	0	0	0	0	0	27.3	72.7
PHF	.250	.250	.417	.250	.694	.000	.650	.000	.000	.000	.375	.800
			.500						.000			.611

Groups Printed- 3 Axle Vehicles

Start Time	I-215 Southbound Off Ramp Southbound				Van Buren Boulevard Westbound				I-215 Southbound On Ramp Northbound				Van Buren Boulevard Eastbound											
	Left	Thru	Right	RTOR	App. Total	Left	Thru	Right	RTOR	App. Total	Left	Thru	Right	RTOR	App. Total	Left	Thru	Right	RTOR	App. Total	Exclu. Total	Inclu. Total	Int. Total	
04:00 PM	0	0	4	0	4	0	0	0	0	3	0	0	0	0	0	0	1	1	0	0	2	0	9	9
04:15 PM	0	0	5	0	5	0	0	0	0	0	0	0	0	0	0	0	2	1	0	0	3	0	8	8
04:30 PM	0	0	2	0	2	0	0	0	0	2	0	0	0	0	0	0	2	2	0	0	4	0	8	8
04:45 PM	0	0	0	0	0	0	0	0	0	0	0	0	0	0	0	0	1	5	0	0	6	0	6	6
Total	0	0	11	0	11	0	5	0	0	5	0	0	0	0	0	0	6	9	0	0	15	0	31	31
05:00 PM	0	0	2	0	2	0	2	0	0	2	0	0	0	0	0	0	0	3	0	0	3	0	7	7
05:15 PM	0	0	1	0	1	0	3	0	0	3	0	0	0	0	0	0	1	3	0	0	4	0	8	8
05:30 PM	0	0	1	0	1	0	2	0	0	2	0	0	0	0	0	0	2	5	0	0	7	0	10	10
05:45 PM	0	2	2	0	4	0	2	0	0	2	0	0	0	0	0	0	2	1	0	0	3	0	9	9
Total	0	2	6	0	8	0	9	0	0	9	0	0	0	0	0	0	5	12	0	0	17	0	34	34
Grand Total	0	2	17	0	19	0	14	0	0	14	0	0	0	0	0	0	11	21	0	0	32	0	65	65
T-Approch %	0	10.5	89.5			0	100	0			0	0	0			0	34.4	65.6			49.2	0	100	100
T-Total %	0	3.1	26.2		29.2	0	21.5	0		21.5	0	0	0			0	16.9	32.3				0		

Start Time	I-215 Southbound Off Ramp Southbound				Van Buren Boulevard Westbound				I-215 Southbound On Ramp Northbound				Van Buren Boulevard Eastbound											
	Left	Thru	Right	RTOR	App. Total	Left	Thru	Right	RTOR	App. Total	Left	Thru	Right	RTOR	App. Total	Left	Thru	Right	RTOR	App. Total	Exclu. Total	Inclu. Total	Int. Total	
05:00 PM	0	0	2	0	2	0	2	0	0	2	0	0	0	0	0	0	0	0	0	0	0	0	3	3
05:15 PM	0	0	1	0	1	0	3	0	0	3	0	0	0	0	0	0	1	3	0	0	1	3	4	8
05:30 PM	0	0	1	0	1	0	2	0	0	2	0	0	0	0	0	0	2	5	0	0	2	5	7	10
05:45 PM	0	2	2	0	4	0	2	0	0	2	0	0	0	0	0	0	2	1	0	0	2	1	3	9
Total Volume	0	2	6	0	8	0	9	0	0	9	0	0	0	0	0	0	5	12	0	0	17	0	34	34
% App. Total	0	.25	.75		.500	0	.750	0		.750	0	0	0			0	29.4	70.6			.607	0	.850	.850
PHF	.000	.250	.750		.500	.000	.750	.000		.750	.000	.000	.000			.000	.625	.600			.607	0	.850	.850

Peak Hour Analysis From 05:00 PM to 05:45 PM - Peak 1 of 1
 Peak Hour for Entire Intersection Begins at 05:00 PM

Counts Unlimited, Inc.
 PO Box 1178
 Corona, CA 92878
 (951)268-6268

County of Riverside
 N/S: I-215 Southbound Ramps
 E/W: Van Buren Boulevard
 Weather: Clear

File Name : 29_CRV_215S_VB_PM
 Site Code : 05121716
 Start Date : 11/30/2021
 Page No : 2

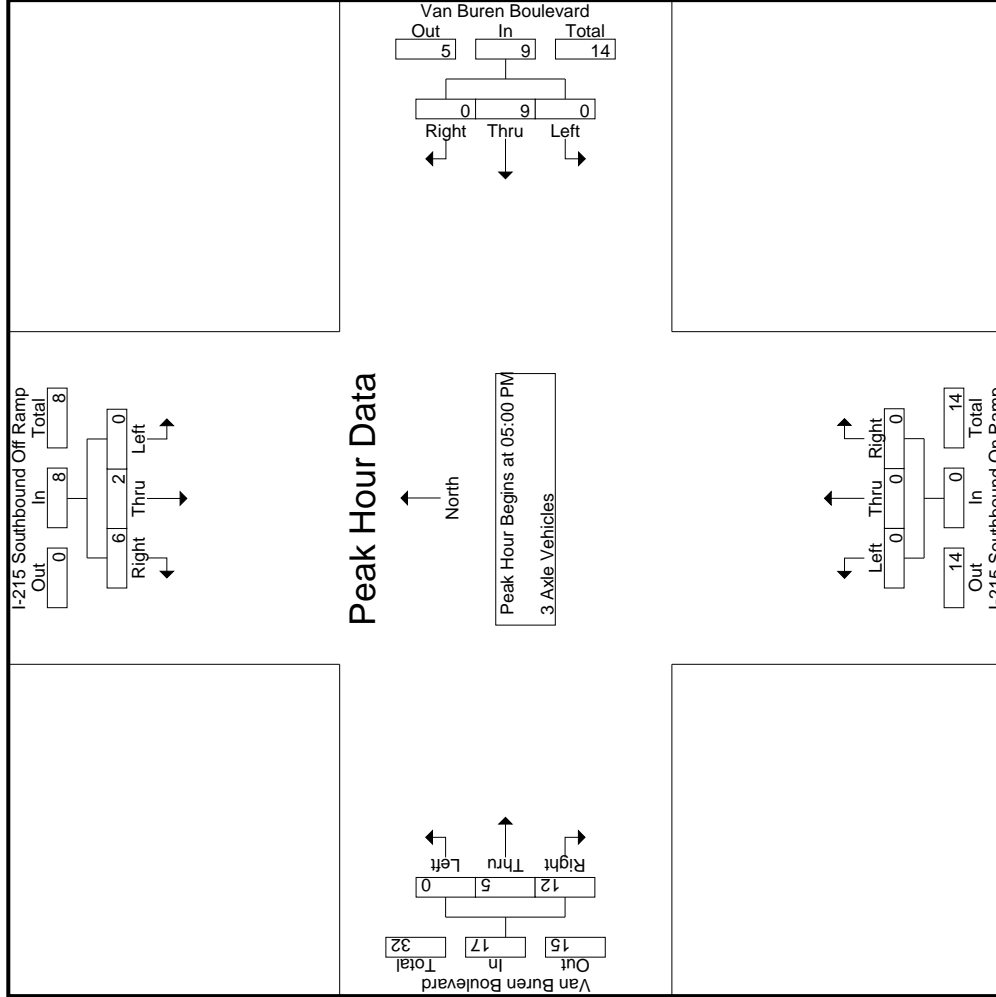

Counts Unlimited, Inc.
 PO Box 1178
 Corona, CA 92878
 (951)268-6268

File Name : 29_CRV_215S_VB_PM
 Site Code : 05121716
 Start Date : 11/30/2021
 Page No : 3

County of Riverside
 N/S: I-215 Southbound Ramps
 E/W: Van Buren Boulevard
 Weather: Clear

Start Time	I-215 Southbound Off Ramp Southbound			Van Buren Boulevard Westbound			I-215 Southbound On Ramp Northbound			Van Buren Boulevard Eastbound		
	Left	Thru	Right	Left	Thru	Right	Left	Thru	Right	Left	Thru	Right
Peak Hour Analysis From 05:00 PM to 05:45 PM - Peak 1 of 1												
Peak Hour for Each Approach Begins at:												
+0 mins.	0	0	2	0	2	0	0	0	0	0	0	0
+15 mins.	0	0	1	0	3	0	0	0	0	0	1	3
+30 mins.	0	0	1	0	2	0	0	0	0	0	2	5
+45 mins.	0	2	2	0	2	0	0	0	0	0	2	1
Total Volume	0	2	6	0	9	0	0	0	0	0	5	12
% App. Total	0	.25	.75	0	100	0	0	0	0	0	29.4	70.6
PHF	.000	.250	.750	.000	.750	.000	.000	.750	.000	.000	.625	.600

Counts Unlimited, Inc.
 PO Box 1178
 Corona, CA 92878
 (951)268-6268

County of Riverside
 N/S: I-215 Southbound Ramps
 E/W: Van Buren Boulevard
 Weather: Clear

File Name : 29_CRV_215S_VB PM
 Site Code : 05121716
 Start Date : 11/30/2021
 Page No : 1

Groups Printed- 4+ Axle Trucks

Start Time	I-215 Southbound Off Ramp Southbound				Van Buren Boulevard Westbound				I-215 Southbound On Ramp Northbound				Van Buren Boulevard Eastbound										
	Left	Thru	Right	RTOR	App. Total	Left	Thru	Right	RTOR	App. Total	Left	Thru	Right	RTOR	App. Total	Exclu. Total	Inclu. Total	Int. Total					
04:00 PM	0	0	5	0	5	0	10	0	0	10	0	0	0	0	0	0	7	4	1	11	1	26	27
04:15 PM	0	2	7	0	9	0	2	0	0	2	0	0	0	0	0	0	8	1	0	9	0	20	20
04:30 PM	0	1	6	0	7	0	5	0	0	5	0	0	0	0	0	0	4	5	0	9	0	21	21
04:45 PM	0	0	3	0	3	0	5	0	0	5	0	0	0	0	0	0	6	5	0	11	0	19	19
Total	0	3	21	0	24	0	22	0	0	22	0	0	0	0	0	0	25	15	1	40	1	86	87
05:00 PM	0	0	4	0	4	0	2	0	0	2	0	0	0	0	0	0	4	12	0	16	0	22	22
05:15 PM	0	0	1	0	1	0	2	0	0	2	0	0	0	0	0	0	12	5	0	17	0	20	20
05:30 PM	0	0	4	0	4	1	1	0	0	1	0	0	0	0	0	0	8	5	1	13	1	18	19
05:45 PM	0	0	6	0	6	0	5	0	0	5	0	0	0	0	0	0	6	6	0	12	0	23	23
Total	0	0	15	0	15	0	10	0	0	10	0	0	0	0	0	0	30	28	1	58	1	83	84
Grand Total	0	3	36	0	39	0	32	0	0	32	0	0	0	0	0	0	55	43	2	98	2	169	171
T-Approch %	0	7.7	92.3			0	100	0		0	0	0				0	56.1	43.9		0	1.2	98.8	
Total %	0	1.8	21.3		23.1	0	18.9	0		18.9	0	0				0	32.5	25.4		58			

Start Time	I-215 Southbound Off Ramp Southbound				Van Buren Boulevard Westbound				I-215 Southbound On Ramp Northbound				Van Buren Boulevard Eastbound										
	Left	Thru	Right	App. Total	Left	Thru	Right	App. Total	Left	Thru	Right	App. Total	Left	Thru	Right	App. Total	Int. Total						
05:00 PM	0	0	4	4	0	2	0	2	0	0	0	0	0	0	0	0	4	12	0	16	0	16	22
05:15 PM	0	0	1	1	0	2	0	2	0	0	0	0	0	0	0	0	12	5	0	17	0	20	20
05:30 PM	0	0	4	4	0	1	0	1	0	0	0	0	0	0	0	0	8	5	0	13	0	18	18
05:45 PM	0	0	6	6	0	5	0	5	0	0	0	0	0	0	0	0	6	6	0	12	0	23	23
Total Volume	0	0	15	15	0	10	0	10	0	0	0	0	0	0	0	0	30	28	0	58	0	83	83
% App. Total	0	0	100		0	100	0		0	0	0	0	0	0	0	0	51.7	48.3		90.2			
PHF	.000	.000	.625	.625	.000	.500	.000	.500	.000	.000	.000	.000	.000	.000	.000	.625	.583		.853				

Peak Hour Analysis From 05:00 PM to 05:45 PM - Peak 1 of 1
 Peak Hour for Entire Intersection Begins at 05:00 PM

Counts Unlimited, Inc.
 PO Box 1178
 Corona, CA 92878
 (951)268-6268

County of Riverside
 N/S: I-215 Southbound Ramps
 E/W: Van Buren Boulevard
 Weather: Clear

File Name : 29_CRV_215S_VB PM
 Site Code : 05121716
 Start Date : 11/30/2021
 Page No : 2

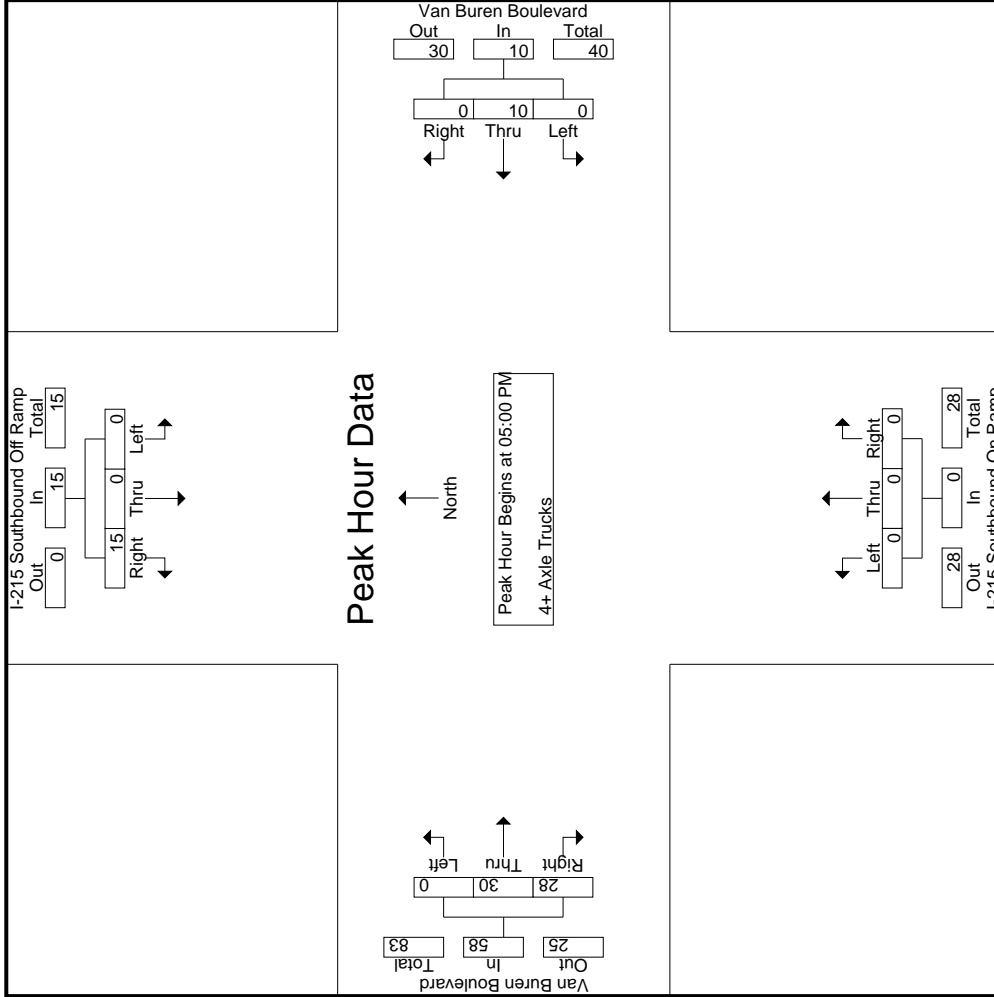

Counts Unlimited, Inc.
 PO Box 1178
 Corona, CA 92878
 (951)268-6268

File Name : 29_CRV_215S_VB_PM
 Site Code : 05121716
 Start Date : 11/30/2021
 Page No : 3

County of Riverside
 N/S: I-215 Southbound Ramps
 E/W: Van Buren Boulevard
 Weather: Clear

Start Time	I-215 Southbound Off Ramp Southbound			Van Buren Boulevard Westbound			I-215 Southbound On Ramp Northbound			Van Buren Boulevard Eastbound		
	Left	Thru	Right	Left	Thru	Right	Left	Thru	Right	Left	Thru	Right
Peak Hour Analysis From 05:00 PM to 05:45 PM - Peak 1 of 1												
Peak Hour for Each Approach Begins at:												
+0 mins.	0	0	4	0	2	0	0	0	0	0	0	4
+15 mins.	0	0	1	0	2	0	0	0	0	0	0	12
+30 mins.	0	0	4	0	1	0	0	0	0	0	0	5
+45 mins.	0	0	6	0	5	0	0	0	0	0	0	5
Total Volume	0	0	15	0	10	0	0	0	0	0	0	30
% App. Total	0	0	100	0	100	0	0	0	0	0	0	51.7
PHF	.000	.000	.625	.000	.500	.000	.000	.500	.000	.000	.625	.583

Location: County of Riverside
 N/S: I-215 SB Ramps
 E/W: Van Buren Boulevard



Date: 11/30/2021
 Day: Tuesday

PEDESTRIANS

	North Leg I-215 SB Ramps	East Leg Van Buren Boulevard	South Leg I-215 SB Ramps	West Leg Van Buren Boulevard	
	Pedestrians	Pedestrians	Pedestrians	Pedestrians	
7:00 AM	0	0	0	0	0
7:15 AM	1	0	0	0	1
7:30 AM	0	0	0	0	0
7:45 AM	0	0	0	0	0
8:00 AM	0	0	0	0	0
8:15 AM	0	0	0	0	0
8:30 AM	0	0	0	0	0
8:45 AM	0	0	0	0	0
TOTAL VOLUMES:	1	0	0	0	1

	North Leg I-215 SB Ramps	East Leg Van Buren Boulevard	South Leg I-215 SB Ramps	West Leg Van Buren Boulevard	
	Pedestrians	Pedestrians	Pedestrians	Pedestrians	
4:00 PM	0	0	0	0	0
4:15 PM	0	0	0	0	0
4:30 PM	0	0	0	0	0
4:45 PM	0	0	0	0	0
5:00 PM	0	0	0	0	0
5:15 PM	0	0	0	0	0
5:30 PM	0	0	0	0	0
5:45 PM	0	0	0	0	0
TOTAL VOLUMES:	0	0	0	0	0

Location: County of Riverside
 N/S: I-215 SB Ramps
 E/W: Van Buren Boulevard



Date: 11/30/2021
 Day: Tuesday

BICYCLES

	Southbound I-215 SB Ramps			Westbound Van Buren Boulevard			Northbound I-215 SB Ramps			Eastbound Van Buren Boulevard			
	Left	Thru	Right	Left	Thru	Right	Left	Thru	Right	Left	Thru	Right	
7:00 AM	0	0	0	0	0	0	0	0	0	0	0	0	0
7:15 AM	0	0	0	0	0	0	0	0	0	0	0	0	0
7:30 AM	0	0	0	0	0	0	0	0	0	0	0	0	0
7:45 AM	0	0	0	0	0	0	0	0	0	0	0	0	0
8:00 AM	0	0	0	0	0	0	0	0	0	0	0	0	0
8:15 AM	0	0	0	0	0	0	0	0	0	0	0	0	0
8:30 AM	0	0	0	0	0	0	0	0	0	0	0	0	0
8:45 AM	0	0	0	0	0	0	0	0	0	0	0	0	0
TOTAL VOLUMES:	0	0	0	0	0	0	0	0	0	0	0	0	0

	Southbound I-215 SB Ramps			Westbound Van Buren Boulevard			Northbound I-215 SB Ramps			Eastbound Van Buren Boulevard			
	Left	Thru	Right	Left	Thru	Right	Left	Thru	Right	Left	Thru	Right	
4:00 PM	0	0	0	0	0	0	0	0	0	0	0	0	0
4:15 PM	0	0	0	0	0	0	0	0	0	0	0	0	0
4:30 PM	0	0	0	0	0	0	0	0	0	0	0	0	0
4:45 PM	0	0	0	0	0	0	0	0	0	0	0	0	0
5:00 PM	0	0	0	0	0	0	0	0	0	0	0	0	0
5:15 PM	0	0	0	0	0	0	0	0	0	0	0	0	0
5:30 PM	0	0	0	0	0	0	0	0	0	0	0	0	0
5:45 PM	0	0	0	0	0	0	0	0	0	0	0	0	0
TOTAL VOLUMES:	0	0	0	0	0	0	0	0	0	0	0	0	0

County of Riverside
 N/S: I-215 Northbound Ramps
 E/W: Van Buren Boulevard
 Weather: Clear

File Name : 30_CRV_215N_VB AM
 Site Code : 05121716
 Start Date : 11/30/2021
 Page No : 1

Groups Printed- Passenger Vehicles - Large 2 Axle Vehicles - 3 Axle Vehicles - 4+ Axle Trucks

Start Time	Van Buren Boulevard Westbound			I-215 Northbound Ramps Northbound				Van Buren Boulevard Eastbound				Exclu. Total	Inclu. Total	Int. Total
	Left	Thru	App. Total	Left	Right	RTOR	App. Total	Thru	Right	RTOR	App. Total			
07:00 AM	0	8	8	212	1	0	213	1	104	2	105	2	326	328
07:15 AM	0	4	4	177	0	0	177	7	110	7	117	7	298	305
07:30 AM	0	2	2	192	2	0	194	4	114	0	118	0	314	314
07:45 AM	0	7	7	217	1	0	218	8	132	2	140	2	365	367
Total	0	21	21	798	4	0	802	20	460	11	480	11	1303	1314
08:00 AM	0	4	4	202	1	0	203	8	126	6	134	6	341	347
08:15 AM	0	9	9	207	0	0	207	7	101	6	108	6	324	330
08:30 AM	0	0	0	194	0	0	194	4	97	4	101	4	295	299
08:45 AM	0	3	3	193	0	0	193	8	88	1	96	1	292	293
Total	0	16	16	796	1	0	797	27	412	17	439	17	1252	1269
Grand Total	0	37	37	1594	5	0	1599	47	872	28	919	28	2555	2583
Apprch %	0	100		99.7	0.3			5.1	94.9					
Total %	0	1.4	1.4	62.4	0.2		62.6	1.8	34.1		36	1.1	98.9	
Passenger Vehicles	0	12	12	1515	3		1518	26	800		854	0	0	2384
% Passenger Vehicles	0	32.4	32.4	95	60	0	94.9	55.3	91.7	100	90.2	0	0	92.3
Large 2 Axle Vehicles	0	5	5	39	1		40	4	22		26	0	0	71
% Large 2 Axle Vehicles	0	13.5	13.5	2.4	20	0	2.5	8.5	2.5	0	2.7	0	0	2.7
3 Axle Vehicles	0	14	14	11	0		11	11	10		21	0	0	46
% 3 Axle Vehicles	0	37.8	37.8	0.7	0	0	0.7	23.4	1.1	0	2.2	0	0	1.8
4+ Axle Trucks	0	6	6	29	1		30	6	40		46	0	0	82
% 4+ Axle Trucks	0	16.2	16.2	1.8	20	0	1.9	12.8	4.6	0	4.9	0	0	3.2

Start Time	Van Buren Boulevard Westbound			I-215 Northbound Ramps Northbound			Van Buren Boulevard Eastbound			Int. Total
	Left	Thru	App. Total	Left	Right	App. Total	Thru	Right	App. Total	
Peak Hour Analysis From 07:00 AM to 08:45 AM - Peak 1 of 1										
Peak Hour for Entire Intersection Begins at 07:30 AM										
07:30 AM	0	2	2	192	2	194	4	114	118	314
07:45 AM	0	7	7	217	1	218	8	132	140	365
08:00 AM	0	4	4	202	1	203	8	126	134	341
08:15 AM	0	9	9	207	0	207	7	101	108	324
Total Volume	0	22	22	818	4	822	27	473	500	1344
% App. Total	0	100		99.5	0.5		5.4	94.6		
PHF	.000	.611	.611	.942	.500	.943	.844	.896	.893	.921

County of Riverside
 N/S: I-215 Northbound Ramps
 E/W: Van Buren Boulevard
 Weather: Clear

File Name : 30_CRV_215N_VB AM
 Site Code : 05121716
 Start Date : 11/30/2021
 Page No : 2

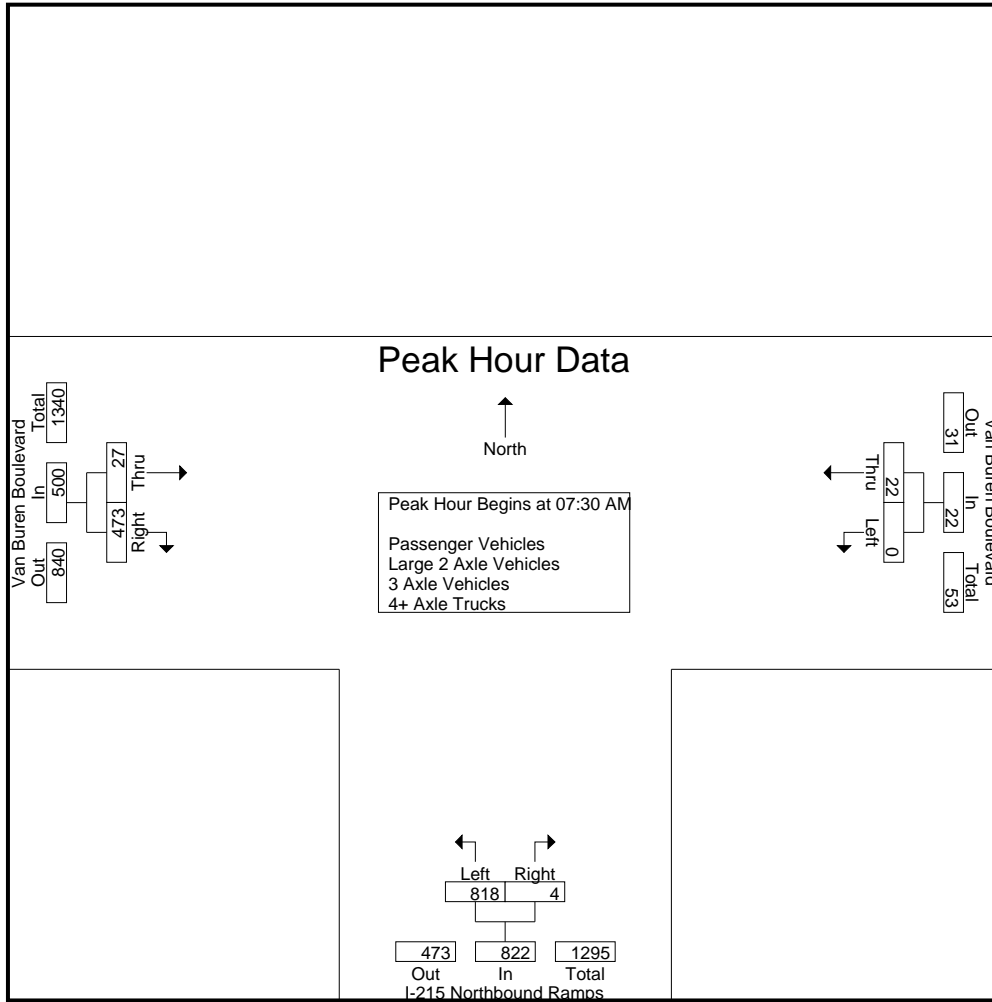

Peak Hour Analysis From 07:00 AM to 08:45 AM - Peak 1 of 1
 Peak Hour for Each Approach Begins at:

	07:30 AM			07:30 AM			07:15 AM		
+0 mins.	0	2	2	192	2	194	7	110	117
+15 mins.	0	7	7	217	1	218	4	114	118
+30 mins.	0	4	4	202	1	203	8	132	140
+45 mins.	0	9	9	207	0	207	8	126	134
Total Volume	0	22	22	818	4	822	27	482	509
% App. Total	0	100		99.5	0.5		5.3	94.7	
PHF	.000	.611	.611	.942	.500	.943	.844	.913	.909

County of Riverside
 N/S: I-215 Northbound Ramps
 E/W: Van Buren Boulevard
 Weather: Clear

File Name : 30_CRV_215N_VB AM
 Site Code : 05121716
 Start Date : 11/30/2021
 Page No : 1

Groups Printed- Passenger Vehicles

Start Time	Van Buren Boulevard Westbound			I-215 Northbound Ramps Northbound				Van Buren Boulevard Eastbound				Exclu. Total	Inclu. Total	Int. Total
	Left	Thru	App. Total	Left	Right	RTOR	App. Total	Thru	Right	RTOR	App. Total			
07:00 AM	0	1	1	202	1	0	203	1	93	2	94	2	298	300
07:15 AM	0	1	1	169	0	0	169	3	103	7	106	7	276	283
07:30 AM	0	1	1	183	1	0	184	1	107	0	108	0	293	293
07:45 AM	0	3	3	212	0	0	212	5	121	2	126	2	341	343
Total	0	6	6	766	2	0	768	10	424	11	434	11	1208	1219
08:00 AM	0	3	3	187	1	0	188	4	121	6	125	6	316	322
08:15 AM	0	2	2	192	0	0	192	4	94	6	98	6	292	298
08:30 AM	0	0	0	181	0	0	181	2	87	4	89	4	270	274
08:45 AM	0	1	1	189	0	0	189	6	74	1	80	1	270	271
Total	0	6	6	749	1	0	750	16	376	17	392	17	1148	1165
Grand Total	0	12	12	1515	3	0	1518	26	800	28	826	28	2356	2384
Apprch %	0	100		99.8	0.2			3.1	96.9					
Total %	0	0.5	0.5	64.3	0.1		64.4	1.1	34		35.1	1.2	98.8	

Start Time	Van Buren Boulevard Westbound			I-215 Northbound Ramps Northbound			Van Buren Boulevard Eastbound			Int. Total
	Left	Thru	App. Total	Left	Right	App. Total	Thru	Right	App. Total	
07:30 AM	0	1	1	183	1	184	1	107	108	293
07:45 AM	0	3	3	212	0	212	5	121	126	341
08:00 AM	0	3	3	187	1	188	4	121	125	316
08:15 AM	0	2	2	192	0	192	4	94	98	292
Total Volume	0	9	9	774	2	776	14	443	457	1242
% App. Total	0	100		99.7	0.3		3.1	96.9		
PHF	.000	.750	.750	.913	.500	.915	.700	.915	.907	.911

County of Riverside
 N/S: I-215 Northbound Ramps
 E/W: Van Buren Boulevard
 Weather: Clear

File Name : 30_CRV_215N_VB AM
 Site Code : 05121716
 Start Date : 11/30/2021
 Page No : 2

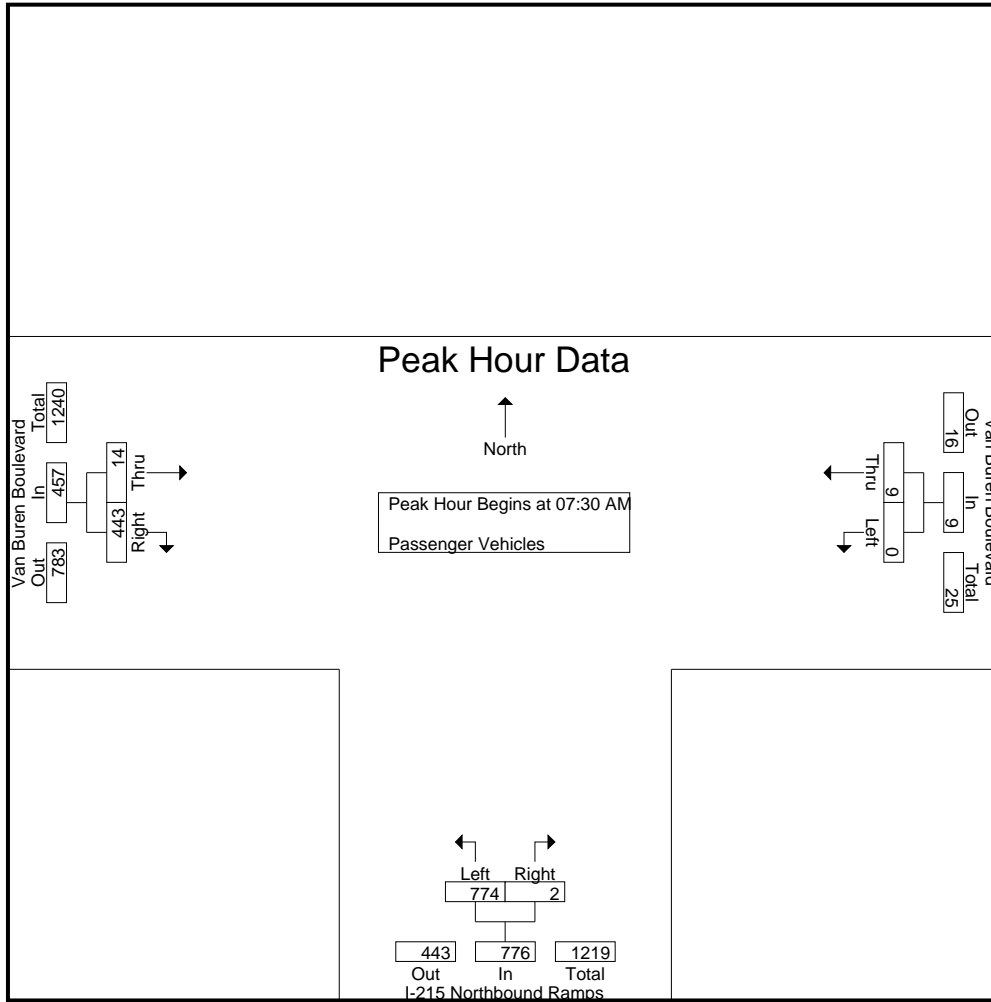

Peak Hour Analysis From 07:30 AM to 08:15 AM - Peak 1 of 1
 Peak Hour for Each Approach Begins at:

	07:30 AM			07:30 AM			07:30 AM		
+0 mins.	0	1	1	183	1	184	1	107	108
+15 mins.	0	3	3	212	0	212	5	121	126
+30 mins.	0	3	3	187	1	188	4	121	125
+45 mins.	0	2	2	192	0	192	4	94	98
Total Volume	0	9	9	774	2	776	14	443	457
% App. Total	0	100		99.7	0.3		3.1	96.9	
PHF	.000	.750	.750	.913	.500	.915	.700	.915	.907

County of Riverside
 N/S: I-215 Northbound Ramps
 E/W: Van Buren Boulevard
 Weather: Clear

File Name : 30_CRV_215N_VB AM
 Site Code : 05121716
 Start Date : 11/30/2021
 Page No : 1

Groups Printed- Large 2 Axle Vehicles

Start Time	Van Buren Boulevard Westbound			I-215 Northbound Ramps Northbound				Van Buren Boulevard Eastbound				Exclu. Total	Inclu. Total	Int. Total
	Left	Thru	App. Total	Left	Right	RTOR	App. Total	Thru	Right	RTOR	App. Total			
07:00 AM	0	2	2	5	0	0	5	0	2	0	2	0	9	9
07:15 AM	0	1	1	3	0	0	3	1	3	0	4	0	8	8
07:30 AM	0	0	0	2	0	0	2	0	3	0	3	0	5	5
07:45 AM	0	0	0	2	1	0	3	0	4	0	4	0	7	7
Total	0	3	3	12	1	0	13	1	12	0	13	0	29	29
08:00 AM	0	0	0	8	0	0	8	1	2	0	3	0	11	11
08:15 AM	0	1	1	12	0	0	12	2	0	0	2	0	15	15
08:30 AM	0	0	0	6	0	0	6	0	5	0	5	0	11	11
08:45 AM	0	1	1	1	0	0	1	0	3	0	3	0	5	5
Total	0	2	2	27	0	0	27	3	10	0	13	0	42	42
Grand Total	0	5	5	39	1	0	40	4	22	0	26	0	71	71
Apprch %	0	100		97.5	2.5			15.4	84.6					
Total %	0	7	7	54.9	1.4		56.3	5.6	31		36.6	0	100	

Start Time	Van Buren Boulevard Westbound			I-215 Northbound Ramps Northbound			Van Buren Boulevard Eastbound			Int. Total
	Left	Thru	App. Total	Left	Right	App. Total	Thru	Right	App. Total	
07:30 AM	0	0	0	2	0	2	0	3	3	5
07:45 AM	0	0	0	2	1	3	0	4	4	7
08:00 AM	0	0	0	8	0	8	1	2	3	11
08:15 AM	0	1	1	12	0	12	2	0	2	15
Total Volume	0	1	1	24	1	25	3	9	12	38
% App. Total	0	100		96	4		25	75		
PHF	.000	.250	.250	.500	.250	.521	.375	.563	.750	.633

County of Riverside
 N/S: I-215 Northbound Ramps
 E/W: Van Buren Boulevard
 Weather: Clear

File Name : 30_CRV_215N_VB AM
 Site Code : 05121716
 Start Date : 11/30/2021
 Page No : 2

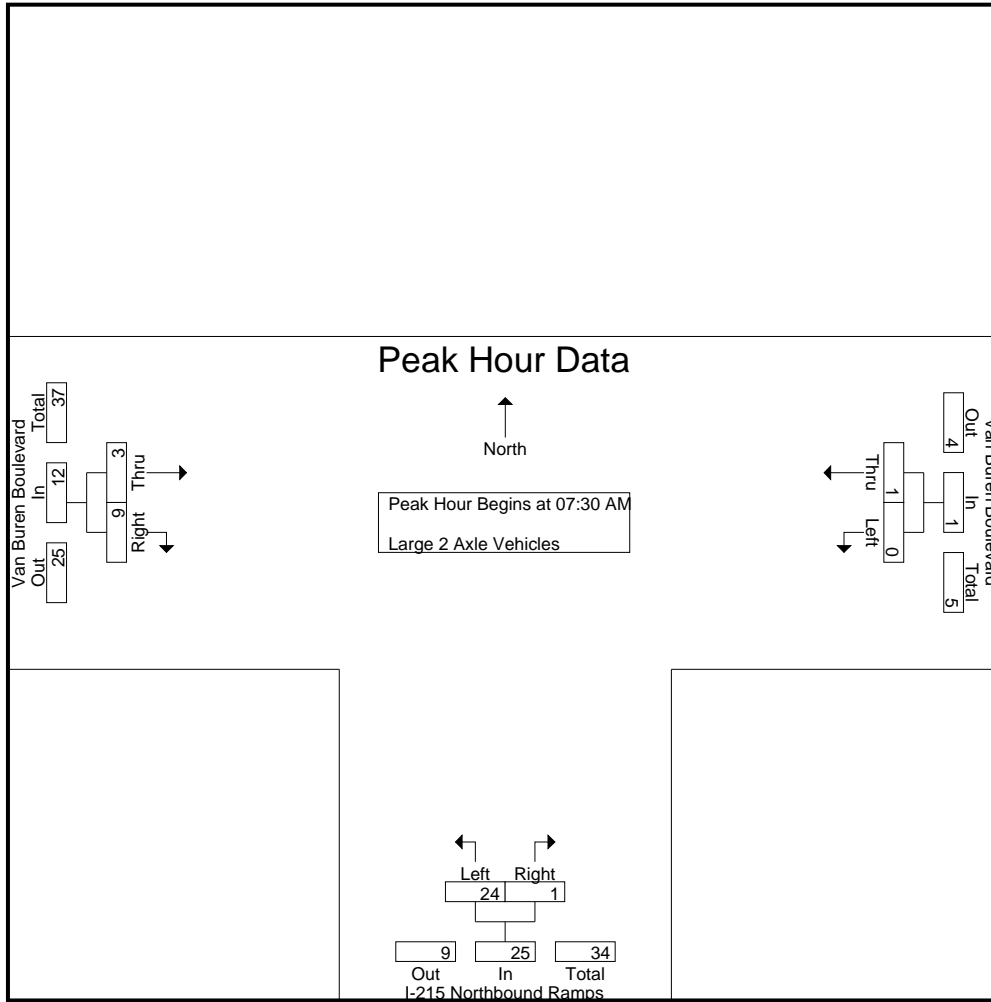

Peak Hour Analysis From 07:30 AM to 08:15 AM - Peak 1 of 1
 Peak Hour for Each Approach Begins at:

	07:30 AM			07:30 AM			07:30 AM		
+0 mins.	0	0	0	2	0	2	0	3	3
+15 mins.	0	0	0	2	1	3	0	4	4
+30 mins.	0	0	0	8	0	8	1	2	3
+45 mins.	0	1	1	12	0	12	2	0	2
Total Volume	0	1	1	24	1	25	3	9	12
% App. Total	0	100		96	4		25	75	
PHF	.000	.250	.250	.500	.250	.521	.375	.563	.750

County of Riverside
 N/S: I-215 Northbound Ramps
 E/W: Van Buren Boulevard
 Weather: Clear

File Name : 30_CRV_215N_VB AM
 Site Code : 05121716
 Start Date : 11/30/2021
 Page No : 1

Groups Printed- 3 Axle Vehicles

Start Time	Van Buren Boulevard Westbound			I-215 Northbound Ramps Northbound				Van Buren Boulevard Eastbound				Exclu. Total	Inclu. Total	Int. Total
	Left	Thru	App. Total	Left	Right	RTOR	App. Total	Thru	Right	RTOR	App. Total			
07:00 AM	0	4	4	1	0	0	1	0	3	0	3	0	8	8
07:15 AM	0	2	2	2	0	0	2	2	0	0	2	0	6	6
07:30 AM	0	1	1	1	0	0	1	3	0	0	3	0	5	5
07:45 AM	0	3	3	1	0	0	1	1	1	0	2	0	6	6
Total	0	10	10	5	0	0	5	6	4	0	10	0	25	25
08:00 AM	0	0	0	2	0	0	2	1	1	0	2	0	4	4
08:15 AM	0	3	3	0	0	0	0	1	0	0	1	0	4	4
08:30 AM	0	0	0	2	0	0	2	2	2	0	4	0	6	6
08:45 AM	0	1	1	2	0	0	2	1	3	0	4	0	7	7
Total	0	4	4	6	0	0	6	5	6	0	11	0	21	21
Grand Total	0	14	14	11	0	0	11	11	10	0	21	0	46	46
Apprch %	0	100		100	0			52.4	47.6					
Total %	0	30.4	30.4	23.9	0		23.9	23.9	21.7		45.7	0	100	

Start Time	Van Buren Boulevard Westbound			I-215 Northbound Ramps Northbound			Van Buren Boulevard Eastbound			Int. Total
	Left	Thru	App. Total	Left	Right	App. Total	Thru	Right	App. Total	
07:30 AM	0	1	1	1	0	1	3	0	3	5
07:45 AM	0	3	3	1	0	1	1	1	2	6
08:00 AM	0	0	0	2	0	2	1	1	2	4
08:15 AM	0	3	3	0	0	0	1	0	1	4
Total Volume	0	7	7	4	0	4	6	2	8	19
% App. Total	0	100		100	0		75	25		
PHF	.000	.583	.583	.500	.000	.500	.500	.500	.667	.792

County of Riverside
 N/S: I-215 Northbound Ramps
 E/W: Van Buren Boulevard
 Weather: Clear

File Name : 30_CRV_215N_VB AM
 Site Code : 05121716
 Start Date : 11/30/2021
 Page No : 2

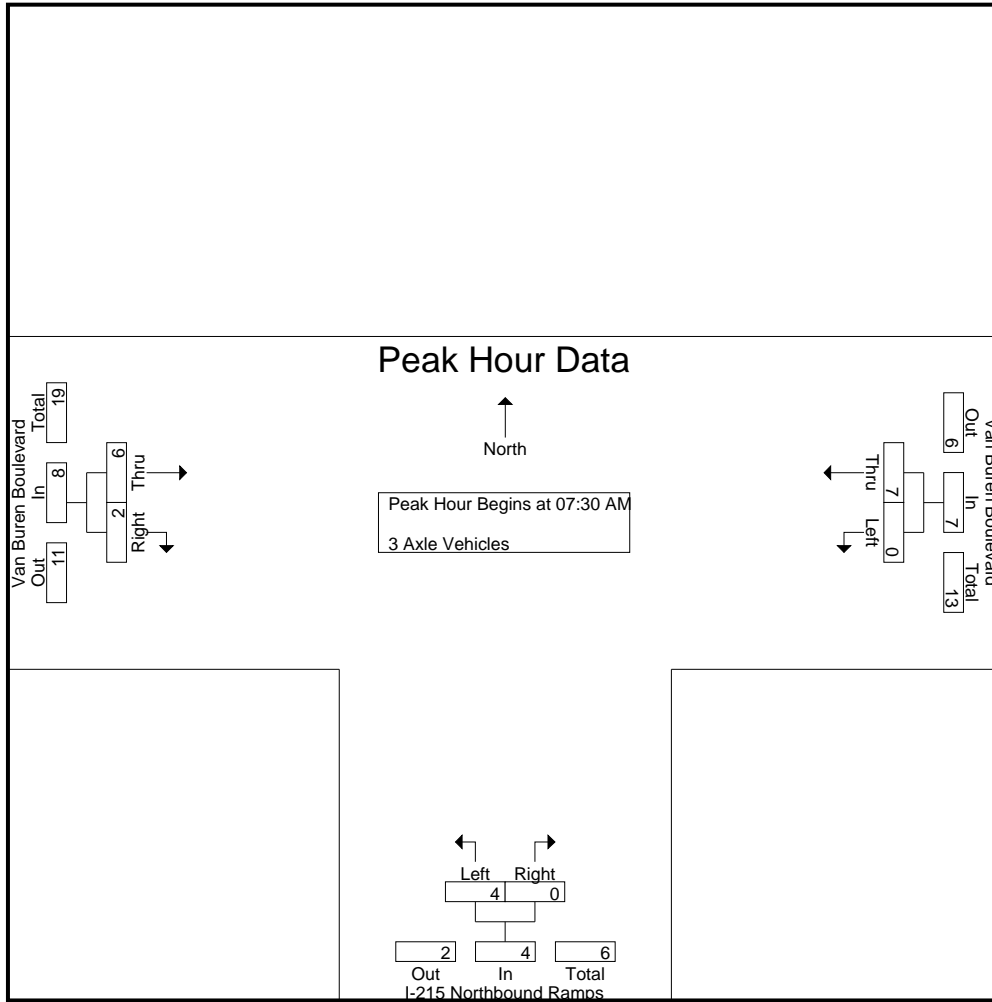

Peak Hour Analysis From 07:30 AM to 08:15 AM - Peak 1 of 1
 Peak Hour for Each Approach Begins at:

	07:30 AM			07:30 AM			07:30 AM		
+0 mins.	0	1	1	1	0	1	3	0	3
+15 mins.	0	3	3	1	0	1	1	1	2
+30 mins.	0	0	0	2	0	2	1	1	2
+45 mins.	0	3	3	0	0	0	1	0	1
Total Volume	0	7	7	4	0	4	6	2	8
% App. Total	0	100		100	0		75	25	
PHF	.000	.583	.583	.500	.000	.500	.500	.500	.667

County of Riverside
 N/S: I-215 Northbound Ramps
 E/W: Van Buren Boulevard
 Weather: Clear

File Name : 30_CRV_215N_VB AM
 Site Code : 05121716
 Start Date : 11/30/2021
 Page No : 1

Groups Printed- 4+ Axle Trucks

Start Time	Van Buren Boulevard Westbound			I-215 Northbound Ramps Northbound				Van Buren Boulevard Eastbound				Exclu. Total	Inclu. Total	Int. Total
	Left	Thru	App. Total	Left	Right	RTOR	App. Total	Thru	Right	RTOR	App. Total			
07:00 AM	0	1	1	4	0	0	4	0	6	0	6	0	11	11
07:15 AM	0	0	0	3	0	0	3	1	4	0	5	0	8	8
07:30 AM	0	0	0	6	1	0	7	0	4	0	4	0	11	11
07:45 AM	0	1	1	2	0	0	2	2	6	0	8	0	11	11
Total	0	2	2	15	1	0	16	3	20	0	23	0	41	41
08:00 AM	0	1	1	5	0	0	5	2	2	0	4	0	10	10
08:15 AM	0	3	3	3	0	0	3	0	7	0	7	0	13	13
08:30 AM	0	0	0	5	0	0	5	0	3	0	3	0	8	8
08:45 AM	0	0	0	1	0	0	1	1	8	0	9	0	10	10
Total	0	4	4	14	0	0	14	3	20	0	23	0	41	41
Grand Total	0	6	6	29	1	0	30	6	40	0	46	0	82	82
Apprch %	0	100		96.7	3.3			13	87					
Total %	0	7.3	7.3	35.4	1.2		36.6	7.3	48.8		56.1	0	100	

Start Time	Van Buren Boulevard Westbound			I-215 Northbound Ramps Northbound			Van Buren Boulevard Eastbound			Int. Total
	Left	Thru	App. Total	Left	Right	App. Total	Thru	Right	App. Total	
07:30 AM	0	0	0	6	1	7	0	4	4	11
07:45 AM	0	1	1	2	0	2	2	6	8	11
08:00 AM	0	1	1	5	0	5	2	2	4	10
08:15 AM	0	3	3	3	0	3	0	7	7	13
Total Volume	0	5	5	16	1	17	4	19	23	45
% App. Total	0	100		94.1	5.9		17.4	82.6		
PHF	.000	.417	.417	.667	.250	.607	.500	.679	.719	.865

County of Riverside
 N/S: I-215 Northbound Ramps
 E/W: Van Buren Boulevard
 Weather: Clear

File Name : 30_CRV_215N_VB AM
 Site Code : 05121716
 Start Date : 11/30/2021
 Page No : 2

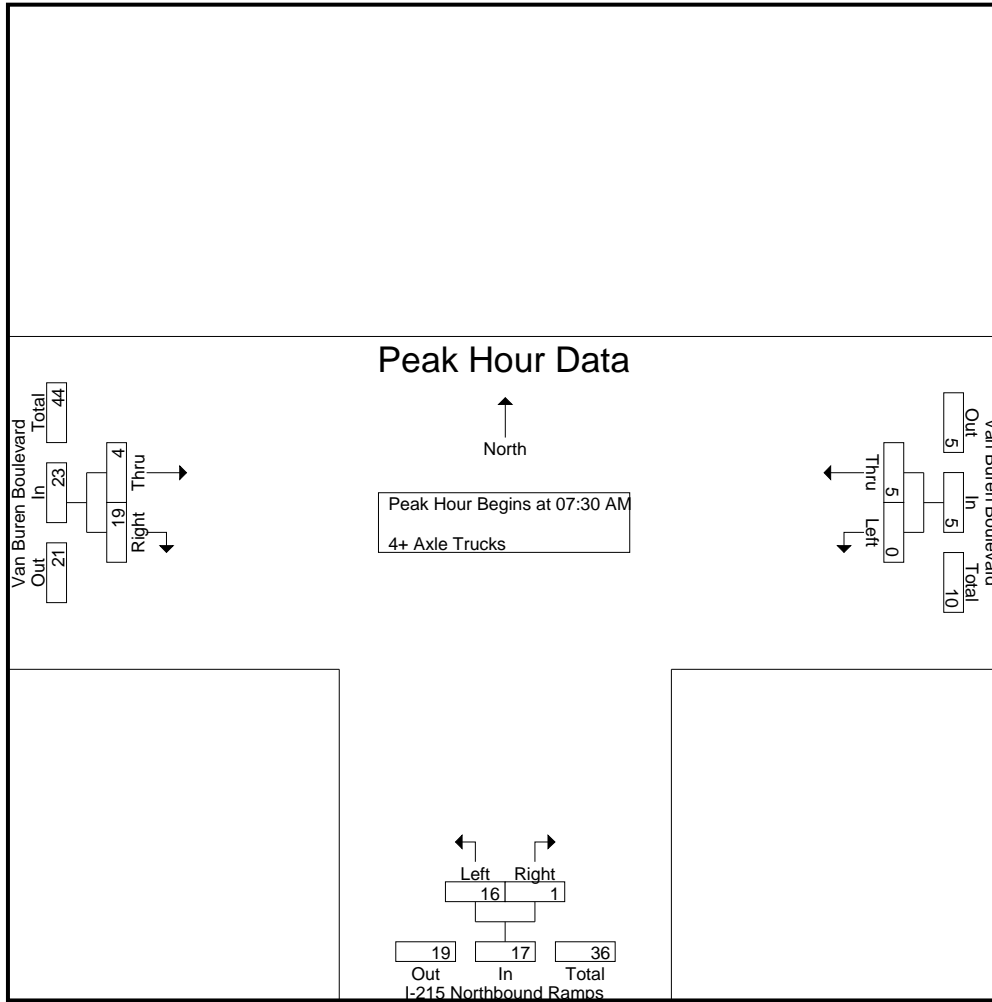

Peak Hour Analysis From 07:30 AM to 08:15 AM - Peak 1 of 1
 Peak Hour for Each Approach Begins at:

	07:30 AM			07:30 AM			07:30 AM		
+0 mins.	0	0	0	6	1	7	0	4	4
+15 mins.	0	1	1	2	0	2	2	6	8
+30 mins.	0	1	1	5	0	5	2	2	4
+45 mins.	0	3	3	3	0	3	0	7	7
Total Volume	0	5	5	16	1	17	4	19	23
% App. Total	0	100		94.1	5.9		17.4	82.6	
PHF	.000	.417	.417	.667	.250	.607	.500	.679	.719

County of Riverside
 N/S: I-215 Northbound Ramps
 E/W: Van Buren Boulevard
 Weather: Clear

File Name : 30_CRV_215N_VB PM
 Site Code : 05121716
 Start Date : 11/30/2021
 Page No : 1

Groups Printed- Passenger Vehicles - Large 2 Axle Vehicles - 3 Axle Vehicles - 4+ Axle Trucks

Start Time	Van Buren Boulevard Westbound			I-215 Northbound Ramps Northbound				Van Buren Boulevard Eastbound				Exclu. Total	Inclu. Total	Int. Total
	Left	Thru	App. Total	Left	Right	RTOR	App. Total	Thru	Right	RTOR	App. Total			
04:00 PM	0	7	7	195	0	0	195	1	129	7	130	7	332	339
04:15 PM	0	6	6	178	3	0	181	2	110	0	112	0	299	299
04:30 PM	0	6	6	183	1	0	184	1	146	1	147	1	337	338
04:45 PM	0	2	2	203	0	0	203	0	112	0	112	0	317	317
Total	0	21	21	759	4	0	763	4	497	8	501	8	1285	1293
05:00 PM	0	11	11	165	0	0	165	0	126	10	126	10	302	312
05:15 PM	0	3	3	198	0	0	198	0	128	4	128	4	329	333
05:30 PM	0	5	5	195	1	0	196	0	112	2	112	2	313	315
05:45 PM	1	4	5	212	0	0	212	3	108	3	111	3	328	331
Total	1	23	24	770	1	0	771	3	474	19	477	19	1272	1291
Grand Total	1	44	45	1529	5	0	1534	7	971	27	978	27	2557	2584
Apprch %	2.2	97.8		99.7	0.3			0.7	99.3					
Total %	0	1.7	1.8	59.8	0.2		60	0.3	38		38.2	1	99	
Passenger Vehicles	0	40	40	1439	2		1441	7	878		911	0	0	2392
% Passenger Vehicles	0	90.9	88.9	94.1	40	0	93.9	100	90.4	96.3	90.6	0	0	92.6
Large 2 Axle Vehicles	1	3	4	45	3		48	0	21		22	0	0	74
% Large 2 Axle Vehicles	100	6.8	8.9	2.9	60	0	3.1	0	2.2	3.7	2.2	0	0	2.9
3 Axle Vehicles	0	1	1	12	0		12	0	12		12	0	0	25
% 3 Axle Vehicles	0	2.3	2.2	0.8	0	0	0.8	0	1.2	0	1.2	0	0	1
4+ Axle Trucks	0	0	0	33	0		33	0	60		60	0	0	93
% 4+ Axle Trucks	0	0	0	2.2	0	0	2.2	0	6.2	0	6	0	0	3.6

Start Time	Van Buren Boulevard Westbound			I-215 Northbound Ramps Northbound			Van Buren Boulevard Eastbound			Int. Total
	Left	Thru	App. Total	Left	Right	App. Total	Thru	Right	App. Total	
Peak Hour Analysis From 04:00 PM to 05:45 PM - Peak 1 of 1										
Peak Hour for Entire Intersection Begins at 04:00 PM										
04:00 PM	0	7	7	195	0	195	1	129	130	332
04:15 PM	0	6	6	178	3	181	2	110	112	299
04:30 PM	0	6	6	183	1	184	1	146	147	337
04:45 PM	0	2	2	203	0	203	0	112	112	317
Total Volume	0	21	21	759	4	763	4	497	501	1285
% App. Total	0	100		99.5	0.5		0.8	99.2		
PHF	.000	.750	.750	.935	.333	.940	.500	.851	.852	.953

County of Riverside
 N/S: I-215 Northbound Ramps
 E/W: Van Buren Boulevard
 Weather: Clear

File Name : 30_CRV_215N_VB PM
 Site Code : 05121716
 Start Date : 11/30/2021
 Page No : 2

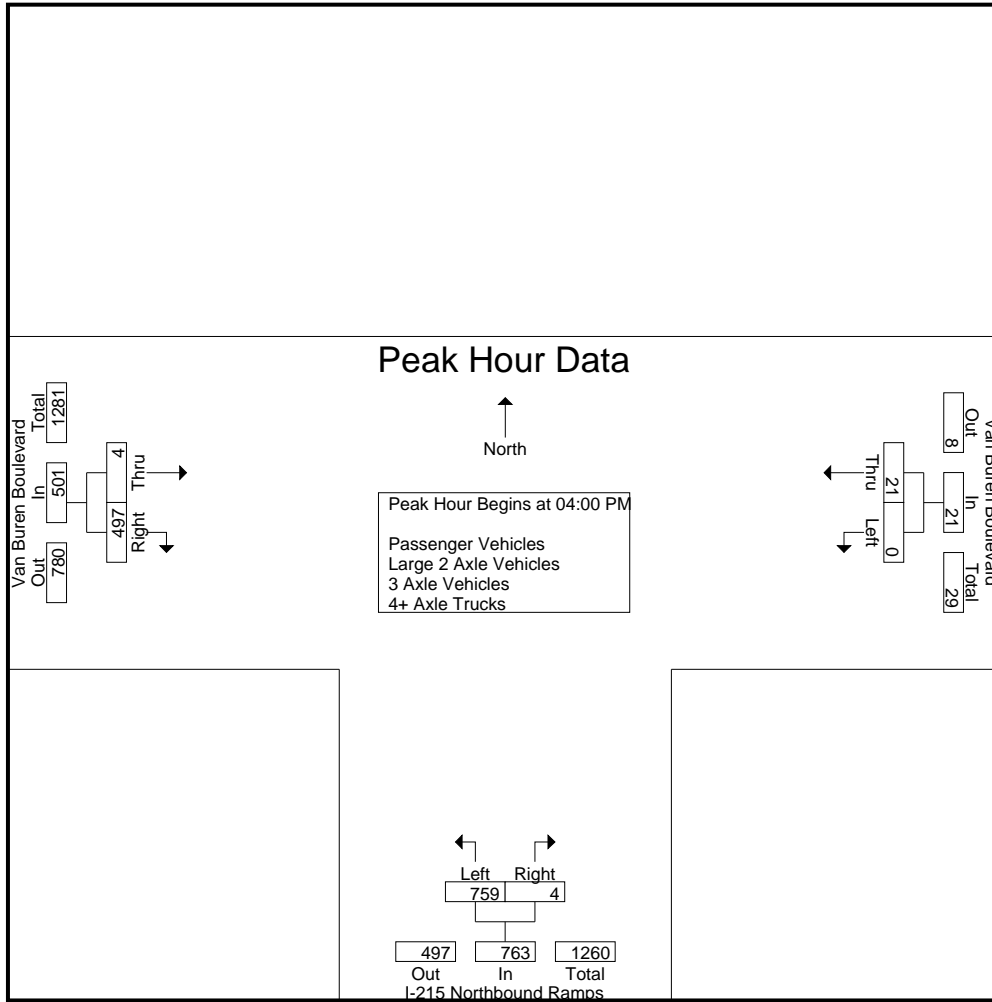

Peak Hour Analysis From 04:00 PM to 05:45 PM - Peak 1 of 1
 Peak Hour for Each Approach Begins at:

	04:15 PM			05:00 PM			04:30 PM		
+0 mins.	0	6	6	165	0	165	1	146	147
+15 mins.	0	6	6	198	0	198	0	112	112
+30 mins.	0	2	2	195	1	196	0	126	126
+45 mins.	0	11	11	212	0	212	0	128	128
Total Volume	0	25	25	770	1	771	1	512	513
% App. Total	0	100		99.9	0.1		0.2	99.8	
PHF	.000	.568	.568	.908	.250	.909	.250	.877	.872

County of Riverside
 N/S: I-215 Northbound Ramps
 E/W: Van Buren Boulevard
 Weather: Clear

File Name : 30_CRV_215N_VB PM
 Site Code : 05121716
 Start Date : 11/30/2021
 Page No : 1

Groups Printed- Passenger Vehicles

Start Time	Van Buren Boulevard Westbound			I-215 Northbound Ramps Northbound				Van Buren Boulevard Eastbound				Exclu. Total	Inclu. Total	Int. Total
	Left	Thru	App. Total	Left	Right	RTOR	App. Total	Thru	Right	RTOR	App. Total			
04:00 PM	0	7	7	179	0	0	179	1	117	6	118	6	304	310
04:15 PM	0	6	6	171	1	0	172	2	98	0	100	0	278	278
04:30 PM	0	4	4	167	1	0	168	1	136	1	137	1	309	310
04:45 PM	0	2	2	193	0	0	193	0	102	0	102	0	297	297
Total	0	19	19	710	2	0	712	4	453	7	457	7	1188	1195
05:00 PM	0	11	11	153	0	0	153	0	120	10	120	10	284	294
05:15 PM	0	3	3	189	0	0	189	0	106	4	106	4	298	302
05:30 PM	0	4	4	182	0	0	182	0	98	2	98	2	284	286
05:45 PM	0	3	3	205	0	0	205	3	101	3	104	3	312	315
Total	0	21	21	729	0	0	729	3	425	19	428	19	1178	1197
Grand Total	0	40	40	1439	2	0	1441	7	878	26	885	26	2366	2392
Apprch %	0	100		99.9	0.1			0.8	99.2					
Total %	0	1.7	1.7	60.8	0.1		60.9	0.3	37.1		37.4	1.1	98.9	

Start Time	Van Buren Boulevard Westbound			I-215 Northbound Ramps Northbound			Van Buren Boulevard Eastbound			Int. Total
	Left	Thru	App. Total	Left	Right	App. Total	Thru	Right	App. Total	

Peak Hour Analysis From 04:00 PM to 04:45 PM - Peak 1 of 1

Peak Hour for Entire Intersection Begins at 04:00 PM

04:00 PM	0	7	7	179	0	179	1	117	118	304
04:15 PM	0	6	6	171	1	172	2	98	100	278
04:30 PM	0	4	4	167	1	168	1	136	137	309
04:45 PM	0	2	2	193	0	193	0	102	102	297
Total Volume	0	19	19	710	2	712	4	453	457	1188
% App. Total	0	100		99.7	0.3		0.9	99.1		
PHF	.000	.679	.679	.920	.500	.922	.500	.833	.834	.961

County of Riverside
 N/S: I-215 Northbound Ramps
 E/W: Van Buren Boulevard
 Weather: Clear

File Name : 30_CRV_215N_VB PM
 Site Code : 05121716
 Start Date : 11/30/2021
 Page No : 2

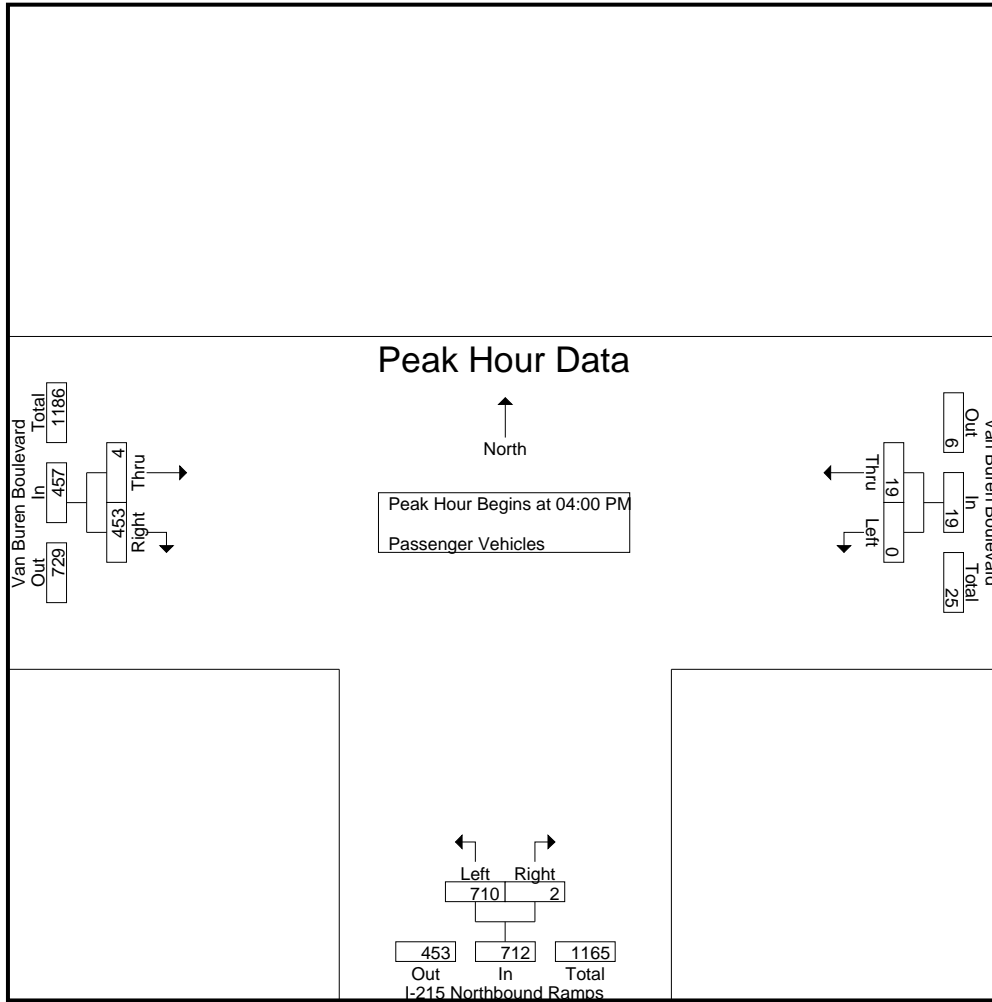

Peak Hour Analysis From 04:00 PM to 04:45 PM - Peak 1 of 1
 Peak Hour for Each Approach Begins at:

	04:00 PM			04:00 PM			04:00 PM		
+0 mins.	0	7	7	179	0	179	1	117	118
+15 mins.	0	6	6	171	1	172	2	98	100
+30 mins.	0	4	4	167	1	168	1	136	137
+45 mins.	0	2	2	193	0	193	0	102	102
Total Volume	0	19	19	710	2	712	4	453	457
% App. Total	0	100		99.7	0.3		0.9	99.1	
PHF	.000	.679	.679	.920	.500	.922	.500	.833	.834

County of Riverside
 N/S: I-215 Northbound Ramps
 E/W: Van Buren Boulevard
 Weather: Clear

File Name : 30_CRV_215N_VB PM
 Site Code : 05121716
 Start Date : 11/30/2021
 Page No : 1

Groups Printed- Large 2 Axle Vehicles

Start Time	Van Buren Boulevard Westbound			I-215 Northbound Ramps Northbound				Van Buren Boulevard Eastbound				Exclu. Total	Inclu. Total	Int. Total
	Left	Thru	App. Total	Left	Right	RTOR	App. Total	Thru	Right	RTOR	App. Total			
04:00 PM	0	0	0	5	0	0	5	0	4	1	4	1	9	10
04:15 PM	0	0	0	6	2	0	8	0	1	0	1	0	9	9
04:30 PM	0	2	2	8	0	0	8	0	3	0	3	0	13	13
04:45 PM	0	0	0	4	0	0	4	0	2	0	2	0	6	6
Total	0	2	2	23	2	0	25	0	10	1	10	1	37	38
05:00 PM	0	0	0	8	0	0	8	0	0	0	0	0	8	8
05:15 PM	0	0	0	4	0	0	4	0	8	0	8	0	12	12
05:30 PM	0	0	0	9	1	0	10	0	2	0	2	0	12	12
05:45 PM	1	1	2	1	0	0	1	0	1	0	1	0	4	4
Total	1	1	2	22	1	0	23	0	11	0	11	0	36	36
Grand Total	1	3	4	45	3	0	48	0	21	1	21	1	73	74
Apprch %	25	75		93.8	6.2			0	100					
Total %	1.4	4.1	5.5	61.6	4.1		65.8	0	28.8		28.8	1.4	98.6	

Start Time	Van Buren Boulevard Westbound			I-215 Northbound Ramps Northbound			Van Buren Boulevard Eastbound			Int. Total
	Left	Thru	App. Total	Left	Right	App. Total	Thru	Right	App. Total	
04:00 PM	0	0	0	5	0	5	0	4	4	9
04:15 PM	0	0	0	6	2	8	0	1	1	9
04:30 PM	0	2	2	8	0	8	0	3	3	13
04:45 PM	0	0	0	4	0	4	0	2	2	6
Total Volume	0	2	2	23	2	25	0	10	10	37
% App. Total	0	100		92	8		0	100		
PHF	.000	.250	.250	.719	.250	.781	.000	.625	.625	.712

Peak Hour Analysis From 04:00 PM to 04:45 PM - Peak 1 of 1
 Peak Hour for Entire Intersection Begins at 04:00 PM

County of Riverside
 N/S: I-215 Northbound Ramps
 E/W: Van Buren Boulevard
 Weather: Clear

File Name : 30_CRV_215N_VB PM
 Site Code : 05121716
 Start Date : 11/30/2021
 Page No : 2

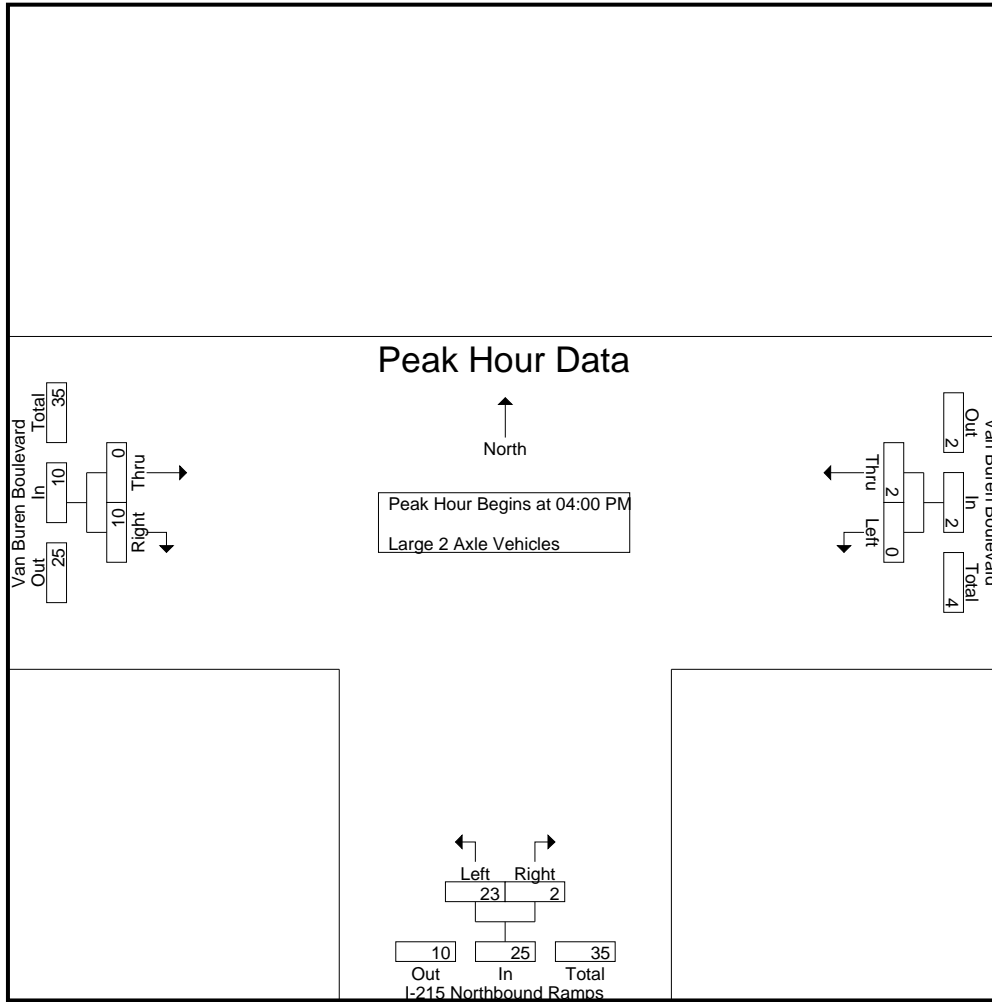

Peak Hour Analysis From 04:00 PM to 04:45 PM - Peak 1 of 1
 Peak Hour for Each Approach Begins at:

	04:00 PM			04:00 PM			04:00 PM		
+0 mins.	0	0	0	5	0	5	0	4	4
+15 mins.	0	0	0	6	2	8	0	1	1
+30 mins.	0	2	2	8	0	8	0	3	3
+45 mins.	0	0	0	4	0	4	0	2	2
Total Volume	0	2	2	23	2	25	0	10	10
% App. Total	0	100		92	8		0	100	
PHF	.000	.250	.250	.719	.250	.781	.000	.625	.625

County of Riverside
 N/S: I-215 Northbound Ramps
 E/W: Van Buren Boulevard
 Weather: Clear

File Name : 30_CRV_215N_VB PM
 Site Code : 05121716
 Start Date : 11/30/2021
 Page No : 1

Groups Printed- 3 Axle Vehicles

Start Time	Van Buren Boulevard Westbound			I-215 Northbound Ramps Northbound				Van Buren Boulevard Eastbound				Exclu. Total	Inclu. Total	Int. Total
	Left	Thru	App. Total	Left	Right	RTOR	App. Total	Thru	Right	RTOR	App. Total			
04:00 PM	0	0	0	1	0	0	1	0	1	0	1	0	2	2
04:15 PM	0	0	0	0	0	0	0	0	2	0	2	0	2	2
04:30 PM	0	0	0	2	0	0	2	0	3	0	3	0	5	5
04:45 PM	0	0	0	1	0	0	1	0	1	0	1	0	2	2
Total	0	0	0	4	0	0	4	0	7	0	7	0	11	11
05:00 PM	0	0	0	2	0	0	2	0	0	0	0	0	2	2
05:15 PM	0	0	0	2	0	0	2	0	1	0	1	0	3	3
05:30 PM	0	1	1	2	0	0	2	0	2	0	2	0	5	5
05:45 PM	0	0	0	2	0	0	2	0	2	0	2	0	4	4
Total	0	1	1	8	0	0	8	0	5	0	5	0	14	14
Grand Total	0	1	1	12	0	0	12	0	12	0	12	0	25	25
Apprch %	0	100		100	0			0	100					
Total %	0	4	4	48	0		48	0	48		48	0	100	

Start Time	Van Buren Boulevard Westbound			I-215 Northbound Ramps Northbound			Van Buren Boulevard Eastbound			Int. Total
	Left	Thru	App. Total	Left	Right	App. Total	Thru	Right	App. Total	
04:00 PM	0	0	0	1	0	1	0	1	1	2
04:15 PM	0	0	0	0	0	0	0	2	2	2
04:30 PM	0	0	0	2	0	2	0	3	3	5
04:45 PM	0	0	0	1	0	1	0	1	1	2
Total Volume	0	0	0	4	0	4	0	7	7	11
% App. Total	0	0		100	0		0	100		
PHF	.000	.000	.000	.500	.000	.500	.000	.583	.583	.550

County of Riverside
 N/S: I-215 Northbound Ramps
 E/W: Van Buren Boulevard
 Weather: Clear

File Name : 30_CRV_215N_VB PM
 Site Code : 05121716
 Start Date : 11/30/2021
 Page No : 2

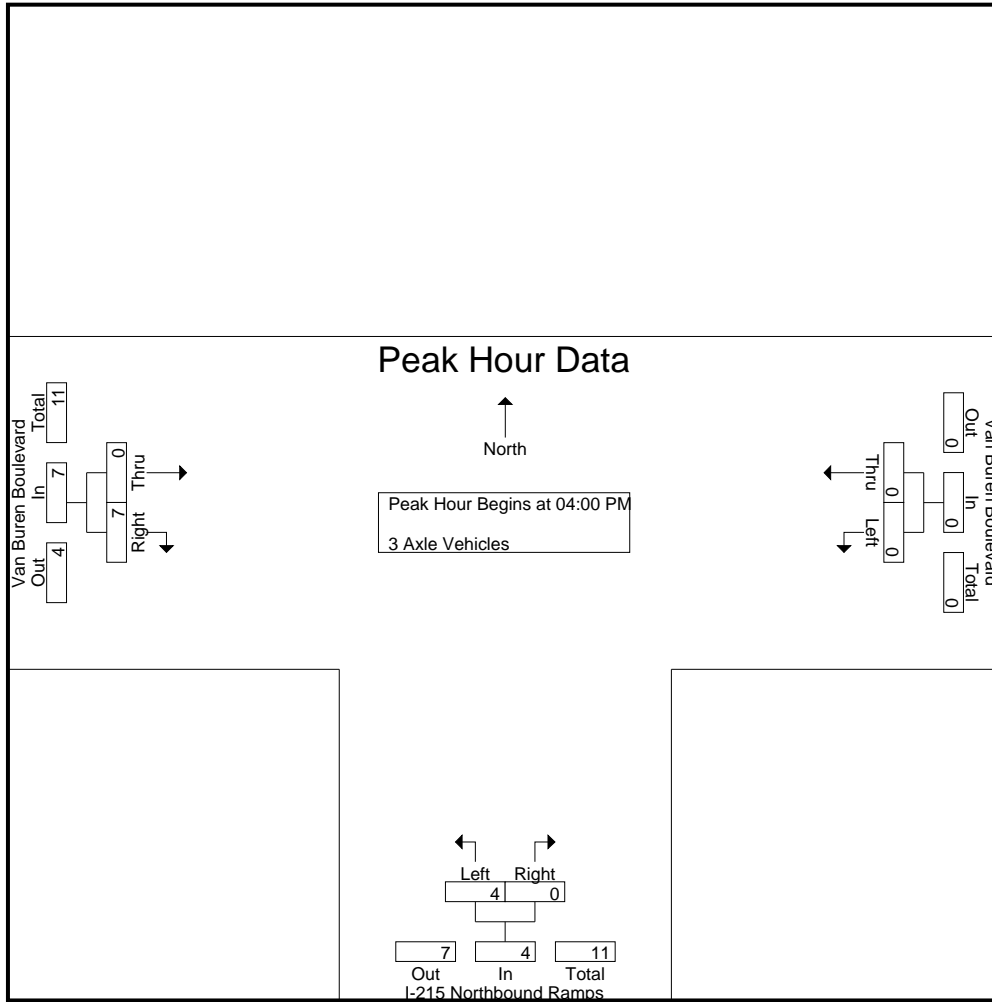

Peak Hour Analysis From 04:00 PM to 04:45 PM - Peak 1 of 1
 Peak Hour for Each Approach Begins at:

	04:00 PM			04:00 PM			04:00 PM		
+0 mins.	0	0	0	1	0	1	0	1	1
+15 mins.	0	0	0	0	0	0	0	2	2
+30 mins.	0	0	0	2	0	2	0	3	3
+45 mins.	0	0	0	1	0	1	0	1	1
Total Volume	0	0	0	4	0	4	0	7	7
% App. Total	0	0	0	100	0	100	0	100	100
PHF	.000	.000	.000	.500	.000	.500	.000	.583	.583

County of Riverside
 N/S: I-215 Northbound Ramps
 E/W: Van Buren Boulevard
 Weather: Clear

File Name : 30_CRV_215N_VB PM
 Site Code : 05121716
 Start Date : 11/30/2021
 Page No : 1

Groups Printed- 4+ Axle Trucks

Start Time	Van Buren Boulevard Westbound			I-215 Northbound Ramps Northbound				Van Buren Boulevard Eastbound				Exclu. Total	Inclu. Total	Int. Total
	Left	Thru	App. Total	Left	Right	RTOR	App. Total	Thru	Right	RTOR	App. Total			
04:00 PM	0	0	0	10	0	0	10	0	7	0	7	0	17	17
04:15 PM	0	0	0	1	0	0	1	0	9	0	9	0	10	10
04:30 PM	0	0	0	6	0	0	6	0	4	0	4	0	10	10
04:45 PM	0	0	0	5	0	0	5	0	7	0	7	0	12	12
Total	0	0	0	22	0	0	22	0	27	0	27	0	49	49
05:00 PM	0	0	0	2	0	0	2	0	6	0	6	0	8	8
05:15 PM	0	0	0	3	0	0	3	0	13	0	13	0	16	16
05:30 PM	0	0	0	2	0	0	2	0	10	0	10	0	12	12
05:45 PM	0	0	0	4	0	0	4	0	4	0	4	0	8	8
Total	0	0	0	11	0	0	11	0	33	0	33	0	44	44
Grand Total	0	0	0	33	0	0	33	0	60	0	60	0	93	93
Apprch %	0	0		100	0			0	100					
Total %	0	0	0	35.5	0		35.5	0	64.5		64.5	0	100	

Start Time	Van Buren Boulevard Westbound			I-215 Northbound Ramps Northbound			Van Buren Boulevard Eastbound			Int. Total
	Left	Thru	App. Total	Left	Right	App. Total	Thru	Right	App. Total	
04:00 PM	0	0	0	10	0	10	0	7	7	17
04:15 PM	0	0	0	1	0	1	0	9	9	10
04:30 PM	0	0	0	6	0	6	0	4	4	10
04:45 PM	0	0	0	5	0	5	0	7	7	12
Total Volume	0	0	0	22	0	22	0	27	27	49
% App. Total	0	0		100	0		0	100		
PHF	.000	.000	.000	.550	.000	.550	.000	.750	.750	.721

Peak Hour Analysis From 04:00 PM to 04:45 PM - Peak 1 of 1
 Peak Hour for Entire Intersection Begins at 04:00 PM

County of Riverside
 N/S: I-215 Northbound Ramps
 E/W: Van Buren Boulevard
 Weather: Clear

File Name : 30_CRV_215N_VB PM
 Site Code : 05121716
 Start Date : 11/30/2021
 Page No : 2

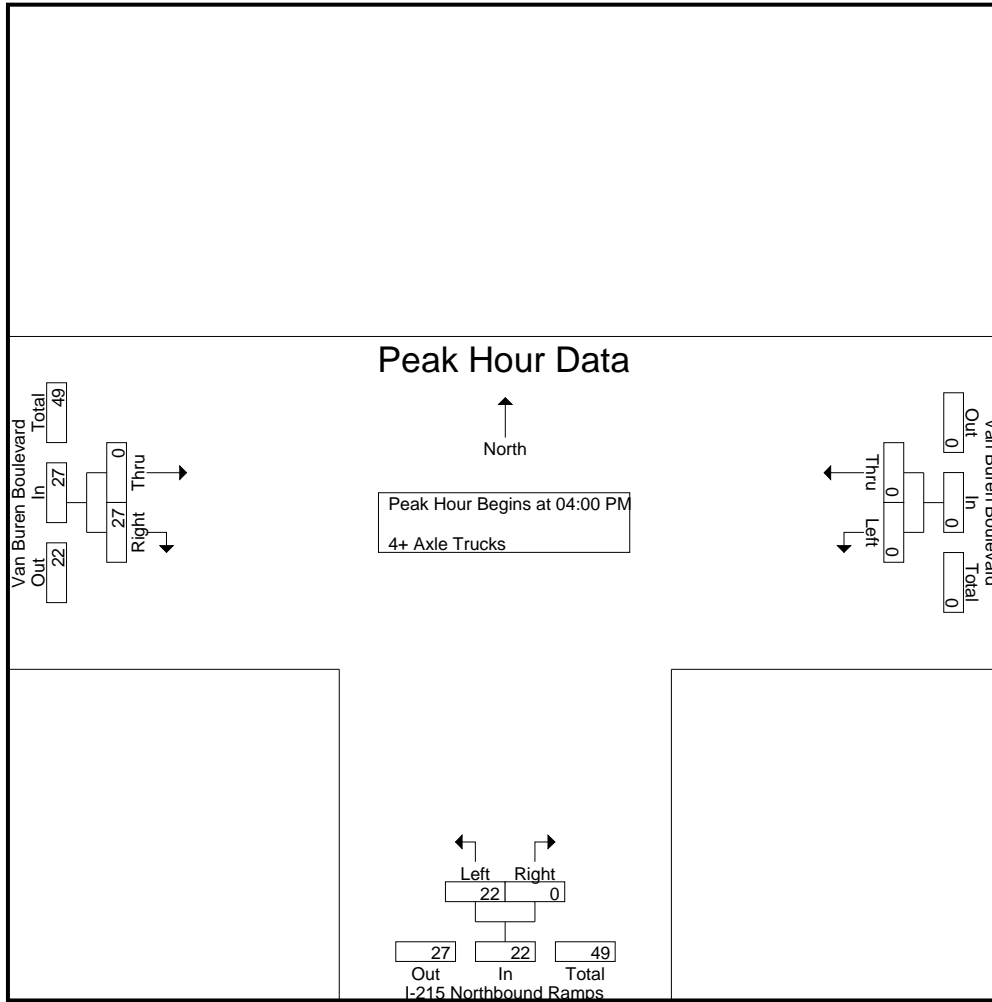

Peak Hour Analysis From 04:00 PM to 04:45 PM - Peak 1 of 1
 Peak Hour for Each Approach Begins at:

	04:00 PM			04:00 PM			04:00 PM		
+0 mins.	0	0	0	10	0	10	0	7	7
+15 mins.	0	0	0	1	0	1	0	9	9
+30 mins.	0	0	0	6	0	6	0	4	4
+45 mins.	0	0	0	5	0	5	0	7	7
Total Volume	0	0	0	22	0	22	0	27	27
% App. Total	0	0	0	100	0	100	0	100	100
PHF	.000	.000	.000	.550	.000	.550	.000	.750	.750

Location: County of Riverside
 N/S: I-215 NB Ramps
 E/W: Van Buren Boulevard



Date: 11/30/2021
 Day: Tuesday

PEDESTRIANS

	North Leg I-215 NB Ramps	East Leg Van Buren Boulevard	South Leg I-215 NB Ramps	West Leg Van Buren Boulevard	
	Pedestrians	Pedestrians	Pedestrians	Pedestrians	
7:00 AM	0	0	0	0	0
7:15 AM	0	0	0	0	0
7:30 AM	0	0	0	0	0
7:45 AM	0	0	0	0	0
8:00 AM	0	0	0	0	0
8:15 AM	0	0	0	0	0
8:30 AM	0	0	0	0	0
8:45 AM	0	0	0	0	0
TOTAL VOLUMES:	0	0	0	0	0

	North Leg I-215 NB Ramps	East Leg Van Buren Boulevard	South Leg I-215 NB Ramps	West Leg Van Buren Boulevard	
	Pedestrians	Pedestrians	Pedestrians	Pedestrians	
4:00 PM	0	0	0	0	0
4:15 PM	0	0	0	0	0
4:30 PM	0	0	0	0	0
4:45 PM	0	0	0	0	0
5:00 PM	0	0	0	0	0
5:15 PM	0	0	0	0	0
5:30 PM	0	0	0	0	0
5:45 PM	0	0	0	0	0
TOTAL VOLUMES:	0	0	0	0	0

Location: County of Riverside
 N/S: I-215 NB Ramps
 E/W: Van Buren Boulevard



Date: 11/30/2021
 Day: Tuesday

BICYCLES

	Southbound I-215 NB Ramps			Westbound Van Buren Boulevard			Northbound I-215 NB Ramps			Eastbound Van Buren Boulevard			
	Left	Thru	Right	Left	Thru	Right	Left	Thru	Right	Left	Thru	Right	
7:00 AM	0	0	0	0	0	0	0	0	0	0	0	0	0
7:15 AM	0	0	0	0	0	0	0	0	0	0	0	0	0
7:30 AM	0	0	0	0	0	0	0	0	0	0	0	0	0
7:45 AM	0	0	0	0	0	0	0	0	0	0	0	0	0
8:00 AM	0	0	0	0	0	0	0	0	0	0	0	0	0
8:15 AM	0	0	0	0	0	0	0	0	0	0	0	0	0
8:30 AM	0	0	0	0	0	0	0	0	0	0	0	0	0
8:45 AM	0	0	0	0	0	0	0	0	0	0	0	0	0
TOTAL VOLUMES:	0	0	0	0	0	0	0	0	0	0	0	0	0

	Southbound I-215 NB Ramps			Westbound Van Buren Boulevard			Northbound I-215 NB Ramps			Eastbound Van Buren Boulevard			
	Left	Thru	Right	Left	Thru	Right	Left	Thru	Right	Left	Thru	Right	
4:00 PM	0	0	0	0	0	0	0	0	0	0	0	0	0
4:15 PM	0	0	0	0	0	0	0	0	0	0	0	0	0
4:30 PM	0	0	0	0	0	0	0	0	0	0	0	0	0
4:45 PM	0	0	0	0	0	0	0	0	0	0	0	0	0
5:00 PM	0	0	0	0	0	0	0	0	0	0	0	0	0
5:15 PM	0	0	0	0	0	0	0	0	0	0	0	0	0
5:30 PM	0	0	0	0	0	0	0	0	0	0	0	0	0
5:45 PM	0	0	0	0	0	0	0	0	0	0	0	0	0
TOTAL VOLUMES:	0	0	0	0	0	0	0	0	0	0	0	0	0

Groups Printed- Passenger Vehicles - Large 2 Axle Vehicles - 3 Axle Vehicles - 4+ Axle Trucks

Start Time	Old 215 Frontage Road Southbound						Alessandro Boulevard Westbound						Old 215 Frontage Road Northbound						Alessandro Boulevard Eastbound					
	Left		Thru		Right		Left		Thru		Right		Left		Thru		Right		Left		Thru		Right	
	Count	%	Count	%	Count	%	Count	%	Count	%	Count	%	Count	%	Count	%	Count	%	Count	%	Count	%	Count	%
07:00 AM	1	5	37	16	43	3	249	19	0	271	7	17	0	0	24	28	114	10	2	152	18	490	508	
07:15 AM	4	6	57	17	67	0	239	15	0	254	10	38	0	0	48	35	122	5	4	162	21	531	552	
07:30 AM	5	11	41	16	57	4	216	16	0	236	11	40	4	3	55	39	144	7	3	190	22	538	560	
07:45 AM	4	8	39	15	51	3	228	18	0	249	5	41	3	2	49	52	188	8	1	248	18	597	615	
Total	14	30	174	64	218	10	932	68	0	1010	33	136	7	5	176	154	568	30	10	752	79	2156	2235	
08:00 AM	6	11	39	10	56	0	240	18	0	258	15	49	4	2	68	51	154	4	2	209	14	591	605	
08:15 AM	1	3	45	21	49	3	236	22	0	261	7	50	3	2	60	61	154	11	3	226	26	596	622	
08:30 AM	5	9	36	14	50	1	196	21	0	218	10	46	4	2	60	69	158	7	4	234	20	562	582	
08:45 AM	10	11	26	9	47	0	227	23	0	250	11	39	5	5	55	64	155	8	3	227	17	579	596	
Total	22	34	146	54	202	4	899	84	0	987	43	184	16	11	243	245	621	30	12	896	77	2328	2405	
Grand Total	36	64	320	118	420	14	1831	152	0	1997	76	320	23	16	419	399	1189	60	22	1648	156	4484	4640	
% Approach	8.6	15.2	76.2			0.7	91.7	7.6			18.1	76.4	5.5			24.2	72.1	3.6						
% Total	0.8	1.4	7.1			0.3	40.8	3.4			1.7	7.1	0.5			8.9	26.5	1.3			3.4	96.6		
Passenger Vehicles	34	54	311			6	1773	138			56	285	20			395	1124	32			0	0	4368	
Large 2 Axle Vehicles	94.4	84.4	97.2	94.1	94.8	42.9	96.8	90.8	0	96	73.7	89.1	87	93.8	86.4	99	94.5	53.3	63.6	93.7	0	0	0	
% Large 2 Axle Vehicles	2.8	1.6	2.2	5.9	3	14.3	1.8	3.9	0	2.1	5.3	2.8	4.3	6.2	3.4	0.3	2.9	10	4.5	2.5	0	0	2.5	
3 Axle Vehicles	1	2	1			3	5	2			4	2	1			1	3	4			9	0	30	
% 3 Axle Vehicles	2.8	3.1	0.3	0	0.7	21.4	0.3	1.3	0	0.5	5.3	0.6	4.3	0	1.6	0.3	0.3	6.7	4.5	0.5	0	0	0.6	
4+ Axle Trucks	0	7	1			3	20	6			12	24	1			2	28	18			54	0	128	
% 4+ Axle Trucks	0	10.9	0.3	0	1.5	21.4	1.1	3.9	0	1.5	15.8	7.5	4.3	0	8.5	0.5	2.4	30	27.3	3.2	0	0	2.8	

Start Time	Old 215 Frontage Road Southbound						Alessandro Boulevard Westbound						Old 215 Frontage Road Northbound						Alessandro Boulevard Eastbound					
	Left		Thru		Right		Left		Thru		Right		Left		Thru		Right		Left		Thru		Right	
	Count	%	Count	%	Count	%	Count	%	Count	%	Count	%	Count	%	Count	%	Count	%	Count	%	Count	%	Count	%
07:45 AM	4	8	39			51					18	249	5	41	3	49	52	188	8	248	597			
08:00 AM	6	11	39			56					18	258	15	49	4	68	51	154	4	209	591			
08:15 AM	1	3	45			49					22	261	7	50	3	60	61	154	11	226	596			
08:30 AM	5	9	36			50					21	218	10	46	4	60	69	158	7	234	562			
Total	16	31	159			206					79	986	37	186	14	237	233	654	30	917	2346			
% App. Total	7.8	15	77.2			8					8	944	15.6	78.5	5.9	8.75	25.4	71.3	3.3	9.24	88.2			
PHF	.667	.705	.883			.920					.944	.617	.930	.875	.871	.875	.844	.870	.682	.924	.982			

Peak Hour Analysis From 07:00 AM to 08:45 AM - Peak 1 of 1
 Peak Hour for Entire Intersection Begins at 07:45 AM

Counts Unlimited, Inc.
 PO Box 1178
 Corona, CA 92878
 (951)268-6268

County of Riverside
 N/S: Old 215 Frontage Road
 E/W: Alessandro Boulevard
 Weather: Clear

File Name : 31_CRV_Old 215_Ales AM
 Site Code : 05121716
 Start Date : 11/30/2021
 Page No : 2

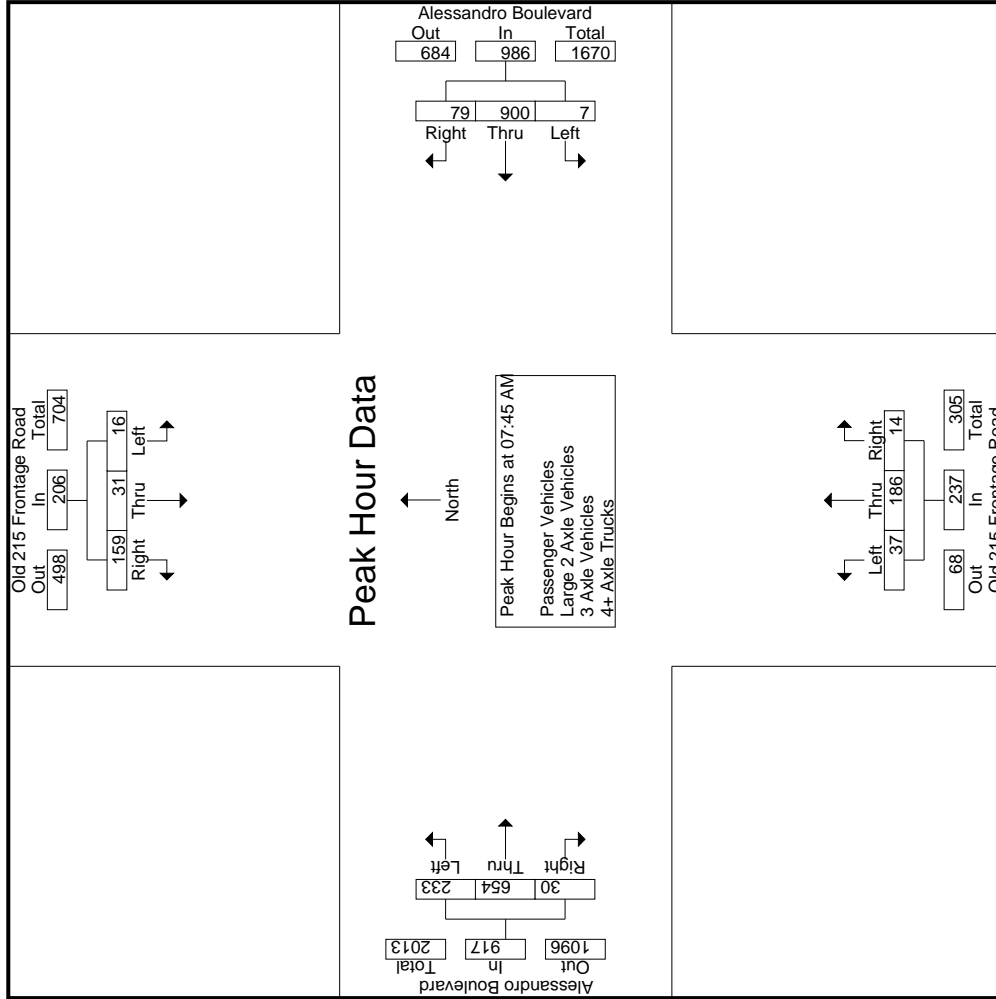

Start Time	Old 215 Frontage Road Southbound			Alessandro Boulevard Westbound			Old 215 Frontage Road Northbound			Alessandro Boulevard Eastbound						
	Left	Thru	Right	Left	Thru	Right	Left	Thru	Right	Left	Thru	Right				
Peak Hour Analysis From 07:00 AM to 08:45 AM - Peak 1 of 1																
Peak Hour for Each Approach Begins at:																
+0 mins.	4	6	57	67	3	249	19	271	15	49	4	68	52	188	8	248
+15 mins.	5	11	41	57	0	239	15	254	7	50	3	60	51	154	4	209
+30 mins.	4	8	39	51	4	216	16	236	10	46	4	60	61	154	11	226
+45 mins.	6	11	39	56	3	228	18	249	11	39	5	55	69	158	7	234
Total Volume	19	36	176	231	10	932	68	1010	43	184	16	243	233	654	30	917
% App. Total	8.2	15.6	76.2	.862	.625	.936	6.7	.932	.717	.920	.800	.893	25.4	71.3	3.3	.924
PHF	.792	.818	.772										.844	.870	.682	

Groups Printed- Passenger Vehicles

Start Time	Old 215 Frontage Road Southbound						Alessandro Boulevard Westbound						Old 215 Frontage Road Northbound						Alessandro Boulevard Eastbound					
	Left	Thru	Right	RTOR	App. Total		Left	Thru	Right	RTOR	App. Total		Left	Thru	Right	RTOR	App. Total		Left	Thru	Right	RTOR	App. Total	
07:00 AM	1	5	36	15	42		2	238	18	0	258		5	13	0	0	18		28	107	4	1	139	
07:15 AM	4	5	57	17	66		0	235	12	0	247		7	34	0	0	41		34	114	4	4	152	
07:30 AM	5	10	39	14	54		3	209	15	0	227		7	34	4	3	45		38	137	3	2	178	
07:45 AM	4	7	38	14	49		1	222	16	0	239		4	38	3	2	45		52	178	6	0	236	
Total	14	27	170	60	211		6	904	61	0	971		23	119	7	5	149		152	536	17	7	705	
08:00 AM	5	8	39	10	52		0	237	18	0	255		13	47	3	2	63		49	145	2	1	196	
08:15 AM	1	3	43	20	47		0	227	20	0	247		6	48	2	2	56		61	149	5	2	215	
08:30 AM	5	9	35	13	49		0	191	17	0	208		7	37	4	2	48		69	153	4	3	226	
08:45 AM	9	7	24	8	40		0	214	22	0	236		7	34	4	4	45		64	141	4	1	209	
Total	20	27	141	51	188		0	869	77	0	946		33	166	13	10	212		243	588	15	7	846	
Grand Total	34	54	311	111	399		6	1773	138	0	1917		56	285	20	15	361		395	1124	32	14	1551	
% Approach	8.5	13.5	77.9				0.3	92.5	7.2		45.3		15.5	78.9	5.5		8.5		25.5	72.5	2.1		36.7	
% Total	0.8	1.3	7.4		9.4		0.1	41.9	3.3				1.3	6.7	0.5				9.3	26.6	0.8			

Start Time	Old 215 Frontage Road Southbound						Alessandro Boulevard Westbound						Old 215 Frontage Road Northbound						Alessandro Boulevard Eastbound					
	Left	Thru	Right	RTOR	App. Total		Left	Thru	Right	RTOR	App. Total		Left	Thru	Right	RTOR	App. Total		Left	Thru	Right	RTOR	App. Total	
07:45 AM	4	7	38		49		1	222	16		239		4	38	3		45		52	178	6		236	
08:00 AM	5	8	39		52		0	237	18		255		13	47	3		63		49	145	2		196	
08:15 AM	1	3	43		47		0	227	20		247		6	48	2		56		61	149	5		215	
08:30 AM	5	9	35		49		0	191	17		208		7	37	4		48		69	153	4		226	
Total Volume	15	27	155		197		1	877	71		949		30	170	12		212		231	625	17		873	
% App. Total	7.6	13.7	78.7				0.1	92.4	7.5				14.2	80.2	5.7				26.5	71.6	1.9			
PHF	.750	.750	.901		.947		.250	.925	.888		.930		.577	.885	.750		.841		.837	.878	.708		.925	

Peak Hour Analysis From 07:45 AM to 08:30 AM - Peak 1 of 1
 Peak Hour for Entire Intersection Begins at 07:45 AM

Counts Unlimited, Inc.
 PO Box 1178
 Corona, CA 92878
 (951)268-6268

County of Riverside
 N/S: Old 215 Frontage Road
 E/W: Alessandro Boulevard
 Weather: Clear

File Name : 31_CRV_Old 215_Ales AM
 Site Code : 05121716
 Start Date : 11/30/2021
 Page No : 2

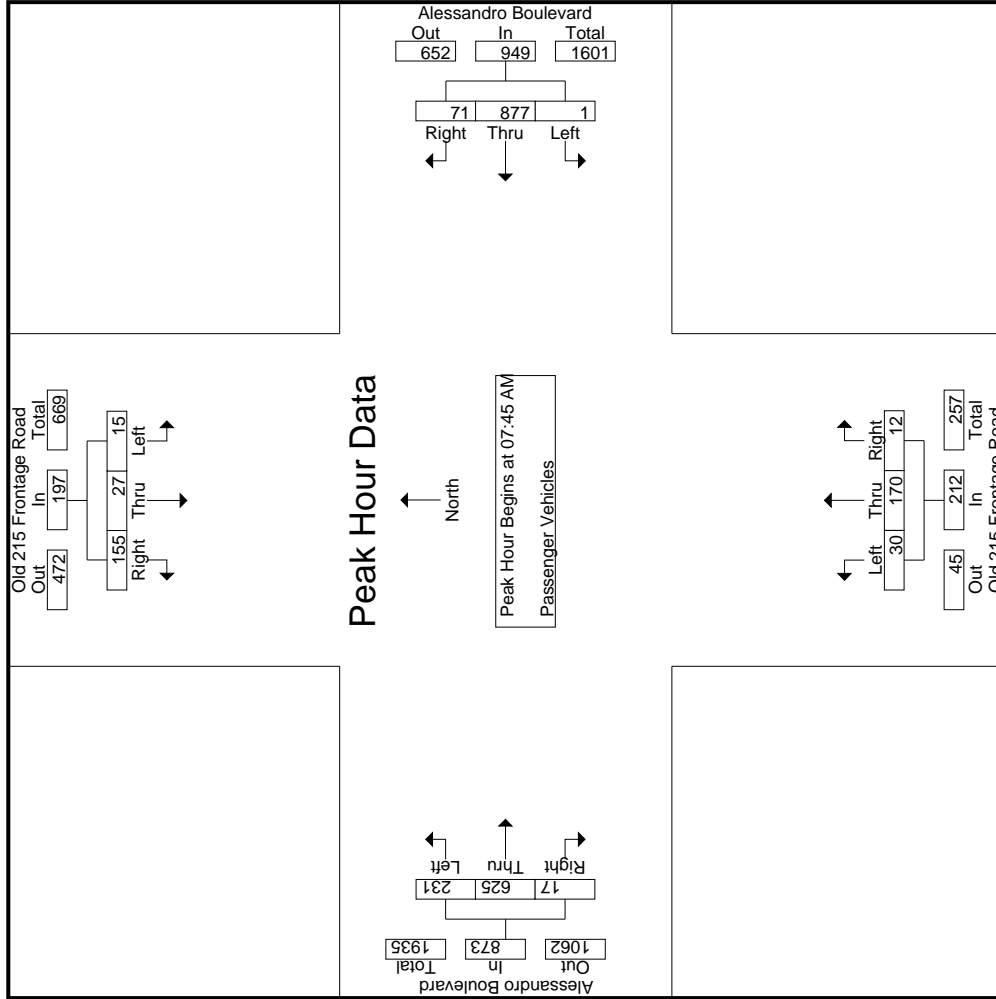

Counts Unlimited, Inc.
 PO Box 1178
 Corona, CA 92878
 (951)268-6268

File Name : 31_CRV_Old 215_Ales AM
 Site Code : 05121716
 Start Date : 11/30/2021
 Page No : 3

County of Riverside
 N/S: Old 215 Frontage Road
 E/W: Alessandro Boulevard
 Weather: Clear

Start Time	Old 215 Frontage Road Southbound			Alessandro Boulevard Westbound			Old 215 Frontage Road Northbound			Alessandro Boulevard Eastbound			
	Left	Thru	Right	Left	Thru	Right	Left	Thru	Right	Left	Thru	Right	
Peak Hour Analysis From 07:45 AM to 08:30 AM - Peak 1 of 1													
Peak Hour for Each Approach Begins at:													
+0 mins.	4	7	38	1	222	16	239	4	38	3	45	178	6
+15 mins.	5	8	39	0	237	18	255	13	47	3	63	145	2
+30 mins.	1	3	43	0	227	20	247	6	48	2	56	149	5
+45 mins.	5	9	35	0	191	17	208	7	37	4	48	153	4
Total Volume	15	27	155	1	877	71	949	30	170	12	212	625	17
% App. Total	7.6	13.7	78.7	0.1	92.4	7.5	930	14.2	80.2	5.7	26.5	71.6	1.9
PHF	.750	.750	.901	.250	.925	.888	.930	.577	.885	.750	.841	.837	.708

Groups Printed- Large 2 Axle Vehicles

Start Time	Old 215 Frontage Road Southbound					Alessandro Boulevard Westbound					Old 215 Frontage Road Northbound					Alessandro Boulevard Eastbound							
	Left	Thru	Right	RTOR	App. Total	Left	Thru	Right	RTOR	App. Total	Left	Thru	Right	RTOR	App. Total	Left	Thru	Right	RTOR	App. Total	Exclu. Total	Inclu. Total	Int. Total
07:00 AM	0	0	1	1	1	0	5	0	0	5	0	0	0	0	0	0	3	2	1	5	2	11	13
07:15 AM	0	0	0	0	0	0	3	1	0	4	1	0	0	0	1	0	5	1	0	6	0	11	11
07:30 AM	0	1	2	2	3	0	3	1	0	4	1	2	0	3	1	4	0	0	5	2	15	17	
07:45 AM	0	0	1	1	1	0	2	1	0	3	0	1	0	0	1	0	6	0	0	6	1	11	12
Total	0	1	4	4	5	0	13	3	0	16	2	3	0	5	1	18	3	1	22	5	48	53	
08:00 AM	1	0	0	0	1	0	3	0	0	3	0	1	0	0	1	0	6	0	0	6	0	11	11
08:15 AM	0	0	1	1	1	2	6	1	0	9	0	0	0	0	0	2	2	0	4	1	14	15	
08:30 AM	0	0	1	1	1	0	3	1	0	4	1	4	0	5	0	3	1	0	4	1	14	15	
08:45 AM	0	0	1	1	1	0	8	1	0	9	1	1	1	3	0	5	0	0	5	2	18	20	
Total	1	0	3	3	4	2	20	3	0	25	2	6	1	9	0	16	3	0	19	4	57	61	
Grand Total	1	1	7	7	9	2	33	6	0	41	4	9	1	14	1	34	6	1	41	9	105	114	
T-Approch %	11.1	11.1	77.8		8.6	4.9	80.5	14.6		28.6	64.3	7.1		13.3	2.4	82.9	14.6		39	7.9	92.1		
Total %	1	1	6.7		8.6	1.9	31.4	5.7		3.8	8.6	1		13.3	1	32.4	5.7		39	7.9	92.1		

Start Time	Old 215 Frontage Road Southbound					Alessandro Boulevard Westbound					Old 215 Frontage Road Northbound					Alessandro Boulevard Eastbound							
	Left	Thru	Right	RTOR	App. Total	Left	Thru	Right	RTOR	App. Total	Left	Thru	Right	RTOR	App. Total	Left	Thru	Right	RTOR	App. Total	Exclu. Total	Inclu. Total	Int. Total
07:45 AM	0	0	0	0	0	0	2	1	0	3	0	0	0	0	0	0	0	0	0	0	0	0	0
08:00 AM	1	0	0	0	1	0	3	0	0	3	0	1	0	0	1	0	6	0	0	6	0	6	6
08:15 AM	0	0	0	0	0	2	6	1	0	9	0	0	0	0	0	2	2	0	2	2	2	4	14
08:30 AM	0	0	0	0	0	0	3	1	0	4	1	4	0	5	0	3	1	0	4	1	14	15	
Total Volume	1	0	0	0	1	2	14	3	0	19	1	6	0	7	0	17	3	0	20	3	50	50	
% App. Total	25	0	0	0	75	10.5	73.7	15.8		14.3	85.7	0		85	0	85	15		85	15	833	893	
PHF	.250	.000	.000	.750	1.00	.250	.583	.750		.528	.250	.375	.000	.350	.000	.708	.375		.833	.375	.893	.893	

Peak Hour Analysis From 07:45 AM to 08:30 AM - Peak 1 of 1
 Peak Hour for Entire Intersection Begins at 07:45 AM

Counts Unlimited, Inc.
 PO Box 1178
 Corona, CA 92878
 (951)268-6268

County of Riverside
 N/S: Old 215 Frontage Road
 E/W: Alessandro Boulevard
 Weather: Clear

File Name : 31_CRV_Old 215_Ales AM
 Site Code : 05121716
 Start Date : 11/30/2021
 Page No : 2

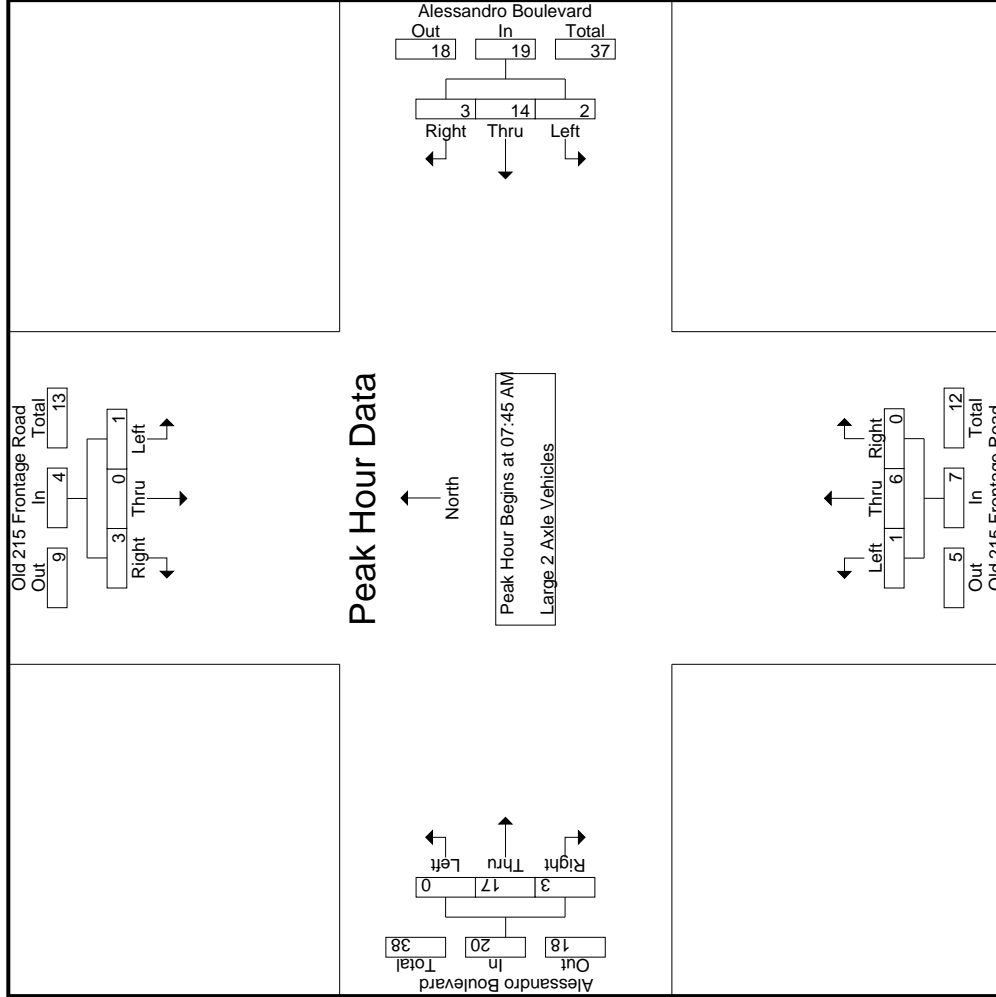

Counts Unlimited, Inc.
 PO Box 1178
 Corona, CA 92878
 (951)268-6268

County of Riverside
 N/S: Old 215 Frontage Road
 E/W: Alessandro Boulevard
 Weather: Clear

File Name : 31_CRV_Old 215_Ales AM
 Site Code : 05121716
 Start Date : 11/30/2021
 Page No : 3

Start Time	Old 215 Frontage Road Southbound			Alessandro Boulevard Westbound			Old 215 Frontage Road Northbound			Alessandro Boulevard Eastbound		
	Left	Thru	Right	Left	Thru	Right	Left	Thru	Right	Left	Thru	Right
Peak Hour Analysis From 07:45 AM to 08:30 AM - Peak 1 of 1												
Peak Hour for Each Approach Begins at:	07:45 AM											
+0 mins.	0	0	1	0	2	1	0	3	1	0	0	0
+15 mins.	1	0	0	3	0	0	3	0	1	0	6	0
+30 mins.	0	0	1	2	6	1	9	0	0	0	2	2
+45 mins.	0	0	1	0	3	1	4	0	5	0	3	1
Total Volume	1	0	3	14	14	3	19	0	7	0	17	3
% App. Total	.250	.000	.750	10.5	73.7	15.8	14.3	85.7	0	0	85	15
PHF	.250	.000	.750	.250	.583	.750	.528	.000	.350	.000	.708	.375

Groups Printed- 3 Axle Vehicles

Start Time	Old 215 Frontage Road Southbound					Alessandro Boulevard Westbound					Old 215 Frontage Road Northbound					Alessandro Boulevard Eastbound								
	Left	Thru	Right	RTOR	App. Total	Left	Thru	Right	RTOR	App. Total	Left	Thru	Right	RTOR	App. Total	Left	Thru	Right	RTOR	App. Total	Exclu. Total	Inclu. Total	Int. Total	
07:00 AM	0	0	0	0	0	1	2	0	0	3	0	0	0	0	0	0	0	1	0	0	0	4	4	4
07:15 AM	0	0	0	0	0	0	1	0	0	1	0	0	0	0	0	0	1	0	0	0	0	2	2	2
07:30 AM	0	0	0	0	0	1	1	0	0	2	1	0	0	0	1	0	0	0	0	0	0	3	3	3
07:45 AM	0	1	0	0	1	1	1	0	0	2	1	0	0	0	1	0	0	0	0	0	0	4	4	4
Total	0	1	0	0	1	3	5	0	0	8	2	0	0	0	2	0	1	1	0	2	0	13	13	13
08:00 AM	0	1	0	0	1	0	0	0	0	0	1	0	0	0	1	1	0	1	1	2	1	4	4	5
08:15 AM	0	0	1	0	1	0	0	0	0	0	0	1	0	0	1	0	0	2	0	2	0	4	4	4
08:30 AM	0	0	0	0	0	2	0	0	0	2	1	0	0	0	1	0	2	0	0	2	0	5	5	5
08:45 AM	1	0	0	0	1	0	0	0	0	0	2	0	0	0	2	0	0	0	0	0	0	3	3	3
Total	1	1	1	0	3	0	0	2	0	2	2	2	1	0	5	1	2	3	1	6	1	16	17	17
Grand Total	1	2	1	0	4	3	5	2	0	10	4	2	1	0	7	1	3	4	1	8	1	29	30	30
T-Approch %	25	50	25			30	50	20			57.1	28.6	14.3			12.5	37.5	50			3.3	96.7		
5 Total %	3.4	6.9	3.4		13.8	10.3	17.2	6.9		34.5	13.8	6.9	3.4		24.1	3.4	10.3	13.8		27.6				

Start Time	Old 215 Frontage Road Southbound					Alessandro Boulevard Westbound					Old 215 Frontage Road Northbound					Alessandro Boulevard Eastbound								
	Left	Thru	Right	RTOR	App. Total	Left	Thru	Right	RTOR	App. Total	Left	Thru	Right	RTOR	App. Total	Left	Thru	Right	RTOR	App. Total	Exclu. Total	Inclu. Total	Int. Total	
07:45 AM	0	1	0	0	1	1	1	0	0	2	1	0	0	0	1	0	0	0	0	0	0	0	0	0
08:00 AM	0	1	0	0	1	0	0	0	0	0	1	0	0	0	1	1	0	0	0	1	0	1	2	4
08:15 AM	0	0	0	0	0	0	0	0	0	0	0	0	0	0	1	0	0	0	0	0	0	2	2	4
08:30 AM	0	0	0	0	0	0	0	0	0	2	1	0	0	0	1	0	0	0	0	2	0	0	2	5
Total Volume	0	2	1		3	1	1	2		4	3	0	1		4	1	2	3		6		17	17	17
% App. Total	0	66.7	33.3		33.3	25	25	50		25	75	0	25		25	16.7	33.3	50		37.5		.850	.850	.850
PHF	.000	.500	.250		.750	.250	.250	.500		.500	.750	.000	.250		1.00	.250	.250	.375		.750		.750	.750	.750

Peak Hour Analysis From 07:45 AM to 08:30 AM - Peak 1 of 1
 Peak Hour for Entire Intersection Begins at 07:45 AM

Counts Unlimited, Inc.
 PO Box 1178
 Corona, CA 92878
 (951)268-6268

County of Riverside
 N/S: Old 215 Frontage Road
 E/W: Alessandro Boulevard
 Weather: Clear

File Name : 31_CRV_Old 215_Ales AM
 Site Code : 05121716
 Start Date : 11/30/2021
 Page No : 2

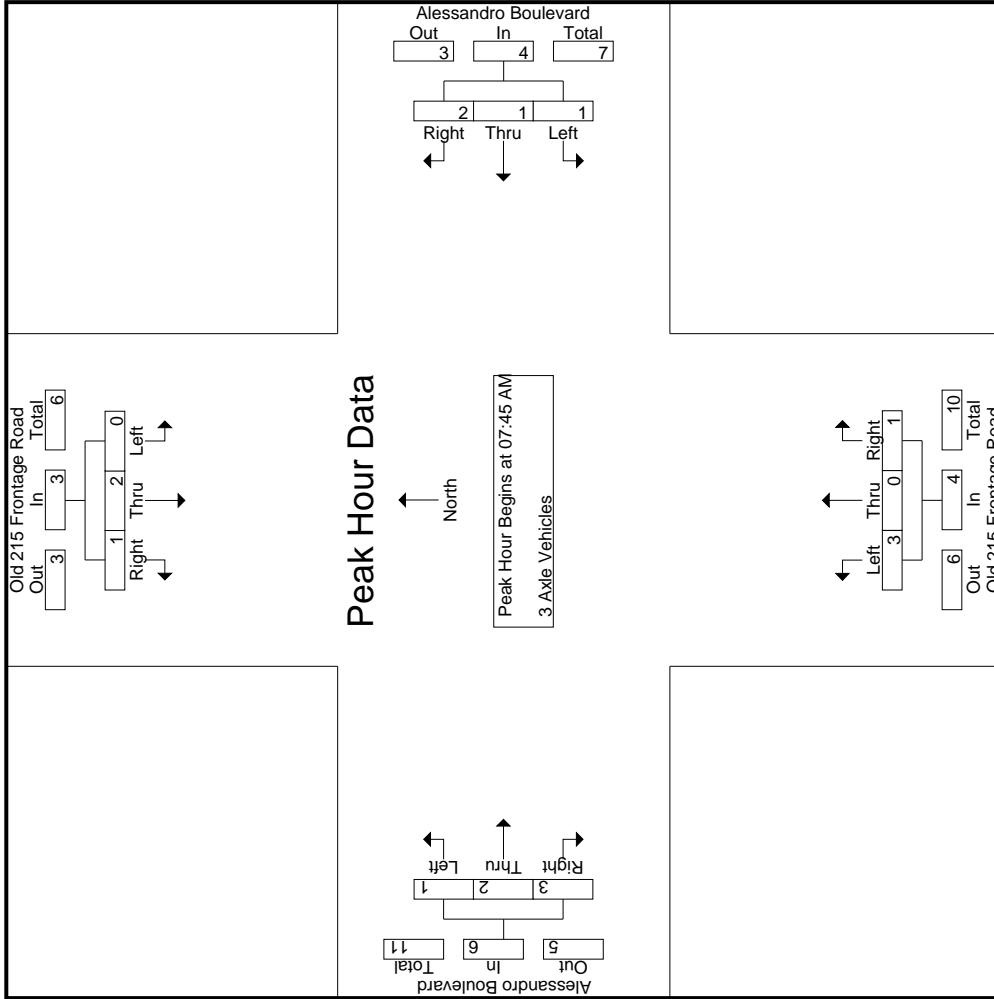

Counts Unlimited, Inc.
 PO Box 1178
 Corona, CA 92878
 (951)268-6268

County of Riverside
 N/S: Old 215 Frontage Road
 E/W: Alessandro Boulevard
 Weather: Clear

File Name : 31_CRV_Old 215_Ales AM
 Site Code : 05121716
 Start Date : 11/30/2021
 Page No : 3

Start Time	Old 215 Frontage Road Southbound			Alessandro Boulevard Westbound			Old 215 Frontage Road Northbound			Alessandro Boulevard Eastbound					
	Left	Thru	Right	Left	Thru	Right	Left	Thru	Right	Left	Thru	Right			
Peak Hour Analysis From 07:45 AM to 08:30 AM - Peak 1 of 1															
Peak Hour for Each Approach Begins at:															
+0 mins.	0	1	0	1	1	0	2	1	0	1	0	0	0	0	0
+15 mins.	0	1	0	0	0	0	0	1	0	0	0	0	1	0	1
+30 mins.	0	0	1	0	0	0	0	0	1	0	0	0	0	0	2
+45 mins.	0	0	0	0	0	2	2	1	0	1	0	0	2	0	2
Total Volume	0	2	1	1	1	2	4	3	1	0	0	1	2	2	3
% App. Total	0	66.7	33.3	.25	.25	.50	.50	.75	.25	.000	.250	.250	.333	.50	.167
PHF	.000	.500	.250	.250	.250	.250	.500	.750	.250	1.000	.250	.250	.375	.500	.125

Counts Unlimited, Inc.
 PO Box 1178
 Corona, CA 92878
 (951)268-6268

County of Riverside
 N/S: Old 215 Frontage Road
 E/W: Alessandro Boulevard
 Weather: Clear

File Name : 31_CRV_Old 215_Ales AM
 Site Code : 05121716
 Start Date : 11/30/2021
 Page No : 1

Groups Printed- 4+ Axle Trucks

Start Time	Old 215 Frontage Road Southbound					Alessandro Boulevard Westbound					Old 215 Frontage Road Northbound					Alessandro Boulevard Eastbound							
	Left	Thru	Right	RTOR	App. Total	Left	Thru	Right	RTOR	App. Total	Left	Thru	Right	RTOR	App. Total	Left	Thru	Right	RTOR	App. Total	Exclu. Total	Inclu. Total	Int. Total
07:00 AM	0	0	0	0	0	0	4	1	0	5	2	4	0	0	6	0	4	3	0	7	0	18	18
07:15 AM	0	1	0	0	1	0	0	2	0	2	2	4	0	0	6	1	2	0	0	3	0	12	12
07:30 AM	0	0	0	0	0	0	3	0	0	3	2	4	0	0	6	0	3	4	1	7	1	16	17
07:45 AM	0	0	0	0	0	1	3	1	0	5	0	2	0	0	2	0	4	2	1	6	1	13	14
Total	0	1	0	0	1	1	10	4	0	15	6	14	0	0	20	1	13	9	2	23	2	59	61
08:00 AM	0	2	0	0	2	0	0	0	0	0	1	1	1	0	3	1	3	1	0	5	0	10	10
08:15 AM	0	0	0	0	0	1	3	1	0	5	1	2	0	0	3	0	3	2	1	5	1	13	14
08:30 AM	0	0	0	0	0	1	2	1	0	4	1	5	0	0	6	0	0	2	1	2	1	12	13
08:45 AM	0	4	1	0	5	0	5	0	0	5	3	2	0	0	5	0	9	4	2	13	2	28	30
Total	0	6	1	0	7	2	10	2	0	14	6	10	1	0	17	1	15	9	4	25	4	63	67
Grand Total	0	7	1	0	8	3	20	6	0	29	12	24	1	0	37	2	28	18	6	48	6	122	128
T-Approch %	0	87.5	12.5			10.3	69	20.7		32.4	64.9	2.7			4.2	58.3	37.5			39.3			
Total %	0	5.7	0.8		6.6	2.5	16.4	4.9		23.8	19.7	0.8		30.3	1.6	23	14.8			4.7	4.7	95.3	

Start Time	Old 215 Frontage Road Southbound					Alessandro Boulevard Westbound					Old 215 Frontage Road Northbound					Alessandro Boulevard Eastbound							
	Left	Thru	Right	RTOR	App. Total	Left	Thru	Right	RTOR	App. Total	Left	Thru	Right	RTOR	App. Total	Left	Thru	Right	RTOR	App. Total	Exclu. Total	Inclu. Total	Int. Total
07:45 AM	0	0	0	0	0	1	3	1	0	5	0	2	0	0	2	0	4	3	0	7	0	18	18
08:00 AM	0	2	0	0	2	0	0	0	0	0	1	1	1	0	3	1	3	2	1	5	0	10	10
08:15 AM	0	0	0	0	0	1	3	1	0	5	1	2	0	0	3	0	3	2	1	5	1	13	14
08:30 AM	0	0	0	0	0	1	2	1	0	4	1	5	0	0	6	0	0	2	1	2	1	12	13
08:45 AM	0	4	1	0	5	0	5	0	0	5	3	2	0	0	5	0	9	4	2	13	2	28	30
Total	0	6	1	0	7	2	10	2	0	14	6	10	1	0	17	1	15	9	4	25	4	63	67
Grand Total	0	7	1	0	8	3	20	6	0	29	12	24	1	0	37	2	28	18	6	48	6	122	128
T-Approch %	0	87.5	12.5			10.3	69	20.7		32.4	64.9	2.7			4.2	58.3	37.5			39.3			
Total %	0	5.7	0.8		6.6	2.5	16.4	4.9		23.8	19.7	0.8		30.3	1.6	23	14.8			4.7	4.7	95.3	

Peak Hour Analysis From 07:45 AM to 08:30 AM - Peak 1 of 1
 Peak Hour for Entire Intersection Begins at 07:45 AM

Start Time	Old 215 Frontage Road Southbound					Alessandro Boulevard Westbound					Old 215 Frontage Road Northbound					Alessandro Boulevard Eastbound							
	Left	Thru	Right	RTOR	App. Total	Left	Thru	Right	RTOR	App. Total	Left	Thru	Right	RTOR	App. Total	Left	Thru	Right	RTOR	App. Total	Exclu. Total	Inclu. Total	Int. Total
07:45 AM	0	0	0	0	0	1	3	1	0	5	0	2	0	0	2	0	4	3	0	7	0	18	18
08:00 AM	0	2	0	0	2	0	0	0	0	0	1	1	1	0	3	1	3	2	1	5	0	10	10
08:15 AM	0	0	0	0	0	1	3	1	0	5	1	2	0	0	3	0	3	2	1	5	1	13	14
08:30 AM	0	0	0	0	0	1	2	1	0	4	1	5	0	0	6	0	0	2	1	2	1	12	13
Total Volume	0	2	0	0	2	3	8	3	0	14	3	10	1	0	14	1	10	7	0	18	2	59	61
% App. Total	0	100	0	0		21.4	57.1	21.4		71.4	21.4	71.4	7.1		55.6	5.6	38.9	38.9		39.3	4.7	95.3	
PHF	.000	.250	.000		.250	.750	.667	.750		.700	.750	.500	.250		.583	.250	.625	.875		.750			

Counts Unlimited, Inc.
 PO Box 1178
 Corona, CA 92878
 (951)268-6268

County of Riverside
 N/S: Old 215 Frontage Road
 E/W: Alessandro Boulevard
 Weather: Clear

File Name : 31_CRV_Old 215_Ales AM
 Site Code : 05121716
 Start Date : 11/30/2021
 Page No : 2

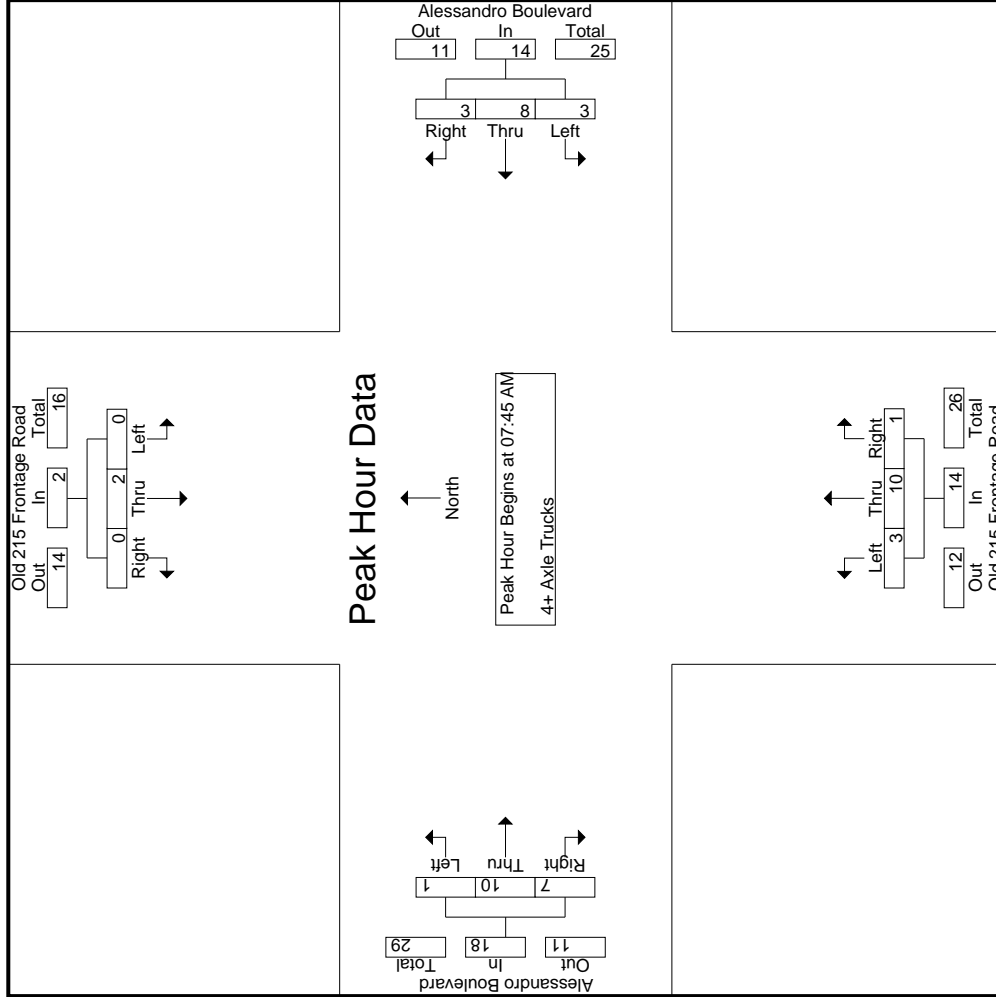

Start Time	Old 215 Frontage Road Southbound			Alessandro Boulevard Westbound			Old 215 Frontage Road Northbound			Alessandro Boulevard Eastbound			
	Left	Thru	Right	Left	Thru	Right	Left	Thru	Right	Left	Thru	Right	
Peak Hour Analysis From 07:45 AM to 08:30 AM - Peak 1 of 1													
Peak Hour for Each Approach Begins at:													
+0 mins.	0	0	0	1	3	1	5	2	0	2	0	4	
+15 mins.	0	2	0	0	0	0	0	1	1	0	1	3	
+30 mins.	0	0	0	1	3	1	5	2	0	3	0	3	
+45 mins.	0	0	0	1	2	1	4	1	5	0	0	0	
Total Volume	0	2	0	3	8	3	14	10	1	14	1	10	
% App. Total	0	100	0	21.4	57.1	21.4	70.0	71.4	7.1	58.3	5.6	38.9	
PHF	.000	.250	.000	.750	.667	.750	.700	.500	.250	.583	.250	.625	

Groups Printed- Passenger Vehicles - Large 2 Axle Vehicles - 3 Axle Vehicles - 4+ Axle Trucks

Start Time	Old 215 Frontage Road										Alessandro Boulevard												
	Southbound					Westbound					Northbound					Eastbound							
	Left	Thru	Right	RTOR	App. Total	Left	Thru	Right	RTOR	App. Total	Left	Thru	Right	RTOR	App. Total	Left	Thru	Right	RTOR	App. Total	Exclu. Total	Inclu. Total	Int. Total
04:00 PM	18	23	36	7	77	2	232	36	0	270	16	51	5	3	72	91	306	11	5	408	15	827	842
04:15 PM	19	27	56	11	102	2	191	25	0	218	6	64	1	1	71	101	283	12	4	396	16	787	803
04:30 PM	26	24	51	16	101	1	212	21	0	234	13	35	0	0	48	81	294	14	1	389	17	772	789
04:45 PM	23	33	58	4	114	3	205	28	0	236	6	56	2	1	64	81	337	20	6	438	11	852	863
Total	86	107	201	38	394	8	840	110	0	958	41	206	8	5	255	354	1220	57	16	1631	59	3238	3297
05:00 PM	27	57	32	6	116	2	237	33	0	272	9	28	5	4	42	65	332	35	10	432	20	862	882
05:15 PM	38	53	45	7	136	2	211	21	0	234	7	28	4	3	39	80	372	27	6	479	16	888	904
05:30 PM	22	54	41	9	117	6	224	23	0	253	9	31	2	2	42	91	349	15	4	455	15	867	882
05:45 PM	37	44	47	8	128	4	161	27	0	192	9	25	2	1	36	78	345	10	4	433	13	789	802
Total	124	208	165	30	497	14	833	104	0	951	34	112	13	10	159	314	1398	87	24	1799	64	3406	3470
Grand Total	210	315	366	68	891	22	1673	214	0	1909	75	318	21	15	414	668	2618	144	40	3430	123	6644	6767
% Approach	23.6	35.4	41.1			1.2	87.6	11.2			18.1	76.8	5.1			19.5	76.3	4.2					
% Total	3.2	4.7	5.5			0.3	25.2	3.2			1.1	4.8	0.3			10.1	39.4	2.2			1.8	98.2	
% Passenger Vehicles	201	290	361		918	19	1628	210		1857	57	305	17		392	660	2577	113		3387	0	0	6554
% Large 2 Axle Vehicles	95.7	92.1	98.6	97.1	95.7	86.4	97.3	98.1	0	97.3	76	95.9	81	86.7	91.4	98.8	98.4	78.5	92.5	97.6	0	0	96.9
% 3 Axle Vehicles	4	2	4		12	3	26	2		31	1	4	2		8	4	18	4		27	0	0	78
% 4+ Axle Trucks	1.9	0.6	1.1	2.9	1.3	13.6	1.6	0.9	0	1.6	1.3	1.3	9.5	6.7	1.9	0.6	0.7	2.8	2.5	0.8	0	0	1.2
% 4+ Axle Trucks	2	2	1		5	0	5	1		6	4	1	1		6	2	6	3		12	0	0	29
% 4+ Axle Trucks	1	0.6	0.3	0	0.5	0	0.3	0.5	0	0.3	5.3	0.3	4.8	0	1.4	0.3	0.2	2.1	2.5	0.3	0	0	0.4
% 4+ Axle Trucks	3	21	0		24	0	14	1		15	13	8	1		23	2	17	24		44	0	0	106
% 4+ Axle Trucks	1.4	6.7	0		2.5	0	0.8	0.5	0	0.8	17.3	2.5	4.8	6.7	5.4	0.3	0.6	16.7	2.5	1.3	0	0	1.6

Start Time	Old 215 Frontage Road					Alessandro Boulevard					Alessandro Boulevard										
	Southbound					Westbound					Eastbound										
	Left	Thru	Right	RTOR	App. Total	Left	Thru	Right	RTOR	App. Total	Left	Thru	Right	RTOR	App. Total	Left	Thru	Right	RTOR	App. Total	Int. Total
04:45 PM	23	33	58		114	3	205	28		236	6	56	2		64	81	337	20		438	852
05:00 PM	27	57	32		116	2	237	33		272	9	28	5		42	65	332	35		432	862
05:15 PM	38	53	45		136	2	211	21		234	7	28	4		39	80	372	27		479	888
05:30 PM	22	54	41		117	6	224	23		253	9	31	2		42	91	349	15		455	867
Total Volume	110	197	176		483	13	877	105		995	31	143	13		187	317	1390	97		1804	3469
% App. Total	22.8	40.8	36.4		36.4	1.3	88.1	10.6		10.6	16.6	76.5	7		7.30	17.6	77.1	5.4		9.42	.977
PHF	.724	.864	.759		.888	.542	.925	.795		.915	.861	.638	.650		.730	.871	.934	.693		.942	.977

Peak Hour Analysis From 04:00 PM to 05:45 PM - Peak 1 of 1
 Peak Hour for Entire Intersection Begins at 04:45 PM

Counts Unlimited, Inc.
 PO Box 1178
 Corona, CA 92878
 (951)268-6268

County of Riverside
 N/S: Old 215 Frontage Road
 E/W: Alessandro Boulevard
 Weather: Clear

File Name : 31_CRV_Old 215_Ales PM
 Site Code : 05121716
 Start Date : 11/30/2021
 Page No : 2

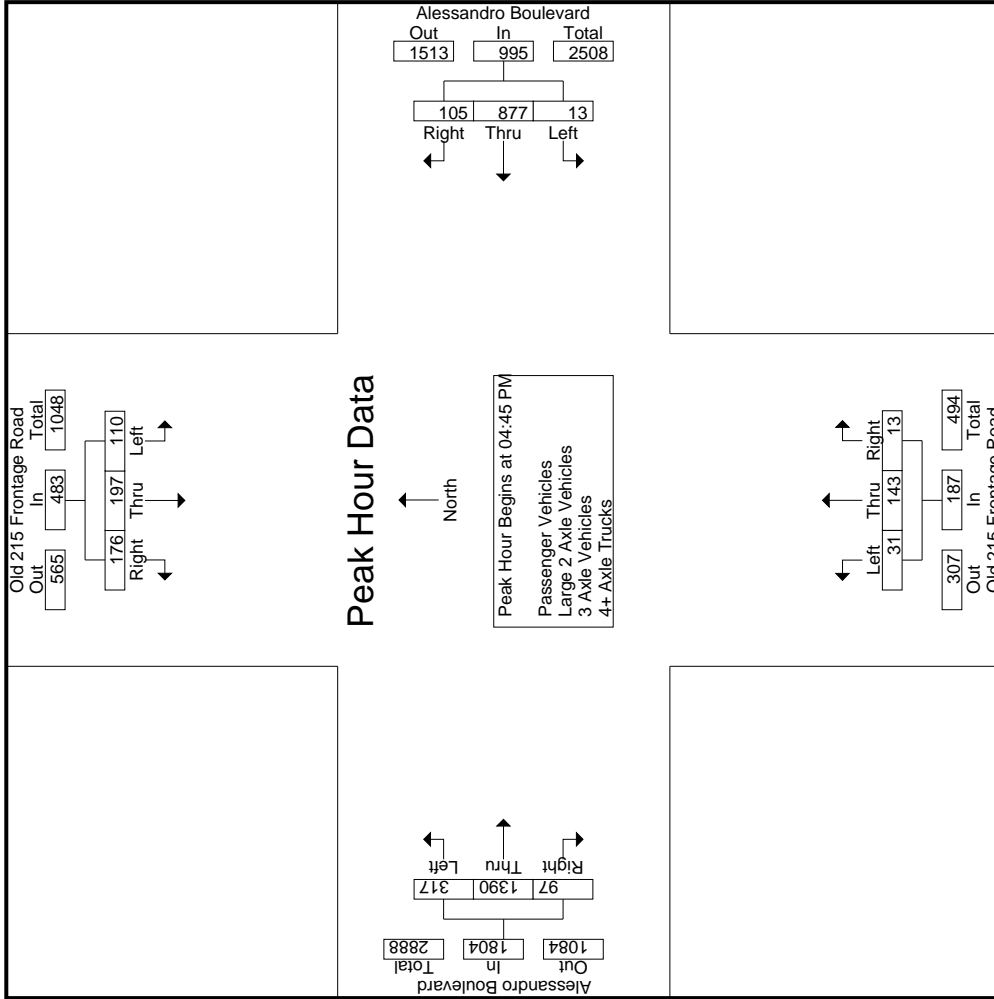

Counts Unlimited, Inc.
 PO Box 1178
 Corona, CA 92878
 (951)268-6268

County of Riverside
 N/S: Old 215 Frontage Road
 E/W: Alessandro Boulevard
 Weather: Clear

File Name : 31_CRV_Old 215_Ales PM
 Site Code : 05121716
 Start Date : 11/30/2021
 Page No : 3

Start Time	Old 215 Frontage Road Southbound			Alessandro Boulevard Westbound			Old 215 Frontage Road Northbound			Alessandro Boulevard Eastbound				
	Left	Thru	Right	Left	Thru	Right	Left	Thru	Right	Left	Thru	Right		
Peak Hour Analysis From 04:00 PM to 05:45 PM - Peak 1 of 1														
Peak Hour for Each Approach Begins at:														
+0 mins.	27	57	32	3	205	28	3	236	16	51	5	81	337	20
+15 mins.	38	53	45	2	237	33	2	272	6	64	1	65	332	35
+30 mins.	22	54	41	2	211	21	2	234	13	35	0	80	372	27
+45 mins.	37	44	47	6	224	23	6	253	6	56	2	91	349	15
Total Volume	124	208	165	13	877	105	13	995	41	206	8	317	1390	97
% App. Total	24.9	41.9	33.2	1.3	88.1	10.6	1.3	91.5	16.1	80.8	3.1	17.6	77.1	5.4
PHF	.816	.912	.878	.542	.925	.795	.542	.915	.641	.805	.400	.871	.934	.693

Groups Printed- Passenger Vehicles

Start Time	Old 215 Frontage Road Southbound					Alessandro Boulevard Westbound					Old 215 Frontage Road Northbound					Alessandro Boulevard Eastbound							
	Left	Thru	Right	RTOR	App. Total	Left	Thru	Right	RTOR	App. Total	Left	Thru	Right	RTOR	App. Total	Left	Thru	Right	RTOR	App. Total	Exclu. Total	Inclu. Total	Int. Total
04:00 PM	18	23	36	7	77	1	222	36	0	259	15	49	4	3	68	91	301	8	5	400	15	804	819
04:15 PM	17	27	56	11	100	2	189	25	0	216	5	59	1	1	65	100	278	8	3	386	15	767	782
04:30 PM	26	23	49	15	98	1	206	20	0	227	10	35	0	0	45	81	286	8	1	375	16	745	761
04:45 PM	23	32	57	4	112	3	199	28	0	230	4	56	2	1	62	79	332	14	5	425	10	829	839
Total	84	105	198	37	387	7	816	109	0	932	34	199	7	5	240	351	1197	38	14	1586	56	3145	3201
05:00 PM	25	53	32	6	110	1	232	32	0	265	7	27	5	4	39	64	325	31	10	420	20	834	854
05:15 PM	34	43	45	7	122	2	205	21	0	228	6	26	2	2	34	79	368	27	6	474	15	858	873
05:30 PM	22	48	41	9	111	5	218	21	0	244	6	29	1	1	36	89	347	10	3	446	13	837	850
05:45 PM	36	41	45	7	122	4	157	27	0	188	4	24	2	1	30	77	340	7	4	424	12	764	776
Total	117	185	163	29	465	12	812	101	0	925	23	106	10	8	139	309	1380	75	23	1764	60	3293	3353
Grand Total	201	290	361	66	852	19	1628	210	0	1857	57	305	17	13	379	660	2577	113	37	3350	116	6438	6554
T-Approach %	23.6	34	42.4			1	87.7	11.3		15	80.5	4.5		5.9	19.7	76.9	40	1.8	52		1.8	98.2	
Total %	3.1	4.5	5.6		13.2	0.3	25.3	3.3		0.9	4.7	0.3		5.9	10.3	40	1.8						

Start Time	Old 215 Frontage Road Southbound					Alessandro Boulevard Westbound					Old 215 Frontage Road Northbound					Alessandro Boulevard Eastbound							
	Left	Thru	Right	RTOR	App. Total	Left	Thru	Right	RTOR	App. Total	Left	Thru	Right	RTOR	App. Total	Left	Thru	Right	RTOR	App. Total	Exclu. Total	Inclu. Total	Int. Total
04:45 PM	23	32	57		112	3	199	28		230	4	56	2		62	79	332	14		425		829	
05:00 PM	25	53	32		110	1	232	32		265	7	27	5		39	64	325	31		420		834	
05:15 PM	34	43	45		122	2	205	21		228	6	26	2		34	79	368	27		474		858	
05:30 PM	22	48	41		111	5	218	21		244	6	29	1		36	89	347	10		446		837	
Total Volume	104	176	175		455	11	854	102		967	23	138	10		171	311	1372	82		1765		3358	
% App. Total	22.9	38.7	38.5		13.2	1.1	88.3	10.5		13.5	80.7	5.8		5.9	19.7	77.7	4.6						
PHF	.765	.830	.768		.932	.550	.920	.797		.912	.821	.616	.500		.690	.874	.932	.661		.931		.978	

Peak Hour Analysis From 04:45 PM to 05:30 PM - Peak 1 of 1
 Peak Hour for Entire Intersection Begins at 04:45 PM

Counts Unlimited, Inc.
 PO Box 1178
 Corona, CA 92878
 (951)268-6268

County of Riverside
 N/S: Old 215 Frontage Road
 E/W: Alessandro Boulevard
 Weather: Clear

File Name : 31_CRV_Old 215_Ales PM
 Site Code : 05121716
 Start Date : 11/30/2021
 Page No : 2

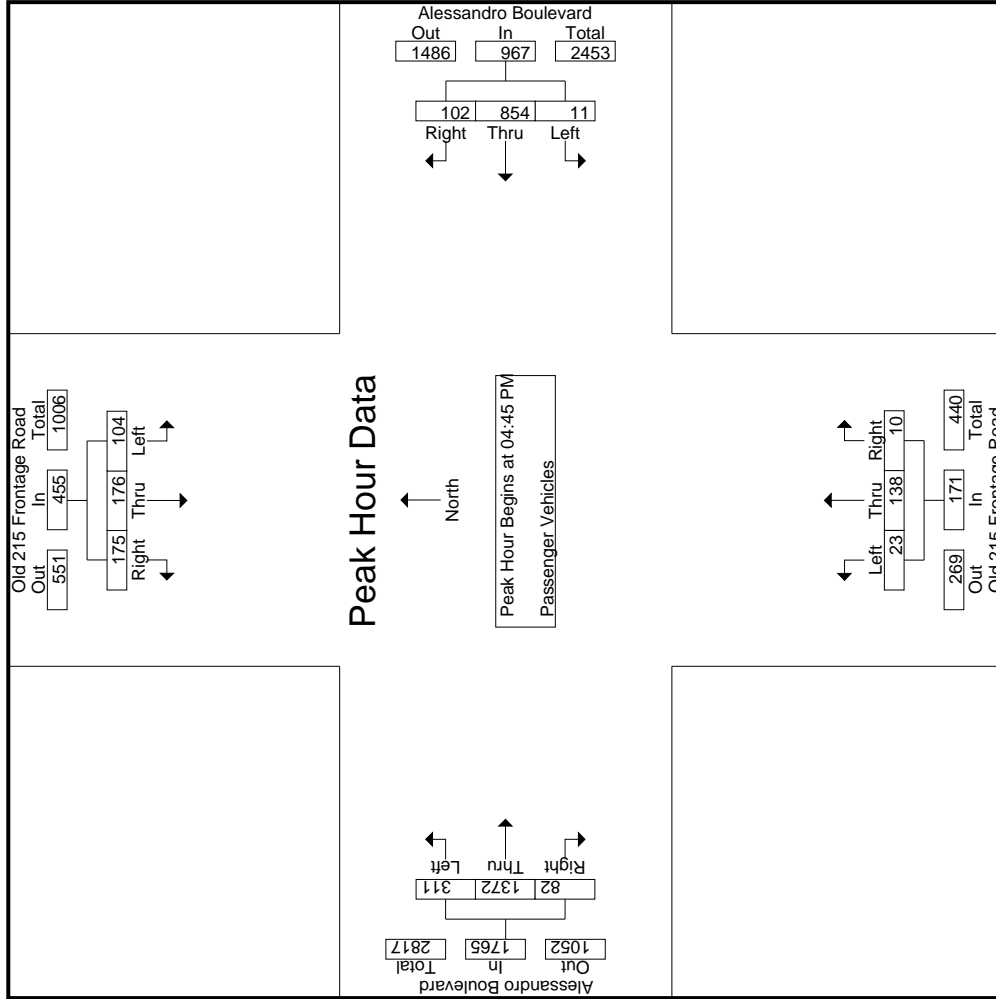

Counts Unlimited, Inc.
 PO Box 1178
 Corona, CA 92878
 (951)268-6268

File Name : 31_CRV_Old 215_Ales PM
 Site Code : 05121716
 Start Date : 11/30/2021
 Page No : 3

County of Riverside
 N/S: Old 215 Frontage Road
 E/W: Alessandro Boulevard
 Weather: Clear

Start Time	Old 215 Frontage Road Southbound			Alessandro Boulevard Westbound			Old 215 Frontage Road Northbound			Alessandro Boulevard Eastbound								
	Left	Thru	Right	Left	Thru	Right	Left	Thru	Right	Left	Thru	Right						
Peak Hour Analysis From 04:45 PM to 05:30 PM - Peak 1 of 1																		
Peak Hour for Each Approach Begins at:	04:45 PM																	
+0 mins.	23	32	57	112	112	3	199	28	230	230	4	56	2	2	79	332	14	425
+15 mins.	25	53	32	110	110	1	232	32	265	265	7	27	5	5	64	325	31	420
+30 mins.	34	43	45	122	122	2	205	21	228	228	6	26	2	2	79	368	27	474
+45 mins.	22	48	41	111	111	5	218	21	244	244	6	29	1	1	89	347	10	446
Total Volume	104	176	175	455	455	11	854	102	967	967	23	138	10	10	311	1372	82	1765
% App. Total	22.9	38.7	38.5	.932	.932	1.1	88.3	10.5	13.5	13.5	80.7	5.8	5.8	5.8	17.6	77.7	4.6	1765
PHF	.765	.830	.768	.932	.932	.550	.920	.797	.912	.912	.821	.616	.500	.500	.874	.932	.661	.931

Groups Printed- Large 2 Axle Vehicles

Start Time	Old 215 Frontage Road Southbound					Alessandro Boulevard Westbound					Old 215 Frontage Road Northbound					Alessandro Boulevard Eastbound							
	Left	Thru	Right	RTOR	App. Total	Left	Thru	Right	RTOR	App. Total	Left	Thru	Right	RTOR	App. Total	Left	Thru	Right	RTOR	App. Total	Exclu. Total	Inclu. Total	Int. Total
04:00 PM	0	0	0	0	0	1	6	0	0	7	1	0	1	0	2	0	2	1	0	3	0	12	12
04:15 PM	0	0	0	0	0	0	2	0	0	2	0	3	0	0	3	0	2	1	1	3	1	8	9
04:30 PM	0	0	2	1	2	0	5	1	0	6	0	0	0	0	0	0	6	0	6	1	1	14	15
04:45 PM	0	0	0	0	0	0	5	0	0	5	0	0	0	0	0	0	0	1	0	1	0	6	6
Total	0	0	2	1	2	1	18	1	0	20	1	3	1	0	5	0	10	3	1	13	2	40	42
05:00 PM	1	0	0	0	1	1	4	0	0	5	0	0	0	0	0	1	3	1	0	5	0	11	11
05:15 PM	2	0	0	0	2	0	2	0	0	2	0	0	0	0	0	1	1	0	0	2	0	6	6
05:30 PM	0	1	0	0	1	1	1	1	0	3	0	0	1	1	1	1	2	0	0	3	1	8	9
05:45 PM	1	1	2	1	4	0	1	0	0	1	0	1	0	0	1	1	2	0	0	3	1	9	10
Total	4	2	2	1	8	2	8	1	0	11	0	1	1	1	2	4	8	1	0	13	2	34	36
Grand Total	4	2	4	2	10	3	26	2	0	31	1	4	2	1	7	4	18	4	1	26	4	74	78
% Approach	40	20	40			9.7	83.9	6.5			14.3	57.1	28.6			15.4	69.2	15.4		35.1	5.1	94.9	
% Total	5.4	2.7	5.4			4.1	35.1	2.7		41.9	1.4	5.4	2.7		9.5	5.4	24.3	5.4					

Start Time	Old 215 Frontage Road Southbound					Alessandro Boulevard Westbound					Old 215 Frontage Road Northbound					Alessandro Boulevard Eastbound							
	Left	Thru	Right	RTOR	App. Total	Left	Thru	Right	RTOR	App. Total	Left	Thru	Right	RTOR	App. Total	Left	Thru	Right	RTOR	App. Total	Exclu. Total	Inclu. Total	Int. Total
04:45 PM	0	0	0	0	0	0	0	0	0	0	0	0	0	0	0	0	0	0	0	0	0	0	0
05:00 PM	1	0	0	0	1	1	4	0	0	5	0	0	0	0	0	1	3	1	0	5	0	1	6
05:15 PM	2	0	0	0	2	0	2	0	0	2	0	0	0	0	0	1	1	0	0	2	0	1	11
05:30 PM	0	1	0	0	1	1	1	1	0	3	0	0	1	1	1	1	2	0	0	3	1	0	6
05:45 PM	3	1	0	0	4	2	12	1	0	15	0	0	0	1	1	3	6	2	0	11	2	0	8
Total Volume	75	25	0	0	100	13.3	80	6.7	0	100	0	0	100	0	18.2	27.3	54.5	18.2	0	11	2	0	31
% App. Total	.375	.250	.000	.500	.500	.500	.600	.250	.750	.250	.000	.000	.250	.250	.250	.750	.500	.500	.550	.550	.500	.550	.705
PHF																							

Peak Hour Analysis From 04:45 PM to 05:30 PM - Peak 1 of 1
 Peak Hour for Entire Intersection Begins at 04:45 PM

Counts Unlimited, Inc.
 PO Box 1178
 Corona, CA 92878
 (951)268-6268

County of Riverside
 N/S: Old 215 Frontage Road
 E/W: Alessandro Boulevard
 Weather: Clear

File Name : 31_CRV_Old 215_Ales PM
 Site Code : 05121716
 Start Date : 11/30/2021
 Page No : 2

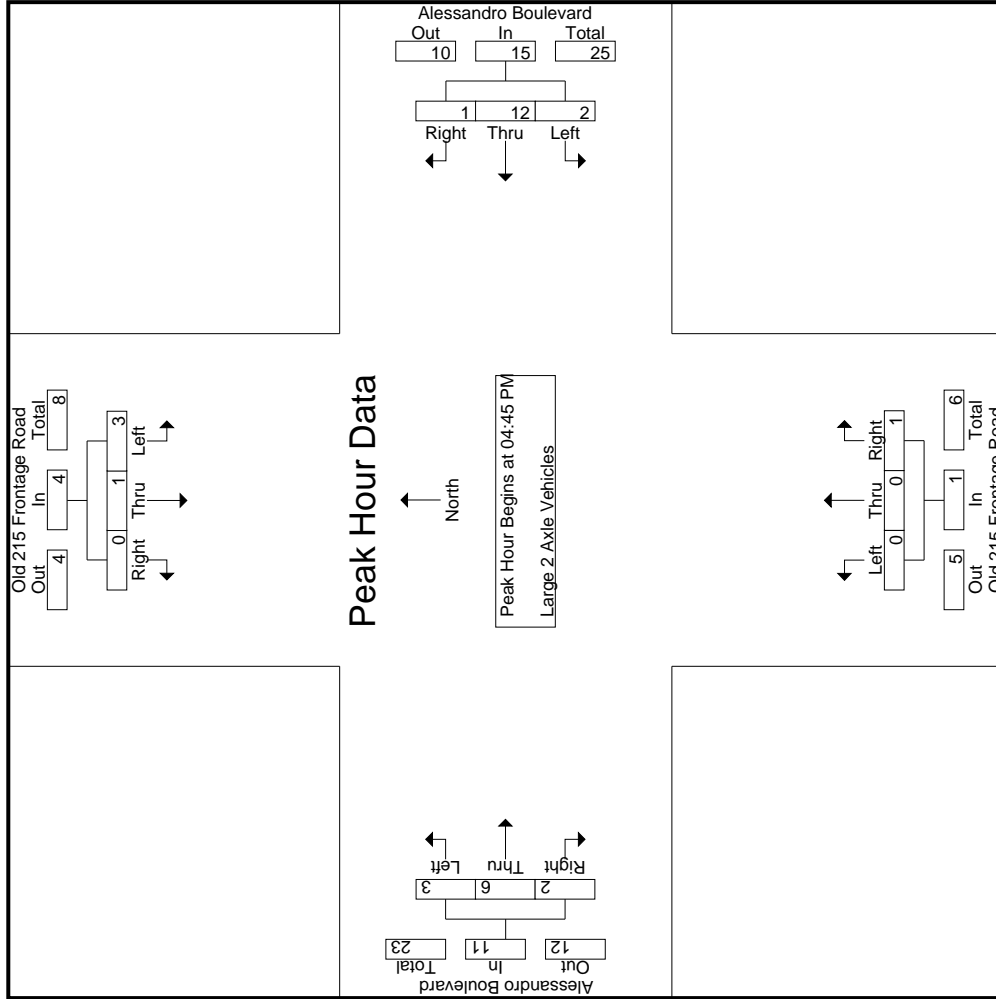

Counts Unlimited, Inc.
 PO Box 1178
 Corona, CA 92878
 (951)268-6268

County of Riverside
 N/S: Old 215 Frontage Road
 E/W: Alessandro Boulevard
 Weather: Clear

File Name : 31_CRV_Old 215_Ales PM
 Site Code : 05121716
 Start Date : 11/30/2021
 Page No : 3

Start Time	Old 215 Frontage Road Southbound			Alessandro Boulevard Westbound			Old 215 Frontage Road Northbound			Alessandro Boulevard Eastbound		
	Left	Thru	Right	Left	Thru	Right	Left	Thru	Right	Left	Thru	Right
Peak Hour Analysis From 04:45 PM to 05:30 PM - Peak 1 of 1												
Peak Hour for Each Approach Begins at:												
+0 mins.	0	0	0	0	5	0	5	0	0	0	0	1
+15 mins.	1	0	0	1	4	0	5	0	0	1	3	1
+30 mins.	2	0	0	2	2	0	2	0	0	1	1	0
+45 mins.	0	1	0	1	1	1	3	0	1	1	2	0
Total Volume	3	1	0	4	12	1	15	0	1	3	6	2
% App. Total	.75	.25	.00	.500	.600	.250	.750	.000	.250	.250	.500	.250
PHF	.375	.250	.000	.500	.600	.250	.750	.000	.250	.250	.500	.250
				04:45 PM	04:45 PM	04:45 PM	04:45 PM	04:45 PM	04:45 PM	04:45 PM	04:45 PM	04:45 PM
				13.3	80	6.7	15	0	100	27.3	54.5	18.2
				.500	.600	.250	.750	.000	.250	.750	.500	.500

Counts Unlimited, Inc.
 PO Box 1178
 Corona, CA 92878
 (951)268-6268

County of Riverside
 N/S: Old 215 Frontage Road
 E/W: Alessandro Boulevard
 Weather: Clear

File Name : 31_CRV_Old 215_Ales PM
 Site Code : 05121716
 Start Date : 11/30/2021
 Page No : 1

Groups Printed- 3 Axle Vehicles

Start Time	Old 215 Frontage Road Southbound					Alessandro Boulevard Westbound					Old 215 Frontage Road Northbound					Alessandro Boulevard Eastbound								
	Left	Thru	Right	RTOR	App. Total	Left	Thru	Right	RTOR	App. Total	Left	Thru	Right	RTOR	App. Total	Left	Thru	Right	RTOR	App. Total	Exclu. Total	Inclu. Total	Int. Total	
04:00 PM	0	0	0	0	0	0	0	0	0	0	0	0	0	0	0	0	0	0	0	0	0	0	0	0
04:15 PM	0	0	0	0	0	0	0	0	0	0	0	0	0	0	0	1	1	0	0	2	0	0	2	2
04:30 PM	0	0	0	0	0	0	0	0	0	1	0	0	0	0	1	0	0	0	0	0	0	0	2	2
04:45 PM	0	0	1	0	1	0	0	0	0	0	0	0	0	0	0	0	2	2	1	4	1	1	5	6
Total	0	0	1	0	1	0	1	0	0	1	0	0	0	0	1	3	2	1	6	1	1	9	10	10
05:00 PM	1	0	0	0	1	0	0	1	0	1	1	0	0	2	0	1	1	0	2	0	0	6	6	6
05:15 PM	1	0	0	0	1	0	2	0	0	2	0	1	0	1	0	1	0	0	1	0	0	5	5	5
05:30 PM	0	1	0	0	1	0	0	0	0	1	0	0	0	1	0	0	0	0	1	0	0	4	4	4
05:45 PM	0	1	0	0	1	0	1	0	0	1	1	0	0	1	0	1	0	0	1	0	0	4	4	4
Total	2	2	0	0	4	0	4	1	0	5	3	1	1	0	5	1	3	1	0	5	0	19	19	19
Grand Total	2	2	1	0	5	0	5	1	0	6	4	1	1	0	6	2	6	3	1	11	1	28	29	29
T-Approch %	40	40	20			0	83.3	16.7		21.4	66.7	16.7	16.7		18.2	54.5	27.3		39.3		3.4	96.6		
Total %	7.1	7.1	3.6		17.9	0	17.9	3.6		21.4	14.3	3.6	3.6		7.1	21.4	10.7							

Start Time	Old 215 Frontage Road Southbound					Alessandro Boulevard Westbound					Old 215 Frontage Road Northbound					Alessandro Boulevard Eastbound								
	Left	Thru	Right	RTOR	App. Total	Left	Thru	Right	RTOR	App. Total	Left	Thru	Right	RTOR	App. Total	Left	Thru	Right	RTOR	App. Total	Exclu. Total	Inclu. Total	Int. Total	
04:45 PM	0	0	0	0	0	0	0	0	0	0	0	0	0	0	0	0	0	0	0	0	0	0	0	0
05:00 PM	1	0	0	0	1	0	0	0	0	1	1	0	0	0	2	0	1	0	0	2	0	1	2	6
05:15 PM	1	0	0	0	1	0	0	0	0	2	0	0	1	0	1	0	1	0	0	1	0	0	1	5
05:30 PM	0	1	0	0	1	0	0	0	0	1	1	0	0	0	1	1	0	0	0	1	0	0	1	4
Total Volume	2	1	1	0	4	0	3	1	0	4	2	1	1	0	4	1	4	3	0	8	0	3	20	20
% App. Total	.500	.250	.250		1.00	.000	.375	.250		.500	.500	.250	.250		.500	.250	.500	.375		.500	.375	.500	.833	.833
PHF	.500	.250	.250		1.00	.000	.375	.250		.500	.500	.250	.250		.500	.250	.500	.375		.500	.375	.500	.833	.833

Peak Hour Analysis From 04:45 PM to 05:30 PM - Peak 1 of 1
 Peak Hour for Entire Intersection Begins at 04:45 PM

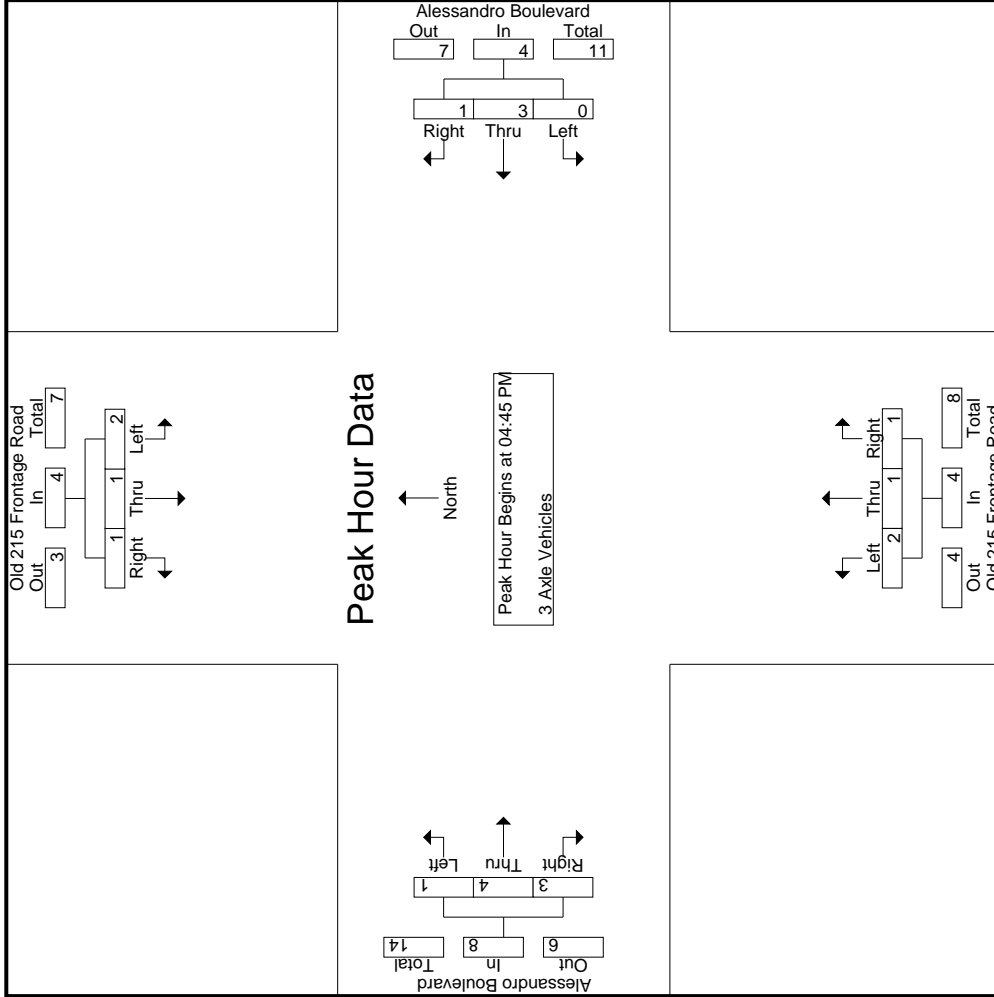

Counts Unlimited, Inc.
 PO Box 1178
 Corona, CA 92878
 (951)268-6268

County of Riverside
 N/S: Old 215 Frontage Road
 E/W: Alessandro Boulevard
 Weather: Clear

File Name : 31_CRV_Old 215_Ales PM
 Site Code : 05121716
 Start Date : 11/30/2021
 Page No : 3

Start Time	Old 215 Frontage Road Southbound			Alessandro Boulevard Westbound			Old 215 Frontage Road Northbound			Alessandro Boulevard Eastbound					
	Left	Thru	Right	Left	Thru	Right	Left	Thru	Right	Left	Thru	Right			
Peak Hour Analysis From 04:45 PM to 05:30 PM - Peak 1 of 1															
Peak Hour for Each Approach Begins at:	04:45 PM														
+0 mins.	0	0	1	0	0	0	0	0	0	0	0	0	2	2	4
+15 mins.	1	0	0	0	0	1	1	1	0	1	0	2	1	1	2
+30 mins.	1	0	0	0	0	2	0	0	1	0	1	1	1	0	1
+45 mins.	0	1	0	0	1	0	1	0	0	1	0	1	0	0	1
Total Volume	2	1	1	0	3	1	2	1	1	2	4	3	4	3	8
% App. Total	50	25	25	0	75	25	50	25	25	50	50	37.5	50	37.5	500
PHF	.500	.250	.250	.000	.375	.250	.500	.250	.250	.500	.375	.375	.500	.375	.500

Groups Printed- 4+ Axle Trucks

Start Time	Old 215 Frontage Road Southbound						Alessandro Boulevard Westbound						Old 215 Frontage Road Northbound						Alessandro Boulevard Eastbound							
	Left		Thru		Right		Left		Thru		Right		Left		Thru		Right		Left		Thru		Right			
	RTOR	App. Total	RTOR	App. Total	RTOR	App. Total	RTOR	App. Total	RTOR	App. Total	RTOR	App. Total	RTOR	App. Total	RTOR	App. Total	RTOR	App. Total	RTOR	App. Total	RTOR	App. Total	RTOR	App. Total		
04:00 PM	0	0	0	0	0	0	4	0	0	0	0	0	2	0	0	0	0	0	3	2	0	0	5	0	11	11
04:15 PM	2	0	0	0	2	0	0	0	0	0	0	0	2	0	0	0	0	0	2	3	0	0	5	0	10	10
04:30 PM	0	1	0	0	0	0	0	0	0	0	0	0	0	0	0	0	0	0	2	6	0	0	8	0	11	11
04:45 PM	0	1	0	0	1	0	1	0	0	0	0	0	2	0	0	0	0	0	3	3	0	0	8	0	12	12
Total	2	2	0	0	4	0	5	0	0	0	0	0	4	0	0	0	0	0	10	14	0	0	26	0	44	44
05:00 PM	0	4	0	0	0	0	1	0	0	0	0	0	0	0	0	0	0	0	3	2	0	0	5	0	11	11
05:15 PM	1	10	0	0	11	0	2	0	0	1	1	4	2	0	0	0	0	0	2	0	0	0	2	1	19	20
05:30 PM	0	4	0	0	4	0	4	1	0	0	0	0	2	0	0	0	0	0	0	5	1	5	5	1	18	19
05:45 PM	0	1	0	0	1	0	2	0	0	0	0	0	4	0	0	0	0	0	2	3	0	0	5	0	12	12
Total	1	19	0	0	20	0	9	1	0	1	1	13	4	1	1	1	13	0	7	10	1	17	2	60	62	
Grand Total	3	21	0	0	24	0	14	1	0	13	8	1	8	1	1	1	22	2	17	24	1	43	2	104	106	
% Approach	12.5	87.5	0	0	0	0	93.3	6.7	0	59.1	36.4	4.5	4.7	39.5	55.8	41.3	1.9	16.3	23.1	1.9	98.1	1.9	98.1			
% Total	2.9	20.2	0	0	23.1	0	13.5	1	14.4	12.5	7.7	1	1.9	16.3	23.1	41.3	1.9	16.3	23.1	1.9	98.1	1.9	98.1			

Start Time	Old 215 Frontage Road Southbound						Alessandro Boulevard Westbound						Old 215 Frontage Road Northbound						Alessandro Boulevard Eastbound						
	Left		Thru		Right		Left		Thru		Right		Left		Thru		Right		Left		Thru		Right		
	RTOR	App. Total	RTOR	App. Total	RTOR	App. Total	RTOR	App. Total	RTOR	App. Total	RTOR	App. Total	RTOR	App. Total	RTOR	App. Total	RTOR	App. Total	RTOR	App. Total	RTOR	App. Total	RTOR	App. Total	
04:45 PM	0	1	0	0	1	0	0	1	0	0	0	0	2	0	0	0	0	0	0	0	0	2	0	3	3
05:00 PM	0	4	0	0	4	0	0	0	0	1	1	4	1	0	0	0	0	0	0	0	0	1	0	2	5
05:15 PM	1	10	0	0	11	0	0	0	0	2	2	6	1	0	0	0	0	2	0	0	0	4	0	2	19
05:30 PM	0	4	0	0	4	0	4	1	0	0	0	0	2	0	0	0	0	0	0	0	0	2	0	5	18
Total	1	19	0	0	20	0	8	1	0	8	4	1	6	4	1	11	4	1	10	10	8	10	20	60	
% App. Total	.250	.475	.000	.455	.455	.000	.000	.500	.250	.450	.750	.500	.250	.688	.250	.667	.500	.250	.667	.500	.625	.625	.789		
PHF																									

Peak Hour Analysis From 04:45 PM to 05:30 PM - Peak 1 of 1
 Peak Hour for Entire Intersection Begins at 04:45 PM

Counts Unlimited, Inc.
 PO Box 1178
 Corona, CA 92878
 (951)268-6268

County of Riverside
 N/S: Old 215 Frontage Road
 E/W: Alessandro Boulevard
 Weather: Clear

File Name : 31_CRV_Old 215_Ales PM
 Site Code : 05121716
 Start Date : 11/30/2021
 Page No : 2

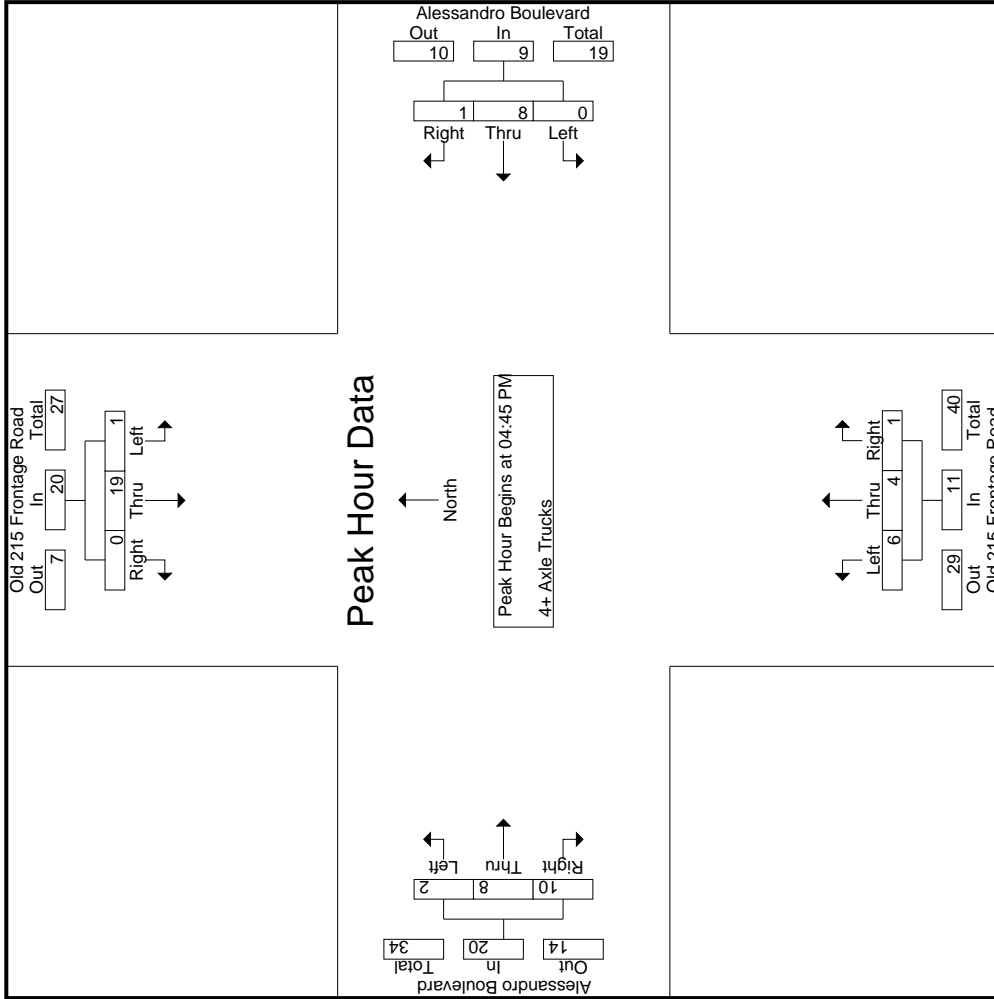

Counts Unlimited, Inc.
 PO Box 1178
 Corona, CA 92878
 (951)268-6268

County of Riverside
 N/S: Old 215 Frontage Road
 E/W: Alessandro Boulevard
 Weather: Clear

File Name : 31_CRV_Old 215_Ales PM
 Site Code : 05121716
 Start Date : 11/30/2021
 Page No : 3

Start Time	Old 215 Frontage Road Southbound			Alessandro Boulevard Westbound			Old 215 Frontage Road Northbound			Alessandro Boulevard Eastbound			Int. Total	
	Left	Thru	Right	Left	Thru	Right	Left	Thru	Right	Left	Thru	Right		App. Total
Peak Hour Analysis From 04:45 PM to 05:30 PM - Peak 1 of 1														
Peak Hour for Each Approach Begins at:														
	04:45 PM													
+0 mins.	0	1	0	0	1	0	0	0	0	2	2	3	3	8
+15 mins.	0	4	0	0	1	0	0	1	0	1	0	3	2	5
+30 mins.	1	10	0	0	2	0	2	1	1	4	0	2	0	2
+45 mins.	0	4	0	0	4	1	5	2	2	4	0	0	5	5
Total Volume	1	19	0	0	8	1	9	6	4	11	2	8	10	20
% App. Total	.250	.475	.000	.000	.450	.250	.450	.750	.500	.688	.250	.667	.500	.625
PHF														

Location: County of Riverside
 N/S: Old 215 Frontage Road
 E/W: Alessandro Boulevard



Date: 11/30/2021
 Day: Tuesday

PEDESTRIANS

	North Leg Old 215 Frontage Road Pedestrians	East Leg Alessandro Boulevard Pedestrians	South Leg Old 215 Frontage Road Pedestrians	West Leg Alessandro Boulevard Pedestrians
7:00 AM	0	0	0	0
7:15 AM	0	0	0	0
7:30 AM	0	0	0	0
7:45 AM	1	0	0	0
8:00 AM	0	0	0	0
8:15 AM	0	0	0	0
8:30 AM	0	0	0	0
8:45 AM	0	0	0	0
TOTAL VOLUMES:	1	0	0	0

	North Leg Old 215 Frontage Road Pedestrians	East Leg Alessandro Boulevard Pedestrians	South Leg Old 215 Frontage Road Pedestrians	West Leg Alessandro Boulevard Pedestrians
4:00 PM	0	0	0	0
4:15 PM	3	0	0	0
4:30 PM	1	0	0	1
4:45 PM	0	0	0	0
5:00 PM	0	0	0	0
5:15 PM	0	0	0	0
5:30 PM	0	0	0	0
5:45 PM	0	0	0	0
TOTAL VOLUMES:	4	0	0	4

Location: County of Riverside
 N/S: Old 215 Frontage Road
 E/W: Alessandro Boulevard

Date: 11/30/2021
 Day: Tuesday



BICYCLES

	Southbound Old 215 Frontage Road			Westbound Alessandro Boulevard			Northbound Old 215 Frontage Road			Eastbound Alessandro Boulevard		
	Left	Thru	Right	Left	Thru	Right	Left	Thru	Right	Left	Thru	Right
	7:00 AM	1	1	0	0	0	0	0	0	0	0	0
7:15 AM	0	0	0	0	0	0	0	0	0	0	0	0
7:30 AM	0	0	0	0	0	0	0	0	0	0	0	0
7:45 AM	0	0	0	0	0	0	0	0	0	0	0	0
8:00 AM	0	0	0	0	0	0	0	0	0	0	0	0
8:15 AM	0	0	0	0	0	0	0	0	0	0	0	0
8:30 AM	0	0	0	0	0	0	0	0	0	0	0	0
8:45 AM	0	0	0	0	0	0	0	0	0	0	0	0
TOTAL VOLUMES:	1	1	0	0	0	0	0	0	0	0	0	0

	Southbound Old 215 Frontage Road			Westbound Alessandro Boulevard			Northbound Old 215 Frontage Road			Eastbound Alessandro Boulevard		
	Left	Thru	Right	Left	Thru	Right	Left	Thru	Right	Left	Thru	Right
	4:00 PM	0	0	0	0	0	0	0	0	0	0	0
4:15 PM	0	0	0	0	0	0	0	0	0	0	0	0
4:30 PM	0	0	0	0	1	0	0	0	0	0	0	0
4:45 PM	0	0	0	0	0	0	0	2	0	0	0	1
5:00 PM	0	0	0	0	0	0	0	0	0	0	1	0
5:15 PM	0	0	0	0	0	0	0	0	0	0	0	0
5:30 PM	0	0	0	0	0	0	0	0	0	0	0	0
5:45 PM	0	0	0	0	0	0	0	0	0	0	0	0
TOTAL VOLUMES:	0	0	0	0	1	0	0	2	0	0	1	0

Groups Printed- Passenger Vehicles - Large 2 Axle Vehicles - 3 Axle Vehicles - 4+ Axle Trucks

Start Time	Day Street Southbound						Alessandro Boulevard Westbound						Day Street Northbound						Alessandro Boulevard Eastbound					
	Left		Thru		Right		Left		Thru		Right		Left		Thru		Right		Left		Thru		Right	
07:00 AM	7	12	17	11	36	4	265	6	2	275	0	5	1	0	6	11	98	0	0	109	13	426	439	
07:15 AM	15	13	27	10	55	6	229	20	4	255	1	9	4	3	14	16	108	0	0	124	17	448	465	
07:30 AM	17	5	15	7	37	2	228	20	8	250	0	28	2	1	30	24	136	4	0	164	16	481	497	
07:45 AM	16	9	16	9	41	2	255	25	10	282	1	34	5	4	40	31	160	2	1	193	24	556	580	
Total	55	39	75	37	169	14	977	71	24	1062	2	76	12	8	90	82	502	6	1	590	70	1911	1981	
08:00 AM	12	8	12	4	32	3	232	34	9	269	2	36	6	5	44	30	128	1	0	159	18	504	522	
08:15 AM	21	11	9	5	41	1	260	26	6	287	6	34	1	1	41	33	120	1	0	154	12	523	535	
08:30 AM	14	3	12	6	29	0	222	24	4	246	1	27	2	0	30	43	130	2	2	175	12	480	492	
08:45 AM	19	6	19	5	44	5	245	18	3	268	1	25	9	3	35	33	134	3	2	170	13	517	530	
Total	66	28	52	20	146	9	959	102	22	1070	10	122	18	9	150	139	512	7	4	658	55	2024	2079	
Grand Total	121	67	127	57	315	23	1936	173	46	2132	12	198	30	17	240	221	1014	13	5	1248	125	3935	4060	
% Approach	38.4	21.3	40.3			1.1	90.8	8.1			5	82.5	12.5			17.7	81.2	1						
% Total	3.1	1.7	3.2		8	0.6	49.2	4.4		54.2	0.3	5	0.8		6.1	5.6	25.8	0.3		31.7	3.1	96.9		
Passenger Vehicles	118	67	121		361	16	1874	170		2106	4	197	23		238	213	966	4		1186	0	0	3891	
% Passenger Vehicles	97.5	100	95.3		96.5	97	69.6	96.8		98.3	100	96.7	76.7		82.4	96.4	95.3	30.8		60	0	0	95.8	
Large 2 Axle Vehicles	3	0	2		5	5	32	2		39	3	1	6		13	7	26	2		36	0	0	93	
% Large 2 Axle Vehicles	2.5	0	1.6		1.3	21.7	1.7	1.2		1.8	25	0.5	20		17.6	3.2	2.6	15.4		20	2.9	0	2.3	
3 Axle Vehicles	0	0	3		5	2	8	1		11	0	0	0		0	1	4	0		5	0	0	21	
% 3 Axle Vehicles	0	0	2.4		1.3	8.7	0.4	0.6		0.5	0	0	0		0	0.5	0.4	0		0.4	0	0	0.5	
4+ Axle Trucks	0	0	1		1	0	22	0		22	5	0	1		6	0	18	7		26	0	0	55	
% 4+ Axle Trucks	0	0	0.8		0.3	0	1.1	0		1	41.7	0	3.3		2.3	0	1.8	53.8		20	2.1	0	1.4	

Start Time	Day Street Southbound						Alessandro Boulevard Westbound						Day Street Northbound						Alessandro Boulevard Eastbound					
	Left		Thru		Right		Left		Thru		Right		Left		Thru		Right		Left		Thru		Right	
07:30 AM	17	5	15		37	2	228	20		250	0	28	2		30	24	136	4		164	4	164	481	
07:45 AM	16	9	16		41	2	255	25		282	1	34	5		40	31	160	2		193	2	193	556	
08:00 AM	12	8	12		32	3	232	34		269	2	36	6		44	30	128	1		159	18	504	522	
08:15 AM	21	11	9		41	1	260	26		287	6	34	1		41	33	120	1		154	12	523	535	
Total	66	28	52		146	9	959	102		1070	10	122	18		150	139	512	7		658	55	2024	2079	
PHF	.786	.750	.750		.813	.667	.938	.772		.948	.375	.917	.583		.881	.894	.850	.850		.868	.850	.500	.928	

Peak Hour Analysis From 07:00 AM to 08:45 AM - Peak 1 of 1
 Peak Hour for Entire Intersection Begins at 07:30 AM

Counts Unlimited, Inc.
 PO Box 1178
 Corona, CA 92878
 (951)268-6268

City of Moreno Valley
 N/S: Day Street
 E/W: Alessandro Boulevard
 Weather: Clear

File Name : 32_MRV_Day_Ales AM
 Site Code : 05121716
 Start Date : 11/30/2021
 Page No : 2

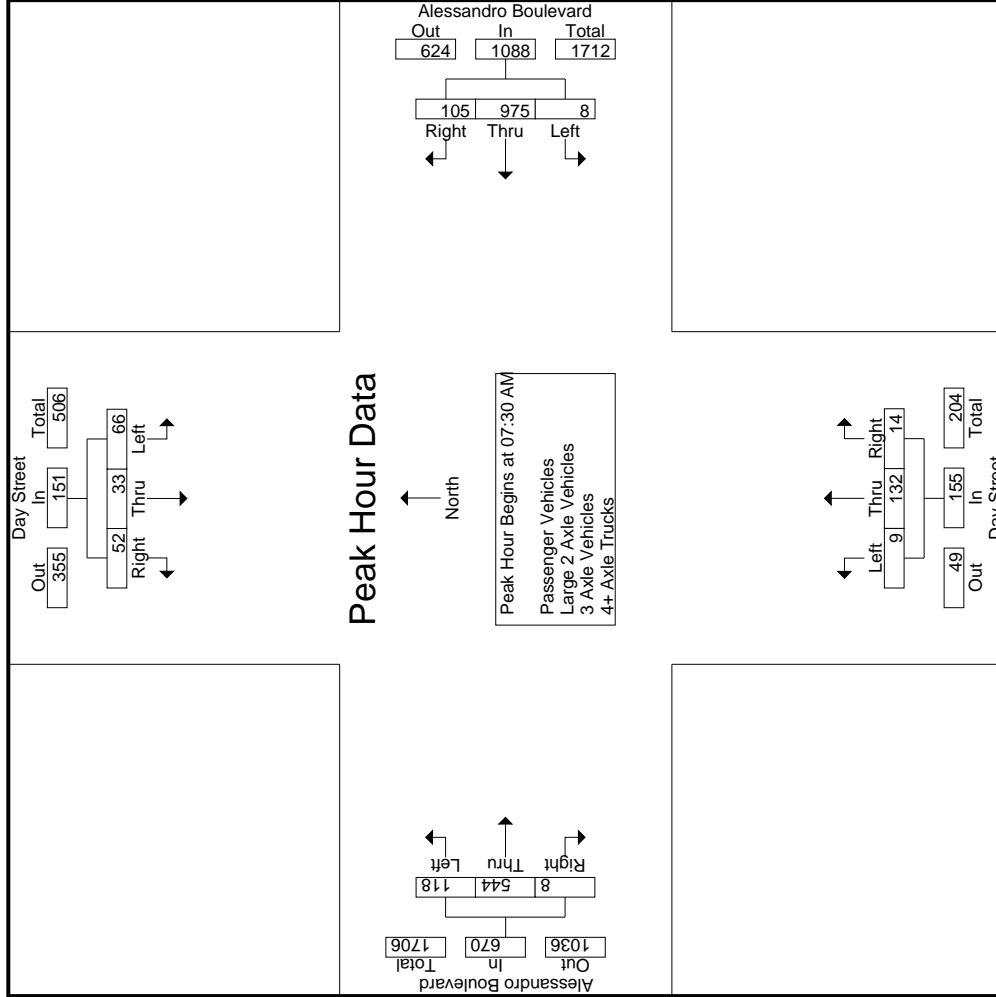

Counts Unlimited, Inc.
 PO Box 1178
 Corona, CA 92878
 (951)268-6268

City of Moreno Valley
 N/S: Day Street
 E/W: Alessandro Boulevard
 Weather: Clear

File Name : 32_MRV_Day_Ales AM
 Site Code : 05121716
 Start Date : 11/30/2021
 Page No : 3

Start Time	Day Street Southbound			Alessandro Boulevard Westbound			Day Street Northbound			Alessandro Boulevard Eastbound			Int. Total		
	Left	Thru	Right	Left	Thru	Right	Left	Thru	Right	Left	Thru	Right		App. Total	
Peak Hour Analysis From 07:00 AM to 08:45 AM - Peak 1 of 1	Peak Hour for Each Approach Begins at:														
	07:00 AM			07:30 AM			07:30 AM			07:45 AM					
+0 mins.	7	12	17	2	228	20	250	0	28	2	30	31	160	2	193
+15 mins.	15	13	27	2	255	25	282	1	34	5	40	30	128	1	159
+30 mins.	17	5	15	3	232	34	269	2	36	6	44	33	120	1	154
+45 mins.	16	9	16	1	260	26	287	6	34	1	41	43	130	2	175
Total Volume	55	39	75	8	975	105	1088	9	132	14	155	137	538	6	681
% App. Total	32.5	23.1	44.4	0.7	89.6	9.7	9.7	5.8	85.2	9	9	20.1	79	0.9	79
PHF	.809	.750	.694	.667	.938	.772	.948	.375	.917	.583	.881	.797	.841	.750	.882

Counts Unlimited, Inc.
 PO Box 1178
 Corona, CA 92878
 (951)268-6268

City of Moreno Valley
 N/S: Day Street
 E/W: Alessandro Boulevard
 Weather: Clear

File Name : 32_MRV_Day_Ales AM
 Site Code : 05121716
 Start Date : 11/30/2021
 Page No : 1

Groups Printed- Passenger Vehicles

Start Time	Day Street Southbound				Alessandro Boulevard Westbound				Day Street Northbound				Alessandro Boulevard Eastbound							
	Left	Thru	Right	RTOR	Left	Thru	Right	RTOR	Left	Thru	Right	RTOR	Left	Thru	Right	RTOR	App. Total	Exclu. Total	Inclu. Total	Int. Total
07:00 AM	6	12	17	11	35	262	2	6	5	1	0	0	6	11	93	0	104	13	407	420
07:15 AM	15	13	26	10	54	245	4	245	9	3	2	12	12	16	102	0	118	16	429	445
07:30 AM	17	5	15	7	37	243	8	243	28	2	1	30	30	22	133	1	156	16	466	482
07:45 AM	15	9	16	9	40	272	10	272	33	5	4	38	38	31	154	1	186	24	536	560
Total	53	39	74	37	166	1022	24	1022	75	11	7	86	86	80	482	2	564	69	1838	1907
08:00 AM	12	8	12	4	32	266	9	266	36	4	3	41	41	28	122	0	150	16	489	505
08:15 AM	20	11	7	4	38	281	6	281	34	1	1	36	36	32	113	0	145	11	500	511
08:30 AM	14	3	11	5	28	235	4	235	27	0	0	28	28	42	127	1	170	10	461	471
08:45 AM	19	6	17	5	42	256	3	256	25	7	3	33	33	31	122	1	154	12	485	497
Total	65	28	47	18	140	1038	22	1038	122	12	7	138	138	133	484	2	619	49	1935	1984
Grand Total	118	67	121	55	306	2060	46	2060	197	23	14	224	224	213	966	4	1183	118	3773	3891
T-Approch %	38.6	21.9	39.5						1.8	87.9	10.3			18	81.7	0.3				
ch Total %	3.1	1.8	3.2		8.1	54.6		54.6	0.1	5.2	0.6		5.9	5.6	25.6	0.1	31.4	3	97	

Start Time	Day Street Southbound				Alessandro Boulevard Westbound				Day Street Northbound				Alessandro Boulevard Eastbound							
	Left	Thru	Right	RTOR	Left	Thru	Right	RTOR	Left	Thru	Right	RTOR	Left	Thru	Right	RTOR	App. Total	Exclu. Total	Inclu. Total	Int. Total
07:30 AM	17	5	15		37	243	0	243	28	2			30	22	133	1	156			466
07:45 AM	15	9	16		40	272	0	272	33	5			38	31	154	1	186			536
08:00 AM	12	8	12		32	266	1	266	36	4			41	28	122	0	150			489
08:15 AM	20	11	7		38	281	1	281	34	1			36	32	113	0	145			500
Total Volume	64	33	50		147	1062	2	1062	131	12			145	113	522	2	637			1991
% App. Total	43.5	22.4	34		34	9.6	1.4	90.3	8.3				17.7	81.9	0.3					
PHF	.800	.750	.781		.919	.945	.500	.910	.600	.884	.847	.500	.856	.883	.847	.500	.856			.929

Peak Hour Analysis From 07:30 AM to 08:15 AM - Peak 1 of 1
 Peak Hour for Entire Intersection Begins at 07:30 AM

Counts Unlimited, Inc.
 PO Box 1178
 Corona, CA 92878
 (951)268-6268

City of Moreno Valley
 N/S: Day Street
 E/W: Alessandro Boulevard
 Weather: Clear

File Name : 32_MRV_Day_Ales AM
 Site Code : 05121716
 Start Date : 11/30/2021
 Page No : 2

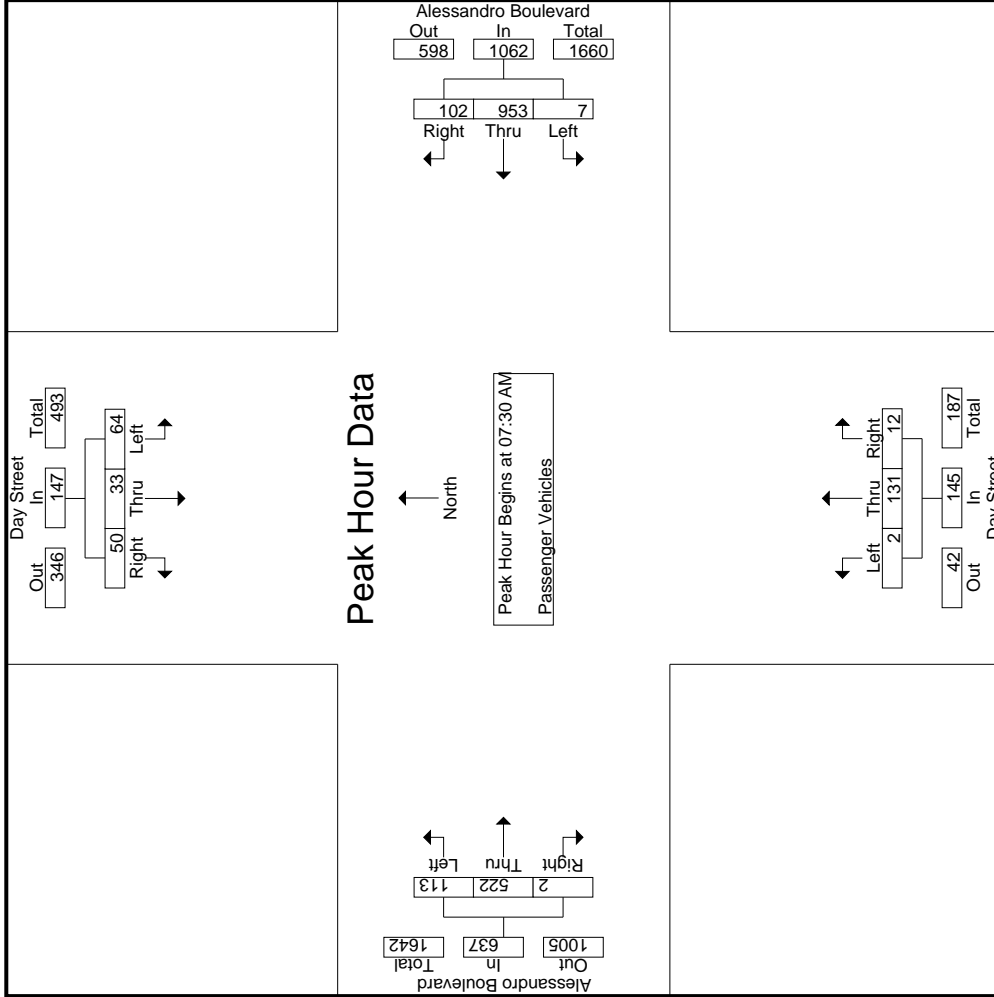

Counts Unlimited, Inc.
 PO Box 1178
 Corona, CA 92878
 (951)268-6268

City of Moreno Valley
 N/S: Day Street
 E/W: Alessandro Boulevard
 Weather: Clear

File Name : 32_MRV_Day_Ales AM
 Site Code : 05121716
 Start Date : 11/30/2021
 Page No : 3

Start Time	Day Street Southbound			Alessandro Boulevard Westbound			Day Street Northbound			Alessandro Boulevard Eastbound			Int. Total	
	Left	Thru	Right	Left	Thru	Right	Left	Thru	Right	Left	Thru	Right		App. Total
Peak Hour Analysis From 07:30 AM to 08:15 AM - Peak 1 of 1	07:30 AM													
Peak Hour for Each Approach Begins at:	07:30 AM													
+0 mins.	17	5	15	2	221	20	243	0	28	2	30	133	1	156
+15 mins.	15	9	16	1	247	24	272	0	33	5	38	154	1	186
+30 mins.	12	8	12	3	231	32	266	1	36	4	41	122	0	150
+45 mins.	20	11	7	1	254	26	281	1	34	1	36	32	0	145
Total Volume	64	33	50	7	953	102	1062	2	131	12	145	113	2	637
% App. Total	43.5	22.4	34	0.7	89.7	9.6	94.5	1.4	90.3	8.3	100.0	81.9	0.3	100.0
PHF	.800	.750	.781	.583	.938	.797	.945	.500	.910	.600	.884	.847	.500	.856

Groups Printed- Large 2 Axle Vehicles

Start Time	Day Street Southbound				Alessandro Boulevard Westbound				Day Street Northbound				Alessandro Boulevard Eastbound				Exclu. Total	Inclu. Total	Int. Total
	Left	Thru	Right	RTOR	Left	Thru	Right	RTOR	Left	Thru	Right	RTOR	Left	Thru	Right	RTOR			
07:00 AM	1	0	0	0	1	5	0	0	6	0	0	0	0	1	0	0	1	0	8
07:15 AM	0	0	1	0	3	2	0	0	5	1	0	1	2	0	4	0	4	1	12
07:30 AM	0	0	0	0	0	3	0	0	3	0	0	0	0	2	2	1	0	5	8
07:45 AM	1	0	0	0	1	4	1	0	6	0	1	0	1	0	4	0	4	0	12
Total	2	0	1	0	5	14	1	0	20	1	1	1	3	2	11	1	0	14	41
08:00 AM	0	0	0	0	0	1	1	0	2	1	0	2	3	2	5	0	0	7	14
08:15 AM	1	0	1	0	0	5	0	0	5	1	0	0	1	1	5	0	6	0	14
08:30 AM	0	0	0	0	0	6	0	0	6	0	1	0	1	0	2	0	2	0	9
08:45 AM	0	0	0	0	0	6	0	0	6	0	2	0	2	2	3	1	1	6	15
Total	1	0	1	0	0	18	1	0	19	2	0	5	7	5	15	1	1	21	52
Grand Total	3	0	2	0	5	32	2	0	39	3	1	6	3	7	26	2	1	35	89
T-Approch %	60	0	40		12.8	82.1	5.1		43.8	30	10	60	11.2	20	74.3	5.7		39.3	95.7
597	3.4	0	2.2		5.6	36	2.2		43.8	3.4	1.1	6.7	11.2	7.9	29.2	2.2		4.3	95.7

Start Time	Day Street Southbound				Alessandro Boulevard Westbound				Day Street Northbound				Alessandro Boulevard Eastbound				Exclu. Total	Inclu. Total	Int. Total
	Left	Thru	Right	RTOR	Left	Thru	Right	RTOR	Left	Thru	Right	RTOR	Left	Thru	Right	RTOR			
07:30 AM	0	0	0	0	0	3	0	0	3	0	0	0	0	0	0	0	0	0	5
07:45 AM	1	0	0	0	1	4	1	0	6	0	1	0	1	0	4	0	0	4	12
08:00 AM	0	0	0	0	0	1	1	0	2	1	0	2	3	2	5	0	0	7	12
08:15 AM	1	0	1	0	2	0	0	0	5	1	0	0	1	1	5	0	0	6	14
Total	2	0	1	0	3	13	2	0	16	2	1	2	5	5	16	1	1	22	46
% App. Total	66.7	0	33.3		6.2	81.2	12.5		43.8	40	20	40	11.2	22.7	72.7	4.5		4.3	95.7
PHF	.500	.000	.250		.250	.650	.500		.667	.500	.250	.250	.417	.625	.800	.250		.786	.821

Peak Hour Analysis From 07:30 AM to 08:15 AM - Peak 1 of 1
 Peak Hour for Entire Intersection Begins at 07:30 AM

Counts Unlimited, Inc.
 PO Box 1178
 Corona, CA 92878
 (951)268-6268

City of Moreno Valley
 N/S: Day Street
 E/W: Alessandro Boulevard
 Weather: Clear

File Name : 32_MRV_Day_Ales AM
 Site Code : 05121716
 Start Date : 11/30/2021
 Page No : 2

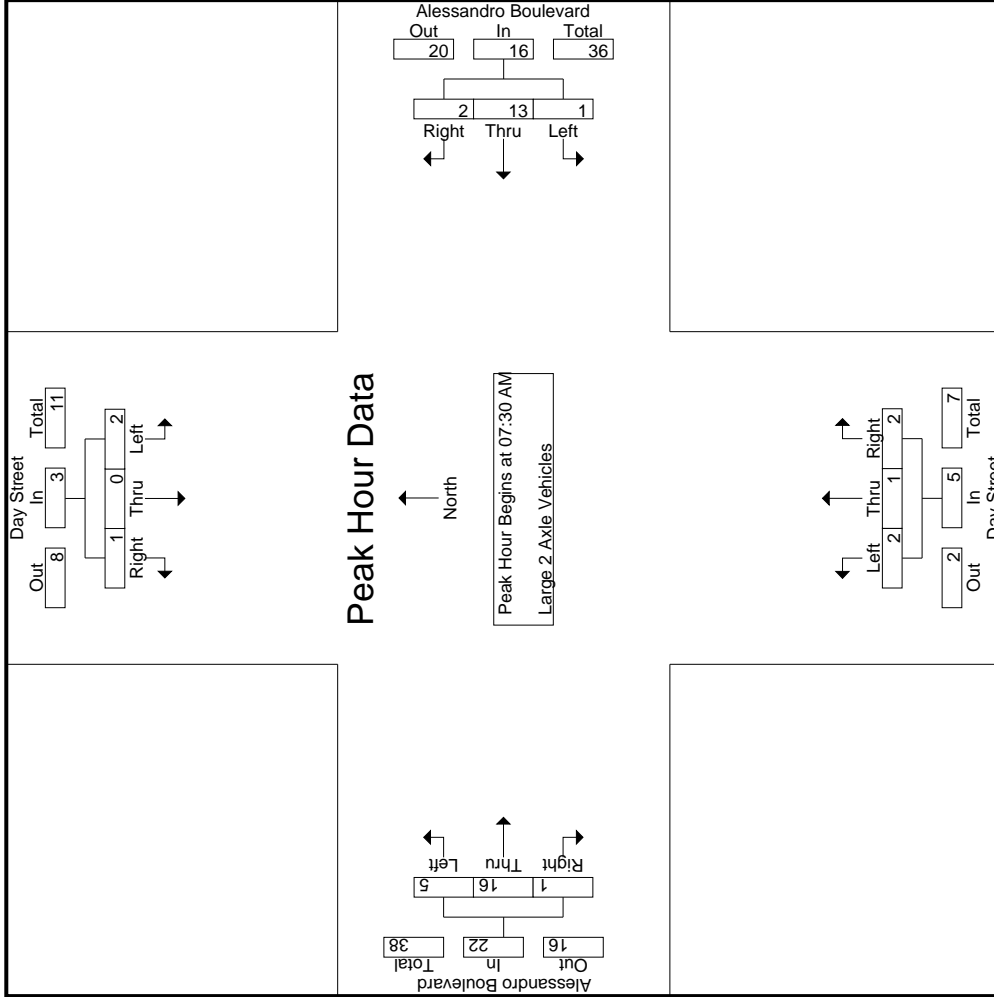

Counts Unlimited, Inc.
 PO Box 1178
 Corona, CA 92878
 (951)268-6268

City of Moreno Valley
 N/S: Day Street
 E/W: Alessandro Boulevard
 Weather: Clear

File Name : 32_MRV_Day_Ales AM
 Site Code : 05121716
 Start Date : 11/30/2021
 Page No : 3

Start Time	Day Street Southbound			Alessandro Boulevard Westbound			Day Street Northbound			Alessandro Boulevard Eastbound			Int. Total	
	Left	Thru	Right	Left	Thru	Right	Left	Thru	Right	Left	Thru	Right		App. Total
Peak Hour Analysis From 07:30 AM to 08:15 AM - Peak 1 of 1														
Peak Hour for Each Approach Begins at:														
	07:30 AM			07:30 AM			07:30 AM			07:30 AM				
+0 mins.	0	0	0	0	3	0	0	0	0	0	2	2	1	5
+15 mins.	1	0	0	1	4	1	0	1	0	1	0	4	0	4
+30 mins.	0	0	0	0	1	1	0	0	2	3	2	5	0	7
+45 mins.	1	0	1	0	5	0	1	0	0	1	1	5	0	6
Total Volume	2	0	1	1	13	2	1	2	2	5	5	16	1	22
% App. Total	66.7	0	33.3	6.2	81.2	12.5	40	20	40	22.7	72.7	4.5	4.5	
PHF	.500	.000	.250	.250	.650	.500	.500	.250	.250	.625	.800	.250	.786	

Counts Unlimited, Inc.
 PO Box 1178
 Corona, CA 92878
 (951)268-6268

City of Moreno Valley
 N/S: Day Street
 E/W: Alessandro Boulevard
 Weather: Clear

File Name : 32_MRV_Day_Ales AM
 Site Code : 05121716
 Start Date : 11/30/2021
 Page No : 1

Groups Printed- 3 Axle Vehicles

Start Time	Day Street Southbound				Alessandro Boulevard Westbound				Day Street Northbound				Alessandro Boulevard Eastbound				Exclu. Total	Inclu. Total	Int. Total
	Left	Thru	Right	RTOR	Left	Thru	Right	RTOR	Left	Thru	Right	RTOR	Left	Thru	Right	RTOR			
07:00 AM	0	0	0	0	0	0	0	0	2	0	0	0	0	0	0	0	0	2	
07:15 AM	0	0	0	0	1	1	0	0	2	0	0	0	0	1	0	0	1	3	
07:30 AM	0	0	0	0	0	2	0	0	2	0	0	0	0	0	0	0	0	2	
07:45 AM	0	0	0	0	2	0	0	0	2	0	0	0	0	0	0	0	0	2	
Total	0	0	0	0	1	7	0	0	8	0	0	0	0	1	0	0	1	9	
08:00 AM	0	0	0	0	0	0	1	0	1	0	0	0	0	0	0	0	0	1	
08:15 AM	0	0	1	1	0	0	0	0	0	0	0	0	0	1	0	0	1	2	
08:30 AM	0	0	1	1	1	0	0	0	1	0	0	0	1	1	0	0	2	4	
08:45 AM	0	0	1	0	1	0	0	0	1	0	0	0	0	1	0	0	1	3	
Total	0	0	3	2	3	1	1	0	3	0	0	0	0	1	3	0	4	12	
Grand Total	0	0	3	2	3	2	8	1	11	0	0	0	0	1	4	0	5	21	
% Apprch %	0	0	100		18.2	72.7	9.1		57.9	0	0	0	0	20	80	0	26.3	90.5	
% Total %	0	0	15.8		10.5	42.1	5.3			0	0	0	0	5.3	21.1	0	9.5	90.5	

Start Time	Day Street Southbound				Alessandro Boulevard Westbound				Day Street Northbound				Alessandro Boulevard Eastbound				Exclu. Total	Inclu. Total	Int. Total
	Left	Thru	Right	RTOR	Left	Thru	Right	RTOR	Left	Thru	Right	RTOR	Left	Thru	Right	RTOR			
07:30 AM	0	0	0	0	0	0	0	0	0	0	0	0	0	0	0	0	0	0	
07:45 AM	0	0	0	0	0	2	0	0	2	0	0	0	0	0	0	0	0	2	
08:00 AM	0	0	0	0	0	0	1	0	1	0	0	0	0	0	0	0	0	1	
08:15 AM	0	0	1	1	0	0	0	0	0	0	0	0	0	0	0	0	0	1	
Total Volume	0	0	1	1	0	4	1	0	5	0	0	0	0	0	1	0	1	7	
% App. Total	0	0	100		0	80	20		.625	0	0	0	0	.250	.250	0	.250	.875	
PHF	.000	.000	.250		.000	.500	.250		.625	.000	.000	.000	.000	.250	.000	.250	.250	.875	

Peak Hour Analysis From 07:30 AM to 08:15 AM - Peak 1 of 1
 Peak Hour for Entire Intersection Begins at 07:30 AM

Counts Unlimited, Inc.
 PO Box 1178
 Corona, CA 92878
 (951)268-6268

City of Moreno Valley
 N/S: Day Street
 E/W: Alessandro Boulevard
 Weather: Clear

File Name : 32_MRV_Day_Ales AM
 Site Code : 05121716
 Start Date : 11/30/2021
 Page No : 2

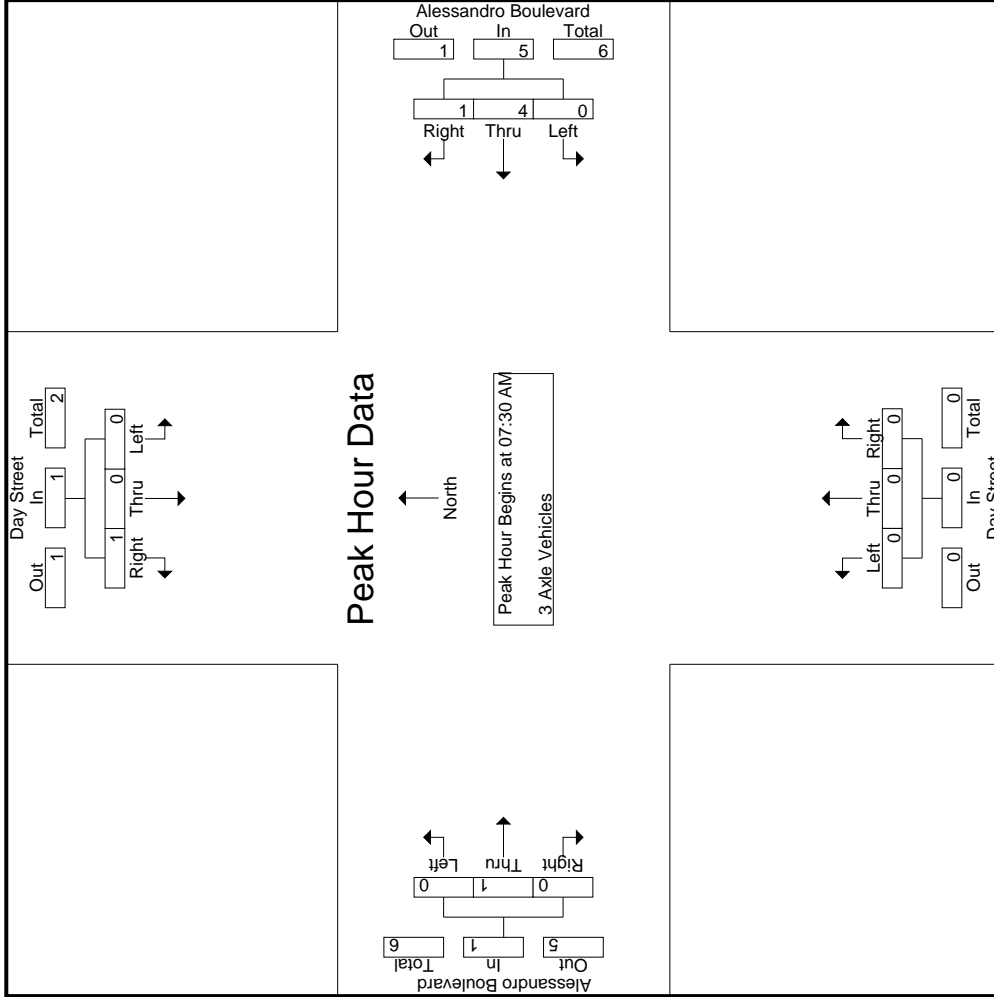

Counts Unlimited, Inc.
 PO Box 1178
 Corona, CA 92878
 (951)268-6268

City of Moreno Valley
 N/S: Day Street
 E/W: Alessandro Boulevard
 Weather: Clear

File Name : 32_MRV_Day_Ales AM
 Site Code : 05121716
 Start Date : 11/30/2021
 Page No : 3

Start Time	Day Street Southbound			Alessandro Boulevard Westbound			Day Street Northbound			Alessandro Boulevard Eastbound			Int. Total	
	Left	Thru	Right	Left	Thru	Right	Left	Thru	Right	Left	Thru	Right		App. Total
Peak Hour Analysis From 07:30 AM to 08:15 AM - Peak 1 of 1	07:30 AM													
Peak Hour for Each Approach Begins at:	07:30 AM													
+0 mins.	0	0	0	0	2	0	0	2	0	0	0	0	0	0
+15 mins.	0	0	0	0	2	0	0	2	0	0	0	0	0	0
+30 mins.	0	0	0	0	0	1	0	1	0	0	0	0	0	0
+45 mins.	0	0	1	0	0	0	0	0	0	0	0	1	0	1
Total Volume	0	0	1	0	4	1	0	5	0	0	0	1	0	1
% App. Total	0	0	100	0	80	20	0	100	0	0	0	100	0	0
PHF	.000	.000	.250	.000	.500	.250	.000	.625	.000	.000	.250	.000	.000	.250

Counts Unlimited, Inc.
 PO Box 1178
 Corona, CA 92878
 (951)268-6268

City of Moreno Valley
 N/S: Day Street
 E/W: Alessandro Boulevard
 Weather: Clear

File Name : 32_MRV_Day_Ales AM
 Site Code : 05121716
 Start Date : 11/30/2021
 Page No : 1

Groups Printed- 4+ Axle Trucks

Start Time	Day Street Southbound				Alessandro Boulevard Westbound				Day Street Northbound				Alessandro Boulevard Eastbound				Exclu. Total	Inclu. Total	Int. Total		
	Left	Thru	Right	RTOR	App. Total	Left	Thru	Right	RTOR	App. Total	Left	Thru	Right	RTOR	App. Total	Left				Thru	Right
07:00 AM	0	0	0	0	0	0	5	0	0	0	0	0	0	0	0	4	0	0	0	0	9
07:15 AM	0	0	0	0	0	3	0	0	0	0	0	0	0	0	0	1	0	0	0	0	4
07:30 AM	0	0	0	0	0	2	0	0	0	0	0	0	0	0	0	3	0	0	0	0	5
07:45 AM	0	0	0	0	0	2	0	0	0	0	1	0	0	0	0	3	0	0	0	0	6
Total	0	0	0	0	0	12	0	0	0	0	1	0	0	0	0	11	0	0	0	0	24
08:00 AM	0	0	0	0	0	0	0	0	0	0	0	0	0	0	0	2	0	0	0	0	2
08:15 AM	0	0	0	0	0	1	0	0	0	0	4	0	0	0	0	2	0	0	0	0	7
08:30 AM	0	0	0	0	0	4	0	0	0	1	0	0	0	0	0	1	0	0	0	0	6
08:45 AM	0	0	1	0	0	5	0	0	0	0	0	0	0	0	0	9	0	0	0	0	15
Total	0	0	1	0	0	10	0	0	0	1	0	0	0	0	0	14	0	0	0	0	30
Grand Total	0	0	1	0	0	22	0	0	0	0	1	0	0	0	0	25	0	0	0	0	54
T-Approch %	0	0	100			100	0			83.3	0	16.7			0	72	0	28		1.8	98.2
Total %	0	0	1.9			40.7	0			9.3	0	1.9			0	33.3	0	13			

Start Time	Day Street Southbound				Alessandro Boulevard Westbound				Day Street Northbound				Alessandro Boulevard Eastbound				Exclu. Total	Inclu. Total	Int. Total		
	Left	Thru	Right	RTOR	App. Total	Left	Thru	Right	RTOR	App. Total	Left	Thru	Right	RTOR	App. Total	Left				Thru	Right
07:30 AM	0	0	0	0	0	0	2	0	0	0	0	0	0	0	0	0	0	0	0	0	0
07:45 AM	0	0	0	0	0	2	0	0	0	0	0	0	0	0	0	1	0	0	0	0	3
08:00 AM	0	0	0	0	0	0	0	0	0	0	0	0	0	0	0	0	0	0	0	0	2
08:15 AM	0	0	0	0	0	0	1	0	0	0	4	0	0	0	0	4	0	0	0	0	7
Total Volume	0	0	0	0	0	0	5	0	0	5	0	0	0	0	5	0	5	0	0	0	10
% App. Total	0	0	0	0	0	100	0	0	0	100	0	0	0	0	50	0	50	0	0	0	100
PHF	.000	.000	.000	.000	.000	.000	.625	.000	.000	.313	.000	.000	.000	.000	.313	.000	.625	.000	.000	.625	.833

Peak Hour Analysis From 07:30 AM to 08:15 AM - Peak 1 of 1
 Peak Hour for Entire Intersection Begins at 07:30 AM

Counts Unlimited, Inc.
 PO Box 1178
 Corona, CA 92878
 (951)268-6268

City of Moreno Valley
 N/S: Day Street
 E/W: Alessandro Boulevard
 Weather: Clear

File Name : 32_MRV_Day_Ales AM
 Site Code : 05121716
 Start Date : 11/30/2021
 Page No : 2

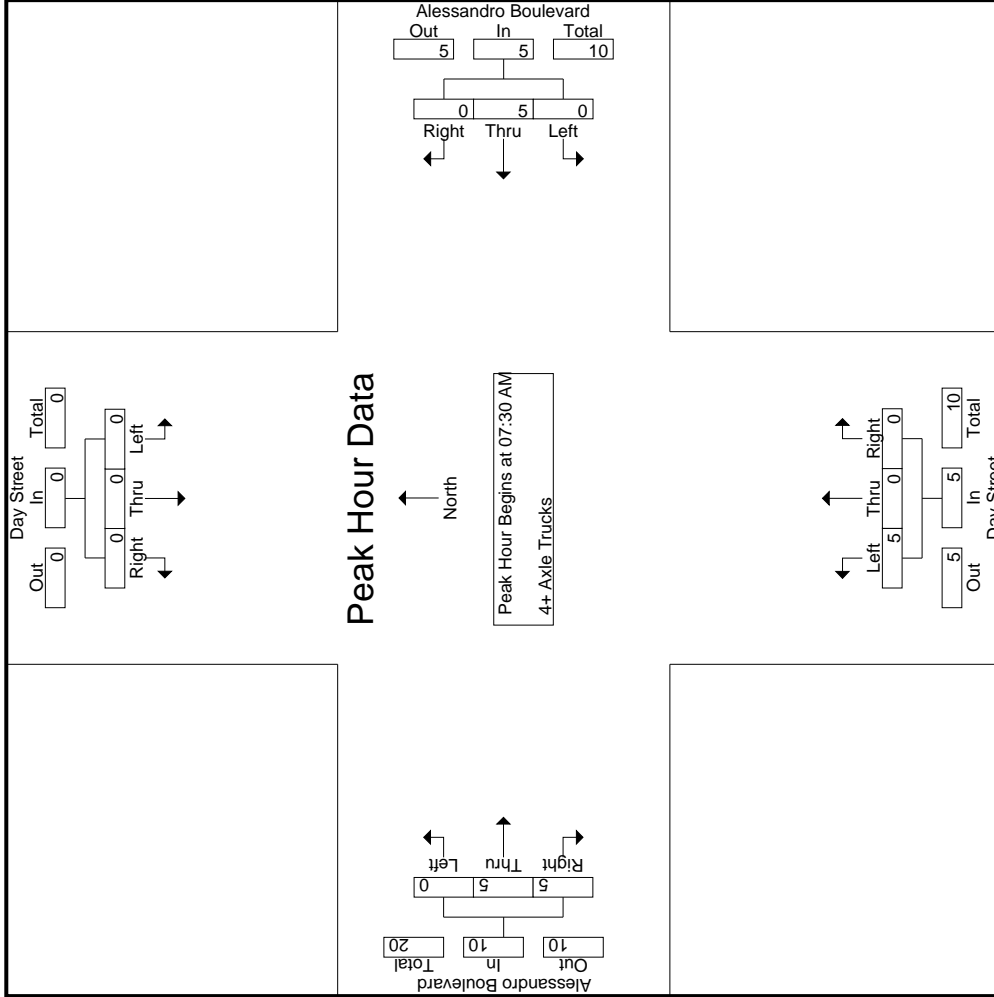

Counts Unlimited, Inc.
 PO Box 1178
 Corona, CA 92878
 (951)268-6268

City of Moreno Valley
 N/S: Day Street
 E/W: Alessandro Boulevard
 Weather: Clear

File Name : 32_MRV_Day_Ales AM
 Site Code : 05121716
 Start Date : 11/30/2021
 Page No : 3

Start Time	Day Street Southbound			Alessandro Boulevard Westbound			Day Street Northbound			Alessandro Boulevard Eastbound			Int. Total	
	Left	Thru	Right	Left	Thru	Right	Left	Thru	Right	Left	Thru	Right		App. Total
Peak Hour Analysis From 07:30 AM to 08:15 AM - Peak 1 of 1	07:30 AM													
Peak Hour for Each Approach Begins at:	07:30 AM													
+0 mins.	0	0	0	0	2	0	0	0	0	0	0	1	2	3
+15 mins.	0	0	0	0	2	0	0	0	0	1	0	2	1	3
+30 mins.	0	0	0	0	0	0	0	0	0	0	0	1	1	2
+45 mins.	0	0	0	0	1	0	0	0	0	4	0	1	1	2
Total Volume	0	0	0	0	5	0	0	0	0	5	0	5	5	10
% App. Total	0	0	0	0	100	0	0	0	0	100	0	50	50	
PHF	.000	.000	.000	.000	.625	.000	.000	.000	.000	.313	.000	.625	.625	.833

Counts Unlimited, Inc.
 PO Box 1178
 Corona, CA 92878
 (951)268-6268

File Name : 32_MRV_Day_Ales PM
 Site Code : 05121716
 Start Date : 11/30/2021
 Page No : 1

City of Moreno Valley
 N/S: Day Street
 E/W: Alessandro Boulevard
 Weather: Clear

Groups Printed- Passenger Vehicles - Large 2 Axle Vehicles - 3 Axle Vehicles - 4+ Axle Trucks

Start Time	Day Street Southbound						Alessandro Boulevard Westbound						Day Street Northbound						Alessandro Boulevard Eastbound					
	Left		Thru		Right		Left		Thru		Right		Left		Thru		Right		Left		Thru		Right	
		RTOR		RTOR		RTOR		RTOR		RTOR		RTOR		RTOR		RTOR		RTOR		RTOR		RTOR		RTOR
04:00 PM	38	25	18	3	81	2	219	52	16	273	3	30	3	1	36	38	286	1	0	325	20	715	735	
04:15 PM	44	19	25	4	88	1	193	31	14	225	5	40	3	1	48	39	281	1	0	321	19	682	701	
04:30 PM	35	17	20	3	72	4	217	27	10	248	4	30	2	1	36	41	270	2	1	313	16	669	685	
04:45 PM	40	23	20	6	83	2	189	57	25	248	3	36	3	1	42	51	336	5	4	392	36	765	801	
Total	157	84	83	16	324	9	818	167	65	994	15	136	11	5	162	169	1173	9	5	1351	91	2831	2922	
05:00 PM	35	22	18	8	75	4	232	45	18	281	4	35	4	2	43	41	328	7	1	376	29	775	804	
05:15 PM	53	32	32	7	117	4	201	31	12	236	4	30	3	1	37	51	383	3	0	437	20	827	847	
05:30 PM	73	55	34	9	162	2	208	40	16	250	4	33	1	1	38	47	325	6	2	378	28	828	856	
05:45 PM	56	25	31	12	112	1	143	25	8	169	2	15	7	3	24	33	356	2	1	391	24	696	720	
Total	217	134	115	36	466	11	784	141	54	936	14	113	15	7	142	172	1392	18	4	1582	101	3126	3227	
Grand Total	374	218	198	52	790	20	1602	308	119	1930	29	249	26	12	304	341	2565	27	9	2933	192	5957	6149	
% Approach	47.3	27.6	25.1			1	83	16		9.5	81.9	8.6			11.6	87.5	0.9			0.9	3.1	96.9		
% Total	6.3	3.7	3.3		13.3	0.3	26.9	5.2		32.4	0.5	4.2	0.4		5.1	5.7	43.1	0.5		49.2	0	0	6035	
Passenger Vehicles	372	214	196		834	20	1567	308		2014	22	248	25		306	339	2513	22		2881	0	0	6035	
Large 2 Axle Vehicles	99.5	98.2	99	100	99	100	97.8	100	100	98.3	75.9	99.6	96.2	91.7	96.8	99.4	98	81.5	77.8	97.9	0	0	98.1	
% Large 2 Axle Vehicles	1	3	1	5	0.6	0	1.2	0	0	0.9	3.4	0.4	0	0	0.6	1	23	5	31	0	0	0	57	
% 3 Axle Vehicles	0.3	1.4	0.5	0	0.1	0	0.3	0	0	0.2	0.5	0	0	0	0.3	0.3	0.9	18.5	22.2	1.1	0	0	0.9	
% 3 Axle Vehicles	0	1	0	0	0.1	0	0.3	0	0	0.2	3.4	0	3.8	8.3	0.9	0	0.4	0	0	0.3	0	0	0.3	
4+ Axle Trucks	1	0	1	0	0.1	0	0.3	0	0	0.2	3.4	0	3.8	8.3	0.9	0	0.4	0	0	0.3	0	0	0.3	
% 4+ Axle Trucks	0.3	0	0.5	0	0.2	0	0.7	0	0	0.5	17.2	0	0	0	1.6	0.3	0.8	0	0	0.7	0	0	0.6	

Start Time	Day Street Southbound						Alessandro Boulevard Westbound						Day Street Northbound						Alessandro Boulevard Eastbound					
	Left		Thru		Right		Left		Thru		Right		Left		Thru		Right		Left		Thru		Right	
		RTOR		RTOR		RTOR		RTOR		RTOR		RTOR		RTOR		RTOR		RTOR		RTOR		RTOR		RTOR
04:45 PM	40	23	20	83		2	189	57		248	3	36	3		42	51	336	5		392	765			
05:00 PM	35	22	18	75		4	232	45		281	4	35	4		43	41	328	7		376	775			
05:15 PM	53	32	32	117		4	201	31		236	4	30	3		37	51	383	3		437	827			
05:30 PM	73	55	34	162		2	189	57		248	4	36	3		38	47	325	6		378	828			
Total Volume	201	132	104	437		12	830	173		1015	15	134	11		160	190	1372	21		1583	3195			
% App. Total	46	30.2	23.8			1.2	81.8	17		9.4	9.4	83.8	6.9		12	86.7	1.3							
PHF	.688	.600	.765	.674		.750	.894	.759		.903	.938	.931	.688		.930	.931	.896	.750		.906	.965			

Peak Hour Analysis From 04:00 PM to 05:45 PM - Peak 1 of 1
 Peak Hour for Entire Intersection Begins at 04:45 PM

Counts Unlimited, Inc.
 PO Box 1178
 Corona, CA 92878
 (951)268-6268

City of Moreno Valley
 N/S: Day Street
 E/W: Alessandro Boulevard
 Weather: Clear

File Name : 32_MRV_Day_Ales PM
 Site Code : 05121716
 Start Date : 11/30/2021
 Page No : 2

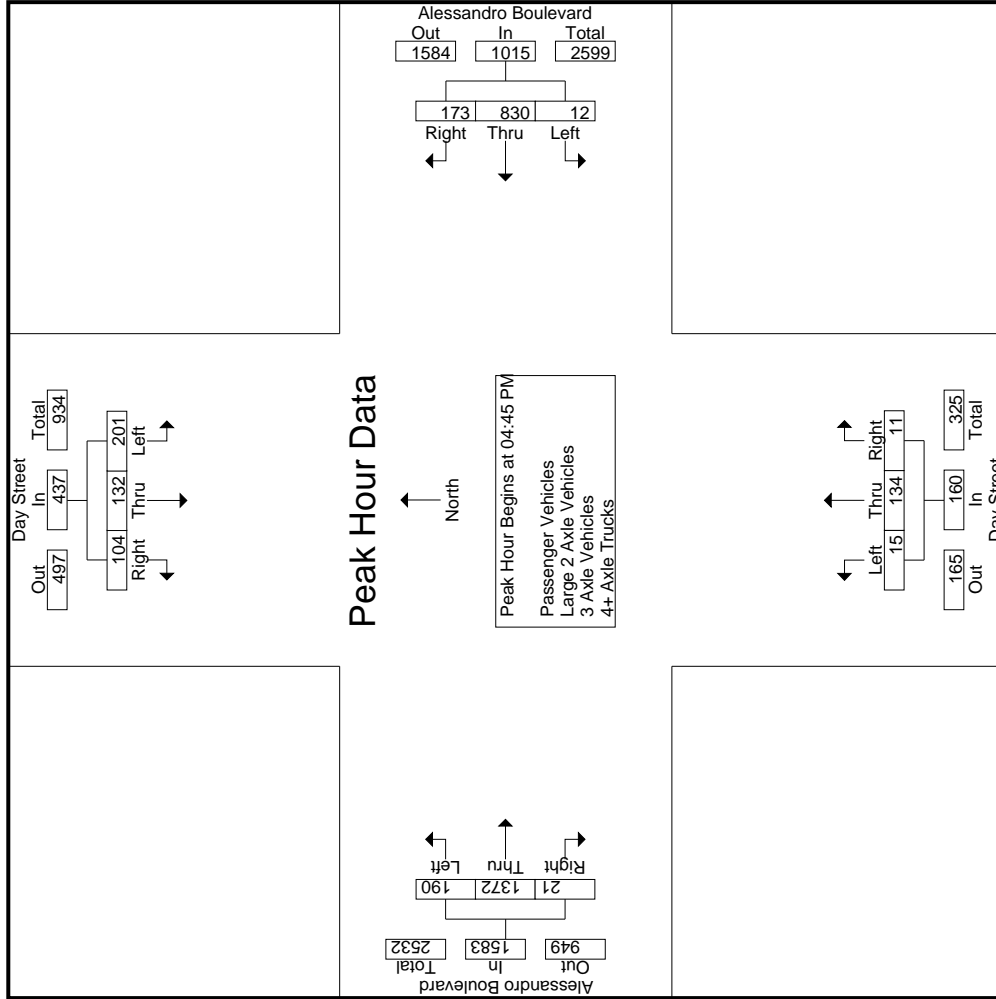

Counts Unlimited, Inc.
 PO Box 1178
 Corona, CA 92878
 (951)268-6268

City of Moreno Valley
 N/S: Day Street
 E/W: Alessandro Boulevard
 Weather: Clear

File Name : 32_MRV_Day_Ales PM
 Site Code : 05121716
 Start Date : 11/30/2021
 Page No : 3

Start Time	Day Street Southbound			Alessandro Boulevard Westbound			Day Street Northbound			Alessandro Boulevard Eastbound			Int. Total		
	Left	Thru	Right	Left	Thru	Right	Left	Thru	Right	Left	Thru	Right		App. Total	
Peak Hour Analysis From 04:00 PM to 05:45 PM - Peak 1 of 1	Peak Hour for Each Approach Begins at:														
	05:00 PM			04:45 PM			04:15 PM			04:45 PM					
+0 mins.	35	22	18	2	189	57	248	5	40	3	48	51	336	5	392
+15 mins.	53	32	32	4	232	45	281	4	30	2	36	41	328	7	376
+30 mins.	73	55	34	4	201	31	236	3	36	3	42	51	383	3	437
+45 mins.	56	25	31	2	208	40	250	4	35	4	43	47	325	6	378
Total Volume	217	134	115	12	830	173	1015	16	141	12	169	190	1372	21	1583
% App. Total	46.6	28.8	24.7	1.2	81.8	17	9.5	83.4	7.1	7.1	12	86.7	86.7	1.3	90.6
PHF	.743	.609	.846	.750	.894	.759	.903	.800	.881	.750	.880	.931	.896	.750	.906

Counts Unlimited, Inc.
 PO Box 1178
 Corona, CA 92878
 (951)268-6268

City of Moreno Valley
 N/S: Day Street
 E/W: Alessandro Boulevard
 Weather: Clear

File Name : 32_MRV_Day_Ales_PM
 Site Code : 05121716
 Start Date : 11/30/2021
 Page No : 1

Groups Printed- Passenger Vehicles

Start Time	Day Street Southbound					Alessandro Boulevard Westbound					Day Street Northbound					Alessandro Boulevard Eastbound							
	Left	Thru	Right	RTOR	App. Total	Left	Thru	Right	RTOR	App. Total	Left	Thru	Right	RTOR	App. Total	Left	Thru	Right	RTOR	App. Total	Exclu. Total	Inclu. Total	Int. Total
04:00 PM	38	23	18	3	79	2	212	52	16	266	3	30	3	1	36	38	281	1	0	320	20	701	721
04:15 PM	44	19	25	4	88	1	191	31	14	223	4	39	3	1	46	38	275	1	0	314	19	671	690
04:30 PM	35	17	20	3	72	4	212	27	10	243	2	30	2	2	34	41	263	1	1	305	16	654	670
04:45 PM	39	23	20	6	82	2	187	57	25	246	2	36	2	0	40	51	331	3	2	385	33	753	786
Total	156	82	83	16	321	9	802	167	65	978	11	135	10	4	156	168	1150	6	3	1324	88	2779	2867
05:00 PM	35	22	18	8	75	4	226	45	18	275	3	35	4	2	42	41	319	6	1	366	29	758	787
05:15 PM	52	32	31	7	115	4	196	31	12	231	3	30	3	1	36	50	371	3	0	424	20	806	826
05:30 PM	73	53	33	9	159	2	203	40	16	245	3	33	1	1	37	47	322	5	2	374	28	815	843
05:45 PM	56	25	31	12	112	1	140	25	8	166	2	15	7	3	24	33	351	2	1	386	24	688	712
Total	216	132	113	36	461	11	765	141	54	917	11	113	15	7	139	171	1363	16	4	1550	101	3067	3168
Grand Total	372	214	196	52	782	20	1567	308	119	1895	22	248	25	11	295	339	2513	22	7	2874	189	5846	6035
T-Approch %	47.6	27.4	25.1			1.1	82.7	16.3		32.4	7.5	84.1	8.5		11.8	87.4	0.8			49.2	3.1	96.9	
on Total %	6.4	3.7	3.4		13.4	0.3	26.8	5.3			0.4	4.2	0.4		5	5.8	43	0.4					

Start Time	Day Street Southbound					Alessandro Boulevard Westbound					Day Street Northbound					Alessandro Boulevard Eastbound							
	Left	Thru	Right	RTOR	App. Total	Left	Thru	Right	RTOR	App. Total	Left	Thru	Right	RTOR	App. Total	Left	Thru	Right	RTOR	App. Total	Exclu. Total	Inclu. Total	Int. Total
04:45 PM	39	23	20		82	2	187	57		246	2	36	2		40	51	331	3		385			753
05:00 PM	35	22	18		75	4	226	45		275	3	35	4		42	41	319	6		366			758
05:15 PM	52	32	31		115	4	196	31		231	3	30	3		36	50	371	3		424			806
05:30 PM	73	53	33		159	2	203	40		245	3	33	1		37	47	322	5		374			815
Total Volume	199	130	102		431	12	812	173		997	11	134	10		155	189	1343	17		1549			3132
% App. Total	46.2	30.2	23.7			1.2	81.4	17.4		32.4	7.1	86.5	6.5		49.2	12.2	86.7	1.1					961
PHF	.682	.613	.773		.678	.750	.898	.759		.906	.917	.931	.625		.923	.926	.905	.708					

Peak Hour Analysis From 04:45 PM to 05:30 PM - Peak 1 of 1
 Peak Hour for Entire Intersection Begins at 04:45 PM

Counts Unlimited, Inc.
 PO Box 1178
 Corona, CA 92878
 (951)268-6268

City of Moreno Valley
 N/S: Day Street
 E/W: Alessandro Boulevard
 Weather: Clear

File Name : 32_MRV_Day_Ales PM
 Site Code : 05121716
 Start Date : 11/30/2021
 Page No : 2

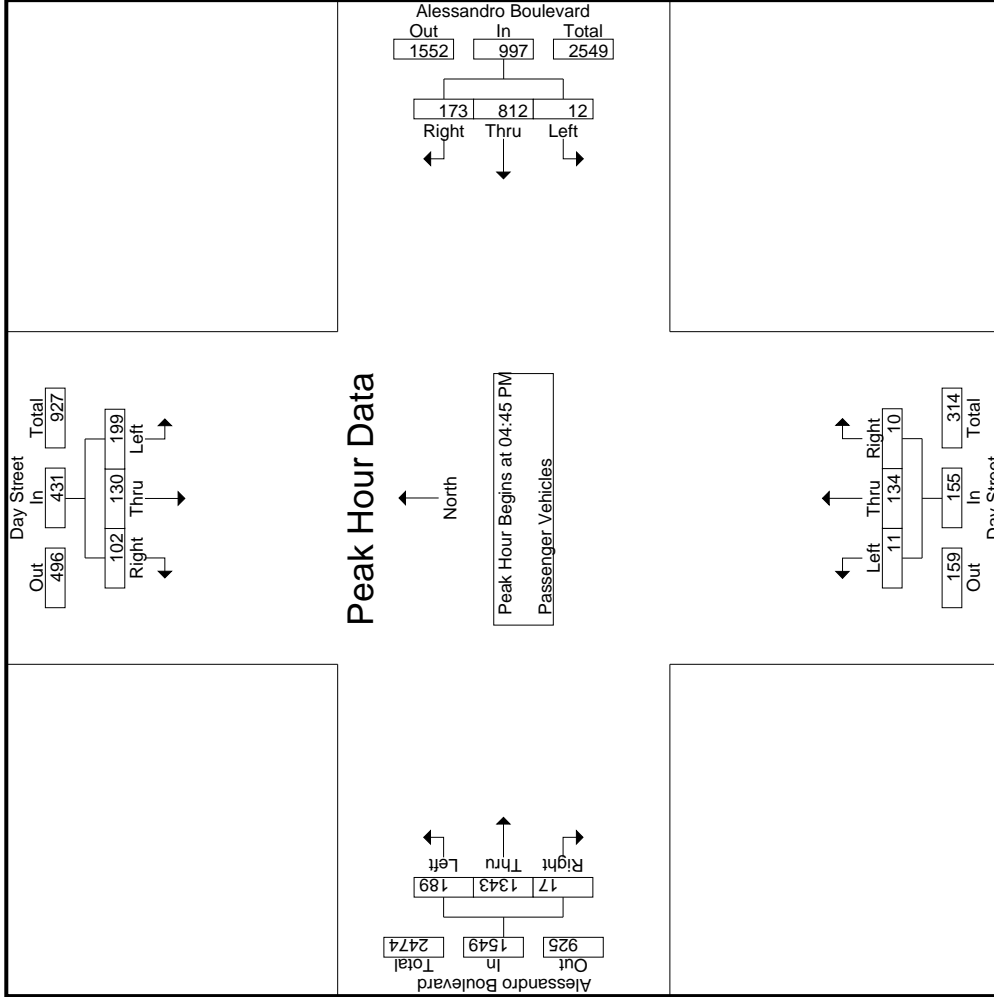

Counts Unlimited, Inc.
 PO Box 1178
 Corona, CA 92878
 (951)268-6268

City of Moreno Valley
 N/S: Day Street
 E/W: Alessandro Boulevard
 Weather: Clear

File Name : 32_MRV_Day_Ales PM
 Site Code : 05121716
 Start Date : 11/30/2021
 Page No : 3

Start Time	Day Street Southbound			Alessandro Boulevard Westbound			Day Street Northbound			Alessandro Boulevard Eastbound			Int. Total			
	Left	Thru	Right	Left	Thru	Right	Left	Thru	Right	Left	Thru	Right		App. Total		
Peak Hour Analysis From 04:45 PM to 05:30 PM - Peak 1 of 1																
Peak Hour for Each Approach Begins at:																
	04:45 PM			04:45 PM			04:45 PM			04:45 PM						
+0 mins.	39	23	20	2	187	57	2	246	2	36	2	40	51	331	3	385
+15 mins.	35	22	18	4	226	45	3	275	3	35	4	42	41	319	6	366
+30 mins.	52	32	31	4	196	31	3	231	3	30	3	36	50	371	3	424
+45 mins.	73	53	33	2	203	40	3	245	3	33	1	37	47	322	5	374
Total Volume	199	130	102	12	812	173	11	997	11	134	10	155	189	1343	17	1549
% App. Total	46.2	30.2	23.7	1.2	81.4	17.4	7.1	86.5	6.5	86.5	6.5	12.2	86.7	86.7	1.1	91.3
PHF	.682	.613	.773	.750	.898	.759	.917	.906	.931	.625	.625	.923	.926	.905	.708	.913

Groups Printed- Large 2 Axle Vehicles

Start Time	Day Street Southbound					Alessandro Boulevard Westbound					Day Street Northbound					Alessandro Boulevard Eastbound							
	Left	Thru	Right	RTOR	App. Total	Left	Thru	Right	RTOR	App. Total	Left	Thru	Right	RTOR	App. Total	Left	Thru	Right	RTOR	App. Total	Exclu. Total	Inclu. Total	Int. Total
04:00 PM	0	1	0	0	1	0	5	0	0	5	0	0	0	0	0	0	2	0	0	2	0	8	8
04:15 PM	0	0	0	0	0	0	2	0	0	2	0	1	0	0	1	1	2	0	0	3	0	6	6
04:30 PM	0	0	0	0	0	0	3	0	0	3	1	0	0	1	1	0	4	1	0	5	0	9	9
04:45 PM	1	0	0	0	1	0	2	0	0	2	0	0	0	2	2	0	1	2	2	3	2	6	8
Total	1	1	0	0	2	0	12	0	0	12	1	1	0	0	2	1	9	3	2	13	2	29	31
05:00 PM	0	0	0	0	0	0	3	0	0	3	0	0	0	0	0	0	3	1	0	4	0	7	7
05:15 PM	0	0	1	0	1	0	1	0	0	1	0	0	0	0	0	0	5	0	0	5	0	7	7
05:30 PM	0	2	0	0	2	0	2	0	0	2	0	0	0	0	0	0	3	1	0	4	0	8	8
05:45 PM	0	0	0	0	0	0	1	0	0	1	0	0	0	0	0	0	3	0	0	3	0	4	4
Total	0	2	1	0	3	0	7	0	0	7	0	0	0	0	0	0	14	2	0	16	0	26	26
Grand Total	1	3	1	0	5	0	19	0	0	19	1	1	0	0	2	1	23	5	2	29	2	55	57
T-Approch %	20	60	20			0	100	0		34.5	50	50	0		3.6	3.4	79.3	17.2		52.7	3.5	96.5	
on Total %	1.8	5.5	1.8		9.1	0	34.5	0			1.8	1.8	0			1.8	41.8	9.1					

Start Time	Day Street Southbound					Alessandro Boulevard Westbound					Day Street Northbound					Alessandro Boulevard Eastbound							
	Left	Thru	Right	RTOR	App. Total	Left	Thru	Right	RTOR	App. Total	Left	Thru	Right	RTOR	App. Total	Left	Thru	Right	RTOR	App. Total	Exclu. Total	Inclu. Total	Int. Total
04:45 PM	1	0	0	0	1	0	2	0	0	2	0	0	0	0	0	0	1	2	0	3	0	3	6
05:00 PM	0	0	0	0	0	0	3	0	0	3	0	0	0	0	0	0	3	1	0	4	1	4	7
05:15 PM	0	0	0	0	0	0	1	0	0	1	0	0	0	0	0	0	5	0	0	5	0	5	7
05:30 PM	0	2	0	0	2	0	2	0	0	2	0	0	0	0	0	0	3	1	0	4	1	4	8
Total Volume	1	2	0	0	3	0	8	0	0	8	0	0	0	0	0	0	12	4	0	16	2	28	28
% App. Total	25	50	25			0	100	0		66.7	0	0	0		0	0	75	25		800	50	875	
PHF	.250	.250	.250		.500	.000	.667	.000		.667	.000	.000	.000		.000	.000	.600	.500		.800	.500	.875	

Peak Hour Analysis From 04:45 PM to 05:30 PM - Peak 1 of 1
 Peak Hour for Entire Intersection Begins at 04:45 PM

Counts Unlimited, Inc.
 PO Box 1178
 Corona, CA 92878
 (951)268-6268

City of Moreno Valley
 N/S: Day Street
 E/W: Alessandro Boulevard
 Weather: Clear

File Name : 32_MRV_Day_Ales PM
 Site Code : 05121716
 Start Date : 11/30/2021
 Page No : 2

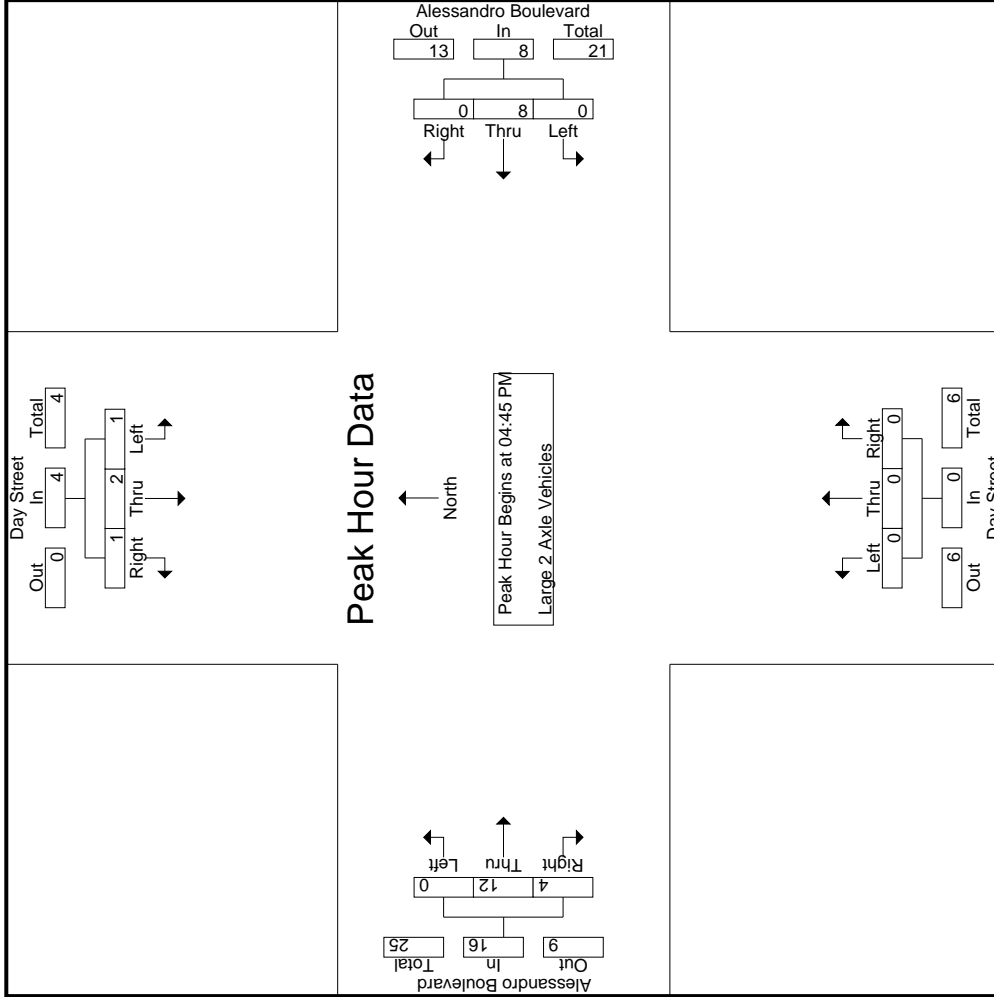

Start Time	Day Street Southbound			Alessandro Boulevard Westbound			Day Street Northbound			Alessandro Boulevard Eastbound			Int. Total	
	Left	Thru	Right	Left	Thru	Right	Left	Thru	Right	Left	Thru	Right		App. Total
Peak Hour Analysis From 04:45 PM to 05:30 PM - Peak 1 of 1														
Peak Hour for Each Approach Begins at:														
	04:45 PM			04:45 PM			04:45 PM			04:45 PM				
+0 mins.	1	0	0	1	0	0	2	0	0	0	0	1	2	3
+15 mins.	0	0	0	0	3	0	3	0	0	0	0	3	1	4
+30 mins.	0	0	1	0	1	0	1	0	0	0	0	5	0	5
+45 mins.	0	2	0	2	2	0	2	0	0	0	0	3	1	4
Total Volume	1	2	1	4	8	0	8	0	0	0	0	12	4	16
% App. Total	.25	.50	.25	.50	.100	.0	.667	.0	.0	.0	.0	.75	.25	.800
PHF	.250	.250	.250	.500	.000	.000	.667	.000	.000	.000	.000	.600	.500	.800

Groups Printed- 3 Axle Vehicles

Start Time	Day Street Southbound				Alessandro Boulevard Westbound				Day Street Northbound				Alessandro Boulevard Eastbound											
	Left	Thru	Right	RTOR	App. Total	Left	Thru	Right	RTOR	App. Total	Left	Thru	Right	RTOR	App. Total	Left	Thru	Right	RTOR	App. Total	Exclu. Total	Inclu. Total	Int. Total	
04:00 PM	0	1	0	0	1	0	0	0	0	0	0	0	0	0	0	0	0	0	0	0	0	1	1	1
04:15 PM	0	0	0	0	0	0	0	0	0	0	0	0	0	0	0	0	1	0	0	0	0	0	1	1
04:30 PM	0	0	0	0	0	0	0	0	0	1	0	0	0	0	0	0	0	0	0	0	0	0	1	1
04:45 PM	0	0	0	0	0	0	0	0	0	0	0	1	1	1	1	0	2	0	0	0	2	1	3	4
Total	0	1	0	0	1	0	1	0	0	1	0	0	1	1	1	0	3	0	0	0	3	1	6	7
05:00 PM	0	0	0	0	0	0	2	0	0	2	0	0	0	0	0	0	3	0	0	0	3	0	5	5
05:15 PM	0	0	0	0	0	0	0	0	0	0	1	0	0	0	1	0	3	0	0	0	3	0	4	4
05:30 PM	0	0	0	0	0	2	0	0	0	2	0	0	0	0	0	0	0	0	0	0	0	0	2	2
05:45 PM	0	0	0	0	0	0	0	0	0	0	0	0	0	0	0	0	0	0	0	0	0	0	0	0
Total	0	0	0	0	0	4	0	0	0	4	1	0	0	0	1	0	6	0	0	0	6	0	11	11
Grand Total	0	1	0	0	1	0	5	0	0	5	1	0	1	1	2	0	9	0	0	0	9	1	17	18
T-Approch %	0	100	0	0	0	0	100	0	0	50	0	0	50	0	0	0	100	0	0	0	52.9	5.6	94.4	
on Total %	0	5.9	0	0	5.9	0	29.4	0	0	29.4	5.9	0	5.9	0	11.8	0	52.9	0	0	0	52.9	5.6	94.4	

Start Time	Day Street Southbound				Alessandro Boulevard Westbound				Day Street Northbound				Alessandro Boulevard Eastbound											
	Left	Thru	Right	RTOR	App. Total	Left	Thru	Right	RTOR	App. Total	Left	Thru	Right	RTOR	App. Total	Left	Thru	Right	RTOR	App. Total	Exclu. Total	Inclu. Total	Int. Total	
04:45 PM	0	0	0	0	0	0	0	0	0	0	0	0	0	0	0	0	2	0	0	0	0	0	2	3
05:00 PM	0	0	0	0	0	0	2	0	0	2	0	0	0	0	0	0	3	0	0	0	3	0	3	5
05:15 PM	0	0	0	0	0	0	0	0	0	0	1	0	0	0	0	0	3	0	0	0	3	0	3	4
05:30 PM	0	0	0	0	0	0	2	0	0	2	0	0	0	0	0	0	0	0	0	0	0	0	0	2
Total Volume	0	0	0	0	0	0	4	0	0	4	1	0	1	1	2	0	8	0	0	0	8	0	8	14
% App. Total	0	0	0	0	0	0	100	0	0	100	50	0	50	0	100	0	100	0	0	0	100	0	100	100
PHF	.000	.000	.000	.000	.000	.000	.500	.000	.000	.500	.250	.000	.250	.000	.500	.000	.667	.000	.000	.667	.000	.667	.700	.700

Peak Hour Analysis From 04:45 PM to 05:30 PM - Peak 1 of 1
 Peak Hour for Entire Intersection Begins at 04:45 PM

Counts Unlimited, Inc.
 PO Box 1178
 Corona, CA 92878
 (951)268-6268

City of Moreno Valley
 N/S: Day Street
 E/W: Alessandro Boulevard
 Weather: Clear

File Name : 32_MRV_Day_Ales PM
 Site Code : 05121716
 Start Date : 11/30/2021
 Page No : 2

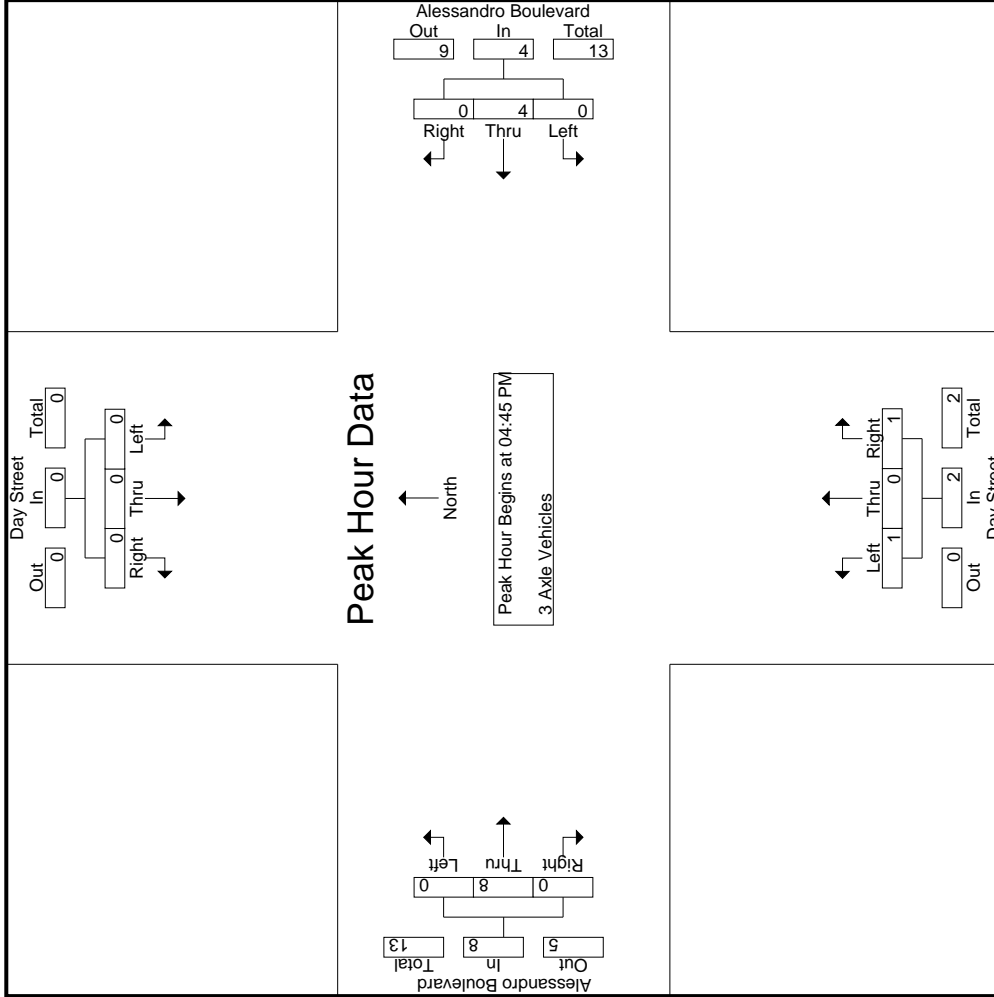

Counts Unlimited, Inc.
 PO Box 1178
 Corona, CA 92878
 (951)268-6268

City of Moreno Valley
 N/S: Day Street
 E/W: Alessandro Boulevard
 Weather: Clear

File Name : 32_MRV_Day_Ales PM
 Site Code : 05121716
 Start Date : 11/30/2021
 Page No : 3

Start Time	Day Street Southbound			Alessandro Boulevard Westbound			Day Street Northbound			Alessandro Boulevard Eastbound			Int. Total
	Left	Thru	Right	Left	Thru	Right	Left	Thru	Right	Left	Thru	Right	
Peak Hour Analysis From 04:45 PM to 05:30 PM - Peak 1 of 1													
Peak Hour for Each Approach Begins at:													
	04:45 PM			04:45 PM			04:45 PM			04:45 PM			
+0 mins.	0	0	0	0	0	0	0	0	0	1	2	0	2
+15 mins.	0	0	0	0	2	0	0	0	0	0	3	0	3
+30 mins.	0	0	0	0	0	0	1	0	0	0	3	0	3
+45 mins.	0	0	0	0	2	0	0	0	0	0	0	0	0
Total Volume	0	0	0	0	4	0	1	0	1	2	8	0	8
% App. Total	0	0	0	0	100	0	50	0	50	.500	100	0	.667
PHF	.000	.000	.000	.000	.500	.000	.250	.000	.250	.500	.667	.000	.667

Groups Printed- 4+ Axle Trucks

Start Time	Day Street Southbound				Alessandro Boulevard Westbound				Day Street Northbound				Alessandro Boulevard Eastbound				Exclu. Total	Inclu. Total	Int. Total
	Left	Thru	Right	RTOR	Left	Thru	Right	RTOR	Left	Thru	Right	RTOR	Left	Thru	Right	RTOR			
04:00 PM	0	0	0	0	0	2	0	0	0	0	0	0	0	3	0	0	3	0	5
04:15 PM	0	0	0	0	0	0	0	0	0	1	0	0	1	0	3	0	3	0	4
04:30 PM	0	0	0	0	0	1	0	0	0	1	0	0	0	3	0	0	3	0	5
04:45 PM	0	0	0	0	0	0	0	0	0	1	0	0	1	0	2	0	2	0	3
Total	0	0	0	0	0	3	0	0	0	3	0	0	3	0	11	0	11	0	17
05:00 PM	0	0	0	0	0	1	0	0	0	1	0	0	1	0	3	0	3	0	5
05:15 PM	1	0	0	1	0	4	0	0	0	0	0	0	1	4	0	0	5	0	10
05:30 PM	0	0	1	0	1	1	0	0	0	1	0	0	0	0	0	0	0	0	3
05:45 PM	0	0	0	0	0	2	0	0	0	2	0	0	0	2	0	0	2	0	4
Total	1	0	1	0	2	8	0	0	0	2	0	0	2	1	9	0	10	0	22
Grand Total	1	0	1	0	2	11	0	0	0	5	0	0	5	1	20	0	21	0	39
Approch %	50	0	50		0	100	0		100	0	0		12.8	4.8	95.2	0	53.8	0	100
Total %	2.6	0	2.6		0	28.2	0		12.8	0	0		12.8	2.6	51.3	0	53.8	0	100

Start Time	Day Street Southbound				Alessandro Boulevard Westbound				Day Street Northbound				Alessandro Boulevard Eastbound				Exclu. Total	Inclu. Total	Int. Total
	Left	Thru	Right	RTOR	Left	Thru	Right	RTOR	Left	Thru	Right	RTOR	Left	Thru	Right	RTOR			
04:45 PM	0	0	0	0	0	0	0	0	0	0	0	0	0	0	0	0	0	0	0
05:00 PM	0	0	0	0	0	1	0	0	1	0	0	0	0	1	0	0	2	0	3
05:15 PM	1	0	0	0	0	4	0	0	0	0	0	0	1	4	0	0	5	0	10
05:30 PM	0	0	1	0	1	1	0	0	0	1	0	0	0	0	0	0	0	0	3
05:45 PM	0	0	0	0	0	2	0	0	0	2	0	0	0	2	0	0	2	0	4
Total	1	0	1	0	2	8	0	0	2	0	0	0	2	1	9	0	10	0	22
Grand Total	1	0	1	0	2	11	0	0	5	0	0	0	5	1	20	0	21	0	39
Approch %	50	0	50		0	100	0		100	0	0		12.8	4.8	95.2	0	53.8	0	100
Total %	2.6	0	2.6		0	28.2	0		12.8	0	0		12.8	2.6	51.3	0	53.8	0	100

Peak Hour Analysis From 04:45 PM to 05:30 PM - Peak 1 of 1
 Peak Hour for Entire Intersection Begins at 04:45 PM

Start Time	Day Street Southbound				Alessandro Boulevard Westbound				Day Street Northbound				Alessandro Boulevard Eastbound				Exclu. Total	Inclu. Total	Int. Total
	Left	Thru	Right	RTOR	Left	Thru	Right	RTOR	Left	Thru	Right	RTOR	Left	Thru	Right	RTOR			
04:45 PM	0	0	0	0	0	0	0	0	0	0	0	0	0	0	0	0	0	0	0
05:00 PM	0	0	0	0	0	1	0	0	1	0	0	0	0	1	0	0	2	0	3
05:15 PM	1	0	0	0	0	4	0	0	0	0	0	0	1	4	0	0	5	0	10
05:30 PM	0	0	1	0	1	1	0	0	0	1	0	0	0	0	0	0	0	0	3
Total	1	0	1	0	2	6	0	0	6	3	0	0	3	1	9	0	10	0	21
% App. Total	50	0	50		0	100	0		100	0	0		12.8	4.8	95.2	0	53.8	0	100
PHF	.250	.000	.250		.000	.375	.000		.375	.750	.000		.750	.250	.563	.000	.500	.000	.525

Counts Unlimited, Inc.
 PO Box 1178
 Corona, CA 92878
 (951)268-6268

City of Moreno Valley
 N/S: Day Street
 E/W: Alessandro Boulevard
 Weather: Clear

File Name : 32_MRV_Day_Ales PM
 Site Code : 05121716
 Start Date : 11/30/2021
 Page No : 2

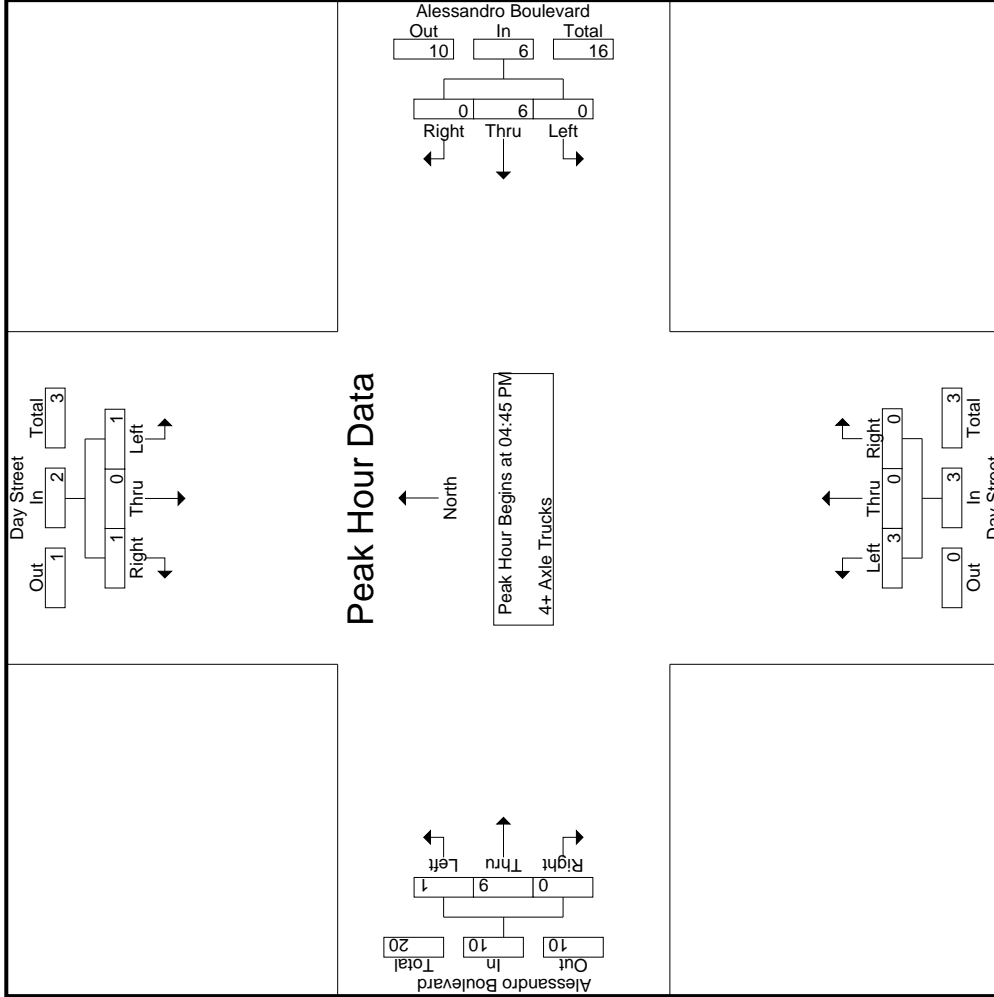

Counts Unlimited, Inc.
 PO Box 1178
 Corona, CA 92878
 (951)268-6268

City of Moreno Valley
 N/S: Day Street
 E/W: Alessandro Boulevard
 Weather: Clear

File Name : 32_MRV_Day_Ales PM
 Site Code : 05121716
 Start Date : 11/30/2021
 Page No : 3

Start Time	Day Street Southbound			Alessandro Boulevard Westbound			Day Street Northbound			Alessandro Boulevard Eastbound			Int. Total
	Left	Thru	Right	Left	Thru	Right	Left	Thru	Right	Left	Thru	Right	
Peak Hour Analysis From 04:45 PM to 05:30 PM - Peak 1 of 1													
Peak Hour for Each Approach Begins at:													
	04:45 PM			04:45 PM			04:45 PM			04:45 PM			
+0 mins.	0	0	0	0	0	0	0	0	0	0	2	0	2
+15 mins.	0	0	0	0	1	0	1	0	0	0	3	0	3
+30 mins.	1	0	0	0	4	0	4	0	0	1	4	0	5
+45 mins.	0	0	1	0	1	0	1	0	0	0	0	0	0
Total Volume	1	0	1	0	6	0	6	0	0	3	9	0	10
% App. Total	50	0	50	0	100	0	100	0	0	100	90	0	100
PHF	.250	.000	.250	.000	.375	.000	.375	.000	.000	.750	.563	.000	.500

Location: Moreno Valley
 N/S: Day Street
 E/W: Alessandro Boulevard



Date: 11/30/2021
 Day: Tuesday

PEDESTRIANS

	North Leg Day Street	East Leg Alessandro Boulevard	South Leg Day Street	West Leg Alessandro Boulevard	
	Pedestrians	Pedestrians	Pedestrians	Pedestrians	
7:00 AM	0	0	0	0	0
7:15 AM	0	0	0	0	0
7:30 AM	0	1	0	0	1
7:45 AM	0	0	0	0	0
8:00 AM	0	0	0	0	0
8:15 AM	0	0	0	0	0
8:30 AM	0	0	0	0	0
8:45 AM	0	0	0	0	0
TOTAL VOLUMES:	0	1	0	0	1

	North Leg Day Street	East Leg Alessandro Boulevard	South Leg Day Street	West Leg Alessandro Boulevard	
	Pedestrians	Pedestrians	Pedestrians	Pedestrians	
4:00 PM	0	0	0	0	0
4:15 PM	0	0	0	0	0
4:30 PM	0	0	0	0	0
4:45 PM	0	0	0	0	0
5:00 PM	0	0	0	0	0
5:15 PM	0	0	0	0	0
5:30 PM	0	0	0	0	0
5:45 PM	1	0	0	0	1
TOTAL VOLUMES:	1	0	0	0	1

Location: Moreno Valley
 N/S: Day Street
 E/W: Alessandro Boulevard



Date: 11/30/2021
 Day: Tuesday

BICYCLES

	Southbound Day Street			Westbound Alessandro Boulevard			Northbound Day Street			Eastbound Alessandro Boulevard			
	Left	Thru	Right	Left	Thru	Right	Left	Thru	Right	Left	Thru	Right	
7:00 AM	0	0	0	0	0	0	0	0	0	0	0	0	0
7:15 AM	0	0	0	0	0	0	1	1	0	0	0	0	2
7:30 AM	0	0	0	0	0	0	0	0	0	0	0	0	0
7:45 AM	0	0	0	0	0	0	0	0	0	0	0	0	0
8:00 AM	0	0	0	0	0	0	0	0	0	0	1	0	1
8:15 AM	0	0	0	0	0	0	0	0	0	0	0	0	0
8:30 AM	0	0	0	0	0	0	0	0	0	0	1	0	1
8:45 AM	0	0	0	0	0	0	0	0	0	0	0	0	0
TOTAL VOLUMES:	0	0	0	0	0	0	1	1	0	0	2	0	4

	Southbound Day Street			Westbound Alessandro Boulevard			Northbound Day Street			Eastbound Alessandro Boulevard			
	Left	Thru	Right	Left	Thru	Right	Left	Thru	Right	Left	Thru	Right	
4:00 PM	0	0	0	0	1	0	0	0	0	0	0	0	1
4:15 PM	0	0	0	0	0	0	0	0	0	0	0	0	0
4:30 PM	0	0	0	0	0	1	0	0	0	0	0	0	1
4:45 PM	0	0	0	0	1	0	0	0	0	0	0	0	1
5:00 PM	0	0	0	0	0	0	0	0	0	0	1	0	1
5:15 PM	0	0	0	0	0	0	0	0	0	0	2	0	2
5:30 PM	0	0	0	0	1	0	0	0	0	0	0	0	1
5:45 PM	0	0	1	0	0	0	0	0	0	0	0	0	1
TOTAL VOLUMES:	0	0	1	0	3	1	0	0	0	0	3	0	8

Groups Printed- Passenger Vehicles - Large 2 Axle Vehicles - 3 Axle Vehicles - 4+ Axle Trucks

Start Time	Elsworth Street Southbound					Cactus Avenue Westbound					March ARB Northbound					Cactus Avenue Eastbound							
	Left	Thru	Right	RTOR	App. Total	Left	Thru	Right	RTOR	App. Total	Left	Thru	Right	RTOR	App. Total	Left	Thru	Right	RTOR	App. Total	Exclu. Total	Inclu. Total	Int. Total
07:00 AM	13	17	38	29	68	8	380	16	9	404	7	2	1	1	10	15	237	53	1	305	40	787	827
07:15 AM	16	14	35	17	65	8	419	20	8	447	4	1	2	1	7	29	270	61	0	360	26	879	905
07:30 AM	17	8	29	15	54	20	359	19	7	398	7	2	2	1	11	35	335	73	0	443	23	906	929
07:45 AM	22	16	38	15	76	20	345	31	18	396	4	3	6	4	13	45	311	52	0	408	37	893	930
Total	68	55	140	76	263	56	1503	86	42	1645	22	8	11	7	41	124	1153	239	1	1516	126	3465	3591
08:00 AM	17	13	37	19	67	13	343	36	14	392	5	3	4	2	12	49	285	68	0	402	35	873	908
08:15 AM	25	12	36	21	73	13	358	28	12	399	5	0	2	1	7	30	250	50	0	330	34	809	843
08:30 AM	30	7	36	23	73	10	256	21	11	287	8	2	5	4	15	39	276	38	0	353	38	728	768
08:45 AM	11	6	20	10	37	5	264	39	23	308	10	2	6	4	18	32	248	38	0	318	37	681	718
Total	83	38	129	73	250	41	1221	124	60	1386	28	7	17	11	52	150	1059	194	0	1403	144	3091	3235
Grand Total	151	93	269	149	513	97	2724	210	102	3031	50	15	28	18	93	274	2212	433	1	2919	270	6556	6826
% Approach	29.4	18.1	52.4			3.2	89.9	6.9			53.8	16.1	30.1			9.4	75.8	14.8					
% Total	2.3	1.4	4.1			1.5	41.5	3.2			0.8	0.2	0.4			4.2	33.7	6.6			4	96	
% Passenger Vehicles	143	91	254		631	96	2584	204		2984	45	15	28		106	252	2018	428		2699	0	0	6420
% Large 2 Axle Vehicles	94.7	97.8	94.4	96	95.3	99	94.9	97.1	98	95.2	90	100	100	100	95.5	92	91.2	98.8	100	92.4	0	0	94.1
% 3 Axle Vehicles	6	2	8	3	18	0	35	2	1	38	2	0	0	0	2	8	53	3	0	64	0	0	122
% 4+ Axle Trucks	4	2.2	3	1.3	2.7	0	1.3	1	1	1.2	4	0	0	0	1.8	2.9	2.4	0.7	0	2.2	0	0	1.8
% 3 Axle Vehicles	0	0	4		5	1	33	1		35	1	0	0	1		2	21	1		24	0	0	65
% 4+ Axle Trucks	2	0	3		8	0	72	3		76	2	0	0	2		12	120	1		133	0	0	219
% 4+ Axle Trucks	1.3	0	1.1	2	1.2	0	2.6	1.4	1	2.4	4	0	0	0	1.8	4.4	5.4	0.2	0	4.6	0	0	3.2

Start Time	Elsworth Street Southbound					Cactus Avenue Westbound					March ARB Northbound					Cactus Avenue Eastbound							
	Left	Thru	Right	RTOR	App. Total	Left	Thru	Right	RTOR	App. Total	Left	Thru	Right	RTOR	App. Total	Left	Thru	Right	RTOR	App. Total	Exclu. Total	Inclu. Total	Int. Total
07:15 AM	16	14	35	17	65	8	419	20	8	447	4	1	2	1	10	15	237	53	1	305	40	787	827
07:30 AM	17	8	29	15	54	20	359	19	7	398	7	2	2	1	11	35	335	73	0	443	23	906	929
07:45 AM	22	16	38	15	76	20	345	31	18	396	4	3	6	4	13	45	311	52	0	408	37	893	930
08:00 AM	17	13	37	19	67	13	343	36	14	392	5	3	4	2	12	49	285	68	0	402	35	873	908
Total Volume	72	51	139	76	263	61	1466	106	42	1633	20	9	14	9	43	158	1201	254	0	1613	126	3465	3591
% App. Total	27.5	19.5	53.1			3.7	89.8	6.5			46.5	20.9	32.6			9.8	74.5	15.7					
PHF	.818	.797	.914		.862	.763	.875	.736		.913	.714	.750	.583		.827	.806	.896	.870		.910			

Peak Hour Analysis From 07:00 AM to 08:45 AM - Peak 1 of 1
 Peak Hour for Entire Intersection Begins at 07:15 AM

Counts Unlimited, Inc.
 PO Box 1178
 Corona, CA 92878
 (951)268-6268

County of Riverside
 N/S: Elsworth Street/March ARB
 E/W: Cactus Avenue
 Weather: Clear

File Name : 33_CRV_Els_Cactus AM
 Site Code : 05121716
 Start Date : 11/30/2021
 Page No : 2

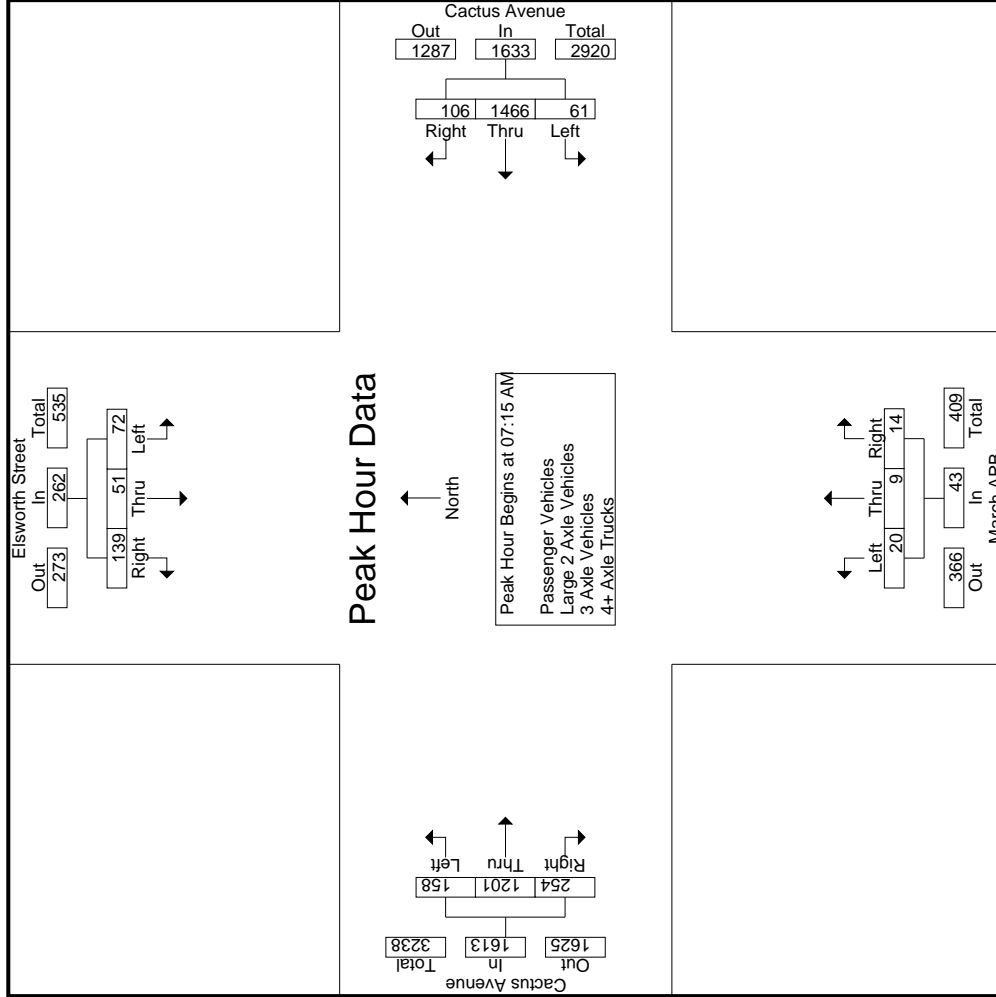

Counts Unlimited, Inc.
 PO Box 1178
 Corona, CA 92878
 (951)268-6268

County of Riverside
 N/S: Elsworth Street/March ARB
 E/W: Cactus Avenue
 Weather: Clear

File Name : 33_CRV_Els_Cactus AM
 Site Code : 05121716
 Start Date : 11/30/2021
 Page No : 3

Start Time	Elsworth Street Southbound			Cactus Avenue Westbound			March ARB Northbound			Cactus Avenue Eastbound						
	Left	Thru	Right	App. Total	Left	Thru	Right	App. Total	Left	Thru	Right	App. Total	Int. Total			
Peak Hour Analysis From 07:00 AM to 08:45 AM - Peak 1 of 1																
Peak Hour for Each Approach Begins at:																
	07:45 AM				07:00 AM				08:00 AM			07:15 AM				
+0 mins.	22	16	38	76	8	380	16	404	5	3	4	12	29	270	61	360
+15 mins.	17	13	37	67	8	419	20	447	5	0	2	7	35	335	73	443
+30 mins.	25	12	36	73	20	359	19	398	8	2	5	15	45	311	52	408
+45 mins.	30	7	36	73	20	345	31	396	10	2	6	18	49	285	68	402
Total Volume	94	48	147	289	56	1503	86	1645	28	7	17	52	158	1201	254	1613
% App. Total	32.5	16.6	50.9		3.4	91.4	5.2		53.8	13.5	32.7		9.8	74.5	15.7	
PHF	.783	.750	.967	.951	.700	.897	.694	.920	.700	.583	.708	.722	.806	.896	.870	.910

Counts Unlimited, Inc.
 PO Box 1178
 Corona, CA 92878
 (951)268-6268

County of Riverside
 N/S: Elsworth Street/March ARB
 E/W: Cactus Avenue
 Weather: Clear

File Name : 33_CRV_Els_Cactus AM
 Site Code : 05121716
 Start Date : 11/30/2021
 Page No : 1

Groups Printed- Passenger Vehicles

Start Time	Elsworth Street Southbound				Cactus Avenue Westbound				March ARB Northbound				Cactus Avenue Eastbound									
	Left	Thru	Right	RTOR	App. Total	Left	Thru	Right	RTOR	App. Total	Left	Thru	Right	RTOR	App. Total	Exclu. Total	Inclu. Total	Int. Total				
07:00 AM	13	17	36	27	66	8	355	16	9	379	7	2	1	1	10	12	218	53	283	38	738	776
07:15 AM	16	14	34	17	64	8	401	20	8	429	4	1	2	1	7	26	257	60	343	26	843	869
07:30 AM	16	8	28	15	52	20	347	16	7	383	5	2	2	1	9	32	309	71	412	23	856	879
07:45 AM	20	16	34	13	70	20	329	31	18	380	3	3	6	4	12	43	283	52	378	35	840	875
Total	65	55	132	72	252	56	1432	83	42	1571	19	8	11	7	38	113	1067	236	1416	122	3277	3399
08:00 AM	16	13	35	18	64	13	320	35	13	368	4	3	4	2	11	47	258	67	372	33	815	848
08:15 AM	24	10	36	21	70	12	337	28	12	377	5	0	2	1	7	26	225	49	300	34	754	788
08:30 AM	28	7	34	23	69	10	246	20	10	276	8	2	5	4	15	37	243	38	318	37	678	715
08:45 AM	10	6	17	9	33	5	249	38	23	292	9	2	6	4	17	29	225	38	292	36	634	670
Total	78	36	122	71	236	40	1152	121	58	1313	26	7	17	11	50	139	951	192	1282	140	2881	3021
Grand Total	143	91	254	143	488	96	2584	204	100	2884	45	15	28	18	88	252	2018	428	2698	262	6158	6420
T-Approch %	29.3	18.6	52		7.9	3.3	89.6	7.1		46.8	51.1	17	31.8		1.4	9.3	74.8	15.9	43.8	4.1	95.9	
Q Total %	2.3	1.5	4.1			1.6	42	3.3			0.7	0.2	0.5			4.1	32.8	7				

Start Time	Elsworth Street Southbound				Cactus Avenue Westbound				March ARB Northbound				Cactus Avenue Eastbound										
	Left	Thru	Right	RTOR	App. Total	Left	Thru	Right	RTOR	App. Total	Left	Thru	Right	RTOR	App. Total	Left	Thru	Right	RTOR	App. Total	Exclu. Total	Inclu. Total	Int. Total
07:15 AM	16	14	34	17	64	8	401	20	9	429	4	1	2	1	10	12	218	53	283	38	738	776	
07:30 AM	16	8	28	15	52	20	347	16	7	383	5	2	2	1	9	32	309	71	412	23	856	879	
07:45 AM	20	16	34	13	70	20	329	31	18	380	3	3	6	4	12	43	283	52	378	35	840	875	
08:00 AM	68	51	131	72	250	61	1397	102	42	1560	16	9	14	7	38	113	1067	236	1416	122	3277	3399	
Total Volume	27.2	20.4	52.4		7.9	3.9	89.6	6.5		46.8	41	23.1	35.9		1.4	9.8	73.6	16.6	43.8	4.1	95.9		
% App. Total	.850	.797	.936		.893	.763	.871	.729		.909	.800	.750	.583		.813	.787	.896	.880	.913				
PHF																							

Peak Hour Analysis From 07:15 AM to 08:00 AM - Peak 1 of 1
 Peak Hour for Entire Intersection Begins at 07:15 AM

Counts Unlimited, Inc.
 PO Box 1178
 Corona, CA 92878
 (951)268-6268

County of Riverside
 N/S: Elsworth Street/March ARB
 E/W: Cactus Avenue
 Weather: Clear

File Name : 33_CRV_Els_Cactus AM
 Site Code : 05121716
 Start Date : 11/30/2021
 Page No : 2

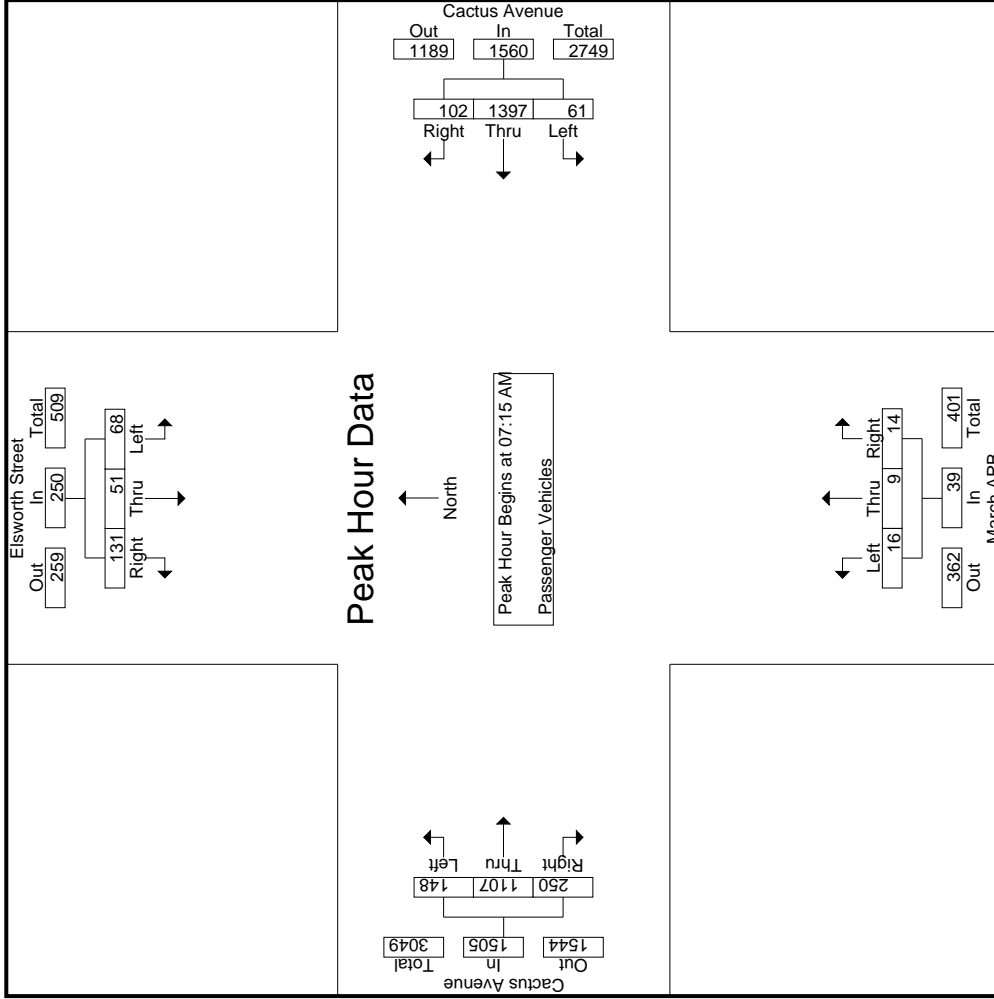

Counts Unlimited, Inc.
 PO Box 1178
 Corona, CA 92878
 (951)268-6268

County of Riverside
 N/S: Elsworth Street/March ARB
 E/W: Cactus Avenue
 Weather: Clear

File Name : 33_CRV_Els_Cactus AM
 Site Code : 05121716
 Start Date : 11/30/2021
 Page No : 3

Start Time	Elsworth Street Southbound			Cactus Avenue Westbound			March ARB Northbound			Cactus Avenue Eastbound		
	Left	Thru	Right	Left	Thru	Right	Left	Thru	Right	Left	Thru	Right
Peak Hour Analysis From 07:15 AM to 08:00 AM - Peak 1 of 1												
Peak Hour for Each Approach Begins at:												
+0 mins.	16	14	34	8	401	20	4	1	2	7	26	60
+15 mins.	16	8	28	20	347	16	5	2	2	9	32	71
+30 mins.	20	16	34	20	329	31	3	3	6	12	43	52
+45 mins.	16	13	35	13	320	35	4	3	4	11	47	67
Total Volume	68	51	131	61	1397	102	16	9	14	39	148	250
% App. Total	27.2	20.4	52.4	3.9	89.6	6.5	41	23.1	35.9	9.8	73.6	16.6
PHF	.850	.797	.936	.763	.871	.729	.800	.750	.583	.787	.896	.880

Counts Unlimited, Inc.
 PO Box 1178
 Corona, CA 92878
 (951)268-6268

County of Riverside
 N/S: Elsworth Street/March ARB
 E/W: Cactus Avenue
 Weather: Clear

File Name : 33_CRV_Els_Cactus AM
 Site Code : 05121716
 Start Date : 11/30/2021
 Page No : 1

Groups Printed- Large 2 Axle Vehicles

Start Time	Elsworth Street Southbound				Cactus Avenue Westbound				March ARB Northbound				Cactus Avenue Eastbound											
	Left	Thru	Right	RTOR	App. Total	Left	Thru	Right	RTOR	App. Total	Left	Thru	Right	RTOR	App. Total	Left	Thru	Right	RTOR	App. Total	Exclu. Total	Inclu. Total	Int. Total	
07:00 AM	0	0	1	1	1	0	7	0	0	7	0	0	0	0	0	0	6	0	0	0	6	1	14	15
07:15 AM	0	0	0	0	0	0	6	0	0	6	0	0	0	0	0	0	7	1	0	0	7	0	13	13
07:30 AM	1	0	1	0	2	0	2	0	0	2	0	0	0	0	2	0	6	0	0	6	0	12	12	12
07:45 AM	2	0	2	1	4	0	3	0	0	3	0	0	0	0	0	1	8	0	0	9	1	16	17	17
Total	3	0	4	2	7	0	17	1	0	18	2	0	0	0	2	2	25	1	0	28	2	55	57	57
08:00 AM	1	0	1	0	2	0	2	0	0	2	0	0	0	0	0	1	8	1	0	10	0	14	14	14
08:15 AM	1	2	0	0	3	0	9	0	0	9	0	0	0	0	0	3	4	1	0	8	0	20	20	20
08:30 AM	1	0	1	0	2	0	4	1	1	5	0	0	0	0	0	1	10	0	0	11	1	18	19	19
08:45 AM	0	0	2	0	2	0	3	0	0	3	0	0	0	0	0	1	6	0	0	7	0	12	12	12
Total	3	2	4	0	9	0	18	1	1	19	0	0	0	0	0	6	28	2	0	36	1	64	65	65
Grand Total	6	2	8	2	16	0	35	2	1	37	2	0	0	0	2	8	53	3	0	64	3	119	122	122
Approch %	37.5	12.5	50			0	94.6	5.4		31.1	100	0	0		12.5	82.8	4.7		53.8		2.5	97.5		
Total %	5	1.7	6.7		13.4	0	29.4	1.7		31.1	1.7	0	0		6.7	44.5	2.5		53.8		2.5	97.5		

Start Time	Elsworth Street Southbound				Cactus Avenue Westbound				March ARB Northbound				Cactus Avenue Eastbound											
	Left	Thru	Right	RTOR	App. Total	Left	Thru	Right	RTOR	App. Total	Left	Thru	Right	RTOR	App. Total	Left	Thru	Right	RTOR	App. Total	Exclu. Total	Inclu. Total	Int. Total	
07:15 AM	0	0	0	0	0	0	6	0	0	6	0	0	0	0	0	1	5	1	0	7	0	7	13	13
07:30 AM	1	0	1	0	2	0	1	1	0	2	2	0	0	0	0	0	6	0	0	6	0	6	12	12
07:45 AM	2	0	2	0	4	0	3	0	0	3	0	0	0	0	0	1	8	0	0	9	0	9	16	16
08:00 AM	1	0	1	0	2	0	2	0	0	2	0	0	0	0	0	1	8	1	0	10	1	10	14	14
Total Volume	4	0	4	0	8	0	12	1	13	13	2	0	0	0	2	3	27	2	0	32	2	32	55	55
% App. Total	50	0	50		50	0	92.3	7.7		7.7	100	0	0		9.4	84.4	6.2		84.4		6.2	.800	.859	.859
PHF	.500	.000	.500		.500	.000	.500	.250	.542	.250	.250	.000	.000	.000	.250	.750	.844	.500	.844	.500	.800	.859	.859	.859

Peak Hour Analysis From 07:15 AM to 08:00 AM - Peak 1 of 1
 Peak Hour for Entire Intersection Begins at 07:15 AM

Counts Unlimited, Inc.
 PO Box 1178
 Corona, CA 92878
 (951)268-6268

County of Riverside
 N/S: Elsworth Street/March ARB
 E/W: Cactus Avenue
 Weather: Clear

File Name : 33_CRV_Els_Cactus AM
 Site Code : 05121716
 Start Date : 11/30/2021
 Page No : 2

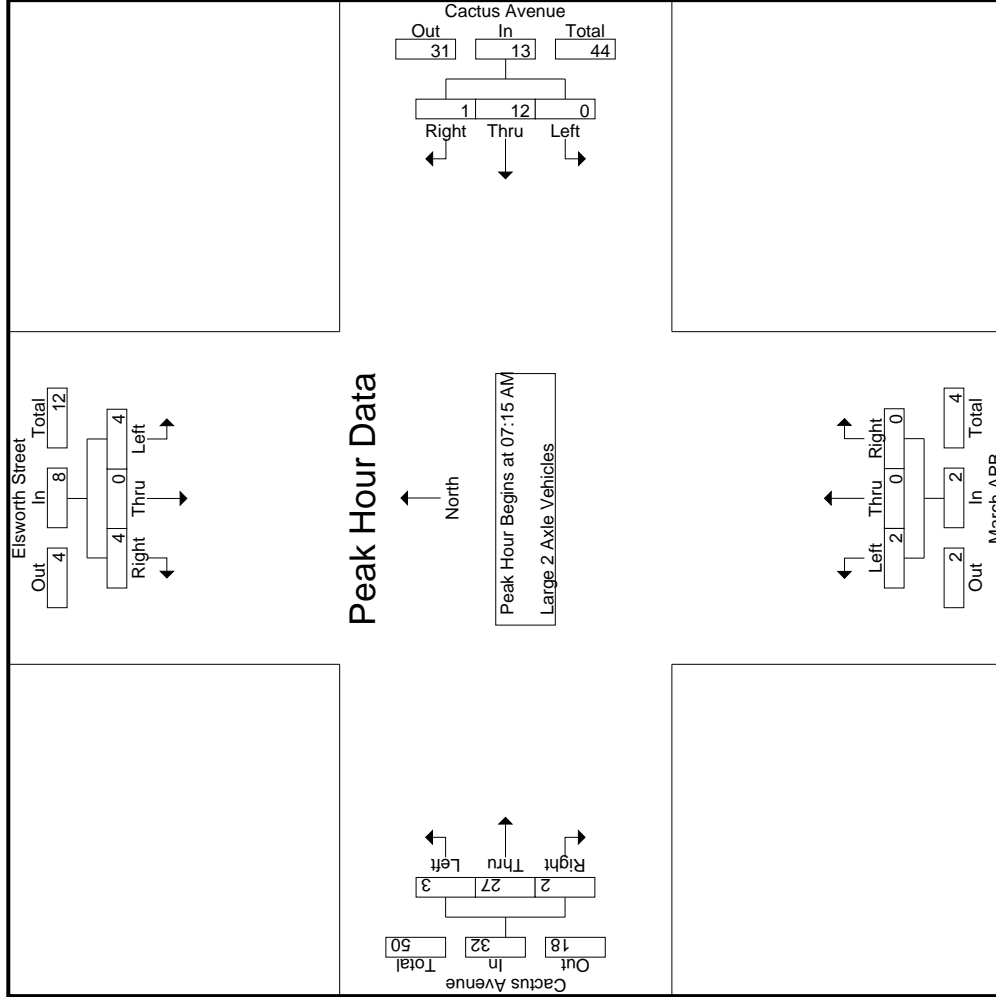

Counts Unlimited, Inc.
 PO Box 1178
 Corona, CA 92878
 (951)268-6268

County of Riverside
 N/S: Elsworth Street/March ARB
 E/W: Cactus Avenue
 Weather: Clear

File Name : 33_CRV_Els_Cactus AM
 Site Code : 05121716
 Start Date : 11/30/2021
 Page No : 3

Start Time	Elsworth Street Southbound			Cactus Avenue Westbound			March ARB Northbound			Cactus Avenue Eastbound			Int. Total		
	Left	Thru	Right	Left	Thru	Right	Left	Thru	Right	Left	Thru	Right		App. Total	
Peak Hour Analysis From 07:15 AM to 08:00 AM - Peak 1 of 1															
Peak Hour for Each Approach Begins at:															
+0 mins.	0	0	0	0	6	0	0	0	0	0	0	1	5	1	7
+15 mins.	1	0	1	0	1	1	2	0	0	2	0	0	6	0	6
+30 mins.	2	0	2	0	3	0	3	0	0	0	0	1	8	0	9
+45 mins.	1	0	1	0	2	0	2	0	0	0	0	1	8	1	10
Total Volume	4	0	4	0	12	1	13	2	0	2	3	2	27	2	32
% App. Total	50	0	50	0	92.3	7.7	100	0	0	9.4	84.4	6.2	84.4	6.2	90.6
PHF	.500	.000	.500	.000	.500	.250	.542	.250	.000	.250	.750	.500	.844	.500	.800

Counts Unlimited, Inc.
 PO Box 1178
 Corona, CA 92878
 (951)268-6268

County of Riverside
 N/S: Elsworth Street/March ARB
 E/W: Cactus Avenue
 Weather: Clear

File Name : 33_CRV_Els_Cactus AM
 Site Code : 05121716
 Start Date : 11/30/2021
 Page No : 1

Groups Printed- 3 Axle Vehicles

Start Time	Elsworth Street Southbound				Cactus Avenue Westbound				March ARB Northbound				Cactus Avenue Eastbound					
	Left	Thru	Right	RTOR	App. Total	Left	Thru	Right	RTOR	App. Total	Left	Thru	Right	RTOR	App. Total	Exclu. Total	Inclu. Total	Int. Total
07:00 AM	0	0	0	0	0	0	6	0	0	6	0	0	0	0	0	0	11	11
07:15 AM	0	0	1	0	1	0	3	0	0	3	0	0	0	0	2	0	6	6
07:30 AM	0	0	0	0	0	0	1	0	0	1	0	0	0	0	5	0	6	6
07:45 AM	0	0	1	0	1	0	6	0	0	6	0	0	0	0	2	0	9	9
Total	0	0	2	0	2	0	15	1	0	16	0	0	0	0	14	0	32	32
08:00 AM	0	0	1	1	1	0	8	0	0	8	1	0	0	0	3	1	13	14
08:15 AM	0	0	0	0	0	1	5	0	0	6	0	0	0	0	3	0	9	9
08:30 AM	0	0	1	0	1	0	2	0	0	2	0	0	0	0	1	0	4	4
08:45 AM	0	0	0	0	0	0	3	0	0	3	0	0	0	0	3	0	6	6
Total	0	0	2	1	2	1	18	0	0	19	1	0	0	0	10	1	32	33
Grand Total	0	0	4	1	4	1	33	1	0	35	1	0	0	0	24	1	64	65
T-Approch %	0	0	100		2.9	94.3	2.9			100	0	0		8.3	87.5	4.2		
on Total %	0	0	6.2		6.2	1.6	51.6	1.6		54.7	1.6	0		3.1	32.8	1.6		98.5

Start Time	Elsworth Street Southbound				Cactus Avenue Westbound				March ARB Northbound				Cactus Avenue Eastbound					
	Left	Thru	Right	RTOR	App. Total	Left	Thru	Right	RTOR	App. Total	Left	Thru	Right	RTOR	App. Total	Exclu. Total	Inclu. Total	Int. Total
07:15 AM	0	0	1	0	1	0	3	0	0	3	0	0	0	0	0	0	2	2
07:30 AM	0	0	0	0	0	0	1	0	0	1	0	0	0	0	0	0	5	5
07:45 AM	0	0	0	0	0	0	6	0	0	6	0	0	0	0	1	0	2	2
08:00 AM	0	0	1	1	1	0	8	0	0	8	1	0	0	0	3	0	3	13
Total Volume	0	0	3	3	3	0	17	1	18	18	1	0	0	1	9	1	12	34
% App. Total	0	0	100		750	0	94.4	5.6		100	0	0		16.7	75	8.3		
PHF	.000	.000	.750		.750	.000	.531	.250		.563	.250	.000		.500	.750	.250		.654

Peak Hour Analysis From 07:15 AM to 08:00 AM - Peak 1 of 1
 Peak Hour for Entire Intersection Begins at 07:15 AM

Counts Unlimited, Inc.
 PO Box 1178
 Corona, CA 92878
 (951)268-6268

County of Riverside
 N/S: Elsworth Street/March ARB
 E/W: Cactus Avenue
 Weather: Clear

File Name : 33_CRV_Els_Cactus AM
 Site Code : 05121716
 Start Date : 11/30/2021
 Page No : 2

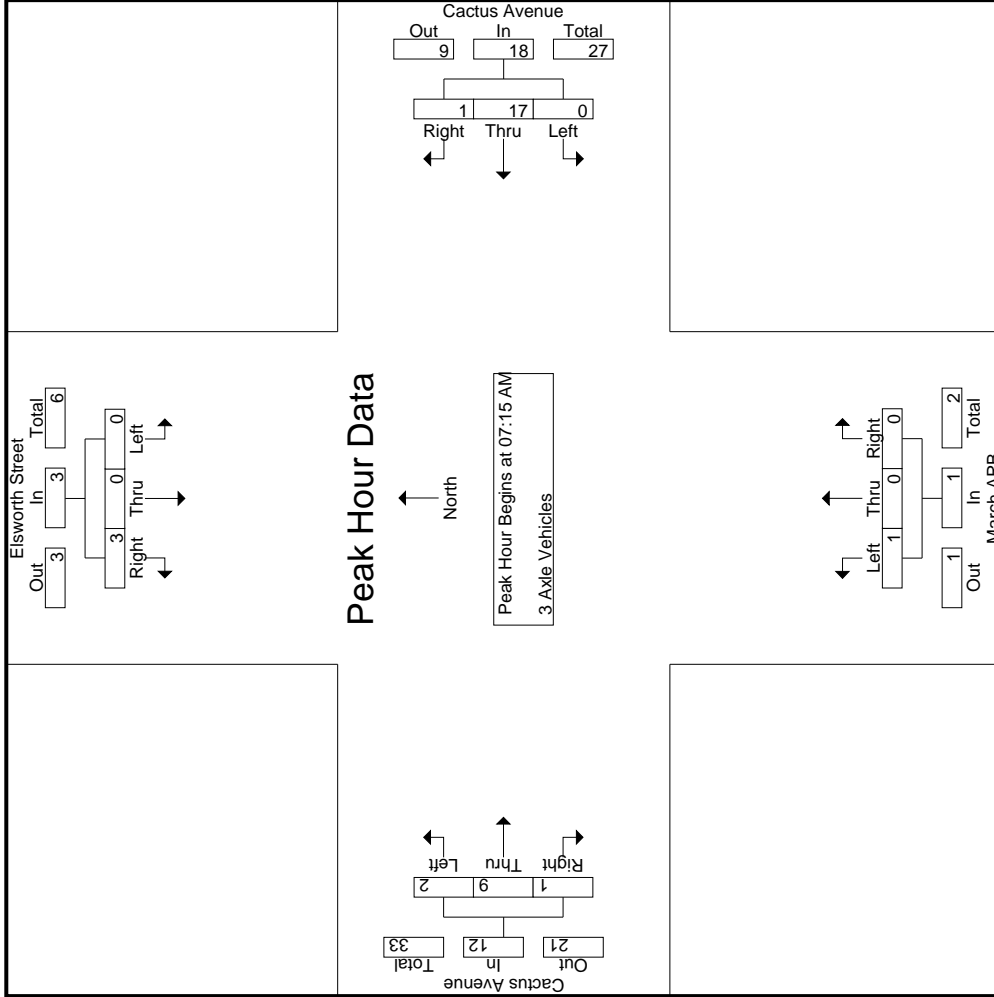

Counts Unlimited, Inc.
 PO Box 1178
 Corona, CA 92878
 (951)268-6268

County of Riverside
 N/S: Elsworth Street/March ARB
 E/W: Cactus Avenue
 Weather: Clear

File Name : 33_CRV_Els_Cactus AM
 Site Code : 05121716
 Start Date : 11/30/2021
 Page No : 3

Start Time	Elsworth Street Southbound			Cactus Avenue Westbound			March ARB Northbound			Cactus Avenue Eastbound			Int. Total	
	Left	Thru	Right	Left	Thru	Right	Left	Thru	Right	Left	Thru	Right		App. Total
Peak Hour Analysis From 07:15 AM to 08:00 AM - Peak 1 of 1	Peak Hour for Each Approach Begins at:													
	07:15 AM			07:15 AM			07:15 AM			07:15 AM				
+0 mins.	0	0	1	0	3	0	0	0	0	0	0	2	0	2
+15 mins.	0	0	0	0	0	1	0	0	0	0	1	3	1	5
+30 mins.	0	0	1	0	6	0	0	0	0	0	1	1	0	2
+45 mins.	0	0	1	0	8	0	1	0	0	1	0	3	0	3
Total Volume	0	0	3	0	17	1	1	0	0	1	2	9	1	12
% App. Total	0	0	100	0	94.4	5.6	100	0	0	16.7	75	8.3		
PHF	.000	.000	.750	.000	.531	.250	.250	.000	.000	.500	.750	.250		.600

Counts Unlimited, Inc.
 PO Box 1178
 Corona, CA 92878
 (951)268-6268

County of Riverside
 N/S: Elsworth Street/March ARB
 E/W: Cactus Avenue
 Weather: Clear

File Name : 33_CRV_Els_Cactus AM
 Site Code : 05121716
 Start Date : 11/30/2021
 Page No : 1

Groups Printed- 4+ Axle Trucks

Start Time	Elsworth Street Southbound				Cactus Avenue Westbound				March ARB Northbound				Cactus Avenue Eastbound					
	Left	Thru	Right	RTOR	App. Total	Left	Thru	Right	RTOR	App. Total	Left	Thru	Right	RTOR	App. Total	Exclu. Total	Inclu. Total	Int. Total
07:00 AM	0	0	1	1	1	0	12	0	0	12	0	0	0	0	0	1	24	25
07:15 AM	0	0	0	0	0	0	9	0	0	9	0	0	0	0	0	0	17	17
07:30 AM	0	0	0	0	0	0	11	1	0	12	0	0	0	0	0	0	32	32
07:45 AM	0	0	1	1	1	0	7	0	0	7	1	0	0	0	1	1	28	29
Total	0	0	2	2	2	0	39	1	0	40	1	0	0	0	2	2	101	103
08:00 AM	0	0	0	0	0	0	13	1	1	14	0	0	0	0	0	1	31	32
08:15 AM	0	0	0	0	0	0	7	0	0	7	0	0	0	0	0	0	26	26
08:30 AM	1	0	0	0	1	0	4	0	0	4	0	0	0	0	0	0	28	28
08:45 AM	1	0	1	1	2	0	9	1	0	10	1	0	0	0	1	1	29	30
Total	2	0	1	1	3	0	33	2	1	35	1	0	0	0	2	2	114	116
Grand Total	2	0	3	3	5	0	72	3	1	75	2	0	0	0	2	4	215	219
T-Approch %	40	0	60			0	96	4		100	0	0			0.9	5.6	98.2	
on Total %	0.9	0	1.4		2.3	0	33.5	1.4		34.9	0.9	0			0.9	5.6	98.2	

Start Time	Elsworth Street Southbound				Cactus Avenue Westbound				March ARB Northbound				Cactus Avenue Eastbound						
	Left	Thru	Right	RTOR	App. Total	Left	Thru	Right	RTOR	App. Total	Left	Thru	Right	RTOR	App. Total	Exclu. Total	Inclu. Total	Int. Total	
07:15 AM	0	0	0	0	0	0	9	0	0	9	0	0	0	0	0	0	8	17	
07:30 AM	0	0	0	0	0	0	11	1	0	12	0	0	0	0	0	0	20	32	
07:45 AM	0	0	0	0	0	0	7	0	0	7	1	0	0	0	0	0	19	28	
08:00 AM	0	0	0	0	0	0	13	1	0	14	0	0	0	0	0	0	17	31	
Total Volume	0	0	0	0	0	0	40	2	0	42	1	0	0	0	1	5	64	108	
% App. Total	0	0	0	0	0	0	95.2	4.8		100	0	0			7.8	90.6	1.6		
PHF	.000	.000	.000	.250	.250	.000	.769	.500		.750	.250	.000	.000	.000	.250	.625	.763	.250	.844

Peak Hour Analysis From 07:15 AM to 08:00 AM - Peak 1 of 1
 Peak Hour for Entire Intersection Begins at 07:15 AM

Counts Unlimited, Inc.
 PO Box 1178
 Corona, CA 92878
 (951)268-6268

County of Riverside
 N/S: Elsworth Street/March ARB
 E/W: Cactus Avenue
 Weather: Clear

File Name : 33_CRV_Els_Cactus AM
 Site Code : 05121716
 Start Date : 11/30/2021
 Page No : 2

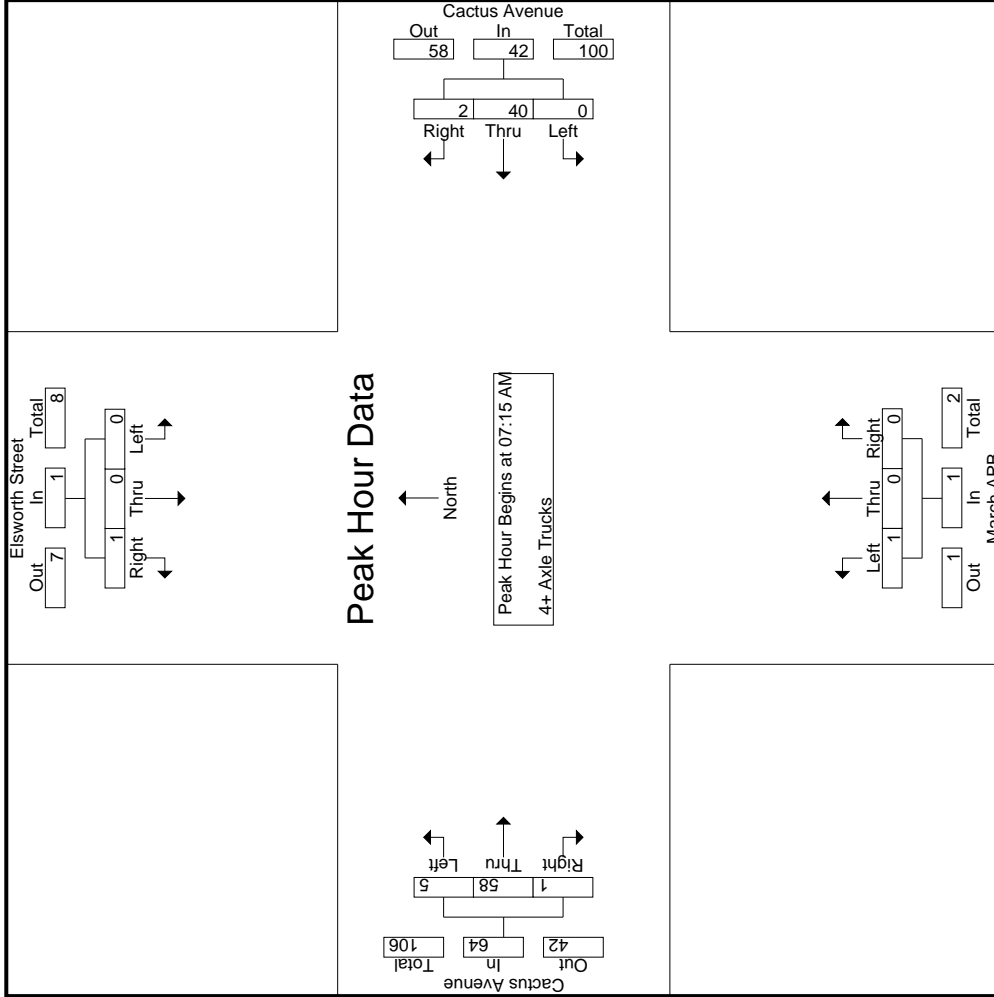

Counts Unlimited, Inc.
 PO Box 1178
 Corona, CA 92878
 (951)268-6268

County of Riverside
 N/S: Elsworth Street/March ARB
 E/W: Cactus Avenue
 Weather: Clear

File Name : 33_CRV_Els_Cactus AM
 Site Code : 05121716
 Start Date : 11/30/2021
 Page No : 3

Start Time	Elsworth Street Southbound			Cactus Avenue Westbound			March ARB Northbound			Cactus Avenue Eastbound			Int. Total	
	Left	Thru	Right	Left	Thru	Right	Left	Thru	Right	Left	Thru	Right		App. Total
Peak Hour Analysis From 07:15 AM to 08:00 AM - Peak 1 of 1	Peak Hour for Each Approach Begins at:													
	07:15 AM			07:15 AM			07:15 AM			07:15 AM				
+0 mins.	0	0	0	0	9	0	9	0	0	0	0	6	0	8
+15 mins.	0	0	0	0	11	1	12	0	0	0	2	17	1	20
+30 mins.	0	0	1	0	7	0	7	1	0	1	0	19	0	19
+45 mins.	0	0	0	0	13	1	14	0	0	0	1	16	0	17
Total Volume	0	0	1	0	40	2	42	1	0	0	5	58	1	64
% App. Total	0	0	100	0	95.2	4.8	100	0	0	0	7.8	90.6	1.6	100
PHF	.000	.000	.250	.000	.769	.500	.750	.250	.000	.000	.625	.763	.250	.800

Counts Unlimited, Inc.
 PO Box 1178
 Corona, CA 92878
 (951)268-6268

County of Riverside
 N/S: Elsworth Street/March ARB
 E/W: Cactus Avenue
 Weather: Clear

File Name : 33_CRV_Els_Cactus PM
 Site Code : 05121716
 Start Date : 11/30/2021
 Page No : 1

Groups Printed- Passenger Vehicles - Large 2 Axle Vehicles - 3 Axle Vehicles - 4+ Axle Trucks

Start Time	Elsworth Street Southbound							Cactus Avenue Westbound							March ARB Northbound							Cactus Avenue Eastbound						
	Left	Thru	Right	RTOR	App. Total	Left	Thru	Right	RTOR	App. Total	Left	Thru	Right	RTOR	App. Total	Left	Thru	Right	RTOR	App. Total	Left	Thru	Right	RTOR	App. Total	Exclu. Total	Inclu. Total	Int. Total
	04:00 PM	44	3	32	11	79	3	257	18	11	278	81	23	32	8	136	25	434	2	0	461	30	954	984				
04:15 PM	48	2	24	16	74	3	227	21	11	251	72	22	26	5	120	42	427	2	0	471	32	916	948					
04:30 PM	49	4	46	27	99	4	317	27	13	348	57	22	16	5	95	32	460	8	0	500	45	1042	1087					
04:45 PM	49	3	53	28	105	3	323	25	8	351	25	8	17	9	50	35	482	10	1	527	46	1033	1079					
Total	190	12	155	82	357	13	1124	91	43	1228	235	75	91	27	401	134	1803	22	1	1959	153	3945	4098					
05:00 PM	53	4	55	32	112	5	312	9	3	326	35	11	14	4	60	30	475	6	0	511	39	1009	1048					
05:15 PM	55	2	37	17	94	4	265	26	18	295	29	10	14	5	53	35	381	4	0	420	40	862	902					
05:30 PM	49	2	27	17	78	1	313	24	15	338	23	7	2	1	32	19	399	2	0	420	33	868	901					
05:45 PM	51	3	24	13	78	1	239	16	5	256	14	5	2	2	21	22	495	0	0	517	20	872	892					
Total	208	11	143	79	362	11	1129	75	41	1215	101	33	32	12	166	106	1750	12	0	1868	132	3611	3743					
Grand Total	398	23	298	161	719	24	2253	166	84	2443	336	108	123	39	567	240	3553	34	1	3827	285	7556	7841					
% Approach	55.4	3.2	41.4			1	92.2	6.8			59.3	19	21.7			6.3	92.8	0.9										
on Total %	5.3	0.3	3.9		9.5	0.3	29.8	2.2		32.3	4.4	1.4	1.6		7.5	3.2	47	0.4		50.6	3.6	96.4						
% Passenger Vehicles	396	22	291		864	24	2159	164		2430	334	108	122		603	233	3390	32		3656	0	0	7553					
% Large 2 Axle Vehicles	99.5	95.7	97.7	96.3	98.2	100	95.8	98.8	98.8	96.2	99.4	100	99.2	100	99.5	97.1	95.4	94.1	100	95.5	0	0	96.3					
% 3 Axle Vehicles	1	1	3		7	0	33	2		36	1	0	0		1	5	67	0		72	0	0	116					
% 4+ Axle Trucks	0.3	4.3	1	1.2	0.8	0	1.5	1.2	1.2	1.4	0.3	0	0	0	0.2	2.1	1.9	0	0	1.9	0	0	1.5					
% 3 Axle Trucks	0	0	3		6	0	5	0		5	0	0	1		1	0	14	0		14	0	0	26					
% 4+ Axle Trucks	0	0	1	1.9	0.7	0	0.2	0	0	0.2	0	0	0.8	0	0.2	0	0.4	0	0	0.4	0	0	0.3					
% 4+ Axle Trucks	1	0	1		3	0	56	0		56	1	0	0		1	2	82	2		86	0	0	146					
% 4+ Axle Trucks	0.3	0	0.3	0.6	0.3	0	2.5	0	0	2.2	0.3	0	0	0	0.2	0.8	2.3	5.9	0	2.2	0	0	1.9					

Start Time	Elsworth Street Southbound							Cactus Avenue Westbound							March ARB Northbound							Cactus Avenue Eastbound						
	Left	Thru	Right	RTOR	App. Total	Left	Thru	Right	RTOR	App. Total	Left	Thru	Right	RTOR	App. Total	Left	Thru	Right	RTOR	App. Total	Left	Thru	Right	RTOR	App. Total	Exclu. Total	Inclu. Total	Int. Total
	04:15 PM	48	2	24		74	3	227	21		251	72	22	26		120	42	427	2		471	2	471	916				
04:30 PM	49	4	46		99	4	317	27		348	57	22	16		95	32	460	8		500	8	500	1042					
04:45 PM	49	3	53		105	3	323	25		351	25	8	17		50	35	482	10		1033	10	1033	1087					
05:00 PM	53	4	55		112	5	312	9		326	35	11	14		60	30	475	6		511	6	511	1009					
Total Volume	199	13	178		390	15	1179	82		1276	189	63	73		325	139	1844	26		2009	26	2009	4000					
% App. Total	51	3.3	45.6		.871	1.2	92.4	6.4		.759	58.2	19.4	22.5		.677	6.9	91.8	1.3		.953	1.3	.953	.960					
PHF	.939	.813	.809			.750	.913	.759		.909	.656	.716	.702		.677	.827	.956	.650										

Peak Hour Analysis From 04:00 PM to 05:45 PM - Peak 1 of 1
 Peak Hour for Entire Intersection Begins at 04:15 PM

Counts Unlimited, Inc.
 PO Box 1178
 Corona, CA 92878
 (951)268-6268

County of Riverside
 N/S: Elsworth Street/March ARB
 E/W: Cactus Avenue
 Weather: Clear

File Name : 33_CRV_Els_Cactus PM
 Site Code : 05121716
 Start Date : 11/30/2021
 Page No : 2

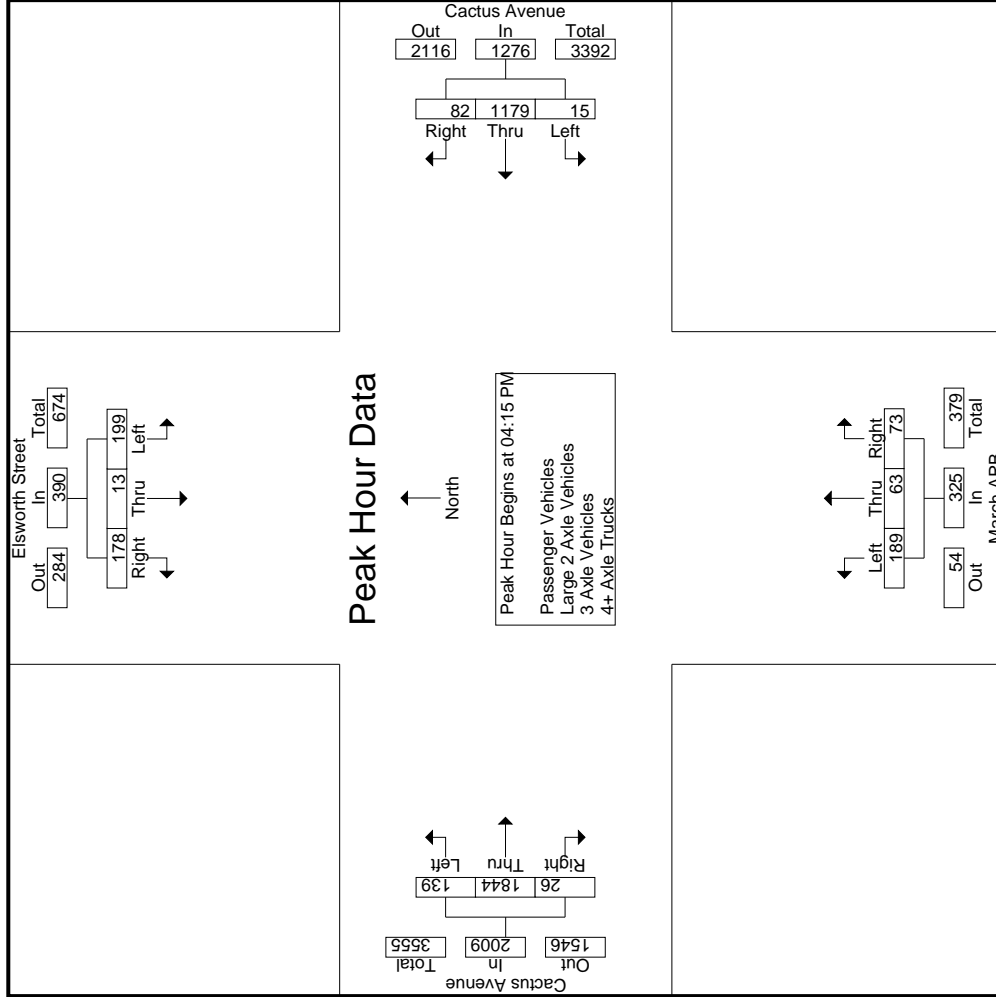

Counts Unlimited, Inc.
 PO Box 1178
 Corona, CA 92878
 (951)268-6268

County of Riverside
 N/S: Elsworth Street/March ARB
 E/W: Cactus Avenue
 Weather: Clear

File Name : 33_CRV_Els_Cactus PM
 Site Code : 05121716
 Start Date : 11/30/2021
 Page No : 3

Start Time	Elsworth Street Southbound			Cactus Avenue Westbound			March ARB Northbound			Cactus Avenue Eastbound						
	Left	Thru	Right	App. Total	Left	Thru	Right	App. Total	Left	Thru	Right	App. Total	Int. Total			
Peak Hour Analysis From 04:00 PM to 05:45 PM - Peak 1 of 1																
Peak Hour for Each Approach Begins at:																
	04:30 PM				04:30 PM				04:00 PM				04:15 PM			
+0 mins.	49	4	46	99	4	317	27	348	81	23	32	136	42	427	2	471
+15 mins.	49	3	53	105	3	323	25	351	72	22	26	120	32	460	8	500
+30 mins.	53	4	55	112	5	312	9	326	57	22	16	95	35	482	10	527
+45 mins.	55	2	37	94	4	265	26	295	25	8	17	50	30	475	6	511
Total Volume	206	13	191	410	16	1217	87	1320	235	75	91	401	139	1844	26	2009
% App. Total	50.2	3.2	46.6		1.2	92.2	6.6		58.6	18.7	22.7		6.9	91.8	1.3	
PHF	.936	.813	.868	.915	.800	.942	.806	.940	.725	.815	.711	.737	.827	.956	.650	.953

Counts Unlimited, Inc.
 PO Box 1178
 Corona, CA 92878
 (951)268-6268

County of Riverside
 N/S: Elsworth Street/March ARB
 E/W: Cactus Avenue
 Weather: Clear

File Name : 33_CRV_Els_Cactus PM
 Site Code : 05121716
 Start Date : 11/30/2021
 Page No : 1

Groups Printed- Passenger Vehicles

Start Time	Elsworth Street Southbound				Cactus Avenue Westbound				March ARB Northbound				Cactus Avenue Eastbound										
	Left	Thru	Right	RTOR	App. Total	Left	Thru	Right	RTOR	App. Total	Left	Thru	Right	RTOR	App. Total	Left	Thru	Right	RTOR	App. Total	Exclu. Total	Inclu. Total	Int. Total
04:00 PM	43	3	32	11	78	3	240	17	11	260	81	23	32	8	136	24	409	2	0	435	30	909	939
04:15 PM	48	2	24	16	74	3	213	21	11	237	71	22	26	5	119	41	402	1	0	444	32	874	906
04:30 PM	49	4	46	27	99	4	308	27	13	339	57	22	16	5	95	32	439	7	0	478	45	1011	1056
04:45 PM	48	3	52	27	103	3	313	24	7	340	25	8	17	9	50	32	457	10	1	499	44	992	1036
Total	188	12	154	81	354	13	1074	89	42	1176	234	75	91	27	400	129	1707	20	1	1856	151	3786	3937
05:00 PM	53	4	55	32	112	5	294	9	3	308	35	11	13	4	59	29	465	6	0	500	39	979	1018
05:15 PM	55	2	34	15	91	4	254	26	18	284	29	10	14	5	53	34	362	4	0	400	38	828	866
05:30 PM	49	1	26	16	76	1	305	24	15	330	22	7	2	1	31	19	382	2	0	403	32	840	872
05:45 PM	51	3	22	11	76	1	232	16	5	249	14	5	2	2	21	22	474	0	0	496	18	842	860
Total	208	10	137	74	355	11	1085	75	41	1171	100	33	31	12	164	104	1683	12	0	1799	127	3489	3616
Grand Total	396	22	291	155	709	24	2159	164	83	2347	334	108	122	39	564	233	3390	32	1	3655	278	7275	7553
T-Approch %	55.9	3.1	41			1	92	7			59.2	19.1	21.6			6.4	92.7	0.9					
Op. Total %	5.4	0.3	4		9.7	0.3	29.7	2.3		32.3	4.6	1.5	1.7		7.8	3.2	46.6	0.4		50.2	3.7	96.3	

Start Time	Elsworth Street Southbound				Cactus Avenue Westbound				March ARB Northbound				Cactus Avenue Eastbound													
	Left	Thru	Right	RTOR	App. Total	Left	Thru	Right	RTOR	App. Total	Left	Thru	Right	RTOR	App. Total	Left	Thru	Right	RTOR	App. Total	Left	Thru	Right	RTOR	App. Total	Int. Total
04:15 PM	48	2	24		74	3	213	21		237	71	22	26		119	41	402	1								874
04:30 PM	49	4	46		99	4	308	27		339	57	22	16		95	32	439	7								1011
04:45 PM	48	3	52		103	3	313	24		340	25	8	17		50	32	457	10								992
05:00 PM	53	4	55		112	5	294	9		308	35	11	13		59	29	465	6								979
Total Volume	198	13	177		388	15	1128	81		1224	188	63	72		323	134	1763	24								3856
% App. Total	51	3.4	45.6		805	1.2	92.2	6.6		58.2	19.5	22.3		7.8	6.4	92.7	0.9									96.3
PHF	.934	.813	.805		.866	.750	.901	.750		.900	.662	.716	.692		.679	.817	.948	.600								.954

Peak Hour Analysis From 04:15 PM to 05:00 PM - Peak 1 of 1
 Peak Hour for Entire Intersection Begins at 04:15 PM

Counts Unlimited, Inc.
 PO Box 1178
 Corona, CA 92878
 (951)268-6268

County of Riverside
 N/S: Elsworth Street/March ARB
 E/W: Cactus Avenue
 Weather: Clear

File Name : 33_CRV_Els_Cactus PM
 Site Code : 05121716
 Start Date : 11/30/2021
 Page No : 2

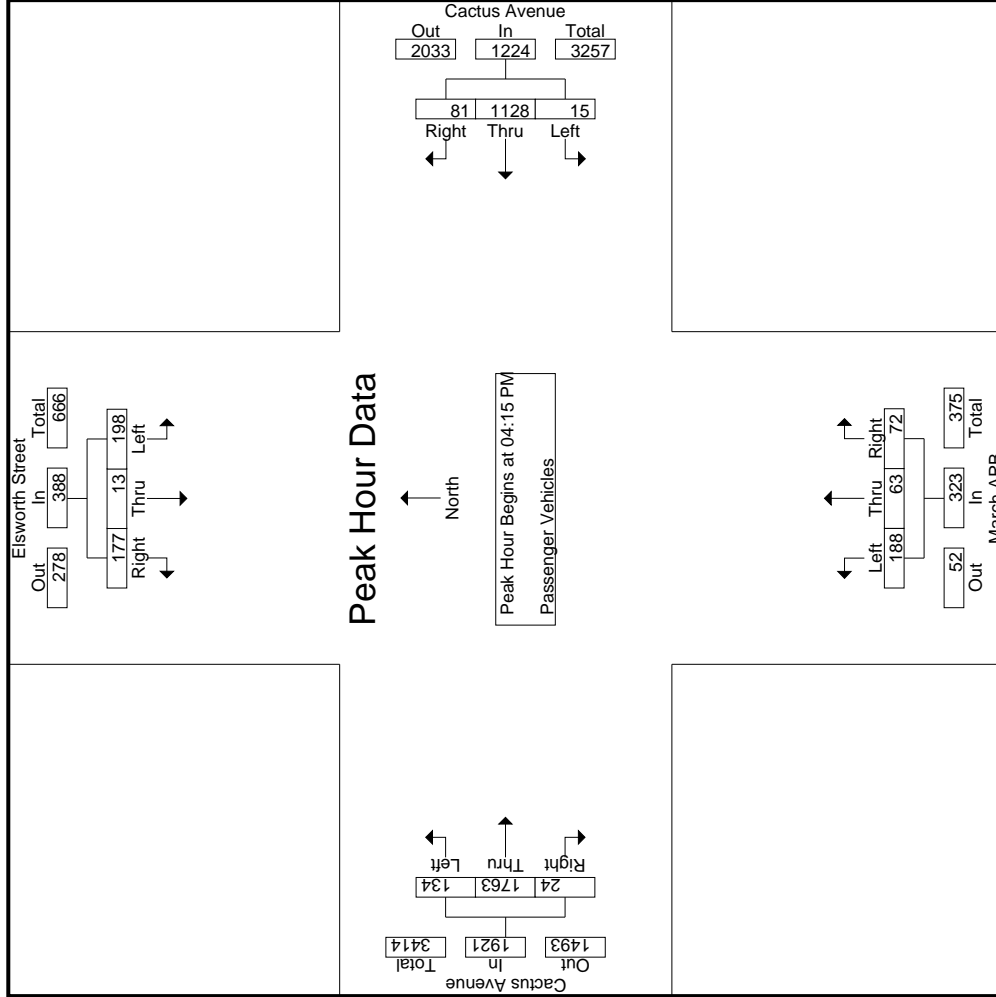

Counts Unlimited, Inc.
 PO Box 1178
 Corona, CA 92878
 (951)268-6268

County of Riverside
 N/S: Elsworth Street/March ARB
 E/W: Cactus Avenue
 Weather: Clear

File Name : 33_CRV_Els_Cactus PM
 Site Code : 05121716
 Start Date : 11/30/2021
 Page No : 3

Start Time	Elsworth Street Southbound			Cactus Avenue Westbound			March ARB Northbound			Cactus Avenue Eastbound				
	Left	Thru	Right	Left	Thru	Right	Left	Thru	Right	Left	Thru	Right		
Peak Hour Analysis From 04:15 PM to 05:00 PM - Peak 1 of 1	Peak Hour for Each Approach Begins at:													
	04:15 PM			04:15 PM			04:15 PM			04:15 PM				
+0 mins.	48	2	24	3	213	21	237	71	22	26	41	402	1	444
+15 mins.	49	4	46	4	308	27	339	57	22	16	32	439	7	478
+30 mins.	48	3	52	3	313	24	340	25	8	17	32	457	10	499
+45 mins.	53	4	55	5	294	9	308	35	11	13	29	465	6	500
Total Volume	198	13	177	15	1128	81	1224	188	63	72	134	1763	24	1921
% App. Total	51	3.4	45.6	1.2	92.2	6.6	58.2	58.2	19.5	22.3	7	91.8	1.2	1921
PHF	.934	.813	.805	.750	.901	.750	.900	.662	.716	.692	.817	.948	.600	.961

Groups Printed- Large 2 Axle Vehicles

Start Time	Elsworth Street Southbound				Cactus Avenue Westbound				March ARB Northbound				Cactus Avenue Eastbound											
	Left	Thru	Right	RTOR	App. Total	Left	Thru	Right	RTOR	App. Total	Left	Thru	Right	RTOR	App. Total	Left	Thru	Right	RTOR	App. Total	Exclu. Total	Inclu. Total	Int. Total	
04:00 PM	1	0	0	0	1	0	6	1	0	7	0	0	0	0	0	0	18	0	0	0	18	0	26	26
04:15 PM	0	0	0	0	0	2	0	0	0	2	0	0	0	0	0	0	11	0	0	0	11	0	13	13
04:30 PM	0	0	0	0	0	5	0	0	0	5	0	0	0	0	0	7	0	0	0	7	0	12	12	
04:45 PM	0	0	0	0	0	5	1	1	1	6	0	0	0	0	0	3	12	0	0	15	1	21	22	
Total	1	0	0	0	1	18	2	1	20	20	0	0	0	0	0	3	48	0	0	51	1	72	73	
05:00 PM	0	0	0	0	0	7	0	0	0	7	0	0	0	0	0	1	2	0	0	3	0	10	10	
05:15 PM	0	0	3	2	3	2	0	0	0	2	0	0	0	0	0	1	7	0	0	8	2	13	15	
05:30 PM	0	1	0	0	1	4	0	0	0	4	1	0	0	1	0	0	8	0	0	8	0	14	14	
05:45 PM	0	0	0	0	0	2	0	0	0	2	0	0	0	0	0	2	0	0	0	2	0	4	4	
Total	0	1	3	2	4	15	0	0	15	15	1	0	0	0	1	2	19	0	0	21	2	41	43	
Grand Total	1	1	3	2	5	0	33	2	1	35	1	0	0	0	1	5	67	0	0	72	3	113	116	
T-Approch %	20	20	60			0	94.3	5.7		100	0	0	0		6.9	93.1	0	0	63.7		2.6	97.4		
Total %	0.9	0.9	2.7		4.4	0	29.2	1.8		0.9	0	0	0		4.4	59.3	0	0						

Start Time	Elsworth Street Southbound				Cactus Avenue Westbound				March ARB Northbound				Cactus Avenue Eastbound										
	Left	Thru	Right	RTOR	App. Total	Left	Thru	Right	RTOR	App. Total	Left	Thru	Right	RTOR	App. Total	Left	Thru	Right	RTOR	App. Total	Exclu. Total	Inclu. Total	Int. Total
04:15 PM	0	0	0	0	0	0	2	0	0	2	0	0	0	0	0	0	11	0	0	0	0	11	11
04:30 PM	0	0	0	0	0	0	5	0	0	5	0	0	0	0	0	0	7	0	0	0	0	7	12
04:45 PM	0	0	0	0	0	0	5	1	0	6	0	0	0	0	0	3	12	0	0	0	0	15	21
05:00 PM	0	0	0	0	0	0	7	0	0	7	0	0	0	0	0	1	2	0	0	0	0	3	10
Total Volume	0	0	0	0	0	0	19	1	20	20	0	0	0	0	0	4	32	0	0	36	0	66	66
% App. Total	0	0	0	0	0	0	95	5	0	0	0	0	0	0	0	11.1	88.9	0	0	66.7	0	600	667
PHF	.000	.000	.000	.000	.000	.000	.679	.250	.714	.000	.000	.000	.000	.000	.000	.333	.667	.000	.600	.667			

Peak Hour Analysis From 04:15 PM to 05:00 PM - Peak 1 of 1
 Peak Hour for Entire Intersection Begins at 04:15 PM

Counts Unlimited, Inc.
 PO Box 1178
 Corona, CA 92878
 (951)268-6268

County of Riverside
 N/S: Elsworth Street/March ARB
 E/W: Cactus Avenue
 Weather: Clear

File Name : 33_CRV_Els_Cactus PM
 Site Code : 05121716
 Start Date : 11/30/2021
 Page No : 2

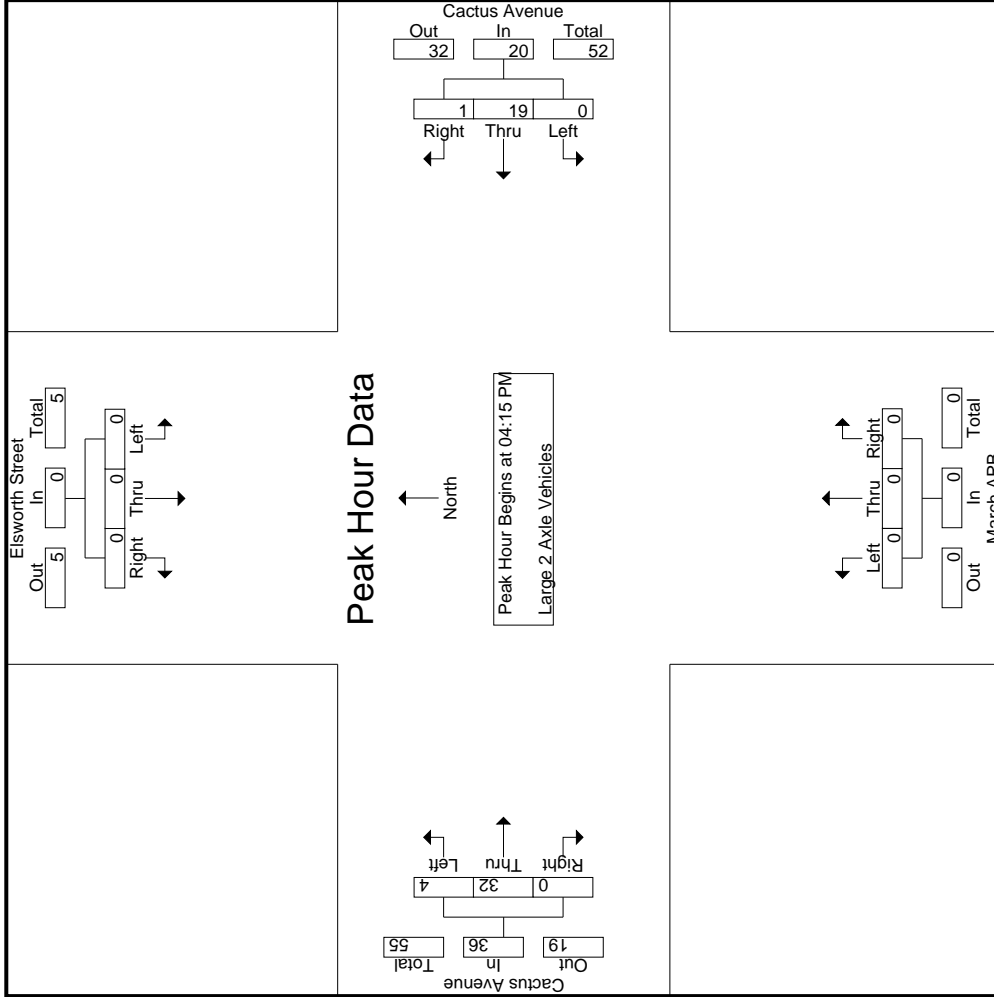

Counts Unlimited, Inc.
 PO Box 1178
 Corona, CA 92878
 (951)268-6268

County of Riverside
 N/S: Elsworth Street/March ARB
 E/W: Cactus Avenue
 Weather: Clear

File Name : 33_CRV_Els_Cactus PM
 Site Code : 05121716
 Start Date : 11/30/2021
 Page No : 3

Start Time	Elsworth Street Southbound			Cactus Avenue Westbound			March ARB Northbound			Cactus Avenue Eastbound			Int. Total	
	Left	Thru	Right	Left	Thru	Right	Left	Thru	Right	Left	Thru	Right		
Peak Hour Analysis From 04:15 PM to 05:00 PM - Peak 1 of 1	04:15 PM													
Peak Hour for Each Approach Begins at:	04:15 PM													
+0 mins.	0	0	0	0	2	0	2	0	0	0	0	11	0	11
+15 mins.	0	0	0	0	5	0	5	0	0	0	0	7	0	7
+30 mins.	0	0	0	0	5	1	6	0	0	0	3	12	0	15
+45 mins.	0	0	0	0	7	0	7	0	0	0	1	2	0	3
Total Volume	0	0	0	0	19	1	20	0	0	0	4	32	0	36
% App. Total	0	0	0	0	95	5	95	0	0	0	11.1	88.9	0	0
PHF	.000	.000	.000	.000	.679	.250	.714	.000	.000	.000	.333	.667	.000	.600

Counts Unlimited, Inc.
 PO Box 1178
 Corona, CA 92878
 (951)268-6268

County of Riverside
 N/S: Elsworth Street/March ARB
 E/W: Cactus Avenue
 Weather: Clear

File Name : 33_CRV_Els_Cactus PM
 Site Code : 05121716
 Start Date : 11/30/2021
 Page No : 1

Groups Printed- 3 Axle Vehicles

Start Time	Elsworth Street Southbound				Cactus Avenue Westbound				March ARB Northbound				Cactus Avenue Eastbound					
	Left	Thru	Right	RTOR	App. Total	Left	Thru	Right	RTOR	App. Total	Left	Thru	Right	RTOR	App. Total	Exclu. Total	Inclu. Total	Int. Total
04:00 PM	0	0	0	0	0	2	0	0	0	2	0	0	0	0	0	0	2	2
04:15 PM	0	0	0	0	0	0	0	0	0	0	0	0	0	0	3	0	3	3
04:30 PM	0	0	0	0	0	0	0	0	0	0	0	0	0	0	1	0	1	1
04:45 PM	0	0	1	1	1	1	0	0	0	1	0	0	0	0	5	1	7	8
Total	0	0	1	1	1	3	0	0	0	3	0	0	0	0	9	1	13	14
05:00 PM	0	0	0	0	0	0	0	0	0	0	0	0	0	0	1	0	2	2
05:15 PM	0	0	0	0	0	0	0	0	0	0	0	0	0	0	1	0	1	1
05:30 PM	0	0	0	0	0	1	0	0	0	1	0	0	0	0	1	0	2	2
05:45 PM	0	0	2	2	2	1	0	0	0	1	0	0	0	0	2	2	5	7
Total	0	0	2	2	2	2	0	0	0	2	0	0	0	0	5	2	10	12
Grand Total	0	0	3	3	3	5	0	0	0	5	0	0	0	0	14	3	23	26
T-Approch %	0	0	100			100	0	0	100		0	0	100		60.9	11.5	88.5	
Total %	0	0	13		13	21.7	0	0	4.3	4.3	0	60.9	0	0	60.9	11.5	88.5	

Start Time	Elsworth Street Southbound				Cactus Avenue Westbound				March ARB Northbound				Cactus Avenue Eastbound					
	Left	Thru	Right	RTOR	App. Total	Left	Thru	Right	RTOR	App. Total	Left	Thru	Right	RTOR	App. Total	Exclu. Total	Inclu. Total	Int. Total
04:15 PM	0	0	0	0	0	0	0	0	0	0	0	0	0	0	0	0	0	3
04:30 PM	0	0	0	0	0	0	0	0	0	0	0	0	0	0	1	0	1	1
04:45 PM	0	0	0	0	0	1	0	0	0	1	0	0	0	0	5	0	5	7
05:00 PM	0	0	0	0	0	0	0	0	0	0	0	0	0	0	1	0	1	2
Total Volume	0	0	0	0	0	1	0	0	0	1	0	0	0	0	10	0	10	13
% App. Total	0	0	0	0	0	100	0	0	100	0	0	100	0	0	100	0	100	13
PHF	.000	.000	.000	.250	.250	.000	.250	.000	.250	.250	.000	.250	.000	.000	.500	.000	.500	.464

Peak Hour Analysis From 04:15 PM to 05:00 PM - Peak 1 of 1
 Peak Hour for Entire Intersection Begins at 04:15 PM

Counts Unlimited, Inc.
 PO Box 1178
 Corona, CA 92878
 (951)268-6268

County of Riverside
 N/S: Elsworth Street/March ARB
 E/W: Cactus Avenue
 Weather: Clear

File Name : 33_CRV_Els_Cactus PM
 Site Code : 05121716
 Start Date : 11/30/2021
 Page No : 2

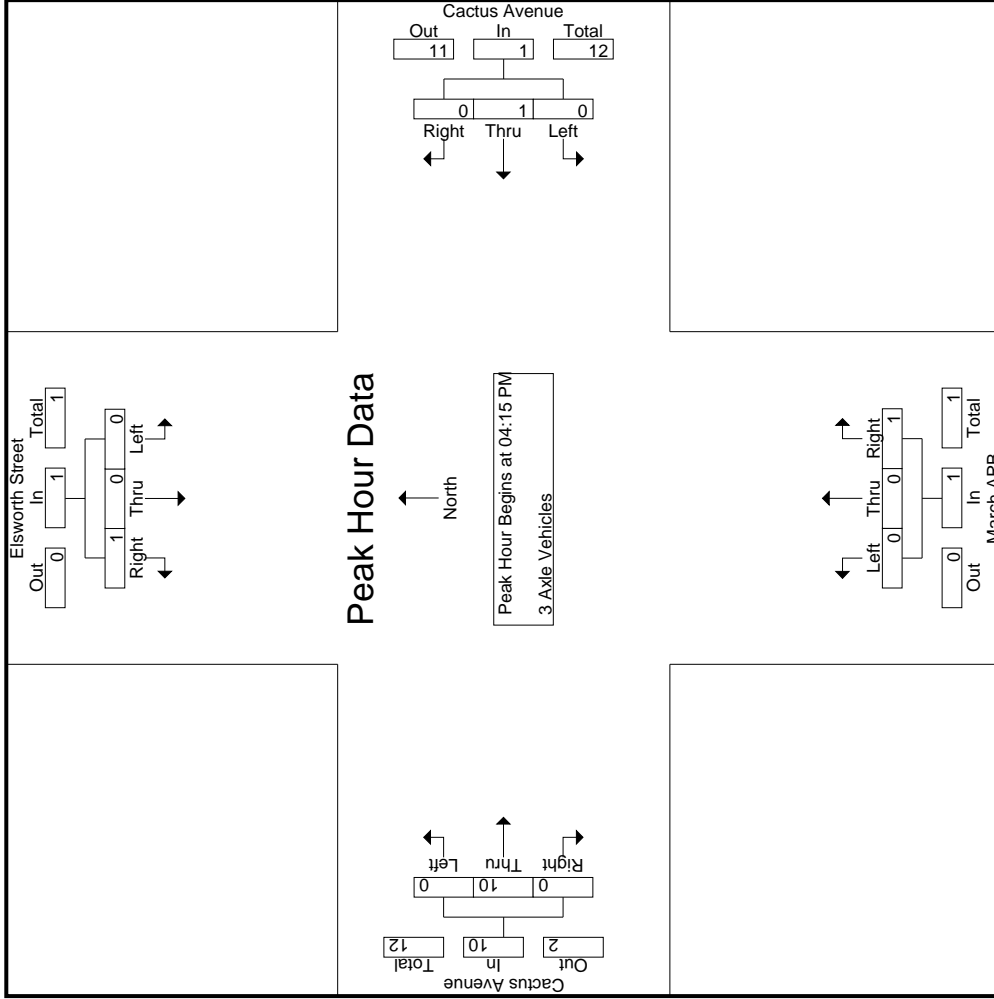

Counts Unlimited, Inc.
 PO Box 1178
 Corona, CA 92878
 (951)268-6268

County of Riverside
 N/S: Elsworth Street/March ARB
 E/W: Cactus Avenue
 Weather: Clear

File Name : 33_CRV_Els_Cactus PM
 Site Code : 05121716
 Start Date : 11/30/2021
 Page No : 3

Start Time	Elsworth Street Southbound			Cactus Avenue Westbound			March ARB Northbound			Cactus Avenue Eastbound			Int. Total
	Left	Thru	Right	Left	Thru	Right	Left	Thru	Right	Left	Thru	Right	
Peak Hour Analysis From 04:15 PM to 05:00 PM - Peak 1 of 1	04:15 PM												
Peak Hour for Each Approach Begins at:	04:15 PM												
+0 mins.	0	0	0	0	0	0	0	0	0	0	0	0	0
+15 mins.	0	0	0	0	0	0	0	0	0	0	0	0	0
+30 mins.	0	0	1	0	1	0	1	0	0	0	0	0	5
+45 mins.	0	0	0	0	0	0	0	0	1	0	0	0	1
Total Volume	0	0	1	0	1	0	1	0	0	0	0	0	10
% App. Total	0	0	100	0	100	0	0	0	100	0	0	0	0
PHF	.000	.000	.250	.000	.250	.000	.250	.000	.250	.000	.500	.000	.500

Counts Unlimited, Inc.
 PO Box 1178
 Corona, CA 92878
 (951)268-6268

County of Riverside
 N/S: Elsworth Street/March ARB
 E/W: Cactus Avenue
 Weather: Clear

File Name : 33_CRV_Els_Cactus PM
 Site Code : 05121716
 Start Date : 11/30/2021
 Page No : 1

Groups Printed- 4+ Axle Trucks

Start Time	Elsworth Street Southbound				Cactus Avenue Westbound				March ARB Northbound				Cactus Avenue Eastbound				Exclu. Total	Inclu. Total	Int. Total				
	Left	Thru	Right	RTOR	App. Total	Left	Thru	Right	RTOR	App. Total	Left	Thru	Right	RTOR	App. Total	Left				Thru	Right	RTOR	App. Total
04:00 PM	0	0	0	0	0	9	0	0	0	0	0	0	0	0	0	1	7	0	0	8	0	17	17
04:15 PM	0	0	0	0	12	0	0	0	0	1	1	11	1	0	13	0	13	1	0	13	0	26	26
04:30 PM	0	0	0	0	4	0	0	0	0	0	0	13	1	0	14	0	13	1	0	14	0	18	18
04:45 PM	1	0	0	0	4	0	0	0	0	0	0	8	0	0	8	0	8	0	0	8	0	13	13
Total	1	0	0	0	29	0	0	0	0	1	2	39	2	0	43	0	39	2	0	43	0	74	74
05:00 PM	0	0	0	0	11	0	0	0	0	0	0	7	0	0	7	0	7	0	0	7	0	18	18
05:15 PM	0	0	0	0	9	0	0	0	0	0	0	11	0	0	11	0	11	0	0	11	0	20	20
05:30 PM	0	0	1	1	3	0	0	0	0	0	0	8	0	0	8	0	8	0	0	8	1	12	13
05:45 PM	0	0	0	0	4	0	0	0	0	0	0	17	0	0	17	0	17	0	0	17	0	21	21
Total	0	0	1	1	27	0	0	0	0	0	0	43	0	0	43	0	43	0	0	43	1	71	72
Grand Total	1	0	1	1	56	0	0	0	0	1	2	82	2	0	86	1	82	2	0	86	1	145	146
T-Approch %	50	0	50		100	0	0	0	0	0.7	2.3	95.3	2.3		59.3	0.7	99.3	1.4		0.7	99.3		
on Total %	0.7	0	0.7	1.4	38.6	0	0	0	0	0.7	1.4	56.6	1.4										

Start Time	Elsworth Street Southbound				Cactus Avenue Westbound				March ARB Northbound				Cactus Avenue Eastbound				Exclu. Total	Inclu. Total	Int. Total				
	Left	Thru	Right	RTOR	App. Total	Left	Thru	Right	RTOR	App. Total	Left	Thru	Right	RTOR	App. Total	Left				Thru	Right	RTOR	App. Total
04:15 PM	0	0	0	0	0	12	0	0	0	0	1	12	0	0	12	0	12	0	0	12	0	13	26
04:30 PM	0	0	0	0	4	0	0	0	0	0	4	4	0	0	4	0	4	0	0	4	0	14	18
04:45 PM	1	0	0	0	1	0	0	0	0	0	4	4	0	0	4	0	4	0	0	4	0	8	13
05:00 PM	0	0	0	0	0	11	0	0	0	0	11	11	0	0	11	0	11	0	0	11	0	7	18
Total Volume	1	0	0	0	31	0	0	0	0	31	1	39	1	0	42	1	39	2	0	42	2	75	75
% App. Total	100	0	0	0	100	0	0	0	0	100	.250	92.9	4.8		.750	.250	92.9	4.8		.750	.500	.721	
PHF	.250	.000	.000	.250	.646	.000	.646	.000	.000	.646	.250	.750	.500		.750	.250	.750	.500		.750	.500	.721	

Peak Hour Analysis From 04:15 PM to 05:00 PM - Peak 1 of 1
 Peak Hour for Entire Intersection Begins at 04:15 PM

Counts Unlimited, Inc.
 PO Box 1178
 Corona, CA 92878
 (951)268-6268

County of Riverside
 N/S: Elsworth Street/March ARB
 E/W: Cactus Avenue
 Weather: Clear

File Name : 33_CRV_Els_Cactus PM
 Site Code : 05121716
 Start Date : 11/30/2021
 Page No : 2

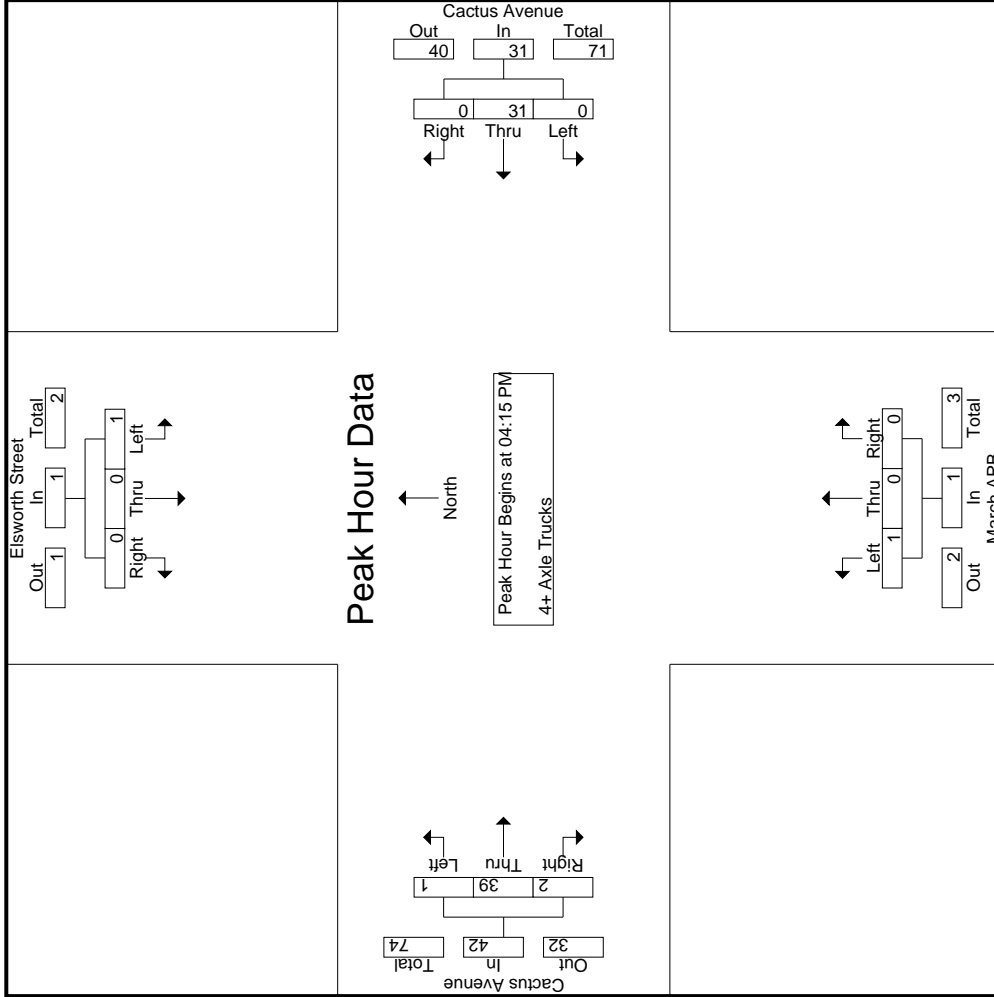

Counts Unlimited, Inc.
 PO Box 1178
 Corona, CA 92878
 (951)268-6268

County of Riverside
 N/S: Elsworth Street/March ARB
 E/W: Cactus Avenue
 Weather: Clear

File Name : 33_CRV_Els_Cactus PM
 Site Code : 05121716
 Start Date : 11/30/2021
 Page No : 3

Start Time	Elsworth Street Southbound			Cactus Avenue Westbound			March ARB Northbound			Cactus Avenue Eastbound		
	Left	Thru	Right	Left	Thru	Right	Left	Thru	Right	Left	Thru	Right
Peak Hour Analysis From 04:15 PM to 05:00 PM - Peak 1 of 1												
Peak Hour for Each Approach Begins at:												
+0 mins.	0	0	0	0	0	0	12	0	0	1	11	1
+15 mins.	0	0	0	0	0	4	4	0	0	0	13	1
+30 mins.	1	0	0	0	0	4	4	0	0	0	8	0
+45 mins.	0	0	0	0	0	11	11	0	0	0	7	0
Total Volume	1	0	0	0	31	0	31	0	0	1	39	2
% App. Total	100	0	0	0	100	0	100	0	0	2.4	92.9	4.8
PHF	.250	.000	.000	.000	.646	.000	.646	.000	.000	.250	.750	.500

Location: County of Riverside
 N/S: Elsworth Street/March ARB
 E/W: Cactus Avenue



Date: 11/30/2021
 Day: Tuesday

PEDESTRIANS

	North Leg Elsworth Street	East Leg Cactus Avenue	South Leg March ARB	West Leg Cactus Avenue	
	Pedestrians	Pedestrians	Pedestrians	Pedestrians	
7:00 AM	1	0	0	0	1
7:15 AM	0	0	0	0	0
7:30 AM	0	0	0	0	0
7:45 AM	0	0	0	0	0
8:00 AM	0	0	0	0	0
8:15 AM	0	0	0	0	0
8:30 AM	1	0	0	0	1
8:45 AM	0	0	1	0	1
TOTAL VOLUMES:	2	0	1	0	3

	North Leg Elsworth Street	East Leg Cactus Avenue	South Leg March ARB	West Leg Cactus Avenue	
	Pedestrians	Pedestrians	Pedestrians	Pedestrians	
4:00 PM	0	0	0	0	0
4:15 PM	0	0	0	0	0
4:30 PM	0	0	0	0	0
4:45 PM	0	0	0	0	0
5:00 PM	0	0	0	0	0
5:15 PM	0	0	0	0	0
5:30 PM	0	0	0	0	0
5:45 PM	0	0	0	0	0
TOTAL VOLUMES:	0	0	0	0	0

Location: County of Riverside
 N/S: Elsworth Street/March ARB
 E/W: Cactus Avenue



Date: 11/30/2021
 Day: Tuesday

BICYCLES

	Southbound Elsworth Street			Westbound Cactus Avenue			Northbound March ARB			Eastbound Cactus Avenue			
	Left	Thru	Right	Left	Thru	Right	Left	Thru	Right	Left	Thru	Right	
7:00 AM	0	0	0	0	0	0	0	0	0	0	0	0	0
7:15 AM	0	0	0	0	1	0	0	0	0	0	0	0	1
7:30 AM	0	0	0	0	0	0	0	0	0	0	0	0	0
7:45 AM	0	0	0	0	0	0	0	0	0	0	0	0	0
8:00 AM	0	0	0	0	0	0	0	0	0	0	0	0	0
8:15 AM	0	0	0	0	0	0	0	0	0	0	0	0	0
8:30 AM	0	0	0	0	0	0	0	0	0	0	0	0	0
8:45 AM	0	0	0	0	0	0	0	0	0	0	0	0	0
TOTAL VOLUMES:	0	0	0	0	1	0	0	0	0	0	0	0	1

	Southbound Elsworth Street			Westbound Cactus Avenue			Northbound March ARB			Eastbound Cactus Avenue			
	Left	Thru	Right	Left	Thru	Right	Left	Thru	Right	Left	Thru	Right	
4:00 PM	0	0	0	0	0	0	0	0	0	0	1	0	1
4:15 PM	0	0	0	0	0	0	0	0	0	0	0	0	0
4:30 PM	0	0	0	0	0	0	0	0	0	0	0	0	0
4:45 PM	0	0	0	0	0	0	0	0	0	0	0	0	0
5:00 PM	0	0	0	0	0	0	0	0	0	0	0	0	0
5:15 PM	0	0	0	0	0	0	0	0	0	0	0	0	0
5:30 PM	0	0	0	0	0	0	0	0	0	0	0	0	0
5:45 PM	0	0	0	0	0	0	0	0	0	0	0	0	0
TOTAL VOLUMES:	0	0	0	0	0	0	0	0	0	0	1	0	1

County of Riverside
 N/S: Frederick Street
 E/W: Cactus Avenue
 Weather: Clear

File Name : 34_CRV_Fred_Cactus AM
 Site Code : 05121716
 Start Date : 11/30/2021
 Page No : 1

Groups Printed- Passenger Vehicles - Large 2 Axle Vehicles - 3 Axle Vehicles - 4+ Axle Trucks

Start Time	Frederick Street Southbound				Cactus Avenue Westbound				Cactus Avenue Eastbound			Exclu. Total	Inclu. Total	Int. Total
	Left	Right	RTOR	App. Total	Thru	Right	RTOR	App. Total	Left	Thru	App. Total			
07:00 AM	18	18	9	36	407	12	3	419	23	207	230	12	685	697
07:15 AM	28	13	6	41	449	21	3	470	35	237	272	9	783	792
07:30 AM	34	22	9	56	379	28	9	407	45	260	305	18	768	786
07:45 AM	42	24	15	66	425	37	12	462	42	309	351	27	879	906
Total	122	77	39	199	1660	98	27	1758	145	1013	1158	66	3115	3181
08:00 AM	30	23	8	53	439	43	16	482	45	269	314	24	849	873
08:15 AM	32	24	9	56	357	21	6	378	28	256	284	15	718	733
08:30 AM	25	23	9	48	332	34	10	366	34	266	300	19	714	733
08:45 AM	26	17	5	43	284	27	6	311	31	211	242	11	596	607
Total	113	87	31	200	1412	125	38	1537	138	1002	1140	69	2877	2946
Grand Total	235	164	70	399	3072	223	65	3295	283	2015	2298	135	5992	6127
Apprch %	58.9	41.1			93.2	6.8			12.3	87.7				
Total %	3.9	2.7		6.7	51.3	3.7		55	4.7	33.6	38.4	2.2	97.8	
Passenger Vehicles	225	153		445	2941	203		3203	259	1853	2112	0	0	5760
% Passenger Vehicles	95.7	93.3	95.7	94.9	95.7	91	90.8	95.3	91.5	92	91.9	0	0	94
Large 2 Axle Vehicles	7	5		13	26	7		34	7	42	49	0	0	96
% Large 2 Axle Vehicles	3	3	1.4	2.8	0.8	3.1	1.5	1	2.5	2.1	2.1	0	0	1.6
3 Axle Vehicles	0	3		4	34	1		35	2	21	23	0	0	62
% 3 Axle Vehicles	0	1.8	1.4	0.9	1.1	0.4	0	1	0.7	1	1	0	0	1
4+ Axle Trucks	3	3		7	71	12		88	15	99	114	0	0	209
% 4+ Axle Trucks	1.3	1.8	1.4	1.5	2.3	5.4	7.7	2.6	5.3	4.9	5	0	0	3.4

Start Time	Frederick Street Southbound			Cactus Avenue Westbound			Cactus Avenue Eastbound			Int. Total
	Left	Right	App. Total	Thru	Right	App. Total	Left	Thru	App. Total	
Peak Hour Analysis From 07:00 AM to 08:45 AM - Peak 1 of 1										
Peak Hour for Entire Intersection Begins at 07:15 AM										
07:15 AM	28	13	41	449	21	470	35	237	272	783
07:30 AM	34	22	56	379	28	407	45	260	305	768
07:45 AM	42	24	66	425	37	462	42	309	351	879
08:00 AM	30	23	53	439	43	482	45	269	314	849
Total Volume	134	82	216	1692	129	1821	167	1075	1242	3279
% App. Total	62	38		92.9	7.1		13.4	86.6		
PHF	.798	.854	.818	.942	.750	.945	.928	.870	.885	.933

County of Riverside
 N/S: Frederick Street
 E/W: Cactus Avenue
 Weather: Clear

File Name : 34_CRV_Fred_Cactus AM
 Site Code : 05121716
 Start Date : 11/30/2021
 Page No : 2

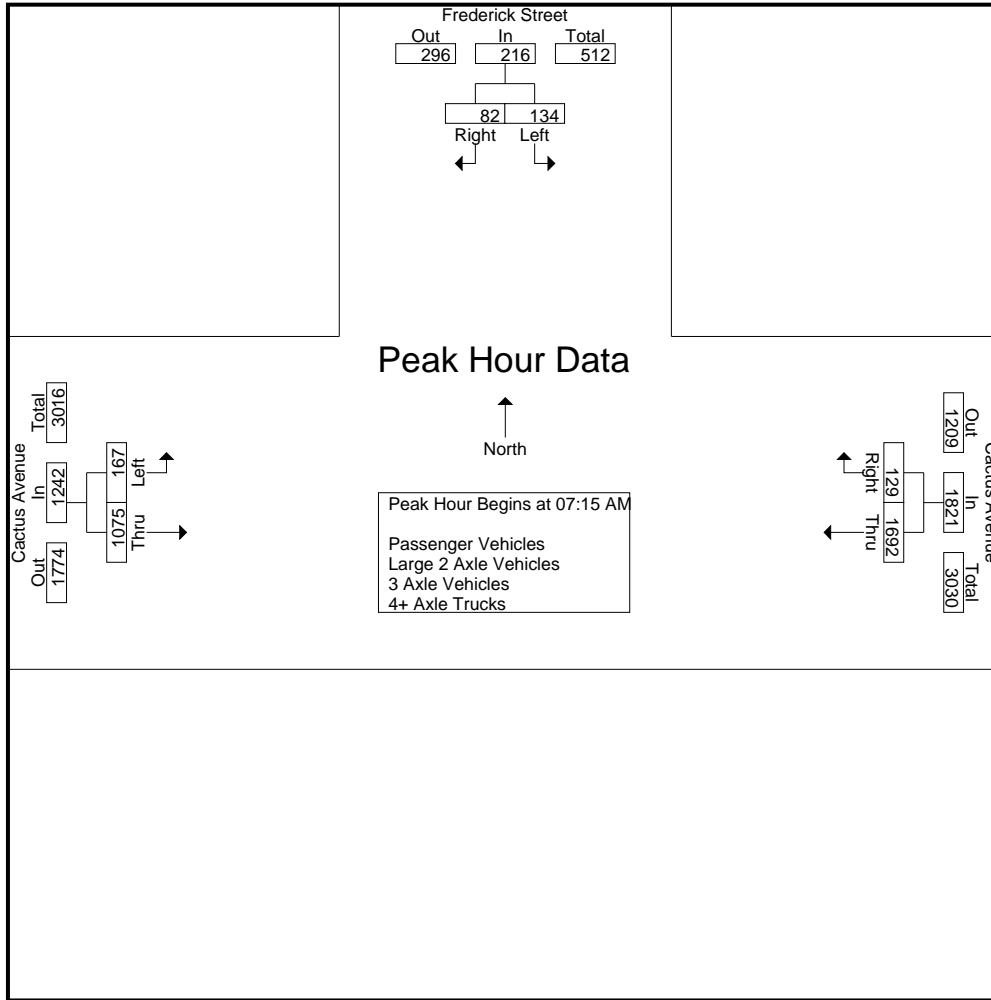

Peak Hour Analysis From 07:00 AM to 08:45 AM - Peak 1 of 1
 Peak Hour for Each Approach Begins at:

	07:30 AM			07:15 AM			07:30 AM		
+0 mins.	34	22	56	449	21	470	45	260	305
+15 mins.	42	24	66	379	28	407	42	309	351
+30 mins.	30	23	53	425	37	462	45	269	314
+45 mins.	32	24	56	439	43	482	28	256	284
Total Volume	138	93	231	1692	129	1821	160	1094	1254
% App. Total	59.7	40.3		92.9	7.1		12.8	87.2	
PHF	.821	.969	.875	.942	.750	.945	.889	.885	.893

County of Riverside
 N/S: Frederick Street
 E/W: Cactus Avenue
 Weather: Clear

File Name : 34_CRV_Fred_Cactus AM
 Site Code : 05121716
 Start Date : 11/30/2021
 Page No : 1

Groups Printed- Passenger Vehicles

Start Time	Frederick Street Southbound				Cactus Avenue Westbound				Cactus Avenue Eastbound			Exclu. Total	Inclu. Total	Int. Total
	Left	Right	RTOR	App. Total	Thru	Right	RTOR	App. Total	Left	Thru	App. Total			
07:00 AM	17	17	9	34	388	10	2	398	21	189	210	11	642	653
07:15 AM	28	12	6	40	433	20	3	453	34	225	259	9	752	761
07:30 AM	32	20	9	52	367	27	9	394	44	242	286	18	732	750
07:45 AM	41	23	15	64	407	37	12	444	40	282	322	27	830	857
Total	118	72	39	190	1595	94	26	1689	139	938	1077	65	2956	3021
08:00 AM	29	21	8	50	414	42	16	456	39	249	288	24	794	818
08:15 AM	31	23	8	54	342	18	4	360	23	232	255	12	669	681
08:30 AM	23	21	7	44	319	24	8	343	32	237	269	15	656	671
08:45 AM	24	16	5	40	271	25	5	296	26	197	223	10	559	569
Total	107	81	28	188	1346	109	33	1455	120	915	1035	61	2678	2739
Grand Total	225	153	67	378	2941	203	59	3144	259	1853	2112	126	5634	5760
Apprch %	59.5	40.5			93.5	6.5			12.3	87.7				
Total %	4	2.7		6.7	52.2	3.6		55.8	4.6	32.9	37.5	2.2	97.8	

Start Time	Frederick Street Southbound			Cactus Avenue Westbound			Cactus Avenue Eastbound			Int. Total
	Left	Right	App. Total	Thru	Right	App. Total	Left	Thru	App. Total	
07:15 AM	28	12	40	433	20	453	34	225	259	752
07:30 AM	32	20	52	367	27	394	44	242	286	732
07:45 AM	41	23	64	407	37	444	40	282	322	830
08:00 AM	29	21	50	414	42	456	39	249	288	794
Total Volume	130	76	206	1621	126	1747	157	998	1155	3108
% App. Total	63.1	36.9		92.8	7.2		13.6	86.4		
PHF	.793	.826	.805	.936	.750	.958	.892	.885	.897	.936

Peak Hour Analysis From 07:15 AM to 08:00 AM - Peak 1 of 1
 Peak Hour for Entire Intersection Begins at 07:15 AM

County of Riverside
 N/S: Frederick Street
 E/W: Cactus Avenue
 Weather: Clear

File Name : 34_CRV_Fred_Cactus AM
 Site Code : 05121716
 Start Date : 11/30/2021
 Page No : 2

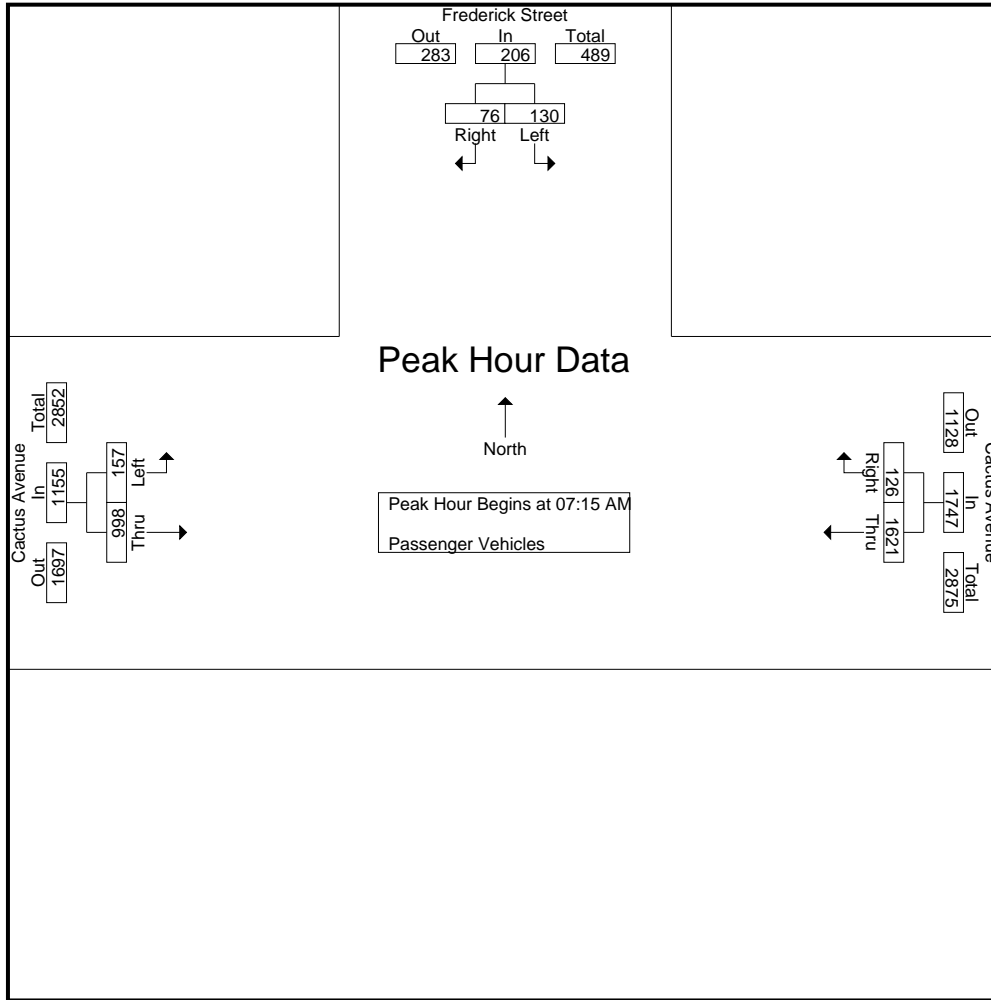

Peak Hour Analysis From 07:15 AM to 08:00 AM - Peak 1 of 1
 Peak Hour for Each Approach Begins at:

	07:15 AM			07:15 AM			07:15 AM		
+0 mins.	28	12	40	433	20	453	34	225	259
+15 mins.	32	20	52	367	27	394	44	242	286
+30 mins.	41	23	64	407	37	444	40	282	322
+45 mins.	29	21	50	414	42	456	39	249	288
Total Volume	130	76	206	1621	126	1747	157	998	1155
% App. Total	63.1	36.9		92.8	7.2		13.6	86.4	
PHF	.793	.826	.805	.936	.750	.958	.892	.885	.897

County of Riverside
 N/S: Frederick Street
 E/W: Cactus Avenue
 Weather: Clear

File Name : 34_CRV_Fred_Cactus AM
 Site Code : 05121716
 Start Date : 11/30/2021
 Page No : 1

Groups Printed- Large 2 Axle Vehicles

Start Time	Frederick Street Southbound				Cactus Avenue Westbound				Cactus Avenue Eastbound			Exclu. Total	Inclu. Total	Int. Total
	Left	Right	RTOR	App. Total	Thru	Right	RTOR	App. Total	Left	Thru	App. Total			
07:00 AM	1	0	0	1	6	0	0	6	0	5	5	0	12	12
07:15 AM	0	1	0	1	2	0	0	2	0	4	4	0	7	7
07:30 AM	1	1	0	2	2	1	0	3	0	3	3	0	8	8
07:45 AM	1	1	0	2	3	0	0	3	1	10	11	0	16	16
Total	3	3	0	6	13	1	0	14	1	22	23	0	43	43
08:00 AM	1	0	0	1	7	1	0	8	0	7	7	0	16	16
08:15 AM	1	0	0	1	2	2	1	4	2	2	4	1	9	10
08:30 AM	0	1	1	1	4	3	0	7	1	9	10	1	18	19
08:45 AM	2	1	0	3	0	0	0	0	3	2	5	0	8	8
Total	4	2	1	6	13	6	1	19	6	20	26	2	51	53
Grand Total	7	5	1	12	26	7	1	33	7	42	49	2	94	96
Apprch %	58.3	41.7			78.8	21.2			14.3	85.7				
Total %	7.4	5.3		12.8	27.7	7.4		35.1	7.4	44.7	52.1	2.1	97.9	

Start Time	Frederick Street Southbound			Cactus Avenue Westbound			Cactus Avenue Eastbound			Int. Total
	Left	Right	App. Total	Thru	Right	App. Total	Left	Thru	App. Total	
07:15 AM	0	1	1	2	0	2	0	4	4	7
07:30 AM	1	1	2	2	1	3	0	3	3	8
07:45 AM	1	1	2	3	0	3	1	10	11	16
08:00 AM	1	0	1	7	1	8	0	7	7	16
Total Volume	3	3	6	14	2	16	1	24	25	47
% App. Total	50	50		87.5	12.5		4	96		
PHF	.750	.750	.750	.500	.500	.500	.250	.600	.568	.734

Peak Hour Analysis From 07:15 AM to 08:00 AM - Peak 1 of 1

Peak Hour for Entire Intersection Begins at 07:15 AM

County of Riverside
 N/S: Frederick Street
 E/W: Cactus Avenue
 Weather: Clear

File Name : 34_CRV_Fred_Cactus AM
 Site Code : 05121716
 Start Date : 11/30/2021
 Page No : 2

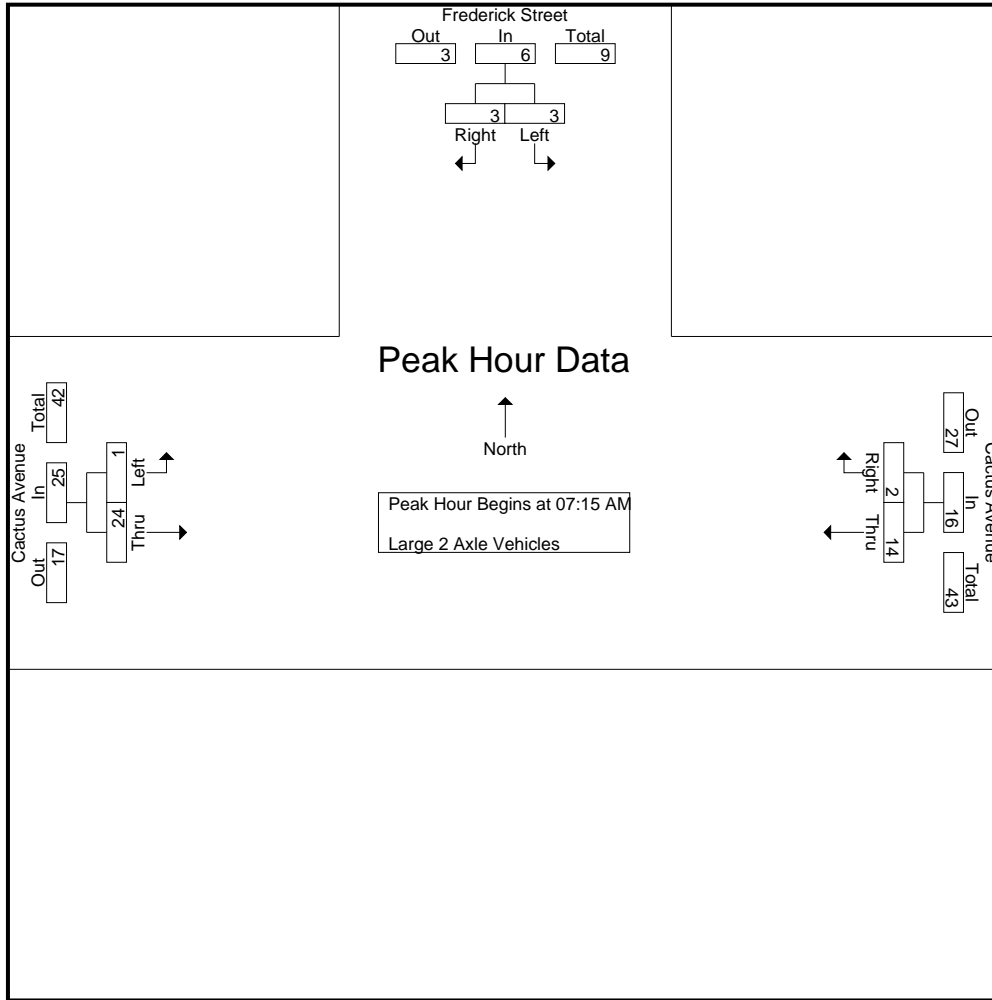

Peak Hour Analysis From 07:15 AM to 08:00 AM - Peak 1 of 1
 Peak Hour for Each Approach Begins at:

	07:15 AM			07:15 AM			07:15 AM		
+0 mins.	0	1	1	2	0	2	0	4	4
+15 mins.	1	1	2	2	1	3	0	3	3
+30 mins.	1	1	2	3	0	3	1	10	11
+45 mins.	1	0	1	7	1	8	0	7	7
Total Volume	3	3	6	14	2	16	1	24	25
% App. Total	50	50		87.5	12.5		4	96	
PHF	.750	.750	.750	.500	.500	.500	.250	.600	.568

County of Riverside
 N/S: Frederick Street
 E/W: Cactus Avenue
 Weather: Clear

File Name : 34_CRV_Fred_Cactus AM
 Site Code : 05121716
 Start Date : 11/30/2021
 Page No : 1

Groups Printed- 3 Axle Vehicles

Start Time	Frederick Street Southbound				Cactus Avenue Westbound				Cactus Avenue Eastbound			Exclu. Total	Inclu. Total	Int. Total
	Left	Right	RTOR	App. Total	Thru	Right	RTOR	App. Total	Left	Thru	App. Total			
07:00 AM	0	0	0	0	6	0	0	6	1	4	5	0	11	11
07:15 AM	0	0	0	0	2	0	0	2	0	2	2	0	4	4
07:30 AM	0	1	0	1	1	0	0	1	0	2	2	0	4	4
07:45 AM	0	0	0	0	6	0	0	6	0	0	0	0	6	6
Total	0	1	0	1	15	0	0	15	1	8	9	0	25	25
08:00 AM	0	1	0	1	5	0	0	5	1	4	5	0	11	11
08:15 AM	0	1	1	1	6	0	0	6	0	6	6	1	13	14
08:30 AM	0	0	0	0	4	1	0	5	0	1	1	0	6	6
08:45 AM	0	0	0	0	4	0	0	4	0	2	2	0	6	6
Total	0	2	1	2	19	1	0	20	1	13	14	1	36	37
Grand Total	0	3	1	3	34	1	0	35	2	21	23	1	61	62
Apprch %	0	100			97.1	2.9			8.7	91.3				
Total %	0	4.9		4.9	55.7	1.6		57.4	3.3	34.4	37.7	1.6	98.4	

Start Time	Frederick Street Southbound			Cactus Avenue Westbound			Cactus Avenue Eastbound			Int. Total
	Left	Right	App. Total	Thru	Right	App. Total	Left	Thru	App. Total	
07:15 AM	0	0	0	2	0	2	0	2	2	4
07:30 AM	0	1	1	1	0	1	0	2	2	4
07:45 AM	0	0	0	6	0	6	0	0	0	6
08:00 AM	0	1	1	5	0	5	1	4	5	11
Total Volume	0	2	2	14	0	14	1	8	9	25
% App. Total	0	100		100	0		11.1	88.9		
PHF	.000	.500	.500	.583	.000	.583	.250	.500	.450	.568

Peak Hour Analysis From 07:15 AM to 08:00 AM - Peak 1 of 1

Peak Hour for Entire Intersection Begins at 07:15 AM

County of Riverside
 N/S: Frederick Street
 E/W: Cactus Avenue
 Weather: Clear

File Name : 34_CRV_Fred_Cactus AM
 Site Code : 05121716
 Start Date : 11/30/2021
 Page No : 2

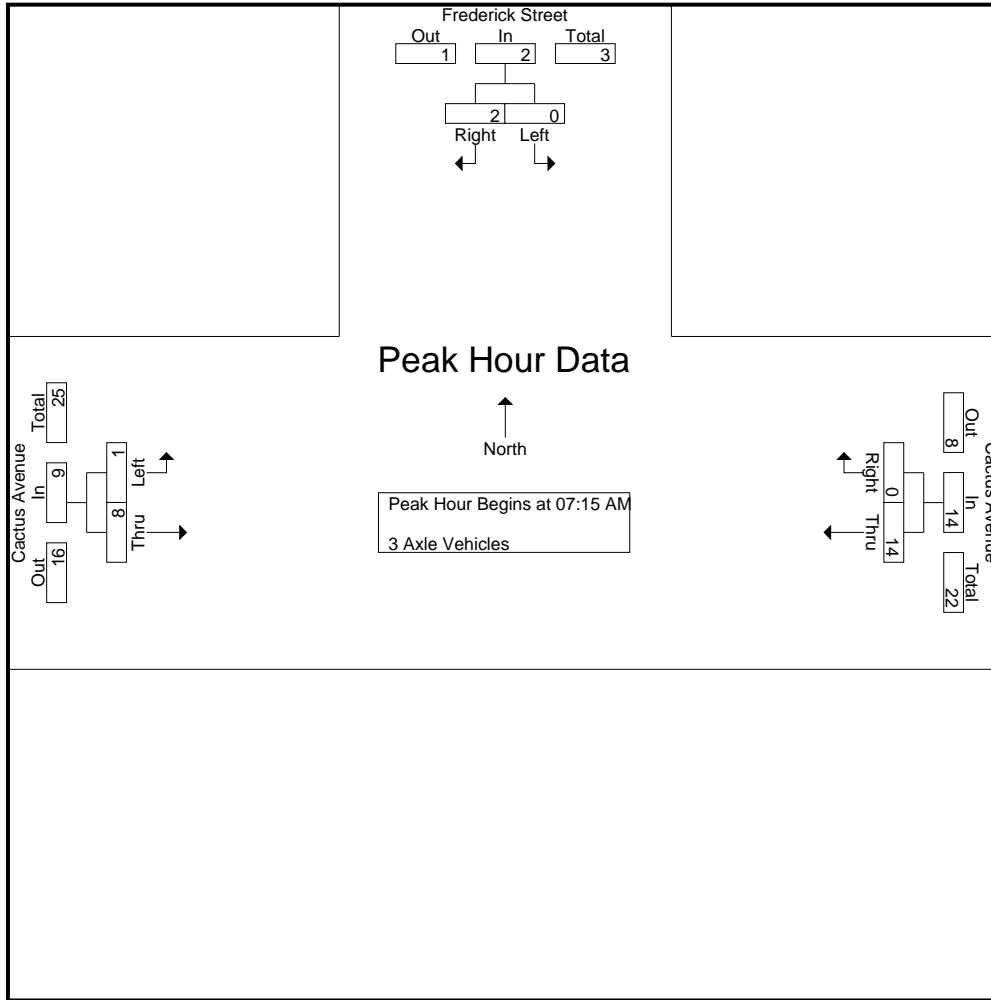

Peak Hour Analysis From 07:15 AM to 08:00 AM - Peak 1 of 1
 Peak Hour for Each Approach Begins at:

	07:15 AM			07:15 AM			07:15 AM		
+0 mins.	0	0	0	2	0	2	0	2	2
+15 mins.	0	1	1	1	0	1	0	2	2
+30 mins.	0	0	0	6	0	6	0	0	0
+45 mins.	0	1	1	5	0	5	1	4	5
Total Volume	0	2	2	14	0	14	1	8	9
% App. Total	0	100		100	0		11.1	88.9	
PHF	.000	.500	.500	.583	.000	.583	.250	.500	.450

County of Riverside
 N/S: Frederick Street
 E/W: Cactus Avenue
 Weather: Clear

File Name : 34_CRV_Fred_Cactus AM
 Site Code : 05121716
 Start Date : 11/30/2021
 Page No : 1

Groups Printed- 4+ Axle Trucks

Start Time	Frederick Street Southbound				Cactus Avenue Westbound				Cactus Avenue Eastbound			Exclu. Total	Inclu. Total	Int. Total
	Left	Right	RTOR	App. Total	Thru	Right	RTOR	App. Total	Left	Thru	App. Total			
07:00 AM	0	1	0	1	7	2	1	9	1	9	10	1	20	21
07:15 AM	0	0	0	0	12	1	0	13	1	6	7	0	20	20
07:30 AM	1	0	0	1	9	0	0	9	1	13	14	0	24	24
07:45 AM	0	0	0	0	9	0	0	9	1	17	18	0	27	27
Total	1	1	0	2	37	3	1	40	4	45	49	1	91	92
08:00 AM	0	1	0	1	13	0	0	13	5	9	14	0	28	28
08:15 AM	0	0	0	0	7	1	1	8	3	16	19	1	27	28
08:30 AM	2	1	1	3	5	6	2	11	1	19	20	3	34	37
08:45 AM	0	0	0	0	9	2	1	11	2	10	12	1	23	24
Total	2	2	1	4	34	9	4	43	11	54	65	5	112	117
Grand Total	3	3	1	6	71	12	5	83	15	99	114	6	203	209
Apprch %	50	50			85.5	14.5			13.2	86.8				
Total %	1.5	1.5		3	35	5.9		40.9	7.4	48.8	56.2	2.9	97.1	

Start Time	Frederick Street Southbound			Cactus Avenue Westbound			Cactus Avenue Eastbound			Int. Total
	Left	Right	App. Total	Thru	Right	App. Total	Left	Thru	App. Total	
07:15 AM	0	0	0	12	1	13	1	6	7	20
07:30 AM	1	0	1	9	0	9	1	13	14	24
07:45 AM	0	0	0	9	0	9	1	17	18	27
08:00 AM	0	1	1	13	0	13	5	9	14	28
Total Volume	1	1	2	43	1	44	8	45	53	99
% App. Total	50	50		97.7	2.3		15.1	84.9		
PHF	.250	.250	.500	.827	.250	.846	.400	.662	.736	.884

Peak Hour Analysis From 07:15 AM to 08:00 AM - Peak 1 of 1

Peak Hour for Entire Intersection Begins at 07:15 AM

County of Riverside
 N/S: Frederick Street
 E/W: Cactus Avenue
 Weather: Clear

File Name : 34_CRV_Fred_Cactus AM
 Site Code : 05121716
 Start Date : 11/30/2021
 Page No : 2

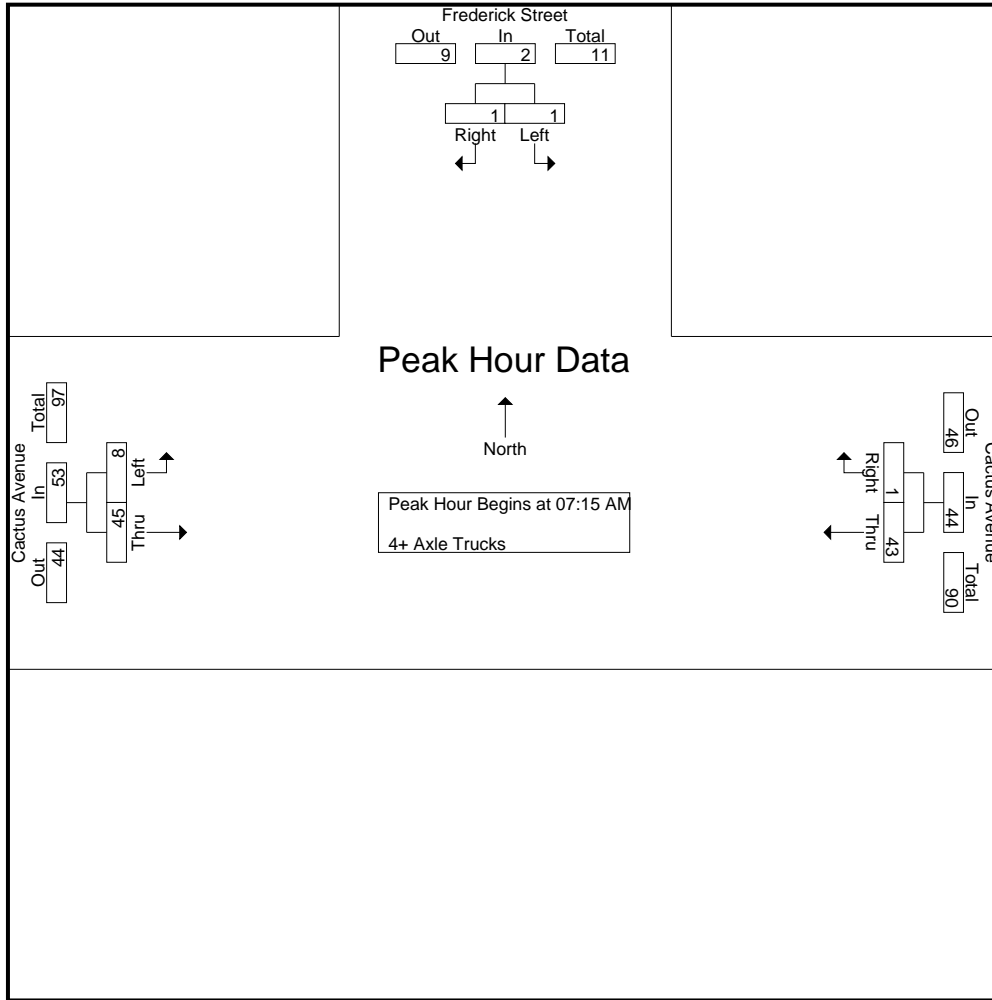

Peak Hour Analysis From 07:15 AM to 08:00 AM - Peak 1 of 1
 Peak Hour for Each Approach Begins at:

	07:15 AM			07:15 AM			07:15 AM		
+0 mins.	0	0	0	12	1	13	1	6	7
+15 mins.	1	0	1	9	0	9	1	13	14
+30 mins.	0	0	0	9	0	9	1	17	18
+45 mins.	0	1	1	13	0	13	5	9	14
Total Volume	1	1	2	43	1	44	8	45	53
% App. Total	50	50		97.7	2.3		15.1	84.9	
PHF	.250	.250	.500	.827	.250	.846	.400	.662	.736

County of Riverside
 N/S: Frederick Street
 E/W: Cactus Avenue
 Weather: Clear

File Name : 34_CRV_Fred_Cactus PM
 Site Code : 05121716
 Start Date : 11/30/2021
 Page No : 1

Groups Printed- Passenger Vehicles - Large 2 Axle Vehicles - 3 Axle Vehicles - 4+ Axle Trucks

Start Time	Frederick Street Southbound				Cactus Avenue Westbound				Cactus Avenue Eastbound			Exclu. Total	Inclu. Total	Int. Total
	Left	Right	RTOR	App. Total	Thru	Right	RTOR	App. Total	Left	Thru	App. Total			
04:00 PM	82	22	5	104	278	38	15	316	51	480	531	20	951	971
04:15 PM	78	20	16	98	257	37	13	294	52	461	513	29	905	934
04:30 PM	112	45	25	157	308	44	15	352	58	439	497	40	1006	1046
04:45 PM	75	32	15	107	309	33	11	342	49	519	568	26	1017	1043
Total	347	119	61	466	1152	152	54	1304	210	1899	2109	115	3879	3994
05:00 PM	138	65	30	203	254	37	15	291	41	521	562	45	1056	1101
05:15 PM	107	33	22	140	277	39	18	316	48	438	486	40	942	982
05:30 PM	136	36	11	172	285	45	14	330	40	417	457	25	959	984
05:45 PM	108	25	12	133	233	42	7	275	51	535	586	19	994	1013
Total	489	159	75	648	1049	163	54	1212	180	1911	2091	129	3951	4080
Grand Total	836	278	136	1114	2201	315	108	2516	390	3810	4200	244	7830	8074
Apprch %	75	25			87.5	12.5			9.3	90.7				
Total %	10.7	3.6		14.2	28.1	4		32.1	5	48.7	53.6	3	97	
Passenger Vehicles	818	269		1220	2125	308		2538	371	3688	4059	0	0	7817
% Passenger Vehicles	97.8	96.8	97.8	97.6	96.5	97.8	97.2	96.7	95.1	96.8	96.6	0	0	96.8
Large 2 Axle Vehicles	5	2		8	26	2		29	0	39	39	0	0	76
% Large 2 Axle Vehicles	0.6	0.7	0.7	0.6	1.2	0.6	0.9	1.1	0	1	0.9	0	0	0.9
3 Axle Vehicles	6	0		6	5	0		5	3	16	19	0	0	30
% 3 Axle Vehicles	0.7	0	0	0.5	0.2	0	0	0.2	0.8	0.4	0.5	0	0	0.4
4+ Axle Trucks	7	7		16	45	5		52	16	67	83	0	0	151
% 4+ Axle Trucks	0.8	2.5	1.5	1.3	2	1.6	1.9	2	4.1	1.8	2	0	0	1.9

Start Time	Frederick Street Southbound			Cactus Avenue Westbound			Cactus Avenue Eastbound			Int. Total
	Left	Right	App. Total	Thru	Right	App. Total	Left	Thru	App. Total	
Peak Hour Analysis From 04:00 PM to 05:45 PM - Peak 1 of 1										
Peak Hour for Entire Intersection Begins at 04:30 PM										
04:30 PM	112	45	157	308	44	352	58	439	497	1006
04:45 PM	75	32	107	309	33	342	49	519	568	1017
05:00 PM	138	65	203	254	37	291	41	521	562	1056
05:15 PM	107	33	140	277	39	316	48	438	486	942
Total Volume	432	175	607	1148	153	1301	196	1917	2113	4021
% App. Total	71.2	28.8		88.2	11.8		9.3	90.7		
PHF	.783	.673	.748	.929	.869	.924	.845	.920	.930	.952

County of Riverside
 N/S: Frederick Street
 E/W: Cactus Avenue
 Weather: Clear

File Name : 34_CRV_Fred_Cactus PM
 Site Code : 05121716
 Start Date : 11/30/2021
 Page No : 2

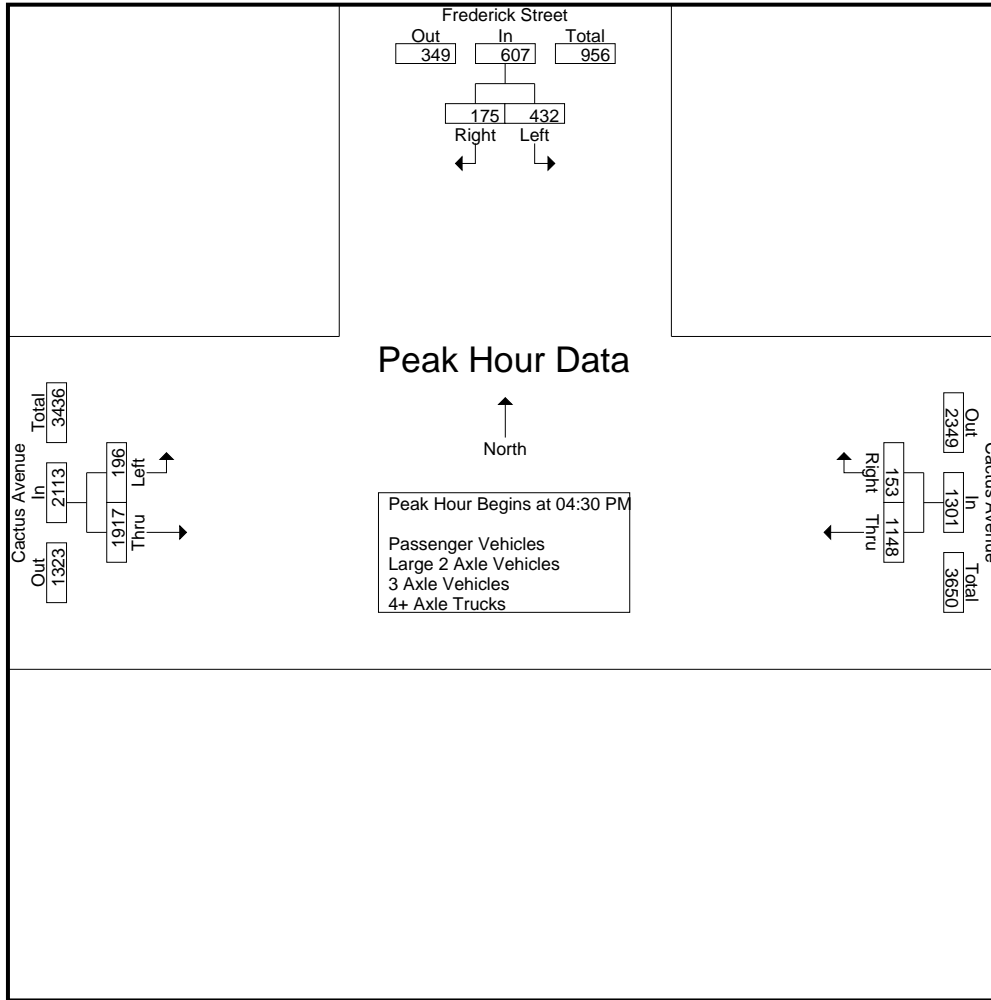

Peak Hour Analysis From 04:00 PM to 05:45 PM - Peak 1 of 1
 Peak Hour for Each Approach Begins at:

	05:00 PM			04:00 PM			04:15 PM		
+0 mins.	138	65	203	278	38	316	52	461	513
+15 mins.	107	33	140	257	37	294	58	439	497
+30 mins.	136	36	172	308	44	352	49	519	568
+45 mins.	108	25	133	309	33	342	41	521	562
Total Volume	489	159	648	1152	152	1304	200	1940	2140
% App. Total	75.5	24.5		88.3	11.7		9.3	90.7	
PHF	.886	.612	.798	.932	.864	.926	.862	.931	.942

County of Riverside
 N/S: Frederick Street
 E/W: Cactus Avenue
 Weather: Clear

File Name : 34_CRV_Fred_Cactus PM
 Site Code : 05121716
 Start Date : 11/30/2021
 Page No : 1

Groups Printed- Passenger Vehicles

Start Time	Frederick Street Southbound				Cactus Avenue Westbound				Cactus Avenue Eastbound			Exclu. Total	Inclu. Total	Int. Total
	Left	Right	RTOR	App. Total	Thru	Right	RTOR	App. Total	Left	Thru	App. Total			
04:00 PM	81	22	5	103	261	37	14	298	50	460	510	19	911	930
04:15 PM	77	19	16	96	248	36	13	284	50	443	493	29	873	902
04:30 PM	111	43	24	154	300	43	15	343	55	427	482	39	979	1018
04:45 PM	73	32	15	105	301	33	11	334	44	498	542	26	981	1007
Total	342	116	60	458	1110	149	53	1259	199	1828	2027	113	3744	3857
05:00 PM	135	65	30	200	239	36	15	275	40	509	549	45	1024	1069
05:15 PM	101	30	22	131	270	38	17	308	47	426	473	39	912	951
05:30 PM	134	35	10	169	278	45	14	323	37	405	442	24	934	958
05:45 PM	106	23	11	129	228	40	6	268	48	520	568	17	965	982
Total	476	153	73	629	1015	159	52	1174	172	1860	2032	125	3835	3960
Grand Total	818	269	133	1087	2125	308	105	2433	371	3688	4059	238	7579	7817
Apprch %	75.3	24.7			87.3	12.7			9.1	90.9				
Total %	10.8	3.5		14.3	28	4.1		32.1	4.9	48.7	53.6	3	97	

Start Time	Frederick Street Southbound			Cactus Avenue Westbound			Cactus Avenue Eastbound			Int. Total
	Left	Right	App. Total	Thru	Right	App. Total	Left	Thru	App. Total	
04:30 PM	111	43	154	300	43	343	55	427	482	979
04:45 PM	73	32	105	301	33	334	44	498	542	981
05:00 PM	135	65	200	239	36	275	40	509	549	1024
05:15 PM	101	30	131	270	38	308	47	426	473	912
Total Volume	420	170	590	1110	150	1260	186	1860	2046	3896
% App. Total	71.2	28.8		88.1	11.9		9.1	90.9		
PHF	.778	.654	.738	.922	.872	.918	.845	.914	.932	.951

Peak Hour Analysis From 04:30 PM to 05:15 PM - Peak 1 of 1
 Peak Hour for Entire Intersection Begins at 04:30 PM

County of Riverside
 N/S: Frederick Street
 E/W: Cactus Avenue
 Weather: Clear

File Name : 34_CRV_Fred_Cactus PM
 Site Code : 05121716
 Start Date : 11/30/2021
 Page No : 2

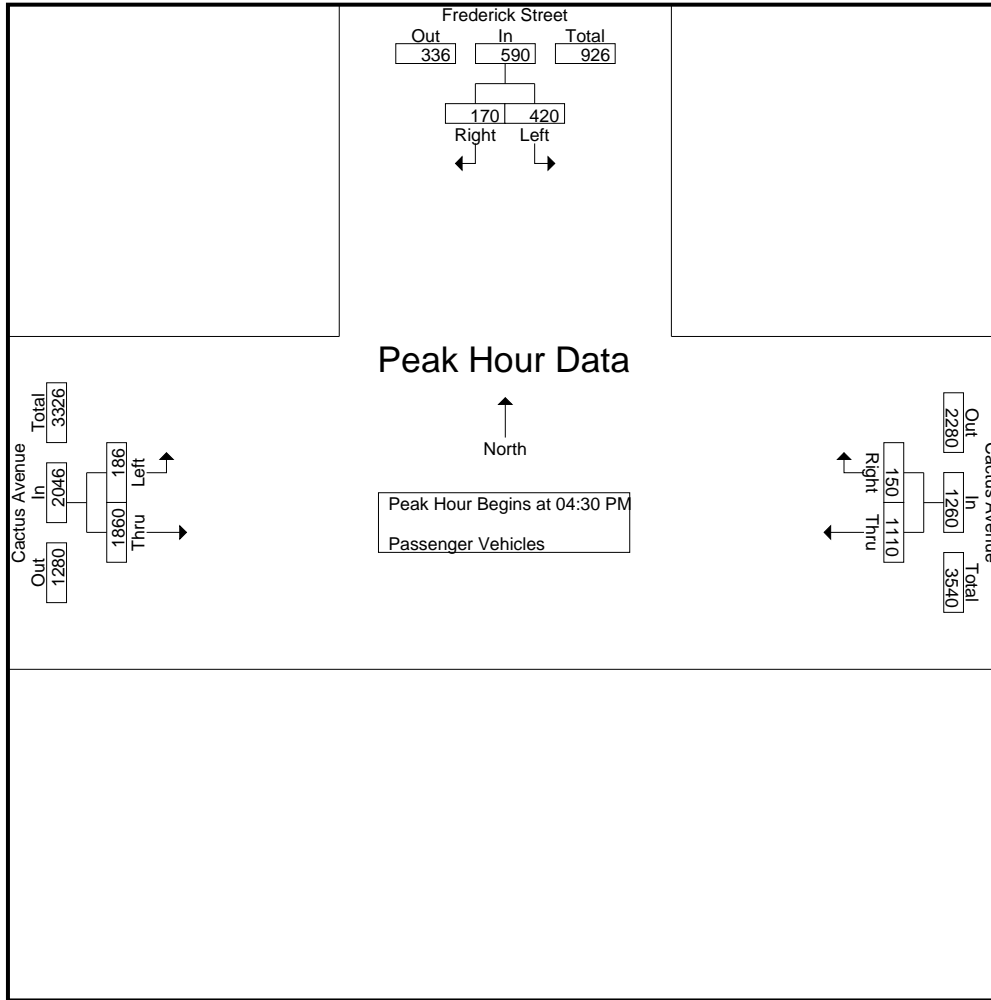

Peak Hour Analysis From 04:30 PM to 05:15 PM - Peak 1 of 1
 Peak Hour for Each Approach Begins at:

	04:30 PM			04:30 PM			04:30 PM		
+0 mins.	111	43	154	300	43	343	55	427	482
+15 mins.	73	32	105	301	33	334	44	498	542
+30 mins.	135	65	200	239	36	275	40	509	549
+45 mins.	101	30	131	270	38	308	47	426	473
Total Volume	420	170	590	1110	150	1260	186	1860	2046
% App. Total	71.2	28.8		88.1	11.9		9.1	90.9	
PHF	.778	.654	.738	.922	.872	.918	.845	.914	.932

County of Riverside
 N/S: Frederick Street
 E/W: Cactus Avenue
 Weather: Clear

File Name : 34_CRV_Fred_Cactus PM
 Site Code : 05121716
 Start Date : 11/30/2021
 Page No : 1

Groups Printed- Large 2 Axle Vehicles

Start Time	Frederick Street Southbound				Cactus Avenue Westbound				Cactus Avenue Eastbound			Exclu. Total	Inclu. Total	Int. Total
	Left	Right	RTOR	App. Total	Thru	Right	RTOR	App. Total	Left	Thru	App. Total			
04:00 PM	1	0	0	1	4	0	0	4	0	8	8	0	13	13
04:15 PM	0	0	0	0	2	0	0	2	0	6	6	0	8	8
04:30 PM	0	1	1	1	5	1	0	6	0	3	3	1	10	11
04:45 PM	0	0	0	0	2	0	0	2	0	11	11	0	13	13
Total	1	1	1	2	13	1	0	14	0	28	28	1	44	45
05:00 PM	1	0	0	1	6	0	0	6	0	3	3	0	10	10
05:15 PM	1	0	0	1	2	0	0	2	0	2	2	0	5	5
05:30 PM	1	0	0	1	4	0	0	4	0	5	5	0	10	10
05:45 PM	1	1	0	2	1	1	1	2	0	1	1	1	5	6
Total	4	1	0	5	13	1	1	14	0	11	11	1	30	31
Grand Total	5	2	1	7	26	2	1	28	0	39	39	2	74	76
Apprch %	71.4	28.6			92.9	7.1			0	100				
Total %	6.8	2.7		9.5	35.1	2.7		37.8	0	52.7	52.7	2.6	97.4	

Start Time	Frederick Street Southbound			Cactus Avenue Westbound			Cactus Avenue Eastbound			Int. Total
	Left	Right	App. Total	Thru	Right	App. Total	Left	Thru	App. Total	
04:30 PM	0	1	1	5	1	6	0	3	3	10
04:45 PM	0	0	0	2	0	2	0	11	11	13
05:00 PM	1	0	1	6	0	6	0	3	3	10
05:15 PM	1	0	1	2	0	2	0	2	2	5
Total Volume	2	1	3	15	1	16	0	19	19	38
% App. Total	66.7	33.3		93.8	6.2		0	100		
PHF	.500	.250	.750	.625	.250	.667	.000	.432	.432	.731

Peak Hour Analysis From 04:30 PM to 05:15 PM - Peak 1 of 1
 Peak Hour for Entire Intersection Begins at 04:30 PM

County of Riverside
 N/S: Frederick Street
 E/W: Cactus Avenue
 Weather: Clear

File Name : 34_CRV_Fred_Cactus PM
 Site Code : 05121716
 Start Date : 11/30/2021
 Page No : 2

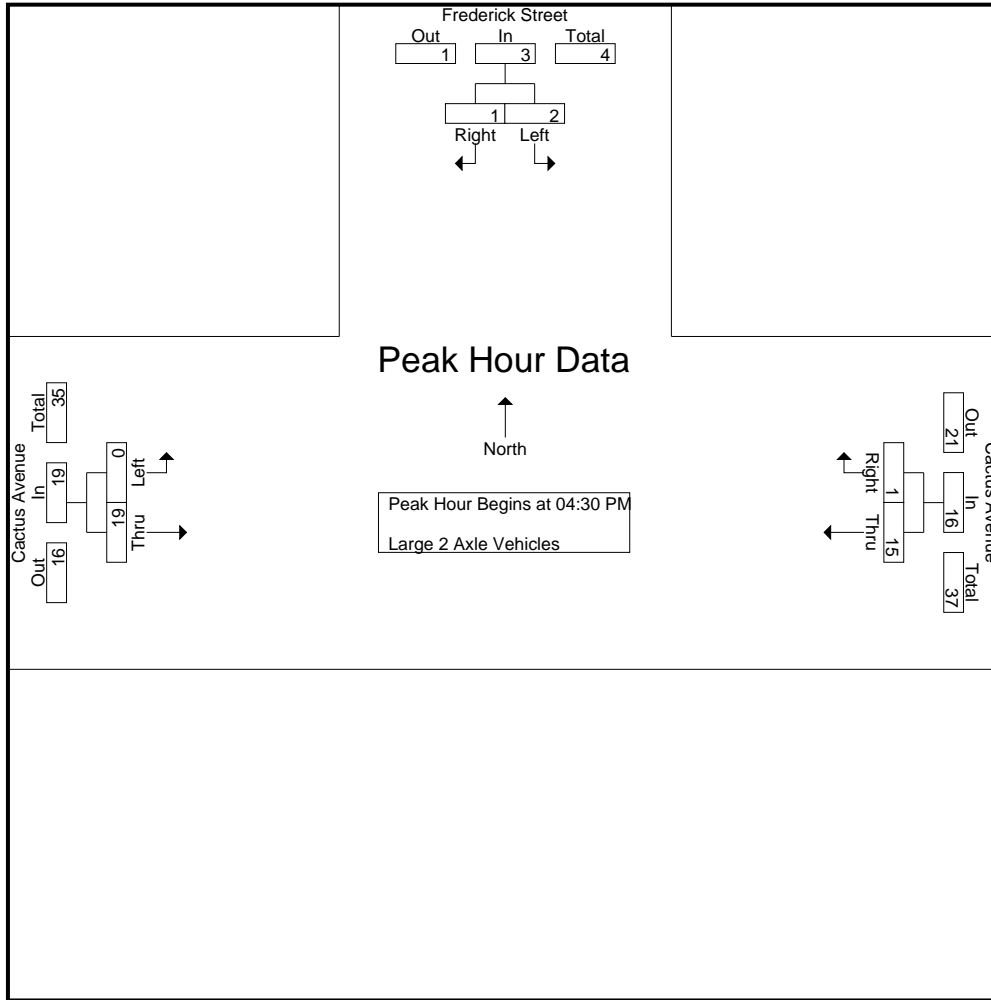

Peak Hour Analysis From 04:30 PM to 05:15 PM - Peak 1 of 1
 Peak Hour for Each Approach Begins at:

	04:30 PM			04:30 PM			04:30 PM		
+0 mins.	0	1	1	5	1	6	0	3	3
+15 mins.	0	0	0	2	0	2	0	11	11
+30 mins.	1	0	1	6	0	6	0	3	3
+45 mins.	1	0	1	2	0	2	0	2	2
Total Volume	2	1	3	15	1	16	0	19	19
% App. Total	66.7	33.3		93.8	6.2		0	100	
PHF	.500	.250	.750	.625	.250	.667	.000	.432	.432

County of Riverside
 N/S: Frederick Street
 E/W: Cactus Avenue
 Weather: Clear

File Name : 34_CRV_Fred_Cactus PM
 Site Code : 05121716
 Start Date : 11/30/2021
 Page No : 1

Groups Printed- 3 Axle Vehicles

Start Time	Frederick Street Southbound				Cactus Avenue Westbound				Cactus Avenue Eastbound			Exclu. Total	Inclu. Total	Int. Total
	Left	Right	RTOR	App. Total	Thru	Right	RTOR	App. Total	Left	Thru	App. Total			
04:00 PM	0	0	0	0	1	0	0	1	0	3	3	0	4	4
04:15 PM	0	0	0	0	1	0	0	1	2	2	4	0	5	5
04:30 PM	0	0	0	0	0	0	0	0	0	1	1	0	1	1
04:45 PM	2	0	0	2	1	0	0	1	1	4	5	0	8	8
Total	2	0	0	2	3	0	0	3	3	10	13	0	18	18
05:00 PM	2	0	0	2	0	0	0	0	0	1	1	0	3	3
05:15 PM	2	0	0	2	0	0	0	0	0	0	0	0	2	2
05:30 PM	0	0	0	0	1	0	0	1	0	3	3	0	4	4
05:45 PM	0	0	0	0	1	0	0	1	0	2	2	0	3	3
Total	4	0	0	4	2	0	0	2	0	6	6	0	12	12
Grand Total	6	0	0	6	5	0	0	5	3	16	19	0	30	30
Apprch %	100	0			100	0			15.8	84.2				
Total %	20	0		20	16.7	0		16.7	10	53.3	63.3	0	100	

Start Time	Frederick Street Southbound			Cactus Avenue Westbound			Cactus Avenue Eastbound			Int. Total
	Left	Right	App. Total	Thru	Right	App. Total	Left	Thru	App. Total	
04:30 PM	0	0	0	0	0	0	0	1	1	1
04:45 PM	2	0	2	1	0	1	1	4	5	8
05:00 PM	2	0	2	0	0	0	0	1	1	3
05:15 PM	2	0	2	0	0	0	0	0	0	2
Total Volume	6	0	6	1	0	1	1	6	7	14
% App. Total	100	0		100	0		14.3	85.7		
PHF	.750	.000	.750	.250	.000	.250	.250	.375	.350	.438

Peak Hour Analysis From 04:30 PM to 05:15 PM - Peak 1 of 1

Peak Hour for Entire Intersection Begins at 04:30 PM

County of Riverside
 N/S: Frederick Street
 E/W: Cactus Avenue
 Weather: Clear

File Name : 34_CRV_Fred_Cactus PM
 Site Code : 05121716
 Start Date : 11/30/2021
 Page No : 2

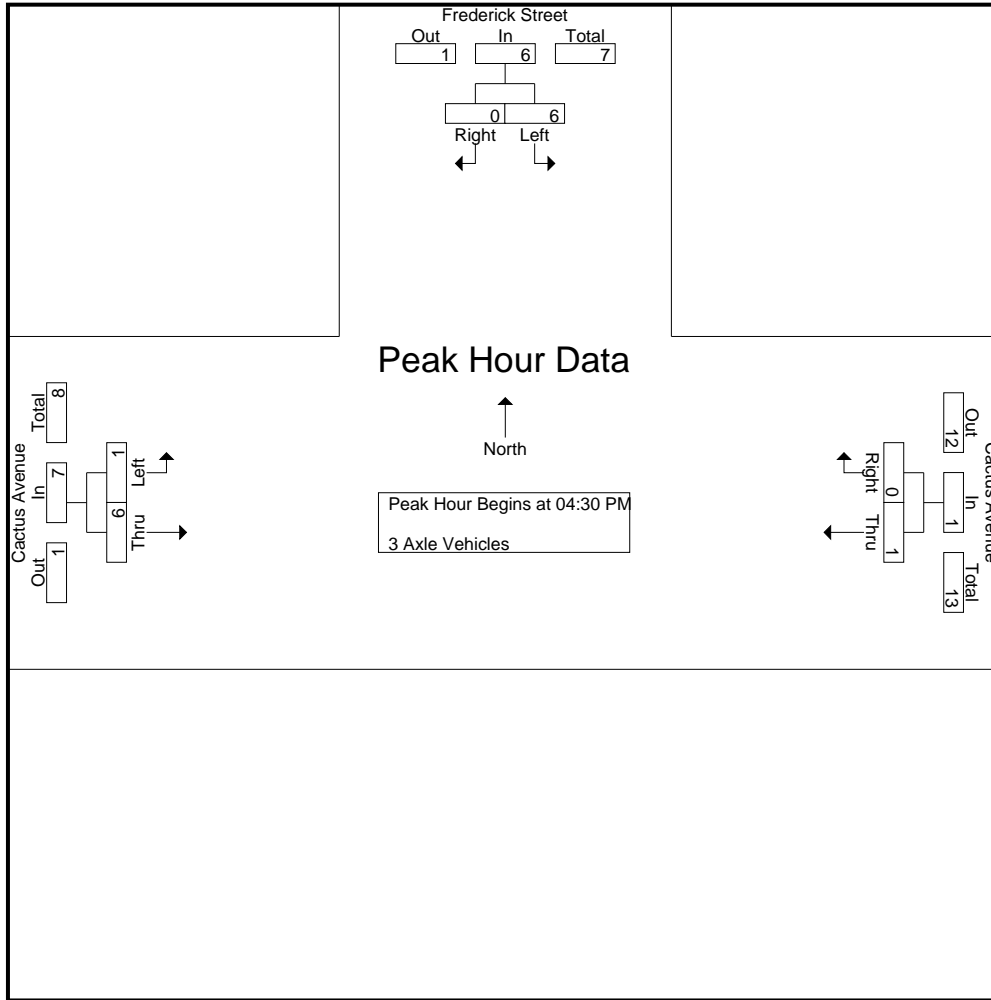

Peak Hour Analysis From 04:30 PM to 05:15 PM - Peak 1 of 1
 Peak Hour for Each Approach Begins at:

	04:30 PM			04:30 PM			04:30 PM		
+0 mins.	0	0	0	0	0	0	0	1	1
+15 mins.	2	0	2	1	0	1	1	4	5
+30 mins.	2	0	2	0	0	0	0	1	1
+45 mins.	2	0	2	0	0	0	0	0	0
Total Volume	6	0	6	1	0	1	1	6	7
% App. Total	100	0		100	0		14.3	85.7	
PHF	.750	.000	.750	.250	.000	.250	.250	.375	.350

County of Riverside
 N/S: Frederick Street
 E/W: Cactus Avenue
 Weather: Clear

File Name : 34_CRV_Fred_Cactus PM
 Site Code : 05121716
 Start Date : 11/30/2021
 Page No : 1

Groups Printed- 4+ Axle Trucks

Start Time	Frederick Street Southbound				Cactus Avenue Westbound				Cactus Avenue Eastbound			Exclu. Total	Inclu. Total	Int. Total
	Left	Right	RTOR	App. Total	Thru	Right	RTOR	App. Total	Left	Thru	App. Total			
04:00 PM	0	0	0	0	12	1	1	13	1	9	10	1	23	24
04:15 PM	1	1	0	2	6	1	0	7	0	10	10	0	19	19
04:30 PM	1	1	0	2	3	0	0	3	3	8	11	0	16	16
04:45 PM	0	0	0	0	5	0	0	5	4	6	10	0	15	15
Total	2	2	0	4	26	2	1	28	8	33	41	1	73	74
05:00 PM	0	0	0	0	9	1	0	10	1	8	9	0	19	19
05:15 PM	3	3	0	6	5	1	1	6	1	10	11	1	23	24
05:30 PM	1	1	1	2	2	0	0	2	3	4	7	1	11	12
05:45 PM	1	1	1	2	3	1	0	4	3	12	15	1	21	22
Total	5	5	2	10	19	3	1	22	8	34	42	3	74	77
Grand Total	7	7	2	14	45	5	2	50	16	67	83	4	147	151
Apprch %	50	50			90	10			19.3	80.7				
Total %	4.8	4.8		9.5	30.6	3.4		34	10.9	45.6	56.5	2.6	97.4	

Start Time	Frederick Street Southbound			Cactus Avenue Westbound			Cactus Avenue Eastbound			Int. Total
	Left	Right	App. Total	Thru	Right	App. Total	Left	Thru	App. Total	
04:30 PM	1	1	2	3	0	3	3	8	11	16
04:45 PM	0	0	0	5	0	5	4	6	10	15
05:00 PM	0	0	0	9	1	10	1	8	9	19
05:15 PM	3	3	6	5	1	6	1	10	11	23
Total Volume	4	4	8	22	2	24	9	32	41	73
% App. Total	50	50		91.7	8.3		22	78		
PHF	.333	.333	.333	.611	.500	.600	.563	.800	.932	.793

Peak Hour Analysis From 04:30 PM to 05:15 PM - Peak 1 of 1
 Peak Hour for Entire Intersection Begins at 04:30 PM

County of Riverside
 N/S: Frederick Street
 E/W: Cactus Avenue
 Weather: Clear

File Name : 34_CRV_Fred_Cactus PM
 Site Code : 05121716
 Start Date : 11/30/2021
 Page No : 2

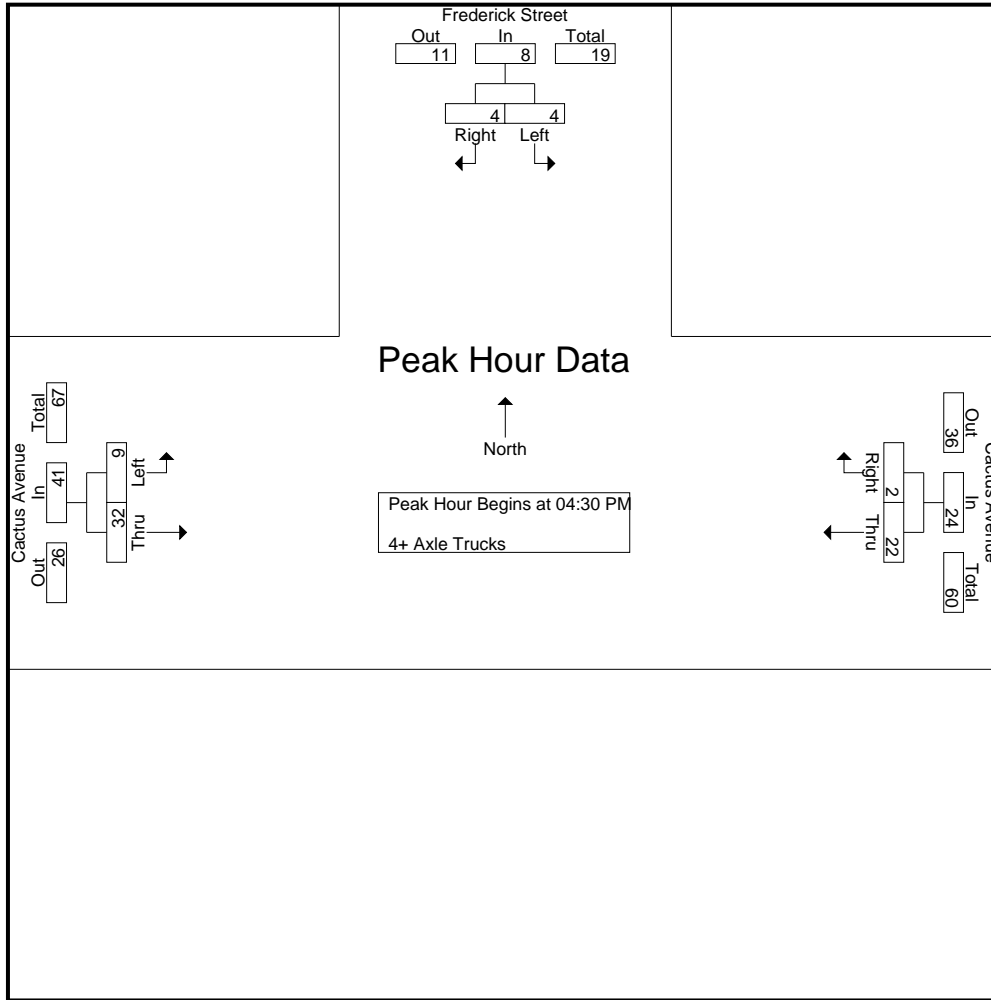

Peak Hour Analysis From 04:30 PM to 05:15 PM - Peak 1 of 1
 Peak Hour for Each Approach Begins at:

	04:30 PM			04:30 PM			04:30 PM		
+0 mins.	1	1	2	3	0	3	3	8	11
+15 mins.	0	0	0	5	0	5	4	6	10
+30 mins.	0	0	0	9	1	10	1	8	9
+45 mins.	3	3	6	5	1	6	1	10	11
Total Volume	4	4	8	22	2	24	9	32	41
% App. Total	50	50		91.7	8.3		22	78	
PHF	.333	.333	.333	.611	.500	.600	.563	.800	.932

Location: County of Riverside
 N/S: Frederick Street
 E/W: Cactus Avenue



Date: 11/30/2021
 Day: Tuesday

PEDESTRIANS

	North Leg Frederick Street Pedestrians	East Leg Cactus Avenue Pedestrians	South Leg Dead End Pedestrians	West Leg Cactus Avenue Pedestrians	
7:00 AM	0	0	0	0	0
7:15 AM	1	0	0	0	1
7:30 AM	0	0	0	0	0
7:45 AM	0	0	0	0	0
8:00 AM	0	0	0	0	0
8:15 AM	0	0	0	0	0
8:30 AM	0	0	0	0	0
8:45 AM	0	0	0	0	0
TOTAL VOLUMES:	1	0	0	0	1

	North Leg Frederick Street Pedestrians	East Leg Cactus Avenue Pedestrians	South Leg Dead End Pedestrians	West Leg Cactus Avenue Pedestrians	
4:00 PM	0	0	0	0	0
4:15 PM	0	0	0	0	0
4:30 PM	0	0	0	0	0
4:45 PM	0	0	0	0	0
5:00 PM	0	0	0	0	0
5:15 PM	0	0	0	0	0
5:30 PM	0	0	0	0	0
5:45 PM	0	0	0	0	0
TOTAL VOLUMES:	0	0	0	0	0

Location: County of Riverside
 N/S: Frederick Street
 E/W: Cactus Avenue



Date: 11/30/2021
 Day: Tuesday

BICYCLES

	Southbound Frederick Street			Westbound Cactus Avenue			Northbound Dead End			Eastbound Cactus Avenue			
	Left	Thru	Right	Left	Thru	Right	Left	Thru	Right	Left	Thru	Right	
7:00 AM	0	0	0	0	0	0	0	0	0	0	0	0	0
7:15 AM	0	0	0	0	1	0	0	0	0	0	0	0	1
7:30 AM	0	0	0	0	0	0	0	0	0	0	0	0	0
7:45 AM	0	0	0	0	0	0	0	0	0	0	0	0	0
8:00 AM	0	0	0	0	0	0	0	0	0	0	0	0	0
8:15 AM	0	0	0	0	0	0	0	0	0	0	0	0	0
8:30 AM	0	0	0	0	0	0	0	0	0	0	0	0	0
8:45 AM	0	0	0	0	0	0	0	0	0	0	0	0	0
TOTAL VOLUMES:	0	0	0	0	1	0	0	0	0	0	0	0	1

	Southbound Frederick Street			Westbound Cactus Avenue			Northbound Dead End			Eastbound Cactus Avenue			
	Left	Thru	Right	Left	Thru	Right	Left	Thru	Right	Left	Thru	Right	
4:00 PM	0	0	0	0	0	0	0	0	0	0	0	0	0
4:15 PM	0	0	0	0	0	0	0	0	0	0	0	0	0
4:30 PM	0	0	0	0	0	0	0	0	0	0	0	0	0
4:45 PM	0	0	0	0	4	0	0	0	0	0	0	0	4
5:00 PM	0	0	0	0	0	0	0	0	0	0	0	0	0
5:15 PM	0	0	0	0	0	0	0	0	0	0	0	0	0
5:30 PM	0	0	0	0	0	0	0	0	0	0	0	0	0
5:45 PM	0	0	0	0	0	0	0	0	0	0	0	0	0
TOTAL VOLUMES:	0	0	0	0	4	0	0	0	0	0	0	0	4

Counts Unlimited, Inc.
 PO Box 1178
 Corona, CA 92878
 (951)268-6268

County of Riverside
 N/S: Graham Street/Riverside Drive
 E/W: Cactus Avenue
 Weather: Clear

File Name : 35_CRV_Graham_Cactus AM
 Site Code : 05121716
 Start Date : 11/30/2021
 Page No : 1

Groups Printed- Passenger Vehicles - Large 2 Axle Vehicles - 3 Axle Vehicles - 4+ Axle Trucks

Start Time	Graham Street Southbound						Cactus Avenue Westbound						Riverside Drive Northbound						Cactus Avenue Eastbound						
	Left		Thru		Right		Left		Thru		Right		Left		Thru		Right		Left		Thru		Right		
		App. Total		RTOR		App. Total		RTOR		App. Total		RTOR		App. Total		RTOR		App. Total		RTOR		App. Total		RTOR	
07:00 AM	9	14	11	32	2	407	10	0	419	5	0	0	0	5	14	200	27	7	241	18	697	715	18	697	715
07:15 AM	18	12	26	56	1	408	8	0	417	0	0	0	0	0	7	220	33	5	260	27	733	760	27	733	760
07:30 AM	18	11	25	54	2	394	20	1	416	2	0	0	0	2	11	265	37	2	313	23	785	808	23	785	808
07:45 AM	20	8	21	49	4	419	26	0	449	3	0	0	0	3	19	279	29	1	327	19	828	847	19	828	847
Total	65	40	86	191	9	1628	64	1	1701	10	0	0	0	10	51	964	126	15	1141	87	3043	3130	87	3043	3130
08:00 AM	16	8	27	51	1	419	22	0	442	3	0	0	0	3	16	233	39	3	288	23	784	807	23	784	807
08:15 AM	20	7	8	35	4	364	22	1	390	1	0	0	0	1	26	230	33	4	289	11	715	726	11	715	726
08:30 AM	20	5	23	48	6	294	20	3	320	0	0	0	0	0	11	219	42	4	272	29	640	669	29	640	669
08:45 AM	13	6	10	29	8	292	18	1	318	4	0	0	0	4	20	207	37	6	264	17	615	632	17	615	632
Total	69	26	68	163	19	1369	82	5	1470	8	0	0	0	8	73	889	151	17	1113	80	2754	2834	80	2754	2834
Grand Total	134	66	154	354	28	2997	146	6	3171	18	0	0	0	18	124	1853	277	32	2254	167	5797	5964	167	5797	5964
% Approach	37.9	18.6	43.5		0.9	94.5	4.6			100	0	0			5.5	82.2	12.3			2.8	97.2				
on Total %	2.3	1.1	2.7	6.1	0.5	51.7	2.5		54.7	0.3	0	0		0.3	2.1	32	4.8		38.9	0	0				
Passenger Vehicles	132	65	138	453	28	2856	144		3034	8	0	0		8	109	1698	259		2094	0	0				
% Passenger Vehicles	98.5	98.5	89.6	91.5	100	95.3	98.6	100	95.5	44.4	0	0		44.4	87.9	91.6	93.5	87.5	91.6	0	0				
Large 2 Axle Vehicles	1	1	3	7	0	38	0		38	0	0	0		0	1	56	6		64	0	0				
% Large 2 Axle Vehicles	0.7	1.5	1.9	1.6	0	1.3	0		1.2	0	0	0		0	0.8	3	2.2	3.1	2.8	0	0				
3 Axle Vehicles	0	0	2	3	0	25	0		25	10	0	0		10	1	11	7		21	0	0				
% 3 Axle Vehicles	0	0	1.3	0.6	0	0.8	0		0.8	55.6	0	0		55.6	0.8	0.6	2.5	6.2	0.9	0	0				
4+ Axle Trucks	1	0	11	20	0	78	2		80	0	0	0		0	13	88	5		107	0	0				
% 4+ Axle Trucks	0.7	0	7.1	4.1	0	2.6	1.4		2.5	0	0	0		0	10.5	4.7	1.8	3.1	4.7	0	0				

Start Time	Graham Street Southbound						Cactus Avenue Westbound						Riverside Drive Northbound						Cactus Avenue Eastbound					
	Left		Thru		Right		Left		Thru		Right		Left		Thru		Right		Left		Thru		Right	
		App. Total		RTOR		App. Total		RTOR		App. Total		RTOR		App. Total		RTOR		App. Total		RTOR		App. Total		RTOR
07:15 AM	18	12	26	56	1	408	8		417	0	0	0		0	0	0	0		7	220	33		260	
07:30 AM	18	11	25	54	2	394	20		416	2	0	0		2	0	0	0		11	265	37		313	
07:45 AM	20	8	21	49	4	419	26		449	3	0	0		3	19	279	29		19	279	29		828	
08:00 AM	16	8	27	51	1	419	26		442	3	0	0		3	19	279	29		16	233	39		288	
Total Volume	72	39	99	210	8	1640	76		1724	8	0	0		8	53	997	138		53	997	138		1188	
% App. Total	34.3	18.6	47.1		0.5	95.1	4.4		4.4	100	0	0		0	4.5	83.9	11.6		4.5	83.9	11.6		11.6	
PHF	.900	.813	.917	.938	.500	.979	.731		.960	.667	.000	.000		.667	.697	.893	.885		.697	.893	.885		.908	

Peak Hour Analysis From 07:00 AM to 08:45 AM - Peak 1 of 1
 Peak Hour for Entire Intersection Begins at 07:15 AM

Counts Unlimited, Inc.
 PO Box 1178
 Corona, CA 92878
 (951)268-6268

County of Riverside
 N/S: Graham Street/Riverside Drive
 E/W: Cactus Avenue
 Weather: Clear

File Name : 35_CRV_Graham_Cactus AM
 Site Code : 05121716
 Start Date : 11/30/2021
 Page No : 2

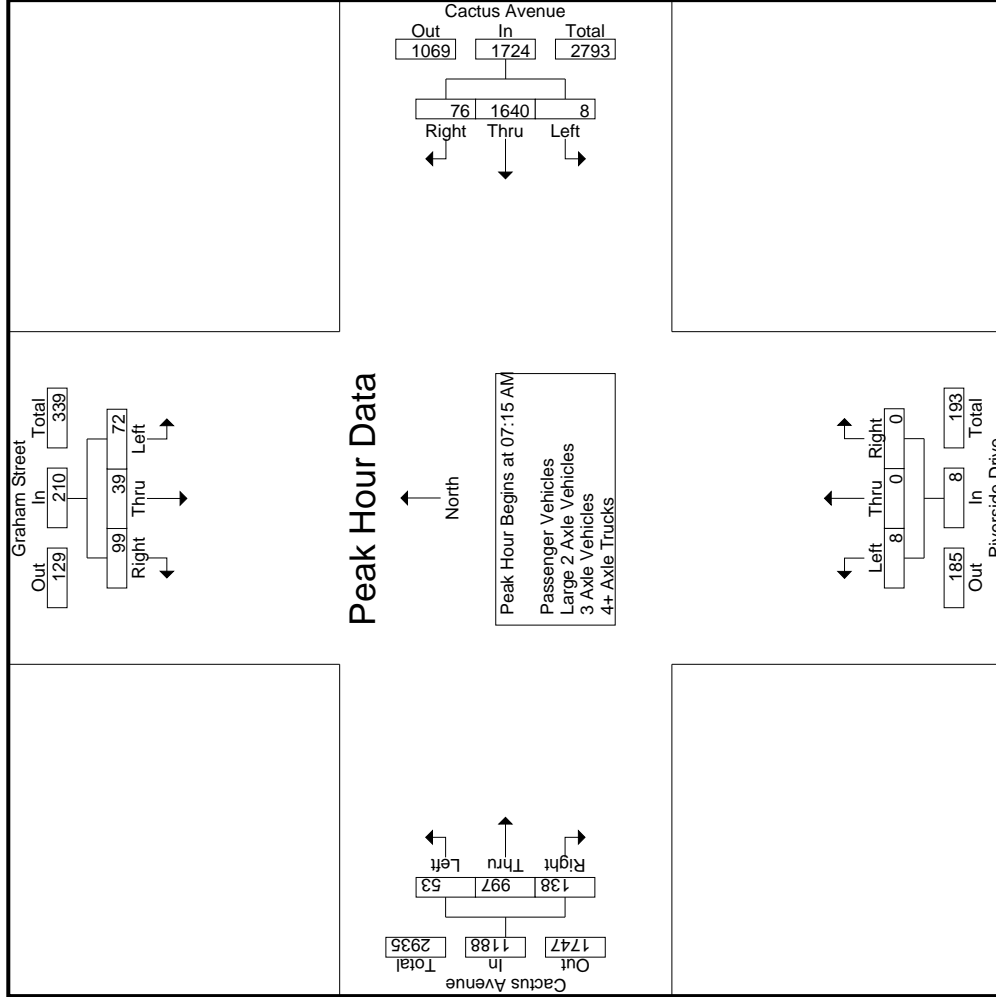

Counts Unlimited, Inc.
 PO Box 1178
 Corona, CA 92878
 (951)268-6268

County of Riverside
 N/S: Graham Street/Riverside Drive
 E/W: Cactus Avenue
 Weather: Clear

File Name : 35_CRV_Graham_Cactus AM
 Site Code : 05121716
 Start Date : 11/30/2021
 Page No : 3

Start Time	Graham Street Southbound			Cactus Avenue Westbound			Riverside Drive Northbound			Cactus Avenue Eastbound				
	Left	Thru	Right	Left	Thru	Right	Left	Thru	Right	Left	Thru	Right		
	App. Total			App. Total			App. Total			App. Total				
Peak Hour Analysis From 07:00 AM to 08:45 AM - Peak 1 of 1														
Peak Hour for Each Approach Begins at:														
	07:15 AM			07:15 AM			07:00 AM			07:30 AM				
+0 mins.	18	12	26	1	408	8	417	0	0	0	11	265	37	313
+15 mins.	18	11	25	2	394	20	416	0	0	0	19	279	29	327
+30 mins.	20	8	21	4	419	26	449	0	0	0	16	233	39	288
+45 mins.	16	8	27	1	419	22	442	0	0	0	26	230	33	289
Total Volume	72	39	99	8	1640	76	1724	0	0	0	72	1007	138	1217
% App. Total	34.3	18.6	47.1	0.5	95.1	4.4		0	0	0	5.9	82.7	11.3	
PHF	.900	.813	.917	.500	.979	.731	.960	.500	.000	.000	.692	.902	.885	.930

Counts Unlimited, Inc.
 PO Box 1178
 Corona, CA 92878
 (951)268-6268

County of Riverside
 N/S: Graham Street/Riverside Drive
 E/W: Cactus Avenue
 Weather: Clear

File Name : 35_CRV_Graham_Cactus AM
 Site Code : 05121716
 Start Date : 11/30/2021
 Page No : 1

Groups Printed- Passenger Vehicles

Start Time	Graham Street Southbound				Cactus Avenue Westbound				Riverside Drive Northbound				Cactus Avenue Eastbound										
	Left	Thru	Right	RTOR	App. Total	Left	Thru	Right	RTOR	App. Total	Left	Thru	Right	RTOR	App. Total	Exclu. Total	Inclu. Total	Int. Total					
07:00 AM	9	13	11	31	401	2	389	10	0	401	1	0	0	0	1	14	181	25	7	220	18	653	671
07:15 AM	18	12	23	53	397	1	388	8	0	397	0	0	0	0	0	7	208	29	4	244	24	694	718
07:30 AM	17	11	23	51	404	2	383	19	1	404	1	0	0	0	1	9	246	36	2	291	22	747	769
07:45 AM	20	8	19	47	434	4	405	25	0	434	0	0	0	0	0	18	255	29	1	302	18	783	801
Total	64	40	78	182	1636	9	1565	62	1	1636	2	0	0	0	2	48	890	119	14	1057	82	2877	2959
08:00 AM	15	7	26	48	418	1	395	22	0	418	3	0	0	0	3	14	213	33	2	260	21	729	750
08:15 AM	20	7	8	35	370	4	344	22	1	370	1	0	0	0	1	19	217	30	2	266	9	672	681
08:30 AM	20	5	18	43	304	6	278	20	3	304	0	0	0	0	0	11	197	40	4	248	25	595	620
08:45 AM	13	6	8	27	300	8	274	18	1	300	2	0	0	2	2	17	181	37	6	235	15	564	579
Total	68	25	60	153	1392	19	1291	82	5	1392	6	0	0	0	6	61	808	140	14	1009	70	2560	2630
Grand Total	132	65	138	335	3028	28	2856	144	6	3028	8	0	0	0	8	109	1698	259	28	2066	152	5437	5589
T-Approch %	39.4	19.4	41.2	6.2	55.7	0.9	94.3	4.8		55.7	100	0	0		5.3	82.2	12.5		38		2.7	97.3	
80	2.4	1.2	2.5			0.5	52.5	2.6			0.1	0	0		2	31.2	4.8						

Start Time	Graham Street Southbound				Cactus Avenue Westbound				Riverside Drive Northbound				Cactus Avenue Eastbound											
	Left	Thru	Right	RTOR	App. Total	Left	Thru	Right	RTOR	App. Total	Left	Thru	Right	RTOR	App. Total	Left	Thru	Right	RTOR	App. Total	Exclu. Total	Inclu. Total	Int. Total	
07:15 AM	18	12	23	53	397	0	0	0	0	0	0	0	0	0	0	0	0	0	0	0	0	0	0	0
07:30 AM	17	11	23	51	404	1	0	0	0	404	1	0	0	0	0	0	0	0	0	0	0	0	0	0
07:45 AM	20	8	19	47	434	4	0	0	0	434	0	0	0	0	0	0	0	0	0	0	0	0	0	0
08:00 AM	15	7	26	48	418	8	0	0	0	418	3	0	0	0	3	14	213	33	2	260	21	729	750	
Total Volume	70	38	91	199	1653	4	0	0	0	1653	4	0	0	0	4	48	922	127	1097	2953				
% App. Total	35.2	19.1	45.7	6.2	55.7	0.5	95	4.5		55.7	100	0	0		5.3	82.2	12.5		38		2.7	97.3		
PHF	.875	.792	.875	.939	.740	.500	.970	.740		.952	.333	.000	.000		.333	.667	.904	.882	.908	.943				

Peak Hour Analysis From 07:15 AM to 08:00 AM - Peak 1 of 1
 Peak Hour for Entire Intersection Begins at 07:15 AM

Counts Unlimited, Inc.
 PO Box 1178
 Corona, CA 92878
 (951)268-6268

County of Riverside
 N/S: Graham Street/Riverside Drive
 E/W: Cactus Avenue
 Weather: Clear

File Name : 35_CRV_Graham_Cactus AM
 Site Code : 05121716
 Start Date : 1/30/2021
 Page No : 2

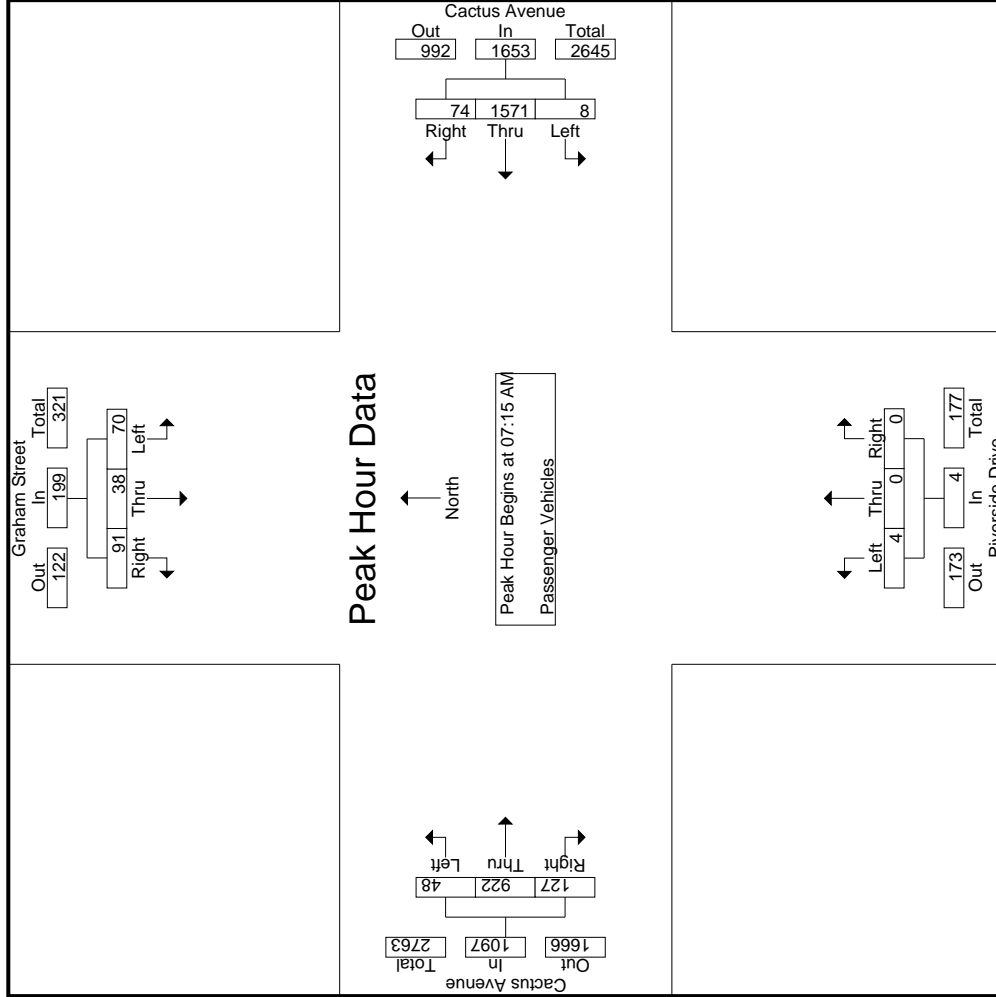

Counts Unlimited, Inc.
 PO Box 1178
 Corona, CA 92878
 (951)268-6268

County of Riverside
 N/S: Graham Street/Riverside Drive
 E/W: Cactus Avenue
 Weather: Clear

File Name : 35_CRV_Graham_Cactus AM
 Site Code : 05121716
 Start Date : 11/30/2021
 Page No : 3

Start Time	Graham Street Southbound			Cactus Avenue Westbound			Riverside Drive Northbound			Cactus Avenue Eastbound			Int. Total			
	Left	Thru	Right	App. Total	Left	Thru	Right	App. Total	Left	Thru	Right	App. Total				
Peak Hour Analysis From 07:15 AM to 08:00 AM - Peak 1 of 1																
Peak Hour for Each Approach Begins at:																
	07:15 AM				07:15 AM				07:15 AM				07:15 AM			
+0 mins.	18	12	23	53	1	388	8	397	0	0	0	0	7	208	29	244
+15 mins.	17	11	23	51	2	383	19	404	1	0	0	0	9	246	36	291
+30 mins.	20	8	19	47	4	405	25	434	0	0	0	0	18	255	29	302
+45 mins.	15	7	26	48	1	395	22	418	3	0	0	0	14	213	33	260
Total Volume	70	38	91	199	8	1571	74	1653	4	0	0	0	48	922	127	1097
% App. Total	35.2	19.1	45.7		0.5	95	4.5		100	0	0	0	4.4	84	11.6	
PHF	.875	.792	.875	.939	.500	.970	.740	.952	.333	.000	.000	.333	.667	.904	.882	.908

Counts Unlimited, Inc.
 PO Box 1178
 Corona, CA 92878
 (951)268-6268

County of Riverside
 N/S: Graham Street/Riverside Drive
 E/W: Cactus Avenue
 Weather: Clear

File Name : 35_CRV_Graham_Cactus AM
 Site Code : 05121716
 Start Date : 11/30/2021
 Page No : 1

Groups Printed- Large 2-Axle Vehicles

Start Time	Graham Street Southbound				Cactus Avenue Westbound				Riverside Drive Northbound				Cactus Avenue Eastbound											
	Left	Thru	Right	RTOR	App. Total	Left	Thru	Right	RTOR	App. Total	Left	Thru	Right	RTOR	App. Total	Left	Thru	Right	RTOR	App. Total	Exclu. Total	Inclu. Total	Int. Total	
07:00 AM	0	0	0	0	0	0	5	0	0	0	0	0	0	0	0	0	7	1	0	0	8	0	13	13
07:15 AM	0	0	1	0	1	4	4	0	0	0	0	0	0	0	0	0	6	0	0	0	6	0	11	11
07:30 AM	0	0	0	0	0	3	0	0	0	0	0	0	0	0	0	1	6	0	0	7	0	10	10	
07:45 AM	0	0	1	1	1	4	0	0	0	0	0	0	0	0	0	0	11	0	0	11	1	16	17	
Total	0	0	2	1	2	16	0	0	0	0	0	0	0	0	0	1	30	1	0	32	1	50	51	
08:00 AM	1	1	0	0	2	6	0	0	0	0	0	0	0	0	0	0	7	2	0	9	0	17	17	
08:15 AM	0	0	0	0	0	6	0	0	0	0	0	0	0	0	0	0	3	1	1	4	1	10	11	
08:30 AM	0	0	1	1	1	8	0	0	0	0	0	0	0	0	0	0	7	2	0	9	1	18	19	
08:45 AM	0	0	0	0	0	2	0	0	0	0	0	0	0	0	0	0	9	0	0	9	0	11	11	
Total	1	1	1	1	3	22	0	0	0	0	0	0	0	0	0	0	26	5	1	31	2	56	58	
Grand Total	1	1	3	2	5	38	0	0	0	0	0	0	0	0	0	1	56	6	1	63	3	106	109	
T-Approch %	20	20	60			100	0	0	0	0	0	0	0	0	0	1.6	88.9	9.5		59.4	2.8	97.2		
on Total %	0.9	0.9	2.8		4.7	35.8	0	0	0	0	0	0	0	0	0	0.9	52.8	5.7						

Start Time	Graham Street Southbound				Cactus Avenue Westbound				Riverside Drive Northbound				Cactus Avenue Eastbound										
	Left	Thru	Right	RTOR	App. Total	Left	Thru	Right	RTOR	App. Total	Left	Thru	Right	RTOR	App. Total	Left	Thru	Right	RTOR	App. Total	Exclu. Total	Inclu. Total	Int. Total
07:15 AM	0	0	1	0	1	0	4	0	0	0	0	0	0	0	0	0	6	0	0	6	0	6	11
07:30 AM	0	0	0	0	0	3	0	0	0	0	0	0	0	0	0	0	6	0	0	6	0	7	10
07:45 AM	0	0	1	1	1	4	0	0	0	0	0	0	0	0	0	0	11	0	0	11	0	11	16
08:00 AM	1	1	0	0	2	6	0	0	0	0	0	0	0	0	0	0	7	2	0	9	1	17	17
Total Volume	1	1	2		4	0	17	0	0	0	0	0	0	0	0	1	30	2		33	6.1	54	54
% App. Total	25	25	50		50	100	0	0	0	0	0	0	0	0	0	3	90.9	6.1		68.2	.250	.750	.794
PHF	.250	.250	.500		.500	.708	.000	.708	.000	.000	.000	.000	.000	.000	.000	.250	.682	.250		.750			

Peak Hour Analysis From 07:15 AM to 08:00 AM - Peak 1 of 1
 Peak Hour for Entire Intersection Begins at 07:15 AM

Counts Unlimited, Inc.
 PO Box 1178
 Corona, CA 92878
 (951)268-6268

County of Riverside
 N/S: Graham Street/Riverside Drive
 E/W: Cactus Avenue
 Weather: Clear

File Name : 35_CRV_Graham_Cactus AM
 Site Code : 05121716
 Start Date : 1/30/2021
 Page No : 2

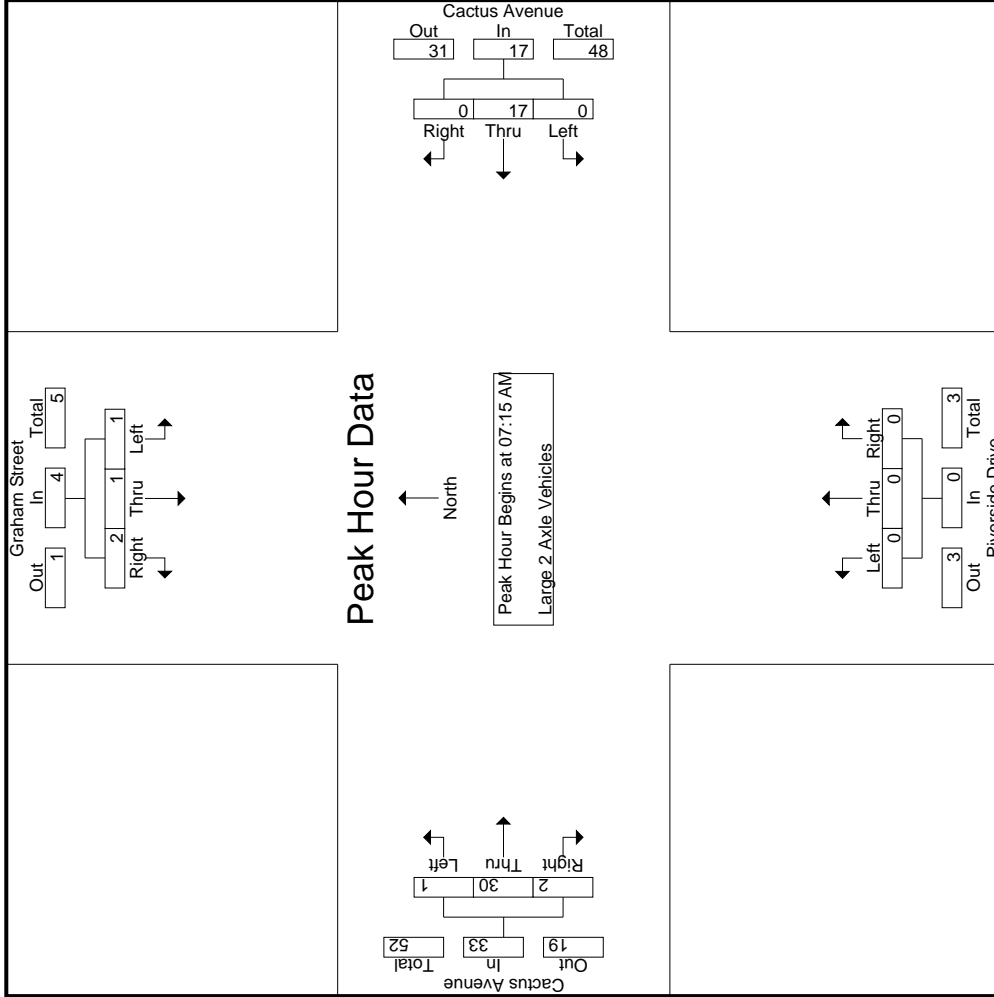

Counts Unlimited, Inc.
 PO Box 1178
 Corona, CA 92878
 (951)268-6268

County of Riverside
 N/S: Graham Street/Riverside Drive
 E/W: Cactus Avenue
 Weather: Clear

File Name : 35_CRV_Graham_Cactus AM
 Site Code : 05121716
 Start Date : 11/30/2021
 Page No : 3

Start Time	Graham Street Southbound			Cactus Avenue Westbound			Riverside Drive Northbound			Cactus Avenue Eastbound		
	Left	Thru	Right	Left	Thru	Right	Left	Thru	Right	Left	Thru	Right
	App. Total			App. Total			App. Total			App. Total		
Peak Hour Analysis From 07:15 AM to 08:00 AM - Peak 1 of 1												
Peak Hour for Each Approach Begins at:												
	07:15 AM			07:15 AM			07:15 AM			07:15 AM		
+0 mins.	0	0	1	0	4	0	0	0	0	0	0	0
+15 mins.	0	0	0	0	3	0	0	0	0	1	6	0
+30 mins.	0	0	1	0	4	0	0	0	0	0	11	0
+45 mins.	1	1	0	0	6	0	0	0	0	0	7	2
Total Volume	1	1	2	0	17	0	0	0	0	1	30	2
% App. Total	.25	.25	.50	0	100	0	0	0	0	3	90.9	6.1
PHF	.250	.250	.500	.000	.708	.000	.000	.000	.000	.250	.682	.250
					.708	.000	.000	.000	.000		.682	.250

Groups Printed- 3 Axle Vehicles

Start Time	Graham Street Southbound				Cactus Avenue Westbound				Riverside Drive Northbound				Cactus Avenue Eastbound											
	Left	Thru	Right	RTOR	App. Total	Left	Thru	Right	RTOR	App. Total	Left	Thru	Right	RTOR	App. Total	Left	Thru	Right	RTOR	App. Total	Exclu. Total	Inclu. Total	Int. Total	
07:00 AM	0	0	0	0	0	2	0	0	0	2	4	0	0	0	4	0	2	1	0	0	3	0	9	9
07:15 AM	0	0	1	1	1	3	0	0	0	3	0	0	0	0	0	0	0	2	0	0	2	1	6	7
07:30 AM	0	0	0	0	0	0	0	0	0	0	1	0	0	0	1	1	1	0	0	0	2	0	3	3
07:45 AM	0	0	1	0	1	3	0	0	0	3	3	0	0	0	3	0	1	0	0	1	1	0	8	8
Total	0	0	2	1	2	8	0	0	0	8	8	0	0	0	8	1	4	3	0	8	1	26	27	27
08:00 AM	0	0	0	0	0	5	0	0	0	5	0	0	0	0	0	0	0	2	1	0	2	1	7	8
08:15 AM	0	0	0	0	0	6	0	0	0	6	0	0	0	0	0	0	3	2	1	5	1	11	12	
08:30 AM	0	0	0	0	0	2	0	0	0	2	0	0	0	0	0	0	1	0	0	1	0	0	3	3
08:45 AM	0	0	0	0	0	4	0	0	0	4	2	0	0	0	2	0	3	0	0	3	0	9	9	9
Total	0	0	0	0	0	17	0	0	0	17	2	0	0	0	2	0	7	4	2	11	2	30	32	32
Grand Total	0	0	2	1	2	25	0	0	0	25	10	0	0	0	10	1	11	7	2	19	3	56	59	59
T-Approch %	0	0	100			100	0	0		100	0	0	0		100	5.3	57.9	36.8		33.9	5.1	94.9		
88 Total %	0	0	3.6		3.6	44.6	0	0		44.6	17.9	0	0		17.9	1.8	19.6	12.5						

Start Time	Graham Street Southbound				Cactus Avenue Westbound				Riverside Drive Northbound				Cactus Avenue Eastbound											
	Left	Thru	Right	RTOR	App. Total	Left	Thru	Right	RTOR	App. Total	Left	Thru	Right	RTOR	App. Total	Left	Thru	Right	RTOR	App. Total	Exclu. Total	Inclu. Total	Int. Total	
07:15 AM	0	0	1	1	1	0	0	0	0	0	0	0	0	0	0	0	0	0	0	0	0	0	0	0
07:30 AM	0	0	0	0	0	0	0	0	0	0	1	0	0	0	1	1	1	0	0	2	0	2	2	3
07:45 AM	0	0	0	0	0	0	0	0	0	0	3	0	0	0	3	0	0	0	0	3	0	1	1	8
08:00 AM	0	0	0	0	0	0	0	0	0	0	5	0	0	0	5	0	0	0	0	2	0	2	2	7
Total Volume	0	0	2	2	2	0	11	0	0	11	4	0	0	0	4	1	2	4	7	24				
% App. Total	0	0	100			100	0	0		100	100	0	0		100	14.3	28.6	57.1		75.0				
PHF	.000	.000	.500		.500	.000	.550	.000		.550	.333	.000	.000		.333	.250	.500	.500		.875				.750

Peak Hour Analysis From 07:15 AM to 08:00 AM - Peak 1 of 1
 Peak Hour for Entire Intersection Begins at 07:15 AM

Counts Unlimited, Inc.
 PO Box 1178
 Corona, CA 92878
 (951)268-6268

County of Riverside
 N/S: Graham Street/Riverside Drive
 E/W: Cactus Avenue
 Weather: Clear

File Name : 35_CRV_Graham_Cactus AM
 Site Code : 05121716
 Start Date : 11/30/2021
 Page No : 2

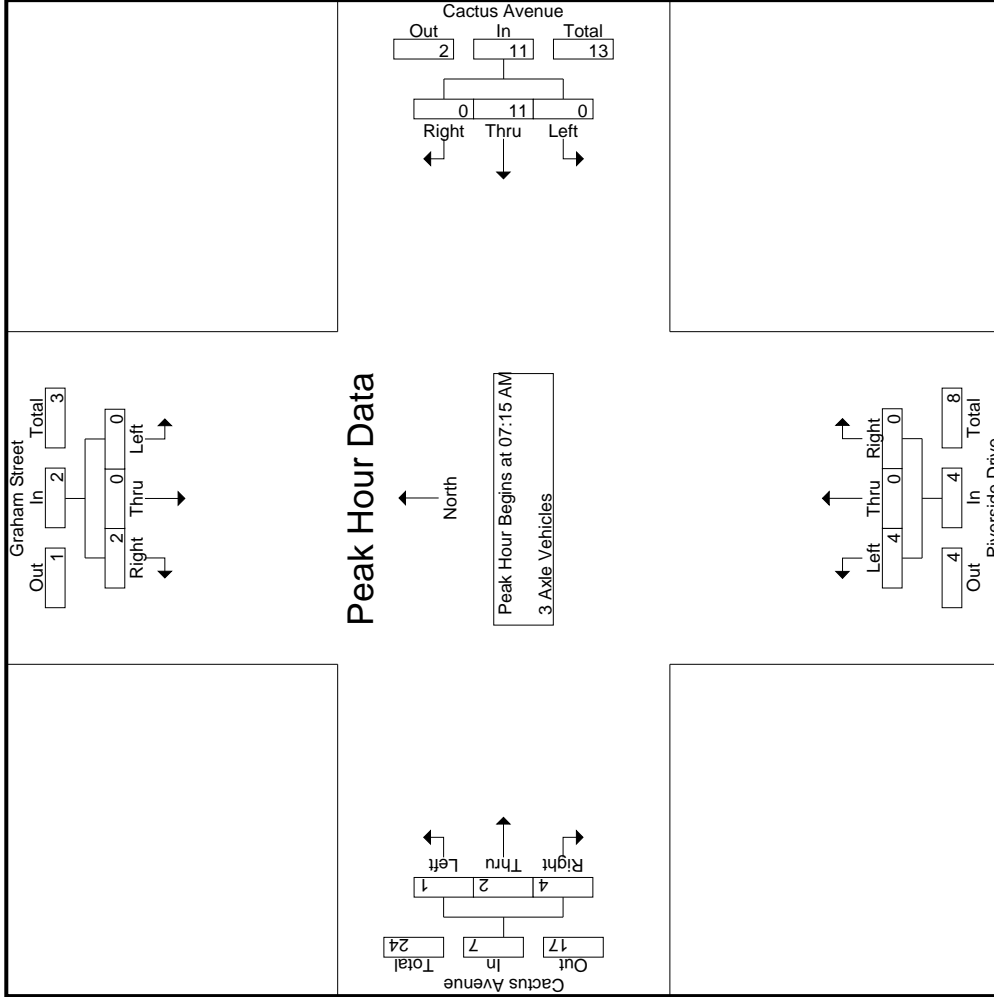

Counts Unlimited, Inc.
 PO Box 1178
 Corona, CA 92878
 (951)268-6268

County of Riverside
 N/S: Graham Street/Riverside Drive
 E/W: Cactus Avenue
 Weather: Clear

File Name : 35_CRV_Graham_Cactus AM
 Site Code : 05121716
 Start Date : 11/30/2021
 Page No : 3

Start Time	Graham Street Southbound			Cactus Avenue Westbound			Riverside Drive Northbound			Cactus Avenue Eastbound		
	Left	Thru	Right	Left	Thru	Right	Left	Thru	Right	Left	Thru	Right
Peak Hour Analysis From 07:15 AM to 08:00 AM - Peak 1 of 1												
Peak Hour for Each Approach Begins at:	07:15 AM											
+0 mins.	0	0	1	0	3	0	0	0	0	0	0	0
+15 mins.	0	0	0	0	0	0	1	0	0	1	1	0
+30 mins.	0	0	1	0	3	0	3	0	0	0	1	0
+45 mins.	0	0	0	0	5	0	5	0	0	0	0	2
Total Volume	0	0	2	0	11	0	11	0	0	4	2	4
% App. Total	0	0	100	0	100	0	100	0	0	14.3	28.6	57.1
PHF	.000	.000	.500	.000	.550	.000	.550	.000	.000	.250	.500	.500

Counts Unlimited, Inc.
 PO Box 1178
 Corona, CA 92878
 (951)268-6268

County of Riverside
 N/S: Graham Street/Riverside Drive
 E/W: Cactus Avenue
 Weather: Clear

File Name : 35_CRV_Graham_Cactus AM
 Site Code : 05121716
 Start Date : 11/30/2021
 Page No : 1

Groups Printed- 4+ Axle Trucks

Start Time	Graham Street Southbound				Cactus Avenue Westbound				Riverside Drive Northbound				Cactus Avenue Eastbound											
	Left	Thru	Right	RTOR	App. Total	Left	Thru	Right	RTOR	App. Total	Left	Thru	Right	RTOR	App. Total	Left	Thru	Right	RTOR	App. Total	Exclu. Total	Inclu. Total	Int. Total	
07:00 AM	0	0	1	0	1	0	11	0	0	11	0	0	0	0	0	0	10	0	0	0	10	0	22	22
07:15 AM	0	0	1	1	1	0	13	0	0	13	0	0	0	0	0	0	8	2	2	1	8	2	22	24
07:30 AM	1	0	2	1	3	0	8	1	0	9	0	0	0	0	0	0	13	1	0	13	1	25	26	
07:45 AM	0	0	0	0	0	0	7	1	0	8	0	0	0	0	0	1	12	0	0	13	0	21	21	
Total	1	0	4	2	5	0	39	2	0	41	0	0	0	0	0	1	40	3	1	44	3	90	93	
08:00 AM	0	0	1	1	1	0	13	0	0	13	0	0	0	0	0	2	13	2	0	17	1	31	32	
08:15 AM	0	0	0	0	0	0	8	0	0	8	0	0	0	0	0	7	7	0	0	14	0	22	22	
08:30 AM	0	0	4	3	4	0	6	0	0	6	0	0	0	0	0	0	14	0	0	14	3	24	27	
08:45 AM	0	0	2	2	2	0	12	0	0	12	0	0	0	0	0	3	14	0	0	17	2	31	33	
Total	0	0	7	6	7	0	39	0	0	39	0	0	0	0	0	12	48	2	0	62	6	108	114	
Grand Total	1	0	11	8	12	0	78	2	0	80	0	0	0	0	0	13	88	5	1	106	9	198	207	
T-Approch %	8.3	0	91.7			0	97.5	2.5		40.4	0	0	0	0	0	12.3	83	4.7		53.5	4.3	95.7		
g Total %	0.5	0	5.6		6.1	0	39.4	1			0	0	0	0	0	6.6	44.4	2.5						

Start Time	Graham Street Southbound				Cactus Avenue Westbound				Riverside Drive Northbound				Cactus Avenue Eastbound										
	Left	Thru	Right	RTOR	App. Total	Left	Thru	Right	RTOR	App. Total	Left	Thru	Right	RTOR	App. Total	Left	Thru	Right	RTOR	App. Total	Exclu. Total	Inclu. Total	Int. Total
07:15 AM	0	0	1	0	1	0	13	0	0	13	0	0	0	0	0	0	6	2	1	8	0	22	22
07:30 AM	1	0	2	1	3	0	8	1	0	9	0	0	0	0	0	0	12	1	0	13	1	25	26
07:45 AM	0	0	0	0	0	0	7	1	0	8	0	0	0	0	0	1	12	0	0	13	0	21	21
08:00 AM	0	0	0	0	0	0	13	0	0	13	0	0	0	0	0	2	13	2	0	17	2	31	31
Total Volume	1	0	4	2	5	0	41	2	0	43	0	0	0	0	0	3	43	5	0	51	5	99	99
% App. Total	20	0	80			0	95.3	4.7		40.4	0	0	0	0	0	5.9	84.3	9.8					
PHF	.250	.000	.500		.417	.000	.788	.500		.827	.000	.000	.000	.000	.000	.375	.827	.625		.750			.798

Peak Hour Analysis From 07:15 AM to 08:00 AM - Peak 1 of 1
 Peak Hour for Entire Intersection Begins at 07:15 AM

Counts Unlimited, Inc.
 PO Box 1178
 Corona, CA 92878
 (951)268-6268

County of Riverside
 N/S: Graham Street/Riverside Drive
 E/W: Cactus Avenue
 Weather: Clear

File Name : 35_CRV_Graham_Cactus AM
 Site Code : 05121716
 Start Date : 11/30/2021
 Page No : 2

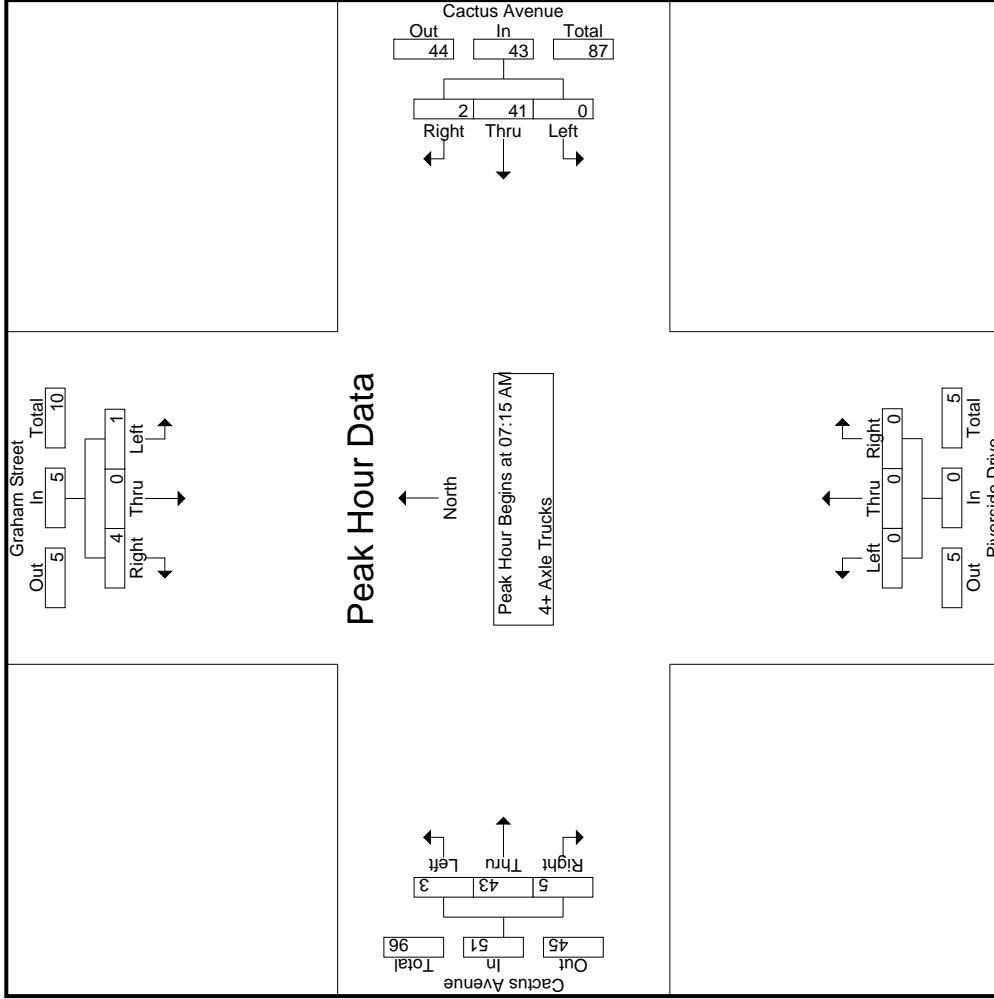

Counts Unlimited, Inc.
 PO Box 1178
 Corona, CA 92878
 (951)268-6268

County of Riverside
 N/S: Graham Street/Riverside Drive
 E/W: Cactus Avenue
 Weather: Clear

File Name : 35_CRV_Graham_Cactus AM
 Site Code : 05121716
 Start Date : 11/30/2021
 Page No : 3

Start Time	Graham Street Southbound			Cactus Avenue Westbound			Riverside Drive Northbound			Cactus Avenue Eastbound			Int. Total
	Left	Thru	Right	Left	Thru	Right	Left	Thru	Right	Left	Thru	Right	
Peak Hour Analysis From 07:15 AM to 08:00 AM - Peak 1 of 1	07:15 AM												
Peak Hour for Each Approach Begins at:	07:15 AM												
+0 mins.	0	0	1	0	13	0	13	0	0	0	0	6	8
+15 mins.	1	0	2	0	8	1	9	0	0	0	0	12	13
+30 mins.	0	0	0	0	7	1	8	0	0	0	1	12	13
+45 mins.	0	0	1	0	13	0	13	0	0	0	2	13	17
Total Volume	1	0	4	0	41	2	43	0	0	0	3	43	51
% App. Total	20	0	80	0	95.3	4.7	98.7	0	0	0	5.9	84.3	98.8
PHF	.250	.000	.500	.000	.788	.500	.827	.000	.000	.000	.375	.827	.750

Counts Unlimited, Inc.
 PO Box 1178
 Corona, CA 92878
 (951)268-6268

County of Riverside
 N/S: Graham Street/Riverside Drive
 E/W: Cactus Avenue
 Weather: Clear

File Name : 35_CRV_Graham_Cactus PM
 Site Code : 05121716
 Start Date : 11/30/2021
 Page No : 1

Groups Printed- Passenger Vehicles - Large 2 Axle Vehicles - 3 Axle Vehicles - 4+ Axle Trucks

Start Time	Graham Street Southbound					Cactus Avenue Westbound					Riverside Drive Northbound					Cactus Avenue Eastbound							
	Left	Thru	Right	RTOR	App. Total	Left	Thru	Right	RTOR	App. Total	Left	Thru	Right	RTOR	App. Total	Left	Thru	Right	RTOR	App. Total	Exclu. Total	Inclu. Total	Int. Total
	04:00 PM	33	25	21	16	79	0	290	26	4	316	0	0	0	0	0	22	451	66	12	539	32	934
04:15 PM	30	21	17	13	68	4	270	16	0	290	1	0	0	0	1	22	448	85	11	555	24	914	938
04:30 PM	31	21	30	28	82	5	304	22	3	331	0	0	0	0	0	17	459	67	11	543	42	956	998
04:45 PM	26	23	17	14	66	3	301	18	3	322	0	0	0	0	0	34	460	76	7	570	24	958	982
Total	120	90	85	71	295	12	1165	82	10	1259	1	0	0	0	1	95	1818	294	41	2207	122	3762	3884
05:00 PM	26	16	27	17	69	3	297	19	2	319	1	0	1	1	2	20	547	96	15	663	35	1053	1088
05:15 PM	35	27	13	9	75	1	267	21	3	289	0	0	1	1	1	20	428	89	12	537	25	902	927
05:30 PM	35	18	15	12	68	3	283	28	1	314	0	0	0	0	0	24	447	71	8	542	21	924	945
05:45 PM	43	33	24	21	100	0	226	10	1	236	1	0	0	0	1	20	501	88	12	609	34	946	980
Total	139	94	79	59	312	7	1073	78	7	1158	2	0	2	2	4	84	1923	344	47	2351	115	3825	3940
Grand Total	259	184	164	130	607	19	2238	160	17	2417	3	0	2	2	5	179	3741	638	88	4558	237	7587	7824
% Approach	42.7	30.3	27			0.8	92.6	6.6			60	0	40			3.9	82.1	14					
% Total	3.4	2.4	2.2		8	0.3	29.5	2.1		31.9	0	0	0	0.1		2.4	49.3	8.4		60.1	3	97	
% Passenger Vehicles	255	183	156	717	717	19	2158	160	100	2354	3	0	2	7	171	3589	632	4479			0	0	7557
% Large 2 Axle Vehicles	98.5	99.5	95.1	94.6	97.3	100	96.4	100	100	96.7	100	0	100	100	100	95.5	95.9	99.1	98.9	96.4	0	0	96.6
% 3 Axle Vehicles	2	1	2	1.5	0.9	0	1.3	0	0	1.2	0	0	0	0	0	3	62	6	1.1	72	0	0	108
% 4+ Axle Trucks	0.8	0.5	1.2	0	0	0	4	0	0	4	0	0	0	0	0	1.7	1.7	0.9	1.1	1.5	0	0	1.4
% App. Total	0	0	0	0	0	0	0.2	0	0	0.2	0	0	0	0	0	0	0.6	0	0	0.5	0	0	0.3
% Exclu. Total	2	0	6	13	13	0	47	0	0	47	0	0	0	0	0	5	69	0	0	74	0	0	134
% Int. Total	0.8	0	3.7	3.8	1.8	0	2.1	0	0	1.9	0	0	0	0	0	2.8	1.8	0	0	1.6	0	0	1.7

Start Time	Graham Street Southbound					Cactus Avenue Westbound					Riverside Drive Northbound					Cactus Avenue Eastbound							
	Left	Thru	Right	RTOR	App. Total	Left	Thru	Right	RTOR	App. Total	Left	Thru	Right	RTOR	App. Total	Left	Thru	Right	RTOR	App. Total	Exclu. Total	Inclu. Total	Int. Total
	04:15 PM	30	21	17		68	4	270	16		290	1	0	0		1	22	448	85		555		
04:30 PM	31	21	30		82	5	304	22		331	0	0	0		0	17	459	67		543			956
04:45 PM	26	23	17		66	3	301	18		322	0	0	0		0	34	460	76		570			958
05:00 PM	26	16	27		69	3	297	19		319	1	0	1		2	20	547	96		663			1053
Total Volume	113	81	91		285	15	1172	75		1262	2	0	1		3	93	1914	324		2331			3881
% App. Total	39.6	28.4	31.9		31.9	1.2	92.9	5.9		66.7	0	33.3			4	82.1	13.9						
PHF	.911	.880	.758		.869	.750	.964	.852		.953	.500	.000	.250		.375	.684	.875			.844			.879

Peak Hour Analysis From 04:00 PM to 05:45 PM - Peak 1 of 1
 Peak Hour for Entire Intersection Begins at 04:15 PM

Counts Unlimited, Inc.
 PO Box 1178
 Corona, CA 92878
 (951)268-6268

County of Riverside
 N/S: Graham Street/Riverside Drive
 E/W: Cactus Avenue
 Weather: Clear

File Name : 35_CRV_Graham_Cactus PM
 Site Code : 05121716
 Start Date : 11/30/2021
 Page No : 2

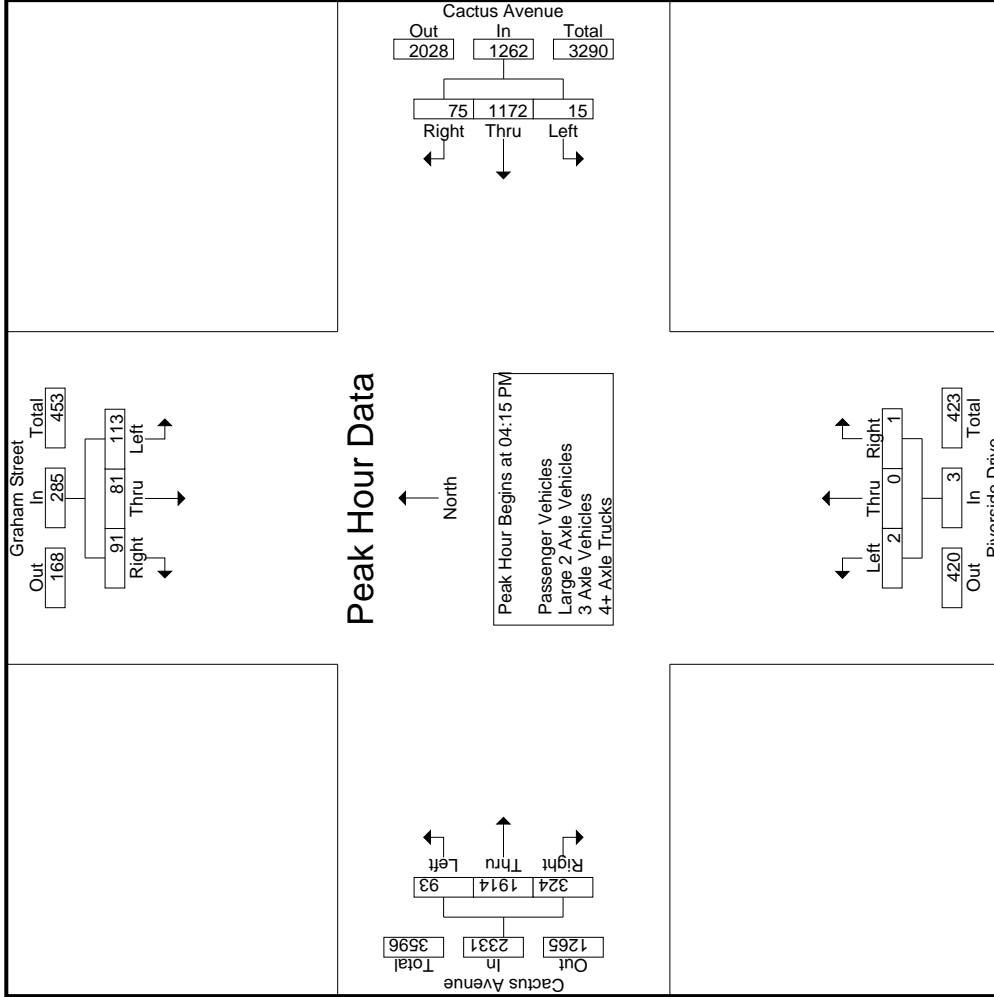

Counts Unlimited, Inc.
 PO Box 1178
 Corona, CA 92878
 (951)268-6268

County of Riverside
 N/S: Graham Street/Riverside Drive
 E/W: Cactus Avenue
 Weather: Clear

File Name : 35_CRV_Graham_Cactus PM
 Site Code : 05121716
 Start Date : 11/30/2021
 Page No : 3

Start Time	Graham Street Southbound			Cactus Avenue Westbound			Riverside Drive Northbound			Cactus Avenue Eastbound				
	Left	Thru	Right	Left	Thru	Right	Left	Thru	Right	Left	Thru	Right		
	App. Total			App. Total			App. Total			App. Total				
Peak Hour Analysis From 04:00 PM to 05:45 PM - Peak 1 of 1														
Peak Hour for Each Approach Begins at:														
	05:00 PM			04:15 PM			05:00 PM			05:00 PM				
+0 mins.	26	16	27	4	270	16	290	1	0	1	20	547	96	663
+15 mins.	35	27	13	5	304	22	331	0	0	1	20	428	89	537
+30 mins.	35	18	15	3	301	18	322	0	0	0	24	447	71	542
+45 mins.	43	33	24	3	297	19	319	1	0	0	20	501	88	609
Total Volume	139	94	79	15	1172	75	1262	2	0	2	84	1923	344	2351
% App. Total	44.6	30.1	25.3	1.2	92.9	5.9	953	50	0	50	3.6	81.8	14.6	887
PHF	.808	.712	.731	.750	.964	.852	.953	.500	.000	.500	.875	.879	.896	.887

Counts Unlimited, Inc.
 PO Box 1178
 Corona, CA 92878
 (951)268-6268

County of Riverside
 N/S: Graham Street/Riverside Drive
 E/W: Cactus Avenue
 Weather: Clear

File Name : 35_CRV_Graham_Cactus PM
 Site Code : 05121716
 Start Date : 11/30/2021
 Page No : 1

Groups Printed- Passenger Vehicles

Start Time	Graham Street Southbound				Cactus Avenue Westbound				Riverside Drive Northbound				Cactus Avenue Eastbound										
	Left	Thru	Right	RTOR	App. Total	Left	Thru	Right	RTOR	App. Total	Left	Thru	Right	RTOR	App. Total	Left	Thru	Right	RTOR	App. Total	Exclu. Total	Inclu. Total	Int. Total
04:00 PM	32	25	20	15	77	0	272	26	4	298	0	0	0	0	0	21	423	64	12	508	31	883	914
04:15 PM	30	21	16	12	67	4	258	16	0	278	1	0	0	0	1	21	424	84	10	529	22	875	897
04:30 PM	29	20	30	28	79	5	298	22	3	325	0	0	0	0	0	17	441	67	11	525	42	929	971
04:45 PM	26	23	16	13	65	3	295	18	3	316	0	0	0	0	0	34	442	74	7	550	23	931	954
Total	117	89	82	68	288	12	1123	82	10	1217	1	0	0	0	1	93	1730	289	40	2112	118	3618	3736
05:00 PM	26	16	24	15	66	3	279	19	2	301	1	0	1	1	2	17	533	95	15	645	33	1014	1047
05:15 PM	35	27	12	8	74	1	260	21	3	282	0	0	1	1	1	20	412	89	12	521	24	878	902
05:30 PM	34	18	14	11	66	3	276	28	1	307	0	0	0	0	0	23	431	71	8	525	20	898	918
05:45 PM	43	33	24	21	100	0	220	10	1	230	1	0	0	0	1	18	483	88	12	589	34	920	954
Total	138	94	74	55	306	7	1035	78	7	1120	2	0	2	2	4	78	1859	343	47	2280	111	3710	3821
Grand Total	255	183	156	123	594	19	2158	160	17	2337	3	0	2	2	5	171	3589	632	87	4392	229	7328	7557
% Approach	42.9	30.8	26.3			0.8	92.3	6.8		60	0	0	40		3.9	81.7	14.4						
% Total	3.5	2.5	2.1		8.1	0.3	29.4	2.2		31.9	0	0	0		2.3	49	8.6			59.9	3	97	

Start Time	Graham Street Southbound				Cactus Avenue Westbound				Riverside Drive Northbound				Cactus Avenue Eastbound										
	Left	Thru	Right	RTOR	App. Total	Left	Thru	Right	RTOR	App. Total	Left	Thru	Right	RTOR	App. Total	Left	Thru	Right	RTOR	App. Total	Exclu. Total	Inclu. Total	Int. Total
04:15 PM	30	21	16		67	4	258	16		278	1	0	0		1	21	424	84		529			875
04:30 PM	29	20	30		79	5	298	22		325	0	0	0		0	17	441	67		525			929
04:45 PM	26	23	16		65	3	295	18		316	0	0	0		0	34	442	74		550			931
05:00 PM	26	16	24		66	3	279	19		301	1	0	1		2	17	533	95		645			1014
Total Volume	111	80	86		277	15	1130	75		1220	2	0	1		3	89	1840	320		2249			3749
% App. Total	40.1	28.9	31			1.2	92.6	6.1		66.7	0	33.3			4	81.8	14.2						
PHF	.925	.870	.717		.877	.750	.948	.852		.938	.500	.000	.250		.375	.654	.863	.842		.872			.924

Peak Hour Analysis From 04:15 PM to 05:00 PM - Peak 1 of 1
 Peak Hour for Entire Intersection Begins at 04:15 PM

Counts Unlimited, Inc.
 PO Box 1178
 Corona, CA 92878
 (951)268-6268

County of Riverside
 N/S: Graham Street/Riverside Drive
 E/W: Cactus Avenue
 Weather: Clear

File Name : 35_CRV_Graham_Cactus PM
 Site Code : 05121716
 Start Date : 1/30/2021
 Page No : 2

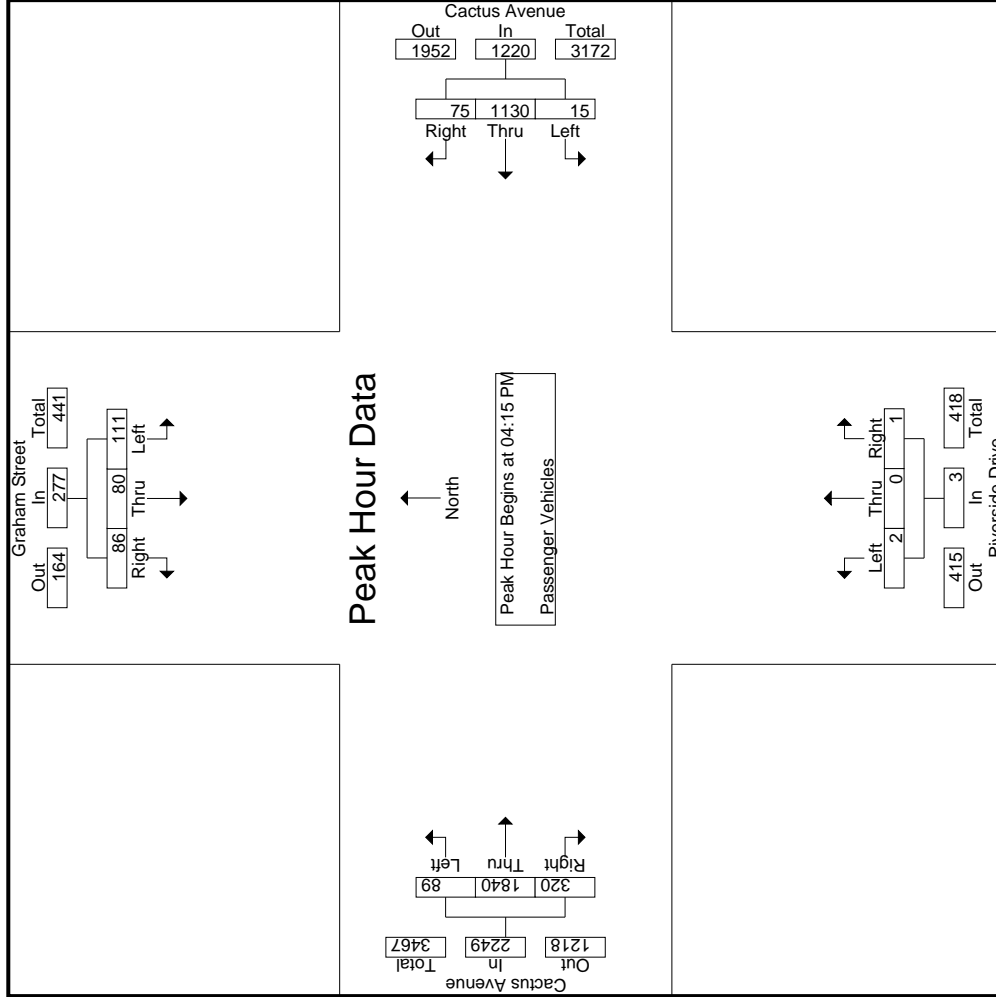

Counts Unlimited, Inc.
 PO Box 1178
 Corona, CA 92878
 (951)268-6268

County of Riverside
 N/S: Graham Street/Riverside Drive
 E/W: Cactus Avenue
 Weather: Clear

File Name : 35_CRV_Graham_Cactus PM
 Site Code : 05121716
 Start Date : 11/30/2021
 Page No : 3

Start Time	Graham Street Southbound			Cactus Avenue Westbound			Riverside Drive Northbound			Cactus Avenue Eastbound						
	Left	Thru	Right	App. Total	Left	Thru	Right	App. Total	Left	Thru	Right	App. Total	Int. Total			
Peak Hour Analysis From 04:15 PM to 05:00 PM - Peak 1 of 1																
Peak Hour for Each Approach Begins at:																
	04:15 PM			04:15 PM			04:15 PM			04:15 PM						
+0 mins.	30	21	16	67	4	258	16	278	1	0	0	1	21	424	84	529
+15 mins.	29	20	30	79	5	298	22	325	0	0	0	0	17	441	67	525
+30 mins.	26	23	16	65	3	295	18	316	0	0	0	0	34	442	74	550
+45 mins.	26	16	24	66	3	279	19	301	1	0	1	2	17	533	95	645
Total Volume	111	80	86	277	15	1130	75	1220	2	0	1	3	89	1840	320	2249
% App. Total	40.1	28.9	31		1.2	92.6	6.1		66.7	0	33.3	4	4	81.8	14.2	
PHF	.925	.870	.717	.877	.750	.948	.852	.938	.500	.000	.250	.375	.654	.863	.842	.872

Counts Unlimited, Inc.
 PO Box 1178
 Corona, CA 92878
 (951)268-6268

County of Riverside
 N/S: Graham Street/Riverside Drive
 E/W: Cactus Avenue
 Weather: Clear

File Name : 35_CRV_Graham_Cactus PM
 Site Code : 05121716
 Start Date : 11/30/2021
 Page No : 1

Groups Printed- Large 2-Axle Vehicles

Start Time	Graham Street Southbound				Cactus Avenue Westbound				Riverside Drive Northbound				Cactus Avenue Eastbound				Exclu. Total	Inclu. Total	Int. Total				
	Left	Thru	Right	RTOR	App. Total	Left	Thru	Right	RTOR	App. Total	Left	Thru	Right	RTOR	App. Total	Left				Thru	Right	RTOR	App. Total
04:00 PM	1	0	0	0	1	0	5	0	0	5	0	0	0	0	0	1	15	2	0	18	0	24	24
04:15 PM	0	0	0	0	0	4	4	0	0	4	0	0	0	0	0	0	10	1	1	11	1	15	16
04:30 PM	0	1	0	0	1	0	4	0	0	4	0	0	0	0	0	0	7	0	0	7	0	12	12
04:45 PM	0	0	0	0	0	2	2	0	0	2	0	0	0	0	0	0	9	2	0	11	0	13	13
Total	1	1	0	0	2	0	15	0	0	15	0	0	0	0	0	1	41	5	1	47	1	64	65
05:00 PM	0	0	1	1	1	0	7	0	0	7	0	0	0	0	0	1	5	1	0	7	1	15	16
05:15 PM	0	0	0	0	0	2	2	0	0	2	0	0	0	0	0	0	3	0	0	3	0	5	5
05:30 PM	1	0	1	1	2	0	4	0	0	4	0	0	0	0	0	1	8	0	0	9	1	15	16
05:45 PM	0	0	0	0	0	1	1	0	0	1	0	0	0	0	0	0	5	0	0	5	0	6	6
Total	1	0	2	2	3	0	14	0	0	14	0	0	0	0	0	2	21	1	0	24	2	41	43
Grand Total	2	1	2	2	5	0	29	0	0	29	0	0	0	0	0	3	62	6	1	71	3	105	108
% Apprch %	40	20	40			0	100	0		27.6	0	0	0		4.2	87.3	8.5		67.6	2.8	97.2		
% Total %	1.9	1	1.9		4.8	0	27.6	0		27.6	0	0	0		2.9	59	5.7						

Start Time	Graham Street Southbound				Cactus Avenue Westbound				Riverside Drive Northbound				Cactus Avenue Eastbound				Exclu. Total	Inclu. Total	Int. Total				
	Left	Thru	Right	RTOR	App. Total	Left	Thru	Right	RTOR	App. Total	Left	Thru	Right	RTOR	App. Total	Left				Thru	Right	RTOR	App. Total
04:15 PM	0	0	0	0	0	4	0	0	0	4	0	0	0	0	0	0	10	1	0	11	1	11	15
04:30 PM	0	1	0	0	1	0	4	0	0	4	0	0	0	0	0	0	7	0	0	7	0	7	12
04:45 PM	0	0	0	0	0	2	0	0	0	2	0	0	0	0	0	0	9	0	0	9	2	11	13
05:00 PM	0	0	0	0	0	7	0	0	0	7	0	0	0	0	0	1	5	1	0	6	1	7	15
Total Volume	0	1	1	1	2	0	17	0	0	17	0	0	0	0	0	1	31	4	0	36	4	36	55
% App. Total	0	50	50		50	0	100	0		60.7	0	0	0		0	2.8	86.1	11.1		77.5	.500	.818	.917
PHF	.000	.250	.250		.500	.000	.607	.000		.607	.000	.000	.000		.000	.250	.775	.500		.818			

Peak Hour Analysis From 04:15 PM to 05:00 PM - Peak 1 of 1
 Peak Hour for Entire Intersection Begins at 04:15 PM

Counts Unlimited, Inc.
 PO Box 1178
 Corona, CA 92878
 (951)268-6268

County of Riverside
 N/S: Graham Street/Riverside Drive
 E/W: Cactus Avenue
 Weather: Clear

File Name : 35_CRV_Graham_Cactus PM
 Site Code : 05121716
 Start Date : 1/30/2021
 Page No : 2

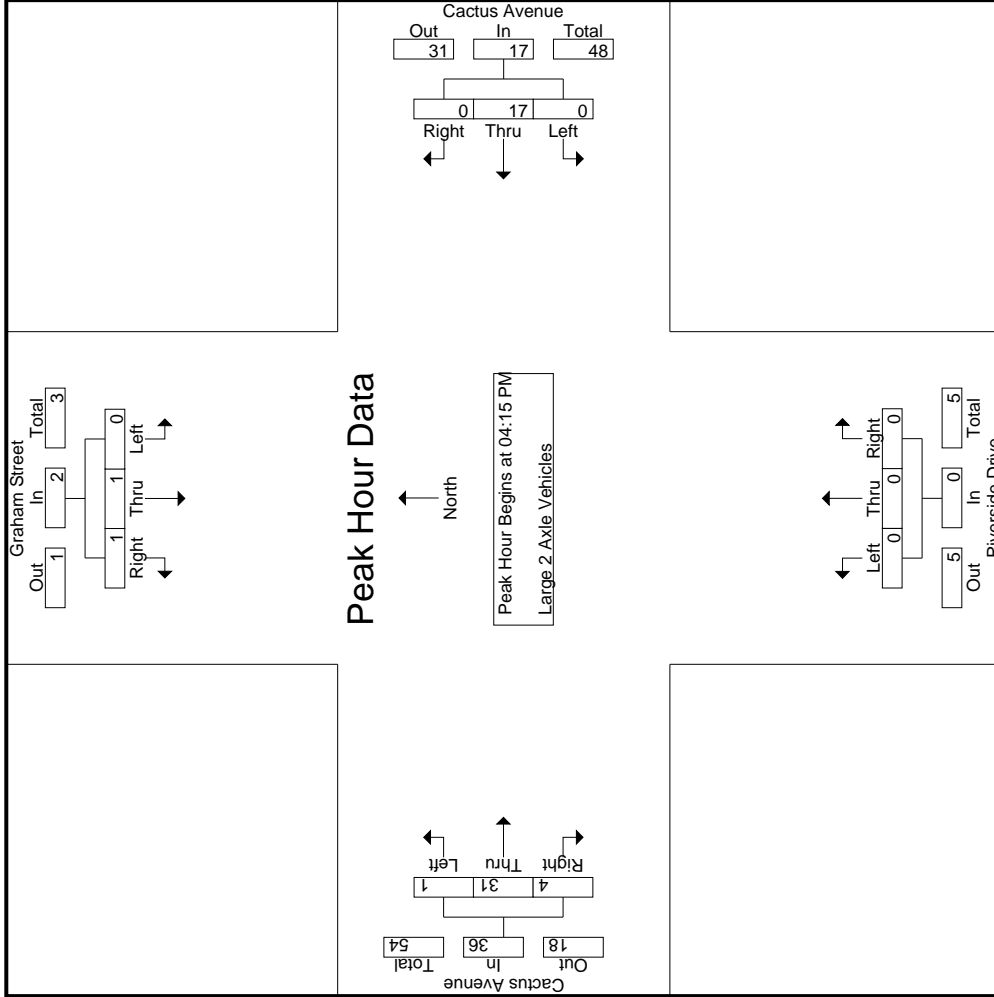

Counts Unlimited, Inc.
 PO Box 1178
 Corona, CA 92878
 (951)268-6268

County of Riverside
 N/S: Graham Street/Riverside Drive
 E/W: Cactus Avenue
 Weather: Clear

File Name : 35_CRV_Graham_Cactus PM
 Site Code : 05121716
 Start Date : 11/30/2021
 Page No : 3

Start Time	Graham Street Southbound			Cactus Avenue Westbound			Riverside Drive Northbound			Cactus Avenue Eastbound				
	Left	Thru	Right	Left	Thru	Right	Left	Thru	Right	Left	Thru	Right		
Peak Hour Analysis From 04:15 PM to 05:00 PM - Peak 1 of 1	Peak Hour for Each Approach Begins at:													
	04:15 PM			04:15 PM			04:15 PM			04:15 PM				
+0 mins.	0	0	0	4	4	0	0	0	0	0	0	10	1	11
+15 mins.	0	1	0	4	4	0	0	0	0	0	0	7	0	7
+30 mins.	0	0	0	2	0	0	0	0	0	0	0	9	2	11
+45 mins.	0	0	1	7	0	0	0	0	0	1	0	5	1	7
Total Volume	0	1	1	17	0	0	0	0	0	1	31	4	4	36
% App. Total	0	50	50	100	0	0	0	0	0	2.8	86.1	11.1	11.1	36
PHF	.000	.250	.250	.607	.000	.000	.607	.000	.000	.250	.775	.500	.500	.818

Groups Printed- 3 Axle Vehicles

Start Time	Graham Street Southbound				Cactus Avenue Westbound				Riverside Drive Northbound				Cactus Avenue Eastbound					
	Left	Thru	Right	RTOR	App. Total	Left	Thru	Right	RTOR	App. Total	Left	Thru	Right	RTOR	App. Total	Exclu. Total	Inclu. Total	Int. Total
04:00 PM	0	0	0	0	0	0	0	0	0	0	0	0	0	0	5	0	5	5
04:15 PM	0	0	0	0	1	0	0	0	0	0	0	0	0	0	2	0	3	3
04:30 PM	0	0	0	0	0	0	0	0	0	0	0	0	0	0	1	0	1	1
04:45 PM	0	0	0	0	1	0	0	0	0	0	0	0	0	0	3	0	4	4
Total	0	0	0	0	2	0	0	0	0	0	0	0	0	0	11	0	13	13
05:00 PM	0	0	0	0	0	0	0	0	0	0	0	0	0	0	4	0	4	4
05:15 PM	0	0	0	0	0	0	0	0	0	0	0	0	0	0	2	0	2	2
05:30 PM	0	0	0	0	1	0	0	0	0	0	0	0	0	0	2	0	3	3
05:45 PM	0	0	0	0	1	0	0	0	0	0	0	0	0	0	2	0	3	3
Total	0	0	0	0	2	0	0	0	0	0	0	0	0	0	10	0	12	12
Grand Total	0	0	0	0	4	0	0	0	0	0	0	0	0	0	21	0	25	25
T-Approch %	0	0	0	0	100	0	0	0	0	0	0	0	0	0	100	0	100	100
Total %	0	0	0	0	16	0	0	0	0	0	0	0	0	0	84	0	100	100

Start Time	Graham Street Southbound				Cactus Avenue Westbound				Riverside Drive Northbound				Cactus Avenue Eastbound					
	Left	Thru	Right	RTOR	App. Total	Left	Thru	Right	RTOR	App. Total	Left	Thru	Right	RTOR	App. Total	Exclu. Total	Inclu. Total	Int. Total
04:15 PM	0	0	0	0	0	0	0	0	0	0	0	0	0	0	0	0	0	0
04:30 PM	0	0	0	0	0	0	0	0	0	0	0	0	0	0	0	0	0	0
04:45 PM	0	0	0	0	0	0	0	0	0	0	0	0	0	0	0	0	0	0
05:00 PM	0	0	0	0	0	0	0	0	0	0	0	0	0	0	0	0	0	0
Total Volume	0	0	0	0	0	0	0	0	0	0	0	0	0	0	0	0	0	0
% App. Total	0	0	0	0	0	0	0	0	0	0	0	0	0	0	0	0	0	0
PHF	.000	.000	.000	.000	.000	.500	.000	.000	.000	.000	.000	.000	.000	.000	.625	.000	.625	.750

Peak Hour Analysis From 04:15 PM to 05:00 PM - Peak 1 of 1
 Peak Hour for Entire Intersection Begins at 04:15 PM

Counts Unlimited, Inc.
 PO Box 1178
 Corona, CA 92878
 (951)268-6268

County of Riverside
 N/S: Graham Street/Riverside Drive
 E/W: Cactus Avenue
 Weather: Clear

File Name : 35_CRV_Graham_Cactus PM
 Site Code : 05121716
 Start Date : 11/30/2021
 Page No : 2

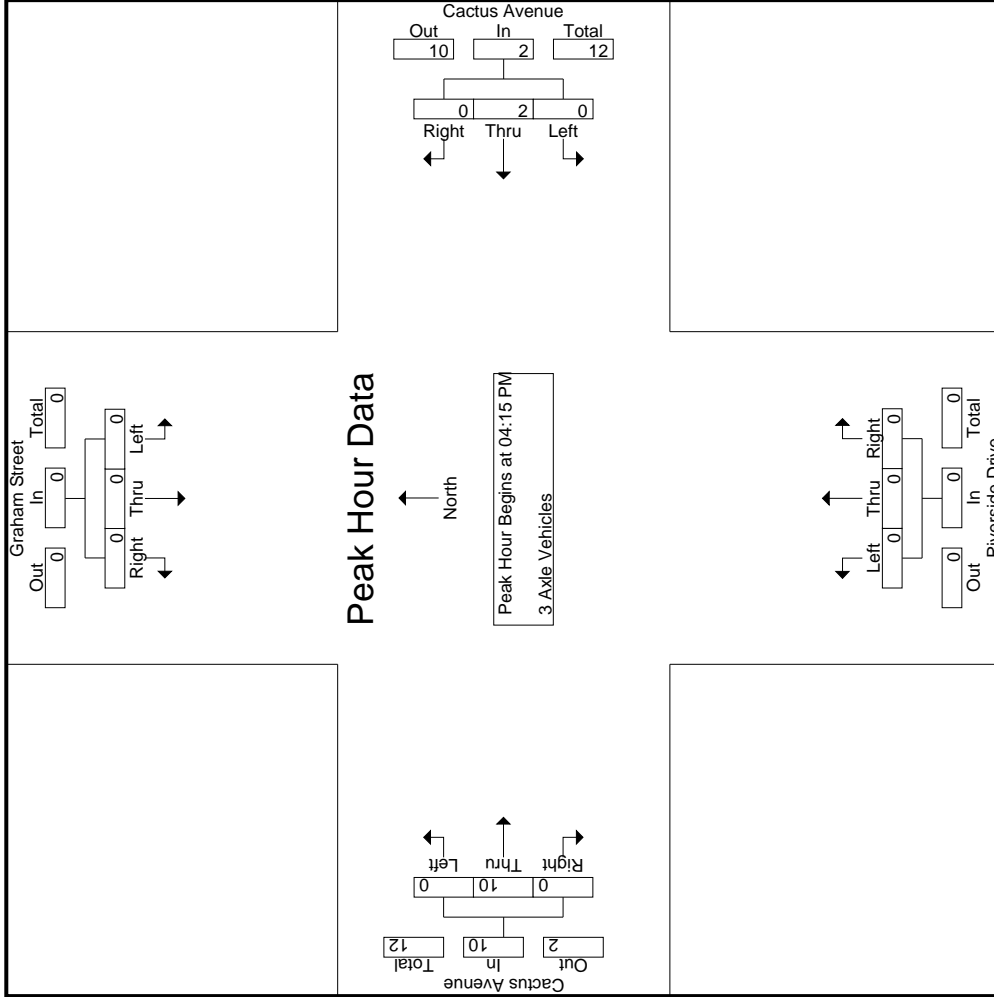

Counts Unlimited, Inc.
 PO Box 1178
 Corona, CA 92878
 (951)268-6268

County of Riverside
 N/S: Graham Street/Riverside Drive
 E/W: Cactus Avenue
 Weather: Clear

File Name : 35_CRV_Graham_Cactus PM
 Site Code : 05121716
 Start Date : 11/30/2021
 Page No : 3

Start Time	Graham Street Southbound			Cactus Avenue Westbound			Riverside Drive Northbound			Cactus Avenue Eastbound								
	Left	Thru	Right	App. Total	Left	Thru	Right	App. Total	Left	Thru	Right	App. Total	Int. Total					
Peak Hour Analysis From 04:15 PM to 05:00 PM - Peak 1 of 1																		
Peak Hour for Each Approach Begins at:																		
	04:15 PM				04:15 PM				04:15 PM				04:15 PM					
+0 mins.	0	0	0	0	0	0	0	1	0	0	0	0	0	0	2	0	0	2
+15 mins.	0	0	0	0	0	0	0	0	0	0	0	0	0	0	1	0	0	1
+30 mins.	0	0	0	0	0	0	0	1	0	0	0	0	0	0	3	0	0	3
+45 mins.	0	0	0	0	0	0	0	0	0	0	0	0	0	0	4	0	0	4
Total Volume	0	0	0	0	0	2	0	2	0	0	0	0	0	0	10	0	0	10
% App. Total	0	0	0	0	0	100	0	0	0	0	0	0	0	0	100	0	0	100
PHF	.000	.000	.000	.000	.000	.500	.000	.500	.000	.000	.000	.000	.000	.000	.625	.000	.000	.625

Counts Unlimited, Inc.
 PO Box 1178
 Corona, CA 92878
 (951)268-6268

County of Riverside
 N/S: Graham Street/Riverside Drive
 E/W: Cactus Avenue
 Weather: Clear

File Name : 35_CRV_Graham_Cactus PM
 Site Code : 05121716
 Start Date : 11/30/2021
 Page No : 1

Groups Printed- 4+ Axle Trucks

Start Time	Graham Street Southbound				Cactus Avenue Westbound				Riverside Drive Northbound				Cactus Avenue Eastbound											
	Left	Thru	Right	RTOR	App. Total	Left	Thru	Right	RTOR	App. Total	Left	Thru	Right	RTOR	App. Total	Left	Thru	Right	RTOR	App. Total	Exclu. Total	Inclu. Total	Int. Total	
04:00 PM	0	0	1	1	1	0	13	0	0	13	0	0	0	0	0	0	8	0	0	0	8	1	22	23
04:15 PM	0	0	1	1	1	0	7	0	0	7	0	0	0	0	0	1	12	0	0	13	1	21	22	
04:30 PM	2	0	0	0	2	0	2	0	0	2	0	0	0	0	0	0	10	0	0	10	0	14	14	
04:45 PM	0	0	1	1	1	0	3	0	0	3	0	0	0	0	0	0	6	0	0	6	1	10	11	
Total	2	0	3	3	5	0	25	0	0	25	0	0	0	0	0	1	36	0	0	37	3	67	70	
05:00 PM	0	0	2	1	2	0	11	0	0	11	0	0	0	0	0	2	5	0	0	7	1	20	21	
05:15 PM	0	0	1	1	1	0	5	0	0	5	0	0	0	0	0	0	11	0	0	11	1	17	18	
05:30 PM	0	0	0	0	0	2	0	0	0	2	0	0	0	0	0	0	6	0	0	6	0	8	8	
05:45 PM	0	0	0	0	0	0	4	0	0	4	0	0	0	0	0	2	11	0	0	13	0	17	17	
Total	0	0	3	2	3	0	22	0	0	22	0	0	0	0	0	4	33	0	0	37	2	62	64	
Grand Total	2	0	6	5	8	0	47	0	0	47	0	0	0	0	0	5	69	0	0	74	5	129	134	
T-Approch %	25	0	75			0	100	0	0	36.4	0	0	0	0	6.8	93.2	0	0	0	57.4	3.7	96.3		
T-Total %	1.6	0	4.7		6.2	0	36.4	0	0	36.4	0	0	0	0	3.9	53.5	0	0	0					

Start Time	Graham Street Southbound				Cactus Avenue Westbound				Riverside Drive Northbound				Cactus Avenue Eastbound										
	Left	Thru	Right	RTOR	App. Total	Left	Thru	Right	RTOR	App. Total	Left	Thru	Right	RTOR	App. Total	Left	Thru	Right	RTOR	App. Total	Exclu. Total	Inclu. Total	Int. Total
04:15 PM	0	0	1	1	1	0	7	0	0	7	0	0	0	0	0	1	12	0	0	13	0	13	21
04:30 PM	2	0	0	0	2	0	2	0	0	2	0	0	0	0	0	0	10	0	0	10	0	10	14
04:45 PM	0	0	1	1	1	0	3	0	0	3	0	0	0	0	0	0	6	0	0	6	0	6	10
05:00 PM	0	0	2	2	2	0	11	0	0	11	0	0	0	0	0	2	5	0	0	7	0	7	20
Total Volume	2	0	4	4	6	0	23	0	0	23	0	0	0	0	0	3	33	0	0	36	0	36	65
% App. Total	33.3	0	66.7		66.7	0	100	0	0	36.4	0	0	0	0	8.3	91.7	0	0	0				
PHF	.250	.000	.500		.750	.000	.523	.000	.000	.523	.000	.000	.000	.000	.688	.375	.688	.000	.692				.774

Peak Hour Analysis From 04:15 PM to 05:00 PM - Peak 1 of 1
 Peak Hour for Entire Intersection Begins at 04:15 PM

Counts Unlimited, Inc.
 PO Box 1178
 Corona, CA 92878
 (951)268-6268

County of Riverside
 N/S: Graham Street/Riverside Drive
 E/W: Cactus Avenue
 Weather: Clear

File Name : 35_CRV_Graham_Cactus PM
 Site Code : 05121716
 Start Date : 11/30/2021
 Page No : 2

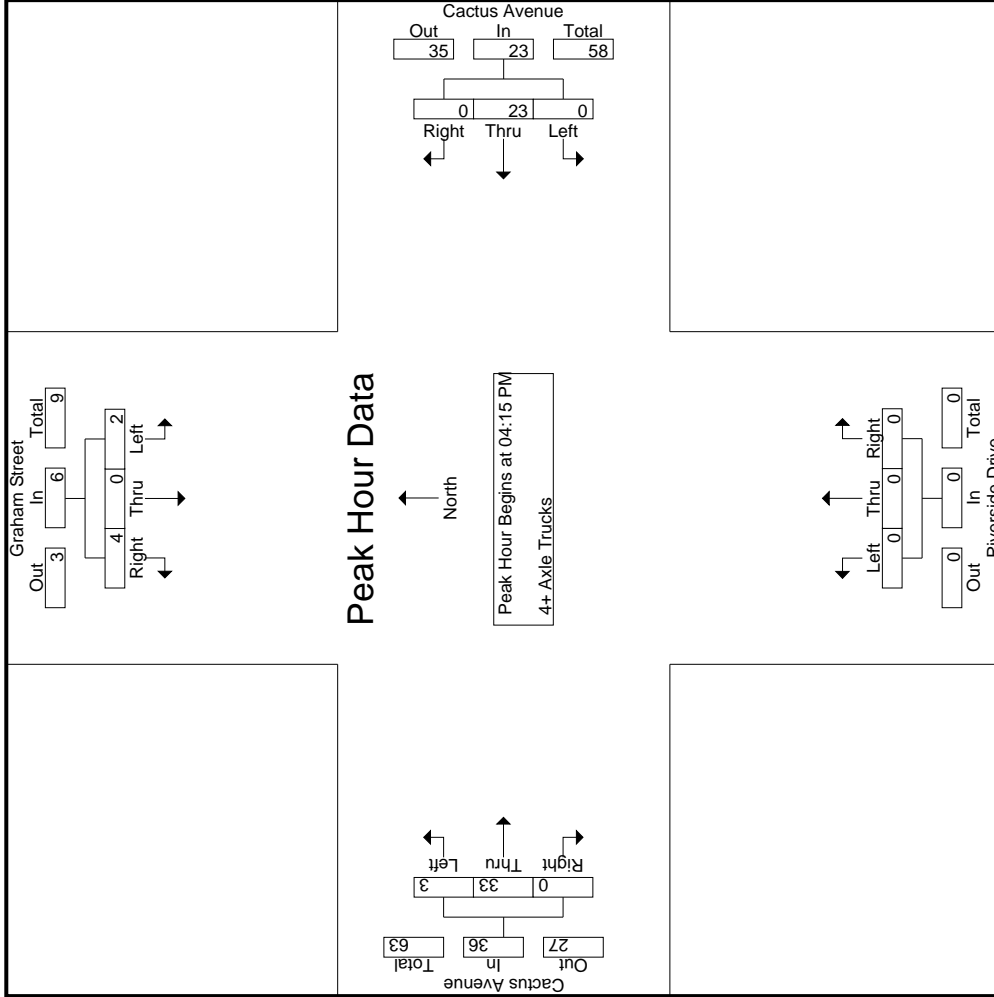

Counts Unlimited, Inc.
 PO Box 1178
 Corona, CA 92878
 (951)268-6268

County of Riverside
 N/S: Graham Street/Riverside Drive
 E/W: Cactus Avenue
 Weather: Clear

File Name : 35_CRV_Graham_Cactus PM
 Site Code : 05121716
 Start Date : 11/30/2021
 Page No : 3

Start Time	Graham Street Southbound			Cactus Avenue Westbound			Riverside Drive Northbound			Cactus Avenue Eastbound					
	Left	Thru	Right	Left	Thru	Right	Left	Thru	Right	Left	Thru	Right			
Peak Hour Analysis From 04:15 PM to 05:00 PM - Peak 1 of 1															
Peak Hour for Each Approach Begins at:															
	04:15 PM														
+0 mins.	0	0	1	0	7	0	0	7	0	0	0	0	1	12	0
+15 mins.	2	0	2	0	2	0	0	2	0	0	0	0	0	10	0
+30 mins.	0	0	1	0	3	0	0	3	0	0	0	0	0	6	0
+45 mins.	0	0	2	0	11	0	0	11	0	0	0	0	2	5	0
Total Volume	2	0	4	0	23	0	0	23	0	0	0	0	3	33	0
% App. Total	33.3	0	66.7	0	100	0	0	100	0	0	0	0	8.3	91.7	0
PHF	.250	.000	.500	.000	.523	.000	.000	.523	.000	.000	.000	.000	.375	.688	.000

Location: County of Riverside
 N/S: Graham Street/Riverside Drive
 E/W: Cactus Avenue



Date: 11/30/2021
 Day: Tuesday

PEDESTRIANS

	North Leg Graham Street	East Leg Cactus Avenue	South Leg Riverside Drive	West Leg Cactus Avenue	
	Pedestrians	Pedestrians	Pedestrians	Pedestrians	
7:00 AM	0	0	1	0	1
7:15 AM	0	0	0	0	0
7:30 AM	1	0	0	0	1
7:45 AM	0	0	0	0	0
8:00 AM	0	0	0	0	0
8:15 AM	0	0	0	0	0
8:30 AM	0	0	0	0	0
8:45 AM	0	0	0	0	0
TOTAL VOLUMES:	1	0	1	0	2

	North Leg Graham Street	East Leg Cactus Avenue	South Leg Riverside Drive	West Leg Cactus Avenue	
	Pedestrians	Pedestrians	Pedestrians	Pedestrians	
4:00 PM	0	0	0	0	0
4:15 PM	0	0	0	0	0
4:30 PM	0	0	0	0	0
4:45 PM	0	0	0	0	0
5:00 PM	0	0	0	0	0
5:15 PM	0	0	0	0	0
5:30 PM	0	0	0	0	0
5:45 PM	0	0	0	0	0
TOTAL VOLUMES:	0	0	0	0	0

Location: County of Riverside
 N/S: Graham Street/Riverside Drive
 E/W: Cactus Avenue



Date: 11/30/2021
 Day: Tuesday

BICYCLES

	Southbound Graham Street			Westbound Cactus Avenue			Northbound Riverside Drive			Eastbound Cactus Avenue			
	Left	Thru	Right	Left	Thru	Right	Left	Thru	Right	Left	Thru	Right	
7:00 AM	0	0	0	0	1	0	0	0	0	0	0	0	1
7:15 AM	0	0	0	0	0	0	0	0	0	0	0	0	0
7:30 AM	0	0	0	0	0	0	0	0	0	0	0	0	0
7:45 AM	0	0	0	0	0	0	0	1	0	0	0	0	1
8:00 AM	0	0	0	0	0	0	0	0	0	0	0	0	0
8:15 AM	0	0	0	0	0	0	0	0	0	0	0	0	0
8:30 AM	0	0	0	0	0	0	0	0	0	0	0	0	0
8:45 AM	0	0	0	0	0	0	0	0	0	0	0	0	0
TOTAL VOLUMES:	0	0	0	0	1	0	0	1	0	0	0	0	2

	Southbound Graham Street			Westbound Cactus Avenue			Northbound Riverside Drive			Eastbound Cactus Avenue			
	Left	Thru	Right	Left	Thru	Right	Left	Thru	Right	Left	Thru	Right	
4:00 PM	0	0	0	0	0	0	0	0	0	0	0	0	0
4:15 PM	0	0	0	0	0	0	0	0	0	0	0	0	0
4:30 PM	0	0	0	0	2	0	0	0	0	0	0	0	2
4:45 PM	0	0	0	0	0	0	0	0	0	0	0	0	0
5:00 PM	0	0	0	0	0	0	0	0	0	0	0	0	0
5:15 PM	0	0	0	0	0	0	0	0	0	0	0	0	0
5:30 PM	0	0	0	0	0	0	0	0	0	0	0	0	0
5:45 PM	0	0	0	0	0	0	0	0	0	0	0	0	0
TOTAL VOLUMES:	0	0	0	0	2	0	0	0	0	0	0	0	2

Counts Unlimited, Inc.

City of Riverside
 Alessandro Boulevard
 E/ Trautwein Road
 24 Hour Directional Classification Count
Eastbound

PO Box 1178
 Corona, CA 92878
 Phone: (951) 268-6268
 email: counts@countsunlimited.com

RIV001
 Site Code: 051-21716

Start Time	Bikes	Cars & Trailers	2 Axle Long	Buses	2 Axle 6 Tire	3 Axle Single	4 Axle Single	<5 Axl Double	5 Axle Double	>6 Axl Double	<6 Axl Multi	6 Axle Multi	>6 Axl Multi	Total
11/30/21	0	76	19	0	2	0	0	0	1	0	0	0	0	98
01:00	0	42	12	0	1	0	0	0	2	0	0	0	0	57
02:00	0	45	12	0	2	1	0	0	0	0	0	0	0	60
03:00	0	72	26	0	3	0	0	0	1	0	0	0	0	102
04:00	1	179	49	0	2	1	0	1	0	0	0	0	0	233
05:00	1	322	86	0	10	0	0	2	0	0	0	0	0	421
06:00	0	485	105	5	11	2	0	0	1	0	0	0	0	609
07:00	0	653	109	5	7	0	0	1	3	0	0	0	0	778
08:00	0	678	97	4	11	1	0	0	0	0	0	0	0	791
09:00	3	601	102	1	10	1	0	0	1	0	0	0	0	719
10:00	1	575	132	3	23	1	0	2	1	0	0	0	0	738
11:00	3	774	149	5	16	0	0	1	1	0	0	0	0	949
12 PM	1	809	156	1	8	0	0	0	0	0	0	0	0	975
13:00	8	862	161	2	11	0	0	1	1	0	0	0	0	1046
14:00	0	991	182	5	10	0	0	0	1	0	0	0	0	1189
15:00	6	1206	203	5	4	1	0	1	1	0	0	0	0	1427
16:00	2	1487	252	1	12	3	0	1	0	0	0	0	0	1758
17:00	2	1608	156	4	8	0	0	0	0	0	0	0	0	1778
18:00	3	1451	187	3	4	1	0	1	1	0	0	0	0	1651
19:00	4	748	123	2	2	0	0	0	1	0	0	0	0	880
20:00	0	534	82	1	0	0	0	0	2	0	0	0	0	619
21:00	0	391	50	0	0	0	0	0	0	0	0	0	0	441
22:00	1	267	26	0	1	0	0	0	1	0	0	0	0	296
23:00	1	142	20	0	0	0	0	0	0	0	0	0	0	163
Total	37	14998	2496	47	158	12	0	11	19	0	0	0	0	17778
Percent	0.2%	84.4%	14.0%	0.3%	0.9%	0.1%	0.0%	0.1%	0.1%	0.0%	0.0%	0.0%	0.0%	
AM Peak	09:00	11:00	11:00	06:00	10:00	06:00		05:00	07:00					11:00
Vol.	3	774	149	5	23	2		2	3					949
PM Peak	13:00	17:00	16:00	14:00	16:00	16:00		13:00	20:00					17:00
Vol.	8	1608	252	5	12	3		1	2					1778
Grand Total	37	14998	2496	47	158	12	0	11	19	0	0	0	0	17778
Percent	0.2%	84.4%	14.0%	0.3%	0.9%	0.1%	0.0%	0.1%	0.1%	0.0%	0.0%	0.0%	0.0%	

Counts Unlimited, Inc.

City of Riverside
 Alessandro Boulevard
 E/ Trautwein Road
 24 Hour Directional Classification Count
 Westbound

PO Box 1178
 Corona, CA 92878
 Phone: (951) 268-6268
 email: counts@countsunlimited.com

RIV001
 Site Code: 051-21716

Start Time	Bikes	Cars & Trailers	2 Axle Long	Buses	2 Axle 6 Tire	3 Axle Single	4 Axle Single	<5 Axl Double	5 Axle Double	>6 Axl Double	<6 Axl Multi	6 Axle Multi	>6 Axl Multi	Total
11/30/21	0	125	18	0	0	0	0	0	1	0	0	0	0	144
01:00	2	68	22	0	2	0	0	0	0	0	0	0	0	94
02:00	0	55	5	0	2	0	0	0	0	0	0	0	0	62
03:00	0	125	27	0	4	0	0	0	0	0	0	0	0	156
04:00	1	351	67	0	4	0	0	0	1	1	0	0	0	425
05:00	1	971	142	1	22	2	1	1	1	0	0	0	0	1142
06:00	2	1397	258	4	18	4	0	1	0	0	0	0	0	1684
07:00	3	1838	241	6	19	0	0	1	3	0	0	0	0	2111
08:00	3	1716	250	3	24	5	0	2	6	0	0	0	0	2009
09:00	5	1269	199	3	26	4	0	3	8	0	0	0	0	1517
10:00	2	1136	183	8	36	1	1	0	3	0	0	0	0	1370
11:00	1	990	166	3	24	1	0	0	4	0	0	0	0	1189
12 PM	4	1048	168	6	20	2	0	2	2	0	0	0	0	1252
13:00	4	1232	201	3	31	2	0	0	1	0	0	0	0	1474
14:00	8	1354	216	9	30	2	0	1	1	0	0	0	0	1621
15:00	3	1539	310	13	28	5	0	1	3	0	1	0	0	1903
16:00	8	1735	290	3	27	0	0	0	2	0	0	0	0	2065
17:00	3	1554	176	2	11	2	0	1	3	0	0	0	0	1752
18:00	0	957	121	1	17	0	0	1	1	0	0	0	0	1098
19:00	2	645	73	2	4	0	0	0	0	0	0	0	0	726
20:00	1	422	44	1	3	0	0	0	1	0	0	0	0	472
21:00	0	326	41	0	6	0	0	0	1	0	0	0	0	374
22:00	0	220	29	0	1	0	0	0	0	0	0	0	0	250
23:00	0	143	47	0	1	0	0	0	0	0	0	0	0	191
Total	53	21216	3294	68	360	30	2	14	42	1	1	0	0	25081
Percent	0.2%	84.6%	13.1%	0.3%	1.4%	0.1%	0.0%	0.1%	0.2%	0.0%	0.0%	0.0%	0.0%	
AM Peak	09:00	07:00	06:00	10:00	10:00	08:00	05:00	09:00	09:00	04:00				07:00
Vol.	5	1838	258	8	36	5	1	3	8	1				2111
PM Peak	14:00	16:00	15:00	15:00	13:00	15:00		12:00	15:00		15:00			16:00
Vol.	8	1735	310	13	31	5		2	3		1			2065
Grand Total	53	21216	3294	68	360	30	2	14	42	1	1	0	0	25081
Percent	0.2%	84.6%	13.1%	0.3%	1.4%	0.1%	0.0%	0.1%	0.2%	0.0%	0.0%	0.0%	0.0%	

Counts Unlimited, Inc.

City of Riverside
Alessandro Boulevard
E/ Trautwein Road
24 Hour Directional Classification Count
Eastbound, Westbound

PO Box 1178
Corona, CA 92878
Phone: (951) 268-6268
email: counts@countsunlimited.com

RIV001
Site Code: 051-21716

Start Time	Bikes	Cars & Trailers	2 Axle Long	Buses	2 Axle 6 Tire	3 Axle Single	4 Axle Single	<5 Axl Double	5 Axle Double	>6 Axl Double	<6 Axl Multi	6 Axle Multi	>6 Axl Multi	Total
11/30/21	0	201	37	0	2	0	0	0	2	0	0	0	0	242
01:00	2	110	34	0	3	0	0	0	2	0	0	0	0	151
02:00	0	100	17	0	4	1	0	0	0	0	0	0	0	122
03:00	0	197	53	0	7	0	0	0	1	0	0	0	0	258
04:00	2	530	116	0	6	1	0	1	1	1	0	0	0	658
05:00	2	1293	228	1	32	2	1	3	1	0	0	0	0	1563
06:00	2	1882	363	9	29	6	0	1	1	0	0	0	0	2293
07:00	3	2491	350	11	26	0	0	2	6	0	0	0	0	2889
08:00	3	2394	347	7	35	6	0	2	6	0	0	0	0	2800
09:00	8	1870	301	4	36	5	0	3	9	0	0	0	0	2236
10:00	3	1711	315	11	59	2	1	2	4	0	0	0	0	2108
11:00	4	1764	315	8	40	1	0	1	5	0	0	0	0	2138
12 PM	5	1857	324	7	28	2	0	2	2	0	0	0	0	2227
13:00	12	2094	362	5	42	2	0	1	2	0	0	0	0	2520
14:00	8	2345	398	14	40	2	0	1	2	0	0	0	0	2810
15:00	9	2745	513	18	32	6	0	2	4	0	1	0	0	3330
16:00	10	3222	542	4	39	3	0	1	2	0	0	0	0	3823
17:00	5	3162	332	6	19	2	0	1	3	0	0	0	0	3530
18:00	3	2408	308	4	21	1	0	2	2	0	0	0	0	2749
19:00	6	1393	196	4	6	0	0	0	1	0	0	0	0	1606
20:00	1	956	126	2	3	0	0	0	3	0	0	0	0	1091
21:00	0	717	91	0	6	0	0	0	1	0	0	0	0	815
22:00	1	487	55	0	2	0	0	0	1	0	0	0	0	546
23:00	1	285	67	0	1	0	0	0	0	0	0	0	0	354
Total	90	36214	5790	115	518	42	2	25	61	1	1	0	0	42859
Percent	0.2%	84.5%	13.5%	0.3%	1.2%	0.1%	0.0%	0.1%	0.1%	0.0%	0.0%	0.0%	0.0%	
AM Peak	09:00	07:00	06:00	07:00	10:00	06:00	05:00	05:00	09:00	04:00				07:00
Vol.	8	2491	363	11	59	6	1	3	9	1				2889
PM Peak	13:00	16:00	16:00	15:00	13:00	15:00		12:00	15:00		15:00			16:00
Vol.	12	3222	542	18	42	6		2	4		1			3823
Grand Total	90	36214	5790	115	518	42	2	25	61	1	1	0	0	42859
Percent	0.2%	84.5%	13.5%	0.3%	1.2%	0.1%	0.0%	0.1%	0.1%	0.0%	0.0%	0.0%	0.0%	

Counts Unlimited, Inc.

County of Riverside
 Brown Street
 S/ Alessandro Boulevard
 24 Hour Directional Classification Count

PO Box 1178
 Corona, CA 92878
 Phone: (951) 268-6268
 email: counts@countsunlimited.com

CRV001
 Site Code: 051-21648

Northbound

Start Time	Bikes	Cars & Trailers	2 Axle Long	Buses	2 Axle 6 Tire	3 Axle Single	4 Axle Single	<5 Axl Double	5 Axle Double	>6 Axl Double	<6 Axl Multi	6 Axle Multi	>6 Axl Multi	Total
11/02/21	0	4	1	0	0	0	0	0	0	0	0	0	0	5
01:00	0	0	0	0	0	0	0	0	0	0	0	0	0	0
02:00	0	0	0	0	0	0	0	0	0	0	0	0	0	0
03:00	0	0	0	0	0	1	0	0	0	0	0	0	0	1
04:00	0	2	0	0	0	0	0	0	0	0	0	0	0	2
05:00	0	4	0	0	0	0	0	0	0	0	0	0	0	4
06:00	0	2	1	0	0	0	0	0	0	0	0	0	0	3
07:00	0	1	1	0	0	1	0	0	0	0	0	0	0	3
08:00	0	3	1	0	0	0	0	0	2	0	0	0	0	6
09:00	0	9	3	0	1	2	0	1	6	0	0	0	0	22
10:00	0	6	2	0	2	1	0	0	5	0	0	0	0	16
11:00	0	7	4	0	2	2	0	2	8	0	0	0	0	25
12 PM	0	18	5	0	0	2	0	1	11	0	0	0	0	37
13:00	0	10	4	0	1	2	0	1	10	0	0	0	0	28
14:00	1	63	5	0	7	0	0	2	6	0	0	0	0	84
15:00	0	31	3	0	1	0	0	2	11	0	0	0	0	48
16:00	0	21	8	0	2	0	0	1	9	0	0	0	0	41
17:00	0	17	2	0	0	0	0	0	2	0	0	0	0	21
18:00	0	13	5	0	0	1	0	0	1	0	0	0	0	20
19:00	0	3	1	0	0	0	0	0	0	0	0	0	0	4
20:00	0	2	0	0	0	1	0	0	0	0	0	0	0	3
21:00	1	3	0	0	0	0	0	0	0	0	0	0	0	4
22:00	0	0	0	0	0	0	0	0	0	0	0	0	0	0
23:00	0	3	1	0	0	0	0	0	0	0	0	0	0	4
Total	2	222	47	0	16	13	0	10	71	0	0	0	0	381
Percent	0.5%	58.3%	12.3%	0.0%	4.2%	3.4%	0.0%	2.6%	18.6%	0.0%	0.0%	0.0%	0.0%	
AM Peak		09:00	11:00		10:00	09:00		11:00	11:00					11:00
Vol.		9	4		2	2		2	8					25
PM Peak	14:00	14:00	16:00		14:00	12:00		14:00	12:00					14:00
Vol.	1	63	8		7	2		2	11					84
Grand Total	2	222	47	0	16	13	0	10	71	0	0	0	0	381
Percent	0.5%	58.3%	12.3%	0.0%	4.2%	3.4%	0.0%	2.6%	18.6%	0.0%	0.0%	0.0%	0.0%	

Counts Unlimited, Inc.

County of Riverside
 Brown Street
 S/ Alessandro Boulevard
 24 Hour Directional Classification Count
 Southbound

PO Box 1178
 Corona, CA 92878
 Phone: (951) 268-6268
 email: counts@countsunlimited.com

CRV001
 Site Code: 051-21648

Start Time	Bikes	Cars & Trailers	2 Axle Long	Buses	2 Axle 6 Tire	3 Axle Single	4 Axle Single	<5 Axl Double	5 Axle Double	>6 Axl Double	<6 Axl Multi	6 Axle Multi	>6 Axl Multi	Total
11/02/21	0	1	0	0	0	0	0	0	0	0	0	0	0	1
01:00	0	0	0	0	0	0	0	0	0	0	0	0	0	0
02:00	0	0	0	0	0	1	0	0	0	0	0	0	0	1
03:00	0	0	0	0	0	0	0	0	0	0	0	0	0	0
04:00	0	19	1	0	0	0	0	0	0	0	0	0	0	20
05:00	0	69	5	0	0	0	0	0	1	0	0	0	0	75
06:00	0	35	4	0	0	0	0	0	1	0	0	0	0	40
07:00	0	5	3	0	0	1	0	0	7	0	0	0	0	16
08:00	0	7	3	0	0	1	0	1	6	0	0	0	0	18
09:00	0	8	5	0	3	1	0	0	11	0	0	0	0	28
10:00	0	7	2	0	2	0	0	3	6	0	0	0	0	20
11:00	0	5	5	0	0	0	0	2	8	0	0	0	0	20
12 PM	0	16	7	0	1	3	0	0	9	0	0	0	0	36
13:00	0	13	2	0	3	2	0	2	8	0	0	0	0	30
14:00	0	9	1	0	3	2	0	0	4	0	0	0	0	19
15:00	0	10	3	0	2	0	0	2	7	0	0	0	0	24
16:00	0	6	4	0	1	1	0	1	2	0	0	0	0	15
17:00	0	4	1	0	0	0	0	0	0	0	0	0	0	5
18:00	0	2	1	0	0	1	0	0	1	0	0	0	0	5
19:00	0	2	1	0	0	0	0	0	0	0	0	0	0	3
20:00	1	1	0	0	0	0	0	0	0	0	0	0	0	2
21:00	0	3	0	0	0	0	0	0	0	0	0	0	0	3
22:00	0	0	0	0	0	0	0	0	0	0	0	0	0	0
23:00	0	3	0	0	0	0	0	0	1	0	0	0	0	4
Total	1	225	48	0	15	13	0	11	72	0	0	0	0	385
Percent	0.3%	58.4%	12.5%	0.0%	3.9%	3.4%	0.0%	2.9%	18.7%	0.0%	0.0%	0.0%	0.0%	
AM Peak		05:00	05:00		09:00	02:00		10:00	09:00					05:00
Vol.		69	5		3	1		3	11					75
PM Peak	20:00	12:00	12:00		13:00	12:00		13:00	12:00					12:00
Vol.	1	16	7		3	3		2	9					36
Grand Total	1	225	48	0	15	13	0	11	72	0	0	0	0	385
Percent	0.3%	58.4%	12.5%	0.0%	3.9%	3.4%	0.0%	2.9%	18.7%	0.0%	0.0%	0.0%	0.0%	

Counts Unlimited, Inc.

County of Riverside
 Brown Street
 S/ Alessandro Boulevard
 24 Hour Directional Classification Count
 Northbound, Southbound

PO Box 1178
 Corona, CA 92878
 Phone: (951) 268-6268
 email: counts@countsunlimited.com

CRV001
 Site Code: 051-21648

Start Time	Bikes	Cars & Trailers	2 Axle Long	Buses	2 Axle 6 Tire	3 Axle Single	4 Axle Single	<5 Axl Double	5 Axle Double	>6 Axl Double	<6 Axl Multi	6 Axle Multi	>6 Axl Multi	Total
11/02/21	0	5	1	0	0	0	0	0	0	0	0	0	0	6
01:00	0	0	0	0	0	0	0	0	0	0	0	0	0	0
02:00	0	0	0	0	0	1	0	0	0	0	0	0	0	1
03:00	0	0	0	0	0	1	0	0	0	0	0	0	0	1
04:00	0	21	1	0	0	0	0	0	0	0	0	0	0	22
05:00	0	73	5	0	0	0	0	0	1	0	0	0	0	79
06:00	0	37	5	0	0	0	0	0	1	0	0	0	0	43
07:00	0	6	4	0	0	2	0	0	7	0	0	0	0	19
08:00	0	10	4	0	0	1	0	1	8	0	0	0	0	24
09:00	0	17	8	0	4	3	0	1	17	0	0	0	0	50
10:00	0	13	4	0	4	1	0	3	11	0	0	0	0	36
11:00	0	12	9	0	2	2	0	4	16	0	0	0	0	45
12 PM	0	34	12	0	1	5	0	1	20	0	0	0	0	73
13:00	0	23	6	0	4	4	0	3	18	0	0	0	0	58
14:00	1	72	6	0	10	2	0	2	10	0	0	0	0	103
15:00	0	41	6	0	3	0	0	4	18	0	0	0	0	72
16:00	0	27	12	0	3	1	0	2	11	0	0	0	0	56
17:00	0	21	3	0	0	0	0	0	2	0	0	0	0	26
18:00	0	15	6	0	0	2	0	0	2	0	0	0	0	25
19:00	0	5	2	0	0	0	0	0	0	0	0	0	0	7
20:00	1	3	0	0	0	1	0	0	0	0	0	0	0	5
21:00	1	6	0	0	0	0	0	0	0	0	0	0	0	7
22:00	0	0	0	0	0	0	0	0	0	0	0	0	0	0
23:00	0	6	1	0	0	0	0	0	1	0	0	0	0	8
Total	3	447	95	0	31	26	0	21	143	0	0	0	0	766
Percent	0.4%	58.4%	12.4%	0.0%	4.0%	3.4%	0.0%	2.7%	18.7%	0.0%	0.0%	0.0%	0.0%	
AM Peak		05:00	11:00		09:00	09:00		11:00	09:00					05:00
Vol.		73	9		4	3		4	17					79
PM Peak	14:00	14:00	12:00		14:00	12:00		15:00	12:00					14:00
Vol.	1	72	12		10	5		4	20					103
Grand Total	3	447	95	0	31	26	0	21	143	0	0	0	0	766
Percent	0.4%	58.4%	12.4%	0.0%	4.0%	3.4%	0.0%	2.7%	18.7%	0.0%	0.0%	0.0%	0.0%	

Counts Unlimited, Inc.

City of Riverside
Alessandro Boulevard
B/ Meridian Parkway - Interstate 215 Ramps
24 Hour Directional Classification Count

PO Box 1178
Corona, CA 92878
Phone: (951) 268-6268
email: counts@countsunlimited.com

RIV002
Site Code: 051-21716

Eastbound

Start Time	Bikes	Cars & Trailers	2 Axle Long	Buses	2 Axle 6 Tire	3 Axle Single	4 Axle Single	<5 Axl Double	5 Axle Double	>6 Axl Double	<6 Axl Multi	6 Axle Multi	>6 Axl Multi	Total
11/30/21	2	120	20	0	1	1	0	0	2	0	0	0	0	146
01:00	0	91	7	0	1	2	0	0	2	0	0	0	0	103
02:00	0	55	8	0	2	2	0	0	3	0	0	0	0	70
03:00	0	86	9	0	2	1	0	1	7	0	0	0	0	106
04:00	0	159	24	0	10	4	0	0	3	0	0	0	0	200
05:00	0	270	37	0	14	0	0	1	5	0	0	0	0	327
06:00	0	519	63	1	13	2	0	0	6	0	0	0	0	604
07:00	0	762	102	1	12	3	0	0	19	0	0	0	0	899
08:00	0	753	120	4	10	2	1	0	23	0	0	0	0	913
09:00	3	764	106	2	13	4	0	0	24	0	0	0	0	916
10:00	3	755	102	2	21	6	0	4	15	0	0	0	0	908
11:00	3	878	185	3	21	4	0	1	16	0	0	0	0	1111
12 PM	2	948	142	2	29	7	0	0	16	0	0	0	0	1146
13:00	4	984	149	2	21	3	0	2	17	0	1	0	0	1183
14:00	1	1027	144	2	15	2	0	3	16	0	0	0	0	1210
15:00	5	1212	124	0	10	2	0	1	13	0	0	0	0	1367
16:00	6	1348	155	1	10	4	1	2	11	0	2	0	0	1540
17:00	2	1576	113	0	11	1	0	1	10	0	0	0	0	1714
18:00	1	1329	111	1	4	0	0	1	7	0	1	0	0	1455
19:00	3	831	55	2	4	1	0	1	5	0	0	0	0	902
20:00	0	593	76	2	1	0	0	1	4	0	0	0	0	677
21:00	0	473	32	0	1	0	0	0	4	0	0	0	0	510
22:00	1	347	21	0	1	3	0	0	3	0	0	0	0	376
23:00	0	225	19	0	1	0	0	0	3	0	0	0	0	248
Total	36	16105	1924	25	228	54	2	19	234	0	4	0	0	18631
Percent	0.2%	86.4%	10.3%	0.1%	1.2%	0.3%	0.0%	0.1%	1.3%	0.0%	0.0%	0.0%	0.0%	
AM Peak	09:00	11:00	11:00	08:00	10:00	10:00	08:00	10:00	09:00					11:00
Vol.	3	878	185	4	21	6	1	4	24					1111
PM Peak	16:00	17:00	16:00	12:00	12:00	12:00	16:00	14:00	13:00		16:00			17:00
Vol.	6	1576	155	2	29	7	1	3	17		2			1714
Grand Total	36	16105	1924	25	228	54	2	19	234	0	4	0	0	18631
Percent	0.2%	86.4%	10.3%	0.1%	1.2%	0.3%	0.0%	0.1%	1.3%	0.0%	0.0%	0.0%	0.0%	

Counts Unlimited, Inc.

City of Riverside
 Alessandro Boulevard
 B/ Meridian Parkway - Interstate 215 Ramps
 24 Hour Directional Classification Count

PO Box 1178
 Corona, CA 92878
 Phone: (951) 268-6268
 email: counts@countsunlimited.com

RIV002
 Site Code: 051-21716

Westbound

Start Time	Bikes	Cars & Trailers	2 Axle Long	Buses	2 Axle 6 Tire	3 Axle Single	4 Axle Single	<5 Axl Double	5 Axle Double	>6 Axl Double	<6 Axl Multi	6 Axle Multi	>6 Axl Multi	Total
11/30/21	0	116	22	0	2	0	0	0	1	0	0	0	0	141
01:00	2	87	2	0	0	1	0	0	0	0	0	0	0	92
02:00	0	155	15	0	0	2	0	0	7	0	0	0	0	179
03:00	0	166	22	0	3	1	0	0	5	0	0	0	0	197
04:00	0	362	69	0	4	3	0	1	2	0	0	0	0	441
05:00	0	1198	188	2	7	3	0	0	12	0	0	0	0	1410
06:00	2	1417	282	5	8	5	0	5	15	0	0	0	0	1739
07:00	3	1719	262	1	23	4	0	3	19	0	0	0	0	2034
08:00	4	1597	258	2	34	8	0	1	17	0	0	0	0	1921
09:00	4	1321	231	2	38	16	1	3	54	0	3	0	0	1673
10:00	2	1049	213	7	31	4	1	5	33	0	0	0	0	1345
11:00	5	1010	196	1	30	4	0	5	21	0	0	0	0	1272
12 PM	2	1034	188	4	18	4	0	3	27	0	1	0	0	1281
13:00	5	1176	218	2	27	10	0	6	23	0	0	0	0	1467
14:00	3	1244	232	7	30	7	0	1	15	0	0	0	0	1539
15:00	4	1423	309	1	39	9	0	4	19	0	2	0	0	1810
16:00	3	1638	319	2	35	7	0	3	24	0	0	0	0	2031
17:00	0	1488	291	1	22	12	1	3	22	0	2	0	0	1842
18:00	0	846	127	1	14	0	0	2	12	0	0	0	0	1002
19:00	1	618	110	1	10	1	0	0	6	0	0	0	0	747
20:00	2	475	77	1	3	1	0	0	2	0	0	0	0	561
21:00	1	358	16	0	0	1	0	0	2	0	0	0	0	378
22:00	0	182	21	0	1	0	0	0	3	0	0	0	0	207
23:00	0	111	17	0	3	1	0	0	0	0	0	0	0	132
Total	43	20790	3685	40	382	104	3	45	341	0	8	0	0	25441
Percent	0.2%	81.7%	14.5%	0.2%	1.5%	0.4%	0.0%	0.2%	1.3%	0.0%	0.0%	0.0%	0.0%	
AM Peak	11:00	07:00	06:00	10:00	09:00	09:00	09:00	06:00	09:00		09:00			07:00
Vol.	5	1719	282	7	38	16	1	5	54		3			2034
PM Peak	13:00	16:00	16:00	14:00	15:00	17:00	17:00	13:00	12:00		15:00			16:00
Vol.	5	1638	319	7	39	12	1	6	27		2			2031
Grand Total	43	20790	3685	40	382	104	3	45	341	0	8	0	0	25441
Percent	0.2%	81.7%	14.5%	0.2%	1.5%	0.4%	0.0%	0.2%	1.3%	0.0%	0.0%	0.0%	0.0%	

Counts Unlimited, Inc.

City of Riverside
 Alessandro Boulevard
 B/ Meridian Parkway - Interstate 215 Ramps
 24 Hour Directional Classification Count
 Eastbound, Westbound

PO Box 1178
 Corona, CA 92878
 Phone: (951) 268-6268
 email: counts@countsunlimited.com

RIV002
 Site Code: 051-21716

Start Time	Bikes	Cars & Trailers	2 Axle Long	Buses	2 Axle 6 Tire	3 Axle Single	4 Axle Single	<5 Axl Double	5 Axle Double	>6 Axl Double	<6 Axl Multi	6 Axle Multi	>6 Axl Multi	Total
11/30/21	2	236	42	0	3	1	0	0	3	0	0	0	0	287
01:00	2	178	9	0	1	3	0	0	2	0	0	0	0	195
02:00	0	210	23	0	2	4	0	0	10	0	0	0	0	249
03:00	0	252	31	0	5	2	0	1	12	0	0	0	0	303
04:00	0	521	93	0	14	7	0	1	5	0	0	0	0	641
05:00	0	1468	225	2	21	3	0	1	17	0	0	0	0	1737
06:00	2	1936	345	6	21	7	0	5	21	0	0	0	0	2343
07:00	3	2481	364	2	35	7	0	3	38	0	0	0	0	2933
08:00	4	2350	378	6	44	10	1	1	40	0	0	0	0	2834
09:00	7	2085	337	4	51	20	1	3	78	0	3	0	0	2589
10:00	5	1804	315	9	52	10	1	9	48	0	0	0	0	2253
11:00	8	1888	381	4	51	8	0	6	37	0	0	0	0	2383
12 PM	4	1982	330	6	47	11	0	3	43	0	1	0	0	2427
13:00	9	2160	367	4	48	13	0	8	40	0	1	0	0	2650
14:00	4	2271	376	9	45	9	0	4	31	0	0	0	0	2749
15:00	9	2635	433	1	49	11	0	5	32	0	2	0	0	3177
16:00	9	2986	474	3	45	11	1	5	35	0	2	0	0	3571
17:00	2	3064	404	1	33	13	1	4	32	0	2	0	0	3556
18:00	1	2175	238	2	18	0	0	3	19	0	1	0	0	2457
19:00	4	1449	165	3	14	2	0	1	11	0	0	0	0	1649
20:00	2	1068	153	3	4	1	0	1	6	0	0	0	0	1238
21:00	1	831	48	0	1	1	0	0	6	0	0	0	0	888
22:00	1	529	42	0	2	3	0	0	6	0	0	0	0	583
23:00	0	336	36	0	4	1	0	0	3	0	0	0	0	380
Total	79	36895	5609	65	610	158	5	64	575	0	12	0	0	44072
Percent	0.2%	83.7%	12.7%	0.1%	1.4%	0.4%	0.0%	0.1%	1.3%	0.0%	0.0%	0.0%	0.0%	
AM Peak	11:00	07:00	11:00	10:00	10:00	09:00	08:00	10:00	09:00		09:00			07:00
Vol.	8	2481	381	9	52	20	1	9	78		3			2933
PM Peak	13:00	17:00	16:00	14:00	15:00	13:00	16:00	13:00	12:00		15:00			16:00
Vol.	9	3064	474	9	49	13	1	8	43		2			3571
Grand Total	79	36895	5609	65	610	158	5	64	575	0	12	0	0	44072
Percent	0.2%	83.7%	12.7%	0.1%	1.4%	0.4%	0.0%	0.1%	1.3%	0.0%	0.0%	0.0%	0.0%	

Counts Unlimited, Inc.

City of Riverside
 Cactus Avenue
 B/ Meridian Parkway - Innovation Drive
 24 Hour Directional Classification Count

PO Box 1178
 Corona, CA 92878
 Phone: (951) 268-6268
 email: counts@countsunlimited.com

RIV003
 Site Code: 051-21716

Eastbound

Start Time	Bikes	Cars & Trailers	2 Axle Long	Buses	2 Axle 6 Tire	3 Axle Single	4 Axle Single	<5 Axl Double	5 Axle Double	>6 Axl Double	<6 Axl Multi	6 Axle Multi	>6 Axl Multi	Total
11/30/21	0	206	29	0	1	0	0	0	2	0	0	0	0	238
01:00	0	44	4	0	0	1	0	0	10	0	2	0	0	61
02:00	0	16	2	0	1	0	0	1	11	0	0	0	0	31
03:00	0	36	4	0	1	0	0	1	28	0	1	0	0	71
04:00	1	51	7	0	2	2	0	2	37	0	0	0	0	102
05:00	1	79	8	0	0	3	0	0	19	0	0	0	0	110
06:00	0	166	16	0	4	0	0	1	14	0	0	0	0	201
07:00	0	252	31	0	4	1	0	2	10	0	0	0	0	300
08:00	2	215	26	0	7	1	0	0	17	0	0	0	0	268
09:00	2	225	30	0	5	3	0	2	24	0	0	0	0	291
10:00	0	166	32	0	5	1	0	1	21	0	0	0	0	226
11:00	2	207	45	0	8	4	0	3	20	0	0	0	0	289
12 PM	1	258	46	0	6	1	0	1	29	0	0	0	0	342
13:00	1	236	45	0	6	1	0	4	13	0	0	0	0	306
14:00	0	426	77	0	14	1	0	2	15	0	0	0	0	535
15:00	1	479	69	0	10	3	0	5	10	0	0	0	0	577
16:00	3	578	76	0	11	2	0	4	15	0	0	0	0	689
17:00	1	629	95	0	3	2	0	2	20	0	0	0	0	752
18:00	1	510	52	0	4	1	0	0	8	0	0	0	0	576
19:00	0	242	33	0	4	2	0	0	20	0	1	0	0	302
20:00	3	162	20	0	2	0	0	0	11	0	0	0	0	198
21:00	2	96	18	0	3	1	0	1	23	0	3	0	0	147
22:00	1	97	9	0	4	0	0	0	31	0	0	0	0	142
23:00	0	51	7	0	3	0	0	0	14	0	0	0	0	75
Total	22	5427	781	0	108	30	0	32	422	0	7	0	0	6829
Percent	0.3%	79.5%	11.4%	0.0%	1.6%	0.4%	0.0%	0.5%	6.2%	0.0%	0.1%	0.0%	0.0%	
AM Peak	08:00	07:00	11:00		11:00	11:00		11:00	04:00		01:00			07:00
Vol.	2	252	45		8	4		3	37		2			300
PM Peak	16:00	17:00	17:00		14:00	15:00		15:00	22:00		21:00			17:00
Vol.	3	629	95		14	3		5	31		3			752
Grand Total	22	5427	781	0	108	30	0	32	422	0	7	0	0	6829
Percent	0.3%	79.5%	11.4%	0.0%	1.6%	0.4%	0.0%	0.5%	6.2%	0.0%	0.1%	0.0%	0.0%	

Counts Unlimited, Inc.

City of Riverside
 Cactus Avenue
 B/ Meridian Parkway - Innovation Drive
 24 Hour Directional Classification Count
 Westbound

PO Box 1178
 Corona, CA 92878
 Phone: (951) 268-6268
 email: counts@countsunlimited.com

RIV003
 Site Code: 051-21716

Start Time	Bikes	Cars & Trailers	2 Axle Long	Buses	2 Axle 6 Tire	3 Axle Single	4 Axle Single	<5 Axl Double	5 Axle Double	>6 Axl Double	<6 Axl Multi	6 Axle Multi	>6 Axl Multi	Total
11/30/21	0	49	1	0	3	1	0	0	18	0	0	1	0	73
01:00	0	44	2	0	1	2	0	2	14	0	0	0	0	65
02:00	0	49	4	0	0	0	0	0	19	0	0	0	0	72
03:00	0	70	12	0	1	0	0	0	25	0	0	0	0	108
04:00	0	194	25	0	1	3	0	0	22	0	0	0	0	245
05:00	1	646	80	0	7	2	0	1	19	0	0	1	0	757
06:00	1	684	128	1	5	6	0	2	26	0	0	0	0	853
07:00	1	906	134	1	16	9	0	0	41	0	0	0	0	1108
08:00	3	847	126	2	14	6	1	3	53	0	0	0	0	1055
09:00	2	500	89	1	16	10	2	2	51	0	0	0	0	673
10:00	2	364	87	0	22	4	0	4	41	0	0	0	0	524
11:00	1	349	62	0	11	6	1	4	38	0	0	0	0	472
12 PM	2	352	103	1	14	15	1	3	38	0	0	0	0	529
13:00	16	470	81	0	13	10	0	7	26	0	0	0	0	623
14:00	2	638	115	1	15	8	0	4	26	0	0	0	0	809
15:00	4	830	136	0	16	8	1	8	31	0	0	0	0	1034
16:00	2	925	134	1	19	4	1	9	22	0	0	0	0	1117
17:00	1	808	126	0	13	2	0	2	22	0	0	0	0	974
18:00	0	320	73	2	6	1	0	5	15	0	0	0	0	422
19:00	0	191	29	0	2	2	0	2	4	0	1	0	0	231
20:00	0	116	12	0	1	2	0	4	11	0	0	0	0	146
21:00	0	89	9	0	2	0	1	1	13	0	1	0	0	116
22:00	0	73	8	0	0	0	0	3	15	0	0	0	0	99
23:00	1	54	5	0	0	0	0	2	15	0	0	0	0	77
Total	39	9568	1581	10	198	101	8	68	605	0	2	2	0	12182
Percent	0.3%	78.5%	13.0%	0.1%	1.6%	0.8%	0.1%	0.6%	5.0%	0.0%	0.0%	0.0%	0.0%	
AM Peak	08:00	07:00	07:00	08:00	10:00	09:00	09:00	10:00	08:00			00:00		07:00
Vol.	3	906	134	2	22	10	2	4	53			1		1108
PM Peak	13:00	16:00	15:00	18:00	16:00	12:00	12:00	16:00	12:00		19:00			16:00
Vol.	16	925	136	2	19	15	1	9	38		1			1117
Grand Total	39	9568	1581	10	198	101	8	68	605	0	2	2	0	12182
Percent	0.3%	78.5%	13.0%	0.1%	1.6%	0.8%	0.1%	0.6%	5.0%	0.0%	0.0%	0.0%	0.0%	

Counts Unlimited, Inc.

PO Box 1178
Corona, CA 92878

Phone: (951) 268-6268

email: counts@countsunlimited.com

City of Riverside
Cactus Avenue
B/ Meridian Parkway - Innovation Drive
24 Hour Directional Classification Count
Eastbound, Westbound

RIV003
Site Code: 051-21716

Start Time	Bikes	Cars & Trailers	2 Axle Long	Buses	2 Axle 6 Tire	3 Axle Single	4 Axle Single	<5 Axl Double	5 Axle Double	>6 Axl Double	<6 Axl Multi	6 Axle Multi	>6 Axl Multi	Total
11/30/21	0	255	30	0	4	1	0	0	20	0	0	1	0	311
01:00	0	88	6	0	1	3	0	2	24	0	2	0	0	126
02:00	0	65	6	0	1	0	0	1	30	0	0	0	0	103
03:00	0	106	16	0	2	0	0	1	53	0	1	0	0	179
04:00	1	245	32	0	3	5	0	2	59	0	0	0	0	347
05:00	2	725	88	0	7	5	0	1	38	0	0	1	0	867
06:00	1	850	144	1	9	6	0	3	40	0	0	0	0	1054
07:00	1	1158	165	1	20	10	0	2	51	0	0	0	0	1408
08:00	5	1062	152	2	21	7	1	3	70	0	0	0	0	1323
09:00	4	725	119	1	21	13	2	4	75	0	0	0	0	964
10:00	2	530	119	0	27	5	0	5	62	0	0	0	0	750
11:00	3	556	107	0	19	10	1	7	58	0	0	0	0	761
12 PM	3	610	149	1	20	16	1	4	67	0	0	0	0	871
13:00	17	706	126	0	19	11	0	11	39	0	0	0	0	929
14:00	2	1064	192	1	29	9	0	6	41	0	0	0	0	1344
15:00	5	1309	205	0	26	11	1	13	41	0	0	0	0	1611
16:00	5	1503	210	1	30	6	1	13	37	0	0	0	0	1806
17:00	2	1437	221	0	16	4	0	4	42	0	0	0	0	1726
18:00	1	830	125	2	10	2	0	5	23	0	0	0	0	998
19:00	0	433	62	0	6	4	0	2	24	0	2	0	0	533
20:00	3	278	32	0	3	2	0	4	22	0	0	0	0	344
21:00	2	185	27	0	5	1	1	2	36	0	4	0	0	263
22:00	1	170	17	0	4	0	0	3	46	0	0	0	0	241
23:00	1	105	12	0	3	0	0	2	29	0	0	0	0	152
Total	61	14995	2362	10	306	131	8	100	1027	0	9	2	0	19011
Percent	0.3%	78.9%	12.4%	0.1%	1.6%	0.7%	0.0%	0.5%	5.4%	0.0%	0.0%	0.0%	0.0%	
AM Peak	08:00	07:00	07:00	08:00	10:00	09:00	09:00	11:00	09:00		01:00	00:00		07:00
Vol.	5	1158	165	2	27	13	2	7	75		2	1		1408
PM Peak	13:00	16:00	17:00	18:00	16:00	12:00	12:00	15:00	12:00		21:00			16:00
Vol.	17	1503	221	2	30	16	1	13	67		4			1806
Grand Total	61	14995	2362	10	306	131	8	100	1027	0	9	2	0	19011
Percent	0.3%	78.9%	12.4%	0.1%	1.6%	0.7%	0.0%	0.5%	5.4%	0.0%	0.0%	0.0%	0.0%	

Counts Unlimited, Inc.

City of Riverside
 Meridian Parkway
 N/ Van Buren Boulevard
 24 Hour Directional Classification Count

PO Box 1178
 Corona, CA 92878
 Phone: (951) 268-6268
 email: counts@countsunlimited.com

RIV004
 Site Code: 051-21716

Northbound

Start Time	Bikes	Cars & Trailers	2 Axle Long	Buses	2 Axle 6 Tire	3 Axle Single	4 Axle Single	<5 Axl Double	5 Axle Double	>6 Axl Double	<6 Axl Multi	6 Axle Multi	>6 Axl Multi	Total
11/30/21	0	15	6	0	0	1	0	1	1	0	1	0	0	25
01:00	0	24	5	0	0	0	0	1	4	0	0	0	0	34
02:00	1	21	3	0	1	0	0	1	7	0	0	0	0	34
03:00	1	32	11	0	1	0	0	0	3	0	1	0	0	49
04:00	1	64	16	0	1	0	0	0	8	0	0	0	0	90
05:00	0	178	34	0	3	0	0	0	5	0	0	0	0	220
06:00	1	203	47	0	10	3	0	0	5	0	0	0	0	269
07:00	0	369	54	0	4	1	1	2	7	0	0	0	0	438
08:00	1	301	50	0	5	6	0	2	14	0	0	0	0	379
09:00	1	220	49	1	22	5	0	2	14	0	0	0	0	314
10:00	1	221	54	1	11	2	0	0	8	0	0	0	0	298
11:00	2	170	44	0	7	3	0	5	6	0	0	0	0	237
12 PM	1	186	38	0	7	1	0	7	7	0	0	0	0	247
13:00	1	210	43	1	10	4	0	4	5	0	0	0	0	278
14:00	5	267	49	0	9	1	0	8	7	0	0	0	0	346
15:00	4	267	57	0	5	1	0	7	9	0	0	0	0	350
16:00	3	332	56	1	8	4	0	6	12	0	0	0	0	422
17:00	1	241	25	0	3	1	0	3	4	0	0	0	0	278
18:00	2	225	21	0	1	0	0	3	3	0	0	0	0	255
19:00	0	91	14	0	2	2	0	3	4	0	0	0	0	116
20:00	1	68	9	0	1	2	0	3	8	0	1	0	0	93
21:00	0	44	19	0	0	2	0	6	11	0	0	0	0	82
22:00	0	40	6	0	1	0	0	1	6	0	0	0	0	54
23:00	0	37	6	0	1	1	0	3	2	0	1	0	0	51
Total	27	3826	716	4	113	40	1	68	160	0	4	0	0	4959
Percent	0.5%	77.2%	14.4%	0.1%	2.3%	0.8%	0.0%	1.4%	3.2%	0.0%	0.1%	0.0%	0.0%	
AM Peak	11:00	07:00	07:00	09:00	09:00	08:00	07:00	11:00	08:00		00:00			07:00
Vol.	2	369	54	1	22	6	1	5	14		1			438
PM Peak	14:00	16:00	15:00	13:00	13:00	13:00		14:00	16:00		20:00			16:00
Vol.	5	332	57	1	10	4		8	12		1			422
Grand Total	27	3826	716	4	113	40	1	68	160	0	4	0	0	4959
Percent	0.5%	77.2%	14.4%	0.1%	2.3%	0.8%	0.0%	1.4%	3.2%	0.0%	0.1%	0.0%	0.0%	

Counts Unlimited, Inc.

City of Riverside
 Meridian Parkway
 N/ Van Buren Boulevard
 24 Hour Directional Classification Count
 Southbound

PO Box 1178
 Corona, CA 92878
 Phone: (951) 268-6268
 email: counts@countsunlimited.com

RIV004
 Site Code: 051-21716

Start Time	Bikes	Cars & Trailers	2 Axle Long	Buses	2 Axle 6 Tire	3 Axle Single	4 Axle Single	<5 Axl Double	5 Axle Double	>6 Axl Double	<6 Axl Multi	6 Axle Multi	>6 Axl Multi	Total
11/30/21	0	52	4	0	1	1	0	0	1	0	0	0	0	59
01:00	2	59	3	0	0	0	0	0	1	0	0	0	0	65
02:00	0	13	2	0	1	0	0	1	0	0	0	0	0	17
03:00	0	29	2	0	1	0	0	3	6	0	0	0	0	41
04:00	0	32	8	0	1	0	0	3	5	0	1	0	0	50
05:00	0	94	18	0	1	0	0	1	8	0	0	0	0	122
06:00	1	188	25	0	5	1	0	0	10	0	0	0	0	230
07:00	0	270	42	1	6	1	0	0	9	0	0	0	0	329
08:00	0	210	48	1	5	4	1	1	9	0	0	0	0	279
09:00	0	193	40	1	8	1	1	2	14	0	0	0	0	260
10:00	1	187	37	0	9	1	0	0	11	0	1	0	0	247
11:00	1	223	43	1	10	1	1	3	8	0	0	0	0	291
12 PM	2	222	40	0	7	2	1	0	7	0	0	0	0	281
13:00	15	345	82	0	8	4	0	3	16	0	0	0	0	473
14:00	2	586	99	1	6	7	0	2	10	0	1	0	0	714
15:00	4	692	105	2	12	1	0	2	8	0	0	0	0	826
16:00	1	927	129	1	12	2	0	2	15	0	0	0	0	1089
17:00	0	1202	138	1	28	13	0	5	27	0	0	0	0	1414
18:00	0	529	52	1	7	3	0	2	7	0	0	0	0	601
19:00	0	160	21	0	1	3	0	1	4	0	0	0	0	190
20:00	0	113	16	0	1	5	0	1	5	0	0	0	0	141
21:00	1	75	9	0	1	7	0	0	4	0	0	0	0	97
22:00	0	51	8	0	1	5	0	1	11	0	0	0	0	77
23:00	1	39	4	0	1	2	0	0	4	0	0	0	0	51
Total	31	6491	975	10	133	64	4	33	200	0	3	0	0	7944
Percent	0.4%	81.7%	12.3%	0.1%	1.7%	0.8%	0.1%	0.4%	2.5%	0.0%	0.0%	0.0%	0.0%	
AM Peak	01:00	07:00	08:00	07:00	11:00	08:00	08:00	03:00	09:00		04:00			07:00
Vol.	2	270	48	1	10	4	1	3	14		1			329
PM Peak	13:00	17:00	17:00	15:00	17:00	17:00	12:00	17:00	17:00		14:00			17:00
Vol.	15	1202	138	2	28	13	1	5	27		1			1414
Grand Total	31	6491	975	10	133	64	4	33	200	0	3	0	0	7944
Percent	0.4%	81.7%	12.3%	0.1%	1.7%	0.8%	0.1%	0.4%	2.5%	0.0%	0.0%	0.0%	0.0%	

Counts Unlimited, Inc.

City of Riverside
 Meridian Parkway
 N/ Van Buren Boulevard
 24 Hour Directional Classification Count
 Northbound, Southbound

PO Box 1178
 Corona, CA 92878
 Phone: (951) 268-6268
 email: counts@countsunlimited.com

RIV004
 Site Code: 051-21716

Start Time	Bikes	Cars & Trailers	2 Axle Long	Buses	2 Axle 6 Tire	3 Axle Single	4 Axle Single	<5 Axl Double	5 Axle Double	>6 Axl Double	<6 Axl Multi	6 Axle Multi	>6 Axl Multi	Total
11/30/21	0	67	10	0	1	2	0	1	2	0	1	0	0	84
01:00	2	83	8	0	0	0	0	1	5	0	0	0	0	99
02:00	1	34	5	0	2	0	0	2	7	0	0	0	0	51
03:00	1	61	13	0	2	0	0	3	9	0	1	0	0	90
04:00	1	96	24	0	2	0	0	3	13	0	1	0	0	140
05:00	0	272	52	0	4	0	0	1	13	0	0	0	0	342
06:00	2	391	72	0	15	4	0	0	15	0	0	0	0	499
07:00	0	639	96	1	10	2	1	2	16	0	0	0	0	767
08:00	1	511	98	1	10	10	1	3	23	0	0	0	0	658
09:00	1	413	89	2	30	6	1	4	28	0	0	0	0	574
10:00	2	408	91	1	20	3	0	0	19	0	1	0	0	545
11:00	3	393	87	1	17	4	1	8	14	0	0	0	0	528
12 PM	3	408	78	0	14	3	1	7	14	0	0	0	0	528
13:00	16	555	125	1	18	8	0	7	21	0	0	0	0	751
14:00	7	853	148	1	15	8	0	10	17	0	1	0	0	1060
15:00	8	959	162	2	17	2	0	9	17	0	0	0	0	1176
16:00	4	1259	185	2	20	6	0	8	27	0	0	0	0	1511
17:00	1	1443	163	1	31	14	0	8	31	0	0	0	0	1692
18:00	2	754	73	1	8	3	0	5	10	0	0	0	0	856
19:00	0	251	35	0	3	5	0	4	8	0	0	0	0	306
20:00	1	181	25	0	2	7	0	4	13	0	1	0	0	234
21:00	1	119	28	0	1	9	0	6	15	0	0	0	0	179
22:00	0	91	14	0	2	5	0	2	17	0	0	0	0	131
23:00	1	76	10	0	2	3	0	3	6	0	1	0	0	102
Total	58	10317	1691	14	246	104	5	101	360	0	7	0	0	12903
Percent	0.4%	80.0%	13.1%	0.1%	1.9%	0.8%	0.0%	0.8%	2.8%	0.0%	0.1%	0.0%	0.0%	
AM Peak	11:00	07:00	08:00	09:00	09:00	08:00	07:00	11:00	09:00		00:00			07:00
Vol.	3	639	98	2	30	10	1	8	28		1			767
PM Peak	13:00	17:00	16:00	15:00	17:00	17:00	12:00	14:00	17:00		14:00			17:00
Vol.	16	1443	185	2	31	14	1	10	31		1			1692
Grand Total	58	10317	1691	14	246	104	5	101	360	0	7	0	0	12903
Percent	0.4%	80.0%	13.1%	0.1%	1.9%	0.8%	0.0%	0.8%	2.8%	0.0%	0.1%	0.0%	0.0%	

City of Riverside
 N/S: Washington Street
 E/W: Van Buren Boulevard
 Weather: Clear

File Name : 01_RIV_Wash_VB Sat
 Site Code : 05122815
 Start Date : 9/17/2022
 Page No : 1

Groups Printed- Passenger Vehicles - Large 2 Axle Vehicles - 3 Axle Vehicles - 4+ Axle Trucks

Start Time	Washington Street Southbound					Van Buren Boulevard Westbound					Washington Street Northbound					Van Buren Boulevard Eastbound					Exclu. Total	Inclu. Total	Int. Total
	Left	Thru	Right	RTOR	App. Total	Left	Thru	Right	RTOR	App. Total	Left	Thru	Right	RTOR	App. Total	Left	Thru	Right	RTOR	App. Total			
11:00 AM	53	47	17	12	117	23	189	49	15	261	28	53	28	17	109	30	139	12	3	181	47	668	715
11:15 AM	46	40	17	9	103	30	208	51	12	289	27	45	27	24	99	35	160	7	1	202	46	693	739
11:30 AM	67	41	21	16	129	37	156	51	18	244	28	58	30	18	116	25	153	15	7	193	59	682	741
11:45 AM	44	40	20	12	104	33	199	57	16	289	24	46	28	24	98	29	170	9	4	208	56	699	755
Total	210	168	75	49	453	123	752	208	61	1083	107	202	113	83	422	119	622	43	15	784	208	2742	2950
12:00 PM	66	34	28	22	128	35	183	55	14	273	33	52	21	15	106	28	159	8	2	195	53	702	755
12:15 PM	80	41	17	6	138	21	189	42	7	252	30	42	29	22	101	28	208	14	4	250	39	741	780
12:30 PM	67	44	19	16	130	21	183	53	15	257	28	42	37	18	107	30	177	19	6	226	55	720	775
12:45 PM	71	40	15	11	126	32	152	42	18	226	32	58	16	9	106	29	202	16	3	247	41	705	746
Total	284	159	79	55	522	109	707	192	54	1008	123	194	103	64	420	115	746	57	15	918	188	2868	3056
01:00 PM	56	41	21	12	118	18	203	53	11	274	37	49	24	15	110	23	162	19	7	204	45	706	751
01:15 PM	62	40	22	14	124	22	197	64	13	283	22	49	20	16	91	32	181	15	12	228	55	726	781
01:30 PM	66	41	18	12	125	21	170	39	16	230	31	47	17	16	95	28	167	15	5	210	49	660	709
01:45 PM	56	46	12	9	114	31	211	54	11	296	27	41	26	18	94	36	173	15	5	224	43	728	771
Total	240	168	73	47	481	92	781	210	51	1083	117	186	87	65	390	119	683	64	29	866	192	2820	3012
Grand Total	734	495	227	151	1456	324	2240	610	166	3174	347	582	303	212	1232	353	2051	164	59	2568	588	8430	9018
Apprch %	50.4	34	15.6			10.2	70.6	19.2			28.2	47.2	24.6			13.7	79.9	6.4					
Total %	8.7	5.9	2.7		17.3	3.8	26.6	7.2		37.7	4.1	6.9	3.6		14.6	4.2	24.3	1.9		30.5	6.5	93.5	
Passenger Vehicles	723	490	224		1585	321	2213	603		3301	345	570	299		1424	351	2020	158		2585	0	0	8895
% Passenger Vehicles	98.5	99	98.7	98	98.6	99.1	98.8	98.9	98.8	98.8	99.4	97.9	98.7	99.1	98.6	99.4	98.5	96.3	94.9	98.4	0	0	98.6
Large 2 Axle Vehicles	9	5	0		14	3	25	5		35	2	12	4		20	1	26	4		33	0	0	102
% Large 2 Axle Vehicles	1.2	1	0	0	0.9	0.9	1.1	0.8	1.2	1	0.6	2.1	1.3	0.9	1.4	0.3	1.3	2.4	3.4	1.3	0	0	1.1
3 Axle Vehicles	1	0	3		7	0	2	1		3	0	0	0		0	1	1	1		3	0	0	13
% 3 Axle Vehicles	0.1	0	1.3	2	0.4	0	0.1	0.2	0	0.1	0	0	0	0	0	0.3	0	0.6	0	0.1	0	0	0.1
4+ Axle Trucks	1	0	0		1	0	0	1		1	0	0	0		0	0	4	1		6	0	0	8
% 4+ Axle Trucks	0.1	0	0	0	0.1	0	0	0.2	0	0	0	0	0	0	0	0	0.2	0.6	1.7	0.2	0	0	0.1

City of Riverside
 N/S: Washington Street
 E/W: Van Buren Boulevard
 Weather: Clear

File Name : 01_RIV_Wash_VB Sat
 Site Code : 05122815
 Start Date : 9/17/2022
 Page No : 2

Start Time	Washington Street Southbound				Van Buren Boulevard Westbound				Washington Street Northbound				Van Buren Boulevard Eastbound				Int. Total
	Left	Thru	Right	App. Total	Left	Thru	Right	App. Total	Left	Thru	Right	App. Total	Left	Thru	Right	App. Total	
Peak Hour Analysis From 11:00 AM to 01:45 PM - Peak 1 of 1																	
Peak Hour for Entire Intersection Begins at 12:15 PM																	
12:15 PM	80	41	17	138	21	189	42	252	30	42	29	101	28	208	14	250	741
12:30 PM	67	44	19	130	21	183	53	257	28	42	37	107	30	177	19	226	720
12:45 PM	71	40	15	126	32	152	42	226	32	58	16	106	29	202	16	247	705
01:00 PM	56	41	21	118	18	203	53	274	37	49	24	110	23	162	19	204	706
Total Volume	274	166	72	512	92	727	190	1009	127	191	106	424	110	749	68	927	2872
% App. Total	53.5	32.4	14.1		9.1	72.1	18.8		30	45	25		11.9	80.8	7.3		
PHF	.856	.943	.857	.928	.719	.895	.896	.921	.858	.823	.716	.964	.917	.900	.895	.927	.969

City of Riverside
 N/S: Washington Street
 E/W: Van Buren Boulevard
 Weather: Clear

File Name : 01_RIV_Wash_VB Sat
 Site Code : 05122815
 Start Date : 9/17/2022
 Page No : 3

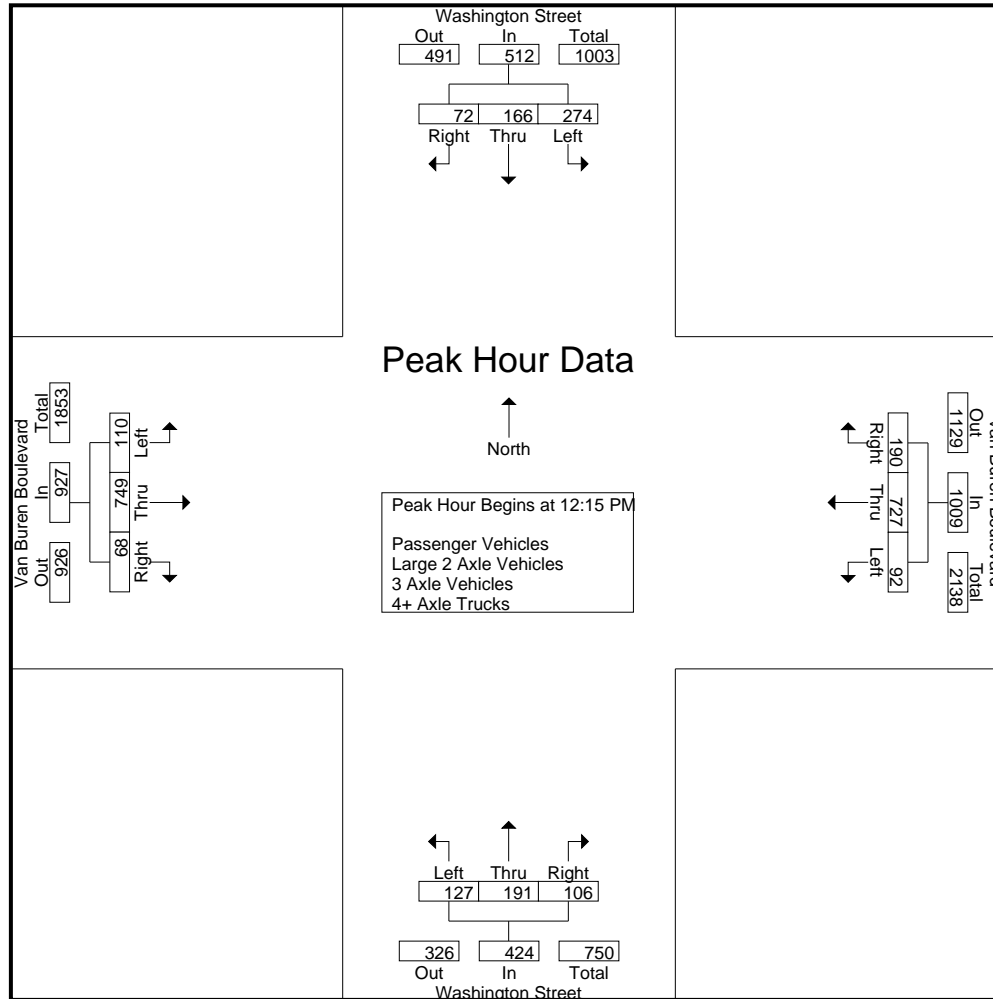

City of Riverside
 N/S: Washington Street
 E/W: Van Buren Boulevard
 Weather: Clear

File Name : 01_RIV_Wash_VB Sat
 Site Code : 05122815
 Start Date : 9/17/2022
 Page No : 4

Start Time	Washington Street Southbound				Van Buren Boulevard Westbound				Washington Street Northbound				Van Buren Boulevard Eastbound				Int. Total
	Left	Thru	Right	App. Total	Left	Thru	Right	App. Total	Left	Thru	Right	App. Total	Left	Thru	Right	App. Total	
Peak Hour Analysis From 11:00 AM to 01:45 PM - Peak 1 of 1																	
Peak Hour for Each Approach Begins at:																	
	12:00 PM				11:15 AM				12:15 PM				12:15 PM				
+0 mins.	66	34	28	128	30	208	51	289	30	42	29	101	28	208	14	250	
+15 mins.	80	41	17	138	37	156	51	244	28	42	37	107	30	177	19	226	
+30 mins.	67	44	19	130	33	199	57	289	32	58	16	106	29	202	16	247	
+45 mins.	71	40	15	126	35	183	55	273	37	49	24	110	23	162	19	204	
Total Volume	284	159	79	522	135	746	214	1095	127	191	106	424	110	749	68	927	
% App. Total	54.4	30.5	15.1		12.3	68.1	19.5		30	45	25		11.9	80.8	7.3		
PHF	.888	.903	.705	.946	.912	.897	.939	.947	.858	.823	.716	.964	.917	.900	.895	.927	

City of Riverside
 N/S: Washington Street
 E/W: Van Buren Boulevard
 Weather: Clear

File Name : 01_RIV_Wash_VB Sat
 Site Code : 05122815
 Start Date : 9/17/2022
 Page No : 1

Groups Printed- Passenger Vehicles

Start Time	Washington Street Southbound					Van Buren Boulevard Westbound					Washington Street Northbound					Van Buren Boulevard Eastbound					Exclu. Total	Inclu. Total	Int. Total
	Left	Thru	Right	RTOR	App. Total	Left	Thru	Right	RTOR	App. Total	Left	Thru	Right	RTOR	App. Total	Left	Thru	Right	RTOR	App. Total			
11:00 AM	53	46	17	12	116	23	188	49	15	260	28	52	27	16	107	30	137	10	3	177	46	660	706
11:15 AM	45	39	15	7	99	30	207	50	12	287	27	45	27	24	99	35	160	7	1	202	44	687	731
11:30 AM	66	41	21	16	128	37	153	51	18	241	27	55	29	18	111	24	152	14	6	190	58	670	728
11:45 AM	43	40	20	12	103	33	198	56	16	287	24	45	28	24	97	29	167	9	4	205	56	692	748
Total	207	166	73	47	446	123	746	206	61	1075	106	197	111	82	414	118	616	40	14	774	204	2709	2913
12:00 PM	64	33	28	22	125	35	182	55	14	272	33	51	19	14	103	28	156	7	1	191	51	691	742
12:15 PM	80	41	17	6	138	21	187	42	7	250	30	41	29	22	100	28	202	14	4	244	39	732	771
12:30 PM	67	43	19	16	129	19	181	52	14	252	28	41	37	18	106	29	176	19	6	224	54	711	765
12:45 PM	69	40	15	11	124	32	150	42	18	224	32	57	16	9	105	29	198	16	3	243	41	696	737
Total	280	157	79	55	516	107	700	191	53	998	123	190	101	63	414	114	732	56	14	902	185	2830	3015
01:00 PM	55	41	20	11	116	17	202	52	11	271	37	48	24	15	109	23	161	17	6	201	43	697	740
01:15 PM	61	39	22	14	122	22	193	62	12	277	22	49	20	16	91	32	178	15	12	225	54	715	769
01:30 PM	64	41	18	12	123	21	167	38	16	226	30	46	17	16	93	28	163	15	5	206	49	648	697
01:45 PM	56	46	12	9	114	31	205	54	11	290	27	40	26	18	93	36	170	15	5	221	43	718	761
Total	236	167	72	46	475	91	767	206	50	1064	116	183	87	65	386	119	672	62	28	853	189	2778	2967
Grand Total	723	490	224	148	1437	321	2213	603	164	3137	345	570	299	210	1214	351	2020	158	56	2529	578	8317	8895
Apprch %	50.3	34.1	15.6			10.2	70.5	19.2			28.4	47	24.6			13.9	79.9	6.2					
Total %	8.7	5.9	2.7		17.3	3.9	26.6	7.3		37.7	4.1	6.9	3.6		14.6	4.2	24.3	1.9		30.4	6.5	93.5	

Start Time	Washington Street Southbound				Van Buren Boulevard Westbound				Washington Street Northbound				Van Buren Boulevard Eastbound				Int. Total
	Left	Thru	Right	App. Total	Left	Thru	Right	App. Total	Left	Thru	Right	App. Total	Left	Thru	Right	App. Total	
Peak Hour Analysis From 12:15 PM to 01:00 PM - Peak 1 of 1																	
Peak Hour for Entire Intersection Begins at 12:15 PM																	
12:15 PM	80	41	17	138	21	187	42	250	30	41	29	100	28	202	14	244	732
12:30 PM	67	43	19	129	19	181	52	252	28	41	37	106	29	176	19	224	711
12:45 PM	69	40	15	124	32	150	42	224	32	57	16	105	29	198	16	243	696
01:00 PM	55	41	20	116	17	202	52	271	37	48	24	109	23	161	17	201	697
Total Volume	271	165	71	507	89	720	188	997	127	187	106	420	109	737	66	912	2836
% App. Total	53.5	32.5	14		8.9	72.2	18.9		30.2	44.5	25.2		12	80.8	7.2		
PHF	.847	.959	.888	.918	.695	.891	.904	.920	.858	.820	.716	.963	.940	.912	.868	.934	.969

City of Riverside
 N/S: Washington Street
 E/W: Van Buren Boulevard
 Weather: Clear

File Name : 01_RIV_Wash_VB Sat
 Site Code : 05122815
 Start Date : 9/17/2022
 Page No : 2

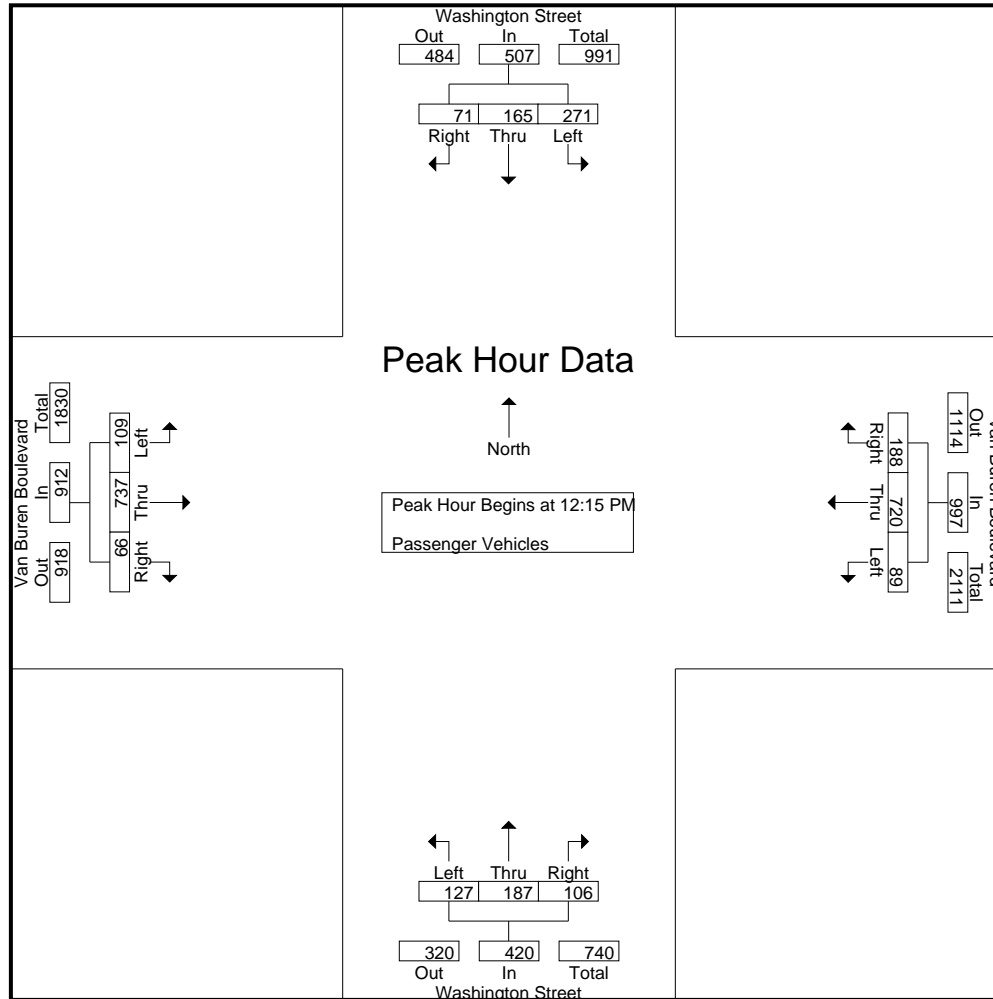

City of Riverside
 N/S: Washington Street
 E/W: Van Buren Boulevard
 Weather: Clear

File Name : 01_RIV_Wash_VB Sat
 Site Code : 05122815
 Start Date : 9/17/2022
 Page No : 3

Start Time	Washington Street Southbound				Van Buren Boulevard Westbound				Washington Street Northbound				Van Buren Boulevard Eastbound				Int. Total
	Left	Thru	Right	App. Total	Left	Thru	Right	App. Total	Left	Thru	Right	App. Total	Left	Thru	Right	App. Total	
Peak Hour Analysis From 12:15 PM to 01:00 PM - Peak 1 of 1																	
Peak Hour for Each Approach Begins at:																	
	12:15 PM				12:15 PM				12:15 PM				12:15 PM				
+0 mins.	80	41	17	138	21	187	42	250	30	41	29	100	28	202	14	244	
+15 mins.	67	43	19	129	19	181	52	252	28	41	37	106	29	176	19	224	
+30 mins.	69	40	15	124	32	150	42	224	32	57	16	105	29	198	16	243	
+45 mins.	55	41	20	116	17	202	52	271	37	48	24	109	23	161	17	201	
Total Volume	271	165	71	507	89	720	188	997	127	187	106	420	109	737	66	912	
% App. Total	53.5	32.5	14		8.9	72.2	18.9		30.2	44.5	25.2		12	80.8	7.2		
PHF	.847	.959	.888	.918	.695	.891	.904	.920	.858	.820	.716	.963	.940	.912	.868	.934	

City of Riverside
 N/S: Washington Street
 E/W: Van Buren Boulevard
 Weather: Clear

File Name : 01_RIV_Wash_VB Sat
 Site Code : 05122815
 Start Date : 9/17/2022
 Page No : 1

Groups Printed- Large 2 Axle Vehicles

Start Time	Washington Street Southbound					Van Buren Boulevard Westbound					Washington Street Northbound					Van Buren Boulevard Eastbound					Exclu. Total	Inclu. Total	Int. Total
	Left	Thru	Right	RTOR	App. Total	Left	Thru	Right	RTOR	App. Total	Left	Thru	Right	RTOR	App. Total	Left	Thru	Right	RTOR	App. Total			
11:00 AM	0	1	0	0	1	0	1	0	0	1	0	1	1	1	2	0	1	2	0	3	1	7	8
11:15 AM	0	1	0	0	1	0	1	1	0	2	0	0	0	0	0	0	0	0	0	0	0	3	3
11:30 AM	1	0	0	0	1	0	3	0	0	3	1	3	1	0	5	0	1	1	1	2	1	11	12
11:45 AM	1	0	0	0	1	0	0	0	0	0	0	1	0	0	1	0	2	0	0	2	0	4	4
Total	2	2	0	0	4	0	5	1	0	6	1	5	2	1	8	0	4	3	1	7	2	25	27
12:00 PM	2	1	0	0	3	0	1	0	0	1	0	1	2	1	3	0	3	0	0	3	1	10	11
12:15 PM	0	0	0	0	0	0	2	0	0	2	0	1	0	0	1	0	6	0	0	6	0	9	9
12:30 PM	0	1	0	0	1	2	2	1	1	5	0	1	0	0	1	1	1	0	0	2	1	9	10
12:45 PM	2	0	0	0	2	0	1	0	0	1	0	1	0	0	1	0	3	0	0	3	0	7	7
Total	4	2	0	0	6	2	6	1	1	9	0	4	2	1	6	1	13	0	0	14	2	35	37
01:00 PM	0	0	0	0	0	1	1	1	0	3	0	1	0	0	1	0	1	1	1	2	1	6	7
01:15 PM	1	1	0	0	2	0	4	2	1	6	0	0	0	0	0	0	3	0	0	3	1	11	12
01:30 PM	2	0	0	0	2	0	3	0	0	3	1	1	0	0	2	0	3	0	0	3	0	10	10
01:45 PM	0	0	0	0	0	0	6	0	0	6	0	1	0	0	1	0	2	0	0	2	0	9	9
Total	3	1	0	0	4	1	14	3	1	18	1	3	0	0	4	0	9	1	1	10	2	36	38
Grand Total	9	5	0	0	14	3	25	5	2	33	2	12	4	2	18	1	26	4	2	31	6	96	102
Apprch %	64.3	35.7	0			9.1	75.8	15.2			11.1	66.7	22.2			3.2	83.9	12.9					
Total %	9.4	5.2	0		14.6	3.1	26	5.2		34.4	2.1	12.5	4.2		18.8	1	27.1	4.2		32.3	5.9	94.1	

Start Time	Washington Street Southbound				Van Buren Boulevard Westbound				Washington Street Northbound				Van Buren Boulevard Eastbound				Int. Total
	Left	Thru	Right	App. Total	Left	Thru	Right	App. Total	Left	Thru	Right	App. Total	Left	Thru	Right	App. Total	
Peak Hour Analysis From 12:15 PM to 01:00 PM - Peak 1 of 1																	
Peak Hour for Entire Intersection Begins at 12:15 PM																	
12:15 PM	0	0	0	0	0	2	0	2	0	1	0	1	0	6	0	6	9
12:30 PM	0	1	0	1	2	2	1	5	0	1	0	1	1	1	0	2	9
12:45 PM	2	0	0	2	0	1	0	1	0	1	0	1	0	3	0	3	7
01:00 PM	0	0	0	0	1	1	1	3	0	1	0	1	0	1	1	2	6
Total Volume	2	1	0	3	3	6	2	11	0	4	0	4	1	11	1	13	31
% App. Total	66.7	33.3	0		27.3	54.5	18.2		0	100	0		7.7	84.6	7.7		
PHF	.250	.250	.000	.375	.375	.750	.500	.550	.000	1.00	.000	1.00	.250	.458	.250	.542	.861

City of Riverside
 N/S: Washington Street
 E/W: Van Buren Boulevard
 Weather: Clear

File Name : 01_RIV_Wash_VB Sat
 Site Code : 05122815
 Start Date : 9/17/2022
 Page No : 2

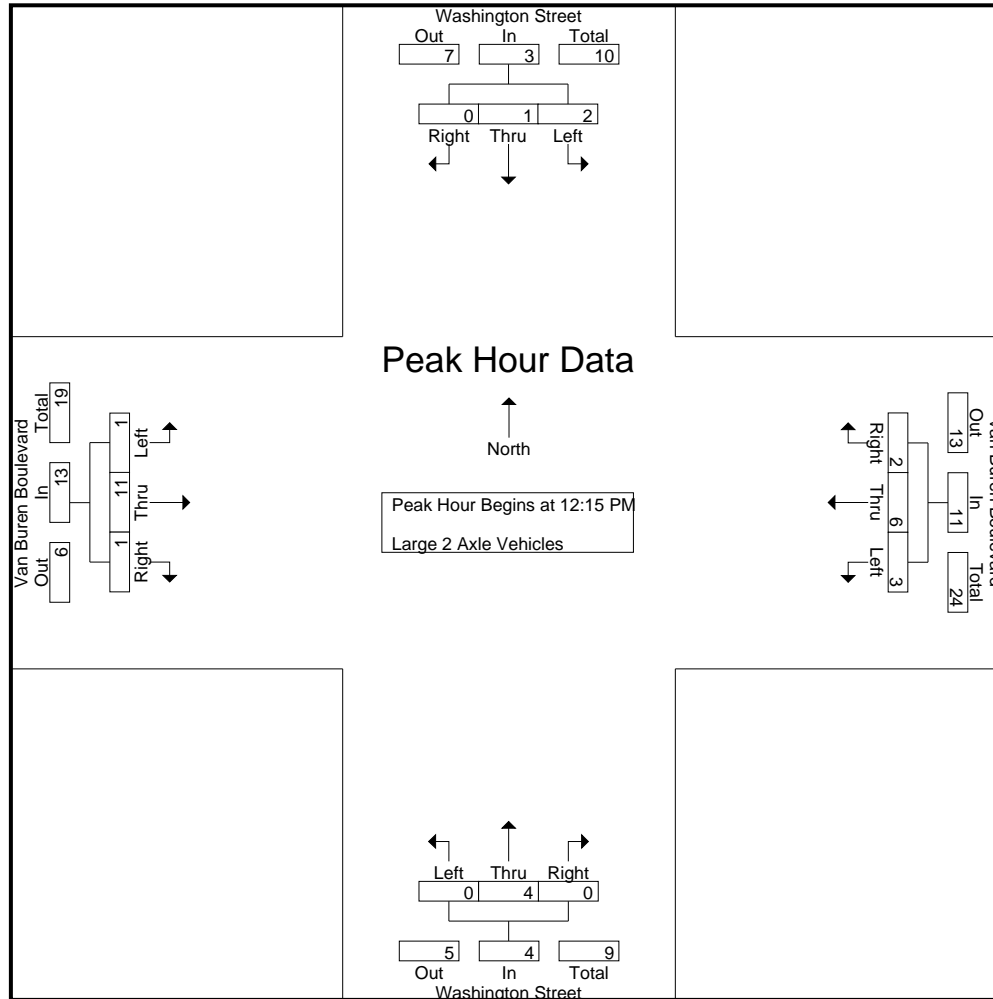

City of Riverside
 N/S: Washington Street
 E/W: Van Buren Boulevard
 Weather: Clear

File Name : 01_RIV_Wash_VB Sat
 Site Code : 05122815
 Start Date : 9/17/2022
 Page No : 3

Start Time	Washington Street Southbound				Van Buren Boulevard Westbound				Washington Street Northbound				Van Buren Boulevard Eastbound				Int. Total
	Left	Thru	Right	App. Total	Left	Thru	Right	App. Total	Left	Thru	Right	App. Total	Left	Thru	Right	App. Total	
Peak Hour Analysis From 12:15 PM to 01:00 PM - Peak 1 of 1																	
Peak Hour for Each Approach Begins at:																	
	12:15 PM				12:15 PM				12:15 PM				12:15 PM				
+0 mins.	0	0	0	0	0	2	0	2	0	1	0	1	0	6	0	6	
+15 mins.	0	1	0	1	2	2	1	5	0	1	0	1	1	1	0	2	
+30 mins.	2	0	0	2	0	1	0	1	0	1	0	1	0	3	0	3	
+45 mins.	0	0	0	0	1	1	1	3	0	1	0	1	0	1	1	2	
Total Volume	2	1	0	3	3	6	2	11	0	4	0	4	1	11	1	13	
% App. Total	66.7	33.3	0		27.3	54.5	18.2		0	100	0		7.7	84.6	7.7		
PHF	.250	.250	.000	.375	.375	.750	.500	.550	.000	1.000	.000	1.000	.250	.458	.250	.542	

City of Riverside
 N/S: Washington Street
 E/W: Van Buren Boulevard
 Weather: Clear

File Name : 01_RIV_Wash_VB Sat
 Site Code : 05122815
 Start Date : 9/17/2022
 Page No : 1

Groups Printed- 3 Axle Vehicles

Start Time	Washington Street Southbound					Van Buren Boulevard Westbound					Washington Street Northbound					Van Buren Boulevard Eastbound					Exclu. Total	Inclu. Total	Int. Total	
	Left	Thru	Right	RTOR	App. Total	Left	Thru	Right	RTOR	App. Total	Left	Thru	Right	RTOR	App. Total	Left	Thru	Right	RTOR	App. Total				
11:00 AM	0	0	0	0	0	0	0	0	0	0	0	0	0	0	0	0	1	0	0	1	0	0	1	1
11:15 AM	1	0	2	2	3	0	0	0	0	0	0	0	0	0	0	0	0	0	0	0	2	3	5	5
11:30 AM	0	0	0	0	0	0	0	0	0	0	0	0	0	0	0	1	0	0	0	1	0	1	1	1
11:45 AM	0	0	0	0	0	0	1	0	0	1	0	0	0	0	0	0	0	0	0	0	0	1	1	1
Total	1	0	2	2	3	0	1	0	0	1	0	0	0	0	0	1	1	0	0	2	2	6	8	8
12:00 PM	0	0	0	0	0	0	0	0	0	0	0	0	0	0	0	0	0	0	0	0	0	0	0	0
12:15 PM	0	0	0	0	0	0	0	0	0	0	0	0	0	0	0	0	0	0	0	0	0	0	0	0
12:30 PM	0	0	0	0	0	0	0	0	0	0	0	0	0	0	0	0	0	0	0	0	0	0	0	0
12:45 PM	0	0	0	0	0	0	1	0	0	1	0	0	0	0	0	0	0	0	0	0	0	1	1	1
Total	0	0	0	0	0	0	1	0	0	1	0	0	0	0	0	0	0	0	0	0	0	1	1	1
01:00 PM	0	0	1	1	1	0	0	0	0	0	0	0	0	0	0	0	0	1	0	1	1	2	3	3
01:15 PM	0	0	0	0	0	0	0	0	0	0	0	0	0	0	0	0	0	0	0	0	0	0	0	0
01:30 PM	0	0	0	0	0	0	0	1	0	1	0	0	0	0	0	0	0	0	0	0	0	1	1	1
01:45 PM	0	0	0	0	0	0	0	0	0	0	0	0	0	0	0	0	0	0	0	0	0	0	0	0
Total	0	0	1	1	1	0	0	1	0	1	0	0	0	0	0	0	0	1	0	1	1	3	4	4
Grand Total	1	0	3	3	4	0	2	1	0	3	0	0	0	0	0	1	1	1	0	3	3	10	13	13
Apprch %	25	0	75			0	66.7	33.3			0	0	0			33.3	33.3	33.3						
Total %	10	0	30		40	0	20	10		30	0	0	0		0	10	10	10		30	23.1	76.9		

Start Time	Washington Street Southbound				Van Buren Boulevard Westbound				Washington Street Northbound				Van Buren Boulevard Eastbound				Int. Total
	Left	Thru	Right	App. Total	Left	Thru	Right	App. Total	Left	Thru	Right	App. Total	Left	Thru	Right	App. Total	
Peak Hour Analysis From 12:15 PM to 01:00 PM - Peak 1 of 1																	
Peak Hour for Entire Intersection Begins at 12:15 PM																	
12:15 PM	0	0	0	0	0	0	0	0	0	0	0	0	0	0	0	0	
12:30 PM	0	0	0	0	0	0	0	0	0	0	0	0	0	0	0	0	
12:45 PM	0	0	0	0	0	1	0	1	0	0	0	0	0	0	0	0	
01:00 PM	0	0	1	1	0	0	0	0	0	0	0	0	0	0	1	1	
Total Volume	0	0	1	1	0	1	0	1	0	0	0	0	0	0	1	1	
% App. Total	0	0	100		0	100	0		0	0	0		0	0	100		
PHF	.000	.000	.250	.250	.000	.250	.000	.250	.000	.000	.000	.000	.000	.000	.250	.250	

City of Riverside
 N/S: Washington Street
 E/W: Van Buren Boulevard
 Weather: Clear

File Name : 01_RIV_Wash_VB Sat
 Site Code : 05122815
 Start Date : 9/17/2022
 Page No : 2

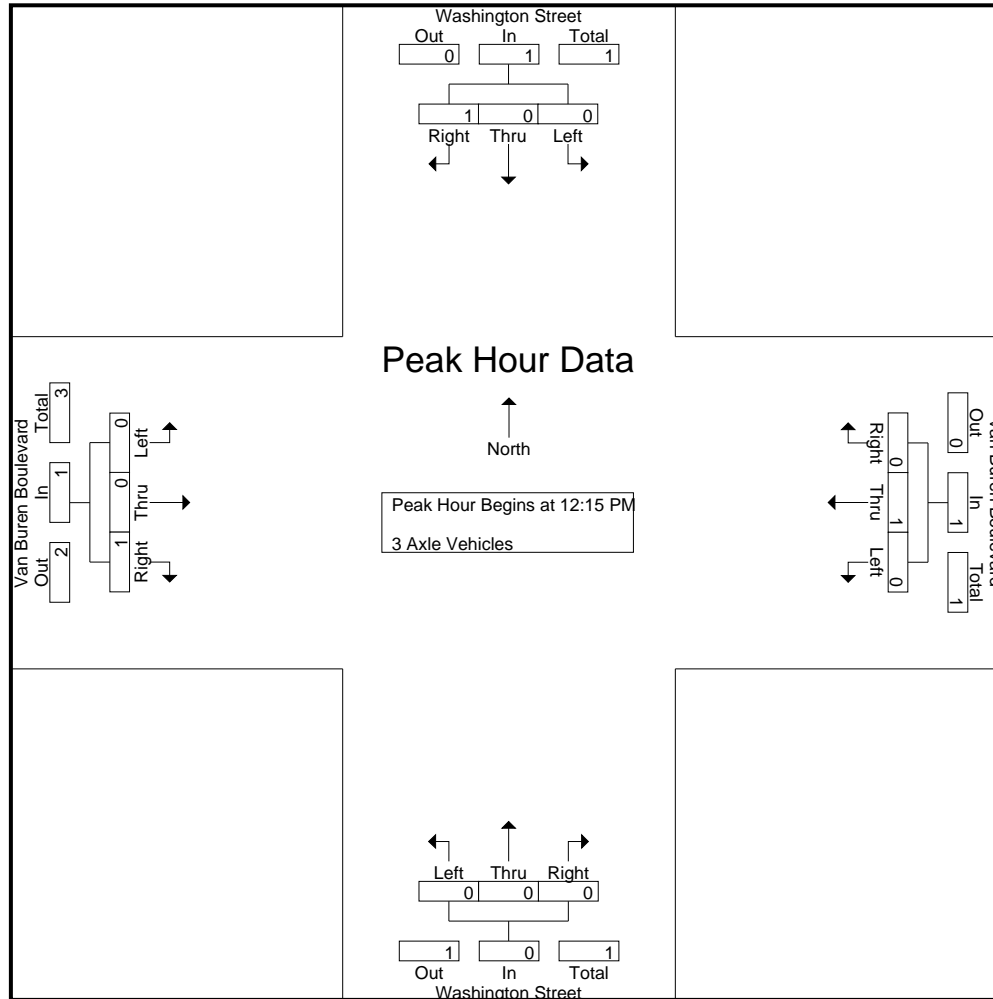

City of Riverside
 N/S: Washington Street
 E/W: Van Buren Boulevard
 Weather: Clear

File Name : 01_RIV_Wash_VB Sat
 Site Code : 05122815
 Start Date : 9/17/2022
 Page No : 3

Start Time	Washington Street Southbound				Van Buren Boulevard Westbound				Washington Street Northbound				Van Buren Boulevard Eastbound				Int. Total
	Left	Thru	Right	App. Total	Left	Thru	Right	App. Total	Left	Thru	Right	App. Total	Left	Thru	Right	App. Total	
Peak Hour Analysis From 12:15 PM to 01:00 PM - Peak 1 of 1																	
Peak Hour for Each Approach Begins at:																	
	12:15 PM				12:15 PM				12:15 PM				12:15 PM				
+0 mins.	0	0	0	0	0	0	0	0	0	0	0	0	0	0	0	0	
+15 mins.	0	0	0	0	0	0	0	0	0	0	0	0	0	0	0	0	
+30 mins.	0	0	0	0	0	1	0	1	0	0	0	0	0	0	0	0	
+45 mins.	0	0	1	1	0	0	0	0	0	0	0	0	0	0	1	1	
Total Volume	0	0	1	1	0	1	0	1	0	0	0	0	0	0	1	1	
% App. Total	0	0	100		0	100	0		0	0	0		0	0	100		
PHF	.000	.000	.250	.250	.000	.250	.000	.250	.000	.000	.000	.000	.000	.000	.250	.250	

City of Riverside
 N/S: Washington Street
 E/W: Van Buren Boulevard
 Weather: Clear

File Name : 01_RIV_Wash_VB Sat
 Site Code : 05122815
 Start Date : 9/17/2022
 Page No : 1

Groups Printed- 4+ Axle Trucks

Start Time	Washington Street Southbound					Van Buren Boulevard Westbound					Washington Street Northbound					Van Buren Boulevard Eastbound					Exclu. Total	Inclu. Total	Int. Total					
	Left	Thru	Right	RTOR	App. Total	Left	Thru	Right	RTOR	App. Total	Left	Thru	Right	RTOR	App. Total	Left	Thru	Right	RTOR	App. Total								
11:00 AM	0	0	0	0	0	0	0	0	0	0	0	0	0	0	0	0	0	0	0	0	0	0	0	0	0	0	0	0
11:15 AM	0	0	0	0	0	0	0	0	0	0	0	0	0	0	0	0	0	0	0	0	0	0	0	0	0	0	0	0
11:30 AM	0	0	0	0	0	0	0	0	0	0	0	0	0	0	0	0	0	0	0	0	0	0	0	0	0	0	0	0
11:45 AM	0	0	0	0	0	0	0	1	0	1	0	0	0	0	0	0	1	0	0	1	0	0	0	0	1	0	2	2
Total	0	0	0	0	0	0	0	1	0	1	0	0	0	0	0	0	1	0	0	1	0	0	0	0	1	0	2	2
12:00 PM	0	0	0	0	0	0	0	0	0	0	0	0	0	0	0	0	0	1	1	1	1	1	1	1	1	1	1	2
12:15 PM	0	0	0	0	0	0	0	0	0	0	0	0	0	0	0	0	0	0	0	0	0	0	0	0	0	0	0	0
12:30 PM	0	0	0	0	0	0	0	0	0	0	0	0	0	0	0	0	0	0	0	0	0	0	0	0	0	0	0	0
12:45 PM	0	0	0	0	0	0	0	0	0	0	0	0	0	0	0	0	1	0	0	1	0	0	0	1	1	0	1	1
Total	0	0	0	0	0	0	0	0	0	0	0	0	0	0	0	0	1	1	1	2	1	1	1	2	1	1	2	3
01:00 PM	1	0	0	0	1	0	0	0	0	0	0	0	0	0	0	0	0	0	0	0	0	0	0	0	0	0	1	1
01:15 PM	0	0	0	0	0	0	0	0	0	0	0	0	0	0	0	0	0	0	0	0	0	0	0	0	0	0	0	0
01:30 PM	0	0	0	0	0	0	0	0	0	0	0	0	0	0	0	0	1	0	0	1	0	0	0	1	1	0	1	1
01:45 PM	0	0	0	0	0	0	0	0	0	0	0	0	0	0	0	0	1	0	0	1	0	0	0	1	1	0	1	1
Total	1	0	0	0	1	0	0	0	0	0	0	0	0	0	0	0	2	0	0	2	0	0	0	2	1	0	3	3
Grand Total	1	0	0	0	1	0	0	1	0	1	0	0	0	0	0	0	4	1	1	5	1	1	1	5	1	7	8	
Apprch %	100	0	0			0	0	100			0	0	0			0	80	20										
Total %	14.3	0	0		14.3	0	0	14.3		14.3	0	0	0		0	0	57.1	14.3		71.4	12.5			12.5	87.5			

Start Time	Washington Street Southbound				Van Buren Boulevard Westbound				Washington Street Northbound				Van Buren Boulevard Eastbound				Int. Total
	Left	Thru	Right	App. Total	Left	Thru	Right	App. Total	Left	Thru	Right	App. Total	Left	Thru	Right	App. Total	
Peak Hour Analysis From 12:15 PM to 01:00 PM - Peak 1 of 1																	
Peak Hour for Entire Intersection Begins at 12:15 PM																	
12:15 PM	0	0	0	0	0	0	0	0	0	0	0	0	0	0	0	0	
12:30 PM	0	0	0	0	0	0	0	0	0	0	0	0	0	0	0	0	
12:45 PM	0	0	0	0	0	0	0	0	0	0	0	0	0	1	0	1	
01:00 PM	1	0	0	1	0	0	0	0	0	0	0	0	0	0	0	0	
Total Volume	1	0	0	1	0	0	0	0	0	0	0	0	0	1	0	1	
% App. Total	100	0	0		0	0	0		0	0	0		0	100	0		
PHF	.250	.000	.000	.250	.000	.000	.000	.000	.000	.000	.000	.000	.000	.250	.000	.250	

City of Riverside
 N/S: Washington Street
 E/W: Van Buren Boulevard
 Weather: Clear

File Name : 01_RIV_Wash_VB Sat
 Site Code : 05122815
 Start Date : 9/17/2022
 Page No : 2

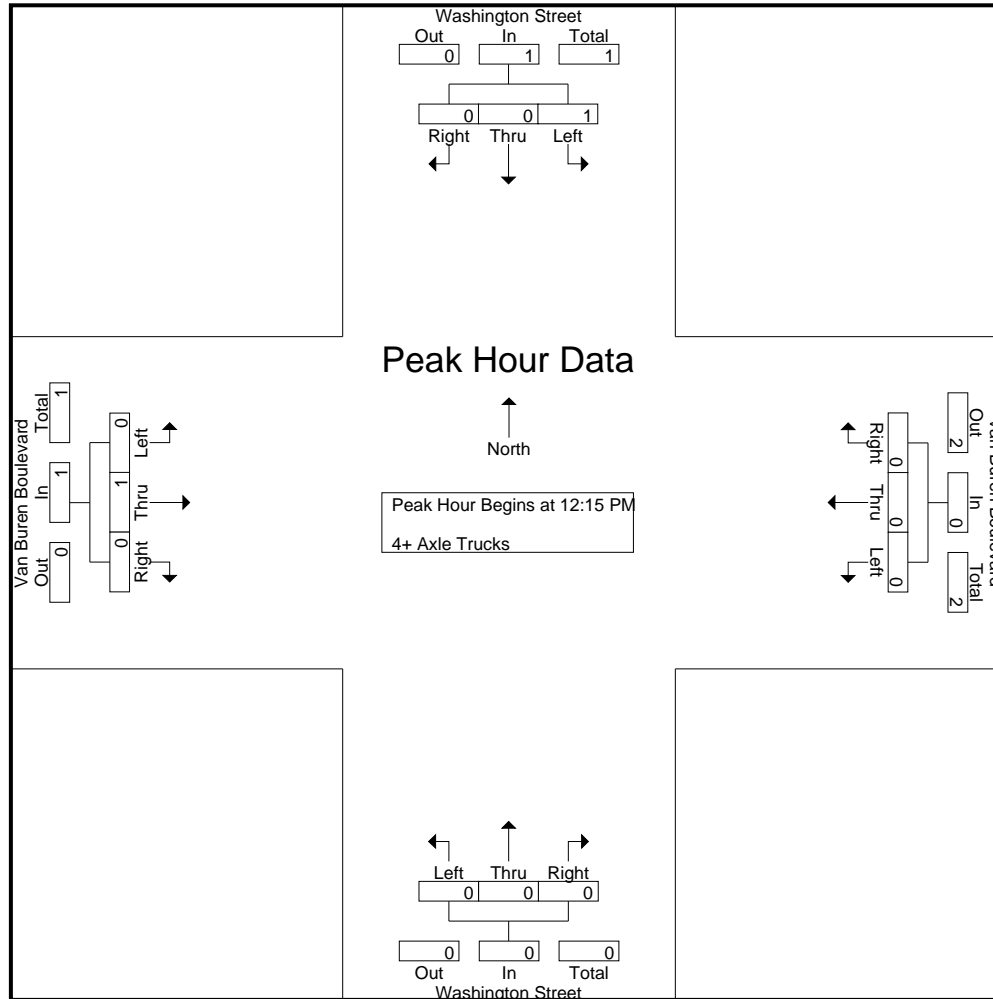

City of Riverside
 N/S: Washington Street
 E/W: Van Buren Boulevard
 Weather: Clear

File Name : 01_RIV_Wash_VB Sat
 Site Code : 05122815
 Start Date : 9/17/2022
 Page No : 3

Start Time	Washington Street Southbound				Van Buren Boulevard Westbound				Washington Street Northbound				Van Buren Boulevard Eastbound				Int. Total
	Left	Thru	Right	App. Total	Left	Thru	Right	App. Total	Left	Thru	Right	App. Total	Left	Thru	Right	App. Total	
Peak Hour Analysis From 12:15 PM to 01:00 PM - Peak 1 of 1																	
Peak Hour for Each Approach Begins at:																	
	12:15 PM				12:15 PM				12:15 PM				12:15 PM				
+0 mins.	0	0	0	0	0	0	0	0	0	0	0	0	0	0	0	0	
+15 mins.	0	0	0	0	0	0	0	0	0	0	0	0	0	0	0	0	
+30 mins.	0	0	0	0	0	0	0	0	0	0	0	0	0	1	0	1	
+45 mins.	1	0	0	1	0	0	0	0	0	0	0	0	0	0	0	0	
Total Volume	1	0	0	1	0	0	0	0	0	0	0	0	0	1	0	1	
% App. Total	100	0	0		0	0	0		0	0	0		0	100	0		
PHF	.250	.000	.000	.250	.000	.000	.000	.000	.000	.000	.000	.000	.000	.250	.000	.250	

Location: Riverside
 N/S: Washington St
 E/W: Van Buren Blvd



Date: 9/17/2022
 Day Saturday

PEDESTRIANS

Time	North Leg Washington St	East Leg Van Buren Blvd	South Leg Washington St	West Leg Van Buren Blvd	TOTAL
11:00 AM	2	0	0	1	3
11:15 AM	1	0	0	1	2
11:30 AM	0	0	0	0	0
11:45 AM	0	1	0	0	1
12:00 PM	0	0	0	0	0
12:15 PM	0	0	0	0	0
12:30 PM	0	0	0	0	0
12:45 PM	0	0	0	0	0
1:00 PM	0	2	0	0	2
1:15 PM	0	0	0	0	0
1:30 PM	0	1	0	0	1
1:45 PM	1	1	1	0	3
TOTAL VOLUMES:	4	5	1	2	12

Location: Riverside
 N/S: Washington St
 E/W: Van Buren Blvd

Date: 9/17/2022
 Day: Saturday



BICYCLES

	Southbound Washington St			Westbound Van Buren Blvd			Northbound Washington St			Eastbound Van Buren Blvd			
	Left	Thru	Right	Left	Thru	Right	Left	Thru	Right	Left	Thru	Right	
11:00 AM	0	0	0	0	0	0	0	0	0	0	0	0	0
11:15 AM	0	0	0	0	0	0	0	0	0	0	1	0	1
11:30 AM	0	0	0	0	0	0	0	0	0	0	0	0	0
11:45 AM	0	0	0	0	0	0	0	0	0	0	0	0	0
12:00 PM	0	0	0	0	0	0	0	0	0	0	0	0	0
12:15 PM	0	1	0	0	1	0	0	0	0	0	0	0	2
12:30 PM	0	0	0	0	0	0	0	1	0	0	1	0	2
12:45 PM	0	0	0	0	0	0	0	0	0	0	0	0	0
1:00 PM	0	0	0	0	0	0	0	0	0	0	0	0	0
1:15 PM	0	0	0	0	0	0	0	0	0	0	0	0	0
1:30 PM	0	0	0	0	0	0	0	0	0	0	1	0	1
1:45 PM	0	0	0	0	1	0	0	0	0	0	0	0	1
TOTAL VOLUMES:	0	1	0	0	2	0	0	1	0	0	3	0	7

City of Riverside
 N/S: Alessandro Boulevard
 E/W: Arlington Ave/Chicago Ave
 Weather: Clear

File Name : 02_RIV_Ales_Arl Sat
 Site Code : 05122815
 Start Date : 9/17/2022
 Page No : 1

Groups Printed- Passenger Vehicles - Large 2 Axle Vehicles - 3 Axle Vehicles - 4+ Axle Trucks

Start Time	Alessandro Boulevard Southbound					Chicago Avenue Westbound					Alessandro Boulevard Northbound					Arlington Avenue Eastbound					Exclu. Total	Inclu. Total	Int. Total
	Left	Thru	Right	RTOR	App. Total	Left	Thru	Right	RTOR	App. Total	Left	Thru	Right	RTOR	App. Total	Left	Thru	Right	RTOR	App. Total			
11:00 AM	51	110	5	1	166	31	93	63	24	187	135	133	29	15	297	8	60	108	53	176	93	826	919
11:15 AM	59	149	4	0	212	28	90	42	21	160	120	159	39	12	318	1	64	77	51	142	84	832	916
11:30 AM	43	125	9	4	177	49	99	49	31	197	132	182	30	14	344	5	64	107	54	176	103	894	997
11:45 AM	56	156	4	1	216	44	97	49	29	190	143	191	36	18	370	5	69	103	53	177	101	953	1054
Total	209	540	22	6	771	152	379	203	105	734	530	665	134	59	1329	19	257	395	211	671	381	3505	3886
12:00 PM	59	159	9	0	227	50	89	36	22	175	152	145	33	15	330	7	83	114	56	204	93	936	1029
12:15 PM	54	205	11	1	270	35	111	53	28	199	134	191	45	12	370	4	74	101	48	179	89	1018	1107
12:30 PM	58	124	11	2	193	53	105	48	22	206	142	181	29	12	352	4	76	127	65	207	101	958	1059
12:45 PM	66	160	9	2	235	39	126	49	22	214	141	185	40	21	366	4	73	103	79	180	124	995	1119
Total	237	648	40	5	925	177	431	186	94	794	569	702	147	60	1418	19	306	445	248	770	407	3907	4314
01:00 PM	64	172	3	1	239	35	84	44	19	163	171	165	44	17	380	4	87	131	91	222	128	1004	1132
01:15 PM	49	187	9	4	245	42	105	37	23	184	171	144	36	12	351	4	81	140	59	225	98	1005	1103
01:30 PM	56	184	9	2	249	46	124	33	17	203	138	162	47	18	347	7	68	118	64	193	101	992	1093
01:45 PM	43	207	6	0	256	38	109	47	20	194	136	183	32	15	351	6	80	111	70	197	105	998	1103
Total	212	750	27	7	989	161	422	161	79	744	616	654	159	62	1429	21	316	500	284	837	432	3999	4431
Grand Total	658	1938	89	18	2685	490	1232	550	278	2272	1715	2021	440	181	4176	59	879	1340	743	2278	1220	11411	12631
Apprch %	24.5	72.2	3.3			21.6	54.2	24.2			41.1	48.4	10.5			2.6	38.6	58.8					
Total %	5.8	17	0.8		23.5	4.3	10.8	4.8		19.9	15	17.7	3.9		36.6	0.5	7.7	11.7		20	9.7	90.3	
Passenger Vehicles	654	1914	89		2675	480	1226	546		2528	1700	1989	432		4299	59	873	1326		2994	0	0	12496
% Passenger Vehicles	99.4	98.8	100	100	99	98	99.5	99.3	99.3	99.1	99.1	98.4	98.2	98.3	98.7	100	99.3	99	99.1	99.1	0	0	98.9
Large 2 Axle Vehicles	4	23	0		27	10	6	4		22	15	26	8		52	0	6	13		26	0	0	127
% Large 2 Axle Vehicles	0.6	1.2	0	0	1	2	0.5	0.7	0.7	0.9	0.9	1.3	1.8	1.7	1.2	0	0.7	1	0.9	0.9	0	0	1
3 Axle Vehicles	0	0	0		0	0	0	0		0	0	2	0		2	0	0	1		1	0	0	3
% 3 Axle Vehicles	0	0	0	0	0	0	0	0	0	0	0	0.1	0	0	0	0	0	0.1	0	0	0	0	0
4+ Axle Trucks	0	1	0		1	0	0	0		0	0	4	0		4	0	0	0		0	0	0	5
% 4+ Axle Trucks	0	0.1	0	0	0	0	0	0	0	0	0	0.2	0	0	0.1	0	0	0	0	0	0	0	0

City of Riverside
 N/S: Alessandro Boulevard
 E/W: Arlington Ave/Chicago Ave
 Weather: Clear

File Name : 02_RIV_Ales_Arl Sat
 Site Code : 05122815
 Start Date : 9/17/2022
 Page No : 2

Start Time	Alessandro Boulevard Southbound				Chicago Avenue Westbound				Alessandro Boulevard Northbound				Arlington Avenue Eastbound				Int. Total
	Left	Thru	Right	App. Total	Left	Thru	Right	App. Total	Left	Thru	Right	App. Total	Left	Thru	Right	App. Total	
Peak Hour Analysis From 11:00 AM to 01:45 PM - Peak 1 of 1																	
Peak Hour for Entire Intersection Begins at 01:00 PM																	
01:00 PM	64	172	3	239	35	84	44	163	171	165	44	380	4	87	131	222	1004
01:15 PM	49	187	9	245	42	105	37	184	171	144	36	351	4	81	140	225	1005
01:30 PM	56	184	9	249	46	124	33	203	138	162	47	347	7	68	118	193	992
01:45 PM	43	207	6	256	38	109	47	194	136	183	32	351	6	80	111	197	998
Total Volume	212	750	27	989	161	422	161	744	616	654	159	1429	21	316	500	837	3999
% App. Total	21.4	75.8	2.7		21.6	56.7	21.6		43.1	45.8	11.1		2.5	37.8	59.7		
PHF	.828	.906	.750	.966	.875	.851	.856	.916	.901	.893	.846	.940	.750	.908	.893	.930	.995

City of Riverside
 N/S: Alessandro Boulevard
 E/W: Arlington Ave/Chicago Ave
 Weather: Clear

File Name : 02_RIV_Ales_Arl Sat
 Site Code : 05122815
 Start Date : 9/17/2022
 Page No : 3

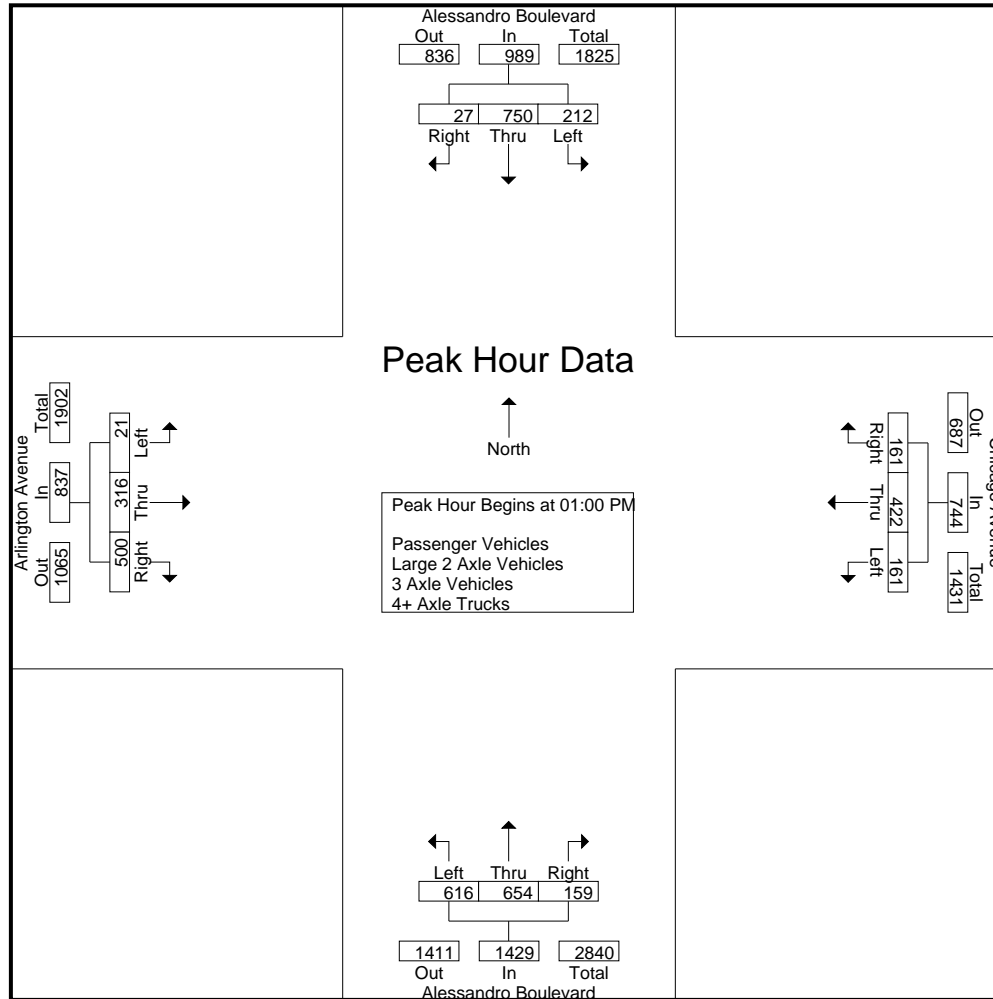

City of Riverside
 N/S: Alessandro Boulevard
 E/W: Arlington Ave/Chicago Ave
 Weather: Clear

File Name : 02_RIV_Ales_Arl Sat
 Site Code : 05122815
 Start Date : 9/17/2022
 Page No : 4

Start Time	Alessandro Boulevard Southbound				Chicago Avenue Westbound				Alessandro Boulevard Northbound				Arlington Avenue Eastbound				Int. Total
	Left	Thru	Right	App. Total	Left	Thru	Right	App. Total	Left	Thru	Right	App. Total	Left	Thru	Right	App. Total	
Peak Hour Analysis From 11:00 AM to 01:45 PM - Peak 1 of 1																	
Peak Hour for Each Approach Begins at:																	
	01:00 PM				12:00 PM				12:15 PM				01:00 PM				
+0 mins.	64	172	3	239	50	89	36	175	134	191	45	370	4	87	131	222	
+15 mins.	49	187	9	245	35	111	53	199	142	181	29	352	4	81	140	225	
+30 mins.	56	184	9	249	53	105	48	206	141	185	40	366	7	68	118	193	
+45 mins.	43	207	6	256	39	126	49	214	171	165	44	380	6	80	111	197	
Total Volume	212	750	27	989	177	431	186	794	588	722	158	1468	21	316	500	837	
% App. Total	21.4	75.8	2.7		22.3	54.3	23.4		40.1	49.2	10.8		2.5	37.8	59.7		
PHF	.828	.906	.750	.966	.835	.855	.877	.928	.860	.945	.878	.966	.750	.908	.893	.930	

City of Riverside
 N/S: Alessandro Boulevard
 E/W: Arlington Ave/Chicago Ave
 Weather: Clear

File Name : 02_RIV_Ales_Arl Sat
 Site Code : 05122815
 Start Date : 9/17/2022
 Page No : 1

Groups Printed- Passenger Vehicles

Start Time	Alessandro Boulevard Southbound					Chicago Avenue Westbound					Alessandro Boulevard Northbound					Arlington Avenue Eastbound					Exclu. Total	Inclu. Total	Int. Total
	Left	Thru	Right	RTOR	App. Total	Left	Thru	Right	RTOR	App. Total	Left	Thru	Right	RTOR	App. Total	Left	Thru	Right	RTOR	App. Total			
11:00 AM	51	110	5	1	166	29	93	62	24	184	133	132	28	15	293	8	60	105	51	173	91	816	907
11:15 AM	58	149	4	0	211	27	90	42	21	159	120	156	38	12	314	1	64	74	48	139	81	823	904
11:30 AM	43	123	9	4	175	47	99	49	31	195	130	182	29	13	341	5	64	104	54	173	102	884	986
11:45 AM	55	153	4	1	212	44	95	48	28	187	141	187	35	17	363	5	69	103	53	177	99	939	1038
Total	207	535	22	6	764	147	377	201	104	725	524	657	130	57	1311	19	257	386	206	662	373	3462	3835
12:00 PM	59	155	9	0	223	49	88	36	22	173	150	144	33	15	327	7	82	113	56	202	93	925	1018
12:15 PM	54	203	11	1	268	35	111	53	28	199	134	186	44	12	364	4	74	100	47	178	88	1009	1097
12:30 PM	58	123	11	2	192	52	104	48	22	204	141	180	29	12	350	4	76	126	64	206	100	952	1052
12:45 PM	65	160	9	2	234	38	125	49	22	212	140	180	39	20	359	4	72	103	79	179	123	984	1107
Total	236	641	40	5	917	174	428	186	94	788	565	690	145	59	1400	19	304	442	246	765	404	3870	4274
01:00 PM	63	170	3	1	236	35	83	44	19	162	169	162	44	17	375	4	87	131	91	222	128	995	1123
01:15 PM	49	184	9	4	242	41	105	36	22	182	170	138	35	12	343	4	80	140	59	224	97	991	1088
01:30 PM	56	181	9	2	246	45	124	33	17	202	136	162	47	18	345	7	67	116	64	190	101	983	1084
01:45 PM	43	203	6	0	252	38	109	46	20	193	136	180	31	15	347	6	78	111	70	195	105	987	1092
Total	211	738	27	7	976	159	421	159	78	739	611	642	157	62	1410	21	312	498	284	831	431	3956	4387
Grand Total	654	1914	89	18	2657	480	1226	546	276	2252	1700	1989	432	178	4121	59	873	1326	736	2258	1208	11288	12496
Apprch %	24.6	72	3.3			21.3	54.4	24.2			41.3	48.3	10.5			2.6	38.7	58.7					
Total %	5.8	17	0.8		23.5	4.3	10.9	4.8		20	15.1	17.6	3.8		36.5	0.5	7.7	11.7		20	9.7	90.3	

Start Time	Alessandro Boulevard Southbound				Chicago Avenue Westbound				Alessandro Boulevard Northbound				Arlington Avenue Eastbound				Int. Total
	Left	Thru	Right	App. Total	Left	Thru	Right	App. Total	Left	Thru	Right	App. Total	Left	Thru	Right	App. Total	
Peak Hour Analysis From 01:00 PM to 01:45 PM - Peak 1 of 1																	
Peak Hour for Entire Intersection Begins at 01:00 PM																	
01:00 PM	63	170	3	236	35	83	44	162	169	162	44	375	4	87	131	222	995
01:15 PM	49	184	9	242	41	105	36	182	170	138	35	343	4	80	140	224	991
01:30 PM	56	181	9	246	45	124	33	202	136	162	47	345	7	67	116	190	983
01:45 PM	43	203	6	252	38	109	46	193	136	180	31	347	6	78	111	195	987
Total Volume	211	738	27	976	159	421	159	739	611	642	157	1410	21	312	498	831	3956
% App. Total	21.6	75.6	2.8		21.5	57	21.5		43.3	45.5	11.1		2.5	37.5	59.9		
PHF	.837	.909	.750	.968	.883	.849	.864	.915	.899	.892	.835	.940	.750	.897	.889	.927	.994

City of Riverside
 N/S: Alessandro Boulevard
 E/W: Arlington Ave/Chicago Ave
 Weather: Clear

File Name : 02_RIV_Ales_Arl Sat
 Site Code : 05122815
 Start Date : 9/17/2022
 Page No : 2

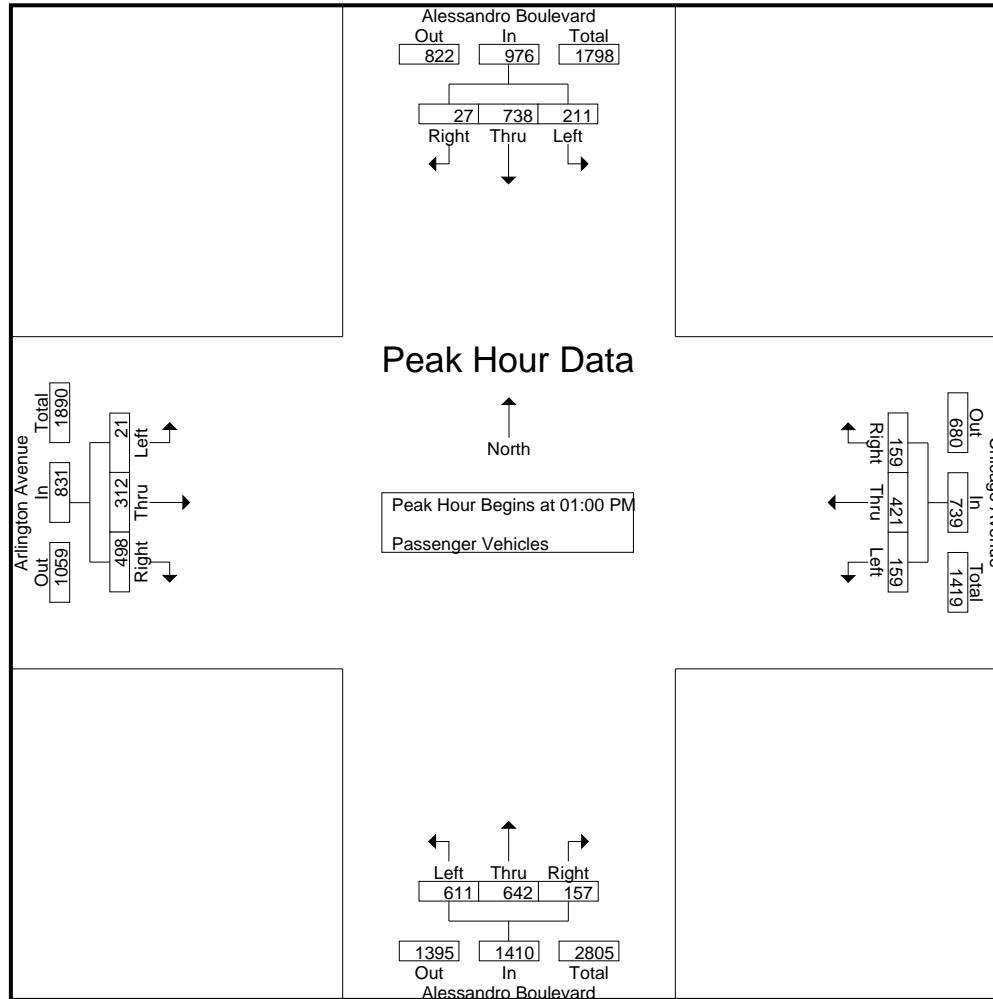

City of Riverside
 N/S: Alessandro Boulevard
 E/W: Arlington Ave/Chicago Ave
 Weather: Clear

File Name : 02_RIV_Ales_Arl Sat
 Site Code : 05122815
 Start Date : 9/17/2022
 Page No : 3

Start Time	Alessandro Boulevard Southbound				Chicago Avenue Westbound				Alessandro Boulevard Northbound				Arlington Avenue Eastbound				Int. Total
	Left	Thru	Right	App. Total	Left	Thru	Right	App. Total	Left	Thru	Right	App. Total	Left	Thru	Right	App. Total	
Peak Hour Analysis From 01:00 PM to 01:45 PM - Peak 1 of 1																	
Peak Hour for Each Approach Begins at:																	
	01:00 PM				01:00 PM				01:00 PM				01:00 PM				
+0 mins.	63	170	3	236	35	83	44	162	169	162	44	375	4	87	131	222	
+15 mins.	49	184	9	242	41	105	36	182	170	138	35	343	4	80	140	224	
+30 mins.	56	181	9	246	45	124	33	202	136	162	47	345	7	67	116	190	
+45 mins.	43	203	6	252	38	109	46	193	136	180	31	347	6	78	111	195	
Total Volume	211	738	27	976	159	421	159	739	611	642	157	1410	21	312	498	831	
% App. Total	21.6	75.6	2.8		21.5	57	21.5		43.3	45.5	11.1		2.5	37.5	59.9		
PHF	.837	.909	.750	.968	.883	.849	.864	.915	.899	.892	.835	.940	.750	.897	.889	.927	

City of Riverside
 N/S: Alessandro Boulevard
 E/W: Arlington Ave/Chicago Ave
 Weather: Clear

File Name : 02_RIV_Ales_Arl Sat
 Site Code : 05122815
 Start Date : 9/17/2022
 Page No : 1

Groups Printed- Large 2 Axle Vehicles

Start Time	Alessandro Boulevard Southbound					Chicago Avenue Westbound					Alessandro Boulevard Northbound					Arlington Avenue Eastbound					Exclu. Total	Inclu. Total	Int. Total
	Left	Thru	Right	RTOR	App. Total	Left	Thru	Right	RTOR	App. Total	Left	Thru	Right	RTOR	App. Total	Left	Thru	Right	RTOR	App. Total			
11:00 AM	0	0	0	0	0	2	0	1	0	3	2	1	1	0	4	0	0	3	2	3	2	10	12
11:15 AM	1	0	0	0	1	1	0	0	0	1	0	3	1	0	4	0	0	3	3	3	3	9	12
11:30 AM	0	2	0	0	2	2	0	0	0	2	2	0	1	1	3	0	0	2	0	2	1	9	10
11:45 AM	1	3	0	0	4	0	2	1	1	3	2	4	1	1	7	0	0	0	0	0	2	14	16
Total	2	5	0	0	7	5	2	2	1	9	6	8	4	2	18	0	0	8	5	8	8	42	50
12:00 PM	0	4	0	0	4	1	1	0	0	2	2	0	0	0	2	0	1	1	0	2	0	10	10
12:15 PM	0	2	0	0	2	0	0	0	0	0	0	4	1	0	5	0	0	1	1	1	1	8	9
12:30 PM	0	1	0	0	1	1	1	0	0	2	1	0	0	0	1	0	0	1	1	1	1	5	6
12:45 PM	1	0	0	0	1	1	1	0	0	2	1	4	1	1	6	0	1	0	0	1	1	10	11
Total	1	7	0	0	8	3	3	0	0	6	4	8	2	1	14	0	2	3	2	5	3	33	36
01:00 PM	1	2	0	0	3	0	1	0	0	1	2	2	0	0	4	0	0	0	0	0	0	8	8
01:15 PM	0	3	0	0	3	1	0	1	1	2	1	5	1	0	7	0	1	0	0	1	1	13	14
01:30 PM	0	3	0	0	3	1	0	0	0	1	2	0	0	0	2	0	1	2	0	3	0	9	9
01:45 PM	0	3	0	0	3	0	0	1	0	1	0	3	1	0	4	0	2	0	0	2	0	10	10
Total	1	11	0	0	12	2	1	2	1	5	5	10	2	0	17	0	4	2	0	6	1	40	41
Grand Total	4	23	0	0	27	10	6	4	2	20	15	26	8	3	49	0	6	13	7	19	12	115	127
Apprch %	14.8	85.2	0			50	30	20			30.6	53.1	16.3			0	31.6	68.4					
Total %	3.5	20	0		23.5	8.7	5.2	3.5		17.4	13	22.6	7		42.6	0	5.2	11.3		16.5	9.4	90.6	

Start Time	Alessandro Boulevard Southbound				Chicago Avenue Westbound				Alessandro Boulevard Northbound				Arlington Avenue Eastbound				Int. Total
	Left	Thru	Right	App. Total	Left	Thru	Right	App. Total	Left	Thru	Right	App. Total	Left	Thru	Right	App. Total	
Peak Hour Analysis From 01:00 PM to 01:45 PM - Peak 1 of 1																	
Peak Hour for Entire Intersection Begins at 01:00 PM																	
01:00 PM	1	2	0	3	0	1	0	1	2	2	0	4	0	0	0	0	8
01:15 PM	0	3	0	3	1	0	1	2	1	5	1	7	0	1	0	1	13
01:30 PM	0	3	0	3	1	0	0	1	2	0	0	2	0	1	2	3	9
01:45 PM	0	3	0	3	0	0	1	1	0	3	1	4	0	2	0	2	10
Total Volume	1	11	0	12	2	1	2	5	5	10	2	17	0	4	2	6	40
% App. Total	8.3	91.7	0		40	20	40		29.4	58.8	11.8		0	66.7	33.3		
PHF	.250	.917	.000	1.00	.500	.250	.500	.625	.625	.500	.500	.607	.000	.500	.250	.500	.769

City of Riverside
 N/S: Alessandro Boulevard
 E/W: Arlington Ave/Chicago Ave
 Weather: Clear

File Name : 02_RIV_Ales_Arl Sat
 Site Code : 05122815
 Start Date : 9/17/2022
 Page No : 2

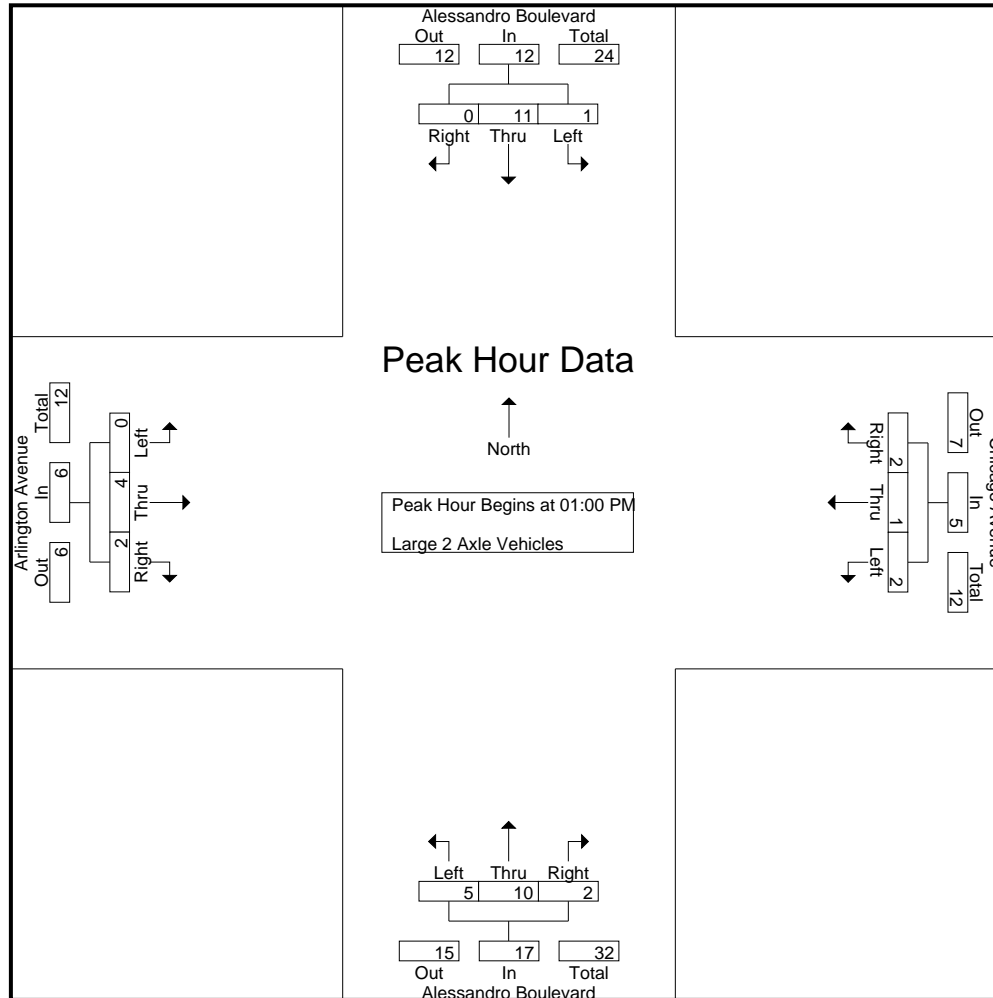

City of Riverside
 N/S: Alessandro Boulevard
 E/W: Arlington Ave/Chicago Ave
 Weather: Clear

File Name : 02_RIV_Ales_Arl Sat
 Site Code : 05122815
 Start Date : 9/17/2022
 Page No : 3

Start Time	Alessandro Boulevard Southbound				Chicago Avenue Westbound				Alessandro Boulevard Northbound				Arlington Avenue Eastbound				Int. Total
	Left	Thru	Right	App. Total	Left	Thru	Right	App. Total	Left	Thru	Right	App. Total	Left	Thru	Right	App. Total	
Peak Hour Analysis From 01:00 PM to 01:45 PM - Peak 1 of 1																	
Peak Hour for Each Approach Begins at:																	
	01:00 PM				01:00 PM				01:00 PM				01:00 PM				
+0 mins.	1	2	0	3	0	1	0	1	2	2	0	4	0	0	0	0	
+15 mins.	0	3	0	3	1	0	1	2	1	5	1	7	0	1	0	1	
+30 mins.	0	3	0	3	1	0	0	1	2	0	0	2	0	1	2	3	
+45 mins.	0	3	0	3	0	0	1	1	0	3	1	4	0	2	0	2	
Total Volume	1	11	0	12	2	1	2	5	5	10	2	17	0	4	2	6	
% App. Total	8.3	91.7	0		40	20	40		29.4	58.8	11.8		0	66.7	33.3		
PHF	.250	.917	.000	1.000	.500	.250	.500	.625	.625	.500	.500	.607	.000	.500	.250	.500	

City of Riverside
 N/S: Alessandro Boulevard
 E/W: Arlington Ave/Chicago Ave
 Weather: Clear

File Name : 02_RIV_Ales_Arl Sat
 Site Code : 05122815
 Start Date : 9/17/2022
 Page No : 1

Groups Printed- 3 Axle Vehicles

Start Time	Alessandro Boulevard Southbound					Chicago Avenue Westbound					Alessandro Boulevard Northbound					Arlington Avenue Eastbound					Exclu. Total	Inclu. Total	Int. Total					
	Left	Thru	Right	RTOR	App. Total	Left	Thru	Right	RTOR	App. Total	Left	Thru	Right	RTOR	App. Total	Left	Thru	Right	RTOR	App. Total								
11:00 AM	0	0	0	0	0	0	0	0	0	0	0	0	0	0	0	0	0	0	0	0	0	0	0	0	0	0	0	0
11:15 AM	0	0	0	0	0	0	0	0	0	0	0	0	0	0	0	0	0	0	0	0	0	0	0	0	0	0	0	0
11:30 AM	0	0	0	0	0	0	0	0	0	0	0	0	0	0	0	0	0	1	0	1	0	0	1	0	1	0	1	1
11:45 AM	0	0	0	0	0	0	0	0	0	0	0	0	0	0	0	0	0	0	0	0	0	0	0	0	0	0	0	0
Total	0	0	0	0	0	0	0	0	0	0	0	0	0	0	0	0	0	1	0	1	0	0	1	0	1	0	1	1
12:00 PM	0	0	0	0	0	0	0	0	0	0	0	0	0	0	0	0	0	0	0	0	0	0	0	0	0	0	0	0
12:15 PM	0	0	0	0	0	0	0	0	0	0	0	0	0	0	0	0	0	0	0	0	0	0	0	0	0	0	0	0
12:30 PM	0	0	0	0	0	0	0	0	0	0	0	1	0	0	1	0	0	0	0	0	0	0	0	0	0	0	1	1
12:45 PM	0	0	0	0	0	0	0	0	0	0	0	0	0	0	0	0	0	0	0	0	0	0	0	0	0	0	0	0
Total	0	0	0	0	0	0	0	0	0	0	0	1	0	0	1	0	0	0	0	0	0	0	0	0	0	0	1	1
01:00 PM	0	0	0	0	0	0	0	0	0	0	0	1	0	0	1	0	0	0	0	0	0	0	0	0	0	0	1	1
01:15 PM	0	0	0	0	0	0	0	0	0	0	0	0	0	0	0	0	0	0	0	0	0	0	0	0	0	0	0	0
01:30 PM	0	0	0	0	0	0	0	0	0	0	0	0	0	0	0	0	0	0	0	0	0	0	0	0	0	0	0	0
01:45 PM	0	0	0	0	0	0	0	0	0	0	0	0	0	0	0	0	0	0	0	0	0	0	0	0	0	0	0	0
Total	0	0	0	0	0	0	0	0	0	0	0	1	0	0	1	0	0	0	0	0	0	0	0	0	0	0	1	1
Grand Total	0	0	0	0	0	0	0	0	0	0	0	2	0	0	2	0	0	1	0	1	0	0	1	0	1	0	3	3
Apprch %	0	0	0			0	0	0			0	100	0			0	0	100										
Total %	0	0	0			0	0	0			0	66.7	0		66.7	0	0	33.3		33.3						0	100	

Start Time	Alessandro Boulevard Southbound				Chicago Avenue Westbound				Alessandro Boulevard Northbound				Arlington Avenue Eastbound				Int. Total
	Left	Thru	Right	App. Total	Left	Thru	Right	App. Total	Left	Thru	Right	App. Total	Left	Thru	Right	App. Total	
Peak Hour Analysis From 01:00 PM to 01:45 PM - Peak 1 of 1																	
Peak Hour for Entire Intersection Begins at 01:00 PM																	
01:00 PM	0	0	0	0	0	0	0	0	0	1	0	1	0	0	0	0	1
01:15 PM	0	0	0	0	0	0	0	0	0	0	0	0	0	0	0	0	0
01:30 PM	0	0	0	0	0	0	0	0	0	0	0	0	0	0	0	0	0
01:45 PM	0	0	0	0	0	0	0	0	0	0	0	0	0	0	0	0	0
Total Volume	0	0	0	0	0	0	0	0	0	1	0	1	0	0	0	0	1
% App. Total	0	0	0		0	0	0		0	100	0		0	0	0		
PHF	.000	.000	.000	.000	.000	.000	.000	.000	.000	.250	.000	.250	.000	.000	.000	.000	.250

City of Riverside
 N/S: Alessandro Boulevard
 E/W: Arlington Ave/Chicago Ave
 Weather: Clear

File Name : 02_RIV_Ales_Arl Sat
 Site Code : 05122815
 Start Date : 9/17/2022
 Page No : 2

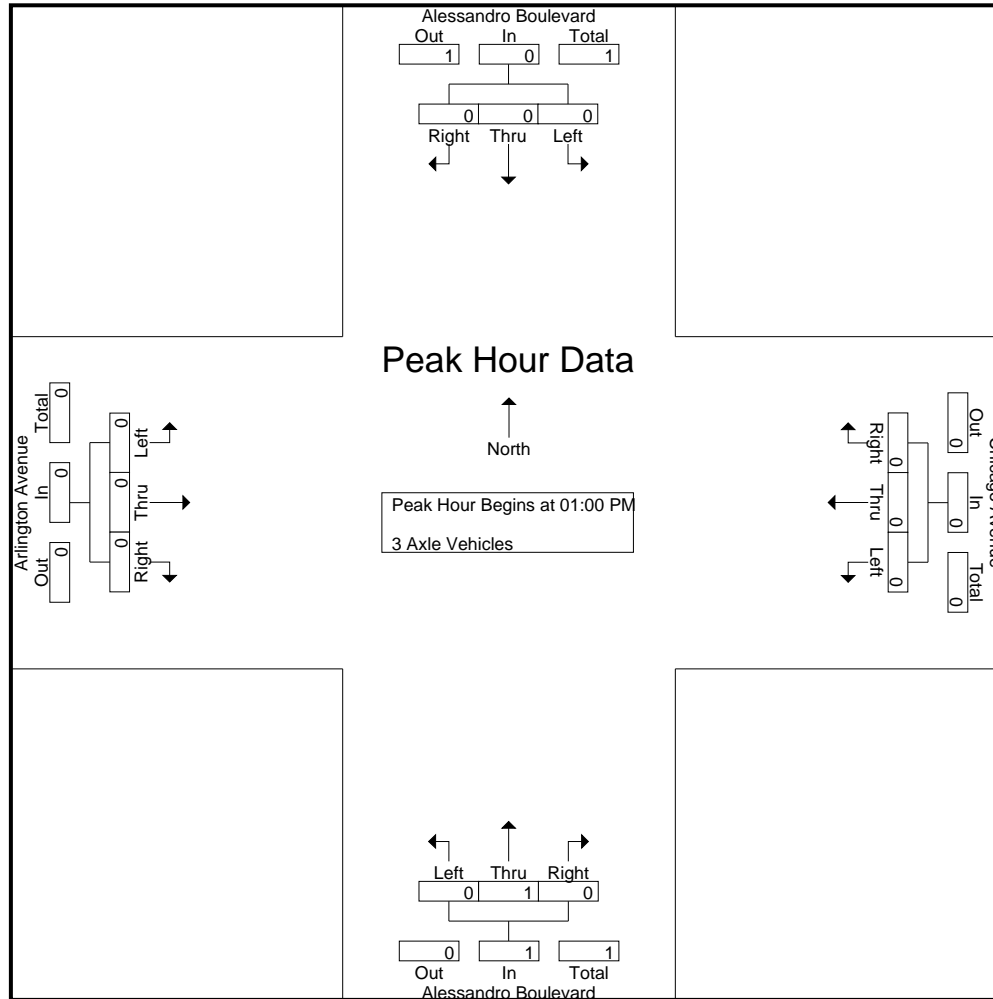

City of Riverside
 N/S: Alessandro Boulevard
 E/W: Arlington Ave/Chicago Ave
 Weather: Clear

File Name : 02_RIV_Ales_Arl Sat
 Site Code : 05122815
 Start Date : 9/17/2022
 Page No : 3

Start Time	Alessandro Boulevard Southbound				Chicago Avenue Westbound				Alessandro Boulevard Northbound				Arlington Avenue Eastbound				Int. Total
	Left	Thru	Right	App. Total	Left	Thru	Right	App. Total	Left	Thru	Right	App. Total	Left	Thru	Right	App. Total	
Peak Hour Analysis From 01:00 PM to 01:45 PM - Peak 1 of 1																	
Peak Hour for Each Approach Begins at:																	
	01:00 PM				01:00 PM				01:00 PM				01:00 PM				
+0 mins.	0	0	0	0	0	0	0	0	0	1	0	1	0	0	0	0	0
+15 mins.	0	0	0	0	0	0	0	0	0	0	0	0	0	0	0	0	0
+30 mins.	0	0	0	0	0	0	0	0	0	0	0	0	0	0	0	0	0
+45 mins.	0	0	0	0	0	0	0	0	0	0	0	0	0	0	0	0	0
Total Volume	0	0	0	0	0	0	0	0	0	1	0	1	0	0	0	0	0
% App. Total	0	0	0	0	0	0	0	0	0	100	0	0	0	0	0	0	0
PHF	.000	.000	.000	.000	.000	.000	.000	.000	.000	.250	.000	.250	.000	.000	.000	.000	.000

City of Riverside
 N/S: Alessandro Boulevard
 E/W: Arlington Ave/Chicago Ave
 Weather: Clear

File Name : 02_RIV_Ales_Arl Sat
 Site Code : 05122815
 Start Date : 9/17/2022
 Page No : 1

Groups Printed- 4+ Axle Trucks

Start Time	Alessandro Boulevard Southbound					Chicago Avenue Westbound					Alessandro Boulevard Northbound					Arlington Avenue Eastbound					Exclu. Total	Inclu. Total	Int. Total					
	Left	Thru	Right	RTOR	App. Total	Left	Thru	Right	RTOR	App. Total	Left	Thru	Right	RTOR	App. Total	Left	Thru	Right	RTOR	App. Total								
11:00 AM	0	0	0	0	0	0	0	0	0	0	0	0	0	0	0	0	0	0	0	0	0	0	0	0	0	0	0	0
11:15 AM	0	0	0	0	0	0	0	0	0	0	0	0	0	0	0	0	0	0	0	0	0	0	0	0	0	0	0	0
11:30 AM	0	0	0	0	0	0	0	0	0	0	0	0	0	0	0	0	0	0	0	0	0	0	0	0	0	0	0	0
11:45 AM	0	0	0	0	0	0	0	0	0	0	0	0	0	0	0	0	0	0	0	0	0	0	0	0	0	0	0	0
Total	0	0	0	0	0	0	0	0	0	0	0	0	0	0	0	0	0	0	0	0	0	0	0	0	0	0	0	0
12:00 PM	0	0	0	0	0	0	0	0	0	0	0	1	0	0	1	0	0	0	0	0	0	0	0	0	0	0	1	1
12:15 PM	0	0	0	0	0	0	0	0	0	0	0	1	0	0	1	0	0	0	0	0	0	0	0	0	0	0	1	1
12:30 PM	0	0	0	0	0	0	0	0	0	0	0	0	0	0	0	0	0	0	0	0	0	0	0	0	0	0	0	0
12:45 PM	0	0	0	0	0	0	0	0	0	0	0	1	0	0	1	0	0	0	0	0	0	0	0	0	0	0	1	1
Total	0	0	0	0	0	0	0	0	0	0	0	3	0	0	3	0	0	0	0	0	0	0	0	0	0	0	3	3
01:00 PM	0	0	0	0	0	0	0	0	0	0	0	0	0	0	0	0	0	0	0	0	0	0	0	0	0	0	0	0
01:15 PM	0	0	0	0	0	0	0	0	0	0	0	1	0	0	1	0	0	0	0	0	0	0	0	0	0	0	1	1
01:30 PM	0	0	0	0	0	0	0	0	0	0	0	0	0	0	0	0	0	0	0	0	0	0	0	0	0	0	0	0
01:45 PM	0	1	0	0	1	0	0	0	0	0	0	0	0	0	0	0	0	0	0	0	0	0	0	0	0	0	1	1
Total	0	1	0	0	1	0	0	0	0	0	0	1	0	0	1	0	0	0	0	0	0	0	0	0	0	0	2	2
Grand Total	0	1	0	0	1	0	0	0	0	0	0	4	0	0	4	0	0	0	0	0	0	0	0	0	0	0	5	5
Apprch %	0	100	0			0	0	0			0	100	0			0	0	0			0	0	0			0		
Total %	0	20	0		20	0	0	0		0	0	80	0		80	0	0	0		0	0	0	0		0	0	100	

Start Time	Alessandro Boulevard Southbound				Chicago Avenue Westbound				Alessandro Boulevard Northbound				Arlington Avenue Eastbound				Int. Total				
	Left	Thru	Right	App. Total	Left	Thru	Right	App. Total	Left	Thru	Right	App. Total	Left	Thru	Right	App. Total					
Peak Hour Analysis From 01:00 PM to 01:45 PM - Peak 1 of 1																					
Peak Hour for Entire Intersection Begins at 01:00 PM																					
01:00 PM	0	0	0	0	0	0	0	0	0	0	0	0	0	0	0	0	0	0	0	0	0
01:15 PM	0	0	0	0	0	0	0	0	0	1	0	1	0	0	0	0	0	0	0	0	1
01:30 PM	0	0	0	0	0	0	0	0	0	0	0	0	0	0	0	0	0	0	0	0	0
01:45 PM	0	1	0	1	0	0	0	0	0	0	0	0	0	0	0	0	0	0	0	0	1
Total Volume	0	1	0	1	0	0	0	0	0	1	0	1	0	0	0	0	0	0	0	0	2
% App. Total	0	100	0		0	0	0		0	100	0		0	0	0		0	0	0		
PHF	.000	.250	.000	.250	.000	.000	.000	.000	.000	.250	.000	.250	.000	.000	.000	.000	.000	.000	.000	.000	.500

City of Riverside
 N/S: Alessandro Boulevard
 E/W: Arlington Ave/Chicago Ave
 Weather: Clear

File Name : 02_RIV_Ales_Arl Sat
 Site Code : 05122815
 Start Date : 9/17/2022
 Page No : 2

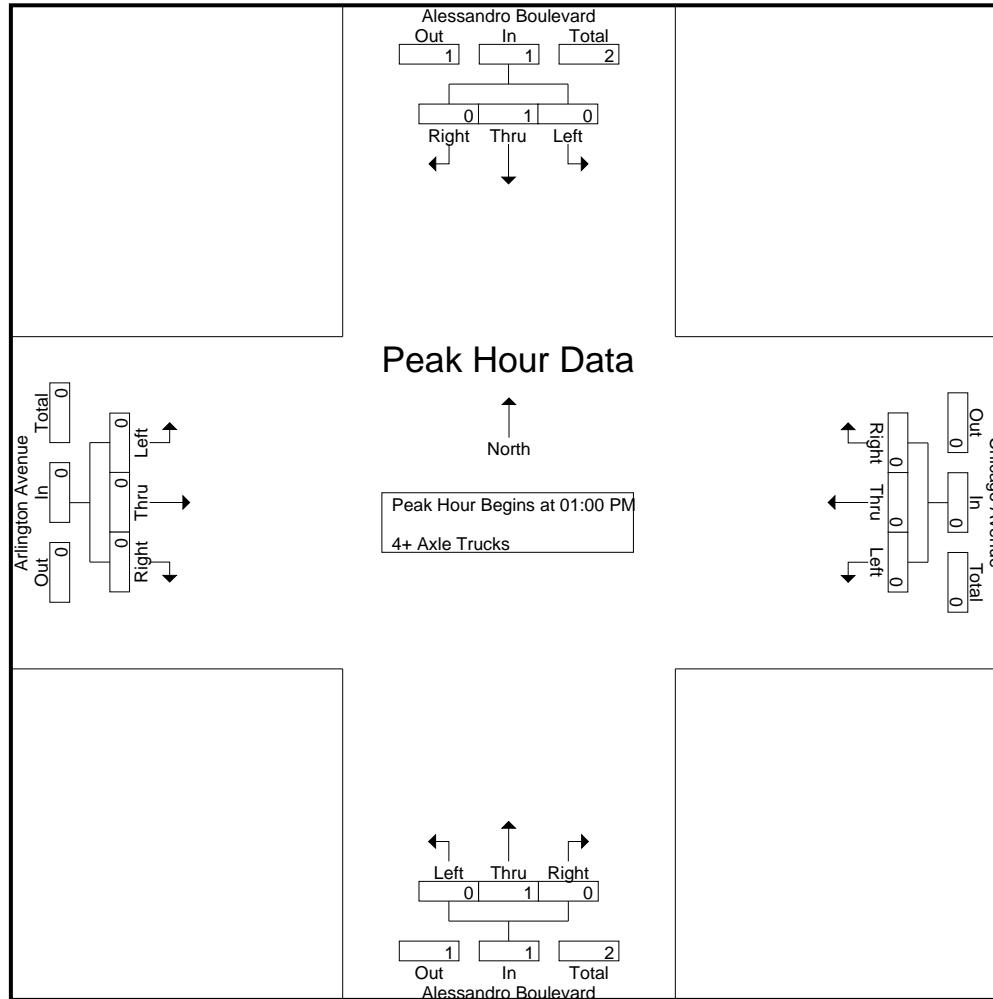

City of Riverside
 N/S: Alessandro Boulevard
 E/W: Arlington Ave/Chicago Ave
 Weather: Clear

File Name : 02_RIV_Ales_Arl Sat
 Site Code : 05122815
 Start Date : 9/17/2022
 Page No : 3

Start Time	Alessandro Boulevard Southbound				Chicago Avenue Westbound				Alessandro Boulevard Northbound				Arlington Avenue Eastbound				Int. Total
	Left	Thru	Right	App. Total	Left	Thru	Right	App. Total	Left	Thru	Right	App. Total	Left	Thru	Right	App. Total	
Peak Hour Analysis From 01:00 PM to 01:45 PM - Peak 1 of 1																	
Peak Hour for Each Approach Begins at:																	
	01:00 PM				01:00 PM				01:00 PM				01:00 PM				
+0 mins.	0	0	0	0	0	0	0	0	0	0	0	0	0	0	0	0	
+15 mins.	0	0	0	0	0	0	0	0	0	1	0	1	0	0	0	0	
+30 mins.	0	0	0	0	0	0	0	0	0	0	0	0	0	0	0	0	
+45 mins.	0	1	0	1	0	0	0	0	0	0	0	0	0	0	0	0	
Total Volume	0	1	0	1	0	0	0	0	0	1	0	1	0	0	0	0	
% App. Total	0	100	0		0	0	0		0	100	0		0	0	0		
PHF	.000	.250	.000	.250	.000	.000	.000	.000	.000	.250	.000	.250	.000	.000	.000	.000	

Location: Riverside
 N/S: Alessandro Blvd
 E/W: Arlington Ave/Chicago Ave



Date: 9/17/2022
 Day Saturday

PEDESTRIANS

Time	North Leg Alessandro Blvd	East Leg Chicago Avenue	South Leg Alessandro Blvd	West Leg Arlington Avenue	TOTAL
11:00 AM	0	1	0	0	1
11:15 AM	0	0	0	0	0
11:30 AM	0	0	0	0	0
11:45 AM	0	0	0	0	0
12:00 PM	0	0	0	0	0
12:15 PM	0	0	0	1	1
12:30 PM	0	0	0	0	0
12:45 PM	0	0	0	0	0
1:00 PM	0	0	0	0	0
1:15 PM	0	0	0	0	0
1:30 PM	0	0	0	0	0
1:45 PM	0	0	0	0	0
TOTAL VOLUMES:	0	1	0	1	2

Location: Riverside
 N/S: Alessandro Blvd
 E/W: Arlington Ave/Chicago Ave

Date: 9/17/2022
 Day: Saturday



BICYCLES

	Southbound Alessandro Blvd			Westbound Chicago Avenue			Northbound Alessandro Blvd			Eastbound Arlington Avenue			
	Left	Thru	Right	Left	Thru	Right	Left	Thru	Right	Left	Thru	Right	
11:00 AM	0	0	0	0	2	0	0	1	0	0	0	0	3
11:15 AM	0	0	1	0	0	0	0	0	0	1	1	0	3
11:30 AM	0	0	0	0	0	0	0	0	0	0	0	0	0
11:45 AM	0	0	0	0	0	0	0	0	0	0	0	0	0
12:00 PM	0	0	0	0	0	0	0	0	0	0	0	0	0
12:15 PM	0	0	0	0	0	0	0	0	0	0	0	0	0
12:30 PM	1	0	0	0	0	0	0	0	0	0	0	0	1
12:45 PM	0	0	0	0	0	0	0	0	0	0	0	0	0
1:00 PM	0	0	0	0	0	0	0	0	0	0	0	0	0
1:15 PM	0	1	0	0	0	0	0	0	0	0	0	0	1
1:30 PM	0	0	0	0	0	0	0	0	0	0	0	0	0
1:45 PM	0	0	0	0	0	0	0	0	0	0	0	0	0
TOTAL VOLUMES:	1	1	1	0	2	0	0	1	0	1	1	0	8

City of Riverside
 N/S: Canyon Crest Dr/Overlook Pkwy
 E/W: Alessandro Boulevard
 Weather: Clear

File Name : 03_RIV_Cyn C_Ales Sat
 Site Code : 05122815
 Start Date : 9/17/2022
 Page No : 1

Groups Printed- Passenger Vehicles - Large 2 Axle Vehicles - 3 Axle Vehicles - 4+ Axle Trucks

Start Time	Canyon Crest Drive Southbound					Alessandro Boulevard Westbound					Overlook Parkway Northbound					Alessandro Boulevard Eastbound					Exclu. Total	Inclu. Total	Int. Total
	Left	Thru	Right	RTOR	App. Total	Left	Thru	Right	RTOR	App. Total	Left	Thru	Right	RTOR	App. Total	Left	Thru	Right	RTOR	App. Total			
11:00 AM	69	1	3	1	73	4	282	78	21	364	1	3	4	2	8	5	242	1	0	248	24	693	717
11:15 AM	81	3	6	4	90	2	264	104	24	370	2	1	2	1	5	7	273	3	0	283	29	748	777
11:30 AM	63	5	11	3	79	4	339	91	26	434	1	2	1	1	4	4	244	3	0	251	30	768	798
11:45 AM	65	1	7	3	73	0	332	87	23	419	4	2	2	2	8	9	300	1	0	310	28	810	838
Total	278	10	27	11	315	10	1217	360	94	1587	8	8	9	6	25	25	1059	8	0	1092	111	3019	3130
12:00 PM	78	3	11	7	92	2	300	95	31	397	4	1	1	1	6	14	294	2	0	310	39	805	844
12:15 PM	81	2	9	3	92	0	347	90	15	437	1	1	1	0	3	4	307	1	0	312	18	844	862
12:30 PM	79	2	10	8	91	1	320	85	13	406	4	0	0	0	4	4	268	3	1	275	22	776	798
12:45 PM	62	2	5	5	69	2	368	93	26	463	3	2	4	3	9	10	298	2	0	310	34	851	885
Total	300	9	35	23	344	5	1335	363	85	1703	12	4	6	4	22	32	1167	8	1	1207	113	3276	3389
01:00 PM	72	1	8	5	81	1	383	101	32	485	2	0	1	0	3	10	297	3	0	310	37	879	916
01:15 PM	74	0	1	1	75	2	330	95	11	427	3	2	3	2	8	9	311	2	0	322	14	832	846
01:30 PM	70	4	3	3	77	2	333	106	18	441	3	1	4	4	8	7	336	5	0	348	25	874	899
01:45 PM	88	1	6	5	95	2	341	91	17	434	2	3	3	2	8	7	312	3	0	322	24	859	883
Total	304	6	18	14	328	7	1387	393	78	1787	10	6	11	8	27	33	1256	13	0	1302	100	3444	3544
Grand Total	882	25	80	48	987	22	3939	1116	257	5077	30	18	26	18	74	90	3482	29	1	3601	324	9739	10063
Apprch %	89.4	2.5	8.1			0.4	77.6	22			40.5	24.3	35.1			2.5	96.7	0.8					
Total %	9.1	0.3	0.8		10.1	0.2	40.4	11.5		52.1	0.3	0.2	0.3		0.8	0.9	35.8	0.3		37	3.2	96.8	
Passenger Vehicles	868	25	77		1016	22	3874	1099		5249	29	18	25		90	89	3436	28		3554	0	0	9909
% Passenger Vehicles	98.4	100	96.2	95.8	98.2	100	98.3	98.5	98.8	98.4	96.7	100	96.2	100	97.8	98.9	98.7	96.6	100	98.7	0	0	98.5
Large 2 Axle Vehicles	12	0	3		17	0	61	16		80	1	0	1		2	1	45	1		47	0	0	146
% Large 2 Axle Vehicles	1.4	0	3.8	4.2	1.6	0	1.5	1.4	1.2	1.5	3.3	0	3.8	0	2.2	1.1	1.3	3.4	0	1.3	0	0	1.5
3 Axle Vehicles	2	0	0		2	0	2	1		3	0	0	0		0	0	1	0		1	0	0	6
% 3 Axle Vehicles	0.2	0	0	0	0.2	0	0.1	0.1	0	0.1	0	0	0	0	0	0	0	0	0	0	0	0	0.1
4+ Axle Trucks	0	0	0		0	0	2	0		2	0	0	0		0	0	0	0		0	0	0	2
% 4+ Axle Trucks	0	0	0	0	0	0	0.1	0	0	0	0	0	0	0	0	0	0	0	0	0	0	0	0

City of Riverside
 N/S: Canyon Crest Dr/Overlook Pkwy
 E/W: Alessandro Boulevard
 Weather: Clear

File Name : 03_RIV_Cyn C_Ales Sat
 Site Code : 05122815
 Start Date : 9/17/2022
 Page No : 2

Start Time	Canyon Crest Drive Southbound				Alessandro Boulevard Westbound				Overlook Parkway Northbound				Alessandro Boulevard Eastbound				Int. Total
	Left	Thru	Right	App. Total	Left	Thru	Right	App. Total	Left	Thru	Right	App. Total	Left	Thru	Right	App. Total	
Peak Hour Analysis From 11:00 AM to 01:45 PM - Peak 1 of 1																	
Peak Hour for Entire Intersection Begins at 01:00 PM																	
01:00 PM	72	1	8	81	1	383	101	485	2	0	1	3	10	297	3	310	879
01:15 PM	74	0	1	75	2	330	95	427	3	2	3	8	9	311	2	322	832
01:30 PM	70	4	3	77	2	333	106	441	3	1	4	8	7	336	5	348	874
01:45 PM	88	1	6	95	2	341	91	434	2	3	3	8	7	312	3	322	859
Total Volume	304	6	18	328	7	1387	393	1787	10	6	11	27	33	1256	13	1302	3444
% App. Total	92.7	1.8	5.5		0.4	77.6	22		37	22.2	40.7		2.5	96.5	1		
PHF	.864	.375	.563	.863	.875	.905	.927	.921	.833	.500	.688	.844	.825	.935	.650	.935	.980

City of Riverside
 N/S: Canyon Crest Dr/Overlook Pkwy
 E/W: Alessandro Boulevard
 Weather: Clear

File Name : 03_RIV_Cyn C_Ales Sat
 Site Code : 05122815
 Start Date : 9/17/2022
 Page No : 3

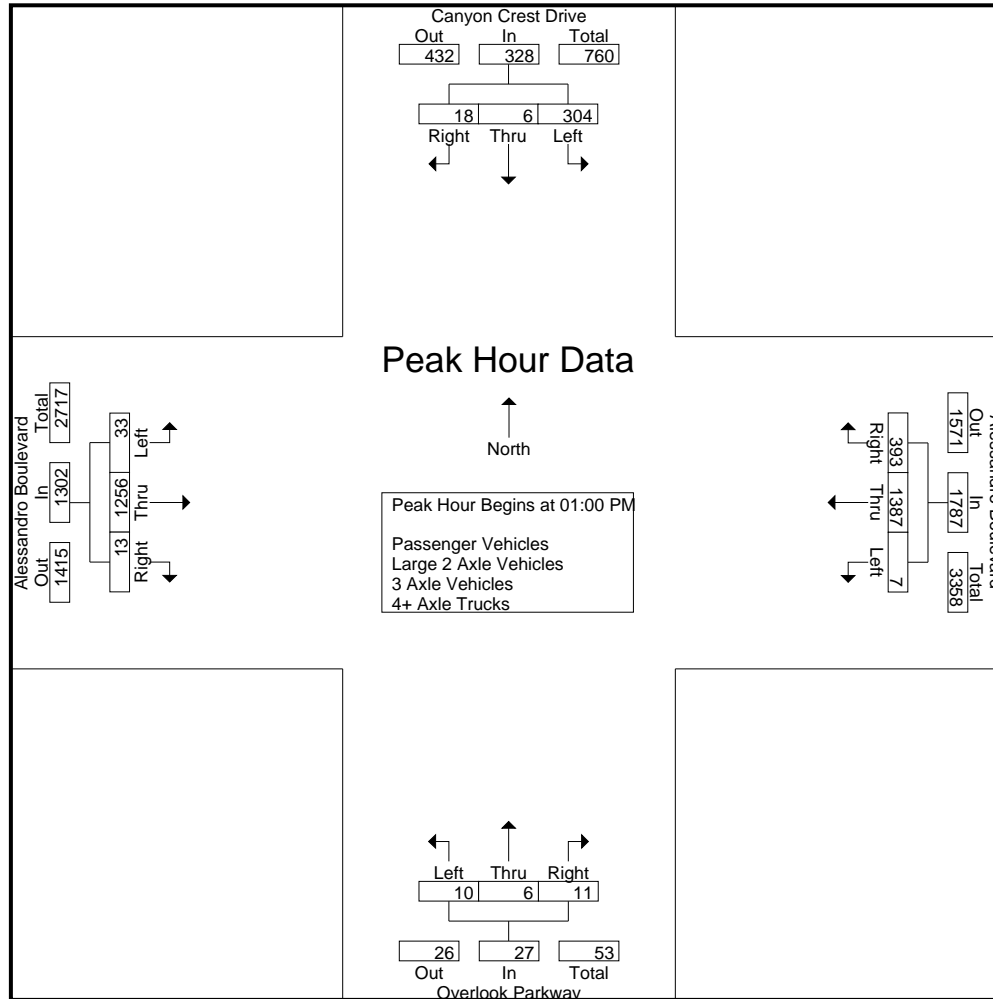

City of Riverside
 N/S: Canyon Crest Dr/Overlook Pkwy
 E/W: Alessandro Boulevard
 Weather: Clear

File Name : 03_RIV_Cyn C_Ales Sat
 Site Code : 05122815
 Start Date : 9/17/2022
 Page No : 4

Start Time	Canyon Crest Drive Southbound				Alessandro Boulevard Westbound				Overlook Parkway Northbound				Alessandro Boulevard Eastbound				Int. Total
	Left	Thru	Right	App. Total	Left	Thru	Right	App. Total	Left	Thru	Right	App. Total	Left	Thru	Right	App. Total	
Peak Hour Analysis From 11:00 AM to 01:45 PM - Peak 1 of 1																	
Peak Hour for Each Approach Begins at:																	
	11:45 AM				12:45 PM				12:45 PM				01:00 PM				
+0 mins.	65	1	7	73	2	368	93	463	3	2	4	9	10	297	3	310	
+15 mins.	78	3	11	92	1	383	101	485	2	0	1	3	9	311	2	322	
+30 mins.	81	2	9	92	2	330	95	427	3	2	3	8	7	336	5	348	
+45 mins.	79	2	10	91	2	333	106	441	3	1	4	8	7	312	3	322	
Total Volume	303	8	37	348	7	1414	395	1816	11	5	12	28	33	1256	13	1302	
% App. Total	87.1	2.3	10.6		0.4	77.9	21.8		39.3	17.9	42.9		2.5	96.5	1		
PHF	.935	.667	.841	.946	.875	.923	.932	.936	.917	.625	.750	.778	.825	.935	.650	.935	

City of Riverside
 N/S: Canyon Crest Dr/Overlook Pkwy
 E/W: Alessandro Boulevard
 Weather: Clear

File Name : 03_RIV_Cyn C_Ales Sat
 Site Code : 05122815
 Start Date : 9/17/2022
 Page No : 1

Groups Printed- Passenger Vehicles

Start Time	Canyon Crest Drive Southbound					Alessandro Boulevard Westbound					Overlook Parkway Northbound					Alessandro Boulevard Eastbound					Exclu. Total	Inclu. Total	Int. Total
	Left	Thru	Right	RTOR	App. Total	Left	Thru	Right	RTOR	App. Total	Left	Thru	Right	RTOR	App. Total	Left	Thru	Right	RTOR	App. Total			
11:00 AM	67	1	3	1	71	4	280	78	21	362	1	3	4	2	8	5	237	1	0	243	24	684	708
11:15 AM	79	3	6	4	88	2	261	103	24	366	2	1	1	1	4	7	269	2	0	278	29	736	765
11:30 AM	63	5	11	3	79	4	333	90	25	427	1	2	1	1	4	4	237	3	0	244	29	754	783
11:45 AM	65	1	7	3	73	0	329	84	23	413	4	2	2	2	8	9	297	1	0	307	28	801	829
Total	274	10	27	11	311	10	1203	355	93	1568	8	8	8	6	24	25	1040	7	0	1072	110	2975	3085
12:00 PM	77	3	11	7	91	2	295	93	31	390	4	1	1	1	6	14	288	2	0	304	39	791	830
12:15 PM	77	2	8	3	87	0	340	88	15	428	1	1	1	0	3	4	305	1	0	310	18	828	846
12:30 PM	77	2	9	7	88	1	314	82	12	397	4	0	0	0	4	4	265	3	1	272	20	761	781
12:45 PM	61	2	5	5	68	2	360	92	26	454	3	2	4	3	9	10	295	2	0	307	34	838	872
Total	292	9	33	22	334	5	1309	355	84	1669	12	4	6	4	22	32	1153	8	1	1193	111	3218	3329
01:00 PM	71	1	8	5	80	1	376	100	32	477	2	0	1	0	3	10	295	3	0	308	37	868	905
01:15 PM	74	0	1	1	75	2	324	95	11	421	3	2	3	2	8	9	308	2	0	319	14	823	837
01:30 PM	69	4	3	3	76	2	328	104	17	434	2	1	4	4	7	7	331	5	0	343	24	860	884
01:45 PM	88	1	5	4	94	2	334	90	17	426	2	3	3	2	8	6	309	3	0	318	23	846	869
Total	302	6	17	13	325	7	1362	389	77	1758	9	6	11	8	26	32	1243	13	0	1288	98	3397	3495
Grand Total	868	25	77	46	970	22	3874	1099	254	4995	29	18	25	18	72	89	3436	28	1	3553	319	9590	9909
Apprch %	89.5	2.6	7.9			0.4	77.6	22			40.3	25	34.7			2.5	96.7	0.8					
Total %	9.1	0.3	0.8		10.1	0.2	40.4	11.5		52.1	0.3	0.2	0.3		0.8	0.9	35.8	0.3		37	3.2	96.8	

Start Time	Canyon Crest Drive Southbound				Alessandro Boulevard Westbound				Overlook Parkway Northbound				Alessandro Boulevard Eastbound				Int. Total
	Left	Thru	Right	App. Total	Left	Thru	Right	App. Total	Left	Thru	Right	App. Total	Left	Thru	Right	App. Total	
Peak Hour Analysis From 01:00 PM to 01:45 PM - Peak 1 of 1																	
Peak Hour for Entire Intersection Begins at 01:00 PM																	
01:00 PM	71	1	8	80	1	376	100	477	2	0	1	3	10	295	3	308	868
01:15 PM	74	0	1	75	2	324	95	421	3	2	3	8	9	308	2	319	823
01:30 PM	69	4	3	76	2	328	104	434	2	1	4	7	7	331	5	343	860
01:45 PM	88	1	5	94	2	334	90	426	2	3	3	8	6	309	3	318	846
Total Volume	302	6	17	325	7	1362	389	1758	9	6	11	26	32	1243	13	1288	3397
% App. Total	92.9	1.8	5.2		0.4	77.5	22.1		34.6	23.1	42.3		2.5	96.5	1		
PHF	.858	.375	.531	.864	.875	.906	.935	.921	.750	.500	.688	.813	.800	.939	.650	.939	.978

City of Riverside
 N/S: Canyon Crest Dr/Overlook Pkwy
 E/W: Alessandro Boulevard
 Weather: Clear

File Name : 03_RIV_Cyn C_Ales Sat
 Site Code : 05122815
 Start Date : 9/17/2022
 Page No : 2

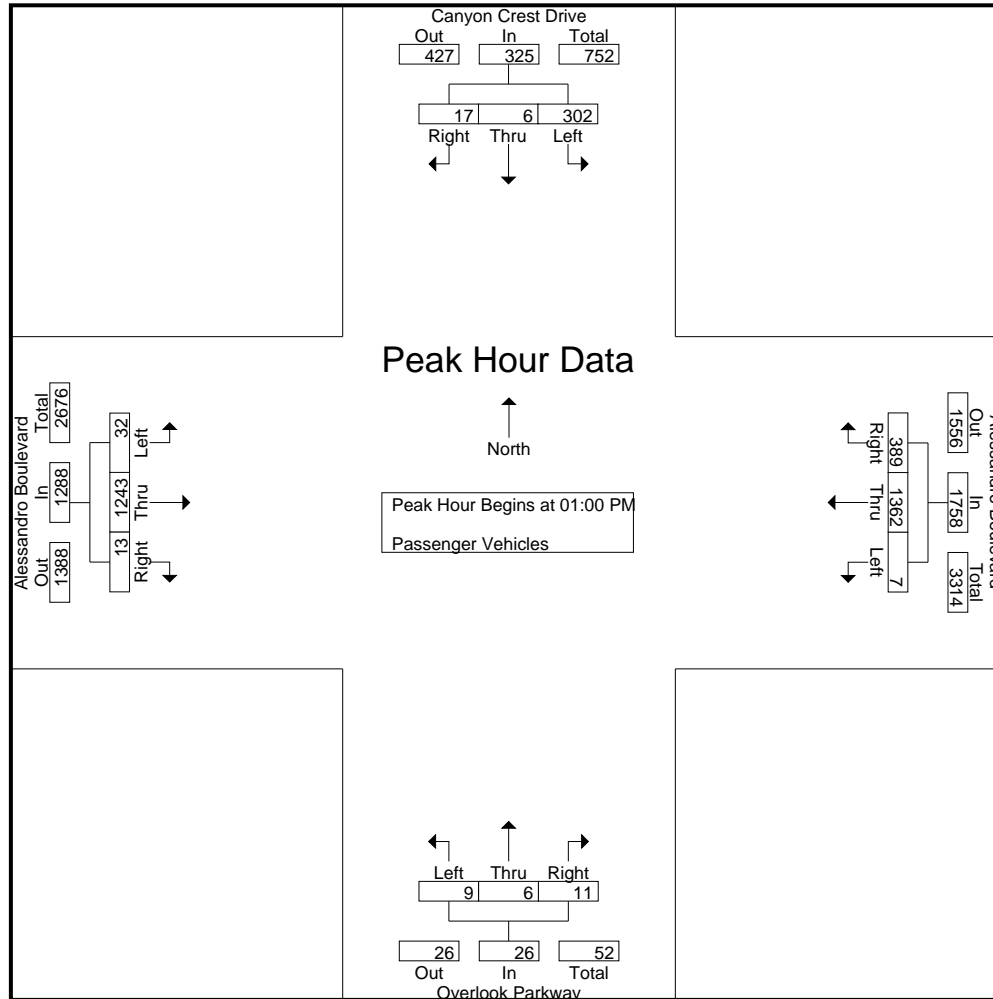

City of Riverside
 N/S: Canyon Crest Dr/Overlook Pkwy
 E/W: Alessandro Boulevard
 Weather: Clear

File Name : 03_RIV_Cyn C_Ales Sat
 Site Code : 05122815
 Start Date : 9/17/2022
 Page No : 3

Start Time	Canyon Crest Drive Southbound				Alessandro Boulevard Westbound				Overlook Parkway Northbound				Alessandro Boulevard Eastbound				Int. Total
	Left	Thru	Right	App. Total	Left	Thru	Right	App. Total	Left	Thru	Right	App. Total	Left	Thru	Right	App. Total	
Peak Hour Analysis From 01:00 PM to 01:45 PM - Peak 1 of 1																	
Peak Hour for Each Approach Begins at:																	
	01:00 PM				01:00 PM				01:00 PM				01:00 PM				
+0 mins.	71	1	8	80	1	376	100	477	2	0	1	3	10	295	3	308	
+15 mins.	74	0	1	75	2	324	95	421	3	2	3	8	9	308	2	319	
+30 mins.	69	4	3	76	2	328	104	434	2	1	4	7	7	331	5	343	
+45 mins.	88	1	5	94	2	334	90	426	2	3	3	8	6	309	3	318	
Total Volume	302	6	17	325	7	1362	389	1758	9	6	11	26	32	1243	13	1288	
% App. Total	92.9	1.8	5.2		0.4	77.5	22.1		34.6	23.1	42.3		2.5	96.5	1		
PHF	.858	.375	.531	.864	.875	.906	.935	.921	.750	.500	.688	.813	.800	.939	.650	.939	

City of Riverside
 N/S: Canyon Crest Dr/Overlook Pkwy
 E/W: Alessandro Boulevard
 Weather: Clear

File Name : 03_RIV_Cyn C_Ales Sat
 Site Code : 05122815
 Start Date : 9/17/2022
 Page No : 1

Groups Printed- Large 2 Axle Vehicles

Start Time	Canyon Crest Drive Southbound					Alessandro Boulevard Westbound					Overlook Parkway Northbound					Alessandro Boulevard Eastbound					Exclu. Total	Inclu. Total	Int. Total
	Left	Thru	Right	RTOR	App. Total	Left	Thru	Right	RTOR	App. Total	Left	Thru	Right	RTOR	App. Total	Left	Thru	Right	RTOR	App. Total			
11:00 AM	2	0	0	0	2	0	2	0	0	2	0	0	0	0	0	0	5	0	0	5	0	9	9
11:15 AM	2	0	0	0	2	0	3	1	0	4	0	0	1	0	1	0	4	1	0	5	0	12	12
11:30 AM	0	0	0	0	0	0	6	1	1	7	0	0	0	0	0	0	6	0	0	6	1	13	14
11:45 AM	0	0	0	0	0	0	3	3	0	6	0	0	0	0	0	0	3	0	0	3	0	9	9
Total	4	0	0	0	4	0	14	5	1	19	0	0	1	0	1	0	18	1	0	19	1	43	44
12:00 PM	1	0	0	0	1	0	4	2	0	6	0	0	0	0	0	0	6	0	0	6	0	13	13
12:15 PM	3	0	1	0	4	0	7	1	0	8	0	0	0	0	0	0	2	0	0	2	0	14	14
12:30 PM	1	0	1	1	2	0	5	3	1	8	0	0	0	0	0	0	3	0	0	3	2	13	15
12:45 PM	1	0	0	0	1	0	8	1	0	9	0	0	0	0	0	0	3	0	0	3	0	13	13
Total	6	0	2	1	8	0	24	7	1	31	0	0	0	0	0	0	14	0	0	14	2	53	55
01:00 PM	1	0	0	0	1	0	6	1	0	7	0	0	0	0	0	0	2	0	0	2	0	10	10
01:15 PM	0	0	0	0	0	0	6	0	0	6	0	0	0	0	0	0	3	0	0	3	0	9	9
01:30 PM	1	0	0	0	1	0	5	2	1	7	1	0	0	0	1	0	5	0	0	5	1	14	15
01:45 PM	0	0	1	1	1	0	6	1	0	7	0	0	0	0	0	1	3	0	0	4	1	12	13
Total	2	0	1	1	3	0	23	4	1	27	1	0	0	0	1	1	13	0	0	14	2	45	47
Grand Total	12	0	3	2	15	0	61	16	3	77	1	0	1	0	2	1	45	1	0	47	5	141	146
Apprch %	80	0	20			0	79.2	20.8			50	0	50			2.1	95.7	2.1					
Total %	8.5	0	2.1		10.6	0	43.3	11.3		54.6	0.7	0	0.7		1.4	0.7	31.9	0.7		33.3	3.4	96.6	

Start Time	Canyon Crest Drive Southbound				Alessandro Boulevard Westbound				Overlook Parkway Northbound				Alessandro Boulevard Eastbound				Int. Total
	Left	Thru	Right	App. Total	Left	Thru	Right	App. Total	Left	Thru	Right	App. Total	Left	Thru	Right	App. Total	
Peak Hour Analysis From 01:00 PM to 01:45 PM - Peak 1 of 1																	
Peak Hour for Entire Intersection Begins at 01:00 PM																	
01:00 PM	1	0	0	1	0	6	1	7	0	0	0	0	0	2	0	2	10
01:15 PM	0	0	0	0	0	6	0	6	0	0	0	0	0	3	0	3	9
01:30 PM	1	0	0	1	0	5	2	7	1	0	0	1	0	5	0	5	14
01:45 PM	0	0	1	1	0	6	1	7	0	0	0	0	1	3	0	4	12
Total Volume	2	0	1	3	0	23	4	27	1	0	0	1	1	13	0	14	45
% App. Total	66.7	0	33.3		0	85.2	14.8		100	0	0		7.1	92.9	0		
PHF	.500	.000	.250	.750	.000	.958	.500	.964	.250	.000	.000	.250	.250	.650	.000	.700	.804

City of Riverside
 N/S: Canyon Crest Dr/Overlook Pkwy
 E/W: Alessandro Boulevard
 Weather: Clear

File Name : 03_RIV_Cyn C_Ales Sat
 Site Code : 05122815
 Start Date : 9/17/2022
 Page No : 2

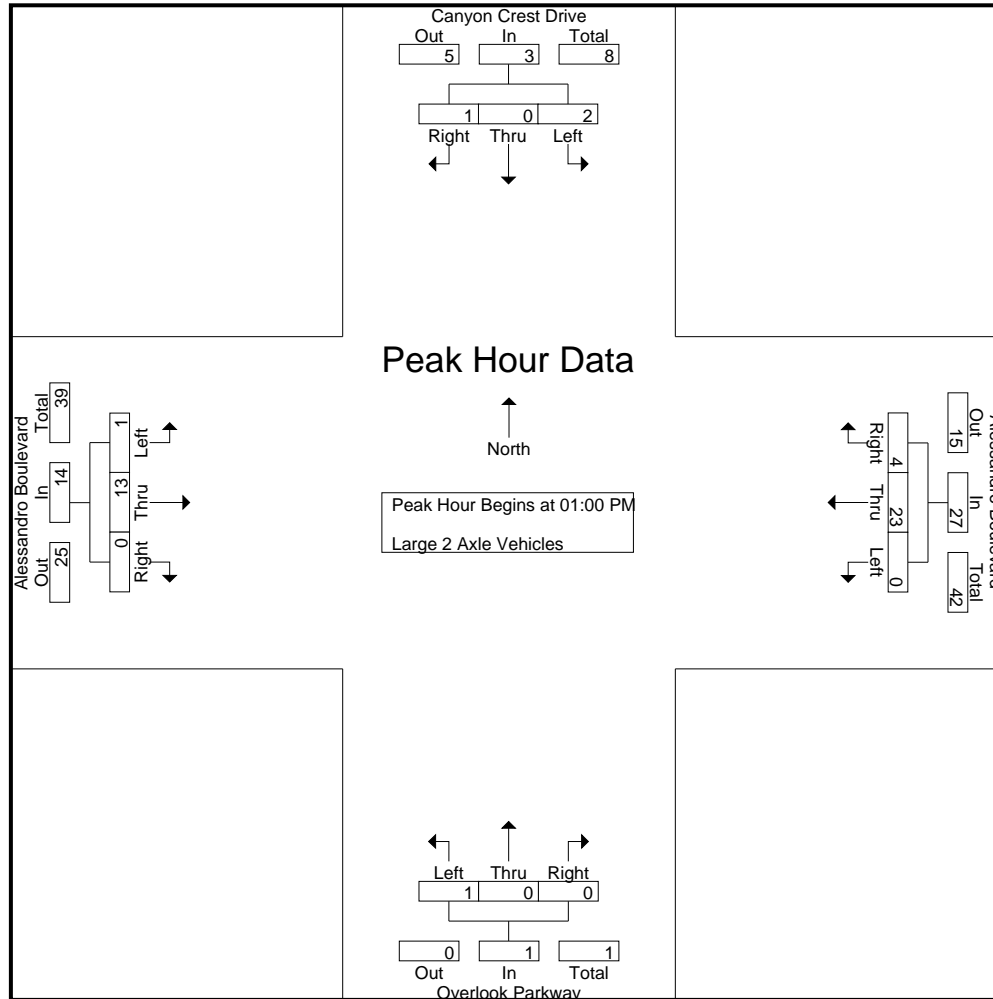

City of Riverside
 N/S: Canyon Crest Dr/Overlook Pkwy
 E/W: Alessandro Boulevard
 Weather: Clear

File Name : 03_RIV_Cyn C_Ales Sat
 Site Code : 05122815
 Start Date : 9/17/2022
 Page No : 3

Start Time	Canyon Crest Drive Southbound				Alessandro Boulevard Westbound				Overlook Parkway Northbound				Alessandro Boulevard Eastbound				Int. Total
	Left	Thru	Right	App. Total	Left	Thru	Right	App. Total	Left	Thru	Right	App. Total	Left	Thru	Right	App. Total	
Peak Hour Analysis From 01:00 PM to 01:45 PM - Peak 1 of 1																	
Peak Hour for Each Approach Begins at:																	
	01:00 PM				01:00 PM				01:00 PM				01:00 PM				
+0 mins.	1	0	0	1	0	6	1	7	0	0	0	0	0	2	0	2	
+15 mins.	0	0	0	0	0	6	0	6	0	0	0	0	0	3	0	3	
+30 mins.	1	0	0	1	0	5	2	7	1	0	0	1	0	5	0	5	
+45 mins.	0	0	1	1	0	6	1	7	0	0	0	0	1	3	0	4	
Total Volume	2	0	1	3	0	23	4	27	1	0	0	1	1	13	0	14	
% App. Total	66.7	0	33.3		0	85.2	14.8		100	0	0		7.1	92.9	0		
PHF	.500	.000	.250	.750	.000	.958	.500	.964	.250	.000	.000	.250	.250	.650	.000	.700	

City of Riverside
 N/S: Canyon Crest Dr/Overlook Pkwy
 E/W: Alessandro Boulevard
 Weather: Clear

File Name : 03_RIV_Cyn C_Ales Sat
 Site Code : 05122815
 Start Date : 9/17/2022
 Page No : 1

Groups Printed- 3 Axle Vehicles

Start Time	Canyon Crest Drive Southbound					Alessandro Boulevard Westbound					Overlook Parkway Northbound					Alessandro Boulevard Eastbound					Exclu. Total	Inclu. Total	Int. Total			
	Left	Thru	Right	RTOR	App. Total	Left	Thru	Right	RTOR	App. Total	Left	Thru	Right	RTOR	App. Total	Left	Thru	Right	RTOR	App. Total						
11:00 AM	0	0	0	0	0	0	0	0	0	0	0	0	0	0	0	0	0	0	0	0	0	0	0	0	0	0
11:15 AM	0	0	0	0	0	0	0	0	0	0	0	0	0	0	0	0	0	0	0	0	0	0	0	0	0	0
11:30 AM	0	0	0	0	0	0	0	0	0	0	0	0	0	0	0	0	1	0	0	1	0	0	0	0	1	1
11:45 AM	0	0	0	0	0	0	0	0	0	0	0	0	0	0	0	0	0	0	0	0	0	0	0	0	0	0
Total	0	0	0	0	0	0	0	0	0	0	0	0	0	0	0	0	1	0	0	1	0	0	0	0	1	1
12:00 PM	0	0	0	0	0	0	0	0	0	0	0	0	0	0	0	0	0	0	0	0	0	0	0	0	0	0
12:15 PM	1	0	0	0	1	0	0	1	0	1	0	0	0	0	0	0	0	0	0	0	0	0	0	0	2	2
12:30 PM	1	0	0	0	1	0	1	0	0	1	0	0	0	0	0	0	0	0	0	0	0	0	0	0	2	2
12:45 PM	0	0	0	0	0	0	0	0	0	0	0	0	0	0	0	0	0	0	0	0	0	0	0	0	0	0
Total	2	0	0	0	2	0	1	1	0	2	0	0	0	0	0	0	0	0	0	0	0	0	0	0	4	4
01:00 PM	0	0	0	0	0	0	1	0	0	1	0	0	0	0	0	0	0	0	0	0	0	0	0	0	1	1
01:15 PM	0	0	0	0	0	0	0	0	0	0	0	0	0	0	0	0	0	0	0	0	0	0	0	0	0	0
01:30 PM	0	0	0	0	0	0	0	0	0	0	0	0	0	0	0	0	0	0	0	0	0	0	0	0	0	0
01:45 PM	0	0	0	0	0	0	0	0	0	0	0	0	0	0	0	0	0	0	0	0	0	0	0	0	0	0
Total	0	0	0	0	0	0	1	0	0	1	0	0	0	0	0	0	0	0	0	0	0	0	0	0	1	1
Grand Total	2	0	0	0	2	0	2	1	0	3	0	0	0	0	0	0	1	0	0	1	0	0	0	0	6	6
Apprch %	100	0	0			0	66.7	33.3			0	0	0			0	100	0			0	0	0	0	0	0
Total %	33.3	0	0		33.3	0	33.3	16.7		50	0	0	0		0	0	16.7	0		16.7	0	0	0	0	100	0

Start Time	Canyon Crest Drive Southbound				Alessandro Boulevard Westbound				Overlook Parkway Northbound				Alessandro Boulevard Eastbound				Int. Total
	Left	Thru	Right	App. Total	Left	Thru	Right	App. Total	Left	Thru	Right	App. Total	Left	Thru	Right	App. Total	
Peak Hour Analysis From 01:00 PM to 01:45 PM - Peak 1 of 1																	
Peak Hour for Entire Intersection Begins at 01:00 PM																	
01:00 PM	0	0	0	0	0	1	0	1	0	0	0	0	0	0	0	0	1
01:15 PM	0	0	0	0	0	0	0	0	0	0	0	0	0	0	0	0	0
01:30 PM	0	0	0	0	0	0	0	0	0	0	0	0	0	0	0	0	0
01:45 PM	0	0	0	0	0	0	0	0	0	0	0	0	0	0	0	0	0
Total Volume	0	0	0	0	0	1	0	1	0	0	0	0	0	0	0	0	1
% App. Total	0	0	0		0	100	0		0	0	0		0	0	0		
PHF	.000	.000	.000	.000	.000	.250	.000	.250	.000	.000	.000	.000	.000	.000	.000	.000	.250

City of Riverside
 N/S: Canyon Crest Dr/Overlook Pkwy
 E/W: Alessandro Boulevard
 Weather: Clear

File Name : 03_RIV_Cyn C_Ales Sat
 Site Code : 05122815
 Start Date : 9/17/2022
 Page No : 2

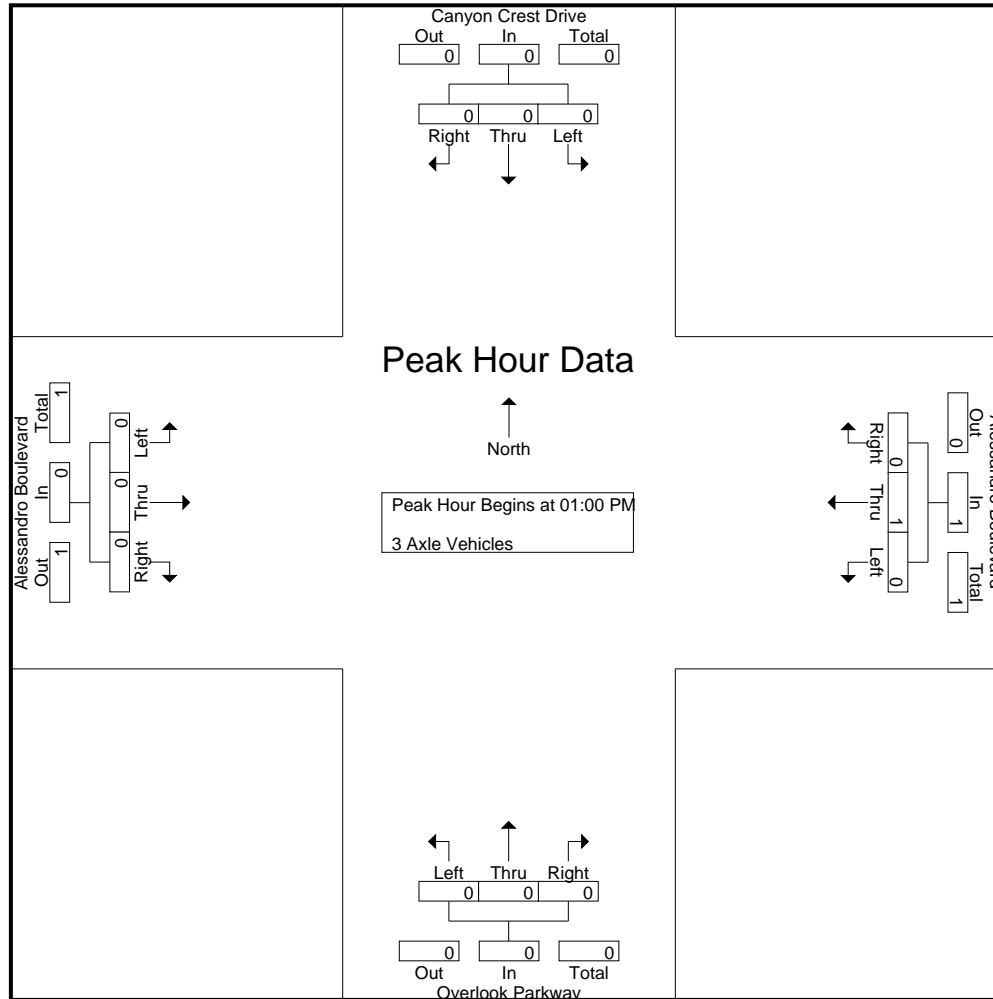

City of Riverside
 N/S: Canyon Crest Dr/Overlook Pkwy
 E/W: Alessandro Boulevard
 Weather: Clear

File Name : 03_RIV_Cyn C_Ales Sat
 Site Code : 05122815
 Start Date : 9/17/2022
 Page No : 3

Start Time	Canyon Crest Drive Southbound				Alessandro Boulevard Westbound				Overlook Parkway Northbound				Alessandro Boulevard Eastbound				Int. Total
	Left	Thru	Right	App. Total	Left	Thru	Right	App. Total	Left	Thru	Right	App. Total	Left	Thru	Right	App. Total	
Peak Hour Analysis From 01:00 PM to 01:45 PM - Peak 1 of 1																	
Peak Hour for Each Approach Begins at:																	
	01:00 PM				01:00 PM				01:00 PM				01:00 PM				
+0 mins.	0	0	0	0	0	1	0	1	0	0	0	0	0	0	0	0	0
+15 mins.	0	0	0	0	0	0	0	0	0	0	0	0	0	0	0	0	0
+30 mins.	0	0	0	0	0	0	0	0	0	0	0	0	0	0	0	0	0
+45 mins.	0	0	0	0	0	0	0	0	0	0	0	0	0	0	0	0	0
Total Volume	0	0	0	0	0	1	0	1	0	0	0	0	0	0	0	0	0
% App. Total	0	0	0	0	0	100	0	0	0	0	0	0	0	0	0	0	0
PHF	.000	.000	.000	.000	.000	.250	.000	.250	.000	.000	.000	.000	.000	.000	.000	.000	.000

City of Riverside
 N/S: Canyon Crest Dr/Overlook Pkwy
 E/W: Alessandro Boulevard
 Weather: Clear

File Name : 03_RIV_Cyn C_Ales Sat
 Site Code : 05122815
 Start Date : 9/17/2022
 Page No : 1

Groups Printed- 4+ Axle Trucks

Start Time	Canyon Crest Drive Southbound					Alessandro Boulevard Westbound					Overlook Parkway Northbound					Alessandro Boulevard Eastbound					Exclu. Total	Inclu. Total	Int. Total				
	Left	Thru	Right	RTOR	App. Total	Left	Thru	Right	RTOR	App. Total	Left	Thru	Right	RTOR	App. Total	Left	Thru	Right	RTOR	App. Total							
11:00 AM	0	0	0	0	0	0	0	0	0	0	0	0	0	0	0	0	0	0	0	0	0	0	0	0	0	0	0
11:15 AM	0	0	0	0	0	0	0	0	0	0	0	0	0	0	0	0	0	0	0	0	0	0	0	0	0	0	0
11:30 AM	0	0	0	0	0	0	0	0	0	0	0	0	0	0	0	0	0	0	0	0	0	0	0	0	0	0	0
11:45 AM	0	0	0	0	0	0	0	0	0	0	0	0	0	0	0	0	0	0	0	0	0	0	0	0	0	0	0
Total	0	0	0	0	0	0	0	0	0	0	0	0	0	0	0	0	0	0	0	0	0	0	0	0	0	0	0
12:00 PM	0	0	0	0	0	0	1	0	0	1	0	0	0	0	0	0	0	0	0	0	0	0	0	0	0	1	1
12:15 PM	0	0	0	0	0	0	0	0	0	0	0	0	0	0	0	0	0	0	0	0	0	0	0	0	0	0	0
12:30 PM	0	0	0	0	0	0	0	0	0	0	0	0	0	0	0	0	0	0	0	0	0	0	0	0	0	0	0
12:45 PM	0	0	0	0	0	0	0	0	0	0	0	0	0	0	0	0	0	0	0	0	0	0	0	0	0	0	0
Total	0	0	0	0	0	0	1	0	0	1	0	0	0	0	0	0	0	0	0	0	0	0	0	0	0	1	1
01:00 PM	0	0	0	0	0	0	0	0	0	0	0	0	0	0	0	0	0	0	0	0	0	0	0	0	0	0	0
01:15 PM	0	0	0	0	0	0	0	0	0	0	0	0	0	0	0	0	0	0	0	0	0	0	0	0	0	0	0
01:30 PM	0	0	0	0	0	0	0	0	0	0	0	0	0	0	0	0	0	0	0	0	0	0	0	0	0	0	0
01:45 PM	0	0	0	0	0	0	1	0	0	1	0	0	0	0	0	0	0	0	0	0	0	0	0	0	0	1	1
Total	0	0	0	0	0	0	1	0	0	1	0	0	0	0	0	0	0	0	0	0	0	0	0	0	0	1	1
Grand Total	0	0	0	0	0	0	2	0	0	2	0	0	0	0	0	0	0	0	0	0	0	0	0	0	0	2	2
Apprch %	0	0	0			0	100	0			0	0	0			0	0	0			0	0	0		0	100	
Total %	0	0	0			0	100	0		100	0	0	0		0	0	0	0		0	0	0	0		0	100	

Start Time	Canyon Crest Drive Southbound				Alessandro Boulevard Westbound				Overlook Parkway Northbound				Alessandro Boulevard Eastbound				Int. Total
	Left	Thru	Right	App. Total	Left	Thru	Right	App. Total	Left	Thru	Right	App. Total	Left	Thru	Right	App. Total	
Peak Hour Analysis From 01:00 PM to 01:45 PM - Peak 1 of 1																	
Peak Hour for Entire Intersection Begins at 01:00 PM																	
01:00 PM	0	0	0	0	0	0	0	0	0	0	0	0	0	0	0	0	0
01:15 PM	0	0	0	0	0	0	0	0	0	0	0	0	0	0	0	0	0
01:30 PM	0	0	0	0	0	0	0	0	0	0	0	0	0	0	0	0	0
01:45 PM	0	0	0	0	0	1	0	1	0	0	0	0	0	0	0	0	1
Total Volume	0	0	0	0	0	1	0	1	0	0	0	0	0	0	0	0	1
% App. Total	0	0	0		0	100	0		0	0	0		0	0	0		
PHF	.000	.000	.000	.000	.000	.250	.000	.250	.000	.000	.000	.000	.000	.000	.000	.000	.250

City of Riverside
 N/S: Canyon Crest Dr/Overlook Pkwy
 E/W: Alessandro Boulevard
 Weather: Clear

File Name : 03_RIV_Cyn C_Ales Sat
 Site Code : 05122815
 Start Date : 9/17/2022
 Page No : 2

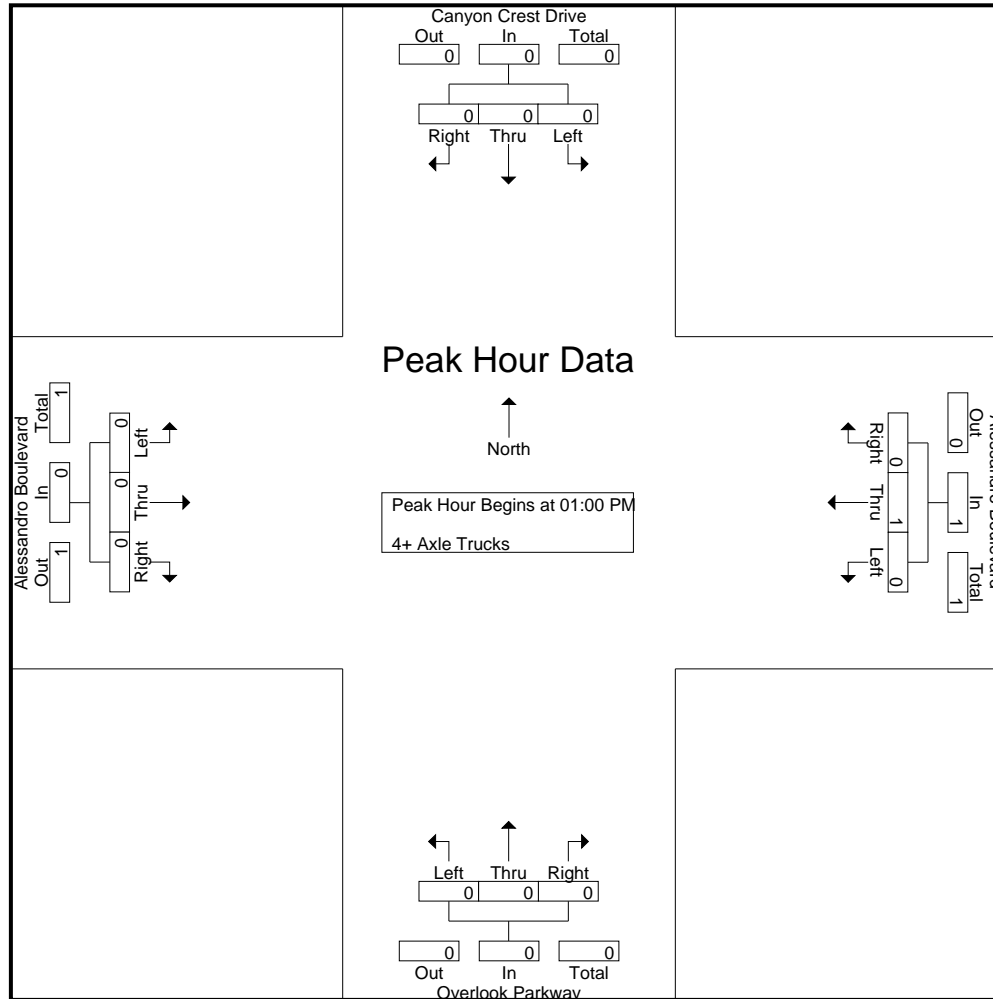

City of Riverside
 N/S: Canyon Crest Dr/Overlook Pkwy
 E/W: Alessandro Boulevard
 Weather: Clear

File Name : 03_RIV_Cyn C_Ales Sat
 Site Code : 05122815
 Start Date : 9/17/2022
 Page No : 3

Start Time	Canyon Crest Drive Southbound				Alessandro Boulevard Westbound				Overlook Parkway Northbound				Alessandro Boulevard Eastbound				Int. Total
	Left	Thru	Right	App. Total	Left	Thru	Right	App. Total	Left	Thru	Right	App. Total	Left	Thru	Right	App. Total	
Peak Hour Analysis From 01:00 PM to 01:45 PM - Peak 1 of 1																	
Peak Hour for Each Approach Begins at:																	
	01:00 PM				01:00 PM				01:00 PM				01:00 PM				
+0 mins.	0	0	0	0	0	0	0	0	0	0	0	0	0	0	0	0	0
+15 mins.	0	0	0	0	0	0	0	0	0	0	0	0	0	0	0	0	0
+30 mins.	0	0	0	0	0	0	0	0	0	0	0	0	0	0	0	0	0
+45 mins.	0	0	0	0	0	1	0	1	0	0	0	0	0	0	0	0	0
Total Volume	0	0	0	0	0	1	0	1	0	0	0	0	0	0	0	0	0
% App. Total	0	0	0	0	0	100	0	0	0	0	0	0	0	0	0	0	0
PHF	.000	.000	.000	.000	.000	.250	.000	.250	.000	.000	.000	.000	.000	.000	.000	.000	.000

Location: Riverside
 N/S: Canyon Crest Dr/Overlook Pkwy
 E/W: Alessandro Boulevard



Date: 9/17/2022
 Day Saturday

PEDESTRIANS

Time	North Leg Canyon Crest Drive	East Leg Alessandro Boulevard	South Leg Overlook Parkway	West Leg Alessandro Boulevard	TOTAL
11:00 AM	0	0	0	0	0
11:15 AM	1	0	0	0	1
11:30 AM	0	0	0	0	0
11:45 AM	0	0	1	0	1
12:00 PM	0	0	0	0	0
12:15 PM	0	0	0	0	0
12:30 PM	0	0	0	0	0
12:45 PM	0	0	0	0	0
1:00 PM	0	0	0	0	0
1:15 PM	0	0	0	0	0
1:30 PM	0	0	0	0	0
1:45 PM	0	0	0	0	0
TOTAL VOLUMES:	1	0	1	0	2

Location: Riverside
 N/S: Canyon Crest Dr/Overlook Pkwy
 E/W: Alessandro Boulevard

Date: 9/17/2022
 Day: Saturday



BICYCLES

	Southbound Canyon Crest Drive			Westbound Alessandro Boulevard			Northbound Overlook Parkway			Eastbound Alessandro Boulevard			
	Left	Thru	Right	Left	Thru	Right	Left	Thru	Right	Left	Thru	Right	
11:00 AM	0	0	0	0	0	0	0	0	0	0	0	0	0
11:15 AM	1	0	0	0	0	0	0	0	0	0	0	0	1
11:30 AM	0	0	0	0	0	0	0	0	0	0	1	0	1
11:45 AM	0	0	0	0	0	0	0	0	0	0	0	0	0
12:00 PM	0	0	0	0	0	0	0	0	0	0	0	0	0
12:15 PM	0	0	0	0	0	0	0	0	0	0	0	0	0
12:30 PM	0	0	0	0	0	0	0	0	0	0	0	0	0
12:45 PM	0	0	0	0	0	0	0	0	0	0	0	0	0
1:00 PM	0	0	0	0	0	0	0	0	0	0	0	0	0
1:15 PM	0	0	0	0	0	0	0	0	0	0	0	0	0
1:30 PM	0	0	0	0	0	0	0	0	0	0	0	0	0
1:45 PM	1	0	0	0	0	0	0	0	0	0	0	0	1
TOTAL VOLUMES:	2	0	0	0	0	0	0	0	0	0	1	0	3

City of Riverside
 N/S: Wood Road
 E/W: Van Buren Boulevard
 Weather: Clear

File Name : 04_RIV_Wood_VB Sat
 Site Code : 05122815
 Start Date : 9/17/2022
 Page No : 1

Groups Printed- Passenger Vehicles - Large 2 Axle Vehicles - 3 Axle Vehicles - 4+ Axle Trucks

Start Time	Wood Road Southbound					Van Buren Boulevard Westbound					Wood Road Northbound					Van Buren Boulevard Eastbound					Exclu. Total	Inclu. Total	Int. Total
	Left	Thru	Right	RTOR	App. Total	Left	Thru	Right	RTOR	App. Total	Left	Thru	Right	RTOR	App. Total	Left	Thru	Right	RTOR	App. Total			
11:00 AM	12	31	37	13	80	29	202	10	7	241	46	39	29	19	114	26	196	37	13	259	52	694	746
11:15 AM	14	26	34	11	74	34	198	12	2	244	49	33	24	16	106	32	178	34	16	244	45	668	713
11:30 AM	13	25	27	15	65	39	207	11	5	257	45	24	19	11	88	31	194	33	13	258	44	668	712
11:45 AM	19	18	25	18	62	39	230	15	5	284	52	31	30	16	113	28	183	40	13	251	52	710	762
Total	58	100	123	57	281	141	837	48	19	1026	192	127	102	62	421	117	751	144	55	1012	193	2740	2933
12:00 PM	26	27	32	20	85	33	201	14	9	248	56	34	19	8	109	31	183	34	17	248	54	690	744
12:15 PM	30	47	37	9	114	43	222	16	6	281	38	30	17	7	85	31	252	36	18	319	40	799	839
12:30 PM	32	41	41	13	114	32	203	14	6	249	43	29	25	15	97	35	222	57	17	314	51	774	825
12:45 PM	28	32	28	9	88	33	206	19	9	258	41	33	25	18	99	28	231	38	17	297	53	742	795
Total	116	147	138	51	401	141	832	63	30	1036	178	126	86	48	390	125	888	165	69	1178	198	3005	3203
01:00 PM	24	22	29	10	75	47	248	16	8	311	38	30	26	16	94	25	207	32	9	264	43	744	787
01:15 PM	16	27	30	12	73	40	200	15	10	255	44	33	34	24	111	16	200	51	12	267	58	706	764
01:30 PM	18	31	29	10	78	36	214	18	8	268	45	26	29	23	100	27	220	44	12	291	53	737	790
01:45 PM	15	38	35	9	88	32	203	11	6	246	43	35	24	15	102	27	229	35	9	291	39	727	766
Total	73	118	123	41	314	155	865	60	32	1080	170	124	113	78	407	95	856	162	42	1113	193	2914	3107
Grand Total	247	365	384	149	996	437	2534	171	81	3142	540	377	301	188	1218	337	2495	471	166	3303	584	8659	9243
Apprch %	24.8	36.6	38.6			13.9	80.6	5.4			44.3	31	24.7			10.2	75.5	14.3					
Total %	2.9	4.2	4.4		11.5	5	29.3	2		36.3	6.2	4.4	3.5		14.1	3.9	28.8	5.4		38.1	6.3	93.7	
Passenger Vehicles	242	363	380		1132	427	2503	167		3178	533	372	296		1385	334	2460	466		3424	0	0	9119
% Passenger Vehicles	98	99.5	99	98.7	98.9	97.7	98.8	97.7	100	98.6	98.7	98.7	98.3	97.9	98.5	99.1	98.6	98.9	98.8	98.7	0	0	98.7
Large 2 Axle Vehicles	5	2	4		13	10	27	4		41	7	4	5		20	3	28	4		37	0	0	111
% Large 2 Axle Vehicles	2	0.5	1	1.3	1.1	2.3	1.1	2.3	0	1.3	1.3	1.1	1.7	2.1	1.4	0.9	1.1	0.8	1.2	1.1	0	0	1.2
3 Axle Vehicles	0	0	0		0	0	3	0		3	0	1	0		1	0	2	1		3	0	0	7
% 3 Axle Vehicles	0	0	0	0	0	0	0.1	0	0	0.1	0	0.3	0	0	0.1	0	0.1	0.2	0	0.1	0	0	0.1
4+ Axle Trucks	0	0	0		0	0	1	0		1	0	0	0		0	0	5	0		5	0	0	6
% 4+ Axle Trucks	0	0	0	0	0	0	0	0	0	0	0	0	0	0	0	0	0.2	0	0	0.1	0	0	0.1

City of Riverside
 N/S: Wood Road
 E/W: Van Buren Boulevard
 Weather: Clear

File Name : 04_RIV_Wood_VB Sat
 Site Code : 05122815
 Start Date : 9/17/2022
 Page No : 2

Start Time	Wood Road Southbound				Van Buren Boulevard Westbound				Wood Road Northbound				Van Buren Boulevard Eastbound				Int. Total
	Left	Thru	Right	App. Total	Left	Thru	Right	App. Total	Left	Thru	Right	App. Total	Left	Thru	Right	App. Total	
Peak Hour Analysis From 11:00 AM to 01:45 PM - Peak 1 of 1																	
Peak Hour for Entire Intersection Begins at 12:15 PM																	
12:15 PM	30	47	37	114	43	222	16	281	38	30	17	85	31	252	36	319	799
12:30 PM	32	41	41	114	32	203	14	249	43	29	25	97	35	222	57	314	774
12:45 PM	28	32	28	88	33	206	19	258	41	33	25	99	28	231	38	297	742
01:00 PM	24	22	29	75	47	248	16	311	38	30	26	94	25	207	32	264	744
Total Volume	114	142	135	391	155	879	65	1099	160	122	93	375	119	912	163	1194	3059
% App. Total	29.2	36.3	34.5		14.1	80	5.9		42.7	32.5	24.8		10	76.4	13.7		
PHF	.891	.755	.823	.857	.824	.886	.855	.883	.930	.924	.894	.947	.850	.905	.715	.936	.957

City of Riverside
 N/S: Wood Road
 E/W: Van Buren Boulevard
 Weather: Clear

File Name : 04_RIV_Wood_VB Sat
 Site Code : 05122815
 Start Date : 9/17/2022
 Page No : 3

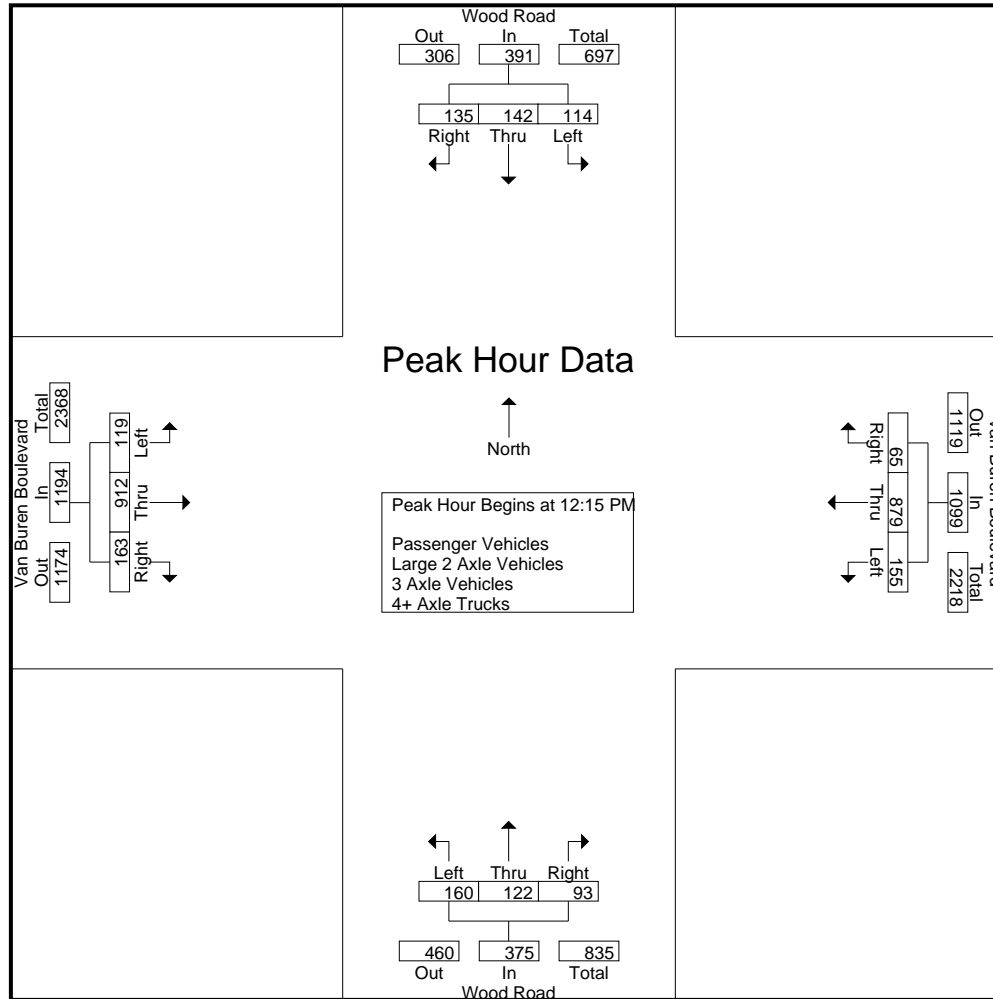

City of Riverside
 N/S: Wood Road
 E/W: Van Buren Boulevard
 Weather: Clear

File Name : 04_RIV_Wood_VB Sat
 Site Code : 05122815
 Start Date : 9/17/2022
 Page No : 4

Start Time	Wood Road Southbound				Van Buren Boulevard Westbound				Wood Road Northbound				Van Buren Boulevard Eastbound				Int. Total
	Left	Thru	Right	App. Total	Left	Thru	Right	App. Total	Left	Thru	Right	App. Total	Left	Thru	Right	App. Total	
Peak Hour Analysis From 11:00 AM to 01:45 PM - Peak 1 of 1																	
Peak Hour for Each Approach Begins at:																	
	12:00 PM				12:15 PM				11:00 AM				12:15 PM				
+0 mins.	26	27	32	85	43	222	16	281	46	39	29	114	31	252	36	319	
+15 mins.	30	47	37	114	32	203	14	249	49	33	24	106	35	222	57	314	
+30 mins.	32	41	41	114	33	206	19	258	45	24	19	88	28	231	38	297	
+45 mins.	28	32	28	88	47	248	16	311	52	31	30	113	25	207	32	264	
Total Volume	116	147	138	401	155	879	65	1099	192	127	102	421	119	912	163	1194	
% App. Total	28.9	36.7	34.4		14.1	80	5.9		45.6	30.2	24.2		10	76.4	13.7		
PHF	.906	.782	.841	.879	.824	.886	.855	.883	.923	.814	.850	.923	.850	.905	.715	.936	

City of Riverside
 N/S: Wood Road
 E/W: Van Buren Boulevard
 Weather: Clear

File Name : 04_RIV_Wood_VB Sat
 Site Code : 05122815
 Start Date : 9/17/2022
 Page No : 1

Groups Printed- Passenger Vehicles

Start Time	Wood Road Southbound					Van Buren Boulevard Westbound					Wood Road Northbound					Van Buren Boulevard Eastbound					Exclu. Total	Inclu. Total	Int. Total
	Left	Thru	Right	RTOR	App. Total	Left	Thru	Right	RTOR	App. Total	Left	Thru	Right	RTOR	App. Total	Left	Thru	Right	RTOR	App. Total			
11:00 AM	12	31	37	13	80	27	201	10	7	238	46	39	28	18	113	26	193	36	13	255	51	686	737
11:15 AM	13	25	34	11	72	33	194	12	2	239	49	32	23	15	104	31	177	33	16	241	44	656	700
11:30 AM	13	25	27	15	65	38	203	11	5	252	44	23	19	11	86	31	193	32	13	256	44	659	703
11:45 AM	19	18	25	18	62	39	229	15	5	283	52	29	30	16	111	28	178	39	12	245	51	701	752
Total	57	99	123	57	279	137	827	48	19	1012	191	123	100	60	414	116	741	140	54	997	190	2702	2892
12:00 PM	26	26	32	20	84	33	200	13	9	246	56	34	18	8	108	31	180	34	17	245	54	683	737
12:15 PM	29	47	35	8	111	42	221	16	6	279	38	30	17	7	85	30	247	36	18	313	39	788	827
12:30 PM	30	41	40	12	111	31	200	13	6	244	40	29	25	15	94	35	220	57	17	312	50	761	811
12:45 PM	28	32	27	9	87	33	205	18	9	256	41	33	25	18	99	27	227	38	17	292	53	734	787
Total	113	146	134	49	393	139	826	60	30	1025	175	126	85	48	386	123	874	165	69	1162	196	2966	3162
01:00 PM	24	22	29	10	75	46	242	16	8	304	37	30	24	14	91	25	204	32	9	261	41	731	772
01:15 PM	16	27	30	12	73	39	198	14	10	251	43	32	34	24	109	16	198	51	12	265	58	698	756
01:30 PM	17	31	29	10	77	34	211	18	8	263	45	26	29	23	100	27	216	44	12	287	53	727	780
01:45 PM	15	38	35	9	88	32	199	11	6	242	42	35	24	15	101	27	227	34	8	288	38	719	757
Total	72	118	123	41	313	151	850	59	32	1060	167	123	111	76	401	95	845	161	41	1101	190	2875	3065
Grand Total	242	363	380	147	985	427	2503	167	81	3097	533	372	296	184	1201	334	2460	466	164	3260	576	8543	9119
Apprch %	24.6	36.9	38.6			13.8	80.8	5.4			44.4	31	24.6			10.2	75.5	14.3					
Total %	2.8	4.2	4.4		11.5	5	29.3	2		36.3	6.2	4.4	3.5		14.1	3.9	28.8	5.5		38.2	6.3	93.7	

Start Time	Wood Road Southbound				Van Buren Boulevard Westbound				Wood Road Northbound				Van Buren Boulevard Eastbound				Int. Total
	Left	Thru	Right	App. Total	Left	Thru	Right	App. Total	Left	Thru	Right	App. Total	Left	Thru	Right	App. Total	
Peak Hour Analysis From 12:15 PM to 01:00 PM - Peak 1 of 1																	
Peak Hour for Entire Intersection Begins at 12:15 PM																	
12:15 PM	29	47	35	111	42	221	16	279	38	30	17	85	30	247	36	313	788
12:30 PM	30	41	40	111	31	200	13	244	40	29	25	94	35	220	57	312	761
12:45 PM	28	32	27	87	33	205	18	256	41	33	25	99	27	227	38	292	734
01:00 PM	24	22	29	75	46	242	16	304	37	30	24	91	25	204	32	261	731
Total Volume	111	142	131	384	152	868	63	1083	156	122	91	369	117	898	163	1178	3014
% App. Total	28.9	37	34.1		14	80.1	5.8		42.3	33.1	24.7		9.9	76.2	13.8		
PHF	.925	.755	.819	.865	.826	.897	.875	.891	.951	.924	.910	.932	.836	.909	.715	.941	.956

City of Riverside
 N/S: Wood Road
 E/W: Van Buren Boulevard
 Weather: Clear

File Name : 04_RIV_Wood_VB Sat
 Site Code : 05122815
 Start Date : 9/17/2022
 Page No : 2

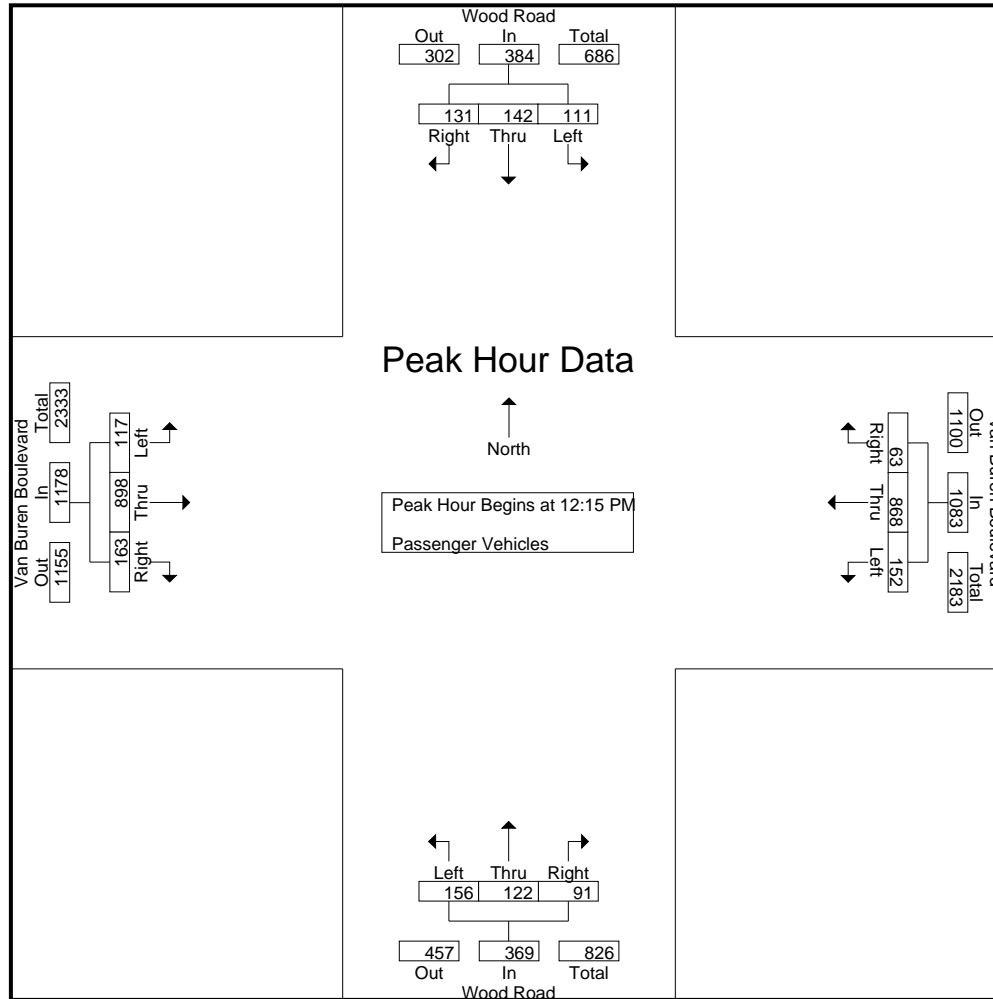

City of Riverside
 N/S: Wood Road
 E/W: Van Buren Boulevard
 Weather: Clear

File Name : 04_RIV_Wood_VB Sat
 Site Code : 05122815
 Start Date : 9/17/2022
 Page No : 3

Start Time	Wood Road Southbound				Van Buren Boulevard Westbound				Wood Road Northbound				Van Buren Boulevard Eastbound				Int. Total
	Left	Thru	Right	App. Total	Left	Thru	Right	App. Total	Left	Thru	Right	App. Total	Left	Thru	Right	App. Total	
Peak Hour Analysis From 12:15 PM to 01:00 PM - Peak 1 of 1																	
Peak Hour for Each Approach Begins at:																	
	12:15 PM				12:15 PM				12:15 PM				12:15 PM				
+0 mins.	29	47	35	111	42	221	16	279	38	30	17	85	30	247	36	313	
+15 mins.	30	41	40	111	31	200	13	244	40	29	25	94	35	220	57	312	
+30 mins.	28	32	27	87	33	205	18	256	41	33	25	99	27	227	38	292	
+45 mins.	24	22	29	75	46	242	16	304	37	30	24	91	25	204	32	261	
Total Volume	111	142	131	384	152	868	63	1083	156	122	91	369	117	898	163	1178	
% App. Total	28.9	37	34.1		14	80.1	5.8		42.3	33.1	24.7		9.9	76.2	13.8		
PHF	.925	.755	.819	.865	.826	.897	.875	.891	.951	.924	.910	.932	.836	.909	.715	.941	

City of Riverside
 N/S: Wood Road
 E/W: Van Buren Boulevard
 Weather: Clear

File Name : 04_RIV_Wood_VB Sat
 Site Code : 05122815
 Start Date : 9/17/2022
 Page No : 1

Groups Printed- Large 2 Axle Vehicles

Start Time	Wood Road Southbound					Van Buren Boulevard Westbound					Wood Road Northbound					Van Buren Boulevard Eastbound					Exclu. Total	Inclu. Total	Int. Total
	Left	Thru	Right	RTOR	App. Total	Left	Thru	Right	RTOR	App. Total	Left	Thru	Right	RTOR	App. Total	Left	Thru	Right	RTOR	App. Total			
11:00 AM	0	0	0	0	0	2	1	0	0	3	0	0	1	1	1	0	2	1	0	3	1	7	8
11:15 AM	1	1	0	0	2	1	4	0	0	5	0	1	1	1	2	1	1	1	0	3	1	12	13
11:30 AM	0	0	0	0	0	1	2	0	0	3	1	1	0	0	2	0	1	0	0	1	0	6	6
11:45 AM	0	0	0	0	0	0	1	0	0	1	0	2	0	0	2	0	4	1	1	5	1	8	9
Total	1	1	0	0	2	4	8	0	0	12	1	4	2	2	7	1	8	3	1	12	3	33	36
12:00 PM	0	1	0	0	1	0	1	1	0	2	0	0	1	0	1	0	3	0	0	3	0	7	7
12:15 PM	1	0	2	1	3	1	0	0	0	1	0	0	0	0	0	1	4	0	0	5	1	9	10
12:30 PM	2	0	1	1	3	1	2	1	0	4	3	0	0	0	3	0	2	0	0	2	1	12	13
12:45 PM	0	0	1	0	1	0	1	1	0	2	0	0	0	0	0	1	3	0	0	4	0	7	7
Total	3	1	4	2	8	2	4	3	0	9	3	0	1	0	4	2	12	0	0	14	2	35	37
01:00 PM	0	0	0	0	0	1	6	0	0	7	1	0	2	2	3	0	2	0	0	2	2	12	14
01:15 PM	0	0	0	0	0	1	2	1	0	4	1	0	0	0	1	0	2	0	0	2	0	7	7
01:30 PM	1	0	0	0	1	2	3	0	0	5	0	0	0	0	0	0	3	0	0	3	0	9	9
01:45 PM	0	0	0	0	0	0	4	0	0	4	1	0	0	0	1	0	1	1	1	2	1	7	8
Total	1	0	0	0	1	4	15	1	0	20	3	0	2	2	5	0	8	1	1	9	3	35	38
Grand Total	5	2	4	2	11	10	27	4	0	41	7	4	5	4	16	3	28	4	2	35	8	103	111
Apprch %	45.5	18.2	36.4			24.4	65.9	9.8			43.8	25	31.2			8.6	80	11.4					
Total %	4.9	1.9	3.9		10.7	9.7	26.2	3.9		39.8	6.8	3.9	4.9		15.5	2.9	27.2	3.9		34	7.2	92.8	

Start Time	Wood Road Southbound				Van Buren Boulevard Westbound				Wood Road Northbound				Van Buren Boulevard Eastbound				Int. Total
	Left	Thru	Right	App. Total	Left	Thru	Right	App. Total	Left	Thru	Right	App. Total	Left	Thru	Right	App. Total	
Peak Hour Analysis From 12:15 PM to 01:00 PM - Peak 1 of 1																	
Peak Hour for Entire Intersection Begins at 12:15 PM																	
12:15 PM	1	0	2	3	1	0	0	1	0	0	0	0	1	4	0	5	9
12:30 PM	2	0	1	3	1	2	1	4	3	0	0	3	0	2	0	2	12
12:45 PM	0	0	1	1	0	1	1	2	0	0	0	0	1	3	0	4	7
01:00 PM	0	0	0	0	1	6	0	7	1	0	2	3	0	2	0	2	12
Total Volume	3	0	4	7	3	9	2	14	4	0	2	6	2	11	0	13	40
% App. Total	42.9	0	57.1		21.4	64.3	14.3		66.7	0	33.3		15.4	84.6	0		
PHF	.375	.000	.500	.583	.750	.375	.500	.500	.333	.000	.250	.500	.500	.688	.000	.650	.833

City of Riverside
 N/S: Wood Road
 E/W: Van Buren Boulevard
 Weather: Clear

File Name : 04_RIV_Wood_VB Sat
 Site Code : 05122815
 Start Date : 9/17/2022
 Page No : 2

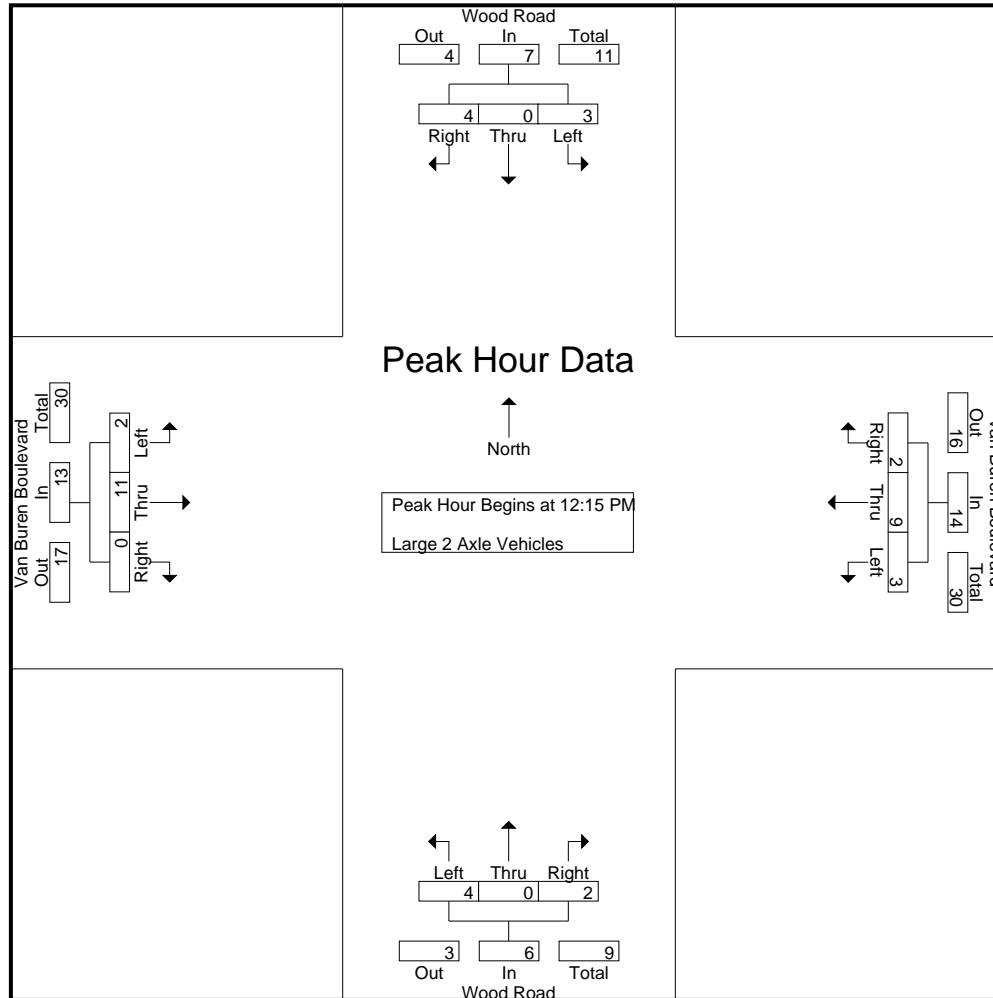

City of Riverside
 N/S: Wood Road
 E/W: Van Buren Boulevard
 Weather: Clear

File Name : 04_RIV_Wood_VB Sat
 Site Code : 05122815
 Start Date : 9/17/2022
 Page No : 3

Start Time	Wood Road Southbound				Van Buren Boulevard Westbound				Wood Road Northbound				Van Buren Boulevard Eastbound				Int. Total
	Left	Thru	Right	App. Total	Left	Thru	Right	App. Total	Left	Thru	Right	App. Total	Left	Thru	Right	App. Total	
Peak Hour Analysis From 12:15 PM to 01:00 PM - Peak 1 of 1																	
Peak Hour for Each Approach Begins at:																	
	12:15 PM				12:15 PM				12:15 PM				12:15 PM				
+0 mins.	1	0	2	3	1	0	0	1	0	0	0	0	1	4	0	5	
+15 mins.	2	0	1	3	1	2	1	4	3	0	0	3	0	2	0	2	
+30 mins.	0	0	1	1	0	1	1	2	0	0	0	0	1	3	0	4	
+45 mins.	0	0	0	0	1	6	0	7	1	0	2	3	0	2	0	2	
Total Volume	3	0	4	7	3	9	2	14	4	0	2	6	2	11	0	13	
% App. Total	42.9	0	57.1		21.4	64.3	14.3		66.7	0	33.3		15.4	84.6	0		
PHF	.375	.000	.500	.583	.750	.375	.500	.500	.333	.000	.250	.500	.500	.688	.000	.650	

City of Riverside
 N/S: Wood Road
 E/W: Van Buren Boulevard
 Weather: Clear

File Name : 04_RIV_Wood_VB Sat
 Site Code : 05122815
 Start Date : 9/17/2022
 Page No : 1

Groups Printed- 3 Axle Vehicles

Start Time	Wood Road Southbound					Van Buren Boulevard Westbound					Wood Road Northbound					Van Buren Boulevard Eastbound					Exclu. Total	Inclu. Total	Int. Total						
	Left	Thru	Right	RTOR	App. Total	Left	Thru	Right	RTOR	App. Total	Left	Thru	Right	RTOR	App. Total	Left	Thru	Right	RTOR	App. Total									
11:00 AM	0	0	0	0	0	0	0	0	0	0	0	0	0	0	0	0	1	0	0	1	0	0	0	0	0	0	0	1	1
11:15 AM	0	0	0	0	0	0	0	0	0	0	0	0	0	0	0	0	0	0	0	0	0	0	0	0	0	0	0	0	0
11:30 AM	0	0	0	0	0	0	1	0	0	1	0	0	0	0	0	0	0	1	0	1	0	0	1	0	1	0	2	2	2
11:45 AM	0	0	0	0	0	0	0	0	0	0	0	0	0	0	0	0	0	0	0	0	0	0	0	0	0	0	0	0	0
Total	0	0	0	0	0	0	1	0	0	1	0	0	0	0	0	0	1	1	0	2	0	0	1	0	2	0	3	3	3
12:00 PM	0	0	0	0	0	0	0	0	0	0	0	0	0	0	0	0	0	0	0	0	0	0	0	0	0	0	0	0	0
12:15 PM	0	0	0	0	0	0	1	0	0	1	0	0	0	0	0	0	1	0	0	1	0	0	0	0	1	0	2	2	2
12:30 PM	0	0	0	0	0	0	1	0	0	1	0	0	0	0	0	0	0	0	0	0	0	0	0	0	0	0	1	1	1
12:45 PM	0	0	0	0	0	0	0	0	0	0	0	0	0	0	0	0	0	0	0	0	0	0	0	0	0	0	0	0	0
Total	0	0	0	0	0	0	2	0	0	2	0	0	0	0	0	0	1	0	0	1	0	0	0	0	1	0	3	3	3
01:00 PM	0	0	0	0	0	0	0	0	0	0	0	0	0	0	0	0	0	0	0	0	0	0	0	0	0	0	0	0	0
01:15 PM	0	0	0	0	0	0	0	0	0	0	0	1	0	0	1	0	0	0	0	0	0	0	0	0	0	0	1	1	1
01:30 PM	0	0	0	0	0	0	0	0	0	0	0	0	0	0	0	0	0	0	0	0	0	0	0	0	0	0	0	0	0
01:45 PM	0	0	0	0	0	0	0	0	0	0	0	0	0	0	0	0	0	0	0	0	0	0	0	0	0	0	0	0	0
Total	0	0	0	0	0	0	0	0	0	0	0	1	0	0	1	0	0	0	0	0	0	0	0	0	0	0	1	1	1
Grand Total	0	0	0	0	0	0	3	0	0	3	0	1	0	0	1	0	2	1	0	3	0	0	1	0	3	0	7	7	7
Apprch %	0	0	0			0	100	0			0	100	0			0	66.7	33.3											
Total %	0	0	0			0	42.9	0		42.9	0	14.3	0		14.3	0	28.6	14.3		42.9	0	0	100			0	100		

Start Time	Wood Road Southbound				Van Buren Boulevard Westbound				Wood Road Northbound				Van Buren Boulevard Eastbound				Int. Total
	Left	Thru	Right	App. Total	Left	Thru	Right	App. Total	Left	Thru	Right	App. Total	Left	Thru	Right	App. Total	
Peak Hour Analysis From 12:15 PM to 01:00 PM - Peak 1 of 1																	
Peak Hour for Entire Intersection Begins at 12:15 PM																	
12:15 PM	0	0	0	0	0	1	0	1	0	0	0	0	0	1	0	1	2
12:30 PM	0	0	0	0	0	1	0	1	0	0	0	0	0	0	0	0	1
12:45 PM	0	0	0	0	0	0	0	0	0	0	0	0	0	0	0	0	0
01:00 PM	0	0	0	0	0	0	0	0	0	0	0	0	0	0	0	0	0
Total Volume	0	0	0	0	0	2	0	2	0	0	0	0	0	1	0	1	3
% App. Total	0	0	0		0	100	0		0	0	0		0	100	0		
PHF	.000	.000	.000	.000	.000	.500	.000	.500	.000	.000	.000	.000	.000	.250	.000	.250	.375

City of Riverside
 N/S: Wood Road
 E/W: Van Buren Boulevard
 Weather: Clear

File Name : 04_RIV_Wood_VB Sat
 Site Code : 05122815
 Start Date : 9/17/2022
 Page No : 2

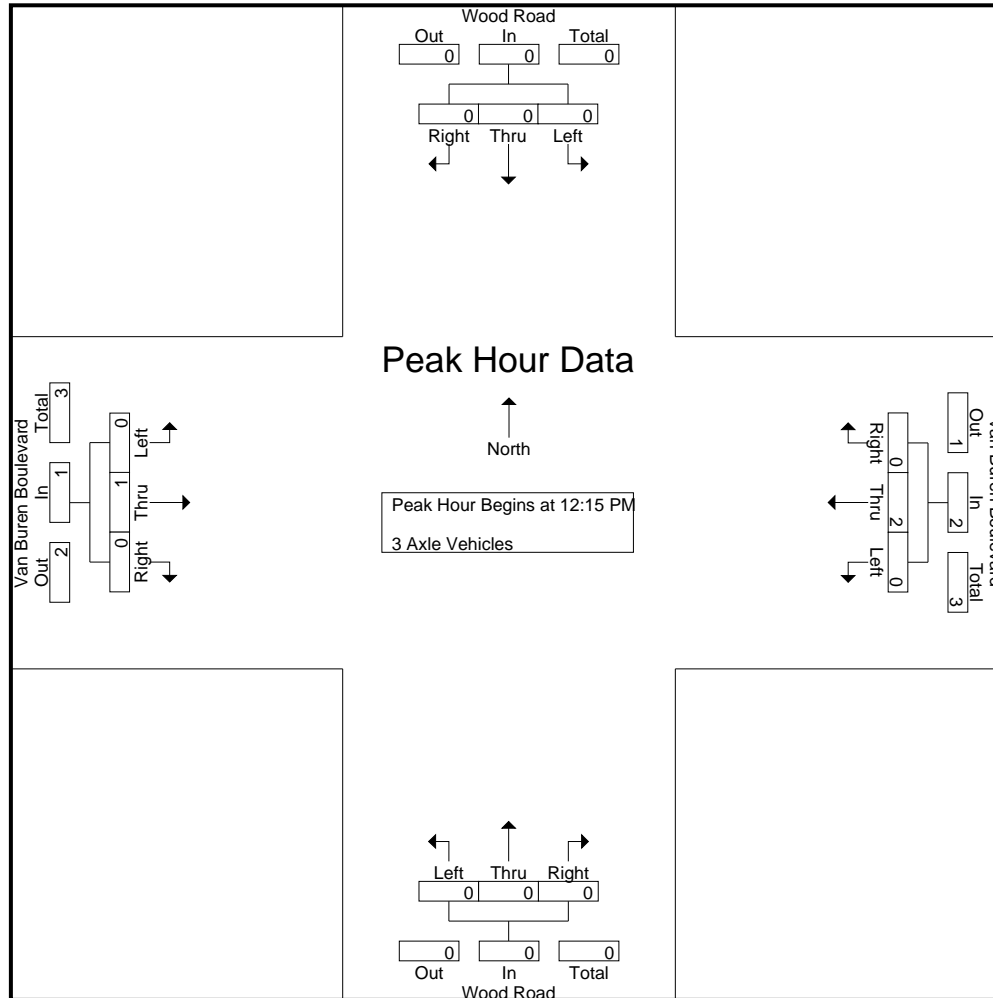

City of Riverside
 N/S: Wood Road
 E/W: Van Buren Boulevard
 Weather: Clear

File Name : 04_RIV_Wood_VB Sat
 Site Code : 05122815
 Start Date : 9/17/2022
 Page No : 3

Start Time	Wood Road Southbound				Van Buren Boulevard Westbound				Wood Road Northbound				Van Buren Boulevard Eastbound				Int. Total
	Left	Thru	Right	App. Total	Left	Thru	Right	App. Total	Left	Thru	Right	App. Total	Left	Thru	Right	App. Total	
Peak Hour Analysis From 12:15 PM to 01:00 PM - Peak 1 of 1																	
Peak Hour for Each Approach Begins at:																	
	12:15 PM				12:15 PM				12:15 PM				12:15 PM				
+0 mins.	0	0	0	0	0	1	0	1	0	0	0	0	0	1	0	1	
+15 mins.	0	0	0	0	0	1	0	1	0	0	0	0	0	0	0	0	
+30 mins.	0	0	0	0	0	0	0	0	0	0	0	0	0	0	0	0	
+45 mins.	0	0	0	0	0	0	0	0	0	0	0	0	0	0	0	0	
Total Volume	0	0	0	0	0	2	0	2	0	0	0	0	0	1	0	1	
% App. Total	0	0	0	0	0	100	0	0	0	0	0	0	0	100	0	0	
PHF	.000	.000	.000	.000	.000	.500	.000	.500	.000	.000	.000	.000	.000	.250	.000	.250	

City of Riverside
 N/S: Wood Road
 E/W: Van Buren Boulevard
 Weather: Clear

File Name : 04_RIV_Wood_VB Sat
 Site Code : 05122815
 Start Date : 9/17/2022
 Page No : 1

Groups Printed- 4+ Axle Trucks

Start Time	Wood Road Southbound					Van Buren Boulevard Westbound					Wood Road Northbound					Van Buren Boulevard Eastbound					Exclu. Total	Inclu. Total	Int. Total					
	Left	Thru	Right	RTOR	App. Total	Left	Thru	Right	RTOR	App. Total	Left	Thru	Right	RTOR	App. Total	Left	Thru	Right	RTOR	App. Total								
11:00 AM	0	0	0	0	0	0	0	0	0	0	0	0	0	0	0	0	0	0	0	0	0	0	0	0	0	0	0	0
11:15 AM	0	0	0	0	0	0	0	0	0	0	0	0	0	0	0	0	0	0	0	0	0	0	0	0	0	0	0	0
11:30 AM	0	0	0	0	0	0	1	0	0	1	0	0	0	0	0	0	0	0	0	0	0	0	0	0	0	0	1	1
11:45 AM	0	0	0	0	0	0	0	0	0	0	0	0	0	0	0	0	1	0	0	0	0	1	0	0	1	0	1	1
Total	0	0	0	0	0	0	1	0	0	1	0	0	0	0	0	0	1	0	0	0	0	1	0	0	1	0	2	2
12:00 PM	0	0	0	0	0	0	0	0	0	0	0	0	0	0	0	0	0	0	0	0	0	0	0	0	0	0	0	0
12:15 PM	0	0	0	0	0	0	0	0	0	0	0	0	0	0	0	0	0	0	0	0	0	0	0	0	0	0	0	0
12:30 PM	0	0	0	0	0	0	0	0	0	0	0	0	0	0	0	0	0	0	0	0	0	0	0	0	0	0	0	0
12:45 PM	0	0	0	0	0	0	0	0	0	0	0	0	0	0	0	0	1	0	0	0	0	1	0	0	1	0	1	1
Total	0	0	0	0	0	0	0	0	0	0	0	0	0	0	0	0	1	0	0	0	0	1	0	0	1	0	1	1
01:00 PM	0	0	0	0	0	0	0	0	0	0	0	0	0	0	0	0	1	0	0	0	0	1	0	0	1	0	1	1
01:15 PM	0	0	0	0	0	0	0	0	0	0	0	0	0	0	0	0	0	0	0	0	0	0	0	0	0	0	0	0
01:30 PM	0	0	0	0	0	0	0	0	0	0	0	0	0	0	0	0	1	0	0	0	0	1	0	0	1	0	1	1
01:45 PM	0	0	0	0	0	0	0	0	0	0	0	0	0	0	0	0	1	0	0	0	0	1	0	0	1	0	1	1
Total	0	0	0	0	0	0	0	0	0	0	0	0	0	0	0	0	3	0	0	0	0	3	0	0	3	0	3	3
Grand Total	0	0	0	0	0	0	1	0	0	1	0	0	0	0	0	0	5	0	0	0	0	5	0	0	5	0	6	6
Apprch %	0	0	0			0	100	0			0	0	0			0	100	0			0					0		
Total %	0	0	0			0	16.7	0		16.7	0	0	0		0	0	83.3	0		83.3	0					0	100	

Start Time	Wood Road Southbound				Van Buren Boulevard Westbound				Wood Road Northbound				Van Buren Boulevard Eastbound				Int. Total				
	Left	Thru	Right	App. Total	Left	Thru	Right	App. Total	Left	Thru	Right	App. Total	Left	Thru	Right	App. Total					
Peak Hour Analysis From 12:15 PM to 01:00 PM - Peak 1 of 1																					
Peak Hour for Entire Intersection Begins at 12:15 PM																					
12:15 PM	0	0	0	0	0	0	0	0	0	0	0	0	0	0	0	0	0	0	0	0	0
12:30 PM	0	0	0	0	0	0	0	0	0	0	0	0	0	0	0	0	0	0	0	0	0
12:45 PM	0	0	0	0	0	0	0	0	0	0	0	0	0	1	0	0	0	1	0	0	1
01:00 PM	0	0	0	0	0	0	0	0	0	0	0	0	0	1	0	0	0	1	0	0	1
Total Volume	0	0	0	0	0	0	0	0	0	0	0	0	0	2	0	0	0	2	0	0	2
% App. Total	0	0	0		0	0	0		0	0	0		0	100	0		0				
PHF	.000	.000	.000	.000	.000	.000	.000	.000	.000	.000	.000	.000	.000	.500	.000	.500	.000	.500	.000	.500	.500

City of Riverside
 N/S: Wood Road
 E/W: Van Buren Boulevard
 Weather: Clear

File Name : 04_RIV_Wood_VB Sat
 Site Code : 05122815
 Start Date : 9/17/2022
 Page No : 2

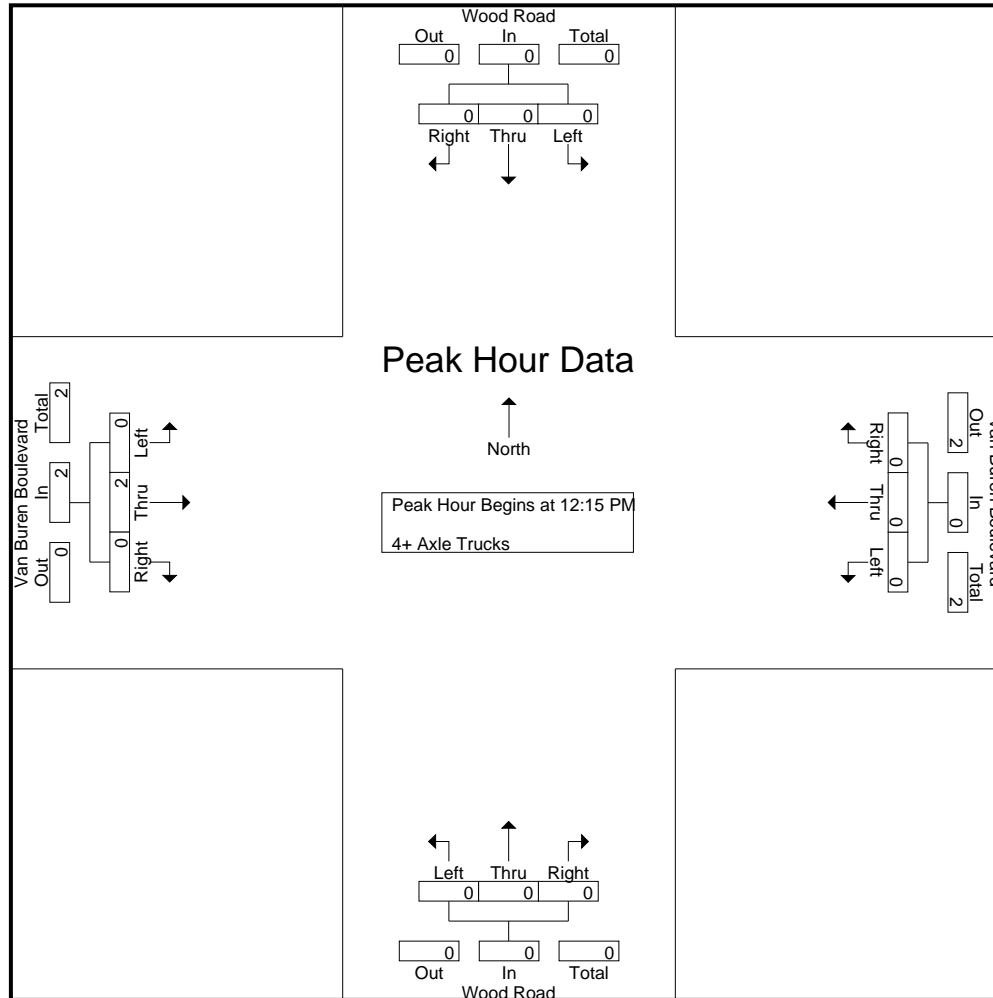

City of Riverside
 N/S: Wood Road
 E/W: Van Buren Boulevard
 Weather: Clear

File Name : 04_RIV_Wood_VB Sat
 Site Code : 05122815
 Start Date : 9/17/2022
 Page No : 3

Start Time	Wood Road Southbound				Van Buren Boulevard Westbound				Wood Road Northbound				Van Buren Boulevard Eastbound				Int. Total
	Left	Thru	Right	App. Total	Left	Thru	Right	App. Total	Left	Thru	Right	App. Total	Left	Thru	Right	App. Total	
Peak Hour Analysis From 12:15 PM to 01:00 PM - Peak 1 of 1																	
Peak Hour for Each Approach Begins at:																	
	12:15 PM				12:15 PM				12:15 PM				12:15 PM				
+0 mins.	0	0	0	0	0	0	0	0	0	0	0	0	0	0	0	0	0
+15 mins.	0	0	0	0	0	0	0	0	0	0	0	0	0	0	0	0	0
+30 mins.	0	0	0	0	0	0	0	0	0	0	0	0	0	1	0	0	1
+45 mins.	0	0	0	0	0	0	0	0	0	0	0	0	0	1	0	0	1
Total Volume	0	0	0	0	0	0	0	0	0	0	0	0	0	2	0	0	2
% App. Total	0	0	0	0	0	0	0	0	0	0	0	0	0	100	0	0	
PHF	.000	.000	.000	.000	.000	.000	.000	.000	.000	.000	.000	.000	.000	.500	.000	.500	

Location: Riverside
 N/S: Wood Road
 E/W: Van Buren Blvd



Date: 9/17/2022
 Day Saturday

PEDESTRIANS

Time	North Leg Wood Road	East Leg Van Buren Blvd	South Leg Wood Road	West Leg Van Buren Blvd	TOTAL
11:00 AM	0	0	2	0	2
11:15 AM	0	0	0	0	0
11:30 AM	0	7	2	0	9
11:45 AM	0	4	1	0	5
12:00 PM	0	0	0	0	0
12:15 PM	2	5	0	0	7
12:30 PM	1	0	0	0	1
12:45 PM	1	3	0	0	4
1:00 PM	0	0	0	0	0
1:15 PM	0	6	0	0	6
1:30 PM	0	0	0	0	0
1:45 PM	1	1	1	0	3
TOTAL VOLUMES:	5	26	6	0	37

Location: Riverside
 N/S: Wood Road
 E/W: Van Buren Blvd

Date: 9/17/2022
 Day: Saturday



BICYCLES

	Southbound Wood Road			Westbound Van Buren Blvd			Northbound Wood Road			Eastbound Van Buren Blvd			
	Left	Thru	Right	Left	Thru	Right	Left	Thru	Right	Left	Thru	Right	
11:00 AM	0	0	0	0	0	0	0	0	0	0	1	0	1
11:15 AM	0	0	0	0	0	0	0	0	0	0	0	0	0
11:30 AM	1	0	0	0	0	0	0	0	0	0	1	0	2
11:45 AM	0	0	0	0	0	0	0	0	0	0	0	0	0
12:00 PM	0	0	0	0	0	0	0	0	0	0	0	0	0
12:15 PM	0	0	0	0	0	0	0	0	0	0	0	0	0
12:30 PM	0	0	0	0	0	0	0	0	0	0	0	0	0
12:45 PM	0	0	0	0	0	0	0	0	0	0	0	0	0
1:00 PM	0	0	0	0	0	0	0	1	0	0	2	0	3
1:15 PM	0	0	0	0	0	0	0	0	0	0	0	0	0
1:30 PM	0	0	0	0	0	0	0	0	0	0	0	0	0
1:45 PM	0	0	0	0	0	0	0	0	0	0	0	0	0
TOTAL VOLUMES:	1	0	0	0	0	0	0	1	0	0	4	0	6

City of Riverside
 N/S: Trautwein Road
 E/W: Alessandro Boulevard
 Weather: Clear

File Name : 05_RIV_Traut_Ales Sat
 Site Code : 05122815
 Start Date : 9/17/2022
 Page No : 1

Groups Printed- Passenger Vehicles - Large 2 Axle Vehicles - 3 Axle Vehicles - 4+ Axle Trucks

Start Time	Alessandro Boulevard Westbound			Trautwein Road Northbound				Alessandro Boulevard Eastbound				Exclu. Total	Inclu. Total	Int. Total
	Left	Thru	App. Total	Left	Right	RTOR	App. Total	Thru	Right	RTOR	App. Total			
11:00 AM	44	217	261	152	1	0	153	183	1	0	184	0	598	598
11:15 AM	41	238	279	161	3	0	164	198	1	0	199	0	642	642
11:30 AM	49	263	312	183	6	1	189	170	2	0	172	1	673	674
11:45 AM	34	265	299	187	3	0	190	197	0	0	197	0	686	686
Total	168	983	1151	683	13	1	696	748	4	0	752	1	2599	2600
12:00 PM	42	248	290	161	3	2	164	229	1	0	230	2	684	686
12:15 PM	26	230	256	203	4	0	207	228	3	0	231	0	694	694
12:30 PM	34	291	325	163	4	0	167	200	0	0	200	0	692	692
12:45 PM	28	269	297	200	4	1	204	188	2	0	190	1	691	692
Total	130	1038	1168	727	15	3	742	845	6	0	851	3	2761	2764
01:00 PM	32	287	319	208	2	0	210	213	0	0	213	0	742	742
01:15 PM	41	282	323	150	4	0	154	268	0	0	268	0	745	745
01:30 PM	48	290	338	181	3	0	184	209	3	0	212	0	734	734
01:45 PM	49	285	334	176	1	0	177	261	5	0	266	0	777	777
Total	170	1144	1314	715	10	0	725	951	8	0	959	0	2998	2998
Grand Total	468	3165	3633	2125	38	4	2163	2544	18	0	2562	4	8358	8362
Apprch %	12.9	87.1		98.2	1.8			99.3	0.7					
Total %	5.6	37.9	43.5	25.4	0.5		25.9	30.4	0.2		30.7	0	100	
Passenger Vehicles	462	3134	3596	2087	36		2127	2520	17		2537	0	0	8260
% Passenger Vehicles	98.7	99	99	98.2	94.7	100	98.2	99.1	94.4	0	99	0	0	98.8
Large 2 Axle Vehicles	6	28	34	34	2		36	23	1		24	0	0	94
% Large 2 Axle Vehicles	1.3	0.9	0.9	1.6	5.3	0	1.7	0.9	5.6	0	0.9	0	0	1.1
3 Axle Vehicles	0	1	1	2	0		2	1	0		1	0	0	4
% 3 Axle Vehicles	0	0	0	0.1	0	0	0.1	0	0	0	0	0	0	0
4+ Axle Trucks	0	2	2	2	0		2	0	0		0	0	0	4
% 4+ Axle Trucks	0	0.1	0.1	0.1	0	0	0.1	0	0	0	0	0	0	0

Start Time	Alessandro Boulevard Westbound			Trautwein Road Northbound			Alessandro Boulevard Eastbound			Int. Total
	Left	Thru	App. Total	Left	Right	App. Total	Thru	Right	App. Total	
Peak Hour Analysis From 11:00 AM to 01:45 PM - Peak 1 of 1										
Peak Hour for Entire Intersection Begins at 01:00 PM										
01:00 PM	32	287	319	208	2	210	213	0	213	742
01:15 PM	41	282	323	150	4	154	268	0	268	745
01:30 PM	48	290	338	181	3	184	209	3	212	734
01:45 PM	49	285	334	176	1	177	261	5	266	777
Total Volume	170	1144	1314	715	10	725	951	8	959	2998
% App. Total	12.9	87.1		98.6	1.4		99.2	0.8		
PHF	.867	.986	.972	.859	.625	.863	.887	.400	.895	.965

City of Riverside
 N/S: Trautwein Road
 E/W: Alessandro Boulevard
 Weather: Clear

File Name : 05_RIV_Traut_Ales Sat
 Site Code : 05122815
 Start Date : 9/17/2022
 Page No : 2

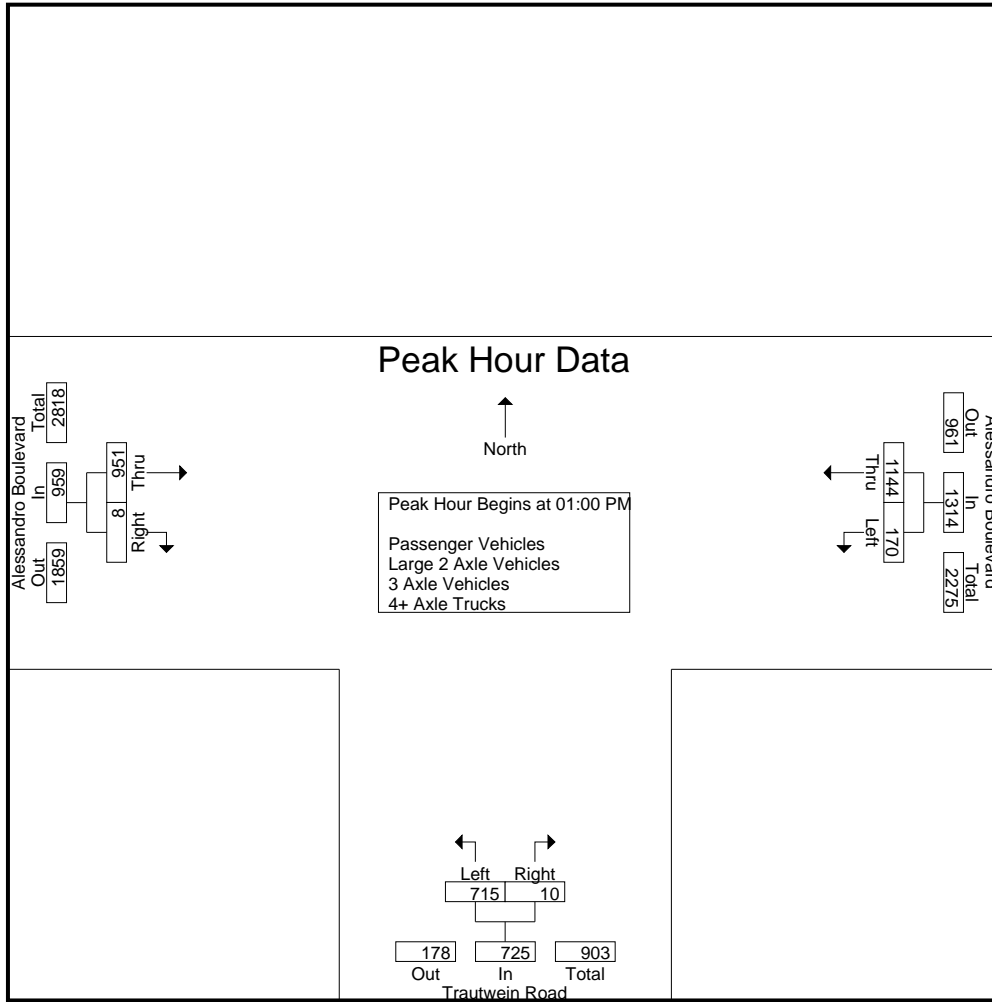

Peak Hour Analysis From 11:00 AM to 01:45 PM - Peak 1 of 1
 Peak Hour for Each Approach Begins at:

	01:00 PM			12:15 PM			01:00 PM		
+0 mins.	32	287	319	203	4	207	213	0	213
+15 mins.	41	282	323	163	4	167	268	0	268
+30 mins.	48	290	338	200	4	204	209	3	212
+45 mins.	49	285	334	208	2	210	261	5	266
Total Volume	170	1144	1314	774	14	788	951	8	959
% App. Total	12.9	87.1		98.2	1.8		99.2	0.8	
PHF	.867	.986	.972	.930	.875	.938	.887	.400	.895

City of Riverside
 N/S: Trautwein Road
 E/W: Alessandro Boulevard
 Weather: Clear

File Name : 05_RIV_Traut_Ales Sat
 Site Code : 05122815
 Start Date : 9/17/2022
 Page No : 1

Groups Printed- Passenger Vehicles

Start Time	Alessandro Boulevard Westbound			Trautwein Road Northbound				Alessandro Boulevard Eastbound				Exclu. Total	Inclu. Total	Int. Total
	Left	Thru	App. Total	Left	Right	RTOR	App. Total	Thru	Right	RTOR	App. Total			
11:00 AM	43	216	259	150	1	0	151	179	0	0	179	0	589	589
11:15 AM	39	238	277	159	3	0	162	195	1	0	196	0	635	635
11:30 AM	49	262	311	180	5	1	185	168	2	0	170	1	666	667
11:45 AM	33	262	295	184	3	0	187	197	0	0	197	0	679	679
Total	164	978	1142	673	12	1	685	739	3	0	742	1	2569	2570
12:00 PM	41	244	285	158	3	2	161	226	1	0	227	2	673	675
12:15 PM	26	228	254	199	3	0	202	228	3	0	231	0	687	687
12:30 PM	34	286	320	158	4	0	162	196	0	0	196	0	678	678
12:45 PM	28	267	295	193	4	1	197	187	2	0	189	1	681	682
Total	129	1025	1154	708	14	3	722	837	6	0	843	3	2719	2722
01:00 PM	32	286	318	205	2	0	207	212	0	0	212	0	737	737
01:15 PM	40	278	318	148	4	0	152	265	0	0	265	0	735	735
01:30 PM	48	287	335	179	3	0	182	207	3	0	210	0	727	727
01:45 PM	49	280	329	174	1	0	175	260	5	0	265	0	769	769
Total	169	1131	1300	706	10	0	716	944	8	0	952	0	2968	2968
Grand Total	462	3134	3596	2087	36	4	2123	2520	17	0	2537	4	8256	8260
Apprch %	12.8	87.2		98.3	1.7			99.3	0.7					
Total %	5.6	38	43.6	25.3	0.4		25.7	30.5	0.2		30.7	0	100	

Start Time	Alessandro Boulevard Westbound			Trautwein Road Northbound			Alessandro Boulevard Eastbound			Int. Total
	Left	Thru	App. Total	Left	Right	App. Total	Thru	Right	App. Total	
01:00 PM	32	286	318	205	2	207	212	0	212	737
01:15 PM	40	278	318	148	4	152	265	0	265	735
01:30 PM	48	287	335	179	3	182	207	3	210	727
01:45 PM	49	280	329	174	1	175	260	5	265	769
Total Volume	169	1131	1300	706	10	716	944	8	952	2968
% App. Total	13	87		98.6	1.4		99.2	0.8		
PHF	.862	.985	.970	.861	.625	.865	.891	.400	.898	.965

City of Riverside
 N/S: Trautwein Road
 E/W: Alessandro Boulevard
 Weather: Clear

File Name : 05_RIV_Traut_Ales Sat
 Site Code : 05122815
 Start Date : 9/17/2022
 Page No : 2

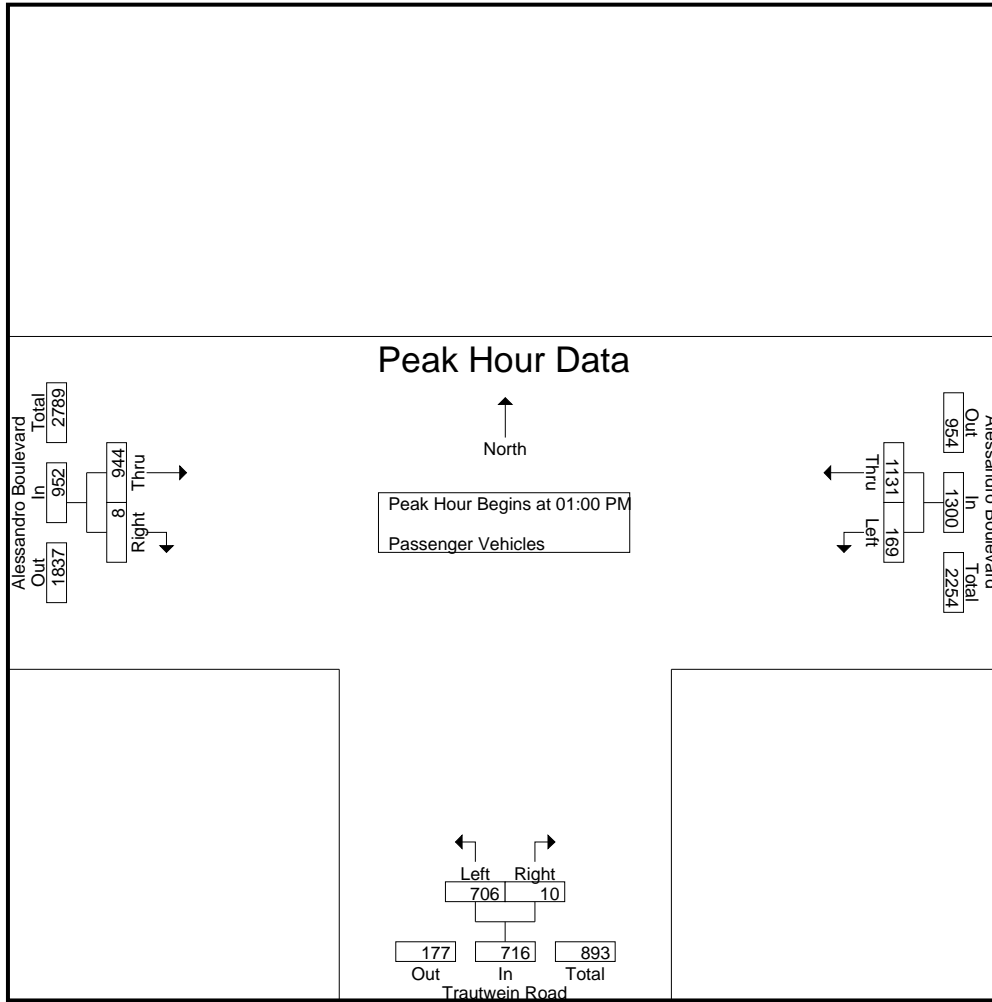

Peak Hour Analysis From 01:00 PM to 01:45 PM - Peak 1 of 1
 Peak Hour for Each Approach Begins at:

	01:00 PM			01:00 PM			01:00 PM		
+0 mins.	32	286	318	205	2	207	212	0	212
+15 mins.	40	278	318	148	4	152	265	0	265
+30 mins.	48	287	335	179	3	182	207	3	210
+45 mins.	49	280	329	174	1	175	260	5	265
Total Volume	169	1131	1300	706	10	716	944	8	952
% App. Total	13	87		98.6	1.4		99.2	0.8	
PHF	.862	.985	.970	.861	.625	.865	.891	.400	.898

City of Riverside
 N/S: Trautwein Road
 E/W: Alessandro Boulevard
 Weather: Clear

File Name : 05_RIV_Traut_Ales Sat
 Site Code : 05122815
 Start Date : 9/17/2022
 Page No : 1

Groups Printed- Large 2 Axle Vehicles

Start Time	Alessandro Boulevard Westbound			Trautwein Road Northbound				Alessandro Boulevard Eastbound				Exclu. Total	Inclu. Total	Int. Total
	Left	Thru	App. Total	Left	Right	RTOR	App. Total	Thru	Right	RTOR	App. Total			
11:00 AM	1	1	2	2	0	0	2	4	1	0	5	0	9	9
11:15 AM	2	0	2	2	0	0	2	3	0	0	3	0	7	7
11:30 AM	0	1	1	3	1	0	4	1	0	0	1	0	6	6
11:45 AM	1	3	4	3	0	0	3	0	0	0	0	0	7	7
Total	4	5	9	10	1	0	11	8	1	0	9	0	29	29
12:00 PM	1	3	4	3	0	0	3	3	0	0	3	0	10	10
12:15 PM	0	1	1	3	1	0	4	0	0	0	0	0	5	5
12:30 PM	0	5	5	4	0	0	4	4	0	0	4	0	13	13
12:45 PM	0	2	2	6	0	0	6	1	0	0	1	0	9	9
Total	1	11	12	16	1	0	17	8	0	0	8	0	37	37
01:00 PM	0	1	1	3	0	0	3	1	0	0	1	0	5	5
01:15 PM	1	4	5	2	0	0	2	3	0	0	3	0	10	10
01:30 PM	0	3	3	1	0	0	1	2	0	0	2	0	6	6
01:45 PM	0	4	4	2	0	0	2	1	0	0	1	0	7	7
Total	1	12	13	8	0	0	8	7	0	0	7	0	28	28
Grand Total	6	28	34	34	2	0	36	23	1	0	24	0	94	94
Apprch %	17.6	82.4		94.4	5.6			95.8	4.2					
Total %	6.4	29.8	36.2	36.2	2.1		38.3	24.5	1.1		25.5	0	100	

Start Time	Alessandro Boulevard Westbound			Trautwein Road Northbound			Alessandro Boulevard Eastbound			Int. Total
	Left	Thru	App. Total	Left	Right	App. Total	Thru	Right	App. Total	
01:00 PM	0	1	1	3	0	3	1	0	1	5
01:15 PM	1	4	5	2	0	2	3	0	3	10
01:30 PM	0	3	3	1	0	1	2	0	2	6
01:45 PM	0	4	4	2	0	2	1	0	1	7
Total Volume	1	12	13	8	0	8	7	0	7	28
% App. Total	7.7	92.3		100	0		100	0		
PHF	.250	.750	.650	.667	.000	.667	.583	.000	.583	.700

City of Riverside
 N/S: Trautwein Road
 E/W: Alessandro Boulevard
 Weather: Clear

File Name : 05_RIV_Traut_Ales Sat
 Site Code : 05122815
 Start Date : 9/17/2022
 Page No : 2

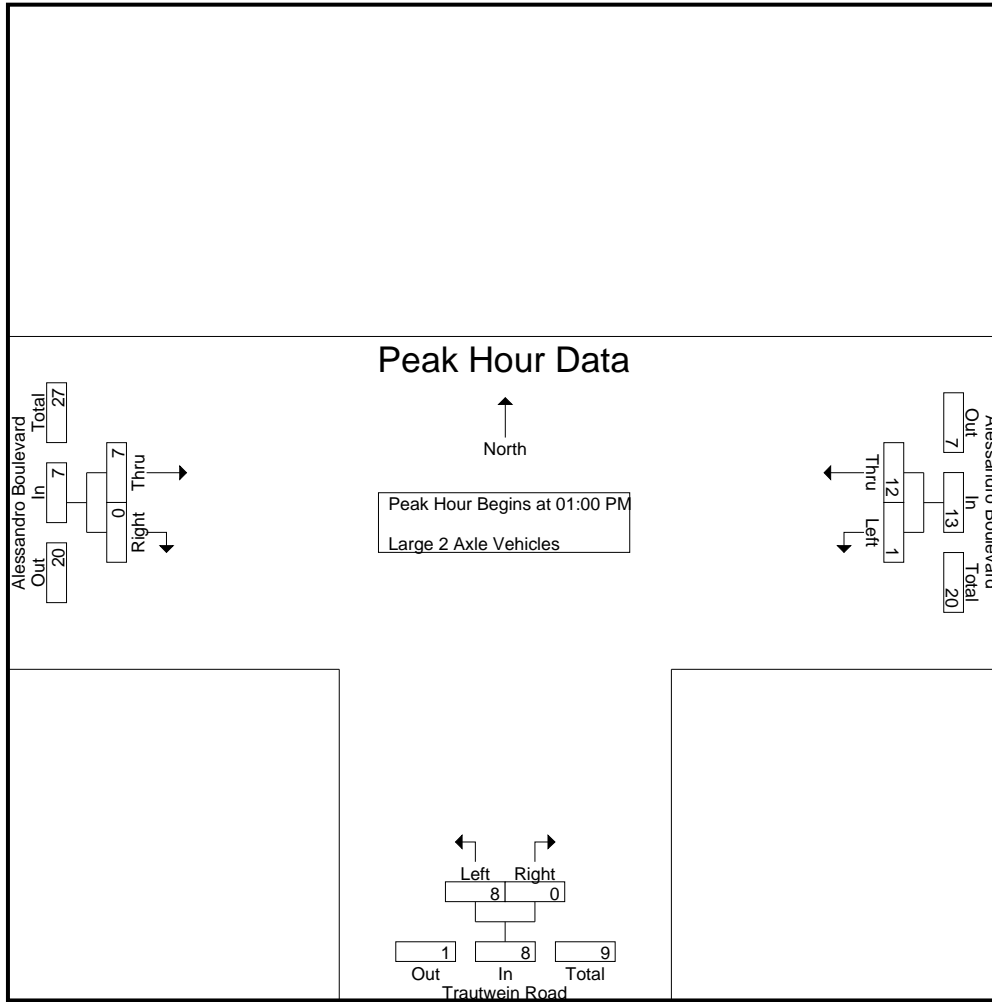

Peak Hour Analysis From 01:00 PM to 01:45 PM - Peak 1 of 1
 Peak Hour for Each Approach Begins at:

	01:00 PM			01:00 PM			01:00 PM		
+0 mins.	0	1	1	3	0	3	1	0	1
+15 mins.	1	4	5	2	0	2	3	0	3
+30 mins.	0	3	3	1	0	1	2	0	2
+45 mins.	0	4	4	2	0	2	1	0	1
Total Volume	1	12	13	8	0	8	7	0	7
% App. Total	7.7	92.3		100	0		100	0	
PHF	.250	.750	.650	.667	.000	.667	.583	.000	.583

City of Riverside
 N/S: Trautwein Road
 E/W: Alessandro Boulevard
 Weather: Clear

File Name : 05_RIV_Traut_Ales Sat
 Site Code : 05122815
 Start Date : 9/17/2022
 Page No : 1

Groups Printed- 3 Axle Vehicles

Start Time	Alessandro Boulevard Westbound			Trautwein Road Northbound				Alessandro Boulevard Eastbound				Exclu. Total	Inclu. Total	Int. Total	
	Left	Thru	App. Total	Left	Right	RTOR	App. Total	Thru	Right	RTOR	App. Total				
11:00 AM	0	0	0	0	0	0	0	0	0	0	0	0	0	0	0
11:15 AM	0	0	0	0	0	0	0	0	0	0	0	0	0	0	0
11:30 AM	0	0	0	0	0	0	0	1	0	0	1	0	1	1	1
11:45 AM	0	0	0	0	0	0	0	0	0	0	0	0	0	0	0
Total	0	0	0	0	0	0	0	1	0	0	1	0	1	1	1
12:00 PM	0	0	0	0	0	0	0	0	0	0	0	0	0	0	0
12:15 PM	0	1	1	1	0	0	1	0	0	0	0	0	2	2	2
12:30 PM	0	0	0	0	0	0	0	0	0	0	0	0	0	0	0
12:45 PM	0	0	0	1	0	0	1	0	0	0	0	0	1	1	1
Total	0	1	1	2	0	0	2	0	0	0	0	0	3	3	3
01:00 PM	0	0	0	0	0	0	0	0	0	0	0	0	0	0	0
01:15 PM	0	0	0	0	0	0	0	0	0	0	0	0	0	0	0
01:30 PM	0	0	0	0	0	0	0	0	0	0	0	0	0	0	0
01:45 PM	0	0	0	0	0	0	0	0	0	0	0	0	0	0	0
Total	0	0	0	0	0	0	0	0	0	0	0	0	0	0	0
Grand Total	0	1	1	2	0	0	2	1	0	0	1	0	4	4	4
Apprch %	0	100		100	0			100	0						
Total %	0	25	25	50	0		50	25	0		25	0	100		

Start Time	Alessandro Boulevard Westbound			Trautwein Road Northbound			Alessandro Boulevard Eastbound			Int. Total
	Left	Thru	App. Total	Left	Right	App. Total	Thru	Right	App. Total	
01:00 PM	0	0	0	0	0	0	0	0	0	0
01:15 PM	0	0	0	0	0	0	0	0	0	0
01:30 PM	0	0	0	0	0	0	0	0	0	0
01:45 PM	0	0	0	0	0	0	0	0	0	0
Total Volume	0	0	0	0	0	0	0	0	0	0
% App. Total	0	0		0	0		0	0		
PHF	.000	.000	.000	.000	.000	.000	.000	.000	.000	.000

City of Riverside
 N/S: Trautwein Road
 E/W: Alessandro Boulevard
 Weather: Clear

File Name : 05_RIV_Traut_Ales Sat
 Site Code : 05122815
 Start Date : 9/17/2022
 Page No : 2

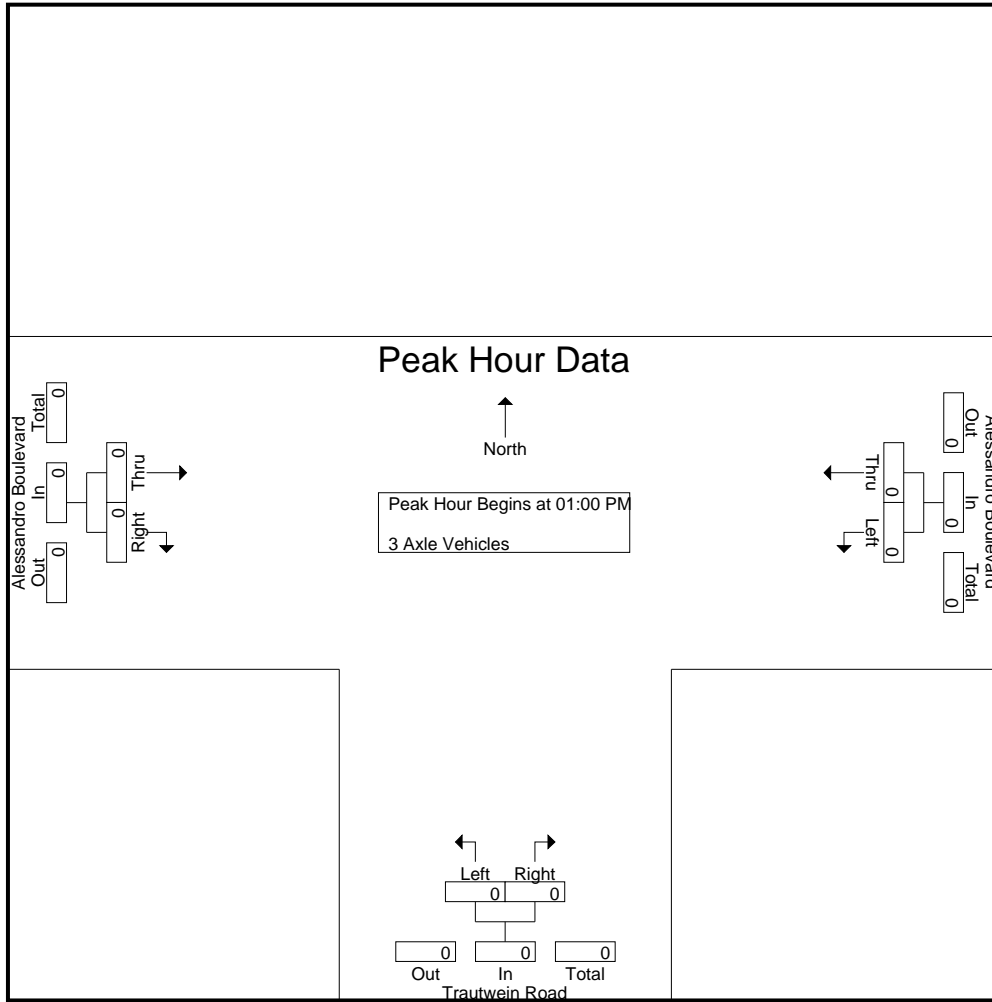

Peak Hour Analysis From 01:00 PM to 01:45 PM - Peak 1 of 1
 Peak Hour for Each Approach Begins at:

	01:00 PM			01:00 PM			01:00 PM		
+0 mins.	0	0	0	0	0	0	0	0	0
+15 mins.	0	0	0	0	0	0	0	0	0
+30 mins.	0	0	0	0	0	0	0	0	0
+45 mins.	0	0	0	0	0	0	0	0	0
Total Volume	0	0	0	0	0	0	0	0	0
% App. Total	0	0	0	0	0	0	0	0	0
PHF	.000	.000	.000	.000	.000	.000	.000	.000	.000

City of Riverside
 N/S: Trautwein Road
 E/W: Alessandro Boulevard
 Weather: Clear

File Name : 05_RIV_Traut_Ales Sat
 Site Code : 05122815
 Start Date : 9/17/2022
 Page No : 1

Groups Printed- 4+ Axle Trucks

Start Time	Alessandro Boulevard Westbound			Trautwein Road Northbound				Alessandro Boulevard Eastbound				Exclu. Total	Inclu. Total	Int. Total	
	Left	Thru	App. Total	Left	Right	RTOR	App. Total	Thru	Right	RTOR	App. Total				
11:00 AM	0	0	0	0	0	0	0	0	0	0	0	0	0	0	0
11:15 AM	0	0	0	0	0	0	0	0	0	0	0	0	0	0	0
11:30 AM	0	0	0	0	0	0	0	0	0	0	0	0	0	0	0
11:45 AM	0	0	0	0	0	0	0	0	0	0	0	0	0	0	0
Total	0	0	0	0	0	0	0	0	0	0	0	0	0	0	0
12:00 PM	0	1	1	0	0	0	0	0	0	0	0	0	0	1	1
12:15 PM	0	0	0	0	0	0	0	0	0	0	0	0	0	0	0
12:30 PM	0	0	0	1	0	0	1	0	0	0	0	0	0	1	1
12:45 PM	0	0	0	0	0	0	0	0	0	0	0	0	0	0	0
Total	0	1	1	1	0	0	1	0	0	0	0	0	0	2	2
01:00 PM	0	0	0	0	0	0	0	0	0	0	0	0	0	0	0
01:15 PM	0	0	0	0	0	0	0	0	0	0	0	0	0	0	0
01:30 PM	0	0	0	1	0	0	1	0	0	0	0	0	0	1	1
01:45 PM	0	1	1	0	0	0	0	0	0	0	0	0	0	1	1
Total	0	1	1	1	0	0	1	0	0	0	0	0	0	2	2
Grand Total	0	2	2	2	0	0	2	0	0	0	0	0	0	4	4
Apprch %	0	100		100	0			0	0						
Total %	0	50	50	50	0		50	0	0		0		0	100	

Start Time	Alessandro Boulevard Westbound			Trautwein Road Northbound			Alessandro Boulevard Eastbound			Int. Total
	Left	Thru	App. Total	Left	Right	App. Total	Thru	Right	App. Total	
01:00 PM	0	0	0	0	0	0	0	0	0	0
01:15 PM	0	0	0	0	0	0	0	0	0	0
01:30 PM	0	0	0	1	0	1	0	0	0	1
01:45 PM	0	1	1	0	0	0	0	0	0	1
Total Volume	0	1	1	1	0	1	0	0	0	2
% App. Total	0	100		100	0		0	0		
PHF	.000	.250	.250	.250	.000	.250	.000	.000	.000	.500

City of Riverside
 N/S: Trautwein Road
 E/W: Alessandro Boulevard
 Weather: Clear

File Name : 05_RIV_Traut_Ales Sat
 Site Code : 05122815
 Start Date : 9/17/2022
 Page No : 2

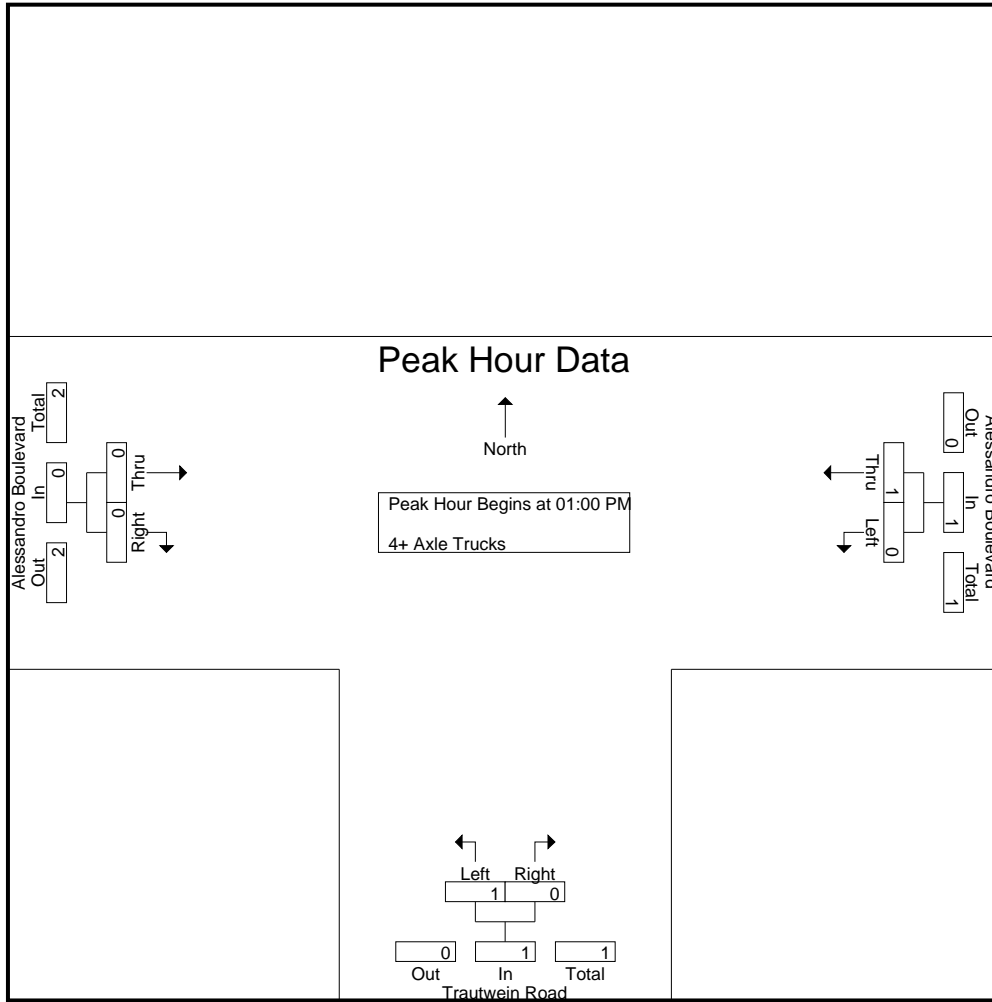

Peak Hour Analysis From 01:00 PM to 01:45 PM - Peak 1 of 1
 Peak Hour for Each Approach Begins at:

	01:00 PM			01:00 PM			01:00 PM		
+0 mins.	0	0	0	0	0	0	0	0	0
+15 mins.	0	0	0	0	0	0	0	0	0
+30 mins.	0	0	0	1	0	1	0	0	0
+45 mins.	0	1	1	0	0	0	0	0	0
Total Volume	0	1	1	1	0	1	0	0	0
% App. Total	0	100		100	0		0	0	
PHF	.000	.250	.250	.250	.000	.250	.000	.000	.000

Location: Riverside
 N/S: Trautwein Road
 E/W: Alessandro Boulevard



Date: 9/17/2022
 Day Saturday

PEDESTRIANS

Time	North Leg Dead End	East Leg Alessandro Boulevard	South Leg Trautwein Road	West Leg Alessandro Boulevard	TOTAL
11:00 AM	0	0	0	0	0
11:15 AM	0	0	0	0	0
11:30 AM	0	0	0	0	0
11:45 AM	0	0	0	0	0
12:00 PM	0	0	0	0	0
12:15 PM	0	0	2	0	2
12:30 PM	0	0	0	0	0
12:45 PM	0	0	0	0	0
1:00 PM	0	0	0	0	0
1:15 PM	0	0	0	0	0
1:30 PM	0	0	0	0	0
1:45 PM	0	0	0	0	0
TOTAL VOLUMES:	0	0	2	0	2

Location: Riverside
 N/S: Trautwein Road
 E/W: Alessandro Boulevard

Date: 9/17/2022
 Day: Saturday



BICYCLES

	Southbound Dead End			Westbound Alessandro Boulevard			Northbound Trautwein Road			Eastbound Alessandro Boulevard			
	Left	Thru	Right	Left	Thru	Right	Left	Thru	Right	Left	Thru	Right	
11:00 AM	0	0	0	0	0	0	0	0	0	0	0	0	0
11:15 AM	0	0	0	0	0	0	0	0	0	0	0	0	0
11:30 AM	0	0	0	0	3	0	1	0	0	0	0	0	4
11:45 AM	0	0	0	0	0	0	0	0	0	0	0	0	0
12:00 PM	0	0	0	0	0	0	0	0	0	0	0	0	0
12:15 PM	0	0	0	0	0	0	0	0	0	0	0	0	0
12:30 PM	0	0	0	0	0	0	0	0	0	0	0	0	0
12:45 PM	0	0	0	0	0	0	0	0	0	0	0	0	0
1:00 PM	0	0	0	0	0	0	0	0	0	0	0	0	0
1:15 PM	0	0	0	0	0	0	0	0	0	0	0	0	0
1:30 PM	0	0	0	0	0	0	0	0	0	0	0	0	0
1:45 PM	0	0	0	0	0	0	0	0	0	0	0	0	0
TOTAL VOLUMES:	0	0	0	0	3	0	1	0	0	0	0	0	4

City of Riverside
 N/S: Trautwein Road
 E/W: Grove Community Drive
 Weather: Clear

File Name : 06_RIV_Traut_Gr Com Sat
 Site Code : 05122815
 Start Date : 9/17/2022
 Page No : 1

Groups Printed- Passenger Vehicles - Large 2 Axle Vehicles - 3 Axle Vehicles - 4+ Axle Trucks

Start Time	Trautwein Road Southbound			Grove Community Drive Westbound				Trautwein Road Northbound				Exclu. Total	Inclu. Total	Int. Total
	Left	Thru	App. Total	Left	Right	RTOR	App. Total	Thru	Right	RTOR	App. Total			
11:00 AM	61	162	223	10	36	33	46	184	21	1	205	34	474	508
11:15 AM	95	167	262	9	56	47	65	173	15	2	188	49	515	564
11:30 AM	60	145	205	35	99	59	134	182	19	2	201	61	540	601
11:45 AM	58	95	153	41	146	72	187	162	14	3	176	75	516	591
Total	274	569	843	95	337	211	432	701	69	8	770	219	2045	2264
12:00 PM	62	95	157	27	74	48	101	192	9	1	201	49	459	508
12:15 PM	78	113	191	22	70	45	92	181	21	4	202	49	485	534
12:30 PM	90	119	209	17	79	51	96	174	37	2	211	53	516	569
12:45 PM	91	114	205	32	120	67	152	172	18	4	190	71	547	618
Total	321	441	762	98	343	211	441	719	85	11	804	222	2007	2229
01:00 PM	101	165	266	35	110	51	145	180	13	3	193	54	604	658
01:15 PM	51	213	264	15	62	48	77	157	11	5	168	53	509	562
01:30 PM	59	168	227	7	49	38	56	181	8	0	189	38	472	510
01:45 PM	61	183	244	9	59	43	68	202	10	1	212	44	524	568
Total	272	729	1001	66	280	180	346	720	42	9	762	189	2109	2298
Grand Total	867	1739	2606	259	960	602	1219	2140	196	28	2336	630	6161	6791
Apprch %	33.3	66.7		21.2	78.8			91.6	8.4					
Total %	14.1	28.2	42.3	4.2	15.6		19.8	34.7	3.2		37.9	9.3	90.7	
Passenger Vehicles	857	1718	2575	258	952		1807	2112	194		2334	0	0	6716
% Passenger Vehicles	98.8	98.8	98.8	99.6	99.2	99.2	99.2	98.7	99	100	98.7	0	0	98.9
Large 2 Axle Vehicles	10	20	30	1	7		13	26	2		28	0	0	71
% Large 2 Axle Vehicles	1.2	1.2	1.2	0.4	0.7	0.8	0.7	1.2	1	0	1.2	0	0	1
3 Axle Vehicles	0	1	1	0	1		1	2	0		2	0	0	4
% 3 Axle Vehicles	0	0.1	0	0	0.1	0	0.1	0.1	0	0	0.1	0	0	0.1
4+ Axle Trucks	0	0	0	0	0		0	0	0		0	0	0	0
% 4+ Axle Trucks	0	0	0	0	0	0	0	0	0	0	0	0	0	0

Start Time	Trautwein Road Southbound			Grove Community Drive Westbound			Trautwein Road Northbound			Int. Total
	Left	Thru	App. Total	Left	Right	App. Total	Thru	Right	App. Total	
Peak Hour Analysis From 11:00 AM to 01:45 PM - Peak 1 of 1										
Peak Hour for Entire Intersection Begins at 12:30 PM										
12:30 PM	90	119	209	17	79	96	174	37	211	516
12:45 PM	91	114	205	32	120	152	172	18	190	547
01:00 PM	101	165	266	35	110	145	180	13	193	604
01:15 PM	51	213	264	15	62	77	157	11	168	509
Total Volume	333	611	944	99	371	470	683	79	762	2176
% App. Total	35.3	64.7		21.1	78.9		89.6	10.4		
PHF	.824	.717	.887	.707	.773	.773	.949	.534	.903	.901

City of Riverside
 N/S: Trautwein Road
 E/W: Grove Community Drive
 Weather: Clear

File Name : 06_RIV_Traut_Gr Com Sat
 Site Code : 05122815
 Start Date : 9/17/2022
 Page No : 2

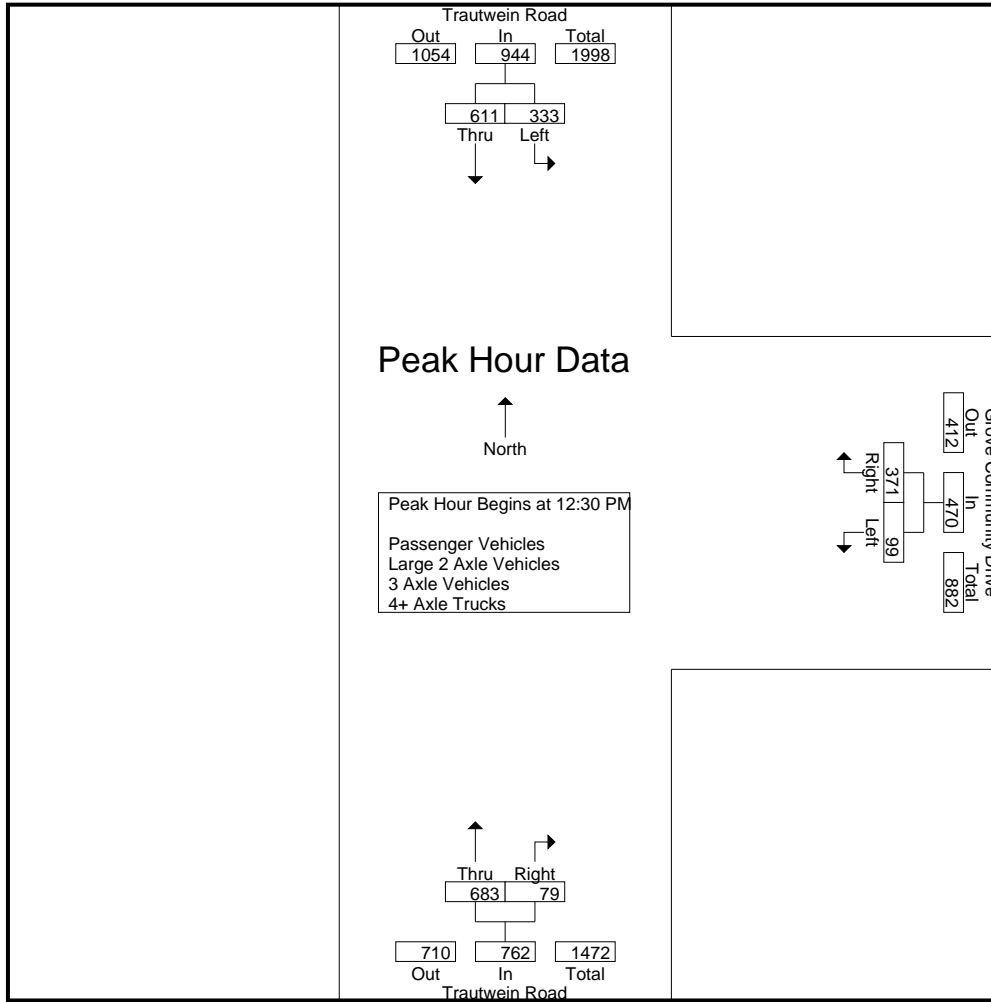

Peak Hour Analysis From 11:00 AM to 01:45 PM - Peak 1 of 1
 Peak Hour for Each Approach Begins at:

	01:00 PM			11:30 AM			12:00 PM		
+0 mins.	101	165	266	35	99	134	192	9	201
+15 mins.	51	213	264	41	146	187	181	21	202
+30 mins.	59	168	227	27	74	101	174	37	211
+45 mins.	61	183	244	22	70	92	172	18	190
Total Volume	272	729	1001	125	389	514	719	85	804
% App. Total	27.2	72.8		24.3	75.7		89.4	10.6	
PHF	.673	.856	.941	.762	.666	.687	.936	.574	.953

City of Riverside
 N/S: Trautwein Road
 E/W: Grove Community Drive
 Weather: Clear

File Name : 06_RIV_Traut_Gr Com Sat
 Site Code : 05122815
 Start Date : 9/17/2022
 Page No : 1

Groups Printed- Passenger Vehicles

Start Time	Trautwein Road Southbound			Grove Community Drive Westbound				Trautwein Road Northbound				Exclu. Total	Inclu. Total	Int. Total
	Left	Thru	App. Total	Left	Right	RTOR	App. Total	Thru	Right	RTOR	App. Total			
11:00 AM	60	159	219	10	36	33	46	183	20	1	203	34	468	502
11:15 AM	95	164	259	8	56	47	64	169	15	2	184	49	507	556
11:30 AM	59	143	202	35	99	59	134	179	19	2	198	61	534	595
11:45 AM	56	93	149	41	146	72	187	161	14	3	175	75	511	586
Total	270	559	829	94	337	211	431	692	68	8	760	219	2020	2239
12:00 PM	62	93	155	27	73	47	100	188	9	1	197	48	452	500
12:15 PM	77	111	188	22	68	44	90	179	21	4	200	48	478	526
12:30 PM	89	118	207	17	79	51	96	170	37	2	207	53	510	563
12:45 PM	91	112	203	32	118	66	150	169	18	4	187	70	540	610
Total	319	434	753	98	338	208	436	706	85	11	791	219	1980	2199
01:00 PM	101	165	266	35	110	51	145	176	13	3	189	54	600	654
01:15 PM	49	212	261	15	61	48	76	156	11	5	167	53	504	557
01:30 PM	59	167	226	7	48	37	55	180	7	0	187	37	468	505
01:45 PM	59	181	240	9	58	42	67	202	10	1	212	43	519	562
Total	268	725	993	66	277	178	343	714	41	9	755	187	2091	2278
Grand Total	857	1718	2575	258	952	597	1210	2112	194	28	2306	625	6091	6716
Apprch %	33.3	66.7		21.3	78.7			91.6	8.4					
Total %	14.1	28.2	42.3	4.2	15.6		19.9	34.7	3.2		37.9	9.3	90.7	

Start Time	Trautwein Road Southbound			Grove Community Drive Westbound			Trautwein Road Northbound			Int. Total
	Left	Thru	App. Total	Left	Right	App. Total	Thru	Right	App. Total	
12:30 PM	89	118	207	17	79	96	170	37	207	510
12:45 PM	91	112	203	32	118	150	169	18	187	540
01:00 PM	101	165	266	35	110	145	176	13	189	600
01:15 PM	49	212	261	15	61	76	156	11	167	504
Total Volume	330	607	937	99	368	467	671	79	750	2154
% App. Total	35.2	64.8		21.2	78.8		89.5	10.5		
PHF	.817	.716	.881	.707	.780	.778	.953	.534	.906	.898

Peak Hour Analysis From 12:30 PM to 01:15 PM - Peak 1 of 1
 Peak Hour for Entire Intersection Begins at 12:30 PM

City of Riverside
 N/S: Trautwein Road
 E/W: Grove Community Drive
 Weather: Clear

File Name : 06_RIV_Traut_Gr Com Sat
 Site Code : 05122815
 Start Date : 9/17/2022
 Page No : 2

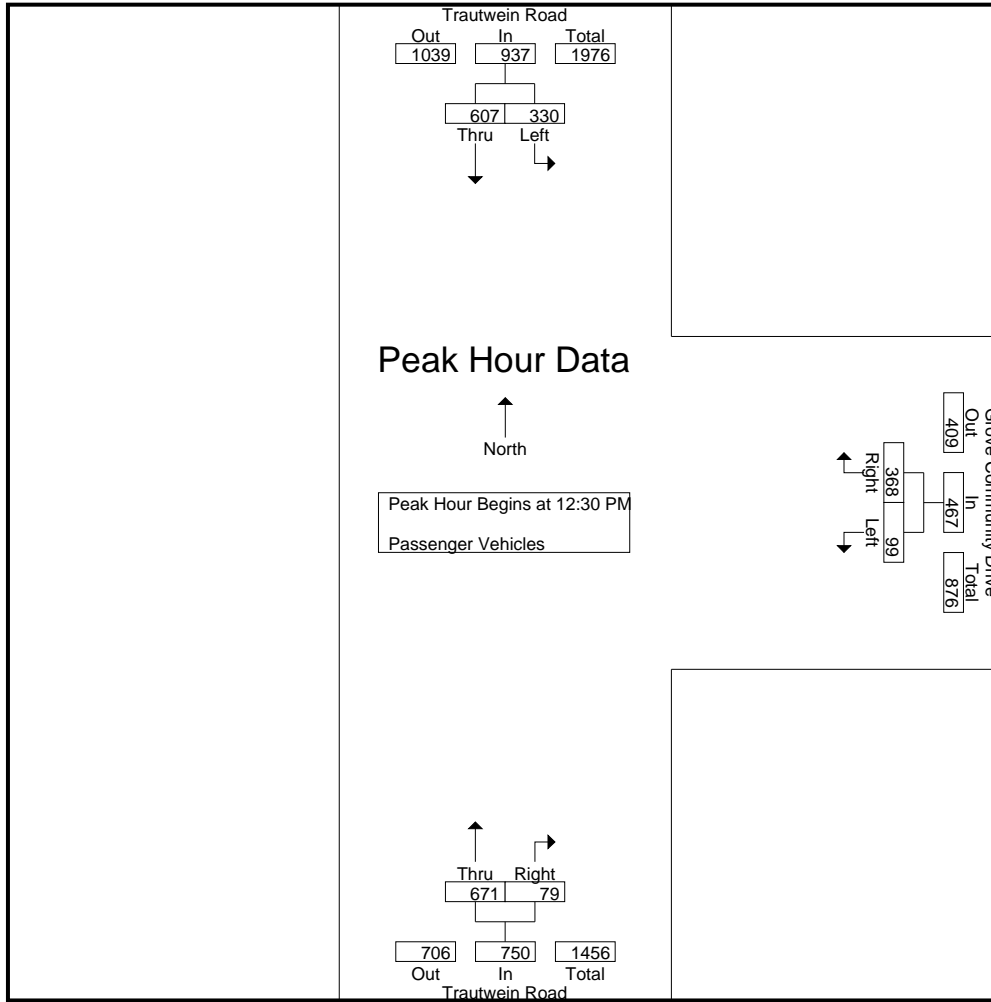

Peak Hour Analysis From 12:30 PM to 01:15 PM - Peak 1 of 1
 Peak Hour for Each Approach Begins at:

	12:30 PM			12:30 PM			12:30 PM		
+0 mins.	89	118	207	17	79	96	170	37	207
+15 mins.	91	112	203	32	118	150	169	18	187
+30 mins.	101	165	266	35	110	145	176	13	189
+45 mins.	49	212	261	15	61	76	156	11	167
Total Volume	330	607	937	99	368	467	671	79	750
% App. Total	35.2	64.8		21.2	78.8		89.5	10.5	
PHF	.817	.716	.881	.707	.780	.778	.953	.534	.906

City of Riverside
 N/S: Trautwein Road
 E/W: Grove Community Drive
 Weather: Clear

File Name : 06_RIV_Traut_Gr Com Sat
 Site Code : 05122815
 Start Date : 9/17/2022
 Page No : 1

Groups Printed- Large 2 Axle Vehicles

Start Time	Trautwein Road Southbound			Grove Community Drive Westbound				Trautwein Road Northbound				Exclu. Total	Inclu. Total	Int. Total
	Left	Thru	App. Total	Left	Right	RTOR	App. Total	Thru	Right	RTOR	App. Total			
11:00 AM	1	3	4	0	0	0	0	1	1	0	2	0	6	6
11:15 AM	0	3	3	1	0	0	1	4	0	0	4	0	8	8
11:30 AM	1	2	3	0	0	0	0	2	0	0	2	0	5	5
11:45 AM	2	2	4	0	0	0	0	1	0	0	1	0	5	5
Total	4	10	14	1	0	0	1	8	1	0	9	0	24	24
12:00 PM	0	2	2	0	1	1	1	4	0	0	4	1	7	8
12:15 PM	1	2	3	0	2	1	2	1	0	0	1	1	6	7
12:30 PM	1	1	2	0	0	0	0	4	0	0	4	0	6	6
12:45 PM	0	1	1	0	1	1	1	3	0	0	3	1	5	6
Total	2	6	8	0	4	3	4	12	0	0	12	3	24	27
01:00 PM	0	0	0	0	0	0	0	4	0	0	4	0	4	4
01:15 PM	2	1	3	0	1	0	1	1	0	0	1	0	5	5
01:30 PM	0	1	1	0	1	1	1	1	1	0	2	1	4	5
01:45 PM	2	2	4	0	1	1	1	0	0	0	0	1	5	6
Total	4	4	8	0	3	2	3	6	1	0	7	2	18	20
Grand Total	10	20	30	1	7	5	8	26	2	0	28	5	66	71
Apprch %	33.3	66.7		12.5	87.5			92.9	7.1					
Total %	15.2	30.3	45.5	1.5	10.6		12.1	39.4	3		42.4	7	93	

Start Time	Trautwein Road Southbound			Grove Community Drive Westbound			Trautwein Road Northbound			Int. Total
	Left	Thru	App. Total	Left	Right	App. Total	Thru	Right	App. Total	
12:30 PM	1	1	2	0	0	0	4	0	4	6
12:45 PM	0	1	1	0	1	1	3	0	3	5
01:00 PM	0	0	0	0	0	0	4	0	4	4
01:15 PM	2	1	3	0	1	1	1	0	1	5
Total Volume	3	3	6	0	2	2	12	0	12	20
% App. Total	50	50		0	100		100	0		
PHF	.375	.750	.500	.000	.500	.500	.750	.000	.750	.833

City of Riverside
 N/S: Trautwein Road
 E/W: Grove Community Drive
 Weather: Clear

File Name : 06_RIV_Traut_Gr Com Sat
 Site Code : 05122815
 Start Date : 9/17/2022
 Page No : 2

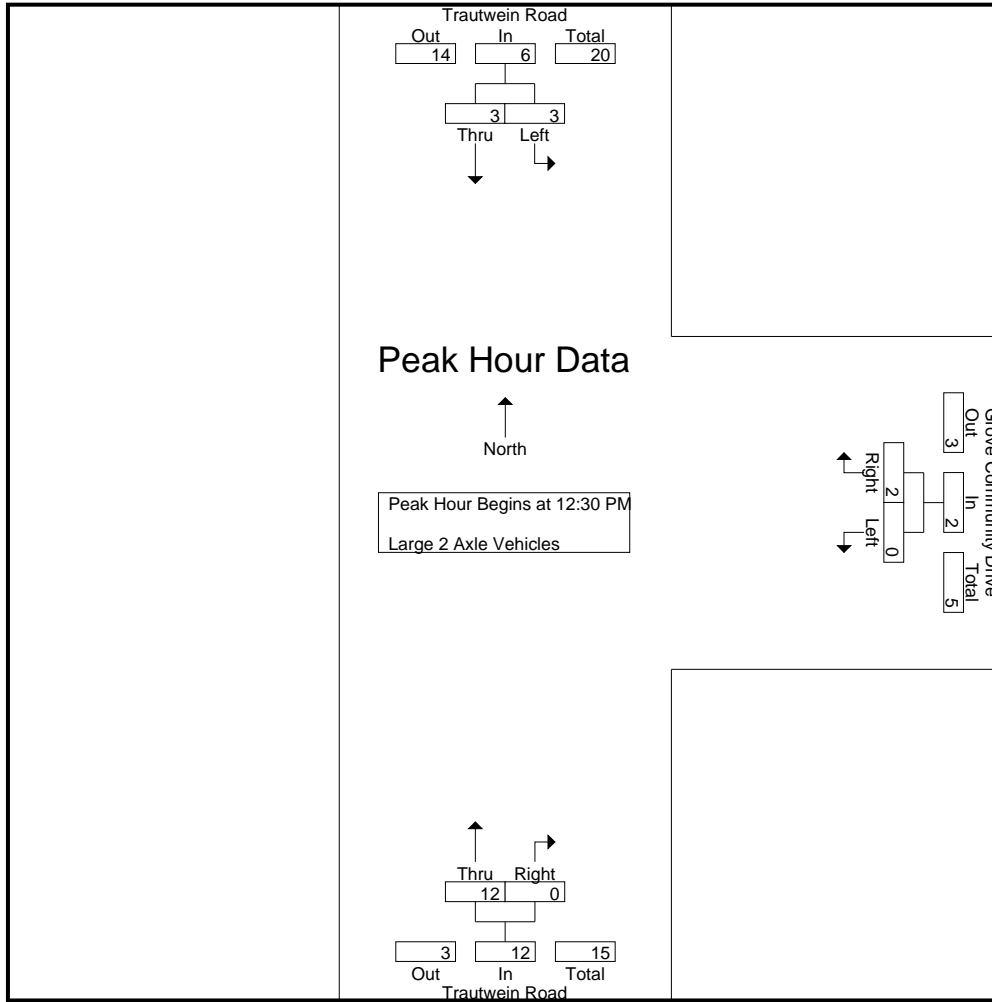

Peak Hour Analysis From 12:30 PM to 01:15 PM - Peak 1 of 1
 Peak Hour for Each Approach Begins at:

	12:30 PM			12:30 PM			12:30 PM		
+0 mins.	1	1	2	0	0	0	4	0	4
+15 mins.	0	1	1	0	1	1	3	0	3
+30 mins.	0	0	0	0	0	0	4	0	4
+45 mins.	2	1	3	0	1	1	1	0	1
Total Volume	3	3	6	0	2	2	12	0	12
% App. Total	50	50		0	100		100	0	
PHF	.375	.750	.500	.000	.500	.500	.750	.000	.750

City of Riverside
 N/S: Trautwein Road
 E/W: Grove Community Drive
 Weather: Clear

File Name : 06_RIV_Traut_Gr Com Sat
 Site Code : 05122815
 Start Date : 9/17/2022
 Page No : 1

Groups Printed- 3 Axle Vehicles

Start Time	Trautwein Road Southbound			Grove Community Drive Westbound				Trautwein Road Northbound				Exclu. Total	Inclu. Total	Int. Total	
	Left	Thru	App. Total	Left	Right	RTOR	App. Total	Thru	Right	RTOR	App. Total				
11:00 AM	0	0	0	0	0	0	0	0	0	0	0	0	0	0	0
11:15 AM	0	0	0	0	0	0	0	0	0	0	0	0	0	0	0
11:30 AM	0	0	0	0	0	0	0	1	0	0	1	0	1	1	1
11:45 AM	0	0	0	0	0	0	0	0	0	0	0	0	0	0	0
Total	0	0	0	0	0	0	0	1	0	0	1	0	1	1	1
12:00 PM	0	0	0	0	0	0	0	0	0	0	0	0	0	0	0
12:15 PM	0	0	0	0	0	0	0	1	0	0	1	0	1	1	1
12:30 PM	0	0	0	0	0	0	0	0	0	0	0	0	0	0	0
12:45 PM	0	1	1	0	1	0	1	0	0	0	0	0	2	2	2
Total	0	1	1	0	1	0	1	1	0	0	1	0	3	3	3
01:00 PM	0	0	0	0	0	0	0	0	0	0	0	0	0	0	0
01:15 PM	0	0	0	0	0	0	0	0	0	0	0	0	0	0	0
01:30 PM	0	0	0	0	0	0	0	0	0	0	0	0	0	0	0
01:45 PM	0	0	0	0	0	0	0	0	0	0	0	0	0	0	0
Total	0	0	0	0	0	0	0	0	0	0	0	0	0	0	0
Grand Total	0	1	1	0	1	0	1	2	0	0	2	0	4	4	4
Apprch %	0	100		0	100			100	0						
Total %	0	25	25	0	25		25	50	0		50	0	100		

Start Time	Trautwein Road Southbound			Grove Community Drive Westbound			Trautwein Road Northbound			Int. Total
	Left	Thru	App. Total	Left	Right	App. Total	Thru	Right	App. Total	
12:30 PM	0	0	0	0	0	0	0	0	0	0
12:45 PM	0	1	1	0	1	1	0	0	0	2
01:00 PM	0	0	0	0	0	0	0	0	0	0
01:15 PM	0	0	0	0	0	0	0	0	0	0
Total Volume	0	1	1	0	1	1	0	0	0	2
% App. Total	0	100		0	100		0	0		
PHF	.000	.250	.250	.000	.250	.250	.000	.000	.000	.250

City of Riverside
 N/S: Trautwein Road
 E/W: Grove Community Drive
 Weather: Clear

File Name : 06_RIV_Traut_Gr Com Sat
 Site Code : 05122815
 Start Date : 9/17/2022
 Page No : 2

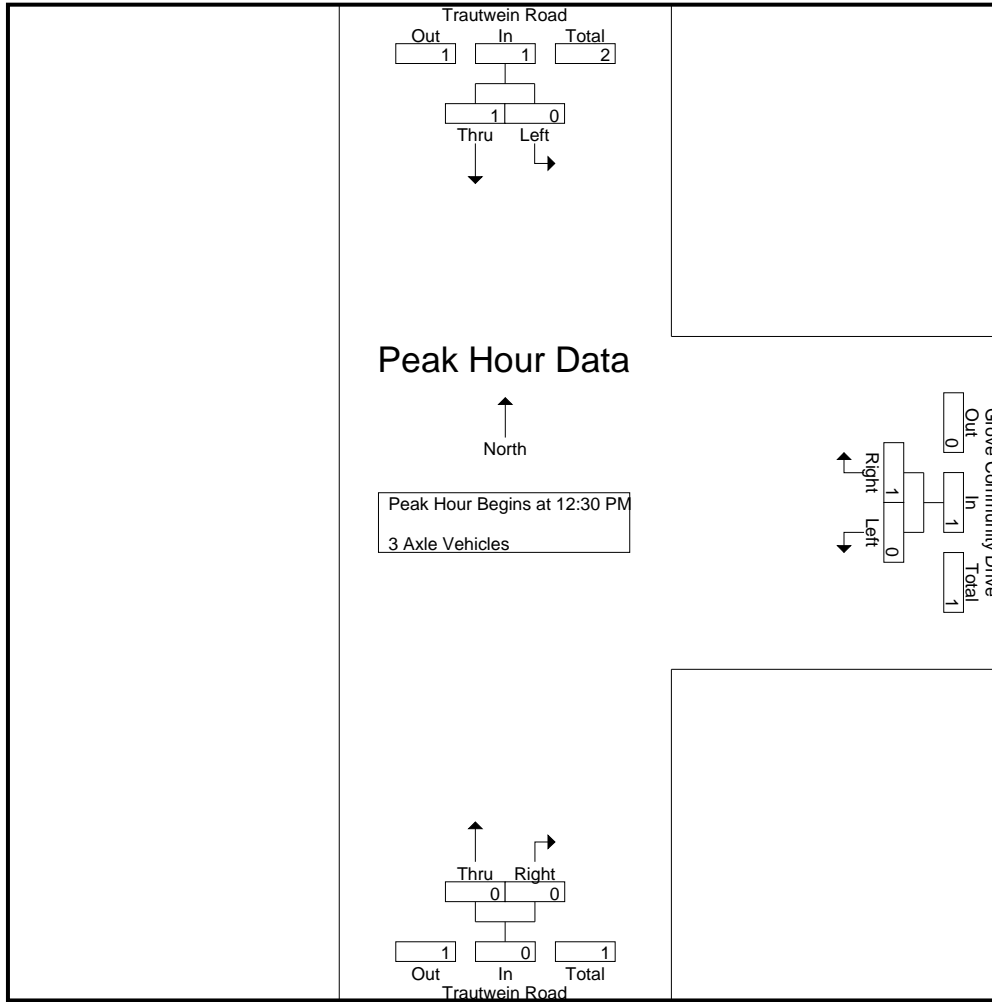

Peak Hour Analysis From 12:30 PM to 01:15 PM - Peak 1 of 1
 Peak Hour for Each Approach Begins at:

	12:30 PM			12:30 PM			12:30 PM		
+0 mins.	0	0	0	0	0	0	0	0	0
+15 mins.	0	1	1	0	1	1	0	0	0
+30 mins.	0	0	0	0	0	0	0	0	0
+45 mins.	0	0	0	0	0	0	0	0	0
Total Volume	0	1	1	0	1	1	0	0	0
% App. Total	0	100		0	100		0	0	
PHF	.000	.250	.250	.000	.250	.250	.000	.000	.000

City of Riverside
 N/S: Trautwein Road
 E/W: Grove Community Drive
 Weather: Clear

File Name : 06_RIV_Traut_Gr Com Sat
 Site Code : 05122815
 Start Date : 9/17/2022
 Page No : 1

Groups Printed- 4+ Axle Trucks

Start Time	Trautwein Road Southbound			Grove Community Drive Westbound				Trautwein Road Northbound				Exclu. Total	Inclu. Total	Int. Total	
	Left	Thru	App. Total	Left	Right	RTOR	App. Total	Thru	Right	RTOR	App. Total				
11:00 AM	0	0	0	0	0	0	0	0	0	0	0	0	0	0	0
11:15 AM	0	0	0	0	0	0	0	0	0	0	0	0	0	0	0
11:30 AM	0	0	0	0	0	0	0	0	0	0	0	0	0	0	0
11:45 AM	0	0	0	0	0	0	0	0	0	0	0	0	0	0	0
Total	0	0	0	0	0	0	0	0	0	0	0	0	0	0	0
12:00 PM	0	0	0	0	0	0	0	0	0	0	0	0	0	0	0
12:15 PM	0	0	0	0	0	0	0	0	0	0	0	0	0	0	0
12:30 PM	0	0	0	0	0	0	0	0	0	0	0	0	0	0	0
12:45 PM	0	0	0	0	0	0	0	0	0	0	0	0	0	0	0
Total	0	0	0	0	0	0	0	0	0	0	0	0	0	0	0
01:00 PM	0	0	0	0	0	0	0	0	0	0	0	0	0	0	0
01:15 PM	0	0	0	0	0	0	0	0	0	0	0	0	0	0	0
01:30 PM	0	0	0	0	0	0	0	0	0	0	0	0	0	0	0
01:45 PM	0	0	0	0	0	0	0	0	0	0	0	0	0	0	0
Total	0	0	0	0	0	0	0	0	0	0	0	0	0	0	0
Grand Total	0	0	0	0	0	0	0	0	0	0	0	0	0	0	0
Apprch %	0	0		0	0			0	0						
Total %												0	0		

Start Time	Trautwein Road Southbound			Grove Community Drive Westbound			Trautwein Road Northbound			Int. Total
	Left	Thru	App. Total	Left	Right	App. Total	Thru	Right	App. Total	
12:30 PM	0	0	0	0	0	0	0	0	0	0
12:45 PM	0	0	0	0	0	0	0	0	0	0
01:00 PM	0	0	0	0	0	0	0	0	0	0
01:15 PM	0	0	0	0	0	0	0	0	0	0
Total Volume	0	0	0	0	0	0	0	0	0	0
% App. Total	0	0		0	0			0	0	
PHF	.000	.000	.000	.000	.000	.000	.000	.000	.000	.000

City of Riverside
 N/S: Trautwein Road
 E/W: Grove Community Drive
 Weather: Clear

File Name : 06_RIV_Traut_Gr Com Sat
 Site Code : 05122815
 Start Date : 9/17/2022
 Page No : 2

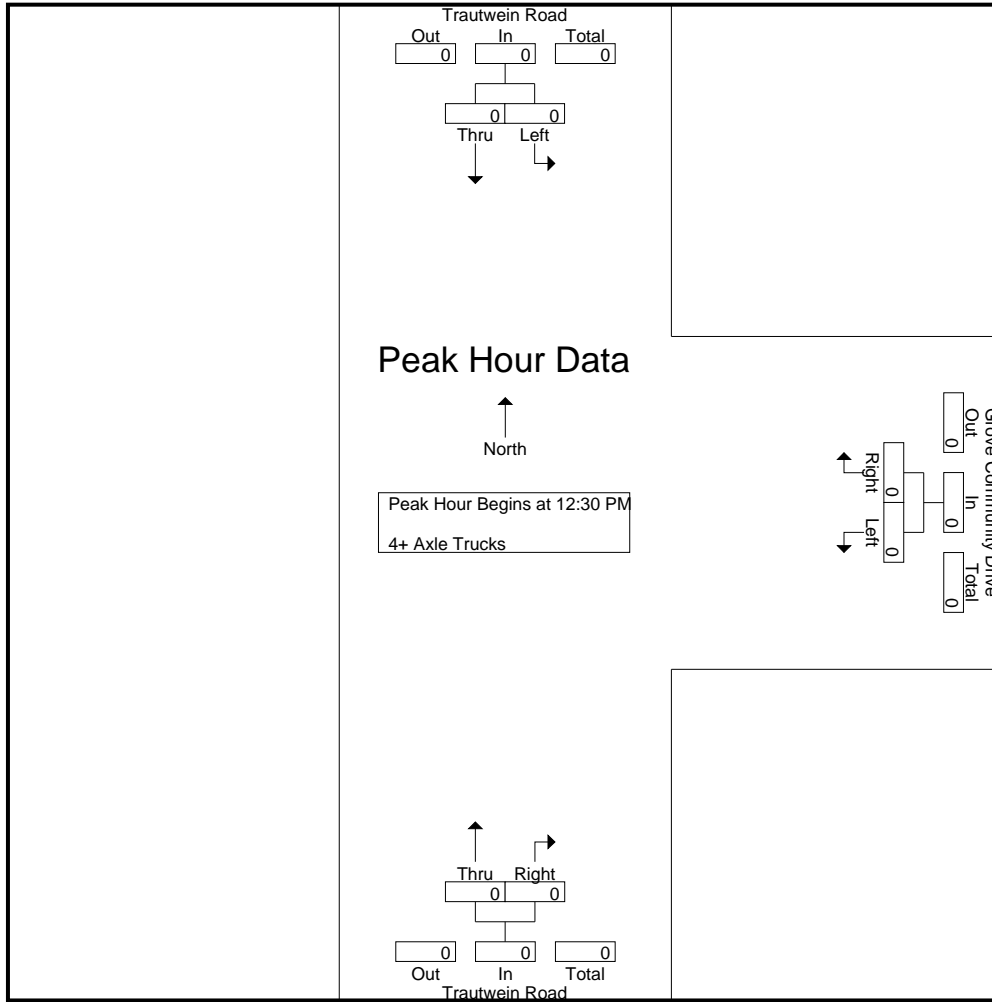

Peak Hour Analysis From 12:30 PM to 01:15 PM - Peak 1 of 1
 Peak Hour for Each Approach Begins at:

	12:30 PM			12:30 PM			12:30 PM		
+0 mins.	0	0	0	0	0	0	0	0	0
+15 mins.	0	0	0	0	0	0	0	0	0
+30 mins.	0	0	0	0	0	0	0	0	0
+45 mins.	0	0	0	0	0	0	0	0	0
Total Volume	0	0	0	0	0	0	0	0	0
% App. Total	0	0	0	0	0	0	0	0	0
PHF	.000	.000	.000	.000	.000	.000	.000	.000	.000

Location: Riverside
 N/S: Trautwein Road
 E/W: Grove Community Drive



Date: 9/17/2022
 Day Saturday

PEDESTRIANS

Time	North Leg Trautwein Road	East Leg Grove Community Drive	South Leg Trautwein Road	West Leg Dead End	TOTAL
11:00 AM	0	1	1	0	2
11:15 AM	0	0	0	0	0
11:30 AM	0	0	0	0	0
11:45 AM	0	0	0	0	0
12:00 PM	0	0	0	0	0
12:15 PM	0	1	0	0	1
12:30 PM	0	0	0	0	0
12:45 PM	0	0	0	0	0
1:00 PM	0	1	0	0	1
1:15 PM	0	0	0	0	0
1:30 PM	0	0	1	0	1
1:45 PM	0	0	0	0	0
TOTAL VOLUMES:	0	3	2	0	5

Location: Riverside
 N/S: Trautwein Road
 E/W: Grove Community Drive

Date: 9/17/2022
 Day: Saturday



BICYCLES

	Southbound Trautwein Road			Westbound Grove Community Drive			Northbound Trautwein Road			Eastbound Dead End			
	Left	Thru	Right	Left	Thru	Right	Left	Thru	Right	Left	Thru	Right	
11:00 AM	0	1	0	0	0	1	0	2	2	0	0	0	6
11:15 AM	1	0	0	0	0	0	0	1	0	0	0	0	2
11:30 AM	0	0	0	0	0	0	0	0	0	0	0	0	0
11:45 AM	0	1	0	0	0	2	0	0	0	0	0	0	3
12:00 PM	0	1	0	0	0	0	0	0	1	0	0	0	2
12:15 PM	0	1	0	0	0	0	0	0	1	0	0	0	2
12:30 PM	0	1	0	0	0	1	0	0	0	0	0	0	2
12:45 PM	0	0	0	0	0	1	0	0	0	0	0	0	1
1:00 PM	0	0	0	0	0	1	0	0	0	0	0	0	1
1:15 PM	0	0	0	0	0	0	0	0	0	0	0	0	0
1:30 PM	0	0	0	0	0	0	0	0	0	0	0	0	0
1:45 PM	0	1	0	0	0	0	0	0	0	0	0	0	1
TOTAL VOLUMES:	1	6	0	0	0	6	0	3	4	0	0	0	20

City of Riverside
 N/S: Trautwein Road
 E/W: Orange Terrace Parkway
 Weather: Clear

File Name : 07_RIV_Traut_Or Ter Sat
 Site Code : 05122815
 Start Date : 9/17/2022
 Page No : 1

Groups Printed- Passenger Vehicles - Large 2 Axle Vehicles - 3 Axle Vehicles - 4+ Axle Trucks

Start Time	Trautwein Road Southbound					Orange Terrace Parkway Westbound					Trautwein Road Northbound					Orange Terrace Parkway Eastbound					Exclu. Total	Inclu. Total	Int. Total
	Left	Thru	Right	RTOR	App. Total	Left	Thru	Right	RTOR	App. Total	Left	Thru	Right	RTOR	App. Total	Left	Thru	Right	RTOR	App. Total			
11:00 AM	28	143	3	2	174	35	5	43	29	83	9	145	38	11	192	9	7	3	3	19	45	468	513
11:15 AM	43	130	9	2	182	34	7	37	26	78	4	145	27	14	176	11	4	3	3	18	45	454	499
11:30 AM	39	133	6	0	178	29	3	43	34	75	4	143	41	22	188	12	5	1	0	18	56	459	515
11:45 AM	19	116	3	1	138	50	7	41	26	98	7	126	30	20	163	8	4	2	2	14	49	413	462
Total	129	522	21	5	672	148	22	164	115	334	24	559	136	67	719	40	20	9	8	69	195	1794	1989
12:00 PM	26	92	2	0	120	57	3	63	42	123	4	138	30	12	172	8	8	4	1	20	55	435	490
12:15 PM	43	97	2	0	142	35	4	56	37	95	6	125	44	27	175	11	22	2	0	35	64	447	511
12:30 PM	37	96	3	0	136	28	4	42	30	74	4	146	44	12	194	10	3	2	1	15	43	419	462
12:45 PM	38	117	2	1	157	34	6	36	24	76	2	152	32	16	186	11	7	3	2	21	43	440	483
Total	144	402	9	1	555	154	17	197	133	368	16	561	150	67	727	40	40	11	4	91	205	1741	1946
01:00 PM	47	162	3	0	212	35	6	35	29	76	9	138	43	13	190	9	4	3	1	16	43	494	537
01:15 PM	49	165	5	0	219	52	3	37	19	92	12	132	35	17	179	9	3	7	2	19	38	509	547
01:30 PM	40	131	6	1	177	31	2	40	28	73	5	145	30	10	180	6	2	7	4	15	43	445	488
01:45 PM	54	130	5	0	189	36	0	41	32	77	6	150	34	22	190	6	8	2	1	16	55	472	527
Total	190	588	19	1	797	154	11	153	108	318	32	565	142	62	739	30	17	19	8	66	179	1920	2099
Grand Total	463	1512	49	7	2024	456	50	514	356	1020	72	1685	428	196	2185	110	77	39	20	226	579	5455	6034
Apprch %	22.9	74.7	2.4			44.7	4.9	50.4			3.3	77.1	19.6			48.7	34.1	17.3					
Total %	8.5	27.7	0.9		37.1	8.4	0.9	9.4		18.7	1.3	30.9	7.8		40.1	2	1.4	0.7		4.1	9.6	90.4	
Passenger Vehicles	462	1495	48		2012	450	50	509		1362	71	1663	424		2353	110	76	38		244	0	0	5971
% Passenger Vehicles	99.8	98.9	98	100	99.1	98.7	100	99	99.2	99	98.6	98.7	99.1	99.5	98.8	100	98.7	97.4	100	99.2	0	0	99
Large 2 Axle Vehicles	1	16	1		18	6	0	5		14	1	20	4		26	0	1	1		2	0	0	60
% Large 2 Axle Vehicles	0.2	1.1	2	0	0.9	1.3	0	1	0.8	1	1.4	1.2	0.9	0.5	1.1	0	1.3	2.6	0	0.8	0	0	1
3 Axle Vehicles	0	1	0		1	0	0	0		0	0	2	0		2	0	0	0		0	0	0	3
% 3 Axle Vehicles	0	0.1	0	0	0	0	0	0	0	0	0	0.1	0	0	0.1	0	0	0	0	0	0	0	0
4+ Axle Trucks	0	0	0		0	0	0	0		0	0	0	0		0	0	0	0		0	0	0	0
% 4+ Axle Trucks	0	0	0	0	0	0	0	0	0	0	0	0	0	0	0	0	0	0	0	0	0	0	0

City of Riverside
 N/S: Trautwein Road
 E/W: Orange Terrace Parkway
 Weather: Clear

File Name : 07_RIV_Traut_Or Ter Sat
 Site Code : 05122815
 Start Date : 9/17/2022
 Page No : 2

Start Time	Trautwein Road Southbound				Orange Terrace Parkway Westbound				Trautwein Road Northbound				Orange Terrace Parkway Eastbound				Int. Total
	Left	Thru	Right	App. Total	Left	Thru	Right	App. Total	Left	Thru	Right	App. Total	Left	Thru	Right	App. Total	
Peak Hour Analysis From 11:00 AM to 01:45 PM - Peak 1 of 1																	
Peak Hour for Entire Intersection Begins at 01:00 PM																	
01:00 PM	47	162	3	212	35	6	35	76	9	138	43	190	9	4	3	16	494
01:15 PM	49	165	5	219	52	3	37	92	12	132	35	179	9	3	7	19	509
01:30 PM	40	131	6	177	31	2	40	73	5	145	30	180	6	2	7	15	445
01:45 PM	54	130	5	189	36	0	41	77	6	150	34	190	6	8	2	16	472
Total Volume	190	588	19	797	154	11	153	318	32	565	142	739	30	17	19	66	1920
% App. Total	23.8	73.8	2.4		48.4	3.5	48.1		4.3	76.5	19.2		45.5	25.8	28.8		
PHF	.880	.891	.792	.910	.740	.458	.933	.864	.667	.942	.826	.972	.833	.531	.679	.868	.943

City of Riverside
 N/S: Trautwein Road
 E/W: Orange Terrace Parkway
 Weather: Clear

File Name : 07_RIV_Traut_Or Ter Sat
 Site Code : 05122815
 Start Date : 9/17/2022
 Page No : 3

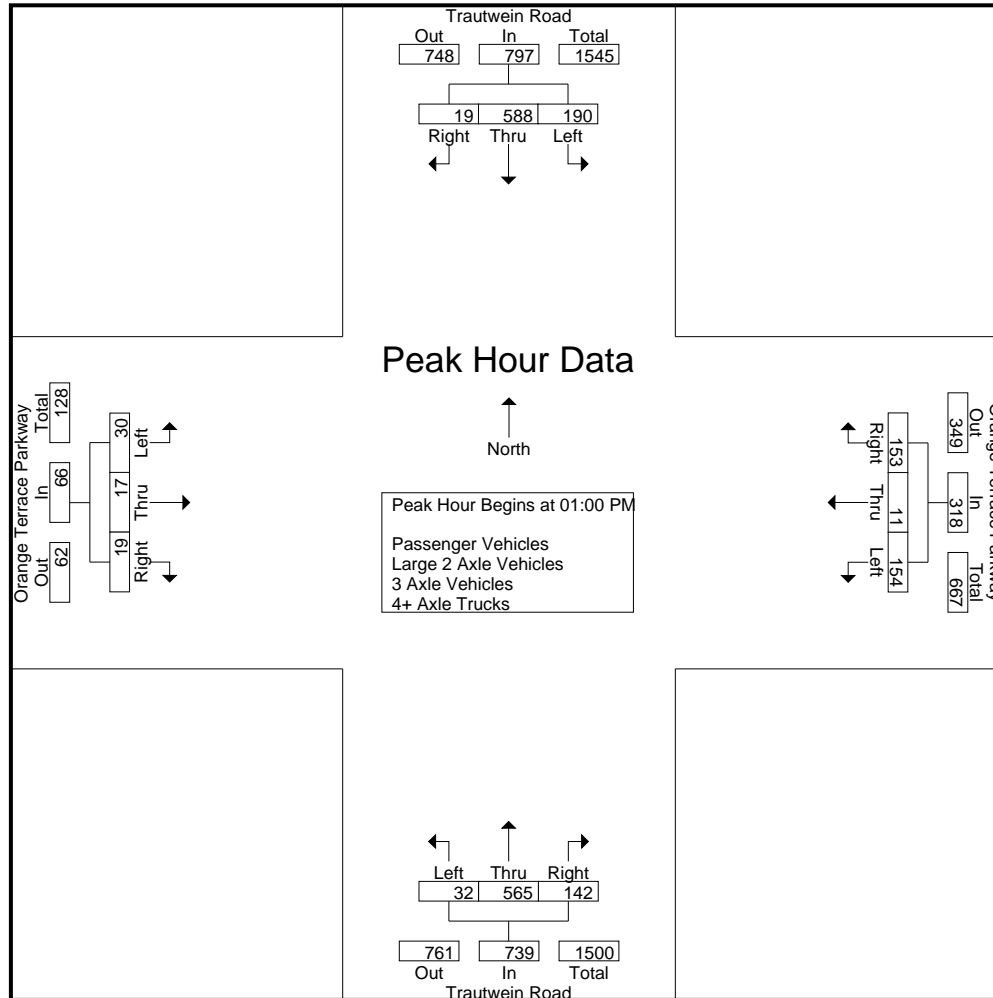

City of Riverside
 N/S: Trautwein Road
 E/W: Orange Terrace Parkway
 Weather: Clear

File Name : 07_RIV_Traut_Or Ter Sat
 Site Code : 05122815
 Start Date : 9/17/2022
 Page No : 4

Start Time	Trautwein Road Southbound				Orange Terrace Parkway Westbound				Trautwein Road Northbound				Orange Terrace Parkway Eastbound				Int. Total
	Left	Thru	Right	App. Total	Left	Thru	Right	App. Total	Left	Thru	Right	App. Total	Left	Thru	Right	App. Total	
Peak Hour Analysis From 11:00 AM to 01:45 PM - Peak 1 of 1																	
Peak Hour for Each Approach Begins at:																	
	01:00 PM				11:30 AM				12:30 PM				12:00 PM				
+0 mins.	47	162	3	212	29	3	43	75	4	146	44	194	8	8	4	20	
+15 mins.	49	165	5	219	50	7	41	98	2	152	32	186	11	22	2	35	
+30 mins.	40	131	6	177	57	3	63	123	9	138	43	190	10	3	2	15	
+45 mins.	54	130	5	189	35	4	56	95	12	132	35	179	11	7	3	21	
Total Volume	190	588	19	797	171	17	203	391	27	568	154	749	40	40	11	91	
% App. Total	23.8	73.8	2.4		43.7	4.3	51.9		3.6	75.8	20.6		44	44	12.1		
PHF	.880	.891	.792	.910	.750	.607	.806	.795	.563	.934	.875	.965	.909	.455	.688	.650	

City of Riverside
 N/S: Trautwein Road
 E/W: Orange Terrace Parkway
 Weather: Clear

File Name : 07_RIV_Traut_Or Ter Sat
 Site Code : 05122815
 Start Date : 9/17/2022
 Page No : 1

Groups Printed- Passenger Vehicles

Start Time	Trautwein Road Southbound					Orange Terrace Parkway Westbound					Trautwein Road Northbound					Orange Terrace Parkway Eastbound					Exclu. Total	Inclu. Total	Int. Total
	Left	Thru	Right	RTOR	App. Total	Left	Thru	Right	RTOR	App. Total	Left	Thru	Right	RTOR	App. Total	Left	Thru	Right	RTOR	App. Total			
11:00 AM	27	140	2	2	169	34	5	42	29	81	9	144	37	11	190	9	7	3	3	19	45	459	504
11:15 AM	43	127	9	2	179	34	7	37	26	78	4	142	27	14	173	11	4	3	3	18	45	448	493
11:30 AM	39	133	6	0	178	29	3	42	33	74	4	140	41	22	185	12	5	1	0	18	55	455	510
11:45 AM	19	113	3	1	135	50	7	40	26	97	7	126	29	19	162	8	3	2	2	13	48	407	455
Total	128	513	20	5	661	147	22	161	114	330	24	552	134	66	710	40	19	9	8	68	193	1769	1962
12:00 PM	26	92	2	0	120	56	3	63	42	122	4	135	30	12	169	8	8	4	1	20	55	431	486
12:15 PM	43	96	2	0	141	35	4	56	37	95	6	123	44	27	173	11	22	2	0	35	64	444	508
12:30 PM	37	95	3	0	135	28	4	40	28	72	4	144	43	12	191	10	3	2	1	15	41	413	454
12:45 PM	38	115	2	1	155	33	6	36	24	75	2	148	32	16	182	11	7	3	2	21	43	433	476
Total	144	398	9	1	551	152	17	195	131	364	16	550	149	67	715	40	40	11	4	91	203	1721	1924
01:00 PM	47	161	3	0	211	33	6	35	29	74	9	136	42	13	187	9	4	3	1	16	43	488	531
01:15 PM	49	165	5	0	219	51	3	37	19	91	11	131	35	17	177	9	3	6	2	18	38	505	543
01:30 PM	40	130	6	1	176	31	2	40	28	73	5	144	30	10	179	6	2	7	4	15	43	443	486
01:45 PM	54	128	5	0	187	36	0	41	32	77	6	150	34	22	190	6	8	2	1	16	55	470	525
Total	190	584	19	1	793	151	11	153	108	315	31	561	141	62	733	30	17	18	8	65	179	1906	2085
Grand Total	462	1495	48	7	2005	450	50	509	353	1009	71	1663	424	195	2158	110	76	38	20	224	575	5396	5971
Apprch %	23	74.6	2.4			44.6	5	50.4			3.3	77.1	19.6			49.1	33.9	17					
Total %	8.6	27.7	0.9		37.2	8.3	0.9	9.4		18.7	1.3	30.8	7.9		40	2	1.4	0.7		4.2	9.6	90.4	

Start Time	Trautwein Road Southbound				Orange Terrace Parkway Westbound				Trautwein Road Northbound				Orange Terrace Parkway Eastbound				Int. Total
	Left	Thru	Right	App. Total	Left	Thru	Right	App. Total	Left	Thru	Right	App. Total	Left	Thru	Right	App. Total	
Peak Hour Analysis From 01:00 PM to 01:45 PM - Peak 1 of 1																	
Peak Hour for Entire Intersection Begins at 01:00 PM																	
01:00 PM	47	161	3	211	33	6	35	74	9	136	42	187	9	4	3	16	488
01:15 PM	49	165	5	219	51	3	37	91	11	131	35	177	9	3	6	18	505
01:30 PM	40	130	6	176	31	2	40	73	5	144	30	179	6	2	7	15	443
01:45 PM	54	128	5	187	36	0	41	77	6	150	34	190	6	8	2	16	470
Total Volume	190	584	19	793	151	11	153	315	31	561	141	733	30	17	18	65	1906
% App. Total	24	73.6	2.4		47.9	3.5	48.6		4.2	76.5	19.2		46.2	26.2	27.7		
PHF	.880	.885	.792	.905	.740	.458	.933	.865	.705	.935	.839	.964	.833	.531	.643	.903	.944

City of Riverside
 N/S: Trautwein Road
 E/W: Orange Terrace Parkway
 Weather: Clear

File Name : 07_RIV_Traut_Or Ter Sat
 Site Code : 05122815
 Start Date : 9/17/2022
 Page No : 2

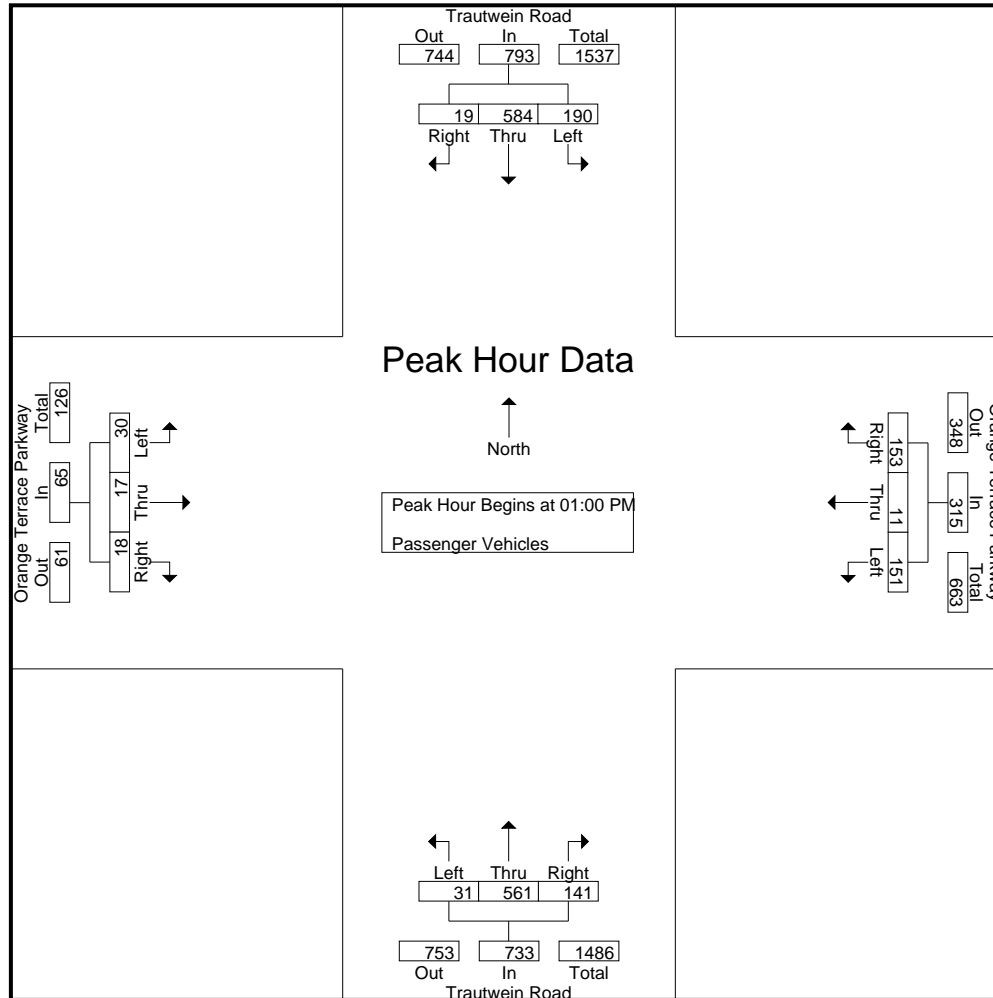

City of Riverside
 N/S: Trautwein Road
 E/W: Orange Terrace Parkway
 Weather: Clear

File Name : 07_RIV_Traut_Or Ter Sat
 Site Code : 05122815
 Start Date : 9/17/2022
 Page No : 3

Start Time	Trautwein Road Southbound				Orange Terrace Parkway Westbound				Trautwein Road Northbound				Orange Terrace Parkway Eastbound				Int. Total
	Left	Thru	Right	App. Total	Left	Thru	Right	App. Total	Left	Thru	Right	App. Total	Left	Thru	Right	App. Total	
Peak Hour Analysis From 01:00 PM to 01:45 PM - Peak 1 of 1																	
Peak Hour for Each Approach Begins at:																	
	01:00 PM				01:00 PM				01:00 PM				01:00 PM				
+0 mins.	47	161	3	211	33	6	35	74	9	136	42	187	9	4	3	16	
+15 mins.	49	165	5	219	51	3	37	91	11	131	35	177	9	3	6	18	
+30 mins.	40	130	6	176	31	2	40	73	5	144	30	179	6	2	7	15	
+45 mins.	54	128	5	187	36	0	41	77	6	150	34	190	6	8	2	16	
Total Volume	190	584	19	793	151	11	153	315	31	561	141	733	30	17	18	65	
% App. Total	24	73.6	2.4		47.9	3.5	48.6		4.2	76.5	19.2		46.2	26.2	27.7		
PHF	.880	.885	.792	.905	.740	.458	.933	.865	.705	.935	.839	.964	.833	.531	.643	.903	

City of Riverside
 N/S: Trautwein Road
 E/W: Orange Terrace Parkway
 Weather: Clear

File Name : 07_RIV_Traut_Or Ter Sat
 Site Code : 05122815
 Start Date : 9/17/2022
 Page No : 1

Groups Printed- Large 2 Axle Vehicles

Start Time	Trautwein Road Southbound					Orange Terrace Parkway Westbound					Trautwein Road Northbound					Orange Terrace Parkway Eastbound					Exclu. Total	Inclu. Total	Int. Total					
	Left	Thru	Right	RTOR	App. Total	Left	Thru	Right	RTOR	App. Total	Left	Thru	Right	RTOR	App. Total	Left	Thru	Right	RTOR	App. Total								
11:00 AM	1	3	1	0	5	1	0	1	0	2	0	1	1	0	2	0	0	0	0	0	0	0	0	0	0	0	9	9
11:15 AM	0	3	0	0	3	0	0	0	0	0	0	3	0	0	3	0	0	0	0	0	0	0	0	0	0	0	6	6
11:30 AM	0	0	0	0	0	0	0	1	1	1	0	2	0	0	2	0	0	0	0	0	0	0	0	0	0	1	3	4
11:45 AM	0	3	0	0	3	0	0	1	0	1	0	0	1	1	1	0	1	0	0	1	0	1	0	0	1	1	6	7
Total	1	9	1	0	11	1	0	3	1	4	0	6	2	1	8	0	1	0	0	1	0	1	0	0	1	2	24	26
12:00 PM	0	0	0	0	0	1	0	0	0	1	0	3	0	0	3	0	0	0	0	0	0	0	0	0	0	0	4	4
12:15 PM	0	1	0	0	1	0	0	0	0	0	0	1	0	0	1	0	0	0	0	0	0	0	0	0	0	0	2	2
12:30 PM	0	1	0	0	1	0	0	2	2	2	0	2	1	0	3	0	0	0	0	0	0	0	0	0	0	2	6	8
12:45 PM	0	1	0	0	1	1	0	0	0	1	0	4	0	0	4	0	0	0	0	0	0	0	0	0	0	0	6	6
Total	0	3	0	0	3	2	0	2	2	4	0	10	1	0	11	0	0	0	0	0	0	0	0	0	0	2	18	20
01:00 PM	0	1	0	0	1	2	0	0	0	2	0	2	1	0	3	0	0	0	0	0	0	0	0	0	0	0	6	6
01:15 PM	0	0	0	0	0	1	0	0	0	1	1	1	0	0	2	0	0	1	0	1	0	0	1	0	1	0	4	4
01:30 PM	0	1	0	0	1	0	0	0	0	0	0	1	0	0	1	0	0	0	0	0	0	0	0	0	0	0	2	2
01:45 PM	0	2	0	0	2	0	0	0	0	0	0	0	0	0	0	0	0	0	0	0	0	0	0	0	0	0	2	2
Total	0	4	0	0	4	3	0	0	0	3	1	4	1	0	6	0	0	1	0	1	0	0	1	0	1	0	14	14
Grand Total	1	16	1	0	18	6	0	5	3	11	1	20	4	1	25	0	1	1	0	2	0	1	1	0	2	4	56	60
Apprch %	5.6	88.9	5.6			54.5	0	45.5			4	80	16			0	50	50										
Total %	1.8	28.6	1.8		32.1	10.7	0	8.9		19.6	1.8	35.7	7.1		44.6	0	1.8	1.8		3.6	6.7	93.3						

Start Time	Trautwein Road Southbound				Orange Terrace Parkway Westbound				Trautwein Road Northbound				Orange Terrace Parkway Eastbound				Int. Total
	Left	Thru	Right	App. Total	Left	Thru	Right	App. Total	Left	Thru	Right	App. Total	Left	Thru	Right	App. Total	
Peak Hour Analysis From 01:00 PM to 01:45 PM - Peak 1 of 1																	
Peak Hour for Entire Intersection Begins at 01:00 PM																	
01:00 PM	0	1	0	1	2	0	0	2	0	2	1	3	0	0	0	0	6
01:15 PM	0	0	0	0	1	0	0	1	1	1	0	2	0	0	1	1	4
01:30 PM	0	1	0	1	0	0	0	0	0	1	0	1	0	0	0	0	2
01:45 PM	0	2	0	2	0	0	0	0	0	0	0	0	0	0	0	0	2
Total Volume	0	4	0	4	3	0	0	3	1	4	1	6	0	0	1	1	14
% App. Total	0	100	0		100	0	0		16.7	66.7	16.7		0	0	100		
PHF	.000	.500	.000	.500	.375	.000	.000	.375	.250	.500	.250	.500	.000	.000	.250	.250	.583

City of Riverside
 N/S: Trautwein Road
 E/W: Orange Terrace Parkway
 Weather: Clear

File Name : 07_RIV_Traut_Or Ter Sat
 Site Code : 05122815
 Start Date : 9/17/2022
 Page No : 2

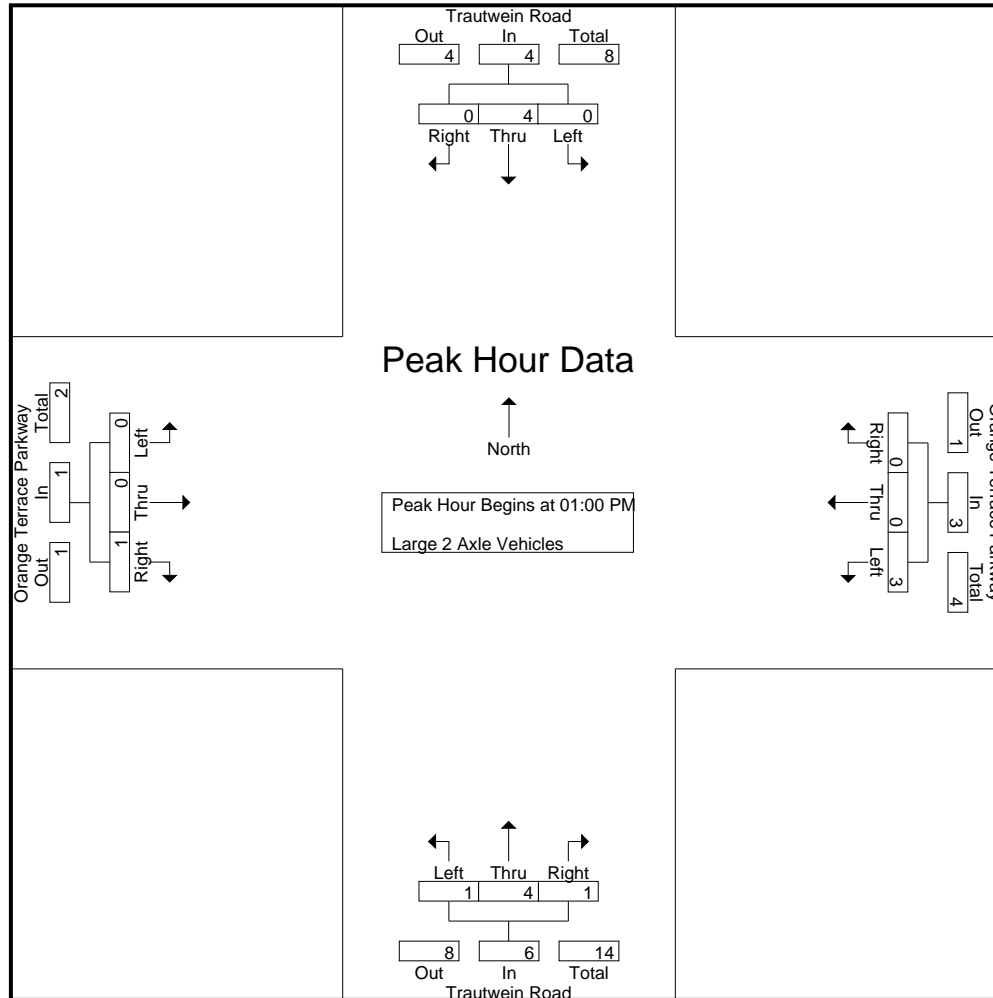

City of Riverside
 N/S: Trautwein Road
 E/W: Orange Terrace Parkway
 Weather: Clear

File Name : 07_RIV_Traut_Or Ter Sat
 Site Code : 05122815
 Start Date : 9/17/2022
 Page No : 3

Start Time	Trautwein Road Southbound				Orange Terrace Parkway Westbound				Trautwein Road Northbound				Orange Terrace Parkway Eastbound				Int. Total
	Left	Thru	Right	App. Total	Left	Thru	Right	App. Total	Left	Thru	Right	App. Total	Left	Thru	Right	App. Total	
Peak Hour Analysis From 01:00 PM to 01:45 PM - Peak 1 of 1																	
Peak Hour for Each Approach Begins at:																	
	01:00 PM				01:00 PM				01:00 PM				01:00 PM				
+0 mins.	0	1	0	1	2	0	0	2	0	2	1	3	0	0	0	0	
+15 mins.	0	0	0	0	1	0	0	1	1	1	0	2	0	0	1	1	
+30 mins.	0	1	0	1	0	0	0	0	0	1	0	1	0	0	0	0	
+45 mins.	0	2	0	2	0	0	0	0	0	0	0	0	0	0	0	0	
Total Volume	0	4	0	4	3	0	0	3	1	4	1	6	0	0	1	1	
% App. Total	0	100	0		100	0	0		16.7	66.7	16.7		0	0	100		
PHF	.000	.500	.000	.500	.375	.000	.000	.375	.250	.500	.250	.500	.000	.000	.250	.250	

City of Riverside
 N/S: Trautwein Road
 E/W: Orange Terrace Parkway
 Weather: Clear

File Name : 07_RIV_Traut_Or Ter Sat
 Site Code : 05122815
 Start Date : 9/17/2022
 Page No : 1

Groups Printed- 3 Axle Vehicles

Start Time	Trautwein Road Southbound					Orange Terrace Parkway Westbound					Trautwein Road Northbound					Orange Terrace Parkway Eastbound					Exclu. Total	Inclu. Total	Int. Total					
	Left	Thru	Right	RTOR	App. Total	Left	Thru	Right	RTOR	App. Total	Left	Thru	Right	RTOR	App. Total	Left	Thru	Right	RTOR	App. Total								
11:00 AM	0	0	0	0	0	0	0	0	0	0	0	0	0	0	0	0	0	0	0	0	0	0	0	0	0	0	0	0
11:15 AM	0	0	0	0	0	0	0	0	0	0	0	0	0	0	0	0	0	0	0	0	0	0	0	0	0	0	0	0
11:30 AM	0	0	0	0	0	0	0	0	0	0	0	1	0	0	1	0	0	0	0	0	0	0	0	0	0	0	1	1
11:45 AM	0	0	0	0	0	0	0	0	0	0	0	0	0	0	0	0	0	0	0	0	0	0	0	0	0	0	0	0
Total	0	0	0	0	0	0	0	0	0	0	0	1	0	0	1	0	0	0	0	0	0	0	0	0	0	0	1	1
12:00 PM	0	0	0	0	0	0	0	0	0	0	0	0	0	0	0	0	0	0	0	0	0	0	0	0	0	0	0	0
12:15 PM	0	0	0	0	0	0	0	0	0	0	0	1	0	0	1	0	0	0	0	0	0	0	0	0	0	0	1	1
12:30 PM	0	0	0	0	0	0	0	0	0	0	0	0	0	0	0	0	0	0	0	0	0	0	0	0	0	0	0	0
12:45 PM	0	1	0	0	1	0	0	0	0	0	0	0	0	0	0	0	0	0	0	0	0	0	0	0	0	0	1	1
Total	0	1	0	0	1	0	0	0	0	0	0	1	0	0	1	0	0	0	0	0	0	0	0	0	0	0	2	2
01:00 PM	0	0	0	0	0	0	0	0	0	0	0	0	0	0	0	0	0	0	0	0	0	0	0	0	0	0	0	0
01:15 PM	0	0	0	0	0	0	0	0	0	0	0	0	0	0	0	0	0	0	0	0	0	0	0	0	0	0	0	0
01:30 PM	0	0	0	0	0	0	0	0	0	0	0	0	0	0	0	0	0	0	0	0	0	0	0	0	0	0	0	0
01:45 PM	0	0	0	0	0	0	0	0	0	0	0	0	0	0	0	0	0	0	0	0	0	0	0	0	0	0	0	0
Total	0	0	0	0	0	0	0	0	0	0	0	0	0	0	0	0	0	0	0	0	0	0	0	0	0	0	0	0
Grand Total	0	1	0	0	1	0	0	0	0	0	0	2	0	0	2	0	0	0	0	0	0	0	0	0	0	0	3	3
Apprch %	0	100	0			0	0	0			0	100	0			0	0	0			0	0	0			0		
Total %	0	33.3	0		33.3	0	0	0		0	0	66.7	0		66.7	0	0	0		0	0	0	0		0	0	100	

Start Time	Trautwein Road Southbound				Orange Terrace Parkway Westbound				Trautwein Road Northbound				Orange Terrace Parkway Eastbound				Int. Total				
	Left	Thru	Right	App. Total	Left	Thru	Right	App. Total	Left	Thru	Right	App. Total	Left	Thru	Right	App. Total					
Peak Hour Analysis From 01:00 PM to 01:45 PM - Peak 1 of 1																					
Peak Hour for Entire Intersection Begins at 01:00 PM																					
01:00 PM	0	0	0	0	0	0	0	0	0	0	0	0	0	0	0	0	0	0	0	0	0
01:15 PM	0	0	0	0	0	0	0	0	0	0	0	0	0	0	0	0	0	0	0	0	0
01:30 PM	0	0	0	0	0	0	0	0	0	0	0	0	0	0	0	0	0	0	0	0	0
01:45 PM	0	0	0	0	0	0	0	0	0	0	0	0	0	0	0	0	0	0	0	0	0
Total Volume	0	0	0	0	0	0	0	0	0	0	0	0	0	0	0	0	0	0	0	0	0
% App. Total	0	0	0		0	0	0		0	0	0		0	0	0		0	0	0		
PHF	.000	.000	.000	.000	.000	.000	.000	.000	.000	.000	.000	.000	.000	.000	.000	.000	.000	.000	.000	.000	.000

City of Riverside
N/S: Trautwein Road
E/W: Orange Terrace Parkway
Weather: Clear

File Name : 07_RIV_Traut_Or Ter Sat
Site Code : 05122815
Start Date : 9/17/2022
Page No : 2

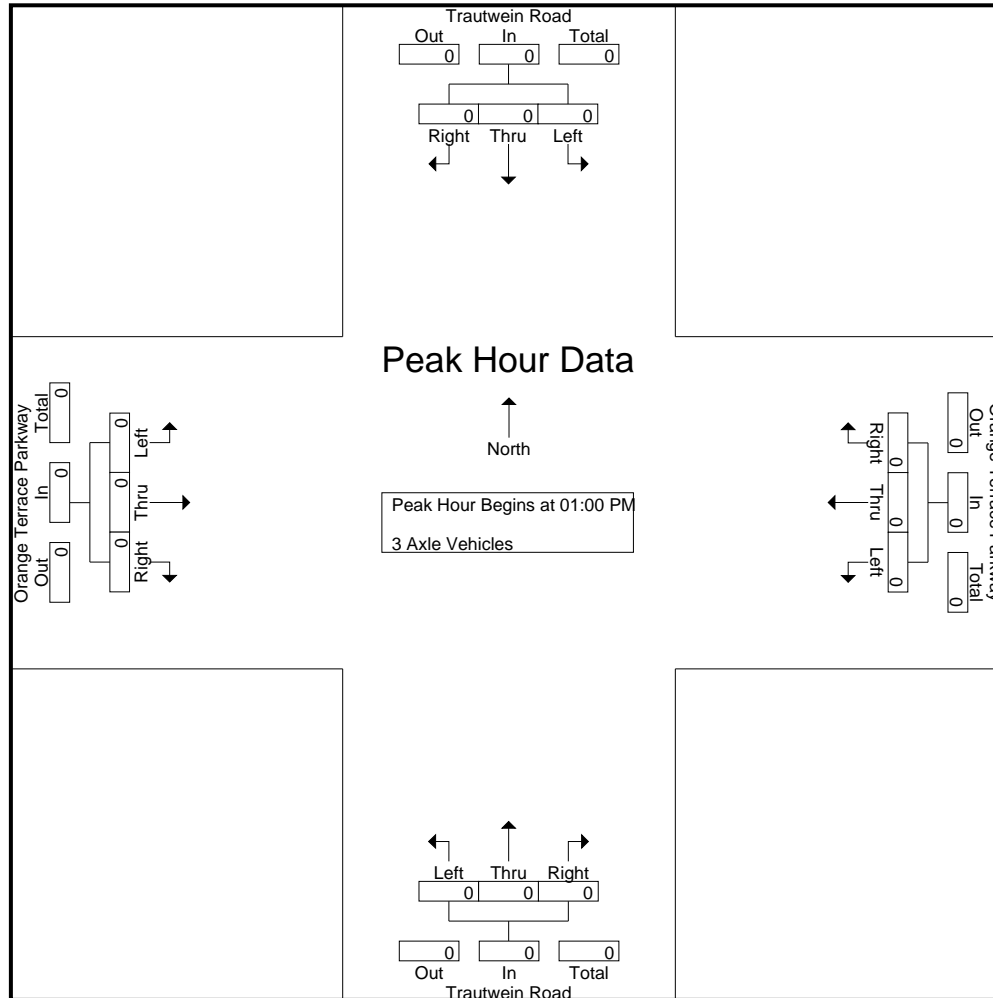

City of Riverside
 N/S: Trautwein Road
 E/W: Orange Terrace Parkway
 Weather: Clear

File Name : 07_RIV_Traut_Or Ter Sat
 Site Code : 05122815
 Start Date : 9/17/2022
 Page No : 3

Start Time	Trautwein Road Southbound				Orange Terrace Parkway Westbound				Trautwein Road Northbound				Orange Terrace Parkway Eastbound				Int. Total
	Left	Thru	Right	App. Total	Left	Thru	Right	App. Total	Left	Thru	Right	App. Total	Left	Thru	Right	App. Total	
Peak Hour Analysis From 01:00 PM to 01:45 PM - Peak 1 of 1																	
Peak Hour for Each Approach Begins at:																	
	01:00 PM				01:00 PM				01:00 PM				01:00 PM				
+0 mins.	0	0	0	0	0	0	0	0	0	0	0	0	0	0	0	0	0
+15 mins.	0	0	0	0	0	0	0	0	0	0	0	0	0	0	0	0	0
+30 mins.	0	0	0	0	0	0	0	0	0	0	0	0	0	0	0	0	0
+45 mins.	0	0	0	0	0	0	0	0	0	0	0	0	0	0	0	0	0
Total Volume	0	0	0	0	0	0	0	0	0	0	0	0	0	0	0	0	0
% App. Total	0	0	0	0	0	0	0	0	0	0	0	0	0	0	0	0	0
PHF	.000	.000	.000	.000	.000	.000	.000	.000	.000	.000	.000	.000	.000	.000	.000	.000	.000

City of Riverside
 N/S: Trautwein Road
 E/W: Orange Terrace Parkway
 Weather: Clear

File Name : 07_RIV_Traut_Or Ter Sat
 Site Code : 05122815
 Start Date : 9/17/2022
 Page No : 1

Groups Printed- 4+ Axle Trucks

Start Time	Trautwein Road Southbound					Orange Terrace Parkway Westbound					Trautwein Road Northbound					Orange Terrace Parkway Eastbound					Exclu. Total	Inclu. Total	Int. Total				
	Left	Thru	Right	RTOR	App. Total	Left	Thru	Right	RTOR	App. Total	Left	Thru	Right	RTOR	App. Total	Left	Thru	Right	RTOR	App. Total							
11:00 AM	0	0	0	0	0	0	0	0	0	0	0	0	0	0	0	0	0	0	0	0	0	0	0	0	0	0	0
11:15 AM	0	0	0	0	0	0	0	0	0	0	0	0	0	0	0	0	0	0	0	0	0	0	0	0	0	0	0
11:30 AM	0	0	0	0	0	0	0	0	0	0	0	0	0	0	0	0	0	0	0	0	0	0	0	0	0	0	0
11:45 AM	0	0	0	0	0	0	0	0	0	0	0	0	0	0	0	0	0	0	0	0	0	0	0	0	0	0	0
Total	0	0	0	0	0	0	0	0	0	0	0	0	0	0	0	0	0	0	0	0	0	0	0	0	0	0	0
12:00 PM	0	0	0	0	0	0	0	0	0	0	0	0	0	0	0	0	0	0	0	0	0	0	0	0	0	0	0
12:15 PM	0	0	0	0	0	0	0	0	0	0	0	0	0	0	0	0	0	0	0	0	0	0	0	0	0	0	0
12:30 PM	0	0	0	0	0	0	0	0	0	0	0	0	0	0	0	0	0	0	0	0	0	0	0	0	0	0	0
12:45 PM	0	0	0	0	0	0	0	0	0	0	0	0	0	0	0	0	0	0	0	0	0	0	0	0	0	0	0
Total	0	0	0	0	0	0	0	0	0	0	0	0	0	0	0	0	0	0	0	0	0	0	0	0	0	0	0
01:00 PM	0	0	0	0	0	0	0	0	0	0	0	0	0	0	0	0	0	0	0	0	0	0	0	0	0	0	0
01:15 PM	0	0	0	0	0	0	0	0	0	0	0	0	0	0	0	0	0	0	0	0	0	0	0	0	0	0	0
01:30 PM	0	0	0	0	0	0	0	0	0	0	0	0	0	0	0	0	0	0	0	0	0	0	0	0	0	0	0
01:45 PM	0	0	0	0	0	0	0	0	0	0	0	0	0	0	0	0	0	0	0	0	0	0	0	0	0	0	0
Total	0	0	0	0	0	0	0	0	0	0	0	0	0	0	0	0	0	0	0	0	0	0	0	0	0	0	0
Grand Total	0	0	0	0	0	0	0	0	0	0	0	0	0	0	0	0	0	0	0	0	0	0	0	0	0	0	0
Apprch %	0	0	0			0	0	0			0	0	0			0	0	0									
Total %																					0	0					

Start Time	Trautwein Road Southbound				Orange Terrace Parkway Westbound				Trautwein Road Northbound				Orange Terrace Parkway Eastbound				Int. Total				
	Left	Thru	Right	App. Total	Left	Thru	Right	App. Total	Left	Thru	Right	App. Total	Left	Thru	Right	App. Total					
Peak Hour Analysis From 01:00 PM to 01:45 PM - Peak 1 of 1																					
Peak Hour for Entire Intersection Begins at 01:00 PM																					
01:00 PM	0	0	0	0	0	0	0	0	0	0	0	0	0	0	0	0	0	0	0	0	0
01:15 PM	0	0	0	0	0	0	0	0	0	0	0	0	0	0	0	0	0	0	0	0	0
01:30 PM	0	0	0	0	0	0	0	0	0	0	0	0	0	0	0	0	0	0	0	0	0
01:45 PM	0	0	0	0	0	0	0	0	0	0	0	0	0	0	0	0	0	0	0	0	0
Total Volume	0	0	0	0	0	0	0	0	0	0	0	0	0	0	0	0	0	0	0	0	0
% App. Total	0	0	0		0	0	0		0	0	0		0	0	0		0	0	0		
PHF	.000	.000	.000	.000	.000	.000	.000	.000	.000	.000	.000	.000	.000	.000	.000	.000	.000	.000	.000	.000	.000

City of Riverside
N/S: Trautwein Road
E/W: Orange Terrace Parkway
Weather: Clear

File Name : 07_RIV_Traut_Or Ter Sat
Site Code : 05122815
Start Date : 9/17/2022
Page No : 2

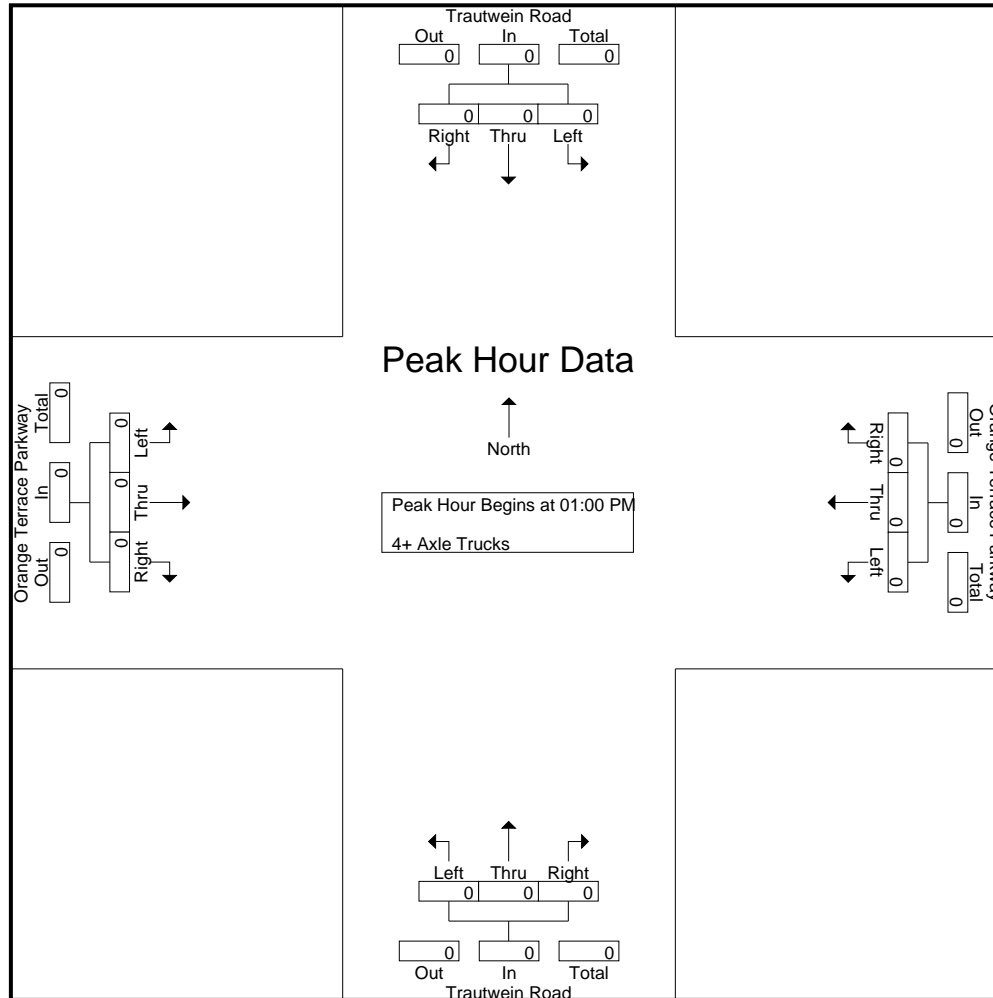

City of Riverside
 N/S: Trautwein Road
 E/W: Orange Terrace Parkway
 Weather: Clear

File Name : 07_RIV_Traut_Or Ter Sat
 Site Code : 05122815
 Start Date : 9/17/2022
 Page No : 3

Start Time	Trautwein Road Southbound				Orange Terrace Parkway Westbound				Trautwein Road Northbound				Orange Terrace Parkway Eastbound				Int. Total
	Left	Thru	Right	App. Total	Left	Thru	Right	App. Total	Left	Thru	Right	App. Total	Left	Thru	Right	App. Total	
Peak Hour Analysis From 01:00 PM to 01:45 PM - Peak 1 of 1																	
Peak Hour for Each Approach Begins at:																	
	01:00 PM				01:00 PM				01:00 PM				01:00 PM				
+0 mins.	0	0	0	0	0	0	0	0	0	0	0	0	0	0	0	0	0
+15 mins.	0	0	0	0	0	0	0	0	0	0	0	0	0	0	0	0	0
+30 mins.	0	0	0	0	0	0	0	0	0	0	0	0	0	0	0	0	0
+45 mins.	0	0	0	0	0	0	0	0	0	0	0	0	0	0	0	0	0
Total Volume	0	0	0	0	0	0	0	0	0	0	0	0	0	0	0	0	0
% App. Total	0	0	0	0	0	0	0	0	0	0	0	0	0	0	0	0	0
PHF	.000	.000	.000	.000	.000	.000	.000	.000	.000	.000	.000	.000	.000	.000	.000	.000	.000

Location: Riverside
 N/S: Trautwein Road
 E/W: Orange Terrace Parkway



Date: 9/17/2022
 Day Saturday

PEDESTRIANS

Time	North Leg Trautwein Road	East Leg Orange Terrace Parkway	South Leg Trautwein Road	West Leg Orange Terrace Parkway	TOTAL
11:00 AM	0	1	0	2	3
11:15 AM	1	0	0	1	2
11:30 AM	0	0	3	1	4
11:45 AM	0	0	0	3	3
12:00 PM	0	1	0	0	1
12:15 PM	0	1	3	0	4
12:30 PM	0	2	0	0	2
12:45 PM	0	1	0	0	1
1:00 PM	0	0	0	0	0
1:15 PM	2	0	0	2	4
1:30 PM	0	0	1	0	1
1:45 PM	0	0	0	0	0
TOTAL VOLUMES:	3	6	7	9	25

Location: Riverside
 N/S: Trautwein Road
 E/W: Orange Terrace Parkway

Date: 9/17/2022
 Day: Saturday



BICYCLES

	Southbound Trautwein Road			Westbound Orange Terrace Parkway			Northbound Trautwein Road			Eastbound Orange Terrace Parkway			
	Left	Thru	Right	Left	Thru	Right	Left	Thru	Right	Left	Thru	Right	
11:00 AM	0	0	0	0	0	0	0	1	0	1	0	0	2
11:15 AM	0	0	0	0	0	0	0	1	0	0	0	0	1
11:30 AM	0	0	0	0	0	0	0	0	0	0	0	0	0
11:45 AM	0	1	0	0	0	0	0	1	0	0	0	0	2
12:00 PM	0	1	0	0	0	0	1	0	0	0	2	0	4
12:15 PM	0	0	0	0	0	0	0	0	0	0	0	0	0
12:30 PM	0	1	0	0	0	0	0	0	0	0	0	0	1
12:45 PM	0	0	0	0	0	0	0	0	0	0	0	0	0
1:00 PM	0	0	0	0	0	0	0	0	0	0	0	0	0
1:15 PM	0	0	0	0	0	0	0	0	0	0	0	0	0
1:30 PM	0	0	0	0	0	0	0	0	0	0	0	0	0
1:45 PM	0	1	0	0	0	0	0	0	0	0	0	0	1
TOTAL VOLUMES:	0	4	0	0	0	0	1	3	0	1	2	0	11

City of Riverside
 N/S: Trautwein Road/Cole Avenue
 E/W: Van Buren Boulevard
 Weather: Clear

File Name : 08_RIV_Traut_VB Sat
 Site Code : 05122815
 Start Date : 9/17/2022
 Page No : 1

Groups Printed- Passenger Vehicles - Large 2 Axle Vehicles - 3 Axle Vehicles - 4+ Axle Trucks

Start Time	Trautwein Road Southbound					Van Buren Boulevard Westbound					Cole Avenue Northbound					Van Buren Boulevard Eastbound					Exclu. Total	Inclu. Total	Int. Total
	Left	Thru	Right	RTOR	App. Total	Left	Thru	Right	RTOR	App. Total	Left	Thru	Right	RTOR	App. Total	Left	Thru	Right	RTOR	App. Total			
11:00 AM	41	46	58	36	145	17	147	41	12	205	25	68	7	3	100	72	145	14	7	231	58	681	739
11:15 AM	42	39	53	35	134	32	193	35	17	260	19	50	5	1	74	76	118	12	7	206	60	674	734
11:30 AM	36	71	57	31	164	25	178	39	18	242	14	53	15	9	82	72	139	15	7	226	65	714	779
11:45 AM	31	53	49	24	133	18	188	43	21	249	11	52	11	1	74	70	130	15	7	215	53	671	724
Total	150	209	217	126	576	92	706	158	68	956	69	223	38	14	330	290	532	56	28	878	236	2740	2976
12:00 PM	27	42	54	28	123	19	190	44	15	253	14	52	9	2	75	65	145	12	6	222	51	673	724
12:15 PM	33	23	47	28	103	27	202	28	8	257	25	51	7	1	83	78	182	17	8	277	45	720	765
12:30 PM	32	32	35	26	99	36	207	37	14	280	11	44	9	6	64	98	151	19	7	268	53	711	764
12:45 PM	41	58	53	34	152	21	180	39	25	240	24	64	14	2	102	92	174	15	10	281	71	775	846
Total	133	155	189	116	477	103	779	148	62	1030	74	211	39	11	324	333	652	63	31	1048	220	2879	3099
01:00 PM	46	49	60	33	155	26	218	43	16	287	19	56	13	2	88	69	167	24	3	260	54	790	844
01:15 PM	34	44	51	27	129	27	198	30	10	255	27	54	7	1	88	79	184	16	8	279	46	751	797
01:30 PM	32	54	52	31	138	29	166	52	16	247	22	55	9	4	86	62	180	15	5	257	56	728	784
01:45 PM	34	60	44	35	138	21	203	53	25	277	20	46	7	2	73	70	198	17	8	285	70	773	843
Total	146	207	207	126	560	103	785	178	67	1066	88	211	36	9	335	280	729	72	24	1081	226	3042	3268
Grand Total	429	571	613	368	1613	298	2270	484	197	3052	231	645	113	34	989	903	1913	191	83	3007	682	8661	9343
Apprch %	26.6	35.4	38			9.8	74.4	15.9			23.4	65.2	11.4			30	63.6	6.4					
Total %	5	6.6	7.1		18.6	3.4	26.2	5.6		35.2	2.7	7.4	1.3		11.4	10.4	22.1	2.2		34.7	7.3	92.7	
Passenger Vehicles	417	568	607		1958	294	2244	472		3204	229	640	113		1016	892	1880	191		3046	0	0	9224
% Passenger Vehicles	97.2	99.5	99	99.5	98.8	98.7	98.9	97.5	98.5	98.6	99.1	99.2	100	100	99.3	98.8	98.3	100	100	98.6	0	0	98.7
Large 2 Axle Vehicles	11	3	6		22	2	22	10		37	1	5	0		6	11	25	0		36	0	0	101
% Large 2 Axle Vehicles	2.6	0.5	1	0.5	1.1	0.7	1	2.1	1.5	1.1	0.4	0.8	0	0	0.6	1.2	1.3	0	0	1.2	0	0	1.1
3 Axle Vehicles	1	0	0		1	2	3	2		7	1	0	0		1	0	3	0		3	0	0	12
% 3 Axle Vehicles	0.2	0	0	0	0.1	0.7	0.1	0.4	0	0.2	0.4	0	0	0	0.1	0	0.2	0	0	0.1	0	0	0.1
4+ Axle Trucks	0	0	0		0	0	1	0		1	0	0	0		0	0	5	0		5	0	0	6
% 4+ Axle Trucks	0	0	0	0	0	0	0	0	0	0	0	0	0	0	0	0	0.3	0	0	0.2	0	0	0.1

City of Riverside
 N/S: Trautwein Road/Cole Avenue
 E/W: Van Buren Boulevard
 Weather: Clear

File Name : 08_RIV_Traut_VB Sat
 Site Code : 05122815
 Start Date : 9/17/2022
 Page No : 2

Start Time	Trautwein Road Southbound				Van Buren Boulevard Westbound				Cole Avenue Northbound				Van Buren Boulevard Eastbound				Int. Total
	Left	Thru	Right	App. Total	Left	Thru	Right	App. Total	Left	Thru	Right	App. Total	Left	Thru	Right	App. Total	
Peak Hour Analysis From 11:00 AM to 01:45 PM - Peak 1 of 1																	
Peak Hour for Entire Intersection Begins at 12:45 PM																	
12:45 PM	41	58	53	152	21	180	39	240	24	64	14	102	92	174	15	281	775
01:00 PM	46	49	60	155	26	218	43	287	19	56	13	88	69	167	24	260	790
01:15 PM	34	44	51	129	27	198	30	255	27	54	7	88	79	184	16	279	751
01:30 PM	32	54	52	138	29	166	52	247	22	55	9	86	62	180	15	257	728
Total Volume	153	205	216	574	103	762	164	1029	92	229	43	364	302	705	70	1077	3044
% App. Total	26.7	35.7	37.6		10	74.1	15.9		25.3	62.9	11.8		28	65.5	6.5		
PHF	.832	.884	.900	.926	.888	.874	.788	.896	.852	.895	.768	.892	.821	.958	.729	.958	.963

City of Riverside
 N/S: Trautwein Road/Cole Avenue
 E/W: Van Buren Boulevard
 Weather: Clear

File Name : 08_RIV_Traut_VB Sat
 Site Code : 05122815
 Start Date : 9/17/2022
 Page No : 3

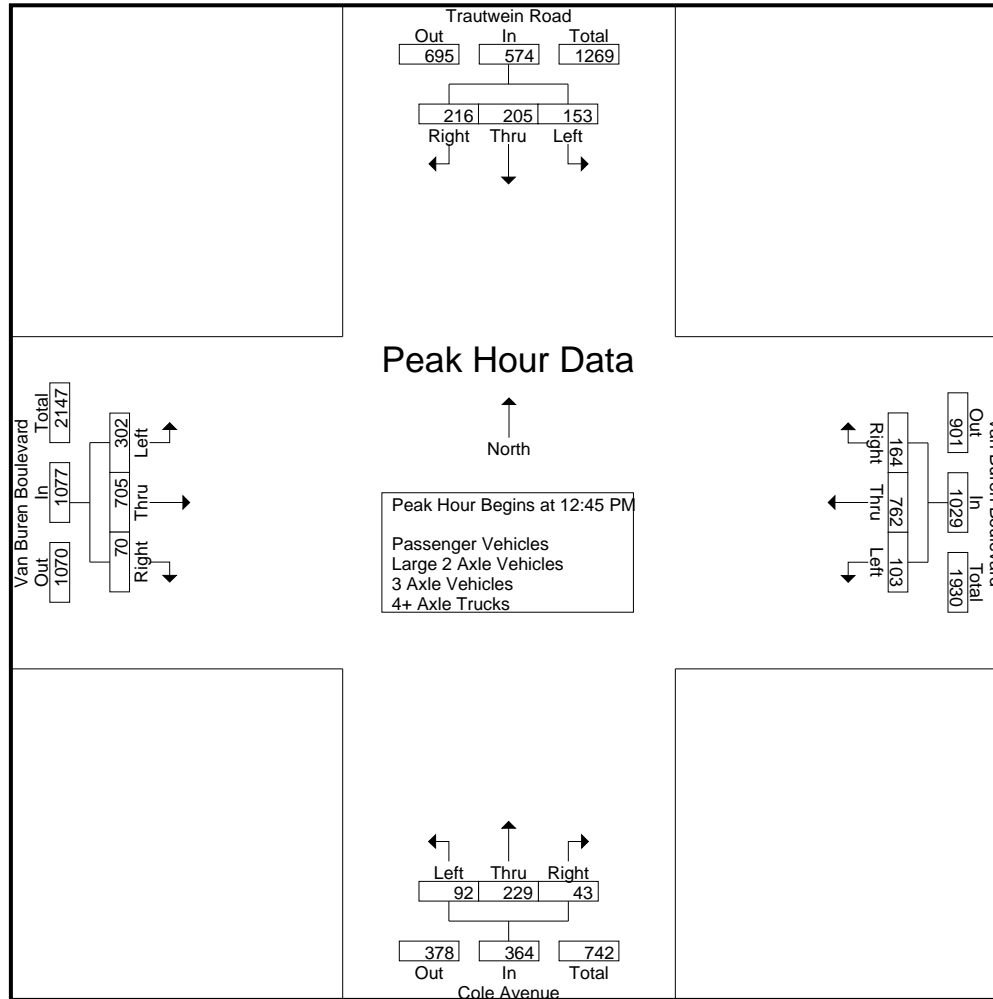

City of Riverside
 N/S: Trautwein Road/Cole Avenue
 E/W: Van Buren Boulevard
 Weather: Clear

File Name : 08_RIV_Traut_VB Sat
 Site Code : 05122815
 Start Date : 9/17/2022
 Page No : 4

Start Time	Trautwein Road Southbound				Van Buren Boulevard Westbound				Cole Avenue Northbound				Van Buren Boulevard Eastbound				Int. Total
	Left	Thru	Right	App. Total	Left	Thru	Right	App. Total	Left	Thru	Right	App. Total	Left	Thru	Right	App. Total	
Peak Hour Analysis From 11:00 AM to 01:45 PM - Peak 1 of 1																	
Peak Hour for Each Approach Begins at:																	
	11:00 AM				01:00 PM				12:45 PM				12:30 PM				
+0 mins.	41	46	58	145	26	218	43	287	24	64	14	102	98	151	19	268	
+15 mins.	42	39	53	134	27	198	30	255	19	56	13	88	92	174	15	281	
+30 mins.	36	71	57	164	29	166	52	247	27	54	7	88	69	167	24	260	
+45 mins.	31	53	49	133	21	203	53	277	22	55	9	86	79	184	16	279	
Total Volume	150	209	217	576	103	785	178	1066	92	229	43	364	338	676	74	1088	
% App. Total	26	36.3	37.7		9.7	73.6	16.7		25.3	62.9	11.8		31.1	62.1	6.8		
PHF	.893	.736	.935	.878	.888	.900	.840	.929	.852	.895	.768	.892	.862	.918	.771	.968	

City of Riverside
 N/S: Trautwein Road/Cole Avenue
 E/W: Van Buren Boulevard
 Weather: Clear

File Name : 08_RIV_Traut_VB Sat
 Site Code : 05122815
 Start Date : 9/17/2022
 Page No : 1

Groups Printed- Passenger Vehicles

Start Time	Trautwein Road Southbound					Van Buren Boulevard Westbound					Cole Avenue Northbound					Van Buren Boulevard Eastbound					Exclu. Total	Inclu. Total	Int. Total
	Left	Thru	Right	RTOR	App. Total	Left	Thru	Right	RTOR	App. Total	Left	Thru	Right	RTOR	App. Total	Left	Thru	Right	RTOR	App. Total			
11:00 AM	40	46	56	35	142	17	147	41	12	205	25	68	7	3	100	71	142	14	7	227	57	674	731
11:15 AM	40	37	53	35	130	31	189	34	16	254	19	50	5	1	74	74	118	12	7	204	59	662	721
11:30 AM	35	71	56	31	162	25	175	38	18	238	13	52	15	9	80	71	139	15	7	225	65	705	770
11:45 AM	30	52	49	24	131	18	186	42	21	246	10	52	11	1	73	69	127	15	7	211	53	661	714
Total	145	206	214	125	565	91	697	155	67	943	67	222	38	14	327	285	526	56	28	867	234	2702	2936
12:00 PM	26	42	53	28	121	19	189	43	15	251	14	50	9	2	73	64	142	12	6	218	51	663	714
12:15 PM	32	23	47	28	102	26	201	27	8	254	25	50	7	1	82	78	176	17	8	271	45	709	754
12:30 PM	31	32	35	26	98	36	204	36	14	276	11	44	9	6	64	97	149	19	7	265	53	703	756
12:45 PM	40	58	53	34	151	21	179	35	23	235	24	64	14	2	102	91	172	15	10	278	69	766	835
Total	129	155	188	116	472	102	773	141	60	1016	74	208	39	11	321	330	639	63	31	1032	218	2841	3059
01:00 PM	46	49	59	32	154	26	216	42	16	284	19	56	13	2	88	67	164	24	3	255	53	781	834
01:15 PM	33	44	51	27	128	26	197	29	10	252	27	53	7	1	87	79	178	16	8	273	46	740	786
01:30 PM	32	54	51	31	137	28	162	52	16	242	22	55	9	4	86	61	176	15	5	252	56	717	773
01:45 PM	32	60	44	35	136	21	199	53	25	273	20	46	7	2	73	70	197	17	8	284	70	766	836
Total	143	207	205	125	555	101	774	176	67	1051	88	210	36	9	334	277	715	72	24	1064	225	3004	3229
Grand Total	417	568	607	366	1592	294	2244	472	194	3010	229	640	113	34	982	892	1880	191	83	2963	677	8547	9224
Apprch %	26.2	35.7	38.1			9.8	74.6	15.7			23.3	65.2	11.5			30.1	63.4	6.4					
Total %	4.9	6.6	7.1		18.6	3.4	26.3	5.5		35.2	2.7	7.5	1.3		11.5	10.4	22	2.2		34.7	7.3	92.7	

Start Time	Trautwein Road Southbound				Van Buren Boulevard Westbound				Cole Avenue Northbound				Van Buren Boulevard Eastbound				Int. Total
	Left	Thru	Right	App. Total	Left	Thru	Right	App. Total	Left	Thru	Right	App. Total	Left	Thru	Right	App. Total	
Peak Hour Analysis From 12:45 PM to 01:30 PM - Peak 1 of 1																	
Peak Hour for Entire Intersection Begins at 12:45 PM																	
12:45 PM	40	58	53	151	21	179	35	235	24	64	14	102	91	172	15	278	766
01:00 PM	46	49	59	154	26	216	42	284	19	56	13	88	67	164	24	255	781
01:15 PM	33	44	51	128	26	197	29	252	27	53	7	87	79	178	16	273	740
01:30 PM	32	54	51	137	28	162	52	242	22	55	9	86	61	176	15	252	717
Total Volume	151	205	214	570	101	754	158	1013	92	228	43	363	298	690	70	1058	3004
% App. Total	26.5	36	37.5		10	74.4	15.6		25.3	62.8	11.8		28.2	65.2	6.6		
PHF	.821	.884	.907	.925	.902	.873	.760	.892	.852	.891	.768	.890	.819	.969	.729	.951	.962

City of Riverside
 N/S: Trautwein Road/Cole Avenue
 E/W: Van Buren Boulevard
 Weather: Clear

File Name : 08_RIV_Traut_VB Sat
 Site Code : 05122815
 Start Date : 9/17/2022
 Page No : 2

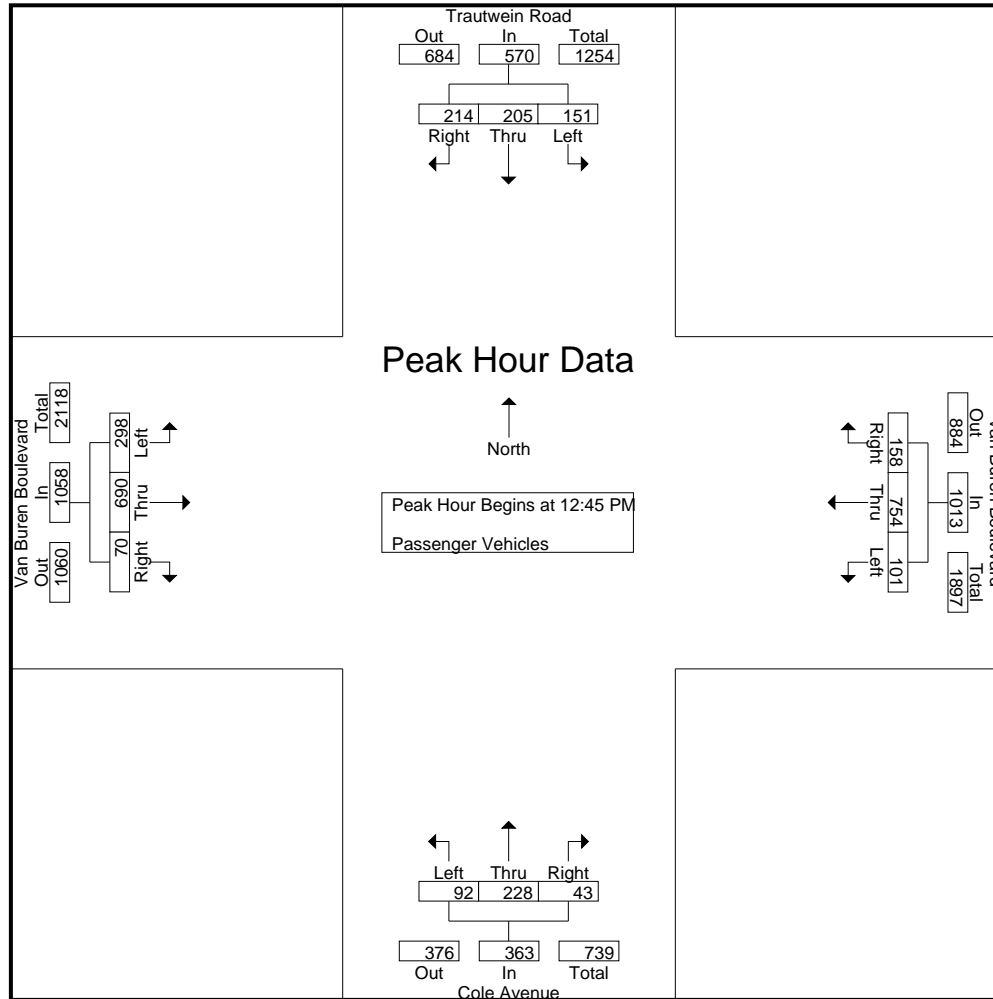

City of Riverside
 N/S: Trautwein Road/Cole Avenue
 E/W: Van Buren Boulevard
 Weather: Clear

File Name : 08_RIV_Traut_VB Sat
 Site Code : 05122815
 Start Date : 9/17/2022
 Page No : 3

Start Time	Trautwein Road Southbound				Van Buren Boulevard Westbound				Cole Avenue Northbound				Van Buren Boulevard Eastbound				Int. Total
	Left	Thru	Right	App. Total	Left	Thru	Right	App. Total	Left	Thru	Right	App. Total	Left	Thru	Right	App. Total	
Peak Hour Analysis From 12:45 PM to 01:30 PM - Peak 1 of 1																	
Peak Hour for Each Approach Begins at:																	
	12:45 PM				12:45 PM				12:45 PM				12:45 PM				
+0 mins.	40	58	53	151	21	179	35	235	24	64	14	102	91	172	15	278	
+15 mins.	46	49	59	154	26	216	42	284	19	56	13	88	67	164	24	255	
+30 mins.	33	44	51	128	26	197	29	252	27	53	7	87	79	178	16	273	
+45 mins.	32	54	51	137	28	162	52	242	22	55	9	86	61	176	15	252	
Total Volume	151	205	214	570	101	754	158	1013	92	228	43	363	298	690	70	1058	
% App. Total	26.5	36	37.5		10	74.4	15.6		25.3	62.8	11.8		28.2	65.2	6.6		
PHF	.821	.884	.907	.925	.902	.873	.760	.892	.852	.891	.768	.890	.819	.969	.729	.951	

City of Riverside
 N/S: Trautwein Road/Cole Avenue
 E/W: Van Buren Boulevard
 Weather: Clear

File Name : 08_RIV_Traut_VB Sat
 Site Code : 05122815
 Start Date : 9/17/2022
 Page No : 1

Groups Printed- Large 2 Axle Vehicles

Start Time	Trautwein Road Southbound					Van Buren Boulevard Westbound					Cole Avenue Northbound					Van Buren Boulevard Eastbound					Exclu. Total	Inclu. Total	Int. Total
	Left	Thru	Right	RTOR	App. Total	Left	Thru	Right	RTOR	App. Total	Left	Thru	Right	RTOR	App. Total	Left	Thru	Right	RTOR	App. Total			
11:00 AM	1	0	2	1	3	0	0	0	0	0	0	0	0	0	0	1	2	0	0	3	1	6	7
11:15 AM	2	2	0	0	4	1	4	1	1	6	0	0	0	0	0	2	0	0	0	2	1	12	13
11:30 AM	1	0	1	0	2	0	1	0	0	1	1	1	0	0	2	1	0	0	0	1	0	6	6
11:45 AM	1	1	0	0	2	0	2	1	0	3	0	0	0	0	0	1	2	0	0	3	0	8	8
Total	5	3	3	1	11	1	7	2	1	10	1	1	0	0	2	5	4	0	0	9	2	32	34
12:00 PM	1	0	1	0	2	0	1	1	0	2	0	2	0	0	2	1	3	0	0	4	0	10	10
12:15 PM	1	0	0	0	1	0	1	1	0	2	0	1	0	0	1	0	5	0	0	5	0	9	9
12:30 PM	1	0	0	0	1	0	2	1	0	3	0	0	0	0	0	1	2	0	0	3	0	7	7
12:45 PM	0	0	0	0	0	0	0	4	2	4	0	0	0	0	0	1	1	0	0	2	2	6	8
Total	3	0	1	0	4	0	4	7	2	11	0	3	0	0	3	3	11	0	0	14	2	32	34
01:00 PM	0	0	1	1	1	0	2	1	0	3	0	0	0	0	0	2	2	0	0	4	1	8	9
01:15 PM	1	0	0	0	1	0	1	0	0	1	0	1	0	0	1	0	5	0	0	5	0	8	8
01:30 PM	0	0	1	0	1	1	4	0	0	5	0	0	0	0	0	1	3	0	0	4	0	10	10
01:45 PM	2	0	0	0	2	0	4	0	0	4	0	0	0	0	0	0	0	0	0	0	0	6	6
Total	3	0	2	1	5	1	11	1	0	13	0	1	0	0	1	3	10	0	0	13	1	32	33
Grand Total	11	3	6	2	20	2	22	10	3	34	1	5	0	0	6	11	25	0	0	36	5	96	101
Apprch %	55	15	30			5.9	64.7	29.4			16.7	83.3	0			30.6	69.4	0					
Total %	11.5	3.1	6.2		20.8	2.1	22.9	10.4		35.4	1	5.2	0		6.2	11.5	26	0		37.5	5	95	

Start Time	Trautwein Road Southbound				Van Buren Boulevard Westbound				Cole Avenue Northbound				Van Buren Boulevard Eastbound				Int. Total
	Left	Thru	Right	App. Total	Left	Thru	Right	App. Total	Left	Thru	Right	App. Total	Left	Thru	Right	App. Total	
Peak Hour Analysis From 12:45 PM to 01:30 PM - Peak 1 of 1																	
Peak Hour for Entire Intersection Begins at 12:45 PM																	
12:45 PM	0	0	0	0	0	0	4	4	0	0	0	0	1	1	0	2	6
01:00 PM	0	0	1	1	0	2	1	3	0	0	0	0	2	2	0	4	8
01:15 PM	1	0	0	1	0	1	0	1	0	1	0	1	0	5	0	5	8
01:30 PM	0	0	1	1	1	4	0	5	0	0	0	0	1	3	0	4	10
Total Volume	1	0	2	3	1	7	5	13	0	1	0	1	4	11	0	15	32
% App. Total	33.3	0	66.7		7.7	53.8	38.5		0	100	0		26.7	73.3	0		
PHF	.250	.000	.500	.750	.250	.438	.313	.650	.000	.250	.000	.250	.500	.550	.000	.750	.800

City of Riverside
 N/S: Trautwein Road/Cole Avenue
 E/W: Van Buren Boulevard
 Weather: Clear

File Name : 08_RIV_Traut_VB Sat
 Site Code : 05122815
 Start Date : 9/17/2022
 Page No : 2

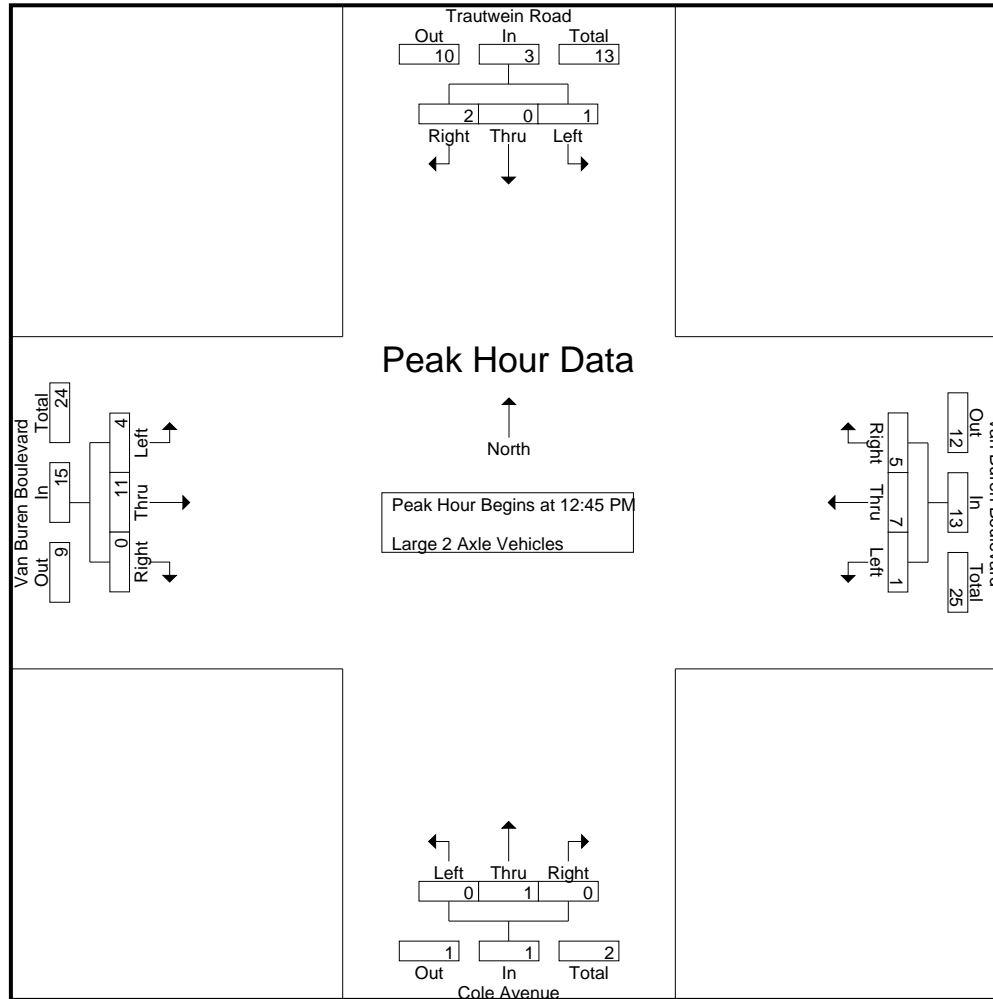

City of Riverside
 N/S: Trautwein Road/Cole Avenue
 E/W: Van Buren Boulevard
 Weather: Clear

File Name : 08_RIV_Traut_VB Sat
 Site Code : 05122815
 Start Date : 9/17/2022
 Page No : 3

Start Time	Trautwein Road Southbound				Van Buren Boulevard Westbound				Cole Avenue Northbound				Van Buren Boulevard Eastbound				Int. Total
	Left	Thru	Right	App. Total	Left	Thru	Right	App. Total	Left	Thru	Right	App. Total	Left	Thru	Right	App. Total	
Peak Hour Analysis From 12:45 PM to 01:30 PM - Peak 1 of 1																	
Peak Hour for Each Approach Begins at:																	
	12:45 PM				12:45 PM				12:45 PM				12:45 PM				
+0 mins.	0	0	0	0	0	0	4	4	0	0	0	0	1	1	0	2	
+15 mins.	0	0	1	1	0	2	1	3	0	0	0	0	2	2	0	4	
+30 mins.	1	0	0	1	0	1	0	1	0	1	0	1	0	5	0	5	
+45 mins.	0	0	1	1	1	4	0	5	0	0	0	0	1	3	0	4	
Total Volume	1	0	2	3	1	7	5	13	0	1	0	1	4	11	0	15	
% App. Total	33.3	0	66.7		7.7	53.8	38.5		0	100	0		26.7	73.3	0		
PHF	.250	.000	.500	.750	.250	.438	.313	.650	.000	.250	.000	.250	.500	.550	.000	.750	

City of Riverside
 N/S: Trautwein Road/Cole Avenue
 E/W: Van Buren Boulevard
 Weather: Clear

File Name : 08_RIV_Traut_VB Sat
 Site Code : 05122815
 Start Date : 9/17/2022
 Page No : 1

Groups Printed- 3 Axle Vehicles

Start Time	Trautwein Road Southbound					Van Buren Boulevard Westbound					Cole Avenue Northbound					Van Buren Boulevard Eastbound					Exclu. Total	Inclu. Total	Int. Total	
	Left	Thru	Right	RTOR	App. Total	Left	Thru	Right	RTOR	App. Total	Left	Thru	Right	RTOR	App. Total	Left	Thru	Right	RTOR	App. Total				
11:00 AM	0	0	0	0	0	0	0	0	0	0	0	0	0	0	0	0	1	0	0	1	0	0	1	0
11:15 AM	0	0	0	0	0	0	0	0	0	0	0	0	0	0	0	0	0	0	0	0	0	0	0	0
11:30 AM	0	0	0	0	0	0	1	1	0	2	0	0	0	0	0	0	0	0	0	0	0	0	2	0
11:45 AM	0	0	0	0	0	0	0	0	0	0	1	0	0	0	1	0	0	0	0	0	0	0	1	0
Total	0	0	0	0	0	0	1	1	0	2	1	0	0	0	1	0	1	0	0	1	0	0	4	0
12:00 PM	0	0	0	0	0	0	0	0	0	0	0	0	0	0	0	0	0	0	0	0	0	0	0	0
12:15 PM	0	0	0	0	0	1	0	0	0	1	0	0	0	0	0	0	1	0	0	1	0	0	2	0
12:30 PM	0	0	0	0	0	0	1	0	0	1	0	0	0	0	0	0	0	0	0	0	0	0	1	0
12:45 PM	1	0	0	0	1	0	1	0	0	1	0	0	0	0	0	0	0	0	0	0	0	0	2	0
Total	1	0	0	0	1	1	2	0	0	3	0	0	0	0	0	0	1	0	0	1	0	0	5	0
01:00 PM	0	0	0	0	0	0	0	0	0	0	0	0	0	0	0	0	0	0	0	0	0	0	0	0
01:15 PM	0	0	0	0	0	1	0	1	0	2	0	0	0	0	0	0	1	0	0	1	0	0	3	0
01:30 PM	0	0	0	0	0	0	0	0	0	0	0	0	0	0	0	0	0	0	0	0	0	0	0	0
01:45 PM	0	0	0	0	0	0	0	0	0	0	0	0	0	0	0	0	0	0	0	0	0	0	0	0
Total	0	0	0	0	0	1	0	1	0	2	0	0	0	0	0	0	1	0	0	1	0	0	3	0
Grand Total	1	0	0	0	1	2	3	2	0	7	1	0	0	0	1	0	3	0	0	3	0	0	12	0
Apprch %	100	0	0			28.6	42.9	28.6			100	0	0			0	100	0			0	0		
Total %	8.3	0	0		8.3	16.7	25	16.7		58.3	8.3	0	0		8.3	0	25	0		25	0	0	100	

Start Time	Trautwein Road Southbound				Van Buren Boulevard Westbound				Cole Avenue Northbound				Van Buren Boulevard Eastbound				Int. Total
	Left	Thru	Right	App. Total	Left	Thru	Right	App. Total	Left	Thru	Right	App. Total	Left	Thru	Right	App. Total	
Peak Hour Analysis From 12:45 PM to 01:30 PM - Peak 1 of 1																	
Peak Hour for Entire Intersection Begins at 12:45 PM																	
12:45 PM	1	0	0	1	0	1	0	1	0	0	0	0	0	0	0	0	2
01:00 PM	0	0	0	0	0	0	0	0	0	0	0	0	0	0	0	0	0
01:15 PM	0	0	0	0	1	0	1	2	0	0	0	0	0	1	0	1	3
01:30 PM	0	0	0	0	0	0	0	0	0	0	0	0	0	0	0	0	0
Total Volume	1	0	0	1	1	1	1	3	0	0	0	0	0	1	0	1	5
% App. Total	100	0	0		33.3	33.3	33.3		0	0	0		0	100	0		
PHF	.250	.000	.000	.250	.250	.250	.250	.375	.000	.000	.000	.000	.000	.250	.000	.250	.417

City of Riverside
 N/S: Trautwein Road/Cole Avenue
 E/W: Van Buren Boulevard
 Weather: Clear

File Name : 08_RIV_Traut_VB Sat
 Site Code : 05122815
 Start Date : 9/17/2022
 Page No : 2

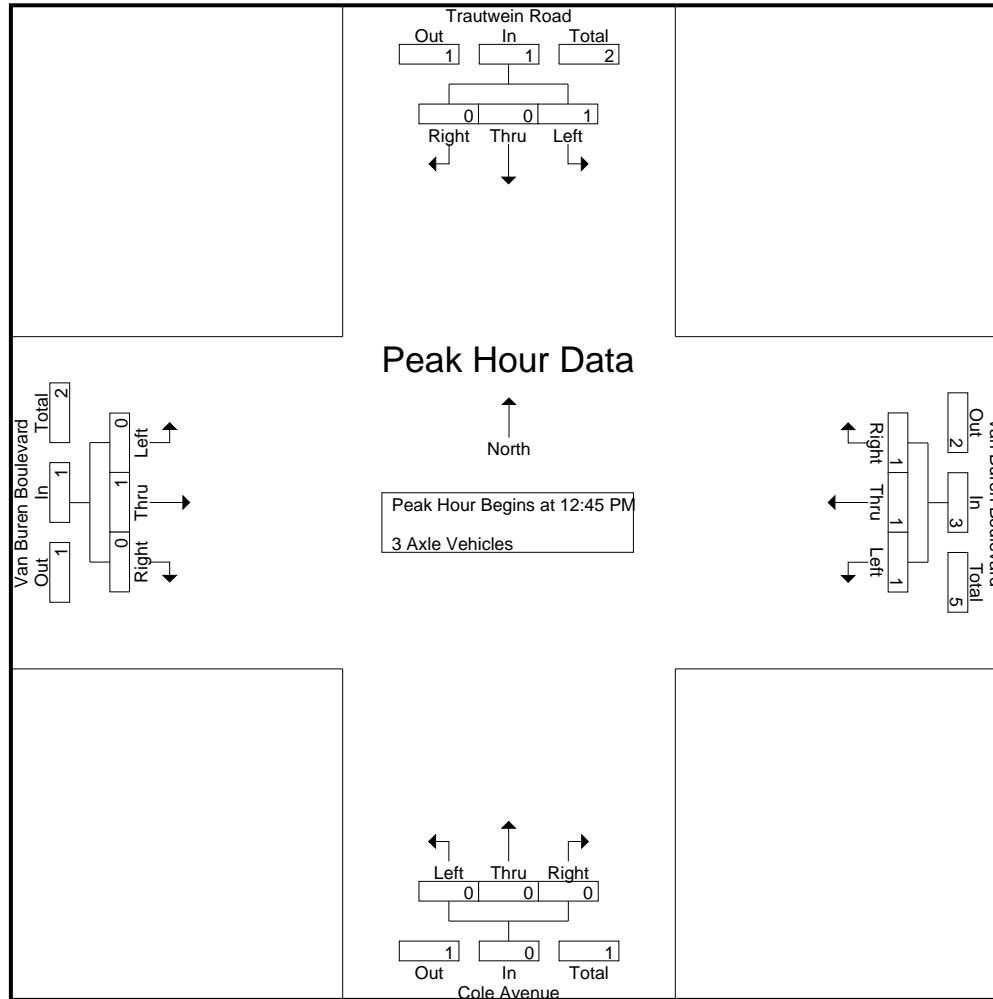

City of Riverside
 N/S: Trautwein Road/Cole Avenue
 E/W: Van Buren Boulevard
 Weather: Clear

File Name : 08_RIV_Traut_VB Sat
 Site Code : 05122815
 Start Date : 9/17/2022
 Page No : 3

Start Time	Trautwein Road Southbound				Van Buren Boulevard Westbound				Cole Avenue Northbound				Van Buren Boulevard Eastbound				Int. Total
	Left	Thru	Right	App. Total	Left	Thru	Right	App. Total	Left	Thru	Right	App. Total	Left	Thru	Right	App. Total	
Peak Hour Analysis From 12:45 PM to 01:30 PM - Peak 1 of 1																	
Peak Hour for Each Approach Begins at:																	
	12:45 PM				12:45 PM				12:45 PM				12:45 PM				
+0 mins.	1	0	0	1	0	1	0	1	0	0	0	0	0	0	0	0	
+15 mins.	0	0	0	0	0	0	0	0	0	0	0	0	0	0	0	0	
+30 mins.	0	0	0	0	1	0	1	2	0	0	0	0	0	1	0	1	
+45 mins.	0	0	0	0	0	0	0	0	0	0	0	0	0	0	0	0	
Total Volume	1	0	0	1	1	1	1	3	0	0	0	0	0	1	0	1	
% App. Total	100	0	0		33.3	33.3	33.3		0	0	0		0	100	0		
PHF	.250	.000	.000	.250	.250	.250	.250	.375	.000	.000	.000	.000	.000	.250	.000	.250	

City of Riverside
 N/S: Trautwein Road/Cole Avenue
 E/W: Van Buren Boulevard
 Weather: Clear

File Name : 08_RIV_Traut_VB Sat
 Site Code : 05122815
 Start Date : 9/17/2022
 Page No : 1

Groups Printed- 4+ Axle Trucks

Start Time	Trautwein Road Southbound					Van Buren Boulevard Westbound					Cole Avenue Northbound					Van Buren Boulevard Eastbound					Exclu. Total	Inclu. Total	Int. Total					
	Left	Thru	Right	RTOR	App. Total	Left	Thru	Right	RTOR	App. Total	Left	Thru	Right	RTOR	App. Total	Left	Thru	Right	RTOR	App. Total								
11:00 AM	0	0	0	0	0	0	0	0	0	0	0	0	0	0	0	0	0	0	0	0	0	0	0	0	0	0	0	0
11:15 AM	0	0	0	0	0	0	0	0	0	0	0	0	0	0	0	0	0	0	0	0	0	0	0	0	0	0	0	0
11:30 AM	0	0	0	0	0	0	1	0	0	1	0	0	0	0	0	0	0	0	0	0	0	0	0	0	0	0	1	1
11:45 AM	0	0	0	0	0	0	0	0	0	0	0	0	0	0	0	0	1	0	0	0	0	1	0	0	1	0	1	1
Total	0	0	0	0	0	0	1	0	0	1	0	0	0	0	0	0	1	0	0	0	0	1	0	0	1	0	2	2
12:00 PM	0	0	0	0	0	0	0	0	0	0	0	0	0	0	0	0	0	0	0	0	0	0	0	0	0	0	0	0
12:15 PM	0	0	0	0	0	0	0	0	0	0	0	0	0	0	0	0	0	0	0	0	0	0	0	0	0	0	0	0
12:30 PM	0	0	0	0	0	0	0	0	0	0	0	0	0	0	0	0	0	0	0	0	0	0	0	0	0	0	0	0
12:45 PM	0	0	0	0	0	0	0	0	0	0	0	0	0	0	0	0	1	0	0	0	0	1	0	0	1	0	1	1
Total	0	0	0	0	0	0	0	0	0	0	0	0	0	0	0	0	1	0	0	0	0	1	0	0	1	0	1	1
01:00 PM	0	0	0	0	0	0	0	0	0	0	0	0	0	0	0	0	1	0	0	0	0	1	0	0	1	0	1	1
01:15 PM	0	0	0	0	0	0	0	0	0	0	0	0	0	0	0	0	0	0	0	0	0	0	0	0	0	0	0	0
01:30 PM	0	0	0	0	0	0	0	0	0	0	0	0	0	0	0	0	1	0	0	0	0	1	0	0	1	0	1	1
01:45 PM	0	0	0	0	0	0	0	0	0	0	0	0	0	0	0	0	1	0	0	0	0	1	0	0	1	0	1	1
Total	0	0	0	0	0	0	0	0	0	0	0	0	0	0	0	0	3	0	0	0	0	3	0	0	3	0	3	3
Grand Total	0	0	0	0	0	0	1	0	0	1	0	0	0	0	0	0	5	0	0	0	0	5	0	0	5	0	6	6
Apprch %	0	0	0			0	100	0			0	0	0			0	100	0			0					0		
Total %	0	0	0			0	16.7	0		16.7	0	0	0		0	0	83.3	0		83.3	0					0	100	

Start Time	Trautwein Road Southbound				Van Buren Boulevard Westbound				Cole Avenue Northbound				Van Buren Boulevard Eastbound				Int. Total
	Left	Thru	Right	App. Total	Left	Thru	Right	App. Total	Left	Thru	Right	App. Total	Left	Thru	Right	App. Total	
Peak Hour Analysis From 12:45 PM to 01:30 PM - Peak 1 of 1																	
Peak Hour for Entire Intersection Begins at 12:45 PM																	
12:45 PM	0	0	0	0	0	0	0	0	0	0	0	0	0	1	0	0	1
01:00 PM	0	0	0	0	0	0	0	0	0	0	0	0	0	1	0	0	1
01:15 PM	0	0	0	0	0	0	0	0	0	0	0	0	0	0	0	0	0
01:30 PM	0	0	0	0	0	0	0	0	0	0	0	0	0	1	0	0	1
Total Volume	0	0	0	0	0	0	0	0	0	0	0	0	0	3	0	0	3
% App. Total	0	0	0		0	0	0		0	0	0		0	100	0		
PHF	.000	.000	.000	.000	.000	.000	.000	.000	.000	.000	.000	.000	.000	.750	.000	.750	.750

City of Riverside
 N/S: Trautwein Road/Cole Avenue
 E/W: Van Buren Boulevard
 Weather: Clear

File Name : 08_RIV_Traut_VB Sat
 Site Code : 05122815
 Start Date : 9/17/2022
 Page No : 2

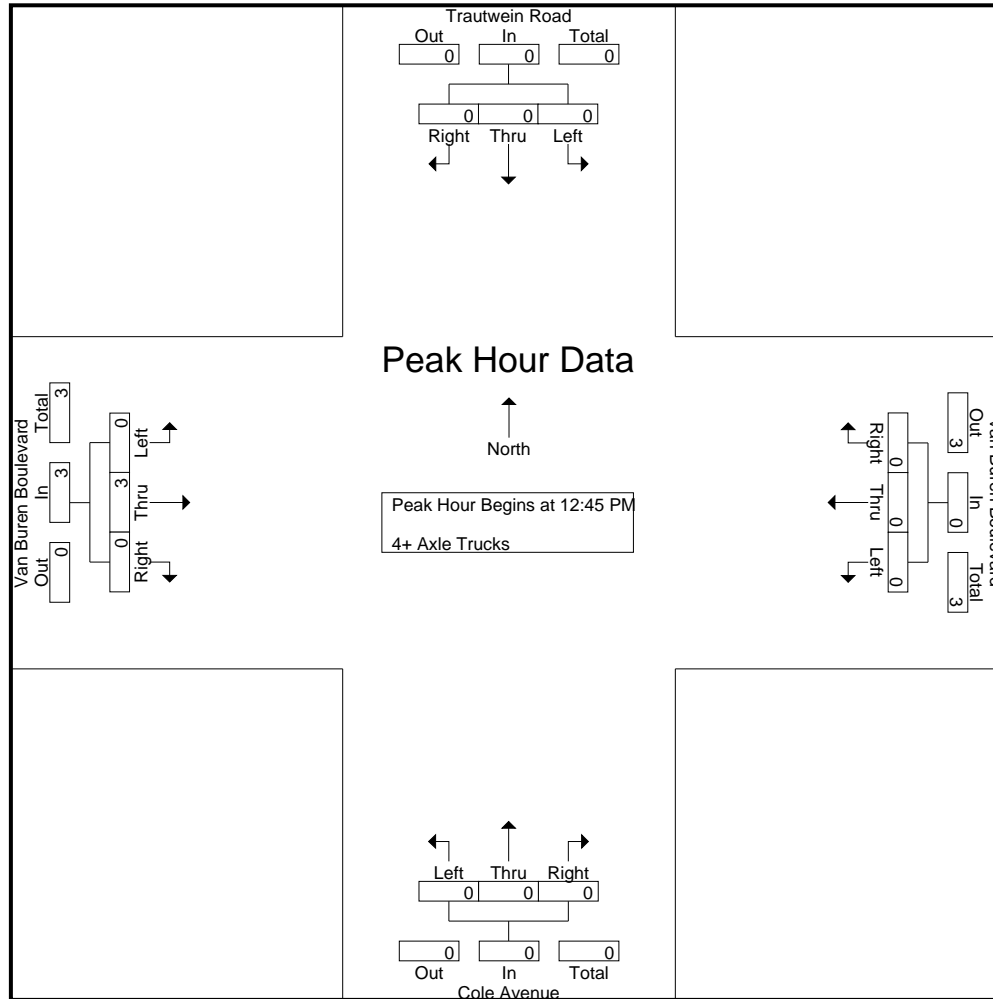

City of Riverside
 N/S: Trautwein Road/Cole Avenue
 E/W: Van Buren Boulevard
 Weather: Clear

File Name : 08_RIV_Traut_VB Sat
 Site Code : 05122815
 Start Date : 9/17/2022
 Page No : 3

Start Time	Trautwein Road Southbound				Van Buren Boulevard Westbound				Cole Avenue Northbound				Van Buren Boulevard Eastbound				Int. Total
	Left	Thru	Right	App. Total	Left	Thru	Right	App. Total	Left	Thru	Right	App. Total	Left	Thru	Right	App. Total	
Peak Hour Analysis From 12:45 PM to 01:30 PM - Peak 1 of 1																	
Peak Hour for Each Approach Begins at:																	
	12:45 PM				12:45 PM				12:45 PM				12:45 PM				
+0 mins.	0	0	0	0	0	0	0	0	0	0	0	0	0	1	0	1	
+15 mins.	0	0	0	0	0	0	0	0	0	0	0	0	0	1	0	1	
+30 mins.	0	0	0	0	0	0	0	0	0	0	0	0	0	0	0	0	
+45 mins.	0	0	0	0	0	0	0	0	0	0	0	0	0	1	0	1	
Total Volume	0	0	0	0	0	0	0	0	0	0	0	0	0	3	0	3	
% App. Total	0	0	0	0	0	0	0	0	0	0	0	0	0	100	0	0	
PHF	.000	.000	.000	.000	.000	.000	.000	.000	.000	.000	.000	.000	.000	.750	.000	.750	

Location: Riverside
 N/S: Trautwein Rd/Cole Ave
 E/W: Van Buren Boulevard



Date: 9/17/2022
 Day Saturday

PEDESTRIANS

Time	North Leg Trautwein Road	East Leg Van Buren Boulevard	South Leg Cole Avenue	West Leg Van Buren Boulevard	TOTAL
11:00 AM	0	1	0	0	1
11:15 AM	0	0	0	0	0
11:30 AM	0	0	0	1	1
11:45 AM	0	0	1	1	2
12:00 PM	1	0	0	1	2
12:15 PM	0	0	0	0	0
12:30 PM	1	0	0	1	2
12:45 PM	0	0	0	1	1
1:00 PM	0	0	0	0	0
1:15 PM	0	0	0	0	0
1:30 PM	1	0	0	0	1
1:45 PM	0	0	0	0	0
TOTAL VOLUMES:	3	1	1	5	10

Location: Riverside
 N/S: Trautwein Rd/Cole Ave
 E/W: Van Buren Boulevard

Date: 9/17/2022
 Day: Saturday



BICYCLES

	Southbound Trautwein Road			Westbound Van Buren Boulevard			Northbound Cole Avenue			Eastbound Van Buren Boulevard			
	Left	Thru	Right	Left	Thru	Right	Left	Thru	Right	Left	Thru	Right	
11:00 AM	0	0	0	0	0	0	0	0	0	0	0	0	0
11:15 AM	0	0	0	0	0	0	0	0	0	0	0	0	0
11:30 AM	0	0	0	0	0	0	0	0	0	0	0	0	0
11:45 AM	0	0	0	0	0	0	0	1	0	0	0	0	1
12:00 PM	0	0	0	0	0	0	0	0	0	0	0	0	0
12:15 PM	0	0	0	0	0	0	3	0	0	0	0	0	3
12:30 PM	0	0	0	1	0	0	0	0	0	0	0	1	2
12:45 PM	0	1	0	0	0	0	0	0	0	0	0	0	1
1:00 PM	0	0	0	0	0	0	0	0	0	0	0	0	0
1:15 PM	0	0	0	0	0	0	0	0	0	0	0	0	0
1:30 PM	0	0	0	0	0	0	0	0	0	0	0	0	0
1:45 PM	0	0	0	0	0	0	0	0	0	0	0	0	0
TOTAL VOLUMES:	0	1	0	1	0	0	3	1	0	0	0	1	7

City of Riverside
 N/S: Deercreek Drive
 E/W: Grove Community Drive
 Weather: Clear

File Name : 09_RIV_Deer_Gr Com Sat
 Site Code : 05122815
 Start Date : 9/17/2022
 Page No : 1

Groups Printed- Passenger Vehicles - Large 2 Axle Vehicles - 3 Axle Vehicles - 4+ Axle Trucks

Start Time	Grove Community Drive Westbound			Deercreek Drive Northbound			Grove Community Drive Eastbound			Int. Total
	Left	Thru	App. Total	Left	Right	App. Total	Thru	Right	App. Total	
11:00 AM	1	29	30	4	13	17	33	2	35	82
11:15 AM	8	36	44	13	11	24	32	0	32	100
11:30 AM	13	60	73	15	15	30	35	6	41	144
11:45 AM	23	56	79	11	13	24	40	7	47	150
Total	45	181	226	43	52	95	140	15	155	476
12:00 PM	15	41	56	11	6	17	24	1	25	98
12:15 PM	7	41	48	6	7	13	32	4	36	97
12:30 PM	7	52	59	12	15	27	30	1	31	117
12:45 PM	10	60	70	10	10	20	56	5	61	151
Total	39	194	233	39	38	77	142	11	153	463
01:00 PM	5	27	32	9	8	17	49	4	53	102
01:15 PM	5	39	44	3	6	9	34	7	41	94
01:30 PM	2	35	37	3	6	9	33	3	36	82
01:45 PM	6	39	45	4	12	16	41	3	44	105
Total	18	140	158	19	32	51	157	17	174	383
Grand Total	102	515	617	101	122	223	439	43	482	1322
Apprch %	16.5	83.5		45.3	54.7		91.1	8.9		
Total %	7.7	39	46.7	7.6	9.2	16.9	33.2	3.3	36.5	
Passenger Vehicles	100	511	611	101	121	222	434	42	476	1309
% Passenger Vehicles	98	99.2	99	100	99.2	99.6	98.9	97.7	98.8	99
Large 2 Axle Vehicles	1	4	5	0	1	1	5	1	6	12
% Large 2 Axle Vehicles	1	0.8	0.8	0	0.8	0.4	1.1	2.3	1.2	0.9
3 Axle Vehicles	0	0	0	0	0	0	0	0	0	0
% 3 Axle Vehicles	0	0	0	0	0	0	0	0	0	0
4+ Axle Trucks	1	0	1	0	0	0	0	0	0	1
% 4+ Axle Trucks	1	0	0.2	0	0	0	0	0	0	0.1

Start Time	Grove Community Drive Westbound			Deercreek Drive Northbound			Grove Community Drive Eastbound			Int. Total
	Left	Thru	App. Total	Left	Right	App. Total	Thru	Right	App. Total	
11:15 AM	8	36	44	13	11	24	32	0	32	100
11:30 AM	13	60	73	15	15	30	35	6	41	144
11:45 AM	23	56	79	11	13	24	40	7	47	150
12:00 PM	15	41	56	11	6	17	24	1	25	98
Total Volume	59	193	252	50	45	95	131	14	145	492
% App. Total	23.4	76.6		52.6	47.4		90.3	9.7		
PHF	.641	.804	.797	.833	.750	.792	.819	.500	.771	.820

Peak Hour Analysis From 11:00 AM to 01:45 PM - Peak 1 of 1
 Peak Hour for Entire Intersection Begins at 11:15 AM

City of Riverside
 N/S: Deercreek Drive
 E/W: Grove Community Drive
 Weather: Clear

File Name : 09_RIV_Deer_Gr Com Sat
 Site Code : 05122815
 Start Date : 9/17/2022
 Page No : 2

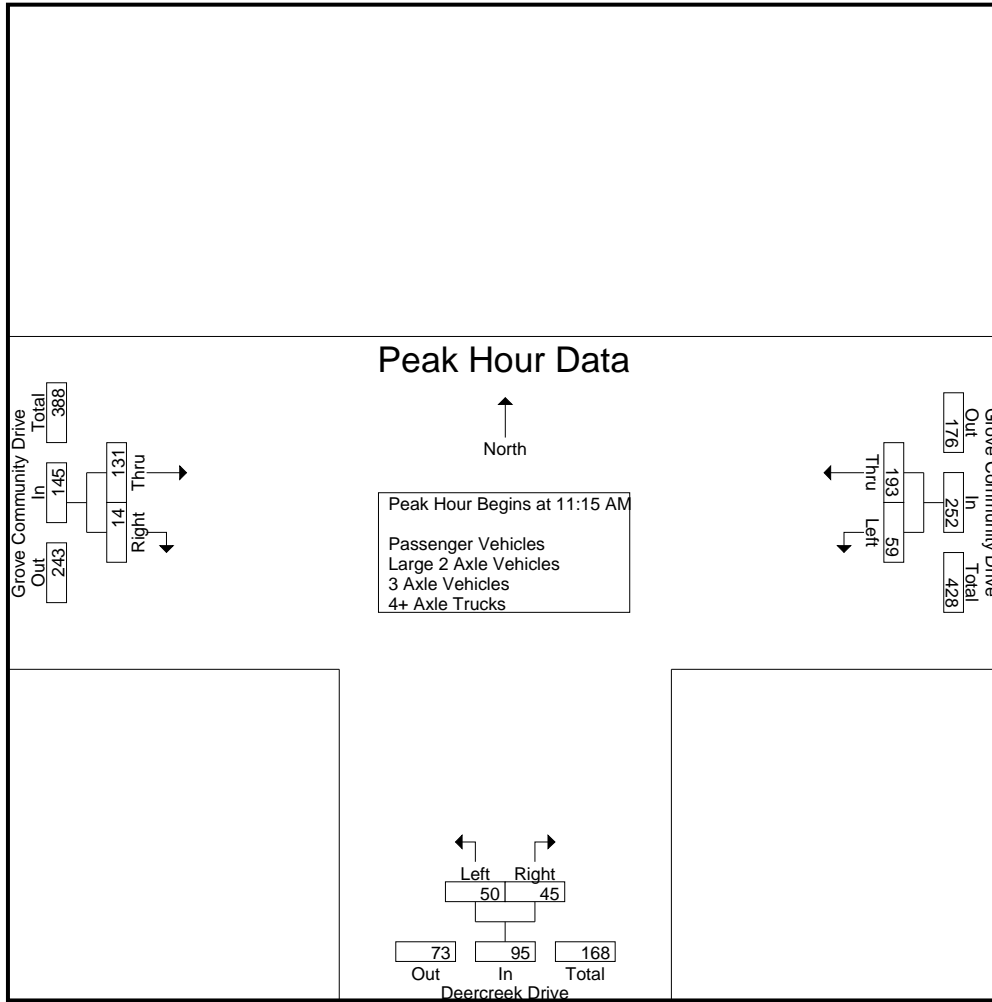

Peak Hour Analysis From 11:00 AM to 01:45 PM - Peak 1 of 1
 Peak Hour for Each Approach Begins at:

	11:30 AM			11:00 AM			12:45 PM		
+0 mins.	13	60	73	4	13	17	56	5	61
+15 mins.	23	56	79	13	11	24	49	4	53
+30 mins.	15	41	56	15	15	30	34	7	41
+45 mins.	7	41	48	11	13	24	33	3	36
Total Volume	58	198	256	43	52	95	172	19	191
% App. Total	22.7	77.3		45.3	54.7		90.1	9.9	
PHF	.630	.825	.810	.717	.867	.792	.768	.679	.783

City of Riverside
 N/S: Deercreek Drive
 E/W: Grove Community Drive
 Weather: Clear

File Name : 09_RIV_Deer_Gr Com Sat
 Site Code : 05122815
 Start Date : 9/17/2022
 Page No : 1

Groups Printed- Passenger Vehicles

Start Time	Grove Community Drive Westbound			Deercreek Drive Northbound			Grove Community Drive Eastbound			Int. Total
	Left	Thru	App. Total	Left	Right	App. Total	Thru	Right	App. Total	
11:00 AM	1	28	29	4	13	17	33	2	35	81
11:15 AM	8	36	44	13	11	24	32	0	32	100
11:30 AM	12	60	72	15	15	30	35	5	40	142
11:45 AM	23	56	79	11	12	23	39	7	46	148
Total	44	180	224	43	51	94	139	14	153	471
12:00 PM	15	40	55	11	6	17	23	1	24	96
12:15 PM	6	40	46	6	7	13	31	4	35	94
12:30 PM	7	52	59	12	15	27	30	1	31	117
12:45 PM	10	60	70	10	10	20	56	5	61	151
Total	38	192	230	39	38	77	140	11	151	458
01:00 PM	5	27	32	9	8	17	49	4	53	102
01:15 PM	5	39	44	3	6	9	34	7	41	94
01:30 PM	2	35	37	3	6	9	32	3	35	81
01:45 PM	6	38	44	4	12	16	40	3	43	103
Total	18	139	157	19	32	51	155	17	172	380
Grand Total	100	511	611	101	121	222	434	42	476	1309
Apprch %	16.4	83.6		45.5	54.5		91.2	8.8		
Total %	7.6	39	46.7	7.7	9.2	17	33.2	3.2	36.4	

Start Time	Grove Community Drive Westbound			Deercreek Drive Northbound			Grove Community Drive Eastbound			Int. Total
	Left	Thru	App. Total	Left	Right	App. Total	Thru	Right	App. Total	
11:15 AM	8	36	44	13	11	24	32	0	32	100
11:30 AM	12	60	72	15	15	30	35	5	40	142
11:45 AM	23	56	79	11	12	23	39	7	46	148
12:00 PM	15	40	55	11	6	17	23	1	24	96
Total Volume	58	192	250	50	44	94	129	13	142	486
% App. Total	23.2	76.8		53.2	46.8		90.8	9.2		
PHF	.630	.800	.791	.833	.733	.783	.827	.464	.772	.821

Peak Hour Analysis From 11:15 AM to 12:00 PM - Peak 1 of 1
 Peak Hour for Entire Intersection Begins at 11:15 AM

City of Riverside
 N/S: Deercreek Drive
 E/W: Grove Community Drive
 Weather: Clear

File Name : 09_RIV_Deer_Gr Com Sat
 Site Code : 05122815
 Start Date : 9/17/2022
 Page No : 2

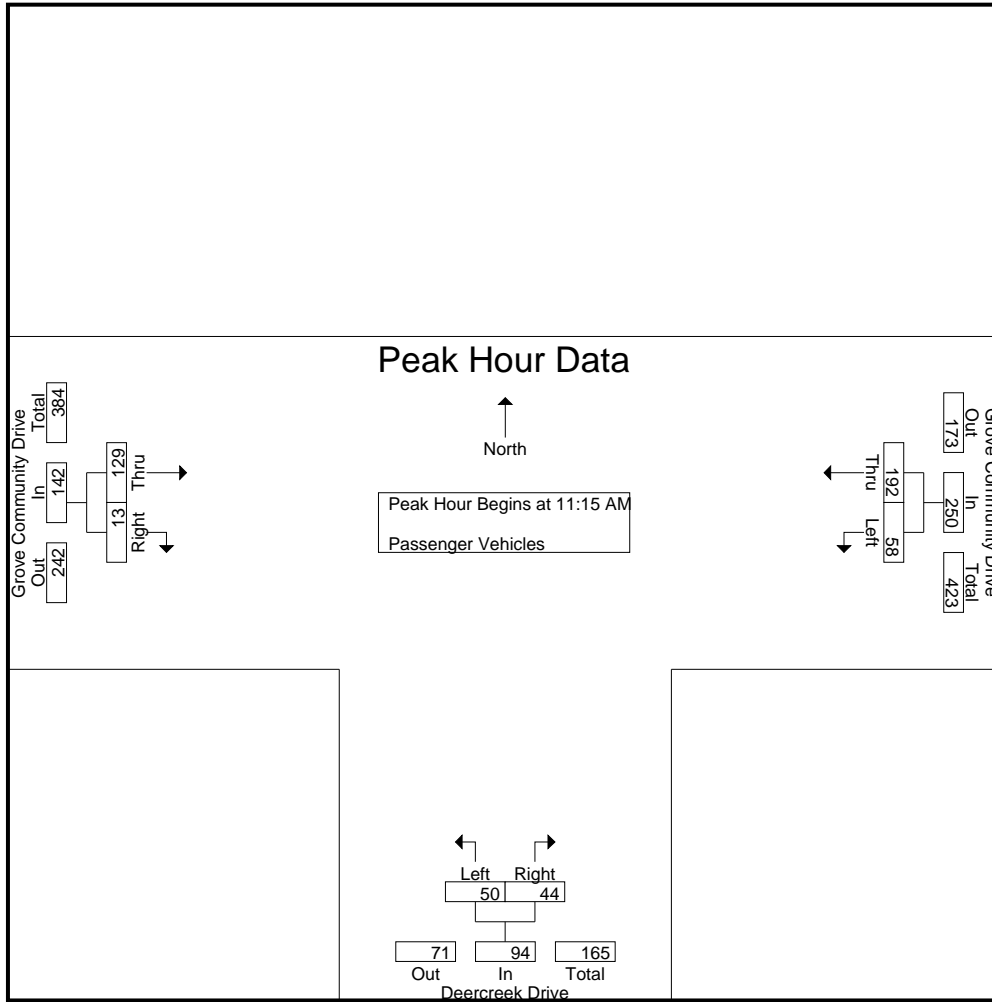

Peak Hour Analysis From 11:15 AM to 12:00 PM - Peak 1 of 1
 Peak Hour for Each Approach Begins at:

	11:15 AM			11:15 AM			11:15 AM		
+0 mins.	8	36	44	13	11	24	32	0	32
+15 mins.	12	60	72	15	15	30	35	5	40
+30 mins.	23	56	79	11	12	23	39	7	46
+45 mins.	15	40	55	11	6	17	23	1	24
Total Volume	58	192	250	50	44	94	129	13	142
% App. Total	23.2	76.8		53.2	46.8		90.8	9.2	
PHF	.630	.800	.791	.833	.733	.783	.827	.464	.772

City of Riverside
 N/S: Deercreek Drive
 E/W: Grove Community Drive
 Weather: Clear

File Name : 09_RIV_Deer_Gr Com Sat
 Site Code : 05122815
 Start Date : 9/17/2022
 Page No : 1

Groups Printed- Large 2 Axle Vehicles

Start Time	Grove Community Drive Westbound			Deercreek Drive Northbound			Grove Community Drive Eastbound			Int. Total
	Left	Thru	App. Total	Left	Right	App. Total	Thru	Right	App. Total	
11:00 AM	0	1	1	0	0	0	0	0	0	1
11:15 AM	0	0	0	0	0	0	0	0	0	0
11:30 AM	1	0	1	0	0	0	0	1	1	2
11:45 AM	0	0	0	0	1	1	1	0	1	2
Total	1	1	2	0	1	1	1	1	2	5
12:00 PM	0	1	1	0	0	0	1	0	1	2
12:15 PM	0	1	1	0	0	0	1	0	1	2
12:30 PM	0	0	0	0	0	0	0	0	0	0
12:45 PM	0	0	0	0	0	0	0	0	0	0
Total	0	2	2	0	0	0	2	0	2	4
01:00 PM	0	0	0	0	0	0	0	0	0	0
01:15 PM	0	0	0	0	0	0	0	0	0	0
01:30 PM	0	0	0	0	0	0	1	0	1	1
01:45 PM	0	1	1	0	0	0	1	0	1	2
Total	0	1	1	0	0	0	2	0	2	3
Grand Total	1	4	5	0	1	1	5	1	6	12
Apprch %	20	80		0	100		83.3	16.7		
Total %	8.3	33.3	41.7	0	8.3	8.3	41.7	8.3	50	

Start Time	Grove Community Drive Westbound			Deercreek Drive Northbound			Grove Community Drive Eastbound			Int. Total
	Left	Thru	App. Total	Left	Right	App. Total	Thru	Right	App. Total	
11:15 AM	0	0	0	0	0	0	0	0	0	0
11:30 AM	1	0	1	0	0	0	0	1	1	2
11:45 AM	0	0	0	0	1	1	1	0	1	2
12:00 PM	0	1	1	0	0	0	1	0	1	2
Total Volume	1	1	2	0	1	1	2	1	3	6
% App. Total	50	50		0	100		66.7	33.3		
PHF	.250	.250	.500	.000	.250	.250	.500	.250	.750	.750

Peak Hour Analysis From 11:15 AM to 12:00 PM - Peak 1 of 1

Peak Hour for Entire Intersection Begins at 11:15 AM

City of Riverside
 N/S: Deercreek Drive
 E/W: Grove Community Drive
 Weather: Clear

File Name : 09_RIV_Deer_Gr Com Sat
 Site Code : 05122815
 Start Date : 9/17/2022
 Page No : 2

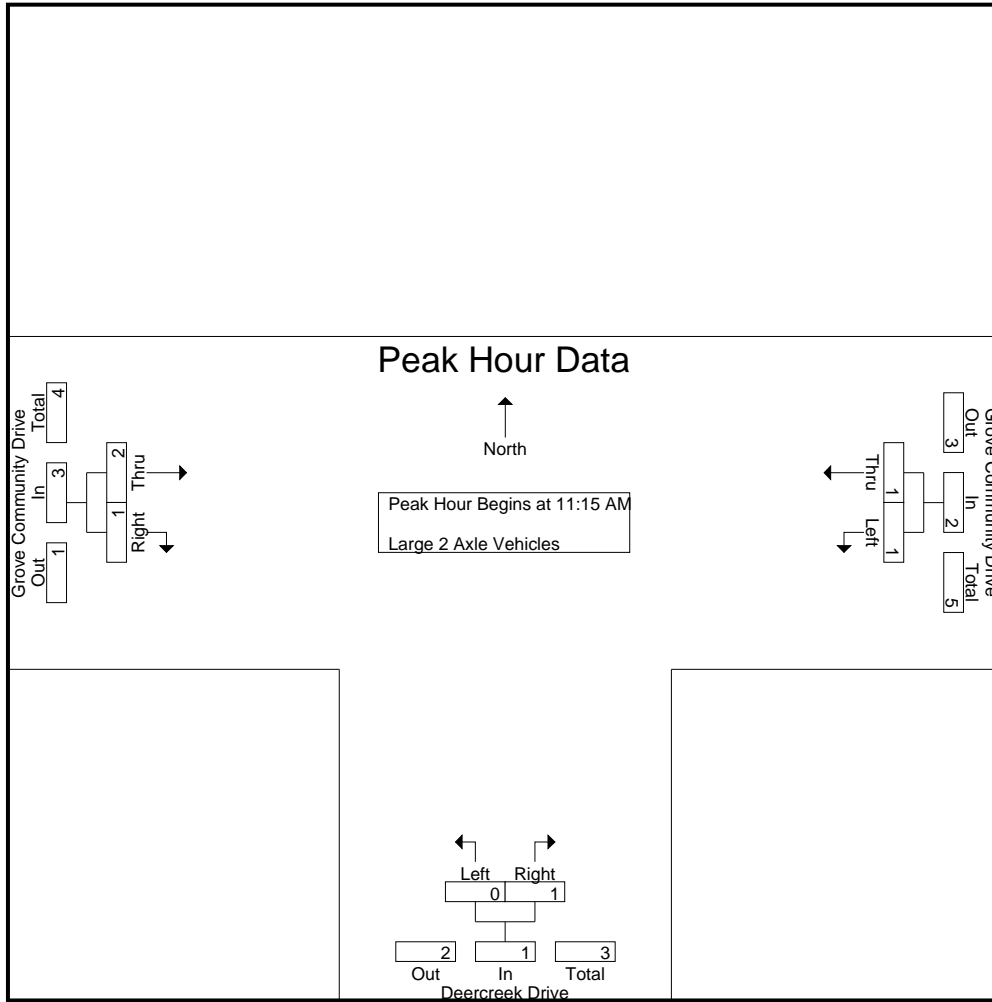

Peak Hour Analysis From 11:15 AM to 12:00 PM - Peak 1 of 1
 Peak Hour for Each Approach Begins at:

	11:15 AM			11:15 AM			11:15 AM		
+0 mins.	0	0	0	0	0	0	0	0	0
+15 mins.	1	0	1	0	0	0	0	1	1
+30 mins.	0	0	0	0	1	1	1	0	1
+45 mins.	0	1	1	0	0	0	1	0	1
Total Volume	1	1	2	0	1	1	2	1	3
% App. Total	50	50		0	100		66.7	33.3	
PHF	.250	.250	.500	.000	.250	.250	.500	.250	.750

City of Riverside
 N/S: Deercreek Drive
 E/W: Grove Community Drive
 Weather: Clear

File Name : 09_RIV_Deer_Gr Com Sat
 Site Code : 05122815
 Start Date : 9/17/2022
 Page No : 1

Groups Printed- 3 Axle Vehicles

Start Time	Grove Community Drive Westbound			Deercreek Drive Northbound			Grove Community Drive Eastbound			Int. Total
	Left	Thru	App. Total	Left	Right	App. Total	Thru	Right	App. Total	
11:00 AM	0	0	0	0	0	0	0	0	0	0
11:15 AM	0	0	0	0	0	0	0	0	0	0
11:30 AM	0	0	0	0	0	0	0	0	0	0
11:45 AM	0	0	0	0	0	0	0	0	0	0
Total	0	0	0	0	0	0	0	0	0	0
12:00 PM	0	0	0	0	0	0	0	0	0	0
12:15 PM	0	0	0	0	0	0	0	0	0	0
12:30 PM	0	0	0	0	0	0	0	0	0	0
12:45 PM	0	0	0	0	0	0	0	0	0	0
Total	0	0	0	0	0	0	0	0	0	0
01:00 PM	0	0	0	0	0	0	0	0	0	0
01:15 PM	0	0	0	0	0	0	0	0	0	0
01:30 PM	0	0	0	0	0	0	0	0	0	0
01:45 PM	0	0	0	0	0	0	0	0	0	0
Total	0	0	0	0	0	0	0	0	0	0
Grand Total	0	0	0	0	0	0	0	0	0	0
Apprch %	0	0		0	0		0	0		
Total %										

Start Time	Grove Community Drive Westbound			Deercreek Drive Northbound			Grove Community Drive Eastbound			Int. Total
	Left	Thru	App. Total	Left	Right	App. Total	Thru	Right	App. Total	
Peak Hour Analysis From 11:15 AM to 12:00 PM - Peak 1 of 1										
Peak Hour for Entire Intersection Begins at 11:15 AM										
11:15 AM	0	0	0	0	0	0	0	0	0	0
11:30 AM	0	0	0	0	0	0	0	0	0	0
11:45 AM	0	0	0	0	0	0	0	0	0	0
12:00 PM	0	0	0	0	0	0	0	0	0	0
Total Volume	0	0	0	0	0	0	0	0	0	0
% App. Total	0	0		0	0		0	0		
PHF	.000	.000	.000	.000	.000	.000	.000	.000	.000	.000

City of Riverside
 N/S: Deercreek Drive
 E/W: Grove Community Drive
 Weather: Clear

File Name : 09_RIV_Deer_Gr Com Sat
 Site Code : 05122815
 Start Date : 9/17/2022
 Page No : 2

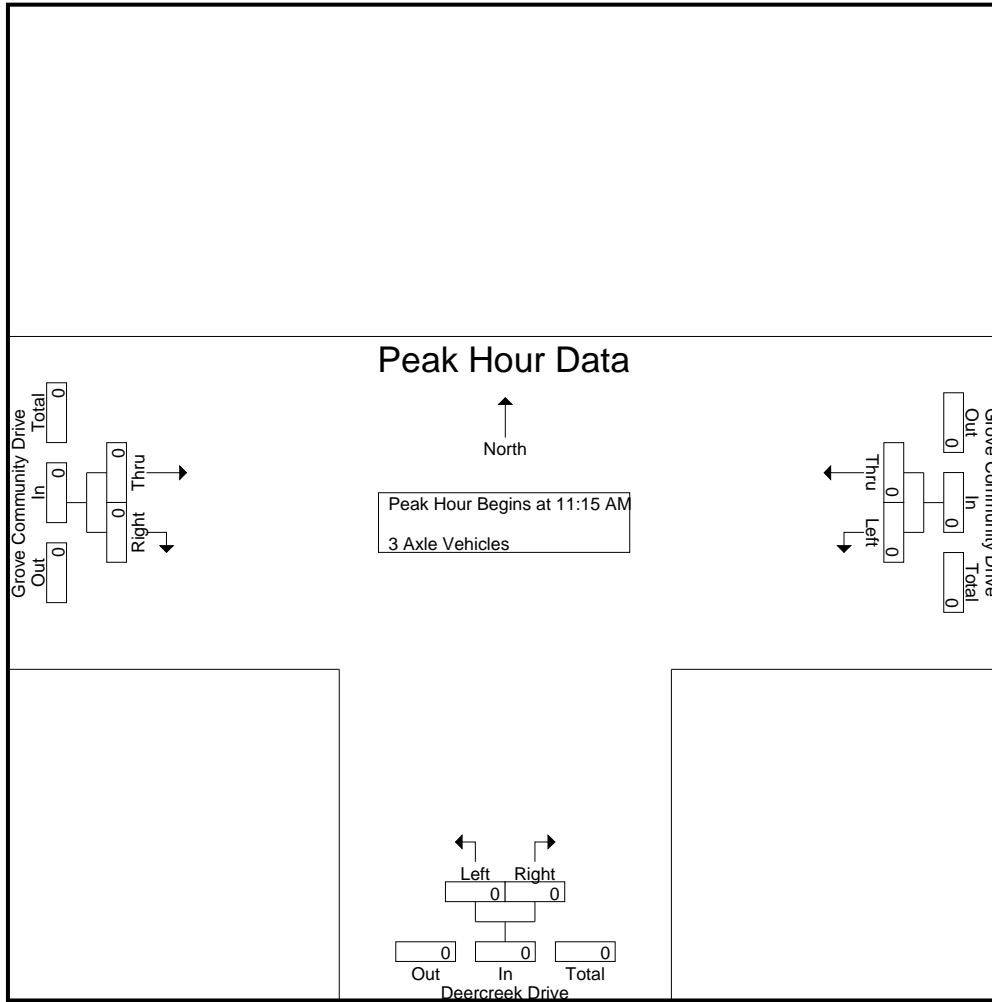

Peak Hour Analysis From 11:15 AM to 12:00 PM - Peak 1 of 1
 Peak Hour for Each Approach Begins at:

	11:15 AM			11:15 AM			11:15 AM		
+0 mins.	0	0	0	0	0	0	0	0	0
+15 mins.	0	0	0	0	0	0	0	0	0
+30 mins.	0	0	0	0	0	0	0	0	0
+45 mins.	0	0	0	0	0	0	0	0	0
Total Volume	0	0	0	0	0	0	0	0	0
% App. Total	0	0	0	0	0	0	0	0	0
PHF	.000	.000	.000	.000	.000	.000	.000	.000	.000

City of Riverside
 N/S: Deercreek Drive
 E/W: Grove Community Drive
 Weather: Clear

File Name : 09_RIV_Deer_Gr Com Sat
 Site Code : 05122815
 Start Date : 9/17/2022
 Page No : 1

Groups Printed- 4+ Axle Trucks

Start Time	Grove Community Drive Westbound			Deercreek Drive Northbound			Grove Community Drive Eastbound			Int. Total
	Left	Thru	App. Total	Left	Right	App. Total	Thru	Right	App. Total	
11:00 AM	0	0	0	0	0	0	0	0	0	0
11:15 AM	0	0	0	0	0	0	0	0	0	0
11:30 AM	0	0	0	0	0	0	0	0	0	0
11:45 AM	0	0	0	0	0	0	0	0	0	0
Total	0	0	0	0	0	0	0	0	0	0
12:00 PM	0	0	0	0	0	0	0	0	0	0
12:15 PM	1	0	1	0	0	0	0	0	0	1
12:30 PM	0	0	0	0	0	0	0	0	0	0
12:45 PM	0	0	0	0	0	0	0	0	0	0
Total	1	0	1	0	0	0	0	0	0	1
01:00 PM	0	0	0	0	0	0	0	0	0	0
01:15 PM	0	0	0	0	0	0	0	0	0	0
01:30 PM	0	0	0	0	0	0	0	0	0	0
01:45 PM	0	0	0	0	0	0	0	0	0	0
Total	0	0	0	0	0	0	0	0	0	0
Grand Total	1	0	1	0	0	0	0	0	0	1
Apprch %	100	0		0	0		0	0		
Total %	100	0	100	0	0	0	0	0	0	

Start Time	Grove Community Drive Westbound			Deercreek Drive Northbound			Grove Community Drive Eastbound			Int. Total
	Left	Thru	App. Total	Left	Right	App. Total	Thru	Right	App. Total	
11:15 AM	0	0	0	0	0	0	0	0	0	0
11:30 AM	0	0	0	0	0	0	0	0	0	0
11:45 AM	0	0	0	0	0	0	0	0	0	0
12:00 PM	0	0	0	0	0	0	0	0	0	0
Total Volume	0	0	0	0	0	0	0	0	0	0
% App. Total	0	0		0	0		0	0		
PHF	.000	.000	.000	.000	.000	.000	.000	.000	.000	.000

Peak Hour Analysis From 11:15 AM to 12:00 PM - Peak 1 of 1
 Peak Hour for Entire Intersection Begins at 11:15 AM

City of Riverside
 N/S: Deercreek Drive
 E/W: Grove Community Drive
 Weather: Clear

File Name : 09_RIV_Deer_Gr Com Sat
 Site Code : 05122815
 Start Date : 9/17/2022
 Page No : 2

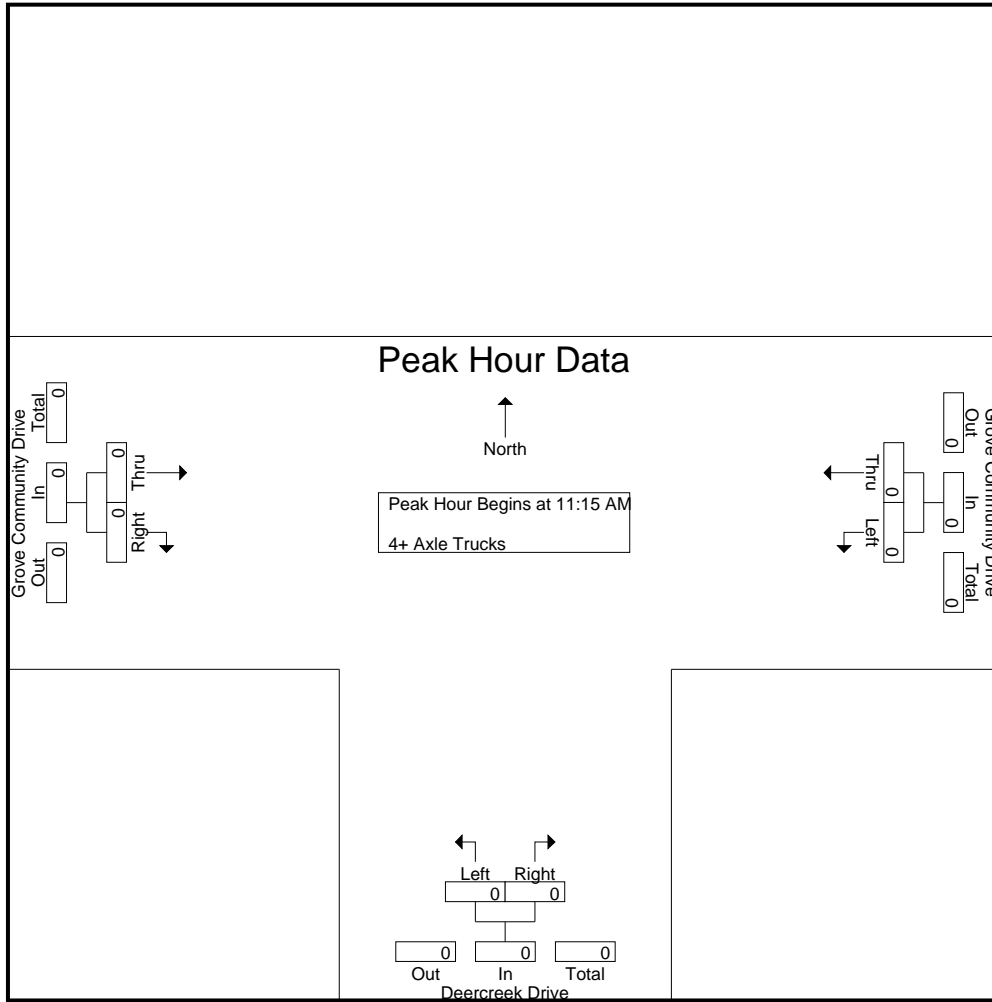

Peak Hour Analysis From 11:15 AM to 12:00 PM - Peak 1 of 1
 Peak Hour for Each Approach Begins at:

	11:15 AM			11:15 AM			11:15 AM		
+0 mins.	0	0	0	0	0	0	0	0	0
+15 mins.	0	0	0	0	0	0	0	0	0
+30 mins.	0	0	0	0	0	0	0	0	0
+45 mins.	0	0	0	0	0	0	0	0	0
Total Volume	0	0	0	0	0	0	0	0	0
% App. Total	0	0	0	0	0	0	0	0	0
PHF	.000	.000	.000	.000	.000	.000	.000	.000	.000

Location: Riverside
 N/S: Deercreek Drive
 E/W: Grove Community Drive



Date: 9/17/2022
 Day Saturday

PEDESTRIANS

Time	North Leg Dead End	East Leg Grove Community Drive	South Leg Deercreek Drive	West Leg Grove Community Drive	TOTAL
11:00 AM	0	0	0	0	0
11:15 AM	0	0	2	0	2
11:30 AM	0	0	1	0	1
11:45 AM	0	0	0	0	0
12:00 PM	0	0	0	0	0
12:15 PM	0	0	2	0	2
12:30 PM	0	0	1	0	1
12:45 PM	0	0	0	2	2
1:00 PM	0	1	0	0	1
1:15 PM	0	0	0	0	0
1:30 PM	0	0	1	0	1
1:45 PM	0	0	0	0	0
TOTAL VOLUMES:	0	1	7	2	10

Location: Riverside
 N/S: Deercreek Drive
 E/W: Grove Community Drive

Date: 9/17/2022
 Day: Saturday



BICYCLES

	Southbound Dead End			Westbound Grove Community Drive			Northbound Deercreek Drive			Eastbound Grove Community Drive			
	Left	Thru	Right	Left	Thru	Right	Left	Thru	Right	Left	Thru	Right	
11:00 AM	0	0	0	0	1	0	0	0	0	0	0	0	1
11:15 AM	0	0	0	0	2	0	3	0	0	0	4	0	9
11:30 AM	0	0	0	1	0	0	0	0	3	0	0	0	4
11:45 AM	0	0	0	0	0	0	0	0	0	0	0	0	0
12:00 PM	0	0	0	0	0	0	0	0	0	0	0	0	0
12:15 PM	0	0	0	0	0	0	0	0	0	0	0	0	0
12:30 PM	0	0	0	0	0	0	0	0	0	0	0	0	0
12:45 PM	0	0	0	0	0	0	0	0	0	0	2	0	2
1:00 PM	0	0	0	0	0	0	0	0	0	0	0	0	0
1:15 PM	0	0	0	0	0	0	1	0	0	0	0	0	1
1:30 PM	0	0	0	0	0	0	0	0	0	0	0	0	0
1:45 PM	0	0	0	0	0	0	0	0	0	0	0	0	0
TOTAL VOLUMES:	0	0	0	1	3	0	4	0	3	0	6	0	17

City of Riverside
 N/S: Deercreek Drive
 E/W: Orange Terrace Parkway
 Weather: Clear

File Name : 10_RIV_Deer_Or Ter Sat
 Site Code : 05122815
 Start Date : 9/17/2022
 Page No : 1

Groups Printed- Passenger Vehicles - Large 2 Axle Vehicles - 3 Axle Vehicles - 4+ Axle Trucks

Start Time	Deercreek Drive Southbound				Orange Terrace Parkway Westbound				Deercreek Drive Northbound				Orange Terrace Parkway Eastbound				Int. Total
	Left	Thru	Right	App. Total	Left	Thru	Right	App. Total	Left	Thru	Right	App. Total	Left	Thru	Right	App. Total	
11:00 AM	5	2	4	11	1	51	16	68	2	1	0	3	16	39	2	57	139
11:15 AM	8	0	9	17	2	46	13	61	4	0	2	6	13	53	2	68	152
11:30 AM	9	1	7	17	0	52	11	63	4	5	0	9	16	48	3	67	156
11:45 AM	13	3	25	41	4	55	8	67	6	2	0	8	14	40	2	56	172
Total	35	6	45	86	7	204	48	259	16	8	2	26	59	180	9	248	619
12:00 PM	16	0	14	30	3	84	15	102	6	0	0	6	8	41	4	53	191
12:15 PM	11	1	7	19	0	68	13	81	8	0	2	10	18	72	1	91	201
12:30 PM	7	1	5	13	1	60	14	75	4	2	2	8	11	51	1	63	159
12:45 PM	8	0	10	18	2	41	14	57	6	1	2	9	7	49	4	60	144
Total	42	2	36	80	6	253	56	315	24	3	6	33	44	213	10	267	695
01:00 PM	1	0	11	12	2	51	15	68	3	1	1	5	13	64	3	80	165
01:15 PM	5	0	6	11	2	51	9	62	2	0	0	2	10	48	2	60	135
01:30 PM	3	2	2	7	1	54	8	63	5	0	1	6	7	39	3	49	125
01:45 PM	6	2	11	19	2	57	11	70	4	0	0	4	11	61	2	74	167
Total	15	4	30	49	7	213	43	263	14	1	2	17	41	212	10	263	592
Grand Total	92	12	111	215	20	670	147	837	54	12	10	76	144	605	29	778	1906
Apprch %	42.8	5.6	51.6		2.4	80	17.6		71.1	15.8	13.2		18.5	77.8	3.7		
Total %	4.8	0.6	5.8	11.3	1	35.2	7.7	43.9	2.8	0.6	0.5	4	7.6	31.7	1.5	40.8	
Passenger Vehicles	92	12	110	214	19	662	147	828	54	12	10	76	142	602	29	773	1891
% Passenger Vehicles	100	100	99.1	99.5	95	98.8	100	98.9	100	100	100	100	98.6	99.5	100	99.4	99.2
Large 2 Axle Vehicles	0	0	1	1	1	8	0	9	0	0	0	0	2	3	0	5	15
% Large 2 Axle Vehicles	0	0	0.9	0.5	5	1.2	0	1.1	0	0	0	0	1.4	0.5	0	0.6	0.8
3 Axle Vehicles	0	0	0	0	0	0	0	0	0	0	0	0	0	0	0	0	0
% 3 Axle Vehicles	0	0	0	0	0	0	0	0	0	0	0	0	0	0	0	0	0
4+ Axle Trucks	0	0	0	0	0	0	0	0	0	0	0	0	0	0	0	0	0
% 4+ Axle Trucks	0	0	0	0	0	0	0	0	0	0	0	0	0	0	0	0	0

Start Time	Deercreek Drive Southbound				Orange Terrace Parkway Westbound				Deercreek Drive Northbound				Orange Terrace Parkway Eastbound				Int. Total
	Left	Thru	Right	App. Total	Left	Thru	Right	App. Total	Left	Thru	Right	App. Total	Left	Thru	Right	App. Total	
Peak Hour Analysis From 11:00 AM to 01:45 PM - Peak 1 of 1																	
Peak Hour for Entire Intersection Begins at 11:45 AM																	
11:45 AM	13	3	25	41	4	55	8	67	6	2	0	8	14	40	2	56	172
12:00 PM	16	0	14	30	3	84	15	102	6	0	0	6	8	41	4	53	191
12:15 PM	11	1	7	19	0	68	13	81	8	0	2	10	18	72	1	91	201
12:30 PM	7	1	5	13	1	60	14	75	4	2	2	8	11	51	1	63	159
Total Volume	47	5	51	103	8	267	50	325	24	4	4	32	51	204	8	263	723
% App. Total	45.6	4.9	49.5		2.5	82.2	15.4		75	12.5	12.5		19.4	77.6	3		
PHF	.734	.417	.510	.628	.500	.795	.833	.797	.750	.500	.500	.800	.708	.708	.500	.723	.899

City of Riverside
 N/S: Deercreek Drive
 E/W: Orange Terrace Parkway
 Weather: Clear

File Name : 10_RIV_Deer_Or Ter Sat
 Site Code : 05122815
 Start Date : 9/17/2022
 Page No : 2

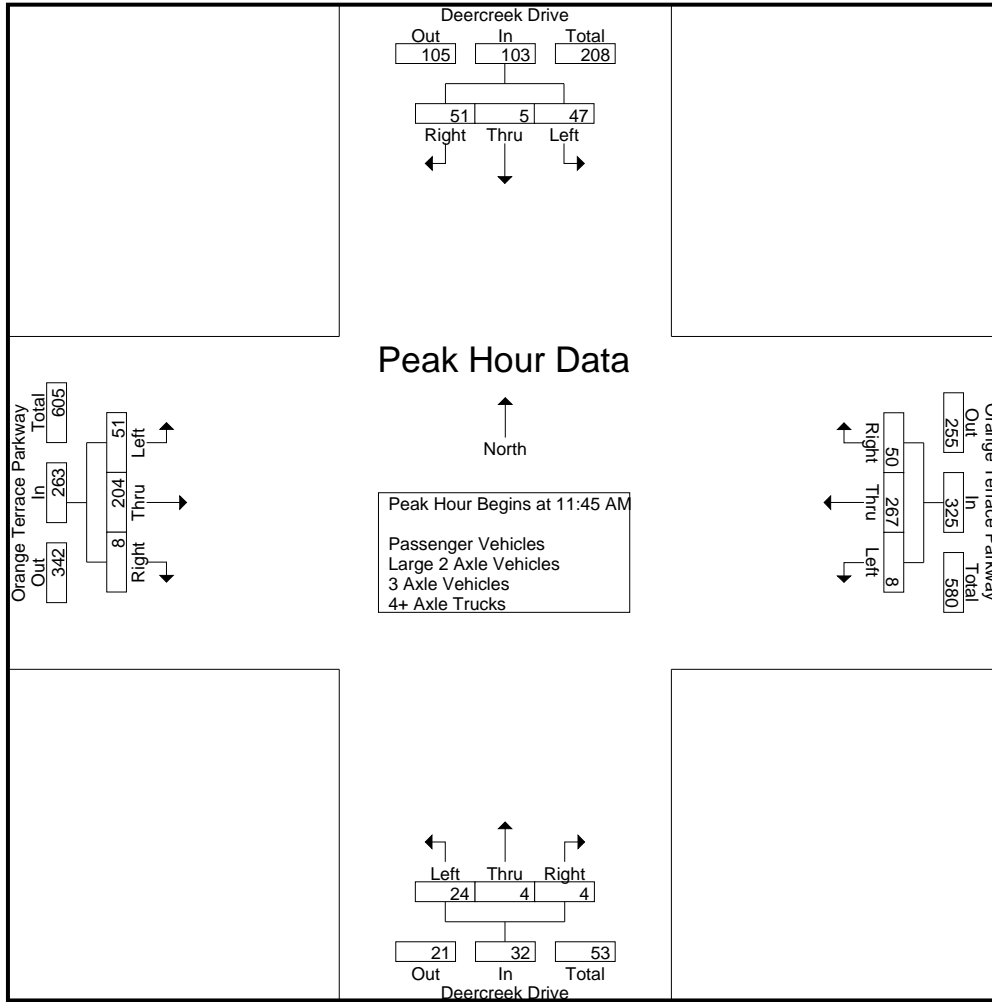

Peak Hour Analysis From 11:00 AM to 01:45 PM - Peak 1 of 1
 Peak Hour for Each Approach Begins at:

	11:30 AM				11:45 AM				11:30 AM				12:15 PM			
+0 mins.	9	1	7	17	4	55	8	67	4	5	0	9	18	72	1	91
+15 mins.	13	3	25	41	3	84	15	102	6	2	0	8	11	51	1	63
+30 mins.	16	0	14	30	0	68	13	81	6	0	0	6	7	49	4	60
+45 mins.	11	1	7	19	1	60	14	75	8	0	2	10	13	64	3	80
Total Volume	49	5	53	107	8	267	50	325	24	7	2	33	49	236	9	294
% App. Total	45.8	4.7	49.5		2.5	82.2	15.4		72.7	21.2	6.1		16.7	80.3	3.1	
PHF	.766	.417	.530	.652	.500	.795	.833	.797	.750	.350	.250	.825	.681	.819	.563	.808

City of Riverside
 N/S: Deercreek Drive
 E/W: Orange Terrace Parkway
 Weather: Clear

File Name : 10_RIV_Deer_Or Ter Sat
 Site Code : 05122815
 Start Date : 9/17/2022
 Page No : 1

Groups Printed- Passenger Vehicles

Start Time	Deercreek Drive Southbound				Orange Terrace Parkway Westbound				Deercreek Drive Northbound				Orange Terrace Parkway Eastbound				Int. Total
	Left	Thru	Right	App. Total	Left	Thru	Right	App. Total	Left	Thru	Right	App. Total	Left	Thru	Right	App. Total	
11:00 AM	5	2	4	11	1	50	16	67	2	1	0	3	16	38	2	56	137
11:15 AM	8	0	9	17	2	46	13	61	4	0	2	6	13	53	2	68	152
11:30 AM	9	1	6	16	0	50	11	61	4	5	0	9	16	48	3	67	153
11:45 AM	13	3	25	41	3	55	8	66	6	2	0	8	13	40	2	55	170
Total	35	6	44	85	6	201	48	255	16	8	2	26	58	179	9	246	612
12:00 PM	16	0	14	30	3	83	15	101	6	0	0	6	8	40	4	52	189
12:15 PM	11	1	7	19	0	68	13	81	8	0	2	10	18	72	1	91	201
12:30 PM	7	1	5	13	1	58	14	73	4	2	2	8	10	51	1	62	156
12:45 PM	8	0	10	18	2	40	14	56	6	1	2	9	7	49	4	60	143
Total	42	2	36	80	6	249	56	311	24	3	6	33	43	212	10	265	689
01:00 PM	1	0	11	12	2	50	15	67	3	1	1	5	13	63	3	79	163
01:15 PM	5	0	6	11	2	51	9	62	2	0	0	2	10	48	2	60	135
01:30 PM	3	2	2	7	1	54	8	63	5	0	1	6	7	39	3	49	125
01:45 PM	6	2	11	19	2	57	11	70	4	0	0	4	11	61	2	74	167
Total	15	4	30	49	7	212	43	262	14	1	2	17	41	211	10	262	590
Grand Total	92	12	110	214	19	662	147	828	54	12	10	76	142	602	29	773	1891
Apprch %	43	5.6	51.4		2.3	80	17.8		71.1	15.8	13.2		18.4	77.9	3.8		
Total %	4.9	0.6	5.8	11.3	1	35	7.8	43.8	2.9	0.6	0.5	4	7.5	31.8	1.5	40.9	

Start Time	Deercreek Drive Southbound				Orange Terrace Parkway Westbound				Deercreek Drive Northbound				Orange Terrace Parkway Eastbound				Int. Total
	Left	Thru	Right	App. Total	Left	Thru	Right	App. Total	Left	Thru	Right	App. Total	Left	Thru	Right	App. Total	
Peak Hour Analysis From 11:45 AM to 12:30 PM - Peak 1 of 1																	
Peak Hour for Entire Intersection Begins at 11:45 AM																	
11:45 AM	13	3	25	41	3	55	8	66	6	2	0	8	13	40	2	55	170
12:00 PM	16	0	14	30	3	83	15	101	6	0	0	6	8	40	4	52	189
12:15 PM	11	1	7	19	0	68	13	81	8	0	2	10	18	72	1	91	201
12:30 PM	7	1	5	13	1	58	14	73	4	2	2	8	10	51	1	62	156
Total Volume	47	5	51	103	7	264	50	321	24	4	4	32	49	203	8	260	716
% App. Total	45.6	4.9	49.5		2.2	82.2	15.6		75	12.5	12.5		18.8	78.1	3.1		
PHF	.734	.417	.510	.628	.583	.795	.833	.795	.750	.500	.500	.800	.681	.705	.500	.714	.891

City of Riverside
 N/S: Deercreek Drive
 E/W: Orange Terrace Parkway
 Weather: Clear

File Name : 10_RIV_Deer_Or Ter Sat
 Site Code : 05122815
 Start Date : 9/17/2022
 Page No : 2

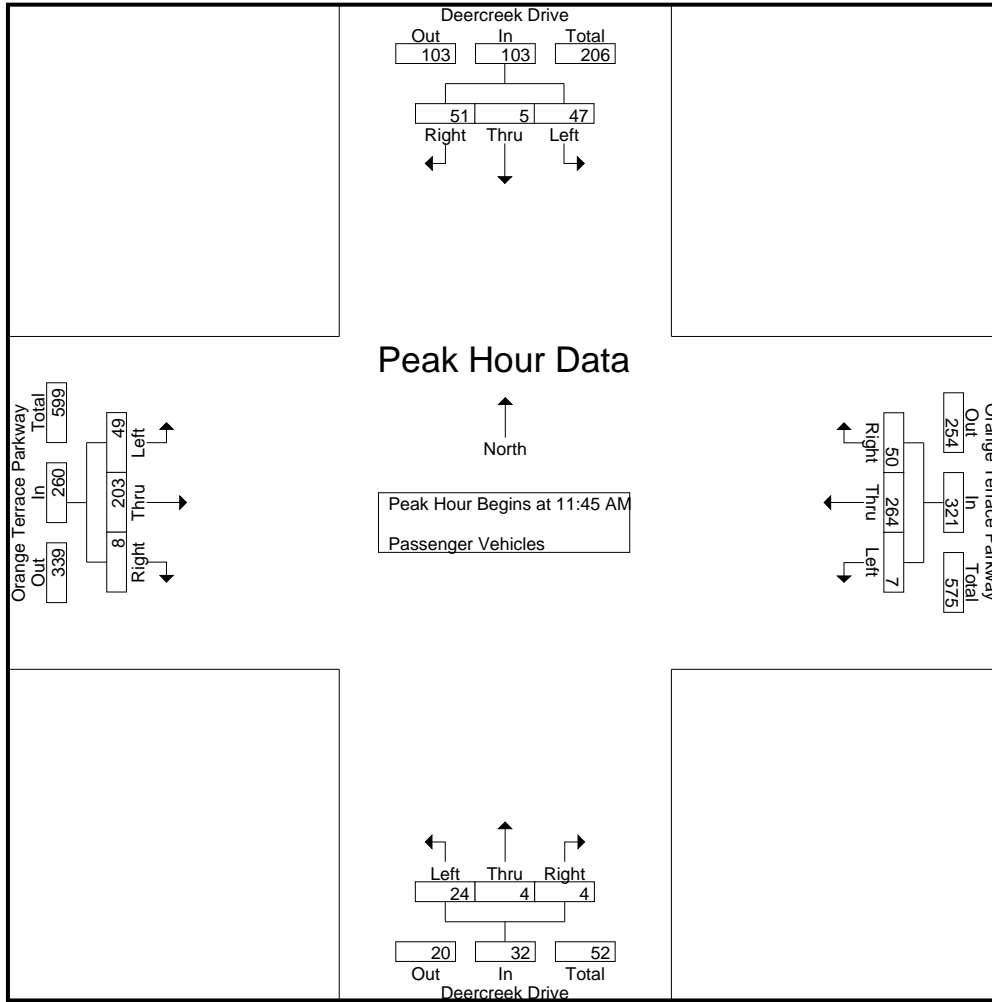

Peak Hour Analysis From 11:45 AM to 12:30 PM - Peak 1 of 1
 Peak Hour for Each Approach Begins at:

	11:45 AM				11:45 AM				11:45 AM				11:45 AM			
+0 mins.	13	3	25	41	3	55	8	66	6	2	0	8	13	40	2	55
+15 mins.	16	0	14	30	3	83	15	101	6	0	0	6	8	40	4	52
+30 mins.	11	1	7	19	0	68	13	81	8	0	2	10	18	72	1	91
+45 mins.	7	1	5	13	1	58	14	73	4	2	2	8	10	51	1	62
Total Volume	47	5	51	103	7	264	50	321	24	4	4	32	49	203	8	260
% App. Total	45.6	4.9	49.5		2.2	82.2	15.6		75	12.5	12.5		18.8	78.1	3.1	
PHF	.734	.417	.510	.628	.583	.795	.833	.795	.750	.500	.500	.800	.681	.705	.500	.714

City of Riverside
 N/S: Deercreek Drive
 E/W: Orange Terrace Parkway
 Weather: Clear

File Name : 10_RIV_Deer_Or Ter Sat
 Site Code : 05122815
 Start Date : 9/17/2022
 Page No : 1

Groups Printed- Large 2 Axle Vehicles

Start Time	Deercreek Drive Southbound				Orange Terrace Parkway Westbound				Deercreek Drive Northbound				Orange Terrace Parkway Eastbound				Int. Total
	Left	Thru	Right	App. Total	Left	Thru	Right	App. Total	Left	Thru	Right	App. Total	Left	Thru	Right	App. Total	
11:00 AM	0	0	0	0	0	1	0	1	0	0	0	0	0	1	0	1	2
11:15 AM	0	0	0	0	0	0	0	0	0	0	0	0	0	0	0	0	0
11:30 AM	0	0	1	1	0	2	0	2	0	0	0	0	0	0	0	0	3
11:45 AM	0	0	0	0	1	0	0	1	0	0	0	0	1	0	0	1	2
Total	0	0	1	1	1	3	0	4	0	0	0	0	1	1	0	2	7
12:00 PM	0	0	0	0	0	1	0	1	0	0	0	0	0	1	0	1	2
12:15 PM	0	0	0	0	0	0	0	0	0	0	0	0	0	0	0	0	0
12:30 PM	0	0	0	0	0	2	0	2	0	0	0	0	1	0	0	1	3
12:45 PM	0	0	0	0	0	1	0	1	0	0	0	0	0	0	0	0	1
Total	0	0	0	0	0	4	0	4	0	0	0	0	1	1	0	2	6
01:00 PM	0	0	0	0	0	1	0	1	0	0	0	0	0	1	0	1	2
01:15 PM	0	0	0	0	0	0	0	0	0	0	0	0	0	0	0	0	0
01:30 PM	0	0	0	0	0	0	0	0	0	0	0	0	0	0	0	0	0
01:45 PM	0	0	0	0	0	0	0	0	0	0	0	0	0	0	0	0	0
Total	0	0	0	0	0	1	0	1	0	0	0	0	0	1	0	1	2
Grand Total	0	0	1	1	1	8	0	9	0	0	0	0	2	3	0	5	15
Apprch %	0	0	100		11.1	88.9	0		0	0	0		40	60	0		
Total %	0	0	6.7	6.7	6.7	53.3	0	60	0	0	0	0	13.3	20	0	33.3	

Start Time	Deercreek Drive Southbound				Orange Terrace Parkway Westbound				Deercreek Drive Northbound				Orange Terrace Parkway Eastbound				Int. Total
	Left	Thru	Right	App. Total	Left	Thru	Right	App. Total	Left	Thru	Right	App. Total	Left	Thru	Right	App. Total	
Peak Hour Analysis From 11:45 AM to 12:30 PM - Peak 1 of 1																	
Peak Hour for Entire Intersection Begins at 11:45 AM																	
11:45 AM	0	0	0	0	1	0	0	1	0	0	0	0	1	0	0	1	2
12:00 PM	0	0	0	0	0	1	0	1	0	0	0	0	0	1	0	1	2
12:15 PM	0	0	0	0	0	0	0	0	0	0	0	0	0	0	0	0	0
12:30 PM	0	0	0	0	0	2	0	2	0	0	0	0	1	0	0	1	3
Total Volume	0	0	0	0	1	3	0	4	0	0	0	0	2	1	0	3	7
% App. Total	0	0	0		25	75	0		0	0	0		66.7	33.3	0		
PHF	.000	.000	.000	.000	.250	.375	.000	.500	.000	.000	.000	.000	.500	.250	.000	.750	.583

City of Riverside
 N/S: Deercreek Drive
 E/W: Orange Terrace Parkway
 Weather: Clear

File Name : 10_RIV_Deer_Or Ter Sat
 Site Code : 05122815
 Start Date : 9/17/2022
 Page No : 2

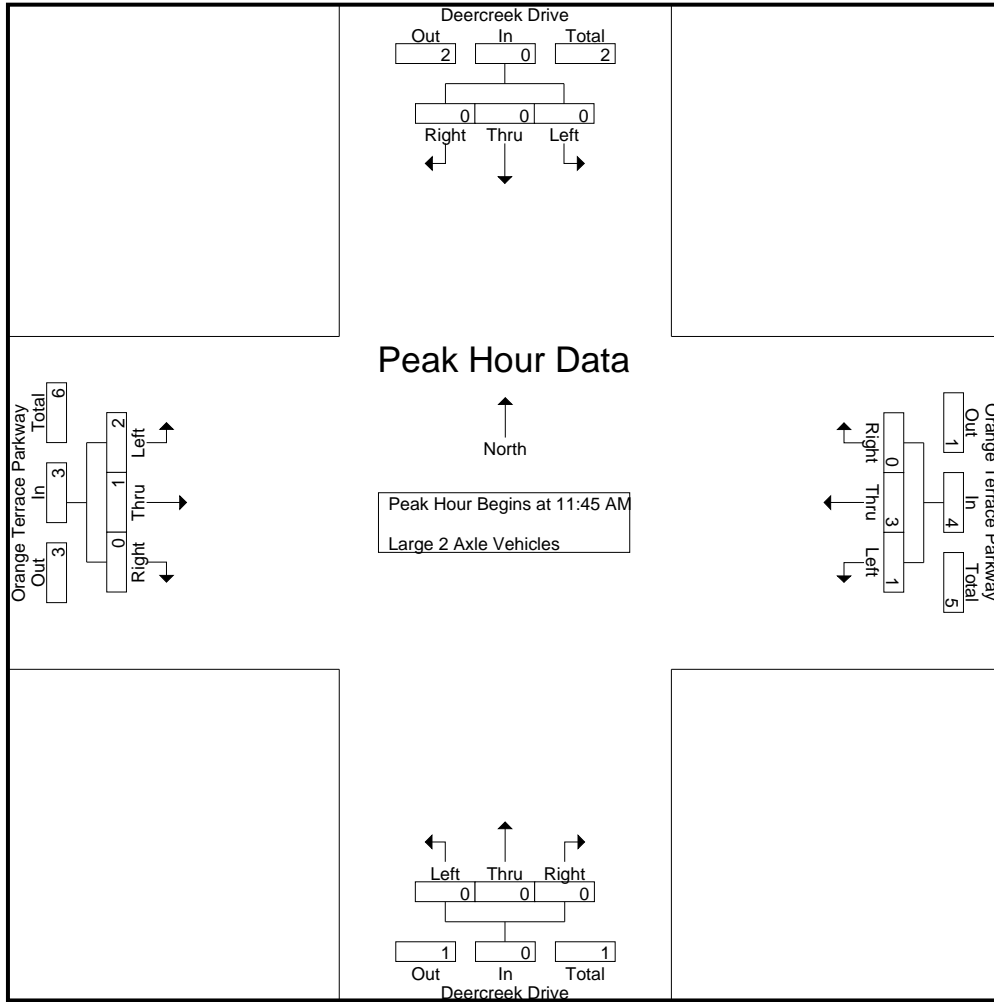

Peak Hour Analysis From 11:45 AM to 12:30 PM - Peak 1 of 1
 Peak Hour for Each Approach Begins at:

	11:45 AM				11:45 AM				11:45 AM				11:45 AM			
+0 mins.	0	0	0	0	1	0	0	1	0	0	0	0	1	0	0	1
+15 mins.	0	0	0	0	0	1	0	1	0	0	0	0	0	1	0	1
+30 mins.	0	0	0	0	0	0	0	0	0	0	0	0	0	0	0	0
+45 mins.	0	0	0	0	0	2	0	2	0	0	0	0	1	0	0	1
Total Volume	0	0	0	0	1	3	0	4	0	0	0	0	2	1	0	3
% App. Total	0	0	0	0	25	75	0	100	0	0	0	0	66.7	33.3	0	100
PHF	.000	.000	.000	.000	.250	.375	.000	.500	.000	.000	.000	.000	.500	.250	.000	.750

City of Riverside
 N/S: Deercreek Drive
 E/W: Orange Terrace Parkway
 Weather: Clear

File Name : 10_RIV_Deer_Or Ter Sat
 Site Code : 05122815
 Start Date : 9/17/2022
 Page No : 1

Groups Printed- 3 Axle Vehicles

Start Time	Deercreek Drive Southbound				Orange Terrace Parkway Westbound				Deercreek Drive Northbound				Orange Terrace Parkway Eastbound				Int. Total
	Left	Thru	Right	App. Total	Left	Thru	Right	App. Total	Left	Thru	Right	App. Total	Left	Thru	Right	App. Total	
11:00 AM	0	0	0	0	0	0	0	0	0	0	0	0	0	0	0	0	0
11:15 AM	0	0	0	0	0	0	0	0	0	0	0	0	0	0	0	0	0
11:30 AM	0	0	0	0	0	0	0	0	0	0	0	0	0	0	0	0	0
11:45 AM	0	0	0	0	0	0	0	0	0	0	0	0	0	0	0	0	0
Total	0	0	0	0	0	0	0	0	0	0	0	0	0	0	0	0	0
12:00 PM	0	0	0	0	0	0	0	0	0	0	0	0	0	0	0	0	0
12:15 PM	0	0	0	0	0	0	0	0	0	0	0	0	0	0	0	0	0
12:30 PM	0	0	0	0	0	0	0	0	0	0	0	0	0	0	0	0	0
12:45 PM	0	0	0	0	0	0	0	0	0	0	0	0	0	0	0	0	0
Total	0	0	0	0	0	0	0	0	0	0	0	0	0	0	0	0	0
01:00 PM	0	0	0	0	0	0	0	0	0	0	0	0	0	0	0	0	0
01:15 PM	0	0	0	0	0	0	0	0	0	0	0	0	0	0	0	0	0
01:30 PM	0	0	0	0	0	0	0	0	0	0	0	0	0	0	0	0	0
01:45 PM	0	0	0	0	0	0	0	0	0	0	0	0	0	0	0	0	0
Total	0	0	0	0	0	0	0	0	0	0	0	0	0	0	0	0	0
Grand Total	0	0	0	0	0	0	0	0	0	0	0	0	0	0	0	0	0
Apprch %	0	0	0		0	0	0		0	0	0		0	0	0		
Total %																	

Start Time	Deercreek Drive Southbound				Orange Terrace Parkway Westbound				Deercreek Drive Northbound				Orange Terrace Parkway Eastbound				Int. Total
	Left	Thru	Right	App. Total	Left	Thru	Right	App. Total	Left	Thru	Right	App. Total	Left	Thru	Right	App. Total	
Peak Hour Analysis From 11:45 AM to 12:30 PM - Peak 1 of 1																	
Peak Hour for Entire Intersection Begins at 11:45 AM																	
11:45 AM	0	0	0	0	0	0	0	0	0	0	0	0	0	0	0	0	0
12:00 PM	0	0	0	0	0	0	0	0	0	0	0	0	0	0	0	0	0
12:15 PM	0	0	0	0	0	0	0	0	0	0	0	0	0	0	0	0	0
12:30 PM	0	0	0	0	0	0	0	0	0	0	0	0	0	0	0	0	0
Total Volume	0	0	0	0	0	0	0	0	0	0	0	0	0	0	0	0	0
% App. Total	0	0	0		0	0	0		0	0	0		0	0	0		
PHF	.000	.000	.000	.000	.000	.000	.000	.000	.000	.000	.000	.000	.000	.000	.000	.000	.000

City of Riverside
 N/S: Deercreek Drive
 E/W: Orange Terrace Parkway
 Weather: Clear

File Name : 10_RIV_Deer_Or Ter Sat
 Site Code : 05122815
 Start Date : 9/17/2022
 Page No : 2

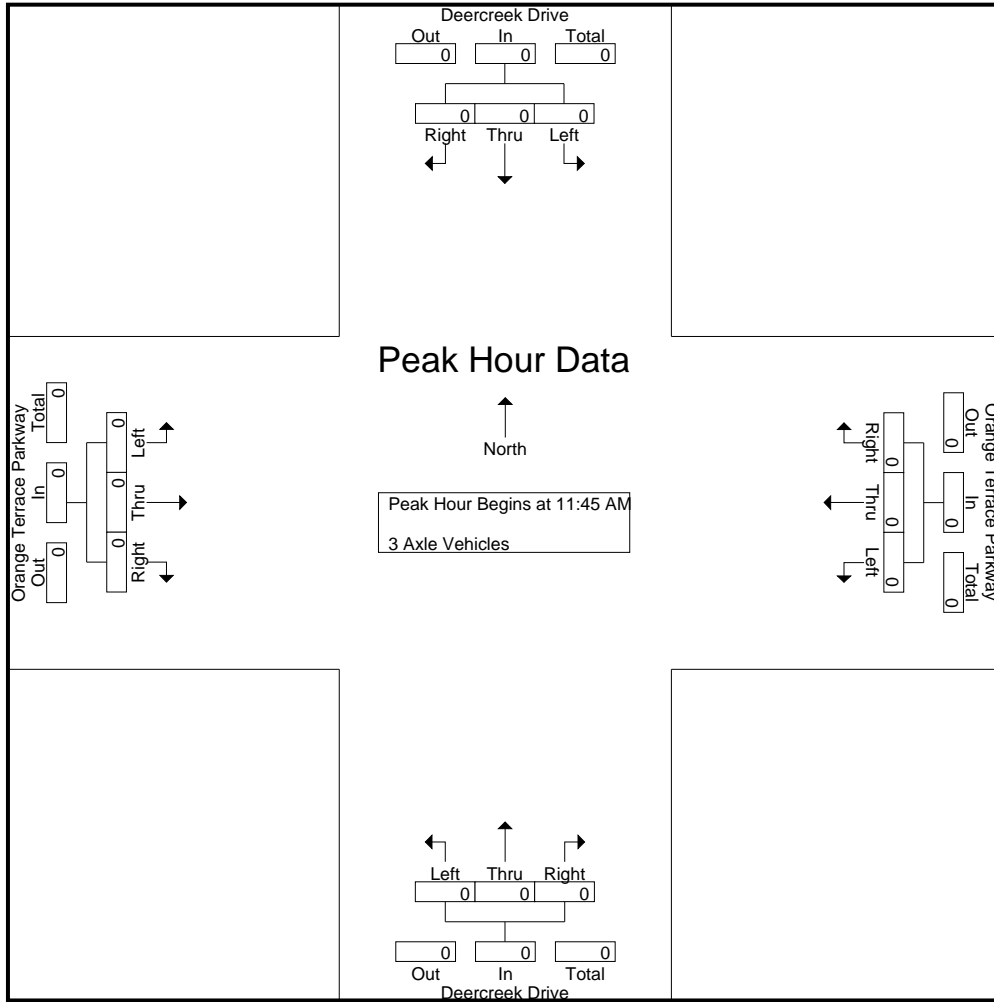

Peak Hour Analysis From 11:45 AM to 12:30 PM - Peak 1 of 1
 Peak Hour for Each Approach Begins at:

	11:45 AM				11:45 AM				11:45 AM				11:45 AM			
+0 mins.	0	0	0	0	0	0	0	0	0	0	0	0	0	0	0	0
+15 mins.	0	0	0	0	0	0	0	0	0	0	0	0	0	0	0	0
+30 mins.	0	0	0	0	0	0	0	0	0	0	0	0	0	0	0	0
+45 mins.	0	0	0	0	0	0	0	0	0	0	0	0	0	0	0	0
Total Volume	0	0	0	0	0	0	0	0	0	0	0	0	0	0	0	0
% App. Total	0	0	0	0	0	0	0	0	0	0	0	0	0	0	0	0
PHF	.000	.000	.000	.000	.000	.000	.000	.000	.000	.000	.000	.000	.000	.000	.000	.000

City of Riverside
 N/S: Deercreek Drive
 E/W: Orange Terrace Parkway
 Weather: Clear

File Name : 10_RIV_Deer_Or Ter Sat
 Site Code : 05122815
 Start Date : 9/17/2022
 Page No : 1

Groups Printed- 4+ Axle Trucks

Start Time	Deercreek Drive Southbound				Orange Terrace Parkway Westbound				Deercreek Drive Northbound				Orange Terrace Parkway Eastbound				Int. Total
	Left	Thru	Right	App. Total	Left	Thru	Right	App. Total	Left	Thru	Right	App. Total	Left	Thru	Right	App. Total	
11:00 AM	0	0	0	0	0	0	0	0	0	0	0	0	0	0	0	0	0
11:15 AM	0	0	0	0	0	0	0	0	0	0	0	0	0	0	0	0	0
11:30 AM	0	0	0	0	0	0	0	0	0	0	0	0	0	0	0	0	0
11:45 AM	0	0	0	0	0	0	0	0	0	0	0	0	0	0	0	0	0
Total	0	0	0	0	0	0	0	0	0	0	0	0	0	0	0	0	0
12:00 PM	0	0	0	0	0	0	0	0	0	0	0	0	0	0	0	0	0
12:15 PM	0	0	0	0	0	0	0	0	0	0	0	0	0	0	0	0	0
12:30 PM	0	0	0	0	0	0	0	0	0	0	0	0	0	0	0	0	0
12:45 PM	0	0	0	0	0	0	0	0	0	0	0	0	0	0	0	0	0
Total	0	0	0	0	0	0	0	0	0	0	0	0	0	0	0	0	0
01:00 PM	0	0	0	0	0	0	0	0	0	0	0	0	0	0	0	0	0
01:15 PM	0	0	0	0	0	0	0	0	0	0	0	0	0	0	0	0	0
01:30 PM	0	0	0	0	0	0	0	0	0	0	0	0	0	0	0	0	0
01:45 PM	0	0	0	0	0	0	0	0	0	0	0	0	0	0	0	0	0
Total	0	0	0	0	0	0	0	0	0	0	0	0	0	0	0	0	0
Grand Total	0	0	0	0	0	0	0	0	0	0	0	0	0	0	0	0	0
Apprch %	0	0	0		0	0	0		0	0	0		0	0	0		
Total %																	

Start Time	Deercreek Drive Southbound				Orange Terrace Parkway Westbound				Deercreek Drive Northbound				Orange Terrace Parkway Eastbound				Int. Total
	Left	Thru	Right	App. Total	Left	Thru	Right	App. Total	Left	Thru	Right	App. Total	Left	Thru	Right	App. Total	
Peak Hour Analysis From 11:45 AM to 12:30 PM - Peak 1 of 1																	
Peak Hour for Entire Intersection Begins at 11:45 AM																	
11:45 AM	0	0	0	0	0	0	0	0	0	0	0	0	0	0	0	0	0
12:00 PM	0	0	0	0	0	0	0	0	0	0	0	0	0	0	0	0	0
12:15 PM	0	0	0	0	0	0	0	0	0	0	0	0	0	0	0	0	0
12:30 PM	0	0	0	0	0	0	0	0	0	0	0	0	0	0	0	0	0
Total Volume	0	0	0	0	0	0	0	0	0	0	0	0	0	0	0	0	0
% App. Total	0	0	0		0	0	0		0	0	0		0	0	0		
PHF	.000	.000	.000	.000	.000	.000	.000	.000	.000	.000	.000	.000	.000	.000	.000	.000	.000

City of Riverside
 N/S: Deercreek Drive
 E/W: Orange Terrace Parkway
 Weather: Clear

File Name : 10_RIV_Deer_Or Ter Sat
 Site Code : 05122815
 Start Date : 9/17/2022
 Page No : 2

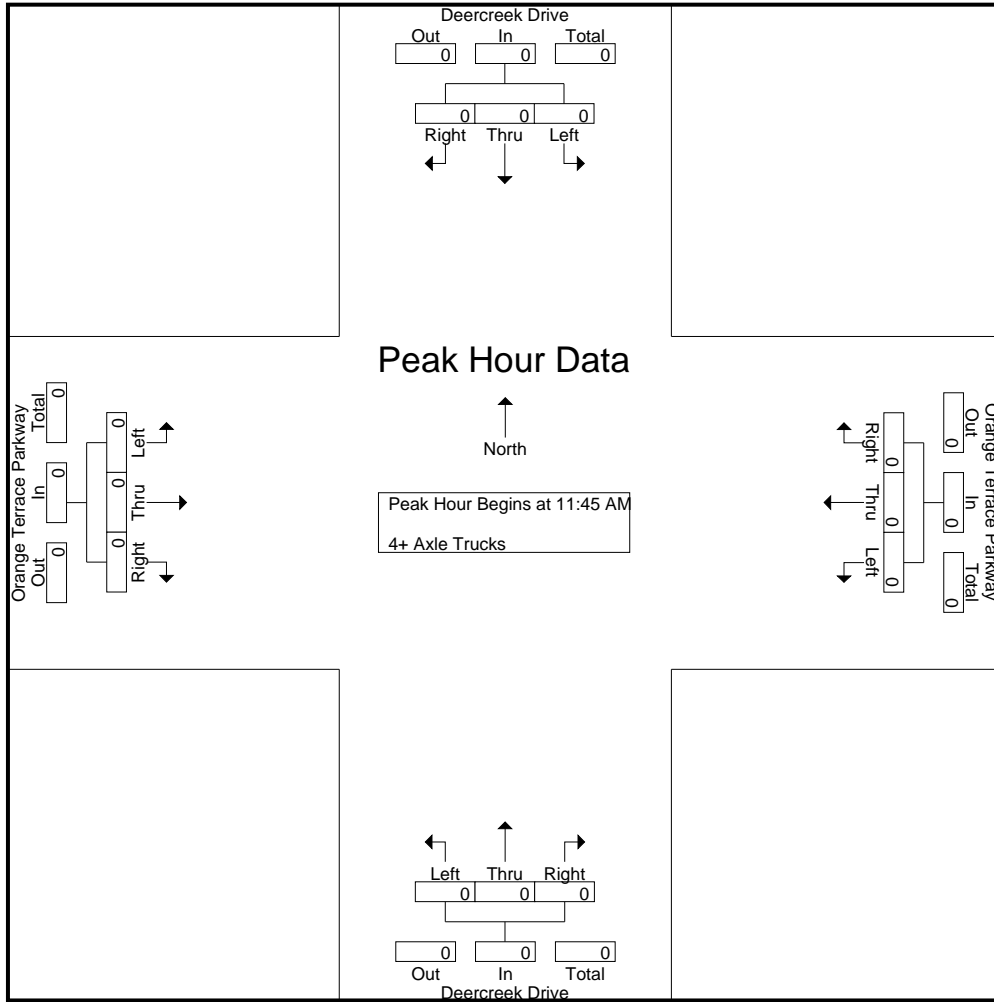

Peak Hour Analysis From 11:45 AM to 12:30 PM - Peak 1 of 1
 Peak Hour for Each Approach Begins at:

	11:45 AM				11:45 AM				11:45 AM				11:45 AM			
+0 mins.	0	0	0	0	0	0	0	0	0	0	0	0	0	0	0	0
+15 mins.	0	0	0	0	0	0	0	0	0	0	0	0	0	0	0	0
+30 mins.	0	0	0	0	0	0	0	0	0	0	0	0	0	0	0	0
+45 mins.	0	0	0	0	0	0	0	0	0	0	0	0	0	0	0	0
Total Volume	0	0	0	0	0	0	0	0	0	0	0	0	0	0	0	0
% App. Total	0	0	0	0	0	0	0	0	0	0	0	0	0	0	0	0
PHF	.000	.000	.000	.000	.000	.000	.000	.000	.000	.000	.000	.000	.000	.000	.000	.000

Location: Riverside
 N/S: Deercreek Drive
 E/W: Orange Terrace Parkway



Date: 9/17/2022
 Day Saturday

PEDESTRIANS

Time	North Leg Deercreek Drive	East Leg Orange Terrace Parkway	South Leg Deercreek Drive	West Leg Orange Terrace Parkway	TOTAL
11:00 AM	1	1	0	0	2
11:15 AM	0	5	2	0	7
11:30 AM	1	0	0	0	1
11:45 AM	1	2	1	0	4
12:00 PM	1	0	0	0	1
12:15 PM	0	3	1	1	5
12:30 PM	0	1	1	1	3
12:45 PM	0	0	0	0	0
1:00 PM	1	0	0	0	1
1:15 PM	0	0	0	0	0
1:30 PM	2	0	0	0	2
1:45 PM	0	2	1	0	3
TOTAL VOLUMES:	7	14	6	2	29

Location: Riverside
 N/S: Deercreek Drive
 E/W: Orange Terrace Parkway

Date: 9/17/2022
 Day: Saturday



BICYCLES

	Southbound Deercreek Drive			Westbound Orange Terrace Parkway			Northbound Deercreek Drive			Eastbound Orange Terrace Parkway			
	Left	Thru	Right	Left	Thru	Right	Left	Thru	Right	Left	Thru	Right	
11:00 AM	0	0	0	0	0	0	0	0	0	0	0	0	0
11:15 AM	2	0	0	0	0	0	0	0	0	0	0	0	2
11:30 AM	0	0	1	0	1	1	0	0	3	0	0	0	6
11:45 AM	0	0	0	0	0	0	0	0	0	0	0	0	0
12:00 PM	0	0	0	0	0	0	0	0	0	2	0	0	2
12:15 PM	0	0	0	0	0	0	0	0	0	0	1	0	1
12:30 PM	0	0	0	0	0	0	0	0	0	0	0	0	0
12:45 PM	0	2	0	0	0	0	0	0	0	0	0	0	2
1:00 PM	0	0	0	0	0	0	0	0	0	0	0	0	0
1:15 PM	0	0	0	0	0	1	0	0	0	0	0	0	1
1:30 PM	0	0	0	0	0	0	0	0	0	0	0	0	0
1:45 PM	0	0	0	0	2	0	0	0	0	0	0	0	2
TOTAL VOLUMES:	2	2	1	0	3	2	0	0	3	2	1	0	16

City of Riverside
 N/S: Barton Street
 E/W: Alessandro Boulevard
 Weather: Clear

File Name : 11_RIV_Bar St_Ales Sat
 Site Code : 05122815
 Start Date : 9/17/2022
 Page No : 1

Groups Printed- Passenger Vehicles - Large 2 Axle Vehicles - 3 Axle Vehicles - 4+ Axle Trucks

Start Time	Barton Street Southbound					Alessandro Boulevard Westbound					Barton Street Northbound					Alessandro Boulevard Eastbound					Exclu. Total	Inclu. Total	Int. Total
	Left	Thru	Right	RTOR	App. Total	Left	Thru	Right	RTOR	App. Total	Left	Thru	Right	RTOR	App. Total	Left	Thru	Right	RTOR	App. Total			
11:00 AM	3	0	2	2	5	11	260	0	0	271	14	0	3	2	17	2	217	5	0	224	4	517	521
11:15 AM	0	0	0	0	0	11	292	2	0	305	14	0	5	2	19	1	247	5	0	253	2	577	579
11:30 AM	3	1	1	1	5	7	276	1	0	284	10	0	7	5	17	3	238	7	1	248	7	554	561
11:45 AM	0	1	1	1	2	15	293	0	0	308	18	0	9	8	27	2	237	9	0	248	9	585	594
Total	6	2	4	4	12	44	1121	3	0	1168	56	0	24	17	80	8	939	26	1	973	22	2233	2255
12:00 PM	0	0	0	0	0	12	281	0	0	293	15	0	8	5	23	3	317	5	0	325	5	641	646
12:15 PM	4	0	3	3	7	18	275	1	0	294	16	0	5	4	21	2	281	5	0	288	7	610	617
12:30 PM	0	1	1	1	2	19	293	0	0	312	12	1	10	9	23	0	307	10	2	317	12	654	666
12:45 PM	0	0	2	1	2	11	302	0	0	313	14	0	8	7	22	5	264	5	0	274	8	611	619
Total	4	1	6	5	11	60	1151	1	0	1212	57	1	31	25	89	10	1169	25	2	1204	32	2516	2548
01:00 PM	2	0	1	1	3	20	309	1	0	330	14	0	12	9	26	1	307	8	0	316	10	675	685
01:15 PM	0	0	0	0	0	19	320	1	0	340	14	0	9	7	23	2	255	5	1	262	8	625	633
01:30 PM	1	0	1	1	2	15	344	2	0	361	9	0	8	7	17	0	335	4	0	339	8	719	727
01:45 PM	1	0	1	1	2	12	334	0	0	346	9	1	4	3	14	1	285	11	0	297	4	659	663
Total	4	0	3	3	7	66	1307	4	0	1377	46	1	33	26	80	4	1182	28	1	1214	30	2678	2708
Grand Total	14	3	13	12	30	170	3579	8	0	3757	159	2	88	68	249	22	3290	79	4	3391	84	7427	7511
Apprch %	46.7	10	43.3			4.5	95.3	0.2			63.9	0.8	35.3			0.6	97	2.3					
Total %	0.2	0	0.2		0.4	2.3	48.2	0.1		50.6	2.1	0	1.2		3.4	0.3	44.3	1.1		45.7	1.1	98.9	
Passenger Vehicles	13	2	13		40	169	3530	8		3707	159	2	87		315	21	3259	78		3362	0	0	7424
% Passenger Vehicles	92.9	66.7	100	100	95.2	99.4	98.6	100	0	98.7	100	100	98.9	98.5	99.4	95.5	99.1	98.7	100	99	0	0	98.8
Large 2 Axle Vehicles	1	1	0		2	1	43	0		44	0	0	1		2	1	28	1		30	0	0	78
% Large 2 Axle Vehicles	7.1	33.3	0	0	4.8	0.6	1.2	0	0	1.2	0	0	1.1	1.5	0.6	4.5	0.9	1.3	0	0.9	0	0	1
3 Axle Vehicles	0	0	0		0	0	2	0		2	0	0	0		0	0	2	0		2	0	0	4
% 3 Axle Vehicles	0	0	0	0	0	0	0.1	0	0	0.1	0	0	0	0	0	0	0.1	0	0	0.1	0	0	0.1
4+ Axle Trucks	0	0	0		0	0	4	0		4	0	0	0		0	0	1	0		1	0	0	5
% 4+ Axle Trucks	0	0	0	0	0	0	0.1	0	0	0.1	0	0	0	0	0	0	0	0	0	0	0	0	0.1

City of Riverside
 N/S: Barton Street
 E/W: Alessandro Boulevard
 Weather: Clear

File Name : 11_RIV_Bar St_Ales Sat
 Site Code : 05122815
 Start Date : 9/17/2022
 Page No : 2

Start Time	Barton Street Southbound				Alessandro Boulevard Westbound				Barton Street Northbound				Alessandro Boulevard Eastbound				Int. Total
	Left	Thru	Right	App. Total	Left	Thru	Right	App. Total	Left	Thru	Right	App. Total	Left	Thru	Right	App. Total	
Peak Hour Analysis From 11:00 AM to 01:45 PM - Peak 1 of 1																	
Peak Hour for Entire Intersection Begins at 01:00 PM																	
01:00 PM	2	0	1	3	20	309	1	330	14	0	12	26	1	307	8	316	675
01:15 PM	0	0	0	0	19	320	1	340	14	0	9	23	2	255	5	262	625
01:30 PM	1	0	1	2	15	344	2	361	9	0	8	17	0	335	4	339	719
01:45 PM	1	0	1	2	12	334	0	346	9	1	4	14	1	285	11	297	659
Total Volume	4	0	3	7	66	1307	4	1377	46	1	33	80	4	1182	28	1214	2678
% App. Total	57.1	0	42.9		4.8	94.9	0.3		57.5	1.2	41.2		0.3	97.4	2.3		
PHF	.500	.000	.750	.583	.825	.950	.500	.954	.821	.250	.688	.769	.500	.882	.636	.895	.931

City of Riverside
 N/S: Barton Street
 E/W: Alessandro Boulevard
 Weather: Clear

File Name : 11_RIV_Bar St_Ales Sat
 Site Code : 05122815
 Start Date : 9/17/2022
 Page No : 3

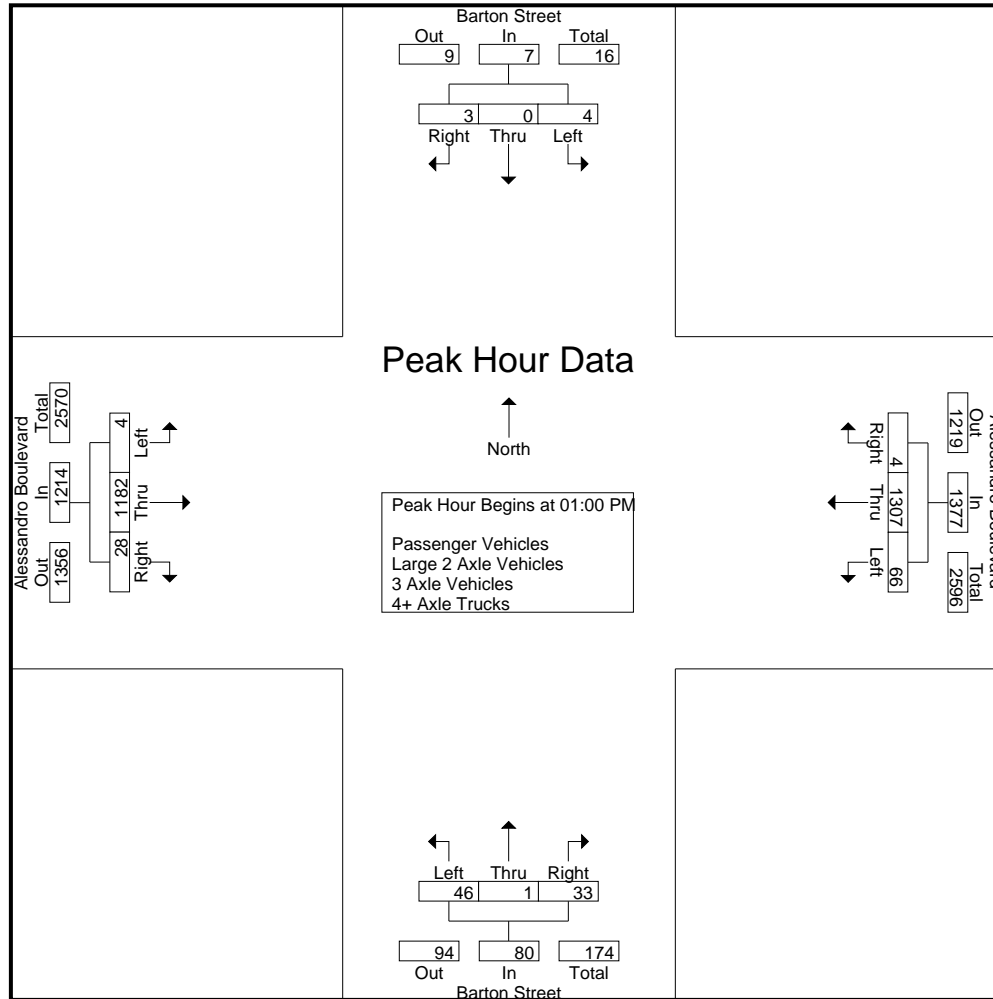

City of Riverside
 N/S: Barton Street
 E/W: Alessandro Boulevard
 Weather: Clear

File Name : 11_RIV_Bar St_Ales Sat
 Site Code : 05122815
 Start Date : 9/17/2022
 Page No : 4

Start Time	Barton Street Southbound				Alessandro Boulevard Westbound				Barton Street Northbound				Alessandro Boulevard Eastbound				Int. Total
	Left	Thru	Right	App. Total	Left	Thru	Right	App. Total	Left	Thru	Right	App. Total	Left	Thru	Right	App. Total	
Peak Hour Analysis From 11:00 AM to 01:45 PM - Peak 1 of 1																	
Peak Hour for Each Approach Begins at:																	
	11:30 AM				01:00 PM				11:45 AM				01:00 PM				
+0 mins.	3	1	1	5	20	309	1	330	18	0	9	27	1	307	8	316	
+15 mins.	0	1	1	2	19	320	1	340	15	0	8	23	2	255	5	262	
+30 mins.	0	0	0	0	15	344	2	361	16	0	5	21	0	335	4	339	
+45 mins.	4	0	3	7	12	334	0	346	12	1	10	23	1	285	11	297	
Total Volume	7	2	5	14	66	1307	4	1377	61	1	32	94	4	1182	28	1214	
% App. Total	50	14.3	35.7		4.8	94.9	0.3		64.9	1.1	34		0.3	97.4	2.3		
PHF	.438	.500	.417	.500	.825	.950	.500	.954	.847	.250	.800	.870	.500	.882	.636	.895	

City of Riverside
 N/S: Barton Street
 E/W: Alessandro Boulevard
 Weather: Clear

File Name : 11_RIV_Bar St_Ales Sat
 Site Code : 05122815
 Start Date : 9/17/2022
 Page No : 1

Groups Printed- Passenger Vehicles

Start Time	Barton Street Southbound					Alessandro Boulevard Westbound					Barton Street Northbound					Alessandro Boulevard Eastbound					Exclu. Total	Inclu. Total	Int. Total
	Left	Thru	Right	RTOR	App. Total	Left	Thru	Right	RTOR	App. Total	Left	Thru	Right	RTOR	App. Total	Left	Thru	Right	RTOR	App. Total			
11:00 AM	3	0	2	2	5	11	258	0	0	269	14	0	3	2	17	2	214	5	0	221	4	512	516
11:15 AM	0	0	0	0	0	11	290	2	0	303	14	0	5	2	19	1	245	5	0	251	2	573	575
11:30 AM	3	1	1	1	5	7	273	1	0	281	10	0	7	5	17	3	235	7	1	245	7	548	555
11:45 AM	0	1	1	1	2	15	288	0	0	303	18	0	9	8	27	2	235	8	0	245	9	577	586
Total	6	2	4	4	12	44	1109	3	0	1156	56	0	24	17	80	8	929	25	1	962	22	2210	2232
12:00 PM	0	0	0	0	0	12	276	0	0	288	15	0	8	5	23	3	315	5	0	323	5	634	639
12:15 PM	3	0	3	3	6	18	272	1	0	291	16	0	5	4	21	1	278	5	0	284	7	602	609
12:30 PM	0	0	1	1	1	19	285	0	0	304	12	1	10	9	23	0	305	10	2	315	12	643	655
12:45 PM	0	0	2	1	2	11	301	0	0	312	14	0	7	6	21	5	261	5	0	271	7	606	613
Total	3	0	6	5	9	60	1134	1	0	1195	57	1	30	24	88	9	1159	25	2	1193	31	2485	2516
01:00 PM	2	0	1	1	3	20	304	1	0	325	14	0	12	9	26	1	304	8	0	313	10	667	677
01:15 PM	0	0	0	0	0	19	315	1	0	335	14	0	9	7	23	2	253	5	1	260	8	618	626
01:30 PM	1	0	1	1	2	15	337	2	0	354	9	0	8	7	17	0	331	4	0	335	8	708	716
01:45 PM	1	0	1	1	2	11	331	0	0	342	9	1	4	3	14	1	283	11	0	295	4	653	657
Total	4	0	3	3	7	65	1287	4	0	1356	46	1	33	26	80	4	1171	28	1	1203	30	2646	2676
Grand Total	13	2	13	12	28	169	3530	8	0	3707	159	2	87	67	248	21	3259	78	4	3358	83	7341	7424
Apprch %	46.4	7.1	46.4			4.6	95.2	0.2			64.1	0.8	35.1			0.6	97.1	2.3					
Total %	0.2	0	0.2		0.4	2.3	48.1	0.1		50.5	2.2	0	1.2		3.4	0.3	44.4	1.1		45.7	1.1	98.9	

Start Time	Barton Street Southbound				Alessandro Boulevard Westbound				Barton Street Northbound				Alessandro Boulevard Eastbound				Int. Total
	Left	Thru	Right	App. Total	Left	Thru	Right	App. Total	Left	Thru	Right	App. Total	Left	Thru	Right	App. Total	
Peak Hour Analysis From 01:00 PM to 01:45 PM - Peak 1 of 1																	
Peak Hour for Entire Intersection Begins at 01:00 PM																	
01:00 PM	2	0	1	3	20	304	1	325	14	0	12	26	1	304	8	313	667
01:15 PM	0	0	0	0	19	315	1	335	14	0	9	23	2	253	5	260	618
01:30 PM	1	0	1	2	15	337	2	354	9	0	8	17	0	331	4	335	708
01:45 PM	1	0	1	2	11	331	0	342	9	1	4	14	1	283	11	295	653
Total Volume	4	0	3	7	65	1287	4	1356	46	1	33	80	4	1171	28	1203	2646
% App. Total	57.1	0	42.9		4.8	94.9	0.3		57.5	1.2	41.2		0.3	97.3	2.3		
PHF	.500	.000	.750	.583	.813	.955	.500	.958	.821	.250	.688	.769	.500	.884	.636	.898	.934

City of Riverside
 N/S: Barton Street
 E/W: Alessandro Boulevard
 Weather: Clear

File Name : 11_RIV_Bar St_Ales Sat
 Site Code : 05122815
 Start Date : 9/17/2022
 Page No : 2

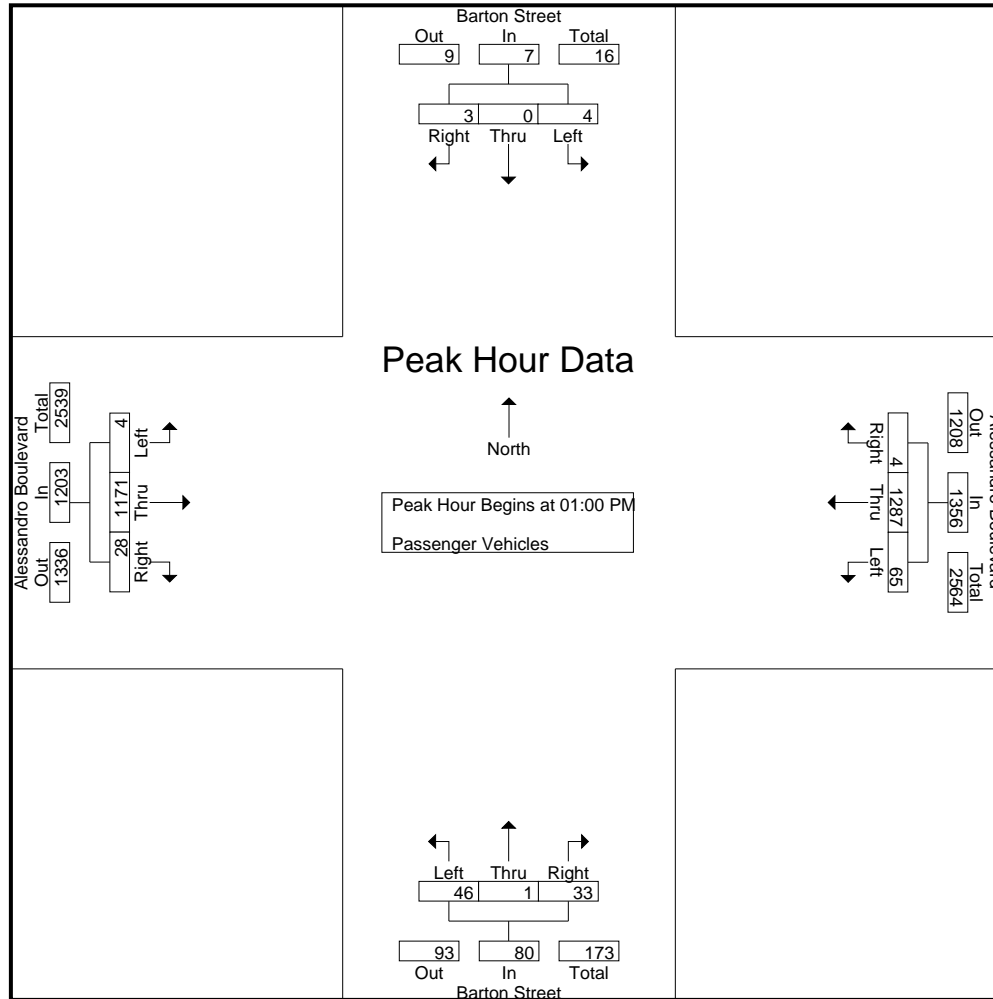

City of Riverside
 N/S: Barton Street
 E/W: Alessandro Boulevard
 Weather: Clear

File Name : 11_RIV_Bar St_Ales Sat
 Site Code : 05122815
 Start Date : 9/17/2022
 Page No : 3

Start Time	Barton Street Southbound				Alessandro Boulevard Westbound				Barton Street Northbound				Alessandro Boulevard Eastbound				Int. Total
	Left	Thru	Right	App. Total	Left	Thru	Right	App. Total	Left	Thru	Right	App. Total	Left	Thru	Right	App. Total	
Peak Hour Analysis From 01:00 PM to 01:45 PM - Peak 1 of 1																	
Peak Hour for Each Approach Begins at:																	
	01:00 PM				01:00 PM				01:00 PM				01:00 PM				
+0 mins.	2	0	1	3	20	304	1	325	14	0	12	26	1	304	8	313	
+15 mins.	0	0	0	0	19	315	1	335	14	0	9	23	2	253	5	260	
+30 mins.	1	0	1	2	15	337	2	354	9	0	8	17	0	331	4	335	
+45 mins.	1	0	1	2	11	331	0	342	9	1	4	14	1	283	11	295	
Total Volume	4	0	3	7	65	1287	4	1356	46	1	33	80	4	1171	28	1203	
% App. Total	57.1	0	42.9		4.8	94.9	0.3		57.5	1.2	41.2		0.3	97.3	2.3		
PHF	.500	.000	.750	.583	.813	.955	.500	.958	.821	.250	.688	.769	.500	.884	.636	.898	

City of Riverside
 N/S: Barton Street
 E/W: Alessandro Boulevard
 Weather: Clear

File Name : 11_RIV_Bar St_Ales Sat
 Site Code : 05122815
 Start Date : 9/17/2022
 Page No : 1

Groups Printed- Large 2 Axle Vehicles

Start Time	Barton Street Southbound					Alessandro Boulevard Westbound					Barton Street Northbound					Alessandro Boulevard Eastbound					Exclu. Total	Inclu. Total	Int. Total	
	Left	Thru	Right	RTOR	App. Total	Left	Thru	Right	RTOR	App. Total	Left	Thru	Right	RTOR	App. Total	Left	Thru	Right	RTOR	App. Total				
11:00 AM	0	0	0	0	0	0	2	0	0	2	0	0	0	0	0	0	3	0	0	3	0	0	5	5
11:15 AM	0	0	0	0	0	0	1	0	0	1	0	0	0	0	0	0	2	0	0	2	0	0	3	3
11:30 AM	0	0	0	0	0	0	3	0	0	3	0	0	0	0	0	0	2	0	0	2	0	0	5	5
11:45 AM	0	0	0	0	0	0	5	0	0	5	0	0	0	0	0	0	2	1	0	3	0	0	8	8
Total	0	0	0	0	0	0	11	0	0	11	0	0	0	0	0	0	9	1	0	10	0	0	21	21
12:00 PM	0	0	0	0	0	0	3	0	0	3	0	0	0	0	0	0	2	0	0	2	0	0	5	5
12:15 PM	1	0	0	0	1	0	3	0	0	3	0	0	0	0	0	1	3	0	0	4	0	0	8	8
12:30 PM	0	1	0	0	1	0	8	0	0	8	0	0	0	0	0	0	1	0	0	1	0	0	10	10
12:45 PM	0	0	0	0	0	0	1	0	0	1	0	0	1	1	1	0	3	0	0	3	1	0	5	6
Total	1	1	0	0	2	0	15	0	0	15	0	0	1	1	1	1	9	0	0	10	1	0	28	29
01:00 PM	0	0	0	0	0	0	3	0	0	3	0	0	0	0	0	0	3	0	0	3	0	0	6	6
01:15 PM	0	0	0	0	0	0	5	0	0	5	0	0	0	0	0	0	2	0	0	2	0	0	7	7
01:30 PM	0	0	0	0	0	0	7	0	0	7	0	0	0	0	0	0	3	0	0	3	0	0	10	10
01:45 PM	0	0	0	0	0	1	2	0	0	3	0	0	0	0	0	0	2	0	0	2	0	0	5	5
Total	0	0	0	0	0	1	17	0	0	18	0	0	0	0	0	0	10	0	0	10	0	0	28	28
Grand Total	1	1	0	0	2	1	43	0	0	44	0	0	1	1	1	1	28	1	0	30	1	0	77	78
Apprch %	50	50	0			2.3	97.7	0			0	0	100			3.3	93.3	3.3						
Total %	1.3	1.3	0		2.6	1.3	55.8	0		57.1	0	0	1.3		1.3	1.3	36.4	1.3		39	1.3	0	98.7	

Start Time	Barton Street Southbound				Alessandro Boulevard Westbound				Barton Street Northbound				Alessandro Boulevard Eastbound				Int. Total
	Left	Thru	Right	App. Total	Left	Thru	Right	App. Total	Left	Thru	Right	App. Total	Left	Thru	Right	App. Total	
Peak Hour Analysis From 01:00 PM to 01:45 PM - Peak 1 of 1																	
Peak Hour for Entire Intersection Begins at 01:00 PM																	
01:00 PM	0	0	0	0	0	3	0	3	0	0	0	0	0	3	0	3	6
01:15 PM	0	0	0	0	0	5	0	5	0	0	0	0	0	2	0	2	7
01:30 PM	0	0	0	0	0	7	0	7	0	0	0	0	0	3	0	3	10
01:45 PM	0	0	0	0	1	2	0	3	0	0	0	0	0	2	0	2	5
Total Volume	0	0	0	0	1	17	0	18	0	0	0	0	0	10	0	10	28
% App. Total	0	0	0		5.6	94.4	0		0	0	0		0	100	0		
PHF	.000	.000	.000	.000	.250	.607	.000	.643	.000	.000	.000	.000	.000	.833	.000	.833	.700

City of Riverside
 N/S: Barton Street
 E/W: Alessandro Boulevard
 Weather: Clear

File Name : 11_RIV_Bar St_Ales Sat
 Site Code : 05122815
 Start Date : 9/17/2022
 Page No : 2

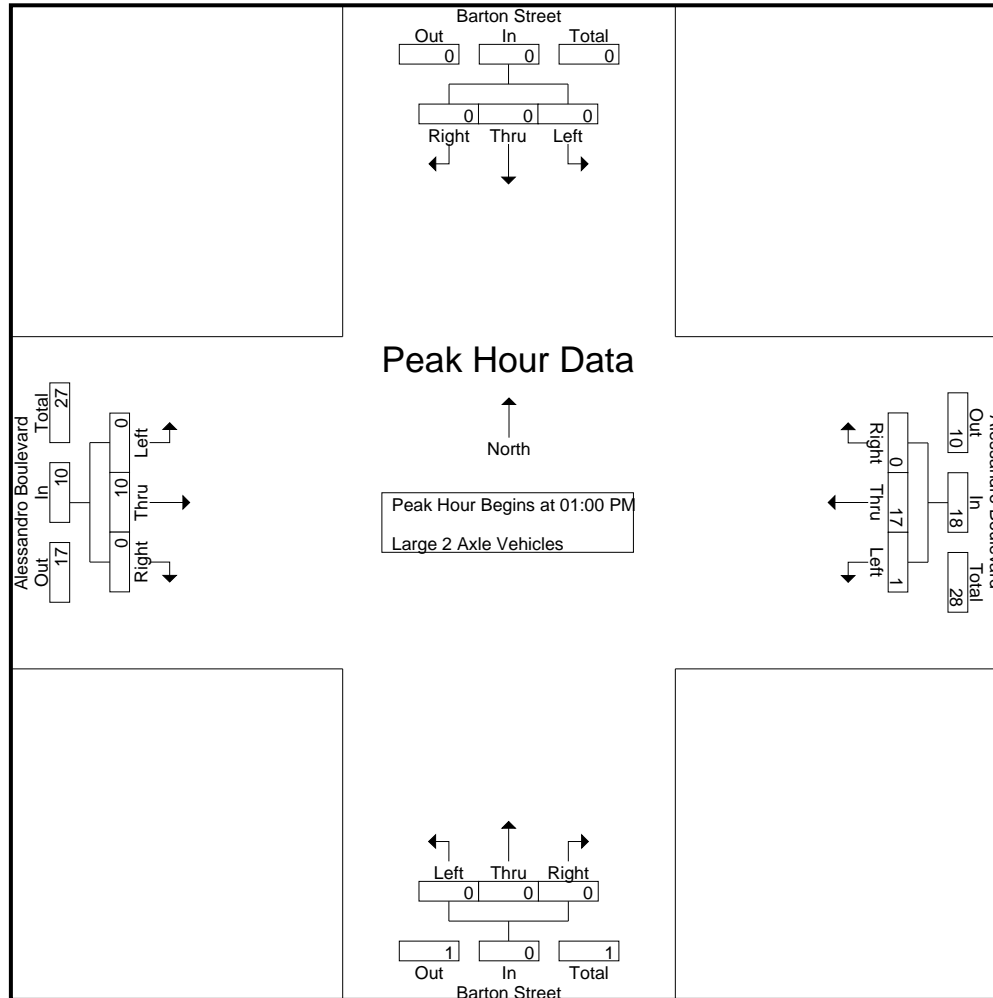

City of Riverside
 N/S: Barton Street
 E/W: Alessandro Boulevard
 Weather: Clear

File Name : 11_RIV_Bar St_Ales Sat
 Site Code : 05122815
 Start Date : 9/17/2022
 Page No : 3

Start Time	Barton Street Southbound				Alessandro Boulevard Westbound				Barton Street Northbound				Alessandro Boulevard Eastbound				Int. Total
	Left	Thru	Right	App. Total	Left	Thru	Right	App. Total	Left	Thru	Right	App. Total	Left	Thru	Right	App. Total	
Peak Hour Analysis From 01:00 PM to 01:45 PM - Peak 1 of 1																	
Peak Hour for Each Approach Begins at:																	
	01:00 PM				01:00 PM				01:00 PM				01:00 PM				
+0 mins.	0	0	0	0	0	3	0	3	0	0	0	0	0	3	0	3	
+15 mins.	0	0	0	0	0	5	0	5	0	0	0	0	0	2	0	2	
+30 mins.	0	0	0	0	0	7	0	7	0	0	0	0	0	3	0	3	
+45 mins.	0	0	0	0	1	2	0	3	0	0	0	0	0	2	0	2	
Total Volume	0	0	0	0	1	17	0	18	0	0	0	0	0	10	0	10	
% App. Total	0	0	0	0	5.6	94.4	0	64.3	0	0	0	0	0	100	0	83.3	
PHF	.000	.000	.000	.000	.250	.607	.000	.643	.000	.000	.000	.000	.000	.833	.000	.833	

City of Riverside
 N/S: Barton Street
 E/W: Alessandro Boulevard
 Weather: Clear

File Name : 11_RIV_Bar St_Ales Sat
 Site Code : 05122815
 Start Date : 9/17/2022
 Page No : 1

Groups Printed- 3 Axle Vehicles

Start Time	Barton Street Southbound					Alessandro Boulevard Westbound					Barton Street Northbound					Alessandro Boulevard Eastbound					Exclu. Total	Inclu. Total	Int. Total					
	Left	Thru	Right	RTOR	App. Total	Left	Thru	Right	RTOR	App. Total	Left	Thru	Right	RTOR	App. Total	Left	Thru	Right	RTOR	App. Total								
11:00 AM	0	0	0	0	0	0	0	0	0	0	0	0	0	0	0	0	0	0	0	0	0	0	0	0	0	0	0	0
11:15 AM	0	0	0	0	0	0	0	0	0	0	0	0	0	0	0	0	0	0	0	0	0	0	0	0	0	0	0	0
11:30 AM	0	0	0	0	0	0	0	0	0	0	0	0	0	0	0	0	1	0	0	1	0	0	0	0	0	0	1	1
11:45 AM	0	0	0	0	0	0	0	0	0	0	0	0	0	0	0	0	0	0	0	0	0	0	0	0	0	0	0	0
Total	0	0	0	0	0	0	0	0	0	0	0	0	0	0	0	0	1	0	0	1	0	0	0	0	0	0	1	1
12:00 PM	0	0	0	0	0	0	0	0	0	0	0	0	0	0	0	0	0	0	0	0	0	0	0	0	0	0	0	0
12:15 PM	0	0	0	0	0	0	0	0	0	0	0	0	0	0	0	0	0	0	0	0	0	0	0	0	0	0	0	0
12:30 PM	0	0	0	0	0	0	0	0	0	0	0	0	0	0	0	0	0	0	0	0	0	0	0	0	0	0	0	0
12:45 PM	0	0	0	0	0	0	0	0	0	0	0	0	0	0	0	0	0	0	0	0	0	0	0	0	0	0	0	0
Total	0	0	0	0	0	0	0	0	0	0	0	0	0	0	0	0	0	0	0	0	0	0	0	0	0	0	0	0
01:00 PM	0	0	0	0	0	0	2	0	0	2	0	0	0	0	0	0	0	0	0	0	0	0	0	0	0	0	2	2
01:15 PM	0	0	0	0	0	0	0	0	0	0	0	0	0	0	0	0	0	0	0	0	0	0	0	0	0	0	0	0
01:30 PM	0	0	0	0	0	0	0	0	0	0	0	0	0	0	0	0	1	0	0	1	0	0	0	0	0	0	1	1
01:45 PM	0	0	0	0	0	0	0	0	0	0	0	0	0	0	0	0	0	0	0	0	0	0	0	0	0	0	0	0
Total	0	0	0	0	0	0	2	0	0	2	0	0	0	0	0	0	1	0	0	1	0	0	0	0	0	0	3	3
Grand Total	0	0	0	0	0	0	2	0	0	2	0	0	0	0	0	0	2	0	0	2	0	0	0	0	0	0	4	4
Apprch %	0	0	0			0	100	0			0	0	0			0	100	0			0	0	0			0	100	
Total %	0	0	0			0	50	0		50	0	0	0		0	0	50	0		50	0	0	0			0	100	

Start Time	Barton Street Southbound				Alessandro Boulevard Westbound				Barton Street Northbound				Alessandro Boulevard Eastbound				Int. Total
	Left	Thru	Right	App. Total	Left	Thru	Right	App. Total	Left	Thru	Right	App. Total	Left	Thru	Right	App. Total	
Peak Hour Analysis From 01:00 PM to 01:45 PM - Peak 1 of 1																	
Peak Hour for Entire Intersection Begins at 01:00 PM																	
01:00 PM	0	0	0	0	0	2	0	2	0	0	0	0	0	0	0	0	2
01:15 PM	0	0	0	0	0	0	0	0	0	0	0	0	0	0	0	0	0
01:30 PM	0	0	0	0	0	0	0	0	0	0	0	0	0	1	0	1	1
01:45 PM	0	0	0	0	0	0	0	0	0	0	0	0	0	0	0	0	0
Total Volume	0	0	0	0	0	2	0	2	0	0	0	0	0	1	0	1	3
% App. Total	0	0	0		0	100	0		0	0	0		0	100	0		
PHF	.000	.000	.000	.000	.000	.250	.000	.250	.000	.000	.000	.000	.000	.250	.000	.250	.375

City of Riverside
 N/S: Barton Street
 E/W: Alessandro Boulevard
 Weather: Clear

File Name : 11_RIV_Bar St_Ales Sat
 Site Code : 05122815
 Start Date : 9/17/2022
 Page No : 2

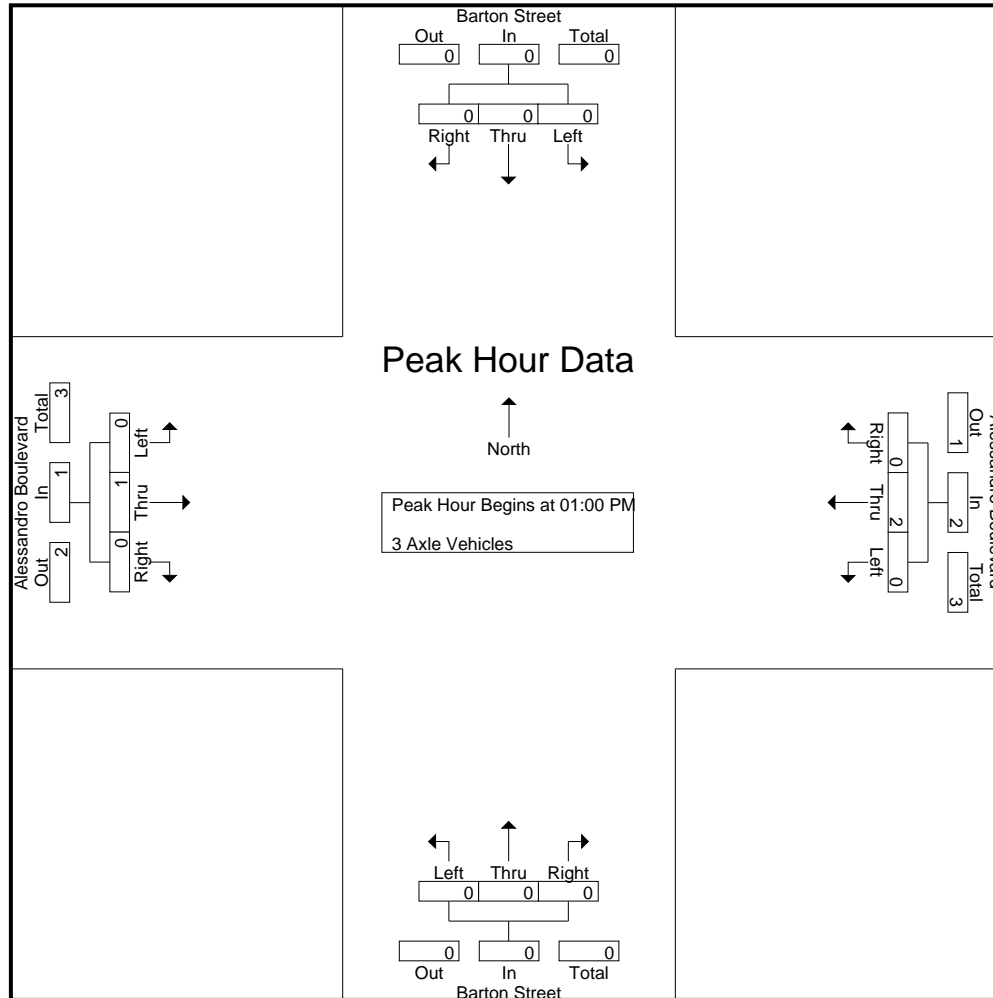

City of Riverside
 N/S: Barton Street
 E/W: Alessandro Boulevard
 Weather: Clear

File Name : 11_RIV_Bar St_Ales Sat
 Site Code : 05122815
 Start Date : 9/17/2022
 Page No : 3

Start Time	Barton Street Southbound				Alessandro Boulevard Westbound				Barton Street Northbound				Alessandro Boulevard Eastbound				Int. Total
	Left	Thru	Right	App. Total	Left	Thru	Right	App. Total	Left	Thru	Right	App. Total	Left	Thru	Right	App. Total	
Peak Hour Analysis From 01:00 PM to 01:45 PM - Peak 1 of 1																	
Peak Hour for Each Approach Begins at:																	
	01:00 PM				01:00 PM				01:00 PM				01:00 PM				
+0 mins.	0	0	0	0	0	2	0	2	0	0	0	0	0	0	0	0	
+15 mins.	0	0	0	0	0	0	0	0	0	0	0	0	0	0	0	0	
+30 mins.	0	0	0	0	0	0	0	0	0	0	0	0	0	1	0	1	
+45 mins.	0	0	0	0	0	0	0	0	0	0	0	0	0	0	0	0	
Total Volume	0	0	0	0	0	2	0	2	0	0	0	0	0	1	0	1	
% App. Total	0	0	0	0	0	100	0	0	0	0	0	0	0	100	0	0	
PHF	.000	.000	.000	.000	.000	.250	.000	.250	.000	.000	.000	.000	.000	.250	.000	.250	

City of Riverside
 N/S: Barton Street
 E/W: Alessandro Boulevard
 Weather: Clear

File Name : 11_RIV_Bar St_Ales Sat
 Site Code : 05122815
 Start Date : 9/17/2022
 Page No : 1

Groups Printed- 4+ Axle Trucks

Start Time	Barton Street Southbound					Alessandro Boulevard Westbound					Barton Street Northbound					Alessandro Boulevard Eastbound					Exclu. Total	Inclu. Total	Int. Total					
	Left	Thru	Right	RTOR	App. Total	Left	Thru	Right	RTOR	App. Total	Left	Thru	Right	RTOR	App. Total	Left	Thru	Right	RTOR	App. Total								
11:00 AM	0	0	0	0	0	0	0	0	0	0	0	0	0	0	0	0	0	0	0	0	0	0	0	0	0	0	0	0
11:15 AM	0	0	0	0	0	0	1	0	0	1	0	0	0	0	0	0	0	0	0	0	0	0	0	0	0	0	1	1
11:30 AM	0	0	0	0	0	0	0	0	0	0	0	0	0	0	0	0	0	0	0	0	0	0	0	0	0	0	0	0
11:45 AM	0	0	0	0	0	0	0	0	0	0	0	0	0	0	0	0	0	0	0	0	0	0	0	0	0	0	0	0
Total	0	0	0	0	0	0	1	0	0	1	0	0	0	0	0	0	0	0	0	0	0	0	0	0	0	0	1	1
12:00 PM	0	0	0	0	0	0	2	0	0	2	0	0	0	0	0	0	0	0	0	0	0	0	0	0	0	0	2	2
12:15 PM	0	0	0	0	0	0	0	0	0	0	0	0	0	0	0	0	0	0	0	0	0	0	0	0	0	0	0	0
12:30 PM	0	0	0	0	0	0	0	0	0	0	0	0	0	0	0	0	1	0	0	1	0	0	0	0	1	0	1	1
12:45 PM	0	0	0	0	0	0	0	0	0	0	0	0	0	0	0	0	0	0	0	0	0	0	0	0	0	0	0	0
Total	0	0	0	0	0	0	2	0	0	2	0	0	0	0	0	0	1	0	0	1	0	0	0	0	1	0	3	3
01:00 PM	0	0	0	0	0	0	0	0	0	0	0	0	0	0	0	0	0	0	0	0	0	0	0	0	0	0	0	0
01:15 PM	0	0	0	0	0	0	0	0	0	0	0	0	0	0	0	0	0	0	0	0	0	0	0	0	0	0	0	0
01:30 PM	0	0	0	0	0	0	0	0	0	0	0	0	0	0	0	0	0	0	0	0	0	0	0	0	0	0	0	0
01:45 PM	0	0	0	0	0	0	1	0	0	1	0	0	0	0	0	0	0	0	0	0	0	0	0	0	0	0	1	1
Total	0	0	0	0	0	0	1	0	0	1	0	0	0	0	0	0	0	0	0	0	0	0	0	0	0	0	1	1
Grand Total	0	0	0	0	0	0	4	0	0	4	0	0	0	0	0	0	1	0	0	1	0	0	0	0	1	0	5	5
Apprch %	0	0	0			0	100	0			0	0	0			0	100	0			0	0	0			0	0	0
Total %	0	0	0			0	80	0		80	0	0	0		0	0	20	0		20	0	0	0		20	0	100	

Start Time	Barton Street Southbound				Alessandro Boulevard Westbound				Barton Street Northbound				Alessandro Boulevard Eastbound				Int. Total
	Left	Thru	Right	App. Total	Left	Thru	Right	App. Total	Left	Thru	Right	App. Total	Left	Thru	Right	App. Total	
Peak Hour Analysis From 01:00 PM to 01:45 PM - Peak 1 of 1																	
Peak Hour for Entire Intersection Begins at 01:00 PM																	
01:00 PM	0	0	0	0	0	0	0	0	0	0	0	0	0	0	0	0	0
01:15 PM	0	0	0	0	0	0	0	0	0	0	0	0	0	0	0	0	0
01:30 PM	0	0	0	0	0	0	0	0	0	0	0	0	0	0	0	0	0
01:45 PM	0	0	0	0	0	1	0	1	0	0	0	0	0	0	0	0	1
Total Volume	0	0	0	0	0	1	0	1	0	0	0	0	0	0	0	0	1
% App. Total	0	0	0		0	100	0		0	0	0		0	0	0		100
PHF	.000	.000	.000	.000	.000	.250	.000	.250	.000	.000	.000	.000	.000	.000	.000	.000	.250

City of Riverside
 N/S: Barton Street
 E/W: Alessandro Boulevard
 Weather: Clear

File Name : 11_RIV_Bar St_Ales Sat
 Site Code : 05122815
 Start Date : 9/17/2022
 Page No : 2

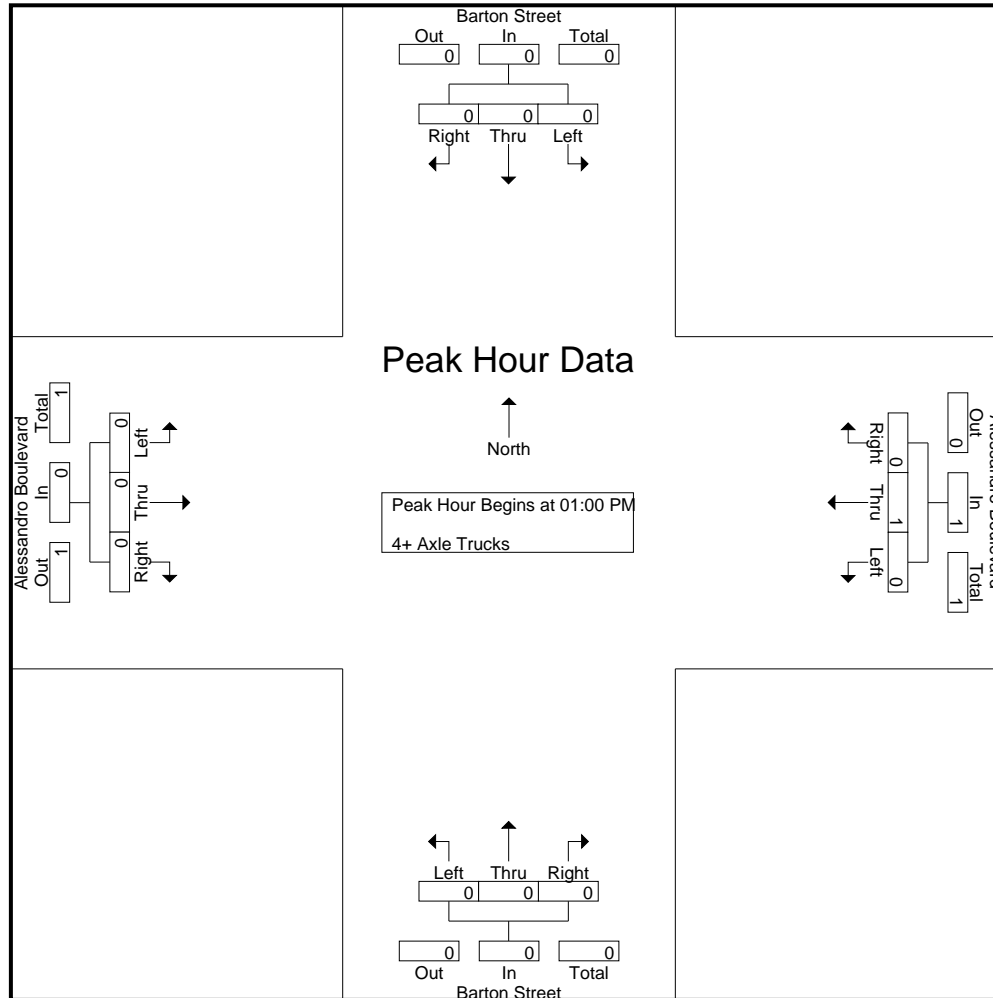

City of Riverside
 N/S: Barton Street
 E/W: Alessandro Boulevard
 Weather: Clear

File Name : 11_RIV_Bar St_Ales Sat
 Site Code : 05122815
 Start Date : 9/17/2022
 Page No : 3

Start Time	Barton Street Southbound				Alessandro Boulevard Westbound				Barton Street Northbound				Alessandro Boulevard Eastbound				Int. Total
	Left	Thru	Right	App. Total	Left	Thru	Right	App. Total	Left	Thru	Right	App. Total	Left	Thru	Right	App. Total	
Peak Hour Analysis From 01:00 PM to 01:45 PM - Peak 1 of 1																	
Peak Hour for Each Approach Begins at:																	
	01:00 PM				01:00 PM				01:00 PM				01:00 PM				
+0 mins.	0	0	0	0	0	0	0	0	0	0	0	0	0	0	0	0	0
+15 mins.	0	0	0	0	0	0	0	0	0	0	0	0	0	0	0	0	0
+30 mins.	0	0	0	0	0	0	0	0	0	0	0	0	0	0	0	0	0
+45 mins.	0	0	0	0	0	1	0	1	0	0	0	0	0	0	0	0	0
Total Volume	0	0	0	0	0	1	0	1	0	0	0	0	0	0	0	0	0
% App. Total	0	0	0	0	0	100	0	0	0	0	0	0	0	0	0	0	0
PHF	.000	.000	.000	.000	.000	.250	.000	.250	.000	.000	.000	.000	.000	.000	.000	.000	.000

Location: Riverside
 N/S: Barton Street
 E/W: Alessandro Boulevard



Date: 9/17/2022
 Day Saturday

PEDESTRIANS

Time	North Leg Barton Street	East Leg Alessandro Boulevard	South Leg Barton Street	West Leg Alessandro Boulevard	TOTAL
11:00 AM	0	0	0	0	0
11:15 AM	0	0	0	0	0
11:30 AM	0	0	0	0	0
11:45 AM	0	0	0	0	0
12:00 PM	0	0	0	0	0
12:15 PM	0	0	0	0	0
12:30 PM	0	1	0	0	1
12:45 PM	0	1	0	0	1
1:00 PM	0	0	0	0	0
1:15 PM	0	0	0	0	0
1:30 PM	1	0	0	0	1
1:45 PM	0	0	0	0	0
TOTAL VOLUMES:	1	2	0	0	3

Location: Riverside
 N/S: Barton Street
 E/W: Alessandro Boulevard

Date: 9/17/2022
 Day: Saturday



BICYCLES

	Southbound Barton Street			Westbound Alessandro Boulevard			Northbound Barton Street			Eastbound Alessandro Boulevard			
	Left	Thru	Right	Left	Thru	Right	Left	Thru	Right	Left	Thru	Right	
11:00 AM	0	0	0	0	0	0	1	0	0	0	1	0	2
11:15 AM	0	1	0	0	0	0	0	0	0	0	0	0	1
11:30 AM	0	1	0	0	0	0	0	0	0	0	0	0	1
11:45 AM	0	0	0	0	0	0	0	0	0	0	0	0	0
12:00 PM	0	0	0	0	0	0	0	0	0	0	0	0	0
12:15 PM	0	0	0	0	0	0	0	0	0	0	0	0	0
12:30 PM	0	0	0	0	1	0	0	1	0	0	0	0	2
12:45 PM	0	0	0	0	0	0	0	0	0	0	0	0	0
1:00 PM	0	0	0	1	0	0	0	1	0	0	2	0	4
1:15 PM	0	0	0	0	0	0	0	0	0	0	0	0	0
1:30 PM	0	0	0	0	0	0	0	0	0	0	0	0	0
1:45 PM	0	0	0	0	0	0	0	0	0	0	0	0	0
TOTAL VOLUMES:	0	2	0	1	1	0	1	2	0	0	3	0	10

City of Riverside
 N/S: Barton Drive
 E/W: Grove Community Drive
 Weather: Clear

File Name : 12_RIV_Bar Dr_Gr Com Sat
 Site Code : 05122815
 Start Date : 9/17/2022
 Page No : 1

Groups Printed- Passenger Vehicles - Large 2 Axle Vehicles - 3 Axle Vehicles - 4+ Axle Trucks

Start Time	Barton Drive Southbound			Grove Community Drive Westbound			Grove Community Drive Eastbound			Int. Total
	Left	Right	App. Total	Thru	Right	App. Total	Left	Thru	App. Total	
11:00 AM	0	0	0	28	2	30	3	30	33	63
11:15 AM	0	3	3	40	4	44	7	29	36	83
11:30 AM	5	16	21	50	4	54	8	33	41	116
11:45 AM	15	25	40	46	2	48	5	38	43	131
Total	20	44	64	164	12	176	23	130	153	393
12:00 PM	2	4	6	41	4	45	2	27	29	80
12:15 PM	0	1	1	42	7	49	3	31	34	84
12:30 PM	0	4	4	48	3	51	10	33	43	98
12:45 PM	10	18	28	42	4	46	6	48	54	128
Total	12	27	39	173	18	191	21	139	160	390
01:00 PM	7	8	15	24	3	27	8	45	53	95
01:15 PM	3	6	9	33	3	36	1	35	36	81
01:30 PM	0	4	4	34	0	34	2	33	35	73
01:45 PM	0	1	1	39	1	40	3	43	46	87
Total	10	19	29	130	7	137	14	156	170	336
Grand Total	42	90	132	467	37	504	58	425	483	1119
Apprch %	31.8	68.2		92.7	7.3		12	88		
Total %	3.8	8	11.8	41.7	3.3	45	5.2	38	43.2	
Passenger Vehicles	42	90	132	461	37	498	58	418	476	1106
% Passenger Vehicles	100	100	100	98.7	100	98.8	100	98.4	98.6	98.8
Large 2 Axle Vehicles	0	0	0	6	0	6	0	7	7	13
% Large 2 Axle Vehicles	0	0	0	1.3	0	1.2	0	1.6	1.4	1.2
3 Axle Vehicles	0	0	0	0	0	0	0	0	0	0
% 3 Axle Vehicles	0	0	0	0	0	0	0	0	0	0
4+ Axle Trucks	0	0	0	0	0	0	0	0	0	0
% 4+ Axle Trucks	0	0	0	0	0	0	0	0	0	0

Start Time	Barton Drive Southbound			Grove Community Drive Westbound			Grove Community Drive Eastbound			Int. Total
	Left	Right	App. Total	Thru	Right	App. Total	Left	Thru	App. Total	
11:30 AM	5	16	21	50	4	54	8	33	41	116
11:45 AM	15	25	40	46	2	48	5	38	43	131
12:00 PM	2	4	6	41	4	45	2	27	29	80
12:15 PM	0	1	1	42	7	49	3	31	34	84
Total Volume	22	46	68	179	17	196	18	129	147	411
% App. Total	32.4	67.6		91.3	8.7		12.2	87.8		
PHF	.367	.460	.425	.895	.607	.907	.563	.849	.855	.784

Peak Hour Analysis From 11:00 AM to 01:45 PM - Peak 1 of 1
 Peak Hour for Entire Intersection Begins at 11:30 AM

City of Riverside
 N/S: Barton Drive
 E/W: Grove Community Drive
 Weather: Clear

File Name : 12_RIV_Bar Dr_Gr Com Sat
 Site Code : 05122815
 Start Date : 9/17/2022
 Page No : 2

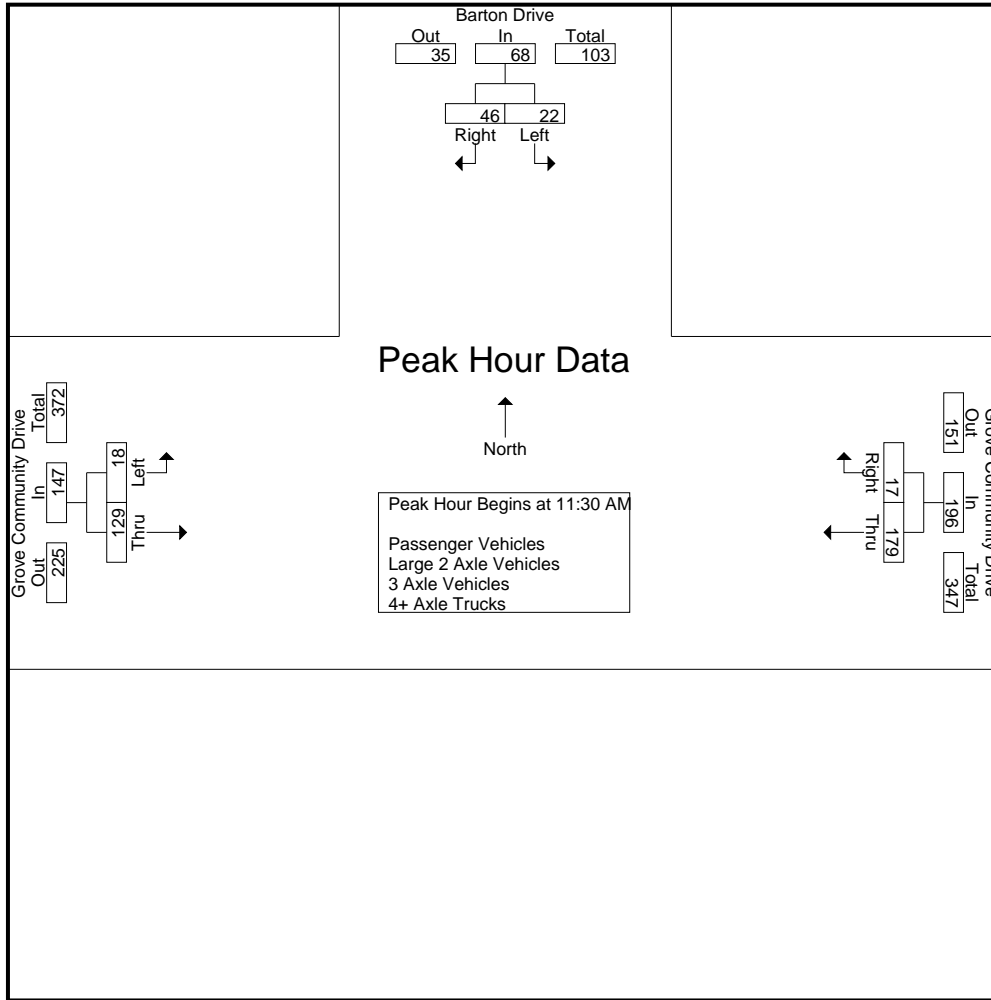

Peak Hour Analysis From 11:00 AM to 01:45 PM - Peak 1 of 1
 Peak Hour for Each Approach Begins at:

	11:15 AM			11:30 AM			12:30 PM		
+0 mins.	0	3	3	50	4	54	10	33	43
+15 mins.	5	16	21	46	2	48	6	48	54
+30 mins.	15	25	40	41	4	45	8	45	53
+45 mins.	2	4	6	42	7	49	1	35	36
Total Volume	22	48	70	179	17	196	25	161	186
% App. Total	31.4	68.6		91.3	8.7		13.4	86.6	
PHF	.367	.480	.438	.895	.607	.907	.625	.839	.861

City of Riverside
 N/S: Barton Drive
 E/W: Grove Community Drive
 Weather: Clear

File Name : 12_RIV_Bar Dr_Gr Com Sat
 Site Code : 05122815
 Start Date : 9/17/2022
 Page No : 1

Groups Printed- Passenger Vehicles

Start Time	Barton Drive Southbound			Grove Community Drive Westbound			Grove Community Drive Eastbound			Int. Total
	Left	Right	App. Total	Thru	Right	App. Total	Left	Thru	App. Total	
11:00 AM	0	0	0	28	2	30	3	30	33	63
11:15 AM	0	3	3	40	4	44	7	29	36	83
11:30 AM	5	16	21	49	4	53	8	33	41	115
11:45 AM	15	25	40	46	2	48	5	36	41	129
Total	20	44	64	163	12	175	23	128	151	390
12:00 PM	2	4	6	40	4	44	2	26	28	78
12:15 PM	0	1	1	40	7	47	3	29	32	80
12:30 PM	0	4	4	48	3	51	10	33	43	98
12:45 PM	10	18	28	42	4	46	6	48	54	128
Total	12	27	39	170	18	188	21	136	157	384
01:00 PM	7	8	15	24	3	27	8	45	53	95
01:15 PM	3	6	9	33	3	36	1	35	36	81
01:30 PM	0	4	4	34	0	34	2	32	34	72
01:45 PM	0	1	1	37	1	38	3	42	45	84
Total	10	19	29	128	7	135	14	154	168	332
Grand Total	42	90	132	461	37	498	58	418	476	1106
Apprch %	31.8	68.2		92.6	7.4		12.2	87.8		
Total %	3.8	8.1	11.9	41.7	3.3	45	5.2	37.8	43	

Start Time	Barton Drive Southbound			Grove Community Drive Westbound			Grove Community Drive Eastbound			Int. Total
	Left	Right	App. Total	Thru	Right	App. Total	Left	Thru	App. Total	
Peak Hour Analysis From 11:30 AM to 12:15 PM - Peak 1 of 1										
Peak Hour for Entire Intersection Begins at 11:30 AM										
11:30 AM	5	16	21	49	4	53	8	33	41	115
11:45 AM	15	25	40	46	2	48	5	36	41	129
12:00 PM	2	4	6	40	4	44	2	26	28	78
12:15 PM	0	1	1	40	7	47	3	29	32	80
Total Volume	22	46	68	175	17	192	18	124	142	402
% App. Total	32.4	67.6		91.1	8.9		12.7	87.3		
PHF	.367	.460	.425	.893	.607	.906	.563	.861	.866	.779

City of Riverside
 N/S: Barton Drive
 E/W: Grove Community Drive
 Weather: Clear

File Name : 12_RIV_Bar Dr_Gr Com Sat
 Site Code : 05122815
 Start Date : 9/17/2022
 Page No : 2

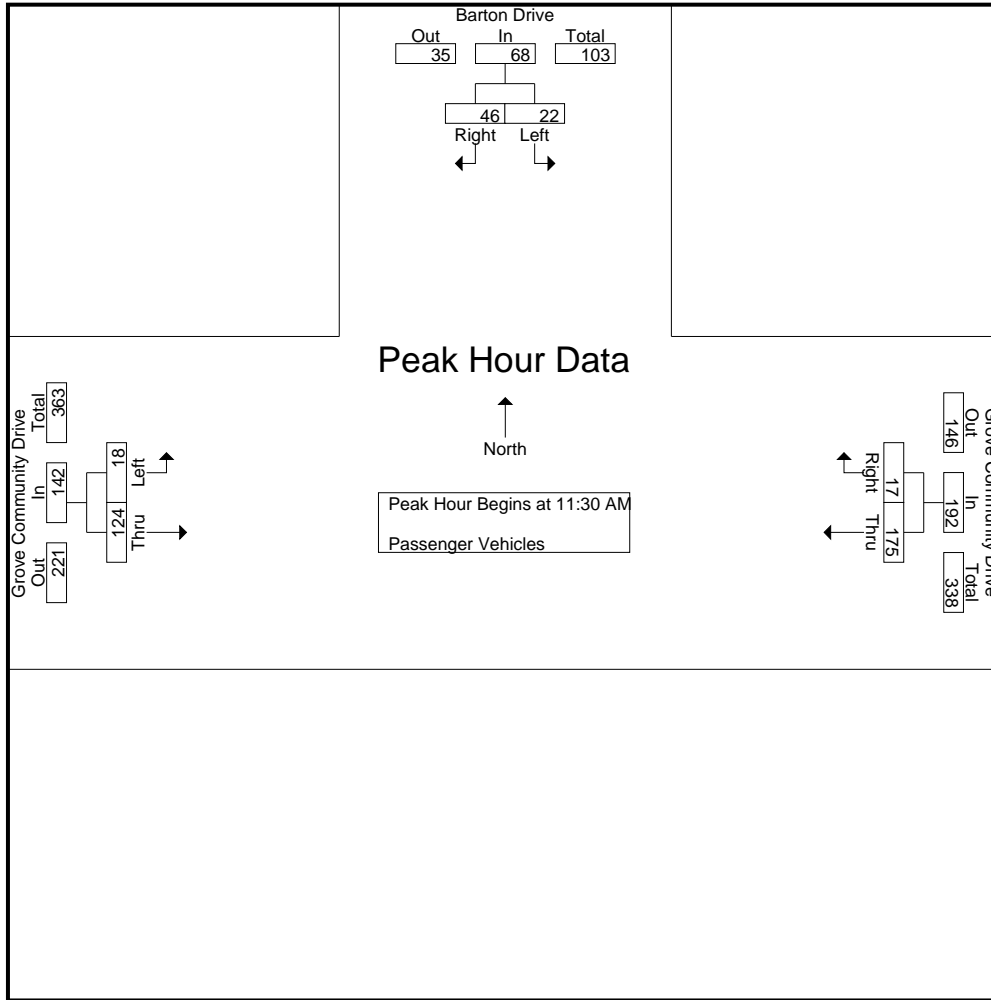

Peak Hour Analysis From 11:30 AM to 12:15 PM - Peak 1 of 1
 Peak Hour for Each Approach Begins at:

	11:30 AM			11:30 AM			11:30 AM		
+0 mins.	5	16	21	49	4	53	8	33	41
+15 mins.	15	25	40	46	2	48	5	36	41
+30 mins.	2	4	6	40	4	44	2	26	28
+45 mins.	0	1	1	40	7	47	3	29	32
Total Volume	22	46	68	175	17	192	18	124	142
% App. Total	32.4	67.6		91.1	8.9		12.7	87.3	
PHF	.367	.460	.425	.893	.607	.906	.563	.861	.866

City of Riverside
 N/S: Barton Drive
 E/W: Grove Community Drive
 Weather: Clear

File Name : 12_RIV_Bar Dr_Gr Com Sat
 Site Code : 05122815
 Start Date : 9/17/2022
 Page No : 1

Groups Printed- Large 2 Axle Vehicles

Start Time	Barton Drive Southbound			Grove Community Drive Westbound			Grove Community Drive Eastbound			Int. Total
	Left	Right	App. Total	Thru	Right	App. Total	Left	Thru	App. Total	
11:00 AM	0	0	0	0	0	0	0	0	0	0
11:15 AM	0	0	0	0	0	0	0	0	0	0
11:30 AM	0	0	0	1	0	1	0	0	0	1
11:45 AM	0	0	0	0	0	0	0	2	2	2
Total	0	0	0	1	0	1	0	2	2	3
12:00 PM	0	0	0	1	0	1	0	1	1	2
12:15 PM	0	0	0	2	0	2	0	2	2	4
12:30 PM	0	0	0	0	0	0	0	0	0	0
12:45 PM	0	0	0	0	0	0	0	0	0	0
Total	0	0	0	3	0	3	0	3	3	6
01:00 PM	0	0	0	0	0	0	0	0	0	0
01:15 PM	0	0	0	0	0	0	0	0	0	0
01:30 PM	0	0	0	0	0	0	0	1	1	1
01:45 PM	0	0	0	2	0	2	0	1	1	3
Total	0	0	0	2	0	2	0	2	2	4
Grand Total	0	0	0	6	0	6	0	7	7	13
Apprch %	0	0	0	100	0	0	0	100	0	
Total %	0	0	0	46.2	0	46.2	0	53.8	53.8	

Start Time	Barton Drive Southbound			Grove Community Drive Westbound			Grove Community Drive Eastbound			Int. Total
	Left	Right	App. Total	Thru	Right	App. Total	Left	Thru	App. Total	
Peak Hour Analysis From 11:30 AM to 12:15 PM - Peak 1 of 1										
Peak Hour for Entire Intersection Begins at 11:30 AM										
11:30 AM	0	0	0	1	0	1	0	0	0	1
11:45 AM	0	0	0	0	0	0	0	2	2	2
12:00 PM	0	0	0	1	0	1	0	1	1	2
12:15 PM	0	0	0	2	0	2	0	2	2	4
Total Volume	0	0	0	4	0	4	0	5	5	9
% App. Total	0	0	0	100	0	0	0	100	0	
PHF	.000	.000	.000	.500	.000	.500	.000	.625	.625	.563

City of Riverside
 N/S: Barton Drive
 E/W: Grove Community Drive
 Weather: Clear

File Name : 12_RIV_Bar Dr_Gr Com Sat
 Site Code : 05122815
 Start Date : 9/17/2022
 Page No : 2

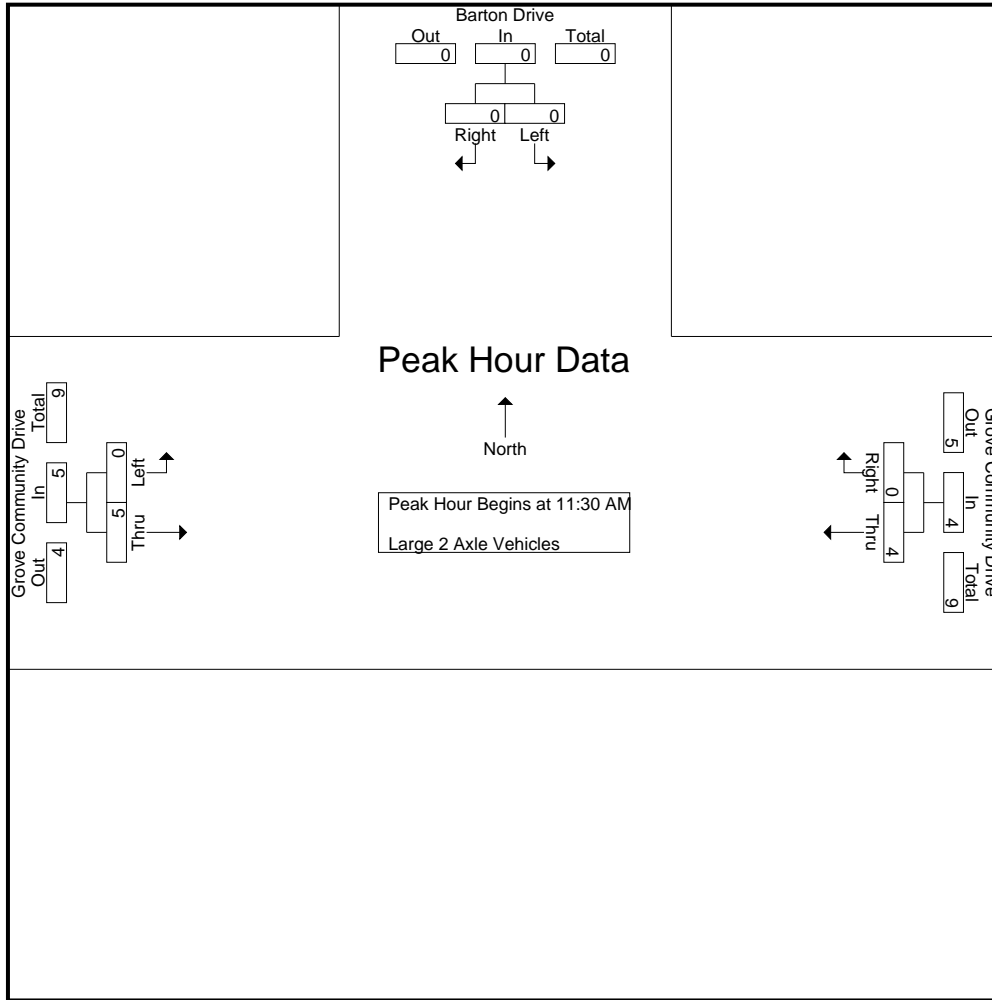

Peak Hour Analysis From 11:30 AM to 12:15 PM - Peak 1 of 1
 Peak Hour for Each Approach Begins at:

	11:30 AM			11:30 AM			11:30 AM		
+0 mins.	0	0	0	1	0	1	0	0	0
+15 mins.	0	0	0	0	0	0	0	2	2
+30 mins.	0	0	0	1	0	1	0	1	1
+45 mins.	0	0	0	2	0	2	0	2	2
Total Volume	0	0	0	4	0	4	0	5	5
% App. Total	0	0	0	100	0	100	0	100	100
PHF	.000	.000	.000	.500	.000	.500	.000	.625	.625

City of Riverside
 N/S: Barton Drive
 E/W: Grove Community Drive
 Weather: Clear

File Name : 12_RIV_Bar Dr_Gr Com Sat
 Site Code : 05122815
 Start Date : 9/17/2022
 Page No : 1

Groups Printed- 3 Axle Vehicles

Start Time	Barton Drive Southbound			Grove Community Drive Westbound			Grove Community Drive Eastbound			Int. Total
	Left	Right	App. Total	Thru	Right	App. Total	Left	Thru	App. Total	
11:00 AM	0	0	0	0	0	0	0	0	0	0
11:15 AM	0	0	0	0	0	0	0	0	0	0
11:30 AM	0	0	0	0	0	0	0	0	0	0
11:45 AM	0	0	0	0	0	0	0	0	0	0
Total	0	0	0	0	0	0	0	0	0	0
12:00 PM	0	0	0	0	0	0	0	0	0	0
12:15 PM	0	0	0	0	0	0	0	0	0	0
12:30 PM	0	0	0	0	0	0	0	0	0	0
12:45 PM	0	0	0	0	0	0	0	0	0	0
Total	0	0	0	0	0	0	0	0	0	0
01:00 PM	0	0	0	0	0	0	0	0	0	0
01:15 PM	0	0	0	0	0	0	0	0	0	0
01:30 PM	0	0	0	0	0	0	0	0	0	0
01:45 PM	0	0	0	0	0	0	0	0	0	0
Total	0	0	0	0	0	0	0	0	0	0
Grand Total	0	0	0	0	0	0	0	0	0	0
Apprch %	0	0		0	0		0	0		
Total %										

Start Time	Barton Drive Southbound			Grove Community Drive Westbound			Grove Community Drive Eastbound			Int. Total
	Left	Right	App. Total	Thru	Right	App. Total	Left	Thru	App. Total	
Peak Hour Analysis From 11:30 AM to 12:15 PM - Peak 1 of 1										
Peak Hour for Entire Intersection Begins at 11:30 AM										
11:30 AM	0	0	0	0	0	0	0	0	0	0
11:45 AM	0	0	0	0	0	0	0	0	0	0
12:00 PM	0	0	0	0	0	0	0	0	0	0
12:15 PM	0	0	0	0	0	0	0	0	0	0
Total Volume	0	0	0	0	0	0	0	0	0	0
% App. Total	0	0		0	0		0	0		
PHF	.000	.000	.000	.000	.000	.000	.000	.000	.000	.000

City of Riverside
 N/S: Barton Drive
 E/W: Grove Community Drive
 Weather: Clear

File Name : 12_RIV_Bar Dr_Gr Com Sat
 Site Code : 05122815
 Start Date : 9/17/2022
 Page No : 2

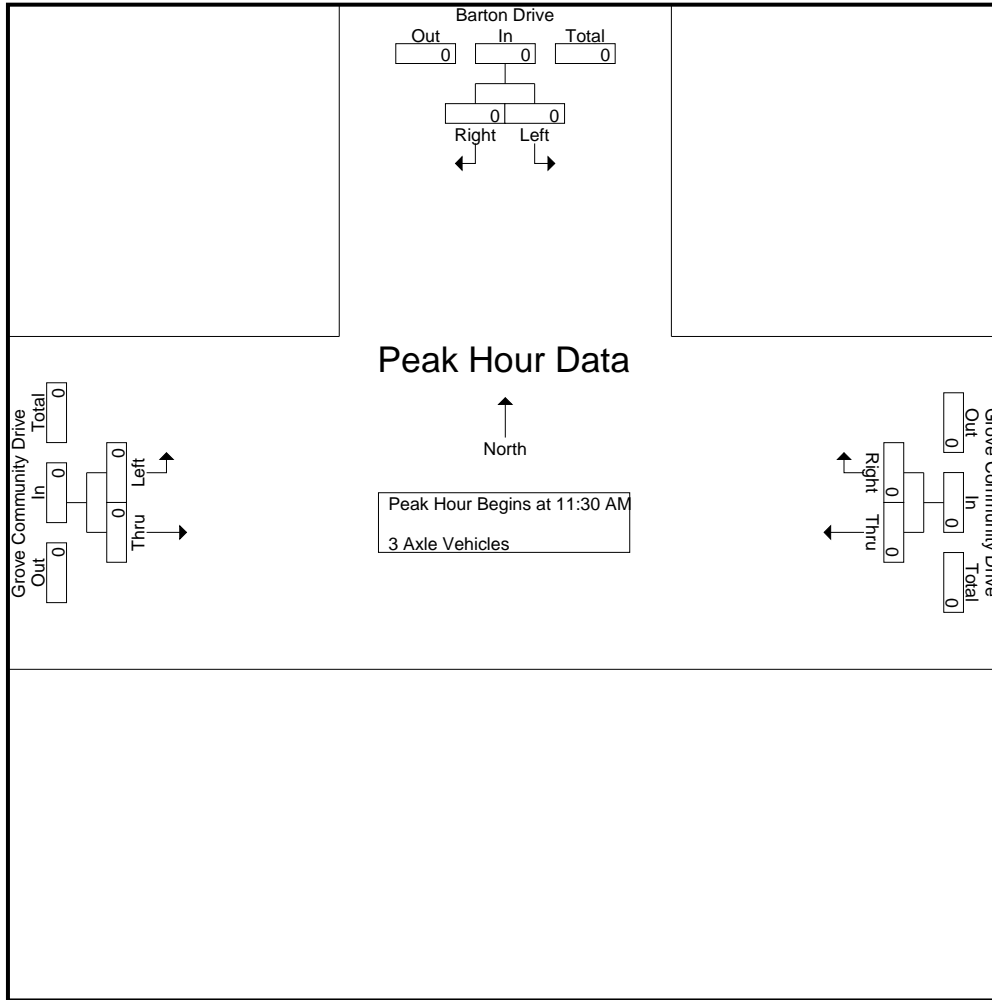

Peak Hour Analysis From 11:30 AM to 12:15 PM - Peak 1 of 1
 Peak Hour for Each Approach Begins at:

	11:30 AM			11:30 AM			11:30 AM		
+0 mins.	0	0	0	0	0	0	0	0	0
+15 mins.	0	0	0	0	0	0	0	0	0
+30 mins.	0	0	0	0	0	0	0	0	0
+45 mins.	0	0	0	0	0	0	0	0	0
Total Volume	0	0	0	0	0	0	0	0	0
% App. Total	0	0	0	0	0	0	0	0	0
PHF	.000	.000	.000	.000	.000	.000	.000	.000	.000

City of Riverside
 N/S: Barton Drive
 E/W: Grove Community Drive
 Weather: Clear

File Name : 12_RIV_Bar Dr_Gr Com Sat
 Site Code : 05122815
 Start Date : 9/17/2022
 Page No : 1

Groups Printed- 4+ Axle Trucks

Start Time	Barton Drive Southbound			Grove Community Drive Westbound			Grove Community Drive Eastbound			Int. Total
	Left	Right	App. Total	Thru	Right	App. Total	Left	Thru	App. Total	
11:00 AM	0	0	0	0	0	0	0	0	0	0
11:15 AM	0	0	0	0	0	0	0	0	0	0
11:30 AM	0	0	0	0	0	0	0	0	0	0
11:45 AM	0	0	0	0	0	0	0	0	0	0
Total	0	0	0	0	0	0	0	0	0	0
12:00 PM	0	0	0	0	0	0	0	0	0	0
12:15 PM	0	0	0	0	0	0	0	0	0	0
12:30 PM	0	0	0	0	0	0	0	0	0	0
12:45 PM	0	0	0	0	0	0	0	0	0	0
Total	0	0	0	0	0	0	0	0	0	0
01:00 PM	0	0	0	0	0	0	0	0	0	0
01:15 PM	0	0	0	0	0	0	0	0	0	0
01:30 PM	0	0	0	0	0	0	0	0	0	0
01:45 PM	0	0	0	0	0	0	0	0	0	0
Total	0	0	0	0	0	0	0	0	0	0
Grand Total	0	0	0	0	0	0	0	0	0	0
Apprch %	0	0		0	0		0	0		
Total %										

Start Time	Barton Drive Southbound			Grove Community Drive Westbound			Grove Community Drive Eastbound			Int. Total
	Left	Right	App. Total	Thru	Right	App. Total	Left	Thru	App. Total	
Peak Hour Analysis From 11:30 AM to 12:15 PM - Peak 1 of 1										
Peak Hour for Entire Intersection Begins at 11:30 AM										
11:30 AM	0	0	0	0	0	0	0	0	0	0
11:45 AM	0	0	0	0	0	0	0	0	0	0
12:00 PM	0	0	0	0	0	0	0	0	0	0
12:15 PM	0	0	0	0	0	0	0	0	0	0
Total Volume	0	0	0	0	0	0	0	0	0	0
% App. Total	0	0		0	0		0	0		
PHF	.000	.000	.000	.000	.000	.000	.000	.000	.000	.000

City of Riverside
 N/S: Barton Drive
 E/W: Grove Community Drive
 Weather: Clear

File Name : 12_RIV_Bar Dr_Gr Com Sat
 Site Code : 05122815
 Start Date : 9/17/2022
 Page No : 2

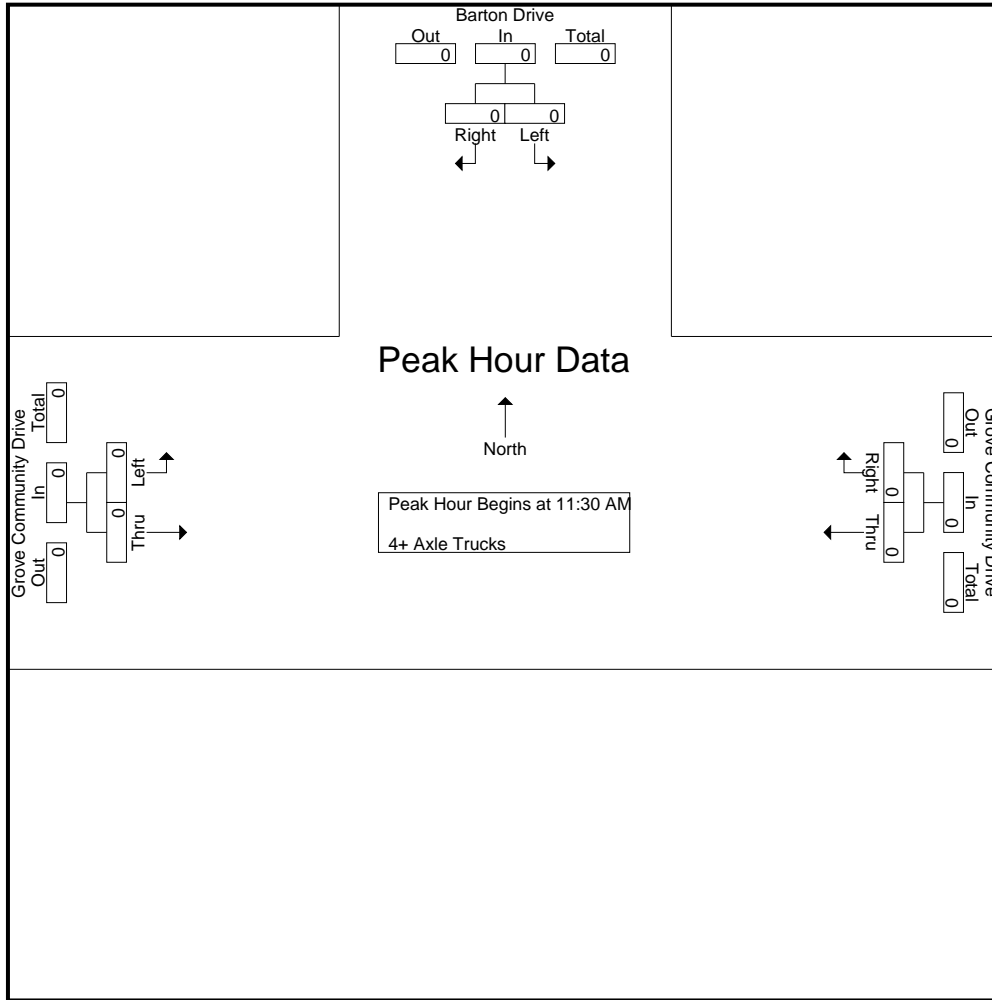

Peak Hour Analysis From 11:30 AM to 12:15 PM - Peak 1 of 1
 Peak Hour for Each Approach Begins at:

	11:30 AM			11:30 AM			11:30 AM		
+0 mins.	0	0	0	0	0	0	0	0	0
+15 mins.	0	0	0	0	0	0	0	0	0
+30 mins.	0	0	0	0	0	0	0	0	0
+45 mins.	0	0	0	0	0	0	0	0	0
Total Volume	0	0	0	0	0	0	0	0	0
% App. Total	0	0	0	0	0	0	0	0	0
PHF	.000	.000	.000	.000	.000	.000	.000	.000	.000

Location: Riverside
 N/S: Barton Drive
 E/W: Grove Community Drive



Date: 9/17/2022
 Day Saturday

PEDESTRIANS

Time	North Leg Barton Drive	East Leg Grove Community Drive	South Leg Dead End	West Leg Grove Community Drive	TOTAL
11:00 AM	0	0	0	0	0
11:15 AM	0	0	0	0	0
11:30 AM	2	0	0	0	2
11:45 AM	0	0	0	0	0
12:00 PM	0	0	0	0	0
12:15 PM	0	0	0	0	0
12:30 PM	1	0	0	0	1
12:45 PM	0	0	0	0	0
1:00 PM	0	0	0	0	0
1:15 PM	0	0	0	0	0
1:30 PM	0	0	0	0	0
1:45 PM	0	0	0	0	0
TOTAL VOLUMES:	3	0	0	0	3

Location: Riverside
 N/S: Barton Drive
 E/W: Grove Community Drive

Date: 9/17/2022
 Day: Saturday



BICYCLES

	Southbound Barton Drive			Westbound Grove Community Drive			Northbound Dead End			Eastbound Grove Community Drive			
	Left	Thru	Right	Left	Thru	Right	Left	Thru	Right	Left	Thru	Right	
11:00 AM	0	0	0	0	1	0	0	0	0	0	0	0	1
11:15 AM	0	0	0	0	3	1	0	0	0	1	1	0	6
11:30 AM	0	1	1	0	0	0	0	0	0	2	0	0	4
11:45 AM	0	0	0	0	0	0	0	0	0	0	0	0	0
12:00 PM	0	0	0	0	0	0	0	0	0	0	0	0	0
12:15 PM	0	0	0	0	0	0	0	0	0	0	0	0	0
12:30 PM	0	0	0	0	0	0	0	0	0	0	0	0	0
12:45 PM	0	0	0	0	0	0	0	0	0	0	0	0	0
1:00 PM	0	0	0	0	0	0	0	0	0	0	0	0	0
1:15 PM	0	0	0	0	0	0	0	0	0	0	0	0	0
1:30 PM	0	0	0	0	0	0	0	0	0	0	0	0	0
1:45 PM	0	0	0	0	0	0	0	0	0	0	0	0	0
TOTAL VOLUMES:	0	1	1	0	4	1	0	0	0	3	1	0	11

City of Riverside
 N/S: Barton Street
 E/W: Orange Terrace Parkway
 Weather: Clear

File Name : 13_RIV_Bar St_Or Ter Sat
 Site Code : 05122815
 Start Date : 9/17/2022
 Page No : 1

Groups Printed- Passenger Vehicles - Large 2 Axle Vehicles - 3 Axle Vehicles - 4+ Axle Trucks

Start Time	Orange Terrace Parkway Westbound			Barton Street Northbound			Orange Terrace Parkway Eastbound			Int. Total
	Left	Thru	App. Total	Left	Right	App. Total	Thru	Right	App. Total	
11:00 AM	6	51	57	17	4	21	39	4	43	121
11:15 AM	3	52	55	11	2	13	54	7	61	129
11:30 AM	4	56	60	10	3	13	52	8	60	133
11:45 AM	9	56	65	9	3	12	44	14	58	135
Total	22	215	237	47	12	59	189	33	222	518
12:00 PM	25	87	112	8	2	10	47	11	58	180
12:15 PM	16	72	88	6	5	11	79	6	85	184
12:30 PM	1	64	65	12	4	16	49	8	57	138
12:45 PM	7	51	58	4	11	15	47	11	58	131
Total	49	274	323	30	22	52	222	36	258	633
01:00 PM	19	62	81	8	7	15	55	10	65	161
01:15 PM	11	51	62	7	10	17	52	2	54	133
01:30 PM	7	57	64	10	8	18	40	4	44	126
01:45 PM	13	59	72	7	12	19	55	7	62	153
Total	50	229	279	32	37	69	202	23	225	573
Grand Total	121	718	839	109	71	180	613	92	705	1724
Apprch %	14.4	85.6		60.6	39.4		87	13		
Total %	7	41.6	48.7	6.3	4.1	10.4	35.6	5.3	40.9	
Passenger Vehicles	121	711	832	108	71	179	609	91	700	1711
% Passenger Vehicles	100	99	99.2	99.1	100	99.4	99.3	98.9	99.3	99.2
Large 2 Axle Vehicles	0	7	7	1	0	1	4	1	5	13
% Large 2 Axle Vehicles	0	1	0.8	0.9	0	0.6	0.7	1.1	0.7	0.8
3 Axle Vehicles	0	0	0	0	0	0	0	0	0	0
% 3 Axle Vehicles	0	0	0	0	0	0	0	0	0	0
4+ Axle Trucks	0	0	0	0	0	0	0	0	0	0
% 4+ Axle Trucks	0	0	0	0	0	0	0	0	0	0

Start Time	Orange Terrace Parkway Westbound			Barton Street Northbound			Orange Terrace Parkway Eastbound			Int. Total
	Left	Thru	App. Total	Left	Right	App. Total	Thru	Right	App. Total	
11:45 AM	9	56	65	9	3	12	44	14	58	135
12:00 PM	25	87	112	8	2	10	47	11	58	180
12:15 PM	16	72	88	6	5	11	79	6	85	184
12:30 PM	1	64	65	12	4	16	49	8	57	138
Total Volume	51	279	330	35	14	49	219	39	258	637
% App. Total	15.5	84.5		71.4	28.6		84.9	15.1		
PHF	.510	.802	.737	.729	.700	.766	.693	.696	.759	.865

Peak Hour Analysis From 11:00 AM to 01:45 PM - Peak 1 of 1
 Peak Hour for Entire Intersection Begins at 11:45 AM

City of Riverside
 N/S: Barton Street
 E/W: Orange Terrace Parkway
 Weather: Clear

File Name : 13_RIV_Bar St_Or Ter Sat
 Site Code : 05122815
 Start Date : 9/17/2022
 Page No : 2

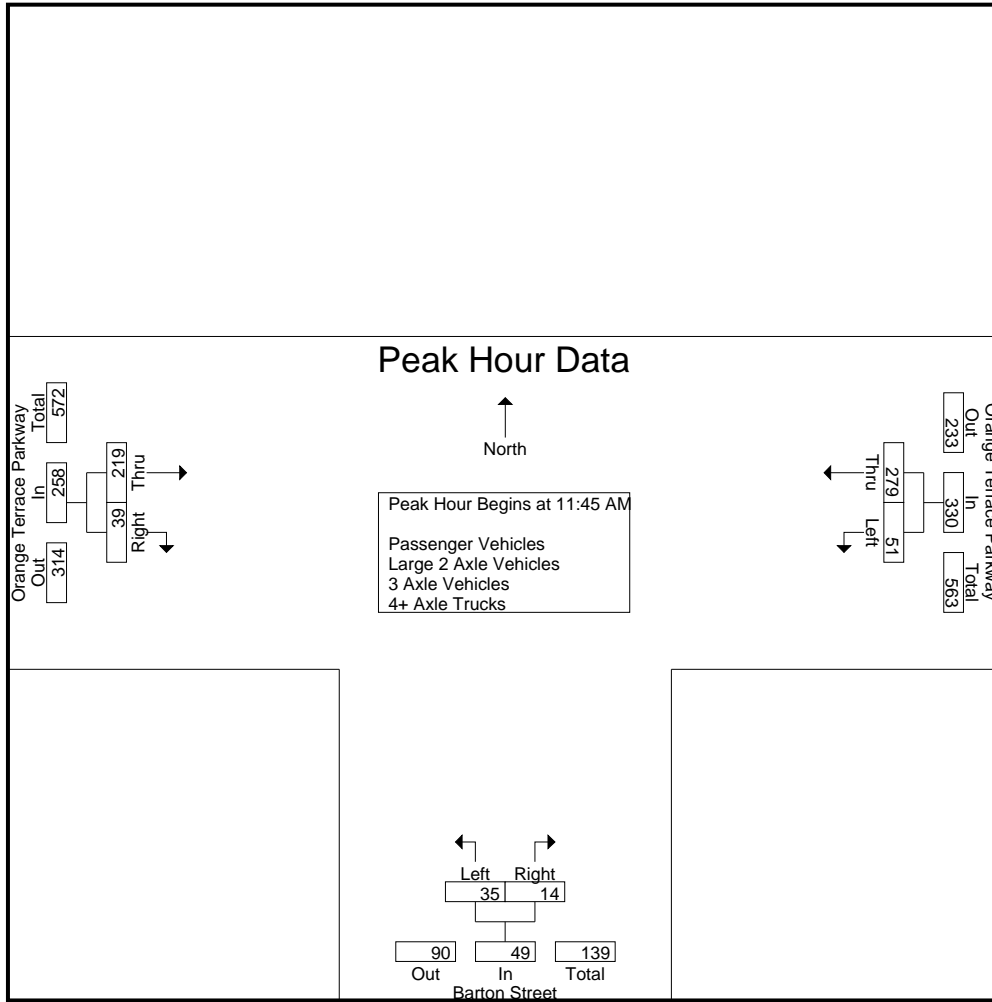

Peak Hour Analysis From 11:00 AM to 01:45 PM - Peak 1 of 1
 Peak Hour for Each Approach Begins at:

	11:45 AM			01:00 PM			12:15 PM		
+0 mins.	9	56	65	8	7	15	79	6	85
+15 mins.	25	87	112	7	10	17	49	8	57
+30 mins.	16	72	88	10	8	18	47	11	58
+45 mins.	1	64	65	7	12	19	55	10	65
Total Volume	51	279	330	32	37	69	230	35	265
% App. Total	15.5	84.5		46.4	53.6		86.8	13.2	
PHF	.510	.802	.737	.800	.771	.908	.728	.795	.779

City of Riverside
 N/S: Barton Street
 E/W: Orange Terrace Parkway
 Weather: Clear

File Name : 13_RIV_Bar St_Or Ter Sat
 Site Code : 05122815
 Start Date : 9/17/2022
 Page No : 1

Groups Printed- Passenger Vehicles

Start Time	Orange Terrace Parkway Westbound			Barton Street Northbound			Orange Terrace Parkway Eastbound			Int. Total
	Left	Thru	App. Total	Left	Right	App. Total	Thru	Right	App. Total	
11:00 AM	6	50	56	17	4	21	38	4	42	119
11:15 AM	3	52	55	11	2	13	54	7	61	129
11:30 AM	4	54	58	10	3	13	52	8	60	131
11:45 AM	9	56	65	9	3	12	44	13	57	134
Total	22	212	234	47	12	59	188	32	220	513
12:00 PM	25	86	111	8	2	10	46	11	57	178
12:15 PM	16	72	88	6	5	11	79	6	85	184
12:30 PM	1	63	64	11	4	15	49	8	57	136
12:45 PM	7	50	57	4	11	15	47	11	58	130
Total	49	271	320	29	22	51	221	36	257	628
01:00 PM	19	61	80	8	7	15	53	10	63	158
01:15 PM	11	51	62	7	10	17	52	2	54	133
01:30 PM	7	57	64	10	8	18	40	4	44	126
01:45 PM	13	59	72	7	12	19	55	7	62	153
Total	50	228	278	32	37	69	200	23	223	570
Grand Total	121	711	832	108	71	179	609	91	700	1711
Apprch %	14.5	85.5		60.3	39.7		87	13		
Total %	7.1	41.6	48.6	6.3	4.1	10.5	35.6	5.3	40.9	

Start Time	Orange Terrace Parkway Westbound			Barton Street Northbound			Orange Terrace Parkway Eastbound			Int. Total
	Left	Thru	App. Total	Left	Right	App. Total	Thru	Right	App. Total	
11:45 AM	9	56	65	9	3	12	44	13	57	134
12:00 PM	25	86	111	8	2	10	46	11	57	178
12:15 PM	16	72	88	6	5	11	79	6	85	184
12:30 PM	1	63	64	11	4	15	49	8	57	136
Total Volume	51	277	328	34	14	48	218	38	256	632
% App. Total	15.5	84.5		70.8	29.2		85.2	14.8		
PHF	.510	.805	.739	.773	.700	.800	.690	.731	.753	.859

Peak Hour Analysis From 11:45 AM to 12:30 PM - Peak 1 of 1
 Peak Hour for Entire Intersection Begins at 11:45 AM

City of Riverside
 N/S: Barton Street
 E/W: Orange Terrace Parkway
 Weather: Clear

File Name : 13_RIV_Bar St_Or Ter Sat
 Site Code : 05122815
 Start Date : 9/17/2022
 Page No : 2

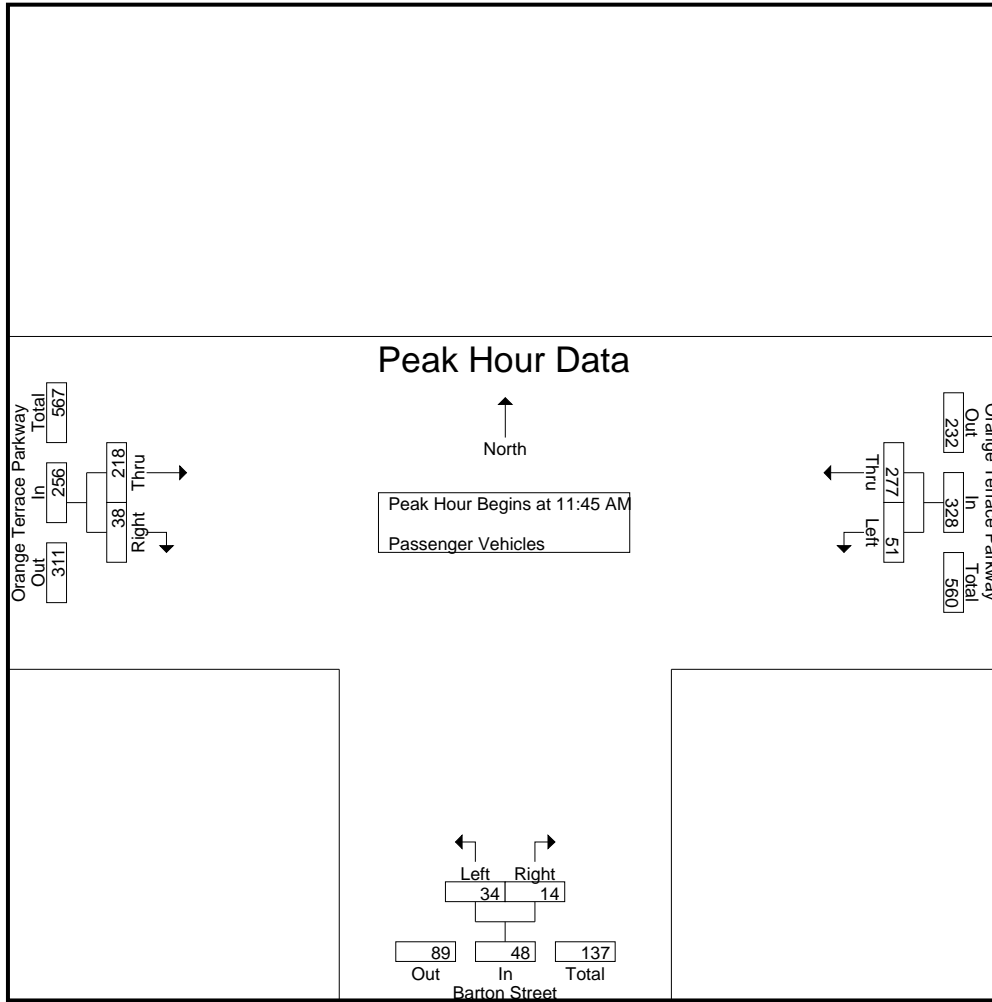

Peak Hour Analysis From 11:45 AM to 12:30 PM - Peak 1 of 1
 Peak Hour for Each Approach Begins at:

	11:45 AM			11:45 AM			11:45 AM		
+0 mins.	9	56	65	9	3	12	44	13	57
+15 mins.	25	86	111	8	2	10	46	11	57
+30 mins.	16	72	88	6	5	11	79	6	85
+45 mins.	1	63	64	11	4	15	49	8	57
Total Volume	51	277	328	34	14	48	218	38	256
% App. Total	15.5	84.5		70.8	29.2		85.2	14.8	
PHF	.510	.805	.739	.773	.700	.800	.690	.731	.753

City of Riverside
 N/S: Barton Street
 E/W: Orange Terrace Parkway
 Weather: Clear

File Name : 13_RIV_Bar St_Or Ter Sat
 Site Code : 05122815
 Start Date : 9/17/2022
 Page No : 1

Groups Printed- Large 2 Axle Vehicles

Start Time	Orange Terrace Parkway Westbound			Barton Street Northbound			Orange Terrace Parkway Eastbound			Int. Total
	Left	Thru	App. Total	Left	Right	App. Total	Thru	Right	App. Total	
11:00 AM	0	1	1	0	0	0	1	0	1	2
11:15 AM	0	0	0	0	0	0	0	0	0	0
11:30 AM	0	2	2	0	0	0	0	0	0	2
11:45 AM	0	0	0	0	0	0	0	1	1	1
Total	0	3	3	0	0	0	1	1	2	5
12:00 PM	0	1	1	0	0	0	1	0	1	2
12:15 PM	0	0	0	0	0	0	0	0	0	0
12:30 PM	0	1	1	1	0	1	0	0	0	2
12:45 PM	0	1	1	0	0	0	0	0	0	1
Total	0	3	3	1	0	1	1	0	1	5
01:00 PM	0	1	1	0	0	0	2	0	2	3
01:15 PM	0	0	0	0	0	0	0	0	0	0
01:30 PM	0	0	0	0	0	0	0	0	0	0
01:45 PM	0	0	0	0	0	0	0	0	0	0
Total	0	1	1	0	0	0	2	0	2	3
Grand Total	0	7	7	1	0	1	4	1	5	13
Apprch %	0	100		100	0		80	20		
Total %	0	53.8	53.8	7.7	0	7.7	30.8	7.7	38.5	

Start Time	Orange Terrace Parkway Westbound			Barton Street Northbound			Orange Terrace Parkway Eastbound			Int. Total
	Left	Thru	App. Total	Left	Right	App. Total	Thru	Right	App. Total	
11:45 AM	0	0	0	0	0	0	0	1	1	1
12:00 PM	0	1	1	0	0	0	1	0	1	2
12:15 PM	0	0	0	0	0	0	0	0	0	0
12:30 PM	0	1	1	1	0	1	0	0	0	2
Total Volume	0	2	2	1	0	1	1	1	2	5
% App. Total	0	100		100	0		50	50		
PHF	.000	.500	.500	.250	.000	.250	.250	.250	.500	.625

Peak Hour Analysis From 11:45 AM to 12:30 PM - Peak 1 of 1

Peak Hour for Entire Intersection Begins at 11:45 AM

City of Riverside
 N/S: Barton Street
 E/W: Orange Terrace Parkway
 Weather: Clear

File Name : 13_RIV_Bar St_Or Ter Sat
 Site Code : 05122815
 Start Date : 9/17/2022
 Page No : 2

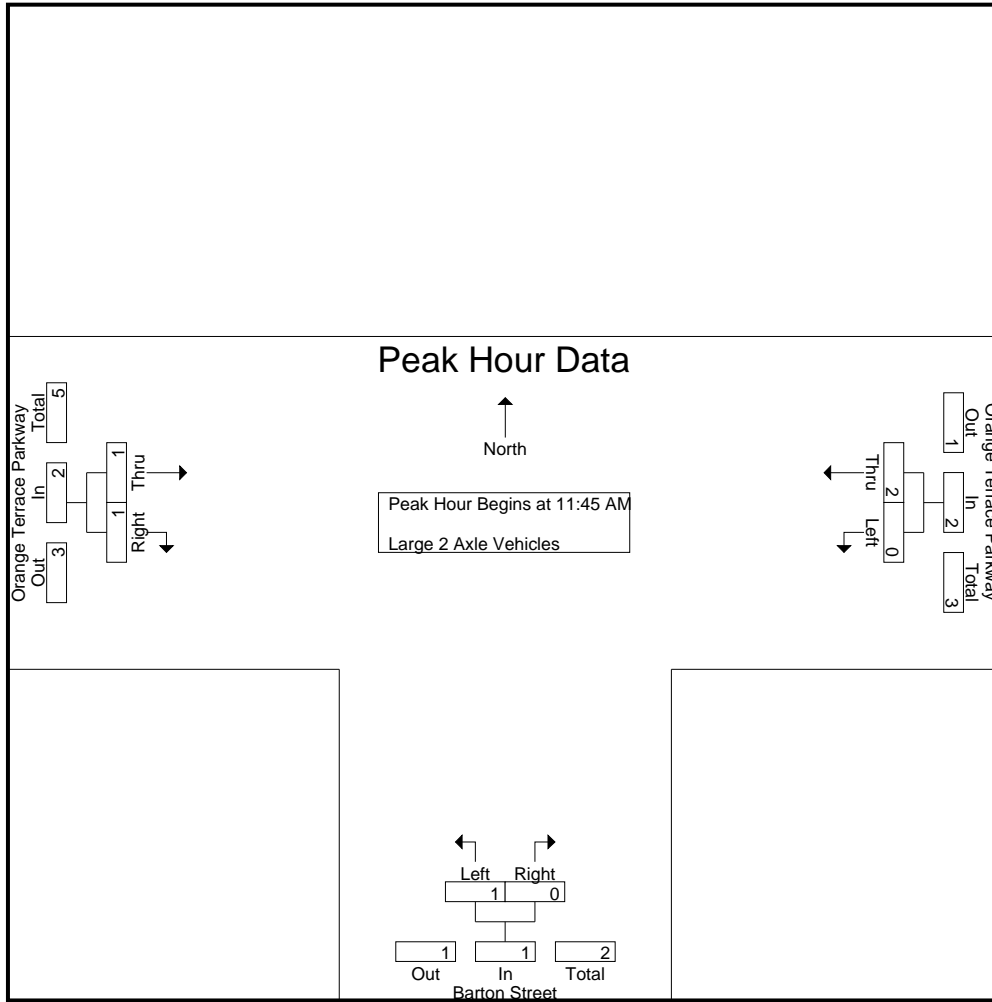

Peak Hour Analysis From 11:45 AM to 12:30 PM - Peak 1 of 1
 Peak Hour for Each Approach Begins at:

	11:45 AM			11:45 AM			11:45 AM		
+0 mins.	0	0	0	0	0	0	0	1	1
+15 mins.	0	1	1	0	0	0	1	0	1
+30 mins.	0	0	0	0	0	0	0	0	0
+45 mins.	0	1	1	1	0	1	0	0	0
Total Volume	0	2	2	1	0	1	1	1	2
% App. Total	0	100		100	0		50	50	
PHF	.000	.500	.500	.250	.000	.250	.250	.250	.500

City of Riverside
 N/S: Barton Street
 E/W: Orange Terrace Parkway
 Weather: Clear

File Name : 13_RIV_Bar St_Or Ter Sat
 Site Code : 05122815
 Start Date : 9/17/2022
 Page No : 1

Groups Printed- 3 Axle Vehicles

Start Time	Orange Terrace Parkway Westbound			Barton Street Northbound			Orange Terrace Parkway Eastbound			Int. Total
	Left	Thru	App. Total	Left	Right	App. Total	Thru	Right	App. Total	
11:00 AM	0	0	0	0	0	0	0	0	0	0
11:15 AM	0	0	0	0	0	0	0	0	0	0
11:30 AM	0	0	0	0	0	0	0	0	0	0
11:45 AM	0	0	0	0	0	0	0	0	0	0
Total	0	0	0	0	0	0	0	0	0	0
12:00 PM	0	0	0	0	0	0	0	0	0	0
12:15 PM	0	0	0	0	0	0	0	0	0	0
12:30 PM	0	0	0	0	0	0	0	0	0	0
12:45 PM	0	0	0	0	0	0	0	0	0	0
Total	0	0	0	0	0	0	0	0	0	0
01:00 PM	0	0	0	0	0	0	0	0	0	0
01:15 PM	0	0	0	0	0	0	0	0	0	0
01:30 PM	0	0	0	0	0	0	0	0	0	0
01:45 PM	0	0	0	0	0	0	0	0	0	0
Total	0	0	0	0	0	0	0	0	0	0
Grand Total	0	0	0	0	0	0	0	0	0	0
Apprch %	0	0		0	0		0	0		
Total %										

Start Time	Orange Terrace Parkway Westbound			Barton Street Northbound			Orange Terrace Parkway Eastbound			Int. Total
	Left	Thru	App. Total	Left	Right	App. Total	Thru	Right	App. Total	
11:45 AM	0	0	0	0	0	0	0	0	0	0
12:00 PM	0	0	0	0	0	0	0	0	0	0
12:15 PM	0	0	0	0	0	0	0	0	0	0
12:30 PM	0	0	0	0	0	0	0	0	0	0
Total Volume	0	0	0	0	0	0	0	0	0	0
% App. Total	0	0		0	0		0	0		
PHF	.000	.000	.000	.000	.000	.000	.000	.000	.000	.000

City of Riverside
 N/S: Barton Street
 E/W: Orange Terrace Parkway
 Weather: Clear

File Name : 13_RIV_Bar St_Or Ter Sat
 Site Code : 05122815
 Start Date : 9/17/2022
 Page No : 2

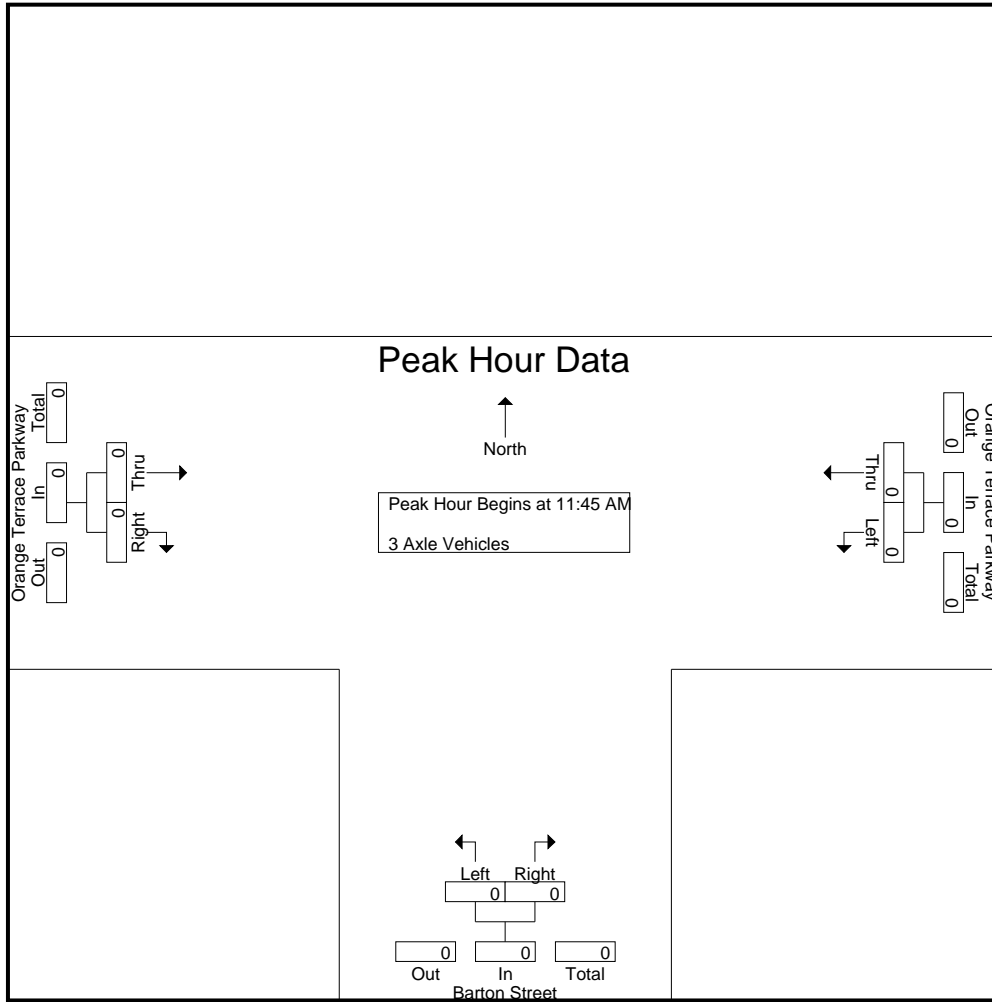

Peak Hour Analysis From 11:45 AM to 12:30 PM - Peak 1 of 1
 Peak Hour for Each Approach Begins at:

	11:45 AM			11:45 AM			11:45 AM		
+0 mins.	0	0	0	0	0	0	0	0	0
+15 mins.	0	0	0	0	0	0	0	0	0
+30 mins.	0	0	0	0	0	0	0	0	0
+45 mins.	0	0	0	0	0	0	0	0	0
Total Volume	0	0	0	0	0	0	0	0	0
% App. Total	0	0	0	0	0	0	0	0	0
PHF	.000	.000	.000	.000	.000	.000	.000	.000	.000

City of Riverside
 N/S: Barton Street
 E/W: Orange Terrace Parkway
 Weather: Clear

File Name : 13_RIV_Bar St_Or Ter Sat
 Site Code : 05122815
 Start Date : 9/17/2022
 Page No : 1

Groups Printed- 4+ Axle Trucks

Start Time	Orange Terrace Parkway Westbound			Barton Street Northbound			Orange Terrace Parkway Eastbound			Int. Total
	Left	Thru	App. Total	Left	Right	App. Total	Thru	Right	App. Total	
11:00 AM	0	0	0	0	0	0	0	0	0	0
11:15 AM	0	0	0	0	0	0	0	0	0	0
11:30 AM	0	0	0	0	0	0	0	0	0	0
11:45 AM	0	0	0	0	0	0	0	0	0	0
Total	0	0	0	0	0	0	0	0	0	0
12:00 PM	0	0	0	0	0	0	0	0	0	0
12:15 PM	0	0	0	0	0	0	0	0	0	0
12:30 PM	0	0	0	0	0	0	0	0	0	0
12:45 PM	0	0	0	0	0	0	0	0	0	0
Total	0	0	0	0	0	0	0	0	0	0
01:00 PM	0	0	0	0	0	0	0	0	0	0
01:15 PM	0	0	0	0	0	0	0	0	0	0
01:30 PM	0	0	0	0	0	0	0	0	0	0
01:45 PM	0	0	0	0	0	0	0	0	0	0
Total	0	0	0	0	0	0	0	0	0	0
Grand Total	0	0	0	0	0	0	0	0	0	0
Apprch %	0	0		0	0		0	0		
Total %										

Start Time	Orange Terrace Parkway Westbound			Barton Street Northbound			Orange Terrace Parkway Eastbound			Int. Total
	Left	Thru	App. Total	Left	Right	App. Total	Thru	Right	App. Total	
11:45 AM	0	0	0	0	0	0	0	0	0	0
12:00 PM	0	0	0	0	0	0	0	0	0	0
12:15 PM	0	0	0	0	0	0	0	0	0	0
12:30 PM	0	0	0	0	0	0	0	0	0	0
Total Volume	0	0	0	0	0	0	0	0	0	0
% App. Total	0	0		0	0		0	0		
PHF	.000	.000	.000	.000	.000	.000	.000	.000	.000	.000

City of Riverside
 N/S: Barton Street
 E/W: Orange Terrace Parkway
 Weather: Clear

File Name : 13_RIV_Bar St_Or Ter Sat
 Site Code : 05122815
 Start Date : 9/17/2022
 Page No : 2

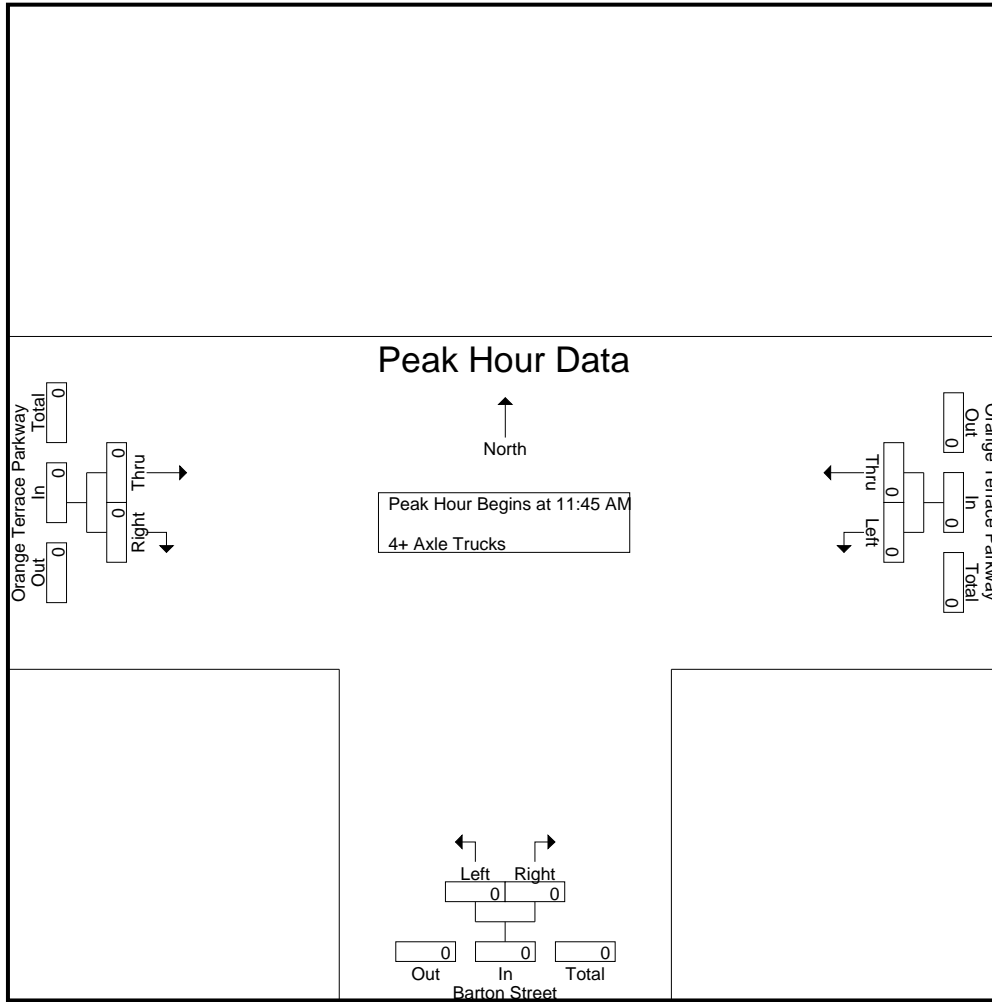

Peak Hour Analysis From 11:45 AM to 12:30 PM - Peak 1 of 1
 Peak Hour for Each Approach Begins at:

	11:45 AM			11:45 AM			11:45 AM		
+0 mins.	0	0	0	0	0	0	0	0	0
+15 mins.	0	0	0	0	0	0	0	0	0
+30 mins.	0	0	0	0	0	0	0	0	0
+45 mins.	0	0	0	0	0	0	0	0	0
Total Volume	0	0	0	0	0	0	0	0	0
% App. Total	0	0	0	0	0	0	0	0	0
PHF	.000	.000	.000	.000	.000	.000	.000	.000	.000

Location: Riverside
 N/S: Barton Street
 E/W: Orange Terrace Parkway



Date: 9/17/2022
 Day Saturday

PEDESTRIANS

Time	North Leg Dead End	East Leg Orange Terrace Parkway	South Leg Barton Street	West Leg Orange Terrace Parkway	TOTAL
11:00 AM	0	0	0	0	0
11:15 AM	0	0	1	0	1
11:30 AM	0	0	0	0	0
11:45 AM	0	0	0	1	1
12:00 PM	0	0	1	0	1
12:15 PM	0	0	1	1	2
12:30 PM	0	0	0	0	0
12:45 PM	0	0	0	0	0
1:00 PM	0	0	0	0	0
1:15 PM	0	0	0	0	0
1:30 PM	0	0	0	0	0
1:45 PM	0	0	1	0	1
TOTAL VOLUMES:	0	0	4	2	6

Location: Riverside
 N/S: Barton Street
 E/W: Orange Terrace Parkway

Date: 9/17/2022
 Day: Saturday



BICYCLES

	Southbound Dead End			Westbound Orange Terrace Parkway			Northbound Barton Street			Eastbound Orange Terrace Parkway			
	Left	Thru	Right	Left	Thru	Right	Left	Thru	Right	Left	Thru	Right	
11:00 AM	0	0	0	0	0	0	0	0	0	0	0	0	0
11:15 AM	0	0	0	0	0	0	0	0	0	0	0	0	3
11:30 AM	0	0	0	0	1	0	1	0	0	0	0	0	2
11:45 AM	0	0	0	0	0	0	1	0	0	0	0	0	1
12:00 PM	0	0	0	0	0	0	0	0	0	0	0	0	0
12:15 PM	0	0	0	0	0	0	0	0	0	0	0	0	0
12:30 PM	0	1	0	0	0	0	0	0	0	0	0	0	1
12:45 PM	0	0	0	0	0	0	0	0	0	0	0	0	0
1:00 PM	0	0	0	0	0	0	0	0	0	0	0	0	0
1:15 PM	0	0	0	0	0	0	0	0	0	0	0	0	0
1:30 PM	0	0	0	0	0	0	0	0	0	0	0	0	0
1:45 PM	0	0	0	0	0	0	0	0	0	0	0	0	0
TOTAL VOLUMES:	0	1	0	0	1	0	2	0	0	0	0	3	7

City of Riverside
 N/S: Barton Street
 E/W: Van Buren Boulevard
 Weather: Clear

File Name : 14_RIV_Bar St_VB Sat
 Site Code : 05122815
 Start Date : 9/17/2022
 Page No : 1

Groups Printed- Passenger Vehicles - Large 2 Axle Vehicles - 3 Axle Vehicles - 4+ Axle Trucks

Start Time	Barton Street Southbound					Van Buren Boulevard Westbound					Barton Street Northbound					Van Buren Boulevard Eastbound					Exclu. Total	Inclu. Total	Int. Total
	Left	Thru	Right	RTOR	App. Total	Left	Thru	Right	RTOR	App. Total	Left	Thru	Right	RTOR	App. Total	Left	Thru	Right	RTOR	App. Total			
11:00 AM	5	4	25	22	34	28	166	10	2	204	47	9	35	23	91	17	169	38	4	224	51	553	604
11:15 AM	5	1	19	18	25	29	182	9	3	220	56	6	27	15	89	20	159	29	1	208	37	542	579
11:30 AM	10	2	20	16	32	36	176	9	1	221	46	6	38	26	90	15	160	31	5	206	48	549	597
11:45 AM	9	12	22	13	43	38	207	8	3	253	41	4	31	22	76	10	155	33	4	198	42	570	612
Total	29	19	86	69	134	131	731	36	9	898	190	25	131	86	346	62	643	131	14	836	178	2214	2392
12:00 PM	10	13	12	7	35	38	177	6	1	221	40	3	49	32	92	19	156	34	8	209	48	557	605
12:15 PM	9	11	18	13	38	42	230	12	3	284	28	4	26	19	58	21	186	33	5	240	40	620	660
12:30 PM	4	5	19	16	28	44	208	8	1	260	47	9	35	25	91	24	156	30	3	210	45	589	634
12:45 PM	10	4	22	18	36	37	202	11	3	250	51	7	28	20	86	15	186	34	6	235	47	607	654
Total	33	33	71	54	137	161	817	37	8	1015	166	23	138	96	327	79	684	131	22	894	180	2373	2553
01:00 PM	6	10	19	12	35	49	221	6	0	276	39	15	39	21	93	24	168	33	3	225	36	629	665
01:15 PM	6	7	24	15	37	61	213	11	3	285	60	7	41	24	108	13	223	43	6	279	48	709	757
01:30 PM	8	2	21	17	31	32	182	9	4	223	54	5	25	12	84	21	199	37	4	257	37	595	632
01:45 PM	5	6	21	15	32	33	200	8	2	241	42	11	36	21	89	22	188	49	9	259	47	621	668
Total	25	25	85	59	135	175	816	34	9	1025	195	38	141	78	374	80	778	162	22	1020	168	2554	2722
Grand Total	87	77	242	182	406	467	2364	107	26	2938	551	86	410	260	1047	221	2105	424	58	2750	526	7141	7667
Apprch %	21.4	19	59.6			15.9	80.5	3.6			52.6	8.2	39.2			8	76.5	15.4					
Total %	1.2	1.1	3.4		5.7	6.5	33.1	1.5		41.1	7.7	1.2	5.7		14.7	3.1	29.5	5.9		38.5	6.9	93.1	
Passenger Vehicles	86	77	242		587	461	2332	106		2924	543	86	405		1293	221	2069	415		2762	0	0	7566
% Passenger Vehicles	98.9	100	100	100	99.8	98.7	98.6	99.1	96.2	98.7	98.5	100	98.8	99.6	98.9	100	98.3	97.9	98.3	98.4	0	0	98.7
Large 2 Axle Vehicles	1	0	0		1	6	28	0		34	7	0	4		11	0	31	7		38	0	0	84
% Large 2 Axle Vehicles	1.1	0	0	0	0.2	1.3	1.2	0	0	1.1	1.3	0	1	0	0.8	0	1.5	1.7	0	1.4	0	0	1.1
3 Axle Vehicles	0	0	0		0	0	3	1		5	1	0	0		1	0	1	1		3	0	0	9
% 3 Axle Vehicles	0	0	0	0	0	0	0.1	0.9	3.8	0.2	0.2	0	0	0	0.1	0	0	0.2	1.7	0.1	0	0	0.1
4+ Axle Trucks	0	0	0		0	0	1	0		1	0	0	1		2	0	4	1		5	0	0	8
% 4+ Axle Trucks	0	0	0	0	0	0	0	0	0	0	0	0	0.2	0.4	0.2	0	0.2	0.2	0	0.2	0	0	0.1

City of Riverside
 N/S: Barton Street
 E/W: Van Buren Boulevard
 Weather: Clear

File Name : 14_RIV_Bar St_VB Sat
 Site Code : 05122815
 Start Date : 9/17/2022
 Page No : 2

Start Time	Barton Street Southbound				Van Buren Boulevard Westbound				Barton Street Northbound				Van Buren Boulevard Eastbound				Int. Total
	Left	Thru	Right	App. Total	Left	Thru	Right	App. Total	Left	Thru	Right	App. Total	Left	Thru	Right	App. Total	
Peak Hour Analysis From 11:00 AM to 01:45 PM - Peak 1 of 1																	
Peak Hour for Entire Intersection Begins at 01:00 PM																	
01:00 PM	6	10	19	35	49	221	6	276	39	15	39	93	24	168	33	225	629
01:15 PM	6	7	24	37	61	213	11	285	60	7	41	108	13	223	43	279	709
01:30 PM	8	2	21	31	32	182	9	223	54	5	25	84	21	199	37	257	595
01:45 PM	5	6	21	32	33	200	8	241	42	11	36	89	22	188	49	259	621
Total Volume	25	25	85	135	175	816	34	1025	195	38	141	374	80	778	162	1020	2554
% App. Total	18.5	18.5	63		17.1	79.6	3.3		52.1	10.2	37.7		7.8	76.3	15.9		
PHF	.781	.625	.885	.912	.717	.923	.773	.899	.813	.633	.860	.866	.833	.872	.827	.914	.901

City of Riverside
 N/S: Barton Street
 E/W: Van Buren Boulevard
 Weather: Clear

File Name : 14_RIV_Bar St_VB Sat
 Site Code : 05122815
 Start Date : 9/17/2022
 Page No : 3

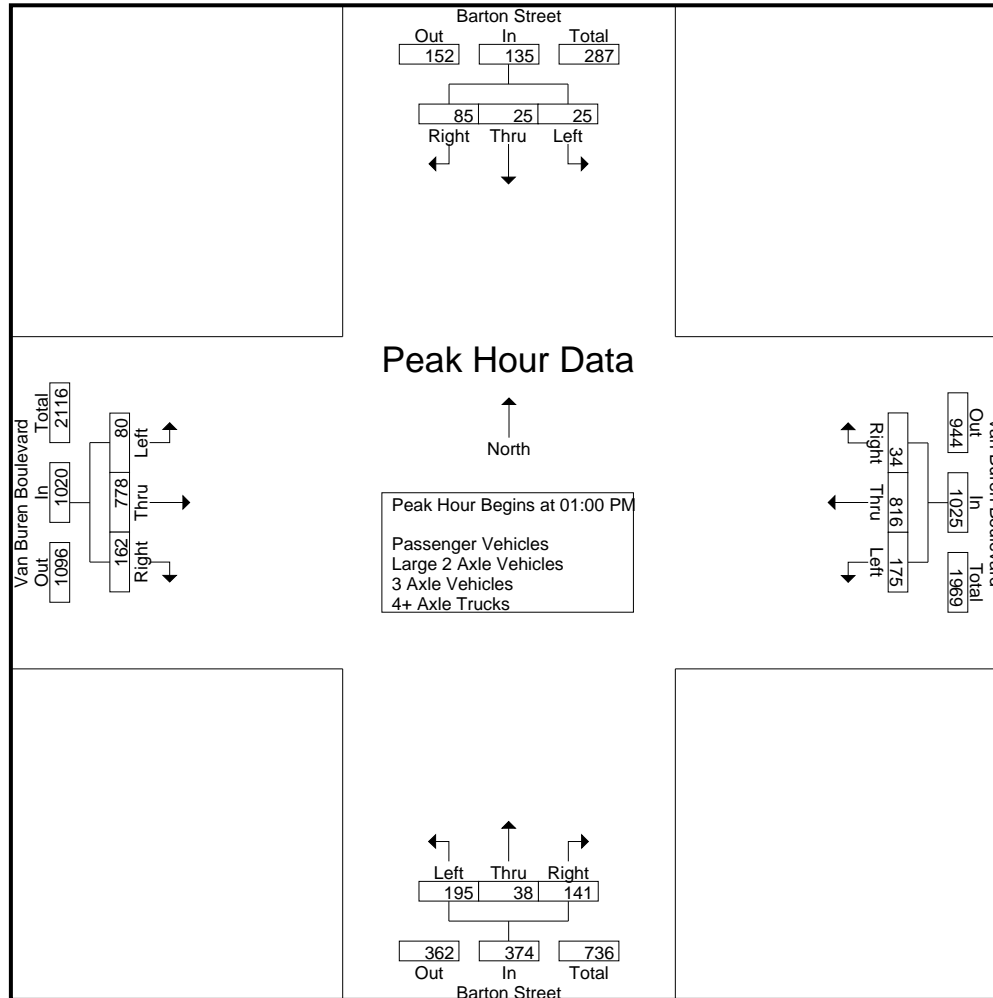

City of Riverside
 N/S: Barton Street
 E/W: Van Buren Boulevard
 Weather: Clear

File Name : 14_RIV_Bar St_VB Sat
 Site Code : 05122815
 Start Date : 9/17/2022
 Page No : 4

Start Time	Barton Street Southbound				Van Buren Boulevard Westbound				Barton Street Northbound				Van Buren Boulevard Eastbound				Int. Total
	Left	Thru	Right	App. Total	Left	Thru	Right	App. Total	Left	Thru	Right	App. Total	Left	Thru	Right	App. Total	
Peak Hour Analysis From 11:00 AM to 01:45 PM - Peak 1 of 1																	
Peak Hour for Each Approach Begins at:																	
	11:30 AM				12:30 PM				12:30 PM				01:00 PM				
+0 mins.	10	2	20	32	44	208	8	260	47	9	35	91	24	168	33	225	
+15 mins.	9	12	22	43	37	202	11	250	51	7	28	86	13	223	43	279	
+30 mins.	10	13	12	35	49	221	6	276	39	15	39	93	21	199	37	257	
+45 mins.	9	11	18	38	61	213	11	285	60	7	41	108	22	188	49	259	
Total Volume	38	38	72	148	191	844	36	1071	197	38	143	378	80	778	162	1020	
% App. Total	25.7	25.7	48.6		17.8	78.8	3.4		52.1	10.1	37.8		7.8	76.3	15.9		
PHF	.950	.731	.818	.860	.783	.955	.818	.939	.821	.633	.872	.875	.833	.872	.827	.914	

City of Riverside
 N/S: Barton Street
 E/W: Van Buren Boulevard
 Weather: Clear

File Name : 14_RIV_Bar St_VB Sat
 Site Code : 05122815
 Start Date : 9/17/2022
 Page No : 1

Groups Printed- Passenger Vehicles

Start Time	Barton Street Southbound					Van Buren Boulevard Westbound					Barton Street Northbound					Van Buren Boulevard Eastbound					Exclu. Total	Inclu. Total	Int. Total
	Left	Thru	Right	RTOR	App. Total	Left	Thru	Right	RTOR	App. Total	Left	Thru	Right	RTOR	App. Total	Left	Thru	Right	RTOR	App. Total			
11:00 AM	5	4	25	22	34	28	165	10	2	203	46	9	34	23	89	17	166	38	4	221	51	547	598
11:15 AM	5	1	19	18	25	29	179	9	3	217	56	6	26	15	88	20	158	27	1	205	37	535	572
11:30 AM	10	2	20	16	32	34	173	9	1	216	45	6	38	26	89	15	159	31	5	205	48	542	590
11:45 AM	9	12	22	13	43	38	206	8	3	252	40	4	31	22	75	10	153	32	4	195	42	565	607
Total	29	19	86	69	134	129	723	36	9	888	187	25	129	86	341	62	636	128	14	826	178	2189	2367
12:00 PM	10	13	12	7	35	38	175	6	1	219	40	3	49	32	92	19	153	33	8	205	48	551	599
12:15 PM	9	11	18	13	38	41	228	12	3	281	28	4	26	19	58	21	180	33	5	234	40	611	651
12:30 PM	4	5	19	16	28	43	204	8	1	255	47	9	34	24	90	24	152	30	3	206	44	579	623
12:45 PM	10	4	22	18	36	37	200	11	3	248	47	7	28	20	82	15	183	32	5	230	46	596	642
Total	33	33	71	54	137	159	807	37	8	1003	162	23	137	95	322	79	668	128	21	875	178	2337	2515
01:00 PM	6	10	19	12	35	48	216	6	0	270	39	15	38	21	92	24	167	33	3	224	36	621	657
01:15 PM	5	7	24	15	36	60	212	10	2	282	60	7	41	24	108	13	219	42	6	274	47	700	747
01:30 PM	8	2	21	17	31	32	179	9	4	220	53	5	24	12	82	21	194	37	4	252	37	585	622
01:45 PM	5	6	21	15	32	33	195	8	2	236	42	11	36	21	89	22	185	47	9	254	47	611	658
Total	24	25	85	59	134	173	802	33	8	1008	194	38	139	78	371	80	765	159	22	1004	167	2517	2684
Grand Total	86	77	242	182	405	461	2332	106	25	2899	543	86	405	259	1034	221	2069	415	57	2705	523	7043	7566
Apprch %	21.2	19	59.8			15.9	80.4	3.7			52.5	8.3	39.2			8.2	76.5	15.3					
Total %	1.2	1.1	3.4		5.8	6.5	33.1	1.5		41.2	7.7	1.2	5.8		14.7	3.1	29.4	5.9		38.4	6.9	93.1	

Start Time	Barton Street Southbound				Van Buren Boulevard Westbound				Barton Street Northbound				Van Buren Boulevard Eastbound				Int. Total
	Left	Thru	Right	App. Total	Left	Thru	Right	App. Total	Left	Thru	Right	App. Total	Left	Thru	Right	App. Total	
Peak Hour Analysis From 01:00 PM to 01:45 PM - Peak 1 of 1																	
Peak Hour for Entire Intersection Begins at 01:00 PM																	
01:00 PM	6	10	19	35	48	216	6	270	39	15	38	92	24	167	33	224	621
01:15 PM	5	7	24	36	60	212	10	282	60	7	41	108	13	219	42	274	700
01:30 PM	8	2	21	31	32	179	9	220	53	5	24	82	21	194	37	252	585
01:45 PM	5	6	21	32	33	195	8	236	42	11	36	89	22	185	47	254	611
Total Volume	24	25	85	134	173	802	33	1008	194	38	139	371	80	765	159	1004	2517
% App. Total	17.9	18.7	63.4		17.2	79.6	3.3		52.3	10.2	37.5		8	76.2	15.8		
PHF	.750	.625	.885	.931	.721	.928	.825	.894	.808	.633	.848	.859	.833	.873	.846	.916	.899

City of Riverside
 N/S: Barton Street
 E/W: Van Buren Boulevard
 Weather: Clear

File Name : 14_RIV_Bar St_VB Sat
 Site Code : 05122815
 Start Date : 9/17/2022
 Page No : 2

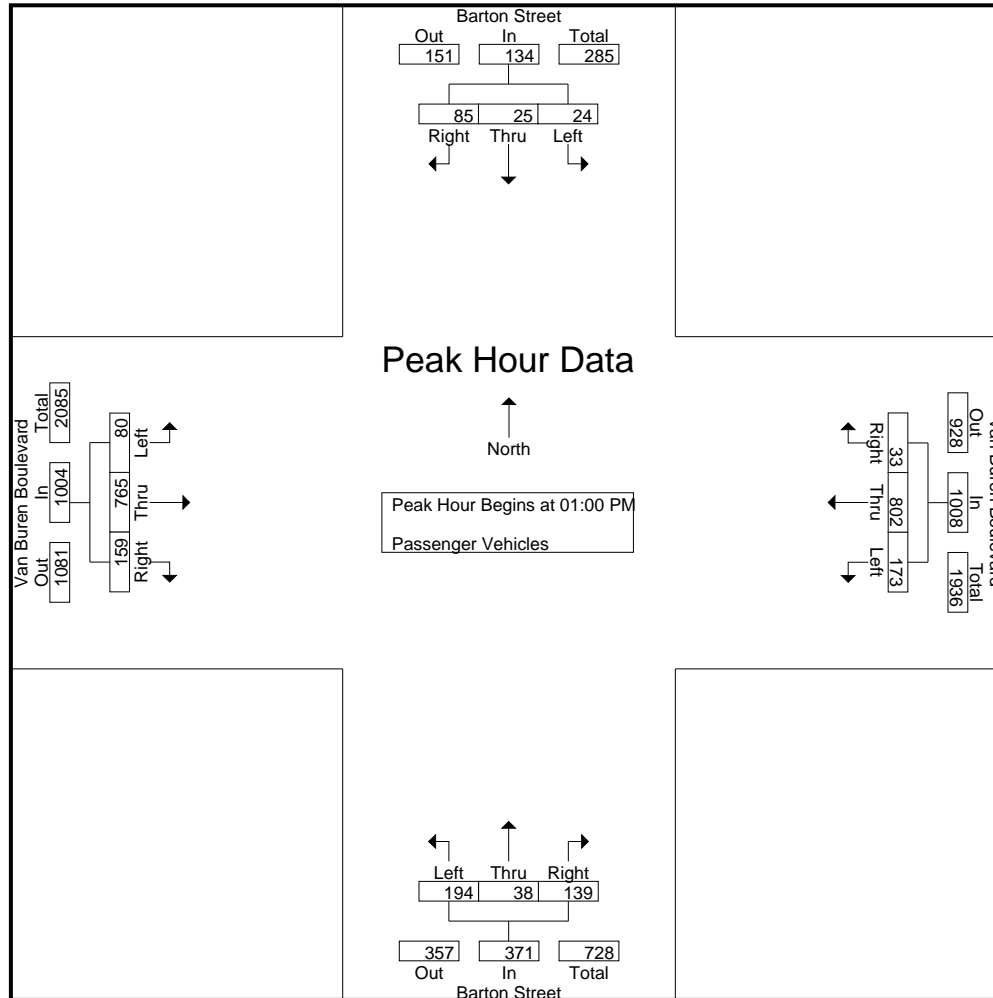

City of Riverside
 N/S: Barton Street
 E/W: Van Buren Boulevard
 Weather: Clear

File Name : 14_RIV_Bar St_VB Sat
 Site Code : 05122815
 Start Date : 9/17/2022
 Page No : 3

Start Time	Barton Street Southbound				Van Buren Boulevard Westbound				Barton Street Northbound				Van Buren Boulevard Eastbound				Int. Total
	Left	Thru	Right	App. Total	Left	Thru	Right	App. Total	Left	Thru	Right	App. Total	Left	Thru	Right	App. Total	
Peak Hour Analysis From 01:00 PM to 01:45 PM - Peak 1 of 1																	
Peak Hour for Each Approach Begins at:																	
	01:00 PM				01:00 PM				01:00 PM				01:00 PM				
+0 mins.	6	10	19	35	48	216	6	270	39	15	38	92	24	167	33	224	
+15 mins.	5	7	24	36	60	212	10	282	60	7	41	108	13	219	42	274	
+30 mins.	8	2	21	31	32	179	9	220	53	5	24	82	21	194	37	252	
+45 mins.	5	6	21	32	33	195	8	236	42	11	36	89	22	185	47	254	
Total Volume	24	25	85	134	173	802	33	1008	194	38	139	371	80	765	159	1004	
% App. Total	17.9	18.7	63.4		17.2	79.6	3.3		52.3	10.2	37.5		8	76.2	15.8		
PHF	.750	.625	.885	.931	.721	.928	.825	.894	.808	.633	.848	.859	.833	.873	.846	.916	

City of Riverside
 N/S: Barton Street
 E/W: Van Buren Boulevard
 Weather: Clear

File Name : 14_RIV_Bar St_VB Sat
 Site Code : 05122815
 Start Date : 9/17/2022
 Page No : 1

Groups Printed- Large 2 Axle Vehicles

Start Time	Barton Street Southbound					Van Buren Boulevard Westbound					Barton Street Northbound					Van Buren Boulevard Eastbound					Exclu. Total	Inclu. Total	Int. Total	
	Left	Thru	Right	RTOR	App. Total	Left	Thru	Right	RTOR	App. Total	Left	Thru	Right	RTOR	App. Total	Left	Thru	Right	RTOR	App. Total				
11:00 AM	0	0	0	0	0	0	1	0	0	1	1	0	1	0	2	0	2	0	0	2	0	0	5	5
11:15 AM	0	0	0	0	0	0	3	0	0	3	0	0	1	0	1	0	1	2	0	3	0	0	7	7
11:30 AM	0	0	0	0	0	2	1	0	0	3	0	0	0	0	0	0	1	0	0	1	0	0	4	4
11:45 AM	0	0	0	0	0	0	1	0	0	1	1	0	0	0	1	0	1	1	0	2	0	0	4	4
Total	0	0	0	0	0	2	6	0	0	8	2	0	2	0	4	0	5	3	0	8	0	0	20	20
12:00 PM	0	0	0	0	0	0	2	0	0	2	0	0	0	0	0	0	3	1	0	4	0	0	6	6
12:15 PM	0	0	0	0	0	1	1	0	0	2	0	0	0	0	0	0	6	0	0	6	0	0	8	8
12:30 PM	0	0	0	0	0	1	3	0	0	4	0	0	0	0	0	0	4	0	0	4	0	0	8	8
12:45 PM	0	0	0	0	0	0	2	0	0	2	4	0	0	0	4	0	2	1	0	3	0	0	9	9
Total	0	0	0	0	0	2	8	0	0	10	4	0	0	0	4	0	15	2	0	17	0	0	31	31
01:00 PM	0	0	0	0	0	1	5	0	0	6	0	0	1	0	1	0	1	0	0	1	0	0	8	8
01:15 PM	1	0	0	0	1	1	1	0	0	2	0	0	0	0	0	0	4	0	0	4	0	0	7	7
01:30 PM	0	0	0	0	0	0	3	0	0	3	1	0	1	0	2	0	4	0	0	4	0	0	9	9
01:45 PM	0	0	0	0	0	0	5	0	0	5	0	0	0	0	0	0	2	2	0	4	0	0	9	9
Total	1	0	0	0	1	2	14	0	0	16	1	0	2	0	3	0	11	2	0	13	0	0	33	33
Grand Total	1	0	0	0	1	6	28	0	0	34	7	0	4	0	11	0	31	7	0	38	0	0	84	84
Apprch %	100	0	0			17.6	82.4	0			63.6	0	36.4			0	81.6	18.4						
Total %	1.2	0	0		1.2	7.1	33.3	0		40.5	8.3	0	4.8		13.1	0	36.9	8.3		45.2	0	0	100	

Start Time	Barton Street Southbound				Van Buren Boulevard Westbound				Barton Street Northbound				Van Buren Boulevard Eastbound				Int. Total
	Left	Thru	Right	App. Total	Left	Thru	Right	App. Total	Left	Thru	Right	App. Total	Left	Thru	Right	App. Total	
Peak Hour Analysis From 01:00 PM to 01:45 PM - Peak 1 of 1																	
Peak Hour for Entire Intersection Begins at 01:00 PM																	
01:00 PM	0	0	0	0	1	5	0	6	0	0	1	1	0	1	0	1	8
01:15 PM	1	0	0	1	1	1	0	2	0	0	0	0	0	4	0	4	7
01:30 PM	0	0	0	0	0	3	0	3	1	0	1	2	0	4	0	4	9
01:45 PM	0	0	0	0	0	5	0	5	0	0	0	0	0	2	2	4	9
Total Volume	1	0	0	1	2	14	0	16	1	0	2	3	0	11	2	13	33
% App. Total	100	0	0		12.5	87.5	0		33.3	0	66.7		0	84.6	15.4		
PHF	.250	.000	.000	.250	.500	.700	.000	.667	.250	.000	.500	.375	.000	.688	.250	.813	.917

City of Riverside
 N/S: Barton Street
 E/W: Van Buren Boulevard
 Weather: Clear

File Name : 14_RIV_Bar St_VB Sat
 Site Code : 05122815
 Start Date : 9/17/2022
 Page No : 2

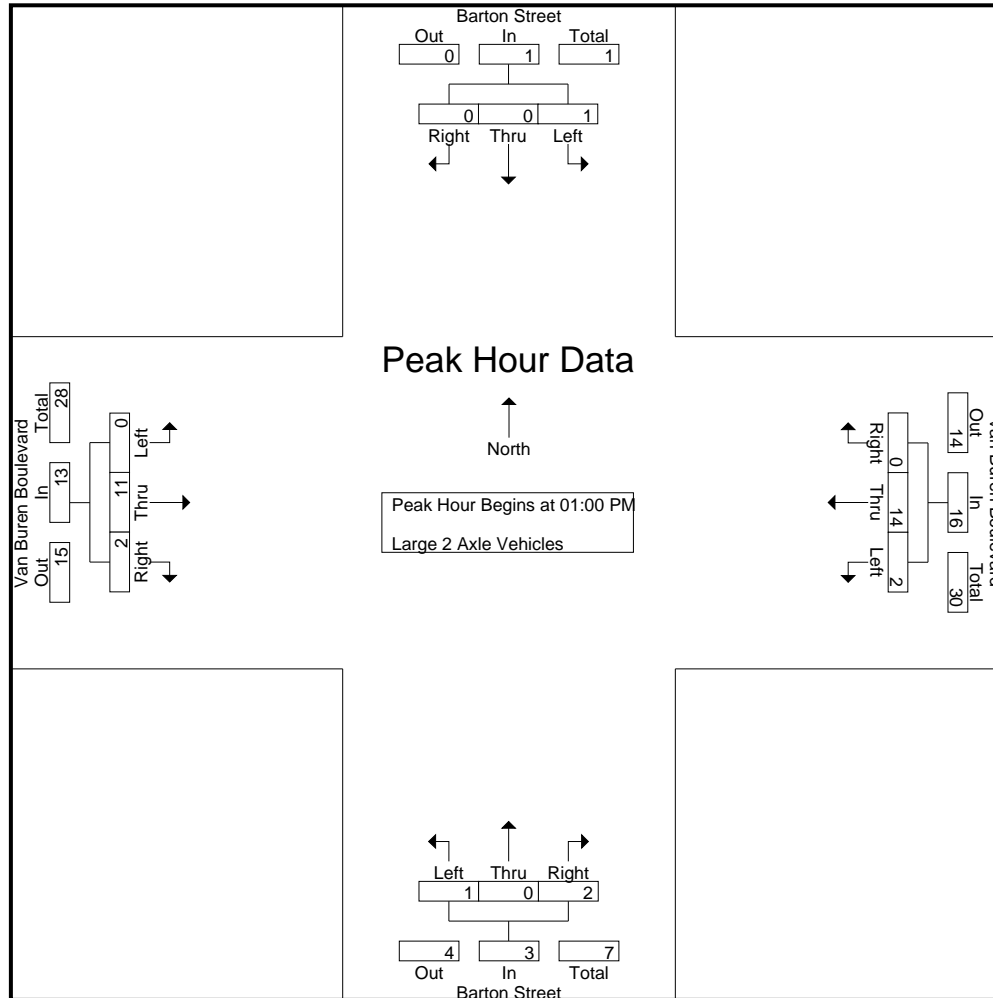

City of Riverside
 N/S: Barton Street
 E/W: Van Buren Boulevard
 Weather: Clear

File Name : 14_RIV_Bar St_VB Sat
 Site Code : 05122815
 Start Date : 9/17/2022
 Page No : 3

Start Time	Barton Street Southbound				Van Buren Boulevard Westbound				Barton Street Northbound				Van Buren Boulevard Eastbound				Int. Total
	Left	Thru	Right	App. Total	Left	Thru	Right	App. Total	Left	Thru	Right	App. Total	Left	Thru	Right	App. Total	
Peak Hour Analysis From 01:00 PM to 01:45 PM - Peak 1 of 1																	
Peak Hour for Each Approach Begins at:																	
	01:00 PM				01:00 PM				01:00 PM				01:00 PM				
+0 mins.	0	0	0	0	1	5	0	6	0	0	1	1	0	1	0	1	
+15 mins.	1	0	0	1	1	1	0	2	0	0	0	0	0	4	0	4	
+30 mins.	0	0	0	0	0	3	0	3	1	0	1	2	0	4	0	4	
+45 mins.	0	0	0	0	0	5	0	5	0	0	0	0	0	2	2	4	
Total Volume	1	0	0	1	2	14	0	16	1	0	2	3	0	11	2	13	
% App. Total	100	0	0		12.5	87.5	0		33.3	0	66.7		0	84.6	15.4		
PHF	.250	.000	.000	.250	.500	.700	.000	.667	.250	.000	.500	.375	.000	.688	.250	.813	

City of Riverside
 N/S: Barton Street
 E/W: Van Buren Boulevard
 Weather: Clear

File Name : 14_RIV_Bar St_VB Sat
 Site Code : 05122815
 Start Date : 9/17/2022
 Page No : 1

Groups Printed- 3 Axle Vehicles

Start Time	Barton Street Southbound					Van Buren Boulevard Westbound					Barton Street Northbound					Van Buren Boulevard Eastbound					Exclu. Total	Inclu. Total	Int. Total					
	Left	Thru	Right	RTOR	App. Total	Left	Thru	Right	RTOR	App. Total	Left	Thru	Right	RTOR	App. Total	Left	Thru	Right	RTOR	App. Total								
11:00 AM	0	0	0	0	0	0	0	0	0	0	0	0	0	0	0	0	1	0	0	1	0	0	0	0	0	0	1	1
11:15 AM	0	0	0	0	0	0	0	0	0	0	0	0	0	0	0	0	0	0	0	0	0	0	0	0	0	0	0	0
11:30 AM	0	0	0	0	0	0	1	0	0	1	1	0	0	0	1	0	0	0	0	0	0	0	0	0	0	0	2	2
11:45 AM	0	0	0	0	0	0	0	0	0	0	0	0	0	0	0	0	0	0	0	0	0	0	0	0	0	0	0	0
Total	0	0	0	0	0	0	1	0	0	1	1	0	0	0	1	0	1	0	0	1	0	0	0	0	0	0	3	3
12:00 PM	0	0	0	0	0	0	0	0	0	0	0	0	0	0	0	0	0	0	0	0	0	0	0	0	0	0	0	0
12:15 PM	0	0	0	0	0	0	1	0	0	1	0	0	0	0	0	0	0	0	0	0	0	0	0	0	0	0	1	1
12:30 PM	0	0	0	0	0	0	1	0	0	1	0	0	0	0	0	0	0	0	0	0	0	0	0	0	0	0	1	1
12:45 PM	0	0	0	0	0	0	0	0	0	0	0	0	0	0	0	0	0	1	1	1	1	1	1	1	1	1	2	2
Total	0	0	0	0	0	0	2	0	0	2	0	0	0	0	0	0	0	1	1	1	1	1	1	1	1	3	4	4
01:00 PM	0	0	0	0	0	0	0	0	0	0	0	0	0	0	0	0	0	0	0	0	0	0	0	0	0	0	0	0
01:15 PM	0	0	0	0	0	0	0	1	1	1	0	0	0	0	0	0	0	0	0	0	0	0	0	0	1	1	2	2
01:30 PM	0	0	0	0	0	0	0	0	0	0	0	0	0	0	0	0	0	0	0	0	0	0	0	0	0	0	0	0
01:45 PM	0	0	0	0	0	0	0	0	0	0	0	0	0	0	0	0	0	0	0	0	0	0	0	0	0	0	0	0
Total	0	0	0	0	0	0	0	1	1	1	0	0	0	0	0	0	0	0	0	0	0	0	0	0	1	1	2	2
Grand Total	0	0	0	0	0	0	3	1	1	4	1	0	0	0	1	0	1	1	1	2	2	2	2	2	2	7	9	9
Apprch %	0	0	0			0	75	25			100	0	0			0	50	50										
Total %	0	0	0			0	42.9	14.3		57.1	14.3	0	0		14.3	0	14.3	14.3		28.6	22.2	22.2	22.2	22.2	77.8	77.8	77.8	77.8

Start Time	Barton Street Southbound				Van Buren Boulevard Westbound				Barton Street Northbound				Van Buren Boulevard Eastbound				Int. Total	
	Left	Thru	Right	App. Total	Left	Thru	Right	App. Total	Left	Thru	Right	App. Total	Left	Thru	Right	App. Total		
Peak Hour Analysis From 01:00 PM to 01:45 PM - Peak 1 of 1																		
Peak Hour for Entire Intersection Begins at 01:00 PM																		
01:00 PM	0	0	0	0	0	0	0	0	0	0	0	0	0	0	0	0	0	0
01:15 PM	0	0	0	0	0	0	1	1	0	0	0	0	0	0	0	0	0	0
01:30 PM	0	0	0	0	0	0	0	0	0	0	0	0	0	0	0	0	0	0
01:45 PM	0	0	0	0	0	0	0	0	0	0	0	0	0	0	0	0	0	0
Total Volume	0	0	0	0	0	0	1	1	0	0	0	0	0	0	0	0	0	0
% App. Total	0	0	0		0	0	100		0	0	0		0	0	0		0	0
PHF	.000	.000	.000	.000	.000	.000	.250	.250	.000	.000	.000	.000	.000	.000	.000	.000	.000	.000

City of Riverside
 N/S: Barton Street
 E/W: Van Buren Boulevard
 Weather: Clear

File Name : 14_RIV_Bar St_VB Sat
 Site Code : 05122815
 Start Date : 9/17/2022
 Page No : 2

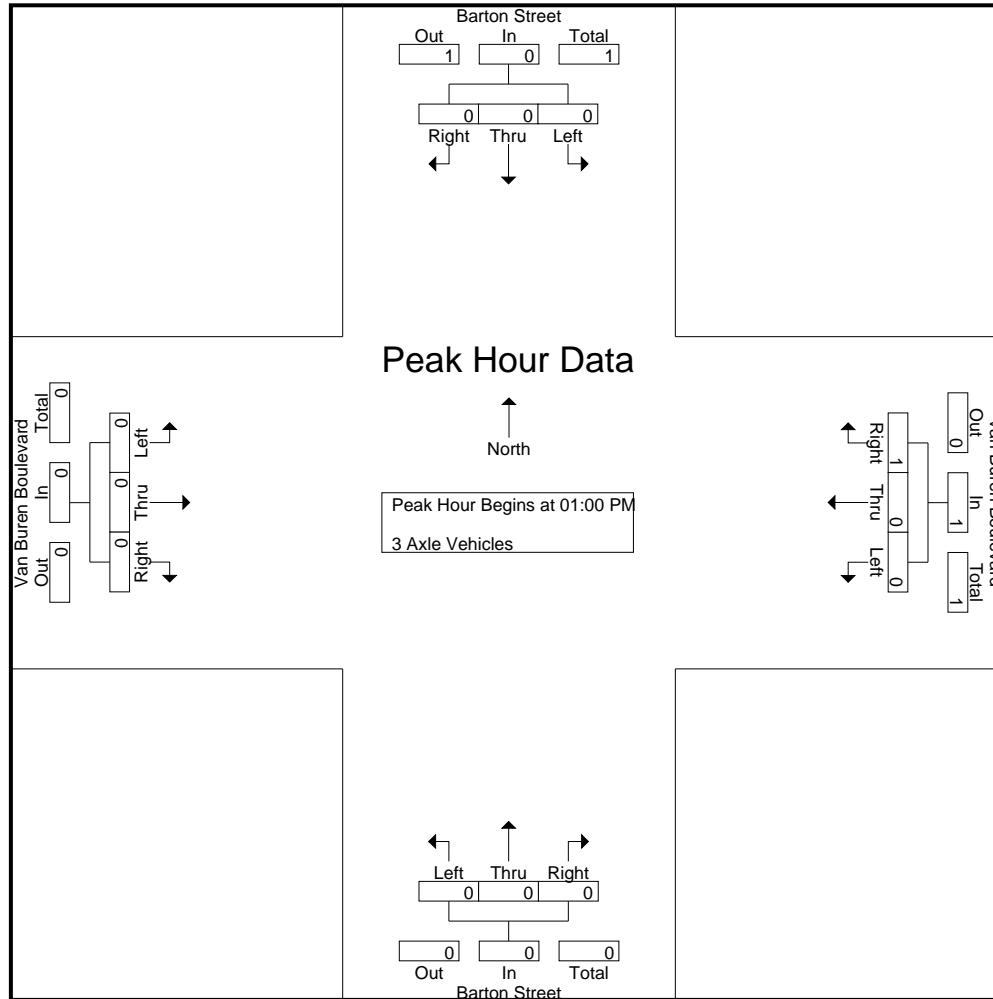

City of Riverside
 N/S: Barton Street
 E/W: Van Buren Boulevard
 Weather: Clear

File Name : 14_RIV_Bar St_VB Sat
 Site Code : 05122815
 Start Date : 9/17/2022
 Page No : 3

Start Time	Barton Street Southbound				Van Buren Boulevard Westbound				Barton Street Northbound				Van Buren Boulevard Eastbound				Int. Total
	Left	Thru	Right	App. Total	Left	Thru	Right	App. Total	Left	Thru	Right	App. Total	Left	Thru	Right	App. Total	
Peak Hour Analysis From 01:00 PM to 01:45 PM - Peak 1 of 1																	
Peak Hour for Each Approach Begins at:																	
	01:00 PM				01:00 PM				01:00 PM				01:00 PM				
+0 mins.	0	0	0	0	0	0	0	0	0	0	0	0	0	0	0	0	0
+15 mins.	0	0	0	0	0	0	1	1	0	0	0	0	0	0	0	0	0
+30 mins.	0	0	0	0	0	0	0	0	0	0	0	0	0	0	0	0	0
+45 mins.	0	0	0	0	0	0	0	0	0	0	0	0	0	0	0	0	0
Total Volume	0	0	0	0	0	0	1	1	0	0	0	0	0	0	0	0	0
% App. Total	0	0	0	0	0	0	100	100	0	0	0	0	0	0	0	0	0
PHF	.000	.000	.000	.000	.000	.000	.250	.250	.000	.000	.000	.000	.000	.000	.000	.000	.000

City of Riverside
 N/S: Barton Street
 E/W: Van Buren Boulevard
 Weather: Clear

File Name : 14_RIV_Bar St_VB Sat
 Site Code : 05122815
 Start Date : 9/17/2022
 Page No : 1

Groups Printed- 4+ Axle Trucks

Start Time	Barton Street Southbound					Van Buren Boulevard Westbound					Barton Street Northbound					Van Buren Boulevard Eastbound					Exclu. Total	Inclu. Total	Int. Total					
	Left	Thru	Right	RTOR	App. Total	Left	Thru	Right	RTOR	App. Total	Left	Thru	Right	RTOR	App. Total	Left	Thru	Right	RTOR	App. Total								
11:00 AM	0	0	0	0	0	0	0	0	0	0	0	0	0	0	0	0	0	0	0	0	0	0	0	0	0	0	0	0
11:15 AM	0	0	0	0	0	0	0	0	0	0	0	0	0	0	0	0	0	0	0	0	0	0	0	0	0	0	0	0
11:30 AM	0	0	0	0	0	0	1	0	0	1	0	0	0	0	0	0	0	0	0	0	0	0	0	0	0	0	1	1
11:45 AM	0	0	0	0	0	0	0	0	0	0	0	0	0	0	0	0	1	0	0	0	0	1	0	0	1	0	1	1
Total	0	0	0	0	0	0	1	0	0	1	0	0	0	0	0	0	1	0	0	0	0	1	0	0	1	0	2	2
12:00 PM	0	0	0	0	0	0	0	0	0	0	0	0	0	0	0	0	0	0	0	0	0	0	0	0	0	0	0	0
12:15 PM	0	0	0	0	0	0	0	0	0	0	0	0	0	0	0	0	0	0	0	0	0	0	0	0	0	0	0	0
12:30 PM	0	0	0	0	0	0	0	0	0	0	0	0	1	1	1	0	0	0	0	0	0	1	0	0	0	1	1	2
12:45 PM	0	0	0	0	0	0	0	0	0	0	0	0	0	0	0	0	1	0	0	0	0	1	0	0	1	0	1	1
Total	0	0	0	0	0	0	0	0	0	0	0	0	1	1	1	0	1	0	0	0	0	1	0	0	1	1	2	3
01:00 PM	0	0	0	0	0	0	0	0	0	0	0	0	0	0	0	0	0	0	0	0	0	0	0	0	0	0	0	0
01:15 PM	0	0	0	0	0	0	0	0	0	0	0	0	0	0	0	0	0	1	0	0	0	1	0	0	1	0	1	1
01:30 PM	0	0	0	0	0	0	0	0	0	0	0	0	0	0	0	0	1	0	0	0	0	1	0	0	1	0	1	1
01:45 PM	0	0	0	0	0	0	0	0	0	0	0	0	0	0	0	0	1	0	0	0	0	1	0	0	1	0	1	1
Total	0	0	0	0	0	0	0	0	0	0	0	0	0	0	0	0	2	1	0	0	0	3	0	0	3	0	3	3
Grand Total	0	0	0	0	0	0	1	0	0	1	0	0	1	1	1	0	4	1	0	5	0	5	1	0	5	1	7	8
Apprch %	0	0	0			0	100	0			0	0	100			0	80	20										
Total %	0	0	0			0	14.3	0		14.3	0	0	14.3		14.3	0	57.1	14.3		71.4	12.5				87.5			

Start Time	Barton Street Southbound				Van Buren Boulevard Westbound				Barton Street Northbound				Van Buren Boulevard Eastbound				Int. Total				
	Left	Thru	Right	App. Total	Left	Thru	Right	App. Total	Left	Thru	Right	App. Total	Left	Thru	Right	App. Total					
Peak Hour Analysis From 01:00 PM to 01:45 PM - Peak 1 of 1																					
Peak Hour for Entire Intersection Begins at 01:00 PM																					
01:00 PM	0	0	0	0	0	0	0	0	0	0	0	0	0	0	0	0	0	0	0	0	0
01:15 PM	0	0	0	0	0	0	0	0	0	0	0	0	0	0	1	0	0	0	1	0	1
01:30 PM	0	0	0	0	0	0	0	0	0	0	0	0	0	1	0	0	0	0	0	0	1
01:45 PM	0	0	0	0	0	0	0	0	0	0	0	0	0	1	0	0	0	0	0	0	1
Total Volume	0	0	0	0	0	0	0	0	0	0	0	0	0	2	1	0	0	0	1	0	3
% App. Total	0	0	0		0	0	0		0	0	0		0	66.7	33.3						
PHF	.000	.000	.000	.000	.000	.000	.000	.000	.000	.000	.000	.000	.000	.500	.250	.750					.750

City of Riverside
 N/S: Barton Street
 E/W: Van Buren Boulevard
 Weather: Clear

File Name : 14_RIV_Bar St_VB Sat
 Site Code : 05122815
 Start Date : 9/17/2022
 Page No : 2

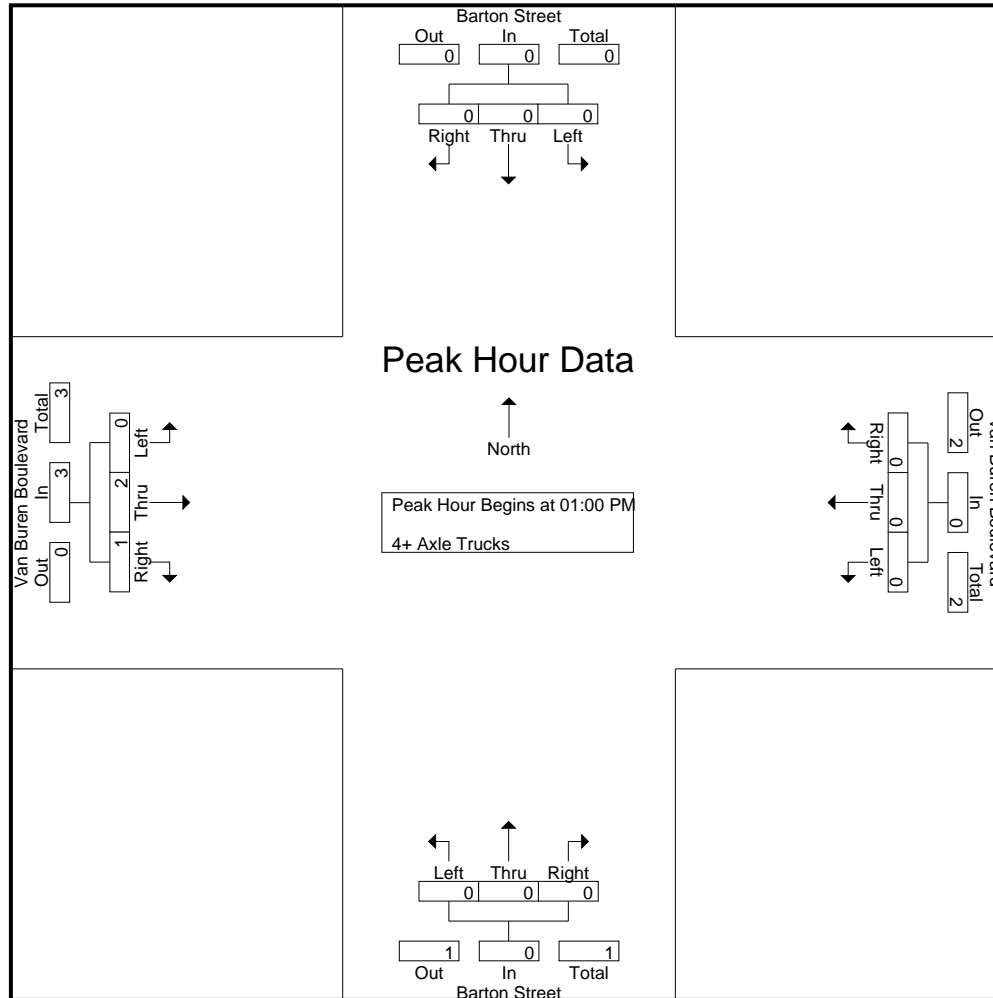

City of Riverside
 N/S: Barton Street
 E/W: Van Buren Boulevard
 Weather: Clear

File Name : 14_RIV_Bar St_VB Sat
 Site Code : 05122815
 Start Date : 9/17/2022
 Page No : 3

Start Time	Barton Street Southbound				Van Buren Boulevard Westbound				Barton Street Northbound				Van Buren Boulevard Eastbound				Int. Total
	Left	Thru	Right	App. Total	Left	Thru	Right	App. Total	Left	Thru	Right	App. Total	Left	Thru	Right	App. Total	
Peak Hour Analysis From 01:00 PM to 01:45 PM - Peak 1 of 1																	
Peak Hour for Each Approach Begins at:																	
	01:00 PM				01:00 PM				01:00 PM				01:00 PM				
+0 mins.	0	0	0	0	0	0	0	0	0	0	0	0	0	0	0	0	0
+15 mins.	0	0	0	0	0	0	0	0	0	0	0	0	0	0	1	0	1
+30 mins.	0	0	0	0	0	0	0	0	0	0	0	0	0	1	0	0	1
+45 mins.	0	0	0	0	0	0	0	0	0	0	0	0	0	1	0	0	1
Total Volume	0	0	0	0	0	0	0	0	0	0	0	0	0	2	1	0	3
% App. Total	0	0	0	0	0	0	0	0	0	0	0	0	0	66.7	33.3	0	
PHF	.000	.000	.000	.000	.000	.000	.000	.000	.000	.000	.000	.000	.000	.500	.250	0	.750

Location: Riverside
 N/S: Barton Street
 E/W: Van Buren Boulevard



Date: 9/17/2022
 Day Saturday

PEDESTRIANS

Time	North Leg Barton Street	East Leg Van Buren Boulevard	South Leg Barton Street	West Leg Van Buren Boulevard	TOTAL
11:00 AM	0	0	0	0	0
11:15 AM	0	0	0	0	0
11:30 AM	0	0	0	0	0
11:45 AM	0	0	0	0	0
12:00 PM	0	0	0	0	0
12:15 PM	0	0	0	0	0
12:30 PM	1	2	0	0	3
12:45 PM	0	0	0	0	0
1:00 PM	0	0	0	0	0
1:15 PM	1	1	0	0	2
1:30 PM	1	1	0	0	2
1:45 PM	1	1	0	0	2
TOTAL VOLUMES:	4	5	0	0	9

Location: Riverside
 N/S: Barton Street
 E/W: Van Buren Boulevard

Date: 9/17/2022
 Day: Saturday



BICYCLES

	Southbound Barton Street			Westbound Van Buren Boulevard			Northbound Barton Street			Eastbound Van Buren Boulevard			
	Left	Thru	Right	Left	Thru	Right	Left	Thru	Right	Left	Thru	Right	
11:00 AM	0	0	0	0	0	0	0	0	0	0	0	0	0
11:15 AM	0	0	0	0	0	0	0	0	0	0	0	0	0
11:30 AM	0	0	0	0	0	0	0	1	0	0	0	0	1
11:45 AM	0	0	0	0	0	0	0	0	0	0	0	0	0
12:00 PM	0	0	0	0	0	0	0	0	0	0	0	0	0
12:15 PM	0	0	0	0	0	0	0	0	0	0	0	0	0
12:30 PM	0	0	0	0	0	0	0	0	0	0	0	0	0
12:45 PM	0	1	0	0	0	0	0	0	0	0	0	0	1
1:00 PM	0	0	0	0	0	0	0	0	0	0	0	0	0
1:15 PM	0	0	0	0	0	0	0	0	0	0	0	0	0
1:30 PM	0	0	0	0	0	0	0	0	0	0	0	0	0
1:45 PM	0	0	0	0	0	0	0	0	0	0	0	0	0
TOTAL VOLUMES:	0	1	0	0	0	0	0	1	0	0	0	0	2

City of Riverside
 N/S: Abrams Drive
 E/W: Grove Community Drive
 Weather: Clear

File Name : 16_RIV_Abr_Gr Com Sat
 Site Code : 05122815
 Start Date : 9/17/2022
 Page No : 1

Groups Printed- Passenger Vehicles - Large 2 Axle Vehicles - 3 Axle Vehicles - 4+ Axle Trucks

Start Time	Grove Community Drive Westbound			Abrams Drive Northbound			Grove Community Drive Eastbound			Int. Total
	Left	Thru	App. Total	Left	Right	App. Total	Thru	Right	App. Total	
11:00 AM	3	13	16	10	5	15	16	12	28	59
11:15 AM	6	23	29	15	7	22	17	10	27	78
11:30 AM	12	32	44	25	6	31	19	14	33	108
11:45 AM	5	24	29	10	8	18	22	28	50	97
Total	26	92	118	60	26	86	74	64	138	342
12:00 PM	7	21	28	11	6	17	19	17	36	81
12:15 PM	11	27	38	20	12	32	15	10	25	95
12:30 PM	5	24	29	19	9	28	14	12	26	83
12:45 PM	8	21	29	18	7	25	27	26	53	107
Total	31	93	124	68	34	102	75	65	140	366
01:00 PM	4	16	20	12	10	22	23	26	49	91
01:15 PM	7	22	29	10	7	17	25	8	33	79
01:30 PM	6	22	28	11	6	17	15	8	23	68
01:45 PM	8	22	30	8	9	17	23	19	42	89
Total	25	82	107	41	32	73	86	61	147	327
Grand Total	82	267	349	169	92	261	235	190	425	1035
Apprch %	23.5	76.5		64.8	35.2		55.3	44.7		
Total %	7.9	25.8	33.7	16.3	8.9	25.2	22.7	18.4	41.1	
Passenger Vehicles	80	262	342	169	92	261	229	189	418	1021
% Passenger Vehicles	97.6	98.1	98	100	100	100	97.4	99.5	98.4	98.6
Large 2 Axle Vehicles	2	5	7	0	0	0	6	1	7	14
% Large 2 Axle Vehicles	2.4	1.9	2	0	0	0	2.6	0.5	1.6	1.4
3 Axle Vehicles	0	0	0	0	0	0	0	0	0	0
% 3 Axle Vehicles	0	0	0	0	0	0	0	0	0	0
4+ Axle Trucks	0	0	0	0	0	0	0	0	0	0
% 4+ Axle Trucks	0	0	0	0	0	0	0	0	0	0

Start Time	Grove Community Drive Westbound			Abrams Drive Northbound			Grove Community Drive Eastbound			Int. Total
	Left	Thru	App. Total	Left	Right	App. Total	Thru	Right	App. Total	
11:30 AM	12	32	44	25	6	31	19	14	33	108
11:45 AM	5	24	29	10	8	18	22	28	50	97
12:00 PM	7	21	28	11	6	17	19	17	36	81
12:15 PM	11	27	38	20	12	32	15	10	25	95
Total Volume	35	104	139	66	32	98	75	69	144	381
% App. Total	25.2	74.8		67.3	32.7		52.1	47.9		
PHF	.729	.813	.790	.660	.667	.766	.852	.616	.720	.882

Peak Hour Analysis From 11:00 AM to 01:45 PM - Peak 1 of 1
 Peak Hour for Entire Intersection Begins at 11:30 AM

City of Riverside
 N/S: Abrams Drive
 E/W: Grove Community Drive
 Weather: Clear

File Name : 16_RIV_Abr_Gr Com Sat
 Site Code : 05122815
 Start Date : 9/17/2022
 Page No : 2

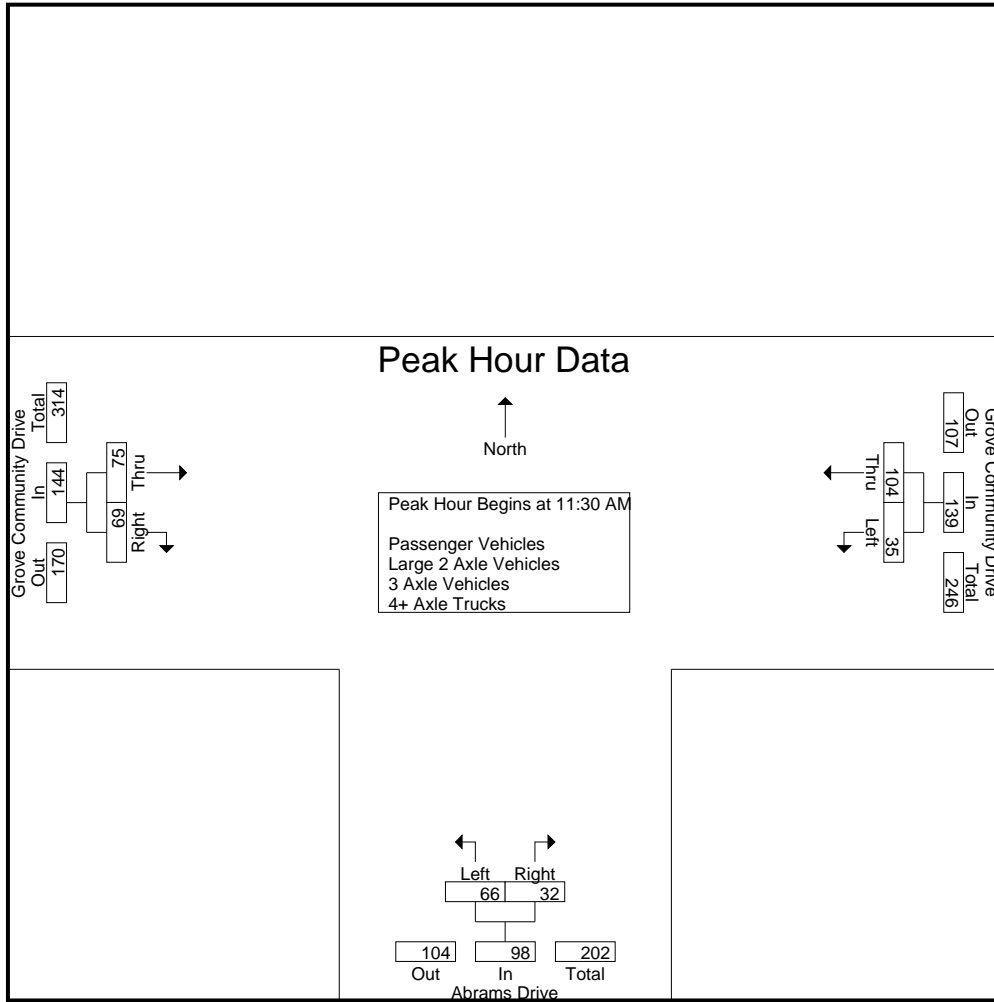

Peak Hour Analysis From 11:00 AM to 01:45 PM - Peak 1 of 1
 Peak Hour for Each Approach Begins at:

	11:30 AM			12:15 PM			12:30 PM		
+0 mins.	12	32	44	20	12	32	14	12	26
+15 mins.	5	24	29	19	9	28	27	26	53
+30 mins.	7	21	28	18	7	25	23	26	49
+45 mins.	11	27	38	12	10	22	25	8	33
Total Volume	35	104	139	69	38	107	89	72	161
% App. Total	25.2	74.8		64.5	35.5		55.3	44.7	
PHF	.729	.813	.790	.863	.792	.836	.824	.692	.759

City of Riverside
 N/S: Abrams Drive
 E/W: Grove Community Drive
 Weather: Clear

File Name : 16_RIV_Abr_Gr Com Sat
 Site Code : 05122815
 Start Date : 9/17/2022
 Page No : 1

Groups Printed- Passenger Vehicles

Start Time	Grove Community Drive Westbound			Abrams Drive Northbound			Grove Community Drive Eastbound			Int. Total
	Left	Thru	App. Total	Left	Right	App. Total	Thru	Right	App. Total	
11:00 AM	3	13	16	10	5	15	16	12	28	59
11:15 AM	6	23	29	15	7	22	17	10	27	78
11:30 AM	12	31	43	25	6	31	19	14	33	107
11:45 AM	5	24	29	10	8	18	21	28	49	96
Total	26	91	117	60	26	86	73	64	137	340
12:00 PM	7	20	27	11	6	17	18	16	34	78
12:15 PM	10	25	35	20	12	32	13	10	23	90
12:30 PM	5	24	29	19	9	28	14	12	26	83
12:45 PM	7	21	28	18	7	25	27	26	53	106
Total	29	90	119	68	34	102	72	64	136	357
01:00 PM	4	16	20	12	10	22	23	26	49	91
01:15 PM	7	22	29	10	7	17	25	8	33	79
01:30 PM	6	22	28	11	6	17	14	8	22	67
01:45 PM	8	21	29	8	9	17	22	19	41	87
Total	25	81	106	41	32	73	84	61	145	324
Grand Total	80	262	342	169	92	261	229	189	418	1021
Apprch %	23.4	76.6		64.8	35.2		54.8	45.2		
Total %	7.8	25.7	33.5	16.6	9	25.6	22.4	18.5	40.9	

Start Time	Grove Community Drive Westbound			Abrams Drive Northbound			Grove Community Drive Eastbound			Int. Total
	Left	Thru	App. Total	Left	Right	App. Total	Thru	Right	App. Total	
Peak Hour Analysis From 11:30 AM to 12:15 PM - Peak 1 of 1										
Peak Hour for Entire Intersection Begins at 11:30 AM										
11:30 AM	12	31	43	25	6	31	19	14	33	107
11:45 AM	5	24	29	10	8	18	21	28	49	96
12:00 PM	7	20	27	11	6	17	18	16	34	78
12:15 PM	10	25	35	20	12	32	13	10	23	90
Total Volume	34	100	134	66	32	98	71	68	139	371
% App. Total	25.4	74.6		67.3	32.7		51.1	48.9		
PHF	.708	.806	.779	.660	.667	.766	.845	.607	.709	.867

City of Riverside
 N/S: Abrams Drive
 E/W: Grove Community Drive
 Weather: Clear

File Name : 16_RIV_Abr_Gr Com Sat
 Site Code : 05122815
 Start Date : 9/17/2022
 Page No : 2

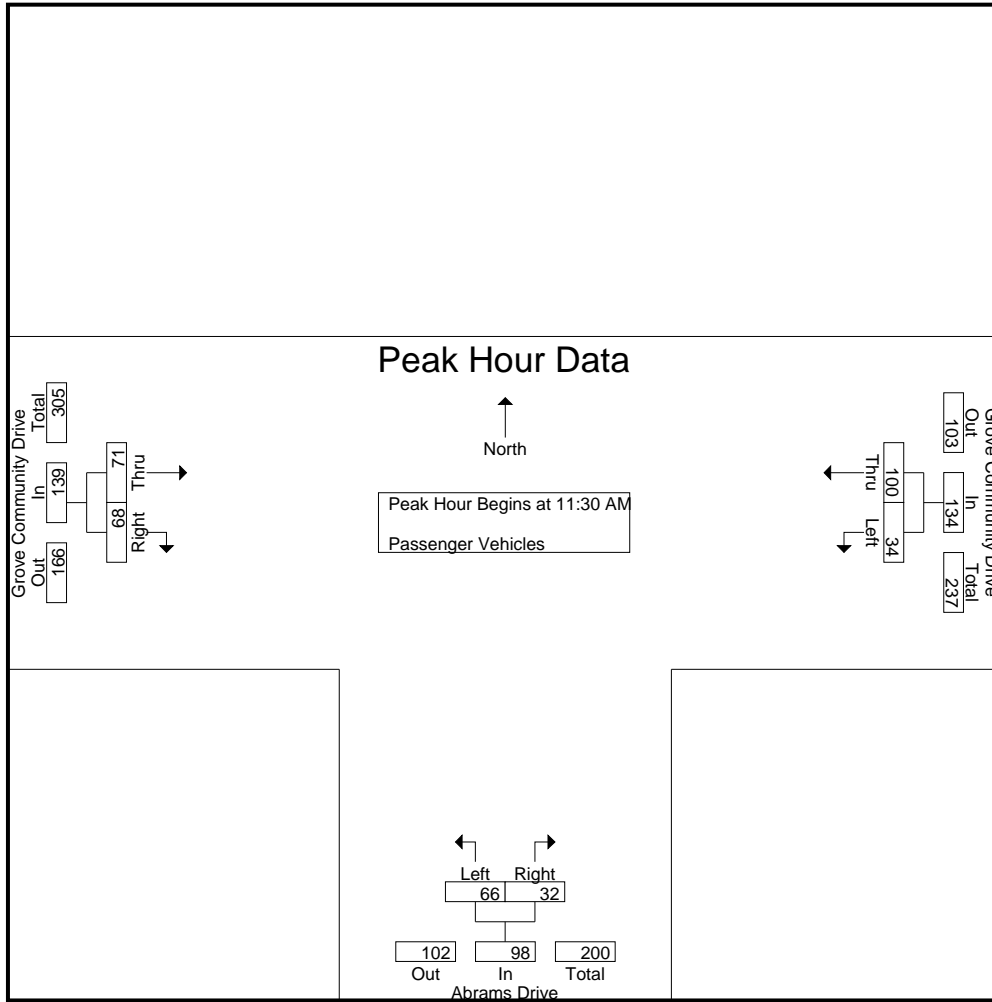

Peak Hour Analysis From 11:30 AM to 12:15 PM - Peak 1 of 1
 Peak Hour for Each Approach Begins at:

	11:30 AM			11:30 AM			11:30 AM		
+0 mins.	12	31	43	25	6	31	19	14	33
+15 mins.	5	24	29	10	8	18	21	28	49
+30 mins.	7	20	27	11	6	17	18	16	34
+45 mins.	10	25	35	20	12	32	13	10	23
Total Volume	34	100	134	66	32	98	71	68	139
% App. Total	25.4	74.6		67.3	32.7		51.1	48.9	
PHF	.708	.806	.779	.660	.667	.766	.845	.607	.709

City of Riverside
 N/S: Abrams Drive
 E/W: Grove Community Drive
 Weather: Clear

File Name : 16_RIV_Abr_Gr Com Sat
 Site Code : 05122815
 Start Date : 9/17/2022
 Page No : 1

Groups Printed- Large 2 Axle Vehicles

Start Time	Grove Community Drive Westbound			Abrams Drive Northbound			Grove Community Drive Eastbound			Int. Total
	Left	Thru	App. Total	Left	Right	App. Total	Thru	Right	App. Total	
11:00 AM	0	0	0	0	0	0	0	0	0	0
11:15 AM	0	0	0	0	0	0	0	0	0	0
11:30 AM	0	1	1	0	0	0	0	0	0	1
11:45 AM	0	0	0	0	0	0	1	0	1	1
Total	0	1	1	0	0	0	1	0	1	2
12:00 PM	0	1	1	0	0	0	1	1	2	3
12:15 PM	1	2	3	0	0	0	2	0	2	5
12:30 PM	0	0	0	0	0	0	0	0	0	0
12:45 PM	1	0	1	0	0	0	0	0	0	1
Total	2	3	5	0	0	0	3	1	4	9
01:00 PM	0	0	0	0	0	0	0	0	0	0
01:15 PM	0	0	0	0	0	0	0	0	0	0
01:30 PM	0	0	0	0	0	0	1	0	1	1
01:45 PM	0	1	1	0	0	0	1	0	1	2
Total	0	1	1	0	0	0	2	0	2	3
Grand Total	2	5	7	0	0	0	6	1	7	14
Apprch %	28.6	71.4		0	0		85.7	14.3		
Total %	14.3	35.7	50	0	0	0	42.9	7.1	50	

Start Time	Grove Community Drive Westbound			Abrams Drive Northbound			Grove Community Drive Eastbound			Int. Total
	Left	Thru	App. Total	Left	Right	App. Total	Thru	Right	App. Total	
11:30 AM	0	1	1	0	0	0	0	0	0	1
11:45 AM	0	0	0	0	0	0	1	0	1	1
12:00 PM	0	1	1	0	0	0	1	1	2	3
12:15 PM	1	2	3	0	0	0	2	0	2	5
Total Volume	1	4	5	0	0	0	4	1	5	10
% App. Total	20	80		0	0		80	20		
PHF	.250	.500	.417	.000	.000	.000	.500	.250	.625	.500

Peak Hour Analysis From 11:30 AM to 12:15 PM - Peak 1 of 1
 Peak Hour for Entire Intersection Begins at 11:30 AM

City of Riverside
 N/S: Abrams Drive
 E/W: Grove Community Drive
 Weather: Clear

File Name : 16_RIV_Abr_Gr Com Sat
 Site Code : 05122815
 Start Date : 9/17/2022
 Page No : 2

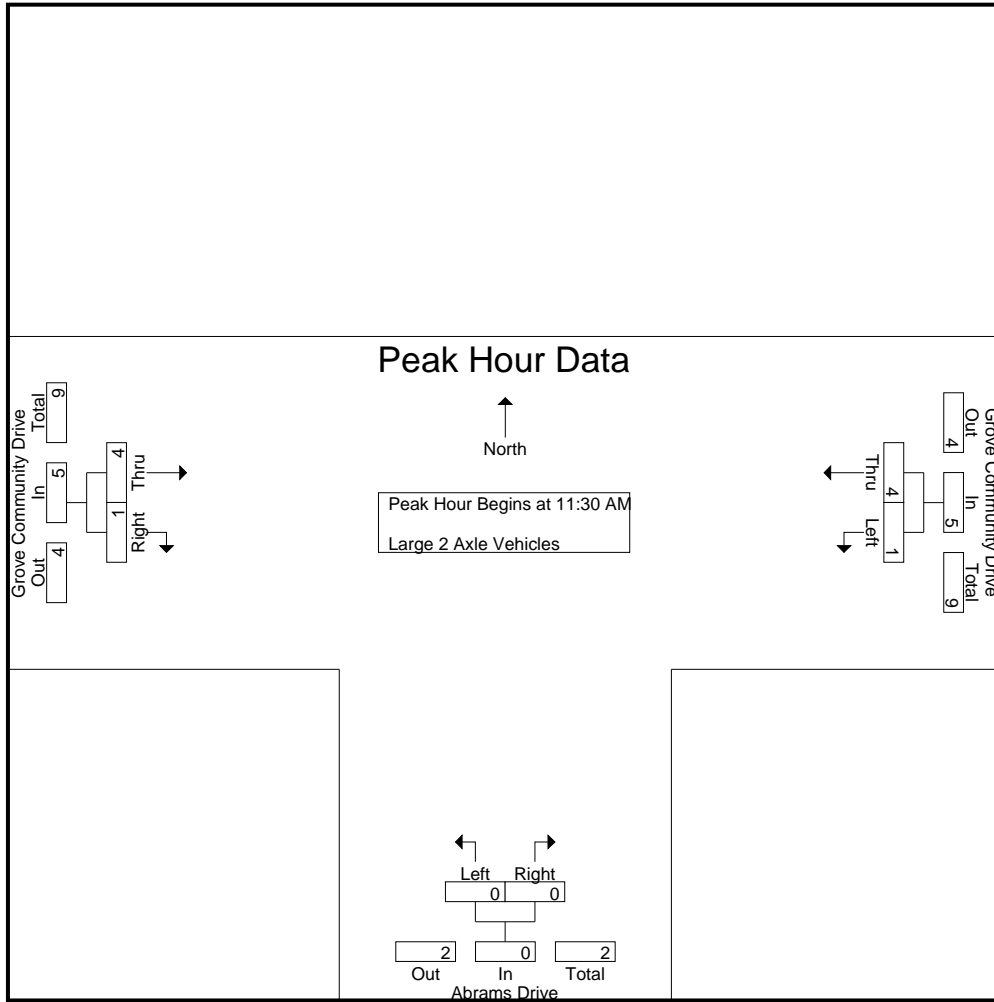

Peak Hour Analysis From 11:30 AM to 12:15 PM - Peak 1 of 1
 Peak Hour for Each Approach Begins at:

	11:30 AM			11:30 AM			11:30 AM		
+0 mins.	0	1	1	0	0	0	0	0	0
+15 mins.	0	0	0	0	0	0	1	0	1
+30 mins.	0	1	1	0	0	0	1	1	2
+45 mins.	1	2	3	0	0	0	2	0	2
Total Volume	1	4	5	0	0	0	4	1	5
% App. Total	20	80		0	0		80	20	
PHF	.250	.500	.417	.000	.000	.000	.500	.250	.625

City of Riverside
 N/S: Abrams Drive
 E/W: Grove Community Drive
 Weather: Clear

File Name : 16_RIV_Abr_Gr Com Sat
 Site Code : 05122815
 Start Date : 9/17/2022
 Page No : 1

Groups Printed- 3 Axle Vehicles

Start Time	Grove Community Drive Westbound			Abrams Drive Northbound			Grove Community Drive Eastbound			Int. Total
	Left	Thru	App. Total	Left	Right	App. Total	Thru	Right	App. Total	
11:00 AM	0	0	0	0	0	0	0	0	0	0
11:15 AM	0	0	0	0	0	0	0	0	0	0
11:30 AM	0	0	0	0	0	0	0	0	0	0
11:45 AM	0	0	0	0	0	0	0	0	0	0
Total	0	0	0	0	0	0	0	0	0	0
12:00 PM	0	0	0	0	0	0	0	0	0	0
12:15 PM	0	0	0	0	0	0	0	0	0	0
12:30 PM	0	0	0	0	0	0	0	0	0	0
12:45 PM	0	0	0	0	0	0	0	0	0	0
Total	0	0	0	0	0	0	0	0	0	0
01:00 PM	0	0	0	0	0	0	0	0	0	0
01:15 PM	0	0	0	0	0	0	0	0	0	0
01:30 PM	0	0	0	0	0	0	0	0	0	0
01:45 PM	0	0	0	0	0	0	0	0	0	0
Total	0	0	0	0	0	0	0	0	0	0
Grand Total	0	0	0	0	0	0	0	0	0	0
Apprch %	0	0		0	0		0	0		
Total %										

Start Time	Grove Community Drive Westbound			Abrams Drive Northbound			Grove Community Drive Eastbound			Int. Total
	Left	Thru	App. Total	Left	Right	App. Total	Thru	Right	App. Total	
11:30 AM	0	0	0	0	0	0	0	0	0	0
11:45 AM	0	0	0	0	0	0	0	0	0	0
12:00 PM	0	0	0	0	0	0	0	0	0	0
12:15 PM	0	0	0	0	0	0	0	0	0	0
Total Volume	0	0	0	0	0	0	0	0	0	0
% App. Total	0	0		0	0		0	0		
PHF	.000	.000	.000	.000	.000	.000	.000	.000	.000	.000

Peak Hour Analysis From 11:30 AM to 12:15 PM - Peak 1 of 1
 Peak Hour for Entire Intersection Begins at 11:30 AM

City of Riverside
 N/S: Abrams Drive
 E/W: Grove Community Drive
 Weather: Clear

File Name : 16_RIV_Abr_Gr Com Sat
 Site Code : 05122815
 Start Date : 9/17/2022
 Page No : 2

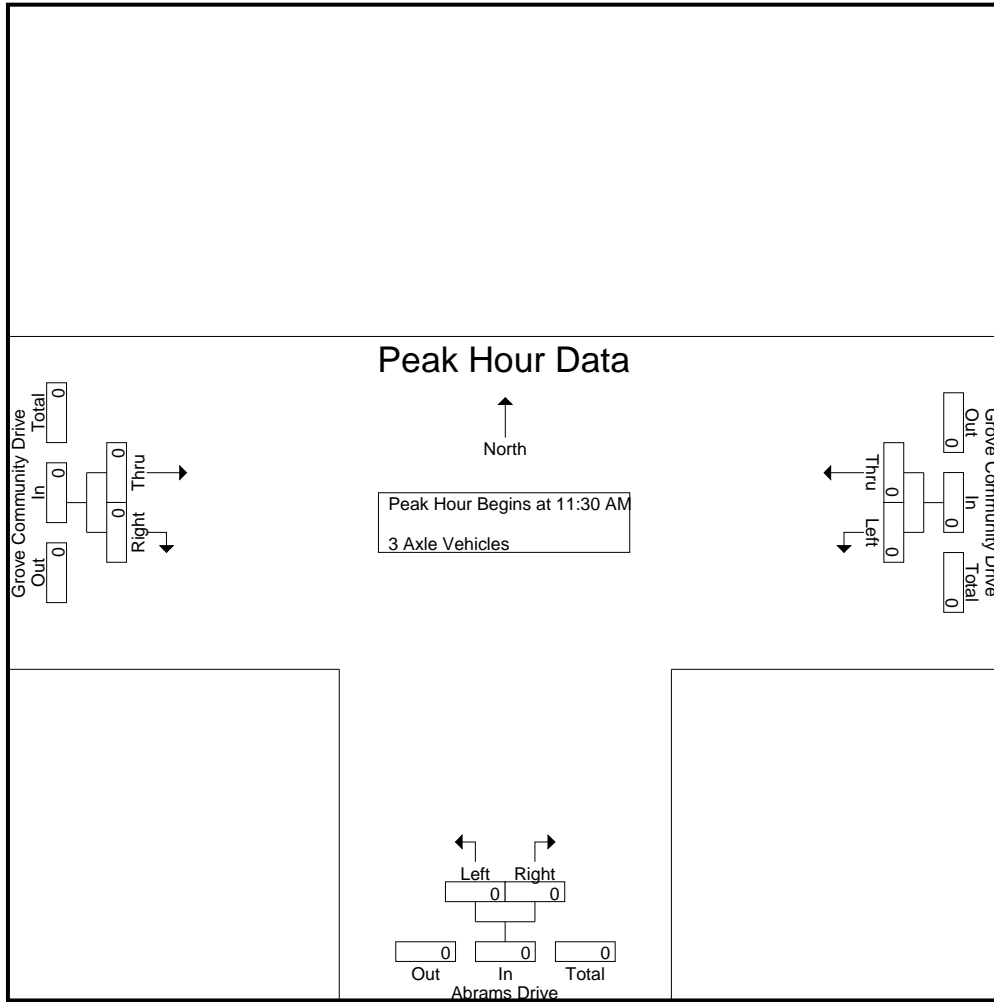

Peak Hour Analysis From 11:30 AM to 12:15 PM - Peak 1 of 1
 Peak Hour for Each Approach Begins at:

	11:30 AM			11:30 AM			11:30 AM		
+0 mins.	0	0	0	0	0	0	0	0	0
+15 mins.	0	0	0	0	0	0	0	0	0
+30 mins.	0	0	0	0	0	0	0	0	0
+45 mins.	0	0	0	0	0	0	0	0	0
Total Volume	0	0	0	0	0	0	0	0	0
% App. Total	0	0	0	0	0	0	0	0	0
PHF	.000	.000	.000	.000	.000	.000	.000	.000	.000

City of Riverside
 N/S: Abrams Drive
 E/W: Grove Community Drive
 Weather: Clear

File Name : 16_RIV_Abr_Gr Com Sat
 Site Code : 05122815
 Start Date : 9/17/2022
 Page No : 1

Groups Printed- 4+ Axle Trucks

Start Time	Grove Community Drive Westbound			Abrams Drive Northbound			Grove Community Drive Eastbound			Int. Total
	Left	Thru	App. Total	Left	Right	App. Total	Thru	Right	App. Total	
11:00 AM	0	0	0	0	0	0	0	0	0	0
11:15 AM	0	0	0	0	0	0	0	0	0	0
11:30 AM	0	0	0	0	0	0	0	0	0	0
11:45 AM	0	0	0	0	0	0	0	0	0	0
Total	0	0	0	0	0	0	0	0	0	0
12:00 PM	0	0	0	0	0	0	0	0	0	0
12:15 PM	0	0	0	0	0	0	0	0	0	0
12:30 PM	0	0	0	0	0	0	0	0	0	0
12:45 PM	0	0	0	0	0	0	0	0	0	0
Total	0	0	0	0	0	0	0	0	0	0
01:00 PM	0	0	0	0	0	0	0	0	0	0
01:15 PM	0	0	0	0	0	0	0	0	0	0
01:30 PM	0	0	0	0	0	0	0	0	0	0
01:45 PM	0	0	0	0	0	0	0	0	0	0
Total	0	0	0	0	0	0	0	0	0	0
Grand Total	0	0	0	0	0	0	0	0	0	0
Apprch %	0	0		0	0		0	0		
Total %										

Start Time	Grove Community Drive Westbound			Abrams Drive Northbound			Grove Community Drive Eastbound			Int. Total
	Left	Thru	App. Total	Left	Right	App. Total	Thru	Right	App. Total	
11:30 AM	0	0	0	0	0	0	0	0	0	0
11:45 AM	0	0	0	0	0	0	0	0	0	0
12:00 PM	0	0	0	0	0	0	0	0	0	0
12:15 PM	0	0	0	0	0	0	0	0	0	0
Total Volume	0	0	0	0	0	0	0	0	0	0
% App. Total	0	0		0	0		0	0		
PHF	.000	.000	.000	.000	.000	.000	.000	.000	.000	.000

Peak Hour Analysis From 11:30 AM to 12:15 PM - Peak 1 of 1
 Peak Hour for Entire Intersection Begins at 11:30 AM

City of Riverside
 N/S: Abrams Drive
 E/W: Grove Community Drive
 Weather: Clear

File Name : 16_RIV_Abr_Gr Com Sat
 Site Code : 05122815
 Start Date : 9/17/2022
 Page No : 2

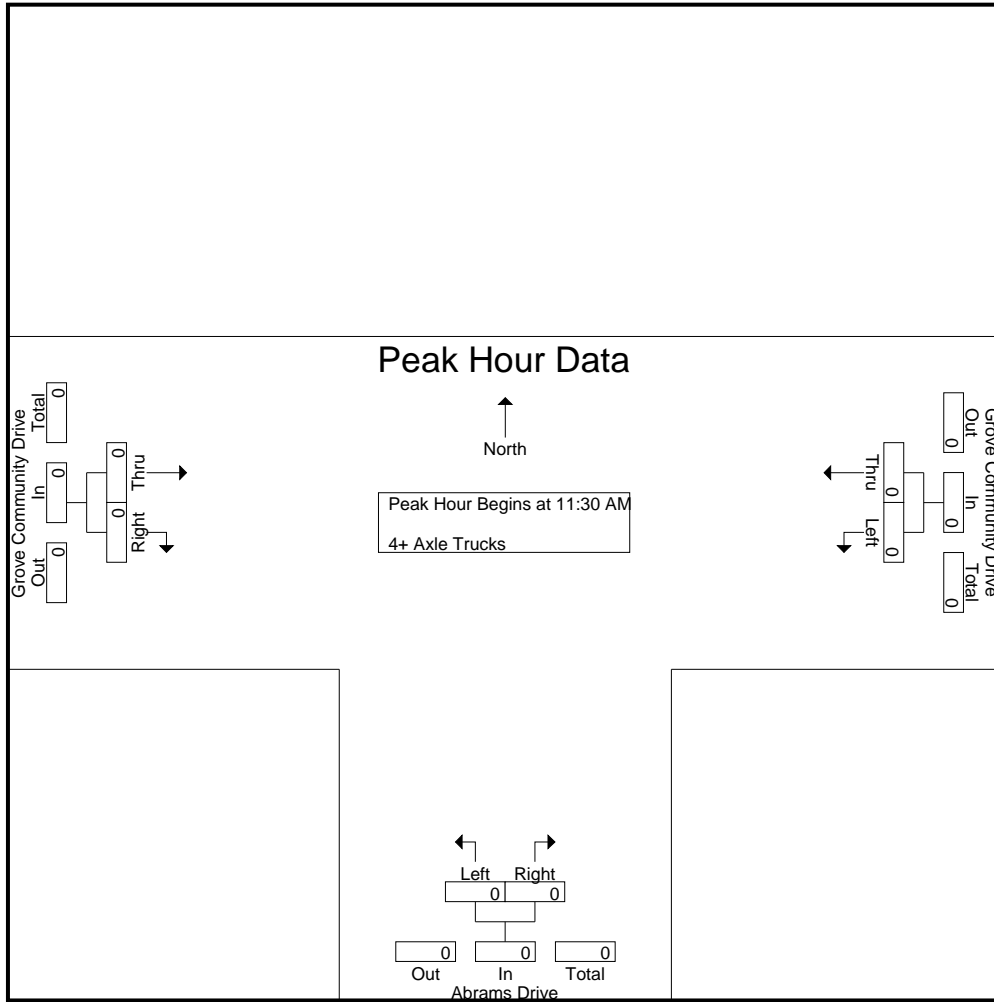

Peak Hour Analysis From 11:30 AM to 12:15 PM - Peak 1 of 1
 Peak Hour for Each Approach Begins at:

	11:30 AM			11:30 AM			11:30 AM		
+0 mins.	0	0	0	0	0	0	0	0	0
+15 mins.	0	0	0	0	0	0	0	0	0
+30 mins.	0	0	0	0	0	0	0	0	0
+45 mins.	0	0	0	0	0	0	0	0	0
Total Volume	0	0	0	0	0	0	0	0	0
% App. Total	0	0	0	0	0	0	0	0	0
PHF	.000	.000	.000	.000	.000	.000	.000	.000	.000

Location: Riverside
 N/S: Abrams Drive
 E/W: Grove Community Drive



Date: 9/17/2022
 Day Saturday

PEDESTRIANS

Time	North Leg Dead End	East Leg Grove Community Drive	South Leg Abrams Drive	West Leg Grove Community Drive	TOTAL
11:00 AM	0	0	1	0	1
11:15 AM	0	0	0	0	0
11:30 AM	0	0	3	0	3
11:45 AM	0	0	0	0	0
12:00 PM	0	0	1	0	1
12:15 PM	0	0	2	0	2
12:30 PM	0	0	0	0	0
12:45 PM	0	0	1	0	1
1:00 PM	0	0	0	0	0
1:15 PM	0	0	0	0	0
1:30 PM	0	0	0	0	0
1:45 PM	0	0	2	0	2
TOTAL VOLUMES:	0	0	10	0	10

Location: Riverside
 N/S: Abrams Drive
 E/W: Grove Community Drive

Date: 9/17/2022
 Day: Saturday



BICYCLES

	Southbound Dead End			Westbound Grove Community Drive			Northbound Abrams Drive			Eastbound Grove Community Drive			
	Left	Thru	Right	Left	Thru	Right	Left	Thru	Right	Left	Thru	Right	
11:00 AM	0	0	0	0	1	0	1	0	0	0	0	0	2
11:15 AM	0	0	0	0	2	0	0	0	0	0	0	1	3
11:30 AM	0	0	0	0	0	0	0	0	0	0	0	0	0
11:45 AM	0	0	0	0	0	0	0	0	0	0	0	0	0
12:00 PM	0	0	0	0	0	0	0	0	0	0	0	0	0
12:15 PM	0	0	0	0	0	0	0	0	0	0	0	0	0
12:30 PM	0	0	0	0	0	0	0	0	0	0	0	0	0
12:45 PM	0	0	0	0	0	0	0	0	0	0	0	0	0
1:00 PM	0	0	0	0	0	0	0	0	0	0	0	0	0
1:15 PM	0	0	0	0	0	0	0	0	0	0	0	0	0
1:30 PM	0	0	0	0	0	0	0	0	0	0	0	0	0
1:45 PM	0	0	0	0	0	0	0	0	0	0	0	0	0
TOTAL VOLUMES:	0	0	0	0	3	0	1	0	0	0	0	1	5

City of Riverside
 N/S: Abrams Drive
 E/W: Orange Terrace Parkway
 Weather: Clear

File Name : 17_RIV_Abr_Or Ter Sat
 Site Code : 05122815
 Start Date : 9/17/2022
 Page No : 1

Groups Printed- Passenger Vehicles - Large 2 Axle Vehicles - 3 Axle Vehicles - 4+ Axle Trucks

Start Time	Abrams Drive Southbound			Orange Terrace Parkway Westbound			Orange Terrace Parkway Eastbound			Int. Total
	Left	Right	App. Total	Thru	Right	App. Total	Left	Thru	App. Total	
11:00 AM	6	10	16	38	8	46	21	19	40	102
11:15 AM	5	14	19	41	10	51	22	36	58	128
11:30 AM	5	18	23	34	21	55	24	35	59	137
11:45 AM	23	13	36	37	6	43	18	27	45	124
Total	39	55	94	150	45	195	85	117	202	491
12:00 PM	13	16	29	58	8	66	18	36	54	149
12:15 PM	6	18	24	42	19	61	34	46	80	165
12:30 PM	9	10	19	46	18	64	23	34	57	140
12:45 PM	18	16	34	33	15	48	27	29	56	138
Total	46	60	106	179	60	239	102	145	247	592
01:00 PM	19	10	29	48	11	59	29	35	64	152
01:15 PM	8	15	23	31	9	40	23	36	59	122
01:30 PM	2	12	14	40	11	51	13	32	45	110
01:45 PM	8	17	25	32	6	38	31	40	71	134
Total	37	54	91	151	37	188	96	143	239	518
Grand Total	122	169	291	480	142	622	283	405	688	1601
Apprch %	41.9	58.1		77.2	22.8		41.1	58.9		
Total %	7.6	10.6	18.2	30	8.9	38.9	17.7	25.3	43	
Passenger Vehicles	121	168	289	473	141	614	282	402	684	1587
% Passenger Vehicles	99.2	99.4	99.3	98.5	99.3	98.7	99.6	99.3	99.4	99.1
Large 2 Axle Vehicles	1	1	2	7	1	8	1	3	4	14
% Large 2 Axle Vehicles	0.8	0.6	0.7	1.5	0.7	1.3	0.4	0.7	0.6	0.9
3 Axle Vehicles	0	0	0	0	0	0	0	0	0	0
% 3 Axle Vehicles	0	0	0	0	0	0	0	0	0	0
4+ Axle Trucks	0	0	0	0	0	0	0	0	0	0
% 4+ Axle Trucks	0	0	0	0	0	0	0	0	0	0

Start Time	Abrams Drive Southbound			Orange Terrace Parkway Westbound			Orange Terrace Parkway Eastbound			Int. Total
	Left	Right	App. Total	Thru	Right	App. Total	Left	Thru	App. Total	
12:15 PM	6	18	24	42	19	61	34	46	80	165
12:30 PM	9	10	19	46	18	64	23	34	57	140
12:45 PM	18	16	34	33	15	48	27	29	56	138
01:00 PM	19	10	29	48	11	59	29	35	64	152
Total Volume	52	54	106	169	63	232	113	144	257	595
% App. Total	49.1	50.9		72.8	27.2		44	56		
PHF	.684	.750	.779	.880	.829	.906	.831	.783	.803	.902

Peak Hour Analysis From 11:00 AM to 01:45 PM - Peak 1 of 1
 Peak Hour for Entire Intersection Begins at 12:15 PM

City of Riverside
 N/S: Abrams Drive
 E/W: Orange Terrace Parkway
 Weather: Clear

File Name : 17_RIV_Abr_Or Ter Sat
 Site Code : 05122815
 Start Date : 9/17/2022
 Page No : 2

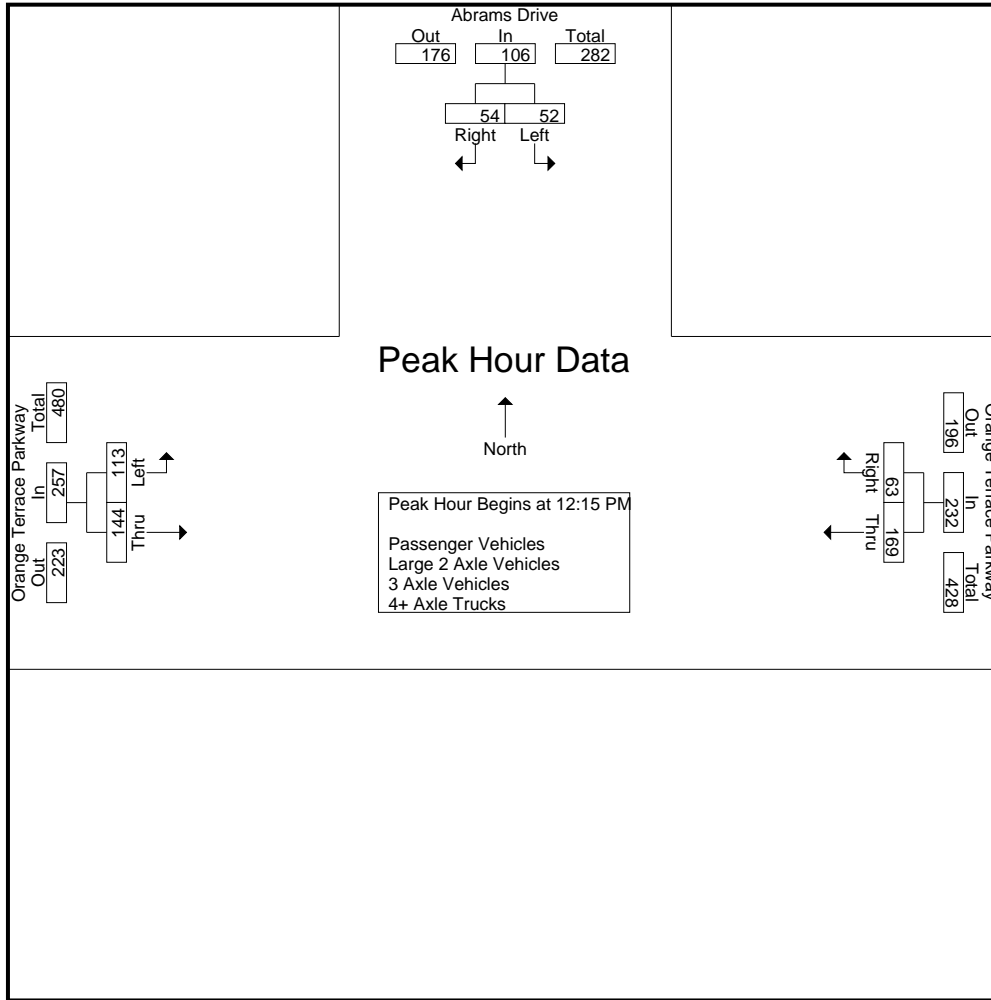

Peak Hour Analysis From 11:00 AM to 01:45 PM - Peak 1 of 1
 Peak Hour for Each Approach Begins at:

	11:30 AM			12:00 PM			12:15 PM		
+0 mins.	5	18	23	58	8	66	34	46	80
+15 mins.	23	13	36	42	19	61	23	34	57
+30 mins.	13	16	29	46	18	64	27	29	56
+45 mins.	6	18	24	33	15	48	29	35	64
Total Volume	47	65	112	179	60	239	113	144	257
% App. Total	42	58		74.9	25.1		44	56	
PHF	.511	.903	.778	.772	.789	.905	.831	.783	.803

City of Riverside
 N/S: Abrams Drive
 E/W: Orange Terrace Parkway
 Weather: Clear

File Name : 17_RIV_Abr_Or Ter Sat
 Site Code : 05122815
 Start Date : 9/17/2022
 Page No : 1

Groups Printed- Passenger Vehicles

Start Time	Abrams Drive Southbound			Orange Terrace Parkway Westbound			Orange Terrace Parkway Eastbound			Int. Total
	Left	Right	App. Total	Thru	Right	App. Total	Left	Thru	App. Total	
11:00 AM	6	10	16	37	8	45	21	18	39	100
11:15 AM	5	14	19	40	10	50	22	36	58	127
11:30 AM	5	18	23	32	21	53	24	35	59	135
11:45 AM	23	13	36	37	6	43	18	27	45	124
Total	39	55	94	146	45	191	85	116	201	486
12:00 PM	12	16	28	57	8	65	18	35	53	146
12:15 PM	6	18	24	42	19	61	34	46	80	165
12:30 PM	9	10	19	45	18	63	23	34	57	139
12:45 PM	18	15	33	33	15	48	26	29	55	136
Total	45	59	104	177	60	237	101	144	245	586
01:00 PM	19	10	29	47	10	57	29	34	63	149
01:15 PM	8	15	23	31	9	40	23	36	59	122
01:30 PM	2	12	14	40	11	51	13	32	45	110
01:45 PM	8	17	25	32	6	38	31	40	71	134
Total	37	54	91	150	36	186	96	142	238	515
Grand Total	121	168	289	473	141	614	282	402	684	1587
Apprch %	41.9	58.1		77	23		41.2	58.8		
Total %	7.6	10.6	18.2	29.8	8.9	38.7	17.8	25.3	43.1	

Start Time	Abrams Drive Southbound			Orange Terrace Parkway Westbound			Orange Terrace Parkway Eastbound			Int. Total
	Left	Right	App. Total	Thru	Right	App. Total	Left	Thru	App. Total	
12:15 PM	6	18	24	42	19	61	34	46	80	165
12:30 PM	9	10	19	45	18	63	23	34	57	139
12:45 PM	18	15	33	33	15	48	26	29	55	136
01:00 PM	19	10	29	47	10	57	29	34	63	149
Total Volume	52	53	105	167	62	229	112	143	255	589
% App. Total	49.5	50.5		72.9	27.1		43.9	56.1		
PHF	.684	.736	.795	.888	.816	.909	.824	.777	.797	.892

Peak Hour Analysis From 12:15 PM to 01:00 PM - Peak 1 of 1

Peak Hour for Entire Intersection Begins at 12:15 PM

City of Riverside
 N/S: Abrams Drive
 E/W: Orange Terrace Parkway
 Weather: Clear

File Name : 17_RIV_Abr_Or Ter Sat
 Site Code : 05122815
 Start Date : 9/17/2022
 Page No : 2

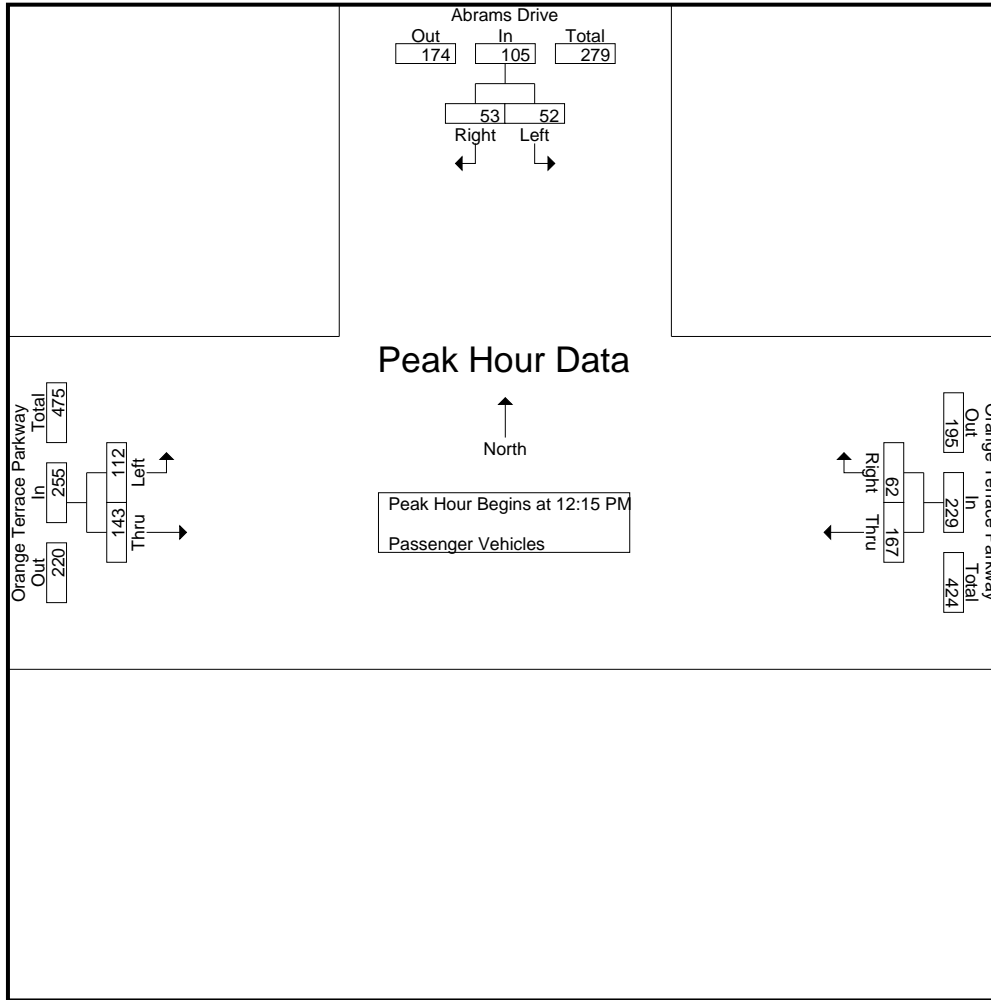

Peak Hour Analysis From 12:15 PM to 01:00 PM - Peak 1 of 1
 Peak Hour for Each Approach Begins at:

	12:15 PM			12:15 PM			12:15 PM		
+0 mins.	6	18	24	42	19	61	34	46	80
+15 mins.	9	10	19	45	18	63	23	34	57
+30 mins.	18	15	33	33	15	48	26	29	55
+45 mins.	19	10	29	47	10	57	29	34	63
Total Volume	52	53	105	167	62	229	112	143	255
% App. Total	49.5	50.5		72.9	27.1		43.9	56.1	
PHF	.684	.736	.795	.888	.816	.909	.824	.777	.797

City of Riverside
 N/S: Abrams Drive
 E/W: Orange Terrace Parkway
 Weather: Clear

File Name : 17_RIV_Abr_Or Ter Sat
 Site Code : 05122815
 Start Date : 9/17/2022
 Page No : 1

Groups Printed- Large 2 Axle Vehicles

Start Time	Abrams Drive Southbound			Orange Terrace Parkway Westbound			Orange Terrace Parkway Eastbound			Int. Total
	Left	Right	App. Total	Thru	Right	App. Total	Left	Thru	App. Total	
11:00 AM	0	0	0	1	0	1	0	1	1	2
11:15 AM	0	0	0	1	0	1	0	0	0	1
11:30 AM	0	0	0	2	0	2	0	0	0	2
11:45 AM	0	0	0	0	0	0	0	0	0	0
Total	0	0	0	4	0	4	0	1	1	5
12:00 PM	1	0	1	1	0	1	0	1	1	3
12:15 PM	0	0	0	0	0	0	0	0	0	0
12:30 PM	0	0	0	1	0	1	0	0	0	1
12:45 PM	0	1	1	0	0	0	1	0	1	2
Total	1	1	2	2	0	2	1	1	2	6
01:00 PM	0	0	0	1	1	2	0	1	1	3
01:15 PM	0	0	0	0	0	0	0	0	0	0
01:30 PM	0	0	0	0	0	0	0	0	0	0
01:45 PM	0	0	0	0	0	0	0	0	0	0
Total	0	0	0	1	1	2	0	1	1	3
Grand Total	1	1	2	7	1	8	1	3	4	14
Apprch %	50	50		87.5	12.5		25	75		
Total %	7.1	7.1	14.3	50	7.1	57.1	7.1	21.4	28.6	

Start Time	Abrams Drive Southbound			Orange Terrace Parkway Westbound			Orange Terrace Parkway Eastbound			Int. Total
	Left	Right	App. Total	Thru	Right	App. Total	Left	Thru	App. Total	
12:15 PM	0	0	0	0	0	0	0	0	0	0
12:30 PM	0	0	0	1	0	1	0	0	0	1
12:45 PM	0	1	1	0	0	0	1	0	1	2
01:00 PM	0	0	0	1	1	2	0	1	1	3
Total Volume	0	1	1	2	1	3	1	1	2	6
% App. Total	0	100		66.7	33.3		50	50		
PHF	.000	.250	.250	.500	.250	.375	.250	.250	.500	.500

Peak Hour Analysis From 12:15 PM to 01:00 PM - Peak 1 of 1

Peak Hour for Entire Intersection Begins at 12:15 PM

City of Riverside
 N/S: Abrams Drive
 E/W: Orange Terrace Parkway
 Weather: Clear

File Name : 17_RIV_Abr_Or Ter Sat
 Site Code : 05122815
 Start Date : 9/17/2022
 Page No : 2

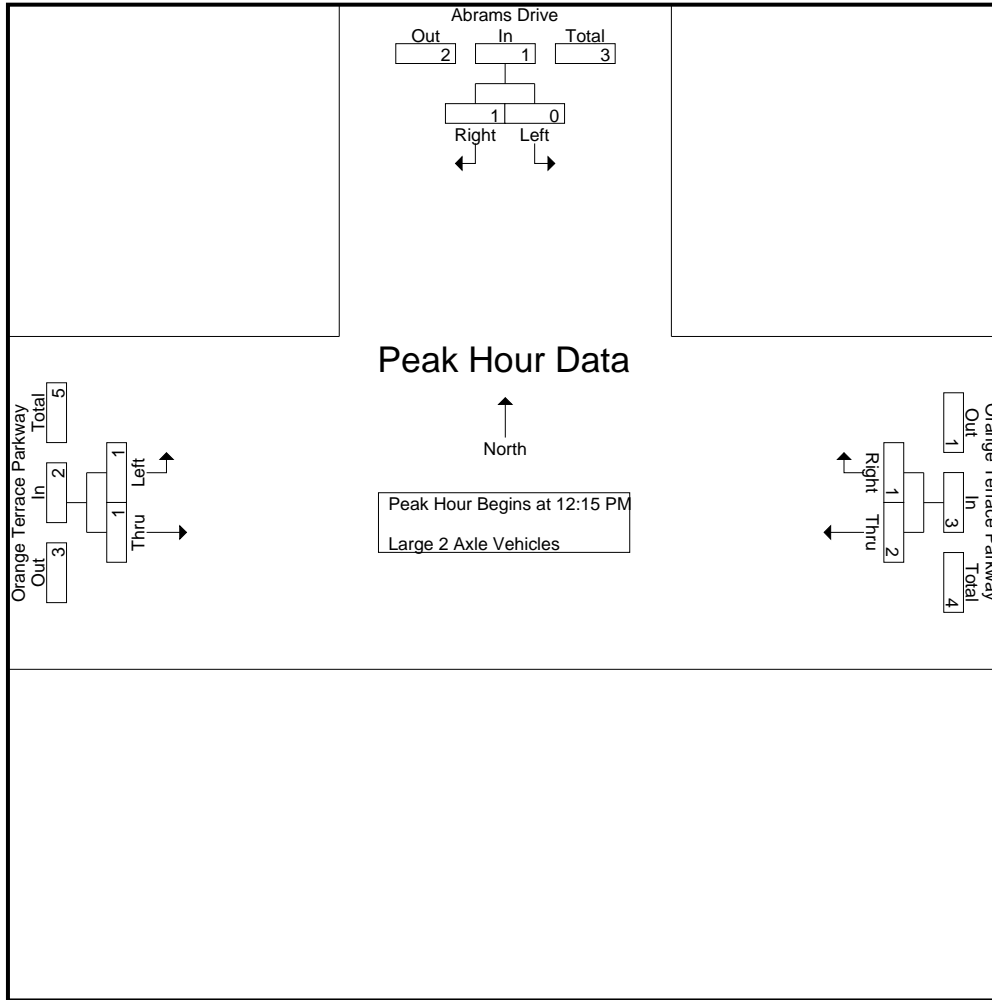

Peak Hour Analysis From 12:15 PM to 01:00 PM - Peak 1 of 1
 Peak Hour for Each Approach Begins at:

	12:15 PM			12:15 PM			12:15 PM		
+0 mins.	0	0	0	0	0	0	0	0	0
+15 mins.	0	0	0	1	0	1	0	0	0
+30 mins.	0	1	1	0	0	0	1	0	1
+45 mins.	0	0	0	1	1	2	0	1	1
Total Volume	0	1	1	2	1	3	1	1	2
% App. Total	0	100		66.7	33.3		50	50	
PHF	.000	.250	.250	.500	.250	.375	.250	.250	.500

City of Riverside
 N/S: Abrams Drive
 E/W: Orange Terrace Parkway
 Weather: Clear

File Name : 17_RIV_Abr_Or Ter Sat
 Site Code : 05122815
 Start Date : 9/17/2022
 Page No : 1

Groups Printed- 3 Axle Vehicles

Start Time	Abrams Drive Southbound			Orange Terrace Parkway Westbound			Orange Terrace Parkway Eastbound			Int. Total
	Left	Right	App. Total	Thru	Right	App. Total	Left	Thru	App. Total	
11:00 AM	0	0	0	0	0	0	0	0	0	0
11:15 AM	0	0	0	0	0	0	0	0	0	0
11:30 AM	0	0	0	0	0	0	0	0	0	0
11:45 AM	0	0	0	0	0	0	0	0	0	0
Total	0	0	0	0	0	0	0	0	0	0
12:00 PM	0	0	0	0	0	0	0	0	0	0
12:15 PM	0	0	0	0	0	0	0	0	0	0
12:30 PM	0	0	0	0	0	0	0	0	0	0
12:45 PM	0	0	0	0	0	0	0	0	0	0
Total	0	0	0	0	0	0	0	0	0	0
01:00 PM	0	0	0	0	0	0	0	0	0	0
01:15 PM	0	0	0	0	0	0	0	0	0	0
01:30 PM	0	0	0	0	0	0	0	0	0	0
01:45 PM	0	0	0	0	0	0	0	0	0	0
Total	0	0	0	0	0	0	0	0	0	0
Grand Total	0	0	0	0	0	0	0	0	0	0
Apprch %	0	0		0	0		0	0		
Total %										

Start Time	Abrams Drive Southbound			Orange Terrace Parkway Westbound			Orange Terrace Parkway Eastbound			Int. Total
	Left	Right	App. Total	Thru	Right	App. Total	Left	Thru	App. Total	
12:15 PM	0	0	0	0	0	0	0	0	0	0
12:30 PM	0	0	0	0	0	0	0	0	0	0
12:45 PM	0	0	0	0	0	0	0	0	0	0
01:00 PM	0	0	0	0	0	0	0	0	0	0
Total Volume	0	0	0	0	0	0	0	0	0	0
% App. Total	0	0		0	0		0	0		
PHF	.000	.000	.000	.000	.000	.000	.000	.000	.000	.000

City of Riverside
 N/S: Abrams Drive
 E/W: Orange Terrace Parkway
 Weather: Clear

File Name : 17_RIV_Abr_Or Ter Sat
 Site Code : 05122815
 Start Date : 9/17/2022
 Page No : 2

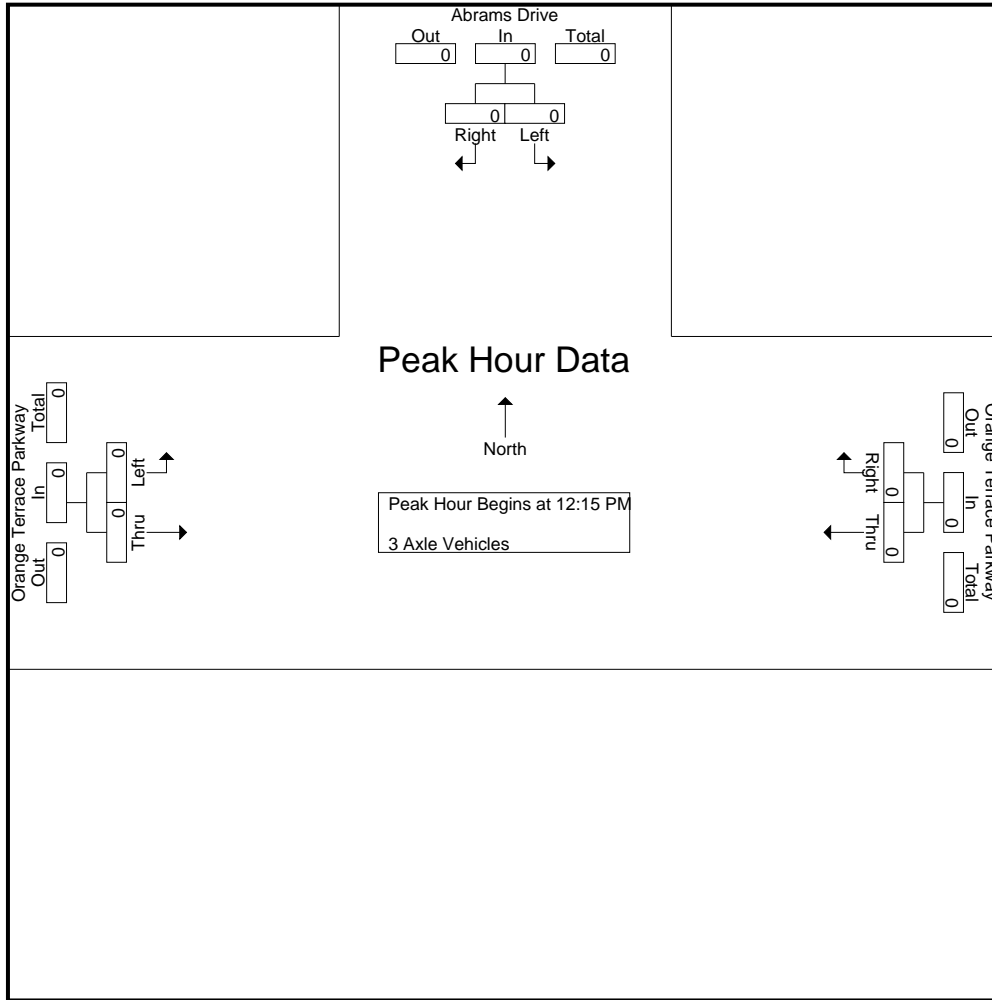

Peak Hour Analysis From 12:15 PM to 01:00 PM - Peak 1 of 1
 Peak Hour for Each Approach Begins at:

	12:15 PM			12:15 PM			12:15 PM		
+0 mins.	0	0	0	0	0	0	0	0	0
+15 mins.	0	0	0	0	0	0	0	0	0
+30 mins.	0	0	0	0	0	0	0	0	0
+45 mins.	0	0	0	0	0	0	0	0	0
Total Volume	0	0	0	0	0	0	0	0	0
% App. Total	0	0	0	0	0	0	0	0	0
PHF	.000	.000	.000	.000	.000	.000	.000	.000	.000

City of Riverside
 N/S: Abrams Drive
 E/W: Orange Terrace Parkway
 Weather: Clear

File Name : 17_RIV_Abr_Or Ter Sat
 Site Code : 05122815
 Start Date : 9/17/2022
 Page No : 1

Groups Printed- 4+ Axle Trucks

Start Time	Abrams Drive Southbound			Orange Terrace Parkway Westbound			Orange Terrace Parkway Eastbound			Int. Total
	Left	Right	App. Total	Thru	Right	App. Total	Left	Thru	App. Total	
11:00 AM	0	0	0	0	0	0	0	0	0	0
11:15 AM	0	0	0	0	0	0	0	0	0	0
11:30 AM	0	0	0	0	0	0	0	0	0	0
11:45 AM	0	0	0	0	0	0	0	0	0	0
Total	0	0	0	0	0	0	0	0	0	0
12:00 PM	0	0	0	0	0	0	0	0	0	0
12:15 PM	0	0	0	0	0	0	0	0	0	0
12:30 PM	0	0	0	0	0	0	0	0	0	0
12:45 PM	0	0	0	0	0	0	0	0	0	0
Total	0	0	0	0	0	0	0	0	0	0
01:00 PM	0	0	0	0	0	0	0	0	0	0
01:15 PM	0	0	0	0	0	0	0	0	0	0
01:30 PM	0	0	0	0	0	0	0	0	0	0
01:45 PM	0	0	0	0	0	0	0	0	0	0
Total	0	0	0	0	0	0	0	0	0	0
Grand Total	0	0	0	0	0	0	0	0	0	0
Apprch %	0	0		0	0		0	0		
Total %										

Start Time	Abrams Drive Southbound			Orange Terrace Parkway Westbound			Orange Terrace Parkway Eastbound			Int. Total
	Left	Right	App. Total	Thru	Right	App. Total	Left	Thru	App. Total	
12:15 PM	0	0	0	0	0	0	0	0	0	0
12:30 PM	0	0	0	0	0	0	0	0	0	0
12:45 PM	0	0	0	0	0	0	0	0	0	0
01:00 PM	0	0	0	0	0	0	0	0	0	0
Total Volume	0	0	0	0	0	0	0	0	0	0
% App. Total	0	0		0	0		0	0		
PHF	.000	.000	.000	.000	.000	.000	.000	.000	.000	.000

City of Riverside
 N/S: Abrams Drive
 E/W: Orange Terrace Parkway
 Weather: Clear

File Name : 17_RIV_Abr_Or Ter Sat
 Site Code : 05122815
 Start Date : 9/17/2022
 Page No : 2

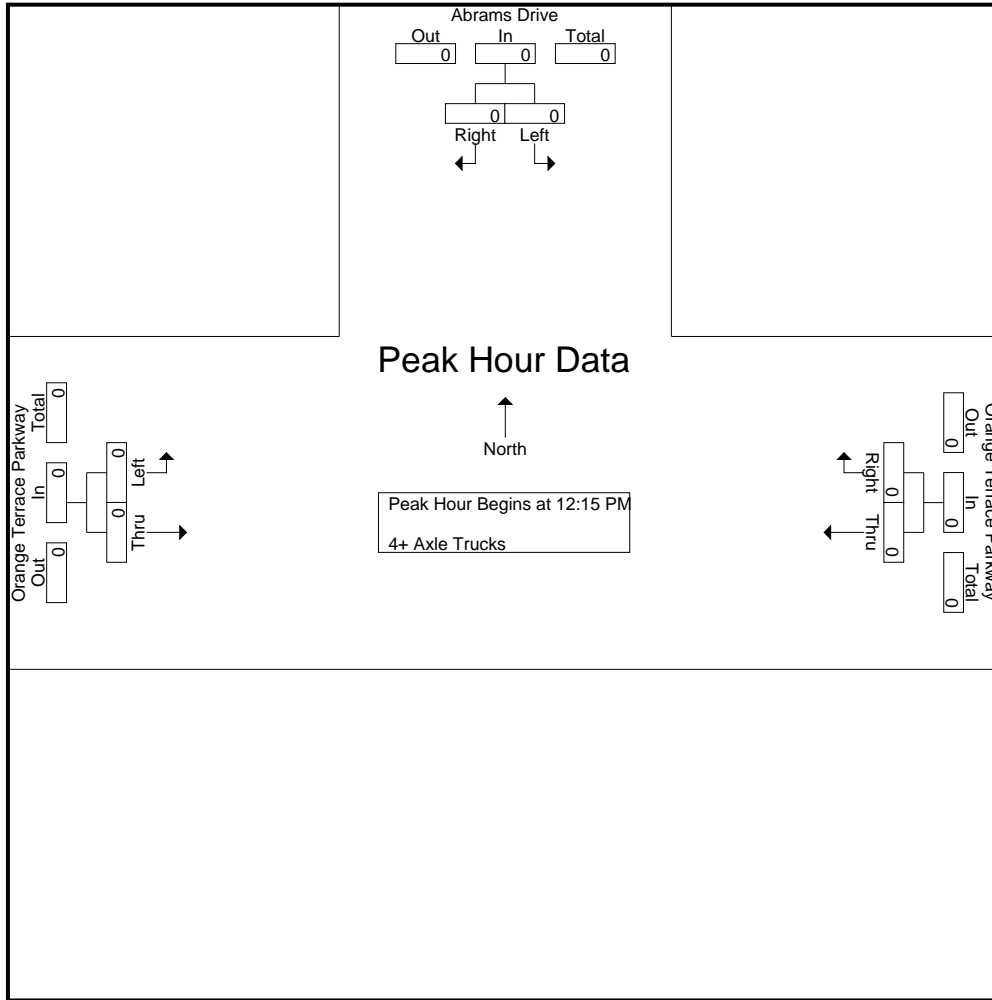

Peak Hour Analysis From 12:15 PM to 01:00 PM - Peak 1 of 1
 Peak Hour for Each Approach Begins at:

	12:15 PM			12:15 PM			12:15 PM		
+0 mins.	0	0	0	0	0	0	0	0	0
+15 mins.	0	0	0	0	0	0	0	0	0
+30 mins.	0	0	0	0	0	0	0	0	0
+45 mins.	0	0	0	0	0	0	0	0	0
Total Volume	0	0	0	0	0	0	0	0	0
% App. Total	0	0	0	0	0	0	0	0	0
PHF	.000	.000	.000	.000	.000	.000	.000	.000	.000

Location: Riverside
 N/S: Abrams Drive
 E/W: Orange Terrace Parkway



Date: 9/17/2022
 Day Saturday

PEDESTRIANS

Time	North Leg Abrams Drive	East Leg Orange Terrace Parkway	South Leg Dead End	West Leg Orange Terrace Parkway	TOTAL
11:00 AM	2	0	0	0	2
11:15 AM	1	0	0	0	1
11:30 AM	0	0	0	0	0
11:45 AM	3	2	0	0	5
12:00 PM	1	0	0	0	1
12:15 PM	2	2	0	0	4
12:30 PM	3	6	0	0	9
12:45 PM	3	1	0	0	4
1:00 PM	0	0	0	0	0
1:15 PM	0	0	0	0	0
1:30 PM	0	0	0	0	0
1:45 PM	0	0	0	0	0
TOTAL VOLUMES:	15	11	0	0	26

Location: Riverside
 N/S: Abrams Drive
 E/W: Orange Terrace Parkway

Date: 9/17/2022
 Day: Saturday



BICYCLES

	Southbound Abrams Drive			Westbound Orange Terrace Parkway			Northbound Dead End			Eastbound Orange Terrace Parkway			
	Left	Thru	Right	Left	Thru	Right	Left	Thru	Right	Left	Thru	Right	
11:00 AM	0	0	0	0	0	0	0	0	0	0	0	0	0
11:15 AM	1	0	0	0	0	0	0	0	0	0	0	0	1
11:30 AM	0	0	0	0	1	0	0	0	0	0	1	0	2
11:45 AM	0	0	0	0	0	0	0	0	0	0	0	0	0
12:00 PM	0	0	0	0	0	0	0	0	0	0	0	0	0
12:15 PM	0	0	0	0	0	0	0	0	0	0	1	0	1
12:30 PM	0	0	0	0	0	0	0	0	0	0	0	0	0
12:45 PM	0	0	0	0	0	0	0	0	0	0	0	0	0
1:00 PM	0	0	0	0	0	0	0	0	0	0	0	0	0
1:15 PM	0	0	0	0	0	0	0	0	0	0	0	0	0
1:30 PM	0	0	0	0	0	0	0	0	0	0	0	0	0
1:45 PM	0	0	0	0	0	0	0	0	0	0	0	0	0
TOTAL VOLUMES:	1	0	0	0	1	0	0	0	0	0	2	0	4

City of Riverside
 N/S: Orange Terrace Parkway
 E/W: Van Buren Boulevard
 Weather: Clear

File Name : 19_RIV_Or Ter_VB Sat
 Site Code : 05122815
 Start Date : 9/17/2022
 Page No : 1

Groups Printed- Passenger Vehicles - Large 2 Axle Vehicles - 3 Axle Vehicles - 4+ Axle Trucks

Start Time	Orange Terrace Parkway Southbound					Van Buren Boulevard Westbound					Farmer Boys Driveway Northbound					Van Buren Boulevard Eastbound					Exclu. Total	Inclu. Total	Int. Total
	Left	Thru	Right	RTOR	App. Total	Left	Thru	Right	RTOR	App. Total	Left	Thru	Right	RTOR	App. Total	Left	Thru	Right	RTOR	App. Total			
11:00 AM	40	5	13	11	58	8	161	46	15	215	18	10	6	3	34	18	186	16	6	220	35	527	562
11:15 AM	47	10	20	16	77	3	184	44	12	231	10	2	7	4	19	19	162	9	4	190	36	517	553
11:30 AM	36	10	25	15	71	2	188	45	19	235	9	10	8	4	27	14	189	10	3	213	41	546	587
11:45 AM	36	13	21	15	70	11	208	31	8	250	10	7	9	7	26	26	146	15	8	187	38	533	571
Total	159	38	79	57	276	24	741	166	54	931	47	29	30	18	106	77	683	50	21	810	150	2123	2273
12:00 PM	43	12	19	15	74	5	184	44	15	233	14	8	9	5	31	16	199	17	5	232	40	570	610
12:15 PM	47	11	18	8	76	11	262	71	31	344	11	5	14	7	30	18	183	13	7	214	53	664	717
12:30 PM	34	6	11	7	51	10	225	68	23	303	15	17	9	4	41	37	154	18	5	209	39	604	643
12:45 PM	52	8	18	10	78	7	231	49	14	287	17	14	10	8	41	11	213	11	4	235	36	641	677
Total	176	37	66	40	279	33	902	232	83	1167	57	44	42	24	143	82	749	59	21	890	168	2479	2647
01:00 PM	51	11	22	16	84	4	241	53	22	298	9	10	5	3	24	18	178	7	1	203	42	609	651
01:15 PM	34	8	28	19	70	7	238	46	14	291	10	5	4	4	19	28	222	12	6	262	43	642	685
01:30 PM	34	8	19	8	61	6	175	42	23	223	11	16	12	10	39	23	183	19	7	225	48	548	596
01:45 PM	38	12	12	5	62	5	222	43	17	270	9	4	9	5	22	23	203	11	4	237	31	591	622
Total	157	39	81	48	277	22	876	184	76	1082	39	35	30	22	104	92	786	49	18	927	164	2390	2554
Grand Total	492	114	226	145	832	79	2519	582	213	3180	143	108	102	64	353	251	2218	158	60	2627	482	6992	7474
Apprch %	59.1	13.7	27.2			2.5	79.2	18.3			40.5	30.6	28.9			9.6	84.4	6					
Total %	7	1.6	3.2		11.9	1.1	36	8.3		45.5	2	1.5	1.5		5	3.6	31.7	2.3		37.6	6.4	93.6	
Passenger Vehicles	486	114	224		967	77	2463	576		3325	141	108	97		409	251	2177	153		2639	0	0	7340
% Passenger Vehicles	98.8	100	99.1	98.6	99	97.5	97.8	99	98.1	98	98.6	100	95.1	98.4	98.1	100	98.2	96.8	96.7	98.2	0	0	98.2
Large 2 Axle Vehicles	5	0	2		9	1	36	6		47	1	0	3		5	0	25	3		28	0	0	89
% Large 2 Axle Vehicles	1	0	0.9	1.4	0.9	1.3	1.4	1	1.9	1.4	0.7	0	2.9	1.6	1.2	0	1.1	1.9	0	1	0	0	1.2
3 Axle Vehicles	0	0	0		0	1	6	0		7	1	0	1		2	0	3	2		7	0	0	16
% 3 Axle Vehicles	0	0	0	0	0	1.3	0.2	0	0	0.2	0.7	0	1	0	0.5	0	0.1	1.3	3.3	0.3	0	0	0.2
4+ Axle Trucks	1	0	0		1	0	14	0		14	0	0	1		1	0	13	0		13	0	0	29
% 4+ Axle Trucks	0.2	0	0	0	0.1	0	0.6	0	0	0.4	0	0	1	0	0.2	0	0.6	0	0	0.5	0	0	0.4

City of Riverside
 N/S: Orange Terrace Parkway
 E/W: Van Buren Boulevard
 Weather: Clear

File Name : 19_RIV_Or Ter_VB Sat
 Site Code : 05122815
 Start Date : 9/17/2022
 Page No : 2

Start Time	Orange Terrace Parkway Southbound				Van Buren Boulevard Westbound				Farmer Boys Driveway Northbound				Van Buren Boulevard Eastbound				Int. Total
	Left	Thru	Right	App. Total	Left	Thru	Right	App. Total	Left	Thru	Right	App. Total	Left	Thru	Right	App. Total	
Peak Hour Analysis From 11:00 AM to 01:45 PM - Peak 1 of 1																	
Peak Hour for Entire Intersection Begins at 12:15 PM																	
12:15 PM	47	11	18	76	11	262	71	344	11	5	14	30	18	183	13	214	664
12:30 PM	34	6	11	51	10	225	68	303	15	17	9	41	37	154	18	209	604
12:45 PM	52	8	18	78	7	231	49	287	17	14	10	41	11	213	11	235	641
01:00 PM	51	11	22	84	4	241	53	298	9	10	5	24	18	178	7	203	609
Total Volume	184	36	69	289	32	959	241	1232	52	46	38	136	84	728	49	861	2518
% App. Total	63.7	12.5	23.9		2.6	77.8	19.6		38.2	33.8	27.9		9.8	84.6	5.7		
PHF	.885	.818	.784	.860	.727	.915	.849	.895	.765	.676	.679	.829	.568	.854	.681	.916	.948

City of Riverside
 N/S: Orange Terrace Parkway
 E/W: Van Buren Boulevard
 Weather: Clear

File Name : 19_RIV_Or Ter_VB Sat
 Site Code : 05122815
 Start Date : 9/17/2022
 Page No : 3

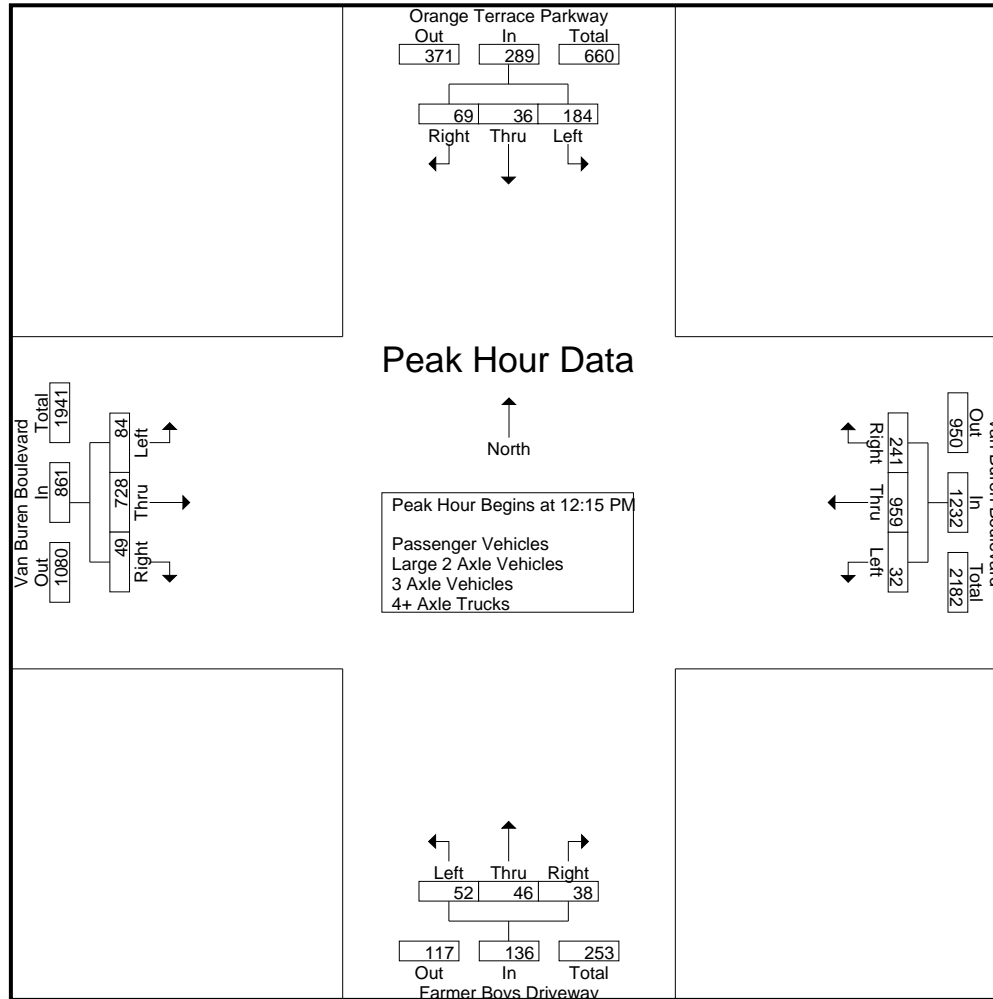

City of Riverside
 N/S: Orange Terrace Parkway
 E/W: Van Buren Boulevard
 Weather: Clear

File Name : 19_RIV_Or Ter_VB Sat
 Site Code : 05122815
 Start Date : 9/17/2022
 Page No : 4

Start Time	Orange Terrace Parkway Southbound				Van Buren Boulevard Westbound				Farmer Boys Driveway Northbound				Van Buren Boulevard Eastbound				Int. Total
	Left	Thru	Right	App. Total	Left	Thru	Right	App. Total	Left	Thru	Right	App. Total	Left	Thru	Right	App. Total	
Peak Hour Analysis From 11:00 AM to 01:45 PM - Peak 1 of 1																	
Peak Hour for Each Approach Begins at:																	
	12:45 PM				12:15 PM				12:00 PM				01:00 PM				
+0 mins.	52	8	18	78	11	262	71	344	14	8	9	31	18	178	7	203	
+15 mins.	51	11	22	84	10	225	68	303	11	5	14	30	28	222	12	262	
+30 mins.	34	8	28	70	7	231	49	287	15	17	9	41	23	183	19	225	
+45 mins.	34	8	19	61	4	241	53	298	17	14	10	41	23	203	11	237	
Total Volume	171	35	87	293	32	959	241	1232	57	44	42	143	92	786	49	927	
% App. Total	58.4	11.9	29.7		2.6	77.8	19.6		39.9	30.8	29.4		9.9	84.8	5.3		
PHF	.822	.795	.777	.872	.727	.915	.849	.895	.838	.647	.750	.872	.821	.885	.645	.885	

City of Riverside
 N/S: Orange Terrace Parkway
 E/W: Van Buren Boulevard
 Weather: Clear

File Name : 19_RIV_Or Ter_VB Sat
 Site Code : 05122815
 Start Date : 9/17/2022
 Page No : 1

Groups Printed- Passenger Vehicles

Start Time	Orange Terrace Parkway Southbound					Van Buren Boulevard Westbound					Farmer Boys Driveway Northbound					Van Buren Boulevard Eastbound					Exclu. Total	Inclu. Total	Int. Total
	Left	Thru	Right	RTOR	App. Total	Left	Thru	Right	RTOR	App. Total	Left	Thru	Right	RTOR	App. Total	Left	Thru	Right	RTOR	App. Total			
11:00 AM	39	5	13	11	57	8	159	45	14	212	18	10	6	3	34	18	180	16	6	214	34	517	551
11:15 AM	47	10	20	16	77	3	181	44	12	228	10	2	6	4	18	19	161	9	4	189	36	512	548
11:30 AM	36	10	23	13	69	2	183	45	19	230	9	10	8	4	27	14	187	10	3	211	39	537	576
11:45 AM	36	13	21	15	70	10	206	31	8	247	10	7	9	7	26	26	143	15	8	184	38	527	565
Total	158	38	77	55	273	23	729	165	53	917	47	29	29	18	105	77	671	50	21	798	147	2093	2240
12:00 PM	41	12	19	15	72	5	182	43	14	230	14	8	9	5	31	16	198	16	5	230	39	563	602
12:15 PM	46	11	18	8	75	11	254	69	29	334	11	5	12	7	28	18	176	13	7	207	51	644	695
12:30 PM	33	6	11	7	50	10	218	67	23	295	15	17	9	4	41	37	150	18	5	205	39	591	630
12:45 PM	52	8	18	10	78	6	226	48	14	280	16	14	10	8	40	11	211	10	3	232	35	630	665
Total	172	37	66	40	275	32	880	227	80	1139	56	44	40	24	140	82	735	57	20	874	164	2428	2592
01:00 PM	50	11	22	16	83	4	236	53	22	293	9	10	5	3	24	18	177	7	1	202	42	602	644
01:15 PM	34	8	28	19	70	7	235	46	14	288	10	5	4	4	19	28	219	12	6	259	43	636	679
01:30 PM	34	8	19	8	61	6	170	42	23	218	10	16	12	10	38	23	178	17	6	218	47	535	582
01:45 PM	38	12	12	5	62	5	213	43	17	261	9	4	7	4	20	23	197	10	4	230	30	573	603
Total	156	39	81	48	276	22	854	184	76	1060	38	35	28	21	101	92	771	46	17	909	162	2346	2508
Grand Total	486	114	224	143	824	77	2463	576	209	3116	141	108	97	63	346	251	2177	153	58	2581	473	6867	7340
Apprch %	59	13.8	27.2			2.5	79	18.5			40.8	31.2	28			9.7	84.3	5.9					
Total %	7.1	1.7	3.3		12	1.1	35.9	8.4		45.4	2.1	1.6	1.4		5	3.7	31.7	2.2		37.6	6.4	93.6	

Start Time	Orange Terrace Parkway Southbound				Van Buren Boulevard Westbound				Farmer Boys Driveway Northbound				Van Buren Boulevard Eastbound				Int. Total
	Left	Thru	Right	App. Total	Left	Thru	Right	App. Total	Left	Thru	Right	App. Total	Left	Thru	Right	App. Total	
Peak Hour Analysis From 12:15 PM to 01:00 PM - Peak 1 of 1																	
Peak Hour for Entire Intersection Begins at 12:15 PM																	
12:15 PM	46	11	18	75	11	254	69	334	11	5	12	28	18	176	13	207	644
12:30 PM	33	6	11	50	10	218	67	295	15	17	9	41	37	150	18	205	591
12:45 PM	52	8	18	78	6	226	48	280	16	14	10	40	11	211	10	232	630
01:00 PM	50	11	22	83	4	236	53	293	9	10	5	24	18	177	7	202	602
Total Volume	181	36	69	286	31	934	237	1202	51	46	36	133	84	714	48	846	2467
% App. Total	63.3	12.6	24.1		2.6	77.7	19.7		38.3	34.6	27.1		9.9	84.4	5.7		
PHF	.870	.818	.784	.861	.705	.919	.859	.900	.797	.676	.750	.811	.568	.846	.667	.912	.958

City of Riverside
 N/S: Orange Terrace Parkway
 E/W: Van Buren Boulevard
 Weather: Clear

File Name : 19_RIV_Or Ter_VB Sat
 Site Code : 05122815
 Start Date : 9/17/2022
 Page No : 2

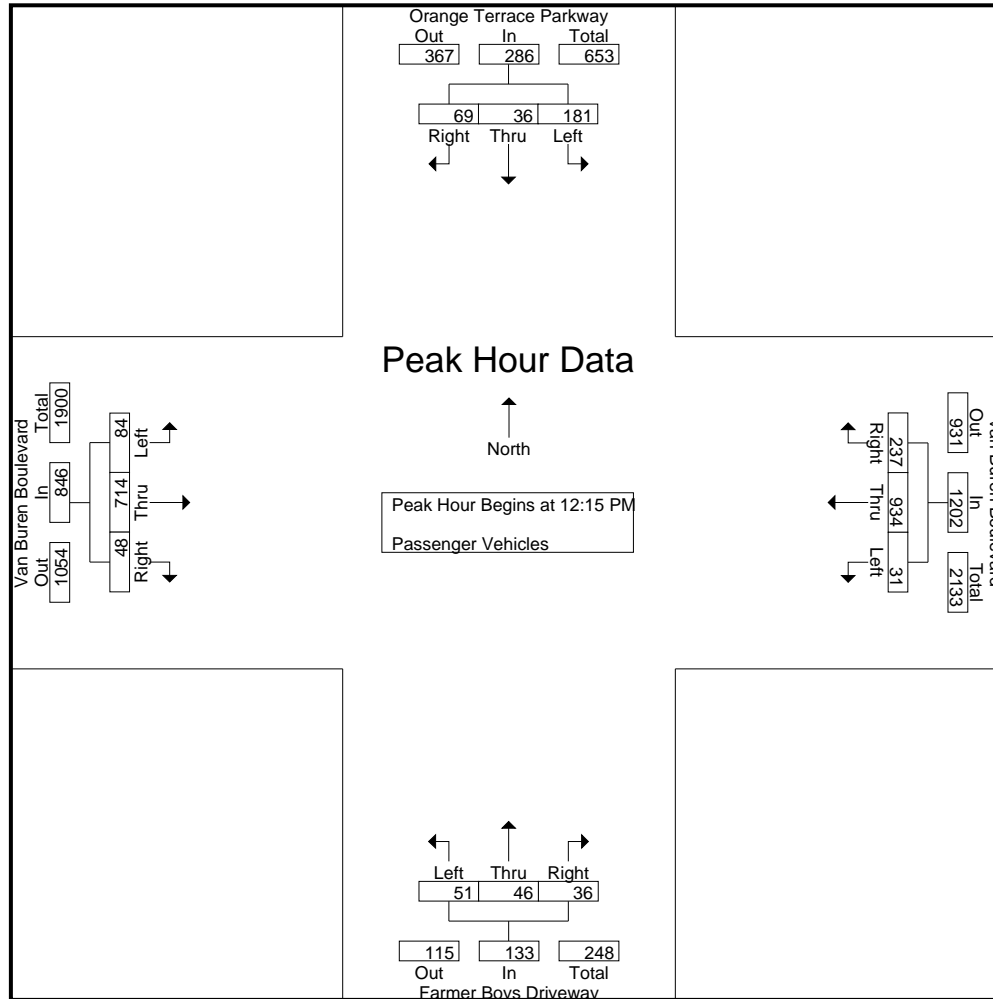

City of Riverside
 N/S: Orange Terrace Parkway
 E/W: Van Buren Boulevard
 Weather: Clear

File Name : 19_RIV_Or Ter_VB Sat
 Site Code : 05122815
 Start Date : 9/17/2022
 Page No : 3

Start Time	Orange Terrace Parkway Southbound				Van Buren Boulevard Westbound				Farmer Boys Driveway Northbound				Van Buren Boulevard Eastbound				Int. Total
	Left	Thru	Right	App. Total	Left	Thru	Right	App. Total	Left	Thru	Right	App. Total	Left	Thru	Right	App. Total	
Peak Hour Analysis From 12:15 PM to 01:00 PM - Peak 1 of 1																	
Peak Hour for Each Approach Begins at:																	
	12:15 PM				12:15 PM				12:15 PM				12:15 PM				
+0 mins.	46	11	18	75	11	254	69	334	11	5	12	28	18	176	13	207	
+15 mins.	33	6	11	50	10	218	67	295	15	17	9	41	37	150	18	205	
+30 mins.	52	8	18	78	6	226	48	280	16	14	10	40	11	211	10	232	
+45 mins.	50	11	22	83	4	236	53	293	9	10	5	24	18	177	7	202	
Total Volume	181	36	69	286	31	934	237	1202	51	46	36	133	84	714	48	846	
% App. Total	63.3	12.6	24.1		2.6	77.7	19.7		38.3	34.6	27.1		9.9	84.4	5.7		
PHF	.870	.818	.784	.861	.705	.919	.859	.900	.797	.676	.750	.811	.568	.846	.667	.912	

City of Riverside
 N/S: Orange Terrace Parkway
 E/W: Van Buren Boulevard
 Weather: Clear

File Name : 19_RIV_Or Ter_VB Sat
 Site Code : 05122815
 Start Date : 9/17/2022
 Page No : 1

Groups Printed- Large 2 Axle Vehicles

Start Time	Orange Terrace Parkway Southbound					Van Buren Boulevard Westbound					Farmer Boys Driveway Northbound					Van Buren Boulevard Eastbound					Exclu. Total	Inclu. Total	Int. Total
	Left	Thru	Right	RTOR	App. Total	Left	Thru	Right	RTOR	App. Total	Left	Thru	Right	RTOR	App. Total	Left	Thru	Right	RTOR	App. Total			
11:00 AM	1	0	0	0	1	0	1	1	1	2	0	0	0	0	0	0	4	0	0	4	1	7	8
11:15 AM	0	0	0	0	0	0	3	0	0	3	0	0	0	0	0	0	1	0	0	1	0	4	4
11:30 AM	0	0	2	2	2	0	2	0	0	2	0	0	0	0	0	0	1	0	0	1	2	5	7
11:45 AM	0	0	0	0	0	0	2	0	0	2	0	0	0	0	0	0	1	0	0	1	0	3	3
Total	1	0	2	2	3	0	8	1	1	9	0	0	0	0	0	0	7	0	0	7	3	19	22
12:00 PM	2	0	0	0	2	0	1	1	1	2	0	0	0	0	0	0	1	1	0	2	1	6	7
12:15 PM	1	0	0	0	1	0	6	2	2	8	0	0	1	0	1	0	7	0	0	7	2	17	19
12:30 PM	1	0	0	0	1	0	3	1	0	4	0	0	0	0	0	0	3	0	0	3	0	8	8
12:45 PM	0	0	0	0	0	1	2	1	0	4	1	0	0	0	1	0	1	0	0	1	0	6	6
Total	4	0	0	0	4	1	12	5	3	18	1	0	1	0	2	0	12	1	0	13	3	37	40
01:00 PM	0	0	0	0	0	0	4	0	0	4	0	0	0	0	0	0	1	0	0	1	0	5	5
01:15 PM	0	0	0	0	0	0	2	0	0	2	0	0	0	0	0	0	2	0	0	2	0	4	4
01:30 PM	0	0	0	0	0	0	4	0	0	4	0	0	0	0	0	0	3	1	0	4	0	8	8
01:45 PM	0	0	0	0	0	0	6	0	0	6	0	0	2	1	2	0	0	1	0	1	1	9	10
Total	0	0	0	0	0	0	16	0	0	16	0	0	2	1	2	0	6	2	0	8	1	26	27
Grand Total	5	0	2	2	7	1	36	6	4	43	1	0	3	1	4	0	25	3	0	28	7	82	89
Apprch %	71.4	0	28.6			2.3	83.7	14			25	0	75			0	89.3	10.7					
Total %	6.1	0	2.4		8.5	1.2	43.9	7.3		52.4	1.2	0	3.7		4.9	0	30.5	3.7		34.1	7.9	92.1	

Start Time	Orange Terrace Parkway Southbound				Van Buren Boulevard Westbound				Farmer Boys Driveway Northbound				Van Buren Boulevard Eastbound				Int. Total
	Left	Thru	Right	App. Total	Left	Thru	Right	App. Total	Left	Thru	Right	App. Total	Left	Thru	Right	App. Total	
Peak Hour Analysis From 12:15 PM to 01:00 PM - Peak 1 of 1																	
Peak Hour for Entire Intersection Begins at 12:15 PM																	
12:15 PM	1	0	0	1	0	6	2	8	0	0	1	1	0	7	0	7	17
12:30 PM	1	0	0	1	0	3	1	4	0	0	0	0	0	3	0	3	8
12:45 PM	0	0	0	0	1	2	1	4	1	0	0	1	0	1	0	1	6
01:00 PM	0	0	0	0	0	4	0	4	0	0	0	0	0	1	0	1	5
Total Volume	2	0	0	2	1	15	4	20	1	0	1	2	0	12	0	12	36
% App. Total	100	0	0		5	75	20		50	0	50		0	100	0		
PHF	.500	.000	.000	.500	.250	.625	.500	.625	.250	.000	.250	.500	.000	.429	.000	.429	.529

City of Riverside
 N/S: Orange Terrace Parkway
 E/W: Van Buren Boulevard
 Weather: Clear

File Name : 19_RIV_Or Ter_VB Sat
 Site Code : 05122815
 Start Date : 9/17/2022
 Page No : 2

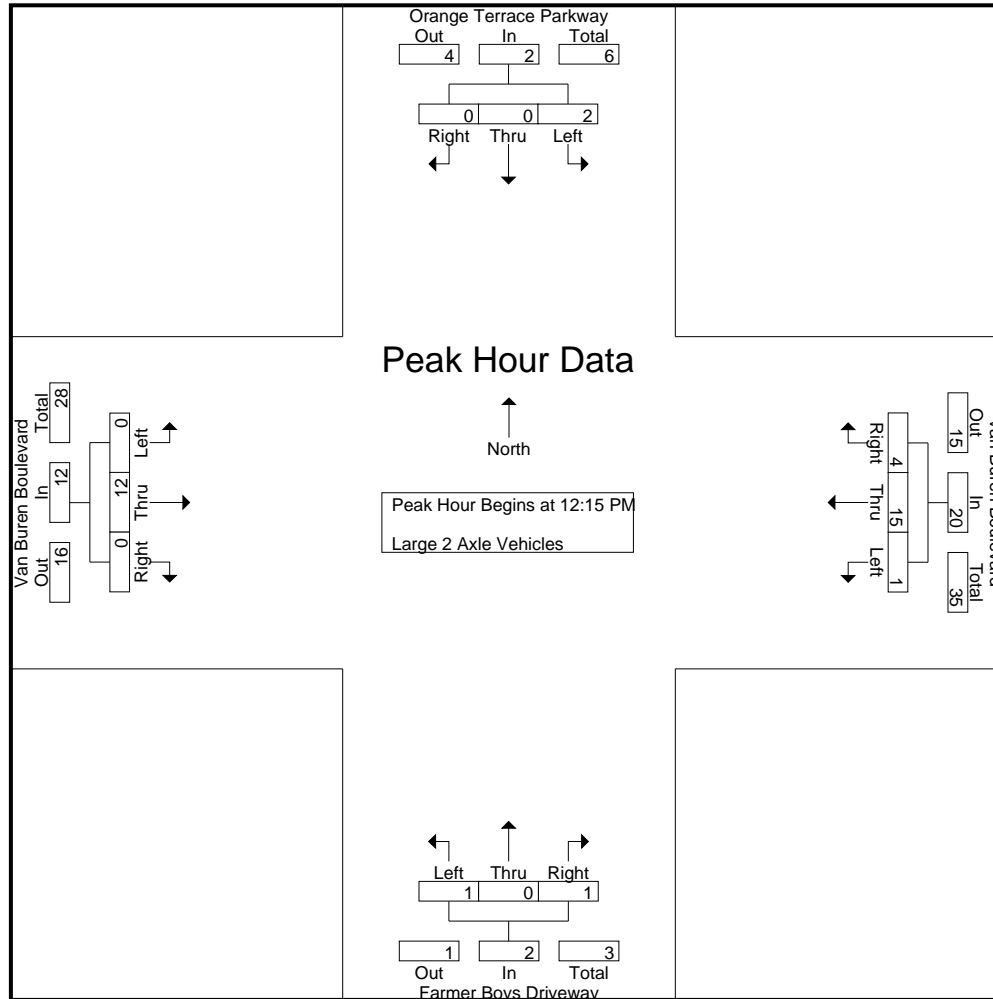

City of Riverside
 N/S: Orange Terrace Parkway
 E/W: Van Buren Boulevard
 Weather: Clear

File Name : 19_RIV_Or Ter_VB Sat
 Site Code : 05122815
 Start Date : 9/17/2022
 Page No : 3

Start Time	Orange Terrace Parkway Southbound				Van Buren Boulevard Westbound				Farmer Boys Driveway Northbound				Van Buren Boulevard Eastbound				Int. Total
	Left	Thru	Right	App. Total	Left	Thru	Right	App. Total	Left	Thru	Right	App. Total	Left	Thru	Right	App. Total	
Peak Hour Analysis From 12:15 PM to 01:00 PM - Peak 1 of 1																	
Peak Hour for Each Approach Begins at:																	
	12:15 PM				12:15 PM				12:15 PM				12:15 PM				
+0 mins.	1	0	0	1	0	6	2	8	0	0	1	1	0	7	0	7	
+15 mins.	1	0	0	1	0	3	1	4	0	0	0	0	0	3	0	3	
+30 mins.	0	0	0	0	1	2	1	4	1	0	0	1	0	1	0	1	
+45 mins.	0	0	0	0	0	4	0	4	0	0	0	0	0	1	0	1	
Total Volume	2	0	0	2	1	15	4	20	1	0	1	2	0	12	0	12	
% App. Total	100	0	0		5	75	20		50	0	50		0	100	0		
PHF	.500	.000	.000	.500	.250	.625	.500	.625	.250	.000	.250	.500	.000	.429	.000	.429	

City of Riverside
 N/S: Orange Terrace Parkway
 E/W: Van Buren Boulevard
 Weather: Clear

File Name : 19_RIV_Or Ter_VB Sat
 Site Code : 05122815
 Start Date : 9/17/2022
 Page No : 1

Groups Printed- 3 Axle Vehicles

Start Time	Orange Terrace Parkway Southbound					Van Buren Boulevard Westbound					Farmer Boys Driveway Northbound					Van Buren Boulevard Eastbound					Exclu. Total	Inclu. Total	Int. Total				
	Left	Thru	Right	RTOR	App. Total	Left	Thru	Right	RTOR	App. Total	Left	Thru	Right	RTOR	App. Total	Left	Thru	Right	RTOR	App. Total							
11:00 AM	0	0	0	0	0	0	0	0	0	0	0	0	0	0	0	0	1	0	0	1	0	0	1	0	0	0	1
11:15 AM	0	0	0	0	0	0	0	0	0	0	0	0	0	0	0	0	0	0	0	0	0	0	0	0	0	0	0
11:30 AM	0	0	0	0	0	0	1	0	0	1	0	0	0	0	0	0	0	0	0	0	0	0	0	0	0	1	1
11:45 AM	0	0	0	0	0	1	0	0	0	1	0	0	0	0	0	0	1	0	0	1	0	0	0	0	0	2	2
Total	0	0	0	0	0	1	1	0	0	2	0	0	0	0	0	0	2	0	0	2	0	0	0	0	0	4	4
12:00 PM	0	0	0	0	0	0	1	0	0	1	0	0	0	0	0	0	0	0	0	0	0	0	0	0	0	1	1
12:15 PM	0	0	0	0	0	0	1	0	0	1	0	0	1	0	1	0	0	0	0	0	0	0	0	0	0	2	2
12:30 PM	0	0	0	0	0	0	2	0	0	2	0	0	0	0	0	0	0	0	0	0	0	0	0	0	0	2	2
12:45 PM	0	0	0	0	0	0	1	0	0	1	0	0	0	0	0	0	0	1	1	1	1	1	2	1	1	2	3
Total	0	0	0	0	0	0	5	0	0	5	0	0	1	0	1	0	0	1	1	1	1	1	1	1	1	7	8
01:00 PM	0	0	0	0	0	0	0	0	0	0	0	0	0	0	0	0	0	0	0	0	0	0	0	0	0	0	0
01:15 PM	0	0	0	0	0	0	0	0	0	0	0	0	0	0	0	0	0	0	0	0	0	0	0	0	0	0	0
01:30 PM	0	0	0	0	0	0	0	0	0	0	1	0	0	0	1	0	1	1	1	2	1	1	3	1	1	3	4
01:45 PM	0	0	0	0	0	0	0	0	0	0	0	0	0	0	0	0	0	0	0	0	0	0	0	0	0	0	0
Total	0	0	0	0	0	0	0	0	0	0	1	0	0	0	1	0	1	1	1	2	1	1	3	1	1	3	4
Grand Total	0	0	0	0	0	1	6	0	0	7	1	0	1	0	2	0	3	2	2	5	2	2	14	2	2	14	16
Apprch %	0	0	0			14.3	85.7	0			50	0	50			0	60	40									
Total %	0	0	0			7.1	42.9	0		50	7.1	0	7.1		14.3	0	21.4	14.3		35.7	12.5	12.5	87.5				

Start Time	Orange Terrace Parkway Southbound				Van Buren Boulevard Westbound				Farmer Boys Driveway Northbound				Van Buren Boulevard Eastbound				Int. Total
	Left	Thru	Right	App. Total	Left	Thru	Right	App. Total	Left	Thru	Right	App. Total	Left	Thru	Right	App. Total	
Peak Hour Analysis From 12:15 PM to 01:00 PM - Peak 1 of 1																	
Peak Hour for Entire Intersection Begins at 12:15 PM																	
12:15 PM	0	0	0	0	0	1	0	1	0	0	1	1	0	0	0	0	2
12:30 PM	0	0	0	0	0	2	0	2	0	0	0	0	0	0	0	0	2
12:45 PM	0	0	0	0	0	1	0	1	0	0	0	0	0	0	1	1	2
01:00 PM	0	0	0	0	0	0	0	0	0	0	0	0	0	0	0	0	0
Total Volume	0	0	0	0	0	4	0	4	0	0	1	1	0	0	1	1	6
% App. Total	0	0	0		0	100	0		0	0	100		0	0	100		
PHF	.000	.000	.000	.000	.000	.500	.000	.500	.000	.000	.250	.250	.000	.000	.250	.250	.750

City of Riverside
 N/S: Orange Terrace Parkway
 E/W: Van Buren Boulevard
 Weather: Clear

File Name : 19_RIV_Or Ter_VB Sat
 Site Code : 05122815
 Start Date : 9/17/2022
 Page No : 2

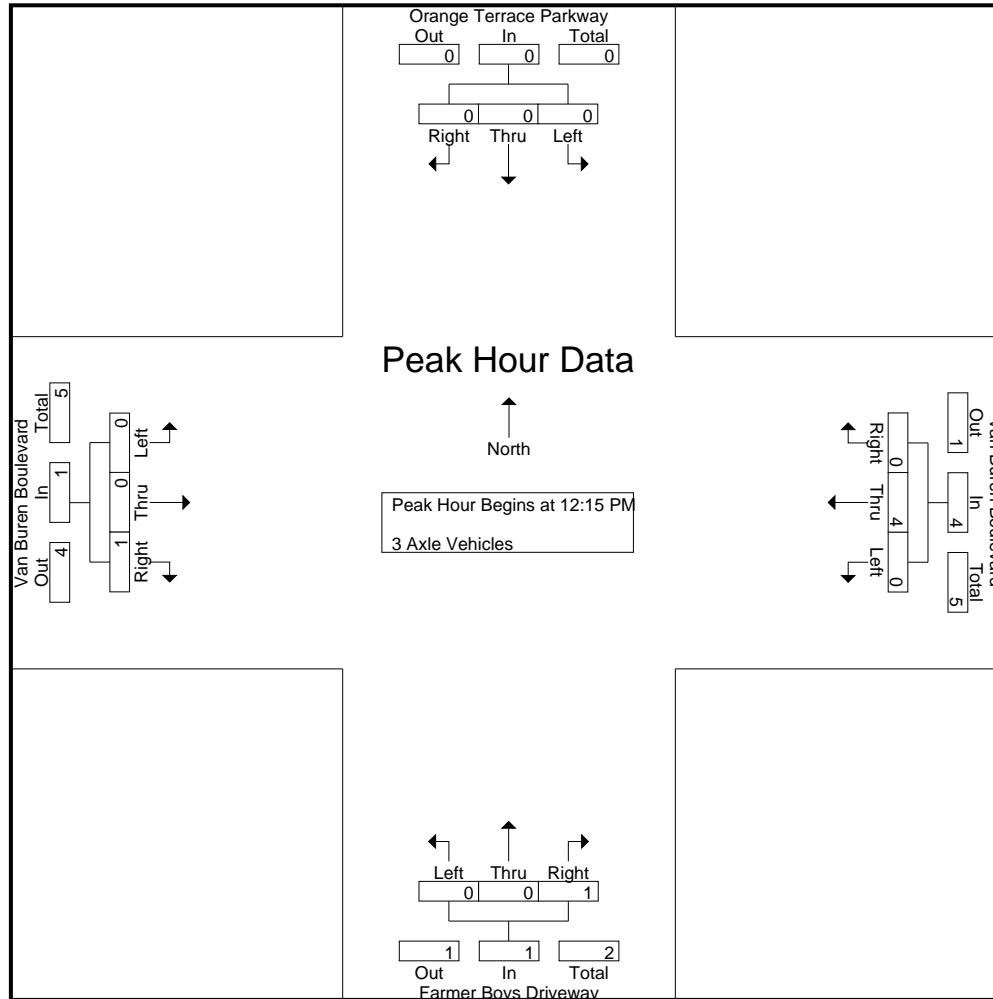

City of Riverside
 N/S: Orange Terrace Parkway
 E/W: Van Buren Boulevard
 Weather: Clear

File Name : 19_RIV_Or Ter_VB Sat
 Site Code : 05122815
 Start Date : 9/17/2022
 Page No : 3

Start Time	Orange Terrace Parkway Southbound				Van Buren Boulevard Westbound				Farmer Boys Driveway Northbound				Van Buren Boulevard Eastbound				Int. Total
	Left	Thru	Right	App. Total	Left	Thru	Right	App. Total	Left	Thru	Right	App. Total	Left	Thru	Right	App. Total	
Peak Hour Analysis From 12:15 PM to 01:00 PM - Peak 1 of 1																	
Peak Hour for Each Approach Begins at:																	
	12:15 PM				12:15 PM				12:15 PM				12:15 PM				
+0 mins.	0	0	0	0	0	1	0	1	0	0	1	1	0	0	0	0	0
+15 mins.	0	0	0	0	0	2	0	2	0	0	0	0	0	0	0	0	0
+30 mins.	0	0	0	0	0	1	0	1	0	0	0	0	0	0	1	1	0
+45 mins.	0	0	0	0	0	0	0	0	0	0	0	0	0	0	0	0	0
Total Volume	0	0	0	0	0	4	0	4	0	0	1	1	0	0	1	1	0
% App. Total	0	0	0	0	0	100	0	100	0	0	100	100	0	0	100	100	0
PHF	.000	.000	.000	.000	.000	.500	.000	.500	.000	.000	.250	.250	.000	.000	.250	.250	

City of Riverside
 N/S: Orange Terrace Parkway
 E/W: Van Buren Boulevard
 Weather: Clear

File Name : 19_RIV_Or Ter_VB Sat
 Site Code : 05122815
 Start Date : 9/17/2022
 Page No : 1

Groups Printed- 4+ Axle Trucks

Start Time	Orange Terrace Parkway Southbound					Van Buren Boulevard Westbound					Farmer Boys Driveway Northbound					Van Buren Boulevard Eastbound					Exclu. Total	Inclu. Total	Int. Total	
	Left	Thru	Right	RTOR	App. Total	Left	Thru	Right	RTOR	App. Total	Left	Thru	Right	RTOR	App. Total	Left	Thru	Right	RTOR	App. Total				
11:00 AM	0	0	0	0	0	0	1	0	0	1	0	0	0	0	0	0	1	0	0	1	0	0	2	2
11:15 AM	0	0	0	0	0	0	0	0	0	0	0	0	1	0	1	0	0	0	0	0	0	1	1	1
11:30 AM	0	0	0	0	0	0	2	0	0	2	0	0	0	0	0	0	1	0	0	1	0	3	3	3
11:45 AM	0	0	0	0	0	0	0	0	0	0	0	0	0	0	0	0	1	0	0	1	0	1	1	1
Total	0	0	0	0	0	0	3	0	0	3	0	0	1	0	1	0	3	0	0	3	0	7	7	7
12:00 PM	0	0	0	0	0	0	0	0	0	0	0	0	0	0	0	0	0	0	0	0	0	0	0	0
12:15 PM	0	0	0	0	0	0	1	0	0	1	0	0	0	0	0	0	0	0	0	0	0	1	1	1
12:30 PM	0	0	0	0	0	0	2	0	0	2	0	0	0	0	0	0	1	0	0	1	0	3	3	3
12:45 PM	0	0	0	0	0	0	2	0	0	2	0	0	0	0	0	0	1	0	0	1	0	3	3	3
Total	0	0	0	0	0	0	5	0	0	5	0	0	0	0	0	0	2	0	0	2	0	7	7	7
01:00 PM	1	0	0	0	1	0	1	0	0	1	0	0	0	0	0	0	0	0	0	0	0	2	2	2
01:15 PM	0	0	0	0	0	0	1	0	0	1	0	0	0	0	0	0	1	0	0	1	0	2	2	2
01:30 PM	0	0	0	0	0	0	1	0	0	1	0	0	0	0	0	0	1	0	0	1	0	2	2	2
01:45 PM	0	0	0	0	0	0	3	0	0	3	0	0	0	0	0	0	6	0	0	6	0	9	9	9
Total	1	0	0	0	1	0	6	0	0	6	0	0	0	0	0	0	8	0	0	8	0	15	15	15
Grand Total	1	0	0	0	1	0	14	0	0	14	0	0	1	0	1	0	13	0	0	13	0	29	29	29
Apprch %	100	0	0			0	100	0			0	0	100			0	100	0			0			
Total %	3.4	0	0		3.4	0	48.3	0		48.3	0	0	3.4		3.4	0	44.8	0		44.8	0	100		

Start Time	Orange Terrace Parkway Southbound				Van Buren Boulevard Westbound				Farmer Boys Driveway Northbound				Van Buren Boulevard Eastbound				Int. Total
	Left	Thru	Right	App. Total	Left	Thru	Right	App. Total	Left	Thru	Right	App. Total	Left	Thru	Right	App. Total	
Peak Hour Analysis From 12:15 PM to 01:00 PM - Peak 1 of 1																	
Peak Hour for Entire Intersection Begins at 12:15 PM																	
12:15 PM	0	0	0	0	0	1	0	1	0	0	0	0	0	0	0	0	1
12:30 PM	0	0	0	0	0	2	0	2	0	0	0	0	0	1	0	1	3
12:45 PM	0	0	0	0	0	2	0	2	0	0	0	0	0	1	0	1	3
01:00 PM	1	0	0	1	0	1	0	1	0	0	0	0	0	0	0	0	2
Total Volume	1	0	0	1	0	6	0	6	0	0	0	0	0	2	0	2	9
% App. Total	100	0	0		0	100	0		0	0	0		0	100	0		
PHF	.250	.000	.000	.250	.000	.750	.000	.750	.000	.000	.000	.000	.000	.500	.000	.500	.750

City of Riverside
 N/S: Orange Terrace Parkway
 E/W: Van Buren Boulevard
 Weather: Clear

File Name : 19_RIV_Or Ter_VB Sat
 Site Code : 05122815
 Start Date : 9/17/2022
 Page No : 2

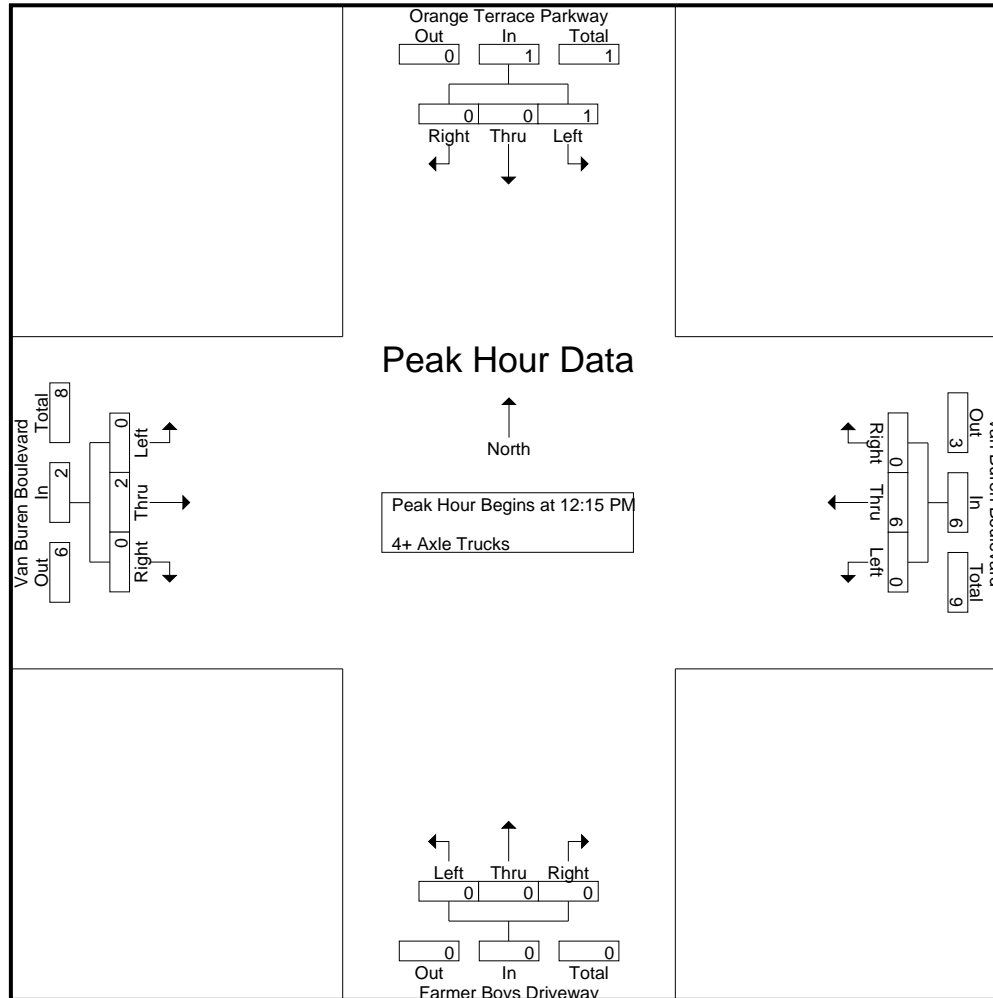

City of Riverside
 N/S: Orange Terrace Parkway
 E/W: Van Buren Boulevard
 Weather: Clear

File Name : 19_RIV_Or Ter_VB Sat
 Site Code : 05122815
 Start Date : 9/17/2022
 Page No : 3

Start Time	Orange Terrace Parkway Southbound				Van Buren Boulevard Westbound				Farmer Boys Driveway Northbound				Van Buren Boulevard Eastbound				Int. Total
	Left	Thru	Right	App. Total	Left	Thru	Right	App. Total	Left	Thru	Right	App. Total	Left	Thru	Right	App. Total	
Peak Hour Analysis From 12:15 PM to 01:00 PM - Peak 1 of 1																	
Peak Hour for Each Approach Begins at:																	
	12:15 PM				12:15 PM				12:15 PM				12:15 PM				
+0 mins.	0	0	0	0	0	1	0	1	0	0	0	0	0	0	0	0	
+15 mins.	0	0	0	0	0	2	0	2	0	0	0	0	0	1	0	1	
+30 mins.	0	0	0	0	0	2	0	2	0	0	0	0	0	1	0	1	
+45 mins.	1	0	0	1	0	1	0	1	0	0	0	0	0	0	0	0	
Total Volume	1	0	0	1	0	6	0	6	0	0	0	0	0	2	0	2	
% App. Total	100	0	0		0	100	0		0	0	0		0	100	0		
PHF	.250	.000	.000	.250	.000	.750	.000	.750	.000	.000	.000	.000	.000	.500	.000	.500	

Location: Riverside
 N/S: Orange Terrace Parkway
 E/W: Van Buren Boulevard



Date: 9/17/2022
 Day Saturday

PEDESTRIANS

Time	North Leg Orange Terrace Parkway	East Leg Van Buren Boulevard	South Leg Farmer Boys DW	West Leg Van Buren Boulevard	TOTAL
11:00 AM	0	1	0	0	1
11:15 AM	0	0	0	0	0
11:30 AM	0	0	0	0	0
11:45 AM	0	0	0	0	0
12:00 PM	0	0	0	0	0
12:15 PM	0	0	3	3	6
12:30 PM	0	0	0	0	0
12:45 PM	0	0	0	0	0
1:00 PM	0	0	0	2	2
1:15 PM	0	0	0	0	0
1:30 PM	0	0	0	2	2
1:45 PM	0	0	0	1	1
TOTAL VOLUMES:	0	1	3	8	12

Location: Riverside
 N/S: Orange Terrace Parkway
 E/W: Van Buren Boulevard

Date: 9/17/2022
 Day: Saturday



BICYCLES

	Southbound Orange Terrace Parkway			Westbound Van Buren Boulevard			Northbound Farmer Boys DW			Eastbound Van Buren Boulevard			
	Left	Thru	Right	Left	Thru	Right	Left	Thru	Right	Left	Thru	Right	
11:00 AM	0	0	0	0	0	0	0	0	0	0	0	0	0
11:15 AM	0	0	0	0	0	0	0	0	0	0	0	0	0
11:30 AM	0	0	0	0	0	1	0	0	0	0	0	0	1
11:45 AM	0	0	0	0	0	0	0	0	0	0	0	0	0
12:00 PM	0	0	0	0	0	0	0	0	0	0	0	0	0
12:15 PM	0	0	0	0	0	0	0	0	0	0	0	0	0
12:30 PM	0	0	0	0	0	0	0	0	0	0	0	0	0
12:45 PM	0	0	0	0	0	0	0	0	0	0	0	0	0
1:00 PM	0	0	0	0	0	0	0	0	0	0	0	0	0
1:15 PM	0	0	0	0	0	0	0	0	0	0	0	0	0
1:30 PM	0	0	0	0	0	1	0	0	0	0	0	0	1
1:45 PM	0	0	0	0	0	0	0	0	0	0	0	0	0
TOTAL VOLUMES:	0	0	0	0	0	2	0	0	0	0	0	0	2

City of Riverside
 N/S: San Gorgonio Drive/Brown Street
 E/W: Alessandro Boulevard
 Weather: Clear

File Name : 20_RIV_Brown_Ales Sat
 Site Code : 05122815
 Start Date : 9/17/2022
 Page No : 1

Groups Printed- Passenger Vehicles - Large 2 Axle Vehicles - 3 Axle Vehicles - 4+ Axle Trucks

Start Time	San Gorgonio Drive Southbound					Alessandro Boulevard Westbound					Brown Street Northbound					Alessandro Boulevard Eastbound					Exclu. Total	Inclu. Total	Int. Total
	Left	Thru	Right	RTOR	App. Total	Left	Thru	Right	RTOR	App. Total	Left	Thru	Right	RTOR	App. Total	Left	Thru	Right	RTOR	App. Total			
11:00 AM	7	0	8	8	15	2	253	5	0	260	0	0	3	3	3	4	223	2	0	229	11	507	518
11:15 AM	10	0	6	5	16	2	289	1	0	292	1	0	3	2	4	8	236	0	0	244	7	556	563
11:30 AM	10	0	4	2	14	3	303	5	2	311	2	0	2	2	4	3	246	3	0	252	6	581	587
11:45 AM	10	0	5	5	15	2	329	2	0	333	0	0	0	0	0	6	258	0	0	264	5	612	617
Total	37	0	23	20	60	9	1174	13	2	1196	3	0	8	7	11	21	963	5	0	989	29	2256	2285
12:00 PM	9	0	9	9	18	0	263	5	2	268	0	0	0	0	0	10	294	0	0	304	11	590	601
12:15 PM	14	0	10	6	24	3	305	9	0	317	0	0	2	1	2	8	315	0	0	323	7	666	673
12:30 PM	25	0	16	10	41	2	261	7	1	270	3	0	7	7	10	9	286	1	0	296	18	617	635
12:45 PM	20	0	3	2	23	0	332	20	1	352	1	0	2	1	3	6	290	0	0	296	4	674	678
Total	68	0	38	27	106	5	1161	41	4	1207	4	0	11	9	15	33	1185	1	0	1219	40	2547	2587
01:00 PM	9	0	11	10	20	1	318	8	3	327	0	0	0	0	0	8	306	0	0	314	13	661	674
01:15 PM	8	0	10	10	18	2	320	8	2	330	0	0	0	0	0	9	263	0	0	272	12	620	632
01:30 PM	12	0	5	5	17	0	358	12	1	370	0	0	0	0	0	6	333	0	0	339	6	726	732
01:45 PM	7	0	7	5	14	0	361	3	0	364	0	0	0	0	0	6	294	0	0	300	5	678	683
Total	36	0	33	30	69	3	1357	31	6	1391	0	0	0	0	0	29	1196	0	0	1225	36	2685	2721
Grand Total	141	0	94	77	235	17	3692	85	12	3794	7	0	19	16	26	83	3344	6	0	3433	105	7488	7593
Apprch %	60	0	40			0.4	97.3	2.2			26.9	0	73.1			2.4	97.4	0.2					
Total %	1.9	0	1.3		3.1	0.2	49.3	1.1		50.7	0.1	0	0.3		0.3	1.1	44.7	0.1		45.8	1.4	98.6	
Passenger Vehicles	139	0	93		308	17	3643	83		3755	7	0	18		40	82	3311	6		3399	0	0	7502
% Passenger Vehicles	98.6	0	98.9	98.7	98.7	100	98.7	97.6	100	98.7	100	0	94.7	93.8	95.2	98.8	99	100	0	99	0	0	98.8
Large 2 Axle Vehicles	0	0	1		2	0	43	0		43	0	0	0		0	1	30	0		31	0	0	76
% Large 2 Axle Vehicles	0	0	1.1	1.3	0.6	0	1.2	0	0	1.1	0	0	0	0	0	1.2	0.9	0	0	0.9	0	0	1
3 Axle Vehicles	0	0	0		0	0	3	0		3	0	0	0		0	0	3	0		3	0	0	6
% 3 Axle Vehicles	0	0	0	0	0	0	0.1	0	0	0.1	0	0	0	0	0	0	0.1	0	0	0.1	0	0	0.1
4+ Axle Trucks	2	0	0		2	0	3	2		5	0	0	1		2	0	0	0		0	0	0	9
% 4+ Axle Trucks	1.4	0	0	0	0.6	0	0.1	2.4	0	0.1	0	0	5.3	6.2	4.8	0	0	0	0	0	0	0	0.1

City of Riverside
 N/S: San Geronio Drive/Brown Street
 E/W: Alessandro Boulevard
 Weather: Clear

File Name : 20_RIV_Brown_Ales Sat
 Site Code : 05122815
 Start Date : 9/17/2022
 Page No : 2

Start Time	San Geronio Drive Southbound				Alessandro Boulevard Westbound				Brown Street Northbound				Alessandro Boulevard Eastbound				Int. Total
	Left	Thru	Right	App. Total	Left	Thru	Right	App. Total	Left	Thru	Right	App. Total	Left	Thru	Right	App. Total	
Peak Hour Analysis From 11:00 AM to 01:45 PM - Peak 1 of 1																	
Peak Hour for Entire Intersection Begins at 01:00 PM																	
01:00 PM	9	0	11	20	1	318	8	327	0	0	0	0	8	306	0	314	661
01:15 PM	8	0	10	18	2	320	8	330	0	0	0	0	9	263	0	272	620
01:30 PM	12	0	5	17	0	358	12	370	0	0	0	0	6	333	0	339	726
01:45 PM	7	0	7	14	0	361	3	364	0	0	0	0	6	294	0	300	678
Total Volume	36	0	33	69	3	1357	31	1391	0	0	0	0	29	1196	0	1225	2685
% App. Total	52.2	0	47.8		0.2	97.6	2.2		0	0	0		2.4	97.6	0		
PHF	.750	.000	.750	.863	.375	.940	.646	.940	.000	.000	.000	.000	.806	.898	.000	.903	.925

City of Riverside
 N/S: San Gorgonio Drive/Brown Street
 E/W: Alessandro Boulevard
 Weather: Clear

File Name : 20_RIV_Brown_Ales Sat
 Site Code : 05122815
 Start Date : 9/17/2022
 Page No : 3

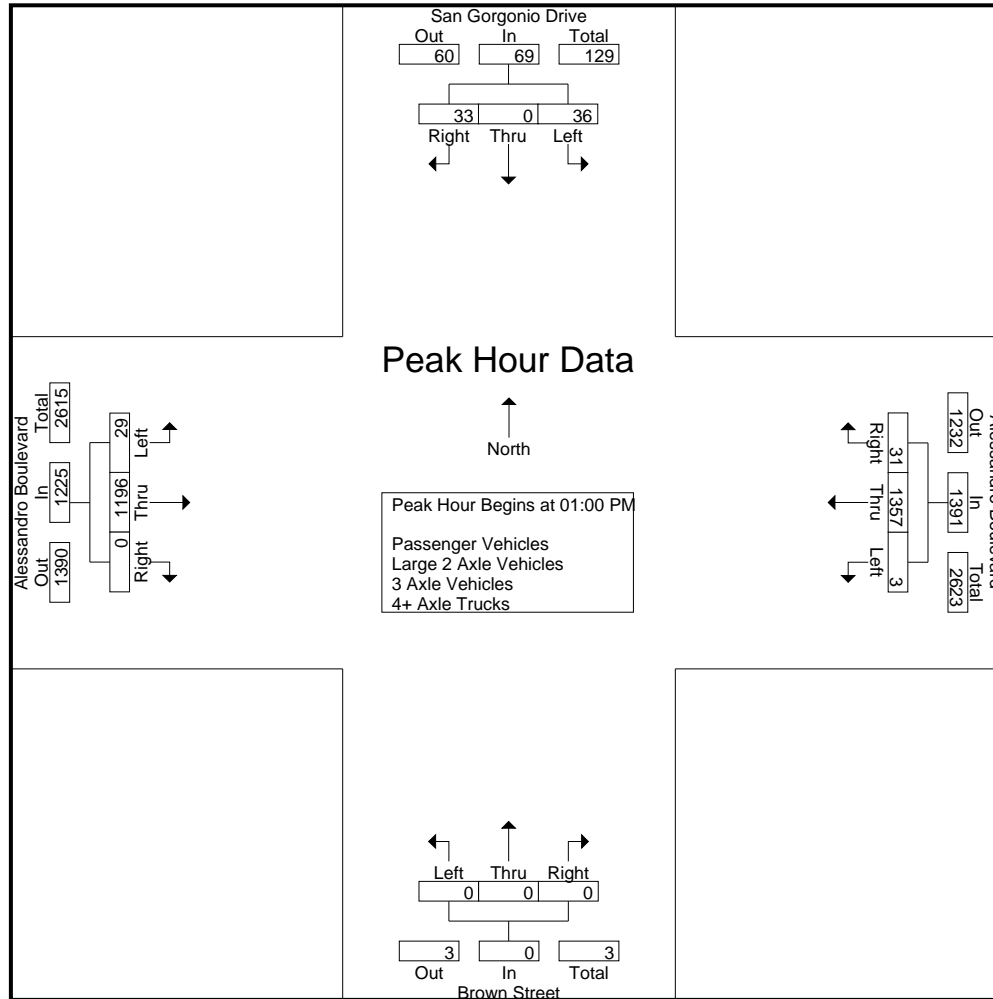

City of Riverside
 N/S: San Geronio Drive/Brown Street
 E/W: Alessandro Boulevard
 Weather: Clear

File Name : 20_RIV_Brown_Ales Sat
 Site Code : 05122815
 Start Date : 9/17/2022
 Page No : 4

Start Time	San Geronio Drive Southbound				Alessandro Boulevard Westbound				Brown Street Northbound				Alessandro Boulevard Eastbound				Int. Total
	Left	Thru	Right	App. Total	Left	Thru	Right	App. Total	Left	Thru	Right	App. Total	Left	Thru	Right	App. Total	
Peak Hour Analysis From 11:00 AM to 01:45 PM - Peak 1 of 1																	
Peak Hour for Each Approach Begins at:																	
	12:15 PM				01:00 PM				12:00 PM				12:15 PM				
+0 mins.	14	0	10	24	1	318	8	327	0	0	0	0	8	315	0	323	
+15 mins.	25	0	16	41	2	320	8	330	0	0	2	2	9	286	1	296	
+30 mins.	20	0	3	23	0	358	12	370	3	0	7	10	6	290	0	296	
+45 mins.	9	0	11	20	0	361	3	364	1	0	2	3	8	306	0	314	
Total Volume	68	0	40	108	3	1357	31	1391	4	0	11	15	31	1197	1	1229	
% App. Total	63	0	37		0.2	97.6	2.2		26.7	0	73.3		2.5	97.4	0.1		
PHF	.680	.000	.625	.659	.375	.940	.646	.940	.333	.000	.393	.375	.861	.950	.250	.951	

City of Riverside
 N/S: San Gorgonio Drive/Brown Street
 E/W: Alessandro Boulevard
 Weather: Clear

File Name : 20_RIV_Brown_Ales Sat
 Site Code : 05122815
 Start Date : 9/17/2022
 Page No : 1

Groups Printed- Passenger Vehicles

Start Time	San Gorgonio Drive Southbound					Alessandro Boulevard Westbound					Brown Street Northbound					Alessandro Boulevard Eastbound					Exclu. Total	Inclu. Total	Int. Total
	Left	Thru	Right	RTOR	App. Total	Left	Thru	Right	RTOR	App. Total	Left	Thru	Right	RTOR	App. Total	Left	Thru	Right	RTOR	App. Total			
11:00 AM	7	0	7	7	14	2	252	5	0	259	0	0	2	2	2	4	219	2	0	225	9	500	509
11:15 AM	10	0	6	5	16	2	285	1	0	288	1	0	3	2	4	8	234	0	0	242	7	550	557
11:30 AM	10	0	4	2	14	3	299	5	2	307	2	0	2	2	4	3	244	3	0	250	6	575	581
11:45 AM	10	0	5	5	15	2	323	2	0	327	0	0	0	0	0	6	255	0	0	261	5	603	608
Total	37	0	22	19	59	9	1159	13	2	1181	3	0	7	6	10	21	952	5	0	978	27	2228	2255
12:00 PM	8	0	9	9	17	0	257	4	2	261	0	0	0	0	0	10	294	0	0	304	11	582	593
12:15 PM	14	0	10	6	24	3	301	8	0	312	0	0	2	1	2	8	310	0	0	318	7	656	663
12:30 PM	25	0	16	10	41	2	256	7	1	265	3	0	7	7	10	9	283	1	0	293	18	609	627
12:45 PM	20	0	3	2	23	0	331	20	1	351	1	0	2	1	3	6	286	0	0	292	4	669	673
Total	67	0	38	27	105	5	1145	39	4	1189	4	0	11	9	15	33	1173	1	0	1207	40	2516	2556
01:00 PM	8	0	11	10	19	1	312	8	3	321	0	0	0	0	0	8	304	0	0	312	13	652	665
01:15 PM	8	0	10	10	18	2	317	8	2	327	0	0	0	0	0	8	261	0	0	269	12	614	626
01:30 PM	12	0	5	5	17	0	352	12	1	364	0	0	0	0	0	6	329	0	0	335	6	716	722
01:45 PM	7	0	7	5	14	0	358	3	0	361	0	0	0	0	0	6	292	0	0	298	5	673	678
Total	35	0	33	30	68	3	1339	31	6	1373	0	0	0	0	0	28	1186	0	0	1214	36	2655	2691
Grand Total	139	0	93	76	232	17	3643	83	12	3743	7	0	18	15	25	82	3311	6	0	3399	103	7399	7502
Apprch %	59.9	0	40.1			0.5	97.3	2.2			28	0	72			2.4	97.4	0.2					
Total %	1.9	0	1.3		3.1	0.2	49.2	1.1		50.6	0.1	0	0.2		0.3	1.1	44.7	0.1		45.9	1.4	98.6	

Start Time	San Gorgonio Drive Southbound				Alessandro Boulevard Westbound				Brown Street Northbound				Alessandro Boulevard Eastbound				Int. Total
	Left	Thru	Right	App. Total	Left	Thru	Right	App. Total	Left	Thru	Right	App. Total	Left	Thru	Right	App. Total	
Peak Hour Analysis From 01:00 PM to 01:45 PM - Peak 1 of 1																	
Peak Hour for Entire Intersection Begins at 01:00 PM																	
01:00 PM	8	0	11	19	1	312	8	321	0	0	0	0	8	304	0	312	652
01:15 PM	8	0	10	18	2	317	8	327	0	0	0	0	8	261	0	269	614
01:30 PM	12	0	5	17	0	352	12	364	0	0	0	0	6	329	0	335	716
01:45 PM	7	0	7	14	0	358	3	361	0	0	0	0	6	292	0	298	673
Total Volume	35	0	33	68	3	1339	31	1373	0	0	0	0	28	1186	0	1214	2655
% App. Total	51.5	0	48.5		0.2	97.5	2.3		0	0	0		2.3	97.7	0		
PHF	.729	.000	.750	.895	.375	.935	.646	.943	.000	.000	.000	.000	.875	.901	.000	.906	.927

City of Riverside
 N/S: San Gorgonio Drive/Brown Street
 E/W: Alessandro Boulevard
 Weather: Clear

File Name : 20_RIV_Brown_Ales Sat
 Site Code : 05122815
 Start Date : 9/17/2022
 Page No : 2

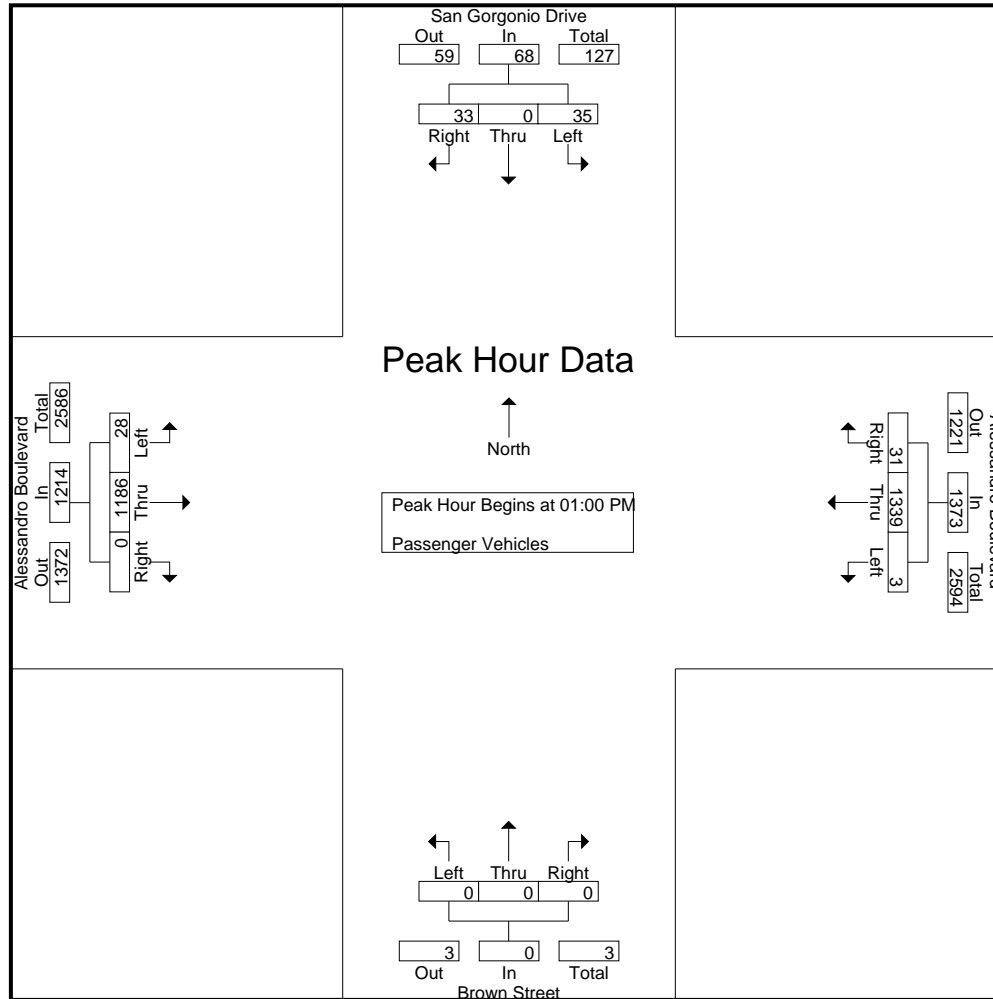

City of Riverside
 N/S: San Geronio Drive/Brown Street
 E/W: Alessandro Boulevard
 Weather: Clear

File Name : 20_RIV_Brown_Ales Sat
 Site Code : 05122815
 Start Date : 9/17/2022
 Page No : 3

Start Time	San Geronio Drive Southbound				Alessandro Boulevard Westbound				Brown Street Northbound				Alessandro Boulevard Eastbound				Int. Total
	Left	Thru	Right	App. Total	Left	Thru	Right	App. Total	Left	Thru	Right	App. Total	Left	Thru	Right	App. Total	
Peak Hour Analysis From 01:00 PM to 01:45 PM - Peak 1 of 1																	
Peak Hour for Each Approach Begins at:																	
	01:00 PM				01:00 PM				01:00 PM				01:00 PM				
+0 mins.	8	0	11	19	1	312	8	321	0	0	0	0	8	304	0	312	
+15 mins.	8	0	10	18	2	317	8	327	0	0	0	0	8	261	0	269	
+30 mins.	12	0	5	17	0	352	12	364	0	0	0	0	6	329	0	335	
+45 mins.	7	0	7	14	0	358	3	361	0	0	0	0	6	292	0	298	
Total Volume	35	0	33	68	3	1339	31	1373	0	0	0	0	28	1186	0	1214	
% App. Total	51.5	0	48.5		0.2	97.5	2.3		0	0	0		2.3	97.7	0		
PHF	.729	.000	.750	.895	.375	.935	.646	.943	.000	.000	.000	.000	.875	.901	.000	.906	

City of Riverside
 N/S: San Gorgonio Drive/Brown Street
 E/W: Alessandro Boulevard
 Weather: Clear

File Name : 20_RIV_Brown_Ales Sat
 Site Code : 05122815
 Start Date : 9/17/2022
 Page No : 1

Groups Printed- Large 2 Axle Vehicles

Start Time	San Gorgonio Drive Southbound					Alessandro Boulevard Westbound					Brown Street Northbound					Alessandro Boulevard Eastbound					Exclu. Total	Inclu. Total	Int. Total
	Left	Thru	Right	RTOR	App. Total	Left	Thru	Right	RTOR	App. Total	Left	Thru	Right	RTOR	App. Total	Left	Thru	Right	RTOR	App. Total			
11:00 AM	0	0	1	1	1	0	1	0	0	1	0	0	0	0	0	0	4	0	0	4	1	6	7
11:15 AM	0	0	0	0	0	0	3	0	0	3	0	0	0	0	0	0	2	0	0	2	0	5	5
11:30 AM	0	0	0	0	0	0	4	0	0	4	0	0	0	0	0	0	1	0	0	1	0	5	5
11:45 AM	0	0	0	0	0	0	6	0	0	6	0	0	0	0	0	0	3	0	0	3	0	9	9
Total	0	0	1	1	1	0	14	0	0	14	0	0	0	0	0	0	10	0	0	10	1	25	26
12:00 PM	0	0	0	0	0	0	4	0	0	4	0	0	0	0	0	0	0	0	0	0	0	4	4
12:15 PM	0	0	0	0	0	0	4	0	0	4	0	0	0	0	0	0	5	0	0	5	0	9	9
12:30 PM	0	0	0	0	0	0	5	0	0	5	0	0	0	0	0	0	2	0	0	2	0	7	7
12:45 PM	0	0	0	0	0	0	1	0	0	1	0	0	0	0	0	0	4	0	0	4	0	5	5
Total	0	0	0	0	0	0	14	0	0	14	0	0	0	0	0	0	11	0	0	11	0	25	25
01:00 PM	0	0	0	0	0	0	4	0	0	4	0	0	0	0	0	0	2	0	0	2	0	6	6
01:15 PM	0	0	0	0	0	0	3	0	0	3	0	0	0	0	0	1	2	0	0	3	0	6	6
01:30 PM	0	0	0	0	0	0	6	0	0	6	0	0	0	0	0	0	3	0	0	3	0	9	9
01:45 PM	0	0	0	0	0	0	2	0	0	2	0	0	0	0	0	0	2	0	0	2	0	4	4
Total	0	0	0	0	0	0	15	0	0	15	0	0	0	0	0	1	9	0	0	10	0	25	25
Grand Total	0	0	1	1	1	0	43	0	0	43	0	0	0	0	0	1	30	0	0	31	1	75	76
Apprch %	0	0	100			0	100	0			0	0	0			3.2	96.8	0					
Total %	0	0	1.3		1.3	0	57.3	0		57.3	0	0	0		0	1.3	40	0		41.3	1.3	98.7	

Start Time	San Gorgonio Drive Southbound				Alessandro Boulevard Westbound				Brown Street Northbound				Alessandro Boulevard Eastbound				Int. Total
	Left	Thru	Right	App. Total	Left	Thru	Right	App. Total	Left	Thru	Right	App. Total	Left	Thru	Right	App. Total	
Peak Hour Analysis From 01:00 PM to 01:45 PM - Peak 1 of 1																	
Peak Hour for Entire Intersection Begins at 01:00 PM																	
01:00 PM	0	0	0	0	0	4	0	4	0	0	0	0	0	2	0	2	6
01:15 PM	0	0	0	0	0	3	0	3	0	0	0	0	1	2	0	3	6
01:30 PM	0	0	0	0	0	6	0	6	0	0	0	0	0	3	0	3	9
01:45 PM	0	0	0	0	0	2	0	2	0	0	0	0	0	2	0	2	4
Total Volume	0	0	0	0	0	15	0	15	0	0	0	0	1	9	0	10	25
% App. Total	0	0	0		0	100	0		0	0	0		10	90	0		
PHF	.000	.000	.000	.000	.000	.625	.000	.625	.000	.000	.000	.000	.250	.750	.000	.833	.694

City of Riverside
 N/S: San Gorgonio Drive/Brown Street
 E/W: Alessandro Boulevard
 Weather: Clear

File Name : 20_RIV_Brown_Ales Sat
 Site Code : 05122815
 Start Date : 9/17/2022
 Page No : 2

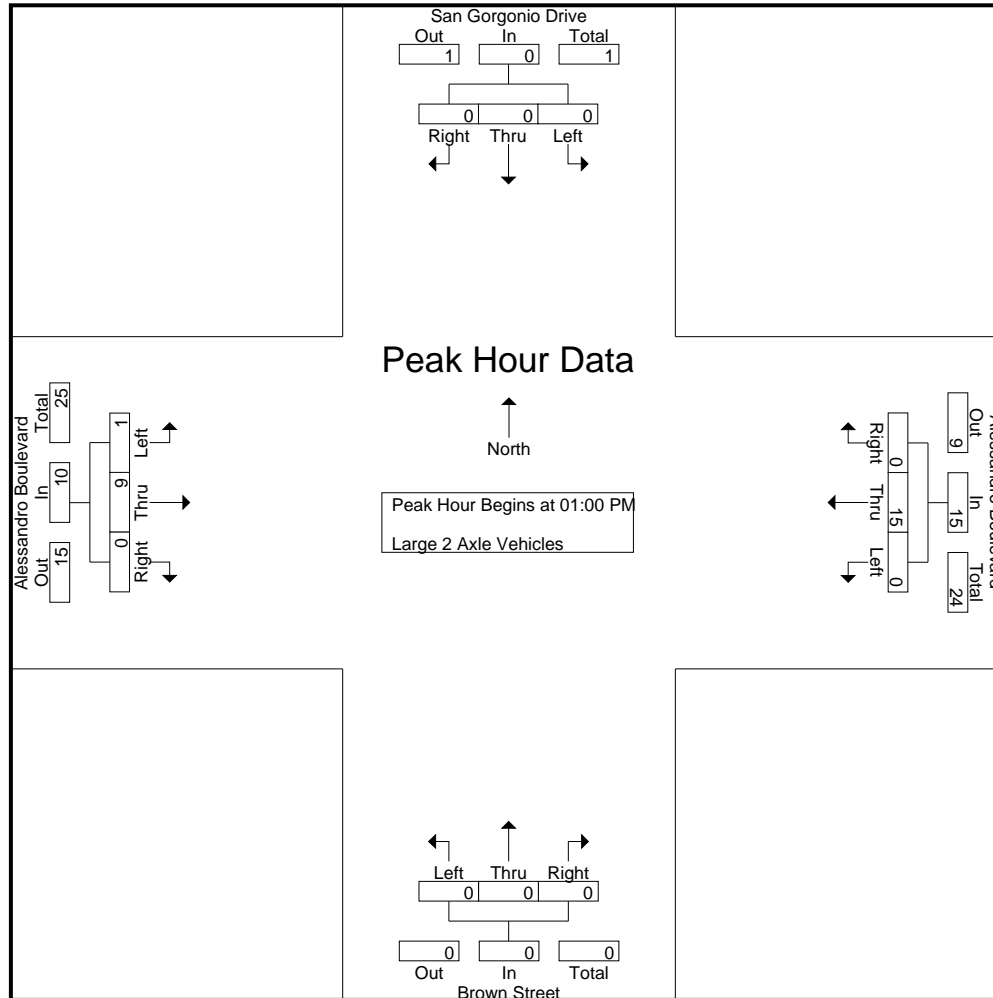

City of Riverside
 N/S: San Geronio Drive/Brown Street
 E/W: Alessandro Boulevard
 Weather: Clear

File Name : 20_RIV_Brown_Ales Sat
 Site Code : 05122815
 Start Date : 9/17/2022
 Page No : 3

Start Time	San Geronio Drive Southbound				Alessandro Boulevard Westbound				Brown Street Northbound				Alessandro Boulevard Eastbound				Int. Total
	Left	Thru	Right	App. Total	Left	Thru	Right	App. Total	Left	Thru	Right	App. Total	Left	Thru	Right	App. Total	
Peak Hour Analysis From 01:00 PM to 01:45 PM - Peak 1 of 1																	
Peak Hour for Each Approach Begins at:																	
	01:00 PM				01:00 PM				01:00 PM				01:00 PM				
+0 mins.	0	0	0	0	0	4	0	4	0	0	0	0	0	2	0	2	
+15 mins.	0	0	0	0	0	3	0	3	0	0	0	0	1	2	0	3	
+30 mins.	0	0	0	0	0	6	0	6	0	0	0	0	0	3	0	3	
+45 mins.	0	0	0	0	0	2	0	2	0	0	0	0	0	2	0	2	
Total Volume	0	0	0	0	0	15	0	15	0	0	0	0	1	9	0	10	
% App. Total	0	0	0	0	0	100	0	100	0	0	0	0	10	90	0	100	
PHF	.000	.000	.000	.000	.000	.625	.000	.625	.000	.000	.000	.000	.250	.750	.000	.833	

City of Riverside
 N/S: San Gorgonio Drive/Brown Street
 E/W: Alessandro Boulevard
 Weather: Clear

File Name : 20_RIV_Brown_Ales Sat
 Site Code : 05122815
 Start Date : 9/17/2022
 Page No : 1

Groups Printed- 3 Axle Vehicles

Start Time	San Gorgonio Drive Southbound					Alessandro Boulevard Westbound					Brown Street Northbound					Alessandro Boulevard Eastbound					Exclu. Total	Inclu. Total	Int. Total				
	Left	Thru	Right	RTOR	App. Total	Left	Thru	Right	RTOR	App. Total	Left	Thru	Right	RTOR	App. Total	Left	Thru	Right	RTOR	App. Total							
11:00 AM	0	0	0	0	0	0	0	0	0	0	0	0	0	0	0	0	0	0	0	0	0	0	0	0	0	0	0
11:15 AM	0	0	0	0	0	0	1	0	0	1	0	0	0	0	0	0	0	0	0	0	0	0	0	0	0	1	1
11:30 AM	0	0	0	0	0	0	0	0	0	0	0	0	0	0	0	0	1	0	0	1	0	0	0	0	0	1	1
11:45 AM	0	0	0	0	0	0	0	0	0	0	0	0	0	0	0	0	0	0	0	0	0	0	0	0	0	0	0
Total	0	0	0	0	0	0	1	0	0	1	0	0	0	0	0	0	1	0	0	1	0	0	0	0	0	2	2
12:00 PM	0	0	0	0	0	0	0	0	0	0	0	0	0	0	0	0	0	0	0	0	0	0	0	0	0	0	0
12:15 PM	0	0	0	0	0	0	0	0	0	0	0	0	0	0	0	0	0	0	0	0	0	0	0	0	0	0	0
12:30 PM	0	0	0	0	0	0	0	0	0	0	0	0	0	0	0	0	1	0	0	1	0	0	0	0	0	1	1
12:45 PM	0	0	0	0	0	0	0	0	0	0	0	0	0	0	0	0	0	0	0	0	0	0	0	0	0	0	0
Total	0	0	0	0	0	0	0	0	0	0	0	0	0	0	0	0	1	0	0	1	0	0	0	0	0	1	1
01:00 PM	0	0	0	0	0	0	2	0	0	2	0	0	0	0	0	0	0	0	0	0	0	0	0	0	0	2	2
01:15 PM	0	0	0	0	0	0	0	0	0	0	0	0	0	0	0	0	0	0	0	0	0	0	0	0	0	0	0
01:30 PM	0	0	0	0	0	0	0	0	0	0	0	0	0	0	0	0	1	0	0	1	0	0	0	0	0	1	1
01:45 PM	0	0	0	0	0	0	0	0	0	0	0	0	0	0	0	0	0	0	0	0	0	0	0	0	0	0	0
Total	0	0	0	0	0	0	2	0	0	2	0	0	0	0	0	0	1	0	0	1	0	0	0	0	0	3	3
Grand Total	0	0	0	0	0	0	3	0	0	3	0	0	0	0	0	0	3	0	0	3	0	0	0	0	0	6	6
Apprch %	0	0	0			0	100	0			0	0	0			0	100	0			0	0	0		0	0	0
Total %	0	0	0			0	50	0		50	0	0	0		0	0	50	0		50	0	0	0		0	100	0

Start Time	San Gorgonio Drive Southbound				Alessandro Boulevard Westbound				Brown Street Northbound				Alessandro Boulevard Eastbound				Int. Total
	Left	Thru	Right	App. Total	Left	Thru	Right	App. Total	Left	Thru	Right	App. Total	Left	Thru	Right	App. Total	
Peak Hour Analysis From 01:00 PM to 01:45 PM - Peak 1 of 1																	
Peak Hour for Entire Intersection Begins at 01:00 PM																	
01:00 PM	0	0	0	0	0	2	0	2	0	0	0	0	0	0	0	0	2
01:15 PM	0	0	0	0	0	0	0	0	0	0	0	0	0	0	0	0	0
01:30 PM	0	0	0	0	0	0	0	0	0	0	0	0	0	1	0	1	1
01:45 PM	0	0	0	0	0	0	0	0	0	0	0	0	0	0	0	0	0
Total Volume	0	0	0	0	0	2	0	2	0	0	0	0	0	1	0	1	3
% App. Total	0	0	0		0	100	0		0	0	0		0	100	0		
PHF	.000	.000	.000	.000	.000	.250	.000	.250	.000	.000	.000	.000	.000	.250	.000	.250	.375

City of Riverside
 N/S: San Gorgonio Drive/Brown Street
 E/W: Alessandro Boulevard
 Weather: Clear

File Name : 20_RIV_Brown_Ales Sat
 Site Code : 05122815
 Start Date : 9/17/2022
 Page No : 2

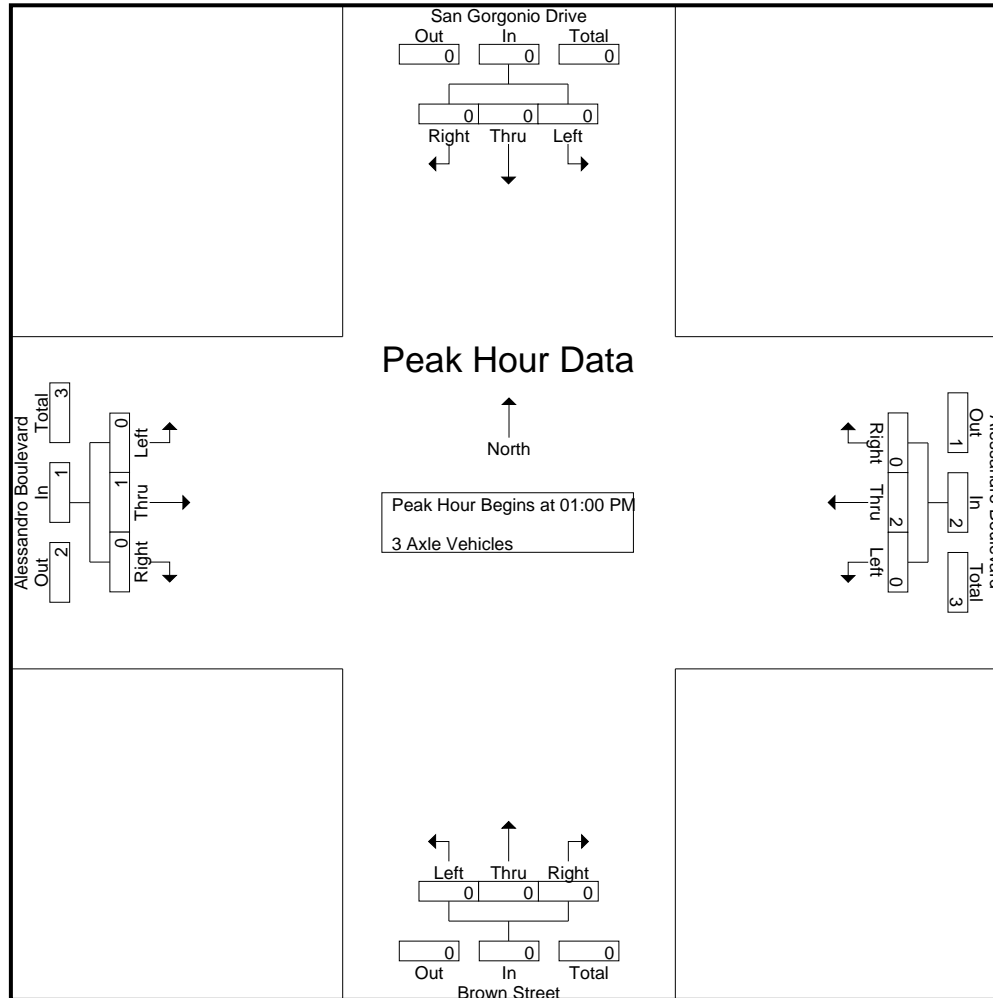

City of Riverside
 N/S: San Geronio Drive/Brown Street
 E/W: Alessandro Boulevard
 Weather: Clear

File Name : 20_RIV_Brown_Ales Sat
 Site Code : 05122815
 Start Date : 9/17/2022
 Page No : 3

Start Time	San Geronio Drive Southbound				Alessandro Boulevard Westbound				Brown Street Northbound				Alessandro Boulevard Eastbound				Int. Total
	Left	Thru	Right	App. Total	Left	Thru	Right	App. Total	Left	Thru	Right	App. Total	Left	Thru	Right	App. Total	
Peak Hour Analysis From 01:00 PM to 01:45 PM - Peak 1 of 1																	
Peak Hour for Each Approach Begins at:																	
	01:00 PM				01:00 PM				01:00 PM				01:00 PM				
+0 mins.	0	0	0	0	0	2	0	2	0	0	0	0	0	0	0	0	
+15 mins.	0	0	0	0	0	0	0	0	0	0	0	0	0	0	0	0	
+30 mins.	0	0	0	0	0	0	0	0	0	0	0	0	0	1	0	1	
+45 mins.	0	0	0	0	0	0	0	0	0	0	0	0	0	0	0	0	
Total Volume	0	0	0	0	0	2	0	2	0	0	0	0	0	1	0	1	
% App. Total	0	0	0	0	0	100	0	0	0	0	0	0	0	100	0	0	
PHF	.000	.000	.000	.000	.000	.250	.000	.250	.000	.000	.000	.000	.000	.250	.000	.250	

City of Riverside
 N/S: San Gorgonio Drive/Brown Street
 E/W: Alessandro Boulevard
 Weather: Clear

File Name : 20_RIV_Brown_Ales Sat
 Site Code : 05122815
 Start Date : 9/17/2022
 Page No : 1

Groups Printed- 4+ Axle Trucks

Start Time	San Gorgonio Drive Southbound					Alessandro Boulevard Westbound					Brown Street Northbound					Alessandro Boulevard Eastbound					Exclu. Total	Inclu. Total	Int. Total
	Left	Thru	Right	RTOR	App. Total	Left	Thru	Right	RTOR	App. Total	Left	Thru	Right	RTOR	App. Total	Left	Thru	Right	RTOR	App. Total			
11:00 AM	0	0	0	0	0	0	0	0	0	0	0	0	1	1	1	0	0	0	0	0	1	1	2
11:15 AM	0	0	0	0	0	0	0	0	0	0	0	0	0	0	0	0	0	0	0	0	0	0	0
11:30 AM	0	0	0	0	0	0	0	0	0	0	0	0	0	0	0	0	0	0	0	0	0	0	0
11:45 AM	0	0	0	0	0	0	0	0	0	0	0	0	0	0	0	0	0	0	0	0	0	0	0
Total	0	0	0	0	0	0	0	0	0	0	0	0	1	1	1	0	0	0	0	0	1	1	2
12:00 PM	1	0	0	0	1	0	2	1	0	3	0	0	0	0	0	0	0	0	0	0	0	4	4
12:15 PM	0	0	0	0	0	0	0	1	0	1	0	0	0	0	0	0	0	0	0	0	0	1	1
12:30 PM	0	0	0	0	0	0	0	0	0	0	0	0	0	0	0	0	0	0	0	0	0	0	0
12:45 PM	0	0	0	0	0	0	0	0	0	0	0	0	0	0	0	0	0	0	0	0	0	0	0
Total	1	0	0	0	1	0	2	2	0	4	0	0	0	0	0	0	0	0	0	0	0	5	5
01:00 PM	1	0	0	0	1	0	0	0	0	0	0	0	0	0	0	0	0	0	0	0	0	1	1
01:15 PM	0	0	0	0	0	0	0	0	0	0	0	0	0	0	0	0	0	0	0	0	0	0	0
01:30 PM	0	0	0	0	0	0	0	0	0	0	0	0	0	0	0	0	0	0	0	0	0	0	0
01:45 PM	0	0	0	0	0	0	1	0	0	1	0	0	0	0	0	0	0	0	0	0	0	1	1
Total	1	0	0	0	1	0	1	0	0	1	0	0	0	0	0	0	0	0	0	0	0	2	2
Grand Total	2	0	0	0	2	0	3	2	0	5	0	0	1	1	1	0	0	0	0	0	1	8	9
Apprch %	100	0	0			0	60	40			0	0	100			0	0	0					
Total %	25	0	0		25	0	37.5	25		62.5	0	0	12.5		12.5	0	0	0		0	11.1	88.9	

Start Time	San Gorgonio Drive Southbound				Alessandro Boulevard Westbound				Brown Street Northbound				Alessandro Boulevard Eastbound				Int. Total
	Left	Thru	Right	App. Total	Left	Thru	Right	App. Total	Left	Thru	Right	App. Total	Left	Thru	Right	App. Total	
Peak Hour Analysis From 01:00 PM to 01:45 PM - Peak 1 of 1																	
Peak Hour for Entire Intersection Begins at 01:00 PM																	
01:00 PM	1	0	0	1	0	0	0	0	0	0	0	0	0	0	0	0	1
01:15 PM	0	0	0	0	0	0	0	0	0	0	0	0	0	0	0	0	0
01:30 PM	0	0	0	0	0	0	0	0	0	0	0	0	0	0	0	0	0
01:45 PM	0	0	0	0	0	1	0	1	0	0	0	0	0	0	0	0	1
Total Volume	1	0	0	1	0	1	0	1	0	0	0	0	0	0	0	0	2
% App. Total	100	0	0		0	100	0		0	0	0		0	0	0		
PHF	.250	.000	.000	.250	.000	.250	.000	.250	.000	.000	.000	.000	.000	.000	.000	.000	.500

City of Riverside
 N/S: San Gorgonio Drive/Brown Street
 E/W: Alessandro Boulevard
 Weather: Clear

File Name : 20_RIV_Brown_Ales Sat
 Site Code : 05122815
 Start Date : 9/17/2022
 Page No : 2

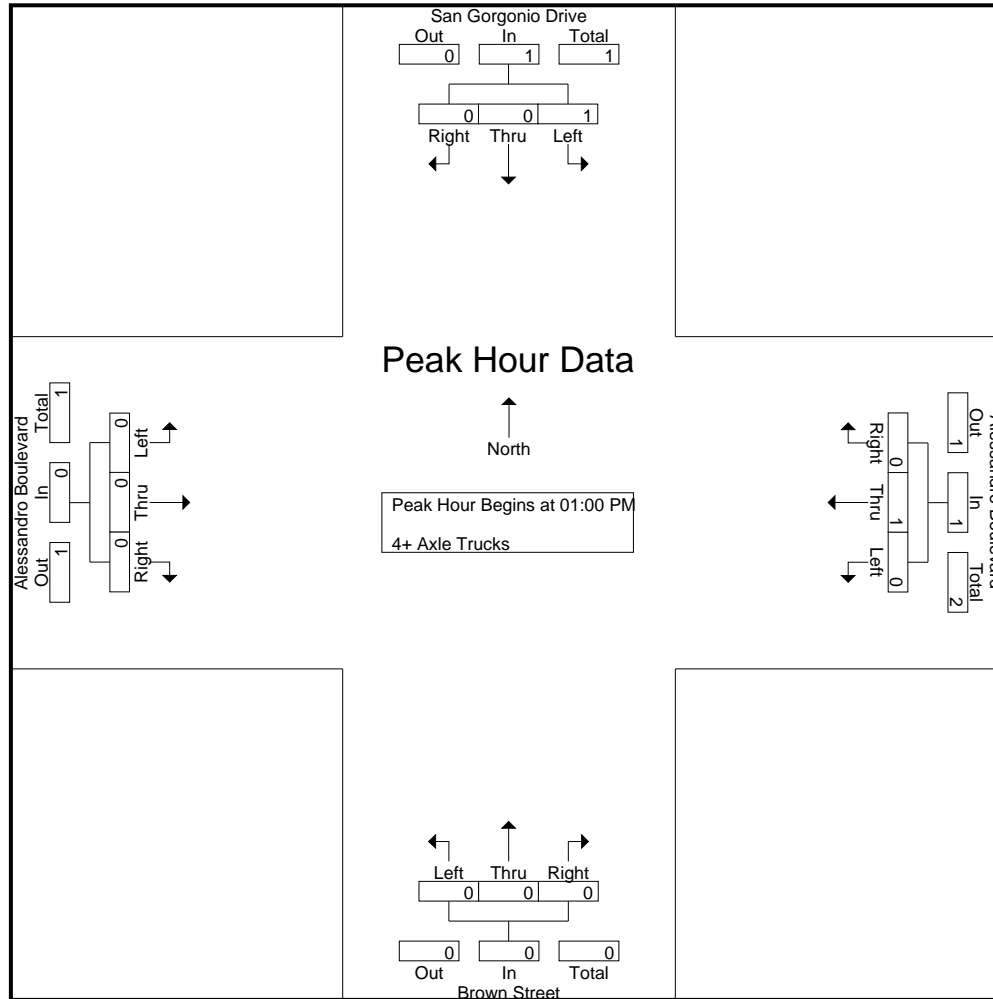

City of Riverside
 N/S: San Geronio Drive/Brown Street
 E/W: Alessandro Boulevard
 Weather: Clear

File Name : 20_RIV_Brown_Ales Sat
 Site Code : 05122815
 Start Date : 9/17/2022
 Page No : 3

Start Time	San Geronio Drive Southbound				Alessandro Boulevard Westbound				Brown Street Northbound				Alessandro Boulevard Eastbound				Int. Total
	Left	Thru	Right	App. Total	Left	Thru	Right	App. Total	Left	Thru	Right	App. Total	Left	Thru	Right	App. Total	
Peak Hour Analysis From 01:00 PM to 01:45 PM - Peak 1 of 1																	
Peak Hour for Each Approach Begins at:																	
	01:00 PM				01:00 PM				01:00 PM				01:00 PM				
+0 mins.	1	0	0	1	0	0	0	0	0	0	0	0	0	0	0	0	
+15 mins.	0	0	0	0	0	0	0	0	0	0	0	0	0	0	0	0	
+30 mins.	0	0	0	0	0	0	0	0	0	0	0	0	0	0	0	0	
+45 mins.	0	0	0	0	0	1	0	1	0	0	0	0	0	0	0	0	
Total Volume	1	0	0	1	0	1	0	1	0	0	0	0	0	0	0	0	
% App. Total	100	0	0		0	100	0		0	0	0		0	0	0		
PHF	.250	.000	.000	.250	.000	.250	.000	.250	.000	.000	.000	.000	.000	.000	.000	.000	

Location: Riverside
 N/S: San Gorgonio Dr/Brown St
 E/W: Alessandro Boulevard



Date: 9/17/2022
 Day Saturday

PEDESTRIANS

Time	North Leg San Gorgonio Drive	East Leg Alessandro Boulevard	South Leg Brown Street	West Leg Alessandro Boulevard	TOTAL
11:00 AM	0	0	0	0	0
11:15 AM	0	0	0	0	0
11:30 AM	0	1	1	0	2
11:45 AM	0	1	0	0	1
12:00 PM	0	0	0	0	0
12:15 PM	0	0	0	0	0
12:30 PM	0	0	0	0	0
12:45 PM	0	0	0	0	0
1:00 PM	0	0	0	0	0
1:15 PM	0	1	1	0	2
1:30 PM	0	0	0	0	0
1:45 PM	0	0	0	0	0
TOTAL VOLUMES:	0	3	2	0	5

Location: Riverside
 N/S: San Gorgonio Dr/Brown St
 E/W: Alessandro Boulevard

Date: 9/17/2022
 Day: Saturday



BICYCLES

	Southbound San Gorgonio Drive			Westbound Alessandro Boulevard			Northbound Brown Street			Eastbound Alessandro Boulevard			
	Left	Thru	Right	Left	Thru	Right	Left	Thru	Right	Left	Thru	Right	
11:00 AM	0	0	0	0	0	0	0	0	0	0	1	0	1
11:15 AM	0	0	0	0	0	0	0	0	0	0	0	0	0
11:30 AM	0	0	0	0	0	0	0	0	0	0	0	0	0
11:45 AM	0	0	0	0	0	0	0	0	0	0	1	0	1
12:00 PM	0	0	0	0	0	0	0	0	0	0	0	0	0
12:15 PM	0	0	0	0	0	0	0	0	0	0	0	0	0
12:30 PM	0	0	0	0	1	0	0	0	0	0	0	0	1
12:45 PM	0	0	0	0	1	0	0	0	0	0	0	0	1
1:00 PM	0	0	0	0	0	0	0	0	0	0	2	0	2
1:15 PM	0	0	0	0	0	0	0	0	0	0	0	0	0
1:30 PM	0	0	0	0	0	0	0	0	0	0	0	0	0
1:45 PM	0	0	0	0	0	0	0	0	0	0	0	0	0
TOTAL VOLUMES:	0	0	0	0	2	0	0	0	0	0	4	0	6

City of Riverside
 N/S: Sycamore Canyon Boulevard
 E/W: Eastridge Avenue
 Weather: Clear

File Name : 22_RIV_Syc_East Sat
 Site Code : 05122815
 Start Date : 9/17/2022
 Page No : 1

Groups Printed- Passenger Vehicles - Large 2 Axle Vehicles - 3 Axle Vehicles - 4+ Axle Trucks

Start Time	Sycamore Canyon Boulevard Southbound					Eastridge Avenue Westbound					Sycamore Canyon Boulevard Northbound					Eastridge Avenue Eastbound					Exclu. Total	Inclu. Total	Int. Total
	Left	Thru	Right	RTOR	App. Total	Left	Thru	Right	RTOR	App. Total	Left	Thru	Right	RTOR	App. Total	Left	Thru	Right	RTOR	App. Total			
11:00 AM	18	29	4	1	51	24	9	39	31	72	4	31	19	8	54	13	23	10	0	46	40	223	263
11:15 AM	14	28	4	2	46	18	9	49	23	76	5	70	20	5	95	5	13	3	0	21	30	238	268
11:30 AM	18	32	2	0	52	21	11	37	18	69	3	72	19	5	94	5	7	9	0	21	23	236	259
11:45 AM	22	27	5	1	54	26	12	52	32	90	6	58	15	2	79	11	11	3	0	25	35	248	283
Total	72	116	15	4	203	89	41	177	104	307	18	231	73	20	322	34	54	25	0	113	128	945	1073
12:00 PM	32	32	8	4	72	16	9	60	34	85	4	25	18	9	47	8	18	7	0	33	47	237	284
12:15 PM	32	37	9	1	78	33	8	42	33	83	4	34	20	12	58	4	5	4	0	13	46	232	278
12:30 PM	31	28	7	1	66	44	6	68	38	118	7	69	16	5	92	9	9	2	0	20	44	296	340
12:45 PM	25	34	3	0	62	44	8	53	24	105	2	79	13	4	94	8	4	4	1	16	29	277	306
Total	120	131	27	6	278	137	31	223	129	391	17	207	67	30	291	29	36	17	1	82	166	1042	1208
01:00 PM	25	21	5	1	51	52	13	77	39	142	3	81	7	1	91	9	17	6	0	32	41	316	357
01:15 PM	32	22	4	2	58	67	9	84	32	160	12	62	17	6	91	6	9	2	0	17	40	326	366
01:30 PM	29	50	14	2	93	45	11	70	34	126	15	61	21	6	97	9	16	4	0	29	42	345	387
01:45 PM	29	26	7	2	62	19	19	66	40	104	14	84	23	6	121	15	24	4	0	43	48	330	378
Total	115	119	30	7	264	183	52	297	145	532	44	288	68	19	400	39	66	16	0	121	171	1317	1488
Grand Total	307	366	72	17	745	409	124	697	378	1230	79	726	208	69	1013	102	156	58	1	316	465	3304	3769
Apprch %	41.2	49.1	9.7			33.3	10.1	56.7			7.8	71.7	20.5			32.3	49.4	18.4					
Total %	9.3	11.1	2.2		22.5	12.4	3.8	21.1		37.2	2.4	22	6.3		30.7	3.1	4.7	1.8		9.6	12.3	87.7	
Passenger Vehicles	301	346	48		708	396	102	678		1545	70	672	197		1007	75	117	52		245	0	0	3505
% Passenger Vehicles	98	94.5	66.7	76.5	92.9	96.8	82.3	97.3	97.6	96.1	88.6	92.6	94.7	98.6	93.1	73.5	75	89.7	100	77.3	0	0	93
Large 2 Axle Vehicles	4	5	0		9	4	3	8		18	1	12	3		17	0	2	2		4	0	0	48
% Large 2 Axle Vehicles	1.3	1.4	0	0	1.2	1	2.4	1.1	0.8	1.1	1.3	1.7	1.4	1.4	1.6	0	1.3	3.4	0	1.3	0	0	1.3
3 Axle Vehicles	0	1	1		2	3	0	0		3	0	14	1		15	0	0	1		1	0	0	21
% 3 Axle Vehicles	0	0.3	1.4	0	0.3	0.7	0	0	0	0.2	0	1.9	0.5	0	1.4	0	0	1.7	0	0.3	0	0	0.6
4+ Axle Trucks	2	14	23		43	6	19	11		42	8	28	7		43	27	37	3		67	0	0	195
% 4+ Axle Trucks	0.7	3.8	31.9	23.5	5.6	1.5	15.3	1.6	1.6	2.6	10.1	3.9	3.4	0	4	26.5	23.7	5.2	0	21.1	0	0	5.2

City of Riverside
 N/S: Sycamore Canyon Boulevard
 E/W: Eastridge Avenue
 Weather: Clear

File Name : 22_RIV_Syc_East Sat
 Site Code : 05122815
 Start Date : 9/17/2022
 Page No : 2

Start Time	Sycamore Canyon Boulevard Southbound				Eastridge Avenue Westbound				Sycamore Canyon Boulevard Northbound				Eastridge Avenue Eastbound				Int. Total
	Left	Thru	Right	App. Total	Left	Thru	Right	App. Total	Left	Thru	Right	App. Total	Left	Thru	Right	App. Total	
Peak Hour Analysis From 11:00 AM to 01:45 PM - Peak 1 of 1																	
Peak Hour for Entire Intersection Begins at 01:00 PM																	
01:00 PM	25	21	5	51	52	13	77	142	3	81	7	91	9	17	6	32	316
01:15 PM	32	22	4	58	67	9	84	160	12	62	17	91	6	9	2	17	326
01:30 PM	29	50	14	93	45	11	70	126	15	61	21	97	9	16	4	29	345
01:45 PM	29	26	7	62	19	19	66	104	14	84	23	121	15	24	4	43	330
Total Volume	115	119	30	264	183	52	297	532	44	288	68	400	39	66	16	121	1317
% App. Total	43.6	45.1	11.4		34.4	9.8	55.8		11	72	17		32.2	54.5	13.2		
PHF	.898	.595	.536	.710	.683	.684	.884	.831	.733	.857	.739	.826	.650	.688	.667	.703	.954

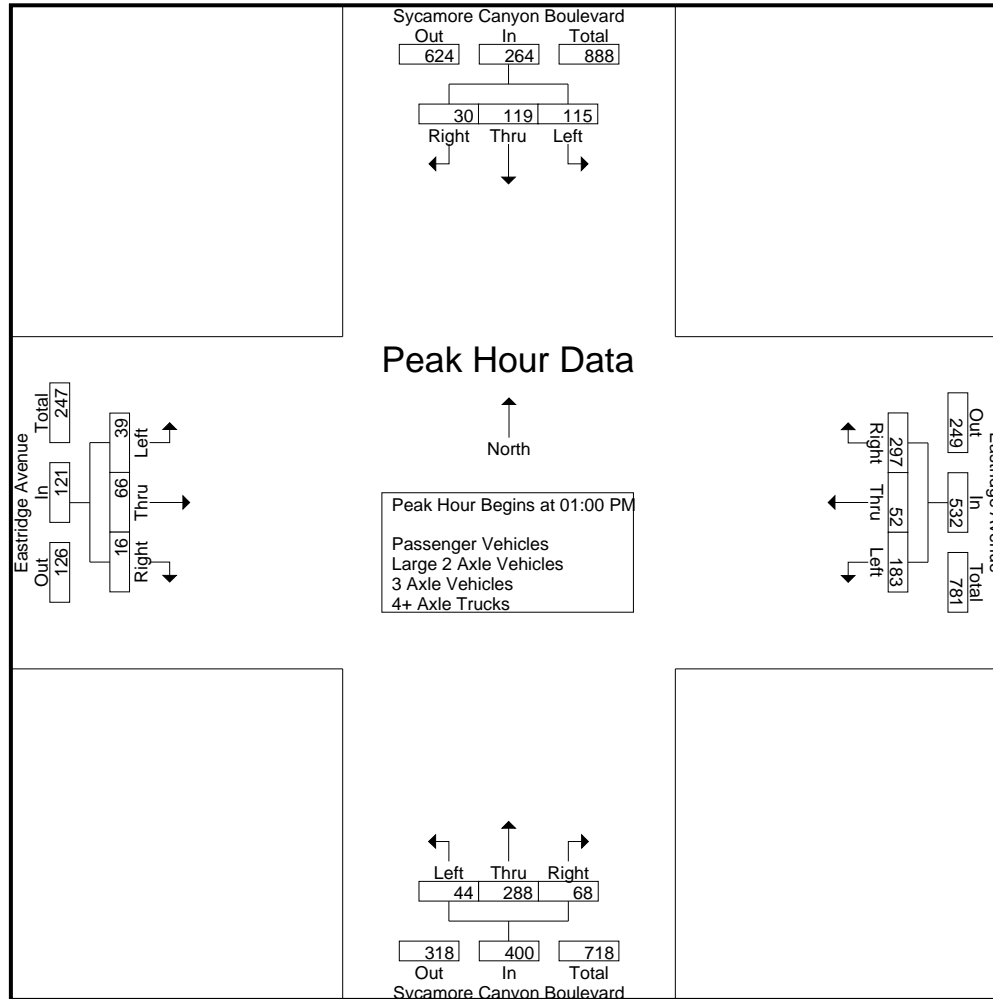

City of Riverside
 N/S: Sycamore Canyon Boulevard
 E/W: Eastridge Avenue
 Weather: Clear

File Name : 22_RIV_Syc_East Sat
 Site Code : 05122815
 Start Date : 9/17/2022
 Page No : 4

Start Time	Sycamore Canyon Boulevard Southbound				Eastridge Avenue Westbound				Sycamore Canyon Boulevard Northbound				Eastridge Avenue Eastbound				Int. Total
	Left	Thru	Right	App. Total	Left	Thru	Right	App. Total	Left	Thru	Right	App. Total	Left	Thru	Right	App. Total	
Peak Hour Analysis From 11:00 AM to 01:45 PM - Peak 1 of 1																	
Peak Hour for Each Approach Begins at:																	
	12:00 PM				12:45 PM				01:00 PM				01:00 PM				
+0 mins.	32	32	8	72	44	8	53	105	3	81	7	91	9	17	6	32	
+15 mins.	32	37	9	78	52	13	77	142	12	62	17	91	6	9	2	17	
+30 mins.	31	28	7	66	67	9	84	160	15	61	21	97	9	16	4	29	
+45 mins.	25	34	3	62	45	11	70	126	14	84	23	121	15	24	4	43	
Total Volume	120	131	27	278	208	41	284	533	44	288	68	400	39	66	16	121	
% App. Total	43.2	47.1	9.7		39	7.7	53.3		11	72	17		32.2	54.5	13.2		
PHF	.938	.885	.750	.891	.776	.788	.845	.833	.733	.857	.739	.826	.650	.688	.667	.703	

City of Riverside
 N/S: Sycamore Canyon Boulevard
 E/W: Eastridge Avenue
 Weather: Clear

File Name : 22_RIV_Syc_East Sat
 Site Code : 05122815
 Start Date : 9/17/2022
 Page No : 1

Groups Printed- Passenger Vehicles

Start Time	Sycamore Canyon Boulevard Southbound					Eastridge Avenue Westbound					Sycamore Canyon Boulevard Northbound					Eastridge Avenue Eastbound					Exclu. Total	Inclu. Total	Int. Total
	Left	Thru	Right	RTOR	App. Total	Left	Thru	Right	RTOR	App. Total	Left	Thru	Right	RTOR	App. Total	Left	Thru	Right	RTOR	App. Total			
11:00 AM	18	29	2	1	49	24	8	38	30	70	4	30	18	8	52	11	18	9	0	38	39	209	248
11:15 AM	13	23	2	2	38	18	8	49	23	75	4	65	20	5	89	3	11	3	0	17	30	219	249
11:30 AM	18	30	2	0	50	21	8	37	18	66	2	67	18	5	87	5	7	7	0	19	23	222	245
11:45 AM	22	25	4	0	51	26	9	50	30	85	5	56	13	2	74	8	9	3	0	20	32	230	262
Total	71	107	10	3	188	89	33	174	101	296	15	218	69	20	302	27	45	22	0	94	124	880	1004
12:00 PM	32	30	6	3	68	15	6	56	33	77	4	20	18	9	42	6	13	6	0	25	45	212	257
12:15 PM	30	34	8	1	72	33	7	41	32	81	4	29	20	12	53	3	2	4	0	9	45	215	260
12:30 PM	31	27	1	0	59	42	4	66	38	112	5	67	13	4	85	8	5	2	0	15	42	271	313
12:45 PM	23	32	1	0	56	42	8	49	21	99	1	72	13	4	86	3	3	4	1	10	26	251	277
Total	116	123	16	4	255	132	25	212	124	369	14	188	64	29	266	20	23	16	1	59	158	949	1107
01:00 PM	25	21	4	1	50	50	10	74	39	134	2	73	6	1	81	8	14	4	0	26	41	291	332
01:15 PM	31	20	4	2	55	63	6	83	32	152	12	58	16	6	86	5	4	2	0	11	40	304	344
01:30 PM	29	50	11	2	90	44	10	70	34	124	14	56	21	6	91	5	11	4	0	20	42	325	367
01:45 PM	29	25	3	1	57	18	18	65	39	101	13	79	21	6	113	10	20	4	0	34	46	305	351
Total	114	116	22	6	252	175	44	292	144	511	41	266	64	19	371	28	49	14	0	91	169	1225	1394
Grand Total	301	346	48	13	695	396	102	678	369	1176	70	672	197	68	939	75	117	52	1	244	451	3054	3505
Apprch %	43.3	49.8	6.9			33.7	8.7	57.7			7.5	71.6	21			30.7	48	21.3					
Total %	9.9	11.3	1.6		22.8	13	3.3	22.2		38.5	2.3	22	6.5		30.7	2.5	3.8	1.7		8	12.9	87.1	

Start Time	Sycamore Canyon Boulevard Southbound				Eastridge Avenue Westbound				Sycamore Canyon Boulevard Northbound				Eastridge Avenue Eastbound				Int. Total
	Left	Thru	Right	App. Total	Left	Thru	Right	App. Total	Left	Thru	Right	App. Total	Left	Thru	Right	App. Total	
Peak Hour Analysis From 01:00 PM to 01:45 PM - Peak 1 of 1																	
Peak Hour for Entire Intersection Begins at 01:00 PM																	
01:00 PM	25	21	4	50	50	10	74	134	2	73	6	81	8	14	4	26	291
01:15 PM	31	20	4	55	63	6	83	152	12	58	16	86	5	4	2	11	304
01:30 PM	29	50	11	90	44	10	70	124	14	56	21	91	5	11	4	20	325
01:45 PM	29	25	3	57	18	18	65	101	13	79	21	113	10	20	4	34	351
Total Volume	114	116	22	252	175	44	292	511	41	266	64	371	28	49	14	91	1225
% App. Total	45.2	46	8.7		34.2	8.6	57.1		11.1	71.7	17.3		30.8	53.8	15.4		
PHF	.919	.580	.500	.700	.694	.611	.880	.840	.732	.842	.762	.821	.700	.613	.875	.669	.942

City of Riverside
 N/S: Sycamore Canyon Boulevard
 E/W: Eastridge Avenue
 Weather: Clear

File Name : 22_RIV_Syc_East Sat
 Site Code : 05122815
 Start Date : 9/17/2022
 Page No : 2

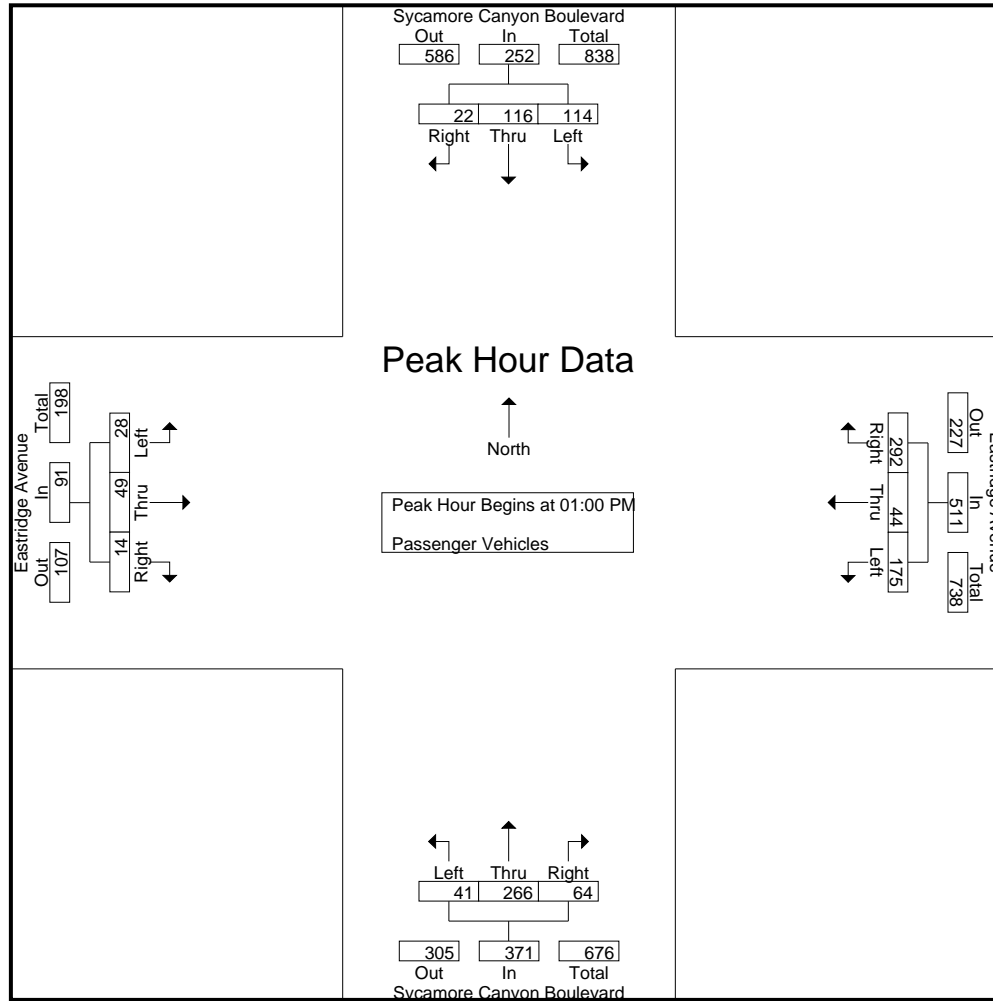

City of Riverside
 N/S: Sycamore Canyon Boulevard
 E/W: Eastridge Avenue
 Weather: Clear

File Name : 22_RIV_Syc_East Sat
 Site Code : 05122815
 Start Date : 9/17/2022
 Page No : 3

Start Time	Sycamore Canyon Boulevard Southbound				Eastridge Avenue Westbound				Sycamore Canyon Boulevard Northbound				Eastridge Avenue Eastbound				Int. Total
	Left	Thru	Right	App. Total	Left	Thru	Right	App. Total	Left	Thru	Right	App. Total	Left	Thru	Right	App. Total	
Peak Hour Analysis From 01:00 PM to 01:45 PM - Peak 1 of 1																	
Peak Hour for Each Approach Begins at:																	
	01:00 PM				01:00 PM				01:00 PM				01:00 PM				
+0 mins.	25	21	4	50	50	10	74	134	2	73	6	81	8	14	4	26	
+15 mins.	31	20	4	55	63	6	83	152	12	58	16	86	5	4	2	11	
+30 mins.	29	50	11	90	44	10	70	124	14	56	21	91	5	11	4	20	
+45 mins.	29	25	3	57	18	18	65	101	13	79	21	113	10	20	4	34	
Total Volume	114	116	22	252	175	44	292	511	41	266	64	371	28	49	14	91	
% App. Total	45.2	46	8.7		34.2	8.6	57.1		11.1	71.7	17.3		30.8	53.8	15.4		
PHF	.919	.580	.500	.700	.694	.611	.880	.840	.732	.842	.762	.821	.700	.613	.875	.669	

City of Riverside
 N/S: Sycamore Canyon Boulevard
 E/W: Eastridge Avenue
 Weather: Clear

File Name : 22_RIV_Syc_East Sat
 Site Code : 05122815
 Start Date : 9/17/2022
 Page No : 1

Groups Printed- Large 2 Axle Vehicles

Start Time	Sycamore Canyon Boulevard Southbound					Eastridge Avenue Westbound					Sycamore Canyon Boulevard Northbound					Eastridge Avenue Eastbound					Exclu. Total	Inclu. Total	Int. Total
	Left	Thru	Right	RTOR	App. Total	Left	Thru	Right	RTOR	App. Total	Left	Thru	Right	RTOR	App. Total	Left	Thru	Right	RTOR	App. Total			
11:00 AM	0	0	0	0	0	0	0	1	1	1	0	0	0	0	0	0	0	0	0	0	1	1	2
11:15 AM	1	0	0	0	1	0	1	0	0	1	0	4	0	0	4	0	0	0	0	0	0	6	6
11:30 AM	0	1	0	0	1	0	1	0	0	1	0	0	0	0	0	0	0	1	0	1	0	3	3
11:45 AM	0	0	0	0	0	0	0	0	0	0	0	0	0	0	0	0	0	0	0	0	0	0	0
Total	1	1	0	0	2	0	2	1	1	3	0	4	0	0	4	0	0	1	0	1	1	10	11
12:00 PM	0	0	0	0	0	0	0	1	0	1	0	0	0	0	0	0	0	0	0	0	0	1	1
12:15 PM	1	1	0	0	2	0	0	1	1	1	0	1	0	0	1	0	0	0	0	0	1	4	5
12:30 PM	0	0	0	0	0	0	0	0	0	0	0	0	1	1	1	0	0	0	0	0	1	1	2
12:45 PM	1	1	0	0	2	0	0	1	0	1	0	2	0	0	2	0	0	0	0	0	0	5	5
Total	2	2	0	0	4	0	0	3	1	3	0	3	1	1	4	0	0	0	0	0	2	11	13
01:00 PM	0	0	0	0	0	0	0	2	0	2	1	3	1	0	5	0	0	1	0	1	0	8	8
01:15 PM	1	1	0	0	2	3	0	1	0	4	0	2	1	0	3	0	0	0	0	0	0	9	9
01:30 PM	0	0	0	0	0	1	0	0	0	1	0	0	0	0	0	0	1	0	0	1	0	2	2
01:45 PM	0	1	0	0	1	0	1	1	1	2	0	0	0	0	0	0	1	0	0	1	1	4	5
Total	1	2	0	0	3	4	1	4	1	9	1	5	2	0	8	0	2	1	0	3	1	23	24
Grand Total	4	5	0	0	9	4	3	8	3	15	1	12	3	1	16	0	2	2	0	4	4	44	48
Apprch %	44.4	55.6	0			26.7	20	53.3			6.2	75	18.8			0	50	50					
Total %	9.1	11.4	0		20.5	9.1	6.8	18.2		34.1	2.3	27.3	6.8		36.4	0	4.5	4.5		9.1	8.3	91.7	

Start Time	Sycamore Canyon Boulevard Southbound				Eastridge Avenue Westbound				Sycamore Canyon Boulevard Northbound				Eastridge Avenue Eastbound				Int. Total
	Left	Thru	Right	App. Total	Left	Thru	Right	App. Total	Left	Thru	Right	App. Total	Left	Thru	Right	App. Total	
Peak Hour Analysis From 01:00 PM to 01:45 PM - Peak 1 of 1																	
Peak Hour for Entire Intersection Begins at 01:00 PM																	
01:00 PM	0	0	0	0	0	0	2	2	1	3	1	5	0	0	1	1	8
01:15 PM	1	1	0	2	3	0	1	4	0	2	1	3	0	0	0	0	9
01:30 PM	0	0	0	0	1	0	0	1	0	0	0	0	0	1	0	1	2
01:45 PM	0	1	0	1	0	1	1	2	0	0	0	0	0	1	0	1	4
Total Volume	1	2	0	3	4	1	4	9	1	5	2	8	0	2	1	3	23
% App. Total	33.3	66.7	0		44.4	11.1	44.4		12.5	62.5	25		0	66.7	33.3		
PHF	.250	.500	.000	.375	.333	.250	.500	.563	.250	.417	.500	.400	.000	.500	.250	.750	.639

City of Riverside
 N/S: Sycamore Canyon Boulevard
 E/W: Eastridge Avenue
 Weather: Clear

File Name : 22_RIV_Syc_East Sat
 Site Code : 05122815
 Start Date : 9/17/2022
 Page No : 2

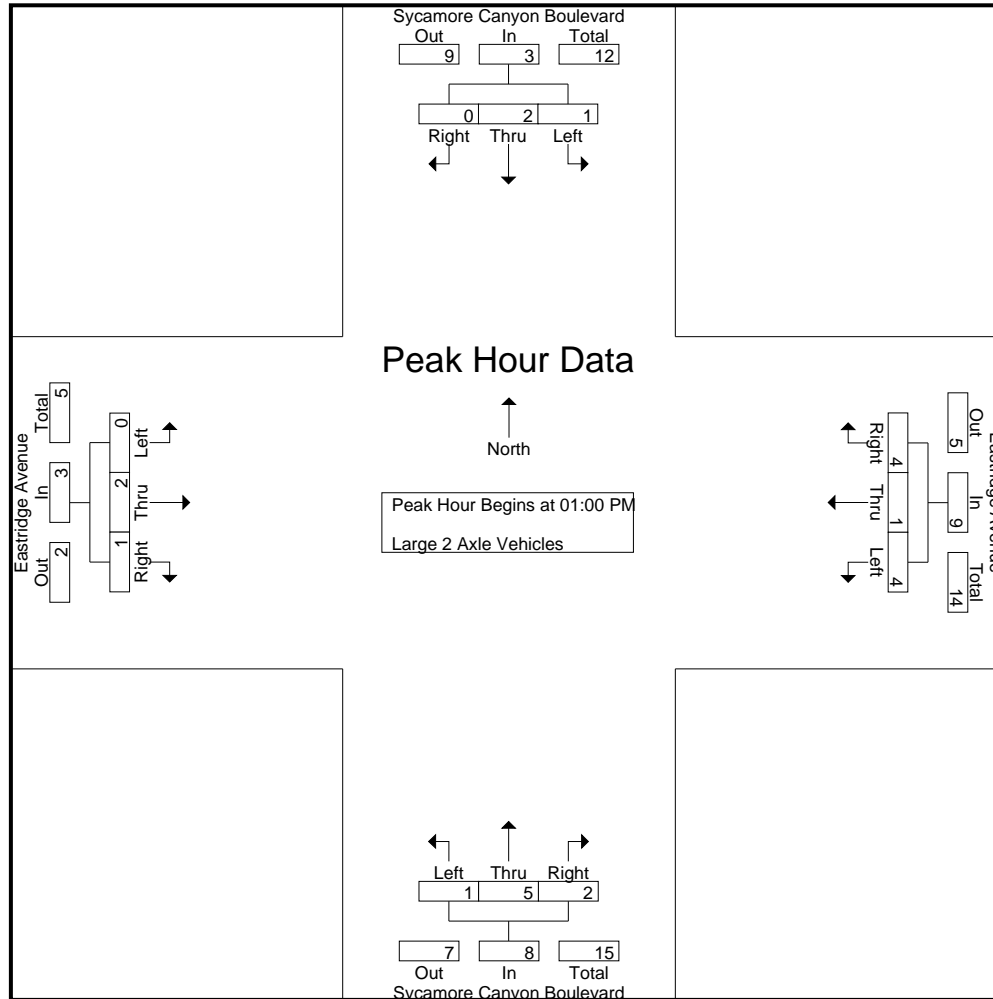

City of Riverside
 N/S: Sycamore Canyon Boulevard
 E/W: Eastridge Avenue
 Weather: Clear

File Name : 22_RIV_Syc_East Sat
 Site Code : 05122815
 Start Date : 9/17/2022
 Page No : 3

Start Time	Sycamore Canyon Boulevard Southbound				Eastridge Avenue Westbound				Sycamore Canyon Boulevard Northbound				Eastridge Avenue Eastbound				Int. Total
	Left	Thru	Right	App. Total	Left	Thru	Right	App. Total	Left	Thru	Right	App. Total	Left	Thru	Right	App. Total	
Peak Hour Analysis From 01:00 PM to 01:45 PM - Peak 1 of 1																	
Peak Hour for Each Approach Begins at:																	
	01:00 PM				01:00 PM				01:00 PM				01:00 PM				
+0 mins.	0	0	0	0	0	0	2	2	1	3	1	5	0	0	1	1	
+15 mins.	1	1	0	2	3	0	1	4	0	2	1	3	0	0	0	0	
+30 mins.	0	0	0	0	1	0	0	1	0	0	0	0	0	1	0	1	
+45 mins.	0	1	0	1	0	1	1	2	0	0	0	0	0	1	0	1	
Total Volume	1	2	0	3	4	1	4	9	1	5	2	8	0	2	1	3	
% App. Total	33.3	66.7	0		44.4	11.1	44.4		12.5	62.5	25		0	66.7	33.3		
PHF	.250	.500	.000	.375	.333	.250	.500	.563	.250	.417	.500	.400	.000	.500	.250	.750	

City of Riverside
 N/S: Sycamore Canyon Boulevard
 E/W: Eastridge Avenue
 Weather: Clear

File Name : 22_RIV_Syc_East Sat
 Site Code : 05122815
 Start Date : 9/17/2022
 Page No : 1

Groups Printed- 3 Axle Vehicles

Start Time	Sycamore Canyon Boulevard Southbound					Eastridge Avenue Westbound					Sycamore Canyon Boulevard Northbound					Eastridge Avenue Eastbound					Exclu. Total	Inclu. Total	Int. Total				
	Left	Thru	Right	RTOR	App. Total	Left	Thru	Right	RTOR	App. Total	Left	Thru	Right	RTOR	App. Total	Left	Thru	Right	RTOR	App. Total							
11:00 AM	0	0	0	0	0	0	0	0	0	0	0	0	0	0	0	0	0	0	0	0	0	0	0	0	0	0	0
11:15 AM	0	0	0	0	0	0	0	0	0	0	0	0	0	0	0	0	0	0	0	0	0	0	0	0	0	0	0
11:30 AM	0	0	0	0	0	0	0	0	0	0	0	1	0	0	1	0	0	0	0	0	0	0	0	0	0	1	1
11:45 AM	0	0	0	0	0	0	0	0	0	0	0	1	0	0	1	0	0	0	0	0	0	0	0	0	0	1	1
Total	0	0	0	0	0	0	0	0	0	0	0	2	0	0	2	0	0	0	0	0	0	0	0	0	0	2	2
12:00 PM	0	1	0	0	1	1	0	0	0	1	0	3	0	0	3	0	0	0	0	0	0	0	0	0	0	5	5
12:15 PM	0	0	0	0	0	0	0	0	0	0	0	1	0	0	1	0	0	0	0	0	0	0	0	0	0	1	1
12:30 PM	0	0	0	0	0	0	1	0	0	1	0	1	1	0	2	0	0	0	0	0	0	0	0	0	0	3	3
12:45 PM	0	0	0	0	0	0	0	0	0	0	0	1	0	0	1	0	0	0	0	0	0	0	0	0	0	1	1
Total	0	1	0	0	1	2	0	0	0	2	0	6	1	0	7	0	0	0	0	0	0	0	0	0	0	10	10
01:00 PM	0	0	0	0	0	1	0	0	0	1	0	1	0	0	1	0	0	1	0	1	0	0	0	0	0	3	3
01:15 PM	0	0	0	0	0	0	0	0	0	0	0	1	0	0	1	0	0	0	0	0	0	0	0	0	0	1	1
01:30 PM	0	0	0	0	0	0	0	0	0	0	0	1	0	0	1	0	0	0	0	0	0	0	0	0	0	1	1
01:45 PM	0	0	1	0	1	0	0	0	0	0	0	3	0	0	3	0	0	0	0	0	0	0	0	0	0	4	4
Total	0	0	1	0	1	1	0	0	0	1	0	6	0	0	6	0	0	1	0	1	0	0	0	0	0	9	9
Grand Total	0	1	1	0	2	3	0	0	0	3	0	14	1	0	15	0	0	1	0	1	0	0	0	0	0	21	21
Apprch %	0	50	50			100	0	0			0	93.3	6.7			0	0	100									
Total %	0	4.8	4.8		9.5	14.3	0	0		14.3	0	66.7	4.8		71.4	0	0	4.8		4.8					0	100	

Start Time	Sycamore Canyon Boulevard Southbound				Eastridge Avenue Westbound				Sycamore Canyon Boulevard Northbound				Eastridge Avenue Eastbound				Int. Total
	Left	Thru	Right	App. Total	Left	Thru	Right	App. Total	Left	Thru	Right	App. Total	Left	Thru	Right	App. Total	
Peak Hour Analysis From 01:00 PM to 01:45 PM - Peak 1 of 1																	
Peak Hour for Entire Intersection Begins at 01:00 PM																	
01:00 PM	0	0	0	0	1	0	0	1	0	1	0	1	0	0	1	1	3
01:15 PM	0	0	0	0	0	0	0	0	0	1	0	1	0	0	0	0	1
01:30 PM	0	0	0	0	0	0	0	0	0	1	0	1	0	0	0	0	1
01:45 PM	0	0	1	1	0	0	0	0	0	3	0	3	0	0	0	0	4
Total Volume	0	0	1	1	1	0	0	1	0	6	0	6	0	0	1	1	9
% App. Total	0	0	100		100	0	0		0	100	0		0	0	100		
PHF	.000	.000	.250	.250	.250	.000	.000	.250	.000	.500	.000	.500	.000	.000	.250	.250	.563

City of Riverside
 N/S: Sycamore Canyon Boulevard
 E/W: Eastridge Avenue
 Weather: Clear

File Name : 22_RIV_Syc_East Sat
 Site Code : 05122815
 Start Date : 9/17/2022
 Page No : 2

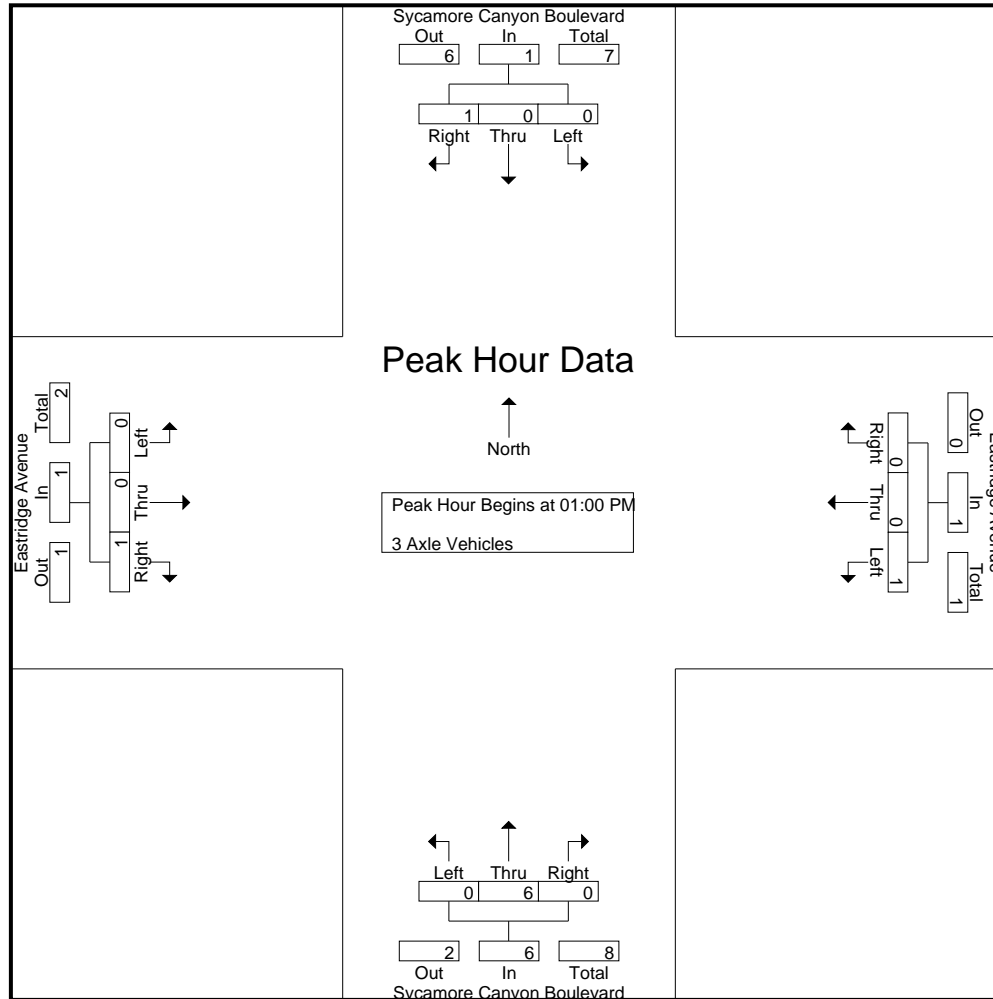

City of Riverside
 N/S: Sycamore Canyon Boulevard
 E/W: Eastridge Avenue
 Weather: Clear

File Name : 22_RIV_Syc_East Sat
 Site Code : 05122815
 Start Date : 9/17/2022
 Page No : 3

Start Time	Sycamore Canyon Boulevard Southbound				Eastridge Avenue Westbound				Sycamore Canyon Boulevard Northbound				Eastridge Avenue Eastbound				Int. Total
	Left	Thru	Right	App. Total	Left	Thru	Right	App. Total	Left	Thru	Right	App. Total	Left	Thru	Right	App. Total	
Peak Hour Analysis From 01:00 PM to 01:45 PM - Peak 1 of 1																	
Peak Hour for Each Approach Begins at:																	
	01:00 PM				01:00 PM				01:00 PM				01:00 PM				
+0 mins.	0	0	0	0	1	0	0	1	0	1	0	1	0	0	1	1	
+15 mins.	0	0	0	0	0	0	0	0	0	1	0	1	0	0	0	0	
+30 mins.	0	0	0	0	0	0	0	0	0	1	0	1	0	0	0	0	
+45 mins.	0	0	1	1	0	0	0	0	0	3	0	3	0	0	0	0	
Total Volume	0	0	1	1	1	0	0	1	0	6	0	6	0	0	1	1	
% App. Total	0	0	100		100	0	0		0	100	0		0	0	100		
PHF	.000	.000	.250	.250	.250	.000	.000	.250	.000	.500	.000	.500	.000	.000	.250	.250	

City of Riverside
 N/S: Sycamore Canyon Boulevard
 E/W: Eastridge Avenue
 Weather: Clear

File Name : 22_RIV_Syc_East Sat
 Site Code : 05122815
 Start Date : 9/17/2022
 Page No : 1

Groups Printed- 4+ Axle Trucks

Start Time	Sycamore Canyon Boulevard Southbound					Eastridge Avenue Westbound					Sycamore Canyon Boulevard Northbound					Eastridge Avenue Eastbound					Exclu. Total	Inclu. Total	Int. Total
	Left	Thru	Right	RTOR	App. Total	Left	Thru	Right	RTOR	App. Total	Left	Thru	Right	RTOR	App. Total	Left	Thru	Right	RTOR	App. Total			
11:00 AM	0	0	2	0	2	0	1	0	0	1	0	1	1	0	2	2	5	1	0	8	0	13	13
11:15 AM	0	5	2	0	7	0	0	0	0	0	1	1	0	0	2	2	2	0	0	4	0	13	13
11:30 AM	0	1	0	0	1	0	2	0	0	2	1	4	1	0	6	0	0	1	0	1	0	10	10
11:45 AM	0	2	1	1	3	0	3	2	2	5	1	1	2	0	4	3	2	0	0	5	3	17	20
Total	0	8	5	1	13	0	6	2	2	8	3	7	4	0	14	7	9	2	0	18	3	53	56
12:00 PM	0	1	2	1	3	0	3	3	1	6	0	2	0	0	2	2	5	1	0	8	2	19	21
12:15 PM	1	2	1	0	4	0	1	0	0	1	0	3	0	0	3	1	3	0	0	4	0	12	12
12:30 PM	0	1	6	1	7	1	2	2	0	5	2	1	1	0	4	1	4	0	0	5	1	21	22
12:45 PM	1	1	2	0	4	2	0	3	3	5	1	4	0	0	5	5	1	0	0	6	3	20	23
Total	2	5	11	2	18	3	6	8	4	17	3	10	1	0	14	9	13	1	0	23	6	72	78
01:00 PM	0	0	1	0	1	1	3	1	0	5	0	4	0	0	4	1	3	0	0	4	0	14	14
01:15 PM	0	1	0	0	1	1	3	0	0	4	0	1	0	0	1	1	5	0	0	6	0	12	12
01:30 PM	0	0	3	0	3	0	1	0	0	1	1	4	0	0	5	4	4	0	0	8	0	17	17
01:45 PM	0	0	3	1	3	1	0	0	0	1	1	2	2	0	5	5	3	0	0	8	1	17	18
Total	0	1	7	1	8	3	7	1	0	11	2	11	2	0	15	11	15	0	0	26	1	60	61
Grand Total	2	14	23	4	39	6	19	11	6	36	8	28	7	0	43	27	37	3	0	67	10	185	195
Apprch %	5.1	35.9	59			16.7	52.8	30.6			18.6	65.1	16.3			40.3	55.2	4.5					
Total %	1.1	7.6	12.4		21.1	3.2	10.3	5.9		19.5	4.3	15.1	3.8		23.2	14.6	20	1.6		36.2	5.1	94.9	

Start Time	Sycamore Canyon Boulevard Southbound				Eastridge Avenue Westbound				Sycamore Canyon Boulevard Northbound				Eastridge Avenue Eastbound				Int. Total
	Left	Thru	Right	App. Total	Left	Thru	Right	App. Total	Left	Thru	Right	App. Total	Left	Thru	Right	App. Total	
Peak Hour Analysis From 01:00 PM to 01:45 PM - Peak 1 of 1																	
Peak Hour for Entire Intersection Begins at 01:00 PM																	
01:00 PM	0	0	1	1	1	3	1	5	0	4	0	4	1	3	0	4	14
01:15 PM	0	1	0	1	1	3	0	4	0	1	0	1	1	5	0	6	12
01:30 PM	0	0	3	3	0	1	0	1	1	4	0	5	4	4	0	8	17
01:45 PM	0	0	3	3	1	0	0	1	1	2	2	5	5	3	0	8	17
Total Volume	0	1	7	8	3	7	1	11	2	11	2	15	11	15	0	26	60
% App. Total	0	12.5	87.5		27.3	63.6	9.1		13.3	73.3	13.3		42.3	57.7	0		
PHF	.000	.250	.583	.667	.750	.583	.250	.550	.500	.688	.250	.750	.550	.750	.000	.813	.882

City of Riverside
 N/S: Sycamore Canyon Boulevard
 E/W: Eastridge Avenue
 Weather: Clear

File Name : 22_RIV_Syc_East Sat
 Site Code : 05122815
 Start Date : 9/17/2022
 Page No : 2

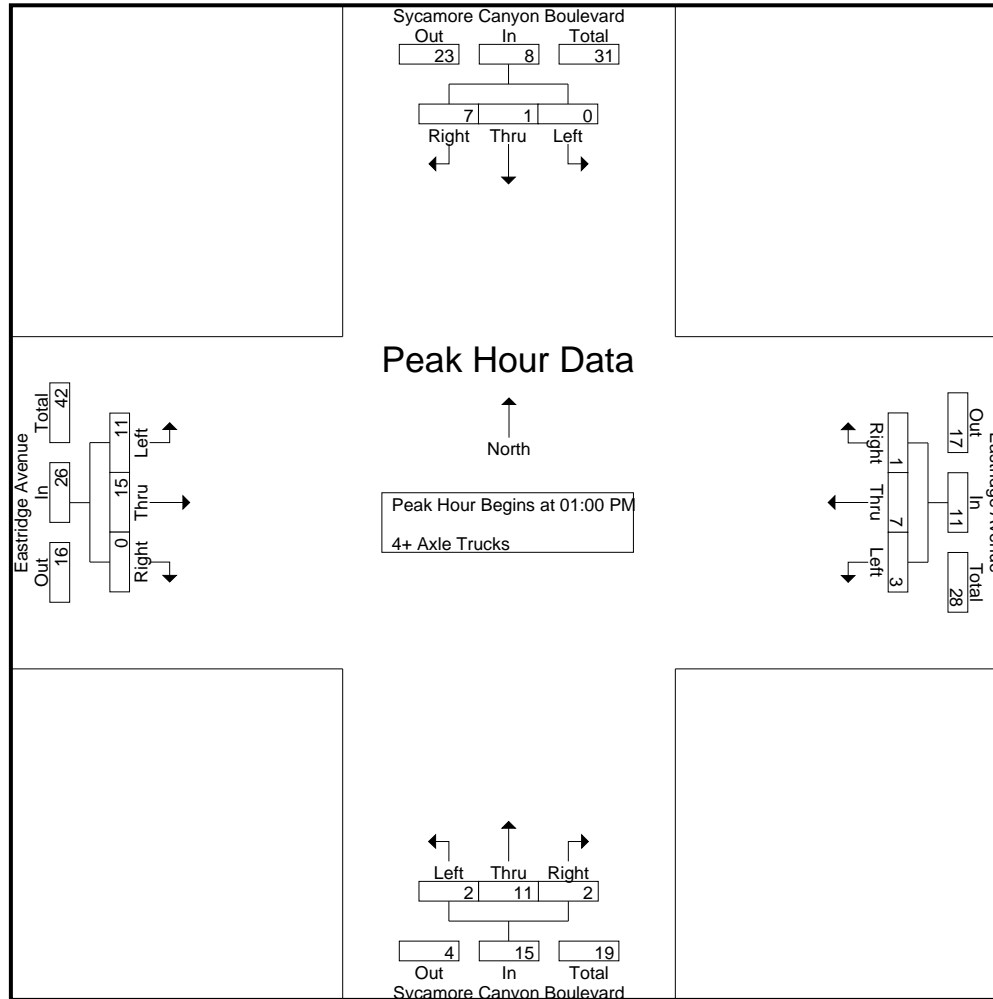

City of Riverside
 N/S: Sycamore Canyon Boulevard
 E/W: Eastridge Avenue
 Weather: Clear

File Name : 22_RIV_Syc_East Sat
 Site Code : 05122815
 Start Date : 9/17/2022
 Page No : 3

Start Time	Sycamore Canyon Boulevard Southbound				Eastridge Avenue Westbound				Sycamore Canyon Boulevard Northbound				Eastridge Avenue Eastbound				Int. Total
	Left	Thru	Right	App. Total	Left	Thru	Right	App. Total	Left	Thru	Right	App. Total	Left	Thru	Right	App. Total	
Peak Hour Analysis From 01:00 PM to 01:45 PM - Peak 1 of 1																	
Peak Hour for Each Approach Begins at:																	
	01:00 PM				01:00 PM				01:00 PM				01:00 PM				
+0 mins.	0	0	1	1	1	3	1	5	0	4	0	4	1	3	0	4	
+15 mins.	0	1	0	1	1	3	0	4	0	1	0	1	1	5	0	6	
+30 mins.	0	0	3	3	0	1	0	1	1	4	0	5	4	4	0	8	
+45 mins.	0	0	3	3	1	0	0	1	1	2	2	5	5	3	0	8	
Total Volume	0	1	7	8	3	7	1	11	2	11	2	15	11	15	0	26	
% App. Total	0	12.5	87.5		27.3	63.6	9.1		13.3	73.3	13.3		42.3	57.7	0		
PHF	.000	.250	.583	.667	.750	.583	.250	.550	.500	.688	.250	.750	.550	.750	.000	.813	

Location: Riverside
 N/S: Sycamore Canyon Blvd
 E/W: Eastridge Avenue



Date: 9/17/2022
 Day Saturday

PEDESTRIANS

Time	North Leg Sycamore Canyon Blvd	East Leg Eastridge Avenue	South Leg Sycamore Canyon Blvd	West Leg Eastridge Avenue	TOTAL
11:00 AM	0	0	0	0	0
11:15 AM	0	0	1	0	1
11:30 AM	0	0	0	0	0
11:45 AM	0	0	0	0	0
12:00 PM	0	0	0	0	0
12:15 PM	0	0	0	0	0
12:30 PM	0	0	0	0	0
12:45 PM	0	0	1	2	3
1:00 PM	0	0	1	0	1
1:15 PM	0	0	0	0	0
1:30 PM	0	0	1	0	1
1:45 PM	0	0	0	0	0
TOTAL VOLUMES:	0	0	4	2	6

Location: Riverside
 N/S: Sycamore Canyon Blvd
 E/W: Eastridge Avenue

Date: 9/17/2022
 Day: Saturday



BICYCLES

	Southbound Sycamore Canyon Blvd			Westbound Eastridge Avenue			Northbound Sycamore Canyon Blvd			Eastbound Eastridge Avenue			
	Left	Thru	Right	Left	Thru	Right	Left	Thru	Right	Left	Thru	Right	
11:00 AM	0	0	0	0	0	0	0	0	0	0	2	0	2
11:15 AM	0	0	0	0	0	0	0	0	0	0	0	0	0
11:30 AM	0	3	0	0	0	0	0	0	0	0	0	0	3
11:45 AM	0	0	0	0	0	0	0	0	0	0	0	0	0
12:00 PM	0	0	0	0	0	0	0	0	0	0	0	0	0
12:15 PM	0	0	0	0	0	0	0	0	0	1	0	0	1
12:30 PM	0	0	0	0	0	0	0	0	0	0	0	0	0
12:45 PM	0	0	0	0	0	0	0	0	0	0	0	0	0
1:00 PM	0	0	0	0	0	0	0	0	0	0	0	0	0
1:15 PM	0	0	0	0	0	0	0	0	0	0	0	0	0
1:30 PM	0	0	0	0	0	0	0	0	0	0	0	0	0
1:45 PM	0	0	0	0	0	0	0	0	0	0	0	0	0
TOTAL VOLUMES:	0	3	0	0	0	0	0	0	0	1	2	0	6

City of Riverside
 N/S: Sycamore Canyon Boulevard
 E/W: Cottonwood Avenue
 Weather: Clear

File Name : 23_RIV_Syc_Cot Sat
 Site Code : 05122815
 Start Date : 9/17/2022
 Page No : 1

Groups Printed- Passenger Vehicles - Large 2 Axle Vehicles - 3 Axle Vehicles - 4+ Axle Trucks

Start Time	Sycamore Canyon Boulevard Southbound			Cottonwood Avenue Westbound				Sycamore Canyon Boulevard Northbound				Exclu. Total	Inclu. Total	Int. Total
	Left	Thru	App. Total	Left	Right	RTOR	App. Total	Thru	Right	RTOR	App. Total			
11:00 AM	1	56	57	4	1	0	5	59	1	0	60	0	122	122
11:15 AM	8	40	48	4	0	0	4	91	2	0	93	0	145	145
11:30 AM	3	63	66	2	6	3	8	73	5	0	78	3	152	155
11:45 AM	2	56	58	3	3	2	6	67	6	0	73	2	137	139
Total	14	215	229	13	10	5	23	290	14	0	304	5	556	561
12:00 PM	5	54	59	6	3	2	9	47	4	1	51	3	119	122
12:15 PM	7	66	73	4	5	2	9	46	2	1	48	3	130	133
12:30 PM	3	73	76	4	5	2	9	71	0	0	71	2	156	158
12:45 PM	3	84	87	1	4	4	5	84	2	0	86	4	178	182
Total	18	277	295	15	17	10	32	248	8	2	256	12	583	595
01:00 PM	0	79	79	1	3	3	4	93	0	0	93	3	176	179
01:15 PM	7	92	99	1	3	2	4	80	1	0	81	2	184	186
01:30 PM	5	97	102	1	7	6	8	86	3	0	89	6	199	205
01:45 PM	8	47	55	4	8	4	12	104	3	1	107	5	174	179
Total	20	315	335	7	21	15	28	363	7	1	370	16	733	749
Grand Total	52	807	859	35	48	30	83	901	29	3	930	33	1872	1905
Apprch %	6.1	93.9		42.2	57.8			96.9	3.1					
Total %	2.8	43.1	45.9	1.9	2.6		4.4	48.1	1.5		49.7	1.7	98.3	
Passenger Vehicles	39	781	820	28	13		51	870	16		888	0	0	1759
% Passenger Vehicles	75	96.8	95.5	80	27.1	33.3	45.1	96.6	55.2	66.7	95.2	0	0	92.3
Large 2 Axle Vehicles	2	9	11	0	1		1	13	0		13	0	0	25
% Large 2 Axle Vehicles	3.8	1.1	1.3	0	2.1	0	0.9	1.4	0	0	1.4	0	0	1.3
3 Axle Vehicles	1	3	4	3	8		16	6	4		10	0	0	30
% 3 Axle Vehicles	1.9	0.4	0.5	8.6	16.7	16.7	14.2	0.7	13.8	0	1.1	0	0	1.6
4+ Axle Trucks	10	14	24	4	26		45	12	9		22	0	0	91
% 4+ Axle Trucks	19.2	1.7	2.8	11.4	54.2	50	39.8	1.3	31	33.3	2.4	0	0	4.8

Start Time	Sycamore Canyon Boulevard Southbound			Cottonwood Avenue Westbound			Sycamore Canyon Boulevard Northbound			Int. Total
	Left	Thru	App. Total	Left	Right	App. Total	Thru	Right	App. Total	
Peak Hour Analysis From 11:00 AM to 01:45 PM - Peak 1 of 1										
Peak Hour for Entire Intersection Begins at 12:45 PM										
12:45 PM	3	84	87	1	4	5	84	2	86	178
01:00 PM	0	79	79	1	3	4	93	0	93	176
01:15 PM	7	92	99	1	3	4	80	1	81	184
01:30 PM	5	97	102	1	7	8	86	3	89	199
Total Volume	15	352	367	4	17	21	343	6	349	737
% App. Total	4.1	95.9		19	81		98.3	1.7		
PHF	.536	.907	.900	1.00	.607	.656	.922	.500	.938	.926

City of Riverside
 N/S: Sycamore Canyon Boulevard
 E/W: Cottonwood Avenue
 Weather: Clear

File Name : 23_RIV_Syc_Cot Sat
 Site Code : 05122815
 Start Date : 9/17/2022
 Page No : 2

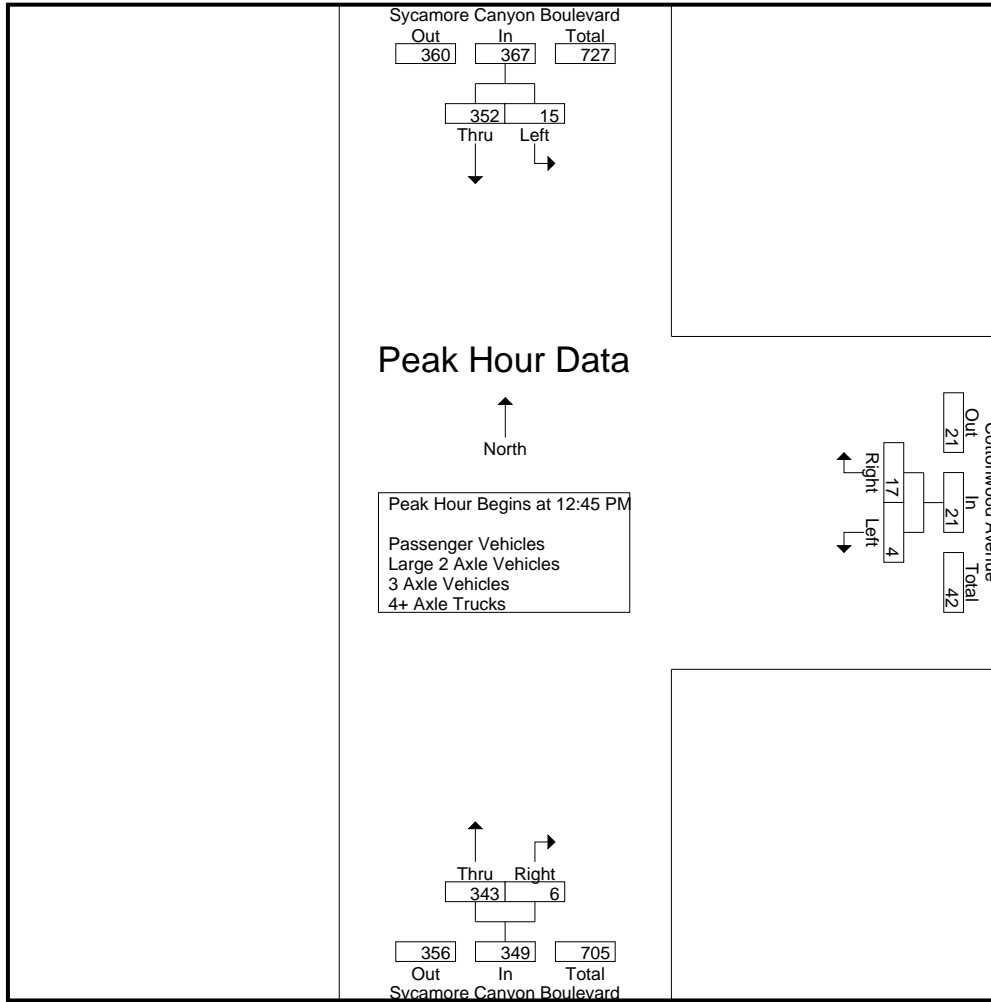

Peak Hour Analysis From 11:00 AM to 01:45 PM - Peak 1 of 1
 Peak Hour for Each Approach Begins at:

	12:45 PM			11:45 AM			01:00 PM		
+0 mins.	3	84	87	3	3	6	93	0	93
+15 mins.	0	79	79	6	3	9	80	1	81
+30 mins.	7	92	99	4	5	9	86	3	89
+45 mins.	5	97	102	4	5	9	104	3	107
Total Volume	15	352	367	17	16	33	363	7	370
% App. Total	4.1	95.9		51.5	48.5		98.1	1.9	
PHF	.536	.907	.900	.708	.800	.917	.873	.583	.864

City of Riverside
 N/S: Sycamore Canyon Boulevard
 E/W: Cottonwood Avenue
 Weather: Clear

File Name : 23_RIV_Syc_Cot Sat
 Site Code : 05122815
 Start Date : 9/17/2022
 Page No : 1

Groups Printed- Passenger Vehicles

Start Time	Sycamore Canyon Boulevard Southbound			Cottonwood Avenue Westbound				Sycamore Canyon Boulevard Northbound				Exclu. Total	Inclu. Total	Int. Total
	Left	Thru	App. Total	Left	Right	RTOR	App. Total	Thru	Right	RTOR	App. Total			
11:00 AM	1	55	56	4	0	0	4	58	1	0	59	0	119	119
11:15 AM	5	39	44	3	0	0	3	89	1	0	90	0	137	137
11:30 AM	0	60	60	2	2	0	4	73	2	0	75	0	139	139
11:45 AM	2	54	56	3	0	0	3	66	2	0	68	0	127	127
Total	8	208	216	12	2	0	14	286	6	0	292	0	522	522
12:00 PM	3	52	55	5	0	0	5	45	2	0	47	0	107	107
12:15 PM	7	64	71	2	1	0	3	43	2	1	45	1	119	120
12:30 PM	1	72	73	2	1	1	3	69	0	0	69	1	145	146
12:45 PM	2	82	84	1	2	2	3	78	2	0	80	2	167	169
Total	13	270	283	10	4	3	14	235	6	1	241	4	538	542
01:00 PM	0	75	75	1	2	2	3	85	0	0	85	2	163	165
01:15 PM	6	87	93	1	1	1	2	79	0	0	79	1	174	175
01:30 PM	5	96	101	1	1	1	2	84	2	0	86	1	189	190
01:45 PM	7	45	52	3	3	3	6	101	2	1	103	4	161	165
Total	18	303	321	6	7	7	13	349	4	1	353	8	687	695
Grand Total	39	781	820	28	13	10	41	870	16	2	886	12	1747	1759
Apprch %	4.8	95.2		68.3	31.7			98.2	1.8					
Total %	2.2	44.7	46.9	1.6	0.7		2.3	49.8	0.9		50.7	0.7	99.3	

Start Time	Sycamore Canyon Boulevard Southbound			Cottonwood Avenue Westbound			Sycamore Canyon Boulevard Northbound			Int. Total
	Left	Thru	App. Total	Left	Right	App. Total	Thru	Right	App. Total	
12:45 PM	2	82	84	1	2	3	78	2	80	167
01:00 PM	0	75	75	1	2	3	85	0	85	163
01:15 PM	6	87	93	1	1	2	79	0	79	174
01:30 PM	5	96	101	1	1	2	84	2	86	189
Total Volume	13	340	353	4	6	10	326	4	330	693
% App. Total	3.7	96.3		40	60		98.8	1.2		
PHF	.542	.885	.874	1.00	.750	.833	.959	.500	.959	.917

Peak Hour Analysis From 12:45 PM to 01:30 PM - Peak 1 of 1
 Peak Hour for Entire Intersection Begins at 12:45 PM

City of Riverside
 N/S: Sycamore Canyon Boulevard
 E/W: Cottonwood Avenue
 Weather: Clear

File Name : 23_RIV_Syc_Cot Sat
 Site Code : 05122815
 Start Date : 9/17/2022
 Page No : 2

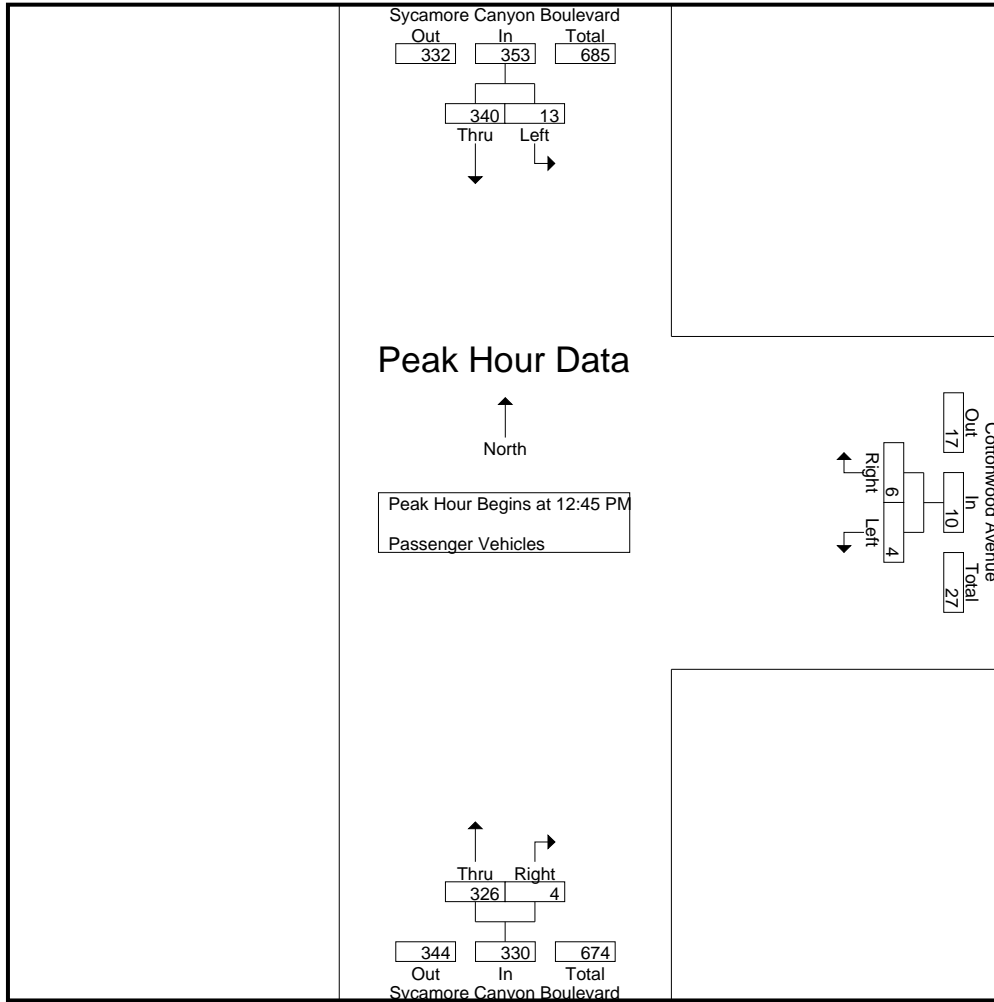

Peak Hour Analysis From 12:45 PM to 01:30 PM - Peak 1 of 1
 Peak Hour for Each Approach Begins at:

	12:45 PM			12:45 PM			12:45 PM		
+0 mins.	2	82	84	1	2	3	78	2	80
+15 mins.	0	75	75	1	2	3	85	0	85
+30 mins.	6	87	93	1	1	2	79	0	79
+45 mins.	5	96	101	1	1	2	84	2	86
Total Volume	13	340	353	4	6	10	326	4	330
% App. Total	3.7	96.3		40	60		98.8	1.2	
PHF	.542	.885	.874	1.000	.750	.833	.959	.500	.959

City of Riverside
 N/S: Sycamore Canyon Boulevard
 E/W: Cottonwood Avenue
 Weather: Clear

File Name : 23_RIV_Syc_Cot Sat
 Site Code : 05122815
 Start Date : 9/17/2022
 Page No : 1

Groups Printed- Large 2 Axle Vehicles

Start Time	Sycamore Canyon Boulevard Southbound			Cottonwood Avenue Westbound				Sycamore Canyon Boulevard Northbound				Exclu. Total	Inclu. Total	Int. Total
	Left	Thru	App. Total	Left	Right	RTOR	App. Total	Thru	Right	RTOR	App. Total			
11:00 AM	0	0	0	0	0	0	0	1	0	0	1	0	1	1
11:15 AM	0	0	0	0	0	0	0	1	0	0	1	0	1	1
11:30 AM	2	1	3	0	0	0	0	0	0	0	0	0	3	3
11:45 AM	0	0	0	0	0	0	0	0	0	0	0	0	0	0
Total	2	1	3	0	0	0	0	2	0	0	2	0	5	5
12:00 PM	0	0	0	0	0	0	0	0	0	0	0	0	0	0
12:15 PM	0	1	1	0	0	0	0	3	0	0	3	0	4	4
12:30 PM	0	1	1	0	0	0	0	0	0	0	0	0	1	1
12:45 PM	0	1	1	0	0	0	0	2	0	0	2	0	3	3
Total	0	3	3	0	0	0	0	5	0	0	5	0	8	8
01:00 PM	0	1	1	0	0	0	0	5	0	0	5	0	6	6
01:15 PM	0	2	2	0	1	0	1	0	0	0	0	0	3	3
01:30 PM	0	1	1	0	0	0	0	0	0	0	0	0	1	1
01:45 PM	0	1	1	0	0	0	0	1	0	0	1	0	2	2
Total	0	5	5	0	1	0	1	6	0	0	6	0	12	12
Grand Total	2	9	11	0	1	0	1	13	0	0	13	0	25	25
Apprch %	18.2	81.8		0	100			100	0			0		
Total %	8	36	44	0	4		4	52	0		52	0	100	

Start Time	Sycamore Canyon Boulevard Southbound			Cottonwood Avenue Westbound			Sycamore Canyon Boulevard Northbound			Int. Total
	Left	Thru	App. Total	Left	Right	App. Total	Thru	Right	App. Total	
12:45 PM	0	1	1	0	0	0	2	0	2	3
01:00 PM	0	1	1	0	0	0	5	0	5	6
01:15 PM	0	2	2	0	1	1	0	0	0	3
01:30 PM	0	1	1	0	0	0	0	0	0	1
Total Volume	0	5	5	0	1	1	7	0	7	13
% App. Total	0	100		0	100		100	0		
PHF	.000	.625	.625	.000	.250	.250	.350	.000	.350	.542

City of Riverside
 N/S: Sycamore Canyon Boulevard
 E/W: Cottonwood Avenue
 Weather: Clear

File Name : 23_RIV_Syc_Cot Sat
 Site Code : 05122815
 Start Date : 9/17/2022
 Page No : 2

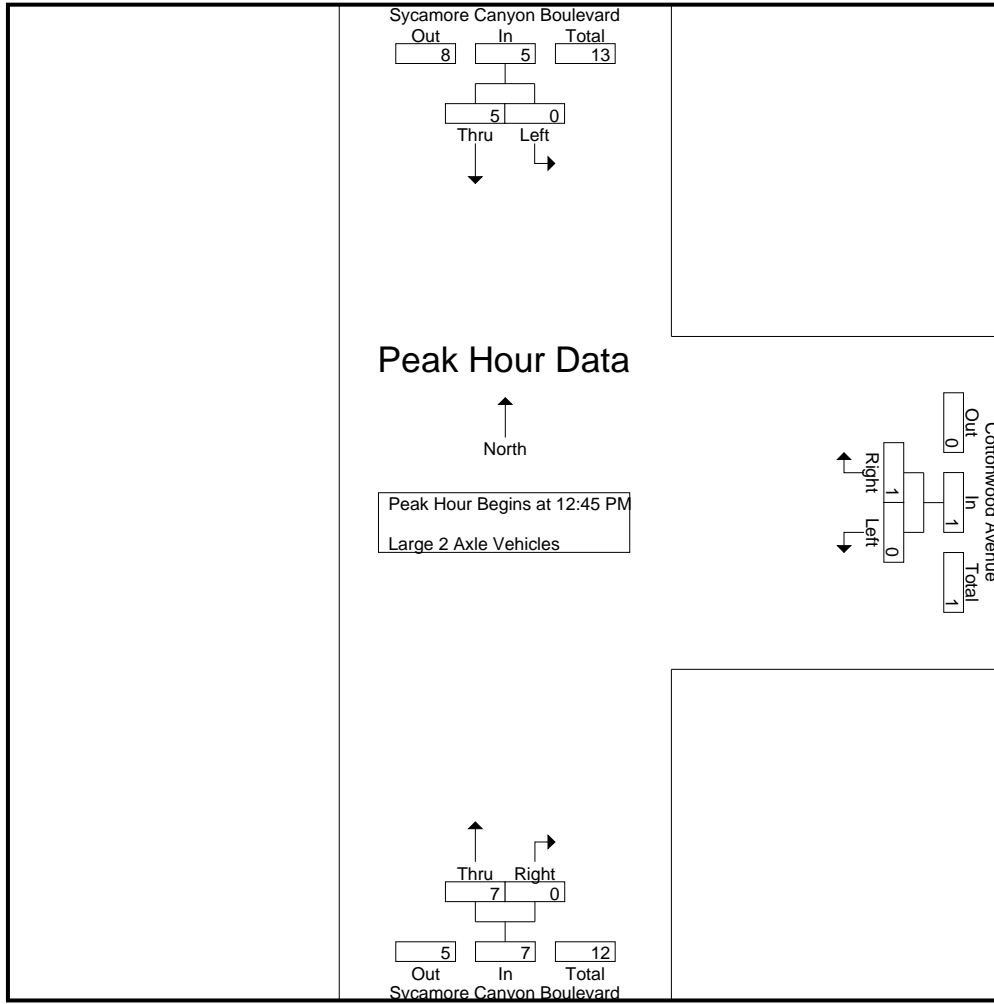

Peak Hour Analysis From 12:45 PM to 01:30 PM - Peak 1 of 1
 Peak Hour for Each Approach Begins at:

	12:45 PM			12:45 PM			12:45 PM		
+0 mins.	0	1	1	0	0	0	2	0	2
+15 mins.	0	1	1	0	0	0	5	0	5
+30 mins.	0	2	2	0	1	1	0	0	0
+45 mins.	0	1	1	0	0	0	0	0	0
Total Volume	0	5	5	0	1	1	7	0	7
% App. Total	0	100		0	100		100	0	
PHF	.000	.625	.625	.000	.250	.250	.350	.000	.350

City of Riverside
 N/S: Sycamore Canyon Boulevard
 E/W: Cottonwood Avenue
 Weather: Clear

File Name : 23_RIV_Syc_Cot Sat
 Site Code : 05122815
 Start Date : 9/17/2022
 Page No : 1

Groups Printed- 3 Axle Vehicles

Start Time	Sycamore Canyon Boulevard Southbound			Cottonwood Avenue Westbound				Sycamore Canyon Boulevard Northbound				Exclu. Total	Inclu. Total	Int. Total	
	Left	Thru	App. Total	Left	Right	RTOR	App. Total	Thru	Right	RTOR	App. Total				
11:00 AM	0	0	0	0	0	0	0	0	0	0	0	0	0	0	0
11:15 AM	0	0	0	1	0	0	1	0	0	0	0	0	0	1	1
11:30 AM	0	0	0	0	1	1	1	0	3	0	3	1	4	5	
11:45 AM	0	0	0	0	1	1	1	0	0	0	0	1	1	2	
Total	0	0	0	1	2	2	3	0	3	0	3	2	6	8	
12:00 PM	1	1	2	0	1	1	1	2	0	0	2	1	5	6	
12:15 PM	0	0	0	1	1	1	2	0	0	0	0	1	2	3	
12:30 PM	0	0	0	1	2	0	3	1	0	0	1	0	4	4	
12:45 PM	0	0	0	0	0	0	0	0	0	0	0	0	0	0	
Total	1	1	2	2	4	2	6	3	0	0	3	2	11	13	
01:00 PM	0	2	2	0	0	0	0	1	0	0	1	0	3	3	
01:15 PM	0	0	0	0	0	0	0	0	0	0	0	0	0	0	
01:30 PM	0	0	0	0	1	1	1	2	1	0	3	1	4	5	
01:45 PM	0	0	0	0	1	0	1	0	0	0	0	0	1	1	
Total	0	2	2	0	2	1	2	3	1	0	4	1	8	9	
Grand Total	1	3	4	3	8	5	11	6	4	0	10	5	25	30	
Apprch %	25	75		27.3	72.7			60	40						
Total %	4	12	16	12	32		44	24	16		40	16.7	83.3		

Start Time	Sycamore Canyon Boulevard Southbound			Cottonwood Avenue Westbound			Sycamore Canyon Boulevard Northbound			Int. Total
	Left	Thru	App. Total	Left	Right	App. Total	Thru	Right	App. Total	
12:45 PM	0	0	0	0	0	0	0	0	0	0
01:00 PM	0	2	2	0	0	0	1	0	1	3
01:15 PM	0	0	0	0	0	0	0	0	0	0
01:30 PM	0	0	0	0	1	1	2	1	3	4
Total Volume	0	2	2	0	1	1	3	1	4	7
% App. Total	0	100		0	100		75	25		
PHF	.000	.250	.250	.000	.250	.250	.375	.250	.333	.438

Peak Hour Analysis From 12:45 PM to 01:30 PM - Peak 1 of 1
 Peak Hour for Entire Intersection Begins at 12:45 PM

City of Riverside
 N/S: Sycamore Canyon Boulevard
 E/W: Cottonwood Avenue
 Weather: Clear

File Name : 23_RIV_Syc_Cot Sat
 Site Code : 05122815
 Start Date : 9/17/2022
 Page No : 2

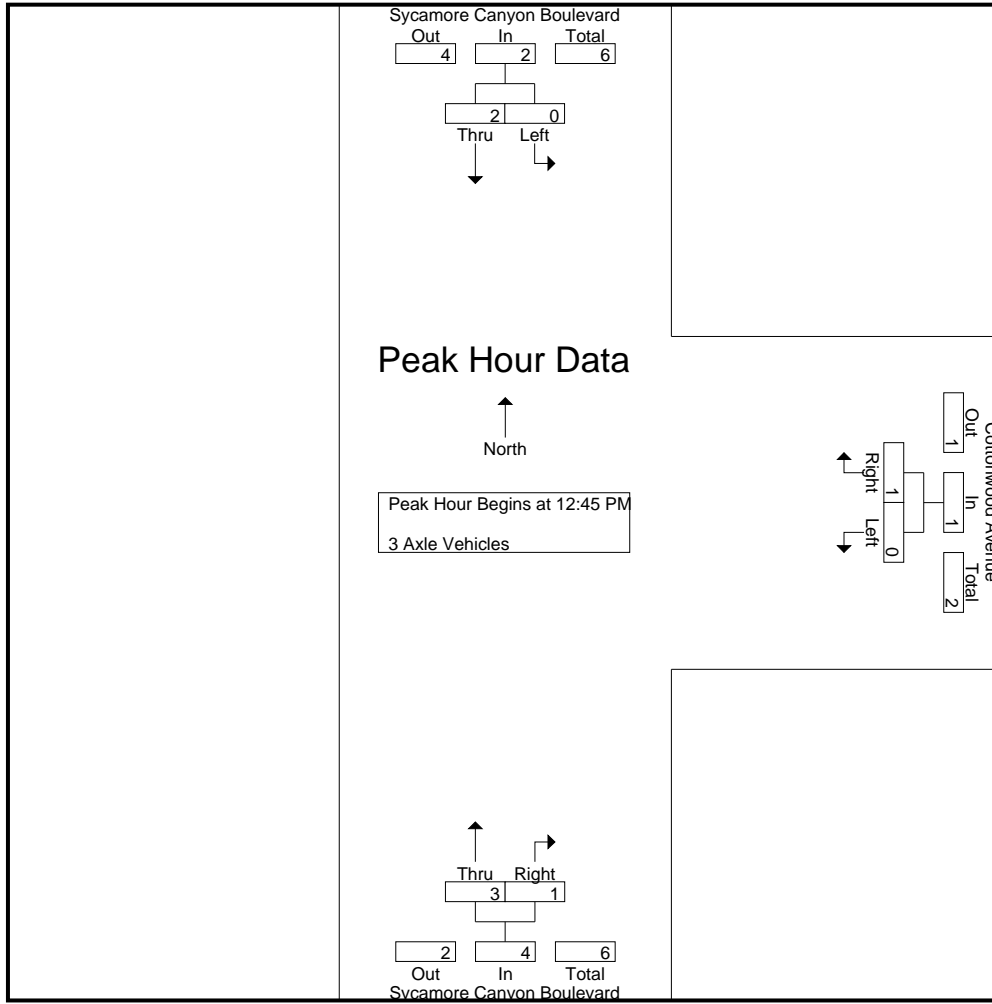

Peak Hour Analysis From 12:45 PM to 01:30 PM - Peak 1 of 1
 Peak Hour for Each Approach Begins at:

	12:45 PM			12:45 PM			12:45 PM		
+0 mins.	0	0	0	0	0	0	0	0	0
+15 mins.	0	2	2	0	0	0	1	0	1
+30 mins.	0	0	0	0	0	0	0	0	0
+45 mins.	0	0	0	0	1	1	2	1	3
Total Volume	0	2	2	0	1	1	3	1	4
% App. Total	0	100		0	100		75	25	
PHF	.000	.250	.250	.000	.250	.250	.375	.250	.333

City of Riverside
 N/S: Sycamore Canyon Boulevard
 E/W: Cottonwood Avenue
 Weather: Clear

File Name : 23_RIV_Syc_Cot Sat
 Site Code : 05122815
 Start Date : 9/17/2022
 Page No : 1

Groups Printed- 4+ Axle Trucks

Start Time	Sycamore Canyon Boulevard Southbound			Cottonwood Avenue Westbound				Sycamore Canyon Boulevard Northbound				Exclu. Total	Inclu. Total	Int. Total	
	Left	Thru	App. Total	Left	Right	RTOR	App. Total	Thru	Right	RTOR	App. Total				
11:00 AM	0	1	1	0	1	0	1	0	0	0	0	0	0	2	2
11:15 AM	3	1	4	0	0	0	0	1	1	0	2	0	6	6	
11:30 AM	1	2	3	0	3	2	3	0	0	0	0	2	6	8	
11:45 AM	0	2	2	0	2	1	2	1	4	0	5	1	9	10	
Total	4	6	10	0	6	3	6	2	5	0	7	3	23	26	
12:00 PM	1	1	2	1	2	1	3	0	2	1	2	2	7	9	
12:15 PM	0	1	1	1	3	1	4	0	0	0	0	1	5	6	
12:30 PM	2	0	2	1	2	1	3	1	0	0	1	1	6	7	
12:45 PM	1	1	2	0	2	2	2	4	0	0	4	2	8	10	
Total	4	3	7	3	9	5	12	5	2	1	7	6	26	32	
01:00 PM	0	1	1	0	1	1	1	2	0	0	2	1	4	5	
01:15 PM	1	3	4	0	1	1	1	1	1	0	2	1	7	8	
01:30 PM	0	0	0	0	5	4	5	0	0	0	0	4	5	9	
01:45 PM	1	1	2	1	4	1	5	2	1	0	3	1	10	11	
Total	2	5	7	1	11	7	12	5	2	0	7	7	26	33	
Grand Total	10	14	24	4	26	15	30	12	9	1	21	16	75	91	
Apprch %	41.7	58.3		13.3	86.7			57.1	42.9						
Total %	13.3	18.7	32	5.3	34.7		40	16	12		28	17.6	82.4		

Start Time	Sycamore Canyon Boulevard Southbound			Cottonwood Avenue Westbound			Sycamore Canyon Boulevard Northbound			Int. Total
	Left	Thru	App. Total	Left	Right	App. Total	Thru	Right	App. Total	
12:45 PM	1	1	2	0	2	2	4	0	4	8
01:00 PM	0	1	1	0	1	1	2	0	2	4
01:15 PM	1	3	4	0	1	1	1	1	2	7
01:30 PM	0	0	0	0	5	5	0	0	0	5
Total Volume	2	5	7	0	9	9	7	1	8	24
% App. Total	28.6	71.4		0	100		87.5	12.5		
PHF	.500	.417	.438	.000	.450	.450	.438	.250	.500	.750

City of Riverside
 N/S: Sycamore Canyon Boulevard
 E/W: Cottonwood Avenue
 Weather: Clear

File Name : 23_RIV_Syc_Cot Sat
 Site Code : 05122815
 Start Date : 9/17/2022
 Page No : 2

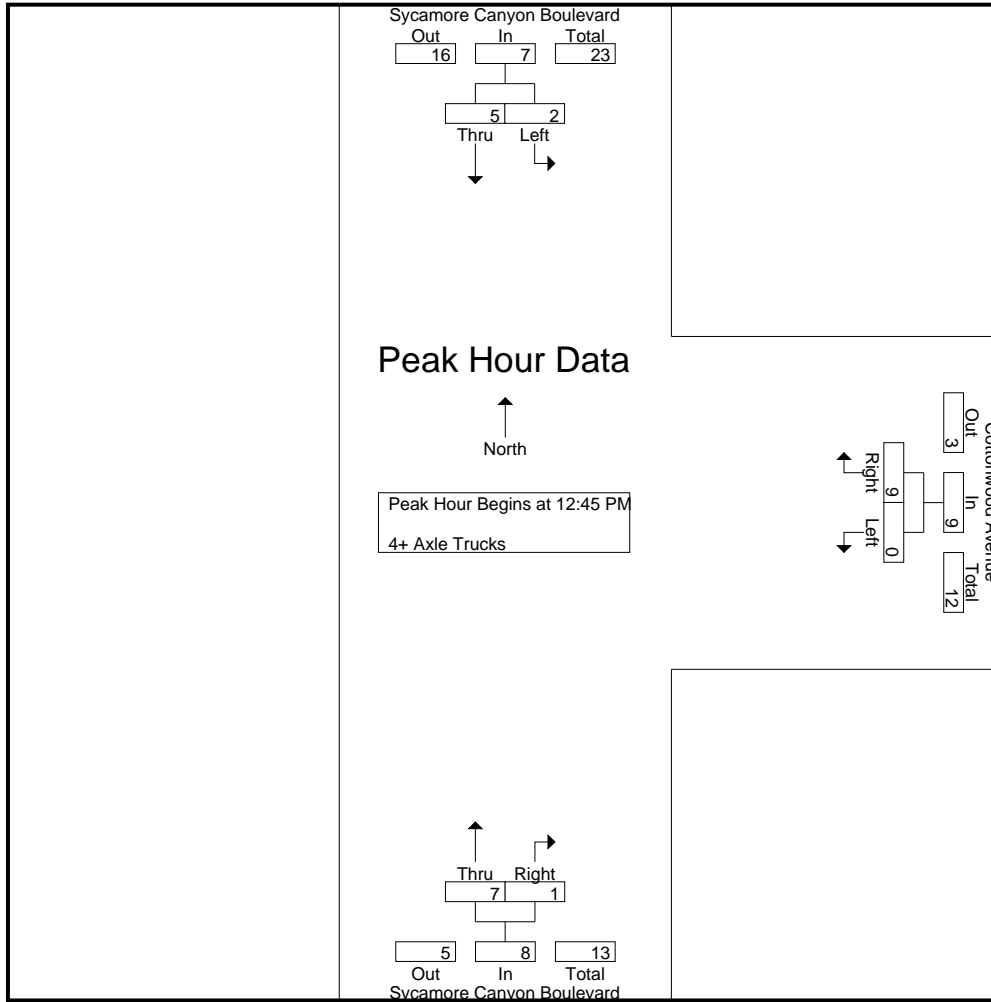

Peak Hour Analysis From 12:45 PM to 01:30 PM - Peak 1 of 1
 Peak Hour for Each Approach Begins at:

	12:45 PM			12:45 PM			12:45 PM		
+0 mins.	1	1	2	0	2	2	4	0	4
+15 mins.	0	1	1	0	1	1	2	0	2
+30 mins.	1	3	4	0	1	1	1	1	2
+45 mins.	0	0	0	0	5	5	0	0	0
Total Volume	2	5	7	0	9	9	7	1	8
% App. Total	28.6	71.4		0	100		87.5	12.5	
PHF	.500	.417	.438	.000	.450	.450	.438	.250	.500

Location: Riverside
 N/S: Sycamore Canyon Blvd
 E/W: Cottonwood Avenue



Date: 9/17/2022
 Day Saturday

PEDESTRIANS

Time	North Leg Sycamore Canyon Blvd	East Leg Cottonwood Avenue	South Leg Sycamore Canyon Blvd	West Leg Cottonwood Avenue	TOTAL
11:00 AM	0	0	0	0	0
11:15 AM	0	0	0	0	0
11:30 AM	0	0	0	0	0
11:45 AM	0	0	0	0	0
12:00 PM	0	0	0	0	0
12:15 PM	0	0	0	0	0
12:30 PM	0	1	0	0	1
12:45 PM	0	0	0	0	0
1:00 PM	0	0	0	0	0
1:15 PM	0	0	0	0	0
1:30 PM	0	0	0	0	0
1:45 PM	0	0	0	0	0
TOTAL VOLUMES:	0	1	0	0	1

Location: Riverside
 N/S: Sycamore Canyon Blvd
 E/W: Cottonwood Avenue

Date: 9/17/2022
 Day: Saturday



BICYCLES

	Southbound Sycamore Canyon Blvd			Westbound Cottonwood Avenue			Northbound Sycamore Canyon Blvd			Eastbound Cottonwood Avenue			
	Left	Thru	Right	Left	Thru	Right	Left	Thru	Right	Left	Thru	Right	
11:00 AM	0	0	0	0	0	0	0	0	0	0	0	0	0
11:15 AM	0	0	0	0	0	0	0	0	0	0	0	0	0
11:30 AM	0	3	0	0	0	0	0	0	0	0	0	0	3
11:45 AM	0	0	0	0	0	0	0	0	0	0	0	0	0
12:00 PM	0	0	0	0	0	0	0	0	0	0	0	0	0
12:15 PM	0	0	0	0	0	0	0	0	0	0	0	0	0
12:30 PM	0	0	0	0	0	0	0	0	0	0	0	0	0
12:45 PM	0	0	0	0	0	0	0	0	0	0	0	0	0
1:00 PM	0	0	0	0	0	0	0	0	0	0	0	0	0
1:15 PM	0	0	0	0	0	0	0	0	0	0	0	0	0
1:30 PM	0	0	0	0	0	0	0	0	0	0	0	0	0
1:45 PM	0	0	0	0	0	0	0	0	0	0	0	0	0
TOTAL VOLUMES:	0	3	0	0	0	0	0	0	0	0	0	0	3

City of Riverside
 N/S: Sycamore Canyon Blvd/Meridian Pkwy
 E/W: Alessandro Boulevard
 Weather: Clear

File Name : 24_RIV_Syc_Ales Sat
 Site Code : 05122815
 Start Date : 9/17/2022
 Page No : 1

Groups Printed- Passenger Vehicles - Large 2 Axle Vehicles - 3 Axle Vehicles - 4+ Axle Trucks

Start Time	Sycamore Canyon Boulevard Southbound					Alessandro Boulevard Westbound					Meridian Parkway Northbound					Alessandro Boulevard Eastbound					Exclu. Total	Inclu. Total	Int. Total
	Left	Thru	Right	RTOR	App. Total	Left	Thru	Right	RTOR	App. Total	Left	Thru	Right	RTOR	App. Total	Left	Thru	Right	RTOR	App. Total			
11:00 AM	11	9	7	19	27	7	203	15	6	225	29	19	4	12	52	20	199	9	9	228	46	532	578
11:15 AM	9	14	11	14	34	8	222	19	21	249	37	30	3	11	70	19	187	9	13	215	59	568	627
11:30 AM	16	16	5	19	37	8	255	20	13	283	45	28	4	9	77	18	243	10	6	271	47	668	715
11:45 AM	15	22	12	18	49	8	258	19	7	285	39	22	2	14	63	23	220	13	7	256	46	653	699
Total	51	61	35	70	147	31	938	73	47	1042	150	99	13	46	262	80	849	41	35	970	198	2421	2619
12:00 PM	16	14	5	9	35	11	231	11	4	253	36	23	1	20	60	15	243	28	15	286	48	634	682
12:15 PM	18	32	9	12	59	10	228	8	3	246	50	19	6	12	75	22	229	29	29	280	56	660	716
12:30 PM	20	26	9	24	55	8	234	10	8	252	33	24	4	10	61	33	284	23	7	340	49	708	757
12:45 PM	13	36	8	18	57	18	297	29	13	344	41	29	2	7	72	21	242	30	17	293	55	766	821
Total	67	108	31	63	206	47	990	58	28	1095	160	95	13	49	268	91	998	110	68	1199	208	2768	2976
01:00 PM	14	35	14	17	63	12	276	26	14	314	40	37	5	2	82	14	242	29	15	285	48	744	792
01:15 PM	12	43	9	17	64	7	279	15	10	301	32	33	3	12	68	27	240	16	12	283	51	716	767
01:30 PM	15	36	18	32	69	14	283	13	15	310	51	34	5	7	90	30	281	16	13	327	67	796	863
01:45 PM	22	16	12	17	50	12	285	24	18	321	42	44	5	9	91	24	227	15	5	266	49	728	777
Total	63	130	53	83	246	45	1123	78	57	1246	165	148	18	30	331	95	990	76	45	1161	215	2984	3199
Grand Total	181	299	119	216	599	123	3051	209	132	3383	475	342	44	125	861	266	2837	227	148	3330	621	8173	8794
Apprch %	30.2	49.9	19.9			3.6	90.2	6.2			55.2	39.7	5.1			8	85.2	6.8					
Total %	2.2	3.7	1.5		7.3	1.5	37.3	2.6		41.4	5.8	4.2	0.5		10.5	3.3	34.7	2.8		40.7	7.1	92.9	
Passenger Vehicles	167	283	118		781	119	3018	191		3454	467	330	41		961	257	2819	226		3449	0	0	8645
% Passenger Vehicles	92.3	94.6	99.2	98.6	95.8	96.7	98.9	91.4	95.5	98.3	98.3	96.5	93.2	98.4	97.5	96.6	99.4	99.6	99.3	99.2	0	0	98.3
Large 2 Axle Vehicles	3	5	0		10	1	29	5		36	7	2	0		11	5	15	1		22	0	0	79
% Large 2 Axle Vehicles	1.7	1.7	0	0.9	1.2	0.8	1	2.4	0.8	1	1.5	0.6	0	1.6	1.1	1.9	0.5	0.4	0.7	0.6	0	0	0.9
3 Axle Vehicles	5	2	1		8	0	1	3		7	0	3	2		5	2	1	0		3	0	0	23
% 3 Axle Vehicles	2.8	0.7	0.8	0	1	0	0	1.4	2.3	0.2	0	0.9	4.5	0	0.5	0.8	0	0	0	0.1	0	0	0.3
4+ Axle Trucks	6	9	0		16	3	3	10		18	1	7	1		9	2	2	0		4	0	0	47
% 4+ Axle Trucks	3.3	3	0	0.5	2	2.4	0.1	4.8	1.5	0.5	0.2	2	2.3	0	0.9	0.8	0.1	0	0	0.1	0	0	0.5

City of Riverside
 N/S: Sycamore Canyon Blvd/Meridian Pkwy
 E/W: Alessandro Boulevard
 Weather: Clear

File Name : 24_RIV_Syc_Ales Sat
 Site Code : 05122815
 Start Date : 9/17/2022
 Page No : 2

Start Time	Sycamore Canyon Boulevard Southbound				Alessandro Boulevard Westbound				Meridian Parkway Northbound				Alessandro Boulevard Eastbound				Int. Total
	Left	Thru	Right	App. Total	Left	Thru	Right	App. Total	Left	Thru	Right	App. Total	Left	Thru	Right	App. Total	
Peak Hour Analysis From 11:00 AM to 01:45 PM - Peak 1 of 1																	
Peak Hour for Entire Intersection Begins at 12:45 PM																	
12:45 PM	13	36	8	57	18	297	29	344	41	29	2	72	21	242	30	293	766
01:00 PM	14	35	14	63	12	276	26	314	40	37	5	82	14	242	29	285	744
01:15 PM	12	43	9	64	7	279	15	301	32	33	3	68	27	240	16	283	716
01:30 PM	15	36	18	69	14	283	13	310	51	34	5	90	30	281	16	327	796
Total Volume	54	150	49	253	51	1135	83	1269	164	133	15	312	92	1005	91	1188	3022
% App. Total	21.3	59.3	19.4		4	89.4	6.5		52.6	42.6	4.8		7.7	84.6	7.7		
PHF	.900	.872	.681	.917	.708	.955	.716	.922	.804	.899	.750	.867	.767	.894	.758	.908	.949

City of Riverside
 N/S: Sycamore Canyon Blvd/Meridian Pkwy
 E/W: Alessandro Boulevard
 Weather: Clear

File Name : 24_RIV_Syc_Ales Sat
 Site Code : 05122815
 Start Date : 9/17/2022
 Page No : 3

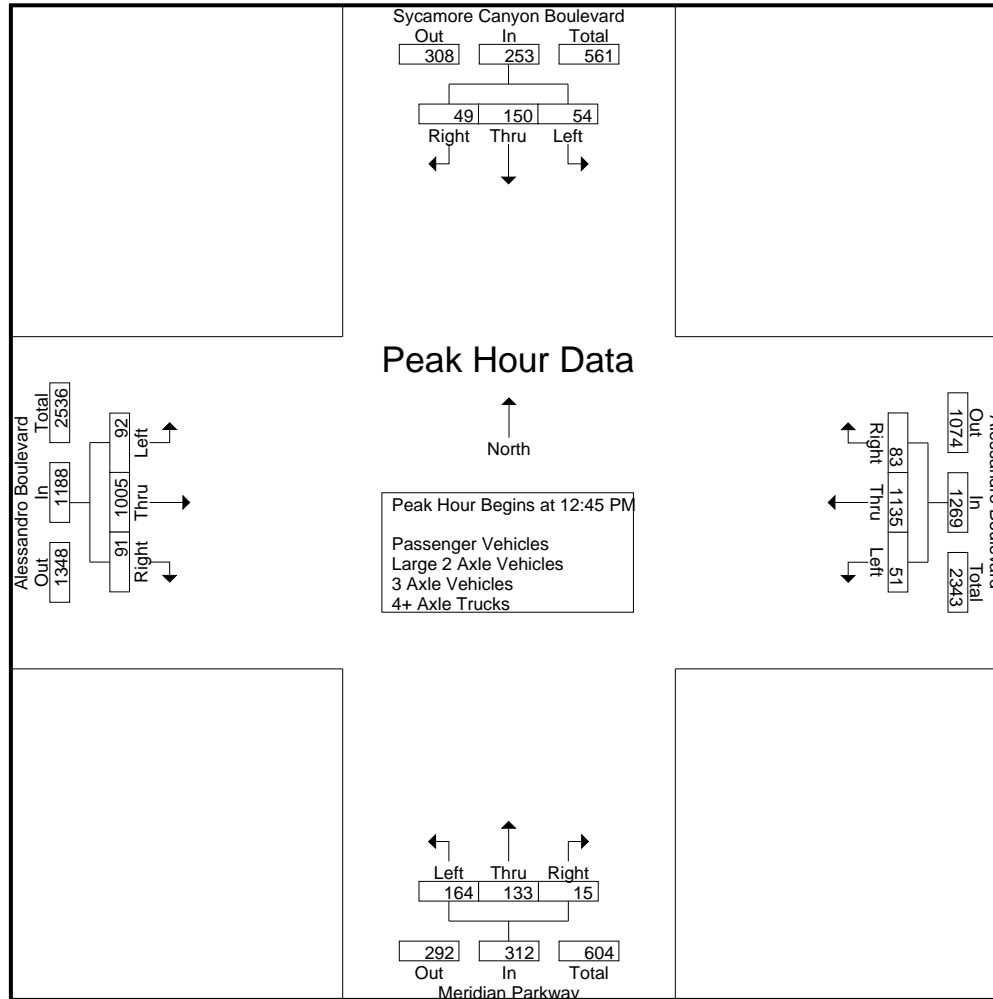

City of Riverside
 N/S: Sycamore Canyon Blvd/Meridian Pkwy
 E/W: Alessandro Boulevard
 Weather: Clear

File Name : 24_RIV_Syc_Ales Sat
 Site Code : 05122815
 Start Date : 9/17/2022
 Page No : 4

Start Time	Sycamore Canyon Boulevard Southbound				Alessandro Boulevard Westbound				Meridian Parkway Northbound				Alessandro Boulevard Eastbound				Int. Total
	Left	Thru	Right	App. Total	Left	Thru	Right	App. Total	Left	Thru	Right	App. Total	Left	Thru	Right	App. Total	
Peak Hour Analysis From 11:00 AM to 01:45 PM - Peak 1 of 1																	
Peak Hour for Each Approach Begins at:																	
	12:45 PM				12:45 PM				01:00 PM				12:30 PM				
+0 mins.	13	36	8	57	18	297	29	344	40	37	5	82	33	284	23	340	
+15 mins.	14	35	14	63	12	276	26	314	32	33	3	68	21	242	30	293	
+30 mins.	12	43	9	64	7	279	15	301	51	34	5	90	14	242	29	285	
+45 mins.	15	36	18	69	14	283	13	310	42	44	5	91	27	240	16	283	
Total Volume	54	150	49	253	51	1135	83	1269	165	148	18	331	95	1008	98	1201	
% App. Total	21.3	59.3	19.4		4	89.4	6.5		49.8	44.7	5.4		7.9	83.9	8.2		
PHF	.900	.872	.681	.917	.708	.955	.716	.922	.809	.841	.900	.909	.720	.887	.817	.883	

City of Riverside
 N/S: Sycamore Canyon Blvd/Meridian Pkwy
 E/W: Alessandro Boulevard
 Weather: Clear

File Name : 24_RIV_Syc_Ales Sat
 Site Code : 05122815
 Start Date : 9/17/2022
 Page No : 1

Groups Printed- Passenger Vehicles

Start Time	Sycamore Canyon Boulevard Southbound					Alessandro Boulevard Westbound					Meridian Parkway Northbound					Alessandro Boulevard Eastbound					Exclu. Total	Inclu. Total	Int. Total
	Left	Thru	Right	RTOR	App. Total	Left	Thru	Right	RTOR	App. Total	Left	Thru	Right	RTOR	App. Total	Left	Thru	Right	RTOR	App. Total			
11:00 AM	10	9	7	19	26	7	202	14	6	223	29	19	4	11	52	20	196	9	9	225	45	526	571
11:15 AM	9	14	11	13	34	6	222	18	20	246	36	27	3	11	66	19	186	9	12	214	56	560	616
11:30 AM	13	14	5	19	32	8	254	19	12	281	45	27	4	9	76	16	243	10	6	269	46	658	704
11:45 AM	14	21	12	18	47	8	255	17	5	280	39	21	2	14	62	23	219	13	7	255	44	644	688
Total	46	58	35	69	139	29	933	68	43	1030	149	94	13	45	256	78	844	41	34	963	191	2388	2579
12:00 PM	16	14	5	9	35	10	226	10	4	246	35	21	1	20	57	14	241	28	15	283	48	621	669
12:15 PM	15	29	9	12	53	10	226	7	3	243	48	19	6	11	73	20	229	29	29	278	55	647	702
12:30 PM	18	25	9	24	52	8	232	9	8	249	31	24	4	10	59	32	282	23	7	337	49	697	746
12:45 PM	13	35	8	18	56	18	295	27	13	340	40	26	1	7	67	20	239	30	17	289	55	752	807
Total	62	103	31	63	196	46	979	53	28	1078	154	90	12	48	256	86	991	110	68	1187	207	2717	2924
01:00 PM	13	34	13	16	60	11	272	22	14	305	40	37	5	2	82	13	241	29	15	283	47	730	777
01:15 PM	12	39	9	17	60	7	274	14	9	295	32	33	2	12	67	27	238	16	12	281	50	703	753
01:30 PM	14	33	18	32	65	14	279	12	14	305	50	33	5	7	88	29	278	16	13	323	66	781	847
01:45 PM	20	16	12	16	48	12	281	22	18	315	42	43	4	9	89	24	227	14	5	265	48	717	765
Total	59	122	52	81	233	44	1106	70	55	1220	164	146	16	30	326	93	984	75	45	1152	211	2931	3142
Grand Total	167	283	118	213	568	119	3018	191	126	3328	467	330	41	123	838	257	2819	226	147	3302	609	8036	8645
Apprch %	29.4	49.8	20.8			3.6	90.7	5.7			55.7	39.4	4.9			7.8	85.4	6.8					
Total %	2.1	3.5	1.5		7.1	1.5	37.6	2.4		41.4	5.8	4.1	0.5	10.4		3.2	35.1	2.8		41.1	7	93	

Start Time	Sycamore Canyon Boulevard Southbound				Alessandro Boulevard Westbound				Meridian Parkway Northbound				Alessandro Boulevard Eastbound				Int. Total
	Left	Thru	Right	App. Total	Left	Thru	Right	App. Total	Left	Thru	Right	App. Total	Left	Thru	Right	App. Total	
Peak Hour Analysis From 12:45 PM to 01:30 PM - Peak 1 of 1																	
Peak Hour for Entire Intersection Begins at 12:45 PM																	
12:45 PM	13	35	8	56	18	295	27	340	40	26	1	67	20	239	30	289	752
01:00 PM	13	34	13	60	11	272	22	305	40	37	5	82	13	241	29	283	730
01:15 PM	12	39	9	60	7	274	14	295	32	33	2	67	27	238	16	281	703
01:30 PM	14	33	18	65	14	279	12	305	50	33	5	88	29	278	16	323	781
Total Volume	52	141	48	241	50	1120	75	1245	162	129	13	304	89	996	91	1176	2966
% App. Total	21.6	58.5	19.9		4	90	6		53.3	42.4	4.3		7.6	84.7	7.7		
PHF	.929	.904	.667	.927	.694	.949	.694	.915	.810	.872	.650	.864	.767	.896	.758	.910	.949

City of Riverside
 N/S: Sycamore Canyon Blvd/Meridian Pkwy
 E/W: Alessandro Boulevard
 Weather: Clear

File Name : 24_RIV_Syc_Ales Sat
 Site Code : 05122815
 Start Date : 9/17/2022
 Page No : 2

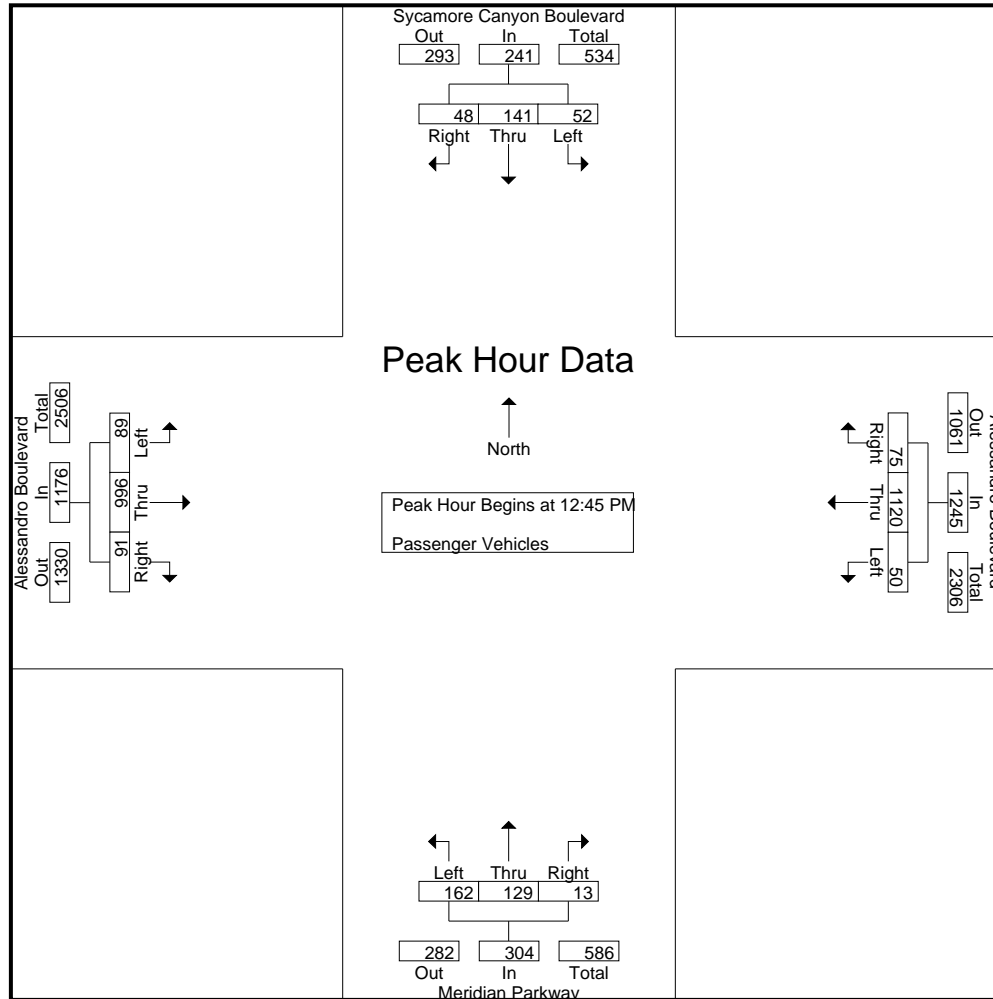

City of Riverside
 N/S: Sycamore Canyon Blvd/Meridian Pkwy
 E/W: Alessandro Boulevard
 Weather: Clear

File Name : 24_RIV_Syc_Ales Sat
 Site Code : 05122815
 Start Date : 9/17/2022
 Page No : 3

Start Time	Sycamore Canyon Boulevard Southbound				Alessandro Boulevard Westbound				Meridian Parkway Northbound				Alessandro Boulevard Eastbound				Int. Total
	Left	Thru	Right	App. Total	Left	Thru	Right	App. Total	Left	Thru	Right	App. Total	Left	Thru	Right	App. Total	
Peak Hour Analysis From 12:45 PM to 01:30 PM - Peak 1 of 1																	
Peak Hour for Each Approach Begins at:																	
	12:45 PM				12:45 PM				12:45 PM				12:45 PM				
+0 mins.	13	35	8	56	18	295	27	340	40	26	1	67	20	239	30	289	
+15 mins.	13	34	13	60	11	272	22	305	40	37	5	82	13	241	29	283	
+30 mins.	12	39	9	60	7	274	14	295	32	33	2	67	27	238	16	281	
+45 mins.	14	33	18	65	14	279	12	305	50	33	5	88	29	278	16	323	
Total Volume	52	141	48	241	50	1120	75	1245	162	129	13	304	89	996	91	1176	
% App. Total	21.6	58.5	19.9		4	90	6		53.3	42.4	4.3		7.6	84.7	7.7		
PHF	.929	.904	.667	.927	.694	.949	.694	.915	.810	.872	.650	.864	.767	.896	.758	.910	

City of Riverside
 N/S: Sycamore Canyon Blvd/Meridian Pkwy
 E/W: Alessandro Boulevard
 Weather: Clear

File Name : 24_RIV_Syc_Ales Sat
 Site Code : 05122815
 Start Date : 9/17/2022
 Page No : 1

Groups Printed- Large 2 Axle Vehicles

Start Time	Sycamore Canyon Boulevard Southbound					Alessandro Boulevard Westbound					Meridian Parkway Northbound					Alessandro Boulevard Eastbound					Exclu. Total	Inclu. Total	Int. Total
	Left	Thru	Right	RTOR	App. Total	Left	Thru	Right	RTOR	App. Total	Left	Thru	Right	RTOR	App. Total	Left	Thru	Right	RTOR	App. Total			
11:00 AM	0	0	0	0	0	0	1	1	0	2	0	0	0	1	0	0	2	0	0	2	1	4	5
11:15 AM	0	0	0	0	0	1	0	0	1	1	1	2	0	0	3	0	1	0	1	1	2	5	7
11:30 AM	1	0	0	0	1	0	1	0	0	1	0	0	0	0	0	0	0	0	0	0	0	2	2
11:45 AM	0	0	0	0	0	0	3	0	0	3	0	0	0	0	0	0	1	0	0	1	0	4	4
Total	1	0	0	0	1	1	5	1	1	7	1	2	0	1	3	0	4	0	1	4	3	15	18
12:00 PM	0	0	0	0	0	0	4	0	0	4	0	0	0	0	0	0	2	0	0	2	0	6	6
12:15 PM	0	1	0	0	1	0	1	1	0	2	2	0	0	1	2	2	0	0	0	2	1	7	8
12:30 PM	0	0	0	0	0	0	2	0	0	2	2	0	0	0	2	0	2	0	0	2	0	6	6
12:45 PM	0	0	0	0	0	0	2	1	0	3	1	0	0	0	1	1	3	0	0	4	0	8	8
Total	0	1	0	0	1	0	9	2	0	11	5	0	0	1	5	3	7	0	0	10	1	27	28
01:00 PM	1	0	0	1	1	0	3	1	0	4	0	0	0	0	0	1	0	0	0	1	1	6	7
01:15 PM	0	1	0	0	1	0	5	0	0	5	0	0	0	0	0	0	2	0	0	2	0	8	8
01:30 PM	0	3	0	0	3	0	4	0	0	4	1	0	0	0	1	1	2	0	0	3	0	11	11
01:45 PM	1	0	0	1	1	0	3	1	0	4	0	0	0	0	0	0	0	1	0	1	1	6	7
Total	2	4	0	2	6	0	15	2	0	17	1	0	0	0	1	2	4	1	0	7	2	31	33
Grand Total	3	5	0	2	8	1	29	5	1	35	7	2	0	2	9	5	15	1	1	21	6	73	79
Apprch %	37.5	62.5	0			2.9	82.9	14.3			77.8	22.2	0			23.8	71.4	4.8					
Total %	4.1	6.8	0		11	1.4	39.7	6.8		47.9	9.6	2.7	0		12.3	6.8	20.5	1.4		28.8	7.6	92.4	

Start Time	Sycamore Canyon Boulevard Southbound				Alessandro Boulevard Westbound				Meridian Parkway Northbound				Alessandro Boulevard Eastbound				Int. Total
	Left	Thru	Right	App. Total	Left	Thru	Right	App. Total	Left	Thru	Right	App. Total	Left	Thru	Right	App. Total	
Peak Hour Analysis From 12:45 PM to 01:30 PM - Peak 1 of 1																	
Peak Hour for Entire Intersection Begins at 12:45 PM																	
12:45 PM	0	0	0	0	0	2	1	3	1	0	0	1	1	3	0	4	8
01:00 PM	1	0	0	1	0	3	1	4	0	0	0	0	1	0	0	1	6
01:15 PM	0	1	0	1	0	5	0	5	0	0	0	0	0	2	0	2	8
01:30 PM	0	3	0	3	0	4	0	4	1	0	0	1	1	2	0	3	11
Total Volume	1	4	0	5	0	14	2	16	2	0	0	2	3	7	0	10	33
% App. Total	20	80	0		0	87.5	12.5		100	0	0		30	70	0		
PHF	.250	.333	.000	.417	.000	.700	.500	.800	.500	.000	.000	.500	.750	.583	.000	.625	.750

City of Riverside
 N/S: Sycamore Canyon Blvd/Meridian Pkwy
 E/W: Alessandro Boulevard
 Weather: Clear

File Name : 24_RIV_Syc_Ales Sat
 Site Code : 05122815
 Start Date : 9/17/2022
 Page No : 2

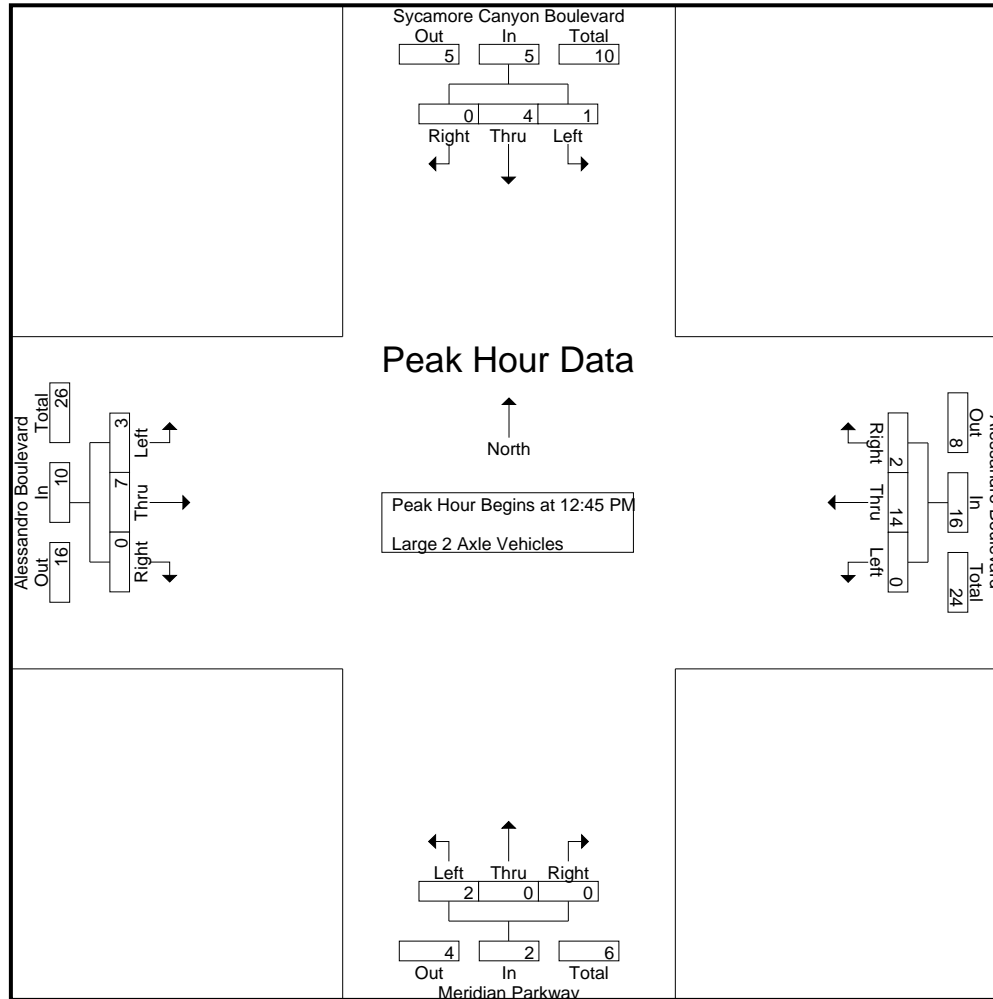

City of Riverside
 N/S: Sycamore Canyon Blvd/Meridian Pkwy
 E/W: Alessandro Boulevard
 Weather: Clear

File Name : 24_RIV_Syc_Ales Sat
 Site Code : 05122815
 Start Date : 9/17/2022
 Page No : 3

Start Time	Sycamore Canyon Boulevard Southbound				Alessandro Boulevard Westbound				Meridian Parkway Northbound				Alessandro Boulevard Eastbound				Int. Total
	Left	Thru	Right	App. Total	Left	Thru	Right	App. Total	Left	Thru	Right	App. Total	Left	Thru	Right	App. Total	
Peak Hour Analysis From 12:45 PM to 01:30 PM - Peak 1 of 1																	
Peak Hour for Each Approach Begins at:																	
	12:45 PM				12:45 PM				12:45 PM				12:45 PM				
+0 mins.	0	0	0	0	0	2	1	3	1	0	0	1	1	3	0	4	
+15 mins.	1	0	0	1	0	3	1	4	0	0	0	0	1	0	0	1	
+30 mins.	0	1	0	1	0	5	0	5	0	0	0	0	0	2	0	2	
+45 mins.	0	3	0	3	0	4	0	4	1	0	0	1	1	2	0	3	
Total Volume	1	4	0	5	0	14	2	16	2	0	0	2	3	7	0	10	
% App. Total	20	80	0		0	87.5	12.5		100	0	0		30	70	0		
PHF	.250	.333	.000	.417	.000	.700	.500	.800	.500	.000	.000	.500	.750	.583	.000	.625	

City of Riverside
 N/S: Sycamore Canyon Blvd/Meridian Pkwy
 E/W: Alessandro Boulevard
 Weather: Clear

File Name : 24_RIV_Syc_Ales Sat
 Site Code : 05122815
 Start Date : 9/17/2022
 Page No : 1

Groups Printed- 3 Axle Vehicles

Start Time	Sycamore Canyon Boulevard Southbound					Alessandro Boulevard Westbound					Meridian Parkway Northbound					Alessandro Boulevard Eastbound					Exclu. Total	Inclu. Total	Int. Total				
	Left	Thru	Right	RTOR	App. Total	Left	Thru	Right	RTOR	App. Total	Left	Thru	Right	RTOR	App. Total	Left	Thru	Right	RTOR	App. Total							
11:00 AM	0	0	0	0	0	0	0	0	0	0	0	0	0	0	0	0	0	0	0	0	0	0	0	0	0	0	0
11:15 AM	0	0	0	0	0	0	0	0	0	0	0	0	0	0	0	0	0	0	0	0	0	0	0	0	0	0	0
11:30 AM	2	0	0	0	2	0	0	0	1	0	0	0	0	0	0	2	0	0	0	2	1	4	5				
11:45 AM	0	0	0	0	0	0	0	0	0	0	0	0	0	0	0	0	0	0	0	0	0	0	0	0	0	0	
Total	2	0	0	0	2	0	0	0	1	0	0	0	0	0	0	2	0	0	0	2	1	4	5				
12:00 PM	0	0	0	0	0	0	0	0	0	0	0	2	0	0	2	0	0	0	0	0	0	2	2				
12:15 PM	1	0	0	0	1	0	0	0	0	0	0	0	0	0	0	0	0	0	0	0	0	1	1				
12:30 PM	1	1	0	0	2	0	0	1	0	1	0	0	0	0	0	0	0	0	0	0	0	3	3				
12:45 PM	0	0	0	0	0	0	0	0	0	0	0	0	0	0	0	0	0	0	0	0	0	0	0				
Total	2	1	0	0	3	0	0	1	0	1	0	2	0	0	2	0	0	0	0	0	0	6	6				
01:00 PM	0	0	1	0	1	0	1	1	0	2	0	0	0	0	0	0	0	0	0	0	0	3	3				
01:15 PM	0	1	0	0	1	0	0	0	1	0	0	0	1	0	1	0	0	0	0	0	1	2	3				
01:30 PM	1	0	0	0	1	0	0	1	1	1	0	1	0	0	1	0	1	0	0	1	1	4	5				
01:45 PM	0	0	0	0	0	0	0	0	0	0	0	0	1	0	1	0	0	0	0	0	0	1	1				
Total	1	1	1	0	3	0	1	2	2	3	0	1	2	0	3	0	1	0	0	1	2	10	12				
Grand Total	5	2	1	0	8	0	1	3	3	4	0	3	2	0	5	2	1	0	0	3	3	20	23				
Apprch %	62.5	25	12.5			0	25	75			0	60	40			66.7	33.3	0									
Total %	25	10	5		40	0	5	15		20	0	15	10		25	10	5	0		15	13	87					

Start Time	Sycamore Canyon Boulevard Southbound				Alessandro Boulevard Westbound				Meridian Parkway Northbound				Alessandro Boulevard Eastbound				Int. Total
	Left	Thru	Right	App. Total	Left	Thru	Right	App. Total	Left	Thru	Right	App. Total	Left	Thru	Right	App. Total	
Peak Hour Analysis From 12:45 PM to 01:30 PM - Peak 1 of 1																	
Peak Hour for Entire Intersection Begins at 12:45 PM																	
12:45 PM	0	0	0	0	0	0	0	0	0	0	0	0	0	0	0	0	0
01:00 PM	0	0	1	1	0	1	1	2	0	0	0	0	0	0	0	0	0
01:15 PM	0	1	0	1	0	0	0	0	0	0	1	1	0	0	0	0	0
01:30 PM	1	0	0	1	0	0	1	1	0	1	0	1	0	1	0	1	4
Total Volume	1	1	1	3	0	1	2	3	0	1	1	2	0	1	0	1	9
% App. Total	33.3	33.3	33.3		0	33.3	66.7		0	50	50		0	100	0		
PHF	.250	.250	.250	.750	.000	.250	.500	.375	.000	.250	.250	.500	.000	.250	.000	.250	.563

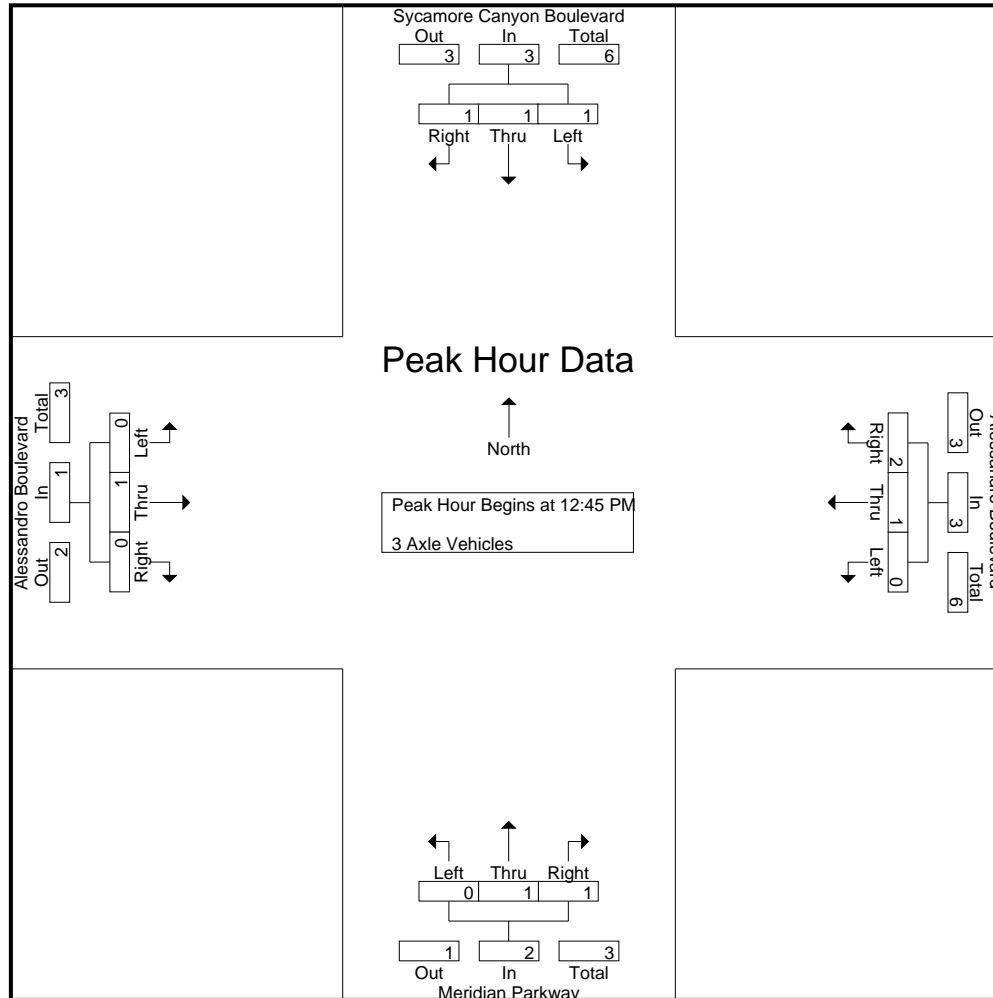

City of Riverside
 N/S: Sycamore Canyon Blvd/Meridian Pkwy
 E/W: Alessandro Boulevard
 Weather: Clear

File Name : 24_RIV_Syc_Ales Sat
 Site Code : 05122815
 Start Date : 9/17/2022
 Page No : 3

Start Time	Sycamore Canyon Boulevard Southbound				Alessandro Boulevard Westbound				Meridian Parkway Northbound				Alessandro Boulevard Eastbound				Int. Total
	Left	Thru	Right	App. Total	Left	Thru	Right	App. Total	Left	Thru	Right	App. Total	Left	Thru	Right	App. Total	
Peak Hour Analysis From 12:45 PM to 01:30 PM - Peak 1 of 1																	
Peak Hour for Each Approach Begins at:																	
	12:45 PM				12:45 PM				12:45 PM				12:45 PM				
+0 mins.	0	0	0	0	0	0	0	0	0	0	0	0	0	0	0	0	
+15 mins.	0	0	1	1	0	1	1	2	0	0	0	0	0	0	0	0	
+30 mins.	0	1	0	1	0	0	0	0	0	0	1	1	0	0	0	0	
+45 mins.	1	0	0	1	0	0	1	1	0	1	0	1	0	1	0	1	
Total Volume	1	1	1	3	0	1	2	3	0	1	1	2	0	1	0	1	
% App. Total	33.3	33.3	33.3		0	33.3	66.7		0	50	50		0	100	0		
PHF	.250	.250	.250	.750	.000	.250	.500	.375	.000	.250	.250	.500	.000	.250	.000	.250	

City of Riverside
 N/S: Sycamore Canyon Blvd/Meridian Pkwy
 E/W: Alessandro Boulevard
 Weather: Clear

File Name : 24_RIV_Syc_Ales Sat
 Site Code : 05122815
 Start Date : 9/17/2022
 Page No : 1

Groups Printed- 4+ Axle Trucks

Start Time	Sycamore Canyon Boulevard Southbound					Alessandro Boulevard Westbound					Meridian Parkway Northbound					Alessandro Boulevard Eastbound					Exclu. Total	Inclu. Total	Int. Total	
	Left	Thru	Right	RTOR	App. Total	Left	Thru	Right	RTOR	App. Total	Left	Thru	Right	RTOR	App. Total	Left	Thru	Right	RTOR	App. Total				
11:00 AM	1	0	0	0	1	0	0	0	0	0	0	0	0	0	0	0	1	0	0	1	0	0	2	2
11:15 AM	0	0	0	1	0	1	0	1	0	2	0	1	0	0	1	0	0	0	0	0	1	3	4	4
11:30 AM	0	2	0	0	2	0	0	1	0	1	0	1	0	0	1	0	0	0	0	0	0	4	4	4
11:45 AM	1	1	0	0	2	0	0	2	2	2	0	1	0	0	1	0	0	0	0	0	2	5	7	7
Total	2	3	0	1	5	1	0	4	2	5	0	3	0	0	3	0	1	0	0	1	3	14	17	17
12:00 PM	0	0	0	0	0	1	1	1	0	3	1	0	0	0	1	1	0	0	0	1	0	5	5	5
12:15 PM	2	2	0	0	4	0	1	0	0	1	0	0	0	0	0	0	0	0	0	0	0	5	5	5
12:30 PM	1	0	0	0	1	0	0	0	0	0	0	0	0	0	0	1	0	0	0	1	0	2	2	2
12:45 PM	0	1	0	0	1	0	0	1	0	1	0	3	1	0	4	0	0	0	0	0	0	6	6	6
Total	3	3	0	0	6	1	2	2	0	5	1	3	1	0	5	2	0	0	0	2	0	18	18	18
01:00 PM	0	1	0	0	1	1	0	2	0	3	0	0	0	0	0	0	1	0	0	1	0	5	5	5
01:15 PM	0	2	0	0	2	0	0	1	0	1	0	0	0	0	0	0	0	0	0	0	0	3	3	3
01:30 PM	0	0	0	0	0	0	0	0	0	0	0	0	0	0	0	0	0	0	0	0	0	0	0	0
01:45 PM	1	0	0	0	1	0	1	1	0	2	0	1	0	0	1	0	0	0	0	0	0	4	4	4
Total	1	3	0	0	4	1	1	4	0	6	0	1	0	0	1	0	1	0	0	1	0	12	12	12
Grand Total	6	9	0	1	15	3	3	10	2	16	1	7	1	0	9	2	2	0	0	4	3	44	47	47
Apprch %	40	60	0			18.8	18.8	62.5			11.1	77.8	11.1			50	50	0						
Total %	13.6	20.5	0		34.1	6.8	6.8	22.7		36.4	2.3	15.9	2.3		20.5	4.5	4.5	0		9.1	6.4	93.6		

Start Time	Sycamore Canyon Boulevard Southbound				Alessandro Boulevard Westbound				Meridian Parkway Northbound				Alessandro Boulevard Eastbound				Int. Total				
	Left	Thru	Right	App. Total	Left	Thru	Right	App. Total	Left	Thru	Right	App. Total	Left	Thru	Right	App. Total					
Peak Hour Analysis From 12:45 PM to 01:30 PM - Peak 1 of 1																					
Peak Hour for Entire Intersection Begins at 12:45 PM																					
12:45 PM	0	1	0	1	0	0	1	1	0	3	1	4	0	0	0	0	0	0	0	0	6
01:00 PM	0	1	0	1	1	0	2	3	0	0	0	0	0	1	0	1	0	0	0	0	5
01:15 PM	0	2	0	2	0	0	1	1	0	0	0	0	0	0	0	0	0	0	0	0	3
01:30 PM	0	0	0	0	0	0	0	0	0	0	0	0	0	0	0	0	0	0	0	0	0
Total Volume	0	4	0	4	1	0	4	5	0	3	1	4	0	1	0	1	0	0	0	0	14
% App. Total	0	100	0		20	0	80		0	75	25		0	100	0						
PHF	.000	.500	.000	.500	.250	.000	.500	.417	.000	.250	.250	.250	.000	.250	.000	.250					.583

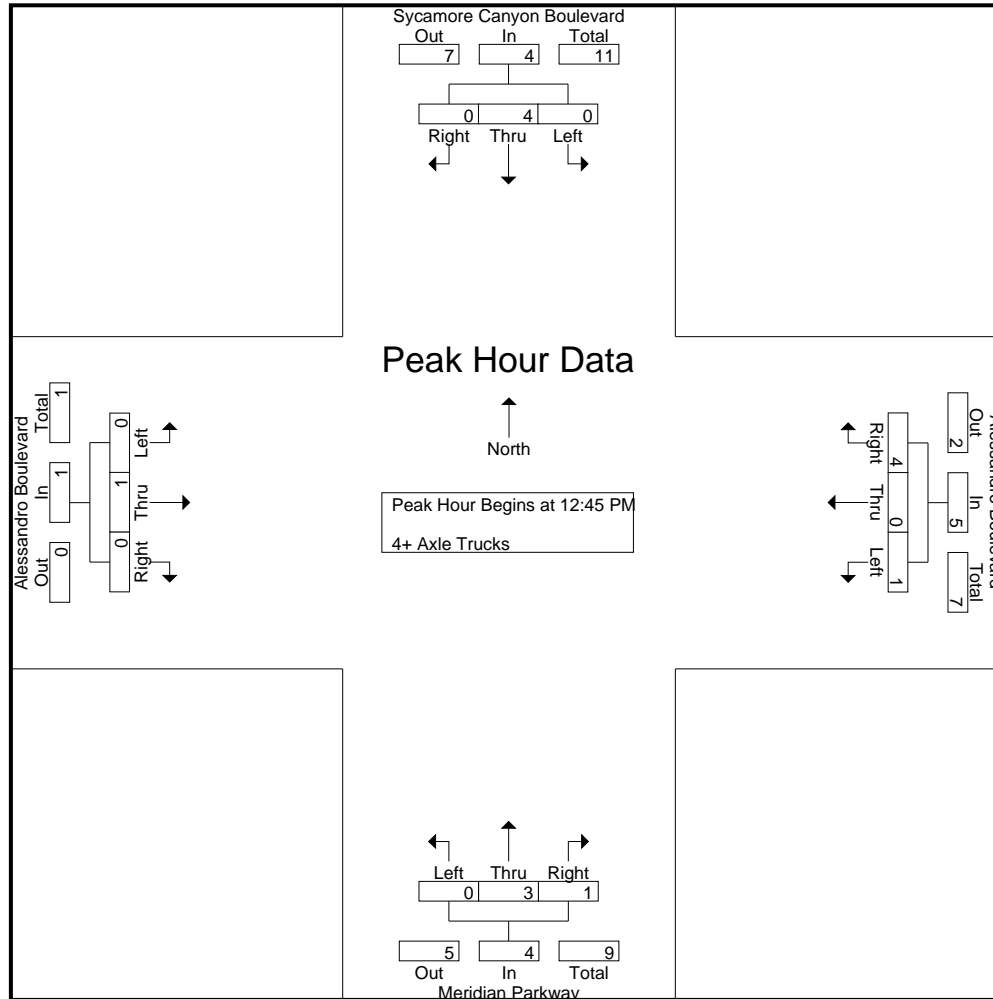

City of Riverside
 N/S: Sycamore Canyon Blvd/Meridian Pkwy
 E/W: Alessandro Boulevard
 Weather: Clear

File Name : 24_RIV_Syc_Ales Sat
 Site Code : 05122815
 Start Date : 9/17/2022
 Page No : 3

Start Time	Sycamore Canyon Boulevard Southbound				Alessandro Boulevard Westbound				Meridian Parkway Northbound				Alessandro Boulevard Eastbound				Int. Total
	Left	Thru	Right	App. Total	Left	Thru	Right	App. Total	Left	Thru	Right	App. Total	Left	Thru	Right	App. Total	
Peak Hour Analysis From 12:45 PM to 01:30 PM - Peak 1 of 1																	
Peak Hour for Each Approach Begins at:																	
	12:45 PM				12:45 PM				12:45 PM				12:45 PM				
+0 mins.	0	1	0	1	0	0	1	1	0	3	1	4	0	0	0	0	
+15 mins.	0	1	0	1	1	0	2	3	0	0	0	0	0	1	0	1	
+30 mins.	0	2	0	2	0	0	1	1	0	0	0	0	0	0	0	0	
+45 mins.	0	0	0	0	0	0	0	0	0	0	0	0	0	0	0	0	
Total Volume	0	4	0	4	1	0	4	5	0	3	1	4	0	1	0	1	
% App. Total	0	100	0		20	0	80		0	75	25		0	100	0		
PHF	.000	.500	.000	.500	.250	.000	.500	.417	.000	.250	.250	.250	.000	.250	.000	.250	

Location: Riverside
 N/S: Sycamore Canyon Blvd/Meridian Pkwy
 E/W: Alessandro Boulevard



Date: 9/17/2022
 Day Saturday

PEDESTRIANS

Time	North Leg Sycamore Canyon Blvd	East Leg Alessandro Boulevard	South Leg Meridian Parkway	West Leg Alessandro Boulevard	TOTAL
11:00 AM	0	0	0	0	0
11:15 AM	0	0	0	0	0
11:30 AM	0	0	0	0	0
11:45 AM	1	0	0	0	1
12:00 PM	0	0	0	0	0
12:15 PM	0	0	0	0	0
12:30 PM	0	0	0	0	0
12:45 PM	1	0	0	0	1
1:00 PM	0	0	0	0	0
1:15 PM	0	0	0	0	0
1:30 PM	0	0	0	0	0
1:45 PM	0	0	0	0	0
TOTAL VOLUMES:	2	0	0	0	2

Location: Riverside
 N/S: Sycamore Canyon Blvd/Meridian Pkwy
 E/W: Alessandro Boulevard

Date: 9/17/2022
 Day: Saturday



BICYCLES

	Southbound Sycamore Canyon Blvd			Westbound Alessandro Boulevard			Northbound Meridian Parkway			Eastbound Alessandro Boulevard			
	Left	Thru	Right	Left	Thru	Right	Left	Thru	Right	Left	Thru	Right	
11:00 AM	0	0	0	0	0	0	0	0	0	0	0	0	0
11:15 AM	0	0	0	0	0	0	0	6	0	0	0	1	7
11:30 AM	0	3	0	0	0	0	1	0	0	0	0	0	4
11:45 AM	0	1	0	0	0	0	0	0	0	0	0	0	1
12:00 PM	0	0	0	0	0	0	0	0	0	0	1	0	1
12:15 PM	0	0	0	0	1	0	0	0	0	0	0	0	1
12:30 PM	0	0	0	0	0	0	0	0	0	0	0	0	0
12:45 PM	0	0	0	0	1	0	0	0	0	0	0	0	1
1:00 PM	0	0	0	0	0	0	0	0	0	0	0	2	2
1:15 PM	0	0	0	0	0	0	0	0	0	0	0	0	0
1:30 PM	0	0	0	0	0	0	0	0	0	0	0	0	0
1:45 PM	0	0	0	0	0	0	0	0	0	0	0	0	0
TOTAL VOLUMES:	0	4	0	0	2	0	1	6	0	0	1	3	17

County of Riverside
 N/S: Meridian Parkway
 E/W: Cactus Avenue
 Weather: Clear

File Name : 25_CRV_Mer_Cac Sat
 Site Code : 05122815
 Start Date : 9/17/2022
 Page No : 1

Groups Printed- Passenger Vehicles - Large 2 Axle Vehicles - 3 Axle Vehicles - 4+ Axle Trucks

Start Time	Meridian Parkway Southbound					Cactus Avenue Westbound					Meridian Parkway Northbound					Cactus Avenue Eastbound					Exclu. Total	Inclu. Total	Int. Total
	Left	Thru	Right	RTOR	App. Total	Left	Thru	Right	RTOR	App. Total	Left	Thru	Right	RTOR	App. Total	Left	Thru	Right	RTOR	App. Total			
11:00 AM	16	24	0	0	40	24	2	23	17	49	0	40	21	5	61	0	2	0	0	2	22	152	174
11:15 AM	17	19	0	0	36	35	3	41	19	79	0	46	26	3	72	0	2	0	0	2	22	189	211
11:30 AM	21	23	1	0	45	36	2	55	31	93	0	32	20	8	52	0	0	1	0	1	39	191	230
11:45 AM	25	22	0	0	47	35	0	53	32	88	0	29	26	18	55	0	0	0	0	0	50	190	240
Total	79	88	1	0	168	130	7	172	99	309	0	147	93	34	240	0	4	1	0	5	133	722	855
12:00 PM	21	44	1	1	66	33	1	44	26	78	0	31	26	9	57	0	1	0	0	1	36	202	238
12:15 PM	26	67	0	0	93	46	1	54	17	101	0	27	22	19	49	0	1	0	0	1	36	244	280
12:30 PM	19	54	0	0	73	36	3	37	21	76	0	33	26	14	59	1	1	0	0	2	35	210	245
12:45 PM	29	63	1	0	93	32	0	39	28	71	0	34	27	12	61	1	1	2	1	4	41	229	270
Total	95	228	2	1	325	147	5	174	92	326	0	125	101	54	226	2	4	2	1	8	148	885	1033
01:00 PM	30	66	2	1	98	35	1	55	30	91	0	26	20	9	46	2	0	0	0	2	40	237	277
01:15 PM	29	58	1	1	88	37	3	50	18	90	1	45	29	13	75	1	2	1	1	4	33	257	290
01:30 PM	33	44	1	1	78	44	3	44	25	91	0	47	42	16	89	1	1	0	0	2	42	260	302
01:45 PM	23	26	1	0	50	45	2	47	22	94	0	31	31	20	62	11	25	3	2	39	44	245	289
Total	115	194	5	3	314	161	9	196	95	366	1	149	122	58	272	15	28	4	3	47	159	999	1158
Grand Total	289	510	8	4	807	438	21	542	286	1001	1	421	316	146	738	17	36	7	4	60	440	2606	3046
Apprch %	35.8	63.2	1			43.8	2.1	54.1			0.1	57	42.8			28.3	60	11.7					
Total %	11.1	19.6	0.3		31	16.8	0.8	20.8		38.4	0	16.2	12.1		28.3	0.7	1.4	0.3		2.3	14.4	85.6	
Passenger Vehicles	281	497	5		786	406	17	530		1234	1	410	307		859	14	35	7		60	0	0	2939
% Passenger Vehicles	97.2	97.5	62.5	75	96.9	92.7	81	97.8	98.3	95.9	100	97.4	97.2	96.6	97.2	82.4	97.2	100	100	93.8	0	0	96.5
Large 2 Axle Vehicles	4	6	0		10	6	0	5		13	0	6	5		15	0	0	0		0	0	0	38
% Large 2 Axle Vehicles	1.4	1.2	0	0	1.2	1.4	0	0.9	0.7	1	0	1.4	1.6	2.7	1.7	0	0	0	0	0	0	0	1.2
3 Axle Vehicles	0	2	0		2	2	0	3		6	0	0	0		0	2	0	0		2	0	0	10
% 3 Axle Vehicles	0	0.4	0	0	0.2	0.5	0	0.6	0.3	0.5	0	0	0	0	0	11.8	0	0	0	3.1	0	0	0.3
4+ Axle Trucks	4	5	3		13	24	4	4		34	0	5	4		10	1	1	0		2	0	0	59
% 4+ Axle Trucks	1.4	1	37.5	25	1.6	5.5	19	0.7	0.7	2.6	0	1.2	1.3	0.7	1.1	5.9	2.8	0	0	3.1	0	0	1.9

County of Riverside
 N/S: Meridian Parkway
 E/W: Cactus Avenue
 Weather: Clear

File Name : 25_CRV_Mer_Cac Sat
 Site Code : 05122815
 Start Date : 9/17/2022
 Page No : 2

Start Time	Meridian Parkway Southbound				Cactus Avenue Westbound				Meridian Parkway Northbound				Cactus Avenue Eastbound				Int. Total
	Left	Thru	Right	App. Total	Left	Thru	Right	App. Total	Left	Thru	Right	App. Total	Left	Thru	Right	App. Total	
Peak Hour Analysis From 11:00 AM to 01:45 PM - Peak 1 of 1																	
Peak Hour for Entire Intersection Begins at 01:00 PM																	
01:00 PM	30	66	2	98	35	1	55	91	0	26	20	46	2	0	0	2	237
01:15 PM	29	58	1	88	37	3	50	90	1	45	29	75	1	2	1	4	257
01:30 PM	33	44	1	78	44	3	44	91	0	47	42	89	1	1	0	2	260
01:45 PM	23	26	1	50	45	2	47	94	0	31	31	62	11	25	3	39	245
Total Volume	115	194	5	314	161	9	196	366	1	149	122	272	15	28	4	47	999
% App. Total	36.6	61.8	1.6		44	2.5	53.6		0.4	54.8	44.9		31.9	59.6	8.5		
PHF	.871	.735	.625	.801	.894	.750	.891	.973	.250	.793	.726	.764	.341	.280	.333	.301	.961

County of Riverside
 N/S: Meridian Parkway
 E/W: Cactus Avenue
 Weather: Clear

File Name : 25_CRV_Mer_Cac Sat
 Site Code : 05122815
 Start Date : 9/17/2022
 Page No : 3

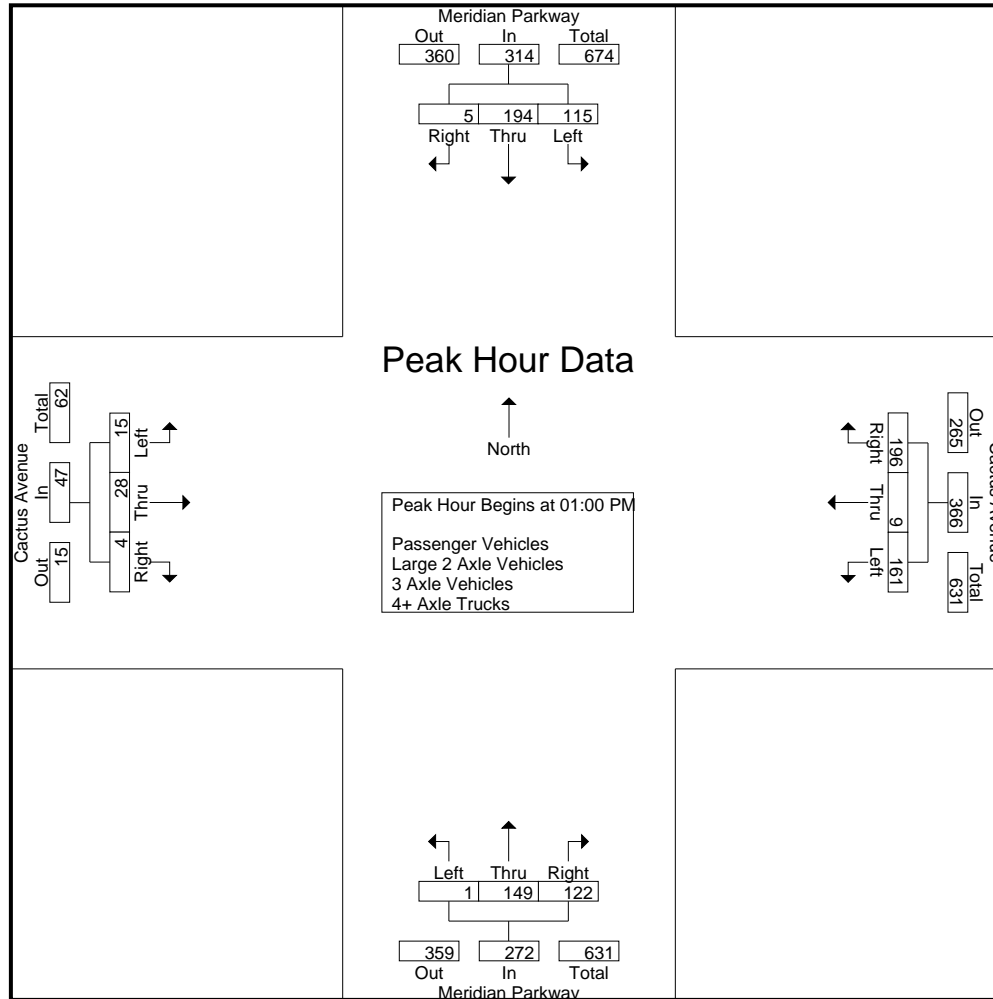

County of Riverside
 N/S: Meridian Parkway
 E/W: Cactus Avenue
 Weather: Clear

File Name : 25_CRV_Mer_Cac Sat
 Site Code : 05122815
 Start Date : 9/17/2022
 Page No : 4

Start Time	Meridian Parkway Southbound				Cactus Avenue Westbound				Meridian Parkway Northbound				Cactus Avenue Eastbound				Int. Total
	Left	Thru	Right	App. Total	Left	Thru	Right	App. Total	Left	Thru	Right	App. Total	Left	Thru	Right	App. Total	
Peak Hour Analysis From 11:00 AM to 01:45 PM - Peak 1 of 1																	
Peak Hour for Each Approach Begins at:																	
	12:15 PM				01:00 PM				01:00 PM				01:00 PM				
+0 mins.	26	67	0	93	35	1	55	91	0	26	20	46	2	0	0	2	
+15 mins.	19	54	0	73	37	3	50	90	1	45	29	75	1	2	1	4	
+30 mins.	29	63	1	93	44	3	44	91	0	47	42	89	1	1	0	2	
+45 mins.	30	66	2	98	45	2	47	94	0	31	31	62	11	25	3	39	
Total Volume	104	250	3	357	161	9	196	366	1	149	122	272	15	28	4	47	
% App. Total	29.1	70	0.8		44	2.5	53.6		0.4	54.8	44.9		31.9	59.6	8.5		
PHF	.867	.933	.375	.911	.894	.750	.891	.973	.250	.793	.726	.764	.341	.280	.333	.301	

County of Riverside
 N/S: Meridian Parkway
 E/W: Cactus Avenue
 Weather: Clear

File Name : 25_CRV_Mer_Cac Sat
 Site Code : 05122815
 Start Date : 9/17/2022
 Page No : 1

Groups Printed- Passenger Vehicles

Start Time	Meridian Parkway Southbound					Cactus Avenue Westbound					Meridian Parkway Northbound					Cactus Avenue Eastbound					Exclu. Total	Inclu. Total	Int. Total
	Left	Thru	Right	RTOR	App. Total	Left	Thru	Right	RTOR	App. Total	Left	Thru	Right	RTOR	App. Total	Left	Thru	Right	RTOR	App. Total			
11:00 AM	14	24	0	0	38	22	2	23	17	47	0	39	20	5	59	0	2	0	0	2	22	146	168
11:15 AM	17	17	0	0	34	33	3	41	19	77	0	43	24	3	67	0	2	0	0	2	22	180	202
11:30 AM	19	23	0	0	42	35	2	54	30	91	0	32	19	8	51	0	0	1	0	1	38	185	223
11:45 AM	25	22	0	0	47	33	0	52	31	85	0	29	26	18	55	0	0	0	0	0	49	187	236
Total	75	86	0	0	161	123	7	170	97	300	0	143	89	34	232	0	4	1	0	5	131	698	829
12:00 PM	21	43	0	0	64	28	1	41	25	70	0	31	25	8	56	0	0	0	0	0	33	190	223
12:15 PM	24	66	0	0	90	39	0	52	17	91	0	26	22	19	48	0	1	0	0	1	36	230	266
12:30 PM	19	53	0	0	72	32	2	36	21	70	0	32	25	13	57	1	1	0	0	2	34	201	235
12:45 PM	28	63	1	0	92	30	0	38	27	68	0	32	25	10	57	0	1	2	1	3	38	220	258
Total	92	225	1	0	318	129	3	167	90	299	0	121	97	50	218	1	3	2	1	6	141	841	982
01:00 PM	30	66	1	1	97	34	0	54	29	88	0	25	20	9	45	1	0	0	0	1	39	231	270
01:15 PM	28	54	1	1	83	36	3	50	18	89	1	45	29	13	75	1	2	1	1	4	33	251	284
01:30 PM	33	41	1	1	75	41	2	43	25	86	0	46	41	15	87	0	1	0	0	1	41	249	290
01:45 PM	23	25	1	0	49	43	2	46	22	91	0	30	31	20	61	11	25	3	2	39	44	240	284
Total	114	186	4	3	304	154	7	193	94	354	1	146	121	57	268	13	28	4	3	45	157	971	1128
Grand Total	281	497	5	3	783	406	17	530	281	953	1	410	307	141	718	14	35	7	4	56	429	2510	2939
Apprch %	35.9	63.5	0.6			42.6	1.8	55.6			0.1	57.1	42.8			25	62.5	12.5					
Total %	11.2	19.8	0.2		31.2	16.2	0.7	21.1		38	0	16.3	12.2		28.6	0.6	1.4	0.3		2.2	14.6	85.4	

Start Time	Meridian Parkway Southbound				Cactus Avenue Westbound				Meridian Parkway Northbound				Cactus Avenue Eastbound				Int. Total
	Left	Thru	Right	App. Total	Left	Thru	Right	App. Total	Left	Thru	Right	App. Total	Left	Thru	Right	App. Total	
Peak Hour Analysis From 01:00 PM to 01:45 PM - Peak 1 of 1																	
Peak Hour for Entire Intersection Begins at 01:00 PM																	
01:00 PM	30	66	1	97	34	0	54	88	0	25	20	45	1	0	0	1	231
01:15 PM	28	54	1	83	36	3	50	89	1	45	29	75	1	2	1	4	251
01:30 PM	33	41	1	75	41	2	43	86	0	46	41	87	0	1	0	1	249
01:45 PM	23	25	1	49	43	2	46	91	0	30	31	61	11	25	3	39	240
Total Volume	114	186	4	304	154	7	193	354	1	146	121	268	13	28	4	45	971
% App. Total	37.5	61.2	1.3		43.5	2	54.5		0.4	54.5	45.1		28.9	62.2	8.9		
PHF	.864	.705	1.00	.784	.895	.583	.894	.973	.250	.793	.738	.770	.295	.280	.333	.288	.967

County of Riverside
 N/S: Meridian Parkway
 E/W: Cactus Avenue
 Weather: Clear

File Name : 25_CRV_Mer_Cac Sat
 Site Code : 05122815
 Start Date : 9/17/2022
 Page No : 2

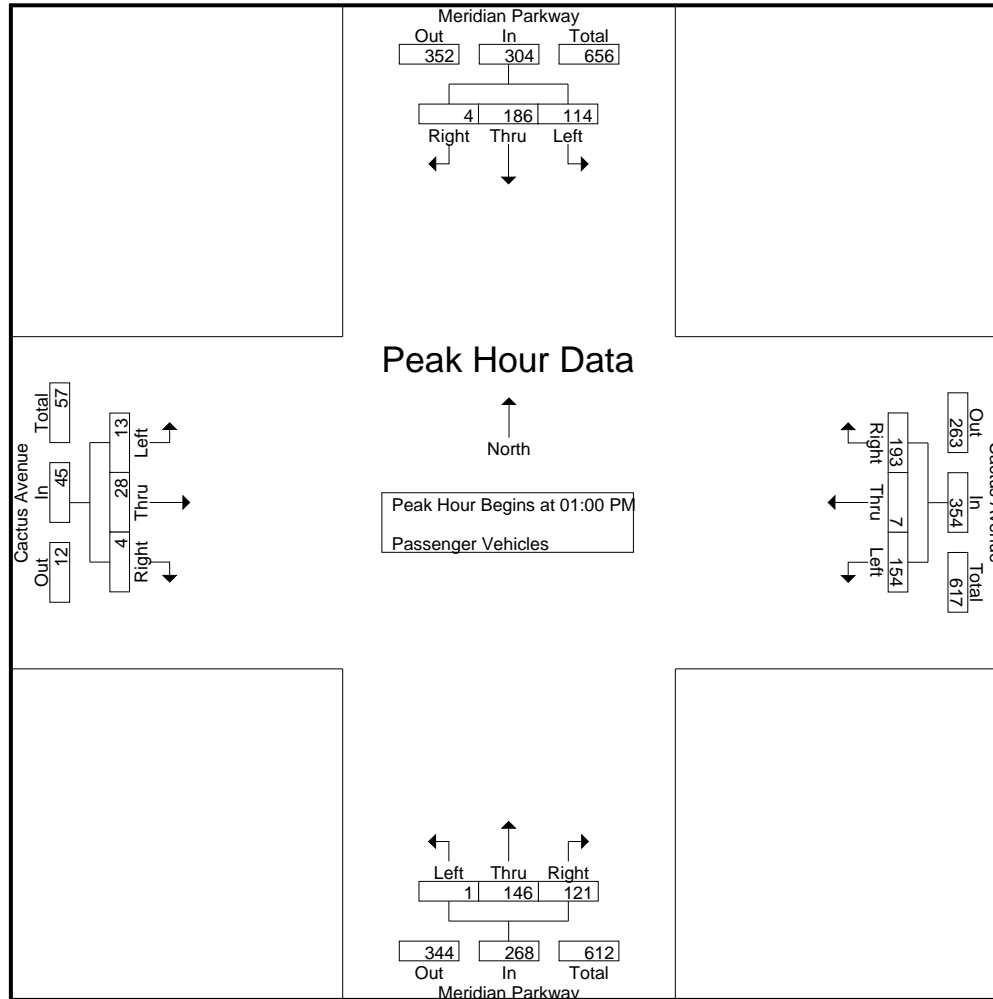

County of Riverside
 N/S: Meridian Parkway
 E/W: Cactus Avenue
 Weather: Clear

File Name : 25_CRV_Mer_Cac Sat
 Site Code : 05122815
 Start Date : 9/17/2022
 Page No : 3

Start Time	Meridian Parkway Southbound				Cactus Avenue Westbound				Meridian Parkway Northbound				Cactus Avenue Eastbound				Int. Total
	Left	Thru	Right	App. Total	Left	Thru	Right	App. Total	Left	Thru	Right	App. Total	Left	Thru	Right	App. Total	
Peak Hour Analysis From 01:00 PM to 01:45 PM - Peak 1 of 1																	
Peak Hour for Each Approach Begins at:																	
	01:00 PM				01:00 PM				01:00 PM				01:00 PM				
+0 mins.	30	66	1	97	34	0	54	88	0	25	20	45	1	0	0	1	
+15 mins.	28	54	1	83	36	3	50	89	1	45	29	75	1	2	1	4	
+30 mins.	33	41	1	75	41	2	43	86	0	46	41	87	0	1	0	1	
+45 mins.	23	25	1	49	43	2	46	91	0	30	31	61	11	25	3	39	
Total Volume	114	186	4	304	154	7	193	354	1	146	121	268	13	28	4	45	
% App. Total	37.5	61.2	1.3		43.5	2	54.5		0.4	54.5	45.1		28.9	62.2	8.9		
PHF	.864	.705	1.000	.784	.895	.583	.894	.973	.250	.793	.738	.770	.295	.280	.333	.288	

County of Riverside
 N/S: Meridian Parkway
 E/W: Cactus Avenue
 Weather: Clear

File Name : 25_CRV_Mer_Cac Sat
 Site Code : 05122815
 Start Date : 9/17/2022
 Page No : 1

Groups Printed- Large 2 Axle Vehicles

Start Time	Meridian Parkway Southbound					Cactus Avenue Westbound					Meridian Parkway Northbound					Cactus Avenue Eastbound					Exclu. Total	Inclu. Total	Int. Total					
	Left	Thru	Right	RTOR	App. Total	Left	Thru	Right	RTOR	App. Total	Left	Thru	Right	RTOR	App. Total	Left	Thru	Right	RTOR	App. Total								
11:00 AM	2	0	0	0	2	0	0	0	0	0	0	1	0	0	1	0	0	0	0	0	0	0	0	0	0	0	3	3
11:15 AM	0	1	0	0	1	1	0	0	0	1	0	1	1	0	2	0	0	0	0	0	0	0	0	0	0	0	4	4
11:30 AM	1	0	0	0	1	1	0	1	1	2	0	0	0	0	0	0	0	0	0	0	0	0	0	0	0	1	3	4
11:45 AM	0	0	0	0	0	0	0	0	0	0	0	0	0	0	0	0	0	0	0	0	0	0	0	0	0	0	0	0
Total	3	1	0	0	4	2	0	1	1	3	0	2	1	0	3	0	0	0	0	0	0	0	0	0	0	1	10	11
12:00 PM	0	0	0	0	0	0	0	0	0	0	0	0	1	1	1	0	0	0	0	0	0	0	0	0	0	1	1	2
12:15 PM	1	0	0	0	1	1	0	2	0	3	0	1	0	0	1	0	0	0	0	0	0	0	0	0	0	0	5	5
12:30 PM	0	0	0	0	0	1	0	1	0	2	0	0	0	0	0	0	0	0	0	0	0	0	0	0	0	0	2	2
12:45 PM	0	0	0	0	0	0	0	0	0	0	0	1	2	2	3	0	0	0	0	0	0	0	0	0	0	2	3	5
Total	1	0	0	0	1	2	0	3	0	5	0	2	3	3	5	0	0	0	0	0	0	0	0	0	0	3	11	14
01:00 PM	0	0	0	0	0	0	0	1	1	1	0	1	0	0	1	0	0	0	0	0	0	0	0	0	0	1	2	3
01:15 PM	0	1	0	0	1	0	0	0	0	0	0	0	0	0	0	0	0	0	0	0	0	0	0	0	0	0	1	1
01:30 PM	0	3	0	0	3	1	0	0	0	1	0	1	1	1	2	0	0	0	0	0	0	0	0	0	0	1	6	7
01:45 PM	0	1	0	0	1	1	0	0	0	1	0	0	0	0	0	0	0	0	0	0	0	0	0	0	0	0	2	2
Total	0	5	0	0	5	2	0	1	1	3	0	2	1	1	3	0	0	0	0	0	0	0	0	0	0	2	11	13
Grand Total	4	6	0	0	10	6	0	5	2	11	0	6	5	4	11	0	0	0	0	0	0	0	0	0	0	6	32	38
Apprch %	40	60	0			54.5	0	45.5			0	54.5	45.5			0	0	0										
Total %	12.5	18.8	0		31.2	18.8	0	15.6		34.4	0	18.8	15.6		34.4	0	0	0		0						15.8	84.2	

Start Time	Meridian Parkway Southbound				Cactus Avenue Westbound				Meridian Parkway Northbound				Cactus Avenue Eastbound				Int. Total
	Left	Thru	Right	App. Total	Left	Thru	Right	App. Total	Left	Thru	Right	App. Total	Left	Thru	Right	App. Total	
Peak Hour Analysis From 01:00 PM to 01:45 PM - Peak 1 of 1																	
Peak Hour for Entire Intersection Begins at 01:00 PM																	
01:00 PM	0	0	0	0	0	0	1	1	0	1	0	1	0	0	0	0	2
01:15 PM	0	1	0	1	0	0	0	0	0	0	0	0	0	0	0	0	1
01:30 PM	0	3	0	3	1	0	0	1	0	1	1	2	0	0	0	0	6
01:45 PM	0	1	0	1	1	0	0	1	0	0	0	0	0	0	0	0	2
Total Volume	0	5	0	5	2	0	1	3	0	2	1	3	0	0	0	0	11
% App. Total	0	100	0		66.7	0	33.3		0	66.7	33.3		0	0	0		
PHF	.000	.417	.000	.417	.500	.000	.250	.750	.000	.500	.250	.375	.000	.000	.000	.000	.458

County of Riverside
 N/S: Meridian Parkway
 E/W: Cactus Avenue
 Weather: Clear

File Name : 25_CRV_Mer_Cac Sat
 Site Code : 05122815
 Start Date : 9/17/2022
 Page No : 2

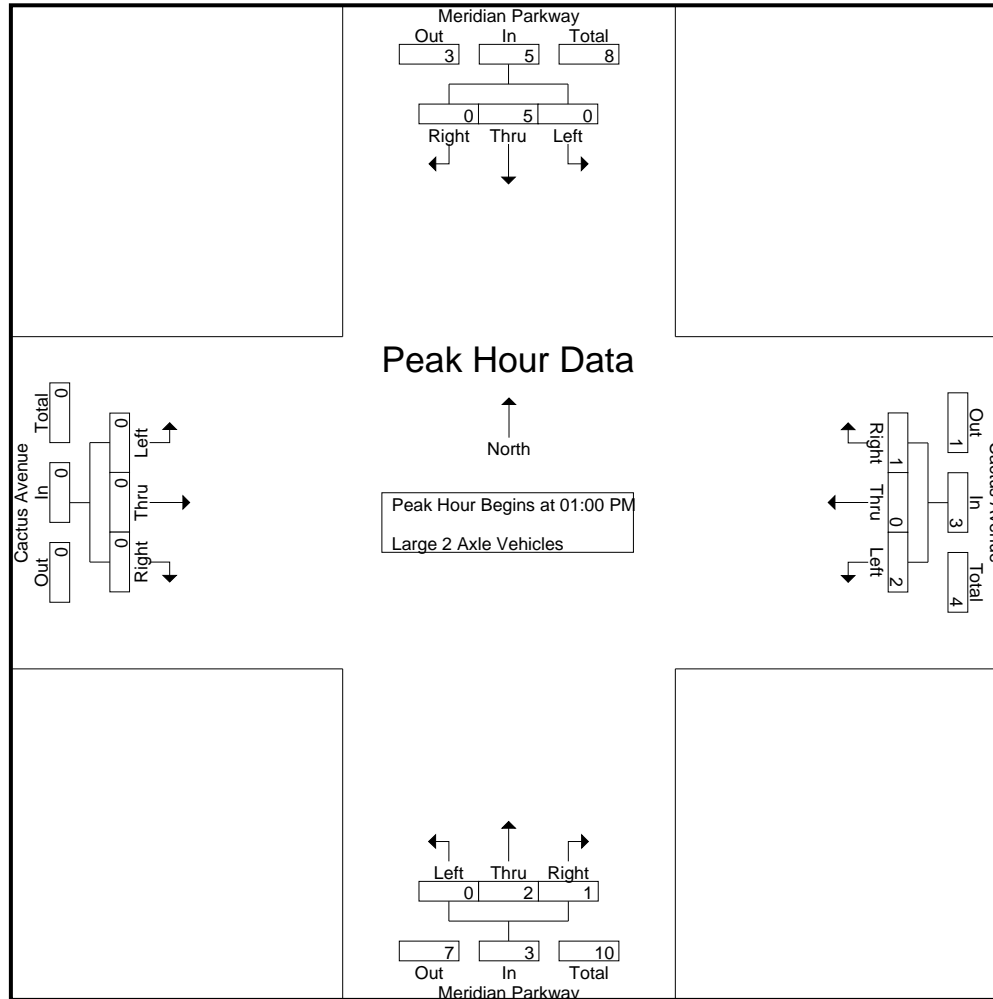

County of Riverside
 N/S: Meridian Parkway
 E/W: Cactus Avenue
 Weather: Clear

File Name : 25_CRV_Mer_Cac Sat
 Site Code : 05122815
 Start Date : 9/17/2022
 Page No : 3

Start Time	Meridian Parkway Southbound				Cactus Avenue Westbound				Meridian Parkway Northbound				Cactus Avenue Eastbound				Int. Total
	Left	Thru	Right	App. Total	Left	Thru	Right	App. Total	Left	Thru	Right	App. Total	Left	Thru	Right	App. Total	
Peak Hour Analysis From 01:00 PM to 01:45 PM - Peak 1 of 1																	
Peak Hour for Each Approach Begins at:																	
	01:00 PM				01:00 PM				01:00 PM				01:00 PM				
+0 mins.	0	0	0	0	0	0	1	1	0	1	0	1	0	0	0	0	
+15 mins.	0	1	0	1	0	0	0	0	0	0	0	0	0	0	0	0	
+30 mins.	0	3	0	3	1	0	0	1	0	1	1	2	0	0	0	0	
+45 mins.	0	1	0	1	1	0	0	1	0	0	0	0	0	0	0	0	
Total Volume	0	5	0	5	2	0	1	3	0	2	1	3	0	0	0	0	
% App. Total	0	100	0		66.7	0	33.3		0	66.7	33.3		0	0	0		
PHF	.000	.417	.000	.417	.500	.000	.250	.750	.000	.500	.250	.375	.000	.000	.000	.000	

County of Riverside
 N/S: Meridian Parkway
 E/W: Cactus Avenue
 Weather: Clear

File Name : 25_CRV_Mer_Cac Sat
 Site Code : 05122815
 Start Date : 9/17/2022
 Page No : 1

Groups Printed- 3 Axle Vehicles

Start Time	Meridian Parkway Southbound					Cactus Avenue Westbound					Meridian Parkway Northbound					Cactus Avenue Eastbound					Exclu. Total	Inclu. Total	Int. Total				
	Left	Thru	Right	RTOR	App. Total	Left	Thru	Right	RTOR	App. Total	Left	Thru	Right	RTOR	App. Total	Left	Thru	Right	RTOR	App. Total							
11:00 AM	0	0	0	0	0	0	0	0	0	0	0	0	0	0	0	0	0	0	0	0	0	0	0	0	0	0	0
11:15 AM	0	0	0	0	0	0	0	0	0	0	0	0	0	0	0	0	0	0	0	0	0	0	0	0	0	0	0
11:30 AM	0	0	0	0	0	0	0	0	0	0	0	0	0	0	0	0	0	0	0	0	0	0	0	0	0	0	0
11:45 AM	0	0	0	0	0	0	0	0	0	0	0	0	0	0	0	0	0	0	0	0	0	0	0	0	0	0	0
Total	0	0	0	0	0	0	0	0	0	0	0	0	0	0	0	0	0	0	0	0	0	0	0	0	0	0	0
12:00 PM	0	0	0	0	0	0	0	2	1	2	0	0	0	0	0	0	0	0	0	0	0	0	0	0	1	2	3
12:15 PM	0	0	0	0	0	0	0	0	0	0	0	0	0	0	0	0	0	0	0	0	0	0	0	0	0	0	0
12:30 PM	0	1	0	0	1	0	0	0	0	0	0	0	0	0	0	0	0	0	0	0	0	0	0	0	0	1	1
12:45 PM	0	0	0	0	0	0	0	0	0	0	0	0	0	0	0	0	0	0	0	0	0	0	0	0	0	0	0
Total	0	1	0	0	1	0	0	2	1	2	0	0	0	0	0	0	0	0	0	0	0	0	0	0	1	3	4
01:00 PM	0	0	0	0	0	0	0	0	0	0	0	0	0	0	0	1	0	0	0	1	0	0	0	0	0	1	1
01:15 PM	0	1	0	0	1	1	0	0	0	1	0	0	0	0	0	0	0	0	0	0	0	0	0	0	0	2	2
01:30 PM	0	0	0	0	0	1	0	1	0	2	0	0	0	0	0	1	0	0	0	1	0	0	0	0	0	3	3
01:45 PM	0	0	0	0	0	0	0	0	0	0	0	0	0	0	0	0	0	0	0	0	0	0	0	0	0	0	0
Total	0	1	0	0	1	2	0	1	0	3	0	0	0	0	0	2	0	0	0	2	0	0	0	0	0	6	6
Grand Total	0	2	0	0	2	2	0	3	1	5	0	0	0	0	0	2	0	0	0	2	1	0	0	0	1	9	10
Apprch %	0	100	0			40	0	60			0	0	0			100	0	0									
Total %	0	22.2	0		22.2	22.2	0	33.3		55.6	0	0	0		0	22.2	0	0		22.2	10	0	0		10	90	

Start Time	Meridian Parkway Southbound				Cactus Avenue Westbound				Meridian Parkway Northbound				Cactus Avenue Eastbound				Int. Total
	Left	Thru	Right	App. Total	Left	Thru	Right	App. Total	Left	Thru	Right	App. Total	Left	Thru	Right	App. Total	
Peak Hour Analysis From 01:00 PM to 01:45 PM - Peak 1 of 1																	
Peak Hour for Entire Intersection Begins at 01:00 PM																	
01:00 PM	0	0	0	0	0	0	0	0	0	0	0	0	1	0	0	1	1
01:15 PM	0	1	0	1	1	0	0	1	0	0	0	0	0	0	0	0	2
01:30 PM	0	0	0	0	1	0	1	2	0	0	0	0	1	0	0	1	3
01:45 PM	0	0	0	0	0	0	0	0	0	0	0	0	0	0	0	0	0
Total Volume	0	1	0	1	2	0	1	3	0	0	0	0	2	0	0	2	6
% App. Total	0	100	0		66.7	0	33.3		0	0	0		100	0	0		
PHF	.000	.250	.000	.250	.500	.000	.250	.375	.000	.000	.000	.000	.500	.000	.000	.500	.500

County of Riverside
 N/S: Meridian Parkway
 E/W: Cactus Avenue
 Weather: Clear

File Name : 25_CRV_Mer_Cac Sat
 Site Code : 05122815
 Start Date : 9/17/2022
 Page No : 2

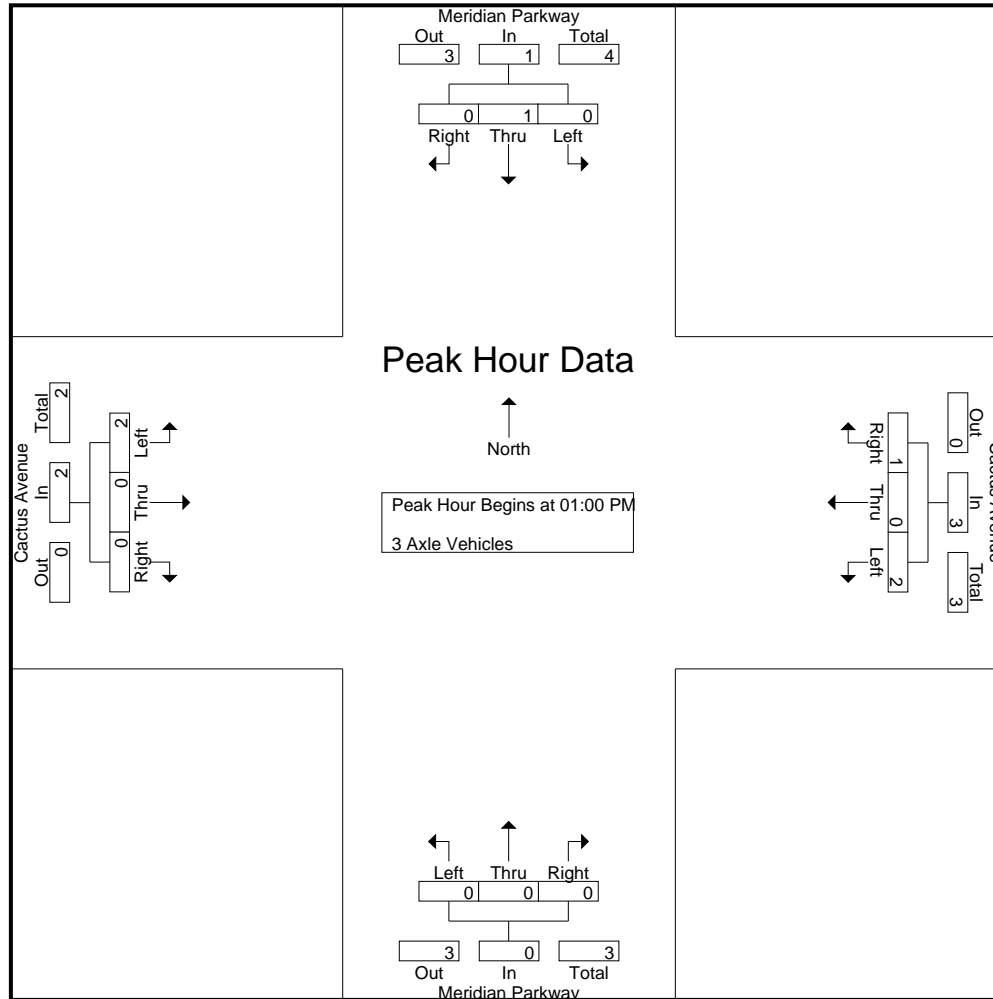

County of Riverside
 N/S: Meridian Parkway
 E/W: Cactus Avenue
 Weather: Clear

File Name : 25_CRV_Mer_Cac Sat
 Site Code : 05122815
 Start Date : 9/17/2022
 Page No : 3

Start Time	Meridian Parkway Southbound				Cactus Avenue Westbound				Meridian Parkway Northbound				Cactus Avenue Eastbound				Int. Total
	Left	Thru	Right	App. Total	Left	Thru	Right	App. Total	Left	Thru	Right	App. Total	Left	Thru	Right	App. Total	
Peak Hour Analysis From 01:00 PM to 01:45 PM - Peak 1 of 1																	
Peak Hour for Each Approach Begins at:																	
	01:00 PM				01:00 PM				01:00 PM				01:00 PM				
+0 mins.	0	0	0	0	0	0	0	0	0	0	0	0	1	0	0	1	
+15 mins.	0	1	0	1	1	0	0	1	0	0	0	0	0	0	0	0	
+30 mins.	0	0	0	0	1	0	1	2	0	0	0	0	1	0	0	1	
+45 mins.	0	0	0	0	0	0	0	0	0	0	0	0	0	0	0	0	
Total Volume	0	1	0	1	2	0	1	3	0	0	0	0	2	0	0	2	
% App. Total	0	100	0		66.7	0	33.3		0	0	0		100	0	0		
PHF	.000	.250	.000	.250	.500	.000	.250	.375	.000	.000	.000	.000	.500	.000	.000	.500	

County of Riverside
 N/S: Meridian Parkway
 E/W: Cactus Avenue
 Weather: Clear

File Name : 25_CRV_Mer_Cac Sat
 Site Code : 05122815
 Start Date : 9/17/2022
 Page No : 1

Groups Printed- 4+ Axle Trucks

Start Time	Meridian Parkway Southbound					Cactus Avenue Westbound					Meridian Parkway Northbound					Cactus Avenue Eastbound					Exclu. Total	Inclu. Total	Int. Total	
	Left	Thru	Right	RTOR	App. Total	Left	Thru	Right	RTOR	App. Total	Left	Thru	Right	RTOR	App. Total	Left	Thru	Right	RTOR	App. Total				
11:00 AM	0	0	0	0	0	2	0	0	0	2	0	0	1	0	1	0	0	0	0	0	0	0	3	3
11:15 AM	0	1	0	0	1	1	0	0	0	1	0	2	1	0	3	0	0	0	0	0	0	5	5	5
11:30 AM	1	0	1	0	2	0	0	0	0	0	0	0	1	0	1	0	0	0	0	0	0	3	3	3
11:45 AM	0	0	0	0	0	2	0	1	1	3	0	0	0	0	0	0	0	0	0	0	1	3	4	4
Total	1	1	1	0	3	5	0	1	1	6	0	2	3	0	5	0	0	0	0	0	1	14	15	15
12:00 PM	0	1	1	1	2	5	0	1	0	6	0	0	0	0	0	0	1	0	0	1	1	9	10	10
12:15 PM	1	1	0	0	2	6	1	0	0	7	0	0	0	0	0	0	0	0	0	0	0	9	9	9
12:30 PM	0	0	0	0	0	3	1	0	0	4	0	1	1	1	2	0	0	0	0	0	1	6	7	7
12:45 PM	1	0	0	0	1	2	0	1	1	3	0	1	0	0	1	1	0	0	0	1	1	6	7	7
Total	2	2	1	1	5	16	2	2	1	20	0	2	1	1	3	1	1	0	0	2	3	30	33	33
01:00 PM	0	0	1	0	1	1	1	0	0	2	0	0	0	0	0	0	0	0	0	0	0	3	3	3
01:15 PM	1	2	0	0	3	0	0	0	0	0	0	0	0	0	0	0	0	0	0	0	0	3	3	3
01:30 PM	0	0	0	0	0	1	1	0	0	2	0	0	0	0	0	0	0	0	0	0	0	2	2	2
01:45 PM	0	0	0	0	0	1	0	1	0	2	0	1	0	0	1	0	0	0	0	0	0	3	3	3
Total	1	2	1	0	4	3	2	1	0	6	0	1	0	0	1	0	0	0	0	0	0	11	11	11
Grand Total	4	5	3	1	12	24	4	4	2	32	0	5	4	1	9	1	1	0	0	2	4	55	59	59
Apprch %	33.3	41.7	25			75	12.5	12.5			0	55.6	44.4			50	50	0						
Total %	7.3	9.1	5.5		21.8	43.6	7.3	7.3		58.2	0	9.1	7.3		16.4	1.8	1.8	0		3.6	6.8	93.2		

Start Time	Meridian Parkway Southbound				Cactus Avenue Westbound				Meridian Parkway Northbound				Cactus Avenue Eastbound				Int. Total
	Left	Thru	Right	App. Total	Left	Thru	Right	App. Total	Left	Thru	Right	App. Total	Left	Thru	Right	App. Total	
Peak Hour Analysis From 01:00 PM to 01:45 PM - Peak 1 of 1																	
Peak Hour for Entire Intersection Begins at 01:00 PM																	
01:00 PM	0	0	1	1	1	1	0	2	0	0	0	0	0	0	0	0	3
01:15 PM	1	2	0	3	0	0	0	0	0	0	0	0	0	0	0	0	3
01:30 PM	0	0	0	0	1	1	0	2	0	0	0	0	0	0	0	0	2
01:45 PM	0	0	0	0	1	0	1	2	0	1	0	1	0	0	0	0	3
Total Volume	1	2	1	4	3	2	1	6	0	1	0	1	0	0	0	0	11
% App. Total	25	50	25		50	33.3	16.7		0	100	0		0	0	0		
PHF	.250	.250	.250	.333	.750	.500	.250	.750	.000	.250	.000	.250	.000	.000	.000	.000	.917

County of Riverside
 N/S: Meridian Parkway
 E/W: Cactus Avenue
 Weather: Clear

File Name : 25_CRV_Mer_Cac Sat
 Site Code : 05122815
 Start Date : 9/17/2022
 Page No : 2

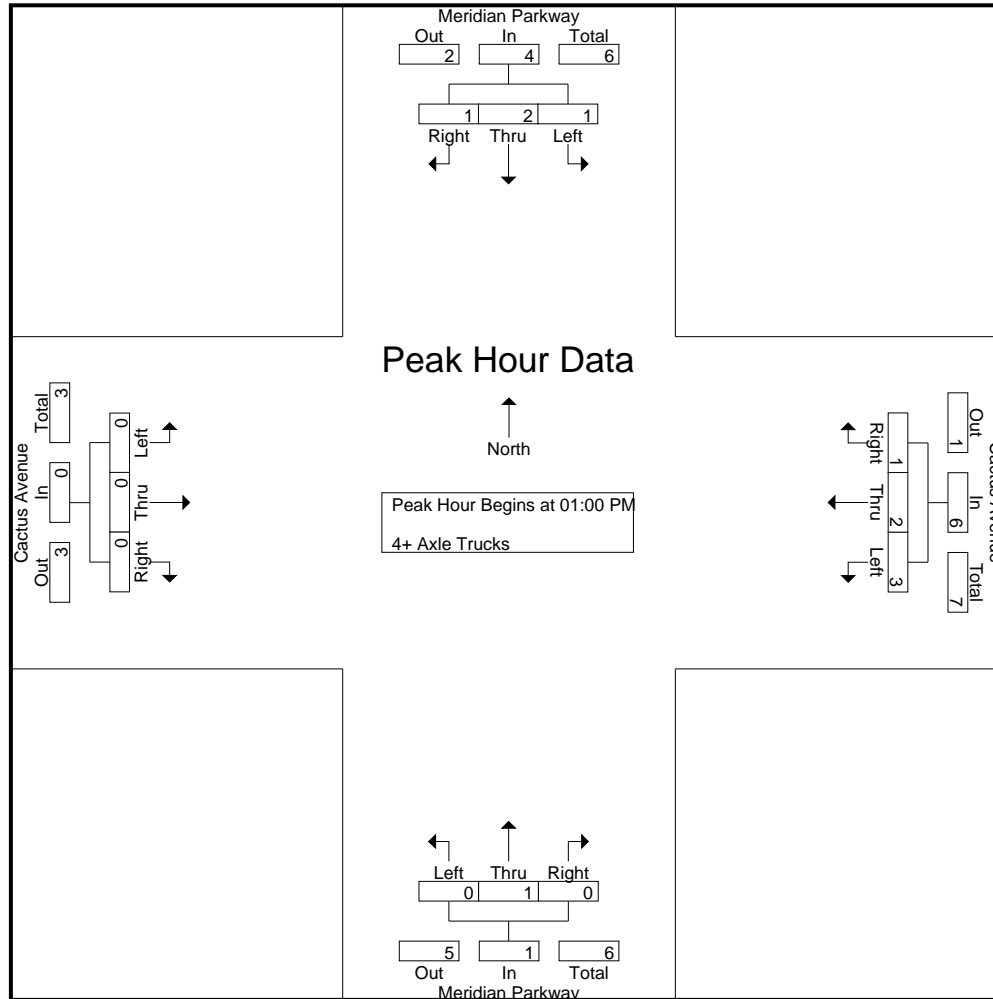

County of Riverside
 N/S: Meridian Parkway
 E/W: Cactus Avenue
 Weather: Clear

File Name : 25_CRV_Mer_Cac Sat
 Site Code : 05122815
 Start Date : 9/17/2022
 Page No : 3

Start Time	Meridian Parkway Southbound				Cactus Avenue Westbound				Meridian Parkway Northbound				Cactus Avenue Eastbound				Int. Total
	Left	Thru	Right	App. Total	Left	Thru	Right	App. Total	Left	Thru	Right	App. Total	Left	Thru	Right	App. Total	
Peak Hour Analysis From 01:00 PM to 01:45 PM - Peak 1 of 1																	
Peak Hour for Each Approach Begins at:																	
	01:00 PM				01:00 PM				01:00 PM				01:00 PM				
+0 mins.	0	0	1	1	1	1	0	2	0	0	0	0	0	0	0	0	
+15 mins.	1	2	0	3	0	0	0	0	0	0	0	0	0	0	0	0	
+30 mins.	0	0	0	0	1	1	0	2	0	0	0	0	0	0	0	0	
+45 mins.	0	0	0	0	1	0	1	2	0	1	0	1	0	0	0	0	
Total Volume	1	2	1	4	3	2	1	6	0	1	0	1	0	0	0	0	
% App. Total	25	50	25		50	33.3	16.7		0	100	0		0	0	0		
PHF	.250	.250	.250	.333	.750	.500	.250	.750	.000	.250	.000	.250	.000	.000	.000	.000	

Location: County of Riverside
 N/S: Meridian Parkway
 E/W: Cactus Avenue



Date: 9/17/2022
 Day Saturday

PEDESTRIANS

Time	North Leg Meridian Parkway	East Leg Cactus Avenue	South Leg Meridian Parkway	West Leg Cactus Avenue	TOTAL
11:00 AM	0	0	0	0	0
11:15 AM	0	0	0	0	0
11:30 AM	0	0	0	0	0
11:45 AM	0	0	0	0	0
12:00 PM	0	0	0	0	0
12:15 PM	0	0	0	0	0
12:30 PM	0	0	0	0	0
12:45 PM	0	0	0	0	0
1:00 PM	0	0	0	0	0
1:15 PM	0	0	0	0	0
1:30 PM	0	0	0	0	0
1:45 PM	0	0	0	0	0
TOTAL VOLUMES:	0	0	0	0	0

Location: County of Riverside
 N/S: Meridian Parkway
 E/W: Cactus Avenue

Date: 9/17/2022
 Day: Saturday



BICYCLES

	Southbound Meridian Parkway			Westbound Cactus Avenue			Northbound Meridian Parkway			Eastbound Cactus Avenue			
	Left	Thru	Right	Left	Thru	Right	Left	Thru	Right	Left	Thru	Right	
11:00 AM	0	0	0	0	0	0	0	0	0	0	0	0	0
11:15 AM	0	1	0	0	0	0	0	0	0	0	0	0	1
11:30 AM	0	0	0	0	0	0	0	0	0	0	1	0	1
11:45 AM	0	0	0	0	0	0	0	0	0	0	0	0	0
12:00 PM	0	0	0	0	0	0	0	0	0	0	0	0	0
12:15 PM	0	0	0	0	0	0	0	0	0	0	0	0	0
12:30 PM	0	0	0	0	0	0	0	0	0	0	0	0	0
12:45 PM	0	0	0	0	0	0	0	0	0	0	0	0	0
1:00 PM	1	1	0	0	0	0	0	0	0	0	0	0	2
1:15 PM	0	0	0	0	0	0	0	0	0	0	0	0	0
1:30 PM	0	0	0	0	0	0	0	0	0	0	0	0	0
1:45 PM	0	0	0	0	0	0	0	0	0	0	0	0	0
TOTAL VOLUMES:	1	2	0	0	0	0	0	0	0	0	1	0	4

County of Riverside
 N/S: Meridian Pkwy/Harmon St
 E/W: Van Buren Boulevard
 Weather: Clear

File Name : 26_CRV_Mer_VB Sat
 Site Code : 05122815
 Start Date : 9/17/2022
 Page No : 1

Groups Printed- Passenger Vehicles - Large 2 Axle Vehicles - 3 Axle Vehicles - 4+ Axle Trucks

Start Time	Meridian Parkway Southbound					Van Buren Boulevard Westbound					Harmon Street Northbound					Van Buren Boulevard Eastbound					Exclu. Total	Inclu. Total	Int. Total
	Left	Thru	Right	RTOR	App. Total	Left	Thru	Right	RTOR	App. Total	Left	Thru	Right	RTOR	App. Total	Left	Thru	Right	RTOR	App. Total			
11:00 AM	13	2	42	29	57	8	185	7	4	200	2	2	4	1	8	32	223	4	0	259	34	524	558
11:15 AM	9	1	48	23	58	9	221	13	2	243	1	1	13	10	15	39	207	4	0	250	35	566	601
11:30 AM	11	2	42	31	55	12	171	3	1	186	4	0	15	9	19	30	188	5	0	223	41	483	524
11:45 AM	7	4	49	35	60	11	197	6	2	214	2	2	3	3	7	38	193	2	0	233	40	514	554
Total	40	9	181	118	230	40	774	29	9	843	9	5	35	23	49	139	811	15	0	965	150	2087	2237
12:00 PM	10	3	46	30	59	2	205	3	0	210	5	4	5	4	14	33	215	2	0	250	34	533	567
12:15 PM	10	2	93	69	105	10	233	7	1	250	4	1	7	5	12	39	226	1	0	266	75	633	708
12:30 PM	16	4	74	45	94	5	247	5	0	257	1	1	6	6	8	35	182	2	0	219	51	578	629
12:45 PM	14	1	69	43	84	8	224	5	0	237	0	1	2	1	3	36	197	2	0	235	44	559	603
Total	50	10	282	187	342	25	909	20	1	954	10	7	20	16	37	143	820	7	0	970	204	2303	2507
01:00 PM	11	2	91	62	104	10	219	8	2	237	2	3	3	1	8	34	244	1	1	279	66	628	694
01:15 PM	20	0	67	44	87	9	189	13	2	211	1	0	7	6	8	51	221	2	0	274	52	580	632
01:30 PM	22	2	58	34	82	7	186	9	2	202	3	3	6	5	12	57	197	2	0	256	41	552	593
01:45 PM	21	2	46	19	69	6	204	6	3	216	3	0	6	5	9	42	197	3	0	242	27	536	563
Total	74	6	262	159	342	32	798	36	9	866	9	6	22	17	37	184	859	8	1	1051	186	2296	2482
Grand Total	164	25	725	464	914	97	2481	85	19	2663	28	18	77	56	123	466	2490	30	1	2986	540	6686	7226
Apprch %	17.9	2.7	79.3			3.6	93.2	3.2			22.8	14.6	62.6			15.6	83.4	1					
Total %	2.5	0.4	10.8		13.7	1.5	37.1	1.3		39.8	0.4	0.3	1.2		1.8	7	37.2	0.4		44.7	7.5	92.5	
Passenger Vehicles	149	25	716		1347	96	2387	77		2578	28	18	77		179	459	2401	30		2891	0	0	6995
% Passenger Vehicles	90.9	100	98.8	98.5	97.8	99	96.2	90.6	94.7	96.1	100	100	100	100	100	98.5	96.4	100	100	96.8	0	0	96.8
Large 2 Axle Vehicles	5	0	7		19	1	39	1		41	0	0	0		0	5	49	0		54	0	0	114
% Large 2 Axle Vehicles	3	0	1	1.5	1.4	1	1.6	1.2	0	1.5	0	0	0	0	0	1.1	2	0	0	1.8	0	0	1.6
3 Axle Vehicles	2	0	1		3	0	14	0		14	0	0	0		0	0	15	0		15	0	0	32
% 3 Axle Vehicles	1.2	0	0.1	0	0.2	0	0.6	0	0	0.5	0	0	0	0	0	0	0.6	0	0	0.5	0	0	0.4
4+ Axle Trucks	8	0	1		9	0	41	7		49	0	0	0		0	2	25	0		27	0	0	85
% 4+ Axle Trucks	4.9	0	0.1	0	0.7	0	1.7	8.2	5.3	1.8	0	0	0	0	0	0.4	1	0	0	0.9	0	0	1.2

County of Riverside
 N/S: Meridian Pkwy/Harmon St
 E/W: Van Buren Boulevard
 Weather: Clear

File Name : 26_CRV_Mer_VB Sat
 Site Code : 05122815
 Start Date : 9/17/2022
 Page No : 2

Start Time	Meridian Parkway Southbound				Van Buren Boulevard Westbound				Harmon Street Northbound				Van Buren Boulevard Eastbound				Int. Total
	Left	Thru	Right	App. Total	Left	Thru	Right	App. Total	Left	Thru	Right	App. Total	Left	Thru	Right	App. Total	
Peak Hour Analysis From 11:00 AM to 01:45 PM - Peak 1 of 1																	
Peak Hour for Entire Intersection Begins at 12:15 PM																	
12:15 PM	10	2	93	105	10	233	7	250	4	1	7	12	39	226	1	266	633
12:30 PM	16	4	74	94	5	247	5	257	1	1	6	8	35	182	2	219	578
12:45 PM	14	1	69	84	8	224	5	237	0	1	2	3	36	197	2	235	559
01:00 PM	11	2	91	104	10	219	8	237	2	3	3	8	34	244	1	279	628
Total Volume	51	9	327	387	33	923	25	981	7	6	18	31	144	849	6	999	2398
% App. Total	13.2	2.3	84.5		3.4	94.1	2.5		22.6	19.4	58.1		14.4	85	0.6		
PHF	.797	.563	.879	.921	.825	.934	.781	.954	.438	.500	.643	.646	.923	.870	.750	.895	.947

County of Riverside
 N/S: Meridian Pkwy/Harmon St
 E/W: Van Buren Boulevard
 Weather: Clear

File Name : 26_CRV_Mer_VB Sat
 Site Code : 05122815
 Start Date : 9/17/2022
 Page No : 3

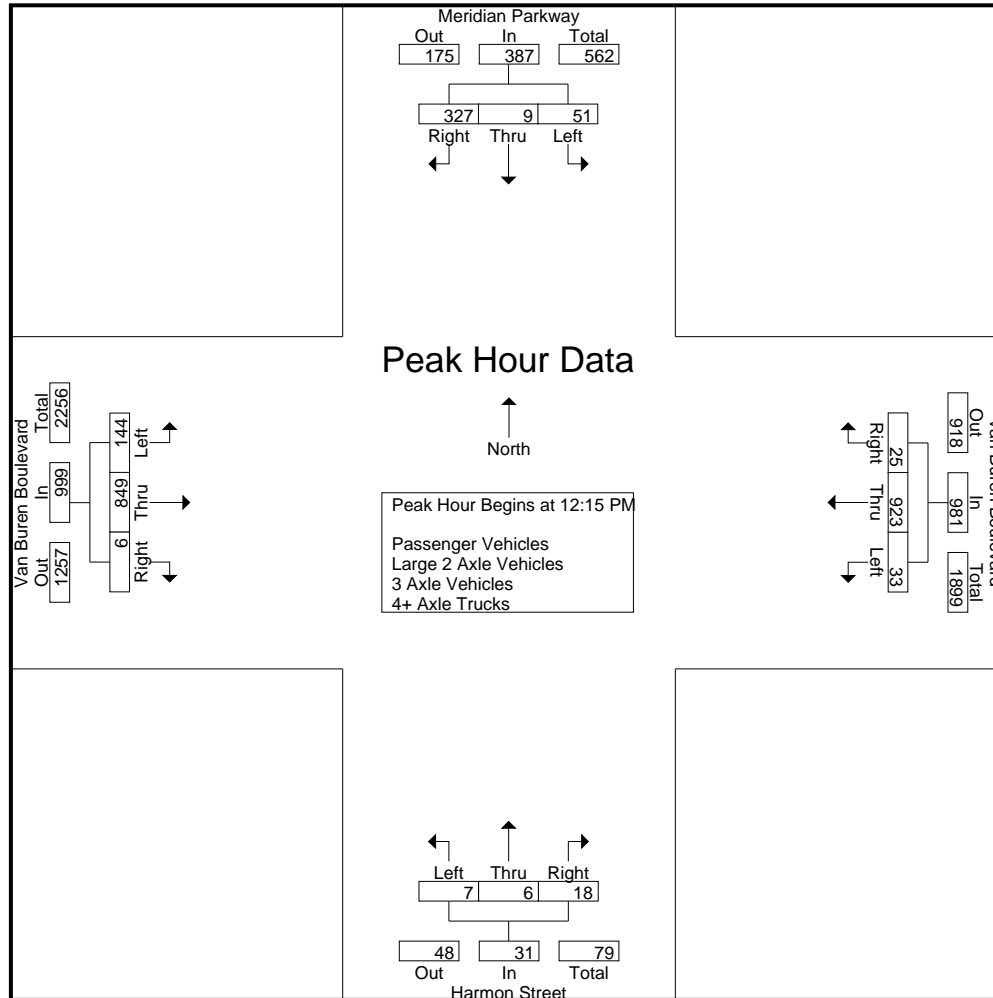

County of Riverside
 N/S: Meridian Pkwy/Harmon St
 E/W: Van Buren Boulevard
 Weather: Clear

File Name : 26_CRV_Mer_VB Sat
 Site Code : 05122815
 Start Date : 9/17/2022
 Page No : 4

Start Time	Meridian Parkway Southbound				Van Buren Boulevard Westbound				Harmon Street Northbound				Van Buren Boulevard Eastbound				Int. Total
	Left	Thru	Right	App. Total	Left	Thru	Right	App. Total	Left	Thru	Right	App. Total	Left	Thru	Right	App. Total	
Peak Hour Analysis From 11:00 AM to 01:45 PM - Peak 1 of 1																	
Peak Hour for Each Approach Begins at:																	
	12:15 PM				12:15 PM				11:15 AM				01:00 PM				
+0 mins.	10	2	93	105	10	233	7	250	1	1	13	15	34	244	1	279	
+15 mins.	16	4	74	94	5	247	5	257	4	0	15	19	51	221	2	274	
+30 mins.	14	1	69	84	8	224	5	237	2	2	3	7	57	197	2	256	
+45 mins.	11	2	91	104	10	219	8	237	5	4	5	14	42	197	3	242	
Total Volume	51	9	327	387	33	923	25	981	12	7	36	55	184	859	8	1051	
% App. Total	13.2	2.3	84.5		3.4	94.1	2.5		21.8	12.7	65.5		17.5	81.7	0.8		
PHF	.797	.563	.879	.921	.825	.934	.781	.954	.600	.438	.600	.724	.807	.880	.667	.942	

County of Riverside
 N/S: Meridian Pkwy/Harmon St
 E/W: Van Buren Boulevard
 Weather: Clear

File Name : 26_CRV_Mer_VB Sat
 Site Code : 05122815
 Start Date : 9/17/2022
 Page No : 1

Groups Printed- Passenger Vehicles

Start Time	Meridian Parkway Southbound					Van Buren Boulevard Westbound					Harmon Street Northbound					Van Buren Boulevard Eastbound					Exclu. Total	Inclu. Total	Int. Total
	Left	Thru	Right	RTOR	App. Total	Left	Thru	Right	RTOR	App. Total	Left	Thru	Right	RTOR	App. Total	Left	Thru	Right	RTOR	App. Total			
11:00 AM	12	2	41	28	55	8	179	6	4	193	2	2	4	1	8	30	212	4	0	246	33	502	535
11:15 AM	7	1	48	23	56	9	214	12	2	235	1	1	13	10	15	37	197	4	0	238	35	544	579
11:30 AM	11	2	41	31	54	11	164	3	1	178	4	0	15	9	19	30	184	5	0	219	41	470	511
11:45 AM	5	4	49	35	58	11	193	6	2	210	2	2	3	3	7	38	186	2	0	226	40	501	541
Total	35	9	179	117	223	39	750	27	9	816	9	5	35	23	49	135	779	15	0	929	149	2017	2166
12:00 PM	10	3	46	30	59	2	200	3	0	205	5	4	5	4	14	33	207	2	0	242	34	520	554
12:15 PM	10	2	91	68	103	10	221	6	1	237	4	1	7	5	12	38	217	1	0	256	74	608	682
12:30 PM	16	4	71	42	91	5	235	3	0	243	1	1	6	6	8	35	175	2	0	212	48	554	602
12:45 PM	12	1	69	43	82	8	219	5	0	232	0	1	2	1	3	36	194	2	0	232	44	549	593
Total	48	10	277	183	335	25	875	17	1	917	10	7	20	16	37	142	793	7	0	942	200	2231	2431
01:00 PM	11	2	91	62	104	10	209	8	2	227	2	3	3	1	8	33	238	1	1	272	66	611	677
01:15 PM	17	0	67	44	84	9	183	12	2	204	1	0	7	6	8	51	216	2	0	269	52	565	617
01:30 PM	19	2	56	32	77	7	174	8	1	189	3	3	6	5	12	56	188	2	0	246	38	524	562
01:45 PM	19	2	46	19	67	6	196	5	3	207	3	0	6	5	9	42	187	3	0	232	27	515	542
Total	66	6	260	157	332	32	762	33	8	827	9	6	22	17	37	182	829	8	1	1019	183	2215	2398
Grand Total	149	25	716	457	890	96	2387	77	18	2560	28	18	77	56	123	459	2401	30	1	2890	532	6463	6995
Apprch %	16.7	2.8	80.4			3.8	93.2	3			22.8	14.6	62.6			15.9	83.1	1					
Total %	2.3	0.4	11.1		13.8	1.5	36.9	1.2		39.6	0.4	0.3	1.2		1.9	7.1	37.1	0.5		44.7	7.6	92.4	

Start Time	Meridian Parkway Southbound				Van Buren Boulevard Westbound				Harmon Street Northbound				Van Buren Boulevard Eastbound				Int. Total
	Left	Thru	Right	App. Total	Left	Thru	Right	App. Total	Left	Thru	Right	App. Total	Left	Thru	Right	App. Total	
Peak Hour Analysis From 12:15 PM to 01:00 PM - Peak 1 of 1																	
Peak Hour for Entire Intersection Begins at 12:15 PM																	
12:15 PM	10	2	91	103	10	221	6	237	4	1	7	12	38	217	1	256	608
12:30 PM	16	4	71	91	5	235	3	243	1	1	6	8	35	175	2	212	554
12:45 PM	12	1	69	82	8	219	5	232	0	1	2	3	36	194	2	232	549
01:00 PM	11	2	91	104	10	209	8	227	2	3	3	8	33	238	1	272	677
Total Volume	49	9	322	380	33	884	22	939	7	6	18	31	142	824	6	972	2322
% App. Total	12.9	2.4	84.7		3.5	94.1	2.3		22.6	19.4	58.1		14.6	84.8	0.6		
PHF	.766	.563	.885	.913	.825	.940	.688	.966	.438	.500	.643	.646	.934	.866	.750	.893	.950

County of Riverside
 N/S: Meridian Pkwy/Harmon St
 E/W: Van Buren Boulevard
 Weather: Clear

File Name : 26_CRV_Mer_VB Sat
 Site Code : 05122815
 Start Date : 9/17/2022
 Page No : 2

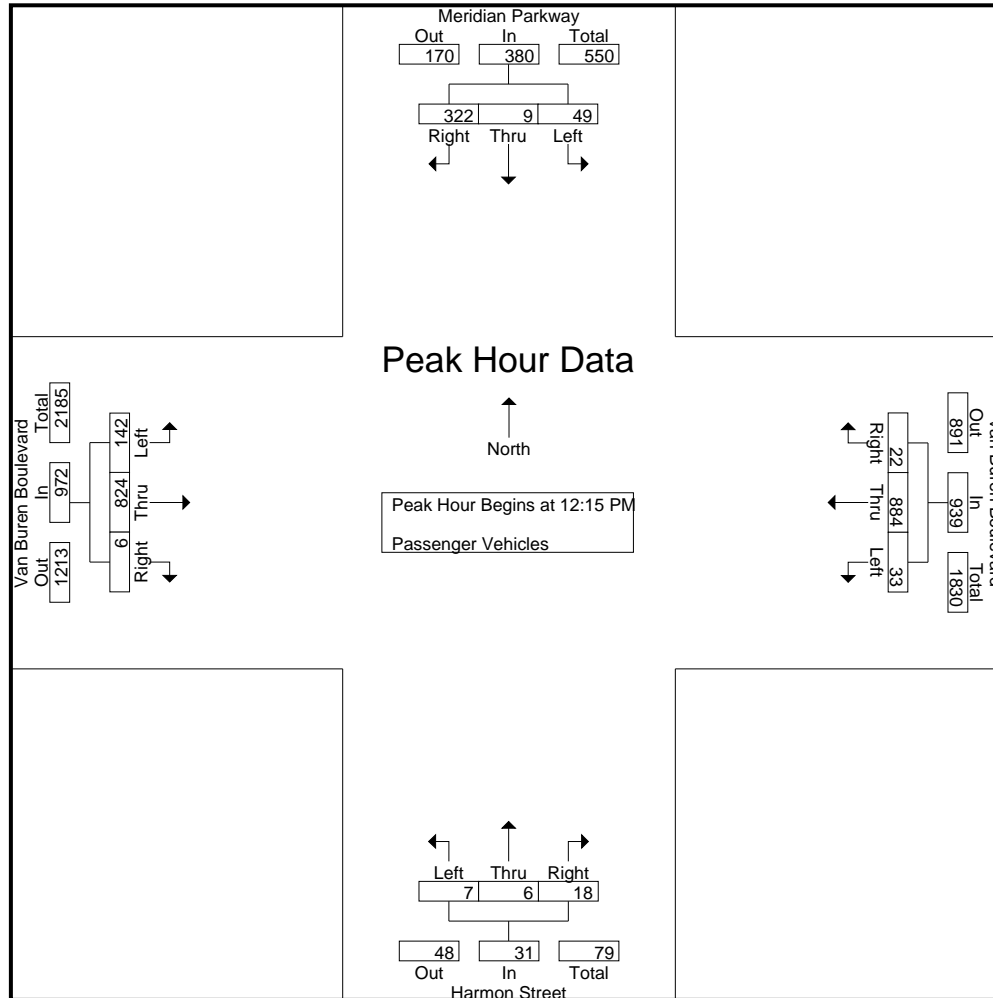

County of Riverside
 N/S: Meridian Pkwy/Harmon St
 E/W: Van Buren Boulevard
 Weather: Clear

File Name : 26_CRV_Mer_VB Sat
 Site Code : 05122815
 Start Date : 9/17/2022
 Page No : 3

Start Time	Meridian Parkway Southbound				Van Buren Boulevard Westbound				Harmon Street Northbound				Van Buren Boulevard Eastbound				Int. Total
	Left	Thru	Right	App. Total	Left	Thru	Right	App. Total	Left	Thru	Right	App. Total	Left	Thru	Right	App. Total	
Peak Hour Analysis From 12:15 PM to 01:00 PM - Peak 1 of 1																	
Peak Hour for Each Approach Begins at:																	
	12:15 PM				12:15 PM				12:15 PM				12:15 PM				
+0 mins.	10	2	91	103	10	221	6	237	4	1	7	12	38	217	1	256	
+15 mins.	16	4	71	91	5	235	3	243	1	1	6	8	35	175	2	212	
+30 mins.	12	1	69	82	8	219	5	232	0	1	2	3	36	194	2	232	
+45 mins.	11	2	91	104	10	209	8	227	2	3	3	8	33	238	1	272	
Total Volume	49	9	322	380	33	884	22	939	7	6	18	31	142	824	6	972	
% App. Total	12.9	2.4	84.7		3.5	94.1	2.3		22.6	19.4	58.1		14.6	84.8	0.6		
PHF	.766	.563	.885	.913	.825	.940	.688	.966	.438	.500	.643	.646	.934	.866	.750	.893	

County of Riverside
 N/S: Meridian Pkwy/Harmon St
 E/W: Van Buren Boulevard
 Weather: Clear

File Name : 26_CRV_Mer_VB Sat
 Site Code : 05122815
 Start Date : 9/17/2022
 Page No : 1

Groups Printed- Large 2 Axle Vehicles

Start Time	Meridian Parkway Southbound					Van Buren Boulevard Westbound					Harmon Street Northbound					Van Buren Boulevard Eastbound					Exclu. Total	Inclu. Total	Int. Total
	Left	Thru	Right	RTOR	App. Total	Left	Thru	Right	RTOR	App. Total	Left	Thru	Right	RTOR	App. Total	Left	Thru	Right	RTOR	App. Total			
11:00 AM	0	0	1	1	1	0	2	0	0	2	0	0	0	0	0	1	9	0	0	10	1	13	14
11:15 AM	1	0	0	0	1	0	3	0	0	3	0	0	0	0	0	1	2	0	0	3	0	7	7
11:30 AM	0	0	0	0	0	1	2	0	0	3	0	0	0	0	0	0	0	0	0	0	0	3	3
11:45 AM	0	0	0	0	0	0	2	0	0	2	0	0	0	0	0	0	2	0	0	2	0	4	4
Total	1	0	1	1	2	1	9	0	0	10	0	0	0	0	0	2	13	0	0	15	1	27	28
12:00 PM	0	0	0	0	0	0	2	0	0	2	0	0	0	0	0	0	6	0	0	6	0	8	8
12:15 PM	0	0	1	1	1	0	4	1	0	5	0	0	0	0	0	1	7	0	0	8	1	14	15
12:30 PM	0	0	3	3	3	0	3	0	0	3	0	0	0	0	0	0	5	0	0	5	3	11	14
12:45 PM	0	0	0	0	0	0	2	0	0	2	0	0	0	0	0	0	2	0	0	2	0	4	4
Total	0	0	4	4	4	0	11	1	0	12	0	0	0	0	0	1	20	0	0	21	4	37	41
01:00 PM	0	0	0	0	0	0	6	0	0	6	0	0	0	0	0	1	5	0	0	6	0	12	12
01:15 PM	1	0	0	0	1	0	2	0	0	2	0	0	0	0	0	0	2	0	0	2	0	5	5
01:30 PM	2	0	2	2	4	0	6	0	0	6	0	0	0	0	0	1	7	0	0	8	2	18	20
01:45 PM	1	0	0	0	1	0	5	0	0	5	0	0	0	0	0	0	2	0	0	2	0	8	8
Total	4	0	2	2	6	0	19	0	0	19	0	0	0	0	0	2	16	0	0	18	2	43	45
Grand Total	5	0	7	7	12	1	39	1	0	41	0	0	0	0	0	5	49	0	0	54	7	107	114
Apprch %	41.7	0	58.3			2.4	95.1	2.4			0	0	0			9.3	90.7	0					
Total %	4.7	0	6.5		11.2	0.9	36.4	0.9		38.3	0	0	0		0	4.7	45.8	0		50.5	6.1	93.9	

Start Time	Meridian Parkway Southbound				Van Buren Boulevard Westbound				Harmon Street Northbound				Van Buren Boulevard Eastbound				Int. Total
	Left	Thru	Right	App. Total	Left	Thru	Right	App. Total	Left	Thru	Right	App. Total	Left	Thru	Right	App. Total	
Peak Hour Analysis From 12:15 PM to 01:00 PM - Peak 1 of 1																	
Peak Hour for Entire Intersection Begins at 12:15 PM																	
12:15 PM	0	0	1	1	0	4	1	5	0	0	0	0	1	7	0	8	14
12:30 PM	0	0	3	3	0	3	0	3	0	0	0	0	0	5	0	5	11
12:45 PM	0	0	0	0	0	2	0	2	0	0	0	0	0	2	0	2	4
01:00 PM	0	0	0	0	0	6	0	6	0	0	0	0	1	5	0	6	12
Total Volume	0	0	4	4	0	15	1	16	0	0	0	0	2	19	0	21	41
% App. Total	0	0	100		0	93.8	6.2		0	0	0		9.5	90.5	0		
PHF	.000	.000	.333	.333	.000	.625	.250	.667	.000	.000	.000	.000	.500	.679	.000	.656	.732

County of Riverside
 N/S: Meridian Pkwy/Harmon St
 E/W: Van Buren Boulevard
 Weather: Clear

File Name : 26_CRV_Mer_VB Sat
 Site Code : 05122815
 Start Date : 9/17/2022
 Page No : 2

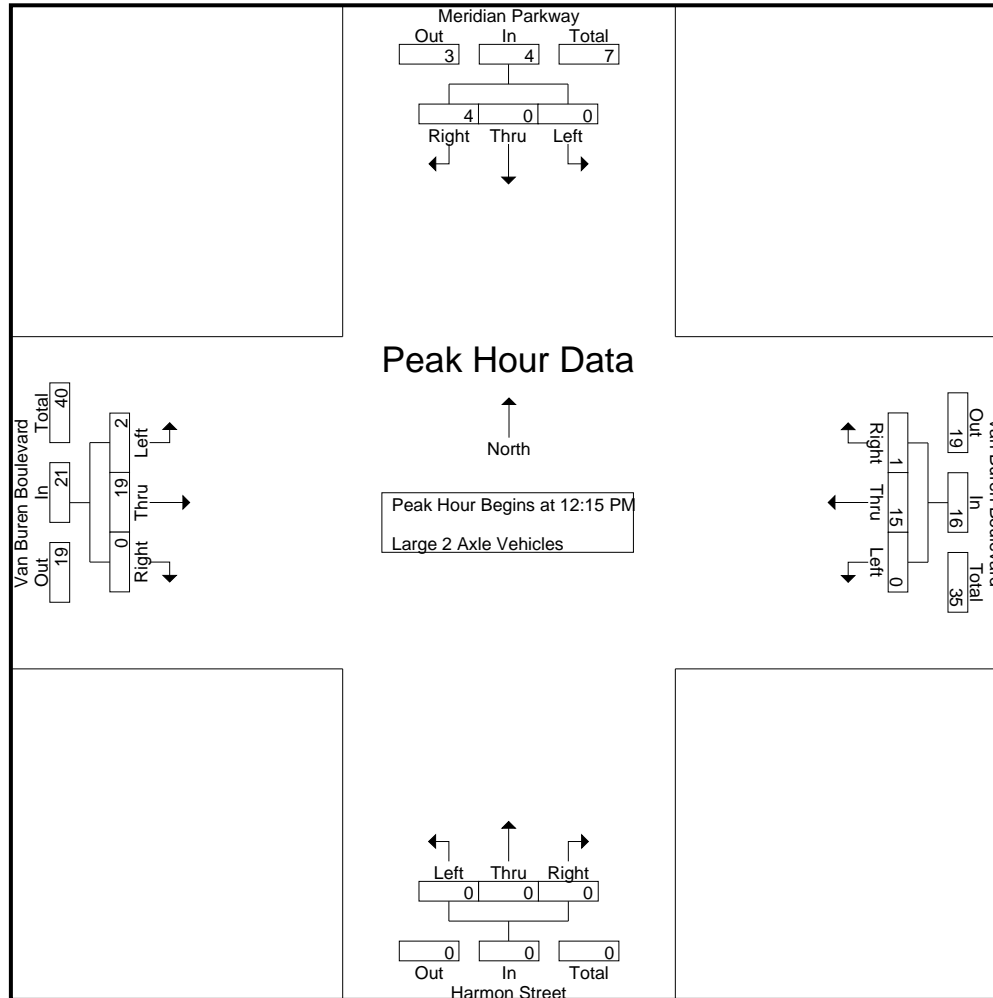

County of Riverside
 N/S: Meridian Pkwy/Harmon St
 E/W: Van Buren Boulevard
 Weather: Clear

File Name : 26_CRV_Mer_VB Sat
 Site Code : 05122815
 Start Date : 9/17/2022
 Page No : 3

Start Time	Meridian Parkway Southbound				Van Buren Boulevard Westbound				Harmon Street Northbound				Van Buren Boulevard Eastbound				Int. Total
	Left	Thru	Right	App. Total	Left	Thru	Right	App. Total	Left	Thru	Right	App. Total	Left	Thru	Right	App. Total	
Peak Hour Analysis From 12:15 PM to 01:00 PM - Peak 1 of 1																	
Peak Hour for Each Approach Begins at:																	
	12:15 PM				12:15 PM				12:15 PM				12:15 PM				
+0 mins.	0	0	1	1	0	4	1	5	0	0	0	0	1	7	0	8	
+15 mins.	0	0	3	3	0	3	0	3	0	0	0	0	0	5	0	5	
+30 mins.	0	0	0	0	0	2	0	2	0	0	0	0	0	2	0	2	
+45 mins.	0	0	0	0	0	6	0	6	0	0	0	0	1	5	0	6	
Total Volume	0	0	4	4	0	15	1	16	0	0	0	0	2	19	0	21	
% App. Total	0	0	100		0	93.8	6.2		0	0	0		9.5	90.5	0		
PHF	.000	.000	.333	.333	.000	.625	.250	.667	.000	.000	.000	.000	.500	.679	.000	.656	

County of Riverside
 N/S: Meridian Pkwy/Harmon St
 E/W: Van Buren Boulevard
 Weather: Clear

File Name : 26_CRV_Mer_VB Sat
 Site Code : 05122815
 Start Date : 9/17/2022
 Page No : 1

Groups Printed- 3 Axle Vehicles

Start Time	Meridian Parkway Southbound					Van Buren Boulevard Westbound					Harmon Street Northbound					Van Buren Boulevard Eastbound					Exclu. Total	Inclu. Total	Int. Total	
	Left	Thru	Right	RTOR	App. Total	Left	Thru	Right	RTOR	App. Total	Left	Thru	Right	RTOR	App. Total	Left	Thru	Right	RTOR	App. Total				
11:00 AM	0	0	0	0	0	0	1	0	0	1	0	0	0	0	0	0	1	0	0	1	0	0	2	2
11:15 AM	1	0	0	0	1	0	2	0	0	2	0	0	0	0	0	0	4	0	0	4	0	0	7	7
11:30 AM	0	0	1	0	1	0	2	0	0	2	0	0	0	0	0	0	2	0	0	2	0	0	5	5
11:45 AM	0	0	0	0	0	0	1	0	0	1	0	0	0	0	0	0	3	0	0	3	0	0	4	4
Total	1	0	1	0	2	0	6	0	0	6	0	0	0	0	0	0	10	0	0	10	0	0	18	18
12:00 PM	0	0	0	0	0	0	2	0	0	2	0	0	0	0	0	0	1	0	0	1	0	0	3	3
12:15 PM	0	0	0	0	0	0	1	0	0	1	0	0	0	0	0	0	0	0	0	0	0	0	1	1
12:30 PM	0	0	0	0	0	0	2	0	0	2	0	0	0	0	0	0	0	0	0	0	0	0	2	2
12:45 PM	0	0	0	0	0	0	0	0	0	0	0	0	0	0	0	0	1	0	0	1	0	0	1	1
Total	0	0	0	0	0	0	5	0	0	5	0	0	0	0	0	0	2	0	0	2	0	0	7	7
01:00 PM	0	0	0	0	0	0	0	0	0	0	0	0	0	0	0	0	1	0	0	1	0	0	1	1
01:15 PM	1	0	0	0	1	0	2	0	0	2	0	0	0	0	0	0	0	0	0	0	0	0	3	3
01:30 PM	0	0	0	0	0	0	1	0	0	1	0	0	0	0	0	0	0	0	0	0	0	0	1	1
01:45 PM	0	0	0	0	0	0	0	0	0	0	0	0	0	0	0	0	2	0	0	2	0	0	2	2
Total	1	0	0	0	1	0	3	0	0	3	0	0	0	0	0	0	3	0	0	3	0	0	7	7
Grand Total	2	0	1	0	3	0	14	0	0	14	0	0	0	0	0	0	15	0	0	15	0	0	32	32
Apprch %	66.7	0	33.3			0	100	0			0	0	0			0	100	0			0	0		
Total %	6.2	0	3.1		9.4	0	43.8	0		43.8	0	0	0		0	0	46.9	0		46.9	0	0	100	

Start Time	Meridian Parkway Southbound				Van Buren Boulevard Westbound				Harmon Street Northbound				Van Buren Boulevard Eastbound				Int. Total
	Left	Thru	Right	App. Total	Left	Thru	Right	App. Total	Left	Thru	Right	App. Total	Left	Thru	Right	App. Total	
Peak Hour Analysis From 12:15 PM to 01:00 PM - Peak 1 of 1																	
Peak Hour for Entire Intersection Begins at 12:15 PM																	
12:15 PM	0	0	0	0	0	1	0	1	0	0	0	0	0	0	0	0	1
12:30 PM	0	0	0	0	0	2	0	2	0	0	0	0	0	0	0	0	2
12:45 PM	0	0	0	0	0	0	0	0	0	0	0	0	0	1	0	1	1
01:00 PM	0	0	0	0	0	0	0	0	0	0	0	0	0	1	0	1	1
Total Volume	0	0	0	0	0	3	0	3	0	0	0	0	0	2	0	2	5
% App. Total	0	0	0		0	100	0		0	0	0		0	100	0		
PHF	.000	.000	.000	.000	.000	.375	.000	.375	.000	.000	.000	.000	.000	.500	.000	.500	.625

County of Riverside
 N/S: Meridian Pkwy/Harmon St
 E/W: Van Buren Boulevard
 Weather: Clear

File Name : 26_CRV_Mer_VB Sat
 Site Code : 05122815
 Start Date : 9/17/2022
 Page No : 2

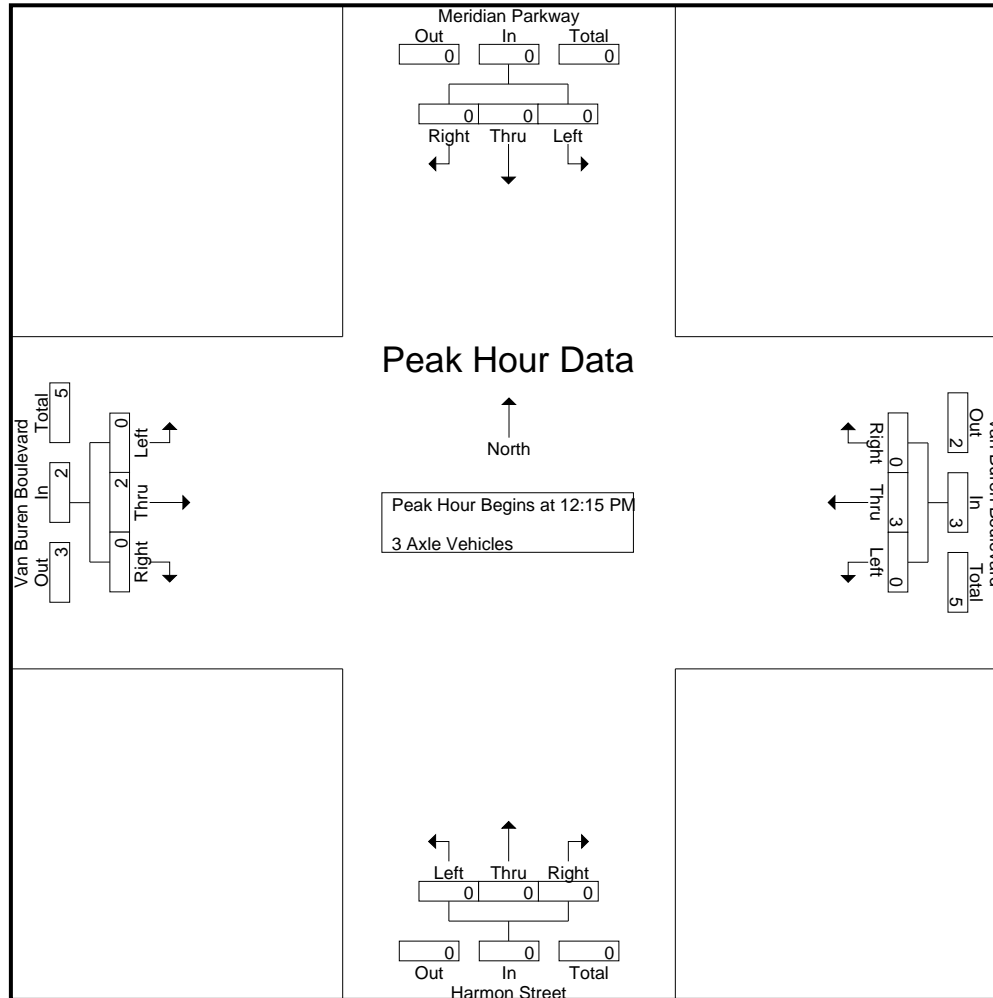

County of Riverside
 N/S: Meridian Pkwy/Harmon St
 E/W: Van Buren Boulevard
 Weather: Clear

File Name : 26_CRV_Mer_VB Sat
 Site Code : 05122815
 Start Date : 9/17/2022
 Page No : 3

Start Time	Meridian Parkway Southbound				Van Buren Boulevard Westbound				Harmon Street Northbound				Van Buren Boulevard Eastbound				Int. Total
	Left	Thru	Right	App. Total	Left	Thru	Right	App. Total	Left	Thru	Right	App. Total	Left	Thru	Right	App. Total	
Peak Hour Analysis From 12:15 PM to 01:00 PM - Peak 1 of 1																	
Peak Hour for Each Approach Begins at:																	
	12:15 PM				12:15 PM				12:15 PM				12:15 PM				
+0 mins.	0	0	0	0	0	1	0	1	0	0	0	0	0	0	0	0	
+15 mins.	0	0	0	0	0	2	0	2	0	0	0	0	0	0	0	0	
+30 mins.	0	0	0	0	0	0	0	0	0	0	0	0	0	1	0	1	
+45 mins.	0	0	0	0	0	0	0	0	0	0	0	0	0	1	0	1	
Total Volume	0	0	0	0	0	3	0	3	0	0	0	0	0	2	0	2	
% App. Total	0	0	0	0	0	100	0	0	0	0	0	0	0	100	0	0	
PHF	.000	.000	.000	.000	.000	.375	.000	.375	.000	.000	.000	.000	.000	.500	.000	.500	

County of Riverside
 N/S: Meridian Pkwy/Harmon St
 E/W: Van Buren Boulevard
 Weather: Clear

File Name : 26_CRV_Mer_VB Sat
 Site Code : 05122815
 Start Date : 9/17/2022
 Page No : 1

Groups Printed- 4+ Axle Trucks

Start Time	Meridian Parkway Southbound					Van Buren Boulevard Westbound					Harmon Street Northbound					Van Buren Boulevard Eastbound					Exclu. Total	Inclu. Total	Int. Total
	Left	Thru	Right	RTOR	App. Total	Left	Thru	Right	RTOR	App. Total	Left	Thru	Right	RTOR	App. Total	Left	Thru	Right	RTOR	App. Total			
11:00 AM	1	0	0	0	1	0	3	1	0	4	0	0	0	0	0	1	1	0	0	2	0	7	7
11:15 AM	0	0	0	0	0	0	2	1	0	3	0	0	0	0	0	1	4	0	0	5	0	8	8
11:30 AM	0	0	0	0	0	0	3	0	0	3	0	0	0	0	0	0	2	0	0	2	0	5	5
11:45 AM	2	0	0	0	2	0	1	0	0	1	0	0	0	0	0	0	2	0	0	2	0	5	5
Total	3	0	0	0	3	0	9	2	0	11	0	0	0	0	0	2	9	0	0	11	0	25	25
12:00 PM	0	0	0	0	0	0	1	0	0	1	0	0	0	0	0	0	1	0	0	1	0	2	2
12:15 PM	0	0	1	0	1	0	7	0	0	7	0	0	0	0	0	0	2	0	0	2	0	10	10
12:30 PM	0	0	0	0	0	0	7	2	0	9	0	0	0	0	0	0	2	0	0	2	0	11	11
12:45 PM	2	0	0	0	2	0	3	0	0	3	0	0	0	0	0	0	0	0	0	0	0	5	5
Total	2	0	1	0	3	0	18	2	0	20	0	0	0	0	0	0	5	0	0	5	0	28	28
01:00 PM	0	0	0	0	0	0	4	0	0	4	0	0	0	0	0	0	0	0	0	0	0	4	4
01:15 PM	1	0	0	0	1	0	2	1	0	3	0	0	0	0	0	0	3	0	0	3	0	7	7
01:30 PM	1	0	0	0	1	0	5	1	1	6	0	0	0	0	0	0	2	0	0	2	1	9	10
01:45 PM	1	0	0	0	1	0	3	1	0	4	0	0	0	0	0	0	6	0	0	6	0	11	11
Total	3	0	0	0	3	0	14	3	1	17	0	0	0	0	0	0	11	0	0	11	1	31	32
Grand Total	8	0	1	0	9	0	41	7	1	48	0	0	0	0	0	2	25	0	0	27	1	84	85
Apprch %	88.9	0	11.1			0	85.4	14.6			0	0	0			7.4	92.6	0					
Total %	9.5	0	1.2		10.7	0	48.8	8.3		57.1	0	0	0		0	2.4	29.8	0		32.1	1.2	98.8	

Start Time	Meridian Parkway Southbound				Van Buren Boulevard Westbound				Harmon Street Northbound				Van Buren Boulevard Eastbound				Int. Total
	Left	Thru	Right	App. Total	Left	Thru	Right	App. Total	Left	Thru	Right	App. Total	Left	Thru	Right	App. Total	
Peak Hour Analysis From 12:15 PM to 01:00 PM - Peak 1 of 1																	
Peak Hour for Entire Intersection Begins at 12:15 PM																	
12:15 PM	0	0	1	1	0	7	0	7	0	0	0	0	0	2	0	2	10
12:30 PM	0	0	0	0	0	7	2	9	0	0	0	0	0	2	0	2	11
12:45 PM	2	0	0	2	0	3	0	3	0	0	0	0	0	0	0	0	5
01:00 PM	0	0	0	0	0	4	0	4	0	0	0	0	0	0	0	0	4
Total Volume	2	0	1	3	0	21	2	23	0	0	0	0	0	4	0	4	30
% App. Total	66.7	0	33.3		0	91.3	8.7		0	0	0		0	100	0		
PHF	.250	.000	.250	.375	.000	.750	.250	.639	.000	.000	.000	.000	.000	.500	.000	.500	.682

County of Riverside
 N/S: Meridian Pkwy/Harmon St
 E/W: Van Buren Boulevard
 Weather: Clear

File Name : 26_CRV_Mer_VB Sat
 Site Code : 05122815
 Start Date : 9/17/2022
 Page No : 2

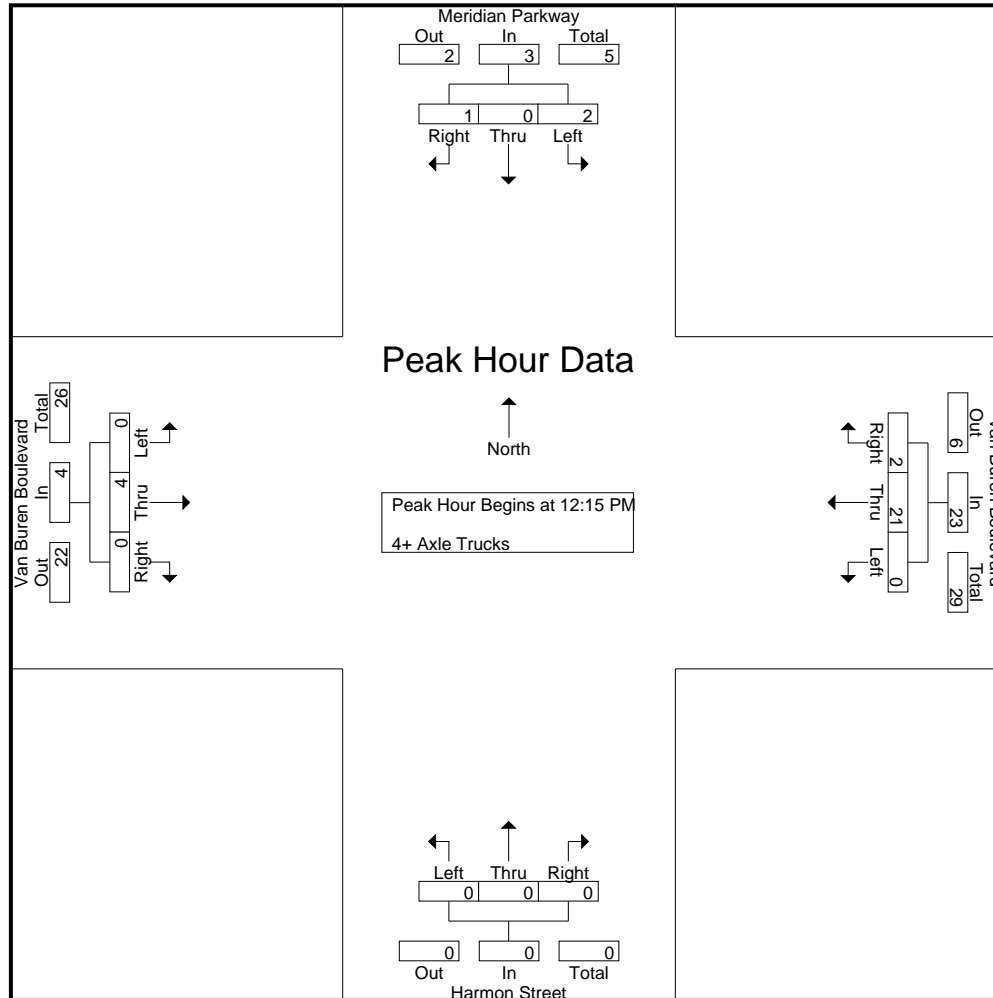

County of Riverside
 N/S: Meridian Pkwy/Harmon St
 E/W: Van Buren Boulevard
 Weather: Clear

File Name : 26_CRV_Mer_VB Sat
 Site Code : 05122815
 Start Date : 9/17/2022
 Page No : 3

Start Time	Meridian Parkway Southbound				Van Buren Boulevard Westbound				Harmon Street Northbound				Van Buren Boulevard Eastbound				Int. Total
	Left	Thru	Right	App. Total	Left	Thru	Right	App. Total	Left	Thru	Right	App. Total	Left	Thru	Right	App. Total	
Peak Hour Analysis From 12:15 PM to 01:00 PM - Peak 1 of 1																	
Peak Hour for Each Approach Begins at:																	
	12:15 PM				12:15 PM				12:15 PM				12:15 PM				
+0 mins.	0	0	1	1	0	7	0	7	0	0	0	0	0	2	0	2	
+15 mins.	0	0	0	0	0	7	2	9	0	0	0	0	0	2	0	2	
+30 mins.	2	0	0	2	0	3	0	3	0	0	0	0	0	0	0	0	
+45 mins.	0	0	0	0	0	4	0	4	0	0	0	0	0	0	0	0	
Total Volume	2	0	1	3	0	21	2	23	0	0	0	0	0	4	0	4	
% App. Total	66.7	0	33.3		0	91.3	8.7		0	0	0		0	100	0		
PHF	.250	.000	.250	.375	.000	.750	.250	.639	.000	.000	.000	.000	.000	.500	.000	.500	

Location: County of Riverside
 N/S: Meridian Pkwy/Harmon St
 E/W: Van Buren Boulevard



Date: 9/17/2022
 Day Saturday

PEDESTRIANS

Time	North Leg Meridian Parkway	East Leg Van Buren Boulevard	South Leg Harmon Street	West Leg Van Buren Boulevard	TOTAL
11:00 AM	0	0	0	0	0
11:15 AM	0	0	0	3	3
11:30 AM	0	0	0	0	0
11:45 AM	0	0	0	0	0
12:00 PM	0	0	0	0	0
12:15 PM	0	0	0	0	0
12:30 PM	0	0	0	0	0
12:45 PM	0	0	0	0	0
1:00 PM	0	0	0	0	0
1:15 PM	0	0	0	0	0
1:30 PM	0	0	0	0	0
1:45 PM	0	0	0	0	0
TOTAL VOLUMES:	0	0	0	3	3

Location: County of Riverside
 N/S: Meridian Pkwy/Harmon St
 E/W: Van Buren Boulevard

Date: 9/17/2022
 Day: Saturday



BICYCLES

	Southbound Meridian Parkway			Westbound Van Buren Boulevard			Northbound Harmon Street			Eastbound Van Buren Boulevard			
	Left	Thru	Right	Left	Thru	Right	Left	Thru	Right	Left	Thru	Right	
11:00 AM	0	0	0	0	0	0	0	0	0	0	0	0	0
11:15 AM	0	0	0	0	0	0	0	0	0	0	0	0	0
11:30 AM	0	0	0	0	0	0	0	0	0	0	0	0	0
11:45 AM	0	0	0	0	0	0	0	0	0	0	0	0	0
12:00 PM	0	0	0	0	0	0	0	0	0	0	0	0	0
12:15 PM	0	0	0	0	0	0	0	0	0	0	0	0	0
12:30 PM	0	0	0	0	0	0	0	0	0	0	0	0	0
12:45 PM	0	0	0	0	0	0	0	0	0	0	0	0	0
1:00 PM	0	0	0	0	0	0	0	0	0	0	0	0	0
1:15 PM	0	0	0	0	0	0	0	0	0	0	0	0	0
1:30 PM	0	0	0	0	2	0	0	0	0	0	0	0	2
1:45 PM	0	0	0	0	0	0	0	0	0	0	0	0	0
TOTAL VOLUMES:	0	0	0	0	2	0	0	0	0	0	0	0	2

County of Riverside
 N/S: Innovation Drive
 E/W: Cactus Avenue
 Weather: Clear

File Name : 27_CRV_Inno_Cac Sat
 Site Code : 05122815
 Start Date : 9/17/2022
 Page No : 1

Groups Printed- Passenger Vehicles - Large 2 Axle Vehicles - 3 Axle Vehicles - 4+ Axle Trucks

Start Time	Innovation Drive Southbound					Cactus Avenue Westbound					Innovation Drive Northbound					Cactus Avenue Eastbound					Exclu. Total	Inclu. Total	Int. Total
	Left	Thru	Right	RTOR	App. Total	Left	Thru	Right	RTOR	App. Total	Left	Thru	Right	RTOR	App. Total	Left	Thru	Right	RTOR	App. Total			
11:00 AM	0	0	0	0	0	11	51	1	0	63	2	0	3	3	5	0	38	0	0	38	3	106	109
11:15 AM	0	0	0	0	0	6	83	1	0	90	0	0	16	10	16	0	44	0	0	44	10	150	160
11:30 AM	0	0	0	0	0	4	83	0	0	87	2	0	5	0	7	0	42	0	0	42	0	136	136
11:45 AM	1	0	1	1	2	6	91	3	0	100	0	0	3	1	3	0	47	0	0	47	2	152	154
Total	1	0	1	1	2	27	308	5	0	340	4	0	27	14	31	0	171	0	0	171	15	544	559
12:00 PM	0	0	0	0	0	6	78	0	0	84	1	0	2	1	3	0	52	1	0	53	1	140	141
12:15 PM	0	0	0	0	0	6	100	0	0	106	1	0	7	4	8	0	46	2	0	48	4	162	166
12:30 PM	0	0	0	0	0	3	79	0	0	82	1	0	2	2	3	0	45	1	0	46	2	131	133
12:45 PM	0	0	0	0	0	1	64	0	0	65	4	0	2	0	6	1	54	2	0	57	0	128	128
Total	0	0	0	0	0	16	321	0	0	337	7	0	13	7	20	1	197	6	0	204	7	561	568
01:00 PM	0	0	0	0	0	8	93	0	0	101	0	0	7	5	7	1	46	0	0	47	5	155	160
01:15 PM	0	0	1	1	1	5	93	1	0	99	0	0	3	1	3	0	61	1	0	62	2	165	167
01:30 PM	0	0	0	0	0	4	87	1	0	92	0	0	6	3	6	0	70	0	0	70	3	168	171
01:45 PM	0	0	0	0	0	5	93	2	0	100	1	0	5	3	6	0	87	0	0	87	3	193	196
Total	0	0	1	1	1	22	366	4	0	392	1	0	21	12	22	1	264	1	0	266	13	681	694
Grand Total	1	0	2	2	3	65	995	9	0	1069	12	0	61	33	73	2	632	7	0	641	35	1786	1821
Apprch %	33.3	0	66.7			6.1	93.1	0.8			16.4	0	83.6			0.3	98.6	1.1					
Total %	0.1	0	0.1		0.2	3.6	55.7	0.5		59.9	0.7	0	3.4		4.1	0.1	35.4	0.4		35.9	1.9	98.1	
Passenger Vehicles	1	0	2		5	53	947	9		1009	9	0	53		95	2	616	6		624	0	0	1733
% Passenger Vehicles	100	0	100	100	100	81.5	95.2	100	0	94.4	75	0	86.9	100	89.6	100	97.5	85.7	0	97.3	0	0	95.2
Large 2 Axle Vehicles	0	0	0		0	1	12	0		13	1	0	0		1	0	8	0		8	0	0	22
% Large 2 Axle Vehicles	0	0	0	0	0	1.5	1.2	0	0	1.2	8.3	0	0	0	0.9	0	1.3	0	0	1.2	0	0	1.2
3 Axle Vehicles	0	0	0		0	3	4	0		7	1	0	1		2	0	0	0		0	0	0	9
% 3 Axle Vehicles	0	0	0	0	0	4.6	0.4	0	0	0.7	8.3	0	1.6	0	1.9	0	0	0	0	0	0	0	0.5
4+ Axle Trucks	0	0	0		0	8	32	0		40	1	0	7		8	0	8	1		9	0	0	57
% 4+ Axle Trucks	0	0	0	0	0	12.3	3.2	0	0	3.7	8.3	0	11.5	0	7.5	0	1.3	14.3	0	1.4	0	0	3.1

County of Riverside
 N/S: Innovation Drive
 E/W: Cactus Avenue
 Weather: Clear

File Name : 27_CRV_Inno_Cac Sat
 Site Code : 05122815
 Start Date : 9/17/2022
 Page No : 2

Start Time	Innovation Drive Southbound				Cactus Avenue Westbound				Innovation Drive Northbound				Cactus Avenue Eastbound				Int. Total
	Left	Thru	Right	App. Total	Left	Thru	Right	App. Total	Left	Thru	Right	App. Total	Left	Thru	Right	App. Total	
Peak Hour Analysis From 11:00 AM to 01:45 PM - Peak 1 of 1																	
Peak Hour for Entire Intersection Begins at 01:00 PM																	
01:00 PM	0	0	0	0	8	93	0	101	0	0	7	7	1	46	0	47	155
01:15 PM	0	0	1	1	5	93	1	99	0	0	3	3	0	61	1	62	165
01:30 PM	0	0	0	0	4	87	1	92	0	0	6	6	0	70	0	70	168
01:45 PM	0	0	0	0	5	93	2	100	1	0	5	6	0	87	0	87	193
Total Volume	0	0	1	1	22	366	4	392	1	0	21	22	1	264	1	266	681
% App. Total	0	0	100		5.6	93.4	1		4.5	0	95.5		0.4	99.2	0.4		
PHF	.000	.000	.250	.250	.688	.984	.500	.970	.250	.000	.750	.786	.250	.759	.250	.764	.882

County of Riverside
 N/S: Innovation Drive
 E/W: Cactus Avenue
 Weather: Clear

File Name : 27_CRV_Inno_Cac Sat
 Site Code : 05122815
 Start Date : 9/17/2022
 Page No : 3

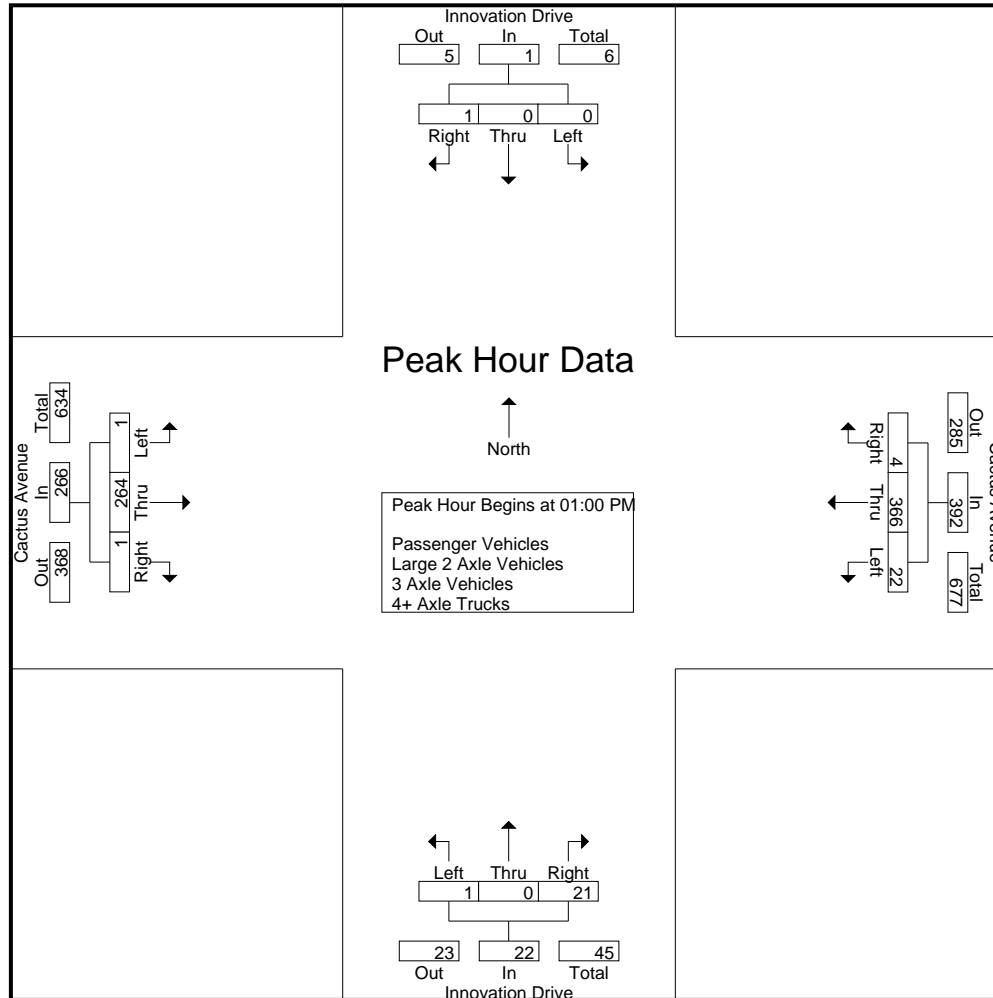

County of Riverside
 N/S: Innovation Drive
 E/W: Cactus Avenue
 Weather: Clear

File Name : 27_CRV_Inno_Cac Sat
 Site Code : 05122815
 Start Date : 9/17/2022
 Page No : 4

Start Time	Innovation Drive Southbound				Cactus Avenue Westbound				Innovation Drive Northbound				Cactus Avenue Eastbound				Int. Total
	Left	Thru	Right	App. Total	Left	Thru	Right	App. Total	Left	Thru	Right	App. Total	Left	Thru	Right	App. Total	
Peak Hour Analysis From 11:00 AM to 01:45 PM - Peak 1 of 1																	
Peak Hour for Each Approach Begins at:																	
	11:00 AM				01:00 PM				11:00 AM				01:00 PM				
+0 mins.	0	0	0	0	8	93	0	101	2	0	3	5	1	46	0	47	
+15 mins.	0	0	0	0	5	93	1	99	0	0	16	16	0	61	1	62	
+30 mins.	0	0	0	0	4	87	1	92	2	0	5	7	0	70	0	70	
+45 mins.	1	0	1	2	5	93	2	100	0	0	3	3	0	87	0	87	
Total Volume	1	0	1	2	22	366	4	392	4	0	27	31	1	264	1	266	
% App. Total	50	0	50		5.6	93.4	1		12.9	0	87.1		0.4	99.2	0.4		
PHF	.250	.000	.250	.250	.688	.984	.500	.970	.500	.000	.422	.484	.250	.759	.250	.764	

County of Riverside
 N/S: Innovation Drive
 E/W: Cactus Avenue
 Weather: Clear

File Name : 27_CRV_Inno_Cac Sat
 Site Code : 05122815
 Start Date : 9/17/2022
 Page No : 1

Groups Printed- Passenger Vehicles

Start Time	Innovation Drive Southbound					Cactus Avenue Westbound					Innovation Drive Northbound					Cactus Avenue Eastbound					Exclu. Total	Inclu. Total	Int. Total
	Left	Thru	Right	RTOR	App. Total	Left	Thru	Right	RTOR	App. Total	Left	Thru	Right	RTOR	App. Total	Left	Thru	Right	RTOR	App. Total			
11:00 AM	0	0	0	0	0	10	49	1	0	60	1	0	3	3	4	0	36	0	0	36	3	100	103
11:15 AM	0	0	0	0	0	4	80	1	0	85	0	0	13	10	13	0	42	0	0	42	10	140	150
11:30 AM	0	0	0	0	0	3	81	0	0	84	2	0	4	0	6	0	38	0	0	38	0	128	128
11:45 AM	1	0	1	1	2	3	88	3	0	94	0	0	3	1	3	0	47	0	0	47	2	146	148
Total	1	0	1	1	2	20	298	5	0	323	3	0	23	14	26	0	163	0	0	163	15	514	529
12:00 PM	0	0	0	0	0	4	71	0	0	75	0	0	1	1	1	0	50	1	0	51	1	127	128
12:15 PM	0	0	0	0	0	6	90	0	0	96	1	0	6	4	7	0	45	2	0	47	4	150	154
12:30 PM	0	0	0	0	0	2	73	0	0	75	1	0	2	2	3	0	44	1	0	45	2	123	125
12:45 PM	0	0	0	0	0	1	62	0	0	63	3	0	1	0	4	1	51	2	0	54	0	121	121
Total	0	0	0	0	0	13	296	0	0	309	5	0	10	7	15	1	190	6	0	197	7	521	528
01:00 PM	0	0	0	0	0	8	90	0	0	98	0	0	7	5	7	1	46	0	0	47	5	152	157
01:15 PM	0	0	1	1	1	4	91	1	0	96	0	0	3	1	3	0	61	0	0	61	2	161	163
01:30 PM	0	0	0	0	0	4	82	1	0	87	0	0	6	3	6	0	69	0	0	69	3	162	165
01:45 PM	0	0	0	0	0	4	90	2	0	96	1	0	4	3	5	0	87	0	0	87	3	188	191
Total	0	0	1	1	1	20	353	4	0	377	1	0	20	12	21	1	263	0	0	264	13	663	676
Grand Total	1	0	2	2	3	53	947	9	0	1009	9	0	53	33	62	2	616	6	0	624	35	1698	1733
Apprch %	33.3	0	66.7			5.3	93.9	0.9			14.5	0	85.5			0.3	98.7	1					
Total %	0.1	0	0.1		0.2	3.1	55.8	0.5		59.4	0.5	0	3.1		3.7	0.1	36.3	0.4		36.7	2	98	

Start Time	Innovation Drive Southbound				Cactus Avenue Westbound				Innovation Drive Northbound				Cactus Avenue Eastbound				Int. Total
	Left	Thru	Right	App. Total	Left	Thru	Right	App. Total	Left	Thru	Right	App. Total	Left	Thru	Right	App. Total	
Peak Hour Analysis From 01:00 PM to 01:45 PM - Peak 1 of 1																	
Peak Hour for Entire Intersection Begins at 01:00 PM																	
01:00 PM	0	0	0	0	8	90	0	98	0	0	7	7	1	46	0	47	152
01:15 PM	0	0	1	1	4	91	1	96	0	0	3	3	0	61	0	61	161
01:30 PM	0	0	0	0	4	82	1	87	0	0	6	6	0	69	0	69	162
01:45 PM	0	0	0	0	4	90	2	96	1	0	4	5	0	87	0	87	188
Total Volume	0	0	1	1	20	353	4	377	1	0	20	21	1	263	0	264	663
% App. Total	0	0	100		5.3	93.6	1.1		4.8	0	95.2		0.4	99.6	0		
PHF	.000	.000	.250	.250	.625	.970	.500	.962	.250	.000	.714	.750	.250	.756	.000	.759	.882

County of Riverside
 N/S: Innovation Drive
 E/W: Cactus Avenue
 Weather: Clear

File Name : 27_CRV_Inno_Cac Sat
 Site Code : 05122815
 Start Date : 9/17/2022
 Page No : 2

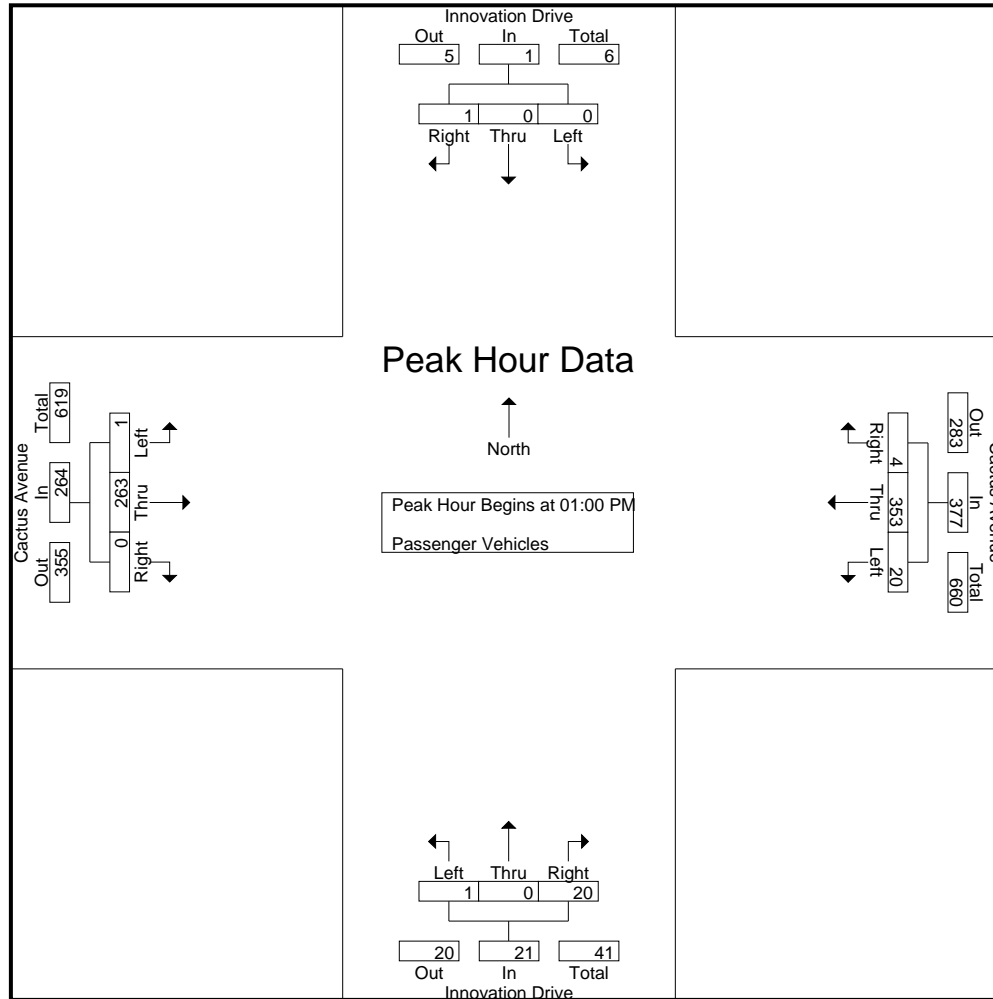

County of Riverside
 N/S: Innovation Drive
 E/W: Cactus Avenue
 Weather: Clear

File Name : 27_CRV_Inno_Cac Sat
 Site Code : 05122815
 Start Date : 9/17/2022
 Page No : 3

Start Time	Innovation Drive Southbound				Cactus Avenue Westbound				Innovation Drive Northbound				Cactus Avenue Eastbound				Int. Total
	Left	Thru	Right	App. Total	Left	Thru	Right	App. Total	Left	Thru	Right	App. Total	Left	Thru	Right	App. Total	
Peak Hour Analysis From 01:00 PM to 01:45 PM - Peak 1 of 1																	
Peak Hour for Each Approach Begins at:																	
	01:00 PM				01:00 PM				01:00 PM				01:00 PM				
+0 mins.	0	0	0	0	8	90	0	98	0	0	7	7	1	46	0	47	
+15 mins.	0	0	1	1	4	91	1	96	0	0	3	3	0	61	0	61	
+30 mins.	0	0	0	0	4	82	1	87	0	0	6	6	0	69	0	69	
+45 mins.	0	0	0	0	4	90	2	96	1	0	4	5	0	87	0	87	
Total Volume	0	0	1	1	20	353	4	377	1	0	20	21	1	263	0	264	
% App. Total	0	0	100		5.3	93.6	1.1		4.8	0	95.2		0.4	99.6	0		
PHF	.000	.000	.250	.250	.625	.970	.500	.962	.250	.000	.714	.750	.250	.756	.000	.759	

County of Riverside
 N/S: Innovation Drive
 E/W: Cactus Avenue
 Weather: Clear

File Name : 27_CRV_Inno_Cac Sat
 Site Code : 05122815
 Start Date : 9/17/2022
 Page No : 1

Groups Printed- Large 2 Axle Vehicles

Start Time	Innovation Drive Southbound					Cactus Avenue Westbound					Innovation Drive Northbound					Cactus Avenue Eastbound					Exclu. Total	Inclu. Total	Int. Total	
	Left	Thru	Right	RTOR	App. Total	Left	Thru	Right	RTOR	App. Total	Left	Thru	Right	RTOR	App. Total	Left	Thru	Right	RTOR	App. Total				
11:00 AM	0	0	0	0	0	0	0	0	0	0	1	0	0	0	1	0	1	0	0	1	0	0	2	2
11:15 AM	0	0	0	0	0	0	2	0	0	2	0	0	0	0	0	0	1	0	0	1	0	3	3	3
11:30 AM	0	0	0	0	0	0	2	0	0	2	0	0	0	0	0	0	2	0	0	2	0	4	4	4
11:45 AM	0	0	0	0	0	0	0	0	0	0	0	0	0	0	0	0	0	0	0	0	0	0	0	0
Total	0	0	0	0	0	0	4	0	0	4	1	0	0	0	1	0	4	0	0	4	0	9	9	9
12:00 PM	0	0	0	0	0	1	0	0	0	1	0	0	0	0	0	0	1	0	0	1	0	2	2	2
12:15 PM	0	0	0	0	0	0	4	0	0	4	0	0	0	0	0	0	0	0	0	0	0	4	4	4
12:30 PM	0	0	0	0	0	0	2	0	0	2	0	0	0	0	0	0	0	0	0	0	0	2	2	2
12:45 PM	0	0	0	0	0	0	0	0	0	0	0	0	0	0	0	0	2	0	0	2	0	2	2	2
Total	0	0	0	0	0	1	6	0	0	7	0	0	0	0	0	0	3	0	0	3	0	10	10	10
01:00 PM	0	0	0	0	0	0	1	0	0	1	0	0	0	0	0	0	0	0	0	0	0	1	1	1
01:15 PM	0	0	0	0	0	0	0	0	0	0	0	0	0	0	0	0	0	0	0	0	0	0	0	0
01:30 PM	0	0	0	0	0	0	0	0	0	0	0	0	0	0	0	0	1	0	0	1	0	1	1	1
01:45 PM	0	0	0	0	0	0	1	0	0	1	0	0	0	0	0	0	0	0	0	0	0	1	1	1
Total	0	0	0	0	0	0	2	0	0	2	0	0	0	0	0	0	1	0	0	1	0	3	3	3
Grand Total	0	0	0	0	0	1	12	0	0	13	1	0	0	0	1	0	8	0	0	8	0	22	22	22
Apprch %	0	0	0			7.7	92.3	0			100	0	0			0	100	0			0			
Total %	0	0	0			4.5	54.5	0		59.1	4.5	0	0		4.5	0	36.4	0		36.4	0	100		

Start Time	Innovation Drive Southbound				Cactus Avenue Westbound				Innovation Drive Northbound				Cactus Avenue Eastbound				Int. Total
	Left	Thru	Right	App. Total	Left	Thru	Right	App. Total	Left	Thru	Right	App. Total	Left	Thru	Right	App. Total	
Peak Hour Analysis From 01:00 PM to 01:45 PM - Peak 1 of 1																	
Peak Hour for Entire Intersection Begins at 01:00 PM																	
01:00 PM	0	0	0	0	0	1	0	1	0	0	0	0	0	0	0	0	1
01:15 PM	0	0	0	0	0	0	0	0	0	0	0	0	0	0	0	0	0
01:30 PM	0	0	0	0	0	0	0	0	0	0	0	0	0	1	0	1	1
01:45 PM	0	0	0	0	0	1	0	1	0	0	0	0	0	0	0	0	1
Total Volume	0	0	0	0	0	2	0	2	0	0	0	0	0	1	0	1	3
% App. Total	0	0	0		0	100	0		0	0	0		0	100	0		
PHF	.000	.000	.000	.000	.000	.500	.000	.500	.000	.000	.000	.000	.000	.250	.000	.250	.750

County of Riverside
 N/S: Innovation Drive
 E/W: Cactus Avenue
 Weather: Clear

File Name : 27_CRV_Inno_Cac Sat
 Site Code : 05122815
 Start Date : 9/17/2022
 Page No : 2

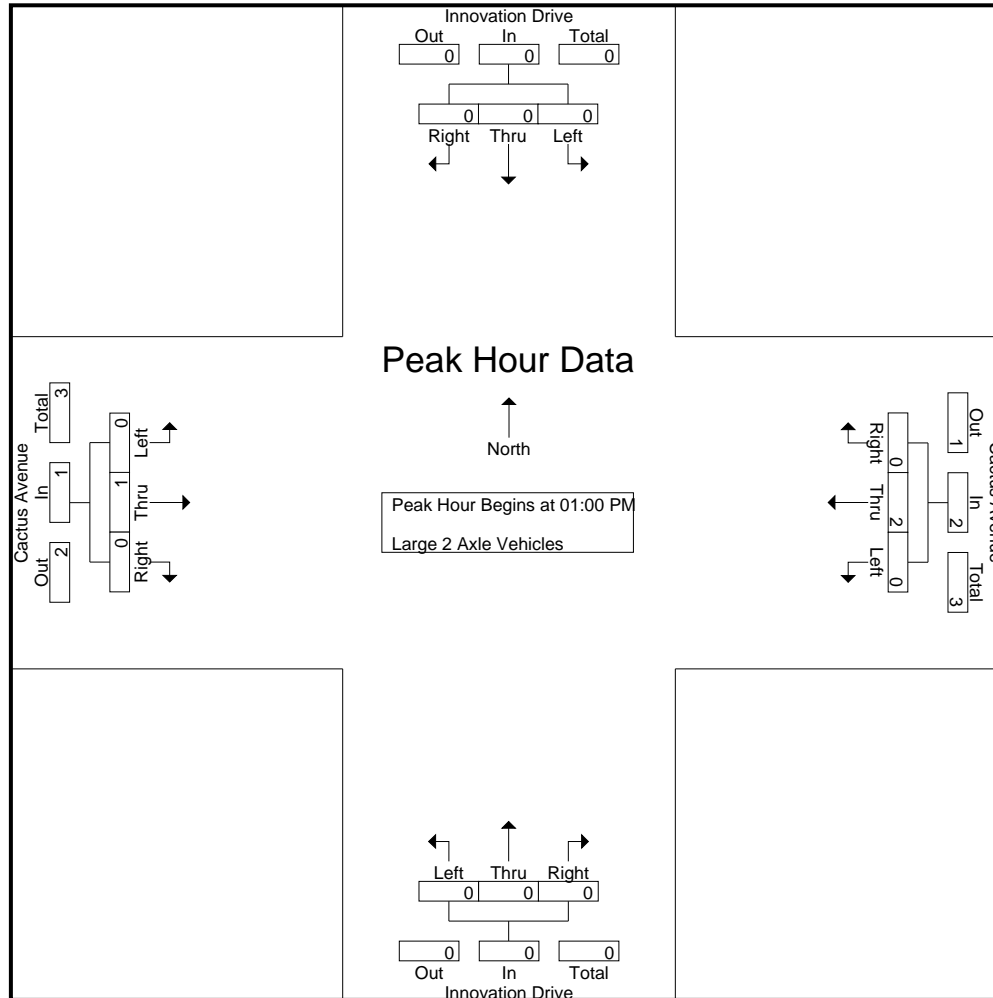

County of Riverside
 N/S: Innovation Drive
 E/W: Cactus Avenue
 Weather: Clear

File Name : 27_CRV_Inno_Cac Sat
 Site Code : 05122815
 Start Date : 9/17/2022
 Page No : 3

Start Time	Innovation Drive Southbound				Cactus Avenue Westbound				Innovation Drive Northbound				Cactus Avenue Eastbound				Int. Total
	Left	Thru	Right	App. Total	Left	Thru	Right	App. Total	Left	Thru	Right	App. Total	Left	Thru	Right	App. Total	
Peak Hour Analysis From 01:00 PM to 01:45 PM - Peak 1 of 1																	
Peak Hour for Each Approach Begins at:																	
	01:00 PM				01:00 PM				01:00 PM				01:00 PM				
+0 mins.	0	0	0	0	0	1	0	1	0	0	0	0	0	0	0	0	0
+15 mins.	0	0	0	0	0	0	0	0	0	0	0	0	0	0	0	0	0
+30 mins.	0	0	0	0	0	0	0	0	0	0	0	0	0	1	0	0	1
+45 mins.	0	0	0	0	0	1	0	1	0	0	0	0	0	0	0	0	0
Total Volume	0	0	0	0	0	2	0	2	0	0	0	0	0	1	0	0	1
% App. Total	0	0	0	0	0	100	0	0	0	0	0	0	0	100	0	0	0
PHF	.000	.000	.000	.000	.000	.500	.000	.500	.000	.000	.000	.000	.000	.250	.000	.250	

County of Riverside
 N/S: Innovation Drive
 E/W: Cactus Avenue
 Weather: Clear

File Name : 27_CRV_Inno_Cac Sat
 Site Code : 05122815
 Start Date : 9/17/2022
 Page No : 1

Groups Printed- 3 Axle Vehicles

Start Time	Innovation Drive Southbound					Cactus Avenue Westbound					Innovation Drive Northbound					Cactus Avenue Eastbound					Exclu. Total	Inclu. Total	Int. Total				
	Left	Thru	Right	RTOR	App. Total	Left	Thru	Right	RTOR	App. Total	Left	Thru	Right	RTOR	App. Total	Left	Thru	Right	RTOR	App. Total							
11:00 AM	0	0	0	0	0	0	0	0	0	0	0	0	0	0	0	0	0	0	0	0	0	0	0	0	0	0	0
11:15 AM	0	0	0	0	0	0	0	0	0	0	0	0	0	0	0	0	0	0	0	0	0	0	0	0	0	0	0
11:30 AM	0	0	0	0	0	0	0	0	0	0	0	0	0	0	0	0	0	0	0	0	0	0	0	0	0	0	0
11:45 AM	0	0	0	0	0	1	0	0	0	1	0	0	0	0	0	0	0	0	0	0	0	0	0	0	0	1	1
Total	0	0	0	0	0	1	0	0	0	1	0	0	0	0	0	0	0	0	0	0	0	0	0	0	0	1	1
12:00 PM	0	0	0	0	0	0	1	0	0	1	1	0	1	0	2	0	0	0	0	0	0	0	0	0	0	3	3
12:15 PM	0	0	0	0	0	0	0	0	0	0	0	0	0	0	0	0	0	0	0	0	0	0	0	0	0	0	0
12:30 PM	0	0	0	0	0	0	1	0	0	1	0	0	0	0	0	0	0	0	0	0	0	0	0	0	0	1	1
12:45 PM	0	0	0	0	0	0	0	0	0	0	0	0	0	0	0	0	0	0	0	0	0	0	0	0	0	0	0
Total	0	0	0	0	0	1	1	0	0	2	1	0	1	0	2	0	0	0	0	0	0	0	0	0	0	4	4
01:00 PM	0	0	0	0	0	0	0	0	0	0	0	0	0	0	0	0	0	0	0	0	0	0	0	0	0	0	0
01:15 PM	0	0	0	0	0	0	1	0	0	1	0	0	0	0	0	0	0	0	0	0	0	0	0	0	0	1	1
01:30 PM	0	0	0	0	0	0	2	0	0	2	0	0	0	0	0	0	0	0	0	0	0	0	0	0	0	2	2
01:45 PM	0	0	0	0	0	1	0	0	0	1	0	0	0	0	0	0	0	0	0	0	0	0	0	0	0	1	1
Total	0	0	0	0	0	1	3	0	0	4	0	0	0	0	0	0	0	0	0	0	0	0	0	0	0	4	4
Grand Total	0	0	0	0	0	3	4	0	0	7	1	0	1	0	2	0	0	0	0	0	0	0	0	0	0	9	9
Apprch %	0	0	0			42.9	57.1	0			50	0	50			0	0	0									
Total %	0	0	0			33.3	44.4	0		77.8	11.1	0	11.1		22.2	0	0	0		0					0	100	

Start Time	Innovation Drive Southbound				Cactus Avenue Westbound				Innovation Drive Northbound				Cactus Avenue Eastbound				Int. Total
	Left	Thru	Right	App. Total	Left	Thru	Right	App. Total	Left	Thru	Right	App. Total	Left	Thru	Right	App. Total	
Peak Hour Analysis From 01:00 PM to 01:45 PM - Peak 1 of 1																	
Peak Hour for Entire Intersection Begins at 01:00 PM																	
01:00 PM	0	0	0	0	0	0	0	0	0	0	0	0	0	0	0	0	0
01:15 PM	0	0	0	0	0	1	0	1	0	0	0	0	0	0	0	0	1
01:30 PM	0	0	0	0	0	2	0	2	0	0	0	0	0	0	0	0	2
01:45 PM	0	0	0	0	1	0	0	1	0	0	0	0	0	0	0	0	1
Total Volume	0	0	0	0	1	3	0	4	0	0	0	0	0	0	0	0	4
% App. Total	0	0	0		25	75	0		0	0	0		0	0	0		
PHF	.000	.000	.000	.000	.250	.375	.000	.500	.000	.000	.000	.000	.000	.000	.000	.000	.500

County of Riverside
 N/S: Innovation Drive
 E/W: Cactus Avenue
 Weather: Clear

File Name : 27_CRV_Inno_Cac Sat
 Site Code : 05122815
 Start Date : 9/17/2022
 Page No : 2

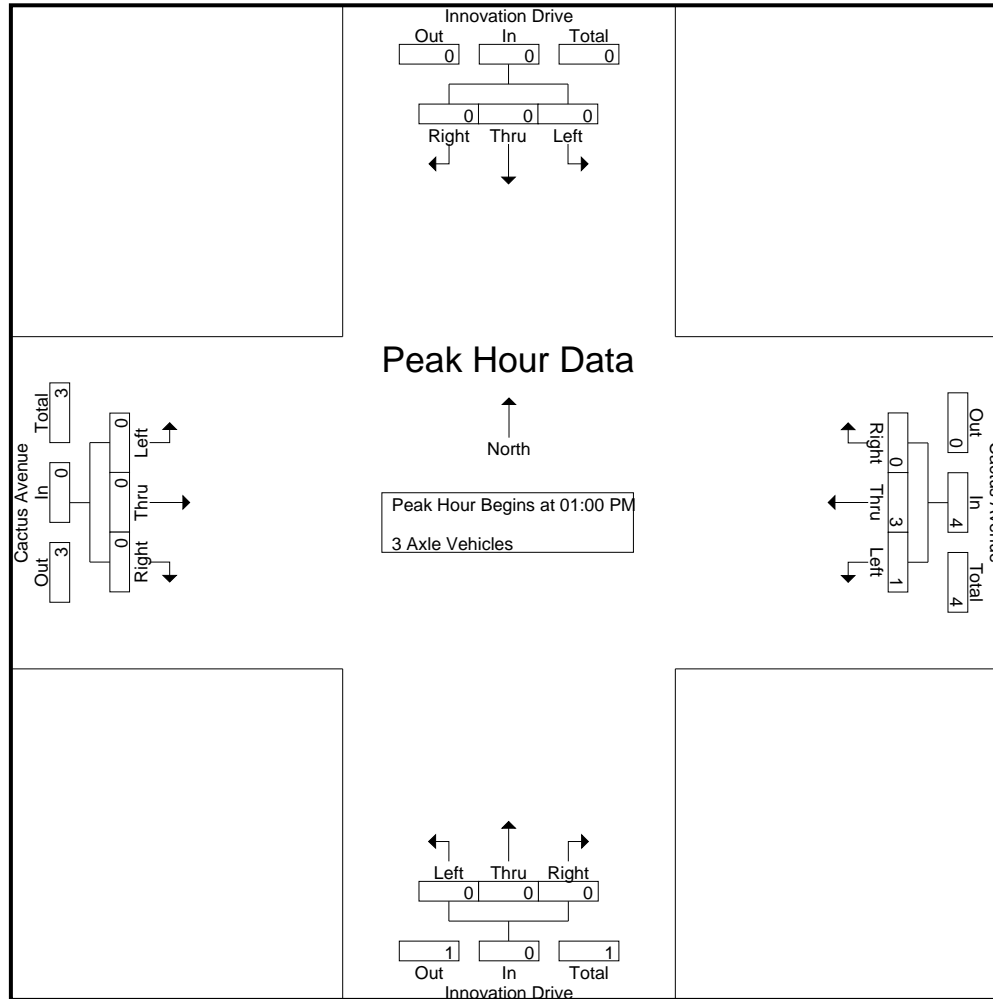

County of Riverside
 N/S: Innovation Drive
 E/W: Cactus Avenue
 Weather: Clear

File Name : 27_CRV_Inno_Cac Sat
 Site Code : 05122815
 Start Date : 9/17/2022
 Page No : 3

Start Time	Innovation Drive Southbound				Cactus Avenue Westbound				Innovation Drive Northbound				Cactus Avenue Eastbound				Int. Total
	Left	Thru	Right	App. Total	Left	Thru	Right	App. Total	Left	Thru	Right	App. Total	Left	Thru	Right	App. Total	
Peak Hour Analysis From 01:00 PM to 01:45 PM - Peak 1 of 1																	
Peak Hour for Each Approach Begins at:																	
	01:00 PM				01:00 PM				01:00 PM				01:00 PM				
+0 mins.	0	0	0	0	0	0	0	0	0	0	0	0	0	0	0	0	0
+15 mins.	0	0	0	0	0	1	0	1	0	0	0	0	0	0	0	0	0
+30 mins.	0	0	0	0	0	2	0	2	0	0	0	0	0	0	0	0	0
+45 mins.	0	0	0	0	1	0	0	1	0	0	0	0	0	0	0	0	0
Total Volume	0	0	0	0	1	3	0	4	0	0	0	0	0	0	0	0	0
% App. Total	0	0	0	0	25	75	0		0	0	0		0	0	0		
PHF	.000	.000	.000	.000	.250	.375	.000	.500	.000	.000	.000	.000	.000	.000	.000	.000	.000

County of Riverside
 N/S: Innovation Drive
 E/W: Cactus Avenue
 Weather: Clear

File Name : 27_CRV_Inno_Cac Sat
 Site Code : 05122815
 Start Date : 9/17/2022
 Page No : 1

Groups Printed- 4+ Axle Trucks

Start Time	Innovation Drive Southbound					Cactus Avenue Westbound					Innovation Drive Northbound					Cactus Avenue Eastbound					Exclu. Total	Inclu. Total	Int. Total				
	Left	Thru	Right	RTOR	App. Total	Left	Thru	Right	RTOR	App. Total	Left	Thru	Right	RTOR	App. Total	Left	Thru	Right	RTOR	App. Total							
11:00 AM	0	0	0	0	0	1	2	0	0	3	0	0	0	0	0	0	1	0	0	1	0	0	4	4	0	4	4
11:15 AM	0	0	0	0	0	2	1	0	0	3	0	0	3	0	3	0	1	0	0	1	0	0	7	7	0	7	7
11:30 AM	0	0	0	0	0	1	0	0	0	1	0	0	1	0	1	0	2	0	0	2	0	0	4	4	0	4	4
11:45 AM	0	0	0	0	0	2	3	0	0	5	0	0	0	0	0	0	0	0	0	0	0	0	5	5	0	5	5
Total	0	0	0	0	0	6	6	0	0	12	0	0	4	0	4	0	4	0	0	4	0	0	20	20	0	20	20
12:00 PM	0	0	0	0	0	1	6	0	0	7	0	0	0	0	0	0	1	0	0	1	0	0	8	8	0	8	8
12:15 PM	0	0	0	0	0	0	6	0	0	6	0	0	1	0	1	0	1	0	0	1	0	0	8	8	0	8	8
12:30 PM	0	0	0	0	0	0	4	0	0	4	0	0	0	0	0	0	1	0	0	1	0	0	5	5	0	5	5
12:45 PM	0	0	0	0	0	0	2	0	0	2	1	0	1	0	2	0	1	0	0	1	0	0	5	5	0	5	5
Total	0	0	0	0	0	1	18	0	0	19	1	0	2	0	3	0	4	0	0	4	0	0	26	26	0	26	26
01:00 PM	0	0	0	0	0	0	2	0	0	2	0	0	0	0	0	0	0	0	0	0	0	0	2	2	0	2	2
01:15 PM	0	0	0	0	0	1	1	0	0	2	0	0	0	0	0	0	0	1	0	1	0	0	3	3	0	3	3
01:30 PM	0	0	0	0	0	0	3	0	0	3	0	0	0	0	0	0	0	0	0	0	0	0	3	3	0	3	3
01:45 PM	0	0	0	0	0	0	2	0	0	2	0	0	1	0	1	0	0	0	0	0	0	0	3	3	0	3	3
Total	0	0	0	0	0	1	8	0	0	9	0	0	1	0	1	0	0	1	0	1	0	0	11	11	0	11	11
Grand Total	0	0	0	0	0	8	32	0	0	40	1	0	7	0	8	0	8	1	0	9	0	0	57	57	0	57	57
Apprch %	0	0	0			20	80	0			12.5	0	87.5			0	88.9	11.1			0	0			0		
Total %	0	0	0			14	56.1	0		70.2	1.8	0	12.3		14	0	14	1.8		15.8	0	0	100		0	100	

Start Time	Innovation Drive Southbound				Cactus Avenue Westbound				Innovation Drive Northbound				Cactus Avenue Eastbound				Int. Total
	Left	Thru	Right	App. Total	Left	Thru	Right	App. Total	Left	Thru	Right	App. Total	Left	Thru	Right	App. Total	
Peak Hour Analysis From 01:00 PM to 01:45 PM - Peak 1 of 1																	
Peak Hour for Entire Intersection Begins at 01:00 PM																	
01:00 PM	0	0	0	0	0	2	0	2	0	0	0	0	0	0	0	0	2
01:15 PM	0	0	0	0	1	1	0	2	0	0	0	0	0	0	1	1	3
01:30 PM	0	0	0	0	0	3	0	3	0	0	0	0	0	0	0	0	3
01:45 PM	0	0	0	0	0	2	0	2	0	0	1	1	0	0	0	0	3
Total Volume	0	0	0	0	1	8	0	9	0	0	1	1	0	0	1	1	11
% App. Total	0	0	0		11.1	88.9	0		0	0	100		0	0	100		
PHF	.000	.000	.000	.000	.250	.667	.000	.750	.000	.000	.250	.250	.000	.000	.250	.250	.917

County of Riverside
 N/S: Innovation Drive
 E/W: Cactus Avenue
 Weather: Clear

File Name : 27_CRV_Inno_Cac Sat
 Site Code : 05122815
 Start Date : 9/17/2022
 Page No : 2

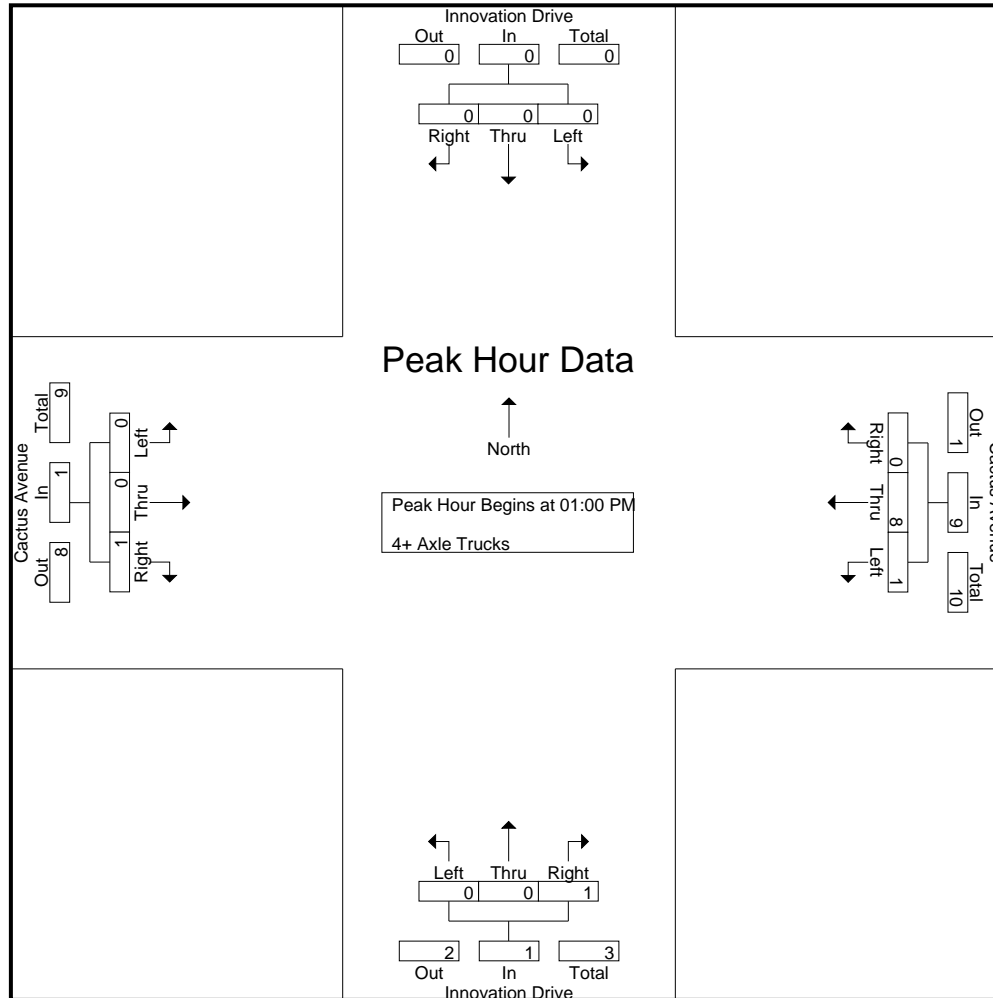

County of Riverside
 N/S: Innovation Drive
 E/W: Cactus Avenue
 Weather: Clear

File Name : 27_CRV_Inno_Cac Sat
 Site Code : 05122815
 Start Date : 9/17/2022
 Page No : 3

Start Time	Innovation Drive Southbound				Cactus Avenue Westbound				Innovation Drive Northbound				Cactus Avenue Eastbound				Int. Total
	Left	Thru	Right	App. Total	Left	Thru	Right	App. Total	Left	Thru	Right	App. Total	Left	Thru	Right	App. Total	
Peak Hour Analysis From 01:00 PM to 01:45 PM - Peak 1 of 1																	
Peak Hour for Each Approach Begins at:																	
	01:00 PM				01:00 PM				01:00 PM				01:00 PM				
+0 mins.	0	0	0	0	0	2	0	2	0	0	0	0	0	0	0	0	0
+15 mins.	0	0	0	0	1	1	0	2	0	0	0	0	0	0	1	0	1
+30 mins.	0	0	0	0	0	3	0	3	0	0	0	0	0	0	0	0	0
+45 mins.	0	0	0	0	0	2	0	2	0	0	1	1	0	0	0	0	0
Total Volume	0	0	0	0	1	8	0	9	0	0	1	1	0	0	1	1	1
% App. Total	0	0	0	0	11.1	88.9	0		0	0	100		0	0	100		
PHF	.000	.000	.000	.000	.250	.667	.000	.750	.000	.000	.250	.250	.000	.000	.250	.250	

Location: County of Riverside
 N/S: Innovation Drive
 E/W: Cactus Avenue



Date: 9/17/2022
 Day Saturday

PEDESTRIANS

Time	North Leg Innovation Drive	East Leg Cactus Avenue	South Leg Innovation Drive	West Leg Cactus Avenue	TOTAL
11:00 AM	0	0	0	0	0
11:15 AM	0	0	0	0	0
11:30 AM	0	0	0	0	0
11:45 AM	0	0	0	0	0
12:00 PM	0	0	0	0	0
12:15 PM	0	0	0	0	0
12:30 PM	0	0	0	0	0
12:45 PM	0	0	0	0	0
1:00 PM	0	0	0	0	0
1:15 PM	0	0	0	0	0
1:30 PM	0	0	0	0	0
1:45 PM	0	0	0	0	0
TOTAL VOLUMES:	0	0	0	0	0

Location: County of Riverside
 N/S: Innovation Drive
 E/W: Cactus Avenue

Date: 9/17/2022
 Day: Saturday



BICYCLES

	Southbound Innovation Drive			Westbound Cactus Avenue			Northbound Innovation Drive			Eastbound Cactus Avenue			
	Left	Thru	Right	Left	Thru	Right	Left	Thru	Right	Left	Thru	Right	
11:00 AM	0	0	0	0	0	0	0	0	0	0	0	0	0
11:15 AM	0	0	0	0	0	0	0	0	0	0	0	0	0
11:30 AM	0	0	0	0	0	0	0	0	0	0	1	0	1
11:45 AM	0	0	0	0	0	0	0	0	0	0	0	0	0
12:00 PM	0	0	0	0	0	0	0	0	0	0	0	0	0
12:15 PM	0	0	0	0	0	0	0	0	0	0	0	0	0
12:30 PM	0	0	0	0	0	0	0	0	0	0	0	0	0
12:45 PM	0	0	0	0	0	0	0	0	0	0	0	0	0
1:00 PM	0	0	0	0	0	0	0	0	0	0	0	0	0
1:15 PM	0	0	0	0	0	0	0	0	0	0	0	0	0
1:30 PM	0	0	0	0	0	0	0	0	0	0	0	0	0
1:45 PM	0	0	0	0	0	0	0	0	0	0	0	0	0
TOTAL VOLUMES:	0	0	0	0	0	0	0	0	0	0	1	0	1

City of Riverside
 N/S: I-215 Southbound Ramps
 E/W: Alessandro Boulevard
 Weather: Clear

File Name : 28_RIV_215S_Ales Sat
 Site Code : 05122815
 Start Date : 9/17/2022
 Page No : 1

Groups Printed- Passenger Vehicles - Large 2 Axle Vehicles - 3 Axle Vehicles - 4+ Axle Trucks

Start Time	I-215 Southbound Ramps Southbound					Alessandro Boulevard Westbound					I-215 Southbound On Ramp Northbound					Alessandro Boulevard Eastbound					Exclu. Total	Inclu. Total	Int. Total
	Left	Thru	Right	RTOR	App. Total	Left	Thru	Right	RTOR	App. Total	Left	Thru	Right	RTOR	App. Total	Left	Thru	Right	RTOR	App. Total			
11:00 AM	30	0	60	37	90	0	166	22	0	188	0	0	0	0	0	0	164	57	0	221	37	499	536
11:15 AM	20	0	57	40	77	0	201	34	0	235	0	0	0	0	0	0	152	55	0	207	40	519	559
11:30 AM	40	0	62	37	102	0	218	38	0	256	0	0	0	0	0	0	184	67	0	251	37	609	646
11:45 AM	35	0	65	40	100	0	228	22	0	250	0	0	0	0	0	0	182	71	0	253	40	603	643
Total	125	0	244	154	369	0	813	116	0	929	0	0	0	0	0	0	682	250	0	932	154	2230	2384
12:00 PM	34	0	51	25	85	0	196	21	0	217	0	0	0	0	0	0	187	73	0	260	25	562	587
12:15 PM	28	0	61	45	89	0	187	13	0	200	0	0	0	0	0	0	169	92	0	261	45	550	595
12:30 PM	43	0	48	34	91	0	200	41	0	241	0	0	0	0	0	0	208	83	0	291	34	623	657
12:45 PM	17	0	67	46	84	0	259	24	0	283	0	0	0	0	0	0	189	65	0	254	46	621	667
Total	122	0	227	150	349	0	842	99	0	941	0	0	0	0	0	0	753	313	0	1066	150	2356	2506
01:00 PM	26	0	58	35	84	0	256	23	0	279	0	0	0	0	0	0	182	74	0	256	35	619	654
01:15 PM	32	0	58	24	90	0	236	37	0	273	0	0	0	0	0	0	178	76	0	254	24	617	641
01:30 PM	29	0	78	45	107	0	234	19	0	253	0	0	0	0	0	0	216	82	0	298	45	658	703
01:45 PM	38	0	59	26	97	0	247	32	0	279	0	0	0	0	0	0	184	75	0	259	26	635	661
Total	125	0	253	130	378	0	973	111	0	1084	0	0	0	0	0	0	760	307	0	1067	130	2529	2659
Grand Total	372	0	724	434	1096	0	2628	326	0	2954	0	0	0	0	0	0	2195	870	0	3065	434	7115	7549
Apprch %	33.9	0	66.1			0	89	11			0	0	0			0	71.6	28.4					
Total %	5.2	0	10.2		15.4	0	36.9	4.6		41.5	0	0	0		0	0	30.9	12.2		43.1	5.7	94.3	
Passenger Vehicles	344	0	711		1486	0	2580	323		2903	0	0	0		0	0	2177	854		3031	0	0	7420
% Passenger Vehicles	92.5	0	98.2	99.3	97.1	0	98.2	99.1	0	98.3	0	0	0	0	0	0	99.2	98.2	0	98.9	0	0	98.3
Large 2 Axle Vehicles	10	0	5		18	0	31	3		34	0	0	0		0	0	8	10		18	0	0	70
% Large 2 Axle Vehicles	2.7	0	0.7	0.7	1.2	0	1.2	0.9	0	1.2	0	0	0	0	0	0	0.4	1.1	0	0.6	0	0	0.9
3 Axle Vehicles	2	0	0		2	0	7	0		7	0	0	0		0	0	5	2		7	0	0	16
% 3 Axle Vehicles	0.5	0	0	0	0.1	0	0.3	0	0	0.2	0	0	0	0	0	0	0.2	0.2	0	0.2	0	0	0.2
4+ Axle Trucks	16	0	8		24	0	10	0		10	0	0	0		0	0	5	4		9	0	0	43
% 4+ Axle Trucks	4.3	0	1.1	0	1.6	0	0.4	0	0	0.3	0	0	0	0	0	0	0.2	0.5	0	0.3	0	0	0.6

City of Riverside
 N/S: I-215 Southbound Ramps
 E/W: Alessandro Boulevard
 Weather: Clear

File Name : 28_RIV_215S_Ales Sat
 Site Code : 05122815
 Start Date : 9/17/2022
 Page No : 2

Start Time	I-215 Southbound Ramps Southbound				Alessandro Boulevard Westbound				I-215 Southbound On Ramp Northbound				Alessandro Boulevard Eastbound				Int. Total
	Left	Thru	Right	App. Total	Left	Thru	Right	App. Total	Left	Thru	Right	App. Total	Left	Thru	Right	App. Total	
Peak Hour Analysis From 11:00 AM to 01:45 PM - Peak 1 of 1																	
Peak Hour for Entire Intersection Begins at 01:00 PM																	
01:00 PM	26	0	58	84	0	256	23	279	0	0	0	0	0	182	74	256	619
01:15 PM	32	0	58	90	0	236	37	273	0	0	0	0	0	178	76	254	617
01:30 PM	29	0	78	107	0	234	19	253	0	0	0	0	0	216	82	298	658
01:45 PM	38	0	59	97	0	247	32	279	0	0	0	0	0	184	75	259	635
Total Volume	125	0	253	378	0	973	111	1084	0	0	0	0	0	760	307	1067	2529
% App. Total	33.1	0	66.9		0	89.8	10.2		0	0	0		0	71.2	28.8		
PHF	.822	.000	.811	.883	.000	.950	.750	.971	.000	.000	.000	.000	.000	.880	.936	.895	.961

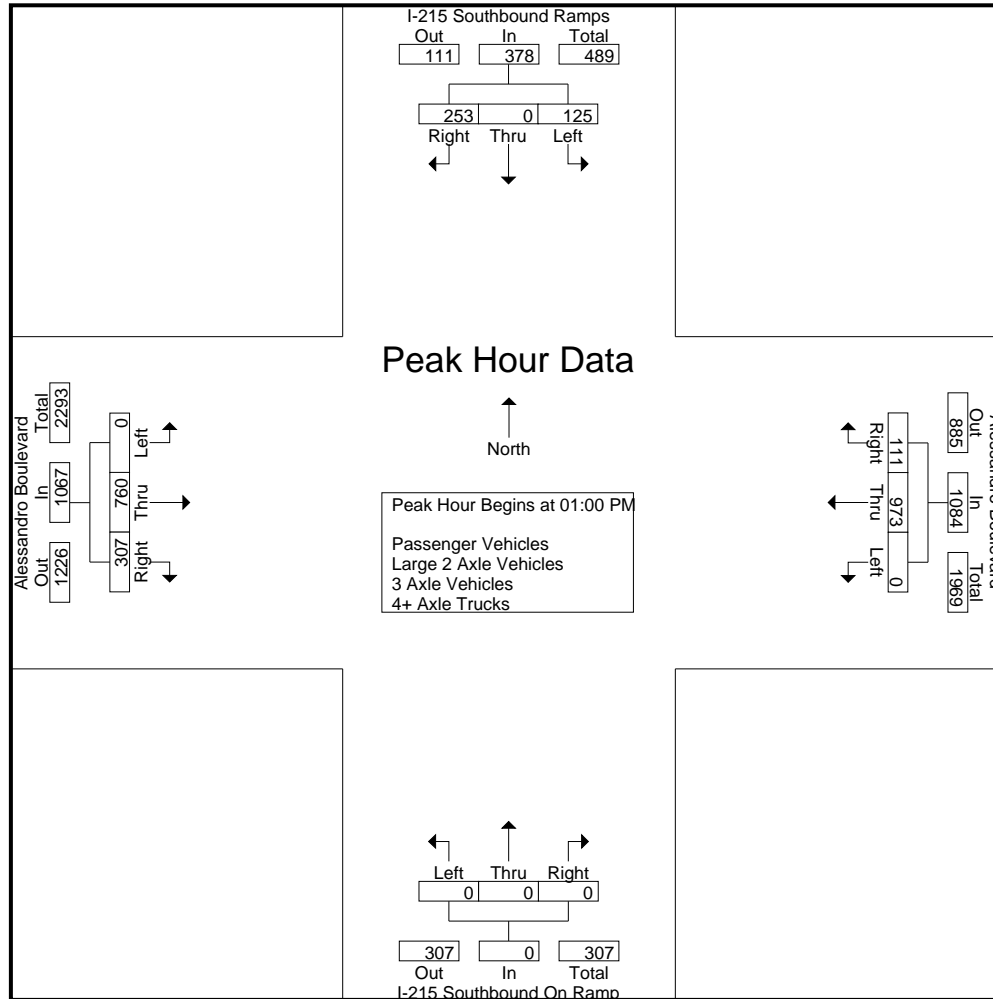

City of Riverside
 N/S: I-215 Southbound Ramps
 E/W: Alessandro Boulevard
 Weather: Clear

File Name : 28_RIV_215S_Ales Sat
 Site Code : 05122815
 Start Date : 9/17/2022
 Page No : 4

Start Time	I-215 Southbound Ramps Southbound				Alessandro Boulevard Westbound				I-215 Southbound On Ramp Northbound				Alessandro Boulevard Eastbound				Int. Total
	Left	Thru	Right	App. Total	Left	Thru	Right	App. Total	Left	Thru	Right	App. Total	Left	Thru	Right	App. Total	
Peak Hour Analysis From 11:00 AM to 01:45 PM - Peak 1 of 1																	
Peak Hour for Each Approach Begins at:																	
	01:00 PM				12:45 PM				11:00 AM				01:00 PM				
+0 mins.	26	0	58	84	0	259	24	283	0	0	0	0	0	182	74	256	
+15 mins.	32	0	58	90	0	256	23	279	0	0	0	0	0	178	76	254	
+30 mins.	29	0	78	107	0	236	37	273	0	0	0	0	0	216	82	298	
+45 mins.	38	0	59	97	0	234	19	253	0	0	0	0	0	184	75	259	
Total Volume	125	0	253	378	0	985	103	1088	0	0	0	0	0	760	307	1067	
% App. Total	33.1	0	66.9		0	90.5	9.5		0	0	0		0	71.2	28.8		
PHF	.822	.000	.811	.883	.000	.951	.696	.961	.000	.000	.000	.000	.000	.880	.936	.895	

City of Riverside
 N/S: I-215 Southbound Ramps
 E/W: Alessandro Boulevard
 Weather: Clear

File Name : 28_RIV_215S_Ales Sat
 Site Code : 05122815
 Start Date : 9/17/2022
 Page No : 1

Groups Printed- Passenger Vehicles

Start Time	I-215 Southbound Ramps Southbound					Alessandro Boulevard Westbound					I-215 Southbound On Ramp Northbound					Alessandro Boulevard Eastbound					Exclu. Total	Inclu. Total	Int. Total
	Left	Thru	Right	RTOR	App. Total	Left	Thru	Right	RTOR	App. Total	Left	Thru	Right	RTOR	App. Total	Left	Thru	Right	RTOR	App. Total			
11:00 AM	22	0	59	37	81	0	165	22	0	187	0	0	0	0	0	0	162	54	0	216	37	484	521
11:15 AM	18	0	56	40	74	0	198	34	0	232	0	0	0	0	0	0	151	55	0	206	40	512	552
11:30 AM	38	0	62	37	100	0	214	37	0	251	0	0	0	0	0	0	183	66	0	249	37	600	637
11:45 AM	35	0	62	39	97	0	221	22	0	243	0	0	0	0	0	0	181	68	0	249	39	589	628
Total	113	0	239	153	352	0	798	115	0	913	0	0	0	0	0	0	677	243	0	920	153	2185	2338
12:00 PM	33	0	49	25	82	0	193	21	0	214	0	0	0	0	0	0	187	72	0	259	25	555	580
12:15 PM	27	0	58	44	85	0	187	13	0	200	0	0	0	0	0	0	167	89	0	256	44	541	585
12:30 PM	39	0	48	34	87	0	197	40	0	237	0	0	0	0	0	0	207	81	0	288	34	612	646
12:45 PM	15	0	67	46	82	0	256	24	0	280	0	0	0	0	0	0	185	65	0	250	46	612	658
Total	114	0	222	149	336	0	833	98	0	931	0	0	0	0	0	0	746	307	0	1053	149	2320	2469
01:00 PM	25	0	57	35	82	0	248	23	0	271	0	0	0	0	0	0	181	74	0	255	35	608	643
01:15 PM	28	0	57	23	85	0	230	36	0	266	0	0	0	0	0	0	177	74	0	251	23	602	625
01:30 PM	29	0	78	45	107	0	228	19	0	247	0	0	0	0	0	0	214	81	0	295	45	649	694
01:45 PM	35	0	58	26	93	0	243	32	0	275	0	0	0	0	0	0	182	75	0	257	26	625	651
Total	117	0	250	129	367	0	949	110	0	1059	0	0	0	0	0	0	754	304	0	1058	129	2484	2613
Grand Total	344	0	711	431	1055	0	2580	323	0	2903	0	0	0	0	0	0	2177	854	0	3031	431	6989	7420
Apprch %	32.6	0	67.4			0	88.9	11.1			0	0	0				71.8	28.2					
Total %	4.9	0	10.2		15.1	0	36.9	4.6		41.5	0	0	0				31.1	12.2		43.4	5.8	94.2	

Start Time	I-215 Southbound Ramps Southbound				Alessandro Boulevard Westbound				I-215 Southbound On Ramp Northbound				Alessandro Boulevard Eastbound				Int. Total
	Left	Thru	Right	App. Total	Left	Thru	Right	App. Total	Left	Thru	Right	App. Total	Left	Thru	Right	App. Total	
Peak Hour Analysis From 01:00 PM to 01:45 PM - Peak 1 of 1																	
Peak Hour for Entire Intersection Begins at 01:00 PM																	
01:00 PM	25	0	57	82	0	248	23	271	0	0	0	0	0	181	74	255	608
01:15 PM	28	0	57	85	0	230	36	266	0	0	0	0	0	177	74	251	602
01:30 PM	29	0	78	107	0	228	19	247	0	0	0	0	0	214	81	295	649
01:45 PM	35	0	58	93	0	243	32	275	0	0	0	0	0	182	75	257	625
Total Volume	117	0	250	367	0	949	110	1059	0	0	0	0	0	754	304	1058	2484
% App. Total	31.9	0	68.1		0	89.6	10.4		0	0	0		0	71.3	28.7		
PHF	.836	.000	.801	.857	.000	.957	.764	.963	.000	.000	.000	.000	.000	.881	.938	.897	.957

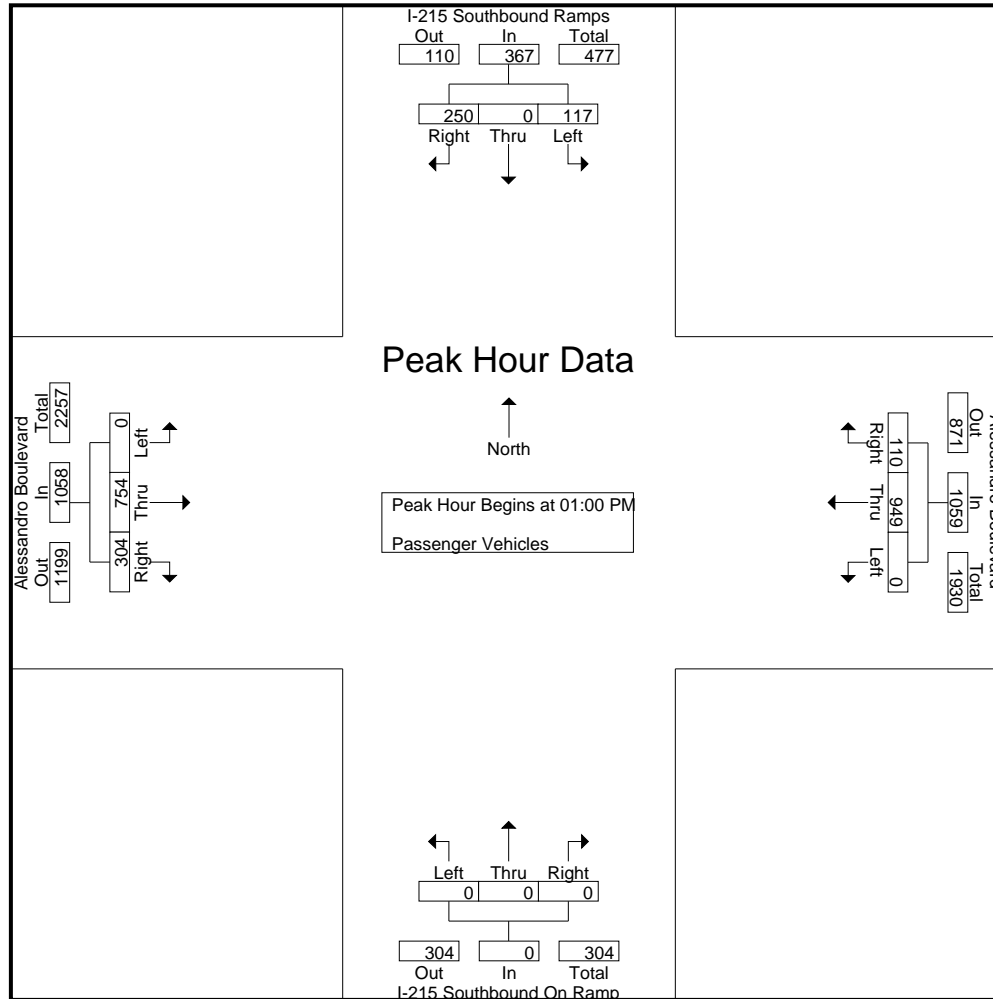

City of Riverside
 N/S: I-215 Southbound Ramps
 E/W: Alessandro Boulevard
 Weather: Clear

File Name : 28_RIV_215S_Ales Sat
 Site Code : 05122815
 Start Date : 9/17/2022
 Page No : 3

Start Time	I-215 Southbound Ramps Southbound				Alessandro Boulevard Westbound				I-215 Southbound On Ramp Northbound				Alessandro Boulevard Eastbound				Int. Total
	Left	Thru	Right	App. Total	Left	Thru	Right	App. Total	Left	Thru	Right	App. Total	Left	Thru	Right	App. Total	
Peak Hour Analysis From 01:00 PM to 01:45 PM - Peak 1 of 1																	
Peak Hour for Each Approach Begins at:																	
	01:00 PM				01:00 PM				01:00 PM				01:00 PM				
+0 mins.	25	0	57	82	0	248	23	271	0	0	0	0	0	181	74	255	
+15 mins.	28	0	57	85	0	230	36	266	0	0	0	0	0	177	74	251	
+30 mins.	29	0	78	107	0	228	19	247	0	0	0	0	0	214	81	295	
+45 mins.	35	0	58	93	0	243	32	275	0	0	0	0	0	182	75	257	
Total Volume	117	0	250	367	0	949	110	1059	0	0	0	0	0	754	304	1058	
% App. Total	31.9	0	68.1		0	89.6	10.4		0	0	0		0	71.3	28.7		
PHF	.836	.000	.801	.857	.000	.957	.764	.963	.000	.000	.000	.000	.000	.881	.938	.897	

City of Riverside
 N/S: I-215 Southbound Ramps
 E/W: Alessandro Boulevard
 Weather: Clear

File Name : 28_RIV_215S_Ales Sat
 Site Code : 05122815
 Start Date : 9/17/2022
 Page No : 1

Groups Printed- Large 2 Axle Vehicles

Start Time	I-215 Southbound Ramps Southbound					Alessandro Boulevard Westbound					I-215 Southbound On Ramp Northbound					Alessandro Boulevard Eastbound					Exclu. Total	Inclu. Total	Int. Total
	Left	Thru	Right	RTOR	App. Total	Left	Thru	Right	RTOR	App. Total	Left	Thru	Right	RTOR	App. Total	Left	Thru	Right	RTOR	App. Total			
11:00 AM	2	0	1	0	3	0	1	0	0	1	0	0	0	0	0	0	1	2	0	3	0	7	7
11:15 AM	0	0	0	0	0	0	2	0	0	2	0	0	0	0	0	0	1	0	0	1	0	3	3
11:30 AM	2	0	0	0	2	0	2	1	0	3	0	0	0	0	0	0	1	1	0	2	0	7	7
11:45 AM	0	0	1	1	1	0	6	0	0	6	0	0	0	0	0	0	1	2	0	3	1	10	11
Total	4	0	2	1	6	0	11	1	0	12	0	0	0	0	0	0	4	5	0	9	1	27	28
12:00 PM	1	0	0	0	1	0	2	0	0	2	0	0	0	0	0	0	0	1	0	1	0	4	4
12:15 PM	1	0	2	1	3	0	0	0	0	0	0	0	0	0	0	0	1	1	0	2	1	5	6
12:30 PM	2	0	0	0	2	0	2	1	0	3	0	0	0	0	0	0	0	1	0	1	0	6	6
12:45 PM	1	0	0	0	1	0	2	0	0	2	0	0	0	0	0	0	3	0	0	3	0	6	6
Total	5	0	2	1	7	0	6	1	0	7	0	0	0	0	0	0	4	3	0	7	1	21	22
01:00 PM	0	0	0	0	0	0	4	0	0	4	0	0	0	0	0	0	0	0	0	0	0	4	4
01:15 PM	1	0	1	1	2	0	4	1	0	5	0	0	0	0	0	0	0	2	0	2	1	9	10
01:30 PM	0	0	0	0	0	0	4	0	0	4	0	0	0	0	0	0	0	0	0	0	0	4	4
01:45 PM	0	0	0	0	0	0	2	0	0	2	0	0	0	0	0	0	0	0	0	0	0	2	2
Total	1	0	1	1	2	0	14	1	0	15	0	0	0	0	0	0	0	2	0	2	1	19	20
Grand Total	10	0	5	3	15	0	31	3	0	34	0	0	0	0	0	0	8	10	0	18	3	67	70
Apprch %	66.7	0	33.3			0	91.2	8.8			0	0	0			0	44.4	55.6					
Total %	14.9	0	7.5		22.4	0	46.3	4.5		50.7	0	0	0		0	0	11.9	14.9		26.9	4.3	95.7	

Start Time	I-215 Southbound Ramps Southbound				Alessandro Boulevard Westbound				I-215 Southbound On Ramp Northbound				Alessandro Boulevard Eastbound				Int. Total
	Left	Thru	Right	App. Total	Left	Thru	Right	App. Total	Left	Thru	Right	App. Total	Left	Thru	Right	App. Total	
Peak Hour Analysis From 01:00 PM to 01:45 PM - Peak 1 of 1																	
Peak Hour for Entire Intersection Begins at 01:00 PM																	
01:00 PM	0	0	0	0	0	4	0	4	0	0	0	0	0	0	0	0	4
01:15 PM	1	0	1	2	0	4	1	5	0	0	0	0	0	0	2	2	9
01:30 PM	0	0	0	0	0	4	0	4	0	0	0	0	0	0	0	0	4
01:45 PM	0	0	0	0	0	2	0	2	0	0	0	0	0	0	0	0	2
Total Volume	1	0	1	2	0	14	1	15	0	0	0	0	0	0	2	2	19
% App. Total	50	0	50		0	93.3	6.7		0	0	0		0	0	100		
PHF	.250	.000	.250	.250	.000	.875	.250	.750	.000	.000	.000	.000	.000	.000	.250	.250	.528

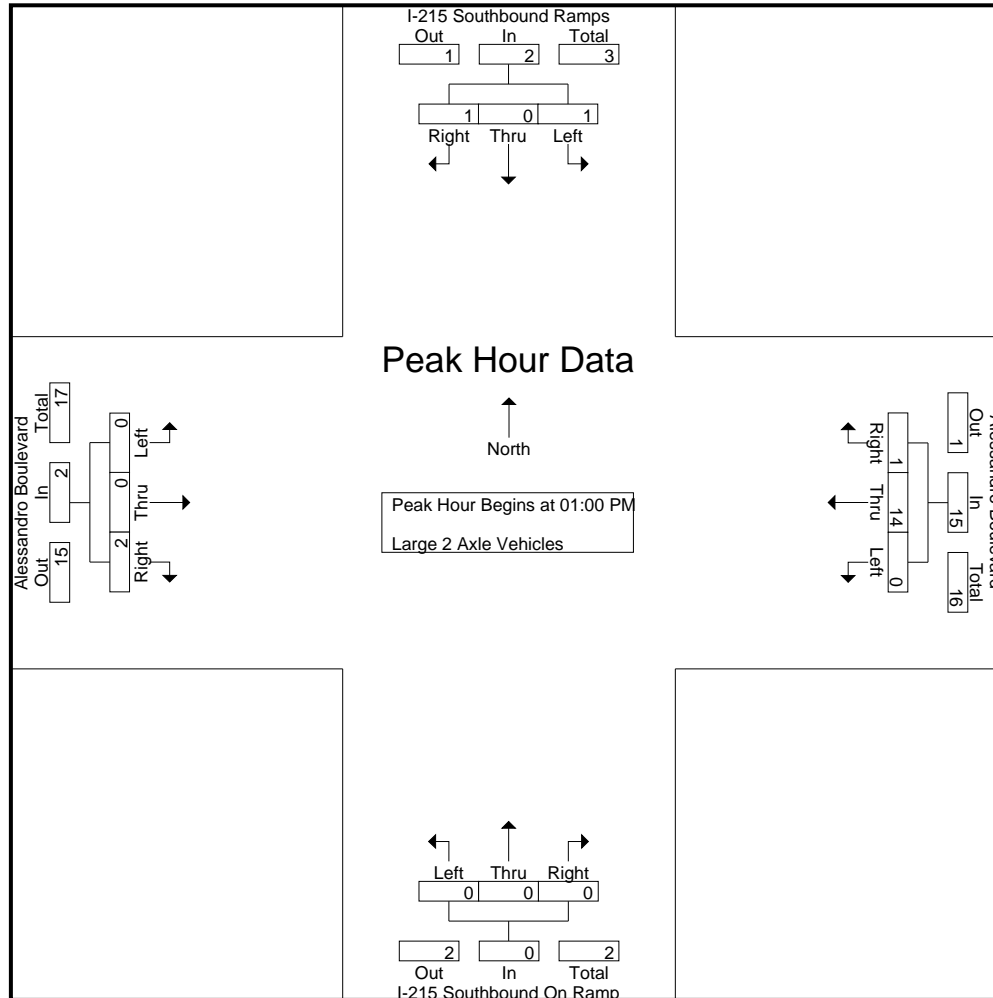

City of Riverside
 N/S: I-215 Southbound Ramps
 E/W: Alessandro Boulevard
 Weather: Clear

File Name : 28_RIV_215S_Ales Sat
 Site Code : 05122815
 Start Date : 9/17/2022
 Page No : 3

Start Time	I-215 Southbound Ramps Southbound				Alessandro Boulevard Westbound				I-215 Southbound On Ramp Northbound				Alessandro Boulevard Eastbound				Int. Total
	Left	Thru	Right	App. Total	Left	Thru	Right	App. Total	Left	Thru	Right	App. Total	Left	Thru	Right	App. Total	
Peak Hour Analysis From 01:00 PM to 01:45 PM - Peak 1 of 1																	
Peak Hour for Each Approach Begins at:																	
	01:00 PM				01:00 PM				01:00 PM				01:00 PM				
+0 mins.	0	0	0	0	0	4	0	4	0	0	0	0	0	0	0	0	
+15 mins.	1	0	1	2	0	4	1	5	0	0	0	0	0	0	2	2	
+30 mins.	0	0	0	0	0	4	0	4	0	0	0	0	0	0	0	0	
+45 mins.	0	0	0	0	0	2	0	2	0	0	0	0	0	0	0	0	
Total Volume	1	0	1	2	0	14	1	15	0	0	0	0	0	0	2	2	
% App. Total	50	0	50		0	93.3	6.7		0	0	0		0	0	100		
PHF	.250	.000	.250	.250	.000	.875	.250	.750	.000	.000	.000	.000	.000	.000	.250	.250	

City of Riverside
 N/S: I-215 Southbound Ramps
 E/W: Alessandro Boulevard
 Weather: Clear

File Name : 28_RIV_215S_Ales Sat
 Site Code : 05122815
 Start Date : 9/17/2022
 Page No : 1

Groups Printed- 3 Axle Vehicles

Start Time	I-215 Southbound Ramps Southbound					Alessandro Boulevard Westbound					I-215 Southbound On Ramp Northbound					Alessandro Boulevard Eastbound					Exclu. Total	Inclu. Total	Int. Total			
	Left	Thru	Right	RTOR	App. Total	Left	Thru	Right	RTOR	App. Total	Left	Thru	Right	RTOR	App. Total	Left	Thru	Right	RTOR	App. Total						
11:00 AM	0	0	0	0	0	0	0	0	0	0	0	0	0	0	0	0	0	0	0	0	0	0	0	0	0	0
11:15 AM	0	0	0	0	0	0	0	0	0	0	0	0	0	0	0	0	0	0	0	0	0	0	0	0	0	0
11:30 AM	0	0	0	0	0	0	1	0	0	1	0	0	0	0	0	0	0	0	0	0	0	0	0	0	1	1
11:45 AM	0	0	0	0	0	0	0	0	0	0	0	0	0	0	0	0	0	0	0	0	0	0	0	0	0	0
Total	0	0	0	0	0	0	1	0	0	1	0	0	0	0	0	0	0	0	0	0	0	0	0	0	1	1
12:00 PM	0	0	0	0	0	0	0	0	0	0	0	0	0	0	0	0	0	0	0	0	0	0	0	0	0	0
12:15 PM	0	0	0	0	0	0	0	0	0	0	0	0	0	0	0	0	1	0	0	1	0	0	1	0	1	1
12:30 PM	1	0	0	0	1	0	1	0	0	1	0	0	0	0	0	0	0	1	0	1	0	0	3	0	3	3
12:45 PM	0	0	0	0	0	0	0	0	0	0	0	0	0	0	0	0	0	0	0	0	0	0	0	0	0	0
Total	1	0	0	0	1	0	1	0	0	1	0	0	0	0	0	0	1	1	0	2	0	0	4	0	4	4
01:00 PM	1	0	0	0	1	0	2	0	0	2	0	0	0	0	0	0	0	0	0	0	0	0	3	0	3	3
01:15 PM	0	0	0	0	0	0	1	0	0	1	0	0	0	0	0	0	1	0	0	1	0	0	2	0	2	2
01:30 PM	0	0	0	0	0	0	2	0	0	2	0	0	0	0	0	0	2	1	0	3	0	0	5	0	5	5
01:45 PM	0	0	0	0	0	0	0	0	0	0	0	0	0	0	0	0	1	0	0	1	0	0	1	0	1	1
Total	1	0	0	0	1	0	5	0	0	5	0	0	0	0	0	0	4	1	0	5	0	0	11	0	11	11
Grand Total	2	0	0	0	2	0	7	0	0	7	0	0	0	0	0	0	5	2	0	7	0	0	16	0	16	16
Apprch %	100	0	0			0	100	0			0	0	0			0	71.4	28.6								
Total %	12.5	0	0		12.5	0	43.8	0		43.8	0	0	0		0	0	31.2	12.5		43.8	0	0	100			

Start Time	I-215 Southbound Ramps Southbound				Alessandro Boulevard Westbound				I-215 Southbound On Ramp Northbound				Alessandro Boulevard Eastbound				Int. Total
	Left	Thru	Right	App. Total	Left	Thru	Right	App. Total	Left	Thru	Right	App. Total	Left	Thru	Right	App. Total	
Peak Hour Analysis From 01:00 PM to 01:45 PM - Peak 1 of 1																	
Peak Hour for Entire Intersection Begins at 01:00 PM																	
01:00 PM	1	0	0	1	0	2	0	2	0	0	0	0	0	0	0	0	3
01:15 PM	0	0	0	0	0	1	0	1	0	0	0	0	0	1	0	1	2
01:30 PM	0	0	0	0	0	2	0	2	0	0	0	0	0	2	1	3	5
01:45 PM	0	0	0	0	0	0	0	0	0	0	0	0	0	1	0	1	1
Total Volume	1	0	0	1	0	5	0	5	0	0	0	0	0	4	1	5	11
% App. Total	100	0	0		0	100	0		0	0	0		0	80	20		
PHF	.250	.000	.000	.250	.000	.625	.000	.625	.000	.000	.000	.000	.000	.500	.250	.417	.550

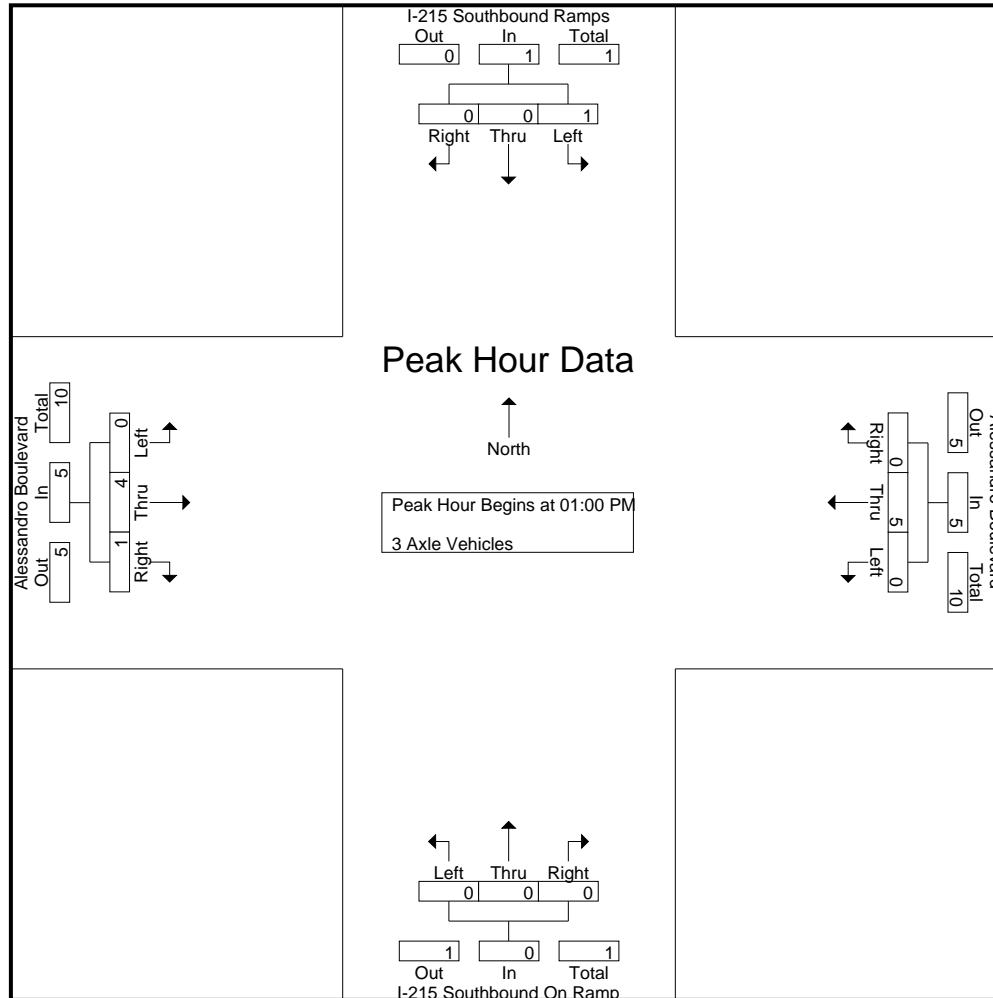

City of Riverside
 N/S: I-215 Southbound Ramps
 E/W: Alessandro Boulevard
 Weather: Clear

File Name : 28_RIV_215S_Ales Sat
 Site Code : 05122815
 Start Date : 9/17/2022
 Page No : 3

Start Time	I-215 Southbound Ramps Southbound				Alessandro Boulevard Westbound				I-215 Southbound On Ramp Northbound				Alessandro Boulevard Eastbound				Int. Total
	Left	Thru	Right	App. Total	Left	Thru	Right	App. Total	Left	Thru	Right	App. Total	Left	Thru	Right	App. Total	
Peak Hour Analysis From 01:00 PM to 01:45 PM - Peak 1 of 1																	
Peak Hour for Each Approach Begins at:																	
	01:00 PM				01:00 PM				01:00 PM				01:00 PM				
+0 mins.	1	0	0	1	0	2	0	2	0	0	0	0	0	0	0	0	0
+15 mins.	0	0	0	0	0	1	0	1	0	0	0	0	0	1	0	1	1
+30 mins.	0	0	0	0	0	2	0	2	0	0	0	0	0	2	1	3	3
+45 mins.	0	0	0	0	0	0	0	0	0	0	0	0	0	1	0	1	1
Total Volume	1	0	0	1	0	5	0	5	0	0	0	0	0	4	1	5	5
% App. Total	100	0	0		0	100	0		0	0	0		0	80	20		
PHF	.250	.000	.000	.250	.000	.625	.000	.625	.000	.000	.000	.000	.000	.500	.250	.417	

City of Riverside
 N/S: I-215 Southbound Ramps
 E/W: Alessandro Boulevard
 Weather: Clear

File Name : 28_RIV_215S_Ales Sat
 Site Code : 05122815
 Start Date : 9/17/2022
 Page No : 1

Groups Printed- 4+ Axle Trucks

Start Time	I-215 Southbound Ramps Southbound					Alessandro Boulevard Westbound					I-215 Southbound On Ramp Northbound					Alessandro Boulevard Eastbound					Exclu. Total	Inclu. Total	Int. Total	
	Left	Thru	Right	RTOR	App. Total	Left	Thru	Right	RTOR	App. Total	Left	Thru	Right	RTOR	App. Total	Left	Thru	Right	RTOR	App. Total				
11:00 AM	6	0	0	0	6	0	0	0	0	0	0	0	0	0	0	0	1	1	0	2	0	0	8	8
11:15 AM	2	0	1	0	3	0	1	0	0	1	0	0	0	0	0	0	0	0	0	0	0	0	4	4
11:30 AM	0	0	0	0	0	0	1	0	0	1	0	0	0	0	0	0	0	0	0	0	0	0	1	1
11:45 AM	0	0	2	0	2	0	1	0	0	1	0	0	0	0	0	0	0	1	0	1	0	0	4	4
Total	8	0	3	0	11	0	3	0	0	3	0	0	0	0	0	0	1	2	0	3	0	0	17	17
12:00 PM	0	0	2	0	2	0	1	0	0	1	0	0	0	0	0	0	0	0	0	0	0	0	3	3
12:15 PM	0	0	1	0	1	0	0	0	0	0	0	0	0	0	0	0	0	2	0	2	0	0	3	3
12:30 PM	1	0	0	0	1	0	0	0	0	0	0	0	0	0	0	0	1	0	0	1	0	0	2	2
12:45 PM	1	0	0	0	1	0	1	0	0	1	0	0	0	0	0	0	1	0	0	1	0	0	3	3
Total	2	0	3	0	5	0	2	0	0	2	0	0	0	0	0	0	2	2	0	4	0	0	11	11
01:00 PM	0	0	1	0	1	0	2	0	0	2	0	0	0	0	0	0	1	0	0	1	0	0	4	4
01:15 PM	3	0	0	0	3	0	1	0	0	1	0	0	0	0	0	0	0	0	0	0	0	0	4	4
01:30 PM	0	0	0	0	0	0	0	0	0	0	0	0	0	0	0	0	0	0	0	0	0	0	0	0
01:45 PM	3	0	1	0	4	0	2	0	0	2	0	0	0	0	0	0	1	0	0	1	0	0	7	7
Total	6	0	2	0	8	0	5	0	0	5	0	0	0	0	0	0	2	0	0	2	0	0	15	15
Grand Total	16	0	8	0	24	0	10	0	0	10	0	0	0	0	0	0	5	4	0	9	0	0	43	43
Apprch %	66.7	0	33.3			0	100	0			0	0	0			0	55.6	44.4			0	0		
Total %	37.2	0	18.6		55.8	0	23.3	0		23.3	0	0	0		0	0	11.6	9.3		20.9	0	0	100	

Start Time	I-215 Southbound Ramps Southbound				Alessandro Boulevard Westbound				I-215 Southbound On Ramp Northbound				Alessandro Boulevard Eastbound				Int. Total
	Left	Thru	Right	App. Total	Left	Thru	Right	App. Total	Left	Thru	Right	App. Total	Left	Thru	Right	App. Total	
Peak Hour Analysis From 01:00 PM to 01:45 PM - Peak 1 of 1																	
Peak Hour for Entire Intersection Begins at 01:00 PM																	
01:00 PM	0	0	1	1	0	2	0	2	0	0	0	0	0	1	0	1	4
01:15 PM	3	0	0	3	0	1	0	1	0	0	0	0	0	0	0	0	4
01:30 PM	0	0	0	0	0	0	0	0	0	0	0	0	0	0	0	0	0
01:45 PM	3	0	1	4	0	2	0	2	0	0	0	0	0	1	0	1	7
Total Volume	6	0	2	8	0	5	0	5	0	0	0	0	0	2	0	2	15
% App. Total	75	0	25		0	100	0		0	0	0		0	100	0		
PHF	.500	.000	.500	.500	.000	.625	.000	.625	.000	.000	.000	.000	.000	.500	.000	.500	.536

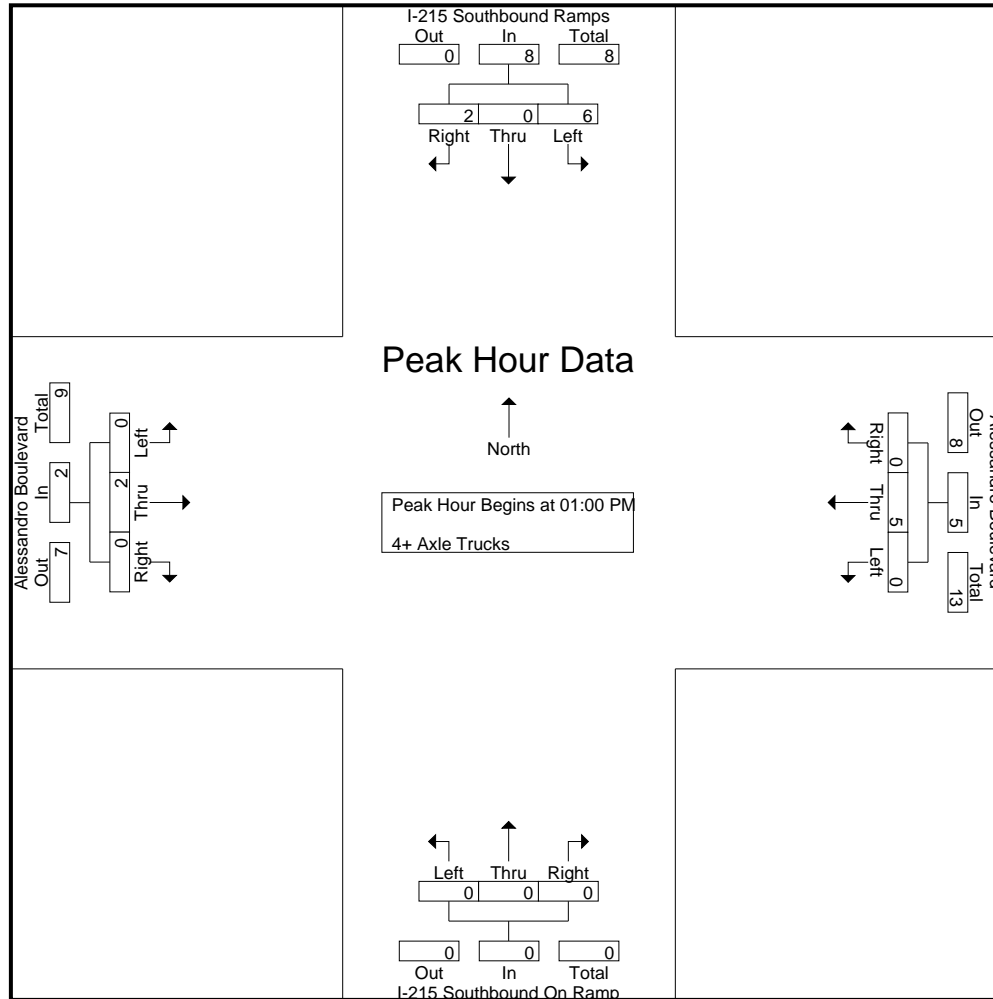

City of Riverside
 N/S: I-215 Southbound Ramps
 E/W: Alessandro Boulevard
 Weather: Clear

File Name : 28_RIV_215S_Ales Sat
 Site Code : 05122815
 Start Date : 9/17/2022
 Page No : 3

Start Time	I-215 Southbound Ramps Southbound				Alessandro Boulevard Westbound				I-215 Southbound On Ramp Northbound				Alessandro Boulevard Eastbound				Int. Total
	Left	Thru	Right	App. Total	Left	Thru	Right	App. Total	Left	Thru	Right	App. Total	Left	Thru	Right	App. Total	
Peak Hour Analysis From 01:00 PM to 01:45 PM - Peak 1 of 1																	
Peak Hour for Each Approach Begins at:																	
	01:00 PM				01:00 PM				01:00 PM				01:00 PM				
+0 mins.	0	0	1	1	0	2	0	2	0	0	0	0	0	1	0	1	
+15 mins.	3	0	0	3	0	1	0	1	0	0	0	0	0	0	0	0	
+30 mins.	0	0	0	0	0	0	0	0	0	0	0	0	0	0	0	0	
+45 mins.	3	0	1	4	0	2	0	2	0	0	0	0	0	1	0	1	
Total Volume	6	0	2	8	0	5	0	5	0	0	0	0	0	2	0	2	
% App. Total	75	0	25		0	100	0		0	0	0		0	100	0		
PHF	.500	.000	.500	.500	.000	.625	.000	.625	.000	.000	.000	.000	.000	.500	.000	.500	

Location: Riverside
 N/S: I-215 SB Ramps
 E/W: Alessandro Boulevard



Date: 9/17/2022
 Day Saturday

PEDESTRIANS

Time	North Leg I-215 SB Ramps	East Leg Alessandro Boulevard	South Leg I-215 SB Ramps	West Leg Alessandro Boulevard	TOTAL
11:00 AM	1	0	0	0	1
11:15 AM	0	0	0	0	0
11:30 AM	1	0	0	0	1
11:45 AM	1	0	0	0	1
12:00 PM	0	0	0	0	0
12:15 PM	4	0	0	0	4
12:30 PM	0	0	0	0	0
12:45 PM	1	0	0	0	1
1:00 PM	0	0	0	0	0
1:15 PM	0	0	0	0	0
1:30 PM	0	0	0	0	0
1:45 PM	0	0	0	0	0
TOTAL VOLUMES:	8	0	0	0	8

Location: Riverside
 N/S: I-215 SB Ramps
 E/W: Alessandro Boulevard

Date: 9/17/2022
 Day: Saturday



BICYCLES

	Southbound I-215 SB Ramps			Westbound Alessandro Boulevard			Northbound I-215 SB Ramps			Eastbound Alessandro Boulevard			
	Left	Thru	Right	Left	Thru	Right	Left	Thru	Right	Left	Thru	Right	
11:00 AM	0	0	0	0	0	0	0	0	0	0	0	0	0
11:15 AM	0	0	0	0	0	0	0	0	0	0	0	0	0
11:30 AM	0	0	0	0	0	0	0	0	0	0	0	0	0
11:45 AM	0	0	0	0	0	0	0	0	0	0	0	0	0
12:00 PM	0	0	0	0	0	0	0	0	0	0	1	0	1
12:15 PM	0	0	0	0	1	0	0	0	0	0	0	0	1
12:30 PM	0	0	0	0	0	0	0	0	0	0	0	0	0
12:45 PM	0	0	0	0	1	0	0	0	0	0	0	0	1
1:00 PM	0	0	0	0	0	0	0	0	0	0	0	0	0
1:15 PM	0	0	0	0	0	0	0	0	0	0	0	0	0
1:30 PM	0	0	0	0	0	0	0	0	0	0	0	0	0
1:45 PM	0	0	0	0	0	0	0	0	0	0	0	0	0
TOTAL VOLUMES:	0	0	0	0	2	0	0	0	0	0	1	0	3

City of Riverside
 N/S: I-215 Northbound Ramps
 E/W: Alessandro Boulevard
 Weather: Clear

File Name : 29_RIV_215N_Ales Sat
 Site Code : 05122815
 Start Date : 9/17/2022
 Page No : 1

Groups Printed- Passenger Vehicles - Large 2 Axle Vehicles - 3 Axle Vehicles - 4+ Axle Trucks

Start Time	I-215 Northbound On Ramp Southbound					Alessandro Boulevard Westbound					I-215 Northbound Off Ramp Northbound					Alessandro Boulevard Eastbound					Exclu. Total	Inclu. Total	Int. Total
	Left	Thru	Right	RTOR	App. Total	Left	Thru	Right	RTOR	App. Total	Left	Thru	Right	RTOR	App. Total	Left	Thru	Right	RTOR	App. Total			
11:00 AM	45	0	33	17	78	33	174	0	0	207	0	0	0	0	0	0	147	47	5	194	22	479	501
11:15 AM	117	3	85	37	205	25	157	0	0	182	0	0	0	0	0	0	145	46	11	191	48	578	626
11:30 AM	114	4	81	35	199	35	188	0	0	223	0	0	0	0	0	0	164	48	11	212	46	634	680
11:45 AM	85	1	48	27	134	39	181	0	0	220	0	0	0	0	0	0	167	48	7	215	34	569	603
Total	361	8	247	116	616	132	700	0	0	832	0	0	0	0	0	0	623	189	34	812	150	2260	2410
12:00 PM	65	2	34	21	101	36	178	0	0	214	0	0	0	0	0	0	169	50	10	219	31	534	565
12:15 PM	74	1	38	23	113	41	162	0	0	203	0	0	0	0	0	0	164	38	4	202	27	518	545
12:30 PM	79	1	44	19	124	44	205	0	0	249	0	0	0	0	0	0	193	47	6	240	25	613	638
12:45 PM	126	4	65	27	195	30	208	0	0	238	0	0	0	0	0	0	172	47	10	219	37	652	689
Total	344	8	181	90	533	151	753	0	0	904	0	0	0	0	0	0	698	182	30	880	120	2317	2437
01:00 PM	117	3	86	33	206	29	196	0	0	225	0	0	0	0	0	0	181	36	5	217	38	648	686
01:15 PM	95	2	43	21	140	33	218	0	0	251	0	0	0	0	0	0	168	45	6	213	27	604	631
01:30 PM	89	0	28	16	117	45	220	0	0	265	0	0	0	0	0	0	202	39	3	241	19	623	642
01:45 PM	101	2	61	24	164	27	218	0	0	245	0	0	0	0	0	0	196	34	5	230	29	639	668
Total	402	7	218	94	627	134	852	0	0	986	0	0	0	0	0	0	747	154	19	901	113	2514	2627
Grand Total	1107	23	646	300	1776	417	2305	0	0	2722	0	0	0	0	0	0	2068	525	83	2593	383	7091	7474
Apprch %	62.3	1.3	36.4			15.3	84.7	0			0	0	0				79.8	20.2					
Total %	15.6	0.3	9.1		25	5.9	32.5	0		38.4	0	0	0				29.2	7.4		36.6	5.1	94.9	
Passenger Vehicles	1074	23	641		2038	398	2266	0		2664	0	0	0				2037	491		2610	0	0	7312
% Passenger Vehicles	97	100	99.2	100	98.2	95.4	98.3	0	0	97.9	0	0	0	0	0	0	98.5	93.5	98.8	97.5	0	0	97.8
Large 2 Axle Vehicles	20	0	0		20	10	20	0		30	0	0	0				25	10		35	0	0	85
% Large 2 Axle Vehicles	1.8	0	0	0	1	2.4	0.9	0	0	1.1	0	0	0	0	0	0	1.2	1.9	0	1.3	0	0	1.1
3 Axle Vehicles	4	0	2		6	3	4	0		7	0	0	0				4	12		16	0	0	29
% 3 Axle Vehicles	0.4	0	0.3	0	0.3	0.7	0.2	0	0	0.3	0	0	0	0	0	0	0.2	2.3	0	0.6	0	0	0.4
4+ Axle Trucks	9	0	3		12	6	15	0		21	0	0	0				2	12		15	0	0	48
% 4+ Axle Trucks	0.8	0	0.5	0	0.6	1.4	0.7	0	0	0.8	0	0	0	0	0	0	0.1	2.3	1.2	0.6	0	0	0.6

City of Riverside
 N/S: I-215 Northbound Ramps
 E/W: Alessandro Boulevard
 Weather: Clear

File Name : 29_RIV_215N_Ales Sat
 Site Code : 05122815
 Start Date : 9/17/2022
 Page No : 2

Start Time	I-215 Northbound On Ramp Southbound				Alessandro Boulevard Westbound				I-215 Northbound Off Ramp Northbound				Alessandro Boulevard Eastbound				Int. Total
	Left	Thru	Right	App. Total	Left	Thru	Right	App. Total	Left	Thru	Right	App. Total	Left	Thru	Right	App. Total	
Peak Hour Analysis From 11:00 AM to 01:45 PM - Peak 1 of 1																	
Peak Hour for Entire Intersection Begins at 12:45 PM																	
12:45 PM	126	4	65	195	30	208	0	238	0	0	0	0	0	172	47	219	652
01:00 PM	117	3	86	206	29	196	0	225	0	0	0	0	0	181	36	217	648
01:15 PM	95	2	43	140	33	218	0	251	0	0	0	0	0	168	45	213	604
01:30 PM	89	0	28	117	45	220	0	265	0	0	0	0	0	202	39	241	623
Total Volume	427	9	222	658	137	842	0	979	0	0	0	0	0	723	167	890	2527
% App. Total	64.9	1.4	33.7		14	86	0		0	0	0		0	81.2	18.8		
PHF	.847	.563	.645	.799	.761	.957	.000	.924	.000	.000	.000	.000	.000	.895	.888	.923	.969

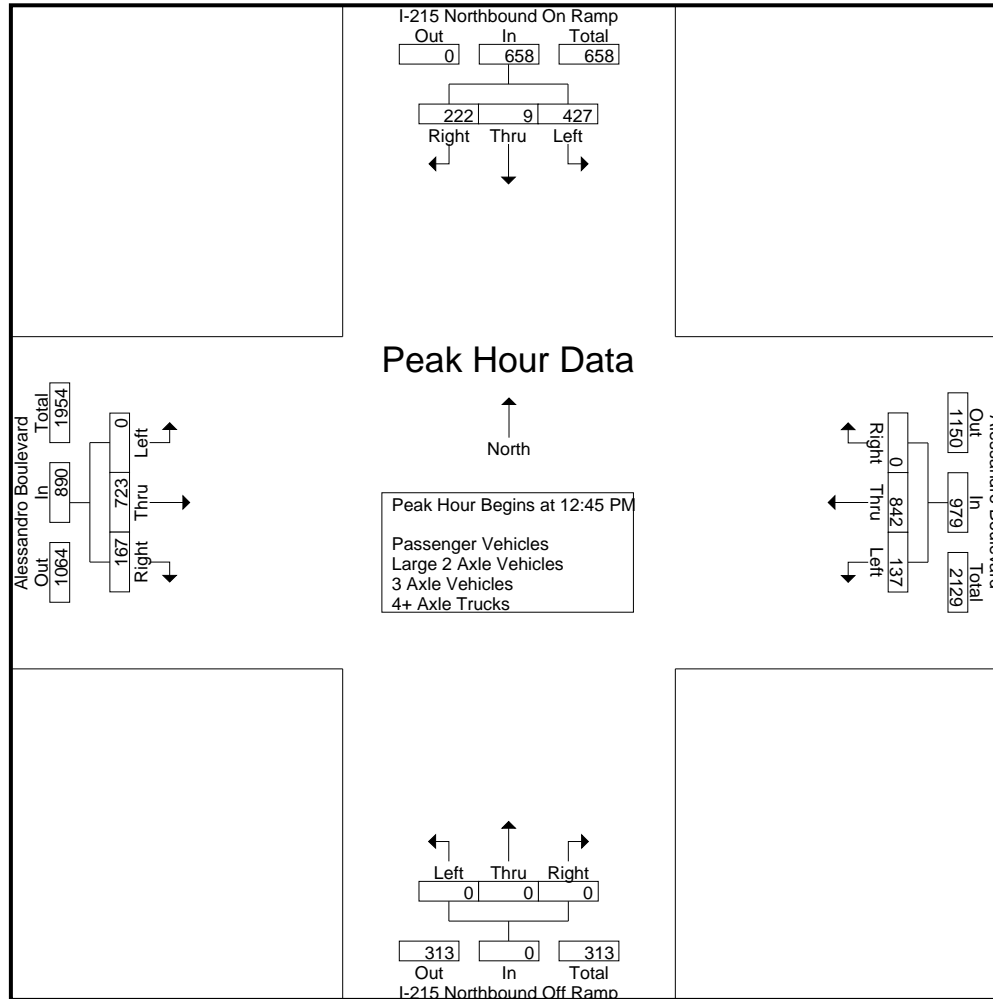

City of Riverside
 N/S: I-215 Northbound Ramps
 E/W: Alessandro Boulevard
 Weather: Clear

File Name : 29_RIV_215N_Ales Sat
 Site Code : 05122815
 Start Date : 9/17/2022
 Page No : 4

Start Time	I-215 Northbound On Ramp Southbound				Alessandro Boulevard Westbound				I-215 Northbound Off Ramp Northbound				Alessandro Boulevard Eastbound				Int. Total
	Left	Thru	Right	App. Total	Left	Thru	Right	App. Total	Left	Thru	Right	App. Total	Left	Thru	Right	App. Total	
Peak Hour Analysis From 11:00 AM to 01:45 PM - Peak 1 of 1																	
Peak Hour for Each Approach Begins at:																	
	12:30 PM				01:00 PM				11:00 AM				01:00 PM				
+0 mins.	79	1	44	124	29	196	0	225	0	0	0	0	0	181	36	217	
+15 mins.	126	4	65	195	33	218	0	251	0	0	0	0	0	168	45	213	
+30 mins.	117	3	86	206	45	220	0	265	0	0	0	0	0	202	39	241	
+45 mins.	95	2	43	140	27	218	0	245	0	0	0	0	0	196	34	230	
Total Volume	417	10	238	665	134	852	0	986	0	0	0	0	0	747	154	901	
% App. Total	62.7	1.5	35.8		13.6	86.4	0		0	0	0	0	0	82.9	17.1		
PHF	.827	.625	.692	.807	.744	.968	.000	.930	.000	.000	.000	.000	.000	.925	.856	.935	

City of Riverside
 N/S: I-215 Northbound Ramps
 E/W: Alessandro Boulevard
 Weather: Clear

File Name : 29_RIV_215N_Ales Sat
 Site Code : 05122815
 Start Date : 9/17/2022
 Page No : 1

Groups Printed- Passenger Vehicles

Start Time	I-215 Northbound On Ramp Southbound					Alessandro Boulevard Westbound					I-215 Northbound Off Ramp Northbound					Alessandro Boulevard Eastbound					Exclu. Total	Inclu. Total	Int. Total
	Left	Thru	Right	RTOR	App. Total	Left	Thru	Right	RTOR	App. Total	Left	Thru	Right	RTOR	App. Total	Left	Thru	Right	RTOR	App. Total			
11:00 AM	44	0	33	17	77	32	165	0	0	197	0	0	0	0	0	0	147	45	5	192	22	466	488
11:15 AM	114	3	83	37	200	23	155	0	0	178	0	0	0	0	0	0	144	40	11	184	48	562	610
11:30 AM	110	4	81	35	195	33	185	0	0	218	0	0	0	0	0	0	160	46	10	206	45	619	664
11:45 AM	82	1	48	27	131	39	180	0	0	219	0	0	0	0	0	0	162	43	7	205	34	555	589
Total	350	8	245	116	603	127	685	0	0	812	0	0	0	0	0	0	613	174	33	787	149	2202	2351
12:00 PM	64	2	34	21	100	35	177	0	0	212	0	0	0	0	0	0	166	50	10	216	31	528	559
12:15 PM	74	1	38	23	113	40	160	0	0	200	0	0	0	0	0	0	163	34	4	197	27	510	537
12:30 PM	77	1	44	19	122	43	202	0	0	245	0	0	0	0	0	0	190	44	6	234	25	601	626
12:45 PM	122	4	65	27	191	27	201	0	0	228	0	0	0	0	0	0	172	45	10	217	37	636	673
Total	337	8	181	90	526	145	740	0	0	885	0	0	0	0	0	0	691	173	30	864	120	2275	2395
01:00 PM	112	3	84	33	199	28	195	0	0	223	0	0	0	0	0	0	176	36	5	212	38	634	672
01:15 PM	89	2	42	21	133	31	214	0	0	245	0	0	0	0	0	0	165	40	6	205	27	583	610
01:30 PM	88	0	28	16	116	42	219	0	0	261	0	0	0	0	0	0	196	38	3	234	19	611	630
01:45 PM	98	2	61	24	161	25	213	0	0	238	0	0	0	0	0	0	196	30	5	226	29	625	654
Total	387	7	215	94	609	126	841	0	0	967	0	0	0	0	0	0	733	144	19	877	113	2453	2566
Grand Total	1074	23	641	300	1738	398	2266	0	0	2664	0	0	0	0	0	0	2037	491	82	2528	382	6930	7312
Apprch %	61.8	1.3	36.9			14.9	85.1	0			0	0	0				80.6	19.4					
Total %	15.5	0.3	9.2		25.1	5.7	32.7	0		38.4	0	0	0				29.4	7.1		36.5	5.2	94.8	

Start Time	I-215 Northbound On Ramp Southbound				Alessandro Boulevard Westbound				I-215 Northbound Off Ramp Northbound				Alessandro Boulevard Eastbound				Int. Total
	Left	Thru	Right	App. Total	Left	Thru	Right	App. Total	Left	Thru	Right	App. Total	Left	Thru	Right	App. Total	
Peak Hour Analysis From 12:45 PM to 01:30 PM - Peak 1 of 1																	
Peak Hour for Entire Intersection Begins at 12:45 PM																	
12:45 PM	122	4	65	191	27	201	0	228	0	0	0	0	0	172	45	217	636
01:00 PM	112	3	84	199	28	195	0	223	0	0	0	0	0	176	36	212	634
01:15 PM	89	2	42	133	31	214	0	245	0	0	0	0	0	165	40	205	583
01:30 PM	88	0	28	116	42	219	0	261	0	0	0	0	0	196	38	234	611
Total Volume	411	9	219	639	128	829	0	957	0	0	0	0	0	709	159	868	2464
% App. Total	64.3	1.4	34.3		13.4	86.6	0		0	0	0		0	81.7	18.3		
PHF	.842	.563	.652	.803	.762	.946	.000	.917	.000	.000	.000	.000	.000	.904	.883	.927	.969

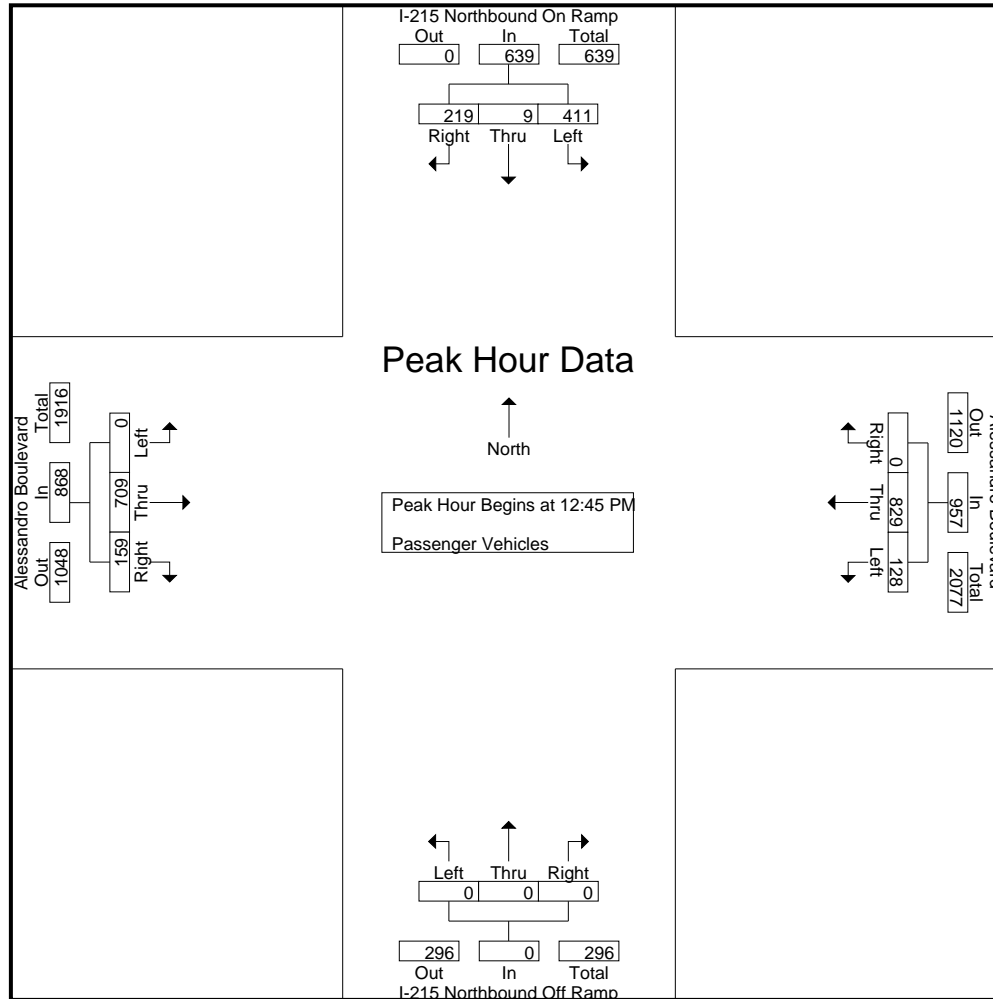

City of Riverside
 N/S: I-215 Northbound Ramps
 E/W: Alessandro Boulevard
 Weather: Clear

File Name : 29_RIV_215N_Ales Sat
 Site Code : 05122815
 Start Date : 9/17/2022
 Page No : 3

Start Time	I-215 Northbound On Ramp Southbound				Alessandro Boulevard Westbound				I-215 Northbound Off Ramp Northbound				Alessandro Boulevard Eastbound				Int. Total
	Left	Thru	Right	App. Total	Left	Thru	Right	App. Total	Left	Thru	Right	App. Total	Left	Thru	Right	App. Total	
Peak Hour Analysis From 12:45 PM to 01:30 PM - Peak 1 of 1																	
Peak Hour for Each Approach Begins at:																	
	12:45 PM				12:45 PM				12:45 PM				12:45 PM				
+0 mins.	122	4	65	191	27	201	0	228	0	0	0	0	0	172	45	217	
+15 mins.	112	3	84	199	28	195	0	223	0	0	0	0	0	176	36	212	
+30 mins.	89	2	42	133	31	214	0	245	0	0	0	0	0	165	40	205	
+45 mins.	88	0	28	116	42	219	0	261	0	0	0	0	0	196	38	234	
Total Volume	411	9	219	639	128	829	0	957	0	0	0	0	0	709	159	868	
% App. Total	64.3	1.4	34.3		13.4	86.6	0		0	0	0		0	81.7	18.3		
PHF	.842	.563	.652	.803	.762	.946	.000	.917	.000	.000	.000	.000	.000	.904	.883	.927	

City of Riverside
 N/S: I-215 Northbound Ramps
 E/W: Alessandro Boulevard
 Weather: Clear

File Name : 29_RIV_215N_Ales Sat
 Site Code : 05122815
 Start Date : 9/17/2022
 Page No : 1

Groups Printed- Large 2 Axle Vehicles

Start Time	I-215 Northbound On Ramp Southbound					Alessandro Boulevard Westbound					I-215 Northbound Off Ramp Northbound					Alessandro Boulevard Eastbound					Exclu. Total	Inclu. Total	Int. Total	
	Left	Thru	Right	RTOR	App. Total	Left	Thru	Right	RTOR	App. Total	Left	Thru	Right	RTOR	App. Total	Left	Thru	Right	RTOR	App. Total				
11:00 AM	1	0	0	0	1	0	3	0	0	3	0	0	0	0	0	0	0	1	0	1	0	0	5	5
11:15 AM	2	0	0	0	2	2	0	0	0	2	0	0	0	0	0	0	1	2	0	3	0	0	7	7
11:30 AM	2	0	0	0	2	2	3	0	0	5	0	0	0	0	0	0	3	0	0	3	0	0	10	10
11:45 AM	2	0	0	0	2	0	1	0	0	1	0	0	0	0	0	0	4	1	0	5	0	0	8	8
Total	7	0	0	0	7	4	7	0	0	11	0	0	0	0	0	0	8	4	0	12	0	0	30	30
12:00 PM	0	0	0	0	0	1	1	0	0	2	0	0	0	0	0	0	3	0	0	3	0	0	5	5
12:15 PM	0	0	0	0	0	1	1	0	0	2	0	0	0	0	0	0	1	0	0	1	0	0	3	3
12:30 PM	1	0	0	0	1	0	2	0	0	2	0	0	0	0	0	0	3	2	0	5	0	0	8	8
12:45 PM	3	0	0	0	3	2	5	0	0	7	0	0	0	0	0	0	0	0	0	0	0	0	10	10
Total	4	0	0	0	4	4	9	0	0	13	0	0	0	0	0	0	7	2	0	9	0	0	26	26
01:00 PM	3	0	0	0	3	0	0	0	0	0	0	0	0	0	0	0	3	0	0	3	0	0	6	6
01:15 PM	4	0	0	0	4	1	1	0	0	2	0	0	0	0	0	0	3	1	0	4	0	0	10	10
01:30 PM	1	0	0	0	1	1	1	0	0	2	0	0	0	0	0	0	4	0	0	4	0	0	7	7
01:45 PM	1	0	0	0	1	0	2	0	0	2	0	0	0	0	0	0	0	3	0	3	0	0	6	6
Total	9	0	0	0	9	2	4	0	0	6	0	0	0	0	0	0	10	4	0	14	0	0	29	29
Grand Total	20	0	0	0	20	10	20	0	0	30	0	0	0	0	0	0	25	10	0	35	0	0	85	85
Apprch %	100	0	0			33.3	66.7	0			0	0	0			0	71.4	28.6						
Total %	23.5	0	0		23.5	11.8	23.5	0		35.3	0	0	0		0	0	29.4	11.8		41.2	0	0	100	

Start Time	I-215 Northbound On Ramp Southbound				Alessandro Boulevard Westbound				I-215 Northbound Off Ramp Northbound				Alessandro Boulevard Eastbound				Int. Total
	Left	Thru	Right	App. Total	Left	Thru	Right	App. Total	Left	Thru	Right	App. Total	Left	Thru	Right	App. Total	
Peak Hour Analysis From 12:45 PM to 01:30 PM - Peak 1 of 1																	
Peak Hour for Entire Intersection Begins at 12:45 PM																	
12:45 PM	3	0	0	3	2	5	0	7	0	0	0	0	0	0	0	0	10
01:00 PM	3	0	0	3	0	0	0	0	0	0	0	0	0	3	0	3	6
01:15 PM	4	0	0	4	1	1	0	2	0	0	0	0	0	3	1	4	10
01:30 PM	1	0	0	1	1	1	0	2	0	0	0	0	0	4	0	4	7
Total Volume	11	0	0	11	4	7	0	11	0	0	0	0	0	10	1	11	33
% App. Total	100	0	0		36.4	63.6	0		0	0	0		0	90.9	9.1		
PHF	.688	.000	.000	.688	.500	.350	.000	.393	.000	.000	.000	.000	.000	.625	.250	.688	.825

City of Riverside
 N/S: I-215 Northbound Ramps
 E/W: Alessandro Boulevard
 Weather: Clear

File Name : 29_RIV_215N_Ales Sat
 Site Code : 05122815
 Start Date : 9/17/2022
 Page No : 2

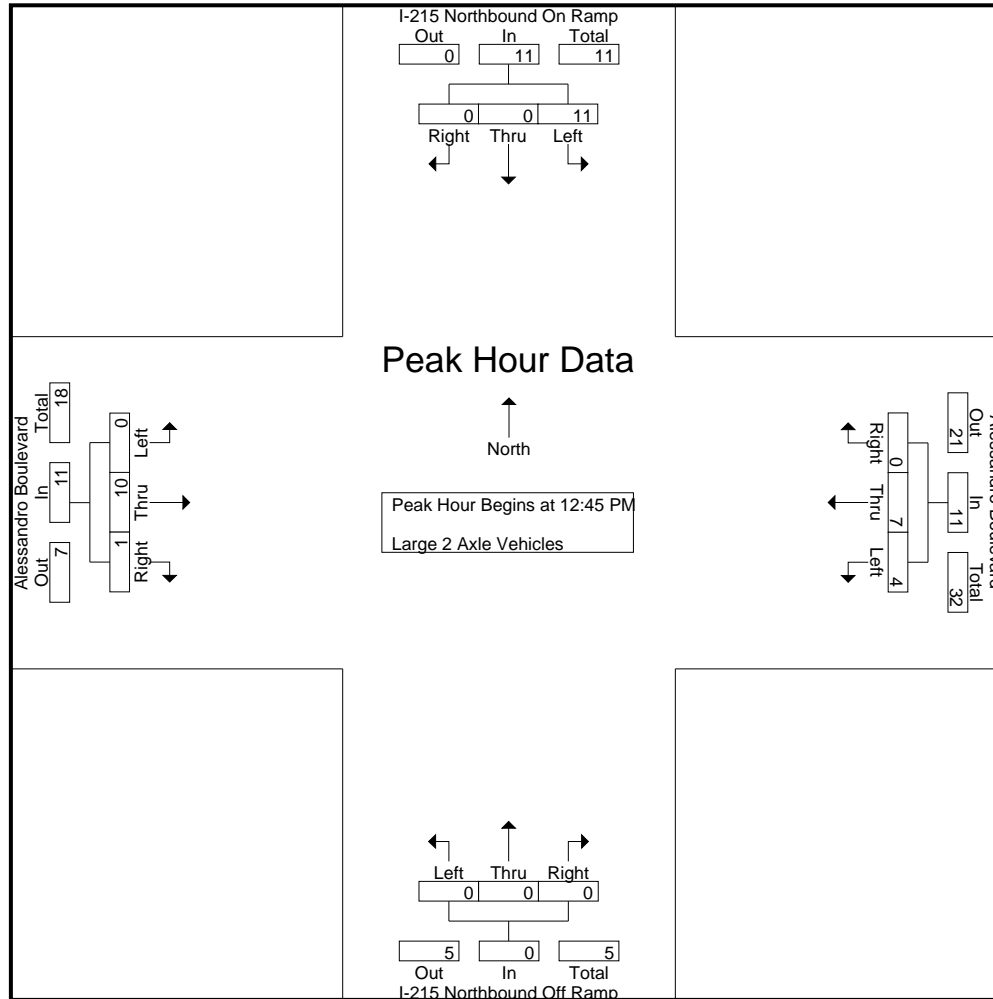

City of Riverside
 N/S: I-215 Northbound Ramps
 E/W: Alessandro Boulevard
 Weather: Clear

File Name : 29_RIV_215N_Ales Sat
 Site Code : 05122815
 Start Date : 9/17/2022
 Page No : 3

Start Time	I-215 Northbound On Ramp Southbound				Alessandro Boulevard Westbound				I-215 Northbound Off Ramp Northbound				Alessandro Boulevard Eastbound				Int. Total
	Left	Thru	Right	App. Total	Left	Thru	Right	App. Total	Left	Thru	Right	App. Total	Left	Thru	Right	App. Total	
Peak Hour Analysis From 12:45 PM to 01:30 PM - Peak 1 of 1																	
Peak Hour for Each Approach Begins at:																	
	12:45 PM				12:45 PM				12:45 PM				12:45 PM				
+0 mins.	3	0	0	3	2	5	0	7	0	0	0	0	0	0	0	0	
+15 mins.	3	0	0	3	0	0	0	0	0	0	0	0	0	3	0	3	
+30 mins.	4	0	0	4	1	1	0	2	0	0	0	0	0	3	1	4	
+45 mins.	1	0	0	1	1	1	0	2	0	0	0	0	0	4	0	4	
Total Volume	11	0	0	11	4	7	0	11	0	0	0	0	0	10	1	11	
% App. Total	100	0	0		36.4	63.6	0		0	0	0		0	90.9	9.1		
PHF	.688	.000	.000	.688	.500	.350	.000	.393	.000	.000	.000	.000	.000	.625	.250	.688	

City of Riverside
 N/S: I-215 Northbound Ramps
 E/W: Alessandro Boulevard
 Weather: Clear

File Name : 29_RIV_215N_Ales Sat
 Site Code : 05122815
 Start Date : 9/17/2022
 Page No : 1

Groups Printed- 3 Axle Vehicles

Start Time	I-215 Northbound On Ramp Southbound					Alessandro Boulevard Westbound					I-215 Northbound Off Ramp Northbound					Alessandro Boulevard Eastbound					Exclu. Total	Inclu. Total	Int. Total				
	Left	Thru	Right	RTOR	App. Total	Left	Thru	Right	RTOR	App. Total	Left	Thru	Right	RTOR	App. Total	Left	Thru	Right	RTOR	App. Total							
11:00 AM	0	0	0	0	0	0	0	0	0	0	0	0	0	0	0	0	0	0	0	0	0	0	0	0	0	0	0
11:15 AM	0	0	0	0	0	0	0	0	0	0	0	0	0	0	0	0	0	2	0	2	0	0	2	2	0	2	2
11:30 AM	1	0	0	0	1	0	0	0	0	0	0	0	0	0	0	0	0	1	0	1	0	0	2	2	0	2	2
11:45 AM	0	0	0	0	0	0	0	0	0	0	0	0	0	0	0	0	1	3	0	4	0	0	4	4	0	4	4
Total	1	0	0	0	1	0	0	0	0	0	0	0	0	0	0	0	1	6	0	7	0	0	8	8	0	8	8
12:00 PM	0	0	0	0	0	0	0	0	0	0	0	0	0	0	0	0	0	0	0	0	0	0	0	0	0	0	0
12:15 PM	0	0	0	0	0	0	1	0	0	1	0	0	0	0	0	0	0	0	0	0	0	0	1	1	0	1	1
12:30 PM	1	0	0	0	1	0	1	0	0	1	0	0	0	0	0	0	0	0	0	0	0	0	2	2	0	2	2
12:45 PM	0	0	0	0	0	0	0	0	0	0	0	0	0	0	0	0	0	0	0	0	0	0	0	0	0	0	0
Total	1	0	0	0	1	0	2	0	0	2	0	0	0	0	0	0	0	0	0	0	0	0	3	3	0	3	3
01:00 PM	1	0	1	0	2	0	1	0	0	1	0	0	0	0	0	0	1	0	0	1	0	0	4	4	0	4	4
01:15 PM	1	0	1	0	2	1	0	0	0	1	0	0	0	0	0	0	0	4	0	4	0	0	7	7	0	7	7
01:30 PM	0	0	0	0	0	2	0	0	0	2	0	0	0	0	0	0	2	1	0	3	0	0	5	5	0	5	5
01:45 PM	0	0	0	0	0	0	1	0	0	1	0	0	0	0	0	0	0	1	0	1	0	0	2	2	0	2	2
Total	2	0	2	0	4	3	2	0	0	5	0	0	0	0	0	0	3	6	0	9	0	0	18	18	0	18	18
Grand Total	4	0	2	0	6	3	4	0	0	7	0	0	0	0	0	0	4	12	0	16	0	0	29	29	0	29	29
Apprch %	66.7	0	33.3			42.9	57.1	0			0	0	0			0	25	75									
Total %	13.8	0	6.9		20.7	10.3	13.8	0		24.1	0	0	0		0	0	13.8	41.4		55.2	0	0	100		0	100	

Start Time	I-215 Northbound On Ramp Southbound				Alessandro Boulevard Westbound				I-215 Northbound Off Ramp Northbound				Alessandro Boulevard Eastbound				Int. Total
	Left	Thru	Right	App. Total	Left	Thru	Right	App. Total	Left	Thru	Right	App. Total	Left	Thru	Right	App. Total	
Peak Hour Analysis From 12:45 PM to 01:30 PM - Peak 1 of 1																	
Peak Hour for Entire Intersection Begins at 12:45 PM																	
12:45 PM	0	0	0	0	0	0	0	0	0	0	0	0	0	0	0	0	0
01:00 PM	1	0	1	2	0	1	0	1	0	0	0	0	0	1	0	1	4
01:15 PM	1	0	1	2	1	0	0	1	0	0	0	0	0	0	4	4	7
01:30 PM	0	0	0	0	2	0	0	2	0	0	0	0	0	2	1	3	5
Total Volume	2	0	2	4	3	1	0	4	0	0	0	0	0	3	5	8	16
% App. Total	50	0	50		75	25	0		0	0	0		0	37.5	62.5		
PHF	.500	.000	.500	.500	.375	.250	.000	.500	.000	.000	.000	.000	.000	.375	.313	.500	.571

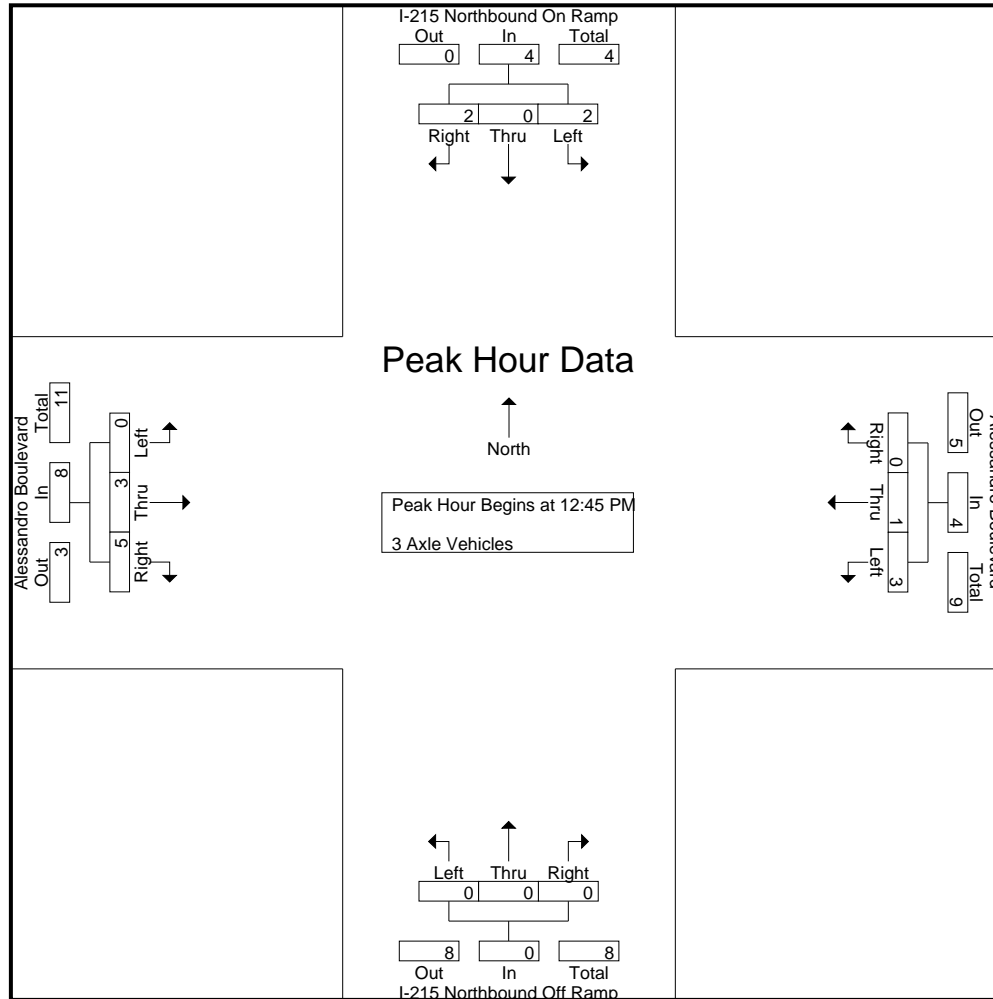

City of Riverside
 N/S: I-215 Northbound Ramps
 E/W: Alessandro Boulevard
 Weather: Clear

File Name : 29_RIV_215N_Ales Sat
 Site Code : 05122815
 Start Date : 9/17/2022
 Page No : 3

Start Time	I-215 Northbound On Ramp Southbound				Alessandro Boulevard Westbound				I-215 Northbound Off Ramp Northbound				Alessandro Boulevard Eastbound				Int. Total
	Left	Thru	Right	App. Total	Left	Thru	Right	App. Total	Left	Thru	Right	App. Total	Left	Thru	Right	App. Total	
Peak Hour Analysis From 12:45 PM to 01:30 PM - Peak 1 of 1																	
Peak Hour for Each Approach Begins at:																	
	12:45 PM				12:45 PM				12:45 PM				12:45 PM				
+0 mins.	0	0	0	0	0	0	0	0	0	0	0	0	0	0	0	0	
+15 mins.	1	0	1	2	0	1	0	1	0	0	0	0	0	1	0	1	
+30 mins.	1	0	1	2	1	0	0	1	0	0	0	0	0	0	4	4	
+45 mins.	0	0	0	0	2	0	0	2	0	0	0	0	0	2	1	3	
Total Volume	2	0	2	4	3	1	0	4	0	0	0	0	0	3	5	8	
% App. Total	50	0	50		75	25	0		0	0	0		0	37.5	62.5		
PHF	.500	.000	.500	.500	.375	.250	.000	.500	.000	.000	.000	.000	.000	.375	.313	.500	

City of Riverside
 N/S: I-215 Northbound Ramps
 E/W: Alessandro Boulevard
 Weather: Clear

File Name : 29_RIV_215N_Ales Sat
 Site Code : 05122815
 Start Date : 9/17/2022
 Page No : 1

Groups Printed- 4+ Axle Trucks

Start Time	I-215 Northbound On Ramp Southbound					Alessandro Boulevard Westbound					I-215 Northbound Off Ramp Northbound					Alessandro Boulevard Eastbound					Exclu. Total	Inclu. Total	Int. Total	
	Left	Thru	Right	RTOR	App. Total	Left	Thru	Right	RTOR	App. Total	Left	Thru	Right	RTOR	App. Total	Left	Thru	Right	RTOR	App. Total				
11:00 AM	0	0	0	0	0	1	6	0	0	7	0	0	0	0	0	0	0	1	0	1	0	0	8	8
11:15 AM	1	0	2	0	3	0	2	0	0	2	0	0	0	0	0	0	0	2	0	2	0	0	7	7
11:30 AM	1	0	0	0	1	0	0	0	0	0	0	0	0	0	0	0	1	1	1	2	1	0	3	4
11:45 AM	1	0	0	0	1	0	0	0	0	0	0	0	0	0	0	0	0	1	0	1	0	0	2	2
Total	3	0	2	0	5	1	8	0	0	9	0	0	0	0	0	0	1	5	1	6	1	0	20	21
12:00 PM	1	0	0	0	1	0	0	0	0	0	0	0	0	0	0	0	0	0	0	0	0	0	1	1
12:15 PM	0	0	0	0	0	0	0	0	0	0	0	0	0	0	0	0	0	4	0	4	0	0	4	4
12:30 PM	0	0	0	0	0	1	0	0	0	1	0	0	0	0	0	0	0	1	0	1	0	0	2	2
12:45 PM	1	0	0	0	1	1	2	0	0	3	0	0	0	0	0	0	0	2	0	2	0	0	6	6
Total	2	0	0	0	2	2	2	0	0	4	0	0	0	0	0	0	0	7	0	7	0	0	13	13
01:00 PM	1	0	1	0	2	1	0	0	0	1	0	0	0	0	0	0	1	0	0	1	0	0	4	4
01:15 PM	1	0	0	0	1	0	3	0	0	3	0	0	0	0	0	0	0	0	0	0	0	0	4	4
01:30 PM	0	0	0	0	0	0	0	0	0	0	0	0	0	0	0	0	0	0	0	0	0	0	0	0
01:45 PM	2	0	0	0	2	2	2	0	0	4	0	0	0	0	0	0	0	0	0	0	0	0	6	6
Total	4	0	1	0	5	3	5	0	0	8	0	0	0	0	0	0	1	0	0	1	0	0	14	14
Grand Total	9	0	3	0	12	6	15	0	0	21	0	0	0	0	0	0	2	12	1	14	1	0	47	48
Apprch %	75	0	25			28.6	71.4	0			0	0	0			0	14.3	85.7						
Total %	19.1	0	6.4		25.5	12.8	31.9	0		44.7	0	0	0		0	0	4.3	25.5		29.8	2.1		97.9	

Start Time	I-215 Northbound On Ramp Southbound				Alessandro Boulevard Westbound				I-215 Northbound Off Ramp Northbound				Alessandro Boulevard Eastbound				Int. Total
	Left	Thru	Right	App. Total	Left	Thru	Right	App. Total	Left	Thru	Right	App. Total	Left	Thru	Right	App. Total	
Peak Hour Analysis From 12:45 PM to 01:30 PM - Peak 1 of 1																	
Peak Hour for Entire Intersection Begins at 12:45 PM																	
12:45 PM	1	0	0	1	1	2	0	3	0	0	0	0	0	0	2	2	6
01:00 PM	1	0	1	2	1	0	0	1	0	0	0	0	0	1	0	1	4
01:15 PM	1	0	0	1	0	3	0	3	0	0	0	0	0	0	0	0	4
01:30 PM	0	0	0	0	0	0	0	0	0	0	0	0	0	0	0	0	0
Total Volume	3	0	1	4	2	5	0	7	0	0	0	0	0	1	2	3	14
% App. Total	75	0	25		28.6	71.4	0		0	0	0		0	33.3	66.7		
PHF	.750	.000	.250	.500	.500	.417	.000	.583	.000	.000	.000	.000	.000	.250	.250	.375	.583

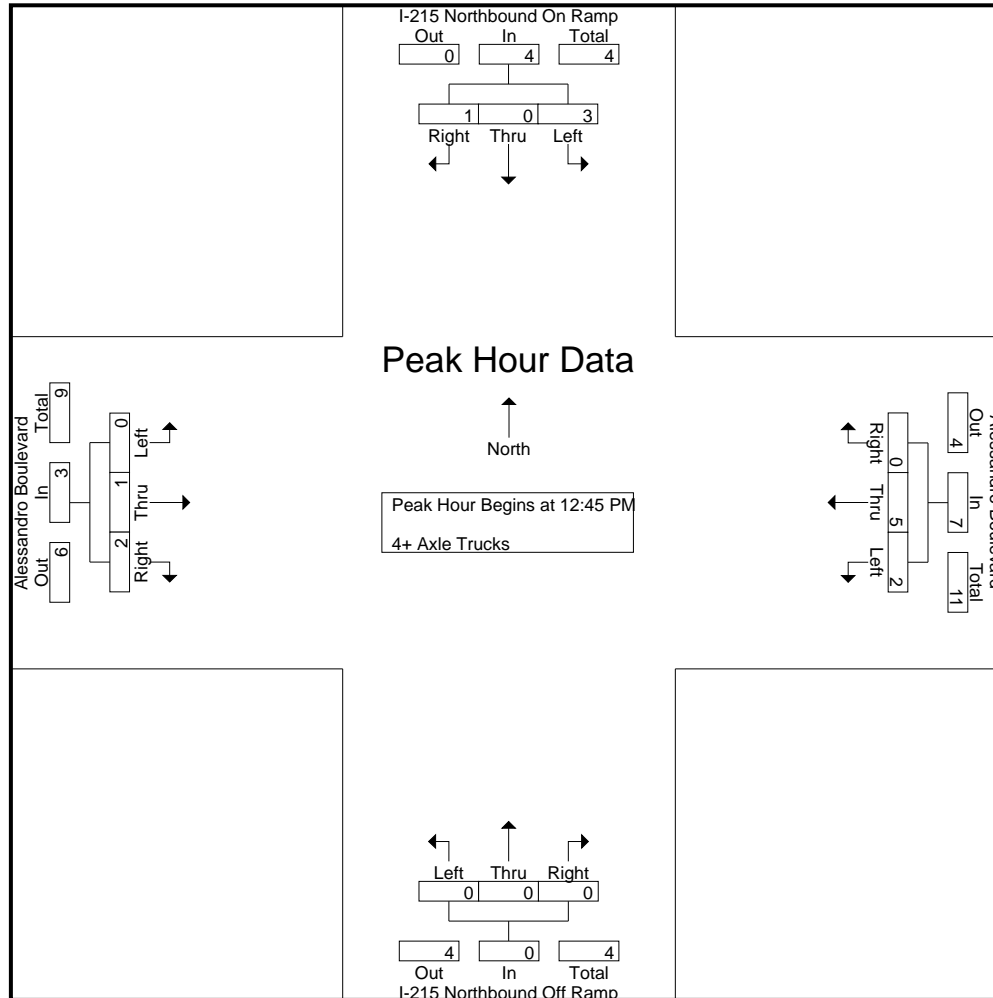

City of Riverside
 N/S: I-215 Northbound Ramps
 E/W: Alessandro Boulevard
 Weather: Clear

File Name : 29_RIV_215N_Ales Sat
 Site Code : 05122815
 Start Date : 9/17/2022
 Page No : 3

Start Time	I-215 Northbound On Ramp Southbound				Alessandro Boulevard Westbound				I-215 Northbound Off Ramp Northbound				Alessandro Boulevard Eastbound				Int. Total
	Left	Thru	Right	App. Total	Left	Thru	Right	App. Total	Left	Thru	Right	App. Total	Left	Thru	Right	App. Total	
Peak Hour Analysis From 12:45 PM to 01:30 PM - Peak 1 of 1																	
Peak Hour for Each Approach Begins at:																	
	12:45 PM				12:45 PM				12:45 PM				12:45 PM				
+0 mins.	1	0	0	1	1	2	0	3	0	0	0	0	0	0	2	2	
+15 mins.	1	0	1	2	1	0	0	1	0	0	0	0	0	1	0	1	
+30 mins.	1	0	0	1	0	3	0	3	0	0	0	0	0	0	0	0	
+45 mins.	0	0	0	0	0	0	0	0	0	0	0	0	0	0	0	0	
Total Volume	3	0	1	4	2	5	0	7	0	0	0	0	0	1	2	3	
% App. Total	75	0	25		28.6	71.4	0		0	0	0		0	33.3	66.7		
PHF	.750	.000	.250	.500	.500	.417	.000	.583	.000	.000	.000	.000	.000	.250	.250	.375	

Location: Riverside
 N/S: I-215 NB Ramps
 E/W: Alessandro Boulevard



Date: 9/17/2022
 Day Saturday

PEDESTRIANS

Time	North Leg I-215 NB Ramps	East Leg Alessandro Boulevard	South Leg I-215 NB Ramps	West Leg Alessandro Boulevard	TOTAL
11:00 AM	0	0	0	0	0
11:15 AM	0	0	0	0	0
11:30 AM	0	0	2	0	2
11:45 AM	0	0	0	0	0
12:00 PM	0	0	0	0	0
12:15 PM	0	0	0	0	0
12:30 PM	0	0	0	0	0
12:45 PM	0	0	0	0	0
1:00 PM	0	0	0	0	0
1:15 PM	0	0	0	0	0
1:30 PM	0	0	0	0	0
1:45 PM	0	0	0	0	0
TOTAL VOLUMES:	0	0	2	0	2

Location: Riverside
 N/S: I-215 NB Ramps
 E/W: Alessandro Boulevard

Date: 9/17/2022
 Day: Saturday



BICYCLES

	Southbound I-215 NB Ramps			Westbound Alessandro Boulevard			Northbound I-215 NB Ramps			Eastbound Alessandro Boulevard			
	Left	Thru	Right	Left	Thru	Right	Left	Thru	Right	Left	Thru	Right	
11:00 AM	0	0	0	0	0	0	0	0	0	0	0	0	0
11:15 AM	0	0	0	0	0	0	0	0	0	0	0	0	0
11:30 AM	0	0	0	0	0	0	0	0	0	0	0	0	0
11:45 AM	0	0	0	0	0	0	0	0	0	0	0	0	0
12:00 PM	0	0	0	0	1	0	0	0	0	0	0	0	1
12:15 PM	0	0	0	0	0	0	0	0	0	0	1	0	1
12:30 PM	0	0	0	0	0	0	0	0	0	0	1	0	1
12:45 PM	0	0	0	0	0	0	0	0	0	0	0	0	0
1:00 PM	0	0	0	0	0	0	0	0	0	0	0	0	0
1:15 PM	0	0	0	0	0	0	0	0	0	0	0	0	0
1:30 PM	0	0	0	0	0	0	0	0	0	0	0	0	0
1:45 PM	0	0	0	0	0	0	0	0	0	0	0	0	0
TOTAL VOLUMES:	0	0	0	0	1	0	0	0	0	0	2	0	3

County of Riverside
 N/S: I-215 Southbound Ramps
 E/W: Cactus Avenue
 Weather: Clear

File Name : 30_CRV_215S_Cac Sat
 Site Code : 05122815
 Start Date : 9/17/2022
 Page No : 1

Groups Printed- Passenger Vehicles - Large 2 Axle Vehicles - 3 Axle Vehicles - 4+ Axle Trucks

Start Time	I-215 Southbound Off Ramp Southbound					Cactus Avenue Westbound					I-215 Southbound Ramps Northbound					Cactus Avenue Eastbound					Exclu. Total	Inclu. Total	Int. Total
	Left	Thru	Right	RTOR	App. Total	Left	Thru	Right	RTOR	App. Total	Left	Thru	Right	RTOR	App. Total	Left	Thru	Right	RTOR	App. Total			
11:00 AM	0	0	11	7	11	82	53	0	0	135	0	0	59	0	59	0	42	5	1	47	8	252	260
11:15 AM	0	0	16	12	16	84	77	0	0	161	0	0	59	0	59	0	63	6	1	69	13	305	318
11:30 AM	0	0	15	10	15	58	76	0	0	134	0	0	78	0	78	0	47	4	0	51	10	278	288
11:45 AM	0	0	15	13	15	83	83	0	0	166	0	0	85	0	85	0	48	3	0	51	13	317	330
Total	0	0	57	42	57	307	289	0	0	596	0	0	281	0	281	0	200	18	2	218	44	1152	1196
12:00 PM	0	0	21	16	21	67	67	0	0	134	0	0	83	0	83	0	57	1	0	58	16	296	312
12:15 PM	0	0	33	18	33	95	82	0	0	177	0	0	83	0	83	0	62	4	1	66	19	359	378
12:30 PM	0	1	10	7	11	78	75	0	0	153	0	0	105	0	105	0	46	6	2	52	9	321	330
12:45 PM	0	0	6	4	6	88	59	0	0	147	0	0	73	0	73	0	53	3	0	56	4	282	286
Total	0	1	70	45	71	328	283	0	0	611	0	0	344	0	344	0	218	14	3	232	48	1258	1306
01:00 PM	1	0	15	12	16	69	84	0	0	153	1	1	63	0	65	0	55	4	1	59	13	293	306
01:15 PM	0	0	13	11	13	75	87	0	0	162	0	0	74	0	74	0	63	2	0	65	11	314	325
01:30 PM	1	0	13	11	14	89	82	0	0	171	0	0	71	0	71	0	72	7	0	79	11	335	346
01:45 PM	0	0	15	12	15	90	85	0	0	175	0	0	96	0	96	0	81	13	2	94	14	380	394
Total	2	0	56	46	58	323	338	0	0	661	1	1	304	0	306	0	271	26	3	297	49	1322	1371
Grand Total	2	1	183	133	186	958	910	0	0	1868	1	1	929	0	931	0	689	58	8	747	141	3732	3873
Apprch %	1.1	0.5	98.4			51.3	48.7	0			0.1	0.1	99.8			0	92.2	7.8					
Total %	0.1	0	4.9		5	25.7	24.4	0		50.1	0	0	24.9		24.9	0	18.5	1.6		20	3.6	96.4	
Passenger Vehicles	1	1	139		251	943	891	0		1834	1	1	829		831	0	665	52		725	0	0	3641
% Passenger Vehicles	50	100	76	82.7	78.7	98.4	97.9	0	0	98.2	100	100	89.2	0	89.3	0	96.5	89.7	100	96	0	0	94
Large 2 Axle Vehicles	0	0	5		7	8	11	0		19	0	0	16		16	0	9	3		12	0	0	54
% Large 2 Axle Vehicles	0	0	2.7	1.5	2.2	0.8	1.2	0	0	1	0	0	1.7	0	1.7	0	1.3	5.2	0	1.6	0	0	1.4
3 Axle Vehicles	0	0	6		11	2	1	0		3	0	0	24		24	0	1	0		1	0	0	39
% 3 Axle Vehicles	0	0	3.3	3.8	3.4	0.2	0.1	0	0	0.2	0	0	2.6	0	2.6	0	0.1	0	0	0.1	0	0	1
4+ Axle Trucks	1	0	33		50	5	7	0		12	0	0	60		60	0	14	3		17	0	0	139
% 4+ Axle Trucks	50	0	18	12	15.7	0.5	0.8	0	0	0.6	0	0	6.5	0	6.4	0	2	5.2	0	2.3	0	0	3.6

County of Riverside
 N/S: I-215 Southbound Ramps
 E/W: Cactus Avenue
 Weather: Clear

File Name : 30_CRV_215S_Cac Sat
 Site Code : 05122815
 Start Date : 9/17/2022
 Page No : 2

Start Time	I-215 Southbound Off Ramp Southbound				Cactus Avenue Westbound				I-215 Southbound Ramps Northbound				Cactus Avenue Eastbound				Int. Total
	Left	Thru	Right	App. Total	Left	Thru	Right	App. Total	Left	Thru	Right	App. Total	Left	Thru	Right	App. Total	
Peak Hour Analysis From 11:00 AM to 01:45 PM - Peak 1 of 1																	
Peak Hour for Entire Intersection Begins at 01:00 PM																	
01:00 PM	1	0	15	16	69	84	0	153	1	1	63	65	0	55	4	59	293
01:15 PM	0	0	13	13	75	87	0	162	0	0	74	74	0	63	2	65	314
01:30 PM	1	0	13	14	89	82	0	171	0	0	71	71	0	72	7	79	335
01:45 PM	0	0	15	15	90	85	0	175	0	0	96	96	0	81	13	94	380
Total Volume	2	0	56	58	323	338	0	661	1	1	304	306	0	271	26	297	1322
% App. Total	3.4	0	96.6		48.9	51.1	0		0.3	0.3	99.3		0	91.2	8.8		
PHF	.500	.000	.933	.906	.897	.971	.000	.944	.250	.250	.792	.797	.000	.836	.500	.790	.870

County of Riverside
 N/S: I-215 Southbound Ramps
 E/W: Cactus Avenue
 Weather: Clear

File Name : 30_CRV_215S_Cac Sat
 Site Code : 05122815
 Start Date : 9/17/2022
 Page No : 3

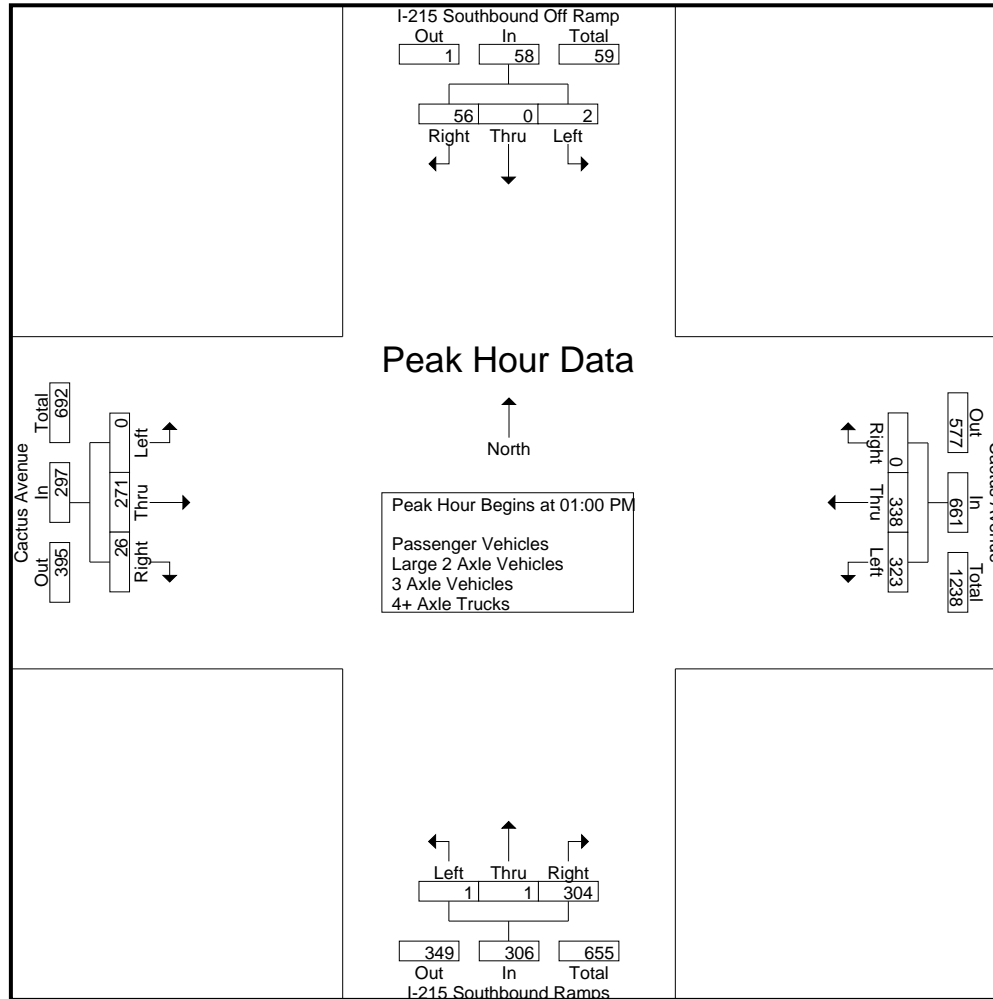

County of Riverside
 N/S: I-215 Southbound Ramps
 E/W: Cactus Avenue
 Weather: Clear

File Name : 30_CRV_215S_Cac Sat
 Site Code : 05122815
 Start Date : 9/17/2022
 Page No : 4

Start Time	I-215 Southbound Off Ramp Southbound				Cactus Avenue Westbound				I-215 Southbound Ramps Northbound				Cactus Avenue Eastbound				Int. Total
	Left	Thru	Right	App. Total	Left	Thru	Right	App. Total	Left	Thru	Right	App. Total	Left	Thru	Right	App. Total	
Peak Hour Analysis From 11:00 AM to 01:45 PM - Peak 1 of 1																	
Peak Hour for Each Approach Begins at:																	
	11:30 AM				01:00 PM				11:45 AM				01:00 PM				
+0 mins.	0	0	15	15	69	84	0	153	0	0	85	85	0	55	4	59	
+15 mins.	0	0	15	15	75	87	0	162	0	0	83	83	0	63	2	65	
+30 mins.	0	0	21	21	89	82	0	171	0	0	83	83	0	72	7	79	
+45 mins.	0	0	33	33	90	85	0	175	0	0	105	105	0	81	13	94	
Total Volume	0	0	84	84	323	338	0	661	0	0	356	356	0	271	26	297	
% App. Total	0	0	100		48.9	51.1	0		0	0	100		0	91.2	8.8		
PHF	.000	.000	.636	.636	.897	.971	.000	.944	.000	.000	.848	.848	.000	.836	.500	.790	

County of Riverside
 N/S: I-215 Southbound Ramps
 E/W: Cactus Avenue
 Weather: Clear

File Name : 30_CRV_215S_Cac Sat
 Site Code : 05122815
 Start Date : 9/17/2022
 Page No : 1

Groups Printed- Passenger Vehicles

Start Time	I-215 Southbound Off Ramp Southbound					Cactus Avenue Westbound					I-215 Southbound Ramps Northbound					Cactus Avenue Eastbound					Exclu. Total	Inclu. Total	Int. Total
	Left	Thru	Right	RTOR	App. Total	Left	Thru	Right	RTOR	App. Total	Left	Thru	Right	RTOR	App. Total	Left	Thru	Right	RTOR	App. Total			
11:00 AM	0	0	8	6	8	82	52	0	0	134	0	0	52	0	52	0	38	5	1	43	7	237	244
11:15 AM	0	0	14	11	14	84	75	0	0	159	0	0	52	0	52	0	58	6	1	64	12	289	301
11:30 AM	0	0	12	8	12	58	75	0	0	133	0	0	68	0	68	0	44	1	0	45	8	258	266
11:45 AM	0	0	12	10	12	83	81	0	0	164	0	0	70	0	70	0	48	3	0	51	10	297	307
Total	0	0	46	35	46	307	283	0	0	590	0	0	242	0	242	0	188	15	2	203	37	1081	1118
12:00 PM	0	0	14	12	14	65	65	0	0	130	0	0	69	0	69	0	54	1	0	55	12	268	280
12:15 PM	0	0	24	16	24	93	78	0	0	171	0	0	78	0	78	0	59	3	1	62	17	335	352
12:30 PM	0	1	5	3	6	74	72	0	0	146	0	0	99	0	99	0	45	5	2	50	5	301	306
12:45 PM	0	0	5	4	5	84	58	0	0	142	0	0	61	0	61	0	50	2	0	52	4	260	264
Total	0	1	48	35	49	316	273	0	0	589	0	0	307	0	307	0	208	11	3	219	38	1164	1202
01:00 PM	1	0	13	11	14	69	83	0	0	152	1	1	57	0	59	0	55	4	1	59	12	284	296
01:15 PM	0	0	11	10	11	75	87	0	0	162	0	0	66	0	66	0	63	2	0	65	10	304	314
01:30 PM	0	0	9	9	9	88	81	0	0	169	0	0	68	0	68	0	71	7	0	78	9	324	333
01:45 PM	0	0	12	10	12	88	84	0	0	172	0	0	89	0	89	0	80	13	2	93	12	366	378
Total	1	0	45	40	46	320	335	0	0	655	1	1	280	0	282	0	269	26	3	295	43	1278	1321
Grand Total	1	1	139	110	141	943	891	0	0	1834	1	1	829	0	831	0	665	52	8	717	118	3523	3641
Apprch %	0.7	0.7	98.6			51.4	48.6	0			0.1	0.1	99.8			0	92.7	7.3					
Total %	0	0	3.9		4	26.8	25.3	0		52.1	0	0	23.5		23.6	0	18.9	1.5		20.4	3.2	96.8	

Start Time	I-215 Southbound Off Ramp Southbound				Cactus Avenue Westbound				I-215 Southbound Ramps Northbound				Cactus Avenue Eastbound				Int. Total		
	Left	Thru	Right	App. Total	Left	Thru	Right	App. Total	Left	Thru	Right	App. Total	Left	Thru	Right	App. Total			
Peak Hour Analysis From 01:00 PM to 01:45 PM - Peak 1 of 1																			
Peak Hour for Entire Intersection Begins at 01:00 PM																			
01:00 PM	1	0	13	14	69	83	0	152	1	1	57	59	0	55	4	59	284		
01:15 PM	0	0	11	11	75	87	0	162	0	0	66	66	0	63	2	65	304		
01:30 PM	0	0	9	9	88	81	0	169	0	0	68	68	0	71	7	78	324		
01:45 PM	0	0	12	12	88	84	0	172	0	0	89	89	0	80	13	93	366		
Total Volume	1	0	45	46	320	335	0	655	1	1	280	282	0	269	26	295	1278		
% App. Total	2.2	0	97.8		48.9	51.1	0		0.4	0.4	99.3		0	91.2	8.8				
PHF	.250	.000	.865	.821	.909	.963	.000	.952	.250	.250	.787	.792	.000	.841	.500	.793	.873		

County of Riverside
 N/S: I-215 Southbound Ramps
 E/W: Cactus Avenue
 Weather: Clear

File Name : 30_CRV_215S_Cac Sat
 Site Code : 05122815
 Start Date : 9/17/2022
 Page No : 2

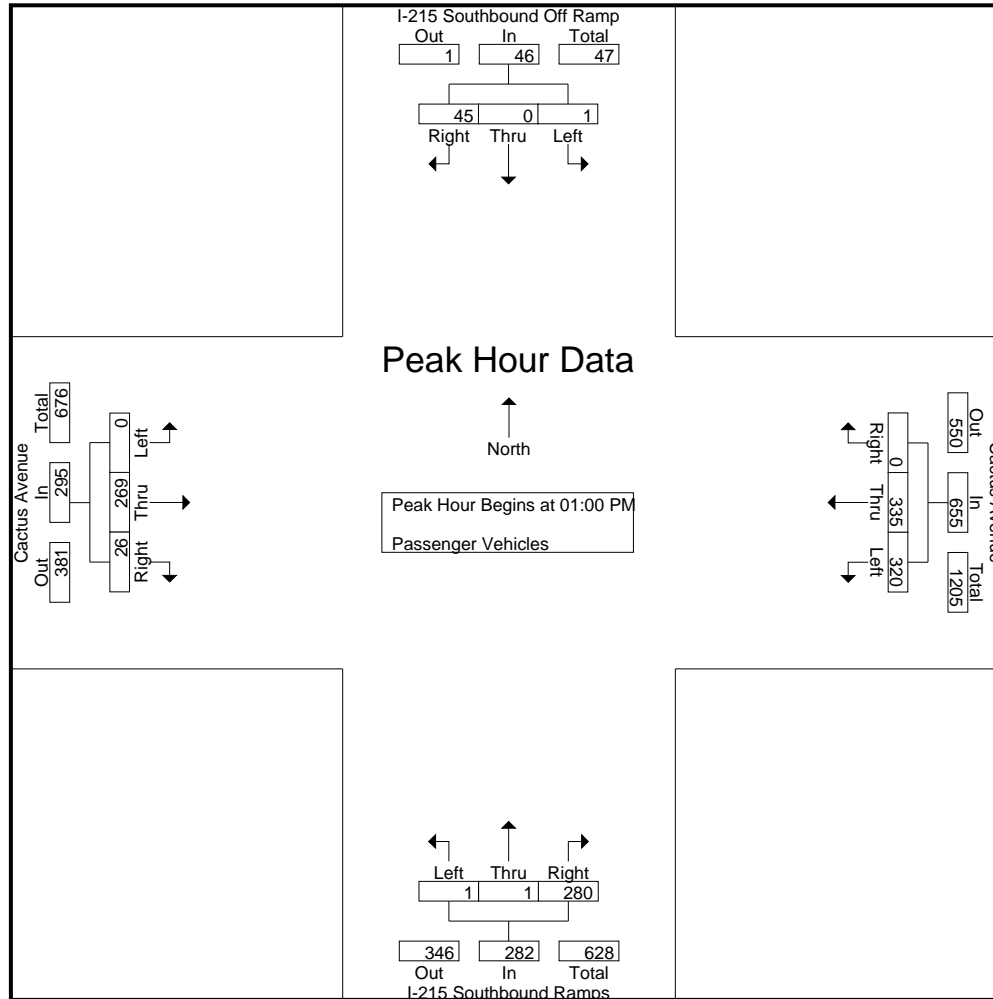

County of Riverside
 N/S: I-215 Southbound Ramps
 E/W: Cactus Avenue
 Weather: Clear

File Name : 30_CRV_215S_Cac Sat
 Site Code : 05122815
 Start Date : 9/17/2022
 Page No : 3

Start Time	I-215 Southbound Off Ramp Southbound				Cactus Avenue Westbound				I-215 Southbound Ramps Northbound				Cactus Avenue Eastbound				Int. Total
	Left	Thru	Right	App. Total	Left	Thru	Right	App. Total	Left	Thru	Right	App. Total	Left	Thru	Right	App. Total	
Peak Hour Analysis From 01:00 PM to 01:45 PM - Peak 1 of 1																	
Peak Hour for Each Approach Begins at:																	
	01:00 PM				01:00 PM				01:00 PM				01:00 PM				
+0 mins.	1	0	13	14	69	83	0	152	1	1	57	59	0	55	4	59	
+15 mins.	0	0	11	11	75	87	0	162	0	0	66	66	0	63	2	65	
+30 mins.	0	0	9	9	88	81	0	169	0	0	68	68	0	71	7	78	
+45 mins.	0	0	12	12	88	84	0	172	0	0	89	89	0	80	13	93	
Total Volume	1	0	45	46	320	335	0	655	1	1	280	282	0	269	26	295	
% App. Total	2.2	0	97.8		48.9	51.1	0		0.4	0.4	99.3		0	91.2	8.8		
PHF	.250	.000	.865	.821	.909	.963	.000	.952	.250	.250	.787	.792	.000	.841	.500	.793	

County of Riverside
 N/S: I-215 Southbound Ramps
 E/W: Cactus Avenue
 Weather: Clear

File Name : 30_CRV_215S_Cac Sat
 Site Code : 05122815
 Start Date : 9/17/2022
 Page No : 1

Groups Printed- Large 2 Axle Vehicles

Start Time	I-215 Southbound Off Ramp Southbound					Cactus Avenue Westbound					I-215 Southbound Ramps Northbound					Cactus Avenue Eastbound					Exclu. Total	Inclu. Total	Int. Total	
	Left	Thru	Right	RTOR	App. Total	Left	Thru	Right	RTOR	App. Total	Left	Thru	Right	RTOR	App. Total	Left	Thru	Right	RTOR	App. Total				
11:00 AM	0	0	0	0	0	0	1	0	0	1	0	0	2	0	2	0	2	0	0	2	0	0	5	5
11:15 AM	0	0	1	0	1	0	0	0	0	0	0	0	0	0	0	0	1	0	0	1	0	2	2	2
11:30 AM	0	0	1	1	1	0	1	0	0	1	0	0	0	0	0	0	1	2	0	3	1	5	6	6
11:45 AM	0	0	0	0	0	0	0	0	0	0	0	0	2	0	2	0	0	0	0	0	0	2	2	2
Total	0	0	2	1	2	0	2	0	0	2	0	0	4	0	4	0	4	2	0	6	1	14	15	15
12:00 PM	0	0	1	1	1	1	0	0	0	1	0	0	1	0	1	0	1	0	0	1	1	4	5	5
12:15 PM	0	0	2	0	2	2	4	0	0	6	0	0	0	0	0	0	1	1	0	2	0	10	10	10
12:30 PM	0	0	0	0	0	1	2	0	0	3	0	0	2	0	2	0	0	0	0	0	0	5	5	5
12:45 PM	0	0	0	0	0	1	0	0	0	1	0	0	3	0	3	0	2	0	0	2	0	6	6	6
Total	0	0	3	1	3	5	6	0	0	11	0	0	6	0	6	0	4	1	0	5	1	25	26	26
01:00 PM	0	0	0	0	0	0	1	0	0	1	0	0	0	0	0	0	0	0	0	0	0	1	1	1
01:15 PM	0	0	0	0	0	0	0	0	0	0	0	0	2	0	2	0	0	0	0	0	0	2	2	2
01:30 PM	0	0	0	0	0	1	1	0	0	2	0	0	0	0	0	0	1	0	0	1	0	3	3	3
01:45 PM	0	0	0	0	0	2	1	0	0	3	0	0	4	0	4	0	0	0	0	0	0	7	7	7
Total	0	0	0	0	0	3	3	0	0	6	0	0	6	0	6	0	1	0	0	1	0	13	13	13
Grand Total	0	0	5	2	5	8	11	0	0	19	0	0	16	0	16	0	9	3	0	12	2	52	54	54
Apprch %	0	0	100			42.1	57.9	0			0	0	100			0	75	25						
Total %	0	0	9.6		9.6	15.4	21.2	0		36.5	0	0	30.8		30.8	0	17.3	5.8		23.1	3.7	96.3		

Start Time	I-215 Southbound Off Ramp Southbound				Cactus Avenue Westbound				I-215 Southbound Ramps Northbound				Cactus Avenue Eastbound				Int. Total				
	Left	Thru	Right	App. Total	Left	Thru	Right	App. Total	Left	Thru	Right	App. Total	Left	Thru	Right	App. Total					
Peak Hour Analysis From 01:00 PM to 01:45 PM - Peak 1 of 1																					
Peak Hour for Entire Intersection Begins at 01:00 PM																					
01:00 PM	0	0	0	0	0	1	0	1	0	0	0	0	0	0	0	0	0	0	0	0	1
01:15 PM	0	0	0	0	0	0	0	0	0	0	2	2	0	0	0	0	0	0	0	0	2
01:30 PM	0	0	0	0	1	1	0	2	0	0	0	0	0	1	0	1	0	0	0	0	3
01:45 PM	0	0	0	0	2	1	0	3	0	0	4	4	0	0	0	0	0	0	0	0	7
Total Volume	0	0	0	0	3	3	0	6	0	0	6	6	0	1	0	1	0	0	0	0	13
% App. Total	0	0	0		50	50	0		0	0	100		0	100	0						
PHF	.000	.000	.000	.000	.375	.750	.000	.500	.000	.000	.375	.375	.000	.250	.000	.250					.464

County of Riverside
 N/S: I-215 Southbound Ramps
 E/W: Cactus Avenue
 Weather: Clear

File Name : 30_CRV_215S_Cac Sat
 Site Code : 05122815
 Start Date : 9/17/2022
 Page No : 2

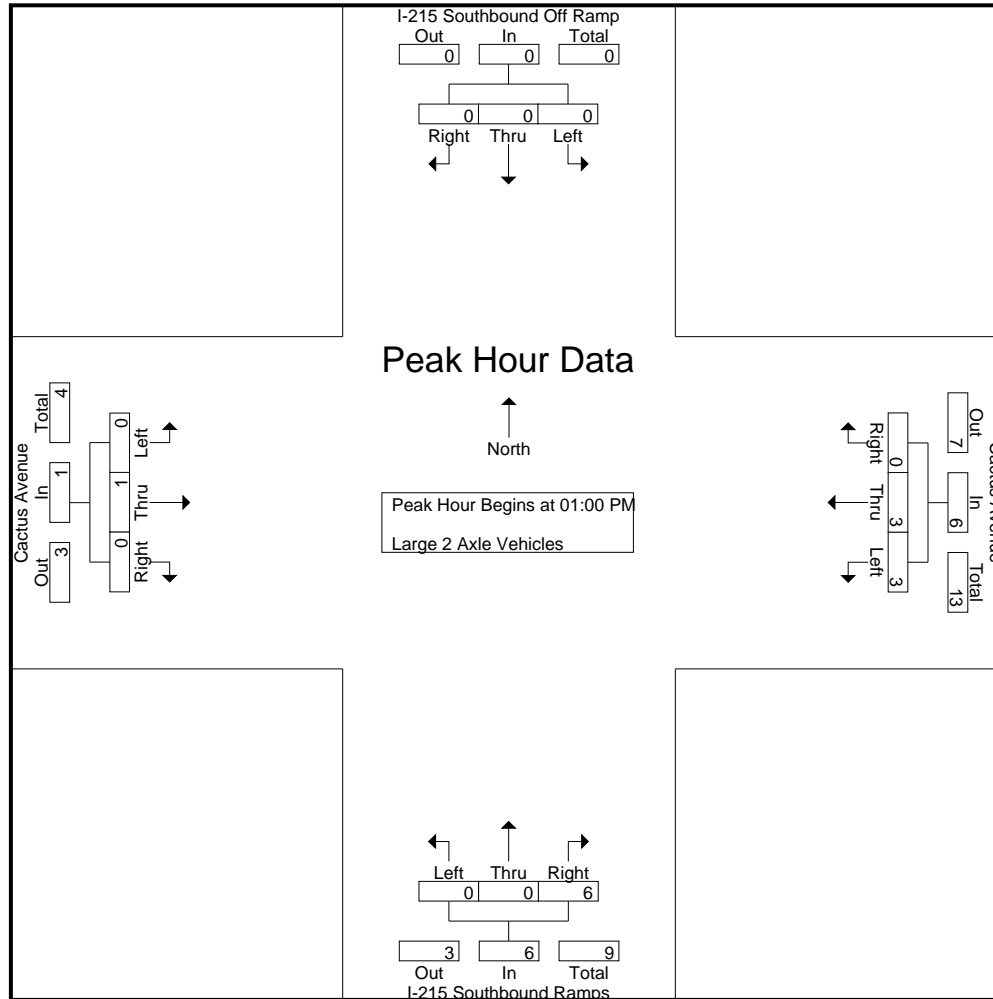

County of Riverside
 N/S: I-215 Southbound Ramps
 E/W: Cactus Avenue
 Weather: Clear

File Name : 30_CRV_215S_Cac Sat
 Site Code : 05122815
 Start Date : 9/17/2022
 Page No : 3

Start Time	I-215 Southbound Off Ramp Southbound				Cactus Avenue Westbound				I-215 Southbound Ramps Northbound				Cactus Avenue Eastbound				Int. Total
	Left	Thru	Right	App. Total	Left	Thru	Right	App. Total	Left	Thru	Right	App. Total	Left	Thru	Right	App. Total	
Peak Hour Analysis From 01:00 PM to 01:45 PM - Peak 1 of 1																	
Peak Hour for Each Approach Begins at:																	
	01:00 PM				01:00 PM				01:00 PM				01:00 PM				
+0 mins.	0	0	0	0	0	1	0	1	0	0	0	0	0	0	0	0	0
+15 mins.	0	0	0	0	0	0	0	0	0	0	2	2	0	0	0	0	0
+30 mins.	0	0	0	0	1	1	0	2	0	0	0	0	0	1	0	0	1
+45 mins.	0	0	0	0	2	1	0	3	0	0	4	4	0	0	0	0	0
Total Volume	0	0	0	0	3	3	0	6	0	0	6	6	0	1	0	0	1
% App. Total	0	0	0	0	50	50	0	50	0	0	100	100	0	100	0	0	100
PHF	.000	.000	.000	.000	.375	.750	.000	.500	.000	.000	.375	.375	.000	.250	.000	.250	.250

County of Riverside
 N/S: I-215 Southbound Ramps
 E/W: Cactus Avenue
 Weather: Clear

File Name : 30_CRV_215S_Cac Sat
 Site Code : 05122815
 Start Date : 9/17/2022
 Page No : 1

Groups Printed- 3 Axle Vehicles

Start Time	I-215 Southbound Off Ramp Southbound					Cactus Avenue Westbound					I-215 Southbound Ramps Northbound					Cactus Avenue Eastbound					Exclu. Total	Inclu. Total	Int. Total	
	Left	Thru	Right	RTOR	App. Total	Left	Thru	Right	RTOR	App. Total	Left	Thru	Right	RTOR	App. Total	Left	Thru	Right	RTOR	App. Total				
11:00 AM	0	0	0	0	0	0	0	0	0	0	0	0	2	0	2	0	0	0	0	0	0	0	2	2
11:15 AM	0	0	0	0	0	0	0	0	0	0	0	0	1	0	1	0	0	0	0	0	0	0	1	1
11:30 AM	0	0	0	0	0	0	0	0	0	0	0	0	4	0	4	0	0	0	0	0	0	0	4	4
11:45 AM	0	0	1	1	1	0	0	0	0	0	0	0	6	0	6	0	0	0	0	0	0	1	7	8
Total	0	0	1	1	1	0	0	0	0	0	0	0	13	0	13	0	0	0	0	0	0	1	14	15
12:00 PM	0	0	0	0	0	0	1	0	0	1	0	0	2	0	2	0	1	0	0	1	0	4	4	4
12:15 PM	0	0	0	0	0	0	0	0	0	0	0	0	1	0	1	0	0	0	0	0	0	1	1	1
12:30 PM	0	0	1	1	1	1	0	0	0	1	0	0	0	0	0	0	0	0	0	0	0	2	3	3
12:45 PM	0	0	0	0	0	1	0	0	0	1	0	0	3	0	3	0	0	0	0	0	0	4	4	4
Total	0	0	1	1	1	2	1	0	0	3	0	0	6	0	6	0	1	0	0	1	0	11	12	12
01:00 PM	0	0	0	0	0	0	0	0	0	0	0	0	0	0	0	0	0	0	0	0	0	0	0	0
01:15 PM	0	0	1	1	1	0	0	0	0	0	0	0	2	0	2	0	0	0	0	0	0	3	4	4
01:30 PM	0	0	2	1	2	0	0	0	0	0	0	0	1	0	1	0	0	0	0	0	0	3	4	4
01:45 PM	0	0	1	1	1	0	0	0	0	0	0	0	2	0	2	0	0	0	0	0	0	3	4	4
Total	0	0	4	3	4	0	0	0	0	0	0	0	5	0	5	0	0	0	0	0	0	9	12	12
Grand Total	0	0	6	5	6	2	1	0	0	3	0	0	24	0	24	0	1	0	0	1	5	34	39	39
Apprch %	0	0	100			66.7	33.3	0			0	0	100			0	100	0						
Total %	0	0	17.6		17.6	5.9	2.9	0		8.8	0	0	70.6		70.6	0	2.9	0		2.9	12.8	87.2		

Start Time	I-215 Southbound Off Ramp Southbound				Cactus Avenue Westbound				I-215 Southbound Ramps Northbound				Cactus Avenue Eastbound				Int. Total				
	Left	Thru	Right	App. Total	Left	Thru	Right	App. Total	Left	Thru	Right	App. Total	Left	Thru	Right	App. Total					
Peak Hour Analysis From 01:00 PM to 01:45 PM - Peak 1 of 1																					
Peak Hour for Entire Intersection Begins at 01:00 PM																					
01:00 PM	0	0	0	0	0	0	0	0	0	0	0	0	0	0	0	0	0	0	0	0	0
01:15 PM	0	0	1	1	0	0	0	0	0	0	2	2	0	0	0	0	0	0	0	0	3
01:30 PM	0	0	2	2	0	0	0	0	0	0	1	1	0	0	0	0	0	0	0	0	3
01:45 PM	0	0	1	1	0	0	0	0	0	0	2	2	0	0	0	0	0	0	0	0	3
Total Volume	0	0	4	4	0	0	0	0	0	0	5	5	0	0	0	0	0	0	0	0	9
% App. Total	0	0	100		0	0	0		0	0	100		0	0	0		0	0	0		
PHF	.000	.000	.500	.500	.000	.000	.000	.000	.000	.000	.625	.625	.000	.000	.000	.000	.000	.000	.000	.000	.750

County of Riverside
 N/S: I-215 Southbound Ramps
 E/W: Cactus Avenue
 Weather: Clear

File Name : 30_CRV_215S_Cac Sat
 Site Code : 05122815
 Start Date : 9/17/2022
 Page No : 2

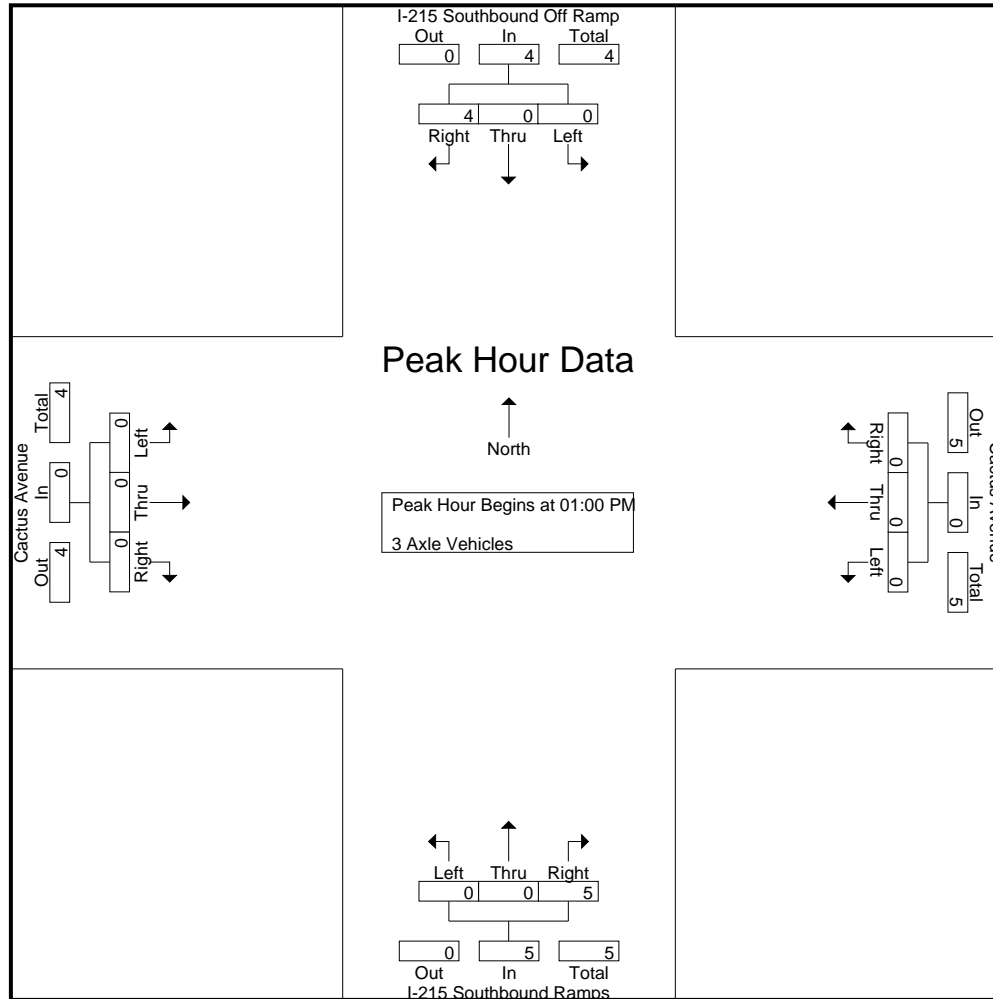

County of Riverside
 N/S: I-215 Southbound Ramps
 E/W: Cactus Avenue
 Weather: Clear

File Name : 30_CRV_215S_Cac Sat
 Site Code : 05122815
 Start Date : 9/17/2022
 Page No : 3

Start Time	I-215 Southbound Off Ramp Southbound				Cactus Avenue Westbound				I-215 Southbound Ramps Northbound				Cactus Avenue Eastbound				Int. Total
	Left	Thru	Right	App. Total	Left	Thru	Right	App. Total	Left	Thru	Right	App. Total	Left	Thru	Right	App. Total	
Peak Hour Analysis From 01:00 PM to 01:45 PM - Peak 1 of 1																	
Peak Hour for Each Approach Begins at:																	
	01:00 PM				01:00 PM				01:00 PM				01:00 PM				
+0 mins.	0	0	0	0	0	0	0	0	0	0	0	0	0	0	0	0	
+15 mins.	0	0	1	1	0	0	0	0	0	0	2	2	0	0	0	0	
+30 mins.	0	0	2	2	0	0	0	0	0	0	1	1	0	0	0	0	
+45 mins.	0	0	1	1	0	0	0	0	0	0	2	2	0	0	0	0	
Total Volume	0	0	4	4	0	0	0	0	0	0	5	5	0	0	0	0	
% App. Total	0	0	100		0	0	0		0	0	100		0	0	0		
PHF	.000	.000	.500	.500	.000	.000	.000	.000	.000	.000	.625	.625	.000	.000	.000	.000	

County of Riverside
 N/S: I-215 Southbound Ramps
 E/W: Cactus Avenue
 Weather: Clear

File Name : 30_CRV_215S_Cac Sat
 Site Code : 05122815
 Start Date : 9/17/2022
 Page No : 1

Groups Printed- 4+ Axle Trucks

Start Time	I-215 Southbound Off Ramp Southbound					Cactus Avenue Westbound					I-215 Southbound Ramps Northbound					Cactus Avenue Eastbound					Exclu. Total	Inclu. Total	Int. Total
	Left	Thru	Right	RTOR	App. Total	Left	Thru	Right	RTOR	App. Total	Left	Thru	Right	RTOR	App. Total	Left	Thru	Right	RTOR	App. Total			
11:00 AM	0	0	3	1	3	0	0	0	0	0	0	0	3	0	3	0	2	0	0	2	1	8	9
11:15 AM	0	0	1	1	1	0	2	0	0	2	0	0	6	0	6	0	4	0	0	4	1	13	14
11:30 AM	0	0	2	1	2	0	0	0	0	0	0	0	6	0	6	0	2	1	0	3	1	11	12
11:45 AM	0	0	2	2	2	0	2	0	0	2	0	0	7	0	7	0	0	0	0	0	2	11	13
Total	0	0	8	5	8	0	4	0	0	4	0	0	22	0	22	0	8	1	0	9	5	43	48
12:00 PM	0	0	6	3	6	1	1	0	0	2	0	0	11	0	11	0	1	0	0	1	3	20	23
12:15 PM	0	0	7	2	7	0	0	0	0	0	0	0	4	0	4	0	2	0	0	2	2	13	15
12:30 PM	0	0	4	3	4	2	1	0	0	3	0	0	4	0	4	0	1	1	0	2	3	13	16
12:45 PM	0	0	1	0	1	2	1	0	0	3	0	0	6	0	6	0	1	1	0	2	0	12	12
Total	0	0	18	8	18	5	3	0	0	8	0	0	25	0	25	0	5	2	0	7	8	58	66
01:00 PM	0	0	2	1	2	0	0	0	0	0	0	0	6	0	6	0	0	0	0	0	1	8	9
01:15 PM	0	0	1	0	1	0	0	0	0	0	0	0	4	0	4	0	0	0	0	0	0	5	5
01:30 PM	1	0	2	1	3	0	0	0	0	0	0	0	2	0	2	0	0	0	0	0	1	5	6
01:45 PM	0	0	2	1	2	0	0	0	0	0	0	0	1	0	1	0	1	0	0	1	1	4	5
Total	1	0	7	3	8	0	0	0	0	0	0	0	13	0	13	0	1	0	0	1	3	22	25
Grand Total	1	0	33	16	34	5	7	0	0	12	0	0	60	0	60	0	14	3	0	17	16	123	139
Apprch %	2.9	0	97.1			41.7	58.3	0			0	0	100			0	82.4	17.6					
Total %	0.8	0	26.8		27.6	4.1	5.7	0		9.8	0	0	48.8		48.8	0	11.4	2.4		13.8	11.5	88.5	

Start Time	I-215 Southbound Off Ramp Southbound				Cactus Avenue Westbound				I-215 Southbound Ramps Northbound				Cactus Avenue Eastbound				Int. Total
	Left	Thru	Right	App. Total	Left	Thru	Right	App. Total	Left	Thru	Right	App. Total	Left	Thru	Right	App. Total	
Peak Hour Analysis From 01:00 PM to 01:45 PM - Peak 1 of 1																	
Peak Hour for Entire Intersection Begins at 01:00 PM																	
01:00 PM	0	0	2	2	0	0	0	0	0	0	6	6	0	0	0	0	8
01:15 PM	0	0	1	1	0	0	0	0	0	0	4	4	0	0	0	0	5
01:30 PM	1	0	2	3	0	0	0	0	0	0	2	2	0	0	0	0	5
01:45 PM	0	0	2	2	0	0	0	0	0	0	1	1	0	1	0	1	4
Total Volume	1	0	7	8	0	0	0	0	0	0	13	13	0	1	0	1	22
% App. Total	12.5	0	87.5		0	0	0		0	0	100		0	100	0		
PHF	.250	.000	.875	.667	.000	.000	.000	.000	.000	.000	.542	.542	.000	.250	.000	.250	.688

County of Riverside
 N/S: I-215 Southbound Ramps
 E/W: Cactus Avenue
 Weather: Clear

File Name : 30_CRV_215S_Cac Sat
 Site Code : 05122815
 Start Date : 9/17/2022
 Page No : 2

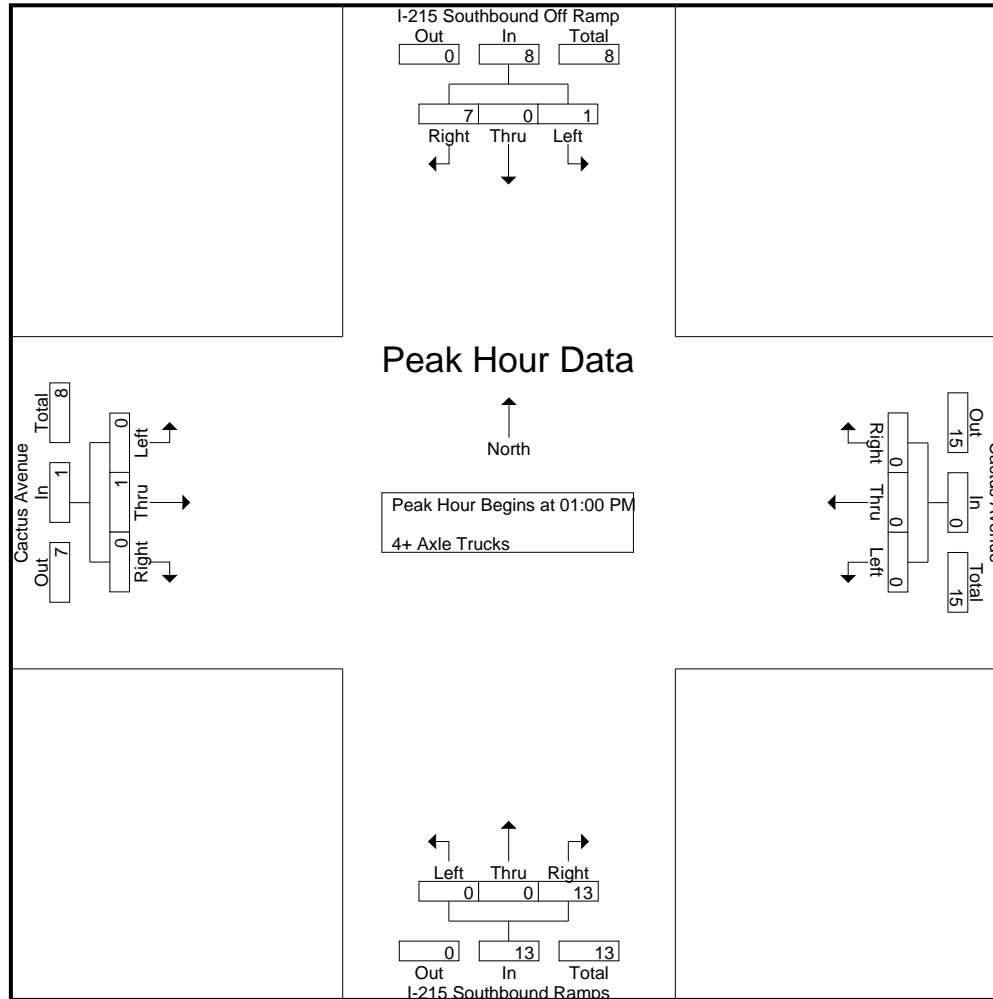

County of Riverside
 N/S: I-215 Southbound Ramps
 E/W: Cactus Avenue
 Weather: Clear

File Name : 30_CRV_215S_Cac Sat
 Site Code : 05122815
 Start Date : 9/17/2022
 Page No : 3

Start Time	I-215 Southbound Off Ramp Southbound				Cactus Avenue Westbound				I-215 Southbound Ramps Northbound				Cactus Avenue Eastbound				Int. Total
	Left	Thru	Right	App. Total	Left	Thru	Right	App. Total	Left	Thru	Right	App. Total	Left	Thru	Right	App. Total	
Peak Hour Analysis From 01:00 PM to 01:45 PM - Peak 1 of 1																	
Peak Hour for Each Approach Begins at:																	
	01:00 PM				01:00 PM				01:00 PM				01:00 PM				
+0 mins.	0	0	2	2	0	0	0	0	0	0	6	6	0	0	0	0	
+15 mins.	0	0	1	1	0	0	0	0	0	0	4	4	0	0	0	0	
+30 mins.	1	0	2	3	0	0	0	0	0	0	2	2	0	0	0	0	
+45 mins.	0	0	2	2	0	0	0	0	0	0	1	1	0	1	0	1	
Total Volume	1	0	7	8	0	0	0	0	0	0	13	13	0	1	0	1	
% App. Total	12.5	0	87.5		0	0	0		0	0	100		0	100	0		
PHF	.250	.000	.875	.667	.000	.000	.000	.000	.000	.000	.542	.542	.000	.250	.000	.250	

Location: County of Riverside
 N/S: I-215 SB Ramps
 E/W: Cactus Avenue



Date: 9/17/2022
 Day Saturday

PEDESTRIANS

Time	North Leg I-215 SB Ramps	East Leg Cactus Avenue	South Leg I-215 SB Ramps	West Leg Cactus Avenue	TOTAL
11:00 AM	0	0	0	0	0
11:15 AM	0	0	0	0	0
11:30 AM	0	0	0	0	0
11:45 AM	0	0	0	0	0
12:00 PM	0	0	0	0	0
12:15 PM	0	0	0	0	0
12:30 PM	0	0	0	0	0
12:45 PM	0	0	0	0	0
1:00 PM	0	0	0	0	0
1:15 PM	0	0	0	0	0
1:30 PM	0	0	0	0	0
1:45 PM	0	0	0	0	0
TOTAL VOLUMES:	0	0	0	0	0

Location: County of Riverside
 N/S: I-215 SB Ramps
 E/W: Cactus Avenue

Date: 9/17/2022
 Day: Saturday



BICYCLES

	Southbound I-215 SB Ramps			Westbound Cactus Avenue			Northbound I-215 SB Ramps			Eastbound Cactus Avenue			
	Left	Thru	Right	Left	Thru	Right	Left	Thru	Right	Left	Thru	Right	
11:00 AM	0	0	0	0	0	0	0	0	0	0	0	0	0
11:15 AM	0	0	0	0	0	0	0	0	0	0	0	0	0
11:30 AM	0	0	0	0	0	0	0	0	0	0	1	0	1
11:45 AM	0	0	0	0	0	0	0	0	0	0	0	0	0
12:00 PM	0	0	0	0	0	0	0	0	0	0	0	0	0
12:15 PM	0	0	0	0	0	0	0	0	0	0	0	0	0
12:30 PM	0	0	0	0	0	0	0	0	0	0	0	0	0
12:45 PM	0	0	0	0	0	0	0	0	0	0	0	0	0
1:00 PM	0	0	0	0	0	0	0	0	0	0	0	0	0
1:15 PM	0	0	0	0	0	0	0	0	0	0	0	0	0
1:30 PM	0	0	0	0	0	0	0	0	0	0	0	0	0
1:45 PM	0	0	0	0	0	0	0	0	0	0	0	0	0
TOTAL VOLUMES:	0	0	0	0	0	0	0	0	0	0	1	0	1

County of Riverside
 N/S: Old 215 Frontage Rd/I-215 NB Ramps
 E/W: Cactus Avenue
 Weather: Clear

File Name : 31_CRV_215N_Cac Sat
 Site Code : 05122815
 Start Date : 9/17/2022
 Page No : 1

Groups Printed- Passenger Vehicles - Large 2 Axle Vehicles - 3 Axle Vehicles - 4+ Axle Trucks

Start Time	Old 215 Frontage Road Southbound					Cactus Avenue Westbound					I-215 Northbound Ramps Northbound					Cactus Avenue Eastbound					Exclu. Total	Inclu. Total	Int. Total
	Left	Thru	Right	RTOR	App. Total	Left	Thru	Right	RTOR	App. Total	Left	Thru	Right	RTOR	App. Total	Left	Thru	Right	RTOR	App. Total			
11:00 AM	12	2	11	5	25	0	251	29	0	280	3	20	0	0	23	3	89	4	0	96	5	424	429
11:15 AM	4	0	10	8	14	0	218	29	0	247	4	20	2	1	26	7	111	8	0	126	9	413	422
11:30 AM	16	0	6	1	22	0	197	26	2	223	5	24	0	0	29	5	111	5	1	121	4	395	399
11:45 AM	24	0	15	8	39	0	214	26	2	240	9	16	0	0	25	4	123	3	1	130	11	434	445
Total	56	2	42	22	100	0	880	110	4	990	21	80	2	1	103	19	434	20	2	473	29	1666	1695
12:00 PM	20	1	11	8	32	0	207	27	1	234	6	22	0	0	28	4	139	2	0	145	9	439	448
12:15 PM	16	0	7	3	23	0	250	21	2	271	4	17	0	0	21	6	138	6	1	150	6	465	471
12:30 PM	28	0	11	4	39	0	233	25	1	258	6	17	2	2	25	3	149	4	1	156	8	478	486
12:45 PM	31	0	18	9	49	0	198	18	6	216	8	19	0	0	27	4	122	6	1	132	16	424	440
Total	95	1	47	24	143	0	888	91	10	979	24	75	2	2	101	17	548	18	3	583	39	1806	1845
01:00 PM	28	0	14	5	42	0	211	22	2	233	10	9	1	0	20	6	109	2	0	117	7	412	419
01:15 PM	31	0	15	9	46	0	245	29	5	274	9	16	1	0	26	2	138	5	0	145	14	491	505
01:30 PM	23	1	18	6	42	0	256	34	9	290	9	21	0	0	30	3	137	10	1	150	16	512	528
01:45 PM	19	0	10	7	29	0	256	24	4	280	7	15	1	0	23	3	174	8	0	185	11	517	528
Total	101	1	57	27	159	0	968	109	20	1077	35	61	3	0	99	14	558	25	1	597	48	1932	1980
Grand Total	252	4	146	73	402	0	2736	310	34	3046	80	216	7	3	303	50	1540	63	6	1653	116	5404	5520
Apprch %	62.7	1	36.3			0	89.8	10.2			26.4	71.3	2.3			3	93.2	3.8					
Total %	4.7	0.1	2.7		7.4	0	50.6	5.7		56.4	1.5	4	0.1		5.6	0.9	28.5	1.2		30.6	2.1	97.9	
Passenger Vehicles	249	4	137		460	0	2638	306		2978	74	204	7		288	45	1443	49		1543	0	0	5269
% Passenger Vehicles	98.8	100	93.8	95.9	96.8	0	96.4	98.7	100	96.7	92.5	94.4	100	100	94.1	90	93.7	77.8	100	93	0	0	95.5
Large 2 Axle Vehicles	2	0	4		8	0	26	3		29	0	3	0		3	2	17	2		21	0	0	61
% Large 2 Axle Vehicles	0.8	0	2.7	2.7	1.7	0	1	1	0	0.9	0	1.4	0	0	1	4	1.1	3.2	0	1.3	0	0	1.1
3 Axle Vehicles	1	0	2		4	0	20	1		21	1	6	0		7	0	24	0		24	0	0	56
% 3 Axle Vehicles	0.4	0	1.4	1.4	0.8	0	0.7	0.3	0	0.7	1.2	2.8	0	0	2.3	0	1.6	0	0	1.4	0	0	1
4+ Axle Trucks	0	0	3		3	0	52	0		52	5	3	0		8	3	56	12		71	0	0	134
% 4+ Axle Trucks	0	0	2.1	0	0.6	0	1.9	0	0	1.7	6.2	1.4	0	0	2.6	6	3.6	19	0	4.3	0	0	2.4

County of Riverside
 N/S: Old 215 Frontage Rd/I-215 NB Ramps
 E/W: Cactus Avenue
 Weather: Clear

File Name : 31_CRV_215N_Cac Sat
 Site Code : 05122815
 Start Date : 9/17/2022
 Page No : 2

Start Time	Old 215 Frontage Road Southbound				Cactus Avenue Westbound				I-215 Northbound Ramps Northbound				Cactus Avenue Eastbound				Int. Total
	Left	Thru	Right	App. Total	Left	Thru	Right	App. Total	Left	Thru	Right	App. Total	Left	Thru	Right	App. Total	
Peak Hour Analysis From 11:00 AM to 01:45 PM - Peak 1 of 1																	
Peak Hour for Entire Intersection Begins at 01:00 PM																	
01:00 PM	28	0	14	42	0	211	22	233	10	9	1	20	6	109	2	117	412
01:15 PM	31	0	15	46	0	245	29	274	9	16	1	26	2	138	5	145	491
01:30 PM	23	1	18	42	0	256	34	290	9	21	0	30	3	137	10	150	512
01:45 PM	19	0	10	29	0	256	24	280	7	15	1	23	3	174	8	185	517
Total Volume	101	1	57	159	0	968	109	1077	35	61	3	99	14	558	25	597	1932
% App. Total	63.5	0.6	35.8		0	89.9	10.1		35.4	61.6	3		2.3	93.5	4.2		
PHF	.815	.250	.792	.864	.000	.945	.801	.928	.875	.726	.750	.825	.583	.802	.625	.807	.934

County of Riverside
 N/S: Old 215 Frontage Rd/I-215 NB Ramps
 E/W: Cactus Avenue
 Weather: Clear

File Name : 31_CRV_215N_Cac Sat
 Site Code : 05122815
 Start Date : 9/17/2022
 Page No : 3

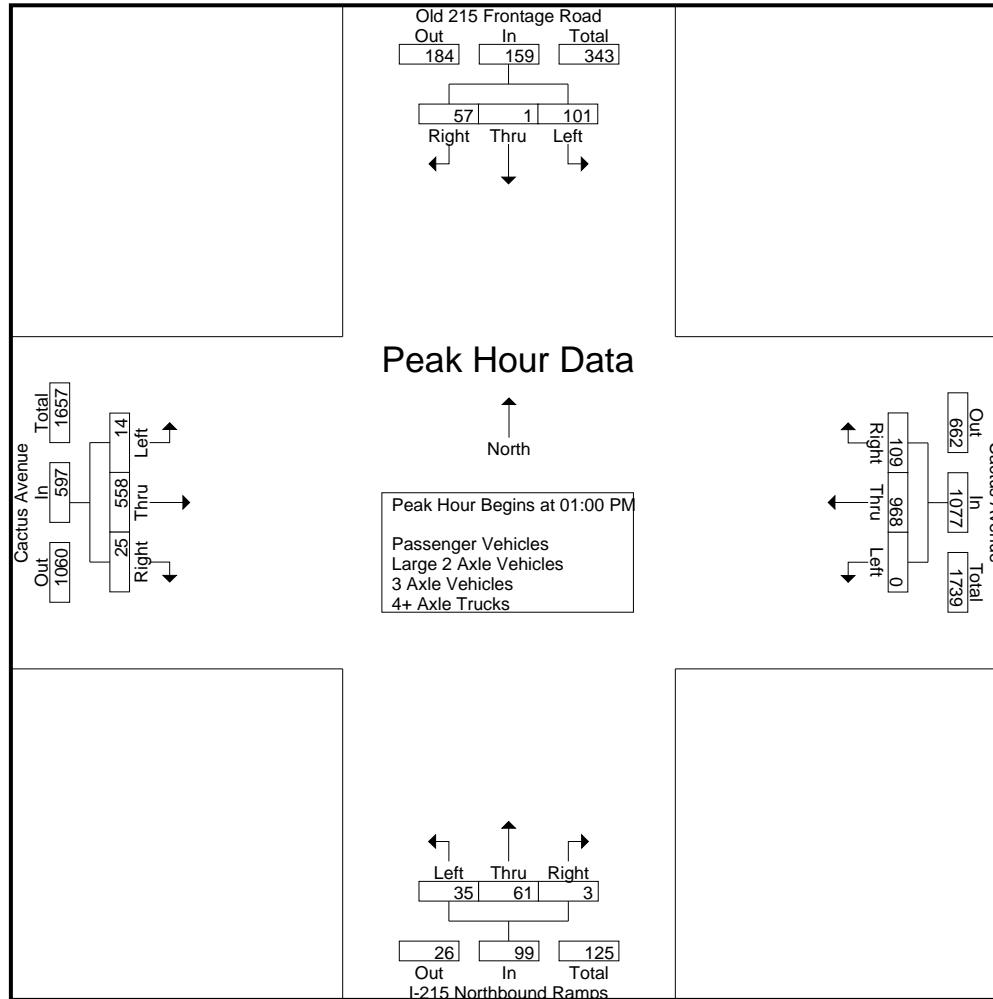

County of Riverside
 N/S: Old 215 Frontage Rd/I-215 NB Ramps
 E/W: Cactus Avenue
 Weather: Clear

File Name : 31_CRV_215N_Cac Sat
 Site Code : 05122815
 Start Date : 9/17/2022
 Page No : 4

Start Time	Old 215 Frontage Road Southbound				Cactus Avenue Westbound				I-215 Northbound Ramps Northbound				Cactus Avenue Eastbound				Int. Total
	Left	Thru	Right	App. Total	Left	Thru	Right	App. Total	Left	Thru	Right	App. Total	Left	Thru	Right	App. Total	
Peak Hour Analysis From 11:00 AM to 01:45 PM - Peak 1 of 1																	
Peak Hour for Each Approach Begins at:																	
	12:45 PM				01:00 PM				11:15 AM				01:00 PM				
+0 mins.	31	0	18	49	0	211	22	233	4	20	2	26	6	109	2	117	
+15 mins.	28	0	14	42	0	245	29	274	5	24	0	29	2	138	5	145	
+30 mins.	31	0	15	46	0	256	34	290	9	16	0	25	3	137	10	150	
+45 mins.	23	1	18	42	0	256	24	280	6	22	0	28	3	174	8	185	
Total Volume	113	1	65	179	0	968	109	1077	24	82	2	108	14	558	25	597	
% App. Total	63.1	0.6	36.3		0	89.9	10.1		22.2	75.9	1.9		2.3	93.5	4.2		
PHF	.911	.250	.903	.913	.000	.945	.801	.928	.667	.854	.250	.931	.583	.802	.625	.807	

County of Riverside
 N/S: Old 215 Frontage Rd/I-215 NB Ramps
 E/W: Cactus Avenue
 Weather: Clear

File Name : 31_CRV_215N_Cac Sat
 Site Code : 05122815
 Start Date : 9/17/2022
 Page No : 1

Groups Printed- Passenger Vehicles

Start Time	Old 215 Frontage Road Southbound					Cactus Avenue Westbound					I-215 Northbound Ramps Northbound					Cactus Avenue Eastbound					Exclu. Total	Inclu. Total	Int. Total
	Left	Thru	Right	RTOR	App. Total	Left	Thru	Right	RTOR	App. Total	Left	Thru	Right	RTOR	App. Total	Left	Thru	Right	RTOR	App. Total			
11:00 AM	12	2	11	5	25	0	243	29	0	272	2	19	0	0	21	2	82	3	0	87	5	405	410
11:15 AM	4	0	10	8	14	0	214	29	0	243	3	19	2	1	24	7	104	5	0	116	9	397	406
11:30 AM	16	0	6	1	22	0	190	26	2	216	5	20	0	0	25	5	101	3	1	109	4	372	376
11:45 AM	24	0	13	8	37	0	208	25	2	233	8	15	0	0	23	3	110	2	1	115	11	408	419
Total	56	2	40	22	98	0	855	109	4	964	18	73	2	1	93	17	397	13	2	427	29	1582	1611
12:00 PM	19	1	10	7	30	0	197	27	1	224	5	22	0	0	27	3	122	1	0	126	8	407	415
12:15 PM	16	0	6	2	22	0	242	20	2	262	4	17	0	0	21	5	132	5	1	142	5	447	452
12:30 PM	27	0	9	4	36	0	218	25	1	243	5	14	2	2	21	2	146	3	1	151	8	451	459
12:45 PM	30	0	16	9	46	0	190	17	6	207	7	19	0	0	26	4	112	3	1	119	16	398	414
Total	92	1	41	22	134	0	847	89	10	936	21	72	2	2	95	14	512	12	3	538	37	1703	1740
01:00 PM	28	0	14	5	42	0	206	22	2	228	10	8	1	0	19	6	102	2	0	110	7	399	406
01:15 PM	31	0	15	9	46	0	239	29	5	268	9	15	1	0	25	2	132	5	0	139	14	478	492
01:30 PM	23	1	18	6	42	0	244	34	9	278	9	21	0	0	30	3	133	10	1	146	16	496	512
01:45 PM	19	0	9	6	28	0	247	23	4	270	7	15	1	0	23	3	167	7	0	177	10	498	508
Total	101	1	56	26	158	0	936	108	20	1044	35	59	3	0	97	14	534	24	1	572	47	1871	1918
Grand Total	249	4	137	70	390	0	2638	306	34	2944	74	204	7	3	285	45	1443	49	6	1537	113	5156	5269
Apprch %	63.8	1	35.1			0	89.6	10.4			26	71.6	2.5			2.9	93.9	3.2					
Total %	4.8	0.1	2.7		7.6	0	51.2	5.9		57.1	1.4	4	0.1		5.5	0.9	28	1		29.8	2.1	97.9	

Start Time	Old 215 Frontage Road Southbound				Cactus Avenue Westbound				I-215 Northbound Ramps Northbound				Cactus Avenue Eastbound				Int. Total
	Left	Thru	Right	App. Total	Left	Thru	Right	App. Total	Left	Thru	Right	App. Total	Left	Thru	Right	App. Total	
Peak Hour Analysis From 01:00 PM to 01:45 PM - Peak 1 of 1																	
Peak Hour for Entire Intersection Begins at 01:00 PM																	
01:00 PM	28	0	14	42	0	206	22	228	10	8	1	19	6	102	2	110	399
01:15 PM	31	0	15	46	0	239	29	268	9	15	1	25	2	132	5	139	478
01:30 PM	23	1	18	42	0	244	34	278	9	21	0	30	3	133	10	146	496
01:45 PM	19	0	9	28	0	247	23	270	7	15	1	23	3	167	7	177	498
Total Volume	101	1	56	158	0	936	108	1044	35	59	3	97	14	534	24	572	1871
% App. Total	63.9	0.6	35.4		0	89.7	10.3		36.1	60.8	3.1		2.4	93.4	4.2		
PHF	.815	.250	.778	.859	.000	.947	.794	.939	.875	.702	.750	.808	.583	.799	.600	.808	.939

County of Riverside
 N/S: Old 215 Frontage Rd/I-215 NB Ramps
 E/W: Cactus Avenue
 Weather: Clear

File Name : 31_CRV_215N_Cac Sat
 Site Code : 05122815
 Start Date : 9/17/2022
 Page No : 2

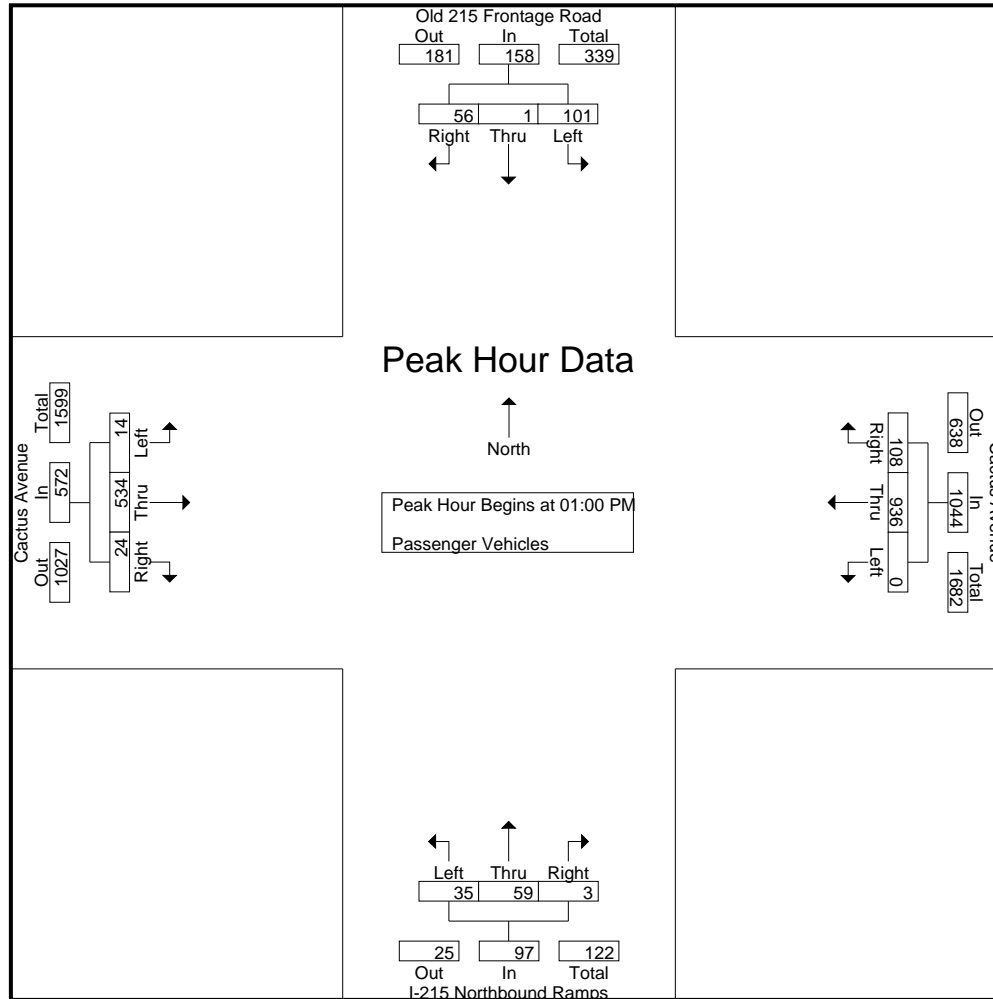

County of Riverside
 N/S: Old 215 Frontage Rd/I-215 NB Ramps
 E/W: Cactus Avenue
 Weather: Clear

File Name : 31_CRV_215N_Cac Sat
 Site Code : 05122815
 Start Date : 9/17/2022
 Page No : 3

Start Time	Old 215 Frontage Road Southbound				Cactus Avenue Westbound				I-215 Northbound Ramps Northbound				Cactus Avenue Eastbound				Int. Total
	Left	Thru	Right	App. Total	Left	Thru	Right	App. Total	Left	Thru	Right	App. Total	Left	Thru	Right	App. Total	
Peak Hour Analysis From 01:00 PM to 01:45 PM - Peak 1 of 1																	
Peak Hour for Each Approach Begins at:																	
	01:00 PM				01:00 PM				01:00 PM				01:00 PM				
+0 mins.	28	0	14	42	0	206	22	228	10	8	1	19	6	102	2	110	
+15 mins.	31	0	15	46	0	239	29	268	9	15	1	25	2	132	5	139	
+30 mins.	23	1	18	42	0	244	34	278	9	21	0	30	3	133	10	146	
+45 mins.	19	0	9	28	0	247	23	270	7	15	1	23	3	167	7	177	
Total Volume	101	1	56	158	0	936	108	1044	35	59	3	97	14	534	24	572	
% App. Total	63.9	0.6	35.4		0	89.7	10.3		36.1	60.8	3.1		2.4	93.4	4.2		
PHF	.815	.250	.778	.859	.000	.947	.794	.939	.875	.702	.750	.808	.583	.799	.600	.808	

County of Riverside
 N/S: Old 215 Frontage Rd/I-215 NB Ramps
 E/W: Cactus Avenue
 Weather: Clear

File Name : 31_CRV_215N_Cac Sat
 Site Code : 05122815
 Start Date : 9/17/2022
 Page No : 1

Groups Printed- Large 2 Axle Vehicles

Start Time	Old 215 Frontage Road Southbound					Cactus Avenue Westbound					I-215 Northbound Ramps Northbound					Cactus Avenue Eastbound					Exclu. Total	Inclu. Total	Int. Total	
	Left	Thru	Right	RTOR	App. Total	Left	Thru	Right	RTOR	App. Total	Left	Thru	Right	RTOR	App. Total	Left	Thru	Right	RTOR	App. Total				
11:00 AM	0	0	0	0	0	0	2	0	0	2	0	0	0	0	0	0	3	0	0	3	0	0	5	5
11:15 AM	0	0	0	0	0	0	0	0	0	0	0	0	0	0	0	0	1	0	0	1	0	1	1	1
11:30 AM	0	0	0	0	0	0	1	0	0	1	0	1	0	0	1	0	0	0	0	0	0	2	2	2
11:45 AM	0	0	1	0	1	0	0	1	0	1	0	0	0	0	0	1	1	0	0	2	0	4	4	4
Total	0	0	1	0	1	0	3	1	0	4	0	1	0	0	1	1	5	0	0	6	0	12	12	12
12:00 PM	0	0	0	0	0	0	3	0	0	3	0	0	0	0	0	0	3	0	0	3	0	6	6	6
12:15 PM	0	0	1	1	1	0	4	1	0	5	0	0	0	0	0	0	1	0	0	1	1	7	8	8
12:30 PM	1	0	1	0	2	0	6	0	0	6	0	1	0	0	1	1	0	0	0	1	0	10	10	10
12:45 PM	1	0	0	0	1	0	3	1	0	4	0	0	0	0	0	0	3	2	0	5	0	10	10	10
Total	2	0	2	1	4	0	16	2	0	18	0	1	0	0	1	1	7	2	0	10	1	33	34	34
01:00 PM	0	0	0	0	0	0	2	0	0	2	0	1	0	0	1	0	0	0	0	0	0	3	3	3
01:15 PM	0	0	0	0	0	0	0	0	0	0	0	0	0	0	0	0	1	0	0	1	0	1	1	1
01:30 PM	0	0	0	0	0	0	2	0	0	2	0	0	0	0	0	0	0	0	0	0	0	2	2	2
01:45 PM	0	0	1	1	1	0	3	0	0	3	0	0	0	0	0	0	4	0	0	4	1	8	9	9
Total	0	0	1	1	1	0	7	0	0	7	0	1	0	0	1	0	5	0	0	5	1	14	15	15
Grand Total	2	0	4	2	6	0	26	3	0	29	0	3	0	0	3	2	17	2	0	21	2	59	61	61
Apprch %	33.3	0	66.7			0	89.7	10.3			0	100	0			9.5	81	9.5						
Total %	3.4	0	6.8		10.2	0	44.1	5.1		49.2	0	5.1	0		5.1	3.4	28.8	3.4		35.6	3.3	96.7		

Start Time	Old 215 Frontage Road Southbound				Cactus Avenue Westbound				I-215 Northbound Ramps Northbound				Cactus Avenue Eastbound				Int. Total	
	Left	Thru	Right	App. Total	Left	Thru	Right	App. Total	Left	Thru	Right	App. Total	Left	Thru	Right	App. Total		
Peak Hour Analysis From 01:00 PM to 01:45 PM - Peak 1 of 1																		
Peak Hour for Entire Intersection Begins at 01:00 PM																		
01:00 PM	0	0	0	0	0	2	0	2	0	1	0	1	0	0	0	0	0	3
01:15 PM	0	0	0	0	0	0	0	0	0	0	0	0	0	1	0	1	0	1
01:30 PM	0	0	0	0	0	2	0	2	0	0	0	0	0	0	0	0	0	2
01:45 PM	0	0	1	1	0	3	0	3	0	0	0	0	0	4	0	4	1	8
Total Volume	0	0	1	1	0	7	0	7	0	1	0	1	0	5	0	5	1	14
% App. Total	0	0	100		0	100	0		0	100	0		0	100	0			
PHF	.000	.000	.250	.250	.000	.583	.000	.583	.000	.250	.000	.250	.000	.313	.000	.313		.438

County of Riverside
 N/S: Old 215 Frontage Rd/I-215 NB Ramps
 E/W: Cactus Avenue
 Weather: Clear

File Name : 31_CRV_215N_Cac Sat
 Site Code : 05122815
 Start Date : 9/17/2022
 Page No : 2

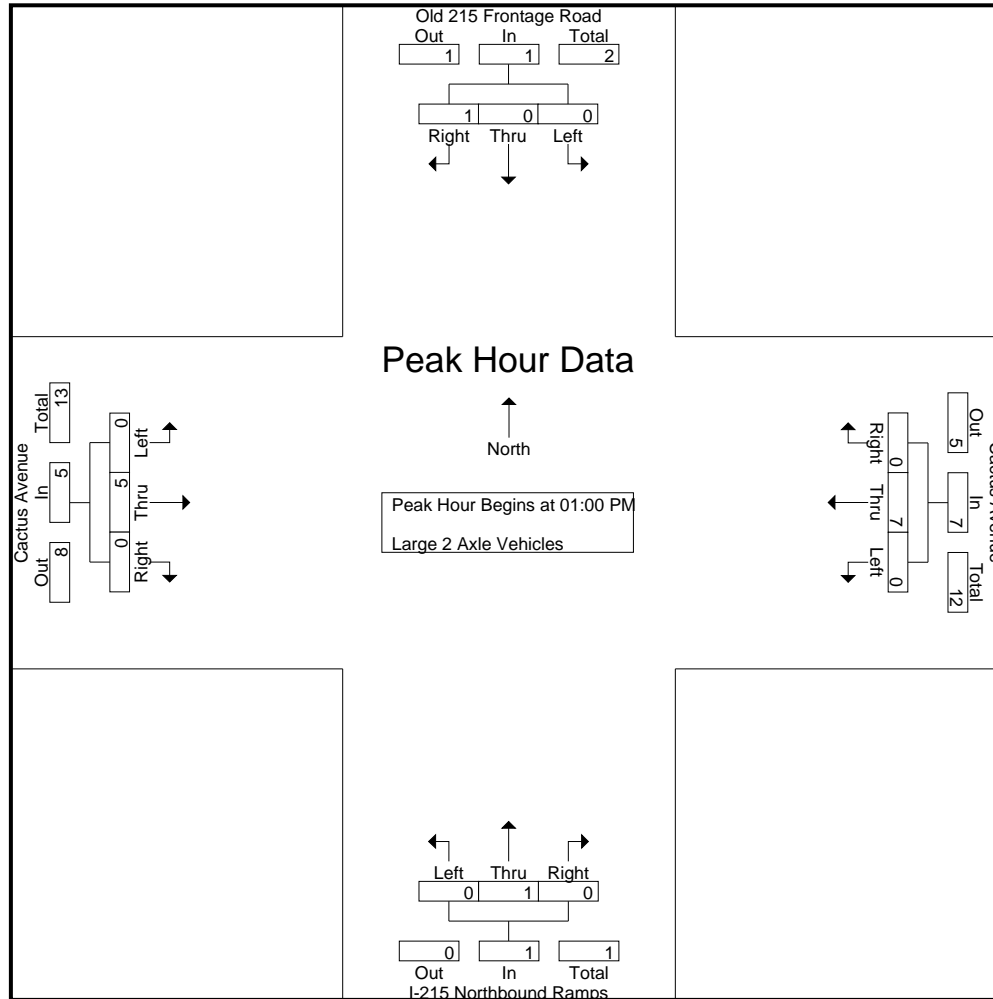

County of Riverside
 N/S: Old 215 Frontage Rd/I-215 NB Ramps
 E/W: Cactus Avenue
 Weather: Clear

File Name : 31_CRV_215N_Cac Sat
 Site Code : 05122815
 Start Date : 9/17/2022
 Page No : 3

Start Time	Old 215 Frontage Road Southbound				Cactus Avenue Westbound				I-215 Northbound Ramps Northbound				Cactus Avenue Eastbound				Int. Total
	Left	Thru	Right	App. Total	Left	Thru	Right	App. Total	Left	Thru	Right	App. Total	Left	Thru	Right	App. Total	
Peak Hour Analysis From 01:00 PM to 01:45 PM - Peak 1 of 1																	
Peak Hour for Each Approach Begins at:																	
	01:00 PM				01:00 PM				01:00 PM				01:00 PM				
+0 mins.	0	0	0	0	0	2	0	2	0	1	0	1	0	0	0	0	
+15 mins.	0	0	0	0	0	0	0	0	0	0	0	0	0	1	0	1	
+30 mins.	0	0	0	0	0	2	0	2	0	0	0	0	0	0	0	0	
+45 mins.	0	0	1	1	0	3	0	3	0	0	0	0	0	4	0	4	
Total Volume	0	0	1	1	0	7	0	7	0	1	0	1	0	5	0	5	
% App. Total	0	0	100		0	100	0		0	100	0		0	100	0		
PHF	.000	.000	.250	.250	.000	.583	.000	.583	.000	.250	.000	.250	.000	.313	.000	.313	

County of Riverside
 N/S: Old 215 Frontage Rd/I-215 NB Ramps
 E/W: Cactus Avenue
 Weather: Clear

File Name : 31_CRV_215N_Cac Sat
 Site Code : 05122815
 Start Date : 9/17/2022
 Page No : 1

Groups Printed- 3 Axle Vehicles

Start Time	Old 215 Frontage Road Southbound					Cactus Avenue Westbound					I-215 Northbound Ramps Northbound					Cactus Avenue Eastbound					Exclu. Total	Inclu. Total	Int. Total	
	Left	Thru	Right	RTOR	App. Total	Left	Thru	Right	RTOR	App. Total	Left	Thru	Right	RTOR	App. Total	Left	Thru	Right	RTOR	App. Total				
11:00 AM	0	0	0	0	0	0	3	0	0	3	0	1	0	0	1	0	2	0	0	2	0	0	6	6
11:15 AM	0	0	0	0	0	0	2	0	0	2	0	1	0	0	1	0	1	0	0	1	0	0	4	4
11:30 AM	0	0	0	0	0	0	1	0	0	1	0	1	0	0	1	0	3	0	0	3	0	0	5	5
11:45 AM	0	0	0	0	0	0	1	0	0	1	0	1	0	0	1	0	7	0	0	7	0	0	9	9
Total	0	0	0	0	0	0	7	0	0	7	0	4	0	0	4	0	13	0	0	13	0	0	24	24
12:00 PM	1	0	1	1	2	0	2	0	0	2	1	0	0	0	1	0	3	0	0	3	1	0	8	9
12:15 PM	0	0	0	0	0	0	2	0	0	2	0	0	0	0	0	0	1	0	0	1	0	0	3	3
12:30 PM	0	0	0	0	0	0	3	0	0	3	0	1	0	0	1	0	0	0	0	0	0	0	4	4
12:45 PM	0	0	1	0	1	0	2	0	0	2	0	0	0	0	0	0	2	0	0	2	0	0	5	5
Total	1	0	2	1	3	0	9	0	0	9	1	1	0	0	2	0	6	0	0	6	1	0	20	21
01:00 PM	0	0	0	0	0	0	0	0	0	0	0	0	0	0	0	0	1	0	0	1	0	0	1	1
01:15 PM	0	0	0	0	0	0	1	0	0	1	0	1	0	0	1	0	1	0	0	1	0	0	3	3
01:30 PM	0	0	0	0	0	0	1	0	0	1	0	0	0	0	0	0	1	0	0	1	0	0	2	2
01:45 PM	0	0	0	0	0	0	2	1	0	3	0	0	0	0	0	0	2	0	0	2	0	0	5	5
Total	0	0	0	0	0	0	4	1	0	5	0	1	0	0	1	0	5	0	0	5	0	0	11	11
Grand Total	1	0	2	1	3	0	20	1	0	21	1	6	0	0	7	0	24	0	0	24	1	0	55	56
Apprch %	33.3	0	66.7			0	95.2	4.8			14.3	85.7	0			0	100	0						
Total %	1.8	0	3.6		5.5	0	36.4	1.8		38.2	1.8	10.9	0		12.7	0	43.6	0		43.6	1.8		98.2	

Start Time	Old 215 Frontage Road Southbound				Cactus Avenue Westbound				I-215 Northbound Ramps Northbound				Cactus Avenue Eastbound				Int. Total
	Left	Thru	Right	App. Total	Left	Thru	Right	App. Total	Left	Thru	Right	App. Total	Left	Thru	Right	App. Total	
Peak Hour Analysis From 01:00 PM to 01:45 PM - Peak 1 of 1																	
Peak Hour for Entire Intersection Begins at 01:00 PM																	
01:00 PM	0	0	0	0	0	0	0	0	0	0	0	0	0	1	0	1	1
01:15 PM	0	0	0	0	0	1	0	1	0	1	0	1	0	1	0	1	3
01:30 PM	0	0	0	0	0	1	0	1	0	0	0	0	0	1	0	1	2
01:45 PM	0	0	0	0	0	2	1	3	0	0	0	0	0	2	0	2	5
Total Volume	0	0	0	0	0	4	1	5	0	1	0	1	0	5	0	5	11
% App. Total	0	0	0		0	80	20		0	100	0		0	100	0		
PHF	.000	.000	.000	.000	.000	.500	.250	.417	.000	.250	.000	.250	.000	.625	.000	.625	.550

County of Riverside
 N/S: Old 215 Frontage Rd/I-215 NB Ramps
 E/W: Cactus Avenue
 Weather: Clear

File Name : 31_CRV_215N_Cac Sat
 Site Code : 05122815
 Start Date : 9/17/2022
 Page No : 2

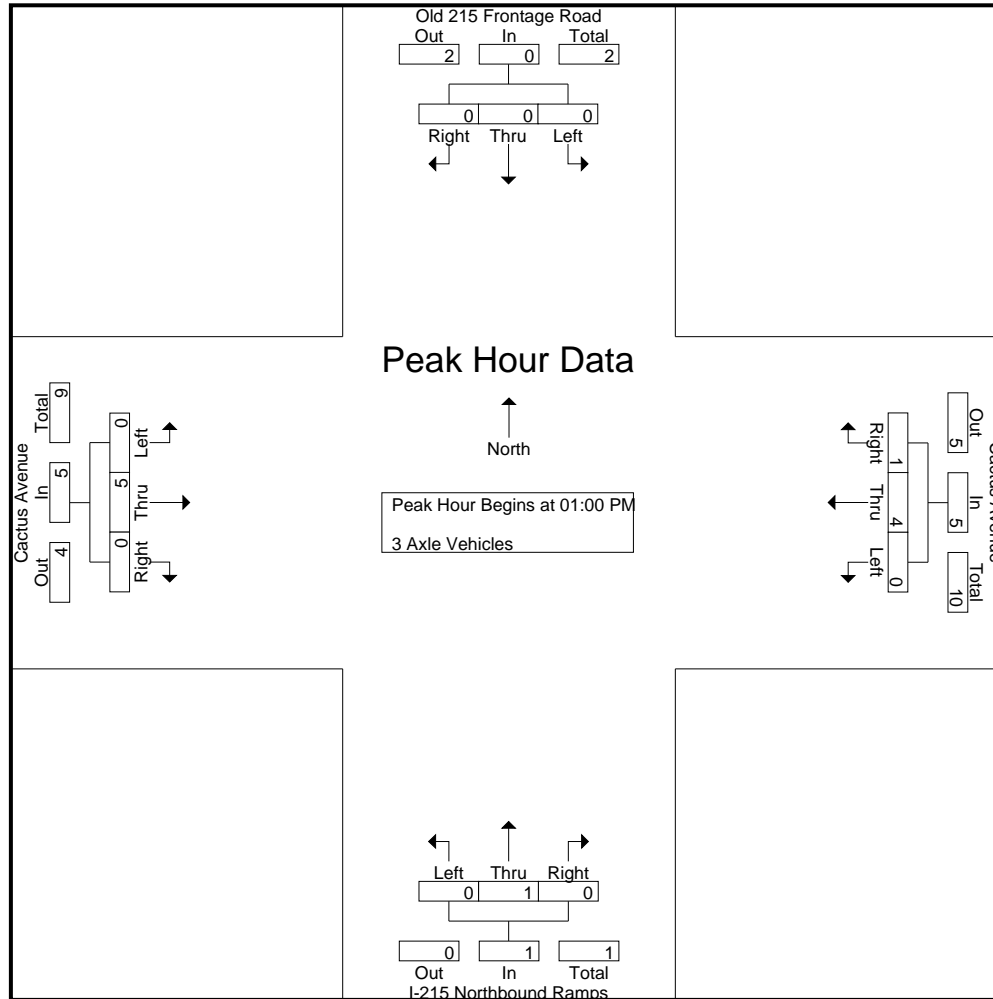

County of Riverside
 N/S: Old 215 Frontage Rd/I-215 NB Ramps
 E/W: Cactus Avenue
 Weather: Clear

File Name : 31_CRV_215N_Cac Sat
 Site Code : 05122815
 Start Date : 9/17/2022
 Page No : 3

Start Time	Old 215 Frontage Road Southbound				Cactus Avenue Westbound				I-215 Northbound Ramps Northbound				Cactus Avenue Eastbound				Int. Total
	Left	Thru	Right	App. Total	Left	Thru	Right	App. Total	Left	Thru	Right	App. Total	Left	Thru	Right	App. Total	
Peak Hour Analysis From 01:00 PM to 01:45 PM - Peak 1 of 1																	
Peak Hour for Each Approach Begins at:																	
	01:00 PM				01:00 PM				01:00 PM				01:00 PM				
+0 mins.	0	0	0	0	0	0	0	0	0	0	0	0	0	1	0	1	
+15 mins.	0	0	0	0	0	1	0	1	0	1	0	1	0	1	0	1	
+30 mins.	0	0	0	0	0	1	0	1	0	0	0	0	0	1	0	1	
+45 mins.	0	0	0	0	0	2	1	3	0	0	0	0	0	2	0	2	
Total Volume	0	0	0	0	0	4	1	5	0	1	0	1	0	5	0	5	
% App. Total	0	0	0	0	0	80	20		0	100	0		0	100	0		
PHF	.000	.000	.000	.000	.000	.500	.250	.417	.000	.250	.000	.250	.000	.625	.000	.625	

County of Riverside
 N/S: Old 215 Frontage Rd/I-215 NB Ramps
 E/W: Cactus Avenue
 Weather: Clear

File Name : 31_CRV_215N_Cac Sat
 Site Code : 05122815
 Start Date : 9/17/2022
 Page No : 1

Groups Printed- 4+ Axle Trucks

Start Time	Old 215 Frontage Road Southbound					Cactus Avenue Westbound					I-215 Northbound Ramps Northbound					Cactus Avenue Eastbound					Exclu. Total	Inclu. Total	Int. Total
	Left	Thru	Right	RTOR	App. Total	Left	Thru	Right	RTOR	App. Total	Left	Thru	Right	RTOR	App. Total	Left	Thru	Right	RTOR	App. Total			
11:00 AM	0	0	0	0	0	0	3	0	0	3	1	0	0	0	1	1	2	1	0	4	0	8	8
11:15 AM	0	0	0	0	0	0	2	0	0	2	1	0	0	0	1	0	5	3	0	8	0	11	11
11:30 AM	0	0	0	0	0	0	5	0	0	5	0	2	0	0	2	0	7	2	0	9	0	16	16
11:45 AM	0	0	1	0	1	0	5	0	0	5	1	0	0	0	1	0	5	1	0	6	0	13	13
Total	0	0	1	0	1	0	15	0	0	15	3	2	0	0	5	1	19	7	0	27	0	48	48
12:00 PM	0	0	0	0	0	0	5	0	0	5	0	0	0	0	0	1	11	1	0	13	0	18	18
12:15 PM	0	0	0	0	0	0	2	0	0	2	0	0	0	0	0	1	4	1	0	6	0	8	8
12:30 PM	0	0	1	0	1	0	6	0	0	6	1	1	0	0	2	0	3	1	0	4	0	13	13
12:45 PM	0	0	1	0	1	0	3	0	0	3	1	0	0	0	1	0	5	1	0	6	0	11	11
Total	0	0	2	0	2	0	16	0	0	16	2	1	0	0	3	2	23	4	0	29	0	50	50
01:00 PM	0	0	0	0	0	0	3	0	0	3	0	0	0	0	0	0	6	0	0	6	0	9	9
01:15 PM	0	0	0	0	0	0	5	0	0	5	0	0	0	0	0	0	4	0	0	4	0	9	9
01:30 PM	0	0	0	0	0	0	9	0	0	9	0	0	0	0	0	0	3	0	0	3	0	12	12
01:45 PM	0	0	0	0	0	0	4	0	0	4	0	0	0	0	0	0	1	1	0	2	0	6	6
Total	0	0	0	0	0	0	21	0	0	21	0	0	0	0	0	0	14	1	0	15	0	36	36
Grand Total	0	0	3	0	3	0	52	0	0	52	5	3	0	0	8	3	56	12	0	71	0	134	134
Apprch %	0	0	100			0	100	0			62.5	37.5	0			4.2	78.9	16.9					
Total %	0	0	2.2		2.2	0	38.8	0		38.8	3.7	2.2	0		6	2.2	41.8	9		53	0	100	

Start Time	Old 215 Frontage Road Southbound				Cactus Avenue Westbound				I-215 Northbound Ramps Northbound				Cactus Avenue Eastbound				Int. Total
	Left	Thru	Right	App. Total	Left	Thru	Right	App. Total	Left	Thru	Right	App. Total	Left	Thru	Right	App. Total	
Peak Hour Analysis From 01:00 PM to 01:45 PM - Peak 1 of 1																	
Peak Hour for Entire Intersection Begins at 01:00 PM																	
01:00 PM	0	0	0	0	0	3	0	3	0	0	0	0	0	6	0	6	9
01:15 PM	0	0	0	0	0	5	0	5	0	0	0	0	0	4	0	4	9
01:30 PM	0	0	0	0	0	9	0	9	0	0	0	0	0	3	0	3	12
01:45 PM	0	0	0	0	0	4	0	4	0	0	0	0	0	1	1	2	6
Total Volume	0	0	0	0	0	21	0	21	0	0	0	0	0	14	1	15	36
% App. Total	0	0	0		0	100	0		0	0	0		0	93.3	6.7		
PHF	.000	.000	.000	.000	.000	.583	.000	.583	.000	.000	.000	.000	.000	.583	.250	.625	.750

County of Riverside
 N/S: Old 215 Frontage Rd/I-215 NB Ramps
 E/W: Cactus Avenue
 Weather: Clear

File Name : 31_CRV_215N_Cac Sat
 Site Code : 05122815
 Start Date : 9/17/2022
 Page No : 2

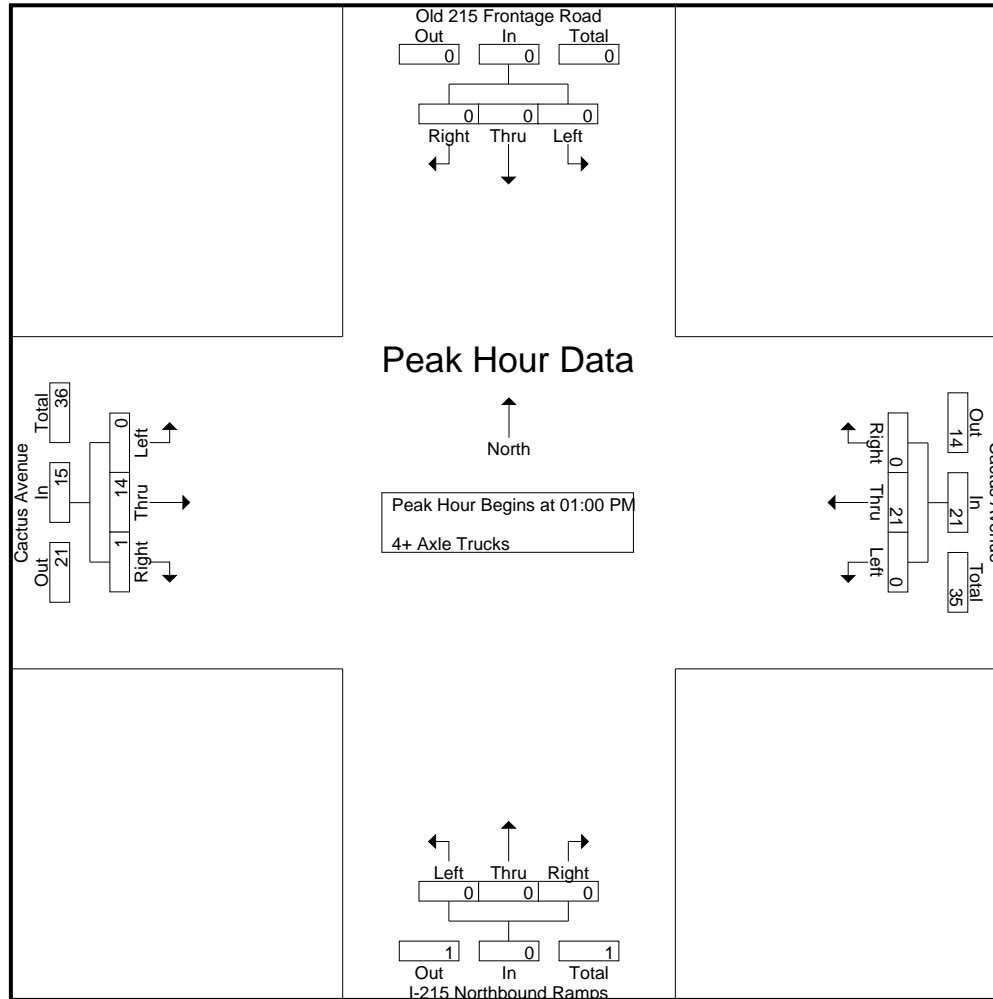

County of Riverside
 N/S: Old 215 Frontage Rd/I-215 NB Ramps
 E/W: Cactus Avenue
 Weather: Clear

File Name : 31_CRV_215N_Cac Sat
 Site Code : 05122815
 Start Date : 9/17/2022
 Page No : 3

Start Time	Old 215 Frontage Road Southbound				Cactus Avenue Westbound				I-215 Northbound Ramps Northbound				Cactus Avenue Eastbound				Int. Total
	Left	Thru	Right	App. Total	Left	Thru	Right	App. Total	Left	Thru	Right	App. Total	Left	Thru	Right	App. Total	
Peak Hour Analysis From 01:00 PM to 01:45 PM - Peak 1 of 1																	
Peak Hour for Each Approach Begins at:																	
	01:00 PM				01:00 PM				01:00 PM				01:00 PM				
+0 mins.	0	0	0	0	0	3	0	3	0	0	0	0	0	6	0	6	
+15 mins.	0	0	0	0	0	5	0	5	0	0	0	0	0	4	0	4	
+30 mins.	0	0	0	0	0	9	0	9	0	0	0	0	0	3	0	3	
+45 mins.	0	0	0	0	0	4	0	4	0	0	0	0	0	1	1	2	
Total Volume	0	0	0	0	0	21	0	21	0	0	0	0	0	14	1	15	
% App. Total	0	0	0	0	0	100	0	100	0	0	0	0	0	93.3	6.7	100	
PHF	.000	.000	.000	.000	.000	.583	.000	.583	.000	.000	.000	.000	.000	.583	.250	.625	

Location: County of Riverside
 N/S: Old 215 Frontage Rd/I-215 NB Ramps
 E/W: Cactus Avenue



Date: 9/17/2022
 Day Saturday

PEDESTRIANS

Time	North Leg Old 215 Frontage Road	East Leg Cactus Avenue	South Leg I-215 NB Ramps	West Leg Cactus Avenue	TOTAL
11:00 AM	0	0	0	0	0
11:15 AM	0	0	0	0	0
11:30 AM	0	0	0	0	0
11:45 AM	0	0	0	0	0
12:00 PM	0	0	0	0	0
12:15 PM	0	0	0	0	0
12:30 PM	0	0	0	0	0
12:45 PM	0	0	0	0	0
1:00 PM	0	0	0	0	0
1:15 PM	0	0	0	0	0
1:30 PM	0	0	0	0	0
1:45 PM	0	0	0	0	0
TOTAL VOLUMES:	0	0	0	0	0

Location: County of Riverside
 N/S: Old 215 Frontage Rd/I-215 NB Ramps
 E/W: Cactus Avenue

Date: 9/17/2022
 Day: Saturday



BICYCLES

	Southbound Old 215 Frontage Road			Westbound Cactus Avenue			Northbound I-215 NB Ramps			Eastbound Cactus Avenue			
	Left	Thru	Right	Left	Thru	Right	Left	Thru	Right	Left	Thru	Right	
11:00 AM	0	0	0	0	0	0	0	0	0	0	0	0	0
11:15 AM	0	0	0	0	0	0	0	0	0	0	0	0	0
11:30 AM	0	0	0	0	0	0	0	0	0	1	0	0	1
11:45 AM	0	0	0	0	0	0	0	0	0	0	0	0	0
12:00 PM	0	0	0	0	0	0	0	0	0	0	0	0	0
12:15 PM	0	0	0	0	0	0	0	0	0	0	0	0	0
12:30 PM	0	0	0	0	0	0	0	0	0	0	0	0	0
12:45 PM	0	0	0	0	0	0	0	0	0	0	0	0	0
1:00 PM	0	0	0	0	0	0	0	0	0	0	0	0	0
1:15 PM	0	0	0	0	0	0	0	0	0	0	0	0	0
1:30 PM	0	0	0	0	0	0	0	0	0	0	0	0	0
1:45 PM	0	0	0	0	0	0	0	0	0	0	0	0	0
TOTAL VOLUMES:	0	0	0	0	0	0	0	0	0	1	0	0	1

County of Riverside
 N/S: I-215 Southbound Ramps
 E/W: Van Buren Boulevard
 Weather: Clear

File Name : 32_CRV_215S_VB Sat
 Site Code : 05122815
 Start Date : 9/17/2022
 Page No : 1

Groups Printed- Passenger Vehicles - Large 2 Axle Vehicles - 3 Axle Vehicles - 4+ Axle Trucks

Start Time	I-215 Southbound Off Ramp Southbound					Van Buren Boulevard Westbound					I-215 Southbound On Ramp Northbound					Van Buren Boulevard Eastbound					Exclu. Total	Inclu. Total	Int. Total
	Left	Thru	Right	RTOR	App. Total	Left	Thru	Right	RTOR	App. Total	Left	Thru	Right	RTOR	App. Total	Left	Thru	Right	RTOR	App. Total			
11:00 AM	2	0	98	73	100	0	114	0	0	114	0	0	0	0	0	0	100	131	8	231	81	445	526
11:15 AM	4	0	109	92	113	1	112	0	0	113	0	0	0	0	0	0	104	112	6	216	98	442	540
11:30 AM	8	0	96	77	104	0	120	0	0	120	0	0	0	0	0	0	110	141	16	251	93	475	568
11:45 AM	2	0	100	68	102	3	110	0	0	113	0	0	0	0	0	0	95	115	18	210	86	425	511
Total	16	0	403	310	419	4	456	0	0	460	0	0	0	0	0	0	409	499	48	908	358	1787	2145
12:00 PM	2	0	97	54	99	8	125	0	0	133	0	0	0	0	0	0	110	121	23	231	77	463	540
12:15 PM	6	0	134	70	140	2	130	0	0	132	0	0	0	0	0	0	109	141	14	250	84	522	606
12:30 PM	5	0	143	95	148	4	121	0	0	125	0	0	0	0	0	0	83	119	12	202	107	475	582
12:45 PM	7	0	120	90	127	3	122	0	0	125	0	0	0	0	0	0	123	116	18	239	108	491	599
Total	20	0	494	309	514	17	498	0	0	515	0	0	0	0	0	0	425	497	67	922	376	1951	2327
01:00 PM	1	0	94	79	95	3	122	0	0	125	0	0	0	0	0	0	104	148	7	252	86	472	558
01:15 PM	5	0	109	86	114	4	116	0	0	120	0	0	0	0	0	0	113	145	12	258	98	492	590
01:30 PM	2	0	102	71	104	4	121	0	0	125	0	0	0	0	0	0	94	147	11	241	82	470	552
01:45 PM	3	2	97	82	102	3	126	0	0	129	0	0	0	0	0	0	101	137	18	238	100	469	569
Total	11	2	402	318	415	14	485	0	0	499	0	0	0	0	0	0	412	577	48	989	366	1903	2269
Grand Total	47	2	1299	937	1348	35	1439	0	0	1474	0	0	0	0	0	0	1246	1573	163	2819	1100	5641	6741
Apprch %	3.5	0.1	96.4			2.4	97.6	0			0	0	0			0	44.2	55.8					
Total %	0.8	0	23		23.9	0.6	25.5	0		26.1	0	0	0		0	0	22.1	27.9		50	16.3	83.7	
Passenger Vehicles	45	2	1234		2176	35	1393	0		1428	0	0	0		0	0	1192	1528		2880	0	0	6484
% Passenger Vehicles	95.7	100	95	95.5	95.2	100	96.8	0	0	96.9	0	0	0	0	0	0	95.7	97.1	98.2	96.6	0	0	96.2
Large 2 Axle Vehicles	0	0	14		23	0	27	0		27	0	0	0		0	0	15	28		45	0	0	95
% Large 2 Axle Vehicles	0	0	1.1	1	1	0	1.9	0	0	1.8	0	0	0	0	0	0	1.2	1.8	1.2	1.5	0	0	1.4
3 Axle Vehicles	1	0	9		17	0	5	0		5	0	0	0		0	0	13	5		18	0	0	40
% 3 Axle Vehicles	2.1	0	0.7	0.7	0.7	0	0.3	0	0	0.3	0	0	0	0	0	0	1	0.3	0	0.6	0	0	0.6
4+ Axle Trucks	1	0	42		69	0	14	0		14	0	0	0		0	0	26	12		39	0	0	122
% 4+ Axle Trucks	2.1	0	3.2	2.8	3	0	1	0	0	0.9	0	0	0	0	0	0	2.1	0.8	0.6	1.3	0	0	1.8

County of Riverside
 N/S: I-215 Southbound Ramps
 E/W: Van Buren Boulevard
 Weather: Clear

File Name : 32_CRV_215S_VB Sat
 Site Code : 05122815
 Start Date : 9/17/2022
 Page No : 2

Start Time	I-215 Southbound Off Ramp Southbound				Van Buren Boulevard Westbound				I-215 Southbound On Ramp Northbound				Van Buren Boulevard Eastbound				Int. Total
	Left	Thru	Right	App. Total	Left	Thru	Right	App. Total	Left	Thru	Right	App. Total	Left	Thru	Right	App. Total	
Peak Hour Analysis From 11:00 AM to 01:45 PM - Peak 1 of 1																	
Peak Hour for Entire Intersection Begins at 12:15 PM																	
12:15 PM	6	0	134	140	2	130	0	132	0	0	0	0	0	109	141	250	522
12:30 PM	5	0	143	148	4	121	0	125	0	0	0	0	0	83	119	202	475
12:45 PM	7	0	120	127	3	122	0	125	0	0	0	0	0	123	116	239	491
01:00 PM	1	0	94	95	3	122	0	125	0	0	0	0	0	104	148	252	472
Total Volume	19	0	491	510	12	495	0	507	0	0	0	0	0	419	524	943	1960
% App. Total	3.7	0	96.3		2.4	97.6	0		0	0	0		0	44.4	55.6		
PHF	.679	.000	.858	.861	.750	.952	.000	.960	.000	.000	.000	.000	.000	.852	.885	.936	.939

County of Riverside
 N/S: I-215 Southbound Ramps
 E/W: Van Buren Boulevard
 Weather: Clear

File Name : 32_CRV_215S_VB Sat
 Site Code : 05122815
 Start Date : 9/17/2022
 Page No : 3

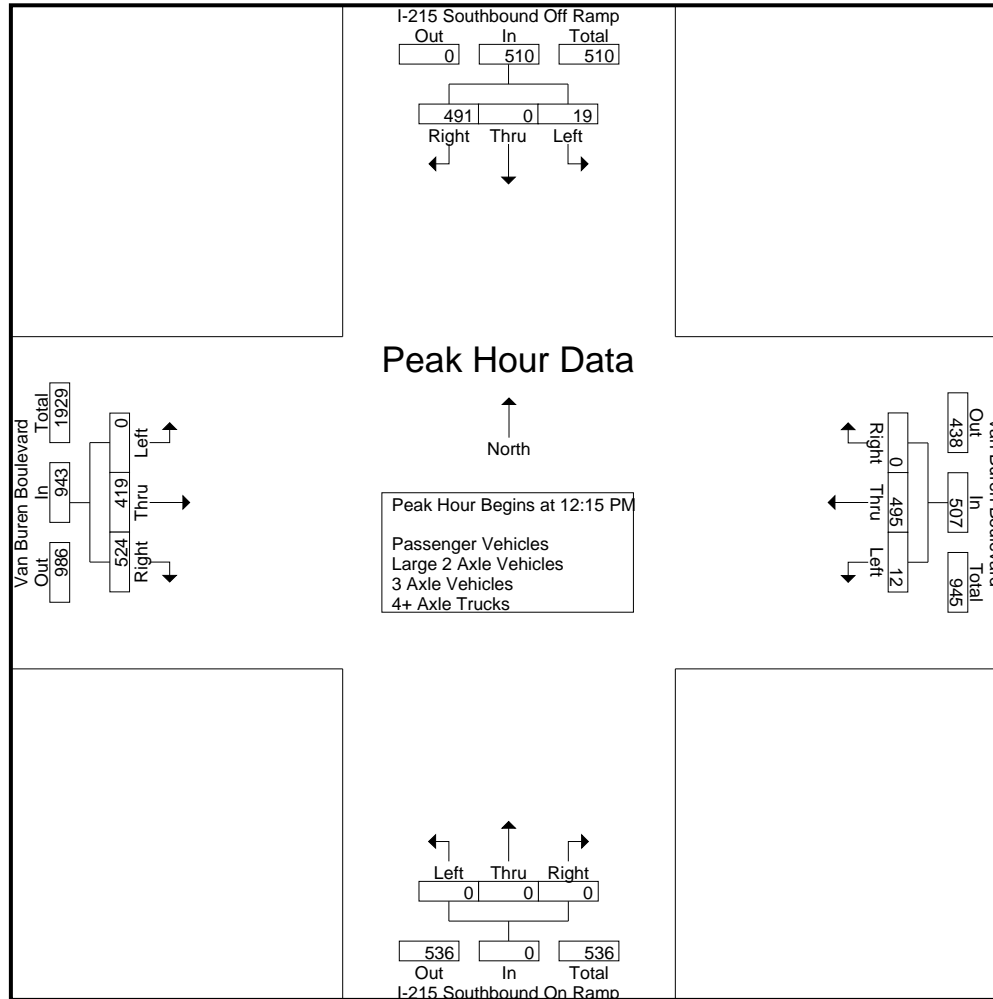

County of Riverside
 N/S: I-215 Southbound Ramps
 E/W: Van Buren Boulevard
 Weather: Clear

File Name : 32_CRV_215S_VB Sat
 Site Code : 05122815
 Start Date : 9/17/2022
 Page No : 4

Start Time	I-215 Southbound Off Ramp Southbound				Van Buren Boulevard Westbound				I-215 Southbound On Ramp Northbound				Van Buren Boulevard Eastbound				Int. Total
	Left	Thru	Right	App. Total	Left	Thru	Right	App. Total	Left	Thru	Right	App. Total	Left	Thru	Right	App. Total	
Peak Hour Analysis From 11:00 AM to 01:45 PM - Peak 1 of 1																	
Peak Hour for Each Approach Begins at:																	
	12:00 PM				12:00 PM				11:00 AM				12:45 PM				
+0 mins.	2	0	97	99	8	125	0	133	0	0	0	0	0	123	116	239	
+15 mins.	6	0	134	140	2	130	0	132	0	0	0	0	0	104	148	252	
+30 mins.	5	0	143	148	4	121	0	125	0	0	0	0	0	113	145	258	
+45 mins.	7	0	120	127	3	122	0	125	0	0	0	0	0	94	147	241	
Total Volume	20	0	494	514	17	498	0	515	0	0	0	0	0	434	556	990	
% App. Total	3.9	0	96.1		3.3	96.7	0		0	0	0		0	43.8	56.2		
PHF	.714	.000	.864	.868	.531	.958	.000	.968	.000	.000	.000	.000	.000	.882	.939	.959	

County of Riverside
 N/S: I-215 Southbound Ramps
 E/W: Van Buren Boulevard
 Weather: Clear

File Name : 32_CRV_215S_VB Sat
 Site Code : 05122815
 Start Date : 9/17/2022
 Page No : 1

Groups Printed- Passenger Vehicles

Start Time	I-215 Southbound Off Ramp Southbound					Van Buren Boulevard Westbound					I-215 Southbound On Ramp Northbound					Van Buren Boulevard Eastbound					Exclu. Total	Inclu. Total	Int. Total
	Left	Thru	Right	RTOR	App. Total	Left	Thru	Right	RTOR	App. Total	Left	Thru	Right	RTOR	App. Total	Left	Thru	Right	RTOR	App. Total			
11:00 AM	2	0	92	70	94	0	108	0	0	108	0	0	0	0	0	0	96	125	8	221	78	423	501
11:15 AM	4	0	106	90	110	1	109	0	0	110	0	0	0	0	0	0	95	111	6	206	96	426	522
11:30 AM	7	0	90	73	97	0	116	0	0	116	0	0	0	0	0	0	107	140	16	247	89	460	549
11:45 AM	2	0	97	67	99	3	108	0	0	111	0	0	0	0	0	0	89	110	17	199	84	409	493
Total	15	0	385	300	400	4	441	0	0	445	0	0	0	0	0	0	387	486	47	873	347	1718	2065
12:00 PM	2	0	91	50	93	8	123	0	0	131	0	0	0	0	0	0	107	118	23	225	73	449	522
12:15 PM	6	0	124	63	130	2	128	0	0	130	0	0	0	0	0	0	106	133	14	239	77	499	576
12:30 PM	4	0	135	90	139	4	115	0	0	119	0	0	0	0	0	0	81	115	12	196	102	454	556
12:45 PM	7	0	116	87	123	3	120	0	0	123	0	0	0	0	0	0	117	115	18	232	105	478	583
Total	19	0	466	290	485	17	486	0	0	503	0	0	0	0	0	0	411	481	67	892	357	1880	2237
01:00 PM	1	0	90	78	91	3	119	0	0	122	0	0	0	0	0	0	102	145	7	247	85	460	545
01:15 PM	5	0	101	81	106	4	114	0	0	118	0	0	0	0	0	0	109	140	11	249	92	473	565
01:30 PM	2	0	97	66	99	4	113	0	0	117	0	0	0	0	0	0	92	140	10	232	76	448	524
01:45 PM	3	2	95	80	100	3	120	0	0	123	0	0	0	0	0	0	91	136	18	227	98	450	548
Total	11	2	383	305	396	14	466	0	0	480	0	0	0	0	0	0	394	561	46	955	351	1831	2182
Grand Total	45	2	1234	895	1281	35	1393	0	0	1428	0	0	0	0	0	0	1192	1528	160	2720	1055	5429	6484
Apprch %	3.5	0.2	96.3			2.5	97.5	0			0	0	0			0	43.8	56.2					
Total %	0.8	0	22.7		23.6	0.6	25.7	0		26.3	0	0	0		0	0	22	28.1		50.1	16.3	83.7	

Start Time	I-215 Southbound Off Ramp Southbound				Van Buren Boulevard Westbound				I-215 Southbound On Ramp Northbound				Van Buren Boulevard Eastbound				Int. Total
	Left	Thru	Right	App. Total	Left	Thru	Right	App. Total	Left	Thru	Right	App. Total	Left	Thru	Right	App. Total	
Peak Hour Analysis From 12:15 PM to 01:00 PM - Peak 1 of 1																	
Peak Hour for Entire Intersection Begins at 12:15 PM																	
12:15 PM	6	0	124	130	2	128	0	130	0	0	0	0	0	106	133	239	499
12:30 PM	4	0	135	139	4	115	0	119	0	0	0	0	0	81	115	196	454
12:45 PM	7	0	116	123	3	120	0	123	0	0	0	0	0	117	115	232	478
01:00 PM	1	0	90	91	3	119	0	122	0	0	0	0	0	102	145	247	460
Total Volume	18	0	465	483	12	482	0	494	0	0	0	0	0	406	508	914	1891
% App. Total	3.7	0	96.3		2.4	97.6	0		0	0	0		0	44.4	55.6		
PHF	.643	.000	.861	.869	.750	.941	.000	.950	.000	.000	.000	.000	.000	.868	.876	.925	.947

County of Riverside
 N/S: I-215 Southbound Ramps
 E/W: Van Buren Boulevard
 Weather: Clear

File Name : 32_CRV_215S_VB Sat
 Site Code : 05122815
 Start Date : 9/17/2022
 Page No : 2

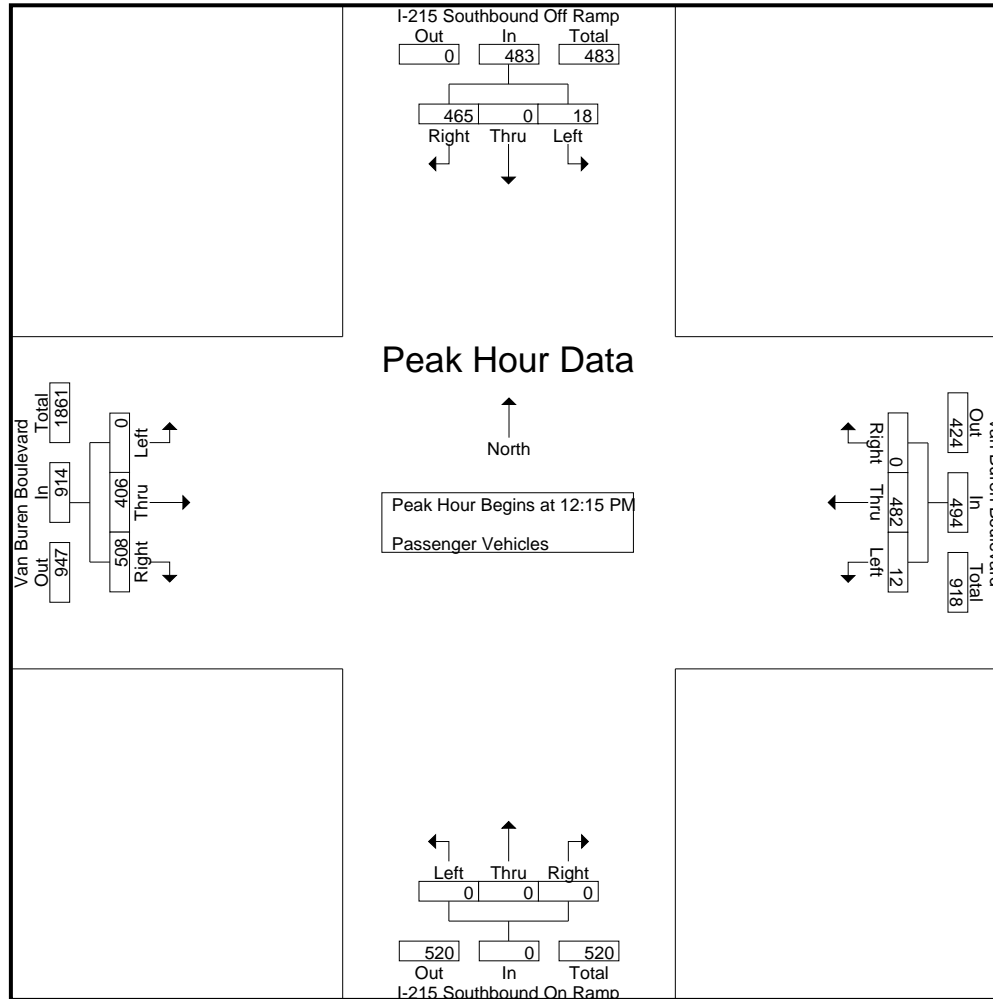

County of Riverside
 N/S: I-215 Southbound Ramps
 E/W: Van Buren Boulevard
 Weather: Clear

File Name : 32_CRV_215S_VB Sat
 Site Code : 05122815
 Start Date : 9/17/2022
 Page No : 3

Start Time	I-215 Southbound Off Ramp Southbound				Van Buren Boulevard Westbound				I-215 Southbound On Ramp Northbound				Van Buren Boulevard Eastbound				Int. Total
	Left	Thru	Right	App. Total	Left	Thru	Right	App. Total	Left	Thru	Right	App. Total	Left	Thru	Right	App. Total	
Peak Hour Analysis From 12:15 PM to 01:00 PM - Peak 1 of 1																	
Peak Hour for Each Approach Begins at:																	
	12:15 PM				12:15 PM				12:15 PM				12:15 PM				
+0 mins.	6	0	124	130	2	128	0	130	0	0	0	0	0	106	133	239	
+15 mins.	4	0	135	139	4	115	0	119	0	0	0	0	0	81	115	196	
+30 mins.	7	0	116	123	3	120	0	123	0	0	0	0	0	117	115	232	
+45 mins.	1	0	90	91	3	119	0	122	0	0	0	0	0	102	145	247	
Total Volume	18	0	465	483	12	482	0	494	0	0	0	0	0	406	508	914	
% App. Total	3.7	0	96.3		2.4	97.6	0		0	0	0		0	44.4	55.6		
PHF	.643	.000	.861	.869	.750	.941	.000	.950	.000	.000	.000	.000	.000	.868	.876	.925	

County of Riverside
 N/S: I-215 Southbound Ramps
 E/W: Van Buren Boulevard
 Weather: Clear

File Name : 32_CRV_215S_VB Sat
 Site Code : 05122815
 Start Date : 9/17/2022
 Page No : 1

Groups Printed- Large 2 Axle Vehicles

Start Time	I-215 Southbound Off Ramp Southbound					Van Buren Boulevard Westbound					I-215 Southbound On Ramp Northbound					Van Buren Boulevard Eastbound					Exclu. Total	Inclu. Total	Int. Total
	Left	Thru	Right	RTOR	App. Total	Left	Thru	Right	RTOR	App. Total	Left	Thru	Right	RTOR	App. Total	Left	Thru	Right	RTOR	App. Total			
11:00 AM	0	0	2	1	2	0	2	0	0	2	0	0	0	0	0	0	4	3	0	7	1	11	12
11:15 AM	0	0	0	0	0	0	2	0	0	2	0	0	0	0	0	0	1	0	0	1	0	3	3
11:30 AM	0	0	2	1	2	0	1	0	0	1	0	0	0	0	0	0	0	0	0	0	1	3	4
11:45 AM	0	0	1	0	1	0	2	0	0	2	0	0	0	0	0	0	1	1	0	2	0	5	5
Total	0	0	5	2	5	0	7	0	0	7	0	0	0	0	0	0	6	4	0	10	2	22	24
12:00 PM	0	0	1	1	1	0	2	0	0	2	0	0	0	0	0	0	1	3	0	4	1	7	8
12:15 PM	0	0	2	1	2	0	2	0	0	2	0	0	0	0	0	0	2	6	0	8	1	12	13
12:30 PM	0	0	1	1	1	0	2	0	0	2	0	0	0	0	0	0	0	4	0	4	1	7	8
12:45 PM	0	0	2	2	2	0	1	0	0	1	0	0	0	0	0	0	2	0	0	2	2	5	7
Total	0	0	6	5	6	0	7	0	0	7	0	0	0	0	0	0	5	13	0	18	5	31	36
01:00 PM	0	0	1	0	1	0	2	0	0	2	0	0	0	0	0	0	2	2	0	4	0	7	7
01:15 PM	0	0	2	2	2	0	1	0	0	1	0	0	0	0	0	0	0	3	1	3	3	6	9
01:30 PM	0	0	0	0	0	0	5	0	0	5	0	0	0	0	0	0	1	6	1	7	1	12	13
01:45 PM	0	0	0	0	0	0	5	0	0	5	0	0	0	0	0	0	1	0	0	1	0	6	6
Total	0	0	3	2	3	0	13	0	0	13	0	0	0	0	0	0	4	11	2	15	4	31	35
Grand Total	0	0	14	9	14	0	27	0	0	27	0	0	0	0	0	0	15	28	2	43	11	84	95
Apprch %	0	0	100			0	100	0			0	0	0			0	34.9	65.1					
Total %	0	0	16.7		16.7	0	32.1	0		32.1	0	0	0		0	0	17.9	33.3		51.2	11.6	88.4	

Start Time	I-215 Southbound Off Ramp Southbound				Van Buren Boulevard Westbound				I-215 Southbound On Ramp Northbound				Van Buren Boulevard Eastbound				Int. Total
	Left	Thru	Right	App. Total	Left	Thru	Right	App. Total	Left	Thru	Right	App. Total	Left	Thru	Right	App. Total	
Peak Hour Analysis From 12:15 PM to 01:00 PM - Peak 1 of 1																	
Peak Hour for Entire Intersection Begins at 12:15 PM																	
12:15 PM	0	0	2	2	0	2	0	2	0	0	0	0	0	2	6	8	12
12:30 PM	0	0	1	1	0	2	0	2	0	0	0	0	0	0	4	4	7
12:45 PM	0	0	2	2	0	1	0	1	0	0	0	0	0	2	0	2	5
01:00 PM	0	0	1	1	0	2	0	2	0	0	0	0	0	2	2	4	7
Total Volume	0	0	6	6	0	7	0	7	0	0	0	0	0	6	12	18	31
% App. Total	0	0	100		0	100	0		0	0	0		0	33.3	66.7		
PHF	.000	.000	.750	.750	.000	.875	.000	.875	.000	.000	.000	.000	.000	.750	.500	.563	.646

County of Riverside
 N/S: I-215 Southbound Ramps
 E/W: Van Buren Boulevard
 Weather: Clear

File Name : 32_CRV_215S_VB Sat
 Site Code : 05122815
 Start Date : 9/17/2022
 Page No : 2

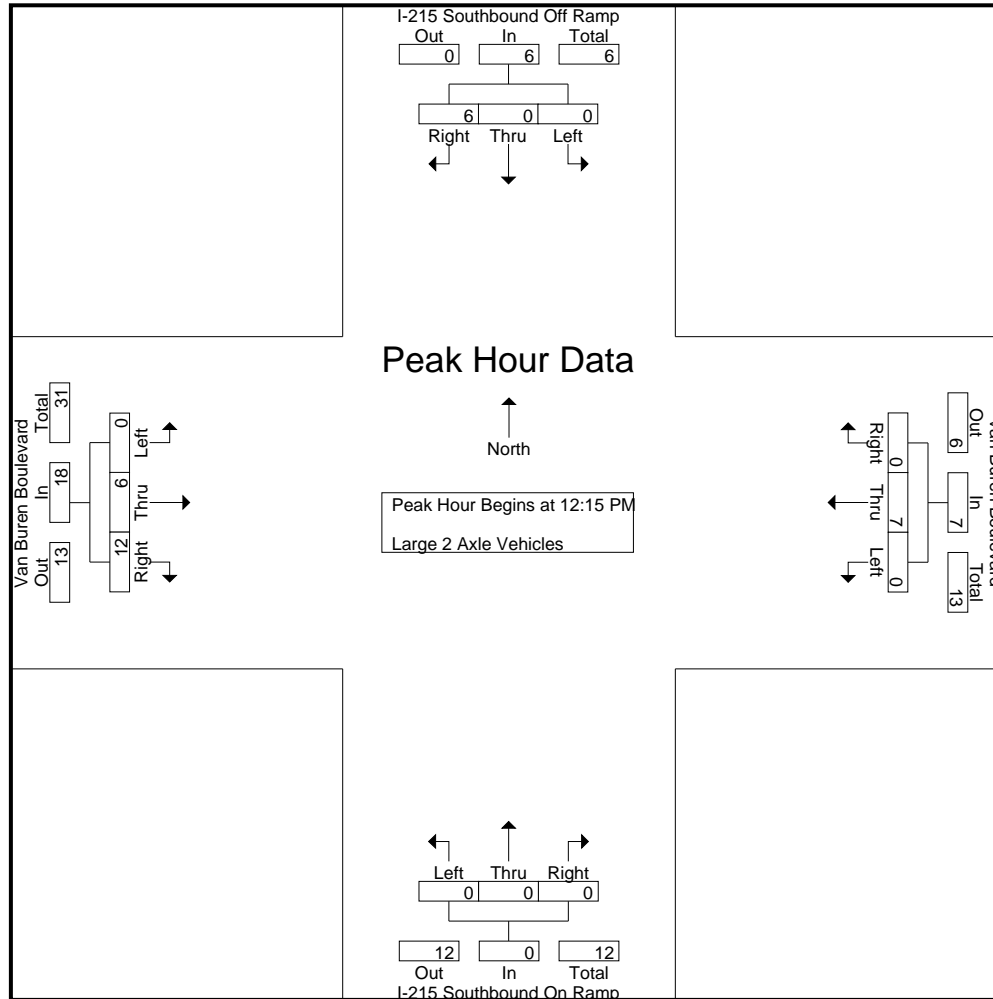

County of Riverside
 N/S: I-215 Southbound Ramps
 E/W: Van Buren Boulevard
 Weather: Clear

File Name : 32_CRV_215S_VB Sat
 Site Code : 05122815
 Start Date : 9/17/2022
 Page No : 3

Start Time	I-215 Southbound Off Ramp Southbound				Van Buren Boulevard Westbound				I-215 Southbound On Ramp Northbound				Van Buren Boulevard Eastbound				Int. Total
	Left	Thru	Right	App. Total	Left	Thru	Right	App. Total	Left	Thru	Right	App. Total	Left	Thru	Right	App. Total	
Peak Hour Analysis From 12:15 PM to 01:00 PM - Peak 1 of 1																	
Peak Hour for Each Approach Begins at:																	
	12:15 PM				12:15 PM				12:15 PM				12:15 PM				
+0 mins.	0	0	2	2	0	2	0	2	0	0	0	0	0	2	6	8	
+15 mins.	0	0	1	1	0	2	0	2	0	0	0	0	0	0	4	4	
+30 mins.	0	0	2	2	0	1	0	1	0	0	0	0	0	2	0	2	
+45 mins.	0	0	1	1	0	2	0	2	0	0	0	0	0	2	2	4	
Total Volume	0	0	6	6	0	7	0	7	0	0	0	0	0	6	12	18	
% App. Total	0	0	100		0	100	0		0	0	0		0	33.3	66.7		
PHF	.000	.000	.750	.750	.000	.875	.000	.875	.000	.000	.000	.000	.000	.750	.500	.563	

County of Riverside
 N/S: I-215 Southbound Ramps
 E/W: Van Buren Boulevard
 Weather: Clear

File Name : 32_CRV_215S_VB Sat
 Site Code : 05122815
 Start Date : 9/17/2022
 Page No : 1

Groups Printed- 3 Axle Vehicles

Start Time	I-215 Southbound Off Ramp Southbound					Van Buren Boulevard Westbound					I-215 Southbound On Ramp Northbound					Van Buren Boulevard Eastbound					Exclu. Total	Inclu. Total	Int. Total	
	Left	Thru	Right	RTOR	App. Total	Left	Thru	Right	RTOR	App. Total	Left	Thru	Right	RTOR	App. Total	Left	Thru	Right	RTOR	App. Total				
11:00 AM	0	0	0	0	0	0	2	0	0	2	0	0	0	0	0	0	0	1	0	1	0	0	3	3
11:15 AM	0	0	1	1	1	0	0	0	0	0	0	0	0	0	0	0	4	1	0	5	1	6	7	7
11:30 AM	0	0	0	0	0	0	1	0	0	1	0	0	0	0	0	0	1	1	0	2	0	3	3	3
11:45 AM	0	0	1	1	1	0	0	0	0	0	0	0	0	0	0	0	3	0	0	3	1	4	5	5
Total	0	0	2	2	2	0	3	0	0	3	0	0	0	0	0	0	8	3	0	11	2	16	18	18
12:00 PM	0	0	2	2	2	0	0	0	0	0	0	0	0	0	0	0	1	0	0	1	2	3	5	5
12:15 PM	0	0	1	1	1	0	0	0	0	0	0	0	0	0	0	0	0	0	0	0	1	1	2	2
12:30 PM	1	0	1	1	2	0	1	0	0	1	0	0	0	0	0	0	0	0	0	0	1	3	4	4
12:45 PM	0	0	0	0	0	0	0	0	0	0	0	0	0	0	0	0	2	0	0	2	0	2	2	2
Total	1	0	4	4	5	0	1	0	0	1	0	0	0	0	0	0	3	0	0	3	4	9	13	13
01:00 PM	0	0	0	0	0	0	0	0	0	0	0	0	0	0	0	0	0	1	0	1	0	1	1	1
01:15 PM	0	0	3	1	3	0	0	0	0	0	0	0	0	0	0	0	0	1	0	1	1	4	5	5
01:30 PM	0	0	0	0	0	0	1	0	0	1	0	0	0	0	0	0	0	0	0	0	0	1	1	1
01:45 PM	0	0	0	0	0	0	0	0	0	0	0	0	0	0	0	0	2	0	0	2	0	2	2	2
Total	0	0	3	1	3	0	1	0	0	1	0	0	0	0	0	0	2	2	0	4	1	8	9	9
Grand Total	1	0	9	7	10	0	5	0	0	5	0	0	0	0	0	0	13	5	0	18	7	33	40	40
Apprch %	10	0	90			0	100	0			0	0	0			0	72.2	27.8						
Total %	3	0	27.3		30.3	0	15.2	0		15.2	0	0	0		0	0	39.4	15.2		54.5	17.5	82.5		

Start Time	I-215 Southbound Off Ramp Southbound				Van Buren Boulevard Westbound				I-215 Southbound On Ramp Northbound				Van Buren Boulevard Eastbound				Int. Total	
	Left	Thru	Right	App. Total	Left	Thru	Right	App. Total	Left	Thru	Right	App. Total	Left	Thru	Right	App. Total		
Peak Hour Analysis From 12:15 PM to 01:00 PM - Peak 1 of 1																		
Peak Hour for Entire Intersection Begins at 12:15 PM																		
12:15 PM	0	0	1	1	0	0	0	0	0	0	0	0	0	0	0	0	1	1
12:30 PM	1	0	1	2	0	1	0	1	0	0	0	0	0	0	0	0	0	3
12:45 PM	0	0	0	0	0	0	0	0	0	0	0	0	0	2	0	2	0	2
01:00 PM	0	0	0	0	0	0	0	0	0	0	0	0	0	0	1	1	1	1
Total Volume	1	0	2	3	0	1	0	1	0	0	0	0	0	2	1	3	3	7
% App. Total	33.3	0	66.7		0	100	0		0	0	0		0	66.7	33.3			
PHF	.250	.000	.500	.375	.000	.250	.000	.250	.000	.000	.000	.000	.000	.250	.250	.375	.375	.583

County of Riverside
 N/S: I-215 Southbound Ramps
 E/W: Van Buren Boulevard
 Weather: Clear

File Name : 32_CRV_215S_VB Sat
 Site Code : 05122815
 Start Date : 9/17/2022
 Page No : 2

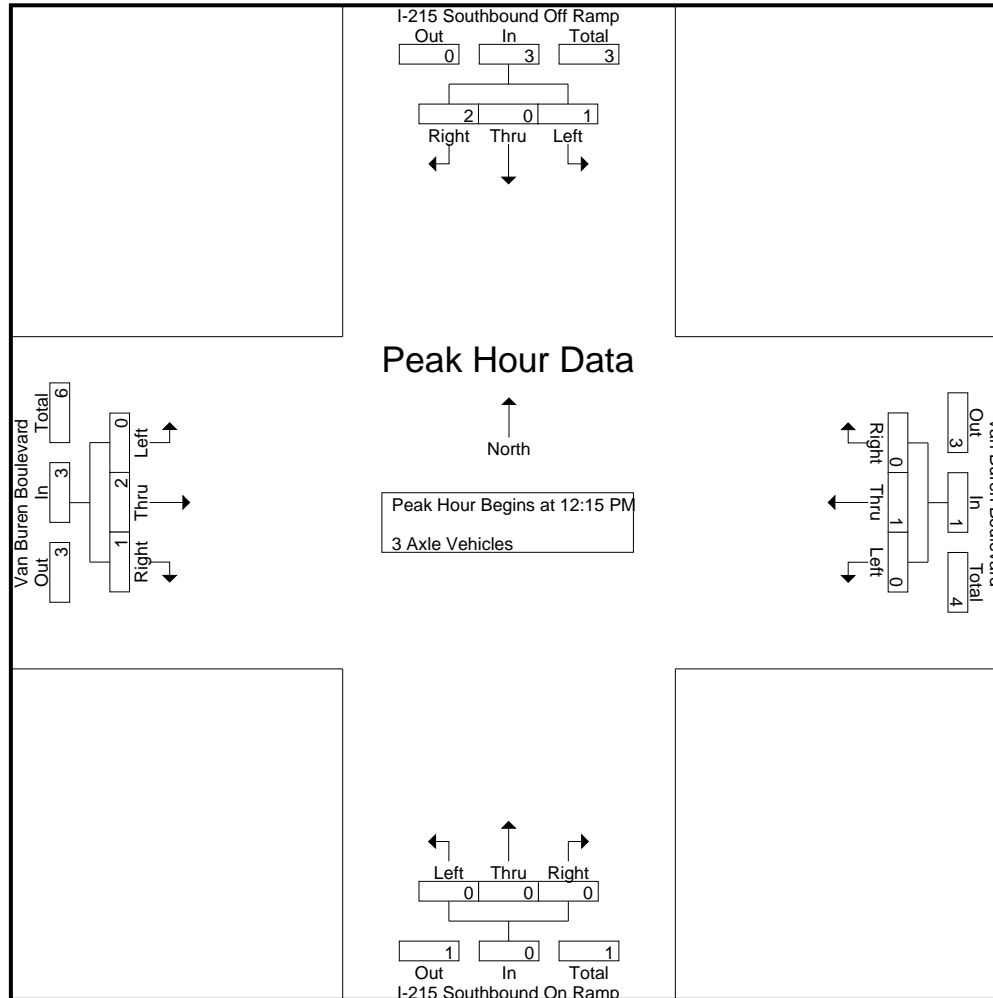

County of Riverside
 N/S: I-215 Southbound Ramps
 E/W: Van Buren Boulevard
 Weather: Clear

File Name : 32_CRV_215S_VB Sat
 Site Code : 05122815
 Start Date : 9/17/2022
 Page No : 3

Start Time	I-215 Southbound Off Ramp Southbound				Van Buren Boulevard Westbound				I-215 Southbound On Ramp Northbound				Van Buren Boulevard Eastbound				Int. Total
	Left	Thru	Right	App. Total	Left	Thru	Right	App. Total	Left	Thru	Right	App. Total	Left	Thru	Right	App. Total	
Peak Hour Analysis From 12:15 PM to 01:00 PM - Peak 1 of 1																	
Peak Hour for Each Approach Begins at:																	
	12:15 PM				12:15 PM				12:15 PM				12:15 PM				
+0 mins.	0	0	1	1	0	0	0	0	0	0	0	0	0	0	0	0	
+15 mins.	1	0	1	2	0	1	0	1	0	0	0	0	0	0	0	0	
+30 mins.	0	0	0	0	0	0	0	0	0	0	0	0	0	2	0	2	
+45 mins.	0	0	0	0	0	0	0	0	0	0	0	0	0	0	1	1	
Total Volume	1	0	2	3	0	1	0	1	0	0	0	0	0	2	1	3	
% App. Total	33.3	0	66.7		0	100	0		0	0	0		0	66.7	33.3		
PHF	.250	.000	.500	.375	.000	.250	.000	.250	.000	.000	.000	.000	.000	.250	.250	.375	

County of Riverside
 N/S: I-215 Southbound Ramps
 E/W: Van Buren Boulevard
 Weather: Clear

File Name : 32_CRV_215S_VB Sat
 Site Code : 05122815
 Start Date : 9/17/2022
 Page No : 1

Groups Printed- 4+ Axle Trucks

Start Time	I-215 Southbound Off Ramp Southbound					Van Buren Boulevard Westbound					I-215 Southbound On Ramp Northbound					Van Buren Boulevard Eastbound					Exclu. Total	Inclu. Total	Int. Total	
	Left	Thru	Right	RTOR	App. Total	Left	Thru	Right	RTOR	App. Total	Left	Thru	Right	RTOR	App. Total	Left	Thru	Right	RTOR	App. Total				
11:00 AM	0	0	4	2	4	0	2	0	0	2	0	0	0	0	0	0	0	2	0	2	2	2	8	10
11:15 AM	0	0	2	1	2	0	1	0	0	1	0	0	0	0	0	0	4	0	0	4	1	7	8	
11:30 AM	1	0	4	3	5	0	2	0	0	2	0	0	0	0	0	0	2	0	0	2	3	9	12	
11:45 AM	0	0	1	0	1	0	0	0	0	0	0	0	0	0	0	0	2	4	1	6	1	7	8	
Total	1	0	11	6	12	0	5	0	0	5	0	0	0	0	0	0	8	6	1	14	7	31	38	
12:00 PM	0	0	3	1	3	0	0	0	0	0	0	0	0	0	0	0	1	0	0	1	1	4	5	
12:15 PM	0	0	7	5	7	0	0	0	0	0	0	0	0	0	0	0	1	2	0	3	5	10	15	
12:30 PM	0	0	6	3	6	0	3	0	0	3	0	0	0	0	0	0	2	0	0	2	3	11	14	
12:45 PM	0	0	2	1	2	0	1	0	0	1	0	0	0	0	0	0	2	1	0	3	1	6	7	
Total	0	0	18	10	18	0	4	0	0	4	0	0	0	0	0	0	6	3	0	9	10	31	41	
01:00 PM	0	0	3	1	3	0	1	0	0	1	0	0	0	0	0	0	0	0	0	0	1	4	5	
01:15 PM	0	0	3	2	3	0	1	0	0	1	0	0	0	0	0	0	4	1	0	5	2	9	11	
01:30 PM	0	0	5	5	5	0	2	0	0	2	0	0	0	0	0	0	1	1	0	2	5	9	14	
01:45 PM	0	0	2	2	2	0	1	0	0	1	0	0	0	0	0	0	7	1	0	8	2	11	13	
Total	0	0	13	10	13	0	5	0	0	5	0	0	0	0	0	0	12	3	0	15	10	33	43	
Grand Total	1	0	42	26	43	0	14	0	0	14	0	0	0	0	0	0	26	12	1	38	27	95	122	
Apprch %	2.3	0	97.7			0	100	0			0	0	0			0	68.4	31.6						
Total %	1.1	0	44.2		45.3	0	14.7	0		14.7	0	0	0		0	0	27.4	12.6		40	22.1	77.9		

Start Time	I-215 Southbound Off Ramp Southbound				Van Buren Boulevard Westbound				I-215 Southbound On Ramp Northbound				Van Buren Boulevard Eastbound				Int. Total		
	Left	Thru	Right	App. Total	Left	Thru	Right	App. Total	Left	Thru	Right	App. Total	Left	Thru	Right	App. Total			
Peak Hour Analysis From 12:15 PM to 01:00 PM - Peak 1 of 1																			
Peak Hour for Entire Intersection Begins at 12:15 PM																			
12:15 PM	0	0	7	7	0	0	0	0	0	0	0	0	0	1	2	3	10		
12:30 PM	0	0	6	6	0	3	0	3	0	0	0	0	0	2	0	2	11		
12:45 PM	0	0	2	2	0	1	0	1	0	0	0	0	0	2	1	3	6		
01:00 PM	0	0	3	3	0	1	0	1	0	0	0	0	0	0	0	0	4		
Total Volume	0	0	18	18	0	5	0	5	0	0	0	0	0	5	3	8	31		
% App. Total	0	0	100		0	100	0		0	0	0		0	62.5	37.5				
PHF	.000	.000	.643	.643	.000	.417	.000	.417	.000	.000	.000	.000	.000	.625	.375	.667	.705		

County of Riverside
 N/S: I-215 Southbound Ramps
 E/W: Van Buren Boulevard
 Weather: Clear

File Name : 32_CRV_215S_VB Sat
 Site Code : 05122815
 Start Date : 9/17/2022
 Page No : 2

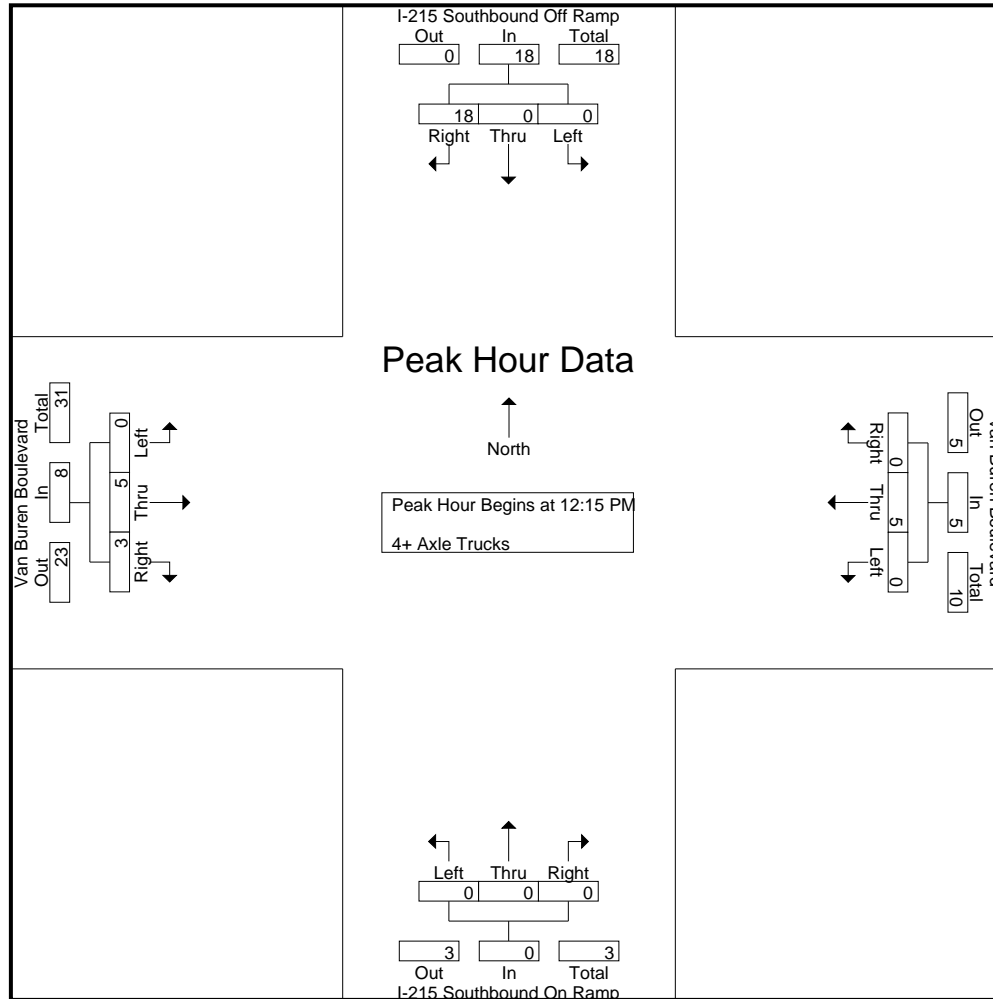

County of Riverside
 N/S: I-215 Southbound Ramps
 E/W: Van Buren Boulevard
 Weather: Clear

File Name : 32_CRV_215S_VB Sat
 Site Code : 05122815
 Start Date : 9/17/2022
 Page No : 3

Start Time	I-215 Southbound Off Ramp Southbound				Van Buren Boulevard Westbound				I-215 Southbound On Ramp Northbound				Van Buren Boulevard Eastbound				Int. Total
	Left	Thru	Right	App. Total	Left	Thru	Right	App. Total	Left	Thru	Right	App. Total	Left	Thru	Right	App. Total	
Peak Hour Analysis From 12:15 PM to 01:00 PM - Peak 1 of 1																	
Peak Hour for Each Approach Begins at:																	
	12:15 PM				12:15 PM				12:15 PM				12:15 PM				
+0 mins.	0	0	7	7	0	0	0	0	0	0	0	0	0	1	2	3	
+15 mins.	0	0	6	6	0	3	0	3	0	0	0	0	0	2	0	2	
+30 mins.	0	0	2	2	0	1	0	1	0	0	0	0	0	2	1	3	
+45 mins.	0	0	3	3	0	1	0	1	0	0	0	0	0	0	0	0	
Total Volume	0	0	18	18	0	5	0	5	0	0	0	0	0	5	3	8	
% App. Total	0	0	100		0	100	0		0	0	0		0	62.5	37.5		
PHF	.000	.000	.643	.643	.000	.417	.000	.417	.000	.000	.000	.000	.000	.625	.375	.667	

Location: County of Riverside
 N/S: I-215 SB Ramps
 E/W: Van Buren Boulevard



Date: 9/17/2022
 Day Saturday

PEDESTRIANS

Time	North Leg I-215 SB Ramps	East Leg Van Buren Boulevard	South Leg I-215 SB Ramps	West Leg Van Buren Boulevard	TOTAL
11:00 AM	0	0	0	0	0
11:15 AM	0	0	0	0	0
11:30 AM	0	0	0	0	0
11:45 AM	0	0	0	0	0
12:00 PM	0	0	0	0	0
12:15 PM	0	0	0	0	0
12:30 PM	0	0	0	0	0
12:45 PM	0	0	0	0	0
1:00 PM	0	0	0	0	0
1:15 PM	0	0	0	0	0
1:30 PM	0	0	0	0	0
1:45 PM	0	0	0	0	0
TOTAL VOLUMES:	0	0	0	0	0

Location: County of Riverside
 N/S: I-215 SB Ramps
 E/W: Van Buren Boulevard

Date: 9/17/2022
 Day: Saturday



BICYCLES

	Southbound I-215 SB Ramps			Westbound Van Buren Boulevard			Northbound I-215 SB Ramps			Eastbound Van Buren Boulevard			
	Left	Thru	Right	Left	Thru	Right	Left	Thru	Right	Left	Thru	Right	
11:00 AM	0	0	0	0	0	0	0	0	0	0	0	0	0
11:15 AM	0	0	0	0	0	0	0	0	0	0	0	0	0
11:30 AM	0	0	0	0	0	0	0	0	0	0	0	0	0
11:45 AM	0	0	0	0	0	0	0	0	0	0	0	0	0
12:00 PM	0	0	0	0	0	0	0	0	0	0	0	0	0
12:15 PM	0	0	0	0	0	0	0	0	0	0	0	0	0
12:30 PM	0	0	0	0	0	0	0	0	0	0	0	0	0
12:45 PM	0	0	0	0	0	0	0	0	0	0	0	0	0
1:00 PM	0	0	0	0	0	0	0	0	0	0	0	0	0
1:15 PM	0	0	0	0	0	0	0	0	0	0	0	0	0
1:30 PM	0	0	0	0	0	0	0	0	0	0	0	0	0
1:45 PM	0	0	0	0	0	0	0	0	0	0	0	0	0
TOTAL VOLUMES:	0	0	0	0	0	0	0	0	0	0	0	0	0

County of Riverside
 N/S: Van Buren Boulevard
 E/W: I-215 Northbound Ramps
 Weather: Clear

File Name : 33_CRV_VB_215n Sat
 Site Code : 05122815
 Start Date : 9/17/2022
 Page No : 1

Groups Printed- Passenger Vehicles - Large 2 Axle Vehicles - 3 Axle Vehicles - 4+ Axle Trucks

Start Time	Van Buren Boulevard Southbound				Van Buren Boulevard Northbound			I-215 Northbound Ramps Eastbound				Exclu. Total	Inclu. Total	Int. Total
	Thru	Right	RTOR	App. Total	Left	Thru	App. Total	Left	Right	RTOR	App. Total			
11:00 AM	2	99	0	101	0	2	2	118	3	0	121	0	224	224
11:15 AM	6	109	0	115	0	7	7	111	2	0	113	0	235	235
11:30 AM	5	112	0	117	0	5	5	117	3	0	120	0	242	242
11:45 AM	2	99	0	101	0	4	4	108	4	0	112	0	217	217
Total	15	419	0	434	0	18	18	454	12	0	466	0	918	918
12:00 PM	4	105	0	109	0	14	14	123	6	1	129	1	252	253
12:15 PM	7	113	0	120	0	6	6	124	2	0	126	0	252	252
12:30 PM	3	89	0	92	0	6	6	123	3	0	126	0	224	224
12:45 PM	12	116	0	128	1	11	12	118	4	0	122	0	262	262
Total	26	423	0	449	1	37	38	488	15	1	503	1	990	991
01:00 PM	1	105	0	106	0	6	6	122	2	0	124	0	236	236
01:15 PM	5	106	0	111	0	7	7	114	0	0	114	0	232	232
01:30 PM	7	89	0	96	0	11	11	119	5	0	124	0	231	231
01:45 PM	6	99	0	105	0	9	9	127	2	1	129	1	243	244
Total	19	399	0	418	0	33	33	482	9	1	491	1	942	943
Grand Total	60	1241	0	1301	1	88	89	1424	36	2	1460	2	2850	2852
Apprch %	4.6	95.4			1.1	98.9		97.5	2.5					
Total %	2.1	43.5		45.6	0	3.1	3.1	50	1.3		51.2	0.1	99.9	
Passenger Vehicles	60	1184		1244	1	88	89	1376	36		1414	0	0	2747
% Passenger Vehicles	100	95.4	0	95.6	100	100	100	96.6	100	100	96.7	0	0	96.3
Large 2 Axle Vehicles	0	16		16	0	0	0	29	0		29	0	0	45
% Large 2 Axle Vehicles	0	1.3	0	1.2	0	0	0	2	0	0	2	0	0	1.6
3 Axle Vehicles	0	16		16	0	0	0	6	0		6	0	0	22
% 3 Axle Vehicles	0	1.3	0	1.2	0	0	0	0.4	0	0	0.4	0	0	0.8
4+ Axle Trucks	0	25		25	0	0	0	13	0		13	0	0	38
% 4+ Axle Trucks	0	2	0	1.9	0	0	0	0.9	0	0	0.9	0	0	1.3

Start Time	Van Buren Boulevard Southbound			Van Buren Boulevard Northbound			I-215 Northbound Ramps Eastbound			Int. Total
	Thru	Right	App. Total	Left	Thru	App. Total	Left	Right	App. Total	
Peak Hour Analysis From 11:00 AM to 01:45 PM - Peak 1 of 1										
Peak Hour for Entire Intersection Begins at 12:00 PM										
12:00 PM	4	105	109	0	14	14	123	6	129	252
12:15 PM	7	113	120	0	6	6	124	2	126	252
12:30 PM	3	89	92	0	6	6	123	3	126	224
12:45 PM	12	116	128	1	11	12	118	4	122	262
Total Volume	26	423	449	1	37	38	488	15	503	990
% App. Total	5.8	94.2		2.6	97.4		97	3		
PHF	.542	.912	.877	.250	.661	.679	.984	.625	.975	.945

County of Riverside
 N/S: Van Buren Boulevard
 E/W: I-215 Northbound Ramps
 Weather: Clear

File Name : 33_CRV_VB_215n Sat
 Site Code : 05122815
 Start Date : 9/17/2022
 Page No : 2

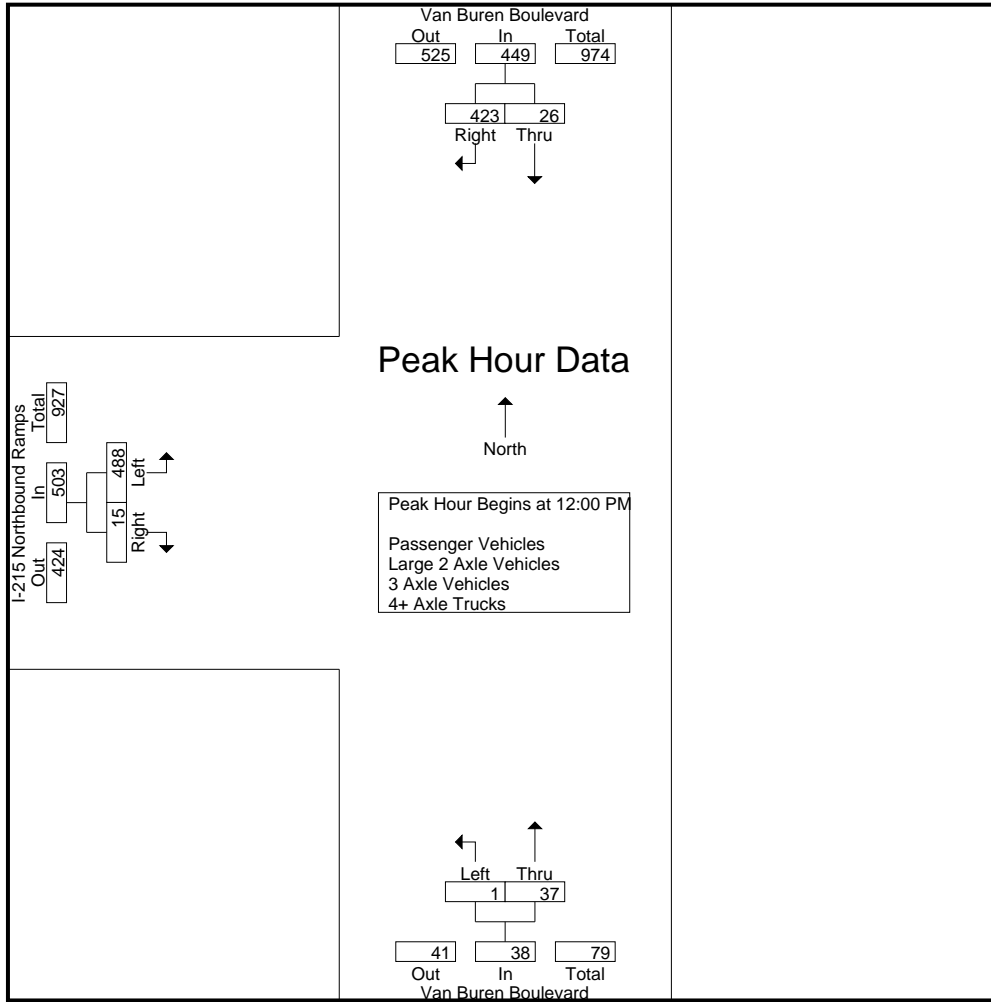

Peak Hour Analysis From 11:00 AM to 01:45 PM - Peak 1 of 1
 Peak Hour for Each Approach Begins at:

	12:00 PM			12:00 PM			12:00 PM		
+0 mins.	4	105	109	0	14	14	123	6	129
+15 mins.	7	113	120	0	6	6	124	2	126
+30 mins.	3	89	92	0	6	6	123	3	126
+45 mins.	12	116	128	1	11	12	118	4	122
Total Volume	26	423	449	1	37	38	488	15	503
% App. Total	5.8	94.2		2.6	97.4		97	3	
PHF	.542	.912	.877	.250	.661	.679	.984	.625	.975

County of Riverside
 N/S: Van Buren Boulevard
 E/W: I-215 Northbound Ramps
 Weather: Clear

File Name : 33_CRV_VB_215n Sat
 Site Code : 05122815
 Start Date : 9/17/2022
 Page No : 1

Groups Printed- Passenger Vehicles

Start Time	Van Buren Boulevard Southbound				Van Buren Boulevard Northbound			I-215 Northbound Ramps Eastbound				Exclu. Total	Inclu. Total	Int. Total
	Thru	Right	RTOR	App. Total	Left	Thru	App. Total	Left	Right	RTOR	App. Total			
11:00 AM	2	94	0	96	0	2	2	112	3	0	115	0	213	213
11:15 AM	6	100	0	106	0	7	7	108	2	0	110	0	223	223
11:30 AM	5	108	0	113	0	5	5	113	3	0	116	0	234	234
11:45 AM	2	93	0	95	0	4	4	106	4	0	110	0	209	209
Total	15	395	0	410	0	18	18	439	12	0	451	0	879	879
12:00 PM	4	102	0	106	0	14	14	121	6	1	127	1	247	248
12:15 PM	7	110	0	117	0	6	6	121	2	0	123	0	246	246
12:30 PM	3	86	0	89	0	6	6	118	3	0	121	0	216	216
12:45 PM	12	111	0	123	1	11	12	116	4	0	120	0	255	255
Total	26	409	0	435	1	37	38	476	15	1	491	1	964	965
01:00 PM	1	103	0	104	0	6	6	116	2	0	118	0	228	228
01:15 PM	5	102	0	107	0	7	7	111	0	0	111	0	225	225
01:30 PM	7	86	0	93	0	11	11	112	5	0	117	0	221	221
01:45 PM	6	89	0	95	0	9	9	122	2	1	124	1	228	229
Total	19	380	0	399	0	33	33	461	9	1	470	1	902	903
Grand Total	60	1184	0	1244	1	88	89	1376	36	2	1412	2	2745	2747
Apprch %	4.8	95.2			1.1	98.9		97.5	2.5					
Total %	2.2	43.1		45.3	0	3.2	3.2	50.1	1.3		51.4	0.1	99.9	

Start Time	Van Buren Boulevard Southbound			Van Buren Boulevard Northbound			I-215 Northbound Ramps Eastbound			Int. Total
	Thru	Right	App. Total	Left	Thru	App. Total	Left	Right	App. Total	
12:00 PM	4	102	106	0	14	14	121	6	127	247
12:15 PM	7	110	117	0	6	6	121	2	123	246
12:30 PM	3	86	89	0	6	6	118	3	121	216
12:45 PM	12	111	123	1	11	12	116	4	120	255
Total Volume	26	409	435	1	37	38	476	15	491	964
% App. Total	6	94		2.6	97.4		96.9	3.1		
PHF	.542	.921	.884	.250	.661	.679	.983	.625	.967	.945

County of Riverside
 N/S: Van Buren Boulevard
 E/W: I-215 Northbound Ramps
 Weather: Clear

File Name : 33_CRV_VB_215n Sat
 Site Code : 05122815
 Start Date : 9/17/2022
 Page No : 2

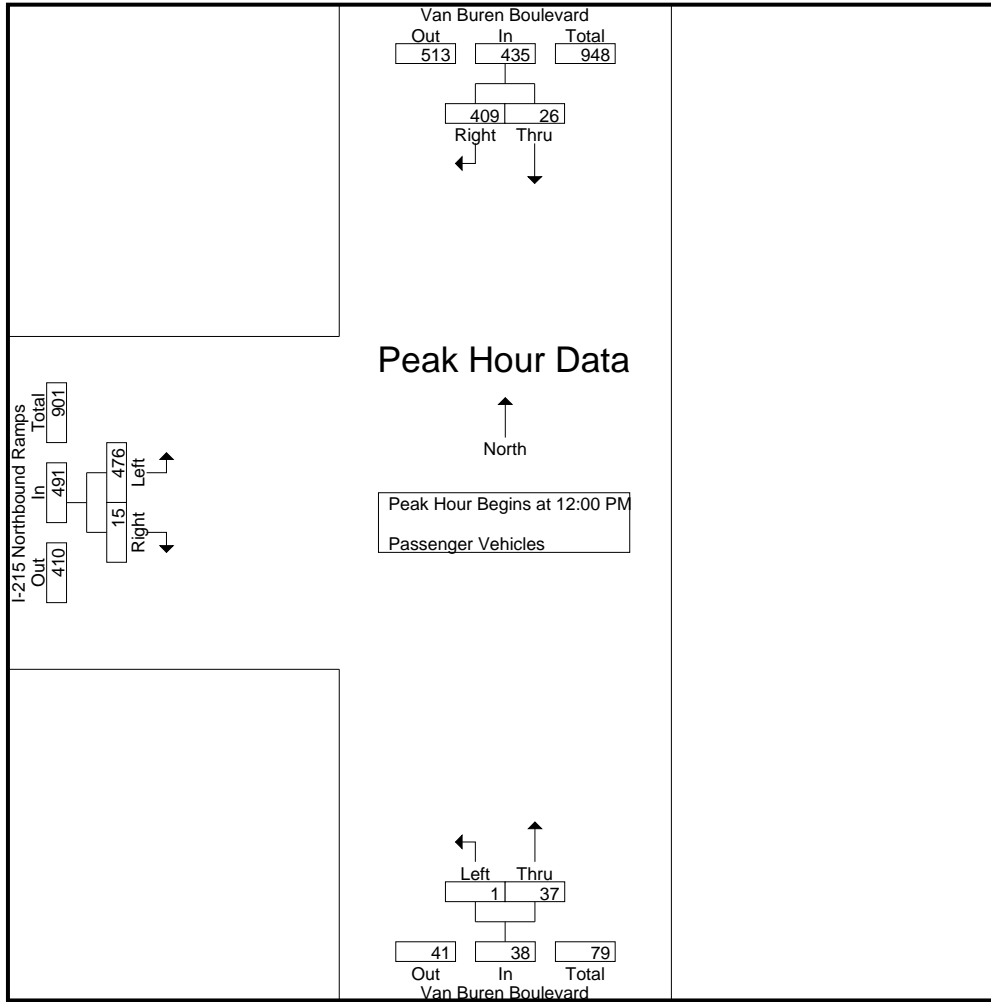

Peak Hour Analysis From 12:00 PM to 12:45 PM - Peak 1 of 1
 Peak Hour for Each Approach Begins at:

	12:00 PM			12:00 PM			12:00 PM		
+0 mins.	4	102	106	0	14	14	121	6	127
+15 mins.	7	110	117	0	6	6	121	2	123
+30 mins.	3	86	89	0	6	6	118	3	121
+45 mins.	12	111	123	1	11	12	116	4	120
Total Volume	26	409	435	1	37	38	476	15	491
% App. Total	6	94		2.6	97.4		96.9	3.1	
PHF	.542	.921	.884	.250	.661	.679	.983	.625	.967

County of Riverside
 N/S: Van Buren Boulevard
 E/W: I-215 Northbound Ramps
 Weather: Clear

File Name : 33_CRV_VB_215n Sat
 Site Code : 05122815
 Start Date : 9/17/2022
 Page No : 1

Groups Printed- Large 2 Axle Vehicles

Start Time	Van Buren Boulevard Southbound				Van Buren Boulevard Northbound			I-215 Northbound Ramps Eastbound				Exclu. Total	Inclu. Total	Int. Total
	Thru	Right	RTOR	App. Total	Left	Thru	App. Total	Left	Right	RTOR	App. Total			
11:00 AM	0	4	0	4	0	0	0	2	0	0	2	0	6	6
11:15 AM	0	1	0	1	0	0	0	2	0	0	2	0	3	3
11:30 AM	0	1	0	1	0	0	0	1	0	0	1	0	2	2
11:45 AM	0	2	0	2	0	0	0	2	0	0	2	0	4	4
Total	0	8	0	8	0	0	0	7	0	0	7	0	15	15
12:00 PM	0	1	0	1	0	0	0	2	0	0	2	0	3	3
12:15 PM	0	2	0	2	0	0	0	3	0	0	3	0	5	5
12:30 PM	0	0	0	0	0	0	0	1	0	0	1	0	1	1
12:45 PM	0	0	0	0	0	0	0	1	0	0	1	0	1	1
Total	0	3	0	3	0	0	0	7	0	0	7	0	10	10
01:00 PM	0	2	0	2	0	0	0	5	0	0	5	0	7	7
01:15 PM	0	0	0	0	0	0	0	2	0	0	2	0	2	2
01:30 PM	0	2	0	2	0	0	0	4	0	0	4	0	6	6
01:45 PM	0	1	0	1	0	0	0	4	0	0	4	0	5	5
Total	0	5	0	5	0	0	0	15	0	0	15	0	20	20
Grand Total	0	16	0	16	0	0	0	29	0	0	29	0	45	45
Apprch %	0	100			0	0		100	0					
Total %	0	35.6		35.6	0	0	0	64.4	0		64.4	0	100	

Start Time	Van Buren Boulevard Southbound			Van Buren Boulevard Northbound			I-215 Northbound Ramps Eastbound			Int. Total
	Thru	Right	App. Total	Left	Thru	App. Total	Left	Right	App. Total	
12:00 PM	0	1	1	0	0	0	2	0	2	3
12:15 PM	0	2	2	0	0	0	3	0	3	5
12:30 PM	0	0	0	0	0	0	1	0	1	1
12:45 PM	0	0	0	0	0	0	1	0	1	1
Total Volume	0	3	3	0	0	0	7	0	7	10
% App. Total	0	100		0	0		100	0		
PHF	.000	.375	.375	.000	.000	.000	.583	.000	.583	.500

County of Riverside
 N/S: Van Buren Boulevard
 E/W: I-215 Northbound Ramps
 Weather: Clear

File Name : 33_CRV_VB_215n Sat
 Site Code : 05122815
 Start Date : 9/17/2022
 Page No : 2

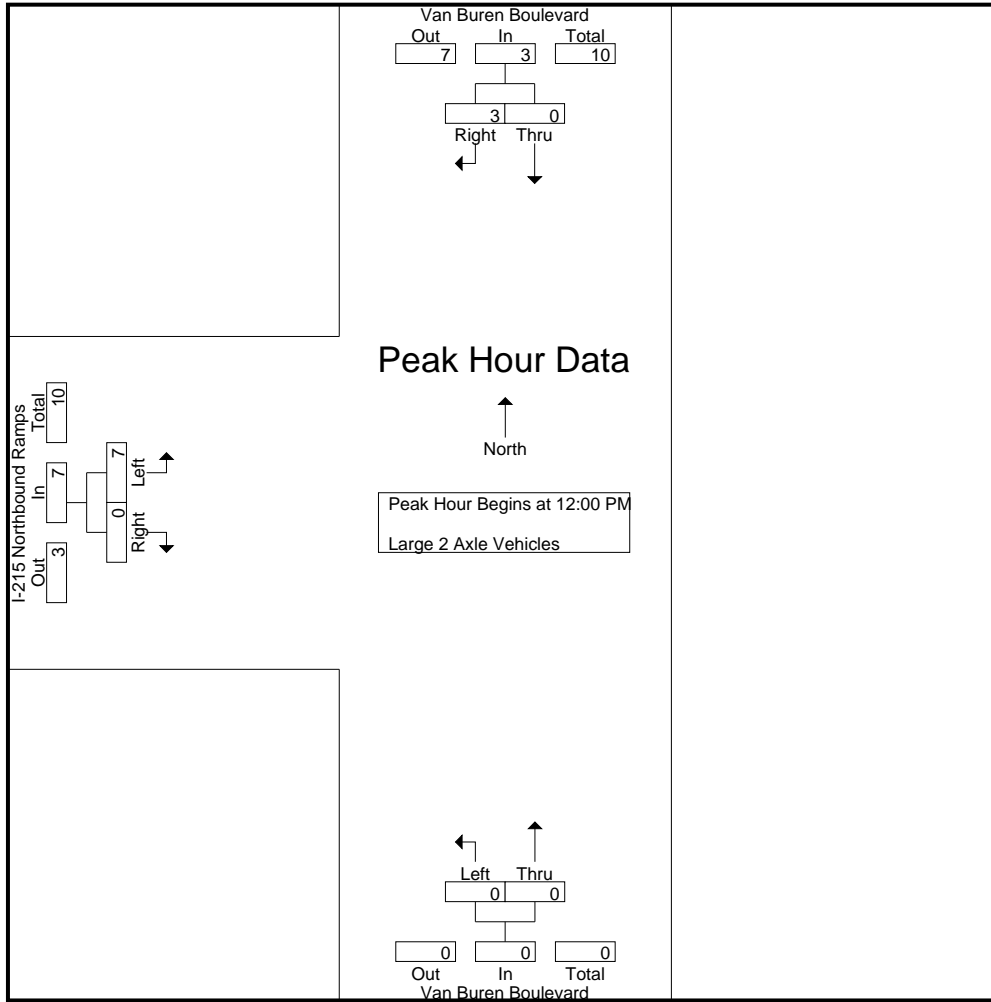

Peak Hour Analysis From 12:00 PM to 12:45 PM - Peak 1 of 1
 Peak Hour for Each Approach Begins at:

	12:00 PM			12:00 PM			12:00 PM		
+0 mins.	0	1	1	0	0	0	2	0	2
+15 mins.	0	2	2	0	0	0	3	0	3
+30 mins.	0	0	0	0	0	0	1	0	1
+45 mins.	0	0	0	0	0	0	1	0	1
Total Volume	0	3	3	0	0	0	7	0	7
% App. Total	0	100		0	0		100	0	
PHF	.000	.375	.375	.000	.000	.000	.583	.000	.583

County of Riverside
 N/S: Van Buren Boulevard
 E/W: I-215 Northbound Ramps
 Weather: Clear

File Name : 33_CRV_VB_215n Sat
 Site Code : 05122815
 Start Date : 9/17/2022
 Page No : 1

Groups Printed- 3 Axle Vehicles

Start Time	Van Buren Boulevard Southbound				Van Buren Boulevard Northbound			I-215 Northbound Ramps Eastbound				Exclu. Total	Inclu. Total	Int. Total
	Thru	Right	RTOR	App. Total	Left	Thru	App. Total	Left	Right	RTOR	App. Total			
11:00 AM	0	1	0	1	0	0	0	2	0	0	2	0	3	3
11:15 AM	0	4	0	4	0	0	0	0	0	0	0	0	4	4
11:30 AM	0	1	0	1	0	0	0	1	0	0	1	0	2	2
11:45 AM	0	2	0	2	0	0	0	0	0	0	0	0	2	2
Total	0	8	0	8	0	0	0	3	0	0	3	0	11	11
12:00 PM	0	1	0	1	0	0	0	0	0	0	0	0	1	1
12:15 PM	0	0	0	0	0	0	0	0	0	0	0	0	0	0
12:30 PM	0	1	0	1	0	0	0	1	0	0	1	0	2	2
12:45 PM	0	3	0	3	0	0	0	0	0	0	0	0	3	3
Total	0	5	0	5	0	0	0	1	0	0	1	0	6	6
01:00 PM	0	0	0	0	0	0	0	0	0	0	0	0	0	0
01:15 PM	0	0	0	0	0	0	0	0	0	0	0	0	0	0
01:30 PM	0	0	0	0	0	0	0	2	0	0	2	0	2	2
01:45 PM	0	3	0	3	0	0	0	0	0	0	0	0	3	3
Total	0	3	0	3	0	0	0	2	0	0	2	0	5	5
Grand Total	0	16	0	16	0	0	0	6	0	0	6	0	22	22
Apprch %	0	100			0	0		100	0					
Total %	0	72.7		72.7	0	0		27.3	0		27.3	0	100	

Start Time	Van Buren Boulevard Southbound			Van Buren Boulevard Northbound			I-215 Northbound Ramps Eastbound			Int. Total
	Thru	Right	App. Total	Left	Thru	App. Total	Left	Right	App. Total	
12:00 PM	0	1	1	0	0	0	0	0	0	1
12:15 PM	0	0	0	0	0	0	0	0	0	0
12:30 PM	0	1	1	0	0	0	1	0	1	2
12:45 PM	0	3	3	0	0	0	0	0	0	3
Total Volume	0	5	5	0	0	0	1	0	1	6
% App. Total	0	100		0	0		100	0		
PHF	.000	.417	.417	.000	.000	.000	.250	.000	.250	.500

County of Riverside
 N/S: Van Buren Boulevard
 E/W: I-215 Northbound Ramps
 Weather: Clear

File Name : 33_CRV_VB_215n Sat
 Site Code : 05122815
 Start Date : 9/17/2022
 Page No : 2

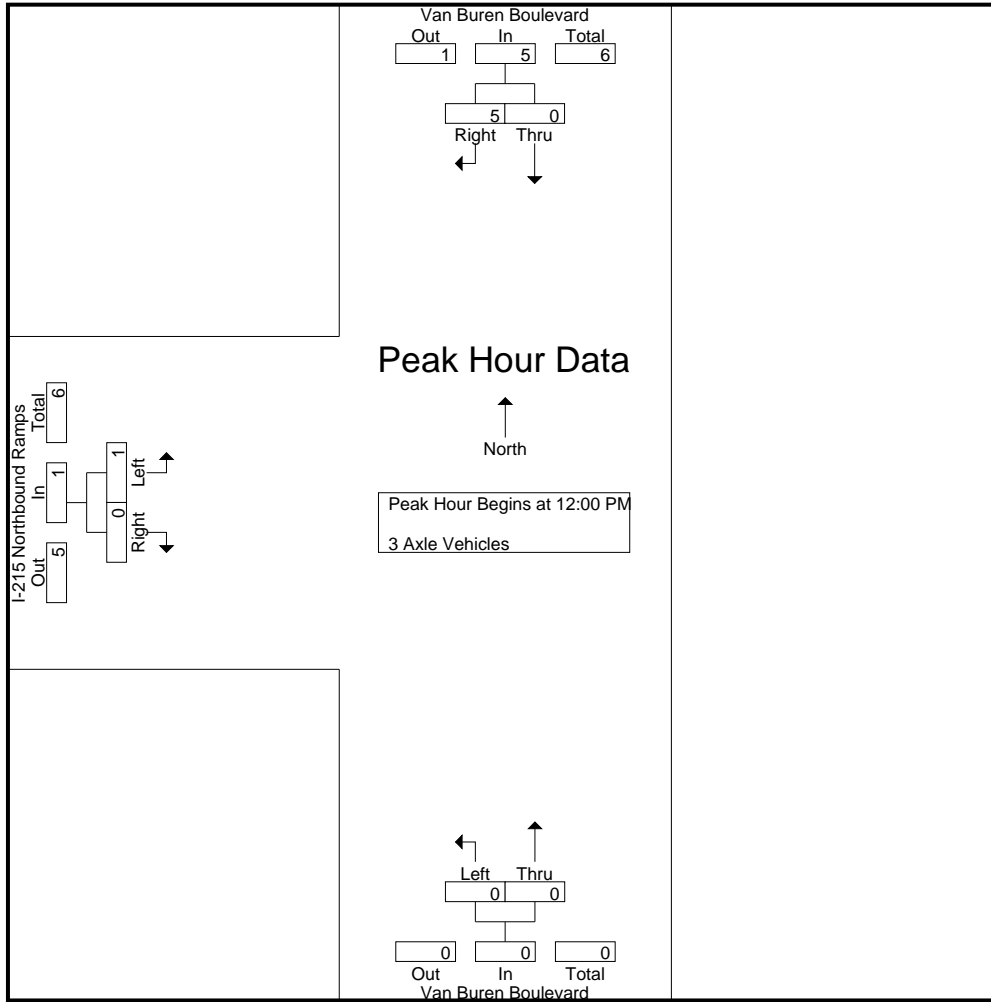

Peak Hour Analysis From 12:00 PM to 12:45 PM - Peak 1 of 1
 Peak Hour for Each Approach Begins at:

	12:00 PM			12:00 PM			12:00 PM		
+0 mins.	0	1	1	0	0	0	0	0	0
+15 mins.	0	0	0	0	0	0	0	0	0
+30 mins.	0	1	1	0	0	0	1	0	1
+45 mins.	0	3	3	0	0	0	0	0	0
Total Volume	0	5	5	0	0	0	1	0	1
% App. Total	0	100		0	0		100	0	
PHF	.000	.417	.417	.000	.000	.000	.250	.000	.250

County of Riverside
 N/S: Van Buren Boulevard
 E/W: I-215 Northbound Ramps
 Weather: Clear

File Name : 33_CRV_VB_215n Sat
 Site Code : 05122815
 Start Date : 9/17/2022
 Page No : 1

Groups Printed- 4+ Axle Trucks

Start Time	Van Buren Boulevard Southbound				Van Buren Boulevard Northbound			I-215 Northbound Ramps Eastbound				Exclu. Total	Inclu. Total	Int. Total
	Thru	Right	RTOR	App. Total	Left	Thru	App. Total	Left	Right	RTOR	App. Total			
11:00 AM	0	0	0	0	0	0	0	2	0	0	2	0	2	2
11:15 AM	0	4	0	4	0	0	0	1	0	0	1	0	5	5
11:30 AM	0	2	0	2	0	0	0	2	0	0	2	0	4	4
11:45 AM	0	2	0	2	0	0	0	0	0	0	0	0	2	2
Total	0	8	0	8	0	0	0	5	0	0	5	0	13	13
12:00 PM	0	1	0	1	0	0	0	0	0	0	0	0	1	1
12:15 PM	0	1	0	1	0	0	0	0	0	0	0	0	1	1
12:30 PM	0	2	0	2	0	0	0	3	0	0	3	0	5	5
12:45 PM	0	2	0	2	0	0	0	1	0	0	1	0	3	3
Total	0	6	0	6	0	0	0	4	0	0	4	0	10	10
01:00 PM	0	0	0	0	0	0	0	1	0	0	1	0	1	1
01:15 PM	0	4	0	4	0	0	0	1	0	0	1	0	5	5
01:30 PM	0	1	0	1	0	0	0	1	0	0	1	0	2	2
01:45 PM	0	6	0	6	0	0	0	1	0	0	1	0	7	7
Total	0	11	0	11	0	0	0	4	0	0	4	0	15	15
Grand Total	0	25	0	25	0	0	0	13	0	0	13	0	38	38
Apprch %	0	100			0	0		100	0					
Total %	0	65.8		65.8	0	0		34.2	0		34.2	0	100	

Start Time	Van Buren Boulevard Southbound			Van Buren Boulevard Northbound			I-215 Northbound Ramps Eastbound			Int. Total
	Thru	Right	App. Total	Left	Thru	App. Total	Left	Right	App. Total	
12:00 PM	0	1	1	0	0	0	0	0	0	1
12:15 PM	0	1	1	0	0	0	0	0	0	1
12:30 PM	0	2	2	0	0	0	3	0	3	5
12:45 PM	0	2	2	0	0	0	1	0	1	3
Total Volume	0	6	6	0	0	0	4	0	4	10
% App. Total	0	100		0	0		100	0		
PHF	.000	.750	.750	.000	.000	.000	.333	.000	.333	.500

Peak Hour Analysis From 12:00 PM to 12:45 PM - Peak 1 of 1
 Peak Hour for Entire Intersection Begins at 12:00 PM

County of Riverside
 N/S: Van Buren Boulevard
 E/W: I-215 Northbound Ramps
 Weather: Clear

File Name : 33_CRV_VB_215n Sat
 Site Code : 05122815
 Start Date : 9/17/2022
 Page No : 2

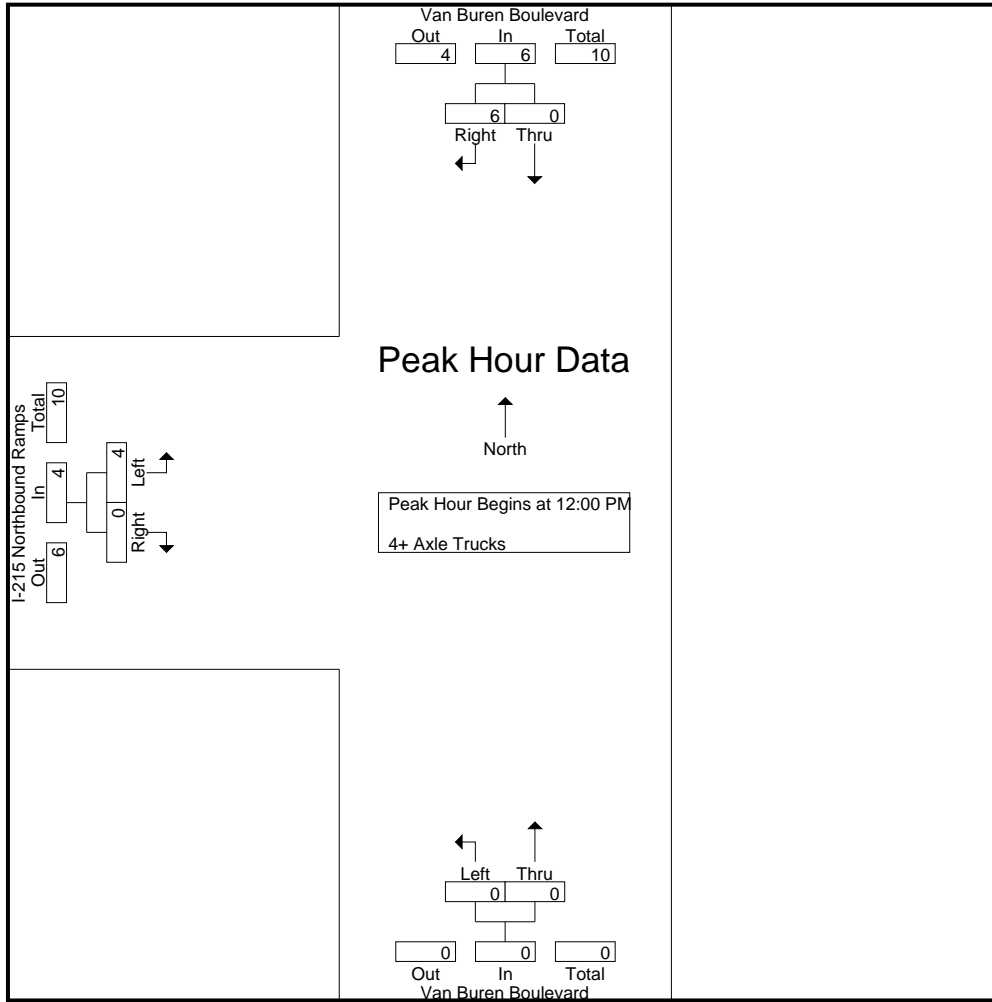

Peak Hour Analysis From 12:00 PM to 12:45 PM - Peak 1 of 1
 Peak Hour for Each Approach Begins at:

	12:00 PM			12:00 PM			12:00 PM		
+0 mins.	0	1	1	0	0	0	0	0	0
+15 mins.	0	1	1	0	0	0	0	0	0
+30 mins.	0	2	2	0	0	0	3	0	3
+45 mins.	0	2	2	0	0	0	1	0	1
Total Volume	0	6	6	0	0	0	4	0	4
% App. Total	0	100		0	0		100	0	
PHF	.000	.750	.750	.000	.000	.000	.333	.000	.333

Location: County of Riverside
 N/S: Van Buren Boulevard
 E/W: I-215 NB Ramps



Date: 9/17/2022
 Day Saturday

PEDESTRIANS

Time	North Leg Van Buren Boulevard	East Leg Dead End	South Leg Van Buren Boulevard	West Leg I-215 NB Ramps	TOTAL
11:00 AM	0	0	0	0	0
11:15 AM	0	0	0	0	0
11:30 AM	0	0	0	0	0
11:45 AM	0	0	0	0	0
12:00 PM	0	0	0	0	0
12:15 PM	0	0	0	0	0
12:30 PM	0	0	0	0	0
12:45 PM	0	0	0	0	0
1:00 PM	0	0	0	0	0
1:15 PM	0	0	0	0	0
1:30 PM	0	0	0	0	0
1:45 PM	0	0	0	0	0
TOTAL VOLUMES:	0	0	0	0	0

Location: County of Riverside
 N/S: Van Buren Boulevard
 E/W: I-215 NB Ramps

Date: 9/17/2022
 Day: Saturday



BICYCLES

	Southbound Van Buren Boulevard			Westbound Dead End			Northbound Van Buren Boulevard			Eastbound I-215 NB Ramps			
	Left	Thru	Right	Left	Thru	Right	Left	Thru	Right	Left	Thru	Right	
11:00 AM	0	0	0	0	0	0	0	0	0	0	0	0	0
11:15 AM	0	0	0	0	0	0	0	0	0	0	0	0	0
11:30 AM	0	0	0	0	0	0	0	0	0	0	0	0	0
11:45 AM	0	0	0	0	0	0	0	0	0	0	0	0	0
12:00 PM	0	0	0	0	0	0	0	0	0	0	0	0	0
12:15 PM	0	0	0	0	0	0	0	0	0	0	0	0	0
12:30 PM	0	0	0	0	0	0	0	0	0	0	0	0	0
12:45 PM	0	0	0	0	0	0	0	0	0	0	0	0	0
1:00 PM	0	0	0	0	0	0	0	0	0	0	0	0	0
1:15 PM	0	0	0	0	0	0	0	0	0	0	0	0	0
1:30 PM	0	0	0	0	0	0	0	0	0	0	0	0	0
1:45 PM	0	0	0	0	0	0	0	0	0	0	0	0	0
TOTAL VOLUMES:	0	0	0	0	0	0	0	0	0	0	0	0	0

City of Moreno Valley
 N/S: Old 215 Frontage Road
 E/W: Alessandro Boulevard
 Weather: Clear

File Name : 34_MRV_Old215_Ales Sat
 Site Code : 05122815
 Start Date : 9/17/2022
 Page No : 1

Groups Printed- Passenger Vehicles - Large 2 Axle Vehicles - 3 Axle Vehicles - 4+ Axle Trucks

Start Time	Old 215 Frontage Road Southbound					Alessandro Boulevard Westbound					Old 215 Frontage Road Northbound					Alessandro Boulevard Eastbound					Exclu. Total	Inclu. Total	Int. Total
	Left	Thru	Right	RTOR	App. Total	Left	Thru	Right	RTOR	App. Total	Left	Thru	Right	RTOR	App. Total	Left	Thru	Right	RTOR	App. Total			
11:00 AM	9	9	31	0	49	0	148	18	0	166	5	24	0	0	29	53	129	5	3	187	3	431	434
11:15 AM	12	8	30	0	50	2	134	18	0	154	8	24	3	2	35	87	144	2	1	233	3	472	475
11:30 AM	16	11	40	0	67	2	147	12	0	161	5	27	1	1	33	75	184	1	1	260	2	521	523
11:45 AM	13	16	48	0	77	4	152	19	0	175	2	20	0	0	22	66	136	5	3	207	3	481	484
Total	50	44	149	0	243	8	581	67	0	656	20	95	4	3	119	281	593	13	8	887	11	1905	1916
12:00 PM	10	9	42	0	61	0	158	27	0	185	4	24	3	2	31	56	161	3	0	220	2	497	499
12:15 PM	10	5	36	0	51	0	143	21	0	164	3	20	0	0	23	53	162	2	0	217	0	455	455
12:30 PM	14	13	42	0	69	1	169	17	0	187	8	26	6	3	40	68	174	5	1	247	4	543	547
12:45 PM	15	24	39	0	78	5	172	23	0	200	5	14	5	2	24	72	199	4	2	275	4	577	581
Total	49	51	159	0	259	6	642	88	0	736	20	84	14	7	118	249	696	14	3	959	10	2072	2082
01:00 PM	23	23	53	0	99	2	146	15	0	163	3	20	4	2	27	93	177	5	1	275	3	564	567
01:15 PM	26	26	45	0	97	1	166	25	0	192	6	19	2	2	27	52	168	0	0	220	2	536	538
01:30 PM	14	18	54	0	86	2	171	23	0	196	7	19	1	1	27	68	172	2	0	242	1	551	552
01:45 PM	11	9	49	0	69	3	162	22	0	187	3	18	0	0	21	58	208	2	1	268	1	545	546
Total	74	76	201	0	351	8	645	85	0	738	19	76	7	5	102	271	725	9	2	1005	7	2196	2203
Grand Total	173	171	509	0	853	22	1868	240	0	2130	59	255	25	15	339	801	2014	36	13	2851	28	6173	6201
Apprch %	20.3	20	59.7			1	87.7	11.3			17.4	75.2	7.4			28.1	70.6	1.3					
Total %	2.8	2.8	8.2		13.8	0.4	30.3	3.9		34.5	1	4.1	0.4		5.5	13	32.6	0.6		46.2	0.5	99.5	
Passenger Vehicles	170	166	504		840	21	1826	236		2083	44	246	25		330	799	1985	27		2820	0	0	6073
% Passenger Vehicles	98.3	97.1	99	0	98.5	95.5	97.8	98.3	0	97.8	74.6	96.5	100	100	93.2	99.8	98.6	75	69.2	98.5	0	0	97.9
Large 2 Axle Vehicles	2	1	4		7	0	25	2		27	1	3	0		4	0	13	2		15	0	0	53
% Large 2 Axle Vehicles	1.2	0.6	0.8	0	0.8	0	1.3	0.8	0	1.3	1.7	1.2	0	0	1.1	0	0.6	5.6	0	0.5	0	0	0.9
3 Axle Vehicles	0	1	0		1	1	6	0		7	9	0	0		9	1	4	1		6	0	0	23
% 3 Axle Vehicles	0	0.6	0	0	0.1	4.5	0.3	0	0	0.3	15.3	0	0	0	2.5	0.1	0.2	2.8	0	0.2	0	0	0.4
4+ Axle Trucks	1	3	1		5	0	11	2		13	5	6	0		11	1	12	6		23	0	0	52
% 4+ Axle Trucks	0.6	1.8	0.2	0	0.6	0	0.6	0.8	0	0.6	8.5	2.4	0	0	3.1	0.1	0.6	16.7	30.8	0.8	0	0	0.8

City of Moreno Valley
 N/S: Old 215 Frontage Road
 E/W: Alessandro Boulevard
 Weather: Clear

File Name : 34_MRV_Old215_Ales Sat
 Site Code : 05122815
 Start Date : 9/17/2022
 Page No : 2

Start Time	Old 215 Frontage Road Southbound				Alessandro Boulevard Westbound				Old 215 Frontage Road Northbound				Alessandro Boulevard Eastbound				Int. Total
	Left	Thru	Right	App. Total	Left	Thru	Right	App. Total	Left	Thru	Right	App. Total	Left	Thru	Right	App. Total	
Peak Hour Analysis From 11:00 AM to 01:45 PM - Peak 1 of 1																	
Peak Hour for Entire Intersection Begins at 12:45 PM																	
12:45 PM	15	24	39	78	5	172	23	200	5	14	5	24	72	199	4	275	577
01:00 PM	23	23	53	99	2	146	15	163	3	20	4	27	93	177	5	275	564
01:15 PM	26	26	45	97	1	166	25	192	6	19	2	27	52	168	0	220	536
01:30 PM	14	18	54	86	2	171	23	196	7	19	1	27	68	172	2	242	551
Total Volume	78	91	191	360	10	655	86	751	21	72	12	105	285	716	11	1012	2228
% App. Total	21.7	25.3	53.1		1.3	87.2	11.5		20	68.6	11.4		28.2	70.8	1.1		
PHF	.750	.875	.884	.909	.500	.952	.860	.939	.750	.900	.600	.972	.766	.899	.550	.920	.965

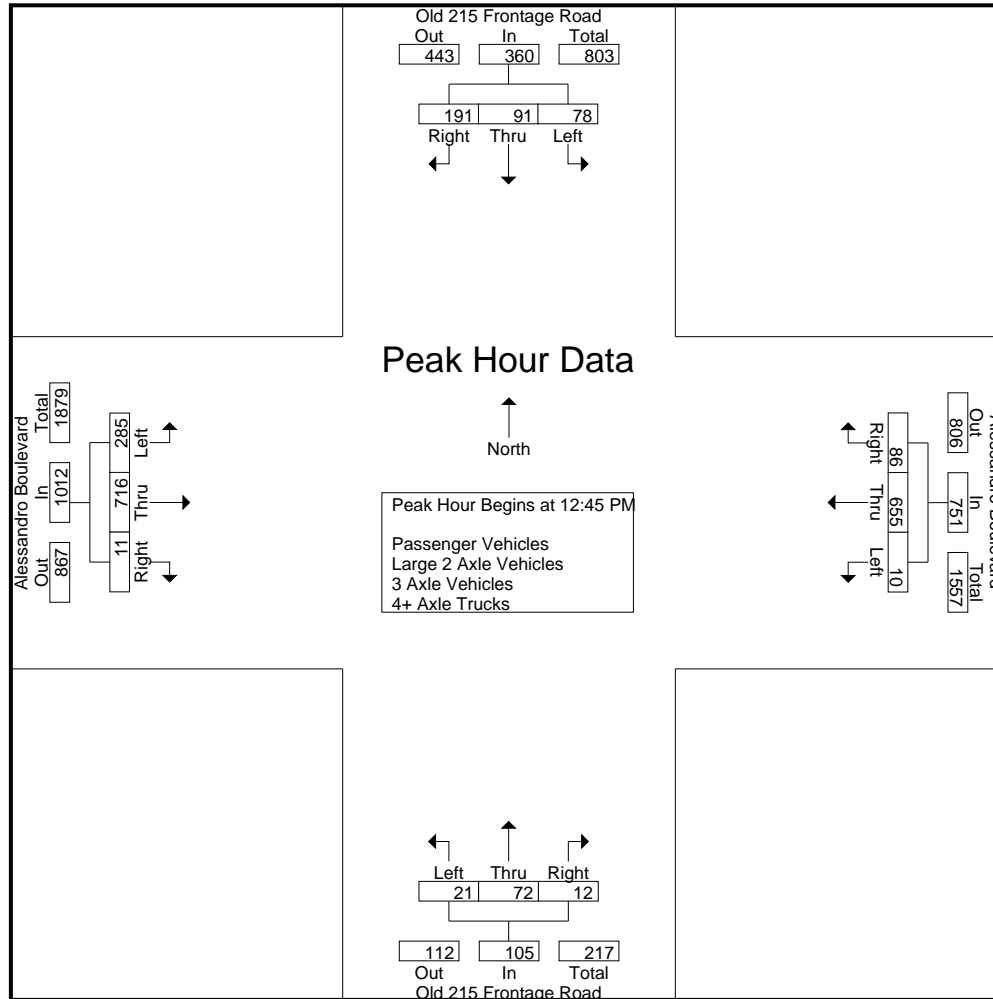

City of Moreno Valley
 N/S: Old 215 Frontage Road
 E/W: Alessandro Boulevard
 Weather: Clear

File Name : 34_MRV_Old215_Ales Sat
 Site Code : 05122815
 Start Date : 9/17/2022
 Page No : 4

Start Time	Old 215 Frontage Road Southbound				Alessandro Boulevard Westbound				Old 215 Frontage Road Northbound				Alessandro Boulevard Eastbound				Int. Total
	Left	Thru	Right	App. Total	Left	Thru	Right	App. Total	Left	Thru	Right	App. Total	Left	Thru	Right	App. Total	
Peak Hour Analysis From 11:00 AM to 01:45 PM - Peak 1 of 1																	
Peak Hour for Each Approach Begins at:																	
	12:45 PM				12:45 PM				11:15 AM				12:30 PM				
+0 mins.	15	24	39	78	5	172	23	200	8	24	3	35	68	174	5	247	
+15 mins.	23	23	53	99	2	146	15	163	5	27	1	33	72	199	4	275	
+30 mins.	26	26	45	97	1	166	25	192	2	20	0	22	93	177	5	275	
+45 mins.	14	18	54	86	2	171	23	196	4	24	3	31	52	168	0	220	
Total Volume	78	91	191	360	10	655	86	751	19	95	7	121	285	718	14	1017	
% App. Total	21.7	25.3	53.1		1.3	87.2	11.5		15.7	78.5	5.8		28	70.6	1.4		
PHF	.750	.875	.884	.909	.500	.952	.860	.939	.594	.880	.583	.864	.766	.902	.700	.925	

City of Moreno Valley
 N/S: Old 215 Frontage Road
 E/W: Alessandro Boulevard
 Weather: Clear

File Name : 34_MRV_Old215_Ales Sat
 Site Code : 05122815
 Start Date : 9/17/2022
 Page No : 1

Groups Printed- Passenger Vehicles

Start Time	Old 215 Frontage Road Southbound					Alessandro Boulevard Westbound					Old 215 Frontage Road Northbound					Alessandro Boulevard Eastbound					Exclu. Total	Inclu. Total	Int. Total
	Left	Thru	Right	RTOR	App. Total	Left	Thru	Right	RTOR	App. Total	Left	Thru	Right	RTOR	App. Total	Left	Thru	Right	RTOR	App. Total			
11:00 AM	9	9	31	0	49	0	146	18	0	164	4	23	0	0	27	53	125	1	0	179	0	419	419
11:15 AM	12	7	30	0	49	2	132	18	0	152	5	23	3	2	31	86	142	1	1	229	3	461	464
11:30 AM	16	11	39	0	66	2	144	12	0	158	2	25	1	1	28	75	183	1	1	259	2	511	513
11:45 AM	13	15	48	0	76	4	145	19	0	168	1	19	0	0	20	66	136	5	3	207	3	471	474
Total	50	42	148	0	240	8	567	67	0	642	12	90	4	3	106	280	586	8	5	874	8	1862	1870
12:00 PM	10	9	42	0	61	0	156	26	0	182	4	24	3	2	31	56	160	3	0	219	2	493	495
12:15 PM	10	5	35	0	50	0	139	21	0	160	2	20	0	0	22	53	161	2	0	216	0	448	448
12:30 PM	14	12	42	0	68	1	166	16	0	183	7	26	6	3	39	68	172	4	1	244	4	534	538
12:45 PM	14	22	39	0	75	5	170	23	0	198	4	11	5	2	20	72	194	3	1	269	3	562	565
Total	48	48	158	0	254	6	631	86	0	723	17	81	14	7	112	249	687	12	2	948	9	2037	2046
01:00 PM	22	23	53	0	98	1	144	15	0	160	2	20	4	2	26	92	175	4	1	271	3	555	558
01:15 PM	26	26	44	0	96	1	160	25	0	186	5	19	2	2	26	52	164	0	0	216	2	524	526
01:30 PM	13	18	53	0	84	2	166	22	0	190	5	19	1	1	25	68	171	2	0	241	1	540	541
01:45 PM	11	9	48	0	68	3	158	21	0	182	3	17	0	0	20	58	202	1	1	261	1	531	532
Total	72	76	198	0	346	7	628	83	0	718	15	75	7	5	97	270	712	7	2	989	7	2150	2157
Grand Total	170	166	504	0	840	21	1826	236	0	2083	44	246	25	15	315	799	1985	27	9	2811	24	6049	6073
Apprch %	20.2	19.8	60			1	87.7	11.3			14	78.1	7.9			28.4	70.6	1					
Total %	2.8	2.7	8.3		13.9	0.3	30.2	3.9		34.4	0.7	4.1	0.4		5.2	13.2	32.8	0.4		46.5	0.4	99.6	

Start Time	Old 215 Frontage Road Southbound				Alessandro Boulevard Westbound				Old 215 Frontage Road Northbound				Alessandro Boulevard Eastbound				Int. Total
	Left	Thru	Right	App. Total	Left	Thru	Right	App. Total	Left	Thru	Right	App. Total	Left	Thru	Right	App. Total	
Peak Hour Analysis From 12:45 PM to 01:30 PM - Peak 1 of 1																	
Peak Hour for Entire Intersection Begins at 12:45 PM																	
12:45 PM	14	22	39	75	5	170	23	198	4	11	5	20	72	194	3	269	562
01:00 PM	22	23	53	98	1	144	15	160	2	20	4	26	92	175	4	271	555
01:15 PM	26	26	44	96	1	160	25	186	5	19	2	26	52	164	0	216	524
01:30 PM	13	18	53	84	2	166	22	190	5	19	1	25	68	171	2	241	540
Total Volume	75	89	189	353	9	640	85	734	16	69	12	97	284	704	9	997	2181
% App. Total	21.2	25.2	53.5		1.2	87.2	11.6		16.5	71.1	12.4		28.5	70.6	0.9		
PHF	.721	.856	.892	.901	.450	.941	.850	.927	.800	.863	.600	.933	.772	.907	.563	.920	.970

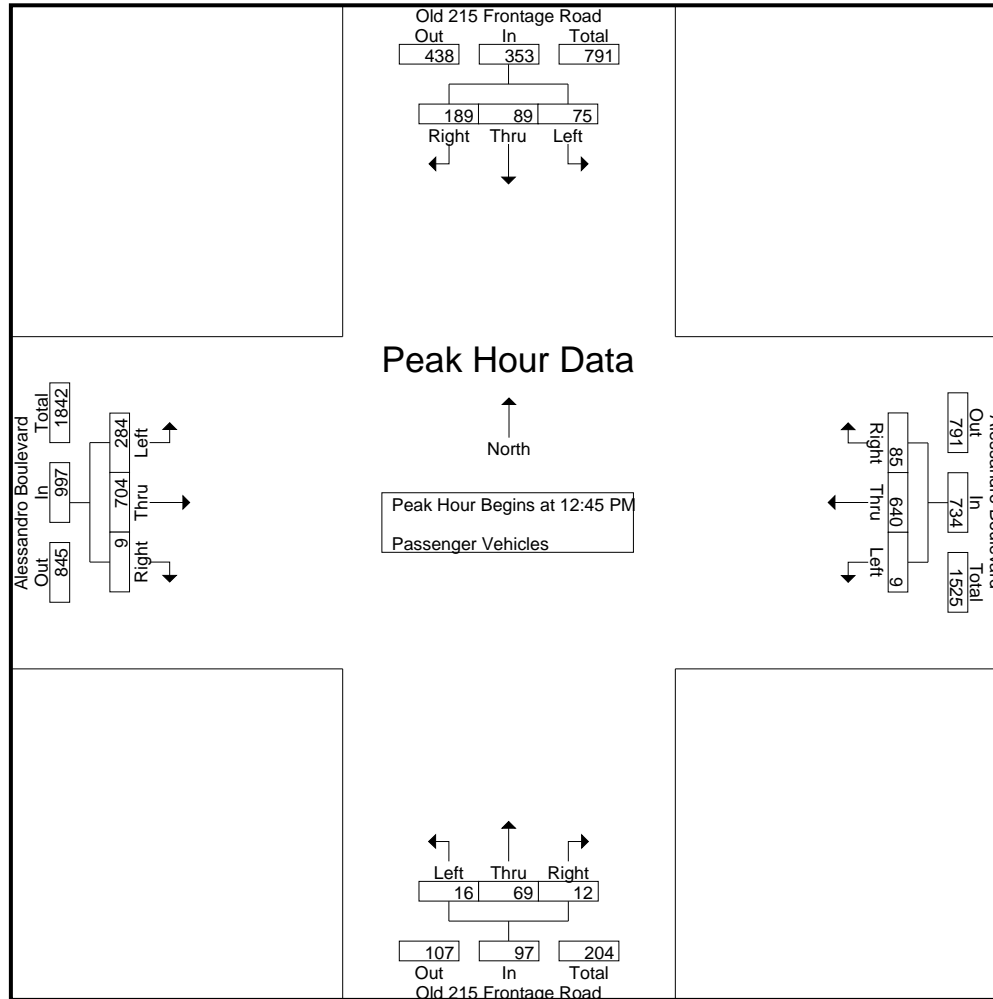

City of Moreno Valley
 N/S: Old 215 Frontage Road
 E/W: Alessandro Boulevard
 Weather: Clear

File Name : 34_MRV_Old215_Ales Sat
 Site Code : 05122815
 Start Date : 9/17/2022
 Page No : 3

Start Time	Old 215 Frontage Road Southbound				Alessandro Boulevard Westbound				Old 215 Frontage Road Northbound				Alessandro Boulevard Eastbound				Int. Total
	Left	Thru	Right	App. Total	Left	Thru	Right	App. Total	Left	Thru	Right	App. Total	Left	Thru	Right	App. Total	
Peak Hour Analysis From 12:45 PM to 01:30 PM - Peak 1 of 1																	
Peak Hour for Each Approach Begins at:																	
	12:45 PM				12:45 PM				12:45 PM				12:45 PM				
+0 mins.	14	22	39	75	5	170	23	198	4	11	5	20	72	194	3	269	
+15 mins.	22	23	53	98	1	144	15	160	2	20	4	26	92	175	4	271	
+30 mins.	26	26	44	96	1	160	25	186	5	19	2	26	52	164	0	216	
+45 mins.	13	18	53	84	2	166	22	190	5	19	1	25	68	171	2	241	
Total Volume	75	89	189	353	9	640	85	734	16	69	12	97	284	704	9	997	
% App. Total	21.2	25.2	53.5		1.2	87.2	11.6		16.5	71.1	12.4		28.5	70.6	0.9		
PHF	.721	.856	.892	.901	.450	.941	.850	.927	.800	.863	.600	.933	.772	.907	.563	.920	

City of Moreno Valley
 N/S: Old 215 Frontage Road
 E/W: Alessandro Boulevard
 Weather: Clear

File Name : 34_MRV_Old215_Ales Sat
 Site Code : 05122815
 Start Date : 9/17/2022
 Page No : 1

Groups Printed- Large 2 Axle Vehicles

Start Time	Old 215 Frontage Road Southbound					Alessandro Boulevard Westbound					Old 215 Frontage Road Northbound					Alessandro Boulevard Eastbound					Exclu. Total	Inclu. Total	Int. Total	
	Left	Thru	Right	RTOR	App. Total	Left	Thru	Right	RTOR	App. Total	Left	Thru	Right	RTOR	App. Total	Left	Thru	Right	RTOR	App. Total				
11:00 AM	0	0	0	0	0	0	0	0	0	0	0	0	0	0	0	0	2	0	0	2	0	0	2	0
11:15 AM	0	0	0	0	0	0	1	0	0	1	0	0	0	0	0	0	0	0	0	0	0	0	1	0
11:30 AM	0	0	1	0	1	0	2	0	0	2	0	0	0	0	0	0	1	0	0	1	0	0	4	0
11:45 AM	0	0	0	0	0	0	6	0	0	6	0	0	0	0	0	0	0	0	0	0	0	0	6	0
Total	0	0	1	0	1	0	9	0	0	9	0	0	0	0	0	0	3	0	0	3	0	0	13	0
12:00 PM	0	0	0	0	0	0	2	1	0	3	0	0	0	0	0	0	1	0	0	1	0	0	4	0
12:15 PM	0	0	0	0	0	0	1	0	0	1	0	0	0	0	0	0	0	0	0	0	0	0	1	0
12:30 PM	0	1	0	0	1	0	1	0	0	1	1	0	0	0	1	0	1	0	0	1	0	0	4	0
12:45 PM	0	0	0	0	0	0	0	0	0	0	0	2	0	0	2	0	4	0	0	4	0	0	6	0
Total	0	1	0	0	1	0	4	1	0	5	1	2	0	0	3	0	6	0	0	6	0	0	15	0
01:00 PM	1	0	0	0	1	0	2	0	0	2	0	0	0	0	0	0	0	1	0	1	0	0	4	0
01:15 PM	0	0	1	0	1	0	3	0	0	3	0	0	0	0	0	0	1	0	0	1	0	0	5	0
01:30 PM	1	0	1	0	2	0	4	0	0	4	0	0	0	0	0	0	1	0	0	1	0	0	7	0
01:45 PM	0	0	1	0	1	0	3	1	0	4	0	1	0	0	1	0	2	1	0	3	0	0	9	0
Total	2	0	3	0	5	0	12	1	0	13	0	1	0	0	1	0	4	2	0	6	0	0	25	0
Grand Total	2	1	4	0	7	0	25	2	0	27	1	3	0	0	4	0	13	2	0	15	0	0	53	0
Apprch %	28.6	14.3	57.1			0	92.6	7.4			25	75	0			0	86.7	13.3						
Total %	3.8	1.9	7.5		13.2	0	47.2	3.8		50.9	1.9	5.7	0		7.5	0	24.5	3.8		28.3	0	0	100	

Start Time	Old 215 Frontage Road Southbound				Alessandro Boulevard Westbound				Old 215 Frontage Road Northbound				Alessandro Boulevard Eastbound				Int. Total
	Left	Thru	Right	App. Total	Left	Thru	Right	App. Total	Left	Thru	Right	App. Total	Left	Thru	Right	App. Total	
Peak Hour Analysis From 12:45 PM to 01:30 PM - Peak 1 of 1																	
Peak Hour for Entire Intersection Begins at 12:45 PM																	
12:45 PM	0	0	0	0	0	0	0	0	0	2	0	2	0	4	0	4	6
01:00 PM	1	0	0	1	0	2	0	2	0	0	0	0	0	0	1	1	4
01:15 PM	0	0	1	1	0	3	0	3	0	0	0	0	0	1	0	1	5
01:30 PM	1	0	1	2	0	4	0	4	0	0	0	0	0	1	0	1	7
Total Volume	2	0	2	4	0	9	0	9	0	2	0	2	0	6	1	7	22
% App. Total	50	0	50		0	100	0		0	100	0		0	85.7	14.3		
PHF	.500	.000	.500	.500	.000	.563	.000	.563	.000	.250	.000	.250	.000	.375	.250	.438	.786

City of Moreno Valley
 N/S: Old 215 Frontage Road
 E/W: Alessandro Boulevard
 Weather: Clear

File Name : 34_MRV_Old215_Ales Sat
 Site Code : 05122815
 Start Date : 9/17/2022
 Page No : 2

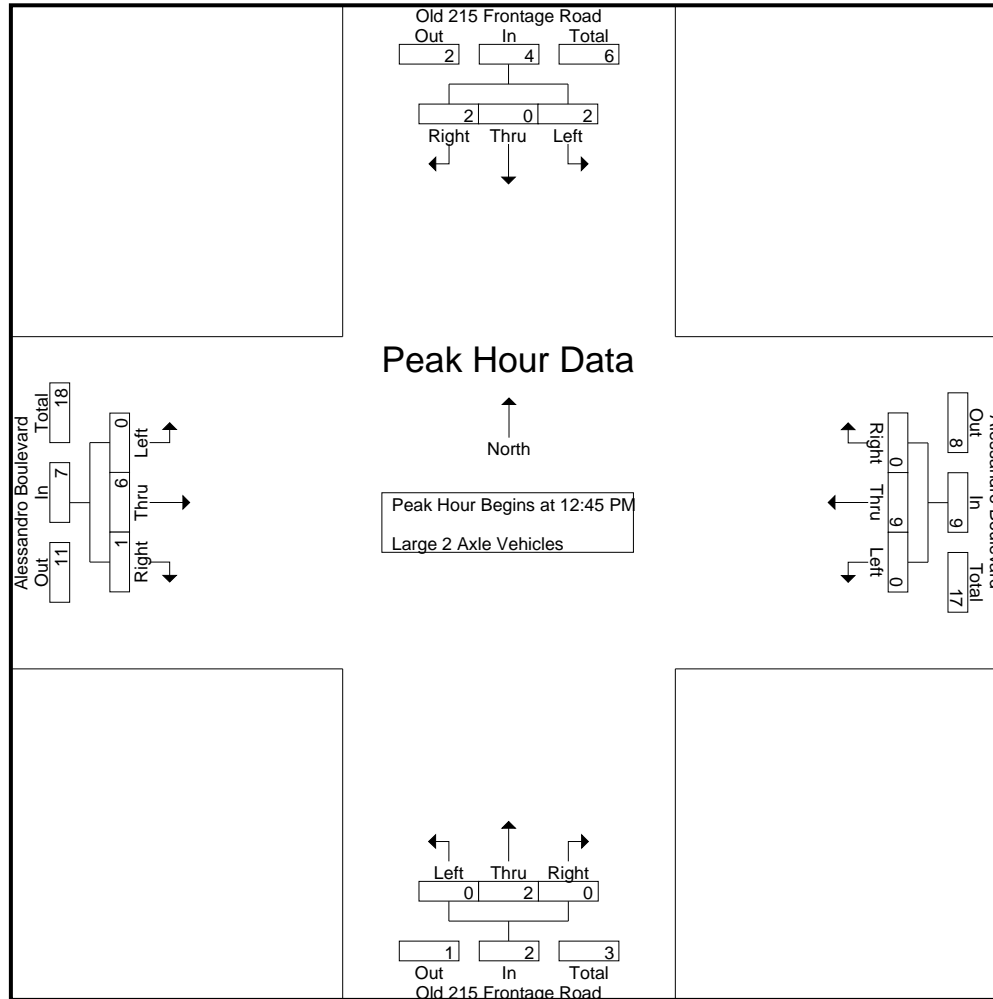

City of Moreno Valley
 N/S: Old 215 Frontage Road
 E/W: Alessandro Boulevard
 Weather: Clear

File Name : 34_MRV_Old215_Ales Sat
 Site Code : 05122815
 Start Date : 9/17/2022
 Page No : 3

Start Time	Old 215 Frontage Road Southbound				Alessandro Boulevard Westbound				Old 215 Frontage Road Northbound				Alessandro Boulevard Eastbound				Int. Total
	Left	Thru	Right	App. Total	Left	Thru	Right	App. Total	Left	Thru	Right	App. Total	Left	Thru	Right	App. Total	
Peak Hour Analysis From 12:45 PM to 01:30 PM - Peak 1 of 1																	
Peak Hour for Each Approach Begins at:																	
	12:45 PM				12:45 PM				12:45 PM				12:45 PM				
+0 mins.	0	0	0	0	0	0	0	0	0	2	0	2	0	4	0	4	
+15 mins.	1	0	0	1	0	2	0	2	0	0	0	0	0	0	1	1	
+30 mins.	0	0	1	1	0	3	0	3	0	0	0	0	0	1	0	1	
+45 mins.	1	0	1	2	0	4	0	4	0	0	0	0	0	1	0	1	
Total Volume	2	0	2	4	0	9	0	9	0	2	0	2	0	6	1	7	
% App. Total	50	0	50		0	100	0		0	100	0		0	85.7	14.3		
PHF	.500	.000	.500	.500	.000	.563	.000	.563	.000	.250	.000	.250	.000	.375	.250	.438	

City of Moreno Valley
 N/S: Old 215 Frontage Road
 E/W: Alessandro Boulevard
 Weather: Clear

File Name : 34_MRV_Old215_Ales Sat
 Site Code : 05122815
 Start Date : 9/17/2022
 Page No : 1

Groups Printed- 3 Axle Vehicles

Start Time	Old 215 Frontage Road Southbound					Alessandro Boulevard Westbound					Old 215 Frontage Road Northbound					Alessandro Boulevard Eastbound					Exclu. Total	Inclu. Total	Int. Total				
	Left	Thru	Right	RTOR	App. Total	Left	Thru	Right	RTOR	App. Total	Left	Thru	Right	RTOR	App. Total	Left	Thru	Right	RTOR	App. Total							
11:00 AM	0	0	0	0	0	0	0	0	0	0	0	0	0	0	0	0	0	0	0	0	0	0	0	0	0	0	0
11:15 AM	0	0	0	0	0	0	0	0	0	0	2	0	0	0	2	0	0	0	0	0	0	0	0	0	0	2	2
11:30 AM	0	0	0	0	0	0	0	0	0	0	2	0	0	0	2	0	0	0	0	0	0	0	0	0	0	2	2
11:45 AM	0	0	0	0	0	0	1	0	0	1	1	0	0	0	1	0	0	0	0	0	0	0	0	0	0	2	2
Total	0	0	0	0	0	0	1	0	0	1	5	0	0	0	5	0	0	0	0	0	0	0	0	0	0	6	6
12:00 PM	0	0	0	0	0	0	0	0	0	0	0	0	0	0	0	0	0	0	0	0	0	0	0	0	0	0	0
12:15 PM	0	0	0	0	0	0	0	0	0	0	0	0	0	0	0	0	1	0	0	1	0	0	0	0	0	1	1
12:30 PM	0	0	0	0	0	0	0	0	0	0	0	0	0	0	0	0	0	1	0	1	0	0	0	0	0	1	1
12:45 PM	0	1	0	0	1	0	0	0	0	0	1	0	0	0	1	0	0	0	0	0	0	0	0	0	0	2	2
Total	0	1	0	0	1	0	0	0	0	0	1	0	0	0	1	0	1	1	0	2	0	0	0	0	0	4	4
01:00 PM	0	0	0	0	0	1	0	0	0	1	0	0	0	0	0	1	1	0	0	2	0	0	0	0	0	3	3
01:15 PM	0	0	0	0	0	0	3	0	0	3	1	0	0	0	1	0	0	0	0	0	0	0	0	0	0	4	4
01:30 PM	0	0	0	0	0	0	1	0	0	1	2	0	0	0	2	0	0	0	0	0	0	0	0	0	0	3	3
01:45 PM	0	0	0	0	0	0	1	0	0	1	0	0	0	0	0	0	2	0	0	2	0	0	0	0	0	3	3
Total	0	0	0	0	0	1	5	0	0	6	3	0	0	0	3	1	3	0	0	4	0	0	0	0	0	13	13
Grand Total	0	1	0	0	1	1	6	0	0	7	9	0	0	0	9	1	4	1	0	6	0	0	0	0	0	23	23
Apprch %	0	100	0			14.3	85.7	0			100	0	0			16.7	66.7	16.7									
Total %	0	4.3	0		4.3	4.3	26.1	0		30.4	39.1	0	0		39.1	4.3	17.4	4.3		26.1	0	0	0		0	100	

Start Time	Old 215 Frontage Road Southbound				Alessandro Boulevard Westbound				Old 215 Frontage Road Northbound				Alessandro Boulevard Eastbound				Int. Total
	Left	Thru	Right	App. Total	Left	Thru	Right	App. Total	Left	Thru	Right	App. Total	Left	Thru	Right	App. Total	
Peak Hour Analysis From 12:45 PM to 01:30 PM - Peak 1 of 1																	
Peak Hour for Entire Intersection Begins at 12:45 PM																	
12:45 PM	0	1	0	1	0	0	0	0	1	0	0	1	0	0	0	0	2
01:00 PM	0	0	0	0	1	0	0	1	0	0	0	0	1	1	0	2	3
01:15 PM	0	0	0	0	0	3	0	3	1	0	0	1	0	0	0	0	4
01:30 PM	0	0	0	0	0	1	0	1	2	0	0	2	0	0	0	0	3
Total Volume	0	1	0	1	1	4	0	5	4	0	0	4	1	1	0	2	12
% App. Total	0	100	0		20	80	0		100	0	0		50	50	0		
PHF	.000	.250	.000	.250	.250	.333	.000	.417	.500	.000	.000	.500	.250	.250	.000	.250	.750

City of Moreno Valley
 N/S: Old 215 Frontage Road
 E/W: Alessandro Boulevard
 Weather: Clear

File Name : 34_MRV_Old215_Ales Sat
 Site Code : 05122815
 Start Date : 9/17/2022
 Page No : 2

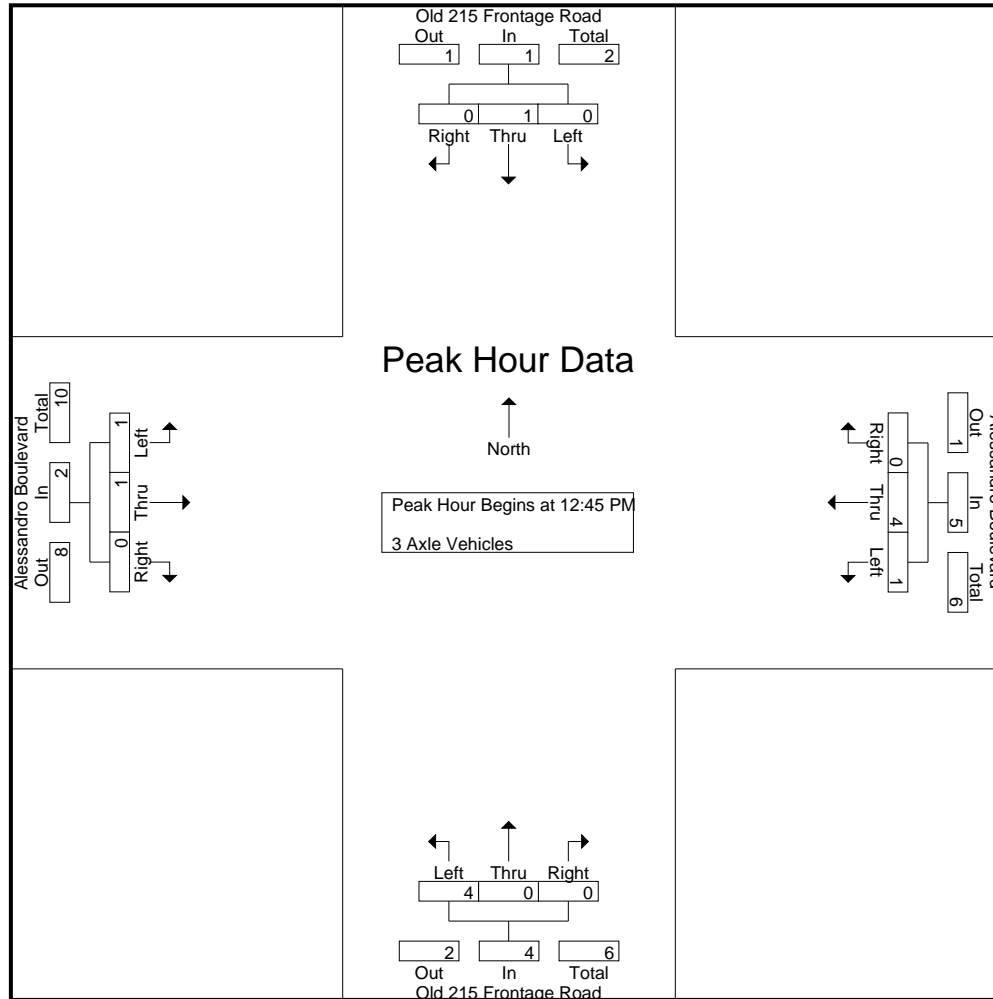

City of Moreno Valley
 N/S: Old 215 Frontage Road
 E/W: Alessandro Boulevard
 Weather: Clear

File Name : 34_MRV_Old215_Ales Sat
 Site Code : 05122815
 Start Date : 9/17/2022
 Page No : 3

Start Time	Old 215 Frontage Road Southbound				Alessandro Boulevard Westbound				Old 215 Frontage Road Northbound				Alessandro Boulevard Eastbound				Int. Total
	Left	Thru	Right	App. Total	Left	Thru	Right	App. Total	Left	Thru	Right	App. Total	Left	Thru	Right	App. Total	
Peak Hour Analysis From 12:45 PM to 01:30 PM - Peak 1 of 1																	
Peak Hour for Each Approach Begins at:																	
	12:45 PM				12:45 PM				12:45 PM				12:45 PM				
+0 mins.	0	1	0	1	0	0	0	0	1	0	0	1	0	0	0	0	
+15 mins.	0	0	0	0	1	0	0	1	0	0	0	0	1	1	0	2	
+30 mins.	0	0	0	0	0	3	0	3	1	0	0	1	0	0	0	0	
+45 mins.	0	0	0	0	0	1	0	1	2	0	0	2	0	0	0	0	
Total Volume	0	1	0	1	1	4	0	5	4	0	0	4	1	1	0	2	
% App. Total	0	100	0		20	80	0		100	0	0		50	50	0		
PHF	.000	.250	.000	.250	.250	.333	.000	.417	.500	.000	.000	.500	.250	.250	.000	.250	

City of Moreno Valley
 N/S: Old 215 Frontage Road
 E/W: Alessandro Boulevard
 Weather: Clear

File Name : 34_MRV_Old215_Ales Sat
 Site Code : 05122815
 Start Date : 9/17/2022
 Page No : 1

Groups Printed- 4+ Axle Trucks

Start Time	Old 215 Frontage Road Southbound					Alessandro Boulevard Westbound					Old 215 Frontage Road Northbound					Alessandro Boulevard Eastbound					Exclu. Total	Inclu. Total	Int. Total
	Left	Thru	Right	RTOR	App. Total	Left	Thru	Right	RTOR	App. Total	Left	Thru	Right	RTOR	App. Total	Left	Thru	Right	RTOR	App. Total			
11:00 AM	0	0	0	0	0	0	2	0	0	2	1	1	0	0	2	0	2	4	3	6	3	10	13
11:15 AM	0	1	0	0	1	0	1	0	0	1	1	1	0	0	2	1	2	1	0	4	0	8	8
11:30 AM	0	0	0	0	0	0	1	0	0	1	1	2	0	0	3	0	0	0	0	0	0	4	4
11:45 AM	0	1	0	0	1	0	0	0	0	0	0	1	0	0	1	0	0	0	0	0	0	2	2
Total	0	2	0	0	2	0	4	0	0	4	3	5	0	0	8	1	4	5	3	10	3	24	27
12:00 PM	0	0	0	0	0	0	0	0	0	0	0	0	0	0	0	0	0	0	0	0	0	0	0
12:15 PM	0	0	1	0	1	0	3	0	0	3	1	0	0	0	1	0	0	0	0	0	0	5	5
12:30 PM	0	0	0	0	0	0	2	1	0	3	0	0	0	0	0	0	1	0	0	1	0	4	4
12:45 PM	1	1	0	0	2	0	2	0	0	2	0	1	0	0	1	0	1	1	1	2	1	7	8
Total	1	1	1	0	3	0	7	1	0	8	1	1	0	0	2	0	2	1	1	3	1	16	17
01:00 PM	0	0	0	0	0	0	0	0	0	0	1	0	0	0	1	0	1	0	0	1	0	2	2
01:15 PM	0	0	0	0	0	0	0	0	0	0	0	0	0	0	0	0	3	0	0	3	0	3	3
01:30 PM	0	0	0	0	0	0	0	1	0	1	0	0	0	0	0	0	0	0	0	0	0	1	1
01:45 PM	0	0	0	0	0	0	0	0	0	0	0	0	0	0	0	0	2	0	0	2	0	2	2
Total	0	0	0	0	0	0	0	1	0	1	1	0	0	0	1	0	6	0	0	6	0	8	8
Grand Total	1	3	1	0	5	0	11	2	0	13	5	6	0	0	11	1	12	6	4	19	4	48	52
Apprch %	20	60	20			0	84.6	15.4			45.5	54.5	0			5.3	63.2	31.6					
Total %	2.1	6.2	2.1		10.4	0	22.9	4.2		27.1	10.4	12.5	0		22.9	2.1	25	12.5		39.6	7.7	92.3	

Start Time	Old 215 Frontage Road Southbound				Alessandro Boulevard Westbound				Old 215 Frontage Road Northbound				Alessandro Boulevard Eastbound				Int. Total
	Left	Thru	Right	App. Total	Left	Thru	Right	App. Total	Left	Thru	Right	App. Total	Left	Thru	Right	App. Total	
Peak Hour Analysis From 12:45 PM to 01:30 PM - Peak 1 of 1																	
Peak Hour for Entire Intersection Begins at 12:45 PM																	
12:45 PM	1	1	0	2	0	2	0	2	0	1	0	1	0	1	1	2	7
01:00 PM	0	0	0	0	0	0	0	0	1	0	0	1	0	1	0	1	2
01:15 PM	0	0	0	0	0	0	0	0	0	0	0	0	0	3	0	3	3
01:30 PM	0	0	0	0	0	0	1	1	0	0	0	0	0	0	0	0	1
Total Volume	1	1	0	2	0	2	1	3	1	1	0	2	0	5	1	6	13
% App. Total	50	50	0		0	66.7	33.3		50	50	0		0	83.3	16.7		
PHF	.250	.250	.000	.250	.000	.250	.250	.375	.250	.250	.000	.500	.000	.417	.250	.500	.464

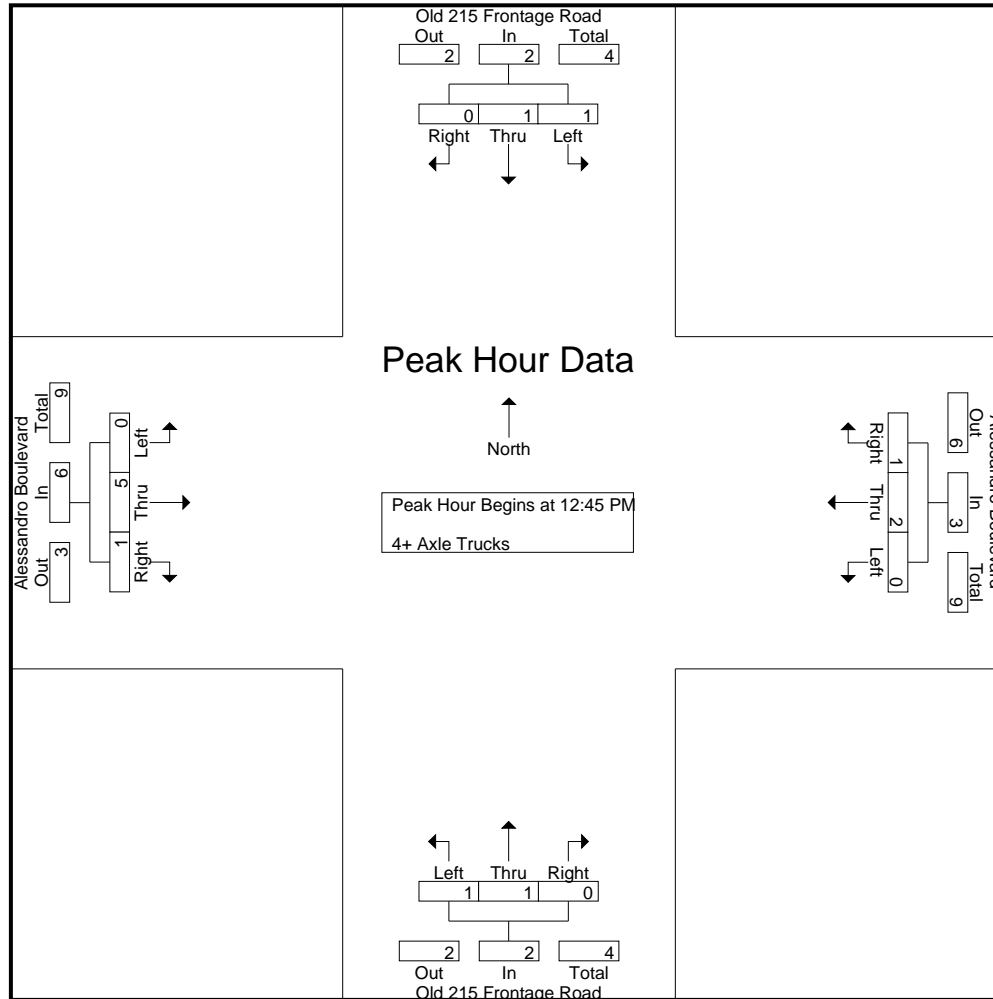

City of Moreno Valley
 N/S: Old 215 Frontage Road
 E/W: Alessandro Boulevard
 Weather: Clear

File Name : 34_MRV_Old215_Ales Sat
 Site Code : 05122815
 Start Date : 9/17/2022
 Page No : 3

Start Time	Old 215 Frontage Road Southbound				Alessandro Boulevard Westbound				Old 215 Frontage Road Northbound				Alessandro Boulevard Eastbound				Int. Total
	Left	Thru	Right	App. Total	Left	Thru	Right	App. Total	Left	Thru	Right	App. Total	Left	Thru	Right	App. Total	
Peak Hour Analysis From 12:45 PM to 01:30 PM - Peak 1 of 1																	
Peak Hour for Each Approach Begins at:																	
	12:45 PM				12:45 PM				12:45 PM				12:45 PM				
+0 mins.	1	1	0	2	0	2	0	2	0	1	0	1	0	1	1	2	
+15 mins.	0	0	0	0	0	0	0	0	1	0	0	1	0	1	0	1	
+30 mins.	0	0	0	0	0	0	0	0	0	0	0	0	0	3	0	3	
+45 mins.	0	0	0	0	0	0	1	1	0	0	0	0	0	0	0	0	
Total Volume	1	1	0	2	0	2	1	3	1	1	0	2	0	5	1	6	
% App. Total	50	50	0		0	66.7	33.3		50	50	0		0	83.3	16.7		
PHF	.250	.250	.000	.250	.000	.250	.250	.375	.250	.250	.000	.500	.000	.417	.250	.500	

Location: Moreno Valley
 N/S: Old 215 Frontage Road
 E/W: Alessandro Boulevard



Date: 9/17/2022
 Day Saturday

PEDESTRIANS

Time	North Leg Old 215 Frontage Road	East Leg Alessandro Boulevard	South Leg Old 215 Frontage Road	West Leg Alessandro Boulevard	TOTAL
11:00 AM	0	0	0	0	0
11:15 AM	0	0	0	0	0
11:30 AM	0	0	0	0	0
11:45 AM	0	0	0	0	0
12:00 PM	0	0	0	0	0
12:15 PM	0	0	0	0	0
12:30 PM	0	0	0	0	0
12:45 PM	1	0	0	0	1
1:00 PM	0	0	0	0	0
1:15 PM	0	0	0	0	0
1:30 PM	0	0	0	0	0
1:45 PM	0	0	0	0	0
TOTAL VOLUMES:	1	0	0	0	1

Location: Moreno Valley
 N/S: Old 215 Frontage Road
 E/W: Alessandro Boulevard

Date: 9/17/2022
 Day: Saturday



BICYCLES

	Southbound Old 215 Frontage Road			Westbound Alessandro Boulevard			Northbound Old 215 Frontage Road			Eastbound Alessandro Boulevard			
	Left	Thru	Right	Left	Thru	Right	Left	Thru	Right	Left	Thru	Right	
11:00 AM	0	0	0	0	0	0	0	0	0	0	0	0	0
11:15 AM	0	0	0	0	0	0	0	0	0	0	0	0	0
11:30 AM	0	0	0	0	0	0	0	0	0	0	0	0	0
11:45 AM	0	0	0	0	0	0	1	0	0	0	0	0	1
12:00 PM	0	0	0	0	0	0	0	0	0	0	3	0	3
12:15 PM	0	0	1	0	0	0	0	0	0	0	0	0	1
12:30 PM	0	0	0	0	1	0	0	0	0	0	0	0	1
12:45 PM	0	0	0	0	0	0	0	0	0	0	0	0	0
1:00 PM	0	0	0	0	0	0	0	0	0	0	0	0	0
1:15 PM	0	0	0	0	0	0	0	0	0	0	0	0	0
1:30 PM	0	0	0	0	0	0	0	0	0	0	0	0	0
1:45 PM	0	0	0	0	0	0	0	0	0	0	0	0	0
TOTAL VOLUMES:	0	0	1	0	1	0	1	0	0	0	3	0	6

City of Moreno Valley
 N/S: Day Street
 E/W: Alessandro Boulevard
 Weather: Clear

File Name : 35_MRV_Day_Ales Sat
 Site Code : 05122815
 Start Date : 9/17/2022
 Page No : 1

Groups Printed- Passenger Vehicles - Large 2 Axle Vehicles - 3 Axle Vehicles - 4+ Axle Trucks

Start Time	Day Street Southbound					Alessandro Boulevard Westbound					Day Street Northbound					Alessandro Boulevard Eastbound					Exclu. Total	Inclu. Total	Int. Total
	Left	Thru	Right	RTOR	App. Total	Left	Thru	Right	RTOR	App. Total	Left	Thru	Right	RTOR	App. Total	Left	Thru	Right	RTOR	App. Total			
11:00 AM	25	5	17	9	47	5	152	31	11	188	2	22	5	1	29	28	113	0	0	141	21	405	426
11:15 AM	26	3	24	12	53	1	147	31	15	179	3	19	1	1	23	30	132	0	0	162	28	417	445
11:30 AM	34	10	18	6	62	2	138	29	10	169	1	25	5	4	31	53	136	1	0	190	20	452	472
11:45 AM	16	14	13	6	43	2	150	32	13	184	3	22	2	1	27	41	125	1	0	167	20	421	441
Total	101	32	72	33	205	10	587	123	49	720	9	88	13	7	110	152	506	2	0	660	89	1695	1784
12:00 PM	25	13	22	8	60	2	160	28	10	190	1	17	3	2	21	27	135	3	1	165	21	436	457
12:15 PM	37	13	12	5	62	0	133	28	9	161	4	11	6	3	21	25	121	0	0	146	17	390	407
12:30 PM	25	5	17	9	47	5	156	31	11	192	0	21	6	2	27	28	142	0	0	170	22	436	458
12:45 PM	26	4	24	12	54	1	147	31	15	179	3	19	2	1	24	30	156	0	0	186	28	443	471
Total	113	35	75	34	223	8	596	118	45	722	8	68	17	8	93	110	554	3	1	667	88	1705	1793
01:00 PM	34	10	18	6	62	3	137	29	10	169	1	25	5	4	31	53	147	1	0	201	20	463	483
01:15 PM	17	14	13	6	44	2	148	33	13	183	4	22	3	1	29	41	127	1	0	169	20	425	445
01:30 PM	25	13	24	10	62	2	162	28	10	192	1	17	3	2	21	27	135	4	1	166	23	441	464
01:45 PM	37	13	12	5	62	0	135	28	9	163	2	10	6	3	18	25	154	0	0	179	17	422	439
Total	113	50	67	27	230	7	582	118	42	707	8	74	17	10	99	146	563	6	1	715	80	1751	1831
Grand Total	327	117	214	94	658	25	1765	359	136	2149	25	230	47	25	302	408	1623	11	2	2042	257	5151	5408
Apprch %	49.7	17.8	32.5			1.2	82.1	16.7			8.3	76.2	15.6			20	79.5	0.5					
Total %	6.3	2.3	4.2		12.8	0.5	34.3	7		41.7	0.5	4.5	0.9		5.9	7.9	31.5	0.2		39.6	4.8	95.2	
Passenger Vehicles	326	116	212		746	24	1720	358		2238	20	228	44		316	408	1592	8		2010	0	0	5310
% Passenger Vehicles	99.7	99.1	99.1	97.9	99.2	96	97.5	99.7	100	97.9	80	99.1	93.6	96	96.6	100	98.1	72.7	100	98.3	0	0	98.2
Large 2 Axle Vehicles	0	1	2		5	0	30	0		30	4	1	2		7	0	18	1		19	0	0	61
% Large 2 Axle Vehicles	0	0.9	0.9	2.1	0.7	0	1.7	0	0	1.3	16	0.4	4.3	0	2.1	0	1.1	9.1	0	0.9	0	0	1.1
3 Axle Vehicles	0	0	0		0	1	7	0		8	0	0	1		2	0	2	2		4	0	0	14
% 3 Axle Vehicles	0	0	0	0	0	4	0.4	0	0	0.4	0	0	2.1	4	0.6	0	0.1	18.2	0	0.2	0	0	0.3
4+ Axle Trucks	1	0	0		1	0	8	1		9	1	1	0		2	0	11	0		11	0	0	23
% 4+ Axle Trucks	0.3	0	0	0	0.1	0	0.5	0.3	0	0.4	4	0.4	0	0	0.6	0	0.7	0	0	0.5	0	0	0.4

City of Moreno Valley
 N/S: Day Street
 E/W: Alessandro Boulevard
 Weather: Clear

File Name : 35_MRV_Day_Ales Sat
 Site Code : 05122815
 Start Date : 9/17/2022
 Page No : 2

Start Time	Day Street Southbound				Alessandro Boulevard Westbound				Day Street Northbound				Alessandro Boulevard Eastbound				Int. Total
	Left	Thru	Right	App. Total	Left	Thru	Right	App. Total	Left	Thru	Right	App. Total	Left	Thru	Right	App. Total	
Peak Hour Analysis From 11:00 AM to 01:45 PM - Peak 1 of 1																	
Peak Hour for Entire Intersection Begins at 12:45 PM																	
12:45 PM	26	4	24	54	1	147	31	179	3	19	2	24	30	156	0	186	443
01:00 PM	34	10	18	62	3	137	29	169	1	25	5	31	53	147	1	201	463
01:15 PM	17	14	13	44	2	148	33	183	4	22	3	29	41	127	1	169	425
01:30 PM	25	13	24	62	2	162	28	192	1	17	3	21	27	135	4	166	441
Total Volume	102	41	79	222	8	594	121	723	9	83	13	105	151	565	6	722	1772
% App. Total	45.9	18.5	35.6		1.1	82.2	16.7		8.6	79	12.4		20.9	78.3	0.8		
PHF	.750	.732	.823	.895	.667	.917	.917	.941	.563	.830	.650	.847	.712	.905	.375	.898	.957

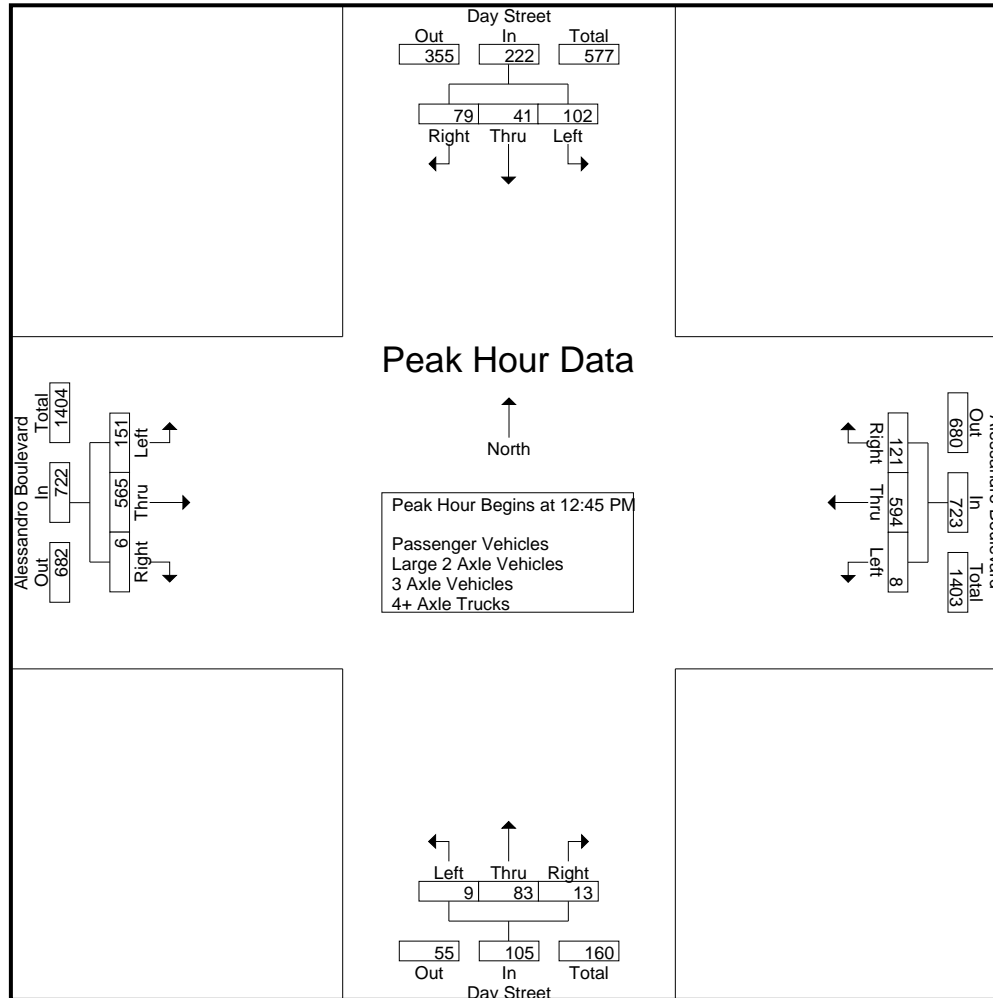

City of Moreno Valley
 N/S: Day Street
 E/W: Alessandro Boulevard
 Weather: Clear

File Name : 35_MRV_Day_Ales Sat
 Site Code : 05122815
 Start Date : 9/17/2022
 Page No : 4

Start Time	Day Street Southbound				Alessandro Boulevard Westbound				Day Street Northbound				Alessandro Boulevard Eastbound				Int. Total
	Left	Thru	Right	App. Total	Left	Thru	Right	App. Total	Left	Thru	Right	App. Total	Left	Thru	Right	App. Total	
Peak Hour Analysis From 11:00 AM to 01:45 PM - Peak 1 of 1																	
Peak Hour for Each Approach Begins at:																	
	01:00 PM				11:45 AM				12:30 PM				12:30 PM				
+0 mins.	34	10	18	62	2	150	32	184	0	21	6	27	28	142	0	170	
+15 mins.	17	14	13	44	2	160	28	190	3	19	2	24	30	156	0	186	
+30 mins.	25	13	24	62	0	133	28	161	1	25	5	31	53	147	1	201	
+45 mins.	37	13	12	62	5	156	31	192	4	22	3	29	41	127	1	169	
Total Volume	113	50	67	230	9	599	119	727	8	87	16	111	152	572	2	726	
% App. Total	49.1	21.7	29.1		1.2	82.4	16.4		7.2	78.4	14.4		20.9	78.8	0.3		
PHF	.764	.893	.698	.927	.450	.936	.930	.947	.500	.870	.667	.895	.717	.917	.500	.903	

City of Moreno Valley
 N/S: Day Street
 E/W: Alessandro Boulevard
 Weather: Clear

File Name : 35_MRV_Day_Ales Sat
 Site Code : 05122815
 Start Date : 9/17/2022
 Page No : 1

Groups Printed- Passenger Vehicles

Start Time	Day Street Southbound					Alessandro Boulevard Westbound					Day Street Northbound					Alessandro Boulevard Eastbound					Exclu. Total	Inclu. Total	Int. Total
	Left	Thru	Right	RTOR	App. Total	Left	Thru	Right	RTOR	App. Total	Left	Thru	Right	RTOR	App. Total	Left	Thru	Right	RTOR	App. Total			
11:00 AM	25	5	17	9	47	5	151	31	11	187	0	21	5	1	26	28	109	0	0	137	21	397	418
11:15 AM	26	3	24	12	53	1	145	31	15	177	3	19	1	1	23	30	130	0	0	160	28	413	441
11:30 AM	34	10	18	6	62	2	134	29	10	165	1	25	5	4	31	53	135	0	0	188	20	446	466
11:45 AM	16	14	13	6	43	2	143	32	13	177	3	22	2	1	27	41	123	1	0	165	20	412	432
Total	101	32	72	33	205	10	573	123	49	706	7	87	13	7	107	152	497	1	0	650	89	1668	1757
12:00 PM	25	13	22	8	60	2	157	28	10	187	1	17	3	2	21	27	134	3	1	164	21	432	453
12:15 PM	37	13	12	5	62	0	130	28	9	158	2	10	6	3	18	25	120	0	0	145	17	383	400
12:30 PM	25	5	17	9	47	5	151	31	11	187	0	21	5	1	26	28	139	0	0	167	21	427	448
12:45 PM	26	3	24	12	53	1	145	31	15	177	3	19	1	1	23	30	150	0	0	180	28	433	461
Total	113	34	75	34	222	8	583	118	45	709	6	67	15	7	88	110	543	3	1	656	87	1675	1762
01:00 PM	34	10	18	6	62	2	134	29	10	165	1	25	5	4	31	53	145	0	0	198	20	456	476
01:15 PM	16	14	13	6	43	2	143	32	13	177	3	22	2	1	27	41	123	1	0	165	20	412	432
01:30 PM	25	13	22	8	60	2	157	28	10	187	1	17	3	2	21	27	134	3	1	164	21	432	453
01:45 PM	37	13	12	5	62	0	130	28	9	158	2	10	6	3	18	25	150	0	0	175	17	413	430
Total	112	50	65	25	227	6	564	117	42	687	7	74	16	10	97	146	552	4	1	702	78	1713	1791
Grand Total	326	116	212	92	654	24	1720	358	136	2102	20	228	44	24	292	408	1592	8	2	2008	254	5056	5310
Apprch %	49.8	17.7	32.4			1.1	81.8	17			6.8	78.1	15.1			20.3	79.3	0.4					
Total %	6.4	2.3	4.2		12.9	0.5	34	7.1		41.6	0.4	4.5	0.9		5.8	8.1	31.5	0.2		39.7	4.8	95.2	

Start Time	Day Street Southbound				Alessandro Boulevard Westbound				Day Street Northbound				Alessandro Boulevard Eastbound				Int. Total
	Left	Thru	Right	App. Total	Left	Thru	Right	App. Total	Left	Thru	Right	App. Total	Left	Thru	Right	App. Total	
Peak Hour Analysis From 12:45 PM to 01:30 PM - Peak 1 of 1																	
Peak Hour for Entire Intersection Begins at 12:45 PM																	
12:45 PM	26	3	24	53	1	145	31	177	3	19	1	23	30	150	0	180	433
01:00 PM	34	10	18	62	2	134	29	165	1	25	5	31	53	145	0	198	456
01:15 PM	16	14	13	43	2	143	32	177	3	22	2	27	41	123	1	165	412
01:30 PM	25	13	22	60	2	157	28	187	1	17	3	21	27	134	3	164	432
Total Volume	101	40	77	218	7	579	120	706	8	83	11	102	151	552	4	707	1733
% App. Total	46.3	18.3	35.3		1	82	17		7.8	81.4	10.8		21.4	78.1	0.6		
PHF	.743	.714	.802	.879	.875	.922	.938	.944	.667	.830	.550	.823	.712	.920	.333	.893	.950

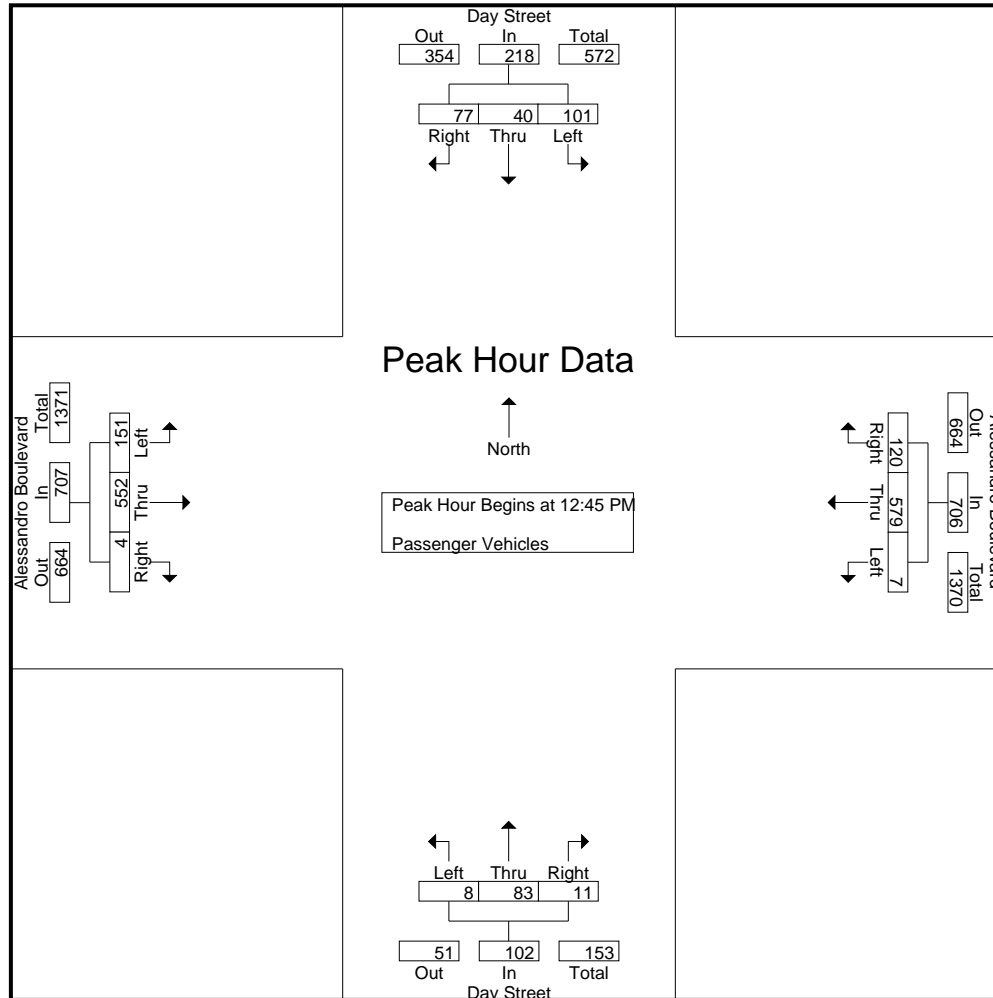

City of Moreno Valley
 N/S: Day Street
 E/W: Alessandro Boulevard
 Weather: Clear

File Name : 35_MRV_Day_Ales Sat
 Site Code : 05122815
 Start Date : 9/17/2022
 Page No : 3

Start Time	Day Street Southbound				Alessandro Boulevard Westbound				Day Street Northbound				Alessandro Boulevard Eastbound				Int. Total
	Left	Thru	Right	App. Total	Left	Thru	Right	App. Total	Left	Thru	Right	App. Total	Left	Thru	Right	App. Total	
Peak Hour Analysis From 12:45 PM to 01:30 PM - Peak 1 of 1																	
Peak Hour for Each Approach Begins at:																	
	12:45 PM				12:45 PM				12:45 PM				12:45 PM				
+0 mins.	26	3	24	53	1	145	31	177	3	19	1	23	30	150	0	180	
+15 mins.	34	10	18	62	2	134	29	165	1	25	5	31	53	145	0	198	
+30 mins.	16	14	13	43	2	143	32	177	3	22	2	27	41	123	1	165	
+45 mins.	25	13	22	60	2	157	28	187	1	17	3	21	27	134	3	164	
Total Volume	101	40	77	218	7	579	120	706	8	83	11	102	151	552	4	707	
% App. Total	46.3	18.3	35.3		1	82	17		7.8	81.4	10.8		21.4	78.1	0.6		
PHF	.743	.714	.802	.879	.875	.922	.938	.944	.667	.830	.550	.823	.712	.920	.333	.893	

City of Moreno Valley
 N/S: Day Street
 E/W: Alessandro Boulevard
 Weather: Clear

File Name : 35_MRV_Day_Ales Sat
 Site Code : 05122815
 Start Date : 9/17/2022
 Page No : 1

Groups Printed- Large 2 Axle Vehicles

Start Time	Day Street Southbound					Alessandro Boulevard Westbound					Day Street Northbound					Alessandro Boulevard Eastbound					Exclu. Total	Inclu. Total	Int. Total	
	Left	Thru	Right	RTOR	App. Total	Left	Thru	Right	RTOR	App. Total	Left	Thru	Right	RTOR	App. Total	Left	Thru	Right	RTOR	App. Total				
11:00 AM	0	0	0	0	0	0	1	0	0	1	2	0	0	0	2	0	2	0	0	2	0	0	5	5
11:15 AM	0	0	0	0	0	0	1	0	0	1	0	0	0	0	0	0	0	0	0	0	0	1	1	1
11:30 AM	0	0	0	0	0	0	3	0	0	3	0	0	0	0	0	0	1	0	0	1	0	4	4	4
11:45 AM	0	0	0	0	0	0	6	0	0	6	0	0	0	0	0	0	2	0	0	2	0	8	8	8
Total	0	0	0	0	0	0	11	0	0	11	2	0	0	0	2	0	5	0	0	5	0	18	18	18
12:00 PM	0	0	0	0	0	0	3	0	0	3	0	0	0	0	0	0	1	0	0	1	0	4	4	4
12:15 PM	0	0	0	0	0	0	1	0	0	1	1	1	0	0	2	0	0	0	0	0	0	3	3	3
12:30 PM	0	0	0	0	0	0	4	0	0	4	0	0	0	0	0	0	3	0	0	3	0	7	7	7
12:45 PM	0	1	0	0	1	0	0	0	0	0	0	0	1	0	1	0	4	0	0	4	0	6	6	6
Total	0	1	0	0	1	0	8	0	0	8	1	1	1	0	3	0	8	0	0	8	0	20	20	20
01:00 PM	0	0	0	0	0	0	2	0	0	2	0	0	0	0	0	0	1	0	0	1	0	3	3	3
01:15 PM	0	0	0	0	0	0	2	0	0	2	1	0	1	0	2	0	1	0	0	1	0	5	5	5
01:30 PM	0	0	2	2	2	0	3	0	0	3	0	0	0	0	0	0	1	1	0	2	2	7	9	9
01:45 PM	0	0	0	0	0	0	4	0	0	4	0	0	0	0	0	0	2	0	0	2	0	6	6	6
Total	0	0	2	2	2	0	11	0	0	11	1	0	1	0	2	0	5	1	0	6	2	21	23	23
Grand Total	0	1	2	2	3	0	30	0	0	30	4	1	2	0	7	0	18	1	0	19	2	59	61	61
Apprch %	0	33.3	66.7			0	100	0			57.1	14.3	28.6			0	94.7	5.3						
Total %	0	1.7	3.4		5.1	0	50.8	0		50.8	6.8	1.7	3.4		11.9	0	30.5	1.7		32.2	3.3	96.7		

Start Time	Day Street Southbound				Alessandro Boulevard Westbound				Day Street Northbound				Alessandro Boulevard Eastbound				Int. Total
	Left	Thru	Right	App. Total	Left	Thru	Right	App. Total	Left	Thru	Right	App. Total	Left	Thru	Right	App. Total	
Peak Hour Analysis From 12:45 PM to 01:30 PM - Peak 1 of 1																	
Peak Hour for Entire Intersection Begins at 12:45 PM																	
12:45 PM	0	1	0	1	0	0	0	0	0	0	1	1	0	4	0	4	6
01:00 PM	0	0	0	0	0	2	0	2	0	0	0	0	0	1	0	1	3
01:15 PM	0	0	0	0	0	2	0	2	1	0	1	2	0	1	0	1	5
01:30 PM	0	0	2	2	0	3	0	3	0	0	0	0	0	1	1	2	7
Total Volume	0	1	2	3	0	7	0	7	1	0	2	3	0	7	1	8	21
% App. Total	0	33.3	66.7		0	100	0		33.3	0	66.7		0	87.5	12.5		
PHF	.000	.250	.250	.375	.000	.583	.000	.583	.250	.000	.500	.375	.000	.438	.250	.500	.750

City of Moreno Valley
 N/S: Day Street
 E/W: Alessandro Boulevard
 Weather: Clear

File Name : 35_MR_V_Day_Ales Sat
 Site Code : 05122815
 Start Date : 9/17/2022
 Page No : 2

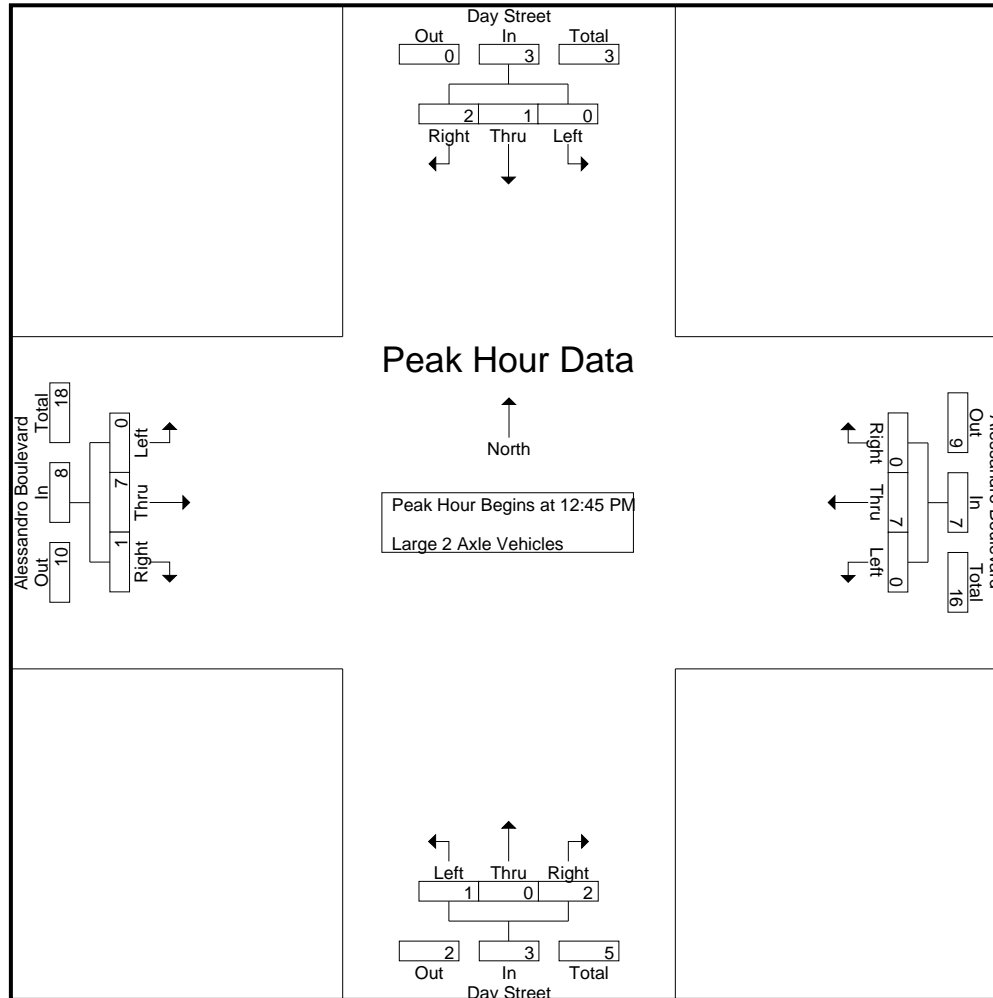

City of Moreno Valley
 N/S: Day Street
 E/W: Alessandro Boulevard
 Weather: Clear

File Name : 35_MRV_Day_Ales Sat
 Site Code : 05122815
 Start Date : 9/17/2022
 Page No : 3

Start Time	Day Street Southbound				Alessandro Boulevard Westbound				Day Street Northbound				Alessandro Boulevard Eastbound				Int. Total
	Left	Thru	Right	App. Total	Left	Thru	Right	App. Total	Left	Thru	Right	App. Total	Left	Thru	Right	App. Total	
Peak Hour Analysis From 12:45 PM to 01:30 PM - Peak 1 of 1																	
Peak Hour for Each Approach Begins at:																	
	12:45 PM				12:45 PM				12:45 PM				12:45 PM				
+0 mins.	0	1	0	1	0	0	0	0	0	0	1	1	0	4	0	4	
+15 mins.	0	0	0	0	0	2	0	2	0	0	0	0	0	1	0	1	
+30 mins.	0	0	0	0	0	2	0	2	1	0	1	2	0	1	0	1	
+45 mins.	0	0	2	2	0	3	0	3	0	0	0	0	0	1	1	2	
Total Volume	0	1	2	3	0	7	0	7	1	0	2	3	0	7	1	8	
% App. Total	0	33.3	66.7		0	100	0		33.3	0	66.7		0	87.5	12.5		
PHF	.000	.250	.250	.375	.000	.583	.000	.583	.250	.000	.500	.375	.000	.438	.250	.500	

City of Moreno Valley
 N/S: Day Street
 E/W: Alessandro Boulevard
 Weather: Clear

File Name : 35_MRV_Day_Ales Sat
 Site Code : 05122815
 Start Date : 9/17/2022
 Page No : 1

Groups Printed- 3 Axle Vehicles

Start Time	Day Street Southbound					Alessandro Boulevard Westbound					Day Street Northbound					Alessandro Boulevard Eastbound					Exclu. Total	Inclu. Total	Int. Total					
	Left	Thru	Right	RTOR	App. Total	Left	Thru	Right	RTOR	App. Total	Left	Thru	Right	RTOR	App. Total	Left	Thru	Right	RTOR	App. Total								
11:00 AM	0	0	0	0	0	0	0	0	0	0	0	0	0	0	0	0	0	0	0	0	0	0	0	0	0	0	0	0
11:15 AM	0	0	0	0	0	0	0	0	0	0	0	0	0	0	0	0	0	0	0	0	0	0	0	0	0	0	0	0
11:30 AM	0	0	0	0	0	0	0	0	0	0	0	0	0	0	0	0	0	1	0	1	0	0	1	0	1	0	1	1
11:45 AM	0	0	0	0	0	0	1	0	0	1	0	0	0	0	0	0	0	0	0	0	0	0	0	0	0	0	1	1
Total	0	0	0	0	0	0	1	0	0	1	0	0	0	0	0	0	0	1	0	1	0	0	1	0	1	0	2	2
12:00 PM	0	0	0	0	0	0	0	0	0	0	0	0	0	0	0	0	0	0	0	0	0	0	0	0	0	0	0	0
12:15 PM	0	0	0	0	0	0	0	0	0	0	0	0	0	0	0	0	1	0	0	1	0	0	1	0	1	0	1	1
12:30 PM	0	0	0	0	0	0	0	0	0	0	0	0	1	1	1	0	0	0	0	0	0	0	0	0	0	0	1	2
12:45 PM	0	0	0	0	0	0	0	0	0	0	0	0	0	0	0	0	0	0	0	0	0	0	0	0	0	0	0	0
Total	0	0	0	0	0	0	0	0	0	0	0	0	1	1	1	0	1	0	0	1	0	0	1	0	1	0	1	3
01:00 PM	0	0	0	0	0	1	1	0	0	2	0	0	0	0	0	0	0	1	0	1	0	0	1	0	1	0	3	3
01:15 PM	0	0	0	0	0	0	3	0	0	3	0	0	0	0	0	0	0	0	0	0	0	0	0	0	0	0	3	3
01:30 PM	0	0	0	0	0	0	1	0	0	1	0	0	0	0	0	0	0	0	0	0	0	0	0	0	0	0	1	1
01:45 PM	0	0	0	0	0	0	1	0	0	1	0	0	0	0	0	0	1	0	0	1	0	0	0	0	1	0	2	2
Total	0	0	0	0	0	1	6	0	0	7	0	0	0	0	0	0	1	1	0	2	0	0	1	0	2	0	9	9
Grand Total	0	0	0	0	0	1	7	0	0	8	0	0	1	1	1	0	2	2	0	4	0	0	1	0	4	1	13	14
Apprch %	0	0	0			12.5	87.5	0			0	0	100			0	50	50										
Total %	0	0	0			7.7	53.8	0		61.5	0	0	7.7		7.7	0	15.4	15.4		30.8						7.1	92.9	

Start Time	Day Street Southbound				Alessandro Boulevard Westbound				Day Street Northbound				Alessandro Boulevard Eastbound				Int. Total				
	Left	Thru	Right	App. Total	Left	Thru	Right	App. Total	Left	Thru	Right	App. Total	Left	Thru	Right	App. Total					
Peak Hour Analysis From 12:45 PM to 01:30 PM - Peak 1 of 1																					
Peak Hour for Entire Intersection Begins at 12:45 PM																					
12:45 PM	0	0	0	0	0	0	0	0	0	0	0	0	0	0	0	0	0	0	0	0	0
01:00 PM	0	0	0	0	1	1	0	2	0	0	0	0	0	0	1	1	0	0	0	0	3
01:15 PM	0	0	0	0	0	3	0	3	0	0	0	0	0	0	0	0	0	0	0	0	3
01:30 PM	0	0	0	0	0	1	0	1	0	0	0	0	0	0	0	0	0	0	0	0	1
Total Volume	0	0	0	0	1	5	0	6	0	0	0	0	0	0	1	1	0	0	0	0	7
% App. Total	0	0	0		16.7	83.3	0		0	0	0		0	0	100						
PHF	.000	.000	.000	.000	.250	.417	.000	.500	.000	.000	.000	.000	.000	.000	.250	.250					.583

City of Moreno Valley
 N/S: Day Street
 E/W: Alessandro Boulevard
 Weather: Clear

File Name : 35_MRV_Day_Ales Sat
 Site Code : 05122815
 Start Date : 9/17/2022
 Page No : 2

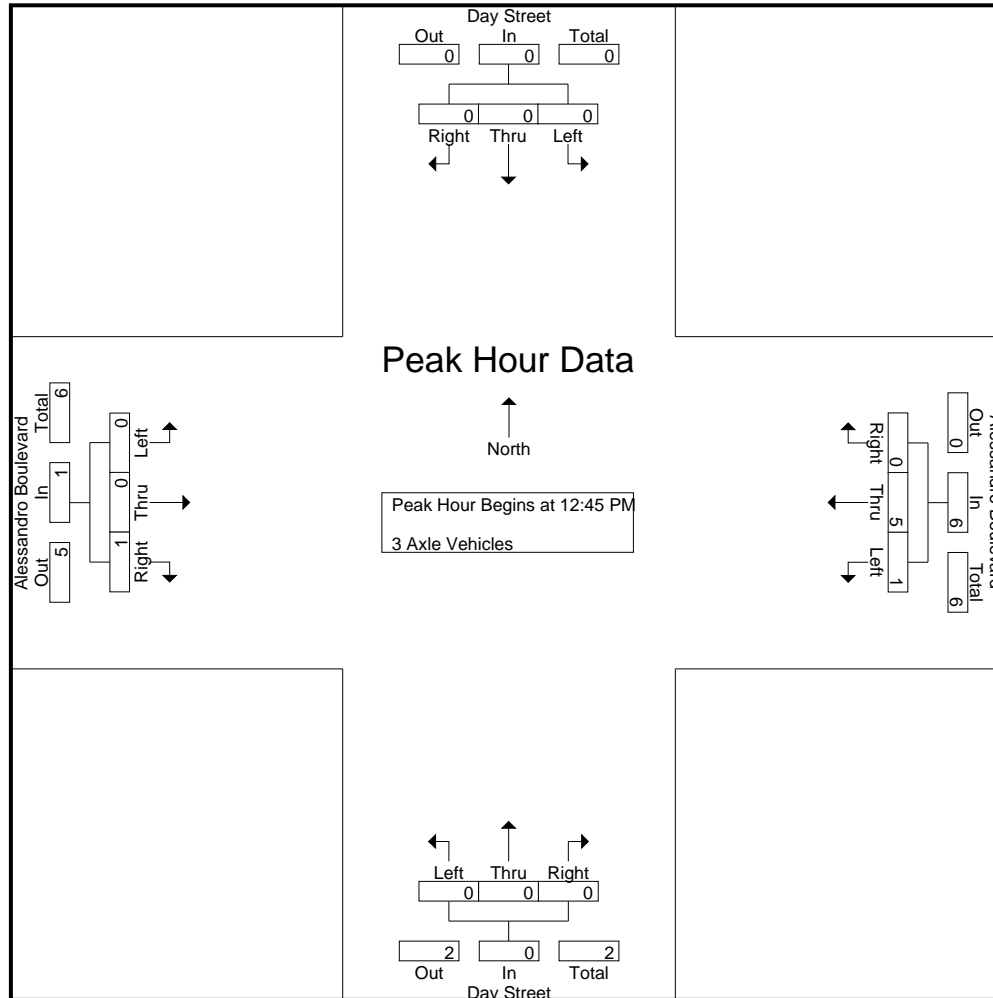

City of Moreno Valley
 N/S: Day Street
 E/W: Alessandro Boulevard
 Weather: Clear

File Name : 35_MRV_Day_Ales Sat
 Site Code : 05122815
 Start Date : 9/17/2022
 Page No : 3

Start Time	Day Street Southbound				Alessandro Boulevard Westbound				Day Street Northbound				Alessandro Boulevard Eastbound				Int. Total
	Left	Thru	Right	App. Total	Left	Thru	Right	App. Total	Left	Thru	Right	App. Total	Left	Thru	Right	App. Total	
Peak Hour Analysis From 12:45 PM to 01:30 PM - Peak 1 of 1																	
Peak Hour for Each Approach Begins at:																	
	12:45 PM				12:45 PM				12:45 PM				12:45 PM				
+0 mins.	0	0	0	0	0	0	0	0	0	0	0	0	0	0	0	0	0
+15 mins.	0	0	0	0	1	1	0	2	0	0	0	0	0	0	1	1	1
+30 mins.	0	0	0	0	0	3	0	3	0	0	0	0	0	0	0	0	0
+45 mins.	0	0	0	0	0	1	0	1	0	0	0	0	0	0	0	0	0
Total Volume	0	0	0	0	1	5	0	6	0	0	0	0	0	0	1	1	1
% App. Total	0	0	0	0	16.7	83.3	0		0	0	0		0	0	100		
PHF	.000	.000	.000	.000	.250	.417	.000	.500	.000	.000	.000	.000	.000	.000	.250	.250	

City of Moreno Valley
 N/S: Day Street
 E/W: Alessandro Boulevard
 Weather: Clear

File Name : 35_MRV_Day_Ales Sat
 Site Code : 05122815
 Start Date : 9/17/2022
 Page No : 1

Groups Printed- 4+ Axle Trucks

Start Time	Day Street Southbound					Alessandro Boulevard Westbound					Day Street Northbound					Alessandro Boulevard Eastbound					Exclu. Total	Inclu. Total	Int. Total	
	Left	Thru	Right	RTOR	App. Total	Left	Thru	Right	RTOR	App. Total	Left	Thru	Right	RTOR	App. Total	Left	Thru	Right	RTOR	App. Total				
11:00 AM	0	0	0	0	0	0	0	0	0	0	0	1	0	0	1	0	2	0	0	2	0	0	3	3
11:15 AM	0	0	0	0	0	0	1	0	0	1	0	0	0	0	0	0	2	0	0	2	0	0	3	3
11:30 AM	0	0	0	0	0	0	1	0	0	1	0	0	0	0	0	0	0	0	0	0	0	0	1	1
11:45 AM	0	0	0	0	0	0	0	0	0	0	0	0	0	0	0	0	0	0	0	0	0	0	0	0
Total	0	0	0	0	0	0	2	0	0	2	0	1	0	0	1	0	4	0	0	4	0	0	7	7
12:00 PM	0	0	0	0	0	0	0	0	0	0	0	0	0	0	0	0	0	0	0	0	0	0	0	0
12:15 PM	0	0	0	0	0	0	2	0	0	2	1	0	0	0	1	0	0	0	0	0	0	0	3	3
12:30 PM	0	0	0	0	0	0	1	0	0	1	0	0	0	0	0	0	0	0	0	0	0	0	1	1
12:45 PM	0	0	0	0	0	0	2	0	0	2	0	0	0	0	0	0	2	0	0	2	0	0	4	4
Total	0	0	0	0	0	0	5	0	0	5	1	0	0	0	1	0	2	0	0	2	0	0	8	8
01:00 PM	0	0	0	0	0	0	0	0	0	0	0	0	0	0	0	0	1	0	0	1	0	0	1	1
01:15 PM	1	0	0	0	1	0	0	1	0	1	0	0	0	0	0	0	3	0	0	3	0	0	5	5
01:30 PM	0	0	0	0	0	0	1	0	0	1	0	0	0	0	0	0	0	0	0	0	0	0	1	1
01:45 PM	0	0	0	0	0	0	0	0	0	0	0	0	0	0	0	0	1	0	0	1	0	0	1	1
Total	1	0	0	0	1	0	1	1	0	2	0	0	0	0	0	0	5	0	0	5	0	0	8	8
Grand Total	1	0	0	0	1	0	8	1	0	9	1	1	0	0	2	0	11	0	0	11	0	0	23	23
Apprch %	100	0	0			0	88.9	11.1			50	50	0			0	100	0			0	0		
Total %	4.3	0	0		4.3	0	34.8	4.3		39.1	4.3	4.3	0		8.7	0	47.8	0		47.8	0	0	100	

Start Time	Day Street Southbound				Alessandro Boulevard Westbound				Day Street Northbound				Alessandro Boulevard Eastbound				Int. Total
	Left	Thru	Right	App. Total	Left	Thru	Right	App. Total	Left	Thru	Right	App. Total	Left	Thru	Right	App. Total	
Peak Hour Analysis From 12:45 PM to 01:30 PM - Peak 1 of 1																	
Peak Hour for Entire Intersection Begins at 12:45 PM																	
12:45 PM	0	0	0	0	0	2	0	2	0	0	0	0	0	2	0	2	4
01:00 PM	0	0	0	0	0	0	0	0	0	0	0	0	0	1	0	1	1
01:15 PM	1	0	0	1	0	0	1	1	0	0	0	0	0	3	0	3	5
01:30 PM	0	0	0	0	0	1	0	1	0	0	0	0	0	0	0	0	1
Total Volume	1	0	0	1	0	3	1	4	0	0	0	0	0	6	0	6	11
% App. Total	100	0	0		0	75	25		0	0	0		0	100	0		
PHF	.250	.000	.000	.250	.000	.375	.250	.500	.000	.000	.000	.000	.000	.500	.000	.500	.550

City of Moreno Valley
 N/S: Day Street
 E/W: Alessandro Boulevard
 Weather: Clear

File Name : 35_MRV_Day_Ales Sat
 Site Code : 05122815
 Start Date : 9/17/2022
 Page No : 2

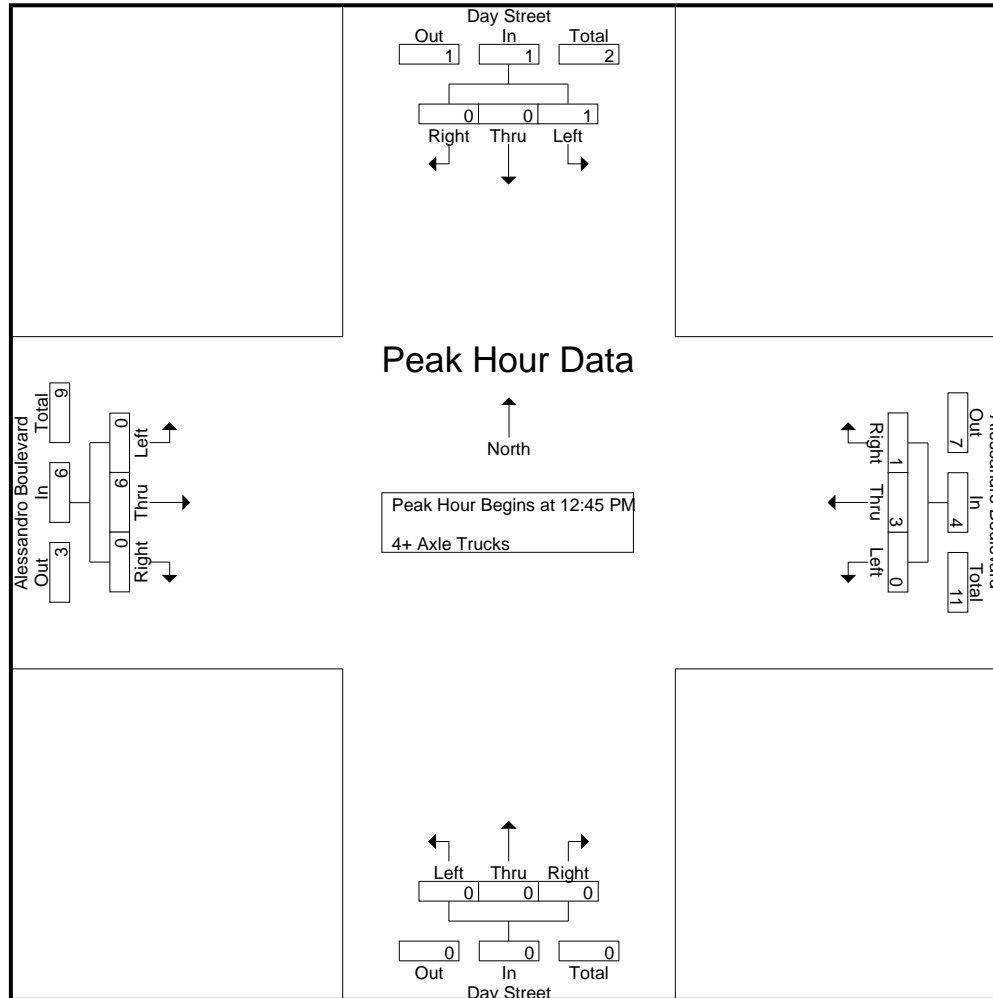

City of Moreno Valley
 N/S: Day Street
 E/W: Alessandro Boulevard
 Weather: Clear

File Name : 35_MRV_Day_Ales Sat
 Site Code : 05122815
 Start Date : 9/17/2022
 Page No : 3

Start Time	Day Street Southbound				Alessandro Boulevard Westbound				Day Street Northbound				Alessandro Boulevard Eastbound				Int. Total
	Left	Thru	Right	App. Total	Left	Thru	Right	App. Total	Left	Thru	Right	App. Total	Left	Thru	Right	App. Total	
Peak Hour Analysis From 12:45 PM to 01:30 PM - Peak 1 of 1																	
Peak Hour for Each Approach Begins at:																	
	12:45 PM				12:45 PM				12:45 PM				12:45 PM				
+0 mins.	0	0	0	0	0	2	0	2	0	0	0	0	0	2	0	2	
+15 mins.	0	0	0	0	0	0	0	0	0	0	0	0	0	1	0	1	
+30 mins.	1	0	0	1	0	0	1	1	0	0	0	0	0	3	0	3	
+45 mins.	0	0	0	0	0	1	0	1	0	0	0	0	0	0	0	0	
Total Volume	1	0	0	1	0	3	1	4	0	0	0	0	0	6	0	6	
% App. Total	100	0	0		0	75	25		0	0	0		0	100	0		
PHF	.250	.000	.000	.250	.000	.375	.250	.500	.000	.000	.000	.000	.000	.500	.000	.500	

Location: Moreno Valley
 N/S: Day Street
 E/W: Alessandro Boulevard



Date: 9/17/2022
 Day Saturday

PEDESTRIANS

Time	North Leg Day Street	East Leg Alessandro Boulevard	South Leg Day Street	West Leg Alessandro Boulevard	TOTAL
11:00 AM	0	0	0	0	0
11:15 AM	0	0	0	0	0
11:30 AM	0	0	0	0	0
11:45 AM	0	0	0	0	0
12:00 PM	0	0	0	0	0
12:15 PM	0	0	0	0	0
12:30 PM	0	0	0	0	0
12:45 PM	0	0	0	0	0
1:00 PM	2	1	0	0	3
1:15 PM	0	0	0	0	0
1:30 PM	0	0	0	0	0
1:45 PM	0	0	0	0	0
TOTAL VOLUMES:	2	1	0	0	3

Location: Moreno Valley
 N/S: Day Street
 E/W: Alessandro Boulevard

Date: 9/17/2022
 Day: Saturday



BICYCLES

	Southbound Day Street			Westbound Alessandro Boulevard			Northbound Day Street			Eastbound Alessandro Boulevard			
	Left	Thru	Right	Left	Thru	Right	Left	Thru	Right	Left	Thru	Right	
11:00 AM	0	0	0	0	0	0	0	0	0	0	0	0	0
11:15 AM	0	0	0	0	0	0	0	0	0	0	0	0	0
11:30 AM	0	0	0	0	0	0	0	0	0	0	0	0	0
11:45 AM	0	0	0	0	0	0	0	1	0	0	0	0	1
12:00 PM	0	0	0	0	0	0	0	0	0	1	0	1	2
12:15 PM	0	0	0	0	0	0	0	0	0	0	0	0	0
12:30 PM	0	0	0	0	1	0	0	0	0	0	0	0	1
12:45 PM	0	0	0	0	0	0	0	0	0	0	0	0	0
1:00 PM	0	0	0	0	0	0	0	0	0	0	1	0	1
1:15 PM	0	0	0	0	0	0	0	0	0	0	0	0	0
1:30 PM	0	0	0	0	0	0	0	0	0	0	0	0	0
1:45 PM	0	0	0	0	0	0	0	0	0	0	0	0	0
TOTAL VOLUMES:	0	0	0	0	1	0	0	1	0	1	1	1	5

City of Moreno Valley
 N/S: Elsworth Street
 E/W: Alessandro Boulevard
 Weather: Clear

File Name : 36_MRV_Elsw_Ales Sat
 Site Code : 05122815
 Start Date : 9/17/2022
 Page No : 1

Groups Printed- Passenger Vehicles - Large 2 Axle Vehicles - 3 Axle Vehicles - 4+ Axle Trucks

Start Time	Elsworth Street Southbound					Alessandro Boulevard Westbound					Elsworth Street Northbound					Alessandro Boulevard Eastbound					Exclu. Total	Inclu. Total	Int. Total
	Left	Thru	Right	RTOR	App. Total	Left	Thru	Right	RTOR	App. Total	Left	Thru	Right	RTOR	App. Total	Left	Thru	Right	RTOR	App. Total			
11:00 AM	35	3	23	17	61	1	218	22	5	241	17	9	6	5	32	22	170	2	0	194	27	528	555
11:15 AM	27	3	23	18	53	2	213	21	4	236	11	18	7	0	36	31	168	6	0	205	22	530	552
11:30 AM	26	2	18	10	46	8	202	29	2	239	8	5	7	3	20	32	191	4	0	227	15	532	547
11:45 AM	28	9	33	27	70	2	171	20	4	193	4	5	7	5	16	36	194	9	0	239	36	518	554
Total	116	17	97	72	230	13	804	92	15	909	40	37	27	13	104	121	723	21	0	865	100	2108	2208
12:00 PM	35	12	27	22	74	4	194	23	4	221	5	3	6	4	14	29	210	5	1	244	31	553	584
12:15 PM	21	6	24	18	51	4	251	28	1	283	5	2	1	1	8	22	235	4	0	261	20	603	623
12:30 PM	32	9	12	10	53	6	220	29	6	255	5	4	0	0	9	29	219	10	0	258	16	575	591
12:45 PM	41	7	20	14	68	7	196	23	8	226	3	1	4	4	8	21	217	17	0	255	26	557	583
Total	129	34	83	64	246	21	861	103	19	985	18	10	11	9	39	101	881	36	1	1018	93	2288	2381
01:00 PM	30	6	26	21	62	5	210	25	5	240	4	2	3	2	9	32	200	8	0	240	28	551	579
01:15 PM	35	3	20	20	58	4	248	28	2	280	0	2	3	3	5	33	218	8	0	259	25	602	627
01:30 PM	43	3	26	17	72	0	206	53	3	259	4	3	2	2	9	20	236	2	0	258	22	598	620
01:45 PM	31	3	25	21	59	3	242	10	0	255	11	3	0	0	14	34	255	9	1	298	22	626	648
Total	139	15	97	79	251	12	906	116	10	1034	19	10	8	7	37	119	909	27	1	1055	97	2377	2474
Grand Total	384	66	277	215	727	46	2571	311	44	2928	77	57	46	29	180	341	2513	84	2	2938	290	6773	7063
Apprch %	52.8	9.1	38.1			1.6	87.8	10.6			42.8	31.7	25.6			11.6	85.5	2.9					
Total %	5.7	1	4.1		10.7	0.7	38	4.6		43.2	1.1	0.8	0.7		2.7	5	37.1	1.2		43.4	4.1	95.9	
Passenger Vehicles	376	66	271		923	46	2475	304		2869	77	57	46		209	331	2392	84		2809	0	0	6810
% Passenger Vehicles	97.9	100	97.8		98	100	96.3	97.7		96.5	100	100	100		100	97.1	95.2	100		95.5	0	0	96.4
Large 2 Axle Vehicles	5	0	3		11	0	28	5		33	0	0	0		0	6	33	0		39	0	0	83
% Large 2 Axle Vehicles	1.3	0	1.1		1.2	0	1.1	1.6		1.1	0	0	0		0	1.8	1.3	0		1.3	0	0	1.2
3 Axle Vehicles	1	0	1		3	0	19	0		19	0	0	0		0	2	26	0		28	0	0	50
% 3 Axle Vehicles	0.3	0	0.4		0.3	0	0.7	0		0.6	0	0	0		0	0.6	1	0		1	0	0	0.7
4+ Axle Trucks	2	0	2		5	0	49	2		51	0	0	0		0	2	62	0		64	0	0	120
% 4+ Axle Trucks	0.5	0	0.7		0.5	0	1.9	0.6		1.7	0	0	0		0	0.6	2.5	0		2.2	0	0	1.7

City of Moreno Valley
 N/S: Elsworth Street
 E/W: Alessandro Boulevard
 Weather: Clear

File Name : 36_MRV_Elsw_Ales Sat
 Site Code : 05122815
 Start Date : 9/17/2022
 Page No : 2

Start Time	Elsworth Street Southbound				Alessandro Boulevard Westbound				Elsworth Street Northbound				Alessandro Boulevard Eastbound				Int. Total
	Left	Thru	Right	App. Total	Left	Thru	Right	App. Total	Left	Thru	Right	App. Total	Left	Thru	Right	App. Total	
Peak Hour Analysis From 11:00 AM to 01:45 PM - Peak 1 of 1																	
Peak Hour for Entire Intersection Begins at 01:00 PM																	
01:00 PM	30	6	26	62	5	210	25	240	4	2	3	9	32	200	8	240	551
01:15 PM	35	3	20	58	4	248	28	280	0	2	3	5	33	218	8	259	602
01:30 PM	43	3	26	72	0	206	53	259	4	3	2	9	20	236	2	258	598
01:45 PM	31	3	25	59	3	242	10	255	11	3	0	14	34	255	9	298	626
Total Volume	139	15	97	251	12	906	116	1034	19	10	8	37	119	909	27	1055	2377
% App. Total	55.4	6	38.6		1.2	87.6	11.2		51.4	27	21.6		11.3	86.2	2.6		
PHF	.808	.625	.933	.872	.600	.913	.547	.923	.432	.833	.667	.661	.875	.891	.750	.885	.949

City of Moreno Valley
 N/S: Elsworth Street
 E/W: Alessandro Boulevard
 Weather: Clear

File Name : 36_MRV_Elsw_Ales Sat
 Site Code : 05122815
 Start Date : 9/17/2022
 Page No : 3

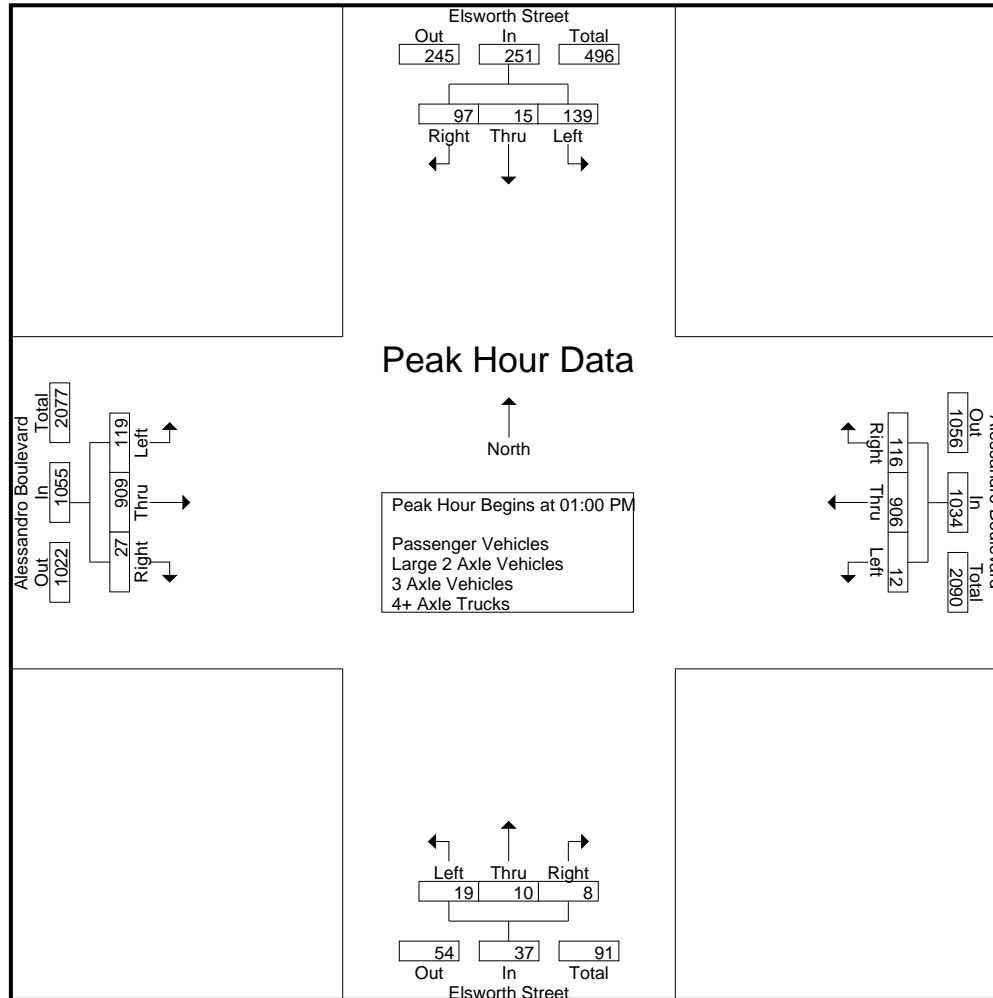

City of Moreno Valley
 N/S: Elsworth Street
 E/W: Alessandro Boulevard
 Weather: Clear

File Name : 36_MRV_Elsw_Ales Sat
 Site Code : 05122815
 Start Date : 9/17/2022
 Page No : 4

Start Time	Elsworth Street Southbound				Alessandro Boulevard Westbound				Elsworth Street Northbound				Alessandro Boulevard Eastbound				Int. Total
	Left	Thru	Right	App. Total	Left	Thru	Right	App. Total	Left	Thru	Right	App. Total	Left	Thru	Right	App. Total	
Peak Hour Analysis From 11:00 AM to 01:45 PM - Peak 1 of 1																	
Peak Hour for Each Approach Begins at:																	
	12:45 PM				01:00 PM				11:00 AM				01:00 PM				
+0 mins.	41	7	20	68	5	210	25	240	17	9	6	32	32	200	8	240	
+15 mins.	30	6	26	62	4	248	28	280	11	18	7	36	33	218	8	259	
+30 mins.	35	3	20	58	0	206	53	259	8	5	7	20	20	236	2	258	
+45 mins.	43	3	26	72	3	242	10	255	4	5	7	16	34	255	9	298	
Total Volume	149	19	92	260	12	906	116	1034	40	37	27	104	119	909	27	1055	
% App. Total	57.3	7.3	35.4		1.2	87.6	11.2		38.5	35.6	26		11.3	86.2	2.6		
PHF	.866	.679	.885	.903	.600	.913	.547	.923	.588	.514	.964	.722	.875	.891	.750	.885	

City of Moreno Valley
 N/S: Elsworth Street
 E/W: Alessandro Boulevard
 Weather: Clear

File Name : 36_MRV_Elsw_Ales Sat
 Site Code : 05122815
 Start Date : 9/17/2022
 Page No : 1

Groups Printed- Passenger Vehicles

Start Time	Elsworth Street Southbound					Alessandro Boulevard Westbound					Elsworth Street Northbound					Alessandro Boulevard Eastbound					Exclu. Total	Inclu. Total	Int. Total
	Left	Thru	Right	RTOR	App. Total	Left	Thru	Right	RTOR	App. Total	Left	Thru	Right	RTOR	App. Total	Left	Thru	Right	RTOR	App. Total			
11:00 AM	35	3	22	16	60	1	213	21	5	235	17	9	6	5	32	21	161	2	0	184	26	511	537
11:15 AM	26	3	23	18	52	2	209	21	4	232	11	18	7	0	36	31	159	6	0	196	22	516	538
11:30 AM	26	2	18	10	46	8	193	29	2	230	8	5	7	3	20	32	179	4	0	215	15	511	526
11:45 AM	28	9	32	26	69	2	167	20	4	189	4	5	7	5	16	34	180	9	0	223	35	497	532
Total	115	17	95	70	227	13	782	91	15	886	40	37	27	13	104	118	679	21	0	818	98	2035	2133
12:00 PM	33	12	27	22	72	4	183	23	4	210	5	3	6	4	14	28	195	5	1	228	31	524	555
12:15 PM	21	6	24	18	51	4	238	27	1	269	5	2	1	1	8	20	223	4	0	247	20	575	595
12:30 PM	32	9	11	9	52	6	207	28	6	241	5	4	0	0	9	29	214	10	0	253	15	555	570
12:45 PM	41	7	19	13	67	7	189	22	8	218	3	1	4	4	8	21	201	17	0	239	25	532	557
Total	127	34	81	62	242	21	817	100	19	938	18	10	11	9	39	98	833	36	1	967	91	2186	2277
01:00 PM	27	6	26	21	59	5	206	25	5	236	4	2	3	2	9	31	193	8	0	232	28	536	564
01:15 PM	35	3	20	20	58	4	241	26	2	271	0	2	3	3	5	32	209	8	0	249	25	583	608
01:30 PM	42	3	24	16	69	0	197	52	3	249	4	3	2	2	9	20	230	2	0	252	21	579	600
01:45 PM	30	3	25	21	58	3	232	10	0	245	11	3	0	0	14	32	248	9	1	289	22	606	628
Total	134	15	95	78	244	12	876	113	10	1001	19	10	8	7	37	115	880	27	1	1022	96	2304	2400
Grand Total	376	66	271	210	713	46	2475	304	44	2825	77	57	46	29	180	331	2392	84	2	2807	285	6525	6810
Apprch %	52.7	9.3	38			1.6	87.6	10.8			42.8	31.7	25.6			11.8	85.2	3					
Total %	5.8	1	4.2		10.9	0.7	37.9	4.7		43.3	1.2	0.9	0.7		2.8	5.1	36.7	1.3		43	4.2	95.8	

Start Time	Elsworth Street Southbound				Alessandro Boulevard Westbound				Elsworth Street Northbound				Alessandro Boulevard Eastbound				Int. Total
	Left	Thru	Right	App. Total	Left	Thru	Right	App. Total	Left	Thru	Right	App. Total	Left	Thru	Right	App. Total	
Peak Hour Analysis From 01:00 PM to 01:45 PM - Peak 1 of 1																	
Peak Hour for Entire Intersection Begins at 01:00 PM																	
01:00 PM	27	6	26	59	5	206	25	236	4	2	3	9	31	193	8	232	536
01:15 PM	35	3	20	58	4	241	26	271	0	2	3	5	32	209	8	249	583
01:30 PM	42	3	24	69	0	197	52	249	4	3	2	9	20	230	2	252	579
01:45 PM	30	3	25	58	3	232	10	245	11	3	0	14	32	248	9	289	606
Total Volume	134	15	95	244	12	876	113	1001	19	10	8	37	115	880	27	1022	2304
% App. Total	54.9	6.1	38.9		1.2	87.5	11.3		51.4	27	21.6		11.3	86.1	2.6		
PHF	.798	.625	.913	.884	.600	.909	.543	.923	.432	.833	.667	.661	.898	.887	.750	.884	.950

City of Moreno Valley
 N/S: Elsworth Street
 E/W: Alessandro Boulevard
 Weather: Clear

File Name : 36_MRV_Elsw_Ales Sat
 Site Code : 05122815
 Start Date : 9/17/2022
 Page No : 2

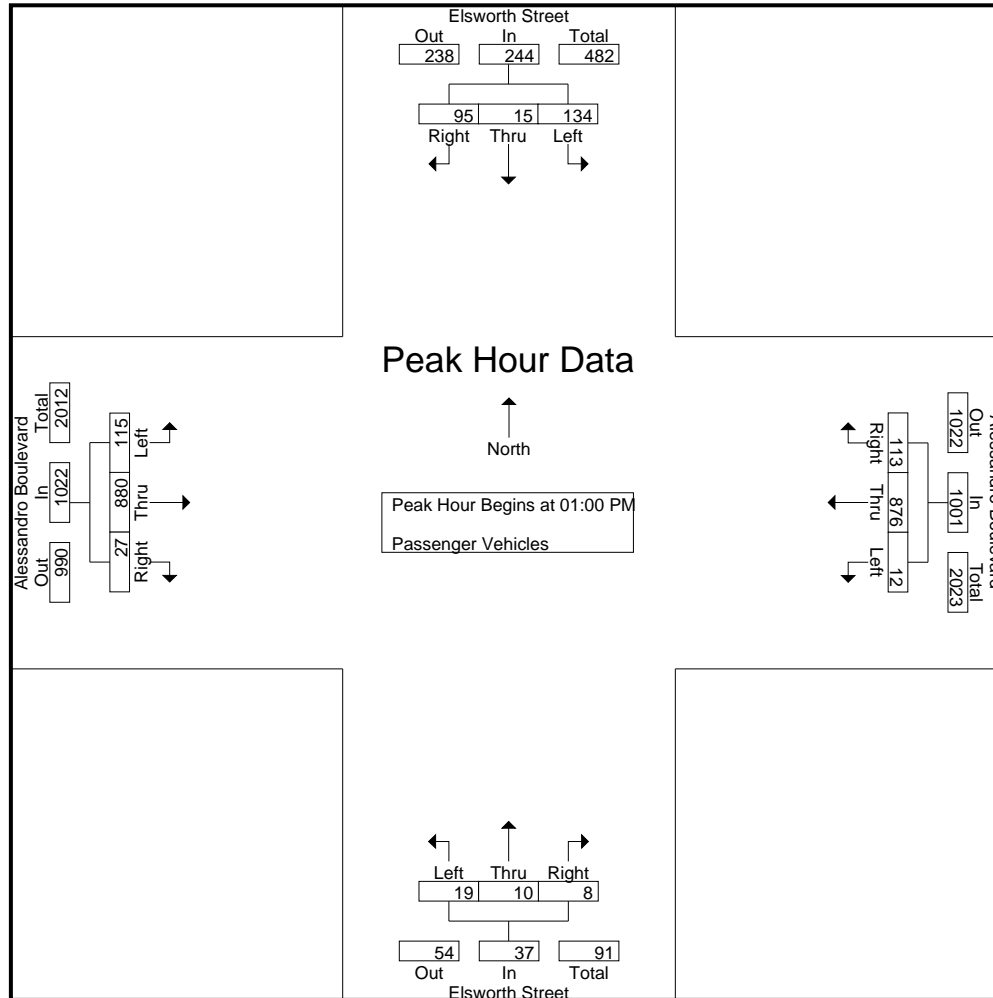

City of Moreno Valley
 N/S: Elsworth Street
 E/W: Alessandro Boulevard
 Weather: Clear

File Name : 36_MRV_Elsw_Ales Sat
 Site Code : 05122815
 Start Date : 9/17/2022
 Page No : 3

Start Time	Elsworth Street Southbound				Alessandro Boulevard Westbound				Elsworth Street Northbound				Alessandro Boulevard Eastbound				Int. Total
	Left	Thru	Right	App. Total	Left	Thru	Right	App. Total	Left	Thru	Right	App. Total	Left	Thru	Right	App. Total	
Peak Hour Analysis From 01:00 PM to 01:45 PM - Peak 1 of 1																	
Peak Hour for Each Approach Begins at:																	
	01:00 PM				01:00 PM				01:00 PM				01:00 PM				
+0 mins.	27	6	26	59	5	206	25	236	4	2	3	9	31	193	8	232	
+15 mins.	35	3	20	58	4	241	26	271	0	2	3	5	32	209	8	249	
+30 mins.	42	3	24	69	0	197	52	249	4	3	2	9	20	230	2	252	
+45 mins.	30	3	25	58	3	232	10	245	11	3	0	14	32	248	9	289	
Total Volume	134	15	95	244	12	876	113	1001	19	10	8	37	115	880	27	1022	
% App. Total	54.9	6.1	38.9		1.2	87.5	11.3		51.4	27	21.6		11.3	86.1	2.6		
PHF	.798	.625	.913	.884	.600	.909	.543	.923	.432	.833	.667	.661	.898	.887	.750	.884	

City of Moreno Valley
 N/S: Elsworth Street
 E/W: Alessandro Boulevard
 Weather: Clear

File Name : 36_MRV_Elsw_Ales Sat
 Site Code : 05122815
 Start Date : 9/17/2022
 Page No : 1

Groups Printed- Large 2 Axle Vehicles

Start Time	Elsworth Street Southbound					Alessandro Boulevard Westbound					Elsworth Street Northbound					Alessandro Boulevard Eastbound					Exclu. Total	Inclu. Total	Int. Total
	Left	Thru	Right	RTOR	App. Total	Left	Thru	Right	RTOR	App. Total	Left	Thru	Right	RTOR	App. Total	Left	Thru	Right	RTOR	App. Total			
11:00 AM	0	0	1	1	1	0	2	1	0	3	0	0	0	0	0	1	5	0	0	6	1	10	11
11:15 AM	0	0	0	0	0	0	0	0	0	0	0	0	0	0	0	0	2	0	0	2	0	2	2
11:30 AM	0	0	0	0	0	0	1	0	0	1	0	0	0	0	0	0	1	0	0	1	0	2	2
11:45 AM	0	0	1	1	1	0	0	0	0	0	0	0	0	0	0	1	2	0	0	3	1	4	5
Total	0	0	2	2	2	0	3	1	0	4	0	0	0	0	0	2	10	0	0	12	2	18	20
12:00 PM	1	0	0	0	1	0	3	0	0	3	0	0	0	0	0	1	1	0	0	2	0	6	6
12:15 PM	0	0	0	0	0	0	9	1	0	10	0	0	0	0	0	1	3	0	0	4	0	14	14
12:30 PM	0	0	0	0	0	0	5	0	0	5	0	0	0	0	0	0	1	0	0	1	0	6	6
12:45 PM	0	0	1	1	1	0	2	1	0	3	0	0	0	0	0	0	7	0	0	7	1	11	12
Total	1	0	1	1	2	0	19	2	0	21	0	0	0	0	0	2	12	0	0	14	1	37	38
01:00 PM	2	0	0	0	2	0	1	0	0	1	0	0	0	0	0	0	1	0	0	1	0	4	4
01:15 PM	0	0	0	0	0	0	0	1	0	1	0	0	0	0	0	1	3	0	0	4	0	5	5
01:30 PM	1	0	0	0	1	0	3	1	0	4	0	0	0	0	0	0	2	0	0	2	0	7	7
01:45 PM	1	0	0	0	1	0	2	0	0	2	0	0	0	0	0	1	5	0	0	6	0	9	9
Total	4	0	0	0	4	0	6	2	0	8	0	0	0	0	0	2	11	0	0	13	0	25	25
Grand Total	5	0	3	3	8	0	28	5	0	33	0	0	0	0	0	6	33	0	0	39	3	80	83
Apprch %	62.5	0	37.5			0	84.8	15.2			0	0	0			15.4	84.6	0					
Total %	6.2	0	3.8		10	0	35	6.2		41.2	0	0	0		0	7.5	41.2	0		48.8	3.6	96.4	

Start Time	Elsworth Street Southbound				Alessandro Boulevard Westbound				Elsworth Street Northbound				Alessandro Boulevard Eastbound				Int. Total
	Left	Thru	Right	App. Total	Left	Thru	Right	App. Total	Left	Thru	Right	App. Total	Left	Thru	Right	App. Total	
Peak Hour Analysis From 01:00 PM to 01:45 PM - Peak 1 of 1																	
Peak Hour for Entire Intersection Begins at 01:00 PM																	
01:00 PM	2	0	0	2	0	1	0	1	0	0	0	0	0	1	0	1	4
01:15 PM	0	0	0	0	0	0	1	1	0	0	0	0	1	3	0	4	5
01:30 PM	1	0	0	1	0	3	1	4	0	0	0	0	0	2	0	2	7
01:45 PM	1	0	0	1	0	2	0	2	0	0	0	0	1	5	0	6	9
Total Volume	4	0	0	4	0	6	2	8	0	0	0	0	2	11	0	13	25
% App. Total	100	0	0		0	75	25		0	0	0		15.4	84.6	0		
PHF	.500	.000	.000	.500	.000	.500	.500	.500	.000	.000	.000	.000	.500	.550	.000	.542	.694

City of Moreno Valley
 N/S: Elsworth Street
 E/W: Alessandro Boulevard
 Weather: Clear

File Name : 36_MRV_Elsw_Ales Sat
 Site Code : 05122815
 Start Date : 9/17/2022
 Page No : 2

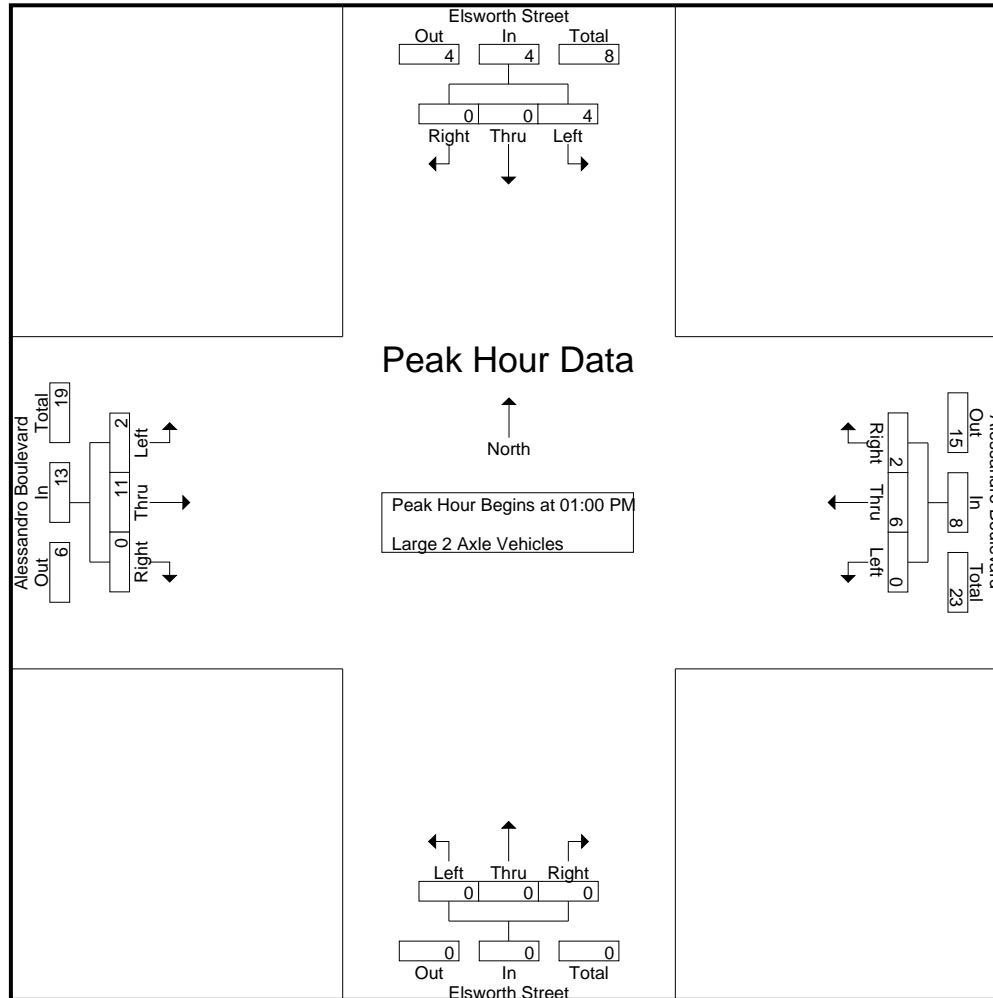

City of Moreno Valley
 N/S: Elsworth Street
 E/W: Alessandro Boulevard
 Weather: Clear

File Name : 36_MRV_Elsw_Ales Sat
 Site Code : 05122815
 Start Date : 9/17/2022
 Page No : 3

Start Time	Elsworth Street Southbound				Alessandro Boulevard Westbound				Elsworth Street Northbound				Alessandro Boulevard Eastbound				Int. Total
	Left	Thru	Right	App. Total	Left	Thru	Right	App. Total	Left	Thru	Right	App. Total	Left	Thru	Right	App. Total	
Peak Hour Analysis From 01:00 PM to 01:45 PM - Peak 1 of 1																	
Peak Hour for Each Approach Begins at:																	
	01:00 PM				01:00 PM				01:00 PM				01:00 PM				
+0 mins.	2	0	0	2	0	1	0	1	0	0	0	0	0	1	0	1	
+15 mins.	0	0	0	0	0	0	1	1	0	0	0	0	1	3	0	4	
+30 mins.	1	0	0	1	0	3	1	4	0	0	0	0	0	2	0	2	
+45 mins.	1	0	0	1	0	2	0	2	0	0	0	0	1	5	0	6	
Total Volume	4	0	0	4	0	6	2	8	0	0	0	0	2	11	0	13	
% App. Total	100	0	0		0	75	25		0	0	0		15.4	84.6	0		
PHF	.500	.000	.000	.500	.000	.500	.500	.500	.000	.000	.000	.000	.500	.550	.000	.542	

City of Moreno Valley
 N/S: Elsworth Street
 E/W: Alessandro Boulevard
 Weather: Clear

File Name : 36_MRV_Elsw_Ales Sat
 Site Code : 05122815
 Start Date : 9/17/2022
 Page No : 1

Groups Printed- 3 Axle Vehicles

Start Time	Elsworth Street Southbound					Alessandro Boulevard Westbound					Elsworth Street Northbound					Alessandro Boulevard Eastbound					Exclu. Total	Inclu. Total	Int. Total	
	Left	Thru	Right	RTOR	App. Total	Left	Thru	Right	RTOR	App. Total	Left	Thru	Right	RTOR	App. Total	Left	Thru	Right	RTOR	App. Total				
11:00 AM	0	0	0	0	0	0	2	0	0	2	0	0	0	0	0	0	2	0	0	2	0	0	4	4
11:15 AM	0	0	0	0	0	0	2	0	0	2	0	0	0	0	0	0	1	0	0	1	0	3	3	3
11:30 AM	0	0	0	0	0	0	1	0	0	1	0	0	0	0	0	0	3	0	0	3	0	4	4	4
11:45 AM	0	0	0	0	0	0	1	0	0	1	0	0	0	0	0	1	6	0	0	7	0	8	8	8
Total	0	0	0	0	0	0	6	0	0	6	0	0	0	0	0	1	12	0	0	13	0	19	19	19
12:00 PM	1	0	0	0	1	0	3	0	0	3	0	0	0	0	0	0	3	0	0	3	0	7	7	7
12:15 PM	0	0	0	0	0	0	1	0	0	1	0	0	0	0	0	0	3	0	0	3	0	4	4	4
12:30 PM	0	0	1	1	1	0	2	0	0	2	0	0	0	0	0	0	1	0	0	1	1	4	5	5
12:45 PM	0	0	0	0	0	0	2	0	0	2	0	0	0	0	0	0	3	0	0	3	0	5	5	5
Total	1	0	1	1	2	0	8	0	0	8	0	0	0	0	0	0	10	0	0	10	1	20	21	21
01:00 PM	0	0	0	0	0	0	0	0	0	0	0	0	0	0	0	0	1	0	0	1	0	1	1	1
01:15 PM	0	0	0	0	0	0	1	0	0	1	0	0	0	0	0	0	1	0	0	1	0	2	2	2
01:30 PM	0	0	0	0	0	0	1	0	0	1	0	0	0	0	0	0	1	0	0	1	0	2	2	2
01:45 PM	0	0	0	0	0	0	3	0	0	3	0	0	0	0	0	1	1	0	0	2	0	5	5	5
Total	0	0	0	0	0	0	5	0	0	5	0	0	0	0	0	1	4	0	0	5	0	10	10	10
Grand Total	1	0	1	1	2	0	19	0	0	19	0	0	0	0	0	2	26	0	0	28	1	49	50	50
Apprch %	50	0	50			0	100	0			0	0	0			7.1	92.9	0						
Total %	2	0	2		4.1	0	38.8	0		38.8	0	0	0			4.1	53.1	0		57.1	2	98		

Start Time	Elsworth Street Southbound				Alessandro Boulevard Westbound				Elsworth Street Northbound				Alessandro Boulevard Eastbound				Int. Total
	Left	Thru	Right	App. Total	Left	Thru	Right	App. Total	Left	Thru	Right	App. Total	Left	Thru	Right	App. Total	
Peak Hour Analysis From 01:00 PM to 01:45 PM - Peak 1 of 1																	
Peak Hour for Entire Intersection Begins at 01:00 PM																	
01:00 PM	0	0	0	0	0	0	0	0	0	0	0	0	0	1	0	1	1
01:15 PM	0	0	0	0	0	1	0	1	0	0	0	0	0	1	0	1	2
01:30 PM	0	0	0	0	0	1	0	1	0	0	0	0	0	1	0	1	2
01:45 PM	0	0	0	0	0	3	0	3	0	0	0	0	1	1	0	2	5
Total Volume	0	0	0	0	0	5	0	5	0	0	0	0	1	4	0	5	10
% App. Total	0	0	0		0	100	0		0	0	0		20	80	0		
PHF	.000	.000	.000	.000	.000	.417	.000	.417	.000	.000	.000	.000	.250	1.00	.000	.625	.500

City of Moreno Valley
 N/S: Elsworth Street
 E/W: Alessandro Boulevard
 Weather: Clear

File Name : 36_MRV_Elsw_Ales Sat
 Site Code : 05122815
 Start Date : 9/17/2022
 Page No : 2

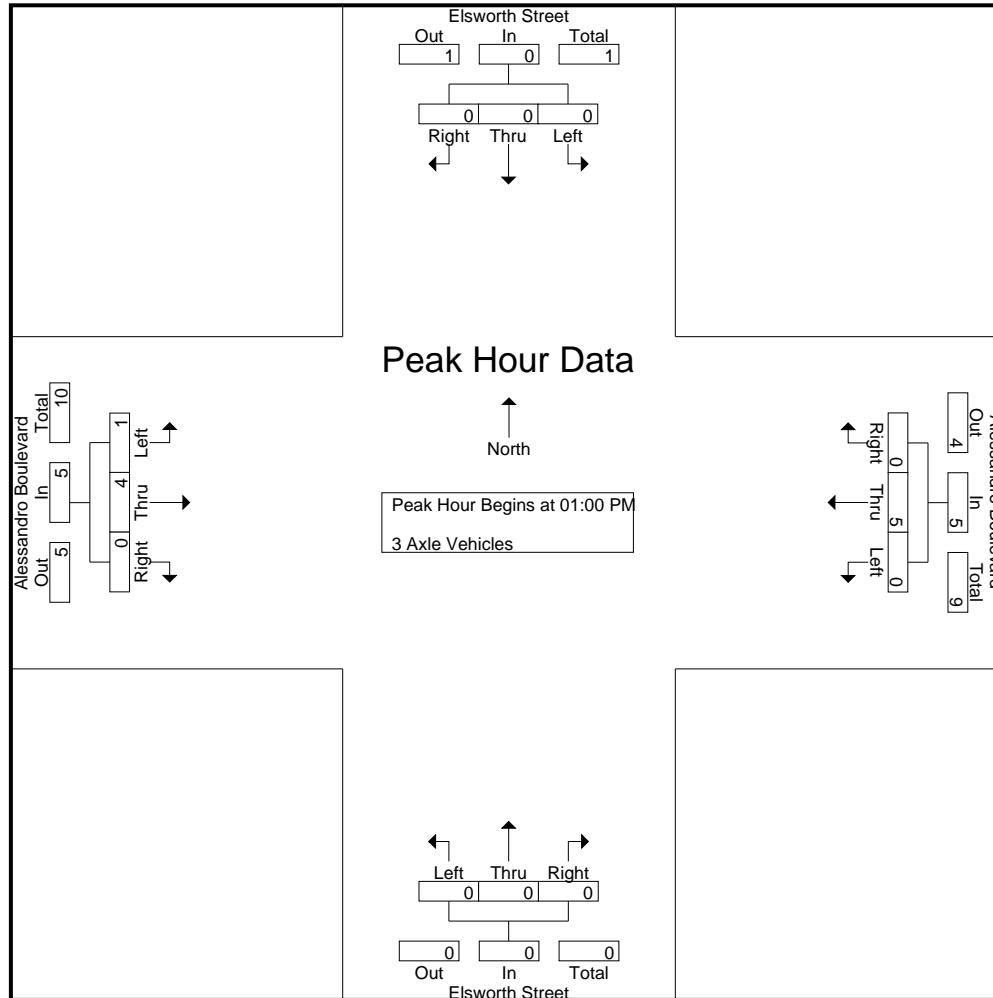

City of Moreno Valley
 N/S: Elsworth Street
 E/W: Alessandro Boulevard
 Weather: Clear

File Name : 36_MRV_Elsw_Ales Sat
 Site Code : 05122815
 Start Date : 9/17/2022
 Page No : 3

Start Time	Elsworth Street Southbound				Alessandro Boulevard Westbound				Elsworth Street Northbound				Alessandro Boulevard Eastbound				Int. Total
	Left	Thru	Right	App. Total	Left	Thru	Right	App. Total	Left	Thru	Right	App. Total	Left	Thru	Right	App. Total	
Peak Hour Analysis From 01:00 PM to 01:45 PM - Peak 1 of 1																	
Peak Hour for Each Approach Begins at:																	
	01:00 PM				01:00 PM				01:00 PM				01:00 PM				
+0 mins.	0	0	0	0	0	0	0	0	0	0	0	0	0	1	0	1	
+15 mins.	0	0	0	0	0	1	0	1	0	0	0	0	0	1	0	1	
+30 mins.	0	0	0	0	0	1	0	1	0	0	0	0	0	1	0	1	
+45 mins.	0	0	0	0	0	3	0	3	0	0	0	0	1	1	0	2	
Total Volume	0	0	0	0	0	5	0	5	0	0	0	0	1	4	0	5	
% App. Total	0	0	0	0	0	100	0	0	0	0	0	0	20	80	0	0	
PHF	.000	.000	.000	.000	.000	.417	.000	.417	.000	.000	.000	.000	.250	1.000	.000	.625	

City of Moreno Valley
 N/S: Elsworth Street
 E/W: Alessandro Boulevard
 Weather: Clear

File Name : 36_MRV_Elsw_Ales Sat
 Site Code : 05122815
 Start Date : 9/17/2022
 Page No : 1

Groups Printed- 4+ Axle Trucks

Start Time	Elsworth Street Southbound					Alessandro Boulevard Westbound					Elsworth Street Northbound					Alessandro Boulevard Eastbound					Exclu. Total	Inclu. Total	Int. Total	
	Left	Thru	Right	RTOR	App. Total	Left	Thru	Right	RTOR	App. Total	Left	Thru	Right	RTOR	App. Total	Left	Thru	Right	RTOR	App. Total				
11:00 AM	0	0	0	0	0	0	1	0	0	1	0	0	0	0	0	0	2	0	0	2	0	0	3	3
11:15 AM	1	0	0	0	1	0	2	0	0	2	0	0	0	0	0	0	6	0	0	6	0	0	9	9
11:30 AM	0	0	0	0	0	0	7	0	0	7	0	0	0	0	0	0	8	0	0	8	0	0	15	15
11:45 AM	0	0	0	0	0	0	3	0	0	3	0	0	0	0	0	0	6	0	0	6	0	0	9	9
Total	1	0	0	0	1	0	13	0	0	13	0	0	0	0	0	0	22	0	0	22	0	0	36	36
12:00 PM	0	0	0	0	0	0	5	0	0	5	0	0	0	0	0	0	11	0	0	11	0	0	16	16
12:15 PM	0	0	0	0	0	0	3	0	0	3	0	0	0	0	0	1	6	0	0	7	0	0	10	10
12:30 PM	0	0	0	0	0	0	6	1	0	7	0	0	0	0	0	0	3	0	0	3	0	0	10	10
12:45 PM	0	0	0	0	0	0	3	0	0	3	0	0	0	0	0	0	6	0	0	6	0	0	9	9
Total	0	0	0	0	0	0	17	1	0	18	0	0	0	0	0	1	26	0	0	27	0	0	45	45
01:00 PM	1	0	0	0	1	0	3	0	0	3	0	0	0	0	0	1	5	0	0	6	0	0	10	10
01:15 PM	0	0	0	0	0	0	6	1	0	7	0	0	0	0	0	0	5	0	0	5	0	0	12	12
01:30 PM	0	0	2	1	2	0	5	0	0	5	0	0	0	0	0	0	3	0	0	3	1	0	10	11
01:45 PM	0	0	0	0	0	0	5	0	0	5	0	0	0	0	0	0	1	0	0	1	0	0	6	6
Total	1	0	2	1	3	0	19	1	0	20	0	0	0	0	0	1	14	0	0	15	1	0	38	39
Grand Total	2	0	2	1	4	0	49	2	0	51	0	0	0	0	0	2	62	0	0	64	1	0	119	120
Apprch %	50	0	50			0	96.1	3.9			0	0	0			3.1	96.9	0						
Total %	1.7	0	1.7		3.4	0	41.2	1.7		42.9	0	0	0		0	1.7	52.1	0		53.8	0.8		99.2	

Start Time	Elsworth Street Southbound				Alessandro Boulevard Westbound				Elsworth Street Northbound				Alessandro Boulevard Eastbound				Int. Total					
	Left	Thru	Right	App. Total	Left	Thru	Right	App. Total	Left	Thru	Right	App. Total	Left	Thru	Right	App. Total						
Peak Hour Analysis From 01:00 PM to 01:45 PM - Peak 1 of 1																						
Peak Hour for Entire Intersection Begins at 01:00 PM																						
01:00 PM	1	0	0	1	0	3	0	3	0	0	0	0	1	5	0	6	0	0	0	0	6	10
01:15 PM	0	0	0	0	0	6	1	7	0	0	0	0	0	5	0	5	0	0	0	0	5	12
01:30 PM	0	0	2	2	0	5	0	5	0	0	0	0	0	3	0	3	0	0	0	0	3	10
01:45 PM	0	0	0	0	0	5	0	5	0	0	0	0	0	1	0	1	0	0	0	0	1	6
Total Volume	1	0	2	3	0	19	1	20	0	0	0	0	1	14	0	15	0	0	0	0	15	38
% App. Total	33.3	0	66.7		0	95	5		0	0	0		6.7	93.3	0							
PHF	.250	.000	.250	.375	.000	.792	.250	.714	.000	.000	.000	.000	.250	.700	.000	.625						.792

City of Moreno Valley
 N/S: Elsworth Street
 E/W: Alessandro Boulevard
 Weather: Clear

File Name : 36_MRV_Elsw_Ales Sat
 Site Code : 05122815
 Start Date : 9/17/2022
 Page No : 2

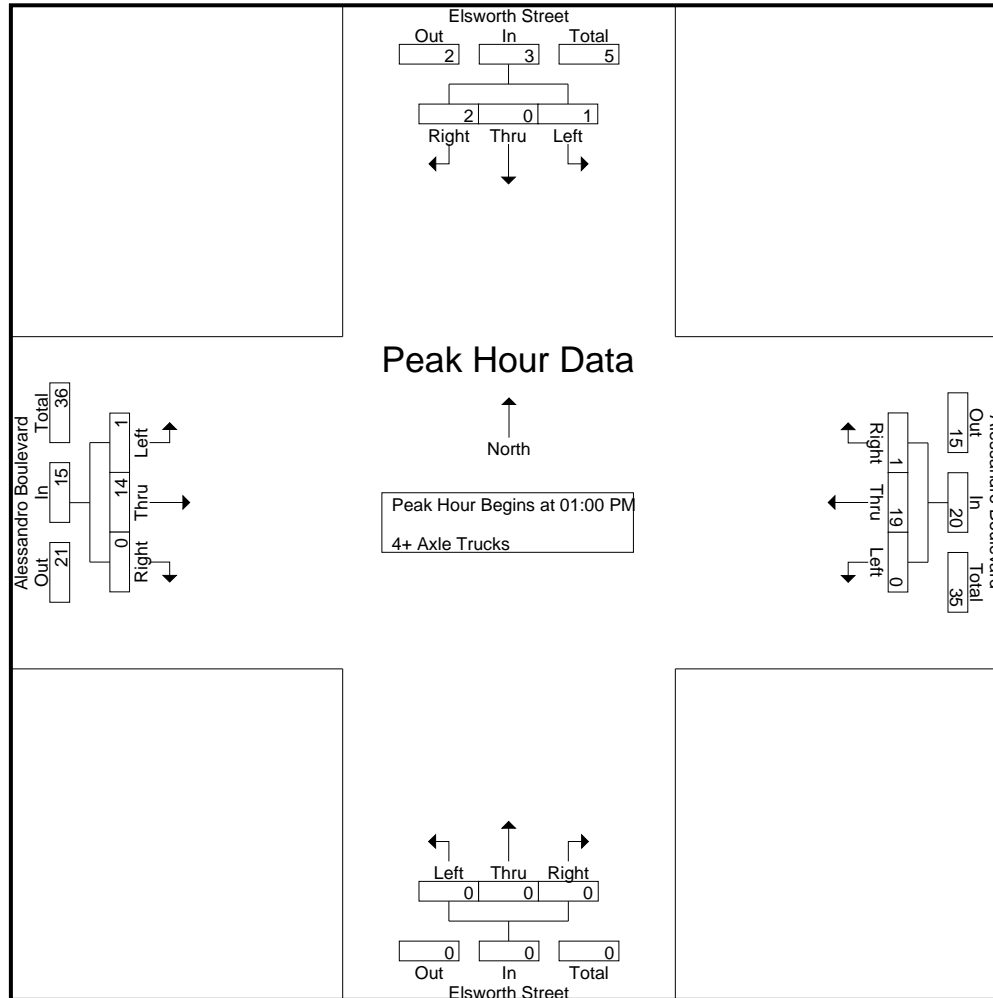

City of Moreno Valley
 N/S: Elsworth Street
 E/W: Alessandro Boulevard
 Weather: Clear

File Name : 36_MRV_Elsw_Ales Sat
 Site Code : 05122815
 Start Date : 9/17/2022
 Page No : 3

Start Time	Elsworth Street Southbound				Alessandro Boulevard Westbound				Elsworth Street Northbound				Alessandro Boulevard Eastbound				Int. Total
	Left	Thru	Right	App. Total	Left	Thru	Right	App. Total	Left	Thru	Right	App. Total	Left	Thru	Right	App. Total	
Peak Hour Analysis From 01:00 PM to 01:45 PM - Peak 1 of 1																	
Peak Hour for Each Approach Begins at:																	
	01:00 PM				01:00 PM				01:00 PM				01:00 PM				
+0 mins.	1	0	0	1	0	3	0	3	0	0	0	0	1	5	0	6	
+15 mins.	0	0	0	0	0	6	1	7	0	0	0	0	0	5	0	5	
+30 mins.	0	0	2	2	0	5	0	5	0	0	0	0	0	3	0	3	
+45 mins.	0	0	0	0	0	5	0	5	0	0	0	0	0	1	0	1	
Total Volume	1	0	2	3	0	19	1	20	0	0	0	0	1	14	0	15	
% App. Total	33.3	0	66.7		0	95	5		0	0	0		6.7	93.3	0		
PHF	.250	.000	.250	.375	.000	.792	.250	.714	.000	.000	.000	.000	.250	.700	.000	.625	

Location: Moreno Valley
 N/S: Elsworth Street
 E/W: Alessandro Boulevard



Date: 9/17/2022
 Day Saturday

PEDESTRIANS

Time	North Leg Elsworth Street	East Leg Alessandro Boulevard	South Leg Elsworth Street	West Leg Alessandro Boulevard	TOTAL
11:00 AM	0	0	0	0	0
11:15 AM	0	0	0	0	0
11:30 AM	15	0	0	0	15
11:45 AM	0	0	0	0	0
12:00 PM	0	0	0	0	0
12:15 PM	0	0	0	0	0
12:30 PM	0	0	0	0	0
12:45 PM	0	0	0	0	0
1:00 PM	0	0	0	0	0
1:15 PM	0	0	0	0	0
1:30 PM	0	0	0	0	0
1:45 PM	0	0	0	0	0
TOTAL VOLUMES:	15	0	0	0	15

Location: Moreno Valley
 N/S: Elsworth Street
 E/W: Alessandro Boulevard

Date: 9/17/2022
 Day: Saturday



BICYCLES

	Southbound Elsworth Street			Westbound Alessandro Boulevard			Northbound Elsworth Street			Eastbound Alessandro Boulevard			
	Left	Thru	Right	Left	Thru	Right	Left	Thru	Right	Left	Thru	Right	
11:00 AM	0	0	0	0	0	0	0	0	0	0	0	0	0
11:15 AM	0	0	0	0	0	0	0	0	0	0	0	0	0
11:30 AM	0	0	0	0	0	0	0	0	0	0	0	0	0
11:45 AM	0	0	0	0	0	0	0	0	0	0	0	0	0
12:00 PM	0	0	0	0	0	0	0	0	0	0	0	0	0
12:15 PM	0	0	0	0	0	0	0	0	0	0	0	0	0
12:30 PM	0	0	0	0	0	0	0	0	0	0	0	0	0
12:45 PM	0	0	0	0	0	0	0	0	0	0	0	0	0
1:00 PM	0	0	0	0	0	0	0	0	0	0	0	0	0
1:15 PM	0	0	0	0	0	0	0	0	0	0	0	0	0
1:30 PM	0	0	0	0	0	0	0	0	0	0	0	0	0
1:45 PM	0	0	0	0	0	0	0	0	0	0	0	0	0
TOTAL VOLUMES:	0	0	0	0	0	0	0	0	0	0	0	0	0

City of Moreno Valley
 N/S: Frederick Street
 E/W: Alessandro Boulevard
 Weather: Clear

File Name : 37_MRV_Fred_Ales Sat
 Site Code : 05122815
 Start Date : 9/17/2022
 Page No : 1

Groups Printed- Passenger Vehicles - Large 2 Axle Vehicles - 3 Axle Vehicles - 4+ Axle Trucks

Start Time	Frederick Street Southbound					Alessandro Boulevard Westbound					Frederick Street Northbound					Alessandro Boulevard Eastbound					Exclu. Total	Inclu. Total	Int. Total
	Left	Thru	Right	RTOR	App. Total	Left	Thru	Right	RTOR	App. Total	Left	Thru	Right	RTOR	App. Total	Left	Thru	Right	RTOR	App. Total			
11:00 AM	38	0	13	9	51	0	221	37	5	258	0	0	0	0	0	13	198	0	0	211	14	520	534
11:15 AM	42	0	8	5	50	1	243	27	9	271	0	0	0	0	0	17	190	1	0	208	14	529	543
11:30 AM	43	0	10	7	53	1	235	33	3	269	0	0	0	0	0	8	208	0	0	216	10	538	548
11:45 AM	37	0	6	4	43	1	208	40	5	249	0	0	0	0	0	15	208	0	0	223	9	515	524
Total	160	0	37	25	197	3	907	137	22	1047	0	0	0	0	0	53	804	1	0	858	47	2102	2149
12:00 PM	39	0	13	9	52	0	225	32	3	257	0	0	0	0	0	14	264	0	0	278	12	587	599
12:15 PM	48	0	15	10	63	1	254	34	2	289	0	0	0	0	0	14	245	0	0	259	12	611	623
12:30 PM	54	0	13	6	67	1	239	42	7	282	0	0	0	0	0	11	238	0	0	249	13	598	611
12:45 PM	63	0	20	10	83	0	208	33	4	241	0	0	0	0	0	18	245	0	0	263	14	587	601
Total	204	0	61	35	265	2	926	141	16	1069	0	0	0	0	0	57	992	0	0	1049	51	2383	2434
01:00 PM	55	0	12	7	67	1	259	46	2	306	0	0	0	0	0	15	217	0	0	232	9	605	614
01:15 PM	58	0	13	8	71	1	258	33	3	292	0	0	0	0	0	18	250	1	1	269	12	632	644
01:30 PM	62	0	17	10	79	0	272	36	0	308	0	0	0	0	0	25	270	0	0	295	10	682	692
01:45 PM	54	0	16	6	70	0	219	29	1	248	0	0	0	0	0	18	267	0	0	285	7	603	610
Total	229	0	58	31	287	2	1008	144	6	1154	0	0	0	0	0	76	1004	1	1	1081	38	2522	2560
Grand Total	593	0	156	91	749	7	2841	422	44	3270	0	0	0	0	0	186	2800	2	1	2988	136	7007	7143
Apprch %	79.2	0	20.8			0.2	86.9	12.9			0	0	0		6.2	93.7	0.1						
Total %	8.5	0	2.2		10.7	0.1	40.5	6		46.7	0	0	0	0	2.7	40	0		42.6		1.9	98.1	
Passenger Vehicles	577	0	149		815	7	2756	408		3213	0	0	0	0	0	176	2688	1		2865	0	0	6893
% Passenger Vehicles	97.3	0	95.5	97.8	97	100	97	96.7	95.5	97	0	0	0	0	0	94.6	96	50	0	95.9	0	0	96.5
Large 2 Axle Vehicles	6	0	2		8	0	26	5		31	0	0	0	0	0	0	33	0		33	0	0	72
% Large 2 Axle Vehicles	1	0	1.3	0	1	0	0.9	1.2	0	0.9	0	0	0	0	0	0	1.2	0	0	1.1	0	0	1
3 Axle Vehicles	0	0	1		1	0	20	8		30	0	0	0	0	0	2	25	0		27	0	0	58
% 3 Axle Vehicles	0	0	0.6	0	0.1	0	0.7	1.9	4.5	0.9	0	0	0	0	0	1.1	0.9	0	0	0.9	0	0	0.8
4+ Axle Trucks	10	0	4		16	0	39	1		40	0	0	0	0	0	8	54	1		64	0	0	120
% 4+ Axle Trucks	1.7	0	2.6	2.2	1.9	0	1.4	0.2	0	1.2	0	0	0	0	0	4.3	1.9	50	100	2.1	0	0	1.7

City of Moreno Valley
 N/S: Frederick Street
 E/W: Alessandro Boulevard
 Weather: Clear

File Name : 37_MRV_Fred_Ales Sat
 Site Code : 05122815
 Start Date : 9/17/2022
 Page No : 2

Start Time	Frederick Street Southbound				Alessandro Boulevard Westbound				Frederick Street Northbound				Alessandro Boulevard Eastbound				Int. Total
	Left	Thru	Right	App. Total	Left	Thru	Right	App. Total	Left	Thru	Right	App. Total	Left	Thru	Right	App. Total	
Peak Hour Analysis From 11:00 AM to 01:45 PM - Peak 1 of 1																	
Peak Hour for Entire Intersection Begins at 01:00 PM																	
01:00 PM	55	0	12	67	1	259	46	306	0	0	0	0	15	217	0	232	605
01:15 PM	58	0	13	71	1	258	33	292	0	0	0	0	18	250	1	269	632
01:30 PM	62	0	17	79	0	272	36	308	0	0	0	0	25	270	0	295	682
01:45 PM	54	0	16	70	0	219	29	248	0	0	0	0	18	267	0	285	603
Total Volume	229	0	58	287	2	1008	144	1154	0	0	0	0	76	1004	1	1081	2522
% App. Total	79.8	0	20.2		0.2	87.3	12.5		0	0	0		7	92.9	0.1		
PHF	.923	.000	.853	.908	.500	.926	.783	.937	.000	.000	.000	.000	.760	.930	.250	.916	.924

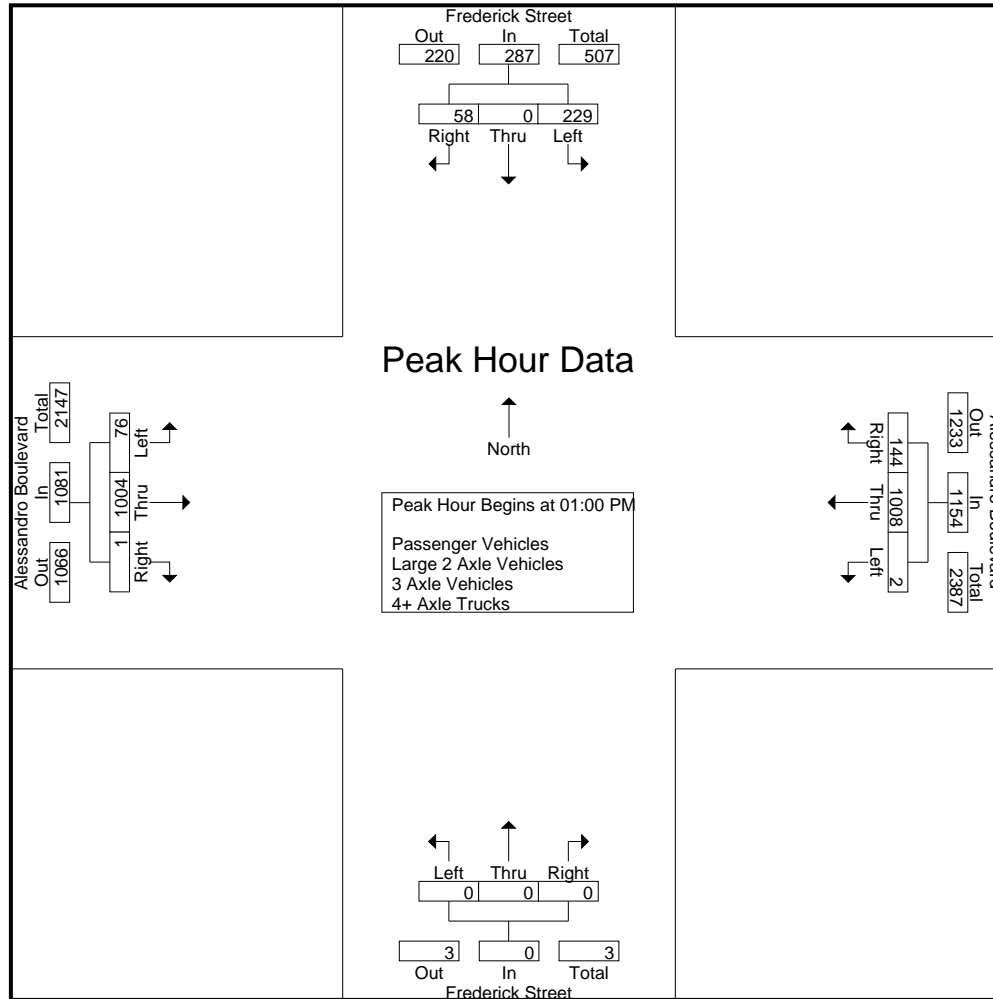

City of Moreno Valley
 N/S: Frederick Street
 E/W: Alessandro Boulevard
 Weather: Clear

File Name : 37_MRV_Fred_Ales Sat
 Site Code : 05122815
 Start Date : 9/17/2022
 Page No : 4

Start Time	Frederick Street Southbound				Alessandro Boulevard Westbound				Frederick Street Northbound				Alessandro Boulevard Eastbound				Int. Total
	Left	Thru	Right	App. Total	Left	Thru	Right	App. Total	Left	Thru	Right	App. Total	Left	Thru	Right	App. Total	
Peak Hour Analysis From 11:00 AM to 01:45 PM - Peak 1 of 1																	
Peak Hour for Each Approach Begins at:																	
	12:45 PM				01:00 PM				11:00 AM				01:00 PM				
+0 mins.	63	0	20	83	1	259	46	306	0	0	0	0	15	217	0	232	
+15 mins.	55	0	12	67	1	258	33	292	0	0	0	0	18	250	1	269	
+30 mins.	58	0	13	71	0	272	36	308	0	0	0	0	25	270	0	295	
+45 mins.	62	0	17	79	0	219	29	248	0	0	0	0	18	267	0	285	
Total Volume	238	0	62	300	2	1008	144	1154	0	0	0	0	76	1004	1	1081	
% App. Total	79.3	0	20.7		0.2	87.3	12.5		0	0	0		7	92.9	0.1		
PHF	.944	.000	.775	.904	.500	.926	.783	.937	.000	.000	.000	.000	.760	.930	.250	.916	

City of Moreno Valley
 N/S: Frederick Street
 E/W: Alessandro Boulevard
 Weather: Clear

File Name : 37_MRV_Fred_Ales Sat
 Site Code : 05122815
 Start Date : 9/17/2022
 Page No : 1

Groups Printed- Passenger Vehicles

Start Time	Frederick Street Southbound					Alessandro Boulevard Westbound					Frederick Street Northbound					Alessandro Boulevard Eastbound					Exclu. Total	Inclu. Total	Int. Total
	Left	Thru	Right	RTOR	App. Total	Left	Thru	Right	RTOR	App. Total	Left	Thru	Right	RTOR	App. Total	Left	Thru	Right	RTOR	App. Total			
11:00 AM	37	0	11	9	48	0	216	35	5	251	0	0	0	0	0	13	188	0	0	201	14	500	514
11:15 AM	40	0	8	5	48	1	239	27	9	267	0	0	0	0	0	17	182	1	0	200	14	515	529
11:30 AM	43	0	9	6	52	1	227	33	3	261	0	0	0	0	0	7	197	0	0	204	9	517	526
11:45 AM	36	0	5	4	41	1	205	37	4	243	0	0	0	0	0	14	196	0	0	210	8	494	502
Total	156	0	33	24	189	3	887	132	21	1022	0	0	0	0	0	51	763	1	0	815	45	2026	2071
12:00 PM	38	0	13	9	51	0	215	30	3	245	0	0	0	0	0	13	249	0	0	262	12	558	570
12:15 PM	46	0	14	10	60	1	243	34	2	278	0	0	0	0	0	11	237	0	0	248	12	586	598
12:30 PM	53	0	13	6	66	1	227	40	6	268	0	0	0	0	0	11	235	0	0	246	12	580	592
12:45 PM	62	0	19	9	81	0	203	33	4	236	0	0	0	0	0	16	230	0	0	246	13	563	576
Total	199	0	59	34	258	2	888	137	15	1027	0	0	0	0	0	51	951	0	0	1002	49	2287	2336
01:00 PM	55	0	12	7	67	1	255	45	2	301	0	0	0	0	0	14	207	0	0	221	9	589	598
01:15 PM	56	0	13	8	69	1	249	30	3	280	0	0	0	0	0	17	246	0	0	263	11	612	623
01:30 PM	59	0	17	10	76	0	265	35	0	300	0	0	0	0	0	25	264	0	0	289	10	665	675
01:45 PM	52	0	15	6	67	0	212	29	1	241	0	0	0	0	0	18	257	0	0	275	7	583	590
Total	222	0	57	31	279	2	981	139	6	1122	0	0	0	0	0	74	974	0	0	1048	37	2449	2486
Grand Total	577	0	149	89	726	7	2756	408	42	3171	0	0	0	0	0	176	2688	1	0	2865	131	6762	6893
Apprch %	79.5	0	20.5			0.2	86.9	12.9			0	0	0			6.1	93.8	0					
Total %	8.5	0	2.2		10.7	0.1	40.8	6		46.9	0	0	0			2.6	39.8	0		42.4	1.9	98.1	

Start Time	Frederick Street Southbound				Alessandro Boulevard Westbound				Frederick Street Northbound				Alessandro Boulevard Eastbound				Int. Total
	Left	Thru	Right	App. Total	Left	Thru	Right	App. Total	Left	Thru	Right	App. Total	Left	Thru	Right	App. Total	
Peak Hour Analysis From 01:00 PM to 01:45 PM - Peak 1 of 1																	
Peak Hour for Entire Intersection Begins at 01:00 PM																	
01:00 PM	55	0	12	67	1	255	45	301	0	0	0	0	14	207	0	221	589
01:15 PM	56	0	13	69	1	249	30	280	0	0	0	0	17	246	0	263	612
01:30 PM	59	0	17	76	0	265	35	300	0	0	0	0	25	264	0	289	665
01:45 PM	52	0	15	67	0	212	29	241	0	0	0	0	18	257	0	275	583
Total Volume	222	0	57	279	2	981	139	1122	0	0	0	0	74	974	0	1048	2449
% App. Total	79.6	0	20.4		0.2	87.4	12.4		0	0	0		7.1	92.9	0		
PHF	.941	.000	.838	.918	.500	.925	.772	.932	.000	.000	.000	.000	.740	.922	.000	.907	.921

City of Moreno Valley
 N/S: Frederick Street
 E/W: Alessandro Boulevard
 Weather: Clear

File Name : 37_MRV_Fred_Ales Sat
 Site Code : 05122815
 Start Date : 9/17/2022
 Page No : 2

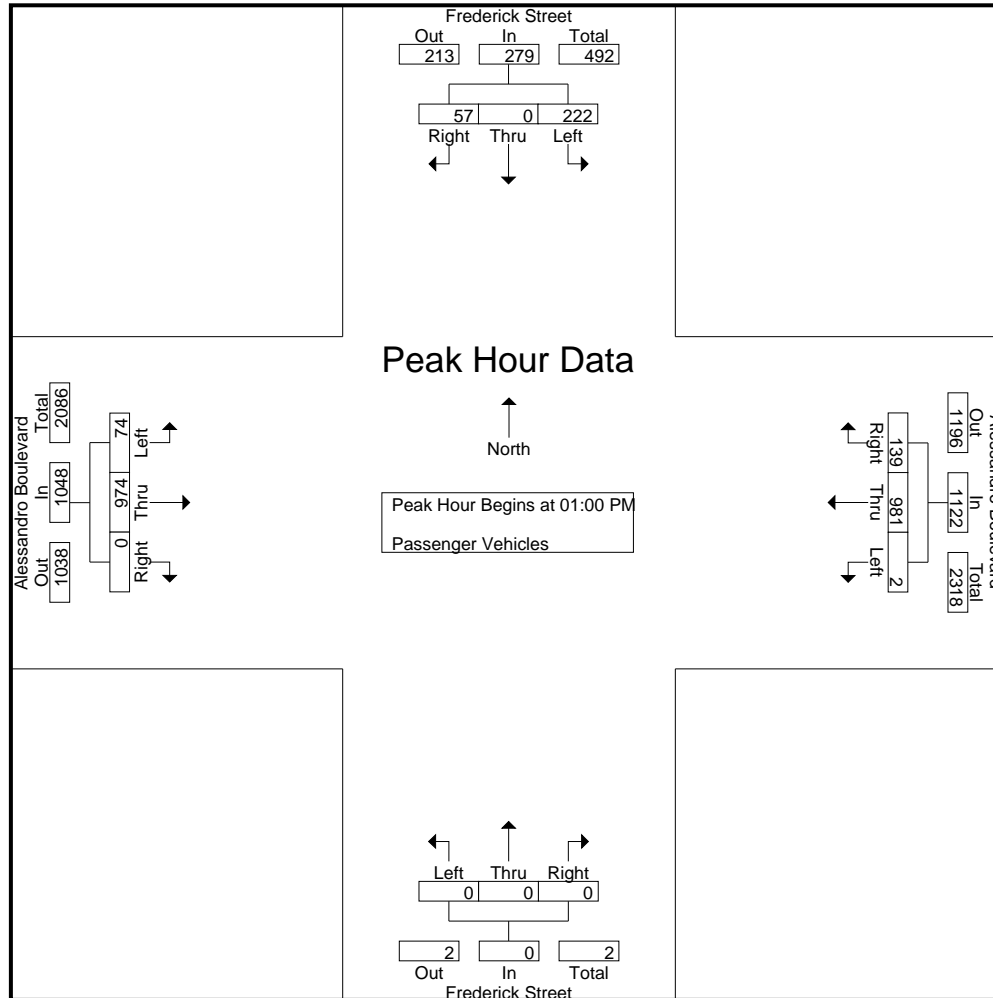

City of Moreno Valley
 N/S: Frederick Street
 E/W: Alessandro Boulevard
 Weather: Clear

File Name : 37_MRV_Fred_Ales Sat
 Site Code : 05122815
 Start Date : 9/17/2022
 Page No : 3

Start Time	Frederick Street Southbound				Alessandro Boulevard Westbound				Frederick Street Northbound				Alessandro Boulevard Eastbound				Int. Total
	Left	Thru	Right	App. Total	Left	Thru	Right	App. Total	Left	Thru	Right	App. Total	Left	Thru	Right	App. Total	
Peak Hour Analysis From 01:00 PM to 01:45 PM - Peak 1 of 1																	
Peak Hour for Each Approach Begins at:																	
	01:00 PM				01:00 PM				01:00 PM				01:00 PM				
+0 mins.	55	0	12	67	1	255	45	301	0	0	0	0	14	207	0	221	
+15 mins.	56	0	13	69	1	249	30	280	0	0	0	0	17	246	0	263	
+30 mins.	59	0	17	76	0	265	35	300	0	0	0	0	25	264	0	289	
+45 mins.	52	0	15	67	0	212	29	241	0	0	0	0	18	257	0	275	
Total Volume	222	0	57	279	2	981	139	1122	0	0	0	0	74	974	0	1048	
% App. Total	79.6	0	20.4		0.2	87.4	12.4		0	0	0		7.1	92.9	0		
PHF	.941	.000	.838	.918	.500	.925	.772	.932	.000	.000	.000	.000	.740	.922	.000	.907	

City of Moreno Valley
 N/S: Frederick Street
 E/W: Alessandro Boulevard
 Weather: Clear

File Name : 37_MRV_Fred_Ales Sat
 Site Code : 05122815
 Start Date : 9/17/2022
 Page No : 1

Groups Printed- Large 2 Axle Vehicles

Start Time	Frederick Street Southbound					Alessandro Boulevard Westbound					Frederick Street Northbound					Alessandro Boulevard Eastbound					Exclu. Total	Inclu. Total	Int. Total
	Left	Thru	Right	RTOR	App. Total	Left	Thru	Right	RTOR	App. Total	Left	Thru	Right	RTOR	App. Total	Left	Thru	Right	RTOR	App. Total			
11:00 AM	1	0	1	0	2	0	2	1	0	3	0	0	0	0	0	0	6	0	0	6	0	11	11
11:15 AM	1	0	0	0	1	0	0	0	0	0	0	0	0	0	0	0	1	0	0	1	0	2	2
11:30 AM	0	0	0	0	0	0	0	0	0	0	0	0	0	0	0	0	1	0	0	1	0	1	1
11:45 AM	0	0	0	0	0	0	1	1	0	2	0	0	0	0	0	0	1	0	0	1	0	3	3
Total	2	0	1	0	3	0	3	2	0	5	0	0	0	0	0	0	9	0	0	9	0	17	17
12:00 PM	0	0	0	0	0	0	3	1	0	4	0	0	0	0	0	0	1	0	0	1	0	5	5
12:15 PM	1	0	0	0	1	0	7	0	0	7	0	0	0	0	0	0	2	0	0	2	0	10	10
12:30 PM	0	0	0	0	0	0	5	0	0	5	0	0	0	0	0	0	1	0	0	1	0	6	6
12:45 PM	0	0	0	0	0	0	2	0	0	2	0	0	0	0	0	0	7	0	0	7	0	9	9
Total	1	0	0	0	1	0	17	1	0	18	0	0	0	0	0	0	11	0	0	11	0	30	30
01:00 PM	0	0	0	0	0	0	1	0	0	1	0	0	0	0	0	0	3	0	0	3	0	4	4
01:15 PM	1	0	0	0	1	0	1	2	0	3	0	0	0	0	0	0	1	0	0	1	0	5	5
01:30 PM	2	0	0	0	2	0	3	0	0	3	0	0	0	0	0	0	3	0	0	3	0	8	8
01:45 PM	0	0	1	0	1	0	1	0	0	1	0	0	0	0	0	0	6	0	0	6	0	8	8
Total	3	0	1	0	4	0	6	2	0	8	0	0	0	0	0	0	13	0	0	13	0	25	25
Grand Total	6	0	2	0	8	0	26	5	0	31	0	0	0	0	0	0	33	0	0	33	0	72	72
Apprch %	75	0	25			0	83.9	16.1			0	0	0			0	100	0			0		
Total %	8.3	0	2.8		11.1	0	36.1	6.9		43.1	0	0	0		0	0	45.8	0		45.8	0	100	

Start Time	Frederick Street Southbound				Alessandro Boulevard Westbound				Frederick Street Northbound				Alessandro Boulevard Eastbound				Int. Total
	Left	Thru	Right	App. Total	Left	Thru	Right	App. Total	Left	Thru	Right	App. Total	Left	Thru	Right	App. Total	
Peak Hour Analysis From 01:00 PM to 01:45 PM - Peak 1 of 1																	
Peak Hour for Entire Intersection Begins at 01:00 PM																	
01:00 PM	0	0	0	0	0	1	0	1	0	0	0	0	0	3	0	3	4
01:15 PM	1	0	0	1	0	1	2	3	0	0	0	0	0	1	0	1	5
01:30 PM	2	0	0	2	0	3	0	3	0	0	0	0	0	3	0	3	8
01:45 PM	0	0	1	1	0	1	0	1	0	0	0	0	0	6	0	6	8
Total Volume	3	0	1	4	0	6	2	8	0	0	0	0	0	13	0	13	25
% App. Total	75	0	25		0	75	25		0	0	0		0	100	0		
PHF	.375	.000	.250	.500	.000	.500	.250	.667	.000	.000	.000	.000	.000	.542	.000	.542	.781

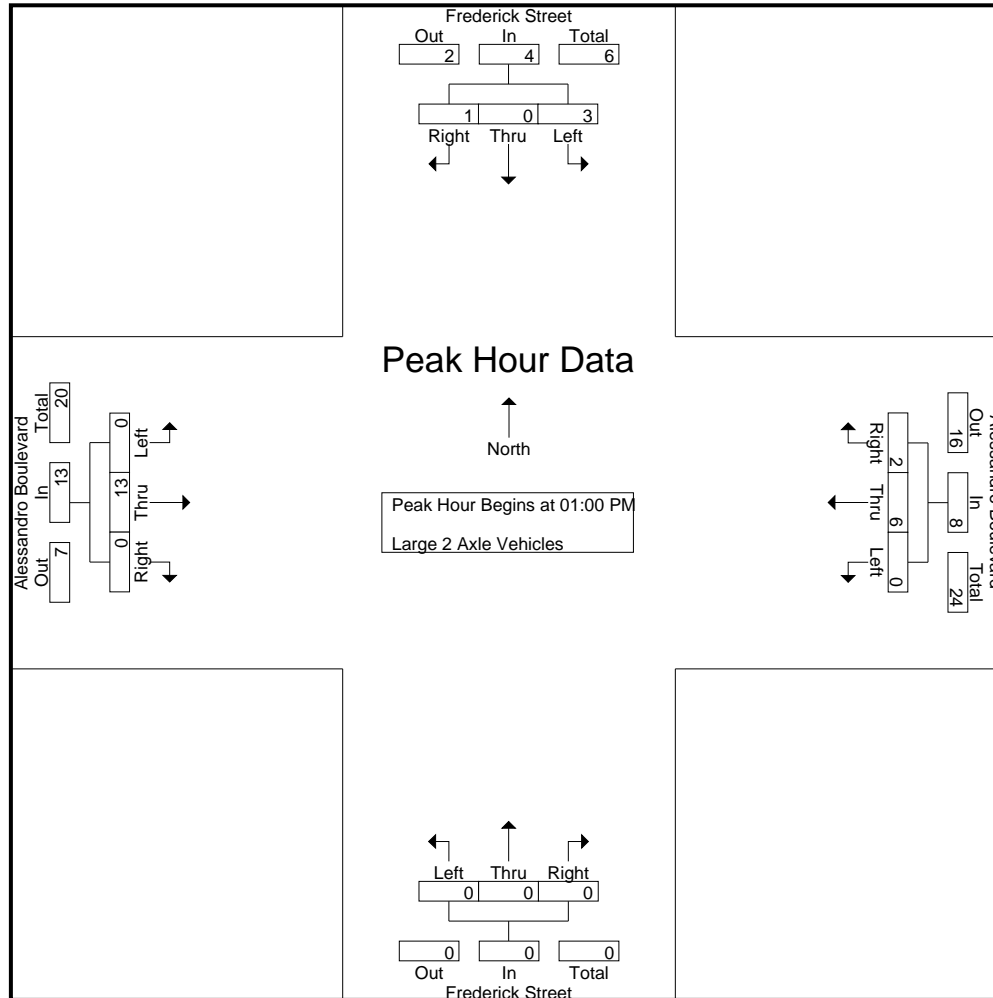

City of Moreno Valley
 N/S: Frederick Street
 E/W: Alessandro Boulevard
 Weather: Clear

File Name : 37_MRV_Fred_Ales Sat
 Site Code : 05122815
 Start Date : 9/17/2022
 Page No : 3

Start Time	Frederick Street Southbound				Alessandro Boulevard Westbound				Frederick Street Northbound				Alessandro Boulevard Eastbound				Int. Total
	Left	Thru	Right	App. Total	Left	Thru	Right	App. Total	Left	Thru	Right	App. Total	Left	Thru	Right	App. Total	
Peak Hour Analysis From 01:00 PM to 01:45 PM - Peak 1 of 1																	
Peak Hour for Each Approach Begins at:																	
	01:00 PM				01:00 PM				01:00 PM				01:00 PM				
+0 mins.	0	0	0	0	0	1	0	1	0	0	0	0	0	3	0	3	
+15 mins.	1	0	0	1	0	1	2	3	0	0	0	0	0	1	0	1	
+30 mins.	2	0	0	2	0	3	0	3	0	0	0	0	0	3	0	3	
+45 mins.	0	0	1	1	0	1	0	1	0	0	0	0	0	6	0	6	
Total Volume	3	0	1	4	0	6	2	8	0	0	0	0	0	13	0	13	
% App. Total	75	0	25		0	75	25		0	0	0		0	100	0		
PHF	.375	.000	.250	.500	.000	.500	.250	.667	.000	.000	.000	.000	.000	.542	.000	.542	

City of Moreno Valley
 N/S: Frederick Street
 E/W: Alessandro Boulevard
 Weather: Clear

File Name : 37_MRV_Fred_Ales Sat
 Site Code : 05122815
 Start Date : 9/17/2022
 Page No : 1

Groups Printed- 3 Axle Vehicles

Start Time	Frederick Street Southbound					Alessandro Boulevard Westbound					Frederick Street Northbound					Alessandro Boulevard Eastbound					Exclu. Total	Inclu. Total	Int. Total	
	Left	Thru	Right	RTOR	App. Total	Left	Thru	Right	RTOR	App. Total	Left	Thru	Right	RTOR	App. Total	Left	Thru	Right	RTOR	App. Total				
11:00 AM	0	0	0	0	0	0	3	0	0	3	0	0	0	0	0	0	2	0	0	2	0	0	5	5
11:15 AM	0	0	0	0	0	0	1	0	0	1	0	0	0	0	0	0	1	0	0	1	0	0	2	2
11:30 AM	0	0	0	0	0	0	2	0	0	2	0	0	0	0	0	0	3	0	0	3	0	0	5	5
11:45 AM	0	0	0	0	0	0	1	2	1	3	0	0	0	0	0	0	6	0	0	6	1	0	9	10
Total	0	0	0	0	0	0	7	2	1	9	0	0	0	0	0	0	12	0	0	12	1	0	21	22
12:00 PM	0	0	0	0	0	0	3	1	0	4	0	0	0	0	0	0	4	0	0	4	0	0	8	8
12:15 PM	0	0	1	0	1	0	1	0	0	1	0	0	0	0	0	2	1	0	0	3	0	0	5	5
12:30 PM	0	0	0	0	0	0	2	2	1	4	0	0	0	0	0	0	0	0	0	0	1	0	4	5
12:45 PM	0	0	0	0	0	0	2	0	0	2	0	0	0	0	0	0	3	0	0	3	0	0	5	5
Total	0	0	1	0	1	0	8	3	1	11	0	0	0	0	0	2	8	0	0	10	1	0	22	23
01:00 PM	0	0	0	0	0	0	0	1	0	1	0	0	0	0	0	0	1	0	0	1	0	0	2	2
01:15 PM	0	0	0	0	0	0	2	1	0	3	0	0	0	0	0	0	1	0	0	1	0	0	4	4
01:30 PM	0	0	0	0	0	0	1	1	0	2	0	0	0	0	0	0	1	0	0	1	0	0	3	3
01:45 PM	0	0	0	0	0	0	2	0	0	2	0	0	0	0	0	0	2	0	0	2	0	0	4	4
Total	0	0	0	0	0	0	5	3	0	8	0	0	0	0	0	0	5	0	0	5	0	0	13	13
Grand Total	0	0	1	0	1	0	20	8	2	28	0	0	0	0	0	2	25	0	0	27	2	0	56	58
Apprch %	0	0	100			0	71.4	28.6			0	0	0			7.4	92.6	0						
Total %	0	0	1.8		1.8	0	35.7	14.3		50	0	0	0		0	3.6	44.6	0		48.2	3.4	0	96.6	

Start Time	Frederick Street Southbound				Alessandro Boulevard Westbound				Frederick Street Northbound				Alessandro Boulevard Eastbound				Int. Total
	Left	Thru	Right	App. Total	Left	Thru	Right	App. Total	Left	Thru	Right	App. Total	Left	Thru	Right	App. Total	
Peak Hour Analysis From 01:00 PM to 01:45 PM - Peak 1 of 1																	
Peak Hour for Entire Intersection Begins at 01:00 PM																	
01:00 PM	0	0	0	0	0	0	1	1	0	0	0	0	0	1	0	1	2
01:15 PM	0	0	0	0	0	2	1	3	0	0	0	0	0	1	0	1	4
01:30 PM	0	0	0	0	0	1	1	2	0	0	0	0	0	1	0	1	3
01:45 PM	0	0	0	0	0	2	0	2	0	0	0	0	0	2	0	2	4
Total Volume	0	0	0	0	0	5	3	8	0	0	0	0	0	5	0	5	13
% App. Total	0	0	0		0	62.5	37.5		0	0	0		0	100	0		
PHF	.000	.000	.000	.000	.000	.625	.750	.667	.000	.000	.000	.000	.000	.625	.000	.625	.813

City of Moreno Valley
 N/S: Frederick Street
 E/W: Alessandro Boulevard
 Weather: Clear

File Name : 37_MR_V_Fred_Ales Sat
 Site Code : 05122815
 Start Date : 9/17/2022
 Page No : 2

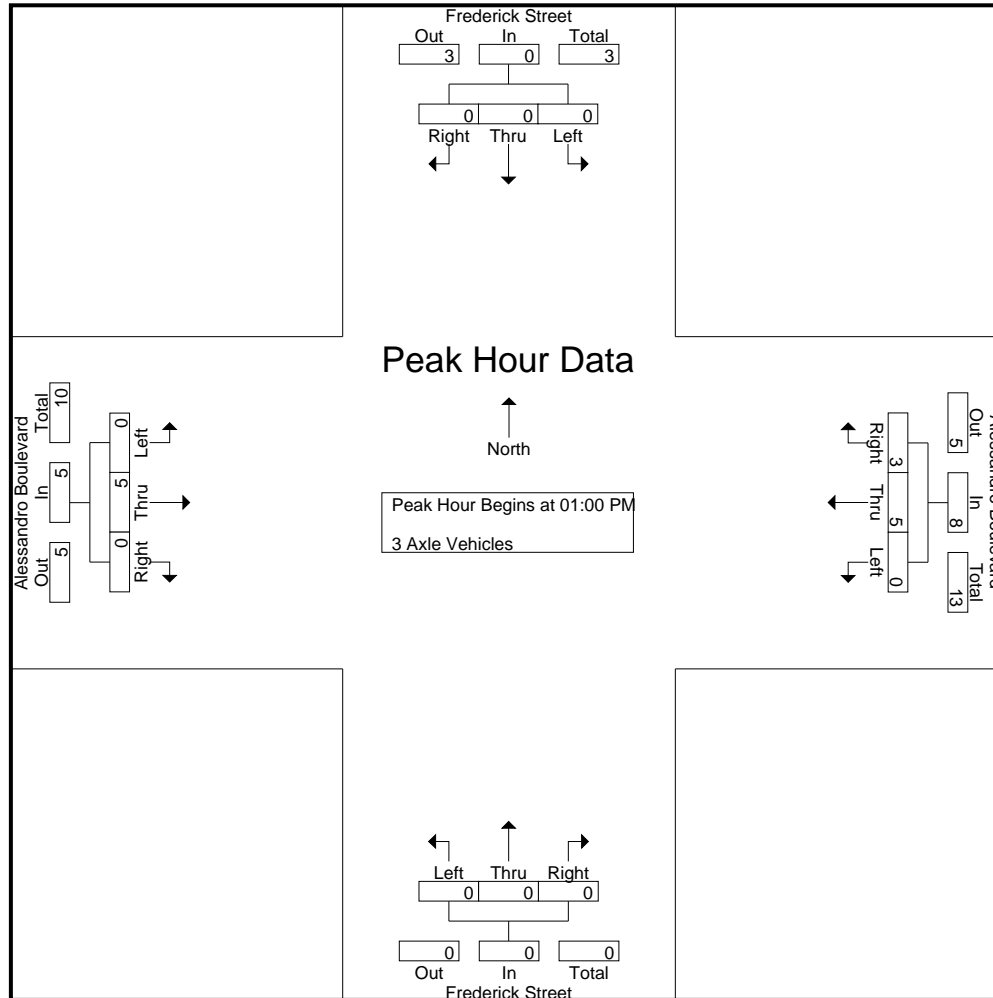

City of Moreno Valley
 N/S: Frederick Street
 E/W: Alessandro Boulevard
 Weather: Clear

File Name : 37_MRV_Fred_Ales Sat
 Site Code : 05122815
 Start Date : 9/17/2022
 Page No : 3

Start Time	Frederick Street Southbound				Alessandro Boulevard Westbound				Frederick Street Northbound				Alessandro Boulevard Eastbound				Int. Total
	Left	Thru	Right	App. Total	Left	Thru	Right	App. Total	Left	Thru	Right	App. Total	Left	Thru	Right	App. Total	
Peak Hour Analysis From 01:00 PM to 01:45 PM - Peak 1 of 1																	
Peak Hour for Each Approach Begins at:																	
	01:00 PM				01:00 PM				01:00 PM				01:00 PM				
+0 mins.	0	0	0	0	0	0	1	1	0	0	0	0	0	1	0	1	
+15 mins.	0	0	0	0	0	2	1	3	0	0	0	0	0	1	0	1	
+30 mins.	0	0	0	0	0	1	1	2	0	0	0	0	0	1	0	1	
+45 mins.	0	0	0	0	0	2	0	2	0	0	0	0	0	2	0	2	
Total Volume	0	0	0	0	0	5	3	8	0	0	0	0	0	5	0	5	
% App. Total	0	0	0	0	0	62.5	37.5		0	0	0	0	0	100	0		
PHF	.000	.000	.000	.000	.000	.625	.750	.667	.000	.000	.000	.000	.000	.625	.000	.625	

City of Moreno Valley
 N/S: Frederick Street
 E/W: Alessandro Boulevard
 Weather: Clear

File Name : 37_MRV_Fred_Ales Sat
 Site Code : 05122815
 Start Date : 9/17/2022
 Page No : 1

Groups Printed- 4+ Axle Trucks

Start Time	Frederick Street Southbound					Alessandro Boulevard Westbound					Frederick Street Northbound					Alessandro Boulevard Eastbound					Exclu. Total	Inclu. Total	Int. Total	
	Left	Thru	Right	RTOR	App. Total	Left	Thru	Right	RTOR	App. Total	Left	Thru	Right	RTOR	App. Total	Left	Thru	Right	RTOR	App. Total				
11:00 AM	0	0	1	0	1	0	0	1	0	1	0	0	0	0	0	0	2	0	0	2	0	0	4	4
11:15 AM	1	0	0	0	1	0	3	0	0	3	0	0	0	0	0	0	6	0	0	6	0	10	10	10
11:30 AM	0	0	1	1	1	0	6	0	0	6	0	0	0	0	0	1	7	0	0	8	1	15	16	16
11:45 AM	1	0	1	0	2	0	1	0	0	1	0	0	0	0	0	1	5	0	0	6	0	9	9	9
Total	2	0	3	1	5	0	10	1	0	11	0	0	0	0	0	2	20	0	0	22	1	38	39	39
12:00 PM	1	0	0	0	1	0	4	0	0	4	0	0	0	0	0	1	10	0	0	11	0	16	16	16
12:15 PM	1	0	0	0	1	0	3	0	0	3	0	0	0	0	0	1	5	0	0	6	0	10	10	10
12:30 PM	1	0	0	0	1	0	5	0	0	5	0	0	0	0	0	0	2	0	0	2	0	8	8	8
12:45 PM	1	0	1	1	2	0	1	0	0	1	0	0	0	0	0	2	5	0	0	7	1	10	11	11
Total	4	0	1	1	5	0	13	0	0	13	0	0	0	0	0	4	22	0	0	26	1	44	45	45
01:00 PM	0	0	0	0	0	0	3	0	0	3	0	0	0	0	0	1	6	0	0	7	0	10	10	10
01:15 PM	1	0	0	0	1	0	6	0	0	6	0	0	0	0	0	1	2	1	1	4	1	11	12	12
01:30 PM	1	0	0	0	1	0	3	0	0	3	0	0	0	0	0	0	2	0	0	2	0	6	6	6
01:45 PM	2	0	0	0	2	0	4	0	0	4	0	0	0	0	0	0	2	0	0	2	0	8	8	8
Total	4	0	0	0	4	0	16	0	0	16	0	0	0	0	0	2	12	1	1	15	1	35	36	36
Grand Total	10	0	4	2	14	0	39	1	0	40	0	0	0	0	0	8	54	1	1	63	3	117	120	120
Apprch %	71.4	0	28.6			0	97.5	2.5			0	0	0			12.7	85.7	1.6						
Total %	8.5	0	3.4		12	0	33.3	0.9		34.2	0	0	0		0	6.8	46.2	0.9		53.8	2.5	97.5		

Start Time	Frederick Street Southbound				Alessandro Boulevard Westbound				Frederick Street Northbound				Alessandro Boulevard Eastbound				Int. Total
	Left	Thru	Right	App. Total	Left	Thru	Right	App. Total	Left	Thru	Right	App. Total	Left	Thru	Right	App. Total	
Peak Hour Analysis From 01:00 PM to 01:45 PM - Peak 1 of 1																	
Peak Hour for Entire Intersection Begins at 01:00 PM																	
01:00 PM	0	0	0	0	0	3	0	3	0	0	0	0	1	6	0	7	10
01:15 PM	1	0	0	1	0	6	0	6	0	0	0	0	1	2	1	4	11
01:30 PM	1	0	0	1	0	3	0	3	0	0	0	0	0	2	0	2	6
01:45 PM	2	0	0	2	0	4	0	4	0	0	0	0	0	2	0	2	8
Total Volume	4	0	0	4	0	16	0	16	0	0	0	0	2	12	1	15	35
% App. Total	100	0	0		0	100	0		0	0	0		13.3	80	6.7		
PHF	.500	.000	.000	.500	.000	.667	.000	.667	.000	.000	.000	.000	.500	.500	.250	.536	.795

City of Moreno Valley
 N/S: Frederick Street
 E/W: Alessandro Boulevard
 Weather: Clear

File Name : 37_MRV_Fred_Ales Sat
 Site Code : 05122815
 Start Date : 9/17/2022
 Page No : 2

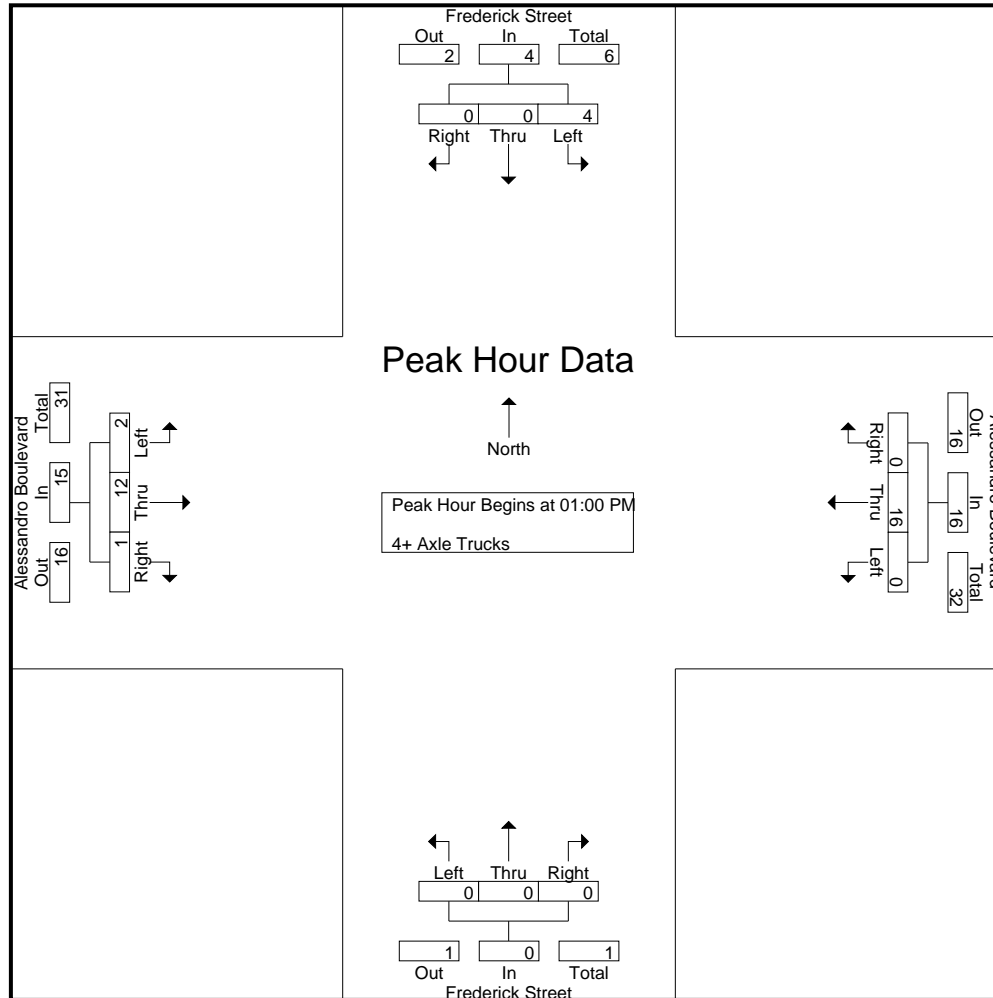

City of Moreno Valley
 N/S: Frederick Street
 E/W: Alessandro Boulevard
 Weather: Clear

File Name : 37_MRV_Fred_Ales Sat
 Site Code : 05122815
 Start Date : 9/17/2022
 Page No : 3

Start Time	Frederick Street Southbound				Alessandro Boulevard Westbound				Frederick Street Northbound				Alessandro Boulevard Eastbound				Int. Total
	Left	Thru	Right	App. Total	Left	Thru	Right	App. Total	Left	Thru	Right	App. Total	Left	Thru	Right	App. Total	
Peak Hour Analysis From 01:00 PM to 01:45 PM - Peak 1 of 1																	
Peak Hour for Each Approach Begins at:																	
	01:00 PM				01:00 PM				01:00 PM				01:00 PM				
+0 mins.	0	0	0	0	0	3	0	3	0	0	0	0	1	6	0	7	
+15 mins.	1	0	0	1	0	6	0	6	0	0	0	0	1	2	1	4	
+30 mins.	1	0	0	1	0	3	0	3	0	0	0	0	0	2	0	2	
+45 mins.	2	0	0	2	0	4	0	4	0	0	0	0	0	2	0	2	
Total Volume	4	0	0	4	0	16	0	16	0	0	0	0	2	12	1	15	
% App. Total	100	0	0		0	100	0		0	0	0		13.3	80	6.7		
PHF	.500	.000	.000	.500	.000	.667	.000	.667	.000	.000	.000	.000	.500	.500	.250	.536	

Location: Moreno Valley
 N/S: Frederick Street
 E/W: Alessandro Boulevard



Date: 9/17/2022
 Day Saturday

PEDESTRIANS

Time	North Leg Frederick Street	East Leg Alessandro Boulevard	South Leg Frederick Street	West Leg Alessandro Boulevard	TOTAL
11:00 AM	0	0	0	0	0
11:15 AM	0	0	0	0	0
11:30 AM	0	0	0	0	0
11:45 AM	0	0	0	0	0
12:00 PM	0	0	0	0	0
12:15 PM	0	0	0	0	0
12:30 PM	0	0	0	0	0
12:45 PM	0	0	0	0	0
1:00 PM	0	0	0	0	0
1:15 PM	0	0	0	0	0
1:30 PM	0	0	0	0	0
1:45 PM	0	0	0	0	0
TOTAL VOLUMES:	0	0	0	0	0

Location: Moreno Valley
 N/S: Frederick Street
 E/W: Alessandro Boulevard

Date: 9/17/2022
 Day: Saturday



BICYCLES

	Southbound Frederick Street			Westbound Alessandro Boulevard			Northbound Frederick Street			Eastbound Alessandro Boulevard			
	Left	Thru	Right	Left	Thru	Right	Left	Thru	Right	Left	Thru	Right	
11:00 AM	0	0	0	0	0	0	0	0	0	0	0	0	0
11:15 AM	0	0	0	0	0	0	0	0	0	0	0	0	0
11:30 AM	0	0	0	0	0	0	0	0	0	0	0	0	0
11:45 AM	0	0	0	0	0	0	0	0	0	0	0	0	0
12:00 PM	0	0	0	0	0	0	0	0	0	0	0	0	0
12:15 PM	0	0	0	0	0	0	0	0	0	0	0	0	0
12:30 PM	0	0	0	0	0	0	0	0	0	0	0	0	0
12:45 PM	0	0	0	0	0	0	0	0	0	0	0	0	0
1:00 PM	0	0	0	0	0	0	0	0	0	0	0	0	0
1:15 PM	0	0	0	0	0	0	0	0	0	0	0	0	0
1:30 PM	0	0	0	0	0	0	0	0	0	0	0	0	0
1:45 PM	0	0	0	0	0	0	0	0	0	0	0	0	0
TOTAL VOLUMES:	0	0	0	0	0	0	0	0	0	0	0	0	0

City of Moreno Valley
 N/S: Graham Street
 E/W: Alessandro Boulevard
 Weather: Clear

File Name : 38_MRV_Grah_Ales Sat
 Site Code : 05122815
 Start Date : 9/17/2022
 Page No : 1

Groups Printed- Passenger Vehicles - Large 2 Axle Vehicles - 3 Axle Vehicles - 4+ Axle Trucks

Start Time	Graham Street Southbound					Alessandro Boulevard Westbound					Graham Street Northbound					Alessandro Boulevard Eastbound					Exclu. Total	Inclu. Total	Int. Total
	Left	Thru	Right	RTOR	App. Total	Left	Thru	Right	RTOR	App. Total	Left	Thru	Right	RTOR	App. Total	Left	Thru	Right	RTOR	App. Total			
11:00 AM	8	7	18	12	33	0	235	9	0	244	24	7	0	0	31	12	188	32	9	232	21	540	561
11:15 AM	9	18	12	10	39	3	210	10	2	223	22	1	2	2	25	10	190	25	11	225	25	512	537
11:30 AM	20	6	19	18	45	2	225	12	0	239	33	15	2	0	50	16	185	33	13	234	31	568	599
11:45 AM	11	13	13	11	37	1	217	6	2	224	21	14	2	1	37	9	193	26	4	228	18	526	544
Total	48	44	62	51	154	6	887	37	4	930	100	37	6	3	143	47	756	116	37	919	95	2146	2241
12:00 PM	11	14	16	12	41	3	234	12	0	249	24	4	4	3	32	14	258	33	6	305	21	627	648
12:15 PM	12	13	15	11	40	2	256	18	2	276	37	16	1	1	54	14	239	35	6	288	20	658	678
12:30 PM	13	9	19	15	41	4	228	10	6	242	37	10	5	4	52	8	215	44	15	267	40	602	642
12:45 PM	19	14	11	10	44	8	224	12	1	244	32	9	6	6	47	12	250	38	8	300	25	635	660
Total	55	50	61	48	166	17	942	52	9	1011	130	39	16	14	185	48	962	150	35	1160	106	2522	2628
01:00 PM	12	15	16	15	43	3	267	16	5	286	31	5	2	1	38	15	235	34	4	284	25	651	676
01:15 PM	15	12	19	17	46	2	215	14	1	231	36	2	1	0	39	15	221	45	18	281	36	597	633
01:30 PM	7	13	16	13	36	2	281	9	2	292	19	5	1	0	25	11	249	34	11	294	26	647	673
01:45 PM	12	14	9	9	35	0	248	13	0	261	23	7	1	0	31	12	251	42	8	305	17	632	649
Total	46	54	60	54	160	7	1011	52	8	1070	109	19	5	1	133	53	956	155	41	1164	104	2527	2631
Grand Total	149	148	183	153	480	30	2840	141	21	3011	339	95	27	18	461	148	2674	421	113	3243	305	7195	7500
Apprch %	31	30.8	38.1			1	94.3	4.7			73.5	20.6	5.9			4.6	82.5	13					
Total %	2.1	2.1	2.5		6.7	0.4	39.5	2		41.8	4.7	1.3	0.4		6.4	2.1	37.2	5.9		45.1	4.1	95.9	
Passenger Vehicles	149	147	177		622	30	2748	140		2939	333	95	27		473	143	2569	416		3241	0	0	7275
% Passenger Vehicles	100	99.3	96.7	97.4	98.3	100	96.8	99.3	100	96.9	98.2	100	100	100	98.7	96.6	96.1	98.8	100	96.6	0	0	97
Large 2 Axle Vehicles	0	1	2		5	0	23	0		23	6	0	0		6	1	23	4		28	0	0	62
% Large 2 Axle Vehicles	0	0.7	1.1	1.3	0.8	0	0.8	0	0	0.8	1.8	0	0	0	1.3	0.7	0.9	1	0	0.8	0	0	0.8
3 Axle Vehicles	0	0	1		2	0	24	0		24	0	0	0		0	1	21	0		22	0	0	48
% 3 Axle Vehicles	0	0	0.5	0.7	0.3	0	0.8	0	0	0.8	0	0	0	0	0	0.7	0.8	0	0	0.7	0	0	0.6
4+ Axle Trucks	0	0	3		4	0	45	1		46	0	0	0		0	3	61	1		65	0	0	115
% 4+ Axle Trucks	0	0	1.6	0.7	0.6	0	1.6	0.7	0	1.5	0	0	0	0	0	2	2.3	0.2	0	1.9	0	0	1.5

City of Moreno Valley
 N/S: Graham Street
 E/W: Alessandro Boulevard
 Weather: Clear

File Name : 38_MRV_Grah_Ales Sat
 Site Code : 05122815
 Start Date : 9/17/2022
 Page No : 2

Start Time	Graham Street Southbound				Alessandro Boulevard Westbound				Graham Street Northbound				Alessandro Boulevard Eastbound				Int. Total
	Left	Thru	Right	App. Total	Left	Thru	Right	App. Total	Left	Thru	Right	App. Total	Left	Thru	Right	App. Total	
Peak Hour Analysis From 11:00 AM to 01:45 PM - Peak 1 of 1																	
Peak Hour for Entire Intersection Begins at 12:15 PM																	
12:15 PM	12	13	15	40	2	256	18	276	37	16	1	54	14	239	35	288	658
12:30 PM	13	9	19	41	4	228	10	242	37	10	5	52	8	215	44	267	602
12:45 PM	19	14	11	44	8	224	12	244	32	9	6	47	12	250	38	300	635
01:00 PM	12	15	16	43	3	267	16	286	31	5	2	38	15	235	34	284	651
Total Volume	56	51	61	168	17	975	56	1048	137	40	14	191	49	939	151	1139	2546
% App. Total	33.3	30.4	36.3		1.6	93	5.3		71.7	20.9	7.3		4.3	82.4	13.3		
PHF	.737	.850	.803	.955	.531	.913	.778	.916	.926	.625	.583	.884	.817	.939	.858	.949	.967

City of Moreno Valley
 N/S: Graham Street
 E/W: Alessandro Boulevard
 Weather: Clear

File Name : 38_MRV_Grah_Ales Sat
 Site Code : 05122815
 Start Date : 9/17/2022
 Page No : 3

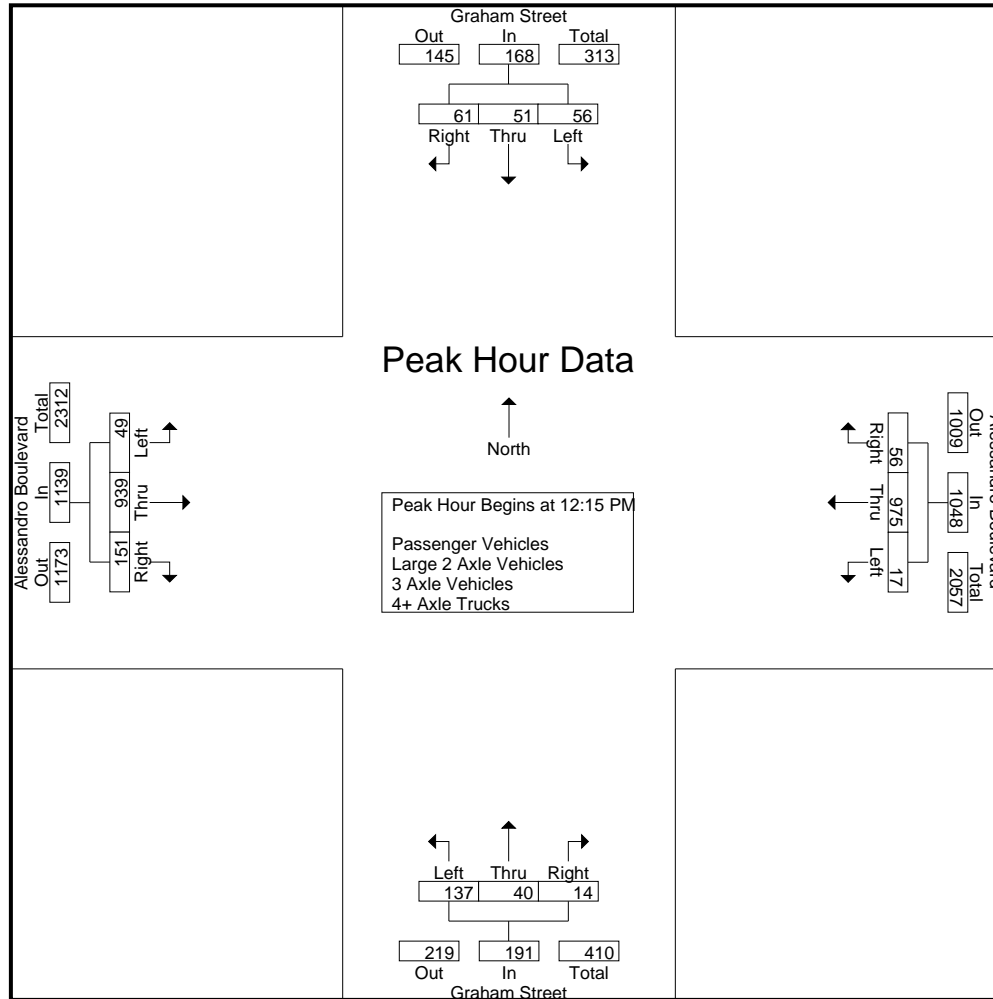

City of Moreno Valley
 N/S: Graham Street
 E/W: Alessandro Boulevard
 Weather: Clear

File Name : 38_MRV_Grah_Ales Sat
 Site Code : 05122815
 Start Date : 9/17/2022
 Page No : 4

Start Time	Graham Street Southbound				Alessandro Boulevard Westbound				Graham Street Northbound				Alessandro Boulevard Eastbound				Int. Total
	Left	Thru	Right	App. Total	Left	Thru	Right	App. Total	Left	Thru	Right	App. Total	Left	Thru	Right	App. Total	
Peak Hour Analysis From 11:00 AM to 01:45 PM - Peak 1 of 1																	
Peak Hour for Each Approach Begins at:																	
	12:30 PM				01:00 PM				12:15 PM				01:00 PM				
+0 mins.	13	9	19	41	3	267	16	286	37	16	1	54	15	235	34	284	
+15 mins.	19	14	11	44	2	215	14	231	37	10	5	52	15	221	45	281	
+30 mins.	12	15	16	43	2	281	9	292	32	9	6	47	11	249	34	294	
+45 mins.	15	12	19	46	0	248	13	261	31	5	2	38	12	251	42	305	
Total Volume	59	50	65	174	7	1011	52	1070	137	40	14	191	53	956	155	1164	
% App. Total	33.9	28.7	37.4		0.7	94.5	4.9		71.7	20.9	7.3		4.6	82.1	13.3		
PHF	.776	.833	.855	.946	.583	.899	.813	.916	.926	.625	.583	.884	.883	.952	.861	.954	

City of Moreno Valley
 N/S: Graham Street
 E/W: Alessandro Boulevard
 Weather: Clear

File Name : 38_MRV_Grah_Ales Sat
 Site Code : 05122815
 Start Date : 9/17/2022
 Page No : 1

Groups Printed- Passenger Vehicles

Start Time	Graham Street Southbound					Alessandro Boulevard Westbound					Graham Street Northbound					Alessandro Boulevard Eastbound					Exclu. Total	Inclu. Total	Int. Total
	Left	Thru	Right	RTOR	App. Total	Left	Thru	Right	RTOR	App. Total	Left	Thru	Right	RTOR	App. Total	Left	Thru	Right	RTOR	App. Total			
11:00 AM	8	7	17	11	32	0	231	8	0	239	22	7	0	0	29	12	179	32	9	223	20	523	543
11:15 AM	9	18	12	10	39	3	207	10	2	220	22	1	2	2	25	10	181	24	11	215	25	499	524
11:30 AM	20	6	19	18	45	2	216	12	0	230	33	15	2	0	50	16	175	33	13	224	31	549	580
11:45 AM	11	12	12	10	35	1	212	6	2	219	20	14	2	1	36	8	181	26	4	215	17	505	522
Total	48	43	60	49	151	6	866	36	4	908	97	37	6	3	140	46	716	115	37	877	93	2076	2169
12:00 PM	11	14	15	12	40	3	224	12	0	239	23	4	4	3	31	14	243	33	6	290	21	600	621
12:15 PM	12	13	13	10	38	2	245	18	2	265	37	16	1	1	54	13	232	34	6	279	19	636	655
12:30 PM	13	9	18	14	40	4	217	10	6	231	37	10	5	4	52	8	212	43	15	263	39	586	625
12:45 PM	19	14	11	10	44	8	219	12	1	239	32	9	6	6	47	12	235	38	8	285	25	615	640
Total	55	50	57	46	162	17	905	52	9	974	129	39	16	14	184	47	922	148	35	1117	104	2437	2541
01:00 PM	12	15	16	15	43	3	261	16	5	280	30	5	2	1	37	13	227	34	4	274	25	634	659
01:15 PM	15	12	19	17	46	2	204	14	1	220	35	2	1	0	38	15	217	44	18	276	36	580	616
01:30 PM	7	13	16	13	36	2	270	9	2	281	19	5	1	0	25	10	244	33	11	287	26	629	655
01:45 PM	12	14	9	9	35	0	242	13	0	255	23	7	1	0	31	12	243	42	8	297	17	618	635
Total	46	54	60	54	160	7	977	52	8	1036	107	19	5	1	131	50	931	153	41	1134	104	2461	2565
Grand Total	149	147	177	149	473	30	2748	140	21	2918	333	95	27	18	455	143	2569	416	113	3128	301	6974	7275
Apprch %	31.5	31.1	37.4			1	94.2	4.8			73.2	20.9	5.9			4.6	82.1	13.3					
Total %	2.1	2.1	2.5		6.8	0.4	39.4	2		41.8	4.8	1.4	0.4		6.5	2.1	36.8	6		44.9	4.1	95.9	

Start Time	Graham Street Southbound				Alessandro Boulevard Westbound				Graham Street Northbound				Alessandro Boulevard Eastbound				Int. Total
	Left	Thru	Right	App. Total	Left	Thru	Right	App. Total	Left	Thru	Right	App. Total	Left	Thru	Right	App. Total	
Peak Hour Analysis From 12:15 PM to 01:00 PM - Peak 1 of 1																	
Peak Hour for Entire Intersection Begins at 12:15 PM																	
12:15 PM	12	13	13	38	2	245	18	265	37	16	1	54	13	232	34	279	636
12:30 PM	13	9	18	40	4	217	10	231	37	10	5	52	8	212	43	263	586
12:45 PM	19	14	11	44	8	219	12	239	32	9	6	47	12	235	38	285	615
01:00 PM	12	15	16	43	3	261	16	280	30	5	2	37	13	227	34	274	634
Total Volume	56	51	58	165	17	942	56	1015	136	40	14	190	46	906	149	1101	2471
% App. Total	33.9	30.9	35.2		1.7	92.8	5.5		71.6	21.1	7.4		4.2	82.3	13.5		
PHF	.737	.850	.806	.938	.531	.902	.778	.906	.919	.625	.583	.880	.885	.964	.866	.966	.971

City of Moreno Valley
 N/S: Graham Street
 E/W: Alessandro Boulevard
 Weather: Clear

File Name : 38_MRV_Grah_Ales Sat
 Site Code : 05122815
 Start Date : 9/17/2022
 Page No : 2

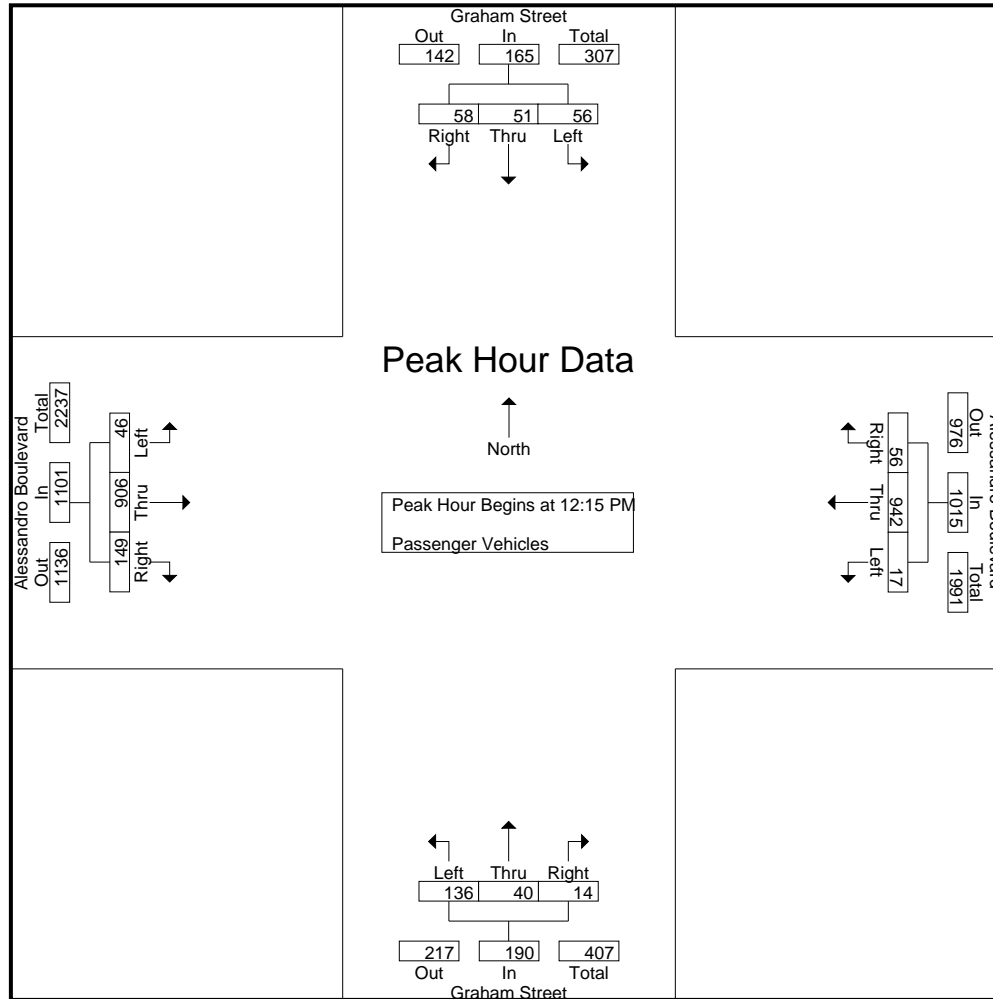

City of Moreno Valley
 N/S: Graham Street
 E/W: Alessandro Boulevard
 Weather: Clear

File Name : 38_MRV_Grah_Ales Sat
 Site Code : 05122815
 Start Date : 9/17/2022
 Page No : 3

Start Time	Graham Street Southbound				Alessandro Boulevard Westbound				Graham Street Northbound				Alessandro Boulevard Eastbound				Int. Total
	Left	Thru	Right	App. Total	Left	Thru	Right	App. Total	Left	Thru	Right	App. Total	Left	Thru	Right	App. Total	
Peak Hour Analysis From 12:15 PM to 01:00 PM - Peak 1 of 1																	
Peak Hour for Each Approach Begins at:																	
	12:15 PM				12:15 PM				12:15 PM				12:15 PM				
+0 mins.	12	13	13	38	2	245	18	265	37	16	1	54	13	232	34	279	
+15 mins.	13	9	18	40	4	217	10	231	37	10	5	52	8	212	43	263	
+30 mins.	19	14	11	44	8	219	12	239	32	9	6	47	12	235	38	285	
+45 mins.	12	15	16	43	3	261	16	280	30	5	2	37	13	227	34	274	
Total Volume	56	51	58	165	17	942	56	1015	136	40	14	190	46	906	149	1101	
% App. Total	33.9	30.9	35.2		1.7	92.8	5.5		71.6	21.1	7.4		4.2	82.3	13.5		
PHF	.737	.850	.806	.938	.531	.902	.778	.906	.919	.625	.583	.880	.885	.964	.866	.966	

City of Moreno Valley
 N/S: Graham Street
 E/W: Alessandro Boulevard
 Weather: Clear

File Name : 38_MRV_Grah_Ales Sat
 Site Code : 05122815
 Start Date : 9/17/2022
 Page No : 1

Groups Printed- Large 2 Axle Vehicles

Start Time	Graham Street Southbound					Alessandro Boulevard Westbound					Graham Street Northbound					Alessandro Boulevard Eastbound					Exclu. Total	Inclu. Total	Int. Total	
	Left	Thru	Right	RTOR	App. Total	Left	Thru	Right	RTOR	App. Total	Left	Thru	Right	RTOR	App. Total	Left	Thru	Right	RTOR	App. Total				
11:00 AM	0	0	0	0	0	0	1	0	0	1	2	0	0	0	2	0	5	0	0	5	0	0	8	8
11:15 AM	0	0	0	0	0	0	0	0	0	0	0	0	0	0	0	0	1	1	0	2	0	2	2	2
11:30 AM	0	0	0	0	0	0	0	0	0	0	0	0	0	0	0	0	1	0	0	1	0	1	1	1
11:45 AM	0	1	0	0	1	0	1	0	0	1	1	0	0	0	1	0	1	0	0	1	0	4	4	4
Total	0	1	0	0	1	0	2	0	0	2	3	0	0	0	3	0	8	1	0	9	0	15	15	15
12:00 PM	0	0	0	0	0	0	4	0	0	4	1	0	0	0	1	0	0	0	0	0	0	5	5	5
12:15 PM	0	0	1	1	1	0	3	0	0	3	0	0	0	0	0	0	1	1	0	2	1	6	7	7
12:30 PM	0	0	1	1	1	0	5	0	0	5	0	0	0	0	0	0	1	0	0	1	1	7	8	8
12:45 PM	0	0	0	0	0	0	2	0	0	2	0	0	0	0	0	0	7	0	0	7	0	9	9	9
Total	0	0	2	2	2	0	14	0	0	14	1	0	0	0	1	0	9	1	0	10	2	27	29	29
01:00 PM	0	0	0	0	0	0	2	0	0	2	1	0	0	0	1	1	2	0	0	3	0	6	6	6
01:15 PM	0	0	0	0	0	0	1	0	0	1	1	0	0	0	1	0	1	1	0	2	0	4	4	4
01:30 PM	0	0	0	0	0	0	3	0	0	3	0	0	0	0	0	0	0	1	0	1	0	4	4	4
01:45 PM	0	0	0	0	0	0	1	0	0	1	0	0	0	0	0	0	3	0	0	3	0	4	4	4
Total	0	0	0	0	0	0	7	0	0	7	2	0	0	0	2	1	6	2	0	9	0	18	18	18
Grand Total	0	1	2	2	3	0	23	0	0	23	6	0	0	0	6	1	23	4	0	28	2	60	62	62
Apprch %	0	33.3	66.7			0	100	0			100	0	0			3.6	82.1	14.3						
Total %	0	1.7	3.3		5	0	38.3	0		38.3	10	0	0		10	1.7	38.3	6.7		46.7	3.2	96.8		

Start Time	Graham Street Southbound				Alessandro Boulevard Westbound				Graham Street Northbound				Alessandro Boulevard Eastbound				Int. Total
	Left	Thru	Right	App. Total	Left	Thru	Right	App. Total	Left	Thru	Right	App. Total	Left	Thru	Right	App. Total	
Peak Hour Analysis From 12:15 PM to 01:00 PM - Peak 1 of 1																	
Peak Hour for Entire Intersection Begins at 12:15 PM																	
12:15 PM	0	0	1	1	0	3	0	3	0	0	0	0	0	1	1	2	6
12:30 PM	0	0	1	1	0	5	0	5	0	0	0	0	0	1	0	1	7
12:45 PM	0	0	0	0	0	2	0	2	0	0	0	0	0	7	0	7	9
01:00 PM	0	0	0	0	0	2	0	2	1	0	0	1	1	2	0	3	6
Total Volume	0	0	2	2	0	12	0	12	1	0	0	1	1	11	1	13	28
% App. Total	0	0	100		0	100	0		100	0	0		7.7	84.6	7.7		
PHF	.000	.000	.500	.500	.000	.600	.000	.600	.250	.000	.000	.250	.250	.393	.250	.464	.778

City of Moreno Valley
 N/S: Graham Street
 E/W: Alessandro Boulevard
 Weather: Clear

File Name : 38_MRV_Grah_Ales Sat
 Site Code : 05122815
 Start Date : 9/17/2022
 Page No : 2

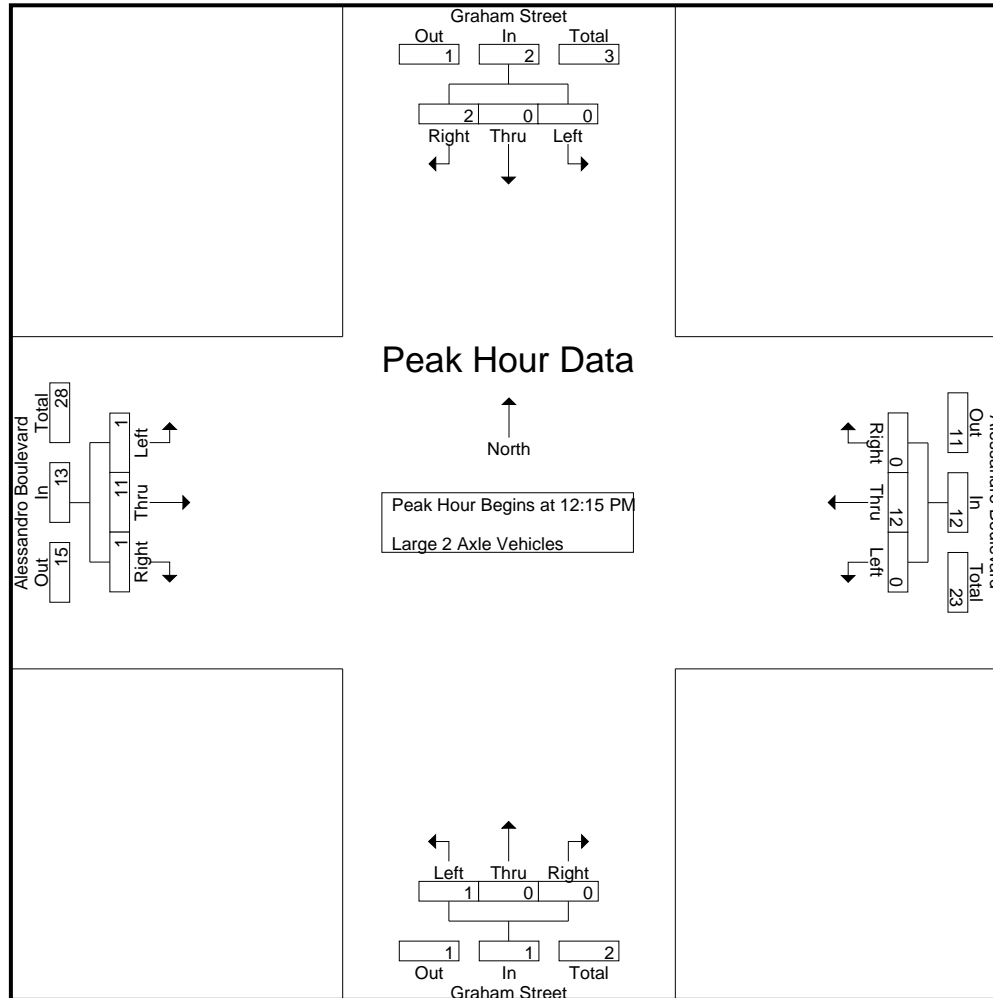

City of Moreno Valley
 N/S: Graham Street
 E/W: Alessandro Boulevard
 Weather: Clear

File Name : 38_MRV_Grah_Ales Sat
 Site Code : 05122815
 Start Date : 9/17/2022
 Page No : 3

Start Time	Graham Street Southbound				Alessandro Boulevard Westbound				Graham Street Northbound				Alessandro Boulevard Eastbound				Int. Total
	Left	Thru	Right	App. Total	Left	Thru	Right	App. Total	Left	Thru	Right	App. Total	Left	Thru	Right	App. Total	
Peak Hour Analysis From 12:15 PM to 01:00 PM - Peak 1 of 1																	
Peak Hour for Each Approach Begins at:																	
	12:15 PM				12:15 PM				12:15 PM				12:15 PM				
+0 mins.	0	0	1	1	0	3	0	3	0	0	0	0	0	1	1	2	
+15 mins.	0	0	1	1	0	5	0	5	0	0	0	0	0	1	0	1	
+30 mins.	0	0	0	0	0	2	0	2	0	0	0	0	0	7	0	7	
+45 mins.	0	0	0	0	0	2	0	2	1	0	0	1	1	2	0	3	
Total Volume	0	0	2	2	0	12	0	12	1	0	0	1	1	11	1	13	
% App. Total	0	0	100		0	100	0		100	0	0		7.7	84.6	7.7		
PHF	.000	.000	.500	.500	.000	.600	.000	.600	.250	.000	.000	.250	.250	.393	.250	.464	

City of Moreno Valley
 N/S: Graham Street
 E/W: Alessandro Boulevard
 Weather: Clear

File Name : 38_MRV_Grah_Ales Sat
 Site Code : 05122815
 Start Date : 9/17/2022
 Page No : 1

Groups Printed- 3 Axle Vehicles

Start Time	Graham Street Southbound					Alessandro Boulevard Westbound					Graham Street Northbound					Alessandro Boulevard Eastbound					Exclu. Total	Inclu. Total	Int. Total	
	Left	Thru	Right	RTOR	App. Total	Left	Thru	Right	RTOR	App. Total	Left	Thru	Right	RTOR	App. Total	Left	Thru	Right	RTOR	App. Total				
11:00 AM	0	0	0	0	0	0	2	0	0	2	0	0	0	0	0	0	2	0	0	2	0	0	4	4
11:15 AM	0	0	0	0	0	0	0	0	0	0	0	0	0	0	0	0	1	0	0	1	0	1	1	1
11:30 AM	0	0	0	0	0	0	2	0	0	2	0	0	0	0	0	0	3	0	0	3	0	5	5	5
11:45 AM	0	0	1	1	1	0	2	0	0	2	0	0	0	0	0	1	4	0	0	5	1	8	9	9
Total	0	0	1	1	1	0	6	0	0	6	0	0	0	0	0	1	10	0	0	11	1	18	19	19
12:00 PM	0	0	0	0	0	0	4	0	0	4	0	0	0	0	0	0	4	0	0	4	0	8	8	8
12:15 PM	0	0	0	0	0	0	4	0	0	4	0	0	0	0	0	0	1	0	0	1	0	5	5	5
12:30 PM	0	0	0	0	0	0	2	0	0	2	0	0	0	0	0	0	0	0	0	0	0	2	2	2
12:45 PM	0	0	0	0	0	0	1	0	0	1	0	0	0	0	0	0	2	0	0	2	0	3	3	3
Total	0	0	0	0	0	0	11	0	0	11	0	0	0	0	0	0	7	0	0	7	0	18	18	18
01:00 PM	0	0	0	0	0	0	0	0	0	0	0	0	0	0	0	0	1	0	0	1	0	1	1	1
01:15 PM	0	0	0	0	0	0	3	0	0	3	0	0	0	0	0	0	1	0	0	1	0	4	4	4
01:30 PM	0	0	0	0	0	0	2	0	0	2	0	0	0	0	0	0	1	0	0	1	0	3	3	3
01:45 PM	0	0	0	0	0	0	2	0	0	2	0	0	0	0	0	0	1	0	0	1	0	3	3	3
Total	0	0	0	0	0	0	7	0	0	7	0	0	0	0	0	0	4	0	0	4	0	11	11	11
Grand Total	0	0	1	1	1	0	24	0	0	24	0	0	0	0	0	1	21	0	0	22	1	47	48	48
Apprch %	0	0	100			0	100	0			0	0	0			4.5	95.5	0						
Total %	0	0	2.1		2.1	0	51.1	0		51.1	0	0	0		0	2.1	44.7	0		46.8	2.1	97.9		

Start Time	Graham Street Southbound				Alessandro Boulevard Westbound				Graham Street Northbound				Alessandro Boulevard Eastbound				Int. Total
	Left	Thru	Right	App. Total	Left	Thru	Right	App. Total	Left	Thru	Right	App. Total	Left	Thru	Right	App. Total	
Peak Hour Analysis From 12:15 PM to 01:00 PM - Peak 1 of 1																	
Peak Hour for Entire Intersection Begins at 12:15 PM																	
12:15 PM	0	0	0	0	0	4	0	4	0	0	0	0	0	1	0	1	5
12:30 PM	0	0	0	0	0	2	0	2	0	0	0	0	0	0	0	0	2
12:45 PM	0	0	0	0	0	1	0	1	0	0	0	0	0	2	0	2	3
01:00 PM	0	0	0	0	0	0	0	0	0	0	0	0	0	1	0	1	1
Total Volume	0	0	0	0	0	7	0	7	0	0	0	0	0	4	0	4	11
% App. Total	0	0	0		0	100	0		0	0	0		0	100	0		
PHF	.000	.000	.000	.000	.000	.438	.000	.438	.000	.000	.000	.000	.000	.500	.000	.500	.550

City of Moreno Valley
 N/S: Graham Street
 E/W: Alessandro Boulevard
 Weather: Clear

File Name : 38_MRV_Grah_Ales Sat
 Site Code : 05122815
 Start Date : 9/17/2022
 Page No : 2

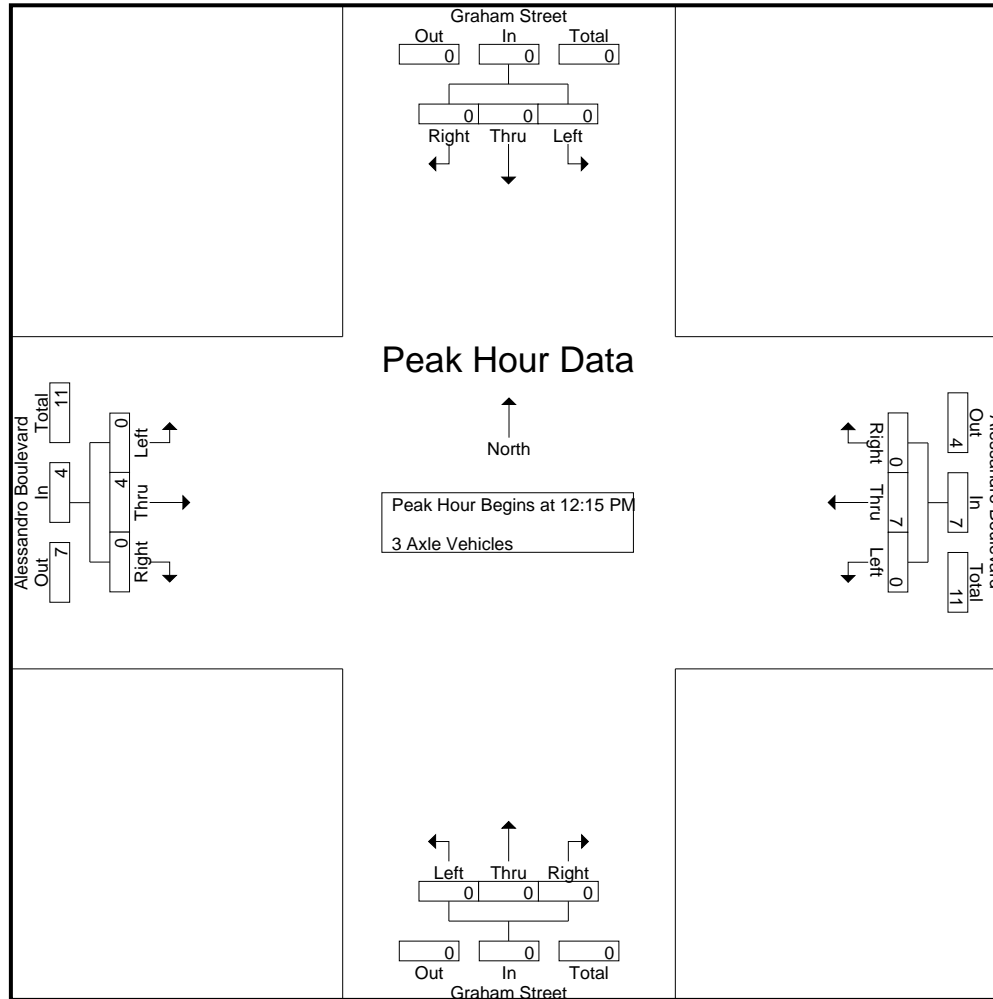

City of Moreno Valley
 N/S: Graham Street
 E/W: Alessandro Boulevard
 Weather: Clear

File Name : 38_MRV_Grah_Ales Sat
 Site Code : 05122815
 Start Date : 9/17/2022
 Page No : 3

Start Time	Graham Street Southbound				Alessandro Boulevard Westbound				Graham Street Northbound				Alessandro Boulevard Eastbound				Int. Total
	Left	Thru	Right	App. Total	Left	Thru	Right	App. Total	Left	Thru	Right	App. Total	Left	Thru	Right	App. Total	
Peak Hour Analysis From 12:15 PM to 01:00 PM - Peak 1 of 1																	
Peak Hour for Each Approach Begins at:																	
	12:15 PM				12:15 PM				12:15 PM				12:15 PM				
+0 mins.	0	0	0	0	0	4	0	4	0	0	0	0	0	1	0	1	
+15 mins.	0	0	0	0	0	2	0	2	0	0	0	0	0	0	0	0	
+30 mins.	0	0	0	0	0	1	0	1	0	0	0	0	0	2	0	2	
+45 mins.	0	0	0	0	0	0	0	0	0	0	0	0	0	1	0	1	
Total Volume	0	0	0	0	0	7	0	7	0	0	0	0	0	4	0	4	
% App. Total	0	0	0	0	0	100	0	0	0	0	0	0	0	100	0	0	
PHF	.000	.000	.000	.000	.000	.438	.000	.438	.000	.000	.000	.000	.000	.500	.000	.500	

City of Moreno Valley
 N/S: Graham Street
 E/W: Alessandro Boulevard
 Weather: Clear

File Name : 38_MRV_Grah_Ales Sat
 Site Code : 05122815
 Start Date : 9/17/2022
 Page No : 1

Groups Printed- 4+ Axle Trucks

Start Time	Graham Street Southbound					Alessandro Boulevard Westbound					Graham Street Northbound					Alessandro Boulevard Eastbound					Exclu. Total	Inclu. Total	Int. Total
	Left	Thru	Right	RTOR	App. Total	Left	Thru	Right	RTOR	App. Total	Left	Thru	Right	RTOR	App. Total	Left	Thru	Right	RTOR	App. Total			
11:00 AM	0	0	1	1	1	0	1	1	0	2	0	0	0	0	0	0	2	0	0	2	1	5	6
11:15 AM	0	0	0	0	0	0	3	0	0	3	0	0	0	0	0	0	7	0	0	7	0	10	10
11:30 AM	0	0	0	0	0	0	7	0	0	7	0	0	0	0	0	0	6	0	0	6	0	13	13
11:45 AM	0	0	0	0	0	0	2	0	0	2	0	0	0	0	0	0	7	0	0	7	0	9	9
Total	0	0	1	1	1	0	13	1	0	14	0	0	0	0	0	0	22	0	0	22	1	37	38
12:00 PM	0	0	1	0	1	0	2	0	0	2	0	0	0	0	0	0	11	0	0	11	0	14	14
12:15 PM	0	0	1	0	1	0	4	0	0	4	0	0	0	0	0	1	5	0	0	6	0	11	11
12:30 PM	0	0	0	0	0	0	4	0	0	4	0	0	0	0	0	0	2	1	0	3	0	7	7
12:45 PM	0	0	0	0	0	0	2	0	0	2	0	0	0	0	0	0	6	0	0	6	0	8	8
Total	0	0	2	0	2	0	12	0	0	12	0	0	0	0	0	1	24	1	0	26	0	40	40
01:00 PM	0	0	0	0	0	0	4	0	0	4	0	0	0	0	0	1	5	0	0	6	0	10	10
01:15 PM	0	0	0	0	0	0	7	0	0	7	0	0	0	0	0	0	2	0	0	2	0	9	9
01:30 PM	0	0	0	0	0	0	6	0	0	6	0	0	0	0	0	1	4	0	0	5	0	11	11
01:45 PM	0	0	0	0	0	0	3	0	0	3	0	0	0	0	0	0	4	0	0	4	0	7	7
Total	0	0	0	0	0	0	20	0	0	20	0	0	0	0	0	2	15	0	0	17	0	37	37
Grand Total	0	0	3	1	3	0	45	1	0	46	0	0	0	0	0	3	61	1	0	65	1	114	115
Apprch %	0	0	100			0	97.8	2.2			0	0	0			4.6	93.8	1.5					
Total %	0	0	2.6		2.6	0	39.5	0.9		40.4	0	0	0		0	2.6	53.5	0.9		57	0.9	99.1	

Start Time	Graham Street Southbound				Alessandro Boulevard Westbound				Graham Street Northbound				Alessandro Boulevard Eastbound				Int. Total
	Left	Thru	Right	App. Total	Left	Thru	Right	App. Total	Left	Thru	Right	App. Total	Left	Thru	Right	App. Total	
Peak Hour Analysis From 12:15 PM to 01:00 PM - Peak 1 of 1																	
Peak Hour for Entire Intersection Begins at 12:15 PM																	
12:15 PM	0	0	1	1	0	4	0	4	0	0	0	0	1	5	0	6	11
12:30 PM	0	0	0	0	0	4	0	4	0	0	0	0	0	2	1	3	7
12:45 PM	0	0	0	0	0	2	0	2	0	0	0	0	0	6	0	6	8
01:00 PM	0	0	0	0	0	4	0	4	0	0	0	0	1	5	0	6	10
Total Volume	0	0	1	1	0	14	0	14	0	0	0	0	2	18	1	21	36
% App. Total	0	0	100		0	100	0		0	0	0		9.5	85.7	4.8		
PHF	.000	.000	.250	.250	.000	.875	.000	.875	.000	.000	.000	.000	.500	.750	.250	.875	.818

City of Moreno Valley
 N/S: Graham Street
 E/W: Alessandro Boulevard
 Weather: Clear

File Name : 38_MRV_Grah_Ales Sat
 Site Code : 05122815
 Start Date : 9/17/2022
 Page No : 2

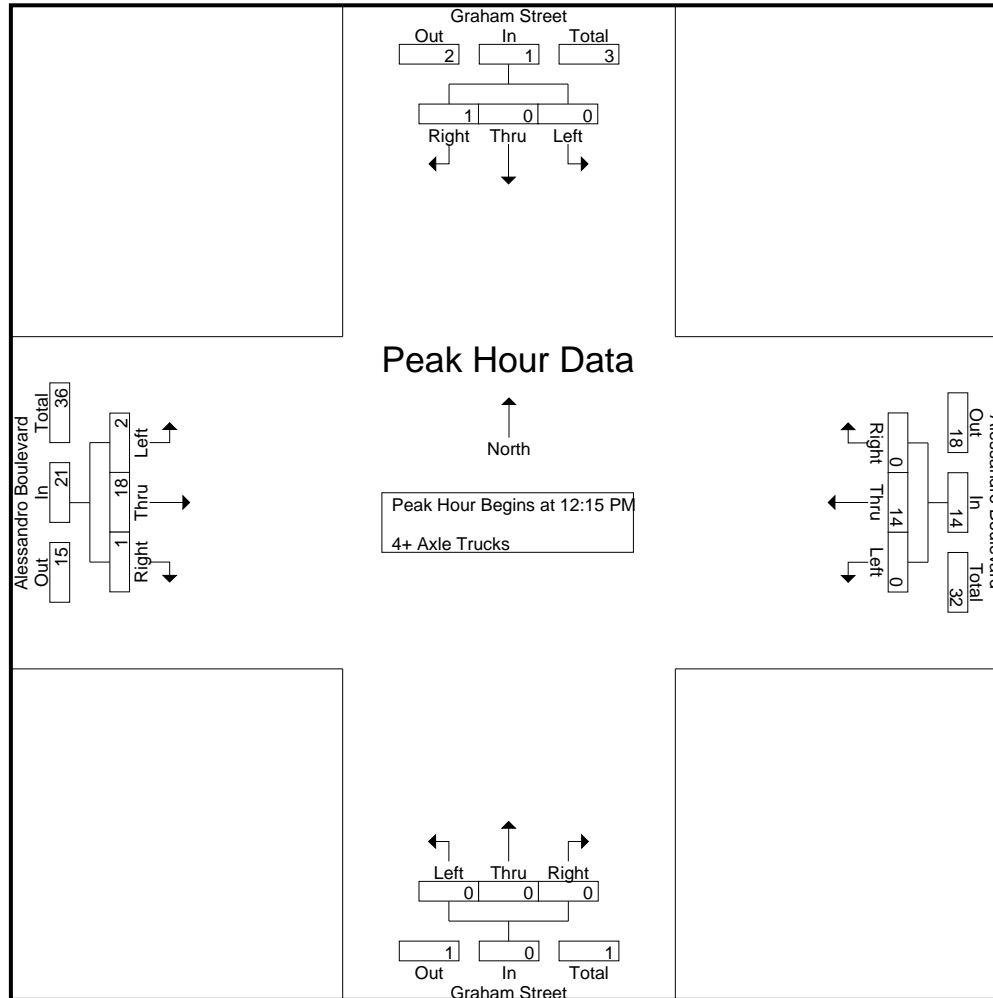

City of Moreno Valley
 N/S: Graham Street
 E/W: Alessandro Boulevard
 Weather: Clear

File Name : 38_MRV_Grah_Ales Sat
 Site Code : 05122815
 Start Date : 9/17/2022
 Page No : 3

Start Time	Graham Street Southbound				Alessandro Boulevard Westbound				Graham Street Northbound				Alessandro Boulevard Eastbound				Int. Total
	Left	Thru	Right	App. Total	Left	Thru	Right	App. Total	Left	Thru	Right	App. Total	Left	Thru	Right	App. Total	
Peak Hour Analysis From 12:15 PM to 01:00 PM - Peak 1 of 1																	
Peak Hour for Each Approach Begins at:																	
	12:15 PM				12:15 PM				12:15 PM				12:15 PM				
+0 mins.	0	0	1	1	0	4	0	4	0	0	0	0	1	5	0	6	
+15 mins.	0	0	0	0	0	4	0	4	0	0	0	0	0	2	1	3	
+30 mins.	0	0	0	0	0	2	0	2	0	0	0	0	0	6	0	6	
+45 mins.	0	0	0	0	0	4	0	4	0	0	0	0	1	5	0	6	
Total Volume	0	0	1	1	0	14	0	14	0	0	0	0	2	18	1	21	
% App. Total	0	0	100		0	100	0		0	0	0		9.5	85.7	4.8		
PHF	.000	.000	.250	.250	.000	.875	.000	.875	.000	.000	.000	.000	.500	.750	.250	.875	

Location: Moreno Valley
 N/S: Graham Street
 E/W: Alessandro Boulevard



Date: 9/17/2022
 Day Saturday

PEDESTRIANS

Time	North Leg Graham Street	East Leg Alessandro Boulevard	South Leg Graham Street	West Leg Alessandro Boulevard	TOTAL
11:00 AM	1	0	0	0	1
11:15 AM	0	0	0	0	0
11:30 AM	0	0	0	0	0
11:45 AM	0	0	0	0	0
12:00 PM	0	0	0	0	0
12:15 PM	0	0	0	0	0
12:30 PM	0	0	0	0	0
12:45 PM	0	0	0	0	0
1:00 PM	0	0	0	0	0
1:15 PM	0	0	0	0	0
1:30 PM	1	1	0	0	2
1:45 PM	0	0	0	0	0
TOTAL VOLUMES:	2	1	0	0	3

Location: Moreno Valley
 N/S: Graham Street
 E/W: Alessandro Boulevard

Date: 9/17/2022
 Day: Saturday



BICYCLES

	Southbound Graham Street			Westbound Alessandro Boulevard			Northbound Graham Street			Eastbound Alessandro Boulevard			
	Left	Thru	Right	Left	Thru	Right	Left	Thru	Right	Left	Thru	Right	
11:00 AM	0	0	0	0	1	0	0	0	0	0	0	0	1
11:15 AM	0	0	0	0	0	0	0	0	0	0	0	0	0
11:30 AM	0	0	0	0	0	0	0	0	0	0	0	0	0
11:45 AM	0	0	0	0	0	0	0	0	0	0	0	0	0
12:00 PM	0	0	0	0	0	0	0	0	0	0	0	0	0
12:15 PM	0	0	0	0	0	0	0	0	0	0	0	0	0
12:30 PM	0	0	0	0	0	0	0	0	0	0	0	0	0
12:45 PM	0	0	0	0	0	0	0	1	0	0	0	0	1
1:00 PM	0	0	0	0	0	0	0	0	0	0	0	0	0
1:15 PM	0	0	0	0	0	0	0	0	0	0	0	0	0
1:30 PM	0	0	0	0	0	0	0	0	0	0	1	0	1
1:45 PM	0	0	0	0	1	0	0	0	0	0	0	0	1
TOTAL VOLUMES:	0	0	0	0	2	0	0	1	0	0	1	0	4

This Page Intentionally Left Blank

APPENDIX 3.2:

EXISTING (2021) CONDITIONS INTERSECTION OPERATIONS ANALYSIS WORKSHEETS

This Page Intentionally Left Blank

Timings
1: Washington St & Van Buren Bl.

West Campus Upper Plateau (JN 14064)

02/16/2022



Lane Group	EBL	EBT	WBL	WBT	WBR	NBL	NBT	NBR	SBL	SBT
Lane Configurations	↙	↕↗	↙	↕↗	↗	↙↗	↕↗	↗	↙↗	↕↗
Traffic Volume (vph)	131	985	91	1293	568	136	509	116	315	176
Future Volume (vph)	131	985	91	1293	568	136	509	116	315	176
Turn Type	Prot	NA	Prot	NA	Perm	Prot	NA	Perm	Prot	NA
Protected Phases	5	2	1	6		3	8		7	4
Permitted Phases					6			8		
Detector Phase	5	2	1	6	6	3	8	8	7	4
Switch Phase										
Minimum Initial (s)	5.0	10.0	5.0	10.0	10.0	5.0	10.0	10.0	5.0	10.0
Minimum Split (s)	9.2	34.2	9.2	33.2	33.2	9.2	38.4	38.4	9.2	30.8
Total Split (s)	14.0	53.1	12.3	51.4	51.4	14.2	38.4	38.4	16.2	40.4
Total Split (%)	11.7%	44.3%	10.3%	42.8%	42.8%	11.8%	32.0%	32.0%	13.5%	33.7%
Yellow Time (s)	3.2	5.2	3.2	5.2	5.2	3.2	4.4	4.4	3.2	4.8
All-Red Time (s)	1.0	1.0	1.0	1.0	1.0	1.0	1.0	1.0	1.0	1.0
Lost Time Adjust (s)	0.0	0.0	0.0	0.0	0.0	0.0	0.0	0.0	0.0	0.0
Total Lost Time (s)	4.2	6.2	4.2	6.2	6.2	4.2	5.4	5.4	4.2	5.8
Lead/Lag	Lead	Lag	Lead	Lag	Lag	Lead	Lag	Lag	Lead	Lag
Lead-Lag Optimize?	Yes	Yes	Yes	Yes	Yes	Yes	Yes	Yes	Yes	Yes
Recall Mode	None	None	None	None	None	None	None	None	None	None
Act Effct Green (s)	9.8	47.2	7.9	45.3	45.3	8.6	23.3	23.3	12.0	26.3
Actuated g/C Ratio	0.09	0.43	0.07	0.41	0.41	0.08	0.21	0.21	0.11	0.24
v/c Ratio	0.87	0.79	0.77	0.94	0.74	0.55	0.71	0.29	0.89	0.31
Control Delay	95.1	32.6	88.0	45.3	21.2	58.5	45.9	8.0	75.4	29.4
Queue Delay	0.0	0.0	0.0	0.0	0.0	0.0	0.0	0.0	0.0	0.0
Total Delay	95.1	32.6	88.0	45.3	21.2	58.5	45.9	8.0	75.4	29.4
LOS	F	C	F	D	C	E	D	A	E	C
Approach Delay		39.2		40.3			42.4			55.6
Approach LOS		D		D			D			E

Intersection Summary

Cycle Length: 120
 Actuated Cycle Length: 110.5
 Natural Cycle: 125
 Control Type: Actuated-Uncoordinated
 Maximum v/c Ratio: 0.94
 Intersection Signal Delay: 42.2
 Intersection LOS: D
 Intersection Capacity Utilization 83.9%
 ICU Level of Service E
 Analysis Period (min) 15

Splits and Phases: 1: Washington St & Van Buren Bl.

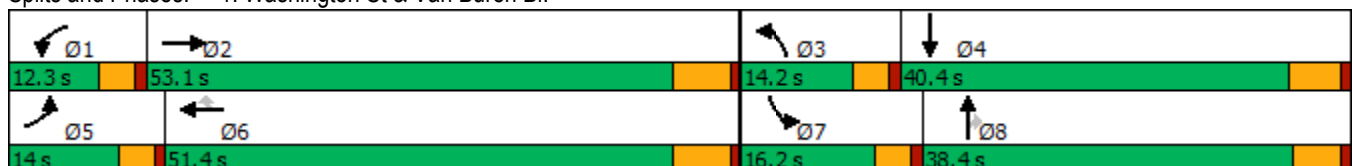

HCM 6th Signalized Intersection Summary
1: Washington St & Van Buren Bl.

West Campus Upper Plateau (JN 14064)

02/16/2022

Movement	EBL	EBT	EBR	WBL	WBT	WBR	NBL	NBT	NBR	SBL	SBT	SBR
Lane Configurations												
Traffic Volume (veh/h)	131	985	120	91	1293	568	136	509	116	315	176	62
Future Volume (veh/h)	131	985	120	91	1293	568	136	509	116	315	176	62
Initial Q (Qb), veh	0	0	0	0	0	0	0	0	0	0	0	0
Ped-Bike Adj(A_pbT)	1.00		0.99	1.00		0.98	1.00		1.00	1.00		1.00
Parking Bus, Adj	1.00	1.00	1.00	1.00	1.00	1.00	1.00	1.00	1.00	1.00	1.00	1.00
Work Zone On Approach		No			No			No			No	
Adj Sat Flow, veh/h/ln	1870	1841	1856	1841	1856	1870	1811	1870	1841	1856	1796	1811
Adj Flow Rate, veh/h	136	1026	102	95	1347	428	142	530	55	328	183	36
Peak Hour Factor	0.96	0.96	0.96	0.96	0.96	0.96	0.96	0.96	0.96	0.96	0.96	0.96
Percent Heavy Veh, %	2	4	3	4	3	2	6	2	4	3	7	6
Cap, veh/h	161	1397	139	119	1455	643	201	703	307	380	709	137
Arrive On Green	0.09	0.44	0.44	0.07	0.41	0.41	0.06	0.20	0.20	0.11	0.25	0.25
Sat Flow, veh/h	1781	3208	319	1753	3526	1557	3346	3554	1553	3428	2853	550
Grp Volume(v), veh/h	136	559	569	95	1347	428	142	530	55	328	108	111
Grp Sat Flow(s),veh/h/ln	1781	1749	1779	1753	1763	1557	1673	1777	1553	1714	1706	1696
Q Serve(g_s), s	8.1	28.7	28.8	5.8	39.3	24.1	4.5	15.2	3.2	10.2	5.5	5.7
Cycle Q Clear(g_c), s	8.1	28.7	28.8	5.8	39.3	24.1	4.5	15.2	3.2	10.2	5.5	5.7
Prop In Lane	1.00		0.18	1.00		1.00	1.00		1.00	1.00		0.32
Lane Grp Cap(c), veh/h	161	761	774	119	1455	643	201	703	307	380	424	422
V/C Ratio(X)	0.84	0.73	0.73	0.80	0.93	0.67	0.71	0.75	0.18	0.86	0.25	0.26
Avail Cap(c_a), veh/h	161	761	774	131	1471	650	309	1083	473	380	545	542
HCM Platoon Ratio	1.00	1.00	1.00	1.00	1.00	1.00	1.00	1.00	1.00	1.00	1.00	1.00
Upstream Filter(I)	1.00	1.00	1.00	1.00	1.00	1.00	1.00	1.00	1.00	1.00	1.00	1.00
Uniform Delay (d), s/veh	48.5	25.4	25.4	49.8	30.2	25.8	50.0	41.0	36.1	47.3	32.6	32.7
Incr Delay (d2), s/veh	30.1	4.0	3.9	23.6	10.4	2.9	1.7	1.7	0.3	17.5	0.3	0.3
Initial Q Delay(d3),s/veh	0.0	0.0	0.0	0.0	0.0	0.0	0.0	0.0	0.0	0.0	0.0	0.0
%ile BackOfQ(50%),veh/ln	4.8	11.7	11.9	3.2	17.2	9.4	1.9	6.8	1.2	5.2	2.3	2.4
Unsig. Movement Delay, s/veh												
LnGrp Delay(d),s/veh	78.6	29.4	29.3	73.4	40.6	28.7	51.7	42.6	36.4	64.8	33.0	33.0
LnGrp LOS	E	C	C	E	D	C	D	D	D	E	C	C
Approach Vol, veh/h		1264			1870			727			547	
Approach Delay, s/veh		34.7			39.6			43.9			52.1	
Approach LOS		C			D			D			D	
Timer - Assigned Phs	1	2	3	4	5	6	7	8				
Phs Duration (G+Y+Rc), s	11.5	53.3	10.7	32.7	14.0	50.9	16.2	27.2				
Change Period (Y+Rc), s	* 4.2	6.2	* 4.2	5.8	* 4.2	6.2	* 4.2	* 5.8				
Max Green Setting (Gmax), s	* 8.1	46.9	* 10	34.6	* 9.8	45.2	* 12	* 33				
Max Q Clear Time (g_c+I1), s	7.8	30.8	6.5	7.7	10.1	41.3	12.2	17.2				
Green Ext Time (p_c), s	0.0	8.2	0.1	1.3	0.0	3.4	0.0	3.5				

Intersection Summary

HCM 6th Ctrl Delay	40.4
HCM 6th LOS	D

Notes

* HCM 6th computational engine requires equal clearance times for the phases crossing the barrier.

Timings
2: Central Ave & Arlington Ave/Chicago Ave

West Campus Upper Plateau (JN 14064)

02/16/2022



Lane Group	EBL	EBT	EBR	WBL	WBT	WBR	NBL	NBT	NBR	SBL	SBT
Lane Configurations	↘	↑↑	↗↗	↘↘	↑↑	↗	↘↘	↑↑	↗	↘↘	↑↑↗
Traffic Volume (vph)	41	491	595	182	812	322	1225	1522	448	225	598
Future Volume (vph)	41	491	595	182	812	322	1225	1522	448	225	598
Turn Type	Prot	NA	pm+ov	Prot	NA	pm+ov	Prot	NA	pm+ov	Prot	NA
Protected Phases	7	4	5	3	8	1	5	2	3	1	6
Permitted Phases			4			8			2		
Detector Phase	7	4	5	3	8	1	5	2	3	1	6
Switch Phase											
Minimum Initial (s)	5.0	10.0	10.0	5.0	10.0	10.0	10.0	10.0	5.0	10.0	10.0
Minimum Split (s)	9.6	35.2	15.8	9.6	38.8	15.8	15.8	38.8	9.6	15.8	38.8
Total Split (s)	9.6	35.6	42.0	12.8	38.8	15.9	42.0	65.7	12.8	15.9	39.6
Total Split (%)	7.4%	27.4%	32.3%	9.8%	29.8%	12.2%	32.3%	50.5%	9.8%	12.2%	30.5%
Yellow Time (s)	3.6	4.8	3.6	3.6	4.8	3.6	3.6	4.4	3.6	3.6	4.4
All-Red Time (s)	1.0	1.0	1.0	1.0	1.0	1.0	1.0	1.0	1.0	1.0	1.0
Lost Time Adjust (s)	0.0	0.0	0.0	0.0	0.0	0.0	0.0	0.0	0.0	0.0	0.0
Total Lost Time (s)	4.6	5.8	4.6	4.6	5.8	4.6	4.6	5.4	4.6	4.6	5.4
Lead/Lag	Lead	Lag	Lead	Lead	Lag	Lead	Lead	Lag	Lead	Lead	Lag
Lead-Lag Optimize?	Yes	Yes	Yes	Yes	Yes	Yes	Yes	Yes	Yes	Yes	Yes
Recall Mode	None	None	None	None	None	None	None	None	None	None	None
Act Effct Green (s)	5.0	27.2	70.5	8.2	32.5	49.5	37.5	59.9	68.9	11.2	33.5
Actuated g/C Ratio	0.04	0.21	0.56	0.06	0.26	0.39	0.30	0.47	0.54	0.09	0.26
v/c Ratio	0.62	0.70	0.40	0.94	0.94	0.50	1.27	0.96	0.54	0.80	0.51
Control Delay	96.5	51.4	15.0	109.2	65.8	23.9	167.8	47.4	16.9	77.5	41.2
Queue Delay	0.0	0.0	0.0	0.0	0.0	0.0	0.0	0.0	0.0	0.0	0.0
Total Delay	96.5	51.4	15.0	109.2	65.8	23.9	167.8	47.4	16.9	77.5	41.2
LOS	F	D	B	F	E	C	F	D	B	E	D
Approach Delay		33.8			61.6			89.2			50.6
Approach LOS		C			E			F			D

Intersection Summary

Cycle Length: 130
 Actuated Cycle Length: 126.9
 Natural Cycle: 125
 Control Type: Actuated-Uncoordinated
 Maximum v/c Ratio: 1.27
 Intersection Signal Delay: 68.9
 Intersection LOS: E
 Intersection Capacity Utilization 94.0%
 ICU Level of Service F
 Analysis Period (min) 15

Splits and Phases: 2: Central Ave & Arlington Ave/Chicago Ave



HCM 6th Signalized Intersection Summary
2: Central Ave & Arlington Ave/Chicago Ave

West Campus Upper Plateau (JN 14064)

02/16/2022



Movement	EBL	EBT	EBR	WBL	WBT	WBR	NBL	NBT	NBR	SBL	SBT	SBR
Lane Configurations	↘	↑↑	↗↗	↘↘	↑↑	↗	↘↘	↑↑	↗	↘↘	↑↑↑	
Traffic Volume (veh/h)	41	491	595	182	812	322	1225	1522	448	225	598	42
Future Volume (veh/h)	41	491	595	182	812	322	1225	1522	448	225	598	42
Initial Q (Qb), veh	0	0	0	0	0	0	0	0	0	0	0	0
Ped-Bike Adj(A_pbT)	1.00		1.00	1.00		1.00	1.00		0.99	1.00		1.00
Parking Bus, Adj	1.00	1.00	1.00	1.00	1.00	1.00	1.00	1.00	1.00	1.00	1.00	1.00
Work Zone On Approach		No			No			No			No	
Adj Sat Flow, veh/h/ln	1900	1856	1870	1752	1885	1885	1885	1885	1885	1856	1856	1856
Adj Flow Rate, veh/h	44	522	376	194	864	261	1303	1619	308	239	636	35
Peak Hour Factor	0.94	0.94	0.94	0.94	0.94	0.94	0.94	0.94	0.94	0.94	0.94	0.94
Percent Heavy Veh, %	0	3	2	10	1	1	1	1	1	3	3	3
Cap, veh/h	57	787	1438	207	916	544	1018	1679	842	290	1284	70
Arrive On Green	0.03	0.22	0.22	0.06	0.26	0.26	0.29	0.47	0.47	0.08	0.26	0.26
Sat Flow, veh/h	1810	3526	2790	3237	3582	1598	3483	3582	1577	3428	4915	269
Grp Volume(v), veh/h	44	522	376	194	864	261	1303	1619	308	239	436	235
Grp Sat Flow(s),veh/h/ln	1810	1763	1395	1618	1791	1598	1742	1791	1577	1714	1689	1807
Q Serve(g_s), s	3.1	17.3	9.7	7.6	30.3	16.5	37.4	56.1	14.5	8.8	14.0	14.1
Cycle Q Clear(g_c), s	3.1	17.3	9.7	7.6	30.3	16.5	37.4	56.1	14.5	8.8	14.0	14.1
Prop In Lane	1.00		1.00	1.00		1.00	1.00		1.00	1.00		0.15
Lane Grp Cap(c), veh/h	57	787	1438	207	916	544	1018	1679	842	290	882	472
V/C Ratio(X)	0.77	0.66	0.26	0.94	0.94	0.48	1.28	0.96	0.37	0.82	0.49	0.50
Avail Cap(c_a), veh/h	71	821	1464	207	923	547	1018	1687	845	303	902	483
HCM Platoon Ratio	1.00	1.00	1.00	1.00	1.00	1.00	1.00	1.00	1.00	1.00	1.00	1.00
Upstream Filter(I)	1.00	1.00	1.00	1.00	1.00	1.00	1.00	1.00	1.00	1.00	1.00	1.00
Uniform Delay (d), s/veh	61.5	45.3	17.4	59.6	46.7	33.3	45.3	33.0	17.4	57.7	40.1	40.2
Incr Delay (d2), s/veh	26.2	1.9	0.1	44.1	17.4	0.7	133.8	14.3	0.3	16.2	0.4	0.8
Initial Q Delay(d3),s/veh	0.0	0.0	0.0	0.0	0.0	0.0	0.0	0.0	0.0	0.0	0.0	0.0
%ile BackOfQ(50%),veh/ln	1.8	7.6	3.0	4.3	15.2	6.3	34.6	26.3	5.1	4.4	5.8	6.3
Unsig. Movement Delay, s/veh												
LnGrp Delay(d),s/veh	87.8	47.2	17.5	103.8	64.1	33.9	179.1	47.3	17.6	73.9	40.5	41.0
LnGrp LOS	F	D	B	F	E	C	F	D	B	E	D	D
Approach Vol, veh/h		942			1319			3230			910	
Approach Delay, s/veh		37.3			64.0			97.6			49.4	
Approach LOS		D			E			F			D	
Timer - Assigned Phs	1	2	3	4	5	6	7	8				
Phs Duration (G+Y+Rc), s	15.4	65.4	12.8	34.4	42.0	38.8	8.6	38.5				
Change Period (Y+Rc), s	4.6	5.4	4.6	5.8	4.6	5.4	4.6	5.8				
Max Green Setting (Gmax), s	11.3	60.3	8.2	29.8	37.4	34.2	5.0	33.0				
Max Q Clear Time (g_c+I1), s	10.8	58.1	9.6	19.3	39.4	16.1	5.1	32.3				
Green Ext Time (p_c), s	0.0	1.9	0.0	3.5	0.0	3.8	0.0	0.5				

Intersection Summary

HCM 6th Ctrl Delay	75.0
HCM 6th LOS	E

Timings

3: Overlook Pkwy./Canyon Crest Dr. & Alessandro Bl/Alessandro Bl.



Lane Group	EBL	EBT	WBL	WBT	WBR	NBL	NBT	NBR	SBL	SBT	SBR
Lane Configurations											
Traffic Volume (vph)	38	1313	2	3114	1016	5	10	2	449	6	49
Future Volume (vph)	38	1313	2	3114	1016	5	10	2	449	6	49
Turn Type	Prot	NA	Prot	NA	pm+ov	Split	NA	Perm	Split	NA	Perm
Protected Phases	5	2	1	6	4	8	8		4	4	
Permitted Phases					6			8			4
Detector Phase	5	2	1	6	4	8	8	8	4	4	4
Switch Phase											
Minimum Initial (s)	5.0	10.0	5.0	10.0	10.0	10.0	10.0	10.0	10.0	10.0	10.0
Minimum Split (s)	9.2	35.2	9.2	35.2	38.8	15.8	15.8	15.8	38.8	38.8	38.8
Total Split (s)	9.2	66.2	9.2	66.2	38.8	15.8	15.8	15.8	38.8	38.8	38.8
Total Split (%)	7.1%	50.9%	7.1%	50.9%	29.8%	12.2%	12.2%	12.2%	29.8%	29.8%	29.8%
Yellow Time (s)	3.2	5.2	3.2	5.2	4.8	4.8	4.8	4.8	4.8	4.8	4.8
All-Red Time (s)	1.0	1.0	1.0	1.0	1.0	1.0	1.0	1.0	1.0	1.0	1.0
Lost Time Adjust (s)	0.0	0.0	0.0	0.0	0.0	0.0	0.0	0.0	0.0	0.0	0.0
Total Lost Time (s)	4.2	6.2	4.2	6.2	5.8	5.8	5.8	5.8	5.8	5.8	5.8
Lead/Lag	Lead	Lag	Lead	Lag							
Lead-Lag Optimize?	Yes	Yes	Yes	Yes							
Recall Mode	None	None	None	None	None	None	None	None	None	None	None
Act Effct Green (s)	5.1	67.0	5.1	61.5	93.4	10.2	10.2	10.2	24.1	24.1	24.1
Actuated g/C Ratio	0.05	0.61	0.05	0.56	0.85	0.09	0.09	0.09	0.22	0.22	0.22
v/c Ratio	0.54	0.45	0.02	1.15	0.73	0.03	0.03	0.01	0.46	0.47	0.12
Control Delay	82.7	15.1	59.5	96.0	5.3	54.2	53.4	0.0	40.3	43.3	0.6
Queue Delay	0.0	0.0	0.0	0.0	0.0	0.0	0.0	0.0	0.0	0.0	0.0
Total Delay	82.7	15.1	59.5	96.0	5.3	54.2	53.4	0.0	40.3	43.3	0.6
LOS	F	B	E	F	A	D	D	A	D	D	A
Approach Delay		17.0		73.7			47.7			37.3	
Approach LOS		B		E			D			D	

Intersection Summary

Cycle Length: 130
 Actuated Cycle Length: 110.3
 Natural Cycle: 130
 Control Type: Actuated-Uncoordinated
 Maximum v/c Ratio: 1.15
 Intersection Signal Delay: 57.8
 Intersection LOS: E
 Intersection Capacity Utilization 91.7%
 ICU Level of Service F
 Analysis Period (min) 15

Splits and Phases: 3: Overlook Pkwy./Canyon Crest Dr. & Alessandro Bl/Alessandro Bl.

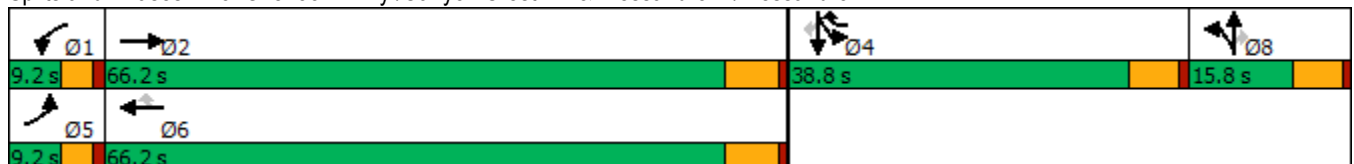

HCM 6th Signalized Intersection Summary

West Campus Upper Plateau (JN 14064)

3: Overlook Pkwy./Canyon Crest Dr. & Alessandro Bl/Alessandro Bl.

02/16/2022



Movement	EBL	EBT	EBR	WBL	WBT	WBR	NBL	NBT	NBR	SBL	SBT	SBR
Lane Configurations	↖	↑↑↑		↖	↑↑↑	↖	↖	↑↑	↖	↖↖	↖	↖
Traffic Volume (veh/h)	38	1313	1	2	3114	1016	5	10	2	449	6	49
Future Volume (veh/h)	38	1313	1	2	3114	1016	5	10	2	449	6	49
Initial Q (Qb), veh	0	0	0	0	0	0	0	0	0	0	0	0
Ped-Bike Adj(A_pbT)	1.00		1.00	1.00		1.00	1.00		1.00	1.00		1.00
Parking Bus, Adj	1.00	1.00	1.00	1.00	1.00	1.00	1.00	1.00	1.00	1.00	1.00	1.00
Work Zone On Approach		No			No			No			No	
Adj Sat Flow, veh/h/ln	1722	1856	1900	1900	1885	1885	1900	1900	1900	1856	1604	1870
Adj Flow Rate, veh/h	40	1382	1	2	3278	906	5	11	0	477	0	35
Peak Hour Factor	0.95	0.95	0.95	0.95	0.95	0.95	0.95	0.95	0.95	0.95	0.95	0.95
Percent Heavy Veh, %	12	3	0	0	1	1	0	0	0	3	20	2
Cap, veh/h	55	3247	2	5	3038	1141	65	129	58	658	0	197
Arrive On Green	0.03	0.62	0.62	0.00	0.59	0.59	0.04	0.04	0.00	0.12	0.00	0.12
Sat Flow, veh/h	1640	5228	4	1810	5147	1598	1810	3610	1610	5302	0	1585
Grp Volume(v), veh/h	40	893	490	2	3278	906	5	11	0	477	0	35
Grp Sat Flow(s),veh/h/ln	1640	1689	1855	1810	1716	1598	1810	1805	1610	1767	0	1585
Q Serve(g_s), s	2.5	13.8	13.8	0.1	60.0	38.0	0.3	0.3	0.0	8.8	0.0	2.0
Cycle Q Clear(g_c), s	2.5	13.8	13.8	0.1	60.0	38.0	0.3	0.3	0.0	8.8	0.0	2.0
Prop In Lane	1.00		0.00	1.00		1.00	1.00		1.00	1.00		1.00
Lane Grp Cap(c), veh/h	55	2097	1152	5	3038	1141	65	129	58	658	0	197
V/C Ratio(X)	0.73	0.43	0.43	0.41	1.08	0.79	0.08	0.09	0.00	0.73	0.00	0.18
Avail Cap(c_a), veh/h	81	2097	1152	89	3038	1141	178	355	158	1721	0	515
HCM Platoon Ratio	1.00	1.00	1.00	1.00	1.00	1.00	1.00	1.00	1.00	1.00	1.00	1.00
Upstream Filter(l)	1.00	1.00	1.00	1.00	1.00	1.00	1.00	1.00	0.00	1.00	0.00	1.00
Uniform Delay (d), s/veh	48.7	9.9	9.9	50.6	20.8	9.6	47.4	47.4	0.0	42.8	0.0	39.9
Incr Delay (d2), s/veh	6.9	0.1	0.3	19.1	42.3	3.9	0.5	0.3	0.0	1.5	0.0	0.4
Initial Q Delay(d3),s/veh	0.0	0.0	0.0	0.0	0.0	0.0	0.0	0.0	0.0	0.0	0.0	0.0
%ile BackOfQ(50%),veh/ln	1.1	4.2	4.7	0.1	31.2	17.6	0.1	0.1	0.0	3.8	0.0	0.8
Unsig. Movement Delay, s/veh												
LnGrp Delay(d),s/veh	55.5	10.1	10.2	69.7	63.1	13.5	47.9	47.7	0.0	44.4	0.0	40.3
LnGrp LOS	E	B	B	E	F	B	D	D	A	D	A	D
Approach Vol, veh/h		1423			4186			16				512
Approach Delay, s/veh		11.4			52.4			47.7				44.1
Approach LOS		B			D			D				D
Timer - Assigned Phs	1	2		4	5	6		8				
Phs Duration (G+Y+Rc), s	4.5	69.3		18.4	7.6	66.2		9.4				
Change Period (Y+Rc), s	* 4.2	6.2		5.8	* 4.2	6.2		5.8				
Max Green Setting (Gmax), s	* 5	60.0		33.0	* 5	60.0		10.0				
Max Q Clear Time (g_c+1), s	2.1	15.8		10.8	4.5	62.0		2.3				
Green Ext Time (p_c), s	0.0	10.9		1.8	0.0	0.0		0.0				

Intersection Summary

HCM 6th Ctrl Delay	42.2
HCM 6th LOS	D

Notes

- User approved pedestrian interval to be less than phase max green.
- User approved volume balancing among the lanes for turning movement.
- * HCM 6th computational engine requires equal clearance times for the phases crossing the barrier.

Timings

4: Van Buren Bl. & Wood Rd.

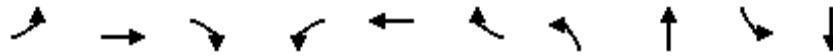

Lane Group	EBL	EBT	EBR	WBL	WBT	WBR	NBL	NBT	SBL	SBT
Lane Configurations	↘	↑↑	↗	↘↗	↑↑	↗	↘↗	↑↑	↘	↑↑
Traffic Volume (vph)	146	823	317	439	1143	102	323	416	83	416
Future Volume (vph)	146	823	317	439	1143	102	323	416	83	416
Turn Type	Prot	NA	pm+ov	Prot	NA	Perm	Prot	NA	Prot	NA
Protected Phases	5	2	3	1	6		3	8	7	4
Permitted Phases			2			6				
Detector Phase	5	2	3	1	6	6	3	8	7	4
Switch Phase										
Minimum Initial (s)	5.0	10.0	5.0	5.0	10.0	10.0	5.0	10.0	5.0	10.0
Minimum Split (s)	9.2	30.2	9.2	9.2	30.2	30.2	9.2	38.4	9.2	15.8
Total Split (s)	16.6	45.0	18.2	25.0	53.4	53.4	18.2	38.4	11.6	31.8
Total Split (%)	13.8%	37.5%	15.2%	20.8%	44.5%	44.5%	15.2%	32.0%	9.7%	26.5%
Yellow Time (s)	3.2	5.2	3.2	3.2	5.2	5.2	3.2	4.4	3.2	4.8
All-Red Time (s)	1.0	1.0	1.0	1.0	1.0	1.0	1.0	1.0	1.0	1.0
Lost Time Adjust (s)	0.0	0.0	0.0	0.0	0.0	0.0	0.0	0.0	0.0	0.0
Total Lost Time (s)	4.2	6.2	4.2	4.2	6.2	6.2	4.2	5.4	4.2	5.8
Lead/Lag	Lead	Lag	Lead	Lead	Lag	Lag	Lead	Lag	Lead	Lag
Lead-Lag Optimize?	Yes	Yes	Yes	Yes	Yes	Yes	Yes	Yes	Yes	Yes
Recall Mode	None	None	None	None	None	None	None	None	None	None
Act Effct Green (s)	12.3	39.8	55.7	19.6	47.1	47.1	13.9	31.7	7.4	24.8
Actuated g/C Ratio	0.10	0.34	0.47	0.17	0.40	0.40	0.12	0.27	0.06	0.21
v/c Ratio	0.91	0.80	0.47	0.87	0.94	0.17	0.91	0.83	0.86	0.88
Control Delay	100.0	42.6	15.8	65.1	49.0	2.8	78.6	42.0	110.3	57.1
Queue Delay	0.0	0.0	0.0	0.0	0.0	0.0	0.0	0.0	0.0	0.0
Total Delay	100.0	42.6	15.8	65.1	49.0	2.8	78.6	42.0	110.3	57.1
LOS	F	D	B	E	D	A	E	D	F	E
Approach Delay		42.5			50.4			53.6		63.7
Approach LOS		D			D			D		E

Intersection Summary

Cycle Length: 120
 Actuated Cycle Length: 118.5
 Natural Cycle: 110
 Control Type: Actuated-Uncoordinated
 Maximum v/c Ratio: 0.94
 Intersection Signal Delay: 50.8
 Intersection LOS: D
 Intersection Capacity Utilization 88.2%
 ICU Level of Service E
 Analysis Period (min) 15

Splits and Phases: 4: Van Buren Bl. & Wood Rd.

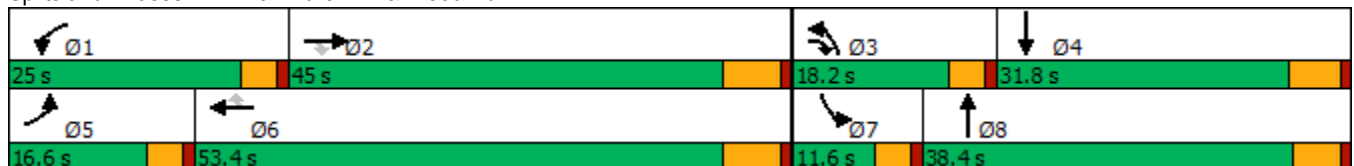

HCM 6th Signalized Intersection Summary
4: Van Buren Bl. & Wood Rd.

West Campus Upper Plateau (JN 14064)

02/16/2022

Movement	EBL	EBT	EBR	WBL	WBT	WBR	NBL	NBT	NBR	SBL	SBT	SBR
Lane Configurations												
Traffic Volume (veh/h)	146	823	317	439	1143	102	323	416	283	83	416	162
Future Volume (veh/h)	146	823	317	439	1143	102	323	416	283	83	416	162
Initial Q (Qb), veh	0	0	0	0	0	0	0	0	0	0	0	0
Ped-Bike Adj(A_pbT)	1.00		0.97	1.00		0.98	1.00		0.90	1.00		0.99
Parking Bus, Adj	1.00	1.00	1.00	1.00	1.00	1.00	1.00	1.00	1.00	1.00	1.00	1.00
Work Zone On Approach		No			No			No			No	
Adj Sat Flow, veh/h/ln	1856	1841	1841	1885	1841	1870	1885	1885	1885	1856	1885	1856
Adj Flow Rate, veh/h	166	935	175	499	1299	66	367	473	179	94	473	89
Peak Hour Factor	0.88	0.88	0.88	0.88	0.88	0.88	0.88	0.88	0.88	0.88	0.88	0.88
Percent Heavy Veh, %	3	4	4	1	4	2	1	1	1	3	1	3
Cap, veh/h	185	1187	701	556	1379	615	412	655	245	111	631	118
Arrive On Green	0.10	0.34	0.34	0.16	0.39	0.39	0.12	0.27	0.27	0.06	0.21	0.21
Sat Flow, veh/h	1767	3497	1520	3483	3497	1560	3483	2464	921	1767	3004	562
Grp Volume(v), veh/h	166	935	175	499	1299	66	367	342	310	94	281	281
Grp Sat Flow(s),veh/h/ln	1767	1749	1520	1742	1749	1560	1742	1791	1594	1767	1791	1775
Q Serve(g_s), s	11.0	28.5	8.3	16.6	42.3	3.2	12.3	20.5	21.0	6.2	17.4	17.6
Cycle Q Clear(g_c), s	11.0	28.5	8.3	16.6	42.3	3.2	12.3	20.5	21.0	6.2	17.4	17.6
Prop In Lane	1.00		1.00	1.00		1.00	1.00		0.58	1.00		0.32
Lane Grp Cap(c), veh/h	185	1187	701	556	1379	615	412	476	424	111	376	373
V/C Ratio(X)	0.90	0.79	0.25	0.90	0.94	0.11	0.89	0.72	0.73	0.85	0.75	0.75
Avail Cap(c_a), veh/h	185	1187	701	612	1395	623	412	500	445	111	394	390
HCM Platoon Ratio	1.00	1.00	1.00	1.00	1.00	1.00	1.00	1.00	1.00	1.00	1.00	1.00
Upstream Filter(I)	1.00	1.00	1.00	1.00	1.00	1.00	1.00	1.00	1.00	1.00	1.00	1.00
Uniform Delay (d), s/veh	52.3	35.2	19.7	48.7	34.5	22.7	51.4	39.4	39.6	54.9	43.8	43.9
Incr Delay (d2), s/veh	37.6	3.8	0.3	14.2	12.8	0.1	20.1	4.7	5.8	41.5	7.3	7.8
Initial Q Delay(d3),s/veh	0.0	0.0	0.0	0.0	0.0	0.0	0.0	0.0	0.0	0.0	0.0	0.0
%ile BackOfQ(50%),veh/ln	6.6	12.1	2.9	8.0	19.1	1.2	6.4	9.4	8.7	4.0	8.3	8.4
Unsig. Movement Delay, s/veh												
LnGrp Delay(d),s/veh	89.9	39.0	19.9	63.0	47.4	22.8	71.5	44.1	45.4	96.4	51.1	51.6
LnGrp LOS	F	D	B	E	D	C	E	D	D	F	D	D
Approach Vol, veh/h		1276			1864			1019			656	
Approach Delay, s/veh		43.0			50.7			54.4			57.8	
Approach LOS		D			D			D			E	
Timer - Assigned Phs	1	2	3	4	5	6	7	8				
Phs Duration (G+Y+Rc), s	23.1	46.4	18.2	30.6	16.6	52.8	11.6	37.2				
Change Period (Y+Rc), s	* 4.2	6.2	* 4.2	5.8	* 4.2	6.2	* 4.2	* 5.8				
Max Green Setting (Gmax), s	* 21	38.8	* 14	26.0	* 12	47.2	* 7.4	* 33				
Max Q Clear Time (g_c+I1), s	18.6	30.5	14.3	19.6	13.0	44.3	8.2	23.0				
Green Ext Time (p_c), s	0.3	5.0	0.0	1.7	0.0	2.3	0.0	2.8				

Intersection Summary

HCM 6th Ctrl Delay	50.4
HCM 6th LOS	D

Notes

* HCM 6th computational engine requires equal clearance times for the phases crossing the barrier.

Timings
5: Trautwein Rd. & Alessandro Bl.

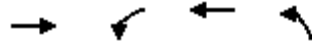

Lane Group	EBT	WBL	WBT	NBL
Lane Configurations	↑↑↑	↔↔	↑↑↑	↔↔↔
Traffic Volume (vph)	1015	157	3031	1847
Future Volume (vph)	1015	157	3031	1847
Turn Type	NA	Prot	NA	Prot
Protected Phases	2	1	6	8
Permitted Phases				
Detector Phase	2	1	6	8
Switch Phase				
Minimum Initial (s)	10.0	5.0	10.0	10.0
Minimum Split (s)	33.2	9.2	16.2	16.2
Total Split (s)	54.6	17.4	72.0	48.0
Total Split (%)	45.5%	14.5%	60.0%	40.0%
Yellow Time (s)	5.2	3.2	5.2	5.2
All-Red Time (s)	1.0	1.0	1.0	1.0
Lost Time Adjust (s)	0.0	0.0	0.0	0.0
Total Lost Time (s)	6.2	4.2	6.2	6.2
Lead/Lag	Lag	Lead		
Lead-Lag Optimize?	Yes	Yes		
Recall Mode	None	None	None	None
Act Effct Green (s)	51.2	10.4	65.8	41.8
Actuated g/C Ratio	0.43	0.09	0.55	0.35
v/c Ratio	0.52	0.59	1.18	1.17
Control Delay	26.6	60.8	113.4	119.3
Queue Delay	0.0	0.0	0.0	0.0
Total Delay	26.6	60.8	113.4	119.3
LOS	C	E	F	F
Approach Delay	26.6		110.8	119.3
Approach LOS	C		F	F

Intersection Summary

Cycle Length: 120
 Actuated Cycle Length: 120
 Natural Cycle: 130
 Control Type: Actuated-Uncoordinated
 Maximum v/c Ratio: 1.18
 Intersection Signal Delay: 99.3
 Intersection LOS: F
 Intersection Capacity Utilization 104.2%
 ICU Level of Service G
 Analysis Period (min) 15

Splits and Phases: 5: Trautwein Rd. & Alessandro Bl.

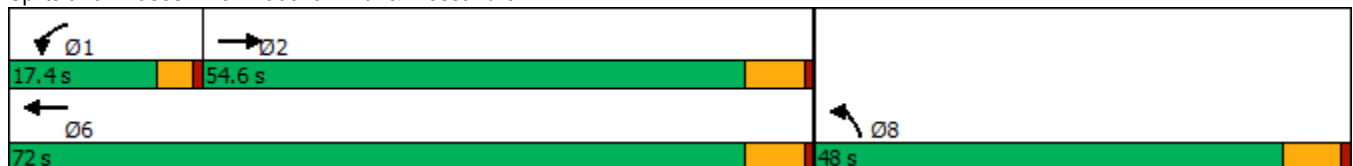

HCM 6th Signalized Intersection Summary
5: Trautwein Rd. & Alessandro Bl.

West Campus Upper Plateau (JN 14064)
02/16/2022

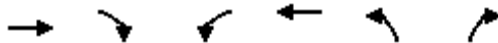

Movement	EBT	EBR	WBL	WBT	NBL	NBR
Lane Configurations	↑↑↑		↵↵	↑↑↑	↵↵↵	
Traffic Volume (veh/h)	1015	4	157	3031	1847	7
Future Volume (veh/h)	1015	4	157	3031	1847	7
Initial Q (Qb), veh	0	0	0	0	0	0
Ped-Bike Adj(A_pbT)		1.00	1.00		1.00	1.00
Parking Bus, Adj	1.00	1.00	1.00	1.00	1.00	1.00
Work Zone On Approach	No			No	No	
Adj Sat Flow, veh/h/ln	1870	1900	1856	1885	1870	1781
Adj Flow Rate, veh/h	1115	4	173	3331	2037	0
Peak Hour Factor	0.91	0.91	0.91	0.91	0.91	0.91
Percent Heavy Veh, %	2	0	3	1	2	8
Cap, veh/h	2343	8	231	2822	1861	526
Arrive On Green	0.45	0.45	0.07	0.55	0.35	0.00
Sat Flow, veh/h	5421	19	3428	5316	5344	1510
Grp Volume(v), veh/h	723	396	173	3331	2037	0
Grp Sat Flow(s),veh/h/ln	1702	1867	1714	1716	1781	1510
Q Serve(g_s), s	17.9	17.9	5.9	65.8	41.8	0.0
Cycle Q Clear(g_c), s	17.9	17.9	5.9	65.8	41.8	0.0
Prop In Lane		0.01	1.00		1.00	1.00
Lane Grp Cap(c), veh/h	1519	833	231	2822	1861	526
V/C Ratio(X)	0.48	0.48	0.75	1.18	1.09	0.00
Avail Cap(c_a), veh/h	1519	833	377	2822	1861	526
HCM Platoon Ratio	1.00	1.00	1.00	1.00	1.00	1.00
Upstream Filter(I)	1.00	1.00	1.00	1.00	1.00	0.00
Uniform Delay (d), s/veh	23.4	23.4	55.0	27.1	39.1	0.0
Incr Delay (d2), s/veh	0.3	0.6	1.9	85.1	51.7	0.0
Initial Q Delay(d3),s/veh	0.0	0.0	0.0	0.0	0.0	0.0
%ile BackOfQ(50%),veh/ln	6.8	7.5	2.5	45.3	26.0	0.0
Unsig. Movement Delay, s/veh						
LnGrp Delay(d),s/veh	23.7	24.0	56.8	112.2	90.8	0.0
LnGrp LOS	C	C	E	F	F	A
Approach Vol, veh/h	1119			3504	2037	
Approach Delay, s/veh	23.8			109.5	90.8	
Approach LOS	C			F	F	
Timer - Assigned Phs	1	2			6	8
Phs Duration (G+Y+Rc), s	12.3	59.7			72.0	48.0
Change Period (Y+Rc), s	* 4.2	6.2			6.2	6.2
Max Green Setting (Gmax), s	* 13	48.4			65.8	41.8
Max Q Clear Time (g_c+I1), s	7.9	19.9			67.8	43.8
Green Ext Time (p_c), s	0.1	10.7			0.0	0.0

Intersection Summary

HCM 6th Ctrl Delay	89.4
HCM 6th LOS	F

Notes

User approved volume balancing among the lanes for turning movement.
* HCM 6th computational engine requires equal clearance times for the phases crossing the barrier.

Timings
6: Trautwein Rd. & Grove Community Dr

West Campus Upper Plateau (JN 14064)

02/16/2022

Lane Group	WBL	WBR	NBT	NBR	SBL	SBT
Lane Configurations						
Traffic Volume (vph)	75	604	1428	22	206	871
Future Volume (vph)	75	604	1428	22	206	871
Turn Type	Prot	pm+ov	NA	Perm	Prot	NA
Protected Phases	8	1	2		1	6
Permitted Phases		8		2		
Detector Phase	8	1	2	2	1	6
Switch Phase						
Minimum Initial (s)	10.0	5.0	10.0	10.0	5.0	10.0
Minimum Split (s)	34.6	9.6	46.2	46.2	9.6	28.2
Total Split (s)	34.6	15.2	70.2	70.2	15.2	85.4
Total Split (%)	28.8%	12.7%	58.5%	58.5%	12.7%	71.2%
Yellow Time (s)	3.6	3.6	5.2	5.2	3.6	5.2
All-Red Time (s)	1.0	1.0	1.0	1.0	1.0	1.0
Lost Time Adjust (s)	0.0	0.0	0.0	0.0	0.0	0.0
Total Lost Time (s)	4.6	4.6	6.2	6.2	4.6	6.2
Lead/Lag		Lead	Lag	Lag	Lead	
Lead-Lag Optimize?		Yes	Yes	Yes	Yes	
Recall Mode	None	None	None	None	None	None
Act Effct Green (s)	14.0	22.0	52.1	52.1	11.5	70.8
Actuated g/C Ratio	0.16	0.25	0.58	0.58	0.13	0.79
v/c Ratio	0.32	1.04	0.83	0.03	0.56	0.38
Control Delay	41.5	75.8	20.7	6.5	48.0	5.1
Queue Delay	0.0	0.0	0.0	0.0	0.0	0.0
Total Delay	41.5	75.8	20.7	6.5	48.0	5.1
LOS	D	E	C	A	D	A
Approach Delay	72.0		20.4			13.3
Approach LOS	E		C			B

Intersection Summary

Cycle Length: 120
 Actuated Cycle Length: 89.2
 Natural Cycle: 105
 Control Type: Actuated-Uncoordinated
 Maximum v/c Ratio: 1.04
 Intersection Signal Delay: 29.0
 Intersection LOS: C
 Intersection Capacity Utilization 69.8%
 ICU Level of Service C
 Analysis Period (min) 15

Splits and Phases: 6: Trautwein Rd. & Grove Community Dr



HCM 6th Signalized Intersection Summary
6: Trautwein Rd. & Grove Community Dr

West Campus Upper Plateau (JN 14064)

02/16/2022



Movement	WBL	WBR	NBT	NBR	SBL	SBT
Lane Configurations						
Traffic Volume (veh/h)	75	604	1428	22	206	871
Future Volume (veh/h)	75	604	1428	22	206	871
Initial Q (Qb), veh	0	0	0	0	0	0
Ped-Bike Adj(A_pbT)	1.00	1.00		0.97	1.00	
Parking Bus, Adj	1.00	1.00	1.00	1.00	1.00	1.00
Work Zone On Approach	No		No			No
Adj Sat Flow, veh/h/ln	1900	1885	1870	1900	1856	1856
Adj Flow Rate, veh/h	90	526	1720	19	248	1049
Peak Hour Factor	0.83	0.83	0.83	0.83	0.83	0.83
Percent Heavy Veh, %	0	1	2	0	3	3
Cap, veh/h	365	823	1974	872	313	2439
Arrive On Green	0.20	0.20	0.56	0.56	0.09	0.69
Sat Flow, veh/h	1810	2812	3647	1570	3428	3618
Grp Volume(v), veh/h	90	526	1720	19	248	1049
Grp Sat Flow(s),veh/h/ln	1810	1406	1777	1570	1714	1763
Q Serve(g_s), s	4.2	16.5	42.3	0.6	7.2	13.2
Cycle Q Clear(g_c), s	4.2	16.5	42.3	0.6	7.2	13.2
Prop In Lane	1.00	1.00		1.00	1.00	
Lane Grp Cap(c), veh/h	365	823	1974	872	313	2439
V/C Ratio(X)	0.25	0.64	0.87	0.02	0.79	0.43
Avail Cap(c_a), veh/h	535	1087	2240	990	358	2750
HCM Platoon Ratio	1.00	1.00	1.00	1.00	1.00	1.00
Upstream Filter(I)	1.00	1.00	1.00	1.00	1.00	1.00
Uniform Delay (d), s/veh	34.0	31.2	19.4	10.2	45.2	6.9
Incr Delay (d2), s/veh	0.3	0.8	3.7	0.0	8.8	0.1
Initial Q Delay(d3),s/veh	0.0	0.0	0.0	0.0	0.0	0.0
%ile BackOfQ(50%),veh/ln	1.9	5.5	15.6	0.2	3.3	3.7
Unsig. Movement Delay, s/veh						
LnGrp Delay(d),s/veh	34.4	32.1	23.1	10.2	54.0	7.0
LnGrp LOS	C	C	C	B	D	A
Approach Vol, veh/h	616		1739			1297
Approach Delay, s/veh	32.4		23.0			16.0
Approach LOS	C		C			B
Timer - Assigned Phs	1	2			6	8
Phs Duration (G+Y+Rc), s	13.9	62.6			76.5	25.1
Change Period (Y+Rc), s	4.6	6.2			6.2	4.6
Max Green Setting (Gmax), s	10.6	64.0			79.2	30.0
Max Q Clear Time (g_c+I1), s	9.2	44.3			15.2	18.5
Green Ext Time (p_c), s	0.1	12.1			8.4	2.0
Intersection Summary						
HCM 6th Ctrl Delay			22.1			
HCM 6th LOS			C			

Timings

7: Trautwein Rd. & Orange Terrace Pkwy

02/16/2022



Lane Group	EBL	EBT	WBL	WBT	WBR	NBL	NBT	NBR	SBL	SBT	SBR
Lane Configurations											
Traffic Volume (vph)	67	63	288	99	485	48	974	239	382	579	20
Future Volume (vph)	67	63	288	99	485	48	974	239	382	579	20
Turn Type	Prot	NA	Prot	NA	pm+ov	Prot	NA	Perm	Prot	NA	Perm
Protected Phases	7	4	3	8	1	5	2		1	6	
Permitted Phases					8			2			6
Detector Phase	7	4	3	8	1	5	2	2	1	6	6
Switch Phase											
Minimum Initial (s)	5.0	10.0	5.0	10.0	5.0	5.0	10.0	10.0	5.0	10.0	10.0
Minimum Split (s)	9.6	38.6	9.6	34.6	9.6	9.6	46.2	46.2	9.6	24.2	24.2
Total Split (s)	16.8	38.6	25.0	46.8	19.0	14.4	47.4	47.4	19.0	52.0	52.0
Total Split (%)	12.9%	29.7%	19.2%	36.0%	14.6%	11.1%	36.5%	36.5%	14.6%	40.0%	40.0%
Yellow Time (s)	3.6	3.6	3.6	3.6	3.6	3.6	5.2	5.2	3.6	5.2	5.2
All-Red Time (s)	1.0	1.0	1.0	1.0	1.0	1.0	1.0	1.0	1.0	1.0	1.0
Lost Time Adjust (s)	0.0	0.0	0.0	0.0	0.0	0.0	0.0	0.0	0.0	0.0	0.0
Total Lost Time (s)	4.6	4.6	4.6	4.6	4.6	4.6	6.2	6.2	4.6	6.2	6.2
Lead/Lag	Lead	Lag	Lead	Lag	Lead	Lead	Lag	Lag	Lead	Lag	Lag
Lead-Lag Optimize?	Yes	Yes	Yes	Yes	Yes	Yes	Yes	Yes	Yes	Yes	Yes
Recall Mode	None	None	None	None	None	None	None	None	None	None	None
Act Effct Green (s)	8.8	14.5	20.7	25.2	39.8	7.6	41.7	41.7	14.6	51.0	51.0
Actuated g/C Ratio	0.08	0.13	0.19	0.23	0.37	0.07	0.39	0.39	0.13	0.47	0.47
v/c Ratio	0.55	0.36	1.01	0.27	0.52	0.47	0.87	0.41	1.00	0.42	0.03
Control Delay	64.4	43.2	96.2	36.2	18.9	64.1	40.4	13.8	89.1	23.2	0.1
Queue Delay	0.0	0.0	0.0	0.0	0.0	0.0	0.0	0.0	0.0	0.0	0.0
Total Delay	64.4	43.2	96.2	36.2	18.9	64.1	40.4	13.8	89.1	23.2	0.1
LOS	E	D	F	D	B	E	D	B	F	C	A
Approach Delay		53.3		46.4			36.3			48.4	
Approach LOS		D		D			D			D	

Intersection Summary

Cycle Length: 130
 Actuated Cycle Length: 108.2
 Natural Cycle: 125
 Control Type: Actuated-Uncoordinated
 Maximum v/c Ratio: 1.01
 Intersection Signal Delay: 43.4
 Intersection LOS: D
 Intersection Capacity Utilization 74.1%
 ICU Level of Service D
 Analysis Period (min) 15



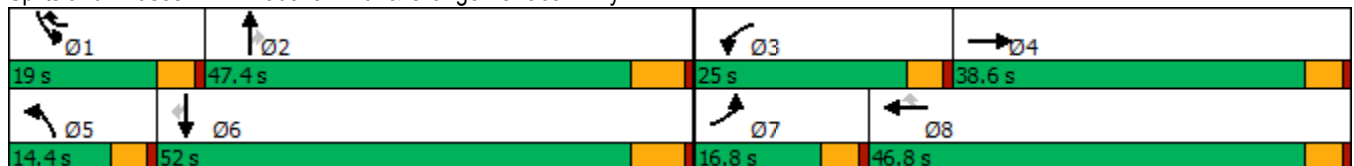



















Splits and Phases: 7: Trautwein Rd. & Orange Terrace Pkwy



HCM 6th Signalized Intersection Summary
7: Trautwein Rd. & Orange Terrace Pkwy

West Campus Upper Plateau (JN 14064)

02/16/2022

												
Movement	EBL	EBT	EBR	WBL	WBT	WBR	NBL	NBT	NBR	SBL	SBT	SBR
Lane Configurations												
Traffic Volume (veh/h)	67	63	12	288	99	485	48	974	239	382	579	20
Future Volume (veh/h)	67	63	12	288	99	485	48	974	239	382	579	20
Initial Q (Qb), veh	0	0	0	0	0	0	0	0	0	0	0	0
Ped-Bike Adj(A_pbT)	1.00		0.99	1.00		0.96	1.00		1.00	1.00		0.98
Parking Bus, Adj	1.00	1.00	1.00	1.00	1.00	1.00	1.00	1.00	1.00	1.00	1.00	1.00
Work Zone On Approach		No			No			No			No	
Adj Sat Flow, veh/h/ln	1900	1870	1900	1885	1885	1870	1856	1841	1856	1856	1856	1811
Adj Flow Rate, veh/h	80	75	9	343	118	332	57	1160	200	455	689	16
Peak Hour Factor	0.84	0.84	0.84	0.84	0.84	0.84	0.84	0.84	0.84	0.84	0.84	0.84
Percent Heavy Veh, %	0	2	0	1	1	2	3	4	3	3	3	6
Cap, veh/h	103	208	25	339	489	1070	73	1277	573	458	1611	685
Arrive On Green	0.06	0.13	0.13	0.19	0.26	0.26	0.04	0.37	0.37	0.13	0.46	0.46
Sat Flow, veh/h	1810	1636	196	1795	1885	2690	1767	3497	1570	3428	3526	1498
Grp Volume(v), veh/h	80	0	84	343	118	332	57	1160	200	455	689	16
Grp Sat Flow(s),veh/h/ln	1810	0	1832	1795	1885	1345	1767	1749	1570	1714	1763	1498
Q Serve(g_s), s	4.7	0.0	4.5	20.4	5.3	9.2	3.4	34.0	10.0	14.3	14.2	0.6
Cycle Q Clear(g_c), s	4.7	0.0	4.5	20.4	5.3	9.2	3.4	34.0	10.0	14.3	14.2	0.6
Prop In Lane	1.00		0.11	1.00		1.00	1.00		1.00	1.00		1.00
Lane Grp Cap(c), veh/h	103	0	233	339	489	1070	73	1277	573	458	1611	685
V/C Ratio(X)	0.78	0.00	0.36	1.01	0.24	0.31	0.78	0.91	0.35	0.99	0.43	0.02
Avail Cap(c_a), veh/h	205	0	577	339	737	1425	161	1335	599	458	1611	685
HCM Platoon Ratio	1.00	1.00	1.00	1.00	1.00	1.00	1.00	1.00	1.00	1.00	1.00	1.00
Upstream Filter(I)	1.00	0.00	1.00	1.00	1.00	1.00	1.00	1.00	1.00	1.00	1.00	1.00
Uniform Delay (d), s/veh	50.2	0.0	43.1	43.7	31.6	22.7	51.2	32.5	24.9	46.7	19.8	16.1
Incr Delay (d2), s/veh	4.7	0.0	0.9	51.5	0.3	0.2	6.5	9.1	0.4	40.5	0.2	0.0
Initial Q Delay(d3),s/veh	0.0	0.0	0.0	0.0	0.0	0.0	0.0	0.0	0.0	0.0	0.0	0.0
%ile BackOfQ(50%),veh/ln	2.3	0.0	2.1	13.5	2.4	2.8	1.6	14.9	3.6	8.4	5.4	0.2
Unsig. Movement Delay, s/veh												
LnGrp Delay(d),s/veh	54.9	0.0	44.0	95.3	31.8	22.9	57.7	41.7	25.3	87.2	19.9	16.1
LnGrp LOS	D	A	D	F	C	C	E	D	C	F	B	B
Approach Vol, veh/h		164			793			1417			1160	
Approach Delay, s/veh		49.3			55.5			40.0			46.3	
Approach LOS		D			E			D			D	
Timer - Assigned Phs	1	2	3	4	5	6	7	8				
Phs Duration (G+Y+Rc), s	19.0	45.6	25.0	18.3	9.1	55.5	10.7	32.6				
Change Period (Y+Rc), s	4.6	6.2	4.6	4.6	4.6	6.2	4.6	4.6				
Max Green Setting (Gmax), s	14.4	41.2	20.4	34.0	9.8	45.8	12.2	42.2				
Max Q Clear Time (g_c+I1), s	16.3	36.0	22.4	6.5	5.4	16.2	6.7	11.2				
Green Ext Time (p_c), s	0.0	3.3	0.0	0.4	0.0	4.5	0.0	2.0				
Intersection Summary												
HCM 6th Ctrl Delay			46.0									
HCM 6th LOS			D									

Timings
8: Cole Av. & Van Buren Bl.

West Campus Upper Plateau (JN 14064)

02/16/2022



Lane Group	EBL	EBT	EBR	WBL	WBT	WBR	NBL	NBT	SBL	SBT	SBR
Lane Configurations	↔↔	↑↑	↗	↖	↑↑↑	↗	↖	↑↔	↖↖	↑↑	↗
Traffic Volume (vph)	301	884	92	142	1214	332	215	535	176	329	226
Future Volume (vph)	301	884	92	142	1214	332	215	535	176	329	226
Turn Type	Prot	NA	pm+ov	Prot	NA	pm+ov	Prot	NA	Prot	NA	pm+ov
Protected Phases	5	2	3	1	6	7	3	8	7	4	5
Permitted Phases			2			6					4
Detector Phase	5	2	3	1	6	7	3	8	7	4	5
Switch Phase											
Minimum Initial (s)	5.0	10.0	5.0	5.0	10.0	5.0	5.0	10.0	5.0	10.0	5.0
Minimum Split (s)	9.1	36.2	9.1	9.1	36.2	9.1	9.1	42.2	9.1	49.2	9.1
Total Split (s)	15.0	37.8	19.0	14.0	36.8	21.6	19.0	46.6	21.6	49.2	15.0
Total Split (%)	12.5%	31.5%	15.8%	11.7%	30.7%	18.0%	15.8%	38.8%	18.0%	41.0%	12.5%
Yellow Time (s)	3.2	5.2	3.2	3.2	5.2	3.2	3.2	5.2	3.2	5.2	3.2
All-Red Time (s)	0.5	1.0	0.5	0.5	1.0	0.5	0.5	1.0	0.5	1.0	0.5
Lost Time Adjust (s)	0.0	0.0	0.0	0.0	0.0	0.0	0.0	0.0	0.0	0.0	0.0
Total Lost Time (s)	3.7	6.2	3.7	3.7	6.2	3.7	3.7	6.2	3.7	6.2	3.7
Lead/Lag	Lead	Lag	Lead	Lead	Lag	Lead	Lead	Lag	Lead	Lag	Lead
Lead-Lag Optimize?	Yes	Yes	Yes	Yes	Yes	Yes	Yes	Yes	Yes	Yes	Yes
Recall Mode	None	None	None	None	None	None	None	None	None	None	None
Act Effct Green (s)	11.4	31.8	53.5	10.4	30.8	43.6	15.4	26.5	10.2	21.3	35.2
Actuated g/C Ratio	0.12	0.32	0.54	0.11	0.31	0.44	0.16	0.27	0.10	0.22	0.36
v/c Ratio	0.86	0.88	0.12	0.84	0.87	0.51	0.88	0.76	0.56	0.48	0.43
Control Delay	66.7	43.4	5.2	80.0	40.4	16.9	74.0	38.0	49.8	35.2	17.6
Queue Delay	0.0	0.0	0.0	0.0	0.0	0.0	0.0	0.0	0.0	0.0	0.0
Total Delay	66.7	43.4	5.2	80.0	40.4	16.9	74.0	38.0	49.8	35.2	17.6
LOS	E	D	A	E	D	B	E	D	D	D	B
Approach Delay		46.2			39.1			47.2		33.3	
Approach LOS		D			D			D		C	

Intersection Summary

Cycle Length: 120
 Actuated Cycle Length: 98.9
 Natural Cycle: 125
 Control Type: Actuated-Uncoordinated
 Maximum v/c Ratio: 0.88
 Intersection Signal Delay: 41.7
 Intersection LOS: D
 Intersection Capacity Utilization 72.7%
 ICU Level of Service C
 Analysis Period (min) 15



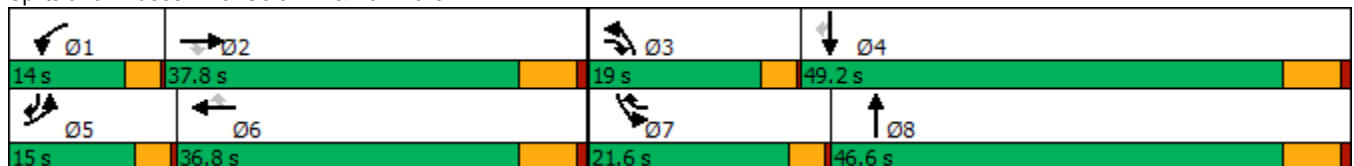





















Splits and Phases: 8: Cole Av. & Van Buren Bl.



HCM 6th Signalized Intersection Summary
8: Cole Av. & Van Buren Bl.

West Campus Upper Plateau (JN 14064)

02/16/2022

												
Movement	EBL	EBT	EBR	WBL	WBT	WBR	NBL	NBT	NBR	SBL	SBT	SBR
Lane Configurations												
Traffic Volume (veh/h)	301	884	92	142	1214	332	215	535	100	176	329	226
Future Volume (veh/h)	301	884	92	142	1214	332	215	535	100	176	329	226
Initial Q (Qb), veh	0	0	0	0	0	0	0	0	0	0	0	0
Ped-Bike Adj(A_pbT)	1.00		1.00	1.00		0.99	1.00		1.00	1.00		1.00
Parking Bus, Adj	1.00	1.00	1.00	1.00	1.00	1.00	1.00	1.00	1.00	1.00	1.00	1.00
Work Zone On Approach		No			No			No			No	
Adj Sat Flow, veh/h/ln	1841	1841	1826	1900	1841	1841	1856	1856	1856	1841	1870	1826
Adj Flow Rate, veh/h	334	982	61	158	1349	279	239	594	102	196	366	179
Peak Hour Factor	0.90	0.90	0.90	0.90	0.90	0.90	0.90	0.90	0.90	0.90	0.90	0.90
Percent Heavy Veh, %	4	4	5	0	4	4	3	3	3	4	2	5
Cap, veh/h	404	1187	764	192	1640	628	273	764	131	274	639	461
Arrive On Green	0.12	0.34	0.34	0.11	0.33	0.33	0.15	0.25	0.25	0.08	0.18	0.18
Sat Flow, veh/h	3401	3497	1547	1810	5025	1540	1767	3009	516	3401	3554	1542
Grp Volume(v), veh/h	334	982	61	158	1349	279	239	347	349	196	366	179
Grp Sat Flow(s),veh/h/ln	1700	1749	1547	1810	1675	1540	1767	1763	1762	1700	1777	1542
Q Serve(g_s), s	8.6	23.2	1.9	7.7	22.2	11.8	11.9	16.4	16.5	5.1	8.5	8.3
Cycle Q Clear(g_c), s	8.6	23.2	1.9	7.7	22.2	11.8	11.9	16.4	16.5	5.1	8.5	8.3
Prop In Lane	1.00		1.00	1.00		1.00	1.00		0.29	1.00		1.00
Lane Grp Cap(c), veh/h	404	1187	764	192	1640	628	273	448	447	274	639	461
V/C Ratio(X)	0.83	0.83	0.08	0.82	0.82	0.44	0.87	0.78	0.78	0.72	0.57	0.39
Avail Cap(c_a), veh/h	428	1230	784	207	1712	650	301	793	792	678	1701	922
HCM Platoon Ratio	1.00	1.00	1.00	1.00	1.00	1.00	1.00	1.00	1.00	1.00	1.00	1.00
Upstream Filter(I)	1.00	1.00	1.00	1.00	1.00	1.00	1.00	1.00	1.00	1.00	1.00	1.00
Uniform Delay (d), s/veh	38.7	27.3	12.0	39.3	27.9	19.3	37.1	31.1	31.2	40.3	33.7	25.0
Incr Delay (d2), s/veh	11.1	4.9	0.1	19.9	3.4	0.7	20.8	2.9	3.0	1.3	0.8	0.5
Initial Q Delay(d3),s/veh	0.0	0.0	0.0	0.0	0.0	0.0	0.0	0.0	0.0	0.0	0.0	0.0
%ile BackOfQ(50%),veh/ln	4.0	9.5	0.6	4.3	8.5	3.9	6.4	6.8	6.8	2.0	3.5	2.8
Unsig. Movement Delay, s/veh												
LnGrp Delay(d),s/veh	49.8	32.2	12.0	59.2	31.3	20.0	57.9	34.1	34.2	41.6	34.5	25.5
LnGrp LOS	D	C	B	E	C	B	E	C	C	D	C	C
Approach Vol, veh/h		1377			1786			935			741	
Approach Delay, s/veh		35.6			32.0			40.2			34.2	
Approach LOS		D			C			D			C	
Timer - Assigned Phs	1	2	3	4	5	6	7	8				
Phs Duration (G+Y+Rc), s	13.2	36.7	17.6	22.3	14.4	35.5	10.9	29.0				
Change Period (Y+Rc), s	3.7	6.2	3.7	6.2	3.7	6.2	3.7	6.2				
Max Green Setting (Gmax), s	10.3	31.6	15.3	43.0	11.3	30.6	17.9	40.4				
Max Q Clear Time (g_c+I1), s	9.7	25.2	13.9	10.5	10.6	24.2	7.1	18.5				
Green Ext Time (p_c), s	0.0	4.0	0.1	2.8	0.1	5.1	0.2	3.8				
Intersection Summary												
HCM 6th Ctrl Delay			34.9									
HCM 6th LOS			C									

Intersection	
Intersection Delay, s/veh	17.2
Intersection LOS	C

Movement	EBT	EBR	WBL	WBT	NBL	NBR
Lane Configurations	↔		↔	↑	↔	↔
Traffic Vol, veh/h	91	79	49	325	203	31
Future Vol, veh/h	91	79	49	325	203	31
Peak Hour Factor	0.76	0.76	0.76	0.76	0.76	0.76
Heavy Vehicles, %	2	1	2	2	0	0
Mvmt Flow	120	104	64	428	267	41
Number of Lanes	1	0	1	1	1	1

Approach	EB	WB	NB
Opposing Approach	WB	EB	
Opposing Lanes	2	1	0
Conflicting Approach Left		NB	EB
Conflicting Lanes Left	0	2	1
Conflicting Approach Right	NB		WB
Conflicting Lanes Right	2	0	2
HCM Control Delay	12.3	20.2	15.9
HCM LOS	B	C	C

Lane	NBLn1	NBLn2	EBLn1	WBLn1	WBLn2
Vol Left, %	100%	0%	0%	100%	0%
Vol Thru, %	0%	0%	54%	0%	100%
Vol Right, %	0%	100%	46%	0%	0%
Sign Control	Stop	Stop	Stop	Stop	Stop
Traffic Vol by Lane	203	31	170	49	325
LT Vol	203	0	0	49	0
Through Vol	0	0	91	0	325
RT Vol	0	31	79	0	0
Lane Flow Rate	267	41	224	64	428
Geometry Grp	7	7	4	7	7
Degree of Util (X)	0.518	0.065	0.365	0.115	0.705
Departure Headway (Hd)	6.975	5.757	5.877	6.438	5.932
Convergence, Y/N	Yes	Yes	Yes	Yes	Yes
Cap	516	621	611	556	607
Service Time	4.721	3.503	3.929	4.183	3.677
HCM Lane V/C Ratio	0.517	0.066	0.367	0.115	0.705
HCM Control Delay	17	8.9	12.3	10	21.7
HCM Lane LOS	C	A	B	A	C
HCM 95th-tile Q	2.9	0.2	1.7	0.4	5.7

Intersection

Intersection Delay, s/veh 51.8

Intersection LOS F

Movement	EBL	EBT	EBR	WBL	WBT	WBR	NBL	NBT	NBR	SBL	SBT	SBR
Lane Configurations	↙	↕		↙	↕			↕			↕	
Traffic Vol, veh/h	219	418	41	4	539	50	156	39	6	82	30	36
Future Vol, veh/h	219	418	41	4	539	50	156	39	6	82	30	36
Peak Hour Factor	0.75	0.75	0.75	0.75	0.75	0.75	0.75	0.75	0.75	0.75	0.75	0.75
Heavy Vehicles, %	0	2	0	0	0	2	1	0	0	0	4	3
Mvmt Flow	292	557	55	5	719	67	208	52	8	109	40	48
Number of Lanes	1	2	0	1	2	0	0	1	0	0	1	0

Approach	EB	WB	NB	SB
Opposing Approach	WB	EB	SB	NB
Opposing Lanes	3	3	1	1
Conflicting Approach Left SB		NB	EB	WB
Conflicting Lanes Left	1	1	3	3
Conflicting Approach Right NB		SB	WB	EB
Conflicting Lanes Right	1	1	3	3
HCM Control Delay	34.1	84.7	35.3	24
HCM LOS	D	F	E	C

Lane	NBLn1	EBLn1	EBLn2	EBLn3	WBLn1	WBLn2	WBLn3	SBLn1
Vol Left, %	78%	100%	0%	0%	100%	0%	0%	55%
Vol Thru, %	19%	0%	100%	77%	0%	100%	78%	20%
Vol Right, %	3%	0%	0%	23%	0%	0%	22%	24%
Sign Control	Stop	Stop	Stop	Stop	Stop	Stop	Stop	Stop
Traffic Vol by Lane	201	219	279	180	4	359	230	148
LT Vol	156	219	0	0	4	0	0	82
Through Vol	39	0	279	139	0	359	180	30
RT Vol	6	0	0	41	0	0	50	36
Lane Flow Rate	268	292	372	240	5	479	306	197
Geometry Grp	7	7	7	7	7	7	7	7
Degree of Util (X)	0.724	0.711	0.856	0.541	0.014	1.149	0.724	0.535
Departure Headway (Hd)	10.117	9.124	8.634	8.432	9.162	8.637	8.513	10.189
Convergence, Y/N	Yes	Yes	Yes	Yes	Yes	Yes	Yes	Yes
Cap	359	400	424	430	390	422	423	357
Service Time	7.817	6.824	6.334	6.132	6.943	6.418	6.294	7.889
HCM Lane V/C Ratio	0.747	0.73	0.877	0.558	0.013	1.135	0.723	0.552
HCM Control Delay	35.3	31.3	45.1	20.6	12.1	120	30.8	24
HCM Lane LOS	E	D	E	C	B	F	D	C
HCM 95th-tile Q	5.5	5.4	8.4	3.1	0	17.7	5.7	3

Timings

11: Barton St & Alessandro Bl.



Lane Group	EBL	EBT	WBL	WBT	NBL	NBT	NBR	SBL	SBT	SBR
Lane Configurations	↙	↕↕↕	↙	↕↕↕		↕	↗		↕	↗
Traffic Volume (vph)	6	1320	36	2499	72	1	48	4	0	7
Future Volume (vph)	6	1320	36	2499	72	1	48	4	0	7
Turn Type	Prot	NA	Prot	NA	Perm	NA	Perm	Perm	NA	Perm
Protected Phases	5	2	1	6		8			4	
Permitted Phases					8		8	4		4
Detector Phase	5	2	1	6	8	8	8	4	4	4
Switch Phase										
Minimum Initial (s)	5.0	10.0	5.0	10.0	10.0	10.0	10.0	10.0	10.0	10.0
Minimum Split (s)	9.2	28.5	11.0	28.5	40.6	40.6	40.6	26.6	26.6	26.6
Total Split (s)	9.2	68.4	11.0	70.2	40.6	40.6	40.6	40.6	40.6	40.6
Total Split (%)	7.7%	57.0%	9.2%	58.5%	33.8%	33.8%	33.8%	33.8%	33.8%	33.8%
Yellow Time (s)	3.2	5.5	3.2	5.5	3.6	3.6	3.6	3.6	3.6	3.6
All-Red Time (s)	1.0	1.0	1.0	1.0	1.0	1.0	1.0	1.0	1.0	1.0
Lost Time Adjust (s)	0.0	0.0	0.0	0.0		0.0	0.0		0.0	0.0
Total Lost Time (s)	4.2	6.5	4.2	6.5		4.6	4.6		4.6	4.6
Lead/Lag	Lead	Lag	Lead	Lag						
Lead-Lag Optimize?	Yes	Yes	Yes	Yes						
Recall Mode	None	None	None	None	Max	Max	Max	Max	Max	Max
Act Effct Green (s)	5.0	59.0	6.2	63.7		36.0	36.0		36.0	36.0
Actuated g/C Ratio	0.04	0.52	0.06	0.57		0.32	0.32		0.32	0.32
v/c Ratio	0.09	0.53	0.38	0.91		0.17	0.09		0.02	0.02
Control Delay	56.3	19.2	63.5	27.9		29.6	4.0		28.2	0.1
Queue Delay	0.0	0.0	0.0	0.0		0.0	0.0		0.0	0.0
Total Delay	56.3	19.2	63.5	27.9		29.6	4.0		28.2	0.1
LOS	E	B	E	C		C	A		C	A
Approach Delay		19.3		28.4		19.5			10.4	
Approach LOS		B		C		B			B	

Intersection Summary

Cycle Length: 120
 Actuated Cycle Length: 112.6
 Natural Cycle: 115
 Control Type: Actuated-Uncoordinated
 Maximum v/c Ratio: 0.91
 Intersection Signal Delay: 25.0
 Intersection LOS: C
 Intersection Capacity Utilization 99.8%
 ICU Level of Service F
 Analysis Period (min) 15

Splits and Phases: 11: Barton St & Alessandro Bl.



HCM 6th Signalized Intersection Summary
11: Barton St & Alessandro Bl.

West Campus Upper Plateau (JN 14064)

02/16/2022



Movement	EBL	EBT	EBR	WBL	WBT	WBR	NBL	NBT	NBR	SBL	SBT	SBR
Lane Configurations	↖	↑↑↑		↖	↑↑↑			↑	↗		↑	↗
Traffic Volume (veh/h)	6	1320	33	36	2499	5	72	1	48	4	0	7
Future Volume (veh/h)	6	1320	33	36	2499	5	72	1	48	4	0	7
Initial Q (Qb), veh	0	0	0	0	0	0	0	0	0	0	0	0
Ped-Bike Adj(A_pbT)	1.00		0.98	1.00		1.00	1.00		1.00	1.00		1.00
Parking Bus, Adj	1.00	1.00	1.00	1.00	1.00	1.00	1.00	1.00	1.00	1.00	1.00	1.00
Work Zone On Approach		No			No			No			No	
Adj Sat Flow, veh/h/ln	1604	1870	1841	1900	1870	1530	1900	1900	1856	418	1900	1159
Adj Flow Rate, veh/h	6	1375	31	38	2603	5	75	1	20	4	0	2
Peak Hour Factor	0.96	0.96	0.96	0.96	0.96	0.96	0.96	0.96	0.96	0.96	0.96	0.96
Percent Heavy Veh, %	20	2	4	0	2	25	0	0	3	100	0	50
Cap, veh/h	12	2698	61	55	2886	6	62	0	490	62	0	306
Arrive On Green	0.01	0.53	0.53	0.03	0.55	0.55	0.31	0.31	0.31	0.31	0.00	0.31
Sat Flow, veh/h	1527	5135	116	1810	5262	10	0	1	1571	0	0	982
Grp Volume(v), veh/h	6	912	494	38	1683	925	76	0	20	4	0	2
Grp Sat Flow(s),veh/h/ln	1527	1702	1847	1810	1702	1869	1	0	1571	0	0	982
Q Serve(g_s), s	0.5	20.0	20.0	2.4	51.0	51.1	0.0	0.0	1.0	0.0	0.0	0.2
Cycle Q Clear(g_c), s	0.5	20.0	20.0	2.4	51.0	51.1	36.0	0.0	1.0	36.0	0.0	0.2
Prop In Lane	1.00		0.06	1.00		0.01	0.99		1.00	1.00		1.00
Lane Grp Cap(c), veh/h	12	1789	970	55	1867	1025	62	0	490	62	0	306
V/C Ratio(X)	0.52	0.51	0.51	0.69	0.90	0.90	1.22	0.00	0.04	0.06	0.00	0.01
Avail Cap(c_a), veh/h	66	1824	989	107	1877	1030	62	0	490	62	0	306
HCM Platoon Ratio	1.00	1.00	1.00	1.00	1.00	1.00	1.00	1.00	1.00	1.00	1.00	1.00
Upstream Filter(I)	1.00	1.00	1.00	1.00	1.00	1.00	1.00	0.00	1.00	1.00	0.00	1.00
Uniform Delay (d), s/veh	57.1	17.8	17.8	55.5	23.3	23.3	57.5	0.0	27.7	57.8	0.0	27.4
Incr Delay (d2), s/veh	12.7	0.3	0.6	5.6	6.6	11.1	184.2	0.0	0.2	2.0	0.0	0.0
Initial Q Delay(d3),s/veh	0.0	0.0	0.0	0.0	0.0	0.0	0.0	0.0	0.0	0.0	0.0	0.0
%ile BackOfQ(50%),veh/ln	0.2	7.1	7.7	1.2	21.0	24.4	5.0	0.0	0.4	0.2	0.0	0.0
Unsig. Movement Delay, s/veh												
LnGrp Delay(d),s/veh	69.8	18.1	18.4	61.0	29.9	34.4	241.7	0.0	27.9	59.7	0.0	27.5
LnGrp LOS	E	B	B	E	C	C	F	A	C	E	A	C
Approach Vol, veh/h		1412			2646			96				6
Approach Delay, s/veh		18.4			31.9			197.2				49.0
Approach LOS		B			C			F				D
Timer - Assigned Phs	1	2		4	5	6		8				
Phs Duration (G+Y+Rc), s	7.7	67.2		40.6	5.1	69.8		40.6				
Change Period (Y+Rc), s	* 4.2	6.5		4.6	* 4.2	6.5		4.6				
Max Green Setting (Gmax), s	* 6.8	61.9		36.0	* 5	63.7		36.0				
Max Q Clear Time (g_c+I1), s	4.4	22.0		38.0	2.5	53.1		38.0				
Green Ext Time (p_c), s	0.0	16.1		0.0	0.0	10.2		0.0				

Intersection Summary

HCM 6th Ctrl Delay	31.2
HCM 6th LOS	C

Notes

* HCM 6th computational engine requires equal clearance times for the phases crossing the barrier.

Intersection						
Int Delay, s/veh	0.6					
Movement	EBL	EBT	WBT	WBR	SBL	SBR
Lane Configurations						
Traffic Vol, veh/h	22	100	369	13	5	6
Future Vol, veh/h	22	100	369	13	5	6
Conflicting Peds, #/hr	0	0	0	5	0	1
Sign Control	Free	Free	Free	Free	Stop	Stop
RT Channelized	-	None	-	None	-	None
Storage Length	100	-	-	-	0	-
Veh in Median Storage, #	-	0	0	-	0	-
Grade, %	-	0	0	-	0	-
Peak Hour Factor	72	72	72	72	72	72
Heavy Vehicles, %	0	2	1	0	0	0
Mvmt Flow	31	139	513	18	7	8

Major/Minor	Major1	Major2	Minor2		
Conflicting Flow All	536	0	-	0	728 528
Stage 1	-	-	-	-	527 -
Stage 2	-	-	-	-	201 -
Critical Hdwy	4.1	-	-	-	6.4 6.2
Critical Hdwy Stg 1	-	-	-	-	5.4 -
Critical Hdwy Stg 2	-	-	-	-	5.4 -
Follow-up Hdwy	2.2	-	-	-	3.5 3.3
Pot Cap-1 Maneuver	1042	-	-	-	393 554
Stage 1	-	-	-	-	596 -
Stage 2	-	-	-	-	838 -
Platoon blocked, %		-	-	-	
Mov Cap-1 Maneuver	1037	-	-	-	377 551
Mov Cap-2 Maneuver	-	-	-	-	377 -
Stage 1	-	-	-	-	575 -
Stage 2	-	-	-	-	834 -

Approach	EB	WB	SB
HCM Control Delay, s	1.5	0	13.2
HCM LOS			B

Minor Lane/Major Mvmt	EBL	EBT	WBT	WBR	SBLn1
Capacity (veh/h)	1037	-	-	-	455
HCM Lane V/C Ratio	0.029	-	-	-	0.034
HCM Control Delay (s)	8.6	-	-	-	13.2
HCM Lane LOS	A	-	-	-	B
HCM 95th %tile Q(veh)	0.1	-	-	-	0.1

Intersection						
Int Delay, s/veh	13.8					
Movement	EBT	EBR	WBL	WBT	NBL	NBR
Lane Configurations	↑↑		↖	↑↑	↘	
Traffic Vol, veh/h	269	238	45	396	197	33
Future Vol, veh/h	269	238	45	396	197	33
Conflicting Peds, #/hr	0	0	0	0	0	0
Sign Control	Free	Free	Free	Free	Stop	Stop
RT Channelized	-	None	-	None	-	None
Storage Length	-	-	125	-	0	-
Veh in Median Storage, #	0	-	-	0	0	-
Grade, %	0	-	-	0	0	-
Peak Hour Factor	80	80	80	80	80	80
Heavy Vehicles, %	3	0	3	1	0	0
Mvmt Flow	336	298	56	495	246	41

Major/Minor	Major1	Major2	Minor1		
Conflicting Flow All	0	0	634	0	845 317
Stage 1	-	-	-	-	485 -
Stage 2	-	-	-	-	360 -
Critical Hdwy	-	-	4.16	-	6.8 6.9
Critical Hdwy Stg 1	-	-	-	-	5.8 -
Critical Hdwy Stg 2	-	-	-	-	5.8 -
Follow-up Hdwy	-	-	2.23	-	3.5 3.3
Pot Cap-1 Maneuver	-	-	938	-	306 685
Stage 1	-	-	-	-	591 -
Stage 2	-	-	-	-	683 -
Platoon blocked, %	-	-	-	-	-
Mov Cap-1 Maneuver	-	-	938	-	288 685
Mov Cap-2 Maneuver	-	-	-	-	288 -
Stage 1	-	-	-	-	591 -
Stage 2	-	-	-	-	642 -

Approach	EB	WB	NB
HCM Control Delay, s	0	0.9	68.8
HCM LOS			F

Minor Lane/Major Mvmt	NBLn1	EBT	EBR	WBL	WBT
Capacity (veh/h)	314	-	-	938	-
HCM Lane V/C Ratio	0.916	-	-	0.06	-
HCM Control Delay (s)	68.8	-	-	9.1	-
HCM Lane LOS	F	-	-	A	-
HCM 95th %tile Q(veh)	8.9	-	-	0.2	-

Timings

14: Barton Rd. & Van Buren Bl.



Lane Group	EBL	EBT	WBL	WBT	NBL	NBT	NBR	SBL	SBT
Lane Configurations	↘	↗	↘	↗	↘	↗	↗	↘	↗
Traffic Volume (vph)	135	1022	250	1233	358	73	345	46	95
Future Volume (vph)	135	1022	250	1233	358	73	345	46	95
Turn Type	Prot	NA	Prot	NA	Prot	NA	Perm	Prot	NA
Protected Phases	5	2	1	6	3	8		7	4
Permitted Phases							8		
Detector Phase	5	2	1	6	3	8	8	7	4
Switch Phase									
Minimum Initial (s)	5.0	10.0	5.0	10.0	5.0	10.0	10.0	5.0	10.0
Minimum Split (s)	9.2	25.2	9.2	25.5	9.1	14.6	14.6	9.1	33.6
Total Split (s)	18.5	47.4	22.0	50.9	17.0	37.5	37.5	13.1	33.6
Total Split (%)	15.4%	39.5%	18.3%	42.4%	14.2%	31.3%	31.3%	10.9%	28.0%
Yellow Time (s)	3.2	5.2	3.2	5.5	3.6	3.6	3.6	3.6	3.6
All-Red Time (s)	1.0	1.0	1.0	1.0	0.5	1.0	1.0	0.5	1.0
Lost Time Adjust (s)	0.0	0.0	0.0	0.0	0.0	0.0	0.0	0.0	0.0
Total Lost Time (s)	4.2	6.2	4.2	6.5	4.1	4.6	4.6	4.1	4.6
Lead/Lag	Lead	Lag	Lead	Lag	Lead	Lag	Lag	Lead	Lag
Lead-Lag Optimize?	Yes	Yes	Yes	Yes	Yes	Yes	Yes	Yes	Yes
Recall Mode	None	None	None	None	None	None	None	None	None
Act Effct Green (s)	12.8	41.3	17.8	46.0	12.9	33.3	33.3	8.0	26.3
Actuated g/C Ratio	0.11	0.35	0.15	0.39	0.11	0.28	0.28	0.07	0.22
v/c Ratio	0.79	1.06	1.08	0.74	1.10	0.16	0.59	0.43	0.92
Control Delay	78.1	80.9	126.2	34.0	124.6	33.9	12.6	64.5	59.0
Queue Delay	0.0	0.0	0.0	0.0	0.0	0.0	0.0	0.0	0.0
Total Delay	78.1	80.9	126.2	34.0	124.6	33.9	12.6	64.5	59.0
LOS	E	F	F	C	F	C	B	E	E
Approach Delay		80.6		49.3		66.2			59.6
Approach LOS		F		D		E			E

Intersection Summary

Cycle Length: 120
 Actuated Cycle Length: 117.4
 Natural Cycle: 130
 Control Type: Actuated-Uncoordinated
 Maximum v/c Ratio: 1.10
 Intersection Signal Delay: 63.7
 Intersection LOS: E
 Intersection Capacity Utilization 93.6%
 ICU Level of Service F
 Analysis Period (min) 15

Splits and Phases: 14: Barton Rd. & Van Buren Bl.

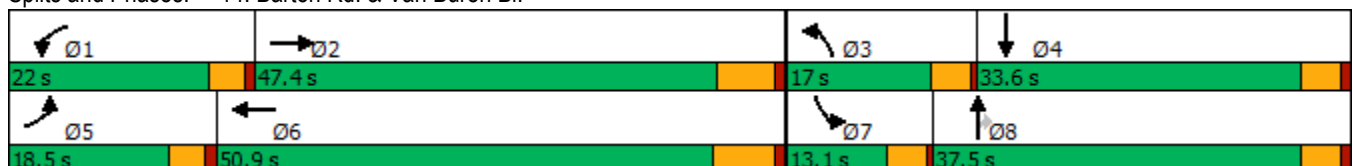

HCM 6th Signalized Intersection Summary
14: Barton Rd. & Van Buren Bl.

West Campus Upper Plateau (JN 14064)

02/16/2022

Movement	EBL	EBT	EBR	WBL	WBT	WBR	NBL	NBT	NBR	SBL	SBT	SBR
Lane Configurations												
Traffic Volume (veh/h)	135	1022	104	250	1233	25	358	73	345	46	95	278
Future Volume (veh/h)	135	1022	104	250	1233	25	358	73	345	46	95	278
Initial Q (Qb), veh	0	0	0	0	0	0	0	0	0	0	0	0
Ped-Bike Adj(A_pbT)	1.00		1.00	1.00		1.00	1.00		1.00	1.00		1.00
Parking Bus, Adj	1.00	1.00	1.00	1.00	1.00	1.00	1.00	1.00	1.00	1.00	1.00	1.00
Work Zone On Approach		No			No			No			No	
Adj Sat Flow, veh/h/ln	1900	1856	1841	1856	1856	1693	1856	1870	1885	1900	1870	1900
Adj Flow Rate, veh/h	155	1175	107	287	1417	23	411	84	181	53	109	198
Peak Hour Factor	0.87	0.87	0.87	0.87	0.87	0.87	0.87	0.87	0.87	0.87	0.87	0.87
Percent Heavy Veh, %	0	3	4	3	3	14	3	2	1	0	2	0
Cap, veh/h	183	1174	107	274	2122	34	386	520	445	69	121	220
Arrive On Green	0.10	0.36	0.36	0.16	0.41	0.41	0.11	0.28	0.28	0.04	0.20	0.20
Sat Flow, veh/h	1810	3268	297	1767	5134	83	3428	1870	1598	1810	595	1081
Grp Volume(v), veh/h	155	633	649	287	932	508	411	84	181	53	0	307
Grp Sat Flow(s),veh/h/ln	1810	1763	1802	1767	1689	1841	1714	1870	1598	1810	0	1676
Q Serve(g_s), s	9.7	41.2	41.2	17.8	25.6	25.6	12.9	3.9	10.6	3.3	0.0	20.5
Cycle Q Clear(g_c), s	9.7	41.2	41.2	17.8	25.6	25.6	12.9	3.9	10.6	3.3	0.0	20.5
Prop In Lane	1.00		0.16	1.00		0.05	1.00		1.00	1.00		0.64
Lane Grp Cap(c), veh/h	183	633	647	274	1395	761	386	520	445	69	0	342
V/C Ratio(X)	0.85	1.00	1.00	1.05	0.67	0.67	1.07	0.16	0.41	0.77	0.00	0.90
Avail Cap(c_a), veh/h	226	633	647	274	1395	761	386	537	458	142	0	424
HCM Platoon Ratio	1.00	1.00	1.00	1.00	1.00	1.00	1.00	1.00	1.00	1.00	1.00	1.00
Upstream Filter(I)	1.00	1.00	1.00	1.00	1.00	1.00	1.00	1.00	1.00	1.00	0.00	1.00
Uniform Delay (d), s/veh	50.6	36.7	36.7	48.4	27.3	27.3	50.9	31.3	33.7	54.7	0.0	44.5
Incr Delay (d2), s/veh	18.1	35.6	35.9	66.9	1.0	1.8	64.3	0.1	0.6	16.3	0.0	18.8
Initial Q Delay(d3),s/veh	0.0	0.0	0.0	0.0	0.0	0.0	0.0	0.0	0.0	0.0	0.0	0.0
%ile BackOfQ(50%),veh/ln	5.1	22.7	23.2	12.6	9.8	10.8	8.8	1.7	4.0	1.8	0.0	10.0
Unsig. Movement Delay, s/veh												
LnGrp Delay(d),s/veh	68.7	72.3	72.7	115.4	28.3	29.1	115.2	31.4	34.3	71.0	0.0	63.3
LnGrp LOS	E	E	F	F	C	C	F	C	C	E	A	E
Approach Vol, veh/h		1437			1727			676			360	
Approach Delay, s/veh		72.1			43.0			83.1			64.5	
Approach LOS		E			D			F			E	
Timer - Assigned Phs	1	2	3	4	5	6	7	8				
Phs Duration (G+Y+Rc), s	22.0	47.7	17.0	28.0	15.8	53.9	8.5	36.5				
Change Period (Y+Rc), s	* 4.2	* 6.5	4.1	4.6	* 4.2	6.5	4.1	4.6				
Max Green Setting (Gmax), s	* 18	* 41	12.9	29.0	* 14	44.4	9.0	32.9				
Max Q Clear Time (g_c+I1), s	19.8	43.2	14.9	22.5	11.7	27.6	5.3	12.6				
Green Ext Time (p_c), s	0.0	0.0	0.0	0.9	0.0	5.4	0.0	0.9				

Intersection Summary

HCM 6th Ctrl Delay	61.2
HCM 6th LOS	E

Notes

* HCM 6th computational engine requires equal clearance times for the phases crossing the barrier.

Intersection

Intersection Delay, s/veh	10.9
Intersection LOS	B

Movement	EBT	EBR	WBL	WBT	NBL	NBR
Lane Configurations						
Traffic Vol, veh/h	50	52	93	213	135	61
Future Vol, veh/h	50	52	93	213	135	61
Peak Hour Factor	0.76	0.76	0.76	0.76	0.76	0.76
Heavy Vehicles, %	5	0	0	2	3	2
Mvmt Flow	66	68	122	280	178	80
Number of Lanes	1	0	1	1	1	0

Approach	EB	WB	NB
Opposing Approach	WB	EB	
Opposing Lanes	2	1	0
Conflicting Approach Left		NB	EB
Conflicting Lanes Left	0	1	1
Conflicting Approach Right	NB		WB
Conflicting Lanes Right	1	0	2
HCM Control Delay	9.2	11.3	11.2
HCM LOS	A	B	B

Lane	NBLn1	EBLn1	WBLn1	WBLn2
Vol Left, %	69%	0%	100%	0%
Vol Thru, %	0%	49%	0%	100%
Vol Right, %	31%	51%	0%	0%
Sign Control	Stop	Stop	Stop	Stop
Traffic Vol by Lane	196	102	93	213
LT Vol	135	0	93	0
Through Vol	0	50	0	213
RT Vol	61	52	0	0
Lane Flow Rate	258	134	122	280
Geometry Grp	2	5	7	7
Degree of Util (X)	0.369	0.184	0.198	0.416
Departure Headway (Hd)	5.155	4.947	5.811	5.341
Convergence, Y/N	Yes	Yes	Yes	Yes
Cap	694	717	613	670
Service Time	3.22	3.034	3.585	3.115
HCM Lane V/C Ratio	0.372	0.187	0.199	0.418
HCM Control Delay	11.2	9.2	10	11.9
HCM Lane LOS	B	A	A	B
HCM 95th-tile Q	1.7	0.7	0.7	2.1

Intersection

Intersection Delay, s/veh	13.1
Intersection LOS	B

Movement	EBL	EBT	WBT	WBR	SBL	SBR
Lane Configurations						
Traffic Vol, veh/h	113	161	301	87	73	104
Future Vol, veh/h	113	161	301	87	73	104
Peak Hour Factor	0.71	0.71	0.71	0.71	0.71	0.71
Heavy Vehicles, %	0	2	0	3	2	1
Mvmt Flow	159	227	424	123	103	146
Number of Lanes	1	2	2	0	1	0

Approach	EB	WB	SB
Opposing Approach	WB	EB	
Opposing Lanes	2	3	0
Conflicting Approach Left SB			WB
Conflicting Lanes Left	1	0	2
Conflicting Approach Right		SB	EB
Conflicting Lanes Right	0	1	3
HCM Control Delay	10.4	14.4	14.6
HCM LOS	B	B	B

Lane	EBLn1	EBLn2	EBLn3	WBLn1	WBLn2	SBLn1
Vol Left, %	100%	0%	0%	0%	0%	41%
Vol Thru, %	0%	100%	100%	100%	54%	0%
Vol Right, %	0%	0%	0%	0%	46%	59%
Sign Control	Stop	Stop	Stop	Stop	Stop	Stop
Traffic Vol by Lane	113	81	81	201	187	177
LT Vol	113	0	0	0	0	73
Through Vol	0	81	81	201	100	0
RT Vol	0	0	0	0	87	104
Lane Flow Rate	159	113	113	283	264	249
Geometry Grp	7	7	7	8	8	7
Degree of Util (X)	0.294	0.194	0.139	0.497	0.443	0.453
Departure Headway (Hd)	6.646	6.172	4.409	6.326	6.048	6.543
Convergence, Y/N	Yes	Yes	Yes	Yes	Yes	Yes
Cap	540	579	808	568	594	548
Service Time	4.401	3.927	2.162	4.082	3.803	4.299
HCM Lane V/C Ratio	0.294	0.195	0.14	0.498	0.444	0.454
HCM Control Delay	12.2	10.4	7.9	15.2	13.6	14.6
HCM Lane LOS	B	B	A	C	B	B
HCM 95th-tile Q	1.2	0.7	0.5	2.8	2.3	2.3

Timings
19: Van Buren Bl. & Orange Terrace Pkwy.

West Campus Upper Plateau (JN 14064)

02/16/2022

Lane Group	EBL	EBT	EBR	WBL	WBT	WBR	NBL	NBT	NBR	SBL	SBT	SBR
Lane Configurations												
Traffic Volume (vph)	135	1221	41	35	1212	125	37	15	32	233	25	214
Future Volume (vph)	135	1221	41	35	1212	125	37	15	32	233	25	214
Turn Type	Prot	NA	Perm	Prot	NA	Perm	Prot	NA	Perm	Prot	NA	pm+ov
Protected Phases	5	2		1	6		3	8		7	4	5
Permitted Phases			2			6			8			4
Detector Phase	5	2	2	1	6	6	3	8	8	7	4	5
Switch Phase												
Minimum Initial (s)	5.0	10.0	10.0	5.0	10.0	10.0	5.0	5.0	5.0	10.0	10.0	5.0
Minimum Split (s)	9.2	25.2	25.2	9.1	25.2	25.2	9.1	26.1	26.1	15.8	24.8	9.2
Total Split (s)	16.0	62.8	62.8	9.1	55.9	55.9	9.1	26.1	26.1	22.0	39.0	16.0
Total Split (%)	13.3%	52.3%	52.3%	7.6%	46.6%	46.6%	7.6%	21.8%	21.8%	18.3%	32.5%	13.3%
Yellow Time (s)	3.2	5.2	5.2	3.6	5.2	5.2	3.6	3.6	3.6	4.8	4.8	3.2
All-Red Time (s)	1.0	1.0	1.0	0.5	1.0	1.0	0.5	0.5	0.5	1.0	1.0	1.0
Lost Time Adjust (s)	0.0	0.0	0.0	0.0	0.0	0.0	0.0	0.0	0.0	0.0	0.0	0.0
Total Lost Time (s)	4.2	6.2	6.2	4.1	6.2	6.2	4.1	4.1	4.1	5.8	5.8	4.2
Lead/Lag	Lead	Lag	Lag	Lead	Lag	Lag	Lead	Lag	Lag	Lead	Lag	Lead
Lead-Lag Optimize?	Yes	Yes	Yes	Yes	Yes	Yes	Yes	Yes	Yes	Yes	Yes	Yes
Recall Mode	None	None	None	None	None	None	None	None	None	None	None	None
Act Effct Green (s)	7.9	35.1	35.1	5.3	27.4	27.4	8.7	6.5	6.5	12.0	12.6	19.9
Actuated g/C Ratio	0.11	0.50	0.50	0.08	0.39	0.39	0.12	0.09	0.09	0.17	0.18	0.28
v/c Ratio	0.36	0.50	0.05	0.14	0.63	0.18	0.09	0.05	0.11	0.40	0.08	0.45
Control Delay	35.9	14.2	0.1	38.8	19.3	1.3	35.3	36.7	0.7	31.7	29.8	18.4
Queue Delay	0.0	0.0	0.0	0.0	0.0	0.0	0.0	0.0	0.0	0.0	0.0	0.0
Total Delay	35.9	14.2	0.1	38.8	19.3	1.3	35.3	36.7	0.7	31.7	29.8	18.4
LOS	D	B	A	D	B	A	D	D	A	C	C	B
Approach Delay		15.8			18.2			22.3			25.6	
Approach LOS		B			B			C			C	

Intersection Summary

Cycle Length: 120
 Actuated Cycle Length: 70.1
 Natural Cycle: 80
 Control Type: Actuated-Uncoordinated
 Maximum v/c Ratio: 0.63
 Intersection Signal Delay: 18.4
 Intersection LOS: B
 Intersection Capacity Utilization 54.7%
 ICU Level of Service A
 Analysis Period (min) 15

Splits and Phases: 19: Van Buren Bl. & Orange Terrace Pkwy.

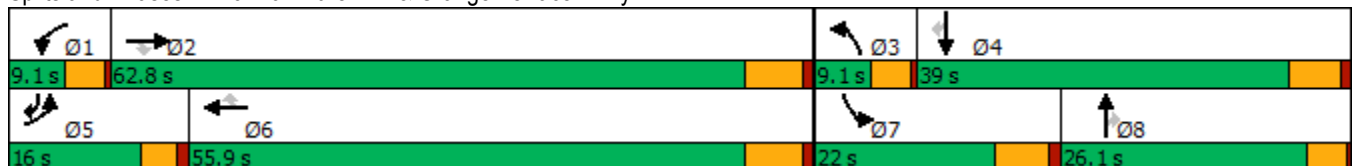

HCM 6th Signalized Intersection Summary
 19: Van Buren Bl. & Orange Terrace Pkwy.

West Campus Upper Plateau (JN 14064)

02/16/2022



Movement	EBL	EBT	EBR	WBL	WBT	WBR	NBL	NBT	NBR	SBL	SBT	SBR
Lane Configurations	↖↗	↑↑↑	↖	↖↗	↑↑↑	↖	↖↗	↑↑	↖	↖↗	↑	↖↗
Traffic Volume (veh/h)	135	1221	41	35	1212	125	37	15	32	233	25	214
Future Volume (veh/h)	135	1221	41	35	1212	125	37	15	32	233	25	214
Initial Q (Qb), veh	0	0	0	0	0	0	0	0	0	0	0	0
Ped-Bike Adj(A_pbT)	1.00		0.99	1.00		1.00	1.00		1.00	1.00		0.98
Parking Bus, Adj	1.00	1.00	1.00	1.00	1.00	1.00	1.00	1.00	1.00	1.00	1.00	1.00
Work Zone On Approach		No			No			No			No	
Adj Sat Flow, veh/h/ln	1870	1856	1781	1900	1870	1870	1900	1900	1693	1885	1900	1870
Adj Flow Rate, veh/h	139	1259	32	36	1249	88	38	15	6	240	26	108
Peak Hour Factor	0.97	0.97	0.97	0.97	0.97	0.97	0.97	0.97	0.97	0.97	0.97	0.97
Percent Heavy Veh, %	2	3	8	0	2	2	0	0	14	1	0	2
Cap, veh/h	238	2105	620	128	1949	605	133	262	104	519	397	435
Arrive On Green	0.07	0.42	0.42	0.04	0.38	0.38	0.04	0.07	0.07	0.15	0.21	0.21
Sat Flow, veh/h	3456	5066	1491	3510	5106	1585	3510	3610	1434	3483	1900	1558
Grp Volume(v), veh/h	139	1259	32	36	1249	88	38	15	6	240	26	108
Grp Sat Flow(s),veh/h/ln	1728	1689	1491	1755	1702	1585	1755	1805	1434	1742	1900	1558
Q Serve(g_s), s	2.6	13.0	0.9	0.7	13.4	2.4	0.7	0.3	0.3	4.2	0.7	3.6
Cycle Q Clear(g_c), s	2.6	13.0	0.9	0.7	13.4	2.4	0.7	0.3	0.3	4.2	0.7	3.6
Prop In Lane	1.00		1.00	1.00		1.00	1.00		1.00	1.00		1.00
Lane Grp Cap(c), veh/h	238	2105	620	128	1949	605	133	262	104	519	397	435
V/C Ratio(X)	0.58	0.60	0.05	0.28	0.64	0.15	0.29	0.06	0.06	0.46	0.07	0.25
Avail Cap(c_a), veh/h	608	4274	1258	262	3783	1174	262	1184	470	841	940	880
HCM Platoon Ratio	1.00	1.00	1.00	1.00	1.00	1.00	1.00	1.00	1.00	1.00	1.00	1.00
Upstream Filter(I)	1.00	1.00	1.00	1.00	1.00	1.00	1.00	1.00	1.00	1.00	1.00	1.00
Uniform Delay (d), s/veh	30.3	15.2	11.7	31.5	17.0	13.6	31.4	29.0	29.0	26.1	21.3	18.8
Incr Delay (d2), s/veh	0.8	0.3	0.0	1.2	0.4	0.1	1.2	0.1	0.2	0.6	0.1	0.3
Initial Q Delay(d3),s/veh	0.0	0.0	0.0	0.0	0.0	0.0	0.0	0.0	0.0	0.0	0.0	0.0
%ile BackOfQ(50%),veh/ln	1.0	4.0	0.3	0.3	4.3	0.8	0.3	0.1	0.1	1.6	0.3	1.3
Unsig. Movement Delay, s/veh												
LnGrp Delay(d),s/veh	31.1	15.5	11.7	32.7	17.3	13.7	32.6	29.1	29.2	26.7	21.3	19.1
LnGrp LOS	C	B	B	C	B	B	C	C	C	C	C	B
Approach Vol, veh/h		1430			1373			59			374	
Approach Delay, s/veh		17.0			17.5			31.3			24.1	
Approach LOS		B			B			C			C	
Timer - Assigned Phs	1	2	3	4	5	6	7	8				
Phs Duration (G+Y+Rc), s	6.5	34.1	6.6	19.8	8.8	31.8	15.8	10.7				
Change Period (Y+Rc), s	4.1	6.2	4.1	5.8	* 4.2	6.2	5.8	* 5.8				
Max Green Setting (Gmax), s	5.0	56.6	5.0	33.2	* 12	49.7	16.2	* 22				
Max Q Clear Time (g_c+I1), s	2.7	15.0	2.7	5.6	4.6	15.4	6.2	2.3				
Green Ext Time (p_c), s	0.0	10.4	0.0	0.4	0.1	10.2	0.5	0.0				

Intersection Summary

HCM 6th Ctrl Delay	18.3
HCM 6th LOS	B

Notes

* HCM 6th computational engine requires equal clearance times for the phases crossing the barrier.

Timings
20: Brown/San Gorgonio Dr & Alessandro Bl.

West Campus Upper Plateau (JN 14064)

02/16/2022



Lane Group	EBL	EBT	WBL	WBT	WBR	NBR	SBL	SBT	SBR	Ø3	Ø8
Lane Configurations	↖	↖↖↖	↖	↖↖↖	↖	↖	↖	↖	↖		
Traffic Volume (vph)	30	1313	13	2372	50	5	29	1	16		
Future Volume (vph)	30	1313	13	2372	50	5	29	1	16		
Turn Type	Prot	NA	Prot	NA	Perm	pm+ov	Prot	NA	pm+ov		
Protected Phases	5	2	1	6		1	7	4	5	3	8
Permitted Phases					6	8			4		
Detector Phase	5	2	1	6	6	1	7	4	5		
Switch Phase											
Minimum Initial (s)	5.0	10.0	5.0	10.0	10.0	5.0	5.0	10.0	5.0	5.0	5.0
Minimum Split (s)	8.7	43.5	9.1	43.5	43.5	9.1	8.7	49.8	8.7	9.1	26.1
Total Split (s)	8.7	51.9	9.2	52.4	52.4	9.2	10.8	49.8	8.7	9.1	48.1
Total Split (%)	7.3%	43.3%	7.7%	43.7%	43.7%	7.7%	9.0%	41.5%	7.3%	8%	40%
Yellow Time (s)	3.2	5.5	3.6	5.5	5.5	3.6	3.2	4.8	3.2	3.6	3.6
All-Red Time (s)	0.5	1.0	0.5	1.0	1.0	0.5	0.5	1.0	0.5	0.5	0.5
Lost Time Adjust (s)	0.0	0.0	0.0	0.0	0.0	0.0	0.0	0.0	0.0		
Total Lost Time (s)	3.7	6.5	4.1	6.5	6.5	4.1	3.7	5.8	3.7		
Lead/Lag	Lead	Lag	Lead	Lag	Lag	Lead	Lead	Lag	Lead	Lead	Lag
Lead-Lag Optimize?	Yes	Yes	Yes	Yes	Yes	Yes	Yes	Yes	Yes	Yes	Yes
Recall Mode	None	None	None	None	None	None	None	None	None	None	None
Act Effct Green (s)	5.4	56.6	5.5	53.2	53.2	10.5	7.2	15.2	14.7		
Actuated g/C Ratio	0.08	0.80	0.08	0.75	0.75	0.15	0.10	0.21	0.21		
v/c Ratio	0.23	0.34	0.16	0.65	0.05	0.02	0.20	0.00	0.04		
Control Delay	44.3	9.3	46.0	13.8	0.8	0.2	40.4	24.0	0.2		
Queue Delay	0.0	0.0	0.0	0.0	0.0	0.0	0.0	0.0	0.0		
Total Delay	44.3	9.3	46.0	13.8	0.8	0.2	40.4	24.0	0.2		
LOS	D	A	D	B	A	A	D	C	A		
Approach Delay		10.1		13.7				26.1			
Approach LOS		B		B				C			

Intersection Summary

Cycle Length: 120
 Actuated Cycle Length: 70.7
 Natural Cycle: 125
 Control Type: Actuated-Uncoordinated
 Maximum v/c Ratio: 0.65
 Intersection Signal Delay: 12.6
 Intersection LOS: B
 Intersection Capacity Utilization 64.4%
 ICU Level of Service C
 Analysis Period (min) 15

Splits and Phases: 20: Brown/San Gorgonio Dr & Alessandro Bl.

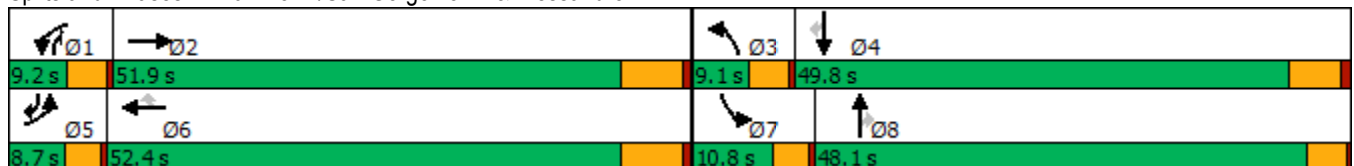

HCM 6th Signalized Intersection Summary
20: Brown/San Gorgonio Dr & Alessandro Bl.

West Campus Upper Plateau (JN 14064)
02/16/2022



Movement	EBL	EBT	EBR	WBL	WBT	WBR	NBL	NBT	NBR	SBL	SBT	SBR
Lane Configurations	↗	↑↑↑		↖	↑↑↑	↗	↖	↑	↗	↖	↑	↗
Traffic Volume (veh/h)	30	1313	2	13	2372	50	0	0	5	29	1	16
Future Volume (veh/h)	30	1313	2	13	2372	50	0	0	5	29	1	16
Initial Q (Qb), veh	0	0	0	0	0	0	0	0	0	0	0	0
Ped-Bike Adj(A_pbT)	1.00		0.98	1.00		1.00	1.00		1.00	1.00		1.00
Parking Bus, Adj	1.00	1.00	1.00	1.00	1.00	1.00	1.00	1.00	1.00	1.00	1.00	1.00
Work Zone On Approach		No			No			No			No	
Adj Sat Flow, veh/h/ln	1900	1870	1900	952	1870	1752	1900	1900	1159	1648	418	1900
Adj Flow Rate, veh/h	32	1382	2	14	2497	53	0	0	2	31	1	3
Peak Hour Factor	0.95	0.95	0.95	0.95	0.95	0.95	0.95	0.95	0.95	0.95	0.95	0.95
Percent Heavy Veh, %	0	2	0	64	2	10	0	0	50	17	100	0
Cap, veh/h	60	3441	5	15	3284	955	3	15	24	51	39	204
Arrive On Green	0.03	0.65	0.65	0.02	0.64	0.64	0.00	0.00	0.01	0.03	0.09	0.09
Sat Flow, veh/h	1810	5265	8	906	5106	1485	1810	1900	982	1570	418	1610
Grp Volume(v), veh/h	32	893	491	14	2497	53	0	0	2	31	1	3
Grp Sat Flow(s),veh/h/ln	1810	1702	1869	906	1702	1485	1810	1900	982	1570	418	1610
Q Serve(g_s), s	1.2	8.6	8.6	1.1	23.7	0.9	0.0	0.0	0.1	1.4	0.2	0.1
Cycle Q Clear(g_c), s	1.2	8.6	8.6	1.1	23.7	0.9	0.0	0.0	0.1	1.4	0.2	0.1
Prop In Lane	1.00		0.00	1.00		1.00	1.00		1.00	1.00		1.00
Lane Grp Cap(c), veh/h	60	2225	1221	15	3284	955	3	15	24	51	39	204
V/C Ratio(X)	0.53	0.40	0.40	0.91	0.76	0.06	0.00	0.00	0.08	0.61	0.03	0.01
Avail Cap(c_a), veh/h	130	2225	1221	66	3371	980	130	1202	638	160	265	1072
HCM Platoon Ratio	1.00	1.00	1.00	1.00	1.00	1.00	1.00	1.00	1.00	1.00	1.00	1.00
Upstream Filter(I)	1.00	1.00	1.00	1.00	1.00	1.00	0.00	0.00	1.00	1.00	1.00	1.00
Uniform Delay (d), s/veh	33.1	5.7	5.7	34.1	8.7	4.6	0.0	0.0	33.1	33.2	28.6	26.6
Incr Delay (d2), s/veh	2.7	0.2	0.3	82.5	1.1	0.0	0.0	0.0	1.4	4.3	0.3	0.0
Initial Q Delay(d3),s/veh	0.0	0.0	0.0	0.0	0.0	0.0	0.0	0.0	0.0	0.0	0.0	0.0
%ile BackOfQ(50%),veh/ln	0.5	1.7	1.9	0.6	6.9	0.2	0.0	0.0	0.0	0.6	0.0	0.0
Unsig. Movement Delay, s/veh												
LnGrp Delay(d),s/veh	35.8	5.8	6.0	116.7	9.8	4.6	0.0	0.0	34.5	37.5	28.9	26.6
LnGrp LOS	D	A	A	F	A	A	A	A	C	D	C	C
Approach Vol, veh/h		1416			2564			2				35
Approach Delay, s/veh		6.5			10.2			34.5				36.3
Approach LOS		A			B			C				D
Timer - Assigned Phs	1	2	3	4	5	6	7	8				
Phs Duration (G+Y+Rc), s	5.3	51.9	0.0	12.3	6.0	51.2	6.0	6.3				
Change Period (Y+Rc), s	4.1	6.5	4.1	5.8	3.7	6.5	3.7	* 5.8				
Max Green Setting (Gmax), s	5.1	45.4	5.0	44.0	5.0	45.9	7.1	* 44				
Max Q Clear Time (g_c+I1), s	3.1	10.6	0.0	2.2	3.2	25.7	3.4	2.1				
Green Ext Time (p_c), s	0.0	14.9	0.0	0.0	0.0	19.0	0.0	0.0				

Intersection Summary

HCM 6th Ctrl Delay	9.2
HCM 6th LOS	A

Notes

* HCM 6th computational engine requires equal clearance times for the phases crossing the barrier.

Timings
22: Sycamore Canyon Bl. & Eastridge Ave

West Campus Upper Plateau (JN 14064)

02/16/2022



Lane Group	EBL	EBT	EBR	WBL	WBT	WBR	NBL	NBT	NBR	SBL	SBT	SBR
Lane Configurations	↖↖	↑↑↑	↗	↖↖	↑↑	↗	↖↖	↑↑	↗	↖↖	↑↑	↗
Traffic Volume (vph)	46	38	16	102	176	457	67	713	84	70	170	39
Future Volume (vph)	46	38	16	102	176	457	67	713	84	70	170	39
Turn Type	Prot	NA	Perm	Prot	NA	pm+ov	Prot	NA	pm+ov	Prot	NA	pm+ov
Protected Phases	5	2		1	6	7	3	8	1	7	4	5
Permitted Phases			2			6			8			4
Detector Phase	5	2	2	1	6	7	3	8	1	7	4	5
Switch Phase												
Minimum Initial (s)	5.0	10.0	10.0	5.0	10.0	5.0	5.0	10.0	5.0	5.0	10.0	5.0
Minimum Split (s)	8.7	43.5	43.5	8.7	43.5	8.7	8.7	15.8	8.7	8.7	49.8	8.7
Total Split (s)	10.1	47.0	47.0	11.0	47.9	21.0	10.6	41.0	11.0	21.0	51.4	10.1
Total Split (%)	8.4%	39.2%	39.2%	9.2%	39.9%	17.5%	8.8%	34.2%	9.2%	17.5%	42.8%	8.4%
Yellow Time (s)	3.2	5.5	5.5	3.2	5.5	3.2	3.2	4.8	3.2	3.2	4.8	3.2
All-Red Time (s)	0.5	1.0	1.0	0.5	1.0	0.5	0.5	1.0	0.5	0.5	1.0	0.5
Lost Time Adjust (s)	0.0	0.0	0.0	0.0	0.0	0.0	0.0	0.0	0.0	0.0	0.0	0.0
Total Lost Time (s)	3.7	6.5	6.5	3.7	6.5	3.7	3.7	5.8	3.7	3.7	5.8	3.7
Lead/Lag	Lead	Lag	Lag	Lead	Lag	Lead	Lead	Lag	Lead	Lead	Lag	Lead
Lead-Lag Optimize?	Yes	Yes	Yes	Yes	Yes	Yes	Yes	Yes	Yes	Yes	Yes	Yes
Recall Mode	None	None	None	None	None	None	None	None	None	None	None	None
Act Effct Green (s)	6.2	14.6	14.6	13.0	15.2	35.5	6.5	26.5	41.7	13.3	36.1	44.5
Actuated g/C Ratio	0.08	0.18	0.18	0.16	0.19	0.45	0.08	0.33	0.53	0.17	0.45	0.56
v/c Ratio	0.26	0.07	0.05	0.25	0.34	0.74	0.29	0.74	0.12	0.15	0.13	0.06
Control Delay	44.9	29.9	0.2	40.5	31.5	24.1	43.9	29.9	3.9	33.5	15.7	2.0
Queue Delay	0.0	0.0	0.0	0.0	0.0	0.0	0.0	0.0	0.0	0.0	0.0	0.0
Total Delay	44.9	29.9	0.2	40.5	31.5	24.1	43.9	29.9	3.9	33.5	15.7	2.0
LOS	D	C	A	D	C	C	D	C	A	C	B	A
Approach Delay		32.2			28.1			28.4			18.2	
Approach LOS		C			C			C			B	

Intersection Summary

Cycle Length: 120
 Actuated Cycle Length: 79.4
 Natural Cycle: 115
 Control Type: Actuated-Uncoordinated
 Maximum v/c Ratio: 0.74
 Intersection Signal Delay: 27.1
 Intersection LOS: C
 Intersection Capacity Utilization 63.7%
 ICU Level of Service B
 Analysis Period (min) 15

Splits and Phases: 22: Sycamore Canyon Bl. & Eastridge Ave

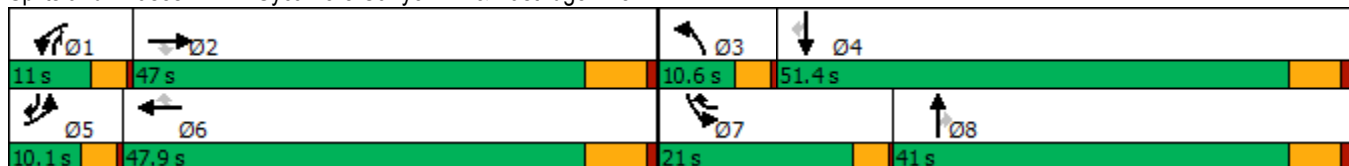

HCM 6th Signalized Intersection Summary
22: Sycamore Canyon Bl. & Eastridge Ave

West Campus Upper Plateau (JN 14064)
02/16/2022



Movement	EBL	EBT	EBR	WBL	WBT	WBR	NBL	NBT	NBR	SBL	SBT	SBR
Lane Configurations	↖↗	↑↑↑	↖	↖↗	↑↑	↖	↖↗	↑↑	↖	↖↗	↑↑	↖
Traffic Volume (veh/h)	46	38	16	102	176	457	67	713	84	70	170	39
Future Volume (veh/h)	46	38	16	102	176	457	67	713	84	70	170	39
Initial Q (Qb), veh	0	0	0	0	0	0	0	0	0	0	0	0
Ped-Bike Adj(A_pbT)	1.00		1.00	1.00		1.00	1.00		0.99	1.00		0.99
Parking Bus, Adj	1.00	1.00	1.00	1.00	1.00	1.00	1.00	1.00	1.00	1.00	1.00	1.00
Work Zone On Approach		No			No			No			No	
Adj Sat Flow, veh/h/ln	1411	1248	1693	1574	1678	1796	1767	1781	1707	1752	1781	1544
Adj Flow Rate, veh/h	53	44	0	117	202	525	77	820	63	80	195	31
Peak Hour Factor	0.87	0.87	0.87	0.87	0.87	0.87	0.87	0.87	0.87	0.87	0.87	0.87
Percent Heavy Veh, %	33	44	14	22	15	7	9	8	13	10	8	24
Cap, veh/h	110	1214		173	1191	645	161	1022	517	162	1024	446
Arrive On Green	0.04	0.36	0.00	0.06	0.37	0.37	0.05	0.30	0.30	0.05	0.30	0.30
Sat Flow, veh/h	2607	3407	1434	2908	3188	1522	3264	3385	1428	3237	3385	1292
Grp Volume(v), veh/h	53	44	0	117	202	525	77	820	63	80	195	31
Grp Sat Flow(s),veh/h/ln	1303	1136	1434	1454	1594	1522	1632	1692	1428	1618	1692	1292
Q Serve(g_s), s	1.7	0.7	0.0	3.3	3.6	25.7	1.9	18.9	2.5	2.0	3.6	1.4
Cycle Q Clear(g_c), s	1.7	0.7	0.0	3.3	3.6	25.7	1.9	18.9	2.5	2.0	3.6	1.4
Prop In Lane	1.00		1.00	1.00		1.00	1.00		1.00	1.00		1.00
Lane Grp Cap(c), veh/h	110	1214		173	1191	645	161	1022	517	162	1024	446
V/C Ratio(X)	0.48	0.04		0.68	0.17	0.81	0.48	0.80	0.12	0.49	0.19	0.07
Avail Cap(c_a), veh/h	197	1628		250	1557	820	266	1406	679	661	1821	750
HCM Platoon Ratio	1.00	1.00	1.00	1.00	1.00	1.00	1.00	1.00	1.00	1.00	1.00	1.00
Upstream Filter(I)	1.00	1.00	0.00	1.00	1.00	1.00	1.00	1.00	1.00	1.00	1.00	1.00
Uniform Delay (d), s/veh	39.7	17.8	0.0	39.1	17.8	21.5	39.2	27.3	18.1	39.2	21.9	18.6
Incr Delay (d2), s/veh	1.2	0.0	0.0	1.7	0.1	5.8	0.8	2.4	0.1	0.9	0.1	0.1
Initial Q Delay(d3),s/veh	0.0	0.0	0.0	0.0	0.0	0.0	0.0	0.0	0.0	0.0	0.0	0.0
%ile BackOfQ(50%),veh/ln	0.5	0.2	0.0	1.2	1.2	9.0	0.8	7.3	0.8	0.8	1.3	0.4
Unsig. Movement Delay, s/veh												
LnGrp Delay(d),s/veh	40.9	17.8	0.0	40.8	17.8	27.2	40.0	29.7	18.2	40.1	22.0	18.7
LnGrp LOS	D	B		D	B	C	D	C	B	D	C	B
Approach Vol, veh/h		97	A		844			960			306	
Approach Delay, s/veh		30.4			26.9			29.7			26.4	
Approach LOS		C			C			C			C	
Timer - Assigned Phs	1	2	3	4	5	6	7	8				
Phs Duration (G+Y+Rc), s	8.7	36.7	7.9	31.4	7.3	38.2	7.9	31.4				
Change Period (Y+Rc), s	3.7	6.5	3.7	5.8	3.7	6.5	3.7	5.8				
Max Green Setting (Gmax), s	7.3	40.5	6.9	45.6	6.4	41.4	17.3	35.2				
Max Q Clear Time (g_c+I1), s	5.3	2.7	3.9	5.6	3.7	27.7	4.0	20.9				
Green Ext Time (p_c), s	0.0	0.3	0.0	1.3	0.0	3.9	0.1	4.7				

Intersection Summary

HCM 6th Ctrl Delay	28.2
HCM 6th LOS	C

Notes

Unsignalized Delay for [EBR] is excluded from calculations of the approach delay and intersection delay.

Timings
23: Sycamore Canyon Bl. & Cottonwood Ave

West Campus Upper Plateau (JN 14064)

02/16/2022



Lane Group	WBL	WBR	NBT	SBL	SBT
Lane Configurations	↙	↗	↕↔	↙	↕↕
Traffic Volume (vph)	13	22	858	56	233
Future Volume (vph)	13	22	858	56	233
Turn Type	Prot	Perm	NA	Prot	NA
Protected Phases	8		2	1	6
Permitted Phases		8			
Detector Phase	8	8	2	1	6
Switch Phase					
Minimum Initial (s)	10.0	10.0	10.0	5.0	10.0
Minimum Split (s)	15.8	15.8	43.5	9.1	43.5
Total Split (s)	21.0	21.0	75.0	24.0	99.0
Total Split (%)	17.5%	17.5%	62.5%	20.0%	82.5%
Yellow Time (s)	4.8	4.8	5.5	3.6	5.5
All-Red Time (s)	1.0	1.0	1.0	0.5	1.0
Lost Time Adjust (s)	0.0	0.0	0.0	0.0	0.0
Total Lost Time (s)	5.8	5.8	6.5	4.1	6.5
Lead/Lag			Lag	Lead	
Lead-Lag Optimize?			Yes	Yes	
Recall Mode	None	None	None	None	None
Act Effct Green (s)	13.9	13.9	35.7	10.7	42.2
Actuated g/C Ratio	0.27	0.27	0.69	0.21	0.81
v/c Ratio	0.04	0.08	0.44	0.25	0.10
Control Delay	29.2	14.1	11.0	29.4	3.1
Queue Delay	0.0	0.0	0.0	0.0	0.0
Total Delay	29.2	14.1	11.0	29.4	3.1
LOS	C	B	B	C	A
Approach Delay	19.6		11.0		8.2
Approach LOS	B		B		A

Intersection Summary

Cycle Length: 120
 Actuated Cycle Length: 52
 Natural Cycle: 70
 Control Type: Actuated-Uncoordinated
 Maximum v/c Ratio: 0.44
 Intersection Signal Delay: 10.6
 Intersection LOS: B
 Intersection Capacity Utilization 50.5%
 ICU Level of Service A
 Analysis Period (min) 15

Splits and Phases: 23: Sycamore Canyon Bl. & Cottonwood Ave



HCM 6th Signalized Intersection Summary
23: Sycamore Canyon Bl. & Cottonwood Ave

West Campus Upper Plateau (JN 14064)

02/16/2022



Movement	WBL	WBR	NBT	NBR	SBL	SBT
Lane Configurations						
Traffic Volume (veh/h)	13	22	858	20	56	233
Future Volume (veh/h)	13	22	858	20	56	233
Initial Q (Qb), veh	0	0	0	0	0	0
Ped-Bike Adj(A_pbT)	1.00	1.00		0.98	1.00	
Parking Bus, Adj	1.00	1.00	1.00	1.00	1.00	1.00
Work Zone On Approach	No		No			No
Adj Sat Flow, veh/h/ln	1233	1203	1796	1722	1248	1811
Adj Flow Rate, veh/h	15	10	998	22	65	271
Peak Hour Factor	0.86	0.86	0.86	0.86	0.86	0.86
Percent Heavy Veh, %	45	47	7	12	44	6
Cap, veh/h	70	61	1742	38	74	2286
Arrive On Green	0.06	0.06	0.51	0.51	0.06	0.66
Sat Flow, veh/h	1174	1020	3502	75	1188	3532
Grp Volume(v), veh/h	15	10	499	521	65	271
Grp Sat Flow(s),veh/h/ln	1174	1020	1706	1781	1188	1721
Q Serve(g_s), s	0.5	0.4	9.0	9.0	2.4	1.3
Cycle Q Clear(g_c), s	0.5	0.4	9.0	9.0	2.4	1.3
Prop In Lane	1.00	1.00		0.04	1.00	
Lane Grp Cap(c), veh/h	70	61	871	909	74	2286
V/C Ratio(X)	0.21	0.16	0.57	0.57	0.88	0.12
Avail Cap(c_a), veh/h	400	348	2621	2736	530	7138
HCM Platoon Ratio	1.00	1.00	1.00	1.00	1.00	1.00
Upstream Filter(I)	1.00	1.00	1.00	1.00	1.00	1.00
Uniform Delay (d), s/veh	20.0	19.9	7.6	7.6	20.8	2.7
Incr Delay (d2), s/veh	1.5	1.3	0.8	0.8	26.4	0.0
Initial Q Delay(d3),s/veh	0.0	0.0	0.0	0.0	0.0	0.0
%ile BackOfQ(50%),veh/ln	0.2	0.1	2.0	2.1	1.1	0.1
Unsig. Movement Delay, s/veh						
LnGrp Delay(d),s/veh	21.5	21.2	8.4	8.4	47.1	2.8
LnGrp LOS	C	C	A	A	D	A
Approach Vol, veh/h	25		1020			336
Approach Delay, s/veh	21.3		8.4			11.3
Approach LOS	C		A			B
Timer - Assigned Phs	1	2			6	8
Phs Duration (G+Y+Rc), s	6.9	29.3			36.1	8.5
Change Period (Y+Rc), s	4.1	6.5			6.5	5.8
Max Green Setting (Gmax), s	19.9	68.5			92.5	15.2
Max Q Clear Time (g_c+I1), s	4.4	11.0			3.3	2.5
Green Ext Time (p_c), s	0.1	11.7			2.5	0.0

Intersection Summary

HCM 6th Ctrl Delay			9.3			
HCM 6th LOS			A			

Timings

West Campus Upper Plateau (JN 14064)

24: Sycamore Canyon Bl. & Alessandro Bl.

02/16/2022



Lane Group	EBL	EBT	EBR	WBL	WBT	WBR	NBL	NBT	NBR	SBL	SBT	SBR
Lane Configurations	↖	↑↑↑	↗	↖↗	↑↑↑	↗	↖↗	↑↑	↖↗	↖↗	↑↑	↖↗
Traffic Volume (vph)	140	963	244	87	1941	535	585	585	61	87	114	126
Future Volume (vph)	140	963	244	87	1941	535	585	585	61	87	114	126
Turn Type	Prot	NA	Perm	Prot	NA	Perm	Prot	NA	pm+ov	Prot	NA	Perm
Protected Phases	5	2		1	6		3	8	1	7	4	
Permitted Phases			2			6			8			4
Detector Phase	5	2	2	1	6	6	3	8	1	7	4	4
Switch Phase												
Minimum Initial (s)	5.0	10.0	10.0	5.0	10.0	10.0	5.0	10.0	5.0	5.0	10.0	10.0
Minimum Split (s)	8.7	43.5	43.5	8.7	43.5	43.5	8.7	15.8	8.7	8.7	49.8	49.8
Total Split (s)	10.0	47.0	47.0	9.2	46.2	46.2	14.0	52.5	9.2	11.3	49.8	49.8
Total Split (%)	8.3%	39.2%	39.2%	7.7%	38.5%	38.5%	11.7%	43.8%	7.7%	9.4%	41.5%	41.5%
Yellow Time (s)	3.2	5.5	5.5	3.2	5.5	5.5	3.2	4.8	3.2	3.2	4.8	4.8
All-Red Time (s)	0.5	1.0	1.0	0.5	1.0	1.0	0.5	1.0	0.5	0.5	1.0	1.0
Lost Time Adjust (s)	0.0	0.0	0.0	0.0	0.0	0.0	0.0	0.0	0.0	0.0	0.0	0.0
Total Lost Time (s)	3.7	6.5	6.5	3.7	6.5	6.5	3.7	5.8	3.7	3.7	5.8	5.8
Lead/Lag	Lead	Lag	Lag	Lead	Lag	Lag	Lead	Lag	Lead	Lead	Lag	Lag
Lead-Lag Optimize?	Yes	Yes	Yes	Yes	Yes	Yes	Yes	Yes	Yes	Yes	Yes	Yes
Recall Mode	None	C-Max	C-Max	None	C-Max	C-Max	None	None	None	None	None	None
Act Effct Green (s)	18.4	57.2	57.2	6.8	45.6	45.6	10.3	29.4	38.2	7.0	26.1	26.1
Actuated g/C Ratio	0.15	0.48	0.48	0.06	0.38	0.38	0.09	0.24	0.32	0.06	0.22	0.22
v/c Ratio	0.53	0.40	0.28	0.48	1.02	0.75	2.01	0.70	0.07	0.49	0.16	0.30
Control Delay	56.7	22.7	4.0	63.8	61.8	27.5	495.0	45.2	4.5	64.3	35.7	9.0
Queue Delay	0.0	0.0	0.0	0.0	0.0	0.0	0.0	0.0	0.0	0.0	0.0	0.0
Total Delay	56.7	22.7	4.0	63.8	61.8	27.5	495.0	45.2	4.5	64.3	35.7	9.0
LOS	E	C	A	E	E	C	F	D	A	E	D	A
Approach Delay		22.8			54.7			256.9			33.0	
Approach LOS		C			D			F			C	

Intersection Summary

Cycle Length: 120
 Actuated Cycle Length: 120
 Offset: 0 (0%), Referenced to phase 2:EBT and 6:WBT, Start of Yellow
 Natural Cycle: 125
 Control Type: Actuated-Coordinated
 Maximum v/c Ratio: 2.01
 Intersection Signal Delay: 91.1
 Intersection LOS: F
 Intersection Capacity Utilization 89.0%
 ICU Level of Service E
 Analysis Period (min) 15

Splits and Phases: 24: Sycamore Canyon Bl. & Alessandro Bl.

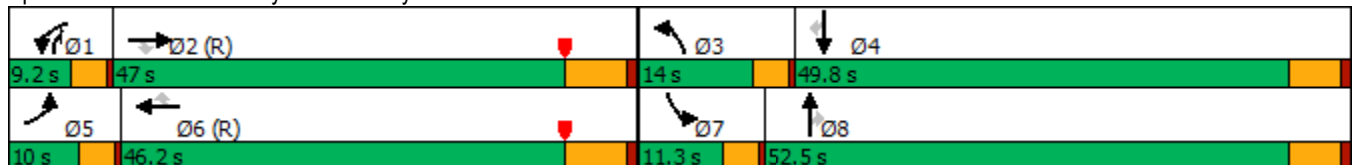

HCM 6th Signalized Intersection Summary
 24: Sycamore Canyon Bl. & Alessandro Bl.

West Campus Upper Plateau (JN 14064)

02/16/2022



Movement	EBL	EBT	EBR	WBL	WBT	WBR	NBL	NBT	NBR	SBL	SBT	SBR
Lane Configurations	↘	↑↑↑	↗	↘↗	↑↑↑	↗	↘↗	↑↑	↗↘	↘↗	↑↑	↗
Traffic Volume (veh/h)	140	963	244	87	1941	535	585	585	61	87	114	126
Future Volume (veh/h)	140	963	244	87	1941	535	585	585	61	87	114	126
Initial Q (Qb), veh	0	0	0	0	0	0	0	0	0	0	0	0
Ped-Bike Adj(A_pbT)	1.00		1.00	1.00		1.00	1.00		1.00	1.00		1.00
Parking Bus, Adj	1.00	1.00	1.00	1.00	1.00	1.00	1.00	1.00	1.00	1.00	1.00	1.00
Work Zone On Approach		No			No			No			No	
Adj Sat Flow, veh/h/ln	1856	1885	1885	1796	1870	1841	1870	1826	1781	1693	1811	1841
Adj Flow Rate, veh/h	141	973	164	88	1961	417	591	591	32	88	115	68
Peak Hour Factor	0.99	0.99	0.99	0.99	0.99	0.99	0.99	0.99	0.99	0.99	0.99	0.99
Percent Heavy Veh, %	3	1	1	7	2	4	2	5	8	14	6	4
Cap, veh/h	93	2790	865	135	2707	827	297	732	668	132	576	260
Arrive On Green	0.05	0.54	0.54	0.04	0.53	0.53	0.09	0.21	0.21	0.04	0.17	0.17
Sat Flow, veh/h	1767	5147	1596	3319	5106	1560	3456	3469	2653	3127	3441	1554
Grp Volume(v), veh/h	141	973	164	88	1961	417	591	591	32	88	115	68
Grp Sat Flow(s),veh/h/ln	1767	1716	1596	1659	1702	1560	1728	1735	1327	1564	1721	1554
Q Serve(g_s), s	6.3	12.8	6.3	3.1	35.2	20.6	10.3	19.4	1.1	3.3	3.5	4.6
Cycle Q Clear(g_c), s	6.3	12.8	6.3	3.1	35.2	20.6	10.3	19.4	1.1	3.3	3.5	4.6
Prop In Lane	1.00		1.00	1.00		1.00	1.00		1.00	1.00		1.00
Lane Grp Cap(c), veh/h	93	2790	865	135	2707	827	297	732	668	132	576	260
V/C Ratio(X)	1.52	0.35	0.19	0.65	0.72	0.50	1.99	0.81	0.05	0.67	0.20	0.26
Avail Cap(c_a), veh/h	93	2790	865	152	2707	827	297	1350	1140	198	1262	570
HCM Platoon Ratio	1.00	1.00	1.00	1.00	1.00	1.00	1.00	1.00	1.00	1.00	1.00	1.00
Upstream Filter(I)	0.95	0.95	0.95	0.68	0.68	0.68	1.00	1.00	1.00	1.00	1.00	1.00
Uniform Delay (d), s/veh	56.8	15.5	14.0	56.7	21.5	18.1	54.8	45.0	34.0	56.6	43.0	43.5
Incr Delay (d2), s/veh	279.1	0.3	0.5	3.8	1.2	1.5	458.5	2.2	0.0	2.2	0.2	0.5
Initial Q Delay(d3),s/veh	0.0	0.0	0.0	0.0	0.0	0.0	0.0	0.0	0.0	0.0	0.0	0.0
%ile BackOfQ(50%),veh/ln	9.9	4.8	2.2	1.4	13.1	7.2	23.3	8.3	0.3	1.3	1.5	1.8
Unsig. Movement Delay, s/veh												
LnGrp Delay(d),s/veh	335.9	15.8	14.5	60.5	22.7	19.6	513.3	47.2	34.0	58.8	43.2	44.0
LnGrp LOS	F	B	B	E	C	B	F	D	C	E	D	D
Approach Vol, veh/h		1278			2466			1214			271	
Approach Delay, s/veh		51.0			23.5			273.8			48.5	
Approach LOS		D			C			F			D	
Timer - Assigned Phs	1	2	3	4	5	6	7	8				
Phs Duration (G+Y+Rc), s	8.6	71.5	14.0	25.9	10.0	70.1	8.8	31.1				
Change Period (Y+Rc), s	3.7	6.5	3.7	5.8	3.7	6.5	3.7	5.8				
Max Green Setting (Gmax), s	5.5	40.5	10.3	44.0	6.3	39.7	7.6	46.7				
Max Q Clear Time (g_c+I1), s	5.1	14.8	12.3	6.6	8.3	37.2	5.3	21.4				
Green Ext Time (p_c), s	0.0	10.5	0.0	0.9	0.0	2.4	0.0	3.9				

Intersection Summary

HCM 6th Ctrl Delay	89.6
HCM 6th LOS	F

Timings
25: Sycamore Canyon Bl. & Cactus Av.

West Campus Upper Plateau (JN 14064)

02/16/2022



Lane Group	EBL	EBT	EBR	WBL	WBT	WBR	NBL	NBT	NBR	SBL	SBT	SBR
Lane Configurations	↘	↑↑	↗	↘↗	↑↑	↗	↘↗	↑↑	↗	↘↗	↑↑	↗
Traffic Volume (vph)	4	6	1	364	20	885	5	366	209	137	140	8
Future Volume (vph)	4	6	1	364	20	885	5	366	209	137	140	8
Turn Type	Prot	NA	Perm	Prot	NA	Perm	Prot	NA	Perm	Prot	NA	Perm
Protected Phases	7	4		3	8		5	2		1	6	
Permitted Phases			4			8			2			6
Detector Phase	7	4	4	3	8	8	5	2	2	1	6	6
Switch Phase												
Minimum Initial (s)	5.0	10.0	10.0	5.0	10.0	10.0	5.0	10.0	10.0	5.0	10.0	10.0
Minimum Split (s)	9.6	32.8	32.8	9.6	32.8	32.8	9.6	34.8	34.8	9.6	34.8	34.8
Total Split (s)	9.6	45.6	45.6	27.0	63.0	63.0	9.6	36.4	36.4	11.0	37.8	37.8
Total Split (%)	8.0%	38.0%	38.0%	22.5%	52.5%	52.5%	8.0%	30.3%	30.3%	9.2%	31.5%	31.5%
Yellow Time (s)	3.6	4.8	4.8	3.6	4.8	4.8	3.6	4.8	4.8	3.6	4.8	4.8
All-Red Time (s)	1.0	1.0	1.0	1.0	1.0	1.0	1.0	1.0	1.0	1.0	1.0	1.0
Lost Time Adjust (s)	0.0	0.0	0.0	0.0	0.0	0.0	0.0	0.0	0.0	0.0	0.0	0.0
Total Lost Time (s)	4.6	5.8	5.8	4.6	5.8	5.8	4.6	5.8	5.8	4.6	5.8	5.8
Lead/Lag	Lead	Lag	Lag	Lead	Lag	Lag	Lead	Lag	Lag	Lead	Lag	Lag
Lead-Lag Optimize?	Yes	Yes	Yes	Yes	Yes	Yes	Yes	Yes	Yes	Yes	Yes	Yes
Recall Mode	None	None	None	None	None	None	None	None	None	None	None	None
Act Effct Green (s)	5.1	21.0	21.0	39.4	53.1	53.1	5.1	17.6	17.6	6.5	27.3	27.3
Actuated g/C Ratio	0.05	0.22	0.22	0.41	0.56	0.56	0.05	0.18	0.18	0.07	0.29	0.29
v/c Ratio	0.08	0.01	0.00	0.30	0.01	0.89	0.03	0.61	0.47	0.62	0.15	0.02
Control Delay	54.0	25.0	0.0	28.6	11.9	24.0	50.2	41.0	8.7	59.2	28.3	0.0
Queue Delay	0.0	0.0	0.0	0.0	0.0	0.3	0.0	0.0	0.0	0.0	0.0	0.0
Total Delay	54.0	25.0	0.0	28.6	11.9	24.4	50.2	41.0	8.7	59.2	28.3	0.0
LOS	D	C	A	C	B	C	D	D	A	E	C	A
Approach Delay		33.3			25.4			29.5			42.4	
Approach LOS		C			C			C			D	

Intersection Summary

Cycle Length: 120
 Actuated Cycle Length: 95.3
 Natural Cycle: 110
 Control Type: Actuated-Uncoordinated
 Maximum v/c Ratio: 0.89
 Intersection Signal Delay: 28.8
 Intersection LOS: C
 Intersection Capacity Utilization 82.6%
 ICU Level of Service E
 Analysis Period (min) 15

Splits and Phases: 25: Sycamore Canyon Bl. & Cactus Av.

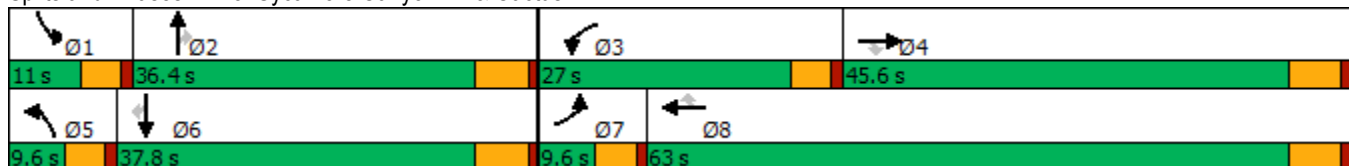

HCM 6th Signalized Intersection Summary
 25: Sycamore Canyon Bl. & Cactus Av.

West Campus Upper Plateau (JN 14064)

02/16/2022



Movement	EBL	EBT	EBR	WBL	WBT	WBR	NBL	NBT	NBR	SBL	SBT	SBR
Lane Configurations												
Traffic Volume (veh/h)	4	6	1	364	20	885	5	366	209	137	140	8
Future Volume (veh/h)	4	6	1	364	20	885	5	366	209	137	140	8
Initial Q (Qb), veh	0	0	0	0	0	0	0	0	0	0	0	0
Ped-Bike Adj(A_pbT)	1.00		1.00	1.00		0.99	1.00		1.00	1.00		0.99
Parking Bus, Adj	1.00	1.00	1.00	1.00	1.00	1.00	1.00	1.00	1.00	1.00	1.00	1.00
Work Zone On Approach		No			No			No			No	
Adj Sat Flow, veh/h/ln	418	1159	1900	1693	1544	1856	1900	1781	1796	1826	1826	1707
Adj Flow Rate, veh/h	4	6	0	375	21	693	5	377	118	141	144	5
Peak Hour Factor	0.97	0.97	0.97	0.97	0.97	0.97	0.97	0.97	0.97	0.97	0.97	0.97
Percent Heavy Veh, %	100	50	0	14	24	3	0	8	7	5	5	13
Cap, veh/h	2	745	545	470	1418	751	23	561	252	217	776	319
Arrive On Green	0.01	0.34	0.00	0.15	0.48	0.48	0.01	0.17	0.17	0.06	0.22	0.22
Sat Flow, veh/h	398	2202	1610	3127	2934	1553	3510	3385	1522	3374	3469	1428
Grp Volume(v), veh/h	4	6	0	375	21	693	5	377	118	141	144	5
Grp Sat Flow(s),veh/h/ln	398	1101	1610	1564	1467	1553	1755	1692	1522	1687	1735	1428
Q Serve(g_s), s	0.4	0.1	0.0	8.6	0.3	30.8	0.1	7.7	5.2	3.0	2.5	0.2
Cycle Q Clear(g_c), s	0.4	0.1	0.0	8.6	0.3	30.8	0.1	7.7	5.2	3.0	2.5	0.2
Prop In Lane	1.00		1.00	1.00		1.00	1.00		1.00	1.00		1.00
Lane Grp Cap(c), veh/h	2	745	545	470	1418	751	23	561	252	217	776	319
V/C Ratio(X)	1.88	0.01	0.00	0.80	0.01	0.92	0.22	0.67	0.47	0.65	0.19	0.02
Avail Cap(c_a), veh/h	27	1185	866	947	2269	1201	237	1400	630	292	1501	618
HCM Platoon Ratio	1.00	1.00	1.00	1.00	1.00	1.00	1.00	1.00	1.00	1.00	1.00	1.00
Upstream Filter(I)	1.00	1.00	0.00	1.00	1.00	1.00	1.00	1.00	1.00	1.00	1.00	1.00
Uniform Delay (d), s/veh	36.8	16.2	0.0	30.3	9.9	17.8	36.6	29.0	27.9	33.8	23.3	22.4
Incr Delay (d2), s/veh	510.7	0.0	0.0	1.2	0.0	7.9	1.7	1.4	1.3	1.2	0.1	0.0
Initial Q Delay(d3),s/veh	0.0	0.0	0.0	0.0	0.0	0.0	0.0	0.0	0.0	0.0	0.0	0.0
%ile BackOfQ(50%),veh/ln	0.3	0.0	0.0	3.0	0.1	10.5	0.0	3.0	1.8	1.2	0.9	0.1
Unsig. Movement Delay, s/veh												
LnGrp Delay(d),s/veh	547.5	16.2	0.0	31.5	10.0	25.8	38.3	30.4	29.3	35.0	23.4	22.4
LnGrp LOS	F	B	A	C	A	C	D	C	C	D	C	C
Approach Vol, veh/h		10			1089			500			290	
Approach Delay, s/veh		228.7			27.4			30.2			29.0	
Approach LOS		F			C			C			C	
Timer - Assigned Phs	1	2	3	4	5	6	7	8				
Phs Duration (G+Y+Rc), s	9.4	18.1	15.7	30.8	5.1	22.3	5.0	41.6				
Change Period (Y+Rc), s	4.6	5.8	4.6	5.8	4.6	5.8	4.6	5.8				
Max Green Setting (Gmax), s	6.4	30.6	22.4	39.8	5.0	32.0	5.0	57.2				
Max Q Clear Time (g_c+I1), s	5.0	9.7	10.6	2.1	2.1	4.5	2.4	32.8				
Green Ext Time (p_c), s	0.0	2.5	0.6	0.0	0.0	0.8	0.0	2.9				

Intersection Summary

HCM 6th Ctrl Delay	29.5
HCM 6th LOS	C

Timings

West Campus Upper Plateau (JN 14064)

26: Sycamore Canyon Bl. & Van Buren Bl.

02/16/2022



Lane Group	EBL	EBT	EBR	WBL	WBT	WBR	NBL	NBT	SBL	SBT	SBR
Lane Configurations											
Traffic Volume (vph)	422	1146	2	46	1322	131	3	1	48	6	313
Future Volume (vph)	422	1146	2	46	1322	131	3	1	48	6	313
Turn Type	Prot	NA	Perm	Prot	NA	Perm	Perm	NA	Split	NA	Perm
Protected Phases	5	2		1	6			8	4	4	
Permitted Phases			2			6	8				4
Detector Phase	5	2	2	1	6	6	8	8	4	4	4
Switch Phase											
Minimum Initial (s)	5.0	10.0	10.0	5.0	10.0	10.0	10.0	10.0	10.0	10.0	10.0
Minimum Split (s)	9.6	29.2	29.2	9.6	29.2	29.2	14.6	14.6	50.8	50.8	50.8
Total Split (s)	25.0	50.9	50.9	13.7	39.6	39.6	14.6	14.6	50.8	50.8	50.8
Total Split (%)	19.2%	39.2%	39.2%	10.5%	30.5%	30.5%	11.2%	11.2%	39.1%	39.1%	39.1%
Yellow Time (s)	3.6	5.2	5.2	3.6	5.2	5.2	3.6	3.6	4.8	4.8	4.8
All-Red Time (s)	1.0	1.0	1.0	1.0	1.0	1.0	1.0	1.0	1.0	1.0	1.0
Lost Time Adjust (s)	0.0	0.0	0.0	0.0	0.0	0.0		0.0	0.0	0.0	0.0
Total Lost Time (s)	4.6	6.2	6.2	4.6	6.2	6.2		4.6	5.8	5.8	5.8
Lead/Lag	Lead	Lag	Lag	Lead	Lag	Lag					
Lead-Lag Optimize?	Yes	Yes	Yes	Yes	Yes	Yes					
Recall Mode	None	None	None	None	None	None	None	None	None	None	None
Act Effct Green (s)	15.7	44.1	44.1	6.9	30.3	30.3		10.8	15.1	15.1	15.1
Actuated g/C Ratio	0.19	0.55	0.55	0.09	0.38	0.38		0.13	0.19	0.19	0.19
v/c Ratio	0.69	0.37	0.00	0.32	0.62	0.22		0.02	0.10	0.02	0.59
Control Delay	39.2	14.9	0.0	47.8	24.7	6.2		35.5	28.6	28.3	8.1
Queue Delay	0.0	0.0	0.0	0.0	0.0	0.0		0.0	0.0	0.0	0.0
Total Delay	39.2	14.9	0.0	47.8	24.7	6.2		35.5	28.6	28.3	8.1
LOS	D	B	A	D	C	A		D	C	C	A
Approach Delay		21.4			23.8			35.5		11.1	
Approach LOS		C			C			D		B	

Intersection Summary

Cycle Length: 130
 Actuated Cycle Length: 80.7
 Natural Cycle: 115
 Control Type: Actuated-Uncoordinated
 Maximum v/c Ratio: 0.69
 Intersection Signal Delay: 21.4
 Intersection Capacity Utilization 60.7%
 Analysis Period (min) 15
 Intersection LOS: C
 ICU Level of Service B

Splits and Phases: 26: Sycamore Canyon Bl. & Van Buren Bl.

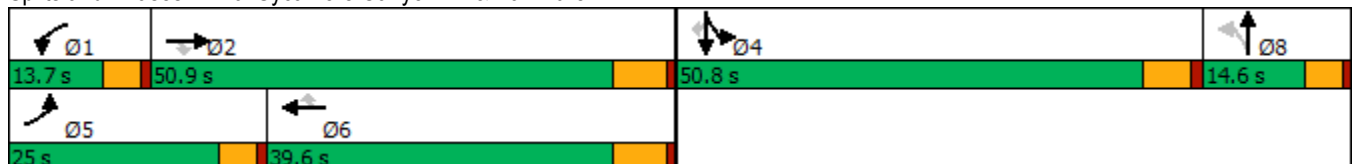

HCM 6th Signalized Intersection Summary
26: Sycamore Canyon Bl. & Van Buren Bl.

West Campus Upper Plateau (JN 14064)

02/16/2022



Movement	EBL	EBT	EBR	WBL	WBT	WBR	NBL	NBT	NBR	SBL	SBT	SBR
Lane Configurations												
Traffic Volume (veh/h)	422	1146	2	46	1322	131	3	1	3	48	6	313
Future Volume (veh/h)	422	1146	2	46	1322	131	3	1	3	48	6	313
Initial Q (Qb), veh	0	0	0	0	0	0	0	0	0	0	0	0
Ped-Bike Adj(A_pbT)	1.00		1.00	1.00		1.00	1.00		1.00	1.00		1.00
Parking Bus, Adj	1.00	1.00	1.00	1.00	1.00	1.00	1.00	1.00	1.00	1.00	1.00	1.00
Work Zone On Approach		No			No			No			No	
Adj Sat Flow, veh/h/ln	1870	1826	1900	1900	1826	1767	1900	1900	1900	1559	1900	1870
Adj Flow Rate, veh/h	459	1246	1	50	1437	117	3	1	1	52	7	0
Peak Hour Factor	0.92	0.92	0.92	0.92	0.92	0.92	0.92	0.92	0.92	0.92	0.92	0.92
Percent Heavy Veh, %	2	5	0	0	5	9	0	0	0	23	0	2
Cap, veh/h	586	3145	806	84	2371	565	24	12	12	295	194	
Arrive On Green	0.17	0.50	0.50	0.05	0.38	0.38	0.01	0.01	0.01	0.10	0.10	0.00
Sat Flow, veh/h	3456	6281	1610	1810	6281	1497	1810	872	872	2881	1900	1585
Grp Volume(v), veh/h	459	1246	1	50	1437	117	3	0	2	52	7	0
Grp Sat Flow(s),veh/h/ln	1728	1570	1610	1810	1570	1497	1810	0	1743	1440	1900	1585
Q Serve(g_s), s	8.0	7.8	0.0	1.7	11.6	3.3	0.1	0.0	0.1	1.0	0.2	0.0
Cycle Q Clear(g_c), s	8.0	7.8	0.0	1.7	11.6	3.3	0.1	0.0	0.1	1.0	0.2	0.0
Prop In Lane	1.00		1.00	1.00		1.00	1.00		0.50	1.00		1.00
Lane Grp Cap(c), veh/h	586	3145	806	84	2371	565	24	0	23	295	194	
V/C Ratio(X)	0.78	0.40	0.00	0.60	0.61	0.21	0.12	0.00	0.09	0.18	0.04	
Avail Cap(c_a), veh/h	1122	4467	1145	262	3338	796	288	0	277	2063	1360	
HCM Platoon Ratio	1.00	1.00	1.00	1.00	1.00	1.00	1.00	1.00	1.00	1.00	1.00	1.00
Upstream Filter(I)	1.00	1.00	1.00	1.00	1.00	1.00	1.00	0.00	1.00	1.00	1.00	0.00
Uniform Delay (d), s/veh	25.0	9.8	7.8	29.4	15.8	13.2	30.6	0.0	30.6	25.8	25.4	0.0
Incr Delay (d2), s/veh	0.9	0.1	0.0	2.5	0.3	0.2	2.3	0.0	1.6	0.3	0.1	0.0
Initial Q Delay(d3),s/veh	0.0	0.0	0.0	0.0	0.0	0.0	0.0	0.0	0.0	0.0	0.0	0.0
%ile BackOfQ(50%),veh/ln	3.0	2.0	0.0	0.7	3.4	1.0	0.1	0.0	0.0	0.3	0.1	0.0
Unsig. Movement Delay, s/veh												
LnGrp Delay(d),s/veh	25.9	9.9	7.8	31.9	16.0	13.4	32.9	0.0	32.2	26.1	25.5	0.0
LnGrp LOS	C	A	A	C	B	B	C	A	C	C	C	
Approach Vol, veh/h		1706			1604			5			59	A
Approach Delay, s/veh		14.2			16.3			32.6			26.0	
Approach LOS		B			B			C			C	
Timer - Assigned Phs	1	2		4	5	6		8				
Phs Duration (G+Y+Rc), s	7.5	37.7		12.2	15.3	29.9		5.4				
Change Period (Y+Rc), s	4.6	6.2		5.8	4.6	6.2		4.6				
Max Green Setting (Gmax), s	9.1	44.7		45.0	20.4	33.4		10.0				
Max Q Clear Time (g_c+I1), s	3.7	9.8		3.0	10.0	13.6		2.1				
Green Ext Time (p_c), s	0.0	10.2		0.2	0.7	10.1		0.0				

Intersection Summary

HCM 6th Ctrl Delay	15.4
HCM 6th LOS	B

Notes

Unsignalized Delay for [SBR] is excluded from calculations of the approach delay and intersection delay.

Timings
27: Innovation Dr. & Cactus Av.

West Campus Upper Plateau (JN 14064)

02/16/2022

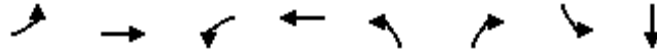

Lane Group	EBL	EBT	WBL	WBT	NBL	NBR	SBL	SBT
Lane Configurations	↖	↖↖↖	↖	↖↖↖	↖	↖	↖	↖
Traffic Volume (vph)	4	333	108	1261	7	20	4	0
Future Volume (vph)	4	333	108	1261	7	20	4	0
Turn Type	Prot	NA	Prot	NA	Perm	Perm	Perm	NA
Protected Phases	5	2	1	6				4
Permitted Phases					8	8	4	
Detector Phase	5	2	1	6	8	8	4	4
Switch Phase								
Minimum Initial (s)	5.0	10.0	5.0	10.0	10.0	10.0	10.0	10.0
Minimum Split (s)	9.2	26.8	9.2	26.8	31.1	31.1	31.1	31.1
Total Split (s)	12.0	57.0	31.0	76.0	32.0	32.0	32.0	32.0
Total Split (%)	10.0%	47.5%	25.8%	63.3%	26.7%	26.7%	26.7%	26.7%
Yellow Time (s)	3.2	4.8	3.2	4.8	4.1	4.1	4.1	4.1
All-Red Time (s)	1.0	1.0	1.0	1.0	1.0	1.0	1.0	1.0
Lost Time Adjust (s)	0.0	0.0	0.0	0.0	0.0	0.0	0.0	0.0
Total Lost Time (s)	4.2	5.8	4.2	5.8	5.1	5.1	5.1	5.1
Lead/Lag	Lead	Lag	Lead	Lag				
Lead-Lag Optimize?	Yes	Yes	Yes	Yes				
Recall Mode	None	None	None	None	None	None	None	None
Act Effct Green (s)	6.7	27.1	9.5	35.2	14.9	14.9	14.9	14.9
Actuated g/C Ratio	0.15	0.63	0.22	0.81	0.34	0.34	0.34	0.34
v/c Ratio	0.01	0.12	0.30	0.33	0.02	0.03	0.01	0.00
Control Delay	30.5	10.0	24.1	6.0	19.1	0.1	19.2	0.0
Queue Delay	0.0	0.0	0.0	0.0	0.0	0.0	0.0	0.0
Total Delay	30.5	10.0	24.1	6.0	19.1	0.1	19.2	0.0
LOS	C	B	C	A	B	A	B	A
Approach Delay		10.3		7.4				12.8
Approach LOS		B		A				B

Intersection Summary

Cycle Length: 120
 Actuated Cycle Length: 43.3
 Natural Cycle: 70
 Control Type: Actuated-Uncoordinated
 Maximum v/c Ratio: 0.33
 Intersection Signal Delay: 8.0
 Intersection Capacity Utilization 50.5%
 Analysis Period (min) 15
 Intersection LOS: A
 ICU Level of Service A

Splits and Phases: 27: Innovation Dr. & Cactus Av.



HCM 6th Signalized Intersection Summary
27: Innovation Dr. & Cactus Av.

West Campus Upper Plateau (JN 14064)

02/16/2022



Movement	EBL	EBT	EBR	WBL	WBT	WBR	NBL	NBT	NBR	SBL	SBT	SBR
Lane Configurations	↖	↑↑↑		↖	↑↑↑		↖	↑	↗	↖	↗	
Traffic Volume (veh/h)	4	333	15	108	1261	46	7	0	20	4	0	2
Future Volume (veh/h)	4	333	15	108	1261	46	7	0	20	4	0	2
Initial Q (Qb), veh	0	0	0	0	0	0	0	0	0	0	0	0
Ped-Bike Adj(A_pbT)	1.00		1.00	1.00		1.00	1.00		1.00	1.00		1.00
Parking Bus, Adj	1.00	1.00	1.00	1.00	1.00	1.00	1.00	1.00	1.00	1.00	1.00	1.00
Work Zone On Approach		No			No			No			No	
Adj Sat Flow, veh/h/ln	1900	1752	1900	1811	1826	1870	1159	1900	1248	1530	1900	1900
Adj Flow Rate, veh/h	4	340	13	110	1287	47	7	0	7	4	0	1
Peak Hour Factor	0.98	0.98	0.98	0.98	0.98	0.98	0.98	0.98	0.98	0.98	0.98	0.98
Percent Heavy Veh, %	0	10	0	6	5	2	50	0	44	25	0	0
Cap, veh/h	10	2472	94	145	2970	108	206	90	50	219	0	76
Arrive On Green	0.01	0.52	0.52	0.08	0.60	0.60	0.05	0.00	0.05	0.05	0.00	0.05
Sat Flow, veh/h	1810	4728	179	1725	4936	180	878	1900	1058	1152	0	1610
Grp Volume(v), veh/h	4	228	125	110	866	468	7	0	7	4	0	1
Grp Sat Flow(s),veh/h/ln	1810	1594	1719	1725	1662	1793	878	1900	1058	1152	0	1610
Q Serve(g_s), s	0.1	1.6	1.6	2.7	6.1	6.1	0.3	0.0	0.3	0.1	0.0	0.0
Cycle Q Clear(g_c), s	0.1	1.6	1.6	2.7	6.1	6.1	0.4	0.0	0.3	0.1	0.0	0.0
Prop In Lane	1.00		0.10	1.00		0.10	1.00		1.00	1.00		1.00
Lane Grp Cap(c), veh/h	10	1667	899	145	1999	1079	206	90	50	219	0	76
V/C Ratio(X)	0.41	0.14	0.14	0.76	0.43	0.43	0.03	0.00	0.14	0.02	0.00	0.01
Avail Cap(c_a), veh/h	323	3738	2016	1058	5342	2883	705	1170	651	874	0	992
HCM Platoon Ratio	1.00	1.00	1.00	1.00	1.00	1.00	1.00	1.00	1.00	1.00	1.00	1.00
Upstream Filter(I)	1.00	1.00	1.00	1.00	1.00	1.00	1.00	0.00	1.00	1.00	0.00	1.00
Uniform Delay (d), s/veh	21.6	5.4	5.4	19.6	4.7	4.7	20.0	0.0	20.0	19.9	0.0	19.8
Incr Delay (d2), s/veh	9.8	0.1	0.1	3.0	0.2	0.4	0.1	0.0	1.3	0.0	0.0	0.1
Initial Q Delay(d3),s/veh	0.0	0.0	0.0	0.0	0.0	0.0	0.0	0.0	0.0	0.0	0.0	0.0
%ile BackOfQ(50%),veh/ln	0.1	0.3	0.3	1.0	0.8	0.9	0.1	0.0	0.1	0.0	0.0	0.0
Unsig. Movement Delay, s/veh												
LnGrp Delay(d),s/veh	31.4	5.4	5.5	22.6	4.9	5.1	20.1	0.0	21.2	19.9	0.0	19.9
LnGrp LOS	C	A	A	C	A	A	C	A	C	B	A	B
Approach Vol, veh/h		357			1444			14				5
Approach Delay, s/veh		5.7			6.3			20.7				19.9
Approach LOS		A			A			C				B
Timer - Assigned Phs	1	2		4	5	6		8				
Phs Duration (G+Y+Rc), s	7.9	28.6		7.2	4.4	32.1		7.2				
Change Period (Y+Rc), s	* 4.2	5.8		5.1	* 4.2	5.8		5.1				
Max Green Setting (Gmax), s	* 27	51.2		26.9	* 7.8	70.2		26.9				
Max Q Clear Time (g_c+I1), s	4.7	3.6		2.1	2.1	8.1		2.4				
Green Ext Time (p_c), s	0.1	3.2		0.0	0.0	18.1		0.0				

Intersection Summary

HCM 6th Ctrl Delay	6.3
HCM 6th LOS	A

Notes

* HCM 6th computational engine requires equal clearance times for the phases crossing the barrier.

Timings
28: I-215 SB Ramps & Alessandro Bl.

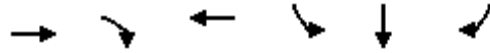

Lane Group	EBT	EBR	WBT	SBL	SBT	SBR
Lane Configurations	↑↑↑	↑	↑↑↑	↑	↔	↑
Traffic Volume (vph)	773	338	2264	172	0	299
Future Volume (vph)	773	338	2264	172	0	299
Turn Type	NA	Perm	NA	Split	NA	Perm
Protected Phases	2		6	4	4	
Permitted Phases		2				4
Detector Phase	2	2	6	4	4	4
Switch Phase						
Minimum Initial (s)	5.0	5.0	5.0	5.0	5.0	5.0
Minimum Split (s)	10.5	10.5	34.5	10.0	10.0	10.0
Total Split (s)	49.0	49.0	49.0	36.0	36.0	36.0
Total Split (%)	57.6%	57.6%	57.6%	42.4%	42.4%	42.4%
Yellow Time (s)	4.5	4.5	4.5	4.0	4.0	4.0
All-Red Time (s)	1.0	1.0	1.0	1.0	1.0	1.0
Lost Time Adjust (s)	0.0	0.0	0.0	0.0	0.0	0.0
Total Lost Time (s)	5.5	5.5	5.5	5.0	5.0	5.0
Lead/Lag						
Lead-Lag Optimize?						
Recall Mode	C-Min	C-Min	C-Min	None	None	None
Act Effct Green (s)	59.5	59.5	59.5	15.0	15.0	15.0
Actuated g/C Ratio	0.70	0.70	0.70	0.18	0.18	0.18
v/c Ratio	0.23	0.30	0.68	0.61	0.61	0.60
Control Delay	5.3	1.8	6.3	41.3	34.8	33.9
Queue Delay	0.0	0.0	0.0	0.0	0.0	0.0
Total Delay	5.3	1.8	6.3	41.3	34.8	33.9
LOS	A	A	A	D	C	C
Approach Delay	4.3		6.3		36.6	
Approach LOS	A		A		D	

Intersection Summary

Cycle Length: 85
 Actuated Cycle Length: 85
 Offset: 50 (59%), Referenced to phase 2:EBT and 6:WBT, Start of Yellow
 Natural Cycle: 55
 Control Type: Actuated-Coordinated
 Maximum v/c Ratio: 0.68
 Intersection Signal Delay: 9.3
 Intersection Capacity Utilization 68.0%
 Analysis Period (min) 15

Intersection LOS: A
 ICU Level of Service C

Splits and Phases: 28: I-215 SB Ramps & Alessandro Bl.

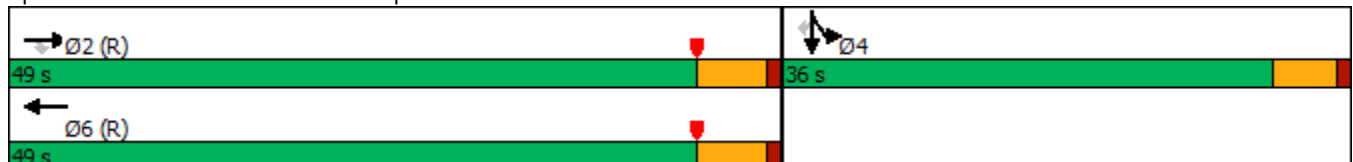

HCM 6th Signalized Intersection Summary
 28: I-215 SB Ramps & Alessandro Bl.

West Campus Upper Plateau (JN 14064)

02/16/2022



Movement	EBL	EBT	EBR	WBL	WBT	WBR	NBL	NBT	NBR	SBL	SBT	SBR
Lane Configurations		↑↑↑	↗		↑↑↑					↘	↕	↗
Traffic Volume (veh/h)	0	773	338	0	2264	143	0	0	0	172	0	299
Future Volume (veh/h)	0	773	338	0	2264	143	0	0	0	172	0	299
Initial Q (Qb), veh	0	0	0	0	0	0				0	0	0
Ped-Bike Adj(A_pbT)	1.00		1.00	1.00		1.00				1.00		1.00
Parking Bus, Adj	1.00	1.00	1.00	1.00	1.00	1.00				1.00	1.00	1.00
Work Zone On Approach		No			No						No	
Adj Sat Flow, veh/h/ln	0	1826	1826	0	1885	1811				1648	1900	1722
Adj Flow Rate, veh/h	0	781	341	0	2287	134				252	0	142
Peak Hour Factor	0.99	0.99	0.99	0.99	0.99	0.99				0.99	0.99	0.99
Percent Heavy Veh, %	0	5	5	0	1	6				17	0	12
Cap, veh/h	0	3711	1151	0	3704	215				414	0	193
Arrive On Green	0.00	0.74	0.74	0.00	0.74	0.74				0.13	0.00	0.13
Sat Flow, veh/h	0	5149	1546	0	5145	289				3139	0	1459
Grp Volume(v), veh/h	0	781	341	0	1571	850				252	0	142
Grp Sat Flow(s),veh/h/ln	0	1662	1546	0	1716	1833				1570	0	1459
Q Serve(g_s), s	0.0	4.0	6.1	0.0	18.4	18.8				6.4	0.0	8.0
Cycle Q Clear(g_c), s	0.0	4.0	6.1	0.0	18.4	18.8				6.4	0.0	8.0
Prop In Lane	0.00		1.00	0.00		0.16				1.00		1.00
Lane Grp Cap(c), veh/h	0	3711	1151	0	2554	1365				414	0	193
V/C Ratio(X)	0.00	0.21	0.30	0.00	0.62	0.62				0.61	0.00	0.74
Avail Cap(c_a), veh/h	0	3711	1151	0	2554	1365				1145	0	532
HCM Platoon Ratio	1.00	1.00	1.00	1.00	1.00	1.00				1.00	1.00	1.00
Upstream Filter(I)	0.00	0.93	0.93	0.00	0.54	0.54				1.00	0.00	1.00
Uniform Delay (d), s/veh	0.0	3.3	3.6	0.0	5.1	5.2				34.8	0.0	35.5
Incr Delay (d2), s/veh	0.0	0.1	0.6	0.0	0.6	1.2				1.4	0.0	5.4
Initial Q Delay(d3),s/veh	0.0	0.0	0.0	0.0	0.0	0.0				0.0	0.0	0.0
%ile BackOfQ(50%),veh/ln	0.0	0.7	1.1	0.0	3.2	3.7				2.4	0.0	2.9
Unsig. Movement Delay, s/veh												
LnGrp Delay(d),s/veh	0.0	3.4	4.2	0.0	5.7	6.3				36.3	0.0	40.9
LnGrp LOS	A	A	A	A	A	A				D	A	D
Approach Vol, veh/h		1122			2421						394	
Approach Delay, s/veh		3.6			5.9						37.9	
Approach LOS		A			A						D	
Timer - Assigned Phs		2		4		6						
Phs Duration (G+Y+Rc), s		68.8		16.2		68.8						
Change Period (Y+Rc), s		5.5		5.0		5.5						
Max Green Setting (Gmax), s		43.5		31.0		43.5						
Max Q Clear Time (g_c+I1), s		8.1		10.0		20.8						
Green Ext Time (p_c), s		6.7		1.3		16.9						

Intersection Summary

HCM 6th Ctrl Delay	8.5
HCM 6th LOS	A

Notes

User approved volume balancing among the lanes for turning movement.

Timings
29: I-215 NB Ramps & Alessandro Bl.

West Campus Upper Plateau (JN 14064)

02/16/2022



Lane Group	EBL	EBT	WBT	WBR	NBL	NBT	NBR
Lane Configurations	↶	↑↑↑	↑↑↑	↷	↶	↕	↷
Traffic Volume (vph)	68	877	1296	78	1111	0	158
Future Volume (vph)	68	877	1296	78	1111	0	158
Turn Type	Prot	NA	NA	Perm	Split	NA	Perm
Protected Phases	5	2	6		8	8	
Permitted Phases				6			8
Detector Phase	5	2	6	6	8	8	8
Switch Phase							
Minimum Initial (s)	5.0	5.0	5.0	5.0	5.0	5.0	5.0
Minimum Split (s)	9.5	10.5	33.5	33.5	10.0	10.0	10.0
Total Split (s)	25.0	60.0	35.0	35.0	25.0	25.0	25.0
Total Split (%)	29.4%	70.6%	41.2%	41.2%	29.4%	29.4%	29.4%
Yellow Time (s)	3.5	4.5	4.5	4.5	4.0	4.0	4.0
All-Red Time (s)	1.0	1.0	1.0	1.0	1.0	1.0	1.0
Lost Time Adjust (s)	0.0	0.0	0.0	0.0	0.0	0.0	0.0
Total Lost Time (s)	4.5	5.5	5.5	5.5	5.0	5.0	5.0
Lead/Lag	Lead		Lag	Lag			
Lead-Lag Optimize?	Yes		Yes	Yes			
Recall Mode	None	C-Min	C-Min	C-Min	Max	Max	Max
Act Effct Green (s)	9.0	50.6	39.0	39.0	23.9	23.9	23.9
Actuated g/C Ratio	0.11	0.60	0.46	0.46	0.28	0.28	0.28
v/c Ratio	0.46	0.30	0.57	0.12	1.24	1.12	0.29
Control Delay	40.6	6.7	18.4	3.8	154.7	104.4	6.6
Queue Delay	0.0	0.0	0.0	0.0	0.0	0.0	0.0
Total Delay	40.6	6.7	18.4	3.8	154.7	104.4	6.6
LOS	D	A	B	A	F	F	A
Approach Delay		9.1	17.6			115.9	
Approach LOS		A	B			F	

Intersection Summary

Cycle Length: 85
 Actuated Cycle Length: 85
 Offset: 20 (24%), Referenced to phase 2:EBT and 6:WBT, Start of Yellow
 Natural Cycle: 80
 Control Type: Actuated-Coordinated
 Maximum v/c Ratio: 1.24
 Intersection Signal Delay: 50.1
 Intersection Capacity Utilization 74.1%
 Analysis Period (min) 15

Intersection LOS: D
 ICU Level of Service D

Splits and Phases: 29: I-215 NB Ramps & Alessandro Bl.

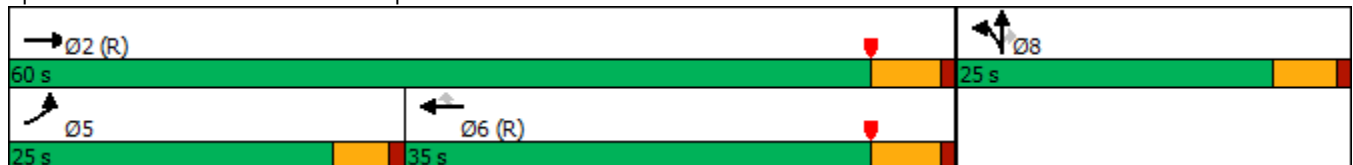

HCM 6th Signalized Intersection Summary
 29: I-215 NB Ramps & Alessandro Bl.

West Campus Upper Plateau (JN 14064)

02/16/2022



Movement	EBL	EBT	EBR	WBL	WBT	WBR	NBL	NBT	NBR	SBL	SBT	SBR
Lane Configurations	↶	↑↑↑			↑↑↑	↶	↶	↕	↶			
Traffic Volume (veh/h)	68	877	0	0	1296	78	1111	0	158	0	0	0
Future Volume (veh/h)	68	877	0	0	1296	78	1111	0	158	0	0	0
Initial Q (Qb), veh	0	0	0	0	0	0	0	0	0			
Ped-Bike Adj(A_pbT)	1.00		1.00	1.00		1.00	1.00		1.00			
Parking Bus, Adj	1.00	1.00	1.00	1.00	1.00	1.00	1.00	1.00	1.00			
Work Zone On Approach		No			No			No				
Adj Sat Flow, veh/h/ln	1485	1841	0	0	1856	1678	1856	1900	1781			
Adj Flow Rate, veh/h	69	895	0	0	1322	73	1160	0	55			
Peak Hour Factor	0.98	0.98	0.98	0.98	0.98	0.98	0.98	0.98	0.98			
Percent Heavy Veh, %	28	4	0	0	3	15	3	0	8			
Cap, veh/h	83	3222	0	0	2682	753	832	0	355			
Arrive On Green	0.02	0.21	0.00	0.00	0.53	0.53	0.24	0.00	0.24			
Sat Flow, veh/h	1414	5191	0	0	5233	1422	3534	0	1510			
Grp Volume(v), veh/h	69	895	0	0	1322	73	1160	0	55			
Grp Sat Flow(s),veh/h/ln	1414	1675	0	0	1689	1422	1767	0	1510			
Q Serve(g_s), s	4.1	12.7	0.0	0.0	14.1	2.2	20.0	0.0	2.5			
Cycle Q Clear(g_c), s	4.1	12.7	0.0	0.0	14.1	2.2	20.0	0.0	2.5			
Prop In Lane	1.00		0.00	0.00		1.00	1.00		1.00			
Lane Grp Cap(c), veh/h	83	3222	0	0	2682	753	832	0	355			
V/C Ratio(X)	0.83	0.28	0.00	0.00	0.49	0.10	1.39	0.00	0.15			
Avail Cap(c_a), veh/h	341	3222	0	0	2682	753	832	0	355			
HCM Platoon Ratio	0.33	0.33	1.00	1.00	1.00	1.00	1.00	1.00	1.00			
Upstream Filter(I)	0.97	0.97	0.00	0.00	1.00	1.00	1.00	0.00	1.00			
Uniform Delay (d), s/veh	41.3	17.0	0.0	0.0	12.7	9.9	32.5	0.0	25.8			
Incr Delay (d2), s/veh	14.0	0.2	0.0	0.0	0.7	0.3	185.0	0.0	0.9			
Initial Q Delay(d3),s/veh	0.0	0.0	0.0	0.0	0.0	0.0	0.0	0.0	0.0			
%ile BackOfQ(50%),veh/ln	1.7	4.9	0.0	0.0	4.4	0.6	29.4	0.0	0.9			
Unsig. Movement Delay, s/veh												
LnGrp Delay(d),s/veh	55.2	17.2	0.0	0.0	13.4	10.2	217.5	0.0	26.7			
LnGrp LOS	E	B	A	A	B	B	F	A	C			
Approach Vol, veh/h		964			1395			1215				
Approach Delay, s/veh		20.0			13.2			208.9				
Approach LOS		B			B			F				
Timer - Assigned Phs		2			5	6		8				
Phs Duration (G+Y+Rc), s		60.0			9.5	50.5		25.0				
Change Period (Y+Rc), s		5.5			4.5	5.5		5.0				
Max Green Setting (Gmax), s		54.5			20.5	29.5		20.0				
Max Q Clear Time (g_c+I1), s		14.7			6.1	16.1		22.0				
Green Ext Time (p_c), s		6.2			0.1	6.9		0.0				

Intersection Summary

HCM 6th Ctrl Delay	81.6
HCM 6th LOS	F

Notes

User approved volume balancing among the lanes for turning movement.

Timings
30: I-215 SB Ramps & Cactus Av.



Lane Group	EBT	EBR	WBL	WBT	NBR	SBR
Lane Configurations	↑↑	↑	↓	↑↑	↑	↑
Traffic Volume (vph)	332	26	579	1219	624	195
Future Volume (vph)	332	26	579	1219	624	195
Turn Type	NA	Perm	Prot	NA	Prot	Prot
Protected Phases	2		1	6	8	4
Permitted Phases		2				
Detector Phase	2	2	1	6	8	4
Switch Phase						
Minimum Initial (s)	5.0	5.0	5.0	5.0	5.0	5.0
Minimum Split (s)	11.0	11.0	9.5	23.0	9.5	9.5
Total Split (s)	23.0	23.0	54.0	77.0	28.0	28.0
Total Split (%)	21.9%	21.9%	51.4%	73.3%	26.7%	26.7%
Yellow Time (s)	5.0	5.0	3.5	5.0	3.5	3.5
All-Red Time (s)	1.0	1.0	1.0	1.0	1.0	1.0
Lost Time Adjust (s)	0.0	0.0	0.0	0.0	0.0	0.0
Total Lost Time (s)	6.0	6.0	4.5	6.0	4.5	4.5
Lead/Lag	Lag	Lag	Lead			
Lead-Lag Optimize?	Yes	Yes	Yes			
Recall Mode	Min	Min	None	Min	None	None
Act Effct Green (s)	13.5	13.5	35.9	54.3	13.9	13.9
Actuated g/C Ratio	0.17	0.17	0.45	0.68	0.17	0.17
v/c Ratio	0.65	0.09	0.87	0.56	0.74	0.75
Control Delay	40.1	2.3	34.7	7.9	5.9	38.9
Queue Delay	0.0	0.0	0.0	0.0	0.0	0.0
Total Delay	40.1	2.3	34.7	7.9	5.9	38.9
LOS	D	A	C	A	A	D
Approach Delay	37.3			16.5		
Approach LOS	D			B		

Intersection Summary

Cycle Length: 105
 Actuated Cycle Length: 79.6
 Natural Cycle: 65
 Control Type: Actuated-Uncoordinated
 Maximum v/c Ratio: 0.87
 Intersection Signal Delay: 18.3
 Intersection LOS: B
 Intersection Capacity Utilization 56.6%
 ICU Level of Service B
 Analysis Period (min) 15

Splits and Phases: 30: I-215 SB Ramps & Cactus Av.

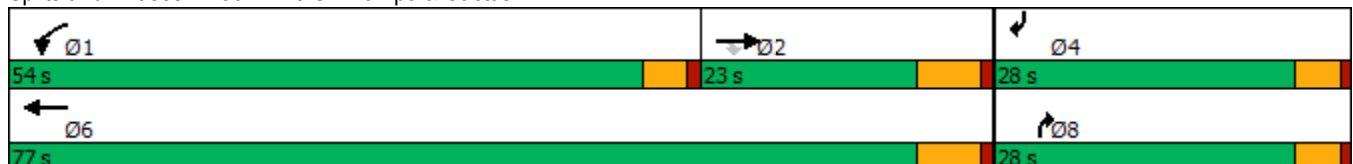

HCM 6th Signalized Intersection Summary
 30: I-215 SB Ramps & Cactus Av.

West Campus Upper Plateau (JN 14064)

02/16/2022



Movement	EBL	EBT	EBR	WBL	WBT	WBR	NBL	NBT	NBR	SBL	SBT	SBR
Lane Configurations		↑↑	↑	↑	↑↑				↑			↑
Traffic Volume (veh/h)	0	332	26	579	1219	0	0	0	624	0	0	195
Future Volume (veh/h)	0	332	26	579	1219	0	0	0	624	0	0	195
Initial Q (Qb), veh	0	0	0	0	0	0	0	0	0	0	0	0
Ped-Bike Adj(A_pbT)	1.00		1.00	1.00		1.00	1.00		1.00	1.00		1.00
Parking Bus, Adj	1.00	1.00	1.00	1.00	1.00	1.00	1.00	1.00	1.00	1.00	1.00	1.00
Work Zone On Approach		No			No			No			No	
Adj Sat Flow, veh/h/ln	0	1781	1826	1752	1870	0	0	0	1737	0	0	1500
Adj Flow Rate, veh/h	0	369	21	643	1354	0	0	0	0	0	0	116
Peak Hour Factor	0.90	0.90	0.90	0.90	0.90	0.90	0.90	0.90	0.90	0.90	0.90	0.90
Percent Heavy Veh, %	0	8	5	10	2	0	0	0	11	0	0	27
Cap, veh/h	0	687	314	743	2840	0	0	0	0	0	0	0
Arrive On Green	0.00	0.20	0.20	0.45	0.80	0.00	0.00	0.00	0.00	0.00	0.00	0.00
Sat Flow, veh/h	0	3474	1547	1668	3647	0		0			0	
Grp Volume(v), veh/h	0	369	21	643	1354	0		0.0			0.0	
Grp Sat Flow(s),veh/h/ln	0	1692	1547	1668	1777	0						
Q Serve(g_s), s	0.0	2.9	0.3	10.4	3.7	0.0						
Cycle Q Clear(g_c), s	0.0	2.9	0.3	10.4	3.7	0.0						
Prop In Lane	0.00		1.00	1.00		0.00						
Lane Grp Cap(c), veh/h	0	687	314	743	2840	0						
V/C Ratio(X)	0.00	0.54	0.07	0.87	0.48	0.00						
Avail Cap(c_a), veh/h	0	1927	881	2766	8451	0						
HCM Platoon Ratio	1.00	1.00	1.00	1.00	1.00	1.00						
Upstream Filter(I)	0.00	1.00	1.00	1.00	1.00	0.00						
Uniform Delay (d), s/veh	0.0	10.6	9.6	7.5	1.0	0.0						
Incr Delay (d2), s/veh	0.0	0.2	0.0	1.2	0.0	0.0						
Initial Q Delay(d3),s/veh	0.0	0.0	0.0	0.0	0.0	0.0						
%ile BackOfQ(50%),veh/ln	0.0	0.6	0.1	1.3	0.0	0.0						
Unsig. Movement Delay, s/veh												
LnGrp Delay(d),s/veh	0.0	10.9	9.6	8.7	1.0	0.0						
LnGrp LOS	A	B	A	A	A	A						
Approach Vol, veh/h		390			1997							
Approach Delay, s/veh		10.8			3.5							
Approach LOS		B			A							
Timer - Assigned Phs	1	2			6							
Phs Duration (G+Y+Rc), s	17.8	12.1			29.9							
Change Period (Y+Rc), s	4.5	6.0			6.0							
Max Green Setting (Gmax), s	49.5	17.0			71.0							
Max Q Clear Time (g_c+I1), s	12.4	4.9			5.7							
Green Ext Time (p_c), s	1.0	1.1			7.5							

Intersection Summary

HCM 6th Ctrl Delay		4.7				
HCM 6th LOS		A				

Notes

Unsignalized Delay for [NBR] is excluded from calculations of the approach delay and intersection delay.

Timings

31: I-215 NB Ramps/Old 215 Frontage Rd. & Cactus Av.



Lane Group	EBL	EBT	WBT	NBL	NBT	NBR	SBL	SBT
Lane Configurations	↖	↕	↕	↖	↕	↗	↖	↕
Traffic Volume (vph)	21	1258	2362	281	292	12	48	0
Future Volume (vph)	21	1258	2362	281	292	12	48	0
Turn Type	Perm	NA	NA	Perm	NA	Perm	Perm	NA
Protected Phases		2	6		8			4
Permitted Phases	2			8		8	4	
Detector Phase	2	2	6	8	8	8	4	4
Switch Phase								
Minimum Initial (s)	5.0	5.0	5.0	5.0	5.0	5.0	5.0	5.0
Minimum Split (s)	11.0	11.0	44.0	10.5	10.5	10.5	10.5	10.5
Total Split (s)	88.0	88.0	88.0	32.0	32.0	32.0	32.0	32.0
Total Split (%)	73.3%	73.3%	73.3%	26.7%	26.7%	26.7%	26.7%	26.7%
Yellow Time (s)	5.0	5.0	5.0	4.5	4.5	4.5	4.5	4.5
All-Red Time (s)	1.0	1.0	1.0	1.0	1.0	1.0	1.0	1.0
Lost Time Adjust (s)	0.0	0.0	0.0	0.0	0.0	0.0	0.0	0.0
Total Lost Time (s)	6.0	6.0	6.0	5.5	5.5	5.5	5.5	5.5
Lead/Lag								
Lead-Lag Optimize?								
Recall Mode	Min	Min	Min	None	None	None	None	None
Act Effct Green (s)	82.0	82.0	82.0	26.5	26.5	26.5	26.5	26.5
Actuated g/C Ratio	0.68	0.68	0.68	0.22	0.22	0.22	0.22	0.22
v/c Ratio	0.45	0.61	1.14	1.15	0.93	0.03	0.55	0.46
Control Delay	43.0	11.7	90.0	146.4	79.8	4.7	65.6	37.8
Queue Delay	0.0	0.0	0.0	0.0	0.0	0.0	0.0	0.0
Total Delay	43.0	11.7	90.0	146.4	79.8	4.7	65.6	37.8
LOS	D	B	F	F	E	A	E	D
Approach Delay		12.2	90.0		110.3			46.1
Approach LOS		B	F		F			D

Intersection Summary

Cycle Length: 120
 Actuated Cycle Length: 120
 Natural Cycle: 120
 Control Type: Actuated-Uncoordinated
 Maximum v/c Ratio: 1.15
 Intersection Signal Delay: 68.6
 Intersection LOS: E
 Intersection Capacity Utilization 106.4%
 ICU Level of Service G
 Analysis Period (min) 15

Splits and Phases: 31: I-215 NB Ramps/Old 215 Frontage Rd. & Cactus Av.

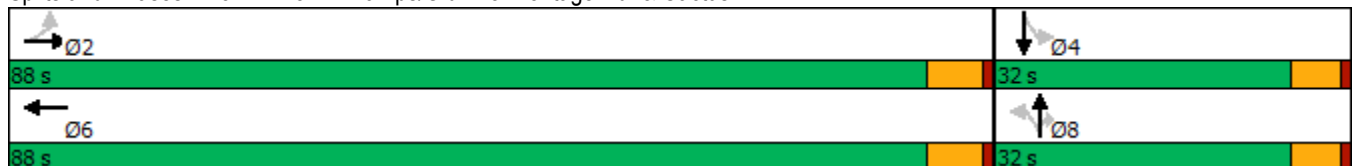

HCM 6th Signalized Intersection Summary

West Campus Upper Plateau (JN 14064)

31: I-215 NB Ramps/Old 215 Frontage Rd. & Cactus Av.

02/16/2022

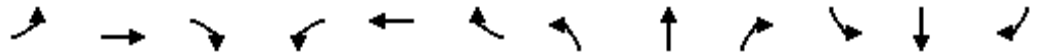

Movement	EBL	EBT	EBR	WBL	WBT	WBR	NBL	NBT	NBR	SBL	SBT	SBR
Lane Configurations												
Traffic Volume (veh/h)	21	1258	42	0	2362	138	281	292	12	48	0	113
Future Volume (veh/h)	21	1258	42	0	2362	138	281	292	12	48	0	113
Initial Q (Qb), veh	0	0	0	0	0	0	0	0	0	0	0	0
Ped-Bike Adj(A_pbT)	1.00		1.00	1.00		1.00	1.00		1.00	1.00		1.00
Parking Bus, Adj	1.00	1.00	1.00	1.00	1.00	1.00	1.00	1.00	1.00	1.00	1.00	1.00
Work Zone On Approach		No			No			No			No	
Adj Sat Flow, veh/h/ln	1470	1811	833	0	1826	1811	1826	1633	1900	1811	1900	1174
Adj Flow Rate, veh/h	22	1338	40	0	2513	127	299	311	0	51	0	110
Peak Hour Factor	0.94	0.94	0.94	0.94	0.94	0.94	0.94	0.94	0.94	0.94	0.94	0.94
Percent Heavy Veh, %	29	6	72	0	5	6	5	18	0	6	0	49
Cap, veh/h	60	2331	70	0	2297	115	265	361		99	0	356
Arrive On Green	0.68	0.68	0.68	0.00	0.68	0.68	0.22	0.22	0.00	0.22	0.00	0.22
Sat Flow, veh/h	90	3411	102	0	3453	168	1253	1633	1610	1035	0	1610
Grp Volume(v), veh/h	22	674	704	0	1286	1354	299	311	0	51	0	110
Grp Sat Flow(s),veh/h/ln	90	1721	1793	0	1735	1796	1253	1633	1610	1035	0	1610
Q Serve(g_s), s	0.0	24.5	24.6	0.0	82.0	82.0	19.6	22.0	0.0	4.5	0.0	6.9
Cycle Q Clear(g_c), s	82.0	24.5	24.6	0.0	82.0	82.0	26.5	22.0	0.0	26.5	0.0	6.9
Prop In Lane	1.00		0.06	0.00		0.09	1.00		1.00	1.00		1.00
Lane Grp Cap(c), veh/h	60	1176	1225	0	1185	1227	265	361		99	0	356
V/C Ratio(X)	0.37	0.57	0.57	0.00	1.09	1.10	1.13	0.86		0.52	0.00	0.31
Avail Cap(c_a), veh/h	60	1176	1225	0	1185	1227	265	361		99	0	356
HCM Platoon Ratio	1.00	1.00	1.00	1.00	1.00	1.00	1.00	1.00	1.00	1.00	1.00	1.00
Upstream Filter(I)	1.00	1.00	1.00	0.00	1.00	1.00	1.00	1.00	0.00	1.00	0.00	1.00
Uniform Delay (d), s/veh	60.0	9.9	9.9	0.0	19.0	19.0	52.4	45.0	0.0	58.3	0.0	39.1
Incr Delay (d2), s/veh	1.4	0.4	0.4	0.0	52.4	58.9	94.2	18.1	0.0	2.1	0.0	0.2
Initial Q Delay(d3),s/veh	0.0	0.0	0.0	0.0	0.0	0.0	0.0	0.0	0.0	0.0	0.0	0.0
%ile BackOfQ(50%),veh/ln	0.7	7.9	8.2	0.0	43.4	47.2	14.8	10.4	0.0	1.6	0.0	2.6
Unsig. Movement Delay, s/veh												
LnGrp Delay(d),s/veh	61.4	10.3	10.3	0.0	71.4	77.9	146.6	63.1	0.0	60.4	0.0	39.3
LnGrp LOS	E	B	B	A	F	F	F	E		E	A	D
Approach Vol, veh/h		1400			2640			610	A			161
Approach Delay, s/veh		11.1			74.7			104.0				46.0
Approach LOS		B			E			F				D
Timer - Assigned Phs		2		4		6		8				
Phs Duration (G+Y+Rc), s		88.0		32.0		88.0		32.0				
Change Period (Y+Rc), s		6.0		5.5		6.0		5.5				
Max Green Setting (Gmax), s		82.0		26.5		82.0		26.5				
Max Q Clear Time (g_c+I1), s		84.0		28.5		84.0		28.5				
Green Ext Time (p_c), s		0.0		0.0		0.0		0.0				

Intersection Summary

HCM 6th Ctrl Delay	59.0
HCM 6th LOS	E

Notes

User approved volume balancing among the lanes for turning movement.
 Unsignalized Delay for [NBR] is excluded from calculations of the approach delay and intersection delay.

Timings

32: I-215 SB Ramps & Van Buren Bl.

02/16/2022



Lane Group	EBT	EBR	WBL	WBT	SBT	SBR
Lane Configurations	↑↑	↑↑	↵	↑↑	↵	↑↑
Traffic Volume (vph)	507	657	2	902	21	719
Future Volume (vph)	507	657	2	902	21	719
Turn Type	NA	Perm	Prot	NA	NA	Perm
Protected Phases	6		5	2	8	
Permitted Phases		6				8
Detector Phase	6	6	5	2	8	8
Switch Phase						
Minimum Initial (s)	5.0	5.0	5.0	5.0	5.0	5.0
Minimum Split (s)	36.0	36.0	11.0	11.0	11.0	11.0
Total Split (s)	37.0	37.0	11.0	48.0	37.0	37.0
Total Split (%)	43.5%	43.5%	12.9%	56.5%	43.5%	43.5%
Yellow Time (s)	5.0	5.0	5.0	5.0	5.0	5.0
All-Red Time (s)	1.0	1.0	1.0	1.0	1.0	1.0
Lost Time Adjust (s)	0.0	0.0	0.0	0.0	0.0	0.0
Total Lost Time (s)	6.0	6.0	6.0	6.0	6.0	6.0
Lead/Lag	Lag	Lag	Lead			
Lead-Lag Optimize?	Yes	Yes	Yes			
Recall Mode	Min	Min	None	Min	Max	Max
Act Effct Green (s)	23.1	23.1	5.1	24.9	31.4	31.4
Actuated g/C Ratio	0.34	0.34	0.07	0.36	0.46	0.46
v/c Ratio	0.48	0.52	0.02	0.77	0.08	0.59
Control Delay	19.6	3.1	34.5	23.2	14.0	14.9
Queue Delay	0.0	0.0	0.0	0.0	0.0	0.0
Total Delay	19.6	3.1	34.5	23.2	14.0	14.9
LOS	B	A	C	C	B	B
Approach Delay	10.3			23.3	14.8	
Approach LOS	B			C	B	

Intersection Summary

Cycle Length: 85
 Actuated Cycle Length: 68.5
 Natural Cycle: 70
 Control Type: Actuated-Uncoordinated
 Maximum v/c Ratio: 0.77
 Intersection Signal Delay: 15.7
 Intersection LOS: B
 Intersection Capacity Utilization 60.1%
 ICU Level of Service B
 Analysis Period (min) 15

Splits and Phases: 32: I-215 SB Ramps & Van Buren Bl.

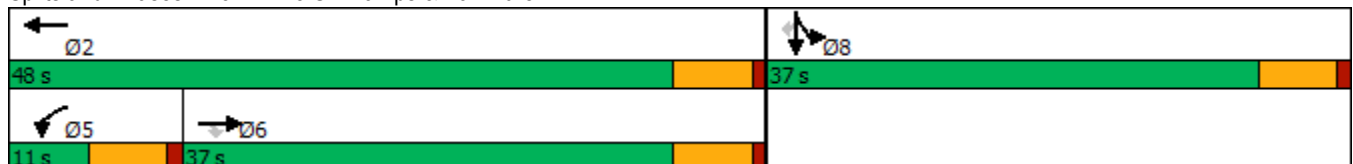

HCM 6th Signalized Intersection Summary
 32: I-215 SB Ramps & Van Buren Bl.

West Campus Upper Plateau (JN 14064)

02/16/2022



Movement	EBL	EBT	EBR	WBL	WBT	WBR	NBL	NBT	NBR	SBL	SBT	SBR
Lane Configurations		↑↑	↑↑	↑	↑↑						↑	↑↑
Traffic Volume (veh/h)	0	507	657	2	902	0	0	0	0	21	21	719
Future Volume (veh/h)	0	507	657	2	902	0	0	0	0	21	21	719
Initial Q (Qb), veh	0	0	0	0	0	0				0	0	0
Ped-Bike Adj(A_pbT)	1.00		1.00	1.00		1.00				1.00		1.00
Parking Bus, Adj	1.00	1.00	1.00	1.00	1.00	1.00				1.00	1.00	1.00
Work Zone On Approach		No			No						No	
Adj Sat Flow, veh/h/ln	0	1796	1767	1900	1841	0				1115	1515	1811
Adj Flow Rate, veh/h	0	545	612	2	970	0				23	23	0
Peak Hour Factor	0.93	0.93	0.93	0.93	0.93	0.93				0.93	0.93	0.93
Percent Heavy Veh, %	0	7	9	0	4	0				53	26	6
Cap, veh/h	0	965	745	120	1500	0				304	304	
Arrive On Green	0.00	0.28	0.28	0.07	0.43	0.00				0.41	0.41	0.00
Sat Flow, veh/h	0	3503	2635	1810	3589	0				739	739	2701
Grp Volume(v), veh/h	0	545	612	2	970	0				46	0	0
Grp Sat Flow(s),veh/h/ln	0	1706	1317	1810	1749	0				1478	0	1351
Q Serve(g_s), s	0.0	10.3	16.3	0.1	16.5	0.0				1.4	0.0	0.0
Cycle Q Clear(g_c), s	0.0	10.3	16.3	0.1	16.5	0.0				1.4	0.0	0.0
Prop In Lane	0.00		1.00	1.00		0.00				0.50		1.00
Lane Grp Cap(c), veh/h	0	965	745	120	1500	0				608	0	
V/C Ratio(X)	0.00	0.56	0.82	0.02	0.65	0.00				0.08	0.00	
Avail Cap(c_a), veh/h	0	1405	1085	120	1951	0				608	0	
HCM Platoon Ratio	1.00	1.00	1.00	1.00	1.00	1.00				1.00	1.00	1.00
Upstream Filter(I)	0.00	1.00	1.00	1.00	1.00	0.00				1.00	0.00	0.00
Uniform Delay (d), s/veh	0.0	23.0	25.2	32.9	17.0	0.0				13.4	0.0	0.0
Incr Delay (d2), s/veh	0.0	0.2	2.1	0.0	0.2	0.0				0.2	0.0	0.0
Initial Q Delay(d3),s/veh	0.0	0.0	0.0	0.0	0.0	0.0				0.0	0.0	0.0
%ile BackOfQ(50%),veh/ln	0.0	3.6	4.6	0.0	5.5	0.0				0.5	0.0	0.0
Unsig. Movement Delay, s/veh												
LnGrp Delay(d),s/veh	0.0	23.2	27.4	32.9	17.2	0.0				13.7	0.0	0.0
LnGrp LOS	A	C	C	C	B	A				B	A	
Approach Vol, veh/h		1157			972						46	A
Approach Delay, s/veh		25.4			17.2						13.7	
Approach LOS		C			B						B	
Timer - Assigned Phs		2			5	6		8				
Phs Duration (G+Y+Rc), s		38.3			11.0	27.3		37.0				
Change Period (Y+Rc), s		6.0			6.0	6.0		6.0				
Max Green Setting (Gmax), s		42.0			5.0	31.0		31.0				
Max Q Clear Time (g_c+I1), s		18.5			2.1	18.3		3.4				
Green Ext Time (p_c), s		4.1			0.0	3.0		0.1				

Intersection Summary

HCM 6th Ctrl Delay	21.5
HCM 6th LOS	C

Notes

Unsignalized Delay for [SBR] is excluded from calculations of the approach delay and intersection delay.

Timings
33: I-215 NB On/Off Ramp & Van Buren Bl.



Lane Group	EBT	EBR	WBT	NBL	NBR
Lane Configurations	↑↑	↑↑	↑↑	↑↑	↑
Traffic Volume (vph)	32	558	26	965	5
Future Volume (vph)	32	558	26	965	5
Turn Type	NA	pm+ov	NA	Prot	Perm
Protected Phases	6	4	2	4	
Permitted Phases		6			4
Detector Phase	6	4	2	4	4
Switch Phase					
Minimum Initial (s)	5.0	5.0	5.0	5.0	5.0
Minimum Split (s)	11.0	42.0	11.0	42.0	42.0
Total Split (s)	15.0	55.0	15.0	55.0	55.0
Total Split (%)	21.4%	78.6%	21.4%	78.6%	78.6%
Yellow Time (s)	5.0	5.0	5.0	5.0	5.0
All-Red Time (s)	1.0	1.0	1.0	1.0	1.0
Lost Time Adjust (s)	0.0	0.0	0.0	0.0	0.0
Total Lost Time (s)	6.0	6.0	6.0	6.0	6.0
Lead/Lag					
Lead-Lag Optimize?					
Recall Mode	None	Min	None	Min	Min
Act Effct Green (s)	5.7	38.9	5.7	33.4	33.4
Actuated g/C Ratio	0.15	1.00	0.15	0.86	0.86
v/c Ratio	0.10	0.23	0.08	0.37	0.01
Control Delay	19.8	0.2	20.0	2.9	2.2
Queue Delay	0.0	0.0	0.0	0.0	0.0
Total Delay	19.8	0.2	20.0	2.9	2.2
LOS	B	A	B	A	A
Approach Delay	1.3		20.0	2.9	
Approach LOS	A		B	A	

Intersection Summary

Cycle Length: 70
 Actuated Cycle Length: 38.9
 Natural Cycle: 55
 Control Type: Actuated-Uncoordinated
 Maximum v/c Ratio: 0.37
 Intersection Signal Delay: 2.6
 Intersection LOS: A
 Intersection Capacity Utilization 41.7%
 ICU Level of Service A
 Analysis Period (min) 15

Splits and Phases: 33: I-215 NB On/Off Ramp & Van Buren Bl.



HCM 6th Signalized Intersection Summary
 33: I-215 NB On/Off Ramp & Van Buren Bl.

West Campus Upper Plateau (JN 14064)

02/16/2022



Movement	EBT	EBR	WBL	WBT	NBL	NBR
Lane Configurations	↑↑	↑↑		↑↑	↑↑	↑
Traffic Volume (veh/h)	32	558	0	26	965	5
Future Volume (veh/h)	32	558	0	26	965	5
Initial Q (Qb), veh	0	0	0	0	0	0
Ped-Bike Adj(A_pbT)		1.00	1.00		1.00	1.00
Parking Bus, Adj	1.00	1.00	1.00	1.00	1.00	1.00
Work Zone On Approach	No			No	No	
Adj Sat Flow, veh/h/ln	1189	1811	0	1026	1826	1159
Adj Flow Rate, veh/h	35	592	0	28	1049	5
Peak Hour Factor	0.92	0.92	0.92	0.92	0.92	0.92
Percent Heavy Veh, %	48	6	0	59	5	50
Cap, veh/h	447	1631	0	385	1369	399
Arrive On Green	0.20	0.20	0.00	0.20	0.41	0.41
Sat Flow, veh/h	2318	2701	0	2051	3374	982
Grp Volume(v), veh/h	35	592	0	28	1049	5
Grp Sat Flow(s),veh/h/ln	1129	1351	0	974	1687	982
Q Serve(g_s), s	0.4	3.4	0.0	0.4	8.1	0.1
Cycle Q Clear(g_c), s	0.4	3.4	0.0	0.4	8.1	0.1
Prop In Lane		1.00	0.00		1.00	1.00
Lane Grp Cap(c), veh/h	447	1631	0	385	1369	399
V/C Ratio(X)	0.08	0.36	0.00	0.07	0.77	0.01
Avail Cap(c_a), veh/h	671	1899	0	579	5461	1590
HCM Platoon Ratio	1.00	1.00	1.00	1.00	1.00	1.00
Upstream Filter(I)	1.00	1.00	0.00	1.00	1.00	1.00
Uniform Delay (d), s/veh	9.9	3.0	0.0	9.9	7.8	5.4
Incr Delay (d2), s/veh	0.0	0.1	0.0	0.0	0.3	0.0
Initial Q Delay(d3),s/veh	0.0	0.0	0.0	0.0	0.0	0.0
%ile BackOfQ(50%),veh/ln	0.1	1.1	0.0	0.0	1.2	0.0
Unsig. Movement Delay, s/veh						
LnGrp Delay(d),s/veh	9.9	3.1	0.0	9.9	8.1	5.4
LnGrp LOS	A	A	A	A	A	A
Approach Vol, veh/h	627			28	1054	
Approach Delay, s/veh	3.5			9.9	8.1	
Approach LOS	A			A	A	
Timer - Assigned Phs		2		4		6
Phs Duration (G+Y+Rc), s		12.0		18.3		12.0
Change Period (Y+Rc), s		6.0		6.0		6.0
Max Green Setting (Gmax), s		9.0		49.0		9.0
Max Q Clear Time (g_c+I1), s		2.4		10.1		5.4
Green Ext Time (p_c), s		0.0		2.2		0.6
Intersection Summary						
HCM 6th Ctrl Delay			6.4			
HCM 6th LOS			A			

Timings

West Campus Upper Plateau (JN 14064)

34: Old 215 Frontage Rd. & Alessandro Bl.

02/16/2022



Lane Group	EBL	EBT	EBR	WBL	WBT	WBR	NBL	NBT	NBR	SBL	SBT	SBR
Lane Configurations	↖↗	↑↑↑	↖	↖	↑↑	↖	↖↗	↑↑	↖	↖	↑↑	↖
Traffic Volume (vph)	324	909	42	10	1250	110	51	258	19	22	43	221
Future Volume (vph)	324	909	42	10	1250	110	51	258	19	22	43	221
Turn Type	Prot	NA	Perm	Prot	NA	Perm	Prot	NA	Perm	Prot	NA	Perm
Protected Phases	5	2		1	6		3	8		7	4	
Permitted Phases			2			6			8			4
Detector Phase	5	2	2	1	6	6	3	8	8	7	4	4
Switch Phase												
Minimum Initial (s)	5.0	10.0	10.0	5.0	10.0	10.0	5.0	10.0	10.0	5.0	10.0	10.0
Minimum Split (s)	8.7	43.5	43.5	8.7	15.8	15.8	8.7	16.2	16.2	8.7	40.2	40.2
Total Split (s)	17.0	62.2	62.2	8.9	54.1	54.1	8.7	39.3	39.3	9.6	40.2	40.2
Total Split (%)	14.2%	51.8%	51.8%	7.4%	45.1%	45.1%	7.3%	32.8%	32.8%	8.0%	33.5%	33.5%
Yellow Time (s)	3.2	5.5	5.5	3.2	4.8	4.8	3.2	5.2	5.2	3.2	5.2	5.2
All-Red Time (s)	0.5	1.0	1.0	0.5	1.0	1.0	0.5	1.0	1.0	0.5	1.0	1.0
Lost Time Adjust (s)	0.0	0.0	0.0	0.0	0.0	0.0	0.0	0.0	0.0	0.0	0.0	0.0
Total Lost Time (s)	3.7	6.5	6.5	3.7	5.8	5.8	3.7	6.2	6.2	3.7	6.2	6.2
Lead/Lag	Lead	Lag	Lag	Lead	Lag	Lag	Lead	Lag	Lag	Lead	Lag	Lag
Lead-Lag Optimize?	Yes	Yes	Yes	Yes	Yes	Yes	Yes	Yes	Yes	Yes	Yes	Yes
Recall Mode	None	None	None	None	None	None	None	Max	Max	None	Max	Max
Act Effct Green (s)	12.9	60.0	60.0	5.1	45.8	45.8	5.0	35.4	35.4	5.6	34.2	34.2
Actuated g/C Ratio	0.11	0.52	0.52	0.04	0.40	0.40	0.04	0.31	0.31	0.05	0.30	0.30
v/c Ratio	0.86	0.36	0.07	0.23	0.92	0.17	0.41	0.26	0.04	0.27	0.05	0.38
Control Delay	72.7	17.3	0.2	68.5	44.7	3.3	65.9	32.7	0.1	63.5	31.6	8.9
Queue Delay	0.0	0.0	0.0	0.0	0.0	0.0	0.0	0.0	0.0	0.0	0.0	0.0
Total Delay	72.7	17.3	0.2	68.5	44.7	3.3	65.9	32.7	0.1	63.5	31.6	8.9
LOS	E	B	A	E	D	A	E	C	A	E	C	A
Approach Delay		30.8			41.6			36.0			16.4	
Approach LOS		C			D			D			B	

Intersection Summary

Cycle Length: 120
 Actuated Cycle Length: 115.4
 Natural Cycle: 105
 Control Type: Actuated-Uncoordinated
 Maximum v/c Ratio: 0.92
 Intersection Signal Delay: 34.6
 Intersection LOS: C
 Intersection Capacity Utilization 73.0%
 ICU Level of Service C
 Analysis Period (min) 15

Splits and Phases: 34: Old 215 Frontage Rd. & Alessandro Bl.

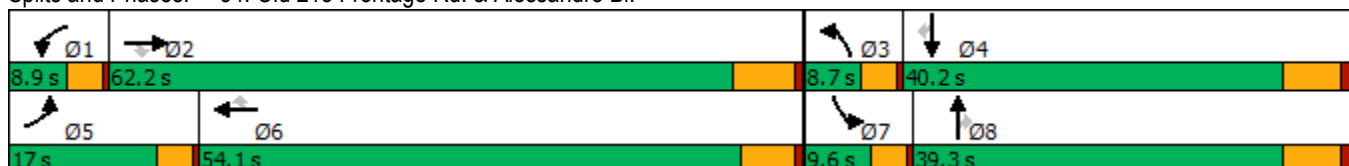

HCM 6th Signalized Intersection Summary
34: Old 215 Frontage Rd. & Alessandro Bl.

West Campus Upper Plateau (JN 14064)

02/16/2022



Movement	EBL	EBT	EBR	WBL	WBT	WBR	NBL	NBT	NBR	SBL	SBT	SBR
Lane Configurations	↔↔	↑↑↑	↔	↔	↑↑	↔	↔↔	↑↑	↔	↔	↑↑	↔
Traffic Volume (veh/h)	324	909	42	10	1250	110	51	258	19	22	43	221
Future Volume (veh/h)	324	909	42	10	1250	110	51	258	19	22	43	221
Initial Q (Qb), veh	0	0	0	0	0	0	0	0	0	0	0	0
Ped-Bike Adj(A_pbT)	1.00		1.00	1.00		1.00	1.00		1.00	1.00		1.00
Parking Bus, Adj	1.00	1.00	1.00	1.00	1.00	1.00	1.00	1.00	1.00	1.00	1.00	1.00
Work Zone On Approach		No			No			No			No	
Adj Sat Flow, veh/h/ln	1885	1841	1263	625	1856	1752	1618	1767	1693	1811	1707	1856
Adj Flow Rate, veh/h	331	928	33	10	1276	0	52	263	11	22	44	0
Peak Hour Factor	0.98	0.98	0.98	0.98	0.98	0.98	0.98	0.98	0.98	0.98	0.98	0.98
Percent Heavy Veh, %	1	4	43	86	3	10	19	9	14	6	13	3
Cap, veh/h	385	2474	527	7	1387		104	1016	434	38	940	
Arrive On Green	0.11	0.49	0.49	0.01	0.39	0.00	0.03	0.30	0.30	0.02	0.29	0.00
Sat Flow, veh/h	3483	5025	1070	596	3526	1485	2990	3357	1434	1725	3244	1572
Grp Volume(v), veh/h	331	928	33	10	1276	0	52	263	11	22	44	0
Grp Sat Flow(s),veh/h/ln	1742	1675	1070	596	1763	1485	1495	1678	1434	1725	1622	1572
Q Serve(g_s), s	11.0	13.5	1.9	1.4	40.4	0.0	2.0	7.0	0.6	1.5	1.1	0.0
Cycle Q Clear(g_c), s	11.0	13.5	1.9	1.4	40.4	0.0	2.0	7.0	0.6	1.5	1.1	0.0
Prop In Lane	1.00		1.00	1.00		1.00	1.00		1.00	1.00		1.00
Lane Grp Cap(c), veh/h	385	2474	527	7	1387		104	1016	434	38	940	
V/C Ratio(X)	0.86	0.38	0.06	1.42	0.92		0.50	0.26	0.03	0.58	0.05	
Avail Cap(c_a), veh/h	395	2474	527	26	1451		127	1016	434	87	940	
HCM Platoon Ratio	1.00	1.00	1.00	1.00	1.00	1.00	1.00	1.00	1.00	1.00	1.00	1.00
Upstream Filter(I)	1.00	1.00	1.00	1.00	1.00	0.00	1.00	1.00	1.00	1.00	1.00	0.00
Uniform Delay (d), s/veh	51.3	18.5	15.6	58.0	33.8	0.0	55.6	30.9	28.7	56.9	30.0	0.0
Incr Delay (d2), s/veh	15.9	0.1	0.0	241.4	9.5	0.0	1.4	0.6	0.1	5.3	0.1	0.0
Initial Q Delay(d3),s/veh	0.0	0.0	0.0	0.0	0.0	0.0	0.0	0.0	0.0	0.0	0.0	0.0
%ile BackOfQ(50%),veh/ln	5.4	4.8	0.4	0.7	18.0	0.0	0.8	2.8	0.2	0.7	0.4	0.0
Unsig. Movement Delay, s/veh												
LnGrp Delay(d),s/veh	67.2	18.6	15.7	299.3	43.4	0.0	57.0	31.6	28.9	62.1	30.1	0.0
LnGrp LOS	E	B	B	F	D		E	C	C	E	C	
Approach Vol, veh/h		1292			1286	A		326			66	A
Approach Delay, s/veh		31.0			45.4			35.5			40.8	
Approach LOS		C			D			D			D	
Timer - Assigned Phs	1	2	3	4	5	6	7	8				
Phs Duration (G+Y+Rc), s	5.1	64.3	7.8	40.2	16.7	52.7	6.3	41.7				
Change Period (Y+Rc), s	3.7	6.5	3.7	6.2	3.7	* 6.5	3.7	6.2				
Max Green Setting (Gmax), s	5.2	55.7	5.0	34.0	13.3	* 48	5.9	33.1				
Max Q Clear Time (g_c+I1), s	3.4	15.5	4.0	3.1	13.0	42.4	3.5	9.0				
Green Ext Time (p_c), s	0.0	6.6	0.0	0.2	0.0	3.8	0.0	1.5				

Intersection Summary

HCM 6th Ctrl Delay	37.9
HCM 6th LOS	D

Notes

* HCM 6th computational engine requires equal clearance times for the phases crossing the barrier.
Unsignalized Delay for [WBR, SBR] is excluded from calculations of the approach delay and intersection delay.

Timings
35: Day St. & Alessandro Bl.

West Campus Upper Plateau (JN 14064)

02/16/2022



Lane Group	EBL	EBT	EBR	WBL	WBT	WBR	NBL	NBT	NBR	SBL	SBT
Lane Configurations	↖	↗↗↗	↖	↖	↗↗	↖	↖	↗	↖	↖	↗
Traffic Volume (vph)	138	638	9	9	1144	123	11	155	16	77	39
Future Volume (vph)	138	638	9	9	1144	123	11	155	16	77	39
Turn Type	Prot	NA	Perm	Prot	NA	Perm	Perm	NA	Perm	Perm	NA
Protected Phases	5	2		1	6			8			4
Permitted Phases			2			6	8		8	4	
Detector Phase	5	2	2	1	6	6	8	8	8	4	4
Switch Phase											
Minimum Initial (s)	5.0	10.0	10.0	5.0	10.0	10.0	10.0	10.0	10.0	10.0	10.0
Minimum Split (s)	9.1	30.8	30.8	9.1	30.8	30.8	42.4	42.4	42.4	41.6	41.6
Total Split (s)	21.0	68.5	68.5	9.1	56.6	56.6	42.4	42.4	42.4	42.4	42.4
Total Split (%)	17.5%	57.1%	57.1%	7.6%	47.2%	47.2%	35.3%	35.3%	35.3%	35.3%	35.3%
Yellow Time (s)	3.6	4.8	4.8	3.6	4.8	4.8	4.4	4.4	4.4	3.6	3.6
All-Red Time (s)	0.5	1.0	1.0	0.5	1.0	1.0	1.0	1.0	1.0	1.0	1.0
Lost Time Adjust (s)	0.0	0.0	0.0	0.0	0.0	0.0	0.0	0.0	0.0	0.0	0.0
Total Lost Time (s)	4.1	5.8	5.8	4.1	5.8	5.8	5.4	5.4	5.4	4.6	4.6
Lead/Lag	Lead	Lag	Lag	Lead	Lag	Lag					
Lead-Lag Optimize?	Yes	Yes	Yes	Yes	Yes	Yes					
Recall Mode	None	None	None	None	None	None	None	None	None	None	None
Act Effct Green (s)	11.9	51.6	51.6	5.4	36.5	36.5	16.4	16.4	16.4	17.3	17.3
Actuated g/C Ratio	0.15	0.63	0.63	0.07	0.45	0.45	0.20	0.20	0.20	0.21	0.21
v/c Ratio	0.58	0.22	0.02	0.10	0.77	0.17	0.08	0.44	0.05	0.36	0.26
Control Delay	47.1	7.9	0.0	49.2	24.1	6.7	31.0	34.2	0.2	34.7	15.6
Queue Delay	0.0	0.0	0.0	0.0	0.0	0.0	0.0	0.0	0.0	0.0	0.0
Total Delay	47.1	7.9	0.0	49.2	24.1	6.7	31.0	34.2	0.2	34.7	15.6
LOS	D	A	A	D	C	A	C	C	A	C	B
Approach Delay		14.6			22.6			31.1			23.9
Approach LOS		B			C			C			C

Intersection Summary

Cycle Length: 120	
Actuated Cycle Length: 81.3	
Natural Cycle: 95	
Control Type: Actuated-Uncoordinated	
Maximum v/c Ratio: 0.77	
Intersection Signal Delay: 20.8	Intersection LOS: C
Intersection Capacity Utilization 73.3%	ICU Level of Service D
Analysis Period (min) 15	





























Splits and Phases: 35: Day St. & Alessandro Bl.



HCM 6th Signalized Intersection Summary
35: Day St. & Alessandro Bl.

West Campus Upper Plateau (JN 14064)

02/16/2022

												
Movement	EBL	EBT	EBR	WBL	WBT	WBR	NBL	NBT	NBR	SBL	SBT	SBR
Lane Configurations		  			 						 	
Traffic Volume (veh/h)	138	638	9	9	1144	123	11	155	16	77	39	61
Future Volume (veh/h)	138	638	9	9	1144	123	11	155	16	77	39	61
Initial Q (Qb), veh	0	0	0	0	0	0	0	0	0	0	0	0
Ped-Bike Adj(A_pbT)	1.00		0.98	1.00		1.00	1.00		1.00	1.00		1.00
Parking Bus, Adj	1.00	1.00	1.00	1.00	1.00	1.00	1.00	1.00	1.00	1.00	1.00	1.00
Work Zone On Approach		No			No			No			No	
Adj Sat Flow, veh/h/ln	1841	1841	788	1707	1870	1856	744	1885	1693	1856	1900	1841
Adj Flow Rate, veh/h	148	686	9	10	1230	97	12	167	5	83	42	39
Peak Hour Factor	0.93	0.93	0.93	0.93	0.93	0.93	0.93	0.93	0.93	0.93	0.93	0.93
Percent Heavy Veh, %	4	4	75	13	2	3	78	1	14	3	0	4
Cap, veh/h	187	2833	369	21	1669	739	189	358	272	243	172	160
Arrive On Green	0.11	0.56	0.56	0.01	0.47	0.47	0.19	0.19	0.19	0.19	0.19	0.19
Sat Flow, veh/h	1753	5025	654	1626	3554	1572	524	1885	1432	1202	907	842
Grp Volume(v), veh/h	148	686	9	10	1230	97	12	167	5	83	0	81
Grp Sat Flow(s),veh/h/ln	1753	1675	654	1626	1777	1572	524	1885	1432	1202	0	1748
Q Serve(g_s), s	5.4	4.5	0.4	0.4	18.4	2.3	1.3	5.2	0.2	4.3	0.0	2.6
Cycle Q Clear(g_c), s	5.4	4.5	0.4	0.4	18.4	2.3	3.9	5.2	0.2	9.5	0.0	2.6
Prop In Lane	1.00		1.00	1.00		1.00	1.00		1.00	1.00		0.48
Lane Grp Cap(c), veh/h	187	2833	369	21	1669	739	189	358	272	243	0	332
V/C Ratio(X)	0.79	0.24	0.02	0.48	0.74	0.13	0.06	0.47	0.02	0.34	0.00	0.24
Avail Cap(c_a), veh/h	452	4811	627	124	2756	1220	385	1065	809	709	0	1009
HCM Platoon Ratio	1.00	1.00	1.00	1.00	1.00	1.00	1.00	1.00	1.00	1.00	1.00	1.00
Upstream Filter(I)	1.00	1.00	1.00	1.00	1.00	1.00	1.00	1.00	1.00	1.00	0.00	1.00
Uniform Delay (d), s/veh	28.5	7.2	6.3	32.1	14.1	9.8	24.2	23.6	21.6	27.8	0.0	22.5
Incr Delay (d2), s/veh	2.8	0.0	0.0	6.4	0.6	0.1	0.1	0.9	0.0	0.8	0.0	0.4
Initial Q Delay(d3),s/veh	0.0	0.0	0.0	0.0	0.0	0.0	0.0	0.0	0.0	0.0	0.0	0.0
%ile BackOfQ(50%),veh/ln	2.2	1.2	0.0	0.2	5.9	0.6	0.2	2.2	0.1	1.3	0.0	1.1
Unsig. Movement Delay, s/veh												
LnGrp Delay(d),s/veh	31.3	7.3	6.3	38.5	14.7	9.9	24.3	24.5	21.6	28.6	0.0	22.9
LnGrp LOS	C	A	A	D	B	A	C	C	C	C	A	C
Approach Vol, veh/h		843			1337			184				164
Approach Delay, s/veh		11.5			14.6			24.4				25.8
Approach LOS		B			B			C				C
Timer - Assigned Phs	1	2		4	5	6		8				
Phs Duration (G+Y+Rc), s	4.9	42.7		17.8	11.1	36.6		17.8				
Change Period (Y+Rc), s	4.1	5.8		* 5.4	4.1	5.8		5.4				
Max Green Setting (Gmax), s	5.0	62.7		* 38	16.9	50.8		37.0				
Max Q Clear Time (g_c+I1), s	2.4	6.5		11.5	7.4	20.4		7.2				
Green Ext Time (p_c), s	0.0	5.0		0.8	0.1	10.4		1.0				

Intersection Summary

HCM 6th Ctrl Delay	15.0
HCM 6th LOS	B

Notes

* HCM 6th computational engine requires equal clearance times for the phases crossing the barrier.

Timings
36: Elsworth St. & Cactus Av.

West Campus Upper Plateau (JN 14064)

02/16/2022



Lane Group	EBL	EBT	EBR	WBL	WBT	WBR	NBL	NBT	SBL	SBT	SBR
Lane Configurations	↘	↑↑↑	↗	↘	↑↑↑	↗	↘	↕	↘	↗	↗
Traffic Volume (vph)	179	1360	288	69	1660	120	23	10	82	58	157
Future Volume (vph)	179	1360	288	69	1660	120	23	10	82	58	157
Turn Type	Prot	NA	Perm	Prot	NA	Perm	Split	NA	Split	NA	pm+ov
Protected Phases	5	2		1	6		8	8	4	4	5
Permitted Phases			2			6					4
Detector Phase	5	2	2	1	6	6	8	8	4	4	5
Switch Phase											
Minimum Initial (s)	5.0	10.0	10.0	5.0	10.0	10.0	10.0	10.0	10.0	10.0	5.0
Minimum Split (s)	9.6	36.2	36.2	9.6	36.2	36.2	35.4	35.4	35.4	35.4	9.6
Total Split (s)	15.0	48.6	48.6	10.6	44.2	44.2	35.4	35.4	35.4	35.4	15.0
Total Split (%)	11.5%	37.4%	37.4%	8.2%	34.0%	34.0%	27.2%	27.2%	27.2%	27.2%	11.5%
Yellow Time (s)	3.6	5.2	5.2	3.6	5.2	5.2	4.4	4.4	4.4	4.4	3.6
All-Red Time (s)	1.0	1.0	1.0	1.0	1.0	1.0	1.0	1.0	1.0	1.0	1.0
Lost Time Adjust (s)	0.0	0.0	0.0	0.0	0.0	0.0	0.0	0.0	0.0	0.0	0.0
Total Lost Time (s)	4.6	6.2	6.2	4.6	6.2	6.2	5.4	5.4	5.4	5.4	4.6
Lead/Lag	Lead	Lag	Lag	Lead	Lag	Lag					Lead
Lead-Lag Optimize?	Yes	Yes	Yes	Yes	Yes	Yes					Yes
Recall Mode	None	None	None	None	None	None	Max	Max	Max	Max	None
Act Effct Green (s)	10.4	42.4	42.4	6.0	38.0	38.0	30.0	30.0	30.0	30.0	41.2
Actuated g/C Ratio	0.08	0.33	0.33	0.05	0.29	0.29	0.23	0.23	0.23	0.23	0.32
v/c Ratio	1.35	0.89	0.41	0.84	1.17	0.24	0.06	0.07	0.19	0.18	0.27
Control Delay	240.7	49.6	5.3	123.4	126.6	10.1	39.9	23.5	41.9	41.6	3.5
Queue Delay	0.0	0.0	0.0	0.0	0.0	0.0	0.0	0.0	0.0	0.0	0.0
Total Delay	240.7	49.6	5.3	123.4	126.6	10.1	39.9	23.5	41.9	41.6	3.5
LOS	F	D	A	F	F	B	D	C	D	D	A
Approach Delay		61.3			118.9			30.5		21.6	
Approach LOS		E			F			C		C	

Intersection Summary

Cycle Length: 130
 Actuated Cycle Length: 130
 Natural Cycle: 130
 Control Type: Actuated-Uncoordinated
 Maximum v/c Ratio: 1.35
 Intersection Signal Delay: 84.5
 Intersection LOS: F
 Intersection Capacity Utilization 66.0%
 ICU Level of Service C
 Analysis Period (min) 15

Splits and Phases: 36: Elsworth St. & Cactus Av.

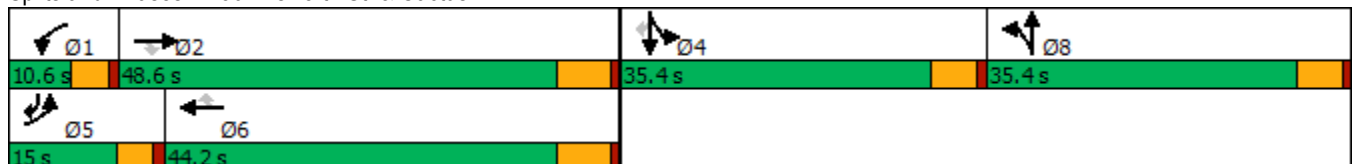

HCM 6th Signalized Intersection Summary
36: Elsworth St. & Cactus Av.

West Campus Upper Plateau (JN 14064)

02/16/2022



Movement	EBL	EBT	EBR	WBL	WBT	WBR	NBL	NBT	NBR	SBL	SBT	SBR
Lane Configurations	↶	↷↷↷	↷	↶	↷↷↷	↷	↶	↷		↶	↷	↷
Traffic Volume (veh/h)	179	1360	288	69	1660	120	23	10	16	82	58	157
Future Volume (veh/h)	179	1360	288	69	1660	120	23	10	16	82	58	157
Initial Q (Qb), veh	0	0	0	0	0	0	0	0	0	0	0	0
Ped-Bike Adj(A_pbT)	1.00		1.00	1.00		0.98	1.00		1.00	1.00		1.00
Parking Bus, Adj	1.00	1.00	1.00	1.00	1.00	1.00	1.00	1.00	1.00	1.00	1.00	1.00
Work Zone On Approach		No			No			No			No	
Adj Sat Flow, veh/h/ln	1811	1781	1870	1900	1826	1841	1604	1900	1900	1811	1900	1811
Adj Flow Rate, veh/h	183	1388	0	70	1694	74	20	14	8	72	76	93
Peak Hour Factor	0.98	0.98	0.98	0.98	0.98	0.98	0.98	0.98	0.98	0.98	0.98	0.98
Percent Heavy Veh, %	6	8	2	0	5	4	20	0	0	6	0	6
Cap, veh/h	138	1586		84	1457	446	352	262	150	398	438	477
Arrive On Green	0.08	0.33	0.00	0.05	0.29	0.29	0.23	0.23	0.23	0.23	0.23	0.23
Sat Flow, veh/h	1725	4863	1585	1810	4985	1527	1527	1135	648	1725	1900	1535
Grp Volume(v), veh/h	183	1388	0	70	1694	74	20	0	22	72	76	93
Grp Sat Flow(s),veh/h/ln	1725	1621	1585	1810	1662	1527	1527	0	1783	1725	1900	1535
Q Serve(g_s), s	10.4	35.0	0.0	5.0	38.0	4.7	1.3	0.0	1.2	4.4	4.2	5.8
Cycle Q Clear(g_c), s	10.4	35.0	0.0	5.0	38.0	4.7	1.3	0.0	1.2	4.4	4.2	5.8
Prop In Lane	1.00		1.00	1.00		1.00	1.00		0.36	1.00		1.00
Lane Grp Cap(c), veh/h	138	1586		84	1457	446	352	0	412	398	438	477
V/C Ratio(X)	1.33	0.88		0.84	1.16	0.17	0.06	0.00	0.05	0.18	0.17	0.19
Avail Cap(c_a), veh/h	138	1586		84	1457	446	352	0	412	398	438	477
HCM Platoon Ratio	1.00	1.00	1.00	1.00	1.00	1.00	1.00	1.00	1.00	1.00	1.00	1.00
Upstream Filter(I)	1.00	1.00	0.00	1.00	1.00	1.00	1.00	0.00	1.00	1.00	1.00	1.00
Uniform Delay (d), s/veh	59.8	41.3	0.0	61.5	46.0	34.2	39.0	0.0	38.9	40.1	40.1	32.9
Incr Delay (d2), s/veh	188.2	5.8	0.0	47.5	81.1	0.2	0.3	0.0	0.2	1.0	0.9	0.9
Initial Q Delay(d3),s/veh	0.0	0.0	0.0	0.0	0.0	0.0	0.0	0.0	0.0	0.0	0.0	0.0
%ile BackOfQ(50%),veh/ln	11.6	14.2	0.0	3.3	25.9	1.7	0.5	0.0	0.6	1.9	2.0	2.3
Unsig. Movement Delay, s/veh												
LnGrp Delay(d),s/veh	248.0	47.1	0.0	109.0	127.1	34.4	39.3	0.0	39.2	41.1	40.9	33.8
LnGrp LOS	F	D		F	F	C	D	A	D	D	D	C
Approach Vol, veh/h		1571	A		1838			42			241	
Approach Delay, s/veh		70.5			122.7			39.2			38.2	
Approach LOS		E			F			D			D	
Timer - Assigned Phs	1	2		4	5	6		8				
Phs Duration (G+Y+Rc), s	10.6	48.6		35.4	15.0	44.2		35.4				
Change Period (Y+Rc), s	4.6	6.2		5.4	4.6	6.2		5.4				
Max Green Setting (Gmax), s	6.0	42.4		30.0	10.4	38.0		30.0				
Max Q Clear Time (g_c+1), s	7.0	37.0		7.8	12.4	40.0		3.3				
Green Ext Time (p_c), s	0.0	3.6		0.8	0.0	0.0		0.1				

Intersection Summary

HCM 6th Ctrl Delay	94.0
HCM 6th LOS	F

Notes

- User approved pedestrian interval to be less than phase max green.
- User approved volume balancing among the lanes for turning movement.
- Unsignalized Delay for [EBR] is excluded from calculations of the approach delay and intersection delay.

Timings
37: Cactus Av. & Frederick St.

West Campus Upper Plateau (JN 14064)

02/16/2022

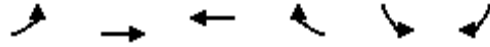

Lane Group	EBL	EBT	WBT	WBR	SBL	SBR
Lane Configurations	↗	↑↑↑	↑↑↑	↖	↗↘	↖
Traffic Volume (vph)	186	1199	1887	144	149	91
Future Volume (vph)	186	1199	1887	144	149	91
Turn Type	Prot	NA	NA	pm+ov	Prot	pm+ov
Protected Phases	5	2	6	4	4	5
Permitted Phases				6		4
Detector Phase	5	2	6	4	4	5
Switch Phase						
Minimum Initial (s)	5.0	10.0	10.0	10.0	10.0	5.0
Minimum Split (s)	9.2	28.2	29.2	36.4	36.4	9.2
Total Split (s)	23.0	83.6	60.6	36.4	36.4	23.0
Total Split (%)	19.2%	69.7%	50.5%	30.3%	30.3%	19.2%
Yellow Time (s)	3.2	5.2	5.2	4.4	4.4	3.2
All-Red Time (s)	1.0	1.0	1.0	1.0	1.0	1.0
Lost Time Adjust (s)	0.0	0.0	0.0	0.0	0.0	0.0
Total Lost Time (s)	4.2	6.2	6.2	5.4	5.4	4.2
Lead/Lag	Lead		Lag			Lead
Lead-Lag Optimize?	Yes		Yes			Yes
Recall Mode	None	None	None	Max	Max	None
Act Effct Green (s)	16.6	74.0	53.2	85.0	31.1	53.1
Actuated g/C Ratio	0.14	0.63	0.46	0.73	0.27	0.46
v/c Ratio	0.83	0.42	0.89	0.13	0.18	0.14
Control Delay	75.8	11.0	35.6	0.8	34.5	19.1
Queue Delay	0.0	0.0	0.0	0.0	0.0	0.0
Total Delay	75.8	11.0	35.6	0.8	34.5	19.1
LOS	E	B	D	A	C	B
Approach Delay		19.7	33.1		28.7	
Approach LOS		B	C		C	

Intersection Summary

Cycle Length: 120
 Actuated Cycle Length: 116.7
 Natural Cycle: 100
 Control Type: Actuated-Uncoordinated
 Maximum v/c Ratio: 0.89
 Intersection Signal Delay: 27.8
 Intersection Capacity Utilization 68.3%
 Analysis Period (min) 15
 Intersection LOS: C
 ICU Level of Service C

Splits and Phases: 37: Cactus Av. & Frederick St.



HCM 6th Signalized Intersection Summary
37: Cactus Av. & Frederick St.

West Campus Upper Plateau (JN 14064)
02/16/2022



Movement	EBL	EBT	WBT	WBR	SBL	SBR
Lane Configurations	↵	↑↑↑	↑↑↑	↵	↵↵	↵
Traffic Volume (veh/h)	186	1199	1887	144	149	91
Future Volume (veh/h)	186	1199	1887	144	149	91
Initial Q (Qb), veh	0	0	0	0	0	0
Ped-Bike Adj(A_pbT)	1.00			0.98	1.00	1.00
Parking Bus, Adj	1.00	1.00	1.00	1.00	1.00	1.00
Work Zone On Approach		No	No		No	
Adj Sat Flow, veh/h/ln	1811	1796	1841	1870	1856	1796
Adj Flow Rate, veh/h	200	1289	2029	101	160	57
Peak Hour Factor	0.93	0.93	0.93	0.93	0.93	0.93
Percent Heavy Veh, %	6	7	4	2	3	7
Cap, veh/h	228	3074	2302	1141	931	614
Arrive On Green	0.13	0.63	0.46	0.46	0.27	0.27
Sat Flow, veh/h	1725	5065	5191	1550	3428	1522
Grp Volume(v), veh/h	200	1289	2029	101	160	57
Grp Sat Flow(s),veh/h/ln	1725	1635	1675	1550	1714	1522
Q Serve(g_s), s	13.0	15.2	41.9	2.2	4.1	2.6
Cycle Q Clear(g_c), s	13.0	15.2	41.9	2.2	4.1	2.6
Prop In Lane	1.00			1.00	1.00	1.00
Lane Grp Cap(c), veh/h	228	3074	2302	1141	931	614
V/C Ratio(X)	0.88	0.42	0.88	0.09	0.17	0.09
Avail Cap(c_a), veh/h	284	3325	2395	1169	931	614
HCM Platoon Ratio	1.00	1.00	1.00	1.00	1.00	1.00
Upstream Filter(I)	1.00	1.00	1.00	1.00	1.00	1.00
Uniform Delay (d), s/veh	48.6	10.8	28.1	4.5	31.8	21.1
Incr Delay (d2), s/veh	19.3	0.1	4.1	0.0	0.4	0.3
Initial Q Delay(d3),s/veh	0.0	0.0	0.0	0.0	0.0	0.0
%ile BackOfQ(50%),veh/ln	6.6	4.7	16.1	1.5	1.7	0.1
Unsig. Movement Delay, s/veh						
LnGrp Delay(d),s/veh	67.9	10.9	32.2	4.5	32.2	21.4
LnGrp LOS	E	B	C	A	C	C
Approach Vol, veh/h		1489	2130		217	
Approach Delay, s/veh		18.5	30.9		29.3	
Approach LOS		B	C		C	
Timer - Assigned Phs		2		4	5	6
Phs Duration (G+Y+Rc), s		77.7		36.4	19.3	58.5
Change Period (Y+Rc), s		6.2		5.4	* 4.2	6.2
Max Green Setting (Gmax), s		77.4		31.0	* 19	54.4
Max Q Clear Time (g_c+I1), s		17.2		6.1	15.0	43.9
Green Ext Time (p_c), s		11.2		0.7	0.1	8.4

Intersection Summary

HCM 6th Ctrl Delay	26.0
HCM 6th LOS	C

Notes

* HCM 6th computational engine requires equal clearance times for the phases crossing the barrier.

Timings
38: Riverside Dr./Graham St. & Cactus Av.

West Campus Upper Plateau (JN 14064)

09/19/2022

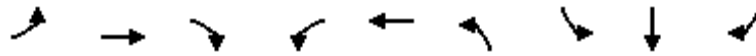

Lane Group	EBL	EBT	EBR	WBL	WBT	NBL	SBL	SBT	SBR	Ø2
Lane Configurations	↘	↑↑↑	↗	↘	↑↑↑	↘	↘	↑↑	↗	
Traffic Volume (vph)	62	1159	160	9	1907	9	84	45	115	
Future Volume (vph)	62	1159	160	9	1907	9	84	45	115	
Turn Type	Prot	NA	Perm	Prot	NA	Prot	Prot	NA	Perm	
Protected Phases	7	4		3	8	5	1	6		2
Permitted Phases			4						6	
Detector Phase	7	4	4	3	8	5	1	6	6	
Switch Phase										
Minimum Initial (s)	5.0	10.0	10.0	5.0	10.0	5.0	5.0	10.0	10.0	10.0
Minimum Split (s)	9.6	39.2	39.2	9.6	39.2	10.4	9.6	40.6	40.6	35.0
Total Split (s)	10.8	59.0	59.0	9.6	57.8	10.4	14.2	41.0	41.0	37.2
Total Split (%)	9.0%	49.2%	49.2%	8.0%	48.2%	8.7%	11.8%	34.2%	34.2%	31%
Yellow Time (s)	3.6	5.2	5.2	3.6	5.2	4.4	3.6	3.6	3.6	4.0
All-Red Time (s)	1.0	1.0	1.0	1.0	1.0	1.0	1.0	1.0	1.0	1.0
Lost Time Adjust (s)	0.0	0.0	0.0	0.0	0.0	0.0	0.0	0.0	0.0	
Total Lost Time (s)	4.6	6.2	6.2	4.6	6.2	5.4	4.6	4.6	4.6	
Lead/Lag	Lead	Lag	Lag	Lead	Lag	Lead	Lead	Lag	Lag	Lag
Lead-Lag Optimize?	Yes	Yes	Yes	Yes	Yes	Yes	Yes	Yes	Yes	Yes
Recall Mode	None	Min	Min	None	Min	None	None	None	None	None
Act Effct Green (s)	6.3	62.1	62.1	5.1	54.9	5.1	9.2	14.2	14.2	
Actuated g/C Ratio	0.07	0.69	0.69	0.06	0.61	0.06	0.10	0.16	0.16	
v/c Ratio	0.58	0.37	0.16	0.10	0.71	0.08	0.50	0.09	0.36	
Control Delay	64.6	9.5	2.7	48.6	17.1	47.6	51.4	31.9	9.1	
Queue Delay	0.0	0.0	0.0	0.0	0.0	0.0	0.0	0.0	0.0	
Total Delay	64.6	9.5	2.7	48.6	17.1	47.6	51.4	31.9	9.1	
LOS	E	A	A	D	B	D	D	C	A	
Approach Delay		11.2			17.2			27.9		
Approach LOS		B			B			C		

Intersection Summary

Cycle Length: 120
 Actuated Cycle Length: 90.4
 Natural Cycle: 110
 Control Type: Actuated-Uncoordinated
 Maximum v/c Ratio: 0.71
 Intersection Signal Delay: 15.7
 Intersection LOS: B
 Intersection Capacity Utilization 67.1%
 ICU Level of Service C
 Analysis Period (min) 15

Splits and Phases: 38: Riverside Dr./Graham St. & Cactus Av.

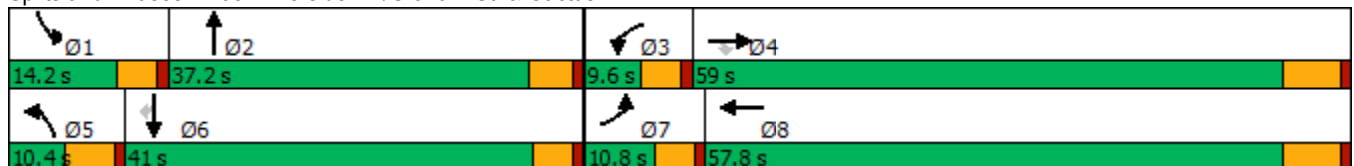

HCM 6th Signalized Intersection Summary
38: Riverside Dr./Graham St. & Cactus Av.

West Campus Upper Plateau (JN 14064)

09/19/2022



Movement	EBL	EBT	EBR	WBL	WBT	WBR	NBL	NBT	NBR	SBL	SBT	SBR
Lane Configurations	↖	↑↑↑	↗	↖	↑↑↑		↖↗	↑↗		↖	↑↑	↗
Traffic Volume (veh/h)	62	1159	160	9	1907	88	9	0	0	84	45	115
Future Volume (veh/h)	62	1159	160	9	1907	88	9	0	0	84	45	115
Initial Q (Qb), veh	0	0	0	0	0	0	0	0	0	0	0	0
Ped-Bike Adj(A_pbT)	1.00		1.00	1.00		1.00	1.00		1.00	1.00		1.00
Parking Bus, Adj	1.00	1.00	1.00	1.00	1.00	1.00	1.00	1.00	1.00	1.00	1.00	1.00
Work Zone On Approach		No			No			No			No	
Adj Sat Flow, veh/h/ln	1767	1781	1781	1900	1841	1856	1159	1900	1900	1856	1856	1781
Adj Flow Rate, veh/h	66	1233	158	10	2029	93	10	0	0	89	48	37
Peak Hour Factor	0.94	0.94	0.94	0.94	0.94	0.94	0.94	0.94	0.94	0.94	0.94	0.94
Percent Heavy Veh, %	9	8	8	0	4	3	50	0	0	3	3	8
Cap, veh/h	83	2833	879	23	2688	123	27	296	0	114	437	187
Arrive On Green	0.05	0.58	0.58	0.01	0.55	0.55	0.01	0.00	0.00	0.06	0.12	0.12
Sat Flow, veh/h	1682	4863	1510	1810	4925	225	2141	3705	0	1767	3526	1510
Grp Volume(v), veh/h	66	1233	158	10	1378	744	10	0	0	89	48	37
Grp Sat Flow(s),veh/h/ln	1682	1621	1510	1810	1675	1800	1071	1805	0	1767	1763	1510
Q Serve(g_s), s	3.1	11.2	3.9	0.4	25.0	25.2	0.4	0.0	0.0	3.9	1.0	1.7
Cycle Q Clear(g_c), s	3.1	11.2	3.9	0.4	25.0	25.2	0.4	0.0	0.0	3.9	1.0	1.7
Prop In Lane	1.00		1.00	1.00		0.13	1.00		0.00	1.00		1.00
Lane Grp Cap(c), veh/h	83	2833	879	23	1828	982	27	296	0	114	437	187
V/C Ratio(X)	0.80	0.44	0.18	0.44	0.75	0.76	0.37	0.00	0.00	0.78	0.11	0.20
Avail Cap(c_a), veh/h	132	3254	1010	115	2191	1177	136	1473	0	215	1626	696
HCM Platoon Ratio	1.00	1.00	1.00	1.00	1.00	1.00	1.00	1.00	1.00	1.00	1.00	1.00
Upstream Filter(I)	1.00	1.00	1.00	1.00	1.00	1.00	1.00	0.00	0.00	1.00	1.00	1.00
Uniform Delay (d), s/veh	37.1	9.2	7.7	38.7	13.8	13.9	38.7	0.0	0.0	36.3	30.7	31.0
Incr Delay (d2), s/veh	6.5	0.1	0.1	5.0	1.2	2.4	3.2	0.0	0.0	4.3	0.1	0.5
Initial Q Delay(d3),s/veh	0.0	0.0	0.0	0.0	0.0	0.0	0.0	0.0	0.0	0.0	0.0	0.0
%ile BackOfQ(50%),veh/ln	1.3	3.0	1.0	0.2	7.5	8.5	0.1	0.0	0.0	1.7	0.4	0.6
Unsig. Movement Delay, s/veh												
LnGrp Delay(d),s/veh	43.6	9.3	7.8	43.7	15.1	16.2	41.9	0.0	0.0	40.6	30.8	31.5
LnGrp LOS	D	A	A	D	B	B	D	A	A	D	C	C
Approach Vol, veh/h		1457			2132			10			174	
Approach Delay, s/veh		10.7			15.6			41.9			36.0	
Approach LOS		B			B			D			D	
Timer - Assigned Phs	1	2	3	4	5	6	7	8				
Phs Duration (G+Y+Rc), s	9.7	11.5	5.6	52.2	6.4	14.8	8.5	49.3				
Change Period (Y+Rc), s	4.6	5.0	4.6	6.2	5.4	* 5	4.6	6.2				
Max Green Setting (Gmax), s	9.6	32.2	5.0	52.8	5.0	* 36	6.2	51.6				
Max Q Clear Time (g_c+1), s	5.9	0.0	2.4	13.2	2.4	3.7	5.1	27.2				
Green Ext Time (p_c), s	0.0	0.0	0.0	10.8	0.0	0.3	0.0	15.8				

Intersection Summary

HCM 6th Ctrl Delay	14.7
HCM 6th LOS	B

Notes

* HCM 6th computational engine requires equal clearance times for the phases crossing the barrier.

Timings

1: Washington St & Van Buren Bl.

02/16/2022



Lane Group	EBL	EBT	WBL	WBT	WBR	NBL	NBT	NBR	SBL	SBT
Lane Configurations	↘	↕	↘	↕	↗	↗	↕	↗	↗	↕
Traffic Volume (vph)	133	1278	161	1007	372	98	240	92	482	346
Future Volume (vph)	133	1278	161	1007	372	98	240	92	482	346
Turn Type	Prot	NA	Prot	NA	Perm	Prot	NA	Perm	Prot	NA
Protected Phases	5	2	1	6		3	8		7	4
Permitted Phases					6			8		
Detector Phase	5	2	1	6	6	3	8	8	7	4
Switch Phase										
Minimum Initial (s)	5.0	10.0	5.0	10.0	10.0	5.0	10.0	10.0	5.0	10.0
Minimum Split (s)	9.2	34.2	9.2	33.2	33.2	9.2	38.4	38.4	9.2	30.8
Total Split (s)	14.2	49.6	14.0	49.4	49.4	11.5	38.4	38.4	18.0	44.9
Total Split (%)	11.8%	41.3%	11.7%	41.2%	41.2%	9.6%	32.0%	32.0%	15.0%	37.4%
Yellow Time (s)	3.2	5.2	3.2	5.2	5.2	3.2	4.4	4.4	3.2	4.8
All-Red Time (s)	1.0	1.0	1.0	1.0	1.0	1.0	1.0	1.0	1.0	1.0
Lost Time Adjust (s)	0.0	0.0	0.0	0.0	0.0	0.0	0.0	0.0	0.0	0.0
Total Lost Time (s)	4.2	6.2	4.2	6.2	6.2	4.2	5.4	5.4	4.2	5.8
Lead/Lag	Lead	Lag	Lead	Lag	Lag	Lead	Lag	Lag	Lead	Lag
Lead-Lag Optimize?	Yes	Yes	Yes	Yes	Yes	Yes	Yes	Yes	Yes	Yes
Recall Mode	None	None	None	None	None	None	None	None	None	None
Act Effct Green (s)	9.9	43.6	9.9	43.6	43.6	6.7	15.2	15.2	13.9	22.0
Actuated g/C Ratio	0.10	0.42	0.10	0.42	0.42	0.07	0.15	0.15	0.14	0.21
v/c Ratio	0.77	0.94	0.95	0.68	0.47	0.44	0.47	0.26	1.04	0.58
Control Delay	74.9	41.8	106.0	28.1	10.8	54.2	42.3	3.0	96.7	36.5
Queue Delay	0.0	0.0	0.0	0.0	0.0	0.0	0.0	0.0	0.0	0.0
Total Delay	74.9	41.8	106.0	28.1	10.8	54.2	42.3	3.0	96.7	36.5
LOS	E	D	F	C	B	D	D	A	F	D
Approach Delay		44.8		32.1			36.6			68.0
Approach LOS		D		C			D			E

Intersection Summary

Cycle Length: 120
 Actuated Cycle Length: 102.7
 Natural Cycle: 115
 Control Type: Actuated-Uncoordinated
 Maximum v/c Ratio: 1.04
 Intersection Signal Delay: 44.4
 Intersection LOS: D
 Intersection Capacity Utilization 86.1%
 ICU Level of Service E
 Analysis Period (min) 15

Splits and Phases: 1: Washington St & Van Buren Bl.

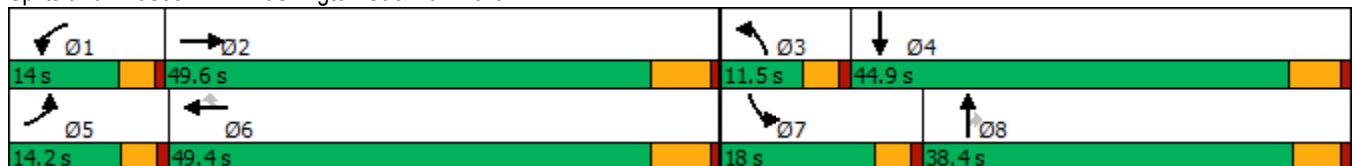

HCM 6th Signalized Intersection Summary
1: Washington St & Van Buren Bl.

West Campus Upper Plateau (JN 14064)

02/16/2022



Movement	EBL	EBT	EBR	WBL	WBT	WBR	NBL	NBT	NBR	SBL	SBT	SBR
Lane Configurations	↰	↻		↰	↻	↻	↰	↻	↻	↰	↻	↻
Traffic Volume (veh/h)	133	1278	79	161	1007	372	98	240	92	482	346	92
Future Volume (veh/h)	133	1278	79	161	1007	372	98	240	92	482	346	92
Initial Q (Qb), veh	0	0	0	0	0	0	0	0	0	0	0	0
Ped-Bike Adj(A_pbT)	1.00		1.00	1.00		1.00	1.00		0.98	1.00		0.98
Parking Bus, Adj	1.00	1.00	1.00	1.00	1.00	1.00	1.00	1.00	1.00	1.00	1.00	1.00
Work Zone On Approach		No			No			No			No	
Adj Sat Flow, veh/h/ln	1900	1841	1856	1885	1856	1885	1885	1856	1870	1885	1885	1900
Adj Flow Rate, veh/h	134	1291	61	163	1017	283	99	242	54	487	349	47
Peak Hour Factor	0.99	0.99	0.99	0.99	0.99	0.99	0.99	0.99	0.99	0.99	0.99	0.99
Percent Heavy Veh, %	0	4	3	1	3	1	1	3	2	1	1	0
Cap, veh/h	165	1455	69	182	1546	699	168	411	181	498	669	89
Arrive On Green	0.09	0.43	0.43	0.10	0.44	0.44	0.05	0.12	0.12	0.14	0.21	0.21
Sat Flow, veh/h	1810	3400	160	1795	3526	1594	3483	3526	1553	3483	3168	423
Grp Volume(v), veh/h	134	663	689	163	1017	283	99	242	54	487	196	200
Grp Sat Flow(s),veh/h/ln	1810	1749	1812	1795	1763	1594	1742	1763	1553	1742	1791	1800
Q Serve(g_s), s	7.0	33.8	33.9	8.7	22.0	11.7	2.7	6.3	3.1	13.5	9.4	9.5
Cycle Q Clear(g_c), s	7.0	33.8	33.9	8.7	22.0	11.7	2.7	6.3	3.1	13.5	9.4	9.5
Prop In Lane	1.00		0.09	1.00		1.00	1.00		1.00	1.00		0.23
Lane Grp Cap(c), veh/h	165	748	775	182	1546	699	168	411	181	498	378	380
V/C Ratio(X)	0.81	0.89	0.89	0.89	0.66	0.40	0.59	0.59	0.30	0.98	0.52	0.53
Avail Cap(c_a), veh/h	187	786	814	182	1577	713	263	1204	531	498	725	729
HCM Platoon Ratio	1.00	1.00	1.00	1.00	1.00	1.00	1.00	1.00	1.00	1.00	1.00	1.00
Upstream Filter(I)	1.00	1.00	1.00	1.00	1.00	1.00	1.00	1.00	1.00	1.00	1.00	1.00
Uniform Delay (d), s/veh	43.1	25.5	25.5	42.9	21.4	18.5	45.0	40.5	39.1	41.3	33.7	33.8
Incr Delay (d2), s/veh	18.6	11.9	11.8	37.8	1.1	0.5	1.2	1.3	0.9	34.6	1.1	1.1
Initial Q Delay(d3),s/veh	0.0	0.0	0.0	0.0	0.0	0.0	0.0	0.0	0.0	0.0	0.0	0.0
%ile BackOfQ(50%),veh/ln	3.8	14.8	15.4	5.6	8.3	4.4	1.2	2.8	1.2	8.1	4.1	4.2
Unsig. Movement Delay, s/veh												
LnGrp Delay(d),s/veh	61.7	37.4	37.3	80.6	22.5	19.1	46.3	41.8	40.0	75.9	34.8	34.9
LnGrp LOS	E	D	D	F	C	B	D	D	D	E	C	C
Approach Vol, veh/h		1486			1463			395			883	
Approach Delay, s/veh		39.5			28.3			42.7			57.5	
Approach LOS		D			C			D			E	
Timer - Assigned Phs	1	2	3	4	5	6	7	8				
Phs Duration (G+Y+Rc), s	14.0	47.5	8.8	26.2	13.0	48.6	18.0	17.1				
Change Period (Y+Rc), s	* 4.2	6.2	* 4.2	5.8	* 4.2	6.2	* 4.2	* 5.8				
Max Green Setting (Gmax), s	* 9.8	43.4	* 7.3	39.1	* 10	43.2	* 14	* 33				
Max Q Clear Time (g_c+I1), s	10.7	35.9	4.7	11.5	9.0	24.0	15.5	8.3				
Green Ext Time (p_c), s	0.0	5.5	0.0	2.4	0.0	10.1	0.0	1.8				

Intersection Summary

HCM 6th Ctrl Delay	39.7
HCM 6th LOS	D

Notes

* HCM 6th computational engine requires equal clearance times for the phases crossing the barrier.

Timings
2: Central Ave & Arlington Ave/Chicago Ave

West Campus Upper Plateau (JN 14064)

02/16/2022



Lane Group	EBL	EBT	EBR	WBL	WBT	WBR	NBL	NBT	NBR	SBL	SBT
Lane Configurations	↘	↑↑	↗↗	↘↘	↑↑	↗	↘↘	↑↑	↗	↘↘	↑↑↗
Traffic Volume (vph)	25	731	1007	527	656	210	783	1013	227	486	1624
Future Volume (vph)	25	731	1007	527	656	210	783	1013	227	486	1624
Turn Type	Prot	NA	pm+ov	Prot	NA	pm+ov	Prot	NA	pm+ov	Prot	NA
Protected Phases	7	4	5	3	8	1	5	2	3	1	6
Permitted Phases			4			8			2		
Detector Phase	7	4	5	3	8	1	5	2	3	1	6
Switch Phase											
Minimum Initial (s)	5.0	10.0	5.0	5.0	10.0	5.0	5.0	10.0	5.0	5.0	10.0
Minimum Split (s)	9.6	32.8	9.6	9.6	30.8	9.6	9.6	35.4	9.6	9.6	30.4
Total Split (s)	10.6	32.8	30.0	22.0	44.2	24.4	30.0	50.8	22.0	24.4	45.2
Total Split (%)	8.2%	25.2%	23.1%	16.9%	34.0%	18.8%	23.1%	39.1%	16.9%	18.8%	34.8%
Yellow Time (s)	3.6	4.8	3.6	3.6	4.8	3.6	3.6	4.4	3.6	3.6	4.4
All-Red Time (s)	1.0	1.0	1.0	1.0	1.0	1.0	1.0	1.0	1.0	1.0	1.0
Lost Time Adjust (s)	0.0	0.0	0.0	0.0	0.0	0.0	0.0	0.0	0.0	0.0	0.0
Total Lost Time (s)	4.6	5.8	4.6	4.6	5.8	4.6	4.6	5.4	4.6	4.6	5.4
Lead/Lag	Lead	Lag	Lead	Lead	Lag	Lead	Lead	Lag	Lead	Lead	Lag
Lead-Lag Optimize?	Yes	Yes	Yes	Yes	Yes	Yes	Yes	Yes	Yes	Yes	Yes
Recall Mode	None	None	None	None	None	None	None	None	None	None	None
Act Effct Green (s)	5.7	27.0	53.6	17.4	42.6	68.2	25.4	45.4	63.6	19.8	39.8
Actuated g/C Ratio	0.04	0.21	0.41	0.13	0.33	0.52	0.20	0.35	0.49	0.15	0.31
v/c Ratio	0.33	1.02	0.87	1.20	0.58	0.25	1.21	0.85	0.30	0.95	1.09
Control Delay	71.7	87.6	38.1	155.3	39.5	10.6	150.4	46.6	13.6	82.8	94.2
Queue Delay	0.0	0.0	0.0	0.0	0.0	0.0	0.0	0.0	0.0	0.0	0.0
Total Delay	71.7	87.6	38.1	155.3	39.5	10.6	150.4	46.6	13.6	82.8	94.2
LOS	E	F	D	F	D	B	F	D	B	F	F
Approach Delay		59.1			78.9			83.1			91.6
Approach LOS		E			E			F			F

Intersection Summary

Cycle Length: 130
 Actuated Cycle Length: 130
 Natural Cycle: 120
 Control Type: Actuated-Uncoordinated
 Maximum v/c Ratio: 1.21
 Intersection Signal Delay: 79.0
 Intersection LOS: E
 Intersection Capacity Utilization 106.5%
 ICU Level of Service G
 Analysis Period (min) 15

Splits and Phases: 2: Central Ave & Arlington Ave/Chicago Ave

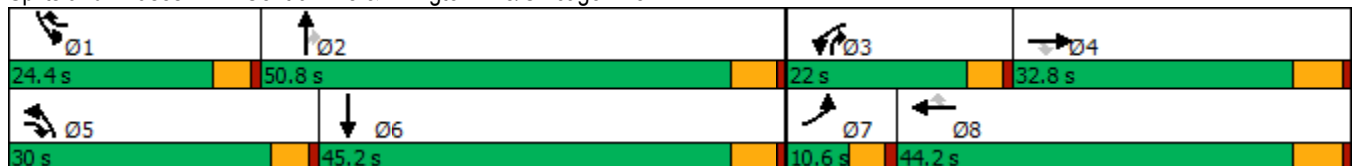

HCM 6th Signalized Intersection Summary
2: Central Ave & Arlington Ave/Chicago Ave

West Campus Upper Plateau (JN 14064)

02/16/2022



Movement	EBL	EBT	EBR	WBL	WBT	WBR	NBL	NBT	NBR	SBL	SBT	SBR
Lane Configurations	↘	↑↑	↗↗	↘↘	↑↑	↗	↘↘	↑↑	↗	↘↘	↑↑↑	
Traffic Volume (veh/h)	25	731	1007	527	656	210	783	1013	227	486	1624	20
Future Volume (veh/h)	25	731	1007	527	656	210	783	1013	227	486	1624	20
Initial Q (Qb), veh	0	0	0	0	0	0	0	0	0	0	0	0
Ped-Bike Adj(A_pbT)	1.00		1.00	1.00		1.00	1.00		0.99	1.00		1.00
Parking Bus, Adj	1.00	1.00	1.00	1.00	1.00	1.00	1.00	1.00	1.00	1.00	1.00	1.00
Work Zone On Approach		No			No			No			No	
Adj Sat Flow, veh/h/ln	1900	1900	1885	1870	1900	1885	1885	1885	1856	1900	1885	1900
Adj Flow Rate, veh/h	26	761	652	549	683	132	816	1055	168	506	1692	19
Peak Hour Factor	0.96	0.96	0.96	0.96	0.96	0.96	0.96	0.96	0.96	0.96	0.96	0.96
Percent Heavy Veh, %	0	0	1	2	0	1	1	1	3	0	1	0
Cap, veh/h	42	750	1133	463	1148	752	681	1251	752	535	1606	18
Arrive On Green	0.02	0.21	0.21	0.13	0.32	0.32	0.20	0.35	0.35	0.15	0.31	0.31
Sat Flow, veh/h	1810	3610	2808	3456	3610	1598	3483	3582	1552	3510	5247	59
Grp Volume(v), veh/h	26	761	652	549	683	132	816	1055	168	506	1106	605
Grp Sat Flow(s),veh/h/ln	1810	1805	1404	1728	1805	1598	1742	1791	1552	1755	1716	1875
Q Serve(g_s), s	1.9	27.0	23.5	17.4	20.7	6.2	25.4	35.3	8.2	18.6	39.8	39.8
Cycle Q Clear(g_c), s	1.9	27.0	23.5	17.4	20.7	6.2	25.4	35.3	8.2	18.6	39.8	39.8
Prop In Lane	1.00		1.00	1.00		1.00	1.00		1.00	1.00		0.03
Lane Grp Cap(c), veh/h	42	750	1133	463	1148	752	681	1251	752	535	1050	574
V/C Ratio(X)	0.61	1.01	0.58	1.19	0.59	0.18	1.20	0.84	0.22	0.95	1.05	1.05
Avail Cap(c_a), veh/h	84	750	1133	463	1148	752	681	1251	752	535	1050	574
HCM Platoon Ratio	1.00	1.00	1.00	1.00	1.00	1.00	1.00	1.00	1.00	1.00	1.00	1.00
Upstream Filter(I)	1.00	1.00	1.00	1.00	1.00	1.00	1.00	1.00	1.00	1.00	1.00	1.00
Uniform Delay (d), s/veh	62.9	51.5	30.2	56.3	37.3	19.9	52.3	39.0	19.5	54.6	45.1	45.1
Incr Delay (d2), s/veh	5.3	36.7	0.7	104.1	0.8	0.1	103.4	5.4	0.1	25.9	42.9	52.4
Initial Q Delay(d3),s/veh	0.0	0.0	0.0	0.0	0.0	0.0	0.0	0.0	0.0	0.0	0.0	0.0
%ile BackOfQ(50%),veh/ln	0.9	15.7	7.7	14.1	9.0	2.3	20.6	16.0	2.9	10.0	22.7	26.3
Unsig. Movement Delay, s/veh												
LnGrp Delay(d),s/veh	68.1	88.2	30.9	160.4	38.1	20.0	155.7	44.4	19.6	80.4	88.0	97.5
LnGrp LOS	E	F	C	F	D	B	F	D	B	F	F	F
Approach Vol, veh/h		1439			1364			2039			2217	
Approach Delay, s/veh		61.8			85.6			86.9			88.9	
Approach LOS		E			F			F			F	
Timer - Assigned Phs	1	2	3	4	5	6	7	8				
Phs Duration (G+Y+Rc), s	24.4	50.8	22.0	32.8	30.0	45.2	7.6	47.2				
Change Period (Y+Rc), s	4.6	5.4	4.6	5.8	4.6	5.4	4.6	5.8				
Max Green Setting (Gmax), s	19.8	45.4	17.4	27.0	25.4	39.8	6.0	38.4				
Max Q Clear Time (g_c+I1), s	20.6	37.3	19.4	29.0	27.4	41.8	3.9	22.7				
Green Ext Time (p_c), s	0.0	4.5	0.0	0.0	0.0	0.0	0.0	4.2				

Intersection Summary

HCM 6th Ctrl Delay	82.2
HCM 6th LOS	F

Timings

3: Overlook Pkwy./Canyon Crest Dr. & Alessandro Bl/Alessandro Bl.



Lane Group	EBL	EBT	WBL	WBT	WBR	NBL	NBT	NBR	SBL	SBT	SBR
Lane Configurations	↘	↗↗↗	↘	↗↗↗	↗	↘	↗↗	↗	↗↗	↘	↗
Traffic Volume (vph)	52	2826	5	2103	599	13	6	8	547	11	23
Future Volume (vph)	52	2826	5	2103	599	13	6	8	547	11	23
Turn Type	Prot	NA	Prot	NA	pm+ov	Split	NA	Perm	Split	NA	Perm
Protected Phases	5	2	1	6	4	8	8		4	4	
Permitted Phases					6			8			4
Detector Phase	5	2	1	6	4	8	8	8	4	4	4
Switch Phase											
Minimum Initial (s)	5.0	10.0	5.0	10.0	10.0	10.0	10.0	10.0	10.0	10.0	10.0
Minimum Split (s)	9.2	35.2	9.2	35.2	38.8	38.8	38.8	38.8	38.8	38.8	38.8
Total Split (s)	9.2	43.2	9.2	43.2	38.8	38.8	38.8	38.8	38.8	38.8	38.8
Total Split (%)	7.1%	33.2%	7.1%	33.2%	29.8%	29.8%	29.8%	29.8%	29.8%	29.8%	29.8%
Yellow Time (s)	3.2	5.2	3.2	5.2	4.8	4.8	4.8	4.8	4.8	4.8	4.8
All-Red Time (s)	1.0	1.0	1.0	1.0	1.0	1.0	1.0	1.0	1.0	1.0	1.0
Lost Time Adjust (s)	0.0	0.0	0.0	0.0	0.0	0.0	0.0	0.0	0.0	0.0	0.0
Total Lost Time (s)	4.2	6.2	4.2	6.2	5.8	5.8	5.8	5.8	5.8	5.8	5.8
Lead/Lag	Lead	Lag	Lead	Lag							
Lead-Lag Optimize?	Yes	Yes	Yes	Yes							
Recall Mode	None	None	None	None	None	None	None	None	None	None	None
Act Effct Green (s)	5.1	46.0	5.1	38.0	65.2	10.3	10.3	10.3	20.8	20.8	20.8
Actuated g/C Ratio	0.06	0.52	0.06	0.43	0.73	0.12	0.12	0.12	0.23	0.23	0.23
v/c Ratio	0.55	1.12	0.05	1.00	0.47	0.07	0.01	0.03	0.51	0.51	0.05
Control Delay	68.2	84.0	48.0	48.0	1.7	43.2	42.2	0.1	32.4	35.3	0.2
Queue Delay	0.0	0.0	0.0	0.0	0.0	0.0	0.0	0.0	0.0	0.0	0.0
Total Delay	68.2	84.0	48.0	48.0	1.7	43.2	42.2	0.1	32.4	35.3	0.2
LOS	E	F	D	D	A	D	D	A	C	D	A
Approach Delay		83.7		37.7			30.7			32.1	
Approach LOS		F		D			C			C	

Intersection Summary

Cycle Length: 130
 Actuated Cycle Length: 89.1
 Natural Cycle: 125
 Control Type: Actuated-Uncoordinated
 Maximum v/c Ratio: 1.12
 Intersection Signal Delay: 58.6
 Intersection LOS: E
 Intersection Capacity Utilization 88.5%
 ICU Level of Service E
 Analysis Period (min) 15

Splits and Phases: 3: Overlook Pkwy./Canyon Crest Dr. & Alessandro Bl/Alessandro Bl.

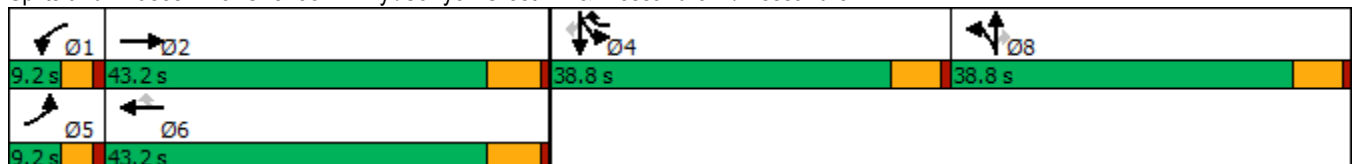

HCM 6th Signalized Intersection Summary

West Campus Upper Plateau (JN 14064)

3: Overlook Pkwy./Canyon Crest Dr. & Alessandro Bl/Alessandro Bl.

02/16/2022



Movement	EBL	EBT	EBR	WBL	WBT	WBR	NBL	NBT	NBR	SBL	SBT	SBR
Lane Configurations	↗	↑↑↑		↖	↑↑↑	↗	↖	↑↑	↗	↖↖	↖	↗
Traffic Volume (veh/h)	52	2826	16	5	2103	599	13	6	8	547	11	23
Future Volume (veh/h)	52	2826	16	5	2103	599	13	6	8	547	11	23
Initial Q (Qb), veh	0	0	0	0	0	0	0	0	0	0	0	0
Ped-Bike Adj(A_pbT)	1.00		1.00	1.00		1.00	1.00		1.00	1.00		1.00
Parking Bus, Adj	1.00	1.00	1.00	1.00	1.00	1.00	1.00	1.00	1.00	1.00	1.00	1.00
Work Zone On Approach		No			No			No			No	
Adj Sat Flow, veh/h/ln	1811	1885	1811	1900	1885	1870	1781	1900	1900	1885	1767	1841
Adj Flow Rate, veh/h	54	2944	17	5	2191	616	14	6	0	578	0	15
Peak Hour Factor	0.96	0.96	0.96	0.96	0.96	0.96	0.96	0.96	0.96	0.96	0.96	0.96
Percent Heavy Veh, %	6	1	6	0	1	2	8	0	0	1	9	4
Cap, veh/h	76	2693	16	12	2430	994	77	163	73	835	0	242
Arrive On Green	0.04	0.51	0.51	0.01	0.47	0.47	0.05	0.05	0.00	0.16	0.00	0.16
Sat Flow, veh/h	1725	5280	30	1810	5147	1585	1697	3610	1610	5386	0	1560
Grp Volume(v), veh/h	54	1911	1050	5	2191	616	14	6	0	578	0	15
Grp Sat Flow(s),veh/h/ln	1725	1716	1880	1810	1716	1585	1697	1805	1610	1795	0	1560
Q Serve(g_s), s	2.4	39.6	39.6	0.2	30.4	18.4	0.6	0.1	0.0	7.9	0.0	0.6
Cycle Q Clear(g_c), s	2.4	39.6	39.6	0.2	30.4	18.4	0.6	0.1	0.0	7.9	0.0	0.6
Prop In Lane	1.00		0.02	1.00		1.00	1.00		1.00	1.00		1.00
Lane Grp Cap(c), veh/h	76	1750	959	12	2430	994	77	163	73	835	0	242
V/C Ratio(X)	0.71	1.09	1.10	0.42	0.90	0.62	0.18	0.04	0.00	0.69	0.00	0.06
Avail Cap(c_a), veh/h	111	1750	959	116	2452	1001	721	1534	684	2289	0	663
HCM Platoon Ratio	1.00	1.00	1.00	1.00	1.00	1.00	1.00	1.00	1.00	1.00	1.00	1.00
Upstream Filter(I)	1.00	1.00	1.00	1.00	1.00	1.00	1.00	1.00	0.00	1.00	0.00	1.00
Uniform Delay (d), s/veh	36.6	19.0	19.0	38.4	18.8	8.8	35.7	35.5	0.0	31.1	0.0	28.0
Incr Delay (d2), s/veh	4.4	51.3	58.7	8.5	5.1	1.2	1.1	0.1	0.0	1.0	0.0	0.1
Initial Q Delay(d3),s/veh	0.0	0.0	0.0	0.0	0.0	0.0	0.0	0.0	0.0	0.0	0.0	0.0
%ile BackOfQ(50%),veh/ln	1.0	24.6	28.9	0.1	10.8	8.0	0.3	0.1	0.0	3.2	0.0	0.2
Unsig. Movement Delay, s/veh												
LnGrp Delay(d),s/veh	41.0	70.4	77.7	46.9	23.9	10.0	36.8	35.6	0.0	32.1	0.0	28.1
LnGrp LOS	D	F	F	D	C	A	D	D	A	C	A	C
Approach Vol, veh/h		3015			2812			20				593
Approach Delay, s/veh		72.4			20.9			36.5				32.0
Approach LOS		E			C			D				C
Timer - Assigned Phs	1	2		4	5	6		8				
Phs Duration (G+Y+Rc), s	4.7	45.8		17.8	7.6	42.9		9.3				
Change Period (Y+Rc), s	* 4.2	6.2		5.8	* 4.2	6.2		5.8				
Max Green Setting (Gmax), s	* 5	37.0		33.0	* 5	37.0		33.0				
Max Q Clear Time (g_c+1), s	2.2	41.6		9.9	4.4	32.4		2.6				
Green Ext Time (p_c), s	0.0	0.0		2.2	0.0	4.3		0.0				

Intersection Summary

HCM 6th Ctrl Delay	46.1
HCM 6th LOS	D

Notes

- User approved pedestrian interval to be less than phase max green.
- User approved volume balancing among the lanes for turning movement.
- * HCM 6th computational engine requires equal clearance times for the phases crossing the barrier.

Timings

West Campus Upper Plateau (JN 14064)

4: Van Buren Bl. & Wood Rd.

02/16/2022

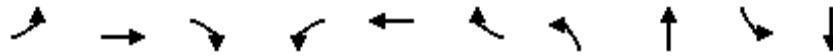

Lane Group	EBL	EBT	EBR	WBL	WBT	WBR	NBL	NBT	SBL	SBT
Lane Configurations	↘	↑↑	↗	↘↗	↑↑	↗	↘↗	↑↔	↘	↑↔
Traffic Volume (vph)	153	1297	197	210	1158	82	285	237	82	241
Future Volume (vph)	153	1297	197	210	1158	82	285	237	82	241
Turn Type	Prot	NA	pm+ov	Prot	NA	Perm	Prot	NA	Prot	NA
Protected Phases	5	2	3	1	6		3	8	7	4
Permitted Phases			2			6				
Detector Phase	5	2	3	1	6	6	3	8	7	4
Switch Phase										
Minimum Initial (s)	5.0	10.0	5.0	5.0	10.0	10.0	5.0	10.0	5.0	10.0
Minimum Split (s)	9.2	30.2	9.2	9.2	30.2	30.2	9.2	38.4	9.2	15.8
Total Split (s)	16.5	57.2	21.7	13.2	53.9	53.9	21.7	38.4	11.2	27.9
Total Split (%)	13.8%	47.7%	18.1%	11.0%	44.9%	44.9%	18.1%	32.0%	9.3%	23.3%
Yellow Time (s)	3.2	5.2	3.2	3.2	5.2	5.2	3.2	4.4	3.2	4.8
All-Red Time (s)	1.0	1.0	1.0	1.0	1.0	1.0	1.0	1.0	1.0	1.0
Lost Time Adjust (s)	0.0	0.0	0.0	0.0	0.0	0.0	0.0	0.0	0.0	0.0
Total Lost Time (s)	4.2	6.2	4.2	4.2	6.2	6.2	4.2	5.4	4.2	5.8
Lead/Lag	Lead	Lag	Lead	Lead	Lag	Lag	Lead	Lag	Lead	Lag
Lead-Lag Optimize?	Yes	Yes	Yes	Yes	Yes	Yes	Yes	Yes	Yes	Yes
Recall Mode	None	None	None	None	None	None	None	None	None	None
Act Effct Green (s)	12.2	49.9	66.1	9.1	46.8	46.8	14.2	24.2	7.0	16.6
Actuated g/C Ratio	0.11	0.45	0.60	0.08	0.42	0.42	0.13	0.22	0.06	0.15
v/c Ratio	0.85	0.90	0.22	0.81	0.85	0.12	0.72	0.55	0.79	0.75
Control Delay	85.2	37.8	4.5	73.5	36.2	1.2	56.8	26.5	95.8	39.6
Queue Delay	0.0	0.0	0.0	0.0	0.0	0.0	0.0	0.0	0.0	0.0
Total Delay	85.2	37.8	4.5	73.5	36.2	1.2	56.8	26.5	95.8	39.6
LOS	F	D	A	E	D	A	E	C	F	D
Approach Delay		38.2			39.6			38.7		48.7
Approach LOS		D			D			D		D

Intersection Summary

Cycle Length: 120
 Actuated Cycle Length: 110.3
 Natural Cycle: 110
 Control Type: Actuated-Uncoordinated
 Maximum v/c Ratio: 0.90
 Intersection Signal Delay: 40.0
 Intersection LOS: D
 Intersection Capacity Utilization 80.9%
 ICU Level of Service D
 Analysis Period (min) 15

Splits and Phases: 4: Van Buren Bl. & Wood Rd.

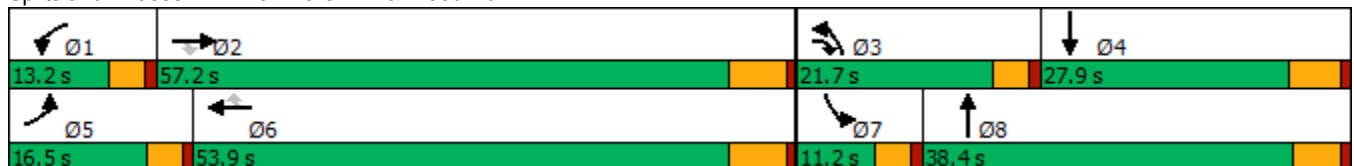

HCM 6th Signalized Intersection Summary
4: Van Buren Bl. & Wood Rd.

West Campus Upper Plateau (JN 14064)

02/16/2022



Movement	EBL	EBT	EBR	WBL	WBT	WBR	NBL	NBT	NBR	SBL	SBT	SBR
Lane Configurations	↘	↑↑	↗	↘↗	↑↑	↗	↘↗	↑↑		↘	↑↑	
Traffic Volume (veh/h)	153	1297	197	210	1158	82	285	237	186	82	241	185
Future Volume (veh/h)	153	1297	197	210	1158	82	285	237	186	82	241	185
Initial Q (Qb), veh	0	0	0	0	0	0	0	0	0	0	0	0
Ped-Bike Adj(A_pbT)	1.00		0.98	1.00		0.99	1.00		0.97	1.00		0.99
Parking Bus, Adj	1.00	1.00	1.00	1.00	1.00	1.00	1.00	1.00	1.00	1.00	1.00	1.00
Work Zone On Approach		No			No			No			No	
Adj Sat Flow, veh/h/ln	1885	1856	1870	1885	1870	1885	1856	1885	1870	1885	1885	1885
Adj Flow Rate, veh/h	168	1425	111	231	1273	43	313	260	123	90	265	128
Peak Hour Factor	0.91	0.91	0.91	0.91	0.91	0.91	0.91	0.91	0.91	0.91	0.91	0.91
Percent Heavy Veh, %	1	3	2	1	2	1	3	1	2	1	1	1
Cap, veh/h	198	1633	900	294	1554	688	383	455	208	114	341	160
Arrive On Green	0.11	0.46	0.46	0.08	0.44	0.44	0.11	0.19	0.19	0.06	0.14	0.14
Sat Flow, veh/h	1795	3526	1561	3483	3554	1574	3428	2362	1079	1795	2357	1103
Grp Volume(v), veh/h	168	1425	111	231	1273	43	313	195	188	90	199	194
Grp Sat Flow(s),veh/h/ln	1795	1763	1561	1742	1777	1574	1714	1791	1650	1795	1791	1669
Q Serve(g_s), s	9.6	37.9	3.4	6.8	32.7	1.6	9.3	10.3	10.8	5.1	11.1	11.7
Cycle Q Clear(g_c), s	9.6	37.9	3.4	6.8	32.7	1.6	9.3	10.3	10.8	5.1	11.1	11.7
Prop In Lane	1.00		1.00	1.00		1.00	1.00		0.65	1.00		0.66
Lane Grp Cap(c), veh/h	198	1633	900	294	1554	688	383	345	318	114	259	242
V/C Ratio(X)	0.85	0.87	0.12	0.79	0.82	0.06	0.82	0.56	0.59	0.79	0.77	0.80
Avail Cap(c_a), veh/h	212	1728	942	301	1629	722	577	568	523	121	380	354
HCM Platoon Ratio	1.00	1.00	1.00	1.00	1.00	1.00	1.00	1.00	1.00	1.00	1.00	1.00
Upstream Filter(I)	1.00	1.00	1.00	1.00	1.00	1.00	1.00	1.00	1.00	1.00	1.00	1.00
Uniform Delay (d), s/veh	45.4	25.2	10.1	46.7	25.7	16.9	45.2	38.0	38.3	48.0	42.8	43.0
Incr Delay (d2), s/veh	23.3	5.2	0.1	11.5	3.5	0.1	3.2	1.4	1.8	24.8	5.6	8.0
Initial Q Delay(d3),s/veh	0.0	0.0	0.0	0.0	0.0	0.0	0.0	0.0	0.0	0.0	0.0	0.0
%ile BackOfQ(50%),veh/ln	5.3	15.2	1.1	3.3	13.1	0.6	4.0	4.5	4.4	3.0	5.2	5.2
Unsig. Movement Delay, s/veh												
LnGrp Delay(d),s/veh	68.7	30.4	10.2	58.3	29.2	17.0	48.4	39.5	40.0	72.8	48.4	51.0
LnGrp LOS	E	C	B	E	C	B	D	D	D	E	D	D
Approach Vol, veh/h		1704			1547			696			483	
Approach Delay, s/veh		32.8			33.2			43.6			54.0	
Approach LOS		C			C			D			D	
Timer - Assigned Phs	1	2	3	4	5	6	7	8				
Phs Duration (G+Y+Rc), s	13.0	54.4	15.8	20.9	15.7	51.7	10.8	25.9				
Change Period (Y+Rc), s	* 4.2	6.2	* 4.2	5.8	* 4.2	6.2	* 4.2	* 5.8				
Max Green Setting (Gmax), s	* 9	51.0	* 18	22.1	* 12	47.7	* 7	* 33				
Max Q Clear Time (g_c+I1), s	8.8	39.9	11.3	13.7	11.6	34.7	7.1	12.8				
Green Ext Time (p_c), s	0.0	8.3	0.3	1.4	0.0	8.5	0.0	2.0				

Intersection Summary

HCM 6th Ctrl Delay	37.0
HCM 6th LOS	D

Notes

* HCM 6th computational engine requires equal clearance times for the phases crossing the barrier.

Timings

5: Trautwein Rd. & Alessandro Bl.

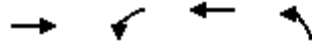

Lane Group	EBT	WBL	WBT	NBL
Lane Configurations	↑↑↑	↔↔	↑↑↑	↔↔↔
Traffic Volume (vph)	1782	234	1882	893
Future Volume (vph)	1782	234	1882	893
Turn Type	NA	Prot	NA	Prot
Protected Phases	2	1	6	8
Permitted Phases				
Detector Phase	2	1	6	8
Switch Phase				
Minimum Initial (s)	10.0	5.0	10.0	10.0
Minimum Split (s)	33.2	9.2	16.2	16.2
Total Split (s)	63.0	19.0	82.0	38.0
Total Split (%)	52.5%	15.8%	68.3%	31.7%
Yellow Time (s)	5.2	3.2	5.2	5.2
All-Red Time (s)	1.0	1.0	1.0	1.0
Lost Time Adjust (s)	0.0	0.0	0.0	0.0
Total Lost Time (s)	6.2	4.2	6.2	6.2
Lead/Lag	Lag	Lead		
Lead-Lag Optimize?	Yes	Yes		
Recall Mode	None	None	None	None
Act Effct Green (s)	54.0	11.9	70.2	26.4
Actuated g/C Ratio	0.49	0.11	0.64	0.24
v/c Ratio	0.75	0.65	0.60	0.79
Control Delay	25.0	56.5	12.5	44.5
Queue Delay	0.0	0.0	0.0	0.0
Total Delay	25.0	56.5	12.5	44.5
LOS	C	E	B	D
Approach Delay	25.0		17.4	44.5
Approach LOS	C		B	D

Intersection Summary

Cycle Length: 120
 Actuated Cycle Length: 109.1
 Natural Cycle: 65
 Control Type: Actuated-Uncoordinated
 Maximum v/c Ratio: 0.79
 Intersection Signal Delay: 25.3
 Intersection LOS: C
 Intersection Capacity Utilization 72.5%
 ICU Level of Service C
 Analysis Period (min) 15

Splits and Phases: 5: Trautwein Rd. & Alessandro Bl.



HCM 6th Signalized Intersection Summary
5: Trautwein Rd. & Alessandro Bl.

West Campus Upper Plateau (JN 14064)
02/16/2022

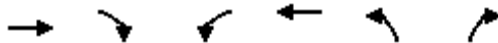

Movement	EBT	EBR	WBL	WBT	NBL	NBR
Lane Configurations	↑↑↑		↵↵	↑↑↑	↵↵↵	
Traffic Volume (veh/h)	1782	17	234	1882	893	11
Future Volume (veh/h)	1782	17	234	1882	893	11
Initial Q (Qb), veh	0	0	0	0	0	0
Ped-Bike Adj(A_pbT)		1.00	1.00		1.00	1.00
Parking Bus, Adj	1.00	1.00	1.00	1.00	1.00	1.00
Work Zone On Approach	No			No	No	
Adj Sat Flow, veh/h/ln	1885	1900	1885	1885	1870	1900
Adj Flow Rate, veh/h	1876	18	246	1981	951	0
Peak Hour Factor	0.95	0.95	0.95	0.95	0.95	0.95
Percent Heavy Veh, %	1	0	1	1	2	0
Cap, veh/h	2670	26	322	3320	1194	360
Arrive On Green	0.51	0.51	0.09	0.65	0.22	0.00
Sat Flow, veh/h	5426	50	3483	5316	5344	1610
Grp Volume(v), veh/h	1224	670	246	1981	951	0
Grp Sat Flow(s),veh/h/ln	1716	1876	1742	1716	1781	1610
Q Serve(g_s), s	25.7	25.8	6.5	20.9	15.8	0.0
Cycle Q Clear(g_c), s	25.7	25.8	6.5	20.9	15.8	0.0
Prop In Lane		0.03	1.00		1.00	1.00
Lane Grp Cap(c), veh/h	1743	953	322	3320	1194	360
V/C Ratio(X)	0.70	0.70	0.76	0.60	0.80	0.00
Avail Cap(c_a), veh/h	2067	1130	547	4138	1803	543
HCM Platoon Ratio	1.00	1.00	1.00	1.00	1.00	1.00
Upstream Filter(I)	1.00	1.00	1.00	1.00	1.00	0.00
Uniform Delay (d), s/veh	17.7	17.7	41.8	9.7	34.6	0.0
Incr Delay (d2), s/veh	1.1	1.9	1.4	0.2	1.5	0.0
Initial Q Delay(d3),s/veh	0.0	0.0	0.0	0.0	0.0	0.0
%ile BackOfQ(50%),veh/ln	8.9	10.0	2.7	5.7	6.6	0.0
Unsig. Movement Delay, s/veh						
LnGrp Delay(d),s/veh	18.8	19.7	43.2	9.9	36.1	0.0
LnGrp LOS	B	B	D	A	D	A
Approach Vol, veh/h	1894			2227	951	
Approach Delay, s/veh	19.1			13.6	36.1	
Approach LOS	B			B	D	
Timer - Assigned Phs	1	2			6	8
Phs Duration (G+Y+Rc), s	12.9	54.1			67.0	27.3
Change Period (Y+Rc), s	* 4.2	6.2			6.2	6.2
Max Green Setting (Gmax), s	* 15	56.8			75.8	31.8
Max Q Clear Time (g_c+I1), s	8.5	27.8			22.9	17.8
Green Ext Time (p_c), s	0.2	20.1			32.0	3.2

Intersection Summary

HCM 6th Ctrl Delay			19.9			
HCM 6th LOS			B			

Notes

User approved volume balancing among the lanes for turning movement.
* HCM 6th computational engine requires equal clearance times for the phases crossing the barrier.

Timings
6: Trautwein Rd. & Grove Community Dr

West Campus Upper Plateau (JN 14064)

02/16/2022



Lane Group	WBL	WBR	NBT	NBR	SBL	SBT
Lane Configurations	↙	↗↗	↕↕	↗	↗↗	↕↕
Traffic Volume (vph)	49	231	780	52	367	1361
Future Volume (vph)	49	231	780	52	367	1361
Turn Type	Prot	pm+ov	NA	Perm	Prot	NA
Protected Phases	8	1	2		1	6
Permitted Phases		8		2		
Detector Phase	8	1	2	2	1	6
Switch Phase						
Minimum Initial (s)	10.0	5.0	10.0	10.0	5.0	10.0
Minimum Split (s)	34.6	9.6	46.2	46.2	9.6	28.2
Total Split (s)	35.0	29.0	56.0	56.0	29.0	85.0
Total Split (%)	29.2%	24.2%	46.7%	46.7%	24.2%	70.8%
Yellow Time (s)	3.6	3.6	5.2	5.2	3.6	5.2
All-Red Time (s)	1.0	1.0	1.0	1.0	1.0	1.0
Lost Time Adjust (s)	0.0	0.0	0.0	0.0	0.0	0.0
Total Lost Time (s)	4.6	4.6	6.2	6.2	4.6	6.2
Lead/Lag		Lead	Lag	Lag	Lead	
Lead-Lag Optimize?		Yes	Yes	Yes	Yes	
Recall Mode	None	None	None	None	None	None
Act Effct Green (s)	13.9	19.4	22.0	22.0	12.4	44.0
Actuated g/C Ratio	0.25	0.34	0.39	0.39	0.22	0.78
v/c Ratio	0.11	0.22	0.57	0.08	0.49	0.50
Control Delay	23.3	4.9	17.9	6.2	25.8	7.0
Queue Delay	0.0	0.0	0.0	0.0	0.0	0.0
Total Delay	23.3	4.9	17.9	6.2	25.8	7.0
LOS	C	A	B	A	C	A
Approach Delay	8.1		17.2			11.0
Approach LOS	A		B			B

Intersection Summary

Cycle Length: 120
 Actuated Cycle Length: 56.5
 Natural Cycle: 95
 Control Type: Actuated-Uncoordinated
 Maximum v/c Ratio: 0.57
 Intersection Signal Delay: 12.5
 Intersection LOS: B
 Intersection Capacity Utilization 55.9%
 ICU Level of Service B
 Analysis Period (min) 15

Splits and Phases: 6: Trautwein Rd. & Grove Community Dr



HCM 6th Signalized Intersection Summary
6: Trautwein Rd. & Grove Community Dr

West Campus Upper Plateau (JN 14064)

02/16/2022



Movement	WBL	WBR	NBT	NBR	SBL	SBT
Lane Configurations						
Traffic Volume (veh/h)	49	231	780	52	367	1361
Future Volume (veh/h)	49	231	780	52	367	1361
Initial Q (Qb), veh	0	0	0	0	0	0
Ped-Bike Adj(A_pbT)	1.00	1.00		1.00	1.00	
Parking Bus, Adj	1.00	1.00	1.00	1.00	1.00	1.00
Work Zone On Approach	No		No			No
Adj Sat Flow, veh/h/ln	1900	1900	1885	1900	1900	1870
Adj Flow Rate, veh/h	50	57	796	48	374	1389
Peak Hour Factor	0.98	0.98	0.98	0.98	0.98	0.98
Percent Heavy Veh, %	0	0	1	0	0	2
Cap, veh/h	292	898	1259	566	546	2153
Arrive On Green	0.16	0.16	0.35	0.35	0.16	0.61
Sat Flow, veh/h	1810	2834	3676	1610	3510	3647
Grp Volume(v), veh/h	50	57	796	48	374	1389
Grp Sat Flow(s),veh/h/ln	1810	1417	1791	1610	1755	1777
Q Serve(g_s), s	1.1	0.7	8.6	0.9	4.7	11.7
Cycle Q Clear(g_c), s	1.1	0.7	8.6	0.9	4.7	11.7
Prop In Lane	1.00	1.00		1.00	1.00	
Lane Grp Cap(c), veh/h	292	898	1259	566	546	2153
V/C Ratio(X)	0.17	0.06	0.63	0.08	0.69	0.65
Avail Cap(c_a), veh/h	1186	2297	3845	1728	1846	6036
HCM Platoon Ratio	1.00	1.00	1.00	1.00	1.00	1.00
Upstream Filter(I)	1.00	1.00	1.00	1.00	1.00	1.00
Uniform Delay (d), s/veh	16.8	11.1	12.5	10.1	18.5	5.9
Incr Delay (d2), s/veh	0.3	0.0	0.5	0.1	0.6	0.3
Initial Q Delay(d3),s/veh	0.0	0.0	0.0	0.0	0.0	0.0
%ile BackOfQ(50%),veh/ln	0.4	0.2	2.4	0.2	1.5	1.6
Unsig. Movement Delay, s/veh						
LnGrp Delay(d),s/veh	17.1	11.1	13.1	10.1	19.1	6.2
LnGrp LOS	B	B	B	B	B	A
Approach Vol, veh/h	107		844			1763
Approach Delay, s/veh	13.9		12.9			9.0
Approach LOS	B		B			A
Timer - Assigned Phs	1	2			6	8
Phs Duration (G+Y+Rc), s	11.8	22.5			34.3	12.1
Change Period (Y+Rc), s	4.6	6.2			6.2	4.6
Max Green Setting (Gmax), s	24.4	49.8			78.8	30.4
Max Q Clear Time (g_c+I1), s	6.7	10.6			13.7	3.1
Green Ext Time (p_c), s	0.6	5.7			13.4	0.3

Intersection Summary

HCM 6th Ctrl Delay	10.4
HCM 6th LOS	B

Timings

West Campus Upper Plateau (JN 14064)

7: Trautwein Rd. & Orange Terrace Pkwy

02/16/2022



Lane Group	EBL	EBT	WBL	WBT	WBR	NBL	NBT	NBR	SBL	SBT	SBR
Lane Configurations											
Traffic Volume (vph)	45	46	148	24	163	31	716	208	333	1050	40
Future Volume (vph)	45	46	148	24	163	31	716	208	333	1050	40
Turn Type	Prot	NA	Prot	NA	pm+ov	Prot	NA	Perm	Prot	NA	Perm
Protected Phases	7	4	3	8	1	5	2		1	6	
Permitted Phases					8			2			6
Detector Phase	7	4	3	8	1	5	2	2	1	6	6
Switch Phase											
Minimum Initial (s)	5.0	10.0	5.0	10.0	5.0	5.0	10.0	10.0	5.0	10.0	10.0
Minimum Split (s)	9.6	38.6	9.6	34.6	9.6	9.6	46.2	46.2	9.6	28.2	28.2
Total Split (s)	13.2	38.6	16.1	41.5	18.0	9.6	47.3	47.3	18.0	55.7	55.7
Total Split (%)	11.0%	32.2%	13.4%	34.6%	15.0%	8.0%	39.4%	39.4%	15.0%	46.4%	46.4%
Yellow Time (s)	3.6	3.6	3.6	3.6	3.6	3.6	5.2	5.2	3.6	5.2	5.2
All-Red Time (s)	1.0	1.0	1.0	1.0	1.0	1.0	1.0	1.0	1.0	1.0	1.0
Lost Time Adjust (s)	0.0	0.0	0.0	0.0	0.0	0.0	0.0	0.0	0.0	0.0	0.0
Total Lost Time (s)	4.6	4.6	4.6	4.6	4.6	4.6	6.2	6.2	4.6	6.2	6.2
Lead/Lag	Lead	Lag	Lead	Lag	Lead	Lead	Lag	Lag	Lead	Lag	Lag
Lead-Lag Optimize?	Yes	Yes	Yes	Yes	Yes	Yes	Yes	Yes	Yes	Yes	Yes
Recall Mode	None	None	None	None	None	None	None	None	None	None	None
Act Effct Green (s)	10.9	14.1	12.0	18.6	33.8	5.4	25.2	25.2	13.2	38.1	38.1
Actuated g/C Ratio	0.13	0.17	0.15	0.23	0.42	0.07	0.31	0.31	0.16	0.47	0.47
v/c Ratio	0.20	0.19	0.59	0.06	0.14	0.28	0.69	0.34	0.63	0.67	0.05
Control Delay	41.1	28.6	49.1	29.2	3.2	50.8	29.4	5.4	41.7	22.1	0.1
Queue Delay	0.0	0.0	0.0	0.0	0.0	0.0	0.0	0.0	0.0	0.0	0.0
Total Delay	41.1	28.6	49.1	29.2	3.2	50.8	29.4	5.4	41.7	22.1	0.1
LOS	D	C	D	C	A	D	C	A	D	C	A
Approach Delay		34.0		25.3			24.9			26.1	
Approach LOS		C		C			C			C	

Intersection Summary

Cycle Length: 120	
Actuated Cycle Length: 81.2	
Natural Cycle: 115	
Control Type: Actuated-Uncoordinated	
Maximum v/c Ratio: 0.69	
Intersection Signal Delay: 25.9	Intersection LOS: C
Intersection Capacity Utilization 60.9%	ICU Level of Service B
Analysis Period (min) 15	

Splits and Phases: 7: Trautwein Rd. & Orange Terrace Pkwy

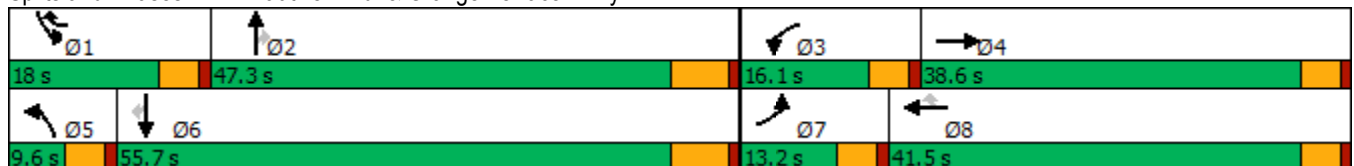

HCM 6th Signalized Intersection Summary
7: Trautwein Rd. & Orange Terrace Pkwy

West Campus Upper Plateau (JN 14064)

02/16/2022



Movement	EBL	EBT	EBR	WBL	WBT	WBR	NBL	NBT	NBR	SBL	SBT	SBR
Lane Configurations	↶	→	↷	↶	↑	↶↷	↶	↑↑	↶	↶↷	↑↑	↶
Traffic Volume (veh/h)	45	46	12	148	24	163	31	716	208	333	1050	40
Future Volume (veh/h)	45	46	12	148	24	163	31	716	208	333	1050	40
Initial Q (Qb), veh	0	0	0	0	0	0	0	0	0	0	0	0
Ped-Bike Adj(A_pbT)	1.00		1.00	1.00		1.00	1.00		1.00	1.00		1.00
Parking Bus, Adj	1.00	1.00	1.00	1.00	1.00	1.00	1.00	1.00	1.00	1.00	1.00	1.00
Work Zone On Approach		No			No			No			No	
Adj Sat Flow, veh/h/ln	1900	1900	1900	1885	1900	1856	1900	1870	1870	1870	1870	1900
Adj Flow Rate, veh/h	47	48	11	156	25	53	33	754	142	351	1105	33
Peak Hour Factor	0.95	0.95	0.95	0.95	0.95	0.95	0.95	0.95	0.95	0.95	0.95	0.95
Percent Heavy Veh, %	0	0	0	1	0	3	0	2	2	2	2	0
Cap, veh/h	79	215	49	196	398	945	62	1132	505	457	1480	670
Arrive On Green	0.04	0.14	0.14	0.11	0.21	0.21	0.03	0.32	0.32	0.13	0.42	0.42
Sat Flow, veh/h	1810	1496	343	1795	1900	2768	1810	3554	1585	3456	3554	1610
Grp Volume(v), veh/h	47	0	59	156	25	53	33	754	142	351	1105	33
Grp Sat Flow(s),veh/h/ln	1810	0	1838	1795	1900	1384	1810	1777	1585	1728	1777	1610
Q Serve(g_s), s	1.7	0.0	1.9	5.7	0.7	0.9	1.2	12.4	4.5	6.6	17.8	0.8
Cycle Q Clear(g_c), s	1.7	0.0	1.9	5.7	0.7	0.9	1.2	12.4	4.5	6.6	17.8	0.8
Prop In Lane	1.00		0.19	1.00		1.00	1.00		1.00	1.00		1.00
Lane Grp Cap(c), veh/h	79	0	264	196	398	945	62	1132	505	457	1480	670
V/C Ratio(X)	0.60	0.00	0.22	0.80	0.06	0.06	0.53	0.67	0.28	0.77	0.75	0.05
Avail Cap(c_a), veh/h	231	0	927	306	1040	1880	134	2166	966	687	2609	1182
HCM Platoon Ratio	1.00	1.00	1.00	1.00	1.00	1.00	1.00	1.00	1.00	1.00	1.00	1.00
Upstream Filter(I)	1.00	0.00	1.00	1.00	1.00	1.00	1.00	1.00	1.00	1.00	1.00	1.00
Uniform Delay (d), s/veh	31.7	0.0	25.5	29.3	21.4	14.9	32.0	19.9	17.2	28.3	16.7	11.7
Incr Delay (d2), s/veh	2.7	0.0	0.4	3.4	0.1	0.0	2.6	0.7	0.3	1.3	0.8	0.0
Initial Q Delay(d3),s/veh	0.0	0.0	0.0	0.0	0.0	0.0	0.0	0.0	0.0	0.0	0.0	0.0
%ile BackOfQ(50%),veh/ln	0.8	0.0	0.8	2.4	0.3	0.2	0.5	4.4	1.5	2.5	5.9	0.3
Unsig. Movement Delay, s/veh												
LnGrp Delay(d),s/veh	34.4	0.0	26.0	32.7	21.4	14.9	34.7	20.6	17.5	29.6	17.4	11.8
LnGrp LOS	C	A	C	C	C	B	C	C	B	C	B	B
Approach Vol, veh/h		106			234			929			1489	
Approach Delay, s/veh		29.7			27.4			20.6			20.2	
Approach LOS		C			C			C			C	
Timer - Assigned Phs	1	2	3	4	5	6	7	8				
Phs Duration (G+Y+Rc), s	13.5	27.7	12.0	14.3	6.9	34.3	7.5	18.7				
Change Period (Y+Rc), s	4.6	6.2	4.6	4.6	4.6	6.2	4.6	4.6				
Max Green Setting (Gmax), s	13.4	41.1	11.5	34.0	5.0	49.5	8.6	36.9				
Max Q Clear Time (g_c+I1), s	8.6	14.4	7.7	3.9	3.2	19.8	3.7	2.9				
Green Ext Time (p_c), s	0.3	5.4	0.1	0.3	0.0	8.3	0.0	0.3				

Intersection Summary

HCM 6th Ctrl Delay			21.3									
HCM 6th LOS			C									

Timings
8: Cole Av. & Van Buren Bl.

West Campus Upper Plateau (JN 14064)

02/16/2022



Lane Group	EBL	EBT	EBR	WBL	WBT	WBR	NBL	NBT	SBL	SBT	SBR
Lane Configurations	↖↗	↑↑	↖	↖	↑↑↑	↖	↖	↑↑	↖↗	↑↑	↖
Traffic Volume (vph)	317	959	100	118	990	248	89	284	287	508	215
Future Volume (vph)	317	959	100	118	990	248	89	284	287	508	215
Turn Type	Prot	NA	pm+ov	Prot	NA	pm+ov	Prot	NA	Prot	NA	pm+ov
Protected Phases	5	2	3	1	6	7	3	8	7	4	5
Permitted Phases			2			6					4
Detector Phase	5	2	3	1	6	7	3	8	7	4	5
Switch Phase											
Minimum Initial (s)	5.0	10.0	5.0	5.0	10.0	5.0	5.0	10.0	5.0	10.0	5.0
Minimum Split (s)	9.1	36.2	9.1	9.1	36.2	9.1	9.1	42.2	9.1	49.2	9.1
Total Split (s)	18.7	44.8	12.0	14.0	40.1	17.5	12.0	43.7	17.5	49.2	18.7
Total Split (%)	15.6%	37.3%	10.0%	11.7%	33.4%	14.6%	10.0%	36.4%	14.6%	41.0%	15.6%
Yellow Time (s)	3.2	5.2	3.2	3.2	5.2	3.2	3.2	5.2	3.2	5.2	3.2
All-Red Time (s)	0.5	1.0	0.5	0.5	1.0	0.5	0.5	1.0	0.5	1.0	0.5
Lost Time Adjust (s)	0.0	0.0	0.0	0.0	0.0	0.0	0.0	0.0	0.0	0.0	0.0
Total Lost Time (s)	3.7	6.2	3.7	3.7	6.2	3.7	3.7	6.2	3.7	6.2	3.7
Lead/Lag	Lead	Lag	Lead	Lead	Lag	Lead	Lead	Lag	Lead	Lag	Lead
Lead-Lag Optimize?	Yes	Yes	Yes	Yes	Yes	Yes	Yes	Yes	Yes	Yes	Yes
Recall Mode	None	None	None	None	None	None	None	None	None	None	None
Act Effct Green (s)	13.3	35.8	50.1	10.0	32.5	51.2	8.0	18.1	12.4	22.4	38.2
Actuated g/C Ratio	0.14	0.37	0.52	0.10	0.34	0.53	0.08	0.19	0.13	0.23	0.40
v/c Ratio	0.72	0.80	0.12	0.70	0.62	0.28	0.64	0.53	0.70	0.65	0.34
Control Delay	51.1	34.1	4.5	65.9	30.1	3.8	66.7	36.7	51.5	37.2	13.9
Queue Delay	0.0	0.0	0.0	0.0	0.0	0.0	0.0	0.0	0.0	0.0	0.0
Total Delay	51.1	34.1	4.5	65.9	30.1	3.8	66.7	36.7	51.5	37.2	13.9
LOS	D	C	A	E	C	A	E	D	D	D	B
Approach Delay		35.8			28.4			43.1		36.3	
Approach LOS		D			C			D		D	

Intersection Summary

Cycle Length: 120	
Actuated Cycle Length: 96.4	
Natural Cycle: 105	
Control Type: Actuated-Uncoordinated	
Maximum v/c Ratio: 0.80	
Intersection Signal Delay: 34.3	Intersection LOS: C
Intersection Capacity Utilization 70.2%	ICU Level of Service C
Analysis Period (min) 15	



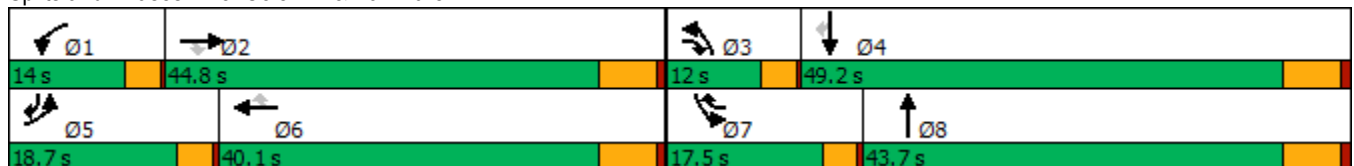



























Splits and Phases: 8: Cole Av. & Van Buren Bl.



HCM 6th Signalized Intersection Summary
8: Cole Av. & Van Buren Bl.

West Campus Upper Plateau (JN 14064)

02/16/2022

												
Movement	EBL	EBT	EBR	WBL	WBT	WBR	NBL	NBT	NBR	SBL	SBT	SBR
Lane Configurations	 	 			  			 		 	 	
Traffic Volume (veh/h)	317	959	100	118	990	248	89	284	46	287	508	215
Future Volume (veh/h)	317	959	100	118	990	248	89	284	46	287	508	215
Initial Q (Qb), veh	0	0	0	0	0	0	0	0	0	0	0	0
Ped-Bike Adj(A_pbT)	1.00		1.00	1.00		1.00	1.00		0.99	1.00		1.00
Parking Bus, Adj	1.00	1.00	1.00	1.00	1.00	1.00	1.00	1.00	1.00	1.00	1.00	1.00
Work Zone On Approach		No			No			No			No	
Adj Sat Flow, veh/h/ln	1856	1826	1856	1856	1856	1870	1885	1885	1870	1856	1885	1885
Adj Flow Rate, veh/h	337	1020	47	126	1053	174	95	302	42	305	540	129
Peak Hour Factor	0.94	0.94	0.94	0.94	0.94	0.94	0.94	0.94	0.94	0.94	0.94	0.94
Percent Heavy Veh, %	3	5	3	3	3	2	1	1	2	3	1	1
Cap, veh/h	424	1314	702	158	1744	726	122	555	76	391	794	552
Arrive On Green	0.12	0.38	0.38	0.09	0.34	0.34	0.07	0.18	0.18	0.11	0.22	0.22
Sat Flow, veh/h	3428	3469	1572	1767	5066	1585	1795	3159	435	3428	3582	1595
Grp Volume(v), veh/h	337	1020	47	126	1053	174	95	170	174	305	540	129
Grp Sat Flow(s),veh/h/ln	1714	1735	1572	1767	1689	1585	1795	1791	1803	1714	1791	1595
Q Serve(g_s), s	7.8	21.1	1.4	5.7	14.1	5.5	4.3	7.1	7.2	7.1	11.3	4.7
Cycle Q Clear(g_c), s	7.8	21.1	1.4	5.7	14.1	5.5	4.3	7.1	7.2	7.1	11.3	4.7
Prop In Lane	1.00		1.00	1.00		1.00	1.00		0.24	1.00		1.00
Lane Grp Cap(c), veh/h	424	1314	702	158	1744	726	122	315	317	391	794	552
V/C Ratio(X)	0.79	0.78	0.07	0.80	0.60	0.24	0.78	0.54	0.55	0.78	0.68	0.23
Avail Cap(c_a), veh/h	629	1639	849	223	2101	838	182	822	827	579	1885	1037
HCM Platoon Ratio	1.00	1.00	1.00	1.00	1.00	1.00	1.00	1.00	1.00	1.00	1.00	1.00
Upstream Filter(I)	1.00	1.00	1.00	1.00	1.00	1.00	1.00	1.00	1.00	1.00	1.00	1.00
Uniform Delay (d), s/veh	34.8	22.3	12.9	36.5	22.2	13.5	37.5	30.7	30.7	35.2	29.1	19.0
Incr Delay (d2), s/veh	2.3	2.2	0.1	8.3	0.5	0.2	5.9	1.4	1.5	2.1	1.0	0.2
Initial Q Delay(d3),s/veh	0.0	0.0	0.0	0.0	0.0	0.0	0.0	0.0	0.0	0.0	0.0	0.0
%ile BackOfQ(50%),veh/ln	3.1	7.8	0.4	2.7	5.0	1.7	1.9	2.9	3.0	2.8	4.5	1.6
Unsig. Movement Delay, s/veh												
LnGrp Delay(d),s/veh	37.1	24.6	13.0	44.8	22.7	13.7	43.4	32.1	32.2	37.3	30.2	19.3
LnGrp LOS	D	C	B	D	C	B	D	C	C	D	C	B
Approach Vol, veh/h		1404			1353			439			974	
Approach Delay, s/veh		27.2			23.6			34.6			31.0	
Approach LOS		C			C			C			C	
Timer - Assigned Phs	1	2	3	4	5	6	7	8				
Phs Duration (G+Y+Rc), s	11.0	37.1	9.2	24.3	13.8	34.3	13.0	20.6				
Change Period (Y+Rc), s	3.7	6.2	3.7	6.2	3.7	6.2	3.7	6.2				
Max Green Setting (Gmax), s	10.3	38.6	8.3	43.0	15.0	33.9	13.8	37.5				
Max Q Clear Time (g_c+I1), s	7.7	23.1	6.3	13.3	9.8	16.1	9.1	9.2				
Green Ext Time (p_c), s	0.0	7.8	0.0	3.8	0.3	9.2	0.3	1.7				
Intersection Summary												
HCM 6th Ctrl Delay				27.7								
HCM 6th LOS				C								

Intersection	
Intersection Delay, s/veh	9.2
Intersection LOS	A

Movement	EBT	EBR	WBL	WBT	NBL	NBR
Lane Configurations	↔		↔	↑	↔	↔
Traffic Vol, veh/h	203	18	21	132	27	35
Future Vol, veh/h	203	18	21	132	27	35
Peak Hour Factor	0.92	0.92	0.92	0.92	0.92	0.92
Heavy Vehicles, %	2	0	5	2	0	0
Mvmt Flow	221	20	23	143	29	38
Number of Lanes	1	0	1	1	1	1

Approach	EB	WB	NB
Opposing Approach	WB	EB	
Opposing Lanes	2	1	0
Conflicting Approach Left		NB	EB
Conflicting Lanes Left	0	2	1
Conflicting Approach Right	NB		WB
Conflicting Lanes Right	2	0	2
HCM Control Delay	9.8	8.7	8.3
HCM LOS	A	A	A

Lane	NBLn1	NBLn2	EBLn1	WBLn1	WBLn2
Vol Left, %	100%	0%	0%	100%	0%
Vol Thru, %	0%	0%	92%	0%	100%
Vol Right, %	0%	100%	8%	0%	0%
Sign Control	Stop	Stop	Stop	Stop	Stop
Traffic Vol by Lane	27	35	221	21	132
LT Vol	27	0	0	21	0
Through Vol	0	0	203	0	132
RT Vol	0	35	18	0	0
Lane Flow Rate	29	38	240	23	143
Geometry Grp	7	7	4	7	7
Degree of Util (X)	0.049	0.05	0.31	0.035	0.195
Departure Headway (Hd)	5.971	4.763	4.652	5.45	4.896
Convergence, Y/N	Yes	Yes	Yes	Yes	Yes
Cap	601	753	776	659	735
Service Time	3.695	2.487	2.668	3.167	2.614
HCM Lane V/C Ratio	0.048	0.05	0.309	0.035	0.195
HCM Control Delay	9	7.7	9.8	8.4	8.8
HCM Lane LOS	A	A	A	A	A
HCM 95th-tile Q	0.2	0.2	1.3	0.1	0.7

Intersection												
Intersection Delay, s/veh	9.9											
Intersection LOS	A											

Movement	EBL	EBT	EBR	WBL	WBT	WBR	NBL	NBT	NBR	SBL	SBT	SBR
Lane Configurations	↖	↕		↖	↕			↕			↕	
Traffic Vol, veh/h	43	422	15	3	237	46	18	4	2	27	7	19
Future Vol, veh/h	43	422	15	3	237	46	18	4	2	27	7	19
Peak Hour Factor	0.96	0.96	0.96	0.96	0.96	0.96	0.96	0.96	0.96	0.96	0.96	0.96
Heavy Vehicles, %	5	2	7	0	1	0	6	0	0	0	0	0
Mvmt Flow	45	440	16	3	247	48	19	4	2	28	7	20
Number of Lanes	1	2	0	1	2	0	0	1	0	0	1	0

Approach	EB	WB	NB	SB
Opposing Approach	WB	EB	SB	NB
Opposing Lanes	3	3	1	1
Conflicting Approach Left	SB	NB	EB	WB
Conflicting Lanes Left	1	1	3	3
Conflicting Approach Right	NB	SB	WB	EB
Conflicting Lanes Right	1	1	3	3
HCM Control Delay	10.4	9.2	9.8	9.6
HCM LOS	B	A	A	A

Lane	NBLn1	EBLn1	EBLn2	EBLn3	WBLn1	WBLn2	WBLn3	SBLn1
Vol Left, %	75%	100%	0%	0%	100%	0%	0%	51%
Vol Thru, %	17%	0%	100%	90%	0%	100%	63%	13%
Vol Right, %	8%	0%	0%	10%	0%	0%	37%	36%
Sign Control	Stop	Stop	Stop	Stop	Stop	Stop	Stop	Stop
Traffic Vol by Lane	24	43	281	156	3	158	125	53
LT Vol	18	43	0	0	3	0	0	27
Through Vol	4	0	281	141	0	158	79	7
RT Vol	2	0	0	15	0	0	46	19
Lane Flow Rate	25	45	293	162	3	165	130	55
Geometry Grp	7	7	7	7	7	7	7	7
Degree of Util (X)	0.046	0.07	0.411	0.228	0.005	0.239	0.179	0.095
Departure Headway (Hd)	6.664	5.6	5.047	5.064	5.715	5.229	4.953	6.193
Convergence, Y/N	Yes	Yes	Yes	Yes	Yes	Yes	Yes	Yes
Cap	534	639	712	707	624	685	721	575
Service Time	4.447	3.344	2.791	2.808	3.466	2.98	2.704	3.97
HCM Lane V/C Ratio	0.047	0.07	0.412	0.229	0.005	0.241	0.18	0.096
HCM Control Delay	9.8	8.8	11.3	9.3	8.5	9.6	8.8	9.6
HCM Lane LOS	A	A	B	A	A	A	A	A
HCM 95th-tile Q	0.1	0.2	2	0.9	0	0.9	0.6	0.3

Timings
11: Barton St & Alessandro Bl.



Lane Group	EBL	EBT	WBL	WBT	NBL	NBT	NBR	SBL	SBT	SBR
Lane Configurations	↙	↕↕↕	↙	↕↕↕		↕	↗		↕	↗
Traffic Volume (vph)	5	1866	67	2030	47	1	33	9	0	12
Future Volume (vph)	5	1866	67	2030	47	1	33	9	0	12
Turn Type	Prot	NA	Prot	NA	Perm	NA	Perm	Perm	NA	Perm
Protected Phases	5	2	1	6		8			4	
Permitted Phases					8		8	4		4
Detector Phase	5	2	1	6	8	8	8	4	4	4
Switch Phase										
Minimum Initial (s)	5.0	10.0	5.0	10.0	10.0	10.0	10.0	10.0	10.0	10.0
Minimum Split (s)	9.2	28.5	11.0	28.5	40.6	40.6	40.6	26.6	26.6	26.6
Total Split (s)	9.2	65.4	14.0	70.2	40.6	40.6	40.6	40.6	40.6	40.6
Total Split (%)	7.7%	54.5%	11.7%	58.5%	33.8%	33.8%	33.8%	33.8%	33.8%	33.8%
Yellow Time (s)	3.2	5.5	3.2	5.5	3.6	3.6	3.6	3.6	3.6	3.6
All-Red Time (s)	1.0	1.0	1.0	1.0	1.0	1.0	1.0	1.0	1.0	1.0
Lost Time Adjust (s)	0.0	0.0	0.0	0.0		0.0	0.0		0.0	0.0
Total Lost Time (s)	4.2	6.5	4.2	6.5		4.6	4.6		4.6	4.6
Lead/Lag	Lead	Lag	Lead	Lag						
Lead-Lag Optimize?	Yes	Yes	Yes	Yes						
Recall Mode	None	None	None	None	None	None	None	None	None	None
Act Effct Green (s)	5.4	59.2	7.8	67.1		14.5	14.5		14.5	14.5
Actuated g/C Ratio	0.06	0.67	0.09	0.76		0.16	0.16		0.16	0.16
v/c Ratio	0.05	0.58	0.44	0.55		0.23	0.10		0.04	0.04
Control Delay	50.4	13.5	53.3	9.1		37.3	0.5		33.8	0.2
Queue Delay	0.0	0.0	0.0	0.0		0.0	0.0		0.0	0.0
Total Delay	50.4	13.5	53.3	9.1		37.3	0.5		33.8	0.2
LOS	D	B	D	A		D	A		C	A
Approach Delay		13.6		10.5		22.4			13.9	
Approach LOS		B		B		C			B	

Intersection Summary

Cycle Length: 120
 Actuated Cycle Length: 87.9
 Natural Cycle: 95
 Control Type: Actuated-Uncoordinated
 Maximum v/c Ratio: 0.58
 Intersection Signal Delay: 12.2
 Intersection LOS: B
 Intersection Capacity Utilization 69.0%
 ICU Level of Service C
 Analysis Period (min) 15

Splits and Phases: 11: Barton St & Alessandro Bl.



HCM 6th Signalized Intersection Summary
11: Barton St & Alessandro Bl.

West Campus Upper Plateau (JN 14064)

02/16/2022



Movement	EBL	EBT	EBR	WBL	WBT	WBR	NBL	NBT	NBR	SBL	SBT	SBR
Lane Configurations	↖	↑↑↑		↖	↑↑↑			↑	↗		↑	↗
Traffic Volume (veh/h)	5	1866	40	67	2030	3	47	1	33	9	0	12
Future Volume (veh/h)	5	1866	40	67	2030	3	47	1	33	9	0	12
Initial Q (Qb), veh	0	0	0	0	0	0	0	0	0	0	0	0
Ped-Bike Adj(A_pbT)	1.00		1.00	1.00		0.98	1.00		1.00	1.00		1.00
Parking Bus, Adj	1.00	1.00	1.00	1.00	1.00	1.00	1.00	1.00	1.00	1.00	1.00	1.00
Work Zone On Approach		No			No			No			No	
Adj Sat Flow, veh/h/ln	1604	1885	1900	1900	1870	1900	1870	1900	1900	1737	1900	1900
Adj Flow Rate, veh/h	5	1944	40	70	2115	3	49	1	8	9	0	2
Peak Hour Factor	0.96	0.96	0.96	0.96	0.96	0.96	0.96	0.96	0.96	0.96	0.96	0.96
Percent Heavy Veh, %	20	1	0	0	2	0	2	0	0	11	0	0
Cap, veh/h	10	3351	69	92	3633	5	94	1	163	95	0	163
Arrive On Green	0.01	0.65	0.65	0.05	0.69	0.69	0.10	0.10	0.10	0.10	0.00	0.10
Sat Flow, veh/h	1527	5190	107	1810	5265	7	0	10	1610	0	0	1610
Grp Volume(v), veh/h	5	1285	699	70	1367	751	50	0	8	9	0	2
Grp Sat Flow(s),veh/h/ln	1527	1716	1866	1810	1702	1869	10	0	1610	0	0	1610
Q Serve(g_s), s	0.2	16.0	16.1	2.9	15.7	15.7	0.0	0.0	0.3	0.0	0.0	0.1
Cycle Q Clear(g_c), s	0.2	16.0	16.1	2.9	15.7	15.7	7.7	0.0	0.3	7.7	0.0	0.1
Prop In Lane	1.00		0.06	1.00		0.00	0.98		1.00	1.00		1.00
Lane Grp Cap(c), veh/h	10	2215	1205	92	2349	1289	95	0	163	95	0	163
V/C Ratio(X)	0.50	0.58	0.58	0.76	0.58	0.58	0.52	0.00	0.05	0.09	0.00	0.01
Avail Cap(c_a), veh/h	101	2671	1453	234	2866	1574	636	0	766	630	0	766
HCM Platoon Ratio	1.00	1.00	1.00	1.00	1.00	1.00	1.00	1.00	1.00	1.00	1.00	1.00
Upstream Filter(I)	1.00	1.00	1.00	1.00	1.00	1.00	1.00	0.00	1.00	1.00	0.00	1.00
Uniform Delay (d), s/veh	37.5	7.6	7.6	35.4	6.1	6.1	37.7	0.0	30.7	37.8	0.0	30.6
Incr Delay (d2), s/veh	13.4	0.3	0.6	4.8	0.3	0.6	4.4	0.0	0.1	0.4	0.0	0.0
Initial Q Delay(d3),s/veh	0.0	0.0	0.0	0.0	0.0	0.0	0.0	0.0	0.0	0.0	0.0	0.0
%ile BackOfQ(50%),veh/ln	0.1	3.6	4.1	1.4	4.2	4.8	1.0	0.0	0.1	0.2	0.0	0.0
Unsig. Movement Delay, s/veh												
LnGrp Delay(d),s/veh	50.8	7.9	8.2	40.2	6.4	6.7	42.1	0.0	30.8	38.3	0.0	30.6
LnGrp LOS	D	A	A	D	A	A	D	A	C	D	A	C
Approach Vol, veh/h		1989			2188			58				11
Approach Delay, s/veh		8.1			7.6			40.5				36.9
Approach LOS		A			A			D				D
Timer - Assigned Phs	1	2		4	5	6		8				
Phs Duration (G+Y+Rc), s	8.1	55.3		12.3	4.7	58.7		12.3				
Change Period (Y+Rc), s	* 4.2	6.5		4.6	* 4.2	6.5		4.6				
Max Green Setting (Gmax), s	* 9.8	58.9		36.0	* 5	63.7		36.0				
Max Q Clear Time (g_c+I1), s	4.9	18.1		9.7	2.2	17.7		9.7				
Green Ext Time (p_c), s	0.0	26.2		0.0	0.0	34.5		0.2				

Intersection Summary

HCM 6th Ctrl Delay	8.4
HCM 6th LOS	A

Notes

* HCM 6th computational engine requires equal clearance times for the phases crossing the barrier.

Intersection						
Int Delay, s/veh	1.2					
Movement	EBL	EBT	WBT	WBR	SBL	SBR
Lane Configurations						
Traffic Vol, veh/h	31	208	127	20	2	27
Future Vol, veh/h	31	208	127	20	2	27
Conflicting Peds, #/hr	0	0	0	7	0	0
Sign Control	Free	Free	Free	Free	Stop	Stop
RT Channelized	-	None	-	None	-	None
Storage Length	100	-	-	-	0	-
Veh in Median Storage, #	-	0	0	-	0	-
Grade, %	-	0	0	-	0	-
Peak Hour Factor	94	94	94	94	94	94
Heavy Vehicles, %	0	1	1	0	0	0
Mvmt Flow	33	221	135	21	2	29

Major/Minor	Major1	Major2	Minor2		
Conflicting Flow All	163	0	-	0	440
Stage 1	-	-	-	-	153
Stage 2	-	-	-	-	287
Critical Hdwy	4.1	-	-	-	6.4
Critical Hdwy Stg 1	-	-	-	-	5.4
Critical Hdwy Stg 2	-	-	-	-	5.4
Follow-up Hdwy	2.2	-	-	-	3.5
Pot Cap-1 Maneuver	1428	-	-	-	578
Stage 1	-	-	-	-	880
Stage 2	-	-	-	-	766
Platoon blocked, %		-	-	-	
Mov Cap-1 Maneuver	1418	-	-	-	557
Mov Cap-2 Maneuver	-	-	-	-	557
Stage 1	-	-	-	-	854
Stage 2	-	-	-	-	761

Approach	EB	WB	SB
HCM Control Delay, s	1	0	9.4
HCM LOS			A

Minor Lane/Major Mvmt	EBL	EBT	WBT	WBR	SBLn1
Capacity (veh/h)	1418	-	-	-	856
HCM Lane V/C Ratio	0.023	-	-	-	0.036
HCM Control Delay (s)	7.6	-	-	-	9.4
HCM Lane LOS	A	-	-	-	A
HCM 95th %tile Q(veh)	0.1	-	-	-	0.1

Intersection						
Int Delay, s/veh	2.2					
Movement	EBT	EBR	WBL	WBT	NBL	NBR
Lane Configurations	↑↑		↖	↑↑	↘	
Traffic Vol, veh/h	370	80	41	221	65	39
Future Vol, veh/h	370	80	41	221	65	39
Conflicting Peds, #/hr	0	2	0	0	0	0
Sign Control	Free	Free	Free	Free	Stop	Stop
RT Channelized	-	None	-	None	-	None
Storage Length	-	-	125	-	0	-
Veh in Median Storage, #	0	-	-	0	0	-
Grade, %	0	-	-	0	0	-
Peak Hour Factor	97	97	97	97	97	97
Heavy Vehicles, %	1	1	0	0	0	0
Mvmt Flow	381	82	42	228	67	40

Major/Minor	Major1	Major2	Minor1	Minor2	Minor3
Conflicting Flow All	0	0	465	0	622
Stage 1	-	-	-	-	424
Stage 2	-	-	-	-	198
Critical Hdwy	-	-	4.1	-	6.8
Critical Hdwy Stg 1	-	-	-	-	5.8
Critical Hdwy Stg 2	-	-	-	-	5.8
Follow-up Hdwy	-	-	2.2	-	3.5
Pot Cap-1 Maneuver	-	-	1107	-	423
Stage 1	-	-	-	-	634
Stage 2	-	-	-	-	822
Platoon blocked, %	-	-	-	-	-
Mov Cap-1 Maneuver	-	-	1105	-	406
Mov Cap-2 Maneuver	-	-	-	-	406
Stage 1	-	-	-	-	633
Stage 2	-	-	-	-	791

Approach	EB	WB	NB
HCM Control Delay, s	0	1.3	14.3
HCM LOS			B

Minor Lane/Major Mvmt	NBLn1	EBT	EBR	WBL	WBT
Capacity (veh/h)	494	-	-	1105	-
HCM Lane V/C Ratio	0.217	-	-	0.038	-
HCM Control Delay (s)	14.3	-	-	8.4	-
HCM Lane LOS	B	-	-	A	-
HCM 95th %tile Q(veh)	0.8	-	-	0.1	-

Timings

14: Barton Rd. & Van Buren Bl.



Lane Group	EBL	EBT	WBL	WBT	NBL	NBT	NBR	SBL	SBT
Lane Configurations	↙	↕	↙	↕	↙	↕	↗	↙	↕
Traffic Volume (vph)	100	1100	255	1114	209	61	212	16	27
Future Volume (vph)	100	1100	255	1114	209	61	212	16	27
Turn Type	Prot	NA	Prot	NA	Prot	NA	Perm	Prot	NA
Protected Phases	5	2	1	6	3	8		7	4
Permitted Phases							8		
Detector Phase	5	2	1	6	3	8	8	7	4
Switch Phase									
Minimum Initial (s)	5.0	10.0	5.0	10.0	5.0	10.0	10.0	5.0	10.0
Minimum Split (s)	9.2	25.2	9.2	25.5	9.1	14.6	14.6	9.1	33.6
Total Split (s)	17.6	52.1	22.2	56.7	12.1	36.3	36.3	9.4	33.6
Total Split (%)	14.7%	43.4%	18.5%	47.3%	10.1%	30.3%	30.3%	7.8%	28.0%
Yellow Time (s)	3.2	5.2	3.2	5.5	3.6	3.6	3.6	3.6	3.6
All-Red Time (s)	1.0	1.0	1.0	1.0	0.5	1.0	1.0	0.5	1.0
Lost Time Adjust (s)	0.0	0.0	0.0	0.0	0.0	0.0	0.0	0.0	0.0
Total Lost Time (s)	4.2	6.2	4.2	6.5	4.1	4.6	4.6	4.1	4.6
Lead/Lag	Lead	Lag	Lead	Lag	Lead	Lag	Lag	Lead	Lag
Lead-Lag Optimize?	Yes	Yes	Yes	Yes	Yes	Yes	Yes	Yes	Yes
Recall Mode	None	None	None	None	None	None	None	None	None
Act Effct Green (s)	9.9	46.1	18.1	54.0	8.0	21.9	21.9	5.3	13.4
Actuated g/C Ratio	0.09	0.44	0.17	0.52	0.08	0.21	0.21	0.05	0.13
v/c Ratio	0.61	0.92	0.87	0.46	0.81	0.16	0.45	0.19	0.40
Control Delay	61.9	38.5	71.1	18.1	71.9	36.2	7.9	55.3	17.6
Queue Delay	0.0	0.0	0.0	0.0	0.0	0.0	0.0	0.0	0.0
Total Delay	61.9	38.5	71.1	18.1	71.9	36.2	7.9	55.3	17.6
LOS	E	D	E	B	E	D	A	E	B
Approach Delay		40.1		27.8		39.2			22.5
Approach LOS		D		C		D			C

Intersection Summary

Cycle Length: 120
 Actuated Cycle Length: 104.8
 Natural Cycle: 120
 Control Type: Actuated-Uncoordinated
 Maximum v/c Ratio: 0.92
 Intersection Signal Delay: 34.3
 Intersection LOS: C
 Intersection Capacity Utilization 76.6%
 ICU Level of Service D
 Analysis Period (min) 15

Splits and Phases: 14: Barton Rd. & Van Buren Bl.



HCM 6th Signalized Intersection Summary
 14: Barton Rd. & Van Buren Bl.

West Campus Upper Plateau (JN 14064)

02/16/2022



Movement	EBL	EBT	EBR	WBL	WBT	WBR	NBL	NBT	NBR	SBL	SBT	SBR
Lane Configurations	↗	↗↘		↗	↗↘↙		↗↘	↑	↗	↗	↘	↘
Traffic Volume (veh/h)	100	1100	218	255	1114	32	209	61	212	16	27	82
Future Volume (veh/h)	100	1100	218	255	1114	32	209	61	212	16	27	82
Initial Q (Qb), veh	0	0	0	0	0	0	0	0	0	0	0	0
Ped-Bike Adj(A_pbT)	1.00		1.00	1.00		1.00	1.00		0.95	1.00		1.00
Parking Bus, Adj	1.00	1.00	1.00	1.00	1.00	1.00	1.00	1.00	1.00	1.00	1.00	1.00
Work Zone On Approach		No			No			No				No
Adj Sat Flow, veh/h/ln	1900	1841	1870	1870	1856	1856	1900	1900	1885	1900	1841	1900
Adj Flow Rate, veh/h	104	1146	198	266	1160	23	218	64	97	17	28	27
Peak Hour Factor	0.96	0.96	0.96	0.96	0.96	0.96	0.96	0.96	0.96	0.96	0.96	0.96
Percent Heavy Veh, %	0	4	2	2	3	3	0	0	1	0	4	0
Cap, veh/h	133	1274	219	301	2671	53	290	328	262	35	94	91
Arrive On Green	0.07	0.43	0.43	0.17	0.52	0.52	0.08	0.17	0.17	0.02	0.11	0.11
Sat Flow, veh/h	1810	2983	513	1781	5113	101	3510	1900	1517	1810	861	830
Grp Volume(v), veh/h	104	670	674	266	766	417	218	64	97	17	0	55
Grp Sat Flow(s),veh/h/ln	1810	1749	1748	1781	1689	1837	1755	1900	1517	1810	0	1691
Q Serve(g_s), s	5.2	32.5	32.9	13.3	12.8	12.8	5.5	2.6	5.2	0.8	0.0	2.7
Cycle Q Clear(g_c), s	5.2	32.5	32.9	13.3	12.8	12.8	5.5	2.6	5.2	0.8	0.0	2.7
Prop In Lane	1.00		0.29	1.00		0.06	1.00		1.00	1.00		0.49
Lane Grp Cap(c), veh/h	133	747	746	301	1764	960	290	328	262	35	0	185
V/C Ratio(X)	0.78	0.90	0.90	0.88	0.43	0.43	0.75	0.20	0.37	0.49	0.00	0.30
Avail Cap(c_a), veh/h	265	879	878	351	1856	1010	307	659	526	105	0	537
HCM Platoon Ratio	1.00	1.00	1.00	1.00	1.00	1.00	1.00	1.00	1.00	1.00	1.00	1.00
Upstream Filter(I)	1.00	1.00	1.00	1.00	1.00	1.00	1.00	1.00	1.00	1.00	0.00	1.00
Uniform Delay (d), s/veh	41.6	24.3	24.4	37.1	13.5	13.5	41.0	32.4	33.4	44.4	0.0	37.5
Incr Delay (d2), s/veh	3.8	9.7	10.4	18.7	0.1	0.1	9.4	0.3	0.9	10.3	0.0	0.9
Initial Q Delay(d3),s/veh	0.0	0.0	0.0	0.0	0.0	0.0	0.0	0.0	0.0	0.0	0.0	0.0
%ile BackOfQ(50%),veh/ln	2.3	13.7	14.0	7.0	4.1	4.5	2.7	1.2	1.9	0.5	0.0	1.2
Unsig. Movement Delay, s/veh												
LnGrp Delay(d),s/veh	45.4	34.1	34.9	55.8	13.5	13.6	50.4	32.6	34.3	54.7	0.0	38.4
LnGrp LOS	D	C	C	E	B	B	D	C	C	D	A	D
Approach Vol, veh/h		1448			1449			379				72
Approach Delay, s/veh		35.2			21.3			43.3				42.2
Approach LOS		D			C			D				D
Timer - Assigned Phs	1	2	3	4	5	6	7	8				
Phs Duration (G+Y+Rc), s	19.6	45.5	11.7	14.6	10.9	54.2	5.9	20.4				
Change Period (Y+Rc), s	* 4.2	* 6.5	4.1	4.6	* 4.2	6.5	4.1	4.6				
Max Green Setting (Gmax), s	* 18	* 46	8.0	29.0	* 13	50.2	5.3	31.7				
Max Q Clear Time (g_c+I1), s	15.3	34.9	7.5	4.7	7.2	14.8	2.8	7.2				
Green Ext Time (p_c), s	0.1	4.1	0.0	0.2	0.1	4.9	0.0	0.6				

Intersection Summary

HCM 6th Ctrl Delay	30.3
HCM 6th LOS	C

Notes

* HCM 6th computational engine requires equal clearance times for the phases crossing the barrier.

Intersection

Intersection Delay, s/veh	8.5
Intersection LOS	A

Movement	EBT	EBR	WBL	WBT	NBL	NBR
Lane Configurations						
Traffic Vol, veh/h	143	61	35	69	49	58
Future Vol, veh/h	143	61	35	69	49	58
Peak Hour Factor	0.94	0.94	0.94	0.94	0.94	0.94
Heavy Vehicles, %	1	2	3	2	2	0
Mvmt Flow	152	65	37	73	52	62
Number of Lanes	1	0	1	1	1	0

Approach	EB	WB	NB
Opposing Approach	WB	EB	
Opposing Lanes	2	1	0
Conflicting Approach Left		NB	EB
Conflicting Lanes Left	0	1	1
Conflicting Approach Right	NB		WB
Conflicting Lanes Right	1	0	2
HCM Control Delay	8.7	8.3	8.2
HCM LOS	A	A	A

Lane	NBLn1	EBLn1	WBLn1	WBLn2
Vol Left, %	46%	0%	100%	0%
Vol Thru, %	0%	70%	0%	100%
Vol Right, %	54%	30%	0%	0%
Sign Control	Stop	Stop	Stop	Stop
Traffic Vol by Lane	107	204	35	69
LT Vol	49	0	35	0
Through Vol	0	143	0	69
RT Vol	58	61	0	0
Lane Flow Rate	114	217	37	73
Geometry Grp	2	5	7	7
Degree of Util (X)	0.14	0.255	0.057	0.101
Departure Headway (Hd)	4.442	4.235	5.477	4.958
Convergence, Y/N	Yes	Yes	Yes	Yes
Cap	809	851	656	724
Service Time	2.46	2.25	3.195	2.675
HCM Lane V/C Ratio	0.141	0.255	0.056	0.101
HCM Control Delay	8.2	8.7	8.5	8.2
HCM Lane LOS	A	A	A	A
HCM 95th-tile Q	0.5	1	0.2	0.3

Intersection	
Intersection Delay, s/veh	8.6
Intersection LOS	A

Movement	EBL	EBT	WBT	WBR	SBL	SBR
Lane Configurations						
Traffic Vol, veh/h	113	278	199	32	25	36
Future Vol, veh/h	113	278	199	32	25	36
Peak Hour Factor	0.97	0.97	0.97	0.97	0.97	0.97
Heavy Vehicles, %	1	0	2	0	4	3
Mvmt Flow	116	287	205	33	26	37
Number of Lanes	1	2	2	0	1	0

Approach	EB	WB	SB
Opposing Approach	WB	EB	
Opposing Lanes	2	3	0
Conflicting Approach Left	SB		WB
Conflicting Lanes Left	1	0	2
Conflicting Approach Right		SB	EB
Conflicting Lanes Right	0	1	3
HCM Control Delay	8.1	9.2	9.1
HCM LOS	A	A	A

Lane	EBLn1	EBLn2	EBLn3	WBLn1	WBLn2	SBLn1
Vol Left, %	100%	0%	0%	0%	0%	41%
Vol Thru, %	0%	100%	100%	100%	67%	0%
Vol Right, %	0%	0%	0%	0%	33%	59%
Sign Control	Stop	Stop	Stop	Stop	Stop	Stop
Traffic Vol by Lane	113	139	139	133	98	61
LT Vol	113	0	0	0	0	25
Through Vol	0	139	139	133	66	0
RT Vol	0	0	0	0	32	36
Lane Flow Rate	116	143	143	137	101	63
Geometry Grp	7	7	7	8	8	7
Degree of Util (X)	0.175	0.195	0.127	0.205	0.145	0.099
Departure Headway (Hd)	5.417	4.898	3.191	5.407	5.144	5.679
Convergence, Y/N	Yes	Yes	Yes	Yes	Yes	Yes
Cap	663	734	1122	663	696	629
Service Time	3.141	2.622	0.914	3.142	2.879	3.425
HCM Lane V/C Ratio	0.175	0.195	0.127	0.207	0.145	0.1
HCM Control Delay	9.3	8.8	6.4	9.5	8.8	9.1
HCM Lane LOS	A	A	A	A	A	A
HCM 95th-tile Q	0.6	0.7	0.4	0.8	0.5	0.3

Timings
19: Van Buren Bl. & Orange Terrace Pkwy.

West Campus Upper Plateau (JN 14064)

02/16/2022

Lane Group	EBL	EBT	EBR	WBL	WBT	WBR	NBL	NBT	NBR	SBL	SBT	SBR
Lane Configurations												
Traffic Volume (vph)	124	1219	77	47	1221	200	59	30	37	107	30	96
Future Volume (vph)	124	1219	77	47	1221	200	59	30	37	107	30	96
Turn Type	Prot	NA	Perm	Prot	NA	Perm	Prot	NA	Perm	Prot	NA	pm+ov
Protected Phases	5	2		1	6		3	8		7	4	5
Permitted Phases			2			6			8			4
Detector Phase	5	2	2	1	6	6	3	8	8	7	4	5
Switch Phase												
Minimum Initial (s)	5.0	10.0	10.0	5.0	10.0	10.0	5.0	5.0	5.0	10.0	10.0	5.0
Minimum Split (s)	9.2	25.2	25.2	9.1	25.2	25.2	9.1	26.1	26.1	15.8	24.8	9.2
Total Split (s)	16.0	63.0	63.0	11.0	58.0	58.0	12.0	27.0	27.0	19.0	34.0	16.0
Total Split (%)	13.3%	52.5%	52.5%	9.2%	48.3%	48.3%	10.0%	22.5%	22.5%	15.8%	28.3%	13.3%
Yellow Time (s)	3.2	5.2	5.2	3.6	5.2	5.2	3.6	3.6	3.6	4.8	4.8	3.2
All-Red Time (s)	1.0	1.0	1.0	0.5	1.0	1.0	0.5	0.5	0.5	1.0	1.0	1.0
Lost Time Adjust (s)	0.0	0.0	0.0	0.0	0.0	0.0	0.0	0.0	0.0	0.0	0.0	0.0
Total Lost Time (s)	4.2	6.2	6.2	4.1	6.2	6.2	4.1	4.1	4.1	5.8	5.8	4.2
Lead/Lag	Lead	Lag	Lag	Lead	Lag	Lag	Lead	Lag	Lag	Lead	Lag	Lead
Lead-Lag Optimize?	Yes	Yes	Yes	Yes	Yes	Yes	Yes	Yes	Yes	Yes	Yes	Yes
Recall Mode	None	None	None	None	None	None	None	None	None	None	None	None
Act Effct Green (s)	8.1	40.7	40.7	7.1	30.8	30.8	7.4	8.5	8.5	11.6	14.8	22.8
Actuated g/C Ratio	0.11	0.57	0.57	0.10	0.43	0.43	0.10	0.12	0.12	0.16	0.21	0.32
v/c Ratio	0.33	0.44	0.09	0.14	0.59	0.26	0.18	0.07	0.11	0.20	0.08	0.18
Control Delay	38.1	14.9	0.2	38.6	18.8	3.5	38.2	34.4	0.6	35.1	31.9	10.4
Queue Delay	0.0	0.0	0.0	0.0	0.0	0.0	0.0	0.0	0.0	0.0	0.0	0.0
Total Delay	38.1	14.9	0.2	38.6	18.8	3.5	38.2	34.4	0.6	35.1	31.9	10.4
LOS	D	B	A	D	B	A	D	C	A	D	C	B
Approach Delay		16.1			17.3			26.1			24.4	
Approach LOS		B			B			C			C	

Intersection Summary

Cycle Length: 120
 Actuated Cycle Length: 71.5
 Natural Cycle: 80
 Control Type: Actuated-Uncoordinated
 Maximum v/c Ratio: 0.59
 Intersection Signal Delay: 17.6
 Intersection LOS: B
 Intersection Capacity Utilization 51.0%
 ICU Level of Service A
 Analysis Period (min) 15

Splits and Phases: 19: Van Buren Bl. & Orange Terrace Pkwy.

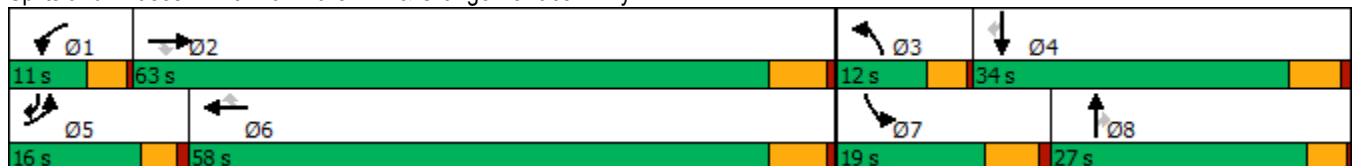

HCM 6th Signalized Intersection Summary
 19: Van Buren Bl. & Orange Terrace Pkwy.

West Campus Upper Plateau (JN 14064)

02/16/2022



Movement	EBL	EBT	EBR	WBL	WBT	WBR	NBL	NBT	NBR	SBL	SBT	SBR
Lane Configurations	↔↔	↑↑↑	↗	↔↔	↑↑↑	↗	↔↔	↑↑	↗	↔↔	↑	↗
Traffic Volume (veh/h)	124	1219	77	47	1221	200	59	30	37	107	30	96
Future Volume (veh/h)	124	1219	77	47	1221	200	59	30	37	107	30	96
Initial Q (Qb), veh	0	0	0	0	0	0	0	0	0	0	0	0
Ped-Bike Adj(A_pbT)	1.00		1.00	1.00		1.00	1.00		1.00	1.00		1.00
Parking Bus, Adj	1.00	1.00	1.00	1.00	1.00	1.00	1.00	1.00	1.00	1.00	1.00	1.00
Work Zone On Approach		No			No			No			No	
Adj Sat Flow, veh/h/ln	1885	1856	1811	1870	1856	1885	1796	1900	1856	1885	1900	1885
Adj Flow Rate, veh/h	129	1270	54	49	1272	149	61	31	8	111	31	27
Peak Hour Factor	0.96	0.96	0.96	0.96	0.96	0.96	0.96	0.96	0.96	0.96	0.96	0.96
Percent Heavy Veh, %	1	3	6	2	3	1	7	0	3	1	0	1
Cap, veh/h	234	2115	641	154	1993	628	167	252	110	506	361	411
Arrive On Green	0.07	0.42	0.42	0.04	0.39	0.39	0.05	0.07	0.07	0.15	0.19	0.19
Sat Flow, veh/h	3483	5066	1535	3456	5066	1598	3319	3610	1572	3483	1900	1598
Grp Volume(v), veh/h	129	1270	54	49	1272	149	61	31	8	111	31	27
Grp Sat Flow(s),veh/h/ln	1742	1689	1535	1728	1689	1598	1659	1805	1572	1742	1900	1598
Q Serve(g_s), s	2.4	13.2	1.4	0.9	13.8	4.2	1.2	0.5	0.3	1.9	0.9	0.9
Cycle Q Clear(g_c), s	2.4	13.2	1.4	0.9	13.8	4.2	1.2	0.5	0.3	1.9	0.9	0.9
Prop In Lane	1.00		1.00	1.00		1.00	1.00		1.00	1.00		1.00
Lane Grp Cap(c), veh/h	234	2115	641	154	1993	628	167	252	110	506	361	411
V/C Ratio(X)	0.55	0.60	0.08	0.32	0.64	0.24	0.37	0.12	0.07	0.22	0.09	0.07
Avail Cap(c_a), veh/h	606	4239	1284	351	3866	1219	386	1218	531	677	789	771
HCM Platoon Ratio	1.00	1.00	1.00	1.00	1.00	1.00	1.00	1.00	1.00	1.00	1.00	1.00
Upstream Filter(I)	1.00	1.00	1.00	1.00	1.00	1.00	1.00	1.00	1.00	1.00	1.00	1.00
Uniform Delay (d), s/veh	30.7	15.4	11.9	31.4	16.7	13.8	31.2	29.6	29.5	25.6	22.6	19.0
Incr Delay (d2), s/veh	0.8	0.3	0.1	1.2	0.3	0.2	1.3	0.2	0.3	0.2	0.1	0.1
Initial Q Delay(d3),s/veh	0.0	0.0	0.0	0.0	0.0	0.0	0.0	0.0	0.0	0.0	0.0	0.0
%ile BackOfQ(50%),veh/ln	0.9	4.1	0.5	0.4	4.4	1.4	0.5	0.2	0.1	0.7	0.4	0.3
Unsig. Movement Delay, s/veh												
LnGrp Delay(d),s/veh	31.4	15.6	12.0	32.6	17.0	14.0	32.5	29.8	29.8	25.8	22.7	19.1
LnGrp LOS	C	B	B	C	B	B	C	C	C	C	C	B
Approach Vol, veh/h		1453			1470			100			169	
Approach Delay, s/veh		16.9			17.2			31.5			24.2	
Approach LOS		B			B			C			C	
Timer - Assigned Phs	1	2	3	4	5	6	7	8				
Phs Duration (G+Y+Rc), s	7.1	34.5	7.5	18.7	8.8	32.9	15.7	10.5				
Change Period (Y+Rc), s	4.1	6.2	4.1	5.8	* 4.2	6.2	5.8	* 5.8				
Max Green Setting (Gmax), s	6.9	56.8	7.9	28.2	* 12	51.8	13.2	* 23				
Max Q Clear Time (g_c+I1), s	2.9	15.2	3.2	2.9	4.4	15.8	3.9	2.5				
Green Ext Time (p_c), s	0.0	10.7	0.0	0.2	0.1	10.9	0.2	0.1				

Intersection Summary

HCM 6th Ctrl Delay	17.9
HCM 6th LOS	B

Notes

* HCM 6th computational engine requires equal clearance times for the phases crossing the barrier.

Timings
20: Brown/San Gorgonio Dr & Alessandro Bl.

West Campus Upper Plateau (JN 14064)

02/16/2022



Lane Group	EBL	EBT	WBL	WBT	WBR	NBL	NBT	NBR	SBL	SBT	SBR
Lane Configurations	↖	↕	↖	↕	↖	↖	↕	↖	↖	↕	↖
Traffic Volume (vph)	26	1967	10	1865	29	14	2	23	108	1	68
Future Volume (vph)	26	1967	10	1865	29	14	2	23	108	1	68
Turn Type	Prot	NA	Prot	NA	Perm	Prot	NA	pm+ov	Prot	NA	pm+ov
Protected Phases	5	2	1	6		3	8	1	7	4	5
Permitted Phases					6			8			4
Detector Phase	5	2	1	6	6	3	8	1	7	4	5
Switch Phase											
Minimum Initial (s)	5.0	10.0	5.0	10.0	10.0	5.0	5.0	5.0	5.0	10.0	5.0
Minimum Split (s)	8.7	43.5	9.1	43.5	43.5	9.1	26.1	9.1	8.7	49.8	8.7
Total Split (s)	8.7	52.0	9.1	52.4	52.4	9.1	39.3	9.1	19.6	49.8	8.7
Total Split (%)	7.3%	43.3%	7.6%	43.7%	43.7%	7.6%	32.8%	7.6%	16.3%	41.5%	7.3%
Yellow Time (s)	3.2	5.5	3.6	5.5	5.5	3.6	3.6	3.6	3.2	4.8	3.2
All-Red Time (s)	0.5	1.0	0.5	1.0	1.0	0.5	0.5	0.5	0.5	1.0	0.5
Lost Time Adjust (s)	0.0	0.0	0.0	0.0	0.0	0.0	0.0	0.0	0.0	0.0	0.0
Total Lost Time (s)	3.7	6.5	4.1	6.5	6.5	4.1	4.1	4.1	3.7	5.8	3.7
Lead/Lag	Lead	Lag	Lead	Lag	Lag	Lead	Lag	Lead	Lead	Lag	Lead
Lead-Lag Optimize?	Yes	Yes	Yes	Yes	Yes	Yes	Yes	Yes	Yes	Yes	Yes
Recall Mode	None	None	None	None	None	None	None	None	None	None	None
Act Effct Green (s)	5.4	52.8	5.4	51.2	51.2	5.4	9.9	10.6	11.5	15.3	22.0
Actuated g/C Ratio	0.07	0.66	0.07	0.64	0.64	0.07	0.12	0.13	0.14	0.19	0.27
v/c Ratio	0.23	0.61	0.13	0.60	0.04	0.14	0.01	0.10	0.47	0.00	0.15
Control Delay	48.6	16.1	48.5	16.5	0.1	47.4	31.5	0.8	43.6	26.0	6.1
Queue Delay	0.0	0.0	0.0	0.0	0.0	0.0	0.0	0.0	0.0	0.0	0.0
Total Delay	48.6	16.1	48.5	16.5	0.1	47.4	31.5	0.8	43.6	26.0	6.1
LOS	D	B	D	B	A	D	C	A	D	C	A
Approach Delay		16.5		16.4			19.4			29.1	
Approach LOS		B		B			B			C	

Intersection Summary

Cycle Length: 120
 Actuated Cycle Length: 80.6
 Natural Cycle: 115
 Control Type: Actuated-Uncoordinated
 Maximum v/c Ratio: 0.61
 Intersection Signal Delay: 17.0
 Intersection LOS: B
 Intersection Capacity Utilization 61.0%
 ICU Level of Service B
 Analysis Period (min) 15

Splits and Phases: 20: Brown/San Gorgonio Dr & Alessandro Bl.

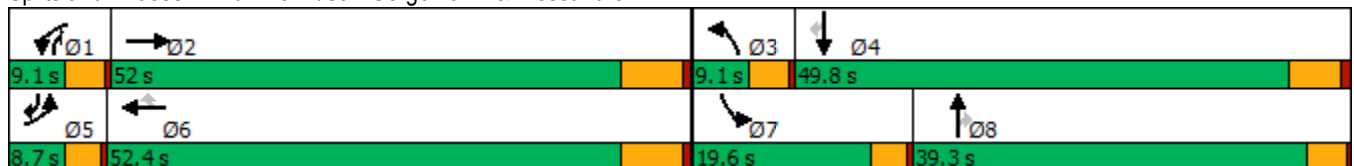

HCM 6th Signalized Intersection Summary
20: Brown/San Gorgonio Dr & Alessandro Bl.

West Campus Upper Plateau (JN 14064)

02/16/2022



Movement	EBL	EBT	EBR	WBL	WBT	WBR	NBL	NBT	NBR	SBL	SBT	SBR
Lane Configurations	↗	↗↗↗		↗	↗↗↗	↗	↗	↗	↗	↗	↗	↗
Traffic Volume (veh/h)	26	1967	4	10	1865	29	14	2	23	108	1	68
Future Volume (veh/h)	26	1967	4	10	1865	29	14	2	23	108	1	68
Initial Q (Qb), veh	0	0	0	0	0	0	0	0	0	0	0	0
Ped-Bike Adj(A_pbT)	1.00		1.00	1.00		1.00	1.00		1.00	1.00		1.00
Parking Bus, Adj	1.00	1.00	1.00	1.00	1.00	1.00	1.00	1.00	1.00	1.00	1.00	1.00
Work Zone On Approach		No			No			No			No	
Adj Sat Flow, veh/h/ln	1900	1900	1900	1307	1885	1396	1796	1900	1322	1796	1900	1885
Adj Flow Rate, veh/h	27	2071	0	11	1963	27	15	2	11	114	1	24
Peak Hour Factor	0.95	0.95	0.95	0.95	0.95	0.95	0.95	0.95	0.95	0.95	0.95	0.95
Percent Heavy Veh, %	0	0	0	40	1	34	7	0	39	7	0	1
Cap, veh/h	52	2942	0	17	2869	660	31	126	90	145	243	250
Arrive On Green	0.03	0.57	0.00	0.01	0.56	0.56	0.02	0.07	0.07	0.08	0.13	0.13
Sat Flow, veh/h	1810	5358	0	1245	5147	1183	1711	1900	1120	1711	1900	1598
Grp Volume(v), veh/h	27	2071	0	11	1963	27	15	2	11	114	1	24
Grp Sat Flow(s),veh/h/ln	1810	1729	0	1245	1716	1183	1711	1900	1120	1711	1900	1598
Q Serve(g_s), s	1.1	21.6	0.0	0.7	20.5	0.8	0.7	0.1	0.7	4.9	0.0	1.0
Cycle Q Clear(g_c), s	1.1	21.6	0.0	0.7	20.5	0.8	0.7	0.1	0.7	4.9	0.0	1.0
Prop In Lane	1.00		0.00	1.00		1.00	1.00		1.00	1.00		1.00
Lane Grp Cap(c), veh/h	52	2942	0	17	2869	660	31	126	90	145	243	250
V/C Ratio(X)	0.52	0.70	0.00	0.65	0.68	0.04	0.49	0.02	0.12	0.79	0.00	0.10
Avail Cap(c_a), veh/h	121	3149	0	83	3152	725	114	892	542	363	1115	984
HCM Platoon Ratio	1.00	1.00	1.00	1.00	1.00	1.00	1.00	1.00	1.00	1.00	1.00	1.00
Upstream Filter(I)	1.00	1.00	0.00	1.00	1.00	1.00	1.00	1.00	1.00	1.00	1.00	1.00
Uniform Delay (d), s/veh	35.9	11.7	0.0	36.8	11.9	7.5	36.5	32.7	32.0	33.6	28.5	27.1
Incr Delay (d2), s/veh	3.0	0.8	0.0	34.5	0.6	0.0	11.6	0.0	0.6	3.6	0.0	0.2
Initial Q Delay(d3),s/veh	0.0	0.0	0.0	0.0	0.0	0.0	0.0	0.0	0.0	0.0	0.0	0.0
%ile BackOfQ(50%),veh/ln	0.5	6.0	0.0	0.4	6.9	0.2	0.4	0.0	0.2	2.1	0.0	0.4
Unsig. Movement Delay, s/veh												
LnGrp Delay(d),s/veh	38.9	12.5	0.0	71.2	12.5	7.5	48.1	32.7	32.6	37.2	28.5	27.2
LnGrp LOS	D	B	A	E	B	A	D	C	C	D	C	C
Approach Vol, veh/h		2098			2001			28				139
Approach Delay, s/veh		12.8			12.8			40.9				35.4
Approach LOS		B			B			D				D
Timer - Assigned Phs	1	2	3	4	5	6	7	8				
Phs Duration (G+Y+Rc), s	5.1	49.0	5.4	15.4	5.8	48.3	10.0	10.8				
Change Period (Y+Rc), s	4.1	6.5	4.1	5.8	3.7	6.5	3.7	* 5.8				
Max Green Setting (Gmax), s	5.0	45.5	5.0	44.0	5.0	45.9	15.9	* 35				
Max Q Clear Time (g_c+I1), s	2.7	23.6	2.7	3.0	3.1	22.5	6.9	2.7				
Green Ext Time (p_c), s	0.0	17.7	0.0	0.1	0.0	19.3	0.1	0.0				

Intersection Summary

HCM 6th Ctrl Delay	13.7
HCM 6th LOS	B

Notes

* HCM 6th computational engine requires equal clearance times for the phases crossing the barrier.

Timings
22: Sycamore Canyon Bl. & Eastridge Ave

West Campus Upper Plateau (JN 14064)

02/16/2022



Lane Group	EBL	EBT	EBR	WBL	WBT	WBR	NBL	NBT	NBR	SBL	SBT	SBR
Lane Configurations	↖↖	↑↑↑	↗	↖↖	↑↑	↗	↖↖	↑↑	↗	↖↖	↑↑	↗
Traffic Volume (vph)	82	86	46	164	60	319	29	605	134	251	323	17
Future Volume (vph)	82	86	46	164	60	319	29	605	134	251	323	17
Turn Type	Prot	NA	Perm	Prot	NA	pm+ov	Prot	NA	pm+ov	Prot	NA	pm+ov
Protected Phases	5	2		1	6	7	3	8	1	7	4	5
Permitted Phases			2			6			8			4
Detector Phase	5	2	2	1	6	7	3	8	1	7	4	5
Switch Phase												
Minimum Initial (s)	5.0	10.0	10.0	5.0	10.0	5.0	5.0	10.0	5.0	5.0	10.0	5.0
Minimum Split (s)	8.7	43.5	43.5	8.7	43.5	8.7	8.7	15.8	8.7	8.7	49.8	8.7
Total Split (s)	11.7	45.5	45.5	15.2	49.0	20.2	8.7	39.1	15.2	20.2	50.6	11.7
Total Split (%)	9.8%	37.9%	37.9%	12.7%	40.8%	16.8%	7.3%	32.6%	12.7%	16.8%	42.2%	9.8%
Yellow Time (s)	3.2	5.5	5.5	3.2	5.5	3.2	3.2	4.8	3.2	3.2	4.8	3.2
All-Red Time (s)	0.5	1.0	1.0	0.5	1.0	0.5	0.5	1.0	0.5	0.5	1.0	0.5
Lost Time Adjust (s)	0.0	0.0	0.0	0.0	0.0	0.0	0.0	0.0	0.0	0.0	0.0	0.0
Total Lost Time (s)	3.7	6.5	6.5	3.7	6.5	3.7	3.7	5.8	3.7	3.7	5.8	3.7
Lead/Lag	Lead	Lag	Lag	Lead	Lag	Lead	Lead	Lag	Lead	Lead	Lag	Lead
Lead-Lag Optimize?	Yes	Yes	Yes	Yes	Yes	Yes	Yes	Yes	Yes	Yes	Yes	Yes
Recall Mode	None	None	None	None	None	None	None	None	None	None	None	None
Act Effct Green (s)	7.1	13.8	13.8	11.3	15.5	29.9	5.5	21.6	35.2	11.3	32.3	41.7
Actuated g/C Ratio	0.10	0.19	0.19	0.15	0.21	0.40	0.07	0.29	0.48	0.15	0.44	0.56
v/c Ratio	0.32	0.12	0.14	0.35	0.12	0.56	0.15	0.69	0.19	0.55	0.24	0.03
Control Delay	41.2	28.9	0.7	37.2	27.2	16.5	42.8	29.2	3.8	37.0	16.3	0.1
Queue Delay	0.0	0.0	0.0	0.0	0.0	0.0	0.0	0.0	0.0	0.0	0.0	0.0
Total Delay	41.2	28.9	0.7	37.2	27.2	16.5	42.8	29.2	3.8	37.0	16.3	0.1
LOS	D	C	A	D	C	B	D	C	A	D	B	A
Approach Delay		27.5			24.0			25.3			24.6	
Approach LOS		C			C			C			C	

Intersection Summary

Cycle Length: 120
 Actuated Cycle Length: 74.1
 Natural Cycle: 115
 Control Type: Actuated-Uncoordinated
 Maximum v/c Ratio: 0.69
 Intersection Signal Delay: 25.0
 Intersection LOS: C
 Intersection Capacity Utilization 52.3%
 ICU Level of Service A
 Analysis Period (min) 15

Splits and Phases: 22: Sycamore Canyon Bl. & Eastridge Ave

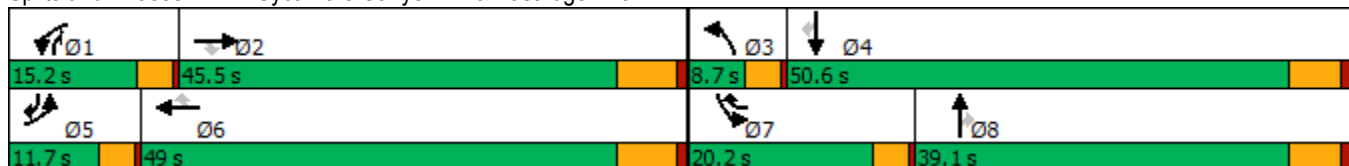

HCM 6th Signalized Intersection Summary
 22: Sycamore Canyon Bl. & Eastridge Ave

West Campus Upper Plateau (JN 14064)

02/16/2022



Movement	EBL	EBT	EBR	WBL	WBT	WBR	NBL	NBT	NBR	SBL	SBT	SBR
Lane Configurations												
Traffic Volume (veh/h)	82	86	46	164	60	319	29	605	134	251	323	17
Future Volume (veh/h)	82	86	46	164	60	319	29	605	134	251	323	17
Initial Q (Qb), veh	0	0	0	0	0	0	0	0	0	0	0	0
Ped-Bike Adj(A_pbT)	1.00		1.00	1.00		1.00	1.00		0.99	1.00		0.99
Parking Bus, Adj	1.00	1.00	1.00	1.00	1.00	1.00	1.00	1.00	1.00	1.00	1.00	1.00
Work Zone On Approach		No			No			No			No	
Adj Sat Flow, veh/h/ln	1648	1589	1826	1856	1396	1796	1618	1796	1826	1841	1826	1530
Adj Flow Rate, veh/h	92	97	0	184	67	174	33	680	94	282	363	15
Peak Hour Factor	0.89	0.89	0.89	0.89	0.89	0.89	0.89	0.89	0.89	0.89	0.89	0.89
Percent Heavy Veh, %	17	21	5	3	34	7	19	7	5	4	5	25
Cap, veh/h	201	761		288	514	475	106	982	570	403	1287	560
Arrive On Green	0.07	0.18	0.00	0.08	0.19	0.19	0.04	0.29	0.29	0.12	0.37	0.37
Sat Flow, veh/h	3045	4337	1547	3428	2653	1520	2990	3413	1528	3401	3469	1279
Grp Volume(v), veh/h	92	97	0	184	67	174	33	680	94	282	363	15
Grp Sat Flow(s),veh/h/ln	1522	1446	1547	1714	1326	1520	1495	1706	1528	1700	1735	1279
Q Serve(g_s), s	1.7	1.1	0.0	3.1	1.2	5.2	0.6	10.5	2.4	4.7	4.3	0.4
Cycle Q Clear(g_c), s	1.7	1.1	0.0	3.1	1.2	5.2	0.6	10.5	2.4	4.7	4.3	0.4
Prop In Lane	1.00		1.00	1.00		1.00	1.00		1.00	1.00		1.00
Lane Grp Cap(c), veh/h	201	761		288	514	475	106	982	570	403	1287	560
V/C Ratio(X)	0.46	0.13		0.64	0.13	0.37	0.31	0.69	0.16	0.70	0.28	0.03
Avail Cap(c_a), veh/h	413	2867		668	1911	1275	253	1926	992	951	2634	1057
HCM Platoon Ratio	1.00	1.00	1.00	1.00	1.00	1.00	1.00	1.00	1.00	1.00	1.00	1.00
Upstream Filter(I)	1.00	1.00	0.00	1.00	1.00	1.00	1.00	1.00	1.00	1.00	1.00	1.00
Uniform Delay (d), s/veh	26.5	20.5	0.0	26.1	19.7	15.8	27.8	18.7	12.4	25.0	13.0	9.5
Incr Delay (d2), s/veh	0.6	0.1	0.0	0.9	0.2	0.7	0.6	0.9	0.1	0.8	0.1	0.0
Initial Q Delay(d3),s/veh	0.0	0.0	0.0	0.0	0.0	0.0	0.0	0.0	0.0	0.0	0.0	0.0
%ile BackOfQ(50%),veh/ln	0.6	0.3	0.0	1.1	0.3	1.6	0.2	3.6	0.7	1.7	1.4	0.1
Unsig. Movement Delay, s/veh												
LnGrp Delay(d),s/veh	27.1	20.6	0.0	27.0	19.8	16.4	28.4	19.6	12.5	25.8	13.2	9.5
LnGrp LOS	C	C		C	B	B	C	B	B	C	B	A
Approach Vol, veh/h		189	A		425			807			660	
Approach Delay, s/veh		23.8			21.6			19.1			18.5	
Approach LOS		C			C			B			B	
Timer - Assigned Phs	1	2	3	4	5	6	7	8				
Phs Duration (G+Y+Rc), s	8.7	16.9	5.8	27.7	7.6	17.9	10.7	22.8				
Change Period (Y+Rc), s	3.7	6.5	3.7	5.8	3.7	6.5	3.7	5.8				
Max Green Setting (Gmax), s	11.5	39.0	5.0	44.8	8.0	42.5	16.5	33.3				
Max Q Clear Time (g_c+I1), s	5.1	3.1	2.6	6.3	3.7	7.2	6.7	12.5				
Green Ext Time (p_c), s	0.2	0.8	0.0	2.3	0.0	1.5	0.4	4.5				

Intersection Summary

HCM 6th Ctrl Delay	19.8
HCM 6th LOS	B

Notes

Unsignalized Delay for [EBR] is excluded from calculations of the approach delay and intersection delay.

Timings
23: Sycamore Canyon Bl. & Cottonwood Ave

West Campus Upper Plateau (JN 14064)

02/16/2022



Lane Group	WBL	WBR	NBT	SBL	SBT
Lane Configurations	↙	↗	↕	↘	↕
Traffic Volume (vph)	25	10	711	31	563
Future Volume (vph)	25	10	711	31	563
Turn Type	Prot	Perm	NA	Prot	NA
Protected Phases	8		2	1	6
Permitted Phases		8			
Detector Phase	8	8	2	1	6
Switch Phase					
Minimum Initial (s)	10.0	10.0	10.0	5.0	10.0
Minimum Split (s)	15.8	15.8	43.5	9.1	43.5
Total Split (s)	23.0	23.0	78.0	19.0	97.0
Total Split (%)	19.2%	19.2%	65.0%	15.8%	80.8%
Yellow Time (s)	4.8	4.8	5.5	3.6	5.5
All-Red Time (s)	1.0	1.0	1.0	0.5	1.0
Lost Time Adjust (s)	0.0	0.0	0.0	0.0	0.0
Total Lost Time (s)	5.8	5.8	6.5	4.1	6.5
Lead/Lag			Lag	Lead	
Lead-Lag Optimize?			Yes	Yes	
Recall Mode	None	None	None	None	None
Act Effct Green (s)	13.6	13.6	29.8	8.7	32.9
Actuated g/C Ratio	0.36	0.36	0.78	0.23	0.86
v/c Ratio	0.06	0.03	0.33	0.11	0.22
Control Delay	20.7	13.6	7.4	22.3	2.8
Queue Delay	0.0	0.0	0.0	0.0	0.0
Total Delay	20.7	13.6	7.4	22.3	2.8
LOS	C	B	A	C	A
Approach Delay	18.6		7.4		3.8
Approach LOS	B		A		A

Intersection Summary

Cycle Length: 120
 Actuated Cycle Length: 38.3
 Natural Cycle: 70
 Control Type: Actuated-Uncoordinated
 Maximum v/c Ratio: 0.33
 Intersection Signal Delay: 6.1
 Intersection Capacity Utilization 44.3%
 Analysis Period (min) 15
 Intersection LOS: A
 ICU Level of Service A

Splits and Phases: 23: Sycamore Canyon Bl. & Cottonwood Ave



HCM 6th Signalized Intersection Summary
 23: Sycamore Canyon Bl. & Cottonwood Ave

West Campus Upper Plateau (JN 14064)

02/16/2022



Movement	WBL	WBR	NBT	NBR	SBL	SBT
Lane Configurations	↶	↷	↕		↶	↕
Traffic Volume (veh/h)	25	10	711	22	31	563
Future Volume (veh/h)	25	10	711	22	31	563
Initial Q (Qb), veh	0	0	0	0	0	0
Ped-Bike Adj(A_pbT)	1.00	1.00		0.98	1.00	
Parking Bus, Adj	1.00	1.00	1.00	1.00	1.00	1.00
Work Zone On Approach	No		No			No
Adj Sat Flow, veh/h/ln	1574	1070	1796	1752	1485	1870
Adj Flow Rate, veh/h	29	2	827	25	36	655
Peak Hour Factor	0.86	0.86	0.86	0.86	0.86	0.86
Percent Heavy Veh, %	22	56	7	10	28	2
Cap, veh/h	110	66	1555	47	59	2160
Arrive On Green	0.07	0.07	0.46	0.46	0.04	0.61
Sat Flow, veh/h	1499	907	3469	102	1414	3647
Grp Volume(v), veh/h	29	2	418	434	36	655
Grp Sat Flow(s),veh/h/ln	1499	907	1706	1775	1414	1777
Q Serve(g_s), s	0.7	0.1	6.7	6.7	1.0	3.4
Cycle Q Clear(g_c), s	0.7	0.1	6.7	6.7	1.0	3.4
Prop In Lane	1.00	1.00		0.06	1.00	
Lane Grp Cap(c), veh/h	110	66	785	817	59	2160
V/C Ratio(X)	0.26	0.03	0.53	0.53	0.61	0.30
Avail Cap(c_a), veh/h	668	404	3163	3290	546	8337
HCM Platoon Ratio	1.00	1.00	1.00	1.00	1.00	1.00
Upstream Filter(I)	1.00	1.00	1.00	1.00	1.00	1.00
Uniform Delay (d), s/veh	16.9	16.6	7.4	7.4	18.2	3.6
Incr Delay (d2), s/veh	1.3	0.2	0.8	0.8	10.0	0.1
Initial Q Delay(d3),s/veh	0.0	0.0	0.0	0.0	0.0	0.0
%ile BackOfQ(50%),veh/ln	0.2	0.0	1.4	1.5	0.4	0.3
Unsig. Movement Delay, s/veh						
LnGrp Delay(d),s/veh	18.2	16.8	8.2	8.2	28.1	3.7
LnGrp LOS	B	B	A	A	C	A
Approach Vol, veh/h	31		852			691
Approach Delay, s/veh	18.1		8.2			5.0
Approach LOS	B		A			A
Timer - Assigned Phs	1	2			6	8
Phs Duration (G+Y+Rc), s	5.7	24.2			29.9	8.6
Change Period (Y+Rc), s	4.1	6.5			6.5	5.8
Max Green Setting (Gmax), s	14.9	71.5			90.5	17.2
Max Q Clear Time (g_c+I1), s	3.0	8.7			5.4	2.7
Green Ext Time (p_c), s	0.0	9.0			7.0	0.0
Intersection Summary						
HCM 6th Ctrl Delay			7.0			
HCM 6th LOS			A			

Timings

West Campus Upper Plateau (JN 14064)

24: Sycamore Canyon Bl. & Alessandro Bl.

02/16/2022



Lane Group	EBL	EBT	EBR	WBL	WBT	WBR	NBL	NBT	NBR	SBL	SBT	SBR
Lane Configurations	↖	↑↑↑	↗	↖↗	↑↑↑	↗	↖↗	↑↑	↖↗	↖↗	↑↑	↖
Traffic Volume (vph)	131	1430	537	289	1515	391	443	394	77	125	490	254
Future Volume (vph)	131	1430	537	289	1515	391	443	394	77	125	490	254
Turn Type	Prot	NA	Perm	Prot	NA	Perm	Prot	NA	pm+ov	Prot	NA	Perm
Protected Phases	5	2		1	6		3	8	1	7	4	
Permitted Phases			2			6			8			4
Detector Phase	5	2	2	1	6	6	3	8	1	7	4	4
Switch Phase												
Minimum Initial (s)	5.0	10.0	10.0	5.0	10.0	10.0	5.0	10.0	5.0	5.0	10.0	10.0
Minimum Split (s)	8.7	43.5	43.5	8.7	43.5	43.5	8.7	15.8	8.7	8.7	49.8	49.8
Total Split (s)	10.0	44.2	44.2	12.0	46.2	46.2	14.0	51.0	12.0	12.8	49.8	49.8
Total Split (%)	8.3%	36.8%	36.8%	10.0%	38.5%	38.5%	11.7%	42.5%	10.0%	10.7%	41.5%	41.5%
Yellow Time (s)	3.2	5.5	5.5	3.2	5.5	5.5	3.2	4.8	3.2	3.2	4.8	4.8
All-Red Time (s)	0.5	1.0	1.0	0.5	1.0	1.0	0.5	1.0	0.5	0.5	1.0	1.0
Lost Time Adjust (s)	0.0	0.0	0.0	0.0	0.0	0.0	0.0	0.0	0.0	0.0	0.0	0.0
Total Lost Time (s)	3.7	6.5	6.5	3.7	6.5	6.5	3.7	5.8	3.7	3.7	5.8	5.8
Lead/Lag	Lead	Lag	Lag	Lead	Lag	Lag	Lead	Lag	Lead	Lead	Lag	Lag
Lead-Lag Optimize?	Yes	Yes	Yes	Yes	Yes	Yes	Yes	Yes	Yes	Yes	Yes	Yes
Recall Mode	None	None	None	None	None	None	None	None	None	None	None	None
Act Effct Green (s)	6.4	38.1	38.1	8.4	40.1	40.1	10.4	25.8	40.0	7.8	23.2	23.2
Actuated g/C Ratio	0.06	0.38	0.38	0.08	0.40	0.40	0.10	0.26	0.40	0.08	0.23	0.23
v/c Ratio	1.18	0.75	0.69	1.12	0.75	0.56	1.27	0.45	0.07	0.49	0.63	0.55
Control Delay	180.8	31.0	17.5	134.1	29.9	16.2	178.7	32.2	6.0	52.8	37.3	20.0
Queue Delay	0.0	0.0	0.0	0.0	0.0	0.0	0.0	0.0	0.0	0.0	0.0	0.0
Total Delay	180.8	31.0	17.5	134.1	29.9	16.2	178.7	32.2	6.0	52.8	37.3	20.0
LOS	F	C	B	F	C	B	F	C	A	D	D	B
Approach Delay		37.0			41.2			100.9			34.5	
Approach LOS		D			D			F			C	

Intersection Summary

Cycle Length: 120
 Actuated Cycle Length: 99.9
 Natural Cycle: 115
 Control Type: Actuated-Uncoordinated
 Maximum v/c Ratio: 1.27
 Intersection Signal Delay: 47.8
 Intersection LOS: D
 Intersection Capacity Utilization 79.6%
 ICU Level of Service D
 Analysis Period (min) 15



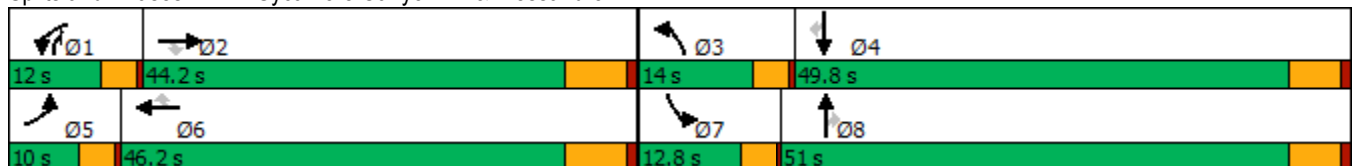





















Splits and Phases: 24: Sycamore Canyon Bl. & Alessandro Bl.



HCM 6th Signalized Intersection Summary
24: Sycamore Canyon Bl. & Alessandro Bl.

West Campus Upper Plateau (JN 14064)

02/16/2022

												
Movement	EBL	EBT	EBR	WBL	WBT	WBR	NBL	NBT	NBR	SBL	SBT	SBR
Lane Configurations												
Traffic Volume (veh/h)	131	1430	537	289	1515	391	443	394	77	125	490	254
Future Volume (veh/h)	131	1430	537	289	1515	391	443	394	77	125	490	254
Initial Q (Qb), veh	0	0	0	0	0	0	0	0	0	0	0	0
Ped-Bike Adj(A_pbT)	1.00		1.00	1.00		0.99	1.00		1.00	1.00		1.00
Parking Bus, Adj	1.00	1.00	1.00	1.00	1.00	1.00	1.00	1.00	1.00	1.00	1.00	1.00
Work Zone On Approach		No			No			No			No	
Adj Sat Flow, veh/h/ln	1900	1885	1885	1737	1885	1781	1870	1841	1841	1826	1826	1870
Adj Flow Rate, veh/h	134	1459	357	295	1546	268	452	402	37	128	500	167
Peak Hour Factor	0.98	0.98	0.98	0.98	0.98	0.98	0.98	0.98	0.98	0.98	0.98	0.98
Percent Heavy Veh, %	0	1	1	11	1	8	2	4	4	5	5	2
Cap, veh/h	125	1960	608	293	2073	600	391	888	948	194	688	314
Arrive On Green	0.07	0.38	0.38	0.09	0.40	0.40	0.11	0.25	0.25	0.06	0.20	0.20
Sat Flow, veh/h	1810	5147	1598	3209	5147	1489	3456	3497	2745	3374	3469	1585
Grp Volume(v), veh/h	134	1459	357	295	1546	268	452	402	37	128	500	167
Grp Sat Flow(s),veh/h/ln	1810	1716	1598	1605	1716	1489	1728	1749	1373	1687	1735	1585
Q Serve(g_s), s	6.3	22.3	16.2	8.3	23.3	11.9	10.3	8.8	0.8	3.4	12.3	8.6
Cycle Q Clear(g_c), s	6.3	22.3	16.2	8.3	23.3	11.9	10.3	8.8	0.8	3.4	12.3	8.6
Prop In Lane	1.00		1.00	1.00		1.00	1.00		1.00	1.00		1.00
Lane Grp Cap(c), veh/h	125	1960	608	293	2073	600	391	888	948	194	688	314
V/C Ratio(X)	1.07	0.74	0.59	1.01	0.75	0.45	1.16	0.45	0.04	0.66	0.73	0.53
Avail Cap(c_a), veh/h	125	2132	662	293	2245	649	391	1737	1614	337	1677	766
HCM Platoon Ratio	1.00	1.00	1.00	1.00	1.00	1.00	1.00	1.00	1.00	1.00	1.00	1.00
Upstream Filter(I)	1.00	1.00	1.00	1.00	1.00	1.00	1.00	1.00	1.00	1.00	1.00	1.00
Uniform Delay (d), s/veh	42.4	24.3	22.5	41.4	23.2	19.8	40.4	28.6	19.8	42.0	34.2	32.7
Incr Delay (d2), s/veh	100.4	1.5	1.5	54.7	1.4	0.7	95.3	0.4	0.0	1.4	1.5	1.4
Initial Q Delay(d3),s/veh	0.0	0.0	0.0	0.0	0.0	0.0	0.0	0.0	0.0	0.0	0.0	0.0
%ile BackOfQ(50%),veh/ln	6.2	8.5	5.8	5.3	8.8	3.9	9.3	3.5	0.2	1.4	5.0	3.2
Unsig. Movement Delay, s/veh												
LnGrp Delay(d),s/veh	142.7	25.8	24.0	96.0	24.6	20.5	135.6	29.0	19.8	43.5	35.7	34.1
LnGrp LOS	F	C	C	F	C	C	F	C	B	D	D	C
Approach Vol, veh/h		1950			2109			891			795	
Approach Delay, s/veh		33.5			34.1			82.7			36.6	
Approach LOS		C			C			F			D	
Timer - Assigned Phs	1	2	3	4	5	6	7	8				
Phs Duration (G+Y+Rc), s	12.0	41.2	14.0	23.9	10.0	43.2	8.9	28.9				
Change Period (Y+Rc), s	3.7	6.5	3.7	5.8	3.7	6.5	3.7	5.8				
Max Green Setting (Gmax), s	8.3	37.7	10.3	44.0	6.3	39.7	9.1	45.2				
Max Q Clear Time (g_c+I1), s	10.3	24.3	12.3	14.3	8.3	25.3	5.4	10.8				
Green Ext Time (p_c), s	0.0	10.4	0.0	3.8	0.0	11.1	0.1	2.7				
Intersection Summary												
HCM 6th Ctrl Delay			41.8									
HCM 6th LOS			D									

Timings
25: Sycamore Canyon Bl. & Cactus Av.

West Campus Upper Plateau (JN 14064)

02/16/2022



Lane Group	EBL	EBT	EBR	WBL	WBT	WBR	NBT	NBR	SBL	SBT	SBR	Ø5
Lane Configurations	↘	↑↑	↗	↘↗	↑↑	↗	↑↑	↗	↘↗	↑↑	↗	
Traffic Volume (vph)	16	13	14	696	14	497	328	221	498	840	5	
Future Volume (vph)	16	13	14	696	14	497	328	221	498	840	5	
Turn Type	Prot	NA	Perm	Prot	NA	Perm	NA	Perm	Prot	NA	Perm	
Protected Phases	7	4		3	8		2		1	6		5
Permitted Phases			4			8		2			6	
Detector Phase	7	4	4	3	8	8	2	2	1	6	6	
Switch Phase												
Minimum Initial (s)	5.0	10.0	10.0	5.0	10.0	10.0	10.0	10.0	5.0	10.0	10.0	5.0
Minimum Split (s)	9.6	32.8	32.8	9.6	32.8	32.8	34.8	34.8	9.6	34.8	34.8	9.6
Total Split (s)	10.3	32.8	32.8	29.0	51.5	51.5	36.2	36.2	22.0	48.6	48.6	9.6
Total Split (%)	8.6%	27.3%	27.3%	24.2%	42.9%	42.9%	30.2%	30.2%	18.3%	40.5%	40.5%	8%
Yellow Time (s)	3.6	4.8	4.8	3.6	4.8	4.8	4.8	4.8	3.6	4.8	4.8	3.6
All-Red Time (s)	1.0	1.0	1.0	1.0	1.0	1.0	1.0	1.0	1.0	1.0	1.0	1.0
Lost Time Adjust (s)	0.0	0.0	0.0	0.0	0.0	0.0	0.0	0.0	0.0	0.0	0.0	0.0
Total Lost Time (s)	4.6	5.8	5.8	4.6	5.8	5.8	5.8	5.8	4.6	5.8	5.8	
Lead/Lag	Lead	Lag	Lag	Lead	Lag	Lag	Lag	Lag	Lead	Lag	Lag	Lead
Lead-Lag Optimize?	Yes	Yes	Yes	Yes	Yes	Yes	Yes	Yes	Yes	Yes	Yes	Yes
Recall Mode	None	None	None	None	None	None	None	None	None	None	None	None
Act Effct Green (s)	5.5	12.9	12.9	25.5	31.7	31.7	16.2	16.2	18.2	39.2	39.2	
Actuated g/C Ratio	0.06	0.15	0.15	0.29	0.37	0.37	0.19	0.19	0.21	0.45	0.45	
v/c Ratio	0.18	0.03	0.04	0.82	0.01	0.67	0.60	0.53	0.80	0.64	0.01	
Control Delay	50.7	35.8	0.2	39.9	20.6	9.9	37.3	8.7	44.8	22.1	0.0	
Queue Delay	0.0	0.0	0.0	0.0	0.0	0.0	0.0	0.0	0.0	0.0	0.0	
Total Delay	50.7	35.8	0.2	39.9	20.6	9.9	37.3	8.7	44.8	22.1	0.0	
LOS	D	D	A	D	C	A	D	A	D	C	A	
Approach Delay		30.1			27.3		25.8			30.4		
Approach LOS		C			C		C			C		

Intersection Summary

Cycle Length: 120
 Actuated Cycle Length: 86.5
 Natural Cycle: 120
 Control Type: Actuated-Uncoordinated
 Maximum v/c Ratio: 0.82
 Intersection Signal Delay: 28.4
 Intersection LOS: C
 Intersection Capacity Utilization 67.4%
 ICU Level of Service C
 Analysis Period (min) 15

Splits and Phases: 25: Sycamore Canyon Bl. & Cactus Av.

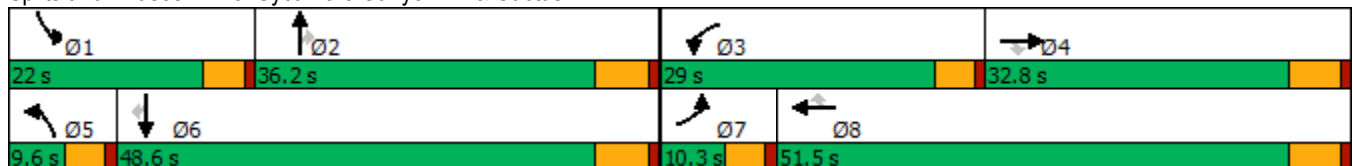

HCM 6th Signalized Intersection Summary
 25: Sycamore Canyon Bl. & Cactus Av.

West Campus Upper Plateau (JN 14064)

02/16/2022



Movement	EBL	EBT	EBR	WBL	WBT	WBR	NBL	NBT	NBR	SBL	SBT	SBR
Lane Configurations	↘	↑↑	↗	↘↗	↑↑	↗	↘↗	↑↑	↗	↘↗	↑↑	↗
Traffic Volume (veh/h)	16	13	14	696	14	497	0	328	221	498	840	5
Future Volume (veh/h)	16	13	14	696	14	497	0	328	221	498	840	5
Initial Q (Qb), veh	0	0	0	0	0	0	0	0	0	0	0	0
Ped-Bike Adj(A_pbT)	1.00		1.00	1.00		1.00	1.00		1.00	1.00		1.00
Parking Bus, Adj	1.00	1.00	1.00	1.00	1.00	1.00	1.00	1.00	1.00	1.00	1.00	1.00
Work Zone On Approach		No			No			No			No	
Adj Sat Flow, veh/h/ln	1811	1678	1796	1826	1796	1870	1900	1811	1781	1885	1796	1011
Adj Flow Rate, veh/h	19	15	6	809	16	308	0	381	154	579	977	6
Peak Hour Factor	0.86	0.86	0.86	0.86	0.86	0.86	0.86	0.86	0.86	0.86	0.86	0.86
Percent Heavy Veh, %	6	15	7	5	7	2	0	6	8	1	7	60
Cap, veh/h	37	395	189	897	1257	584	4	557	244	664	1398	351
Arrive On Green	0.02	0.12	0.12	0.27	0.37	0.37	0.00	0.16	0.16	0.19	0.41	0.41
Sat Flow, veh/h	1725	3188	1522	3374	3413	1585	3510	3441	1510	3483	3413	857
Grp Volume(v), veh/h	19	15	6	809	16	308	0	381	154	579	977	6
Grp Sat Flow(s),veh/h/ln	1725	1594	1522	1687	1706	1585	1755	1721	1510	1742	1706	857
Q Serve(g_s), s	0.9	0.3	0.3	18.7	0.2	12.3	0.0	8.4	7.7	13.0	19.1	0.3
Cycle Q Clear(g_c), s	0.9	0.3	0.3	18.7	0.2	12.3	0.0	8.4	7.7	13.0	19.1	0.3
Prop In Lane	1.00		1.00	1.00		1.00	1.00		1.00	1.00		1.00
Lane Grp Cap(c), veh/h	37	395	189	897	1257	584	4	557	244	664	1398	351
V/C Ratio(X)	0.51	0.04	0.03	0.90	0.01	0.53	0.00	0.68	0.63	0.87	0.70	0.02
Avail Cap(c_a), veh/h	122	1066	509	1020	1932	897	217	1296	569	751	1810	454
HCM Platoon Ratio	1.00	1.00	1.00	1.00	1.00	1.00	1.00	1.00	1.00	1.00	1.00	1.00
Upstream Filter(I)	1.00	1.00	1.00	1.00	1.00	1.00	0.00	1.00	1.00	1.00	1.00	1.00
Uniform Delay (d), s/veh	39.1	31.1	31.1	28.6	16.2	20.0	0.0	31.9	31.6	31.7	19.7	14.2
Incr Delay (d2), s/veh	4.0	0.0	0.1	9.4	0.0	0.7	0.0	1.5	2.7	9.2	0.8	0.0
Initial Q Delay(d3),s/veh	0.0	0.0	0.0	0.0	0.0	0.0	0.0	0.0	0.0	0.0	0.0	0.0
%ile BackOfQ(50%),veh/ln	0.4	0.1	0.1	8.0	0.1	4.2	0.0	3.4	2.8	5.9	6.8	0.1
Unsig. Movement Delay, s/veh												
LnGrp Delay(d),s/veh	43.1	31.2	31.2	38.0	16.2	20.7	0.0	33.4	34.2	40.9	20.5	14.2
LnGrp LOS	D	C	C	D	B	C	A	C	C	D	C	B
Approach Vol, veh/h		40			1133			535			1562	
Approach Delay, s/veh		36.8			33.0			33.6			28.1	
Approach LOS		D			C			C			C	
Timer - Assigned Phs	1	2	3	4	5	6	7	8				
Phs Duration (G+Y+Rc), s	20.0	18.9	26.1	15.8	0.0	38.9	6.3	35.5				
Change Period (Y+Rc), s	4.6	5.8	4.6	5.8	4.6	5.8	4.6	5.8				
Max Green Setting (Gmax), s	17.4	30.4	24.4	27.0	5.0	42.8	5.7	45.7				
Max Q Clear Time (g_c+I1), s	15.0	10.4	20.7	2.3	0.0	21.1	2.9	14.3				
Green Ext Time (p_c), s	0.4	2.6	0.8	0.0	0.0	6.6	0.0	1.1				
Intersection Summary												
HCM 6th Ctrl Delay			30.8									
HCM 6th LOS			C									

Timings

West Campus Upper Plateau (JN 14064)

26: Sycamore Canyon Bl. & Van Buren Bl.

02/16/2022



Lane Group	EBL	EBT	EBR	WBL	WBT	WBR	NBL	NBT	SBL	SBT	SBR
Lane Configurations	↔↔	↑↑↑	↔	↔	↑↑↑	↔		↔↔	↔↔	↑	↔
Traffic Volume (vph)	269	1302	1	7	924	64	11	14	818	13	623
Future Volume (vph)	269	1302	1	7	924	64	11	14	818	13	623
Turn Type	Prot	NA	Perm	Prot	NA	Perm	Perm	NA	Split	NA	Perm
Protected Phases	5	2		1	6			8	4	4	
Permitted Phases			2			6	8				4
Detector Phase	5	2	2	1	6	6	8	8	4	4	4
Switch Phase											
Minimum Initial (s)	5.0	10.0	10.0	5.0	10.0	10.0	10.0	10.0	10.0	10.0	10.0
Minimum Split (s)	9.6	29.2	29.2	9.6	29.2	29.2	14.6	14.6	50.8	50.8	50.8
Total Split (s)	22.0	47.8	47.8	9.6	35.4	35.4	14.6	14.6	58.0	58.0	58.0
Total Split (%)	16.9%	36.8%	36.8%	7.4%	27.2%	27.2%	11.2%	11.2%	44.6%	44.6%	44.6%
Yellow Time (s)	3.6	5.2	5.2	3.6	5.2	5.2	3.6	3.6	4.8	4.8	4.8
All-Red Time (s)	1.0	1.0	1.0	1.0	1.0	1.0	1.0	1.0	1.0	1.0	1.0
Lost Time Adjust (s)	0.0	0.0	0.0	0.0	0.0	0.0		0.0	0.0	0.0	0.0
Total Lost Time (s)	4.6	6.2	6.2	4.6	6.2	6.2		4.6	5.8	5.8	5.8
Lead/Lag	Lead	Lag	Lag	Lead	Lag	Lag					
Lead-Lag Optimize?	Yes	Yes	Yes	Yes	Yes	Yes					
Recall Mode	None	None	None	None	None	None	None	None	None	None	None
Act Effct Green (s)	14.0	42.7	42.7	5.3	25.4	25.4		10.7	40.2	40.2	40.2
Actuated g/C Ratio	0.13	0.40	0.40	0.05	0.24	0.24		0.10	0.37	0.37	0.37
v/c Ratio	0.68	0.57	0.00	0.10	0.70	0.15		0.20	0.71	0.02	0.79
Control Delay	57.1	29.0	0.0	61.9	42.8	0.7		30.1	33.5	23.8	18.4
Queue Delay	0.0	0.0	0.0	0.0	0.0	0.0		0.0	0.0	0.0	0.0
Total Delay	57.1	29.0	0.0	61.9	42.8	0.7		30.1	33.5	23.8	18.4
LOS	E	C	A	E	D	A		C	C	C	B
Approach Delay		33.8			40.2			30.1		26.9	
Approach LOS		C			D			C		C	

Intersection Summary

Cycle Length: 130
 Actuated Cycle Length: 108
 Natural Cycle: 105
 Control Type: Actuated-Uncoordinated
 Maximum v/c Ratio: 0.79
 Intersection Signal Delay: 32.8
 Intersection LOS: C
 Intersection Capacity Utilization 74.1%
 ICU Level of Service D
 Analysis Period (min) 15

Splits and Phases: 26: Sycamore Canyon Bl. & Van Buren Bl.

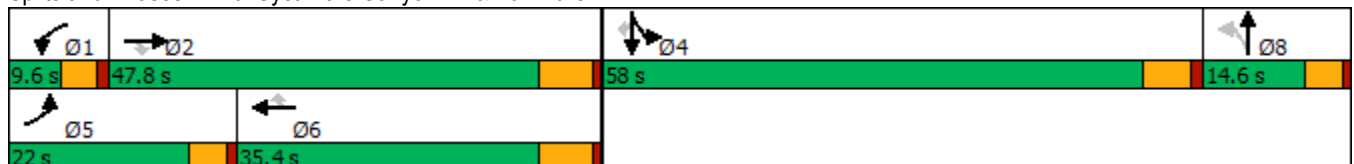

HCM 6th Signalized Intersection Summary
26: Sycamore Canyon Bl. & Van Buren Bl.

West Campus Upper Plateau (JN 14064)

02/16/2022



Movement	EBL	EBT	EBR	WBL	WBT	WBR	NBL	NBT	NBR	SBL	SBT	SBR
Lane Configurations	↔↔	↑↑↑	↗	↖	↑↑↑	↗		↔↔		↖↖	↑	↗
Traffic Volume (veh/h)	269	1302	1	7	924	64	11	14	33	818	13	623
Future Volume (veh/h)	269	1302	1	7	924	64	11	14	33	818	13	623
Initial Q (Qb), veh	0	0	0	0	0	0	0	0	0	0	0	0
Ped-Bike Adj(A_pbT)	1.00		1.00	1.00		0.99	1.00		0.99	1.00		1.00
Parking Bus, Adj	1.00	1.00	1.00	1.00	1.00	1.00	1.00	1.00	1.00	1.00	1.00	1.00
Work Zone On Approach		No			No			No			No	
Adj Sat Flow, veh/h/ln	1811	1826	1900	1693	1796	1870	1900	1900	1900	1841	1900	1841
Adj Flow Rate, veh/h	292	1415	1	8	1004	47	12	15	6	889	14	0
Peak Hour Factor	0.92	0.92	0.92	0.92	0.92	0.92	0.92	0.92	0.92	0.92	0.92	0.92
Percent Heavy Veh, %	6	5	0	14	7	2	0	0	0	4	0	4
Cap, veh/h	381	2189	561	16	1513	383	83	107	44	1064	595	
Arrive On Green	0.11	0.35	0.35	0.01	0.24	0.24	0.06	0.06	0.06	0.31	0.31	0.00
Sat Flow, veh/h	3346	6281	1610	1612	6179	1565	1274	1654	675	3401	1900	1560
Grp Volume(v), veh/h	292	1415	1	8	1004	47	17	0	16	889	14	0
Grp Sat Flow(s),veh/h/ln	1673	1570	1610	1612	1545	1565	1836	0	1767	1700	1900	1560
Q Serve(g_s), s	6.8	15.2	0.0	0.4	11.8	1.9	0.7	0.0	0.7	19.6	0.4	0.0
Cycle Q Clear(g_c), s	6.8	15.2	0.0	0.4	11.8	1.9	0.7	0.0	0.7	19.6	0.4	0.0
Prop In Lane	1.00		1.00	1.00		1.00	0.69		0.38	1.00		1.00
Lane Grp Cap(c), veh/h	381	2189	561	16	1513	383	119	0	115	1064	595	
V/C Ratio(X)	0.77	0.65	0.00	0.49	0.66	0.12	0.15	0.00	0.14	0.84	0.02	
Avail Cap(c_a), veh/h	724	3249	833	100	2243	568	228	0	220	2207	1233	
HCM Platoon Ratio	1.00	1.00	1.00	1.00	1.00	1.00	1.00	1.00	1.00	1.00	1.00	1.00
Upstream Filter(I)	1.00	1.00	1.00	1.00	1.00	1.00	1.00	0.00	1.00	1.00	1.00	0.00
Uniform Delay (d), s/veh	34.6	22.0	17.1	39.6	27.4	23.6	35.5	0.0	35.5	25.7	19.1	0.0
Incr Delay (d2), s/veh	1.2	0.3	0.0	8.1	0.5	0.1	0.6	0.0	0.5	1.8	0.0	0.0
Initial Q Delay(d3),s/veh	0.0	0.0	0.0	0.0	0.0	0.0	0.0	0.0	0.0	0.0	0.0	0.0
%ile BackOfQ(50%),veh/ln	2.7	5.1	0.0	0.2	4.0	0.7	0.3	0.0	0.3	7.4	0.2	0.0
Unsig. Movement Delay, s/veh												
LnGrp Delay(d),s/veh	35.8	22.4	17.1	47.7	27.9	23.8	36.1	0.0	36.0	27.5	19.1	0.0
LnGrp LOS	D	C	B	D	C	C	D	A	D	C	B	
Approach Vol, veh/h		1708			1059			33			903	A
Approach Delay, s/veh		24.7			27.9			36.0			27.4	
Approach LOS		C			C			D			C	
Timer - Assigned Phs	1	2		4	5	6		8				
Phs Duration (G+Y+Rc), s	5.4	34.2		31.0	13.8	25.9		9.8				
Change Period (Y+Rc), s	4.6	6.2		5.8	4.6	6.2		4.6				
Max Green Setting (Gmax), s	5.0	41.6		52.2	17.4	29.2		10.0				
Max Q Clear Time (g_c+I1), s	2.4	17.2		21.6	8.8	13.8		2.7				
Green Ext Time (p_c), s	0.0	10.6		3.6	0.4	5.9		0.0				

Intersection Summary

HCM 6th Ctrl Delay	26.3
HCM 6th LOS	C

Notes

Unsignalized Delay for [SBR] is excluded from calculations of the approach delay and intersection delay.

Timings
27: Innovation Dr. & Cactus Av.

West Campus Upper Plateau (JN 14064)

02/16/2022

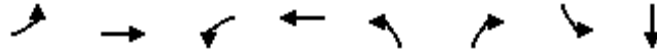

Lane Group	EBL	EBT	WBL	WBT	NBL	NBR	SBL	SBT
Lane Configurations	↖	↖↖↖	↖	↖↖↖	↖	↖	↖	↖
Traffic Volume (vph)	3	724	49	1171	23	65	35	0
Future Volume (vph)	3	724	49	1171	23	65	35	0
Turn Type	Prot	NA	Prot	NA	Perm	Perm	Perm	NA
Protected Phases	5	2	1	6				4
Permitted Phases					8	8	4	
Detector Phase	5	2	1	6	8	8	4	4
Switch Phase								
Minimum Initial (s)	5.0	10.0	5.0	10.0	10.0	10.0	10.0	10.0
Minimum Split (s)	9.2	26.8	9.2	26.8	31.1	31.1	31.1	31.1
Total Split (s)	12.0	63.0	22.0	73.0	35.0	35.0	35.0	35.0
Total Split (%)	10.0%	52.5%	18.3%	60.8%	29.2%	29.2%	29.2%	29.2%
Yellow Time (s)	3.2	4.8	3.2	4.8	4.1	4.1	4.1	4.1
All-Red Time (s)	1.0	1.0	1.0	1.0	1.0	1.0	1.0	1.0
Lost Time Adjust (s)	0.0	0.0	0.0	0.0	0.0	0.0	0.0	0.0
Total Lost Time (s)	4.2	5.8	4.2	5.8	5.1	5.1	5.1	5.1
Lead/Lag	Lead	Lag	Lead	Lag				
Lead-Lag Optimize?	Yes	Yes	Yes	Yes				
Recall Mode	None	None	None	None	None	None	None	None
Act Effct Green (s)	6.3	27.1	7.7	32.2	14.3	14.3	14.3	14.3
Actuated g/C Ratio	0.12	0.53	0.15	0.63	0.28	0.28	0.28	0.28
v/c Ratio	0.01	0.31	0.23	0.42	0.07	0.11	0.10	0.03
Control Delay	32.0	11.8	29.5	8.6	20.6	0.4	20.6	0.1
Queue Delay	0.0	0.0	0.0	0.0	0.0	0.0	0.0	0.0
Total Delay	32.0	11.8	29.5	8.6	20.6	0.4	20.6	0.1
LOS	C	B	C	A	C	A	C	A
Approach Delay		11.9		9.4				14.9
Approach LOS		B		A				B

Intersection Summary

Cycle Length: 120
 Actuated Cycle Length: 50.9
 Natural Cycle: 70
 Control Type: Actuated-Uncoordinated
 Maximum v/c Ratio: 0.42
 Intersection Signal Delay: 10.2
 Intersection LOS: B
 Intersection Capacity Utilization 48.3%
 ICU Level of Service A
 Analysis Period (min) 15

Splits and Phases: 27: Innovation Dr. & Cactus Av.



HCM 6th Signalized Intersection Summary
27: Innovation Dr. & Cactus Av.

West Campus Upper Plateau (JN 14064)

02/16/2022



Movement	EBL	EBT	EBR	WBL	WBT	WBR	NBL	NBT	NBR	SBL	SBT	SBR
Lane Configurations	↖	↑↑↑		↖	↑↑↑		↖	↑	↗	↖	↗	
Traffic Volume (veh/h)	3	724	5	49	1171	13	23	0	65	35	0	13
Future Volume (veh/h)	3	724	5	49	1171	13	23	0	65	35	0	13
Initial Q (Qb), veh	0	0	0	0	0	0	0	0	0	0	0	0
Ped-Bike Adj(A_pbT)	1.00		1.00	1.00		0.98	1.00		1.00	1.00		1.00
Parking Bus, Adj	1.00	1.00	1.00	1.00	1.00	1.00	1.00	1.00	1.00	1.00	1.00	1.00
Work Zone On Approach		No			No			No			No	
Adj Sat Flow, veh/h/ln	1900	1826	1307	1663	1841	1900	1841	1900	1781	1900	1900	1781
Adj Flow Rate, veh/h	3	813	6	55	1316	15	26	0	20	39	0	6
Peak Hour Factor	0.89	0.89	0.89	0.89	0.89	0.89	0.89	0.89	0.89	0.89	0.89	0.89
Percent Heavy Veh, %	0	5	40	16	4	0	4	0	8	0	0	8
Cap, veh/h	7	2556	19	85	2816	32	339	273	217	347	0	231
Arrive On Green	0.00	0.50	0.50	0.05	0.55	0.55	0.14	0.00	0.14	0.14	0.00	0.14
Sat Flow, veh/h	1810	5105	38	1584	5121	58	1388	1900	1510	1414	0	1610
Grp Volume(v), veh/h	3	529	290	55	861	470	26	0	20	39	0	6
Grp Sat Flow(s),veh/h/ln	1810	1662	1819	1584	1675	1829	1388	1900	1510	1414	0	1610
Q Serve(g_s), s	0.1	4.7	4.7	1.7	7.8	7.8	0.8	0.0	0.6	1.2	0.0	0.2
Cycle Q Clear(g_c), s	0.1	4.7	4.7	1.7	7.8	7.8	1.0	0.0	0.6	1.2	0.0	0.2
Prop In Lane	1.00		0.02	1.00		0.03	1.00		1.00	1.00		1.00
Lane Grp Cap(c), veh/h	7	1664	911	85	1843	1006	339	273	217	347	0	231
V/C Ratio(X)	0.41	0.32	0.32	0.65	0.47	0.47	0.08	0.00	0.09	0.11	0.00	0.03
Avail Cap(c_a), veh/h	283	3806	2083	564	4507	2460	970	1137	904	991	0	964
HCM Platoon Ratio	1.00	1.00	1.00	1.00	1.00	1.00	1.00	1.00	1.00	1.00	1.00	1.00
Upstream Filter(I)	1.00	1.00	1.00	1.00	1.00	1.00	1.00	0.00	1.00	1.00	0.00	1.00
Uniform Delay (d), s/veh	24.8	7.4	7.4	23.2	6.8	6.8	18.8	0.0	18.6	18.8	0.0	18.4
Incr Delay (d2), s/veh	12.8	0.2	0.3	3.1	0.3	0.5	0.1	0.0	0.2	0.1	0.0	0.0
Initial Q Delay(d3),s/veh	0.0	0.0	0.0	0.0	0.0	0.0	0.0	0.0	0.0	0.0	0.0	0.0
%ile BackOfQ(50%),veh/ln	0.1	1.1	1.2	0.6	1.6	1.8	0.2	0.0	0.2	0.4	0.0	0.1
Unsig. Movement Delay, s/veh												
LnGrp Delay(d),s/veh	37.6	7.6	7.7	26.3	7.1	7.3	18.9	0.0	18.7	19.0	0.0	18.4
LnGrp LOS	D	A	A	C	A	A	B	A	B	B	A	B
Approach Vol, veh/h		822			1386			46				45
Approach Delay, s/veh		7.7			7.9			18.8				18.9
Approach LOS		A			A			B				B
Timer - Assigned Phs	1	2		4	5	6		8				
Phs Duration (G+Y+Rc), s	6.9	30.8		12.3	4.4	33.3		12.3				
Change Period (Y+Rc), s	* 4.2	5.8		5.1	* 4.2	5.8		5.1				
Max Green Setting (Gmax), s	* 18	57.2		29.9	* 7.8	67.2		29.9				
Max Q Clear Time (g_c+I1), s	3.7	6.7		3.2	2.1	9.8		3.0				
Green Ext Time (p_c), s	0.0	8.5		0.1	0.0	17.7		0.1				

Intersection Summary

HCM 6th Ctrl Delay	8.3
HCM 6th LOS	A

Notes

* HCM 6th computational engine requires equal clearance times for the phases crossing the barrier.

Timings
28: I-215 SB Ramps & Alessandro Bl.

West Campus Upper Plateau (JN 14064)

02/16/2022

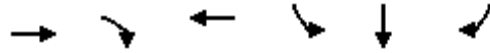

Lane Group	EBT	EBR	WBT	SBL	SBT	SBR
Lane Configurations	↑↑↑	↑	↑↑↑	↑	↔	↑
Traffic Volume (vph)	1349	283	1771	310	0	424
Future Volume (vph)	1349	283	1771	310	0	424
Turn Type	NA	Perm	NA	Split	NA	Perm
Protected Phases	2		6	4	4	
Permitted Phases		2				4
Detector Phase	2	2	6	4	4	4
Switch Phase						
Minimum Initial (s)	5.0	5.0	5.0	5.0	5.0	5.0
Minimum Split (s)	10.5	10.5	34.5	10.0	10.0	10.0
Total Split (s)	52.0	52.0	52.0	33.0	33.0	33.0
Total Split (%)	61.2%	61.2%	61.2%	38.8%	38.8%	38.8%
Yellow Time (s)	4.5	4.5	4.5	4.0	4.0	4.0
All-Red Time (s)	1.0	1.0	1.0	1.0	1.0	1.0
Lost Time Adjust (s)	0.0	0.0	0.0	0.0	0.0	0.0
Total Lost Time (s)	5.5	5.5	5.5	5.0	5.0	5.0
Lead/Lag						
Lead-Lag Optimize?						
Recall Mode	Min	Min	Min	None	None	None
Act Effct Green (s)	34.4	34.4	34.4	17.4	17.4	17.4
Actuated g/C Ratio	0.55	0.55	0.55	0.28	0.28	0.28
v/c Ratio	0.49	0.31	0.67	0.60	0.61	0.59
Control Delay	10.0	4.9	12.1	27.8	25.5	24.8
Queue Delay	0.0	0.0	0.0	0.0	0.0	0.0
Total Delay	10.0	4.9	12.1	27.8	25.5	24.8
LOS	A	A	B	C	C	C
Approach Delay	9.1		12.1		26.1	
Approach LOS	A		B		C	

Intersection Summary

Cycle Length: 85
 Actuated Cycle Length: 63
 Natural Cycle: 50
 Control Type: Actuated-Uncoordinated
 Maximum v/c Ratio: 0.67
 Intersection Signal Delay: 13.4
 Intersection LOS: B
 Intersection Capacity Utilization 61.8%
 ICU Level of Service B
 Analysis Period (min) 15

Splits and Phases: 28: I-215 SB Ramps & Alessandro Bl.

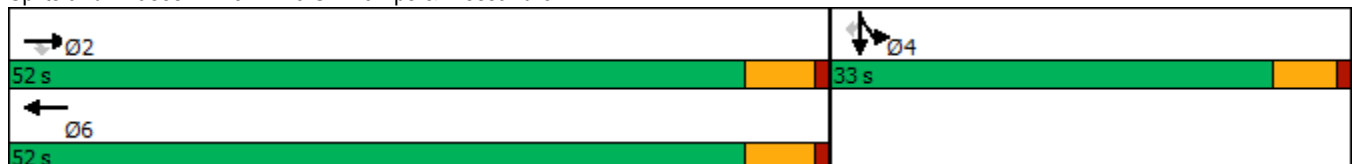

HCM 6th Signalized Intersection Summary
 28: I-215 SB Ramps & Alessandro Bl.

West Campus Upper Plateau (JN 14064)

02/16/2022



Movement	EBL	EBT	EBR	WBL	WBT	WBR	NBL	NBT	NBR	SBL	SBT	SBR
Lane Configurations		↑↑↑	↗		↑↑↑					↘	↕	↗
Traffic Volume (veh/h)	0	1349	283	0	1771	61	0	0	0	310	0	424
Future Volume (veh/h)	0	1349	283	0	1771	61	0	0	0	310	0	424
Initial Q (Qb), veh	0	0	0	0	0	0				0	0	0
Ped-Bike Adj(A_pbT)	1.00		1.00	1.00		0.98				1.00		1.00
Parking Bus, Adj	1.00	1.00	1.00	1.00	1.00	1.00				1.00	1.00	1.00
Work Zone On Approach		No			No						No	
Adj Sat Flow, veh/h/ln	0	1870	1870	0	1870	1781				1737	1900	1752
Adj Flow Rate, veh/h	0	1363	286	0	1789	54				443	0	244
Peak Hour Factor	0.99	0.99	0.99	0.99	0.99	0.99				0.99	0.99	0.99
Percent Heavy Veh, %	0	2	2	0	2	8				11	0	10
Cap, veh/h	0	2878	894	0	2869	87				773	0	347
Arrive On Green	0.00	0.56	0.56	0.00	0.56	0.56				0.23	0.00	0.23
Sat Flow, veh/h	0	5274	1585	0	5258	154				3309	0	1485
Grp Volume(v), veh/h	0	1363	286	0	1196	647				443	0	244
Grp Sat Flow(s),veh/h/ln	0	1702	1585	0	1702	1839				1654	0	1485
Q Serve(g_s), s	0.0	8.2	5.0	0.0	12.2	12.3				6.1	0.0	7.8
Cycle Q Clear(g_c), s	0.0	8.2	5.0	0.0	12.2	12.3				6.1	0.0	7.8
Prop In Lane	0.00		1.00	0.00		0.08				1.00		1.00
Lane Grp Cap(c), veh/h	0	2878	894	0	1919	1037				773	0	347
V/C Ratio(X)	0.00	0.47	0.32	0.00	0.62	0.62				0.57	0.00	0.70
Avail Cap(c_a), veh/h	0	4584	1423	0	3056	1651				1789	0	803
HCM Platoon Ratio	1.00	1.00	1.00	1.00	1.00	1.00				1.00	1.00	1.00
Upstream Filter(I)	0.00	1.00	1.00	0.00	1.00	1.00				1.00	0.00	1.00
Uniform Delay (d), s/veh	0.0	6.7	6.0	0.0	7.6	7.6				17.6	0.0	18.2
Incr Delay (d2), s/veh	0.0	0.1	0.2	0.0	0.3	0.6				0.7	0.0	2.6
Initial Q Delay(d3),s/veh	0.0	0.0	0.0	0.0	0.0	0.0				0.0	0.0	0.0
%ile BackOfQ(50%),veh/ln	0.0	1.4	0.8	0.0	2.2	2.4				2.0	0.0	2.4
Unsig. Movement Delay, s/veh												
LnGrp Delay(d),s/veh	0.0	6.8	6.2	0.0	7.9	8.2				18.2	0.0	20.8
LnGrp LOS	A	A	A	A	A	A				B	A	C
Approach Vol, veh/h		1649			1843						687	
Approach Delay, s/veh		6.7			8.0						19.2	
Approach LOS		A			A						B	
Timer - Assigned Phs		2		4		6						
Phs Duration (G+Y+Rc), s		34.7		17.1		34.7						
Change Period (Y+Rc), s		5.5		5.0		5.5						
Max Green Setting (Gmax), s		46.5		28.0		46.5						
Max Q Clear Time (g_c+I1), s		10.2		9.8		14.3						
Green Ext Time (p_c), s		12.4		2.3		14.9						
Intersection Summary												
HCM 6th Ctrl Delay			9.4									
HCM 6th LOS			A									
Notes												
User approved volume balancing among the lanes for turning movement.												

Timings
29: I-215 NB Ramps & Alessandro Bl.

West Campus Upper Plateau (JN 14064)

02/16/2022



Lane Group	EBL	EBT	WBT	WBR	NBL	NBT	NBR
Lane Configurations	↘	↑↑↑	↑↑↑	↗	↘	↕	↗
Traffic Volume (vph)	94	1565	998	112	834	11	270
Future Volume (vph)	94	1565	998	112	834	11	270
Turn Type	Prot	NA	NA	Perm	Split	NA	Perm
Protected Phases	5	2	6		8	8	
Permitted Phases				6			8
Detector Phase	5	2	6	6	8	8	8
Switch Phase							
Minimum Initial (s)	5.0	5.0	5.0	5.0	5.0	5.0	5.0
Minimum Split (s)	9.5	10.5	33.5	33.5	10.0	10.0	10.0
Total Split (s)	13.0	48.0	35.0	35.0	37.0	37.0	37.0
Total Split (%)	15.3%	56.5%	41.2%	41.2%	43.5%	43.5%	43.5%
Yellow Time (s)	3.5	4.5	4.5	4.5	4.0	4.0	4.0
All-Red Time (s)	1.0	1.0	1.0	1.0	1.0	1.0	1.0
Lost Time Adjust (s)	0.0	0.0	0.0	0.0	0.0	0.0	0.0
Total Lost Time (s)	4.5	5.5	5.5	5.5	5.0	5.0	5.0
Lead/Lag	Lead		Lag	Lag			
Lead-Lag Optimize?	Yes		Yes	Yes			
Recall Mode	None	Min	Min	Min	Max	Max	Max
Act Effct Green (s)	7.9	36.1	26.1	26.1	32.2	32.2	32.2
Actuated g/C Ratio	0.10	0.46	0.33	0.33	0.41	0.41	0.41
v/c Ratio	0.61	0.71	0.63	0.23	0.68	0.72	0.39
Control Delay	52.1	19.0	24.8	9.1	26.8	28.6	13.5
Queue Delay	0.0	0.0	0.0	0.0	0.0	0.0	0.0
Total Delay	52.1	19.0	24.8	9.1	26.8	28.6	13.5
LOS	D	B	C	A	C	C	B
Approach Delay		20.9	23.2			24.6	
Approach LOS		C	C			C	

Intersection Summary

Cycle Length: 85
 Actuated Cycle Length: 78.9
 Natural Cycle: 75
 Control Type: Actuated-Uncoordinated
 Maximum v/c Ratio: 0.72
 Intersection Signal Delay: 22.6
 Intersection Capacity Utilization 65.1%
 Analysis Period (min) 15
 Intersection LOS: C
 ICU Level of Service C

Splits and Phases: 29: I-215 NB Ramps & Alessandro Bl.

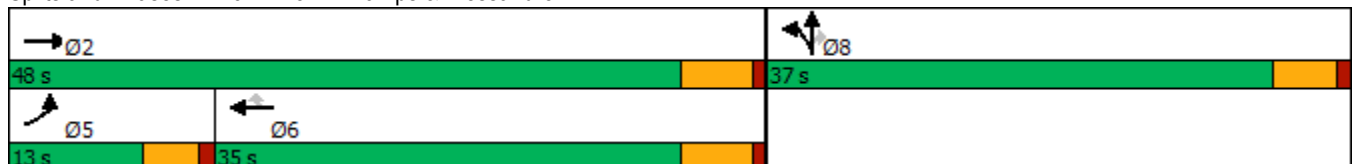

HCM 6th Signalized Intersection Summary
 29: I-215 NB Ramps & Alessandro Bl.

West Campus Upper Plateau (JN 14064)

02/16/2022



Movement	EBL	EBT	EBR	WBL	WBT	WBR	NBL	NBT	NBR	SBL	SBT	SBR
Lane Configurations	↘	↑↑↑			↑↑↑	↗	↘	↕	↗			
Traffic Volume (veh/h)	94	1565	0	0	998	112	834	11	270	0	0	0
Future Volume (veh/h)	94	1565	0	0	998	112	834	11	270	0	0	0
Initial Q (Qb), veh	0	0	0	0	0	0	0	0	0			
Ped-Bike Adj(A_pbT)	1.00		1.00	1.00		0.98	1.00		1.00			
Parking Bus, Adj	1.00	1.00	1.00	1.00	1.00	1.00	1.00	1.00	1.00			
Work Zone On Approach		No			No			No				
Adj Sat Flow, veh/h/ln	1767	1870	0	0	1870	1707	1856	1900	1870			
Adj Flow Rate, veh/h	100	1665	0	0	1062	92	954	0	138			
Peak Hour Factor	0.94	0.94	0.94	0.94	0.94	0.94	0.94	0.94	0.94			
Percent Heavy Veh, %	9	2	0	0	2	13	3	0	2			
Cap, veh/h	126	2248	0	0	1563	434	1490	0	668			
Arrive On Green	0.07	0.44	0.00	0.00	0.31	0.31	0.42	0.00	0.42			
Sat Flow, veh/h	1682	5274	0	0	5274	1416	3534	0	1585			
Grp Volume(v), veh/h	100	1665	0	0	1062	92	954	0	138			
Grp Sat Flow(s),veh/h/ln	1682	1702	0	0	1702	1416	1767	0	1585			
Q Serve(g_s), s	4.4	20.6	0.0	0.0	13.8	3.7	16.2	0.0	4.2			
Cycle Q Clear(g_c), s	4.4	20.6	0.0	0.0	13.8	3.7	16.2	0.0	4.2			
Prop In Lane	1.00		0.00	0.00		1.00	1.00		1.00			
Lane Grp Cap(c), veh/h	126	2248	0	0	1563	434	1490	0	668			
V/C Ratio(X)	0.79	0.74	0.00	0.00	0.68	0.21	0.64	0.00	0.21			
Avail Cap(c_a), veh/h	188	2858	0	0	1984	550	1490	0	668			
HCM Platoon Ratio	1.00	1.00	1.00	1.00	1.00	1.00	1.00	1.00	1.00			
Upstream Filter(I)	1.00	1.00	0.00	0.00	1.00	1.00	1.00	0.00	1.00			
Uniform Delay (d), s/veh	34.5	17.6	0.0	0.0	23.1	19.5	17.4	0.0	13.9			
Incr Delay (d2), s/veh	10.5	0.8	0.0	0.0	0.7	0.2	2.1	0.0	0.7			
Initial Q Delay(d3),s/veh	0.0	0.0	0.0	0.0	0.0	0.0	0.0	0.0	0.0			
%ile BackOfQ(50%),veh/ln	2.0	6.6	0.0	0.0	4.8	1.1	6.2	0.0	1.5			
Unsig. Movement Delay, s/veh												
LnGrp Delay(d),s/veh	45.1	18.4	0.0	0.0	23.7	19.8	19.5	0.0	14.6			
LnGrp LOS	D	B	A	A	C	B	B	A	B			
Approach Vol, veh/h		1765			1154			1092				
Approach Delay, s/veh		19.9			23.4			18.9				
Approach LOS		B			C			B				
Timer - Assigned Phs		2			5	6		8				
Phs Duration (G+Y+Rc), s		38.9			10.2	28.7		37.0				
Change Period (Y+Rc), s		5.5			4.5	5.5		5.0				
Max Green Setting (Gmax), s		42.5			8.5	29.5		32.0				
Max Q Clear Time (g_c+I1), s		22.6			6.4	15.8		18.2				
Green Ext Time (p_c), s		10.9			0.0	5.7		3.7				

Intersection Summary

HCM 6th Ctrl Delay	20.7
HCM 6th LOS	C

Notes

User approved volume balancing among the lanes for turning movement.

Timings
30: I-215 SB Ramps & Cactus Av.



Lane Group	EBT	EBR	WBL	WBT	NBR	SBR
Lane Configurations	↑↑	↑	↓	↑↑	↑	↑
Traffic Volume (vph)	694	130	484	981	546	252
Future Volume (vph)	694	130	484	981	546	252
Turn Type	NA	Perm	Prot	NA	Prot	Prot
Protected Phases	2		1	6	8	4
Permitted Phases		2				
Detector Phase	2	2	1	6	8	4
Switch Phase						
Minimum Initial (s)	5.0	5.0	5.0	5.0	5.0	5.0
Minimum Split (s)	11.0	11.0	9.5	23.0	9.1	9.5
Total Split (s)	35.0	35.0	43.0	78.0	27.0	27.0
Total Split (%)	33.3%	33.3%	41.0%	74.3%	25.7%	25.7%
Yellow Time (s)	5.0	5.0	3.5	5.0	3.6	3.5
All-Red Time (s)	1.0	1.0	1.0	1.0	0.5	1.0
Lost Time Adjust (s)	0.0	0.0	0.0	0.0	0.0	0.0
Total Lost Time (s)	6.0	6.0	4.5	6.0	4.1	4.5
Lead/Lag	Lag	Lag	Lead			
Lead-Lag Optimize?	Yes	Yes	Yes			
Recall Mode	Min	Min	None	Min	None	None
Act Effct Green (s)	21.9	21.9	27.3	54.1	12.5	12.1
Actuated g/C Ratio	0.28	0.28	0.35	0.70	0.16	0.16
v/c Ratio	0.75	0.26	0.82	0.42	0.74	0.75
Control Delay	32.6	6.7	36.7	5.9	8.0	30.0
Queue Delay	0.0	0.0	0.0	0.0	0.0	0.0
Total Delay	32.6	6.7	36.7	5.9	8.0	30.0
LOS	C	A	D	A	A	C
Approach Delay	28.5			16.1		
Approach LOS	C			B		

Intersection Summary

Cycle Length: 105
 Actuated Cycle Length: 77.6
 Natural Cycle: 65
 Control Type: Actuated-Uncoordinated
 Maximum v/c Ratio: 0.82
 Intersection Signal Delay: 19.1
 Intersection LOS: B
 Intersection Capacity Utilization 61.4%
 ICU Level of Service B
 Analysis Period (min) 15



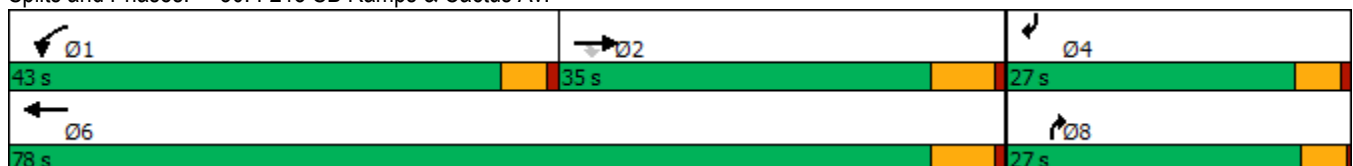









Splits and Phases: 30: I-215 SB Ramps & Cactus Av.



HCM 6th Signalized Intersection Summary
 30: I-215 SB Ramps & Cactus Av.

West Campus Upper Plateau (JN 14064)

02/16/2022

												
Movement	EBL	EBT	EBR	WBL	WBT	WBR	NBL	NBT	NBR	SBL	SBT	SBR
Lane Configurations		↑↑	↗	↖	↑↑				↗			↖
Traffic Volume (veh/h)	0	694	130	484	981	0	0	0	546	0	0	252
Future Volume (veh/h)	0	694	130	484	981	0	0	0	546	0	0	252
Initial Q (Qb), veh	0	0	0	0	0	0	0	0	0	0	0	0
Ped-Bike Adj(A_pbT)	1.00		1.00	1.00		1.00	1.00		1.00	1.00		1.00
Parking Bus, Adj	1.00	1.00	1.00	1.00	1.00	1.00	1.00	1.00	1.00	1.00	1.00	1.00
Work Zone On Approach		No			No			No			No	
Adj Sat Flow, veh/h/ln	0	1841	1826	1870	1870	0	0	0	1796	0	0	1707
Adj Flow Rate, veh/h	0	731	109	509	1033	0	0	0	0	0	0	160
Peak Hour Factor	0.95	0.95	0.95	0.95	0.95	0.95	0.95	0.95	0.95	0.95	0.95	0.95
Percent Heavy Veh, %	0	4	5	2	2	0	0	0	7	0	0	13
Cap, veh/h	0	1167	516	611	2897	0	0	0	0	0	0	0
Arrive On Green	0.00	0.33	0.33	0.34	0.82	0.00	0.00	0.00	0.00	0.00	0.00	0.00
Sat Flow, veh/h	0	3589	1547	1781	3647	0		0			0	
Grp Volume(v), veh/h	0	731	109	509	1033	0		0.0			0.0	
Grp Sat Flow(s),veh/h/ln	0	1749	1547	1781	1777	0						
Q Serve(g_s), s	0.0	5.7	1.6	8.5	2.5	0.0						
Cycle Q Clear(g_c), s	0.0	5.7	1.6	8.5	2.5	0.0						
Prop In Lane	0.00		1.00	1.00		0.00						
Lane Grp Cap(c), veh/h	0	1167	516	611	2897	0						
V/C Ratio(X)	0.00	0.63	0.21	0.83	0.36	0.00						
Avail Cap(c_a), veh/h	0	3124	1382	2112	7881	0						
HCM Platoon Ratio	1.00	1.00	1.00	1.00	1.00	1.00						
Upstream Filter(I)	0.00	1.00	1.00	1.00	1.00	0.00						
Uniform Delay (d), s/veh	0.0	9.1	7.8	9.8	0.8	0.0						
Incr Delay (d2), s/veh	0.0	0.2	0.1	1.2	0.0	0.0						
Initial Q Delay(d3),s/veh	0.0	0.0	0.0	0.0	0.0	0.0						
%ile BackOfQ(50%),veh/ln	0.0	1.2	0.3	1.9	0.0	0.0						
Unsig. Movement Delay, s/veh												
LnGrp Delay(d),s/veh	0.0	9.3	7.8	11.0	0.8	0.0						
LnGrp LOS	A	A	A	B	A	A						
Approach Vol, veh/h		840			1542							
Approach Delay, s/veh		9.1			4.2							
Approach LOS		A			A							
Timer - Assigned Phs	1	2				6						
Phs Duration (G+Y+Rc), s	15.6	16.8				32.5						
Change Period (Y+Rc), s	4.5	6.0				6.0						
Max Green Setting (Gmax), s	38.5	29.0				72.0						
Max Q Clear Time (g_c+I1), s	10.5	7.7				4.5						
Green Ext Time (p_c), s	0.7	3.1				5.0						

Intersection Summary

HCM 6th Ctrl Delay	5.9
HCM 6th LOS	A

Notes

Unsignalized Delay for [NBR] is excluded from calculations of the approach delay and intersection delay.

Timings

31: I-215 NB Ramps/Old 215 Frontage Rd. & Cactus Av.



Lane Group	EBL	EBT	WBT	NBL	NBT	NBR	SBL	SBT
Lane Configurations	↗	↗↘	↗↘	↖	↖	↖	↖	↖
Traffic Volume (vph)	50	1374	1661	115	218	3	166	2
Future Volume (vph)	50	1374	1661	115	218	3	166	2
Turn Type	Perm	NA	NA	Perm	NA	Perm	Perm	NA
Protected Phases		2	6		8			4
Permitted Phases	2			8		8	4	
Detector Phase	2	2	6	8	8	8	4	4
Switch Phase								
Minimum Initial (s)	5.0	5.0	5.0	5.0	5.0	5.0	5.0	5.0
Minimum Split (s)	11.0	11.0	44.0	10.5	10.5	10.5	10.5	10.5
Total Split (s)	57.4	57.4	57.4	27.6	27.6	27.6	27.6	27.6
Total Split (%)	67.5%	67.5%	67.5%	32.5%	32.5%	32.5%	32.5%	32.5%
Yellow Time (s)	5.0	5.0	5.0	4.5	4.5	4.5	4.5	4.5
All-Red Time (s)	1.0	1.0	1.0	1.0	1.0	1.0	1.0	1.0
Lost Time Adjust (s)	0.0	0.0	0.0	0.0	0.0	0.0	0.0	0.0
Total Lost Time (s)	6.0	6.0	6.0	5.5	5.5	5.5	5.5	5.5
Lead/Lag								
Lead-Lag Optimize?								
Recall Mode	Min	Min	Min	None	None	None	None	None
Act Effct Green (s)	45.6	45.6	45.6	17.9	17.9	17.9	17.9	17.9
Actuated g/C Ratio	0.60	0.60	0.60	0.24	0.24	0.24	0.24	0.24
v/c Ratio	0.55	0.72	0.91	0.47	0.55	0.01	0.80	0.42
Control Delay	37.8	13.3	21.9	33.1	31.9	0.0	56.6	25.8
Queue Delay	0.0	0.0	0.0	0.0	0.0	0.0	0.0	0.0
Total Delay	37.8	13.3	21.9	33.1	31.9	0.0	56.6	25.8
LOS	D	B	C	C	C	A	E	C
Approach Delay		14.1	21.9		32.0			41.5
Approach LOS		B	C		C			D

Intersection Summary

Cycle Length: 85
 Actuated Cycle Length: 75.5
 Natural Cycle: 60
 Control Type: Actuated-Uncoordinated
 Maximum v/c Ratio: 0.91
 Intersection Signal Delay: 21.5
 Intersection Capacity Utilization 86.0%
 Analysis Period (min) 15

Intersection LOS: C
 ICU Level of Service E

Splits and Phases: 31: I-215 NB Ramps/Old 215 Frontage Rd. & Cactus Av.

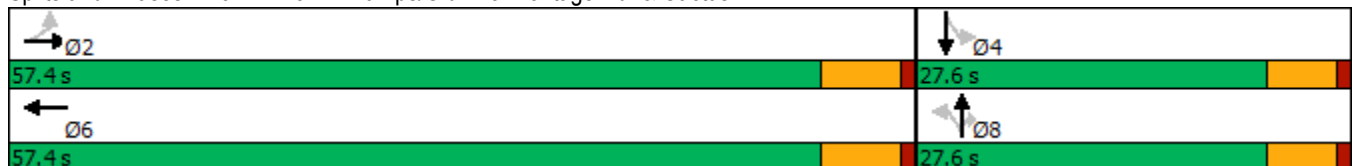

HCM 6th Signalized Intersection Summary

West Campus Upper Plateau (JN 14064)

31: I-215 NB Ramps/Old 215 Frontage Rd. & Cactus Av.

02/16/2022



Movement	EBL	EBT	EBR	WBL	WBT	WBR	NBL	NBT	NBR	SBL	SBT	SBR
Lane Configurations												
Traffic Volume (veh/h)	50	1374	44	0	1661	161	115	218	3	166	2	158
Future Volume (veh/h)	50	1374	44	0	1661	161	115	218	3	166	2	158
Initial Q (Qb), veh	0	0	0	0	0	0	0	0	0	0	0	0
Ped-Bike Adj(A_pbT)	1.00		1.00	1.00		1.00	1.00		1.00	1.00		1.00
Parking Bus, Adj	1.00	1.00	1.00	1.00	1.00	1.00	1.00	1.00	1.00	1.00	1.00	1.00
Work Zone On Approach		No			No			No			No	
Adj Sat Flow, veh/h/ln	1796	1826	1366	0	1841	1885	1722	1856	1900	1841	1900	1885
Adj Flow Rate, veh/h	52	1431	42	0	1730	120	120	227	0	173	2	139
Peak Hour Factor	0.96	0.96	0.96	0.96	0.96	0.96	0.96	0.96	0.96	0.96	0.96	0.96
Percent Heavy Veh, %	7	5	36	0	4	1	12	3	0	4	0	1
Cap, veh/h	124	2081	61	0	2008	138	302	482		263	6	414
Arrive On Green	0.60	0.60	0.60	0.00	0.60	0.60	0.26	0.26	0.00	0.26	0.26	0.26
Sat Flow, veh/h	239	3441	101	0	3412	228	1149	1856	1610	1135	23	1591
Grp Volume(v), veh/h	52	720	753	0	903	947	120	227	0	173	0	141
Grp Sat Flow(s),veh/h/ln	239	1735	1808	0	1749	1799	1149	1856	1610	1135	0	1614
Q Serve(g_s), s	14.1	23.9	24.0	0.0	35.9	37.3	8.0	8.8	0.0	12.9	0.0	6.0
Cycle Q Clear(g_c), s	51.4	23.9	24.0	0.0	35.9	37.3	14.1	8.8	0.0	21.7	0.0	6.0
Prop In Lane	1.00		0.06	0.00		0.13	1.00		1.00	1.00		0.99
Lane Grp Cap(c), veh/h	124	1049	1093	0	1057	1088	302	482		263	0	420
V/C Ratio(X)	0.42	0.69	0.69	0.00	0.85	0.87	0.40	0.47		0.66	0.00	0.34
Avail Cap(c_a), veh/h	124	1049	1093	0	1057	1088	302	482		263	0	420
HCM Platoon Ratio	1.00	1.00	1.00	1.00	1.00	1.00	1.00	1.00	1.00	1.00	1.00	1.00
Upstream Filter(I)	1.00	1.00	1.00	0.00	1.00	1.00	1.00	1.00	0.00	1.00	0.00	1.00
Uniform Delay (d), s/veh	37.1	11.4	11.4	0.0	13.7	14.0	31.2	26.5	0.0	35.6	0.0	25.5
Incr Delay (d2), s/veh	0.8	1.6	1.5	0.0	6.6	7.5	0.3	0.3	0.0	4.8	0.0	0.2
Initial Q Delay(d3),s/veh	0.0	0.0	0.0	0.0	0.0	0.0	0.0	0.0	0.0	0.0	0.0	0.0
%ile BackOfQ(50%),veh/ln	1.1	7.6	7.9	0.0	12.7	13.8	2.1	3.6	0.0	3.6	0.0	2.1
Unsig. Movement Delay, s/veh												
LnGrp Delay(d),s/veh	38.0	12.9	12.9	0.0	20.4	21.5	31.5	26.8	0.0	40.4	0.0	25.7
LnGrp LOS	D	B	B	A	C	C	C	C		D	A	C
Approach Vol, veh/h		1525			1850			347	A		314	
Approach Delay, s/veh		13.8			20.9			28.4			33.8	
Approach LOS		B			C			C			C	
Timer - Assigned Phs		2		4		6		8				
Phs Duration (G+Y+Rc), s		57.4		27.6		57.4		27.6				
Change Period (Y+Rc), s		6.0		5.5		6.0		5.5				
Max Green Setting (Gmax), s		51.4		22.1		51.4		22.1				
Max Q Clear Time (g_c+I1), s		53.4		23.7		39.3		16.1				
Green Ext Time (p_c), s		0.0		0.0		6.7		0.5				

Intersection Summary

HCM 6th Ctrl Delay	19.9
HCM 6th LOS	B

Notes

User approved volume balancing among the lanes for turning movement.
 Unsignalized Delay for [NBR] is excluded from calculations of the approach delay and intersection delay.

Timings
32: I-215 SB Ramps & Van Buren Bl.

West Campus Upper Plateau (JN 14064)

02/16/2022



Lane Group	EBT	EBR	WBL	WBT	SBT	SBR
Lane Configurations	↑↑	↑↑	↵	↑↑	↵	↑↑
Traffic Volume (vph)	444	1604	3	797	85	192
Future Volume (vph)	444	1604	3	797	85	192
Turn Type	NA	Perm	Prot	NA	NA	Perm
Protected Phases	6		5	2	8	
Permitted Phases		6				8
Detector Phase	6	6	5	2	8	8
Switch Phase						
Minimum Initial (s)	5.0	5.0	5.0	5.0	5.0	5.0
Minimum Split (s)	36.0	36.0	11.0	11.0	11.0	11.0
Total Split (s)	60.0	60.0	11.0	71.0	14.0	14.0
Total Split (%)	70.6%	70.6%	12.9%	83.5%	16.5%	16.5%
Yellow Time (s)	5.0	5.0	5.0	5.0	5.0	5.0
All-Red Time (s)	1.0	1.0	1.0	1.0	1.0	1.0
Lost Time Adjust (s)	0.0	0.0	0.0	0.0	0.0	0.0
Total Lost Time (s)	6.0	6.0	6.0	6.0	6.0	6.0
Lead/Lag	Lag	Lag	Lead			
Lead-Lag Optimize?	Yes	Yes	Yes			
Recall Mode	Min	Min	None	Min	Max	Max
Act Effct Green (s)	29.3	29.3	5.5	30.7	8.8	8.8
Actuated g/C Ratio	0.56	0.56	0.10	0.58	0.17	0.17
v/c Ratio	0.26	0.87	0.02	0.43	0.35	0.36
Control Delay	5.9	9.0	31.7	5.8	30.7	7.6
Queue Delay	0.0	0.0	0.0	0.0	0.0	0.0
Total Delay	5.9	9.0	31.7	5.8	30.7	7.6
LOS	A	A	C	A	C	A
Approach Delay	8.3			5.9	15.3	
Approach LOS	A			A	B	

Intersection Summary

Cycle Length: 85
 Actuated Cycle Length: 52.7
 Natural Cycle: 60
 Control Type: Actuated-Uncoordinated
 Maximum v/c Ratio: 0.87
 Intersection Signal Delay: 8.4
 Intersection LOS: A
 Intersection Capacity Utilization 79.5%
 ICU Level of Service D
 Analysis Period (min) 15

Splits and Phases: 32: I-215 SB Ramps & Van Buren Bl.



HCM 6th Signalized Intersection Summary
 32: I-215 SB Ramps & Van Buren Bl.

West Campus Upper Plateau (JN 14064)

02/16/2022



Movement	EBL	EBT	EBR	WBL	WBT	WBR	NBL	NBT	NBR	SBL	SBT	SBR
Lane Configurations		↑↑	↑↑	↑	↑↑						↑	↑↑
Traffic Volume (veh/h)	0	444	1604	3	797	0	0	0	0	11	85	192
Future Volume (veh/h)	0	444	1604	3	797	0	0	0	0	11	85	192
Initial Q (Qb), veh	0	0	0	0	0	0				0	0	0
Ped-Bike Adj(A_pbT)	1.00		1.00	1.00		1.00				1.00		1.00
Parking Bus, Adj	1.00	1.00	1.00	1.00	1.00	1.00				1.00	1.00	1.00
Work Zone On Approach		No			No						No	
Adj Sat Flow, veh/h/ln	0	1767	1856	1411	1811	0				1500	1841	1663
Adj Flow Rate, veh/h	0	477	1626	3	857	0				12	91	0
Peak Hour Factor	0.93	0.93	0.93	0.93	0.93	0.93				0.93	0.93	0.93
Percent Heavy Veh, %	0	9	3	33	6	0				27	4	16
Cap, veh/h	0	2077	1713	83	2595	0				21	159	
Arrive On Green	0.00	0.62	0.62	0.06	0.75	0.00				0.10	0.10	0.00
Sat Flow, veh/h	0	3445	2768	1344	3532	0				213	1617	2480
Grp Volume(v), veh/h	0	477	1626	3	857	0				103	0	0
Grp Sat Flow(s),veh/h/ln	0	1678	1384	1344	1721	0				1830	0	1240
Q Serve(g_s), s	0.0	5.1	44.2	0.2	6.6	0.0				4.4	0.0	0.0
Cycle Q Clear(g_c), s	0.0	5.1	44.2	0.2	6.6	0.0				4.4	0.0	0.0
Prop In Lane	0.00		1.00	1.00		0.00				0.12		1.00
Lane Grp Cap(c), veh/h	0	2077	1713	83	2595	0				180	0	
V/C Ratio(X)	0.00	0.23	0.95	0.04	0.33	0.00				0.57	0.00	
Avail Cap(c_a), veh/h	0	2229	1838	83	2750	0				180	0	
HCM Platoon Ratio	1.00	1.00	1.00	1.00	1.00	1.00				1.00	1.00	1.00
Upstream Filter(I)	0.00	1.00	1.00	1.00	1.00	0.00				1.00	0.00	0.00
Uniform Delay (d), s/veh	0.0	6.9	14.3	35.9	3.3	0.0				35.0	0.0	0.0
Incr Delay (d2), s/veh	0.0	0.0	10.6	0.1	0.0	0.0				12.6	0.0	0.0
Initial Q Delay(d3),s/veh	0.0	0.0	0.0	0.0	0.0	0.0				0.0	0.0	0.0
%ile BackOfQ(50%),veh/ln	0.0	1.3	11.6	0.1	1.0	0.0				2.5	0.0	0.0
Unsig. Movement Delay, s/veh												
LnGrp Delay(d),s/veh	0.0	6.9	24.9	36.0	3.3	0.0				47.6	0.0	0.0
LnGrp LOS	A	A	C	D	A	A				D	A	
Approach Vol, veh/h		2103			860						103	A
Approach Delay, s/veh		20.8			3.4						47.6	
Approach LOS		C			A						D	
Timer - Assigned Phs		2			5	6		8				
Phs Duration (G+Y+Rc), s		67.3			11.0	56.3		14.0				
Change Period (Y+Rc), s		6.0			6.0	6.0		6.0				
Max Green Setting (Gmax), s		65.0			5.0	54.0		8.0				
Max Q Clear Time (g_c+I1), s		8.6			2.2	46.2		6.4				
Green Ext Time (p_c), s		3.7			0.0	4.2		0.0				

Intersection Summary

HCM 6th Ctrl Delay	16.9
HCM 6th LOS	B

Notes

Unsignalized Delay for [SBR] is excluded from calculations of the approach delay and intersection delay.

Timings
33: I-215 NB On/Off Ramp & Van Buren Bl.

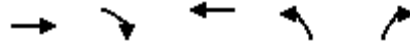

Lane Group	EBT	EBR	WBT	NBL	NBR
Lane Configurations	↑↑	↑↑	↑↑	↑↑	↑
Traffic Volume (vph)	4	497	21	759	4
Future Volume (vph)	4	497	21	759	4
Turn Type	NA	pm+ov	NA	Prot	Perm
Protected Phases	6	4	2	4	
Permitted Phases		6			4
Detector Phase	6	4	2	4	4
Switch Phase					
Minimum Initial (s)	5.0	5.0	5.0	5.0	5.0
Minimum Split (s)	11.0	42.0	11.0	42.0	42.0
Total Split (s)	15.0	55.0	15.0	55.0	55.0
Total Split (%)	21.4%	78.6%	21.4%	78.6%	78.6%
Yellow Time (s)	5.0	5.0	5.0	5.0	5.0
All-Red Time (s)	1.0	1.0	1.0	1.0	1.0
Lost Time Adjust (s)	0.0	0.0	0.0	0.0	0.0
Total Lost Time (s)	6.0	6.0	6.0	6.0	6.0
Lead/Lag					
Lead-Lag Optimize?					
Recall Mode	None	Min	None	Min	Min
Act Effct Green (s)	5.7	37.7	5.7	35.7	35.7
Actuated g/C Ratio	0.15	1.00	0.15	0.95	0.95
v/c Ratio	0.01	0.20	0.04	0.26	0.00
Control Delay	21.5	0.2	20.6	1.1	1.0
Queue Delay	0.0	0.0	0.0	0.0	0.0
Total Delay	21.5	0.2	20.6	1.1	1.0
LOS	C	A	C	A	A
Approach Delay	0.3		20.6	1.1	
Approach LOS	A		C	A	

Intersection Summary

Cycle Length: 70
 Actuated Cycle Length: 37.7
 Natural Cycle: 55
 Control Type: Actuated-Uncoordinated
 Maximum v/c Ratio: 0.26
 Intersection Signal Delay: 1.1
 Intersection LOS: A
 Intersection Capacity Utilization 35.8%
 ICU Level of Service A
 Analysis Period (min) 15

Splits and Phases: 33: I-215 NB On/Off Ramp & Van Buren Bl.



HCM 6th Signalized Intersection Summary
 33: I-215 NB On/Off Ramp & Van Buren Bl.

West Campus Upper Plateau (JN 14064)

02/16/2022

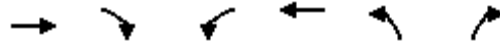

Movement	EBT	EBR	WBL	WBT	NBL	NBR
Lane Configurations	↑↑	↑↑		↑↑	↑↑	↑
Traffic Volume (veh/h)	4	497	0	21	759	4
Future Volume (veh/h)	4	497	0	21	759	4
Initial Q (Qb), veh	0	0	0	0	0	0
Ped-Bike Adj(A_pbT)		1.00	1.00		1.00	1.00
Parking Bus, Adj	1.00	1.00	1.00	1.00	1.00	1.00
Work Zone On Approach	No			No	No	
Adj Sat Flow, veh/h/ln	1900	1767	0	1752	1811	1159
Adj Flow Rate, veh/h	4	515	0	22	799	4
Peak Hour Factor	0.95	0.95	0.95	0.95	0.95	0.95
Percent Heavy Veh, %	0	9	0	10	6	50
Cap, veh/h	734	1435	0	676	1143	335
Arrive On Green	0.20	0.20	0.00	0.20	0.34	0.34
Sat Flow, veh/h	3705	2635	0	3504	3346	982
Grp Volume(v), veh/h	4	515	0	22	799	4
Grp Sat Flow(s),veh/h/ln	1805	1317	0	1664	1673	982
Q Serve(g_s), s	0.0	2.9	0.0	0.1	5.4	0.1
Cycle Q Clear(g_c), s	0.0	2.9	0.0	0.1	5.4	0.1
Prop In Lane		1.00	0.00		1.00	1.00
Lane Grp Cap(c), veh/h	734	1435	0	676	1143	335
V/C Ratio(X)	0.01	0.36	0.00	0.03	0.70	0.01
Avail Cap(c_a), veh/h	1233	1800	0	1137	6221	1826
HCM Platoon Ratio	1.00	1.00	1.00	1.00	1.00	1.00
Upstream Filter(I)	1.00	1.00	0.00	1.00	1.00	1.00
Uniform Delay (d), s/veh	8.4	3.4	0.0	8.4	7.5	5.7
Incr Delay (d2), s/veh	0.0	0.1	0.0	0.0	0.3	0.0
Initial Q Delay(d3),s/veh	0.0	0.0	0.0	0.0	0.0	0.0
%ile BackOfQ(50%),veh/ln	0.0	0.7	0.0	0.0	0.7	0.0
Unsig. Movement Delay, s/veh						
LnGrp Delay(d),s/veh	8.4	3.5	0.0	8.4	7.8	5.7
LnGrp LOS	A	A	A	A	A	A
Approach Vol, veh/h	519			22	803	
Approach Delay, s/veh	3.5			8.4	7.8	
Approach LOS	A			A	A	
Timer - Assigned Phs		2		4		6
Phs Duration (G+Y+Rc), s		11.4		15.0		11.4
Change Period (Y+Rc), s		6.0		6.0		6.0
Max Green Setting (Gmax), s		9.0		49.0		9.0
Max Q Clear Time (g_c+I1), s		2.1		7.4		4.9
Green Ext Time (p_c), s		0.0		1.6		0.5
Intersection Summary						
HCM 6th Ctrl Delay			6.1			
HCM 6th LOS			A			

Timings

West Campus Upper Plateau (JN 14064)

34: Old 215 Frontage Rd. & Alessandro Bl.

02/16/2022

Lane Group	EBL	EBT	EBR	WBL	WBT	WBR	NBL	NBT	NBR	SBL	SBT	SBR
Lane Configurations												
Traffic Volume (vph)	317	1390	97	13	877	105	31	143	13	110	197	176
Future Volume (vph)	317	1390	97	13	877	105	31	143	13	110	197	176
Turn Type	Prot	NA	Perm	Prot	NA	Perm	Prot	NA	Perm	Prot	NA	Perm
Protected Phases	5	2		1	6		3	8		7	4	
Permitted Phases			2			6			8			4
Detector Phase	5	2	2	1	6	6	3	8	8	7	4	4
Switch Phase												
Minimum Initial (s)	5.0	10.0	10.0	5.0	10.0	10.0	5.0	10.0	10.0	5.0	10.0	10.0
Minimum Split (s)	8.7	43.5	43.5	8.7	15.8	15.8	8.7	16.2	16.2	8.7	40.2	40.2
Total Split (s)	22.0	62.4	62.4	8.7	49.1	49.1	8.7	29.7	29.7	19.2	40.2	40.2
Total Split (%)	18.3%	52.0%	52.0%	7.3%	40.9%	40.9%	7.3%	24.8%	24.8%	16.0%	33.5%	33.5%
Yellow Time (s)	3.2	5.5	5.5	3.2	4.8	4.8	3.2	5.2	5.2	3.2	5.2	5.2
All-Red Time (s)	0.5	1.0	1.0	0.5	1.0	1.0	0.5	1.0	1.0	0.5	1.0	1.0
Lost Time Adjust (s)	0.0	0.0	0.0	0.0	0.0	0.0	0.0	0.0	0.0	0.0	0.0	0.0
Total Lost Time (s)	3.7	6.5	6.5	3.7	5.8	5.8	3.7	6.2	6.2	3.7	6.2	6.2
Lead/Lag	Lead	Lag	Lag	Lead	Lag	Lag	Lead	Lag	Lag	Lead	Lag	Lag
Lead-Lag Optimize?	Yes	Yes	Yes	Yes	Yes	Yes	Yes	Yes	Yes	Yes	Yes	Yes
Recall Mode	None	None	None	None	None	None	None	None	None	None	None	None
Act Effct Green (s)	12.9	44.2	44.2	5.3	29.4	29.4	5.3	12.5	12.5	10.3	22.0	22.0
Actuated g/C Ratio	0.15	0.52	0.52	0.06	0.34	0.34	0.06	0.15	0.15	0.12	0.26	0.26
v/c Ratio	0.62	0.53	0.13	0.14	0.74	0.17	0.19	0.28	0.04	0.54	0.24	0.33
Control Delay	42.2	15.5	1.9	51.0	29.9	1.3	48.8	37.3	0.2	49.8	29.3	6.8
Queue Delay	0.0	0.0	0.0	0.0	0.0	0.0	0.0	0.0	0.0	0.0	0.0	0.0
Total Delay	42.2	15.5	1.9	51.0	29.9	1.3	48.8	37.3	0.2	49.8	29.3	6.8
LOS	D	B	A	D	C	A	D	D	A	D	C	A
Approach Delay		19.5			27.1			36.7			25.8	
Approach LOS		B			C			D			C	

Intersection Summary

Cycle Length: 120
 Actuated Cycle Length: 85.5
 Natural Cycle: 105
 Control Type: Actuated-Uncoordinated
 Maximum v/c Ratio: 0.74
 Intersection Signal Delay: 23.5
 Intersection LOS: C
 Intersection Capacity Utilization 64.4%
 ICU Level of Service C
 Analysis Period (min) 15

Splits and Phases: 34: Old 215 Frontage Rd. & Alessandro Bl.



HCM 6th Signalized Intersection Summary
 34: Old 215 Frontage Rd. & Alessandro Bl.

West Campus Upper Plateau (JN 14064)

02/16/2022



Movement	EBL	EBT	EBR	WBL	WBT	WBR	NBL	NBT	NBR	SBL	SBT	SBR
Lane Configurations	↖↗	↑↑↑	↖	↖	↑↑	↖	↖↗	↑↑	↖	↖	↑↑	↖
Traffic Volume (veh/h)	317	1390	97	13	877	105	31	143	13	110	197	176
Future Volume (veh/h)	317	1390	97	13	877	105	31	143	13	110	197	176
Initial Q (Qb), veh	0	0	0	0	0	0	0	0	0	0	0	0
Ped-Bike Adj(A_pbT)	1.00		0.99	1.00		1.00	1.00		0.99	1.00		1.00
Parking Bus, Adj	1.00	1.00	1.00	1.00	1.00	1.00	1.00	1.00	1.00	1.00	1.00	1.00
Work Zone On Approach		No			No			No			No	
Adj Sat Flow, veh/h/ln	1870	1885	1678	1678	1856	1856	1515	1856	1559	1826	1737	1885
Adj Flow Rate, veh/h	323	1418	72	13	895	0	32	146	3	112	201	0
Peak Hour Factor	0.98	0.98	0.98	0.98	0.98	0.98	0.98	0.98	0.98	0.98	0.98	0.98
Percent Heavy Veh, %	2	1	15	15	3	3	26	3	23	5	11	1
Cap, veh/h	434	2341	639	26	1217		94	523	193	143	651	
Arrive On Green	0.13	0.45	0.45	0.02	0.35	0.00	0.03	0.15	0.15	0.08	0.20	0.00
Sat Flow, veh/h	3456	5147	1404	1598	3526	1572	2799	3526	1301	1739	3300	1598
Grp Volume(v), veh/h	323	1418	72	13	895	0	32	146	3	112	201	0
Grp Sat Flow(s),veh/h/ln	1728	1716	1404	1598	1763	1572	1399	1763	1301	1739	1650	1598
Q Serve(g_s), s	6.1	14.0	2.0	0.5	15.0	0.0	0.8	2.5	0.1	4.3	3.5	0.0
Cycle Q Clear(g_c), s	6.1	14.0	2.0	0.5	15.0	0.0	0.8	2.5	0.1	4.3	3.5	0.0
Prop In Lane	1.00		1.00	1.00		1.00	1.00		1.00	1.00		1.00
Lane Grp Cap(c), veh/h	434	2341	639	26	1217		94	523	193	143	651	
V/C Ratio(X)	0.74	0.61	0.11	0.51	0.74		0.34	0.28	0.02	0.78	0.31	
Avail Cap(c_a), veh/h	939	4270	1165	119	2266		208	1230	454	400	1666	
HCM Platoon Ratio	1.00	1.00	1.00	1.00	1.00	1.00	1.00	1.00	1.00	1.00	1.00	1.00
Upstream Filter(I)	1.00	1.00	1.00	1.00	1.00	0.00	1.00	1.00	1.00	1.00	1.00	0.00
Uniform Delay (d), s/veh	28.4	13.8	10.6	32.9	19.4	0.0	31.8	25.5	24.5	30.3	23.1	0.0
Incr Delay (d2), s/veh	1.0	0.3	0.1	5.7	0.9	0.0	0.8	0.3	0.0	3.5	0.3	0.0
Initial Q Delay(d3),s/veh	0.0	0.0	0.0	0.0	0.0	0.0	0.0	0.0	0.0	0.0	0.0	0.0
%ile BackOfQ(50%),veh/ln	2.3	4.1	0.5	0.2	5.4	0.0	0.2	0.9	0.0	1.7	1.2	0.0
Unsig. Movement Delay, s/veh												
LnGrp Delay(d),s/veh	29.4	14.1	10.6	38.6	20.2	0.0	32.6	25.8	24.5	33.8	23.4	0.0
LnGrp LOS	C	B	B	D	C		C	C	C	C	C	
Approach Vol, veh/h		1813			908	A		181			313	A
Approach Delay, s/veh		16.7			20.5			27.0			27.1	
Approach LOS		B			C			C			C	
Timer - Assigned Phs	1	2	3	4	5	6	7	8				
Phs Duration (G+Y+Rc), s	4.8	37.1	6.0	19.5	12.2	29.8	9.3	16.2				
Change Period (Y+Rc), s	3.7	6.5	3.7	6.2	3.7	* 6.5	3.7	6.2				
Max Green Setting (Gmax), s	5.0	55.9	5.0	34.0	18.3	* 43	15.5	23.5				
Max Q Clear Time (g_c+I1), s	2.5	16.0	2.8	5.5	8.1	17.0	6.3	4.5				
Green Ext Time (p_c), s	0.0	12.1	0.0	1.1	0.4	6.2	0.1	0.7				

Intersection Summary

HCM 6th Ctrl Delay	19.3
HCM 6th LOS	B

Notes

* HCM 6th computational engine requires equal clearance times for the phases crossing the barrier.
 Unsignalized Delay for [WBR, SBR] is excluded from calculations of the approach delay and intersection delay.

Timings
35: Day St. & Alessandro Bl.

West Campus Upper Plateau (JN 14064)

02/16/2022



Lane Group	EBL	EBT	EBR	WBL	WBT	WBR	NBL	NBT	NBR	SBL	SBT
Lane Configurations	↖	↗↗↗	↖	↖	↗↗	↖	↖	↗	↖	↖	↗
Traffic Volume (vph)	190	1372	21	12	830	173	15	134	11	201	132
Future Volume (vph)	190	1372	21	12	830	173	15	134	11	201	132
Turn Type	Prot	NA	Perm	Prot	NA	Perm	Perm	NA	Perm	Perm	NA
Protected Phases	5	2		1	6			8			4
Permitted Phases			2			6	8		8	4	
Detector Phase	5	2	2	1	6	6	8	8	8	4	4
Switch Phase											
Minimum Initial (s)	5.0	10.0	10.0	5.0	10.0	10.0	10.0	10.0	10.0	10.0	10.0
Minimum Split (s)	9.1	30.8	30.8	9.1	30.8	30.8	42.4	42.4	42.4	41.6	41.6
Total Split (s)	28.0	67.9	67.9	9.1	49.0	49.0	43.0	43.0	43.0	43.0	43.0
Total Split (%)	23.3%	56.6%	56.6%	7.6%	40.8%	40.8%	35.8%	35.8%	35.8%	35.8%	35.8%
Yellow Time (s)	3.6	4.8	4.8	3.6	4.8	4.8	4.4	4.4	4.4	3.6	3.6
All-Red Time (s)	0.5	1.0	1.0	0.5	1.0	1.0	1.0	1.0	1.0	1.0	1.0
Lost Time Adjust (s)	0.0	0.0	0.0	0.0	0.0	0.0	0.0	0.0	0.0	0.0	0.0
Total Lost Time (s)	4.1	5.8	5.8	4.1	5.8	5.8	5.4	5.4	5.4	4.6	4.6
Lead/Lag	Lead	Lag	Lag	Lead	Lag	Lag					
Lead-Lag Optimize?	Yes	Yes	Yes	Yes	Yes	Yes					
Recall Mode	None	None	None	None	None	None	None	None	None	None	None
Act Effct Green (s)	14.4	45.6	45.6	5.5	27.9	27.9	20.5	20.5	20.5	21.3	21.3
Actuated g/C Ratio	0.18	0.57	0.57	0.07	0.35	0.35	0.26	0.26	0.26	0.27	0.27
v/c Ratio	0.61	0.49	0.03	0.10	0.70	0.29	0.09	0.29	0.02	0.62	0.50
Control Delay	42.9	11.9	0.0	49.0	27.0	12.3	28.0	27.8	0.1	36.9	26.6
Queue Delay	0.0	0.0	0.0	0.0	0.0	0.0	0.0	0.0	0.0	0.0	0.0
Total Delay	42.9	11.9	0.0	49.0	27.0	12.3	28.0	27.8	0.1	36.9	26.6
LOS	D	B	A	D	C	B	C	C	A	D	C
Approach Delay		15.4			24.8			26.0			31.3
Approach LOS		B			C			C			C

Intersection Summary

Cycle Length: 120
 Actuated Cycle Length: 79.6
 Natural Cycle: 85
 Control Type: Actuated-Uncoordinated
 Maximum v/c Ratio: 0.70
 Intersection Signal Delay: 21.1
 Intersection LOS: C
 Intersection Capacity Utilization 71.7%
 ICU Level of Service C
 Analysis Period (min) 15

Splits and Phases: 35: Day St. & Alessandro Bl.



HCM 6th Signalized Intersection Summary
35: Day St. & Alessandro Bl.

West Campus Upper Plateau (JN 14064)

02/16/2022

Movement	EBL	EBT	EBR	WBL	WBT	WBR	NBL	NBT	NBR	SBL	SBT	SBR
Lane Configurations												
Traffic Volume (veh/h)	190	1372	21	12	830	173	15	134	11	201	132	104
Future Volume (veh/h)	190	1372	21	12	830	173	15	134	11	201	132	104
Initial Q (Qb), veh	0	0	0	0	0	0	0	0	0	0	0	0
Ped-Bike Adj(A_pbT)	1.00		0.98	1.00		0.98	1.00		1.00	1.00		1.00
Parking Bus, Adj	1.00	1.00	1.00	1.00	1.00	1.00	1.00	1.00	1.00	1.00	1.00	1.00
Work Zone On Approach		No			No			No			No	
Adj Sat Flow, veh/h/ln	1885	1870	1618	1900	1870	1900	1500	1900	1767	1885	1870	1870
Adj Flow Rate, veh/h	198	1429	16	12	865	112	16	140	6	209	138	77
Peak Hour Factor	0.96	0.96	0.96	0.96	0.96	0.96	0.96	0.96	0.96	0.96	0.96	0.96
Percent Heavy Veh, %	1	2	19	0	2	0	27	0	9	1	2	2
Cap, veh/h	247	2383	626	27	1224	542	279	528	416	389	313	175
Arrive On Green	0.14	0.47	0.47	0.02	0.34	0.34	0.28	0.28	0.28	0.28	0.28	0.28
Sat Flow, veh/h	1795	5106	1341	1810	3554	1575	935	1900	1497	1252	1128	629
Grp Volume(v), veh/h	198	1429	16	12	865	112	16	140	6	209	0	215
Grp Sat Flow(s),veh/h/ln	1795	1702	1341	1810	1777	1575	935	1900	1497	1252	0	1757
Q Serve(g_s), s	6.8	13.2	0.4	0.4	13.4	3.2	0.9	3.7	0.2	9.9	0.0	6.4
Cycle Q Clear(g_c), s	6.8	13.2	0.4	0.4	13.4	3.2	7.3	3.7	0.2	13.6	0.0	6.4
Prop In Lane	1.00		1.00	1.00		1.00	1.00		1.00	1.00		0.36
Lane Grp Cap(c), veh/h	247	2383	626	27	1224	542	279	528	416	389	0	488
V/C Ratio(X)	0.80	0.60	0.03	0.44	0.71	0.21	0.06	0.27	0.01	0.54	0.00	0.44
Avail Cap(c_a), veh/h	674	4980	1308	142	2411	1068	571	1122	884	796	0	1060
HCM Platoon Ratio	1.00	1.00	1.00	1.00	1.00	1.00	1.00	1.00	1.00	1.00	1.00	1.00
Upstream Filter(I)	1.00	1.00	1.00	1.00	1.00	1.00	1.00	1.00	1.00	1.00	0.00	1.00
Uniform Delay (d), s/veh	26.6	12.6	9.2	31.1	18.1	14.7	21.9	17.9	16.7	23.2	0.0	18.9
Incr Delay (d2), s/veh	2.3	0.2	0.0	4.1	0.8	0.2	0.1	0.3	0.0	1.2	0.0	0.6
Initial Q Delay(d3),s/veh	0.0	0.0	0.0	0.0	0.0	0.0	0.0	0.0	0.0	0.0	0.0	0.0
%ile BackOfQ(50%),veh/ln	2.8	3.9	0.1	0.2	4.7	1.0	0.2	1.5	0.1	2.9	0.0	2.6
Unsig. Movement Delay, s/veh												
LnGrp Delay(d),s/veh	28.9	12.8	9.2	35.2	18.8	14.9	22.0	18.2	16.7	24.4	0.0	19.5
LnGrp LOS	C	B	A	D	B	B	C	B	B	C	A	B
Approach Vol, veh/h		1643			989			162			424	
Approach Delay, s/veh		14.7			18.6			18.5			21.9	
Approach LOS		B			B			B			C	
Timer - Assigned Phs	1	2		4	5	6		8				
Phs Duration (G+Y+Rc), s	5.1	35.5		23.1	12.8	27.7		23.1				
Change Period (Y+Rc), s	4.1	5.8		* 5.4	4.1	5.8		5.4				
Max Green Setting (Gmax), s	5.0	62.1		* 38	23.9	43.2		37.6				
Max Q Clear Time (g_c+I1), s	2.4	15.2		15.6	8.8	15.4		9.3				
Green Ext Time (p_c), s	0.0	13.4		2.1	0.2	6.5		0.8				

Intersection Summary

HCM 6th Ctrl Delay	17.1
HCM 6th LOS	B

Notes

* HCM 6th computational engine requires equal clearance times for the phases crossing the barrier.

Timings
36: Elsworth St. & Cactus Av.

West Campus Upper Plateau (JN 14064)

02/16/2022



Lane Group	EBL	EBT	EBR	WBL	WBT	WBR	NBL	NBT	SBL	SBT	SBR
Lane Configurations	↘	↑↑↑	↗	↘	↑↑↑	↗	↘	↕	↘	↗	↗
Traffic Volume (vph)	140	1863	26	15	1191	83	191	64	201	13	180
Future Volume (vph)	140	1863	26	15	1191	83	191	64	201	13	180
Turn Type	Prot	NA	Perm	Prot	NA	Perm	Split	NA	Split	NA	pm+ov
Protected Phases	5	2		1	6		8	8	4	4	5
Permitted Phases			2			6					4
Detector Phase	5	2	2	1	6	6	8	8	4	4	5
Switch Phase											
Minimum Initial (s)	5.0	10.0	10.0	5.0	10.0	10.0	10.0	10.0	10.0	10.0	5.0
Minimum Split (s)	9.6	36.2	36.2	9.6	36.2	36.2	35.4	35.4	35.4	35.4	9.6
Total Split (s)	16.5	49.6	49.6	9.6	42.7	42.7	35.4	35.4	35.4	35.4	16.5
Total Split (%)	12.7%	38.2%	38.2%	7.4%	32.8%	32.8%	27.2%	27.2%	27.2%	27.2%	12.7%
Yellow Time (s)	3.6	5.2	5.2	3.6	5.2	5.2	4.4	4.4	4.4	4.4	3.6
All-Red Time (s)	1.0	1.0	1.0	1.0	1.0	1.0	1.0	1.0	1.0	1.0	1.0
Lost Time Adjust (s)	0.0	0.0	0.0	0.0	0.0	0.0	0.0	0.0	0.0	0.0	0.0
Total Lost Time (s)	4.6	6.2	6.2	4.6	6.2	6.2	5.4	5.4	5.4	5.4	4.6
Lead/Lag	Lead	Lag	Lag	Lead	Lag	Lag					Lead
Lead-Lag Optimize?	Yes	Yes	Yes	Yes	Yes	Yes					Yes
Recall Mode	None	None	None	None	None	None	Max	Max	Max	Max	None
Act Effct Green (s)	11.9	48.5	48.5	5.0	35.9	35.9	30.0	30.0	30.0	30.0	42.7
Actuated g/C Ratio	0.09	0.37	0.37	0.04	0.28	0.28	0.23	0.23	0.23	0.23	0.33
v/c Ratio	0.92	1.04	0.04	0.23	0.90	0.16	0.45	0.41	0.28	0.28	0.30
Control Delay	111.1	70.7	0.1	68.7	54.7	1.1	47.0	38.1	43.4	43.4	4.7
Queue Delay	0.0	0.0	0.0	0.0	0.0	0.0	0.0	0.0	0.0	0.0	0.0
Total Delay	111.1	70.7	0.1	68.7	54.7	1.1	47.0	38.1	43.4	43.4	4.7
LOS	F	E	A	E	D	A	D	D	D	D	A
Approach Delay		72.6			51.4			42.7		25.7	
Approach LOS		E			D			D		C	

Intersection Summary

Cycle Length: 130
 Actuated Cycle Length: 129.4
 Natural Cycle: 120
 Control Type: Actuated-Uncoordinated
 Maximum v/c Ratio: 1.04
 Intersection Signal Delay: 58.8
 Intersection Capacity Utilization 75.7%
 Analysis Period (min) 15
 Intersection LOS: E
 ICU Level of Service D

Splits and Phases: 36: Elsworth St. & Cactus Av.

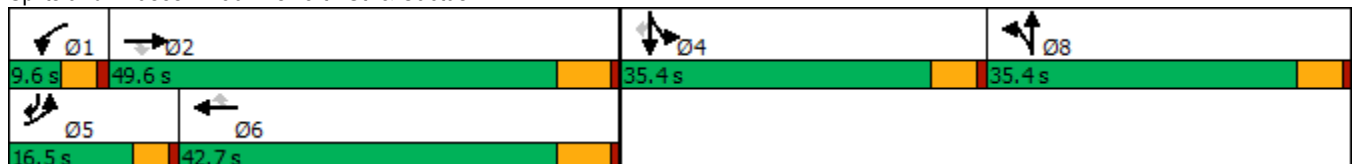

HCM 6th Signalized Intersection Summary
36: Elsworth St. & Cactus Av.

West Campus Upper Plateau (JN 14064)

02/16/2022



Movement	EBL	EBT	EBR	WBL	WBT	WBR	NBL	NBT	NBR	SBL	SBT	SBR
Lane Configurations	↗	↑↑↑	↖	↖	↑↑↑	↖	↖	↕		↖	↖	↖
Traffic Volume (veh/h)	140	1863	26	15	1191	83	191	64	74	201	13	180
Future Volume (veh/h)	140	1863	26	15	1191	83	191	64	74	201	13	180
Initial Q (Qb), veh	0	0	0	0	0	0	0	0	0	0	0	0
Ped-Bike Adj(A_pbT)	1.00		1.00	1.00		1.00	1.00		1.00	1.00		1.00
Parking Bus, Adj	1.00	1.00	1.00	1.00	1.00	1.00	1.00	1.00	1.00	1.00	1.00	1.00
Work Zone On Approach		No			No			No			No	
Adj Sat Flow, veh/h/ln	1841	1841	1781	1900	1841	1885	1885	1900	1885	1885	1900	1885
Adj Flow Rate, veh/h	146	1941	0	16	1241	50	160	122	53	219	0	81
Peak Hour Factor	0.96	0.96	0.96	0.96	0.96	0.96	0.96	0.96	0.96	0.96	0.96	0.96
Percent Heavy Veh, %	4	4	8	0	4	1	1	0	1	1	0	1
Cap, veh/h	162	1754		31	1374	437	419	293	127	837	0	520
Arrive On Green	0.09	0.35	0.00	0.02	0.27	0.27	0.23	0.23	0.23	0.23	0.00	0.23
Sat Flow, veh/h	1753	5025	1510	1810	5025	1598	1795	1256	546	3591	0	1598
Grp Volume(v), veh/h	146	1941	0	16	1241	50	160	0	175	219	0	81
Grp Sat Flow(s),veh/h/ln	1753	1675	1510	1810	1675	1598	1795	0	1802	1795	0	1598
Q Serve(g_s), s	10.6	44.9	0.0	1.1	30.7	3.0	9.7	0.0	10.6	6.4	0.0	4.6
Cycle Q Clear(g_c), s	10.6	44.9	0.0	1.1	30.7	3.0	9.7	0.0	10.6	6.4	0.0	4.6
Prop In Lane	1.00		1.00	1.00		1.00	1.00		0.30	1.00		1.00
Lane Grp Cap(c), veh/h	162	1754		31	1374	437	419	0	420	837	0	520
V/C Ratio(X)	0.90	1.11		0.52	0.90	0.11	0.38	0.00	0.42	0.26	0.00	0.16
Avail Cap(c_a), veh/h	162	1754		70	1425	453	419	0	420	837	0	520
HCM Platoon Ratio	1.00	1.00	1.00	1.00	1.00	1.00	1.00	1.00	1.00	1.00	1.00	1.00
Upstream Filter(I)	1.00	1.00	0.00	1.00	1.00	1.00	1.00	0.00	1.00	1.00	0.00	1.00
Uniform Delay (d), s/veh	57.8	41.9	0.0	62.7	45.1	35.1	41.5	0.0	41.9	40.3	0.0	30.8
Incr Delay (d2), s/veh	42.3	57.0	0.0	5.0	8.2	0.1	2.6	0.0	3.0	0.8	0.0	0.6
Initial Q Delay(d3),s/veh	0.0	0.0	0.0	0.0	0.0	0.0	0.0	0.0	0.0	0.0	0.0	0.0
%ile BackOfQ(50%),veh/ln	6.5	26.8	0.0	0.5	13.2	1.2	4.7	0.0	5.1	2.9	0.0	1.9
Unsig. Movement Delay, s/veh												
LnGrp Delay(d),s/veh	100.1	98.9	0.0	67.8	53.3	35.2	44.2	0.0	44.9	41.1	0.0	31.5
LnGrp LOS	F	F		E	D	D	D	A	D	D	A	C
Approach Vol, veh/h		2087	A		1307			335				300
Approach Delay, s/veh		99.0			52.8			44.6				38.5
Approach LOS		F			D			D				D
Timer - Assigned Phs	1	2		4	5	6		8				
Phs Duration (G+Y+Rc), s	6.8	51.1		35.4	16.5	41.4		35.4				
Change Period (Y+Rc), s	4.6	6.2		5.4	4.6	6.2		5.4				
Max Green Setting (Gmax), s	5.0	43.4		30.0	11.9	36.5		30.0				
Max Q Clear Time (g_c+I1), s	3.1	46.9		8.4	12.6	32.7		12.6				
Green Ext Time (p_c), s	0.0	0.0		0.9	0.0	2.5		1.4				

Intersection Summary

HCM 6th Ctrl Delay	75.0
HCM 6th LOS	E

Notes

- User approved pedestrian interval to be less than phase max green.
- User approved volume balancing among the lanes for turning movement.
- Unsignalized Delay for [EBR] is excluded from calculations of the approach delay and intersection delay.

Timings
37: Cactus Av. & Frederick St.

West Campus Upper Plateau (JN 14064)

02/16/2022



Lane Group	EBL	EBT	WBT	WBR	SBL	SBR
Lane Configurations	↖	↑↑↑	↑↑↑	↗	↙↘	↘
Traffic Volume (vph)	196	1917	1148	153	432	175
Future Volume (vph)	196	1917	1148	153	432	175
Turn Type	Prot	NA	NA	pm+ov	Prot	pm+ov
Protected Phases	5	2	6	4	4	5
Permitted Phases				6		4
Detector Phase	5	2	6	4	4	5
Switch Phase						
Minimum Initial (s)	5.0	10.0	10.0	10.0	10.0	5.0
Minimum Split (s)	9.2	28.2	29.2	36.4	36.4	9.2
Total Split (s)	31.0	81.0	50.0	39.0	39.0	31.0
Total Split (%)	25.8%	67.5%	41.7%	32.5%	32.5%	25.8%
Yellow Time (s)	3.2	5.2	5.2	4.4	4.4	3.2
All-Red Time (s)	1.0	1.0	1.0	1.0	1.0	1.0
Lost Time Adjust (s)	0.0	0.0	0.0	0.0	0.0	0.0
Total Lost Time (s)	4.2	6.2	6.2	5.4	5.4	4.2
Lead/Lag	Lead		Lag			Lead
Lead-Lag Optimize?	Yes		Yes			Yes
Recall Mode	None	None	None	None	None	None
Act Effct Green (s)	14.8	47.8	28.5	47.2	17.8	38.4
Actuated g/C Ratio	0.19	0.61	0.37	0.61	0.23	0.49
v/c Ratio	0.63	0.65	0.66	0.16	0.59	0.24
Control Delay	41.1	11.1	23.5	1.3	31.6	12.1
Queue Delay	0.0	0.0	0.0	0.0	0.0	0.0
Total Delay	41.1	11.1	23.5	1.3	31.6	12.1
LOS	D	B	C	A	C	B
Approach Delay		13.9	20.9		26.0	
Approach LOS		B	C		C	

Intersection Summary

Cycle Length: 120
 Actuated Cycle Length: 78
 Natural Cycle: 80
 Control Type: Actuated-Uncoordinated
 Maximum v/c Ratio: 0.66
 Intersection Signal Delay: 18.0
 Intersection LOS: B
 Intersection Capacity Utilization 59.0%
 ICU Level of Service B
 Analysis Period (min) 15

Splits and Phases: 37: Cactus Av. & Frederick St.

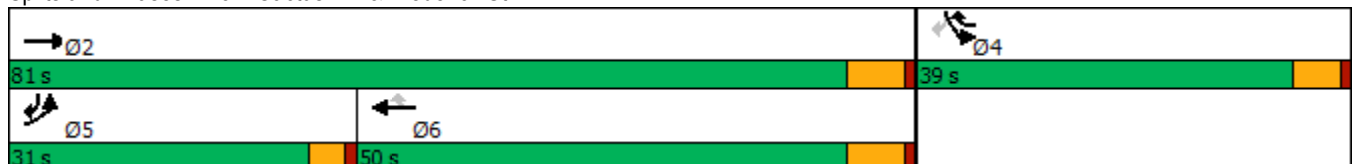

HCM 6th Signalized Intersection Summary
37: Cactus Av. & Frederick St.

West Campus Upper Plateau (JN 14064)

02/16/2022



Movement	EBL	EBT	WBT	WBR	SBL	SBR
Lane Configurations						
Traffic Volume (veh/h)	196	1917	1148	153	432	175
Future Volume (veh/h)	196	1917	1148	153	432	175
Initial Q (Qb), veh	0	0	0	0	0	0
Ped-Bike Adj(A_pbT)	1.00			0.98	1.00	1.00
Parking Bus, Adj	1.00	1.00	1.00	1.00	1.00	1.00
Work Zone On Approach		No	No		No	
Adj Sat Flow, veh/h/ln	1826	1856	1856	1870	1856	1856
Adj Flow Rate, veh/h	206	2018	1208	99	455	87
Peak Hour Factor	0.95	0.95	0.95	0.95	0.95	0.95
Percent Heavy Veh, %	5	3	3	2	3	3
Cap, veh/h	253	3241	2182	958	630	517
Arrive On Green	0.15	0.64	0.43	0.43	0.18	0.18
Sat Flow, veh/h	1739	5233	5233	1548	3428	1572
Grp Volume(v), veh/h	206	2018	1208	99	455	87
Grp Sat Flow(s),veh/h/ln	1739	1689	1689	1548	1714	1572
Q Serve(g_s), s	7.6	15.7	11.7	1.7	8.2	2.6
Cycle Q Clear(g_c), s	7.6	15.7	11.7	1.7	8.2	2.6
Prop In Lane	1.00			1.00	1.00	1.00
Lane Grp Cap(c), veh/h	253	3241	2182	958	630	517
V/C Ratio(X)	0.82	0.62	0.55	0.10	0.72	0.17
Avail Cap(c_a), veh/h	709	5761	3373	1322	1751	1032
HCM Platoon Ratio	1.00	1.00	1.00	1.00	1.00	1.00
Upstream Filter(I)	1.00	1.00	1.00	1.00	1.00	1.00
Uniform Delay (d), s/veh	27.3	7.1	14.0	5.2	25.3	15.7
Incr Delay (d2), s/veh	2.5	0.2	0.2	0.0	1.6	0.2
Initial Q Delay(d3),s/veh	0.0	0.0	0.0	0.0	0.0	0.0
%ile BackOfQ(50%),veh/ln	2.9	3.2	3.5	0.7	3.2	2.7
Unsig. Movement Delay, s/veh						
LnGrp Delay(d),s/veh	29.7	7.3	14.2	5.3	26.8	15.8
LnGrp LOS	C	A	B	A	C	B
Approach Vol, veh/h		2224	1307		542	
Approach Delay, s/veh		9.4	13.5		25.1	
Approach LOS		A	B		C	
Timer - Assigned Phs		2		4	5	6
Phs Duration (G+Y+Rc), s		48.3		17.5	13.8	34.5
Change Period (Y+Rc), s		6.2		5.4	* 4.2	6.2
Max Green Setting (Gmax), s		74.8		33.6	* 27	43.8
Max Q Clear Time (g_c+I1), s		17.7		10.2	9.6	13.7
Green Ext Time (p_c), s		24.4		1.9	0.2	9.5

Intersection Summary

HCM 6th Ctrl Delay	12.8
HCM 6th LOS	B

Notes

* HCM 6th computational engine requires equal clearance times for the phases crossing the barrier.

Timings
38: Riverside Dr./Graham St. & Cactus Av.

West Campus Upper Plateau (JN 14064)

09/19/2022

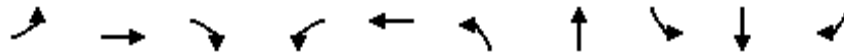

Lane Group	EBL	EBT	EBR	WBL	WBT	NBL	NBT	SBL	SBT	SBR
Lane Configurations	↘	↑↑↑	↗	↘	↑↑↑	↘	↑	↘	↑↑	↗
Traffic Volume (vph)	101	2087	353	16	1278	2	0	123	88	99
Future Volume (vph)	101	2087	353	16	1278	2	0	123	88	99
Turn Type	Prot	NA	Perm	Prot	NA	Prot	NA	Prot	NA	Perm
Protected Phases	7	4		3	8	5	2	1	6	
Permitted Phases			4							6
Detector Phase	7	4	4	3	8	5	2	1	6	6
Switch Phase										
Minimum Initial (s)	5.0	10.0	10.0	5.0	10.0	5.0	10.0	5.0	10.0	10.0
Minimum Split (s)	9.6	39.2	39.2	9.6	39.2	10.4	35.0	9.6	40.6	40.6
Total Split (s)	16.0	59.0	59.0	9.6	52.6	10.4	36.0	15.4	41.0	41.0
Total Split (%)	13.3%	49.2%	49.2%	8.0%	43.8%	8.7%	30.0%	12.8%	34.2%	34.2%
Yellow Time (s)	3.6	5.2	5.2	3.6	5.2	4.4	4.0	3.6	3.6	3.6
All-Red Time (s)	1.0	1.0	1.0	1.0	1.0	1.0	1.0	1.0	1.0	1.0
Lost Time Adjust (s)	0.0	0.0	0.0	0.0	0.0	0.0	0.0	0.0	0.0	0.0
Total Lost Time (s)	4.6	6.2	6.2	4.6	6.2	5.4	5.0	4.6	4.6	4.6
Lead/Lag	Lead	Lag	Lag	Lead	Lag	Lead	Lag	Lead	Lag	Lag
Lead-Lag Optimize?	Yes	Yes	Yes	Yes	Yes	Yes	Yes	Yes	Yes	Yes
Recall Mode	None	Min	Min	None	Min	None	None	None	None	None
Act Effct Green (s)	9.6	54.8	54.8	5.2	41.8	5.2	13.2	10.9	14.4	14.4
Actuated g/C Ratio	0.12	0.66	0.66	0.06	0.50	0.06	0.16	0.13	0.17	0.17
v/c Ratio	0.55	0.69	0.34	0.15	0.59	0.01	0.00	0.58	0.16	0.27
Control Delay	49.0	14.1	5.1	46.8	18.1	45.5	0.0	48.5	29.5	2.7
Queue Delay	0.0	0.0	0.0	0.0	0.0	0.0	0.0	0.0	0.0	0.0
Total Delay	49.0	14.1	5.1	46.8	18.1	45.5	0.0	48.5	29.5	2.7
LOS	D	B	A	D	B	D	A	D	C	A
Approach Delay		14.2			18.4		30.3		28.5	
Approach LOS		B			B		C		C	

Intersection Summary

Cycle Length: 120
 Actuated Cycle Length: 83.1
 Natural Cycle: 120
 Control Type: Actuated-Uncoordinated
 Maximum v/c Ratio: 0.69
 Intersection Signal Delay: 16.6
 Intersection LOS: B
 Intersection Capacity Utilization 70.8%
 ICU Level of Service C
 Analysis Period (min) 15

Splits and Phases: 38: Riverside Dr./Graham St. & Cactus Av.

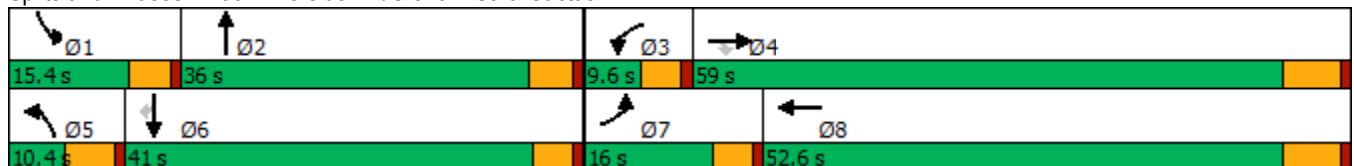

HCM 6th Signalized Intersection Summary
38: Riverside Dr./Graham St. & Cactus Av.

West Campus Upper Plateau (JN 14064)

09/19/2022



Movement	EBL	EBT	EBR	WBL	WBT	WBR	NBL	NBT	NBR	SBL	SBT	SBR
Lane Configurations	↗	↑↑↑	↘	↗	↑↑↑		↗	↑		↘	↑↑	↘
Traffic Volume (veh/h)	101	2087	353	16	1278	82	2	0	1	123	88	99
Future Volume (veh/h)	101	2087	353	16	1278	82	2	0	1	123	88	99
Initial Q (Qb), veh	0	0	0	0	0	0	0	0	0	0	0	0
Ped-Bike Adj(A_pbT)	1.00		1.00	1.00		0.99	1.00		1.00	1.00		1.00
Parking Bus, Adj	1.00	1.00	1.00	1.00	1.00	1.00	1.00	1.00	1.00	1.00	1.00	1.00
Work Zone On Approach		No			No			No			No	
Adj Sat Flow, veh/h/ln	1841	1841	1885	1900	1841	1900	1900	1900	1900	1870	1885	1826
Adj Flow Rate, veh/h	110	2268	336	17	1389	80	2	0	0	134	96	30
Peak Hour Factor	0.92	0.92	0.92	0.92	0.92	0.92	0.92	0.92	0.92	0.92	0.92	0.92
Percent Heavy Veh, %	4	4	1	0	4	0	0	0	0	2	1	5
Cap, veh/h	139	2966	943	36	2576	148	10	153	0	168	444	192
Arrive On Green	0.08	0.59	0.59	0.02	0.53	0.53	0.00	0.00	0.00	0.09	0.12	0.12
Sat Flow, veh/h	1753	5025	1598	1810	4856	280	3510	3705	0	1781	3582	1547
Grp Volume(v), veh/h	110	2268	336	17	958	511	2	0	0	134	96	30
Grp Sat Flow(s),veh/h/ln	1753	1675	1598	1810	1675	1786	1755	1805	0	1781	1791	1547
Q Serve(g_s), s	5.0	27.1	8.8	0.7	15.1	15.1	0.0	0.0	0.0	5.9	1.9	1.4
Cycle Q Clear(g_c), s	5.0	27.1	8.8	0.7	15.1	15.1	0.0	0.0	0.0	5.9	1.9	1.4
Prop In Lane	1.00		1.00	1.00		0.16	1.00		0.00	1.00		1.00
Lane Grp Cap(c), veh/h	139	2966	943	36	1777	947	10	153	0	168	444	192
V/C Ratio(X)	0.79	0.76	0.36	0.48	0.54	0.54	0.21	0.00	0.00	0.80	0.22	0.16
Avail Cap(c_a), veh/h	248	3297	1048	112	1932	1030	218	1391	0	239	1620	700
HCM Platoon Ratio	1.00	1.00	1.00	1.00	1.00	1.00	1.00	1.00	1.00	1.00	1.00	1.00
Upstream Filter(I)	1.00	1.00	1.00	1.00	1.00	1.00	1.00	0.00	0.00	1.00	1.00	1.00
Uniform Delay (d), s/veh	36.4	12.3	8.6	39.0	12.4	12.4	40.0	0.0	0.0	35.7	31.7	31.5
Incr Delay (d2), s/veh	3.7	1.0	0.2	3.7	0.3	0.5	4.0	0.0	0.0	7.6	0.2	0.4
Initial Q Delay(d3),s/veh	0.0	0.0	0.0	0.0	0.0	0.0	0.0	0.0	0.0	0.0	0.0	0.0
%ile BackOfQ(50%),veh/ln	2.1	7.7	2.3	0.3	4.5	4.9	0.0	0.0	0.0	2.8	0.8	0.5
Unsig. Movement Delay, s/veh												
LnGrp Delay(d),s/veh	40.1	13.3	8.8	42.7	12.7	12.9	44.0	0.0	0.0	43.3	32.0	31.9
LnGrp LOS	D	B	A	D	B	B	D	A	A	D	C	C
Approach Vol, veh/h		2714			1486			2			260	
Approach Delay, s/veh		13.8			13.1			44.0			37.8	
Approach LOS		B			B			D			D	
Timer - Assigned Phs	1	2	3	4	5	6	7	8				
Phs Duration (G+Y+Rc), s	12.2	8.4	6.2	53.7	5.6	15.0	11.0	48.9				
Change Period (Y+Rc), s	4.6	5.0	4.6	6.2	5.4	* 5	4.6	6.2				
Max Green Setting (Gmax), s	10.8	31.0	5.0	52.8	5.0	* 36	11.4	46.4				
Max Q Clear Time (g_c+I1), s	7.9	0.0	2.7	29.1	2.0	3.9	7.0	17.1				
Green Ext Time (p_c), s	0.0	0.0	0.0	18.4	0.0	0.6	0.0	10.8				

Intersection Summary

HCM 6th Ctrl Delay	15.0
HCM 6th LOS	B

Notes

* HCM 6th computational engine requires equal clearance times for the phases crossing the barrier.

Timings
1: Washington St & Van Buren Bl.

West Campus Upper Plateau (JN 14064)

09/29/2022



Lane Group	EBL	EBT	WBL	WBT	WBR	NBL	NBT	NBR	SBL	SBT
Lane Configurations	↙	↕	↙	↕	↗	↙	↕	↗	↙	↕
Traffic Volume (vph)	110	749	92	727	190	127	191	106	274	166
Future Volume (vph)	110	749	92	727	190	127	191	106	274	166
Turn Type	Prot	NA	Prot	NA	Perm	Prot	NA	Perm	Prot	NA
Protected Phases	5	2	1	6		3	8		7	4
Permitted Phases					6			8		
Detector Phase	5	2	1	6	6	3	8	8	7	4
Switch Phase										
Minimum Initial (s)	5.0	10.0	5.0	10.0	10.0	5.0	10.0	10.0	5.0	10.0
Minimum Split (s)	9.2	34.2	9.2	33.2	33.2	9.2	38.4	38.4	9.2	30.8
Total Split (s)	14.2	49.6	14.0	49.4	49.4	11.5	38.4	38.4	18.0	44.9
Total Split (%)	11.8%	41.3%	11.7%	41.2%	41.2%	9.6%	32.0%	32.0%	15.0%	37.4%
Yellow Time (s)	3.2	5.2	3.2	5.2	5.2	3.2	4.4	4.4	3.2	4.8
All-Red Time (s)	1.0	1.0	1.0	1.0	1.0	1.0	1.0	1.0	1.0	1.0
Lost Time Adjust (s)	0.0	0.0	0.0	0.0	0.0	0.0	0.0	0.0	0.0	0.0
Total Lost Time (s)	4.2	6.2	4.2	6.2	6.2	4.2	5.4	5.4	4.2	5.8
Lead/Lag	Lead	Lag	Lead	Lag	Lag	Lead	Lag	Lag	Lead	Lag
Lead-Lag Optimize?	Yes	Yes	Yes	Yes	Yes	Yes	Yes	Yes	Yes	Yes
Recall Mode	None	None	None	None	None	None	None	None	None	None
Act Effct Green (s)	9.3	31.6	8.6	28.2	28.2	7.0	14.0	14.0	11.3	17.8
Actuated g/C Ratio	0.11	0.38	0.10	0.34	0.34	0.08	0.17	0.17	0.14	0.21
v/c Ratio	0.56	0.65	0.52	0.63	0.31	0.45	0.34	0.29	0.60	0.32
Control Delay	52.3	25.9	51.7	26.7	7.2	46.7	33.8	4.4	43.0	22.4
Queue Delay	0.0	0.0	0.0	0.0	0.0	0.0	0.0	0.0	0.0	0.0
Total Delay	52.3	25.9	51.7	26.7	7.2	46.7	33.8	4.4	43.0	22.4
LOS	D	C	D	C	A	D	C	A	D	C
Approach Delay		29.0		25.3			30.3			33.4
Approach LOS		C		C			C			C

Intersection Summary

Cycle Length: 120
 Actuated Cycle Length: 83.7
 Natural Cycle: 95
 Control Type: Actuated-Uncoordinated
 Maximum v/c Ratio: 0.65
 Intersection Signal Delay: 28.7
 Intersection LOS: C
 Intersection Capacity Utilization 61.4%
 ICU Level of Service B
 Analysis Period (min) 15



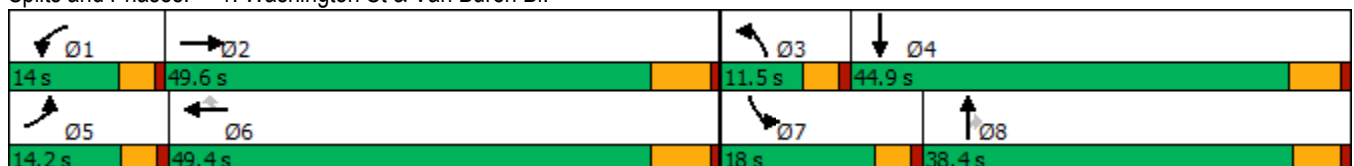



















Splits and Phases: 1: Washington St & Van Buren Bl.



HCM 6th Signalized Intersection Summary
1: Washington St & Van Buren Bl.

West Campus Upper Plateau (JN 14064)

09/29/2022

												
Movement	EBL	EBT	EBR	WBL	WBT	WBR	NBL	NBT	NBR	SBL	SBT	SBR
Lane Configurations												
Traffic Volume (veh/h)	110	749	68	92	727	190	127	191	106	274	166	72
Future Volume (veh/h)	110	749	68	92	727	190	127	191	106	274	166	72
Initial Q (Qb), veh	0	0	0	0	0	0	0	0	0	0	0	0
Ped-Bike Adj(A_pbT)	1.00		1.00	1.00		1.00	1.00		0.98	1.00		0.98
Parking Bus, Adj	1.00	1.00	1.00	1.00	1.00	1.00	1.00	1.00	1.00	1.00	1.00	1.00
Work Zone On Approach		No			No			No			No	
Adj Sat Flow, veh/h/ln	1900	1841	1856	1885	1856	1885	1885	1856	1870	1885	1885	1900
Adj Flow Rate, veh/h	113	772	50	95	749	101	131	197	69	282	171	27
Peak Hour Factor	0.97	0.97	0.97	0.97	0.97	0.97	0.97	0.97	0.97	0.97	0.97	0.97
Percent Heavy Veh, %	0	4	3	1	3	1	1	3	2	1	1	0
Cap, veh/h	146	1147	74	123	1170	529	241	580	256	393	645	100
Arrive On Green	0.08	0.34	0.34	0.07	0.33	0.33	0.07	0.16	0.16	0.11	0.21	0.21
Sat Flow, veh/h	1810	3335	216	1795	3526	1593	3483	3526	1557	3483	3099	480
Grp Volume(v), veh/h	113	405	417	95	749	101	131	197	69	282	97	101
Grp Sat Flow(s),veh/h/ln	1810	1749	1802	1795	1763	1593	1742	1763	1557	1742	1791	1789
Q Serve(g_s), s	4.0	13.0	13.0	3.4	11.8	3.0	2.4	3.2	2.5	5.1	3.0	3.1
Cycle Q Clear(g_c), s	4.0	13.0	13.0	3.4	11.8	3.0	2.4	3.2	2.5	5.1	3.0	3.1
Prop In Lane	1.00		0.12	1.00		1.00	1.00		1.00	1.00		0.27
Lane Grp Cap(c), veh/h	146	602	620	123	1170	529	241	580	256	393	373	372
V/C Ratio(X)	0.78	0.67	0.67	0.77	0.64	0.19	0.54	0.34	0.27	0.72	0.26	0.27
Avail Cap(c_a), veh/h	275	1155	1190	268	2318	1048	387	1771	782	732	1066	1065
HCM Platoon Ratio	1.00	1.00	1.00	1.00	1.00	1.00	1.00	1.00	1.00	1.00	1.00	1.00
Upstream Filter(I)	1.00	1.00	1.00	1.00	1.00	1.00	1.00	1.00	1.00	1.00	1.00	1.00
Uniform Delay (d), s/veh	29.6	18.4	18.4	30.1	18.6	15.7	29.6	24.3	24.0	28.1	21.8	21.8
Incr Delay (d2), s/veh	3.3	1.9	1.8	3.9	0.8	0.2	0.7	0.3	0.6	0.9	0.4	0.4
Initial Q Delay(d3),s/veh	0.0	0.0	0.0	0.0	0.0	0.0	0.0	0.0	0.0	0.0	0.0	0.0
%ile BackOfQ(50%),veh/ln	1.7	4.6	4.8	1.5	4.2	1.1	1.0	1.3	0.9	2.1	1.2	1.3
Unsig. Movement Delay, s/veh												
LnGrp Delay(d),s/veh	32.9	20.3	20.2	34.0	19.5	15.9	30.3	24.6	24.6	29.1	22.2	22.2
LnGrp LOS	C	C	C	C	B	B	C	C	C	C	C	C
Approach Vol, veh/h		935			945			397			480	
Approach Delay, s/veh		21.8			20.5			26.5			26.2	
Approach LOS		C			C			C			C	
Timer - Assigned Phs	1	2	3	4	5	6	7	8				
Phs Duration (G+Y+Rc), s	8.7	28.8	8.7	19.5	9.5	28.0	11.6	16.6				
Change Period (Y+Rc), s	* 4.2	6.2	* 4.2	5.8	* 4.2	6.2	* 4.2	* 5.8				
Max Green Setting (Gmax), s	* 9.8	43.4	* 7.3	39.1	* 10	43.2	* 14	* 33				
Max Q Clear Time (g_c+I1), s	5.4	15.0	4.4	5.1	6.0	13.8	7.1	5.2				
Green Ext Time (p_c), s	0.0	7.3	0.1	1.2	0.0	7.8	0.3	1.6				
Intersection Summary												
HCM 6th Ctrl Delay				22.8								
HCM 6th LOS				C								
Notes												
* HCM 6th computational engine requires equal clearance times for the phases crossing the barrier.												

Timings
2: Central Ave & Arlington Ave/Chicago Ave

West Campus Upper Plateau (JN 14064)

09/29/2022



Lane Group	EBL	EBT	EBR	WBL	WBT	WBR	NBL	NBT	NBR	SBL	SBT
Lane Configurations	↘	↑↑	↗↗	↘↘	↑↑	↗	↘↘	↑↑	↗	↘↘	↑↑↗
Traffic Volume (vph)	21	316	500	161	422	161	616	654	159	212	750
Future Volume (vph)	21	316	500	161	422	161	616	654	159	212	750
Turn Type	Prot	NA	pm+ov	Prot	NA	pm+ov	Prot	NA	pm+ov	Prot	NA
Protected Phases	7	4	5	3	8	1	5	2	3	1	6
Permitted Phases			4			8			2		
Detector Phase	7	4	5	3	8	1	5	2	3	1	6
Switch Phase											
Minimum Initial (s)	5.0	10.0	5.0	5.0	10.0	5.0	5.0	10.0	5.0	5.0	10.0
Minimum Split (s)	9.6	32.8	9.6	9.6	30.8	9.6	9.6	35.4	9.6	9.6	30.4
Total Split (s)	10.6	32.8	30.0	22.0	44.2	24.4	30.0	50.8	22.0	24.4	45.2
Total Split (%)	8.2%	25.2%	23.1%	16.9%	34.0%	18.8%	23.1%	39.1%	16.9%	18.8%	34.8%
Yellow Time (s)	3.6	4.8	3.6	3.6	4.8	3.6	3.6	4.4	3.6	3.6	4.4
All-Red Time (s)	1.0	1.0	1.0	1.0	1.0	1.0	1.0	1.0	1.0	1.0	1.0
Lost Time Adjust (s)	0.0	0.0	0.0	0.0	0.0	0.0	0.0	0.0	0.0	0.0	0.0
Total Lost Time (s)	4.6	5.8	4.6	4.6	5.8	4.6	4.6	5.4	4.6	4.6	5.4
Lead/Lag	Lead	Lag	Lead	Lead	Lag	Lead	Lead	Lag	Lead	Lead	Lag
Lead-Lag Optimize?	Yes	Yes	Yes	Yes	Yes	Yes	Yes	Yes	Yes	Yes	Yes
Recall Mode	None	None	None	None	None	None	None	None	None	None	None
Act Effct Green (s)	5.6	15.0	38.0	9.0	25.2	41.4	21.7	32.4	42.3	10.3	20.9
Actuated g/C Ratio	0.06	0.17	0.43	0.10	0.29	0.47	0.25	0.37	0.48	0.12	0.24
v/c Ratio	0.18	0.52	0.39	0.46	0.41	0.19	0.72	0.50	0.19	0.52	0.64
Control Delay	49.7	37.4	11.0	44.7	28.9	4.0	37.6	24.0	3.1	44.0	33.6
Queue Delay	0.0	0.0	0.0	0.0	0.0	0.0	0.0	0.0	0.0	0.0	0.0
Total Delay	49.7	37.4	11.0	44.7	28.9	4.0	37.6	24.0	3.1	44.0	33.6
LOS	D	D	B	D	C	A	D	C	A	D	C
Approach Delay		21.9			26.9			27.5			35.8
Approach LOS		C			C			C			D

Intersection Summary

Cycle Length: 130
 Actuated Cycle Length: 87.8
 Natural Cycle: 90
 Control Type: Actuated-Uncoordinated
 Maximum v/c Ratio: 0.72
 Intersection Signal Delay: 28.3
 Intersection LOS: C
 Intersection Capacity Utilization 65.5%
 ICU Level of Service C
 Analysis Period (min) 15



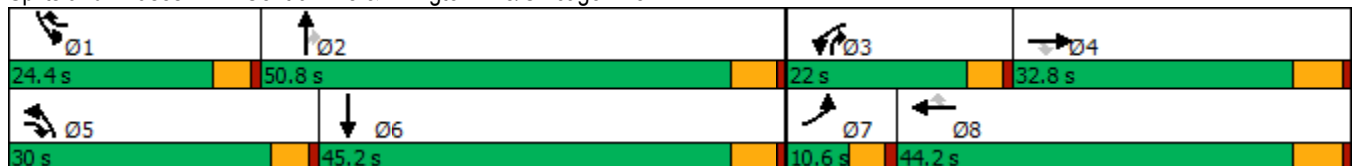





















Splits and Phases: 2: Central Ave & Arlington Ave/Chicago Ave



HCM 6th Signalized Intersection Summary
2: Central Ave & Arlington Ave/Chicago Ave

West Campus Upper Plateau (JN 14064)

09/29/2022

												
Movement	EBL	EBT	EBR	WBL	WBT	WBR	NBL	NBT	NBR	SBL	SBT	SBR
Lane Configurations												
Traffic Volume (veh/h)	21	316	500	161	422	161	616	654	159	212	750	27
Future Volume (veh/h)	21	316	500	161	422	161	616	654	159	212	750	27
Initial Q (Qb), veh	0	0	0	0	0	0	0	0	0	0	0	0
Ped-Bike Adj(A_pbT)	1.00		1.00	1.00		1.00	1.00		0.99	1.00		1.00
Parking Bus, Adj	1.00	1.00	1.00	1.00	1.00	1.00	1.00	1.00	1.00	1.00	1.00	1.00
Work Zone On Approach		No			No			No			No	
Adj Sat Flow, veh/h/ln	1900	1900	1885	1870	1900	1885	1885	1885	1856	1900	1885	1900
Adj Flow Rate, veh/h	21	319	120	163	426	78	622	661	95	214	758	25
Peak Hour Factor	0.99	0.99	0.99	0.99	0.99	0.99	0.99	0.99	0.99	0.99	0.99	0.99
Percent Heavy Veh, %	0	0	1	2	0	1	1	1	3	0	1	0
Cap, veh/h	44	560	1044	260	744	479	755	1305	684	330	1237	41
Arrive On Green	0.02	0.16	0.16	0.08	0.21	0.21	0.22	0.36	0.36	0.09	0.24	0.24
Sat Flow, veh/h	1810	3610	2806	3456	3610	1598	3483	3582	1552	3510	5118	168
Grp Volume(v), veh/h	21	319	120	163	426	78	622	661	95	214	508	275
Grp Sat Flow(s),veh/h/ln	1810	1805	1403	1728	1805	1598	1742	1791	1552	1755	1716	1855
Q Serve(g_s), s	0.8	5.4	1.8	3.0	7.0	2.4	11.2	9.4	2.4	3.9	8.6	8.7
Cycle Q Clear(g_c), s	0.8	5.4	1.8	3.0	7.0	2.4	11.2	9.4	2.4	3.9	8.6	8.7
Prop In Lane	1.00		1.00	1.00		1.00	1.00		1.00	1.00		0.09
Lane Grp Cap(c), veh/h	44	560	1044	260	744	479	755	1305	684	330	829	448
V/C Ratio(X)	0.48	0.57	0.11	0.63	0.57	0.16	0.82	0.51	0.14	0.65	0.61	0.61
Avail Cap(c_a), veh/h	166	1488	1766	918	2116	1086	1350	2482	1194	1061	2084	1127
HCM Platoon Ratio	1.00	1.00	1.00	1.00	1.00	1.00	1.00	1.00	1.00	1.00	1.00	1.00
Upstream Filter(I)	1.00	1.00	1.00	1.00	1.00	1.00	1.00	1.00	1.00	1.00	1.00	1.00
Uniform Delay (d), s/veh	31.6	25.7	13.5	29.4	23.4	16.9	24.5	16.2	11.0	28.6	22.1	22.1
Incr Delay (d2), s/veh	3.0	0.9	0.0	0.9	0.7	0.2	0.9	0.3	0.1	0.8	0.7	1.4
Initial Q Delay(d3),s/veh	0.0	0.0	0.0	0.0	0.0	0.0	0.0	0.0	0.0	0.0	0.0	0.0
%ile BackOfQ(50%),veh/ln	0.3	2.1	0.5	1.2	2.7	0.8	4.2	3.4	0.7	1.5	3.2	3.5
Unsig. Movement Delay, s/veh												
LnGrp Delay(d),s/veh	34.5	26.6	13.6	30.3	24.1	17.0	25.4	16.5	11.0	29.4	22.8	23.5
LnGrp LOS	C	C	B	C	C	B	C	B	B	C	C	C
Approach Vol, veh/h		460			667			1378			997	
Approach Delay, s/veh		23.5			24.8			20.1			24.4	
Approach LOS		C			C			C			C	
Timer - Assigned Phs	1	2	3	4	5	6	7	8				
Phs Duration (G+Y+Rc), s	10.8	29.3	9.5	16.0	18.8	21.2	6.2	19.3				
Change Period (Y+Rc), s	4.6	5.4	4.6	5.8	4.6	5.4	4.6	5.8				
Max Green Setting (Gmax), s	19.8	45.4	17.4	27.0	25.4	39.8	6.0	38.4				
Max Q Clear Time (g_c+I1), s	5.9	11.4	5.0	7.4	13.2	10.7	2.8	9.0				
Green Ext Time (p_c), s	0.3	5.0	0.2	2.2	1.0	5.2	0.0	2.9				
Intersection Summary												
HCM 6th Ctrl Delay				22.7								
HCM 6th LOS				C								

Timings

3: Overlook Pkwy./Canyon Crest Dr. & Alessandro Bl/Alessandro Bl.



Lane Group	EBL	EBT	WBL	WBT	WBR	NBL	NBT	NBR	SBL	SBT	SBR
Lane Configurations	↖	↖↖↖	↖	↖↖↖	↖	↖	↖↖	↖	↖↖	↖	↖
Traffic Volume (vph)	33	1256	7	1367	393	10	6	11	304	6	18
Future Volume (vph)	33	1256	7	1367	393	10	6	11	304	6	18
Turn Type	Prot	NA	Prot	NA	pm+ov	Split	NA	Perm	Split	NA	Perm
Protected Phases	5	2	1	6	4	8	8		4	4	
Permitted Phases					6			8			4
Detector Phase	5	2	1	6	4	8	8	8	4	4	4
Switch Phase											
Minimum Initial (s)	5.0	10.0	5.0	10.0	10.0	10.0	10.0	10.0	10.0	10.0	10.0
Minimum Split (s)	9.2	35.2	9.2	35.2	38.8	38.8	38.8	38.8	38.8	38.8	38.8
Total Split (s)	9.2	43.2	9.2	43.2	38.8	38.8	38.8	38.8	38.8	38.8	38.8
Total Split (%)	7.1%	33.2%	7.1%	33.2%	29.8%	29.8%	29.8%	29.8%	29.8%	29.8%	29.8%
Yellow Time (s)	3.2	5.2	3.2	5.2	4.8	4.8	4.8	4.8	4.8	4.8	4.8
All-Red Time (s)	1.0	1.0	1.0	1.0	1.0	1.0	1.0	1.0	1.0	1.0	1.0
Lost Time Adjust (s)	0.0	0.0	0.0	0.0	0.0	0.0	0.0	0.0	0.0	0.0	0.0
Total Lost Time (s)	4.2	6.2	4.2	6.2	5.8	5.8	5.8	5.8	5.8	5.8	5.8
Lead/Lag	Lead	Lag	Lead	Lag							
Lead-Lag Optimize?	Yes	Yes	Yes	Yes							
Recall Mode	None	None	None	None	None	None	None	None	None	None	None
Act Effct Green (s)	5.6	36.3	5.6	32.9	58.9	11.2	11.2	11.2	15.4	15.4	15.4
Actuated g/C Ratio	0.08	0.51	0.08	0.46	0.83	0.16	0.16	0.16	0.22	0.22	0.22
v/c Ratio	0.25	0.51	0.05	0.60	0.30	0.04	0.01	0.03	0.31	0.30	0.04
Control Delay	46.6	15.4	44.1	18.8	1.1	38.9	38.7	0.2	27.7	30.1	0.2
Queue Delay	0.0	0.0	0.0	0.0	0.0	0.0	0.0	0.0	0.0	0.0	0.0
Total Delay	46.6	15.4	44.1	18.8	1.1	38.9	38.7	0.2	27.7	30.1	0.2
LOS	D	B	D	B	A	D	D	A	C	C	A
Approach Delay		16.1		15.0			23.1			26.9	
Approach LOS		B		B			C			C	

Intersection Summary

Cycle Length: 130
 Actuated Cycle Length: 71.1
 Natural Cycle: 125
 Control Type: Actuated-Uncoordinated
 Maximum v/c Ratio: 0.60
 Intersection Signal Delay: 16.6
 Intersection LOS: B
 Intersection Capacity Utilization 57.9%
 ICU Level of Service B
 Analysis Period (min) 15

Splits and Phases: 3: Overlook Pkwy./Canyon Crest Dr. & Alessandro Bl/Alessandro Bl.

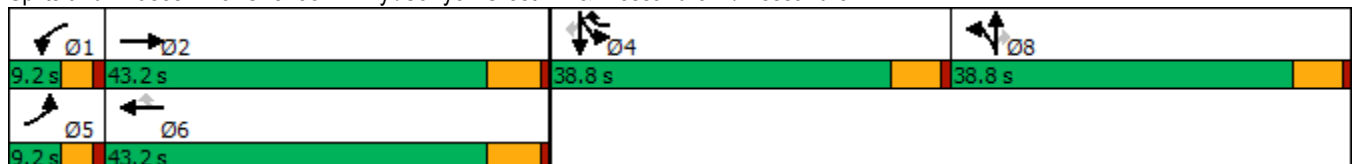

HCM 6th Signalized Intersection Summary

West Campus Upper Plateau (JN 14064)

3: Overlook Pkwy./Canyon Crest Dr. & Alessandro Bl/Alessandro Bl.

09/29/2022



Movement	EBL	EBT	EBR	WBL	WBT	WBR	NBL	NBT	NBR	SBL	SBT	SBR
Lane Configurations	↗	↑↑↑		↖	↑↑↑	↗	↖	↑↑	↗	↖↖	↖	↗
Traffic Volume (veh/h)	33	1256	13	7	1367	393	10	6	11	304	6	18
Future Volume (veh/h)	33	1256	13	7	1367	393	10	6	11	304	6	18
Initial Q (Qb), veh	0	0	0	0	0	0	0	0	0	0	0	0
Ped-Bike Adj(A_pbT)	1.00		1.00	1.00		1.00	1.00		1.00	1.00		1.00
Parking Bus, Adj	1.00	1.00	1.00	1.00	1.00	1.00	1.00	1.00	1.00	1.00	1.00	1.00
Work Zone On Approach		No			No			No			No	
Adj Sat Flow, veh/h/ln	1811	1885	1811	1900	1885	1870	1781	1900	1900	1885	1767	1841
Adj Flow Rate, veh/h	34	1308	14	7	1424	401	10	6	3	321	0	10
Peak Hour Factor	0.96	0.96	0.96	0.96	0.96	0.96	0.96	0.96	0.96	0.96	0.96	0.96
Percent Heavy Veh, %	6	1	6	0	1	2	8	0	0	1	9	4
Cap, veh/h	61	2365	25	17	2183	917	76	161	72	833	0	241
Arrive On Green	0.04	0.45	0.45	0.01	0.42	0.42	0.04	0.04	0.04	0.15	0.00	0.15
Sat Flow, veh/h	1725	5250	56	1810	5147	1585	1697	3610	1610	5386	0	1560
Grp Volume(v), veh/h	34	855	467	7	1424	401	10	6	3	321	0	10
Grp Sat Flow(s),veh/h/ln	1725	1716	1875	1810	1716	1585	1697	1805	1610	1795	0	1560
Q Serve(g_s), s	1.3	11.8	11.8	0.2	14.2	9.2	0.4	0.1	0.1	3.5	0.0	0.4
Cycle Q Clear(g_c), s	1.3	11.8	11.8	0.2	14.2	9.2	0.4	0.1	0.1	3.5	0.0	0.4
Prop In Lane	1.00		0.03	1.00		1.00	1.00		1.00	1.00		1.00
Lane Grp Cap(c), veh/h	61	1545	845	17	2183	917	76	161	72	833	0	241
V/C Ratio(X)	0.56	0.55	0.55	0.42	0.65	0.44	0.13	0.04	0.04	0.39	0.00	0.04
Avail Cap(c_a), veh/h	134	1968	1076	140	2952	1154	868	1847	824	2756	0	798
HCM Platoon Ratio	1.00	1.00	1.00	1.00	1.00	1.00	1.00	1.00	1.00	1.00	1.00	1.00
Upstream Filter(I)	1.00	1.00	1.00	1.00	1.00	1.00	1.00	1.00	1.00	1.00	0.00	1.00
Uniform Delay (d), s/veh	30.6	13.0	13.0	31.8	14.8	7.7	29.6	29.5	29.5	24.5	0.0	23.2
Incr Delay (d2), s/veh	2.9	0.3	0.6	6.3	0.3	0.3	0.8	0.1	0.2	0.3	0.0	0.1
Initial Q Delay(d3),s/veh	0.0	0.0	0.0	0.0	0.0	0.0	0.0	0.0	0.0	0.0	0.0	0.0
%ile BackOfQ(50%),veh/ln	0.5	3.5	3.9	0.1	4.4	3.6	0.2	0.0	0.0	1.3	0.0	0.1
Unsig. Movement Delay, s/veh												
LnGrp Delay(d),s/veh	33.6	13.3	13.5	38.0	15.1	8.0	30.4	29.6	29.7	24.8	0.0	23.3
LnGrp LOS	C	B	B	D	B	A	C	C	C	C	A	C
Approach Vol, veh/h		1356			1832			19			331	
Approach Delay, s/veh		13.9			13.6			30.0			24.8	
Approach LOS		B			B			C			C	
Timer - Assigned Phs	1	2		4	5	6		8				
Phs Duration (G+Y+Rc), s	4.8	35.3		15.8	6.5	33.6		8.7				
Change Period (Y+Rc), s	* 4.2	6.2		5.8	* 4.2	6.2		5.8				
Max Green Setting (Gmax), s	* 5	37.0		33.0	* 5	37.0		33.0				
Max Q Clear Time (g_c+1), s	2.2	13.8		5.5	3.3	16.2		2.4				
Green Ext Time (p_c), s	0.0	8.6		1.2	0.0	11.1		0.0				

Intersection Summary

HCM 6th Ctrl Delay	14.9
HCM 6th LOS	B

Notes

- User approved pedestrian interval to be less than phase max green.
- User approved volume balancing among the lanes for turning movement.
- * HCM 6th computational engine requires equal clearance times for the phases crossing the barrier.

Timings

West Campus Upper Plateau (JN 14064)

4: Van Buren Bl. & Wood Rd.

09/29/2022

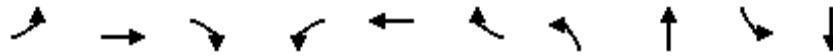

Lane Group	EBL	EBT	EBR	WBL	WBT	WBR	NBL	NBT	SBL	SBT
Lane Configurations	↘	↑↑	↗	↘↗	↑↑	↗	↘↗	↑↔	↘	↑↔
Traffic Volume (vph)	119	912	163	155	879	65	160	122	114	142
Future Volume (vph)	119	912	163	155	879	65	160	122	114	142
Turn Type	Prot	NA	pm+ov	Prot	NA	Perm	Prot	NA	Prot	NA
Protected Phases	5	2	3	1	6		3	8	7	4
Permitted Phases			2			6				
Detector Phase	5	2	3	1	6	6	3	8	7	4
Switch Phase										
Minimum Initial (s)	5.0	10.0	5.0	5.0	10.0	10.0	5.0	10.0	5.0	10.0
Minimum Split (s)	9.2	30.2	9.2	9.2	30.2	30.2	9.2	38.4	9.2	15.8
Total Split (s)	16.5	57.2	21.7	13.2	53.9	53.9	21.7	38.4	11.2	27.9
Total Split (%)	13.8%	47.7%	18.1%	11.0%	44.9%	44.9%	18.1%	32.0%	9.3%	23.3%
Yellow Time (s)	3.2	5.2	3.2	3.2	5.2	5.2	3.2	4.4	3.2	4.8
All-Red Time (s)	1.0	1.0	1.0	1.0	1.0	1.0	1.0	1.0	1.0	1.0
Lost Time Adjust (s)	0.0	0.0	0.0	0.0	0.0	0.0	0.0	0.0	0.0	0.0
Total Lost Time (s)	4.2	6.2	4.2	4.2	6.2	6.2	4.2	5.4	4.2	5.8
Lead/Lag	Lead	Lag	Lead	Lead	Lag	Lag	Lead	Lag	Lead	Lag
Lead-Lag Optimize?	Yes	Yes	Yes	Yes	Yes	Yes	Yes	Yes	Yes	Yes
Recall Mode	None	None	None	None	None	None	None	None	None	None
Act Effct Green (s)	10.6	35.8	47.3	8.3	33.5	33.5	9.4	15.7	7.3	13.2
Actuated g/C Ratio	0.12	0.41	0.54	0.09	0.38	0.38	0.11	0.18	0.08	0.15
v/c Ratio	0.61	0.70	0.19	0.52	0.72	0.10	0.48	0.35	0.84	0.49
Control Delay	53.8	25.1	2.0	48.1	27.2	0.3	44.8	19.9	87.7	21.4
Queue Delay	0.0	0.0	0.0	0.0	0.0	0.0	0.0	0.0	0.0	0.0
Total Delay	53.8	25.1	2.0	48.1	27.2	0.3	44.8	19.9	87.7	21.4
LOS	D	C	A	D	C	A	D	B	F	C
Approach Delay		24.8			28.5			30.5		40.8
Approach LOS		C			C			C		D

Intersection Summary





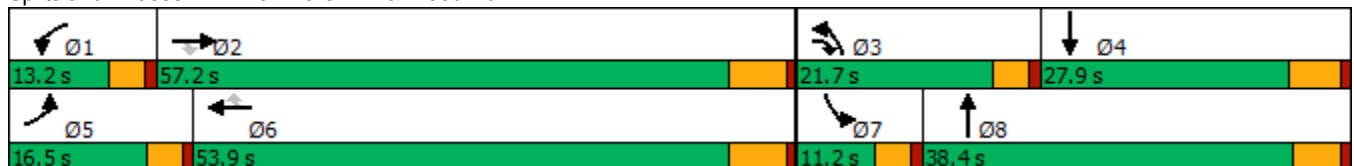



















Cycle Length: 120
 Actuated Cycle Length: 87.9
 Natural Cycle: 90
 Control Type: Actuated-Uncoordinated
 Maximum v/c Ratio: 0.84
 Intersection Signal Delay: 28.9
 Intersection LOS: C
 Intersection Capacity Utilization 68.5%
 ICU Level of Service C
 Analysis Period (min) 15

Splits and Phases: 4: Van Buren Bl. & Wood Rd.



HCM 6th Signalized Intersection Summary
4: Van Buren Bl. & Wood Rd.

West Campus Upper Plateau (JN 14064)
09/29/2022

												
Movement	EBL	EBT	EBR	WBL	WBT	WBR	NBL	NBT	NBR	SBL	SBT	SBR
Lane Configurations												
Traffic Volume (veh/h)	119	912	163	155	879	65	160	122	93	114	142	135
Future Volume (veh/h)	119	912	163	155	879	65	160	122	93	114	142	135
Initial Q (Qb), veh	0	0	0	0	0	0	0	0	0	0	0	0
Ped-Bike Adj(A_pbT)	1.00		0.98	1.00		0.99	1.00		0.97	1.00		0.99
Parking Bus, Adj	1.00	1.00	1.00	1.00	1.00	1.00	1.00	1.00	1.00	1.00	1.00	1.00
Work Zone On Approach		No			No			No			No	
Adj Sat Flow, veh/h/ln	1885	1856	1870	1885	1870	1885	1856	1885	1870	1885	1885	1885
Adj Flow Rate, veh/h	131	1002	74	170	966	24	176	134	21	125	156	73
Peak Hour Factor	0.91	0.91	0.91	0.91	0.91	0.91	0.91	0.91	0.91	0.91	0.91	0.91
Percent Heavy Veh, %	1	3	2	1	2	1	3	1	2	1	1	1
Cap, veh/h	166	1431	756	253	1373	608	264	518	79	158	427	190
Arrive On Green	0.09	0.41	0.41	0.07	0.39	0.39	0.08	0.17	0.17	0.09	0.18	0.18
Sat Flow, veh/h	1795	3526	1561	3483	3554	1574	3428	3097	474	1795	2399	1068
Grp Volume(v), veh/h	131	1002	74	170	966	24	176	76	79	125	114	115
Grp Sat Flow(s),veh/h/ln	1795	1763	1561	1742	1777	1574	1714	1791	1780	1795	1791	1676
Q Serve(g_s), s	5.5	18.1	2.0	3.6	17.5	0.7	3.8	2.8	3.0	5.2	4.3	4.6
Cycle Q Clear(g_c), s	5.5	18.1	2.0	3.6	17.5	0.7	3.8	2.8	3.0	5.2	4.3	4.6
Prop In Lane	1.00		1.00	1.00		1.00	1.00		0.27	1.00		0.64
Lane Grp Cap(c), veh/h	166	1431	756	253	1373	608	264	299	298	158	319	298
V/C Ratio(X)	0.79	0.70	0.10	0.67	0.70	0.04	0.67	0.25	0.26	0.79	0.36	0.38
Avail Cap(c_a), veh/h	288	2347	1161	409	2213	980	783	771	767	164	517	483
HCM Platoon Ratio	1.00	1.00	1.00	1.00	1.00	1.00	1.00	1.00	1.00	1.00	1.00	1.00
Upstream Filter(I)	1.00	1.00	1.00	1.00	1.00	1.00	1.00	1.00	1.00	1.00	1.00	1.00
Uniform Delay (d), s/veh	34.0	18.9	10.7	34.6	19.8	14.6	34.4	27.7	27.8	34.3	27.7	27.8
Incr Delay (d2), s/veh	3.2	0.9	0.1	1.2	0.9	0.0	1.1	0.4	0.5	20.2	0.7	0.8
Initial Q Delay(d3),s/veh	0.0	0.0	0.0	0.0	0.0	0.0	0.0	0.0	0.0	0.0	0.0	0.0
%ile BackOfQ(50%),veh/ln	2.3	6.4	0.6	1.5	6.3	0.2	1.6	1.2	1.2	3.0	1.8	1.8
Unsig. Movement Delay, s/veh												
LnGrp Delay(d),s/veh	37.2	19.8	10.8	35.8	20.7	14.7	35.5	28.2	28.3	54.5	28.3	28.6
LnGrp LOS	D	B	B	D	C	B	D	C	C	D	C	C
Approach Vol, veh/h		1207			1160			331			354	
Approach Delay, s/veh		21.1			22.8			32.1			37.7	
Approach LOS		C			C			C			D	
Timer - Assigned Phs	1	2	3	4	5	6	7	8				
Phs Duration (G+Y+Rc), s	9.8	37.3	10.1	19.4	11.3	35.8	10.9	18.6				
Change Period (Y+Rc), s	* 4.2	6.2	* 4.2	5.8	* 4.2	6.2	* 4.2	* 5.8				
Max Green Setting (Gmax), s	* 9	51.0	* 18	22.1	* 12	47.7	* 7	* 33				
Max Q Clear Time (g_c+I1), s	5.6	20.1	5.8	6.6	7.5	19.5	7.2	5.0				
Green Ext Time (p_c), s	0.1	11.0	0.2	1.0	0.1	9.8	0.0	0.8				
Intersection Summary												
HCM 6th Ctrl Delay				24.9								
HCM 6th LOS				C								
Notes												
* HCM 6th computational engine requires equal clearance times for the phases crossing the barrier.												

Timings
5: Trautwein Rd. & Alessandro Bl.

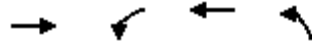

Lane Group	EBT	WBL	WBT	NBL
Lane Configurations	↑↑↑	↵↵	↑↑↑	↵↵↵
Traffic Volume (vph)	961	170	1144	715
Future Volume (vph)	961	170	1144	715
Turn Type	NA	Prot	NA	Prot
Protected Phases	2	1	6	8
Permitted Phases				
Detector Phase	2	1	6	8
Switch Phase				
Minimum Initial (s)	10.0	5.0	10.0	10.0
Minimum Split (s)	33.2	9.2	16.2	16.2
Total Split (s)	63.0	19.0	82.0	38.0
Total Split (%)	52.5%	15.8%	68.3%	31.7%
Yellow Time (s)	5.2	3.2	5.2	5.2
All-Red Time (s)	1.0	1.0	1.0	1.0
Lost Time Adjust (s)	0.0	0.0	0.0	0.0
Total Lost Time (s)	6.2	4.2	6.2	6.2
Lead/Lag	Lag	Lead		
Lead-Lag Optimize?	Yes	Yes		
Recall Mode	None	None	None	None
Act Effect Green (s)	24.4	8.3	37.0	16.4
Actuated g/C Ratio	0.37	0.13	0.56	0.25
v/c Ratio	0.53	0.41	0.41	0.61
Control Delay	17.9	31.9	9.0	25.1
Queue Delay	0.0	0.0	0.0	0.0
Total Delay	17.9	31.9	9.0	25.1
LOS	B	C	A	C
Approach Delay	17.9		11.9	25.1
Approach LOS	B		B	C

Intersection Summary

Cycle Length: 120	
Actuated Cycle Length: 66.2	
Natural Cycle: 60	
Control Type: Actuated-Uncoordinated	
Maximum v/c Ratio: 0.61	
Intersection Signal Delay: 17.0	Intersection LOS: B
Intersection Capacity Utilization 51.2%	ICU Level of Service A
Analysis Period (min) 15	

Splits and Phases: 5: Trautwein Rd. & Alessandro Bl.



HCM 6th Signalized Intersection Summary
5: Trautwein Rd. & Alessandro Bl.

West Campus Upper Plateau (JN 14064)
09/29/2022

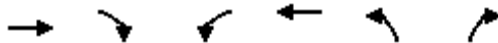

Movement	EBT	EBR	WBL	WBT	NBL	NBR
Lane Configurations	↑↑↑		↵↵	↑↑↑	↵↵↵	
Traffic Volume (veh/h)	961	8	170	1144	715	10
Future Volume (veh/h)	961	8	170	1144	715	10
Initial Q (Qb), veh	0	0	0	0	0	0
Ped-Bike Adj(A_pbT)		1.00	1.00		1.00	1.00
Parking Bus, Adj	1.00	1.00	1.00	1.00	1.00	1.00
Work Zone On Approach	No			No	No	
Adj Sat Flow, veh/h/ln	1885	1900	1885	1885	1870	1900
Adj Flow Rate, veh/h	1001	8	177	1192	754	0
Peak Hour Factor	0.96	0.96	0.96	0.96	0.96	0.96
Percent Heavy Veh, %	1	0	1	1	2	0
Cap, veh/h	2010	16	323	2843	1162	350
Arrive On Green	0.38	0.38	0.09	0.55	0.22	0.00
Sat Flow, veh/h	5436	42	3483	5316	5344	1610
Grp Volume(v), veh/h	652	357	177	1192	754	0
Grp Sat Flow(s),veh/h/ln	1716	1878	1742	1716	1781	1610
Q Serve(g_s), s	7.8	7.8	2.6	7.3	6.9	0.0
Cycle Q Clear(g_c), s	7.8	7.8	2.6	7.3	6.9	0.0
Prop In Lane		0.02	1.00		1.00	1.00
Lane Grp Cap(c), veh/h	1309	717	323	2843	1162	350
V/C Ratio(X)	0.50	0.50	0.55	0.42	0.65	0.00
Avail Cap(c_a), veh/h	3616	1979	957	7239	3153	950
HCM Platoon Ratio	1.00	1.00	1.00	1.00	1.00	1.00
Upstream Filter(I)	1.00	1.00	1.00	1.00	1.00	0.00
Uniform Delay (d), s/veh	12.7	12.7	23.4	7.0	19.2	0.0
Incr Delay (d2), s/veh	0.4	0.8	0.5	0.1	0.6	0.0
Initial Q Delay(d3),s/veh	0.0	0.0	0.0	0.0	0.0	0.0
%ile BackOfQ(50%),veh/ln	2.3	2.6	0.9	1.4	2.4	0.0
Unsig. Movement Delay, s/veh						
LnGrp Delay(d),s/veh	13.1	13.5	23.9	7.2	19.8	0.0
LnGrp LOS	B	B	C	A	B	A
Approach Vol, veh/h	1009			1369	754	
Approach Delay, s/veh	13.3			9.3	19.8	
Approach LOS	B			A	B	
Timer - Assigned Phs	1	2			6	8
Phs Duration (G+Y+Rc), s	9.2	26.8			36.0	17.9
Change Period (Y+Rc), s	* 4.2	6.2			6.2	6.2
Max Green Setting (Gmax), s	* 15	56.8			75.8	31.8
Max Q Clear Time (g_c+I1), s	4.6	9.8			9.3	8.9
Green Ext Time (p_c), s	0.2	10.7			15.1	2.8

Intersection Summary

HCM 6th Ctrl Delay	13.1
HCM 6th LOS	B

Notes

User approved volume balancing among the lanes for turning movement.
* HCM 6th computational engine requires equal clearance times for the phases crossing the barrier.

Timings
6: Trautwein Rd. & Grove Community Dr

West Campus Upper Plateau (JN 14064)

09/29/2022



Lane Group	WBL	WBR	NBT	NBR	SBL	SBT
Lane Configurations	↙	↗↗	↕↕	↗	↗↗	↕↕
Traffic Volume (vph)	99	371	683	79	333	611
Future Volume (vph)	99	371	683	79	333	611
Turn Type	Prot	pm+ov	NA	Perm	Prot	NA
Protected Phases	8	1	2		1	6
Permitted Phases		8		2		
Detector Phase	8	1	2	2	1	6
Switch Phase						
Minimum Initial (s)	10.0	5.0	10.0	10.0	5.0	10.0
Minimum Split (s)	34.6	9.6	46.2	46.2	9.6	28.2
Total Split (s)	35.0	29.0	56.0	56.0	29.0	85.0
Total Split (%)	29.2%	24.2%	46.7%	46.7%	24.2%	70.8%
Yellow Time (s)	3.6	3.6	5.2	5.2	3.6	5.2
All-Red Time (s)	1.0	1.0	1.0	1.0	1.0	1.0
Lost Time Adjust (s)	0.0	0.0	0.0	0.0	0.0	0.0
Total Lost Time (s)	4.6	4.6	6.2	6.2	4.6	6.2
Lead/Lag		Lead	Lag	Lag	Lead	
Lead-Lag Optimize?		Yes	Yes	Yes	Yes	
Recall Mode	None	None	None	None	None	None
Act Effct Green (s)	13.7	22.4	21.8	21.8	12.3	41.6
Actuated g/C Ratio	0.23	0.37	0.36	0.36	0.21	0.69
v/c Ratio	0.27	0.36	0.58	0.14	0.51	0.28
Control Delay	24.9	6.9	19.5	5.2	27.2	6.1
Queue Delay	0.0	0.0	0.0	0.0	0.0	0.0
Total Delay	24.9	6.9	19.5	5.2	27.2	6.1
LOS	C	A	B	A	C	A
Approach Delay	10.7		18.0			13.5
Approach LOS	B		B			B

Intersection Summary

Cycle Length: 120	
Actuated Cycle Length: 59.9	
Natural Cycle: 95	
Control Type: Actuated-Uncoordinated	
Maximum v/c Ratio: 0.58	
Intersection Signal Delay: 14.5	Intersection LOS: B
Intersection Capacity Utilization 50.5%	ICU Level of Service A
Analysis Period (min) 15	

















Splits and Phases: 6: Trautwein Rd. & Grove Community Dr



HCM 6th Signalized Intersection Summary
6: Trautwein Rd. & Grove Community Dr

West Campus Upper Plateau (JN 14064)

09/29/2022

						
Movement	WBL	WBR	NBT	NBR	SBL	SBT
Lane Configurations		 	 		 	 
Traffic Volume (veh/h)	99	371	683	79	333	611
Future Volume (veh/h)	99	371	683	79	333	611
Initial Q (Qb), veh	0	0	0	0	0	0
Ped-Bike Adj(A_pbT)	1.00	1.00		1.00	1.00	
Parking Bus, Adj	1.00	1.00	1.00	1.00	1.00	1.00
Work Zone On Approach	No		No			No
Adj Sat Flow, veh/h/ln	1900	1900	1885	1900	1900	1870
Adj Flow Rate, veh/h	110	218	759	82	370	679
Peak Hour Factor	0.90	0.90	0.90	0.90	0.90	0.90
Percent Heavy Veh, %	0	0	1	0	0	2
Cap, veh/h	365	1002	1191	535	533	2054
Arrive On Green	0.20	0.20	0.33	0.33	0.15	0.58
Sat Flow, veh/h	1810	2834	3676	1610	3510	3647
Grp Volume(v), veh/h	110	218	759	82	370	679
Grp Sat Flow(s),veh/h/ln	1810	1417	1791	1610	1755	1777
Q Serve(g_s), s	2.5	2.6	8.8	1.8	4.9	4.9
Cycle Q Clear(g_c), s	2.5	2.6	8.8	1.8	4.9	4.9
Prop In Lane	1.00	1.00		1.00	1.00	
Lane Grp Cap(c), veh/h	365	1002	1191	535	533	2054
V/C Ratio(X)	0.30	0.22	0.64	0.15	0.69	0.33
Avail Cap(c_a), veh/h	1122	2187	3639	1636	1747	5712
HCM Platoon Ratio	1.00	1.00	1.00	1.00	1.00	1.00
Upstream Filter(I)	1.00	1.00	1.00	1.00	1.00	1.00
Uniform Delay (d), s/veh	16.6	11.1	13.9	11.5	19.7	5.4
Incr Delay (d2), s/veh	0.5	0.1	0.6	0.1	0.6	0.1
Initial Q Delay(d3),s/veh	0.0	0.0	0.0	0.0	0.0	0.0
%ile BackOfQ(50%),veh/ln	1.0	0.7	2.6	0.5	1.6	0.8
Unsig. Movement Delay, s/veh						
LnGrp Delay(d),s/veh	17.1	11.2	14.4	11.6	20.3	5.5
LnGrp LOS	B	B	B	B	C	A
Approach Vol, veh/h	328		841			1049
Approach Delay, s/veh	13.2		14.2			10.7
Approach LOS	B		B			B
Timer - Assigned Phs	1	2			6	8
Phs Duration (G+Y+Rc), s	12.0	22.5			34.5	14.5
Change Period (Y+Rc), s	4.6	6.2			6.2	4.6
Max Green Setting (Gmax), s	24.4	49.8			78.8	30.4
Max Q Clear Time (g_c+I1), s	6.9	10.8			6.9	4.6
Green Ext Time (p_c), s	0.6	5.5			4.6	1.1
Intersection Summary						
HCM 6th Ctrl Delay			12.4			
HCM 6th LOS			B			

Timings

7: Trautwein Rd. & Orange Terrace Pkwy

09/29/2022



Lane Group	EBL	EBT	WBL	WBT	WBR	NBL	NBT	NBR	SBL	SBT	SBR
Lane Configurations											
Traffic Volume (vph)	30	17	154	11	153	32	565	142	190	588	19
Future Volume (vph)	30	17	154	11	153	32	565	142	190	588	19
Turn Type	Prot	NA	Prot	NA	pm+ov	Prot	NA	Perm	Prot	NA	Perm
Protected Phases	7	4	3	8	1	5	2		1	6	
Permitted Phases					8			2			6
Detector Phase	7	4	3	8	1	5	2	2	1	6	6
Switch Phase											
Minimum Initial (s)	5.0	10.0	5.0	10.0	5.0	5.0	10.0	10.0	5.0	10.0	10.0
Minimum Split (s)	9.6	38.6	9.6	34.6	9.6	9.6	46.2	46.2	9.6	28.2	28.2
Total Split (s)	13.2	38.6	16.1	41.5	18.0	9.6	47.3	47.3	18.0	55.7	55.7
Total Split (%)	11.0%	32.2%	13.4%	34.6%	15.0%	8.0%	39.4%	39.4%	15.0%	46.4%	46.4%
Yellow Time (s)	3.6	3.6	3.6	3.6	3.6	3.6	5.2	5.2	3.6	5.2	5.2
All-Red Time (s)	1.0	1.0	1.0	1.0	1.0	1.0	1.0	1.0	1.0	1.0	1.0
Lost Time Adjust (s)	0.0	0.0	0.0	0.0	0.0	0.0	0.0	0.0	0.0	0.0	0.0
Total Lost Time (s)	4.6	4.6	4.6	4.6	4.6	4.6	6.2	6.2	4.6	6.2	6.2
Lead/Lag	Lead	Lag	Lead	Lag	Lead	Lead	Lag	Lag	Lead	Lag	Lag
Lead-Lag Optimize?	Yes	Yes	Yes	Yes	Yes	Yes	Yes	Yes	Yes	Yes	Yes
Recall Mode	None	None	None	None	None	None	None	None	None	None	None
Act Effct Green (s)	10.3	14.2	12.8	18.5	30.1	5.7	19.8	19.8	9.2	31.3	31.3
Actuated g/C Ratio	0.15	0.20	0.18	0.27	0.43	0.08	0.28	0.28	0.13	0.45	0.45
v/c Ratio	0.12	0.10	0.50	0.02	0.13	0.23	0.60	0.27	0.45	0.39	0.03
Control Delay	35.8	18.9	40.3	25.6	4.1	45.6	25.6	6.0	37.0	16.8	0.1
Queue Delay	0.0	0.0	0.0	0.0	0.0	0.0	0.0	0.0	0.0	0.0	0.0
Total Delay	35.8	18.9	40.3	25.6	4.1	45.6	25.6	6.0	37.0	16.8	0.1
LOS	D	B	D	C	A	D	C	A	D	B	A
Approach Delay		26.6		22.4			22.7			21.2	
Approach LOS		C		C			C			C	

Intersection Summary

Cycle Length: 120	
Actuated Cycle Length: 69.7	
Natural Cycle: 105	
Control Type: Actuated-Uncoordinated	
Maximum v/c Ratio: 0.60	
Intersection Signal Delay: 22.2	Intersection LOS: C
Intersection Capacity Utilization 49.1%	ICU Level of Service A
Analysis Period (min) 15	



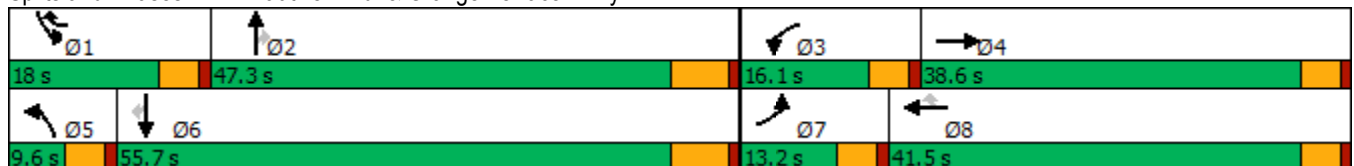



















Splits and Phases: 7: Trautwein Rd. & Orange Terrace Pkwy



HCM 6th Signalized Intersection Summary
7: Trautwein Rd. & Orange Terrace Pkwy

West Campus Upper Plateau (JN 14064)

09/29/2022

												
Movement	EBL	EBT	EBR	WBL	WBT	WBR	NBL	NBT	NBR	SBL	SBT	SBR
Lane Configurations												
Traffic Volume (veh/h)	30	17	19	154	11	153	32	565	142	190	588	19
Future Volume (veh/h)	30	17	19	154	11	153	32	565	142	190	588	19
Initial Q (Qb), veh	0	0	0	0	0	0	0	0	0	0	0	0
Ped-Bike Adj(A_pbT)	1.00		1.00	1.00		1.00	1.00		1.00	1.00		1.00
Parking Bus, Adj	1.00	1.00	1.00	1.00	1.00	1.00	1.00	1.00	1.00	1.00	1.00	1.00
Work Zone On Approach		No			No			No			No	
Adj Sat Flow, veh/h/ln	1900	1900	1900	1885	1900	1856	1900	1870	1870	1870	1870	1900
Adj Flow Rate, veh/h	32	18	18	164	12	43	34	601	73	202	626	10
Peak Hour Factor	0.94	0.94	0.94	0.94	0.94	0.94	0.94	0.94	0.94	0.94	0.94	0.94
Percent Heavy Veh, %	0	0	0	1	0	3	0	2	2	2	2	0
Cap, veh/h	64	136	136	209	451	914	67	933	416	320	1131	512
Arrive On Green	0.04	0.16	0.16	0.12	0.24	0.24	0.04	0.26	0.26	0.09	0.32	0.32
Sat Flow, veh/h	1810	872	872	1795	1900	2768	1810	3554	1585	3456	3554	1610
Grp Volume(v), veh/h	32	0	36	164	12	43	34	601	73	202	626	10
Grp Sat Flow(s),veh/h/ln	1810	0	1743	1795	1900	1384	1810	1777	1585	1728	1777	1610
Q Serve(g_s), s	0.9	0.0	1.0	4.8	0.3	0.6	1.0	8.1	1.9	3.0	7.8	0.2
Cycle Q Clear(g_c), s	0.9	0.0	1.0	4.8	0.3	0.6	1.0	8.1	1.9	3.0	7.8	0.2
Prop In Lane	1.00		0.50	1.00		1.00	1.00		1.00	1.00		1.00
Lane Grp Cap(c), veh/h	64	0	272	209	451	914	67	933	416	320	1131	512
V/C Ratio(X)	0.50	0.00	0.13	0.78	0.03	0.05	0.51	0.64	0.18	0.63	0.55	0.02
Avail Cap(c_a), veh/h	289	0	1102	384	1304	2155	168	2716	1211	861	3271	1482
HCM Platoon Ratio	1.00	1.00	1.00	1.00	1.00	1.00	1.00	1.00	1.00	1.00	1.00	1.00
Upstream Filter(I)	1.00	0.00	1.00	1.00	1.00	1.00	1.00	1.00	1.00	1.00	1.00	1.00
Uniform Delay (d), s/veh	25.5	0.0	19.5	23.1	15.7	12.3	25.4	17.6	15.3	23.5	15.2	12.6
Incr Delay (d2), s/veh	2.2	0.0	0.2	2.4	0.0	0.0	2.2	0.7	0.2	0.8	0.4	0.0
Initial Q Delay(d3),s/veh	0.0	0.0	0.0	0.0	0.0	0.0	0.0	0.0	0.0	0.0	0.0	0.0
%ile BackOfQ(50%),veh/ln	0.4	0.0	0.4	1.9	0.1	0.1	0.4	2.7	0.6	1.1	2.5	0.1
Unsig. Movement Delay, s/veh												
LnGrp Delay(d),s/veh	27.7	0.0	19.8	25.5	15.8	12.3	27.6	18.3	15.5	24.3	15.6	12.6
LnGrp LOS	C	A	B	C	B	B	C	B	B	C	B	B
Approach Vol, veh/h		68			219			708			838	
Approach Delay, s/veh		23.5			22.4			18.5			17.7	
Approach LOS		C			C			B			B	
Timer - Assigned Phs	1	2	3	4	5	6	7	8				
Phs Duration (G+Y+Rc), s	9.6	20.3	10.9	13.0	6.6	23.3	6.5	17.4				
Change Period (Y+Rc), s	4.6	6.2	4.6	4.6	4.6	6.2	4.6	4.6				
Max Green Setting (Gmax), s	13.4	41.1	11.5	34.0	5.0	49.5	8.6	36.9				
Max Q Clear Time (g_c+I1), s	5.0	10.1	6.8	3.0	3.0	9.8	2.9	2.6				
Green Ext Time (p_c), s	0.2	4.1	0.1	0.1	0.0	4.1	0.0	0.2				
Intersection Summary												
HCM 6th Ctrl Delay				18.8								
HCM 6th LOS				B								

Timings
8: Cole Av. & Van Buren Bl.

West Campus Upper Plateau (JN 14064)

09/29/2022



Lane Group	EBL	EBT	EBR	WBL	WBT	WBR	NBL	NBT	SBL	SBT	SBR
Lane Configurations	↖↗	↑↑	↖	↖	↑↑↑	↖	↖	↑↑	↖↗	↑↑	↖
Traffic Volume (vph)	302	705	70	103	762	164	92	229	153	205	216
Future Volume (vph)	302	705	70	103	762	164	92	229	153	205	216
Turn Type	Prot	NA	pm+ov	Prot	NA	pm+ov	Prot	NA	Prot	NA	pm+ov
Protected Phases	5	2	3	1	6	7	3	8	7	4	5
Permitted Phases			2			6					4
Detector Phase	5	2	3	1	6	7	3	8	7	4	5
Switch Phase											
Minimum Initial (s)	5.0	10.0	5.0	5.0	10.0	5.0	5.0	10.0	5.0	10.0	5.0
Minimum Split (s)	9.1	36.2	9.1	9.1	36.2	9.1	9.1	42.2	9.1	49.2	9.1
Total Split (s)	18.7	44.8	12.0	14.0	40.1	17.5	12.0	43.7	17.5	49.2	18.7
Total Split (%)	15.6%	37.3%	10.0%	11.7%	33.4%	14.6%	10.0%	36.4%	14.6%	41.0%	15.6%
Yellow Time (s)	3.2	5.2	3.2	3.2	5.2	3.2	3.2	5.2	3.2	5.2	3.2
All-Red Time (s)	0.5	1.0	0.5	0.5	1.0	0.5	0.5	1.0	0.5	1.0	0.5
Lost Time Adjust (s)	0.0	0.0	0.0	0.0	0.0	0.0	0.0	0.0	0.0	0.0	0.0
Total Lost Time (s)	3.7	6.2	3.7	3.7	6.2	3.7	3.7	6.2	3.7	6.2	3.7
Lead/Lag	Lead	Lag	Lead	Lead	Lag	Lead	Lead	Lag	Lead	Lag	Lead
Lead-Lag Optimize?	Yes	Yes	Yes	Yes	Yes	Yes	Yes	Yes	Yes	Yes	Yes
Recall Mode	None	None	None	None	None	None	None	None	None	None	None
Act Effct Green (s)	12.0	25.0	39.8	9.2	22.2	37.3	8.3	15.5	8.6	15.9	30.5
Actuated g/C Ratio	0.15	0.32	0.50	0.12	0.28	0.47	0.10	0.20	0.11	0.20	0.39
v/c Ratio	0.61	0.68	0.09	0.53	0.56	0.20	0.52	0.41	0.43	0.30	0.35
Control Delay	40.1	28.2	2.4	48.5	27.1	3.3	50.3	28.5	40.6	28.2	12.1
Queue Delay	0.0	0.0	0.0	0.0	0.0	0.0	0.0	0.0	0.0	0.0	0.0
Total Delay	40.1	28.2	2.4	48.5	27.1	3.3	50.3	28.5	40.6	28.2	12.1
LOS	D	C	A	D	C	A	D	C	D	C	B
Approach Delay		29.9			25.5			34.0		25.4	
Approach LOS		C			C			C		C	

Intersection Summary

Cycle Length: 120	
Actuated Cycle Length: 79.2	
Natural Cycle: 105	
Control Type: Actuated-Uncoordinated	
Maximum v/c Ratio: 0.68	
Intersection Signal Delay: 28.0	Intersection LOS: C
Intersection Capacity Utilization 57.6%	ICU Level of Service B
Analysis Period (min) 15	



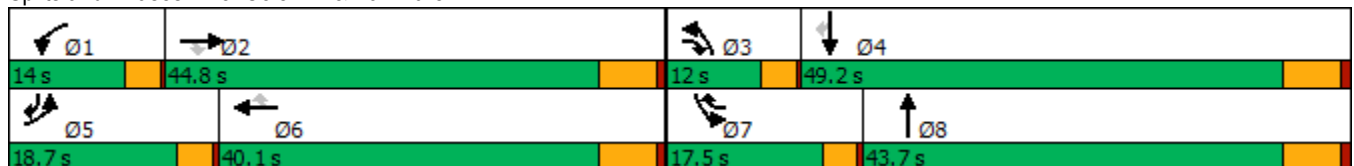





















Splits and Phases: 8: Cole Av. & Van Buren Bl.



HCM 6th Signalized Intersection Summary
8: Cole Av. & Van Buren Bl.

West Campus Upper Plateau (JN 14064)

09/29/2022

												
Movement	EBL	EBT	EBR	WBL	WBT	WBR	NBL	NBT	NBR	SBL	SBT	SBR
Lane Configurations												
Traffic Volume (veh/h)	302	705	70	103	762	164	92	229	43	153	205	216
Future Volume (veh/h)	302	705	70	103	762	164	92	229	43	153	205	216
Initial Q (Qb), veh	0	0	0	0	0	0	0	0	0	0	0	0
Ped-Bike Adj(A_pbT)	1.00		1.00	1.00		1.00	1.00		0.99	1.00		1.00
Parking Bus, Adj	1.00	1.00	1.00	1.00	1.00	1.00	1.00	1.00	1.00	1.00	1.00	1.00
Work Zone On Approach		No			No			No			No	
Adj Sat Flow, veh/h/ln	1856	1826	1856	1856	1856	1870	1885	1885	1870	1856	1885	1885
Adj Flow Rate, veh/h	315	734	16	107	794	82	96	239	38	159	214	127
Peak Hour Factor	0.96	0.96	0.96	0.96	0.96	0.96	0.96	0.96	0.96	0.96	0.96	0.96
Percent Heavy Veh, %	3	5	3	3	3	2	1	1	2	3	1	1
Cap, veh/h	434	1173	640	137	1466	580	124	565	89	262	680	505
Arrive On Green	0.13	0.34	0.34	0.08	0.29	0.29	0.07	0.18	0.18	0.08	0.19	0.19
Sat Flow, veh/h	3428	3469	1572	1767	5066	1585	1795	3099	486	3428	3582	1595
Grp Volume(v), veh/h	315	734	16	107	794	82	96	137	140	159	214	127
Grp Sat Flow(s),veh/h/ln	1714	1735	1572	1767	1689	1585	1795	1791	1794	1714	1791	1595
Q Serve(g_s), s	5.4	10.8	0.4	3.6	8.0	2.1	3.2	4.1	4.2	2.7	3.1	3.6
Cycle Q Clear(g_c), s	5.4	10.8	0.4	3.6	8.0	2.1	3.2	4.1	4.2	2.7	3.1	3.6
Prop In Lane	1.00		1.00	1.00		1.00	1.00		0.27	1.00		1.00
Lane Grp Cap(c), veh/h	434	1173	640	137	1466	580	124	326	327	262	680	505
V/C Ratio(X)	0.73	0.63	0.02	0.78	0.54	0.14	0.78	0.42	0.43	0.61	0.31	0.25
Avail Cap(c_a), veh/h	845	2200	1106	299	2821	1004	245	1103	1105	777	2530	1329
HCM Platoon Ratio	1.00	1.00	1.00	1.00	1.00	1.00	1.00	1.00	1.00	1.00	1.00	1.00
Upstream Filter(I)	1.00	1.00	1.00	1.00	1.00	1.00	1.00	1.00	1.00	1.00	1.00	1.00
Uniform Delay (d), s/veh	25.6	16.9	10.8	27.6	18.2	12.9	27.9	22.0	22.1	27.2	21.2	15.5
Incr Delay (d2), s/veh	0.9	0.8	0.0	3.6	0.4	0.2	3.9	0.9	0.9	0.8	0.3	0.3
Initial Q Delay(d3),s/veh	0.0	0.0	0.0	0.0	0.0	0.0	0.0	0.0	0.0	0.0	0.0	0.0
%ile BackOfQ(50%),veh/ln	2.0	3.6	0.1	1.5	2.6	0.6	1.3	1.6	1.6	1.0	1.2	1.1
Unsig. Movement Delay, s/veh												
LnGrp Delay(d),s/veh	26.5	17.7	10.8	31.1	18.7	13.1	31.8	22.9	23.0	28.1	21.5	15.7
LnGrp LOS	C	B	B	C	B	B	C	C	C	C	C	B
Approach Vol, veh/h		1065			983			373			500	
Approach Delay, s/veh		20.2			19.6			25.2			22.1	
Approach LOS		C			B			C			C	
Timer - Assigned Phs	1	2	3	4	5	6	7	8				
Phs Duration (G+Y+Rc), s	8.4	26.8	7.9	17.8	11.4	23.8	8.4	17.3				
Change Period (Y+Rc), s	3.7	6.2	3.7	6.2	3.7	6.2	3.7	6.2				
Max Green Setting (Gmax), s	10.3	38.6	8.3	43.0	15.0	33.9	13.8	37.5				
Max Q Clear Time (g_c+I1), s	5.6	12.8	5.2	5.6	7.4	10.0	4.7	6.2				
Green Ext Time (p_c), s	0.0	6.8	0.0	1.6	0.4	7.6	0.2	1.4				
Intersection Summary												
HCM 6th Ctrl Delay				20.9								
HCM 6th LOS				C								

Intersection	
Intersection Delay, s/veh	9.6
Intersection LOS	A

Movement	EBT	EBR	WBL	WBT	NBL	NBR
Lane Configurations	↔		↔	↑	↔	↔
Traffic Vol, veh/h	131	14	59	193	50	45
Future Vol, veh/h	131	14	59	193	50	45
Peak Hour Factor	0.82	0.82	0.82	0.82	0.82	0.82
Heavy Vehicles, %	2	0	5	2	0	0
Mvmt Flow	160	17	72	235	61	55
Number of Lanes	1	0	1	1	1	1

Approach	EB	WB	NB
Opposing Approach	WB	EB	
Opposing Lanes	2	1	0
Conflicting Approach Left		NB	EB
Conflicting Lanes Left	0	2	1
Conflicting Approach Right	NB		WB
Conflicting Lanes Right	2	0	2
HCM Control Delay	9.6	9.9	8.9
HCM LOS	A	A	A

Lane	NBLn1	NBLn2	EBLn1	WBLn1	WBLn2
Vol Left, %	100%	0%	0%	100%	0%
Vol Thru, %	0%	0%	90%	0%	100%
Vol Right, %	0%	100%	10%	0%	0%
Sign Control	Stop	Stop	Stop	Stop	Stop
Traffic Vol by Lane	50	45	145	59	193
LT Vol	50	0	0	59	0
Through Vol	0	0	131	0	193
RT Vol	0	45	14	0	0
Lane Flow Rate	61	55	177	72	235
Geometry Grp	7	7	4	7	7
Degree of Util (X)	0.105	0.076	0.243	0.111	0.327
Departure Headway (Hd)	6.171	4.961	4.943	5.56	5.006
Convergence, Y/N	Yes	Yes	Yes	Yes	Yes
Cap	580	720	725	645	718
Service Time	3.914	2.704	2.979	3.294	2.74
HCM Lane V/C Ratio	0.105	0.076	0.244	0.112	0.327
HCM Control Delay	9.6	8.1	9.6	9	10.2
HCM Lane LOS	A	A	A	A	B
HCM 95th-tile Q	0.4	0.2	0.9	0.4	1.4

Intersection	
Intersection Delay, s/veh	9.6
Intersection LOS	A

Movement	EBL	EBT	EBR	WBL	WBT	WBR	NBL	NBT	NBR	SBL	SBT	SBR
Lane Configurations	↖	↕		↖	↕			↕			↕	
Traffic Vol, veh/h	51	204	8	8	267	50	24	4	4	47	5	51
Future Vol, veh/h	51	204	8	8	267	50	24	4	4	47	5	51
Peak Hour Factor	0.90	0.90	0.90	0.90	0.90	0.90	0.90	0.90	0.90	0.90	0.90	0.90
Heavy Vehicles, %	5	2	7	0	1	0	6	0	0	0	0	0
Mvmt Flow	57	227	9	9	297	56	27	4	4	52	6	57
Number of Lanes	1	2	0	1	2	0	0	1	0	0	1	0

Approach	EB	WB	NB	SB
Opposing Approach	WB	EB	SB	NB
Opposing Lanes	3	3	1	1
Conflicting Approach Left	SB	NB	EB	WB
Conflicting Lanes Left	1	1	3	3
Conflicting Approach Right	NB	SB	WB	EB
Conflicting Lanes Right	1	1	3	3
HCM Control Delay	9.4	9.7	9.7	10
HCM LOS	A	A	A	A

Lane	NBLn1	EBLn1	EBLn2	EBLn3	WBLn1	WBLn2	WBLn3	SBLn1
Vol Left, %	75%	100%	0%	0%	100%	0%	0%	46%
Vol Thru, %	12%	0%	100%	89%	0%	100%	64%	5%
Vol Right, %	12%	0%	0%	11%	0%	0%	36%	50%
Sign Control	Stop	Stop	Stop	Stop	Stop	Stop	Stop	Stop
Traffic Vol by Lane	32	51	136	76	8	178	139	103
LT Vol	24	51	0	0	8	0	0	47
Through Vol	4	0	136	68	0	178	89	5
RT Vol	4	0	0	8	0	0	50	51
Lane Flow Rate	36	57	151	84	9	198	154	114
Geometry Grp	7	7	7	7	7	7	7	7
Degree of Util (X)	0.064	0.093	0.224	0.125	0.014	0.289	0.214	0.186
Departure Headway (Hd)	6.493	5.892	5.337	5.348	5.755	5.269	4.998	5.856
Convergence, Y/N	Yes	Yes	Yes	Yes	Yes	Yes	Yes	Yes
Cap	546	605	668	665	619	678	714	608
Service Time	4.292	3.661	3.105	3.117	3.519	3.032	2.761	3.64
HCM Lane V/C Ratio	0.066	0.094	0.226	0.126	0.015	0.292	0.216	0.188
HCM Control Delay	9.7	9.3	9.7	8.9	8.6	10.2	9.1	10
HCM Lane LOS	A	A	A	A	A	B	A	A
HCM 95th-tile Q	0.2	0.3	0.9	0.4	0	1.2	0.8	0.7

Timings
11: Barton St & Alessandro Bl.



Lane Group	EBL	EBT	WBL	WBT	NBL	NBT	NBR	SBL	SBT	SBR
Lane Configurations	↙	↕↕↕	↙	↕↕↕		↕	↗		↕	↗
Traffic Volume (vph)	4	1152	66	1307	46	1	33	4	0	3
Future Volume (vph)	4	1152	66	1307	46	1	33	4	0	3
Turn Type	Prot	NA	Prot	NA	Perm	NA	Perm	Perm	NA	Perm
Protected Phases	5	2	1	6		8			4	
Permitted Phases					8		8	4		4
Detector Phase	5	2	1	6	8	8	8	4	4	4
Switch Phase										
Minimum Initial (s)	5.0	10.0	5.0	10.0	10.0	10.0	10.0	10.0	10.0	10.0
Minimum Split (s)	9.2	28.5	11.0	28.5	40.6	40.6	40.6	26.6	26.6	26.6
Total Split (s)	9.2	65.4	14.0	70.2	40.6	40.6	40.6	40.6	40.6	40.6
Total Split (%)	7.7%	54.5%	11.7%	58.5%	33.8%	33.8%	33.8%	33.8%	33.8%	33.8%
Yellow Time (s)	3.2	5.5	3.2	5.5	3.6	3.6	3.6	3.6	3.6	3.6
All-Red Time (s)	1.0	1.0	1.0	1.0	1.0	1.0	1.0	1.0	1.0	1.0
Lost Time Adjust (s)	0.0	0.0	0.0	0.0		0.0	0.0		0.0	0.0
Total Lost Time (s)	4.2	6.5	4.2	6.5		4.6	4.6		4.6	4.6
Lead/Lag	Lead	Lag	Lead	Lag						
Lead-Lag Optimize?	Yes	Yes	Yes	Yes						
Recall Mode	None	None	None	None	None	None	None	None	None	None
Act Effct Green (s)	6.3	36.3	8.1	44.2		15.4	15.4		15.4	15.4
Actuated g/C Ratio	0.10	0.57	0.13	0.69		0.24	0.24		0.24	0.24
v/c Ratio	0.03	0.44	0.31	0.40		0.15	0.07		0.01	0.01
Control Delay	42.0	13.3	39.2	8.4		26.8	0.3		26.0	0.0
Queue Delay	0.0	0.0	0.0	0.0		0.0	0.0		0.0	0.0
Total Delay	42.0	13.3	39.2	8.4		26.8	0.3		26.0	0.0
LOS	D	B	D	A		C	A		C	A
Approach Delay		13.4		9.9		15.9			14.9	
Approach LOS		B		A		B			B	

Intersection Summary

Cycle Length: 120
 Actuated Cycle Length: 64.2
 Natural Cycle: 85
 Control Type: Actuated-Uncoordinated
 Maximum v/c Ratio: 0.44
 Intersection Signal Delay: 11.6
 Intersection Capacity Utilization 55.1%
 Analysis Period (min) 15
 Intersection LOS: B
 ICU Level of Service B

Splits and Phases: 11: Barton St & Alessandro Bl.



HCM 6th Signalized Intersection Summary
11: Barton St & Alessandro Bl.

West Campus Upper Plateau (JN 14064)

09/29/2022



Movement	EBL	EBT	EBR	WBL	WBT	WBR	NBL	NBT	NBR	SBL	SBT	SBR
Lane Configurations	↖	↑↑↑		↖	↑↑↑			↑	↗		↑	↗
Traffic Volume (veh/h)	4	1152	28	66	1307	4	46	1	33	4	0	3
Future Volume (veh/h)	4	1152	28	66	1307	4	46	1	33	4	0	3
Initial Q (Qb), veh	0	0	0	0	0	0	0	0	0	0	0	0
Ped-Bike Adj(A_pbT)	1.00		1.00	1.00		0.98	1.00		1.00	1.00		1.00
Parking Bus, Adj	1.00	1.00	1.00	1.00	1.00	1.00	1.00	1.00	1.00	1.00	1.00	1.00
Work Zone On Approach		No			No			No			No	
Adj Sat Flow, veh/h/ln	1604	1885	1900	1900	1870	1900	1870	1900	1900	1737	1900	1900
Adj Flow Rate, veh/h	4	1239	28	71	1405	4	49	1	8	4	0	-8
Peak Hour Factor	0.93	0.93	0.93	0.93	0.93	0.93	0.93	0.93	0.93	0.93	0.93	0.93
Percent Heavy Veh, %	20	1	0	0	2	0	2	0	0	11	0	0
Cap, veh/h	8	2805	63	111	3143	9	292	5	167	250	0	167
Arrive On Green	0.01	0.54	0.54	0.06	0.60	0.60	0.10	0.10	0.10	0.10	0.00	0.00
Sat Flow, veh/h	1527	5178	117	1810	5256	15	1501	45	1610	1079	0	1610
Grp Volume(v), veh/h	4	821	446	71	910	499	50	0	8	4	0	-8
Grp Sat Flow(s),veh/h/ln	1527	1716	1864	1810	1702	1867	1546	0	1610	1079	0	1610
Q Serve(g_s), s	0.1	7.5	7.5	2.0	7.7	7.7	0.0	0.0	0.2	0.1	0.0	0.0
Cycle Q Clear(g_c), s	0.1	7.5	7.5	2.0	7.7	7.7	1.3	0.0	0.2	1.5	0.0	0.0
Prop In Lane	1.00		0.06	1.00		0.01	0.98		1.00	1.00		1.00
Lane Grp Cap(c), veh/h	8	1859	1010	111	2035	1116	297	0	167	250	0	167
V/C Ratio(X)	0.49	0.44	0.44	0.64	0.45	0.45	0.17	0.00	0.05	0.02	0.00	-0.05
Avail Cap(c_a), veh/h	146	3867	2101	339	4149	2276	1143	0	1109	1085	0	1109
HCM Platoon Ratio	1.00	1.00	1.00	1.00	1.00	1.00	1.00	1.00	1.00	1.00	1.00	1.00
Upstream Filter(I)	1.00	1.00	1.00	1.00	1.00	1.00	1.00	0.00	1.00	1.00	0.00	0.00
Uniform Delay (d), s/veh	25.9	7.2	7.2	24.0	5.8	5.8	21.6	0.0	21.1	22.2	0.0	0.0
Incr Delay (d2), s/veh	15.5	0.2	0.4	2.3	0.2	0.4	0.3	0.0	0.1	0.0	0.0	0.0
Initial Q Delay(d3),s/veh	0.0	0.0	0.0	0.0	0.0	0.0	0.0	0.0	0.0	0.0	0.0	0.0
%ile BackOfQ(50%),veh/ln	0.1	1.5	1.7	0.9	1.9	2.1	0.5	0.0	0.1	0.0	0.0	0.0
Unsig. Movement Delay, s/veh												
LnGrp Delay(d),s/veh	41.4	7.4	7.6	26.2	6.0	6.2	21.8	0.0	21.2	22.3	0.0	0.0
LnGrp LOS	D	A	A	C	A	A	C	A	C	C	A	A
Approach Vol, veh/h		1271			1480			58				-4
Approach Delay, s/veh		7.6			7.0			21.8			0.0	
Approach LOS		A			A			C			A	
Timer - Assigned Phs	1	2		4	5	6		8				
Phs Duration (G+Y+Rc), s	7.4	34.8		10.0	4.5	37.7		10.0				
Change Period (Y+Rc), s	* 4.2	6.5		4.6	* 4.2	6.5		4.6				
Max Green Setting (Gmax), s	* 9.8	58.9		36.0	* 5	63.7		36.0				
Max Q Clear Time (g_c+I1), s	4.0	9.5		3.5	2.1	9.7		3.3				
Green Ext Time (p_c), s	0.0	14.7		0.0	0.0	21.6		0.2				

Intersection Summary

HCM 6th Ctrl Delay	7.6
HCM 6th LOS	A

Notes

* HCM 6th computational engine requires equal clearance times for the phases crossing the barrier.

Intersection						
Int Delay, s/veh	2.2					
Movement	EBL	EBT	WBT	WBR	SBL	SBR
Lane Configurations						
Traffic Vol, veh/h	18	129	179	17	22	46
Future Vol, veh/h	18	129	179	17	22	46
Conflicting Peds, #/hr	0	0	0	7	0	0
Sign Control	Free	Free	Free	Free	Stop	Stop
RT Channelized	-	None	-	None	-	None
Storage Length	100	-	-	-	0	-
Veh in Median Storage, #	-	0	0	-	0	-
Grade, %	-	0	0	-	0	-
Peak Hour Factor	78	78	78	78	78	78
Heavy Vehicles, %	0	1	1	0	0	0
Mvmt Flow	23	165	229	22	28	59

Major/Minor	Major1	Major2	Minor2		
Conflicting Flow All	258	0	-	0	458 247
Stage 1	-	-	-	-	247 -
Stage 2	-	-	-	-	211 -
Critical Hdwy	4.1	-	-	-	6.4 6.2
Critical Hdwy Stg 1	-	-	-	-	5.4 -
Critical Hdwy Stg 2	-	-	-	-	5.4 -
Follow-up Hdwy	2.2	-	-	-	3.5 3.3
Pot Cap-1 Maneuver	1318	-	-	-	565 797
Stage 1	-	-	-	-	799 -
Stage 2	-	-	-	-	829 -
Platoon blocked, %		-	-	-	
Mov Cap-1 Maneuver	1309	-	-	-	547 792
Mov Cap-2 Maneuver	-	-	-	-	547 -
Stage 1	-	-	-	-	779 -
Stage 2	-	-	-	-	823 -

Approach	EB	WB	SB
HCM Control Delay, s	1	0	11
HCM LOS			B

Minor Lane/Major Mvmt	EBL	EBT	WBT	WBR	SBLn1
Capacity (veh/h)	1309	-	-	-	692
HCM Lane V/C Ratio	0.018	-	-	-	0.126
HCM Control Delay (s)	7.8	-	-	-	11
HCM Lane LOS	A	-	-	-	B
HCM 95th %tile Q(veh)	0.1	-	-	-	0.4

Intersection						
Int Delay, s/veh	9.1					
Movement	EBT	EBR	WBL	WBT	NBL	NBR
Lane Configurations	↑↑		↖	↑↑	↗	
Traffic Vol, veh/h	269	238	45	396	197	33
Future Vol, veh/h	269	238	45	396	197	33
Conflicting Peds, #/hr	0	2	0	0	0	0
Sign Control	Free	Free	Free	Free	Stop	Stop
RT Channelized	-	None	-	None	-	None
Storage Length	-	-	125	-	0	-
Veh in Median Storage, #	0	-	-	0	0	-
Grade, %	0	-	-	0	0	-
Peak Hour Factor	86	86	86	86	86	86
Heavy Vehicles, %	1	1	0	0	0	0
Mvmt Flow	313	277	52	460	229	38

Major/Minor	Major1	Major2	Minor1		
Conflicting Flow All	0	0	592	0	788 297
Stage 1	-	-	-	-	454 -
Stage 2	-	-	-	-	334 -
Critical Hdwy	-	-	4.1	-	6.8 6.9
Critical Hdwy Stg 1	-	-	-	-	5.8 -
Critical Hdwy Stg 2	-	-	-	-	5.8 -
Follow-up Hdwy	-	-	2.2	-	3.5 3.3
Pot Cap-1 Maneuver	-	-	994	-	332 705
Stage 1	-	-	-	-	612 -
Stage 2	-	-	-	-	703 -
Platoon blocked, %	-	-	-	-	-
Mov Cap-1 Maneuver	-	-	992	-	314 704
Mov Cap-2 Maneuver	-	-	-	-	314 -
Stage 1	-	-	-	-	611 -
Stage 2	-	-	-	-	666 -

Approach	EB	WB	NB
HCM Control Delay, s	0	0.9	45
HCM LOS			E

Minor Lane/Major Mvmt	NBLn1	EBT	EBR	WBL	WBT
Capacity (veh/h)	341	-	-	992	-
HCM Lane V/C Ratio	0.784	-	-	0.053	-
HCM Control Delay (s)	45	-	-	8.8	-
HCM Lane LOS	E	-	-	A	-
HCM 95th %tile Q(veh)	6.4	-	-	0.2	-

Timings
14: Barton Rd. & Van Buren Bl.

West Campus Upper Plateau (JN 14064)

09/29/2022



Lane Group	EBL	EBT	WBL	WBT	NBL	NBT	NBR	SBL	SBT
Lane Configurations	↙	↕	↙	↕	↙	↕	↗	↙	↕
Traffic Volume (vph)	80	773	175	816	195	38	141	25	25
Future Volume (vph)	80	773	175	816	195	38	141	25	25
Turn Type	Prot	NA	Prot	NA	Prot	NA	Perm	Prot	NA
Protected Phases	5	2	1	6	3	8		7	4
Permitted Phases							8		
Detector Phase	5	2	1	6	3	8	8	7	4
Switch Phase									
Minimum Initial (s)	5.0	10.0	5.0	10.0	5.0	10.0	10.0	5.0	10.0
Minimum Split (s)	9.2	25.2	9.2	25.5	9.1	14.6	14.6	9.1	33.6
Total Split (s)	17.6	52.1	22.2	56.7	12.1	36.3	36.3	9.4	33.6
Total Split (%)	14.7%	43.4%	18.5%	47.3%	10.1%	30.3%	30.3%	7.8%	28.0%
Yellow Time (s)	3.2	5.2	3.2	5.5	3.6	3.6	3.6	3.6	3.6
All-Red Time (s)	1.0	1.0	1.0	1.0	0.5	1.0	1.0	0.5	1.0
Lost Time Adjust (s)	0.0	0.0	0.0	0.0	0.0	0.0	0.0	0.0	0.0
Total Lost Time (s)	4.2	6.2	4.2	6.5	4.1	4.6	4.6	4.1	4.6
Lead/Lag	Lead	Lag	Lead	Lag	Lead	Lag	Lag	Lead	Lag
Lead-Lag Optimize?	Yes	Yes	Yes	Yes	Yes	Yes	Yes	Yes	Yes
Recall Mode	None	None	None	None	None	None	None	None	None
Act Effct Green (s)	9.0	31.5	14.2	38.9	8.3	20.6	20.6	5.5	13.1
Actuated g/C Ratio	0.10	0.36	0.16	0.45	0.10	0.24	0.24	0.06	0.15
v/c Ratio	0.48	0.84	0.67	0.42	0.65	0.09	0.33	0.25	0.37
Control Delay	50.0	32.5	49.4	18.2	51.5	32.5	7.8	51.7	15.6
Queue Delay	0.0	0.0	0.0	0.0	0.0	0.0	0.0	0.0	0.0
Total Delay	50.0	32.5	49.4	18.2	51.5	32.5	7.8	51.7	15.6
LOS	D	C	D	B	D	C	A	D	B
Approach Delay		33.9		23.5		33.1			22.3
Approach LOS		C		C		C			C

Intersection Summary

Cycle Length: 120
 Actuated Cycle Length: 87
 Natural Cycle: 90
 Control Type: Actuated-Uncoordinated
 Maximum v/c Ratio: 0.84
 Intersection Signal Delay: 29.0
 Intersection LOS: C
 Intersection Capacity Utilization 61.0%
 ICU Level of Service B
 Analysis Period (min) 15























Splits and Phases: 14: Barton Rd. & Van Buren Bl.



HCM 6th Signalized Intersection Summary
 14: Barton Rd. & Van Buren Bl.

West Campus Upper Plateau (JN 14064)

09/29/2022

												
Movement	EBL	EBT	EBR	WBL	WBT	WBR	NBL	NBT	NBR	SBL	SBT	SBR
Lane Configurations												
Traffic Volume (veh/h)	80	773	162	175	816	34	195	38	141	25	25	85
Future Volume (veh/h)	80	773	162	175	816	34	195	38	141	25	25	85
Initial Q (Qb), veh	0	0	0	0	0	0	0	0	0	0	0	0
Ped-Bike Adj(A_pbT)	1.00		1.00	1.00		1.00	1.00		0.95	1.00		1.00
Parking Bus, Adj	1.00	1.00	1.00	1.00	1.00	1.00	1.00	1.00	1.00	1.00	1.00	1.00
Work Zone On Approach		No			No			No			No	
Adj Sat Flow, veh/h/ln	1900	1841	1870	1870	1856	1856	1900	1900	1885	1900	1841	1900
Adj Flow Rate, veh/h	89	859	149	194	907	27	217	42	25	28	28	32
Peak Hour Factor	0.90	0.90	0.90	0.90	0.90	0.90	0.90	0.90	0.90	0.90	0.90	0.90
Percent Heavy Veh, %	0	4	2	2	3	3	0	0	1	0	4	0
Cap, veh/h	116	1038	180	239	2116	63	316	380	305	55	110	125
Arrive On Green	0.06	0.35	0.35	0.13	0.42	0.42	0.09	0.20	0.20	0.03	0.14	0.14
Sat Flow, veh/h	1810	2979	517	1781	5055	150	3510	1900	1525	1810	784	896
Grp Volume(v), veh/h	89	504	504	194	606	328	217	42	25	28	0	60
Grp Sat Flow(s),veh/h/ln	1810	1749	1747	1781	1689	1828	1755	1900	1525	1810	0	1679
Q Serve(g_s), s	3.3	17.8	17.8	7.1	8.6	8.6	4.0	1.2	0.9	1.0	0.0	2.2
Cycle Q Clear(g_c), s	3.3	17.8	17.8	7.1	8.6	8.6	4.0	1.2	0.9	1.0	0.0	2.2
Prop In Lane	1.00		0.30	1.00		0.08	1.00		1.00	1.00		0.53
Lane Grp Cap(c), veh/h	116	609	608	239	1414	765	316	380	305	55	0	235
V/C Ratio(X)	0.77	0.83	0.83	0.81	0.43	0.43	0.69	0.11	0.08	0.51	0.00	0.26
Avail Cap(c_a), veh/h	359	1189	1188	475	2512	1360	416	892	716	142	0	722
HCM Platoon Ratio	1.00	1.00	1.00	1.00	1.00	1.00	1.00	1.00	1.00	1.00	1.00	1.00
Upstream Filter(I)	1.00	1.00	1.00	1.00	1.00	1.00	1.00	1.00	1.00	1.00	0.00	1.00
Uniform Delay (d), s/veh	31.1	20.1	20.1	28.4	13.9	13.9	29.8	22.1	22.0	32.2	0.0	25.9
Incr Delay (d2), s/veh	4.0	1.1	1.1	2.5	0.1	0.1	3.1	0.1	0.1	7.2	0.0	0.6
Initial Q Delay(d3),s/veh	0.0	0.0	0.0	0.0	0.0	0.0	0.0	0.0	0.0	0.0	0.0	0.0
%ile BackOfQ(50%),veh/ln	1.4	6.2	6.2	2.9	2.6	2.9	1.7	0.5	0.3	0.6	0.0	0.9
Unsig. Movement Delay, s/veh												
LnGrp Delay(d),s/veh	35.1	21.3	21.3	30.9	14.0	14.0	32.8	22.2	22.1	39.4	0.0	26.4
LnGrp LOS	D	C	C	C	B	B	C	C	C	D	A	C
Approach Vol, veh/h		1097			1128			284				88
Approach Delay, s/veh		22.4			16.9			30.3				30.6
Approach LOS		C			B			C				C
Timer - Assigned Phs	1	2	3	4	5	6	7	8				
Phs Duration (G+Y+Rc), s	13.3	30.0	10.2	14.1	8.5	34.7	6.1	18.1				
Change Period (Y+Rc), s	* 4.2	* 6.5	4.1	4.6	* 4.2	6.5	4.1	4.6				
Max Green Setting (Gmax), s	* 18	* 46	8.0	29.0	* 13	50.2	5.3	31.7				
Max Q Clear Time (g_c+I1), s	9.1	19.8	6.0	4.2	5.3	10.6	3.0	3.2				
Green Ext Time (p_c), s	0.2	3.7	0.1	0.3	0.0	3.6	0.0	0.2				

Intersection Summary

HCM 6th Ctrl Delay	21.2
HCM 6th LOS	C

Notes

* HCM 6th computational engine requires equal clearance times for the phases crossing the barrier.

Intersection	
Intersection Delay, s/veh	8.4
Intersection LOS	A

Movement	EBT	EBR	WBL	WBT	NBL	NBR
Lane Configurations						
Traffic Vol, veh/h	75	69	35	104	66	32
Future Vol, veh/h	75	69	35	104	66	32
Peak Hour Factor	0.88	0.88	0.88	0.88	0.88	0.88
Heavy Vehicles, %	1	2	3	2	2	0
Mvmt Flow	85	78	40	118	75	36
Number of Lanes	1	0	1	1	1	0

Approach	EB	WB	NB
Opposing Approach	WB	EB	
Opposing Lanes	2	1	0
Conflicting Approach Left		NB	EB
Conflicting Lanes Left	0	1	1
Conflicting Approach Right	NB		WB
Conflicting Lanes Right	1	0	2
HCM Control Delay	8.2	8.6	8.4
HCM LOS	A	A	A

Lane	NBLn1	EBLn1	WBLn1	WBLn2
Vol Left, %	67%	0%	100%	0%
Vol Thru, %	0%	52%	0%	100%
Vol Right, %	33%	48%	0%	0%
Sign Control	Stop	Stop	Stop	Stop
Traffic Vol by Lane	98	144	35	104
LT Vol	66	0	35	0
Through Vol	0	75	0	104
RT Vol	32	69	0	0
Lane Flow Rate	111	164	40	118
Geometry Grp	2	5	7	7
Degree of Util (X)	0.142	0.19	0.06	0.162
Departure Headway (Hd)	4.604	4.182	5.44	4.921
Convergence, Y/N	Yes	Yes	Yes	Yes
Cap	781	861	660	730
Service Time	2.623	2.198	3.157	2.638
HCM Lane V/C Ratio	0.142	0.19	0.061	0.162
HCM Control Delay	8.4	8.2	8.5	8.6
HCM Lane LOS	A	A	A	A
HCM 95th-tile Q	0.5	0.7	0.2	0.6

Intersection	
Intersection Delay, s/veh	8.9
Intersection LOS	A

Movement	EBL	EBT	WBT	WBR	SBL	SBR
Lane Configurations						
Traffic Vol, veh/h	113	144	169	63	52	54
Future Vol, veh/h	113	144	169	63	52	54
Peak Hour Factor	0.90	0.90	0.90	0.90	0.90	0.90
Heavy Vehicles, %	1	0	2	0	4	3
Mvmt Flow	126	160	188	70	58	60
Number of Lanes	1	2	2	0	1	0

Approach	EB	WB	SB
Opposing Approach	WB	EB	
Opposing Lanes	2	3	0
Conflicting Approach Left	SB		WB
Conflicting Lanes Left	1	0	2
Conflicting Approach Right		SB	EB
Conflicting Lanes Right	0	1	3
HCM Control Delay	8.4	9.2	9.7
HCM LOS	A	A	A

Lane	EBLn1	EBLn2	EBLn3	WBLn1	WBLn2	SBLn1
Vol Left, %	100%	0%	0%	0%	0%	49%
Vol Thru, %	0%	100%	100%	100%	47%	0%
Vol Right, %	0%	0%	0%	0%	53%	51%
Sign Control	Stop	Stop	Stop	Stop	Stop	Stop
Traffic Vol by Lane	113	72	72	113	119	106
LT Vol	113	0	0	0	0	52
Through Vol	0	72	72	113	56	0
RT Vol	0	0	0	0	63	54
Lane Flow Rate	126	80	80	125	133	118
Geometry Grp	7	7	7	8	8	7
Degree of Util (X)	0.196	0.113	0.075	0.189	0.185	0.185
Departure Headway (Hd)	5.608	5.088	3.377	5.442	5.036	5.646
Convergence, Y/N	Yes	Yes	Yes	Yes	Yes	Yes
Cap	639	703	1054	657	709	632
Service Time	3.35	2.83	1.118	3.193	2.787	3.403
HCM Lane V/C Ratio	0.197	0.114	0.076	0.19	0.188	0.187
HCM Control Delay	9.7	8.5	6.4	9.5	8.9	9.7
HCM Lane LOS	A	A	A	A	A	A
HCM 95th-tile Q	0.7	0.4	0.2	0.7	0.7	0.7

Timings
19: Van Buren Bl. & Orange Terrace Pkwy.

West Campus Upper Plateau (JN 14064)

09/29/2022

Lane Group	EBL	EBT	EBR	WBL	WBT	WBR	NBL	NBT	NBR	SBL	SBT	SBR
Lane Configurations												
Traffic Volume (vph)	84	728	49	32	959	241	52	46	38	184	36	69
Future Volume (vph)	84	728	49	32	959	241	52	46	38	184	36	69
Turn Type	Prot	NA	Perm	Prot	NA	Perm	Prot	NA	Perm	Prot	NA	pm+ov
Protected Phases	5	2		1	6		3	8		7	4	5
Permitted Phases			2			6			8			4
Detector Phase	5	2	2	1	6	6	3	8	8	7	4	5
Switch Phase												
Minimum Initial (s)	5.0	10.0	10.0	5.0	10.0	10.0	5.0	5.0	5.0	10.0	10.0	5.0
Minimum Split (s)	9.2	25.2	25.2	9.1	25.2	25.2	9.1	26.1	26.1	15.8	24.8	9.2
Total Split (s)	16.0	63.0	63.0	11.0	58.0	58.0	12.0	27.0	27.0	19.0	34.0	16.0
Total Split (%)	13.3%	52.5%	52.5%	9.2%	48.3%	48.3%	10.0%	22.5%	22.5%	15.8%	28.3%	13.3%
Yellow Time (s)	3.2	5.2	5.2	3.6	5.2	5.2	3.6	3.6	3.6	4.8	4.8	3.2
All-Red Time (s)	1.0	1.0	1.0	0.5	1.0	1.0	0.5	0.5	0.5	1.0	1.0	1.0
Lost Time Adjust (s)	0.0	0.0	0.0	0.0	0.0	0.0	0.0	0.0	0.0	0.0	0.0	0.0
Total Lost Time (s)	4.2	6.2	6.2	4.1	6.2	6.2	4.1	4.1	4.1	5.8	5.8	4.2
Lead/Lag	Lead	Lag	Lag	Lead	Lag	Lag	Lead	Lag	Lag	Lead	Lag	Lead
Lead-Lag Optimize?	Yes	Yes	Yes	Yes	Yes	Yes	Yes	Yes	Yes	Yes	Yes	Yes
Recall Mode	None	None	None	None	None	None	None	None	None	None	None	None
Act Effct Green (s)	6.7	27.4	27.4	6.6	23.0	23.0	7.0	7.8	7.8	11.5	14.4	27.4
Actuated g/C Ratio	0.10	0.43	0.43	0.10	0.36	0.36	0.11	0.12	0.12	0.18	0.22	0.43
v/c Ratio	0.24	0.36	0.07	0.10	0.56	0.35	0.15	0.11	0.11	0.31	0.09	0.10
Control Delay	33.6	14.4	0.2	33.3	19.2	4.1	33.0	30.3	0.6	29.7	26.6	5.2
Queue Delay	0.0	0.0	0.0	0.0	0.0	0.0	0.0	0.0	0.0	0.0	0.0	0.0
Total Delay	33.6	14.4	0.2	33.3	19.2	4.1	33.0	30.3	0.6	29.7	26.6	5.2
LOS	C	B	A	C	B	A	C	C	A	C	C	A
Approach Delay		15.4			16.6			23.0			23.4	
Approach LOS		B			B			C			C	

Intersection Summary

Cycle Length: 120	
Actuated Cycle Length: 64.4	
Natural Cycle: 80	
Control Type: Actuated-Uncoordinated	
Maximum v/c Ratio: 0.56	
Intersection Signal Delay: 17.4	Intersection LOS: B
Intersection Capacity Utilization 48.1%	ICU Level of Service A
Analysis Period (min) 15	

Splits and Phases: 19: Van Buren Bl. & Orange Terrace Pkwy.

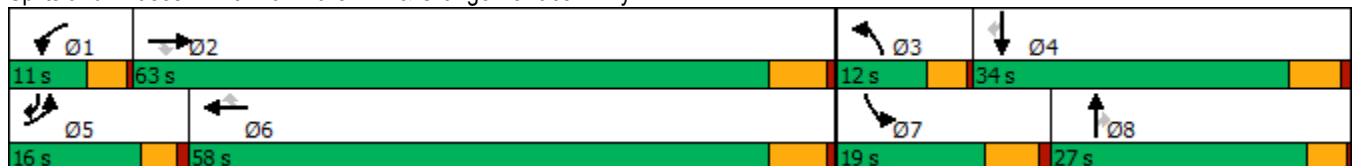

HCM 6th Signalized Intersection Summary
 19: Van Buren Bl. & Orange Terrace Pkwy.

West Campus Upper Plateau (JN 14064)

09/29/2022



Movement	EBL	EBT	EBR	WBL	WBT	WBR	NBL	NBT	NBR	SBL	SBT	SBR
Lane Configurations	↖↗	↑↑↑	↖	↖↗	↑↑↑	↖	↖↗	↑↑	↖	↖↗	↑	↖↗
Traffic Volume (veh/h)	84	728	49	32	959	241	52	46	38	184	36	69
Future Volume (veh/h)	84	728	49	32	959	241	52	46	38	184	36	69
Initial Q (Qb), veh	0	0	0	0	0	0	0	0	0	0	0	0
Ped-Bike Adj(A_pbT)	1.00		1.00	1.00		1.00	1.00		1.00	1.00		1.00
Parking Bus, Adj	1.00	1.00	1.00	1.00	1.00	1.00	1.00	1.00	1.00	1.00	1.00	1.00
Work Zone On Approach		No			No			No			No	
Adj Sat Flow, veh/h/ln	1885	1856	1811	1870	1856	1885	1796	1900	1856	1885	1900	1885
Adj Flow Rate, veh/h	88	766	26	34	1009	194	55	48	8	194	38	-1
Peak Hour Factor	0.95	0.95	0.95	0.95	0.95	0.95	0.95	0.95	0.95	0.95	0.95	0.95
Percent Heavy Veh, %	1	3	6	2	3	1	7	0	3	1	0	1
Cap, veh/h	222	1852	561	124	1703	537	165	272	119	568	412	448
Arrive On Green	0.06	0.37	0.37	0.04	0.34	0.34	0.05	0.08	0.08	0.16	0.22	0.00
Sat Flow, veh/h	3483	5066	1535	3456	5066	1598	3319	3610	1572	3483	1900	1598
Grp Volume(v), veh/h	88	766	26	34	1009	194	55	48	8	194	38	-1
Grp Sat Flow(s),veh/h/ln	1742	1689	1535	1728	1689	1598	1659	1805	1572	1742	1900	1598
Q Serve(g_s), s	1.5	6.9	0.7	0.6	10.0	5.6	1.0	0.8	0.3	3.0	1.0	0.0
Cycle Q Clear(g_c), s	1.5	6.9	0.7	0.6	10.0	5.6	1.0	0.8	0.3	3.0	1.0	0.0
Prop In Lane	1.00		1.00	1.00		1.00	1.00		1.00	1.00		1.00
Lane Grp Cap(c), veh/h	222	1852	561	124	1703	537	165	272	119	568	412	448
V/C Ratio(X)	0.40	0.41	0.05	0.27	0.59	0.36	0.33	0.18	0.07	0.34	0.09	0.00
Avail Cap(c_a), veh/h	676	4730	1433	392	4313	1360	431	1359	592	756	881	842
HCM Platoon Ratio	1.00	1.00	1.00	1.00	1.00	1.00	1.00	1.00	1.00	1.00	1.00	1.00
Upstream Filter(I)	1.00	1.00	1.00	1.00	1.00	1.00	1.00	1.00	1.00	1.00	1.00	0.00
Uniform Delay (d), s/veh	27.4	14.4	12.5	28.6	16.7	15.3	27.9	26.4	26.1	22.6	19.0	0.0
Incr Delay (d2), s/veh	0.4	0.1	0.0	1.2	0.3	0.4	1.2	0.3	0.2	0.4	0.1	0.0
Initial Q Delay(d3),s/veh	0.0	0.0	0.0	0.0	0.0	0.0	0.0	0.0	0.0	0.0	0.0	0.0
%ile BackOfQ(50%),veh/ln	0.6	2.1	0.2	0.2	3.2	1.9	0.4	0.3	0.1	1.1	0.4	0.0
Unsig. Movement Delay, s/veh												
LnGrp Delay(d),s/veh	27.8	14.6	12.5	29.7	17.1	15.7	29.1	26.7	26.4	22.9	19.1	0.0
LnGrp LOS	C	B	B	C	B	B	C	C	C	C	B	A
Approach Vol, veh/h		880			1237			111			231	
Approach Delay, s/veh		15.8			17.2			27.8			22.4	
Approach LOS		B			B			C			C	
Timer - Assigned Phs	1	2	3	4	5	6	7	8				
Phs Duration (G+Y+Rc), s	6.3	28.4	7.1	19.0	8.1	26.7	15.7	10.4				
Change Period (Y+Rc), s	4.1	6.2	4.1	5.8	* 4.2	6.2	5.8	* 5.8				
Max Green Setting (Gmax), s	6.9	56.8	7.9	28.2	* 12	51.8	13.2	* 23				
Max Q Clear Time (g_c+I1), s	2.6	8.9	3.0	3.0	3.5	12.0	5.0	2.8				
Green Ext Time (p_c), s	0.0	5.5	0.0	0.1	0.1	8.4	0.4	0.2				

Intersection Summary

HCM 6th Ctrl Delay	17.7
HCM 6th LOS	B

Notes

* HCM 6th computational engine requires equal clearance times for the phases crossing the barrier.

Timings
20: Brown/San Gorgonio Dr & Alessandro Bl.

West Campus Upper Plateau (JN 14064)

09/29/2022

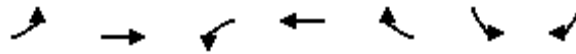

Lane Group	EBL	EBT	WBL	WBT	WBR	SBL	SBR	Ø3	Ø4	Ø8
Lane Configurations	↖	↕↕↕	↖	↕↕↕	↖	↖	↖			
Traffic Volume (vph)	29	1196	3	1357	31	36	33			
Future Volume (vph)	29	1196	3	1357	31	36	33			
Turn Type	Prot	NA	Prot	NA	Perm	Prot	pm+ov			
Protected Phases	5	2	1	6		7	5	3	4	8
Permitted Phases					6		4			
Detector Phase	5	2	1	6	6	7	5			
Switch Phase										
Minimum Initial (s)	5.0	10.0	5.0	10.0	10.0	5.0	5.0	5.0	10.0	5.0
Minimum Split (s)	8.7	43.5	9.1	43.5	43.5	8.7	8.7	9.1	49.8	26.1
Total Split (s)	8.7	52.0	9.1	52.4	52.4	19.6	8.7	9.1	49.8	39.3
Total Split (%)	7.3%	43.3%	7.6%	43.7%	43.7%	16.3%	7.3%	8%	42%	33%
Yellow Time (s)	3.2	5.5	3.6	5.5	5.5	3.2	3.2	3.6	4.8	3.6
All-Red Time (s)	0.5	1.0	0.5	1.0	1.0	0.5	0.5	0.5	1.0	0.5
Lost Time Adjust (s)	0.0	0.0	0.0	0.0	0.0	0.0	0.0			
Total Lost Time (s)	3.7	6.5	4.1	6.5	6.5	3.7	3.7			
Lead/Lag	Lead	Lag	Lead	Lag	Lag	Lead	Lead	Lead	Lag	Lag
Lead-Lag Optimize?	Yes	Yes	Yes	Yes	Yes	Yes	Yes	Yes	Yes	Yes
Recall Mode	None	None	None	None	None	None	None	None	None	None
Act Effct Green (s)	6.6	48.7	6.6	45.7	45.7	9.6	17.8			
Actuated g/C Ratio	0.10	0.76	0.10	0.71	0.71	0.15	0.28			
v/c Ratio	0.17	0.33	0.02	0.40	0.04	0.15	0.07			
Control Delay	43.7	9.1	43.7	11.4	0.1	37.1	0.2			
Queue Delay	0.0	0.0	0.0	0.0	0.0	0.0	0.0			
Total Delay	43.7	9.1	43.7	11.4	0.1	37.1	0.2			
LOS	D	A	D	B	A	D	A			
Approach Delay		9.9		11.2						
Approach LOS		A		B						

Intersection Summary

Cycle Length: 120
 Actuated Cycle Length: 64
 Natural Cycle: 115
 Control Type: Actuated-Uncoordinated
 Maximum v/c Ratio: 0.40
 Intersection Signal Delay: 10.8
 Intersection LOS: B
 Intersection Capacity Utilization 44.8%
 ICU Level of Service A
 Analysis Period (min) 15

Splits and Phases: 20: Brown/San Gorgonio Dr & Alessandro Bl.

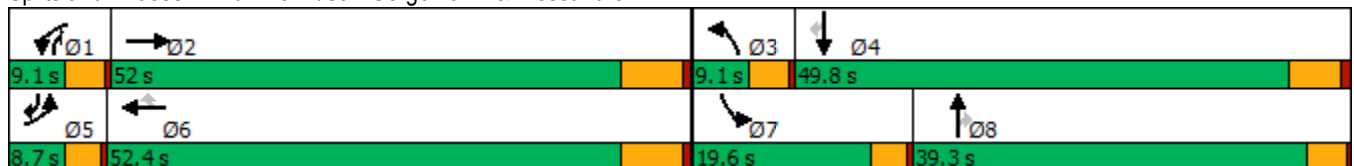

HCM 6th Signalized Intersection Summary
20: Brown/San Gorgonio Dr & Alessandro Bl.

West Campus Upper Plateau (JN 14064)

09/29/2022



Movement	EBL	EBT	EBR	WBL	WBT	WBR	NBL	NBT	NBR	SBL	SBT	SBR
Lane Configurations	↖	↑↑↑		↖	↑↑↑	↖	↖	↑	↖	↖	↑	↖
Traffic Volume (veh/h)	29	1196	0	3	1357	31	0	0	0	36	0	33
Future Volume (veh/h)	29	1196	0	3	1357	31	0	0	0	36	0	33
Initial Q (Qb), veh	0	0	0	0	0	0	0	0	0	0	0	0
Ped-Bike Adj(A_pbT)	1.00		1.00	1.00		1.00	1.00		1.00	1.00		1.00
Parking Bus, Adj	1.00	1.00	1.00	1.00	1.00	1.00	1.00	1.00	1.00	1.00	1.00	1.00
Work Zone On Approach		No			No			No			No	
Adj Sat Flow, veh/h/ln	1900	1900	1900	1307	1885	1396	1796	1900	1322	1796	1900	1885
Adj Flow Rate, veh/h	31	1286	-4	3	1459	29	0	0	-13	39	0	-14
Peak Hour Factor	0.93	0.93	0.93	0.93	0.93	0.93	0.93	0.93	0.93	0.93	0.93	0.93
Percent Heavy Veh, %	0	0	0	40	1	34	7	0	39	7	0	1
Cap, veh/h	64	3358	0	5	3215	739	4	4	7	73	4	60
Arrive On Green	0.04	0.65	0.00	0.00	0.62	0.62	0.00	0.00	0.00	0.04	0.00	0.00
Sat Flow, veh/h	1810	5358	0	1245	5147	1183	1711	1900	1120	1711	1900	1598
Grp Volume(v), veh/h	31	1282	0	3	1459	29	0	0	-13	39	0	-14
Grp Sat Flow(s),veh/h/ln	1810	1729	0	1245	1716	1183	1711	1900	1120	1711	1900	1598
Q Serve(g_s), s	0.8	5.4	0.0	0.1	6.9	0.4	0.0	0.0	0.0	1.0	0.0	0.0
Cycle Q Clear(g_c), s	0.8	5.4	0.0	0.1	6.9	0.4	0.0	0.0	0.0	1.0	0.0	0.0
Prop In Lane	1.00		0.00	1.00		1.00	1.00		1.00	1.00		1.00
Lane Grp Cap(c), veh/h	64	3358	0	5	3215	739	4	4	7	73	4	60
V/C Ratio(X)	0.48	0.38	0.00	0.59	0.45	0.04	0.00	0.00	-1.86	0.54	0.00	-0.23
Avail Cap(c_a), veh/h	194	5050	0	133	5054	1162	183	1431	848	582	1789	1561
HCM Platoon Ratio	1.00	1.00	1.00	1.00	1.00	1.00	1.00	1.00	1.00	1.00	1.00	1.00
Upstream Filter(I)	1.00	1.00	0.00	1.00	1.00	1.00	0.00	0.00	0.00	1.00	0.00	0.00
Uniform Delay (d), s/veh	22.1	3.9	0.0	23.2	4.6	3.4	0.0	0.0	0.0	21.9	0.0	0.0
Incr Delay (d2), s/veh	2.1	0.1	0.0	77.4	0.1	0.0	0.0	0.0	0.0	2.3	0.0	0.0
Initial Q Delay(d3),s/veh	0.0	0.0	0.0	0.0	0.0	0.0	0.0	0.0	0.0	0.0	0.0	0.0
%ile BackOfQ(50%),veh/ln	0.3	0.3	0.0	0.1	1.4	0.1	0.0	0.0	0.0	0.4	0.0	0.0
Unsig. Movement Delay, s/veh												
LnGrp Delay(d),s/veh	24.2	4.0	0.0	100.6	4.7	3.4	0.0	0.0	0.0	24.2	0.0	0.0
LnGrp LOS	C	A	A	F	A	A	A	A	A	C	A	A
Approach Vol, veh/h		1313			1491			-13				25
Approach Delay, s/veh		4.4			4.9			0.0				37.7
Approach LOS		A			A			A				D
Timer - Assigned Phs	1	2	3	4	5	6	7	8				
Phs Duration (G+Y+Rc), s	4.3	36.8	0.0	5.7	5.4	35.7	5.7	0.0				
Change Period (Y+Rc), s	4.1	6.5	4.1	5.8	3.7	6.5	3.7	* 5.8				
Max Green Setting (Gmax), s	5.0	45.5	5.0	44.0	5.0	45.9	15.9	* 35				
Max Q Clear Time (g_c+I1), s	2.1	7.4	0.0	0.0	2.8	8.9	3.0	0.0				
Green Ext Time (p_c), s	0.0	14.7	0.0	0.0	0.0	20.3	0.0	0.0				

Intersection Summary

HCM 6th Ctrl Delay	5.0
HCM 6th LOS	A

Notes

* HCM 6th computational engine requires equal clearance times for the phases crossing the barrier.

Timings
22: Sycamore Canyon Bl. & Eastridge Ave

West Campus Upper Plateau (JN 14064)

09/29/2022



Lane Group	EBL	EBT	EBR	WBL	WBT	WBR	NBL	NBT	NBR	SBL	SBT	SBR
Lane Configurations	↖↖	↑↑↑	↗	↖↖	↑↑	↗	↖↖	↑↑	↗	↖↖	↑↑	↗
Traffic Volume (vph)	39	66	16	183	52	297	44	288	68	115	119	30
Future Volume (vph)	39	66	16	183	52	297	44	288	68	115	119	30
Turn Type	Prot	NA	Perm	Prot	NA	pm+ov	Prot	NA	pm+ov	Prot	NA	pm+ov
Protected Phases	5	2		1	6	7	3	8	1	7	4	5
Permitted Phases			2			6			8			4
Detector Phase	5	2	2	1	6	7	3	8	1	7	4	5
Switch Phase												
Minimum Initial (s)	5.0	10.0	10.0	5.0	10.0	5.0	5.0	10.0	5.0	5.0	10.0	5.0
Minimum Split (s)	8.7	43.5	43.5	8.7	43.5	8.7	8.7	15.8	8.7	8.7	49.8	8.7
Total Split (s)	11.7	45.5	45.5	15.2	49.0	20.2	8.7	39.1	15.2	20.2	50.6	11.7
Total Split (%)	9.8%	37.9%	37.9%	12.7%	40.8%	16.8%	7.3%	32.6%	12.7%	16.8%	42.2%	9.8%
Yellow Time (s)	3.2	5.5	5.5	3.2	5.5	3.2	3.2	4.8	3.2	3.2	4.8	3.2
All-Red Time (s)	0.5	1.0	1.0	0.5	1.0	0.5	0.5	1.0	0.5	0.5	1.0	0.5
Lost Time Adjust (s)	0.0	0.0	0.0	0.0	0.0	0.0	0.0	0.0	0.0	0.0	0.0	0.0
Total Lost Time (s)	3.7	6.5	6.5	3.7	6.5	3.7	3.7	5.8	3.7	3.7	5.8	3.7
Lead/Lag	Lead	Lag	Lag	Lead	Lag	Lead	Lead	Lag	Lead	Lead	Lag	Lead
Lead-Lag Optimize?	Yes	Yes	Yes	Yes	Yes	Yes	Yes	Yes	Yes	Yes	Yes	Yes
Recall Mode	None	None	None	None	None	None	None	None	None	None	None	None
Act Effct Green (s)	5.9	13.6	13.6	10.4	17.8	28.0	5.4	13.3	26.0	7.1	19.6	27.8
Actuated g/C Ratio	0.10	0.22	0.22	0.17	0.29	0.46	0.09	0.22	0.43	0.12	0.32	0.46
v/c Ratio	0.14	0.07	0.04	0.33	0.07	0.37	0.18	0.41	0.10	0.31	0.11	0.05
Control Delay	33.0	21.0	0.2	29.7	18.2	2.9	34.5	24.3	2.3	31.7	19.3	1.2
Queue Delay	0.0	0.0	0.0	0.0	0.0	0.0	0.0	0.0	0.0	0.0	0.0	0.0
Total Delay	33.0	21.0	0.2	29.7	18.2	2.9	34.5	24.3	2.3	31.7	19.3	1.2
LOS	C	C	A	C	B	A	C	C	A	C	B	A
Approach Delay		22.1			13.6			21.7			22.6	
Approach LOS		C			B			C			C	

Intersection Summary

Cycle Length: 120
 Actuated Cycle Length: 61
 Natural Cycle: 115
 Control Type: Actuated-Uncoordinated
 Maximum v/c Ratio: 0.41
 Intersection Signal Delay: 18.6
 Intersection LOS: B
 Intersection Capacity Utilization 42.5%
 ICU Level of Service A
 Analysis Period (min) 15

Splits and Phases: 22: Sycamore Canyon Bl. & Eastridge Ave

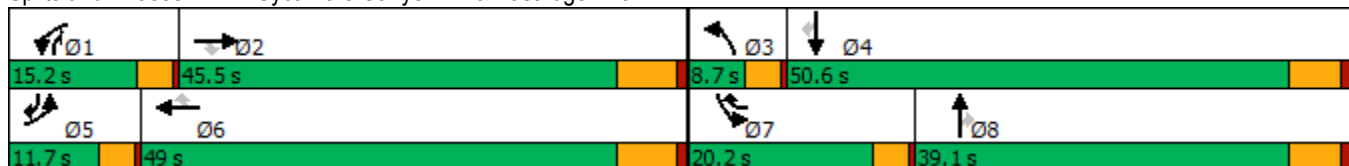

HCM 6th Signalized Intersection Summary
22: Sycamore Canyon Bl. & Eastridge Ave

West Campus Upper Plateau (JN 14064)

09/29/2022



Movement	EBL	EBT	EBR	WBL	WBT	WBR	NBL	NBT	NBR	SBL	SBT	SBR
Lane Configurations	↔↔	↑↑↑	↔	↔↔	↑↑	↔	↔↔	↑↑	↔	↔↔	↑↑	↔
Traffic Volume (veh/h)	39	66	16	183	52	297	44	288	68	115	119	30
Future Volume (veh/h)	39	66	16	183	52	297	44	288	68	115	119	30
Initial Q (Qb), veh	0	0	0	0	0	0	0	0	0	0	0	0
Ped-Bike Adj(A_pbT)	1.00		1.00	1.00		1.00	1.00		0.99	1.00		0.99
Parking Bus, Adj	1.00	1.00	1.00	1.00	1.00	1.00	1.00	1.00	1.00	1.00	1.00	1.00
Work Zone On Approach		No			No			No			No	
Adj Sat Flow, veh/h/ln	1648	1589	1826	1856	1396	1796	1618	1796	1826	1841	1826	1530
Adj Flow Rate, veh/h	41	69	0	193	55	140	46	303	18	121	125	28
Peak Hour Factor	0.95	0.95	0.95	0.95	0.95	0.95	0.95	0.95	0.95	0.95	0.95	0.95
Percent Heavy Veh, %	17	21	5	3	34	7	19	7	5	4	5	25
Cap, veh/h	133	907		327	692	523	142	703	462	282	837	365
Arrive On Green	0.04	0.21	0.00	0.10	0.26	0.26	0.05	0.21	0.21	0.08	0.24	0.24
Sat Flow, veh/h	3045	4337	1547	3428	2653	1521	2990	3413	1527	3401	3469	1278
Grp Volume(v), veh/h	41	69	0	193	55	140	46	303	18	121	125	28
Grp Sat Flow(s),veh/h/ln	1522	1446	1547	1714	1326	1521	1495	1706	1527	1700	1735	1278
Q Serve(g_s), s	0.6	0.6	0.0	2.6	0.8	3.2	0.7	3.7	0.4	1.6	1.4	0.8
Cycle Q Clear(g_c), s	0.6	0.6	0.0	2.6	0.8	3.2	0.7	3.7	0.4	1.6	1.4	0.8
Prop In Lane	1.00		1.00	1.00		1.00	1.00		1.00	1.00		1.00
Lane Grp Cap(c), veh/h	133	907		327	692	523	142	703	462	282	837	365
V/C Ratio(X)	0.31	0.08		0.59	0.08	0.27	0.32	0.43	0.04	0.43	0.15	0.08
Avail Cap(c_a), veh/h	503	3489		813	2326	1459	308	2344	1197	1158	3206	1238
HCM Platoon Ratio	1.00	1.00	1.00	1.00	1.00	1.00	1.00	1.00	1.00	1.00	1.00	1.00
Upstream Filter(I)	1.00	1.00	0.00	1.00	1.00	1.00	1.00	1.00	1.00	1.00	1.00	1.00
Uniform Delay (d), s/veh	22.5	15.4	0.0	21.0	13.5	11.5	22.3	16.8	12.0	21.1	14.5	12.7
Incr Delay (d2), s/veh	0.5	0.1	0.0	0.6	0.1	0.4	0.5	0.4	0.0	0.4	0.1	0.1
Initial Q Delay(d3),s/veh	0.0	0.0	0.0	0.0	0.0	0.0	0.0	0.0	0.0	0.0	0.0	0.0
%ile BackOfQ(50%),veh/ln	0.2	0.2	0.0	0.9	0.2	0.9	0.2	1.2	0.1	0.6	0.4	0.2
Unsig. Movement Delay, s/veh												
LnGrp Delay(d),s/veh	22.9	15.5	0.0	21.6	13.6	11.9	22.8	17.2	12.0	21.5	14.6	12.8
LnGrp LOS	C	B		C	B	B	C	B	B	C	B	B
Approach Vol, veh/h		110			388			367			274	
Approach Delay, s/veh		18.2			17.0			17.6			17.4	
Approach LOS		B			B			B			B	
Timer - Assigned Phs	1	2	3	4	5	6	7	8				
Phs Duration (G+Y+Rc), s	8.3	16.6	6.0	17.5	5.8	19.1	7.7	15.8				
Change Period (Y+Rc), s	3.7	6.5	3.7	5.8	3.7	6.5	3.7	5.8				
Max Green Setting (Gmax), s	11.5	39.0	5.0	44.8	8.0	42.5	16.5	33.3				
Max Q Clear Time (g_c+I1), s	4.6	2.6	2.7	3.4	2.6	5.2	3.6	5.7				
Green Ext Time (p_c), s	0.2	0.5	0.0	0.8	0.0	1.2	0.1	1.8				

Intersection Summary

HCM 6th Ctrl Delay	17.4
HCM 6th LOS	B

Notes

Unsignalized Delay for [EBR] is excluded from calculations of the approach delay and intersection delay.

Timings
23: Sycamore Canyon Bl. & Cottonwood Ave

West Campus Upper Plateau (JN 14064)
09/29/2022



Lane Group	WBL	WBR	NBT	SBL	SBT
Lane Configurations	↙	↗	↕	↙	↕
Traffic Volume (vph)	4	17	343	15	352
Future Volume (vph)	4	17	343	15	352
Turn Type	Prot	Perm	NA	Prot	NA
Protected Phases	8		2	1	6
Permitted Phases		8			
Detector Phase	8	8	2	1	6
Switch Phase					
Minimum Initial (s)	10.0	10.0	10.0	5.0	10.0
Minimum Split (s)	15.8	15.8	43.5	9.1	43.5
Total Split (s)	23.0	23.0	78.0	19.0	97.0
Total Split (%)	19.2%	19.2%	65.0%	15.8%	80.8%
Yellow Time (s)	4.8	4.8	5.5	3.6	5.5
All-Red Time (s)	1.0	1.0	1.0	0.5	1.0
Lost Time Adjust (s)	0.0	0.0	0.0	0.0	0.0
Total Lost Time (s)	5.8	5.8	6.5	4.1	6.5
Lead/Lag			Lag	Lead	
Lead-Lag Optimize?			Yes	Yes	
Recall Mode	None	None	None	None	None
Act Effct Green (s)	13.9	13.9	20.8	8.0	21.7
Actuated g/C Ratio	0.59	0.59	0.88	0.34	0.92
v/c Ratio	0.00	0.03	0.13	0.03	0.12
Control Delay	11.8	7.7	3.8	13.7	1.7
Queue Delay	0.0	0.0	0.0	0.0	0.0
Total Delay	11.8	7.7	3.8	13.7	1.7
LOS	B	A	A	B	A
Approach Delay	8.4		3.8		2.2
Approach LOS	A		A		A

Intersection Summary

Cycle Length: 120
 Actuated Cycle Length: 23.6
 Natural Cycle: 70
 Control Type: Actuated-Uncoordinated
 Maximum v/c Ratio: 0.13
 Intersection Signal Delay: 3.1
 Intersection LOS: A
 Intersection Capacity Utilization 31.0%
 ICU Level of Service A
 Analysis Period (min) 15

Splits and Phases: 23: Sycamore Canyon Bl. & Cottonwood Ave

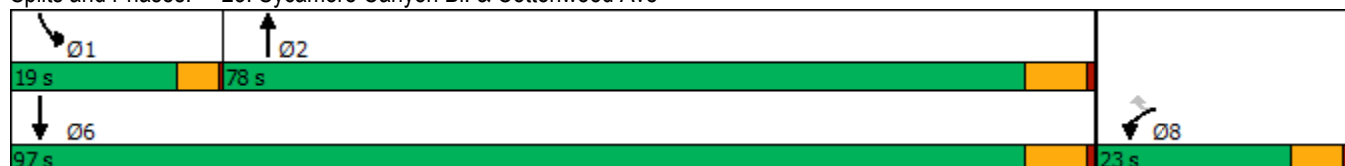

HCM 6th Signalized Intersection Summary
 23: Sycamore Canyon Bl. & Cottonwood Ave

West Campus Upper Plateau (JN 14064)

09/29/2022



Movement	WBL	WBR	NBT	NBR	SBL	SBT
Lane Configurations						
Traffic Volume (veh/h)	4	17	343	6	15	352
Future Volume (veh/h)	4	17	343	6	15	352
Initial Q (Qb), veh	0	0	0	0	0	0
Ped-Bike Adj(A_pbT)	1.00	1.00		0.98	1.00	
Parking Bus, Adj	1.00	1.00	1.00	1.00	1.00	1.00
Work Zone On Approach	No		No			No
Adj Sat Flow, veh/h/ln	1574	1070	1796	1752	1485	1870
Adj Flow Rate, veh/h	4	8	369	5	16	378
Peak Hour Factor	0.93	0.93	0.93	0.93	0.93	0.93
Percent Heavy Veh, %	22	56	7	10	28	2
Cap, veh/h	48	29	1238	17	30	1873
Arrive On Green	0.03	0.03	0.36	0.36	0.02	0.53
Sat Flow, veh/h	1499	907	3536	47	1414	3647
Grp Volume(v), veh/h	4	8	183	191	16	378
Grp Sat Flow(s),veh/h/ln	1499	907	1706	1787	1414	1777
Q Serve(g_s), s	0.1	0.2	2.1	2.1	0.3	1.6
Cycle Q Clear(g_c), s	0.1	0.2	2.1	2.1	0.3	1.6
Prop In Lane	1.00	1.00		0.03	1.00	
Lane Grp Cap(c), veh/h	48	29	613	642	30	1873
V/C Ratio(X)	0.08	0.28	0.30	0.30	0.54	0.20
Avail Cap(c_a), veh/h	924	559	4374	4580	756	11530
HCM Platoon Ratio	1.00	1.00	1.00	1.00	1.00	1.00
Upstream Filter(I)	1.00	1.00	1.00	1.00	1.00	1.00
Uniform Delay (d), s/veh	13.1	13.2	6.4	6.4	13.5	3.5
Incr Delay (d2), s/veh	0.7	5.1	0.4	0.4	14.5	0.1
Initial Q Delay(d3),s/veh	0.0	0.0	0.0	0.0	0.0	0.0
%ile BackOfQ(50%),veh/ln	0.0	0.1	0.4	0.4	0.2	0.0
Unsig. Movement Delay, s/veh						
LnGrp Delay(d),s/veh	13.9	18.3	6.8	6.8	28.0	3.6
LnGrp LOS	B	B	A	A	C	A
Approach Vol, veh/h	12		374			394
Approach Delay, s/veh	16.8		6.8			4.6
Approach LOS	B		A			A
Timer - Assigned Phs	1	2			6	8
Phs Duration (G+Y+Rc), s	4.7	16.5			21.2	6.7
Change Period (Y+Rc), s	4.1	6.5			6.5	5.8
Max Green Setting (Gmax), s	14.9	71.5			90.5	17.2
Max Q Clear Time (g_c+11), s	2.3	4.1			3.6	2.2
Green Ext Time (p_c), s	0.0	3.2			3.6	0.0

Intersection Summary

HCM 6th Ctrl Delay			5.8			
HCM 6th LOS			A			

Timings

West Campus Upper Plateau (JN 14064)

24: Sycamore Canyon Bl. & Alessandro Bl.

09/29/2022



Lane Group	EBL	EBT	EBR	WBL	WBT	WBR	NBL	NBT	NBR	SBL	SBT	SBR
Lane Configurations	↖	↑↑↑	↗	↖↗	↑↑↑	↗	↖↗	↑↑	↖↗	↖↗	↑↑	↖
Traffic Volume (vph)	92	1005	91	51	1135	83	164	133	15	54	150	49
Future Volume (vph)	92	1005	91	51	1135	83	164	133	15	54	150	49
Turn Type	Prot	NA	Perm	Prot	NA	Perm	Prot	NA	pm+ov	Prot	NA	Perm
Protected Phases	5	2		1	6		3	8	1	7	4	
Permitted Phases			2			6			8			4
Detector Phase	5	2	2	1	6	6	3	8	1	7	4	4
Switch Phase												
Minimum Initial (s)	5.0	10.0	10.0	5.0	10.0	10.0	5.0	10.0	5.0	5.0	10.0	10.0
Minimum Split (s)	8.7	43.5	43.5	8.7	43.5	43.5	8.7	15.8	8.7	8.7	49.8	49.8
Total Split (s)	10.0	44.2	44.2	12.0	46.2	46.2	14.0	51.0	12.0	12.8	49.8	49.8
Total Split (%)	8.3%	36.8%	36.8%	10.0%	38.5%	38.5%	11.7%	42.5%	10.0%	10.7%	41.5%	41.5%
Yellow Time (s)	3.2	5.5	5.5	3.2	5.5	5.5	3.2	4.8	3.2	3.2	4.8	4.8
All-Red Time (s)	0.5	1.0	1.0	0.5	1.0	1.0	0.5	1.0	0.5	0.5	1.0	1.0
Lost Time Adjust (s)	0.0	0.0	0.0	0.0	0.0	0.0	0.0	0.0	0.0	0.0	0.0	0.0
Total Lost Time (s)	3.7	6.5	6.5	3.7	6.5	6.5	3.7	5.8	3.7	3.7	5.8	5.8
Lead/Lag	Lead	Lag	Lag	Lead	Lag	Lag	Lead	Lag	Lead	Lead	Lag	Lag
Lead-Lag Optimize?	Yes	Yes	Yes	Yes	Yes	Yes	Yes	Yes	Yes	Yes	Yes	Yes
Recall Mode	None	None	None	None	None	None	None	None	None	None	None	None
Act Effct Green (s)	6.6	33.2	33.2	6.2	30.7	30.7	8.6	19.7	32.0	6.2	15.1	15.1
Actuated g/C Ratio	0.08	0.41	0.41	0.08	0.38	0.38	0.11	0.24	0.39	0.08	0.19	0.19
v/c Ratio	0.67	0.51	0.14	0.22	0.62	0.14	0.48	0.17	0.01	0.22	0.25	0.14
Control Delay	64.4	21.6	6.3	43.4	23.6	5.4	42.9	26.3	0.0	43.2	29.2	1.2
Queue Delay	0.0	0.0	0.0	0.0	0.0	0.0	0.0	0.0	0.0	0.0	0.0	0.0
Total Delay	64.4	21.6	6.3	43.4	23.6	5.4	42.9	26.3	0.0	43.2	29.2	1.2
LOS	E	C	A	D	C	A	D	C	A	D	C	A
Approach Delay		23.7			23.3			33.7			26.7	
Approach LOS		C			C			C			C	

Intersection Summary

Cycle Length: 120	
Actuated Cycle Length: 81.6	
Natural Cycle: 115	
Control Type: Actuated-Uncoordinated	
Maximum v/c Ratio: 0.67	
Intersection Signal Delay: 24.8	Intersection LOS: C
Intersection Capacity Utilization 57.0%	ICU Level of Service B
Analysis Period (min) 15	



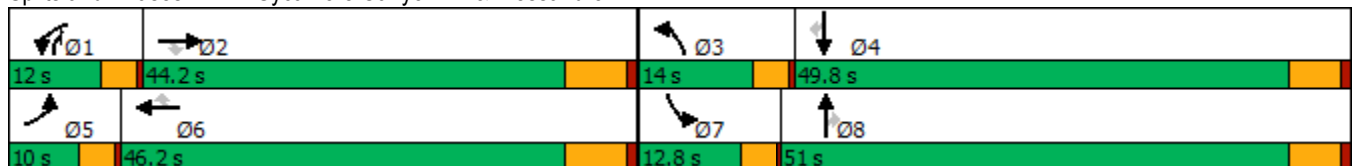































Splits and Phases: 24: Sycamore Canyon Bl. & Alessandro Bl.



HCM 6th Signalized Intersection Summary
24: Sycamore Canyon Bl. & Alessandro Bl.

West Campus Upper Plateau (JN 14064)

09/29/2022

												
Movement	EBL	EBT	EBR	WBL	WBT	WBR	NBL	NBT	NBR	SBL	SBT	SBR
Lane Configurations		  		 	  		 	 	 	 	 	
Traffic Volume (veh/h)	92	1005	91	51	1135	83	164	133	15	54	150	49
Future Volume (veh/h)	92	1005	91	51	1135	83	164	133	15	54	150	49
Initial Q (Qb), veh	0	0	0	0	0	0	0	0	0	0	0	0
Ped-Bike Adj(A_pbT)	1.00		1.00	1.00		1.00	1.00		1.00	1.00		1.00
Parking Bus, Adj	1.00	1.00	1.00	1.00	1.00	1.00	1.00	1.00	1.00	1.00	1.00	1.00
Work Zone On Approach		No			No			No			No	
Adj Sat Flow, veh/h/ln	1900	1885	1885	1737	1885	1781	1870	1841	1841	1826	1826	1870
Adj Flow Rate, veh/h	97	1058	-101	54	1195	-48	173	140	-27	57	158	-43
Peak Hour Factor	0.95	0.95	0.95	0.95	0.95	0.95	0.95	0.95	0.95	0.95	0.95	0.95
Percent Heavy Veh, %	0	1	1	11	1	8	2	4	4	5	5	2
Cap, veh/h	125	2155	669	154	2045	600	268	633	629	167	530	242
Arrive On Green	0.07	0.42	0.00	0.05	0.40	0.00	0.08	0.18	0.00	0.05	0.15	0.00
Sat Flow, veh/h	1810	5147	1598	3209	5147	1510	3456	3497	2745	3374	3469	1585
Grp Volume(v), veh/h	97	1058	-101	54	1195	-48	173	140	-27	57	158	-43
Grp Sat Flow(s),veh/h/ln	1810	1716	1598	1605	1716	1510	1728	1749	1373	1687	1735	1585
Q Serve(g_s), s	3.4	9.8	0.0	1.1	11.9	0.0	3.2	2.2	0.0	1.1	2.6	0.0
Cycle Q Clear(g_c), s	3.4	9.8	0.0	1.1	11.9	0.0	3.2	2.2	0.0	1.1	2.6	0.0
Prop In Lane	1.00		1.00	1.00		1.00	1.00		1.00	1.00		1.00
Lane Grp Cap(c), veh/h	125	2155	669	154	2045	600	268	633	629	167	530	242
V/C Ratio(X)	0.78	0.49	-0.15	0.35	0.58	-0.08	0.64	0.22	-0.04	0.34	0.30	-0.18
Avail Cap(c_a), veh/h	175	2983	926	410	3142	922	547	2431	2040	472	2347	1072
HCM Platoon Ratio	1.00	1.00	1.00	1.00	1.00	1.00	1.00	1.00	1.00	1.00	1.00	1.00
Upstream Filter(I)	1.00	1.00	0.00	1.00	1.00	0.00	1.00	1.00	0.00	1.00	1.00	0.00
Uniform Delay (d), s/veh	29.8	13.8	0.0	30.0	15.4	0.0	29.1	22.7	0.0	29.9	24.4	0.0
Incr Delay (d2), s/veh	8.2	0.2	0.0	0.5	0.4	0.0	1.0	0.2	0.0	0.4	0.3	0.0
Initial Q Delay(d3),s/veh	0.0	0.0	0.0	0.0	0.0	0.0	0.0	0.0	0.0	0.0	0.0	0.0
%ile BackOfQ(50%),veh/ln	1.6	3.1	0.0	0.4	3.9	0.0	1.2	0.8	0.0	0.4	1.0	0.0
Unsig. Movement Delay, s/veh												
LnGrp Delay(d),s/veh	38.0	14.1	0.0	30.5	15.8	0.0	30.1	22.9	0.0	30.3	24.8	0.0
LnGrp LOS	D	B	A	C	B	A	C	C	A	C	C	A
Approach Vol, veh/h		1054			1201			286			172	
Approach Delay, s/veh		17.6			17.0			29.4			32.8	
Approach LOS		B			B			C			C	
Timer - Assigned Phs	1	2	3	4	5	6	7	8				
Phs Duration (G+Y+Rc), s	6.8	33.7	8.8	15.7	8.2	32.3	6.9	17.6				
Change Period (Y+Rc), s	3.7	6.5	3.7	5.8	3.7	6.5	3.7	5.8				
Max Green Setting (Gmax), s	8.3	37.7	10.3	44.0	6.3	39.7	9.1	45.2				
Max Q Clear Time (g_c+I1), s	3.1	11.8	5.2	4.6	5.4	13.9	3.1	4.2				
Green Ext Time (p_c), s	0.0	10.4	0.1	0.9	0.0	12.0	0.0	0.8				
Intersection Summary												
HCM 6th Ctrl Delay				19.6								
HCM 6th LOS				B								

Timings
25: Sycamore Canyon Bl. & Cactus Av.

West Campus Upper Plateau (JN 14064)

09/29/2022



Lane Group	EBL	EBT	EBR	WBL	WBT	WBR	NBL	NBT	NBR	SBL	SBT	SBR
Lane Configurations	↘	↑↑	↗	↘↗	↑↑	↗	↘↗	↑↑	↗	↘↗	↑↑	↗
Traffic Volume (vph)	15	28	4	161	9	196	1	149	122	115	194	5
Future Volume (vph)	15	28	4	161	9	196	1	149	122	115	194	5
Turn Type	Prot	NA	Perm	Prot	NA	Perm	Prot	NA	Perm	Prot	NA	Perm
Protected Phases	7	4		3	8		5	2		1	6	
Permitted Phases			4			8			2			6
Detector Phase	7	4	4	3	8	8	5	2	2	1	6	6
Switch Phase												
Minimum Initial (s)	5.0	10.0	10.0	5.0	10.0	10.0	5.0	10.0	10.0	5.0	10.0	10.0
Minimum Split (s)	9.6	32.8	32.8	9.6	32.8	32.8	9.6	34.8	34.8	9.6	34.8	34.8
Total Split (s)	10.3	32.8	32.8	29.0	51.5	51.5	9.6	36.2	36.2	22.0	48.6	48.6
Total Split (%)	8.6%	27.3%	27.3%	24.2%	42.9%	42.9%	8.0%	30.2%	30.2%	18.3%	40.5%	40.5%
Yellow Time (s)	3.6	4.8	4.8	3.6	4.8	4.8	3.6	4.8	4.8	3.6	4.8	4.8
All-Red Time (s)	1.0	1.0	1.0	1.0	1.0	1.0	1.0	1.0	1.0	1.0	1.0	1.0
Lost Time Adjust (s)	0.0	0.0	0.0	0.0	0.0	0.0	0.0	0.0	0.0	0.0	0.0	0.0
Total Lost Time (s)	4.6	5.8	5.8	4.6	5.8	5.8	4.6	5.8	5.8	4.6	5.8	5.8
Lead/Lag	Lead	Lag	Lag	Lead	Lag	Lag	Lead	Lag	Lag	Lead	Lag	Lag
Lead-Lag Optimize?	Yes	Yes	Yes	Yes	Yes	Yes	Yes	Yes	Yes	Yes	Yes	Yes
Recall Mode	None	None	None	None	None	None	None	None	None	None	None	None
Act Effct Green (s)	6.0	13.5	13.5	10.4	16.6	16.6	5.8	13.7	13.7	7.2	21.9	21.9
Actuated g/C Ratio	0.11	0.25	0.25	0.19	0.31	0.31	0.11	0.25	0.25	0.13	0.40	0.40
v/c Ratio	0.09	0.04	0.01	0.26	0.01	0.33	0.00	0.18	0.24	0.26	0.15	0.01
Control Delay	33.7	21.3	0.0	26.0	16.4	4.8	36.0	20.2	2.0	28.9	13.5	0.0
Queue Delay	0.0	0.0	0.0	0.0	0.0	0.0	0.0	0.0	0.0	0.0	0.0	0.0
Total Delay	33.7	21.3	0.0	26.0	16.4	4.8	36.0	20.2	2.0	28.9	13.5	0.0
LOS	C	C	A	C	B	A	D	C	A	C	B	A
Approach Delay		23.6			14.4			12.1			18.9	
Approach LOS		C			B			B			B	

Intersection Summary

Cycle Length: 120
 Actuated Cycle Length: 54.1
 Natural Cycle: 90
 Control Type: Actuated-Uncoordinated
 Maximum v/c Ratio: 0.33
 Intersection Signal Delay: 15.6
 Intersection LOS: B
 Intersection Capacity Utilization 38.1%
 ICU Level of Service A
 Analysis Period (min) 15

Splits and Phases: 25: Sycamore Canyon Bl. & Cactus Av.

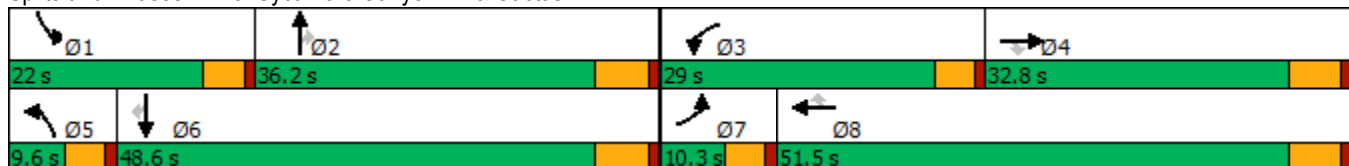

HCM 6th Signalized Intersection Summary
25: Sycamore Canyon Bl. & Cactus Av.

West Campus Upper Plateau (JN 14064)
09/29/2022



Movement	EBL	EBT	EBR	WBL	WBT	WBR	NBL	NBT	NBR	SBL	SBT	SBR
Lane Configurations												
Traffic Volume (veh/h)	15	28	4	161	9	196	1	149	122	115	194	5
Future Volume (veh/h)	15	28	4	161	9	196	1	149	122	115	194	5
Initial Q (Qb), veh	0	0	0	0	0	0	0	0	0	0	0	0
Ped-Bike Adj(A_pbT)	1.00		1.00	1.00		1.00	1.00		1.00	1.00		1.00
Parking Bus, Adj	1.00	1.00	1.00	1.00	1.00	1.00	1.00	1.00	1.00	1.00	1.00	1.00
Work Zone On Approach		No			No			No			No	
Adj Sat Flow, veh/h/ln	1811	1678	1796	1826	1796	1870	1900	1811	1781	1885	1796	1011
Adj Flow Rate, veh/h	16	29	-5	168	9	-38	1	155	34	120	202	5
Peak Hour Factor	0.96	0.96	0.96	0.96	0.96	0.96	0.96	0.96	0.96	0.96	0.96	0.96
Percent Heavy Veh, %	6	15	7	5	7	2	0	6	8	1	7	60
Cap, veh/h	35	374	178	334	669	311	8	774	340	304	1061	266
Arrive On Green	0.02	0.12	0.00	0.10	0.20	0.00	0.00	0.22	0.22	0.09	0.31	0.31
Sat Flow, veh/h	1725	3188	1522	3374	3413	1585	3510	3441	1510	3483	3413	857
Grp Volume(v), veh/h	16	29	-5	168	9	-38	1	155	34	120	202	5
Grp Sat Flow(s),veh/h/ln	1725	1594	1522	1687	1706	1585	1755	1721	1510	1742	1706	857
Q Serve(g_s), s	0.4	0.4	0.0	2.1	0.1	0.0	0.0	1.6	0.8	1.4	1.9	0.2
Cycle Q Clear(g_c), s	0.4	0.4	0.0	2.1	0.1	0.0	0.0	1.6	0.8	1.4	1.9	0.2
Prop In Lane	1.00		1.00	1.00		1.00	1.00		1.00	1.00		1.00
Lane Grp Cap(c), veh/h	35	374	178	334	669	311	8	774	340	304	1061	266
V/C Ratio(X)	0.46	0.08	-0.03	0.50	0.01	-0.12	0.13	0.20	0.10	0.39	0.19	0.02
Avail Cap(c_a), veh/h	223	1951	932	1866	3536	1642	398	2372	1041	1374	3312	831
HCM Platoon Ratio	1.00	1.00	1.00	1.00	1.00	1.00	1.00	1.00	1.00	1.00	1.00	1.00
Upstream Filter(I)	1.00	1.00	0.00	1.00	1.00	0.00	1.00	1.00	1.00	1.00	1.00	1.00
Uniform Delay (d), s/veh	21.4	17.3	0.0	18.8	14.3	0.0	22.0	13.9	13.6	19.0	11.1	10.5
Incr Delay (d2), s/veh	3.5	0.1	0.0	0.4	0.0	0.0	2.6	0.1	0.1	0.3	0.1	0.0
Initial Q Delay(d3),s/veh	0.0	0.0	0.0	0.0	0.0	0.0	0.0	0.0	0.0	0.0	0.0	0.0
%ile BackOfQ(50%),veh/ln	0.2	0.1	0.0	0.7	0.0	0.0	0.0	0.5	0.2	0.5	0.5	0.0
Unsig. Movement Delay, s/veh												
LnGrp Delay(d),s/veh	24.9	17.4	0.0	19.3	14.3	0.0	24.6	14.0	13.7	19.3	11.2	10.6
LnGrp LOS	C	B	A	B	B	A	C	B	B	B	B	B
Approach Vol, veh/h		40			139			190			327	
Approach Delay, s/veh		22.6			24.2			14.0			14.2	
Approach LOS		C			C			B			B	
Timer - Assigned Phs	1	2	3	4	5	6	7	8				
Phs Duration (G+Y+Rc), s	8.5	15.7	9.0	11.0	4.7	19.5	5.5	14.4				
Change Period (Y+Rc), s	4.6	5.8	4.6	5.8	4.6	5.8	4.6	5.8				
Max Green Setting (Gmax), s	17.4	30.4	24.4	27.0	5.0	42.8	5.7	45.7				
Max Q Clear Time (g_c+I1), s	3.4	3.6	4.1	2.4	2.0	3.9	2.4	2.1				
Green Ext Time (p_c), s	0.1	0.9	0.3	0.1	0.0	1.2	0.0	0.0				
Intersection Summary												
HCM 6th Ctrl Delay			16.6									
HCM 6th LOS			B									

Timings

26: Sycamore Canyon Bl. & Van Buren Bl.

09/29/2022



Lane Group	EBL	EBT	EBR	WBL	WBT	WBR	NBL	NBT	SBL	SBT	SBR
Lane Configurations											
Traffic Volume (vph)	144	849	6	33	923	25	7	6	51	9	327
Future Volume (vph)	144	849	6	33	923	25	7	6	51	9	327
Turn Type	Prot	NA	Perm	Prot	NA	Perm	Perm	NA	Split	NA	Perm
Protected Phases	5	2		1	6			8	4	4	
Permitted Phases			2			6	8				4
Detector Phase	5	2	2	1	6	6	8	8	4	4	4
Switch Phase											
Minimum Initial (s)	5.0	10.0	10.0	5.0	10.0	10.0	10.0	10.0	10.0	10.0	10.0
Minimum Split (s)	9.6	29.2	29.2	9.6	29.2	29.2	14.6	14.6	50.8	50.8	50.8
Total Split (s)	22.0	47.8	47.8	9.6	35.4	35.4	14.6	14.6	58.0	58.0	58.0
Total Split (%)	16.9%	36.8%	36.8%	7.4%	27.2%	27.2%	11.2%	11.2%	44.6%	44.6%	44.6%
Yellow Time (s)	3.6	5.2	5.2	3.6	5.2	5.2	3.6	3.6	4.8	4.8	4.8
All-Red Time (s)	1.0	1.0	1.0	1.0	1.0	1.0	1.0	1.0	1.0	1.0	1.0
Lost Time Adjust (s)	0.0	0.0	0.0	0.0	0.0	0.0		0.0	0.0	0.0	0.0
Total Lost Time (s)	4.6	6.2	6.2	4.6	6.2	6.2		4.6	5.8	5.8	5.8
Lead/Lag	Lead	Lag	Lag	Lead	Lag	Lag					
Lead-Lag Optimize?	Yes	Yes	Yes	Yes	Yes	Yes					
Recall Mode	None	None	None	None	None	None	None	None	None	None	None
Act Effct Green (s)	8.6	28.1	28.1	5.7	19.7	19.7		11.4	15.3	15.3	15.3
Actuated g/C Ratio	0.13	0.42	0.42	0.09	0.29	0.29		0.17	0.23	0.23	0.23
v/c Ratio	0.36	0.34	0.01	0.26	0.54	0.05		0.06	0.07	0.02	0.55
Control Delay	35.2	17.3	0.0	44.9	23.5	0.2		23.5	22.8	23.4	6.8
Queue Delay	0.0	0.0	0.0	0.0	0.0	0.0		0.0	0.0	0.0	0.0
Total Delay	35.2	17.3	0.0	44.9	23.5	0.2		23.5	22.8	23.4	6.8
LOS	D	B	A	D	C	A		C	C	C	A
Approach Delay		19.8			23.6			23.5		9.3	
Approach LOS		B			C			C		A	

Intersection Summary

Cycle Length: 130	
Actuated Cycle Length: 66.8	
Natural Cycle: 105	
Control Type: Actuated-Uncoordinated	
Maximum v/c Ratio: 0.55	
Intersection Signal Delay: 19.7	Intersection LOS: B
Intersection Capacity Utilization 55.8%	ICU Level of Service B
Analysis Period (min) 15	

Splits and Phases: 26: Sycamore Canyon Bl. & Van Buren Bl.

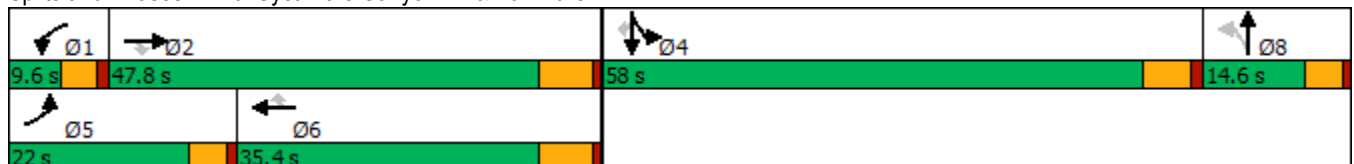

HCM 6th Signalized Intersection Summary
26: Sycamore Canyon Bl. & Van Buren Bl.

West Campus Upper Plateau (JN 14064)

09/29/2022



Movement	EBL	EBT	EBR	WBL	WBT	WBR	NBL	NBT	NBR	SBL	SBT	SBR
Lane Configurations	↔↔	↑↑↑	↗	↖	↑↑↑↑	↗		↔↔		↖↖	↑	↗
Traffic Volume (veh/h)	144	849	6	33	923	25	7	6	18	51	9	327
Future Volume (veh/h)	144	849	6	33	923	25	7	6	18	51	9	327
Initial Q (Qb), veh	0	0	0	0	0	0	0	0	0	0	0	0
Ped-Bike Adj(A_pbT)	1.00		1.00	1.00		0.99	1.00		1.00	1.00		1.00
Parking Bus, Adj	1.00	1.00	1.00	1.00	1.00	1.00	1.00	1.00	1.00	1.00	1.00	1.00
Work Zone On Approach		No			No			No			No	
Adj Sat Flow, veh/h/ln	1811	1826	1900	1693	1796	1870	1900	1900	1900	1841	1900	1841
Adj Flow Rate, veh/h	152	894	6	35	972	4	7	6	-10	54	9	0
Peak Hour Factor	0.95	0.95	0.95	0.95	0.95	0.95	0.95	0.95	0.95	0.95	0.95	0.95
Percent Heavy Veh, %	6	5	0	14	7	2	0	0	0	4	0	4
Cap, veh/h	313	2308	592	63	1934	490	139	0	4873	410	229	
Arrive On Green	0.09	0.37	0.37	0.04	0.31	0.31	0.01	0.01	0.00	0.12	0.12	0.00
Sat Flow, veh/h	3346	6281	1610	1612	6179	1565	1810	1900	0	3401	1900	1560
Grp Volume(v), veh/h	152	894	6	35	972	4	7	-4	0	54	9	0
Grp Sat Flow(s),veh/h/ln	1673	1570	1610	1612	1545	1565	1810	1805	0	1700	1900	1560
Q Serve(g_s), s	2.0	4.8	0.1	1.0	5.9	0.1	0.0	0.0	0.0	0.6	0.2	0.0
Cycle Q Clear(g_c), s	2.0	4.8	0.1	1.0	5.9	0.1	0.0	0.0	0.0	0.6	0.2	0.0
Prop In Lane	1.00		1.00	1.00		1.00	1.00		0.00	1.00		1.00
Lane Grp Cap(c), veh/h	313	2308	592	63	1934	490	0	0	0	410	229	
V/C Ratio(X)	0.49	0.39	0.01	0.55	0.50	0.01	0.00	0.00	0.00	0.13	0.04	
Avail Cap(c_a), veh/h	1276	5727	1468	177	3955	1002	0	0	0	3891	2174	
HCM Platoon Ratio	1.00	1.00	1.00	1.00	1.00	1.00	1.00	1.00	1.00	1.00	1.00	1.00
Upstream Filter(I)	1.00	1.00	1.00	1.00	1.00	1.00	1.00	0.00	0.00	1.00	1.00	0.00
Uniform Delay (d), s/veh	19.6	10.6	9.2	21.5	12.8	10.8	0.0	0.0	0.0	17.9	17.7	0.0
Incr Delay (d2), s/veh	0.4	0.1	0.0	2.8	0.2	0.0	0.0	0.0	0.0	0.1	0.1	0.0
Initial Q Delay(d3),s/veh	0.0	0.0	0.0	0.0	0.0	0.0	0.0	0.0	0.0	0.0	0.0	0.0
%ile BackOfQ(50%),veh/ln	0.6	1.2	0.0	0.4	1.5	0.0	0.0	0.0	0.0	0.2	0.1	0.0
Unsig. Movement Delay, s/veh												
LnGrp Delay(d),s/veh	20.1	10.8	9.2	24.3	13.0	10.8	0.0	0.0	0.0	18.1	17.8	0.0
LnGrp LOS	C	B	A	C	B	B	A	A	A	B	B	
Approach Vol, veh/h		1052			1011			3			63	
Approach Delay, s/veh		12.1			13.4			0.0			18.0	
Approach LOS		B			B			A			B	
Timer - Assigned Phs	1	2		4	5	6		8				
Phs Duration (G+Y+Rc), s	6.4	23.0		11.3	8.9	20.5		5.0				
Change Period (Y+Rc), s	4.6	6.2		5.8	4.6	6.2		4.6				
Max Green Setting (Gmax), s	5.0	41.6		52.2	17.4	29.2		10.0				
Max Q Clear Time (g_c+I1), s	3.0	6.8		2.6	4.0	7.9		2.0				
Green Ext Time (p_c), s	0.0	6.6		0.2	0.2	6.4		0.0				

Intersection Summary

HCM 6th Ctrl Delay	12.9
HCM 6th LOS	B

Notes

Unsignalized Delay for [SBR] is excluded from calculations of the approach delay and intersection delay.

Timings
27: Innovation Dr. & Cactus Av.

West Campus Upper Plateau (JN 14064)

09/29/2022

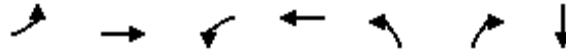

Lane Group	EBL	EBT	WBL	WBT	NBL	NBR	SBT
Lane Configurations	↶	↷	↶	↷	↶	↷	↷
Traffic Volume (vph)	1	264	22	366	1	21	0
Future Volume (vph)	1	264	22	366	1	21	0
Turn Type	Prot	NA	Prot	NA	Perm	Perm	NA
Protected Phases	5	2	1	6			4
Permitted Phases					8	8	
Detector Phase	5	2	1	6	8	8	4
Switch Phase							
Minimum Initial (s)	5.0	10.0	5.0	10.0	10.0	10.0	10.0
Minimum Split (s)	9.2	26.8	9.2	26.8	31.1	31.1	31.1
Total Split (s)	12.0	63.0	22.0	73.0	35.0	35.0	35.0
Total Split (%)	10.0%	52.5%	18.3%	60.8%	29.2%	29.2%	29.2%
Yellow Time (s)	3.2	4.8	3.2	4.8	4.1	4.1	4.1
All-Red Time (s)	1.0	1.0	1.0	1.0	1.0	1.0	1.0
Lost Time Adjust (s)	0.0	0.0	0.0	0.0	0.0	0.0	0.0
Total Lost Time (s)	4.2	5.8	4.2	5.8	5.1	5.1	5.1
Lead/Lag	Lead	Lag	Lead	Lag			
Lead-Lag Optimize?	Yes	Yes	Yes	Yes			
Recall Mode	None	None	None	None	None	None	None
Act Effct Green (s)	7.7	21.8	8.0	21.9	16.6	16.6	16.6
Actuated g/C Ratio	0.30	0.86	0.32	0.87	0.66	0.66	0.66
v/c Ratio	0.00	0.07	0.05	0.10	0.00	0.02	0.00
Control Delay	19.0	5.9	16.2	5.3	8.0	0.0	0.0
Queue Delay	0.0	0.0	0.0	0.0	0.0	0.0	0.0
Total Delay	19.0	5.9	16.2	5.3	8.0	0.0	0.0
LOS	B	A	B	A	A	A	A
Approach Delay		5.9		5.9			
Approach LOS		A		A			

Intersection Summary

Cycle Length: 120	
Actuated Cycle Length: 25.3	
Natural Cycle: 70	
Control Type: Actuated-Uncoordinated	
Maximum v/c Ratio: 0.10	
Intersection Signal Delay: 5.7	Intersection LOS: A
Intersection Capacity Utilization 33.4%	ICU Level of Service A
Analysis Period (min) 15	

Splits and Phases: 27: Innovation Dr. & Cactus Av.



HCM 6th Signalized Intersection Summary
27: Innovation Dr. & Cactus Av.

West Campus Upper Plateau (JN 14064)

09/29/2022



Movement	EBL	EBT	EBR	WBL	WBT	WBR	NBL	NBT	NBR	SBL	SBT	SBR
Lane Configurations	↗	↑↑↑		↖	↑↑↑		↖	↑	↗	↖	↑	↗
Traffic Volume (veh/h)	1	264	1	22	366	4	1	0	21	0	0	1
Future Volume (veh/h)	1	264	1	22	366	4	1	0	21	0	0	1
Initial Q (Qb), veh	0	0	0	0	0	0	0	0	0	0	0	0
Ped-Bike Adj(A_pbT)	1.00		1.00	1.00		0.98	1.00		1.00	1.00		1.00
Parking Bus, Adj	1.00	1.00	1.00	1.00	1.00	1.00	1.00	1.00	1.00	1.00	1.00	1.00
Work Zone On Approach		No			No			No			No	
Adj Sat Flow, veh/h/ln	1900	1826	1307	1663	1841	1900	1841	1900	1781	1900	1900	1781
Adj Flow Rate, veh/h	1	300	1	25	416	5	1	0	-29	0	0	-8
Peak Hour Factor	0.88	0.88	0.88	0.88	0.88	0.88	0.88	0.88	0.88	0.88	0.88	0.88
Percent Heavy Veh, %	0	5	40	16	4	0	4	0	8	0	0	8
Cap, veh/h	8	2195	7	51	2347	28	311	8	7	311	0	401
Arrive On Green	0.00	0.43	0.43	0.03	0.46	0.46	0.00	0.00	0.00	0.00	0.00	0.00
Sat Flow, veh/h	1810	5129	17	1584	5117	61	1753	1900	1510	1810	1900	0
Grp Volume(v), veh/h	1	194	107	25	272	149	1	0	-29	0	-8	-8
Grp Sat Flow(s),veh/h/ln	1810	1662	1823	1584	1675	1828	1753	1900	1510	1810	1900	1610
Q Serve(g_s), s	0.0	0.8	0.8	0.4	1.1	1.1	0.0	0.0	0.0	0.0	0.0	0.0
Cycle Q Clear(g_c), s	0.0	0.8	0.8	0.4	1.1	1.1	0.1	0.0	0.0	0.0	0.0	0.0
Prop In Lane	1.00		0.01	1.00		0.03	1.00		1.00	1.00		0.00
Lane Grp Cap(c), veh/h	8	1422	780	51	1537	838	311	8	7	311	0	0
V/C Ratio(X)	0.13	0.14	0.14	0.49	0.18	0.18	0.00	0.00	-4.45	0.00	0.00	0.00
Avail Cap(c_a), veh/h	610	8214	4505	1218	9728	5308	2773	2455	1951	2853	0	0
HCM Platoon Ratio	1.00	1.00	1.00	1.00	1.00	1.00	1.00	1.00	1.00	1.00	1.00	1.00
Upstream Filter(I)	1.00	1.00	1.00	1.00	1.00	1.00	1.00	0.00	0.00	0.00	0.00	0.00
Uniform Delay (d), s/veh	11.5	4.0	4.0	11.0	3.7	3.7	11.6	0.0	0.0	0.0	0.0	0.0
Incr Delay (d2), s/veh	2.7	0.1	0.1	2.7	0.1	0.1	0.0	0.0	0.0	0.0	0.0	0.0
Initial Q Delay(d3),s/veh	0.0	0.0	0.0	0.0	0.0	0.0	0.0	0.0	0.0	0.0	0.0	0.0
%ile BackOfQ(50%),veh/ln	0.0	0.0	0.0	0.1	0.0	0.0	0.0	0.0	0.0	0.0	0.0	0.0
Unsig. Movement Delay, s/veh												
LnGrp Delay(d),s/veh	14.2	4.1	4.1	13.7	3.8	3.8	11.6	0.0	0.0	0.0	0.0	0.0
LnGrp LOS	B	A	A	B	A	A	B	A	A	A	A	A
Approach Vol, veh/h		302			446			-28				-16
Approach Delay, s/veh		4.1			4.3			0.0				0.0
Approach LOS		A			A			A				A
Timer - Assigned Phs	1	2		4	5	6		8				
Phs Duration (G+Y+Rc), s	4.9	15.7		2.5	4.2	16.4		2.5				
Change Period (Y+Rc), s	* 4.2	5.8		5.1	* 4.2	5.8		5.1				
Max Green Setting (Gmax), s	* 18	57.2		29.9	* 7.8	67.2		29.9				
Max Q Clear Time (g_c+I1), s	2.4	2.8		0.0	2.0	3.1		2.1				
Green Ext Time (p_c), s	0.0	2.7		0.0	0.0	3.9		0.0				

Intersection Summary

HCM 6th Ctrl Delay	4.5
HCM 6th LOS	A

Notes

* HCM 6th computational engine requires equal clearance times for the phases crossing the barrier.

Timings
28: I-215 SB Ramps & Alessandro Bl.

West Campus Upper Plateau (JN 14064)

09/29/2022

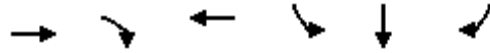

Lane Group	EBT	EBR	WBT	SBL	SBT	SBR
Lane Configurations	↑↑↑	↑	↑↑↑	↑	↔	↑
Traffic Volume (vph)	760	307	973	125	0	253
Future Volume (vph)	760	307	973	125	0	253
Turn Type	NA	Perm	NA	Split	NA	Perm
Protected Phases	2		6	4	4	
Permitted Phases		2				4
Detector Phase	2	2	6	4	4	4
Switch Phase						
Minimum Initial (s)	5.0	5.0	5.0	5.0	5.0	5.0
Minimum Split (s)	10.5	10.5	34.5	10.0	10.0	10.0
Total Split (s)	52.0	52.0	52.0	33.0	33.0	33.0
Total Split (%)	61.2%	61.2%	61.2%	38.8%	38.8%	38.8%
Yellow Time (s)	4.5	4.5	4.5	4.0	4.0	4.0
All-Red Time (s)	1.0	1.0	1.0	1.0	1.0	1.0
Lost Time Adjust (s)	0.0	0.0	0.0	0.0	0.0	0.0
Total Lost Time (s)	5.5	5.5	5.5	5.0	5.0	5.0
Lead/Lag						
Lead-Lag Optimize?						
Recall Mode	Min	Min	Min	None	None	None
Act Effct Green (s)	19.5	19.5	19.5	8.8	8.8	8.8
Actuated g/C Ratio	0.50	0.50	0.50	0.23	0.23	0.23
v/c Ratio	0.31	0.34	0.45	0.34	0.37	0.36
Control Delay	6.3	2.2	6.9	16.2	9.7	9.2
Queue Delay	0.0	0.0	0.0	0.0	0.0	0.0
Total Delay	6.3	2.2	6.9	16.2	9.7	9.2
LOS	A	A	A	B	A	A
Approach Delay	5.1		6.9		11.4	
Approach LOS	A		A		B	

Intersection Summary

Cycle Length: 85
 Actuated Cycle Length: 39.1
 Natural Cycle: 45
 Control Type: Actuated-Uncoordinated
 Maximum v/c Ratio: 0.45
 Intersection Signal Delay: 6.8
 Intersection LOS: A
 Intersection Capacity Utilization 40.5%
 ICU Level of Service A
 Analysis Period (min) 15

Splits and Phases: 28: I-215 SB Ramps & Alessandro Bl.

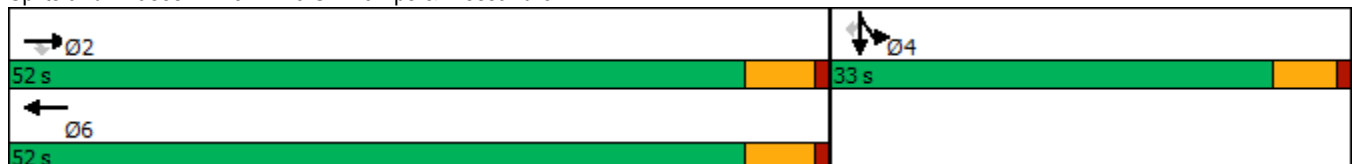

HCM 6th Signalized Intersection Summary
28: I-215 SB Ramps & Alessandro Bl.

West Campus Upper Plateau (JN 14064)
09/29/2022



Movement	EBL	EBT	EBR	WBL	WBT	WBR	NBL	NBT	NBR	SBL	SBT	SBR
Lane Configurations		↑↑↑	↗		↑↑↑					↘	↔	↗
Traffic Volume (veh/h)	0	760	307	0	973	111	0	0	0	125	0	253
Future Volume (veh/h)	0	760	307	0	973	111	0	0	0	125	0	253
Initial Q (Qb), veh	0	0	0	0	0	0				0	0	0
Ped-Bike Adj(A_pbT)	1.00		1.00	1.00		0.98				1.00		1.00
Parking Bus, Adj	1.00	1.00	1.00	1.00	1.00	1.00				1.00	1.00	1.00
Work Zone On Approach		No			No						No	
Adj Sat Flow, veh/h/ln	0	1870	1870	0	1870	1781				1737	1900	1752
Adj Flow Rate, veh/h	0	792	320	0	1014	108				87	0	265
Peak Hour Factor	0.96	0.96	0.96	0.96	0.96	0.96				0.96	0.96	0.96
Percent Heavy Veh, %	0	2	2	0	2	8				11	0	10
Cap, veh/h	0	2407	747	0	2204	234				295	0	529
Arrive On Green	0.00	0.47	0.47	0.00	0.47	0.47				0.18	0.00	0.18
Sat Flow, veh/h	0	5274	1585	0	4844	497				1654	0	2969
Grp Volume(v), veh/h	0	792	320	0	738	384				87	0	265
Grp Sat Flow(s),veh/h/ln	0	1702	1585	0	1702	1768				1654	0	1485
Q Serve(g_s), s	0.0	2.9	4.0	0.0	4.4	4.4				1.4	0.0	2.4
Cycle Q Clear(g_c), s	0.0	2.9	4.0	0.0	4.4	4.4				1.4	0.0	2.4
Prop In Lane	0.00		1.00	0.00		0.28				1.00		1.00
Lane Grp Cap(c), veh/h	0	2407	747	0	1605	834				295	0	529
V/C Ratio(X)	0.00	0.33	0.43	0.00	0.46	0.46				0.30	0.00	0.50
Avail Cap(c_a), veh/h	0	7924	2460	0	5283	2744				1546	0	2775
HCM Platoon Ratio	1.00	1.00	1.00	1.00	1.00	1.00				1.00	1.00	1.00
Upstream Filter(I)	0.00	1.00	1.00	0.00	1.00	1.00				1.00	0.00	1.00
Uniform Delay (d), s/veh	0.0	5.0	5.2	0.0	5.3	5.3				10.7	0.0	11.1
Incr Delay (d2), s/veh	0.0	0.1	0.4	0.0	0.2	0.4				0.6	0.0	0.7
Initial Q Delay(d3),s/veh	0.0	0.0	0.0	0.0	0.0	0.0				0.0	0.0	0.0
%ile BackOfQ(50%),veh/ln	0.0	0.1	0.2	0.0	0.2	0.3				0.3	0.0	0.5
Unsig. Movement Delay, s/veh												
LnGrp Delay(d),s/veh	0.0	5.0	5.6	0.0	5.5	5.7				11.2	0.0	11.8
LnGrp LOS	A	A	A	A	A	A				B	A	B
Approach Vol, veh/h		1112			1122						352	
Approach Delay, s/veh		5.2			5.6						11.7	
Approach LOS		A			A						B	
Timer - Assigned Phs		2		4		6						
Phs Duration (G+Y+Rc), s		19.6		10.3		19.6						
Change Period (Y+Rc), s		5.5		5.0		5.5						
Max Green Setting (Gmax), s		46.5		28.0		46.5						
Max Q Clear Time (g_c+I1), s		6.0		4.4		6.4						
Green Ext Time (p_c), s		6.7		1.2		7.7						

Intersection Summary

HCM 6th Ctrl Delay	6.3
HCM 6th LOS	A

Notes

User approved volume balancing among the lanes for turning movement.

Timings
29: I-215 NB Ramps & Alessandro Bl.

West Campus Upper Plateau (JN 14064)

09/29/2022



Lane Group	EBL	EBT	WBT	WBR	NBL	NBT	NBR
Lane Configurations	↶	↑↑↑	↑↑↑	↷	↶	↕	↷
Traffic Volume (vph)	167	723	842	137	427	9	222
Future Volume (vph)	167	723	842	137	427	9	222
Turn Type	Prot	NA	NA	Perm	Split	NA	Perm
Protected Phases	5	2	6		8	8	
Permitted Phases				6			8
Detector Phase	5	2	6	6	8	8	8
Switch Phase							
Minimum Initial (s)	5.0	5.0	5.0	5.0	5.0	5.0	5.0
Minimum Split (s)	9.5	10.5	33.5	33.5	10.0	10.0	10.0
Total Split (s)	13.0	48.0	35.0	35.0	37.0	37.0	37.0
Total Split (%)	15.3%	56.5%	41.2%	41.2%	43.5%	43.5%	43.5%
Yellow Time (s)	3.5	4.5	4.5	4.5	4.0	4.0	4.0
All-Red Time (s)	1.0	1.0	1.0	1.0	1.0	1.0	1.0
Lost Time Adjust (s)	0.0	0.0	0.0	0.0	0.0	0.0	0.0
Total Lost Time (s)	4.5	5.5	5.5	5.5	5.0	5.0	5.0
Lead/Lag	Lead		Lag	Lag			
Lead-Lag Optimize?	Yes		Yes	Yes			
Recall Mode	None	Min	Min	Min	Max	Max	Max
Act Effct Green (s)	8.5	33.6	20.6	20.6	32.1	32.1	32.1
Actuated g/C Ratio	0.11	0.44	0.27	0.27	0.42	0.42	0.42
v/c Ratio	0.93	0.33	0.63	0.32	0.34	0.35	0.29
Control Delay	88.6	14.2	26.5	11.6	17.8	17.4	6.3
Queue Delay	0.0	0.0	0.0	0.0	0.0	0.0	0.0
Total Delay	88.6	14.2	26.5	11.6	17.8	17.4	6.3
LOS	F	B	C	B	B	B	A
Approach Delay		28.2	24.4			14.2	
Approach LOS		C	C			B	

Intersection Summary

Cycle Length: 85
 Actuated Cycle Length: 76.3
 Natural Cycle: 60
 Control Type: Actuated-Uncoordinated
 Maximum v/c Ratio: 0.93
 Intersection Signal Delay: 23.1
 Intersection LOS: C
 Intersection Capacity Utilization 52.3%
 ICU Level of Service A
 Analysis Period (min) 15

Splits and Phases: 29: I-215 NB Ramps & Alessandro Bl.

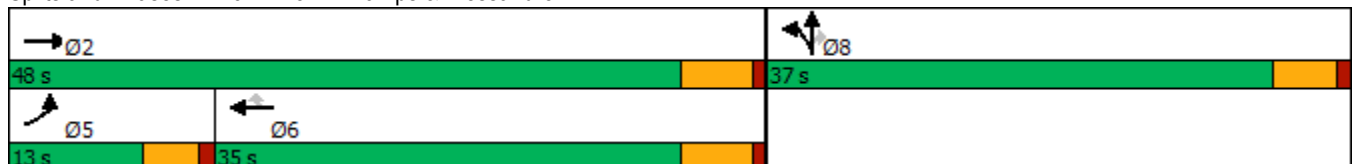

HCM 6th Signalized Intersection Summary
 29: I-215 NB Ramps & Alessandro Bl.

West Campus Upper Plateau (JN 14064)

09/29/2022



Movement	EBL	EBT	EBR	WBL	WBT	WBR	NBL	NBT	NBR	SBL	SBT	SBR
Lane Configurations	↘	↑↑↑			↑↑↑	↗	↘	↕	↗			
Traffic Volume (veh/h)	167	723	0	0	842	137	427	9	222	0	0	0
Future Volume (veh/h)	167	723	0	0	842	137	427	9	222	0	0	0
Initial Q (Qb), veh	0	0	0	0	0	0	0	0	0			
Ped-Bike Adj(A_pbT)	1.00		1.00	1.00		0.98	1.00		1.00			
Parking Bus, Adj	1.00	1.00	1.00	1.00	1.00	1.00	1.00	1.00	1.00			
Work Zone On Approach		No			No			No				
Adj Sat Flow, veh/h/ln	1767	1870	0	0	1870	1707	1856	1900	1870			
Adj Flow Rate, veh/h	172	745	0	0	868	115	489	0	100			
Peak Hour Factor	0.97	0.97	0.97	0.97	0.97	0.97	0.97	0.97	0.97			
Percent Heavy Veh, %	9	2	0	0	2	13	3	0	2			
Cap, veh/h	193	2172	0	0	1274	353	1529	0	686			
Arrive On Green	0.11	0.43	0.00	0.00	0.25	0.25	0.43	0.00	0.43			
Sat Flow, veh/h	1682	5274	0	0	5274	1416	3534	0	1585			
Grp Volume(v), veh/h	172	745	0	0	868	115	489	0	100			
Grp Sat Flow(s),veh/h/ln	1682	1702	0	0	1702	1416	1767	0	1585			
Q Serve(g_s), s	7.5	7.3	0.0	0.0	11.4	4.9	6.7	0.0	2.8			
Cycle Q Clear(g_c), s	7.5	7.3	0.0	0.0	11.4	4.9	6.7	0.0	2.8			
Prop In Lane	1.00		0.00	0.00		1.00	1.00		1.00			
Lane Grp Cap(c), veh/h	193	2172	0	0	1274	353	1529	0	686			
V/C Ratio(X)	0.89	0.34	0.00	0.00	0.68	0.33	0.32	0.00	0.15			
Avail Cap(c_a), veh/h	193	2934	0	0	2037	565	1529	0	686			
HCM Platoon Ratio	1.00	1.00	1.00	1.00	1.00	1.00	1.00	1.00	1.00			
Upstream Filter(I)	1.00	1.00	0.00	0.00	1.00	1.00	1.00	0.00	1.00			
Uniform Delay (d), s/veh	32.3	14.3	0.0	0.0	25.1	22.7	13.8	0.0	12.7			
Incr Delay (d2), s/veh	35.6	0.1	0.0	0.0	0.6	0.5	0.6	0.0	0.4			
Initial Q Delay(d3),s/veh	0.0	0.0	0.0	0.0	0.0	0.0	0.0	0.0	0.0			
%ile BackOfQ(50%),veh/ln	4.6	2.3	0.0	0.0	4.0	1.5	2.5	0.0	1.0			
Unsig. Movement Delay, s/veh												
LnGrp Delay(d),s/veh	67.8	14.4	0.0	0.0	25.7	23.2	14.4	0.0	13.2			
LnGrp LOS	E	B	A	A	C	C	B	A	B			
Approach Vol, veh/h		917			983			589				
Approach Delay, s/veh		24.4			25.4			14.2				
Approach LOS		C			C			B				
Timer - Assigned Phs		2			5	6		8				
Phs Duration (G+Y+Rc), s		37.0			13.0	24.0		37.0				
Change Period (Y+Rc), s		5.5			4.5	5.5		5.0				
Max Green Setting (Gmax), s		42.5			8.5	29.5		32.0				
Max Q Clear Time (g_c+I1), s		9.3			9.5	13.4		8.7				
Green Ext Time (p_c), s		4.8			0.0	5.1		2.1				

Intersection Summary

HCM 6th Ctrl Delay	22.4
HCM 6th LOS	C

Notes

User approved volume balancing among the lanes for turning movement.

Timings
30: I-215 SB Ramps & Cactus Av.

West Campus Upper Plateau (JN 14064)

09/29/2022



Lane Group	EBT	EBR	WBL	WBT	NBR	SBR
Lane Configurations	↑↑	↑	↓	↑↑	↑	↑
Traffic Volume (vph)	271	26	323	338	304	56
Future Volume (vph)	271	26	323	338	304	56
Turn Type	NA	Perm	Prot	NA	Prot	Prot
Protected Phases	2		1	6	8	4
Permitted Phases		2				
Detector Phase	2	2	1	6	8	4
Switch Phase						
Minimum Initial (s)	5.0	5.0	5.0	5.0	5.0	5.0
Minimum Split (s)	11.0	11.0	9.5	23.0	9.1	9.5
Total Split (s)	35.0	35.0	43.0	78.0	27.0	27.0
Total Split (%)	33.3%	33.3%	41.0%	74.3%	25.7%	25.7%
Yellow Time (s)	5.0	5.0	3.5	5.0	3.6	3.5
All-Red Time (s)	1.0	1.0	1.0	1.0	0.5	1.0
Lost Time Adjust (s)	0.0	0.0	0.0	0.0	0.0	0.0
Total Lost Time (s)	6.0	6.0	4.5	6.0	4.1	4.5
Lead/Lag	Lag	Lag	Lead			
Lead-Lag Optimize?	Yes	Yes	Yes			
Recall Mode	Min	Min	None	Min	None	None
Act Effct Green (s)	9.1	9.1	13.9	27.5	5.6	5.1
Actuated g/C Ratio	0.21	0.21	0.32	0.63	0.13	0.12
v/c Ratio	0.43	0.08	0.66	0.17	0.42	0.10
Control Delay	17.6	2.7	19.1	3.2	1.5	0.3
Queue Delay	0.0	0.0	0.0	0.0	0.0	0.0
Total Delay	17.6	2.7	19.1	3.2	1.5	0.3
LOS	B	A	B	A	A	A
Approach Delay	16.3			11.0		
Approach LOS	B			B		

Intersection Summary

Cycle Length: 105
 Actuated Cycle Length: 43.4
 Natural Cycle: 45
 Control Type: Actuated-Uncoordinated
 Maximum v/c Ratio: 0.66
 Intersection Signal Delay: 9.5
 Intersection LOS: A
 Intersection Capacity Utilization 34.7%
 ICU Level of Service A
 Analysis Period (min) 15



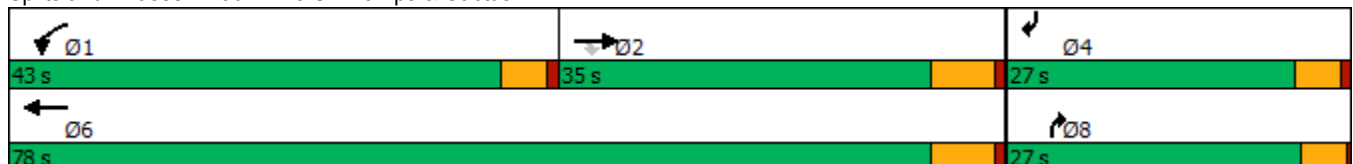









Splits and Phases: 30: I-215 SB Ramps & Cactus Av.



HCM 6th Signalized Intersection Summary
 30: I-215 SB Ramps & Cactus Av.

West Campus Upper Plateau (JN 14064)

09/29/2022

												
Movement	EBL	EBT	EBR	WBL	WBT	WBR	NBL	NBT	NBR	SBL	SBT	SBR
Lane Configurations		↑↑	↗	↖	↑↑				↗			↖
Traffic Volume (veh/h)	0	271	26	323	338	0	0	0	304	0	0	56
Future Volume (veh/h)	0	271	26	323	338	0	0	0	304	0	0	56
Initial Q (Qb), veh	0	0	0	0	0	0	0	0	0	0	0	0
Ped-Bike Adj(A_pbT)	1.00		1.00	1.00		1.00	1.00		1.00	1.00		1.00
Parking Bus, Adj	1.00	1.00	1.00	1.00	1.00	1.00	1.00	1.00	1.00	1.00	1.00	1.00
Work Zone On Approach		No			No			No			No	
Adj Sat Flow, veh/h/ln	0	1841	1826	1870	1870	0	0	0	1796	0	0	1707
Adj Flow Rate, veh/h	0	311	-1	371	389	0	0	0	0	0	0	-51
Peak Hour Factor	0.87	0.87	0.87	0.87	0.87	0.87	0.87	0.87	0.87	0.87	0.87	0.87
Percent Heavy Veh, %	0	4	5	2	2	0	0	0	7	0	0	13
Cap, veh/h	0	819	362	488	2555	0	0	0	0	0	0	0
Arrive On Green	0.00	0.23	0.00	0.27	0.72	0.00	0.00	0.00	0.00	0.00	0.00	0.00
Sat Flow, veh/h	0	3589	1547	1781	3647	0		0			0	
Grp Volume(v), veh/h	0	311	-1	371	389	0		0.0			0.0	
Grp Sat Flow(s),veh/h/ln	0	1749	1547	1781	1777	0						
Q Serve(g_s), s	0.0	1.6	0.0	4.1	0.7	0.0						
Cycle Q Clear(g_c), s	0.0	1.6	0.0	4.1	0.7	0.0						
Prop In Lane	0.00		1.00	1.00		0.00						
Lane Grp Cap(c), veh/h	0	819	362	488	2555	0						
V/C Ratio(X)	0.00	0.38	0.00	0.76	0.15	0.00						
Avail Cap(c_a), veh/h	0	4752	2102	3213	11987	0						
HCM Platoon Ratio	1.00	1.00	1.00	1.00	1.00	1.00						
Upstream Filter(I)	0.00	1.00	0.00	1.00	1.00	0.00						
Uniform Delay (d), s/veh	0.0	6.9	0.0	7.1	0.9	0.0						
Incr Delay (d2), s/veh	0.0	0.1	0.0	0.9	0.0	0.0						
Initial Q Delay(d3),s/veh	0.0	0.0	0.0	0.0	0.0	0.0						
%ile BackOfQ(50%),veh/ln	0.0	0.2	0.0	0.5	0.0	0.0						
Unsig. Movement Delay, s/veh												
LnGrp Delay(d),s/veh	0.0	7.0	0.0	8.0	1.0	0.0						
LnGrp LOS	A	A	A	A	A	A						
Approach Vol, veh/h		310			760							
Approach Delay, s/veh		7.0			4.4							
Approach LOS		A			A							
Timer - Assigned Phs	1	2				6						
Phs Duration (G+Y+Rc), s	10.3	11.0				21.3						
Change Period (Y+Rc), s	4.5	6.0				6.0						
Max Green Setting (Gmax), s	38.5	29.0				72.0						
Max Q Clear Time (g_c+I1), s	6.1	3.6				2.7						
Green Ext Time (p_c), s	0.5	1.1				1.5						

Intersection Summary

HCM 6th Ctrl Delay	5.2
HCM 6th LOS	A

Notes

Unsignalized Delay for [NBR] is excluded from calculations of the approach delay and intersection delay.

Timings

31: I-215 NB Ramps/Old 215 Frontage Rd. & Cactus Av.



Lane Group	EBL	EBT	WBT	NBL	NBT	NBR	SBL	SBT
Lane Configurations	↔	↕↔	↕↔	↔	↕	↕↔	↔	↕
Traffic Volume (vph)	14	558	968	35	61	3	101	1
Future Volume (vph)	14	558	968	35	61	3	101	1
Turn Type	Perm	NA	NA	Perm	NA	Perm	Perm	NA
Protected Phases		2	6		8			4
Permitted Phases	2			8		8	4	
Detector Phase	2	2	6	8	8	8	4	4
Switch Phase								
Minimum Initial (s)	5.0	5.0	5.0	5.0	5.0	5.0	5.0	5.0
Minimum Split (s)	11.0	11.0	44.0	10.5	10.5	10.5	10.5	10.5
Total Split (s)	57.4	57.4	57.4	27.6	27.6	27.6	27.6	27.6
Total Split (%)	67.5%	67.5%	67.5%	32.5%	32.5%	32.5%	32.5%	32.5%
Yellow Time (s)	5.0	5.0	5.0	4.5	4.5	4.5	4.5	4.5
All-Red Time (s)	1.0	1.0	1.0	1.0	1.0	1.0	1.0	1.0
Lost Time Adjust (s)	0.0	0.0	0.0	0.0	0.0	0.0	0.0	0.0
Total Lost Time (s)	6.0	6.0	6.0	5.5	5.5	5.5	5.5	5.5
Lead/Lag								
Lead-Lag Optimize?								
Recall Mode	Min	Min	Min	None	None	None	None	None
Act Effct Green (s)	26.7	26.7	26.7	8.5	8.5	8.5	8.5	8.5
Actuated g/C Ratio	0.63	0.63	0.63	0.20	0.20	0.20	0.20	0.20
v/c Ratio	0.06	0.30	0.54	0.16	0.19	0.01	0.42	0.17
Control Delay	6.2	5.9	7.6	18.4	17.9	0.0	22.6	7.5
Queue Delay	0.0	0.0	0.0	0.0	0.0	0.0	0.0	0.0
Total Delay	6.2	5.9	7.6	18.4	17.9	0.0	22.6	7.5
LOS	A	A	A	B	B	A	C	A
Approach Delay		5.9	7.6		17.6			17.2
Approach LOS		A	A		B			B

Intersection Summary

Cycle Length: 85
 Actuated Cycle Length: 42.7
 Natural Cycle: 55
 Control Type: Actuated-Uncoordinated
 Maximum v/c Ratio: 0.54
 Intersection Signal Delay: 8.4
 Intersection Capacity Utilization 52.2%
 Analysis Period (min) 15

Intersection LOS: A
 ICU Level of Service A

Splits and Phases: 31: I-215 NB Ramps/Old 215 Frontage Rd. & Cactus Av.



HCM 6th Signalized Intersection Summary

West Campus Upper Plateau (JN 14064)

31: I-215 NB Ramps/Old 215 Frontage Rd. & Cactus Av.

09/29/2022



Movement	EBL	EBT	EBR	WBL	WBT	WBR	NBL	NBT	NBR	SBL	SBT	SBR
Lane Configurations												
Traffic Volume (veh/h)	14	558	25	0	968	109	35	61	3	101	1	57
Future Volume (veh/h)	14	558	25	0	968	109	35	61	3	101	1	57
Initial Q (Qb), veh	0	0	0	0	0	0	0	0	0	0	0	0
Ped-Bike Adj(A_pbT)	1.00		1.00	1.00		1.00	1.00		1.00	1.00		1.00
Parking Bus, Adj	1.00	1.00	1.00	1.00	1.00	1.00	1.00	1.00	1.00	1.00	1.00	1.00
Work Zone On Approach		No			No			No			No	
Adj Sat Flow, veh/h/ln	1796	1826	1366	0	1841	1885	1722	1856	1900	1841	1900	1885
Adj Flow Rate, veh/h	15	600	23	0	1041	68	38	66	0	109	1	34
Peak Hour Factor	0.93	0.93	0.93	0.93	0.93	0.93	0.93	0.93	0.93	0.93	0.93	0.93
Percent Heavy Veh, %	7	5	36	0	4	1	12	3	0	4	0	1
Cap, veh/h	343	1581	61	0	1546	101	414	297		405	7	251
Arrive On Green	0.46	0.46	0.46	0.00	0.46	0.46	0.16	0.16	0.00	0.16	0.16	0.16
Sat Flow, veh/h	488	3407	130	0	3424	218	1265	1856	1610	1314	46	1571
Grp Volume(v), veh/h	15	305	318	0	546	563	38	66	0	109	0	35
Grp Sat Flow(s),veh/h/ln	488	1735	1802	0	1749	1801	1265	1856	1610	1314	0	1617
Q Serve(g_s), s	0.8	3.5	3.5	0.0	7.4	7.4	0.8	0.9	0.0	2.4	0.0	0.6
Cycle Q Clear(g_c), s	8.2	3.5	3.5	0.0	7.4	7.4	1.4	0.9	0.0	3.4	0.0	0.6
Prop In Lane	1.00		0.07	0.00		0.12	1.00		1.00	1.00		0.97
Lane Grp Cap(c), veh/h	343	805	836	0	811	836	414	297		405	0	258
V/C Ratio(X)	0.04	0.38	0.38	0.00	0.67	0.67	0.09	0.22		0.27	0.00	0.14
Avail Cap(c_a), veh/h	937	2916	3030	0	2940	3028	1126	1341		1145	0	1169
HCM Platoon Ratio	1.00	1.00	1.00	1.00	1.00	1.00	1.00	1.00	1.00	1.00	1.00	1.00
Upstream Filter(I)	1.00	1.00	1.00	0.00	1.00	1.00	1.00	1.00	0.00	1.00	0.00	1.00
Uniform Delay (d), s/veh	9.6	5.3	5.3	0.0	6.4	6.4	11.6	11.2	0.0	12.6	0.0	11.0
Incr Delay (d2), s/veh	0.0	0.1	0.1	0.0	0.4	0.4	0.0	0.1	0.0	0.1	0.0	0.1
Initial Q Delay(d3),s/veh	0.0	0.0	0.0	0.0	0.0	0.0	0.0	0.0	0.0	0.0	0.0	0.0
%ile BackOfQ(50%),veh/ln	0.0	0.4	0.4	0.0	0.9	0.9	0.2	0.3	0.0	0.4	0.0	0.1
Unsig. Movement Delay, s/veh												
LnGrp Delay(d),s/veh	9.6	5.4	5.4	0.0	6.8	6.7	11.7	11.3	0.0	12.8	0.0	11.1
LnGrp LOS	A	A	A	A	A	A	B	B		B	A	B
Approach Vol, veh/h		638			1109			104				144
Approach Delay, s/veh		5.5			6.7			11.4				12.4
Approach LOS		A			A			B				B
Timer - Assigned Phs		2		4		6		8				
Phs Duration (G+Y+Rc), s		20.2		10.4		20.2		10.4				
Change Period (Y+Rc), s		6.0		5.5		6.0		5.5				
Max Green Setting (Gmax), s		51.4		22.1		51.4		22.1				
Max Q Clear Time (g_c+I1), s		10.2		5.4		9.4		3.4				
Green Ext Time (p_c), s		2.3		0.2		4.5		0.2				

Intersection Summary

HCM 6th Ctrl Delay	7.0
HCM 6th LOS	A

Notes

User approved volume balancing among the lanes for turning movement.
 Unsignalized Delay for [NBR] is excluded from calculations of the approach delay and intersection delay.

Timings
32: I-215 SB Ramps & Van Buren Bl.

West Campus Upper Plateau (JN 14064)

09/29/2022



Lane Group	EBT	EBR	WBL	WBT	SBT	SBR
Lane Configurations	↑↑	↑↑	↙	↑↑	↙	↑↑
Traffic Volume (vph)	419	524	12	495	0	491
Future Volume (vph)	419	524	12	495	0	491
Turn Type	NA	Perm	Prot	NA	NA	Perm
Protected Phases	6		5	2	8	
Permitted Phases		6				8
Detector Phase	6	6	5	2	8	8
Switch Phase						
Minimum Initial (s)	5.0	5.0	5.0	5.0	5.0	5.0
Minimum Split (s)	36.0	36.0	11.0	11.0	11.0	11.0
Total Split (s)	60.0	60.0	11.0	71.0	14.0	14.0
Total Split (%)	70.6%	70.6%	12.9%	83.5%	16.5%	16.5%
Yellow Time (s)	5.0	5.0	5.0	5.0	5.0	5.0
All-Red Time (s)	1.0	1.0	1.0	1.0	1.0	1.0
Lost Time Adjust (s)	0.0	0.0	0.0	0.0	0.0	0.0
Total Lost Time (s)	6.0	6.0	6.0	6.0	6.0	6.0
Lead/Lag	Lag	Lag	Lead			
Lead-Lag Optimize?	Yes	Yes	Yes			
Recall Mode	Min	Min	None	Min	Max	Max
Act Effct Green (s)	12.0	12.0	5.5	13.2	8.8	8.8
Actuated g/C Ratio	0.34	0.34	0.16	0.38	0.25	0.25
v/c Ratio	0.40	0.43	0.06	0.41	0.06	0.52
Control Delay	9.5	2.1	19.6	7.9	16.6	4.6
Queue Delay	0.0	0.0	0.0	0.0	0.0	0.0
Total Delay	9.5	2.1	19.6	7.9	16.6	4.6
LOS	A	A	B	A	B	A
Approach Delay	5.4			8.2	5.1	
Approach LOS	A			A	A	

Intersection Summary

Cycle Length: 85
 Actuated Cycle Length: 35.2
 Natural Cycle: 60
 Control Type: Actuated-Uncoordinated
 Maximum v/c Ratio: 0.52
 Intersection Signal Delay: 6.0
 Intersection LOS: A
 Intersection Capacity Utilization 41.7%
 ICU Level of Service A
 Analysis Period (min) 15

Splits and Phases: 32: I-215 SB Ramps & Van Buren Bl.



HCM 6th Signalized Intersection Summary
 32: I-215 SB Ramps & Van Buren Bl.

West Campus Upper Plateau (JN 14064)

09/29/2022



Movement	EBL	EBT	EBR	WBL	WBT	WBR	NBL	NBT	NBR	SBL	SBT	SBR
Lane Configurations		↑↑	↑↑	↑	↑↑						↑	↑↑
Traffic Volume (veh/h)	0	419	524	12	495	0	0	0	0	19	0	491
Future Volume (veh/h)	0	419	524	12	495	0	0	0	0	19	0	491
Initial Q (Qb), veh	0	0	0	0	0	0				0	0	0
Ped-Bike Adj(A_pbT)	1.00		1.00	1.00		1.00				1.00		1.00
Parking Bus, Adj	1.00	1.00	1.00	1.00	1.00	1.00				1.00	1.00	1.00
Work Zone On Approach		No			No						No	
Adj Sat Flow, veh/h/ln	0	1767	1856	1411	1811	0				1500	1841	1663
Adj Flow Rate, veh/h	0	446	459	13	527	0				20	0	0
Peak Hour Factor	0.94	0.94	0.94	0.94	0.94	0.94				0.94	0.94	0.94
Percent Heavy Veh, %	0	9	3	33	6	0				27	4	16
Cap, veh/h	0	868	716	160	1795	0				336	0	
Arrive On Green	0.00	0.26	0.26	0.12	0.52	0.00				0.19	0.00	0.00
Sat Flow, veh/h	0	3445	2768	1344	3532	0				1753	0	2480
Grp Volume(v), veh/h	0	446	459	13	527	0				20	0	0
Grp Sat Flow(s),veh/h/ln	0	1678	1384	1344	1721	0				1753	0	1240
Q Serve(g_s), s	0.0	4.7	6.2	0.4	3.6	0.0				0.4	0.0	0.0
Cycle Q Clear(g_c), s	0.0	4.7	6.2	0.4	3.6	0.0				0.4	0.0	0.0
Prop In Lane	0.00		1.00	1.00		0.00				1.00		1.00
Lane Grp Cap(c), veh/h	0	868	716	160	1795	0				336	0	
V/C Ratio(X)	0.00	0.51	0.64	0.08	0.29	0.00				0.06	0.00	
Avail Cap(c_a), veh/h	0	4337	3576	161	5351	0				336	0	
HCM Platoon Ratio	1.00	1.00	1.00	1.00	1.00	1.00				1.00	1.00	1.00
Upstream Filter(I)	0.00	1.00	1.00	1.00	1.00	0.00				1.00	0.00	0.00
Uniform Delay (d), s/veh	0.0	13.2	13.8	16.4	5.7	0.0				13.8	0.0	0.0
Incr Delay (d2), s/veh	0.0	0.2	0.4	0.1	0.0	0.0				0.3	0.0	0.0
Initial Q Delay(d3),s/veh	0.0	0.0	0.0	0.0	0.0	0.0				0.0	0.0	0.0
%ile BackOfQ(50%),veh/ln	0.0	1.2	1.3	0.1	0.6	0.0				0.1	0.0	0.0
Unsig. Movement Delay, s/veh												
LnGrp Delay(d),s/veh	0.0	13.4	14.1	16.4	5.7	0.0				14.2	0.0	0.0
LnGrp LOS	A	B	B	B	A	A				B	A	
Approach Vol, veh/h		905			540							20
Approach Delay, s/veh		13.8			5.9							14.2
Approach LOS		B			A							B
Timer - Assigned Phs		2			5	6		8				
Phs Duration (G+Y+Rc), s		27.8			11.0	16.8		14.0				
Change Period (Y+Rc), s		6.0			6.0	6.0		6.0				
Max Green Setting (Gmax), s		65.0			5.0	54.0		8.0				
Max Q Clear Time (g_c+I1), s		5.6			2.4	8.2		2.4				
Green Ext Time (p_c), s		2.1			0.0	2.6		0.0				

Intersection Summary

HCM 6th Ctrl Delay	10.9
HCM 6th LOS	B

Notes

Unsignalized Delay for [SBR] is excluded from calculations of the approach delay and intersection delay.

Timings
33: I-215 NB On/Off Ramp & Van Buren Bl.

Lane Group	EBR	NBL	Ø2	Ø6
Lane Configurations	↔↔	↔↔		
Traffic Volume (vph)	15	1		
Future Volume (vph)	15	1		
Turn Type	pm+ov	Prot		
Protected Phases	4	4	2	6
Permitted Phases	6			
Detector Phase	4	4		
Switch Phase				
Minimum Initial (s)	5.0	5.0	5.0	5.0
Minimum Split (s)	42.0	42.0	11.0	11.0
Total Split (s)	55.0	55.0	15.0	15.0
Total Split (%)	78.6%	78.6%	21%	21%
Yellow Time (s)	5.0	5.0	5.0	5.0
All-Red Time (s)	1.0	1.0	1.0	1.0
Lost Time Adjust (s)	0.0	0.0		
Total Lost Time (s)	6.0	6.0		
Lead/Lag				
Lead-Lag Optimize?				
Recall Mode	Min	Min	None	None
Act Effct Green (s)	32.2	32.2		
Actuated g/C Ratio	1.00	1.00		
v/c Ratio	0.01	0.00		
Control Delay	0.0	0.0		
Queue Delay	0.0	0.0		
Total Delay	0.0	0.0		
LOS	A	A		
Approach Delay				
Approach LOS				

Intersection Summary

Cycle Length: 70
 Actuated Cycle Length: 32.2
 Natural Cycle: 55
 Control Type: Actuated-Uncoordinated
 Maximum v/c Ratio: 0.01
 Intersection Signal Delay: 0.0
 Intersection LOS: A
 Intersection Capacity Utilization 9.2%
 ICU Level of Service A
 Analysis Period (min) 15

Splits and Phases: 33: I-215 NB On/Off Ramp & Van Buren Bl.



HCM 6th Signalized Intersection Summary
 33: I-215 NB On/Off Ramp & Van Buren Bl.

West Campus Upper Plateau (JN 14064)

09/29/2022

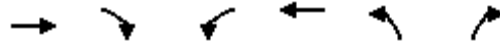

Movement	EBT	EBR	WBL	WBT	NBL	NBR
Lane Configurations	↑↑	↑↑		↑↑	↑↑	↑
Traffic Volume (veh/h)	0	15	0	0	1	0
Future Volume (veh/h)	0	15	0	0	1	0
Initial Q (Qb), veh	0	0	0	0	0	0
Ped-Bike Adj(A_pbT)		1.00	1.00		1.00	1.00
Parking Bus, Adj	1.00	1.00	1.00	1.00	1.00	1.00
Work Zone On Approach	No			No	No	
Adj Sat Flow, veh/h/ln	1900	1767	0	1752	1811	1159
Adj Flow Rate, veh/h	0	7	0	0	1	0
Peak Hour Factor	0.94	0.94	0.94	0.94	0.94	0.94
Percent Heavy Veh, %	0	9	0	10	6	50
Cap, veh/h	35	793	0	32	975	286
Arrive On Green	0.00	0.01	0.00	0.00	0.29	0.00
Sat Flow, veh/h	3705	2635	0	3504	3346	982
Grp Volume(v), veh/h	0	7	0	0	1	0
Grp Sat Flow(s),veh/h/ln	1805	1317	0	1664	1673	982
Q Serve(g_s), s	0.0	0.0	0.0	0.0	0.0	0.0
Cycle Q Clear(g_c), s	0.0	0.0	0.0	0.0	0.0	0.0
Prop In Lane		1.00	0.00		1.00	1.00
Lane Grp Cap(c), veh/h	35	793	0	32	975	286
V/C Ratio(X)	0.00	0.01	0.00	0.00	0.00	0.00
Avail Cap(c_a), veh/h	1893	2149	0	1745	9553	2804
HCM Platoon Ratio	1.00	1.00	1.00	1.00	1.00	1.00
Upstream Filter(I)	0.00	1.00	0.00	0.00	1.00	0.00
Uniform Delay (d), s/veh	0.0	4.2	0.0	0.0	4.3	0.0
Incr Delay (d2), s/veh	0.0	0.0	0.0	0.0	0.0	0.0
Initial Q Delay(d3),s/veh	0.0	0.0	0.0	0.0	0.0	0.0
%ile BackOfQ(50%),veh/ln	0.0	0.0	0.0	0.0	0.0	0.0
Unsig. Movement Delay, s/veh						
LnGrp Delay(d),s/veh	0.0	4.2	0.0	0.0	4.3	0.0
LnGrp LOS	A	A	A	A	A	A
Approach Vol, veh/h	7			0	1	
Approach Delay, s/veh	4.2			0.0	4.3	
Approach LOS	A				A	
Timer - Assigned Phs		2		4		6
Phs Duration (G+Y+Rc), s		6.2		11.0		6.2
Change Period (Y+Rc), s		6.0		6.0		6.0
Max Green Setting (Gmax), s		9.0		49.0		9.0
Max Q Clear Time (g_c+11), s		0.0		2.0		2.0
Green Ext Time (p_c), s		0.0		0.0		0.0
Intersection Summary						
HCM 6th Ctrl Delay			4.2			
HCM 6th LOS			A			

Timings

West Campus Upper Plateau (JN 14064)

34: Old 215 Frontage Rd. & Alessandro Bl.

09/29/2022

Lane Group	EBL	EBT	EBR	WBL	WBT	WBR	NBL	NBT	NBR	SBL	SBT	SBR
Lane Configurations												
Traffic Volume (vph)	285	716	11	10	655	86	21	72	12	78	91	191
Future Volume (vph)	285	716	11	10	655	86	21	72	12	78	91	191
Turn Type	Prot	NA	Perm	Prot	NA	Perm	Prot	NA	Perm	Prot	NA	Perm
Protected Phases	5	2		1	6		3	8		7	4	
Permitted Phases			2			6			8			4
Detector Phase	5	2	2	1	6	6	3	8	8	7	4	4
Switch Phase												
Minimum Initial (s)	5.0	10.0	10.0	5.0	10.0	10.0	5.0	10.0	10.0	5.0	10.0	10.0
Minimum Split (s)	8.7	43.5	43.5	8.7	15.8	15.8	8.7	16.2	16.2	8.7	40.2	40.2
Total Split (s)	22.0	62.4	62.4	8.7	49.1	49.1	8.7	29.7	29.7	19.2	40.2	40.2
Total Split (%)	18.3%	52.0%	52.0%	7.3%	40.9%	40.9%	7.3%	24.8%	24.8%	16.0%	33.5%	33.5%
Yellow Time (s)	3.2	5.5	5.5	3.2	4.8	4.8	3.2	5.2	5.2	3.2	5.2	5.2
All-Red Time (s)	0.5	1.0	1.0	0.5	1.0	1.0	0.5	1.0	1.0	0.5	1.0	1.0
Lost Time Adjust (s)	0.0	0.0	0.0	0.0	0.0	0.0	0.0	0.0	0.0	0.0	0.0	0.0
Total Lost Time (s)	3.7	6.5	6.5	3.7	5.8	5.8	3.7	6.2	6.2	3.7	6.2	6.2
Lead/Lag	Lead	Lag	Lag	Lead	Lag	Lag	Lead	Lag	Lag	Lead	Lag	Lag
Lead-Lag Optimize?	Yes	Yes	Yes	Yes	Yes	Yes	Yes	Yes	Yes	Yes	Yes	Yes
Recall Mode	None	None	None	None	None	None	None	None	None	None	None	None
Act Effct Green (s)	11.4	34.9	34.9	5.4	21.4	21.4	5.4	12.9	12.9	8.5	19.8	19.8
Actuated g/C Ratio	0.16	0.48	0.48	0.07	0.30	0.30	0.07	0.18	0.18	0.12	0.27	0.27
v/c Ratio	0.55	0.30	0.01	0.08	0.66	0.16	0.11	0.12	0.04	0.40	0.11	0.34
Control Delay	35.6	13.3	0.0	43.6	27.3	0.6	42.0	30.0	0.2	41.6	23.4	6.2
Queue Delay	0.0	0.0	0.0	0.0	0.0	0.0	0.0	0.0	0.0	0.0	0.0	0.0
Total Delay	35.6	13.3	0.0	43.6	27.3	0.6	42.0	30.0	0.2	41.6	23.4	6.2
LOS	D	B	A	D	C	A	D	C	A	D	C	A
Approach Delay		19.4			24.4			28.9			18.2	
Approach LOS		B			C			C			B	

Intersection Summary

Cycle Length: 120	
Actuated Cycle Length: 72.5	
Natural Cycle: 105	
Control Type: Actuated-Uncoordinated	
Maximum v/c Ratio: 0.66	
Intersection Signal Delay: 21.4	Intersection LOS: C
Intersection Capacity Utilization 50.6%	ICU Level of Service A
Analysis Period (min) 15	



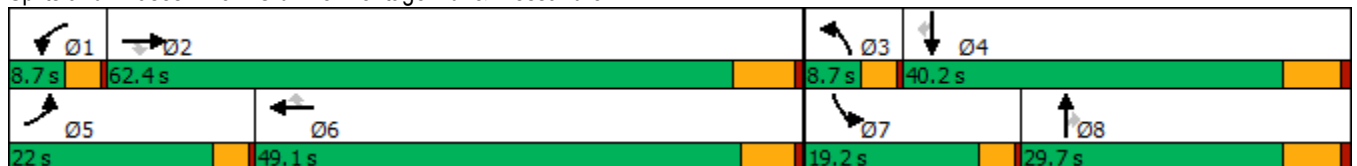



























Splits and Phases: 34: Old 215 Frontage Rd. & Alessandro Bl.



HCM 6th Signalized Intersection Summary
34: Old 215 Frontage Rd. & Alessandro Bl.

West Campus Upper Plateau (JN 14064)

09/29/2022

												
Movement	EBL	EBT	EBR	WBL	WBT	WBR	NBL	NBT	NBR	SBL	SBT	SBR
Lane Configurations	 	  			 		 	 			 	
Traffic Volume (veh/h)	285	716	11	10	655	86	21	72	12	78	91	191
Future Volume (veh/h)	285	716	11	10	655	86	21	72	12	78	91	191
Initial Q (Qb), veh	0	0	0	0	0	0	0	0	0	0	0	0
Ped-Bike Adj(A_pbT)	1.00		1.00	1.00		1.00	1.00		0.99	1.00		1.00
Parking Bus, Adj	1.00	1.00	1.00	1.00	1.00	1.00	1.00	1.00	1.00	1.00	1.00	1.00
Work Zone On Approach		No			No			No			No	
Adj Sat Flow, veh/h/ln	1870	1885	1678	1678	1856	1856	1515	1856	1559	1826	1737	1885
Adj Flow Rate, veh/h	297	746	-16	10	682	0	22	75	2	81	95	0
Peak Hour Factor	0.96	0.96	0.96	0.96	0.96	0.96	0.96	0.96	0.96	0.96	0.96	0.96
Percent Heavy Veh, %	2	1	15	15	3	3	26	3	23	5	11	1
Cap, veh/h	427	2053	567	21	1016		72	594	220	111	681	
Arrive On Green	0.12	0.40	0.00	0.01	0.29	0.00	0.03	0.17	0.17	0.06	0.21	0.00
Sat Flow, veh/h	3456	5147	1422	1598	3526	1572	2799	3526	1302	1739	3300	1598
Grp Volume(v), veh/h	297	746	-16	10	682	0	22	75	2	81	95	0
Grp Sat Flow(s),veh/h/ln	1728	1716	1422	1598	1763	1572	1399	1763	1302	1739	1650	1598
Q Serve(g_s), s	4.7	5.8	0.0	0.4	9.6	0.0	0.4	1.0	0.1	2.6	1.3	0.0
Cycle Q Clear(g_c), s	4.7	5.8	0.0	0.4	9.6	0.0	0.4	1.0	0.1	2.6	1.3	0.0
Prop In Lane	1.00		1.00	1.00		1.00	1.00		1.00	1.00		1.00
Lane Grp Cap(c), veh/h	427	2053	567	21	1016		72	594	220	111	681	
V/C Ratio(X)	0.69	0.36	-0.03	0.49	0.67		0.30	0.13	0.01	0.73	0.14	
Avail Cap(c_a), veh/h	1120	5094	1407	141	2703		248	1467	542	477	1987	
HCM Platoon Ratio	1.00	1.00	1.00	1.00	1.00	1.00	1.00	1.00	1.00	1.00	1.00	1.00
Upstream Filter(I)	1.00	1.00	0.00	1.00	1.00	0.00	1.00	1.00	1.00	1.00	1.00	0.00
Uniform Delay (d), s/veh	23.7	11.9	0.0	27.7	17.7	0.0	27.0	19.9	19.5	26.0	18.3	0.0
Incr Delay (d2), s/veh	0.8	0.1	0.0	6.5	0.8	0.0	0.9	0.1	0.0	3.5	0.1	0.0
Initial Q Delay(d3),s/veh	0.0	0.0	0.0	0.0	0.0	0.0	0.0	0.0	0.0	0.0	0.0	0.0
%ile BackOfQ(50%),veh/ln	1.6	1.6	0.0	0.2	3.3	0.0	0.1	0.4	0.0	1.0	0.4	0.0
Unsig. Movement Delay, s/veh												
LnGrp Delay(d),s/veh	24.5	12.0	0.0	34.2	18.5	0.0	27.9	20.0	19.6	29.4	18.4	0.0
LnGrp LOS	C	B	A	C	B		C	C	B	C	B	
Approach Vol, veh/h		1027			692			99				176
Approach Delay, s/veh		15.8			18.7			21.8				23.5
Approach LOS		B			B			C				C
Timer - Assigned Phs	1	2	3	4	5	6	7	8				
Phs Duration (G+Y+Rc), s	4.4	29.0	5.2	17.9	10.7	22.8	7.3	15.7				
Change Period (Y+Rc), s	3.7	6.5	3.7	6.2	3.7	* 6.5	3.7	6.2				
Max Green Setting (Gmax), s	5.0	55.9	5.0	34.0	18.3	* 43	15.5	23.5				
Max Q Clear Time (g_c+I1), s	2.4	7.8	2.4	3.3	6.7	11.6	4.6	3.0				
Green Ext Time (p_c), s	0.0	5.0	0.0	0.5	0.4	4.6	0.1	0.3				

Intersection Summary

HCM 6th Ctrl Delay	17.8
HCM 6th LOS	B

Notes

* HCM 6th computational engine requires equal clearance times for the phases crossing the barrier.
Unsignalized Delay for [WBR, SBR] is excluded from calculations of the approach delay and intersection delay.

Timings
35: Day St. & Alessandro Bl.

West Campus Upper Plateau (JN 14064)

09/29/2022



Lane Group	EBL	EBT	EBR	WBL	WBT	WBR	NBL	NBT	NBR	SBL	SBT
Lane Configurations	↖	↗↗↗	↖	↖	↗↗	↖	↖	↗	↖	↖	↗
Traffic Volume (vph)	151	565	6	8	594	121	9	83	13	102	41
Future Volume (vph)	151	565	6	8	594	121	9	83	13	102	41
Turn Type	Prot	NA	Perm	Prot	NA	Perm	Perm	NA	Perm	Perm	NA
Protected Phases	5	2		1	6			8			4
Permitted Phases			2			6	8		8	4	
Detector Phase	5	2	2	1	6	6	8	8	8	4	4
Switch Phase											
Minimum Initial (s)	5.0	10.0	10.0	5.0	10.0	10.0	10.0	10.0	10.0	10.0	10.0
Minimum Split (s)	9.1	30.8	30.8	9.1	30.8	30.8	42.4	42.4	42.4	41.6	41.6
Total Split (s)	28.0	67.9	67.9	9.1	49.0	49.0	43.0	43.0	43.0	43.0	43.0
Total Split (%)	23.3%	56.6%	56.6%	7.6%	40.8%	40.8%	35.8%	35.8%	35.8%	35.8%	35.8%
Yellow Time (s)	3.6	4.8	4.8	3.6	4.8	4.8	4.4	4.4	4.4	3.6	3.6
All-Red Time (s)	0.5	1.0	1.0	0.5	1.0	1.0	1.0	1.0	1.0	1.0	1.0
Lost Time Adjust (s)	0.0	0.0	0.0	0.0	0.0	0.0	0.0	0.0	0.0	0.0	0.0
Total Lost Time (s)	4.1	5.8	5.8	4.1	5.8	5.8	5.4	5.4	5.4	4.6	4.6
Lead/Lag	Lead	Lag	Lag	Lead	Lag	Lag					
Lead-Lag Optimize?	Yes	Yes	Yes	Yes	Yes	Yes					
Recall Mode	None	None	None	None	None	None	None	None	None	None	None
Act Effct Green (s)	10.6	31.7	31.7	5.5	17.7	17.7	14.5	14.5	14.5	15.4	15.4
Actuated g/C Ratio	0.18	0.53	0.53	0.09	0.30	0.30	0.24	0.24	0.24	0.26	0.26
v/c Ratio	0.50	0.22	0.01	0.05	0.59	0.24	0.04	0.19	0.03	0.31	0.25
Control Delay	31.6	9.3	0.0	35.6	21.8	8.7	19.7	20.3	0.2	22.1	10.0
Queue Delay	0.0	0.0	0.0	0.0	0.0	0.0	0.0	0.0	0.0	0.0	0.0
Total Delay	31.6	9.3	0.0	35.6	21.8	8.7	19.7	20.3	0.2	22.1	10.0
LOS	C	A	A	D	C	A	B	C	A	C	B
Approach Delay		13.8			19.7			17.7			15.6
Approach LOS		B			B			B			B

Intersection Summary

Cycle Length: 120
 Actuated Cycle Length: 59.6
 Natural Cycle: 85
 Control Type: Actuated-Uncoordinated
 Maximum v/c Ratio: 0.59
 Intersection Signal Delay: 16.7
 Intersection LOS: B
 Intersection Capacity Utilization 49.2%
 ICU Level of Service A
 Analysis Period (min) 15





























Splits and Phases: 35: Day St. & Alessandro Bl.



HCM 6th Signalized Intersection Summary
35: Day St. & Alessandro Bl.

West Campus Upper Plateau (JN 14064)

09/29/2022

												
Movement	EBL	EBT	EBR	WBL	WBT	WBR	NBL	NBT	NBR	SBL	SBT	SBR
Lane Configurations		  			 						 	
Traffic Volume (veh/h)	151	565	6	8	594	121	9	83	13	102	41	79
Future Volume (veh/h)	151	565	6	8	594	121	9	83	13	102	41	79
Initial Q (Qb), veh	0	0	0	0	0	0	0	0	0	0	0	0
Ped-Bike Adj(A_pbT)	1.00		1.00	1.00		0.98	1.00		1.00	1.00		1.00
Parking Bus, Adj	1.00	1.00	1.00	1.00	1.00	1.00	1.00	1.00	1.00	1.00	1.00	1.00
Work Zone On Approach		No			No			No			No	
Adj Sat Flow, veh/h/ln	1885	1870	1618	1900	1870	1900	1500	1900	1767	1885	1870	1870
Adj Flow Rate, veh/h	157	589	0	8	619	58	9	86	9	106	43	51
Peak Hour Factor	0.96	0.96	0.96	0.96	0.96	0.96	0.96	0.96	0.96	0.96	0.96	0.96
Percent Heavy Veh, %	1	2	19	0	2	0	27	0	9	1	2	2
Cap, veh/h	206	2051	551	19	1058	469	360	434	342	421	178	211
Arrive On Green	0.11	0.40	0.00	0.01	0.30	0.30	0.23	0.23	0.23	0.23	0.23	0.23
Sat Flow, veh/h	1795	5106	1372	1810	3554	1574	1044	1900	1497	1311	779	924
Grp Volume(v), veh/h	157	589	0	8	619	58	9	86	9	106	0	94
Grp Sat Flow(s),veh/h/ln	1795	1702	1372	1810	1777	1574	1044	1900	1497	1311	0	1704
Q Serve(g_s), s	3.6	3.3	0.0	0.2	6.3	1.1	0.3	1.6	0.2	3.0	0.0	1.9
Cycle Q Clear(g_c), s	3.6	3.3	0.0	0.2	6.3	1.1	2.2	1.6	0.2	4.6	0.0	1.9
Prop In Lane	1.00		1.00	1.00		1.00	1.00		1.00	1.00		0.54
Lane Grp Cap(c), veh/h	206	2051	551	19	1058	469	360	434	342	421	0	389
V/C Ratio(X)	0.76	0.29	0.00	0.42	0.59	0.12	0.02	0.20	0.03	0.25	0.00	0.24
Avail Cap(c_a), veh/h	1008	7446	2000	212	3605	1597	1044	1678	1322	1303	0	1537
HCM Platoon Ratio	1.00	1.00	1.00	1.00	1.00	1.00	1.00	1.00	1.00	1.00	1.00	1.00
Upstream Filter(I)	1.00	1.00	0.00	1.00	1.00	1.00	1.00	1.00	1.00	1.00	0.00	1.00
Uniform Delay (d), s/veh	18.3	8.6	0.0	20.9	12.7	10.9	14.3	13.3	12.8	15.1	0.0	13.4
Incr Delay (d2), s/veh	2.2	0.1	0.0	5.3	0.5	0.1	0.0	0.2	0.0	0.3	0.0	0.3
Initial Q Delay(d3),s/veh	0.0	0.0	0.0	0.0	0.0	0.0	0.0	0.0	0.0	0.0	0.0	0.0
%ile BackOfQ(50%),veh/ln	1.3	0.8	0.0	0.1	1.9	0.3	0.1	0.5	0.1	0.8	0.0	0.7
Unsig. Movement Delay, s/veh												
LnGrp Delay(d),s/veh	20.5	8.7	0.0	26.2	13.2	11.0	14.4	13.5	12.8	15.4	0.0	13.7
LnGrp LOS	C	A	A	C	B	B	B	B	B	B	A	B
Approach Vol, veh/h		746			685			104			200	
Approach Delay, s/veh		11.2			13.2			13.5			14.6	
Approach LOS		B			B			B			B	
Timer - Assigned Phs	1	2		4	5	6		8				
Phs Duration (G+Y+Rc), s	4.6	22.9		15.1	9.0	18.5		15.1				
Change Period (Y+Rc), s	4.1	5.8		* 5.4	4.1	5.8		5.4				
Max Green Setting (Gmax), s	5.0	62.1		* 38	23.9	43.2		37.6				
Max Q Clear Time (g_c+I1), s	2.2	5.3		6.6	5.6	8.3		4.2				
Green Ext Time (p_c), s	0.0	4.1		0.9	0.2	4.4		0.5				

Intersection Summary

HCM 6th Ctrl Delay	12.5
HCM 6th LOS	B

Notes

* HCM 6th computational engine requires equal clearance times for the phases crossing the barrier.

Timings
36: Elsworth St. & Cactus Av.

West Campus Upper Plateau (JN 14064)

09/29/2022



Lane Group	EBL	EBT	EBR	WBL	WBT	WBR	NBL	NBT	SBL	SBT	SBR
Lane Configurations	↘	↑↑↑	↗	↘	↑↑↑	↗	↘	↕	↘	↗	↗
Traffic Volume (vph)	119	909	27	12	906	116	19	10	139	15	97
Future Volume (vph)	119	909	27	12	906	116	19	10	139	15	97
Turn Type	Prot	NA	Perm	Prot	NA	Perm	Split	NA	Split	NA	pm+ov
Protected Phases	5	2		1	6		8	8	4	4	5
Permitted Phases			2			6					4
Detector Phase	5	2	2	1	6	6	8	8	4	4	5
Switch Phase											
Minimum Initial (s)	5.0	10.0	10.0	5.0	10.0	10.0	10.0	10.0	10.0	10.0	5.0
Minimum Split (s)	9.6	36.2	36.2	9.6	36.2	36.2	35.4	35.4	35.4	35.4	9.6
Total Split (s)	16.5	49.6	49.6	9.6	42.7	42.7	35.4	35.4	35.4	35.4	16.5
Total Split (%)	12.7%	38.2%	38.2%	7.4%	32.8%	32.8%	27.2%	27.2%	27.2%	27.2%	12.7%
Yellow Time (s)	3.6	5.2	5.2	3.6	5.2	5.2	4.4	4.4	4.4	4.4	3.6
All-Red Time (s)	1.0	1.0	1.0	1.0	1.0	1.0	1.0	1.0	1.0	1.0	1.0
Lost Time Adjust (s)	0.0	0.0	0.0	0.0	0.0	0.0	0.0	0.0	0.0	0.0	0.0
Total Lost Time (s)	4.6	6.2	6.2	4.6	6.2	6.2	5.4	5.4	5.4	5.4	4.6
Lead/Lag	Lead	Lag	Lag	Lead	Lag	Lag					Lead
Lead-Lag Optimize?	Yes	Yes	Yes	Yes	Yes	Yes					Yes
Recall Mode	None	None	None	None	None	None	Max	Max	Max	Max	None
Act Effct Green (s)	11.2	43.0	43.0	5.0	30.8	30.8	30.1	30.1	30.1	30.1	42.1
Actuated g/C Ratio	0.09	0.35	0.35	0.04	0.25	0.25	0.24	0.24	0.24	0.24	0.34
v/c Ratio	0.80	0.55	0.05	0.18	0.77	0.24	0.04	0.05	0.19	0.20	0.17
Control Delay	89.3	34.5	0.1	65.4	47.8	4.8	38.5	28.1	40.4	40.4	3.5
Queue Delay	0.0	0.0	0.0	0.0	0.0	0.0	0.0	0.0	0.0	0.0	0.0
Total Delay	89.3	34.5	0.1	65.4	47.8	4.8	38.5	28.1	40.4	40.4	3.5
LOS	F	C	A	E	D	A	D	C	D	D	A
Approach Delay		39.8			43.2			32.9		26.1	
Approach LOS		D			D			C		C	

Intersection Summary

Cycle Length: 130
 Actuated Cycle Length: 123.8
 Natural Cycle: 120
 Control Type: Actuated-Uncoordinated
 Maximum v/c Ratio: 0.80
 Intersection Signal Delay: 39.7
 Intersection LOS: D
 Intersection Capacity Utilization 48.5%
 ICU Level of Service A
 Analysis Period (min) 15



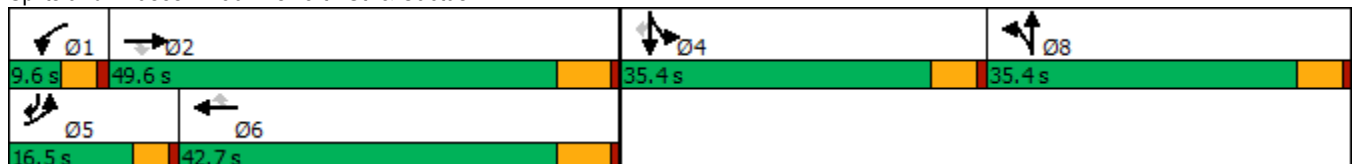



















Splits and Phases: 36: Elsworth St. & Cactus Av.



HCM 6th Signalized Intersection Summary
 36: Elsworth St. & Cactus Av.

West Campus Upper Plateau (JN 14064)

09/29/2022

												
Movement	EBL	EBT	EBR	WBL	WBT	WBR	NBL	NBT	NBR	SBL	SBT	SBR
Lane Configurations												
Traffic Volume (veh/h)	119	909	27	12	906	116	19	10	8	139	15	97
Future Volume (veh/h)	119	909	27	12	906	116	19	10	8	139	15	97
Initial Q (Qb), veh	0	0	0	0	0	0	0	0	0	0	0	0
Ped-Bike Adj(A_pbT)	1.00		1.00	1.00		1.00	1.00		1.00	1.00		1.00
Parking Bus, Adj	1.00	1.00	1.00	1.00	1.00	1.00	1.00	1.00	1.00	1.00	1.00	1.00
Work Zone On Approach		No			No			No			No	
Adj Sat Flow, veh/h/ln	1841	1841	1781	1900	1841	1885	1885	1900	1885	1885	1900	1885
Adj Flow Rate, veh/h	125	957	0	13	954	85	13	0	0	157	0	-6
Peak Hour Factor	0.95	0.95	0.95	0.95	0.95	0.95	0.95	0.95	0.95	0.95	0.95	0.95
Percent Heavy Veh, %	4	4	8	0	4	1	1	0	1	1	0	1
Cap, veh/h	150	1549		26	1192	379	894	473	0	894	0	534
Arrive On Green	0.09	0.31	0.00	0.01	0.24	0.24	0.25	0.00	0.00	0.25	0.00	0.00
Sat Flow, veh/h	1753	5025	1510	1810	5025	1598	3591	1900	0	3591	0	1598
Grp Volume(v), veh/h	125	957	0	13	954	85	13	0	0	157	0	-6
Grp Sat Flow(s),veh/h/ln	1753	1675	1510	1810	1675	1598	1795	1900	0	1795	0	1598
Q Serve(g_s), s	8.5	19.6	0.0	0.9	21.5	5.2	0.3	0.0	0.0	4.1	0.0	0.0
Cycle Q Clear(g_c), s	8.5	19.6	0.0	0.9	21.5	5.2	0.3	0.0	0.0	4.1	0.0	0.0
Prop In Lane	1.00		1.00	1.00		1.00	1.00		0.00	1.00		1.00
Lane Grp Cap(c), veh/h	150	1549		26	1192	379	894	473	0	894	0	534
V/C Ratio(X)	0.83	0.62		0.49	0.80	0.22	0.01	0.00	0.00	0.18	0.00	-0.01
Avail Cap(c_a), veh/h	173	1810		75	1522	484	894	473	0	894	0	534
HCM Platoon Ratio	1.00	1.00	1.00	1.00	1.00	1.00	1.00	1.00	1.00	1.00	1.00	1.00
Upstream Filter(I)	1.00	1.00	0.00	1.00	1.00	1.00	1.00	0.00	0.00	1.00	0.00	0.00
Uniform Delay (d), s/veh	54.2	35.6	0.0	58.9	43.3	37.0	34.1	0.0	0.0	35.5	0.0	0.0
Incr Delay (d2), s/veh	22.5	0.5	0.0	5.1	2.4	0.3	0.0	0.0	0.0	0.4	0.0	0.0
Initial Q Delay(d3),s/veh	0.0	0.0	0.0	0.0	0.0	0.0	0.0	0.0	0.0	0.0	0.0	0.0
%ile BackOfQ(50%),veh/ln	4.5	7.7	0.0	0.4	8.8	2.0	0.2	0.0	0.0	1.8	0.0	0.0
Unsig. Movement Delay, s/veh												
LnGrp Delay(d),s/veh	76.7	36.1	0.0	64.1	45.7	37.3	34.1	0.0	0.0	36.0	0.0	0.0
LnGrp LOS	E	D		E	D	D	C	A	A	D	A	A
Approach Vol, veh/h		1082			1052			13			151	
Approach Delay, s/veh		40.8			45.3			34.1			37.4	
Approach LOS		D			D			C			D	
Timer - Assigned Phs	1	2		4	5	6		8				
Phs Duration (G+Y+Rc), s	6.4	43.4		35.4	14.9	34.8		35.4				
Change Period (Y+Rc), s	4.6	6.2		5.4	4.6	6.2		5.4				
Max Green Setting (Gmax), s	5.0	43.4		30.0	11.9	36.5		30.0				
Max Q Clear Time (g_c+I1), s	2.9	21.6		6.1	10.5	23.5		2.3				
Green Ext Time (p_c), s	0.0	6.1		0.5	0.0	5.1		0.0				

Intersection Summary

HCM 6th Ctrl Delay	42.6
HCM 6th LOS	D

Notes

- User approved pedestrian interval to be less than phase max green.
- User approved volume balancing among the lanes for turning movement.
- Unsignalized Delay for [EBR] is excluded from calculations of the approach delay and intersection delay.

Timings
37: Cactus Av. & Frederick St.

West Campus Upper Plateau (JN 14064)

09/29/2022



Lane Group	EBL	EBT	WBT	WBR	SBL	SBR
Lane Configurations	↗	↑↑↑	↑↑↑	↖	↘↘	↘
Traffic Volume (vph)	76	1004	1008	144	229	58
Future Volume (vph)	76	1004	1008	144	229	58
Turn Type	Prot	NA	NA	pm+ov	Prot	pm+ov
Protected Phases	5	2	6	4	4	5
Permitted Phases				6		4
Detector Phase	5	2	6	4	4	5
Switch Phase						
Minimum Initial (s)	5.0	10.0	10.0	10.0	10.0	5.0
Minimum Split (s)	9.2	28.2	29.2	36.4	36.4	9.2
Total Split (s)	31.0	81.0	50.0	39.0	39.0	31.0
Total Split (%)	25.8%	67.5%	41.7%	32.5%	32.5%	25.8%
Yellow Time (s)	3.2	5.2	5.2	4.4	4.4	3.2
All-Red Time (s)	1.0	1.0	1.0	1.0	1.0	1.0
Lost Time Adjust (s)	0.0	0.0	0.0	0.0	0.0	0.0
Total Lost Time (s)	4.2	6.2	6.2	5.4	5.4	4.2
Lead/Lag	Lead		Lag			Lead
Lead-Lag Optimize?	Yes		Yes			Yes
Recall Mode	None	None	None	None	None	None
Act Effct Green (s)	8.2	31.0	21.3	36.2	14.0	28.2
Actuated g/C Ratio	0.14	0.54	0.37	0.63	0.24	0.49
v/c Ratio	0.34	0.40	0.59	0.15	0.30	0.08
Control Delay	31.7	8.4	17.5	1.0	21.0	8.0
Queue Delay	0.0	0.0	0.0	0.0	0.0	0.0
Total Delay	31.7	8.4	17.5	1.0	21.0	8.0
LOS	C	A	B	A	C	A
Approach Delay		10.1	15.4		18.4	
Approach LOS		B	B		B	

Intersection Summary

Cycle Length: 120
 Actuated Cycle Length: 57.9
 Natural Cycle: 75
 Control Type: Actuated-Uncoordinated
 Maximum v/c Ratio: 0.59
 Intersection Signal Delay: 13.5
 Intersection LOS: B
 Intersection Capacity Utilization 45.2%
 ICU Level of Service A
 Analysis Period (min) 15

Splits and Phases: 37: Cactus Av. & Frederick St.

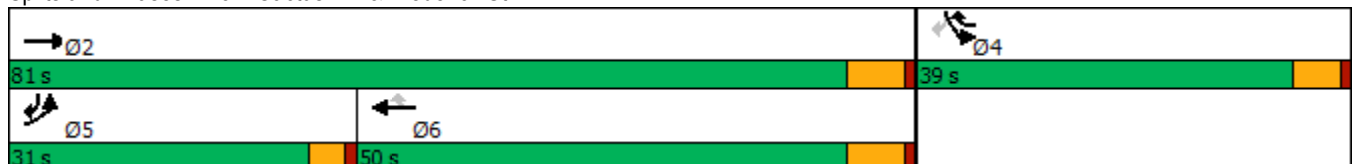

HCM 6th Signalized Intersection Summary
37: Cactus Av. & Frederick St.

West Campus Upper Plateau (JN 14064)

09/29/2022



Movement	EBL	EBT	WBT	WBR	SBL	SBR
Lane Configurations						
Traffic Volume (veh/h)	76	1004	1008	144	229	58
Future Volume (veh/h)	76	1004	1008	144	229	58
Initial Q (Qb), veh	0	0	0	0	0	0
Ped-Bike Adj(A_pbT)	1.00			0.98	1.00	1.00
Parking Bus, Adj	1.00	1.00	1.00	1.00	1.00	1.00
Work Zone On Approach		No	No		No	
Adj Sat Flow, veh/h/ln	1826	1856	1856	1870	1856	1856
Adj Flow Rate, veh/h	83	1091	1096	93	249	-37
Peak Hour Factor	0.92	0.92	0.92	0.92	0.92	0.92
Percent Heavy Veh, %	5	3	3	2	3	3
Cap, veh/h	122	2802	1992	925	685	425
Arrive On Green	0.07	0.55	0.39	0.39	0.20	0.00
Sat Flow, veh/h	1739	5233	5233	1547	3428	1572
Grp Volume(v), veh/h	83	1091	1096	93	249	-37
Grp Sat Flow(s),veh/h/ln	1739	1689	1689	1547	1714	1572
Q Serve(g_s), s	2.2	5.8	7.9	1.2	2.9	0.0
Cycle Q Clear(g_c), s	2.2	5.8	7.9	1.2	2.9	0.0
Prop In Lane	1.00			1.00	1.00	1.00
Lane Grp Cap(c), veh/h	122	2802	1992	925	685	425
V/C Ratio(X)	0.68	0.39	0.55	0.10	0.36	-0.09
Avail Cap(c_a), veh/h	993	8075	4728	1761	2455	1237
HCM Platoon Ratio	1.00	1.00	1.00	1.00	1.00	1.00
Upstream Filter(I)	1.00	1.00	1.00	1.00	1.00	0.00
Uniform Delay (d), s/veh	21.3	6.0	11.0	4.1	16.2	0.0
Incr Delay (d2), s/veh	2.4	0.1	0.2	0.0	0.3	0.0
Initial Q Delay(d3),s/veh	0.0	0.0	0.0	0.0	0.0	0.0
%ile BackOfQ(50%),veh/ln	0.8	1.0	2.0	0.4	1.0	0.0
Unsig. Movement Delay, s/veh						
LnGrp Delay(d),s/veh	23.7	6.1	11.3	4.2	16.5	0.0
LnGrp LOS	C	A	B	A	B	A
Approach Vol, veh/h		1174	1189		212	
Approach Delay, s/veh		7.3	10.7		19.4	
Approach LOS		A	B		B	
Timer - Assigned Phs		2		4	5	6
Phs Duration (G+Y+Rc), s		32.2		14.8	7.5	24.6
Change Period (Y+Rc), s		6.2		5.4	* 4.2	6.2
Max Green Setting (Gmax), s		74.8		33.6	* 27	43.8
Max Q Clear Time (g_c+I1), s		7.8		4.9	4.2	9.9
Green Ext Time (p_c), s		8.7		0.8	0.1	8.6

Intersection Summary

HCM 6th Ctrl Delay	9.9
HCM 6th LOS	A

Notes

* HCM 6th computational engine requires equal clearance times for the phases crossing the barrier.

Timings
38: Riverside Dr./Graham St. & Cactus Av.

West Campus Upper Plateau (JN 14064)

09/29/2022

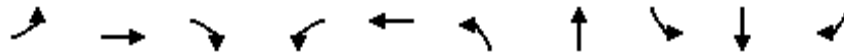

Lane Group	EBL	EBT	EBR	WBL	WBT	NBL	NBT	SBL	SBT	SBR
Lane Configurations	↘	↑↑↑	↗	↘	↑↑↑	↘↗	↑↗	↘	↑↑	↗
Traffic Volume (vph)	49	939	151	17	975	137	40	56	51	61
Future Volume (vph)	49	939	151	17	975	137	40	56	51	61
Turn Type	Prot	NA	Perm	Prot	NA	Prot	NA	Prot	NA	Perm
Protected Phases	7	4		3	8	5	2	1	6	
Permitted Phases			4							6
Detector Phase	7	4	4	3	8	5	2	1	6	6
Switch Phase										
Minimum Initial (s)	5.0	10.0	10.0	5.0	10.0	5.0	10.0	5.0	10.0	10.0
Minimum Split (s)	9.6	39.2	39.2	9.6	39.2	10.4	35.0	9.6	40.6	40.6
Total Split (s)	16.0	59.0	59.0	9.6	52.6	10.4	36.0	15.4	41.0	41.0
Total Split (%)	13.3%	49.2%	49.2%	8.0%	43.8%	8.7%	30.0%	12.8%	34.2%	34.2%
Yellow Time (s)	3.6	5.2	5.2	3.6	5.2	4.4	4.0	3.6	3.6	3.6
All-Red Time (s)	1.0	1.0	1.0	1.0	1.0	1.0	1.0	1.0	1.0	1.0
Lost Time Adjust (s)	0.0	0.0	0.0	0.0	0.0	0.0	0.0	0.0	0.0	0.0
Total Lost Time (s)	4.6	6.2	6.2	4.6	6.2	5.4	5.0	4.6	4.6	4.6
Lead/Lag	Lead	Lag	Lag	Lead	Lag	Lead	Lag	Lead	Lag	Lag
Lead-Lag Optimize?	Yes	Yes	Yes	Yes	Yes	Yes	Yes	Yes	Yes	Yes
Recall Mode	None	Min	Min	None	Min	None	None	None	None	None
Act Effct Green (s)	7.2	32.7	32.7	5.4	27.2	6.8	16.2	7.4	15.0	15.0
Actuated g/C Ratio	0.10	0.47	0.47	0.08	0.39	0.10	0.23	0.11	0.22	0.22
v/c Ratio	0.28	0.41	0.19	0.13	0.54	0.41	0.07	0.31	0.07	0.14
Control Delay	39.7	14.5	3.8	42.2	20.2	41.3	21.3	39.7	24.1	0.6
Queue Delay	0.0	0.0	0.0	0.0	0.0	0.0	0.0	0.0	0.0	0.0
Total Delay	39.7	14.5	3.8	42.2	20.2	41.3	21.3	39.7	24.1	0.6
LOS	D	B	A	D	C	D	C	D	C	A
Approach Delay		14.2			20.6		35.7		20.8	
Approach LOS		B			C		D		C	

Intersection Summary

Cycle Length: 120
 Actuated Cycle Length: 69.1
 Natural Cycle: 100
 Control Type: Actuated-Uncoordinated
 Maximum v/c Ratio: 0.54
 Intersection Signal Delay: 18.9
 Intersection LOS: B
 Intersection Capacity Utilization 48.0%
 ICU Level of Service A
 Analysis Period (min) 15

Splits and Phases: 38: Riverside Dr./Graham St. & Cactus Av.

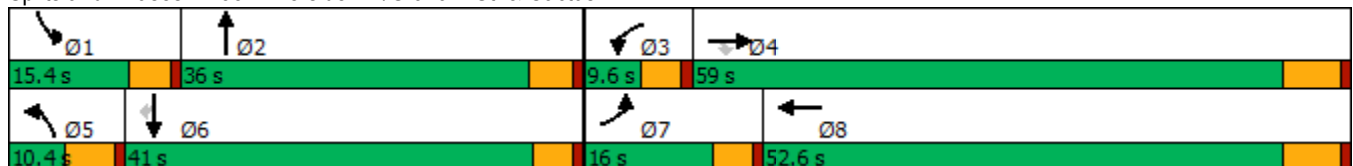

HCM 6th Signalized Intersection Summary
38: Riverside Dr./Graham St. & Cactus Av.

West Campus Upper Plateau (JN 14064)

09/29/2022



Movement	EBL	EBT	EBR	WBL	WBT	WBR	NBL	NBT	NBR	SBL	SBT	SBR
Lane Configurations	↘	↑↑↑	↗	↘	↑↑↑		↘↗	↑↗		↘	↑↑	↗
Traffic Volume (veh/h)	49	939	151	17	975	56	137	40	14	56	51	61
Future Volume (veh/h)	49	939	151	17	975	56	137	40	14	56	51	61
Initial Q (Qb), veh	0	0	0	0	0	0	0	0	0	0	0	0
Ped-Bike Adj(A_pbT)	1.00		1.00	1.00		0.99	1.00		1.00	1.00		1.00
Parking Bus, Adj	1.00	1.00	1.00	1.00	1.00	1.00	1.00	1.00	1.00	1.00	1.00	1.00
Work Zone On Approach		No			No			No			No	
Adj Sat Flow, veh/h/ln	1841	1841	1885	1900	1841	1900	1900	1900	1900	1870	1885	1826
Adj Flow Rate, veh/h	51	968	111	18	1005	50	141	41	13	58	53	-11
Peak Hour Factor	0.97	0.97	0.97	0.97	0.97	0.97	0.97	0.97	0.97	0.97	0.97	0.97
Percent Heavy Veh, %	4	4	1	0	4	0	0	0	0	2	1	5
Cap, veh/h	86	1818	578	39	1641	82	277	551	167	94	578	250
Arrive On Green	0.05	0.36	0.36	0.02	0.33	0.33	0.08	0.20	0.20	0.05	0.16	0.00
Sat Flow, veh/h	1753	5025	1598	1810	4900	243	3510	2731	826	1781	3582	1547
Grp Volume(v), veh/h	51	968	111	18	687	368	141	26	28	58	53	-11
Grp Sat Flow(s),veh/h/ln	1753	1675	1598	1810	1675	1793	1755	1805	1751	1781	1791	1547
Q Serve(g_s), s	1.6	8.6	2.7	0.6	9.7	9.7	2.2	0.7	0.7	1.8	0.7	0.0
Cycle Q Clear(g_c), s	1.6	8.6	2.7	0.6	9.7	9.7	2.2	0.7	0.7	1.8	0.7	0.0
Prop In Lane	1.00		1.00	1.00		0.14	1.00		0.47	1.00		1.00
Lane Grp Cap(c), veh/h	86	1818	578	39	1122	600	277	364	353	94	578	250
V/C Ratio(X)	0.60	0.53	0.19	0.46	0.61	0.61	0.51	0.07	0.08	0.62	0.09	-0.04
Avail Cap(c_a), veh/h	354	4705	1496	160	2757	1475	311	992	963	341	2312	999
HCM Platoon Ratio	1.00	1.00	1.00	1.00	1.00	1.00	1.00	1.00	1.00	1.00	1.00	1.00
Upstream Filter(I)	1.00	1.00	1.00	1.00	1.00	1.00	1.00	1.00	1.00	1.00	1.00	0.00
Uniform Delay (d), s/veh	26.3	14.2	12.3	27.2	15.7	15.7	24.9	18.2	18.3	26.1	20.1	0.0
Incr Delay (d2), s/veh	2.5	0.2	0.2	3.0	0.5	1.0	0.5	0.1	0.1	2.4	0.1	0.0
Initial Q Delay(d3),s/veh	0.0	0.0	0.0	0.0	0.0	0.0	0.0	0.0	0.0	0.0	0.0	0.0
%ile BackOfQ(50%),veh/ln	0.6	2.5	0.8	0.2	3.0	3.3	0.9	0.3	0.3	0.8	0.3	0.0
Unsig. Movement Delay, s/veh												
LnGrp Delay(d),s/veh	28.7	14.5	12.5	30.3	16.2	16.7	25.5	18.3	18.4	28.6	20.2	0.0
LnGrp LOS	C	B	B	C	B	B	C	B	B	C	C	A
Approach Vol, veh/h		1130			1073			195			100	
Approach Delay, s/veh		14.9			16.6			23.5			27.3	
Approach LOS		B			B			C			C	
Timer - Assigned Phs	1	2	3	4	5	6	7	8				
Phs Duration (G+Y+Rc), s	7.6	16.4	5.8	26.6	9.9	14.1	7.4	25.1				
Change Period (Y+Rc), s	4.6	5.0	4.6	6.2	5.4	* 5	4.6	6.2				
Max Green Setting (Gmax), s	10.8	31.0	5.0	52.8	5.0	* 36	11.4	46.4				
Max Q Clear Time (g_c+I1), s	3.8	2.7	2.6	10.6	4.2	2.7	3.6	11.7				
Green Ext Time (p_c), s	0.0	0.2	0.0	7.6	0.0	0.2	0.0	7.2				

Intersection Summary

HCM 6th Ctrl Delay	16.8
HCM 6th LOS	B

Notes

* HCM 6th computational engine requires equal clearance times for the phases crossing the barrier.

APPENDIX 3.3:

EXISTING (2021) CONDITIONS TRAFFIC SIGNAL WARRANT ANALYSIS WORKSHEETS

This Page Intentionally Left Blank

Figure 4C-3. Warrant 3, Peak Hour

Traffic Conditions = **Existing (2021) Conditions - Weekday AM Peak Hour**

Major Street Name = **Grove Community Dr.** Total of Both Approaches (VPH) = **544**
 Number of Approach Lanes on Major Street = **1**

Minor Street Name = **Deercreek Dr.** High Volume Approach (VPH) = **234**
 Number of Approach Lanes On Minor Street = **1**

SIGNAL WARRANT NOT SATISFIED

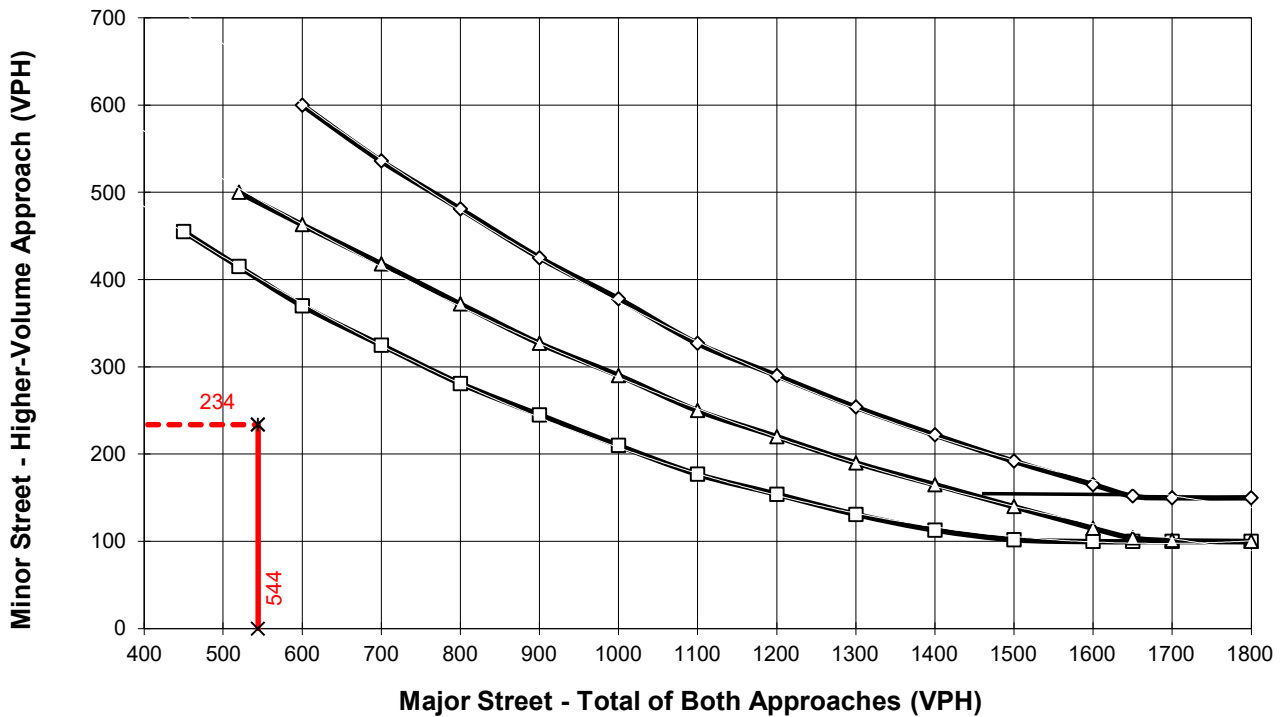

- 1 Lane (Major) & 1 Lane (Minor)
- △— 2+ Lanes (Major) & 1 Lane (Minor) OR 1 Lane (Major) & 2+ Lanes (Minor)
- ◇— 2+ Lanes (Major) & 2+ Lanes (Minor)
- x— Major Street Approaches
- x- Minor Street Approaches

*Note: 150 vph applies as the lower threshold for a minor-street approach with two or more lanes and 100 vph applies as the lower threshold for a minor-street approach with one lane



Figure 4C-3. Warrant 3, Peak Hour

Traffic Conditions = **Existing (2021) Conditions - Weekday AM Peak Hour**

Major Street Name = **Orange Terrace Pkwy** Total of Both Approaches (VPH) = **1272**
 Number of Approach Lanes on Major Street = **1**

Minor Street Name = **Deercreek Dr.** High Volume Approach (VPH) = **201**
 Number of Approach Lanes On Minor Street = **1**

WARRANTED FOR A SIGNAL

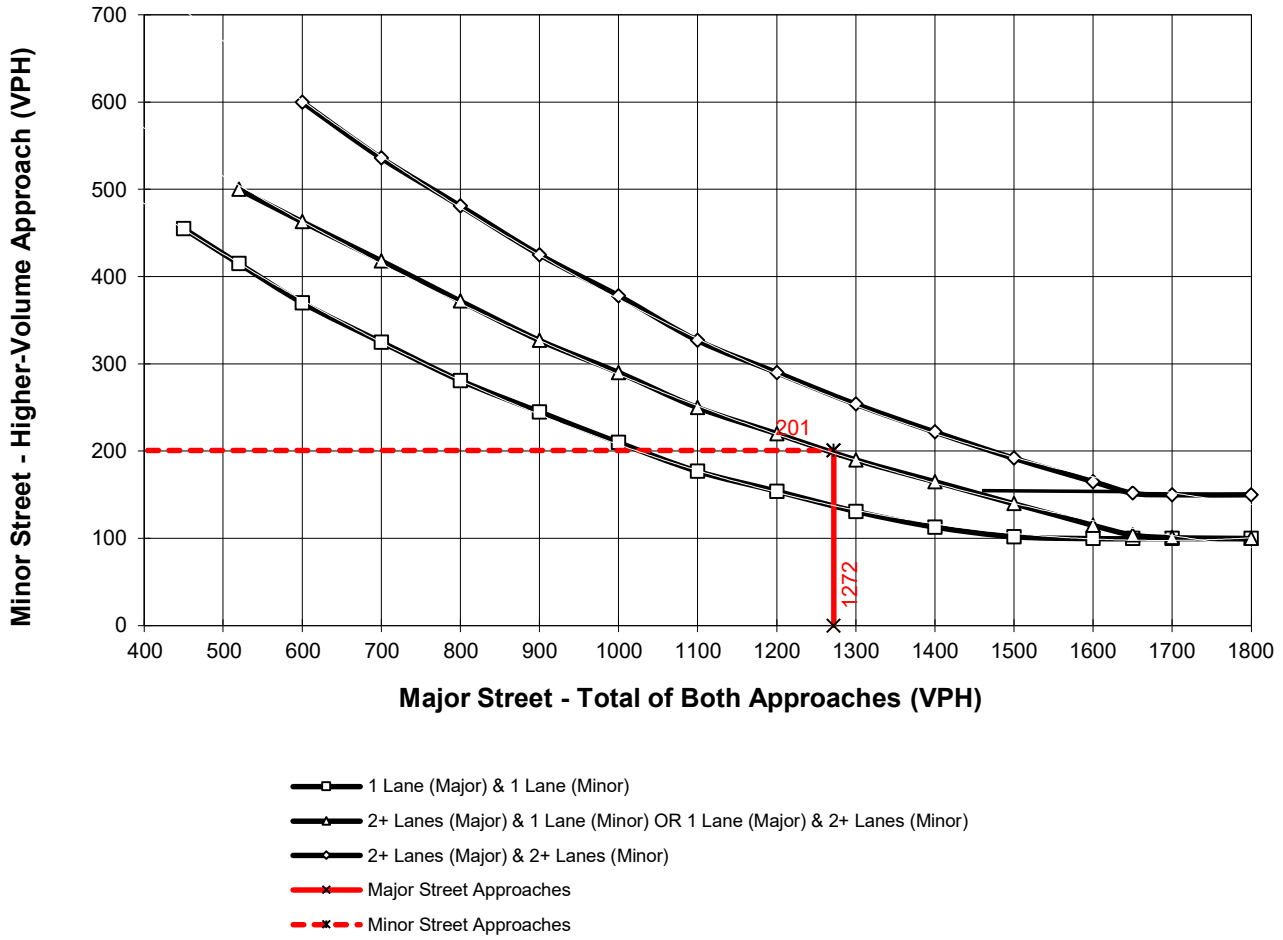

*Note: 150 vph applies as the lower threshold for a minor-street approach with two or more lanes and 100 vph applies as the lower threshold for a minor-street approach with one lane



Figure 4C-3. Warrant 3, Peak Hour

Traffic Conditions = **Existing (2021) Conditions - Weekday PM Peak Hour**

Major Street Name = **Grove Community Dr.** Total of Both Approaches (VPH) = **387**
 Number of Approach Lanes on Major Street = **1**

Minor Street Name = **Barton Rd.** High Volume Approach (VPH) = **29**
 Number of Approach Lanes On Minor Street = **1**

SIGNAL WARRANT NOT SATISFIED

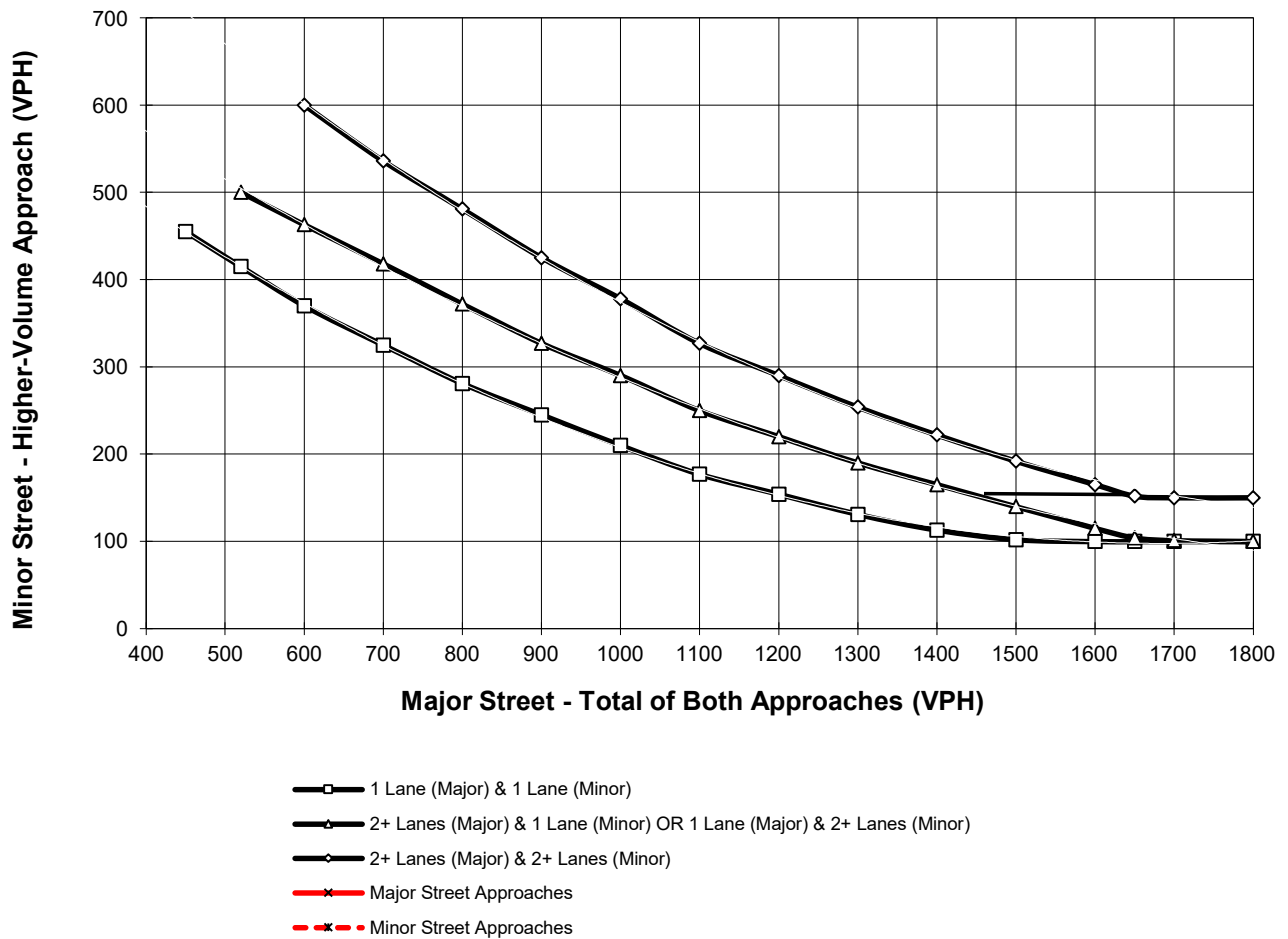

*Note: 150 vph applies as the lower threshold for a minor-street approach with two or more lanes and 100 vph applies as the lower threshold for a minor-street approach with one lane

Figure 4C-3. Warrant 3, Peak Hour

Traffic Conditions = Existing (2021) Conditions - Weekday AM Peak Hour

Major Street Name = Orange Terrace Pkwy Total of Both Approaches (VPH) = 947
 Number of Approach Lanes on Major Street = 1

Minor Street Name = Barton St High Volume Approach (VPH) = 230
 Number of Approach Lanes On Minor Street = 1

WARRANTED FOR A SIGNAL

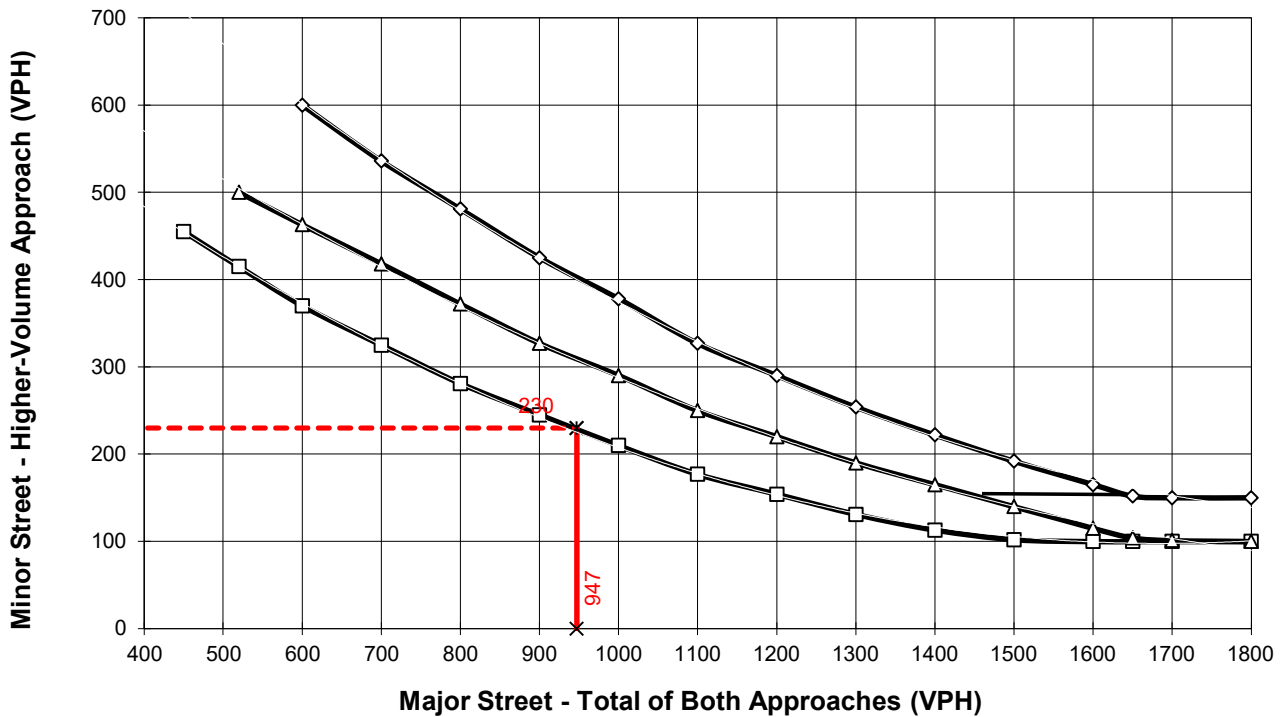

- 1 Lane (Major) & 1 Lane (Minor)
- △— 2+ Lanes (Major) & 1 Lane (Minor) OR 1 Lane (Major) & 2+ Lanes (Minor)
- ◇— 2+ Lanes (Major) & 2+ Lanes (Minor)
- x— Major Street Approaches
- x- Minor Street Approaches

*Note: 150 vph applies as the lower threshold for a minor-street approach with two or more lanes and 100 vph applies as the lower threshold for a minor-street approach with one lane

Figure 4C-3. Warrant 3, Peak Hour

Traffic Conditions = Existing (2021) Conditions - Weekday AM Peak Hour

Major Street Name = Grove Community Dr. Total of Both Approaches (VPH) = 408
 Number of Approach Lanes on Major Street = 1

Minor Street Name = Abrams Dr High Volume Approach (VPH) = 196
 Number of Approach Lanes On Minor Street = 1

SIGNAL WARRANT NOT SATISFIED

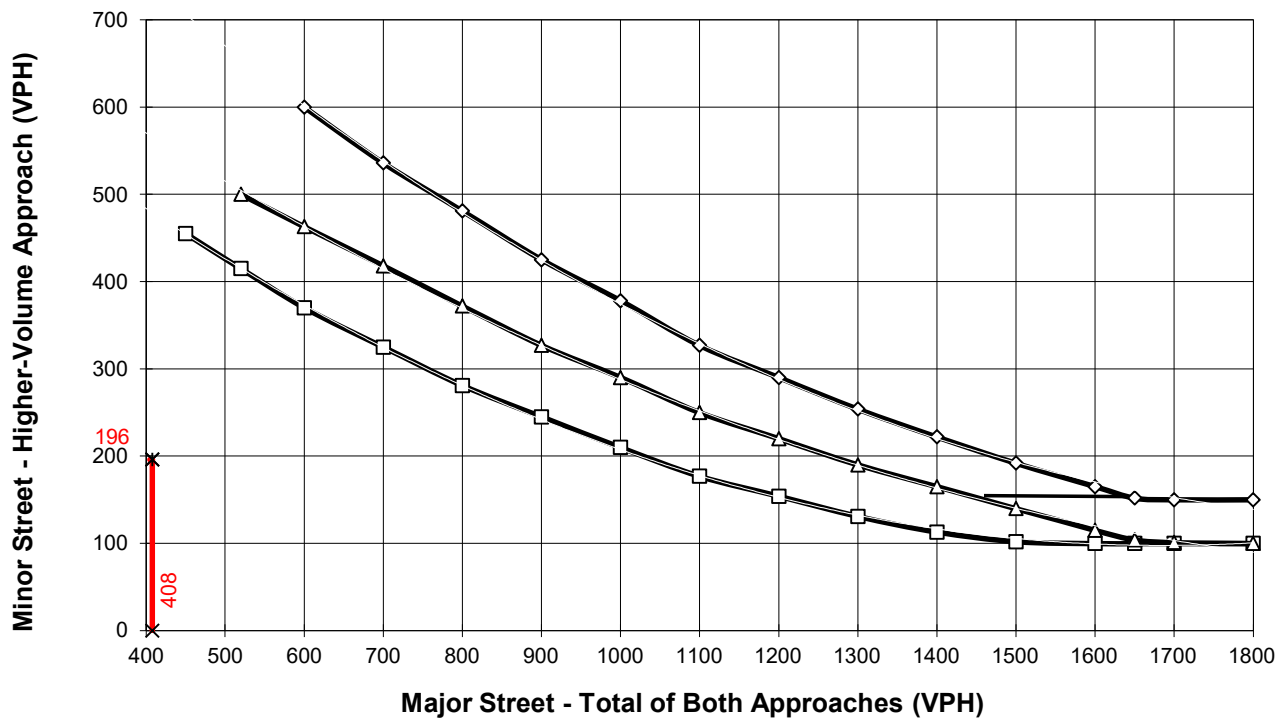

- 1 Lane (Major) & 1 Lane (Minor)
- △— 2+ Lanes (Major) & 1 Lane (Minor) OR 1 Lane (Major) & 2+ Lanes (Minor)
- ◇— 2+ Lanes (Major) & 2+ Lanes (Minor)
- x— Major Street Approaches
- x— Minor Street Approaches

*Note: 150 vph applies as the lower threshold for a minor-street approach with two or more lanes and 100 vph applies as the lower threshold for a minor-street approach with one lane

Figure 4C-3. Warrant 3, Peak Hour

Traffic Conditions = **Existing (2021) Conditions - Weekday AM Peak Hour**

Major Street Name = **Orange Terrace Pkwy**

Total of Both Approaches (VPH) = **661**

Number of Approach Lanes on Major Street = **1**

Minor Street Name = **Abrams Dr.**

High Volume Approach (VPH) = **177**

Number of Approach Lanes On Minor Street = **1**

SIGNAL WARRANT NOT SATISFIED

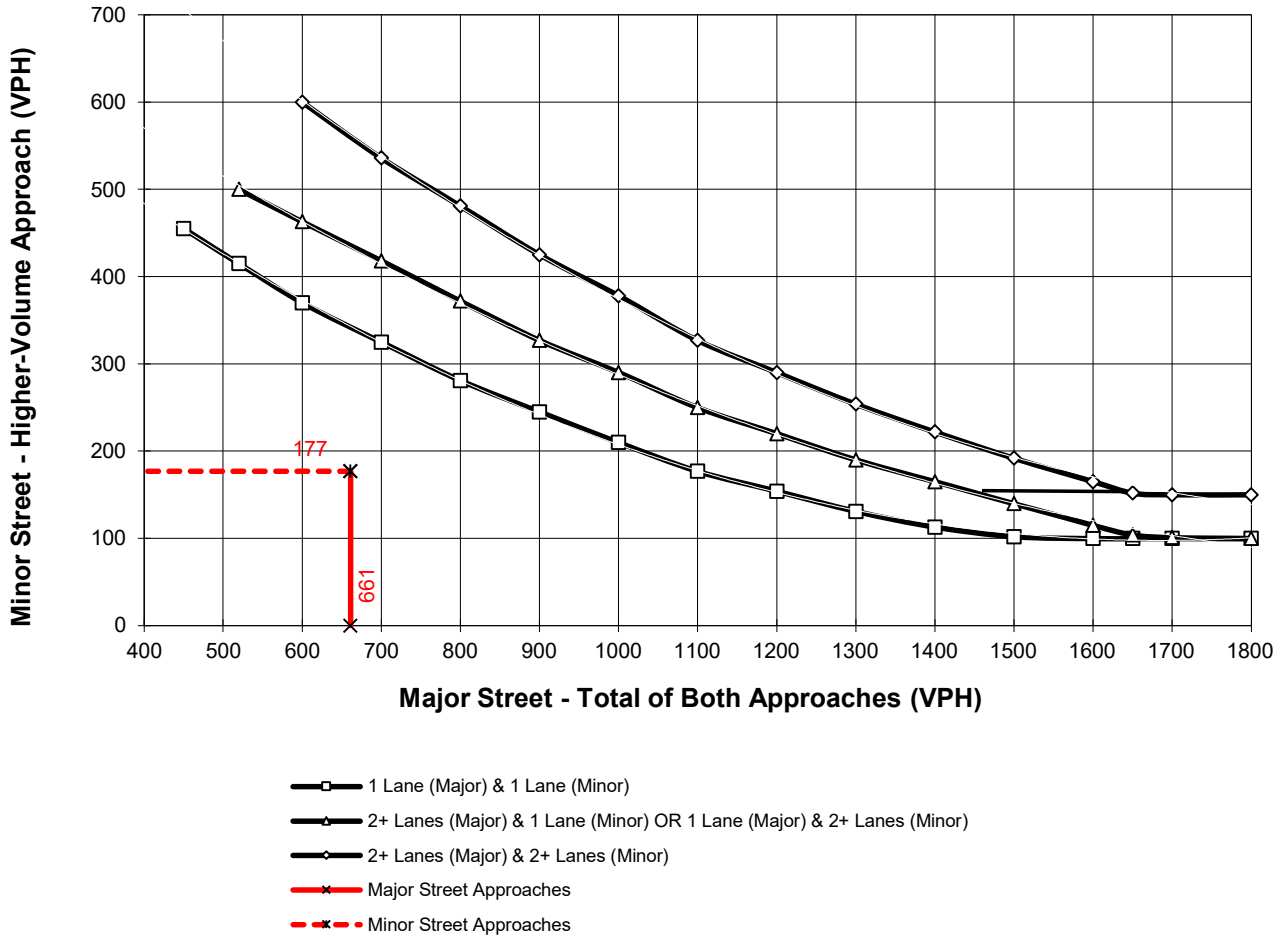

*Note: 150 vph applies as the lower threshold for a minor-street approach with two or more lanes and 100 vph applies as the lower threshold for a minor-street approach with one lane

APPENDIX 3.4:

**EXISTING (2021) CONDITIONS FREEWAY OFF-RAMP QUEUING ANALYSIS
WORKSHEETS**

This Page Intentionally Left Blank

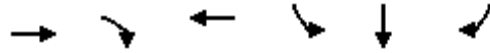

Lane Group	EBT	EBR	WBT	SBL	SBT	SBR
Lane Group Flow (vph)	781	341	2431	157	159	160
v/c Ratio	0.23	0.30	0.68	0.61	0.61	0.60
Control Delay	5.3	1.8	13.8	41.3	34.8	33.9
Queue Delay	0.0	0.0	0.0	0.0	0.0	0.0
Total Delay	5.3	1.8	13.8	41.3	34.8	33.9
Queue Length 50th (ft)	44	4	477	83	69	66
Queue Length 95th (ft)	82	37	570	132	124	118
Internal Link Dist (ft)	750		688		1585	
Turn Bay Length (ft)		50		525		525
Base Capacity (vph)	3458	1147	3557	534	503	519
Starvation Cap Reductn	0	0	0	0	0	0
Spillback Cap Reductn	0	0	0	0	0	0
Storage Cap Reductn	0	0	0	0	0	0
Reduced v/c Ratio	0.23	0.30	0.68	0.29	0.32	0.31

Intersection Summary

Queues

West Campus Upper Plateau (JN 14064)

29: I-215 NB Ramps & Alessandro Bl.

02/16/2022



Lane Group	EBL	EBT	WBT	WBR	NBL	NBT	NBR
Lane Group Flow (vph)	69	895	1322	80	578	572	145
v/c Ratio	0.46	0.38	0.79	0.15	0.85	0.81	0.22
Control Delay	38.7	11.6	29.6	4.1	40.6	31.6	4.7
Queue Delay	0.0	0.0	0.0	0.0	0.0	0.0	0.0
Total Delay	38.7	11.6	29.6	4.1	40.6	31.6	4.7
Queue Length 50th (ft)	34	83	225	0	307	258	0
Queue Length 95th (ft)	68	81	279	22	#572	#520	41
Internal Link Dist (ft)		688	447			1005	
Turn Bay Length (ft)	200			50	400		400
Base Capacity (vph)	340	3198	1747	549	677	709	664
Starvation Cap Reductn	0	0	0	0	0	0	0
Spillback Cap Reductn	0	0	0	0	0	0	0
Storage Cap Reductn	0	0	0	0	0	0	0
Reduced v/c Ratio	0.20	0.28	0.76	0.15	0.85	0.81	0.22

Intersection Summary

95th percentile volume exceeds capacity, queue may be longer.

Queue shown is maximum after two cycles.



Lane Group	EBT	EBR	WBL	WBT	NBR	SBR
Lane Group Flow (vph)	369	29	643	1354	693	217
v/c Ratio	0.64	0.09	0.87	0.56	0.75	0.74
Control Delay	39.1	0.5	34.0	7.6	6.2	36.0
Queue Delay	0.0	0.0	0.0	0.0	0.0	0.0
Total Delay	39.1	0.5	34.0	7.6	6.2	36.0
Queue Length 50th (ft)	88	0	264	141	0	56
Queue Length 95th (ft)	175	0	#577	278	18	155
Internal Link Dist (ft)	658			918		
Turn Bay Length (ft)						
Base Capacity (vph)	793	424	1115	3052	1036	488
Starvation Cap Reductn	0	0	0	0	0	0
Spillback Cap Reductn	0	0	0	0	0	0
Storage Cap Reductn	0	0	0	0	0	0
Reduced v/c Ratio	0.47	0.07	0.58	0.44	0.67	0.44

Intersection Summary

95th percentile volume exceeds capacity, queue may be longer.
Queue shown is maximum after two cycles.



Lane Group	EBL	EBT	WBT	NBL	NBT	NBR	SBL	SBT
Lane Group Flow (vph)	22	1383	2660	299	312	12	51	120
v/c Ratio	0.45	0.61	1.14	1.15	0.93	0.03	0.55	0.46
Control Delay	43.0	11.7	90.0	146.4	79.8	4.7	65.6	37.8
Queue Delay	0.0	0.0	0.0	0.0	0.0	0.0	0.0	0.0
Total Delay	43.0	11.7	90.0	146.4	79.8	4.7	65.6	37.8
Queue Length 50th (ft)	7	276	~1270	~273	250	0	35	62
Queue Length 95th (ft)	#54	336	#1402	#452	#432	7	#92	125
Internal Link Dist (ft)		310	1149		1221			746
Turn Bay Length (ft)	175			145			100	
Base Capacity (vph)	49	2271	2332	259	337	359	93	260
Starvation Cap Reductn	0	0	0	0	0	0	0	0
Spillback Cap Reductn	0	0	0	0	0	0	0	0
Storage Cap Reductn	0	0	0	0	0	0	0	0
Reduced v/c Ratio	0.45	0.61	1.14	1.15	0.93	0.03	0.55	0.46

Intersection Summary

~ Volume exceeds capacity, queue is theoretically infinite.

Queue shown is maximum after two cycles.

95th percentile volume exceeds capacity, queue may be longer.

Queue shown is maximum after two cycles.

Queues

32: I-215 SB Ramps & Van Buren Bl.



Lane Group	EBT	EBR	WBL	WBT	SBT	SBR
Lane Group Flow (vph)	545	706	2	970	46	773
v/c Ratio	0.48	0.52	0.02	0.77	0.08	0.59
Control Delay	19.6	3.1	34.5	23.2	14.0	14.9
Queue Delay	0.0	0.0	0.0	0.0	0.0	0.0
Total Delay	19.6	3.1	34.5	23.2	14.0	14.9
Queue Length 50th (ft)	87	0	1	182	10	97
Queue Length 95th (ft)	159	38	8	240	38	233
Internal Link Dist (ft)	2745		429		1115	
Turn Bay Length (ft)	200					
Base Capacity (vph)	1547	1578	133	2156	609	1306
Starvation Cap Reductn	0	0	0	0	0	0
Spillback Cap Reductn	0	0	0	0	0	0
Storage Cap Reductn	0	0	0	0	0	0
Reduced v/c Ratio	0.35	0.45	0.02	0.45	0.08	0.59

Intersection Summary

Queues

33: I-215 NB On/Off Ramp & Van Buren Bl.



Lane Group	EBT	EBR	WBT	NBL	NBR
Lane Group Flow (vph)	35	607	28	1049	5
v/c Ratio	0.10	0.23	0.08	0.37	0.01
Control Delay	19.8	0.2	20.0	2.9	2.2
Queue Delay	0.0	0.0	0.0	0.0	0.0
Total Delay	19.8	0.2	20.0	2.9	2.2
Queue Length 50th (ft)	2	0	2	0	0
Queue Length 95th (ft)	17	0	14	98	2
Internal Link Dist (ft)	669		611	856	
Turn Bay Length (ft)		300			585
Base Capacity (vph)	606	2682	564	3241	1047
Starvation Cap Reductn	0	0	0	0	0
Spillback Cap Reductn	0	0	0	0	0
Storage Cap Reductn	0	0	0	0	0
Reduced v/c Ratio	0.06	0.23	0.05	0.32	0.00

Intersection Summary

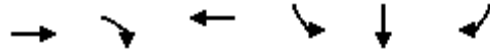

Lane Group	EBT	EBR	WBT	SBL	SBT	SBR
Lane Group Flow (vph)	1363	286	1851	257	244	240
v/c Ratio	0.49	0.31	0.67	0.60	0.61	0.59
Control Delay	10.0	4.9	12.1	27.8	25.5	24.8
Queue Delay	0.0	0.0	0.0	0.0	0.0	0.0
Total Delay	10.0	4.9	12.1	27.8	25.5	24.8
Queue Length 50th (ft)	101	20	159	87	74	70
Queue Length 95th (ft)	189	71	291	191	178	166
Internal Link Dist (ft)	750		688		1585	
Turn Bay Length (ft)		50		525		525
Base Capacity (vph)	3863	1241	3835	732	667	678
Starvation Cap Reductn	0	0	0	0	0	0
Spillback Cap Reductn	0	0	0	0	0	0
Storage Cap Reductn	0	0	0	0	0	0
Reduced v/c Ratio	0.35	0.23	0.48	0.35	0.37	0.35

Intersection Summary

Queues

West Campus Upper Plateau (JN 14064)

29: I-215 NB Ramps & Alessandro Bl.

02/16/2022



Lane Group	EBL	EBT	WBT	WBR	NBL	NBT	NBR
Lane Group Flow (vph)	100	1665	1062	119	461	467	258
v/c Ratio	0.61	0.71	0.63	0.23	0.68	0.72	0.38
Control Delay	52.1	19.0	24.8	7.7	26.8	28.6	12.5
Queue Delay	0.0	0.0	0.0	0.0	0.0	0.0	0.0
Total Delay	52.1	19.0	24.8	7.7	26.8	28.6	12.5
Queue Length 50th (ft)	49	229	168	8	196	210	53
Queue Length 95th (ft)	#116	279	213	44	342	#403	125
Internal Link Dist (ft)		688	447			1005	
Turn Bay Length (ft)	200			50	400		400
Base Capacity (vph)	179	2755	1912	586	679	651	674
Starvation Cap Reductn	0	0	0	0	0	0	0
Spillback Cap Reductn	0	0	0	0	0	0	0
Storage Cap Reductn	0	0	0	0	0	0	0
Reduced v/c Ratio	0.56	0.60	0.56	0.20	0.68	0.72	0.38

Intersection Summary

95th percentile volume exceeds capacity, queue may be longer.

Queue shown is maximum after two cycles.

Queues
30: I-215 SB Ramps & Cactus Av.



Lane Group	EBT	EBR	WBL	WBT	NBR	SBR
Lane Group Flow (vph)	731	137	509	1033	575	265
v/c Ratio	0.75	0.26	0.82	0.42	0.74	0.75
Control Delay	32.6	6.7	36.7	5.9	8.5	30.0
Queue Delay	0.0	0.0	0.0	0.0	0.0	0.0
Total Delay	32.6	6.7	36.7	5.9	8.5	30.0
Queue Length 50th (ft)	165	0	214	87	0	51
Queue Length 95th (ft)	307	45	#440	181	57	157
Internal Link Dist (ft)	658			918		
Turn Bay Length (ft)						
Base Capacity (vph)	1410	706	954	3090	917	561
Starvation Cap Reductn	0	0	0	0	0	0
Spillback Cap Reductn	0	0	0	0	0	0
Storage Cap Reductn	0	0	0	0	0	0
Reduced v/c Ratio	0.52	0.19	0.53	0.33	0.63	0.47

Intersection Summary

95th percentile volume exceeds capacity, queue may be longer.
Queue shown is maximum after two cycles.



Lane Group	EBL	EBT	WBT	NBL	NBT	NBR	SBL	SBT
Lane Group Flow (vph)	52	1477	1898	120	227	3	173	167
v/c Ratio	0.55	0.72	0.91	0.47	0.55	0.01	0.80	0.42
Control Delay	37.8	13.3	21.9	33.1	31.9	0.0	56.6	25.8
Queue Delay	0.0	0.0	0.0	0.0	0.0	0.0	0.0	0.0
Total Delay	37.8	13.3	21.9	33.1	31.9	0.0	56.6	25.8
Queue Length 50th (ft)	15	255	412	53	108	0	84	63
Queue Length 95th (ft)	#78	342	#597	105	181	0	#185	120
Internal Link Dist (ft)		310	1149		1221			746
Turn Bay Length (ft)	175			145			100	
Base Capacity (vph)	110	2397	2428	329	532	493	277	502
Starvation Cap Reductn	0	0	0	0	0	0	0	0
Spillback Cap Reductn	0	0	0	0	0	0	0	0
Storage Cap Reductn	0	0	0	0	0	0	0	0
Reduced v/c Ratio	0.47	0.62	0.78	0.36	0.43	0.01	0.62	0.33

Intersection Summary

95th percentile volume exceeds capacity, queue may be longer.
Queue shown is maximum after two cycles.

Queues

West Campus Upper Plateau (JN 14064)

32: I-215 SB Ramps & Van Buren Bl.

02/16/2022



Lane Group	EBT	EBR	WBL	WBT	SBT	SBR
Lane Group Flow (vph)	477	1725	3	857	103	206
v/c Ratio	0.26	0.87	0.02	0.43	0.35	0.36
Control Delay	5.9	9.0	31.7	5.8	30.7	7.6
Queue Delay	0.0	0.0	0.0	0.0	0.0	0.0
Total Delay	5.9	9.0	31.7	5.8	30.7	7.6
Queue Length 50th (ft)	28	51	1	58	26	0
Queue Length 95th (ft)	72	230	10	78	#121	34
Internal Link Dist (ft)	2745			429	1115	
Turn Bay Length (ft)			200			
Base Capacity (vph)	3051	2623	141	3246	295	580
Starvation Cap Reductn	0	0	0	0	0	0
Spillback Cap Reductn	0	0	0	0	0	0
Storage Cap Reductn	0	0	0	0	0	0
Reduced v/c Ratio	0.16	0.66	0.02	0.26	0.35	0.36

Intersection Summary

95th percentile volume exceeds capacity, queue may be longer.

Queue shown is maximum after two cycles.

Queues

33: I-215 NB On/Off Ramp & Van Buren Bl.



Lane Group	EBT	EBR	WBT	NBL	NBR
Lane Group Flow (vph)	4	523	22	799	4
v/c Ratio	0.01	0.20	0.04	0.26	0.00
Control Delay	21.5	0.2	20.6	1.1	1.0
Queue Delay	0.0	0.0	0.0	0.0	0.0
Total Delay	21.5	0.2	20.6	1.1	1.0
Queue Length 50th (ft)	0	0	1	0	0
Queue Length 95th (ft)	5	0	14	62	2
Internal Link Dist (ft)	669		611	856	
Turn Bay Length (ft)		300			585
Base Capacity (vph)	968	2608	880	3132	1021
Starvation Cap Reductn	0	0	0	0	0
Spillback Cap Reductn	0	0	0	0	0
Storage Cap Reductn	0	0	0	0	0
Reduced v/c Ratio	0.00	0.20	0.03	0.26	0.00

Intersection Summary

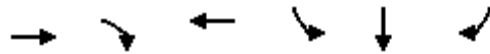

Lane Group	EBT	EBR	WBT	SBL	SBT	SBR
Lane Group Flow (vph)	792	320	1130	117	140	137
v/c Ratio	0.31	0.34	0.45	0.34	0.37	0.36
Control Delay	6.3	2.2	6.9	16.2	9.7	9.2
Queue Delay	0.0	0.0	0.0	0.0	0.0	0.0
Total Delay	6.3	2.2	6.9	16.2	9.7	9.2
Queue Length 50th (ft)	30	1	45	17	7	6
Queue Length 95th (ft)	59	27	86	68	52	48
Internal Link Dist (ft)	750		688		1585	
Turn Bay Length (ft)		50		525		525
Base Capacity (vph)	4970	1554	4857	1140	1021	1054
Starvation Cap Reductn	0	0	0	0	0	0
Spillback Cap Reductn	0	0	0	0	0	0
Storage Cap Reductn	0	0	0	0	0	0
Reduced v/c Ratio	0.16	0.21	0.23	0.10	0.14	0.13

Intersection Summary

Queues

29: I-215 NB Ramps & Alessandro Bl.

09/29/2022



Lane Group	EBL	EBT	WBT	WBR	NBL	NBT	NBR
Lane Group Flow (vph)	172	745	868	141	238	234	206
v/c Ratio	0.93	0.33	0.63	0.32	0.34	0.35	0.29
Control Delay	88.6	14.2	26.5	11.6	17.8	17.4	6.3
Queue Delay	0.0	0.0	0.0	0.0	0.0	0.0	0.0
Total Delay	88.6	14.2	26.5	11.6	17.8	17.4	6.3
Queue Length 50th (ft)	82	80	131	20	76	76	14
Queue Length 95th (ft)	#220	106	169	61	155	158	64
Internal Link Dist (ft)		688	447			1005	
Turn Bay Length (ft)	200			50	400		400
Base Capacity (vph)	185	2844	1974	595	701	673	722
Starvation Cap Reductn	0	0	0	0	0	0	0
Spillback Cap Reductn	0	0	0	0	0	0	0
Storage Cap Reductn	0	0	0	0	0	0	0
Reduced v/c Ratio	0.93	0.26	0.44	0.24	0.34	0.35	0.29

Intersection Summary

95th percentile volume exceeds capacity, queue may be longer.
 Queue shown is maximum after two cycles.

Queues

30: I-215 SB Ramps & Cactus Av.



Lane Group	EBT	EBR	WBL	WBT	NBR	SBR
Lane Group Flow (vph)	311	30	371	389	349	64
v/c Ratio	0.43	0.08	0.66	0.17	0.42	0.10
Control Delay	17.6	2.7	19.1	3.2	1.5	0.3
Queue Delay	0.0	0.0	0.0	0.0	0.0	0.0
Total Delay	17.6	2.7	19.1	3.2	1.5	0.3
Queue Length 50th (ft)	34	0	75	15	0	0
Queue Length 95th (ft)	70	7	148	24	0	0
Internal Link Dist (ft)	658			918		
Turn Bay Length (ft)						
Base Capacity (vph)	2360	1065	1569	3539	1162	1016
Starvation Cap Reductn	0	0	0	0	0	0
Spillback Cap Reductn	0	0	0	0	0	0
Storage Cap Reductn	0	0	0	0	0	0
Reduced v/c Ratio	0.13	0.03	0.24	0.11	0.30	0.06

Intersection Summary

Queues

31: I-215 NB Ramps/Old 215 Frontage Rd. & Cactus Av.



Lane Group	EBL	EBT	WBT	NBL	NBT	NBR	SBL	SBT
Lane Group Flow (vph)	15	627	1158	38	66	3	109	62
v/c Ratio	0.06	0.30	0.54	0.16	0.19	0.01	0.42	0.17
Control Delay	6.2	5.9	7.6	18.4	17.9	0.0	22.6	7.5
Queue Delay	0.0	0.0	0.0	0.0	0.0	0.0	0.0	0.0
Total Delay	6.2	5.9	7.6	18.4	17.9	0.0	22.6	7.5
Queue Length 50th (ft)	1	37	83	7	12	0	20	0
Queue Length 95th (ft)	9	77	167	34	52	0	78	27
Internal Link Dist (ft)		310	1149		1221			746
Turn Bay Length (ft)	175			145			100	
Base Capacity (vph)	361	3249	3294	669	964	861	716	910
Starvation Cap Reductn	0	0	0	0	0	0	0	0
Spillback Cap Reductn	0	0	0	0	0	0	0	0
Storage Cap Reductn	0	0	0	0	0	0	0	0
Reduced v/c Ratio	0.04	0.19	0.35	0.06	0.07	0.00	0.15	0.07

Intersection Summary

Queues

West Campus Upper Plateau (JN 14064)

32: I-215 SB Ramps & Van Buren Bl.

09/29/2022



Lane Group	EBT	EBR	WBL	WBT	SBT	SBR
Lane Group Flow (vph)	446	557	13	527	20	522
v/c Ratio	0.40	0.43	0.06	0.41	0.06	0.52
Control Delay	9.5	2.1	19.6	7.9	16.6	4.6
Queue Delay	0.0	0.0	0.0	0.0	0.0	0.0
Total Delay	9.5	2.1	19.6	7.9	16.6	4.6
Queue Length 50th (ft)	26	0	2	32	2	0
Queue Length 95th (ft)	72	22	19	48	24	42
Internal Link Dist (ft)	2745			429	1115	
Turn Bay Length (ft)			200			
Base Capacity (vph)	3236	2709	211	3406	354	1003
Starvation Cap Reductn	0	0	0	0	0	0
Spillback Cap Reductn	0	0	0	0	0	0
Storage Cap Reductn	0	0	0	0	0	0
Reduced v/c Ratio	0.14	0.21	0.06	0.15	0.06	0.52
Intersection Summary						



Lane Group	EBR	NBL
Lane Group Flow (vph)	16	1
v/c Ratio	0.01	0.00
Control Delay	0.0	0.0
Queue Delay	0.0	0.0
Total Delay	0.0	0.0
Queue Length 50th (ft)	0	0
Queue Length 95th (ft)	0	0
Internal Link Dist (ft)		856
Turn Bay Length (ft)	300	
Base Capacity (vph)	2608	3303
Starvation Cap Reductn	0	0
Spillback Cap Reductn	0	0
Storage Cap Reductn	0	0
Reduced v/c Ratio	0.01	0.00
Intersection Summary		

APPENDIX 4.1:

POST-PROCESS WORKSHEETS

This Page Intentionally Left Blank

Project: West Campus Upper Plateau
 Scenario: Horizon Year (2045) With Project

Job #: 14064
 Analyst: MT
 Date: 2/14/22

LOCATION: Washington St. & Van Buren Blvd.
 FORECAST YEAR: 2045

INDIVIDUAL TURN VOLUME GROWTH REVIEW									
APPROACH	TURNING MOVEMENT	AM PEAK HOUR INPUT DATA				PM PEAK HOUR INPUT DATA			
		EXISTING COUNT	FUTURE VOLUME	DIFF-ERENCE	% CHANGE	EXISTING COUNT	FUTURE VOLUME	DIFF-ERENCE	% CHANGE
NORTH BOUND	Left	136	328	192	141%	98	146	48	49%
	Through	509	1,169	660	130%	240	323	83	35%
	Right	116	224	108	93%	92	105	13	14%
	NB Total	761	1,721	960	126%	430	574	144	34%
SOUTH BOUND	Left	315	330	15	5%	482	432	-50	-10%
	Through	176	227	51	29%	346	587	241	70%
	Right	62	81	19	30%	92	107	15	17%
	SB Total	554	638	84	15%	919	1,126	207	22%
EAST BOUND	Left	131	174	43	32%	133	171	38	28%
	Through	985	1,098	113	11%	1,278	1,393	115	9%
	Right	120	165	45	38%	79	163	84	106%
	EB Total	1,236	1,437	201	16%	1,490	1,727	237	16%
WEST BOUND	Left	91	99	8	8%	161	260	99	61%
	Through	1,293	1,414	121	9%	1,007	1,118	111	11%
	Right	568	591	23	4%	372	375	3	1%
	WB Total	1,953	2,104	151	8%	1,540	1,753	213	14%
TOTAL ENTERING VOLUME		4,503	5,900	1396.84928	31%	4,380	5,180	800	18%

FORECAST PEAK HOUR TO ADT COMPARISON						
		VOLUMES		PERCENT OF ADT		ADT
		AM	PM	AM	PM	
North Leg	Inbound	638	1,126			
North Leg	Outbound	1,934	869			
North Leg	TOTAL	2,572	1,995	11%	9%	22,432
South Leg	Inbound	1,721	574			
South Leg	Outbound	491	1,010			
South Leg	TOTAL	2,212	1,584	11%	8%	19,578
East Leg	Inbound	2,104	1,753			
East Leg	Outbound	1,652	1,930			
East Leg	TOTAL	3,756	3,683	10%	10%	38,156
West Leg	Inbound	1,437	1,727			
West Leg	Outbound	1,823	1,371			
West Leg	TOTAL	3,260	3,098	10%	10%	32,236
OVERALL TOTAL		11,800	10,360	10%	9%	112,403

Z:\Shared\UcJobs\13600-14000\14000\14064\02_LOS\Post Processing\01_Washington St_Van Buren Blvd.xls]Output (3)

Project: West Campus Upper Plateau
 Scenario: Horizon Year (2045) With Project

Job #: 14064
 Analyst: MT
 Date: 2/14/22

LOCATION: Alessandro Blvd. & Arlington Av./Chicago Av.
 FORECAST YEAR: 2045

INDIVIDUAL TURN VOLUME GROWTH REVIEW									
APPROACH	TURNING MOVEMENT	AM PEAK HOUR INPUT DATA				PM PEAK HOUR INPUT DATA			
		EXISTING COUNT	FUTURE VOLUME	DIFF-ERENCE	% CHANGE	EXISTING COUNT	FUTURE VOLUME	DIFF-ERENCE	% CHANGE
NORTH BOUND	Left	1,225	1,172	-53	-4%	783	746	-37	-5%
	Through	1,522	1,489	-33	-2%	1,013	999	-14	-1%
	Right	448	537	89	20%	227	299	72	32%
	NB Total	3,196	3,198	2	0%	2,024	2,044	20	1%
SOUTH BOUND	Left	225	255	30	13%	486	581	95	19%
	Through	598	587	-11	-2%	1,624	1,646	22	1%
	Right	42	38	-4	-10%	20	18	-2	-11%
	SB Total	865	880	15	2%	2,130	2,245	115	5%
EAST BOUND	Left	41	37	-4	-10%	25	20	-5	-18%
	Through	491	539	48	10%	731	810	79	11%
	Right	595	565	-30	-5%	1,007	948	-59	-6%
	EB Total	1,127	1,141	14	1%	1,762	1,778	16	1%
WEST BOUND	Left	182	219	37	20%	527	656	129	24%
	Through	812	903	91	11%	656	696	40	6%
	Right	322	367	45	14%	210	231	21	10%
	WB Total	1,316	1,489	173	13%	1,393	1,583	190	14%
TOTAL ENTERING VOLUME		6,504	6,708	204.230759	3%	7,309	7,650	341	5%

FORECAST PEAK HOUR TO ADT COMPARISON						
		VOLUMES		PERCENT OF ADT		ADT
		AM	PM	AM	PM	
North Leg	Inbound	880	2,245			
North Leg	Outbound	1,893	1,250			
North Leg	TOTAL	2,773	3,495	8%	10%	36,144
South Leg	Inbound	3,198	2,044			
South Leg	Outbound	1,371	3,250			
South Leg	TOTAL	4,569	5,294	8%	10%	54,864
East Leg	Inbound	1,489	1,583			
East Leg	Outbound	1,331	1,690			
East Leg	TOTAL	2,820	3,273	8%	9%	35,305
West Leg	Inbound	1,141	1,778			
West Leg	Outbound	2,113	1,460			
West Leg	TOTAL	3,254	3,238	10%	10%	33,122
OVERALL TOTAL		13,416	15,300	8%	10%	159,435

Z:\Shared\UcJobs\13600-14000\14000\14064\02_LOS\Post Processing\02_Alessandro Blvd_Arlington Av_Chicago Av.xls]Output (3)

Project: West Campus Upper Plateau
 Scenario: Horizon Year (2045) With Project

Job #: 14064
 Analyst: MT
 Date: 2/14/22

LOCATION: Overlook Pkwy./Canyon Crest Dr. & Alessandro Bl.
 FORECAST YEAR: 2045

INDIVIDUAL TURN VOLUME GROWTH REVIEW									
APPROACH	TURNING MOVEMENT	AM PEAK HOUR INPUT DATA				PM PEAK HOUR INPUT DATA			
		EXISTING COUNT	FUTURE VOLUME	DIFF-ERENCE	% CHANGE	EXISTING COUNT	FUTURE VOLUME	DIFF-ERENCE	% CHANGE
NORTH BOUND	Left	5	28	23	512%	13	87	74	569%
	Through	10	60	50	482%	6	47	41	683%
	Right	2	80	78	3395%	8	240	232	2900%
	NB Total	17	168	151	879%	27	374	347	1285%
SOUTH BOUND	Left	449	576	127	28%	547	584	37	7%
	Through	6	50	44	774%	11	78	67	609%
	Right	49	11	-38	-78%	23	5	-18	-78%
	SB Total	504	637	133	26%	581	667	86	15%
EAST BOUND	Left	38	7	-31	-81%	52	14	-38	-73%
	Through	1,313	1,564	251	19%	2,826	2,956	130	5%
	Right	1	9	8	686%	16	111	95	594%
	EB Total	1,352	1,580	228	17%	2,894	3,081	187	6%
WEST BOUND	Left	2	91	89	3876%	5	149	144	2880%
	Through	3,114	3,132	18	1%	2,103	2,100	-3	0%
	Right	1,016	992	-24	-2%	599	697	98	16%
	WB Total	4,133	4,215	82	2%	2,707	2,946	239	9%
TOTAL ENTERING VOLUME		6,005	6,600	594.8112	10%	6,209	7,068	859	14%

FORECAST PEAK HOUR TO ADT COMPARISON						
		VOLUMES		PERCENT OF ADT		ADT
		AM	PM	AM	PM	
North Leg	Inbound	637	667			
North Leg	Outbound	1,059	758			
North Leg	TOTAL	1,696	1,425	12%	10%	14,286
South Leg	Inbound	168	374			
South Leg	Outbound	150	338			
South Leg	TOTAL	318	712	4%	10%	7,434
East Leg	Inbound	4,215	2,946			
East Leg	Outbound	2,220	3,780			
East Leg	TOTAL	6,435	6,726	8%	8%	79,373
West Leg	Inbound	1,580	3,081			
West Leg	Outbound	3,171	2,192			
West Leg	TOTAL	4,751	5,273	9%	10%	54,003
OVERALL TOTAL		13,200	14,136	9%	9%	155,096

Z:\Shared\UcJobs\13600-14000\14000\14064\02_LOS\Post Processing\03 Overlook Pkwy_Canyon Crest_Alessandro.xls)Output (3)

Project: West Campus Upper Plateau
 Scenario: Horizon Year (2045) With Project

Job #: 14064
 Analyst: MT
 Date: 2/14/22

LOCATION: Wood Rd. & Van Buren Blvd.
 FORECAST YEAR: 2045

INDIVIDUAL TURN VOLUME GROWTH REVIEW									
APPROACH	TURNING MOVEMENT	AM PEAK HOUR INPUT DATA				PM PEAK HOUR INPUT DATA			
		EXISTING COUNT	FUTURE VOLUME	DIFF-ERENCE	% CHANGE	EXISTING COUNT	FUTURE VOLUME	DIFF-ERENCE	% CHANGE
NORTH BOUND	Left	323	387	64	20%	285	336	51	18%
	Through	416	471	55	13%	237	322	85	36%
	Right	283	342	59	21%	186	166	-20	-11%
	NB Total	1,023	1,200	177	17%	708	824	116	16%
SOUTH BOUND	Left	83	133	50	60%	82	80	-2	-2%
	Through	416	550	134	32%	241	303	62	26%
	Right	162	257	95	58%	185	240	55	30%
	SB Total	662	940	278	42%	508	623	115	23%
EAST BOUND	Left	146	181	35	24%	153	236	83	54%
	Through	823	1,091	268	33%	1,297	1,314	17	1%
	Right	317	348	31	10%	197	254	57	29%
	EB Total	1,286	1,620	334	26%	1,647	1,804	157	10%
WEST BOUND	Left	439	383	-56	-13%	210	243	33	15%
	Through	1,143	1,196	53	5%	1,158	1,384	226	20%
	Right	102	100	-2	-2%	82	113	31	38%
	WB Total	1,684	1,679	-5	0%	1,450	1,740	290	20%
TOTAL ENTERING VOLUME		4,654	5,439	785.2908	17%	4,312	4,991	679	16%

FORECAST PEAK HOUR TO ADT COMPARISON						
		VOLUMES		PERCENT OF ADT		ADT
		AM	PM	AM	PM	
North Leg	Inbound	940	623			
North Leg	Outbound	752	671			
North Leg	TOTAL	1,692	1,294	10%	8%	16,530
South Leg	Inbound	1,200	824			
South Leg	Outbound	1,281	800			
South Leg	TOTAL	2,481	1,624	14%	9%	17,522
East Leg	Inbound	1,679	1,740			
East Leg	Outbound	1,566	1,560			
East Leg	TOTAL	3,245	3,300	10%	10%	33,170
West Leg	Inbound	1,620	1,804			
West Leg	Outbound	1,840	1,960			
West Leg	TOTAL	3,460	3,764	9%	10%	38,419
OVERALL TOTAL		10,878	9,982	10%	9%	105,640

Z:\Shared\UcJobs\13600-14000\14000\14064\02_LOS\Post Processing\[04_Wood Rd_Van Buren Blvd.xls]Output (3)

Project: West Campus Upper Plateau
 Scenario: Horizon Year (2045) With Project

Job #: 14064
 Analyst: MT
 Date: 2/14/22

LOCATION: Trautwein Rd. & Alessandro Blvd.
 FORECAST YEAR: 2045

INDIVIDUAL TURN VOLUME GROWTH REVIEW									
APPROACH	TURNING MOVEMENT	AM PEAK HOUR INPUT DATA				PM PEAK HOUR INPUT DATA			
		EXISTING COUNT	FUTURE VOLUME	DIFF-ERENCE	% CHANGE	EXISTING COUNT	FUTURE VOLUME	DIFF-ERENCE	% CHANGE
NORTH BOUND	Left	1,847	1,932	85	5%	893	983	90	10%
	Through	0	0	0	#DIV/0!	0	0	0	#DIV/0!
	Right	7	12	5	67%	11	20	9	82%
	NB Total	1,854	1,944	90	5%	904	1,003	99	11%
SOUTH BOUND	Left	0	0	0	#DIV/0!	0	0	0	#DIV/0!
	Through	0	0	0	#DIV/0!	0	0	0	#DIV/0!
	Right	0	0	0	#DIV/0!	0	0	0	#DIV/0!
	SB Total	0	0	0	#DIV/0!	0	0	0	#DIV/0!
EAST BOUND	Left	0	0	0	#DIV/0!	0	0	0	#DIV/0!
	Through	1,015	1,358	343	34%	1,782	2,150	368	21%
	Right	4	3	-1	-16%	17	10	-7	-41%
	EB Total	1,019	1,361	342	34%	1,799	2,160	361	20%
WEST BOUND	Left	157	177	20	13%	234	240	6	3%
	Through	3,031	3,218	187	6%	1,882	2,267	385	20%
	Right	0	0	0	#DIV/0!	0	0	0	#DIV/0!
	WB Total	3,187	3,395	208	7%	2,116	2,507	391	18%
TOTAL ENTERING VOLUME		6,060	6,700	640.058311	11%	4,819	5,670	851	18%

FORECAST PEAK HOUR TO ADT COMPARISON						
		VOLUMES		PERCENT OF ADT		ADT
		AM	PM	AM	PM	
North Leg	Inbound	0	0			
North Leg	Outbound	0	0			
North Leg	TOTAL	0	0	#DIV/0!	#DIV/0!	#DIV/0!
South Leg	Inbound	1,944	1,003			
South Leg	Outbound	180	250			
South Leg	TOTAL	2,124	1,253	16%	9%	13,533
East Leg	Inbound	3,395	2,507			
East Leg	Outbound	1,370	2,170			
East Leg	TOTAL	4,765	4,677	8%	8%	58,023
West Leg	Inbound	1,361	2,160			
West Leg	Outbound	5,150	3,250			
West Leg	TOTAL	6,511	5,410	11%	9%	59,637
OVERALL TOTAL		13,400	11,340	#DIV/0!	#DIV/0!	#DIV/0!

Z:\Shared\UcJobs\13600-14000\14000\14064\02_LOS\Post Processing\05_Trautwein Rd_Alessandro Blvd.xls]Output (3)

Project: West Campus Upper Plateau
 Scenario: Horizon Year (2045) With Project

Job #: 14064
 Analyst: MT
 Date: 2/14/22

LOCATION: Trautwein Rd. & Orange Terrace Pkwy.
 FORECAST YEAR: 2045

INDIVIDUAL TURN VOLUME GROWTH REVIEW									
APPROACH	TURNING MOVEMENT	AM PEAK HOUR INPUT DATA				PM PEAK HOUR INPUT DATA			
		EXISTING COUNT	FUTURE VOLUME	DIFF-ERENCE	% CHANGE	EXISTING COUNT	FUTURE VOLUME	DIFF-ERENCE	% CHANGE
NORTH BOUND	Left	48	17	-31	-65%	31	14	-17	-55%
	Through	974	996	22	2%	716	771	55	8%
	Right	239	247	8	3%	208	397	189	90%
	NB Total	1,262	1,260	-2	0%	955	1,182	227	24%
SOUTH BOUND	Left	382	354	-28	-7%	333	576	243	73%
	Through	579	602	23	4%	1,050	928	-122	-12%
	Right	20	25	5	26%	40	21	-19	-47%
	SB Total	982	981	-1	0%	1,423	1,525	102	7%
EAST BOUND	Left	67	38	-29	-43%	45	17	-28	-62%
	Through	63	85	22	34%	46	77	31	66%
	Right	12	16	4	29%	12	14	2	15%
	EB Total	143	139	-4	-3%	104	108	4	4%
WEST BOUND	Left	288	350	62	22%	148	268	120	81%
	Through	99	129	30	30%	24	55	31	127%
	Right	485	831	346	71%	163	322	159	97%
	WB Total	872	1,310	438	50%	335	645	310	92%
TOTAL ENTERING VOLUME		3,259	3,690	431.4672	13%	2,817	3,460	643	23%

FORECAST PEAK HOUR TO ADT COMPARISON						
		VOLUMES		PERCENT OF ADT		ADT
		AM	PM	AM	PM	
North Leg	Inbound	981	1,525			
North Leg	Outbound	1,865	1,110			
North Leg	TOTAL	2,846	2,635	8%	8%	34,057
South Leg	Inbound	1,260	1,182			
South Leg	Outbound	968	1,210			
South Leg	TOTAL	2,228	2,392	8%	9%	28,062
East Leg	Inbound	1,310	645			
East Leg	Outbound	686	1,050			
East Leg	TOTAL	1,996	1,695	11%	9%	18,352
West Leg	Inbound	139	108			
West Leg	Outbound	171	90			
West Leg	TOTAL	310	198	#DIV/0!	#DIV/0!	-
OVERALL TOTAL		7,380	6,920	9%	9%	80,471

Z:\Shared\UcJobs\13600-14000\14000\14064\02_LOS\Post Processing\07_Trautwein Rd_Orange Terrace Pkwy.xls]Output (3)

Project: West Campus Upper Plateau
 Scenario: Horizon Year (2045) With Project

Job #: 14064
 Analyst: MT
 Date: 2/14/22

LOCATION: Trautwein Rd. & Van Buren Blvd.
 FORECAST YEAR: 2045

INDIVIDUAL TURN VOLUME GROWTH REVIEW									
APPROACH	TURNING MOVEMENT	AM PEAK HOUR INPUT DATA				PM PEAK HOUR INPUT DATA			
		EXISTING COUNT	FUTURE VOLUME	DIFF-ERENCE	% CHANGE	EXISTING COUNT	FUTURE VOLUME	DIFF-ERENCE	% CHANGE
NORTH BOUND	Left	215	176	-39	-18%	89	104	15	17%
	Through	535	493	-42	-8%	284	299	15	5%
	Right	100	91	-9	-9%	46	62	16	35%
	NB Total	851	760	-91	-11%	419	465	46	11%
SOUTH BOUND	Left	176	180	4	2%	287	437	150	52%
	Through	329	373	44	13%	508	480	-28	-6%
	Right	226	208	-18	-8%	215	288	73	34%
	SB Total	731	761	30	4%	1,010	1,205	195	19%
EAST BOUND	Left	301	385	84	28%	317	286	-31	-10%
	Through	884	1,116	232	26%	959	1,101	142	15%
	Right	92	130	38	41%	100	71	-29	-29%
	EB Total	1,278	1,631	353	28%	1,376	1,458	82	6%
WEST BOUND	Left	142	202	60	43%	118	99	-19	-16%
	Through	1,214	1,404	190	16%	990	1,178	188	19%
	Right	332	433	101	30%	248	265	17	7%
	WB Total	1,688	2,039	351	21%	1,356	1,542	186	14%
TOTAL ENTERING VOLUME		4,547	5,191	644.452	14%	4,161	4,670	509	12%

FORECAST PEAK HOUR TO ADT COMPARISON						
		VOLUMES		PERCENT OF ADT		ADT
		AM	PM	AM	PM	
North Leg	Inbound	761	1,205			
North Leg	Outbound	1,311	850			
North Leg	TOTAL	2,072	2,055	10%	10%	20,771
South Leg	Inbound	760	465			
South Leg	Outbound	705	650			
South Leg	TOTAL	1,465	1,115	14%	10%	10,728
East Leg	Inbound	2,039	1,542			
East Leg	Outbound	1,387	1,600			
East Leg	TOTAL	3,426	3,142	10%	10%	32,864
West Leg	Inbound	1,631	1,458			
West Leg	Outbound	1,788	1,570			
West Leg	TOTAL	3,419	3,028	11%	10%	31,228
OVERALL TOTAL		10,382	9,340	11%	10%	95,591

Z:\Shared\UcJobs\13600-14000\14000\14064\02_LOS\Post Processing\08_Trautwein Rd_Van Buren Blvd.xls]Output (3)

Project: West Campus Upper Plateau
 Scenario: Horizon Year (2045) With Project

Job #: 14064
 Analyst: MT
 Date: 2/14/22

LOCATION: Barton St. & Orange Terrace Pkwy.
 FORECAST YEAR: 2045

INDIVIDUAL TURN VOLUME GROWTH REVIEW									
APPROACH	TURNING MOVEMENT	AM PEAK HOUR INPUT DATA				PM PEAK HOUR INPUT DATA			
		EXISTING COUNT	FUTURE VOLUME	DIFF-ERENCE	% CHANGE	EXISTING COUNT	FUTURE VOLUME	DIFF-ERENCE	% CHANGE
NORTH BOUND	Left	197	198	1	1%	65	36	-29	-45%
	Through	0	0	0	#DIV/0!	0	0	0	#DIV/0!
	Right	33	7	-26	-79%	39	16	-23	-59%
	NB Total	230	205	-25	-11%	105	52	-53	-50%
SOUTH BOUND	Left	0	0	0	#DIV/0!	0	0	0	#DIV/0!
	Through	0	0	0	#DIV/0!	0	0	0	#DIV/0!
	Right	0	0	0	#DIV/0!	0	0	0	#DIV/0!
	SB Total	0	0	0	#DIV/0!	0	0	0	#DIV/0!
EAST BOUND	Left	0	0	0	#DIV/0!	0	0	0	#DIV/0!
	Through	269	291	22	8%	370	394	24	6%
	Right	238	138	-100	-42%	80	43	-37	-46%
	EB Total	507	429	-78	-15%	450	437	-13	-3%
WEST BOUND	Left	45	6	-39	-87%	41	17	-24	-58%
	Through	396	470	74	19%	221	244	23	10%
	Right	0	0	0	#DIV/0!	0	0	0	#DIV/0!
	WB Total	441	476	35	8%	262	261	-1	0%
TOTAL ENTERING VOLUME		1,177	1,110	-67.2135861	-6%	817	750	-67	-8%

FORECAST PEAK HOUR TO ADT COMPARISON						
		VOLUMES		PERCENT OF ADT		ADT
		AM	PM	AM	PM	
North Leg	Inbound	0	0			
North Leg	Outbound	0	0			
North Leg	TOTAL	0	0	#DIV/0!	#DIV/0!	#DIV/0!
South Leg	Inbound	205	52			
South Leg	Outbound	144	60			
South Leg	TOTAL	349	112	35%	11%	1,000
East Leg	Inbound	476	261			
East Leg	Outbound	298	410			
East Leg	TOTAL	774	671	12%	10%	6,450
West Leg	Inbound	429	437			
West Leg	Outbound	668	280			
West Leg	TOTAL	1,097	717	16%	10%	7,067
OVERALL TOTAL		2,220	1,500	#DIV/0!	#DIV/0!	#DIV/0!

Z:\Shared\UcJobs\13600-14000\14000\14064\02_LOS\Post Processing\[13_Barton St_Orange Terrace Pkwy.xls]Output (3)

Project: West Campus Upper Plateau
 Scenario: Horizon Year (2045) With Project

Job #: 14064
 Analyst: MT
 Date: 2/14/22

LOCATION: Barton St. & Van Buren Blvd.
 FORECAST YEAR: 2045

INDIVIDUAL TURN VOLUME GROWTH REVIEW									
APPROACH	TURNING MOVEMENT	AM PEAK HOUR INPUT DATA				PM PEAK HOUR INPUT DATA			
		EXISTING COUNT	FUTURE VOLUME	DIFF-ERENCE	% CHANGE	EXISTING COUNT	FUTURE VOLUME	DIFF-ERENCE	% CHANGE
NORTH BOUND	Left	358	606	248	69%	209	321	112	54%
	Through	73	43	-30	-41%	61	23	-38	-62%
	Right	345	343	-2	-1%	212	252	40	19%
	NB Total	775	992	217	28%	482	596	114	24%
SOUTH BOUND	Left	46	17	-29	-63%	16	7	-9	-56%
	Through	95	72	-23	-24%	27	15	-12	-44%
	Right	278	175	-103	-37%	82	48	-34	-41%
	SB Total	419	264	-155	-37%	125	70	-55	-44%
EAST BOUND	Left	135	98	-37	-27%	100	38	-62	-62%
	Through	1,022	1,250	228	22%	1,100	1,301	201	18%
	Right	104	261	157	151%	218	322	104	48%
	EB Total	1,261	1,609	348	28%	1,418	1,661	243	17%
WEST BOUND	Left	250	307	57	23%	255	292	37	15%
	Through	1,233	1,259	26	2%	1,114	1,320	206	18%
	Right	25	9	-16	-63%	32	9	-23	-72%
	WB Total	1,508	1,575	67	4%	1,401	1,621	220	16%
TOTAL ENTERING VOLUME		3,963	4,440	477.1164	12%	3,426	3,948	522	15%

FORECAST PEAK HOUR TO ADT COMPARISON						
		VOLUMES		PERCENT OF ADT		ADT
		AM	PM	AM	PM	
North Leg	Inbound	264	70			
North Leg	Outbound	150	70			
North Leg	TOTAL	414	140	43%	14%	969
South Leg	Inbound	992	596			
South Leg	Outbound	640	629			
South Leg	TOTAL	1,632	1,225	4%	3%	41,438
East Leg	Inbound	1,575	1,621			
East Leg	Outbound	1,610	1,560			
East Leg	TOTAL	3,185	3,181	9%	9%	35,639
West Leg	Inbound	1,609	1,661			
West Leg	Outbound	2,040	1,689			
West Leg	TOTAL	3,649	3,350	10%	9%	37,623
OVERALL TOTAL		8,880	7,896	8%	7%	115,669

Z:\Shared\UcJobs\13600-14000\14000\14064\02_LOS\Post Processing\[14_Barton St_Van Buren Blvd.xls]Output (3)

Project: West Campus Upper Plateau
 Scenario: Horizon Year (2045) With Project

Job #: 14064
 Analyst: MT
 Date: 2/14/22

LOCATION: Orange Terrace Pkwy. & Van Buren Blvd.
 FORECAST YEAR: 2045

INDIVIDUAL TURN VOLUME GROWTH REVIEW									
APPROACH	TURNING MOVEMENT	AM PEAK HOUR INPUT DATA				PM PEAK HOUR INPUT DATA			
		EXISTING COUNT	FUTURE VOLUME	DIFF-ERENCE	% CHANGE	EXISTING COUNT	FUTURE VOLUME	DIFF-ERENCE	% CHANGE
NORTH BOUND	Left	37	11	-26	-70%	59	19	-40	-68%
	Through	15	12	-3	-22%	30	36	6	20%
	Right	32	59	27	86%	37	78	41	111%
	NB Total	84	82	-2	-3%	126	133	7	6%
SOUTH BOUND	Left	233	519	286	122%	107	180	73	68%
	Through	25	29	4	15%	30	24	-6	-20%
	Right	214	96	-118	-55%	96	43	-53	-55%
	SB Total	472	644	172	36%	233	247	14	6%
EAST BOUND	Left	135	44	-91	-67%	124	80	-44	-35%
	Through	1,221	1,911	690	57%	1,219	1,581	362	30%
	Right	41	12	-29	-70%	77	23	-54	-70%
	EB Total	1,396	1,967	571	41%	1,420	1,684	264	19%
WEST BOUND	Left	35	59	24	68%	47	103	56	119%
	Through	1,212	1,733	521	43%	1,221	1,678	457	37%
	Right	125	214	89	71%	200	354	154	77%
	WB Total	1,372	2,006	634	46%	1,468	2,135	667	45%
TOTAL ENTERING VOLUME		3,324	4,699	1374.922	41%	3,247	4,199	952	29%

FORECAST PEAK HOUR TO ADT COMPARISON						
		VOLUMES		PERCENT OF ADT		ADT
		AM	PM	AM	PM	
North Leg	Inbound	644	247			
North Leg	Outbound	270	470			
North Leg	TOTAL	914	717	11%	9%	8,157
South Leg	Inbound	82	133			
South Leg	Outbound	100	150			
South Leg	TOTAL	182	283	#DIV/0!	#DIV/0!	-
East Leg	Inbound	2,006	2,135			
East Leg	Outbound	2,489	1,839			
East Leg	TOTAL	4,495	3,974	10%	8%	47,051
West Leg	Inbound	1,967	1,684			
West Leg	Outbound	1,840	1,740			
West Leg	TOTAL	3,807	3,424	10%	9%	38,894
OVERALL TOTAL		9,398	8,398	10%	9%	94,102

Z:\Shared\UcJobs\13600-14000\14000\14064\02_LOS\Post Processing\19_Orange Terrace Pkwy_Van Buren Blvd.xls]Output (3)

Project: West Campus Upper Plateau
 Scenario: Horizon Year (2045) With Project

Job #: 14064
 Analyst: MT
 Date: 2/14/22

LOCATION: Sycamore Canyon Blvd. & Eastridge Av.
 FORECAST YEAR: 2045

INDIVIDUAL TURN VOLUME GROWTH REVIEW									
APPROACH	TURNING MOVEMENT	AM PEAK HOUR INPUT DATA				PM PEAK HOUR INPUT DATA			
		EXISTING COUNT	FUTURE VOLUME	DIFF-ERENCE	% CHANGE	EXISTING COUNT	FUTURE VOLUME	DIFF-ERENCE	% CHANGE
NORTH BOUND	Left	67	39	-28	-42%	29	15	-14	-48%
	Through	713	744	31	4%	605	617	12	2%
	Right	84	76	-8	-10%	134	141	7	5%
	NB Total	864	859	-5	-1%	768	773	5	1%
SOUTH BOUND	Left	70	71	1	1%	251	203	-48	-19%
	Through	170	172	2	1%	323	367	44	14%
	Right	39	37	-2	-4%	17	22	5	29%
	SB Total	279	280	1	0%	591	592	1	0%
EAST BOUND	Left	46	46	0	1%	82	61	-21	-26%
	Through	38	43	5	15%	86	125	39	45%
	Right	16	11	-5	-33%	46	25	-21	-45%
	EB Total	100	100	0	0%	214	211	-3	-2%
WEST BOUND	Left	102	106	4	4%	164	137	-27	-17%
	Through	176	204	28	16%	60	73	13	22%
	Right	457	430	-27	-6%	319	332	13	4%
	WB Total	735	740	5	1%	543	542	-1	0%
TOTAL ENTERING VOLUME		1,978	1,979	0.66269212	0%	2,116	2,118	2	0%

FORECAST PEAK HOUR TO ADT COMPARISON						
		VOLUMES		PERCENT OF ADT		ADT
		AM	PM	AM	PM	
North Leg	Inbound	280	592			
North Leg	Outbound	1,220	1,010			
North Leg	TOTAL	1,500	1,602	17%	18%	8,895
South Leg	Inbound	859	773			
South Leg	Outbound	289	529			
South Leg	TOTAL	1,148	1,302	35%	40%	3,280
East Leg	Inbound	740	542			
East Leg	Outbound	190	469			
East Leg	TOTAL	930	1,011	17%	18%	5,615
West Leg	Inbound	100	211			
West Leg	Outbound	280	110			
West Leg	TOTAL	380	321	#DIV/0!	#DIV/0!	-
OVERALL TOTAL		3,958	4,236	22%	24%	17,790

Z:\Shared\UcJobs\13600-14000\14000\14064\02_LOS\Post Processing\22_Sycamore Canyon Blvd_Eastridge Av.xls\Output (3)

Project: West Campus Upper Plateau
 Scenario: Horizon Year (2045) With Project

Job #: 14064
 Analyst: MT
 Date: 2/14/22

LOCATION: Meridian Pkwy./Sycamore Canyon Blvd. & Alessandro Blvd.
 FORECAST YEAR: 2045

INDIVIDUAL TURN VOLUME GROWTH REVIEW									
APPROACH	TURNING MOVEMENT	AM PEAK HOUR INPUT DATA				PM PEAK HOUR INPUT DATA			
		EXISTING COUNT	FUTURE VOLUME	DIFF-ERENCE	% CHANGE	EXISTING COUNT	FUTURE VOLUME	DIFF-ERENCE	% CHANGE
NORTH BOUND	Left	585	678	93	16%	443	496	53	12%
	Through	585	795	210	36%	394	394	0	0%
	Right	61	78	17	27%	77	90	13	17%
	NB Total	1,232	1,551	319	26%	914	980	66	7%
SOUTH BOUND	Left	87	94	7	8%	125	150	25	20%
	Through	114	112	-2	-2%	490	498	8	2%
	Right	126	124	-2	-2%	254	292	38	15%
	SB Total	327	330	3	1%	869	940	71	8%
EAST BOUND	Left	140	177	37	26%	131	139	8	6%
	Through	963	1,135	172	18%	1,430	1,768	338	24%
	Right	244	260	16	7%	537	564	27	5%
	EB Total	1,347	1,572	225	17%	2,098	2,471	373	18%
WEST BOUND	Left	87	91	4	5%	289	304	15	5%
	Through	1,941	2,062	121	6%	1,515	1,801	286	19%
	Right	535	666	131	24%	391	415	24	6%
	WB Total	2,563	2,819	256	10%	2,195	2,520	325	15%
TOTAL ENTERING VOLUME		5,469	6,272	803.1724	15%	6,076	6,911	835	14%

FORECAST PEAK HOUR TO ADT COMPARISON						
		VOLUMES		PERCENT OF ADT		ADT
		AM	PM	AM	PM	
North Leg	Inbound	330	940			
North Leg	Outbound	1,638	948			
North Leg	TOTAL	1,968	1,888	5%	5%	38,859
South Leg	Inbound	1,551	980			
South Leg	Outbound	463	1,366			
South Leg	TOTAL	2,014	2,346	6%	6%	36,403
East Leg	Inbound	2,819	2,520			
East Leg	Outbound	1,307	2,008			
East Leg	TOTAL	4,126	4,528	8%	8%	54,342
West Leg	Inbound	1,572	2,471			
West Leg	Outbound	2,864	2,589			
West Leg	TOTAL	4,436	5,060	8%	9%	55,319
OVERALL TOTAL		12,544	13,822	7%	7%	184,923

Z:\Shared\UcJobs\13600-14000\14000\14064\02_LOS\Post Processing\24_Meridian Pkwy_Sycamore Canyon Blvd_Alessandro Blvd.xls\Output (3)

Project: West Campus Upper Plateau
 Scenario: Horizon Year (2045) With Project

Job #: 14064
 Analyst: MT
 Date: 2/14/22

LOCATION: Meridian Pkwy. & Cactus Av.
 FORECAST YEAR: 2045

INDIVIDUAL TURN VOLUME GROWTH REVIEW									
APPROACH	TURNING MOVEMENT	AM PEAK HOUR INPUT DATA				PM PEAK HOUR INPUT DATA			
		EXISTING COUNT	FUTURE VOLUME	DIFF-ERENCE	% CHANGE	EXISTING COUNT	FUTURE VOLUME	DIFF-ERENCE	% CHANGE
NORTH BOUND	Left	5	42	37	693%	0	5	5	#DIV/0!
	Through	366	501	135	37%	328	344	16	5%
	Right	209	283	74	35%	221	201	-20	-9%
	NB Total	581	826	245	42%	549	550	1	0%
SOUTH BOUND	Left	137	163	26	19%	498	412	-86	-17%
	Through	140	165	25	18%	840	917	77	9%
	Right	8	24	16	183%	5	11	6	120%
	SB Total	285	352	67	23%	1,343	1,340	-3	0%
EAST BOUND	Left	4	15	11	254%	16	26	10	63%
	Through	6	74	68	1065%	13	139	126	969%
	Right	1	8	7	655%	14	34	20	143%
	EB Total	12	97	85	733%	43	199	156	363%
WEST BOUND	Left	364	427	63	17%	696	647	-49	-7%
	Through	20	564	544	2720%	14	67	53	379%
	Right	885	745	-140	-16%	497	496	-1	0%
	WB Total	1,269	1,736	467	37%	1,207	1,210	3	0%
TOTAL ENTERING VOLUME		2,147	3,011	863.9068	40%	3,142	3,299	157	5%

FORECAST PEAK HOUR TO ADT COMPARISON						
		VOLUMES		PERCENT OF ADT		ADT
		AM	PM	AM	PM	
North Leg	Inbound	352	1,340			
North Leg	Outbound	1,261	866			
North Leg	TOTAL	1,613	2,206	72%	98%	2,250
South Leg	Inbound	826	550			
South Leg	Outbound	600	1,598			
South Leg	TOTAL	1,426	2,148	18%	27%	8,060
East Leg	Inbound	1,736	1,210			
East Leg	Outbound	520	752			
East Leg	TOTAL	2,256	1,962	21%	18%	10,688
West Leg	Inbound	97	199			
West Leg	Outbound	630	83			
West Leg	TOTAL	727	282	19%	7%	3,775
OVERALL TOTAL		6,022	6,598	24%	27%	24,773

Z:\Shared\UcJobs\13600-14000\14000\14064\02_LOS\Post Processing\[25_Meridian Pkwy_Cactus Av.xls]Output (3)

Project: West Campus Upper Plateau
 Scenario: Horizon Year (2045) With Project

Job #: 14064
 Analyst: MT
 Date: 2/14/22

LOCATION: Meridian Pkwy. & Van Buren Blvd.
 FORECAST YEAR: 2045

INDIVIDUAL TURN VOLUME GROWTH REVIEW									
APPROACH	TURNING MOVEMENT	AM PEAK HOUR INPUT DATA				PM PEAK HOUR INPUT DATA			
		EXISTING COUNT	FUTURE VOLUME	DIFF-ERENCE	% CHANGE	EXISTING COUNT	FUTURE VOLUME	DIFF-ERENCE	% CHANGE
NORTH BOUND	Left	3	5	2	49%	11	27	16	145%
	Through	1	4	3	258%	14	18	4	29%
	Right	3	1	-2	-70%	33	15	-18	-55%
	NB Total	8	10	2	28%	58	60	2	3%
SOUTH BOUND	Left	48	70	22	46%	818	508	-310	-38%
	Through	6	11	5	97%	13	14	1	8%
	Right	313	322	9	3%	623	932	309	50%
	SB Total	367	403	36	10%	1,454	1,454	0	0%
EAST BOUND	Left	422	641	219	52%	269	253	-16	-6%
	Through	1,146	1,819	673	59%	1,302	1,924	622	48%
	Right	2	31	29	1286%	1	6	5	500%
	EB Total	1,570	2,491	921	59%	1,572	2,183	611	39%
WEST BOUND	Left	46	8	-38	-83%	7	2	-5	-71%
	Through	1,322	2,282	960	73%	924	1,531	607	66%
	Right	131	175	44	34%	64	110	46	72%
	WB Total	1,499	2,465	966	64%	995	1,643	648	65%
TOTAL ENTERING VOLUME		3,444	5,369	1925.276	56%	4,079	5,340	1261	31%

FORECAST PEAK HOUR TO ADT COMPARISON						
		VOLUMES		PERCENT OF ADT		ADT
		AM	PM	AM	PM	
North Leg	Inbound	403	1,454			
North Leg	Outbound	820	381			
North Leg	TOTAL	1,223	1,835	18%	26%	6,969
South Leg	Inbound	10	60			
South Leg	Outbound	50	22			
South Leg	TOTAL	60	82	#DIV/0!	#DIV/0!	-
East Leg	Inbound	2,465	1,643			
East Leg	Outbound	1,890	2,447			
East Leg	TOTAL	4,355	4,090	9%	9%	47,781
West Leg	Inbound	2,491	2,183			
West Leg	Outbound	2,609	2,490			
West Leg	TOTAL	5,100	4,673	10%	9%	52,357
OVERALL TOTAL		10,738	10,680	10%	10%	107,107

Z:\Shared\UcJobs\13600-14000\14000\14064\02_LOS\Post Processing\[26_Meridian Pkwy_Van Buren Blvd.xls]Output (3)

Project: West Campus Upper Plateau
 Scenario: Horizon Year (2045) With Project

Job #: 14064
 Analyst: MT
 Date: 2/14/22

LOCATION: I-215 SB Ramps & Alessandro Blvd.
 FORECAST YEAR: 2045

INDIVIDUAL TURN VOLUME GROWTH REVIEW									
APPROACH	TURNING MOVEMENT	AM PEAK HOUR INPUT DATA				PM PEAK HOUR INPUT DATA			
		EXISTING COUNT	FUTURE VOLUME	DIFF-ERENCE	% CHANGE	EXISTING COUNT	FUTURE VOLUME	DIFF-ERENCE	% CHANGE
NORTH BOUND	Left	0	0	0	#DIV/0!	0	0	0	#DIV/0!
	Through	0	0	0	#DIV/0!	0	0	0	#DIV/0!
	Right	0	0	0	#DIV/0!	0	0	0	#DIV/0!
	NB Total	0	0	0	#DIV/0!	0	0	0	#DIV/0!
SOUTH BOUND	Left	172	453	281	164%	310	457	147	47%
	Through	0	0	0	#DIV/0!	0	0	0	#DIV/0!
	Right	299	290	-9	-3%	424	317	-107	-25%
	SB Total	471	743	272	58%	734	774	40	5%
EAST BOUND	Left	0	0	0	#DIV/0!	0	0	0	#DIV/0!
	Through	773	854	81	10%	1,349	1,647	298	22%
	Right	338	525	187	55%	283	385	102	36%
	EB Total	1,111	1,379	268	24%	1,632	2,032	400	25%
WEST BOUND	Left	0	0	0	#DIV/0!	0	0	0	#DIV/0!
	Through	2,264	2,613	349	15%	1,771	2,233	462	26%
	Right	143	144	1	1%	61	61	0	0%
	WB Total	2,406	2,757	351	15%	1,832	2,294	462	25%
TOTAL ENTERING VOLUME		3,989	4,879	890.1772	22%	4,198	5,100	902	21%

FORECAST PEAK HOUR TO ADT COMPARISON						
		VOLUMES		PERCENT OF ADT		ADT
		AM	PM	AM	PM	
North Leg	Inbound	743	774			
North Leg	Outbound	144	61			
North Leg	TOTAL	887	835	8%	8%	10,685
South Leg	Inbound	0	0			
South Leg	Outbound	525	385			
South Leg	TOTAL	525	385	11%	8%	4,880
East Leg	Inbound	2,757	2,294			
East Leg	Outbound	1,307	2,104			
East Leg	TOTAL	4,064	4,398	8%	9%	51,670
West Leg	Inbound	1,379	2,032			
West Leg	Outbound	2,903	2,550			
West Leg	TOTAL	4,282	4,582	8%	8%	54,342
OVERALL TOTAL		9,758	10,200	8%	8%	121,577

Project: West Campus Upper Plateau
 Scenario: Horizon Year (2045) With Project

Job #: 14064
 Analyst: MT
 Date: 2/14/22

LOCATION: I-215 NB Ramps & Alessandro Blvd.
 FORECAST YEAR: 2045

INDIVIDUAL TURN VOLUME GROWTH REVIEW									
APPROACH	TURNING MOVEMENT	AM PEAK HOUR INPUT DATA				PM PEAK HOUR INPUT DATA			
		EXISTING COUNT	FUTURE VOLUME	DIFF-ERENCE	% CHANGE	EXISTING COUNT	FUTURE VOLUME	DIFF-ERENCE	% CHANGE
NORTH BOUND	Left	1,111	909	-202	-18%	834	864	30	4%
	Through	0	0	0	#DIV/0!	11	14	3	27%
	Right	158	496	338	214%	270	418	148	55%
	NB Total	1,269	1,405	136	11%	1,115	1,296	181	16%
SOUTH BOUND	Left	0	0	0	#DIV/0!	0	0	0	#DIV/0!
	Through	0	0	0	#DIV/0!	0	0	0	#DIV/0!
	Right	0	0	0	#DIV/0!	0	0	0	#DIV/0!
	SB Total	0	0	0	#DIV/0!	0	0	0	#DIV/0!
EAST BOUND	Left	68	41	-27	-39%	94	102	8	9%
	Through	877	1,264	387	44%	1,565	1,995	430	27%
	Right	0	0	0	#DIV/0!	0	0	0	#DIV/0!
	EB Total	945	1,305	360	38%	1,659	2,097	438	26%
WEST BOUND	Left	0	0	0	#DIV/0!	0	0	0	#DIV/0!
	Through	1,296	1,941	645	50%	998	1,528	530	53%
	Right	78	189	111	143%	112	218	106	95%
	WB Total	1,373	2,130	757	55%	1,110	1,746	636	57%
TOTAL ENTERING VOLUME		3,588	4,840	1252.3576	35%	3,884	5,139	1255	32%

FORECAST PEAK HOUR TO ADT COMPARISON						
		VOLUMES		PERCENT OF ADT		ADT
		AM	PM	AM	PM	
North Leg	Inbound	0	0			
North Leg	Outbound	230	334			
North Leg	TOTAL	230	334	7%	10%	3,442
South Leg	Inbound	1,405	1,296			
South Leg	Outbound	0	0			
South Leg	TOTAL	1,405	1,296	10%	9%	14,717
East Leg	Inbound	2,130	1,746			
East Leg	Outbound	1,760	2,413			
East Leg	TOTAL	3,890	4,159	7%	8%	54,239
West Leg	Inbound	1,305	2,097			
West Leg	Outbound	2,850	2,392			
West Leg	TOTAL	4,155	4,489	8%	9%	51,508
OVERALL TOTAL		9,680	10,278	8%	8%	123,907

Project: West Campus Upper Plateau
 Scenario: Horizon Year (2045) With Project

Job #: 14064
 Analyst: MT
 Date: 2/14/22

LOCATION: I-215 SB Ramps & Cactus Av.
 FORECAST YEAR: 2045

INDIVIDUAL TURN VOLUME GROWTH REVIEW									
APPROACH	TURNING MOVEMENT	AM PEAK HOUR INPUT DATA				PM PEAK HOUR INPUT DATA			
		EXISTING COUNT	FUTURE VOLUME	DIFF-ERENCE	% CHANGE	EXISTING COUNT	FUTURE VOLUME	DIFF-ERENCE	% CHANGE
NORTH BOUND	Left	0	0	0	#DIV/0!	0	0	0	#DIV/0!
	Through	0	0	0	#DIV/0!	0	0	0	#DIV/0!
	Right	624	775	151	24%	546	615	69	13%
	NB Total	624	775	151	24%	546	615	69	13%
SOUTH BOUND	Left	0	0	0	#DIV/0!	0	0	0	#DIV/0!
	Through	0	0	0	#DIV/0!	0	0	0	#DIV/0!
	Right	195	335	140	71%	252	378	126	50%
	SB Total	195	335	140	71%	252	378	126	50%
EAST BOUND	Left	0	0	0	#DIV/0!	0	0	0	#DIV/0!
	Through	332	995	663	200%	694	1,065	371	53%
	Right	26	16	-10	-39%	130	83	-47	-36%
	EB Total	358	1,011	653	183%	824	1,148	324	39%
WEST BOUND	Left	579	574	-5	-1%	484	517	33	7%
	Through	1,219	2,285	1,066	87%	981	1,522	541	55%
	Right	0	0	0	#DIV/0!	0	0	0	#DIV/0!
	WB Total	1,798	2,859	1,061	59%	1,465	2,039	574	39%
TOTAL ENTERING VOLUME		2,975	4,980	2005.062	67%	3,087	4,180	1093	35%

FORECAST PEAK HOUR TO ADT COMPARISON						
		VOLUMES		PERCENT OF ADT		ADT
		AM	PM	AM	PM	
North Leg	Inbound	335	378			
North Leg	Outbound	0	0			
North Leg	TOTAL	335	378	7%	8%	4,497
South Leg	Inbound	775	615			
South Leg	Outbound	590	600			
South Leg	TOTAL	1,365	1,215	11%	10%	12,106
East Leg	Inbound	2,859	2,039			
East Leg	Outbound	1,770	1,680			
East Leg	TOTAL	4,629	3,719	9%	7%	50,982
West Leg	Inbound	1,011	1,148			
West Leg	Outbound	2,620	1,900			
West Leg	TOTAL	3,631	3,048	11%	9%	34,209
OVERALL TOTAL		9,960	8,360	10%	8%	101,794

Z:\Shared\UcJobs\13600-14000\14000\14064\02_LOS\Post Processing\30_I-215 SB Ramps_Cactus Av.xls]Output (3)

Project: West Campus Upper Plateau
 Scenario: Horizon Year (2045) With Project

Job #: 14064
 Analyst: MT
 Date: 2/14/22

LOCATION: I-215 NB Ramps & Cactus Av.
 FORECAST YEAR: 2045

INDIVIDUAL TURN VOLUME GROWTH REVIEW									
APPROACH	TURNING MOVEMENT	AM PEAK HOUR INPUT DATA				PM PEAK HOUR INPUT DATA			
		EXISTING COUNT	FUTURE VOLUME	DIFF-ERENCE	% CHANGE	EXISTING COUNT	FUTURE VOLUME	DIFF-ERENCE	% CHANGE
NORTH BOUND	Left	281	704	423	150%	115	438	323	280%
	Through	292	239	-53	-18%	218	298	80	37%
	Right	12	49	37	318%	3	65	62	1819%
	NB Total	585	992	407	70%	336	801	465	138%
SOUTH BOUND	Left	48	48	0	-1%	166	198	32	19%
	Through	0	0	0	#DIV/0!	2	3	1	33%
	Right	113	67	-46	-41%	158	37	-121	-77%
	SB Total	161	115	-46	-29%	326	238	-88	-27%
EAST BOUND	Left	21	7	-14	-66%	50	5	-45	-90%
	Through	1,258	2,263	1,005	80%	1,374	2,056	682	50%
	Right	42	40	-2	-6%	44	77	33	75%
	EB Total	1,321	2,310	989	75%	1,468	2,138	670	46%
WEST BOUND	Left	0	0	0	#DIV/0!	0	0	0	#DIV/0!
	Through	2,362	2,829	467	20%	1,661	1,935	274	17%
	Right	138	54	-84	-61%	161	68	-93	-58%
	WB Total	2,499	2,883	384	15%	1,822	2,003	181	10%
TOTAL ENTERING VOLUME		4,566	6,300	1733.6844	38%	3,952	5,180	1228	31%

FORECAST PEAK HOUR TO ADT COMPARISON						
		VOLUMES		PERCENT OF ADT		ADT
		AM	PM	AM	PM	
North Leg	Inbound	115	238			
North Leg	Outbound	300	371			
North Leg	TOTAL	415	609	9%	14%	4,396
South Leg	Inbound	992	801			
South Leg	Outbound	40	80			
South Leg	TOTAL	1,032	881	14%	12%	7,203
East Leg	Inbound	2,883	2,003			
East Leg	Outbound	2,360	2,319			
East Leg	TOTAL	5,243	4,322	12%	10%	42,650
West Leg	Inbound	2,310	2,138			
West Leg	Outbound	3,600	2,410			
West Leg	TOTAL	5,910	4,548	10%	8%	56,477
OVERALL TOTAL		12,600	10,360	11%	9%	110,726

Z:\Shared\UcJobs\13600-14000\14000\14064\02_LOS\Post Processing\31_I-215 NB Ramps_Cactus Av.xls\Output (3)

Project: West Campus Upper Plateau
 Scenario: Horizon Year (2045) With Project

Job #: 14064
 Analyst: MT
 Date: 2/14/22

LOCATION: I-215 SB Ramps & Van Buren Blvd.
 FORECAST YEAR: 2045

INDIVIDUAL TURN VOLUME GROWTH REVIEW									
APPROACH	TURNING MOVEMENT	AM PEAK HOUR INPUT DATA				PM PEAK HOUR INPUT DATA			
		EXISTING COUNT	FUTURE VOLUME	DIFF-ERENCE	% CHANGE	EXISTING COUNT	FUTURE VOLUME	DIFF-ERENCE	% CHANGE
NORTH BOUND	Left	0	0	0	#DIV/0!	0	0	0	#DIV/0!
	Through	0	0	0	#DIV/0!	0	0	0	#DIV/0!
	Right	0	0	0	#DIV/0!	0	0	0	#DIV/0!
	NB Total	0	0	0	#DIV/0!	0	0	0	#DIV/0!
SOUTH BOUND	Left	21	56	35	162%	11	64	53	482%
	Through	21	39	18	83%	85	136	51	60%
	Right	719	1,239	520	72%	192	199	7	4%
	SB Total	762	1,334	572	75%	288	399	111	39%
EAST BOUND	Left	0	0	0	#DIV/0!	0	0	0	#DIV/0!
	Through	507	694	187	37%	444	1,546	1,102	248%
	Right	657	628	-29	-4%	1,604	1,530	-74	-5%
	EB Total	1,164	1,322	158	14%	2,048	3,076	1,028	50%
WEST BOUND	Left	2	3	1	33%	3	5	2	67%
	Through	902	1,001	99	11%	797	801	4	1%
	Right	0	0	0	#DIV/0!	0	0	0	#DIV/0!
	WB Total	905	1,004	99	11%	800	806	6	1%
TOTAL ENTERING VOLUME		2,831	3,660	829.0716	29%	3,136	4,281	1145	37%

FORECAST PEAK HOUR TO ADT COMPARISON						
		VOLUMES		PERCENT OF ADT		ADT
		AM	PM	AM	PM	
North Leg	Inbound	1,334	399			
North Leg	Outbound	0	0			
North Leg	TOTAL	1,334	399	24%	7%	5,564
South Leg	Inbound	0	0			
South Leg	Outbound	670	1,671			
South Leg	TOTAL	670	1,671	4%	9%	17,804
East Leg	Inbound	1,004	806			
East Leg	Outbound	750	1,610			
East Leg	TOTAL	1,754	2,416	9%	12%	20,491
West Leg	Inbound	1,322	3,076			
West Leg	Outbound	2,240	1,000			
West Leg	TOTAL	3,562	4,076	8%	9%	44,531
OVERALL TOTAL		7,320	8,562	8%	10%	88,390

Project: West Campus Upper Plateau
 Scenario: Horizon Year (2045) With Project

Job #: 14064
 Analyst: MT
 Date: 2/14/22

LOCATION: I-215 NB Ramps & Van Buren Blvd.
 FORECAST YEAR: 2045

INDIVIDUAL TURN VOLUME GROWTH REVIEW									
APPROACH	TURNING MOVEMENT	AM PEAK HOUR INPUT DATA				PM PEAK HOUR INPUT DATA			
		EXISTING COUNT	FUTURE VOLUME	DIFF-ERENCE	% CHANGE	EXISTING COUNT	FUTURE VOLUME	DIFF-ERENCE	% CHANGE
NORTH BOUND	Left	965	590	-375	-39%	759	758	-1	0%
	Through	0	0	0	#DIV/0!	0	0	0	#DIV/0!
	Right	5	58	53	1129%	4	56	52	1300%
	NB Total	970	648	-322	-33%	763	814	51	7%
SOUTH BOUND	Left	0	0	0	#DIV/0!	0	0	0	#DIV/0!
	Through	0	0	0	#DIV/0!	0	0	0	#DIV/0!
	Right	0	0	0	#DIV/0!	0	0	0	#DIV/0!
	SB Total	0	0	0	#DIV/0!	0	0	0	#DIV/0!
EAST BOUND	Left	0	0	0	#DIV/0!	0	0	0	#DIV/0!
	Through	32	0	-32	-100%	4	394	390	9750%
	Right	558	1,265	707	127%	497	500	3	1%
	EB Total	590	1,265	675	114%	501	894	393	78%
WEST BOUND	Left	0	0	0	#DIV/0!	0	0	0	#DIV/0!
	Through	26	687	661	2547%	21	22	1	5%
	Right	0	0	0	#DIV/0!	0	0	0	#DIV/0!
	WB Total	26	687	661	2547%	21	22	1	5%
TOTAL ENTERING VOLUME		1,586	2,600	1014.4304	64%	1,285	1,730	445	35%

FORECAST PEAK HOUR TO ADT COMPARISON						
		VOLUMES		PERCENT OF ADT		ADT
		AM	PM	AM	PM	
North Leg	Inbound	0	0			
North Leg	Outbound	0	0			
North Leg	TOTAL	0	0	#DIV/0!	#DIV/0!	#DIV/0!
South Leg	Inbound	648	814			
South Leg	Outbound	1,265	500			
South Leg	TOTAL	1,913	1,314	13%	9%	15,173
East Leg	Inbound	687	22			
East Leg	Outbound	58	450			
East Leg	TOTAL	745	472	2%	1%	42,477
West Leg	Inbound	1,265	894			
West Leg	Outbound	1,277	780			
West Leg	TOTAL	2,542	1,674	15%	10%	17,349
OVERALL TOTAL		5,200	3,460	#DIV/0!	#DIV/0!	#DIV/0!

Z:\Shared\UcJobs\13600-14000\14000\14064\02_LOS\Post Processing\[33_I-215 NB Ramps_Van Buren Blvd.xls]Output (3)

Project: West Campus Upper Plateau
 Scenario: Horizon Year (2045) With Project

Job #: 14064
 Analyst: MT
 Date: 2/14/22

LOCATION: Old 215 Frontage Rd. & Alessandro Blvd.
 FORECAST YEAR: 2045

INDIVIDUAL TURN VOLUME GROWTH REVIEW									
APPROACH	TURNING MOVEMENT	AM PEAK HOUR INPUT DATA				PM PEAK HOUR INPUT DATA			
		EXISTING COUNT	FUTURE VOLUME	DIFF-ERENCE	% CHANGE	EXISTING COUNT	FUTURE VOLUME	DIFF-ERENCE	% CHANGE
NORTH BOUND	Left	51	5	-46	-90%	31	2	-29	-94%
	Through	258	32	-226	-88%	143	16	-127	-89%
	Right	19	3	-16	-85%	13	2	-11	-85%
	NB Total	329	40	-289	-88%	187	20	-167	-89%
SOUTH BOUND	Left	22	53	31	138%	110	322	212	193%
	Through	43	5	-38	-88%	197	31	-166	-84%
	Right	221	318	97	44%	176	198	22	13%
	SB Total	286	376	90	31%	483	551	68	14%
EAST BOUND	Left	324	444	120	37%	317	290	-27	-9%
	Through	909	1,684	775	85%	1,390	2,085	695	50%
	Right	42	4	-38	-90%	97	8	-89	-92%
	EB Total	1,274	2,132	858	67%	1,804	2,383	579	32%
WEST BOUND	Left	10	1	-9	-90%	13	3	-10	-77%
	Through	1,250	1,996	746	60%	877	1,573	696	79%
	Right	110	214	104	95%	105	299	194	185%
	WB Total	1,370	2,211	841	61%	995	1,875	880	88%
TOTAL ENTERING VOLUME		3,260	4,759	1499.4268	46%	3,469	4,829	1360	39%

FORECAST PEAK HOUR TO ADT COMPARISON						
		VOLUMES		PERCENT OF ADT		ADT
		AM	PM	AM	PM	
North Leg	Inbound	376	551			
North Leg	Outbound	690	605			
North Leg	TOTAL	1,066	1,156	8%	9%	13,532
South Leg	Inbound	40	20			
South Leg	Outbound	10	42			
South Leg	TOTAL	50	62	174%	216%	29
East Leg	Inbound	2,211	1,875			
East Leg	Outbound	1,740	2,409			
East Leg	TOTAL	3,951	4,284	7%	7%	60,715
West Leg	Inbound	2,132	2,383			
West Leg	Outbound	2,319	1,773			
West Leg	TOTAL	4,451	4,156	8%	8%	52,445
OVERALL TOTAL		9,518	9,658	8%	8%	126,721

Z:\Shared\UcJobs\13600-14000\14000\14064\02_LOS\Post Processing\34_Old 215 Frontage Rd_Alessandro Blvd.xls]Output (3)

Project: West Campus Upper Plateau
 Scenario: Horizon Year (2045) With Project

Job #: 14064
 Analyst: MT
 Date: 2/14/22

LOCATION: Day St. & Alessandro Blvd.
 FORECAST YEAR: 2045

INDIVIDUAL TURN VOLUME GROWTH REVIEW									
APPROACH	TURNING MOVEMENT	AM PEAK HOUR INPUT DATA				PM PEAK HOUR INPUT DATA			
		EXISTING COUNT	FUTURE VOLUME	DIFF-ERENCE	% CHANGE	EXISTING COUNT	FUTURE VOLUME	DIFF-ERENCE	% CHANGE
NORTH BOUND	Left	11	95	84	800%	15	76	61	407%
	Through	155	54	-101	-65%	134	57	-77	-57%
	Right	16	32	16	95%	11	32	21	191%
	NB Total	182	181	-1	0%	160	165	5	3%
SOUTH BOUND	Left	77	101	24	30%	201	118	-83	-41%
	Through	39	18	-21	-54%	132	55	-77	-58%
	Right	61	295	234	383%	104	281	177	170%
	SB Total	177	414	237	134%	437	454	17	4%
EAST BOUND	Left	138	293	155	112%	190	304	114	60%
	Through	638	1,591	953	149%	1,372	1,530	158	12%
	Right	9	31	22	230%	21	79	58	276%
	EB Total	786	1,915	1,129	144%	1,583	1,913	330	21%
WEST BOUND	Left	9	13	4	38%	12	36	24	200%
	Through	1,144	2,002	858	75%	830	1,653	823	99%
	Right	123	126	3	2%	173	138	-35	-20%
	WB Total	1,277	2,141	864	68%	1,015	1,827	812	80%
TOTAL ENTERING VOLUME		2,422	4,651	2228.9488	92%	3,195	4,359	1164	36%

FORECAST PEAK HOUR TO ADT COMPARISON						
		VOLUMES		PERCENT OF ADT		ADT
		AM	PM	AM	PM	
North Leg	Inbound	414	454			
North Leg	Outbound	473	499			
North Leg	TOTAL	887	953	10%	10%	9,175
South Leg	Inbound	181	165			
South Leg	Outbound	62	170			
South Leg	TOTAL	243	335	#DIV/0!	#DIV/0!	-
East Leg	Inbound	2,141	1,827			
East Leg	Outbound	1,724	1,680			
East Leg	TOTAL	3,865	3,507	10%	9%	39,225
West Leg	Inbound	1,915	1,913			
West Leg	Outbound	2,392	2,010			
West Leg	TOTAL	4,307	3,923	10%	9%	44,077
OVERALL TOTAL		9,302	8,718	10%	9%	92,477

Z:\Shared\UcJobs\13600-14000\14000\14064\02_LOS\Post Processing\[35_Day St_Alessandro Blvd.xls]Output (3)

Project: West Campus Upper Plateau
 Scenario: Horizon Year (2045) With Project

Job #: 14064
 Analyst: MT
 Date: 2/14/22

LOCATION: Elsworth St. & Cactus Av.
 FORECAST YEAR: 2045

INDIVIDUAL TURN VOLUME GROWTH REVIEW									
APPROACH	TURNING MOVEMENT	AM PEAK HOUR INPUT DATA				PM PEAK HOUR INPUT DATA			
		EXISTING COUNT	FUTURE VOLUME	DIFF-ERENCE	% CHANGE	EXISTING COUNT	FUTURE VOLUME	DIFF-ERENCE	% CHANGE
NORTH BOUND	Left	23	90	67	297%	191	556	365	191%
	Through	10	49	39	381%	64	177	113	178%
	Right	16	37	21	133%	74	130	56	76%
	NB Total	49	176	127	262%	328	863	535	163%
SOUTH BOUND	Left	82	94	12	15%	201	286	85	42%
	Through	58	131	73	127%	13	73	60	456%
	Right	157	311	154	98%	180	422	242	135%
	SB Total	297	536	239	81%	394	781	387	98%
EAST BOUND	Left	179	445	266	149%	140	260	120	85%
	Through	1,360	1,639	279	21%	1,863	2,185	322	17%
	Right	288	683	395	138%	26	121	95	361%
	EB Total	1,826	2,767	941	52%	2,030	2,566	536	26%
WEST BOUND	Left	69	86	17	25%	15	36	21	138%
	Through	1,660	1,789	129	8%	1,191	1,185	-6	-1%
	Right	120	156	36	30%	83	79	-4	-5%
	WB Total	1,849	2,031	182	10%	1,289	1,300	11	1%
TOTAL ENTERING VOLUME		4,020	5,510	1489.8944	37%	4,042	5,510	1468	36%

FORECAST PEAK HOUR TO ADT COMPARISON						
		VOLUMES		PERCENT OF ADT		ADT
		AM	PM	AM	PM	
North Leg	Inbound	536	781			
North Leg	Outbound	650	516			
North Leg	TOTAL	1,186	1,297	6%	7%	19,504
South Leg	Inbound	176	863			
South Leg	Outbound	900	230			
South Leg	TOTAL	1,076	1,093	8%	9%	12,823
East Leg	Inbound	2,031	1,300			
East Leg	Outbound	1,770	2,601			
East Leg	TOTAL	3,801	3,901	10%	11%	36,396
West Leg	Inbound	2,767	2,566			
West Leg	Outbound	2,190	2,163			
West Leg	TOTAL	4,957	4,729	10%	9%	50,308
OVERALL TOTAL		11,020	11,020	9%	9%	119,031

Z:\Shared\UcJobs\13600-14000\14000\14064\02_LOS\Post Processing\36_Elsworth St_Cactus Av.xls]Output (3)

Project: West Campus Upper Plateau
 Scenario: Horizon Year (2045) With Project

Job #: 14064
 Analyst: MT
 Date: 2/14/22

LOCATION: Frederick St. & Cactus Av.
 FORECAST YEAR: 2045

INDIVIDUAL TURN VOLUME GROWTH REVIEW									
APPROACH	TURNING MOVEMENT	AM PEAK HOUR INPUT DATA				PM PEAK HOUR INPUT DATA			
		EXISTING COUNT	FUTURE VOLUME	DIFFERENCE	% CHANGE	EXISTING COUNT	FUTURE VOLUME	DIFFERENCE	% CHANGE
NORTH BOUND	Left	0	0	0	#DIV/0!	0	0	0	#DIV/0!
	Through	0	0	0	#DIV/0!	0	0	0	#DIV/0!
	Right	0	0	0	#DIV/0!	0	0	0	#DIV/0!
	NB Total	0	0	0	#DIV/0!	0	0	0	#DIV/0!
SOUTH BOUND	Left	149	176	27	18%	432	340	-92	-21%
	Through	0	0	0	#DIV/0!	0	0	0	#DIV/0!
	Right	91	77	-14	-16%	175	148	-27	-15%
	SB Total	241	253	12	5%	607	488	-119	-20%
EAST BOUND	Left	186	121	-65	-35%	196	327	131	67%
	Through	1,199	1,674	475	40%	1,917	2,100	183	10%
	Right	0	0	0	#DIV/0!	0	0	0	#DIV/0!
	EB Total	1,385	1,795	410	30%	2,113	2,427	314	15%
WEST BOUND	Left	0	0	0	#DIV/0!	0	0	0	#DIV/0!
	Through	1,887	2,013	126	7%	1,148	1,172	24	2%
	Right	144	99	-45	-31%	153	223	70	46%
	WB Total	2,030	2,112	82	4%	1,301	1,395	94	7%
TOTAL ENTERING VOLUME		3,656	4,160	504.0344	14%	4,021	4,310	289	7%

FORECAST PEAK HOUR TO ADT COMPARISON						
		VOLUMES		PERCENT OF ADT		ADT
		AM	PM	AM	PM	
North Leg	Inbound	253	488			
North Leg	Outbound	220	550			
North Leg	TOTAL	473	1,038	11%	24%	4,284
South Leg	Inbound	0	0			
South Leg	Outbound	0	0			
South Leg	TOTAL	0	0	#DIV/0!	#DIV/0!	#DIV/0!
East Leg	Inbound	2,112	1,395			
East Leg	Outbound	1,850	2,440			
East Leg	TOTAL	3,962	3,835	10%	9%	41,696
West Leg	Inbound	1,795	2,427			
West Leg	Outbound	2,090	1,320			
West Leg	TOTAL	3,885	3,747	10%	10%	37,097
OVERALL TOTAL		8,320	8,620	#DIV/0!	#DIV/0!	#DIV/0!

Project: West Campus Upper Plateau
 Scenario: Horizon Year (2045) With Project

Job #: 14064
 Analyst: MT
 Date: 2/14/22

LOCATION: Graham St./Riverside Dr. & Cactus Av.
 FORECAST YEAR: 2045

INDIVIDUAL TURN VOLUME GROWTH REVIEW									
APPROACH	TURNING MOVEMENT	AM PEAK HOUR INPUT DATA				PM PEAK HOUR INPUT DATA			
		EXISTING COUNT	FUTURE VOLUME	DIFF-ERENCE	% CHANGE	EXISTING COUNT	FUTURE VOLUME	DIFF-ERENCE	% CHANGE
NORTH BOUND	Left	9	50	41	438%	2	18	16	725%
	Through	0	0	0	#DIV/0!	0	0	0	#DIV/0!
	Right	0	0	0	#DIV/0!	1	15	14	1276%
	NB Total	9	50	41	438%	3	33	30	909%
SOUTH BOUND	Left	84	355	271	324%	123	382	259	210%
	Through	45	458	413	910%	88	290	202	228%
	Right	115	338	223	194%	99	184	85	85%
	SB Total	244	1,151	907	371%	311	856	545	175%
EAST BOUND	Left	62	222	160	260%	101	432	331	326%
	Through	1,159	1,255	96	8%	2,087	2,024	-63	-3%
	Right	160	414	254	158%	353	363	10	3%
	EB Total	1,381	1,891	510	37%	2,541	2,819	278	11%
WEST BOUND	Left	9	28	19	201%	16	27	11	65%
	Through	1,907	1,701	-206	-11%	1,278	1,189	-89	-7%
	Right	88	378	290	328%	82	558	476	582%
	WB Total	2,005	2,107	102	5%	1,376	1,774	398	29%
TOTAL ENTERING VOLUME		3,639	5,199	1559.6808	43%	4,231	5,482	1251	30%

FORECAST PEAK HOUR TO ADT COMPARISON						
		VOLUMES		PERCENT OF ADT		ADT
		AM	PM	AM	PM	
North Leg	Inbound	1,151	856			
North Leg	Outbound	600	990			
North Leg	TOTAL	1,751	1,846	2%	2%	100,088
South Leg	Inbound	50	33			
South Leg	Outbound	900	680			
South Leg	TOTAL	950	713	3%	2%	33,872
East Leg	Inbound	2,107	1,774			
East Leg	Outbound	1,610	2,421			
East Leg	TOTAL	3,717	4,195	9%	10%	41,441
West Leg	Inbound	1,891	2,819			
West Leg	Outbound	2,089	1,391			
West Leg	TOTAL	3,980	4,210	10%	10%	40,290
OVERALL TOTAL		10,398	10,964	5%	5%	215,692

Z:\Shared\UcJobs\13600-14000\14000\14064\02_LOS\Post Processing\38_Graham St_Riverside Dr_Cactus Av.xls]Output (3)

This Page Intentionally Left Blank

APPENDIX 5.1:

E+P CONDITIONS INTERSECTION OPERATIONS ANALYSIS WORKSHEETS

This Page Intentionally Left Blank

Timings
1: Washington St & Van Buren Bl.



Lane Group	EBL	EBT	WBL	WBT	WBR	NBL	NBT	NBR	SBL	SBT
Lane Configurations	↙	↕	↙	↕	↗	↙↗	↕	↗	↙↗	↕
Traffic Volume (vph)	131	1010	99	1301	576	136	509	141	340	176
Future Volume (vph)	131	1010	99	1301	576	136	509	141	340	176
Turn Type	Prot	NA	Prot	NA	Perm	Prot	NA	Perm	Prot	NA
Protected Phases	5	2	1	6		3	8		7	4
Permitted Phases					6			8		
Detector Phase	5	2	1	6	6	3	8	8	7	4
Switch Phase										
Minimum Initial (s)	5.0	10.0	5.0	10.0	10.0	5.0	10.0	10.0	5.0	10.0
Minimum Split (s)	9.2	34.2	9.2	33.2	33.2	9.2	38.4	38.4	9.2	30.8
Total Split (s)	14.0	53.1	12.3	51.4	51.4	14.2	38.4	38.4	16.2	40.4
Total Split (%)	11.7%	44.3%	10.3%	42.8%	42.8%	11.8%	32.0%	32.0%	13.5%	33.7%
Yellow Time (s)	3.2	5.2	3.2	5.2	5.2	3.2	4.4	4.4	3.2	4.8
All-Red Time (s)	1.0	1.0	1.0	1.0	1.0	1.0	1.0	1.0	1.0	1.0
Lost Time Adjust (s)	0.0	0.0	0.0	0.0	0.0	0.0	0.0	0.0	0.0	0.0
Total Lost Time (s)	4.2	6.2	4.2	6.2	6.2	4.2	5.4	5.4	4.2	5.8
Lead/Lag	Lead	Lag	Lead	Lag	Lag	Lead	Lag	Lag	Lead	Lag
Lead-Lag Optimize?	Yes	Yes	Yes	Yes	Yes	Yes	Yes	Yes	Yes	Yes
Recall Mode	None	None	None	None	None	None	None	None	None	None
Act Effct Green (s)	9.8	47.0	8.1	45.3	45.3	8.6	23.3	23.3	12.0	26.4
Actuated g/C Ratio	0.09	0.42	0.07	0.41	0.41	0.08	0.21	0.21	0.11	0.24
v/c Ratio	0.87	0.80	0.80	0.93	0.74	0.55	0.71	0.33	0.96	0.31
Control Delay	95.2	33.3	92.3	44.8	21.3	58.4	45.8	7.7	87.5	29.3
Queue Delay	0.0	0.0	0.0	0.0	0.0	0.0	0.0	0.0	0.0	0.0
Total Delay	95.2	33.3	92.3	44.8	21.3	58.4	45.8	7.7	87.5	29.3
LOS	F	C	F	D	C	E	D	A	F	C
Approach Delay		39.7		40.3			41.2			63.5
Approach LOS		D		D			D			E

Intersection Summary

Cycle Length: 120
 Actuated Cycle Length: 110.6
 Natural Cycle: 125
 Control Type: Actuated-Uncoordinated
 Maximum v/c Ratio: 0.96
 Intersection Signal Delay: 43.2
 Intersection LOS: D
 Intersection Capacity Utilization 84.9%
 ICU Level of Service E
 Analysis Period (min) 15

Splits and Phases: 1: Washington St & Van Buren Bl.

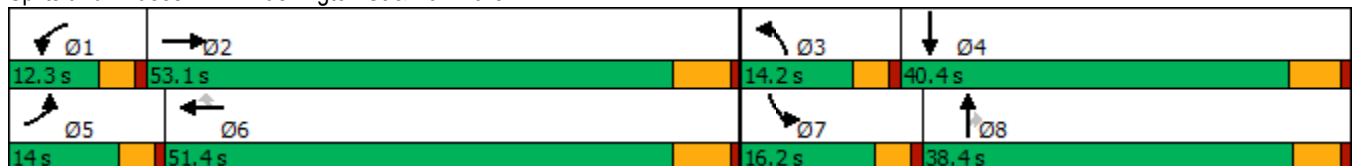

HCM 6th Signalized Intersection Summary
1: Washington St & Van Buren Bl.

West Campus Upper Plateau (JN 14064)

09/19/2022



Movement	EBL	EBT	EBR	WBL	WBT	WBR	NBL	NBT	NBR	SBL	SBT	SBR
Lane Configurations	↖	↕		↖	↕	↖	↖↗	↕	↖	↖↗	↕	↖↗
Traffic Volume (veh/h)	131	1010	120	99	1301	576	136	509	141	340	176	62
Future Volume (veh/h)	131	1010	120	99	1301	576	136	509	141	340	176	62
Initial Q (Qb), veh	0	0	0	0	0	0	0	0	0	0	0	0
Ped-Bike Adj(A_pbT)	1.00		0.99	1.00		0.98	1.00		1.00	1.00		1.00
Parking Bus, Adj	1.00	1.00	1.00	1.00	1.00	1.00	1.00	1.00	1.00	1.00	1.00	1.00
Work Zone On Approach		No			No			No			No	
Adj Sat Flow, veh/h/ln	1870	1856	1856	1856	1870	1885	1826	1870	1856	1856	1811	1826
Adj Flow Rate, veh/h	136	1052	102	103	1355	436	142	530	81	354	183	36
Peak Hour Factor	0.96	0.96	0.96	0.96	0.96	0.96	0.96	0.96	0.96	0.96	0.96	0.96
Percent Heavy Veh, %	2	3	3	3	2	1	5	2	3	3	6	5
Cap, veh/h	161	1395	135	128	1465	647	201	705	310	380	717	138
Arrive On Green	0.09	0.43	0.43	0.07	0.41	0.41	0.06	0.20	0.20	0.11	0.25	0.25
Sat Flow, veh/h	1781	3243	314	1767	3554	1570	3374	3554	1565	3428	2876	555
Grp Volume(v), veh/h	136	572	582	103	1355	436	142	530	81	354	108	111
Grp Sat Flow(s),veh/h/ln	1781	1763	1794	1767	1777	1570	1687	1777	1565	1714	1721	1710
Q Serve(g_s), s	8.1	29.6	29.7	6.2	39.3	24.5	4.5	15.2	4.7	11.1	5.4	5.6
Cycle Q Clear(g_c), s	8.1	29.6	29.7	6.2	39.3	24.5	4.5	15.2	4.7	11.1	5.4	5.6
Prop In Lane	1.00		0.18	1.00		1.00	1.00		1.00	1.00		0.32
Lane Grp Cap(c), veh/h	161	758	772	128	1465	647	201	705	310	380	429	427
V/C Ratio(X)	0.84	0.75	0.75	0.80	0.92	0.67	0.71	0.75	0.26	0.93	0.25	0.26
Avail Cap(c_a), veh/h	161	763	776	132	1482	655	311	1082	477	380	549	546
HCM Platoon Ratio	1.00	1.00	1.00	1.00	1.00	1.00	1.00	1.00	1.00	1.00	1.00	1.00
Upstream Filter(I)	1.00	1.00	1.00	1.00	1.00	1.00	1.00	1.00	1.00	1.00	1.00	1.00
Uniform Delay (d), s/veh	48.5	26.0	26.0	49.5	30.3	25.9	50.0	40.9	36.7	47.8	32.6	32.6
Incr Delay (d2), s/veh	30.2	4.6	4.5	26.5	10.2	3.0	1.7	1.6	0.4	29.3	0.3	0.3
Initial Q Delay(d3),s/veh	0.0	0.0	0.0	0.0	0.0	0.0	0.0	0.0	0.0	0.0	0.0	0.0
%ile BackOfQ(50%),veh/ln	4.8	12.3	12.5	3.6	17.3	9.6	1.9	6.8	1.9	6.3	2.3	2.4
Unsig. Movement Delay, s/veh												
LnGrp Delay(d),s/veh	78.8	30.6	30.5	76.0	40.5	28.9	51.7	42.6	37.2	77.0	32.9	33.0
LnGrp LOS	E	C	C	E	D	C	D	D	D	E	C	C
Approach Vol, veh/h		1290			1894			753				573
Approach Delay, s/veh		35.6			39.8			43.7				60.2
Approach LOS		D			D			D				E
Timer - Assigned Phs	1	2	3	4	5	6	7	8				
Phs Duration (G+Y+Rc), s	12.1	52.8	10.7	32.8	14.0	50.9	16.2	27.3				
Change Period (Y+Rc), s	* 4.2	6.2	* 4.2	5.8	* 4.2	6.2	* 4.2	* 5.8				
Max Green Setting (Gmax), s	* 8.1	46.9	* 10	34.6	* 9.8	45.2	* 12	* 33				
Max Q Clear Time (g_c+I1), s	8.2	31.7	6.5	7.6	10.1	41.3	13.1	17.2				
Green Ext Time (p_c), s	0.0	8.1	0.1	1.3	0.0	3.4	0.0	3.6				

Intersection Summary

HCM 6th Ctrl Delay	41.8
HCM 6th LOS	D

Notes

* HCM 6th computational engine requires equal clearance times for the phases crossing the barrier.

Timings
2: Central Ave & Arlington Ave/Chicago Ave

West Campus Upper Plateau (JN 14064)

09/19/2022



Lane Group	EBL	EBT	EBR	WBL	WBT	WBR	NBL	NBT	NBR	SBL	SBT
Lane Configurations	↘	↑↑	↗↗	↘↘	↑↑	↗	↘↘	↑↑	↗	↘↘	↑↑↗
Traffic Volume (vph)	41	491	620	207	812	322	1233	1530	456	225	623
Future Volume (vph)	41	491	620	207	812	322	1233	1530	456	225	623
Turn Type	Prot	NA	pm+ov	Prot	NA	pm+ov	Prot	NA	pm+ov	Prot	NA
Protected Phases	7	4	5	3	8	1	5	2	3	1	6
Permitted Phases			4			8			2		
Detector Phase	7	4	5	3	8	1	5	2	3	1	6
Switch Phase											
Minimum Initial (s)	5.0	10.0	10.0	5.0	10.0	10.0	10.0	10.0	5.0	10.0	10.0
Minimum Split (s)	9.6	35.2	15.8	9.6	38.8	15.8	15.8	38.8	9.6	15.8	38.8
Total Split (s)	9.6	35.6	42.0	12.8	38.8	15.9	42.0	65.7	12.8	15.9	39.6
Total Split (%)	7.4%	27.4%	32.3%	9.8%	29.8%	12.2%	32.3%	50.5%	9.8%	12.2%	30.5%
Yellow Time (s)	3.6	4.8	3.6	3.6	4.8	3.6	3.6	4.4	3.6	3.6	4.4
All-Red Time (s)	1.0	1.0	1.0	1.0	1.0	1.0	1.0	1.0	1.0	1.0	1.0
Lost Time Adjust (s)	0.0	0.0	0.0	0.0	0.0	0.0	0.0	0.0	0.0	0.0	0.0
Total Lost Time (s)	4.6	5.8	4.6	4.6	5.8	4.6	4.6	5.4	4.6	4.6	5.4
Lead/Lag	Lead	Lag	Lead	Lead	Lag	Lead	Lead	Lag	Lead	Lead	Lag
Lead-Lag Optimize?	Yes	Yes	Yes	Yes	Yes	Yes	Yes	Yes	Yes	Yes	Yes
Recall Mode	None	None	None	None	None	None	None	None	None	None	None
Act Effct Green (s)	5.0	27.2	70.5	8.2	32.5	49.4	37.5	60.2	69.3	11.1	33.9
Actuated g/C Ratio	0.04	0.21	0.55	0.06	0.26	0.39	0.29	0.47	0.54	0.09	0.27
v/c Ratio	0.62	0.70	0.42	1.04	0.95	0.50	1.29	0.96	0.55	0.80	0.53
Control Delay	96.8	51.5	15.7	130.8	66.4	24.0	173.1	47.8	17.1	77.1	41.4
Queue Delay	0.0	0.0	0.0	0.0	0.0	0.0	0.0	0.0	0.0	0.0	0.0
Total Delay	96.8	51.5	15.7	130.8	66.4	24.0	173.1	47.8	17.1	77.1	41.4
LOS	F	D	B	F	E	C	F	D	B	E	D
Approach Delay		33.9			66.1			91.4			50.4
Approach LOS		C			E			F			D

Intersection Summary

Cycle Length: 130
 Actuated Cycle Length: 127.2
 Natural Cycle: 125
 Control Type: Actuated-Uncoordinated
 Maximum v/c Ratio: 1.29
 Intersection Signal Delay: 70.7
 Intersection LOS: E
 Intersection Capacity Utilization 94.2%
 ICU Level of Service F
 Analysis Period (min) 15

Splits and Phases: 2: Central Ave & Arlington Ave/Chicago Ave



HCM 6th Signalized Intersection Summary
2: Central Ave & Arlington Ave/Chicago Ave

West Campus Upper Plateau (JN 14064)

09/19/2022



Movement	EBL	EBT	EBR	WBL	WBT	WBR	NBL	NBT	NBR	SBL	SBT	SBR
Lane Configurations	↘	↑↑	↗↗	↘↘	↑↑	↗	↘↘	↑↑	↗	↘↘	↑↑↑	
Traffic Volume (veh/h)	41	491	620	207	812	322	1233	1530	456	225	623	42
Future Volume (veh/h)	41	491	620	207	812	322	1233	1530	456	225	623	42
Initial Q (Qb), veh	0	0	0	0	0	0	0	0	0	0	0	0
Ped-Bike Adj(A_pbT)	1.00		1.00	1.00		1.00	1.00		0.99	1.00		1.00
Parking Bus, Adj	1.00	1.00	1.00	1.00	1.00	1.00	1.00	1.00	1.00	1.00	1.00	1.00
Work Zone On Approach		No			No			No			No	
Adj Sat Flow, veh/h/ln	1900	1856	1870	1796	1885	1885	1885	1885	1885	1870	1870	1870
Adj Flow Rate, veh/h	44	522	403	220	864	261	1312	1628	316	239	663	35
Peak Hour Factor	0.94	0.94	0.94	0.94	0.94	0.94	0.94	0.94	0.94	0.94	0.94	0.94
Percent Heavy Veh, %	0	3	2	7	1	1	1	1	1	2	2	2
Cap, veh/h	57	787	1437	213	916	543	1017	1681	842	290	1298	68
Arrive On Green	0.03	0.22	0.22	0.06	0.26	0.26	0.29	0.47	0.47	0.08	0.26	0.26
Sat Flow, veh/h	1810	3526	2790	3319	3582	1598	3483	3582	1577	3456	4966	261
Grp Volume(v), veh/h	44	522	403	220	864	261	1312	1628	316	239	453	245
Grp Sat Flow(s),veh/h/ln	1810	1763	1395	1659	1791	1598	1742	1791	1577	1728	1702	1823
Q Serve(g_s), s	3.1	17.3	10.5	8.2	30.3	16.5	37.4	56.6	15.0	8.7	14.5	14.6
Cycle Q Clear(g_c), s	3.1	17.3	10.5	8.2	30.3	16.5	37.4	56.6	15.0	8.7	14.5	14.6
Prop In Lane	1.00		1.00	1.00		1.00	1.00		1.00	1.00		0.14
Lane Grp Cap(c), veh/h	57	787	1437	213	916	543	1017	1681	842	290	890	477
V/C Ratio(X)	0.77	0.66	0.28	1.04	0.94	0.48	1.29	0.97	0.38	0.82	0.51	0.51
Avail Cap(c_a), veh/h	71	821	1464	213	923	546	1017	1687	845	305	909	487
HCM Platoon Ratio	1.00	1.00	1.00	1.00	1.00	1.00	1.00	1.00	1.00	1.00	1.00	1.00
Upstream Filter(I)	1.00	1.00	1.00	1.00	1.00	1.00	1.00	1.00	1.00	1.00	1.00	1.00
Uniform Delay (d), s/veh	61.6	45.3	17.6	59.9	46.7	33.3	45.3	33.0	17.4	57.7	40.3	40.3
Incr Delay (d2), s/veh	26.3	1.9	0.1	71.2	17.4	0.7	137.7	15.0	0.3	15.9	0.5	0.9
Initial Q Delay(d3),s/veh	0.0	0.0	0.0	0.0	0.0	0.0	0.0	0.0	0.0	0.0	0.0	0.0
%ile BackOfQ(50%),veh/ln	1.8	7.6	3.2	5.5	15.2	6.3	35.1	26.7	5.2	4.4	6.0	6.6
Unsig. Movement Delay, s/veh												
LnGrp Delay(d),s/veh	87.8	47.3	17.7	131.1	64.2	34.0	183.1	48.1	17.7	73.6	40.8	41.2
LnGrp LOS	F	D	B	F	E	C	F	D	B	E	D	D
Approach Vol, veh/h		969			1345			3256			937	
Approach Delay, s/veh		36.8			69.3			99.5			49.2	
Approach LOS		D			E			F			D	
Timer - Assigned Phs	1	2	3	4	5	6	7	8				
Phs Duration (G+Y+Rc), s	15.4	65.5	12.8	34.4	42.0	38.9	8.6	38.5				
Change Period (Y+Rc), s	4.6	5.4	4.6	5.8	4.6	5.4	4.6	5.8				
Max Green Setting (Gmax), s	11.3	60.3	8.2	29.8	37.4	34.2	5.0	33.0				
Max Q Clear Time (g_c+I1), s	10.7	58.6	10.2	19.3	39.4	16.6	5.1	32.3				
Green Ext Time (p_c), s	0.0	1.5	0.0	3.6	0.0	3.9	0.0	0.5				

Intersection Summary

HCM 6th Ctrl Delay	76.7
HCM 6th LOS	E

Timings

3: Overlook Pkwy./Canyon Crest Dr. & Alessandro Bl/Alessandro Bl.



Lane Group	EBL	EBT	WBL	WBT	WBR	NBL	NBT	NBR	SBL	SBT	SBR
Lane Configurations	↙	↕↕↕	↙	↕↕↕	↗	↙	↕↕	↗	↕↕	↙	↗
Traffic Volume (vph)	38	1313	27	3114	1016	9	33	10	449	82	49
Future Volume (vph)	38	1313	27	3114	1016	9	33	10	449	82	49
Turn Type	Prot	NA	Prot	NA	pm+ov	Split	NA	Perm	Split	NA	Perm
Protected Phases	5	2	1	6	4	8	8		4	4	
Permitted Phases					6			8			4
Detector Phase	5	2	1	6	4	8	8	8	4	4	4
Switch Phase											
Minimum Initial (s)	5.0	10.0	5.0	10.0	10.0	10.0	10.0	10.0	10.0	10.0	10.0
Minimum Split (s)	9.2	35.2	9.2	35.2	38.8	15.8	15.8	15.8	38.8	38.8	38.8
Total Split (s)	9.2	66.2	9.2	66.2	38.8	15.8	15.8	15.8	38.8	38.8	38.8
Total Split (%)	7.1%	50.9%	7.1%	50.9%	29.8%	12.2%	12.2%	12.2%	29.8%	29.8%	29.8%
Yellow Time (s)	3.2	5.2	3.2	5.2	4.8	4.8	4.8	4.8	4.8	4.8	4.8
All-Red Time (s)	1.0	1.0	1.0	1.0	1.0	1.0	1.0	1.0	1.0	1.0	1.0
Lost Time Adjust (s)	0.0	0.0	0.0	0.0	0.0	0.0	0.0	0.0	0.0	0.0	0.0
Total Lost Time (s)	4.2	6.2	4.2	6.2	5.8	5.8	5.8	5.8	5.8	5.8	5.8
Lead/Lag	Lead	Lag	Lead	Lag							
Lead-Lag Optimize?	Yes	Yes	Yes	Yes							
Recall Mode	None	None	None	None	None	None	None	None	None	None	None
Act Effct Green (s)	5.1	63.5	5.1	61.5	95.8	10.2	10.2	10.2	26.4	26.4	26.4
Actuated g/C Ratio	0.04	0.55	0.04	0.53	0.83	0.09	0.09	0.09	0.23	0.23	0.23
v/c Ratio	0.56	0.50	0.35	1.20	0.76	0.06	0.11	0.05	0.51	0.54	0.12
Control Delay	88.2	20.3	72.1	122.0	8.0	56.4	55.4	0.3	42.3	46.8	0.5
Queue Delay	0.0	0.0	0.0	0.0	0.0	0.0	0.0	0.0	0.0	0.0	0.0
Total Delay	88.2	20.3	72.1	122.0	8.0	56.4	55.4	0.3	42.3	46.8	0.5
LOS	F	C	E	F	A	E	E	A	D	D	A
Approach Delay		22.2		93.8			44.5			40.1	
Approach LOS		C		F			D			D	

Intersection Summary

Cycle Length: 130	
Actuated Cycle Length: 115.7	
Natural Cycle: 130	
Control Type: Actuated-Uncoordinated	
Maximum v/c Ratio: 1.20	
Intersection Signal Delay: 72.4	Intersection LOS: E
Intersection Capacity Utilization 91.7%	ICU Level of Service F
Analysis Period (min) 15	

Splits and Phases: 3: Overlook Pkwy./Canyon Crest Dr. & Alessandro Bl/Alessandro Bl.



HCM 6th Signalized Intersection Summary

West Campus Upper Plateau (JN 14064)

3: Overlook Pkwy./Canyon Crest Dr. & Alessandro Bl/Alessandro Bl.

09/19/2022

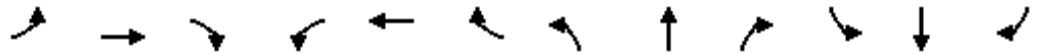

Movement	EBL	EBT	EBR	WBL	WBT	WBR	NBL	NBT	NBR	SBL	SBT	SBR
Lane Configurations	↖	↕↕↕		↖	↕↕↕	↖	↖	↕↕	↖	↕↕	↖	↖
Traffic Volume (veh/h)	38	1313	14	27	3114	1016	9	33	10	449	82	49
Future Volume (veh/h)	38	1313	14	27	3114	1016	9	33	10	449	82	49
Initial Q (Qb), veh	0	0	0	0	0	0	0	0	0	0	0	0
Ped-Bike Adj(A_pbT)	1.00		1.00	1.00		1.00	1.00		1.00	1.00		1.00
Parking Bus, Adj	1.00	1.00	1.00	1.00	1.00	1.00	1.00	1.00	1.00	1.00	1.00	1.00
Work Zone On Approach		No			No			No				No
Adj Sat Flow, veh/h/ln	1737	1870	1900	1900	1885	1885	1900	1900	1900	1856	1648	1870
Adj Flow Rate, veh/h	40	1382	15	28	3278	906	9	35	9	423	156	35
Peak Hour Factor	0.95	0.95	0.95	0.95	0.95	0.95	0.95	0.95	0.95	0.95	0.95	0.95
Percent Heavy Veh, %	11	2	0	0	1	1	0	0	0	3	17	2
Cap, veh/h	53	2857	31	47	2793	1112	132	262	117	543	253	244
Arrive On Green	0.03	0.55	0.55	0.03	0.54	0.54	0.07	0.07	0.07	0.15	0.15	0.15
Sat Flow, veh/h	1654	5208	57	1810	5147	1598	1810	3610	1610	3534	1648	1585
Grp Volume(v), veh/h	40	903	494	28	3278	906	9	35	9	423	156	35
Grp Sat Flow(s),veh/h/ln	1654	1702	1860	1810	1716	1598	1810	1805	1610	1767	1648	1585
Q Serve(g_s), s	2.7	18.0	18.0	1.7	60.0	44.0	0.5	1.0	0.6	12.7	9.8	2.1
Cycle Q Clear(g_c), s	2.7	18.0	18.0	1.7	60.0	44.0	0.5	1.0	0.6	12.7	9.8	2.1
Prop In Lane	1.00		0.03	1.00		1.00	1.00		1.00	1.00		1.00
Lane Grp Cap(c), veh/h	53	1867	1020	47	2793	1112	132	262	117	543	253	244
V/C Ratio(X)	0.76	0.48	0.48	0.59	1.17	0.81	0.07	0.13	0.08	0.78	0.62	0.14
Avail Cap(c_a), veh/h	75	1867	1020	82	2793	1112	164	327	146	1055	492	473
HCM Platoon Ratio	1.00	1.00	1.00	1.00	1.00	1.00	1.00	1.00	1.00	1.00	1.00	1.00
Upstream Filter(I)	1.00	1.00	1.00	1.00	1.00	1.00	1.00	1.00	1.00	1.00	1.00	1.00
Uniform Delay (d), s/veh	53.1	15.3	15.3	53.3	25.3	11.8	47.8	48.0	47.8	45.0	43.7	40.5
Incr Delay (d2), s/veh	13.5	0.2	0.4	4.4	82.3	4.8	0.2	0.2	0.3	2.5	2.4	0.3
Initial Q Delay(d3),s/veh	0.0	0.0	0.0	0.0	0.0	0.0	0.0	0.0	0.0	0.0	0.0	0.0
%ile BackOfQ(50%),veh/ln	1.3	6.2	6.9	0.8	42.2	22.9	0.2	0.4	0.2	5.6	4.0	0.8
Unsig. Movement Delay, s/veh												
LnGrp Delay(d),s/veh	66.6	15.5	15.7	57.6	107.6	16.5	48.0	48.2	48.1	47.4	46.2	40.8
LnGrp LOS	E	B	B	E	F	B	D	D	D	D	D	D
Approach Vol, veh/h		1437			4212			53			614	
Approach Delay, s/veh		17.0			87.6			48.2			46.7	
Approach LOS		B			F			D			D	
Timer - Assigned Phs	1	2		4	5	6		8				
Phs Duration (G+Y+Rc), s	7.1	66.9		22.8	7.7	66.2		13.8				
Change Period (Y+Rc), s	* 4.2	6.2		5.8	* 4.2	6.2		5.8				
Max Green Setting (Gmax), s	* 5	60.0		33.0	* 5	60.0		10.0				
Max Q Clear Time (g_c+I1), s	3.7	20.0		14.7	4.7	62.0		3.0				
Green Ext Time (p_c), s	0.0	10.9		2.3	0.0	0.0		0.1				

Intersection Summary

HCM 6th Ctrl Delay	67.3
HCM 6th LOS	E

Notes

- User approved pedestrian interval to be less than phase max green.
- User approved volume balancing among the lanes for turning movement.
- * HCM 6th computational engine requires equal clearance times for the phases crossing the barrier.

Timings

West Campus Upper Plateau (JN 14064)

4: Van Buren Bl. & Wood Rd.

09/19/2022

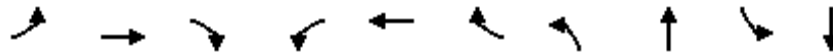

Lane Group	EBL	EBT	EBR	WBL	WBT	WBR	NBL	NBT	SBL	SBT
Lane Configurations	↘	↑↑	↗	↘↗	↑↑	↗	↘↗	↑↑	↘	↑↑
Traffic Volume (vph)	146	899	317	447	1166	102	323	416	83	416
Future Volume (vph)	146	899	317	447	1166	102	323	416	83	416
Turn Type	Prot	NA	pm+ov	Prot	NA	Perm	Prot	NA	Prot	NA
Protected Phases	5	2	3	1	6		3	8	7	4
Permitted Phases			2			6				
Detector Phase	5	2	3	1	6	6	3	8	7	4
Switch Phase										
Minimum Initial (s)	5.0	10.0	5.0	5.0	10.0	10.0	5.0	10.0	5.0	10.0
Minimum Split (s)	9.2	30.2	9.2	9.2	30.2	30.2	9.2	38.4	9.2	15.8
Total Split (s)	16.6	45.0	18.2	25.0	53.4	53.4	18.2	38.4	11.6	31.8
Total Split (%)	13.8%	37.5%	15.2%	20.8%	44.5%	44.5%	15.2%	32.0%	9.7%	26.5%
Yellow Time (s)	3.2	5.2	3.2	3.2	5.2	5.2	3.2	4.4	3.2	4.8
All-Red Time (s)	1.0	1.0	1.0	1.0	1.0	1.0	1.0	1.0	1.0	1.0
Lost Time Adjust (s)	0.0	0.0	0.0	0.0	0.0	0.0	0.0	0.0	0.0	0.0
Total Lost Time (s)	4.2	6.2	4.2	4.2	6.2	6.2	4.2	5.4	4.2	5.8
Lead/Lag	Lead	Lag	Lead	Lead	Lag	Lag	Lead	Lag	Lead	Lag
Lead-Lag Optimize?	Yes	Yes	Yes	Yes	Yes	Yes	Yes	Yes	Yes	Yes
Recall Mode	None	None	None	None	None	None	None	None	None	None
Act Effct Green (s)	12.3	39.9	55.7	19.7	47.2	47.2	13.9	31.6	7.4	24.7
Actuated g/C Ratio	0.10	0.34	0.47	0.17	0.40	0.40	0.12	0.27	0.06	0.21
v/c Ratio	0.91	0.87	0.47	0.88	0.95	0.16	0.91	0.86	0.85	0.88
Control Delay	100.2	46.6	15.8	66.2	49.9	2.8	78.7	43.3	108.9	56.8
Queue Delay	0.0	0.0	0.0	0.0	0.0	0.0	0.0	0.0	0.0	0.0
Total Delay	100.2	46.6	15.8	66.2	49.9	2.8	78.7	43.3	108.9	56.8
LOS	F	D	B	E	D	A	E	D	F	E
Approach Delay		45.2			51.3			54.2		63.3
Approach LOS		D			D			D		E

Intersection Summary

Cycle Length: 120
 Actuated Cycle Length: 118.6
 Natural Cycle: 110
 Control Type: Actuated-Uncoordinated
 Maximum v/c Ratio: 0.95
 Intersection Signal Delay: 51.9
 Intersection LOS: D
 Intersection Capacity Utilization 88.9%
 ICU Level of Service E
 Analysis Period (min) 15

Splits and Phases: 4: Van Buren Bl. & Wood Rd.

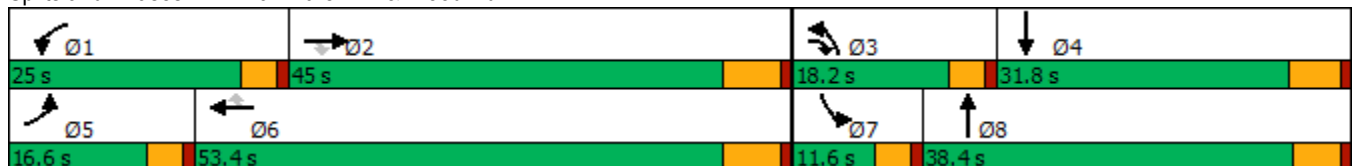

HCM 6th Signalized Intersection Summary
4: Van Buren Bl. & Wood Rd.

West Campus Upper Plateau (JN 14064)

09/19/2022

Movement	EBL	EBT	EBR	WBL	WBT	WBR	NBL	NBT	NBR	SBL	SBT	SBR
Lane Configurations												
Traffic Volume (veh/h)	146	899	317	447	1166	102	323	416	308	83	416	162
Future Volume (veh/h)	146	899	317	447	1166	102	323	416	308	83	416	162
Initial Q (Qb), veh	0	0	0	0	0	0	0	0	0	0	0	0
Ped-Bike Adj(A_pbT)	1.00		0.97	1.00		0.98	1.00		0.90	1.00		0.99
Parking Bus, Adj	1.00	1.00	1.00	1.00	1.00	1.00	1.00	1.00	1.00	1.00	1.00	1.00
Work Zone On Approach		No			No			No			No	
Adj Sat Flow, veh/h/ln	1856	1856	1856	1885	1856	1870	1885	1885	1885	1870	1900	1856
Adj Flow Rate, veh/h	166	1022	175	508	1325	66	367	473	207	94	473	89
Peak Hour Factor	0.88	0.88	0.88	0.88	0.88	0.88	0.88	0.88	0.88	0.88	0.88	0.88
Percent Heavy Veh, %	3	3	3	1	3	2	1	1	1	2	0	3
Cap, veh/h	184	1188	702	564	1391	616	410	626	271	111	641	120
Arrive On Green	0.10	0.34	0.34	0.16	0.39	0.39	0.12	0.27	0.27	0.06	0.21	0.21
Sat Flow, veh/h	1767	3526	1532	3483	3526	1560	3483	2343	1013	1781	3028	566
Grp Volume(v), veh/h	166	1022	175	508	1325	66	367	360	320	94	281	281
Grp Sat Flow(s),veh/h/ln	1767	1763	1532	1742	1763	1560	1742	1791	1565	1781	1805	1789
Q Serve(g_s), s	11.0	32.2	8.4	17.0	43.3	3.2	12.3	21.9	22.4	6.2	17.3	17.5
Cycle Q Clear(g_c), s	11.0	32.2	8.4	17.0	43.3	3.2	12.3	21.9	22.4	6.2	17.3	17.5
Prop In Lane	1.00		1.00	1.00		1.00	1.00		0.65	1.00		0.32
Lane Grp Cap(c), veh/h	184	1188	702	564	1391	616	410	478	418	111	382	379
V/C Ratio(X)	0.90	0.86	0.25	0.90	0.95	0.11	0.89	0.75	0.76	0.85	0.74	0.74
Avail Cap(c_a), veh/h	184	1188	702	610	1401	620	410	497	435	111	395	392
HCM Platoon Ratio	1.00	1.00	1.00	1.00	1.00	1.00	1.00	1.00	1.00	1.00	1.00	1.00
Upstream Filter(I)	1.00	1.00	1.00	1.00	1.00	1.00	1.00	1.00	1.00	1.00	1.00	1.00
Uniform Delay (d), s/veh	52.6	36.8	19.9	48.9	34.9	22.7	51.7	39.9	40.1	55.1	43.7	43.8
Incr Delay (d2), s/veh	38.6	6.8	0.3	15.0	14.4	0.1	20.8	6.2	7.7	40.7	6.8	7.2
Initial Q Delay(d3),s/veh	0.0	0.0	0.0	0.0	0.0	0.0	0.0	0.0	0.0	0.0	0.0	0.0
%ile BackOfQ(50%),veh/ln	6.7	14.1	2.9	8.3	20.0	1.2	6.5	10.2	9.3	4.0	8.3	8.3
Unsig. Movement Delay, s/veh												
LnGrp Delay(d),s/veh	91.2	43.6	20.2	63.9	49.2	22.8	72.5	46.1	47.8	95.8	50.5	51.0
LnGrp LOS	F	D	C	E	D	C	E	D	D	F	D	D
Approach Vol, veh/h		1363			1899			1047			656	
Approach Delay, s/veh		46.4			52.2			55.9			57.2	
Approach LOS		D			D			E			E	
Timer - Assigned Phs	1	2	3	4	5	6	7	8				
Phs Duration (G+Y+Rc), s	23.4	46.2	18.2	30.9	16.6	53.1	11.6	37.5				
Change Period (Y+Rc), s	* 4.2	6.2	* 4.2	5.8	* 4.2	6.2	* 4.2	* 5.8				
Max Green Setting (Gmax), s	* 21	38.8	* 14	26.0	* 12	47.2	* 7.4	* 33				
Max Q Clear Time (g_c+I1), s	19.0	34.2	14.3	19.5	13.0	45.3	8.2	24.4				
Green Ext Time (p_c), s	0.2	3.3	0.0	1.7	0.0	1.6	0.0	2.7				

Intersection Summary

HCM 6th Ctrl Delay	52.0
HCM 6th LOS	D

Notes

* HCM 6th computational engine requires equal clearance times for the phases crossing the barrier.

Timings
5: Trautwein Rd. & Alessandro Bl.

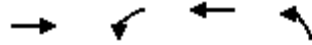

Lane Group	EBT	WBL	WBT	NBL
Lane Configurations	↑↑↑	↰↱	↑↑↑	↰↱↱
Traffic Volume (vph)	1129	157	3065	1847
Future Volume (vph)	1129	157	3065	1847
Turn Type	NA	Prot	NA	Prot
Protected Phases	2	1	6	8
Permitted Phases				
Detector Phase	2	1	6	8
Switch Phase				
Minimum Initial (s)	10.0	5.0	10.0	10.0
Minimum Split (s)	33.2	9.2	16.2	16.2
Total Split (s)	54.6	17.4	72.0	48.0
Total Split (%)	45.5%	14.5%	60.0%	40.0%
Yellow Time (s)	5.2	3.2	5.2	5.2
All-Red Time (s)	1.0	1.0	1.0	1.0
Lost Time Adjust (s)	0.0	0.0	0.0	0.0
Total Lost Time (s)	6.2	4.2	6.2	6.2
Lead/Lag	Lag	Lead		
Lead-Lag Optimize?	Yes	Yes		
Recall Mode	None	None	None	None
Act Effect Green (s)	51.2	10.4	65.8	41.8
Actuated g/C Ratio	0.43	0.09	0.55	0.35
v/c Ratio	0.57	0.59	1.20	1.17
Control Delay	27.7	60.8	119.1	119.3
Queue Delay	0.0	0.0	0.0	0.0
Total Delay	27.7	60.8	119.1	119.3
LOS	C	E	F	F
Approach Delay	27.7		116.3	119.3
Approach LOS	C		F	F

Intersection Summary

Cycle Length: 120	
Actuated Cycle Length: 120	
Natural Cycle: 130	
Control Type: Actuated-Uncoordinated	
Maximum v/c Ratio: 1.20	
Intersection Signal Delay: 101.0	Intersection LOS: F
Intersection Capacity Utilization 104.8%	ICU Level of Service G
Analysis Period (min) 15	

Splits and Phases: 5: Trautwein Rd. & Alessandro Bl.

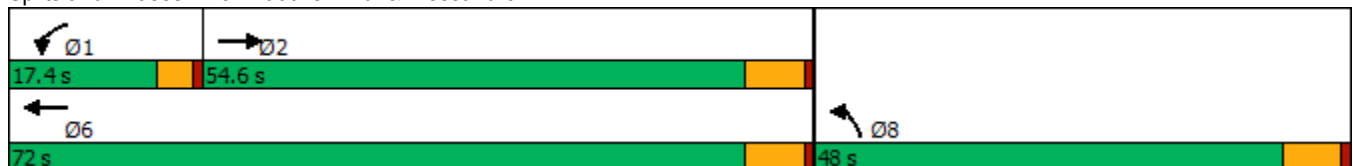

HCM 6th Signalized Intersection Summary
5: Trautwein Rd. & Alessandro Bl.

West Campus Upper Plateau (JN 14064)
09/19/2022

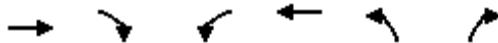

Movement	EBT	EBR	WBL	WBT	NBL	NBR
Lane Configurations	↑↑↑		↵↵	↑↑↑	↵↵↵	
Traffic Volume (veh/h)	1129	4	157	3065	1847	7
Future Volume (veh/h)	1129	4	157	3065	1847	7
Initial Q (Qb), veh	0	0	0	0	0	0
Ped-Bike Adj(A_pbT)		1.00	1.00		1.00	1.00
Parking Bus, Adj	1.00	1.00	1.00	1.00	1.00	1.00
Work Zone On Approach	No			No	No	
Adj Sat Flow, veh/h/ln	1870	1900	1856	1885	1870	1693
Adj Flow Rate, veh/h	1241	4	173	3368	2037	0
Peak Hour Factor	0.91	0.91	0.91	0.91	0.91	0.91
Percent Heavy Veh, %	2	0	3	1	2	14
Cap, veh/h	2344	8	231	2822	1861	500
Arrive On Green	0.45	0.45	0.07	0.55	0.35	0.00
Sat Flow, veh/h	5423	17	3428	5316	5344	1434
Grp Volume(v), veh/h	804	441	173	3368	2037	0
Grp Sat Flow(s),veh/h/ln	1702	1867	1714	1716	1781	1434
Q Serve(g_s), s	20.6	20.6	5.9	65.8	41.8	0.0
Cycle Q Clear(g_c), s	20.6	20.6	5.9	65.8	41.8	0.0
Prop In Lane		0.01	1.00		1.00	1.00
Lane Grp Cap(c), veh/h	1519	833	231	2822	1861	500
V/C Ratio(X)	0.53	0.53	0.75	1.19	1.09	0.00
Avail Cap(c_a), veh/h	1519	833	377	2822	1861	500
HCM Platoon Ratio	1.00	1.00	1.00	1.00	1.00	1.00
Upstream Filter(I)	1.00	1.00	1.00	1.00	1.00	0.00
Uniform Delay (d), s/veh	24.1	24.1	55.0	27.1	39.1	0.0
Incr Delay (d2), s/veh	0.5	0.8	1.9	90.8	51.7	0.0
Initial Q Delay(d3),s/veh	0.0	0.0	0.0	0.0	0.0	0.0
%ile BackOfQ(50%),veh/ln	7.8	8.7	2.5	46.8	26.0	0.0
Unsig. Movement Delay, s/veh						
LnGrp Delay(d),s/veh	24.6	24.9	56.8	117.9	90.8	0.0
LnGrp LOS	C	C	E	F	F	A
Approach Vol, veh/h	1245			3541	2037	
Approach Delay, s/veh	24.7			114.9	90.8	
Approach LOS	C			F	F	
Timer - Assigned Phs	1	2			6	8
Phs Duration (G+Y+Rc), s	12.3	59.7			72.0	48.0
Change Period (Y+Rc), s	* 4.2	6.2			6.2	6.2
Max Green Setting (Gmax), s	* 13	48.4			65.8	41.8
Max Q Clear Time (g_c+I1), s	7.9	22.6			67.8	43.8
Green Ext Time (p_c), s	0.1	11.7			0.0	0.0

Intersection Summary

HCM 6th Ctrl Delay	91.3
HCM 6th LOS	F

Notes

User approved volume balancing among the lanes for turning movement.
* HCM 6th computational engine requires equal clearance times for the phases crossing the barrier.

Timings
6: Trautwein Rd. & Grove Community Dr

West Campus Upper Plateau (JN 14064)

09/19/2022

Lane Group	WBL	WBR	NBT	NBR	SBL	SBT
Lane Configurations						
Traffic Volume (vph)	75	604	1428	22	206	871
Future Volume (vph)	75	604	1428	22	206	871
Turn Type	Prot	pm+ov	NA	Perm	Prot	NA
Protected Phases	8	1	2		1	6
Permitted Phases		8		2		
Detector Phase	8	1	2	2	1	6
Switch Phase						
Minimum Initial (s)	10.0	5.0	10.0	10.0	5.0	10.0
Minimum Split (s)	34.6	9.6	46.2	46.2	9.6	28.2
Total Split (s)	34.6	15.0	70.4	70.4	15.0	85.4
Total Split (%)	28.8%	12.5%	58.7%	58.7%	12.5%	71.2%
Yellow Time (s)	3.6	3.6	5.2	5.2	3.6	5.2
All-Red Time (s)	1.0	1.0	1.0	1.0	1.0	1.0
Lost Time Adjust (s)	0.0	0.0	0.0	0.0	0.0	0.0
Total Lost Time (s)	4.6	4.6	6.2	6.2	4.6	6.2
Lead/Lag		Lead	Lag	Lag	Lead	
Lead-Lag Optimize?		Yes	Yes	Yes	Yes	
Recall Mode	None	None	None	None	None	None
Act Effct Green (s)	14.0	21.8	52.0	52.0	11.3	70.5
Actuated g/C Ratio	0.16	0.25	0.58	0.58	0.13	0.79
v/c Ratio	0.32	1.04	0.83	0.03	0.57	0.38
Control Delay	41.3	77.5	20.5	6.4	48.1	5.1
Queue Delay	0.0	0.0	0.0	0.0	0.0	0.0
Total Delay	41.3	77.5	20.5	6.4	48.1	5.1
LOS	D	E	C	A	D	A
Approach Delay	73.5		20.3			13.3
Approach LOS	E		C			B

Intersection Summary

Cycle Length: 120
 Actuated Cycle Length: 88.9
 Natural Cycle: 105
 Control Type: Actuated-Uncoordinated
 Maximum v/c Ratio: 1.04
 Intersection Signal Delay: 29.2
 Intersection LOS: C
 Intersection Capacity Utilization 69.8%
 ICU Level of Service C
 Analysis Period (min) 15

Splits and Phases: 6: Trautwein Rd. & Grove Community Dr

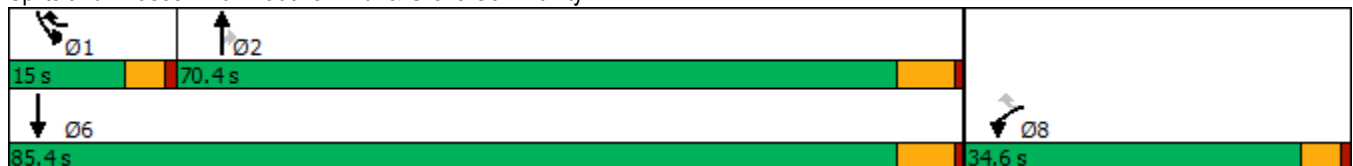

HCM 6th Signalized Intersection Summary
6: Trautwein Rd. & Grove Community Dr

West Campus Upper Plateau (JN 14064)

09/19/2022



Movement	WBL	WBR	NBT	NBR	SBL	SBT
Lane Configurations						
Traffic Volume (veh/h)	75	604	1428	22	206	871
Future Volume (veh/h)	75	604	1428	22	206	871
Initial Q (Qb), veh	0	0	0	0	0	0
Ped-Bike Adj(A_pbT)	1.00	1.00		0.97	1.00	
Parking Bus, Adj	1.00	1.00	1.00	1.00	1.00	1.00
Work Zone On Approach	No		No			No
Adj Sat Flow, veh/h/ln	1900	1885	1870	1900	1870	1856
Adj Flow Rate, veh/h	90	526	1720	19	248	1049
Peak Hour Factor	0.83	0.83	0.83	0.83	0.83	0.83
Percent Heavy Veh, %	0	1	2	0	2	3
Cap, veh/h	365	822	1976	873	313	2439
Arrive On Green	0.20	0.20	0.56	0.56	0.09	0.69
Sat Flow, veh/h	1810	2812	3647	1570	3456	3618
Grp Volume(v), veh/h	90	526	1720	19	248	1049
Grp Sat Flow(s),veh/h/ln	1810	1406	1777	1570	1728	1763
Q Serve(g_s), s	4.2	16.5	42.3	0.6	7.1	13.3
Cycle Q Clear(g_c), s	4.2	16.5	42.3	0.6	7.1	13.3
Prop In Lane	1.00	1.00		1.00	1.00	
Lane Grp Cap(c), veh/h	365	822	1976	873	313	2439
V/C Ratio(X)	0.25	0.64	0.87	0.02	0.79	0.43
Avail Cap(c_a), veh/h	535	1085	2247	993	354	2750
HCM Platoon Ratio	1.00	1.00	1.00	1.00	1.00	1.00
Upstream Filter(I)	1.00	1.00	1.00	1.00	1.00	1.00
Uniform Delay (d), s/veh	34.0	31.3	19.4	10.1	45.2	6.9
Incr Delay (d2), s/veh	0.3	0.8	3.6	0.0	9.0	0.1
Initial Q Delay(d3),s/veh	0.0	0.0	0.0	0.0	0.0	0.0
%ile BackOfQ(50%),veh/ln	1.9	5.5	15.5	0.2	3.3	3.7
Unsig. Movement Delay, s/veh						
LnGrp Delay(d),s/veh	34.4	32.1	23.0	10.1	54.2	7.0
LnGrp LOS	C	C	C	B	D	A
Approach Vol, veh/h	616		1739			1297
Approach Delay, s/veh	32.4		22.9			16.0
Approach LOS	C		C			B
Timer - Assigned Phs	1	2			6	8
Phs Duration (G+Y+Rc), s	13.8	62.6			76.4	25.1
Change Period (Y+Rc), s	4.6	6.2			6.2	4.6
Max Green Setting (Gmax), s	10.4	64.2			79.2	30.0
Max Q Clear Time (g_c+I1), s	9.1	44.3			15.3	18.5
Green Ext Time (p_c), s	0.1	12.2			8.4	2.0

Intersection Summary

HCM 6th Ctrl Delay			22.1			
HCM 6th LOS			C			

Timings

7: Trautwein Rd. & Orange Terrace Pkwy

09/19/2022



Lane Group	EBL	EBT	WBL	WBT	WBR	NBL	NBT	NBR	SBL	SBT	SBR
Lane Configurations											
Traffic Volume (vph)	67	63	288	99	485	48	974	239	382	579	20
Future Volume (vph)	67	63	288	99	485	48	974	239	382	579	20
Turn Type	Prot	NA	Prot	NA	pm+ov	Prot	NA	Perm	Prot	NA	Perm
Protected Phases	7	4	3	8	1	5	2		1	6	
Permitted Phases					8			2			6
Detector Phase	7	4	3	8	1	5	2	2	1	6	6
Switch Phase											
Minimum Initial (s)	5.0	10.0	5.0	10.0	5.0	5.0	10.0	10.0	5.0	10.0	10.0
Minimum Split (s)	9.6	38.6	9.6	34.6	9.6	9.6	46.2	46.2	9.6	24.2	24.2
Total Split (s)	16.8	40.6	23.0	46.8	19.0	13.0	47.4	47.4	19.0	53.4	53.4
Total Split (%)	12.9%	31.2%	17.7%	36.0%	14.6%	10.0%	36.5%	36.5%	14.6%	41.1%	41.1%
Yellow Time (s)	3.6	3.6	3.6	3.6	3.6	3.6	5.2	5.2	3.6	5.2	5.2
All-Red Time (s)	1.0	1.0	1.0	1.0	1.0	1.0	1.0	1.0	1.0	1.0	1.0
Lost Time Adjust (s)	0.0	0.0	0.0	0.0	0.0	0.0	0.0	0.0	0.0	0.0	0.0
Total Lost Time (s)	4.6	4.6	4.6	4.6	4.6	4.6	6.2	6.2	4.6	6.2	6.2
Lead/Lag	Lead	Lag	Lead	Lag	Lead	Lead	Lag	Lag	Lead	Lag	Lag
Lead-Lag Optimize?	Yes	Yes	Yes	Yes	Yes	Yes	Yes	Yes	Yes	Yes	Yes
Recall Mode	None	None	None	None	None	None	None	None	None	None	None
Act Effct Green (s)	8.7	14.4	18.6	23.2	37.8	7.2	41.7	41.7	14.6	51.4	51.4
Actuated g/C Ratio	0.08	0.14	0.18	0.22	0.36	0.07	0.39	0.39	0.14	0.48	0.48
v/c Ratio	0.54	0.35	1.10	0.29	0.53	0.48	0.84	0.40	0.98	0.41	0.03
Control Delay	62.9	42.2	121.4	37.0	19.2	64.7	37.7	12.8	83.3	21.7	0.1
Queue Delay	0.0	0.0	0.0	0.0	0.0	0.0	0.0	0.0	0.0	0.0	0.0
Total Delay	62.9	42.2	121.4	37.0	19.2	64.7	37.7	12.8	83.3	21.7	0.1
LOS	E	D	F	D	B	E	D	B	F	C	A
Approach Delay		52.0		55.0			34.0			45.3	
Approach LOS		D		E			C			D	

Intersection Summary

Cycle Length: 130
 Actuated Cycle Length: 106.2
 Natural Cycle: 125
 Control Type: Actuated-Uncoordinated
 Maximum v/c Ratio: 1.10
 Intersection Signal Delay: 43.8
 Intersection LOS: D
 Intersection Capacity Utilization 74.1%
 ICU Level of Service D
 Analysis Period (min) 15



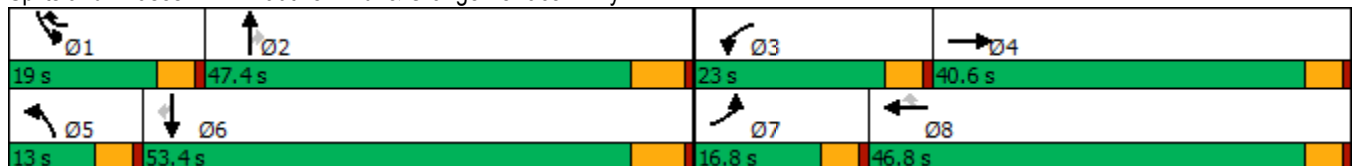



















Splits and Phases: 7: Trautwein Rd. & Orange Terrace Pkwy



HCM 6th Signalized Intersection Summary
7: Trautwein Rd. & Orange Terrace Pkwy

West Campus Upper Plateau (JN 14064)

09/19/2022

												
Movement	EBL	EBT	EBR	WBL	WBT	WBR	NBL	NBT	NBR	SBL	SBT	SBR
Lane Configurations												
Traffic Volume (veh/h)	67	63	12	288	99	485	48	974	239	382	579	20
Future Volume (veh/h)	67	63	12	288	99	485	48	974	239	382	579	20
Initial Q (Qb), veh	0	0	0	0	0	0	0	0	0	0	0	0
Ped-Bike Adj(A_pbT)	1.00		0.99	1.00		0.96	1.00		1.00	1.00		0.98
Parking Bus, Adj	1.00	1.00	1.00	1.00	1.00	1.00	1.00	1.00	1.00	1.00	1.00	1.00
Work Zone On Approach		No			No			No			No	
Adj Sat Flow, veh/h/ln	1900	1870	1900	1885	1885	1885	1870	1856	1870	1856	1856	1826
Adj Flow Rate, veh/h	80	75	9	343	118	332	57	1160	200	455	689	16
Peak Hour Factor	0.84	0.84	0.84	0.84	0.84	0.84	0.84	0.84	0.84	0.84	0.84	0.84
Percent Heavy Veh, %	0	2	0	1	1	1	2	3	2	3	3	5
Cap, veh/h	103	212	25	314	467	1056	73	1298	583	469	1636	701
Arrive On Green	0.06	0.13	0.13	0.17	0.25	0.25	0.04	0.37	0.37	0.14	0.46	0.46
Sat Flow, veh/h	1810	1636	196	1795	1885	2710	1781	3526	1582	3428	3526	1510
Grp Volume(v), veh/h	80	0	84	343	118	332	57	1160	200	455	689	16
Grp Sat Flow(s),veh/h/ln	1810	0	1832	1795	1885	1355	1781	1763	1582	1714	1763	1510
Q Serve(g_s), s	4.6	0.0	4.4	18.4	5.3	9.0	3.3	32.6	9.6	13.9	13.7	0.6
Cycle Q Clear(g_c), s	4.6	0.0	4.4	18.4	5.3	9.0	3.3	32.6	9.6	13.9	13.7	0.6
Prop In Lane	1.00		0.11	1.00		1.00	1.00		1.00	1.00		1.00
Lane Grp Cap(c), veh/h	103	0	237	314	467	1056	73	1298	583	469	1636	701
V/C Ratio(X)	0.78	0.00	0.35	1.09	0.25	0.31	0.78	0.89	0.34	0.97	0.42	0.02
Avail Cap(c_a), veh/h	210	0	627	314	757	1472	142	1381	620	469	1636	701
HCM Platoon Ratio	1.00	1.00	1.00	1.00	1.00	1.00	1.00	1.00	1.00	1.00	1.00	1.00
Upstream Filter(I)	1.00	0.00	1.00	1.00	1.00	1.00	1.00	1.00	1.00	1.00	1.00	1.00
Uniform Delay (d), s/veh	48.9	0.0	41.7	43.4	31.7	22.7	49.9	31.3	24.0	45.2	18.8	15.3
Incr Delay (d2), s/veh	4.7	0.0	0.9	77.6	0.3	0.2	6.4	7.5	0.3	33.4	0.2	0.0
Initial Q Delay(d3),s/veh	0.0	0.0	0.0	0.0	0.0	0.0	0.0	0.0	0.0	0.0	0.0	0.0
%ile BackOfQ(50%),veh/ln	2.2	0.0	2.0	14.6	2.4	2.7	1.6	14.0	3.5	7.8	5.1	0.2
Unsig. Movement Delay, s/veh												
LnGrp Delay(d),s/veh	53.6	0.0	42.6	121.0	32.0	22.9	56.4	38.8	24.4	78.5	18.9	15.3
LnGrp LOS	D	A	D	F	C	C	E	D	C	E	B	B
Approach Vol, veh/h		164			793			1417			1160	
Approach Delay, s/veh		48.0			66.7			37.5			42.3	
Approach LOS		D			E			D			D	
Timer - Assigned Phs	1	2	3	4	5	6	7	8				
Phs Duration (G+Y+Rc), s	19.0	44.9	23.0	18.2	8.9	55.0	10.6	30.6				
Change Period (Y+Rc), s	4.6	6.2	4.6	4.6	4.6	6.2	4.6	4.6				
Max Green Setting (Gmax), s	14.4	41.2	18.4	36.0	8.4	47.2	12.2	42.2				
Max Q Clear Time (g_c+I1), s	15.9	34.6	20.4	6.4	5.3	15.7	6.6	11.0				
Green Ext Time (p_c), s	0.0	4.1	0.0	0.4	0.0	4.6	0.0	2.0				
Intersection Summary												
HCM 6th Ctrl Delay			46.1									
HCM 6th LOS			D									

Timings
8: Cole Av. & Van Buren Bl.

West Campus Upper Plateau (JN 14064)

09/19/2022



Lane Group	EBL	EBT	EBR	WBL	WBT	WBR	NBL	NBT	SBL	SBT	SBR
Lane Configurations	↖↗	↑↑	↖	↖	↑↑↑	↖	↖	↑↑	↖↗	↑↑	↖
Traffic Volume (vph)	301	986	92	150	1244	332	215	535	176	329	226
Future Volume (vph)	301	986	92	150	1244	332	215	535	176	329	226
Turn Type	Prot	NA	pm+ov	Prot	NA	pm+ov	Prot	NA	Prot	NA	pm+ov
Protected Phases	5	2	3	1	6	7	3	8	7	4	5
Permitted Phases			2			6					4
Detector Phase	5	2	3	1	6	7	3	8	7	4	5
Switch Phase											
Minimum Initial (s)	5.0	10.0	5.0	5.0	10.0	5.0	5.0	10.0	5.0	10.0	5.0
Minimum Split (s)	9.1	36.2	9.1	9.1	36.2	9.1	9.1	42.2	9.1	49.2	9.1
Total Split (s)	15.0	37.8	19.0	14.0	36.8	21.6	19.0	46.6	21.6	49.2	15.0
Total Split (%)	12.5%	31.5%	15.8%	11.7%	30.7%	18.0%	15.8%	38.8%	18.0%	41.0%	12.5%
Yellow Time (s)	3.2	5.2	3.2	3.2	5.2	3.2	3.2	5.2	3.2	5.2	3.2
All-Red Time (s)	0.5	1.0	0.5	0.5	1.0	0.5	0.5	1.0	0.5	1.0	0.5
Lost Time Adjust (s)	0.0	0.0	0.0	0.0	0.0	0.0	0.0	0.0	0.0	0.0	0.0
Total Lost Time (s)	3.7	6.2	3.7	3.7	6.2	3.7	3.7	6.2	3.7	6.2	3.7
Lead/Lag	Lead	Lag	Lead	Lead	Lag	Lead	Lead	Lag	Lead	Lag	Lead
Lead-Lag Optimize?	Yes	Yes	Yes	Yes	Yes	Yes	Yes	Yes	Yes	Yes	Yes
Recall Mode	None	None	None	None	None	None	None	None	None	None	None
Act Effct Green (s)	11.4	31.8	53.5	10.4	30.8	43.5	15.4	27.0	10.2	21.7	35.6
Actuated g/C Ratio	0.11	0.32	0.54	0.10	0.31	0.44	0.16	0.27	0.10	0.22	0.36
v/c Ratio	0.86	0.99	0.12	0.89	0.88	0.51	0.88	0.77	0.56	0.47	0.42
Control Delay	66.2	58.9	6.0	88.5	41.7	17.0	74.8	38.2	50.1	35.0	17.4
Queue Delay	0.0	0.0	0.0	0.0	0.0	0.0	0.0	0.0	0.0	0.0	0.0
Total Delay	66.2	58.9	6.0	88.5	41.7	17.0	74.8	38.2	50.1	35.0	17.4
LOS	E	E	A	F	D	B	E	D	D	D	B
Approach Delay		57.0			41.0			47.2		33.2	
Approach LOS		E			D			D		C	

Intersection Summary

Cycle Length: 120
 Actuated Cycle Length: 99.3
 Natural Cycle: 125
 Control Type: Actuated-Uncoordinated
 Maximum v/c Ratio: 0.99
 Intersection Signal Delay: 45.6
 Intersection LOS: D
 Intersection Capacity Utilization 76.8%
 ICU Level of Service D
 Analysis Period (min) 15



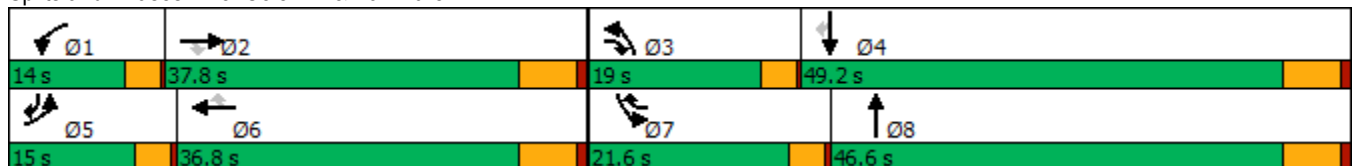





















Splits and Phases: 8: Cole Av. & Van Buren Bl.



HCM 6th Signalized Intersection Summary
8: Cole Av. & Van Buren Bl.

West Campus Upper Plateau (JN 14064)

09/19/2022

												
Movement	EBL	EBT	EBR	WBL	WBT	WBR	NBL	NBT	NBR	SBL	SBT	SBR
Lane Configurations												
Traffic Volume (veh/h)	301	986	92	150	1244	332	215	535	125	176	329	226
Future Volume (veh/h)	301	986	92	150	1244	332	215	535	125	176	329	226
Initial Q (Qb), veh	0	0	0	0	0	0	0	0	0	0	0	0
Ped-Bike Adj(A_pbT)	1.00		1.00	1.00		0.99	1.00		1.00	1.00		1.00
Parking Bus, Adj	1.00	1.00	1.00	1.00	1.00	1.00	1.00	1.00	1.00	1.00	1.00	1.00
Work Zone On Approach		No			No			No			No	
Adj Sat Flow, veh/h/ln	1856	1841	1841	1900	1856	1856	1856	1870	1856	1856	1870	1841
Adj Flow Rate, veh/h	334	1096	61	167	1382	279	239	594	130	196	366	179
Peak Hour Factor	0.90	0.90	0.90	0.90	0.90	0.90	0.90	0.90	0.90	0.90	0.90	0.90
Percent Heavy Veh, %	3	4	4	0	3	3	3	2	3	3	2	4
Cap, veh/h	402	1178	765	200	1671	637	272	754	165	272	659	471
Arrive On Green	0.12	0.34	0.34	0.11	0.33	0.33	0.15	0.26	0.26	0.08	0.19	0.19
Sat Flow, veh/h	3428	3497	1560	1810	5066	1553	1767	2899	633	3428	3554	1555
Grp Volume(v), veh/h	334	1096	61	167	1382	279	239	363	361	196	366	179
Grp Sat Flow(s),veh/h/ln	1714	1749	1560	1810	1689	1553	1767	1777	1756	1714	1777	1555
Q Serve(g_s), s	8.8	28.1	1.9	8.4	23.3	12.0	12.3	17.7	17.7	5.2	8.7	8.4
Cycle Q Clear(g_c), s	8.8	28.1	1.9	8.4	23.3	12.0	12.3	17.7	17.7	5.2	8.7	8.4
Prop In Lane	1.00		1.00	1.00		1.00	1.00		0.36	1.00		1.00
Lane Grp Cap(c), veh/h	402	1178	765	200	1671	637	272	462	456	272	659	471
V/C Ratio(X)	0.83	0.93	0.08	0.84	0.83	0.44	0.88	0.79	0.79	0.72	0.56	0.38
Avail Cap(c_a), veh/h	418	1191	772	201	1671	637	291	774	765	662	1647	904
HCM Platoon Ratio	1.00	1.00	1.00	1.00	1.00	1.00	1.00	1.00	1.00	1.00	1.00	1.00
Upstream Filter(I)	1.00	1.00	1.00	1.00	1.00	1.00	1.00	1.00	1.00	1.00	1.00	1.00
Uniform Delay (d), s/veh	40.0	29.7	12.5	40.4	28.6	19.7	38.4	31.9	32.0	41.7	34.3	25.5
Incr Delay (d2), s/veh	12.0	12.9	0.1	23.8	3.7	0.7	22.6	3.0	3.1	1.4	0.7	0.5
Initial Q Delay(d3),s/veh	0.0	0.0	0.0	0.0	0.0	0.0	0.0	0.0	0.0	0.0	0.0	0.0
%ile BackOfQ(50%),veh/ln	4.2	12.7	0.6	4.8	9.1	4.0	6.7	7.4	7.3	2.1	3.6	2.9
Unsig. Movement Delay, s/veh												
LnGrp Delay(d),s/veh	52.1	42.6	12.6	64.2	32.4	20.4	61.0	34.9	35.1	43.0	35.0	26.0
LnGrp LOS	D	D	B	E	C	C	E	C	D	D	D	C
Approach Vol, veh/h		1491			1828			963			741	
Approach Delay, s/veh		43.5			33.5			41.5			35.0	
Approach LOS		D			C			D			C	
Timer - Assigned Phs	1	2	3	4	5	6	7	8				
Phs Duration (G+Y+Rc), s	13.9	37.4	18.0	23.4	14.6	36.8	11.1	30.3				
Change Period (Y+Rc), s	3.7	6.2	3.7	6.2	3.7	6.2	3.7	6.2				
Max Green Setting (Gmax), s	10.3	31.6	15.3	43.0	11.3	30.6	17.9	40.4				
Max Q Clear Time (g_c+I1), s	10.4	30.1	14.3	10.7	10.8	25.3	7.2	19.7				
Green Ext Time (p_c), s	0.0	1.2	0.0	2.8	0.0	4.4	0.2	3.9				
Intersection Summary												
HCM 6th Ctrl Delay			38.2									
HCM 6th LOS			D									

Intersection

Intersection Delay, s/veh 17.7
Intersection LOS C

Movement	EBT	EBR	WBL	WBT	NBL	NBR
Lane Configurations	↻		↻	↻	↻	↻
Traffic Vol, veh/h	104	79	49	329	203	31
Future Vol, veh/h	104	79	49	329	203	31
Peak Hour Factor	0.76	0.76	0.76	0.76	0.76	0.76
Heavy Vehicles, %	2	1	2	2	0	0
Mvmt Flow	137	104	64	433	267	41
Number of Lanes	1	0	1	1	1	1

Approach	EB	WB	NB
Opposing Approach	WB	EB	
Opposing Lanes	2	1	0
Conflicting Approach Left		NB	EB
Conflicting Lanes Left	0	2	1
Conflicting Approach Right	NB		WB
Conflicting Lanes Right	2	0	2
HCM Control Delay	12.8	20.9	16.2
HCM LOS	B	C	C

Lane	NBLn1	NBLn2	EBLn1	WBLn1	WBLn2
Vol Left, %	100%	0%	0%	100%	0%
Vol Thru, %	0%	0%	57%	0%	100%
Vol Right, %	0%	100%	43%	0%	0%
Sign Control	Stop	Stop	Stop	Stop	Stop
Traffic Vol by Lane	203	31	183	49	329
LT Vol	203	0	0	49	0
Through Vol	0	0	104	0	329
RT Vol	0	31	79	0	0
Lane Flow Rate	267	41	241	64	433
Geometry Grp	7	7	4	7	7
Degree of Util (X)	0.522	0.066	0.396	0.116	0.718
Departure Headway (Hd)	7.036	5.817	5.918	6.475	5.969
Convergence, Y/N	Yes	Yes	Yes	Yes	Yes
Cap	513	614	607	553	606
Service Time	4.787	3.568	3.972	4.223	3.716
HCM Lane V/C Ratio	0.52	0.067	0.397	0.116	0.715
HCM Control Delay	17.3	9	12.8	10.1	22.5
HCM Lane LOS	C	A	B	B	C
HCM 95th-tile Q	3	0.2	1.9	0.4	6

Intersection												
Intersection Delay, s/veh	51.8											
Intersection LOS	F											

Movement	EBL	EBT	EBR	WBL	WBT	WBR	NBL	NBT	NBR	SBL	SBT	SBR
Lane Configurations	↙	↕		↙	↕			↕			↕	
Traffic Vol, veh/h	219	418	41	4	539	50	156	39	6	82	30	36
Future Vol, veh/h	219	418	41	4	539	50	156	39	6	82	30	36
Peak Hour Factor	0.75	0.75	0.75	0.75	0.75	0.75	0.75	0.75	0.75	0.75	0.75	0.75
Heavy Vehicles, %	0	2	0	0	0	1	1	0	0	0	3	2
Mvmt Flow	292	557	55	5	719	67	208	52	8	109	40	48
Number of Lanes	1	2	0	1	2	0	0	1	0	0	1	0

Approach	EB	WB	NB	SB
Opposing Approach	WB	EB	SB	NB
Opposing Lanes	3	3	1	1
Conflicting Approach Left SB		NB	EB	WB
Conflicting Lanes Left	1	1	3	3
Conflicting Approach Right NB		SB	WB	EB
Conflicting Lanes Right	1	1	3	3
HCM Control Delay	34.1	84.6	35.3	24
HCM LOS	D	F	E	C

Lane	NBLn1	EBLn1	EBLn2	EBLn3	WBLn1	WBLn2	WBLn3	SBLn1
Vol Left, %	78%	100%	0%	0%	100%	0%	0%	55%
Vol Thru, %	19%	0%	100%	77%	0%	100%	78%	20%
Vol Right, %	3%	0%	0%	23%	0%	0%	22%	24%
Sign Control	Stop	Stop	Stop	Stop	Stop	Stop	Stop	Stop
Traffic Vol by Lane	201	219	279	180	4	359	230	148
LT Vol	156	219	0	0	4	0	0	82
Through Vol	39	0	279	139	0	359	180	30
RT Vol	6	0	0	41	0	0	50	36
Lane Flow Rate	268	292	372	240	5	479	306	197
Geometry Grp	7	7	7	7	7	7	7	7
Degree of Util (X)	0.724	0.711	0.856	0.541	0.014	1.149	0.723	0.535
Departure Headway (Hd)	10.117	9.124	8.634	8.432	9.161	8.637	8.495	10.189
Convergence, Y/N	Yes	Yes	Yes	Yes	Yes	Yes	Yes	Yes
Cap	359	400	424	430	390	422	426	357
Service Time	7.817	6.824	6.334	6.132	6.943	6.418	6.276	7.889
HCM Lane V/C Ratio	0.747	0.73	0.877	0.558	0.013	1.135	0.718	0.552
HCM Control Delay	35.3	31.3	45.1	20.6	12.1	120	30.6	24
HCM Lane LOS	E	D	E	C	B	F	D	C
HCM 95th-tile Q	5.5	5.4	8.4	3.1	0	17.7	5.6	3

Timings

11: Barton St & Alessandro Bl.

09/19/2022



Lane Group	EBL	EBT	WBL	WBT	NBL	NBT	NBR	SBL	SBT	SBR
Lane Configurations	↙	↕↕↕	↙	↕↕↕		↕	↗		↕	↗
Traffic Volume (vph)	6	1472	36	2544	76	1	48	4	0	7
Future Volume (vph)	6	1472	36	2544	76	1	48	4	0	7
Turn Type	Prot	NA	Prot	NA	Perm	NA	Perm	Perm	NA	Perm
Protected Phases	5	2	1	6		8			4	
Permitted Phases					8		8	4		4
Detector Phase	5	2	1	6	8	8	8	4	4	4
Switch Phase										
Minimum Initial (s)	5.0	10.0	5.0	10.0	10.0	10.0	10.0	10.0	10.0	10.0
Minimum Split (s)	9.2	28.5	11.0	28.5	40.6	40.6	40.6	26.6	26.6	26.6
Total Split (s)	9.2	68.4	11.0	70.2	40.6	40.6	40.6	40.6	40.6	40.6
Total Split (%)	7.7%	57.0%	9.2%	58.5%	33.8%	33.8%	33.8%	33.8%	33.8%	33.8%
Yellow Time (s)	3.2	5.5	3.2	5.5	3.6	3.6	3.6	3.6	3.6	3.6
All-Red Time (s)	1.0	1.0	1.0	1.0	1.0	1.0	1.0	1.0	1.0	1.0
Lost Time Adjust (s)	0.0	0.0	0.0	0.0		0.0	0.0		0.0	0.0
Total Lost Time (s)	4.2	6.5	4.2	6.5		4.6	4.6		4.6	4.6
Lead/Lag	Lead	Lag	Lead	Lag						
Lead-Lag Optimize?	Yes	Yes	Yes	Yes						
Recall Mode	None	None	None	None	Max	Max	Max	Max	Max	Max
Act Effct Green (s)	5.0	59.0	6.2	63.8		36.0	36.0		36.0	36.0
Actuated g/C Ratio	0.04	0.52	0.06	0.57		0.32	0.32		0.32	0.32
v/c Ratio	0.09	0.60	0.38	0.92		0.18	0.09		0.02	0.02
Control Delay	56.2	20.3	63.6	29.2		29.8	4.0		28.2	0.1
Queue Delay	0.0	0.0	0.0	0.0		0.0	0.0		0.0	0.0
Total Delay	56.2	20.3	63.6	29.2		29.8	4.0		28.2	0.1
LOS	E	C	E	C		C	A		C	A
Approach Delay		20.4		29.7		19.9			10.4	
Approach LOS		C		C		B			B	

Intersection Summary

Cycle Length: 120
 Actuated Cycle Length: 112.7
 Natural Cycle: 115
 Control Type: Actuated-Uncoordinated
 Maximum v/c Ratio: 0.92
 Intersection Signal Delay: 26.0
 Intersection LOS: C
 Intersection Capacity Utilization 100.7%
 ICU Level of Service G
 Analysis Period (min) 15

Splits and Phases: 11: Barton St & Alessandro Bl.



HCM 6th Signalized Intersection Summary
11: Barton St & Alessandro Bl.

West Campus Upper Plateau (JN 14064)

09/19/2022



Movement	EBL	EBT	EBR	WBL	WBT	WBR	NBL	NBT	NBR	SBL	SBT	SBR
Lane Configurations	↗	↑↑↑		↖	↑↑↑			↑	↗		↑	↖
Traffic Volume (veh/h)	6	1472	46	36	2544	5	76	1	48	4	0	7
Future Volume (veh/h)	6	1472	46	36	2544	5	76	1	48	4	0	7
Initial Q (Qb), veh	0	0	0	0	0	0	0	0	0	0	0	0
Ped-Bike Adj(A_pbT)	1.00		0.98	1.00		1.00	1.00		1.00	1.00		1.00
Parking Bus, Adj	1.00	1.00	1.00	1.00	1.00	1.00	1.00	1.00	1.00	1.00	1.00	1.00
Work Zone On Approach		No			No			No			No	
Adj Sat Flow, veh/h/ln	1663	1870	1885	1900	1870	1604	1900	1900	1885	700	1900	1307
Adj Flow Rate, veh/h	6	1533	45	38	2650	5	79	1	20	4	0	2
Peak Hour Factor	0.96	0.96	0.96	0.96	0.96	0.96	0.96	0.96	0.96	0.96	0.96	0.96
Percent Heavy Veh, %	16	2	1	0	2	20	0	0	1	81	0	40
Cap, veh/h	12	2679	79	55	2888	5	62	0	497	62	0	345
Arrive On Green	0.01	0.53	0.53	0.03	0.55	0.55	0.31	0.31	0.31	0.31	0.00	0.31
Sat Flow, veh/h	1584	5094	150	1810	5263	10	0	1	1596	0	0	1108
Grp Volume(v), veh/h	6	1024	554	38	1714	941	80	0	20	4	0	2
Grp Sat Flow(s),veh/h/ln	1584	1702	1840	1810	1702	1869	1	0	1596	0	0	1108
Q Serve(g_s), s	0.4	23.6	23.6	2.4	52.9	53.0	0.0	0.0	1.0	0.0	0.0	0.1
Cycle Q Clear(g_c), s	0.4	23.6	23.6	2.4	52.9	53.0	36.0	0.0	1.0	36.0	0.0	0.1
Prop In Lane	1.00		0.08	1.00		0.01	0.99		1.00	1.00		1.00
Lane Grp Cap(c), veh/h	12	1790	967	55	1868	1025	62	0	497	62	0	345
V/C Ratio(X)	0.50	0.57	0.57	0.69	0.92	0.92	1.28	0.00	0.04	0.06	0.00	0.01
Avail Cap(c_a), veh/h	68	1822	985	106	1875	1029	62	0	497	62	0	345
HCM Platoon Ratio	1.00	1.00	1.00	1.00	1.00	1.00	1.00	1.00	1.00	1.00	1.00	1.00
Upstream Filter(I)	1.00	1.00	1.00	1.00	1.00	1.00	1.00	0.00	1.00	1.00	0.00	1.00
Uniform Delay (d), s/veh	57.2	18.6	18.6	55.5	23.7	23.7	57.6	0.0	27.8	57.8	0.0	27.5
Incr Delay (d2), s/veh	11.4	0.5	1.0	5.6	7.8	12.8	208.1	0.0	0.2	2.0	0.0	0.0
Initial Q Delay(d3),s/veh	0.0	0.0	0.0	0.0	0.0	0.0	0.0	0.0	0.0	0.0	0.0	0.0
%ile BackOfQ(50%),veh/ln	0.2	8.4	9.2	1.2	22.0	25.7	5.4	0.0	0.4	0.2	0.0	0.0
Unsig. Movement Delay, s/veh												
LnGrp Delay(d),s/veh	68.6	19.1	19.6	61.1	31.5	36.6	265.7	0.0	27.9	59.8	0.0	27.5
LnGrp LOS	E	B	B	E	C	D	F	A	C	E	A	C
Approach Vol, veh/h		1584			2693			100				6
Approach Delay, s/veh		19.5			33.7			218.1				49.0
Approach LOS		B			C			F				D
Timer - Assigned Phs	1	2		4	5	6		8				
Phs Duration (G+Y+Rc), s	7.7	67.3		40.6	5.1	70.0		40.6				
Change Period (Y+Rc), s	* 4.2	6.5		4.6	* 4.2	6.5		4.6				
Max Green Setting (Gmax), s	* 6.8	61.9		36.0	* 5	63.7		36.0				
Max Q Clear Time (g_c+I1), s	4.4	25.6		38.0	2.4	55.0		38.0				
Green Ext Time (p_c), s	0.0	18.2		0.0	0.0	8.5		0.0				

Intersection Summary

HCM 6th Ctrl Delay	32.8
HCM 6th LOS	C

Notes

* HCM 6th computational engine requires equal clearance times for the phases crossing the barrier.

Intersection						
Int Delay, s/veh	0.9					
Movement	EBL	EBT	WBT	WBR	SBL	SBR
Lane Configurations						
Traffic Vol, veh/h	35	100	369	13	5	10
Future Vol, veh/h	35	100	369	13	5	10
Conflicting Peds, #/hr	0	0	0	5	0	1
Sign Control	Free	Free	Free	Free	Stop	Stop
RT Channelized	-	None	-	None	-	None
Storage Length	100	-	-	-	0	-
Veh in Median Storage, #	-	0	0	-	0	-
Grade, %	-	0	0	-	0	-
Peak Hour Factor	72	72	72	72	72	72
Heavy Vehicles, %	0	2	1	0	0	0
Mvmt Flow	49	139	513	18	7	14

Major/Minor	Major1	Major2	Minor2		
Conflicting Flow All	536	0	-	0	764 528
Stage 1	-	-	-	-	527 -
Stage 2	-	-	-	-	237 -
Critical Hdwy	4.1	-	-	-	6.4 6.2
Critical Hdwy Stg 1	-	-	-	-	5.4 -
Critical Hdwy Stg 2	-	-	-	-	5.4 -
Follow-up Hdwy	2.2	-	-	-	3.5 3.3
Pot Cap-1 Maneuver	1042	-	-	-	375 554
Stage 1	-	-	-	-	596 -
Stage 2	-	-	-	-	807 -
Platoon blocked, %		-	-	-	
Mov Cap-1 Maneuver	1037	-	-	-	354 551
Mov Cap-2 Maneuver	-	-	-	-	354 -
Stage 1	-	-	-	-	565 -
Stage 2	-	-	-	-	803 -

Approach	EB	WB	SB
HCM Control Delay, s	2.2	0	13.1
HCM LOS			B

Minor Lane/Major Mvmt	EBL	EBT	WBT	WBR	SBLn1
Capacity (veh/h)	1037	-	-	-	465
HCM Lane V/C Ratio	0.047	-	-	-	0.045
HCM Control Delay (s)	8.6	-	-	-	13.1
HCM Lane LOS	A	-	-	-	B
HCM 95th %tile Q(veh)	0.1	-	-	-	0.1

Intersection						
Int Delay, s/veh	13.8					
Movement	EBT	EBR	WBL	WBT	NBL	NBR
Lane Configurations	↑↑		↖	↑↑	↘	
Traffic Vol, veh/h	269	238	45	396	197	33
Future Vol, veh/h	269	238	45	396	197	33
Conflicting Peds, #/hr	0	0	0	0	0	0
Sign Control	Free	Free	Free	Free	Stop	Stop
RT Channelized	-	None	-	None	-	None
Storage Length	-	-	125	-	0	-
Veh in Median Storage, #	0	-	-	0	0	-
Grade, %	0	-	-	0	0	-
Peak Hour Factor	80	80	80	80	80	80
Heavy Vehicles, %	3	0	2	1	0	0
Mvmt Flow	336	298	56	495	246	41

Major/Minor	Major1	Major2	Minor1		
Conflicting Flow All	0	0	634	0	845 317
Stage 1	-	-	-	-	485 -
Stage 2	-	-	-	-	360 -
Critical Hdwy	-	-	4.14	-	6.8 6.9
Critical Hdwy Stg 1	-	-	-	-	5.8 -
Critical Hdwy Stg 2	-	-	-	-	5.8 -
Follow-up Hdwy	-	-	2.22	-	3.5 3.3
Pot Cap-1 Maneuver	-	-	945	-	306 685
Stage 1	-	-	-	-	591 -
Stage 2	-	-	-	-	683 -
Platoon blocked, %	-	-	-	-	-
Mov Cap-1 Maneuver	-	-	945	-	288 685
Mov Cap-2 Maneuver	-	-	-	-	288 -
Stage 1	-	-	-	-	591 -
Stage 2	-	-	-	-	643 -

Approach	EB	WB	NB
HCM Control Delay, s	0	0.9	68.8
HCM LOS			F

Minor Lane/Major Mvmt	NBLn1	EBT	EBR	WBL	WBT
Capacity (veh/h)	314	-	-	945	-
HCM Lane V/C Ratio	0.916	-	-	0.06	-
HCM Control Delay (s)	68.8	-	-	9.1	-
HCM Lane LOS	F	-	-	A	-
HCM 95th %tile Q(veh)	8.9	-	-	0.2	-

Timings

14: Barton Rd. & Van Buren Bl.

09/19/2022



Lane Group	EBL	EBT	WBL	WBT	NBL	NBT	NBR	SBL	SBT
Lane Configurations	↘	↗	↘	↗	↘	↗	↗	↘	↗
Traffic Volume (vph)	135	1149	258	1271	358	73	370	71	95
Future Volume (vph)	135	1149	258	1271	358	73	370	71	95
Turn Type	Prot	NA	Prot	NA	Prot	NA	Perm	Prot	NA
Protected Phases	5	2	1	6	3	8		7	4
Permitted Phases							8		
Detector Phase	5	2	1	6	3	8	8	7	4
Switch Phase									
Minimum Initial (s)	5.0	10.0	5.0	10.0	5.0	10.0	10.0	5.0	10.0
Minimum Split (s)	9.2	25.2	9.2	25.5	9.1	14.6	14.6	9.1	33.6
Total Split (s)	18.5	47.4	22.0	50.9	17.0	37.5	37.5	13.1	33.6
Total Split (%)	15.4%	39.5%	18.3%	42.4%	14.2%	31.3%	31.3%	10.9%	28.0%
Yellow Time (s)	3.2	5.2	3.2	5.5	3.6	3.6	3.6	3.6	3.6
All-Red Time (s)	1.0	1.0	1.0	1.0	0.5	1.0	1.0	0.5	1.0
Lost Time Adjust (s)	0.0	0.0	0.0	0.0	0.0	0.0	0.0	0.0	0.0
Total Lost Time (s)	4.2	6.2	4.2	6.5	4.1	4.6	4.6	4.1	4.6
Lead/Lag	Lead	Lag	Lead	Lag	Lead	Lag	Lag	Lead	Lag
Lead-Lag Optimize?	Yes	Yes	Yes	Yes	Yes	Yes	Yes	Yes	Yes
Recall Mode	None	None	None	None	None	None	None	None	None
Act Effct Green (s)	12.8	41.3	17.8	46.0	12.9	33.0	33.0	8.5	26.3
Actuated g/C Ratio	0.11	0.35	0.15	0.39	0.11	0.28	0.28	0.07	0.22
v/c Ratio	0.79	1.17	1.11	0.76	1.10	0.16	0.65	0.63	0.92
Control Delay	78.1	120.3	133.2	34.9	124.6	34.0	17.7	74.9	59.0
Queue Delay	0.0	0.0	0.0	0.0	0.0	0.0	0.0	0.0	0.0
Total Delay	78.1	120.3	133.2	34.9	124.6	34.0	17.7	74.9	59.0
LOS	E	F	F	C	F	C	B	E	E
Approach Delay		116.2		51.1		67.0			61.5
Approach LOS		F		D		E			E

Intersection Summary

Cycle Length: 120
 Actuated Cycle Length: 117.4
 Natural Cycle: 130
 Control Type: Actuated-Uncoordinated
 Maximum v/c Ratio: 1.17
 Intersection Signal Delay: 76.8
 Intersection LOS: E
 Intersection Capacity Utilization 97.6%
 ICU Level of Service F
 Analysis Period (min) 15

Splits and Phases: 14: Barton Rd. & Van Buren Bl.

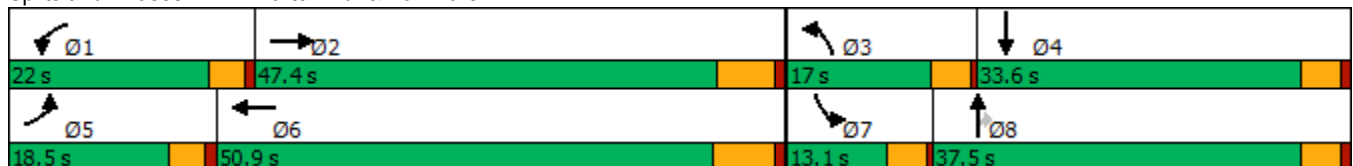

HCM 6th Signalized Intersection Summary
14: Barton Rd. & Van Buren Bl.

West Campus Upper Plateau (JN 14064)

09/19/2022



Movement	EBL	EBT	EBR	WBL	WBT	WBR	NBL	NBT	NBR	SBL	SBT	SBR
Lane Configurations	↗	↕		↖	↕		↗	↕	↖	↗	↕	↖
Traffic Volume (veh/h)	135	1149	104	258	1271	33	358	73	370	71	95	278
Future Volume (veh/h)	135	1149	104	258	1271	33	358	73	370	71	95	278
Initial Q (Qb), veh	0	0	0	0	0	0	0	0	0	0	0	0
Ped-Bike Adj(A_pbT)	1.00		1.00	1.00		1.00	1.00		1.00	1.00		1.00
Parking Bus, Adj	1.00	1.00	1.00	1.00	1.00	1.00	1.00	1.00	1.00	1.00	1.00	1.00
Work Zone On Approach		No			No			No			No	
Adj Sat Flow, veh/h/ln	1900	1870	1841	1870	1856	1722	1856	1885	1885	1900	1870	1900
Adj Flow Rate, veh/h	155	1321	107	297	1461	32	411	84	209	82	109	198
Peak Hour Factor	0.87	0.87	0.87	0.87	0.87	0.87	0.87	0.87	0.87	0.87	0.87	0.87
Percent Heavy Veh, %	0	2	4	2	3	12	3	1	1	0	2	0
Cap, veh/h	183	1195	96	276	2105	46	385	489	414	105	122	221
Arrive On Green	0.10	0.36	0.36	0.16	0.41	0.41	0.11	0.26	0.26	0.06	0.20	0.20
Sat Flow, veh/h	1810	3330	269	1781	5101	112	3428	1885	1598	1810	595	1081
Grp Volume(v), veh/h	155	703	725	297	967	526	411	84	209	82	0	307
Grp Sat Flow(s),veh/h/ln	1810	1777	1822	1781	1689	1835	1714	1885	1598	1810	0	1676
Q Serve(g_s), s	9.7	41.2	41.2	17.8	27.1	27.1	12.9	4.0	12.8	5.1	0.0	20.5
Cycle Q Clear(g_c), s	9.7	41.2	41.2	17.8	27.1	27.1	12.9	4.0	12.8	5.1	0.0	20.5
Prop In Lane	1.00		0.15	1.00		0.06	1.00		1.00	1.00		0.64
Lane Grp Cap(c), veh/h	183	638	654	276	1393	757	385	489	414	105	0	343
V/C Ratio(X)	0.85	1.10	1.11	1.08	0.69	0.69	1.07	0.17	0.50	0.78	0.00	0.89
Avail Cap(c_a), veh/h	225	638	654	276	1393	757	385	540	458	142	0	423
HCM Platoon Ratio	1.00	1.00	1.00	1.00	1.00	1.00	1.00	1.00	1.00	1.00	1.00	1.00
Upstream Filter(I)	1.00	1.00	1.00	1.00	1.00	1.00	1.00	1.00	1.00	1.00	0.00	1.00
Uniform Delay (d), s/veh	50.7	36.8	36.8	48.5	27.8	27.8	51.0	33.0	36.2	53.4	0.0	44.4
Incr Delay (d2), s/veh	18.2	67.1	68.9	75.6	1.3	2.3	64.8	0.2	1.0	17.9	0.0	18.3
Initial Q Delay(d3),s/veh	0.0	0.0	0.0	0.0	0.0	0.0	0.0	0.0	0.0	0.0	0.0	0.0
%ile BackOfQ(50%),veh/ln	5.1	28.5	29.5	13.4	10.4	11.5	8.8	1.8	4.9	2.9	0.0	10.3
Unsig. Movement Delay, s/veh												
LnGrp Delay(d),s/veh	68.9	103.9	105.7	124.2	29.0	30.1	115.7	33.1	37.2	71.2	0.0	62.7
LnGrp LOS	E	F	F	F	C	C	F	C	D	E	A	E
Approach Vol, veh/h		1583			1790			704			389	
Approach Delay, s/veh		101.3			45.1			82.6			64.5	
Approach LOS		F			D			F			E	
Timer - Assigned Phs	1	2	3	4	5	6	7	8				
Phs Duration (G+Y+Rc), s	22.0	47.7	17.0	28.1	15.8	53.9	10.7	34.4				
Change Period (Y+Rc), s	* 4.2	* 6.5	4.1	4.6	* 4.2	6.5	4.1	4.6				
Max Green Setting (Gmax), s	* 18	* 41	12.9	29.0	* 14	44.4	9.0	32.9				
Max Q Clear Time (g_c+I1), s	19.8	43.2	14.9	22.5	11.7	29.1	7.1	14.8				
Green Ext Time (p_c), s	0.0	0.0	0.0	1.0	0.0	5.5	0.0	1.0				

Intersection Summary

HCM 6th Ctrl Delay	72.6
HCM 6th LOS	E

Notes

* HCM 6th computational engine requires equal clearance times for the phases crossing the barrier.

Timings
15: Airman Dr & Cactus Av.



Lane Group	WBL	WBR	NBR	SBL	Ø6
Lane Configurations	↖	↗	↖	↖↗	
Traffic Volume (vph)	331	443	99	133	
Future Volume (vph)	331	443	99	133	
Turn Type	Prot	Perm	Perm	Prot	
Protected Phases	3			1	6
Permitted Phases		8	2		
Detector Phase	3	8	2	1	
Switch Phase					
Minimum Initial (s)	5.0	10.0	10.0	5.0	10.0
Minimum Split (s)	9.6	21.7	21.7	9.6	14.7
Total Split (s)	72.0	72.0	27.0	21.0	48.0
Total Split (%)	60.0%	60.0%	22.5%	17.5%	40%
Yellow Time (s)	3.6	3.7	3.7	3.6	3.7
All-Red Time (s)	1.0	1.0	1.0	1.0	1.0
Lost Time Adjust (s)	0.0	0.0	0.0	0.0	
Total Lost Time (s)	4.6	4.7	4.7	4.6	
Lead/Lag			Lag	Lead	
Lead-Lag Optimize?			Yes	Yes	
Recall Mode	None	None	Min	None	Min
Act Effect Green (s)	15.0	14.9	11.6	7.0	
Actuated g/C Ratio	0.33	0.33	0.26	0.15	
v/c Ratio	0.64	0.60	0.10	0.30	
Control Delay	19.9	5.2	0.2	21.8	
Queue Delay	0.0	0.0	0.0	0.0	
Total Delay	19.9	5.2	0.2	21.8	
LOS	B	A	A	C	
Approach Delay	11.5				
Approach LOS	B				

Intersection Summary

Cycle Length: 120
 Actuated Cycle Length: 45.4
 Natural Cycle: 55
 Control Type: Actuated-Uncoordinated
 Maximum v/c Ratio: 0.64
 Intersection Signal Delay: 11.8
 Intersection Capacity Utilization 34.4%
 Analysis Period (min) 15

Intersection LOS: B
 ICU Level of Service A

Splits and Phases: 15: Airman Dr & Cactus Av.

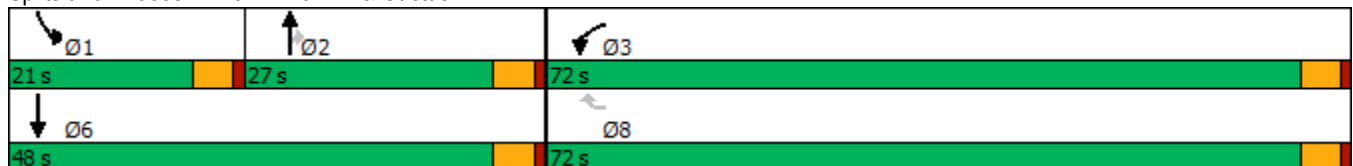

HCM 6th Signalized Intersection Summary
15: Airman Dr & Cactus Av.

West Campus Upper Plateau (JN 14064)

09/19/2022



Movement	WBL	WBR	NBT	NBR	SBL	SBT
Lane Configurations						
Traffic Volume (veh/h)	331	443	0	99	133	0
Future Volume (veh/h)	331	443	0	99	133	0
Initial Q (Qb), veh	0	0	0	0	0	0
Ped-Bike Adj(A_pbT)	1.00	1.00		1.00	1.00	
Parking Bus, Adj	1.00	1.00	1.00	1.00	1.00	1.00
Work Zone On Approach	No		No			No
Adj Sat Flow, veh/h/ln	1811	1752	1900	1811	1752	1900
Adj Flow Rate, veh/h	360	346	0	108	145	0
Peak Hour Factor	0.92	0.92	0.92	0.92	0.92	0.92
Percent Heavy Veh, %	6	10	0	6	10	0
Cap, veh/h	509	438	480	388	326	893
Arrive On Green	0.30	0.30	0.00	0.25	0.10	0.00
Sat Flow, veh/h	1725	1485	1900	1535	3237	1900
Grp Volume(v), veh/h	360	346	0	108	145	0
Grp Sat Flow(s),veh/h/ln	1725	1485	1900	1535	1618	1900
Q Serve(g_s), s	7.4	8.5	0.0	2.2	1.7	0.0
Cycle Q Clear(g_c), s	7.4	8.5	0.0	2.2	1.7	0.0
Prop In Lane	1.00	1.00		1.00	1.00	
Lane Grp Cap(c), veh/h	509	438	480	388	326	893
V/C Ratio(X)	0.71	0.79	0.00	0.28	0.44	0.00
Avail Cap(c_a), veh/h	2939	2529	1071	865	1342	2080
HCM Platoon Ratio	1.00	1.00	1.00	1.00	1.00	1.00
Upstream Filter(I)	1.00	1.00	0.00	1.00	1.00	0.00
Uniform Delay (d), s/veh	12.4	12.8	0.0	11.9	16.7	0.0
Incr Delay (d2), s/veh	0.7	1.2	0.0	0.4	0.4	0.0
Initial Q Delay(d3),s/veh	0.0	0.0	0.0	0.0	0.0	0.0
%ile BackOfQ(50%),veh/ln	2.3	2.3	0.0	0.7	0.5	0.0
Unsig. Movement Delay, s/veh						
LnGrp Delay(d),s/veh	13.1	14.0	0.0	12.3	17.1	0.0
LnGrp LOS	B	B	A	B	B	A
Approach Vol, veh/h	706		108			145
Approach Delay, s/veh	13.6		12.3			17.1
Approach LOS	B		B			B
Timer - Assigned Phs	1	2			6	8
Phs Duration (G+Y+Rc), s	8.6	14.7			23.3	16.3
Change Period (Y+Rc), s	4.6	* 4.7			* 4.7	4.6
Max Green Setting (Gmax), s	16.4	* 22			* 43	67.4
Max Q Clear Time (g_c+I1), s	3.7	4.2			0.0	10.5
Green Ext Time (p_c), s	0.2	0.3			0.0	1.2

Intersection Summary

HCM 6th Ctrl Delay	13.9
HCM 6th LOS	B

Notes

* HCM 6th computational engine requires equal clearance times for the phases crossing the barrier.

Intersection

Intersection Delay, s/veh	11.4
Intersection LOS	B

Movement	EBT	EBR	WBL	WBT	NBL	NBR
Lane Configurations						
Traffic Vol, veh/h	58	52	93	238	135	61
Future Vol, veh/h	58	52	93	238	135	61
Peak Hour Factor	0.76	0.76	0.76	0.76	0.76	0.76
Heavy Vehicles, %	4	0	0	2	2	2
Mvmt Flow	76	68	122	313	178	80
Number of Lanes	1	0	1	1	1	0

Approach	EB	WB	NB
Opposing Approach	WB	EB	
Opposing Lanes	2	1	0
Conflicting Approach Left		NB	EB
Conflicting Lanes Left	0	1	1
Conflicting Approach Right	NB		WB
Conflicting Lanes Right	1	0	2
HCM Control Delay	9.4	12	11.4
HCM LOS	A	B	B

Lane	NBLn1	EBLn1	WBLn1	WBLn2
Vol Left, %	69%	0%	100%	0%
Vol Thru, %	0%	53%	0%	100%
Vol Right, %	31%	47%	0%	0%
Sign Control	Stop	Stop	Stop	Stop
Traffic Vol by Lane	196	110	93	238
LT Vol	135	0	93	0
Through Vol	0	58	0	238
RT Vol	61	52	0	0
Lane Flow Rate	258	145	122	313
Geometry Grp	2	5	7	7
Degree of Util (X)	0.375	0.201	0.198	0.466
Departure Headway (Hd)	5.232	4.996	5.83	5.36
Convergence, Y/N	Yes	Yes	Yes	Yes
Cap	683	709	611	667
Service Time	3.302	3.092	3.612	3.141
HCM Lane V/C Ratio	0.378	0.205	0.2	0.469
HCM Control Delay	11.4	9.4	10.1	12.8
HCM Lane LOS	B	A	B	B
HCM 95th-tile Q	1.7	0.7	0.7	2.5

Intersection

Intersection Delay, s/veh	13.1
Intersection LOS	B

Movement	EBL	EBT	WBT	WBR	SBL	SBR
Lane Configurations						
Traffic Vol, veh/h	113	161	301	87	73	104
Future Vol, veh/h	113	161	301	87	73	104
Peak Hour Factor	0.71	0.71	0.71	0.71	0.71	0.71
Heavy Vehicles, %	0	2	0	2	1	1
Mvmt Flow	159	227	424	123	103	146
Number of Lanes	1	2	2	0	1	0

Approach	EB	WB	SB
Opposing Approach	WB	EB	
Opposing Lanes	2	3	0
Conflicting Approach Left			WB
Conflicting Lanes Left	1	0	2
Conflicting Approach Right		SB	EB
Conflicting Lanes Right	0	1	3
HCM Control Delay	10.4	14.4	14.6
HCM LOS	B	B	B

Lane	EBLn1	EBLn2	EBLn3	WBLn1	WBLn2	SBLn1
Vol Left, %	100%	0%	0%	0%	0%	41%
Vol Thru, %	0%	100%	100%	100%	54%	0%
Vol Right, %	0%	0%	0%	0%	46%	59%
Sign Control	Stop	Stop	Stop	Stop	Stop	Stop
Traffic Vol by Lane	113	81	81	201	187	177
LT Vol	113	0	0	0	0	73
Through Vol	0	81	81	201	100	0
RT Vol	0	0	0	0	87	104
Lane Flow Rate	159	113	113	283	264	249
Geometry Grp	7	7	7	8	8	7
Degree of Util (X)	0.294	0.194	0.139	0.496	0.442	0.452
Departure Headway (Hd)	6.643	6.169	4.406	6.324	6.028	6.525
Convergence, Y/N	Yes	Yes	Yes	Yes	Yes	Yes
Cap	540	581	810	568	596	551
Service Time	4.397	3.923	2.159	4.08	3.784	4.28
HCM Lane V/C Ratio	0.294	0.194	0.14	0.498	0.443	0.452
HCM Control Delay	12.2	10.4	7.9	15.2	13.5	14.6
HCM Lane LOS	B	B	A	C	B	B
HCM 95th-tile Q	1.2	0.7	0.5	2.7	2.3	2.3

Timings
18: Linebacker Dr & Cactus Av.

West Campus Upper Plateau (JN 14064)

09/19/2022

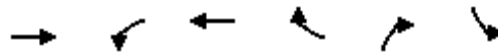

Lane Group	EBT	WBL	WBT	WBR	NBR	SBL	Ø3	Ø4	Ø5	Ø8
Lane Configurations	↑↑	↖	↑	↗	↗	↖↖				
Traffic Volume (vph)	232	277	774	277	84	84				
Future Volume (vph)	232	277	774	277	84	84				
Turn Type	NA	Prot	NA	Perm	pm+ov	Prot				
Protected Phases	2	1	6		1	7	3	4	5	8
Permitted Phases				6	8					
Detector Phase	2	1	6	6	1	7				
Switch Phase										
Minimum Initial (s)	10.0	5.0	10.0	10.0	5.0	5.0	5.0	10.0	5.0	10.0
Minimum Split (s)	27.0	9.6	27.0	27.0	9.6	9.6	9.6	27.0	9.6	27.0
Total Split (s)	27.4	16.0	33.8	33.8	16.0	9.6	9.6	27.0	9.6	27.0
Total Split (%)	34.3%	20.0%	42.3%	42.3%	20.0%	12.0%	12%	34%	12%	34%
Yellow Time (s)	4.0	3.6	4.0	4.0	3.6	3.6	3.6	4.0	3.6	4.0
All-Red Time (s)	1.0	1.0	1.0	1.0	1.0	1.0	1.0	1.0	1.0	1.0
Lost Time Adjust (s)	0.0	0.0	0.0	0.0	0.0	0.0				
Total Lost Time (s)	5.0	4.6	5.0	5.0	4.6	4.6				
Lead/Lag	Lag	Lead	Lag	Lag	Lead	Lead	Lead	Lag	Lead	Lag
Lead-Lag Optimize?	Yes	Yes	Yes	Yes	Yes	Yes	Yes	Yes	Yes	Yes
Recall Mode	None	None	None	None	None	None	None	None	None	None
Act Effct Green (s)	15.2	12.6	35.6	35.6	15.7	5.5				
Actuated g/C Ratio	0.32	0.27	0.76	0.76	0.34	0.12				
v/c Ratio	0.22	0.68	0.63	0.25	0.13	0.24				
Control Delay	15.0	31.7	12.5	2.3	0.4	26.0				
Queue Delay	0.0	0.0	0.0	0.0	0.0	0.0				
Total Delay	15.0	31.7	12.5	2.3	0.4	26.0				
LOS	B	C	B	A	A	C				
Approach Delay	15.0		14.4							
Approach LOS	B		B							

Intersection Summary

Cycle Length: 80
 Actuated Cycle Length: 46.8
 Natural Cycle: 90
 Control Type: Actuated-Uncoordinated
 Maximum v/c Ratio: 0.68
 Intersection Signal Delay: 14.3
 Intersection LOS: B
 Intersection Capacity Utilization 65.4%
 ICU Level of Service C
 Analysis Period (min) 15

Splits and Phases: 18: Linebacker Dr & Cactus Av.

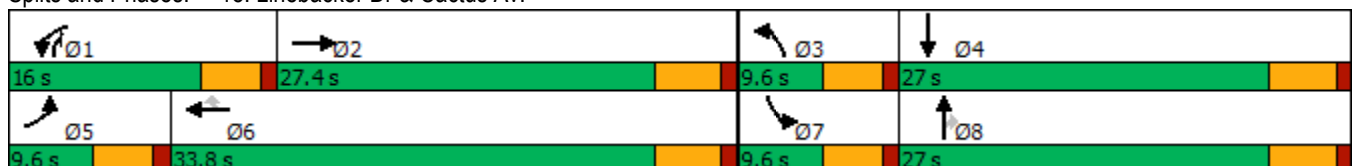

HCM 6th Signalized Intersection Summary
18: Linebacker Dr & Cactus Av.

West Campus Upper Plateau (JN 14064)

09/19/2022



Movement	EBL	EBT	EBR	WBL	WBT	WBR	NBL	NBT	NBR	SBL	SBT	SBR
Lane Configurations	↖	↗↘		↖	↗	↗	↖	↗	↗	↗↘	↘	
Traffic Volume (veh/h)	0	232	0	277	774	277	0	0	84	84	0	0
Future Volume (veh/h)	0	232	0	277	774	277	0	0	84	84	0	0
Initial Q (Qb), veh	0	0	0	0	0	0	0	0	0	0	0	0
Ped-Bike Adj(A_pbT)	1.00		1.00	1.00		1.00	1.00		1.00	1.00		1.00
Parking Bus, Adj	1.00	1.00	1.00	1.00	1.00	1.00	1.00	1.00	1.00	1.00	1.00	1.00
Work Zone On Approach		No			No			No			No	
Adj Sat Flow, veh/h/ln	1900	1767	1900	1752	1781	1752	1900	1900	1767	1752	1900	1900
Adj Flow Rate, veh/h	0	252	0	301	841	301	0	0	91	91	0	0
Peak Hour Factor	0.92	0.92	0.92	0.92	0.92	0.92	0.92	0.92	0.92	0.92	0.92	0.92
Percent Heavy Veh, %	0	9	0	10	8	10	0	0	9	10	0	0
Cap, veh/h	3	776	0	349	919	766	3	264	522	232	562	0
Arrive On Green	0.00	0.22	0.00	0.21	0.52	0.52	0.00	0.00	0.14	0.07	0.00	0.00
Sat Flow, veh/h	1810	3533	0	1668	1781	1485	1810	1900	1497	3337	1900	0
Grp Volume(v), veh/h	0	252	0	301	841	301	0	0	91	91	0	0
Grp Sat Flow(s),veh/h/ln	1810	1767	0	1668	1781	1485	1810	1900	1497	1668	1900	0
Q Serve(g_s), s	0.0	3.2	0.0	9.2	23.0	6.5	0.0	0.0	2.2	1.4	0.0	0.0
Cycle Q Clear(g_c), s	0.0	3.2	0.0	9.2	23.0	6.5	0.0	0.0	2.2	1.4	0.0	0.0
Prop In Lane	1.00		0.00	1.00		1.00	1.00		1.00	1.00		0.00
Lane Grp Cap(c), veh/h	3	776	0	349	919	766	3	264	522	232	562	0
V/C Ratio(X)	0.00	0.32	0.00	0.86	0.92	0.39	0.00	0.00	0.17	0.39	0.00	0.00
Avail Cap(c_a), veh/h	171	1492	0	359	967	806	171	788	935	315	788	0
HCM Platoon Ratio	1.00	1.00	1.00	1.00	1.00	1.00	1.00	1.00	1.00	1.00	1.00	1.00
Upstream Filter(I)	0.00	1.00	0.00	1.00	1.00	1.00	0.00	0.00	1.00	1.00	0.00	0.00
Uniform Delay (d), s/veh	0.0	17.4	0.0	20.2	11.8	7.8	0.0	0.0	12.0	23.6	0.0	0.0
Incr Delay (d2), s/veh	0.0	0.2	0.0	17.6	12.6	0.3	0.0	0.0	0.2	0.4	0.0	0.0
Initial Q Delay(d3),s/veh	0.0	0.0	0.0	0.0	0.0	0.0	0.0	0.0	0.0	0.0	0.0	0.0
%ile BackOfQ(50%),veh/ln	0.0	1.2	0.0	4.9	10.0	1.7	0.0	0.0	0.7	0.5	0.0	0.0
Unsig. Movement Delay, s/veh												
LnGrp Delay(d),s/veh	0.0	17.6	0.0	37.8	24.4	8.1	0.0	0.0	12.1	24.0	0.0	0.0
LnGrp LOS	A	B	A	D	C	A	A	A	B	C	A	A
Approach Vol, veh/h		252			1443			91			91	
Approach Delay, s/veh		17.6			23.8			12.1			24.0	
Approach LOS		B			C			B			C	
Timer - Assigned Phs	1	2	3	4	5	6	7	8				
Phs Duration (G+Y+Rc), s	15.7	16.7	0.0	20.7	0.0	32.4	8.3	12.4				
Change Period (Y+Rc), s	4.6	5.0	4.6	5.0	4.6	5.0	4.6	5.0				
Max Green Setting (Gmax), s	11.4	22.4	5.0	22.0	5.0	28.8	5.0	22.0				
Max Q Clear Time (g_c+I1), s	11.2	5.2	0.0	0.0	0.0	25.0	3.4	4.2				
Green Ext Time (p_c), s	0.0	1.4	0.0	0.0	0.0	2.4	0.0	0.2				

Intersection Summary

HCM 6th Ctrl Delay	22.4
HCM 6th LOS	C

Timings
19: Van Buren Bl. & Orange Terrace Pkwy.

West Campus Upper Plateau (JN 14064)

09/19/2022

Lane Group	EBL	EBT	EBR	WBL	WBT	WBR	NBL	NBT	NBR	SBL	SBT	SBR
Lane Configurations												
Traffic Volume (vph)	135	1399	41	35	1265	125	37	15	32	233	25	214
Future Volume (vph)	135	1399	41	35	1265	125	37	15	32	233	25	214
Turn Type	Prot	NA	Perm	Prot	NA	Perm	Prot	NA	Perm	Prot	NA	pm+ov
Protected Phases	5	2		1	6		3	8		7	4	5
Permitted Phases			2			6			8			4
Detector Phase	5	2	2	1	6	6	3	8	8	7	4	5
Switch Phase												
Minimum Initial (s)	5.0	10.0	10.0	5.0	10.0	10.0	5.0	5.0	5.0	10.0	10.0	5.0
Minimum Split (s)	9.2	25.2	25.2	9.1	25.2	25.2	9.1	26.1	26.1	15.8	24.8	9.2
Total Split (s)	16.0	62.8	62.8	9.1	55.9	55.9	9.1	26.1	26.1	22.0	39.0	16.0
Total Split (%)	13.3%	52.3%	52.3%	7.6%	46.6%	46.6%	7.6%	21.8%	21.8%	18.3%	32.5%	13.3%
Yellow Time (s)	3.2	5.2	5.2	3.6	5.2	5.2	3.6	3.6	3.6	4.8	4.8	3.2
All-Red Time (s)	1.0	1.0	1.0	0.5	1.0	1.0	0.5	0.5	0.5	1.0	1.0	1.0
Lost Time Adjust (s)	0.0	0.0	0.0	0.0	0.0	0.0	0.0	0.0	0.0	0.0	0.0	0.0
Total Lost Time (s)	4.2	6.2	6.2	4.1	6.2	6.2	4.1	4.1	4.1	5.8	5.8	4.2
Lead/Lag	Lead	Lag	Lag	Lead	Lag	Lag	Lead	Lag	Lag	Lead	Lag	Lead
Lead-Lag Optimize?	Yes	Yes	Yes	Yes	Yes	Yes	Yes	Yes	Yes	Yes	Yes	Yes
Recall Mode	None	None	None	None	None	None	None	None	None	None	None	None
Act Effct Green (s)	7.9	36.9	36.9	5.3	29.2	29.2	8.7	6.4	6.4	12.1	12.6	20.0
Actuated g/C Ratio	0.11	0.51	0.51	0.07	0.41	0.41	0.12	0.09	0.09	0.17	0.18	0.28
v/c Ratio	0.37	0.56	0.05	0.14	0.63	0.17	0.09	0.05	0.11	0.41	0.08	0.45
Control Delay	36.9	14.7	0.1	40.1	19.2	1.2	36.4	38.1	0.7	32.7	30.9	19.1
Queue Delay	0.0	0.0	0.0	0.0	0.0	0.0	0.0	0.0	0.0	0.0	0.0	0.0
Total Delay	36.9	14.7	0.1	40.1	19.2	1.2	36.4	38.1	0.7	32.7	30.9	19.1
LOS	D	B	A	D	B	A	D	D	A	C	C	B
Approach Delay		16.2			18.1			23.0			26.4	
Approach LOS		B			B			C			C	

Intersection Summary

Cycle Length: 120
 Actuated Cycle Length: 72
 Natural Cycle: 80
 Control Type: Actuated-Uncoordinated
 Maximum v/c Ratio: 0.63
 Intersection Signal Delay: 18.5
 Intersection LOS: B
 Intersection Capacity Utilization 58.2%
 ICU Level of Service B
 Analysis Period (min) 15

Splits and Phases: 19: Van Buren Bl. & Orange Terrace Pkwy.

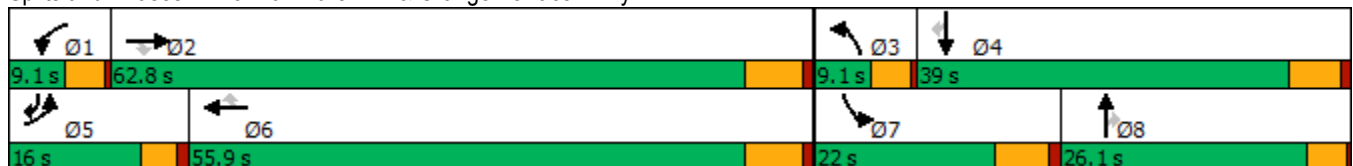

HCM 6th Signalized Intersection Summary
 19: Van Buren Bl. & Orange Terrace Pkwy.

West Campus Upper Plateau (JN 14064)

09/19/2022



Movement	EBL	EBT	EBR	WBL	WBT	WBR	NBL	NBT	NBR	SBL	SBT	SBR
Lane Configurations	↖↗	↑↑↑	↖	↖↗	↑↑↑	↖	↖↗	↑↑	↖	↖↗	↑	↖↗
Traffic Volume (veh/h)	135	1399	41	35	1265	125	37	15	32	233	25	214
Future Volume (veh/h)	135	1399	41	35	1265	125	37	15	32	233	25	214
Initial Q (Qb), veh	0	0	0	0	0	0	0	0	0	0	0	0
Ped-Bike Adj(A_pbT)	1.00		0.99	1.00		1.00	1.00		1.00	1.00		0.98
Parking Bus, Adj	1.00	1.00	1.00	1.00	1.00	1.00	1.00	1.00	1.00	1.00	1.00	1.00
Work Zone On Approach		No			No			No			No	
Adj Sat Flow, veh/h/ln	1885	1856	1796	1900	1870	1870	1900	1900	1707	1885	1900	1885
Adj Flow Rate, veh/h	139	1442	32	36	1304	88	38	15	6	240	26	108
Peak Hour Factor	0.97	0.97	0.97	0.97	0.97	0.97	0.97	0.97	0.97	0.97	0.97	0.97
Percent Heavy Veh, %	1	3	7	0	2	2	0	0	13	1	0	1
Cap, veh/h	234	2202	653	127	2054	637	131	254	102	501	382	423
Arrive On Green	0.07	0.43	0.43	0.04	0.40	0.40	0.04	0.07	0.07	0.14	0.20	0.20
Sat Flow, veh/h	3483	5066	1503	3510	5106	1585	3510	3610	1447	3483	1900	1570
Grp Volume(v), veh/h	139	1442	32	36	1304	88	38	15	6	240	26	108
Grp Sat Flow(s),veh/h/ln	1742	1689	1503	1755	1702	1585	1755	1805	1447	1742	1900	1570
Q Serve(g_s), s	2.7	15.6	0.9	0.7	14.2	2.4	0.7	0.3	0.3	4.4	0.8	3.8
Cycle Q Clear(g_c), s	2.7	15.6	0.9	0.7	14.2	2.4	0.7	0.3	0.3	4.4	0.8	3.8
Prop In Lane	1.00		1.00	1.00		1.00	1.00		1.00	1.00		1.00
Lane Grp Cap(c), veh/h	234	2202	653	127	2054	637	131	254	102	501	382	423
V/C Ratio(X)	0.60	0.65	0.05	0.28	0.63	0.14	0.29	0.06	0.06	0.48	0.07	0.26
Avail Cap(c_a), veh/h	592	4127	1225	253	3653	1134	253	1143	458	812	908	857
HCM Platoon Ratio	1.00	1.00	1.00	1.00	1.00	1.00	1.00	1.00	1.00	1.00	1.00	1.00
Upstream Filter(I)	1.00	1.00	1.00	1.00	1.00	1.00	1.00	1.00	1.00	1.00	1.00	1.00
Uniform Delay (d), s/veh	31.5	15.5	11.3	32.6	16.7	13.1	32.5	30.2	30.2	27.3	22.5	20.0
Incr Delay (d2), s/veh	0.9	0.3	0.0	1.2	0.3	0.1	1.2	0.1	0.2	0.7	0.1	0.3
Initial Q Delay(d3),s/veh	0.0	0.0	0.0	0.0	0.0	0.0	0.0	0.0	0.0	0.0	0.0	0.0
%ile BackOfQ(50%),veh/ln	1.1	4.8	0.3	0.3	4.6	0.8	0.3	0.1	0.1	1.7	0.3	1.3
Unsig. Movement Delay, s/veh												
LnGrp Delay(d),s/veh	32.4	15.9	11.4	33.8	17.0	13.2	33.7	30.3	30.4	28.1	22.5	20.3
LnGrp LOS	C	B	B	C	B	B	C	C	C	C	C	C
Approach Vol, veh/h		1613			1428			59			374	
Approach Delay, s/veh		17.2			17.2			32.5			25.4	
Approach LOS		B			B			C			C	
Timer - Assigned Phs	1	2	3	4	5	6	7	8				
Phs Duration (G+Y+Rc), s	6.6	36.4	6.7	19.8	8.9	34.1	15.8	10.7				
Change Period (Y+Rc), s	4.1	6.2	4.1	5.8	* 4.2	6.2	5.8	* 5.8				
Max Green Setting (Gmax), s	5.0	56.6	5.0	33.2	* 12	49.7	16.2	* 22				
Max Q Clear Time (g_c+I1), s	2.7	17.6	2.7	5.8	4.7	16.2	6.4	2.3				
Green Ext Time (p_c), s	0.0	12.6	0.0	0.4	0.1	10.7	0.5	0.0				

Intersection Summary

HCM 6th Ctrl Delay	18.3
HCM 6th LOS	B

Notes

* HCM 6th computational engine requires equal clearance times for the phases crossing the barrier.

Timings
20: Brown/San Gorgonio Dr & Alessandro Bl.

West Campus Upper Plateau (JN 14064)

09/19/2022



Lane Group	EBL	EBT	WBL	WBT	WBR	NBL	NBR	SBL	SBT	SBR	Ø8
Lane Configurations	↖	↕↕↕	↖	↕↕↕	↖	↖	↖	↖	↕	↖	
Traffic Volume (vph)	30	1313	205	2372	50	45	62	29	1	16	
Future Volume (vph)	30	1313	205	2372	50	45	62	29	1	16	
Turn Type	Prot	NA	Prot	NA	Perm	Prot	pm+ov	Prot	NA	pm+ov	
Protected Phases	5	2	1	6		3	1	7	4	5	8
Permitted Phases					6		8				4
Detector Phase	5	2	1	6	6	3	1	7	4	5	
Switch Phase											
Minimum Initial (s)	5.0	10.0	5.0	10.0	10.0	5.0	5.0	5.0	10.0	5.0	5.0
Minimum Split (s)	8.7	43.5	9.1	43.5	43.5	9.1	9.1	8.7	49.8	8.7	26.1
Total Split (s)	8.7	51.9	9.2	52.4	52.4	9.1	9.2	10.8	49.8	8.7	48.1
Total Split (%)	7.3%	43.3%	7.7%	43.7%	43.7%	7.6%	7.7%	9.0%	41.5%	7.3%	40%
Yellow Time (s)	3.2	5.5	3.6	5.5	5.5	3.6	3.6	3.2	4.8	3.2	3.6
All-Red Time (s)	0.5	1.0	0.5	1.0	1.0	0.5	0.5	0.5	1.0	0.5	0.5
Lost Time Adjust (s)	0.0	0.0	0.0	0.0	0.0	0.0	0.0	0.0	0.0	0.0	0.0
Total Lost Time (s)	3.7	6.5	4.1	6.5	6.5	4.1	4.1	3.7	5.8	3.7	
Lead/Lag	Lead	Lag	Lead	Lag	Lag	Lead	Lead	Lead	Lag	Lead	Lag
Lead-Lag Optimize?	Yes	Yes	Yes	Yes	Yes	Yes	Yes	Yes	Yes	Yes	Yes
Recall Mode	None	None	None	None	None	None	None	None	None	None	None
Act Effct Green (s)	5.5	44.9	5.6	54.0	54.0	5.8	13.5	6.2	15.1	11.6	
Actuated g/C Ratio	0.07	0.61	0.08	0.74	0.74	0.08	0.18	0.08	0.21	0.16	
v/c Ratio	0.24	0.50	1.70	0.66	0.05	0.33	0.20	0.23	0.00	0.05	
Control Delay	46.6	13.1	374.7	15.0	0.8	47.4	7.2	45.0	25.0	0.3	
Queue Delay	0.0	0.0	0.0	0.0	0.0	0.0	0.0	0.0	0.0	0.0	
Total Delay	46.6	13.1	374.7	15.0	0.8	47.4	7.2	45.0	25.0	0.3	
LOS	D	B	F	B	A	D	A	D	C	A	
Approach Delay		13.8		42.8					29.1		
Approach LOS		B		D					C		

Intersection Summary

Cycle Length: 120
 Actuated Cycle Length: 73.4
 Natural Cycle: 125
 Control Type: Actuated-Uncoordinated
 Maximum v/c Ratio: 1.70
 Intersection Signal Delay: 32.0
 Intersection LOS: C
 Intersection Capacity Utilization 71.9%
 ICU Level of Service C
 Analysis Period (min) 15

Splits and Phases: 20: Brown/San Gorgonio Dr & Alessandro Bl.

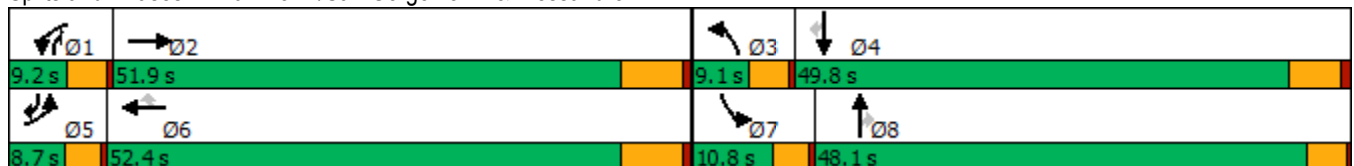

HCM 6th Signalized Intersection Summary
 20: Brown/San Gorgonio Dr & Alessandro Bl.

West Campus Upper Plateau (JN 14064)

09/19/2022



Movement	EBL	EBT	EBR	WBL	WBT	WBR	NBL	NBT	NBR	SBL	SBT	SBR
Lane Configurations	↖	↗↖↗		↖	↗↖↗	↖	↖	↗	↗	↖	↗	↖
Traffic Volume (veh/h)	30	1313	154	205	2372	50	45	0	62	29	1	16
Future Volume (veh/h)	30	1313	154	205	2372	50	45	0	62	29	1	16
Initial Q (Qb), veh	0	0	0	0	0	0	0	0	0	0	0	0
Ped-Bike Adj(A_pbT)	1.00		0.98	1.00		1.00	1.00		1.00	1.00		1.00
Parking Bus, Adj	1.00	1.00	1.00	1.00	1.00	1.00	1.00	1.00	1.00	1.00	1.00	1.00
Work Zone On Approach		No			No			No			No	
Adj Sat Flow, veh/h/ln	1900	1885	1900	1781	1885	1781	1900	1900	1767	1693	670	1900
Adj Flow Rate, veh/h	32	1382	162	216	2497	53	47	0	62	31	1	3
Peak Hour Factor	0.95	0.95	0.95	0.95	0.95	0.95	0.95	0.95	0.95	0.95	0.95	0.95
Percent Heavy Veh, %	0	1	0	8	1	8	0	0	9	14	83	0
Cap, veh/h	58	2469	289	108	2918	856	73	237	282	50	74	229
Arrive On Green	0.03	0.53	0.53	0.06	0.57	0.57	0.04	0.00	0.12	0.03	0.11	0.11
Sat Flow, veh/h	1810	4658	546	1697	5147	1510	1810	1900	1497	1612	670	1610
Grp Volume(v), veh/h	32	1018	526	216	2497	53	47	0	62	31	1	3
Grp Sat Flow(s),veh/h/ln	1810	1716	1773	1697	1716	1510	1810	1900	1497	1612	670	1610
Q Serve(g_s), s	1.4	15.9	15.9	5.1	32.7	1.3	2.1	0.0	2.8	1.5	0.1	0.1
Cycle Q Clear(g_c), s	1.4	15.9	15.9	5.1	32.7	1.3	2.1	0.0	2.8	1.5	0.1	0.1
Prop In Lane	1.00		0.31	1.00		1.00	1.00		1.00	1.00		1.00
Lane Grp Cap(c), veh/h	58	1819	940	108	2918	856	73	237	282	50	74	229
V/C Ratio(X)	0.56	0.56	0.56	2.00	0.86	0.06	0.64	0.00	0.22	0.62	0.01	0.01
Avail Cap(c_a), veh/h	113	1942	1003	108	2945	864	113	1042	916	143	367	934
HCM Platoon Ratio	1.00	1.00	1.00	1.00	1.00	1.00	1.00	1.00	1.00	1.00	1.00	1.00
Upstream Filter(I)	1.00	1.00	1.00	1.00	1.00	1.00	1.00	0.00	1.00	1.00	1.00	1.00
Uniform Delay (d), s/veh	38.3	12.6	12.6	37.6	14.6	7.8	37.9	0.0	27.6	38.4	31.8	29.6
Incr Delay (d2), s/veh	3.1	0.4	0.8	482.4	2.8	0.0	9.0	0.0	0.4	4.6	0.1	0.0
Initial Q Delay(d3),s/veh	0.0	0.0	0.0	0.0	0.0	0.0	0.0	0.0	0.0	0.0	0.0	0.0
%ile BackOfQ(50%),veh/ln	0.6	4.8	5.0	16.5	11.7	0.4	1.1	0.0	1.0	0.7	0.0	0.1
Unsig. Movement Delay, s/veh												
LnGrp Delay(d),s/veh	41.4	13.0	13.4	519.9	17.4	7.8	46.9	0.0	28.0	42.9	31.9	29.6
LnGrp LOS	D	B	B	F	B	A	D	A	C	D	C	C
Approach Vol, veh/h		1576			2766			109				35
Approach Delay, s/veh		13.7			56.4			36.1				41.5
Approach LOS		B			E			D				D
Timer - Assigned Phs	1	2	3	4	5	6	7	8				
Phs Duration (G+Y+Rc), s	9.2	49.0	7.3	14.6	6.2	52.0	6.2	15.8				
Change Period (Y+Rc), s	4.1	6.5	4.1	5.8	3.7	6.5	3.7	* 5.8				
Max Green Setting (Gmax), s	5.1	45.4	5.0	44.0	5.0	45.9	7.1	* 44				
Max Q Clear Time (g_c+I1), s	7.1	17.9	4.1	2.1	3.4	34.7	3.5	4.8				
Green Ext Time (p_c), s	0.0	15.4	0.0	0.0	0.0	10.7	0.0	0.2				

Intersection Summary

HCM 6th Ctrl Delay	40.8
HCM 6th LOS	D

Notes

* HCM 6th computational engine requires equal clearance times for the phases crossing the barrier.

Timings
21: Cactus Av. & Brown St



Lane Group	EBL	EBT	WBT	SBR
Lane Configurations	↘	↑↑	↑↑	↗
Traffic Volume (vph)	102	299	983	344
Future Volume (vph)	102	299	983	344
Turn Type	Prot	NA	NA	Perm
Protected Phases	7	4	8	
Permitted Phases				6
Detector Phase	7	4	8	6
Switch Phase				
Minimum Initial (s)	5.0	10.0	10.0	10.0
Minimum Split (s)	9.6	15.8	27.8	26.7
Total Split (s)	20.2	81.2	61.0	38.8
Total Split (%)	16.8%	67.7%	50.8%	32.3%
Yellow Time (s)	3.6	4.8	4.8	3.7
All-Red Time (s)	1.0	1.0	1.0	1.0
Lost Time Adjust (s)	0.0	0.0	0.0	0.0
Total Lost Time (s)	4.6	5.8	5.8	4.7
Lead/Lag	Lead		Lag	
Lead-Lag Optimize?	Yes		Yes	
Recall Mode	None	None	None	Min
Act Effct Green (s)	9.8	42.9	31.6	14.1
Actuated g/C Ratio	0.14	0.63	0.46	0.21
v/c Ratio	0.43	0.16	0.71	0.68
Control Delay	37.9	5.3	19.3	15.8
Queue Delay	0.0	0.0	0.0	0.0
Total Delay	37.9	5.3	19.3	15.8
LOS	D	A	B	B
Approach Delay		13.6	19.3	
Approach LOS		B	B	

Intersection Summary

Cycle Length: 120	
Actuated Cycle Length: 68.6	
Natural Cycle: 70	
Control Type: Actuated-Uncoordinated	
Maximum v/c Ratio: 0.71	
Intersection Signal Delay: 17.3	Intersection LOS: B
Intersection Capacity Utilization 57.2%	ICU Level of Service B
Analysis Period (min) 15	

Splits and Phases: 21: Cactus Av. & Brown St

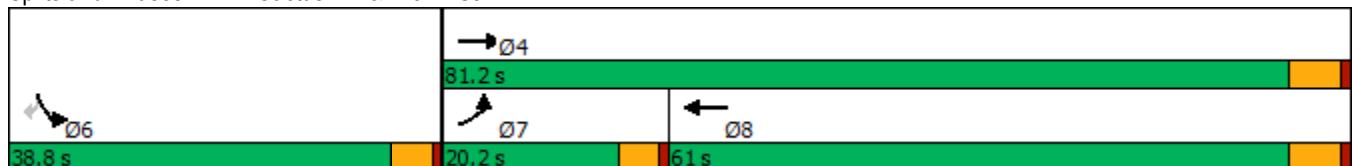

HCM 6th Signalized Intersection Summary
21: Cactus Av. & Brown St

West Campus Upper Plateau (JN 14064)
09/19/2022

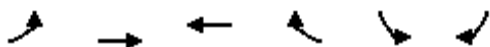

Movement	EBL	EBT	WBT	WBR	SBL	SBR	
Lane Configurations							
Traffic Volume (veh/h)	102	299	983	0	0	344	
Future Volume (veh/h)	102	299	983	0	0	344	
Initial Q (Qb), veh	0	0	0	0	0	0	
Ped-Bike Adj(A_pbT)	1.00			1.00	1.00	1.00	
Parking Bus, Adj	1.00	1.00	1.00	1.00	1.00	1.00	
Work Zone On Approach		No	No		No		
Adj Sat Flow, veh/h/ln	1900	1737	1737	1900	1900	1900	
Adj Flow Rate, veh/h	111	325	1068	0	0	374	
Peak Hour Factor	0.92	0.92	0.92	0.92	0.92	0.92	
Percent Heavy Veh, %	0	11	11	0	0	0	
Cap, veh/h	144	1902	1415	0	486	433	
Arrive On Green	0.08	0.58	0.43	0.00	0.00	0.27	
Sat Flow, veh/h	1810	3387	3474	0	1810	1610	
Grp Volume(v), veh/h	111	325	1068	0	0	374	
Grp Sat Flow(s),veh/h/ln	1810	1650	1650	0	1810	1610	
Q Serve(g_s), s	4.1	3.1	18.5	0.0	0.0	15.0	
Cycle Q Clear(g_c), s	4.1	3.1	18.5	0.0	0.0	15.0	
Prop In Lane	1.00			0.00	1.00	1.00	
Lane Grp Cap(c), veh/h	144	1902	1415	0	486	433	
V/C Ratio(X)	0.77	0.17	0.75	0.00	0.00	0.86	
Avail Cap(c_a), veh/h	417	3674	2690	0	911	811	
HCM Platoon Ratio	1.00	1.00	1.00	1.00	1.00	1.00	
Upstream Filter(I)	1.00	1.00	1.00	0.00	0.00	1.00	
Uniform Delay (d), s/veh	30.6	6.7	16.3	0.0	0.0	23.6	
Incr Delay (d2), s/veh	3.3	0.0	0.8	0.0	0.0	5.3	
Initial Q Delay(d3),s/veh	0.0	0.0	0.0	0.0	0.0	0.0	
%ile BackOfQ(50%),veh/ln	1.8	0.8	5.8	0.0	0.0	0.6	
Unsig. Movement Delay, s/veh							
LnGrp Delay(d),s/veh	33.8	6.8	17.2	0.0	0.0	28.9	
LnGrp LOS	C	A	B	A	A	C	
Approach Vol, veh/h		436	1068		374		
Approach Delay, s/veh		13.7	17.2		28.9		
Approach LOS		B	B		C		
Timer - Assigned Phs				4	6	7	8
Phs Duration (G+Y+Rc), s				44.8	22.9	10.0	34.8
Change Period (Y+Rc), s				5.8	4.7	4.6	5.8
Max Green Setting (Gmax), s				75.4	34.1	15.6	55.2
Max Q Clear Time (g_c+I1), s				5.1	17.0	6.1	20.5
Green Ext Time (p_c), s				2.1	1.2	0.1	8.5
Intersection Summary							
HCM 6th Ctrl Delay			18.7				
HCM 6th LOS			B				

Timings
22: Sycamore Canyon Bl. & Eastridge Ave

West Campus Upper Plateau (JN 14064)

09/19/2022



Lane Group	EBL	EBT	EBR	WBL	WBT	WBR	NBL	NBT	NBR	SBL	SBT	SBR
Lane Configurations	↖↖	↑↑↑	↗	↖↖	↑↑	↗	↖↖	↑↑	↗	↖↖	↑↑	↗
Traffic Volume (vph)	46	38	16	102	176	457	67	722	84	70	200	39
Future Volume (vph)	46	38	16	102	176	457	67	722	84	70	200	39
Turn Type	Prot	NA	Perm	Prot	NA	pm+ov	Prot	NA	pm+ov	Prot	NA	pm+ov
Protected Phases	5	2		1	6	7	3	8	1	7	4	5
Permitted Phases			2			6			8			4
Detector Phase	5	2	2	1	6	7	3	8	1	7	4	5
Switch Phase												
Minimum Initial (s)	5.0	10.0	10.0	5.0	10.0	5.0	5.0	10.0	5.0	5.0	10.0	5.0
Minimum Split (s)	8.7	43.5	43.5	8.7	43.5	8.7	8.7	15.8	8.7	8.7	49.8	8.7
Total Split (s)	9.9	47.0	47.0	11.0	48.1	21.0	10.5	41.0	11.0	21.0	51.5	9.9
Total Split (%)	8.3%	39.2%	39.2%	9.2%	40.1%	17.5%	8.8%	34.2%	9.2%	17.5%	42.9%	8.3%
Yellow Time (s)	3.2	5.5	5.5	3.2	5.5	3.2	3.2	4.8	3.2	3.2	4.8	3.2
All-Red Time (s)	0.5	1.0	1.0	0.5	1.0	0.5	0.5	1.0	0.5	0.5	1.0	0.5
Lost Time Adjust (s)	0.0	0.0	0.0	0.0	0.0	0.0	0.0	0.0	0.0	0.0	0.0	0.0
Total Lost Time (s)	3.7	6.5	6.5	3.7	6.5	3.7	3.7	5.8	3.7	3.7	5.8	3.7
Lead/Lag	Lead	Lag	Lag	Lead	Lag	Lead	Lead	Lag	Lead	Lead	Lag	Lead
Lead-Lag Optimize?	Yes	Yes	Yes	Yes	Yes	Yes	Yes	Yes	Yes	Yes	Yes	Yes
Recall Mode	None	None	None	None	None	None	None	None	None	None	None	None
Act Effct Green (s)	6.1	14.5	14.5	13.0	15.1	35.3	6.4	26.4	41.6	13.2	36.0	44.4
Actuated g/C Ratio	0.08	0.18	0.18	0.16	0.19	0.45	0.08	0.33	0.53	0.17	0.46	0.56
v/c Ratio	0.25	0.06	0.05	0.24	0.33	0.74	0.29	0.74	0.12	0.15	0.15	0.06
Control Delay	44.5	29.7	0.2	40.1	31.2	24.0	43.7	29.6	3.8	33.5	15.7	2.1
Queue Delay	0.0	0.0	0.0	0.0	0.0	0.0	0.0	0.0	0.0	0.0	0.0	0.0
Total Delay	44.5	29.7	0.2	40.1	31.2	24.0	43.7	29.6	3.8	33.5	15.7	2.1
LOS	D	C	A	D	C	C	D	C	A	C	B	A
Approach Delay		31.9			28.0			28.2			18.0	
Approach LOS		C			C			C			B	

Intersection Summary

Cycle Length: 120
 Actuated Cycle Length: 79.1
 Natural Cycle: 115
 Control Type: Actuated-Uncoordinated
 Maximum v/c Ratio: 0.74
 Intersection Signal Delay: 26.7
 Intersection LOS: C
 Intersection Capacity Utilization 63.9%
 ICU Level of Service B
 Analysis Period (min) 15

Splits and Phases: 22: Sycamore Canyon Bl. & Eastridge Ave

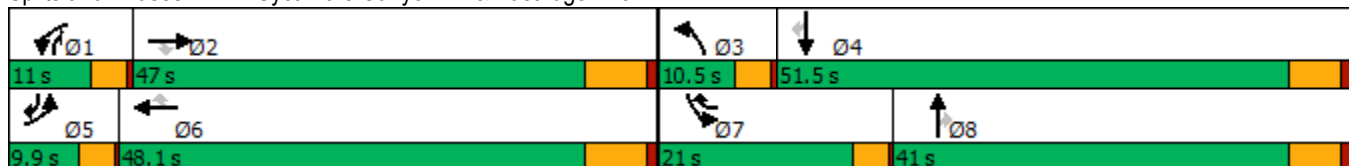

HCM 6th Signalized Intersection Summary
22: Sycamore Canyon Bl. & Eastridge Ave

West Campus Upper Plateau (JN 14064)

09/19/2022



Movement	EBL	EBT	EBR	WBL	WBT	WBR	NBL	NBT	NBR	SBL	SBT	SBR
Lane Configurations	↖↗	↑↑↑	↖	↖↗	↑↑	↖	↖↗	↑↑	↖	↖↗	↑↑	↖
Traffic Volume (veh/h)	46	38	16	102	176	457	67	722	84	70	200	39
Future Volume (veh/h)	46	38	16	102	176	457	67	722	84	70	200	39
Initial Q (Qb), veh	0	0	0	0	0	0	0	0	0	0	0	0
Ped-Bike Adj(A_pbT)	1.00		1.00	1.00		1.00	1.00		0.99	1.00		0.99
Parking Bus, Adj	1.00	1.00	1.00	1.00	1.00	1.00	1.00	1.00	1.00	1.00	1.00	1.00
Work Zone On Approach		No			No			No			No	
Adj Sat Flow, veh/h/ln	1485	1352	1722	1618	1707	1811	1796	1796	1737	1767	1781	1589
Adj Flow Rate, veh/h	53	44	0	117	202	525	77	830	63	80	230	31
Peak Hour Factor	0.87	0.87	0.87	0.87	0.87	0.87	0.87	0.87	0.87	0.87	0.87	0.87
Percent Heavy Veh, %	28	37	12	19	13	6	7	7	11	9	8	21
Cap, veh/h	115	1311		175	1206	647	164	1035	527	163	1029	461
Arrive On Green	0.04	0.36	0.00	0.06	0.37	0.37	0.05	0.30	0.30	0.05	0.30	0.30
Sat Flow, veh/h	2744	3690	1459	2990	3244	1535	3319	3413	1453	3264	3385	1329
Grp Volume(v), veh/h	53	44	0	117	202	525	77	830	63	80	230	31
Grp Sat Flow(s),veh/h/ln	1372	1230	1459	1495	1622	1535	1659	1706	1453	1632	1692	1329
Q Serve(g_s), s	1.6	0.7	0.0	3.2	3.5	25.4	1.9	18.9	2.4	2.0	4.3	1.3
Cycle Q Clear(g_c), s	1.6	0.7	0.0	3.2	3.5	25.4	1.9	18.9	2.4	2.0	4.3	1.3
Prop In Lane	1.00		1.00	1.00		1.00	1.00		1.00	1.00		1.00
Lane Grp Cap(c), veh/h	115	1311		175	1206	647	164	1035	527	163	1029	461
V/C Ratio(X)	0.46	0.03		0.67	0.17	0.81	0.47	0.80	0.12	0.49	0.22	0.07
Avail Cap(c_a), veh/h	201	1766		258	1595	832	267	1420	691	667	1828	775
HCM Platoon Ratio	1.00	1.00	1.00	1.00	1.00	1.00	1.00	1.00	1.00	1.00	1.00	1.00
Upstream Filter(I)	1.00	1.00	0.00	1.00	1.00	1.00	1.00	1.00	1.00	1.00	1.00	1.00
Uniform Delay (d), s/veh	39.6	17.8	0.0	39.0	17.8	21.5	39.1	27.1	18.0	39.1	22.0	18.5
Incr Delay (d2), s/veh	1.1	0.0	0.0	1.7	0.1	5.5	0.8	2.4	0.1	0.8	0.1	0.1
Initial Q Delay(d3),s/veh	0.0	0.0	0.0	0.0	0.0	0.0	0.0	0.0	0.0	0.0	0.0	0.0
%ile BackOfQ(50%),veh/ln	0.5	0.2	0.0	1.2	1.2	9.0	0.8	7.4	0.8	0.8	1.6	0.4
Unsig. Movement Delay, s/veh												
LnGrp Delay(d),s/veh	40.6	17.8	0.0	40.7	17.9	27.0	39.9	29.5	18.1	40.0	22.1	18.6
LnGrp LOS	D	B		D	B	C	D	C	B	D	C	B
Approach Vol, veh/h		97			844			970			341	
Approach Delay, s/veh		30.3			26.7			29.6			26.0	
Approach LOS		C			C			C			C	
Timer - Assigned Phs	1	2	3	4	5	6	7	8				
Phs Duration (G+Y+Rc), s	8.6	36.6	7.9	31.5	7.3	37.9	7.9	31.5				
Change Period (Y+Rc), s	3.7	6.5	3.7	5.8	3.7	6.5	3.7	5.8				
Max Green Setting (Gmax), s	7.3	40.5	6.8	45.7	6.2	41.6	17.3	35.2				
Max Q Clear Time (g_c+I1), s	5.2	2.7	3.9	6.3	3.6	27.4	4.0	20.9				
Green Ext Time (p_c), s	0.0	0.3	0.0	1.5	0.0	4.0	0.1	4.7				

Intersection Summary

HCM 6th Ctrl Delay	28.0
HCM 6th LOS	C

Notes

Unsignalized Delay for [EBR] is excluded from calculations of the approach delay and intersection delay.

Timings
23: Sycamore Canyon Bl. & Cottonwood Ave

West Campus Upper Plateau (JN 14064)

09/19/2022



Lane Group	WBL	WBR	NBT	SBL	SBT
Lane Configurations	↙	↗	↕↔	↙	↕↕
Traffic Volume (vph)	13	22	867	56	263
Future Volume (vph)	13	22	867	56	263
Turn Type	Prot	Perm	NA	Prot	NA
Protected Phases	8		2	1	6
Permitted Phases		8			
Detector Phase	8	8	2	1	6
Switch Phase					
Minimum Initial (s)	10.0	10.0	10.0	5.0	10.0
Minimum Split (s)	15.8	15.8	43.5	9.1	43.5
Total Split (s)	55.0	55.0	52.0	13.0	65.0
Total Split (%)	45.8%	45.8%	43.3%	10.8%	54.2%
Yellow Time (s)	4.8	4.8	5.5	3.6	5.5
All-Red Time (s)	1.0	1.0	1.0	0.5	1.0
Lost Time Adjust (s)	0.0	0.0	0.0	0.0	0.0
Total Lost Time (s)	5.8	5.8	6.5	4.1	6.5
Lead/Lag			Lag	Lead	
Lead-Lag Optimize?			Yes	Yes	
Recall Mode	None	None	None	None	None
Act Effct Green (s)	12.8	12.8	30.2	9.6	41.3
Actuated g/C Ratio	0.25	0.25	0.59	0.19	0.80
v/c Ratio	0.05	0.09	0.52	0.27	0.11
Control Delay	26.2	12.7	11.9	29.6	3.3
Queue Delay	0.0	0.0	0.0	0.0	0.0
Total Delay	26.2	12.7	11.9	29.6	3.3
LOS	C	B	B	C	A
Approach Delay	17.6		11.9		7.9
Approach LOS	B		B		A

Intersection Summary

Cycle Length: 120
 Actuated Cycle Length: 51.6
 Natural Cycle: 70
 Control Type: Actuated-Uncoordinated
 Maximum v/c Ratio: 0.52
 Intersection Signal Delay: 11.1
 Intersection LOS: B
 Intersection Capacity Utilization 50.8%
 ICU Level of Service A
 Analysis Period (min) 15

Splits and Phases: 23: Sycamore Canyon Bl. & Cottonwood Ave

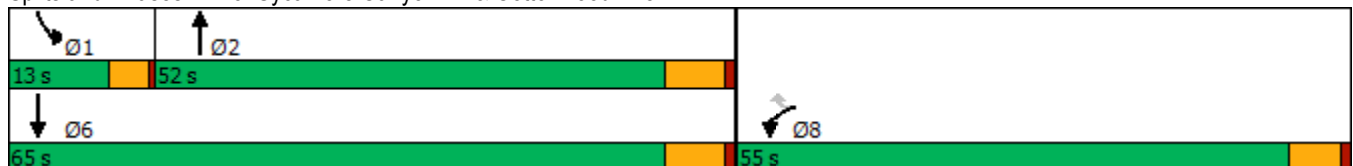

HCM 6th Signalized Intersection Summary
 23: Sycamore Canyon Bl. & Cottonwood Ave

West Campus Upper Plateau (JN 14064)

09/19/2022



Movement	WBL	WBR	NBT	NBR	SBL	SBT
Lane Configurations						
Traffic Volume (veh/h)	13	22	867	20	56	263
Future Volume (veh/h)	13	22	867	20	56	263
Initial Q (Qb), veh	0	0	0	0	0	0
Ped-Bike Adj(A_pbT)	1.00	1.00		0.98	1.00	
Parking Bus, Adj	1.00	1.00	1.00	1.00	1.00	1.00
Work Zone On Approach	No		No			No
Adj Sat Flow, veh/h/ln	1322	1307	1811	1752	1352	1811
Adj Flow Rate, veh/h	15	10	1008	22	65	306
Peak Hour Factor	0.86	0.86	0.86	0.86	0.86	0.86
Percent Heavy Veh, %	39	40	6	10	37	6
Cap, veh/h	75	66	1721	38	81	2261
Arrive On Green	0.06	0.06	0.50	0.50	0.06	0.66
Sat Flow, veh/h	1259	1108	3532	75	1287	3532
Grp Volume(v), veh/h	15	10	504	526	65	306
Grp Sat Flow(s),veh/h/ln	1259	1108	1721	1796	1287	1721
Q Serve(g_s), s	0.5	0.4	9.0	9.0	2.2	1.5
Cycle Q Clear(g_c), s	0.5	0.4	9.0	9.0	2.2	1.5
Prop In Lane	1.00	1.00		0.04	1.00	
Lane Grp Cap(c), veh/h	75	66	860	898	81	2261
V/C Ratio(X)	0.20	0.15	0.59	0.59	0.81	0.14
Avail Cap(c_a), veh/h	1426	1254	1802	1880	264	4633
HCM Platoon Ratio	1.00	1.00	1.00	1.00	1.00	1.00
Upstream Filter(I)	1.00	1.00	1.00	1.00	1.00	1.00
Uniform Delay (d), s/veh	19.4	19.4	7.7	7.7	20.1	2.8
Incr Delay (d2), s/veh	1.3	1.0	0.9	0.9	16.9	0.0
Initial Q Delay(d3),s/veh	0.0	0.0	0.0	0.0	0.0	0.0
%ile BackOfQ(50%),veh/ln	0.2	0.1	2.0	2.1	0.9	0.1
Unsig. Movement Delay, s/veh						
LnGrp Delay(d),s/veh	20.7	20.4	8.6	8.5	37.0	2.8
LnGrp LOS	C	C	A	A	D	A
Approach Vol, veh/h	25		1030			371
Approach Delay, s/veh	20.6		8.6			8.8
Approach LOS	C		A			A
Timer - Assigned Phs	1	2			6	8
Phs Duration (G+Y+Rc), s	6.8	28.2			35.0	8.4
Change Period (Y+Rc), s	4.1	6.5			6.5	5.8
Max Green Setting (Gmax), s	8.9	45.5			58.5	49.2
Max Q Clear Time (g_c+I1), s	4.2	11.0			3.5	2.5
Green Ext Time (p_c), s	0.0	10.7			2.9	0.1

Intersection Summary

HCM 6th Ctrl Delay	8.8
HCM 6th LOS	A

Timings

West Campus Upper Plateau (JN 14064)

24: Sycamore Canyon Bl. & Alessandro Bl.

09/19/2022



Lane Group	EBL	EBT	EBR	WBL	WBT	WBR	NBL	NBT	NBR	SBL	SBT	SBR
Lane Configurations	↖	↑↑↑	↗	↖↗	↑↑↑	↗	↖↗	↑↑	↖↗	↖↗	↑↑	↗
Traffic Volume (vph)	131	1793	537	316	1646	391	443	446	152	125	509	254
Future Volume (vph)	131	1793	537	316	1646	391	443	446	152	125	509	254
Turn Type	Prot	NA	Perm	Prot	NA	Perm	Prot	NA	pm+ov	Prot	NA	Perm
Protected Phases	5	2		1	6		3	8	1	7	4	
Permitted Phases			2			6			8			4
Detector Phase	5	2	2	1	6	6	3	8	1	7	4	4
Switch Phase												
Minimum Initial (s)	5.0	10.0	10.0	5.0	10.0	10.0	5.0	10.0	5.0	5.0	10.0	10.0
Minimum Split (s)	8.7	43.5	43.5	8.7	43.5	43.5	8.7	15.8	8.7	8.7	49.8	49.8
Total Split (s)	11.0	44.0	44.0	12.0	45.0	45.0	14.2	51.0	12.0	13.0	49.8	49.8
Total Split (%)	9.2%	36.7%	36.7%	10.0%	37.5%	37.5%	11.8%	42.5%	10.0%	10.8%	41.5%	41.5%
Yellow Time (s)	3.2	5.5	5.5	3.2	5.5	5.5	3.2	4.8	3.2	3.2	4.8	4.8
All-Red Time (s)	0.5	1.0	1.0	0.5	1.0	1.0	0.5	1.0	0.5	0.5	1.0	1.0
Lost Time Adjust (s)	0.0	0.0	0.0	0.0	0.0	0.0	0.0	0.0	0.0	0.0	0.0	0.0
Total Lost Time (s)	3.7	6.5	6.5	3.7	6.5	6.5	3.7	5.8	3.7	3.7	5.8	5.8
Lead/Lag	Lead	Lag	Lag	Lead	Lag	Lag	Lead	Lag	Lead	Lead	Lag	Lag
Lead-Lag Optimize?	Yes	Yes	Yes	Yes	Yes	Yes	Yes	Yes	Yes	Yes	Yes	Yes
Recall Mode	None	None	None	None	None	None	None	None	None	None	None	None
Act Effct Green (s)	7.4	37.9	37.9	8.4	38.9	38.9	10.6	26.4	40.6	7.9	23.7	23.7
Actuated g/C Ratio	0.07	0.38	0.38	0.08	0.39	0.39	0.11	0.26	0.40	0.08	0.24	0.24
v/c Ratio	1.02	0.95	0.70	1.22	0.85	0.58	1.25	0.50	0.13	0.49	0.64	0.53
Control Delay	131.3	42.6	18.7	166.4	34.2	18.4	171.5	32.9	10.8	52.8	37.6	17.6
Queue Delay	0.0	0.0	0.0	0.0	0.0	0.0	0.0	0.0	0.0	0.0	0.0	0.0
Total Delay	131.3	42.6	18.7	166.4	34.2	18.4	171.5	32.9	10.8	52.8	37.6	17.6
LOS	F	D	B	F	C	B	F	C	B	D	D	B
Approach Delay		42.1			49.3			88.7			34.0	
Approach LOS		D			D			F			C	

Intersection Summary

Cycle Length: 120
 Actuated Cycle Length: 100.4
 Natural Cycle: 115
 Control Type: Actuated-Uncoordinated
 Maximum v/c Ratio: 1.25
 Intersection Signal Delay: 50.7
 Intersection LOS: D
 Intersection Capacity Utilization 87.3%
 ICU Level of Service E
 Analysis Period (min) 15

Splits and Phases: 24: Sycamore Canyon Bl. & Alessandro Bl.

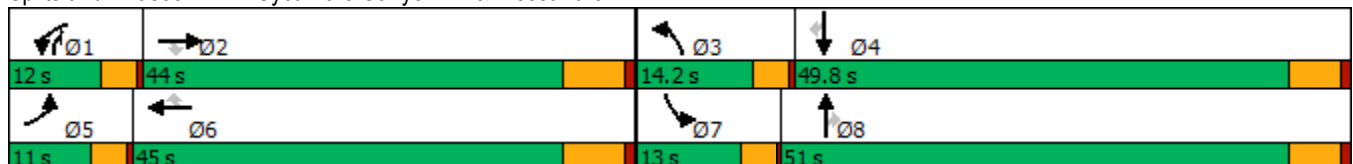

HCM 6th Signalized Intersection Summary
24: Sycamore Canyon Bl. & Alessandro Bl.

West Campus Upper Plateau (JN 14064)

09/19/2022



Movement	EBL	EBT	EBR	WBL	WBT	WBR	NBL	NBT	NBR	SBL	SBT	SBR
Lane Configurations												
Traffic Volume (veh/h)	131	1793	537	316	1646	391	443	446	152	125	509	254
Future Volume (veh/h)	131	1793	537	316	1646	391	443	446	152	125	509	254
Initial Q (Qb), veh	0	0	0	0	0	0	0	0	0	0	0	0
Ped-Bike Adj(A_pbT)	1.00		1.00	1.00		0.99	1.00		1.00	1.00		1.00
Parking Bus, Adj	1.00	1.00	1.00	1.00	1.00	1.00	1.00	1.00	1.00	1.00	1.00	1.00
Work Zone On Approach		No			No			No			No	
Adj Sat Flow, veh/h/ln	1900	1885	1885	1752	1885	1796	1870	1841	1870	1826	1826	1870
Adj Flow Rate, veh/h	134	1830	357	322	1680	268	452	455	113	128	519	167
Peak Hour Factor	0.98	0.98	0.98	0.98	0.98	0.98	0.98	0.98	0.98	0.98	0.98	0.98
Percent Heavy Veh, %	0	1	1	10	1	7	2	4	2	5	5	2
Cap, veh/h	139	2019	627	283	2073	605	382	895	958	192	702	321
Arrive On Green	0.08	0.39	0.39	0.09	0.40	0.40	0.11	0.26	0.26	0.06	0.20	0.20
Sat Flow, veh/h	1810	5147	1598	3237	5147	1501	3456	3497	2790	3374	3469	1585
Grp Volume(v), veh/h	134	1830	357	322	1680	268	452	455	113	128	519	167
Grp Sat Flow(s),veh/h/ln	1810	1716	1598	1618	1716	1501	1728	1749	1395	1687	1735	1585
Q Serve(g_s), s	7.0	31.8	16.6	8.3	27.5	12.3	10.5	10.6	2.6	3.5	13.3	8.9
Cycle Q Clear(g_c), s	7.0	31.8	16.6	8.3	27.5	12.3	10.5	10.6	2.6	3.5	13.3	8.9
Prop In Lane	1.00		1.00	1.00		1.00	1.00		1.00	1.00		1.00
Lane Grp Cap(c), veh/h	139	2019	627	283	2073	605	382	895	958	192	702	321
V/C Ratio(X)	0.96	0.91	0.57	1.14	0.81	0.44	1.18	0.51	0.12	0.67	0.74	0.52
Avail Cap(c_a), veh/h	139	2032	631	283	2086	609	382	1664	1571	330	1607	734
HCM Platoon Ratio	1.00	1.00	1.00	1.00	1.00	1.00	1.00	1.00	1.00	1.00	1.00	1.00
Upstream Filter(I)	1.00	1.00	1.00	1.00	1.00	1.00	1.00	1.00	1.00	1.00	1.00	1.00
Uniform Delay (d), s/veh	43.7	27.2	22.6	43.3	25.1	20.6	42.2	30.2	21.3	43.9	35.5	33.8
Incr Delay (d2), s/veh	64.6	6.5	1.5	96.2	2.6	0.7	106.1	0.4	0.1	1.5	1.6	1.3
Initial Q Delay(d3),s/veh	0.0	0.0	0.0	0.0	0.0	0.0	0.0	0.0	0.0	0.0	0.0	0.0
%ile BackOfQ(50%),veh/ln	5.5	13.0	6.0	7.0	10.7	4.1	9.9	4.3	0.8	1.5	5.5	3.4
Unsig. Movement Delay, s/veh												
LnGrp Delay(d),s/veh	108.3	33.7	24.1	139.5	27.8	21.3	148.3	30.7	21.4	45.4	37.1	35.1
LnGrp LOS	F	C	C	F	C	C	F	C	C	D	D	D
Approach Vol, veh/h		2321			2270			1020			814	
Approach Delay, s/veh		36.5			42.9			81.8			38.0	
Approach LOS		D			D			F			D	
Timer - Assigned Phs	1	2	3	4	5	6	7	8				
Phs Duration (G+Y+Rc), s	12.0	43.8	14.2	25.0	11.0	44.8	9.1	30.1				
Change Period (Y+Rc), s	3.7	6.5	3.7	5.8	3.7	6.5	3.7	5.8				
Max Green Setting (Gmax), s	8.3	37.5	10.5	44.0	7.3	38.5	9.3	45.2				
Max Q Clear Time (g_c+I1), s	10.3	33.8	12.5	15.3	9.0	29.5	5.5	12.6				
Green Ext Time (p_c), s	0.0	3.4	0.0	3.9	0.0	7.7	0.1	3.4				

Intersection Summary

HCM 6th Ctrl Delay	46.1
HCM 6th LOS	D

Timings
25: Sycamore Canyon Bl. & Cactus Av.

West Campus Upper Plateau (JN 14064)

09/19/2022



Lane Group	EBL	EBT	EBR	WBL	WBT	WBR	NBL	NBT	NBR	SBL	SBT	SBR
Lane Configurations	↘	↑↑	↗	↘↗	↑↑	↗	↘↗	↑↑	↗	↘↗	↑↑	↗
Traffic Volume (vph)	25	201	83	364	658	885	281	366	209	137	140	77
Future Volume (vph)	25	201	83	364	658	885	281	366	209	137	140	77
Turn Type	Prot	NA	Perm	Prot	NA	Perm	Prot	NA	Perm	Prot	NA	Perm
Protected Phases	7	4		3	8		5	2		1	6	
Permitted Phases			4			8			2			6
Detector Phase	7	4	4	3	8	8	5	2	2	1	6	6
Switch Phase												
Minimum Initial (s)	5.0	10.0	10.0	5.0	10.0	10.0	5.0	10.0	10.0	5.0	10.0	10.0
Minimum Split (s)	9.6	32.8	32.8	9.6	32.8	32.8	9.6	34.8	34.8	9.6	34.8	34.8
Total Split (s)	11.0	45.6	45.6	15.4	50.0	50.0	9.6	49.0	49.0	10.0	49.4	49.4
Total Split (%)	9.2%	38.0%	38.0%	12.8%	41.7%	41.7%	8.0%	40.8%	40.8%	8.3%	41.2%	41.2%
Yellow Time (s)	3.6	4.8	4.8	3.6	4.8	4.8	3.6	4.8	4.8	3.6	4.8	4.8
All-Red Time (s)	1.0	1.0	1.0	1.0	1.0	1.0	1.0	1.0	1.0	1.0	1.0	1.0
Lost Time Adjust (s)	0.0	0.0	0.0	0.0	0.0	0.0	0.0	0.0	0.0	0.0	0.0	0.0
Total Lost Time (s)	4.6	5.8	5.8	4.6	5.8	5.8	4.6	5.8	5.8	4.6	5.8	5.8
Lead/Lag	Lead	Lag	Lag	Lead	Lag	Lag	Lead	Lag	Lag	Lead	Lag	Lag
Lead-Lag Optimize?	Yes	Yes	Yes	Yes	Yes	Yes	Yes	Yes	Yes	Yes	Yes	Yes
Recall Mode	None	None	None	None	None	None	None	None	None	None	None	None
Act Effct Green (s)	5.8	33.1	33.1	11.0	44.9	44.9	5.1	16.9	16.9	5.5	17.3	17.3
Actuated g/C Ratio	0.07	0.38	0.38	0.13	0.51	0.51	0.06	0.19	0.19	0.06	0.20	0.20
v/c Ratio	0.27	0.17	0.13	0.96	0.41	0.93	1.52	0.58	0.46	0.67	0.21	0.21
Control Delay	50.6	19.3	3.1	77.7	16.1	30.2	289.9	35.9	7.9	59.6	30.2	3.9
Queue Delay	0.0	0.0	0.0	0.0	0.0	0.0	0.0	0.0	0.0	0.0	0.0	0.0
Total Delay	50.6	19.3	3.1	77.7	16.1	30.2	289.9	35.9	7.9	59.6	30.2	3.9
LOS	D	B	A	E	B	C	F	D	A	E	C	A
Approach Delay		17.5			34.4			112.6			35.9	
Approach LOS		B			C			F			D	

Intersection Summary

Cycle Length: 120
 Actuated Cycle Length: 87.6
 Natural Cycle: 110
 Control Type: Actuated-Uncoordinated
 Maximum v/c Ratio: 1.52
 Intersection Signal Delay: 52.6
 Intersection LOS: D
 Intersection Capacity Utilization 82.6%
 ICU Level of Service E
 Analysis Period (min) 15



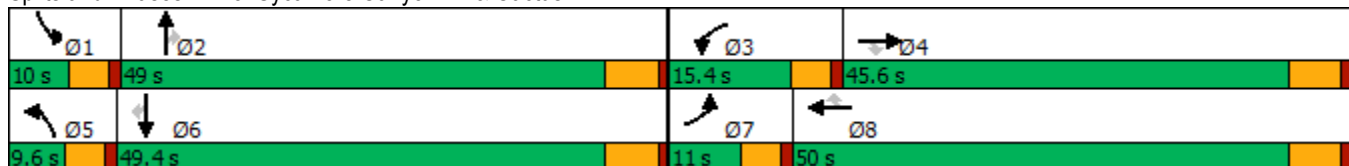





















Splits and Phases: 25: Sycamore Canyon Bl. & Cactus Av.



HCM 6th Signalized Intersection Summary
25: Sycamore Canyon Bl. & Cactus Av.

West Campus Upper Plateau (JN 14064)

09/19/2022

												
Movement	EBL	EBT	EBR	WBL	WBT	WBR	NBL	NBT	NBR	SBL	SBT	SBR
Lane Configurations												
Traffic Volume (veh/h)	25	201	83	364	658	885	281	366	209	137	140	77
Future Volume (veh/h)	25	201	83	364	658	885	281	366	209	137	140	77
Initial Q (Qb), veh	0	0	0	0	0	0	0	0	0	0	0	0
Ped-Bike Adj(A_pbT)	1.00		1.00	1.00		0.99	1.00		1.00	1.00		0.99
Parking Bus, Adj	1.00	1.00	1.00	1.00	1.00	1.00	1.00	1.00	1.00	1.00	1.00	1.00
Work Zone On Approach		No			No			No			No	
Adj Sat Flow, veh/h/ln	1530	1693	1826	1722	1722	1856	1811	1796	1811	1841	1826	1796
Adj Flow Rate, veh/h	26	207	85	375	678	693	290	377	118	141	144	76
Peak Hour Factor	0.97	0.97	0.97	0.97	0.97	0.97	0.97	0.97	0.97	0.97	0.97	0.97
Percent Heavy Veh, %	25	14	5	12	12	3	6	7	6	4	5	7
Cap, veh/h	40	1241	597	423	1609	763	206	554	249	213	567	245
Arrive On Green	0.03	0.39	0.39	0.13	0.49	0.49	0.06	0.16	0.16	0.06	0.16	0.16
Sat Flow, veh/h	1457	3216	1547	3182	3272	1553	3346	3413	1535	3401	3469	1502
Grp Volume(v), veh/h	26	207	85	375	678	693	290	377	118	141	144	76
Grp Sat Flow(s),veh/h/ln	1457	1608	1547	1591	1636	1553	1673	1706	1535	1700	1735	1502
Q Serve(g_s), s	1.4	3.4	2.9	9.4	10.8	33.3	5.0	8.4	5.7	3.3	2.9	3.6
Cycle Q Clear(g_c), s	1.4	3.4	2.9	9.4	10.8	33.3	5.0	8.4	5.7	3.3	2.9	3.6
Prop In Lane	1.00		1.00	1.00		1.00	1.00		1.00	1.00		1.00
Lane Grp Cap(c), veh/h	40	1241	597	423	1609	763	206	554	249	213	567	245
V/C Ratio(X)	0.65	0.17	0.14	0.89	0.42	0.91	1.41	0.68	0.47	0.66	0.25	0.31
Avail Cap(c_a), veh/h	115	1576	758	423	1781	845	206	1816	817	226	1863	806
HCM Platoon Ratio	1.00	1.00	1.00	1.00	1.00	1.00	1.00	1.00	1.00	1.00	1.00	1.00
Upstream Filter(I)	1.00	1.00	1.00	1.00	1.00	1.00	1.00	1.00	1.00	1.00	1.00	1.00
Uniform Delay (d), s/veh	39.1	16.4	16.2	34.6	13.2	18.9	38.1	32.0	30.9	37.2	29.7	29.9
Incr Delay (d2), s/veh	6.6	0.1	0.1	19.1	0.2	12.7	209.7	1.5	1.4	5.0	0.2	0.7
Initial Q Delay(d3),s/veh	0.0	0.0	0.0	0.0	0.0	0.0	0.0	0.0	0.0	0.0	0.0	0.0
%ile BackOfQ(50%),veh/ln	0.6	1.2	0.9	4.5	3.4	12.6	7.9	3.4	2.1	1.4	1.2	1.3
Unsig. Movement Delay, s/veh												
LnGrp Delay(d),s/veh	45.7	16.4	16.3	53.7	13.4	31.7	247.8	33.5	32.2	42.2	29.9	30.6
LnGrp LOS	D	B	B	D	B	C	F	C	C	D	C	C
Approach Vol, veh/h		318			1746			785			361	
Approach Delay, s/veh		18.8			29.3			112.5			34.9	
Approach LOS		B			C			F			C	
Timer - Assigned Phs	1	2	3	4	5	6	7	8				
Phs Duration (G+Y+Rc), s	9.7	19.0	15.4	37.1	9.6	19.1	6.8	45.7				
Change Period (Y+Rc), s	4.6	5.8	4.6	5.8	4.6	5.8	4.6	5.8				
Max Green Setting (Gmax), s	5.4	43.2	10.8	39.8	5.0	43.6	6.4	44.2				
Max Q Clear Time (g_c+I1), s	5.3	10.4	11.4	5.4	7.0	5.6	3.4	35.3				
Green Ext Time (p_c), s	0.0	2.7	0.0	1.6	0.0	1.1	0.0	4.7				
Intersection Summary												
HCM 6th Ctrl Delay			49.2									
HCM 6th LOS			D									

Timings
26: Sycamore Canyon Bl. & Van Buren Bl.

West Campus Upper Plateau (JN 14064)

09/19/2022



Lane Group	EBL	EBT	EBR	WBL	WBT	WBR	NBL	NBT	SBL	SBT	SBR
Lane Configurations											
Traffic Volume (vph)	625	1146	2	46	1322	203	3	1	70	6	373
Future Volume (vph)	625	1146	2	46	1322	203	3	1	70	6	373
Turn Type	Prot	NA	Perm	Prot	NA	Perm	Perm	NA	Split	NA	Perm
Protected Phases	5	2		1	6			8	4	4	
Permitted Phases			2			6	8				4
Detector Phase	5	2	2	1	6	6	8	8	4	4	4
Switch Phase											
Minimum Initial (s)	5.0	10.0	10.0	5.0	10.0	10.0	10.0	10.0	10.0	10.0	10.0
Minimum Split (s)	9.6	29.2	29.2	9.6	29.2	29.2	14.6	14.6	50.8	50.8	50.8
Total Split (s)	25.0	50.9	50.9	13.7	39.6	39.6	14.6	14.6	50.8	50.8	50.8
Total Split (%)	19.2%	39.2%	39.2%	10.5%	30.5%	30.5%	11.2%	11.2%	39.1%	39.1%	39.1%
Yellow Time (s)	3.6	5.2	5.2	3.6	5.2	5.2	3.6	3.6	4.8	4.8	4.8
All-Red Time (s)	1.0	1.0	1.0	1.0	1.0	1.0	1.0	1.0	1.0	1.0	1.0
Lost Time Adjust (s)	0.0	0.0	0.0	0.0	0.0	0.0		0.0	0.0	0.0	0.0
Total Lost Time (s)	4.6	6.2	6.2	4.6	6.2	6.2		4.6	5.8	5.8	5.8
Lead/Lag	Lead	Lag	Lag	Lead	Lag	Lag					
Lead-Lag Optimize?	Yes	Yes	Yes	Yes	Yes	Yes					
Recall Mode	None	None	None	None	None	None	None	None	None	None	None
Act Effct Green (s)	21.4	49.9	49.9	6.9	30.6	30.6		10.5	15.2	15.2	15.2
Actuated g/C Ratio	0.25	0.58	0.58	0.08	0.35	0.35		0.12	0.18	0.18	0.18
v/c Ratio	0.80	0.34	0.00	0.35	0.65	0.33		0.02	0.15	0.02	0.66
Control Delay	41.2	14.3	0.0	50.6	27.3	5.7		36.5	30.7	29.5	8.9
Queue Delay	0.0	0.0	0.0	0.0	0.0	0.0		0.0	0.0	0.0	0.0
Total Delay	41.2	14.3	0.0	50.6	27.3	5.7		36.5	30.7	29.5	8.9
LOS	D	B	A	D	C	A		D	C	C	A
Approach Delay		23.8			25.2			36.5		12.6	
Approach LOS		C			C			D		B	

Intersection Summary

Cycle Length: 130
 Actuated Cycle Length: 86.6
 Natural Cycle: 125
 Control Type: Actuated-Uncoordinated
 Maximum v/c Ratio: 0.80
 Intersection Signal Delay: 23.1
 Intersection LOS: C
 Intersection Capacity Utilization 64.4%
 ICU Level of Service C
 Analysis Period (min) 15

Splits and Phases: 26: Sycamore Canyon Bl. & Van Buren Bl.

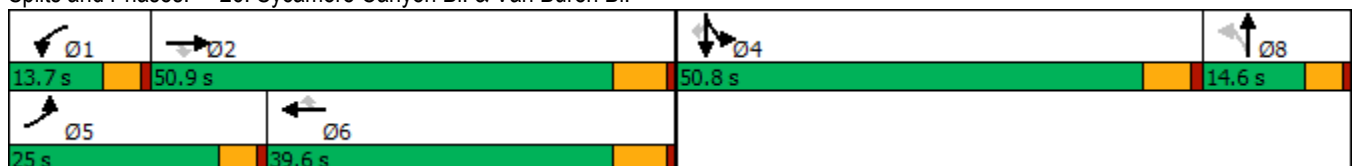

HCM 6th Signalized Intersection Summary
26: Sycamore Canyon Bl. & Van Buren Bl.

West Campus Upper Plateau (JN 14064)

09/19/2022



Movement	EBL	EBT	EBR	WBL	WBT	WBR	NBL	NBT	NBR	SBL	SBT	SBR
Lane Configurations												
Traffic Volume (veh/h)	625	1146	2	46	1322	203	3	1	3	70	6	373
Future Volume (veh/h)	625	1146	2	46	1322	203	3	1	3	70	6	373
Initial Q (Qb), veh	0	0	0	0	0	0	0	0	0	0	0	0
Ped-Bike Adj(A_pbT)	1.00		1.00	1.00		1.00	1.00		1.00	1.00		1.00
Parking Bus, Adj	1.00	1.00	1.00	1.00	1.00	1.00	1.00	1.00	1.00	1.00	1.00	1.00
Work Zone On Approach		No			No			No			No	
Adj Sat Flow, veh/h/ln	1870	1841	1900	1900	1841	1752	1900	1900	1900	1633	1900	1870
Adj Flow Rate, veh/h	679	1246	1	50	1437	196	3	1	1	76	7	0
Peak Hour Factor	0.92	0.92	0.92	0.92	0.92	0.92	0.92	0.92	0.92	0.92	0.92	0.92
Percent Heavy Veh, %	2	4	0	0	4	10	0	0	0	18	0	2
Cap, veh/h	784	3394	863	79	2235	524	24	12	12	339	214	
Arrive On Green	0.23	0.54	0.54	0.04	0.35	0.35	0.01	0.01	0.01	0.11	0.11	0.00
Sat Flow, veh/h	3456	6332	1610	1810	6332	1485	1810	872	872	3018	1900	1585
Grp Volume(v), veh/h	679	1246	1	50	1437	196	3	0	2	76	7	0
Grp Sat Flow(s),veh/h/ln	1728	1583	1610	1810	1583	1485	1810	0	1743	1509	1900	1585
Q Serve(g_s), s	13.6	8.2	0.0	2.0	13.7	7.1	0.1	0.0	0.1	1.7	0.2	0.0
Cycle Q Clear(g_c), s	13.6	8.2	0.0	2.0	13.7	7.1	0.1	0.0	0.1	1.7	0.2	0.0
Prop In Lane	1.00		1.00	1.00		1.00	1.00		0.50	1.00		1.00
Lane Grp Cap(c), veh/h	784	3394	863	79	2235	524	24	0	23	339	214	
V/C Ratio(X)	0.87	0.37	0.00	0.63	0.64	0.37	0.13	0.00	0.09	0.22	0.03	
Avail Cap(c_a), veh/h	979	3930	999	229	2937	688	251	0	242	1885	1187	
HCM Platoon Ratio	1.00	1.00	1.00	1.00	1.00	1.00	1.00	1.00	1.00	1.00	1.00	1.00
Upstream Filter(I)	1.00	1.00	1.00	1.00	1.00	1.00	1.00	0.00	1.00	1.00	1.00	0.00
Uniform Delay (d), s/veh	26.8	9.6	7.8	33.9	19.5	17.4	35.1	0.0	35.1	29.1	28.5	0.0
Incr Delay (d2), s/veh	5.9	0.1	0.0	3.0	0.3	0.4	2.3	0.0	1.6	0.3	0.1	0.0
Initial Q Delay(d3),s/veh	0.0	0.0	0.0	0.0	0.0	0.0	0.0	0.0	0.0	0.0	0.0	0.0
%ile BackOfQ(50%),veh/ln	5.7	2.2	0.0	0.9	4.4	2.2	0.1	0.0	0.0	0.6	0.1	0.0
Unsig. Movement Delay, s/veh												
LnGrp Delay(d),s/veh	32.7	9.7	7.8	36.9	19.8	17.8	37.4	0.0	36.7	29.4	28.5	0.0
LnGrp LOS	C	A	A	D	B	B	D	A	D	C	C	
Approach Vol, veh/h		1926			1683			5			83	
Approach Delay, s/veh		17.8			20.1			37.1			29.4	
Approach LOS		B			C			D			C	
Timer - Assigned Phs	1	2		4	5	6		8				
Phs Duration (G+Y+Rc), s	7.8	44.8		13.9	20.9	31.6		5.6				
Change Period (Y+Rc), s	4.6	6.2		5.8	4.6	6.2		4.6				
Max Green Setting (Gmax), s	9.1	44.7		45.0	20.4	33.4		10.0				
Max Q Clear Time (g_c+I1), s	4.0	10.2		3.7	15.6	15.7		2.1				
Green Ext Time (p_c), s	0.0	10.1		0.3	0.7	9.7		0.0				

Intersection Summary

HCM 6th Ctrl Delay	19.1
HCM 6th LOS	B

Notes

Unsignalized Delay for [SBR] is excluded from calculations of the approach delay and intersection delay.

Timings
27: Innovation Dr. & Cactus Av.

West Campus Upper Plateau (JN 14064)

09/19/2022

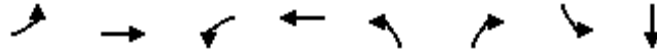

Lane Group	EBL	EBT	WBL	WBT	NBL	NBR	SBL	SBT
Lane Configurations	↖	↕	↖	↕	↖	↗	↖	↗
Traffic Volume (vph)	4	528	108	1899	7	20	4	0
Future Volume (vph)	4	528	108	1899	7	20	4	0
Turn Type	Prot	NA	Prot	NA	Perm	Perm	Perm	NA
Protected Phases	5	2	1	6				4
Permitted Phases					8	8	4	
Detector Phase	5	2	1	6	8	8	4	4
Switch Phase								
Minimum Initial (s)	5.0	10.0	5.0	10.0	10.0	10.0	10.0	10.0
Minimum Split (s)	9.2	26.8	9.2	26.8	31.1	31.1	31.1	31.1
Total Split (s)	12.0	38.0	31.0	57.0	51.0	51.0	51.0	51.0
Total Split (%)	10.0%	31.7%	25.8%	47.5%	42.5%	42.5%	42.5%	42.5%
Yellow Time (s)	3.2	4.8	3.2	4.8	4.1	4.1	4.1	4.1
All-Red Time (s)	1.0	1.0	1.0	1.0	1.0	1.0	1.0	1.0
Lost Time Adjust (s)	0.0	0.0	0.0	0.0	0.0	0.0	0.0	0.0
Total Lost Time (s)	4.2	5.8	4.2	5.8	5.1	5.1	5.1	5.1
Lead/Lag	Lead	Lag	Lead	Lag				
Lead-Lag Optimize?	Yes	Yes	Yes	Yes				
Recall Mode	None	None	None	None	None	None	None	None
Act Effct Green (s)	5.6	40.1	9.0	52.2	13.1	13.1	13.1	13.1
Actuated g/C Ratio	0.09	0.65	0.15	0.85	0.21	0.21	0.21	0.21
v/c Ratio	0.02	0.18	0.45	0.48	0.03	0.03	0.02	0.00
Control Delay	37.8	9.0	35.6	6.7	26.0	0.1	25.8	0.0
Queue Delay	0.0	0.0	0.0	0.0	0.0	0.0	0.0	0.0
Total Delay	37.8	9.0	35.6	6.7	26.0	0.1	25.8	0.0
LOS	D	A	D	A	C	A	C	A
Approach Delay		9.2		8.3				17.2
Approach LOS		A		A				B

Intersection Summary

Cycle Length: 120
 Actuated Cycle Length: 61.7
 Natural Cycle: 80
 Control Type: Actuated-Uncoordinated
 Maximum v/c Ratio: 0.48
 Intersection Signal Delay: 8.5
 Intersection LOS: A
 Intersection Capacity Utilization 62.8%
 ICU Level of Service B
 Analysis Period (min) 15

Splits and Phases: 27: Innovation Dr. & Cactus Av.

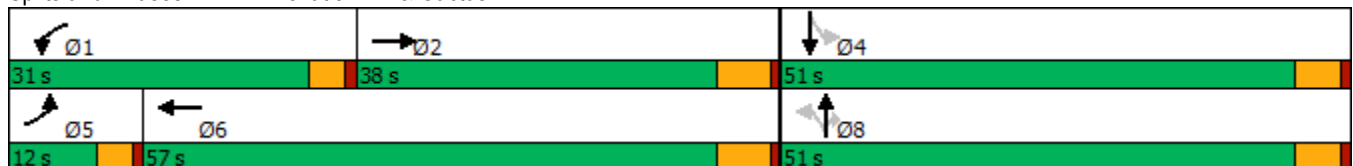

HCM 6th Signalized Intersection Summary
27: Innovation Dr. & Cactus Av.

West Campus Upper Plateau (JN 14064)

09/19/2022



Movement	EBL	EBT	EBR	WBL	WBT	WBR	NBL	NBT	NBR	SBL	SBT	SBR
Lane Configurations	↖	↑↑↑		↖	↑↑↑		↖	↑	↗	↖	↗	
Traffic Volume (veh/h)	4	528	15	108	1899	46	7	0	20	4	0	2
Future Volume (veh/h)	4	528	15	108	1899	46	7	0	20	4	0	2
Initial Q (Qb), veh	0	0	0	0	0	0	0	0	0	0	0	0
Ped-Bike Adj(A_pbT)	1.00		1.00	1.00		1.00	1.00		1.00	1.00		1.00
Parking Bus, Adj	1.00	1.00	1.00	1.00	1.00	1.00	1.00	1.00	1.00	1.00	1.00	1.00
Work Zone On Approach		No			No			No			No	
Adj Sat Flow, veh/h/ln	1900	1752	1900	1811	1796	1870	1218	1900	1292	1559	1900	1900
Adj Flow Rate, veh/h	4	539	13	110	1938	47	7	0	7	4	0	1
Peak Hour Factor	0.98	0.98	0.98	0.98	0.98	0.98	0.98	0.98	0.98	0.98	0.98	0.98
Percent Heavy Veh, %	0	10	0	6	7	2	46	0	41	23	0	0
Cap, veh/h	10	2934	71	142	3386	82	166	86	50	178	0	73
Arrive On Green	0.01	0.61	0.61	0.08	0.69	0.69	0.05	0.00	0.05	0.05	0.00	0.05
Sat Flow, veh/h	1810	4804	116	1725	4925	119	922	1900	1095	1174	0	1610
Grp Volume(v), veh/h	4	357	195	110	1286	699	7	0	7	4	0	1
Grp Sat Flow(s),veh/h/ln	1810	1594	1731	1725	1635	1775	922	1900	1095	1174	0	1610
Q Serve(g_s), s	0.1	2.8	2.8	3.6	11.7	11.7	0.4	0.0	0.4	0.2	0.0	0.0
Cycle Q Clear(g_c), s	0.1	2.8	2.8	3.6	11.7	11.7	0.5	0.0	0.4	0.2	0.0	0.0
Prop In Lane	1.00		0.07	1.00		0.07	1.00		1.00	1.00		1.00
Lane Grp Cap(c), veh/h	10	1947	1057	142	2248	1220	166	86	50	178	0	73
V/C Ratio(X)	0.41	0.18	0.18	0.78	0.57	0.57	0.04	0.00	0.14	0.02	0.00	0.01
Avail Cap(c_a), veh/h	244	1947	1057	801	2899	1574	857	1510	871	1058	0	1280
HCM Platoon Ratio	1.00	1.00	1.00	1.00	1.00	1.00	1.00	1.00	1.00	1.00	1.00	1.00
Upstream Filter(I)	1.00	1.00	1.00	1.00	1.00	1.00	1.00	0.00	1.00	1.00	0.00	1.00
Uniform Delay (d), s/veh	28.6	4.9	4.9	26.0	4.6	4.6	26.5	0.0	26.5	26.4	0.0	26.3
Incr Delay (d2), s/veh	10.0	0.1	0.1	3.4	0.3	0.6	0.1	0.0	1.3	0.1	0.0	0.1
Initial Q Delay(d3),s/veh	0.0	0.0	0.0	0.0	0.0	0.0	0.0	0.0	0.0	0.0	0.0	0.0
%ile BackOfQ(50%),veh/ln	0.1	0.6	0.6	1.4	1.6	1.9	0.1	0.0	0.1	0.1	0.0	0.0
Unsig. Movement Delay, s/veh												
LnGrp Delay(d),s/veh	38.6	5.0	5.0	29.4	5.0	5.3	26.6	0.0	27.7	26.4	0.0	26.4
LnGrp LOS	D	A	A	C	A	A	C	A	C	C	A	C
Approach Vol, veh/h		556			2095			14				5
Approach Delay, s/veh		5.3			6.3			27.2				26.4
Approach LOS		A			A			C				C
Timer - Assigned Phs	1	2		4	5	6		8				
Phs Duration (G+Y+Rc), s	8.9	41.1		7.7	4.5	45.5		7.7				
Change Period (Y+Rc), s	* 4.2	5.8		5.1	* 4.2	5.8		5.1				
Max Green Setting (Gmax), s	* 27	32.2		45.9	* 7.8	51.2		45.9				
Max Q Clear Time (g_c+I1), s	5.6	4.8		2.2	2.1	13.7		2.5				
Green Ext Time (p_c), s	0.1	4.8		0.0	0.0	26.0		0.0				

Intersection Summary

HCM 6th Ctrl Delay	6.3
HCM 6th LOS	A

Notes

* HCM 6th computational engine requires equal clearance times for the phases crossing the barrier.

Timings
28: I-215 SB Ramps & Alessandro Bl.

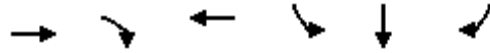

Lane Group	EBT	EBR	WBT	SBL	SBT	SBR
Lane Configurations	↑↑↑	↑	↑↑↑	↑	↔	↑
Traffic Volume (vph)	807	372	2431	172	0	364
Future Volume (vph)	807	372	2431	172	0	364
Turn Type	NA	Perm	NA	Split	NA	Perm
Protected Phases	2		6	4	4	
Permitted Phases		2				4
Detector Phase	2	2	6	4	4	4
Switch Phase						
Minimum Initial (s)	5.0	5.0	5.0	5.0	5.0	5.0
Minimum Split (s)	10.5	10.5	34.5	10.0	10.0	10.0
Total Split (s)	49.0	49.0	49.0	36.0	36.0	36.0
Total Split (%)	57.6%	57.6%	57.6%	42.4%	42.4%	42.4%
Yellow Time (s)	4.5	4.5	4.5	4.0	4.0	4.0
All-Red Time (s)	1.0	1.0	1.0	1.0	1.0	1.0
Lost Time Adjust (s)	0.0	0.0	0.0	0.0	0.0	0.0
Total Lost Time (s)	5.5	5.5	5.5	5.0	5.0	5.0
Lead/Lag						
Lead-Lag Optimize?						
Recall Mode	C-Min	C-Min	C-Min	None	None	None
Act Effct Green (s)	58.3	58.3	58.3	16.2	16.2	16.2
Actuated g/C Ratio	0.69	0.69	0.69	0.19	0.19	0.19
v/c Ratio	0.24	0.33	0.74	0.55	0.68	0.65
Control Delay	5.9	2.2	8.4	37.0	37.5	35.4
Queue Delay	0.0	0.0	0.0	0.0	0.0	0.0
Total Delay	5.9	2.2	8.4	37.0	37.5	35.4
LOS	A	A	A	D	D	D
Approach Delay	4.8		8.4		36.6	
Approach LOS	A		A		D	

Intersection Summary

Cycle Length: 85
 Actuated Cycle Length: 85
 Offset: 50 (59%), Referenced to phase 2:EBT and 6:WBT, Start of Yellow
 Natural Cycle: 50
 Control Type: Actuated-Coordinated
 Maximum v/c Ratio: 0.74
 Intersection Signal Delay: 11.0
 Intersection LOS: B
 Intersection Capacity Utilization 73.9%
 ICU Level of Service D
 Analysis Period (min) 15

Splits and Phases: 28: I-215 SB Ramps & Alessandro Bl.

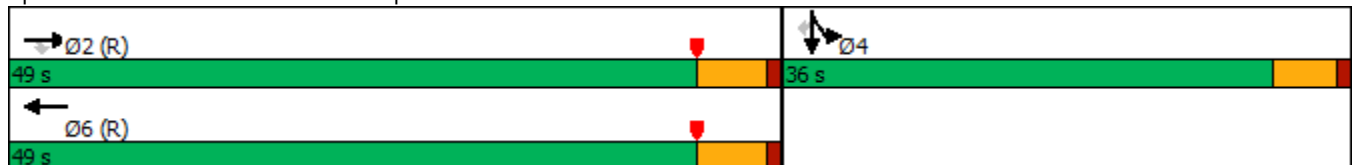

HCM 6th Signalized Intersection Summary
 28: I-215 SB Ramps & Alessandro Bl.

West Campus Upper Plateau (JN 14064)

09/19/2022



Movement	EBL	EBT	EBR	WBL	WBT	WBR	NBL	NBT	NBR	SBL	SBT	SBR
Lane Configurations		↑↑↑	↗		↑↑↑					↘	↔	↗
Traffic Volume (veh/h)	0	807	372	0	2431	143	0	0	0	172	0	364
Future Volume (veh/h)	0	807	372	0	2431	143	0	0	0	172	0	364
Initial Q (Qb), veh	0	0	0	0	0	0				0	0	0
Ped-Bike Adj(A_pbT)	1.00		1.00	1.00		1.00				1.00		1.00
Parking Bus, Adj	1.00	1.00	1.00	1.00	1.00	1.00				1.00	1.00	1.00
Work Zone On Approach		No			No						No	
Adj Sat Flow, veh/h/ln	0	1841	1841	0	1885	1826				1693	1900	1781
Adj Flow Rate, veh/h	0	815	376	0	2456	134				116	0	353
Peak Hour Factor	0.99	0.99	0.99	0.99	0.99	0.99				0.99	0.99	0.99
Percent Heavy Veh, %	0	4	4	0	1	5				14	0	8
Cap, veh/h	0	3628	1125	0	3608	195				249	0	467
Arrive On Green	0.00	0.72	0.72	0.00	0.72	0.72				0.15	0.00	0.15
Sat Flow, veh/h	0	5191	1559	0	5168	270				1612	0	3019
Grp Volume(v), veh/h	0	815	376	0	1678	912				116	0	353
Grp Sat Flow(s),veh/h/ln	0	1675	1559	0	1716	1837				1612	0	1510
Q Serve(g_s), s	0.0	4.6	7.5	0.0	22.6	23.3				5.6	0.0	9.5
Cycle Q Clear(g_c), s	0.0	4.6	7.5	0.0	22.6	23.3				5.6	0.0	9.5
Prop In Lane	0.00		1.00	0.00		0.15				1.00		1.00
Lane Grp Cap(c), veh/h	0	3628	1125	0	2477	1326				249	0	467
V/C Ratio(X)	0.00	0.22	0.33	0.00	0.68	0.69				0.47	0.00	0.76
Avail Cap(c_a), veh/h	0	3628	1125	0	2477	1326				588	0	1101
HCM Platoon Ratio	1.00	1.00	1.00	1.00	1.00	1.00				1.00	1.00	1.00
Upstream Filter(I)	0.00	0.91	0.91	0.00	0.42	0.42				1.00	0.00	1.00
Uniform Delay (d), s/veh	0.0	3.9	4.3	0.0	6.4	6.5				32.7	0.0	34.4
Incr Delay (d2), s/veh	0.0	0.1	0.7	0.0	0.6	1.2				1.4	0.0	2.5
Initial Q Delay(d3),s/veh	0.0	0.0	0.0	0.0	0.0	0.0				0.0	0.0	0.0
%ile BackOfQ(50%),veh/ln	0.0	0.9	1.5	0.0	4.5	5.1				2.1	0.0	3.4
Unsig. Movement Delay, s/veh												
LnGrp Delay(d),s/veh	0.0	4.1	5.1	0.0	7.1	7.8				34.1	0.0	36.9
LnGrp LOS	A	A	A	A	A	A				C	A	D
Approach Vol, veh/h		1191			2590						469	
Approach Delay, s/veh		4.4			7.3						36.2	
Approach LOS		A			A						D	
Timer - Assigned Phs		2		4		6						
Phs Duration (G+Y+Rc), s		66.9		18.1		66.9						
Change Period (Y+Rc), s		5.5		5.0		5.5						
Max Green Setting (Gmax), s		43.5		31.0		43.5						
Max Q Clear Time (g_c+I1), s		9.5		11.5		25.3						
Green Ext Time (p_c), s		7.1		1.6		14.9						

Intersection Summary

HCM 6th Ctrl Delay	9.7
HCM 6th LOS	A

Notes

User approved volume balancing among the lanes for turning movement.

Timings
29: I-215 NB Ramps & Alessandro Bl.

West Campus Upper Plateau (JN 14064)

09/19/2022



Lane Group	EBL	EBT	WBT	WBR	NBL	NBT	NBR
Lane Configurations	↙	↑↑↑	↑↑↑	↘	↙	↕	↘
Traffic Volume (vph)	87	892	1347	78	1227	0	158
Future Volume (vph)	87	892	1347	78	1227	0	158
Turn Type	Prot	NA	NA	Perm	Split	NA	Perm
Protected Phases	5	2	6		8	8	
Permitted Phases				6			8
Detector Phase	5	2	6	6	8	8	8
Switch Phase							
Minimum Initial (s)	5.0	5.0	5.0	5.0	5.0	5.0	5.0
Minimum Split (s)	9.5	10.5	33.5	33.5	10.0	10.0	10.0
Total Split (s)	25.0	60.0	35.0	35.0	25.0	25.0	25.0
Total Split (%)	29.4%	70.6%	41.2%	41.2%	29.4%	29.4%	29.4%
Yellow Time (s)	3.5	4.5	4.5	4.5	4.0	4.0	4.0
All-Red Time (s)	1.0	1.0	1.0	1.0	1.0	1.0	1.0
Lost Time Adjust (s)	0.0	0.0	0.0	0.0	0.0	0.0	0.0
Total Lost Time (s)	4.5	5.5	5.5	5.5	5.0	5.0	5.0
Lead/Lag	Lead		Lag	Lag			
Lead-Lag Optimize?	Yes		Yes	Yes			
Recall Mode	None	C-Min	C-Min	C-Min	Max	Max	Max
Act Effct Green (s)	10.0	51.3	38.8	38.8	23.2	23.2	23.2
Actuated g/C Ratio	0.12	0.60	0.46	0.46	0.27	0.27	0.27
v/c Ratio	0.51	0.30	0.59	0.11	1.40	1.25	0.29
Control Delay	41.0	6.5	18.9	4.0	219.6	154.6	6.7
Queue Delay	0.0	0.0	0.0	0.0	0.0	0.0	0.0
Total Delay	41.0	6.5	18.9	4.0	219.6	154.6	6.7
LOS	D	A	B	A	F	F	A
Approach Delay		9.5	18.1			168.8	
Approach LOS		A	B			F	

Intersection Summary

Cycle Length: 85
 Actuated Cycle Length: 85
 Offset: 20 (24%), Referenced to phase 2:EBT and 6:WBT, Start of Yellow
 Natural Cycle: 90
 Control Type: Actuated-Coordinated
 Maximum v/c Ratio: 1.40
 Intersection Signal Delay: 71.0
 Intersection LOS: E
 Intersection Capacity Utilization 78.9%
 ICU Level of Service D
 Analysis Period (min) 15

Splits and Phases: 29: I-215 NB Ramps & Alessandro Bl.



HCM 6th Signalized Intersection Summary
29: I-215 NB Ramps & Alessandro Bl.

West Campus Upper Plateau (JN 14064)
09/19/2022



Movement	EBL	EBT	EBR	WBL	WBT	WBR	NBL	NBT	NBR	SBL	SBT	SBR
Lane Configurations	↘	↑↑↑			↑↑↑	↗	↘	↕	↗			
Traffic Volume (veh/h)	87	892	0	0	1347	78	1227	0	158	0	0	0
Future Volume (veh/h)	87	892	0	0	1347	78	1227	0	158	0	0	0
Initial Q (Qb), veh	0	0	0	0	0	0	0	0	0			
Ped-Bike Adj(A_pbT)	1.00		1.00	1.00		1.00	1.00		1.00			
Parking Bus, Adj	1.00	1.00	1.00	1.00	1.00	1.00	1.00	1.00	1.00			
Work Zone On Approach		No			No			No				
Adj Sat Flow, veh/h/ln	1574	1841	0	0	1870	1707	1870	1900	1796			
Adj Flow Rate, veh/h	89	910	0	0	1374	73	1278	0	55			
Peak Hour Factor	0.98	0.98	0.98	0.98	0.98	0.98	0.98	0.98	0.98			
Percent Heavy Veh, %	22	4	0	0	2	13	2	0	7			
Cap, veh/h	110	3222	0	0	2628	745	838	0	358			
Arrive On Green	0.02	0.21	0.00	0.00	0.51	0.51	0.24	0.00	0.24			
Sat Flow, veh/h	1499	5191	0	0	5274	1447	3563	0	1522			
Grp Volume(v), veh/h	89	910	0	0	1374	73	1278	0	55			
Grp Sat Flow(s),veh/h/ln	1499	1675	0	0	1702	1447	1781	0	1522			
Q Serve(g_s), s	5.0	12.9	0.0	0.0	15.2	2.2	20.0	0.0	2.4			
Cycle Q Clear(g_c), s	5.0	12.9	0.0	0.0	15.2	2.2	20.0	0.0	2.4			
Prop In Lane	1.00		0.00	0.00		1.00	1.00		1.00			
Lane Grp Cap(c), veh/h	110	3222	0	0	2628	745	838	0	358			
V/C Ratio(X)	0.81	0.28	0.00	0.00	0.52	0.10	1.52	0.00	0.15			
Avail Cap(c_a), veh/h	362	3222	0	0	2628	745	838	0	358			
HCM Platoon Ratio	0.33	0.33	1.00	1.00	1.00	1.00	1.00	1.00	1.00			
Upstream Filter(I)	0.97	0.97	0.00	0.00	1.00	1.00	1.00	0.00	1.00			
Uniform Delay (d), s/veh	40.9	17.1	0.0	0.0	13.7	10.5	32.5	0.0	25.8			
Incr Delay (d2), s/veh	9.6	0.2	0.0	0.0	0.7	0.3	242.2	0.0	0.9			
Initial Q Delay(d3),s/veh	0.0	0.0	0.0	0.0	0.0	0.0	0.0	0.0	0.0			
%ile BackOfQ(50%),veh/ln	2.1	5.0	0.0	0.0	4.9	0.6	36.3	0.0	0.9			
Unsig. Movement Delay, s/veh												
LnGrp Delay(d),s/veh	50.4	17.3	0.0	0.0	14.4	10.8	274.7	0.0	26.7			
LnGrp LOS	D	B	A	A	B	B	F	A	C			
Approach Vol, veh/h		999			1447			1333				
Approach Delay, s/veh		20.3			14.3			264.4				
Approach LOS		C			B			F				
Timer - Assigned Phs		2			5	6		8				
Phs Duration (G+Y+Rc), s		60.0			10.8	49.2		25.0				
Change Period (Y+Rc), s		5.5			4.5	5.5		5.0				
Max Green Setting (Gmax), s		54.5			20.5	29.5		20.0				
Max Q Clear Time (g_c+I1), s		14.9			7.0	17.2		22.0				
Green Ext Time (p_c), s		6.3			0.1	6.8		0.0				

Intersection Summary

HCM 6th Ctrl Delay	104.1
HCM 6th LOS	F

Notes

User approved volume balancing among the lanes for turning movement.

Timings
30: I-215 SB Ramps & Cactus Av.

West Campus Upper Plateau (JN 14064)

09/19/2022



Lane Group	EBT	EBR	WBL	WBT	NBR	SBR
Lane Configurations	↑↑	↑	↓	↑↑	↑	↑
Traffic Volume (vph)	484	69	579	1464	624	588
Future Volume (vph)	484	69	579	1464	624	588
Turn Type	NA	Perm	Prot	NA	Prot	Prot
Protected Phases	2		1	6	8	4
Permitted Phases		2				
Detector Phase	2	2	1	6	8	4
Switch Phase						
Minimum Initial (s)	5.0	5.0	5.0	5.0	5.0	5.0
Minimum Split (s)	11.0	11.0	9.5	23.0	9.5	9.5
Total Split (s)	23.0	23.0	54.0	77.0	28.0	28.0
Total Split (%)	21.9%	21.9%	51.4%	73.3%	26.7%	26.7%
Yellow Time (s)	5.0	5.0	3.5	5.0	3.5	3.5
All-Red Time (s)	1.0	1.0	1.0	1.0	1.0	1.0
Lost Time Adjust (s)	0.0	0.0	0.0	0.0	0.0	0.0
Total Lost Time (s)	6.0	6.0	4.5	6.0	4.5	4.5
Lead/Lag	Lag	Lag	Lead			
Lead-Lag Optimize?	Yes	Yes	Yes			
Recall Mode	Min	Min	None	Min	None	None
Act Effct Green (s)	17.1	17.1	40.5	62.2	23.7	23.7
Actuated g/C Ratio	0.18	0.18	0.42	0.64	0.25	0.25
v/c Ratio	0.91	0.24	0.93	0.72	0.71	1.63
Control Delay	61.1	11.2	46.8	13.3	5.1	319.8
Queue Delay	0.0	0.0	0.0	0.0	0.0	0.0
Total Delay	61.1	11.2	46.8	13.3	5.1	319.8
LOS	E	B	D	B	A	F
Approach Delay	54.8			22.8		
Approach LOS	D			C		

Intersection Summary

Cycle Length: 105
 Actuated Cycle Length: 96.5
 Natural Cycle: 110
 Control Type: Actuated-Uncoordinated
 Maximum v/c Ratio: 1.63
 Intersection Signal Delay: 70.4
 Intersection LOS: E
 Intersection Capacity Utilization 85.6%
 ICU Level of Service E
 Analysis Period (min) 15

Splits and Phases: 30: I-215 SB Ramps & Cactus Av.

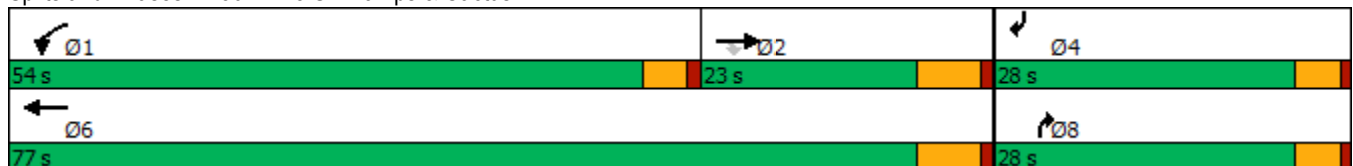

HCM 6th Signalized Intersection Summary
 30: I-215 SB Ramps & Cactus Av.

West Campus Upper Plateau (JN 14064)

09/19/2022



Movement	EBL	EBT	EBR	WBL	WBT	WBR	NBL	NBT	NBR	SBL	SBT	SBR
Lane Configurations		↑↑	↑	↑	↑↑				↑			↑
Traffic Volume (veh/h)	0	484	69	579	1464	0	0	0	624	0	0	588
Future Volume (veh/h)	0	484	69	579	1464	0	0	0	624	0	0	588
Initial Q (Qb), veh	0	0	0	0	0	0	0	0	0	0	0	0
Ped-Bike Adj(A_pbT)	1.00		1.00	1.00		1.00	1.00		1.00	1.00		1.00
Parking Bus, Adj	1.00	1.00	1.00	1.00	1.00	1.00	1.00	1.00	1.00	1.00	1.00	1.00
Work Zone On Approach		No			No			No			No	
Adj Sat Flow, veh/h/ln	0	1781	1767	1767	1856	0	0	0	1752	0	0	1633
Adj Flow Rate, veh/h	0	538	69	643	1627	0	0	0	0	0	0	552
Peak Hour Factor	0.90	0.90	0.90	0.90	0.90	0.90	0.90	0.90	0.90	0.90	0.90	0.90
Percent Heavy Veh, %	0	8	9	9	3	0	0	0	10	0	0	18
Cap, veh/h	0	852	377	734	2897	0	0	0	0	0	0	0
Arrive On Green	0.00	0.25	0.25	0.44	0.82	0.00	0.00	0.00	0.00	0.00	0.00	0.00
Sat Flow, veh/h	0	3474	1497	1682	3618	0		0			0	
Grp Volume(v), veh/h	0	538	69	643	1627	0		0.0			0.0	
Grp Sat Flow(s),veh/h/ln	0	1692	1497	1682	1763	0						
Q Serve(g_s), s	0.0	4.8	1.2	11.7	5.1	0.0						
Cycle Q Clear(g_c), s	0.0	4.8	1.2	11.7	5.1	0.0						
Prop In Lane	0.00		1.00	1.00		0.00						
Lane Grp Cap(c), veh/h	0	852	377	734	2897	0						
V/C Ratio(X)	0.00	0.63	0.18	0.88	0.56	0.00						
Avail Cap(c_a), veh/h	0	1710	756	2475	7439	0						
HCM Platoon Ratio	1.00	1.00	1.00	1.00	1.00	1.00						
Upstream Filter(I)	0.00	1.00	1.00	1.00	1.00	0.00						
Uniform Delay (d), s/veh	0.0	11.2	9.9	8.7	1.0	0.0						
Incr Delay (d2), s/veh	0.0	0.3	0.1	1.4	0.1	0.0						
Initial Q Delay(d3),s/veh	0.0	0.0	0.0	0.0	0.0	0.0						
%ile BackOfQ(50%),veh/ln	0.0	1.1	0.3	2.0	0.0	0.0						
Unsig. Movement Delay, s/veh												
LnGrp Delay(d),s/veh	0.0	11.5	10.0	10.0	1.1	0.0						
LnGrp LOS	A	B	A	B	A	A						
Approach Vol, veh/h		607			2270							
Approach Delay, s/veh		11.3			3.6							
Approach LOS		B			A							
Timer - Assigned Phs	1	2			6							
Phs Duration (G+Y+Rc), s	19.2	14.5			33.6							
Change Period (Y+Rc), s	4.5	6.0			6.0							
Max Green Setting (Gmax), s	49.5	17.0			71.0							
Max Q Clear Time (g_c+I1), s	13.7	6.8			7.1							
Green Ext Time (p_c), s	1.0	1.7			10.4							

Intersection Summary

HCM 6th Ctrl Delay			5.2									
HCM 6th LOS			A									

Notes

Unsignalized Delay for [NBR] is excluded from calculations of the approach delay and intersection delay.

Timings

31: I-215 NB Ramps/Old 215 Frontage Rd. & Cactus Av.



Lane Group	EBL	EBT	WBT	NBL	NBT	NBR	SBL	SBT
Lane Configurations	↖	↕	↕	↖	↕	↗	↖	↕
Traffic Volume (vph)	29	1282	2441	422	292	12	48	0
Future Volume (vph)	29	1282	2441	422	292	12	48	0
Turn Type	Perm	NA	NA	Perm	NA	Perm	Perm	NA
Protected Phases		2	6		8			4
Permitted Phases	2			8		8	4	
Detector Phase	2	2	6	8	8	8	4	4
Switch Phase								
Minimum Initial (s)	5.0	5.0	5.0	5.0	5.0	5.0	5.0	5.0
Minimum Split (s)	11.0	11.0	44.0	10.5	10.5	10.5	10.5	10.5
Total Split (s)	88.0	88.0	88.0	32.0	32.0	32.0	32.0	32.0
Total Split (%)	73.3%	73.3%	73.3%	26.7%	26.7%	26.7%	26.7%	26.7%
Yellow Time (s)	5.0	5.0	5.0	4.5	4.5	4.5	4.5	4.5
All-Red Time (s)	1.0	1.0	1.0	1.0	1.0	1.0	1.0	1.0
Lost Time Adjust (s)	0.0	0.0	0.0	0.0	0.0	0.0	0.0	0.0
Total Lost Time (s)	6.0	6.0	6.0	5.5	5.5	5.5	5.5	5.5
Lead/Lag								
Lead-Lag Optimize?								
Recall Mode	Min	Min	Min	None	None	None	None	None
Act Effct Green (s)	82.0	82.0	82.0	26.5	26.5	26.5	26.5	26.5
Actuated g/C Ratio	0.68	0.68	0.68	0.22	0.22	0.22	0.22	0.22
v/c Ratio	0.56	0.67	1.15	1.92	0.88	0.03	0.54	0.49
Control Delay	54.3	12.8	95.7	456.6	71.1	4.7	64.2	39.5
Queue Delay	0.0	0.0	0.0	0.0	0.0	0.0	0.0	0.0
Total Delay	54.3	12.8	95.7	456.6	71.1	4.7	64.2	39.5
LOS	D	B	F	F	E	A	E	D
Approach Delay		13.6	95.7		294.0			45.9
Approach LOS		B	F		F			D

Intersection Summary

Cycle Length: 120
 Actuated Cycle Length: 120
 Natural Cycle: 90
 Control Type: Actuated-Uncoordinated
 Maximum v/c Ratio: 1.92
 Intersection Signal Delay: 98.5
 Intersection Capacity Utilization 118.0%
 Analysis Period (min) 15
 Intersection LOS: F
 ICU Level of Service H

Splits and Phases: 31: I-215 NB Ramps/Old 215 Frontage Rd. & Cactus Av.

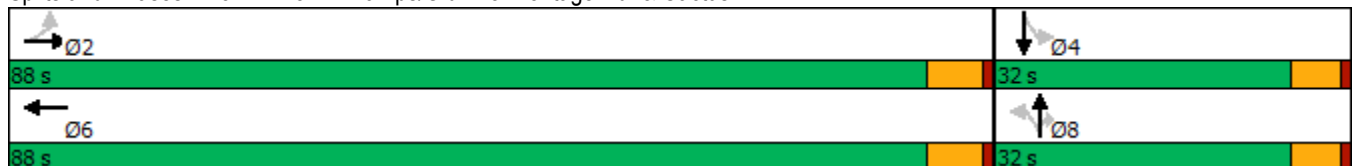

HCM 6th Signalized Intersection Summary

West Campus Upper Plateau (JN 14064)

31: I-215 NB Ramps/Old 215 Frontage Rd. & Cactus Av.

09/19/2022



Movement	EBL	EBT	EBR	WBL	WBT	WBR	NBL	NBT	NBR	SBL	SBT	SBR
Lane Configurations												
Traffic Volume (veh/h)	29	1282	163	0	2441	138	422	292	12	48	0	138
Future Volume (veh/h)	29	1282	163	0	2441	138	422	292	12	48	0	138
Initial Q (Qb), veh	0	0	0	0	0	0	0	0	0	0	0	0
Ped-Bike Adj(A_pbT)	1.00		1.00	1.00		1.00	1.00		1.00	1.00		1.00
Parking Bus, Adj	1.00	1.00	1.00	1.00	1.00	1.00	1.00	1.00	1.00	1.00	1.00	1.00
Work Zone On Approach		No			No			No			No	
Adj Sat Flow, veh/h/ln	1678	1841	1515	0	1856	1841	1811	1722	1900	1841	1900	1485
Adj Flow Rate, veh/h	31	1364	168	0	2597	127	449	311	0	51	0	137
Peak Hour Factor	0.94	0.94	0.94	0.94	0.94	0.94	0.94	0.94	0.94	0.94	0.94	0.94
Percent Heavy Veh, %	15	4	26	0	3	4	6	12	0	4	0	28
Cap, veh/h	60	2143	262	0	2339	113	240	380		112	0	356
Arrive On Green	0.68	0.68	0.68	0.00	0.68	0.68	0.22	0.22	0.00	0.22	0.00	0.22
Sat Flow, veh/h	94	3137	384	0	3515	166	1212	1722	1610	1052	0	1610
Grp Volume(v), veh/h	31	756	776	0	1327	1397	449	311	0	51	0	137
Grp Sat Flow(s),veh/h/ln	94	1749	1772	0	1763	1826	1212	1722	1610	1052	0	1610
Q Serve(g_s), s	0.0	29.0	29.6	0.0	82.0	82.0	17.8	20.6	0.0	5.8	0.0	8.7
Cycle Q Clear(g_c), s	82.0	29.0	29.6	0.0	82.0	82.0	26.5	20.6	0.0	26.4	0.0	8.7
Prop In Lane	1.00		0.22	0.00		0.09	1.00		1.00	1.00		1.00
Lane Grp Cap(c), veh/h	60	1195	1211	0	1205	1248	240	380		112	0	356
V/C Ratio(X)	0.52	0.63	0.64	0.00	1.10	1.12	1.87	0.82		0.46	0.00	0.39
Avail Cap(c_a), veh/h	60	1195	1211	0	1205	1248	240	380		112	0	356
HCM Platoon Ratio	1.00	1.00	1.00	1.00	1.00	1.00	1.00	1.00	1.00	1.00	1.00	1.00
Upstream Filter(I)	1.00	1.00	1.00	0.00	1.00	1.00	1.00	1.00	0.00	1.00	0.00	1.00
Uniform Delay (d), s/veh	60.0	10.6	10.7	0.0	19.0	19.0	53.3	44.5	0.0	57.0	0.0	39.8
Incr Delay (d2), s/veh	3.5	0.8	0.9	0.0	58.4	65.1	407.7	12.3	0.0	1.1	0.0	0.3
Initial Q Delay(d3),s/veh	0.0	0.0	0.0	0.0	0.0	0.0	0.0	0.0	0.0	0.0	0.0	0.0
%ile BackOfQ(50%),veh/ln	1.0	9.6	10.0	0.0	46.2	50.1	34.3	9.8	0.0	1.5	0.0	3.3
Unsig. Movement Delay, s/veh												
LnGrp Delay(d),s/veh	63.5	11.4	11.6	0.0	77.4	84.1	461.1	56.7	0.0	58.1	0.0	40.1
LnGrp LOS	E	B	B	A	F	F	F	E		E	A	D
Approach Vol, veh/h		1563			2724			760				188
Approach Delay, s/veh		12.6			80.8			295.6				45.0
Approach LOS		B			F			F				D
Timer - Assigned Phs		2		4		6		8				
Phs Duration (G+Y+Rc), s		88.0		32.0		88.0		32.0				
Change Period (Y+Rc), s		6.0		5.5		6.0		5.5				
Max Green Setting (Gmax), s		82.0		26.5		82.0		26.5				
Max Q Clear Time (g_c+I1), s		84.0		28.4		84.0		28.5				
Green Ext Time (p_c), s		0.0		0.0		0.0		0.0				

Intersection Summary

HCM 6th Ctrl Delay	90.3
HCM 6th LOS	F

Notes

User approved volume balancing among the lanes for turning movement.
 Unsignalized Delay for [NBR] is excluded from calculations of the approach delay and intersection delay.

Timings
32: I-215 SB Ramps & Van Buren Bl.

West Campus Upper Plateau (JN 14064)

09/19/2022



Lane Group	EBT	EBR	WBL	WBT	SBT	SBR
Lane Configurations	↑↑	↑↑	↵	↑↑	↵	↑↑
Traffic Volume (vph)	507	679	2	974	21	719
Future Volume (vph)	507	679	2	974	21	719
Turn Type	NA	Perm	Prot	NA	NA	Perm
Protected Phases	6		5	2	8	
Permitted Phases		6				8
Detector Phase	6	6	5	2	8	8
Switch Phase						
Minimum Initial (s)	5.0	5.0	5.0	5.0	5.0	5.0
Minimum Split (s)	36.0	36.0	11.0	11.0	11.0	11.0
Total Split (s)	37.0	37.0	11.0	48.0	37.0	37.0
Total Split (%)	43.5%	43.5%	12.9%	56.5%	43.5%	43.5%
Yellow Time (s)	5.0	5.0	5.0	5.0	5.0	5.0
All-Red Time (s)	1.0	1.0	1.0	1.0	1.0	1.0
Lost Time Adjust (s)	0.0	0.0	0.0	0.0	0.0	0.0
Total Lost Time (s)	6.0	6.0	6.0	6.0	6.0	6.0
Lead/Lag	Lag	Lag	Lead			
Lead-Lag Optimize?	Yes	Yes	Yes			
Recall Mode	Min	Min	None	Min	Max	Max
Act Effct Green (s)	25.1	25.1	5.1	26.9	31.3	31.3
Actuated g/C Ratio	0.36	0.36	0.07	0.38	0.44	0.44
v/c Ratio	0.45	0.52	0.02	0.79	0.08	0.61
Control Delay	19.0	3.0	35.0	23.6	14.5	16.5
Queue Delay	0.0	0.0	0.0	0.0	0.0	0.0
Total Delay	19.0	3.0	35.0	23.6	14.5	16.5
LOS	B	A	C	C	B	B
Approach Delay	9.8			23.6	16.4	
Approach LOS	A			C	B	

Intersection Summary

Cycle Length: 85
 Actuated Cycle Length: 70.4
 Natural Cycle: 70
 Control Type: Actuated-Uncoordinated
 Maximum v/c Ratio: 0.79
 Intersection Signal Delay: 16.1
 Intersection LOS: B
 Intersection Capacity Utilization 62.1%
 ICU Level of Service B
 Analysis Period (min) 15

Splits and Phases: 32: I-215 SB Ramps & Van Buren Bl.

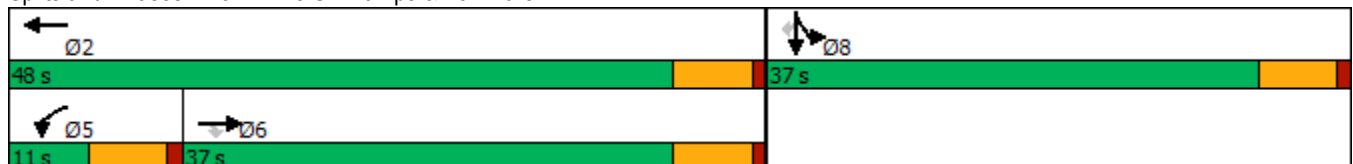

HCM 6th Signalized Intersection Summary
 32: I-215 SB Ramps & Van Buren Bl.

West Campus Upper Plateau (JN 14064)

09/19/2022



Movement	EBL	EBT	EBR	WBL	WBT	WBR	NBL	NBT	NBR	SBL	SBT	SBR
Lane Configurations		↑↑	↑↑	↑	↑↑						↑	↑↑
Traffic Volume (veh/h)	0	507	679	2	974	0	0	0	0	21	21	719
Future Volume (veh/h)	0	507	679	2	974	0	0	0	0	21	21	719
Initial Q (Qb), veh	0	0	0	0	0	0				0	0	0
Ped-Bike Adj(A_pbT)	1.00		1.00	1.00		1.00				1.00		1.00
Parking Bus, Adj	1.00	1.00	1.00	1.00	1.00	1.00				1.00	1.00	1.00
Work Zone On Approach		No			No						No	
Adj Sat Flow, veh/h/ln	0	1796	1781	1900	1841	0				1203	1559	1811
Adj Flow Rate, veh/h	0	545	636	2	1047	0				23	23	0
Peak Hour Factor	0.93	0.93	0.93	0.93	0.93	0.93				0.93	0.93	0.93
Percent Heavy Veh, %	0	7	8	0	4	0				47	23	6
Cap, veh/h	0	986	768	119	1517	0				310	310	
Arrive On Green	0.00	0.29	0.29	0.07	0.43	0.00				0.41	0.41	0.00
Sat Flow, veh/h	0	3503	2657	1810	3589	0				761	761	2701
Grp Volume(v), veh/h	0	545	636	2	1047	0				46	0	0
Grp Sat Flow(s),veh/h/ln	0	1706	1329	1810	1749	0				1521	0	1351
Q Serve(g_s), s	0.0	10.3	17.0	0.1	18.4	0.0				1.4	0.0	0.0
Cycle Q Clear(g_c), s	0.0	10.3	17.0	0.1	18.4	0.0				1.4	0.0	0.0
Prop In Lane	0.00		1.00	1.00		0.00				0.50		1.00
Lane Grp Cap(c), veh/h	0	986	768	119	1517	0				621	0	
V/C Ratio(X)	0.00	0.55	0.83	0.02	0.69	0.00				0.07	0.00	
Avail Cap(c_a), veh/h	0	1393	1084	119	1934	0				621	0	
HCM Platoon Ratio	1.00	1.00	1.00	1.00	1.00	1.00				1.00	1.00	1.00
Upstream Filter(I)	0.00	1.00	1.00	1.00	1.00	0.00				1.00	0.00	0.00
Uniform Delay (d), s/veh	0.0	22.8	25.2	33.2	17.4	0.0				13.7	0.0	0.0
Incr Delay (d2), s/veh	0.0	0.2	2.6	0.0	0.4	0.0				0.2	0.0	0.0
Initial Q Delay(d3),s/veh	0.0	0.0	0.0	0.0	0.0	0.0				0.0	0.0	0.0
%ile BackOfQ(50%),veh/ln	0.0	3.6	4.9	0.0	6.2	0.0				0.5	0.0	0.0
Unsig. Movement Delay, s/veh												
LnGrp Delay(d),s/veh	0.0	23.0	27.9	33.2	17.8	0.0				13.9	0.0	0.0
LnGrp LOS	A	C	C	C	B	A				B	A	
Approach Vol, veh/h		1181			1049							46
Approach Delay, s/veh		25.6			17.8							13.9
Approach LOS		C			B							B
Timer - Assigned Phs		2			5	6		8				
Phs Duration (G+Y+Rc), s		39.0			11.0	28.0		37.0				
Change Period (Y+Rc), s		6.0			6.0	6.0		6.0				
Max Green Setting (Gmax), s		42.0			5.0	31.0		31.0				
Max Q Clear Time (g_c+I1), s		20.4			2.1	19.0		3.4				
Green Ext Time (p_c), s		4.4			0.0	3.0		0.1				

Intersection Summary

HCM 6th Ctrl Delay	21.8
HCM 6th LOS	C

Notes

Unsignalized Delay for [SBR] is excluded from calculations of the approach delay and intersection delay.

Timings
33: I-215 NB On/Off Ramp & Van Buren Bl.



Lane Group	EBT	EBR	WBT	NBL	NBR
Lane Configurations	↑↑	↑↑	↑↑	↑↑	↑
Traffic Volume (vph)	32	558	26	965	5
Future Volume (vph)	32	558	26	965	5
Turn Type	NA	pm+ov	NA	Prot	Perm
Protected Phases	6	4	2	4	
Permitted Phases		6			4
Detector Phase	6	4	2	4	4
Switch Phase					
Minimum Initial (s)	5.0	5.0	5.0	5.0	5.0
Minimum Split (s)	11.0	42.0	11.0	42.0	42.0
Total Split (s)	15.0	55.0	15.0	55.0	55.0
Total Split (%)	21.4%	78.6%	21.4%	78.6%	78.6%
Yellow Time (s)	5.0	5.0	5.0	5.0	5.0
All-Red Time (s)	1.0	1.0	1.0	1.0	1.0
Lost Time Adjust (s)	0.0	0.0	0.0	0.0	0.0
Total Lost Time (s)	6.0	6.0	6.0	6.0	6.0
Lead/Lag					
Lead-Lag Optimize?					
Recall Mode	None	Min	None	Min	Min
Act Effct Green (s)	5.6	38.8	5.6	33.4	33.4
Actuated g/C Ratio	0.14	1.00	0.14	0.86	0.86
v/c Ratio	0.09	0.22	0.08	0.37	0.01
Control Delay	19.8	0.2	19.9	2.9	2.2
Queue Delay	0.0	0.0	0.0	0.0	0.0
Total Delay	19.8	0.2	19.9	2.9	2.2
LOS	B	A	B	A	A
Approach Delay	1.3		19.9	2.9	
Approach LOS	A		B	A	

Intersection Summary

Cycle Length: 70
 Actuated Cycle Length: 38.8
 Natural Cycle: 55
 Control Type: Actuated-Uncoordinated
 Maximum v/c Ratio: 0.37
 Intersection Signal Delay: 2.6
 Intersection Capacity Utilization 41.7%
 Analysis Period (min) 15
 Intersection LOS: A
 ICU Level of Service A

Splits and Phases: 33: I-215 NB On/Off Ramp & Van Buren Bl.



HCM 6th Signalized Intersection Summary
 33: I-215 NB On/Off Ramp & Van Buren Bl.

West Campus Upper Plateau (JN 14064)

09/19/2022

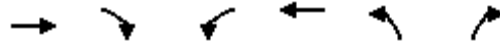

Movement	EBT	EBR	WBL	WBT	NBL	NBR
Lane Configurations	↑↑	↑↑		↑↑	↑↑	↑
Traffic Volume (veh/h)	32	558	0	26	965	5
Future Volume (veh/h)	32	558	0	26	965	5
Initial Q (Qb), veh	0	0	0	0	0	0
Ped-Bike Adj(A_pbT)		1.00	1.00		1.00	1.00
Parking Bus, Adj	1.00	1.00	1.00	1.00	1.00	1.00
Work Zone On Approach	No			No	No	
Adj Sat Flow, veh/h/ln	1292	1826	0	1159	1826	1278
Adj Flow Rate, veh/h	35	592	0	28	1049	5
Peak Hour Factor	0.92	0.92	0.92	0.92	0.92	0.92
Percent Heavy Veh, %	41	5	0	50	5	42
Cap, veh/h	484	1642	0	434	1370	440
Arrive On Green	0.20	0.20	0.00	0.20	0.41	0.41
Sat Flow, veh/h	2520	2723	0	2318	3374	1083
Grp Volume(v), veh/h	35	592	0	28	1049	5
Grp Sat Flow(s),veh/h/ln	1228	1362	0	1101	1687	1083
Q Serve(g_s), s	0.4	3.3	0.0	0.3	8.1	0.1
Cycle Q Clear(g_c), s	0.4	3.3	0.0	0.3	8.1	0.1
Prop In Lane		1.00	0.00		1.00	1.00
Lane Grp Cap(c), veh/h	484	1642	0	434	1370	440
V/C Ratio(X)	0.07	0.36	0.00	0.06	0.77	0.01
Avail Cap(c_a), veh/h	731	1916	0	656	5469	1755
HCM Platoon Ratio	1.00	1.00	1.00	1.00	1.00	1.00
Upstream Filter(I)	1.00	1.00	0.00	1.00	1.00	1.00
Uniform Delay (d), s/veh	9.9	3.0	0.0	9.9	7.7	5.4
Incr Delay (d2), s/veh	0.0	0.0	0.0	0.0	0.3	0.0
Initial Q Delay(d3),s/veh	0.0	0.0	0.0	0.0	0.0	0.0
%ile BackOfQ(50%),veh/ln	0.1	1.1	0.0	0.0	1.1	0.0
Unsig. Movement Delay, s/veh						
LnGrp Delay(d),s/veh	9.9	3.1	0.0	9.9	8.1	5.4
LnGrp LOS	A	A	A	A	A	A
Approach Vol, veh/h	627			28	1054	
Approach Delay, s/veh	3.5			9.9	8.1	
Approach LOS	A			A	A	
Timer - Assigned Phs		2		4		6
Phs Duration (G+Y+Rc), s		12.0		18.3		12.0
Change Period (Y+Rc), s		6.0		6.0		6.0
Max Green Setting (Gmax), s		9.0		49.0		9.0
Max Q Clear Time (g_c+I1), s		2.3		10.1		5.3
Green Ext Time (p_c), s		0.0		2.2		0.6
Intersection Summary						
HCM 6th Ctrl Delay			6.4			
HCM 6th LOS			A			

Timings

West Campus Upper Plateau (JN 14064)

34: Old 215 Frontage Rd. & Alessandro Bl.

09/19/2022

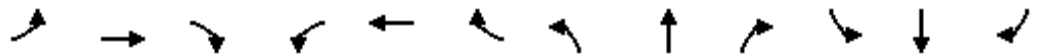

Lane Group	EBL	EBT	EBR	WBL	WBT	WBR	NBL	NBT	NBR	SBL	SBT	SBR
Lane Configurations	↖↗	↑↑↑	↖	↖	↑↑	↖	↖↗	↑↑	↖	↖	↑↑	↖
Traffic Volume (vph)	324	924	42	10	1301	110	51	266	19	22	68	221
Future Volume (vph)	324	924	42	10	1301	110	51	266	19	22	68	221
Turn Type	Prot	NA	Perm	Prot	NA	Perm	Prot	NA	Perm	Prot	NA	Perm
Protected Phases	5	2		1	6		3	8		7	4	
Permitted Phases			2			6			8			4
Detector Phase	5	2	2	1	6	6	3	8	8	7	4	4
Switch Phase												
Minimum Initial (s)	5.0	10.0	10.0	5.0	10.0	10.0	5.0	10.0	10.0	5.0	10.0	10.0
Minimum Split (s)	8.7	43.5	43.5	8.7	15.8	15.8	8.7	16.2	16.2	8.7	40.2	40.2
Total Split (s)	17.0	62.2	62.2	8.9	54.1	54.1	8.7	39.3	39.3	9.6	40.2	40.2
Total Split (%)	14.2%	51.8%	51.8%	7.4%	45.1%	45.1%	7.3%	32.8%	32.8%	8.0%	33.5%	33.5%
Yellow Time (s)	3.2	5.5	5.5	3.2	4.8	4.8	3.2	5.2	5.2	3.2	5.2	5.2
All-Red Time (s)	0.5	1.0	1.0	0.5	1.0	1.0	0.5	1.0	1.0	0.5	1.0	1.0
Lost Time Adjust (s)	0.0	0.0	0.0	0.0	0.0	0.0	0.0	0.0	0.0	0.0	0.0	0.0
Total Lost Time (s)	3.7	6.5	6.5	3.7	5.8	5.8	3.7	6.2	6.2	3.7	6.2	6.2
Lead/Lag	Lead	Lag	Lag	Lead	Lag	Lag	Lead	Lag	Lag	Lead	Lag	Lag
Lead-Lag Optimize?	Yes	Yes	Yes	Yes	Yes	Yes	Yes	Yes	Yes	Yes	Yes	Yes
Recall Mode	None	None	None	None	None	None	None	Max	Max	None	Max	Max
Act Effct Green (s)	12.9	60.8	60.8	5.1	46.6	46.6	5.0	35.3	35.3	5.6	34.1	34.1
Actuated g/C Ratio	0.11	0.52	0.52	0.04	0.40	0.40	0.04	0.30	0.30	0.05	0.29	0.29
v/c Ratio	0.86	0.36	0.06	0.20	0.94	0.17	0.39	0.26	0.04	0.27	0.07	0.37
Control Delay	73.2	17.3	0.2	65.3	46.8	3.3	65.0	32.9	0.1	63.3	31.7	9.0
Queue Delay	0.0	0.0	0.0	0.0	0.0	0.0	0.0	0.0	0.0	0.0	0.0	0.0
Total Delay	73.2	17.3	0.2	65.3	46.8	3.3	65.0	32.9	0.1	63.3	31.7	9.0
LOS	E	B	A	E	D	A	E	C	A	E	C	A
Approach Delay		30.8			43.6			35.9			17.7	
Approach LOS		C			D			D			B	

Intersection Summary

Cycle Length: 120
 Actuated Cycle Length: 116.2
 Natural Cycle: 105
 Control Type: Actuated-Uncoordinated
 Maximum v/c Ratio: 0.94
 Intersection Signal Delay: 35.5
 Intersection LOS: D
 Intersection Capacity Utilization 74.4%
 ICU Level of Service D
 Analysis Period (min) 15



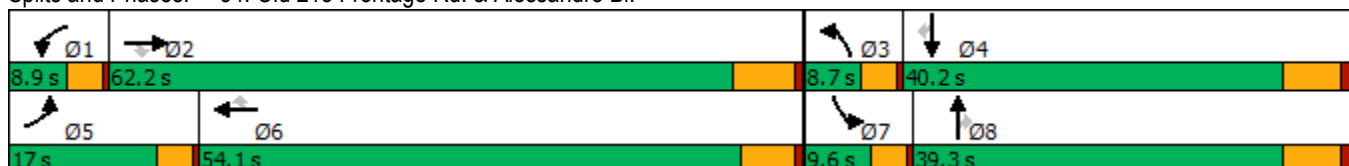





























Splits and Phases: 34: Old 215 Frontage Rd. & Alessandro Bl.



HCM 6th Signalized Intersection Summary
 34: Old 215 Frontage Rd. & Alessandro Bl.

West Campus Upper Plateau (JN 14064)

09/19/2022

												
Movement	EBL	EBT	EBR	WBL	WBT	WBR	NBL	NBT	NBR	SBL	SBT	SBR
Lane Configurations	 	  			 		 	 			 	 
Traffic Volume (veh/h)	324	924	42	10	1301	110	51	266	19	22	68	221
Future Volume (veh/h)	324	924	42	10	1301	110	51	266	19	22	68	221
Initial Q (Qb), veh	0	0	0	0	0	0	0	0	0	0	0	0
Ped-Bike Adj(A_pbT)	1.00		1.00	1.00		1.00	1.00		1.00	1.00		1.00
Parking Bus, Adj	1.00	1.00	1.00	1.00	1.00	1.00	1.00	1.00	1.00	1.00	1.00	1.00
Work Zone On Approach		No			No			No			No	
Adj Sat Flow, veh/h/ln	1885	1856	1441	981	1870	1796	1693	1811	1752	1841	1811	1870
Adj Flow Rate, veh/h	331	943	33	10	1328	0	52	271	11	22	69	0
Peak Hour Factor	0.98	0.98	0.98	0.98	0.98	0.98	0.98	0.98	0.98	0.98	0.98	0.98
Percent Heavy Veh, %	1	3	31	62	2	7	14	6	10	4	6	2
Cap, veh/h	385	2517	607	11	1415		108	1032	445	38	988	
Arrive On Green	0.11	0.50	0.50	0.01	0.40	0.00	0.03	0.30	0.30	0.02	0.29	0.00
Sat Flow, veh/h	3483	5066	1221	934	3554	1522	3127	3441	1485	1753	3441	1585
Grp Volume(v), veh/h	331	943	33	10	1328	0	52	271	11	22	69	0
Grp Sat Flow(s),veh/h/ln	1742	1689	1221	934	1777	1522	1564	1721	1485	1753	1721	1585
Q Serve(g_s), s	11.1	13.6	1.7	1.3	42.5	0.0	1.9	7.1	0.6	1.5	1.7	0.0
Cycle Q Clear(g_c), s	11.1	13.6	1.7	1.3	42.5	0.0	1.9	7.1	0.6	1.5	1.7	0.0
Prop In Lane	1.00		1.00	1.00		1.00	1.00		1.00	1.00		1.00
Lane Grp Cap(c), veh/h	385	2517	607	11	1415		108	1032	445	38	988	
V/C Ratio(X)	0.86	0.37	0.05	0.90	0.94		0.48	0.26	0.02	0.58	0.07	
Avail Cap(c_a), veh/h	391	2517	607	41	1449		132	1032	445	87	988	
HCM Platoon Ratio	1.00	1.00	1.00	1.00	1.00	1.00	1.00	1.00	1.00	1.00	1.00	1.00
Upstream Filter(I)	1.00	1.00	1.00	1.00	1.00	0.00	1.00	1.00	1.00	1.00	1.00	0.00
Uniform Delay (d), s/veh	51.8	18.4	15.4	58.5	34.2	0.0	56.1	31.5	29.3	57.4	30.7	0.0
Incr Delay (d2), s/veh	16.4	0.1	0.0	54.5	11.8	0.0	1.2	0.6	0.1	5.0	0.1	0.0
Initial Q Delay(d3),s/veh	0.0	0.0	0.0	0.0	0.0	0.0	0.0	0.0	0.0	0.0	0.0	0.0
%ile BackOfQ(50%),veh/ln	5.5	4.9	0.4	0.5	19.5	0.0	0.8	2.9	0.2	0.7	0.7	0.0
Unsig. Movement Delay, s/veh												
LnGrp Delay(d),s/veh	68.2	18.5	15.4	112.9	46.0	0.0	57.4	32.1	29.4	62.4	30.9	0.0
LnGrp LOS	E	B	B	F	D		E	C	C	E	C	
Approach Vol, veh/h		1307			1338			334				91
Approach Delay, s/veh		31.0			46.5			36.0				38.5
Approach LOS		C			D			D				D
Timer - Assigned Phs	1	2	3	4	5	6	7	8				
Phs Duration (G+Y+Rc), s	5.1	65.4	7.8	40.2	16.8	53.7	6.3	41.7				
Change Period (Y+Rc), s	3.7	6.5	3.7	6.2	3.7	* 6.5	3.7	6.2				
Max Green Setting (Gmax), s	5.2	55.7	5.0	34.0	13.3	* 48	5.9	33.1				
Max Q Clear Time (g_c+I1), s	3.3	15.6	3.9	3.7	13.1	44.5	3.5	9.1				
Green Ext Time (p_c), s	0.0	6.8	0.0	0.3	0.0	2.7	0.0	1.5				

Intersection Summary

HCM 6th Ctrl Delay	38.5
HCM 6th LOS	D

Notes

* HCM 6th computational engine requires equal clearance times for the phases crossing the barrier.
 Unsignalized Delay for [WBR, SBR] is excluded from calculations of the approach delay and intersection delay.

Timings
35: Day St. & Alessandro Bl.

West Campus Upper Plateau (JN 14064)

09/19/2022



Lane Group	EBL	EBT	EBR	WBL	WBT	WBR	NBL	NBT	NBR	SBL	SBT
Lane Configurations	↖	↗↗↗	↖	↖	↗↗	↖	↖	↗	↖	↖	↗
Traffic Volume (vph)	146	646	9	9	1169	123	11	155	16	77	39
Future Volume (vph)	146	646	9	9	1169	123	11	155	16	77	39
Turn Type	Prot	NA	Perm	Prot	NA	Perm	Perm	NA	Perm	Perm	NA
Protected Phases	5	2		1	6			8			4
Permitted Phases			2			6	8		8	4	
Detector Phase	5	2	2	1	6	6	8	8	8	4	4
Switch Phase											
Minimum Initial (s)	5.0	10.0	10.0	5.0	10.0	10.0	10.0	10.0	10.0	10.0	10.0
Minimum Split (s)	9.1	30.8	30.8	9.1	30.8	30.8	42.4	42.4	42.4	41.6	41.6
Total Split (s)	21.0	68.5	68.5	9.1	56.6	56.6	42.4	42.4	42.4	42.4	42.4
Total Split (%)	17.5%	57.1%	57.1%	7.6%	47.2%	47.2%	35.3%	35.3%	35.3%	35.3%	35.3%
Yellow Time (s)	3.6	4.8	4.8	3.6	4.8	4.8	4.4	4.4	4.4	3.6	3.6
All-Red Time (s)	0.5	1.0	1.0	0.5	1.0	1.0	1.0	1.0	1.0	1.0	1.0
Lost Time Adjust (s)	0.0	0.0	0.0	0.0	0.0	0.0	0.0	0.0	0.0	0.0	0.0
Total Lost Time (s)	4.1	5.8	5.8	4.1	5.8	5.8	5.4	5.4	5.4	4.6	4.6
Lead/Lag	Lead	Lag	Lag	Lead	Lag	Lag					
Lead-Lag Optimize?	Yes	Yes	Yes	Yes	Yes	Yes					
Recall Mode	None	None	None	None	None	None	None	None	None	None	None
Act Effct Green (s)	12.2	52.8	52.8	5.4	37.4	37.4	16.5	16.5	16.5	17.3	17.3
Actuated g/C Ratio	0.15	0.64	0.64	0.07	0.45	0.45	0.20	0.20	0.20	0.21	0.21
v/c Ratio	0.61	0.22	0.02	0.10	0.78	0.17	0.08	0.45	0.05	0.36	0.31
Control Delay	48.0	7.8	0.0	49.7	24.6	6.7	31.5	34.9	0.2	35.4	13.8
Queue Delay	0.0	0.0	0.0	0.0	0.0	0.0	0.0	0.0	0.0	0.0	0.0
Total Delay	48.0	7.8	0.0	49.7	24.6	6.7	31.5	34.9	0.2	35.4	13.8
LOS	D	A	A	D	C	A	C	C	A	D	B
Approach Delay		15.0			23.1			31.6			22.1
Approach LOS		B			C			C			C

Intersection Summary

Cycle Length: 120	
Actuated Cycle Length: 82.5	
Natural Cycle: 95	
Control Type: Actuated-Uncoordinated	
Maximum v/c Ratio: 0.78	
Intersection Signal Delay: 21.0	Intersection LOS: C
Intersection Capacity Utilization 74.4%	ICU Level of Service D
Analysis Period (min) 15	

Splits and Phases: 35: Day St. & Alessandro Bl.



HCM 6th Signalized Intersection Summary
35: Day St. & Alessandro Bl.

West Campus Upper Plateau (JN 14064)

09/19/2022

Movement	EBL	EBT	EBR	WBL	WBT	WBR	NBL	NBT	NBR	SBL	SBT	SBR
Lane Configurations												
Traffic Volume (veh/h)	146	646	9	9	1169	123	11	155	16	77	39	86
Future Volume (veh/h)	146	646	9	9	1169	123	11	155	16	77	39	86
Initial Q (Qb), veh	0	0	0	0	0	0	0	0	0	0	0	0
Ped-Bike Adj(A_pbT)	1.00		0.98	1.00		1.00	1.00		1.00	1.00		1.00
Parking Bus, Adj	1.00	1.00	1.00	1.00	1.00	1.00	1.00	1.00	1.00	1.00	1.00	1.00
Work Zone On Approach		No			No			No			No	
Adj Sat Flow, veh/h/ln	1856	1856	952	1737	1870	1870	922	1885	1722	1856	1900	1870
Adj Flow Rate, veh/h	157	695	9	10	1257	97	12	167	5	83	42	65
Peak Hour Factor	0.93	0.93	0.93	0.93	0.93	0.93	0.93	0.93	0.93	0.93	0.93	0.93
Percent Heavy Veh, %	3	3	64	11	2	2	66	1	12	3	0	2
Cap, veh/h	197	2896	452	21	1680	749	193	360	278	241	128	199
Arrive On Green	0.11	0.57	0.57	0.01	0.47	0.47	0.19	0.19	0.19	0.19	0.19	0.19
Sat Flow, veh/h	1767	5066	790	1654	3554	1585	634	1885	1457	1202	672	1040
Grp Volume(v), veh/h	157	695	9	10	1257	97	12	167	5	83	0	107
Grp Sat Flow(s),veh/h/ln	1767	1689	790	1654	1777	1585	634	1885	1457	1202	0	1713
Q Serve(g_s), s	5.9	4.6	0.3	0.4	19.6	2.3	1.1	5.4	0.2	4.5	0.0	3.7
Cycle Q Clear(g_c), s	5.9	4.6	0.3	0.4	19.6	2.3	4.8	5.4	0.2	9.8	0.0	3.7
Prop In Lane	1.00		1.00	1.00		1.00	1.00		1.00	1.00		0.61
Lane Grp Cap(c), veh/h	197	2896	452	21	1680	749	193	360	278	241	0	327
V/C Ratio(X)	0.80	0.24	0.02	0.48	0.75	0.13	0.06	0.46	0.02	0.34	0.00	0.33
Avail Cap(c_a), veh/h	439	4666	727	122	2652	1183	416	1025	792	679	0	951
HCM Platoon Ratio	1.00	1.00	1.00	1.00	1.00	1.00	1.00	1.00	1.00	1.00	1.00	1.00
Upstream Filter(I)	1.00	1.00	1.00	1.00	1.00	1.00	1.00	1.00	1.00	1.00	0.00	1.00
Uniform Delay (d), s/veh	29.5	7.2	6.3	33.4	14.6	10.1	25.8	24.5	22.4	28.8	0.0	23.8
Incr Delay (d2), s/veh	2.8	0.0	0.0	6.1	0.7	0.1	0.1	0.9	0.0	0.8	0.0	0.6
Initial Q Delay(d3),s/veh	0.0	0.0	0.0	0.0	0.0	0.0	0.0	0.0	0.0	0.0	0.0	0.0
%ile BackOfQ(50%),veh/ln	2.4	1.2	0.0	0.2	6.4	0.7	0.2	2.3	0.1	1.3	0.0	1.5
Unsig. Movement Delay, s/veh												
LnGrp Delay(d),s/veh	32.2	7.3	6.3	39.5	15.3	10.2	26.0	25.4	22.4	29.7	0.0	24.3
LnGrp LOS	C	A	A	D	B	B	C	C	C	C	A	C
Approach Vol, veh/h		861			1364			184				190
Approach Delay, s/veh		11.8			15.1			25.3				26.7
Approach LOS		B			B			C				C
Timer - Assigned Phs	1	2		4	5	6		8				
Phs Duration (G+Y+Rc), s	5.0	44.7		18.4	11.7	38.0		18.4				
Change Period (Y+Rc), s	4.1	5.8		* 5.4	4.1	5.8		5.4				
Max Green Setting (Gmax), s	5.0	62.7		* 38	16.9	50.8		37.0				
Max Q Clear Time (g_c+I1), s	2.4	6.6		11.8	7.9	21.6		7.4				
Green Ext Time (p_c), s	0.0	5.0		0.9	0.1	10.5		1.0				

Intersection Summary

HCM 6th Ctrl Delay	15.6
HCM 6th LOS	B

Notes

* HCM 6th computational engine requires equal clearance times for the phases crossing the barrier.

Timings
36: Elsworth St. & Cactus Av.

West Campus Upper Plateau (JN 14064)

09/19/2022



Lane Group	EBL	EBT	EBR	WBL	WBT	WBR	NBL	NBT	SBL	SBT	SBR
Lane Configurations											
Traffic Volume (vph)	187	1376	288	69	1713	120	23	10	82	58	182
Future Volume (vph)	187	1376	288	69	1713	120	23	10	82	58	182
Turn Type	Prot	NA	Perm	Prot	NA	Perm	Split	NA	Split	NA	pm+ov
Protected Phases	5	2		1	6		8	8	4	4	5
Permitted Phases			2			6					4
Detector Phase	5	2	2	1	6	6	8	8	4	4	5
Switch Phase											
Minimum Initial (s)	5.0	10.0	10.0	5.0	10.0	10.0	10.0	10.0	10.0	10.0	5.0
Minimum Split (s)	9.6	36.2	36.2	9.6	36.2	36.2	35.4	35.4	35.4	35.4	9.6
Total Split (s)	15.0	48.6	48.6	10.6	44.2	44.2	35.4	35.4	35.4	35.4	15.0
Total Split (%)	11.5%	37.4%	37.4%	8.2%	34.0%	34.0%	27.2%	27.2%	27.2%	27.2%	11.5%
Yellow Time (s)	3.6	5.2	5.2	3.6	5.2	5.2	4.4	4.4	4.4	4.4	3.6
All-Red Time (s)	1.0	1.0	1.0	1.0	1.0	1.0	1.0	1.0	1.0	1.0	1.0
Lost Time Adjust (s)	0.0	0.0	0.0	0.0	0.0	0.0	0.0	0.0	0.0	0.0	0.0
Total Lost Time (s)	4.6	6.2	6.2	4.6	6.2	6.2	5.4	5.4	5.4	5.4	4.6
Lead/Lag	Lead	Lag	Lag	Lead	Lag	Lag					Lead
Lead-Lag Optimize?	Yes	Yes	Yes	Yes	Yes	Yes					Yes
Recall Mode	None	None	None	None	None	None	Max	Max	Max	Max	None
Act Effct Green (s)	10.4	42.4	42.4	6.0	38.0	38.0	30.0	30.0	30.0	30.0	41.2
Actuated g/C Ratio	0.08	0.33	0.33	0.05	0.29	0.29	0.23	0.23	0.23	0.23	0.32
v/c Ratio	1.39	0.89	0.41	0.84	1.20	0.23	0.06	0.07	0.19	0.18	0.30
Control Delay	258.4	49.6	5.3	123.4	136.7	10.0	39.9	23.5	41.8	41.6	3.5
Queue Delay	0.0	0.0	0.0	0.0	0.0	0.0	0.0	0.0	0.0	0.0	0.0
Total Delay	258.4	49.6	5.3	123.4	136.7	10.0	39.9	23.5	41.8	41.6	3.5
LOS	F	D	A	F	F	B	D	C	D	D	A
Approach Delay		63.8			128.2			30.5		20.1	
Approach LOS		E			F			C		C	

Intersection Summary

Cycle Length: 130
 Actuated Cycle Length: 130
 Natural Cycle: 130
 Control Type: Actuated-Uncoordinated
 Maximum v/c Ratio: 1.39
 Intersection Signal Delay: 89.7
 Intersection LOS: F
 Intersection Capacity Utilization 67.4%
 ICU Level of Service C
 Analysis Period (min) 15

Splits and Phases: 36: Elsworth St. & Cactus Av.

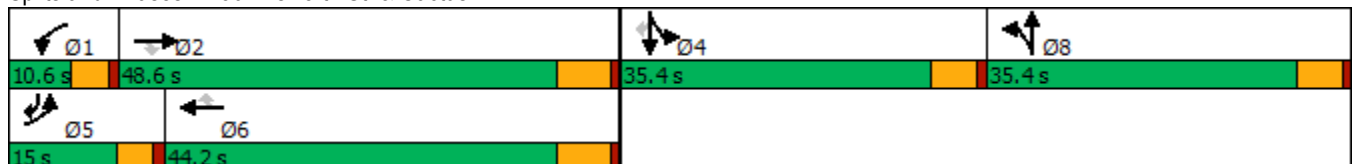

HCM 6th Signalized Intersection Summary
36: Elsworth St. & Cactus Av.

West Campus Upper Plateau (JN 14064)

09/19/2022



Movement	EBL	EBT	EBR	WBL	WBT	WBR	NBL	NBT	NBR	SBL	SBT	SBR
Lane Configurations	↶	↷↷↷	↷	↶	↷↷↷	↷	↶	↷		↶	↷	↷
Traffic Volume (veh/h)	187	1376	288	69	1713	120	23	10	16	82	58	182
Future Volume (veh/h)	187	1376	288	69	1713	120	23	10	16	82	58	182
Initial Q (Qb), veh	0	0	0	0	0	0	0	0	0	0	0	0
Ped-Bike Adj(A_pbT)	1.00		1.00	1.00		0.98	1.00		1.00	1.00		1.00
Parking Bus, Adj	1.00	1.00	1.00	1.00	1.00	1.00	1.00	1.00	1.00	1.00	1.00	1.00
Work Zone On Approach		No			No			No			No	
Adj Sat Flow, veh/h/ln	1826	1796	1885	1900	1841	1856	1633	1900	1900	1826	1900	1841
Adj Flow Rate, veh/h	191	1404	0	70	1748	74	20	14	8	72	76	119
Peak Hour Factor	0.98	0.98	0.98	0.98	0.98	0.98	0.98	0.98	0.98	0.98	0.98	0.98
Percent Heavy Veh, %	5	7	1	0	4	3	18	0	0	5	0	4
Cap, veh/h	139	1599		84	1469	450	359	262	150	401	438	485
Arrive On Green	0.08	0.33	0.00	0.05	0.29	0.29	0.23	0.23	0.23	0.23	0.23	0.23
Sat Flow, veh/h	1739	4904	1598	1810	5025	1539	1555	1135	648	1739	1900	1560
Grp Volume(v), veh/h	191	1404	0	70	1748	74	20	0	22	72	76	119
Grp Sat Flow(s),veh/h/ln	1739	1635	1598	1810	1675	1539	1555	0	1783	1739	1900	1560
Q Serve(g_s), s	10.4	35.1	0.0	5.0	38.0	4.6	1.3	0.0	1.2	4.3	4.2	7.4
Cycle Q Clear(g_c), s	10.4	35.1	0.0	5.0	38.0	4.6	1.3	0.0	1.2	4.3	4.2	7.4
Prop In Lane	1.00		1.00	1.00		1.00	1.00		0.36	1.00		1.00
Lane Grp Cap(c), veh/h	139	1599		84	1469	450	359	0	412	401	438	485
V/C Ratio(X)	1.37	0.88		0.84	1.19	0.16	0.06	0.00	0.05	0.18	0.17	0.25
Avail Cap(c_a), veh/h	139	1599		84	1469	450	359	0	412	401	438	485
HCM Platoon Ratio	1.00	1.00	1.00	1.00	1.00	1.00	1.00	1.00	1.00	1.00	1.00	1.00
Upstream Filter(I)	1.00	1.00	0.00	1.00	1.00	1.00	1.00	0.00	1.00	1.00	1.00	1.00
Uniform Delay (d), s/veh	59.8	41.4	0.0	61.5	46.0	34.2	39.0	0.0	38.9	40.1	40.1	33.4
Incr Delay (d2), s/veh	206.5	5.9	0.0	47.5	92.6	0.2	0.3	0.0	0.2	1.0	0.9	1.2
Initial Q Delay(d3),s/veh	0.0	0.0	0.0	0.0	0.0	0.0	0.0	0.0	0.0	0.0	0.0	0.0
%ile BackOfQ(50%),veh/ln	12.4	14.4	0.0	3.3	27.6	1.7	0.5	0.0	0.6	1.9	2.0	2.9
Unsig. Movement Delay, s/veh												
LnGrp Delay(d),s/veh	266.3	47.3	0.0	109.0	138.6	34.4	39.3	0.0	39.2	41.1	40.9	34.6
LnGrp LOS	F	D		F	F	C	D	A	D	D	D	C
Approach Vol, veh/h		1595			1892			42			267	
Approach Delay, s/veh		73.5			133.4			39.2			38.2	
Approach LOS		E			F			D			D	
Timer - Assigned Phs	1	2		4	5	6		8				
Phs Duration (G+Y+Rc), s	10.6	48.6		35.4	15.0	44.2		35.4				
Change Period (Y+Rc), s	4.6	6.2		5.4	4.6	6.2		5.4				
Max Green Setting (Gmax), s	6.0	42.4		30.0	10.4	38.0		30.0				
Max Q Clear Time (g_c+1), s	7.0	37.1		9.4	12.4	40.0		3.3				
Green Ext Time (p_c), s	0.0	3.6		0.9	0.0	0.0		0.1				

Intersection Summary

HCM 6th Ctrl Delay	100.5
HCM 6th LOS	F

Notes

- User approved pedestrian interval to be less than phase max green.
- User approved volume balancing among the lanes for turning movement.
- Unsignalized Delay for [EBR] is excluded from calculations of the approach delay and intersection delay.

Timings
37: Cactus Av. & Frederick St.

West Campus Upper Plateau (JN 14064)

09/19/2022

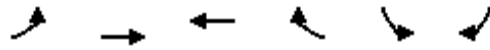

Lane Group	EBL	EBT	WBT	WBR	SBL	SBR
Lane Configurations	↖	↑↑↑	↑↑↑	↗	↖↗	↗
Traffic Volume (vph)	194	1207	1915	144	149	116
Future Volume (vph)	194	1207	1915	144	149	116
Turn Type	Prot	NA	NA	pm+ov	Prot	pm+ov
Protected Phases	5	2	6	4	4	5
Permitted Phases				6		4
Detector Phase	5	2	6	4	4	5
Switch Phase						
Minimum Initial (s)	5.0	10.0	10.0	10.0	10.0	5.0
Minimum Split (s)	9.2	28.2	29.2	36.4	36.4	9.2
Total Split (s)	23.0	83.6	60.6	36.4	36.4	23.0
Total Split (%)	19.2%	69.7%	50.5%	30.3%	30.3%	19.2%
Yellow Time (s)	3.2	5.2	5.2	4.4	4.4	3.2
All-Red Time (s)	1.0	1.0	1.0	1.0	1.0	1.0
Lost Time Adjust (s)	0.0	0.0	0.0	0.0	0.0	0.0
Total Lost Time (s)	4.2	6.2	6.2	5.4	5.4	4.2
Lead/Lag	Lead		Lag			Lead
Lead-Lag Optimize?	Yes		Yes			Yes
Recall Mode	None	None	None	Max	Max	None
Act Effct Green (s)	16.9	74.5	53.4	85.3	31.1	53.4
Actuated g/C Ratio	0.14	0.64	0.46	0.73	0.27	0.46
v/c Ratio	0.85	0.42	0.91	0.13	0.18	0.18
Control Delay	77.8	11.0	36.7	0.8	34.7	19.6
Queue Delay	0.0	0.0	0.0	0.0	0.0	0.0
Total Delay	77.8	11.0	36.7	0.8	34.7	19.6
LOS	E	B	D	A	C	B
Approach Delay		20.3	34.2		28.1	
Approach LOS		C	C		C	

Intersection Summary

Cycle Length: 120
 Actuated Cycle Length: 117.2
 Natural Cycle: 100
 Control Type: Actuated-Uncoordinated
 Maximum v/c Ratio: 0.91
 Intersection Signal Delay: 28.5
 Intersection LOS: C
 Intersection Capacity Utilization 69.2%
 ICU Level of Service C
 Analysis Period (min) 15

Splits and Phases: 37: Cactus Av. & Frederick St.



HCM 6th Signalized Intersection Summary
37: Cactus Av. & Frederick St.

West Campus Upper Plateau (JN 14064)

09/19/2022



Movement	EBL	EBT	WBT	WBR	SBL	SBR
Lane Configurations						
Traffic Volume (veh/h)	194	1207	1915	144	149	116
Future Volume (veh/h)	194	1207	1915	144	149	116
Initial Q (Qb), veh	0	0	0	0	0	0
Ped-Bike Adj(A_pbT)	1.00			0.98	1.00	1.00
Parking Bus, Adj	1.00	1.00	1.00	1.00	1.00	1.00
Work Zone On Approach		No	No		No	
Adj Sat Flow, veh/h/ln	1826	1811	1841	1870	1856	1826
Adj Flow Rate, veh/h	209	1298	2059	101	160	84
Peak Hour Factor	0.93	0.93	0.93	0.93	0.93	0.93
Percent Heavy Veh, %	5	6	4	2	3	5
Cap, veh/h	236	3117	2302	1136	922	627
Arrive On Green	0.14	0.63	0.46	0.46	0.27	0.27
Sat Flow, veh/h	1739	5107	5191	1550	3428	1547
Grp Volume(v), veh/h	209	1298	2059	101	160	84
Grp Sat Flow(s),veh/h/ln	1739	1648	1675	1550	1714	1547
Q Serve(g_s), s	13.6	15.2	43.4	2.2	4.1	3.9
Cycle Q Clear(g_c), s	13.6	15.2	43.4	2.2	4.1	3.9
Prop In Lane	1.00			1.00	1.00	1.00
Lane Grp Cap(c), veh/h	236	3117	2302	1136	922	627
V/C Ratio(X)	0.88	0.42	0.89	0.09	0.17	0.13
Avail Cap(c_a), veh/h	284	3320	2372	1158	922	627
HCM Platoon Ratio	1.00	1.00	1.00	1.00	1.00	1.00
Upstream Filter(I)	1.00	1.00	1.00	1.00	1.00	1.00
Uniform Delay (d), s/veh	48.9	10.7	28.7	4.6	32.3	21.6
Incr Delay (d2), s/veh	21.3	0.1	4.8	0.0	0.4	0.4
Initial Q Delay(d3),s/veh	0.0	0.0	0.0	0.0	0.0	0.0
%ile BackOfQ(50%),veh/ln	7.1	4.7	16.8	1.5	1.7	4.4
Unsig. Movement Delay, s/veh						
LnGrp Delay(d),s/veh	70.2	10.8	33.5	4.6	32.7	22.0
LnGrp LOS	E	B	C	A	C	C
Approach Vol, veh/h		1507	2160		244	
Approach Delay, s/veh		19.0	32.1		29.0	
Approach LOS		B	C		C	
Timer - Assigned Phs		2		4	5	6
Phs Duration (G+Y+Rc), s		78.9		36.4	19.9	59.0
Change Period (Y+Rc), s		6.2		5.4	* 4.2	6.2
Max Green Setting (Gmax), s		77.4		31.0	* 19	54.4
Max Q Clear Time (g_c+I1), s		17.2		6.1	15.6	45.4
Green Ext Time (p_c), s		11.3		0.8	0.1	7.4

Intersection Summary

HCM 6th Ctrl Delay	26.9
HCM 6th LOS	C

Notes

* HCM 6th computational engine requires equal clearance times for the phases crossing the barrier.

Timings
38: Riverside Dr./Graham St. & Cactus Av.

West Campus Upper Plateau (JN 14064)

09/19/2022

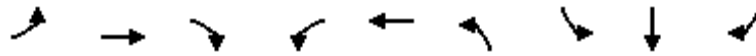

Lane Group	EBL	EBT	EBR	WBL	WBT	NBL	SBL	SBT	SBR	Ø2
Lane Configurations	↘	↑↑↑	↗	↘	↑↑↑	↘	↘	↑↑	↗	
Traffic Volume (vph)	62	1167	160	9	1935	9	84	45	115	
Future Volume (vph)	62	1167	160	9	1935	9	84	45	115	
Turn Type	Prot	NA	Perm	Prot	NA	Prot	Prot	NA	Perm	
Protected Phases	7	4		3	8	5	1	6		2
Permitted Phases			4						6	
Detector Phase	7	4	4	3	8	5	1	6	6	
Switch Phase										
Minimum Initial (s)	5.0	10.0	10.0	5.0	10.0	5.0	5.0	10.0	10.0	10.0
Minimum Split (s)	9.6	39.2	39.2	9.6	39.2	10.4	9.6	40.6	40.6	35.0
Total Split (s)	10.8	59.0	59.0	9.6	57.8	10.4	14.2	41.0	41.0	37.2
Total Split (%)	9.0%	49.2%	49.2%	8.0%	48.2%	8.7%	11.8%	34.2%	34.2%	31%
Yellow Time (s)	3.6	5.2	5.2	3.6	5.2	4.4	3.6	3.6	3.6	4.0
All-Red Time (s)	1.0	1.0	1.0	1.0	1.0	1.0	1.0	1.0	1.0	1.0
Lost Time Adjust (s)	0.0	0.0	0.0	0.0	0.0	0.0	0.0	0.0	0.0	
Total Lost Time (s)	4.6	6.2	6.2	4.6	6.2	5.4	4.6	4.6	4.6	
Lead/Lag	Lead	Lag	Lag	Lead	Lag	Lead	Lead	Lag	Lag	Lag
Lead-Lag Optimize?	Yes	Yes	Yes	Yes	Yes	Yes	Yes	Yes	Yes	Yes
Recall Mode	None	Min	Min	None	Min	None	None	None	None	None
Act Effct Green (s)	6.3	63.1	63.1	5.1	55.8	5.1	9.3	14.3	14.3	
Actuated g/C Ratio	0.07	0.69	0.69	0.06	0.61	0.06	0.10	0.16	0.16	
v/c Ratio	0.58	0.37	0.16	0.10	0.71	0.07	0.50	0.09	0.36	
Control Delay	64.7	9.4	2.7	48.7	17.2	47.6	51.4	31.9	9.1	
Queue Delay	0.0	0.0	0.0	0.0	0.0	0.0	0.0	0.0	0.0	
Total Delay	64.7	9.4	2.7	48.7	17.2	47.6	51.4	31.9	9.1	
LOS	E	A	A	D	B	D	D	C	A	
Approach Delay		11.1			17.3			27.9		
Approach LOS		B			B			C		

Intersection Summary

Cycle Length: 120
 Actuated Cycle Length: 91.4
 Natural Cycle: 120
 Control Type: Actuated-Uncoordinated
 Maximum v/c Ratio: 0.71
 Intersection Signal Delay: 15.7
 Intersection LOS: B
 Intersection Capacity Utilization 67.7%
 ICU Level of Service C
 Analysis Period (min) 15

Splits and Phases: 38: Riverside Dr./Graham St. & Cactus Av.

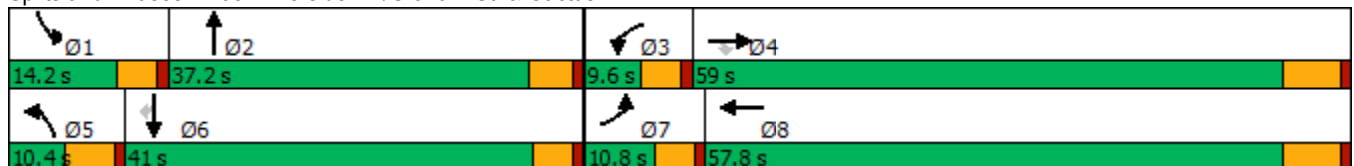

HCM 6th Signalized Intersection Summary
38: Riverside Dr./Graham St. & Cactus Av.

West Campus Upper Plateau (JN 14064)

09/19/2022



Movement	EBL	EBT	EBR	WBL	WBT	WBR	NBL	NBT	NBR	SBL	SBT	SBR
Lane Configurations	↘	↑↑↑	↗	↘	↑↑↑		↘↗	↑↗		↘	↑↑	↗
Traffic Volume (veh/h)	62	1167	160	9	1935	88	9	0	0	84	45	115
Future Volume (veh/h)	62	1167	160	9	1935	88	9	0	0	84	45	115
Initial Q (Qb), veh	0	0	0	0	0	0	0	0	0	0	0	0
Ped-Bike Adj(A_pbT)	1.00		1.00	1.00		1.00	1.00		1.00	1.00		1.00
Parking Bus, Adj	1.00	1.00	1.00	1.00	1.00	1.00	1.00	1.00	1.00	1.00	1.00	1.00
Work Zone On Approach		No			No			No			No	
Adj Sat Flow, veh/h/ln	1781	1796	1796	1900	1841	1870	1263	1900	1900	1870	1870	1796
Adj Flow Rate, veh/h	66	1241	158	10	2059	93	10	0	0	89	48	37
Peak Hour Factor	0.94	0.94	0.94	0.94	0.94	0.94	0.94	0.94	0.94	0.94	0.94	0.94
Percent Heavy Veh, %	8	7	7	0	4	2	43	0	0	2	2	7
Cap, veh/h	83	2871	891	23	2706	122	29	294	0	114	437	187
Arrive On Green	0.05	0.59	0.59	0.01	0.55	0.55	0.01	0.00	0.00	0.06	0.12	0.12
Sat Flow, veh/h	1697	4904	1522	1810	4929	222	2333	3705	0	1781	3554	1522
Grp Volume(v), veh/h	66	1241	158	10	1397	755	10	0	0	89	48	37
Grp Sat Flow(s),veh/h/ln	1697	1635	1522	1810	1675	1801	1167	1805	0	1781	1777	1522
Q Serve(g_s), s	3.1	11.2	3.8	0.4	25.7	25.9	0.3	0.0	0.0	3.9	1.0	1.7
Cycle Q Clear(g_c), s	3.1	11.2	3.8	0.4	25.7	25.9	0.3	0.0	0.0	3.9	1.0	1.7
Prop In Lane	1.00		1.00	1.00		0.12	1.00		0.00	1.00		1.00
Lane Grp Cap(c), veh/h	83	2871	891	23	1839	989	29	294	0	114	437	187
V/C Ratio(X)	0.80	0.43	0.18	0.44	0.76	0.76	0.34	0.00	0.00	0.78	0.11	0.20
Avail Cap(c_a), veh/h	132	3256	1011	114	2174	1168	147	1462	0	215	1627	697
HCM Platoon Ratio	1.00	1.00	1.00	1.00	1.00	1.00	1.00	1.00	1.00	1.00	1.00	1.00
Upstream Filter(I)	1.00	1.00	1.00	1.00	1.00	1.00	1.00	0.00	0.00	1.00	1.00	1.00
Uniform Delay (d), s/veh	37.4	9.1	7.6	39.0	13.9	13.9	38.9	0.0	0.0	36.6	31.0	31.3
Incr Delay (d2), s/veh	6.3	0.1	0.1	5.0	1.3	2.6	2.6	0.0	0.0	4.2	0.1	0.5
Initial Q Delay(d3),s/veh	0.0	0.0	0.0	0.0	0.0	0.0	0.0	0.0	0.0	0.0	0.0	0.0
%ile BackOfQ(50%),veh/ln	1.3	3.0	1.0	0.2	7.7	8.7	0.1	0.0	0.0	1.8	0.4	0.6
Unsig. Movement Delay, s/veh												
LnGrp Delay(d),s/veh	43.8	9.3	7.7	44.0	15.2	16.5	41.5	0.0	0.0	40.9	31.1	31.9
LnGrp LOS	D	A	A	D	B	B	D	A	A	D	C	C
Approach Vol, veh/h		1465			2162			10			174	
Approach Delay, s/veh		10.6			15.8			41.5			36.3	
Approach LOS		B			B			D			D	
Timer - Assigned Phs	1	2	3	4	5	6	7	8				
Phs Duration (G+Y+Rc), s	9.7	11.5	5.6	52.8	6.4	14.8	8.5	49.9				
Change Period (Y+Rc), s	4.6	5.0	4.6	6.2	5.4	* 5	4.6	6.2				
Max Green Setting (Gmax), s	9.6	32.2	5.0	52.8	5.0	* 36	6.2	51.6				
Max Q Clear Time (g_c+I1), s	5.9	0.0	2.4	13.2	2.3	3.7	5.1	27.9				
Green Ext Time (p_c), s	0.0	0.0	0.0	10.9	0.0	0.3	0.0	15.8				

Intersection Summary

HCM 6th Ctrl Delay	14.8
HCM 6th LOS	B

Notes

* HCM 6th computational engine requires equal clearance times for the phases crossing the barrier.

Timings

1: Washington St & Van Buren Bl.

09/19/2022



Lane Group	EBL	EBT	WBL	WBT	WBR	NBL	NBT	NBR	SBL	SBT
Lane Configurations	↙	↕	↙	↕	↗	↙↗	↕	↗	↙↗	↕
Traffic Volume (vph)	133	1295	209	1055	420	98	240	109	499	346
Future Volume (vph)	133	1295	209	1055	420	98	240	109	499	346
Turn Type	Prot	NA	Prot	NA	Perm	Prot	NA	Perm	Prot	NA
Protected Phases	5	2	1	6		3	8		7	4
Permitted Phases					6			8		
Detector Phase	5	2	1	6	6	3	8	8	7	4
Switch Phase										
Minimum Initial (s)	5.0	10.0	5.0	10.0	10.0	5.0	10.0	10.0	5.0	10.0
Minimum Split (s)	9.2	34.2	9.2	33.2	33.2	9.2	38.4	38.4	9.2	30.8
Total Split (s)	14.2	49.6	14.0	49.4	49.4	11.5	38.4	38.4	18.0	44.9
Total Split (%)	11.8%	41.3%	11.7%	41.2%	41.2%	9.6%	32.0%	32.0%	15.0%	37.4%
Yellow Time (s)	3.2	5.2	3.2	5.2	5.2	3.2	4.4	4.4	3.2	4.8
All-Red Time (s)	1.0	1.0	1.0	1.0	1.0	1.0	1.0	1.0	1.0	1.0
Lost Time Adjust (s)	0.0	0.0	0.0	0.0	0.0	0.0	0.0	0.0	0.0	0.0
Total Lost Time (s)	4.2	6.2	4.2	6.2	6.2	4.2	5.4	5.4	4.2	5.8
Lead/Lag	Lead	Lag	Lead	Lag	Lag	Lead	Lag	Lag	Lead	Lag
Lead-Lag Optimize?	Yes	Yes	Yes	Yes	Yes	Yes	Yes	Yes	Yes	Yes
Recall Mode	None	None	None	None	None	None	None	None	None	None
Act Effct Green (s)	9.9	43.6	9.9	43.6	43.6	6.7	15.2	15.2	13.9	22.0
Actuated g/C Ratio	0.10	0.42	0.10	0.42	0.42	0.07	0.15	0.15	0.14	0.21
v/c Ratio	0.77	0.94	1.22	0.71	0.52	0.44	0.47	0.31	1.08	0.58
Control Delay	74.9	42.1	181.6	28.8	12.0	54.2	42.3	4.7	106.7	36.5
Queue Delay	0.0	0.0	0.0	0.0	0.0	0.0	0.0	0.0	0.0	0.0
Total Delay	74.9	42.1	181.6	28.8	12.0	54.2	42.3	4.7	106.7	36.5
LOS	E	D	F	C	B	D	D	A	F	D
Approach Delay		45.0		43.6			35.7			73.9
Approach LOS		D		D			D			E

Intersection Summary

Cycle Length: 120
 Actuated Cycle Length: 102.7
 Natural Cycle: 115
 Control Type: Actuated-Uncoordinated
 Maximum v/c Ratio: 1.22
 Intersection Signal Delay: 49.5
 Intersection LOS: D
 Intersection Capacity Utilization 89.7%
 ICU Level of Service E
 Analysis Period (min) 15



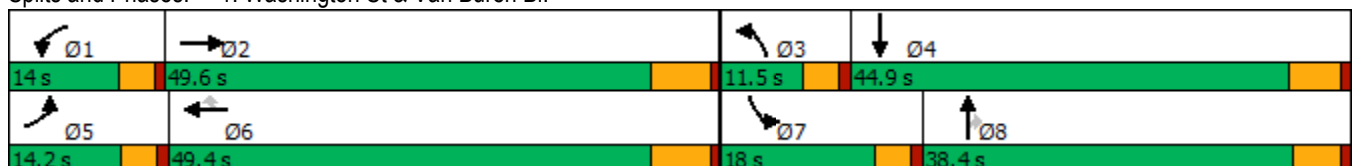



















Splits and Phases: 1: Washington St & Van Buren Bl.



HCM 6th Signalized Intersection Summary
1: Washington St & Van Buren Bl.

West Campus Upper Plateau (JN 14064)

09/19/2022

												
Movement	EBL	EBT	EBR	WBL	WBT	WBR	NBL	NBT	NBR	SBL	SBT	SBR
Lane Configurations												
Traffic Volume (veh/h)	133	1295	79	209	1055	420	98	240	109	499	346	92
Future Volume (veh/h)	133	1295	79	209	1055	420	98	240	109	499	346	92
Initial Q (Qb), veh	0	0	0	0	0	0	0	0	0	0	0	0
Ped-Bike Adj(A_pbT)	1.00		1.00	1.00		1.00	1.00		0.98	1.00		0.98
Parking Bus, Adj	1.00	1.00	1.00	1.00	1.00	1.00	1.00	1.00	1.00	1.00	1.00	1.00
Work Zone On Approach		No			No			No			No	
Adj Sat Flow, veh/h/ln	1900	1856	1856	1900	1870	1900	1885	1856	1870	1885	1885	1900
Adj Flow Rate, veh/h	134	1308	61	211	1066	331	99	242	71	504	349	47
Peak Hour Factor	0.99	0.99	0.99	0.99	0.99	0.99	0.99	0.99	0.99	0.99	0.99	0.99
Percent Heavy Veh, %	0	3	3	0	2	0	1	3	2	1	1	0
Cap, veh/h	165	1470	68	183	1559	705	167	413	182	496	670	89
Arrive On Green	0.09	0.43	0.43	0.10	0.44	0.44	0.05	0.12	0.12	0.14	0.21	0.21
Sat Flow, veh/h	1810	3430	160	1810	3554	1607	3483	3526	1553	3483	3168	423
Grp Volume(v), veh/h	134	671	698	211	1066	331	99	242	71	504	196	200
Grp Sat Flow(s),veh/h/ln	1810	1763	1827	1810	1777	1607	1742	1763	1553	1742	1791	1800
Q Serve(g_s), s	7.0	34.0	34.2	9.8	23.3	14.1	2.7	6.3	4.1	13.8	9.4	9.5
Cycle Q Clear(g_c), s	7.0	34.0	34.2	9.8	23.3	14.1	2.7	6.3	4.1	13.8	9.4	9.5
Prop In Lane	1.00		0.09	1.00		1.00	1.00		1.00	1.00		0.23
Lane Grp Cap(c), veh/h	165	755	783	183	1559	705	167	413	182	496	379	381
V/C Ratio(X)	0.81	0.89	0.89	1.15	0.68	0.47	0.59	0.59	0.39	1.02	0.52	0.53
Avail Cap(c_a), veh/h	187	790	819	183	1585	717	263	1201	529	496	723	727
HCM Platoon Ratio	1.00	1.00	1.00	1.00	1.00	1.00	1.00	1.00	1.00	1.00	1.00	1.00
Upstream Filter(I)	1.00	1.00	1.00	1.00	1.00	1.00	1.00	1.00	1.00	1.00	1.00	1.00
Uniform Delay (d), s/veh	43.2	25.5	25.6	43.5	21.8	19.2	45.2	40.5	39.6	41.5	33.8	33.9
Incr Delay (d2), s/veh	18.8	12.1	12.0	113.4	1.3	0.7	1.2	1.3	1.4	44.3	1.1	1.1
Initial Q Delay(d3),s/veh	0.0	0.0	0.0	0.0	0.0	0.0	0.0	0.0	0.0	0.0	0.0	0.0
%ile BackOfQ(50%),veh/ln	3.8	15.1	15.7	9.9	8.9	5.3	1.2	2.8	1.6	8.9	4.1	4.2
Unsig. Movement Delay, s/veh												
LnGrp Delay(d),s/veh	62.0	37.7	37.6	156.9	23.1	19.9	46.4	41.9	40.9	85.8	34.9	35.0
LnGrp LOS	E	D	D	F	C	B	D	D	D	F	C	C
Approach Vol, veh/h		1503			1608			412			900	
Approach Delay, s/veh		39.8			40.0			42.8			63.4	
Approach LOS		D			D			D			E	
Timer - Assigned Phs	1	2	3	4	5	6	7	8				
Phs Duration (G+Y+Rc), s	14.0	47.7	8.9	26.3	13.0	48.7	18.0	17.1				
Change Period (Y+Rc), s	* 4.2	6.2	* 4.2	5.8	* 4.2	6.2	* 4.2	* 5.8				
Max Green Setting (Gmax), s	* 9.8	43.4	* 7.3	39.1	* 10	43.2	* 14	* 33				
Max Q Clear Time (g_c+I1), s	11.8	36.2	4.7	11.5	9.0	25.3	15.8	8.3				
Green Ext Time (p_c), s	0.0	5.3	0.0	2.4	0.0	10.3	0.0	1.9				

Intersection Summary

HCM 6th Ctrl Delay	45.0
HCM 6th LOS	D

Notes

* HCM 6th computational engine requires equal clearance times for the phases crossing the barrier.

Timings
2: Central Ave & Arlington Ave/Chicago Ave

West Campus Upper Plateau (JN 14064)

09/19/2022



Lane Group	EBL	EBT	EBR	WBL	WBT	WBR	NBL	NBT	NBR	SBL	SBT
Lane Configurations	↘	↑↑	↗↗	↘↘	↑↑	↗	↘↘	↑↑	↗	↘↘	↑↑↗
Traffic Volume (vph)	25	731	1024	544	656	210	831	1061	275	486	1641
Future Volume (vph)	25	731	1024	544	656	210	831	1061	275	486	1641
Turn Type	Prot	NA	pm+ov	Prot	NA	pm+ov	Prot	NA	pm+ov	Prot	NA
Protected Phases	7	4	5	3	8	1	5	2	3	1	6
Permitted Phases			4			8			2		
Detector Phase	7	4	5	3	8	1	5	2	3	1	6
Switch Phase											
Minimum Initial (s)	5.0	10.0	5.0	5.0	10.0	5.0	5.0	10.0	5.0	5.0	10.0
Minimum Split (s)	9.6	32.8	9.6	9.6	30.8	9.6	9.6	35.4	9.6	9.6	30.4
Total Split (s)	10.6	32.8	30.0	22.0	44.2	24.4	30.0	50.8	22.0	24.4	45.2
Total Split (%)	8.2%	25.2%	23.1%	16.9%	34.0%	18.8%	23.1%	39.1%	16.9%	18.8%	34.8%
Yellow Time (s)	3.6	4.8	3.6	3.6	4.8	3.6	3.6	4.4	3.6	3.6	4.4
All-Red Time (s)	1.0	1.0	1.0	1.0	1.0	1.0	1.0	1.0	1.0	1.0	1.0
Lost Time Adjust (s)	0.0	0.0	0.0	0.0	0.0	0.0	0.0	0.0	0.0	0.0	0.0
Total Lost Time (s)	4.6	5.8	4.6	4.6	5.8	4.6	4.6	5.4	4.6	4.6	5.4
Lead/Lag	Lead	Lag	Lead	Lead	Lag	Lead	Lead	Lag	Lead	Lead	Lag
Lead-Lag Optimize?	Yes	Yes	Yes	Yes	Yes	Yes	Yes	Yes	Yes	Yes	Yes
Recall Mode	None	None	None	None	None	None	None	None	None	None	None
Act Effct Green (s)	5.7	27.0	53.6	17.4	42.6	68.2	25.4	45.4	63.6	19.8	39.8
Actuated g/C Ratio	0.04	0.21	0.41	0.13	0.33	0.52	0.20	0.35	0.49	0.15	0.31
v/c Ratio	0.33	1.02	0.87	1.24	0.58	0.24	1.27	0.89	0.36	0.95	1.10
Control Delay	71.7	87.6	38.7	169.6	39.5	10.6	173.7	49.6	15.2	82.8	98.1
Queue Delay	0.0	0.0	0.0	0.0	0.0	0.0	0.0	0.0	0.0	0.0	0.0
Total Delay	71.7	87.6	38.7	169.6	39.5	10.6	173.7	49.6	15.2	82.8	98.1
LOS	E	F	D	F	D	B	F	D	B	F	F
Approach Delay		59.2			85.4			92.9			94.6
Approach LOS		E			F			F			F

Intersection Summary

Cycle Length: 130
 Actuated Cycle Length: 130
 Natural Cycle: 120
 Control Type: Actuated-Uncoordinated
 Maximum v/c Ratio: 1.27
 Intersection Signal Delay: 84.0
 Intersection LOS: F
 Intersection Capacity Utilization 108.7%
 ICU Level of Service G
 Analysis Period (min) 15

Splits and Phases: 2: Central Ave & Arlington Ave/Chicago Ave

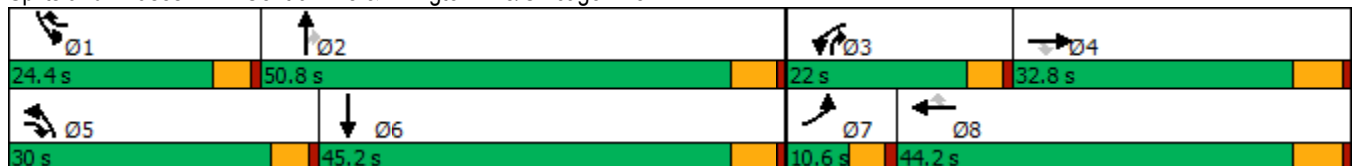

HCM 6th Signalized Intersection Summary
2: Central Ave & Arlington Ave/Chicago Ave

West Campus Upper Plateau (JN 14064)

09/19/2022



Movement	EBL	EBT	EBR	WBL	WBT	WBR	NBL	NBT	NBR	SBL	SBT	SBR
Lane Configurations	↘	↑↑	↗↗	↘↘	↑↑	↗	↘↘	↑↑	↗	↘↘	↑↑↑	
Traffic Volume (veh/h)	25	731	1024	544	656	210	831	1061	275	486	1641	20
Future Volume (veh/h)	25	731	1024	544	656	210	831	1061	275	486	1641	20
Initial Q (Qb), veh	0	0	0	0	0	0	0	0	0	0	0	0
Ped-Bike Adj(A_pbT)	1.00		1.00	1.00		1.00	1.00		0.99	1.00		1.00
Parking Bus, Adj	1.00	1.00	1.00	1.00	1.00	1.00	1.00	1.00	1.00	1.00	1.00	1.00
Work Zone On Approach		No			No			No			No	
Adj Sat Flow, veh/h/ln	1900	1900	1900	1870	1900	1900	1900	1885	1870	1900	1885	1900
Adj Flow Rate, veh/h	26	761	670	567	683	132	866	1105	218	506	1709	19
Peak Hour Factor	0.96	0.96	0.96	0.96	0.96	0.96	0.96	0.96	0.96	0.96	0.96	0.96
Percent Heavy Veh, %	0	0	0	2	0	0	0	1	2	0	1	0
Cap, veh/h	42	750	1141	463	1148	757	686	1251	758	535	1607	18
Arrive On Green	0.02	0.21	0.21	0.13	0.32	0.32	0.20	0.35	0.35	0.15	0.31	0.31
Sat Flow, veh/h	1810	3610	2830	3456	3610	1610	3510	3582	1564	3510	5247	58
Grp Volume(v), veh/h	26	761	670	567	683	132	866	1105	218	506	1117	611
Grp Sat Flow(s),veh/h/ln	1810	1805	1415	1728	1805	1610	1755	1791	1564	1755	1716	1875
Q Serve(g_s), s	1.9	27.0	24.1	17.4	20.7	6.1	25.4	37.7	10.9	18.6	39.8	39.8
Cycle Q Clear(g_c), s	1.9	27.0	24.1	17.4	20.7	6.1	25.4	37.7	10.9	18.6	39.8	39.8
Prop In Lane	1.00		1.00	1.00		1.00	1.00		1.00	1.00		0.03
Lane Grp Cap(c), veh/h	42	750	1141	463	1148	757	686	1251	758	535	1050	574
V/C Ratio(X)	0.61	1.01	0.59	1.23	0.59	0.17	1.26	0.88	0.29	0.95	1.06	1.06
Avail Cap(c_a), veh/h	84	750	1141	463	1148	757	686	1251	758	535	1050	574
HCM Platoon Ratio	1.00	1.00	1.00	1.00	1.00	1.00	1.00	1.00	1.00	1.00	1.00	1.00
Upstream Filter(I)	1.00	1.00	1.00	1.00	1.00	1.00	1.00	1.00	1.00	1.00	1.00	1.00
Uniform Delay (d), s/veh	62.9	51.5	30.3	56.3	37.3	19.9	52.3	39.8	20.2	54.6	45.1	45.1
Incr Delay (d2), s/veh	5.3	36.7	0.8	119.6	0.8	0.1	129.7	7.8	0.2	25.9	46.4	55.7
Initial Q Delay(d3),s/veh	0.0	0.0	0.0	0.0	0.0	0.0	0.0	0.0	0.0	0.0	0.0	0.0
%ile BackOfQ(50%),veh/ln	0.9	15.7	8.0	15.1	9.0	2.3	23.3	17.5	3.9	10.0	23.2	26.9
Unsig. Movement Delay, s/veh												
LnGrp Delay(d),s/veh	68.1	88.2	31.1	175.9	38.1	20.0	182.0	47.6	20.4	80.4	91.5	100.8
LnGrp LOS	E	F	C	F	D	B	F	D	C	F	F	F
Approach Vol, veh/h		1457			1382			2189			2234	
Approach Delay, s/veh		61.6			92.9			98.0			91.5	
Approach LOS		E			F			F			F	
Timer - Assigned Phs	1	2	3	4	5	6	7	8				
Phs Duration (G+Y+Rc), s	24.4	50.8	22.0	32.8	30.0	45.2	7.6	47.2				
Change Period (Y+Rc), s	4.6	5.4	4.6	5.8	4.6	5.4	4.6	5.8				
Max Green Setting (Gmax), s	19.8	45.4	17.4	27.0	25.4	39.8	6.0	38.4				
Max Q Clear Time (g_c+1), s	20.6	39.7	19.4	29.0	27.4	41.8	3.9	22.7				
Green Ext Time (p_c), s	0.0	3.6	0.0	0.0	0.0	0.0	0.0	4.2				

Intersection Summary

HCM 6th Ctrl Delay	87.7
HCM 6th LOS	F

Timings

3: Overlook Pkwy./Canyon Crest Dr. & Alessandro Bl/Alessandro Bl.



Lane Group	EBL	EBT	WBL	WBT	WBR	NBL	NBT	NBR	SBL	SBT	SBR
Lane Configurations	↙	↕↕↕	↙	↕↕↕	↗	↙	↕↕	↗	↕↕	↙	↗
Traffic Volume (vph)	52	2826	22	2103	599	37	150	56	547	63	23
Future Volume (vph)	52	2826	22	2103	599	37	150	56	547	63	23
Turn Type	Prot	NA	Prot	NA	pm+ov	Split	NA	Perm	Split	NA	Perm
Protected Phases	5	2	1	6	4	8	8		4	4	
Permitted Phases					6			8			4
Detector Phase	5	2	1	6	4	8	8	8	4	4	4
Switch Phase											
Minimum Initial (s)	5.0	10.0	5.0	10.0	10.0	10.0	10.0	10.0	10.0	10.0	10.0
Minimum Split (s)	9.2	35.2	9.2	35.2	38.8	38.8	38.8	38.8	38.8	38.8	38.8
Total Split (s)	9.2	43.2	9.2	43.2	38.8	38.8	38.8	38.8	38.8	38.8	38.8
Total Split (%)	7.1%	33.2%	7.1%	33.2%	29.8%	29.8%	29.8%	29.8%	29.8%	29.8%	29.8%
Yellow Time (s)	3.2	5.2	3.2	5.2	4.8	4.8	4.8	4.8	4.8	4.8	4.8
All-Red Time (s)	1.0	1.0	1.0	1.0	1.0	1.0	1.0	1.0	1.0	1.0	1.0
Lost Time Adjust (s)	0.0	0.0	0.0	0.0	0.0	0.0	0.0	0.0	0.0	0.0	0.0
Total Lost Time (s)	4.2	6.2	4.2	6.2	5.8	5.8	5.8	5.8	5.8	5.8	5.8
Lead/Lag	Lead	Lag	Lead	Lag							
Lead-Lag Optimize?	Yes	Yes	Yes	Yes							
Recall Mode	None	None	None	None	None	None	None	None	None	None	None
Act Effct Green (s)	5.0	43.0	5.0	37.2	66.2	10.7	10.7	10.7	22.8	22.8	22.8
Actuated g/C Ratio	0.05	0.44	0.05	0.38	0.68	0.11	0.11	0.11	0.23	0.23	0.23
v/c Ratio	0.62	1.32	0.25	1.12	0.51	0.21	0.40	0.21	0.56	0.57	0.05
Control Delay	78.5	172.3	54.5	92.7	3.3	45.1	45.2	2.2	35.6	39.1	0.2
Queue Delay	0.0	0.0	0.0	0.0	0.0	0.0	0.0	0.0	0.0	0.0	0.0
Total Delay	78.5	172.3	54.5	92.7	3.3	45.1	45.2	2.2	35.6	39.1	0.2
LOS	E	F	D	F	A	D	D	A	D	D	A
Approach Delay		170.6		72.7			35.3			35.5	
Approach LOS		F		E			D			D	

Intersection Summary

Cycle Length: 130
 Actuated Cycle Length: 97.8
 Natural Cycle: 125
 Control Type: Actuated-Uncoordinated
 Maximum v/c Ratio: 1.32
 Intersection Signal Delay: 111.4
 Intersection Capacity Utilization 89.5%
 Analysis Period (min) 15
 Intersection LOS: F
 ICU Level of Service E

Splits and Phases: 3: Overlook Pkwy./Canyon Crest Dr. & Alessandro Bl/Alessandro Bl.

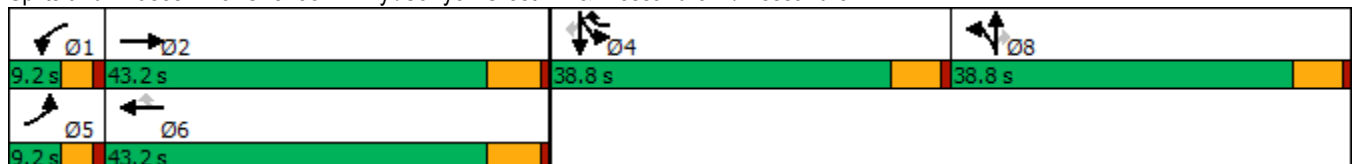

HCM 6th Signalized Intersection Summary

West Campus Upper Plateau (JN 14064)

3: Overlook Pkwy./Canyon Crest Dr. & Alessandro Bl/Alessandro Bl.

09/19/2022



Movement	EBL	EBT	EBR	WBL	WBT	WBR	NBL	NBT	NBR	SBL	SBT	SBR
Lane Configurations	↗	↑↑↑		↖	↑↑↑	↗	↖	↑↑	↗	↖↗	↖	↗
Traffic Volume (veh/h)	52	2826	25	22	2103	599	37	150	56	547	63	23
Future Volume (veh/h)	52	2826	25	22	2103	599	37	150	56	547	63	23
Initial Q (Qb), veh	0	0	0	0	0	0	0	0	0	0	0	0
Ped-Bike Adj(A_pbT)	1.00		1.00	1.00		1.00	1.00		1.00	1.00		1.00
Parking Bus, Adj	1.00	1.00	1.00	1.00	1.00	1.00	1.00	1.00	1.00	1.00	1.00	1.00
Work Zone On Approach		No			No			No			No	
Adj Sat Flow, veh/h/ln	1811	1885	1811	1900	1885	1885	1781	1900	1900	1885	1767	1841
Adj Flow Rate, veh/h	54	2944	26	23	2191	616	39	156	50	497	168	15
Peak Hour Factor	0.96	0.96	0.96	0.96	0.96	0.96	0.96	0.96	0.96	0.96	0.96	0.96
Percent Heavy Veh, %	6	1	6	0	1	1	8	0	0	1	9	4
Cap, veh/h	71	2279	20	44	2142	957	190	405	181	656	323	285
Arrive On Green	0.04	0.43	0.43	0.02	0.42	0.42	0.11	0.11	0.11	0.18	0.18	0.18
Sat Flow, veh/h	1725	5261	46	1810	5147	1598	1697	3610	1610	3591	1767	1560
Grp Volume(v), veh/h	54	1917	1053	23	2191	616	39	156	50	497	168	15
Grp Sat Flow(s),veh/h/ln	1725	1716	1877	1810	1716	1598	1697	1805	1610	1795	1767	1560
Q Serve(g_s), s	2.8	38.5	38.5	1.1	37.0	22.4	1.9	3.6	2.5	11.7	7.6	0.7
Cycle Q Clear(g_c), s	2.8	38.5	38.5	1.1	37.0	22.4	1.9	3.6	2.5	11.7	7.6	0.7
Prop In Lane	1.00		0.02	1.00		1.00	1.00		1.00	1.00		1.00
Lane Grp Cap(c), veh/h	71	1486	813	44	2142	957	190	405	181	656	323	285
V/C Ratio(X)	0.76	1.29	1.30	0.52	1.02	0.64	0.20	0.39	0.28	0.76	0.52	0.05
Avail Cap(c_a), veh/h	97	1486	813	102	2142	957	630	1340	598	1333	656	579
HCM Platoon Ratio	1.00	1.00	1.00	1.00	1.00	1.00	1.00	1.00	1.00	1.00	1.00	1.00
Upstream Filter(I)	1.00	1.00	1.00	1.00	1.00	1.00	1.00	1.00	1.00	1.00	1.00	1.00
Uniform Delay (d), s/veh	42.2	25.2	25.2	42.9	26.0	11.6	35.9	36.6	36.2	34.5	32.8	30.0
Incr Delay (d2), s/veh	12.9	135.5	142.0	3.5	25.5	1.5	0.5	0.6	0.8	1.8	1.3	0.1
Initial Q Delay(d3),s/veh	0.0	0.0	0.0	0.0	0.0	0.0	0.0	0.0	0.0	0.0	0.0	0.0
%ile BackOfQ(50%),veh/ln	1.4	41.3	46.7	0.5	18.1	11.1	0.8	1.5	1.0	5.0	3.2	0.3
Unsig. Movement Delay, s/veh												
LnGrp Delay(d),s/veh	55.0	160.7	167.2	46.4	51.4	13.1	36.4	37.2	37.0	36.3	34.1	30.1
LnGrp LOS	E	F	F	D	F	B	D	D	D	D	C	C
Approach Vol, veh/h		3024			2830			245			680	
Approach Delay, s/veh		161.0			43.1			37.0			35.6	
Approach LOS		F			D			D			D	
Timer - Assigned Phs	1	2		4	5	6		8				
Phs Duration (G+Y+Rc), s	6.4	44.7		22.0	7.9	43.2		15.8				
Change Period (Y+Rc), s	* 4.2	6.2		5.8	* 4.2	6.2		5.8				
Max Green Setting (Gmax), s	* 5	37.0		33.0	* 5	37.0		33.0				
Max Q Clear Time (g_c+I1), s	3.1	40.5		13.7	4.8	39.0		5.6				
Green Ext Time (p_c), s	0.0	0.0		2.6	0.0	0.0		1.1				

Intersection Summary

HCM 6th Ctrl Delay	94.7
HCM 6th LOS	F

Notes

- User approved pedestrian interval to be less than phase max green.
- User approved volume balancing among the lanes for turning movement.
- * HCM 6th computational engine requires equal clearance times for the phases crossing the barrier.

Timings
4: Van Buren Bl. & Wood Rd.

West Campus Upper Plateau (JN 14064)

09/19/2022

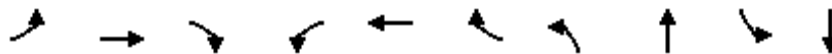

Lane Group	EBL	EBT	EBR	WBL	WBT	WBR	NBL	NBT	SBL	SBT
Lane Configurations	↘	↑↑	↗	↘↗	↑↑	↗	↘↗	↑↔	↘	↑↔
Traffic Volume (vph)	153	1349	197	258	1302	82	285	237	82	241
Future Volume (vph)	153	1349	197	258	1302	82	285	237	82	241
Turn Type	Prot	NA	pm+ov	Prot	NA	Perm	Prot	NA	Prot	NA
Protected Phases	5	2	3	1	6		3	8	7	4
Permitted Phases			2			6				
Detector Phase	5	2	3	1	6	6	3	8	7	4
Switch Phase										
Minimum Initial (s)	5.0	10.0	5.0	5.0	10.0	10.0	5.0	10.0	5.0	10.0
Minimum Split (s)	9.2	30.2	9.2	9.2	30.2	30.2	9.2	38.4	9.2	15.8
Total Split (s)	16.5	57.2	21.7	13.2	53.9	53.9	21.7	38.4	11.2	27.9
Total Split (%)	13.8%	47.7%	18.1%	11.0%	44.9%	44.9%	18.1%	32.0%	9.3%	23.3%
Yellow Time (s)	3.2	5.2	3.2	3.2	5.2	5.2	3.2	4.4	3.2	4.8
All-Red Time (s)	1.0	1.0	1.0	1.0	1.0	1.0	1.0	1.0	1.0	1.0
Lost Time Adjust (s)	0.0	0.0	0.0	0.0	0.0	0.0	0.0	0.0	0.0	0.0
Total Lost Time (s)	4.2	6.2	4.2	4.2	6.2	6.2	4.2	5.4	4.2	5.8
Lead/Lag	Lead	Lag	Lead	Lead	Lag	Lag	Lead	Lag	Lead	Lag
Lead-Lag Optimize?	Yes	Yes	Yes	Yes	Yes	Yes	Yes	Yes	Yes	Yes
Recall Mode	None	None	None	None	None	None	None	None	None	None
Act Effct Green (s)	12.2	51.2	67.3	9.0	48.1	48.1	14.1	24.1	7.0	16.7
Actuated g/C Ratio	0.11	0.46	0.60	0.08	0.43	0.43	0.13	0.22	0.06	0.15
v/c Ratio	0.86	0.92	0.22	1.01	0.94	0.12	0.72	0.57	0.80	0.76
Control Delay	87.3	39.8	4.6	108.8	44.1	1.2	57.3	26.5	97.7	40.1
Queue Delay	0.0	0.0	0.0	0.0	0.0	0.0	0.0	0.0	0.0	0.0
Total Delay	87.3	39.8	4.6	108.8	44.1	1.2	57.3	26.5	97.7	40.1
LOS	F	D	A	F	D	A	E	C	F	D
Approach Delay		40.0			52.1			38.6		49.4
Approach LOS		D			D			D		D

Intersection Summary

Cycle Length: 120
 Actuated Cycle Length: 111.5
 Natural Cycle: 120
 Control Type: Actuated-Uncoordinated
 Maximum v/c Ratio: 1.01
 Intersection Signal Delay: 45.2
 Intersection LOS: D
 Intersection Capacity Utilization 84.1%
 ICU Level of Service E
 Analysis Period (min) 15



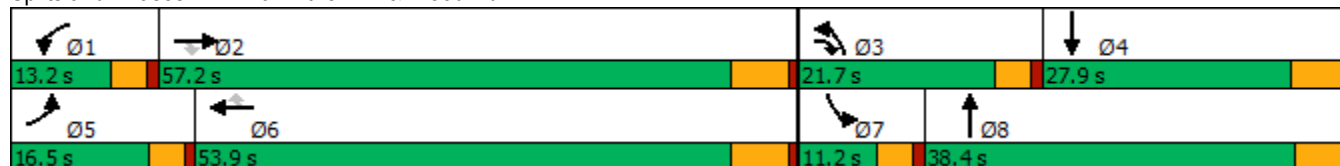





















Splits and Phases: 4: Van Buren Bl. & Wood Rd.



HCM 6th Signalized Intersection Summary
4: Van Buren Bl. & Wood Rd.

West Campus Upper Plateau (JN 14064)

09/19/2022

												
Movement	EBL	EBT	EBR	WBL	WBT	WBR	NBL	NBT	NBR	SBL	SBT	SBR
Lane Configurations												
Traffic Volume (veh/h)	153	1349	197	258	1302	82	285	237	203	82	241	185
Future Volume (veh/h)	153	1349	197	258	1302	82	285	237	203	82	241	185
Initial Q (Qb), veh	0	0	0	0	0	0	0	0	0	0	0	0
Ped-Bike Adj(A_pbT)	1.00		0.99	1.00		0.99	1.00		0.97	1.00		0.99
Parking Bus, Adj	1.00	1.00	1.00	1.00	1.00	1.00	1.00	1.00	1.00	1.00	1.00	1.00
Work Zone On Approach		No			No			No			No	
Adj Sat Flow, veh/h/ln	1885	1856	1870	1885	1870	1885	1870	1885	1870	1885	1885	1885
Adj Flow Rate, veh/h	168	1482	111	284	1431	43	313	260	142	90	265	128
Peak Hour Factor	0.91	0.91	0.91	0.91	0.91	0.91	0.91	0.91	0.91	0.91	0.91	0.91
Percent Heavy Veh, %	1	3	2	1	2	1	2	1	2	1	1	1
Cap, veh/h	198	1647	905	297	1571	696	382	428	225	114	340	159
Arrive On Green	0.11	0.47	0.47	0.09	0.44	0.44	0.11	0.19	0.19	0.06	0.14	0.14
Sat Flow, veh/h	1795	3526	1561	3483	3554	1574	3456	2241	1178	1795	2357	1103
Grp Volume(v), veh/h	168	1482	111	284	1431	43	313	206	196	90	199	194
Grp Sat Flow(s),veh/h/ln	1795	1763	1561	1742	1777	1574	1728	1791	1628	1795	1791	1669
Q Serve(g_s), s	9.7	40.8	3.4	8.6	39.7	1.7	9.4	11.1	11.7	5.2	11.3	11.9
Cycle Q Clear(g_c), s	9.7	40.8	3.4	8.6	39.7	1.7	9.4	11.1	11.7	5.2	11.3	11.9
Prop In Lane	1.00		1.00	1.00		1.00	1.00		0.72	1.00		0.66
Lane Grp Cap(c), veh/h	198	1647	905	297	1571	696	382	342	311	114	258	241
V/C Ratio(X)	0.85	0.90	0.12	0.96	0.91	0.06	0.82	0.60	0.63	0.79	0.77	0.81
Avail Cap(c_a), veh/h	209	1701	929	297	1604	711	572	559	508	119	374	349
HCM Platoon Ratio	1.00	1.00	1.00	1.00	1.00	1.00	1.00	1.00	1.00	1.00	1.00	1.00
Upstream Filter(I)	1.00	1.00	1.00	1.00	1.00	1.00	1.00	1.00	1.00	1.00	1.00	1.00
Uniform Delay (d), s/veh	46.2	25.9	10.1	48.2	27.5	16.9	46.0	39.1	39.3	48.8	43.6	43.8
Incr Delay (d2), s/veh	24.3	7.0	0.1	40.5	8.2	0.1	3.4	1.7	2.1	25.8	6.0	8.5
Initial Q Delay(d3),s/veh	0.0	0.0	0.0	0.0	0.0	0.0	0.0	0.0	0.0	0.0	0.0	0.0
%ile BackOfQ(50%),veh/ln	5.5	16.8	1.1	5.2	16.9	0.6	4.1	4.9	4.7	3.1	5.3	5.3
Unsig. Movement Delay, s/veh												
LnGrp Delay(d),s/veh	70.4	32.9	10.2	88.6	35.8	17.0	49.4	40.8	41.4	74.6	49.5	52.3
LnGrp LOS	E	C	B	F	D	B	D	D	D	E	D	D
Approach Vol, veh/h		1761			1758			715			483	
Approach Delay, s/veh		35.0			43.9			44.7			55.3	
Approach LOS		D			D			D			E	
Timer - Assigned Phs	1	2	3	4	5	6	7	8				
Phs Duration (G+Y+Rc), s	13.2	55.6	15.9	21.0	15.8	52.9	10.9	26.0				
Change Period (Y+Rc), s	* 4.2	6.2	* 4.2	5.8	* 4.2	6.2	* 4.2	* 5.8				
Max Green Setting (Gmax), s	* 9	51.0	* 18	22.1	* 12	47.7	* 7	* 33				
Max Q Clear Time (g_c+I1), s	10.6	42.8	11.4	13.9	11.7	41.7	7.2	13.7				
Green Ext Time (p_c), s	0.0	6.5	0.3	1.4	0.0	4.8	0.0	2.1				

Intersection Summary												
HCM 6th Ctrl Delay				41.9								
HCM 6th LOS				D								

Notes

* HCM 6th computational engine requires equal clearance times for the phases crossing the barrier.

Timings

5: Trautwein Rd. & Alessandro Bl.

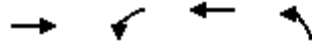

Lane Group	EBT	WBL	WBT	NBL
Lane Configurations	↑↑↑	↔↔	↑↑↑	↔↔↔
Traffic Volume (vph)	1860	234	2098	893
Future Volume (vph)	1860	234	2098	893
Turn Type	NA	Prot	NA	Prot
Protected Phases	2	1	6	8
Permitted Phases				
Detector Phase	2	1	6	8
Switch Phase				
Minimum Initial (s)	10.0	5.0	10.0	10.0
Minimum Split (s)	33.2	9.2	16.2	16.2
Total Split (s)	63.0	19.0	82.0	38.0
Total Split (%)	52.5%	15.8%	68.3%	31.7%
Yellow Time (s)	5.2	3.2	5.2	5.2
All-Red Time (s)	1.0	1.0	1.0	1.0
Lost Time Adjust (s)	0.0	0.0	0.0	0.0
Total Lost Time (s)	6.2	4.2	6.2	6.2
Lead/Lag	Lag	Lead		
Lead-Lag Optimize?	Yes	Yes		
Recall Mode	None	None	None	None
Act Effct Green (s)	55.3	12.0	71.5	26.7
Actuated g/C Ratio	0.50	0.11	0.65	0.24
v/c Ratio	0.77	0.66	0.67	0.79
Control Delay	25.9	57.3	13.7	45.2
Queue Delay	0.0	0.0	0.0	0.0
Total Delay	25.9	57.3	13.7	45.2
LOS	C	E	B	D
Approach Delay	25.9		18.1	45.2
Approach LOS	C		B	D

Intersection Summary

Cycle Length: 120	
Actuated Cycle Length: 110.7	
Natural Cycle: 65	
Control Type: Actuated-Uncoordinated	
Maximum v/c Ratio: 0.79	
Intersection Signal Delay: 25.7	Intersection LOS: C
Intersection Capacity Utilization 74.0%	ICU Level of Service D
Analysis Period (min) 15	

Splits and Phases: 5: Trautwein Rd. & Alessandro Bl.



HCM 6th Signalized Intersection Summary
5: Trautwein Rd. & Alessandro Bl.

West Campus Upper Plateau (JN 14064)

09/19/2022

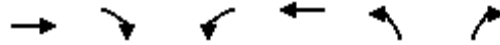

Movement	EBT	EBR	WBL	WBT	NBL	NBR
Lane Configurations	↑↑↑		↵↵	↑↑↑	↵↵↵	
Traffic Volume (veh/h)	1860	17	234	2098	893	11
Future Volume (veh/h)	1860	17	234	2098	893	11
Initial Q (Qb), veh	0	0	0	0	0	0
Ped-Bike Adj(A_pbT)		1.00	1.00		1.00	1.00
Parking Bus, Adj	1.00	1.00	1.00	1.00	1.00	1.00
Work Zone On Approach	No			No	No	
Adj Sat Flow, veh/h/ln	1885	1900	1885	1885	1870	1900
Adj Flow Rate, veh/h	1958	18	246	2208	951	0
Peak Hour Factor	0.95	0.95	0.95	0.95	0.95	0.95
Percent Heavy Veh, %	1	0	1	1	2	0
Cap, veh/h	2705	25	320	3344	1186	357
Arrive On Green	0.51	0.51	0.09	0.65	0.22	0.00
Sat Flow, veh/h	5429	48	3483	5316	5344	1610
Grp Volume(v), veh/h	1277	699	246	2208	951	0
Grp Sat Flow(s),veh/h/ln	1716	1876	1742	1716	1781	1610
Q Serve(g_s), s	27.8	27.9	6.7	25.4	16.3	0.0
Cycle Q Clear(g_c), s	27.8	27.9	6.7	25.4	16.3	0.0
Prop In Lane		0.03	1.00		1.00	1.00
Lane Grp Cap(c), veh/h	1765	965	320	3344	1186	357
V/C Ratio(X)	0.72	0.72	0.77	0.66	0.80	0.00
Avail Cap(c_a), veh/h	2017	1103	533	4037	1758	530
HCM Platoon Ratio	1.00	1.00	1.00	1.00	1.00	1.00
Upstream Filter(I)	1.00	1.00	1.00	1.00	1.00	0.00
Uniform Delay (d), s/veh	18.2	18.2	42.9	10.4	35.6	0.0
Incr Delay (d2), s/veh	1.3	2.4	1.5	0.4	1.7	0.0
Initial Q Delay(d3),s/veh	0.0	0.0	0.0	0.0	0.0	0.0
%ile BackOfQ(50%),veh/ln	9.7	10.9	2.8	7.1	6.8	0.0
Unsig. Movement Delay, s/veh						
LnGrp Delay(d),s/veh	19.5	20.5	44.3	10.8	37.3	0.0
LnGrp LOS	B	C	D	B	D	A
Approach Vol, veh/h	1976			2454	951	
Approach Delay, s/veh	19.8			14.1	37.3	
Approach LOS	B			B	D	
Timer - Assigned Phs	1	2			6	8
Phs Duration (G+Y+Rc), s	13.1	55.9			69.0	27.6
Change Period (Y+Rc), s	* 4.2	6.2			6.2	6.2
Max Green Setting (Gmax), s	* 15	56.8			75.8	31.8
Max Q Clear Time (g_c+I1), s	8.7	29.9			27.4	18.3
Green Ext Time (p_c), s	0.2	19.8			34.8	3.2

Intersection Summary

HCM 6th Ctrl Delay	20.3
HCM 6th LOS	C

Notes

User approved volume balancing among the lanes for turning movement.
* HCM 6th computational engine requires equal clearance times for the phases crossing the barrier.

Timings
6: Trautwein Rd. & Grove Community Dr

West Campus Upper Plateau (JN 14064)

09/19/2022



Lane Group	WBL	WBR	NBT	NBR	SBL	SBT
Lane Configurations	↙	↗↗	↕↕	↗	↗↗	↕↕
Traffic Volume (vph)	49	231	780	52	367	1361
Future Volume (vph)	49	231	780	52	367	1361
Turn Type	Prot	pm+ov	NA	Perm	Prot	NA
Protected Phases	8	1	2		1	6
Permitted Phases		8		2		
Detector Phase	8	1	2	2	1	6
Switch Phase						
Minimum Initial (s)	10.0	5.0	10.0	10.0	5.0	10.0
Minimum Split (s)	34.6	9.6	46.2	46.2	9.6	28.2
Total Split (s)	35.0	29.0	56.0	56.0	29.0	85.0
Total Split (%)	29.2%	24.2%	46.7%	46.7%	24.2%	70.8%
Yellow Time (s)	3.6	3.6	5.2	5.2	3.6	5.2
All-Red Time (s)	1.0	1.0	1.0	1.0	1.0	1.0
Lost Time Adjust (s)	0.0	0.0	0.0	0.0	0.0	0.0
Total Lost Time (s)	4.6	4.6	6.2	6.2	4.6	6.2
Lead/Lag		Lead	Lag	Lag	Lead	
Lead-Lag Optimize?		Yes	Yes	Yes	Yes	
Recall Mode	None	None	None	None	None	None
Act Effct Green (s)	13.9	19.4	22.0	22.0	12.4	44.0
Actuated g/C Ratio	0.25	0.34	0.39	0.39	0.22	0.78
v/c Ratio	0.11	0.22	0.57	0.08	0.49	0.50
Control Delay	23.3	4.9	17.9	6.2	25.8	7.0
Queue Delay	0.0	0.0	0.0	0.0	0.0	0.0
Total Delay	23.3	4.9	17.9	6.2	25.8	7.0
LOS	C	A	B	A	C	A
Approach Delay	8.1		17.2			11.0
Approach LOS	A		B			B

Intersection Summary

Cycle Length: 120
 Actuated Cycle Length: 56.5
 Natural Cycle: 95
 Control Type: Actuated-Uncoordinated
 Maximum v/c Ratio: 0.57
 Intersection Signal Delay: 12.5
 Intersection LOS: B
 Intersection Capacity Utilization 55.9%
 ICU Level of Service B
 Analysis Period (min) 15

Splits and Phases: 6: Trautwein Rd. & Grove Community Dr



HCM 6th Signalized Intersection Summary
6: Trautwein Rd. & Grove Community Dr

West Campus Upper Plateau (JN 14064)
09/19/2022



Movement	WBL	WBR	NBT	NBR	SBL	SBT
Lane Configurations	↶	↶↶	↶↶	↷	↷↷	↶↶
Traffic Volume (veh/h)	49	231	780	52	367	1361
Future Volume (veh/h)	49	231	780	52	367	1361
Initial Q (Qb), veh	0	0	0	0	0	0
Ped-Bike Adj(A_pbT)	1.00	1.00		1.00	1.00	
Parking Bus, Adj	1.00	1.00	1.00	1.00	1.00	1.00
Work Zone On Approach	No		No			No
Adj Sat Flow, veh/h/ln	1900	1900	1885	1900	1900	1870
Adj Flow Rate, veh/h	50	57	796	48	374	1389
Peak Hour Factor	0.98	0.98	0.98	0.98	0.98	0.98
Percent Heavy Veh, %	0	0	1	0	0	2
Cap, veh/h	292	898	1259	566	546	2153
Arrive On Green	0.16	0.16	0.35	0.35	0.16	0.61
Sat Flow, veh/h	1810	2834	3676	1610	3510	3647
Grp Volume(v), veh/h	50	57	796	48	374	1389
Grp Sat Flow(s),veh/h/ln	1810	1417	1791	1610	1755	1777
Q Serve(g_s), s	1.1	0.7	8.6	0.9	4.7	11.7
Cycle Q Clear(g_c), s	1.1	0.7	8.6	0.9	4.7	11.7
Prop In Lane	1.00	1.00		1.00	1.00	
Lane Grp Cap(c), veh/h	292	898	1259	566	546	2153
V/C Ratio(X)	0.17	0.06	0.63	0.08	0.69	0.65
Avail Cap(c_a), veh/h	1186	2297	3845	1728	1846	6036
HCM Platoon Ratio	1.00	1.00	1.00	1.00	1.00	1.00
Upstream Filter(I)	1.00	1.00	1.00	1.00	1.00	1.00
Uniform Delay (d), s/veh	16.8	11.1	12.5	10.1	18.5	5.9
Incr Delay (d2), s/veh	0.3	0.0	0.5	0.1	0.6	0.3
Initial Q Delay(d3),s/veh	0.0	0.0	0.0	0.0	0.0	0.0
%ile BackOfQ(50%),veh/ln	0.4	0.2	2.4	0.2	1.5	1.6
Unsig. Movement Delay, s/veh						
LnGrp Delay(d),s/veh	17.1	11.1	13.1	10.1	19.1	6.2
LnGrp LOS	B	B	B	B	B	A
Approach Vol, veh/h	107		844			1763
Approach Delay, s/veh	13.9		12.9			9.0
Approach LOS	B		B			A
Timer - Assigned Phs	1	2			6	8
Phs Duration (G+Y+Rc), s	11.8	22.5			34.3	12.1
Change Period (Y+Rc), s	4.6	6.2			6.2	4.6
Max Green Setting (Gmax), s	24.4	49.8			78.8	30.4
Max Q Clear Time (g_c+I1), s	6.7	10.6			13.7	3.1
Green Ext Time (p_c), s	0.6	5.7			13.4	0.3

Intersection Summary

HCM 6th Ctrl Delay	10.4
HCM 6th LOS	B

Timings

West Campus Upper Plateau (JN 14064)

7: Trautwein Rd. & Orange Terrace Pkwy

09/19/2022



Lane Group	EBL	EBT	WBL	WBT	WBR	NBL	NBT	NBR	SBL	SBT	SBR
Lane Configurations											
Traffic Volume (vph)	45	46	148	24	163	31	716	208	333	1050	40
Future Volume (vph)	45	46	148	24	163	31	716	208	333	1050	40
Turn Type	Prot	NA	Prot	NA	pm+ov	Prot	NA	Perm	Prot	NA	Perm
Protected Phases	7	4	3	8	1	5	2		1	6	
Permitted Phases					8			2			6
Detector Phase	7	4	3	8	1	5	2	2	1	6	6
Switch Phase											
Minimum Initial (s)	5.0	10.0	5.0	10.0	5.0	5.0	10.0	10.0	5.0	10.0	10.0
Minimum Split (s)	9.6	38.6	9.6	34.6	9.6	9.6	46.2	46.2	9.6	28.2	28.2
Total Split (s)	13.2	38.7	16.0	41.5	18.0	9.6	47.3	47.3	18.0	55.7	55.7
Total Split (%)	11.0%	32.3%	13.3%	34.6%	15.0%	8.0%	39.4%	39.4%	15.0%	46.4%	46.4%
Yellow Time (s)	3.6	3.6	3.6	3.6	3.6	3.6	5.2	5.2	3.6	5.2	5.2
All-Red Time (s)	1.0	1.0	1.0	1.0	1.0	1.0	1.0	1.0	1.0	1.0	1.0
Lost Time Adjust (s)	0.0	0.0	0.0	0.0	0.0	0.0	0.0	0.0	0.0	0.0	0.0
Total Lost Time (s)	4.6	4.6	4.6	4.6	4.6	4.6	6.2	6.2	4.6	6.2	6.2
Lead/Lag	Lead	Lag	Lead	Lag	Lead	Lead	Lag	Lag	Lead	Lag	Lag
Lead-Lag Optimize?	Yes	Yes	Yes	Yes	Yes	Yes	Yes	Yes	Yes	Yes	Yes
Recall Mode	None	None	None	None	None	None	None	None	None	None	None
Act Effct Green (s)	10.9	14.1	11.9	18.6	33.7	5.4	25.2	25.2	13.1	38.1	38.1
Actuated g/C Ratio	0.13	0.17	0.15	0.23	0.42	0.07	0.31	0.31	0.16	0.47	0.47
v/c Ratio	0.20	0.19	0.59	0.06	0.14	0.28	0.69	0.34	0.63	0.66	0.05
Control Delay	41.1	28.6	49.0	29.2	3.2	50.7	29.3	5.4	41.7	22.0	0.1
Queue Delay	0.0	0.0	0.0	0.0	0.0	0.0	0.0	0.0	0.0	0.0	0.0
Total Delay	41.1	28.6	49.0	29.2	3.2	50.7	29.3	5.4	41.7	22.0	0.1
LOS	D	C	D	C	A	D	C	A	D	C	A
Approach Delay		34.0		25.3			24.8			26.0	
Approach LOS		C		C			C			C	

Intersection Summary

Cycle Length: 120	
Actuated Cycle Length: 81.1	
Natural Cycle: 115	
Control Type: Actuated-Uncoordinated	
Maximum v/c Ratio: 0.69	
Intersection Signal Delay: 25.8	Intersection LOS: C
Intersection Capacity Utilization 60.9%	ICU Level of Service B
Analysis Period (min) 15	

Splits and Phases: 7: Trautwein Rd. & Orange Terrace Pkwy

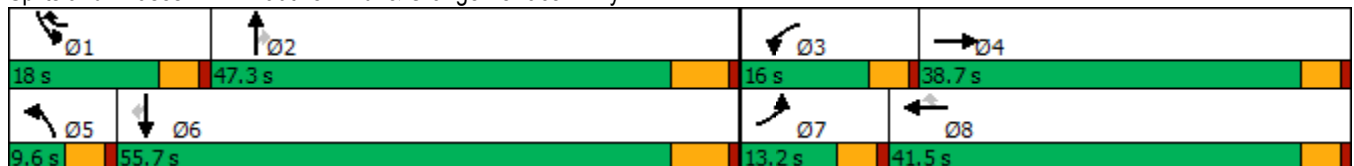

HCM 6th Signalized Intersection Summary
7: Trautwein Rd. & Orange Terrace Pkwy

West Campus Upper Plateau (JN 14064)

09/19/2022

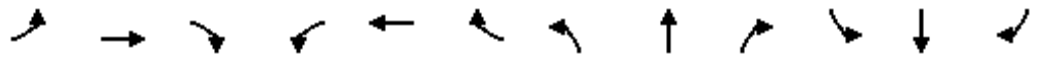

Movement	EBL	EBT	EBR	WBL	WBT	WBR	NBL	NBT	NBR	SBL	SBT	SBR
Lane Configurations												
Traffic Volume (veh/h)	45	46	12	148	24	163	31	716	208	333	1050	40
Future Volume (veh/h)	45	46	12	148	24	163	31	716	208	333	1050	40
Initial Q (Qb), veh	0	0	0	0	0	0	0	0	0	0	0	0
Ped-Bike Adj(A_pbT)	1.00		1.00	1.00		1.00	1.00		1.00	1.00		1.00
Parking Bus, Adj	1.00	1.00	1.00	1.00	1.00	1.00	1.00	1.00	1.00	1.00	1.00	1.00
Work Zone On Approach		No			No			No			No	
Adj Sat Flow, veh/h/ln	1900	1900	1900	1900	1900	1870	1900	1870	1885	1870	1870	1900
Adj Flow Rate, veh/h	47	48	11	156	25	53	33	754	142	351	1105	33
Peak Hour Factor	0.95	0.95	0.95	0.95	0.95	0.95	0.95	0.95	0.95	0.95	0.95	0.95
Percent Heavy Veh, %	0	0	0	0	0	2	0	2	1	2	2	0
Cap, veh/h	79	215	49	196	397	951	62	1132	509	457	1480	671
Arrive On Green	0.04	0.14	0.14	0.11	0.21	0.21	0.03	0.32	0.32	0.13	0.42	0.42
Sat Flow, veh/h	1810	1496	343	1810	1900	2790	1810	3554	1598	3456	3554	1610
Grp Volume(v), veh/h	47	0	59	156	25	53	33	754	142	351	1105	33
Grp Sat Flow(s),veh/h/ln	1810	0	1838	1810	1900	1395	1810	1777	1598	1728	1777	1610
Q Serve(g_s), s	1.7	0.0	1.9	5.7	0.7	0.9	1.2	12.4	4.5	6.6	17.7	0.8
Cycle Q Clear(g_c), s	1.7	0.0	1.9	5.7	0.7	0.9	1.2	12.4	4.5	6.6	17.7	0.8
Prop In Lane	1.00		0.19	1.00		1.00	1.00		1.00	1.00		1.00
Lane Grp Cap(c), veh/h	79	0	264	196	397	951	62	1132	509	457	1480	671
V/C Ratio(X)	0.60	0.00	0.22	0.79	0.06	0.06	0.53	0.67	0.28	0.77	0.75	0.05
Avail Cap(c_a), veh/h	231	0	931	306	1041	1897	134	2169	975	688	2612	1183
HCM Platoon Ratio	1.00	1.00	1.00	1.00	1.00	1.00	1.00	1.00	1.00	1.00	1.00	1.00
Upstream Filter(I)	1.00	0.00	1.00	1.00	1.00	1.00	1.00	1.00	1.00	1.00	1.00	1.00
Uniform Delay (d), s/veh	31.6	0.0	25.5	29.3	21.4	14.9	32.0	19.8	17.2	28.2	16.6	11.7
Incr Delay (d2), s/veh	2.7	0.0	0.4	3.3	0.1	0.0	2.6	0.7	0.3	1.3	0.8	0.0
Initial Q Delay(d3),s/veh	0.0	0.0	0.0	0.0	0.0	0.0	0.0	0.0	0.0	0.0	0.0	0.0
%ile BackOfQ(50%),veh/ln	0.8	0.0	0.8	2.4	0.3	0.2	0.5	4.4	1.5	2.5	5.9	0.3
Unsig. Movement Delay, s/veh												
LnGrp Delay(d),s/veh	34.3	0.0	25.9	32.6	21.4	14.9	34.6	20.5	17.5	29.5	17.4	11.7
LnGrp LOS	C	A	C	C	C	B	C	C	B	C	B	B
Approach Vol, veh/h		106			234			929			1489	
Approach Delay, s/veh		29.7			27.4			20.6			20.1	
Approach LOS		C			C			C			C	
Timer - Assigned Phs	1	2	3	4	5	6	7	8				
Phs Duration (G+Y+Rc), s	13.5	27.7	11.9	14.3	6.9	34.3	7.5	18.7				
Change Period (Y+Rc), s	4.6	6.2	4.6	4.6	4.6	6.2	4.6	4.6				
Max Green Setting (Gmax), s	13.4	41.1	11.4	34.1	5.0	49.5	8.6	36.9				
Max Q Clear Time (g_c+I1), s	8.6	14.4	7.7	3.9	3.2	19.7	3.7	2.9				
Green Ext Time (p_c), s	0.3	5.4	0.1	0.3	0.0	8.3	0.0	0.3				

Intersection Summary

HCM 6th Ctrl Delay	21.3
HCM 6th LOS	C

Timings
8: Cole Av. & Van Buren Bl.

West Campus Upper Plateau (JN 14064)

09/19/2022



Lane Group	EBL	EBT	EBR	WBL	WBT	WBR	NBL	NBT	SBL	SBT	SBR
Lane Configurations	↖↗	↑↑	↗	↖	↑↑↑	↗	↖	↑↔	↖↗	↑↑	↗
Traffic Volume (vph)	317	1029	100	166	1182	248	89	284	287	508	215
Future Volume (vph)	317	1029	100	166	1182	248	89	284	287	508	215
Turn Type	Prot	NA	pm+ov	Prot	NA	pm+ov	Prot	NA	Prot	NA	pm+ov
Protected Phases	5	2	3	1	6	7	3	8	7	4	5
Permitted Phases			2			6					4
Detector Phase	5	2	3	1	6	7	3	8	7	4	5
Switch Phase											
Minimum Initial (s)	5.0	10.0	5.0	5.0	10.0	5.0	5.0	10.0	5.0	10.0	5.0
Minimum Split (s)	9.1	36.2	9.1	9.1	36.2	9.1	9.1	42.2	9.1	49.2	9.1
Total Split (s)	18.7	44.8	12.0	14.0	40.1	17.5	12.0	43.7	17.5	49.2	18.7
Total Split (%)	15.6%	37.3%	10.0%	11.7%	33.4%	14.6%	10.0%	36.4%	14.6%	41.0%	15.6%
Yellow Time (s)	3.2	5.2	3.2	3.2	5.2	3.2	3.2	5.2	3.2	5.2	3.2
All-Red Time (s)	0.5	1.0	0.5	0.5	1.0	0.5	0.5	1.0	0.5	1.0	0.5
Lost Time Adjust (s)	0.0	0.0	0.0	0.0	0.0	0.0	0.0	0.0	0.0	0.0	0.0
Total Lost Time (s)	3.7	6.2	3.7	3.7	6.2	3.7	3.7	6.2	3.7	6.2	3.7
Lead/Lag	Lead	Lag	Lead	Lead	Lag	Lead	Lead	Lag	Lead	Lag	Lead
Lead-Lag Optimize?	Yes	Yes	Yes	Yes	Yes	Yes	Yes	Yes	Yes	Yes	Yes
Recall Mode	None	None	None	None	None	None	None	None	None	None	None
Act Effct Green (s)	13.3	38.5	52.8	10.4	35.7	54.3	8.0	18.3	12.4	22.6	38.4
Actuated g/C Ratio	0.13	0.39	0.53	0.10	0.36	0.55	0.08	0.18	0.12	0.23	0.39
v/c Ratio	0.74	0.82	0.12	0.97	0.70	0.27	0.66	0.57	0.72	0.67	0.35
Control Delay	53.1	35.2	4.5	106.8	31.6	3.7	69.4	37.7	53.7	38.7	14.4
Queue Delay	0.0	0.0	0.0	0.0	0.0	0.0	0.0	0.0	0.0	0.0	0.0
Total Delay	53.1	35.2	4.5	106.8	31.6	3.7	69.4	37.7	53.7	38.7	14.4
LOS	D	D	A	F	C	A	E	D	D	D	B
Approach Delay		37.0			35.1			44.2		37.8	
Approach LOS		D			D			D		D	

Intersection Summary

Cycle Length: 120	
Actuated Cycle Length: 99.6	
Natural Cycle: 115	
Control Type: Actuated-Uncoordinated	
Maximum v/c Ratio: 0.97	
Intersection Signal Delay: 37.2	Intersection LOS: D
Intersection Capacity Utilization 75.3%	ICU Level of Service D
Analysis Period (min) 15	



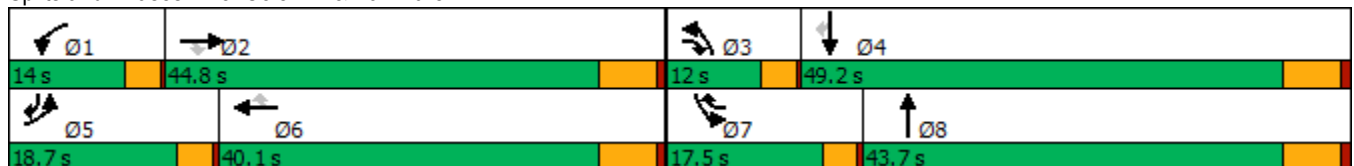





















Splits and Phases: 8: Cole Av. & Van Buren Bl.



HCM 6th Signalized Intersection Summary
8: Cole Av. & Van Buren Bl.

West Campus Upper Plateau (JN 14064)

09/19/2022

												
Movement	EBL	EBT	EBR	WBL	WBT	WBR	NBL	NBT	NBR	SBL	SBT	SBR
Lane Configurations												
Traffic Volume (veh/h)	317	1029	100	166	1182	248	89	284	63	287	508	215
Future Volume (veh/h)	317	1029	100	166	1182	248	89	284	63	287	508	215
Initial Q (Qb), veh	0	0	0	0	0	0	0	0	0	0	0	0
Ped-Bike Adj(A_pbT)	1.00		1.00	1.00		1.00	1.00		0.99	1.00		1.00
Parking Bus, Adj	1.00	1.00	1.00	1.00	1.00	1.00	1.00	1.00	1.00	1.00	1.00	1.00
Work Zone On Approach		No			No			No			No	
Adj Sat Flow, veh/h/ln	1870	1826	1856	1856	1856	1870	1885	1885	1870	1856	1885	1885
Adj Flow Rate, veh/h	337	1095	47	177	1257	174	95	302	60	305	540	129
Peak Hour Factor	0.94	0.94	0.94	0.94	0.94	0.94	0.94	0.94	0.94	0.94	0.94	0.94
Percent Heavy Veh, %	2	5	3	3	3	2	1	1	2	3	1	1
Cap, veh/h	416	1323	706	203	1903	772	121	512	100	382	772	536
Arrive On Green	0.12	0.38	0.38	0.11	0.38	0.38	0.07	0.17	0.17	0.11	0.22	0.22
Sat Flow, veh/h	3456	3469	1572	1767	5066	1585	1795	2982	584	3428	3582	1595
Grp Volume(v), veh/h	337	1095	47	177	1257	174	95	180	182	305	540	129
Grp Sat Flow(s),veh/h/ln	1728	1735	1572	1767	1689	1585	1795	1791	1775	1714	1791	1595
Q Serve(g_s), s	8.5	25.6	1.5	8.8	18.5	5.7	4.7	8.3	8.5	7.8	12.5	5.2
Cycle Q Clear(g_c), s	8.5	25.6	1.5	8.8	18.5	5.7	4.7	8.3	8.5	7.8	12.5	5.2
Prop In Lane	1.00		1.00	1.00		1.00	1.00		0.33	1.00		1.00
Lane Grp Cap(c), veh/h	416	1323	706	203	1903	772	121	307	305	382	772	536
V/C Ratio(X)	0.81	0.83	0.07	0.87	0.66	0.23	0.78	0.58	0.60	0.80	0.70	0.24
Avail Cap(c_a), veh/h	578	1493	783	203	1915	776	166	749	742	528	1718	957
HCM Platoon Ratio	1.00	1.00	1.00	1.00	1.00	1.00	1.00	1.00	1.00	1.00	1.00	1.00
Upstream Filter(I)	1.00	1.00	1.00	1.00	1.00	1.00	1.00	1.00	1.00	1.00	1.00	1.00
Uniform Delay (d), s/veh	38.4	25.1	14.0	39.0	23.2	13.2	41.2	34.2	34.3	38.8	32.5	21.5
Incr Delay (d2), s/veh	4.1	3.9	0.1	30.3	1.0	0.2	10.3	1.8	1.9	4.0	1.2	0.2
Initial Q Delay(d3),s/veh	0.0	0.0	0.0	0.0	0.0	0.0	0.0	0.0	0.0	0.0	0.0	0.0
%ile BackOfQ(50%),veh/ln	3.6	10.0	0.5	5.3	6.7	1.8	2.3	3.5	3.6	3.3	5.1	1.8
Unsig. Movement Delay, s/veh												
LnGrp Delay(d),s/veh	42.5	29.0	14.1	69.3	24.2	13.5	51.4	36.0	36.2	42.8	33.6	21.7
LnGrp LOS	D	C	B	E	C	B	D	D	D	D	C	C
Approach Vol, veh/h		1479			1608			457			974	
Approach Delay, s/veh		31.6			28.0			39.3			34.9	
Approach LOS		C			C			D			C	
Timer - Assigned Phs	1	2	3	4	5	6	7	8				
Phs Duration (G+Y+Rc), s	14.0	40.4	9.8	25.5	14.5	39.9	13.7	21.6				
Change Period (Y+Rc), s	3.7	6.2	3.7	6.2	3.7	6.2	3.7	6.2				
Max Green Setting (Gmax), s	10.3	38.6	8.3	43.0	15.0	33.9	13.8	37.5				
Max Q Clear Time (g_c+1), s	10.8	27.6	6.7	14.5	10.5	20.5	9.8	10.5				
Green Ext Time (p_c), s	0.0	6.6	0.0	3.7	0.3	8.8	0.2	1.8				
Intersection Summary												
HCM 6th Ctrl Delay				31.8								
HCM 6th LOS				C								

Intersection

Intersection Delay, s/veh	9.4
Intersection LOS	A

Movement	EBT	EBR	WBL	WBT	NBL	NBR
Lane Configurations						
Traffic Vol, veh/h	212	18	21	156	27	35
Future Vol, veh/h	212	18	21	156	27	35
Peak Hour Factor	0.92	0.92	0.92	0.92	0.92	0.92
Heavy Vehicles, %	1	0	1	1	0	0
Mvmt Flow	230	20	23	170	29	38
Number of Lanes	1	0	1	1	1	1

Approach	EB	WB	NB
Opposing Approach	WB	EB	
Opposing Lanes	2	1	0
Conflicting Approach Left		NB	EB
Conflicting Lanes Left	0	2	1
Conflicting Approach Right	NB		WB
Conflicting Lanes Right	2	0	2
HCM Control Delay	9.9	9	8.4
HCM LOS	A	A	A

Lane	NBLn1	NBLn2	EBLn1	WBLn1	WBLn2
Vol Left, %	100%	0%	0%	100%	0%
Vol Thru, %	0%	0%	92%	0%	100%
Vol Right, %	0%	100%	8%	0%	0%
Sign Control	Stop	Stop	Stop	Stop	Stop
Traffic Vol by Lane	27	35	230	21	156
LT Vol	27	0	0	21	0
Through Vol	0	0	212	0	156
RT Vol	0	35	18	0	0
Lane Flow Rate	29	38	250	23	170
Geometry Grp	7	7	4	7	7
Degree of Util (X)	0.049	0.051	0.324	0.034	0.23
Departure Headway (Hd)	6.051	4.842	4.668	5.394	4.891
Convergence, Y/N	Yes	Yes	Yes	Yes	Yes
Cap	593	740	773	666	736
Service Time	3.778	2.57	2.684	3.11	2.607
HCM Lane V/C Ratio	0.049	0.051	0.323	0.035	0.231
HCM Control Delay	9.1	7.8	9.9	8.3	9.1
HCM Lane LOS	A	A	A	A	A
HCM 95th-tile Q	0.2	0.2	1.4	0.1	0.9

Intersection	
Intersection Delay, s/veh	9.9
Intersection LOS	A

Movement	EBL	EBT	EBR	WBL	WBT	WBR	NBL	NBT	NBR	SBL	SBT	SBR
Lane Configurations	↘	↕		↘	↕			↕			↕	
Traffic Vol, veh/h	43	422	15	3	237	46	18	4	2	27	7	19
Future Vol, veh/h	43	422	15	3	237	46	18	4	2	27	7	19
Peak Hour Factor	0.96	0.96	0.96	0.96	0.96	0.96	0.96	0.96	0.96	0.96	0.96	0.96
Heavy Vehicles, %	3	2	7	0	1	0	6	0	0	0	0	0
Mvmt Flow	45	440	16	3	247	48	19	4	2	28	7	20
Number of Lanes	1	2	0	1	2	0	0	1	0	0	1	0

Approach	EB	WB	NB	SB
Opposing Approach	WB	EB	SB	NB
Opposing Lanes	3	3	1	1
Conflicting Approach Left	SB	NB	EB	WB
Conflicting Lanes Left	1	1	3	3
Conflicting Approach Right	NB	SB	WB	EB
Conflicting Lanes Right	1	1	3	3
HCM Control Delay	10.4	9.2	9.8	9.6
HCM LOS	B	A	A	A

Lane	NBLn1	EBLn1	EBLn2	EBLn3	WBLn1	WBLn2	WBLn3	SBLn1
Vol Left, %	75%	100%	0%	0%	100%	0%	0%	51%
Vol Thru, %	17%	0%	100%	90%	0%	100%	63%	13%
Vol Right, %	8%	0%	0%	10%	0%	0%	37%	36%
Sign Control	Stop	Stop	Stop	Stop	Stop	Stop	Stop	Stop
Traffic Vol by Lane	24	43	281	156	3	158	125	53
LT Vol	18	43	0	0	3	0	0	27
Through Vol	4	0	281	141	0	158	79	7
RT Vol	2	0	0	15	0	0	46	19
Lane Flow Rate	25	45	293	162	3	165	130	55
Geometry Grp	7	7	7	7	7	7	7	7
Degree of Util (X)	0.046	0.069	0.411	0.228	0.005	0.239	0.179	0.095
Departure Headway (Hd)	6.664	5.566	5.047	5.064	5.715	5.229	4.953	6.193
Convergence, Y/N	Yes	Yes	Yes	Yes	Yes	Yes	Yes	Yes
Cap	534	642	712	707	625	685	721	575
Service Time	4.446	3.31	2.791	2.808	3.465	2.979	2.703	3.969
HCM Lane V/C Ratio	0.047	0.07	0.412	0.229	0.005	0.241	0.18	0.096
HCM Control Delay	9.8	8.7	11.3	9.3	8.5	9.6	8.8	9.6
HCM Lane LOS	A	A	B	A	A	A	A	A
HCM 95th-tile Q	0.1	0.2	2	0.9	0	0.9	0.6	0.3

Timings

11: Barton St & Alessandro Bl.



Lane Group	EBL	EBT	WBL	WBT	NBL	NBT	NBR	SBL	SBT	SBR
Lane Configurations	↙	↕↕↕	↙	↕↕↕		↕	↗		↕	↗
Traffic Volume (vph)	5	1970	67	2318	71	1	33	9	0	12
Future Volume (vph)	5	1970	67	2318	71	1	33	9	0	12
Turn Type	Prot	NA	Prot	NA	Perm	NA	Perm	Perm	NA	Perm
Protected Phases	5	2	1	6		8			4	
Permitted Phases					8		8	4		4
Detector Phase	5	2	1	6	8	8	8	4	4	4
Switch Phase										
Minimum Initial (s)	5.0	10.0	5.0	10.0	10.0	10.0	10.0	10.0	10.0	10.0
Minimum Split (s)	9.2	28.5	11.0	28.5	40.6	40.6	40.6	26.6	26.6	26.6
Total Split (s)	9.2	65.4	14.0	70.2	40.6	40.6	40.6	40.6	40.6	40.6
Total Split (%)	7.7%	54.5%	11.7%	58.5%	33.8%	33.8%	33.8%	33.8%	33.8%	33.8%
Yellow Time (s)	3.2	5.5	3.2	5.5	3.6	3.6	3.6	3.6	3.6	3.6
All-Red Time (s)	1.0	1.0	1.0	1.0	1.0	1.0	1.0	1.0	1.0	1.0
Lost Time Adjust (s)	0.0	0.0	0.0	0.0		0.0	0.0		0.0	0.0
Total Lost Time (s)	4.2	6.5	4.2	6.5		4.6	4.6		4.6	4.6
Lead/Lag	Lead	Lag	Lead	Lag						
Lead-Lag Optimize?	Yes	Yes	Yes	Yes						
Recall Mode	None	None	None	None	None	None	None	None	None	None
Act Effct Green (s)	5.2	62.5	7.7	70.7		14.7	14.7		14.7	14.7
Actuated g/C Ratio	0.06	0.67	0.08	0.76		0.16	0.16		0.16	0.16
v/c Ratio	0.06	0.61	0.47	0.62		0.34	0.10		0.05	0.04
Control Delay	51.4	14.3	55.7	10.5		40.3	0.6		33.9	0.2
Queue Delay	0.0	0.0	0.0	0.0		0.0	0.0		0.0	0.0
Total Delay	51.4	14.3	55.7	10.5		40.3	0.6		33.9	0.2
LOS	D	B	E	B		D	A		C	A
Approach Delay		14.4		11.7		27.9			14.0	
Approach LOS		B		B		C			B	

Intersection Summary

Cycle Length: 120
 Actuated Cycle Length: 92.7
 Natural Cycle: 105
 Control Type: Actuated-Uncoordinated
 Maximum v/c Ratio: 0.62
 Intersection Signal Delay: 13.3
 Intersection LOS: B
 Intersection Capacity Utilization 74.6%
 ICU Level of Service D
 Analysis Period (min) 15

Splits and Phases: 11: Barton St & Alessandro Bl.



HCM 6th Signalized Intersection Summary
11: Barton St & Alessandro Bl.

West Campus Upper Plateau (JN 14064)

09/19/2022



Movement	EBL	EBT	EBR	WBL	WBT	WBR	NBL	NBT	NBR	SBL	SBT	SBR
Lane Configurations	↖	↑↑↑		↖	↑↑↑			↑	↗		↑	↗
Traffic Volume (veh/h)	5	1970	49	67	2318	3	71	1	33	9	0	12
Future Volume (veh/h)	5	1970	49	67	2318	3	71	1	33	9	0	12
Initial Q (Qb), veh	0	0	0	0	0	0	0	0	0	0	0	0
Ped-Bike Adj(A_pbT)	1.00		1.00	1.00		0.98	1.00		1.00	1.00		1.00
Parking Bus, Adj	1.00	1.00	1.00	1.00	1.00	1.00	1.00	1.00	1.00	1.00	1.00	1.00
Work Zone On Approach		No			No			No			No	
Adj Sat Flow, veh/h/ln	1604	1885	1900	1900	1870	1900	1900	1900	1900	1737	1900	1900
Adj Flow Rate, veh/h	5	2052	49	70	2415	3	74	1	8	9	0	2
Peak Hour Factor	0.96	0.96	0.96	0.96	0.96	0.96	0.96	0.96	0.96	0.96	0.96	0.96
Percent Heavy Veh, %	20	1	0	0	2	0	0	0	0	11	0	0
Cap, veh/h	10	3076	73	90	3361	4	81	1	309	81	0	309
Arrive On Green	0.01	0.59	0.59	0.05	0.64	0.64	0.19	0.19	0.19	0.19	0.00	0.19
Sat Flow, veh/h	1527	5171	123	1810	5267	7	22	3	1610	22	0	1610
Grp Volume(v), veh/h	5	1361	740	70	1561	857	75	0	8	9	0	2
Grp Sat Flow(s),veh/h/ln	1527	1716	1863	1810	1702	1869	25	0	1610	22	0	1610
Q Serve(g_s), s	0.3	24.9	25.0	3.6	28.6	28.7	0.3	0.0	0.4	0.3	0.0	0.1
Cycle Q Clear(g_c), s	0.3	24.9	25.0	3.6	28.6	28.7	17.9	0.0	0.4	17.9	0.0	0.1
Prop In Lane	1.00		0.07	1.00		0.00	0.99		1.00	1.00		1.00
Lane Grp Cap(c), veh/h	10	2041	1108	90	2173	1193	81	0	309	81	0	309
V/C Ratio(X)	0.51	0.67	0.67	0.78	0.72	0.72	0.92	0.00	0.03	0.11	0.00	0.01
Avail Cap(c_a), veh/h	82	2161	1173	190	2319	1273	360	0	620	357	0	620
HCM Platoon Ratio	1.00	1.00	1.00	1.00	1.00	1.00	1.00	1.00	1.00	1.00	1.00	1.00
Upstream Filter(I)	1.00	1.00	1.00	1.00	1.00	1.00	1.00	0.00	1.00	1.00	0.00	1.00
Uniform Delay (d), s/veh	46.3	12.7	12.7	43.9	11.3	11.3	46.6	0.0	30.7	46.7	0.0	30.6
Incr Delay (d2), s/veh	14.1	0.9	1.6	5.3	1.1	2.1	30.6	0.0	0.0	0.6	0.0	0.0
Initial Q Delay(d3),s/veh	0.0	0.0	0.0	0.0	0.0	0.0	0.0	0.0	0.0	0.0	0.0	0.0
%ile BackOfQ(50%),veh/ln	0.1	7.6	8.5	1.7	9.7	11.0	2.4	0.0	0.1	0.2	0.0	0.0
Unsig. Movement Delay, s/veh												
LnGrp Delay(d),s/veh	60.4	13.6	14.3	49.2	12.4	13.4	77.2	0.0	30.7	47.3	0.0	30.6
LnGrp LOS	E	B	B	D	B	B	E	A	C	D	A	C
Approach Vol, veh/h		2106			2488			83				11
Approach Delay, s/veh		13.9			13.8			72.7				44.3
Approach LOS		B			B			E				D
Timer - Assigned Phs	1	2		4	5	6		8				
Phs Duration (G+Y+Rc), s	8.9	62.2		22.8	4.8	66.2		22.8				
Change Period (Y+Rc), s	* 4.2	6.5		4.6	* 4.2	6.5		4.6				
Max Green Setting (Gmax), s	* 9.8	58.9		36.0	* 5	63.7		36.0				
Max Q Clear Time (g_c+I1), s	5.6	27.0		19.9	2.3	30.7		19.9				
Green Ext Time (p_c), s	0.0	23.5		0.0	0.0	29.1		0.3				

Intersection Summary

HCM 6th Ctrl Delay	15.0
HCM 6th LOS	B

Notes

* HCM 6th computational engine requires equal clearance times for the phases crossing the barrier.

Intersection						
Int Delay, s/veh	1.8					
Movement	EBL	EBT	WBT	WBR	SBL	SBR
Lane Configurations						
Traffic Vol, veh/h	40	208	127	20	2	51
Future Vol, veh/h	40	208	127	20	2	51
Conflicting Peds, #/hr	0	0	0	7	0	0
Sign Control	Free	Free	Free	Free	Stop	Stop
RT Channelized	-	None	-	None	-	None
Storage Length	100	-	-	-	0	-
Veh in Median Storage, #	-	0	0	-	0	-
Grade, %	-	0	0	-	0	-
Peak Hour Factor	94	94	94	94	94	94
Heavy Vehicles, %	0	0	1	0	0	0
Mvmt Flow	43	221	135	21	2	54

Major/Minor	Major1	Major2	Minor2		
Conflicting Flow All	163	0	-	0	460 153
Stage 1	-	-	-	-	153 -
Stage 2	-	-	-	-	307 -
Critical Hdwy	4.1	-	-	-	6.4 6.2
Critical Hdwy Stg 1	-	-	-	-	5.4 -
Critical Hdwy Stg 2	-	-	-	-	5.4 -
Follow-up Hdwy	2.2	-	-	-	3.5 3.3
Pot Cap-1 Maneuver	1428	-	-	-	563 898
Stage 1	-	-	-	-	880 -
Stage 2	-	-	-	-	751 -
Platoon blocked, %		-	-	-	
Mov Cap-1 Maneuver	1418	-	-	-	538 892
Mov Cap-2 Maneuver	-	-	-	-	538 -
Stage 1	-	-	-	-	847 -
Stage 2	-	-	-	-	746 -

Approach	EB	WB	SB
HCM Control Delay, s	1.2	0	9.4
HCM LOS			A

Minor Lane/Major Mvmt	EBL	EBT	WBT	WBR	SBLn1
Capacity (veh/h)	1418	-	-	-	870
HCM Lane V/C Ratio	0.03	-	-	-	0.065
HCM Control Delay (s)	7.6	-	-	-	9.4
HCM Lane LOS	A	-	-	-	A
HCM 95th %tile Q(veh)	0.1	-	-	-	0.2

Intersection						
Int Delay, s/veh	2.2					
Movement	EBT	EBR	WBL	WBT	NBL	NBR
Lane Configurations	↑↑		↖	↑↑	↘	
Traffic Vol, veh/h	370	80	41	221	65	39
Future Vol, veh/h	370	80	41	221	65	39
Conflicting Peds, #/hr	0	2	0	0	0	0
Sign Control	Free	Free	Free	Free	Stop	Stop
RT Channelized	-	None	-	None	-	None
Storage Length	-	-	125	-	0	-
Veh in Median Storage, #	0	-	-	0	0	-
Grade, %	0	-	-	0	0	-
Peak Hour Factor	97	97	97	97	97	97
Heavy Vehicles, %	1	1	0	0	0	0
Mvmt Flow	381	82	42	228	67	40

Major/Minor	Major1	Major2	Minor1	Minor2	Minor3
Conflicting Flow All	0	0	465	0	622
Stage 1	-	-	-	-	424
Stage 2	-	-	-	-	198
Critical Hdwy	-	-	4.1	-	6.8
Critical Hdwy Stg 1	-	-	-	-	5.8
Critical Hdwy Stg 2	-	-	-	-	5.8
Follow-up Hdwy	-	-	2.2	-	3.5
Pot Cap-1 Maneuver	-	-	1107	-	423
Stage 1	-	-	-	-	634
Stage 2	-	-	-	-	822
Platoon blocked, %	-	-	-	-	-
Mov Cap-1 Maneuver	-	-	1105	-	406
Mov Cap-2 Maneuver	-	-	-	-	406
Stage 1	-	-	-	-	633
Stage 2	-	-	-	-	791

Approach	EB	WB	NB
HCM Control Delay, s	0	1.3	14.3
HCM LOS			B

Minor Lane/Major Mvmt	NBLn1	EBT	EBR	WBL	WBT
Capacity (veh/h)	494	-	-	1105	-
HCM Lane V/C Ratio	0.217	-	-	0.038	-
HCM Control Delay (s)	14.3	-	-	8.4	-
HCM Lane LOS	B	-	-	A	-
HCM 95th %tile Q(veh)	0.8	-	-	0.1	-

Timings

14: Barton Rd. & Van Buren Bl.

09/19/2022



Lane Group	EBL	EBT	WBL	WBT	NBL	NBT	NBR	SBL	SBT
Lane Configurations	↙	↕↗	↙	↕↗↘	↙↗	↕	↗	↙	↗
Traffic Volume (vph)	100	1187	303	1354	209	61	229	33	27
Future Volume (vph)	100	1187	303	1354	209	61	229	33	27
Turn Type	Prot	NA	Prot	NA	Prot	NA	Perm	Prot	NA
Protected Phases	5	2	1	6	3	8		7	4
Permitted Phases							8		
Detector Phase	5	2	1	6	3	8	8	7	4
Switch Phase									
Minimum Initial (s)	5.0	10.0	5.0	10.0	5.0	10.0	10.0	5.0	10.0
Minimum Split (s)	9.2	25.2	9.2	25.5	9.1	14.6	14.6	9.1	33.6
Total Split (s)	17.6	52.1	22.2	56.7	12.1	36.3	36.3	9.4	33.6
Total Split (%)	14.7%	43.4%	18.5%	47.3%	10.1%	30.3%	30.3%	7.8%	28.0%
Yellow Time (s)	3.2	5.2	3.2	5.5	3.6	3.6	3.6	3.6	3.6
All-Red Time (s)	1.0	1.0	1.0	1.0	0.5	1.0	1.0	0.5	1.0
Lost Time Adjust (s)	0.0	0.0	0.0	0.0	0.0	0.0	0.0	0.0	0.0
Total Lost Time (s)	4.2	6.2	4.2	6.5	4.1	4.6	4.6	4.1	4.6
Lead/Lag	Lead	Lag	Lead	Lag	Lead	Lag	Lag	Lead	Lag
Lead-Lag Optimize?	Yes	Yes	Yes	Yes	Yes	Yes	Yes	Yes	Yes
Recall Mode	None	None	None	None	None	None	None	None	None
Act Effct Green (s)	9.9	46.1	18.1	54.0	8.0	20.0	20.0	5.3	13.4
Actuated g/C Ratio	0.09	0.44	0.17	0.52	0.08	0.19	0.19	0.05	0.13
v/c Ratio	0.61	0.97	1.04	0.57	0.81	0.18	0.49	0.37	0.39
Control Delay	61.9	45.6	104.8	19.8	71.9	38.0	8.4	62.3	17.5
Queue Delay	0.0	0.0	0.0	0.0	0.0	0.0	0.0	0.0	0.0
Total Delay	61.9	45.6	104.8	19.8	71.9	38.0	8.4	62.3	17.5
LOS	E	D	F	B	E	D	A	E	B
Approach Delay		46.6		34.6		38.6			27.8
Approach LOS		D		C		D			C

Intersection Summary

Cycle Length: 120
 Actuated Cycle Length: 104.8
 Natural Cycle: 120
 Control Type: Actuated-Uncoordinated
 Maximum v/c Ratio: 1.04
 Intersection Signal Delay: 39.6
 Intersection LOS: D
 Intersection Capacity Utilization 81.7%
 ICU Level of Service D
 Analysis Period (min) 15

Splits and Phases: 14: Barton Rd. & Van Buren Bl.



HCM 6th Signalized Intersection Summary
14: Barton Rd. & Van Buren Bl.

West Campus Upper Plateau (JN 14064)

09/19/2022



Movement	EBL	EBT	EBR	WBL	WBT	WBR	NBL	NBT	NBR	SBL	SBT	SBR
Lane Configurations	↗	↗↘		↗	↗↘↙		↗↘	↑	↗	↗	↘	↘
Traffic Volume (veh/h)	100	1187	218	303	1354	80	209	61	229	33	27	82
Future Volume (veh/h)	100	1187	218	303	1354	80	209	61	229	33	27	82
Initial Q (Qb), veh	0	0	0	0	0	0	0	0	0	0	0	0
Ped-Bike Adj(A_pbT)	1.00		1.00	1.00		1.00	1.00		0.94	1.00		1.00
Parking Bus, Adj	1.00	1.00	1.00	1.00	1.00	1.00	1.00	1.00	1.00	1.00	1.00	1.00
Work Zone On Approach		No			No			No			No	
Adj Sat Flow, veh/h/ln	1900	1856	1870	1870	1870	1856	1900	1900	1885	1900	1885	1900
Adj Flow Rate, veh/h	104	1236	170	316	1410	73	218	64	115	34	28	27
Peak Hour Factor	0.96	0.96	0.96	0.96	0.96	0.96	0.96	0.96	0.96	0.96	0.96	0.96
Percent Heavy Veh, %	0	3	2	2	2	3	0	0	1	0	1	0
Cap, veh/h	132	1345	184	329	2703	140	285	291	231	56	91	87
Arrive On Green	0.07	0.43	0.43	0.18	0.54	0.54	0.08	0.15	0.15	0.03	0.10	0.10
Sat Flow, veh/h	1810	3115	426	1781	4970	257	3510	1900	1509	1810	882	850
Grp Volume(v), veh/h	104	697	709	316	966	517	218	64	115	34	0	55
Grp Sat Flow(s),veh/h/ln	1810	1763	1778	1781	1702	1824	1755	1900	1509	1810	0	1732
Q Serve(g_s), s	5.5	36.2	36.7	17.1	17.6	17.6	5.9	2.9	6.8	1.8	0.0	2.9
Cycle Q Clear(g_c), s	5.5	36.2	36.7	17.1	17.6	17.6	5.9	2.9	6.8	1.8	0.0	2.9
Prop In Lane	1.00		0.24	1.00		0.14	1.00		1.00	1.00		0.49
Lane Grp Cap(c), veh/h	132	761	768	329	1851	992	285	291	231	56	0	178
V/C Ratio(X)	0.79	0.92	0.92	0.96	0.52	0.52	0.76	0.22	0.50	0.61	0.00	0.31
Avail Cap(c_a), veh/h	249	831	839	329	1851	992	289	619	491	99	0	516
HCM Platoon Ratio	1.00	1.00	1.00	1.00	1.00	1.00	1.00	1.00	1.00	1.00	1.00	1.00
Upstream Filter(I)	1.00	1.00	1.00	1.00	1.00	1.00	1.00	1.00	1.00	1.00	0.00	1.00
Uniform Delay (d), s/veh	44.4	26.0	26.1	39.3	14.1	14.1	43.8	36.1	37.8	46.6	0.0	40.5
Incr Delay (d2), s/veh	3.9	13.3	14.3	38.4	0.1	0.2	11.4	0.4	1.7	10.2	0.0	1.0
Initial Q Delay(d3),s/veh	0.0	0.0	0.0	0.0	0.0	0.0	0.0	0.0	0.0	0.0	0.0	0.0
%ile BackOfQ(50%),veh/ln	2.5	16.1	16.7	10.5	5.8	6.2	2.9	1.3	2.5	1.0	0.0	1.3
Unsig. Movement Delay, s/veh												
LnGrp Delay(d),s/veh	48.3	39.3	40.4	77.7	14.3	14.4	55.2	36.5	39.5	56.8	0.0	41.4
LnGrp LOS	D	D	D	E	B	B	E	D	D	E	A	D
Approach Vol, veh/h		1510			1799			397				89
Approach Delay, s/veh		40.4			25.4			47.6				47.3
Approach LOS		D			C			D				D
Timer - Assigned Phs	1	2	3	4	5	6	7	8				
Phs Duration (G+Y+Rc), s	22.2	48.5	12.0	14.6	11.3	59.4	7.1	19.5				
Change Period (Y+Rc), s	* 4.2	* 6.5	4.1	4.6	* 4.2	6.5	4.1	4.6				
Max Green Setting (Gmax), s	* 18	* 46	8.0	29.0	* 13	50.2	5.3	31.7				
Max Q Clear Time (g_c+I1), s	19.1	38.7	7.9	4.9	7.5	19.6	3.8	8.8				
Green Ext Time (p_c), s	0.0	3.4	0.0	0.2	0.0	6.6	0.0	0.6				

Intersection Summary

HCM 6th Ctrl Delay	34.2
HCM 6th LOS	C

Notes

* HCM 6th computational engine requires equal clearance times for the phases crossing the barrier.

Timings
15: Airman Dr & Cactus Av.

West Campus Upper Plateau (JN 14064)

09/19/2022

Lane Group	WBL	WBR	NBR	SBL	Ø6
Lane Configurations	↖	↗	↖	↖↗	
Traffic Volume (vph)	305	379	696	902	
Future Volume (vph)	305	379	696	902	
Turn Type	Prot	Perm	Perm	Prot	
Protected Phases	8			1	6
Permitted Phases		8	2		
Detector Phase	8	8	2	1	
Switch Phase					
Minimum Initial (s)	10.0	10.0	10.0	5.0	10.0
Minimum Split (s)	21.7	21.7	21.7	9.6	14.7
Total Split (s)	30.0	30.0	48.0	42.0	90.0
Total Split (%)	25.0%	25.0%	40.0%	35.0%	75%
Yellow Time (s)	3.7	3.7	3.7	3.6	3.7
All-Red Time (s)	1.0	1.0	1.0	1.0	1.0
Lost Time Adjust (s)	0.0	0.0	0.0	0.0	
Total Lost Time (s)	4.7	4.7	4.7	4.6	
Lead/Lag			Lag	Lead	
Lead-Lag Optimize?			Yes	Yes	
Recall Mode	None	None	Min	None	Min
Act Effct Green (s)	23.6	23.6	33.8	34.1	
Actuated g/C Ratio	0.22	0.22	0.32	0.32	
v/c Ratio	0.85	0.62	0.94	0.91	
Control Delay	63.3	8.5	34.9	49.8	
Queue Delay	0.0	0.0	0.0	0.0	
Total Delay	63.3	8.5	34.9	49.8	
LOS	E	A	C	D	
Approach Delay	33.0				
Approach LOS	C				

Intersection Summary

Cycle Length: 120
 Actuated Cycle Length: 106.1
 Natural Cycle: 80
 Control Type: Actuated-Uncoordinated
 Maximum v/c Ratio: 0.94
 Intersection Signal Delay: 40.2
 Intersection LOS: D
 Intersection Capacity Utilization 76.6%
 ICU Level of Service D
 Analysis Period (min) 15













Splits and Phases: 15: Airman Dr & Cactus Av.



HCM 6th Signalized Intersection Summary
15: Airman Dr & Cactus Av.

West Campus Upper Plateau (JN 14064)

09/19/2022

						
Movement	WBL	WBR	NBT	NBR	SBL	SBT
Lane Configurations					 	
Traffic Volume (veh/h)	305	379	0	696	902	0
Future Volume (veh/h)	305	379	0	696	902	0
Initial Q (Qb), veh	0	0	0	0	0	0
Ped-Bike Adj(A_pbT)	1.00	1.00		1.00	1.00	
Parking Bus, Adj	1.00	1.00	1.00	1.00	1.00	1.00
Work Zone On Approach	No		No			No
Adj Sat Flow, veh/h/ln	1856	1826	1900	1856	1826	1900
Adj Flow Rate, veh/h	332	222	0	404	980	0
Peak Hour Factor	0.92	0.92	0.92	0.92	0.92	0.92
Percent Heavy Veh, %	3	5	0	3	5	0
Cap, veh/h	389	340	546	452	1093	1267
Arrive On Green	0.22	0.22	0.00	0.29	0.32	0.00
Sat Flow, veh/h	1767	1547	1900	1572	3374	1900
Grp Volume(v), veh/h	332	222	0	404	980	0
Grp Sat Flow(s),veh/h/ln	1767	1547	1900	1572	1687	1900
Q Serve(g_s), s	15.0	10.9	0.0	20.5	23.0	0.0
Cycle Q Clear(g_c), s	15.0	10.9	0.0	20.5	23.0	0.0
Prop In Lane	1.00	1.00		1.00	1.00	
Lane Grp Cap(c), veh/h	389	340	546	452	1093	1267
V/C Ratio(X)	0.85	0.65	0.00	0.89	0.90	0.00
Avail Cap(c_a), veh/h	538	471	990	820	1519	1951
HCM Platoon Ratio	1.00	1.00	1.00	1.00	1.00	1.00
Upstream Filter(I)	1.00	1.00	0.00	1.00	1.00	0.00
Uniform Delay (d), s/veh	31.1	29.5	0.0	28.4	26.7	0.0
Incr Delay (d2), s/veh	9.5	2.1	0.0	6.4	4.5	0.0
Initial Q Delay(d3),s/veh	0.0	0.0	0.0	0.0	0.0	0.0
%ile BackOfQ(50%),veh/ln	7.2	4.1	0.0	8.2	9.5	0.0
Unsig. Movement Delay, s/veh						
LnGrp Delay(d),s/veh	40.6	31.6	0.0	34.7	31.3	0.0
LnGrp LOS	D	C	A	C	C	A
Approach Vol, veh/h	554		404			980
Approach Delay, s/veh	37.0		34.7			31.3
Approach LOS	D		C			C
Timer - Assigned Phs	1	2			6	8
Phs Duration (G+Y+Rc), s	31.5	28.6			60.1	23.0
Change Period (Y+Rc), s	4.6	* 4.7			* 4.7	4.7
Max Green Setting (Gmax), s	37.4	* 43			* 85	25.3
Max Q Clear Time (g_c+I1), s	25.0	22.5			0.0	17.0
Green Ext Time (p_c), s	1.9	1.4			0.0	1.3

Intersection Summary

HCM 6th Ctrl Delay	33.6
HCM 6th LOS	C

Notes

* HCM 6th computational engine requires equal clearance times for the phases crossing the barrier.

Intersection

Intersection Delay, s/veh	8.9
Intersection LOS	A

Movement	EBT	EBR	WBL	WBT	NBL	NBR
Lane Configurations						
Traffic Vol, veh/h	191	61	35	86	49	58
Future Vol, veh/h	191	61	35	86	49	58
Peak Hour Factor	0.94	0.94	0.94	0.94	0.94	0.94
Heavy Vehicles, %	1	2	3	1	2	0
Mvmt Flow	203	65	37	91	52	62
Number of Lanes	1	0	1	1	1	0

Approach	EB	WB	NB
Opposing Approach	WB	EB	
Opposing Lanes	2	1	0
Conflicting Approach Left		NB	EB
Conflicting Lanes Left	0	1	1
Conflicting Approach Right	NB		WB
Conflicting Lanes Right	1	0	2
HCM Control Delay	9.3	8.5	8.4
HCM LOS	A	A	A

Lane	NBLn1	EBLn1	WBLn1	WBLn2
Vol Left, %	46%	0%	100%	0%
Vol Thru, %	0%	76%	0%	100%
Vol Right, %	54%	24%	0%	0%
Sign Control	Stop	Stop	Stop	Stop
Traffic Vol by Lane	107	252	35	86
LT Vol	49	0	35	0
Through Vol	0	191	0	86
RT Vol	58	61	0	0
Lane Flow Rate	114	268	37	91
Geometry Grp	2	5	7	7
Degree of Util (X)	0.145	0.32	0.057	0.127
Departure Headway (Hd)	4.597	4.298	5.526	4.989
Convergence, Y/N	Yes	Yes	Yes	Yes
Cap	781	839	649	720
Service Time	2.621	2.316	3.248	2.711
HCM Lane V/C Ratio	0.146	0.319	0.057	0.126
HCM Control Delay	8.4	9.3	8.6	8.4
HCM Lane LOS	A	A	A	A
HCM 95th-tile Q	0.5	1.4	0.2	0.4

Intersection	
Intersection Delay, s/veh	8.6
Intersection LOS	A

Movement	EBL	EBT	WBT	WBR	SBL	SBR
Lane Configurations						
Traffic Vol, veh/h	113	278	199	32	25	36
Future Vol, veh/h	113	278	199	32	25	36
Peak Hour Factor	0.97	0.97	0.97	0.97	0.97	0.97
Heavy Vehicles, %	1	0	2	0	4	3
Mvmt Flow	116	287	205	33	26	37
Number of Lanes	1	2	2	0	1	0

Approach	EB	WB	SB
Opposing Approach	WB	EB	
Opposing Lanes	2	3	0
Conflicting Approach Left	SB		WB
Conflicting Lanes Left	1	0	2
Conflicting Approach Right		SB	EB
Conflicting Lanes Right	0	1	3
HCM Control Delay	8.1	9.2	9.1
HCM LOS	A	A	A

Lane	EBLn1	EBLn2	EBLn3	WBLn1	WBLn2	SBLn1
Vol Left, %	100%	0%	0%	0%	0%	41%
Vol Thru, %	0%	100%	100%	100%	67%	0%
Vol Right, %	0%	0%	0%	0%	33%	59%
Sign Control	Stop	Stop	Stop	Stop	Stop	Stop
Traffic Vol by Lane	113	139	139	133	98	61
LT Vol	113	0	0	0	0	25
Through Vol	0	139	139	133	66	0
RT Vol	0	0	0	0	32	36
Lane Flow Rate	116	143	143	137	101	63
Geometry Grp	7	7	7	8	8	7
Degree of Util (X)	0.175	0.195	0.127	0.205	0.145	0.099
Departure Headway (Hd)	5.417	4.898	3.191	5.407	5.144	5.679
Convergence, Y/N	Yes	Yes	Yes	Yes	Yes	Yes
Cap	663	734	1122	663	696	629
Service Time	3.141	2.622	0.914	3.142	2.879	3.425
HCM Lane V/C Ratio	0.175	0.195	0.127	0.207	0.145	0.1
HCM Control Delay	9.3	8.8	6.4	9.5	8.8	9.1
HCM Lane LOS	A	A	A	A	A	A
HCM 95th-tile Q	0.6	0.7	0.4	0.8	0.5	0.3

Timings
18: Linebacker Dr & Cactus Av.

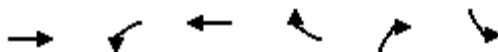

Lane Group	EBT	WBL	WBT	WBR	NBR	SBL	Ø3	Ø4	Ø5	Ø8
Lane Configurations	↑↑	↑	↑	↑	↑	↑↑				
Traffic Volume (vph)	1598	183	684	182	503	502				
Future Volume (vph)	1598	183	684	182	503	502				
Turn Type	NA	Prot	NA	Perm	pm+ov	Prot				
Protected Phases	2	1	6		1	7	3	4	5	8
Permitted Phases				6	8					
Detector Phase	2	1	6	6	1	7				
Switch Phase										
Minimum Initial (s)	10.0	5.0	10.0	10.0	5.0	5.0	5.0	10.0	5.0	10.0
Minimum Split (s)	27.0	9.6	27.0	27.0	9.6	9.6	9.6	27.0	9.6	27.0
Total Split (s)	56.0	17.0	63.4	63.4	17.0	20.0	9.6	37.4	9.6	27.0
Total Split (%)	46.7%	14.2%	52.8%	52.8%	14.2%	16.7%	8%	31%	8%	23%
Yellow Time (s)	4.0	3.6	4.0	4.0	3.6	3.6	3.6	4.0	3.6	4.0
All-Red Time (s)	1.0	1.0	1.0	1.0	1.0	1.0	1.0	1.0	1.0	1.0
Lost Time Adjust (s)	0.0	0.0	0.0	0.0	0.0	0.0				
Total Lost Time (s)	5.0	4.6	5.0	5.0	4.6	4.6				
Lead/Lag	Lead	Lag	Lag	Lag	Lag	Lag	Lag	Lead	Lead	Lead
Lead-Lag Optimize?	Yes	Yes	Yes	Yes	Yes	Yes	Yes	Yes	Yes	Yes
Recall Mode	None	None	None	None	None	None	None	None	None	None
Act Effct Green (s)	51.5	12.5	68.7	68.7	17.0	15.6				
Actuated g/C Ratio	0.52	0.13	0.70	0.70	0.17	0.16				
v/c Ratio	0.91	0.91	0.58	0.18	1.42	1.01				
Control Delay	30.8	86.0	11.9	2.3	226.8	82.4				
Queue Delay	0.0	0.0	0.0	0.0	0.0	0.0				
Total Delay	30.8	86.0	11.9	2.3	226.8	82.4				
LOS	C	F	B	A	F	F				
Approach Delay	30.8		23.2							
Approach LOS	C		C							

Intersection Summary

Cycle Length: 120
 Actuated Cycle Length: 98.4
 Natural Cycle: 120
 Control Type: Actuated-Uncoordinated
 Maximum v/c Ratio: 1.42
 Intersection Signal Delay: 62.7
 Intersection LOS: E
 Intersection Capacity Utilization 101.5%
 ICU Level of Service G
 Analysis Period (min) 15

Splits and Phases: 18: Linebacker Dr & Cactus Av.

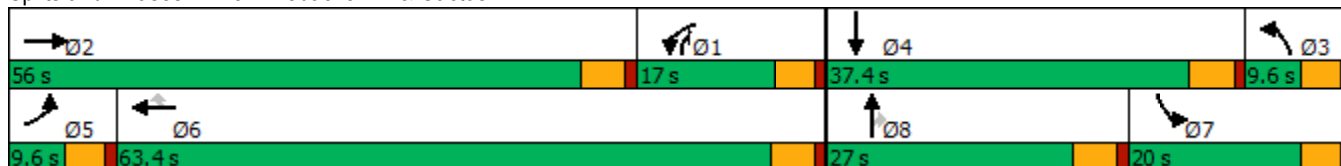

HCM 6th Signalized Intersection Summary
18: Linebacker Dr & Cactus Av.

West Campus Upper Plateau (JN 14064)

09/19/2022



Movement	EBL	EBT	EBR	WBL	WBT	WBR	NBL	NBT	NBR	SBL	SBT	SBR
Lane Configurations	↖	↗		↖	↗	↗	↖	↗	↗	↗	↗	↗
Traffic Volume (veh/h)	0	1598	0	183	684	182	0	0	503	502	0	0
Future Volume (veh/h)	0	1598	0	183	684	182	0	0	503	502	0	0
Initial Q (Qb), veh	0	0	0	0	0	0	0	0	0	0	0	0
Ped-Bike Adj(A_pbT)	1.00		1.00	1.00		1.00	1.00		1.00	1.00		1.00
Parking Bus, Adj	1.00	1.00	1.00	1.00	1.00	1.00	1.00	1.00	1.00	1.00	1.00	1.00
Work Zone On Approach		No			No			No			No	
Adj Sat Flow, veh/h/ln	1900	1841	1900	1826	1841	1826	1900	1900	1826	1826	1900	1900
Adj Flow Rate, veh/h	0	1737	0	199	743	198	0	0	275	546	0	0
Peak Hour Factor	0.92	0.92	0.92	0.92	0.92	0.92	0.92	0.92	0.92	0.92	0.92	0.92
Percent Heavy Veh, %	0	4	0	5	4	5	0	0	5	5	0	0
Cap, veh/h	2	1732	0	199	1162	976	507	175	320	494	2	0
Arrive On Green	0.00	0.47	0.00	0.11	0.63	0.63	0.00	0.00	0.09	0.14	0.00	0.00
Sat Flow, veh/h	1810	3681	0	1739	1841	1547	1810	1900	1547	3478	1900	0
Grp Volume(v), veh/h	0	1737	0	199	743	198	0	0	275	546	0	0
Grp Sat Flow(s),veh/h/ln	1810	1841	0	1739	1841	1547	1810	1900	1547	1739	1900	0
Q Serve(g_s), s	0.0	51.0	0.0	12.4	27.1	2.2	0.0	0.0	6.2	15.4	0.0	0.0
Cycle Q Clear(g_c), s	0.0	51.0	0.0	12.4	27.1	2.2	0.0	0.0	6.2	15.4	0.0	0.0
Prop In Lane	1.00		0.00	1.00		1.00	1.00		1.00	1.00		0.00
Lane Grp Cap(c), veh/h	2	1732	0	199	1162	976	507	175	320	494	2	0
V/C Ratio(X)	0.00	1.00	0.00	1.00	0.64	0.20	0.00	0.00	0.86	1.11	0.00	0.00
Avail Cap(c_a), veh/h	83	1732	0	199	1162	976	507	386	491	494	568	0
HCM Platoon Ratio	1.00	1.00	1.00	1.00	1.00	1.00	1.00	1.00	1.00	1.00	1.00	1.00
Upstream Filter(I)	0.00	1.00	0.00	1.00	1.00	1.00	0.00	0.00	1.00	1.00	0.00	0.00
Uniform Delay (d), s/veh	0.0	28.7	0.0	48.0	12.4	1.2	0.0	0.0	41.5	46.5	0.0	0.0
Incr Delay (d2), s/veh	0.0	22.3	0.0	63.9	1.2	0.1	0.0	0.0	9.3	72.3	0.0	0.0
Initial Q Delay(d3),s/veh	0.0	0.0	0.0	0.0	0.0	0.0	0.0	0.0	0.0	0.0	0.0	0.0
%ile BackOfQ(50%),veh/ln	0.0	26.7	0.0	8.9	10.6	1.7	0.0	0.0	7.9	11.6	0.0	0.0
Unsig. Movement Delay, s/veh												
LnGrp Delay(d),s/veh	0.0	51.0	0.0	111.9	13.6	1.3	0.0	0.0	50.8	118.8	0.0	0.0
LnGrp LOS	A	F	A	F	B	A	A	A	D	F	A	A
Approach Vol, veh/h		1737			1140			275			546	
Approach Delay, s/veh		51.0			28.6			50.8			118.8	
Approach LOS		D			C			D			F	
Timer - Assigned Phs	1	2	3	4	5	6	7	8				
Phs Duration (G+Y+Rc), s	17.4	56.0	35.0	0.0	0.0	73.4	20.0	15.0				
Change Period (Y+Rc), s	5.0	* 5	4.6	5.0	4.6	5.0	4.6	5.0				
Max Green Setting (Gmax), s	12.4	* 51	5.0	32.4	5.0	58.4	15.4	22.0				
Max Q Clear Time (g_c+I1), s	14.4	53.0	0.0	0.0	0.0	29.1	17.4	8.2				
Green Ext Time (p_c), s	0.0	0.0	0.0	0.0	0.0	6.9	0.0	0.8				

Intersection Summary

HCM 6th Ctrl Delay	54.1
HCM 6th LOS	D

Notes

* HCM 6th computational engine requires equal clearance times for the phases crossing the barrier.

Timings
19: Van Buren Bl. & Orange Terrace Pkwy.

West Campus Upper Plateau (JN 14064)

09/19/2022

Lane Group	EBL	EBT	EBR	WBL	WBT	WBR	NBL	NBT	NBR	SBL	SBT	SBR
Lane Configurations												
Traffic Volume (vph)	124	1341	77	47	1557	200	59	30	37	107	30	96
Future Volume (vph)	124	1341	77	47	1557	200	59	30	37	107	30	96
Turn Type	Prot	NA	Perm	Prot	NA	Perm	Prot	NA	Perm	Prot	NA	pm+ov
Protected Phases	5	2		1	6		3	8		7	4	5
Permitted Phases			2			6			8			4
Detector Phase	5	2	2	1	6	6	3	8	8	7	4	5
Switch Phase												
Minimum Initial (s)	5.0	10.0	10.0	5.0	10.0	10.0	5.0	5.0	5.0	10.0	10.0	5.0
Minimum Split (s)	9.2	25.2	25.2	9.1	25.2	25.2	9.1	26.1	26.1	15.8	24.8	9.2
Total Split (s)	16.0	63.0	63.0	11.0	58.0	58.0	12.0	27.0	27.0	19.0	34.0	16.0
Total Split (%)	13.3%	52.5%	52.5%	9.2%	48.3%	48.3%	10.0%	22.5%	22.5%	15.8%	28.3%	13.3%
Yellow Time (s)	3.2	5.2	5.2	3.6	5.2	5.2	3.6	3.6	3.6	4.8	4.8	3.2
All-Red Time (s)	1.0	1.0	1.0	0.5	1.0	1.0	0.5	0.5	0.5	1.0	1.0	1.0
Lost Time Adjust (s)	0.0	0.0	0.0	0.0	0.0	0.0	0.0	0.0	0.0	0.0	0.0	0.0
Total Lost Time (s)	4.2	6.2	6.2	4.1	6.2	6.2	4.1	4.1	4.1	5.8	5.8	4.2
Lead/Lag	Lead	Lag	Lag	Lead	Lag	Lag	Lead	Lag	Lag	Lead	Lag	Lead
Lead-Lag Optimize?	Yes	Yes	Yes	Yes	Yes	Yes	Yes	Yes	Yes	Yes	Yes	Yes
Recall Mode	None	None	None	None	None	None	None	None	None	None	None	None
Act Effct Green (s)	8.3	50.8	50.8	7.0	40.8	40.8	10.7	8.5	8.5	11.4	12.6	17.7
Actuated g/C Ratio	0.10	0.62	0.62	0.09	0.50	0.50	0.13	0.10	0.10	0.14	0.15	0.22
v/c Ratio	0.37	0.44	0.08	0.17	0.64	0.23	0.14	0.08	0.12	0.23	0.11	0.25
Control Delay	44.0	13.6	0.2	44.3	18.7	3.8	41.7	39.9	0.7	40.9	38.1	13.1
Queue Delay	0.0	0.0	0.0	0.0	0.0	0.0	0.0	0.0	0.0	0.0	0.0	0.0
Total Delay	44.0	13.6	0.2	44.3	18.7	3.8	41.7	39.9	0.7	40.9	38.1	13.1
LOS	D	B	A	D	B	A	D	D	A	D	D	B
Approach Delay		15.3			17.7			29.1			29.0	
Approach LOS		B			B			C			C	

Intersection Summary

Cycle Length: 120
 Actuated Cycle Length: 81.7
 Natural Cycle: 90
 Control Type: Actuated-Uncoordinated
 Maximum v/c Ratio: 0.64
 Intersection Signal Delay: 17.8
 Intersection LOS: B
 Intersection Capacity Utilization 57.5%
 ICU Level of Service B
 Analysis Period (min) 15

Splits and Phases: 19: Van Buren Bl. & Orange Terrace Pkwy.

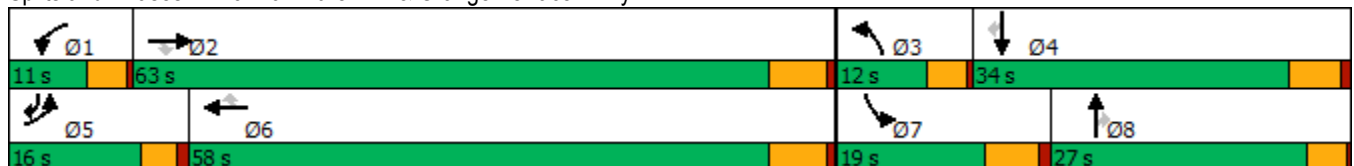

HCM 6th Signalized Intersection Summary
 19: Van Buren Bl. & Orange Terrace Pkwy.

West Campus Upper Plateau (JN 14064)

09/19/2022



Movement	EBL	EBT	EBR	WBL	WBT	WBR	NBL	NBT	NBR	SBL	SBT	SBR
Lane Configurations	↔↔	↑↑↑	↔	↔↔	↑↑↑	↔	↔↔	↑↑	↔	↔↔	↑	↔↔
Traffic Volume (veh/h)	124	1341	77	47	1557	200	59	30	37	107	30	96
Future Volume (veh/h)	124	1341	77	47	1557	200	59	30	37	107	30	96
Initial Q (Qb), veh	0	0	0	0	0	0	0	0	0	0	0	0
Ped-Bike Adj(A_pbT)	1.00		1.00	1.00		1.00	1.00		1.00	1.00		1.00
Parking Bus, Adj	1.00	1.00	1.00	1.00	1.00	1.00	1.00	1.00	1.00	1.00	1.00	1.00
Work Zone On Approach		No			No			No			No	
Adj Sat Flow, veh/h/ln	1885	1870	1811	1870	1856	1885	1796	1900	1856	1885	1900	1885
Adj Flow Rate, veh/h	129	1397	54	49	1622	149	61	31	8	111	31	27
Peak Hour Factor	0.96	0.96	0.96	0.96	0.96	0.96	0.96	0.96	0.96	0.96	0.96	0.96
Percent Heavy Veh, %	1	2	6	2	3	1	7	0	3	1	0	1
Cap, veh/h	212	2465	741	146	2345	739	157	226	98	448	315	362
Arrive On Green	0.06	0.48	0.48	0.04	0.46	0.46	0.05	0.06	0.06	0.13	0.17	0.17
Sat Flow, veh/h	3483	5106	1535	3456	5066	1598	3319	3610	1572	3483	1900	1598
Grp Volume(v), veh/h	129	1397	54	49	1622	149	61	31	8	111	31	27
Grp Sat Flow(s),veh/h/ln	1742	1702	1535	1728	1689	1598	1659	1805	1572	1742	1900	1598
Q Serve(g_s), s	2.8	15.0	1.5	1.1	19.5	4.3	1.4	0.6	0.4	2.2	1.1	1.0
Cycle Q Clear(g_c), s	2.8	15.0	1.5	1.1	19.5	4.3	1.4	0.6	0.4	2.2	1.1	1.0
Prop In Lane	1.00		1.00	1.00		1.00	1.00		1.00	1.00		1.00
Lane Grp Cap(c), veh/h	212	2465	741	146	2345	739	157	226	98	448	315	362
V/C Ratio(X)	0.61	0.57	0.07	0.34	0.69	0.20	0.39	0.14	0.08	0.25	0.10	0.07
Avail Cap(c_a), veh/h	533	3759	1130	309	3401	1073	340	1071	467	596	694	681
HCM Platoon Ratio	1.00	1.00	1.00	1.00	1.00	1.00	1.00	1.00	1.00	1.00	1.00	1.00
Upstream Filter(I)	1.00	1.00	1.00	1.00	1.00	1.00	1.00	1.00	1.00	1.00	1.00	1.00
Uniform Delay (d), s/veh	35.3	14.2	10.7	35.9	16.4	12.3	35.7	34.2	34.1	30.3	27.3	23.5
Incr Delay (d2), s/veh	1.1	0.2	0.0	1.3	0.4	0.1	1.6	0.3	0.3	0.3	0.1	0.1
Initial Q Delay(d3),s/veh	0.0	0.0	0.0	0.0	0.0	0.0	0.0	0.0	0.0	0.0	0.0	0.0
%ile BackOfQ(50%),veh/ln	1.1	4.7	0.5	0.4	6.2	1.4	0.6	0.3	0.1	0.9	0.5	0.4
Unsig. Movement Delay, s/veh												
LnGrp Delay(d),s/veh	36.4	14.4	10.7	37.3	16.7	12.4	37.2	34.5	34.4	30.5	27.4	23.5
LnGrp LOS	D	B	B	D	B	B	D	C	C	C	C	C
Approach Vol, veh/h		1580			1820			100			169	
Approach Delay, s/veh		16.1			16.9			36.2			28.8	
Approach LOS		B			B			D			C	
Timer - Assigned Phs	1	2	3	4	5	6	7	8				
Phs Duration (G+Y+Rc), s	7.4	43.4	7.7	18.6	8.9	41.9	15.7	10.6				
Change Period (Y+Rc), s	4.1	6.2	4.1	5.8	* 4.2	6.2	5.8	* 5.8				
Max Green Setting (Gmax), s	6.9	56.8	7.9	28.2	* 12	51.8	13.2	* 23				
Max Q Clear Time (g_c+I1), s	3.1	17.0	3.4	3.1	4.8	21.5	4.2	2.6				
Green Ext Time (p_c), s	0.0	12.2	0.0	0.2	0.1	14.2	0.2	0.1				

Intersection Summary

HCM 6th Ctrl Delay	17.6
HCM 6th LOS	B

Notes

* HCM 6th computational engine requires equal clearance times for the phases crossing the barrier.

Timings
20: Brown/San Gorgonio Dr & Alessandro Bl.

West Campus Upper Plateau (JN 14064)

09/19/2022



Lane Group	EBL	EBT	WBL	WBT	WBR	NBL	NBT	NBR	SBL	SBT	SBR
Lane Configurations	↙	↕↕↕	↙	↕↕↕	↙	↙	↕	↙	↙	↕	↙
Traffic Volume (vph)	26	1885	223	1783	29	384	2	468	108	1	68
Future Volume (vph)	26	1885	223	1783	29	384	2	468	108	1	68
Turn Type	Prot	NA	Prot	NA	Perm	Prot	NA	pm+ov	Prot	NA	pm+ov
Protected Phases	5	2	1	6		3	8	1	7	4	5
Permitted Phases					6			8			4
Detector Phase	5	2	1	6	6	3	8	1	7	4	5
Switch Phase											
Minimum Initial (s)	5.0	10.0	5.0	10.0	10.0	5.0	5.0	5.0	5.0	10.0	5.0
Minimum Split (s)	8.7	43.5	9.1	43.5	43.5	9.1	26.1	9.1	8.7	49.8	8.7
Total Split (s)	8.7	52.0	9.1	52.4	52.4	9.1	39.3	9.1	19.6	49.8	8.7
Total Split (%)	7.3%	43.3%	7.6%	43.7%	43.7%	7.6%	32.8%	7.6%	16.3%	41.5%	7.3%
Yellow Time (s)	3.2	5.5	3.6	5.5	5.5	3.6	3.6	3.6	3.2	4.8	3.2
All-Red Time (s)	0.5	1.0	0.5	1.0	1.0	0.5	0.5	0.5	0.5	1.0	0.5
Lost Time Adjust (s)	0.0	0.0	0.0	0.0	0.0	0.0	0.0	0.0	0.0	0.0	0.0
Total Lost Time (s)	3.7	6.5	4.1	6.5	6.5	4.1	4.1	4.1	3.7	5.8	3.7
Lead/Lag	Lead	Lag	Lead	Lag	Lag	Lead	Lag	Lead	Lead	Lag	Lead
Lead-Lag Optimize?	Yes	Yes	Yes	Yes	Yes	Yes	Yes	Yes	Yes	Yes	Yes
Recall Mode	None	None	None	None	None	None	None	None	None	None	None
Act Effct Green (s)	5.2	47.3	5.2	49.8	49.8	7.9	9.9	10.6	9.8	15.1	12.1
Actuated g/C Ratio	0.06	0.57	0.06	0.60	0.60	0.10	0.12	0.13	0.12	0.18	0.15
v/c Ratio	0.24	0.74	2.22	0.61	0.04	2.36	0.01	1.73	0.56	0.00	0.25
Control Delay	48.5	18.5	601.4	15.7	0.1	650.4	31.0	364.9	48.4	26.0	8.9
Queue Delay	0.0	0.0	0.0	0.0	0.0	0.0	0.0	0.0	0.0	0.0	0.0
Total Delay	48.5	18.5	601.4	15.7	0.1	650.4	31.0	364.9	48.4	26.0	8.9
LOS	D	B	F	B	A	F	C	F	D	C	A
Approach Delay		18.8		79.7			492.5			33.1	
Approach LOS		B		E			F			C	

Intersection Summary

Cycle Length: 120	
Actuated Cycle Length: 82.6	
Natural Cycle: 115	
Control Type: Actuated-Uncoordinated	
Maximum v/c Ratio: 2.36	
Intersection Signal Delay: 121.6	Intersection LOS: F
Intersection Capacity Utilization 93.2%	ICU Level of Service F
Analysis Period (min) 15	

Splits and Phases: 20: Brown/San Gorgonio Dr & Alessandro Bl.

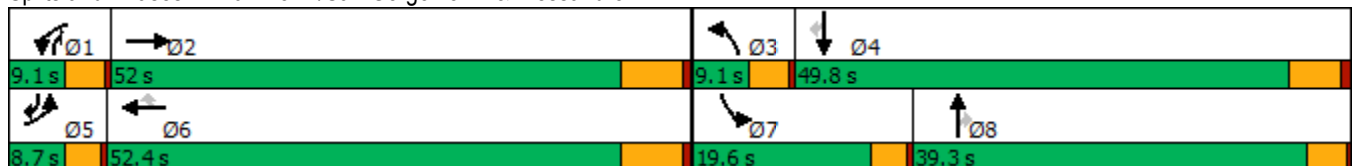

HCM 6th Signalized Intersection Summary
 20: Brown/San Gorgonio Dr & Alessandro Bl.

West Campus Upper Plateau (JN 14064)

09/19/2022



Movement	EBL	EBT	EBR	WBL	WBT	WBR	NBL	NBT	NBR	SBL	SBT	SBR
Lane Configurations	↘	↑↑↑		↘	↑↑↑	↗	↘	↑	↗	↘	↑	↗
Traffic Volume (veh/h)	26	1885	190	223	1783	29	384	2	468	108	1	68
Future Volume (veh/h)	26	1885	190	223	1783	29	384	2	468	108	1	68
Initial Q (Qb), veh	0	0	0	0	0	0	0	0	0	0	0	0
Ped-Bike Adj(A_pbT)	1.00		1.00	1.00		1.00	1.00		1.00	1.00		1.00
Parking Bus, Adj	1.00	1.00	1.00	1.00	1.00	1.00	1.00	1.00	1.00	1.00	1.00	1.00
Work Zone On Approach		No			No			No			No	
Adj Sat Flow, veh/h/ln	1900	1900	1900	1796	1885	1396	1885	1900	1811	1811	1900	1885
Adj Flow Rate, veh/h	27	1984	196	235	1877	27	404	2	480	114	1	24
Peak Hour Factor	0.95	0.95	0.95	0.95	0.95	0.95	0.95	0.95	0.95	0.95	0.95	0.95
Percent Heavy Veh, %	0	0	0	7	1	34	1	0	6	6	0	1
Cap, veh/h	45	1898	186	74	2147	493	78	581	536	139	645	583
Arrive On Green	0.03	0.40	0.40	0.04	0.42	0.42	0.04	0.31	0.31	0.08	0.34	0.34
Sat Flow, veh/h	1810	4803	471	1711	5147	1183	1795	1900	1535	1725	1900	1598
Grp Volume(v), veh/h	27	1424	756	235	1877	27	404	2	480	114	1	24
Grp Sat Flow(s),veh/h/ln	1810	1729	1815	1711	1716	1183	1795	1900	1535	1725	1900	1598
Q Serve(g_s), s	1.7	45.5	45.5	5.0	38.5	1.6	5.0	0.1	34.1	7.5	0.0	1.1
Cycle Q Clear(g_c), s	1.7	45.5	45.5	5.0	38.5	1.6	5.0	0.1	34.1	7.5	0.0	1.1
Prop In Lane	1.00		0.26	1.00		1.00	1.00		1.00	1.00		1.00
Lane Grp Cap(c), veh/h	45	1367	718	74	2147	493	78	581	536	139	645	583
V/C Ratio(X)	0.59	1.04	1.05	3.16	0.87	0.05	5.18	0.00	0.90	0.82	0.00	0.04
Avail Cap(c_a), veh/h	79	1367	718	74	2147	493	78	581	536	238	726	651
HCM Platoon Ratio	1.00	1.00	1.00	1.00	1.00	1.00	1.00	1.00	1.00	1.00	1.00	1.00
Upstream Filter(I)	1.00	1.00	1.00	1.00	1.00	1.00	1.00	1.00	1.00	1.00	1.00	1.00
Uniform Delay (d), s/veh	55.5	34.8	34.8	55.1	30.8	20.0	55.1	27.8	35.5	52.1	25.1	23.6
Incr Delay (d2), s/veh	4.5	36.0	48.5	1007.3	4.5	0.1	1909.2	0.0	17.5	4.4	0.0	0.0
Initial Q Delay(d3),s/veh	0.0	0.0	0.0	0.0	0.0	0.0	0.0	0.0	0.0	0.0	0.0	0.0
%ile BackOfQ(50%),veh/ln	0.8	24.2	27.9	22.9	16.4	0.4	43.6	0.0	15.1	3.4	0.0	0.4
Unsig. Movement Delay, s/veh												
LnGrp Delay(d),s/veh	60.1	70.8	83.3	1062.3	35.3	20.1	1964.3	27.8	53.0	56.5	25.1	23.6
LnGrp LOS	E	F	F	F	D	C	F	C	D	E	C	C
Approach Vol, veh/h		2207			2139			886			139	
Approach Delay, s/veh		75.0			147.9			924.5			50.6	
Approach LOS		E			F			F			D	
Timer - Assigned Phs	1	2	3	4	5	6	7	8				
Phs Duration (G+Y+Rc), s	9.1	52.0	9.1	44.9	6.6	54.5	13.0	41.0				
Change Period (Y+Rc), s	4.1	6.5	4.1	5.8	3.7	6.5	3.7	* 5.8				
Max Green Setting (Gmax), s	5.0	45.5	5.0	44.0	5.0	45.9	15.9	* 35				
Max Q Clear Time (g_c+I1), s	7.0	47.5	7.0	3.1	3.7	40.5	9.5	36.1				
Green Ext Time (p_c), s	0.0	0.0	0.0	0.1	0.0	4.9	0.1	0.0				

Intersection Summary

HCM 6th Ctrl Delay	243.5
HCM 6th LOS	F

Notes

* HCM 6th computational engine requires equal clearance times for the phases crossing the barrier.

Timings
21: Cactus Av. & Brown St



Lane Group	EBL	EBT	WBT	SBR
Lane Configurations	↘	↑↑	↑↑	↗
Traffic Volume (vph)	815	1787	649	400
Future Volume (vph)	815	1787	649	400
Turn Type	Prot	NA	NA	Perm
Protected Phases	7	4	8	
Permitted Phases				6
Detector Phase	7	4	8	6
Switch Phase				
Minimum Initial (s)	5.0	10.0	10.0	10.0
Minimum Split (s)	9.6	15.8	27.8	26.7
Total Split (s)	62.0	92.4	30.4	27.6
Total Split (%)	51.7%	77.0%	25.3%	23.0%
Yellow Time (s)	3.6	4.8	4.8	3.7
All-Red Time (s)	1.0	1.0	1.0	1.0
Lost Time Adjust (s)	0.0	0.0	0.0	0.0
Total Lost Time (s)	4.6	5.8	5.8	4.7
Lead/Lag	Lead		Lag	
Lead-Lag Optimize?	Yes		Yes	
Recall Mode	None	None	None	Min
Act Effct Green (s)	57.5	86.8	24.6	12.2
Actuated g/C Ratio	0.53	0.79	0.22	0.11
v/c Ratio	0.94	0.72	0.92	0.51
Control Delay	42.9	8.1	60.3	2.1
Queue Delay	0.0	0.0	0.0	0.0
Total Delay	42.9	8.1	60.3	2.1
LOS	D	A	E	A
Approach Delay		19.0	60.3	
Approach LOS		B	E	

Intersection Summary

Cycle Length: 120	
Actuated Cycle Length: 109.5	
Natural Cycle: 120	
Control Type: Actuated-Uncoordinated	
Maximum v/c Ratio: 0.94	
Intersection Signal Delay: 24.5	Intersection LOS: C
Intersection Capacity Utilization 71.8%	ICU Level of Service C
Analysis Period (min) 15	

Splits and Phases: 21: Cactus Av. & Brown St



HCM 6th Signalized Intersection Summary
21: Cactus Av. & Brown St

West Campus Upper Plateau (JN 14064)
09/19/2022



Movement	EBL	EBT	WBT	WBR	SBL	SBR	
Lane Configurations	↖	↑↑	↗		↙	↘	
Traffic Volume (veh/h)	815	1787	649	0	0	400	
Future Volume (veh/h)	815	1787	649	0	0	400	
Initial Q (Qb), veh	0	0	0	0	0	0	
Ped-Bike Adj(A_pbT)	1.00			1.00	1.00	1.00	
Parking Bus, Adj	1.00	1.00	1.00	1.00	1.00	1.00	
Work Zone On Approach		No	No		No		
Adj Sat Flow, veh/h/ln	1900	1811	1811	1900	1900	1900	
Adj Flow Rate, veh/h	886	1942	705	0	0	218	
Peak Hour Factor	0.92	0.92	0.92	0.92	0.92	0.92	
Percent Heavy Veh, %	0	6	6	0	0	0	
Cap, veh/h	903	2598	741	0	277	246	
Arrive On Green	0.50	0.75	0.22	0.00	0.00	0.15	
Sat Flow, veh/h	1810	3532	3622	0	1810	1610	
Grp Volume(v), veh/h	886	1942	705	0	0	218	
Grp Sat Flow(s),veh/h/ln	1810	1721	1721	0	1810	1610	
Q Serve(g_s), s	54.9	36.2	23.1	0.0	0.0	15.1	
Cycle Q Clear(g_c), s	54.9	36.2	23.1	0.0	0.0	15.1	
Prop In Lane	1.00			0.00	1.00	1.00	
Lane Grp Cap(c), veh/h	903	2598	741	0	277	246	
V/C Ratio(X)	0.98	0.75	0.95	0.00	0.00	0.88	
Avail Cap(c_a), veh/h	910	2610	741	0	363	323	
HCM Platoon Ratio	1.00	1.00	1.00	1.00	1.00	1.00	
Upstream Filter(I)	1.00	1.00	1.00	0.00	0.00	1.00	
Uniform Delay (d), s/veh	28.1	7.9	44.2	0.0	0.0	47.4	
Incr Delay (d2), s/veh	24.9	1.2	21.8	0.0	0.0	19.9	
Initial Q Delay(d3),s/veh	0.0	0.0	0.0	0.0	0.0	0.0	
%ile BackOfQ(50%),veh/ln	27.6	9.8	11.7	0.0	0.0	14.1	
Unsig. Movement Delay, s/veh							
LnGrp Delay(d),s/veh	53.0	9.1	66.0	0.0	0.0	67.2	
LnGrp LOS	D	A	E	A	A	E	
Approach Vol, veh/h		2828	705		218		
Approach Delay, s/veh		22.8	66.0		67.2		
Approach LOS		C	E		E		
Timer - Assigned Phs				4	6	7	8
Phs Duration (G+Y+Rc), s				92.0	22.2	61.6	30.4
Change Period (Y+Rc), s				5.8	4.7	4.6	5.8
Max Green Setting (Gmax), s				86.6	22.9	57.4	24.6
Max Q Clear Time (g_c+11), s				38.2	17.1	56.9	25.1
Green Ext Time (p_c), s				24.5	0.3	0.2	0.0
Intersection Summary							
HCM 6th Ctrl Delay			33.5				
HCM 6th LOS			C				

Timings
22: Sycamore Canyon Bl. & Eastridge Ave

West Campus Upper Plateau (JN 14064)

09/19/2022



Lane Group	EBL	EBT	EBR	WBL	WBT	WBR	NBL	NBT	NBR	SBL	SBT	SBR
Lane Configurations	↖↖	↑↑↑	↗	↖↖	↑↑	↗	↖↖	↑↑	↗	↖↖	↑↑	↗
Traffic Volume (vph)	82	86	46	164	60	319	29	657	134	251	342	17
Future Volume (vph)	82	86	46	164	60	319	29	657	134	251	342	17
Turn Type	Prot	NA	Perm	Prot	NA	pm+ov	Prot	NA	pm+ov	Prot	NA	pm+ov
Protected Phases	5	2		1	6	7	3	8	1	7	4	5
Permitted Phases			2			6			8			4
Detector Phase	5	2	2	1	6	7	3	8	1	7	4	5
Switch Phase												
Minimum Initial (s)	5.0	10.0	10.0	5.0	10.0	5.0	5.0	10.0	5.0	5.0	10.0	5.0
Minimum Split (s)	8.7	43.5	43.5	8.7	43.5	8.7	8.7	15.8	8.7	8.7	49.8	8.7
Total Split (s)	11.7	45.5	45.5	15.2	49.0	20.2	8.7	39.1	15.2	20.2	50.6	11.7
Total Split (%)	9.8%	37.9%	37.9%	12.7%	40.8%	16.8%	7.3%	32.6%	12.7%	16.8%	42.2%	9.8%
Yellow Time (s)	3.2	5.5	5.5	3.2	5.5	3.2	3.2	4.8	3.2	3.2	4.8	3.2
All-Red Time (s)	0.5	1.0	1.0	0.5	1.0	0.5	0.5	1.0	0.5	0.5	1.0	0.5
Lost Time Adjust (s)	0.0	0.0	0.0	0.0	0.0	0.0	0.0	0.0	0.0	0.0	0.0	0.0
Total Lost Time (s)	3.7	6.5	6.5	3.7	6.5	3.7	3.7	5.8	3.7	3.7	5.8	3.7
Lead/Lag	Lead	Lag	Lag	Lead	Lag	Lead	Lead	Lag	Lead	Lead	Lag	Lead
Lead-Lag Optimize?	Yes	Yes	Yes	Yes	Yes	Yes	Yes	Yes	Yes	Yes	Yes	Yes
Recall Mode	None	None	None	None	None	None	None	None	None	None	None	None
Act Effct Green (s)	7.1	13.8	13.8	11.3	15.5	29.9	5.4	22.7	36.3	11.4	33.6	43.0
Actuated g/C Ratio	0.09	0.18	0.18	0.15	0.21	0.40	0.07	0.30	0.48	0.15	0.45	0.57
v/c Ratio	0.33	0.12	0.14	0.36	0.12	0.57	0.15	0.72	0.19	0.55	0.25	0.02
Control Delay	41.8	29.4	0.7	37.8	27.8	17.6	43.4	29.9	4.3	37.6	16.2	0.1
Queue Delay	0.0	0.0	0.0	0.0	0.0	0.0	0.0	0.0	0.0	0.0	0.0	0.0
Total Delay	41.8	29.4	0.7	37.8	27.8	17.6	43.4	29.9	4.3	37.6	16.2	0.1
LOS	D	C	A	D	C	B	D	C	A	D	B	A
Approach Delay		28.0			24.9			26.2			24.6	
Approach LOS		C			C			C			C	

Intersection Summary

Cycle Length: 120
 Actuated Cycle Length: 75.3
 Natural Cycle: 115
 Control Type: Actuated-Uncoordinated
 Maximum v/c Ratio: 0.72
 Intersection Signal Delay: 25.6
 Intersection LOS: C
 Intersection Capacity Utilization 53.7%
 ICU Level of Service A
 Analysis Period (min) 15

Splits and Phases: 22: Sycamore Canyon Bl. & Eastridge Ave

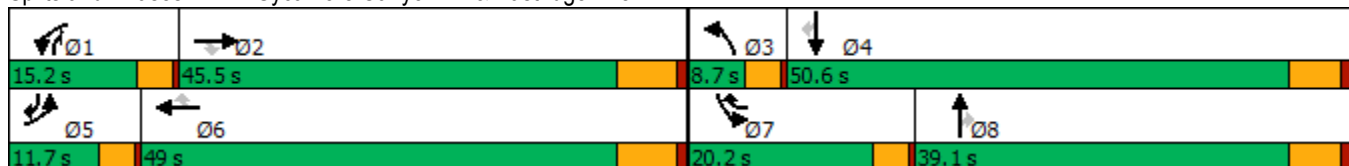

HCM 6th Signalized Intersection Summary
22: Sycamore Canyon Bl. & Eastridge Ave

West Campus Upper Plateau (JN 14064)

09/19/2022



Movement	EBL	EBT	EBR	WBL	WBT	WBR	NBL	NBT	NBR	SBL	SBT	SBR
Lane Configurations	↖↗	↑↑↑	↖	↖↗	↑↑	↖	↖↗	↑↑	↖	↖↗	↑↑	↖
Traffic Volume (veh/h)	82	86	46	164	60	319	29	657	134	251	342	17
Future Volume (veh/h)	82	86	46	164	60	319	29	657	134	251	342	17
Initial Q (Qb), veh	0	0	0	0	0	0	0	0	0	0	0	0
Ped-Bike Adj(A_pbT)	1.00		1.00	1.00		1.00	1.00		0.99	1.00		0.99
Parking Bus, Adj	1.00	1.00	1.00	1.00	1.00	1.00	1.00	1.00	1.00	1.00	1.00	1.00
Work Zone On Approach		No			No			No			No	
Adj Sat Flow, veh/h/ln	1663	1604	1841	1856	1426	1796	1648	1796	1841	1841	1826	1559
Adj Flow Rate, veh/h	92	97	0	184	67	174	33	738	94	282	384	15
Peak Hour Factor	0.89	0.89	0.89	0.89	0.89	0.89	0.89	0.89	0.89	0.89	0.89	0.89
Percent Heavy Veh, %	16	20	4	3	32	7	17	7	4	4	5	23
Cap, veh/h	199	746		286	512	466	107	1040	599	400	1343	590
Arrive On Green	0.06	0.17	0.00	0.08	0.19	0.19	0.04	0.30	0.30	0.12	0.39	0.39
Sat Flow, veh/h	3072	4378	1560	3428	2709	1520	3045	3413	1540	3401	3469	1304
Grp Volume(v), veh/h	92	97	0	184	67	174	33	738	94	282	384	15
Grp Sat Flow(s),veh/h/ln	1536	1459	1560	1714	1354	1520	1522	1706	1540	1700	1735	1304
Q Serve(g_s), s	1.8	1.1	0.0	3.2	1.3	5.5	0.6	11.7	2.4	4.9	4.6	0.4
Cycle Q Clear(g_c), s	1.8	1.1	0.0	3.2	1.3	5.5	0.6	11.7	2.4	4.9	4.6	0.4
Prop In Lane	1.00		1.00	1.00		1.00	1.00		1.00	1.00		1.00
Lane Grp Cap(c), veh/h	199	746		286	512	466	107	1040	599	400	1343	590
V/C Ratio(X)	0.46	0.13		0.64	0.13	0.37	0.31	0.71	0.16	0.71	0.29	0.03
Avail Cap(c_a), veh/h	404	2807		648	1893	1241	250	1868	973	923	2555	1046
HCM Platoon Ratio	1.00	1.00	1.00	1.00	1.00	1.00	1.00	1.00	1.00	1.00	1.00	1.00
Upstream Filter(I)	1.00	1.00	0.00	1.00	1.00	1.00	1.00	1.00	1.00	1.00	1.00	1.00
Uniform Delay (d), s/veh	27.4	21.4	0.0	27.0	20.5	16.5	28.6	18.8	12.1	25.8	12.8	9.2
Incr Delay (d2), s/veh	0.6	0.1	0.0	0.9	0.2	0.7	0.6	0.9	0.1	0.9	0.1	0.0
Initial Q Delay(d3),s/veh	0.0	0.0	0.0	0.0	0.0	0.0	0.0	0.0	0.0	0.0	0.0	0.0
%ile BackOfQ(50%),veh/ln	0.6	0.3	0.0	1.2	0.4	1.7	0.2	4.0	0.7	1.8	1.5	0.1
Unsig. Movement Delay, s/veh												
LnGrp Delay(d),s/veh	28.0	21.5	0.0	27.9	20.7	17.2	29.2	19.7	12.2	26.7	13.0	9.3
LnGrp LOS	C	C		C	C	B	C	B	B	C	B	A
Approach Vol, veh/h		189			425			865			681	
Approach Delay, s/veh		24.7			22.4			19.2			18.6	
Approach LOS		C			C			B			B	
Timer - Assigned Phs	1	2	3	4	5	6	7	8				
Phs Duration (G+Y+Rc), s	8.8	16.9	5.8	29.3	7.6	18.0	10.9	24.3				
Change Period (Y+Rc), s	3.7	6.5	3.7	5.8	3.7	6.5	3.7	5.8				
Max Green Setting (Gmax), s	11.5	39.0	5.0	44.8	8.0	42.5	16.5	33.3				
Max Q Clear Time (g_c+I1), s	5.2	3.1	2.6	6.6	3.8	7.5	6.9	13.7				
Green Ext Time (p_c), s	0.2	0.8	0.0	2.5	0.0	1.5	0.4	4.9				

Intersection Summary

HCM 6th Ctrl Delay	20.1
HCM 6th LOS	C

Notes

Unsignalized Delay for [EBR] is excluded from calculations of the approach delay and intersection delay.

Timings
23: Sycamore Canyon Bl. & Cottonwood Ave

West Campus Upper Plateau (JN 14064)

09/19/2022



Lane Group	WBL	WBR	NBT	SBL	SBT
Lane Configurations	↘	↗	↕↔	↘	↕↕
Traffic Volume (vph)	25	10	763	31	582
Future Volume (vph)	25	10	763	31	582
Turn Type	Prot	Perm	NA	Prot	NA
Protected Phases	8		2	1	6
Permitted Phases		8			
Detector Phase	8	8	2	1	6
Switch Phase					
Minimum Initial (s)	10.0	10.0	10.0	5.0	10.0
Minimum Split (s)	15.8	15.8	43.5	9.1	43.5
Total Split (s)	23.0	23.0	78.0	19.0	97.0
Total Split (%)	19.2%	19.2%	65.0%	15.8%	80.8%
Yellow Time (s)	4.8	4.8	5.5	3.6	5.5
All-Red Time (s)	1.0	1.0	1.0	0.5	1.0
Lost Time Adjust (s)	0.0	0.0	0.0	0.0	0.0
Total Lost Time (s)	5.8	5.8	6.5	4.1	6.5
Lead/Lag			Lag	Lead	
Lead-Lag Optimize?			Yes	Yes	
Recall Mode	None	None	None	None	None
Act Effct Green (s)	13.7	13.7	31.4	8.8	34.5
Actuated g/C Ratio	0.34	0.34	0.79	0.22	0.86
v/c Ratio	0.06	0.03	0.35	0.11	0.22
Control Delay	21.9	14.2	7.3	23.5	2.7
Queue Delay	0.0	0.0	0.0	0.0	0.0
Total Delay	21.9	14.2	7.3	23.5	2.7
LOS	C	B	A	C	A
Approach Delay	19.7		7.3		3.8
Approach LOS	B		A		A

Intersection Summary

Cycle Length: 120
 Actuated Cycle Length: 39.9
 Natural Cycle: 70
 Control Type: Actuated-Uncoordinated
 Maximum v/c Ratio: 0.35
 Intersection Signal Delay: 6.1
 Intersection LOS: A
 Intersection Capacity Utilization 44.3%
 ICU Level of Service A
 Analysis Period (min) 15

Splits and Phases: 23: Sycamore Canyon Bl. & Cottonwood Ave



HCM 6th Signalized Intersection Summary
23: Sycamore Canyon Bl. & Cottonwood Ave

West Campus Upper Plateau (JN 14064)
09/19/2022



Movement	WBL	WBR	NBT	NBR	SBL	SBT
Lane Configurations						
Traffic Volume (veh/h)	25	10	763	22	31	582
Future Volume (veh/h)	25	10	763	22	31	582
Initial Q (Qb), veh	0	0	0	0	0	0
Ped-Bike Adj(A_pbT)	1.00	1.00		0.98	1.00	
Parking Bus, Adj	1.00	1.00	1.00	1.00	1.00	1.00
Work Zone On Approach	No		No			No
Adj Sat Flow, veh/h/ln	1604	1129	1796	1767	1515	1870
Adj Flow Rate, veh/h	29	2	887	25	36	677
Peak Hour Factor	0.86	0.86	0.86	0.86	0.86	0.86
Percent Heavy Veh, %	20	52	7	9	26	2
Cap, veh/h	111	70	1626	46	59	2213
Arrive On Green	0.07	0.07	0.48	0.48	0.04	0.62
Sat Flow, veh/h	1527	957	3477	95	1443	3647
Grp Volume(v), veh/h	29	2	447	465	36	677
Grp Sat Flow(s),veh/h/ln	1527	957	1706	1777	1443	1777
Q Serve(g_s), s	0.7	0.1	7.4	7.4	1.0	3.6
Cycle Q Clear(g_c), s	0.7	0.1	7.4	7.4	1.0	3.6
Prop In Lane	1.00	1.00		0.05	1.00	
Lane Grp Cap(c), veh/h	111	70	819	853	59	2213
V/C Ratio(X)	0.26	0.03	0.55	0.55	0.61	0.31
Avail Cap(c_a), veh/h	650	408	3021	3145	532	7962
HCM Platoon Ratio	1.00	1.00	1.00	1.00	1.00	1.00
Upstream Filter(I)	1.00	1.00	1.00	1.00	1.00	1.00
Uniform Delay (d), s/veh	17.7	17.4	7.4	7.4	19.0	3.6
Incr Delay (d2), s/veh	1.2	0.2	0.8	0.8	9.6	0.1
Initial Q Delay(d3),s/veh	0.0	0.0	0.0	0.0	0.0	0.0
%ile BackOfQ(50%),veh/ln	0.3	0.0	1.6	1.6	0.4	0.3
Unsig. Movement Delay, s/veh						
LnGrp Delay(d),s/veh	18.9	17.6	8.2	8.2	28.6	3.7
LnGrp LOS	B	B	A	A	C	A
Approach Vol, veh/h	31		912			713
Approach Delay, s/veh	18.8		8.2			4.9
Approach LOS	B		A			A
Timer - Assigned Phs	1	2			6	8
Phs Duration (G+Y+Rc), s	5.8	25.9			31.7	8.7
Change Period (Y+Rc), s	4.1	6.5			6.5	5.8
Max Green Setting (Gmax), s	14.9	71.5			90.5	17.2
Max Q Clear Time (g_c+I1), s	3.0	9.4			5.6	2.7
Green Ext Time (p_c), s	0.0	9.9			7.3	0.0

Intersection Summary

HCM 6th Ctrl Delay	7.0
HCM 6th LOS	A

Timings

West Campus Upper Plateau (JN 14064)

24: Sycamore Canyon Bl. & Alessandro Bl.

09/19/2022

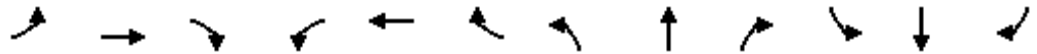

Lane Group	EBL	EBT	EBR	WBL	WBT	WBR	NBL	NBT	NBR	SBL	SBT	SBR
Lane Configurations	↖	↑↑↑	↗	↖↗	↑↑↑	↗	↖↗	↑↑	↖↗	↖↗	↑↑	↗
Traffic Volume (vph)	131	1793	537	316	1646	391	443	446	152	125	509	254
Future Volume (vph)	131	1793	537	316	1646	391	443	446	152	125	509	254
Turn Type	Prot	NA	Perm	Prot	NA	Perm	Prot	NA	pm+ov	Prot	NA	Perm
Protected Phases	5	2		1	6		3	8	1	7	4	
Permitted Phases			2			6			8			4
Detector Phase	5	2	2	1	6	6	3	8	1	7	4	4
Switch Phase												
Minimum Initial (s)	5.0	10.0	10.0	5.0	10.0	10.0	5.0	10.0	5.0	5.0	10.0	10.0
Minimum Split (s)	8.7	43.5	43.5	8.7	43.5	43.5	8.7	15.8	8.7	8.7	49.8	49.8
Total Split (s)	10.0	44.2	44.2	12.0	46.2	46.2	14.0	51.0	12.0	12.8	49.8	49.8
Total Split (%)	8.3%	36.8%	36.8%	10.0%	38.5%	38.5%	11.7%	42.5%	10.0%	10.7%	41.5%	41.5%
Yellow Time (s)	3.2	5.5	5.5	3.2	5.5	5.5	3.2	4.8	3.2	3.2	4.8	4.8
All-Red Time (s)	0.5	1.0	1.0	0.5	1.0	1.0	0.5	1.0	0.5	0.5	1.0	1.0
Lost Time Adjust (s)	0.0	0.0	0.0	0.0	0.0	0.0	0.0	0.0	0.0	0.0	0.0	0.0
Total Lost Time (s)	3.7	6.5	6.5	3.7	6.5	6.5	3.7	5.8	3.7	3.7	5.8	5.8
Lead/Lag	Lead	Lag	Lag	Lead	Lag	Lag	Lead	Lag	Lead	Lead	Lag	Lag
Lead-Lag Optimize?	Yes	Yes	Yes	Yes	Yes	Yes	Yes	Yes	Yes	Yes	Yes	Yes
Recall Mode	None	None	None	None	None	None	None	None	None	None	None	None
Act Effct Green (s)	6.4	38.1	38.1	8.4	40.1	40.1	10.4	26.3	40.5	7.8	23.7	23.7
Actuated g/C Ratio	0.06	0.38	0.38	0.08	0.40	0.40	0.10	0.26	0.40	0.08	0.24	0.24
v/c Ratio	1.18	0.94	0.70	1.22	0.82	0.57	1.27	0.50	0.13	0.49	0.64	0.55
Control Delay	183.1	41.8	18.4	166.4	32.3	17.5	181.1	33.0	10.8	53.0	37.6	19.9
Queue Delay	0.0	0.0	0.0	0.0	0.0	0.0	0.0	0.0	0.0	0.0	0.0	0.0
Total Delay	183.1	41.8	18.4	166.4	32.3	17.5	181.1	33.0	10.8	53.0	37.6	19.9
LOS	F	D	B	F	C	B	F	C	B	D	D	B
Approach Delay		44.3			47.8			92.8			34.7	
Approach LOS		D			D			F			C	

Intersection Summary

Cycle Length: 120
 Actuated Cycle Length: 100.4
 Natural Cycle: 115
 Control Type: Actuated-Uncoordinated
 Maximum v/c Ratio: 1.27
 Intersection Signal Delay: 51.7
 Intersection LOS: D
 Intersection Capacity Utilization 87.3%
 ICU Level of Service E
 Analysis Period (min) 15

Splits and Phases: 24: Sycamore Canyon Bl. & Alessandro Bl.

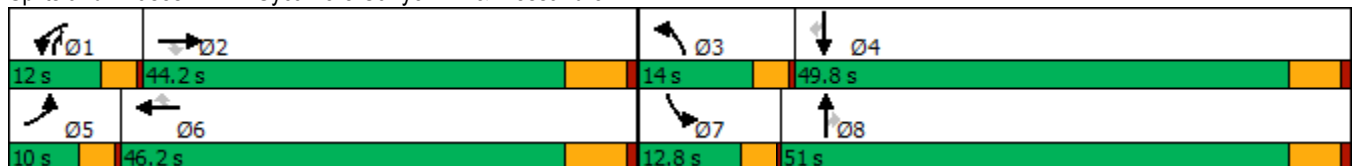

HCM 6th Signalized Intersection Summary
24: Sycamore Canyon Bl. & Alessandro Bl.

West Campus Upper Plateau (JN 14064)

09/19/2022



Movement	EBL	EBT	EBR	WBL	WBT	WBR	NBL	NBT	NBR	SBL	SBT	SBR
Lane Configurations	↘	↑↑↑	↗	↘↗	↑↑↑	↗	↘↗	↑↑	↗↘	↘↗	↑↑	↗
Traffic Volume (veh/h)	131	1793	537	316	1646	391	443	446	152	125	509	254
Future Volume (veh/h)	131	1793	537	316	1646	391	443	446	152	125	509	254
Initial Q (Qb), veh	0	0	0	0	0	0	0	0	0	0	0	0
Ped-Bike Adj(A_pbT)	1.00		1.00	1.00		0.99	1.00		1.00	1.00		1.00
Parking Bus, Adj	1.00	1.00	1.00	1.00	1.00	1.00	1.00	1.00	1.00	1.00	1.00	1.00
Work Zone On Approach		No			No			No			No	
Adj Sat Flow, veh/h/ln	1900	1885	1885	1752	1885	1796	1870	1841	1870	1826	1826	1870
Adj Flow Rate, veh/h	134	1830	357	322	1680	268	452	455	113	128	519	167
Peak Hour Factor	0.98	0.98	0.98	0.98	0.98	0.98	0.98	0.98	0.98	0.98	0.98	0.98
Percent Heavy Veh, %	0	1	1	10	1	7	2	4	2	5	5	2
Cap, veh/h	120	2029	630	283	2137	624	375	888	952	192	702	321
Arrive On Green	0.07	0.39	0.39	0.09	0.42	0.42	0.11	0.25	0.25	0.06	0.20	0.20
Sat Flow, veh/h	1810	5147	1598	3237	5147	1502	3456	3497	2790	3374	3469	1585
Grp Volume(v), veh/h	134	1830	357	322	1680	268	452	455	113	128	519	167
Grp Sat Flow(s),veh/h/ln	1810	1716	1598	1618	1716	1502	1728	1749	1395	1687	1735	1585
Q Serve(g_s), s	6.3	31.7	16.5	8.3	26.9	12.1	10.3	10.6	2.6	3.5	13.3	8.9
Cycle Q Clear(g_c), s	6.3	31.7	16.5	8.3	26.9	12.1	10.3	10.6	2.6	3.5	13.3	8.9
Prop In Lane	1.00		1.00	1.00		1.00	1.00		1.00	1.00		1.00
Lane Grp Cap(c), veh/h	120	2029	630	283	2137	624	375	888	952	192	702	321
V/C Ratio(X)	1.12	0.90	0.57	1.14	0.79	0.43	1.21	0.51	0.12	0.67	0.74	0.52
Avail Cap(c_a), veh/h	120	2044	634	283	2152	628	375	1665	1572	323	1608	735
HCM Platoon Ratio	1.00	1.00	1.00	1.00	1.00	1.00	1.00	1.00	1.00	1.00	1.00	1.00
Upstream Filter(I)	1.00	1.00	1.00	1.00	1.00	1.00	1.00	1.00	1.00	1.00	1.00	1.00
Uniform Delay (d), s/veh	44.3	27.0	22.4	43.3	24.1	19.8	42.3	30.4	21.5	43.9	35.5	33.8
Incr Delay (d2), s/veh	116.7	6.1	1.5	96.0	2.1	0.7	115.2	0.5	0.1	1.5	1.6	1.3
Initial Q Delay(d3),s/veh	0.0	0.0	0.0	0.0	0.0	0.0	0.0	0.0	0.0	0.0	0.0	0.0
%ile BackOfQ(50%),veh/ln	6.6	12.9	6.0	6.9	10.3	4.0	10.2	4.3	0.8	1.5	5.5	3.4
Unsig. Movement Delay, s/veh												
LnGrp Delay(d),s/veh	161.0	33.2	23.9	139.3	26.2	20.4	157.5	30.8	21.5	45.4	37.1	35.1
LnGrp LOS	F	C	C	F	C	C	F	C	C	D	D	D
Approach Vol, veh/h		2321			2270			1020			814	
Approach Delay, s/veh		39.1			41.6			85.9			38.0	
Approach LOS		D			D			F			D	
Timer - Assigned Phs	1	2	3	4	5	6	7	8				
Phs Duration (G+Y+Rc), s	12.0	43.9	14.0	25.0	10.0	45.9	9.1	29.9				
Change Period (Y+Rc), s	3.7	6.5	3.7	5.8	3.7	6.5	3.7	5.8				
Max Green Setting (Gmax), s	8.3	37.7	10.3	44.0	6.3	39.7	9.1	45.2				
Max Q Clear Time (g_c+1), s	10.3	33.7	12.3	15.3	8.3	28.9	5.5	12.6				
Green Ext Time (p_c), s	0.0	3.7	0.0	3.9	0.0	9.1	0.1	3.4				

Intersection Summary

HCM 6th Ctrl Delay	47.3
HCM 6th LOS	D

Timings
25: Sycamore Canyon Bl. & Cactus Av.

West Campus Upper Plateau (JN 14064)

09/19/2022



Lane Group	EBL	EBT	EBR	WBL	WBT	WBR	NBL	NBT	NBR	SBL	SBT	SBR
Lane Configurations	↘	↑↑	↗	↘↗	↑↑	↗	↘↗	↑↑	↗	↘↗	↑↑	↗
Traffic Volume (vph)	143	1159	528	696	431	497	186	328	221	498	840	51
Future Volume (vph)	143	1159	528	696	431	497	186	328	221	498	840	51
Turn Type	Prot	NA	Perm	Prot	NA	Perm	Prot	NA	Perm	Prot	NA	Perm
Protected Phases	7	4		3	8		5	2		1	6	
Permitted Phases			4			8			2			6
Detector Phase	7	4	4	3	8	8	5	2	2	1	6	6
Switch Phase												
Minimum Initial (s)	5.0	10.0	10.0	5.0	10.0	10.0	5.0	10.0	10.0	5.0	10.0	10.0
Minimum Split (s)	9.6	32.8	32.8	9.6	32.8	32.8	9.6	34.8	34.8	9.6	34.8	34.8
Total Split (s)	10.3	32.8	32.8	29.0	51.5	51.5	9.6	36.2	36.2	22.0	48.6	48.6
Total Split (%)	8.6%	27.3%	27.3%	24.2%	42.9%	42.9%	8.0%	30.2%	30.2%	18.3%	40.5%	40.5%
Yellow Time (s)	3.6	4.8	4.8	3.6	4.8	4.8	3.6	4.8	4.8	3.6	4.8	4.8
All-Red Time (s)	1.0	1.0	1.0	1.0	1.0	1.0	1.0	1.0	1.0	1.0	1.0	1.0
Lost Time Adjust (s)	0.0	0.0	0.0	0.0	0.0	0.0	0.0	0.0	0.0	0.0	0.0	0.0
Total Lost Time (s)	4.6	5.8	5.8	4.6	5.8	5.8	4.6	5.8	5.8	4.6	5.8	5.8
Lead/Lag	Lead	Lag	Lag	Lead	Lag	Lag	Lead	Lag	Lag	Lead	Lag	Lag
Lead-Lag Optimize?	Yes	Yes	Yes	Yes	Yes	Yes	Yes	Yes	Yes	Yes	Yes	Yes
Recall Mode	None	None	None	None	None	None	None	None	None	None	None	None
Act Effct Green (s)	5.7	27.1	27.1	24.4	45.8	45.8	5.0	26.2	26.2	17.4	38.7	38.7
Actuated g/C Ratio	0.05	0.23	0.23	0.21	0.39	0.39	0.04	0.23	0.23	0.15	0.33	0.33
v/c Ratio	1.95	1.72	1.20	1.15	0.38	0.68	1.48	0.49	0.48	1.11	0.87	0.10
Control Delay	500.0	356.4	134.0	125.5	26.6	14.2	287.4	41.2	7.5	119.7	45.6	0.3
Queue Delay	0.0	0.0	0.0	0.0	0.0	0.0	0.0	0.0	0.0	0.0	0.0	0.0
Total Delay	500.0	356.4	134.0	125.5	26.6	14.2	287.4	41.2	7.5	119.7	45.6	0.3
LOS	F	F	F	F	C	B	F	D	A	F	D	A
Approach Delay		303.5			65.2			93.3			70.5	
Approach LOS		F			E			F			E	

Intersection Summary

Cycle Length: 120
 Actuated Cycle Length: 116
 Natural Cycle: 120
 Control Type: Actuated-Uncoordinated
 Maximum v/c Ratio: 1.95
 Intersection Signal Delay: 148.4
 Intersection LOS: F
 Intersection Capacity Utilization 97.8%
 ICU Level of Service F
 Analysis Period (min) 15

Splits and Phases: 25: Sycamore Canyon Bl. & Cactus Av.

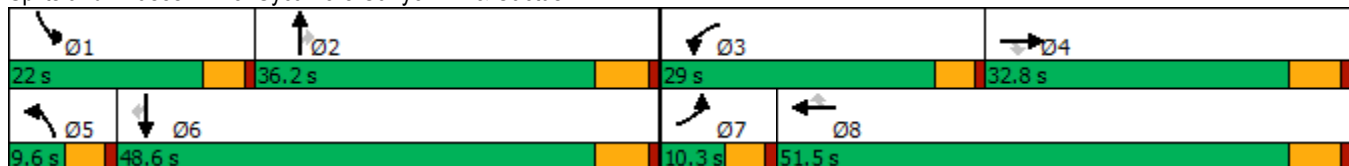

HCM 6th Signalized Intersection Summary
25: Sycamore Canyon Bl. & Cactus Av.

West Campus Upper Plateau (JN 14064)

09/19/2022



Movement	EBL	EBT	EBR	WBL	WBT	WBR	NBL	NBT	NBR	SBL	SBT	SBR
Lane Configurations												
Traffic Volume (veh/h)	143	1159	528	696	431	497	186	328	221	498	840	51
Future Volume (veh/h)	143	1159	528	696	431	497	186	328	221	498	840	51
Initial Q (Qb), veh	0	0	0	0	0	0	0	0	0	0	0	0
Ped-Bike Adj(A_pbT)	1.00		1.00	1.00		1.00	1.00		1.00	1.00		1.00
Parking Bus, Adj	1.00	1.00	1.00	1.00	1.00	1.00	1.00	1.00	1.00	1.00	1.00	1.00
Work Zone On Approach		No			No			No			No	
Adj Sat Flow, veh/h/ln	1841	1796	1856	1826	1796	1870	1856	1811	1781	1885	1796	1767
Adj Flow Rate, veh/h	166	1348	604	809	501	308	216	381	154	579	977	59
Peak Hour Factor	0.86	0.86	0.86	0.86	0.86	0.86	0.86	0.86	0.86	0.86	0.86	0.86
Percent Heavy Veh, %	4	7	3	5	7	2	3	6	8	1	7	9
Cap, veh/h	87	804	370	718	1360	632	150	752	330	529	1115	489
Arrive On Green	0.05	0.24	0.24	0.21	0.40	0.40	0.04	0.22	0.22	0.15	0.33	0.33
Sat Flow, veh/h	1753	3413	1572	3374	3413	1585	3428	3441	1510	3483	3413	1497
Grp Volume(v), veh/h	166	1348	604	809	501	308	216	381	154	579	977	59
Grp Sat Flow(s),veh/h/ln	1753	1706	1572	1687	1706	1585	1714	1721	1510	1742	1706	1497
Q Serve(g_s), s	5.7	27.0	27.0	24.4	11.9	16.6	5.0	11.2	10.2	17.4	31.0	3.2
Cycle Q Clear(g_c), s	5.7	27.0	27.0	24.4	11.9	16.6	5.0	11.2	10.2	17.4	31.0	3.2
Prop In Lane	1.00		1.00	1.00		1.00	1.00		1.00	1.00		1.00
Lane Grp Cap(c), veh/h	87	804	370	718	1360	632	150	752	330	529	1115	489
V/C Ratio(X)	1.90	1.68	1.63	1.13	0.37	0.49	1.44	0.51	0.47	1.10	0.88	0.12
Avail Cap(c_a), veh/h	87	804	370	718	1360	632	150	912	400	529	1274	559
HCM Platoon Ratio	1.00	1.00	1.00	1.00	1.00	1.00	1.00	1.00	1.00	1.00	1.00	1.00
Upstream Filter(I)	1.00	1.00	1.00	1.00	1.00	1.00	1.00	1.00	1.00	1.00	1.00	1.00
Uniform Delay (d), s/veh	54.5	43.8	43.8	45.1	24.3	25.7	54.8	39.4	39.0	48.6	36.4	27.1
Incr Delay (d2), s/veh	446.7	310.2	296.0	74.2	0.2	0.6	233.6	0.5	1.0	67.7	6.5	0.1
Initial Q Delay(d3),s/veh	0.0	0.0	0.0	0.0	0.0	0.0	0.0	0.0	0.0	0.0	0.0	0.0
%ile BackOfQ(50%),veh/ln	13.3	45.7	40.5	17.2	4.6	6.1	7.0	4.6	3.7	12.3	13.2	1.1
Unsig. Movement Delay, s/veh												
LnGrp Delay(d),s/veh	501.2	354.0	339.9	119.3	24.5	26.3	288.5	39.9	40.0	116.3	42.9	27.2
LnGrp LOS	F	F	F	F	C	C	F	D	D	F	D	C
Approach Vol, veh/h		2118			1618			751			1615	
Approach Delay, s/veh		361.5			72.2			111.4			68.7	
Approach LOS		F			E			F			E	
Timer - Assigned Phs	1	2	3	4	5	6	7	8				
Phs Duration (G+Y+Rc), s	22.0	30.9	29.0	32.8	9.6	43.3	10.3	51.5				
Change Period (Y+Rc), s	4.6	5.8	4.6	5.8	4.6	5.8	4.6	5.8				
Max Green Setting (Gmax), s	17.4	30.4	24.4	27.0	5.0	42.8	5.7	45.7				
Max Q Clear Time (g_c+I1), s	19.4	13.2	26.4	29.0	7.0	33.0	7.7	18.6				
Green Ext Time (p_c), s	0.0	2.5	0.0	0.0	0.0	4.5	0.0	4.3				

Intersection Summary

HCM 6th Ctrl Delay	176.5
HCM 6th LOS	F

Timings

West Campus Upper Plateau (JN 14064)

26: Sycamore Canyon Bl. & Van Buren Bl.

09/19/2022



Lane Group	EBL	EBT	EBR	WBL	WBT	WBR	NBL	NBT	SBL	SBT	SBR
Lane Configurations											
Traffic Volume (vph)	408	1302	1	7	924	111	11	14	948	13	1007
Future Volume (vph)	408	1302	1	7	924	111	11	14	948	13	1007
Turn Type	Prot	NA	Perm	Prot	NA	Perm	Perm	NA	Split	NA	Perm
Protected Phases	5	2		1	6			8	4	4	
Permitted Phases			2			6	8				4
Detector Phase	5	2	2	1	6	6	8	8	4	4	4
Switch Phase											
Minimum Initial (s)	5.0	10.0	10.0	5.0	10.0	10.0	10.0	10.0	10.0	10.0	10.0
Minimum Split (s)	9.6	29.2	29.2	9.6	29.2	29.2	14.6	14.6	50.8	50.8	50.8
Total Split (s)	22.0	47.8	47.8	9.6	35.4	35.4	14.6	14.6	58.0	58.0	58.0
Total Split (%)	16.9%	36.8%	36.8%	7.4%	27.2%	27.2%	11.2%	11.2%	44.6%	44.6%	44.6%
Yellow Time (s)	3.6	5.2	5.2	3.6	5.2	5.2	3.6	3.6	4.8	4.8	4.8
All-Red Time (s)	1.0	1.0	1.0	1.0	1.0	1.0	1.0	1.0	1.0	1.0	1.0
Lost Time Adjust (s)	0.0	0.0	0.0	0.0	0.0	0.0		0.0	0.0	0.0	0.0
Total Lost Time (s)	4.6	6.2	6.2	4.6	6.2	6.2		4.6	5.8	5.8	5.8
Lead/Lag	Lead	Lag	Lag	Lead	Lag	Lag					
Lead-Lag Optimize?	Yes	Yes	Yes	Yes	Yes	Yes					
Recall Mode	None	None	None	None	None	None	None	None	None	None	None
Act Effct Green (s)	17.5	47.2	47.2	5.0	26.9	26.9		10.1	52.5	52.5	52.5
Actuated g/C Ratio	0.14	0.38	0.38	0.04	0.22	0.22		0.08	0.42	0.42	0.42
v/c Ratio	0.95	0.60	0.00	0.13	0.76	0.28		0.23	0.73	0.02	1.20
Control Delay	84.7	33.4	0.0	65.0	50.6	6.2		31.6	35.1	23.6	120.6
Queue Delay	0.0	0.0	0.0	0.0	0.0	0.0		0.0	0.0	0.0	0.0
Total Delay	84.7	33.4	0.0	65.0	50.6	6.2		31.6	35.1	23.6	120.6
LOS	F	C	A	E	D	A		C	D	C	F
Approach Delay		45.6			46.0			31.6		78.8	
Approach LOS		D			D			C		E	

Intersection Summary

Cycle Length: 130	
Actuated Cycle Length: 124.9	
Natural Cycle: 115	
Control Type: Actuated-Uncoordinated	
Maximum v/c Ratio: 1.20	
Intersection Signal Delay: 59.2	Intersection LOS: E
Intersection Capacity Utilization 97.9%	ICU Level of Service F
Analysis Period (min) 15	

Splits and Phases: 26: Sycamore Canyon Bl. & Van Buren Bl.

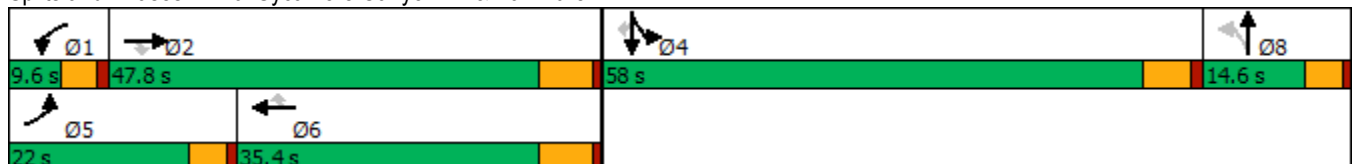

HCM 6th Signalized Intersection Summary
26: Sycamore Canyon Bl. & Van Buren Bl.

West Campus Upper Plateau (JN 14064)

09/19/2022



Movement	EBL	EBT	EBR	WBL	WBT	WBR	NBL	NBT	NBR	SBL	SBT	SBR
Lane Configurations												
Traffic Volume (veh/h)	408	1302	1	7	924	111	11	14	33	948	13	1007
Future Volume (veh/h)	408	1302	1	7	924	111	11	14	33	948	13	1007
Initial Q (Qb), veh	0	0	0	0	0	0	0	0	0	0	0	0
Ped-Bike Adj(A_pbT)	1.00		1.00	1.00		0.99	1.00		0.99	1.00		1.00
Parking Bus, Adj	1.00	1.00	1.00	1.00	1.00	1.00	1.00	1.00	1.00	1.00	1.00	1.00
Work Zone On Approach		No			No			No			No	
Adj Sat Flow, veh/h/ln	1826	1826	1900	1693	1796	1841	1900	1900	1900	1841	1900	1856
Adj Flow Rate, veh/h	443	1415	1	8	1004	98	12	15	6	1030	14	0
Peak Hour Factor	0.92	0.92	0.92	0.92	0.92	0.92	0.92	0.92	0.92	0.92	0.92	0.92
Percent Heavy Veh, %	5	5	0	14	7	4	0	0	0	4	0	3
Cap, veh/h	511	2306	591	16	1393	347	77	100	41	1179	659	
Arrive On Green	0.15	0.37	0.37	0.01	0.23	0.23	0.06	0.06	0.06	0.35	0.35	0.00
Sat Flow, veh/h	3374	6281	1610	1612	6179	1540	1274	1654	675	3401	1900	1572
Grp Volume(v), veh/h	443	1415	1	8	1004	98	17	0	16	1030	14	0
Grp Sat Flow(s),veh/h/ln	1687	1570	1610	1612	1545	1540	1836	0	1767	1700	1900	1572
Q Serve(g_s), s	12.6	18.1	0.0	0.5	14.8	5.2	0.9	0.0	0.8	27.9	0.5	0.0
Cycle Q Clear(g_c), s	12.6	18.1	0.0	0.5	14.8	5.2	0.9	0.0	0.8	27.9	0.5	0.0
Prop In Lane	1.00		1.00	1.00		1.00	0.69		0.38	1.00		1.00
Lane Grp Cap(c), veh/h	511	2306	591	16	1393	347	111	0	107	1179	659	
V/C Ratio(X)	0.87	0.61	0.00	0.50	0.72	0.28	0.16	0.00	0.15	0.87	0.02	
Avail Cap(c_a), veh/h	598	2661	682	82	1837	458	187	0	180	1808	1010	
HCM Platoon Ratio	1.00	1.00	1.00	1.00	1.00	1.00	1.00	1.00	1.00	1.00	1.00	1.00
Upstream Filter(I)	1.00	1.00	1.00	1.00	1.00	1.00	1.00	0.00	1.00	1.00	1.00	0.00
Uniform Delay (d), s/veh	40.7	25.4	19.7	48.4	35.2	31.5	43.8	0.0	43.7	30.1	21.1	0.0
Incr Delay (d2), s/veh	10.2	0.3	0.0	8.6	1.0	0.4	0.6	0.0	0.6	3.3	0.0	0.0
Initial Q Delay(d3),s/veh	0.0	0.0	0.0	0.0	0.0	0.0	0.0	0.0	0.0	0.0	0.0	0.0
%ile BackOfQ(50%),veh/ln	5.7	6.3	0.0	0.2	5.3	1.9	0.4	0.0	0.4	11.1	0.2	0.0
Unsig. Movement Delay, s/veh												
LnGrp Delay(d),s/veh	50.9	25.7	19.7	56.9	36.1	31.9	44.4	0.0	44.4	33.3	21.1	0.0
LnGrp LOS	D	C	B	E	D	C	D	A	D	C	C	
Approach Vol, veh/h		1859			1110			33			1044	
Approach Delay, s/veh		31.7			35.9			44.4			33.2	
Approach LOS		C			D			D			C	
Timer - Assigned Phs	1	2		4	5	6		8				
Phs Duration (G+Y+Rc), s	5.6	42.3		39.8	19.5	28.3		10.5				
Change Period (Y+Rc), s	4.6	6.2		5.8	4.6	6.2		4.6				
Max Green Setting (Gmax), s	5.0	41.6		52.2	17.4	29.2		10.0				
Max Q Clear Time (g_c+I1), s	2.5	20.1		29.9	14.6	16.8		2.9				
Green Ext Time (p_c), s	0.0	10.0		4.2	0.3	5.4		0.0				

Intersection Summary

HCM 6th Ctrl Delay	33.3
HCM 6th LOS	C

Notes

Unsignalized Delay for [SBR] is excluded from calculations of the approach delay and intersection delay.

Timings
27: Innovation Dr. & Cactus Av.

West Campus Upper Plateau (JN 14064)

09/19/2022

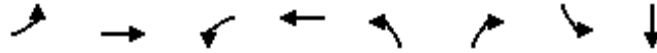

Lane Group	EBL	EBT	WBL	WBT	NBL	NBR	SBL	SBT
Lane Configurations	↖	↖↖↖	↖	↖↖↖	↖	↖	↖	↖
Traffic Volume (vph)	3	1870	49	1588	23	65	35	0
Future Volume (vph)	3	1870	49	1588	23	65	35	0
Turn Type	Prot	NA	Prot	NA	Perm	Perm	Perm	NA
Protected Phases	5	2	1	6				4
Permitted Phases					8	8	4	
Detector Phase	5	2	1	6	8	8	4	4
Switch Phase								
Minimum Initial (s)	5.0	10.0	5.0	10.0	10.0	10.0	10.0	10.0
Minimum Split (s)	9.2	26.8	9.2	26.8	31.1	31.1	31.1	31.1
Total Split (s)	12.0	63.0	22.0	73.0	35.0	35.0	35.0	35.0
Total Split (%)	10.0%	52.5%	18.3%	60.8%	29.2%	29.2%	29.2%	29.2%
Yellow Time (s)	3.2	4.8	3.2	4.8	4.1	4.1	4.1	4.1
All-Red Time (s)	1.0	1.0	1.0	1.0	1.0	1.0	1.0	1.0
Lost Time Adjust (s)	0.0	0.0	0.0	0.0	0.0	0.0	0.0	0.0
Total Lost Time (s)	4.2	5.8	4.2	5.8	5.1	5.1	5.1	5.1
Lead/Lag	Lead	Lag	Lead	Lag				
Lead-Lag Optimize?	Yes	Yes	Yes	Yes				
Recall Mode	None	None	None	None	None	None	None	None
Act Effct Green (s)	5.7	58.4	8.2	66.0	13.7	13.7	13.7	13.7
Actuated g/C Ratio	0.07	0.69	0.10	0.78	0.16	0.16	0.16	0.16
v/c Ratio	0.02	0.63	0.37	0.47	0.12	0.17	0.17	0.04
Control Delay	47.3	13.2	49.8	6.7	37.2	0.9	38.1	0.2
Queue Delay	0.0	0.1	0.0	0.0	0.0	0.0	0.0	0.0
Total Delay	47.3	13.3	49.8	6.7	37.2	0.9	38.1	0.2
LOS	D	B	D	A	D	A	D	A
Approach Delay		13.3		8.0				27.5
Approach LOS		B		A				C

Intersection Summary

Cycle Length: 120
 Actuated Cycle Length: 84.8
 Natural Cycle: 80
 Control Type: Actuated-Uncoordinated
 Maximum v/c Ratio: 0.63
 Intersection Signal Delay: 11.0
 Intersection LOS: B
 Intersection Capacity Utilization 66.2%
 ICU Level of Service C
 Analysis Period (min) 15

Splits and Phases: 27: Innovation Dr. & Cactus Av.



HCM 6th Signalized Intersection Summary
27: Innovation Dr. & Cactus Av.

West Campus Upper Plateau (JN 14064)

09/19/2022



Movement	EBL	EBT	EBR	WBL	WBT	WBR	NBL	NBT	NBR	SBL	SBT	SBR
Lane Configurations	↗	↑↑↑		↖	↑↑↑		↖	↑	↗	↖	↑	↗
Traffic Volume (veh/h)	3	1870	5	49	1588	13	23	0	65	35	0	13
Future Volume (veh/h)	3	1870	5	49	1588	13	23	0	65	35	0	13
Initial Q (Qb), veh	0	0	0	0	0	0	0	0	0	0	0	0
Ped-Bike Adj(A_pbT)	1.00		1.00	1.00		0.98	1.00		1.00	1.00		1.00
Parking Bus, Adj	1.00	1.00	1.00	1.00	1.00	1.00	1.00	1.00	1.00	1.00	1.00	1.00
Work Zone On Approach		No			No			No			No	
Adj Sat Flow, veh/h/ln	1900	1811	1307	1663	1826	1900	1841	1900	1781	1900	1900	1781
Adj Flow Rate, veh/h	3	2101	6	55	1784	15	26	0	20	39	0	6
Peak Hour Factor	0.89	0.89	0.89	0.89	0.89	0.89	0.89	0.89	0.89	0.89	0.89	0.89
Percent Heavy Veh, %	0	6	40	16	5	0	4	0	8	0	0	8
Cap, veh/h	7	3255	9	72	3471	29	249	215	171	257	0	183
Arrive On Green	0.00	0.64	0.64	0.05	0.68	0.68	0.11	0.00	0.11	0.11	0.00	0.11
Sat Flow, veh/h	1810	5090	15	1584	5097	43	1388	1900	1510	1414	0	1610
Grp Volume(v), veh/h	3	1360	747	55	1163	636	26	0	20	39	0	6
Grp Sat Flow(s),veh/h/ln	1810	1648	1808	1584	1662	1817	1388	1900	1510	1414	0	1610
Q Serve(g_s), s	0.1	19.0	19.0	2.6	12.9	12.9	1.3	0.0	0.9	1.9	0.0	0.2
Cycle Q Clear(g_c), s	0.1	19.0	19.0	2.6	12.9	12.9	1.5	0.0	0.9	1.9	0.0	0.2
Prop In Lane	1.00		0.01	1.00		0.02	1.00		1.00	1.00		1.00
Lane Grp Cap(c), veh/h	7	2108	1157	72	2263	1237	249	215	171	257	0	183
V/C Ratio(X)	0.41	0.65	0.65	0.76	0.51	0.51	0.10	0.00	0.12	0.15	0.00	0.03
Avail Cap(c_a), veh/h	188	2517	1381	376	2981	1630	645	758	603	661	0	643
HCM Platoon Ratio	1.00	1.00	1.00	1.00	1.00	1.00	1.00	1.00	1.00	1.00	1.00	1.00
Upstream Filter(I)	1.00	1.00	1.00	1.00	1.00	1.00	1.00	0.00	1.00	1.00	0.00	1.00
Uniform Delay (d), s/veh	37.2	8.3	8.3	35.3	5.9	5.9	30.2	0.0	29.8	30.3	0.0	29.5
Incr Delay (d2), s/veh	13.1	0.6	1.0	6.1	0.3	0.5	0.2	0.0	0.3	0.3	0.0	0.1
Initial Q Delay(d3),s/veh	0.0	0.0	0.0	0.0	0.0	0.0	0.0	0.0	0.0	0.0	0.0	0.0
%ile BackOfQ(50%),veh/ln	0.1	4.7	5.3	1.0	2.8	3.1	0.4	0.0	0.3	0.6	0.0	0.1
Unsig. Movement Delay, s/veh												
LnGrp Delay(d),s/veh	50.3	8.9	9.3	41.5	6.1	6.3	30.4	0.0	30.1	30.5	0.0	29.6
LnGrp LOS	D	A	A	D	A	A	C	A	C	C	A	C
Approach Vol, veh/h		2110			1854			46				45
Approach Delay, s/veh		9.1			7.2			30.3				30.4
Approach LOS		A			A			C				C
Timer - Assigned Phs	1	2		4	5	6		8				
Phs Duration (G+Y+Rc), s	7.6	53.7		13.6	4.5	56.8		13.6				
Change Period (Y+Rc), s	* 4.2	5.8		5.1	* 4.2	5.8		5.1				
Max Green Setting (Gmax), s	* 18	57.2		29.9	* 7.8	67.2		29.9				
Max Q Clear Time (g_c+I1), s	4.6	21.0		3.9	2.1	14.9		3.5				
Green Ext Time (p_c), s	0.0	26.9		0.1	0.0	27.9		0.1				

Intersection Summary

HCM 6th Ctrl Delay	8.7
HCM 6th LOS	A

Notes

* HCM 6th computational engine requires equal clearance times for the phases crossing the barrier.

Timings
28: I-215 SB Ramps & Alessandro Bl.

West Campus Upper Plateau (JN 14064)

09/19/2022

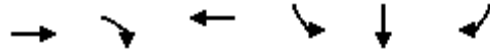

Lane Group	EBT	EBR	WBT	SBL	SBT	SBR
Lane Configurations	↑↑↑	↑	↑↑↑	↑	↔	↑
Traffic Volume (vph)	1568	502	1885	310	0	468
Future Volume (vph)	1568	502	1885	310	0	468
Turn Type	NA	Perm	NA	Split	NA	Perm
Protected Phases	2		6	4	4	
Permitted Phases		2				4
Detector Phase	2	2	6	4	4	4
Switch Phase						
Minimum Initial (s)	5.0	5.0	5.0	5.0	5.0	5.0
Minimum Split (s)	10.5	10.5	34.5	10.0	10.0	10.0
Total Split (s)	52.0	52.0	52.0	33.0	33.0	33.0
Total Split (%)	61.2%	61.2%	61.2%	38.8%	38.8%	38.8%
Yellow Time (s)	4.5	4.5	4.5	4.0	4.0	4.0
All-Red Time (s)	1.0	1.0	1.0	1.0	1.0	1.0
Lost Time Adjust (s)	0.0	0.0	0.0	0.0	0.0	0.0
Total Lost Time (s)	5.5	5.5	5.5	5.0	5.0	5.0
Lead/Lag						
Lead-Lag Optimize?						
Recall Mode	Min	Min	Min	None	None	None
Act Effct Green (s)	37.5	37.5	37.5	18.8	18.8	18.8
Actuated g/C Ratio	0.56	0.56	0.56	0.28	0.28	0.28
v/c Ratio	0.56	0.51	0.70	0.63	0.64	0.61
Control Delay	10.9	7.0	12.9	29.8	27.7	26.6
Queue Delay	0.0	0.0	0.0	0.0	0.0	0.0
Total Delay	10.9	7.0	12.9	29.8	27.7	26.6
LOS	B	A	B	C	C	C
Approach Delay	10.0		12.9		28.1	
Approach LOS	A		B		C	

Intersection Summary

Cycle Length: 85
 Actuated Cycle Length: 67.4
 Natural Cycle: 50
 Control Type: Actuated-Uncoordinated
 Maximum v/c Ratio: 0.70
 Intersection Signal Delay: 14.1
 Intersection LOS: B
 Intersection Capacity Utilization 65.8%
 ICU Level of Service C
 Analysis Period (min) 15

Splits and Phases: 28: I-215 SB Ramps & Alessandro Bl.

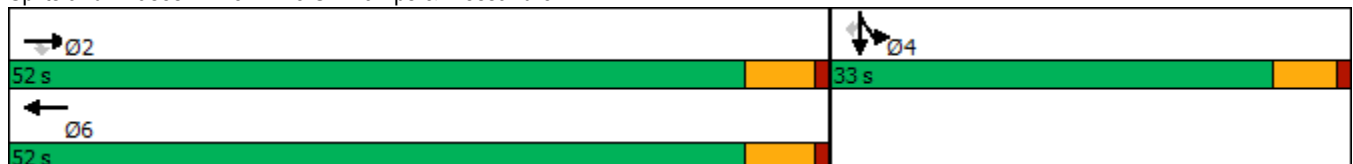

HCM 6th Signalized Intersection Summary
 28: I-215 SB Ramps & Alessandro Bl.

West Campus Upper Plateau (JN 14064)

09/19/2022



Movement	EBL	EBT	EBR	WBL	WBT	WBR	NBL	NBT	NBR	SBL	SBT	SBR
Lane Configurations		↑↑↑	↗		↑↑↑					↖	↔	↗
Traffic Volume (veh/h)	0	1568	502	0	1885	61	0	0	0	310	0	468
Future Volume (veh/h)	0	1568	502	0	1885	61	0	0	0	310	0	468
Initial Q (Qb), veh	0	0	0	0	0	0				0	0	0
Ped-Bike Adj(A_pbT)	1.00		1.00	1.00		0.98				1.00		1.00
Parking Bus, Adj	1.00	1.00	1.00	1.00	1.00	1.00				1.00	1.00	1.00
Work Zone On Approach		No			No						No	
Adj Sat Flow, veh/h/ln	0	1885	1885	0	1870	1781				1737	1900	1767
Adj Flow Rate, veh/h	0	1584	507	0	1904	54				464	0	266
Peak Hour Factor	0.99	0.99	0.99	0.99	0.99	0.99				0.99	0.99	0.99
Percent Heavy Veh, %	0	1	1	0	2	8				11	0	9
Cap, veh/h	0	2940	913	0	2914	83				801	0	362
Arrive On Green	0.00	0.57	0.57	0.00	0.57	0.57				0.24	0.00	0.24
Sat Flow, veh/h	0	5316	1598	0	5269	144				3309	0	1497
Grp Volume(v), veh/h	0	1584	507	0	1270	688				464	0	266
Grp Sat Flow(s),veh/h/ln	0	1716	1598	0	1702	1841				1654	0	1497
Q Serve(g_s), s	0.0	10.7	11.2	0.0	14.4	14.4				7.0	0.0	9.2
Cycle Q Clear(g_c), s	0.0	10.7	11.2	0.0	14.4	14.4				7.0	0.0	9.2
Prop In Lane	0.00		1.00	0.00		0.08				1.00		1.00
Lane Grp Cap(c), veh/h	0	2940	913	0	1945	1052				801	0	362
V/C Ratio(X)	0.00	0.54	0.56	0.00	0.65	0.65				0.58	0.00	0.73
Avail Cap(c_a), veh/h	0	4255	1321	0	2814	1522				1647	0	745
HCM Platoon Ratio	1.00	1.00	1.00	1.00	1.00	1.00				1.00	1.00	1.00
Upstream Filter(I)	0.00	1.00	1.00	0.00	1.00	1.00				1.00	0.00	1.00
Uniform Delay (d), s/veh	0.0	7.5	7.6	0.0	8.2	8.3				18.8	0.0	19.6
Incr Delay (d2), s/veh	0.0	0.2	0.5	0.0	0.4	0.7				0.7	0.0	2.9
Initial Q Delay(d3),s/veh	0.0	0.0	0.0	0.0	0.0	0.0				0.0	0.0	0.0
%ile BackOfQ(50%),veh/ln	0.0	2.1	2.1	0.0	2.8	3.2				2.3	0.0	3.0
Unsig. Movement Delay, s/veh												
LnGrp Delay(d),s/veh	0.0	7.6	8.1	0.0	8.6	9.0				19.5	0.0	22.5
LnGrp LOS	A	A	A	A	A	A				B	A	C
Approach Vol, veh/h		2091			1958						730	
Approach Delay, s/veh		7.7			8.7						20.6	
Approach LOS		A			A						C	
Timer - Assigned Phs		2		4		6						
Phs Duration (G+Y+Rc), s		37.6		18.6		37.6						
Change Period (Y+Rc), s		5.5		5.0		5.5						
Max Green Setting (Gmax), s		46.5		28.0		46.5						
Max Q Clear Time (g_c+I1), s		13.2		11.2		16.4						
Green Ext Time (p_c), s		16.2		2.4		15.7						

Intersection Summary

HCM 6th Ctrl Delay	10.1
HCM 6th LOS	B

Notes

User approved volume balancing among the lanes for turning movement.

Timings
29: I-215 NB Ramps & Alessandro Bl.

West Campus Upper Plateau (JN 14064)

09/19/2022



Lane Group	EBL	EBT	WBT	WBR	NBL	NBT	NBR
Lane Configurations	↶	↑↑↑	↑↑↑	↷	↶	↕	↷
Traffic Volume (vph)	217	1661	1033	112	913	11	270
Future Volume (vph)	217	1661	1033	112	913	11	270
Turn Type	Prot	NA	NA	Perm	Split	NA	Perm
Protected Phases	5	2	6		8	8	
Permitted Phases				6			8
Detector Phase	5	2	6	6	8	8	8
Switch Phase							
Minimum Initial (s)	5.0	5.0	5.0	5.0	5.0	5.0	5.0
Minimum Split (s)	9.5	10.5	33.5	33.5	10.0	10.0	10.0
Total Split (s)	13.0	48.0	35.0	35.0	37.0	37.0	37.0
Total Split (%)	15.3%	56.5%	41.2%	41.2%	43.5%	43.5%	43.5%
Yellow Time (s)	3.5	4.5	4.5	4.5	4.0	4.0	4.0
All-Red Time (s)	1.0	1.0	1.0	1.0	1.0	1.0	1.0
Lost Time Adjust (s)	0.0	0.0	0.0	0.0	0.0	0.0	0.0
Total Lost Time (s)	4.5	5.5	5.5	5.5	5.0	5.0	5.0
Lead/Lag	Lead		Lag	Lag			
Lead-Lag Optimize?	Yes		Yes	Yes			
Recall Mode	None	Min	Min	Min	Max	Max	Max
Act Effct Green (s)	8.5	38.2	25.1	25.1	32.1	32.1	32.1
Actuated g/C Ratio	0.11	0.47	0.31	0.31	0.40	0.40	0.40
v/c Ratio	1.26	0.74	0.70	0.24	0.76	0.79	0.40
Control Delay	189.1	19.3	26.9	9.1	31.0	33.3	14.0
Queue Delay	0.0	0.0	0.0	0.0	0.0	0.0	0.0
Total Delay	189.1	19.3	26.9	9.1	31.0	33.3	14.0
LOS	F	B	C	A	C	C	B
Approach Delay		38.9	25.1			28.5	
Approach LOS		D	C			C	

Intersection Summary

Cycle Length: 85
 Actuated Cycle Length: 80.8
 Natural Cycle: 90
 Control Type: Actuated-Uncoordinated
 Maximum v/c Ratio: 1.26
 Intersection Signal Delay: 32.2
 Intersection LOS: C
 Intersection Capacity Utilization 72.8%
 ICU Level of Service C
 Analysis Period (min) 15

Splits and Phases: 29: I-215 NB Ramps & Alessandro Bl.

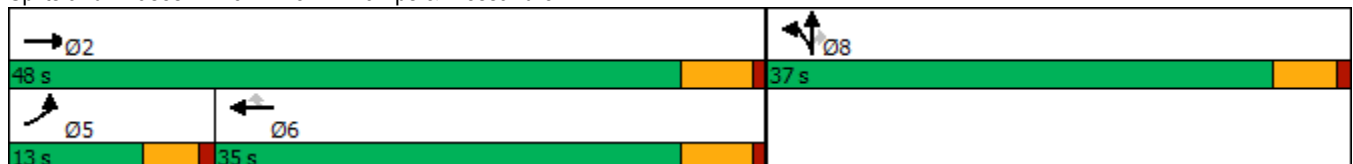

HCM 6th Signalized Intersection Summary
 29: I-215 NB Ramps & Alessandro Bl.

West Campus Upper Plateau (JN 14064)

09/19/2022

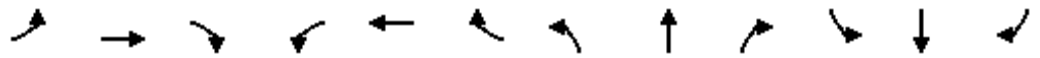

Movement	EBL	EBT	EBR	WBL	WBT	WBR	NBL	NBT	NBR	SBL	SBT	SBR
Lane Configurations	↗	↑↑↑			↑↑↑	↗	↗	↕	↗			
Traffic Volume (veh/h)	217	1661	0	0	1033	112	913	11	270	0	0	0
Future Volume (veh/h)	217	1661	0	0	1033	112	913	11	270	0	0	0
Initial Q (Qb), veh	0	0	0	0	0	0	0	0	0			
Ped-Bike Adj(A_pbT)	1.00		1.00	1.00		0.98	1.00		1.00			
Parking Bus, Adj	1.00	1.00	1.00	1.00	1.00	1.00	1.00	1.00	1.00			
Work Zone On Approach		No			No			No				
Adj Sat Flow, veh/h/ln	1841	1870	0	0	1870	1707	1870	1900	1870			
Adj Flow Rate, veh/h	231	1767	0	0	1099	92	1038	0	138			
Peak Hour Factor	0.94	0.94	0.94	0.94	0.94	0.94	0.94	0.94	0.94			
Percent Heavy Veh, %	4	2	0	0	2	13	2	0	2			
Cap, veh/h	190	2333	0	0	1484	412	1457	0	648			
Arrive On Green	0.11	0.46	0.00	0.00	0.29	0.29	0.41	0.00	0.41			
Sat Flow, veh/h	1753	5274	0	0	5274	1416	3563	0	1585			
Grp Volume(v), veh/h	231	1767	0	0	1099	92	1038	0	138			
Grp Sat Flow(s),veh/h/ln	1753	1702	0	0	1702	1416	1781	0	1585			
Q Serve(g_s), s	8.5	22.5	0.0	0.0	15.2	3.9	19.0	0.0	4.4			
Cycle Q Clear(g_c), s	8.5	22.5	0.0	0.0	15.2	3.9	19.0	0.0	4.4			
Prop In Lane	1.00		0.00	0.00		1.00	1.00		1.00			
Lane Grp Cap(c), veh/h	190	2333	0	0	1484	412	1457	0	648			
V/C Ratio(X)	1.21	0.76	0.00	0.00	0.74	0.22	0.71	0.00	0.21			
Avail Cap(c_a), veh/h	190	2774	0	0	1925	534	1457	0	648			
HCM Platoon Ratio	1.00	1.00	1.00	1.00	1.00	1.00	1.00	1.00	1.00			
Upstream Filter(I)	1.00	1.00	0.00	0.00	1.00	1.00	1.00	0.00	1.00			
Uniform Delay (d), s/veh	34.9	17.7	0.0	0.0	25.1	21.1	19.3	0.0	15.0			
Incr Delay (d2), s/veh	134.2	1.0	0.0	0.0	1.1	0.3	3.0	0.0	0.7			
Initial Q Delay(d3),s/veh	0.0	0.0	0.0	0.0	0.0	0.0	0.0	0.0	0.0			
%ile BackOfQ(50%),veh/ln	10.4	7.2	0.0	0.0	5.5	1.2	7.6	0.0	1.6			
Unsig. Movement Delay, s/veh												
LnGrp Delay(d),s/veh	169.1	18.7	0.0	0.0	26.2	21.3	22.3	0.0	15.7			
LnGrp LOS	F	B	A	A	C	C	C	A	B			
Approach Vol, veh/h		1998			1191			1176				
Approach Delay, s/veh		36.1			25.8			21.5				
Approach LOS		D			C			C				
Timer - Assigned Phs		2			5	6		8				
Phs Duration (G+Y+Rc), s		41.2			13.0	28.2		37.0				
Change Period (Y+Rc), s		5.5			4.5	5.5		5.0				
Max Green Setting (Gmax), s		42.5			8.5	29.5		32.0				
Max Q Clear Time (g_c+I1), s		24.5			10.5	17.2		21.0				
Green Ext Time (p_c), s		10.9			0.0	5.5		3.7				

Intersection Summary

HCM 6th Ctrl Delay	29.4
HCM 6th LOS	C

Notes

User approved volume balancing among the lanes for turning movement.

Timings
30: I-215 SB Ramps & Cactus Av.

West Campus Upper Plateau (JN 14064)

09/19/2022



Lane Group	EBT	EBR	WBL	WBT	NBR	SBR
Lane Configurations	↑↑	↑	↓	↑↑	↑	↑
Traffic Volume (vph)	1587	383	484	1144	546	506
Future Volume (vph)	1587	383	484	1144	546	506
Turn Type	NA	Perm	Prot	NA	Prot	Prot
Protected Phases	2		1	6	8	4
Permitted Phases		2				
Detector Phase	2	2	1	6	8	4
Switch Phase						
Minimum Initial (s)	5.0	5.0	5.0	5.0	5.0	5.0
Minimum Split (s)	11.0	11.0	9.5	23.0	9.1	9.5
Total Split (s)	35.0	35.0	43.0	78.0	27.0	27.0
Total Split (%)	33.3%	33.3%	41.0%	74.3%	25.7%	25.7%
Yellow Time (s)	5.0	5.0	3.5	5.0	3.6	3.5
All-Red Time (s)	1.0	1.0	1.0	1.0	0.5	1.0
Lost Time Adjust (s)	0.0	0.0	0.0	0.0	0.0	0.0
Total Lost Time (s)	6.0	6.0	4.5	6.0	4.1	4.5
Lead/Lag	Lag	Lag	Lead			
Lead-Lag Optimize?	Yes	Yes	Yes			
Recall Mode	Min	Min	None	Min	None	None
Act Effct Green (s)	29.1	29.1	31.5	65.2	23.0	22.6
Actuated g/C Ratio	0.30	0.30	0.32	0.66	0.23	0.23
v/c Ratio	1.64	0.65	0.90	0.51	0.69	1.25
Control Delay	319.8	18.3	51.6	9.2	6.7	160.1
Queue Delay	0.0	0.0	0.0	0.0	0.0	0.0
Total Delay	319.8	18.3	51.6	9.2	6.7	160.1
LOS	F	B	D	A	A	F
Approach Delay	261.3			21.8		
Approach LOS	F			C		

Intersection Summary

Cycle Length: 105
 Actuated Cycle Length: 98.3
 Natural Cycle: 120
 Control Type: Actuated-Uncoordinated
 Maximum v/c Ratio: 1.64
 Intersection Signal Delay: 136.5
 Intersection LOS: F
 Intersection Capacity Utilization 86.1%
 ICU Level of Service E
 Analysis Period (min) 15

Splits and Phases: 30: I-215 SB Ramps & Cactus Av.

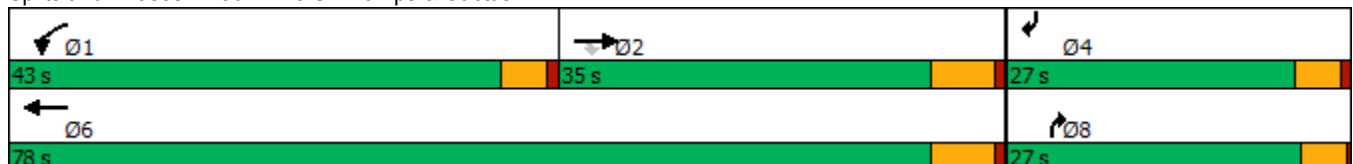

HCM 6th Signalized Intersection Summary
 30: I-215 SB Ramps & Cactus Av.

West Campus Upper Plateau (JN 14064)

09/19/2022



Movement	EBL	EBT	EBR	WBL	WBT	WBR	NBL	NBT	NBR	SBL	SBT	SBR
Lane Configurations		↑↑	↗	↘	↑↑				↗			↗
Traffic Volume (veh/h)	0	1587	383	484	1144	0	0	0	546	0	0	506
Future Volume (veh/h)	0	1587	383	484	1144	0	0	0	546	0	0	506
Initial Q (Qb), veh	0	0	0	0	0	0	0	0	0	0	0	0
Ped-Bike Adj(A_pbT)	1.00		1.00	1.00		1.00	1.00		1.00	1.00		1.00
Parking Bus, Adj	1.00	1.00	1.00	1.00	1.00	1.00	1.00	1.00	1.00	1.00	1.00	1.00
Work Zone On Approach		No			No			No			No	
Adj Sat Flow, veh/h/ln	0	1826	1811	1870	1870	0	0	0	1796	0	0	1752
Adj Flow Rate, veh/h	0	1671	375	509	1204	0	0	0	0	0	0	428
Peak Hour Factor	0.95	0.95	0.95	0.95	0.95	0.95	0.95	0.95	0.95	0.95	0.95	0.95
Percent Heavy Veh, %	0	5	6	2	2	0	0	0	7	0	0	10
Cap, veh/h	0	1734	767	568	3186	0	0	0	0	0	0	0
Arrive On Green	0.00	0.50	0.50	0.32	0.90	0.00	0.00	0.00	0.00	0.00	0.00	0.00
Sat Flow, veh/h	0	3561	1535	1781	3647	0		0			0	
Grp Volume(v), veh/h	0	1671	375	509	1204	0		0.0			0.0	
Grp Sat Flow(s),veh/h/ln	0	1735	1535	1781	1777	0						
Q Serve(g_s), s	0.0	26.9	9.4	15.8	3.1	0.0						
Cycle Q Clear(g_c), s	0.0	26.9	9.4	15.8	3.1	0.0						
Prop In Lane	0.00		1.00	1.00		0.00						
Lane Grp Cap(c), veh/h	0	1734	767	568	3186	0						
V/C Ratio(X)	0.00	0.96	0.49	0.90	0.38	0.00						
Avail Cap(c_a), veh/h	0	1735	768	1183	4413	0						
HCM Platoon Ratio	1.00	1.00	1.00	1.00	1.00	1.00						
Upstream Filter(I)	0.00	1.00	1.00	1.00	1.00	0.00						
Uniform Delay (d), s/veh	0.0	14.0	9.6	18.8	0.5	0.0						
Incr Delay (d2), s/veh	0.0	13.8	0.2	2.1	0.0	0.0						
Initial Q Delay(d3),s/veh	0.0	0.0	0.0	0.0	0.0	0.0						
%ile BackOfQ(50%),veh/ln	0.0	10.6	2.3	5.6	0.0	0.0						
Unsig. Movement Delay, s/veh												
LnGrp Delay(d),s/veh	0.0	27.8	9.8	20.9	0.5	0.0						
LnGrp LOS	A	C	A	C	A	A						
Approach Vol, veh/h		2046			1713							
Approach Delay, s/veh		24.5			6.6							
Approach LOS		C			A							
Timer - Assigned Phs	1	2			6							
Phs Duration (G+Y+Rc), s	23.0	35.0			58.0							
Change Period (Y+Rc), s	4.5	6.0			6.0							
Max Green Setting (Gmax), s	38.5	29.0			72.0							
Max Q Clear Time (g_c+I1), s	17.8	28.9			5.1							
Green Ext Time (p_c), s	0.7	0.0			6.2							

Intersection Summary

HCM 6th Ctrl Delay	16.3
HCM 6th LOS	B

Notes

Unsignalized Delay for [NBR] is excluded from calculations of the approach delay and intersection delay.

Timings

31: I-215 NB Ramps/Old 215 Frontage Rd. & Cactus Av.



Lane Group	EBL	EBT	WBT	NBL	NBT	NBR	SBL	SBT
Lane Configurations	↗	↗↘	↗↘	↗	↘	↗	↗	↘
Traffic Volume (vph)	98	1521	1714	207	218	3	166	2
Future Volume (vph)	98	1521	1714	207	218	3	166	2
Turn Type	Perm	NA	NA	Perm	NA	Perm	Perm	NA
Protected Phases		2	6		8			4
Permitted Phases	2			8		8	4	
Detector Phase	2	2	6	8	8	8	4	4
Switch Phase								
Minimum Initial (s)	5.0	5.0	5.0	5.0	5.0	5.0	5.0	5.0
Minimum Split (s)	11.0	11.0	44.0	10.5	10.5	10.5	10.5	10.5
Total Split (s)	57.4	57.4	57.4	27.6	27.6	27.6	27.6	27.6
Total Split (%)	67.5%	67.5%	67.5%	32.5%	32.5%	32.5%	32.5%	32.5%
Yellow Time (s)	5.0	5.0	5.0	4.5	4.5	4.5	4.5	4.5
All-Red Time (s)	1.0	1.0	1.0	1.0	1.0	1.0	1.0	1.0
Lost Time Adjust (s)	0.0	0.0	0.0	0.0	0.0	0.0	0.0	0.0
Total Lost Time (s)	6.0	6.0	6.0	5.5	5.5	5.5	5.5	5.5
Lead/Lag								
Lead-Lag Optimize?								
Recall Mode	Min	Min	Min	None	None	None	None	None
Act Effct Green (s)	51.5	51.5	51.5	19.6	19.6	19.6	19.6	19.6
Actuated g/C Ratio	0.62	0.62	0.62	0.24	0.24	0.24	0.24	0.24
v/c Ratio	1.13	1.13	0.90	0.89	0.55	0.01	0.83	0.47
Control Delay	163.3	81.6	21.6	68.1	32.9	0.0	62.5	28.1
Queue Delay	0.0	0.0	0.0	0.0	0.0	0.0	0.0	0.0
Total Delay	163.3	81.6	21.6	68.1	32.9	0.0	62.5	28.1
LOS	F	F	C	E	C	A	E	C
Approach Delay		85.0	21.6		49.7			44.8
Approach LOS		F	C		D			D

Intersection Summary

Cycle Length: 85
 Actuated Cycle Length: 82.6
 Natural Cycle: 80
 Control Type: Actuated-Uncoordinated
 Maximum v/c Ratio: 1.13
 Intersection Signal Delay: 55.5
 Intersection LOS: E
 Intersection Capacity Utilization 102.4%
 ICU Level of Service G
 Analysis Period (min) 15

Splits and Phases: 31: I-215 NB Ramps/Old 215 Frontage Rd. & Cactus Av.

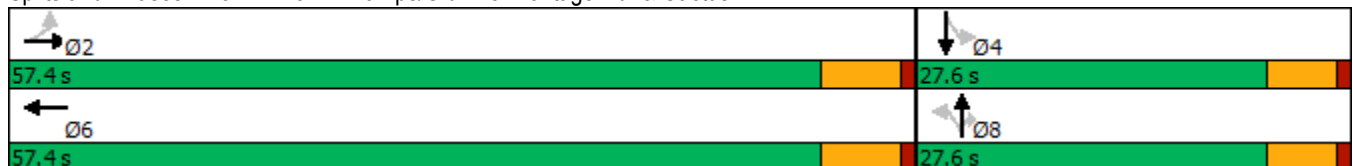

HCM 6th Signalized Intersection Summary

West Campus Upper Plateau (JN 14064)

31: I-215 NB Ramps/Old 215 Frontage Rd. & Cactus Av.

09/19/2022



Movement	EBL	EBT	EBR	WBL	WBT	WBR	NBL	NBT	NBR	SBL	SBT	SBR
Lane Configurations	↗	↗↘			↗↘		↗	↘	↗	↗	↘	↘
Traffic Volume (veh/h)	98	1521	742	0	1714	161	207	218	3	166	2	175
Future Volume (veh/h)	98	1521	742	0	1714	161	207	218	3	166	2	175
Initial Q (Qb), veh	0	0	0	0	0	0	0	0	0	0	0	0
Ped-Bike Adj(A_pbT)	1.00		1.00	1.00		1.00	1.00		1.00	1.00		1.00
Parking Bus, Adj	1.00	1.00	1.00	1.00	1.00	1.00	1.00	1.00	1.00	1.00	1.00	1.00
Work Zone On Approach		No			No			No			No	
Adj Sat Flow, veh/h/ln	1856	1841	1767	0	1856	1885	1767	1856	1900	1841	1900	1885
Adj Flow Rate, veh/h	102	1584	769	0	1785	120	216	227	0	173	2	156
Peak Hour Factor	0.96	0.96	0.96	0.96	0.96	0.96	0.96	0.96	0.96	0.96	0.96	0.96
Percent Heavy Veh, %	3	4	9	0	3	1	9	3	0	4	0	1
Cap, veh/h	119	1420	636	0	2029	135	293	482		263	5	414
Arrive On Green	0.60	0.60	0.60	0.00	0.60	0.60	0.26	0.26	0.00	0.26	0.26	0.26
Sat Flow, veh/h	234	2348	1052	0	3447	223	1160	1856	1610	1135	20	1593
Grp Volume(v), veh/h	102	1146	1207	0	929	976	216	227	0	173	0	158
Grp Sat Flow(s),veh/h/ln	234	1749	1651	0	1763	1815	1160	1856	1610	1135	0	1613
Q Serve(g_s), s	12.3	51.4	51.4	0.0	37.4	39.1	15.3	8.8	0.0	12.9	0.0	6.8
Cycle Q Clear(g_c), s	51.4	51.4	51.4	0.0	37.4	39.1	22.1	8.8	0.0	21.7	0.0	6.8
Prop In Lane	1.00		0.64	0.00		0.12	1.00		1.00	1.00		0.99
Lane Grp Cap(c), veh/h	119	1057	999	0	1066	1098	293	482		263	0	419
V/C Ratio(X)	0.86	1.08	1.21	0.00	0.87	0.89	0.74	0.47		0.66	0.00	0.38
Avail Cap(c_a), veh/h	119	1057	999	0	1066	1098	293	482		263	0	419
HCM Platoon Ratio	1.00	1.00	1.00	1.00	1.00	1.00	1.00	1.00	1.00	1.00	1.00	1.00
Upstream Filter(I)	1.00	1.00	1.00	0.00	1.00	1.00	1.00	1.00	0.00	1.00	0.00	1.00
Uniform Delay (d), s/veh	40.5	16.8	16.8	0.0	14.0	14.4	35.1	26.5	0.0	35.6	0.0	25.8
Incr Delay (d2), s/veh	41.6	53.4	103.3	0.0	7.7	8.9	8.3	0.3	0.0	4.8	0.0	0.2
Initial Q Delay(d3),s/veh	0.0	0.0	0.0	0.0	0.0	0.0	0.0	0.0	0.0	0.0	0.0	0.0
%ile BackOfQ(50%),veh/ln	3.4	31.1	43.2	0.0	13.6	14.9	4.9	3.6	0.0	3.6	0.0	2.4
Unsig. Movement Delay, s/veh												
LnGrp Delay(d),s/veh	82.0	70.2	120.1	0.0	21.8	23.3	43.4	26.8	0.0	40.4	0.0	26.0
LnGrp LOS	F	F	F	A	C	C	D	C		D	A	C
Approach Vol, veh/h		2455			1905			443				331
Approach Delay, s/veh		95.2			22.5			34.9				33.5
Approach LOS		F			C			C				C
Timer - Assigned Phs		2		4		6		8				
Phs Duration (G+Y+Rc), s		57.4		27.6		57.4		27.6				
Change Period (Y+Rc), s		6.0		5.5		6.0		5.5				
Max Green Setting (Gmax), s		51.4		22.1		51.4		22.1				
Max Q Clear Time (g_c+I1), s		53.4		23.7		41.1		24.1				
Green Ext Time (p_c), s		0.0		0.0		6.2		0.0				

Intersection Summary

HCM 6th Ctrl Delay	59.1
HCM 6th LOS	E

Notes

User approved volume balancing among the lanes for turning movement.
 Unsignalized Delay for [NBR] is excluded from calculations of the approach delay and intersection delay.

Timings
32: I-215 SB Ramps & Van Buren Bl.



Lane Group	EBT	EBR	WBL	WBT	SBT	SBR
Lane Configurations	↑↑	↑↑	↵	↑↑	↵	↑↑
Traffic Volume (vph)	444	1734	3	844	85	192
Future Volume (vph)	444	1734	3	844	85	192
Turn Type	NA	Perm	Prot	NA	NA	Perm
Protected Phases	6		5	2	8	
Permitted Phases		6				8
Detector Phase	6	6	5	2	8	8
Switch Phase						
Minimum Initial (s)	5.0	5.0	5.0	5.0	5.0	5.0
Minimum Split (s)	36.0	36.0	11.0	11.0	11.0	11.0
Total Split (s)	60.0	60.0	11.0	71.0	14.0	14.0
Total Split (%)	70.6%	70.6%	12.9%	83.5%	16.5%	16.5%
Yellow Time (s)	5.0	5.0	5.0	5.0	5.0	5.0
All-Red Time (s)	1.0	1.0	1.0	1.0	1.0	1.0
Lost Time Adjust (s)	0.0	0.0	0.0	0.0	0.0	0.0
Total Lost Time (s)	6.0	6.0	6.0	6.0	6.0	6.0
Lead/Lag	Lag	Lag	Lead			
Lead-Lag Optimize?	Yes	Yes	Yes			
Recall Mode	Min	Min	None	Min	Max	Max
Act Effct Green (s)	37.6	37.6	5.4	39.2	8.6	8.6
Actuated g/C Ratio	0.62	0.62	0.09	0.65	0.14	0.14
v/c Ratio	0.23	0.89	0.03	0.41	0.41	0.39
Control Delay	5.2	11.1	34.7	5.1	36.3	8.4
Queue Delay	0.0	0.0	0.0	0.0	0.0	0.0
Total Delay	5.2	11.1	34.7	5.1	36.3	8.4
LOS	A	B	C	A	D	A
Approach Delay	9.9			5.2	17.7	
Approach LOS	A			A	B	

Intersection Summary

Cycle Length: 85
 Actuated Cycle Length: 60.6
 Natural Cycle: 65
 Control Type: Actuated-Uncoordinated
 Maximum v/c Ratio: 0.89
 Intersection Signal Delay: 9.3
 Intersection Capacity Utilization 84.0%
 Analysis Period (min) 15
 Intersection LOS: A
 ICU Level of Service E

Splits and Phases: 32: I-215 SB Ramps & Van Buren Bl.



HCM 6th Signalized Intersection Summary
 32: I-215 SB Ramps & Van Buren Bl.

West Campus Upper Plateau (JN 14064)

09/19/2022



Movement	EBL	EBT	EBR	WBL	WBT	WBR	NBL	NBT	NBR	SBL	SBT	SBR
Lane Configurations		↑↑	↑↑	↑	↑↑						↑	↑↑
Traffic Volume (veh/h)	0	444	1734	3	844	0	0	0	0	11	85	192
Future Volume (veh/h)	0	444	1734	3	844	0	0	0	0	11	85	192
Initial Q (Qb), veh	0	0	0	0	0	0				0	0	0
Ped-Bike Adj(A_pbT)	1.00		1.00	1.00		1.00				1.00		1.00
Parking Bus, Adj	1.00	1.00	1.00	1.00	1.00	1.00				1.00	1.00	1.00
Work Zone On Approach		No			No						No	
Adj Sat Flow, veh/h/ln	0	1767	1841	1411	1811	0				1500	1841	1663
Adj Flow Rate, veh/h	0	477	1766	3	908	0				12	91	0
Peak Hour Factor	0.93	0.93	0.93	0.93	0.93	0.93				0.93	0.93	0.93
Percent Heavy Veh, %	0	9	4	33	6	0				27	4	16
Cap, veh/h	0	2132	1744	79	2631	0				20	152	
Arrive On Green	0.00	0.64	0.64	0.06	0.76	0.00				0.09	0.09	0.00
Sat Flow, veh/h	0	3445	2745	1344	3532	0				213	1617	2480
Grp Volume(v), veh/h	0	477	1766	3	908	0				103	0	0
Grp Sat Flow(s),veh/h/ln	0	1678	1373	1344	1721	0				1830	0	1240
Q Serve(g_s), s	0.0	5.1	54.0	0.2	7.2	0.0				4.6	0.0	0.0
Cycle Q Clear(g_c), s	0.0	5.1	54.0	0.2	7.2	0.0				4.6	0.0	0.0
Prop In Lane	0.00		1.00	1.00		0.00				0.12		1.00
Lane Grp Cap(c), veh/h	0	2132	1744	79	2631	0				172	0	
V/C Ratio(X)	0.00	0.22	1.01	0.04	0.35	0.00				0.60	0.00	
Avail Cap(c_a), veh/h	0	2132	1744	79	2631	0				172	0	
HCM Platoon Ratio	1.00	1.00	1.00	1.00	1.00	1.00				1.00	1.00	1.00
Upstream Filter(I)	0.00	1.00	1.00	1.00	1.00	0.00				1.00	0.00	0.00
Uniform Delay (d), s/veh	0.0	6.6	15.5	37.7	3.2	0.0				37.0	0.0	0.0
Incr Delay (d2), s/veh	0.0	0.0	24.7	0.1	0.0	0.0				14.4	0.0	0.0
Initial Q Delay(d3),s/veh	0.0	0.0	0.0	0.0	0.0	0.0				0.0	0.0	0.0
%ile BackOfQ(50%),veh/ln	0.0	1.3	17.0	0.1	1.1	0.0				2.6	0.0	0.0
Unsig. Movement Delay, s/veh												
LnGrp Delay(d),s/veh	0.0	6.6	40.2	37.8	3.2	0.0				51.4	0.0	0.0
LnGrp LOS	A	A	F	D	A	A				D	A	
Approach Vol, veh/h		2243			911							103
Approach Delay, s/veh		33.0			3.3							51.4
Approach LOS		C			A							D
Timer - Assigned Phs		2			5	6		8				
Phs Duration (G+Y+Rc), s		71.0			11.0	60.0		14.0				
Change Period (Y+Rc), s		6.0			6.0	6.0		6.0				
Max Green Setting (Gmax), s		65.0			5.0	54.0		8.0				
Max Q Clear Time (g_c+I1), s		9.2			2.2	56.0		6.6				
Green Ext Time (p_c), s		4.0			0.0	0.0		0.0				

Intersection Summary

HCM 6th Ctrl Delay	25.3
HCM 6th LOS	C

Notes

Unsignalized Delay for [SBR] is excluded from calculations of the approach delay and intersection delay.

Timings
33: I-215 NB On/Off Ramp & Van Buren Bl.



Lane Group	EBT	EBR	WBT	NBL	NBR
Lane Configurations	↑↑	↑↑	↑↑	↑↑	↑
Traffic Volume (vph)	4	497	21	759	4
Future Volume (vph)	4	497	21	759	4
Turn Type	NA	pm+ov	NA	Prot	Perm
Protected Phases	6	4	2	4	
Permitted Phases		6			4
Detector Phase	6	4	2	4	4
Switch Phase					
Minimum Initial (s)	5.0	5.0	5.0	5.0	5.0
Minimum Split (s)	11.0	42.0	11.0	42.0	42.0
Total Split (s)	15.0	55.0	15.0	55.0	55.0
Total Split (%)	21.4%	78.6%	21.4%	78.6%	78.6%
Yellow Time (s)	5.0	5.0	5.0	5.0	5.0
All-Red Time (s)	1.0	1.0	1.0	1.0	1.0
Lost Time Adjust (s)	0.0	0.0	0.0	0.0	0.0
Total Lost Time (s)	6.0	6.0	6.0	6.0	6.0
Lead/Lag					
Lead-Lag Optimize?					
Recall Mode	None	Min	None	Min	Min
Act Effct Green (s)	5.7	37.7	5.7	35.7	35.7
Actuated g/C Ratio	0.15	1.00	0.15	0.95	0.95
v/c Ratio	0.01	0.20	0.04	0.26	0.00
Control Delay	21.5	0.2	20.6	1.1	1.0
Queue Delay	0.0	0.0	0.0	0.0	0.0
Total Delay	21.5	0.2	20.6	1.1	1.0
LOS	C	A	C	A	A
Approach Delay	0.3		20.6	1.1	
Approach LOS	A		C	A	

Intersection Summary

Cycle Length: 70
 Actuated Cycle Length: 37.7
 Natural Cycle: 55
 Control Type: Actuated-Uncoordinated
 Maximum v/c Ratio: 0.26
 Intersection Signal Delay: 1.1
 Intersection LOS: A
 Intersection Capacity Utilization 35.8%
 ICU Level of Service A
 Analysis Period (min) 15

Splits and Phases: 33: I-215 NB On/Off Ramp & Van Buren Bl.



HCM 6th Signalized Intersection Summary
 33: I-215 NB On/Off Ramp & Van Buren Bl.

West Campus Upper Plateau (JN 14064)

09/19/2022

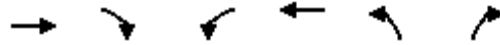

Movement	EBT	EBR	WBL	WBT	NBL	NBR
Lane Configurations	↑↑	↑↑		↑↑	↑↑	↑
Traffic Volume (veh/h)	4	497	0	21	759	4
Future Volume (veh/h)	4	497	0	21	759	4
Initial Q (Qb), veh	0	0	0	0	0	0
Ped-Bike Adj(A_pbT)		1.00	1.00		1.00	1.00
Parking Bus, Adj	1.00	1.00	1.00	1.00	1.00	1.00
Work Zone On Approach	No			No	No	
Adj Sat Flow, veh/h/ln	1900	1767	0	1752	1811	1159
Adj Flow Rate, veh/h	4	515	0	22	799	4
Peak Hour Factor	0.95	0.95	0.95	0.95	0.95	0.95
Percent Heavy Veh, %	0	9	0	10	6	50
Cap, veh/h	734	1435	0	676	1143	335
Arrive On Green	0.20	0.20	0.00	0.20	0.34	0.34
Sat Flow, veh/h	3705	2635	0	3504	3346	982
Grp Volume(v), veh/h	4	515	0	22	799	4
Grp Sat Flow(s),veh/h/ln	1805	1317	0	1664	1673	982
Q Serve(g_s), s	0.0	2.9	0.0	0.1	5.4	0.1
Cycle Q Clear(g_c), s	0.0	2.9	0.0	0.1	5.4	0.1
Prop In Lane		1.00	0.00		1.00	1.00
Lane Grp Cap(c), veh/h	734	1435	0	676	1143	335
V/C Ratio(X)	0.01	0.36	0.00	0.03	0.70	0.01
Avail Cap(c_a), veh/h	1233	1800	0	1137	6221	1826
HCM Platoon Ratio	1.00	1.00	1.00	1.00	1.00	1.00
Upstream Filter(I)	1.00	1.00	0.00	1.00	1.00	1.00
Uniform Delay (d), s/veh	8.4	3.4	0.0	8.4	7.5	5.7
Incr Delay (d2), s/veh	0.0	0.1	0.0	0.0	0.3	0.0
Initial Q Delay(d3),s/veh	0.0	0.0	0.0	0.0	0.0	0.0
%ile BackOfQ(50%),veh/ln	0.0	0.7	0.0	0.0	0.7	0.0
Unsig. Movement Delay, s/veh						
LnGrp Delay(d),s/veh	8.4	3.5	0.0	8.4	7.8	5.7
LnGrp LOS	A	A	A	A	A	A
Approach Vol, veh/h	519			22	803	
Approach Delay, s/veh	3.5			8.4	7.8	
Approach LOS	A			A	A	
Timer - Assigned Phs		2		4		6
Phs Duration (G+Y+Rc), s		11.4		15.0		11.4
Change Period (Y+Rc), s		6.0		6.0		6.0
Max Green Setting (Gmax), s		9.0		49.0		9.0
Max Q Clear Time (g_c+I1), s		2.1		7.4		4.9
Green Ext Time (p_c), s		0.0		1.6		0.5
Intersection Summary						
HCM 6th Ctrl Delay			6.1			
HCM 6th LOS			A			

Timings

West Campus Upper Plateau (JN 14064)

34: Old 215 Frontage Rd. & Alessandro Bl.

09/19/2022

Lane Group	EBL	EBT	EBR	WBL	WBT	WBR	NBL	NBT	NBR	SBL	SBT	SBR
Lane Configurations												
Traffic Volume (vph)	317	1486	97	13	912	105	31	191	13	110	214	176
Future Volume (vph)	317	1486	97	13	912	105	31	191	13	110	214	176
Turn Type	Prot	NA	Perm	Prot	NA	Perm	Prot	NA	Perm	Prot	NA	Perm
Protected Phases	5	2		1	6		3	8		7	4	
Permitted Phases			2			6			8			4
Detector Phase	5	2	2	1	6	6	3	8	8	7	4	4
Switch Phase												
Minimum Initial (s)	5.0	10.0	10.0	5.0	10.0	10.0	5.0	10.0	10.0	5.0	10.0	10.0
Minimum Split (s)	8.7	43.5	43.5	8.7	15.8	15.8	8.7	16.2	16.2	8.7	40.2	40.2
Total Split (s)	22.0	62.4	62.4	8.7	49.1	49.1	8.7	29.7	29.7	19.2	40.2	40.2
Total Split (%)	18.3%	52.0%	52.0%	7.3%	40.9%	40.9%	7.3%	24.8%	24.8%	16.0%	33.5%	33.5%
Yellow Time (s)	3.2	5.5	5.5	3.2	4.8	4.8	3.2	5.2	5.2	3.2	5.2	5.2
All-Red Time (s)	0.5	1.0	1.0	0.5	1.0	1.0	0.5	1.0	1.0	0.5	1.0	1.0
Lost Time Adjust (s)	0.0	0.0	0.0	0.0	0.0	0.0	0.0	0.0	0.0	0.0	0.0	0.0
Total Lost Time (s)	3.7	6.5	6.5	3.7	5.8	5.8	3.7	6.2	6.2	3.7	6.2	6.2
Lead/Lag	Lead	Lag	Lag	Lead	Lag	Lag	Lead	Lag	Lag	Lead	Lag	Lag
Lead-Lag Optimize?	Yes	Yes	Yes	Yes	Yes	Yes	Yes	Yes	Yes	Yes	Yes	Yes
Recall Mode	None	None	None	None	None	None	None	None	None	None	None	None
Act Effct Green (s)	13.1	45.4	45.4	5.3	30.5	30.5	5.3	13.0	13.0	10.4	22.6	22.6
Actuated g/C Ratio	0.15	0.52	0.52	0.06	0.35	0.35	0.06	0.15	0.15	0.12	0.26	0.26
v/c Ratio	0.63	0.57	0.13	0.14	0.76	0.16	0.19	0.37	0.04	0.55	0.26	0.33
Control Delay	43.3	16.2	1.8	52.2	30.7	1.3	50.0	38.5	0.2	51.1	29.8	6.8
Queue Delay	0.0	0.0	0.0	0.0	0.0	0.0	0.0	0.0	0.0	0.0	0.0	0.0
Total Delay	43.3	16.2	1.8	52.2	30.7	1.3	50.0	38.5	0.2	51.1	29.8	6.8
LOS	D	B	A	D	C	A	D	D	A	D	C	A
Approach Delay		20.0			28.0			37.9			26.4	
Approach LOS		B			C			D			C	

Intersection Summary

Cycle Length: 120
 Actuated Cycle Length: 87.3
 Natural Cycle: 105
 Control Type: Actuated-Uncoordinated
 Maximum v/c Ratio: 0.76
 Intersection Signal Delay: 24.2
 Intersection LOS: C
 Intersection Capacity Utilization 65.3%
 ICU Level of Service C
 Analysis Period (min) 15

Splits and Phases: 34: Old 215 Frontage Rd. & Alessandro Bl.

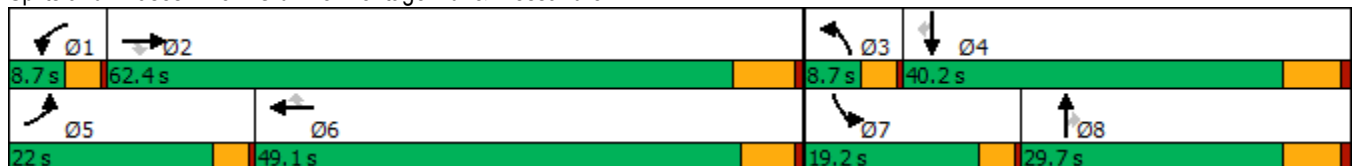

HCM 6th Signalized Intersection Summary
 34: Old 215 Frontage Rd. & Alessandro Bl.

West Campus Upper Plateau (JN 14064)

09/19/2022



Movement	EBL	EBT	EBR	WBL	WBT	WBR	NBL	NBT	NBR	SBL	SBT	SBR
Lane Configurations	↖↗	↑↑↑	↖	↖	↑↑	↖	↖↗	↑↑	↖	↖	↑↑	↖
Traffic Volume (veh/h)	317	1486	97	13	912	105	31	191	13	110	214	176
Future Volume (veh/h)	317	1486	97	13	912	105	31	191	13	110	214	176
Initial Q (Qb), veh	0	0	0	0	0	0	0	0	0	0	0	0
Ped-Bike Adj(A_pbT)	1.00		0.99	1.00		1.00	1.00		0.98	1.00		1.00
Parking Bus, Adj	1.00	1.00	1.00	1.00	1.00	1.00	1.00	1.00	1.00	1.00	1.00	1.00
Work Zone On Approach		No			No			No			No	
Adj Sat Flow, veh/h/ln	1870	1885	1678	1678	1856	1856	1515	1856	1559	1826	1752	1885
Adj Flow Rate, veh/h	323	1516	72	13	931	0	32	195	3	112	218	0
Peak Hour Factor	0.98	0.98	0.98	0.98	0.98	0.98	0.98	0.98	0.98	0.98	0.98	0.98
Percent Heavy Veh, %	2	1	15	15	3	3	26	3	23	5	10	1
Cap, veh/h	432	2388	652	26	1252		93	512	189	143	647	
Arrive On Green	0.13	0.46	0.46	0.02	0.35	0.00	0.03	0.15	0.15	0.08	0.19	0.00
Sat Flow, veh/h	3456	5147	1404	1598	3526	1572	2799	3526	1301	1739	3328	1598
Grp Volume(v), veh/h	323	1516	72	13	931	0	32	195	3	112	218	0
Grp Sat Flow(s),veh/h/ln	1728	1716	1404	1598	1763	1572	1399	1763	1301	1739	1664	1598
Q Serve(g_s), s	6.2	15.4	2.0	0.6	15.9	0.0	0.8	3.4	0.1	4.3	3.9	0.0
Cycle Q Clear(g_c), s	6.2	15.4	2.0	0.6	15.9	0.0	0.8	3.4	0.1	4.3	3.9	0.0
Prop In Lane	1.00		1.00	1.00		1.00	1.00		1.00	1.00		1.00
Lane Grp Cap(c), veh/h	432	2388	652	26	1252		93	512	189	143	647	
V/C Ratio(X)	0.75	0.63	0.11	0.51	0.74		0.34	0.38	0.02	0.78	0.34	
Avail Cap(c_a), veh/h	919	4183	1141	116	2219		203	1205	445	392	1645	
HCM Platoon Ratio	1.00	1.00	1.00	1.00	1.00	1.00	1.00	1.00	1.00	1.00	1.00	1.00
Upstream Filter(I)	1.00	1.00	1.00	1.00	1.00	0.00	1.00	1.00	1.00	1.00	1.00	0.00
Uniform Delay (d), s/veh	29.0	14.0	10.4	33.6	19.4	0.0	32.5	26.6	25.2	31.0	23.9	0.0
Incr Delay (d2), s/veh	1.0	0.3	0.1	5.7	0.9	0.0	0.8	0.5	0.0	3.5	0.3	0.0
Initial Q Delay(d3),s/veh	0.0	0.0	0.0	0.0	0.0	0.0	0.0	0.0	0.0	0.0	0.0	0.0
%ile BackOfQ(50%),veh/ln	2.3	4.5	0.5	0.2	5.7	0.0	0.2	1.3	0.0	1.8	1.4	0.0
Unsig. Movement Delay, s/veh												
LnGrp Delay(d),s/veh	30.0	14.3	10.5	39.3	20.3	0.0	33.3	27.1	25.2	34.4	24.2	0.0
LnGrp LOS	C	B	B	D	C		C	C	C	C	C	
Approach Vol, veh/h		1911			944			230			330	
Approach Delay, s/veh		16.8			20.6			27.9			27.7	
Approach LOS		B			C			C			C	
Timer - Assigned Phs	1	2	3	4	5	6	7	8				
Phs Duration (G+Y+Rc), s	4.8	38.4	6.0	19.6	12.3	30.9	9.4	16.2				
Change Period (Y+Rc), s	3.7	6.5	3.7	6.2	3.7	* 6.5	3.7	6.2				
Max Green Setting (Gmax), s	5.0	55.9	5.0	34.0	18.3	* 43	15.5	23.5				
Max Q Clear Time (g_c+I1), s	2.6	17.4	2.8	5.9	8.2	17.9	6.3	5.4				
Green Ext Time (p_c), s	0.0	13.2	0.0	1.2	0.4	6.5	0.1	0.9				

Intersection Summary

HCM 6th Ctrl Delay	19.6
HCM 6th LOS	B

Notes

* HCM 6th computational engine requires equal clearance times for the phases crossing the barrier.
 Unsignalized Delay for [WBR, SBR] is excluded from calculations of the approach delay and intersection delay.

Timings
35: Day St. & Alessandro Bl.

West Campus Upper Plateau (JN 14064)

09/19/2022



Lane Group	EBL	EBT	EBR	WBL	WBT	WBR	NBL	NBT	NBR	SBL	SBT
Lane Configurations	↖	↗↗↗	↖	↖	↗↗	↖	↖	↗	↖	↖	↗
Traffic Volume (vph)	238	1420	21	12	847	173	15	134	11	201	132
Future Volume (vph)	238	1420	21	12	847	173	15	134	11	201	132
Turn Type	Prot	NA	Perm	Prot	NA	Perm	Perm	NA	Perm	Perm	NA
Protected Phases	5	2		1	6			8			4
Permitted Phases			2			6	8		8	4	
Detector Phase	5	2	2	1	6	6	8	8	8	4	4
Switch Phase											
Minimum Initial (s)	5.0	10.0	10.0	5.0	10.0	10.0	10.0	10.0	10.0	10.0	10.0
Minimum Split (s)	9.1	30.8	30.8	9.1	30.8	30.8	42.4	42.4	42.4	41.6	41.6
Total Split (s)	28.0	67.9	67.9	9.1	49.0	49.0	43.0	43.0	43.0	43.0	43.0
Total Split (%)	23.3%	56.6%	56.6%	7.6%	40.8%	40.8%	35.8%	35.8%	35.8%	35.8%	35.8%
Yellow Time (s)	3.6	4.8	4.8	3.6	4.8	4.8	4.4	4.4	4.4	3.6	3.6
All-Red Time (s)	0.5	1.0	1.0	0.5	1.0	1.0	1.0	1.0	1.0	1.0	1.0
Lost Time Adjust (s)	0.0	0.0	0.0	0.0	0.0	0.0	0.0	0.0	0.0	0.0	0.0
Total Lost Time (s)	4.1	5.8	5.8	4.1	5.8	5.8	5.4	5.4	5.4	4.6	4.6
Lead/Lag	Lead	Lag	Lag	Lead	Lag	Lag					
Lead-Lag Optimize?	Yes	Yes	Yes	Yes	Yes	Yes					
Recall Mode	None	None	None	None	None	None	None	None	None	None	None
Act Effct Green (s)	16.5	49.3	49.3	5.4	29.6	29.6	21.0	21.0	21.0	21.9	21.9
Actuated g/C Ratio	0.20	0.59	0.59	0.06	0.35	0.35	0.25	0.25	0.25	0.26	0.26
v/c Ratio	0.70	0.49	0.03	0.11	0.71	0.29	0.10	0.29	0.02	0.64	0.55
Control Delay	46.3	11.9	0.0	50.8	28.3	12.7	29.5	29.2	0.1	39.4	28.6
Queue Delay	0.0	0.0	0.0	0.0	0.0	0.0	0.0	0.0	0.0	0.0	0.0
Total Delay	46.3	11.9	0.0	50.8	28.3	12.7	29.5	29.2	0.1	39.4	28.6
LOS	D	B	A	D	C	B	C	C	A	D	C
Approach Delay		16.6			25.9			27.3			33.4
Approach LOS		B			C			C			C

Intersection Summary

Cycle Length: 120
 Actuated Cycle Length: 83.7
 Natural Cycle: 85
 Control Type: Actuated-Uncoordinated
 Maximum v/c Ratio: 0.71
 Intersection Signal Delay: 22.3
 Intersection LOS: C
 Intersection Capacity Utilization 75.9%
 ICU Level of Service D
 Analysis Period (min) 15



























Splits and Phases: 35: Day St. & Alessandro Bl.



HCM 6th Signalized Intersection Summary
35: Day St. & Alessandro Bl.

West Campus Upper Plateau (JN 14064)

09/19/2022

												
Movement	EBL	EBT	EBR	WBL	WBT	WBR	NBL	NBT	NBR	SBL	SBT	SBR
Lane Configurations		  			 							
Traffic Volume (veh/h)	238	1420	21	12	847	173	15	134	11	201	132	121
Future Volume (veh/h)	238	1420	21	12	847	173	15	134	11	201	132	121
Initial Q (Qb), veh	0	0	0	0	0	0	0	0	0	0	0	0
Ped-Bike Adj(A_pbT)	1.00		0.98	1.00		0.98	1.00		1.00	1.00		1.00
Parking Bus, Adj	1.00	1.00	1.00	1.00	1.00	1.00	1.00	1.00	1.00	1.00	1.00	1.00
Work Zone On Approach		No			No			No			No	
Adj Sat Flow, veh/h/ln	1900	1870	1618	1900	1870	1900	1500	1900	1767	1885	1870	1870
Adj Flow Rate, veh/h	248	1479	16	12	882	112	16	140	6	209	138	95
Peak Hour Factor	0.96	0.96	0.96	0.96	0.96	0.96	0.96	0.96	0.96	0.96	0.96	0.96
Percent Heavy Veh, %	0	2	19	0	2	0	27	0	9	1	2	2
Cap, veh/h	297	2501	657	27	1211	536	254	523	412	376	284	195
Arrive On Green	0.16	0.49	0.49	0.01	0.34	0.34	0.28	0.28	0.28	0.28	0.28	0.28
Sat Flow, veh/h	1810	5106	1341	1810	3554	1574	920	1900	1497	1252	1032	710
Grp Volume(v), veh/h	248	1479	16	12	882	112	16	140	6	209	0	233
Grp Sat Flow(s),veh/h/ln	1810	1702	1341	1810	1777	1574	920	1900	1497	1252	0	1742
Q Serve(g_s), s	9.2	14.4	0.4	0.5	15.1	3.5	1.0	4.0	0.2	10.9	0.0	7.8
Cycle Q Clear(g_c), s	9.2	14.4	0.4	0.5	15.1	3.5	8.8	4.0	0.2	14.9	0.0	7.8
Prop In Lane	1.00		1.00	1.00		1.00	1.00		1.00	1.00		0.41
Lane Grp Cap(c), veh/h	297	2501	657	27	1211	536	254	523	412	376	0	479
V/C Ratio(X)	0.84	0.59	0.02	0.45	0.73	0.21	0.06	0.27	0.01	0.56	0.00	0.49
Avail Cap(c_a), veh/h	623	4566	1199	130	2211	979	499	1029	811	724	0	963
HCM Platoon Ratio	1.00	1.00	1.00	1.00	1.00	1.00	1.00	1.00	1.00	1.00	1.00	1.00
Upstream Filter(I)	1.00	1.00	1.00	1.00	1.00	1.00	1.00	1.00	1.00	1.00	0.00	1.00
Uniform Delay (d), s/veh	28.1	12.7	9.1	33.9	20.1	16.2	24.8	19.7	18.3	25.5	0.0	21.1
Incr Delay (d2), s/veh	2.4	0.2	0.0	4.2	0.9	0.2	0.1	0.3	0.0	1.3	0.0	0.8
Initial Q Delay(d3),s/veh	0.0	0.0	0.0	0.0	0.0	0.0	0.0	0.0	0.0	0.0	0.0	0.0
%ile BackOfQ(50%),veh/ln	3.8	4.4	0.1	0.2	5.5	1.1	0.2	1.6	0.1	3.3	0.0	3.1
Unsig. Movement Delay, s/veh												
LnGrp Delay(d),s/veh	30.5	12.9	9.2	38.2	20.9	16.4	24.9	20.0	18.3	26.8	0.0	21.8
LnGrp LOS	C	B	A	D	C	B	C	B	B	C	A	C
Approach Vol, veh/h		1743			1006			162			442	
Approach Delay, s/veh		15.4			20.6			20.4			24.2	
Approach LOS		B			C			C			C	
Timer - Assigned Phs	1	2		4	5	6		8				
Phs Duration (G+Y+Rc), s	5.1	39.8		24.5	15.5	29.5		24.5				
Change Period (Y+Rc), s	4.1	5.8		* 5.4	4.1	5.8		5.4				
Max Green Setting (Gmax), s	5.0	62.1		* 38	23.9	43.2		37.6				
Max Q Clear Time (g_c+I1), s	2.5	16.4		16.9	11.2	17.1		10.8				
Green Ext Time (p_c), s	0.0	14.0		2.2	0.3	6.5		0.8				

Intersection Summary

HCM 6th Ctrl Delay	18.4
HCM 6th LOS	B

Notes

* HCM 6th computational engine requires equal clearance times for the phases crossing the barrier.

Timings
36: Elsworth St. & Cactus Av.

West Campus Upper Plateau (JN 14064)

09/19/2022



Lane Group	EBL	EBT	EBR	WBL	WBT	WBR	NBL	NBT	SBL	SBT	SBR
Lane Configurations	↘	↑↑↑	↗	↘	↑↑↑	↗	↘	↕	↘	↗	↗
Traffic Volume (vph)	188	1962	26	15	1227	83	191	64	201	13	197
Future Volume (vph)	188	1962	26	15	1227	83	191	64	201	13	197
Turn Type	Prot	NA	Perm	Prot	NA	Perm	Split	NA	Split	NA	pm+ov
Protected Phases	5	2		1	6		8	8	4	4	5
Permitted Phases			2			6					4
Detector Phase	5	2	2	1	6	6	8	8	4	4	5
Switch Phase											
Minimum Initial (s)	5.0	10.0	10.0	5.0	10.0	10.0	10.0	10.0	10.0	10.0	5.0
Minimum Split (s)	9.6	36.2	36.2	9.6	36.2	36.2	35.4	35.4	35.4	35.4	9.6
Total Split (s)	16.5	49.6	49.6	9.6	42.7	42.7	35.4	35.4	35.4	35.4	16.5
Total Split (%)	12.7%	38.2%	38.2%	7.4%	32.8%	32.8%	27.2%	27.2%	27.2%	27.2%	12.7%
Yellow Time (s)	3.6	5.2	5.2	3.6	5.2	5.2	4.4	4.4	4.4	4.4	3.6
All-Red Time (s)	1.0	1.0	1.0	1.0	1.0	1.0	1.0	1.0	1.0	1.0	1.0
Lost Time Adjust (s)	0.0	0.0	0.0	0.0	0.0	0.0	0.0	0.0	0.0	0.0	0.0
Total Lost Time (s)	4.6	6.2	6.2	4.6	6.2	6.2	5.4	5.4	5.4	5.4	4.6
Lead/Lag	Lead	Lag	Lag	Lead	Lag	Lag					Lead
Lead-Lag Optimize?	Yes	Yes	Yes	Yes	Yes	Yes					Yes
Recall Mode	None	None	None	None	None	None	Max	Max	Max	Max	None
Act Effct Green (s)	11.9	48.8	48.8	5.0	36.1	36.1	30.0	30.0	30.0	30.0	42.7
Actuated g/C Ratio	0.09	0.38	0.38	0.04	0.28	0.28	0.23	0.23	0.23	0.23	0.33
v/c Ratio	1.23	1.09	0.04	0.23	0.92	0.16	0.45	0.41	0.28	0.28	0.32
Control Delay	191.2	87.8	0.1	68.8	56.8	1.1	47.1	38.2	43.4	43.4	5.5
Queue Delay	0.0	0.0	0.0	0.0	0.0	0.0	0.0	0.0	0.0	0.0	0.0
Total Delay	191.2	87.8	0.1	68.8	56.8	1.1	47.1	38.2	43.4	43.4	5.5
LOS	F	F	A	E	E	A	D	D	D	D	A
Approach Delay		95.7			53.4			42.7		25.2	
Approach LOS		F			D			D		C	

Intersection Summary

Cycle Length: 130
 Actuated Cycle Length: 129.6
 Natural Cycle: 120
 Control Type: Actuated-Uncoordinated
 Maximum v/c Ratio: 1.23
 Intersection Signal Delay: 71.5
 Intersection Capacity Utilization 77.6%
 Analysis Period (min) 15
 Intersection LOS: E
 ICU Level of Service D

Splits and Phases: 36: Elsworth St. & Cactus Av.

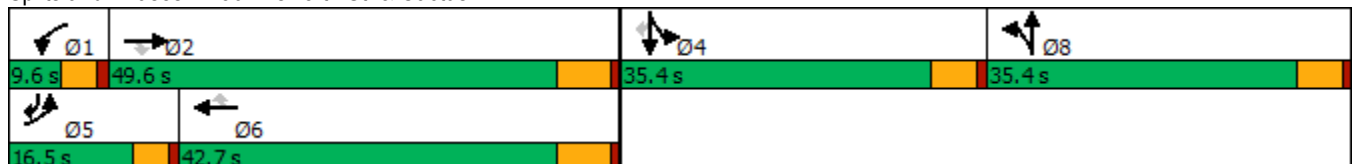

HCM 6th Signalized Intersection Summary
36: Elsworth St. & Cactus Av.

West Campus Upper Plateau (JN 14064)

09/19/2022



Movement	EBL	EBT	EBR	WBL	WBT	WBR	NBL	NBT	NBR	SBL	SBT	SBR
Lane Configurations	↘	↑↑↑	↗	↘	↑↑↑	↗	↘	↕		↘	↗	↗
Traffic Volume (veh/h)	188	1962	26	15	1227	83	191	64	74	201	13	197
Future Volume (veh/h)	188	1962	26	15	1227	83	191	64	74	201	13	197
Initial Q (Qb), veh	0	0	0	0	0	0	0	0	0	0	0	0
Ped-Bike Adj(A_pbT)	1.00		1.00	1.00		1.00	1.00		1.00	1.00		1.00
Parking Bus, Adj	1.00	1.00	1.00	1.00	1.00	1.00	1.00	1.00	1.00	1.00	1.00	1.00
Work Zone On Approach		No			No			No			No	
Adj Sat Flow, veh/h/ln	1856	1841	1781	1900	1841	1885	1885	1900	1885	1900	1900	1885
Adj Flow Rate, veh/h	196	2044	0	16	1278	50	160	122	53	219	0	98
Peak Hour Factor	0.96	0.96	0.96	0.96	0.96	0.96	0.96	0.96	0.96	0.96	0.96	0.96
Percent Heavy Veh, %	3	4	8	0	4	1	1	0	1	0	0	1
Cap, veh/h	163	1767		31	1389	442	417	292	127	840	0	518
Arrive On Green	0.09	0.35	0.00	0.02	0.28	0.28	0.23	0.23	0.23	0.23	0.00	0.23
Sat Flow, veh/h	1767	5025	1510	1810	5025	1598	1795	1256	546	3619	0	1598
Grp Volume(v), veh/h	196	2044	0	16	1278	50	160	0	175	219	0	98
Grp Sat Flow(s),veh/h/ln	1767	1675	1510	1810	1675	1598	1795	0	1802	1810	0	1598
Q Serve(g_s), s	11.9	45.4	0.0	1.1	31.9	3.0	9.7	0.0	10.7	6.4	0.0	5.7
Cycle Q Clear(g_c), s	11.9	45.4	0.0	1.1	31.9	3.0	9.7	0.0	10.7	6.4	0.0	5.7
Prop In Lane	1.00		1.00	1.00		1.00	1.00		0.30	1.00		1.00
Lane Grp Cap(c), veh/h	163	1767		31	1389	442	417	0	418	840	0	518
V/C Ratio(X)	1.20	1.16		0.52	0.92	0.11	0.38	0.00	0.42	0.26	0.00	0.19
Avail Cap(c_a), veh/h	163	1767		70	1419	451	417	0	418	840	0	518
HCM Platoon Ratio	1.00	1.00	1.00	1.00	1.00	1.00	1.00	1.00	1.00	1.00	1.00	1.00
Upstream Filter(I)	1.00	1.00	0.00	1.00	1.00	1.00	1.00	0.00	1.00	1.00	0.00	1.00
Uniform Delay (d), s/veh	58.7	41.9	0.0	63.0	45.4	34.9	41.8	0.0	42.2	40.5	0.0	31.4
Incr Delay (d2), s/veh	136.0	77.4	0.0	5.1	9.9	0.1	2.7	0.0	3.1	0.8	0.0	0.8
Initial Q Delay(d3),s/veh	0.0	0.0	0.0	0.0	0.0	0.0	0.0	0.0	0.0	0.0	0.0	0.0
%ile BackOfQ(50%),veh/ln	11.3	30.4	0.0	0.6	13.9	1.2	4.7	0.0	5.2	2.9	0.0	2.4
Unsig. Movement Delay, s/veh												
LnGrp Delay(d),s/veh	194.7	119.3	0.0	68.1	55.2	35.0	44.5	0.0	45.2	41.3	0.0	32.2
LnGrp LOS	F	F		E	E	D	D	A	D	D	A	C
Approach Vol, veh/h		2240			1344			335				317
Approach Delay, s/veh		125.9			54.6			44.9				38.5
Approach LOS		F			D			D				D
Timer - Assigned Phs	1	2		4	5	6		8				
Phs Duration (G+Y+Rc), s	6.8	51.6		35.4	16.5	41.9		35.4				
Change Period (Y+Rc), s	4.6	6.2		5.4	4.6	6.2		5.4				
Max Green Setting (Gmax), s	5.0	43.4		30.0	11.9	36.5		30.0				
Max Q Clear Time (g_c+I1), s	3.1	47.4		8.4	13.9	33.9		12.7				
Green Ext Time (p_c), s	0.0	0.0		1.0	0.0	1.8		1.4				

Intersection Summary

HCM 6th Ctrl Delay	90.4
HCM 6th LOS	F

Notes

- User approved pedestrian interval to be less than phase max green.
- User approved volume balancing among the lanes for turning movement.
- Unsignalized Delay for [EBR] is excluded from calculations of the approach delay and intersection delay.

Timings
37: Cactus Av. & Frederick St.

West Campus Upper Plateau (JN 14064)

09/19/2022

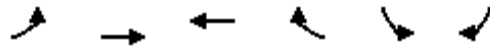

Lane Group	EBL	EBT	WBT	WBR	SBL	SBR
Lane Configurations	↖	↑↑↑	↑↑↑	↗	↙	↘
Traffic Volume (vph)	244	1968	1166	153	432	192
Future Volume (vph)	244	1968	1166	153	432	192
Turn Type	Prot	NA	NA	pm+ov	Prot	pm+ov
Protected Phases	5	2	6	4	4	5
Permitted Phases				6		4
Detector Phase	5	2	6	4	4	5
Switch Phase						
Minimum Initial (s)	5.0	10.0	10.0	10.0	10.0	5.0
Minimum Split (s)	9.2	28.2	29.2	36.4	36.4	9.2
Total Split (s)	31.0	81.0	50.0	39.0	39.0	31.0
Total Split (%)	25.8%	67.5%	41.7%	32.5%	32.5%	25.8%
Yellow Time (s)	3.2	5.2	5.2	4.4	4.4	3.2
All-Red Time (s)	1.0	1.0	1.0	1.0	1.0	1.0
Lost Time Adjust (s)	0.0	0.0	0.0	0.0	0.0	0.0
Total Lost Time (s)	4.2	6.2	6.2	5.4	5.4	4.2
Lead/Lag	Lead		Lag			Lead
Lead-Lag Optimize?	Yes		Yes			Yes
Recall Mode	None	None	None	None	None	None
Act Effct Green (s)	17.4	51.8	30.0	49.2	18.3	41.4
Actuated g/C Ratio	0.21	0.63	0.36	0.60	0.22	0.50
v/c Ratio	0.70	0.65	0.67	0.16	0.60	0.25
Control Delay	43.9	11.0	25.1	1.4	34.0	12.6
Queue Delay	0.0	0.0	0.0	0.0	0.0	0.0
Total Delay	43.9	11.0	25.1	1.4	34.0	12.6
LOS	D	B	C	A	C	B
Approach Delay		14.6	22.3		27.4	
Approach LOS		B	C		C	

Intersection Summary

Cycle Length: 120
 Actuated Cycle Length: 82.5
 Natural Cycle: 80
 Control Type: Actuated-Uncoordinated
 Maximum v/c Ratio: 0.70
 Intersection Signal Delay: 19.0
 Intersection LOS: B
 Intersection Capacity Utilization 61.5%
 ICU Level of Service B
 Analysis Period (min) 15

Splits and Phases: 37: Cactus Av. & Frederick St.



HCM 6th Signalized Intersection Summary
37: Cactus Av. & Frederick St.

West Campus Upper Plateau (JN 14064)
09/19/2022

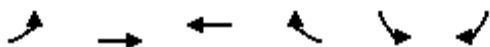

Movement	EBL	EBT	WBT	WBR	SBL	SBR
Lane Configurations						
Traffic Volume (veh/h)	244	1968	1166	153	432	192
Future Volume (veh/h)	244	1968	1166	153	432	192
Initial Q (Qb), veh	0	0	0	0	0	0
Ped-Bike Adj(A_pbT)	1.00			0.98	1.00	1.00
Parking Bus, Adj	1.00	1.00	1.00	1.00	1.00	1.00
Work Zone On Approach		No	No		No	
Adj Sat Flow, veh/h/ln	1841	1856	1856	1870	1856	1856
Adj Flow Rate, veh/h	257	2072	1227	99	455	105
Peak Hour Factor	0.95	0.95	0.95	0.95	0.95	0.95
Percent Heavy Veh, %	4	3	3	2	3	3
Cap, veh/h	305	3278	2084	926	627	561
Arrive On Green	0.17	0.65	0.41	0.41	0.18	0.18
Sat Flow, veh/h	1753	5233	5233	1548	3428	1572
Grp Volume(v), veh/h	257	2072	1227	99	455	105
Grp Sat Flow(s),veh/h/ln	1753	1689	1689	1548	1714	1572
Q Serve(g_s), s	9.7	16.7	12.8	1.9	8.5	3.1
Cycle Q Clear(g_c), s	9.7	16.7	12.8	1.9	8.5	3.1
Prop In Lane	1.00			1.00	1.00	1.00
Lane Grp Cap(c), veh/h	305	3278	2084	926	627	561
V/C Ratio(X)	0.84	0.63	0.59	0.11	0.73	0.19
Avail Cap(c_a), veh/h	689	5558	3255	1284	1690	1049
HCM Platoon Ratio	1.00	1.00	1.00	1.00	1.00	1.00
Upstream Filter(I)	1.00	1.00	1.00	1.00	1.00	1.00
Uniform Delay (d), s/veh	27.2	7.2	15.6	6.0	26.2	15.1
Incr Delay (d2), s/veh	2.4	0.2	0.3	0.1	1.6	0.2
Initial Q Delay(d3),s/veh	0.0	0.0	0.0	0.0	0.0	0.0
%ile BackOfQ(50%),veh/ln	3.8	3.4	4.0	0.8	3.3	3.3
Unsig. Movement Delay, s/veh						
LnGrp Delay(d),s/veh	29.7	7.4	15.9	6.0	27.9	15.3
LnGrp LOS	C	A	B	A	C	B
Approach Vol, veh/h		2329	1326		560	
Approach Delay, s/veh		9.8	15.1		25.5	
Approach LOS		A	B		C	
Timer - Assigned Phs		2		4	5	6
Phs Duration (G+Y+Rc), s		50.3		17.9	16.1	34.2
Change Period (Y+Rc), s		6.2		5.4	* 4.2	6.2
Max Green Setting (Gmax), s		74.8		33.6	* 27	43.8
Max Q Clear Time (g_c+I1), s		18.7		10.5	11.7	14.8
Green Ext Time (p_c), s		25.5		1.9	0.3	9.5

Intersection Summary

HCM 6th Ctrl Delay	13.6
HCM 6th LOS	B

Notes

* HCM 6th computational engine requires equal clearance times for the phases crossing the barrier.

Timings
38: Riverside Dr./Graham St. & Cactus Av.

West Campus Upper Plateau (JN 14064)

09/19/2022

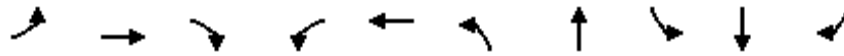

Lane Group	EBL	EBT	EBR	WBL	WBT	NBL	NBT	SBL	SBT	SBR
Lane Configurations	↘	↑↑↑	↗	↘	↑↑↑	↘	↑	↘	↑↑	↗
Traffic Volume (vph)	101	2138	353	16	1296	2	0	123	88	99
Future Volume (vph)	101	2138	353	16	1296	2	0	123	88	99
Turn Type	Prot	NA	Perm	Prot	NA	Prot	NA	Prot	NA	Perm
Protected Phases	7	4		3	8	5	2	1	6	
Permitted Phases			4							6
Detector Phase	7	4	4	3	8	5	2	1	6	6
Switch Phase										
Minimum Initial (s)	5.0	10.0	10.0	5.0	10.0	5.0	10.0	5.0	10.0	10.0
Minimum Split (s)	9.6	39.2	39.2	9.6	39.2	10.4	35.0	9.6	40.6	40.6
Total Split (s)	16.0	59.0	59.0	9.6	52.6	10.4	36.0	15.4	41.0	41.0
Total Split (%)	13.3%	49.2%	49.2%	8.0%	43.8%	8.7%	30.0%	12.8%	34.2%	34.2%
Yellow Time (s)	3.6	5.2	5.2	3.6	5.2	4.4	4.0	3.6	3.6	3.6
All-Red Time (s)	1.0	1.0	1.0	1.0	1.0	1.0	1.0	1.0	1.0	1.0
Lost Time Adjust (s)	0.0	0.0	0.0	0.0	0.0	0.0	0.0	0.0	0.0	0.0
Total Lost Time (s)	4.6	6.2	6.2	4.6	6.2	5.4	5.0	4.6	4.6	4.6
Lead/Lag	Lead	Lag	Lag	Lead	Lag	Lead	Lag	Lead	Lag	Lag
Lead-Lag Optimize?	Yes	Yes	Yes	Yes	Yes	Yes	Yes	Yes	Yes	Yes
Recall Mode	None	Min	Min	None	Min	None	None	None	None	None
Act Effct Green (s)	9.6	54.8	54.8	5.2	41.7	5.2	13.2	10.9	14.4	14.4
Actuated g/C Ratio	0.12	0.66	0.66	0.06	0.50	0.06	0.16	0.13	0.17	0.17
v/c Ratio	0.55	0.71	0.34	0.15	0.60	0.01	0.00	0.58	0.16	0.27
Control Delay	48.8	14.4	5.2	46.8	18.1	45.5	0.0	48.5	29.5	2.7
Queue Delay	0.0	0.0	0.0	0.0	0.0	0.0	0.0	0.0	0.0	0.0
Total Delay	48.8	14.4	5.2	46.8	18.1	45.5	0.0	48.5	29.5	2.7
LOS	D	B	A	D	B	D	A	D	C	A
Approach Delay		14.5			18.5		30.3		28.5	
Approach LOS		B			B		C		C	

Intersection Summary

Cycle Length: 120
 Actuated Cycle Length: 83.1
 Natural Cycle: 120
 Control Type: Actuated-Uncoordinated
 Maximum v/c Ratio: 0.71
 Intersection Signal Delay: 16.8
 Intersection LOS: B
 Intersection Capacity Utilization 71.8%
 ICU Level of Service C
 Analysis Period (min) 15

Splits and Phases: 38: Riverside Dr./Graham St. & Cactus Av.

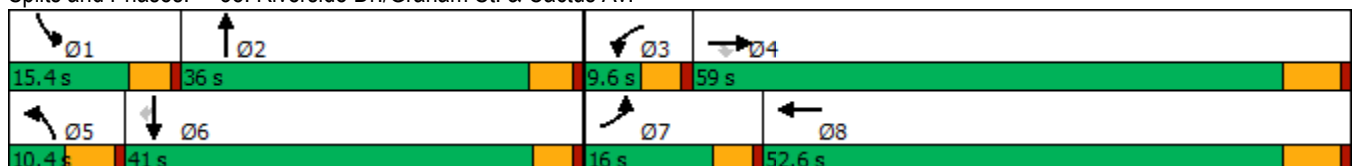

HCM 6th Signalized Intersection Summary
38: Riverside Dr./Graham St. & Cactus Av.

West Campus Upper Plateau (JN 14064)

09/19/2022



Movement	EBL	EBT	EBR	WBL	WBT	WBR	NBL	NBT	NBR	SBL	SBT	SBR
Lane Configurations	↗	↑↑↑	↘	↗	↑↑↑		↗↘	↑↘		↗	↑↑	↘
Traffic Volume (veh/h)	101	2138	353	16	1296	82	2	0	1	123	88	99
Future Volume (veh/h)	101	2138	353	16	1296	82	2	0	1	123	88	99
Initial Q (Qb), veh	0	0	0	0	0	0	0	0	0	0	0	0
Ped-Bike Adj(A_pbT)	1.00		1.00	1.00		0.99	1.00		1.00	1.00		1.00
Parking Bus, Adj	1.00	1.00	1.00	1.00	1.00	1.00	1.00	1.00	1.00	1.00	1.00	1.00
Work Zone On Approach		No			No			No			No	
Adj Sat Flow, veh/h/ln	1841	1841	1885	1900	1856	1900	1900	1900	1900	1870	1885	1826
Adj Flow Rate, veh/h	110	2324	336	17	1409	80	2	0	0	134	96	30
Peak Hour Factor	0.92	0.92	0.92	0.92	0.92	0.92	0.92	0.92	0.92	0.92	0.92	0.92
Percent Heavy Veh, %	4	4	1	0	3	0	0	0	0	2	1	5
Cap, veh/h	139	2986	949	35	2618	149	10	149	0	167	439	190
Arrive On Green	0.08	0.59	0.59	0.02	0.53	0.53	0.00	0.00	0.00	0.09	0.12	0.12
Sat Flow, veh/h	1753	5025	1598	1810	4900	278	3510	3705	0	1781	3582	1547
Grp Volume(v), veh/h	110	2324	336	17	971	518	2	0	0	134	96	30
Grp Sat Flow(s),veh/h/ln	1753	1675	1598	1810	1689	1801	1755	1805	0	1781	1791	1547
Q Serve(g_s), s	5.0	28.4	8.8	0.8	15.3	15.3	0.0	0.0	0.0	6.0	2.0	1.4
Cycle Q Clear(g_c), s	5.0	28.4	8.8	0.8	15.3	15.3	0.0	0.0	0.0	6.0	2.0	1.4
Prop In Lane	1.00		1.00	1.00		0.15	1.00		0.00	1.00		1.00
Lane Grp Cap(c), veh/h	139	2986	949	35	1804	962	10	149	0	167	439	190
V/C Ratio(X)	0.79	0.78	0.35	0.48	0.54	0.54	0.21	0.00	0.00	0.80	0.22	0.16
Avail Cap(c_a), veh/h	246	3264	1038	111	1928	1028	216	1377	0	237	1604	693
HCM Platoon Ratio	1.00	1.00	1.00	1.00	1.00	1.00	1.00	1.00	1.00	1.00	1.00	1.00
Upstream Filter(I)	1.00	1.00	1.00	1.00	1.00	1.00	1.00	0.00	0.00	1.00	1.00	1.00
Uniform Delay (d), s/veh	36.7	12.5	8.5	39.4	12.4	12.4	40.4	0.0	0.0	36.1	32.1	31.9
Incr Delay (d2), s/veh	3.7	1.1	0.2	3.7	0.3	0.5	4.0	0.0	0.0	8.0	0.2	0.4
Initial Q Delay(d3),s/veh	0.0	0.0	0.0	0.0	0.0	0.0	0.0	0.0	0.0	0.0	0.0	0.0
%ile BackOfQ(50%),veh/ln	2.1	8.1	2.3	0.4	4.7	5.0	0.0	0.0	0.0	2.9	0.8	0.5
Unsig. Movement Delay, s/veh												
LnGrp Delay(d),s/veh	40.5	13.6	8.7	43.1	12.6	12.9	44.4	0.0	0.0	44.1	32.4	32.3
LnGrp LOS	D	B	A	D	B	B	D	A	A	D	C	C
Approach Vol, veh/h		2770			1506			2			260	
Approach Delay, s/veh		14.1			13.1			44.4			38.4	
Approach LOS		B			B			D			D	
Timer - Assigned Phs	1	2	3	4	5	6	7	8				
Phs Duration (G+Y+Rc), s	12.2	8.4	6.2	54.5	5.6	15.0	11.1	49.6				
Change Period (Y+Rc), s	4.6	5.0	4.6	6.2	5.4	* 5	4.6	6.2				
Max Green Setting (Gmax), s	10.8	31.0	5.0	52.8	5.0	* 36	11.4	46.4				
Max Q Clear Time (g_c+1), s	8.0	0.0	2.8	30.4	2.0	4.0	7.0	17.3				
Green Ext Time (p_c), s	0.0	0.0	0.0	17.9	0.0	0.6	0.0	11.0				

Intersection Summary

HCM 6th Ctrl Delay	15.1
HCM 6th LOS	B

Notes

* HCM 6th computational engine requires equal clearance times for the phases crossing the barrier.

Timings

1: Washington St & Van Buren Bl.

09/29/2022



Lane Group	EBL	EBT	WBL	WBT	WBR	NBL	NBT	NBR	SBL	SBT
Lane Configurations	↙	↕	↙	↕	↗	↖	↕	↗	↖	↕
Traffic Volume (vph)	110	766	108	743	206	127	191	123	291	166
Future Volume (vph)	110	766	108	743	206	127	191	123	291	166
Turn Type	Prot	NA	Prot	NA	Perm	Prot	NA	Perm	Prot	NA
Protected Phases	5	2	1	6		3	8		7	4
Permitted Phases					6			8		
Detector Phase	5	2	1	6	6	3	8	8	7	4
Switch Phase										
Minimum Initial (s)	5.0	10.0	5.0	10.0	10.0	5.0	10.0	10.0	5.0	10.0
Minimum Split (s)	9.2	34.2	9.2	33.2	33.2	9.2	38.4	38.4	9.2	30.8
Total Split (s)	14.2	49.6	14.0	49.4	49.4	11.5	38.4	38.4	18.0	44.9
Total Split (%)	11.8%	41.3%	11.7%	41.2%	41.2%	9.6%	32.0%	32.0%	15.0%	37.4%
Yellow Time (s)	3.2	5.2	3.2	5.2	5.2	3.2	4.4	4.4	3.2	4.8
All-Red Time (s)	1.0	1.0	1.0	1.0	1.0	1.0	1.0	1.0	1.0	1.0
Lost Time Adjust (s)	0.0	0.0	0.0	0.0	0.0	0.0	0.0	0.0	0.0	0.0
Total Lost Time (s)	4.2	6.2	4.2	6.2	6.2	4.2	5.4	5.4	4.2	5.8
Lead/Lag	Lead	Lag	Lead	Lag	Lag	Lead	Lag	Lag	Lead	Lag
Lead-Lag Optimize?	Yes	Yes	Yes	Yes	Yes	Yes	Yes	Yes	Yes	Yes
Recall Mode	None	None	None	None	None	None	None	None	None	None
Act Effct Green (s)	9.3	29.6	9.2	29.5	29.5	7.0	14.0	14.0	11.8	18.3
Actuated g/C Ratio	0.11	0.35	0.11	0.35	0.35	0.08	0.16	0.16	0.14	0.21
v/c Ratio	0.58	0.72	0.58	0.63	0.32	0.46	0.34	0.34	0.63	0.31
Control Delay	53.4	28.7	53.6	26.8	7.3	47.5	34.5	7.0	43.8	22.6
Queue Delay	0.0	0.0	0.0	0.0	0.0	0.0	0.0	0.0	0.0	0.0
Total Delay	53.4	28.7	53.6	26.8	7.3	47.5	34.5	7.0	43.8	22.6
LOS	D	C	D	C	A	D	C	A	D	C
Approach Delay		31.5		25.7			30.6			34.3
Approach LOS		C		C			C			C

Intersection Summary

Cycle Length: 120	
Actuated Cycle Length: 85.4	
Natural Cycle: 95	
Control Type: Actuated-Uncoordinated	
Maximum v/c Ratio: 0.72	
Intersection Signal Delay: 29.8	Intersection LOS: C
Intersection Capacity Utilization 63.2%	ICU Level of Service B
Analysis Period (min) 15	



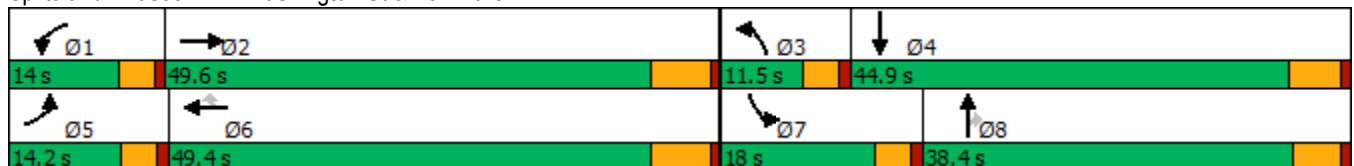



















Splits and Phases: 1: Washington St & Van Buren Bl.



HCM 6th Signalized Intersection Summary
1: Washington St & Van Buren Bl.

West Campus Upper Plateau (JN 14064)

09/29/2022

												
Movement	EBL	EBT	EBR	WBL	WBT	WBR	NBL	NBT	NBR	SBL	SBT	SBR
Lane Configurations												
Traffic Volume (veh/h)	110	766	68	108	743	206	127	191	123	291	166	72
Future Volume (veh/h)	110	766	68	108	743	206	127	191	123	291	166	72
Initial Q (Qb), veh	0	0	0	0	0	0	0	0	0	0	0	0
Ped-Bike Adj(A_pbT)	1.00		1.00	1.00		1.00	1.00		0.98	1.00		0.98
Parking Bus, Adj	1.00	1.00	1.00	1.00	1.00	1.00	1.00	1.00	1.00	1.00	1.00	1.00
Work Zone On Approach		No			No			No			No	
Adj Sat Flow, veh/h/ln	1900	1841	1856	1885	1856	1885	1885	1856	1870	1885	1885	1900
Adj Flow Rate, veh/h	113	790	50	111	766	117	131	197	87	300	171	27
Peak Hour Factor	0.97	0.97	0.97	0.97	0.97	0.97	0.97	0.97	0.97	0.97	0.97	0.97
Percent Heavy Veh, %	0	4	3	1	3	1	1	3	2	1	1	0
Cap, veh/h	146	1148	73	143	1208	546	235	562	248	408	648	100
Arrive On Green	0.08	0.34	0.34	0.08	0.34	0.34	0.07	0.16	0.16	0.12	0.21	0.21
Sat Flow, veh/h	1810	3340	211	1795	3526	1593	3483	3526	1557	3483	3099	480
Grp Volume(v), veh/h	113	414	426	111	766	117	131	197	87	300	97	101
Grp Sat Flow(s),veh/h/ln	1810	1749	1803	1795	1763	1593	1742	1763	1557	1742	1791	1789
Q Serve(g_s), s	4.2	13.8	13.8	4.1	12.4	3.5	2.5	3.4	3.4	5.7	3.1	3.2
Cycle Q Clear(g_c), s	4.2	13.8	13.8	4.1	12.4	3.5	2.5	3.4	3.4	5.7	3.1	3.2
Prop In Lane	1.00		0.12	1.00		1.00	1.00		1.00	1.00		0.27
Lane Grp Cap(c), veh/h	146	601	620	143	1208	546	235	562	248	408	374	374
V/C Ratio(X)	0.78	0.69	0.69	0.78	0.63	0.21	0.56	0.35	0.35	0.74	0.26	0.27
Avail Cap(c_a), veh/h	266	1117	1152	259	2242	1013	374	1713	756	708	1031	1030
HCM Platoon Ratio	1.00	1.00	1.00	1.00	1.00	1.00	1.00	1.00	1.00	1.00	1.00	1.00
Upstream Filter(I)	1.00	1.00	1.00	1.00	1.00	1.00	1.00	1.00	1.00	1.00	1.00	1.00
Uniform Delay (d), s/veh	30.6	19.2	19.2	30.7	18.7	15.8	30.7	25.4	25.4	29.0	22.5	22.5
Incr Delay (d2), s/veh	3.3	2.0	1.9	3.4	0.8	0.3	0.8	0.4	0.8	1.0	0.4	0.4
Initial Q Delay(d3),s/veh	0.0	0.0	0.0	0.0	0.0	0.0	0.0	0.0	0.0	0.0	0.0	0.0
%ile BackOfQ(50%),veh/ln	1.8	5.0	5.1	1.7	4.3	1.3	1.0	1.4	1.3	2.3	1.3	1.3
Unsig. Movement Delay, s/veh												
LnGrp Delay(d),s/veh	34.0	21.2	21.1	34.1	19.5	16.1	31.5	25.8	26.3	30.0	22.8	22.9
LnGrp LOS	C	C	C	C	B	B	C	C	C	C	C	C
Approach Vol, veh/h		953			994			415			498	
Approach Delay, s/veh		22.7			20.8			27.7			27.1	
Approach LOS		C			C			C			C	
Timer - Assigned Phs	1	2	3	4	5	6	7	8				
Phs Duration (G+Y+Rc), s	9.6	29.5	8.8	20.0	9.7	29.5	12.1	16.6				
Change Period (Y+Rc), s	* 4.2	6.2	* 4.2	5.8	* 4.2	6.2	* 4.2	* 5.8				
Max Green Setting (Gmax), s	* 9.8	43.4	* 7.3	39.1	* 10	43.2	* 14	* 33				
Max Q Clear Time (g_c+I1), s	6.1	15.8	4.5	5.2	6.2	14.4	7.7	5.4				
Green Ext Time (p_c), s	0.0	7.4	0.1	1.2	0.0	8.1	0.3	1.6				

Intersection Summary

HCM 6th Ctrl Delay	23.5
HCM 6th LOS	C

Notes

* HCM 6th computational engine requires equal clearance times for the phases crossing the barrier.

Timings
2: Central Ave & Arlington Ave/Chicago Ave

West Campus Upper Plateau (JN 14064)

09/29/2022



Lane Group	EBL	EBT	EBR	WBL	WBT	WBR	NBL	NBT	NBR	SBL	SBT
Lane Configurations	↘	↑↑	↗↗	↘↘	↑↑	↗	↘↘	↑↑	↗	↘↘	↑↑↗
Traffic Volume (vph)	21	316	517	178	422	161	632	670	175	212	767
Future Volume (vph)	21	316	517	178	422	161	632	670	175	212	767
Turn Type	Prot	NA	pm+ov	Prot	NA	pm+ov	Prot	NA	pm+ov	Prot	NA
Protected Phases	7	4	5	3	8	1	5	2	3	1	6
Permitted Phases			4			8			2		
Detector Phase	7	4	5	3	8	1	5	2	3	1	6
Switch Phase											
Minimum Initial (s)	5.0	10.0	5.0	5.0	10.0	5.0	5.0	10.0	5.0	5.0	10.0
Minimum Split (s)	9.6	32.8	9.6	9.6	30.8	9.6	9.6	35.4	9.6	9.6	30.4
Total Split (s)	10.6	32.8	30.0	22.0	44.2	24.4	30.0	50.8	22.0	24.4	45.2
Total Split (%)	8.2%	25.2%	23.1%	16.9%	34.0%	18.8%	23.1%	39.1%	16.9%	18.8%	34.8%
Yellow Time (s)	3.6	4.8	3.6	3.6	4.8	3.6	3.6	4.4	3.6	3.6	4.4
All-Red Time (s)	1.0	1.0	1.0	1.0	1.0	1.0	1.0	1.0	1.0	1.0	1.0
Lost Time Adjust (s)	0.0	0.0	0.0	0.0	0.0	0.0	0.0	0.0	0.0	0.0	0.0
Total Lost Time (s)	4.6	5.8	4.6	4.6	5.8	4.6	4.6	5.4	4.6	4.6	5.4
Lead/Lag	Lead	Lag	Lead	Lead	Lag	Lead	Lead	Lag	Lead	Lead	Lag
Lead-Lag Optimize?	Yes	Yes	Yes	Yes	Yes	Yes	Yes	Yes	Yes	Yes	Yes
Recall Mode	None	None	None	None	None	None	None	None	None	None	None
Act Effct Green (s)	5.6	15.2	39.1	9.5	25.8	42.2	22.7	34.2	44.5	10.4	21.9
Actuated g/C Ratio	0.06	0.17	0.43	0.11	0.29	0.47	0.25	0.38	0.49	0.12	0.24
v/c Ratio	0.19	0.53	0.41	0.50	0.41	0.20	0.73	0.50	0.21	0.53	0.65
Control Delay	50.9	38.7	12.3	45.9	29.5	4.3	38.6	24.2	3.6	45.3	34.2
Queue Delay	0.0	0.0	0.0	0.0	0.0	0.0	0.0	0.0	0.0	0.0	0.0
Total Delay	50.9	38.7	12.3	45.9	29.5	4.3	38.6	24.2	3.6	45.3	34.2
LOS	D	D	B	D	C	A	D	C	A	D	C
Approach Delay		23.0			28.0			27.9			36.5
Approach LOS		C			C			C			D

Intersection Summary

Cycle Length: 130
 Actuated Cycle Length: 90.3
 Natural Cycle: 90
 Control Type: Actuated-Uncoordinated
 Maximum v/c Ratio: 0.73
 Intersection Signal Delay: 29.0
 Intersection LOS: C
 Intersection Capacity Utilization 66.3%
 ICU Level of Service C
 Analysis Period (min) 15

Splits and Phases: 2: Central Ave & Arlington Ave/Chicago Ave

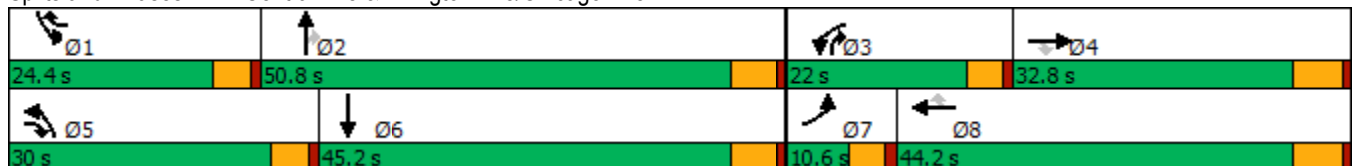

HCM 6th Signalized Intersection Summary
2: Central Ave & Arlington Ave/Chicago Ave

West Campus Upper Plateau (JN 14064)

09/29/2022



Movement	EBL	EBT	EBR	WBL	WBT	WBR	NBL	NBT	NBR	SBL	SBT	SBR
Lane Configurations	↘	↑↑	↗↗	↘↘	↑↑	↗	↘↘	↑↑	↗	↘↘	↑↑↗	
Traffic Volume (veh/h)	21	316	517	178	422	161	632	670	175	212	767	27
Future Volume (veh/h)	21	316	517	178	422	161	632	670	175	212	767	27
Initial Q (Qb), veh	0	0	0	0	0	0	0	0	0	0	0	0
Ped-Bike Adj(A_pbT)	1.00		1.00	1.00		1.00	1.00		0.99	1.00		1.00
Parking Bus, Adj	1.00	1.00	1.00	1.00	1.00	1.00	1.00	1.00	1.00	1.00	1.00	1.00
Work Zone On Approach		No			No			No			No	
Adj Sat Flow, veh/h/ln	1900	1900	1885	1870	1900	1885	1885	1885	1856	1900	1885	1900
Adj Flow Rate, veh/h	21	319	137	180	426	78	638	677	111	214	775	25
Peak Hour Factor	0.99	0.99	0.99	0.99	0.99	0.99	0.99	0.99	0.99	0.99	0.99	0.99
Percent Heavy Veh, %	0	0	1	2	0	1	1	1	3	0	1	0
Cap, veh/h	44	546	1044	279	751	481	768	1329	703	327	1248	40
Arrive On Green	0.02	0.15	0.15	0.08	0.21	0.21	0.22	0.37	0.37	0.09	0.24	0.24
Sat Flow, veh/h	1810	3610	2806	3456	3610	1598	3483	3582	1552	3510	5122	165
Grp Volume(v), veh/h	21	319	137	180	426	78	638	677	111	214	519	281
Grp Sat Flow(s),veh/h/ln	1810	1805	1403	1728	1805	1598	1742	1791	1552	1755	1716	1856
Q Serve(g_s), s	0.8	5.5	2.2	3.4	7.1	2.4	11.7	9.8	2.8	4.0	9.0	9.1
Cycle Q Clear(g_c), s	0.8	5.5	2.2	3.4	7.1	2.4	11.7	9.8	2.8	4.0	9.0	9.1
Prop In Lane	1.00		1.00	1.00		1.00	1.00		1.00	1.00		0.09
Lane Grp Cap(c), veh/h	44	546	1044	279	751	481	768	1329	703	327	836	452
V/C Ratio(X)	0.48	0.58	0.13	0.65	0.57	0.16	0.83	0.51	0.16	0.65	0.62	0.62
Avail Cap(c_a), veh/h	162	1452	1748	896	2065	1063	1318	2422	1176	1035	2034	1100
HCM Platoon Ratio	1.00	1.00	1.00	1.00	1.00	1.00	1.00	1.00	1.00	1.00	1.00	1.00
Upstream Filter(I)	1.00	1.00	1.00	1.00	1.00	1.00	1.00	1.00	1.00	1.00	1.00	1.00
Uniform Delay (d), s/veh	32.3	26.5	13.9	29.9	23.9	17.2	25.0	16.4	10.9	29.4	22.6	22.6
Incr Delay (d2), s/veh	3.0	1.0	0.1	0.9	0.7	0.2	0.9	0.3	0.1	0.8	0.8	1.4
Initial Q Delay(d3),s/veh	0.0	0.0	0.0	0.0	0.0	0.0	0.0	0.0	0.0	0.0	0.0	0.0
%ile BackOfQ(50%),veh/ln	0.3	2.2	0.6	1.3	2.8	0.8	4.5	3.6	0.8	1.6	3.4	3.7
Unsig. Movement Delay, s/veh												
LnGrp Delay(d),s/veh	35.4	27.5	14.0	30.9	24.6	17.4	25.9	16.7	11.0	30.2	23.4	24.0
LnGrp LOS	D	C	B	C	C	B	C	B	B	C	C	C
Approach Vol, veh/h		477			684			1426			1014	
Approach Delay, s/veh		24.0			25.4			20.4			25.0	
Approach LOS		C			C			C			C	
Timer - Assigned Phs	1	2	3	4	5	6	7	8				
Phs Duration (G+Y+Rc), s	10.9	30.3	10.0	16.0	19.4	21.8	6.2	19.8				
Change Period (Y+Rc), s	4.6	5.4	4.6	5.8	4.6	5.4	4.6	5.8				
Max Green Setting (Gmax), s	19.8	45.4	17.4	27.0	25.4	39.8	6.0	38.4				
Max Q Clear Time (g_c+I1), s	6.0	11.8	5.4	7.5	13.7	11.1	2.8	9.1				
Green Ext Time (p_c), s	0.3	5.2	0.2	2.2	1.1	5.3	0.0	2.9				
Intersection Summary												
HCM 6th Ctrl Delay			23.1									
HCM 6th LOS			C									

Timings

3: Overlook Pkwy./Canyon Crest Dr. & Alessandro Bl/Alessandro Bl.



Lane Group	EBL	EBT	WBL	WBT	WBR	NBL	NBT	NBR	SBL	SBT	SBR
Lane Configurations	↙	↕↕↕	↙	↕↕↕	↗	↙	↕↕	↗	↕↕	↙	↗
Traffic Volume (vph)	33	1256	24	1367	393	18	54	27	304	56	18
Future Volume (vph)	33	1256	24	1367	393	18	54	27	304	56	18
Turn Type	Prot	NA	Prot	NA	pm+ov	Split	NA	Perm	Split	NA	Perm
Protected Phases	5	2	1	6	4	8	8		4	4	
Permitted Phases					6			8			4
Detector Phase	5	2	1	6	4	8	8	8	4	4	4
Switch Phase											
Minimum Initial (s)	5.0	10.0	5.0	10.0	10.0	10.0	10.0	10.0	10.0	10.0	10.0
Minimum Split (s)	9.2	35.2	9.2	35.2	38.8	38.8	38.8	38.8	38.8	38.8	38.8
Total Split (s)	9.2	43.2	9.2	43.2	38.8	38.8	38.8	38.8	38.8	38.8	38.8
Total Split (%)	7.1%	33.2%	7.1%	33.2%	29.8%	29.8%	29.8%	29.8%	29.8%	29.8%	29.8%
Yellow Time (s)	3.2	5.2	3.2	5.2	4.8	4.8	4.8	4.8	4.8	4.8	4.8
All-Red Time (s)	1.0	1.0	1.0	1.0	1.0	1.0	1.0	1.0	1.0	1.0	1.0
Lost Time Adjust (s)	0.0	0.0	0.0	0.0	0.0	0.0	0.0	0.0	0.0	0.0	0.0
Total Lost Time (s)	4.2	6.2	4.2	6.2	5.8	5.8	5.8	5.8	5.8	5.8	5.8
Lead/Lag	Lead	Lag	Lead	Lag							
Lead-Lag Optimize?	Yes	Yes	Yes	Yes							
Recall Mode	None	None	None	None	None	None	None	None	None	None	None
Act Effct Green (s)	5.5	35.4	5.5	33.7	59.5	11.1	11.1	11.1	16.8	16.8	16.8
Actuated g/C Ratio	0.07	0.44	0.07	0.42	0.74	0.14	0.14	0.14	0.21	0.21	0.21
v/c Ratio	0.29	0.59	0.20	0.66	0.32	0.08	0.11	0.09	0.36	0.38	0.05
Control Delay	50.8	20.6	48.3	23.0	1.2	40.9	39.3	0.6	31.2	34.3	0.2
Queue Delay	0.0	0.0	0.0	0.0	0.0	0.0	0.0	0.0	0.0	0.0	0.0
Total Delay	50.8	20.6	48.3	23.0	1.2	40.9	39.3	0.6	31.2	34.3	0.2
LOS	D	C	D	C	A	D	D	A	C	C	A
Approach Delay		21.4		18.5			29.1			30.7	
Approach LOS		C		B			C			C	

Intersection Summary

Cycle Length: 130
 Actuated Cycle Length: 80
 Natural Cycle: 125
 Control Type: Actuated-Uncoordinated
 Maximum v/c Ratio: 0.66
 Intersection Signal Delay: 21.2
 Intersection LOS: C
 Intersection Capacity Utilization 57.9%
 ICU Level of Service B
 Analysis Period (min) 15

Splits and Phases: 3: Overlook Pkwy./Canyon Crest Dr. & Alessandro Bl/Alessandro Bl.

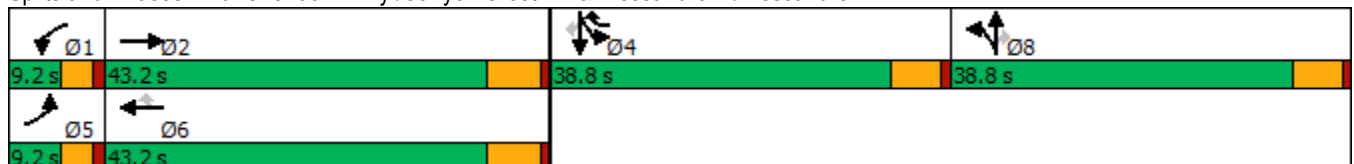

HCM 6th Signalized Intersection Summary

West Campus Upper Plateau (JN 14064)

3: Overlook Pkwy./Canyon Crest Dr. & Alessandro Bl/Alessandro Bl.

09/29/2022

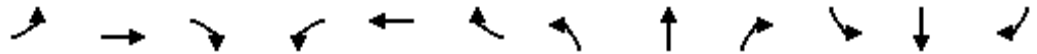

Movement	EBL	EBT	EBR	WBL	WBT	WBR	NBL	NBT	NBR	SBL	SBT	SBR
Lane Configurations	↗	↑↑↑		↖	↑↑↑	↗	↖	↑↑	↗	↖↗	↖	↗
Traffic Volume (veh/h)	33	1256	21	24	1367	393	18	54	27	304	56	18
Future Volume (veh/h)	33	1256	21	24	1367	393	18	54	27	304	56	18
Initial Q (Qb), veh	0	0	0	0	0	0	0	0	0	0	0	0
Ped-Bike Adj(A_pbT)	1.00		1.00	1.00		1.00	1.00		1.00	1.00		1.00
Parking Bus, Adj	1.00	1.00	1.00	1.00	1.00	1.00	1.00	1.00	1.00	1.00	1.00	1.00
Work Zone On Approach		No			No			No			No	
Adj Sat Flow, veh/h/ln	1811	1885	1811	1900	1885	1870	1781	1900	1900	1885	1767	1841
Adj Flow Rate, veh/h	34	1308	22	25	1424	401	19	56	20	284	105	10
Peak Hour Factor	0.96	0.96	0.96	0.96	0.96	0.96	0.96	0.96	0.96	0.96	0.96	0.96
Percent Heavy Veh, %	6	1	6	0	1	2	8	0	0	1	9	4
Cap, veh/h	59	2131	36	49	2068	858	201	427	191	500	246	217
Arrive On Green	0.03	0.41	0.41	0.03	0.40	0.40	0.12	0.12	0.12	0.14	0.14	0.14
Sat Flow, veh/h	1725	5213	88	1810	5147	1585	1697	3610	1610	3591	1767	1560
Grp Volume(v), veh/h	34	861	469	25	1424	401	19	56	20	284	105	10
Grp Sat Flow(s),veh/h/ln	1725	1716	1869	1810	1716	1585	1697	1805	1610	1795	1767	1560
Q Serve(g_s), s	1.4	14.2	14.2	1.0	16.4	11.2	0.7	1.0	0.8	5.3	3.9	0.4
Cycle Q Clear(g_c), s	1.4	14.2	14.2	1.0	16.4	11.2	0.7	1.0	0.8	5.3	3.9	0.4
Prop In Lane	1.00		0.05	1.00		1.00	1.00		1.00	1.00		1.00
Lane Grp Cap(c), veh/h	59	1403	764	49	2068	858	201	427	191	500	246	217
V/C Ratio(X)	0.57	0.61	0.61	0.51	0.69	0.47	0.09	0.13	0.10	0.57	0.43	0.05
Avail Cap(c_a), veh/h	120	1768	963	126	2652	1037	780	1659	740	1650	812	717
HCM Platoon Ratio	1.00	1.00	1.00	1.00	1.00	1.00	1.00	1.00	1.00	1.00	1.00	1.00
Upstream Filter(I)	1.00	1.00	1.00	1.00	1.00	1.00	1.00	1.00	1.00	1.00	1.00	1.00
Uniform Delay (d), s/veh	34.2	16.8	16.8	34.4	17.8	10.1	28.2	28.4	28.3	28.9	28.3	26.8
Incr Delay (d2), s/veh	3.2	0.4	0.8	2.9	0.5	0.4	0.2	0.1	0.2	1.0	1.2	0.1
Initial Q Delay(d3),s/veh	0.0	0.0	0.0	0.0	0.0	0.0	0.0	0.0	0.0	0.0	0.0	0.0
%ile BackOfQ(50%),veh/ln	0.6	4.7	5.2	0.4	5.4	4.5	0.3	0.4	0.3	2.2	1.6	0.1
Unsig. Movement Delay, s/veh												
LnGrp Delay(d),s/veh	37.4	17.2	17.6	37.4	18.3	10.5	28.4	28.5	28.5	29.9	29.5	26.9
LnGrp LOS	D	B	B	D	B	B	C	C	C	C	C	C
Approach Vol, veh/h		1364			1850			95			399	
Approach Delay, s/veh		17.8			16.9			28.5			29.7	
Approach LOS		B			B			C			C	
Timer - Assigned Phs	1	2		4	5	6		8				
Phs Duration (G+Y+Rc), s	6.2	35.6		15.8	6.7	35.1		14.3				
Change Period (Y+Rc), s	* 4.2	6.2		5.8	* 4.2	6.2		5.8				
Max Green Setting (Gmax), s	* 5	37.0		33.0	* 5	37.0		33.0				
Max Q Clear Time (g_c+I1), s	3.0	16.2		7.3	3.4	18.4		3.0				
Green Ext Time (p_c), s	0.0	8.2		1.5	0.0	10.4		0.4				

Intersection Summary

HCM 6th Ctrl Delay	18.9
HCM 6th LOS	B

Notes

- User approved pedestrian interval to be less than phase max green.
- User approved volume balancing among the lanes for turning movement.
- * HCM 6th computational engine requires equal clearance times for the phases crossing the barrier.

Timings
4: Van Buren Bl. & Wood Rd.

West Campus Upper Plateau (JN 14064)

09/29/2022

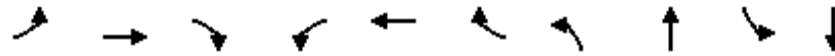

Lane Group	EBL	EBT	EBR	WBL	WBT	WBR	NBL	NBT	SBL	SBT
Lane Configurations	↘	↑↑	↗	↘↗	↑↑	↗	↘↗	↑↔	↘	↑↔
Traffic Volume (vph)	119	962	163	171	927	65	160	122	114	142
Future Volume (vph)	119	962	163	171	927	65	160	122	114	142
Turn Type	Prot	NA	pm+ov	Prot	NA	Perm	Prot	NA	Prot	NA
Protected Phases	5	2	3	1	6		3	8	7	4
Permitted Phases			2			6				
Detector Phase	5	2	3	1	6	6	3	8	7	4
Switch Phase										
Minimum Initial (s)	5.0	10.0	5.0	5.0	10.0	10.0	5.0	10.0	5.0	10.0
Minimum Split (s)	9.2	30.2	9.2	9.2	30.2	30.2	9.2	38.4	9.2	15.8
Total Split (s)	16.5	57.2	21.7	13.2	53.9	53.9	21.7	38.4	11.2	27.9
Total Split (%)	13.8%	47.7%	18.1%	11.0%	44.9%	44.9%	18.1%	32.0%	9.3%	23.3%
Yellow Time (s)	3.2	5.2	3.2	3.2	5.2	5.2	3.2	4.4	3.2	4.8
All-Red Time (s)	1.0	1.0	1.0	1.0	1.0	1.0	1.0	1.0	1.0	1.0
Lost Time Adjust (s)	0.0	0.0	0.0	0.0	0.0	0.0	0.0	0.0	0.0	0.0
Total Lost Time (s)	4.2	6.2	4.2	4.2	6.2	6.2	4.2	5.4	4.2	5.8
Lead/Lag	Lead	Lag	Lead	Lead	Lag	Lag	Lead	Lag	Lead	Lag
Lead-Lag Optimize?	Yes	Yes	Yes	Yes	Yes	Yes	Yes	Yes	Yes	Yes
Recall Mode	None	None	None	None	None	None	None	None	None	None
Act Effct Green (s)	10.6	37.1	48.7	8.6	35.0	35.0	9.5	15.9	7.3	13.2
Actuated g/C Ratio	0.12	0.41	0.54	0.10	0.39	0.39	0.11	0.18	0.08	0.15
v/c Ratio	0.62	0.73	0.19	0.57	0.74	0.10	0.49	0.38	0.86	0.50
Control Delay	55.1	25.8	2.0	49.8	27.7	0.3	45.6	19.1	92.0	21.9
Queue Delay	0.0	0.0	0.0	0.0	0.0	0.0	0.0	0.0	0.0	0.0
Total Delay	55.1	25.8	2.0	49.8	27.7	0.3	45.6	19.1	92.0	21.9
LOS	E	C	A	D	C	A	D	B	F	C
Approach Delay		25.5			29.4			29.9		42.3
Approach LOS		C			C			C		D

Intersection Summary

Cycle Length: 120
 Actuated Cycle Length: 89.6
 Natural Cycle: 90
 Control Type: Actuated-Uncoordinated
 Maximum v/c Ratio: 0.86
 Intersection Signal Delay: 29.5
 Intersection LOS: C
 Intersection Capacity Utilization 69.9%
 ICU Level of Service C
 Analysis Period (min) 15

Splits and Phases: 4: Van Buren Bl. & Wood Rd.

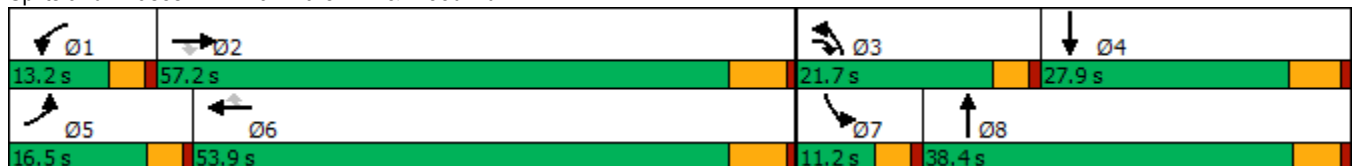

HCM 6th Signalized Intersection Summary
4: Van Buren Bl. & Wood Rd.

West Campus Upper Plateau (JN 14064)
09/29/2022

Movement	EBL	EBT	EBR	WBL	WBT	WBR	NBL	NBT	NBR	SBL	SBT	SBR
Lane Configurations												
Traffic Volume (veh/h)	119	962	163	171	927	65	160	122	110	114	142	135
Future Volume (veh/h)	119	962	163	171	927	65	160	122	110	114	142	135
Initial Q (Qb), veh	0	0	0	0	0	0	0	0	0	0	0	0
Ped-Bike Adj(A_pbT)	1.00		0.98	1.00		0.99	1.00		0.96	1.00		0.99
Parking Bus, Adj	1.00	1.00	1.00	1.00	1.00	1.00	1.00	1.00	1.00	1.00	1.00	1.00
Work Zone On Approach		No			No			No			No	
Adj Sat Flow, veh/h/ln	1885	1856	1870	1885	1870	1885	1856	1885	1870	1885	1885	1885
Adj Flow Rate, veh/h	131	1057	74	188	1019	24	176	134	40	125	156	73
Peak Hour Factor	0.91	0.91	0.91	0.91	0.91	0.91	0.91	0.91	0.91	0.91	0.91	0.91
Percent Heavy Veh, %	1	3	2	1	2	1	3	1	2	1	1	1
Cap, veh/h	165	1474	773	270	1435	635	261	440	126	157	415	185
Arrive On Green	0.09	0.42	0.42	0.08	0.40	0.40	0.08	0.16	0.16	0.09	0.17	0.17
Sat Flow, veh/h	1795	3526	1561	3483	3554	1574	3428	2723	780	1795	2399	1068
Grp Volume(v), veh/h	131	1057	74	188	1019	24	176	86	88	125	114	115
Grp Sat Flow(s),veh/h/ln	1795	1763	1561	1742	1777	1574	1714	1791	1711	1795	1791	1676
Q Serve(g_s), s	5.7	19.9	2.0	4.2	19.2	0.7	4.0	3.4	3.6	5.5	4.5	4.8
Cycle Q Clear(g_c), s	5.7	19.9	2.0	4.2	19.2	0.7	4.0	3.4	3.6	5.5	4.5	4.8
Prop In Lane	1.00		1.00	1.00		1.00	1.00		0.46	1.00		0.64
Lane Grp Cap(c), veh/h	165	1474	773	270	1435	635	261	290	277	157	310	290
V/C Ratio(X)	0.79	0.72	0.10	0.70	0.71	0.04	0.67	0.30	0.32	0.80	0.37	0.40
Avail Cap(c_a), veh/h	276	2250	1117	392	2121	939	751	739	707	157	495	463
HCM Platoon Ratio	1.00	1.00	1.00	1.00	1.00	1.00	1.00	1.00	1.00	1.00	1.00	1.00
Upstream Filter(I)	1.00	1.00	1.00	1.00	1.00	1.00	1.00	1.00	1.00	1.00	1.00	1.00
Uniform Delay (d), s/veh	35.5	19.3	10.7	36.0	19.9	14.4	36.0	29.5	29.6	35.8	29.2	29.3
Incr Delay (d2), s/veh	3.3	0.9	0.1	1.2	0.9	0.0	1.1	0.6	0.7	22.4	0.7	0.9
Initial Q Delay(d3),s/veh	0.0	0.0	0.0	0.0	0.0	0.0	0.0	0.0	0.0	0.0	0.0	0.0
%ile BackOfQ(50%),veh/ln	2.5	7.1	0.6	1.7	6.9	0.2	1.6	1.4	1.5	3.2	1.9	1.9
Unsig. Movement Delay, s/veh												
LnGrp Delay(d),s/veh	38.8	20.3	10.8	37.2	20.9	14.5	37.1	30.1	30.3	58.1	29.9	30.2
LnGrp LOS	D	C	B	D	C	B	D	C	C	E	C	C
Approach Vol, veh/h		1262			1231			350			354	
Approach Delay, s/veh		21.6			23.2			33.6			40.0	
Approach LOS		C			C			C			D	
Timer - Assigned Phs	1	2	3	4	5	6	7	8				
Phs Duration (G+Y+Rc), s	10.4	39.6	10.3	19.6	11.5	38.5	11.2	18.7				
Change Period (Y+Rc), s	* 4.2	6.2	* 4.2	5.8	* 4.2	6.2	* 4.2	* 5.8				
Max Green Setting (Gmax), s	* 9	51.0	* 18	22.1	* 12	47.7	* 7	* 33				
Max Q Clear Time (g_c+I1), s	6.2	21.9	6.0	6.8	7.7	21.2	7.5	5.6				
Green Ext Time (p_c), s	0.1	11.5	0.2	1.0	0.1	10.3	0.0	0.9				
Intersection Summary												
HCM 6th Ctrl Delay				25.6								
HCM 6th LOS				C								
Notes												
* HCM 6th computational engine requires equal clearance times for the phases crossing the barrier.												

Timings
5: Trautwein Rd. & Alessandro Bl.

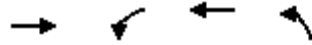

Lane Group	EBT	WBL	WBT	NBL
Lane Configurations	↑↑↑	↰↱	↑↑↑	↰↱↰↱
Traffic Volume (vph)	1036	170	1215	715
Future Volume (vph)	1036	170	1215	715
Turn Type	NA	Prot	NA	Prot
Protected Phases	2	1	6	8
Permitted Phases				
Detector Phase	2	1	6	8
Switch Phase				
Minimum Initial (s)	10.0	5.0	10.0	10.0
Minimum Split (s)	33.2	9.2	16.2	16.2
Total Split (s)	63.0	19.0	82.0	38.0
Total Split (%)	52.5%	15.8%	68.3%	31.7%
Yellow Time (s)	5.2	3.2	5.2	5.2
All-Red Time (s)	1.0	1.0	1.0	1.0
Lost Time Adjust (s)	0.0	0.0	0.0	0.0
Total Lost Time (s)	6.2	4.2	6.2	6.2
Lead/Lag	Lag	Lead		
Lead-Lag Optimize?	Yes	Yes		
Recall Mode	None	None	None	None
Act Effct Green (s)	26.5	8.4	39.2	16.8
Actuated g/C Ratio	0.39	0.12	0.57	0.24
v/c Ratio	0.55	0.42	0.43	0.62
Control Delay	18.0	33.5	9.1	26.4
Queue Delay	0.0	0.0	0.0	0.0
Total Delay	18.0	33.5	9.1	26.4
LOS	B	C	A	C
Approach Delay	18.0		12.1	26.4
Approach LOS	B		B	C

Intersection Summary

Cycle Length: 120	
Actuated Cycle Length: 68.8	
Natural Cycle: 60	
Control Type: Actuated-Uncoordinated	
Maximum v/c Ratio: 0.62	
Intersection Signal Delay: 17.3	Intersection LOS: B
Intersection Capacity Utilization 52.7%	ICU Level of Service A
Analysis Period (min) 15	

Splits and Phases: 5: Trautwein Rd. & Alessandro Bl.



HCM 6th Signalized Intersection Summary
5: Trautwein Rd. & Alessandro Bl.

West Campus Upper Plateau (JN 14064)

09/29/2022

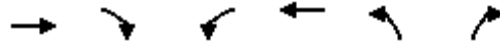

Movement	EBT	EBR	WBL	WBT	NBL	NBR
Lane Configurations	↑↑↑		↵↵	↑↑↑	↵↵↵	
Traffic Volume (veh/h)	1036	8	170	1215	715	10
Future Volume (veh/h)	1036	8	170	1215	715	10
Initial Q (Qb), veh	0	0	0	0	0	0
Ped-Bike Adj(A_pbT)		1.00	1.00		1.00	1.00
Parking Bus, Adj	1.00	1.00	1.00	1.00	1.00	1.00
Work Zone On Approach	No			No	No	
Adj Sat Flow, veh/h/ln	1885	1900	1885	1885	1870	1900
Adj Flow Rate, veh/h	1079	8	177	1266	754	0
Peak Hour Factor	0.96	0.96	0.96	0.96	0.96	0.96
Percent Heavy Veh, %	1	0	1	1	2	0
Cap, veh/h	2116	16	310	2909	1145	345
Arrive On Green	0.40	0.40	0.09	0.57	0.21	0.00
Sat Flow, veh/h	5440	39	3483	5316	5344	1610
Grp Volume(v), veh/h	702	385	177	1266	754	0
Grp Sat Flow(s),veh/h/ln	1716	1878	1742	1716	1781	1610
Q Serve(g_s), s	8.7	8.7	2.7	8.0	7.3	0.0
Cycle Q Clear(g_c), s	8.7	8.7	2.7	8.0	7.3	0.0
Prop In Lane		0.02	1.00		1.00	1.00
Lane Grp Cap(c), veh/h	1378	754	310	2909	1145	345
V/C Ratio(X)	0.51	0.51	0.57	0.44	0.66	0.00
Avail Cap(c_a), veh/h	3467	1898	917	6940	3023	911
HCM Platoon Ratio	1.00	1.00	1.00	1.00	1.00	1.00
Upstream Filter(I)	1.00	1.00	1.00	1.00	1.00	0.00
Uniform Delay (d), s/veh	12.7	12.7	24.6	7.0	20.2	0.0
Incr Delay (d2), s/veh	0.4	0.8	0.6	0.1	0.7	0.0
Initial Q Delay(d3),s/veh	0.0	0.0	0.0	0.0	0.0	0.0
%ile BackOfQ(50%),veh/ln	2.5	2.8	1.0	1.6	2.5	0.0
Unsig. Movement Delay, s/veh						
LnGrp Delay(d),s/veh	13.1	13.4	25.2	7.2	20.9	0.0
LnGrp LOS	B	B	C	A	C	A
Approach Vol, veh/h	1087			1443	754	
Approach Delay, s/veh	13.2			9.4	20.9	
Approach LOS	B			A	C	
Timer - Assigned Phs	1	2			6	8
Phs Duration (G+Y+Rc), s	9.2	28.8			38.0	18.2
Change Period (Y+Rc), s	* 4.2	6.2			6.2	6.2
Max Green Setting (Gmax), s	* 15	56.8			75.8	31.8
Max Q Clear Time (g_c+I1), s	4.7	10.7			10.0	9.3
Green Ext Time (p_c), s	0.2	11.9			16.6	2.8

Intersection Summary

HCM 6th Ctrl Delay	13.3
HCM 6th LOS	B

Notes

User approved volume balancing among the lanes for turning movement.
* HCM 6th computational engine requires equal clearance times for the phases crossing the barrier.

Timings
6: Trautwein Rd. & Grove Community Dr

West Campus Upper Plateau (JN 14064)

09/29/2022



Lane Group	WBL	WBR	NBT	NBR	SBL	SBT
Lane Configurations						
Traffic Volume (vph)	99	371	683	79	333	611
Future Volume (vph)	99	371	683	79	333	611
Turn Type	Prot	pm+ov	NA	Perm	Prot	NA
Protected Phases	8	1	2		1	6
Permitted Phases		8		2		
Detector Phase	8	1	2	2	1	6
Switch Phase						
Minimum Initial (s)	10.0	5.0	10.0	10.0	5.0	10.0
Minimum Split (s)	34.6	9.6	46.2	46.2	9.6	28.2
Total Split (s)	35.0	29.0	56.0	56.0	29.0	85.0
Total Split (%)	29.2%	24.2%	46.7%	46.7%	24.2%	70.8%
Yellow Time (s)	3.6	3.6	5.2	5.2	3.6	5.2
All-Red Time (s)	1.0	1.0	1.0	1.0	1.0	1.0
Lost Time Adjust (s)	0.0	0.0	0.0	0.0	0.0	0.0
Total Lost Time (s)	4.6	4.6	6.2	6.2	4.6	6.2
Lead/Lag		Lead	Lag	Lag	Lead	
Lead-Lag Optimize?		Yes	Yes	Yes	Yes	
Recall Mode	None	None	None	None	None	None
Act Effct Green (s)	13.7	22.4	21.8	21.8	12.3	41.6
Actuated g/C Ratio	0.23	0.37	0.36	0.36	0.21	0.69
v/c Ratio	0.27	0.36	0.58	0.14	0.51	0.28
Control Delay	24.9	6.9	19.5	5.2	27.2	6.1
Queue Delay	0.0	0.0	0.0	0.0	0.0	0.0
Total Delay	24.9	6.9	19.5	5.2	27.2	6.1
LOS	C	A	B	A	C	A
Approach Delay	10.7		18.0			13.5
Approach LOS	B		B			B

Intersection Summary

Cycle Length: 120	
Actuated Cycle Length: 59.9	
Natural Cycle: 95	
Control Type: Actuated-Uncoordinated	
Maximum v/c Ratio: 0.58	
Intersection Signal Delay: 14.5	Intersection LOS: B
Intersection Capacity Utilization 50.5%	ICU Level of Service A
Analysis Period (min) 15	

Splits and Phases: 6: Trautwein Rd. & Grove Community Dr



HCM 6th Signalized Intersection Summary
6: Trautwein Rd. & Grove Community Dr

West Campus Upper Plateau (JN 14064)

09/29/2022



Movement	WBL	WBR	NBT	NBR	SBL	SBT
Lane Configurations	↶	↶↶	↶↶	↷	↶↶	↶↶
Traffic Volume (veh/h)	99	371	683	79	333	611
Future Volume (veh/h)	99	371	683	79	333	611
Initial Q (Qb), veh	0	0	0	0	0	0
Ped-Bike Adj(A_pbT)	1.00	1.00		1.00	1.00	
Parking Bus, Adj	1.00	1.00	1.00	1.00	1.00	1.00
Work Zone On Approach	No		No			No
Adj Sat Flow, veh/h/ln	1900	1900	1885	1900	1900	1870
Adj Flow Rate, veh/h	110	218	759	82	370	679
Peak Hour Factor	0.90	0.90	0.90	0.90	0.90	0.90
Percent Heavy Veh, %	0	0	1	0	0	2
Cap, veh/h	365	1002	1191	535	533	2054
Arrive On Green	0.20	0.20	0.33	0.33	0.15	0.58
Sat Flow, veh/h	1810	2834	3676	1610	3510	3647
Grp Volume(v), veh/h	110	218	759	82	370	679
Grp Sat Flow(s),veh/h/ln	1810	1417	1791	1610	1755	1777
Q Serve(g_s), s	2.5	2.6	8.8	1.8	4.9	4.9
Cycle Q Clear(g_c), s	2.5	2.6	8.8	1.8	4.9	4.9
Prop In Lane	1.00	1.00		1.00	1.00	
Lane Grp Cap(c), veh/h	365	1002	1191	535	533	2054
V/C Ratio(X)	0.30	0.22	0.64	0.15	0.69	0.33
Avail Cap(c_a), veh/h	1122	2187	3639	1636	1747	5712
HCM Platoon Ratio	1.00	1.00	1.00	1.00	1.00	1.00
Upstream Filter(I)	1.00	1.00	1.00	1.00	1.00	1.00
Uniform Delay (d), s/veh	16.6	11.1	13.9	11.5	19.7	5.4
Incr Delay (d2), s/veh	0.5	0.1	0.6	0.1	0.6	0.1
Initial Q Delay(d3),s/veh	0.0	0.0	0.0	0.0	0.0	0.0
%ile BackOfQ(50%),veh/ln	1.0	0.7	2.6	0.5	1.6	0.8
Unsig. Movement Delay, s/veh						
LnGrp Delay(d),s/veh	17.1	11.2	14.4	11.6	20.3	5.5
LnGrp LOS	B	B	B	B	C	A
Approach Vol, veh/h	328		841			1049
Approach Delay, s/veh	13.2		14.2			10.7
Approach LOS	B		B			B
Timer - Assigned Phs	1	2			6	8
Phs Duration (G+Y+Rc), s	12.0	22.5			34.5	14.5
Change Period (Y+Rc), s	4.6	6.2			6.2	4.6
Max Green Setting (Gmax), s	24.4	49.8			78.8	30.4
Max Q Clear Time (g_c+I1), s	6.9	10.8			6.9	4.6
Green Ext Time (p_c), s	0.6	5.5			4.6	1.1
Intersection Summary						
HCM 6th Ctrl Delay			12.4			
HCM 6th LOS			B			

Timings

7: Trautwein Rd. & Orange Terrace Pkwy

09/29/2022



Lane Group	EBL	EBT	WBL	WBT	WBR	NBL	NBT	NBR	SBL	SBT	SBR
Lane Configurations											
Traffic Volume (vph)	30	17	154	11	153	32	565	142	190	588	19
Future Volume (vph)	30	17	154	11	153	32	565	142	190	588	19
Turn Type	Prot	NA	Prot	NA	pm+ov	Prot	NA	Perm	Prot	NA	Perm
Protected Phases	7	4	3	8	1	5	2		1	6	
Permitted Phases					8			2			6
Detector Phase	7	4	3	8	1	5	2	2	1	6	6
Switch Phase											
Minimum Initial (s)	5.0	10.0	5.0	10.0	5.0	5.0	10.0	10.0	5.0	10.0	10.0
Minimum Split (s)	9.6	38.6	9.6	34.6	9.6	9.6	46.2	46.2	9.6	28.2	28.2
Total Split (s)	13.2	38.6	16.1	41.5	18.0	9.6	47.3	47.3	18.0	55.7	55.7
Total Split (%)	11.0%	32.2%	13.4%	34.6%	15.0%	8.0%	39.4%	39.4%	15.0%	46.4%	46.4%
Yellow Time (s)	3.6	3.6	3.6	3.6	3.6	3.6	5.2	5.2	3.6	5.2	5.2
All-Red Time (s)	1.0	1.0	1.0	1.0	1.0	1.0	1.0	1.0	1.0	1.0	1.0
Lost Time Adjust (s)	0.0	0.0	0.0	0.0	0.0	0.0	0.0	0.0	0.0	0.0	0.0
Total Lost Time (s)	4.6	4.6	4.6	4.6	4.6	4.6	6.2	6.2	4.6	6.2	6.2
Lead/Lag	Lead	Lag	Lead	Lag	Lead	Lead	Lag	Lag	Lead	Lag	Lag
Lead-Lag Optimize?	Yes	Yes	Yes	Yes	Yes	Yes	Yes	Yes	Yes	Yes	Yes
Recall Mode	None	None	None	None	None	None	None	None	None	None	None
Act Effct Green (s)	10.3	14.2	12.8	18.5	30.1	5.7	19.8	19.8	9.2	31.3	31.3
Actuated g/C Ratio	0.15	0.20	0.18	0.27	0.43	0.08	0.28	0.28	0.13	0.45	0.45
v/c Ratio	0.12	0.10	0.50	0.02	0.13	0.23	0.60	0.27	0.45	0.39	0.03
Control Delay	35.8	18.9	40.3	25.6	4.1	45.6	25.6	6.0	37.0	16.8	0.1
Queue Delay	0.0	0.0	0.0	0.0	0.0	0.0	0.0	0.0	0.0	0.0	0.0
Total Delay	35.8	18.9	40.3	25.6	4.1	45.6	25.6	6.0	37.0	16.8	0.1
LOS	D	B	D	C	A	D	C	A	D	B	A
Approach Delay		26.6		22.4			22.7			21.2	
Approach LOS		C		C			C			C	

Intersection Summary

Cycle Length: 120	
Actuated Cycle Length: 69.7	
Natural Cycle: 105	
Control Type: Actuated-Uncoordinated	
Maximum v/c Ratio: 0.60	
Intersection Signal Delay: 22.2	Intersection LOS: C
Intersection Capacity Utilization 49.1%	ICU Level of Service A
Analysis Period (min) 15	



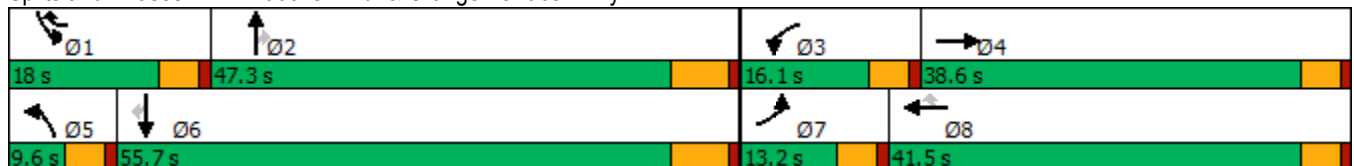



















Splits and Phases: 7: Trautwein Rd. & Orange Terrace Pkwy



HCM 6th Signalized Intersection Summary
7: Trautwein Rd. & Orange Terrace Pkwy

West Campus Upper Plateau (JN 14064)

09/29/2022

												
Movement	EBL	EBT	EBR	WBL	WBT	WBR	NBL	NBT	NBR	SBL	SBT	SBR
Lane Configurations												
Traffic Volume (veh/h)	30	17	19	154	11	153	32	565	142	190	588	19
Future Volume (veh/h)	30	17	19	154	11	153	32	565	142	190	588	19
Initial Q (Qb), veh	0	0	0	0	0	0	0	0	0	0	0	0
Ped-Bike Adj(A_pbT)	1.00		1.00	1.00		1.00	1.00		1.00	1.00		1.00
Parking Bus, Adj	1.00	1.00	1.00	1.00	1.00	1.00	1.00	1.00	1.00	1.00	1.00	1.00
Work Zone On Approach		No			No			No			No	
Adj Sat Flow, veh/h/ln	1900	1900	1900	1885	1900	1856	1900	1870	1870	1870	1870	1900
Adj Flow Rate, veh/h	32	18	18	164	12	43	34	601	73	202	626	10
Peak Hour Factor	0.94	0.94	0.94	0.94	0.94	0.94	0.94	0.94	0.94	0.94	0.94	0.94
Percent Heavy Veh, %	0	0	0	1	0	3	0	2	2	2	2	0
Cap, veh/h	64	136	136	209	451	914	67	933	416	320	1131	512
Arrive On Green	0.04	0.16	0.16	0.12	0.24	0.24	0.04	0.26	0.26	0.09	0.32	0.32
Sat Flow, veh/h	1810	872	872	1795	1900	2768	1810	3554	1585	3456	3554	1610
Grp Volume(v), veh/h	32	0	36	164	12	43	34	601	73	202	626	10
Grp Sat Flow(s),veh/h/ln	1810	0	1743	1795	1900	1384	1810	1777	1585	1728	1777	1610
Q Serve(g_s), s	0.9	0.0	1.0	4.8	0.3	0.6	1.0	8.1	1.9	3.0	7.8	0.2
Cycle Q Clear(g_c), s	0.9	0.0	1.0	4.8	0.3	0.6	1.0	8.1	1.9	3.0	7.8	0.2
Prop In Lane	1.00		0.50	1.00		1.00	1.00		1.00	1.00		1.00
Lane Grp Cap(c), veh/h	64	0	272	209	451	914	67	933	416	320	1131	512
V/C Ratio(X)	0.50	0.00	0.13	0.78	0.03	0.05	0.51	0.64	0.18	0.63	0.55	0.02
Avail Cap(c_a), veh/h	289	0	1102	384	1304	2155	168	2716	1211	861	3271	1482
HCM Platoon Ratio	1.00	1.00	1.00	1.00	1.00	1.00	1.00	1.00	1.00	1.00	1.00	1.00
Upstream Filter(I)	1.00	0.00	1.00	1.00	1.00	1.00	1.00	1.00	1.00	1.00	1.00	1.00
Uniform Delay (d), s/veh	25.5	0.0	19.5	23.1	15.7	12.3	25.4	17.6	15.3	23.5	15.2	12.6
Incr Delay (d2), s/veh	2.2	0.0	0.2	2.4	0.0	0.0	2.2	0.7	0.2	0.8	0.4	0.0
Initial Q Delay(d3),s/veh	0.0	0.0	0.0	0.0	0.0	0.0	0.0	0.0	0.0	0.0	0.0	0.0
%ile BackOfQ(50%),veh/ln	0.4	0.0	0.4	1.9	0.1	0.1	0.4	2.7	0.6	1.1	2.5	0.1
Unsig. Movement Delay, s/veh												
LnGrp Delay(d),s/veh	27.7	0.0	19.8	25.5	15.8	12.3	27.6	18.3	15.5	24.3	15.6	12.6
LnGrp LOS	C	A	B	C	B	B	C	B	B	C	B	B
Approach Vol, veh/h		68			219			708			838	
Approach Delay, s/veh		23.5			22.4			18.5			17.7	
Approach LOS		C			C			B			B	
Timer - Assigned Phs	1	2	3	4	5	6	7	8				
Phs Duration (G+Y+Rc), s	9.6	20.3	10.9	13.0	6.6	23.3	6.5	17.4				
Change Period (Y+Rc), s	4.6	6.2	4.6	4.6	4.6	6.2	4.6	4.6				
Max Green Setting (Gmax), s	13.4	41.1	11.5	34.0	5.0	49.5	8.6	36.9				
Max Q Clear Time (g_c+I1), s	5.0	10.1	6.8	3.0	3.0	9.8	2.9	2.6				
Green Ext Time (p_c), s	0.2	4.1	0.1	0.1	0.0	4.1	0.0	0.2				
Intersection Summary												
HCM 6th Ctrl Delay				18.8								
HCM 6th LOS				B								

Timings
8: Cole Av. & Van Buren Bl.

West Campus Upper Plateau (JN 14064)

09/29/2022



Lane Group	EBL	EBT	EBR	WBL	WBT	WBR	NBL	NBT	SBL	SBT	SBR
Lane Configurations	↖↗	↑↑	↖	↖	↑↑↑	↖	↖	↑↑	↖↗	↑↑	↖
Traffic Volume (vph)	302	772	70	119	826	164	92	229	153	205	216
Future Volume (vph)	302	772	70	119	826	164	92	229	153	205	216
Turn Type	Prot	NA	pm+ov	Prot	NA	pm+ov	Prot	NA	Prot	NA	pm+ov
Protected Phases	5	2	3	1	6	7	3	8	7	4	5
Permitted Phases			2			6					4
Detector Phase	5	2	3	1	6	7	3	8	7	4	5
Switch Phase											
Minimum Initial (s)	5.0	10.0	5.0	5.0	10.0	5.0	5.0	10.0	5.0	10.0	5.0
Minimum Split (s)	9.1	36.2	9.1	9.1	36.2	9.1	9.1	42.2	9.1	49.2	9.1
Total Split (s)	18.7	44.8	12.0	14.0	40.1	17.5	12.0	43.7	17.5	49.2	18.7
Total Split (%)	15.6%	37.3%	10.0%	11.7%	33.4%	14.6%	10.0%	36.4%	14.6%	41.0%	15.6%
Yellow Time (s)	3.2	5.2	3.2	3.2	5.2	3.2	3.2	5.2	3.2	5.2	3.2
All-Red Time (s)	0.5	1.0	0.5	0.5	1.0	0.5	0.5	1.0	0.5	1.0	0.5
Lost Time Adjust (s)	0.0	0.0	0.0	0.0	0.0	0.0	0.0	0.0	0.0	0.0	0.0
Total Lost Time (s)	3.7	6.2	3.7	3.7	6.2	3.7	3.7	6.2	3.7	6.2	3.7
Lead/Lag	Lead	Lag	Lead	Lead	Lag	Lead	Lead	Lag	Lead	Lag	Lead
Lead-Lag Optimize?	Yes	Yes	Yes	Yes	Yes	Yes	Yes	Yes	Yes	Yes	Yes
Recall Mode	None	None	None	None	None	None	None	None	None	None	None
Act Effct Green (s)	12.2	27.0	41.6	10.0	24.7	40.0	8.2	15.7	8.8	16.3	31.1
Actuated g/C Ratio	0.15	0.33	0.51	0.12	0.30	0.49	0.10	0.19	0.11	0.20	0.38
v/c Ratio	0.62	0.71	0.09	0.58	0.57	0.20	0.54	0.44	0.44	0.30	0.35
Control Delay	41.6	29.3	2.3	51.2	27.1	3.3	53.1	29.1	42.0	29.3	12.7
Queue Delay	0.0	0.0	0.0	0.0	0.0	0.0	0.0	0.0	0.0	0.0	0.0
Total Delay	41.6	29.3	2.3	51.2	27.1	3.3	53.1	29.1	42.0	29.3	12.7
LOS	D	C	A	D	C	A	D	C	D	C	B
Approach Delay		30.9			26.2			34.9		26.4	
Approach LOS		C			C			C		C	

Intersection Summary

Cycle Length: 120	
Actuated Cycle Length: 82.2	
Natural Cycle: 105	
Control Type: Actuated-Uncoordinated	
Maximum v/c Ratio: 0.71	
Intersection Signal Delay: 28.9	Intersection LOS: C
Intersection Capacity Utilization 60.3%	ICU Level of Service B
Analysis Period (min) 15	



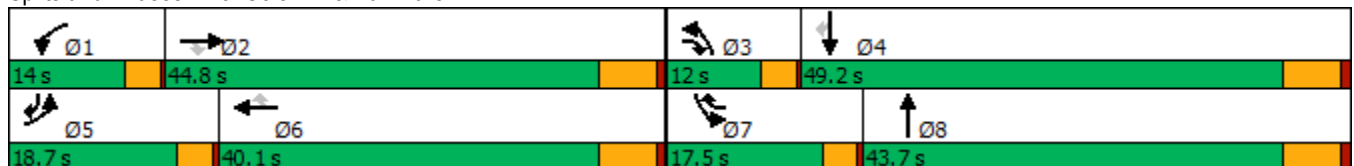



























Splits and Phases: 8: Cole Av. & Van Buren Bl.



HCM 6th Signalized Intersection Summary
8: Cole Av. & Van Buren Bl.

West Campus Upper Plateau (JN 14064)

09/29/2022

												
Movement	EBL	EBT	EBR	WBL	WBT	WBR	NBL	NBT	NBR	SBL	SBT	SBR
Lane Configurations	 	 			  			 		 	 	
Traffic Volume (veh/h)	302	772	70	119	826	164	92	229	60	153	205	216
Future Volume (veh/h)	302	772	70	119	826	164	92	229	60	153	205	216
Initial Q (Qb), veh	0	0	0	0	0	0	0	0	0	0	0	0
Ped-Bike Adj(A_pbT)	1.00		1.00	1.00		1.00	1.00		0.99	1.00		1.00
Parking Bus, Adj	1.00	1.00	1.00	1.00	1.00	1.00	1.00	1.00	1.00	1.00	1.00	1.00
Work Zone On Approach		No			No			No			No	
Adj Sat Flow, veh/h/ln	1856	1826	1856	1856	1856	1870	1885	1885	1870	1856	1885	1885
Adj Flow Rate, veh/h	315	804	16	124	860	82	96	239	55	159	214	127
Peak Hour Factor	0.96	0.96	0.96	0.96	0.96	0.96	0.96	0.96	0.96	0.96	0.96	0.96
Percent Heavy Veh, %	3	5	3	3	3	2	1	1	2	3	1	1
Cap, veh/h	429	1201	653	158	1574	610	124	511	115	255	651	490
Arrive On Green	0.13	0.35	0.35	0.09	0.31	0.31	0.07	0.18	0.18	0.07	0.18	0.18
Sat Flow, veh/h	3428	3469	1572	1767	5066	1585	1795	2899	654	3428	3582	1595
Grp Volume(v), veh/h	315	804	16	124	860	82	96	146	148	159	214	127
Grp Sat Flow(s),veh/h/ln	1714	1735	1572	1767	1689	1585	1795	1791	1762	1714	1791	1595
Q Serve(g_s), s	5.6	12.5	0.4	4.3	8.9	2.1	3.3	4.6	4.8	2.8	3.3	3.8
Cycle Q Clear(g_c), s	5.6	12.5	0.4	4.3	8.9	2.1	3.3	4.6	4.8	2.8	3.3	3.8
Prop In Lane	1.00		1.00	1.00		1.00	1.00		0.37	1.00		1.00
Lane Grp Cap(c), veh/h	429	1201	653	158	1574	610	124	316	311	255	651	490
V/C Ratio(X)	0.73	0.67	0.02	0.78	0.55	0.13	0.78	0.46	0.48	0.62	0.33	0.26
Avail Cap(c_a), veh/h	814	2120	1069	288	2719	968	236	1063	1046	749	2438	1286
HCM Platoon Ratio	1.00	1.00	1.00	1.00	1.00	1.00	1.00	1.00	1.00	1.00	1.00	1.00
Upstream Filter(I)	1.00	1.00	1.00	1.00	1.00	1.00	1.00	1.00	1.00	1.00	1.00	1.00
Uniform Delay (d), s/veh	26.6	17.6	10.9	28.2	18.1	12.6	28.9	23.3	23.4	28.4	22.5	16.5
Incr Delay (d2), s/veh	0.9	0.9	0.0	3.2	0.4	0.1	3.9	1.1	1.1	0.9	0.3	0.3
Initial Q Delay(d3),s/veh	0.0	0.0	0.0	0.0	0.0	0.0	0.0	0.0	0.0	0.0	0.0	0.0
%ile BackOfQ(50%),veh/ln	2.1	4.2	0.1	1.8	2.9	0.6	1.4	1.8	1.8	1.1	1.2	1.2
Unsig. Movement Delay, s/veh												
LnGrp Delay(d),s/veh	27.5	18.5	10.9	31.3	18.5	12.7	32.8	24.4	24.5	29.3	22.8	16.8
LnGrp LOS	C	B	B	C	B	B	C	C	C	C	C	B
Approach Vol, veh/h		1135			1066			390			500	
Approach Delay, s/veh		20.9			19.6			26.5			23.3	
Approach LOS		C			B			C			C	
Timer - Assigned Phs	1	2	3	4	5	6	7	8				
Phs Duration (G+Y+Rc), s	9.4	28.1	8.1	17.7	11.6	25.8	8.4	17.3				
Change Period (Y+Rc), s	3.7	6.2	3.7	6.2	3.7	6.2	3.7	6.2				
Max Green Setting (Gmax), s	10.3	38.6	8.3	43.0	15.0	33.9	13.8	37.5				
Max Q Clear Time (g_c+1), s	6.3	14.5	5.3	5.8	7.6	10.9	4.8	6.8				
Green Ext Time (p_c), s	0.0	7.4	0.0	1.6	0.4	8.1	0.2	1.5				
Intersection Summary												
HCM 6th Ctrl Delay				21.5								
HCM 6th LOS				C								

Intersection	
Intersection Delay, s/veh	9.8
Intersection LOS	A

Movement	EBT	EBR	WBL	WBT	NBL	NBR
Lane Configurations						
Traffic Vol, veh/h	139	14	59	201	50	45
Future Vol, veh/h	139	14	59	201	50	45
Peak Hour Factor	0.82	0.82	0.82	0.82	0.82	0.82
Heavy Vehicles, %	2	0	5	2	0	0
Mvmt Flow	170	17	72	245	61	55
Number of Lanes	1	0	1	1	1	1

Approach	EB	WB	NB
Opposing Approach	WB	EB	
Opposing Lanes	2	1	0
Conflicting Approach Left		NB	EB
Conflicting Lanes Left	0	2	1
Conflicting Approach Right	NB		WB
Conflicting Lanes Right	2	0	2
HCM Control Delay	9.7	10.1	9
HCM LOS	A	B	A

Lane	NBLn1	NBLn2	EBLn1	WBLn1	WBLn2
Vol Left, %	100%	0%	0%	100%	0%
Vol Thru, %	0%	0%	91%	0%	100%
Vol Right, %	0%	100%	9%	0%	0%
Sign Control	Stop	Stop	Stop	Stop	Stop
Traffic Vol by Lane	50	45	153	59	201
LT Vol	50	0	0	59	0
Through Vol	0	0	139	0	201
RT Vol	0	45	14	0	0
Lane Flow Rate	61	55	187	72	245
Geometry Grp	7	7	4	7	7
Degree of Util (X)	0.105	0.076	0.257	0.111	0.342
Departure Headway (Hd)	6.214	5.004	4.958	5.571	5.017
Convergence, Y/N	Yes	Yes	Yes	Yes	Yes
Cap	576	713	724	643	716
Service Time	3.962	2.751	2.994	3.303	2.75
HCM Lane V/C Ratio	0.106	0.077	0.258	0.112	0.342
HCM Control Delay	9.7	8.2	9.7	9	10.4
HCM Lane LOS	A	A	A	A	B
HCM 95th-tile Q	0.4	0.2	1	0.4	1.5

Intersection												
Intersection Delay, s/veh	9.6											
Intersection LOS	A											

Movement	EBL	EBT	EBR	WBL	WBT	WBR	NBL	NBT	NBR	SBL	SBT	SBR
Lane Configurations	↶	↶↷		↶	↶↷			↷↶			↷↶	
Traffic Vol, veh/h	51	204	8	8	267	50	24	4	4	47	5	51
Future Vol, veh/h	51	204	8	8	267	50	24	4	4	47	5	51
Peak Hour Factor	0.90	0.90	0.90	0.90	0.90	0.90	0.90	0.90	0.90	0.90	0.90	0.90
Heavy Vehicles, %	5	2	7	0	1	0	6	0	0	0	0	0
Mvmt Flow	57	227	9	9	297	56	27	4	4	52	6	57
Number of Lanes	1	2	0	1	2	0	0	1	0	0	1	0

Approach	EB	WB	NB	SB
Opposing Approach	WB	EB	SB	NB
Opposing Lanes	3	3	1	1
Conflicting Approach Left	SB	NB	EB	WB
Conflicting Lanes Left	1	1	3	3
Conflicting Approach Right	NB	SB	WB	EB
Conflicting Lanes Right	1	1	3	3
HCM Control Delay	9.4	9.7	9.7	10
HCM LOS	A	A	A	A

Lane	NBLn1	EBLn1	EBLn2	EBLn3	WBLn1	WBLn2	WBLn3	SBLn1
Vol Left, %	75%	100%	0%	0%	100%	0%	0%	46%
Vol Thru, %	12%	0%	100%	89%	0%	100%	64%	5%
Vol Right, %	12%	0%	0%	11%	0%	0%	36%	50%
Sign Control	Stop	Stop	Stop	Stop	Stop	Stop	Stop	Stop
Traffic Vol by Lane	32	51	136	76	8	178	139	103
LT Vol	24	51	0	0	8	0	0	47
Through Vol	4	0	136	68	0	178	89	5
RT Vol	4	0	0	8	0	0	50	51
Lane Flow Rate	36	57	151	84	9	198	154	114
Geometry Grp	7	7	7	7	7	7	7	7
Degree of Util (X)	0.064	0.093	0.224	0.125	0.014	0.289	0.214	0.186
Departure Headway (Hd)	6.493	5.892	5.337	5.348	5.755	5.269	4.998	5.856
Convergence, Y/N	Yes	Yes	Yes	Yes	Yes	Yes	Yes	Yes
Cap	546	605	668	665	619	678	714	608
Service Time	4.292	3.661	3.105	3.117	3.519	3.032	2.761	3.64
HCM Lane V/C Ratio	0.066	0.094	0.226	0.126	0.015	0.292	0.216	0.188
HCM Control Delay	9.7	9.3	9.7	8.9	8.6	10.2	9.1	10
HCM Lane LOS	A	A	A	A	A	B	A	A
HCM 95th-tile Q	0.2	0.3	0.9	0.4	0	1.2	0.8	0.7

Timings
11: Barton St & Alessandro Bl.

West Campus Upper Plateau (JN 14064)

09/29/2022



Lane Group	EBL	EBT	WBL	WBT	NBL	NBT	NBR	SBL	SBT	SBR
Lane Configurations	↙	↗↗↗	↙	↗↗↗		↖	↗		↖	↗
Traffic Volume (vph)	4	1252	66	1402	54	1	33	4	0	3
Future Volume (vph)	4	1252	66	1402	54	1	33	4	0	3
Turn Type	Prot	NA	Prot	NA	Perm	NA	Perm	Perm	NA	Perm
Protected Phases	5	2	1	6		8			4	
Permitted Phases					8		8	4		4
Detector Phase	5	2	1	6	8	8	8	4	4	4
Switch Phase										
Minimum Initial (s)	5.0	10.0	5.0	10.0	10.0	10.0	10.0	10.0	10.0	10.0
Minimum Split (s)	9.2	28.5	11.0	28.5	40.6	40.6	40.6	26.6	26.6	26.6
Total Split (s)	9.2	65.4	14.0	70.2	40.6	40.6	40.6	40.6	40.6	40.6
Total Split (%)	7.7%	54.5%	11.7%	58.5%	33.8%	33.8%	33.8%	33.8%	33.8%	33.8%
Yellow Time (s)	3.2	5.5	3.2	5.5	3.6	3.6	3.6	3.6	3.6	3.6
All-Red Time (s)	1.0	1.0	1.0	1.0	1.0	1.0	1.0	1.0	1.0	1.0
Lost Time Adjust (s)	0.0	0.0	0.0	0.0		0.0	0.0		0.0	0.0
Total Lost Time (s)	4.2	6.5	4.2	6.5		4.6	4.6		4.6	4.6
Lead/Lag	Lead	Lag	Lead	Lag						
Lead-Lag Optimize?	Yes	Yes	Yes	Yes						
Recall Mode	None	None	None	None	None	None	None	None	None	None
Act Effct Green (s)	6.2	39.0	8.1	46.9		15.3	15.3		15.3	15.3
Actuated g/C Ratio	0.09	0.58	0.12	0.70		0.23	0.23		0.23	0.23
v/c Ratio	0.03	0.46	0.32	0.42		0.19	0.08		0.01	0.01
Control Delay	43.0	13.3	40.6	8.5		28.4	0.3		27.0	0.0
Queue Delay	0.0	0.0	0.0	0.0		0.0	0.0		0.0	0.0
Total Delay	43.0	13.3	40.6	8.5		28.4	0.3		27.0	0.0
LOS	D	B	D	A		C	A		C	A
Approach Delay		13.4		9.9		18.0			15.4	
Approach LOS		B		A		B			B	

Intersection Summary

Cycle Length: 120
 Actuated Cycle Length: 66.9
 Natural Cycle: 85
 Control Type: Actuated-Uncoordinated
 Maximum v/c Ratio: 0.46
 Intersection Signal Delay: 11.7
 Intersection LOS: B
 Intersection Capacity Utilization 56.9%
 ICU Level of Service B
 Analysis Period (min) 15

Splits and Phases: 11: Barton St & Alessandro Bl.



HCM 6th Signalized Intersection Summary
11: Barton St & Alessandro Bl.

West Campus Upper Plateau (JN 14064)

09/29/2022



Movement	EBL	EBT	EBR	WBL	WBT	WBR	NBL	NBT	NBR	SBL	SBT	SBR
Lane Configurations	↖	↑↑↑		↖	↑↑↑			↑	↗		↑	↗
Traffic Volume (veh/h)	4	1252	36	66	1402	4	54	1	33	4	0	3
Future Volume (veh/h)	4	1252	36	66	1402	4	54	1	33	4	0	3
Initial Q (Qb), veh	0	0	0	0	0	0	0	0	0	0	0	0
Ped-Bike Adj(A_pbT)	1.00		1.00	1.00		0.98	1.00		1.00	1.00		1.00
Parking Bus, Adj	1.00	1.00	1.00	1.00	1.00	1.00	1.00	1.00	1.00	1.00	1.00	1.00
Work Zone On Approach		No			No			No			No	
Adj Sat Flow, veh/h/ln	1604	1885	1900	1900	1870	1900	1870	1900	1900	1737	1900	1900
Adj Flow Rate, veh/h	4	1346	37	71	1508	4	58	1	8	4	0	-8
Peak Hour Factor	0.93	0.93	0.93	0.93	0.93	0.93	0.93	0.93	0.93	0.93	0.93	0.93
Percent Heavy Veh, %	20	1	0	0	2	0	2	0	0	11	0	0
Cap, veh/h	8	2879	79	108	3224	9	295	4	179	243	0	179
Arrive On Green	0.01	0.56	0.56	0.06	0.61	0.61	0.11	0.11	0.11	0.11	0.00	0.00
Sat Flow, veh/h	1527	5149	142	1810	5258	14	1517	37	1610	1044	0	1610
Grp Volume(v), veh/h	4	897	486	71	976	536	59	0	8	4	0	-8
Grp Sat Flow(s),veh/h/ln	1527	1716	1860	1810	1702	1868	1553	0	1610	1044	0	1610
Q Serve(g_s), s	0.1	8.8	8.8	2.2	8.8	8.8	0.0	0.0	0.3	0.1	0.0	0.0
Cycle Q Clear(g_c), s	0.1	8.8	8.8	2.2	8.8	8.8	1.7	0.0	0.3	1.8	0.0	0.0
Prop In Lane	1.00		0.08	1.00		0.01	0.98		1.00	1.00		1.00
Lane Grp Cap(c), veh/h	8	1919	1040	108	2087	1145	299	0	179	243	0	179
V/C Ratio(X)	0.49	0.47	0.47	0.66	0.47	0.47	0.20	0.00	0.04	0.02	0.00	-0.04
Avail Cap(c_a), veh/h	135	3571	1935	313	3832	2102	1058	0	1024	993	0	1024
HCM Platoon Ratio	1.00	1.00	1.00	1.00	1.00	1.00	1.00	1.00	1.00	1.00	1.00	1.00
Upstream Filter(I)	1.00	1.00	1.00	1.00	1.00	1.00	1.00	0.00	1.00	1.00	0.00	0.00
Uniform Delay (d), s/veh	28.1	7.4	7.4	26.1	5.9	5.9	23.1	0.0	22.5	24.0	0.0	0.0
Incr Delay (d2), s/veh	15.6	0.3	0.5	2.6	0.2	0.4	0.3	0.0	0.1	0.0	0.0	0.0
Initial Q Delay(d3),s/veh	0.0	0.0	0.0	0.0	0.0	0.0	0.0	0.0	0.0	0.0	0.0	0.0
%ile BackOfQ(50%),veh/ln	0.1	1.8	2.1	1.0	2.3	2.5	0.7	0.0	0.1	0.0	0.0	0.0
Unsig. Movement Delay, s/veh												
LnGrp Delay(d),s/veh	43.6	7.7	7.9	28.6	6.2	6.4	23.4	0.0	22.6	24.0	0.0	0.0
LnGrp LOS	D	A	A	C	A	A	C	A	C	C	A	A
Approach Vol, veh/h		1387			1583			67				-4
Approach Delay, s/veh		7.9			7.2			23.3				0.0
Approach LOS		A			A			C				A
Timer - Assigned Phs	1	2		4	5	6		8				
Phs Duration (G+Y+Rc), s	7.6	38.1		10.9	4.5	41.2		10.9				
Change Period (Y+Rc), s	* 4.2	6.5		4.6	* 4.2	6.5		4.6				
Max Green Setting (Gmax), s	* 9.8	58.9		36.0	* 5	63.7		36.0				
Max Q Clear Time (g_c+I1), s	4.2	10.8		3.8	2.1	10.8		3.7				
Green Ext Time (p_c), s	0.0	16.7		0.0	0.0	23.9		0.3				

Intersection Summary

HCM 6th Ctrl Delay	7.9
HCM 6th LOS	A

Notes

* HCM 6th computational engine requires equal clearance times for the phases crossing the barrier.

Intersection						
Int Delay, s/veh	2.4					
Movement	EBL	EBT	WBT	WBR	SBL	SBR
Lane Configurations						
Traffic Vol, veh/h	26	129	179	17	22	54
Future Vol, veh/h	26	129	179	17	22	54
Conflicting Peds, #/hr	0	0	0	7	0	0
Sign Control	Free	Free	Free	Free	Stop	Stop
RT Channelized	-	None	-	None	-	None
Storage Length	100	-	-	-	0	-
Veh in Median Storage, #	-	0	0	-	0	-
Grade, %	-	0	0	-	0	-
Peak Hour Factor	78	78	78	78	78	78
Heavy Vehicles, %	0	1	1	0	0	0
Mvmt Flow	33	165	229	22	28	69

Major/Minor	Major1	Major2	Minor2		
Conflicting Flow All	258	0	-	0	478 247
Stage 1	-	-	-	-	247 -
Stage 2	-	-	-	-	231 -
Critical Hdwy	4.1	-	-	-	6.4 6.2
Critical Hdwy Stg 1	-	-	-	-	5.4 -
Critical Hdwy Stg 2	-	-	-	-	5.4 -
Follow-up Hdwy	2.2	-	-	-	3.5 3.3
Pot Cap-1 Maneuver	1318	-	-	-	550 797
Stage 1	-	-	-	-	799 -
Stage 2	-	-	-	-	812 -
Platoon blocked, %		-	-	-	
Mov Cap-1 Maneuver	1309	-	-	-	529 792
Mov Cap-2 Maneuver	-	-	-	-	529 -
Stage 1	-	-	-	-	773 -
Stage 2	-	-	-	-	806 -

Approach	EB	WB	SB
HCM Control Delay, s	1.3	0	11.1
HCM LOS			B

Minor Lane/Major Mvmt	EBL	EBT	WBT	WBR	SBLn1
Capacity (veh/h)	1309	-	-	-	692
HCM Lane V/C Ratio	0.025	-	-	-	0.141
HCM Control Delay (s)	7.8	-	-	-	11.1
HCM Lane LOS	A	-	-	-	B
HCM 95th %tile Q(veh)	0.1	-	-	-	0.5

Intersection						
Int Delay, s/veh	9.1					
Movement	EBT	EBR	WBL	WBT	NBL	NBR
Lane Configurations	↑↑		↖	↑↑	↘	
Traffic Vol, veh/h	269	238	45	396	197	33
Future Vol, veh/h	269	238	45	396	197	33
Conflicting Peds, #/hr	0	2	0	0	0	0
Sign Control	Free	Free	Free	Free	Stop	Stop
RT Channelized	-	None	-	None	-	None
Storage Length	-	-	125	-	0	-
Veh in Median Storage, #	0	-	-	0	0	-
Grade, %	0	-	-	0	0	-
Peak Hour Factor	86	86	86	86	86	86
Heavy Vehicles, %	1	1	0	0	0	0
Mvmt Flow	313	277	52	460	229	38

Major/Minor	Major1	Major2	Minor1		
Conflicting Flow All	0	0	592	0	788 297
Stage 1	-	-	-	-	454 -
Stage 2	-	-	-	-	334 -
Critical Hdwy	-	-	4.1	-	6.8 6.9
Critical Hdwy Stg 1	-	-	-	-	5.8 -
Critical Hdwy Stg 2	-	-	-	-	5.8 -
Follow-up Hdwy	-	-	2.2	-	3.5 3.3
Pot Cap-1 Maneuver	-	-	994	-	332 705
Stage 1	-	-	-	-	612 -
Stage 2	-	-	-	-	703 -
Platoon blocked, %	-	-	-	-	-
Mov Cap-1 Maneuver	-	-	992	-	314 704
Mov Cap-2 Maneuver	-	-	-	-	314 -
Stage 1	-	-	-	-	611 -
Stage 2	-	-	-	-	666 -

Approach	EB	WB	NB
HCM Control Delay, s	0	0.9	45
HCM LOS			E

Minor Lane/Major Mvmt	NBLn1	EBT	EBR	WBL	WBT
Capacity (veh/h)	341	-	-	992	-
HCM Lane V/C Ratio	0.784	-	-	0.053	-
HCM Control Delay (s)	45	-	-	8.8	-
HCM Lane LOS	E	-	-	A	-
HCM 95th %tile Q(veh)	6.4	-	-	0.2	-

Timings

14: Barton Rd. & Van Buren Bl.

09/29/2022



Lane Group	EBL	EBT	WBL	WBT	NBL	NBT	NBR	SBL	SBT
Lane Configurations	↙	↕↗	↙	↕↗	↙↗	↕	↗	↙	↗
Traffic Volume (vph)	80	857	191	895	195	38	158	42	25
Future Volume (vph)	80	857	191	895	195	38	158	42	25
Turn Type	Prot	NA	Prot	NA	Prot	NA	Perm	Prot	NA
Protected Phases	5	2	1	6	3	8		7	4
Permitted Phases							8		
Detector Phase	5	2	1	6	3	8	8	7	4
Switch Phase									
Minimum Initial (s)	5.0	10.0	5.0	10.0	5.0	10.0	10.0	5.0	10.0
Minimum Split (s)	9.2	25.2	9.2	25.5	9.1	14.6	14.6	9.1	33.6
Total Split (s)	17.6	52.1	22.2	56.7	12.1	36.3	36.3	9.4	33.6
Total Split (%)	14.7%	43.4%	18.5%	47.3%	10.1%	30.3%	30.3%	7.8%	28.0%
Yellow Time (s)	3.2	5.2	3.2	5.5	3.6	3.6	3.6	3.6	3.6
All-Red Time (s)	1.0	1.0	1.0	1.0	0.5	1.0	1.0	0.5	1.0
Lost Time Adjust (s)	0.0	0.0	0.0	0.0	0.0	0.0	0.0	0.0	0.0
Total Lost Time (s)	4.2	6.2	4.2	6.5	4.1	4.6	4.6	4.1	4.6
Lead/Lag	Lead	Lag	Lead	Lag	Lead	Lag	Lag	Lead	Lag
Lead-Lag Optimize?	Yes	Yes	Yes	Yes	Yes	Yes	Yes	Yes	Yes
Recall Mode	None	None	None	None	None	None	None	None	None
Act Effct Green (s)	9.1	35.2	15.4	43.7	8.2	18.4	18.4	5.5	13.2
Actuated g/C Ratio	0.10	0.38	0.17	0.48	0.09	0.20	0.20	0.06	0.14
v/c Ratio	0.50	0.86	0.71	0.44	0.69	0.11	0.39	0.44	0.38
Control Delay	52.7	34.1	52.9	17.9	56.0	34.9	8.2	60.7	16.1
Queue Delay	0.0	0.0	0.0	0.0	0.0	0.0	0.0	0.0	0.0
Total Delay	52.7	34.1	52.9	17.9	56.0	34.9	8.2	60.7	16.1
LOS	D	C	D	B	E	C	A	E	B
Approach Delay		35.5		23.8		34.6			28.5
Approach LOS		D		C		C			C

Intersection Summary

Cycle Length: 120
 Actuated Cycle Length: 91.7
 Natural Cycle: 100
 Control Type: Actuated-Uncoordinated
 Maximum v/c Ratio: 0.86
 Intersection Signal Delay: 30.2
 Intersection LOS: C
 Intersection Capacity Utilization 64.2%
 ICU Level of Service C
 Analysis Period (min) 15

Splits and Phases: 14: Barton Rd. & Van Buren Bl.

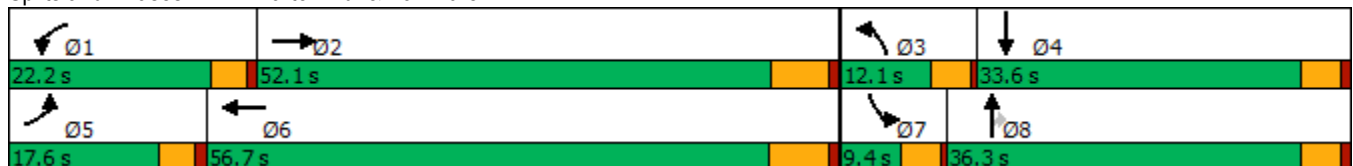

HCM 6th Signalized Intersection Summary
 14: Barton Rd. & Van Buren Bl.

West Campus Upper Plateau (JN 14064)

09/29/2022



Movement	EBL	EBT	EBR	WBL	WBT	WBR	NBL	NBT	NBR	SBL	SBT	SBR
Lane Configurations	↵	↕↗		↵	↕↗↘		↵↗	↕	↗	↵	↗	↘
Traffic Volume (veh/h)	80	857	162	191	895	50	195	38	158	42	25	85
Future Volume (veh/h)	80	857	162	191	895	50	195	38	158	42	25	85
Initial Q (Qb), veh	0	0	0	0	0	0	0	0	0	0	0	0
Ped-Bike Adj(A_pbT)	1.00		1.00	1.00		1.00	1.00		0.95	1.00		1.00
Parking Bus, Adj	1.00	1.00	1.00	1.00	1.00	1.00	1.00	1.00	1.00	1.00	1.00	1.00
Work Zone On Approach		No			No			No			No	
Adj Sat Flow, veh/h/ln	1900	1841	1870	1870	1856	1856	1900	1900	1885	1900	1841	1900
Adj Flow Rate, veh/h	89	952	149	212	994	45	217	42	44	47	28	32
Peak Hour Factor	0.90	0.90	0.90	0.90	0.90	0.90	0.90	0.90	0.90	0.90	0.90	0.90
Percent Heavy Veh, %	0	4	2	2	3	3	0	0	1	0	4	0
Cap, veh/h	116	1124	176	255	2237	101	308	341	272	76	105	120
Arrive On Green	0.06	0.37	0.37	0.14	0.45	0.45	0.09	0.18	0.18	0.04	0.13	0.13
Sat Flow, veh/h	1810	3029	474	1781	4967	225	3510	1900	1519	1810	784	896
Grp Volume(v), veh/h	89	549	552	212	675	364	217	42	44	47	0	60
Grp Sat Flow(s),veh/h/ln	1810	1749	1755	1781	1689	1815	1755	1900	1519	1810	0	1679
Q Serve(g_s), s	3.6	21.1	21.2	8.5	10.1	10.1	4.4	1.4	1.8	1.9	0.0	2.4
Cycle Q Clear(g_c), s	3.6	21.1	21.2	8.5	10.1	10.1	4.4	1.4	1.8	1.9	0.0	2.4
Prop In Lane	1.00		0.27	1.00		0.12	1.00		1.00	1.00		0.53
Lane Grp Cap(c), veh/h	116	649	651	255	1521	817	308	341	272	76	0	224
V/C Ratio(X)	0.77	0.85	0.85	0.83	0.44	0.44	0.70	0.12	0.16	0.62	0.00	0.27
Avail Cap(c_a), veh/h	330	1094	1097	437	2310	1241	383	821	656	131	0	664
HCM Platoon Ratio	1.00	1.00	1.00	1.00	1.00	1.00	1.00	1.00	1.00	1.00	1.00	1.00
Upstream Filter(I)	1.00	1.00	1.00	1.00	1.00	1.00	1.00	1.00	1.00	1.00	0.00	1.00
Uniform Delay (d), s/veh	33.8	21.2	21.2	30.6	13.9	13.9	32.5	25.3	25.4	34.6	0.0	28.6
Incr Delay (d2), s/veh	4.0	1.3	1.3	2.7	0.1	0.1	4.3	0.2	0.3	7.9	0.0	0.6
Initial Q Delay(d3),s/veh	0.0	0.0	0.0	0.0	0.0	0.0	0.0	0.0	0.0	0.0	0.0	0.0
%ile BackOfQ(50%),veh/ln	1.6	7.5	7.5	3.5	3.1	3.4	1.9	0.6	0.6	1.0	0.0	1.0
Unsig. Movement Delay, s/veh												
LnGrp Delay(d),s/veh	37.8	22.4	22.5	33.3	13.9	14.0	36.9	25.4	25.7	42.5	0.0	29.2
LnGrp LOS	D	C	C	C	B	B	D	C	C	D	A	C
Approach Vol, veh/h		1190			1251			303				107
Approach Delay, s/veh		23.6			17.2			33.7				35.0
Approach LOS		C			B			C				D
Timer - Assigned Phs	1	2	3	4	5	6	7	8				
Phs Duration (G+Y+Rc), s	14.7	33.7	10.5	14.4	8.9	39.6	7.2	17.8				
Change Period (Y+Rc), s	* 4.2	* 6.5	4.1	4.6	* 4.2	6.5	4.1	4.6				
Max Green Setting (Gmax), s	* 18	* 46	8.0	29.0	* 13	50.2	5.3	31.7				
Max Q Clear Time (g_c+I1), s	10.5	23.2	6.4	4.4	5.6	12.1	3.9	3.8				
Green Ext Time (p_c), s	0.2	4.1	0.1	0.3	0.0	4.1	0.0	0.3				

Intersection Summary

HCM 6th Ctrl Delay	22.3
HCM 6th LOS	C

Notes

* HCM 6th computational engine requires equal clearance times for the phases crossing the barrier.

Timings
15: Airman Dr & Cactus Av.



Lane Group	WBL	WBR	NBR	SBL	Ø6
Lane Configurations	↖	↗	↖	↖↗	
Traffic Volume (vph)	356	426	345	411	
Future Volume (vph)	356	426	345	411	
Turn Type	Prot	Perm	Perm	Prot	
Protected Phases	3			1	6
Permitted Phases		8	2		
Detector Phase	3	8	2	1	
Switch Phase					
Minimum Initial (s)	5.0	10.0	10.0	5.0	10.0
Minimum Split (s)	9.6	21.7	21.7	9.6	14.7
Total Split (s)	72.0	72.0	27.0	21.0	48.0
Total Split (%)	60.0%	60.0%	22.5%	17.5%	40%
Yellow Time (s)	3.6	3.7	3.7	3.6	3.7
All-Red Time (s)	1.0	1.0	1.0	1.0	1.0
Lost Time Adjust (s)	0.0	0.0	0.0	0.0	
Total Lost Time (s)	4.6	4.7	4.7	4.6	
Lead/Lag			Lag	Lead	
Lead-Lag Optimize?			Yes	Yes	
Recall Mode	None	None	Min	None	Min
Act Effect Green (s)	17.6	17.5	11.3	16.2	
Actuated g/C Ratio	0.30	0.30	0.19	0.27	
v/c Ratio	0.76	0.61	0.37	0.51	
Control Delay	29.8	5.8	1.1	22.2	
Queue Delay	0.0	0.0	0.0	0.0	
Total Delay	29.8	5.8	1.1	22.2	
LOS	C	A	A	C	
Approach Delay	16.7				
Approach LOS	B				

Intersection Summary

Cycle Length: 120	
Actuated Cycle Length: 59.2	
Natural Cycle: 60	
Control Type: Actuated-Uncoordinated	
Maximum v/c Ratio: 0.76	
Intersection Signal Delay: 14.7	Intersection LOS: B
Intersection Capacity Utilization 40.8%	ICU Level of Service A
Analysis Period (min) 15	

Splits and Phases: 15: Airman Dr & Cactus Av.

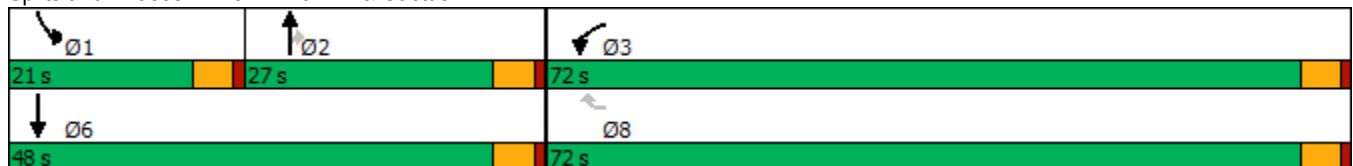

HCM 6th Signalized Intersection Summary
15: Airman Dr & Cactus Av.

West Campus Upper Plateau (JN 14064)

09/29/2022



Movement	WBL	WBR	NBT	NBR	SBL	SBT
Lane Configurations						
Traffic Volume (veh/h)	356	426	0	345	411	0
Future Volume (veh/h)	356	426	0	345	411	0
Initial Q (Qb), veh	0	0	0	0	0	0
Ped-Bike Adj(A_pbT)	1.00	1.00		1.00	1.00	
Parking Bus, Adj	1.00	1.00	1.00	1.00	1.00	1.00
Work Zone On Approach	No		No			No
Adj Sat Flow, veh/h/ln	1811	1752	1900	1811	1752	1900
Adj Flow Rate, veh/h	387	327	0	375	447	0
Peak Hour Factor	0.92	0.92	0.92	0.92	0.92	0.92
Percent Heavy Veh, %	6	10	0	6	10	0
Cap, veh/h	468	403	542	438	584	1050
Arrive On Green	0.27	0.27	0.00	0.29	0.18	0.00
Sat Flow, veh/h	1725	1485	1900	1535	3237	1900
Grp Volume(v), veh/h	387	327	0	375	447	0
Grp Sat Flow(s),veh/h/ln	1725	1485	1900	1535	1618	1900
Q Serve(g_s), s	11.2	10.9	0.0	12.2	7.0	0.0
Cycle Q Clear(g_c), s	11.2	10.9	0.0	12.2	7.0	0.0
Prop In Lane	1.00	1.00		1.00	1.00	
Lane Grp Cap(c), veh/h	468	403	542	438	584	1050
V/C Ratio(X)	0.83	0.81	0.00	0.86	0.77	0.00
Avail Cap(c_a), veh/h	2196	1890	800	647	1003	1554
HCM Platoon Ratio	1.00	1.00	1.00	1.00	1.00	1.00
Upstream Filter(I)	1.00	1.00	0.00	1.00	1.00	0.00
Uniform Delay (d), s/veh	18.1	18.0	0.0	17.9	20.6	0.0
Incr Delay (d2), s/veh	1.4	1.5	0.0	7.5	0.8	0.0
Initial Q Delay(d3),s/veh	0.0	0.0	0.0	0.0	0.0	0.0
%ile BackOfQ(50%),veh/ln	4.1	3.4	0.0	4.7	2.4	0.0
Unsig. Movement Delay, s/veh						
LnGrp Delay(d),s/veh	19.6	19.5	0.0	25.4	21.4	0.0
LnGrp LOS	B	B	A	C	C	A
Approach Vol, veh/h	714		375			447
Approach Delay, s/veh	19.5		25.4			21.4
Approach LOS	B		C			C
Timer - Assigned Phs	1	2			6	8
Phs Duration (G+Y+Rc), s	14.2	19.8			34.0	19.0
Change Period (Y+Rc), s	4.6	* 4.7			* 4.7	4.6
Max Green Setting (Gmax), s	16.4	* 22			* 43	67.4
Max Q Clear Time (g_c+I1), s	9.0	14.2			0.0	13.2
Green Ext Time (p_c), s	0.6	0.9			0.0	1.2

Intersection Summary

HCM 6th Ctrl Delay	21.5
HCM 6th LOS	C

Notes

* HCM 6th computational engine requires equal clearance times for the phases crossing the barrier.

Intersection	
Intersection Delay, s/veh	8.5
Intersection LOS	A

Movement	EBT	EBR	WBL	WBT	NBL	NBR
Lane Configurations						
Traffic Vol, veh/h	91	69	35	121	66	32
Future Vol, veh/h	91	69	35	121	66	32
Peak Hour Factor	0.88	0.88	0.88	0.88	0.88	0.88
Heavy Vehicles, %	1	2	3	2	2	0
Mvmt Flow	103	78	40	138	75	36
Number of Lanes	1	0	1	1	1	0

Approach	EB	WB	NB
Opposing Approach	WB	EB	
Opposing Lanes	2	1	0
Conflicting Approach Left		NB	EB
Conflicting Lanes Left	0	1	1
Conflicting Approach Right	NB		WB
Conflicting Lanes Right	1	0	2
HCM Control Delay	8.4	8.7	8.5
HCM LOS	A	A	A

Lane	NBLn1	EBLn1	WBLn1	WBLn2
Vol Left, %	67%	0%	100%	0%
Vol Thru, %	0%	57%	0%	100%
Vol Right, %	33%	43%	0%	0%
Sign Control	Stop	Stop	Stop	Stop
Traffic Vol by Lane	98	160	35	121
LT Vol	66	0	35	0
Through Vol	0	91	0	121
RT Vol	32	69	0	0
Lane Flow Rate	111	182	40	138
Geometry Grp	2	5	7	7
Degree of Util (X)	0.145	0.214	0.06	0.189
Departure Headway (Hd)	4.687	4.236	5.459	4.939
Convergence, Y/N	Yes	Yes	Yes	Yes
Cap	766	849	658	727
Service Time	2.711	2.256	3.179	2.659
HCM Lane V/C Ratio	0.145	0.214	0.061	0.19
HCM Control Delay	8.5	8.4	8.5	8.8
HCM Lane LOS	A	A	A	A
HCM 95th-tile Q	0.5	0.8	0.2	0.7

Intersection	
Intersection Delay, s/veh	8.9
Intersection LOS	A

Movement	EBL	EBT	WBT	WBR	SBL	SBR
Lane Configurations						
Traffic Vol, veh/h	113	144	169	63	52	54
Future Vol, veh/h	113	144	169	63	52	54
Peak Hour Factor	0.90	0.90	0.90	0.90	0.90	0.90
Heavy Vehicles, %	1	0	2	0	4	3
Mvmt Flow	126	160	188	70	58	60
Number of Lanes	1	2	2	0	1	0

Approach	EB	WB	SB
Opposing Approach	WB	EB	
Opposing Lanes	2	3	0
Conflicting Approach Left	SB		WB
Conflicting Lanes Left	1	0	2
Conflicting Approach Right		SB	EB
Conflicting Lanes Right	0	1	3
HCM Control Delay	8.4	9.2	9.7
HCM LOS	A	A	A

Lane	EBLn1	EBLn2	EBLn3	WBLn1	WBLn2	SBLn1
Vol Left, %	100%	0%	0%	0%	0%	49%
Vol Thru, %	0%	100%	100%	100%	47%	0%
Vol Right, %	0%	0%	0%	0%	53%	51%
Sign Control	Stop	Stop	Stop	Stop	Stop	Stop
Traffic Vol by Lane	113	72	72	113	119	106
LT Vol	113	0	0	0	0	52
Through Vol	0	72	72	113	56	0
RT Vol	0	0	0	0	63	54
Lane Flow Rate	126	80	80	125	133	118
Geometry Grp	7	7	7	8	8	7
Degree of Util (X)	0.196	0.113	0.075	0.189	0.185	0.185
Departure Headway (Hd)	5.608	5.088	3.377	5.442	5.036	5.646
Convergence, Y/N	Yes	Yes	Yes	Yes	Yes	Yes
Cap	639	703	1054	657	709	632
Service Time	3.35	2.83	1.118	3.193	2.787	3.403
HCM Lane V/C Ratio	0.197	0.114	0.076	0.19	0.188	0.187
HCM Control Delay	9.7	8.5	6.4	9.5	8.9	9.7
HCM Lane LOS	A	A	A	A	A	A
HCM 95th-tile Q	0.7	0.4	0.2	0.7	0.7	0.7

Timings
18: Linebacker Dr & Cactus Av.

West Campus Upper Plateau (JN 14064)
09/29/2022

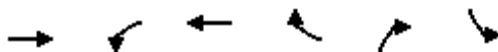

Lane Group	EBT	WBL	WBT	WBR	NBR	SBL	Ø3	Ø4	Ø5	Ø8
Lane Configurations	↑↑	↖	↑	↗	↗	↖↖				
Traffic Volume (vph)	756	169	782	168	159	159				
Future Volume (vph)	756	169	782	168	159	159				
Turn Type	NA	Prot	NA	Perm	pm+ov	Prot				
Protected Phases	2	1	6		1	7	3	4	5	8
Permitted Phases				6	8					
Detector Phase	2	1	6	6	1	7				
Switch Phase										
Minimum Initial (s)	10.0	5.0	10.0	10.0	5.0	5.0	5.0	10.0	5.0	10.0
Minimum Split (s)	27.0	9.6	27.0	27.0	9.6	9.6	9.6	27.0	9.6	27.0
Total Split (s)	27.4	16.0	33.8	33.8	16.0	9.6	9.6	27.0	9.6	27.0
Total Split (%)	34.3%	20.0%	42.3%	42.3%	20.0%	12.0%	12%	34%	12%	34%
Yellow Time (s)	4.0	3.6	4.0	4.0	3.6	3.6	3.6	4.0	3.6	4.0
All-Red Time (s)	1.0	1.0	1.0	1.0	1.0	1.0	1.0	1.0	1.0	1.0
Lost Time Adjust (s)	0.0	0.0	0.0	0.0	0.0	0.0				
Total Lost Time (s)	5.0	4.6	5.0	5.0	4.6	4.6				
Lead/Lag	Lag	Lead	Lag	Lag	Lead	Lead	Lead	Lag	Lead	Lag
Lead-Lag Optimize?	Yes	Yes	Yes	Yes	Yes	Yes	Yes	Yes	Yes	Yes
Recall Mode	None	None	None	None	None	None	None	None	None	None
Act Effct Green (s)	20.1	10.5	35.3	35.3	14.1	5.2				
Actuated g/C Ratio	0.37	0.19	0.65	0.65	0.26	0.10				
v/c Ratio	0.64	0.58	0.74	0.18	0.38	0.55				
Control Delay	19.3	32.8	15.3	2.4	10.5	35.9				
Queue Delay	0.0	0.0	0.0	0.0	0.0	0.0				
Total Delay	19.3	32.8	15.3	2.4	10.5	35.9				
LOS	B	C	B	A	B	D				
Approach Delay	19.3		16.0							
Approach LOS	B		B							

Intersection Summary

Cycle Length: 80
 Actuated Cycle Length: 54.3
 Natural Cycle: 100
 Control Type: Actuated-Uncoordinated
 Maximum v/c Ratio: 0.74
 Intersection Signal Delay: 18.2
 Intersection LOS: B
 Intersection Capacity Utilization 65.8%
 ICU Level of Service C
 Analysis Period (min) 15

Splits and Phases: 18: Linebacker Dr & Cactus Av.

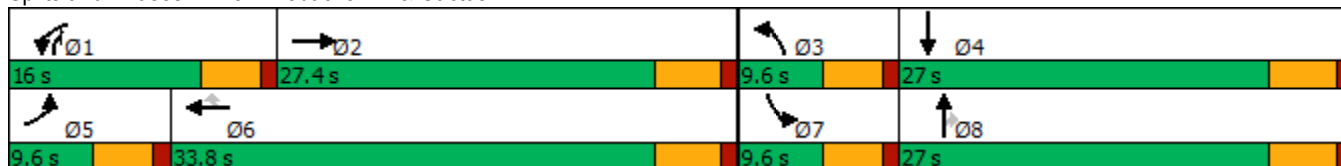

HCM 6th Signalized Intersection Summary
18: Linebacker Dr & Cactus Av.

West Campus Upper Plateau (JN 14064)

09/29/2022



Movement	EBL	EBT	EBR	WBL	WBT	WBR	NBL	NBT	NBR	SBL	SBT	SBR
Lane Configurations												
Traffic Volume (veh/h)	0	756	0	169	782	168	0	0	159	159	0	0
Future Volume (veh/h)	0	756	0	169	782	168	0	0	159	159	0	0
Initial Q (Qb), veh	0	0	0	0	0	0	0	0	0	0	0	0
Ped-Bike Adj(A_pbT)	1.00		1.00	1.00		1.00	1.00		1.00	1.00		1.00
Parking Bus, Adj	1.00	1.00	1.00	1.00	1.00	1.00	1.00	1.00	1.00	1.00	1.00	1.00
Work Zone On Approach		No			No			No			No	
Adj Sat Flow, veh/h/ln	1900	1767	1900	1752	1781	1752	1900	1900	1767	1752	1900	1900
Adj Flow Rate, veh/h	0	822	0	184	850	183	0	0	173	173	0	0
Peak Hour Factor	0.92	0.92	0.92	0.92	0.92	0.92	0.92	0.92	0.92	0.92	0.92	0.92
Percent Heavy Veh, %	0	9	0	10	8	10	0	0	9	10	0	0
Cap, veh/h	3	1070	0	226	919	766	3	302	440	265	600	0
Arrive On Green	0.00	0.30	0.00	0.14	0.52	0.52	0.00	0.00	0.16	0.08	0.00	0.00
Sat Flow, veh/h	1810	3533	0	1668	1781	1485	1810	1900	1497	3337	1900	0
Grp Volume(v), veh/h	0	822	0	184	850	183	0	0	173	173	0	0
Grp Sat Flow(s),veh/h/ln	1810	1767	0	1668	1781	1485	1810	1900	1497	1668	1900	0
Q Serve(g_s), s	0.0	12.5	0.0	6.4	26.2	4.0	0.0	0.0	5.5	3.0	0.0	0.0
Cycle Q Clear(g_c), s	0.0	12.5	0.0	6.4	26.2	4.0	0.0	0.0	5.5	3.0	0.0	0.0
Prop In Lane	1.00		0.00	1.00		1.00	1.00		1.00	1.00		0.00
Lane Grp Cap(c), veh/h	3	1070	0	226	919	766	3	302	440	265	600	0
V/C Ratio(X)	0.00	0.77	0.00	0.81	0.93	0.24	0.00	0.00	0.39	0.65	0.00	0.00
Avail Cap(c_a), veh/h	152	1334	0	321	919	766	152	705	758	281	705	0
HCM Platoon Ratio	1.00	1.00	1.00	1.00	1.00	1.00	1.00	1.00	1.00	1.00	1.00	1.00
Upstream Filter(I)	0.00	1.00	0.00	1.00	1.00	1.00	0.00	0.00	1.00	1.00	0.00	0.00
Uniform Delay (d), s/veh	0.0	18.8	0.0	24.9	13.3	7.9	0.0	0.0	16.7	26.5	0.0	0.0
Incr Delay (d2), s/veh	0.0	2.2	0.0	7.0	14.8	0.2	0.0	0.0	0.6	3.6	0.0	0.0
Initial Q Delay(d3),s/veh	0.0	0.0	0.0	0.0	0.0	0.0	0.0	0.0	0.0	0.0	0.0	0.0
%ile BackOfQ(50%),veh/ln	0.0	4.9	0.0	2.8	12.1	1.1	0.0	0.0	1.8	1.3	0.0	0.0
Unsig. Movement Delay, s/veh												
LnGrp Delay(d),s/veh	0.0	21.0	0.0	31.9	28.2	8.1	0.0	0.0	17.3	30.2	0.0	0.0
LnGrp LOS	A	C	A	C	C	A	A	A	B	C	A	A
Approach Vol, veh/h		822			1217			173			173	
Approach Delay, s/veh		21.0			25.7			17.3			30.2	
Approach LOS		C			C			B			C	
Timer - Assigned Phs	1	2	3	4	5	6	7	8				
Phs Duration (G+Y+Rc), s	12.6	23.0	0.0	23.7	0.0	35.6	9.3	14.4				
Change Period (Y+Rc), s	4.6	5.0	4.6	5.0	4.6	5.0	4.6	5.0				
Max Green Setting (Gmax), s	11.4	22.4	5.0	22.0	5.0	28.8	5.0	22.0				
Max Q Clear Time (g_c+I1), s	8.4	14.5	0.0	0.0	0.0	28.2	5.0	7.5				
Green Ext Time (p_c), s	0.1	3.4	0.0	0.0	0.0	0.4	0.0	0.4				

Intersection Summary

HCM 6th Ctrl Delay	23.8
HCM 6th LOS	C

Timings
19: Van Buren Bl. & Orange Terrace Pkwy.

West Campus Upper Plateau (JN 14064)

09/29/2022

Lane Group	EBL	EBT	EBR	WBL	WBT	WBR	NBL	NBT	NBR	SBL	SBT	SBR
Lane Configurations												
Traffic Volume (vph)	84	845	49	32	1070	241	52	46	38	184	36	69
Future Volume (vph)	84	845	49	32	1070	241	52	46	38	184	36	69
Turn Type	Prot	NA	Perm	Prot	NA	Perm	Prot	NA	Perm	Prot	NA	pm+ov
Protected Phases	5	2		1	6		3	8		7	4	5
Permitted Phases			2			6			8			4
Detector Phase	5	2	2	1	6	6	3	8	8	7	4	5
Switch Phase												
Minimum Initial (s)	5.0	10.0	10.0	5.0	10.0	10.0	5.0	5.0	5.0	10.0	10.0	5.0
Minimum Split (s)	9.2	25.2	25.2	9.1	25.2	25.2	9.1	26.1	26.1	15.8	24.8	9.2
Total Split (s)	16.0	63.0	63.0	11.0	58.0	58.0	12.0	27.0	27.0	19.0	34.0	16.0
Total Split (%)	13.3%	52.5%	52.5%	9.2%	48.3%	48.3%	10.0%	22.5%	22.5%	15.8%	28.3%	13.3%
Yellow Time (s)	3.2	5.2	5.2	3.6	5.2	5.2	3.6	3.6	3.6	4.8	4.8	3.2
All-Red Time (s)	1.0	1.0	1.0	0.5	1.0	1.0	0.5	0.5	0.5	1.0	1.0	1.0
Lost Time Adjust (s)	0.0	0.0	0.0	0.0	0.0	0.0	0.0	0.0	0.0	0.0	0.0	0.0
Total Lost Time (s)	4.2	6.2	6.2	4.1	6.2	6.2	4.1	4.1	4.1	5.8	5.8	4.2
Lead/Lag	Lead	Lag	Lag	Lead	Lag	Lag	Lead	Lag	Lag	Lead	Lag	Lead
Lead-Lag Optimize?	Yes	Yes	Yes	Yes	Yes	Yes	Yes	Yes	Yes	Yes	Yes	Yes
Recall Mode	None	None	None	None	None	None	None	None	None	None	None	None
Act Effct Green (s)	6.8	30.8	30.8	6.6	26.2	26.2	7.0	7.8	7.8	11.6	14.5	27.7
Actuated g/C Ratio	0.10	0.45	0.45	0.10	0.39	0.39	0.10	0.11	0.11	0.17	0.21	0.41
v/c Ratio	0.25	0.39	0.07	0.10	0.58	0.33	0.16	0.12	0.11	0.33	0.09	0.11
Control Delay	35.7	14.1	0.2	35.6	19.0	3.8	35.2	32.5	0.7	31.8	28.7	5.7
Queue Delay	0.0	0.0	0.0	0.0	0.0	0.0	0.0	0.0	0.0	0.0	0.0	0.0
Total Delay	35.7	14.1	0.2	35.6	19.0	3.8	35.2	32.5	0.7	31.8	28.7	5.7
LOS	D	B	A	D	B	A	D	C	A	C	C	A
Approach Delay		15.2			16.6			24.6			25.2	
Approach LOS		B			B			C			C	

Intersection Summary

Cycle Length: 120
 Actuated Cycle Length: 67.9
 Natural Cycle: 80
 Control Type: Actuated-Uncoordinated
 Maximum v/c Ratio: 0.58
 Intersection Signal Delay: 17.4
 Intersection LOS: B
 Intersection Capacity Utilization 50.3%
 ICU Level of Service A
 Analysis Period (min) 15

Splits and Phases: 19: Van Buren Bl. & Orange Terrace Pkwy.



HCM 6th Signalized Intersection Summary
 19: Van Buren Bl. & Orange Terrace Pkwy.

West Campus Upper Plateau (JN 14064)

09/29/2022



Movement	EBL	EBT	EBR	WBL	WBT	WBR	NBL	NBT	NBR	SBL	SBT	SBR
Lane Configurations	↖↗	↑↑↑	↖	↖↗	↑↑↑	↖	↖↗	↑↑	↖	↖↗	↑	↖↗
Traffic Volume (veh/h)	84	845	49	32	1070	241	52	46	38	184	36	69
Future Volume (veh/h)	84	845	49	32	1070	241	52	46	38	184	36	69
Initial Q (Qb), veh	0	0	0	0	0	0	0	0	0	0	0	0
Ped-Bike Adj(A_pbT)	1.00		1.00	1.00		1.00	1.00		1.00	1.00		1.00
Parking Bus, Adj	1.00	1.00	1.00	1.00	1.00	1.00	1.00	1.00	1.00	1.00	1.00	1.00
Work Zone On Approach		No			No			No			No	
Adj Sat Flow, veh/h/ln	1885	1856	1811	1870	1856	1885	1796	1900	1856	1885	1900	1885
Adj Flow Rate, veh/h	88	889	26	34	1126	194	55	48	8	194	38	-1
Peak Hour Factor	0.95	0.95	0.95	0.95	0.95	0.95	0.95	0.95	0.95	0.95	0.95	0.95
Percent Heavy Veh, %	1	3	6	2	3	1	7	0	3	1	0	1
Cap, veh/h	216	1986	602	123	1844	582	162	263	114	543	392	429
Arrive On Green	0.06	0.39	0.39	0.04	0.36	0.36	0.05	0.07	0.07	0.16	0.21	0.00
Sat Flow, veh/h	3483	5066	1535	3456	5066	1598	3319	3610	1572	3483	1900	1598
Grp Volume(v), veh/h	88	889	26	34	1126	194	55	48	8	194	38	-1
Grp Sat Flow(s),veh/h/ln	1742	1689	1535	1728	1689	1598	1659	1805	1572	1742	1900	1598
Q Serve(g_s), s	1.5	8.2	0.7	0.6	11.6	5.6	1.0	0.8	0.3	3.2	1.0	0.0
Cycle Q Clear(g_c), s	1.5	8.2	0.7	0.6	11.6	5.6	1.0	0.8	0.3	3.2	1.0	0.0
Prop In Lane	1.00		1.00	1.00		1.00	1.00		1.00	1.00		1.00
Lane Grp Cap(c), veh/h	216	1986	602	123	1844	582	162	263	114	543	392	429
V/C Ratio(X)	0.41	0.45	0.04	0.28	0.61	0.33	0.34	0.18	0.07	0.36	0.10	0.00
Avail Cap(c_a), veh/h	645	4516	1368	374	4118	1299	411	1297	565	722	841	806
HCM Platoon Ratio	1.00	1.00	1.00	1.00	1.00	1.00	1.00	1.00	1.00	1.00	1.00	1.00
Upstream Filter(I)	1.00	1.00	1.00	1.00	1.00	1.00	1.00	1.00	1.00	1.00	1.00	0.00
Uniform Delay (d), s/veh	28.8	14.3	12.0	29.9	16.6	14.7	29.3	27.8	27.5	24.0	20.5	0.0
Incr Delay (d2), s/veh	0.5	0.2	0.0	1.2	0.3	0.3	1.2	0.3	0.3	0.4	0.1	0.0
Initial Q Delay(d3),s/veh	0.0	0.0	0.0	0.0	0.0	0.0	0.0	0.0	0.0	0.0	0.0	0.0
%ile BackOfQ(50%),veh/ln	0.6	2.5	0.2	0.2	3.7	1.9	0.4	0.3	0.1	1.2	0.4	0.0
Unsig. Movement Delay, s/veh												
LnGrp Delay(d),s/veh	29.2	14.4	12.0	31.1	16.9	15.0	30.5	28.1	27.8	24.4	20.6	0.0
LnGrp LOS	C	B	B	C	B	B	C	C	C	C	C	A
Approach Vol, veh/h		1003			1354			111			231	
Approach Delay, s/veh		15.7			17.0			29.3			23.9	
Approach LOS		B			B			C			C	
Timer - Assigned Phs	1	2	3	4	5	6	7	8				
Phs Duration (G+Y+Rc), s	6.4	31.2	7.2	19.0	8.1	29.4	15.7	10.4				
Change Period (Y+Rc), s	4.1	6.2	4.1	5.8	* 4.2	6.2	5.8	* 5.8				
Max Green Setting (Gmax), s	6.9	56.8	7.9	28.2	* 12	51.8	13.2	* 23				
Max Q Clear Time (g_c+I1), s	2.6	10.2	3.0	3.0	3.5	13.6	5.2	2.8				
Green Ext Time (p_c), s	0.0	6.6	0.0	0.1	0.1	9.6	0.4	0.2				

Intersection Summary

HCM 6th Ctrl Delay	17.6
HCM 6th LOS	B

Notes

* HCM 6th computational engine requires equal clearance times for the phases crossing the barrier.

Timings
20: Brown/San Gorgonio Dr & Alessandro Bl.

West Campus Upper Plateau (JN 14064)

09/29/2022



Lane Group	EBL	EBT	WBL	WBT	WBR	NBL	NBR	SBL	SBR	Ø4	Ø8
Lane Configurations	↖	↕↕↕	↖	↕↕↕	↖	↖	↖	↖	↖		
Traffic Volume (vph)	29	1050	275	1211	31	241	266	36	33		
Future Volume (vph)	29	1050	275	1211	31	241	266	36	33		
Turn Type	Prot	NA	Prot	NA	Perm	Prot	pm+ov	Prot	pm+ov		
Protected Phases	5	2	1	6		3	1	7	5	4	8
Permitted Phases					6		8		4		
Detector Phase	5	2	1	6	6	3	1	7	5		
Switch Phase											
Minimum Initial (s)	5.0	10.0	5.0	10.0	10.0	5.0	5.0	5.0	5.0	10.0	5.0
Minimum Split (s)	8.7	43.5	9.1	43.5	43.5	9.1	9.1	8.7	8.7	49.8	26.1
Total Split (s)	8.7	52.0	9.1	52.4	52.4	9.1	9.1	19.6	8.7	49.8	39.3
Total Split (%)	7.3%	43.3%	7.6%	43.7%	43.7%	7.6%	7.6%	16.3%	7.3%	42%	33%
Yellow Time (s)	3.2	5.5	3.6	5.5	5.5	3.6	3.6	3.2	3.2	4.8	3.6
All-Red Time (s)	0.5	1.0	0.5	1.0	1.0	0.5	0.5	0.5	0.5	1.0	0.5
Lost Time Adjust (s)	0.0	0.0	0.0	0.0	0.0	0.0	0.0	0.0	0.0		
Total Lost Time (s)	3.7	6.5	4.1	6.5	6.5	4.1	4.1	3.7	3.7		
Lead/Lag	Lead	Lag	Lead	Lag	Lag	Lead	Lead	Lead	Lead	Lag	Lag
Lead-Lag Optimize?	Yes	Yes	Yes	Yes	Yes	Yes	Yes	Yes	Yes	Yes	Yes
Recall Mode	None	None	None	None	None	None	None	None	None	None	None
Act Effct Green (s)	5.6	32.0	5.6	37.3	37.3	6.4	16.0	6.9	11.1		
Actuated g/C Ratio	0.08	0.48	0.08	0.56	0.56	0.10	0.24	0.10	0.17		
v/c Ratio	0.20	0.57	2.69	0.45	0.04	1.60	0.70	0.22	0.11		
Control Delay	42.0	14.9	806.2	12.9	0.1	321.7	23.9	38.8	1.5		
Queue Delay	0.0	0.0	0.0	0.0	0.0	0.0	0.0	0.0	0.0		
Total Delay	42.0	14.9	806.2	12.9	0.1	321.7	23.9	38.8	1.5		
LOS	D	B	F	B	A	F	C	D	A		
Approach Delay		15.5		156.6							
Approach LOS		B		F							

Intersection Summary

Cycle Length: 120	
Actuated Cycle Length: 66.1	
Natural Cycle: 115	
Control Type: Actuated-Uncoordinated	
Maximum v/c Ratio: 2.69	
Intersection Signal Delay: 100.5	Intersection LOS: F
Intersection Capacity Utilization 73.3%	ICU Level of Service D
Analysis Period (min) 15	

Splits and Phases: 20: Brown/San Gorgonio Dr & Alessandro Bl.

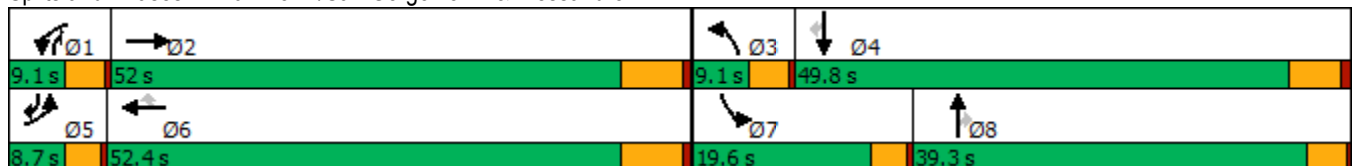

HCM 6th Signalized Intersection Summary
 20: Brown/San Gorgonio Dr & Alessandro Bl.

West Campus Upper Plateau (JN 14064)

09/29/2022



Movement	EBL	EBT	EBR	WBL	WBT	WBR	NBL	NBT	NBR	SBL	SBT	SBR
Lane Configurations	↖	↑↑↑		↖	↑↑↑	↖	↖	↑	↖	↖	↑	↖
Traffic Volume (veh/h)	29	1050	246	275	1211	31	241	0	266	36	0	33
Future Volume (veh/h)	29	1050	246	275	1211	31	241	0	266	36	0	33
Initial Q (Qb), veh	0	0	0	0	0	0	0	0	0	0	0	0
Ped-Bike Adj(A_pbT)	1.00		1.00	1.00		1.00	1.00		1.00	1.00		1.00
Parking Bus, Adj	1.00	1.00	1.00	1.00	1.00	1.00	1.00	1.00	1.00	1.00	1.00	1.00
Work Zone On Approach		No			No			No			No	
Adj Sat Flow, veh/h/ln	1900	1900	1900	1307	1885	1396	1796	1900	1322	1796	1900	1885
Adj Flow Rate, veh/h	31	1129	261	296	1302	29	259	0	273	39	0	-14
Peak Hour Factor	0.93	0.93	0.93	0.93	0.93	0.93	0.93	0.93	0.93	0.93	0.93	0.93
Percent Heavy Veh, %	0	0	0	40	1	34	7	0	39	7	0	1
Cap, veh/h	56	1698	392	76	2255	518	104	485	354	61	428	409
Arrive On Green	0.03	0.40	0.40	0.06	0.44	0.44	0.06	0.00	0.26	0.04	0.00	0.00
Sat Flow, veh/h	1810	4210	973	1245	5147	1183	1711	1900	1120	1711	1900	1598
Grp Volume(v), veh/h	31	927	463	296	1302	29	259	0	273	39	0	-14
Grp Sat Flow(s),veh/h/ln	1810	1729	1725	1245	1716	1183	1711	1900	1120	1711	1900	1598
Q Serve(g_s), s	1.4	18.0	18.0	5.0	15.6	1.2	5.0	0.0	18.1	1.8	0.0	0.0
Cycle Q Clear(g_c), s	1.4	18.0	18.0	5.0	15.6	1.2	5.0	0.0	18.1	1.8	0.0	0.0
Prop In Lane	1.00		0.56	1.00		1.00	1.00		1.00	1.00		1.00
Lane Grp Cap(c), veh/h	56	1394	696	76	2255	518	104	485	354	61	428	409
V/C Ratio(X)	0.55	0.67	0.67	3.90	0.58	0.06	2.49	0.00	0.77	0.64	0.00	-0.03
Avail Cap(c_a), veh/h	110	1917	956	76	2878	662	104	815	549	331	1018	906
HCM Platoon Ratio	1.00	1.00	1.00	1.00	1.00	1.00	1.00	1.00	1.00	1.00	1.00	1.00
Upstream Filter(I)	1.00	1.00	1.00	1.00	1.00	1.00	1.00	0.00	1.00	1.00	0.00	0.00
Uniform Delay (d), s/veh	39.2	20.0	20.0	38.5	17.3	13.3	38.5	0.0	25.4	39.0	0.0	0.0
Incr Delay (d2), s/veh	3.2	0.8	1.6	1337.8	0.3	0.1	696.3	0.0	3.6	4.0	0.0	0.0
Initial Q Delay(d3),s/veh	0.0	0.0	0.0	0.0	0.0	0.0	0.0	0.0	0.0	0.0	0.0	0.0
%ile BackOfQ(50%),veh/ln	0.6	6.2	6.4	29.7	5.8	0.3	22.2	0.0	4.9	0.8	0.0	0.0
Unsig. Movement Delay, s/veh												
LnGrp Delay(d),s/veh	42.4	20.8	21.5	1376.3	17.7	13.3	734.8	0.0	29.0	43.0	0.0	0.0
LnGrp LOS	D	C	C	F	B	B	F	A	C	D	A	A
Approach Vol, veh/h		1421			1627			532				25
Approach Delay, s/veh		21.5			264.8			372.6				67.2
Approach LOS		C			F			F				E
Timer - Assigned Phs	1	2	3	4	5	6	7	8				
Phs Duration (G+Y+Rc), s	9.1	39.6	9.1	24.3	6.2	42.5	6.6	26.7				
Change Period (Y+Rc), s	4.1	6.5	4.1	5.8	3.7	6.5	3.7	* 5.8				
Max Green Setting (Gmax), s	5.0	45.5	5.0	44.0	5.0	45.9	15.9	* 35				
Max Q Clear Time (g_c+I1), s	7.0	20.0	7.0	0.0	3.4	17.6	3.8	20.1				
Green Ext Time (p_c), s	0.0	13.1	0.0	0.0	0.0	15.3	0.0	0.9				

Intersection Summary

HCM 6th Ctrl Delay	183.4
HCM 6th LOS	F

Notes

* HCM 6th computational engine requires equal clearance times for the phases crossing the barrier.

Timings
21: Cactus Av. & Brown St



Lane Group	EBL	EBT	WBT	SBR
Lane Configurations	↶	↕↕	↕↔	↷
Traffic Volume (vph)	507	567	601	518
Future Volume (vph)	507	567	601	518
Turn Type	Prot	NA	NA	Perm
Protected Phases	7	4	8	
Permitted Phases				6
Detector Phase	7	4	8	6
Switch Phase				
Minimum Initial (s)	5.0	10.0	10.0	10.0
Minimum Split (s)	9.6	15.8	27.8	26.7
Total Split (s)	50.0	86.0	36.0	34.0
Total Split (%)	41.7%	71.7%	30.0%	28.3%
Yellow Time (s)	3.6	4.8	4.8	3.7
All-Red Time (s)	1.0	1.0	1.0	1.0
Lost Time Adjust (s)	0.0	0.0	0.0	0.0
Total Lost Time (s)	4.6	5.8	5.8	4.7
Lead/Lag	Lead		Lag	
Lead-Lag Optimize?	Yes		Yes	
Recall Mode	None	None	None	Min
Act Effct Green (s)	30.5	58.4	23.1	12.2
Actuated g/C Ratio	0.37	0.71	0.28	0.15
v/c Ratio	0.82	0.26	0.71	0.70
Control Delay	35.1	4.4	32.7	5.9
Queue Delay	0.0	0.0	0.0	0.0
Total Delay	35.1	4.4	32.7	5.9
LOS	D	A	C	A
Approach Delay		18.9	32.7	
Approach LOS		B	C	

Intersection Summary

Cycle Length: 120	
Actuated Cycle Length: 81.7	
Natural Cycle: 90	
Control Type: Actuated-Uncoordinated	
Maximum v/c Ratio: 0.82	
Intersection Signal Delay: 19.6	Intersection LOS: B
Intersection Capacity Utilization 57.4%	ICU Level of Service B
Analysis Period (min) 15	

Splits and Phases: 21: Cactus Av. & Brown St



HCM 6th Signalized Intersection Summary
21: Cactus Av. & Brown St

West Campus Upper Plateau (JN 14064)
09/29/2022

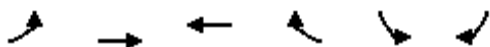

Movement	EBL	EBT	WBT	WBR	SBL	SBR	
Lane Configurations	↖	↑↑	↗		↙	↘	
Traffic Volume (veh/h)	507	567	601	0	0	518	
Future Volume (veh/h)	507	567	601	0	0	518	
Initial Q (Qb), veh	0	0	0	0	0	0	
Ped-Bike Adj(A_pbT)	1.00			1.00	1.00	1.00	
Parking Bus, Adj	1.00	1.00	1.00	1.00	1.00	1.00	
Work Zone On Approach		No	No		No		
Adj Sat Flow, veh/h/ln	1900	1737	1737	1900	1900	1900	
Adj Flow Rate, veh/h	551	616	653	0	0	405	
Peak Hour Factor	0.92	0.92	0.92	0.92	0.92	0.92	
Percent Heavy Veh, %	0	11	11	0	0	0	
Cap, veh/h	588	2029	794	0	494	439	
Arrive On Green	0.32	0.61	0.24	0.00	0.00	0.27	
Sat Flow, veh/h	1810	3387	3474	0	1810	1610	
Grp Volume(v), veh/h	551	616	653	0	0	405	
Grp Sat Flow(s),veh/h/ln	1810	1650	1650	0	1810	1610	
Q Serve(g_s), s	27.6	8.3	17.5	0.0	0.0	22.8	
Cycle Q Clear(g_c), s	27.6	8.3	17.5	0.0	0.0	22.8	
Prop In Lane	1.00			0.00	1.00	1.00	
Lane Grp Cap(c), veh/h	588	2029	794	0	494	439	
V/C Ratio(X)	0.94	0.30	0.82	0.00	0.00	0.92	
Avail Cap(c_a), veh/h	879	2833	1067	0	567	505	
HCM Platoon Ratio	1.00	1.00	1.00	1.00	1.00	1.00	
Upstream Filter(I)	1.00	1.00	1.00	0.00	0.00	1.00	
Uniform Delay (d), s/veh	30.6	8.5	33.6	0.0	0.0	33.0	
Incr Delay (d2), s/veh	10.4	0.1	3.9	0.0	0.0	21.0	
Initial Q Delay(d3),s/veh	0.0	0.0	0.0	0.0	0.0	0.0	
%ile BackOfQ(50%),veh/ln	12.8	2.5	7.0	0.0	0.0	2.6	
Unsig. Movement Delay, s/veh							
LnGrp Delay(d),s/veh	41.1	8.6	37.5	0.0	0.0	54.0	
LnGrp LOS	D	A	D	A	A	D	
Approach Vol, veh/h		1167	653		405		
Approach Delay, s/veh		23.9	37.5		54.0		
Approach LOS		C	D		D		
Timer - Assigned Phs				4	6	7	8
Phs Duration (G+Y+Rc), s				63.3	30.2	35.0	28.3
Change Period (Y+Rc), s				5.8	4.7	4.6	5.8
Max Green Setting (Gmax), s				80.2	29.3	45.4	30.2
Max Q Clear Time (g_c+11), s				10.3	24.8	29.6	19.5
Green Ext Time (p_c), s				4.3	0.6	0.7	3.0
Intersection Summary							
HCM 6th Ctrl Delay			33.4				
HCM 6th LOS			C				

Timings
22: Sycamore Canyon Bl. & Eastridge Ave

West Campus Upper Plateau (JN 14064)

09/29/2022



Lane Group	EBL	EBT	EBR	WBL	WBT	WBR	NBL	NBT	NBR	SBL	SBT	SBR
Lane Configurations	↖↗	↑↑↑	↖	↖↗	↑↑	↖	↖↗	↑↑	↖	↖↗	↑↑	↖
Traffic Volume (vph)	39	66	16	183	52	297	44	304	68	115	136	30
Future Volume (vph)	39	66	16	183	52	297	44	304	68	115	136	30
Turn Type	Prot	NA	Perm	Prot	NA	pm+ov	Prot	NA	pm+ov	Prot	NA	pm+ov
Protected Phases	5	2		1	6	7	3	8	1	7	4	5
Permitted Phases			2			6			8			4
Detector Phase	5	2	2	1	6	7	3	8	1	7	4	5
Switch Phase												
Minimum Initial (s)	5.0	10.0	10.0	5.0	10.0	5.0	5.0	10.0	5.0	5.0	10.0	5.0
Minimum Split (s)	8.7	43.5	43.5	8.7	43.5	8.7	8.7	15.8	8.7	8.7	49.8	8.7
Total Split (s)	11.7	45.5	45.5	15.2	49.0	20.2	8.7	39.1	15.2	20.2	50.6	11.7
Total Split (%)	9.8%	37.9%	37.9%	12.7%	40.8%	16.8%	7.3%	32.6%	12.7%	16.8%	42.2%	9.8%
Yellow Time (s)	3.2	5.5	5.5	3.2	5.5	3.2	3.2	4.8	3.2	3.2	4.8	3.2
All-Red Time (s)	0.5	1.0	1.0	0.5	1.0	0.5	0.5	1.0	0.5	0.5	1.0	0.5
Lost Time Adjust (s)	0.0	0.0	0.0	0.0	0.0	0.0	0.0	0.0	0.0	0.0	0.0	0.0
Total Lost Time (s)	3.7	6.5	6.5	3.7	6.5	3.7	3.7	5.8	3.7	3.7	5.8	3.7
Lead/Lag	Lead	Lag	Lag	Lead	Lag	Lead	Lead	Lag	Lead	Lead	Lag	Lead
Lead-Lag Optimize?	Yes	Yes	Yes	Yes	Yes	Yes	Yes	Yes	Yes	Yes	Yes	Yes
Recall Mode	None	None	None	None	None	None	None	None	None	None	None	None
Act Effct Green (s)	5.9	13.6	13.6	10.4	17.8	27.9	5.4	13.5	26.2	7.1	19.8	28.0
Actuated g/C Ratio	0.10	0.22	0.22	0.17	0.29	0.46	0.09	0.22	0.43	0.12	0.32	0.46
v/c Ratio	0.14	0.07	0.04	0.33	0.07	0.37	0.18	0.43	0.10	0.31	0.13	0.05
Control Delay	33.1	21.0	0.2	29.8	18.3	3.3	34.6	24.5	2.3	31.8	19.4	1.2
Queue Delay	0.0	0.0	0.0	0.0	0.0	0.0	0.0	0.0	0.0	0.0	0.0	0.0
Total Delay	33.1	21.0	0.2	29.8	18.3	3.3	34.6	24.5	2.3	31.8	19.4	1.2
LOS	C	C	A	C	B	A	C	C	A	C	B	A
Approach Delay		22.1			13.9			21.9			22.5	
Approach LOS		C			B			C			C	

Intersection Summary

Cycle Length: 120
 Actuated Cycle Length: 61.1
 Natural Cycle: 115
 Control Type: Actuated-Uncoordinated
 Maximum v/c Ratio: 0.43
 Intersection Signal Delay: 18.9
 Intersection LOS: B
 Intersection Capacity Utilization 42.6%
 ICU Level of Service A
 Analysis Period (min) 15

Splits and Phases: 22: Sycamore Canyon Bl. & Eastridge Ave

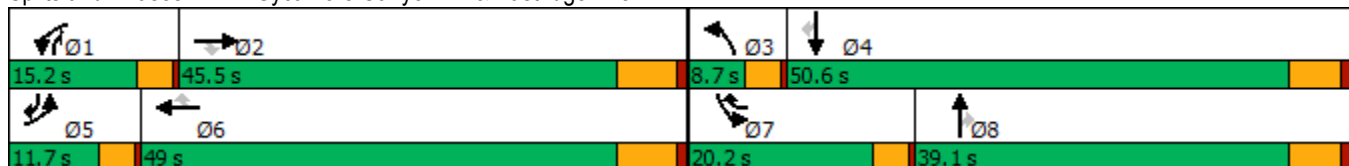

HCM 6th Signalized Intersection Summary
22: Sycamore Canyon Bl. & Eastridge Ave

West Campus Upper Plateau (JN 14064)
09/29/2022



Movement	EBL	EBT	EBR	WBL	WBT	WBR	NBL	NBT	NBR	SBL	SBT	SBR
Lane Configurations	↔↔	↑↑↑	↔	↔↔	↑↑	↔	↔↔	↑↑	↔	↔↔	↑↑	↔
Traffic Volume (veh/h)	39	66	16	183	52	297	44	304	68	115	136	30
Future Volume (veh/h)	39	66	16	183	52	297	44	304	68	115	136	30
Initial Q (Qb), veh	0	0	0	0	0	0	0	0	0	0	0	0
Ped-Bike Adj(A_pbT)	1.00		1.00	1.00		1.00	1.00		0.99	1.00		0.99
Parking Bus, Adj	1.00	1.00	1.00	1.00	1.00	1.00	1.00	1.00	1.00	1.00	1.00	1.00
Work Zone On Approach		No			No			No			No	
Adj Sat Flow, veh/h/ln	1648	1589	1826	1856	1396	1796	1618	1796	1826	1841	1826	1530
Adj Flow Rate, veh/h	41	69	0	193	55	140	46	320	18	121	143	28
Peak Hour Factor	0.95	0.95	0.95	0.95	0.95	0.95	0.95	0.95	0.95	0.95	0.95	0.95
Percent Heavy Veh, %	17	21	5	3	34	7	19	7	5	4	5	25
Cap, veh/h	133	907		327	692	523	142	704	463	282	838	365
Arrive On Green	0.04	0.21	0.00	0.10	0.26	0.26	0.05	0.21	0.21	0.08	0.24	0.24
Sat Flow, veh/h	3045	4337	1547	3428	2653	1521	2990	3413	1527	3401	3469	1278
Grp Volume(v), veh/h	41	69	0	193	55	140	46	320	18	121	143	28
Grp Sat Flow(s),veh/h/ln	1522	1446	1547	1714	1326	1521	1495	1706	1527	1700	1735	1278
Q Serve(g_s), s	0.6	0.6	0.0	2.6	0.8	3.2	0.7	4.0	0.4	1.6	1.6	0.8
Cycle Q Clear(g_c), s	0.6	0.6	0.0	2.6	0.8	3.2	0.7	4.0	0.4	1.6	1.6	0.8
Prop In Lane	1.00		1.00	1.00		1.00	1.00		1.00	1.00		1.00
Lane Grp Cap(c), veh/h	133	907		327	692	523	142	704	463	282	838	365
V/C Ratio(X)	0.31	0.08		0.59	0.08	0.27	0.32	0.45	0.04	0.43	0.17	0.08
Avail Cap(c_a), veh/h	502	3489		813	2325	1459	308	2344	1197	1157	3206	1238
HCM Platoon Ratio	1.00	1.00	1.00	1.00	1.00	1.00	1.00	1.00	1.00	1.00	1.00	1.00
Upstream Filter(I)	1.00	1.00	0.00	1.00	1.00	1.00	1.00	1.00	1.00	1.00	1.00	1.00
Uniform Delay (d), s/veh	22.5	15.4	0.0	21.0	13.5	11.5	22.3	16.9	12.0	21.1	14.5	12.7
Incr Delay (d2), s/veh	0.5	0.1	0.0	0.6	0.1	0.4	0.5	0.5	0.0	0.4	0.1	0.1
Initial Q Delay(d3),s/veh	0.0	0.0	0.0	0.0	0.0	0.0	0.0	0.0	0.0	0.0	0.0	0.0
%ile BackOfQ(50%),veh/ln	0.2	0.2	0.0	0.9	0.2	0.9	0.2	1.3	0.1	0.6	0.5	0.2
Unsig. Movement Delay, s/veh												
LnGrp Delay(d),s/veh	22.9	15.5	0.0	21.6	13.6	11.9	22.8	17.3	12.0	21.5	14.6	12.8
LnGrp LOS	C	B		C	B	B	C	B	B	C	B	B
Approach Vol, veh/h		110			388			384			292	
Approach Delay, s/veh		18.2			17.0			17.7			17.3	
Approach LOS		B			B			B			B	
Timer - Assigned Phs	1	2	3	4	5	6	7	8				
Phs Duration (G+Y+Rc), s	8.3	16.6	6.0	17.5	5.8	19.1	7.7	15.8				
Change Period (Y+Rc), s	3.7	6.5	3.7	5.8	3.7	6.5	3.7	5.8				
Max Green Setting (Gmax), s	11.5	39.0	5.0	44.8	8.0	42.5	16.5	33.3				
Max Q Clear Time (g_c+I1), s	4.6	2.6	2.7	3.6	2.6	5.2	3.6	6.0				
Green Ext Time (p_c), s	0.2	0.5	0.0	0.9	0.0	1.2	0.1	2.0				

Intersection Summary

HCM 6th Ctrl Delay	17.4
HCM 6th LOS	B

Notes

Unsignalized Delay for [EBR] is excluded from calculations of the approach delay and intersection delay.

Timings
23: Sycamore Canyon Bl. & Cottonwood Ave

West Campus Upper Plateau (JN 14064)

09/29/2022



Lane Group	WBL	WBR	NBT	SBL	SBT
Lane Configurations	↙	↗	↕	↙	↕
Traffic Volume (vph)	4	17	359	15	369
Future Volume (vph)	4	17	359	15	369
Turn Type	Prot	Perm	NA	Prot	NA
Protected Phases	8		2	1	6
Permitted Phases		8			
Detector Phase	8	8	2	1	6
Switch Phase					
Minimum Initial (s)	10.0	10.0	10.0	5.0	10.0
Minimum Split (s)	15.8	15.8	43.5	9.1	43.5
Total Split (s)	23.0	23.0	78.0	19.0	97.0
Total Split (%)	19.2%	19.2%	65.0%	15.8%	80.8%
Yellow Time (s)	4.8	4.8	5.5	3.6	5.5
All-Red Time (s)	1.0	1.0	1.0	0.5	1.0
Lost Time Adjust (s)	0.0	0.0	0.0	0.0	0.0
Total Lost Time (s)	5.8	5.8	6.5	4.1	6.5
Lead/Lag			Lag	Lead	
Lead-Lag Optimize?			Yes	Yes	
Recall Mode	None	None	None	None	None
Act Effect Green (s)	13.8	13.8	20.8	8.0	21.7
Actuated g/C Ratio	0.58	0.58	0.88	0.34	0.92
v/c Ratio	0.00	0.03	0.13	0.03	0.12
Control Delay	11.8	7.7	3.8	13.8	1.7
Queue Delay	0.0	0.0	0.0	0.0	0.0
Total Delay	11.8	7.7	3.8	13.8	1.7
LOS	B	A	A	B	A
Approach Delay	8.4		3.8		2.2
Approach LOS	A		A		A

Intersection Summary

Cycle Length: 120
 Actuated Cycle Length: 23.6
 Natural Cycle: 70
 Control Type: Actuated-Uncoordinated
 Maximum v/c Ratio: 0.13
 Intersection Signal Delay: 3.1
 Intersection LOS: A
 Intersection Capacity Utilization 31.0%
 ICU Level of Service A
 Analysis Period (min) 15

Splits and Phases: 23: Sycamore Canyon Bl. & Cottonwood Ave



HCM 6th Signalized Intersection Summary
23: Sycamore Canyon Bl. & Cottonwood Ave

West Campus Upper Plateau (JN 14064)
09/29/2022



Movement	WBL	WBR	NBT	NBR	SBL	SBT
Lane Configurations						
Traffic Volume (veh/h)	4	17	359	6	15	369
Future Volume (veh/h)	4	17	359	6	15	369
Initial Q (Qb), veh	0	0	0	0	0	0
Ped-Bike Adj(A_pbT)	1.00	1.00		0.98	1.00	
Parking Bus, Adj	1.00	1.00	1.00	1.00	1.00	1.00
Work Zone On Approach	No		No			No
Adj Sat Flow, veh/h/ln	1574	1070	1796	1752	1485	1870
Adj Flow Rate, veh/h	4	8	386	5	16	397
Peak Hour Factor	0.93	0.93	0.93	0.93	0.93	0.93
Percent Heavy Veh, %	22	56	7	10	28	2
Cap, veh/h	48	29	1240	16	30	1874
Arrive On Green	0.03	0.03	0.36	0.36	0.02	0.53
Sat Flow, veh/h	1499	907	3539	45	1414	3647
Grp Volume(v), veh/h	4	8	191	200	16	397
Grp Sat Flow(s),veh/h/ln	1499	907	1706	1787	1414	1777
Q Serve(g_s), s	0.1	0.2	2.2	2.3	0.3	1.7
Cycle Q Clear(g_c), s	0.1	0.2	2.2	2.3	0.3	1.7
Prop In Lane	1.00	1.00		0.02	1.00	
Lane Grp Cap(c), veh/h	48	29	613	642	30	1874
V/C Ratio(X)	0.08	0.28	0.31	0.31	0.54	0.21
Avail Cap(c_a), veh/h	924	559	4373	4580	755	11527
HCM Platoon Ratio	1.00	1.00	1.00	1.00	1.00	1.00
Upstream Filter(I)	1.00	1.00	1.00	1.00	1.00	1.00
Uniform Delay (d), s/veh	13.1	13.2	6.4	6.4	13.5	3.5
Incr Delay (d2), s/veh	0.7	5.1	0.4	0.4	14.5	0.1
Initial Q Delay(d3),s/veh	0.0	0.0	0.0	0.0	0.0	0.0
%ile BackOfQ(50%),veh/ln	0.0	0.1	0.4	0.4	0.2	0.0
Unsig. Movement Delay, s/veh						
LnGrp Delay(d),s/veh	13.9	18.3	6.9	6.8	28.0	3.6
LnGrp LOS	B	B	A	A	C	A
Approach Vol, veh/h	12		391			413
Approach Delay, s/veh	16.8		6.8			4.5
Approach LOS	B		A			A
Timer - Assigned Phs	1	2			6	8
Phs Duration (G+Y+Rc), s	4.7	16.5			21.2	6.7
Change Period (Y+Rc), s	4.1	6.5			6.5	5.8
Max Green Setting (Gmax), s	14.9	71.5			90.5	17.2
Max Q Clear Time (g_c+11), s	2.3	4.3			3.7	2.2
Green Ext Time (p_c), s	0.0	3.4			3.9	0.0
Intersection Summary						
HCM 6th Ctrl Delay			5.8			
HCM 6th LOS			A			

Timings

West Campus Upper Plateau (JN 14064)

24: Sycamore Canyon Bl. & Alessandro Bl.

09/29/2022



Lane Group	EBL	EBT	EBR	WBL	WBT	WBR	NBL	NBT	NBR	SBL	SBT	SBR
Lane Configurations	↖	↑↑↑	↗	↖↗	↑↑↑	↗	↖↗	↑↑	↖↗	↖↗	↑↑	↖↗
Traffic Volume (vph)	92	1125	91	77	1261	83	164	149	40	54	167	49
Future Volume (vph)	92	1125	91	77	1261	83	164	149	40	54	167	49
Turn Type	Prot	NA	Perm	Prot	NA	Perm	Prot	NA	pm+ov	Prot	NA	Perm
Protected Phases	5	2		1	6		3	8	1	7	4	
Permitted Phases			2			6			8			4
Detector Phase	5	2	2	1	6	6	3	8	1	7	4	4
Switch Phase												
Minimum Initial (s)	5.0	10.0	10.0	5.0	10.0	10.0	5.0	10.0	5.0	5.0	10.0	10.0
Minimum Split (s)	8.7	43.5	43.5	8.7	43.5	43.5	8.7	15.8	8.7	8.7	49.8	49.8
Total Split (s)	10.0	44.2	44.2	12.0	46.2	46.2	14.0	51.0	12.0	12.8	49.8	49.8
Total Split (%)	8.3%	36.8%	36.8%	10.0%	38.5%	38.5%	11.7%	42.5%	10.0%	10.7%	41.5%	41.5%
Yellow Time (s)	3.2	5.5	5.5	3.2	5.5	5.5	3.2	4.8	3.2	3.2	4.8	4.8
All-Red Time (s)	0.5	1.0	1.0	0.5	1.0	1.0	0.5	1.0	0.5	0.5	1.0	1.0
Lost Time Adjust (s)	0.0	0.0	0.0	0.0	0.0	0.0	0.0	0.0	0.0	0.0	0.0	0.0
Total Lost Time (s)	3.7	6.5	6.5	3.7	6.5	6.5	3.7	5.8	3.7	3.7	5.8	5.8
Lead/Lag	Lead	Lag	Lag	Lead	Lag	Lag	Lead	Lag	Lead	Lead	Lag	Lag
Lead-Lag Optimize?	Yes	Yes	Yes	Yes	Yes	Yes	Yes	Yes	Yes	Yes	Yes	Yes
Recall Mode	None	None	None	None	None	None	None	None	None	None	None	None
Act Effct Green (s)	6.6	36.2	36.2	6.7	34.1	34.1	8.6	19.9	32.7	6.2	15.4	15.4
Actuated g/C Ratio	0.08	0.43	0.43	0.08	0.40	0.40	0.10	0.23	0.38	0.07	0.18	0.18
v/c Ratio	0.70	0.54	0.13	0.33	0.64	0.13	0.50	0.19	0.04	0.23	0.28	0.14
Control Delay	70.0	22.0	6.2	45.8	23.8	5.3	45.1	27.9	1.7	45.1	31.1	1.2
Queue Delay	0.0	0.0	0.0	0.0	0.0	0.0	0.0	0.0	0.0	0.0	0.0	0.0
Total Delay	70.0	22.0	6.2	45.8	23.8	5.3	45.1	27.9	1.7	45.1	31.1	1.2
LOS	E	C	A	D	C	A	D	C	A	D	C	A
Approach Delay		24.3			23.9			33.0			28.4	
Approach LOS		C			C			C			C	

Intersection Summary

Cycle Length: 120
 Actuated Cycle Length: 85.1
 Natural Cycle: 115
 Control Type: Actuated-Uncoordinated
 Maximum v/c Ratio: 0.70
 Intersection Signal Delay: 25.4
 Intersection LOS: C
 Intersection Capacity Utilization 59.4%
 ICU Level of Service B
 Analysis Period (min) 15



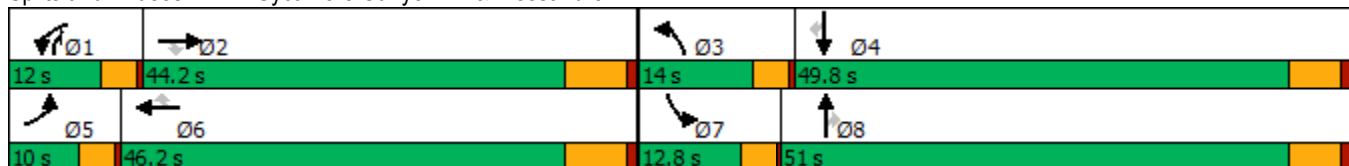





















Splits and Phases: 24: Sycamore Canyon Bl. & Alessandro Bl.



HCM 6th Signalized Intersection Summary
24: Sycamore Canyon Bl. & Alessandro Bl.

West Campus Upper Plateau (JN 14064)

09/29/2022

												
Movement	EBL	EBT	EBR	WBL	WBT	WBR	NBL	NBT	NBR	SBL	SBT	SBR
Lane Configurations												
Traffic Volume (veh/h)	92	1125	91	77	1261	83	164	149	40	54	167	49
Future Volume (veh/h)	92	1125	91	77	1261	83	164	149	40	54	167	49
Initial Q (Qb), veh	0	0	0	0	0	0	0	0	0	0	0	0
Ped-Bike Adj(A_pbT)	1.00		1.00	1.00		1.00	1.00		1.00	1.00		1.00
Parking Bus, Adj	1.00	1.00	1.00	1.00	1.00	1.00	1.00	1.00	1.00	1.00	1.00	1.00
Work Zone On Approach		No			No			No			No	
Adj Sat Flow, veh/h/ln	1900	1885	1885	1737	1885	1781	1870	1841	1841	1826	1826	1870
Adj Flow Rate, veh/h	97	1184	-101	81	1327	-48	173	157	-1	57	176	-43
Peak Hour Factor	0.95	0.95	0.95	0.95	0.95	0.95	0.95	0.95	0.95	0.95	0.95	0.95
Percent Heavy Veh, %	0	1	1	11	1	8	2	4	4	5	5	2
Cap, veh/h	125	2220	689	184	2160	634	265	610	637	163	507	232
Arrive On Green	0.07	0.43	0.00	0.06	0.42	0.00	0.08	0.17	0.00	0.05	0.15	0.00
Sat Flow, veh/h	1810	5147	1598	3209	5147	1510	3456	3497	2745	3374	3469	1585
Grp Volume(v), veh/h	97	1184	-101	81	1327	-48	173	157	-1	57	176	-43
Grp Sat Flow(s),veh/h/ln	1810	1716	1598	1605	1716	1510	1728	1749	1373	1687	1735	1585
Q Serve(g_s), s	3.6	11.6	0.0	1.7	13.8	0.0	3.3	2.7	0.0	1.1	3.1	0.0
Cycle Q Clear(g_c), s	3.6	11.6	0.0	1.7	13.8	0.0	3.3	2.7	0.0	1.1	3.1	0.0
Prop In Lane	1.00		1.00	1.00		1.00	1.00		1.00	1.00		1.00
Lane Grp Cap(c), veh/h	125	2220	689	184	2160	634	265	610	637	163	507	232
V/C Ratio(X)	0.78	0.53	-0.15	0.44	0.61	-0.08	0.65	0.26	0.00	0.35	0.35	-0.19
Avail Cap(c_a), veh/h	167	2840	881	390	2990	877	521	2314	1974	449	2234	1021
HCM Platoon Ratio	1.00	1.00	1.00	1.00	1.00	1.00	1.00	1.00	1.00	1.00	1.00	1.00
Upstream Filter(I)	1.00	1.00	0.00	1.00	1.00	0.00	1.00	1.00	0.00	1.00	1.00	0.00
Uniform Delay (d), s/veh	31.3	14.3	0.0	31.1	15.5	0.0	30.7	24.4	0.0	31.5	26.2	0.0
Incr Delay (d2), s/veh	10.4	0.3	0.0	0.6	0.4	0.0	1.0	0.2	0.0	0.5	0.4	0.0
Initial Q Delay(d3),s/veh	0.0	0.0	0.0	0.0	0.0	0.0	0.0	0.0	0.0	0.0	0.0	0.0
%ile BackOfQ(50%),veh/ln	1.8	3.8	0.0	0.6	4.5	0.0	1.3	1.0	0.0	0.4	1.2	0.0
Unsig. Movement Delay, s/veh												
LnGrp Delay(d),s/veh	41.7	14.6	0.0	31.8	15.9	0.0	31.7	24.6	0.0	31.9	26.6	0.0
LnGrp LOS	D	B	A	C	B	A	C	C	A	C	C	A
Approach Vol, veh/h		1180			1360			329			190	
Approach Delay, s/veh		18.1			17.4			28.4			34.3	
Approach LOS		B			B			C			C	
Timer - Assigned Phs	1	2	3	4	5	6	7	8				
Phs Duration (G+Y+Rc), s	7.6	36.0	8.9	15.8	8.4	35.2	7.0	17.7				
Change Period (Y+Rc), s	3.7	6.5	3.7	5.8	3.7	6.5	3.7	5.8				
Max Green Setting (Gmax), s	8.3	37.7	10.3	44.0	6.3	39.7	9.1	45.2				
Max Q Clear Time (g_c+I1), s	3.7	13.6	5.3	5.1	5.6	15.8	3.1	4.7				
Green Ext Time (p_c), s	0.0	11.4	0.1	1.0	0.0	12.9	0.0	0.9				
Intersection Summary												
HCM 6th Ctrl Delay				19.9								
HCM 6th LOS				B								

Timings
25: Sycamore Canyon Bl. & Cactus Av.

West Campus Upper Plateau (JN 14064)

09/29/2022



Lane Group	EBL	EBT	EBR	WBL	WBT	WBR	NBL	NBT	NBR	SBL	SBT	SBR
Lane Configurations	↘	↑↑	↗	↘↗	↑↑	↗	↘↗	↑↑	↗	↘↗	↑↑	↗
Traffic Volume (vph)	56	386	171	161	390	196	178	149	122	115	194	48
Future Volume (vph)	56	386	171	161	390	196	178	149	122	115	194	48
Turn Type	Prot	NA	Perm	Prot	NA	Perm	Prot	NA	Perm	Prot	NA	Perm
Protected Phases	7	4		3	8		5	2		1	6	
Permitted Phases			4			8			2			6
Detector Phase	7	4	4	3	8	8	5	2	2	1	6	6
Switch Phase												
Minimum Initial (s)	5.0	10.0	10.0	5.0	10.0	10.0	5.0	10.0	10.0	5.0	10.0	10.0
Minimum Split (s)	9.6	32.8	32.8	9.6	32.8	32.8	9.6	34.8	34.8	9.6	34.8	34.8
Total Split (s)	10.3	32.8	32.8	29.0	51.5	51.5	9.6	36.2	36.2	22.0	48.6	48.6
Total Split (%)	8.6%	27.3%	27.3%	24.2%	42.9%	42.9%	8.0%	30.2%	30.2%	18.3%	40.5%	40.5%
Yellow Time (s)	3.6	4.8	4.8	3.6	4.8	4.8	3.6	4.8	4.8	3.6	4.8	4.8
All-Red Time (s)	1.0	1.0	1.0	1.0	1.0	1.0	1.0	1.0	1.0	1.0	1.0	1.0
Lost Time Adjust (s)	0.0	0.0	0.0	0.0	0.0	0.0	0.0	0.0	0.0	0.0	0.0	0.0
Total Lost Time (s)	4.6	5.8	5.8	4.6	5.8	5.8	4.6	5.8	5.8	4.6	5.8	5.8
Lead/Lag	Lead	Lag	Lag	Lead	Lag	Lag	Lead	Lag	Lag	Lead	Lag	Lag
Lead-Lag Optimize?	Yes	Yes	Yes	Yes	Yes	Yes	Yes	Yes	Yes	Yes	Yes	Yes
Recall Mode	None	None	None	None	None	None	None	None	None	None	None	None
Act Effct Green (s)	5.9	15.2	15.2	8.2	20.1	20.1	5.3	15.5	15.5	7.1	14.9	14.9
Actuated g/C Ratio	0.09	0.23	0.23	0.13	0.31	0.31	0.08	0.24	0.24	0.11	0.23	0.23
v/c Ratio	0.38	0.55	0.36	0.40	0.39	0.33	0.66	0.19	0.25	0.32	0.26	0.14
Control Delay	42.1	26.1	5.7	32.5	20.6	5.0	46.2	23.7	2.1	33.1	22.1	0.9
Queue Delay	0.0	0.0	0.0	0.0	0.0	0.0	0.0	0.0	0.0	0.0	0.0	0.0
Total Delay	42.1	26.1	5.7	32.5	20.6	5.0	46.2	23.7	2.1	33.1	22.1	0.9
LOS	D	C	A	C	C	A	D	C	A	C	C	A
Approach Delay		21.9			19.1			26.7			22.8	
Approach LOS		C			B			C			C	

Intersection Summary

Cycle Length: 120
 Actuated Cycle Length: 65.5
 Natural Cycle: 90
 Control Type: Actuated-Uncoordinated
 Maximum v/c Ratio: 0.66
 Intersection Signal Delay: 22.1
 Intersection LOS: C
 Intersection Capacity Utilization 46.0%
 ICU Level of Service A
 Analysis Period (min) 15



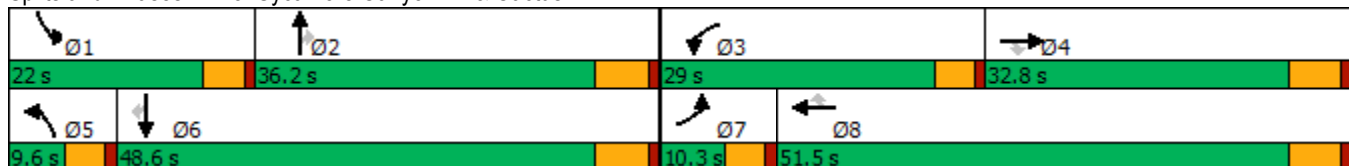





















Splits and Phases: 25: Sycamore Canyon Bl. & Cactus Av.



HCM 6th Signalized Intersection Summary
 25: Sycamore Canyon Bl. & Cactus Av.

West Campus Upper Plateau (JN 14064)

09/29/2022

												
Movement	EBL	EBT	EBR	WBL	WBT	WBR	NBL	NBT	NBR	SBL	SBT	SBR
Lane Configurations												
Traffic Volume (veh/h)	56	386	171	161	390	196	178	149	122	115	194	48
Future Volume (veh/h)	56	386	171	161	390	196	178	149	122	115	194	48
Initial Q (Qb), veh	0	0	0	0	0	0	0	0	0	0	0	0
Ped-Bike Adj(A_pbT)	1.00		1.00	1.00		1.00	1.00		1.00	1.00		1.00
Parking Bus, Adj	1.00	1.00	1.00	1.00	1.00	1.00	1.00	1.00	1.00	1.00	1.00	1.00
Work Zone On Approach		No			No			No			No	
Adj Sat Flow, veh/h/ln	1811	1678	1796	1826	1796	1870	1900	1811	1781	1885	1796	1011
Adj Flow Rate, veh/h	58	402	169	168	406	-38	185	155	34	120	202	50
Peak Hour Factor	0.96	0.96	0.96	0.96	0.96	0.96	0.96	0.96	0.96	0.96	0.96	0.96
Percent Heavy Veh, %	6	15	7	5	7	2	0	6	8	1	7	60
Cap, veh/h	95	673	321	302	838	389	321	717	314	280	674	169
Arrive On Green	0.06	0.21	0.21	0.09	0.25	0.00	0.09	0.21	0.21	0.08	0.20	0.20
Sat Flow, veh/h	1725	3188	1522	3374	3413	1585	3510	3441	1510	3483	3413	857
Grp Volume(v), veh/h	58	402	169	168	406	-38	185	155	34	120	202	50
Grp Sat Flow(s),veh/h/ln	1725	1594	1522	1687	1706	1585	1755	1721	1510	1742	1706	857
Q Serve(g_s), s	1.7	5.8	5.0	2.4	5.2	0.0	2.6	1.9	0.9	1.7	2.6	2.5
Cycle Q Clear(g_c), s	1.7	5.8	5.0	2.4	5.2	0.0	2.6	1.9	0.9	1.7	2.6	2.5
Prop In Lane	1.00		1.00	1.00		1.00	1.00		1.00	1.00		1.00
Lane Grp Cap(c), veh/h	95	673	321	302	838	389	321	717	314	280	674	169
V/C Ratio(X)	0.61	0.60	0.53	0.56	0.48	-0.10	0.58	0.22	0.11	0.43	0.30	0.30
Avail Cap(c_a), veh/h	194	1699	812	1625	3080	1430	347	2066	906	1197	2884	724
HCM Platoon Ratio	1.00	1.00	1.00	1.00	1.00	1.00	1.00	1.00	1.00	1.00	1.00	1.00
Upstream Filter(I)	1.00	1.00	1.00	1.00	1.00	0.00	1.00	1.00	1.00	1.00	1.00	1.00
Uniform Delay (d), s/veh	23.4	18.0	17.7	22.1	16.4	0.0	22.1	16.6	16.2	22.2	17.3	17.3
Incr Delay (d2), s/veh	2.4	0.9	1.3	0.6	0.4	0.0	1.1	0.1	0.1	0.4	0.2	1.0
Initial Q Delay(d3),s/veh	0.0	0.0	0.0	0.0	0.0	0.0	0.0	0.0	0.0	0.0	0.0	0.0
%ile BackOfQ(50%),veh/ln	0.7	1.9	1.5	0.8	1.7	0.0	0.9	0.6	0.3	0.6	0.9	0.5
Unsig. Movement Delay, s/veh												
LnGrp Delay(d),s/veh	25.7	18.9	19.1	22.7	16.8	0.0	23.1	16.8	16.4	22.6	17.6	18.3
LnGrp LOS	C	B	B	C	B	A	C	B	B	C	B	B
Approach Vol, veh/h		629			536			374			372	
Approach Delay, s/veh		19.6			19.8			19.9			19.3	
Approach LOS		B			B			B			B	
Timer - Assigned Phs	1	2	3	4	5	6	7	8				
Phs Duration (G+Y+Rc), s	8.7	16.4	9.1	16.5	9.2	15.8	7.4	18.2				
Change Period (Y+Rc), s	4.6	5.8	4.6	5.8	4.6	5.8	4.6	5.8				
Max Green Setting (Gmax), s	17.4	30.4	24.4	27.0	5.0	42.8	5.7	45.7				
Max Q Clear Time (g_c+I1), s	3.7	3.9	4.4	7.8	4.6	4.6	3.7	7.2				
Green Ext Time (p_c), s	0.1	0.9	0.3	2.9	0.0	1.4	0.0	2.6				
Intersection Summary												
HCM 6th Ctrl Delay				19.7								
HCM 6th LOS				B								

Timings

West Campus Upper Plateau (JN 14064)

26: Sycamore Canyon Bl. & Van Buren Bl.

09/29/2022



Lane Group	EBL	EBT	EBR	WBL	WBT	WBR	NBL	NBT	SBL	SBT	SBR
Lane Configurations											
Traffic Volume (vph)	278	849	6	33	923	68	7	6	91	9	454
Future Volume (vph)	278	849	6	33	923	68	7	6	91	9	454
Turn Type	Prot	NA	Perm	Prot	NA	Perm	Perm	NA	Split	NA	Perm
Protected Phases	5	2		1	6			8	4	4	
Permitted Phases			2			6	8				4
Detector Phase	5	2	2	1	6	6	8	8	4	4	4
Switch Phase											
Minimum Initial (s)	5.0	10.0	10.0	5.0	10.0	10.0	10.0	10.0	10.0	10.0	10.0
Minimum Split (s)	9.6	29.2	29.2	9.6	29.2	29.2	14.6	14.6	50.8	50.8	50.8
Total Split (s)	22.0	47.8	47.8	9.6	35.4	35.4	14.6	14.6	58.0	58.0	58.0
Total Split (%)	16.9%	36.8%	36.8%	7.4%	27.2%	27.2%	11.2%	11.2%	44.6%	44.6%	44.6%
Yellow Time (s)	3.6	5.2	5.2	3.6	5.2	5.2	3.6	3.6	4.8	4.8	4.8
All-Red Time (s)	1.0	1.0	1.0	1.0	1.0	1.0	1.0	1.0	1.0	1.0	1.0
Lost Time Adjust (s)	0.0	0.0	0.0	0.0	0.0	0.0		0.0	0.0	0.0	0.0
Total Lost Time (s)	4.6	6.2	6.2	4.6	6.2	6.2		4.6	5.8	5.8	5.8
Lead/Lag	Lead	Lag	Lag	Lead	Lag	Lag					
Lead-Lag Optimize?	Yes	Yes	Yes	Yes	Yes	Yes					
Recall Mode	None	None	None	None	None	None	None	None	None	None	None
Act Effct Green (s)	12.0	32.8	32.8	5.6	20.8	20.8		11.3	15.9	15.9	15.9
Actuated g/C Ratio	0.17	0.46	0.46	0.08	0.29	0.29		0.16	0.22	0.22	0.22
v/c Ratio	0.53	0.31	0.01	0.28	0.55	0.13		0.07	0.13	0.02	0.68
Control Delay	35.7	16.5	0.0	48.7	25.5	0.5		25.1	24.9	25.6	9.1
Queue Delay	0.0	0.0	0.0	0.0	0.0	0.0		0.0	0.0	0.0	0.0
Total Delay	35.7	16.5	0.0	48.7	25.5	0.5		25.1	24.9	25.6	9.1
LOS	D	B	A	D	C	A		C	C	C	A
Approach Delay		21.2			24.6			25.1		12.0	
Approach LOS		C			C			C		B	

Intersection Summary

Cycle Length: 130	
Actuated Cycle Length: 71.8	
Natural Cycle: 105	
Control Type: Actuated-Uncoordinated	
Maximum v/c Ratio: 0.68	
Intersection Signal Delay: 20.6	Intersection LOS: C
Intersection Capacity Utilization 63.7%	ICU Level of Service B
Analysis Period (min) 15	

Splits and Phases: 26: Sycamore Canyon Bl. & Van Buren Bl.

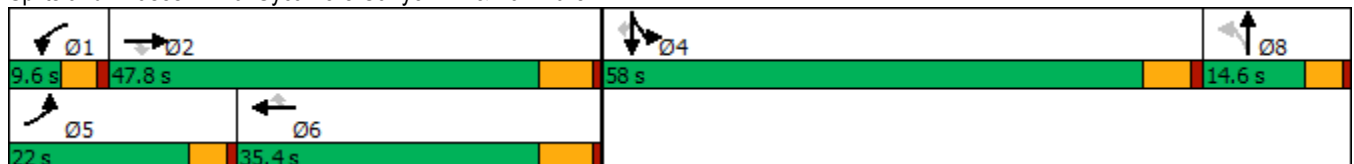

HCM 6th Signalized Intersection Summary
 26: Sycamore Canyon Bl. & Van Buren Bl.

West Campus Upper Plateau (JN 14064)

09/29/2022



Movement	EBL	EBT	EBR	WBL	WBT	WBR	NBL	NBT	NBR	SBL	SBT	SBR
Lane Configurations												
Traffic Volume (veh/h)	278	849	6	33	923	68	7	6	18	91	9	454
Future Volume (veh/h)	278	849	6	33	923	68	7	6	18	91	9	454
Initial Q (Qb), veh	0	0	0	0	0	0	0	0	0	0	0	0
Ped-Bike Adj(A_pbT)	1.00		1.00	1.00		0.99	1.00		1.00	1.00		1.00
Parking Bus, Adj	1.00	1.00	1.00	1.00	1.00	1.00	1.00	1.00	1.00	1.00	1.00	1.00
Work Zone On Approach		No			No			No			No	
Adj Sat Flow, veh/h/ln	1811	1826	1900	1693	1796	1870	1900	1900	1900	1841	1900	1841
Adj Flow Rate, veh/h	293	894	6	35	972	50	7	6	-10	96	9	0
Peak Hour Factor	0.95	0.95	0.95	0.95	0.95	0.95	0.95	0.95	0.95	0.95	0.95	0.95
Percent Heavy Veh, %	6	5	0	14	7	2	0	0	0	4	0	4
Cap, veh/h	430	2434	624	62	1837	465	139	0	4873	515	288	
Arrive On Green	0.13	0.39	0.39	0.04	0.30	0.30	0.01	0.01	0.00	0.15	0.15	0.00
Sat Flow, veh/h	3346	6281	1610	1612	6179	1565	1810	1900	0	3401	1900	1560
Grp Volume(v), veh/h	293	894	6	35	972	50	7	-4	0	96	9	0
Grp Sat Flow(s),veh/h/ln	1673	1570	1610	1612	1545	1565	1810	1805	0	1700	1900	1560
Q Serve(g_s), s	4.3	5.2	0.1	1.1	6.7	1.2	0.0	0.0	0.0	1.3	0.2	0.0
Cycle Q Clear(g_c), s	4.3	5.2	0.1	1.1	6.7	1.2	0.0	0.0	0.0	1.3	0.2	0.0
Prop In Lane	1.00		1.00	1.00		1.00	1.00		0.00	1.00		1.00
Lane Grp Cap(c), veh/h	430	2434	624	62	1837	465	0	0	0	515	288	
V/C Ratio(X)	0.68	0.37	0.01	0.57	0.53	0.11	0.00	0.00	0.00	0.19	0.03	
Avail Cap(c_a), veh/h	1138	5109	1310	158	3528	893	0	0	0	3471	1939	
HCM Platoon Ratio	1.00	1.00	1.00	1.00	1.00	1.00	1.00	1.00	1.00	1.00	1.00	1.00
Upstream Filter(I)	1.00	1.00	1.00	1.00	1.00	1.00	1.00	0.00	0.00	1.00	1.00	0.00
Uniform Delay (d), s/veh	21.3	11.2	9.6	24.2	15.0	13.0	0.0	0.0	0.0	18.9	18.5	0.0
Incr Delay (d2), s/veh	0.7	0.1	0.0	3.0	0.2	0.1	0.0	0.0	0.0	0.2	0.0	0.0
Initial Q Delay(d3),s/veh	0.0	0.0	0.0	0.0	0.0	0.0	0.0	0.0	0.0	0.0	0.0	0.0
%ile BackOfQ(50%),veh/ln	1.5	1.4	0.0	0.4	1.9	0.3	0.0	0.0	0.0	0.4	0.1	0.0
Unsig. Movement Delay, s/veh												
LnGrp Delay(d),s/veh	22.0	11.3	9.6	27.2	15.2	13.1	0.0	0.0	0.0	19.1	18.5	0.0
LnGrp LOS	C	B	A	C	B	B	A	A	A	B	B	
Approach Vol, veh/h		1193			1057			3			105	
Approach Delay, s/veh		13.9			15.5			0.0			19.1	
Approach LOS		B			B			A			B	
Timer - Assigned Phs	1	2		4	5	6		8				
Phs Duration (G+Y+Rc), s	6.6	26.0		13.6	11.2	21.4		5.0				
Change Period (Y+Rc), s	4.6	6.2		5.8	4.6	6.2		4.6				
Max Green Setting (Gmax), s	5.0	41.6		52.2	17.4	29.2		10.0				
Max Q Clear Time (g_c+I1), s	3.1	7.2		3.3	6.3	8.7		2.0				
Green Ext Time (p_c), s	0.0	6.6		0.4	0.4	6.5		0.0				

Intersection Summary

HCM 6th Ctrl Delay	14.8
HCM 6th LOS	B

Notes

Unsignalized Delay for [SBR] is excluded from calculations of the approach delay and intersection delay.

Timings
27: Innovation Dr. & Cactus Av.

West Campus Upper Plateau (JN 14064)

09/29/2022

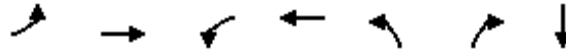

Lane Group	EBL	EBT	WBL	WBT	NBL	NBR	SBT
Lane Configurations	↖	↗↗↗	↖	↔↔↔	↖	↗	↘
Traffic Volume (vph)	1	622	22	747	1	21	0
Future Volume (vph)	1	622	22	747	1	21	0
Turn Type	Prot	NA	Prot	NA	Perm	Perm	NA
Protected Phases	5	2	1	6			4
Permitted Phases					8	8	
Detector Phase	5	2	1	6	8	8	4
Switch Phase							
Minimum Initial (s)	5.0	10.0	5.0	10.0	10.0	10.0	10.0
Minimum Split (s)	9.2	26.8	9.2	26.8	31.1	31.1	31.1
Total Split (s)	12.0	63.0	22.0	73.0	35.0	35.0	35.0
Total Split (%)	10.0%	52.5%	18.3%	60.8%	29.2%	29.2%	29.2%
Yellow Time (s)	3.2	4.8	3.2	4.8	4.1	4.1	4.1
All-Red Time (s)	1.0	1.0	1.0	1.0	1.0	1.0	1.0
Lost Time Adjust (s)	0.0	0.0	0.0	0.0	0.0	0.0	0.0
Total Lost Time (s)	4.2	5.8	4.2	5.8	5.1	5.1	5.1
Lead/Lag	Lead	Lag	Lead	Lag			
Lead-Lag Optimize?	Yes	Yes	Yes	Yes			
Recall Mode	None	None	None	None	None	None	None
Act Effct Green (s)	6.9	24.3	7.3	24.5	15.2	15.2	15.2
Actuated g/C Ratio	0.21	0.75	0.23	0.76	0.47	0.47	0.47
v/c Ratio	0.00	0.19	0.07	0.23	0.00	0.03	0.00
Control Delay	24.0	7.4	20.7	7.0	12.0	0.0	0.0
Queue Delay	0.0	0.0	0.0	0.0	0.0	0.0	0.0
Total Delay	24.0	7.4	20.7	7.0	12.0	0.0	0.0
LOS	C	A	C	A	B	A	A
Approach Delay		7.4		7.4			
Approach LOS		A		A			

Intersection Summary

Cycle Length: 120
 Actuated Cycle Length: 32.3
 Natural Cycle: 70
 Control Type: Actuated-Uncoordinated
 Maximum v/c Ratio: 0.23
 Intersection Signal Delay: 7.3
 Intersection LOS: A
 Intersection Capacity Utilization 35.7%
 ICU Level of Service A
 Analysis Period (min) 15

Splits and Phases: 27: Innovation Dr. & Cactus Av.



HCM 6th Signalized Intersection Summary
27: Innovation Dr. & Cactus Av.

West Campus Upper Plateau (JN 14064)
09/29/2022



Movement	EBL	EBT	EBR	WBL	WBT	WBR	NBL	NBT	NBR	SBL	SBT	SBR
Lane Configurations	↗	↑↑↑		↖	↑↑↑		↖	↑	↗	↖	↑	↗
Traffic Volume (veh/h)	1	622	1	22	747	4	1	0	21	0	0	1
Future Volume (veh/h)	1	622	1	22	747	4	1	0	21	0	0	1
Initial Q (Qb), veh	0	0	0	0	0	0	0	0	0	0	0	0
Ped-Bike Adj(A_pbT)	1.00		1.00	1.00		0.98	1.00		1.00	1.00		1.00
Parking Bus, Adj	1.00	1.00	1.00	1.00	1.00	1.00	1.00	1.00	1.00	1.00	1.00	1.00
Work Zone On Approach		No			No			No			No	
Adj Sat Flow, veh/h/ln	1900	1826	1307	1663	1841	1900	1841	1900	1781	1900	1900	1781
Adj Flow Rate, veh/h	1	707	1	25	849	5	1	0	-29	0	0	-8
Peak Hour Factor	0.88	0.88	0.88	0.88	0.88	0.88	0.88	0.88	0.88	0.88	0.88	0.88
Percent Heavy Veh, %	0	5	40	16	4	0	4	0	8	0	0	8
Cap, veh/h	7	2547	4	50	2711	16	280	7	6	280	0	401
Arrive On Green	0.00	0.50	0.50	0.03	0.53	0.53	0.00	0.00	0.00	0.00	0.00	0.00
Sat Flow, veh/h	1810	5140	7	1584	5154	30	1753	1900	1510	1810	1900	0
Grp Volume(v), veh/h	1	457	251	25	552	302	1	0	-29	0	-8	-8
Grp Sat Flow(s),veh/h/ln	1810	1662	1825	1584	1675	1835	1753	1900	1510	1810	1900	1610
Q Serve(g_s), s	0.0	2.1	2.1	0.4	2.4	2.4	0.0	0.0	0.0	0.0	0.0	0.0
Cycle Q Clear(g_c), s	0.0	2.1	2.1	0.4	2.4	2.4	0.1	0.0	0.0	0.0	0.0	0.0
Prop In Lane	1.00		0.00	1.00		0.02	1.00		1.00	1.00		0.00
Lane Grp Cap(c), veh/h	7	1647	904	50	1762	965	280	7	6	280	0	0
V/C Ratio(X)	0.14	0.28	0.28	0.50	0.31	0.31	0.00	0.00	-4.94	0.00	0.00	0.00
Avail Cap(c_a), veh/h	548	7386	4055	1095	8747	4790	2516	2207	1754	2588	0	0
HCM Platoon Ratio	1.00	1.00	1.00	1.00	1.00	1.00	1.00	1.00	1.00	1.00	1.00	1.00
Upstream Filter(I)	1.00	1.00	1.00	1.00	1.00	1.00	1.00	0.00	0.00	0.00	0.00	0.00
Uniform Delay (d), s/veh	12.8	3.8	3.8	12.3	3.5	3.5	12.9	0.0	0.0	0.0	0.0	0.0
Incr Delay (d2), s/veh	3.4	0.1	0.2	2.8	0.1	0.3	0.0	0.0	0.0	0.0	0.0	0.0
Initial Q Delay(d3),s/veh	0.0	0.0	0.0	0.0	0.0	0.0	0.0	0.0	0.0	0.0	0.0	0.0
%ile BackOfQ(50%),veh/ln	0.0	0.0	0.1	0.1	0.0	0.1	0.0	0.0	0.0	0.0	0.0	0.0
Unsig. Movement Delay, s/veh												
LnGrp Delay(d),s/veh	16.2	3.9	4.0	15.1	3.6	3.7	12.9	0.0	0.0	0.0	0.0	0.0
LnGrp LOS	B	A	A	B	A	A	B	A	A	A	A	A
Approach Vol, veh/h		709			879			-28				-16
Approach Delay, s/veh		4.0			4.0			0.0				0.0
Approach LOS		A			A			A				A
Timer - Assigned Phs	1	2		4	5	6		8				
Phs Duration (G+Y+Rc), s	5.0	18.6		2.2	4.2	19.3		2.2				
Change Period (Y+Rc), s	* 4.2	5.8		5.1	* 4.2	5.8		5.1				
Max Green Setting (Gmax), s	* 18	57.2		29.9	* 7.8	67.2		29.9				
Max Q Clear Time (g_c+I1), s	2.4	4.1		0.0	2.0	4.4		2.1				
Green Ext Time (p_c), s	0.0	7.1		0.0	0.0	9.1		0.0				

Intersection Summary

HCM 6th Ctrl Delay	4.1
HCM 6th LOS	A

Notes

* HCM 6th computational engine requires equal clearance times for the phases crossing the barrier.

Timings
28: I-215 SB Ramps & Alessandro Bl.

West Campus Upper Plateau (JN 14064)

09/29/2022

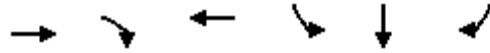

Lane Group	EBT	EBR	WBT	SBL	SBT	SBR
Lane Configurations	↑↑↑	↑	↑↑↑	↑	↔	↑
Traffic Volume (vph)	832	379	1083	125	0	296
Future Volume (vph)	832	379	1083	125	0	296
Turn Type	NA	Perm	NA	Split	NA	Perm
Protected Phases	2		6	4	4	
Permitted Phases		2				4
Detector Phase	2	2	6	4	4	4
Switch Phase						
Minimum Initial (s)	5.0	5.0	5.0	5.0	5.0	5.0
Minimum Split (s)	10.5	10.5	34.5	10.0	10.0	10.0
Total Split (s)	52.0	52.0	52.0	33.0	33.0	33.0
Total Split (%)	61.2%	61.2%	61.2%	38.8%	38.8%	38.8%
Yellow Time (s)	4.5	4.5	4.5	4.0	4.0	4.0
All-Red Time (s)	1.0	1.0	1.0	1.0	1.0	1.0
Lost Time Adjust (s)	0.0	0.0	0.0	0.0	0.0	0.0
Total Lost Time (s)	5.5	5.5	5.5	5.0	5.0	5.0
Lead/Lag						
Lead-Lag Optimize?						
Recall Mode	Min	Min	Min	None	None	None
Act Effct Green (s)	19.9	19.9	19.9	9.3	9.3	9.3
Actuated g/C Ratio	0.50	0.50	0.50	0.23	0.23	0.23
v/c Ratio	0.34	0.41	0.50	0.33	0.44	0.42
Control Delay	6.7	2.8	7.5	16.3	13.0	12.6
Queue Delay	0.0	0.0	0.0	0.0	0.0	0.0
Total Delay	6.7	2.8	7.5	16.3	13.0	12.6
LOS	A	A	A	B	B	B
Approach Delay	5.5		7.5		13.7	
Approach LOS	A		A		B	

Intersection Summary

Cycle Length: 85	
Actuated Cycle Length: 40	
Natural Cycle: 45	
Control Type: Actuated-Uncoordinated	
Maximum v/c Ratio: 0.50	
Intersection Signal Delay: 7.6	Intersection LOS: A
Intersection Capacity Utilization 44.4%	ICU Level of Service A
Analysis Period (min) 15	

Splits and Phases: 28: I-215 SB Ramps & Alessandro Bl.

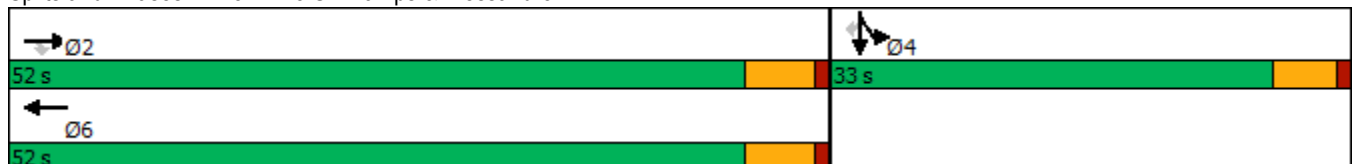

HCM 6th Signalized Intersection Summary
 28: I-215 SB Ramps & Alessandro Bl.

West Campus Upper Plateau (JN 14064)

09/29/2022



Movement	EBL	EBT	EBR	WBL	WBT	WBR	NBL	NBT	NBR	SBL	SBT	SBR
Lane Configurations		↑↑↑	↗		↑↑↑					↘	↔	↗
Traffic Volume (veh/h)	0	832	379	0	1083	111	0	0	0	125	0	296
Future Volume (veh/h)	0	832	379	0	1083	111	0	0	0	125	0	296
Initial Q (Qb), veh	0	0	0	0	0	0				0	0	0
Ped-Bike Adj(A_pbT)	1.00		1.00	1.00		0.98				1.00		1.00
Parking Bus, Adj	1.00	1.00	1.00	1.00	1.00	1.00				1.00	1.00	1.00
Work Zone On Approach		No			No						No	
Adj Sat Flow, veh/h/ln	0	1870	1870	0	1870	1781				1737	1900	1752
Adj Flow Rate, veh/h	0	867	395	0	1128	108				87	0	309
Peak Hour Factor	0.96	0.96	0.96	0.96	0.96	0.96				0.96	0.96	0.96
Percent Heavy Veh, %	0	2	2	0	2	8				11	0	10
Cap, veh/h	0	2497	775	0	2313	221				318	0	570
Arrive On Green	0.00	0.49	0.49	0.00	0.49	0.49				0.19	0.00	0.19
Sat Flow, veh/h	0	5274	1585	0	4898	452				1654	0	2969
Grp Volume(v), veh/h	0	867	395	0	812	424				87	0	309
Grp Sat Flow(s),veh/h/ln	0	1702	1585	0	1702	1778				1654	0	1485
Q Serve(g_s), s	0.0	3.4	5.6	0.0	5.3	5.3				1.5	0.0	3.1
Cycle Q Clear(g_c), s	0.0	3.4	5.6	0.0	5.3	5.3				1.5	0.0	3.1
Prop In Lane	0.00		1.00	0.00		0.25				1.00		1.00
Lane Grp Cap(c), veh/h	0	2497	775	0	1665	869				318	0	570
V/C Ratio(X)	0.00	0.35	0.51	0.00	0.49	0.49				0.27	0.00	0.54
Avail Cap(c_a), veh/h	0	7213	2239	0	4809	2511				1407	0	2526
HCM Platoon Ratio	1.00	1.00	1.00	1.00	1.00	1.00				1.00	1.00	1.00
Upstream Filter(I)	0.00	1.00	1.00	0.00	1.00	1.00				1.00	0.00	1.00
Uniform Delay (d), s/veh	0.0	5.2	5.7	0.0	5.6	5.6				11.3	0.0	12.0
Incr Delay (d2), s/veh	0.0	0.1	0.5	0.0	0.2	0.4				0.5	0.0	0.8
Initial Q Delay(d3),s/veh	0.0	0.0	0.0	0.0	0.0	0.0				0.0	0.0	0.0
%ile BackOfQ(50%),veh/ln	0.0	0.3	0.5	0.0	0.4	0.5				0.4	0.0	0.7
Unsig. Movement Delay, s/veh												
LnGrp Delay(d),s/veh	0.0	5.3	6.2	0.0	5.9	6.1				11.8	0.0	12.8
LnGrp LOS	A	A	A	A	A	A				B	A	B
Approach Vol, veh/h		1262			1236						396	
Approach Delay, s/veh		5.6			5.9						12.6	
Approach LOS		A			A						B	
Timer - Assigned Phs		2		4		6						
Phs Duration (G+Y+Rc), s		21.6		11.3		21.6						
Change Period (Y+Rc), s		5.5		5.0		5.5						
Max Green Setting (Gmax), s		46.5		28.0		46.5						
Max Q Clear Time (g_c+I1), s		7.6		5.1		7.3						
Green Ext Time (p_c), s		7.8		1.4		8.8						
Intersection Summary												
HCM 6th Ctrl Delay			6.7									
HCM 6th LOS			A									
Notes												
User approved volume balancing among the lanes for turning movement.												

Timings
29: I-215 NB Ramps & Alessandro Bl.

West Campus Upper Plateau (JN 14064)

09/29/2022



Lane Group	EBL	EBT	WBT	WBR	NBL	NBT	NBR
Lane Configurations	↘	↑↑↑	↑↑↑	↗	↘	↕	↗
Traffic Volume (vph)	208	755	875	137	503	9	222
Future Volume (vph)	208	755	875	137	503	9	222
Turn Type	Prot	NA	NA	Perm	Split	NA	Perm
Protected Phases	5	2	6		8	8	
Permitted Phases				6			8
Detector Phase	5	2	6	6	8	8	8
Switch Phase							
Minimum Initial (s)	5.0	5.0	5.0	5.0	5.0	5.0	5.0
Minimum Split (s)	9.5	10.5	33.5	33.5	10.0	10.0	10.0
Total Split (s)	13.0	48.0	35.0	35.0	37.0	37.0	37.0
Total Split (%)	15.3%	56.5%	41.2%	41.2%	43.5%	43.5%	43.5%
Yellow Time (s)	3.5	4.5	4.5	4.5	4.0	4.0	4.0
All-Red Time (s)	1.0	1.0	1.0	1.0	1.0	1.0	1.0
Lost Time Adjust (s)	0.0	0.0	0.0	0.0	0.0	0.0	0.0
Total Lost Time (s)	4.5	5.5	5.5	5.5	5.0	5.0	5.0
Lead/Lag	Lead		Lag	Lag			
Lead-Lag Optimize?	Yes		Yes	Yes			
Recall Mode	None	Min	Min	Min	Max	Max	Max
Act Effct Green (s)	8.5	34.1	21.0	21.0	32.1	32.1	32.1
Actuated g/C Ratio	0.11	0.44	0.27	0.27	0.42	0.42	0.42
v/c Ratio	1.16	0.34	0.65	0.32	0.40	0.41	0.29
Control Delay	153.4	14.3	26.7	11.9	18.7	18.7	7.2
Queue Delay	0.0	0.0	0.0	0.0	0.0	0.0	0.0
Total Delay	153.4	14.3	26.7	11.9	18.7	18.7	7.2
LOS	F	B	C	B	B	B	A
Approach Delay		44.3	24.7			15.6	
Approach LOS		D	C			B	

Intersection Summary

Cycle Length: 85
 Actuated Cycle Length: 76.7
 Natural Cycle: 70
 Control Type: Actuated-Uncoordinated
 Maximum v/c Ratio: 1.16
 Intersection Signal Delay: 29.2
 Intersection LOS: C
 Intersection Capacity Utilization 57.4%
 ICU Level of Service B
 Analysis Period (min) 15

Splits and Phases: 29: I-215 NB Ramps & Alessandro Bl.

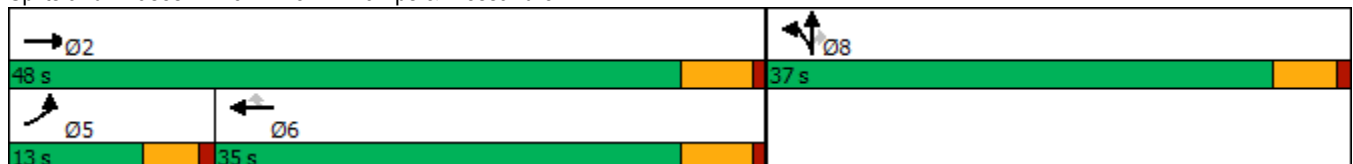

HCM 6th Signalized Intersection Summary
 29: I-215 NB Ramps & Alessandro Bl.

West Campus Upper Plateau (JN 14064)

09/29/2022



Movement	EBL	EBT	EBR	WBL	WBT	WBR	NBL	NBT	NBR	SBL	SBT	SBR
Lane Configurations	↘	↑↑↑			↑↑↑	↗	↘	↕	↗			
Traffic Volume (veh/h)	208	755	0	0	875	137	503	9	222	0	0	0
Future Volume (veh/h)	208	755	0	0	875	137	503	9	222	0	0	0
Initial Q (Qb), veh	0	0	0	0	0	0	0	0	0			
Ped-Bike Adj(A_pbT)	1.00		1.00	1.00		0.98	1.00		1.00			
Parking Bus, Adj	1.00	1.00	1.00	1.00	1.00	1.00	1.00	1.00	1.00			
Work Zone On Approach		No			No			No				
Adj Sat Flow, veh/h/ln	1767	1870	0	0	1870	1707	1856	1900	1870			
Adj Flow Rate, veh/h	214	778	0	0	902	115	568	0	100			
Peak Hour Factor	0.97	0.97	0.97	0.97	0.97	0.97	0.97	0.97	0.97			
Percent Heavy Veh, %	9	2	0	0	2	13	3	0	2			
Cap, veh/h	192	2198	0	0	1308	363	1516	0	680			
Arrive On Green	0.11	0.43	0.00	0.00	0.26	0.26	0.43	0.00	0.43			
Sat Flow, veh/h	1682	5274	0	0	5274	1416	3534	0	1585			
Grp Volume(v), veh/h	214	778	0	0	902	115	568	0	100			
Grp Sat Flow(s),veh/h/ln	1682	1702	0	0	1702	1416	1767	0	1585			
Q Serve(g_s), s	8.5	7.6	0.0	0.0	11.9	4.9	8.2	0.0	2.9			
Cycle Q Clear(g_c), s	8.5	7.6	0.0	0.0	11.9	4.9	8.2	0.0	2.9			
Prop In Lane	1.00		0.00	0.00		1.00	1.00		1.00			
Lane Grp Cap(c), veh/h	192	2198	0	0	1308	363	1516	0	680			
V/C Ratio(X)	1.12	0.35	0.00	0.00	0.69	0.32	0.37	0.00	0.15			
Avail Cap(c_a), veh/h	192	2908	0	0	2019	560	1516	0	680			
HCM Platoon Ratio	1.00	1.00	1.00	1.00	1.00	1.00	1.00	1.00	1.00			
Upstream Filter(I)	1.00	1.00	0.00	0.00	1.00	1.00	1.00	0.00	1.00			
Uniform Delay (d), s/veh	33.1	14.3	0.0	0.0	25.1	22.5	14.5	0.0	13.0			
Incr Delay (d2), s/veh	99.8	0.1	0.0	0.0	0.7	0.5	0.7	0.0	0.5			
Initial Q Delay(d3),s/veh	0.0	0.0	0.0	0.0	0.0	0.0	0.0	0.0	0.0			
%ile BackOfQ(50%),veh/ln	8.4	2.4	0.0	0.0	4.2	1.5	3.0	0.0	1.0			
Unsig. Movement Delay, s/veh												
LnGrp Delay(d),s/veh	132.8	14.4	0.0	0.0	25.7	23.0	15.2	0.0	13.4			
LnGrp LOS	F	B	A	A	C	C	B	A	B			
Approach Vol, veh/h		992			1017			668				
Approach Delay, s/veh		39.9			25.4			14.9				
Approach LOS		D			C			B				
Timer - Assigned Phs		2			5	6		8				
Phs Duration (G+Y+Rc), s		37.6			13.0	24.6		37.0				
Change Period (Y+Rc), s		5.5			4.5	5.5		5.0				
Max Green Setting (Gmax), s		42.5			8.5	29.5		32.0				
Max Q Clear Time (g_c+I1), s		9.6			10.5	13.9		10.2				
Green Ext Time (p_c), s		5.1			0.0	5.2		2.4				

Intersection Summary

HCM 6th Ctrl Delay	28.2
HCM 6th LOS	C

Notes

User approved volume balancing among the lanes for turning movement.

Timings
30: I-215 SB Ramps & Cactus Av.

West Campus Upper Plateau (JN 14064)

09/29/2022



Lane Group	EBT	EBR	WBL	WBT	NBR	SBR
Lane Configurations	↑↑	↑	↓	↑↑	↑	↑
Traffic Volume (vph)	551	105	323	489	304	286
Future Volume (vph)	551	105	323	489	304	286
Turn Type	NA	Perm	Prot	NA	Prot	Prot
Protected Phases	2		1	6	8	4
Permitted Phases		2				
Detector Phase	2	2	1	6	8	4
Switch Phase						
Minimum Initial (s)	5.0	5.0	5.0	5.0	5.0	5.0
Minimum Split (s)	11.0	11.0	9.5	23.0	9.1	9.5
Total Split (s)	35.0	35.0	43.0	78.0	27.0	27.0
Total Split (%)	33.3%	33.3%	41.0%	74.3%	25.7%	25.7%
Yellow Time (s)	5.0	5.0	3.5	5.0	3.6	3.5
All-Red Time (s)	1.0	1.0	1.0	1.0	0.5	1.0
Lost Time Adjust (s)	0.0	0.0	0.0	0.0	0.0	0.0
Total Lost Time (s)	6.0	6.0	4.5	6.0	4.1	4.5
Lead/Lag	Lag	Lag	Lead			
Lead-Lag Optimize?	Yes	Yes	Yes			
Recall Mode	Min	Min	None	Min	None	None
Act Effct Green (s)	16.0	16.0	17.2	38.0	6.7	6.3
Actuated g/C Ratio	0.29	0.29	0.31	0.69	0.12	0.11
v/c Ratio	0.63	0.23	0.67	0.23	0.46	0.66
Control Delay	21.0	5.4	24.4	3.3	2.1	9.3
Queue Delay	0.0	0.0	0.0	0.0	0.0	0.0
Total Delay	21.0	5.4	24.4	3.3	2.1	9.3
LOS	C	A	C	A	A	A
Approach Delay	18.5			11.7		
Approach LOS	B			B		

Intersection Summary

Cycle Length: 105
 Actuated Cycle Length: 55.4
 Natural Cycle: 55
 Control Type: Actuated-Uncoordinated
 Maximum v/c Ratio: 0.67
 Intersection Signal Delay: 12.1
 Intersection LOS: B
 Intersection Capacity Utilization 42.5%
 ICU Level of Service A
 Analysis Period (min) 15



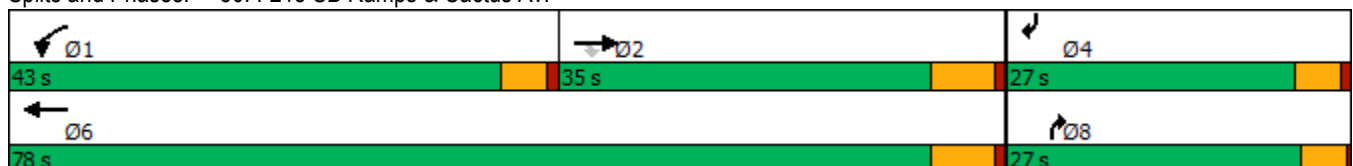









Splits and Phases: 30: I-215 SB Ramps & Cactus Av.



HCM 6th Signalized Intersection Summary
 30: I-215 SB Ramps & Cactus Av.

West Campus Upper Plateau (JN 14064)

09/29/2022

												
Movement	EBL	EBT	EBR	WBL	WBT	WBR	NBL	NBT	NBR	SBL	SBT	SBR
Lane Configurations		↑↑	↗	↖	↑↑				↗			↖
Traffic Volume (veh/h)	0	551	105	323	489	0	0	0	304	0	0	286
Future Volume (veh/h)	0	551	105	323	489	0	0	0	304	0	0	286
Initial Q (Qb), veh	0	0	0	0	0	0	0	0	0	0	0	0
Ped-Bike Adj(A_pbT)	1.00		1.00	1.00		1.00	1.00		1.00	1.00		1.00
Parking Bus, Adj	1.00	1.00	1.00	1.00	1.00	1.00	1.00	1.00	1.00	1.00	1.00	1.00
Work Zone On Approach		No			No			No			No	
Adj Sat Flow, veh/h/ln	0	1841	1826	1870	1870	0	0	0	1796	0	0	1707
Adj Flow Rate, veh/h	0	633	90	371	562	0	0	0	0	0	0	214
Peak Hour Factor	0.87	0.87	0.87	0.87	0.87	0.87	0.87	0.87	0.87	0.87	0.87	0.87
Percent Heavy Veh, %	0	4	5	2	2	0	0	0	7	0	0	13
Cap, veh/h	0	1146	507	478	2734	0	0	0	0	0	0	0
Arrive On Green	0.00	0.33	0.33	0.27	0.77	0.00	0.00	0.00	0.00	0.00	0.00	0.00
Sat Flow, veh/h	0	3589	1547	1781	3647	0		0			0	
Grp Volume(v), veh/h	0	633	90	371	562	0		0.0			0.0	
Grp Sat Flow(s),veh/h/ln	0	1749	1547	1781	1777	0						
Q Serve(g_s), s	0.0	3.9	1.1	5.0	1.1	0.0						
Cycle Q Clear(g_c), s	0.0	3.9	1.1	5.0	1.1	0.0						
Prop In Lane	0.00		1.00	1.00		0.00						
Lane Grp Cap(c), veh/h	0	1146	507	478	2734	0						
V/C Ratio(X)	0.00	0.55	0.18	0.78	0.21	0.00						
Avail Cap(c_a), veh/h	0	3899	1725	2637	9837	0						
HCM Platoon Ratio	1.00	1.00	1.00	1.00	1.00	1.00						
Upstream Filter(I)	0.00	1.00	1.00	1.00	1.00	0.00						
Uniform Delay (d), s/veh	0.0	7.2	6.2	8.8	0.8	0.0						
Incr Delay (d2), s/veh	0.0	0.2	0.1	1.0	0.0	0.0						
Initial Q Delay(d3),s/veh	0.0	0.0	0.0	0.0	0.0	0.0						
%ile BackOfQ(50%),veh/ln	0.0	0.5	0.1	0.9	0.0	0.0						
Unsig. Movement Delay, s/veh												
LnGrp Delay(d),s/veh	0.0	7.3	6.3	9.8	0.8	0.0						
LnGrp LOS	A	A	A	A	A	A						
Approach Vol, veh/h		723			933							
Approach Delay, s/veh		7.2			4.4							
Approach LOS		A			A							
Timer - Assigned Phs	1	2				6						
Phs Duration (G+Y+Rc), s	11.5	14.5				26.0						
Change Period (Y+Rc), s	4.5	6.0				6.0						
Max Green Setting (Gmax), s	38.5	29.0				72.0						
Max Q Clear Time (g_c+I1), s	7.0	5.9				3.1						
Green Ext Time (p_c), s	0.5	2.7				2.3						

Intersection Summary

HCM 6th Ctrl Delay	5.6
HCM 6th LOS	A

Notes

Unsignalized Delay for [NBR] is excluded from calculations of the approach delay and intersection delay.

Timings

31: I-215 NB Ramps/Old 215 Frontage Rd. & Cactus Av.



Lane Group	EBL	EBT	WBT	NBL	NBT	NBR	SBL	SBT
Lane Configurations	↔	↕	↕	↔	↕	↗	↖	↕
Traffic Volume (vph)	30	606	1018	119	61	3	101	1
Future Volume (vph)	30	606	1018	119	61	3	101	1
Turn Type	Perm	NA	NA	Perm	NA	Perm	Perm	NA
Protected Phases		2	6		8			4
Permitted Phases	2			8		8	4	
Detector Phase	2	2	6	8	8	8	4	4
Switch Phase								
Minimum Initial (s)	5.0	5.0	5.0	5.0	5.0	5.0	5.0	5.0
Minimum Split (s)	11.0	11.0	44.0	10.5	10.5	10.5	10.5	10.5
Total Split (s)	57.4	57.4	57.4	27.6	27.6	27.6	27.6	27.6
Total Split (%)	67.5%	67.5%	67.5%	32.5%	32.5%	32.5%	32.5%	32.5%
Yellow Time (s)	5.0	5.0	5.0	4.5	4.5	4.5	4.5	4.5
All-Red Time (s)	1.0	1.0	1.0	1.0	1.0	1.0	1.0	1.0
Lost Time Adjust (s)	0.0	0.0	0.0	0.0	0.0	0.0	0.0	0.0
Total Lost Time (s)	6.0	6.0	6.0	5.5	5.5	5.5	5.5	5.5
Lead/Lag								
Lead-Lag Optimize?								
Recall Mode	Min	Min	Min	None	None	None	None	None
Act Effct Green (s)	27.3	27.3	27.3	9.7	9.7	9.7	9.6	9.6
Actuated g/C Ratio	0.61	0.61	0.61	0.22	0.22	0.22	0.22	0.22
v/c Ratio	0.15	0.48	0.57	0.49	0.17	0.01	0.39	0.20
Control Delay	8.6	6.9	8.7	24.5	17.5	0.0	21.5	6.8
Queue Delay	0.0	0.0	0.0	0.0	0.0	0.0	0.0	0.0
Total Delay	8.6	6.9	8.7	24.5	17.5	0.0	21.5	6.8
LOS	A	A	A	C	B	A	C	A
Approach Delay		6.9	8.7		21.8			15.2
Approach LOS		A	A		C			B

Intersection Summary

Cycle Length: 85
 Actuated Cycle Length: 44.4
 Natural Cycle: 60
 Control Type: Actuated-Uncoordinated
 Maximum v/c Ratio: 0.57
 Intersection Signal Delay: 9.5
 Intersection Capacity Utilization 54.5%
 Analysis Period (min) 15
 Intersection LOS: A
 ICU Level of Service A

Splits and Phases: 31: I-215 NB Ramps/Old 215 Frontage Rd. & Cactus Av.

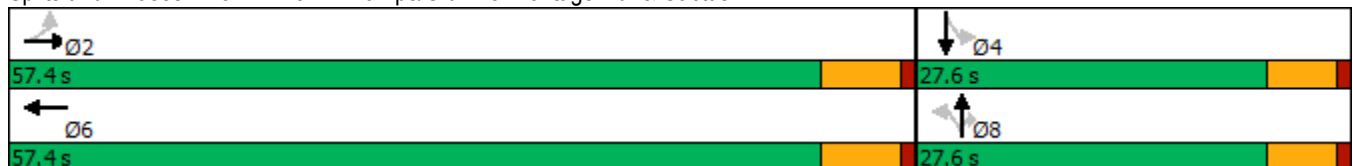

HCM 6th Signalized Intersection Summary

West Campus Upper Plateau (JN 14064)

31: I-215 NB Ramps/Old 215 Frontage Rd. & Cactus Av.

09/29/2022



Movement	EBL	EBT	EBR	WBL	WBT	WBR	NBL	NBT	NBR	SBL	SBT	SBR
Lane Configurations												
Traffic Volume (veh/h)	30	606	241	0	1018	109	119	61	3	101	1	74
Future Volume (veh/h)	30	606	241	0	1018	109	119	61	3	101	1	74
Initial Q (Qb), veh	0	0	0	0	0	0	0	0	0	0	0	0
Ped-Bike Adj(A_pbT)	1.00		1.00	1.00		1.00	1.00		1.00	1.00		1.00
Parking Bus, Adj	1.00	1.00	1.00	1.00	1.00	1.00	1.00	1.00	1.00	1.00	1.00	1.00
Work Zone On Approach		No			No			No			No	
Adj Sat Flow, veh/h/ln	1796	1826	1366	0	1841	1885	1722	1856	1900	1841	1900	1885
Adj Flow Rate, veh/h	32	652	255	0	1095	68	128	66	0	109	1	53
Peak Hour Factor	0.93	0.93	0.93	0.93	0.93	0.93	0.93	0.93	0.93	0.93	0.93	0.93
Percent Heavy Veh, %	7	5	36	0	4	1	12	3	0	4	0	1
Cap, veh/h	314	1176	460	0	1614	100	404	345		413	6	295
Arrive On Green	0.48	0.48	0.48	0.00	0.48	0.48	0.19	0.19	0.00	0.19	0.19	0.19
Sat Flow, veh/h	464	2436	953	0	3436	208	1243	1856	1610	1314	30	1585
Grp Volume(v), veh/h	32	464	443	0	572	591	128	66	0	109	0	54
Grp Sat Flow(s),veh/h/ln	464	1735	1654	0	1749	1803	1243	1856	1610	1314	0	1615
Q Serve(g_s), s	2.0	6.6	6.6	0.0	8.7	8.7	3.4	1.0	0.0	2.6	0.0	1.0
Cycle Q Clear(g_c), s	10.7	6.6	6.6	0.0	8.7	8.7	4.3	1.0	0.0	3.7	0.0	1.0
Prop In Lane	1.00		0.58	0.00		0.12	1.00		1.00	1.00		0.98
Lane Grp Cap(c), veh/h	314	837	798	0	844	870	404	345		413	0	300
V/C Ratio(X)	0.10	0.55	0.55	0.00	0.68	0.68	0.32	0.19		0.26	0.00	0.18
Avail Cap(c_a), veh/h	777	2570	2451	0	2591	2671	964	1182		1005	0	1029
HCM Platoon Ratio	1.00	1.00	1.00	1.00	1.00	1.00	1.00	1.00	1.00	1.00	1.00	1.00
Upstream Filter(I)	1.00	1.00	1.00	0.00	1.00	1.00	1.00	1.00	0.00	1.00	0.00	1.00
Uniform Delay (d), s/veh	11.0	6.3	6.3	0.0	6.9	6.9	13.7	11.9	0.0	13.5	0.0	11.9
Incr Delay (d2), s/veh	0.1	0.2	0.2	0.0	0.4	0.4	0.2	0.1	0.0	0.1	0.0	0.1
Initial Q Delay(d3),s/veh	0.0	0.0	0.0	0.0	0.0	0.0	0.0	0.0	0.0	0.0	0.0	0.0
%ile BackOfQ(50%),veh/ln	0.1	1.0	0.9	0.0	1.3	1.3	0.7	0.3	0.0	0.5	0.0	0.2
Unsig. Movement Delay, s/veh												
LnGrp Delay(d),s/veh	11.1	6.6	6.6	0.0	7.3	7.3	13.9	12.0	0.0	13.6	0.0	12.0
LnGrp LOS	B	A	A	A	A	A	B	B		B	A	B
Approach Vol, veh/h		939			1163			194				163
Approach Delay, s/veh		6.7			7.3			13.2				13.1
Approach LOS		A			A			B				B
Timer - Assigned Phs		2		4		6		8				
Phs Duration (G+Y+Rc), s		22.7		12.0		22.7		12.0				
Change Period (Y+Rc), s		6.0		5.5		6.0		5.5				
Max Green Setting (Gmax), s		51.4		22.1		51.4		22.1				
Max Q Clear Time (g_c+I1), s		12.7		5.7		10.7		6.3				
Green Ext Time (p_c), s		4.0		0.3		4.9		0.3				

Intersection Summary

HCM 6th Ctrl Delay	7.9
HCM 6th LOS	A

Notes

User approved volume balancing among the lanes for turning movement.
 Unsignalized Delay for [NBR] is excluded from calculations of the approach delay and intersection delay.

Timings
32: I-215 SB Ramps & Van Buren Bl.

West Campus Upper Plateau (JN 14064)

09/29/2022



Lane Group	EBT	EBR	WBL	WBT	SBT	SBR
Lane Configurations	↑↑	↑↑	↙	↑↑	↙	↑↑
Traffic Volume (vph)	419	564	12	538	0	491
Future Volume (vph)	419	564	12	538	0	491
Turn Type	NA	Perm	Prot	NA	NA	Perm
Protected Phases	6		5	2	8	
Permitted Phases		6				8
Detector Phase	6	6	5	2	8	8
Switch Phase						
Minimum Initial (s)	5.0	5.0	5.0	5.0	5.0	5.0
Minimum Split (s)	36.0	36.0	11.0	11.0	11.0	11.0
Total Split (s)	60.0	60.0	11.0	71.0	14.0	14.0
Total Split (%)	70.6%	70.6%	12.9%	83.5%	16.5%	16.5%
Yellow Time (s)	5.0	5.0	5.0	5.0	5.0	5.0
All-Red Time (s)	1.0	1.0	1.0	1.0	1.0	1.0
Lost Time Adjust (s)	0.0	0.0	0.0	0.0	0.0	0.0
Total Lost Time (s)	6.0	6.0	6.0	6.0	6.0	6.0
Lead/Lag	Lag	Lag	Lead			
Lead-Lag Optimize?	Yes	Yes	Yes			
Recall Mode	Min	Min	None	Min	Max	Max
Act Effct Green (s)	12.0	12.0	5.5	13.3	8.8	8.8
Actuated g/C Ratio	0.34	0.34	0.16	0.38	0.25	0.25
v/c Ratio	0.39	0.45	0.06	0.45	0.06	0.52
Control Delay	9.5	2.1	19.7	8.2	16.6	4.6
Queue Delay	0.0	0.0	0.0	0.0	0.0	0.0
Total Delay	9.5	2.1	19.7	8.2	16.6	4.6
LOS	A	A	B	A	B	A
Approach Delay	5.2			8.4	5.1	
Approach LOS	A			A	A	

Intersection Summary

Cycle Length: 85
 Actuated Cycle Length: 35.2
 Natural Cycle: 60
 Control Type: Actuated-Uncoordinated
 Maximum v/c Ratio: 0.52
 Intersection Signal Delay: 6.1
 Intersection LOS: A
 Intersection Capacity Utilization 43.1%
 ICU Level of Service A
 Analysis Period (min) 15

Splits and Phases: 32: I-215 SB Ramps & Van Buren Bl.



HCM 6th Signalized Intersection Summary
 32: I-215 SB Ramps & Van Buren Bl.

West Campus Upper Plateau (JN 14064)

09/29/2022



Movement	EBL	EBT	EBR	WBL	WBT	WBR	NBL	NBT	NBR	SBL	SBT	SBR
Lane Configurations		↑↑	↑↑	↑	↑↑						↑	↑↑
Traffic Volume (veh/h)	0	419	564	12	538	0	0	0	0	19	0	491
Future Volume (veh/h)	0	419	564	12	538	0	0	0	0	19	0	491
Initial Q (Qb), veh	0	0	0	0	0	0				0	0	0
Ped-Bike Adj(A_pbT)	1.00		1.00	1.00		1.00				1.00		1.00
Parking Bus, Adj	1.00	1.00	1.00	1.00	1.00	1.00				1.00	1.00	1.00
Work Zone On Approach		No			No						No	
Adj Sat Flow, veh/h/ln	0	1767	1856	1411	1811	0				1500	1841	1663
Adj Flow Rate, veh/h	0	446	502	13	572	0				20	0	0
Peak Hour Factor	0.94	0.94	0.94	0.94	0.94	0.94				0.94	0.94	0.94
Percent Heavy Veh, %	0	9	3	33	6	0				27	4	16
Cap, veh/h	0	915	755	157	1826	0				329	0	
Arrive On Green	0.00	0.27	0.27	0.12	0.53	0.00				0.19	0.00	0.00
Sat Flow, veh/h	0	3445	2768	1344	3532	0				1753	0	2480
Grp Volume(v), veh/h	0	446	502	13	572	0				20	0	0
Grp Sat Flow(s),veh/h/ln	0	1678	1384	1344	1721	0				1753	0	1240
Q Serve(g_s), s	0.0	4.7	6.9	0.4	4.0	0.0				0.4	0.0	0.0
Cycle Q Clear(g_c), s	0.0	4.7	6.9	0.4	4.0	0.0				0.4	0.0	0.0
Prop In Lane	0.00		1.00	1.00		0.00				1.00		1.00
Lane Grp Cap(c), veh/h	0	915	755	157	1826	0				329	0	
V/C Ratio(X)	0.00	0.49	0.67	0.08	0.31	0.00				0.06	0.00	
Avail Cap(c_a), veh/h	0	4253	3507	158	5248	0				329	0	
HCM Platoon Ratio	1.00	1.00	1.00	1.00	1.00	1.00				1.00	1.00	1.00
Upstream Filter(I)	0.00	1.00	1.00	1.00	1.00	0.00				1.00	0.00	0.00
Uniform Delay (d), s/veh	0.0	13.0	13.8	16.8	5.6	0.0				14.2	0.0	0.0
Incr Delay (d2), s/veh	0.0	0.1	0.4	0.1	0.0	0.0				0.4	0.0	0.0
Initial Q Delay(d3),s/veh	0.0	0.0	0.0	0.0	0.0	0.0				0.0	0.0	0.0
%ile BackOfQ(50%),veh/ln	0.0	1.2	1.4	0.1	0.6	0.0				0.2	0.0	0.0
Unsig. Movement Delay, s/veh												
LnGrp Delay(d),s/veh	0.0	13.1	14.1	16.9	5.7	0.0				14.6	0.0	0.0
LnGrp LOS	A	B	B	B	A	A				B	A	
Approach Vol, veh/h		948			585							20
Approach Delay, s/veh		13.7			5.9							14.6
Approach LOS		B			A							B
Timer - Assigned Phs		2			5	6		8				
Phs Duration (G+Y+Rc), s		28.6			11.0	17.6		14.0				
Change Period (Y+Rc), s		6.0			6.0	6.0		6.0				
Max Green Setting (Gmax), s		65.0			5.0	54.0		8.0				
Max Q Clear Time (g_c+I1), s		6.0			2.4	8.9		2.4				
Green Ext Time (p_c), s		2.3			0.0	2.8		0.0				

Intersection Summary

HCM 6th Ctrl Delay	10.8
HCM 6th LOS	B

Notes

Unsignalized Delay for [SBR] is excluded from calculations of the approach delay and intersection delay.

Timings
33: I-215 NB On/Off Ramp & Van Buren Bl.

Lane Group	EBR	NBL	Ø2	Ø6
Lane Configurations	↔↔	↔↔		
Traffic Volume (vph)	15	1		
Future Volume (vph)	15	1		
Turn Type	pm+ov	Prot		
Protected Phases	4	4	2	6
Permitted Phases	6			
Detector Phase	4	4		
Switch Phase				
Minimum Initial (s)	5.0	5.0	5.0	5.0
Minimum Split (s)	42.0	42.0	11.0	11.0
Total Split (s)	55.0	55.0	15.0	15.0
Total Split (%)	78.6%	78.6%	21%	21%
Yellow Time (s)	5.0	5.0	5.0	5.0
All-Red Time (s)	1.0	1.0	1.0	1.0
Lost Time Adjust (s)	0.0	0.0		
Total Lost Time (s)	6.0	6.0		
Lead/Lag				
Lead-Lag Optimize?				
Recall Mode	Min	Min	None	None
Act Effct Green (s)	32.2	32.2		
Actuated g/C Ratio	1.00	1.00		
v/c Ratio	0.01	0.00		
Control Delay	0.0	0.0		
Queue Delay	0.0	0.0		
Total Delay	0.0	0.0		
LOS	A	A		
Approach Delay				
Approach LOS				

Intersection Summary

Cycle Length: 70
 Actuated Cycle Length: 32.2
 Natural Cycle: 55
 Control Type: Actuated-Uncoordinated
 Maximum v/c Ratio: 0.01
 Intersection Signal Delay: 0.0
 Intersection LOS: A
 Intersection Capacity Utilization 9.2%
 ICU Level of Service A
 Analysis Period (min) 15

Splits and Phases: 33: I-215 NB On/Off Ramp & Van Buren Bl.



HCM 6th Signalized Intersection Summary
 33: I-215 NB On/Off Ramp & Van Buren Bl.

West Campus Upper Plateau (JN 14064)

09/29/2022

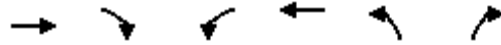

Movement	EBT	EBR	WBL	WBT	NBL	NBR
Lane Configurations	↑↑	↑↑		↑↑	↑↑	↑
Traffic Volume (veh/h)	0	15	0	0	1	0
Future Volume (veh/h)	0	15	0	0	1	0
Initial Q (Qb), veh	0	0	0	0	0	0
Ped-Bike Adj(A_pbT)		1.00	1.00		1.00	1.00
Parking Bus, Adj	1.00	1.00	1.00	1.00	1.00	1.00
Work Zone On Approach	No			No	No	
Adj Sat Flow, veh/h/ln	1900	1767	0	1752	1811	1159
Adj Flow Rate, veh/h	0	7	0	0	1	0
Peak Hour Factor	0.94	0.94	0.94	0.94	0.94	0.94
Percent Heavy Veh, %	0	9	0	10	6	50
Cap, veh/h	35	793	0	32	975	286
Arrive On Green	0.00	0.01	0.00	0.00	0.29	0.00
Sat Flow, veh/h	3705	2635	0	3504	3346	982
Grp Volume(v), veh/h	0	7	0	0	1	0
Grp Sat Flow(s),veh/h/ln	1805	1317	0	1664	1673	982
Q Serve(g_s), s	0.0	0.0	0.0	0.0	0.0	0.0
Cycle Q Clear(g_c), s	0.0	0.0	0.0	0.0	0.0	0.0
Prop In Lane		1.00	0.00		1.00	1.00
Lane Grp Cap(c), veh/h	35	793	0	32	975	286
V/C Ratio(X)	0.00	0.01	0.00	0.00	0.00	0.00
Avail Cap(c_a), veh/h	1893	2149	0	1745	9553	2804
HCM Platoon Ratio	1.00	1.00	1.00	1.00	1.00	1.00
Upstream Filter(I)	0.00	1.00	0.00	0.00	1.00	0.00
Uniform Delay (d), s/veh	0.0	4.2	0.0	0.0	4.3	0.0
Incr Delay (d2), s/veh	0.0	0.0	0.0	0.0	0.0	0.0
Initial Q Delay(d3),s/veh	0.0	0.0	0.0	0.0	0.0	0.0
%ile BackOfQ(50%),veh/ln	0.0	0.0	0.0	0.0	0.0	0.0
Unsig. Movement Delay, s/veh						
LnGrp Delay(d),s/veh	0.0	4.2	0.0	0.0	4.3	0.0
LnGrp LOS	A	A	A	A	A	A
Approach Vol, veh/h	7			0	1	
Approach Delay, s/veh	4.2			0.0	4.3	
Approach LOS	A				A	
Timer - Assigned Phs		2		4		6
Phs Duration (G+Y+Rc), s		6.2		11.0		6.2
Change Period (Y+Rc), s		6.0		6.0		6.0
Max Green Setting (Gmax), s		9.0		49.0		9.0
Max Q Clear Time (g_c+11), s		0.0		2.0		2.0
Green Ext Time (p_c), s		0.0		0.0		0.0
Intersection Summary						
HCM 6th Ctrl Delay			4.2			
HCM 6th LOS			A			

Timings

West Campus Upper Plateau (JN 14064)

34: Old 215 Frontage Rd. & Alessandro Bl.

09/29/2022

Lane Group	EBL	EBT	EBR	WBL	WBT	WBR	NBL	NBT	NBR	SBL	SBT	SBR
Lane Configurations												
Traffic Volume (vph)	285	748	11	10	688	86	21	88	12	78	108	191
Future Volume (vph)	285	748	11	10	688	86	21	88	12	78	108	191
Turn Type	Prot	NA	Perm	Prot	NA	Perm	Prot	NA	Perm	Prot	NA	Perm
Protected Phases	5	2		1	6		3	8		7	4	
Permitted Phases			2			6			8			4
Detector Phase	5	2	2	1	6	6	3	8	8	7	4	4
Switch Phase												
Minimum Initial (s)	5.0	10.0	10.0	5.0	10.0	10.0	5.0	10.0	10.0	5.0	10.0	10.0
Minimum Split (s)	8.7	43.5	43.5	8.7	15.8	15.8	8.7	16.2	16.2	8.7	40.2	40.2
Total Split (s)	22.0	62.4	62.4	8.7	49.1	49.1	8.7	29.7	29.7	19.2	40.2	40.2
Total Split (%)	18.3%	52.0%	52.0%	7.3%	40.9%	40.9%	7.3%	24.8%	24.8%	16.0%	33.5%	33.5%
Yellow Time (s)	3.2	5.5	5.5	3.2	4.8	4.8	3.2	5.2	5.2	3.2	5.2	5.2
All-Red Time (s)	0.5	1.0	1.0	0.5	1.0	1.0	0.5	1.0	1.0	0.5	1.0	1.0
Lost Time Adjust (s)	0.0	0.0	0.0	0.0	0.0	0.0	0.0	0.0	0.0	0.0	0.0	0.0
Total Lost Time (s)	3.7	6.5	6.5	3.7	5.8	5.8	3.7	6.2	6.2	3.7	6.2	6.2
Lead/Lag	Lead	Lag	Lag	Lead	Lag	Lag	Lead	Lag	Lag	Lead	Lag	Lag
Lead-Lag Optimize?	Yes	Yes	Yes	Yes	Yes	Yes	Yes	Yes	Yes	Yes	Yes	Yes
Recall Mode	None	None	None	None	None	None	None	None	None	None	None	None
Act Effct Green (s)	11.6	36.3	36.3	5.4	22.6	22.6	5.4	12.9	12.9	8.5	19.8	19.8
Actuated g/C Ratio	0.16	0.49	0.49	0.07	0.31	0.31	0.07	0.17	0.17	0.12	0.27	0.27
v/c Ratio	0.55	0.31	0.01	0.09	0.67	0.15	0.11	0.15	0.04	0.41	0.13	0.35
Control Delay	36.2	13.1	0.0	44.4	27.3	0.5	42.8	30.9	0.2	42.4	24.1	6.3
Queue Delay	0.0	0.0	0.0	0.0	0.0	0.0	0.0	0.0	0.0	0.0	0.0	0.0
Total Delay	36.2	13.1	0.0	44.4	27.3	0.5	42.8	30.9	0.2	42.4	24.1	6.3
LOS	D	B	A	D	C	A	D	C	A	D	C	A
Approach Delay		19.3			24.5			29.8			18.9	
Approach LOS		B			C			C			B	

Intersection Summary

Cycle Length: 120
 Actuated Cycle Length: 73.8
 Natural Cycle: 105
 Control Type: Actuated-Uncoordinated
 Maximum v/c Ratio: 0.67
 Intersection Signal Delay: 21.5
 Intersection LOS: C
 Intersection Capacity Utilization 51.5%
 ICU Level of Service A
 Analysis Period (min) 15

Splits and Phases: 34: Old 215 Frontage Rd. & Alessandro Bl.



HCM 6th Signalized Intersection Summary
34: Old 215 Frontage Rd. & Alessandro Bl.

West Campus Upper Plateau (JN 14064)

09/29/2022



Movement	EBL	EBT	EBR	WBL	WBT	WBR	NBL	NBT	NBR	SBL	SBT	SBR
Lane Configurations	↔↔	↑↑↑	↔	↔	↑↑	↔	↔↔	↑↑	↔	↔	↑↑	↔
Traffic Volume (veh/h)	285	748	11	10	688	86	21	88	12	78	108	191
Future Volume (veh/h)	285	748	11	10	688	86	21	88	12	78	108	191
Initial Q (Qb), veh	0	0	0	0	0	0	0	0	0	0	0	0
Ped-Bike Adj(A_pbT)	1.00		1.00	1.00		1.00	1.00		0.99	1.00		1.00
Parking Bus, Adj	1.00	1.00	1.00	1.00	1.00	1.00	1.00	1.00	1.00	1.00	1.00	1.00
Work Zone On Approach		No			No			No			No	
Adj Sat Flow, veh/h/ln	1870	1885	1678	1678	1856	1856	1515	1856	1559	1826	1737	1885
Adj Flow Rate, veh/h	297	779	-16	10	717	0	22	92	2	81	112	0
Peak Hour Factor	0.96	0.96	0.96	0.96	0.96	0.96	0.96	0.96	0.96	0.96	0.96	0.96
Percent Heavy Veh, %	2	1	15	15	3	3	26	3	23	5	11	1
Cap, veh/h	424	2102	581	21	1052		72	594	219	109	678	
Arrive On Green	0.12	0.41	0.00	0.01	0.30	0.00	0.03	0.17	0.17	0.06	0.21	0.00
Sat Flow, veh/h	3456	5147	1422	1598	3526	1572	2799	3526	1302	1739	3300	1598
Grp Volume(v), veh/h	297	779	-16	10	717	0	22	92	2	81	112	0
Grp Sat Flow(s),veh/h/ln	1728	1716	1422	1598	1763	1572	1399	1763	1302	1739	1650	1598
Q Serve(g_s), s	4.8	6.1	0.0	0.4	10.4	0.0	0.4	1.3	0.1	2.6	1.6	0.0
Cycle Q Clear(g_c), s	4.8	6.1	0.0	0.4	10.4	0.0	0.4	1.3	0.1	2.6	1.6	0.0
Prop In Lane	1.00		1.00	1.00		1.00	1.00		1.00	1.00		1.00
Lane Grp Cap(c), veh/h	424	2102	581	21	1052		72	594	219	109	678	
V/C Ratio(X)	0.70	0.37	-0.03	0.49	0.68		0.31	0.15	0.01	0.74	0.17	
Avail Cap(c_a), veh/h	1093	4973	1374	138	2639		242	1432	529	466	1939	
HCM Platoon Ratio	1.00	1.00	1.00	1.00	1.00	1.00	1.00	1.00	1.00	1.00	1.00	1.00
Upstream Filter(I)	1.00	1.00	0.00	1.00	1.00	0.00	1.00	1.00	1.00	1.00	1.00	0.00
Uniform Delay (d), s/veh	24.4	11.9	0.0	28.4	17.9	0.0	27.7	20.5	20.0	26.6	18.9	0.0
Incr Delay (d2), s/veh	0.8	0.1	0.0	6.5	0.8	0.0	0.9	0.1	0.0	3.7	0.1	0.0
Initial Q Delay(d3),s/veh	0.0	0.0	0.0	0.0	0.0	0.0	0.0	0.0	0.0	0.0	0.0	0.0
%ile BackOfQ(50%),veh/ln	1.7	1.7	0.0	0.2	3.6	0.0	0.1	0.5	0.0	1.1	0.5	0.0
Unsig. Movement Delay, s/veh												
LnGrp Delay(d),s/veh	25.1	12.0	0.0	34.9	18.7	0.0	28.6	20.7	20.1	30.3	19.0	0.0
LnGrp LOS	C	B	A	C	B		C	C	C	C	B	
Approach Vol, veh/h		1060			727			116			193	
Approach Delay, s/veh		15.9			18.9			22.1			23.7	
Approach LOS		B			B			C			C	
Timer - Assigned Phs	1	2	3	4	5	6	7	8				
Phs Duration (G+Y+Rc), s	4.4	30.1	5.2	18.1	10.8	23.8	7.3	15.9				
Change Period (Y+Rc), s	3.7	6.5	3.7	6.2	3.7	* 6.5	3.7	6.2				
Max Green Setting (Gmax), s	5.0	55.9	5.0	34.0	18.3	* 43	15.5	23.5				
Max Q Clear Time (g_c+I1), s	2.4	8.1	2.4	3.6	6.8	12.4	4.6	3.3				
Green Ext Time (p_c), s	0.0	5.3	0.0	0.6	0.4	4.9	0.1	0.4				

Intersection Summary

HCM 6th Ctrl Delay	18.0
HCM 6th LOS	B

Notes

* HCM 6th computational engine requires equal clearance times for the phases crossing the barrier.
Unsignalized Delay for [WBR, SBR] is excluded from calculations of the approach delay and intersection delay.

Timings
35: Day St. & Alessandro Bl.

West Campus Upper Plateau (JN 14064)

09/29/2022



Lane Group	EBL	EBT	EBR	WBL	WBT	WBR	NBL	NBT	NBR	SBL	SBT
Lane Configurations	↖	↗↗↗	↖	↖	↗↗	↖	↖	↗	↖	↖	↗
Traffic Volume (vph)	167	581	6	8	611	121	9	83	13	102	41
Future Volume (vph)	167	581	6	8	611	121	9	83	13	102	41
Turn Type	Prot	NA	Perm	Prot	NA	Perm	Perm	NA	Perm	Perm	NA
Protected Phases	5	2		1	6			8			4
Permitted Phases			2			6	8		8	4	
Detector Phase	5	2	2	1	6	6	8	8	8	4	4
Switch Phase											
Minimum Initial (s)	5.0	10.0	10.0	5.0	10.0	10.0	10.0	10.0	10.0	10.0	10.0
Minimum Split (s)	9.1	30.8	30.8	9.1	30.8	30.8	42.4	42.4	42.4	41.6	41.6
Total Split (s)	28.0	67.9	67.9	9.1	49.0	49.0	43.0	43.0	43.0	43.0	43.0
Total Split (%)	23.3%	56.6%	56.6%	7.6%	40.8%	40.8%	35.8%	35.8%	35.8%	35.8%	35.8%
Yellow Time (s)	3.6	4.8	4.8	3.6	4.8	4.8	4.4	4.4	4.4	3.6	3.6
All-Red Time (s)	0.5	1.0	1.0	0.5	1.0	1.0	1.0	1.0	1.0	1.0	1.0
Lost Time Adjust (s)	0.0	0.0	0.0	0.0	0.0	0.0	0.0	0.0	0.0	0.0	0.0
Total Lost Time (s)	4.1	5.8	5.8	4.1	5.8	5.8	5.4	5.4	5.4	4.6	4.6
Lead/Lag	Lead	Lag	Lag	Lead	Lag	Lag					
Lead-Lag Optimize?	Yes	Yes	Yes	Yes	Yes	Yes					
Recall Mode	None	None	None	None	None	None	None	None	None	None	None
Act Effct Green (s)	11.4	33.3	33.3	5.5	18.6	18.6	14.6	14.6	14.6	15.4	15.4
Actuated g/C Ratio	0.19	0.54	0.54	0.09	0.30	0.30	0.24	0.24	0.24	0.25	0.25
v/c Ratio	0.53	0.22	0.01	0.05	0.59	0.23	0.04	0.19	0.03	0.32	0.29
Control Delay	32.3	9.0	0.0	36.6	22.1	8.8	20.8	21.4	0.2	23.3	9.9
Queue Delay	0.0	0.0	0.0	0.0	0.0	0.0	0.0	0.0	0.0	0.0	0.0
Total Delay	32.3	9.0	0.0	36.6	22.1	8.8	20.8	21.4	0.2	23.3	9.9
LOS	C	A	A	D	C	A	C	C	A	C	A
Approach Delay		14.1			20.1			18.6			15.6
Approach LOS		B			C			B			B

Intersection Summary

Cycle Length: 120
 Actuated Cycle Length: 61.3
 Natural Cycle: 85
 Control Type: Actuated-Uncoordinated
 Maximum v/c Ratio: 0.59
 Intersection Signal Delay: 17.0
 Intersection LOS: B
 Intersection Capacity Utilization 50.5%
 ICU Level of Service A
 Analysis Period (min) 15

Splits and Phases: 35: Day St. & Alessandro Bl.



HCM 6th Signalized Intersection Summary
35: Day St. & Alessandro Bl.

West Campus Upper Plateau (JN 14064)

09/29/2022

Movement	EBL	EBT	EBR	WBL	WBT	WBR	NBL	NBT	NBR	SBL	SBT	SBR
Lane Configurations												
Traffic Volume (veh/h)	167	581	6	8	611	121	9	83	13	102	41	96
Future Volume (veh/h)	167	581	6	8	611	121	9	83	13	102	41	96
Initial Q (Qb), veh	0	0	0	0	0	0	0	0	0	0	0	0
Ped-Bike Adj(A_pbT)	1.00		1.00	1.00		0.98	1.00		1.00	1.00		1.00
Parking Bus, Adj	1.00	1.00	1.00	1.00	1.00	1.00	1.00	1.00	1.00	1.00	1.00	1.00
Work Zone On Approach		No			No			No			No	
Adj Sat Flow, veh/h/ln	1885	1870	1618	1900	1870	1900	1500	1900	1767	1885	1870	1870
Adj Flow Rate, veh/h	174	605	0	8	636	58	9	86	9	106	43	69
Peak Hour Factor	0.96	0.96	0.96	0.96	0.96	0.96	0.96	0.96	0.96	0.96	0.96	0.96
Percent Heavy Veh, %	1	2	19	0	2	0	27	0	9	1	2	2
Cap, veh/h	227	2128	572	19	1069	473	337	425	335	409	145	232
Arrive On Green	0.13	0.42	0.00	0.01	0.30	0.30	0.22	0.22	0.22	0.22	0.22	0.22
Sat Flow, veh/h	1795	5106	1372	1810	3554	1574	1027	1900	1497	1311	646	1037
Grp Volume(v), veh/h	174	605	0	8	636	58	9	86	9	106	0	112
Grp Sat Flow(s),veh/h/ln	1795	1702	1372	1810	1777	1574	1027	1900	1497	1311	0	1684
Q Serve(g_s), s	4.1	3.4	0.0	0.2	6.7	1.2	0.3	1.6	0.2	3.1	0.0	2.4
Cycle Q Clear(g_c), s	4.1	3.4	0.0	0.2	6.7	1.2	2.7	1.6	0.2	4.7	0.0	2.4
Prop In Lane	1.00		1.00	1.00		1.00	1.00		1.00	1.00		0.62
Lane Grp Cap(c), veh/h	227	2128	572	19	1069	473	337	425	335	409	0	377
V/C Ratio(X)	0.77	0.28	0.00	0.42	0.59	0.12	0.03	0.20	0.03	0.26	0.00	0.30
Avail Cap(c_a), veh/h	979	7235	1943	206	3503	1551	989	1630	1284	1265	0	1475
HCM Platoon Ratio	1.00	1.00	1.00	1.00	1.00	1.00	1.00	1.00	1.00	1.00	1.00	1.00
Upstream Filter(I)	1.00	1.00	0.00	1.00	1.00	1.00	1.00	1.00	1.00	1.00	0.00	1.00
Uniform Delay (d), s/veh	18.5	8.5	0.0	21.5	13.0	11.1	15.3	13.8	13.3	15.8	0.0	14.1
Incr Delay (d2), s/veh	2.0	0.1	0.0	5.3	0.5	0.1	0.0	0.2	0.0	0.3	0.0	0.4
Initial Q Delay(d3),s/veh	0.0	0.0	0.0	0.0	0.0	0.0	0.0	0.0	0.0	0.0	0.0	0.0
%ile BackOfQ(50%),veh/ln	1.5	0.8	0.0	0.1	2.0	0.3	0.1	0.6	0.1	0.9	0.0	0.9
Unsig. Movement Delay, s/veh												
LnGrp Delay(d),s/veh	20.6	8.5	0.0	26.8	13.6	11.2	15.3	14.1	13.3	16.1	0.0	14.6
LnGrp LOS	C	A	A	C	B	B	B	B	B	B	A	B
Approach Vol, veh/h		779			702			104			218	
Approach Delay, s/veh		11.2			13.5			14.1			15.3	
Approach LOS		B			B			B			B	
Timer - Assigned Phs	1	2		4	5	6		8				
Phs Duration (G+Y+Rc), s	4.6	24.1		15.2	9.6	19.0		15.2				
Change Period (Y+Rc), s	4.1	5.8		* 5.4	4.1	5.8		5.4				
Max Green Setting (Gmax), s	5.0	62.1		* 38	23.9	43.2		37.6				
Max Q Clear Time (g_c+I1), s	2.2	5.4		6.7	6.1	8.7		4.7				
Green Ext Time (p_c), s	0.0	4.2		1.1	0.2	4.5		0.5				

Intersection Summary

HCM 6th Ctrl Delay	12.8
HCM 6th LOS	B

Notes

* HCM 6th computational engine requires equal clearance times for the phases crossing the barrier.

Timings
36: Elsworth St. & Cactus Av.

West Campus Upper Plateau (JN 14064)

09/29/2022



Lane Group	EBL	EBT	EBR	WBL	WBT	WBR	NBL	NBT	SBL	SBT	SBR
Lane Configurations	↘	↑↑↑	↗	↘	↑↑↑	↗	↘	↕	↘	↗	↗
Traffic Volume (vph)	135	941	27	12	940	116	19	10	139	15	114
Future Volume (vph)	135	941	27	12	940	116	19	10	139	15	114
Turn Type	Prot	NA	Perm	Prot	NA	Perm	Split	NA	Split	NA	pm+ov
Protected Phases	5	2		1	6		8	8	4	4	5
Permitted Phases			2			6					4
Detector Phase	5	2	2	1	6	6	8	8	4	4	5
Switch Phase											
Minimum Initial (s)	5.0	10.0	10.0	5.0	10.0	10.0	10.0	10.0	10.0	10.0	5.0
Minimum Split (s)	9.6	36.2	36.2	9.6	36.2	36.2	35.4	35.4	35.4	35.4	9.6
Total Split (s)	16.5	49.6	49.6	9.6	42.7	42.7	35.4	35.4	35.4	35.4	16.5
Total Split (%)	12.7%	38.2%	38.2%	7.4%	32.8%	32.8%	27.2%	27.2%	27.2%	27.2%	12.7%
Yellow Time (s)	3.6	5.2	5.2	3.6	5.2	5.2	4.4	4.4	4.4	4.4	3.6
All-Red Time (s)	1.0	1.0	1.0	1.0	1.0	1.0	1.0	1.0	1.0	1.0	1.0
Lost Time Adjust (s)	0.0	0.0	0.0	0.0	0.0	0.0	0.0	0.0	0.0	0.0	0.0
Total Lost Time (s)	4.6	6.2	6.2	4.6	6.2	6.2	5.4	5.4	5.4	5.4	4.6
Lead/Lag	Lead	Lag	Lag	Lead	Lag	Lag					Lead
Lead-Lag Optimize?	Yes	Yes	Yes	Yes	Yes	Yes					Yes
Recall Mode	None	None	None	None	None	None	Max	Max	Max	Max	None
Act Effct Green (s)	11.7	44.7	44.7	5.0	32.1	32.1	30.0	30.0	30.0	30.0	42.6
Actuated g/C Ratio	0.09	0.36	0.36	0.04	0.26	0.26	0.24	0.24	0.24	0.24	0.34
v/c Ratio	0.88	0.56	0.05	0.18	0.78	0.24	0.04	0.05	0.20	0.20	0.19
Control Delay	101.5	34.4	0.1	66.1	48.0	4.8	38.9	28.4	40.9	41.0	3.4
Queue Delay	0.0	0.0	0.0	0.0	0.0	0.0	0.0	0.0	0.0	0.0	0.0
Total Delay	101.5	34.4	0.1	66.1	48.0	4.8	38.9	28.4	40.9	41.0	3.4
LOS	F	C	A	E	D	A	D	C	D	D	A
Approach Delay		41.8			43.5			33.2		25.0	
Approach LOS		D			D			C		C	

Intersection Summary

Cycle Length: 130
 Actuated Cycle Length: 125.5
 Natural Cycle: 120
 Control Type: Actuated-Uncoordinated
 Maximum v/c Ratio: 0.88
 Intersection Signal Delay: 40.6
 Intersection LOS: D
 Intersection Capacity Utilization 50.1%
 ICU Level of Service A
 Analysis Period (min) 15

Splits and Phases: 36: Elsworth St. & Cactus Av.

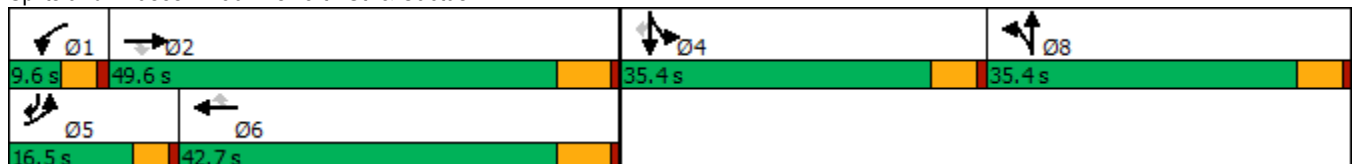

HCM 6th Signalized Intersection Summary
36: Elsworth St. & Cactus Av.

West Campus Upper Plateau (JN 14064)

09/29/2022



Movement	EBL	EBT	EBR	WBL	WBT	WBR	NBL	NBT	NBR	SBL	SBT	SBR
Lane Configurations	↗	↑↑↑	↖	↖	↑↑↑	↖	↖	↕		↖	↗	↖
Traffic Volume (veh/h)	135	941	27	12	940	116	19	10	8	139	15	114
Future Volume (veh/h)	135	941	27	12	940	116	19	10	8	139	15	114
Initial Q (Qb), veh	0	0	0	0	0	0	0	0	0	0	0	0
Ped-Bike Adj(A_pbT)	1.00		1.00	1.00		1.00	1.00		1.00	1.00		1.00
Parking Bus, Adj	1.00	1.00	1.00	1.00	1.00	1.00	1.00	1.00	1.00	1.00	1.00	1.00
Work Zone On Approach		No			No			No			No	
Adj Sat Flow, veh/h/ln	1841	1841	1781	1900	1841	1885	1885	1900	1885	1885	1900	1885
Adj Flow Rate, veh/h	142	991	0	13	989	85	13	0	0	157	0	12
Peak Hour Factor	0.95	0.95	0.95	0.95	0.95	0.95	0.95	0.95	0.95	0.95	0.95	0.95
Percent Heavy Veh, %	4	4	8	0	4	1	1	0	1	1	0	1
Cap, veh/h	167	1621		26	1216	387	875	463	0	875	0	541
Arrive On Green	0.10	0.32	0.00	0.01	0.24	0.24	0.24	0.00	0.00	0.24	0.00	0.24
Sat Flow, veh/h	1753	5025	1510	1810	5025	1598	3591	1900	0	3591	0	1598
Grp Volume(v), veh/h	142	991	0	13	989	85	13	0	0	157	0	12
Grp Sat Flow(s),veh/h/ln	1753	1675	1510	1810	1675	1598	1795	1900	0	1795	0	1598
Q Serve(g_s), s	9.8	20.5	0.0	0.9	22.9	5.2	0.3	0.0	0.0	4.3	0.0	0.6
Cycle Q Clear(g_c), s	9.8	20.5	0.0	0.9	22.9	5.2	0.3	0.0	0.0	4.3	0.0	0.6
Prop In Lane	1.00		1.00	1.00		1.00	1.00		0.00	1.00		1.00
Lane Grp Cap(c), veh/h	167	1621		26	1216	387	875	463	0	875	0	541
V/C Ratio(X)	0.85	0.61		0.49	0.81	0.22	0.01	0.00	0.00	0.18	0.00	0.02
Avail Cap(c_a), veh/h	169	1771		73	1490	474	875	463	0	875	0	541
HCM Platoon Ratio	1.00	1.00	1.00	1.00	1.00	1.00	1.00	1.00	1.00	1.00	1.00	1.00
Upstream Filter(I)	1.00	1.00	0.00	1.00	1.00	1.00	1.00	0.00	0.00	1.00	0.00	1.00
Uniform Delay (d), s/veh	54.8	35.2	0.0	60.2	44.0	37.4	35.3	0.0	0.0	36.8	0.0	27.1
Incr Delay (d2), s/veh	29.8	0.5	0.0	5.2	2.9	0.3	0.0	0.0	0.0	0.4	0.0	0.1
Initial Q Delay(d3),s/veh	0.0	0.0	0.0	0.0	0.0	0.0	0.0	0.0	0.0	0.0	0.0	0.0
%ile BackOfQ(50%),veh/ln	5.6	8.0	0.0	0.4	9.4	2.0	0.2	0.0	0.0	1.9	0.0	0.3
Unsig. Movement Delay, s/veh												
LnGrp Delay(d),s/veh	84.6	35.7	0.0	65.4	47.0	37.6	35.4	0.0	0.0	37.3	0.0	27.2
LnGrp LOS	F	D		E	D	D	D	A	A	D	A	C
Approach Vol, veh/h		1133			1087			13				169
Approach Delay, s/veh		41.9			46.5			35.4				36.6
Approach LOS		D			D			D				D
Timer - Assigned Phs	1	2		4	5	6		8				
Phs Duration (G+Y+Rc), s	6.4	45.9		35.4	16.3	36.0		35.4				
Change Period (Y+Rc), s	4.6	6.2		5.4	4.6	6.2		5.4				
Max Green Setting (Gmax), s	5.0	43.4		30.0	11.9	36.5		30.0				
Max Q Clear Time (g_c+I1), s	2.9	22.5		6.3	11.8	24.9		2.3				
Green Ext Time (p_c), s	0.0	6.3		0.5	0.0	4.9		0.0				

Intersection Summary

HCM 6th Ctrl Delay	43.5
HCM 6th LOS	D

Notes

- User approved pedestrian interval to be less than phase max green.
- User approved volume balancing among the lanes for turning movement.
- Unsignalized Delay for [EBR] is excluded from calculations of the approach delay and intersection delay.

Timings
37: Cactus Av. & Frederick St.

West Campus Upper Plateau (JN 14064)

09/29/2022

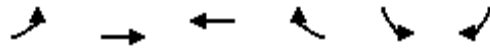

Lane Group	EBL	EBT	WBT	WBR	SBL	SBR
Lane Configurations	↗	↑↑↑	↑↑↑	↗	↘↘	↘
Traffic Volume (vph)	92	1020	1025	144	229	75
Future Volume (vph)	92	1020	1025	144	229	75
Turn Type	Prot	NA	NA	pm+ov	Prot	pm+ov
Protected Phases	5	2	6	4	4	5
Permitted Phases				6		4
Detector Phase	5	2	6	4	4	5
Switch Phase						
Minimum Initial (s)	5.0	10.0	10.0	10.0	10.0	5.0
Minimum Split (s)	9.2	28.2	29.2	36.4	36.4	9.2
Total Split (s)	31.0	81.0	50.0	39.0	39.0	31.0
Total Split (%)	25.8%	67.5%	41.7%	32.5%	32.5%	25.8%
Yellow Time (s)	3.2	5.2	5.2	4.4	4.4	3.2
All-Red Time (s)	1.0	1.0	1.0	1.0	1.0	1.0
Lost Time Adjust (s)	0.0	0.0	0.0	0.0	0.0	0.0
Total Lost Time (s)	4.2	6.2	6.2	5.4	5.4	4.2
Lead/Lag	Lead		Lag			Lead
Lead-Lag Optimize?	Yes		Yes			Yes
Recall Mode	None	None	None	None	None	None
Act Effct Green (s)	8.9	33.1	22.7	37.6	14.0	28.9
Actuated g/C Ratio	0.15	0.55	0.38	0.63	0.23	0.48
v/c Ratio	0.39	0.40	0.58	0.15	0.31	0.11
Control Delay	32.7	8.2	17.7	1.0	22.1	9.0
Queue Delay	0.0	0.0	0.0	0.0	0.0	0.0
Total Delay	32.7	8.2	17.7	1.0	22.1	9.0
LOS	C	A	B	A	C	A
Approach Delay		10.2	15.6		18.8	
Approach LOS		B	B		B	

Intersection Summary

Cycle Length: 120
 Actuated Cycle Length: 59.9
 Natural Cycle: 75
 Control Type: Actuated-Uncoordinated
 Maximum v/c Ratio: 0.58
 Intersection Signal Delay: 13.7
 Intersection LOS: B
 Intersection Capacity Utilization 46.4%
 ICU Level of Service A
 Analysis Period (min) 15

Splits and Phases: 37: Cactus Av. & Frederick St.



HCM 6th Signalized Intersection Summary
37: Cactus Av. & Frederick St.

West Campus Upper Plateau (JN 14064)
09/29/2022



Movement	EBL	EBT	WBT	WBR	SBL	SBR
Lane Configurations						
Traffic Volume (veh/h)	92	1020	1025	144	229	75
Future Volume (veh/h)	92	1020	1025	144	229	75
Initial Q (Qb), veh	0	0	0	0	0	0
Ped-Bike Adj(A_pbT)	1.00			0.98	1.00	1.00
Parking Bus, Adj	1.00	1.00	1.00	1.00	1.00	1.00
Work Zone On Approach		No	No		No	
Adj Sat Flow, veh/h/ln	1826	1856	1856	1870	1856	1856
Adj Flow Rate, veh/h	100	1109	1114	93	249	-18
Peak Hour Factor	0.92	0.92	0.92	0.92	0.92	0.92
Percent Heavy Veh, %	5	3	3	2	3	3
Cap, veh/h	133	2833	2000	926	682	434
Arrive On Green	0.08	0.56	0.39	0.39	0.20	0.00
Sat Flow, veh/h	1739	5233	5233	1547	3428	1572
Grp Volume(v), veh/h	100	1109	1114	93	249	-18
Grp Sat Flow(s),veh/h/ln	1739	1689	1689	1547	1714	1572
Q Serve(g_s), s	2.7	5.9	8.2	1.2	3.0	0.0
Cycle Q Clear(g_c), s	2.7	5.9	8.2	1.2	3.0	0.0
Prop In Lane	1.00			1.00	1.00	1.00
Lane Grp Cap(c), veh/h	133	2833	2000	926	682	434
V/C Ratio(X)	0.75	0.39	0.56	0.10	0.37	-0.04
Avail Cap(c_a), veh/h	972	7902	4627	1729	2402	1223
HCM Platoon Ratio	1.00	1.00	1.00	1.00	1.00	1.00
Upstream Filter(I)	1.00	1.00	1.00	1.00	1.00	0.00
Uniform Delay (d), s/veh	21.7	6.0	11.3	4.2	16.6	0.0
Incr Delay (d2), s/veh	3.1	0.1	0.2	0.0	0.3	0.0
Initial Q Delay(d3),s/veh	0.0	0.0	0.0	0.0	0.0	0.0
%ile BackOfQ(50%),veh/ln	1.0	1.0	2.1	0.4	1.0	0.0
Unsig. Movement Delay, s/veh						
LnGrp Delay(d),s/veh	24.8	6.1	11.5	4.3	16.9	0.0
LnGrp LOS	C	A	B	A	B	A
Approach Vol, veh/h		1209	1207		231	
Approach Delay, s/veh		7.6	10.9		18.2	
Approach LOS		A	B		B	
Timer - Assigned Phs		2		4	5	6
Phs Duration (G+Y+Rc), s		33.0		14.9	7.9	25.1
Change Period (Y+Rc), s		6.2		5.4	* 4.2	6.2
Max Green Setting (Gmax), s		74.8		33.6	* 27	43.8
Max Q Clear Time (g_c+I1), s		7.9		5.0	4.7	10.2
Green Ext Time (p_c), s		8.9		0.8	0.1	8.8

Intersection Summary

HCM 6th Ctrl Delay	10.1
HCM 6th LOS	B

Notes

* HCM 6th computational engine requires equal clearance times for the phases crossing the barrier.

Timings
38: Riverside Dr./Graham St. & Cactus Av.

West Campus Upper Plateau (JN 14064)

09/29/2022

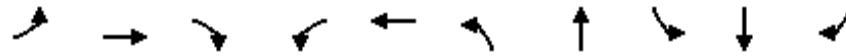

Lane Group	EBL	EBT	EBR	WBL	WBT	NBL	NBT	SBL	SBT	SBR
Lane Configurations	↘	↑↑↑	↗	↘	↑↑↑	↘↗	↑↗	↘	↑↑	↗
Traffic Volume (vph)	49	955	151	17	992	137	40	56	51	61
Future Volume (vph)	49	955	151	17	992	137	40	56	51	61
Turn Type	Prot	NA	Perm	Prot	NA	Prot	NA	Prot	NA	Perm
Protected Phases	7	4		3	8	5	2	1	6	
Permitted Phases			4							6
Detector Phase	7	4	4	3	8	5	2	1	6	6
Switch Phase										
Minimum Initial (s)	5.0	10.0	10.0	5.0	10.0	5.0	10.0	5.0	10.0	10.0
Minimum Split (s)	9.6	39.2	39.2	9.6	39.2	10.4	35.0	9.6	40.6	40.6
Total Split (s)	16.0	59.0	59.0	9.6	52.6	10.4	36.0	15.4	41.0	41.0
Total Split (%)	13.3%	49.2%	49.2%	8.0%	43.8%	8.7%	30.0%	12.8%	34.2%	34.2%
Yellow Time (s)	3.6	5.2	5.2	3.6	5.2	4.4	4.0	3.6	3.6	3.6
All-Red Time (s)	1.0	1.0	1.0	1.0	1.0	1.0	1.0	1.0	1.0	1.0
Lost Time Adjust (s)	0.0	0.0	0.0	0.0	0.0	0.0	0.0	0.0	0.0	0.0
Total Lost Time (s)	4.6	6.2	6.2	4.6	6.2	5.4	5.0	4.6	4.6	4.6
Lead/Lag	Lead	Lag	Lag	Lead	Lag	Lead	Lag	Lead	Lag	Lag
Lead-Lag Optimize?	Yes	Yes	Yes	Yes	Yes	Yes	Yes	Yes	Yes	Yes
Recall Mode	None	Min	Min	None	Min	None	None	None	None	None
Act Effct Green (s)	7.2	33.0	33.0	5.4	27.5	6.8	16.2	7.4	15.0	15.0
Actuated g/C Ratio	0.10	0.48	0.48	0.08	0.40	0.10	0.23	0.11	0.22	0.22
v/c Ratio	0.28	0.42	0.19	0.13	0.55	0.41	0.07	0.31	0.07	0.14
Control Delay	39.8	14.5	3.8	42.5	20.3	41.5	21.4	40.0	24.3	0.6
Queue Delay	0.0	0.0	0.0	0.0	0.0	0.0	0.0	0.0	0.0	0.0
Total Delay	39.8	14.5	3.8	42.5	20.3	41.5	21.4	40.0	24.3	0.6
LOS	D	B	A	D	C	D	C	D	C	A
Approach Delay		14.2			20.6		35.9		21.0	
Approach LOS		B			C		D		C	

Intersection Summary

Cycle Length: 120
 Actuated Cycle Length: 69.4
 Natural Cycle: 100
 Control Type: Actuated-Uncoordinated
 Maximum v/c Ratio: 0.55
 Intersection Signal Delay: 18.9
 Intersection LOS: B
 Intersection Capacity Utilization 48.3%
 ICU Level of Service A
 Analysis Period (min) 15

Splits and Phases: 38: Riverside Dr./Graham St. & Cactus Av.

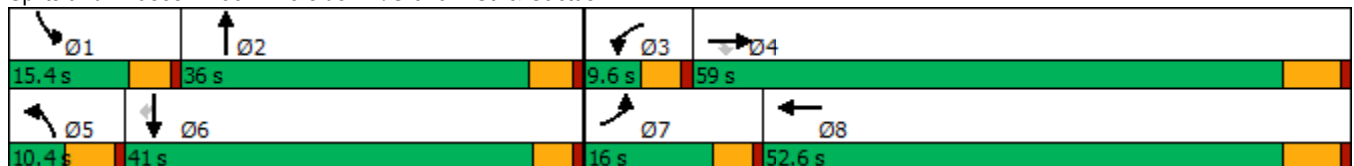

HCM 6th Signalized Intersection Summary
38: Riverside Dr./Graham St. & Cactus Av.

West Campus Upper Plateau (JN 14064)

09/29/2022



Movement	EBL	EBT	EBR	WBL	WBT	WBR	NBL	NBT	NBR	SBL	SBT	SBR
Lane Configurations	↘	↑↑↑	↗	↘	↑↑↑		↘↗	↑↗		↘	↑↑	↗
Traffic Volume (veh/h)	49	955	151	17	992	56	137	40	14	56	51	61
Future Volume (veh/h)	49	955	151	17	992	56	137	40	14	56	51	61
Initial Q (Qb), veh	0	0	0	0	0	0	0	0	0	0	0	0
Ped-Bike Adj(A_pbT)	1.00		1.00	1.00		0.99	1.00		1.00	1.00		1.00
Parking Bus, Adj	1.00	1.00	1.00	1.00	1.00	1.00	1.00	1.00	1.00	1.00	1.00	1.00
Work Zone On Approach		No			No			No			No	
Adj Sat Flow, veh/h/ln	1841	1841	1885	1900	1841	1900	1900	1900	1900	1870	1885	1826
Adj Flow Rate, veh/h	51	985	111	18	1023	50	141	41	13	58	53	-11
Peak Hour Factor	0.97	0.97	0.97	0.97	0.97	0.97	0.97	0.97	0.97	0.97	0.97	0.97
Percent Heavy Veh, %	4	4	1	0	4	0	0	0	0	2	1	5
Cap, veh/h	85	1839	585	39	1663	81	276	547	165	94	575	248
Arrive On Green	0.05	0.37	0.37	0.02	0.34	0.34	0.08	0.20	0.20	0.05	0.16	0.00
Sat Flow, veh/h	1753	5025	1598	1810	4905	239	3510	2731	826	1781	3582	1547
Grp Volume(v), veh/h	51	985	111	18	698	375	141	26	28	58	53	-11
Grp Sat Flow(s),veh/h/ln	1753	1675	1598	1810	1675	1794	1755	1805	1751	1781	1791	1547
Q Serve(g_s), s	1.6	8.8	2.7	0.6	9.9	9.9	2.2	0.7	0.7	1.8	0.7	0.0
Cycle Q Clear(g_c), s	1.6	8.8	2.7	0.6	9.9	9.9	2.2	0.7	0.7	1.8	0.7	0.0
Prop In Lane	1.00		1.00	1.00		0.13	1.00		0.47	1.00		1.00
Lane Grp Cap(c), veh/h	85	1839	585	39	1136	608	276	362	351	94	575	248
V/C Ratio(X)	0.60	0.54	0.19	0.46	0.61	0.62	0.51	0.07	0.08	0.62	0.09	-0.04
Avail Cap(c_a), veh/h	352	4672	1485	159	2737	1465	309	985	956	339	2296	992
HCM Platoon Ratio	1.00	1.00	1.00	1.00	1.00	1.00	1.00	1.00	1.00	1.00	1.00	1.00
Upstream Filter(I)	1.00	1.00	1.00	1.00	1.00	1.00	1.00	1.00	1.00	1.00	1.00	0.00
Uniform Delay (d), s/veh	26.5	14.2	12.3	27.4	15.7	15.7	25.1	18.4	18.4	26.3	20.3	0.0
Incr Delay (d2), s/veh	2.5	0.2	0.2	3.0	0.5	1.0	0.5	0.1	0.1	2.4	0.1	0.0
Initial Q Delay(d3),s/veh	0.0	0.0	0.0	0.0	0.0	0.0	0.0	0.0	0.0	0.0	0.0	0.0
%ile BackOfQ(50%),veh/ln	0.6	2.6	0.8	0.2	3.0	3.3	0.9	0.3	0.3	0.8	0.3	0.0
Unsig. Movement Delay, s/veh												
LnGrp Delay(d),s/veh	29.0	14.4	12.4	30.5	16.2	16.7	25.7	18.5	18.5	28.8	20.4	0.0
LnGrp LOS	C	B	B	C	B	B	C	B	B	C	C	A
Approach Vol, veh/h		1147			1091			195			100	
Approach Delay, s/veh		14.9			16.6			23.7			27.5	
Approach LOS		B			B			C			C	
Timer - Assigned Phs	1	2	3	4	5	6	7	8				
Phs Duration (G+Y+Rc), s	7.6	16.4	5.8	27.0	9.9	14.1	7.4	25.5				
Change Period (Y+Rc), s	4.6	5.0	4.6	6.2	5.4	* 5	4.6	6.2				
Max Green Setting (Gmax), s	10.8	31.0	5.0	52.8	5.0	* 36	11.4	46.4				
Max Q Clear Time (g_c+I1), s	3.8	2.7	2.6	10.8	4.2	2.7	3.6	11.9				
Green Ext Time (p_c), s	0.0	0.2	0.0	7.8	0.0	0.2	0.0	7.3				

Intersection Summary

HCM 6th Ctrl Delay	16.8
HCM 6th LOS	B

Notes

* HCM 6th computational engine requires equal clearance times for the phases crossing the barrier.

APPENDIX 5.2:

E+P CONDITIONS TRAFFIC SIGNAL WARRANT ANALYSIS WORKSHEETS

This Page Intentionally Left Blank

Figure 4C-3. Warrant 3, Peak Hour

Traffic Conditions = **Existing + Project (2021) Conditions - Weekday AM Peak Hour**

Major Street Name = **Grove Community Dr.** Total of Both Approaches (VPH) = **561**
 Number of Approach Lanes on Major Street = **1**

Minor Street Name = **Deercreek Dr.** High Volume Approach (VPH) = **234**
 Number of Approach Lanes On Minor Street = **1**

SIGNAL WARRANT NOT SATISFIED

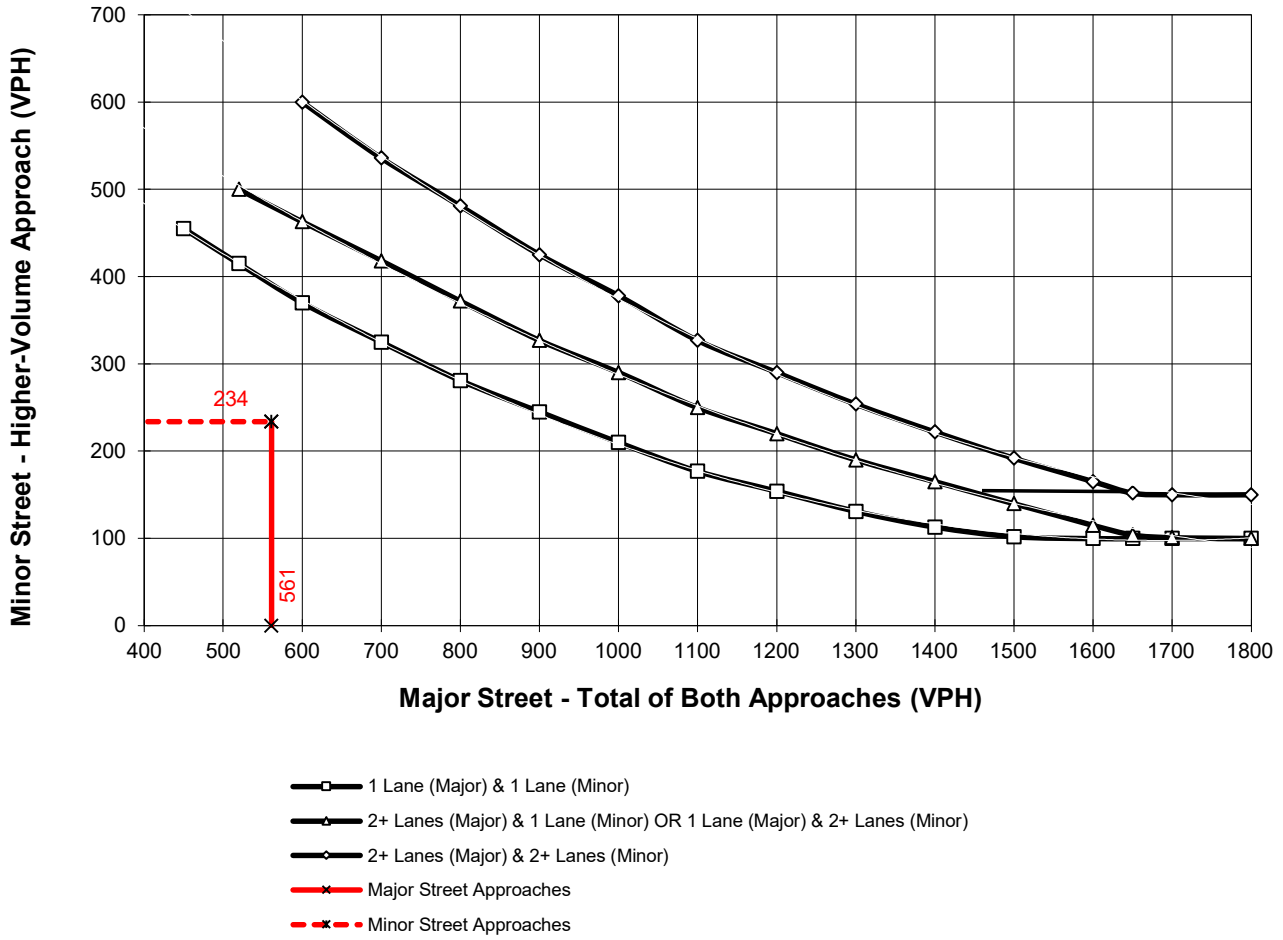

*Note: 150 vph applies as the lower threshold for a minor-street approach with two or more lanes and 100 vph applies as the lower threshold for a minor-street approach with one lane



Figure 4C-3. Warrant 3, Peak Hour

Traffic Conditions = **Existing + Project (2021) Conditions - Weekday PM Peak Hour**

Major Street Name = **Grove Community Dr.** Total of Both Approaches (VPH) = **413**
 Number of Approach Lanes on Major Street = **1**

Minor Street Name = **Barton Rd.** High Volume Approach (VPH) = **53**
 Number of Approach Lanes On Minor Street = **1**

SIGNAL WARRANT NOT SATISFIED

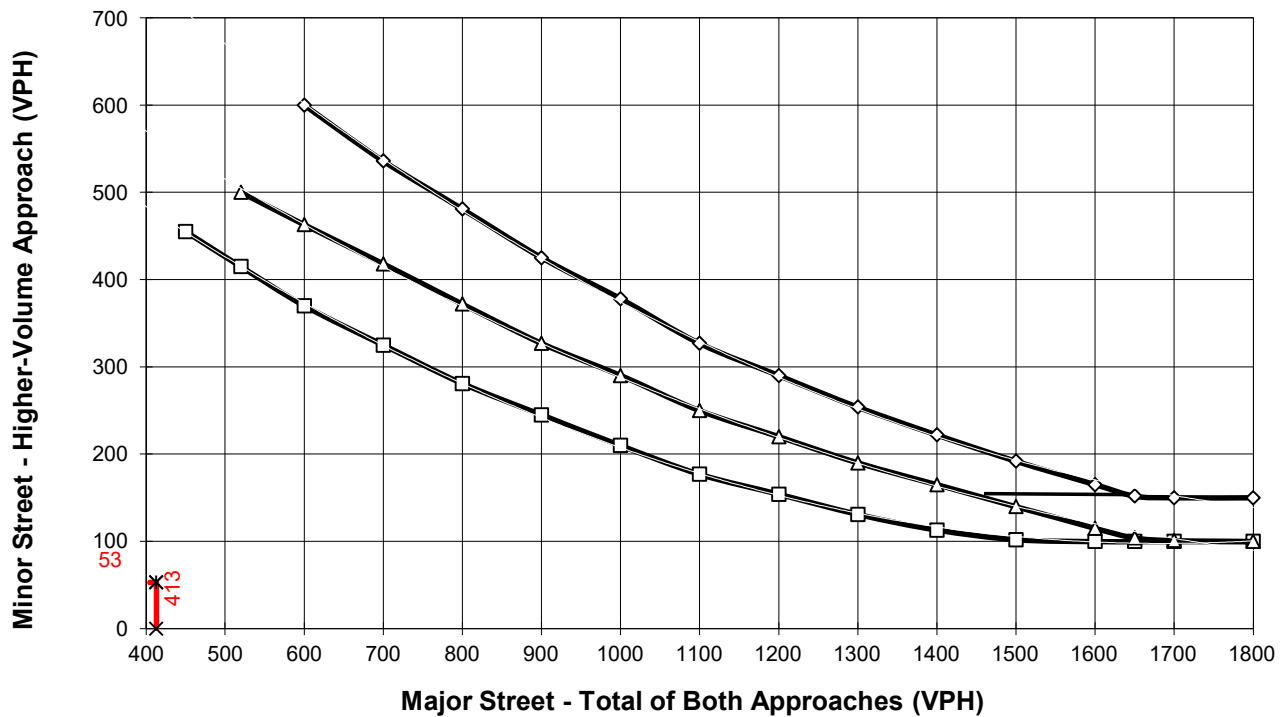

- 1 Lane (Major) & 1 Lane (Minor)
- △— 2+ Lanes (Major) & 1 Lane (Minor) OR 1 Lane (Major) & 2+ Lanes (Minor)
- ◇— 2+ Lanes (Major) & 2+ Lanes (Minor)
- x— Major Street Approaches
- x— Minor Street Approaches

*Note: 150 vph applies as the lower threshold for a minor-street approach with two or more lanes and 100 vph applies as the lower threshold for a minor-street approach with one lane

Figure 4C-103 (CA). Traffic Signal Warrants Worksheet (Average Traffic Estimate Form)

<u>DIST</u>	<u>CO</u>	<u>RTE</u>	<u>PM</u>	CALC <u>MT</u>	TRAFFIC CONDITIONS	<u>E+P</u>
Jurisdiction: <u>City of Riverside</u>				CHK <u>MT</u>		DATE <u>02/17/22</u>
Major Street: <u>Cactus Av.</u>					Critical Approach Speed (Major)	<u>25</u> mph
Minor Street: <u>Airman Dr.</u>					Critical Approach Speed (Minor)	<u>25</u> mph
Major Street Approach Lanes =			<u>1</u>	lane	Minor Street Approach Lanes =	<u>1</u>
Major Street Future ADT =			<u>14,455</u>	vpd	Minor Street Future ADT =	<u>14,455</u>
Speed limit or critical speed on major street traffic > 64 km/h (40 mph);						<input type="checkbox"/>
						or
In built up area of isolated community of < 10,000 population						<input type="checkbox"/>
						URBAN (U)

(Based on Estimated Average Daily Traffic - See Note)

<u>URBAN</u>	<u>RURAL</u>	Minimum Requirements EADT			
XX					
CONDITION A - Minimum Vehicular Volume		Vehicles Per Day on Major Street (Total of Both Approaches)		Vehicles Per Day on Higher-Volume Minor Street Approach (One Direction Only)	
<u>Satisfied</u>	<u>Not Satisfied</u>				
XX		<u>Urban</u>	<u>Rural</u>	<u>Urban</u>	<u>Rural</u>
Number of lanes for moving traffic on each approach					
<u>Major Street</u>	<u>Minor Street</u>				
1 14,455	1 14,455	8,000 *	5,600	2,400 *	1,680
2 +	1	9,600	6,720	2,400	1,680
2 +	2 +	9,600	6,720	3,200	2,240
1	2 +	8,000	5,600	3,200	2,240
CONDITION B - Interruption of Continuous Traffic		Vehicles Per Day on Major Street (Total of Both Approaches)		Vehicles Per Day on Higher-Volume Minor Street Approach (One Direction Only)	
<u>Satisfied</u>	<u>Not Satisfied</u>				
XX		<u>Urban</u>	<u>Rural</u>	<u>Urban</u>	<u>Rural</u>
Number of lanes for moving traffic on each approach					
<u>Major Street</u>	<u>Minor Street</u>				
1 14,455	1 14,455	12,000 *	8,400	1,200 *	850
2 +	1	14,400	10,080	1,200	850
2 +	2 +	14,400	10,080	1,600	1,120
1	2 +	12,000	8,400	1,600	1,120
Combination of CONDITIONS A + B		2 CONDITIONS 80%		2 CONDITIONS 80%	
<u>Satisfied</u>	<u>Not Satisfied</u>				
XX					
No one condition satisfied, but following conditions fulfilled 80% of more					
	<u>A</u>				
	100%				
	<u>B</u>				
	100%				

Note: To be used only for NEW INTERSECTIONS or other locations where it is not reasonable to count actual traffic volumes.

The satisfaction of a traffic signal warrant or warrants shall not in itself require the installation of a traffic control signal.



Figure 4C-3. Warrant 3, Peak Hour

Traffic Conditions = **Existing + Project (2021) Conditions - Weekday AM Peak Hour**

Major Street Name = **Grove Community Dr.** Total of Both Approaches (VPH) = **441**
 Number of Approach Lanes on Major Street = **1**

Minor Street Name = **Abrams Dr** High Volume Approach (VPH) = **196**
 Number of Approach Lanes On Minor Street = **1**

SIGNAL WARRANT NOT SATISFIED

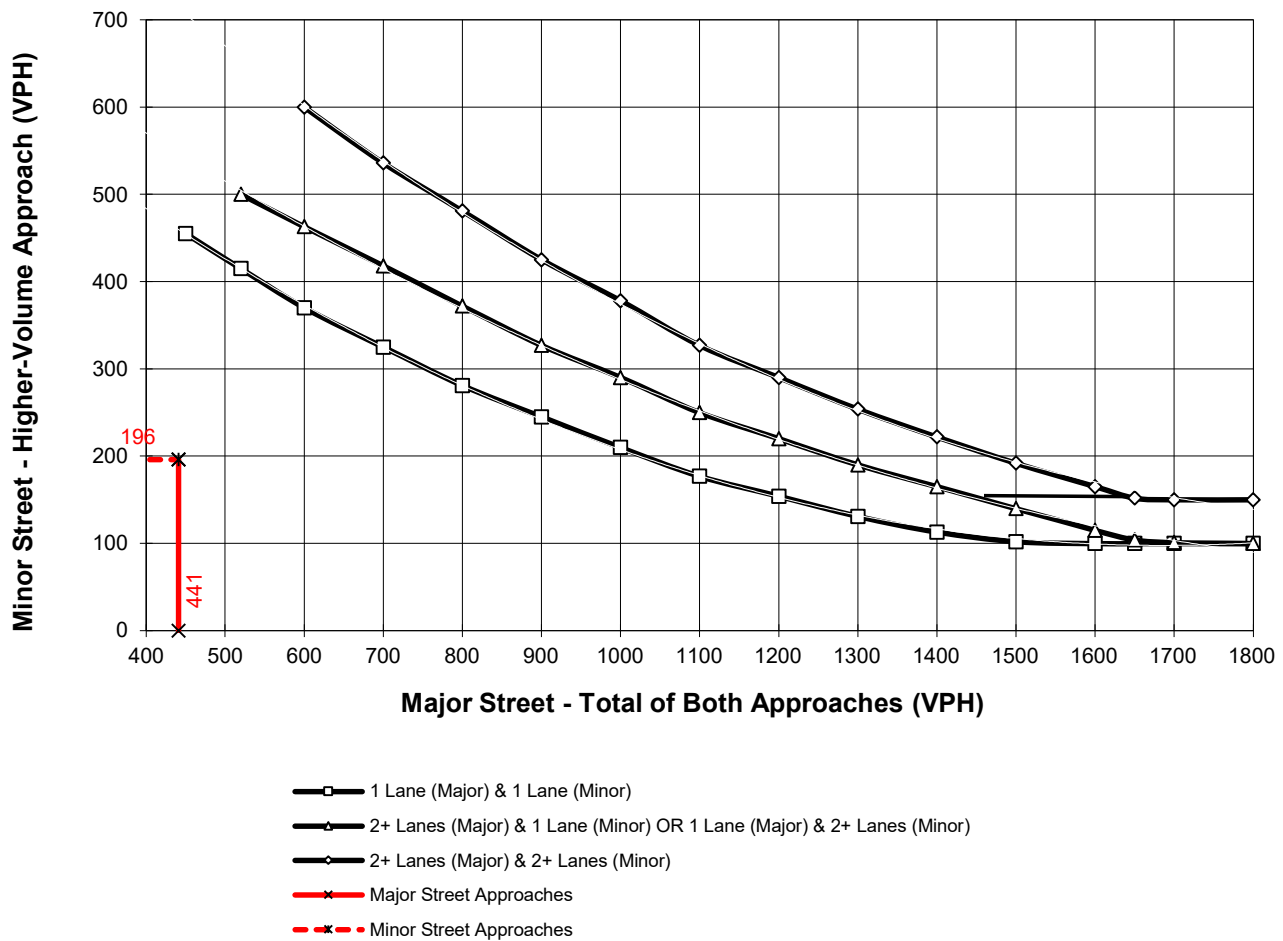

*Note: 150 vph applies as the lower threshold for a minor-street approach with two or more lanes and 100 vph applies as the lower threshold for a minor-street approach with one lane

Figure 4C-3. Warrant 3, Peak Hour

Traffic Conditions = Existing + Project (2021) Conditions - Weekday AM Peak Hour

Major Street Name = Orange Terrace Pkwy Total of Both Approaches (VPH) = 661
 Number of Approach Lanes on Major Street = 1

Minor Street Name = Abrams Dr. High Volume Approach (VPH) = 177
 Number of Approach Lanes On Minor Street = 1

SIGNAL WARRANT NOT SATISFIED

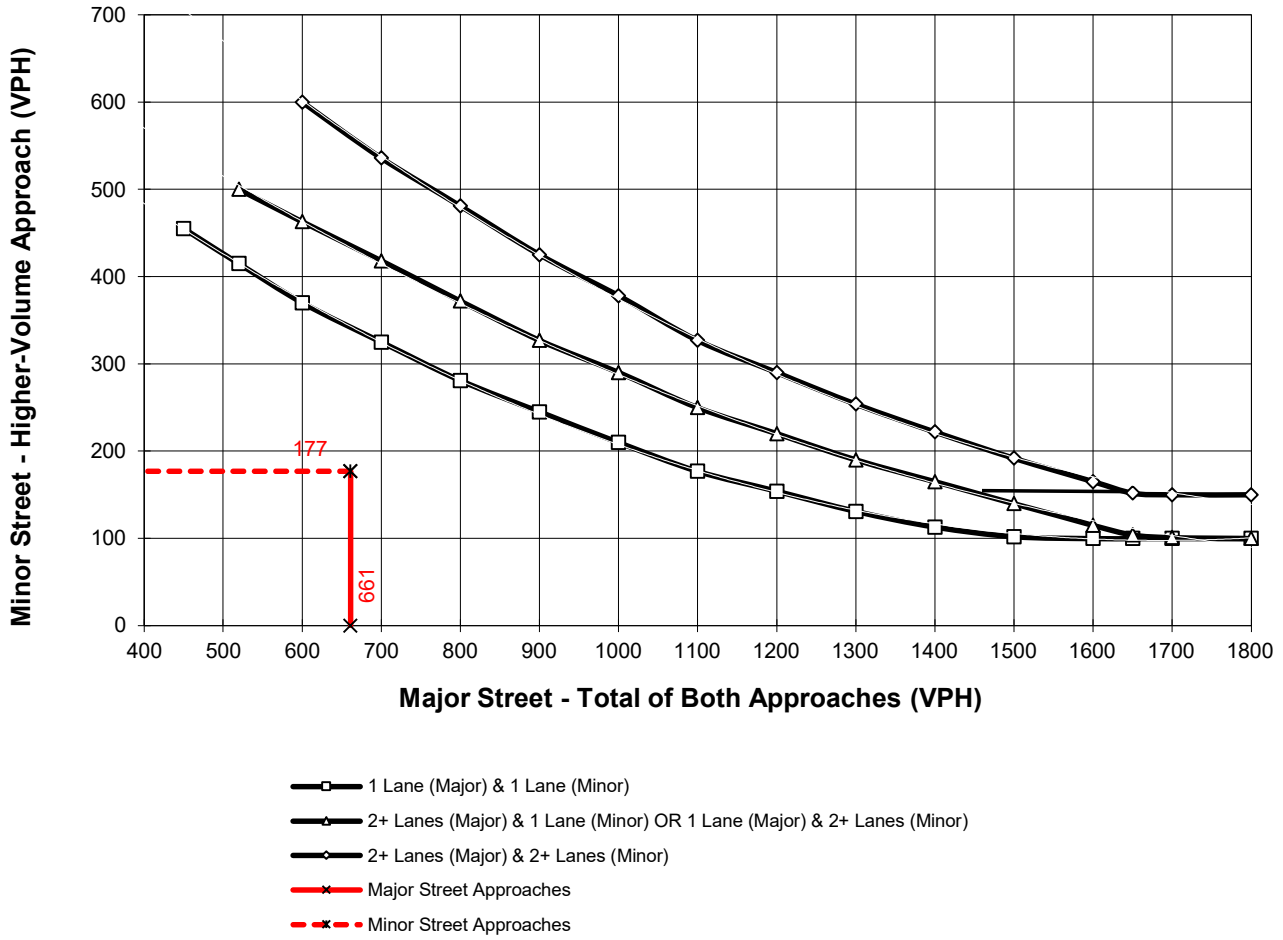

*Note: 150 vph applies as the lower threshold for a minor-street approach with two or more lanes and 100 vph applies as the lower threshold for a minor-street approach with one lane



Figure 4C-103 (CA). Traffic Signal Warrants Worksheet (Average Traffic Estimate Form)

<u>DIST</u>	<u>CO</u>	<u>RTE</u>	<u>PM</u>	CALC <u>MT</u>	TRAFFIC CONDITIONS	<u>E+P</u>
Jurisdiction: <u>City of Riverside</u>				CHK <u>MT</u>		DATE <u>02/17/22</u>
Major Street: <u>Cactus Av.</u>					Critical Approach Speed (Major)	<u>25</u> mph
Minor Street: <u>Linebacker Dr.</u>					Critical Approach Speed (Minor)	<u>25</u> mph
Major Street Approach Lanes =			<u>1</u>	lane	Minor Street Approach Lanes =	<u>1</u>
Major Street Future ADT =			<u>36,129</u>	vpd	Minor Street Future ADT =	<u>7,217</u>
Speed limit or critical speed on major street traffic > 64 km/h (40 mph);						<input type="checkbox"/>
						or
In built up area of isolated community of < 10,000 population						<input type="checkbox"/>

URBAN (U)

(Based on Estimated Average Daily Traffic - See Note)

<u>URBAN</u>	<u>RURAL</u>	Minimum Requirements EADT			
XX		Vehicles Per Day on Major Street (Total of Both Approaches)		Vehicles Per Day on Higher-Volume Minor Street Approach (One Direction Only)	
CONDITION A - Minimum Vehicular Volume					
<u>Satisfied</u>	<u>Not Satisfied</u>	<u>Urban</u>	<u>Rural</u>	<u>Urban</u>	<u>Rural</u>
XX					
Number of lanes for moving traffic on each approach					
<u>Major Street</u>	<u>Minor Street</u>				
1 36,129	1 7,217	8,000 *	5,600	2,400 *	1,680
2 +	1	9,600	6,720	2,400	1,680
2 +	2 +	9,600	6,720	3,200	2,240
1	2 +	8,000	5,600	3,200	2,240
CONDITION B - Interruption of Continuous Traffic					
<u>Satisfied</u>	<u>Not Satisfied</u>	Vehicles Per Day on Major Street (Total of Both Approaches)		Vehicles Per Day on Higher-Volume Minor Street Approach (One Direction Only)	
XX		<u>Urban</u>	<u>Rural</u>	<u>Urban</u>	<u>Rural</u>
Number of lanes for moving traffic on each approach					
<u>Major Street</u>	<u>Minor Street</u>				
1 36,129	1 7,217	12,000 *	8,400	1,200 *	850
2 +	1	14,400	10,080	1,200	850
2 +	2 +	14,400	10,080	1,600	1,120
1	2 +	12,000	8,400	1,600	1,120
Combination of CONDITIONS A + B					
<u>Satisfied</u>	<u>Not Satisfied</u>	2 CONDITIONS 80%		2 CONDITIONS 80%	
XX					
No one condition satisfied, but following conditions fulfilled 80% of more					
	<u>A</u>				
	100%				
	<u>B</u>				
	100%				

Note: To be used only for NEW INTERSECTIONS or other locations where it is not reasonable to count actual traffic volumes.

The satisfaction of a traffic signal warrant or warrants shall not in itself require the installation of a traffic control signal.



Figure 4C-103 (CA). Traffic Signal Warrants Worksheet (Average Traffic Estimate Form)

<u>DIST</u>	<u>CO</u>	<u>RTE</u>	<u>PM</u>	<u>CALC</u>	<u>TRAFFIC CONDITIONS</u>	<u>E+P</u>
Jurisdiction: <u>City of Riverside</u>				<u>MT</u>		<u>DATE</u> <u>02/17/22</u>
Major Street: <u>Cactus Ave</u>				<u>CHK</u> <u>MT</u>	Critical Approach Speed (Major)	<u>25</u> mph
Minor Street: <u>Brown St.</u>					Critical Approach Speed (Minor)	<u>25</u> mph
Major Street Approach Lanes =		<u>2</u>	lane	Minor Street Approach Lanes =		<u>1</u> lane
Major Street Future ADT =		<u>34,486</u>	vpd	Minor Street Future ADT =		<u>8,858</u> vpd
Speed limit or critical speed on major street traffic > 64 km/h (40 mph);						<input type="checkbox"/>
						or
In built up area of isolated community of < 10,000 population						<input type="checkbox"/>

URBAN (U)

(Based on Estimated Average Daily Traffic - See Note)

<u>URBAN</u>		<u>RURAL</u>		Minimum Requirements EADT			
XX CONDITION A - Minimum Vehicular Volume		Not Satisfied		Vehicles Per Day on Major Street		Vehicles Per Day on Higher-Volume Minor Street Approach	
<u>Satisfied</u>		<u>Not Satisfied</u>		(Total of Both Approaches)		(One Direction Only)	
XX				<u>Urban</u>	<u>Rural</u>	<u>Urban</u>	<u>Rural</u>
Number of lanes for moving traffic on each approach							
<u>Major Street</u>		<u>Minor Street</u>					
1		1		8,000	5,600	2,400	1,680
2 + 34,486		1 8,858		9,600 *	6,720	2,400 *	1,680
2 +		2 +		9,600	6,720	3,200	2,240
1		2 +		8,000	5,600	3,200	2,240
CONDITION B - Interruption of Continuous Traffic		Not Satisfied		Vehicles Per Day on Major Street		Vehicles Per Day on Higher-Volume Minor Street Approach	
<u>Satisfied</u>		<u>Not Satisfied</u>		(Total of Both Approaches)		(One Direction Only)	
XX				<u>Urban</u>	<u>Rural</u>	<u>Urban</u>	<u>Rural</u>
Number of lanes for moving traffic on each approach							
<u>Major Street</u>		<u>Minor Street</u>					
1		1		12,000	8,400	1,200	850
2 + 34,486		1 8,858		14,400 *	10,080	1,200 *	850
2 +		2 +		14,400	10,080	1,600	1,120
1		2 +		12,000	8,400	1,600	1,120
Combination of CONDITIONS A + B		Not Satisfied		2 CONDITIONS		2 CONDITIONS	
<u>Satisfied</u>		<u>Not Satisfied</u>		80%		80%	
XX							
No one condition satisfied, but following conditions fulfilled 80% of more							
		<u>A</u>	<u>B</u>				
		100%	100%				

Note: To be used only for NEW INTERSECTIONS or other locations where it is not reasonable to count actual traffic volumes.

The satisfaction of a traffic signal warrant or warrants shall not in itself require the installation of a traffic control signal.



This Page Intentionally Left Blank

APPENDIX 5.3:

E+P CONDITIONS FREEWAY OFF-RAMP QUEUING ANALYSIS WORKSHEETS

This Page Intentionally Left Blank

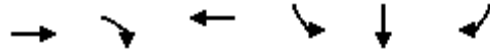

Lane Group	EBT	EBR	WBT	SBL	SBT	SBR
Lane Group Flow (vph)	815	376	2600	157	194	191
v/c Ratio	0.24	0.33	0.74	0.55	0.68	0.65
Control Delay	5.9	2.2	8.4	37.0	37.5	35.4
Queue Delay	0.0	0.0	0.0	0.0	0.0	0.0
Total Delay	5.9	2.2	8.4	37.0	37.5	35.4
Queue Length 50th (ft)	50	7	280	81	89	83
Queue Length 95th (ft)	93	46	m253	126	146	136
Internal Link Dist (ft)	750		688		1585	
Turn Bay Length (ft)		50		525		525
Base Capacity (vph)	3423	1145	3493	548	519	538
Starvation Cap Reductn	0	0	0	0	0	0
Spillback Cap Reductn	0	0	0	0	0	0
Storage Cap Reductn	0	0	0	0	0	0
Reduced v/c Ratio	0.24	0.33	0.74	0.29	0.37	0.36

Intersection Summary

m Volume for 95th percentile queue is metered by upstream signal.

Queues

29: I-215 NB Ramps & Alessandro Bl.



Lane Group	EBL	EBT	WBT	WBR	NBL	NBT	NBR
Lane Group Flow (vph)	89	910	1374	80	639	629	145
v/c Ratio	0.51	0.30	0.59	0.11	1.40	1.25	0.29
Control Delay	41.0	6.5	18.9	4.0	219.6	154.6	6.7
Queue Delay	0.0	0.0	0.0	0.0	0.0	0.0	0.0
Total Delay	41.0	6.5	18.9	4.0	219.6	154.6	6.7
Queue Length 50th (ft)	44	55	190	0	~513	~453	0
Queue Length 95th (ft)	87	67	256	24	#735	#687	47
Internal Link Dist (ft)		688	447			1005	
Turn Bay Length (ft)	200			50	400		400
Base Capacity (vph)	356	3198	2323	697	458	504	496
Starvation Cap Reductn	0	0	0	0	0	0	0
Spillback Cap Reductn	0	0	0	0	0	0	0
Storage Cap Reductn	0	0	0	0	0	0	0
Reduced v/c Ratio	0.25	0.28	0.59	0.11	1.40	1.25	0.29

Intersection Summary

~ Volume exceeds capacity, queue is theoretically infinite.

Queue shown is maximum after two cycles.

95th percentile volume exceeds capacity, queue may be longer.

Queue shown is maximum after two cycles.



Lane Group	EBT	EBR	WBL	WBT	NBR	SBR
Lane Group Flow (vph)	538	77	643	1627	693	653
v/c Ratio	0.91	0.24	0.93	0.72	0.71	1.63
Control Delay	61.1	11.2	46.8	13.3	5.1	319.8
Queue Delay	0.0	0.0	0.0	0.0	0.0	0.0
Total Delay	61.1	11.2	46.8	13.3	5.1	319.8
Queue Length 50th (ft)	176	0	362	311	0	~564
Queue Length 95th (ft)	#306	41	#572	384	20	#842
Internal Link Dist (ft)	658		918			
Turn Bay Length (ft)						
Base Capacity (vph)	594	326	856	2600	981	401
Starvation Cap Reductn	0	0	0	0	0	0
Spillback Cap Reductn	0	0	0	0	0	0
Storage Cap Reductn	0	0	0	0	0	0
Reduced v/c Ratio	0.91	0.24	0.75	0.63	0.71	1.63

Intersection Summary

- ~ Volume exceeds capacity, queue is theoretically infinite.
Queue shown is maximum after two cycles.
- # 95th percentile volume exceeds capacity, queue may be longer.
Queue shown is maximum after two cycles.

Queues

West Campus Upper Plateau (JN 14064)

31: I-215 NB Ramps/Old 215 Frontage Rd. & Cactus Av.

09/19/2022



Lane Group	EBL	EBT	WBT	NBL	NBT	NBR	SBL	SBT
Lane Group Flow (vph)	31	1537	2744	449	312	12	51	147
v/c Ratio	0.56	0.67	1.15	1.92	0.88	0.03	0.54	0.49
Control Delay	54.3	12.8	95.7	456.6	71.1	4.7	64.2	39.5
Queue Delay	0.0	0.0	0.0	0.0	0.0	0.0	0.0	0.0
Total Delay	54.3	12.8	95.7	456.6	71.1	4.7	64.2	39.5
Queue Length 50th (ft)	11	327	~1323	~535	247	0	35	81
Queue Length 95th (ft)	#73	399	#1452	#739	#417	7	#91	150
Internal Link Dist (ft)		310	1149		1221			746
Turn Bay Length (ft)	175			145			100	
Base Capacity (vph)	55	2285	2378	234	355	359	95	299
Starvation Cap Reductn	0	0	0	0	0	0	0	0
Spillback Cap Reductn	0	0	0	0	0	0	0	0
Storage Cap Reductn	0	0	0	0	0	0	0	0
Reduced v/c Ratio	0.56	0.67	1.15	1.92	0.88	0.03	0.54	0.49

Intersection Summary

~ Volume exceeds capacity, queue is theoretically infinite.

Queue shown is maximum after two cycles.

95th percentile volume exceeds capacity, queue may be longer.

Queue shown is maximum after two cycles.

Queues

32: I-215 SB Ramps & Van Buren Bl.



Lane Group	EBT	EBR	WBL	WBT	SBT	SBR
Lane Group Flow (vph)	545	730	2	1047	46	773
v/c Ratio	0.45	0.52	0.02	0.79	0.08	0.61
Control Delay	19.0	3.0	35.0	23.6	14.5	16.5
Queue Delay	0.0	0.0	0.0	0.0	0.0	0.0
Total Delay	19.0	3.0	35.0	23.6	14.5	16.5
Queue Length 50th (ft)	87	0	1	203	11	113
Queue Length 95th (ft)	159	38	8	266	38	241
Internal Link Dist (ft)	2745		429		1115	
Turn Bay Length (ft)	200					
Base Capacity (vph)	1501	1576	129	2092	611	1257
Starvation Cap Reductn	0	0	0	0	0	0
Spillback Cap Reductn	0	0	0	0	0	0
Storage Cap Reductn	0	0	0	0	0	0
Reduced v/c Ratio	0.36	0.46	0.02	0.50	0.08	0.61

Intersection Summary

Queues

33: I-215 NB On/Off Ramp & Van Buren Bl.



Lane Group	EBT	EBR	WBT	NBL	NBR
Lane Group Flow (vph)	35	607	28	1049	5
v/c Ratio	0.09	0.22	0.08	0.37	0.01
Control Delay	19.8	0.2	19.9	2.9	2.2
Queue Delay	0.0	0.0	0.0	0.0	0.0
Total Delay	19.8	0.2	19.9	2.9	2.2
Queue Length 50th (ft)	2	0	2	0	0
Queue Length 95th (ft)	17	0	14	97	2
Internal Link Dist (ft)	669		611	856	
Turn Bay Length (ft)		300			585
Base Capacity (vph)	636	2707	598	3242	1105
Starvation Cap Reductn	0	0	0	0	0
Spillback Cap Reductn	0	0	0	0	0
Storage Cap Reductn	0	0	0	0	0
Reduced v/c Ratio	0.06	0.22	0.05	0.32	0.00

Intersection Summary

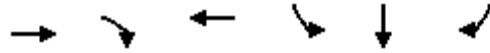

Lane Group	EBT	EBR	WBT	SBL	SBT	SBR
Lane Group Flow (vph)	1584	507	1966	272	259	255
v/c Ratio	0.56	0.51	0.70	0.63	0.64	0.61
Control Delay	10.9	7.0	12.9	29.8	27.7	26.6
Queue Delay	0.0	0.0	0.0	0.0	0.0	0.0
Total Delay	10.9	7.0	12.9	29.8	27.7	26.6
Queue Length 50th (ft)	141	53	197	106	92	86
Queue Length 95th (ft)	231	149	320	204	191	177
Internal Link Dist (ft)	750		688		1585	
Turn Bay Length (ft)		50		525		525
Base Capacity (vph)	3698	1220	3637	681	622	639
Starvation Cap Reductn	0	0	0	0	0	0
Spillback Cap Reductn	0	0	0	0	0	0
Storage Cap Reductn	0	0	0	0	0	0
Reduced v/c Ratio	0.43	0.42	0.54	0.40	0.42	0.40

Intersection Summary



Lane Group	EBL	EBT	WBT	WBR	NBL	NBT	NBR
Lane Group Flow (vph)	231	1767	1099	119	505	507	258
v/c Ratio	1.26	0.74	0.70	0.24	0.76	0.79	0.40
Control Delay	189.1	19.3	26.9	9.1	31.0	33.3	14.0
Queue Delay	0.0	0.0	0.0	0.0	0.0	0.0	0.0
Total Delay	189.1	19.3	26.9	9.1	31.0	33.3	14.0
Queue Length 50th (ft)	~153	252	176	13	231	246	61
Queue Length 95th (ft)	#302	304	221	49	#420	#457	131
Internal Link Dist (ft)		688	447			1005	
Turn Bay Length (ft)	200			50	400		400
Base Capacity (vph)	183	2682	1862	564	667	640	651
Starvation Cap Reductn	0	0	0	0	0	0	0
Spillback Cap Reductn	0	0	0	0	0	0	0
Storage Cap Reductn	0	0	0	0	0	0	0
Reduced v/c Ratio	1.26	0.66	0.59	0.21	0.76	0.79	0.40

Intersection Summary

~ Volume exceeds capacity, queue is theoretically infinite.

Queue shown is maximum after two cycles.

95th percentile volume exceeds capacity, queue may be longer.

Queue shown is maximum after two cycles.



Lane Group	EBT	EBR	WBL	WBT	NBR	SBR
Lane Group Flow (vph)	1671	403	509	1204	575	533
v/c Ratio	1.64	0.65	0.90	0.51	0.69	1.25
Control Delay	319.8	18.3	51.6	9.2	6.7	160.1
Queue Delay	0.0	0.0	0.0	0.0	0.0	0.0
Total Delay	319.8	18.3	51.6	9.2	6.7	160.1
Queue Length 50th (ft)	~815	86	300	180	0	~374
Queue Length 95th (ft)	#1022	208	#440	224	58	#617
Internal Link Dist (ft)	658			918		
Turn Bay Length (ft)						
Base Capacity (vph)	1018	619	696	2603	835	425
Starvation Cap Reductn	0	0	0	0	0	0
Spillback Cap Reductn	0	0	0	0	0	0
Storage Cap Reductn	0	0	0	0	0	0
Reduced v/c Ratio	1.64	0.65	0.73	0.46	0.69	1.25

Intersection Summary

~ Volume exceeds capacity, queue is theoretically infinite.

Queue shown is maximum after two cycles.

95th percentile volume exceeds capacity, queue may be longer.

Queue shown is maximum after two cycles.



Lane Group	EBL	EBT	WBT	NBL	NBT	NBR	SBL	SBT
Lane Group Flow (vph)	102	2357	1953	216	227	3	173	184
v/c Ratio	1.13	1.13	0.90	0.89	0.55	0.01	0.83	0.47
Control Delay	163.3	81.6	21.6	68.1	32.9	0.0	62.5	28.1
Queue Delay	0.0	0.0	0.0	0.0	0.0	0.0	0.0	0.0
Total Delay	163.3	81.6	21.6	68.1	32.9	0.0	62.5	28.1
Queue Length 50th (ft)	~66	~776	447	108	108	0	85	73
Queue Length 95th (ft)	#119	#917	#670	#229	181	0	#190	133
Internal Link Dist (ft)		310	1149		1221			746
Turn Bay Length (ft)	175			145			100	
Base Capacity (vph)	90	2093	2163	273	469	439	235	443
Starvation Cap Reductn	0	0	0	0	0	0	0	0
Spillback Cap Reductn	0	0	0	0	0	0	0	0
Storage Cap Reductn	0	0	0	0	0	0	0	0
Reduced v/c Ratio	1.13	1.13	0.90	0.79	0.48	0.01	0.74	0.42

Intersection Summary

~ Volume exceeds capacity, queue is theoretically infinite.

Queue shown is maximum after two cycles.

95th percentile volume exceeds capacity, queue may be longer.

Queue shown is maximum after two cycles.

Queues

32: I-215 SB Ramps & Van Buren Bl.



Lane Group	EBT	EBR	WBL	WBT	SBT	SBR
Lane Group Flow (vph)	477	1865	3	908	103	206
v/c Ratio	0.23	0.89	0.03	0.41	0.41	0.39
Control Delay	5.2	11.1	34.7	5.1	36.3	8.4
Queue Delay	0.0	0.0	0.0	0.0	0.0	0.0
Total Delay	5.2	11.1	34.7	5.1	36.3	8.4
Queue Length 50th (ft)	28	71	1	63	33	0
Queue Length 95th (ft)	72	347	10	84	#121	34
Internal Link Dist (ft)	2745			429	1115	
Turn Bay Length (ft)			200			
Base Capacity (vph)	2868	2504	119	3191	250	523
Starvation Cap Reductn	0	0	0	0	0	0
Spillback Cap Reductn	0	0	0	0	0	0
Storage Cap Reductn	0	0	0	0	0	0
Reduced v/c Ratio	0.17	0.74	0.03	0.28	0.41	0.39

Intersection Summary

95th percentile volume exceeds capacity, queue may be longer.
 Queue shown is maximum after two cycles.

Queues

33: I-215 NB On/Off Ramp & Van Buren Bl.



Lane Group	EBT	EBR	WBT	NBL	NBR
Lane Group Flow (vph)	4	523	22	799	4
v/c Ratio	0.01	0.20	0.04	0.26	0.00
Control Delay	21.5	0.2	20.6	1.1	1.0
Queue Delay	0.0	0.0	0.0	0.0	0.0
Total Delay	21.5	0.2	20.6	1.1	1.0
Queue Length 50th (ft)	0	0	1	0	0
Queue Length 95th (ft)	5	0	14	62	2
Internal Link Dist (ft)	669		611	856	
Turn Bay Length (ft)		300			585
Base Capacity (vph)	968	2608	880	3132	1021
Starvation Cap Reductn	0	0	0	0	0
Spillback Cap Reductn	0	0	0	0	0
Storage Cap Reductn	0	0	0	0	0
Reduced v/c Ratio	0.00	0.20	0.03	0.26	0.00

Intersection Summary

Queues

28: I-215 SB Ramps & Alessandro Bl.

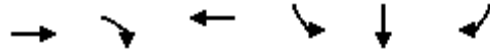

Lane Group	EBT	EBR	WBT	SBL	SBT	SBR
Lane Group Flow (vph)	867	395	1244	117	161	160
v/c Ratio	0.34	0.41	0.50	0.33	0.44	0.42
Control Delay	6.7	2.8	7.5	16.3	13.0	12.6
Queue Delay	0.0	0.0	0.0	0.0	0.0	0.0
Total Delay	6.7	2.8	7.5	16.3	13.0	12.6
Queue Length 50th (ft)	34	4	52	20	16	14
Queue Length 95th (ft)	70	39	105	68	71	66
Internal Link Dist (ft)	750		688		1585	
Turn Bay Length (ft)		50		525		525
Base Capacity (vph)	4945	1549	4841	1117	993	1028
Starvation Cap Reductn	0	0	0	0	0	0
Spillback Cap Reductn	0	0	0	0	0	0
Storage Cap Reductn	0	0	0	0	0	0
Reduced v/c Ratio	0.18	0.26	0.26	0.10	0.16	0.16

Intersection Summary

Queues

29: I-215 NB Ramps & Alessandro Bl.



Lane Group	EBL	EBT	WBT	WBR	NBL	NBT	NBR
Lane Group Flow (vph)	214	778	902	141	275	276	206
v/c Ratio	1.16	0.34	0.65	0.32	0.40	0.41	0.29
Control Delay	153.4	14.3	26.7	11.9	18.7	18.7	7.2
Queue Delay	0.0	0.0	0.0	0.0	0.0	0.0	0.0
Total Delay	153.4	14.3	26.7	11.9	18.7	18.7	7.2
Queue Length 50th (ft)	~123	85	138	21	92	95	18
Queue Length 95th (ft)	#277	111	177	62	180	189	70
Internal Link Dist (ft)		688	447			1005	
Turn Bay Length (ft)	200			50	400		400
Base Capacity (vph)	184	2827	1962	590	696	669	711
Starvation Cap Reductn	0	0	0	0	0	0	0
Spillback Cap Reductn	0	0	0	0	0	0	0
Storage Cap Reductn	0	0	0	0	0	0	0
Reduced v/c Ratio	1.16	0.28	0.46	0.24	0.40	0.41	0.29

Intersection Summary

~ Volume exceeds capacity, queue is theoretically infinite.

Queue shown is maximum after two cycles.

95th percentile volume exceeds capacity, queue may be longer.

Queue shown is maximum after two cycles.

Queues
30: I-215 SB Ramps & Cactus Av.

West Campus Upper Plateau (JN 14064)

09/29/2022



Lane Group	EBT	EBR	WBL	WBT	NBR	SBR
Lane Group Flow (vph)	633	121	371	562	349	329
v/c Ratio	0.63	0.23	0.67	0.23	0.46	0.66
Control Delay	21.0	5.4	24.4	3.3	2.1	9.3
Queue Delay	0.0	0.0	0.0	0.0	0.0	0.0
Total Delay	21.0	5.4	24.4	3.3	2.1	9.3
Queue Length 50th (ft)	86	0	97	23	0	0
Queue Length 95th (ft)	183	33	228	52	0	38
Internal Link Dist (ft)	658			918		
Turn Bay Length (ft)						
Base Capacity (vph)	1922	905	1301	3463	1034	840
Starvation Cap Reductn	0	0	0	0	0	0
Spillback Cap Reductn	0	0	0	0	0	0
Storage Cap Reductn	0	0	0	0	0	0
Reduced v/c Ratio	0.33	0.13	0.29	0.16	0.34	0.39
Intersection Summary						

Queues

West Campus Upper Plateau (JN 14064)

31: I-215 NB Ramps/Old 215 Frontage Rd. & Cactus Av.

09/29/2022



Lane Group	EBL	EBT	WBT	NBL	NBT	NBR	SBL	SBT
Lane Group Flow (vph)	32	911	1212	128	66	3	109	81
v/c Ratio	0.15	0.47	0.57	0.49	0.17	0.01	0.39	0.20
Control Delay	8.5	6.8	8.6	24.5	17.6	0.0	21.5	6.8
Queue Delay	0.0	0.0	0.0	0.0	0.0	0.0	0.0	0.0
Total Delay	8.5	6.8	8.6	24.5	17.6	0.0	21.5	6.8
Queue Length 50th (ft)	4	56	97	26	12	0	22	0
Queue Length 95th (ft)	19	126	200	90	51	0	77	29
Internal Link Dist (ft)		310	1149		1221			746
Turn Bay Length (ft)	175			145			100	
Base Capacity (vph)	321	2909	3278	640	939	840	697	896
Starvation Cap Reductn	0	0	0	0	0	0	0	0
Spillback Cap Reductn	0	0	0	0	0	0	0	0
Storage Cap Reductn	0	0	0	0	0	0	0	0
Reduced v/c Ratio	0.10	0.31	0.37	0.20	0.07	0.00	0.16	0.09

Intersection Summary

Queues

32: I-215 SB Ramps & Van Buren Bl.



Lane Group	EBT	EBR	WBL	WBT	SBT	SBR
Lane Group Flow (vph)	446	600	13	572	20	522
v/c Ratio	0.39	0.45	0.06	0.45	0.06	0.52
Control Delay	9.5	2.1	19.7	8.2	16.6	4.6
Queue Delay	0.0	0.0	0.0	0.0	0.0	0.0
Total Delay	9.5	2.1	19.7	8.2	16.6	4.6
Queue Length 50th (ft)	26	0	2	35	2	0
Queue Length 95th (ft)	72	23	19	52	24	42
Internal Link Dist (ft)	2745				429	1115
Turn Bay Length (ft)			200			
Base Capacity (vph)	3236	2710	211	3406	353	1002
Starvation Cap Reductn	0	0	0	0	0	0
Spillback Cap Reductn	0	0	0	0	0	0
Storage Cap Reductn	0	0	0	0	0	0
Reduced v/c Ratio	0.14	0.22	0.06	0.17	0.06	0.52

Intersection Summary



Lane Group	EBR	NBL
Lane Group Flow (vph)	16	1
v/c Ratio	0.01	0.00
Control Delay	0.0	0.0
Queue Delay	0.0	0.0
Total Delay	0.0	0.0
Queue Length 50th (ft)	0	0
Queue Length 95th (ft)	0	0
Internal Link Dist (ft)		856
Turn Bay Length (ft)	300	
Base Capacity (vph)	2608	3303
Starvation Cap Reductn	0	0
Spillback Cap Reductn	0	0
Storage Cap Reductn	0	0
Reduced v/c Ratio	0.01	0.00
Intersection Summary		

APPENDIX 5.4:

**E+P CONDITIONS INTERSECTION OPERATIONS ANALYSIS WORKSHEETS WITH
IMPROVEMENTS**

This Page Intentionally Left Blank

Timings

3: Overlook Pkwy./Canyon Crest Dr. & Alessandro Bl/Alessandro Bl.



Lane Group	EBL	EBT	WBL	WBT	WBR	NBL	NBT	NBR	SBL	SBT
Lane Configurations	↖	↕↕↕↕	↖	↕↕↕↕	↗	↖	↕↕	↗	↕↕↕↕	↖
Traffic Volume (vph)	38	1313	27	3114	1016	9	33	10	449	82
Future Volume (vph)	38	1313	27	3114	1016	9	33	10	449	82
Turn Type	Prot	NA	Prot	NA	pm+ov	Perm	NA	Perm	Prot	NA
Protected Phases	5	2	1	6	7		8		7	4
Permitted Phases					6	8		8		
Detector Phase	5	2	1	6	7	8	8	8	7	4
Switch Phase										
Minimum Initial (s)	5.0	10.0	5.0	10.0	10.0	10.0	10.0	10.0	10.0	10.0
Minimum Split (s)	9.2	35.2	9.2	35.2	15.8	38.8	38.8	38.8	15.8	38.8
Total Split (s)	9.2	56.0	9.2	56.0	16.0	38.8	38.8	38.8	16.0	54.8
Total Split (%)	7.7%	46.7%	7.7%	46.7%	13.3%	32.3%	32.3%	32.3%	13.3%	45.7%
Yellow Time (s)	3.2	5.2	3.2	5.2	4.8	4.8	4.8	4.8	4.8	4.8
All-Red Time (s)	1.0	1.0	1.0	1.0	1.0	1.0	1.0	1.0	1.0	1.0
Lost Time Adjust (s)	0.0	0.0	0.0	0.0	0.0	0.0	0.0	0.0	0.0	0.0
Total Lost Time (s)	4.2	6.2	4.2	6.2	5.8	5.8	5.8	5.8	5.8	5.8
Lead/Lag	Lead	Lag	Lead	Lag	Lead	Lag	Lag	Lag	Lead	
Lead-Lag Optimize?	Yes	Yes	Yes	Yes	Yes	Yes	Yes	Yes	Yes	
Recall Mode	None	None	None	None	None	None	None	None	None	None
Act Effct Green (s)	5.2	51.8	5.2	51.8	71.8	13.9	13.9	13.9	10.6	22.5
Actuated g/C Ratio	0.06	0.57	0.06	0.57	0.78	0.15	0.15	0.15	0.12	0.25
v/c Ratio	0.44	0.44	0.27	1.03	0.74	0.05	0.06	0.03	0.83	0.33
Control Delay	63.8	15.5	55.9	47.5	6.9	36.2	35.7	0.2	55.7	22.4
Queue Delay	0.0	0.0	0.0	0.0	0.0	0.0	0.0	0.0	0.0	0.0
Total Delay	63.8	15.5	55.9	47.5	6.9	36.2	35.7	0.2	55.7	22.4
LOS	E	B	E	D	A	D	D	A	E	C
Approach Delay		16.8		37.6			28.7			48.2
Approach LOS		B		D			C			D

Intersection Summary

Cycle Length: 120
 Actuated Cycle Length: 91.6
 Natural Cycle: 130
 Control Type: Actuated-Uncoordinated
 Maximum v/c Ratio: 1.03
 Intersection Signal Delay: 33.9
 Intersection LOS: C
 Intersection Capacity Utilization 88.6%
 ICU Level of Service E
 Analysis Period (min) 15

Splits and Phases: 3: Overlook Pkwy./Canyon Crest Dr. & Alessandro Bl/Alessandro Bl.

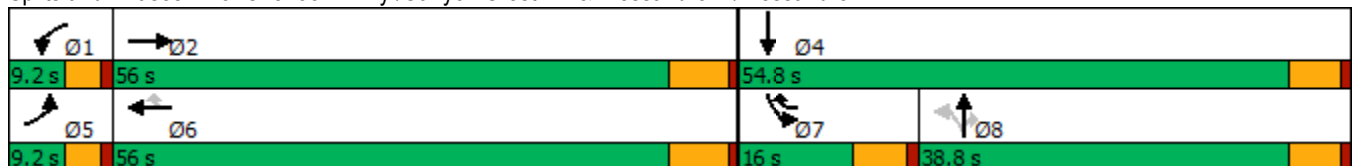

HCM 6th Signalized Intersection Summary

West Campus Upper Plateau (JN 14064)

3: Overlook Pkwy./Canyon Crest Dr. & Alessandro Bl/Alessandro Bl.

09/19/2022

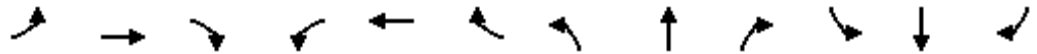

Movement	EBL	EBT	EBR	WBL	WBT	WBR	NBL	NBT	NBR	SBL	SBT	SBR
Lane Configurations	↗	↗↗↗		↗	↗↗↗	↗	↗	↗↗	↗	↗↗↗	↗	
Traffic Volume (veh/h)	38	1313	14	27	3114	1016	9	33	10	449	82	49
Future Volume (veh/h)	38	1313	14	27	3114	1016	9	33	10	449	82	49
Initial Q (Qb), veh	0	0	0	0	0	0	0	0	0	0	0	0
Ped-Bike Adj(A_pbT)	1.00		1.00	1.00		1.00	1.00		1.00	1.00		1.00
Parking Bus, Adj	1.00	1.00	1.00	1.00	1.00	1.00	1.00	1.00	1.00	1.00	1.00	1.00
Work Zone On Approach		No			No			No				No
Adj Sat Flow, veh/h/ln	1737	1870	1900	1900	1885	1885	1900	1900	1900	1856	1648	1870
Adj Flow Rate, veh/h	40	1382	15	28	3278	906	9	35	9	473	86	35
Peak Hour Factor	0.95	0.95	0.95	0.95	0.95	0.95	0.95	0.95	0.95	0.95	0.95	0.95
Percent Heavy Veh, %	11	2	0	0	1	1	0	0	0	3	17	2
Cap, veh/h	57	2937	32	50	2960	1007	210	376	168	534	303	123
Arrive On Green	0.03	0.53	0.53	0.03	0.52	0.52	0.10	0.10	0.10	0.11	0.27	0.27
Sat Flow, veh/h	1654	5540	60	1810	5656	1598	1291	3610	1610	4983	1113	453
Grp Volume(v), veh/h	40	933	464	28	3278	906	9	35	9	473	0	121
Grp Sat Flow(s),veh/h/ln	1654	1870	1860	1810	1885	1598	1291	1805	1610	1661	0	1566
Q Serve(g_s), s	2.3	14.9	14.9	1.5	49.8	46.1	0.6	0.8	0.5	8.9	0.0	5.8
Cycle Q Clear(g_c), s	2.3	14.9	14.9	1.5	49.8	46.1	0.6	0.8	0.5	8.9	0.0	5.8
Prop In Lane	1.00		0.03	1.00		1.00	1.00		1.00	1.00		0.29
Lane Grp Cap(c), veh/h	57	1983	986	50	2960	1007	210	376	168	534	0	426
V/C Ratio(X)	0.71	0.47	0.47	0.56	1.11	0.90	0.04	0.09	0.05	0.89	0.00	0.28
Avail Cap(c_a), veh/h	87	1983	986	95	2960	1007	523	1252	558	534	0	807
HCM Platoon Ratio	1.00	1.00	1.00	1.00	1.00	1.00	1.00	1.00	1.00	1.00	1.00	1.00
Upstream Filter(I)	1.00	1.00	1.00	1.00	1.00	1.00	1.00	1.00	1.00	1.00	0.00	1.00
Uniform Delay (d), s/veh	45.5	14.0	14.0	45.7	22.7	15.0	38.5	38.6	38.4	41.9	0.0	27.3
Incr Delay (d2), s/veh	5.8	0.2	0.4	3.7	54.0	10.9	0.1	0.1	0.1	16.3	0.0	0.4
Initial Q Delay(d3),s/veh	0.0	0.0	0.0	0.0	0.0	0.0	0.0	0.0	0.0	0.0	0.0	0.0
%ile BackOfQ(50%),veh/ln	1.0	5.4	5.4	0.7	33.1	16.0	0.2	0.4	0.2	4.3	0.0	2.1
Unsig. Movement Delay, s/veh												
LnGrp Delay(d),s/veh	51.3	14.2	14.3	49.4	76.7	25.9	38.5	38.7	38.5	58.2	0.0	27.7
LnGrp LOS	D	B	B	D	F	C	D	D	D	E	A	C
Approach Vol, veh/h		1437			4212			53				594
Approach Delay, s/veh		15.3			65.6			38.6				52.0
Approach LOS		B			E			D				D
Timer - Assigned Phs	1	2		4	5	6	7	8				
Phs Duration (G+Y+Rc), s	6.8	56.6		31.7	7.5	56.0	16.0	15.7				
Change Period (Y+Rc), s	* 4.2	6.2		5.8	* 4.2	6.2	5.8	5.8				
Max Green Setting (Gmax), s	* 5	49.8		49.0	* 5	49.8	10.2	33.0				
Max Q Clear Time (g_c+I1), s	3.5	16.9		7.8	4.3	51.8	10.9	2.8				
Green Ext Time (p_c), s	0.0	10.4		0.6	0.0	0.0	0.0	0.2				

Intersection Summary

HCM 6th Ctrl Delay	52.6
HCM 6th LOS	D

Notes

- User approved pedestrian interval to be less than phase max green.
- * HCM 6th computational engine requires equal clearance times for the phases crossing the barrier.

Timings

West Campus Upper Plateau (JN 14064)

14: Barton Rd. & Van Buren Bl.

09/19/2022

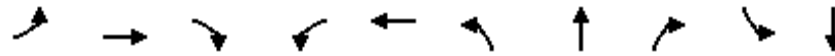

Lane Group	EBL	EBT	EBR	WBL	WBT	NBL	NBT	NBR	SBL	SBT
Lane Configurations	↘	↑↑	↗	↘	↑↑↑	↘↗	↑	↗	↘	↗
Traffic Volume (vph)	135	1149	104	258	1271	358	73	370	71	95
Future Volume (vph)	135	1149	104	258	1271	358	73	370	71	95
Turn Type	Prot	NA	pm+ov	Prot	NA	Prot	NA	Perm	Prot	NA
Protected Phases	5	2	3	1	6	3	8		7	4
Permitted Phases			2					8		
Detector Phase	5	2	3	1	6	3	8	8	7	4
Switch Phase										
Minimum Initial (s)	5.0	10.0	5.0	5.0	10.0	5.0	10.0	10.0	5.0	10.0
Minimum Split (s)	9.2	25.2	9.1	9.2	25.5	9.1	14.6	14.6	9.1	33.6
Total Split (s)	19.5	52.2	19.2	25.0	57.7	19.2	39.6	39.6	13.2	33.6
Total Split (%)	15.0%	40.2%	14.8%	19.2%	44.4%	14.8%	30.5%	30.5%	10.2%	25.8%
Yellow Time (s)	3.2	5.2	3.6	3.2	5.5	3.6	3.6	3.6	3.6	3.6
All-Red Time (s)	1.0	1.0	0.5	1.0	1.0	0.5	1.0	1.0	0.5	1.0
Lost Time Adjust (s)	0.0	0.0	0.0	0.0	0.0	0.0	0.0	0.0	0.0	0.0
Total Lost Time (s)	4.2	6.2	4.1	4.2	6.5	4.1	4.6	4.6	4.1	4.6
Lead/Lag	Lead	Lag	Lead	Lead	Lag	Lead	Lag	Lag	Lead	Lag
Lead-Lag Optimize?	Yes	Yes	Yes	Yes	Yes	Yes	Yes	Yes	Yes	Yes
Recall Mode	None	None	None	None	None	None	None	None	None	None
Act Effct Green (s)	13.8	46.0	67.3	20.8	52.7	15.1	34.5	34.5	8.7	28.1
Actuated g/C Ratio	0.11	0.36	0.52	0.16	0.41	0.12	0.27	0.27	0.07	0.22
v/c Ratio	0.80	1.05	0.14	1.04	0.73	1.04	0.17	0.67	0.68	0.96
Control Delay	85.4	79.3	6.2	116.9	35.3	109.7	37.5	18.8	85.5	71.2
Queue Delay	0.0	0.0	0.0	0.0	0.0	0.0	0.0	0.0	0.0	0.0
Total Delay	85.4	79.3	6.2	116.9	35.3	109.7	37.5	18.8	85.5	71.2
LOS	F	E	A	F	D	F	D	B	F	E
Approach Delay		74.4			48.8		61.1			73.5
Approach LOS		E			D		E			E

Intersection Summary

Cycle Length: 130
 Actuated Cycle Length: 129.1
 Natural Cycle: 130
 Control Type: Actuated-Uncoordinated
 Maximum v/c Ratio: 1.05
 Intersection Signal Delay: 62.2
 Intersection LOS: E
 Intersection Capacity Utilization 94.3%
 ICU Level of Service F
 Analysis Period (min) 15

Splits and Phases: 14: Barton Rd. & Van Buren Bl.

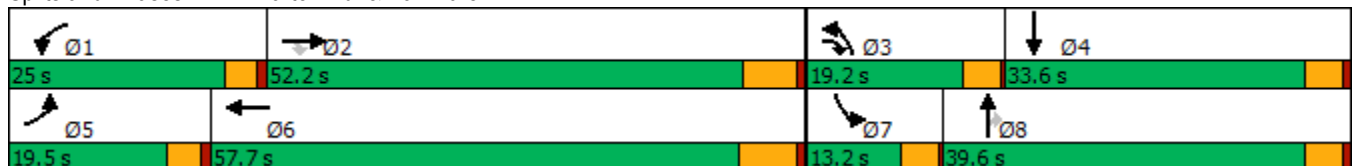

HCM 6th Signalized Intersection Summary
 14: Barton Rd. & Van Buren Bl.

West Campus Upper Plateau (JN 14064)

09/19/2022



Movement	EBL	EBT	EBR	WBL	WBT	WBR	NBL	NBT	NBR	SBL	SBT	SBR
Lane Configurations	↗	↑↑	↘	↗	↑↑↑		↗	↑	↘	↗	↘	↘
Traffic Volume (veh/h)	135	1149	104	258	1271	33	358	73	370	71	95	278
Future Volume (veh/h)	135	1149	104	258	1271	33	358	73	370	71	95	278
Initial Q (Qb), veh	0	0	0	0	0	0	0	0	0	0	0	0
Ped-Bike Adj(A_pbT)	1.00		1.00	1.00		1.00	1.00		1.00	1.00		1.00
Parking Bus, Adj	1.00	1.00	1.00	1.00	1.00	1.00	1.00	1.00	1.00	1.00	1.00	1.00
Work Zone On Approach		No			No			No			No	
Adj Sat Flow, veh/h/ln	1900	1870	1841	1870	1856	1722	1856	1885	1885	1900	1870	1900
Adj Flow Rate, veh/h	155	1321	107	297	1461	32	411	84	178	82	109	142
Peak Hour Factor	0.87	0.87	0.87	0.87	0.87	0.87	0.87	0.87	0.87	0.87	0.87	0.87
Percent Heavy Veh, %	0	2	4	2	3	12	3	1	1	0	2	0
Cap, veh/h	182	1341	782	304	2282	50	425	444	376	104	125	162
Arrive On Green	0.10	0.38	0.38	0.17	0.45	0.45	0.12	0.24	0.24	0.06	0.17	0.17
Sat Flow, veh/h	1810	3554	1560	1781	5101	112	3428	1885	1598	1810	737	960
Grp Volume(v), veh/h	155	1321	107	297	967	526	411	84	178	82	0	251
Grp Sat Flow(s),veh/h/ln	1810	1777	1560	1781	1689	1835	1714	1885	1598	1810	0	1697
Q Serve(g_s), s	10.3	44.9	4.5	20.2	27.0	27.0	14.5	4.3	11.7	5.5	0.0	17.6
Cycle Q Clear(g_c), s	10.3	44.9	4.5	20.2	27.0	27.0	14.5	4.3	11.7	5.5	0.0	17.6
Prop In Lane	1.00		1.00	1.00		0.06	1.00		1.00	1.00		0.57
Lane Grp Cap(c), veh/h	182	1341	782	304	1511	821	425	444	376	104	0	287
V/C Ratio(X)	0.85	0.99	0.14	0.98	0.64	0.64	0.97	0.19	0.47	0.79	0.00	0.87
Avail Cap(c_a), veh/h	227	1341	782	304	1511	821	425	541	459	135	0	404
HCM Platoon Ratio	1.00	1.00	1.00	1.00	1.00	1.00	1.00	1.00	1.00	1.00	1.00	1.00
Upstream Filter(I)	1.00	1.00	1.00	1.00	1.00	1.00	1.00	1.00	1.00	1.00	0.00	1.00
Uniform Delay (d), s/veh	53.9	37.6	16.3	50.3	26.1	26.1	53.2	37.3	40.1	56.7	0.0	49.4
Incr Delay (d2), s/veh	18.5	20.9	0.0	45.1	0.7	1.3	35.3	0.2	0.9	20.3	0.0	14.2
Initial Q Delay(d3),s/veh	0.0	0.0	0.0	0.0	0.0	0.0	0.0	0.0	0.0	0.0	0.0	0.0
%ile BackOfQ(50%),veh/ln	5.5	22.1	1.5	12.5	10.3	11.3	8.2	2.0	4.6	3.1	0.0	8.6
Unsig. Movement Delay, s/veh												
LnGrp Delay(d),s/veh	72.4	58.6	16.3	95.4	26.8	27.4	88.4	37.5	41.0	77.0	0.0	63.6
LnGrp LOS	E	E	B	F	C	C	F	D	D	E	A	E
Approach Vol, veh/h		1583			1790			673				333
Approach Delay, s/veh		57.1			38.4			69.5				66.9
Approach LOS		E			D			E				E
Timer - Assigned Phs	1	2	3	4	5	6	7	8				
Phs Duration (G+Y+Rc), s	25.0	52.5	19.2	25.2	16.5	61.0	11.1	33.3				
Change Period (Y+Rc), s	* 4.2	* 6.5	4.1	4.6	* 4.2	6.5	4.1	4.6				
Max Green Setting (Gmax), s	* 21	* 46	15.1	29.0	* 15	51.2	9.1	35.0				
Max Q Clear Time (g_c+I1), s	22.2	46.9	16.5	19.6	12.3	29.0	7.5	13.7				
Green Ext Time (p_c), s	0.0	0.0	0.0	1.0	0.1	6.2	0.0	0.9				

Intersection Summary

HCM 6th Ctrl Delay	52.1
HCM 6th LOS	D

Notes

* HCM 6th computational engine requires equal clearance times for the phases crossing the barrier.

Timings
25: Sycamore Canyon Bl. & Cactus Av.

West Campus Upper Plateau (JN 14064)

09/19/2022

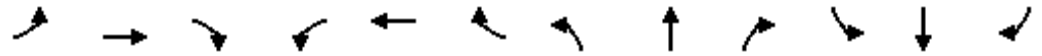

Lane Group	EBL	EBT	EBR	WBL	WBT	WBR	NBL	NBT	NBR	SBL	SBT	SBR
Lane Configurations	↘	↑↑↑	↗	↘↗	↑↑	↗	↘↗	↑↑	↗	↘↗	↑↑	↗
Traffic Volume (vph)	25	201	83	364	658	885	281	366	209	137	140	77
Future Volume (vph)	25	201	83	364	658	885	281	366	209	137	140	77
Turn Type	Prot	NA	Perm	Prot	NA	Perm	Prot	NA	Perm	Prot	NA	Perm
Protected Phases	7	4		3	8		5	2		1	6	
Permitted Phases			4			8			2			6
Detector Phase	7	4	4	3	8	8	5	2	2	1	6	6
Switch Phase												
Minimum Initial (s)	5.0	10.0	10.0	5.0	10.0	10.0	5.0	10.0	10.0	5.0	10.0	10.0
Minimum Split (s)	9.6	32.8	32.8	9.6	32.8	32.8	9.6	34.8	34.8	9.6	34.8	34.8
Total Split (s)	9.7	45.5	45.5	26.6	62.4	62.4	11.7	36.9	36.9	11.0	36.2	36.2
Total Split (%)	8.1%	37.9%	37.9%	22.2%	52.0%	52.0%	9.8%	30.8%	30.8%	9.2%	30.2%	30.2%
Yellow Time (s)	3.6	4.8	4.8	3.6	4.8	4.8	3.6	4.8	4.8	3.6	4.8	4.8
All-Red Time (s)	1.0	1.0	1.0	1.0	1.0	1.0	1.0	1.0	1.0	1.0	1.0	1.0
Lost Time Adjust (s)	0.0	0.0	0.0	0.0	0.0	0.0	0.0	0.0	0.0	0.0	0.0	0.0
Total Lost Time (s)	4.6	5.8	5.8	4.6	5.8	5.8	4.6	5.8	5.8	4.6	5.8	5.8
Lead/Lag	Lead	Lag	Lag	Lead	Lag	Lag	Lead	Lag	Lag	Lead	Lag	Lag
Lead-Lag Optimize?	Yes	Yes	Yes	Yes	Yes	Yes	Yes	Yes	Yes	Yes	Yes	Yes
Recall Mode	None	None	None	None	None	None	None	None	None	None	None	None
Act Effct Green (s)	5.1	41.6	41.6	16.3	57.2	57.2	7.2	18.2	18.2	6.5	17.5	17.5
Actuated g/C Ratio	0.05	0.40	0.40	0.16	0.55	0.55	0.07	0.18	0.18	0.06	0.17	0.17
v/c Ratio	0.37	0.10	0.12	0.76	0.38	0.90	1.27	0.64	0.48	0.67	0.25	0.21
Control Delay	66.6	21.5	0.4	53.2	15.6	28.4	193.0	44.8	8.8	66.3	38.4	1.3
Queue Delay	0.0	0.0	0.0	0.0	0.0	0.7	0.0	0.0	0.0	0.0	0.0	0.0
Total Delay	66.6	21.5	0.4	53.2	15.6	29.2	193.0	44.8	8.8	66.3	38.4	1.3
LOS	E	C	A	D	B	C	F	D	A	E	D	A
Approach Delay		19.5			29.1			84.8			41.1	
Approach LOS		B			C			F			D	

Intersection Summary

Cycle Length: 120
 Actuated Cycle Length: 103.7
 Natural Cycle: 110
 Control Type: Actuated-Uncoordinated
 Maximum v/c Ratio: 1.27
 Intersection Signal Delay: 43.4
 Intersection LOS: D
 Intersection Capacity Utilization 82.6%
 ICU Level of Service E
 Analysis Period (min) 15



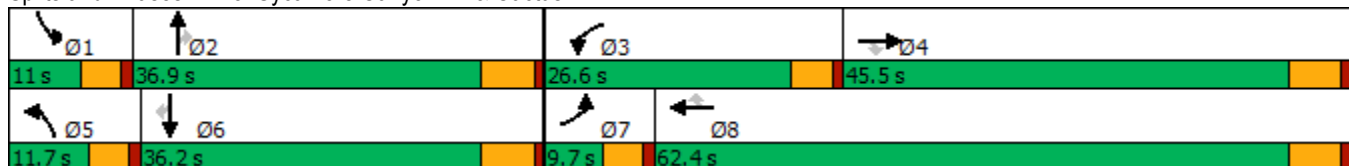





























Splits and Phases: 25: Sycamore Canyon Bl. & Cactus Av.



HCM 6th Signalized Intersection Summary
25: Sycamore Canyon Bl. & Cactus Av.

West Campus Upper Plateau (JN 14064)

09/19/2022

												
Movement	EBL	EBT	EBR	WBL	WBT	WBR	NBL	NBT	NBR	SBL	SBT	SBR
Lane Configurations		  		 	 		 	 		 	 	
Traffic Volume (veh/h)	25	201	83	364	658	885	281	366	209	137	140	77
Future Volume (veh/h)	25	201	83	364	658	885	281	366	209	137	140	77
Initial Q (Qb), veh	0	0	0	0	0	0	0	0	0	0	0	0
Ped-Bike Adj(A_pbT)	1.00		1.00	1.00		0.99	1.00		1.00	1.00		0.99
Parking Bus, Adj	1.00	1.00	1.00	1.00	1.00	1.00	1.00	1.00	1.00	1.00	1.00	1.00
Work Zone On Approach		No			No			No			No	
Adj Sat Flow, veh/h/ln	1530	1693	1826	1722	1722	1856	1811	1796	1811	1841	1826	1796
Adj Flow Rate, veh/h	26	207	85	375	678	693	290	377	118	141	144	76
Peak Hour Factor	0.97	0.97	0.97	0.97	0.97	0.97	0.97	0.97	0.97	0.97	0.97	0.97
Percent Heavy Veh, %	25	14	5	12	12	3	6	7	6	4	5	7
Cap, veh/h	39	1983	604	459	1661	788	280	538	242	211	472	204
Arrive On Green	0.03	0.39	0.39	0.14	0.51	0.51	0.08	0.16	0.16	0.06	0.14	0.14
Sat Flow, veh/h	1457	5078	1547	3182	3272	1553	3346	3413	1535	3401	3469	1502
Grp Volume(v), veh/h	26	207	85	375	678	693	290	377	118	141	144	76
Grp Sat Flow(s),veh/h/ln	1457	1693	1547	1591	1636	1553	1673	1706	1535	1700	1735	1502
Q Serve(g_s), s	1.5	2.2	3.0	9.7	10.9	33.6	7.1	8.9	5.9	3.4	3.2	3.9
Cycle Q Clear(g_c), s	1.5	2.2	3.0	9.7	10.9	33.6	7.1	8.9	5.9	3.4	3.2	3.9
Prop In Lane	1.00		1.00	1.00		1.00	1.00		1.00	1.00		1.00
Lane Grp Cap(c), veh/h	39	1983	604	459	1661	788	280	538	242	211	472	204
V/C Ratio(X)	0.66	0.10	0.14	0.82	0.41	0.88	1.03	0.70	0.49	0.67	0.31	0.37
Avail Cap(c_a), veh/h	88	2379	725	826	2185	1037	280	1252	563	257	1244	539
HCM Platoon Ratio	1.00	1.00	1.00	1.00	1.00	1.00	1.00	1.00	1.00	1.00	1.00	1.00
Upstream Filter(I)	1.00	1.00	1.00	1.00	1.00	1.00	1.00	1.00	1.00	1.00	1.00	1.00
Uniform Delay (d), s/veh	40.8	16.4	16.7	35.2	13.0	18.5	38.8	33.8	32.6	38.9	33.0	33.3
Incr Delay (d2), s/veh	6.8	0.0	0.1	1.4	0.2	7.0	63.0	1.7	1.5	2.9	0.4	1.1
Initial Q Delay(d3),s/veh	0.0	0.0	0.0	0.0	0.0	0.0	0.0	0.0	0.0	0.0	0.0	0.0
%ile BackOfQ(50%),veh/ln	0.6	0.8	1.0	3.6	3.5	11.6	5.2	3.6	2.2	1.4	1.3	1.4
Unsig. Movement Delay, s/veh												
LnGrp Delay(d),s/veh	47.7	16.4	16.8	36.6	13.1	25.6	101.8	35.5	34.1	41.8	33.4	34.4
LnGrp LOS	D	B	B	D	B	C	F	D	C	D	C	C
Approach Vol, veh/h		318			1746			785			361	
Approach Delay, s/veh		19.1			23.1			59.8			36.9	
Approach LOS		B			C			E			D	
Timer - Assigned Phs	1	2	3	4	5	6	7	8				
Phs Duration (G+Y+Rc), s	9.9	19.2	16.8	38.9	11.7	17.3	6.9	48.8				
Change Period (Y+Rc), s	4.6	5.8	4.6	5.8	4.6	5.8	4.6	5.8				
Max Green Setting (Gmax), s	6.4	31.1	22.0	39.7	7.1	30.4	5.1	56.6				
Max Q Clear Time (g_c+1), s	5.4	10.9	11.7	5.0	9.1	5.9	3.5	35.6				
Green Ext Time (p_c), s	0.0	2.5	0.5	1.6	0.0	1.0	0.0	7.4				
Intersection Summary												
HCM 6th Ctrl Delay			33.2									
HCM 6th LOS			C									

Timings
29: I-215 NB Ramps & Alessandro Bl.

West Campus Upper Plateau (JN 14064)

09/19/2022

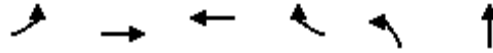

Lane Group	EBL	EBT	WBT	WBR	NBL	NBT
Lane Configurations	↶	↑↑↑	↑↑↑	↷	↶↷	↕
Traffic Volume (vph)	87	892	1347	78	1227	0
Future Volume (vph)	87	892	1347	78	1227	0
Turn Type	Prot	NA	NA	Perm	Split	NA
Protected Phases	5	2	6		8	8
Permitted Phases				6		
Detector Phase	5	2	6	6	8	8
Switch Phase						
Minimum Initial (s)	5.0	5.0	5.0	5.0	5.0	5.0
Minimum Split (s)	9.5	10.5	33.5	33.5	10.0	10.0
Total Split (s)	14.0	65.0	51.0	51.0	45.0	45.0
Total Split (%)	12.7%	59.1%	46.4%	46.4%	40.9%	40.9%
Yellow Time (s)	3.5	4.5	4.5	4.5	4.0	4.0
All-Red Time (s)	1.0	1.0	1.0	1.0	1.0	1.0
Lost Time Adjust (s)	0.0	0.0	0.0	0.0	0.0	0.0
Total Lost Time (s)	4.5	5.5	5.5	5.5	5.0	5.0
Lead/Lag	Lead		Lag	Lag		
Lead-Lag Optimize?	Yes		Yes	Yes		
Recall Mode	None	C-Min	C-Min	C-Min	None	None
Act Effct Green (s)	9.6	60.1	46.0	46.0	39.4	39.4
Actuated g/C Ratio	0.09	0.55	0.42	0.42	0.36	0.36
v/c Ratio	0.69	0.33	0.65	0.13	0.83	0.78
Control Delay	70.5	14.9	27.8	7.7	39.0	36.6
Queue Delay	0.0	0.0	0.0	0.0	0.0	0.0
Total Delay	70.5	14.9	27.8	7.7	39.0	36.6
LOS	E	B	C	A	D	D
Approach Delay		19.9	26.7			38.2
Approach LOS		B	C			D

Intersection Summary

Cycle Length: 110
 Actuated Cycle Length: 110
 Offset: 0 (0%), Referenced to phase 2:EBT and 6:WBT, Start of Yellow
 Natural Cycle: 75
 Control Type: Actuated-Coordinated
 Maximum v/c Ratio: 0.83
 Intersection Signal Delay: 29.2
 Intersection LOS: C
 Intersection Capacity Utilization 69.2%
 ICU Level of Service C
 Analysis Period (min) 15

Splits and Phases: 29: I-215 NB Ramps & Alessandro Bl.

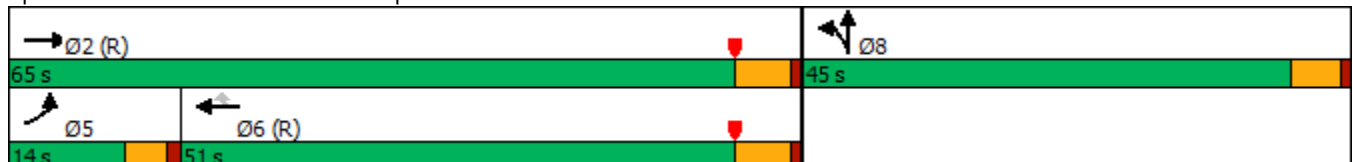

HCM 6th Signalized Intersection Summary
 29: I-215 NB Ramps & Alessandro Bl.

West Campus Upper Plateau (JN 14064)

09/19/2022



Movement	EBL	EBT	EBR	WBL	WBT	WBR	NBL	NBT	NBR	SBL	SBT	SBR
Lane Configurations	↗	↑↑↑			↑↑↑	↗	↗↗	↕				
Traffic Volume (veh/h)	87	892	0	0	1347	78	1227	0	158	0	0	0
Future Volume (veh/h)	87	892	0	0	1347	78	1227	0	158	0	0	0
Initial Q (Qb), veh	0	0	0	0	0	0	0	0	0			
Ped-Bike Adj(A_pbT)	1.00		1.00	1.00		1.00	1.00		1.00			
Parking Bus, Adj	1.00	1.00	1.00	1.00	1.00	1.00	1.00	1.00	1.00			
Work Zone On Approach		No			No			No				
Adj Sat Flow, veh/h/ln	1574	1841	0	0	1870	1707	1870	1900	1796			
Adj Flow Rate, veh/h	89	910	0	0	1374	73	1329	0	0			
Peak Hour Factor	0.98	0.98	0.98	0.98	0.98	0.98	0.98	0.98	0.98			
Percent Heavy Veh, %	22	4	0	0	2	13	2	0	7			
Cap, veh/h	107	3071	0	0	2548	722	1568	558	0			
Arrive On Green	0.14	1.00	0.00	0.00	0.50	0.50	0.29	0.00	0.00			
Sat Flow, veh/h	1499	5191	0	0	5274	1447	5344	1900	0			
Grp Volume(v), veh/h	89	910	0	0	1374	73	1329	0	0			
Grp Sat Flow(s),veh/h/ln	1499	1675	0	0	1702	1447	1781	1900	0			
Q Serve(g_s), s	6.4	0.0	0.0	0.0	20.3	2.9	25.7	0.0	0.0			
Cycle Q Clear(g_c), s	6.4	0.0	0.0	0.0	20.3	2.9	25.7	0.0	0.0			
Prop In Lane	1.00		0.00	0.00		1.00	1.00		0.00			
Lane Grp Cap(c), veh/h	107	3071	0	0	2548	722	1568	558	0			
V/C Ratio(X)	0.84	0.30	0.00	0.00	0.54	0.10	0.85	0.00	0.00			
Avail Cap(c_a), veh/h	129	3071	0	0	2548	722	1943	691	0			
HCM Platoon Ratio	2.00	2.00	1.00	1.00	1.00	1.00	1.00	1.00	1.00			
Upstream Filter(I)	0.97	0.97	0.00	0.00	1.00	1.00	1.00	0.00	0.00			
Uniform Delay (d), s/veh	46.6	0.0	0.0	0.0	18.9	14.5	36.5	0.0	0.0			
Incr Delay (d2), s/veh	28.5	0.2	0.0	0.0	0.8	0.3	3.1	0.0	0.0			
Initial Q Delay(d3),s/veh	0.0	0.0	0.0	0.0	0.0	0.0	0.0	0.0	0.0			
%ile BackOfQ(50%),veh/ln	3.0	0.1	0.0	0.0	7.3	0.9	11.2	0.0	0.0			
Unsig. Movement Delay, s/veh												
LnGrp Delay(d),s/veh	75.1	0.2	0.0	0.0	19.7	14.8	39.6	0.0	0.0			
LnGrp LOS	E	A	A	A	B	B	D	A	A			
Approach Vol, veh/h		999			1447			1329				
Approach Delay, s/veh		6.9			19.5			39.6				
Approach LOS		A			B			D				
Timer - Assigned Phs		2			5	6		8				
Phs Duration (G+Y+Rc), s		72.7			12.3	60.4		37.3				
Change Period (Y+Rc), s		5.5			4.5	5.5		5.0				
Max Green Setting (Gmax), s		59.5			9.5	45.5		40.0				
Max Q Clear Time (g_c+I1), s		2.0			8.4	22.3		27.7				
Green Ext Time (p_c), s		6.5			0.0	9.7		4.6				

Intersection Summary

HCM 6th Ctrl Delay	23.2
HCM 6th LOS	C

Notes

User approved volume balancing among the lanes for turning movement.

Timings

31: I-215 NB Ramps/Old 215 Frontage Rd. & Cactus Av.



Lane Group	EBL	EBT	EBR	WBT	NBL	NBT	NBR	SBL	SBT
Lane Configurations	↶	↶↶	↶	↶↶↶	↶↶	↶	↶	↶	↶
Traffic Volume (vph)	29	1282	163	2441	422	292	12	48	0
Future Volume (vph)	29	1282	163	2441	422	292	12	48	0
Turn Type	Perm	NA	Perm	NA	Prot	NA	Perm	Perm	NA
Protected Phases		2		6	3	8			4
Permitted Phases	2		2				8	4	
Detector Phase	2	2	2	6	3	8	8	4	4
Switch Phase									
Minimum Initial (s)	5.0	5.0	5.0	5.0	5.0	5.0	5.0	5.0	5.0
Minimum Split (s)	11.0	11.0	11.0	44.0	9.1	10.5	10.5	10.5	10.5
Total Split (s)	52.0	52.0	52.0	52.0	16.0	28.0	28.0	12.0	12.0
Total Split (%)	65.0%	65.0%	65.0%	65.0%	20.0%	35.0%	35.0%	15.0%	15.0%
Yellow Time (s)	5.0	5.0	5.0	5.0	3.6	4.5	4.5	4.5	4.5
All-Red Time (s)	1.0	1.0	1.0	1.0	0.5	1.0	1.0	1.0	1.0
Lost Time Adjust (s)	0.0	0.0	0.0	0.0	0.0	0.0	0.0	0.0	0.0
Total Lost Time (s)	6.0	6.0	6.0	6.0	4.1	5.5	5.5	5.5	5.5
Lead/Lag					Lead			Lag	Lag
Lead-Lag Optimize?					Yes			Yes	Yes
Recall Mode	Min	Min	Min	Min	None	None	None	None	None
Act Effct Green (s)	46.0	46.0	46.0	46.0	11.9	22.3	22.3	6.3	6.3
Actuated g/C Ratio	0.58	0.58	0.58	0.58	0.15	0.28	0.28	0.08	0.08
v/c Ratio	0.38	0.68	0.21	0.95	0.91	0.69	0.03	0.55	0.78
Control Delay	25.5	14.1	2.0	25.5	59.1	35.1	0.4	59.7	43.5
Queue Delay	0.0	0.0	0.0	0.0	0.0	0.0	0.0	0.0	0.0
Total Delay	25.5	14.1	2.0	25.5	59.1	35.1	0.4	59.7	43.5
LOS	C	B	A	C	E	D	A	E	D
Approach Delay		13.0		25.5		48.5			47.6
Approach LOS		B		C		D			D

Intersection Summary

Cycle Length: 80
 Actuated Cycle Length: 79.8
 Natural Cycle: 80
 Control Type: Actuated-Uncoordinated
 Maximum v/c Ratio: 0.95
 Intersection Signal Delay: 26.0
 Intersection LOS: C
 Intersection Capacity Utilization 84.2%
 ICU Level of Service E
 Analysis Period (min) 15

Splits and Phases: 31: I-215 NB Ramps/Old 215 Frontage Rd. & Cactus Av.



HCM 6th Signalized Intersection Summary

West Campus Upper Plateau (JN 14064)

31: I-215 NB Ramps/Old 215 Frontage Rd. & Cactus Av.

09/19/2022

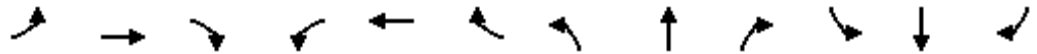

Movement	EBL	EBT	EBR	WBL	WBT	WBR	NBL	NBT	NBR	SBL	SBT	SBR
Lane Configurations	↘	↑↑	↗		↑↑↑		↘↗	↑	↗	↘	↑	↗
Traffic Volume (veh/h)	29	1282	163	0	2441	138	422	292	12	48	0	138
Future Volume (veh/h)	29	1282	163	0	2441	138	422	292	12	48	0	138
Initial Q (Qb), veh	0	0	0	0	0	0	0	0	0	0	0	0
Ped-Bike Adj(A_pbT)	1.00		1.00	1.00		1.00	1.00		1.00	1.00		1.00
Parking Bus, Adj	1.00	1.00	1.00	1.00	1.00	1.00	1.00	1.00	1.00	1.00	1.00	1.00
Work Zone On Approach		No			No			No			No	
Adj Sat Flow, veh/h/ln	1678	1841	1515	0	1856	1841	1811	1722	1900	1841	1900	1485
Adj Flow Rate, veh/h	31	1364	168	0	2597	127	449	311	0	51	0	137
Peak Hour Factor	0.94	0.94	0.94	0.94	0.94	0.94	0.94	0.94	0.94	0.94	0.94	0.94
Percent Heavy Veh, %	15	4	26	0	3	4	6	12	0	4	0	28
Cap, veh/h	99	2011	738	0	2846	138	513	484		175	0	131
Arrive On Green	0.57	0.57	0.57	0.00	0.57	0.57	0.15	0.28	0.00	0.08	0.00	0.08
Sat Flow, veh/h	94	3497	1284	0	5117	239	3450	1722	1610	1052	0	1610
Grp Volume(v), veh/h	31	1364	168	0	1762	962	449	311	0	51	0	137
Grp Sat Flow(s),veh/h/ln	94	1749	1284	0	1689	1812	1725	1722	1610	1052	0	1610
Q Serve(g_s), s	7.5	21.7	5.1	0.0	37.1	38.5	10.2	12.7	0.0	3.7	0.0	6.5
Cycle Q Clear(g_c), s	46.0	21.7	5.1	0.0	37.1	38.5	10.2	12.7	0.0	3.7	0.0	6.5
Prop In Lane	1.00		1.00	0.00		0.13	1.00		1.00	1.00		1.00
Lane Grp Cap(c), veh/h	99	2011	738	0	1942	1042	513	484		175	0	131
V/C Ratio(X)	0.31	0.68	0.23	0.00	0.91	0.92	0.88	0.64		0.29	0.00	1.05
Avail Cap(c_a), veh/h	99	2011	738	0	1942	1042	513	484		175	0	131
HCM Platoon Ratio	1.00	1.00	1.00	1.00	1.00	1.00	1.00	1.00	1.00	1.00	1.00	1.00
Upstream Filter(I)	1.00	1.00	1.00	0.00	1.00	1.00	1.00	1.00	0.00	1.00	0.00	1.00
Uniform Delay (d), s/veh	38.9	11.8	8.3	0.0	15.1	15.4	33.3	25.2	0.0	35.5	0.0	36.8
Incr Delay (d2), s/veh	0.7	0.8	0.1	0.0	6.5	13.0	15.5	2.2	0.0	0.3	0.0	91.8
Initial Q Delay(d3),s/veh	0.0	0.0	0.0	0.0	0.0	0.0	0.0	0.0	0.0	0.0	0.0	0.0
%ile BackOfQ(50%),veh/ln	0.6	6.8	1.1	0.0	12.6	15.8	5.1	5.0	0.0	0.9	0.0	5.7
Unsig. Movement Delay, s/veh												
LnGrp Delay(d),s/veh	39.6	12.6	8.4	0.0	21.6	28.4	48.8	27.5	0.0	35.8	0.0	128.6
LnGrp LOS	D	B	A	A	C	C	D	C		D	A	F
Approach Vol, veh/h		1563			2724			760				188
Approach Delay, s/veh		12.7			24.0			40.1				103.4
Approach LOS		B			C			D				F
Timer - Assigned Phs		2	3	4		6		8				
Phs Duration (G+Y+Rc), s		52.0	16.0	12.0		52.0		28.0				
Change Period (Y+Rc), s		6.0	4.1	5.5		6.0		5.5				
Max Green Setting (Gmax), s		46.0	11.9	6.5		46.0		22.5				
Max Q Clear Time (g_c+I1), s		48.0	12.2	8.5		40.5		14.7				
Green Ext Time (p_c), s		0.0	0.0	0.0		4.7		0.6				

Intersection Summary

HCM 6th Ctrl Delay	25.8
HCM 6th LOS	C

Notes

User approved volume balancing among the lanes for turning movement.
 Unsignalized Delay for [NBR] is excluded from calculations of the approach delay and intersection delay.

Timings

West Campus Upper Plateau (JN 14064)

36: Elsworth St. & Cactus Av.

09/19/2022



Lane Group	EBL	EBT	EBR	WBL	WBT	WBR	NBL	NBT	SBL	SBT	SBR
Lane Configurations	↘	↑↑↑	↗	↘	↑↑↑	↗	↘	↗	↘	↑	↗
Traffic Volume (vph)	187	1376	288	69	1713	120	23	10	82	58	182
Future Volume (vph)	187	1376	288	69	1713	120	23	10	82	58	182
Turn Type	Prot	NA	Free	Prot	NA	Perm	Prot	NA	Prot	NA	pm+ov
Protected Phases	5	2		1	6		3	8	7	4	5
Permitted Phases			Free			6					4
Detector Phase	5	2		1	6	6	3	8	7	4	5
Switch Phase											
Minimum Initial (s)	5.0	10.0		5.0	10.0	10.0	10.0	10.0	10.0	10.0	5.0
Minimum Split (s)	9.6	36.2		9.6	36.2	36.2	35.4	35.4	35.4	35.4	9.6
Total Split (s)	11.0	39.4		9.8	38.2	38.2	35.4	35.4	35.4	35.4	11.0
Total Split (%)	9.2%	32.8%		8.2%	31.8%	31.8%	29.5%	29.5%	29.5%	29.5%	9.2%
Yellow Time (s)	3.6	5.2		3.6	5.2	5.2	4.4	4.4	4.4	4.4	3.6
All-Red Time (s)	1.0	1.0		1.0	1.0	1.0	1.0	1.0	1.0	1.0	1.0
Lost Time Adjust (s)	0.0	0.0		0.0	0.0	0.0	0.0	0.0	0.0	0.0	0.0
Total Lost Time (s)	4.6	6.2		4.6	6.2	6.2	5.4	5.4	5.4	5.4	4.6
Lead/Lag	Lead	Lag		Lead	Lag	Lag	Lag	Lag	Lead	Lead	Lead
Lead-Lag Optimize?	Yes	Yes		Yes	Yes	Yes	Yes	Yes	Yes	Yes	Yes
Recall Mode	None	None		None	None	None	None	None	None	None	None
Act Effct Green (s)	6.8	35.3	72.6	5.5	34.1	34.1	11.3	13.4	11.3	13.4	16.5
Actuated g/C Ratio	0.09	0.49	1.00	0.08	0.47	0.47	0.16	0.18	0.16	0.18	0.23
v/c Ratio	1.19	0.59	0.18	0.51	0.75	0.16	0.10	0.08	0.31	0.17	0.37
Control Delay	166.5	19.4	0.3	53.4	23.0	6.2	34.7	17.7	36.7	29.0	4.4
Queue Delay	0.0	0.0	0.0	0.0	0.0	0.0	0.0	0.0	0.0	0.0	0.0
Total Delay	166.5	19.4	0.3	53.4	23.0	6.2	34.7	17.7	36.7	29.0	4.4
LOS	F	B	A	D	C	A	C	B	D	C	A
Approach Delay		31.3			23.0			25.6		17.1	
Approach LOS		C			C			C		B	

Intersection Summary

Cycle Length: 120
 Actuated Cycle Length: 72.6
 Natural Cycle: 130
 Control Type: Actuated-Uncoordinated
 Maximum v/c Ratio: 1.19
 Intersection Signal Delay: 26.3
 Intersection LOS: C
 Intersection Capacity Utilization 68.2%
 ICU Level of Service C
 Analysis Period (min) 15

Splits and Phases: 36: Elsworth St. & Cactus Av.

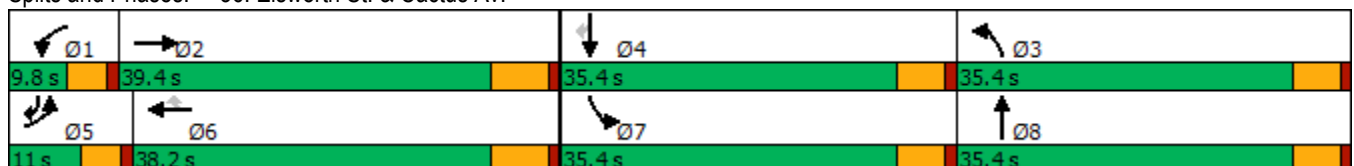

HCM 6th Signalized Intersection Summary
36: Elsworth St. & Cactus Av.

West Campus Upper Plateau (JN 14064)

09/19/2022



Movement	EBL	EBT	EBR	WBL	WBT	WBR	NBL	NBT	NBR	SBL	SBT	SBR
Lane Configurations	↗	↑↑↑	↘	↖	↑↑↑	↗	↖	↑		↘	↑	↗
Traffic Volume (veh/h)	187	1376	288	69	1713	120	23	10	16	82	58	182
Future Volume (veh/h)	187	1376	288	69	1713	120	23	10	16	82	58	182
Initial Q (Qb), veh	0	0	0	0	0	0	0	0	0	0	0	0
Ped-Bike Adj(A_pbT)	1.00		1.00	1.00		0.98	1.00		1.00	1.00		1.00
Parking Bus, Adj	1.00	1.00	1.00	1.00	1.00	1.00	1.00	1.00	1.00	1.00	1.00	1.00
Work Zone On Approach		No			No			No			No	
Adj Sat Flow, veh/h/ln	1826	1796	1885	1900	1841	1856	1633	1900	1900	1826	1900	1841
Adj Flow Rate, veh/h	191	1404	0	70	1748	74	23	10	8	84	59	119
Peak Hour Factor	0.98	0.98	0.98	0.98	0.98	0.98	0.98	0.98	0.98	0.98	0.98	0.98
Percent Heavy Veh, %	5	7	1	0	4	3	18	0	0	5	0	4
Cap, veh/h	141	2085		90	1980	607	195	123	98	220	240	323
Arrive On Green	0.08	0.43	0.00	0.05	0.39	0.39	0.13	0.13	0.13	0.13	0.13	0.13
Sat Flow, veh/h	1739	4904	1598	1810	5025	1540	1555	977	782	1739	1900	1560
Grp Volume(v), veh/h	191	1404	0	70	1748	74	23	0	18	84	59	119
Grp Sat Flow(s),veh/h/ln	1739	1635	1598	1810	1675	1540	1555	0	1759	1739	1900	1560
Q Serve(g_s), s	6.4	18.2	0.0	3.0	25.5	2.4	1.0	0.0	0.7	3.5	2.2	3.1
Cycle Q Clear(g_c), s	6.4	18.2	0.0	3.0	25.5	2.4	1.0	0.0	0.7	3.5	2.2	3.1
Prop In Lane	1.00		1.00	1.00		1.00	1.00		0.44	1.00		1.00
Lane Grp Cap(c), veh/h	141	2085		90	1980	607	195	0	221	220	240	323
V/C Ratio(X)	1.36	0.67		0.78	0.88	0.12	0.12	0.00	0.08	0.38	0.25	0.37
Avail Cap(c_a), veh/h	141	2085		119	2034	623	590	0	668	660	721	718
HCM Platoon Ratio	1.00	1.00	1.00	1.00	1.00	1.00	1.00	1.00	1.00	1.00	1.00	1.00
Upstream Filter(I)	1.00	1.00	0.00	1.00	1.00	1.00	1.00	0.00	1.00	1.00	1.00	1.00
Uniform Delay (d), s/veh	36.3	18.3	0.0	37.1	22.3	15.2	30.7	0.0	30.5	31.7	31.1	11.2
Incr Delay (d2), s/veh	199.5	0.9	0.0	14.6	4.9	0.1	0.3	0.0	0.2	1.1	0.5	0.7
Initial Q Delay(d3),s/veh	0.0	0.0	0.0	0.0	0.0	0.0	0.0	0.0	0.0	0.0	0.0	0.0
%ile BackOfQ(50%),veh/ln	10.3	6.0	0.0	1.6	9.4	0.8	0.4	0.0	0.3	1.5	1.0	1.3
Unsig. Movement Delay, s/veh												
LnGrp Delay(d),s/veh	235.9	19.2	0.0	51.7	27.1	15.3	30.9	0.0	30.7	32.8	31.7	11.9
LnGrp LOS	F	B		D	C	B	C	A	C	C	C	B
Approach Vol, veh/h		1595			1892			41			262	
Approach Delay, s/veh		45.1			27.6			30.8			23.0	
Approach LOS		D			C			C			C	
Timer - Assigned Phs	1	2	3	4	5	6	7	8				
Phs Duration (G+Y+Rc), s	8.5	39.8	15.3	15.4	11.0	37.3	15.4	15.3				
Change Period (Y+Rc), s	4.6	6.2	5.4	5.4	4.6	6.2	5.4	5.4				
Max Green Setting (Gmax), s	5.2	33.2	30.0	30.0	6.4	32.0	30.0	30.0				
Max Q Clear Time (g_c+I1), s	5.0	20.2	3.0	5.1	8.4	27.5	5.5	2.7				
Green Ext Time (p_c), s	0.0	7.2	0.0	0.6	0.0	3.6	0.2	0.0				

Intersection Summary

HCM 6th Ctrl Delay	34.7
HCM 6th LOS	C

Notes

User approved pedestrian interval to be less than phase max green.
Unsignalized Delay for [EBR] is excluded from calculations of the approach delay and intersection delay.

Timings

3: Overlook Pkwy./Canyon Crest Dr. & Alessandro Bl/Alessandro Bl.



Lane Group	EBL	EBT	WBL	WBT	WBR	NBL	NBT	NBR	SBL	SBT
Lane Configurations	↙	↕↕↕↕	↙	↕↕↕	↗	↙	↕↕	↗	↙↙↙	↕
Traffic Volume (vph)	52	2826	22	2103	599	37	150	56	547	63
Future Volume (vph)	52	2826	22	2103	599	37	150	56	547	63
Turn Type	Prot	NA	Prot	NA	pm+ov	Perm	NA	Perm	Prot	NA
Protected Phases	5	2	1	6	7		8		7	4
Permitted Phases					6	8		8		
Detector Phase	5	2	1	6	7	8	8	8	7	4
Switch Phase										
Minimum Initial (s)	5.0	10.0	5.0	10.0	10.0	10.0	10.0	10.0	10.0	10.0
Minimum Split (s)	9.2	35.2	9.2	35.2	38.8	15.8	15.8	15.8	38.8	38.8
Total Split (s)	9.2	56.2	9.2	56.2	38.8	15.8	15.8	15.8	38.8	54.6
Total Split (%)	7.7%	46.8%	7.7%	46.8%	32.3%	13.2%	13.2%	13.2%	32.3%	45.5%
Yellow Time (s)	3.2	5.2	3.2	5.2	4.8	4.8	4.8	4.8	4.8	4.8
All-Red Time (s)	1.0	1.0	1.0	1.0	1.0	1.0	1.0	1.0	1.0	1.0
Lost Time Adjust (s)	0.0	0.0	0.0	0.0	0.0	0.0	0.0	0.0	0.0	0.0
Total Lost Time (s)	4.2	6.2	4.2	6.2	5.8	5.8	5.8	5.8	5.8	5.8
Lead/Lag	Lead	Lag	Lead	Lag	Lead	Lag	Lag	Lag	Lead	
Lead-Lag Optimize?	Yes	Yes	Yes	Yes	Yes	Yes	Yes	Yes	Yes	
Recall Mode	None	None	None	None	None	None	None	None	None	None
Act Effct Green (s)	5.0	54.1	5.0	50.4	77.1	10.1	10.1	10.1	20.4	36.4
Actuated g/C Ratio	0.05	0.51	0.05	0.48	0.73	0.10	0.10	0.10	0.19	0.34
v/c Ratio	0.68	1.03	0.27	0.82	0.52	0.34	0.45	0.22	0.59	0.15
Control Delay	90.2	52.8	60.4	28.4	6.8	56.7	52.1	1.9	41.3	20.0
Queue Delay	0.0	0.0	0.0	0.0	0.0	0.0	0.0	0.0	0.0	0.0
Total Delay	90.2	52.8	60.4	28.4	6.8	56.7	52.1	1.9	41.3	20.0
LOS	F	D	E	C	A	E	D	A	D	B
Approach Delay		53.5		23.9			41.3			38.4
Approach LOS		D		C			D			D

Intersection Summary

Cycle Length: 120
 Actuated Cycle Length: 106
 Natural Cycle: 120
 Control Type: Actuated-Uncoordinated
 Maximum v/c Ratio: 1.03
 Intersection Signal Delay: 39.2
 Intersection LOS: D
 Intersection Capacity Utilization 88.7%
 ICU Level of Service E
 Analysis Period (min) 15

Splits and Phases: 3: Overlook Pkwy./Canyon Crest Dr. & Alessandro Bl/Alessandro Bl.

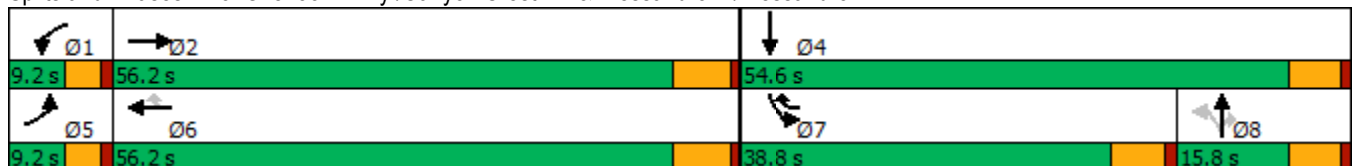

HCM 6th Signalized Intersection Summary

West Campus Upper Plateau (JN 14064)

3: Overlook Pkwy./Canyon Crest Dr. & Alessandro Bl/Alessandro Bl.

09/19/2022



Movement	EBL	EBT	EBR	WBL	WBT	WBR	NBL	NBT	NBR	SBL	SBT	SBR
Lane Configurations	↗	↑↑↑		↖	↑↑↑	↗	↖	↑↑	↗	↖↖↖	↖	
Traffic Volume (veh/h)	52	2826	25	22	2103	599	37	150	56	547	63	23
Future Volume (veh/h)	52	2826	25	22	2103	599	37	150	56	547	63	23
Initial Q (Qb), veh	0	0	0	0	0	0	0	0	0	0	0	0
Ped-Bike Adj(A_pbT)	1.00		1.00	1.00		1.00	1.00		1.00	1.00		1.00
Parking Bus, Adj	1.00	1.00	1.00	1.00	1.00	1.00	1.00	1.00	1.00	1.00	1.00	1.00
Work Zone On Approach		No			No			No				No
Adj Sat Flow, veh/h/ln	1811	1885	1811	1900	1885	1885	1781	1900	1900	1885	1767	1841
Adj Flow Rate, veh/h	54	2944	26	23	2191	616	39	156	50	570	66	15
Peak Hour Factor	0.96	0.96	0.96	0.96	0.96	0.96	0.96	0.96	0.96	0.96	0.96	0.96
Percent Heavy Veh, %	6	1	6	0	1	1	8	0	0	1	9	4
Cap, veh/h	68	2825	25	43	2764	1018	199	364	163	753	429	98
Arrive On Green	0.04	0.50	0.50	0.02	0.49	0.49	0.10	0.10	0.10	0.15	0.31	0.31
Sat Flow, veh/h	1725	5597	49	1810	5656	1598	1255	3610	1610	5063	1393	317
Grp Volume(v), veh/h	54	1980	990	23	2191	616	39	156	50	570	0	81
Grp Sat Flow(s),veh/h/ln	1725	1885	1876	1810	1885	1598	1255	1805	1610	1688	0	1710
Q Serve(g_s), s	3.1	50.0	50.0	1.2	32.0	22.5	2.9	4.0	2.9	10.7	0.0	3.4
Cycle Q Clear(g_c), s	3.1	50.0	50.0	1.2	32.0	22.5	2.9	4.0	2.9	10.7	0.0	3.4
Prop In Lane	1.00		0.03	1.00		1.00	1.00		1.00	1.00		0.19
Lane Grp Cap(c), veh/h	68	1903	947	43	2764	1018	199	364	163	753	0	527
V/C Ratio(X)	0.79	1.04	1.05	0.54	0.79	0.60	0.20	0.43	0.31	0.76	0.00	0.15
Avail Cap(c_a), veh/h	87	1903	947	91	2854	1044	199	364	163	1687	0	842
HCM Platoon Ratio	1.00	1.00	1.00	1.00	1.00	1.00	1.00	1.00	1.00	1.00	1.00	1.00
Upstream Filter(I)	1.00	1.00	1.00	1.00	1.00	1.00	1.00	1.00	1.00	1.00	0.00	1.00
Uniform Delay (d), s/veh	47.2	24.5	24.5	47.8	21.1	10.6	41.3	41.8	41.3	40.5	0.0	24.9
Incr Delay (d2), s/veh	23.8	32.0	41.8	3.8	1.6	1.0	0.5	0.8	1.1	1.6	0.0	0.1
Initial Q Delay(d3),s/veh	0.0	0.0	0.0	0.0	0.0	0.0	0.0	0.0	0.0	0.0	0.0	0.0
%ile BackOfQ(50%),veh/ln	1.7	27.4	29.8	0.6	12.7	6.7	0.9	1.8	1.1	4.4	0.0	1.3
Unsig. Movement Delay, s/veh												
LnGrp Delay(d),s/veh	71.0	56.6	66.4	51.7	22.7	11.6	41.8	42.6	42.4	42.0	0.0	25.0
LnGrp LOS	E	F	F	D	C	B	D	D	D	D	A	C
Approach Vol, veh/h		3024			2830			245			651	
Approach Delay, s/veh		60.0			20.5			42.5			39.9	
Approach LOS		E			C			D			D	
Timer - Assigned Phs	1	2		4	5	6	7	8				
Phs Duration (G+Y+Rc), s	6.5	56.2		36.3	8.1	54.6	20.5	15.8				
Change Period (Y+Rc), s	* 4.2	6.2		5.8	* 4.2	6.2	5.8	5.8				
Max Green Setting (Gmax), s	* 5	50.0		48.8	* 5	50.0	33.0	10.0				
Max Q Clear Time (g_c+I1), s	3.2	52.0		5.4	5.1	34.0	12.7	6.0				
Green Ext Time (p_c), s	0.0	0.0		0.4	0.0	13.5	2.0	0.4				

Intersection Summary

HCM 6th Ctrl Delay	40.9
HCM 6th LOS	D

Notes

- User approved pedestrian interval to be less than phase max green.
- * HCM 6th computational engine requires equal clearance times for the phases crossing the barrier.

Timings

14: Barton Rd. & Van Buren Bl.

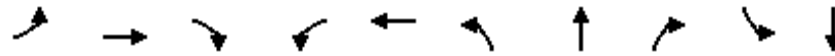

Lane Group	EBL	EBT	EBR	WBL	WBT	NBL	NBT	NBR	SBL	SBT
Lane Configurations	↘	↑↑	↗	↘	↑↑↑	↗	↑	↗	↘	↗
Traffic Volume (vph)	100	1187	218	303	1354	209	61	229	33	27
Future Volume (vph)	100	1187	218	303	1354	209	61	229	33	27
Turn Type	Prot	NA	pm+ov	Prot	NA	Prot	NA	Perm	Prot	NA
Protected Phases	5	2	3	1	6	3	8		7	4
Permitted Phases			2					8		
Detector Phase	5	2	3	1	6	3	8	8	7	4
Switch Phase										
Minimum Initial (s)	5.0	10.0	5.0	5.0	10.0	5.0	10.0	10.0	5.0	10.0
Minimum Split (s)	9.2	25.2	9.1	9.2	25.5	9.1	14.6	14.6	9.1	33.6
Total Split (s)	14.0	55.4	13.0	18.0	59.4	13.0	36.4	36.4	10.2	33.6
Total Split (%)	11.7%	46.2%	10.8%	15.0%	49.5%	10.8%	30.3%	30.3%	8.5%	28.0%
Yellow Time (s)	3.2	5.2	3.6	3.2	5.5	3.6	3.6	3.6	3.6	3.6
All-Red Time (s)	1.0	1.0	0.5	1.0	1.0	0.5	1.0	1.0	0.5	1.0
Lost Time Adjust (s)	0.0	0.0	0.0	0.0	0.0	0.0	0.0	0.0	0.0	0.0
Total Lost Time (s)	4.2	6.2	4.1	4.2	6.5	4.1	4.6	4.6	4.1	4.6
Lead/Lag	Lead	Lag	Lead	Lead	Lag	Lead	Lag	Lag	Lead	Lag
Lead-Lag Optimize?	Yes	Yes	Yes	Yes	Yes	Yes	Yes	Yes	Yes	Yes
Recall Mode	None	None	None	None	None	None	None	None	None	None
Act Effct Green (s)	9.0	37.3	48.5	14.1	42.1	9.1	20.6	20.6	6.1	13.1
Actuated g/C Ratio	0.10	0.40	0.52	0.15	0.45	0.10	0.22	0.22	0.07	0.14
v/c Ratio	0.60	0.88	0.27	1.18	0.65	0.64	0.15	0.46	0.29	0.36
Control Delay	58.7	34.6	8.7	151.2	21.8	52.4	34.3	9.5	53.3	16.5
Queue Delay	0.0	0.0	0.0	0.0	0.0	0.0	0.0	0.0	0.0	0.0
Total Delay	58.7	34.6	8.7	151.2	21.8	52.4	34.3	9.5	53.3	16.5
LOS	E	C	A	F	C	D	C	A	D	B
Approach Delay		32.4			44.4		30.5			25.0
Approach LOS		C			D		C			C

Intersection Summary

Cycle Length: 120
 Actuated Cycle Length: 93.1
 Natural Cycle: 120
 Control Type: Actuated-Uncoordinated
 Maximum v/c Ratio: 1.18
 Intersection Signal Delay: 37.3
 Intersection Capacity Utilization 74.7%
 Analysis Period (min) 15
 Intersection LOS: D
 ICU Level of Service D

Splits and Phases: 14: Barton Rd. & Van Buren Bl.

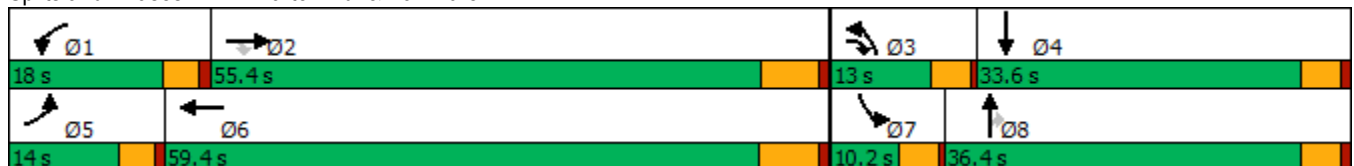

HCM 6th Signalized Intersection Summary
14: Barton Rd. & Van Buren Bl.

West Campus Upper Plateau (JN 14064)

09/19/2022



Movement	EBL	EBT	EBR	WBL	WBT	WBR	NBL	NBT	NBR	SBL	SBT	SBR
Lane Configurations												
Traffic Volume (veh/h)	100	1187	218	303	1354	80	209	61	229	33	27	82
Future Volume (veh/h)	100	1187	218	303	1354	80	209	61	229	33	27	82
Initial Q (Qb), veh	0	0	0	0	0	0	0	0	0	0	0	0
Ped-Bike Adj(A_pbT)	1.00		1.00	1.00		1.00	1.00		0.95	1.00		1.00
Parking Bus, Adj	1.00	1.00	1.00	1.00	1.00	1.00	1.00	1.00	1.00	1.00	1.00	1.00
Work Zone On Approach		No			No			No			No	
Adj Sat Flow, veh/h/ln	1900	1856	1870	1870	1870	1856	1900	1900	1885	1900	1885	1900
Adj Flow Rate, veh/h	104	1236	198	316	1410	73	218	64	115	34	28	27
Peak Hour Factor	0.96	0.96	0.96	0.96	0.96	0.96	0.96	0.96	0.96	0.96	0.96	0.96
Percent Heavy Veh, %	0	3	2	2	2	3	0	0	1	0	1	0
Cap, veh/h	133	1443	783	288	2473	128	298	322	257	59	103	99
Arrive On Green	0.07	0.41	0.41	0.16	0.50	0.50	0.08	0.17	0.17	0.03	0.12	0.12
Sat Flow, veh/h	1810	3526	1583	1781	4970	257	3510	1900	1516	1810	882	850
Grp Volume(v), veh/h	104	1236	198	316	966	517	218	64	115	34	0	55
Grp Sat Flow(s),veh/h/ln	1810	1763	1583	1781	1702	1824	1755	1900	1516	1810	0	1732
Q Serve(g_s), s	4.8	27.2	6.2	13.8	17.0	17.0	5.2	2.5	5.8	1.6	0.0	2.5
Cycle Q Clear(g_c), s	4.8	27.2	6.2	13.8	17.0	17.0	5.2	2.5	5.8	1.6	0.0	2.5
Prop In Lane	1.00		1.00	1.00		0.14	1.00		1.00	1.00		0.49
Lane Grp Cap(c), veh/h	133	1443	783	288	1693	907	298	322	257	59	0	203
V/C Ratio(X)	0.78	0.86	0.25	1.10	0.57	0.57	0.73	0.20	0.45	0.58	0.00	0.27
Avail Cap(c_a), veh/h	208	2032	1047	288	2109	1130	366	708	565	129	0	588
HCM Platoon Ratio	1.00	1.00	1.00	1.00	1.00	1.00	1.00	1.00	1.00	1.00	1.00	1.00
Upstream Filter(I)	1.00	1.00	1.00	1.00	1.00	1.00	1.00	1.00	1.00	1.00	0.00	1.00
Uniform Delay (d), s/veh	38.9	22.9	12.5	35.8	15.0	15.0	38.1	30.5	31.9	40.7	0.0	34.4
Incr Delay (d2), s/veh	3.8	2.0	0.1	81.7	0.1	0.2	5.7	0.3	1.2	8.7	0.0	0.7
Initial Q Delay(d3),s/veh	0.0	0.0	0.0	0.0	0.0	0.0	0.0	0.0	0.0	0.0	0.0	0.0
%ile BackOfQ(50%),veh/ln	2.1	10.1	1.9	12.1	5.5	5.9	2.3	1.1	2.1	0.8	0.0	1.1
Unsig. Movement Delay, s/veh												
LnGrp Delay(d),s/veh	42.7	25.0	12.5	117.5	15.2	15.3	43.9	30.8	33.1	49.5	0.0	35.1
LnGrp LOS	D	C	B	F	B	B	D	C	C	D	A	D
Approach Vol, veh/h		1538			1799			397				89
Approach Delay, s/veh		24.6			33.2			38.6				40.6
Approach LOS		C			C			D				D
Timer - Assigned Phs	1	2	3	4	5	6	7	8				
Phs Duration (G+Y+Rc), s	18.0	41.4	11.3	14.6	10.5	49.0	6.9	19.1				
Change Period (Y+Rc), s	* 4.2	* 6.5	4.1	4.6	* 4.2	6.5	4.1	4.6				
Max Green Setting (Gmax), s	* 14	* 49	8.9	29.0	* 9.8	52.9	6.1	31.8				
Max Q Clear Time (g_c+I1), s	15.8	29.2	7.2	4.5	6.8	19.0	3.6	7.8				
Green Ext Time (p_c), s	0.0	5.7	0.1	0.2	0.0	6.7	0.0	0.6				

Intersection Summary

HCM 6th Ctrl Delay	30.4
HCM 6th LOS	C

Notes

* HCM 6th computational engine requires equal clearance times for the phases crossing the barrier.

Timings
25: Sycamore Canyon Bl. & Cactus Av.

West Campus Upper Plateau (JN 14064)

09/19/2022



Lane Group	EBL	EBT	EBR	WBL	WBT	WBR	NBL	NBT	NBR	SBL	SBT	SBR
Lane Configurations	↘	↑↑↑	↗	↘↗	↑↑	↗	↘↗	↑↑	↗	↘↗	↑↑	↗
Traffic Volume (vph)	143	1159	528	696	431	497	186	328	221	498	840	51
Future Volume (vph)	143	1159	528	696	431	497	186	328	221	498	840	51
Turn Type	Prot	NA	Perm	Prot	NA	pm+ov	Prot	NA	Perm	Prot	NA	Perm
Protected Phases	7	4		3	8	1	5	2		1	6	
Permitted Phases			4			8			2			6
Detector Phase	7	4	4	3	8	1	5	2	2	1	6	6
Switch Phase												
Minimum Initial (s)	5.0	10.0	10.0	5.0	10.0	10.0	10.0	10.0	10.0	10.0	10.0	10.0
Minimum Split (s)	9.6	32.8	32.8	9.6	32.8	15.8	15.8	15.8	15.8	15.8	34.8	34.8
Total Split (s)	25.0	35.0	35.0	30.0	40.0	29.6	15.8	25.4	25.4	29.6	39.2	39.2
Total Split (%)	20.8%	29.2%	29.2%	25.0%	33.3%	24.7%	13.2%	21.2%	21.2%	24.7%	32.7%	32.7%
Yellow Time (s)	3.6	4.8	4.8	3.6	4.8	4.8	4.8	4.8	4.8	4.8	4.8	4.8
All-Red Time (s)	1.0	1.0	1.0	1.0	1.0	1.0	1.0	1.0	1.0	1.0	1.0	1.0
Lost Time Adjust (s)	0.0	0.0	0.0	0.0	0.0	0.0	0.0	0.0	0.0	0.0	0.0	0.0
Total Lost Time (s)	4.6	5.8	5.8	4.6	5.8	5.8	5.8	5.8	5.8	5.8	5.8	5.8
Lead/Lag	Lead	Lag	Lag	Lead	Lag	Lead	Lead	Lag	Lag	Lead	Lag	Lag
Lead-Lag Optimize?	Yes	Yes	Yes	Yes	Yes	Yes	Yes	Yes	Yes	Yes	Yes	Yes
Recall Mode	None	None	None	None	None	None	None	None	None	None	None	None
Act Effct Green (s)	15.5	29.2	29.2	25.4	39.1	68.1	10.0	20.2	20.2	23.2	33.4	33.4
Actuated g/C Ratio	0.13	0.24	0.24	0.21	0.33	0.57	0.08	0.17	0.17	0.19	0.28	0.28
v/c Ratio	0.74	1.04	1.13	1.15	0.46	0.59	0.76	0.66	0.55	0.86	1.04	0.11
Control Delay	69.6	80.3	106.9	125.0	34.5	14.5	71.8	53.3	10.3	61.1	82.8	0.4
Queue Delay	0.0	0.0	0.0	0.0	0.0	0.5	0.0	0.0	0.0	0.0	0.0	0.0
Total Delay	69.6	80.3	106.9	125.0	34.5	14.9	71.8	53.3	10.3	61.1	82.8	0.4
LOS	E	F	F	F	C	B	E	D	B	E	F	A
Approach Delay		87.2			67.3			45.1			72.0	
Approach LOS		F			E			D			E	

Intersection Summary

Cycle Length: 120
 Actuated Cycle Length: 120
 Natural Cycle: 115
 Control Type: Actuated-Uncoordinated
 Maximum v/c Ratio: 1.15
 Intersection Signal Delay: 72.1
 Intersection LOS: E
 Intersection Capacity Utilization 92.1%
 ICU Level of Service F
 Analysis Period (min) 15



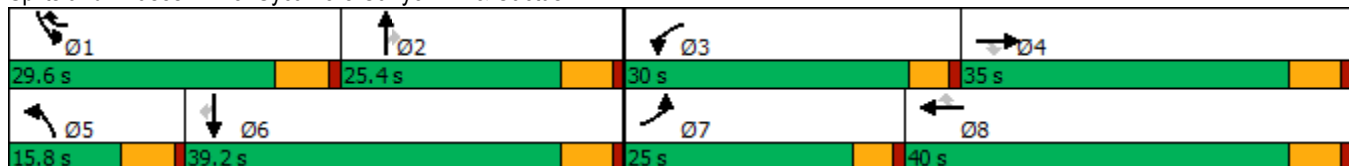





























Splits and Phases: 25: Sycamore Canyon Bl. & Cactus Av.



HCM 6th Signalized Intersection Summary
 25: Sycamore Canyon Bl. & Cactus Av.

West Campus Upper Plateau (JN 14064)

09/19/2022

												
Movement	EBL	EBT	EBR	WBL	WBT	WBR	NBL	NBT	NBR	SBL	SBT	SBR
Lane Configurations		  		 	 		 	 		 	 	
Traffic Volume (veh/h)	143	1159	528	696	431	497	186	328	221	498	840	51
Future Volume (veh/h)	143	1159	528	696	431	497	186	328	221	498	840	51
Initial Q (Qb), veh	0	0	0	0	0	0	0	0	0	0	0	0
Ped-Bike Adj(A_pbT)	1.00		1.00	1.00		1.00	1.00		1.00	1.00		1.00
Parking Bus, Adj	1.00	1.00	1.00	1.00	1.00	1.00	1.00	1.00	1.00	1.00	1.00	1.00
Work Zone On Approach		No			No			No			No	
Adj Sat Flow, veh/h/ln	1841	1796	1856	1826	1796	1870	1856	1811	1781	1885	1796	1767
Adj Flow Rate, veh/h	166	1348	352	809	501	308	216	381	154	579	977	59
Peak Hour Factor	0.86	0.86	0.86	0.86	0.86	0.86	0.86	0.86	0.86	0.86	0.86	0.86
Percent Heavy Veh, %	4	7	3	5	7	2	3	6	8	1	7	9
Cap, veh/h	193	1311	383	714	1176	838	286	611	268	641	950	417
Arrive On Green	0.11	0.24	0.24	0.21	0.34	0.34	0.08	0.18	0.18	0.18	0.28	0.28
Sat Flow, veh/h	1753	5389	1572	3374	3413	1585	3428	3441	1510	3483	3413	1497
Grp Volume(v), veh/h	166	1348	352	809	501	308	216	381	154	579	977	59
Grp Sat Flow(s),veh/h/ln	1753	1796	1572	1687	1706	1585	1714	1721	1510	1742	1706	1497
Q Serve(g_s), s	11.2	29.2	26.2	25.4	13.5	13.6	7.4	12.3	11.2	19.5	33.4	3.6
Cycle Q Clear(g_c), s	11.2	29.2	26.2	25.4	13.5	13.6	7.4	12.3	11.2	19.5	33.4	3.6
Prop In Lane	1.00		1.00	1.00		1.00	1.00		1.00	1.00		1.00
Lane Grp Cap(c), veh/h	193	1311	383	714	1176	838	286	611	268	641	950	417
V/C Ratio(X)	0.86	1.03	0.92	1.13	0.43	0.37	0.76	0.62	0.57	0.90	1.03	0.14
Avail Cap(c_a), veh/h	298	1311	383	714	1176	838	286	611	268	691	950	417
HCM Platoon Ratio	1.00	1.00	1.00	1.00	1.00	1.00	1.00	1.00	1.00	1.00	1.00	1.00
Upstream Filter(I)	1.00	1.00	1.00	1.00	1.00	1.00	1.00	1.00	1.00	1.00	1.00	1.00
Uniform Delay (d), s/veh	52.5	45.4	44.3	47.3	30.2	16.5	53.8	45.6	45.2	47.9	43.3	32.5
Incr Delay (d2), s/veh	9.2	32.3	27.0	76.6	0.2	0.3	11.0	2.0	3.0	14.7	36.7	0.2
Initial Q Delay(d3),s/veh	0.0	0.0	0.0	0.0	0.0	0.0	0.0	0.0	0.0	0.0	0.0	0.0
%ile BackOfQ(50%),veh/ln	5.3	16.5	12.7	17.9	5.4	4.7	3.5	5.3	4.3	9.5	18.3	1.3
Unsig. Movement Delay, s/veh												
LnGrp Delay(d),s/veh	61.6	77.7	71.3	123.9	30.4	16.8	64.8	47.6	48.1	62.6	80.0	32.7
LnGrp LOS	E	F	E	F	C	B	E	D	D	E	F	C
Approach Vol, veh/h		1866			1618			751			1615	
Approach Delay, s/veh		75.0			74.6			52.6			72.0	
Approach LOS		E			E			D			E	
Timer - Assigned Phs	1	2	3	4	5	6	7	8				
Phs Duration (G+Y+Rc), s	27.9	27.1	30.0	35.0	15.8	39.2	17.8	47.2				
Change Period (Y+Rc), s	5.8	5.8	4.6	5.8	5.8	5.8	4.6	5.8				
Max Green Setting (Gmax), s	23.8	19.6	25.4	29.2	10.0	33.4	20.4	34.2				
Max Q Clear Time (g_c+I1), s	21.5	14.3	27.4	31.2	9.4	35.4	13.2	15.6				
Green Ext Time (p_c), s	0.6	1.3	0.0	0.0	0.0	0.0	0.1	3.9				
Intersection Summary												
HCM 6th Ctrl Delay			71.2									
HCM 6th LOS			E									

Timings
29: I-215 NB Ramps & Alessandro Bl.

West Campus Upper Plateau (JN 14064)

09/19/2022

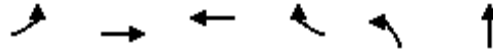

Lane Group	EBL	EBT	WBT	WBR	NBL	NBT
Lane Configurations	↶	↑↑↑	↑↑↑	↷	↶↷	↷
Traffic Volume (vph)	217	1661	1033	112	913	11
Future Volume (vph)	217	1661	1033	112	913	11
Turn Type	Prot	NA	NA	Perm	Split	NA
Protected Phases	5	2	6		8	8
Permitted Phases				6		
Detector Phase	5	2	6	6	8	8
Switch Phase						
Minimum Initial (s)	5.0	5.0	5.0	5.0	5.0	5.0
Minimum Split (s)	9.5	10.5	33.5	33.5	10.0	10.0
Total Split (s)	24.6	67.0	42.4	42.4	43.0	43.0
Total Split (%)	22.4%	60.9%	38.5%	38.5%	39.1%	39.1%
Yellow Time (s)	3.5	4.5	4.5	4.5	4.0	4.0
All-Red Time (s)	1.0	1.0	1.0	1.0	1.0	1.0
Lost Time Adjust (s)	0.0	0.0	0.0	0.0	0.0	0.0
Total Lost Time (s)	4.5	5.5	5.5	5.5	5.0	5.0
Lead/Lag	Lead		Lag	Lag		
Lead-Lag Optimize?	Yes		Yes	Yes		
Recall Mode	None	Min	Min	Min	Max	Max
Act Effct Green (s)	16.9	50.8	29.4	29.4	38.3	38.3
Actuated g/C Ratio	0.17	0.51	0.29	0.29	0.38	0.38
v/c Ratio	0.79	0.68	0.73	0.26	0.71	0.68
Control Delay	60.1	19.6	34.9	15.0	31.3	33.8
Queue Delay	0.0	0.0	0.0	0.0	0.0	0.0
Total Delay	60.1	19.6	34.9	15.0	31.3	33.8
LOS	E	B	C	B	C	C
Approach Delay		24.3	33.0			32.1
Approach LOS		C	C			C

Intersection Summary

Cycle Length: 110
 Actuated Cycle Length: 99.7
 Natural Cycle: 80
 Control Type: Actuated-Uncoordinated
 Maximum v/c Ratio: 0.79
 Intersection Signal Delay: 28.8
 Intersection LOS: C
 Intersection Capacity Utilization 67.0%
 ICU Level of Service C
 Analysis Period (min) 15

Splits and Phases: 29: I-215 NB Ramps & Alessandro Bl.

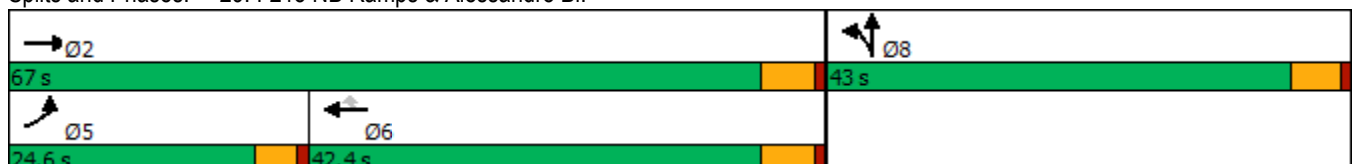

HCM 6th Signalized Intersection Summary
 29: I-215 NB Ramps & Alessandro Bl.

West Campus Upper Plateau (JN 14064)
 09/19/2022



Movement	EBL	EBT	EBR	WBL	WBT	WBR	NBL	NBT	NBR	SBL	SBT	SBR
Lane Configurations	↗	↑↑↑			↑↑↑	↗	↗↗	↕				
Traffic Volume (veh/h)	217	1661	0	0	1033	112	913	11	270	0	0	0
Future Volume (veh/h)	217	1661	0	0	1033	112	913	11	270	0	0	0
Initial Q (Qb), veh	0	0	0	0	0	0	0	0	0			
Ped-Bike Adj(A_pbT)	1.00		1.00	1.00		0.98	1.00		1.00			
Parking Bus, Adj	1.00	1.00	1.00	1.00	1.00	1.00	1.00	1.00	1.00			
Work Zone On Approach		No			No			No				
Adj Sat Flow, veh/h/ln	1841	1870	0	0	1870	1707	1870	1900	1870			
Adj Flow Rate, veh/h	231	1767	0	0	1099	92	880	139	201			
Peak Hour Factor	0.94	0.94	0.94	0.94	0.94	0.94	0.94	0.94	0.94			
Percent Heavy Veh, %	4	2	0	0	2	13	2	0	2			
Cap, veh/h	266	2479	0	0	1459	405	1436	283	409			
Arrive On Green	0.15	0.49	0.00	0.00	0.29	0.29	0.40	0.40	0.40			
Sat Flow, veh/h	1753	5274	0	0	5274	1416	3563	702	1015			
Grp Volume(v), veh/h	231	1767	0	0	1099	92	880	0	340			
Grp Sat Flow(s),veh/h/ln	1753	1702	0	0	1702	1416	1781	0	1717			
Q Serve(g_s), s	12.1	25.7	0.0	0.0	18.5	4.7	18.5	0.0	13.9			
Cycle Q Clear(g_c), s	12.1	25.7	0.0	0.0	18.5	4.7	18.5	0.0	13.9			
Prop In Lane	1.00		0.00	0.00		1.00	1.00		0.59			
Lane Grp Cap(c), veh/h	266	2479	0	0	1459	405	1436	0	692			
V/C Ratio(X)	0.87	0.71	0.00	0.00	0.75	0.23	0.61	0.00	0.49			
Avail Cap(c_a), veh/h	374	3331	0	0	1999	554	1436	0	692			
HCM Platoon Ratio	1.00	1.00	1.00	1.00	1.00	1.00	1.00	1.00	1.00			
Upstream Filter(I)	1.00	1.00	0.00	0.00	1.00	1.00	1.00	0.00	1.00			
Uniform Delay (d), s/veh	39.0	19.1	0.0	0.0	30.6	25.7	22.3	0.0	20.9			
Incr Delay (d2), s/veh	13.0	0.5	0.0	0.0	1.1	0.3	2.0	0.0	2.5			
Initial Q Delay(d3),s/veh	0.0	0.0	0.0	0.0	0.0	0.0	0.0	0.0	0.0			
%ile BackOfQ(50%),veh/ln	5.8	8.6	0.0	0.0	7.0	1.5	7.6	0.0	5.7			
Unsig. Movement Delay, s/veh												
LnGrp Delay(d),s/veh	52.0	19.6	0.0	0.0	31.7	26.0	24.3	0.0	23.4			
LnGrp LOS	D	B	A	A	C	C	C	A	C			
Approach Vol, veh/h		1998			1191			1220				
Approach Delay, s/veh		23.3			31.3			24.0				
Approach LOS		C			C			C				
Timer - Assigned Phs		2			5	6		8				
Phs Duration (G+Y+Rc), s		51.3			18.8	32.4		43.0				
Change Period (Y+Rc), s		5.5			4.5	5.5		5.0				
Max Green Setting (Gmax), s		61.5			20.1	36.9		38.0				
Max Q Clear Time (g_c+I1), s		27.7			14.1	20.5		20.5				
Green Ext Time (p_c), s		15.4			0.2	6.5		5.3				

Intersection Summary

HCM 6th Ctrl Delay	25.7
HCM 6th LOS	C

Notes

User approved volume balancing among the lanes for turning movement.

Timings

31: I-215 NB Ramps/Old 215 Frontage Rd. & Cactus Av.



Lane Group	EBL	EBT	EBR	WBT	NBL	NBT	NBR	SBL	SBT
Lane Configurations	↶	↶↶	↶	↶↶↶	↶↶	↶	↶	↶	↶
Traffic Volume (vph)	98	1521	742	1714	207	218	3	166	2
Future Volume (vph)	98	1521	742	1714	207	218	3	166	2
Turn Type	Perm	NA	Perm	NA	Prot	NA	Perm	Perm	NA
Protected Phases		2		6	3	8			4
Permitted Phases	2		2				8	4	
Detector Phase	2	2	2	6	3	8	8	4	4
Switch Phase									
Minimum Initial (s)	5.0	5.0	5.0	5.0	5.0	5.0	5.0	5.0	5.0
Minimum Split (s)	11.0	11.0	11.0	44.0	9.1	10.5	10.5	10.5	10.5
Total Split (s)	44.2	44.2	44.2	44.2	9.2	25.8	25.8	16.6	16.6
Total Split (%)	63.1%	63.1%	63.1%	63.1%	13.1%	36.9%	36.9%	23.7%	23.7%
Yellow Time (s)	5.0	5.0	5.0	5.0	3.6	4.5	4.5	4.5	4.5
All-Red Time (s)	1.0	1.0	1.0	1.0	0.5	1.0	1.0	1.0	1.0
Lost Time Adjust (s)	0.0	0.0	0.0	0.0	0.0	0.0	0.0	0.0	0.0
Total Lost Time (s)	6.0	6.0	6.0	6.0	4.1	5.5	5.5	5.5	5.5
Lead/Lag					Lead			Lag	Lag
Lead-Lag Optimize?					Yes			Yes	Yes
Recall Mode	Min	Min	Min	Min	None	None	None	None	None
Act Effct Green (s)	38.2	38.2	38.2	38.2	5.1	20.3	20.3	11.1	11.1
Actuated g/C Ratio	0.55	0.55	0.55	0.55	0.07	0.29	0.29	0.16	0.16
v/c Ratio	0.97	0.84	0.67	0.72	0.92	0.45	0.01	0.98	0.69
Control Delay	106.1	18.5	4.0	13.5	77.9	23.7	0.0	98.3	41.8
Queue Delay	0.0	0.0	0.0	0.0	0.0	0.0	0.0	0.0	0.0
Total Delay	106.1	18.5	4.0	13.5	77.9	23.7	0.0	98.3	41.8
LOS	F	B	A	B	E	C	A	F	D
Approach Delay		17.6		13.5		49.8			69.2
Approach LOS		B		B		D			E

Intersection Summary

Cycle Length: 70
 Actuated Cycle Length: 70
 Natural Cycle: 70
 Control Type: Actuated-Uncoordinated
 Maximum v/c Ratio: 0.98
 Intersection Signal Delay: 22.4
 Intersection LOS: C
 Intersection Capacity Utilization 82.0%
 ICU Level of Service E
 Analysis Period (min) 15

Splits and Phases: 31: I-215 NB Ramps/Old 215 Frontage Rd. & Cactus Av.



HCM 6th Signalized Intersection Summary

West Campus Upper Plateau (JN 14064)

31: I-215 NB Ramps/Old 215 Frontage Rd. & Cactus Av.

09/19/2022



Movement	EBL	EBT	EBR	WBL	WBT	WBR	NBL	NBT	NBR	SBL	SBT	SBR
Lane Configurations	↘	↑↑	↗		↑↑↑		↘↘	↗	↗	↘	↗	
Traffic Volume (veh/h)	98	1521	742	0	1714	161	207	218	3	166	2	175
Future Volume (veh/h)	98	1521	742	0	1714	161	207	218	3	166	2	175
Initial Q (Qb), veh	0	0	0	0	0	0	0	0	0	0	0	0
Ped-Bike Adj(A_pbT)	1.00		1.00	1.00		1.00	1.00		1.00	1.00		1.00
Parking Bus, Adj	1.00	1.00	1.00	1.00	1.00	1.00	1.00	1.00	1.00	1.00	1.00	1.00
Work Zone On Approach		No			No			No			No	
Adj Sat Flow, veh/h/ln	1856	1841	1767	0	1856	1885	1767	1856	1900	1841	1900	1885
Adj Flow Rate, veh/h	102	1584	769	0	1785	120	216	227	0	173	2	156
Peak Hour Factor	0.96	0.96	0.96	0.96	0.96	0.96	0.96	0.96	0.96	0.96	0.96	0.96
Percent Heavy Veh, %	3	4	9	0	3	1	9	3	0	4	0	1
Cap, veh/h	169	1909	817	0	2646	177	245	538		283	3	253
Arrive On Green	0.55	0.55	0.55	0.00	0.55	0.55	0.07	0.29	0.00	0.16	0.16	0.16
Sat Flow, veh/h	234	3497	1497	0	5015	325	3365	1856	1610	1135	20	1593
Grp Volume(v), veh/h	102	1584	769	0	1242	663	216	227	0	173	0	158
Grp Sat Flow(s),veh/h/ln	234	1749	1497	0	1689	1796	1682	1856	1610	1135	0	1613
Q Serve(g_s), s	19.6	26.3	33.6	0.0	18.5	18.6	4.5	6.9	0.0	10.6	0.0	6.4
Cycle Q Clear(g_c), s	38.2	26.3	33.6	0.0	18.5	18.6	4.5	6.9	0.0	10.6	0.0	6.4
Prop In Lane	1.00		1.00	0.00		0.18	1.00		1.00	1.00		0.99
Lane Grp Cap(c), veh/h	169	1909	817	0	1843	980	245	538		283	0	256
V/C Ratio(X)	0.61	0.83	0.94	0.00	0.67	0.68	0.88	0.42		0.61	0.00	0.62
Avail Cap(c_a), veh/h	169	1909	817	0	1843	980	245	538		283	0	256
HCM Platoon Ratio	1.00	1.00	1.00	1.00	1.00	1.00	1.00	1.00	1.00	1.00	1.00	1.00
Upstream Filter(I)	1.00	1.00	1.00	0.00	1.00	1.00	1.00	1.00	0.00	1.00	0.00	1.00
Uniform Delay (d), s/veh	28.7	13.2	14.9	0.0	11.4	11.4	32.1	20.1	0.0	29.2	0.0	27.5
Incr Delay (d2), s/veh	4.4	3.0	18.5	0.0	0.8	1.5	28.8	0.2	0.0	2.8	0.0	3.3
Initial Q Delay(d3),s/veh	0.0	0.0	0.0	0.0	0.0	0.0	0.0	0.0	0.0	0.0	0.0	0.0
%ile BackOfQ(50%),veh/ln	1.8	8.4	12.5	0.0	5.4	6.0	2.6	2.7	0.0	2.8	0.0	2.4
Unsig. Movement Delay, s/veh												
LnGrp Delay(d),s/veh	33.1	16.2	33.4	0.0	12.2	13.0	60.9	20.3	0.0	32.0	0.0	30.8
LnGrp LOS	C	B	C	A	B	B	E	C		C	A	C
Approach Vol, veh/h		2455			1905			443				331
Approach Delay, s/veh		22.3			12.5			40.1				31.4
Approach LOS		C			B			D				C
Timer - Assigned Phs		2	3	4		6		8				
Phs Duration (G+Y+Rc), s		44.2	9.2	16.6		44.2		25.8				
Change Period (Y+Rc), s		6.0	4.1	5.5		6.0		5.5				
Max Green Setting (Gmax), s		38.2	5.1	11.1		38.2		20.3				
Max Q Clear Time (g_c+I1), s		40.2	6.5	12.6		20.6		8.9				
Green Ext Time (p_c), s		0.0	0.0	0.0		8.3		0.5				

Intersection Summary

HCM 6th Ctrl Delay	20.8
HCM 6th LOS	C

Notes

User approved volume balancing among the lanes for turning movement.
 Unsignalized Delay for [NBR] is excluded from calculations of the approach delay and intersection delay.

Timings
36: Elsworth St. & Cactus Av.

West Campus Upper Plateau (JN 14064)

09/19/2022



Lane Group	EBL	EBT	EBR	WBL	WBT	WBR	NBL	NBT	SBL	SBT	SBR
Lane Configurations	↘	↑↑↑	↗	↘	↑↑↑	↗	↘	↗	↘	↑	↗
Traffic Volume (vph)	188	1962	26	15	1227	83	191	64	201	13	197
Future Volume (vph)	188	1962	26	15	1227	83	191	64	201	13	197
Turn Type	Prot	NA	Free	Prot	NA	Perm	Prot	NA	Prot	NA	pm+ov
Protected Phases	5	2		1	6		3	8	7	4	5
Permitted Phases			Free			6					4
Detector Phase	5	2		1	6	6	3	8	7	4	5
Switch Phase											
Minimum Initial (s)	5.0	10.0		5.0	10.0	10.0	5.0	10.0	5.0	10.0	5.0
Minimum Split (s)	9.6	36.2		9.6	36.2	36.2	15.4	35.4	15.4	35.4	9.6
Total Split (s)	22.2	55.9		9.6	43.3	43.3	19.1	37.8	16.7	35.4	22.2
Total Split (%)	18.5%	46.6%		8.0%	36.1%	36.1%	15.9%	31.5%	13.9%	29.5%	18.5%
Yellow Time (s)	3.6	5.2		3.6	5.2	5.2	4.4	4.4	4.4	4.4	3.6
All-Red Time (s)	1.0	1.0		1.0	1.0	1.0	1.0	1.0	1.0	1.0	1.0
Lost Time Adjust (s)	0.0	0.0		0.0	0.0	0.0	0.0	0.0	0.0	0.0	0.0
Total Lost Time (s)	4.6	6.2		4.6	6.2	6.2	5.4	5.4	5.4	5.4	4.6
Lead/Lag	Lead	Lag		Lead	Lag	Lag	Lag	Lag	Lead	Lead	Lead
Lead-Lag Optimize?	Yes	Yes		Yes	Yes	Yes	Yes	Yes	Yes	Yes	Yes
Recall Mode	None	None		None	None	None	None	None	None	None	None
Act Effct Green (s)	14.7	50.4	97.1	5.1	34.4	34.4	22.8	14.6	11.5	13.4	21.8
Actuated g/C Ratio	0.15	0.52	1.00	0.05	0.35	0.35	0.23	0.15	0.12	0.14	0.22
v/c Ratio	0.74	0.79	0.02	0.17	0.72	0.12	0.47	0.48	0.98	0.05	0.49
Control Delay	58.6	23.9	0.0	54.0	31.3	0.4	42.0	30.8	103.3	37.5	17.3
Queue Delay	0.0	0.0	0.0	0.0	0.0	0.0	0.0	0.0	0.0	0.0	0.0
Total Delay	58.6	23.9	0.0	54.0	31.3	0.4	42.0	30.8	103.3	37.5	17.3
LOS	E	C	A	D	C	A	D	C	F	D	B
Approach Delay		26.6			29.6			37.3		60.0	
Approach LOS		C			C			D		E	

Intersection Summary

Cycle Length: 120
 Actuated Cycle Length: 97.1
 Natural Cycle: 120
 Control Type: Actuated-Uncoordinated
 Maximum v/c Ratio: 0.98
 Intersection Signal Delay: 31.6
 Intersection LOS: C
 Intersection Capacity Utilization 79.5%
 ICU Level of Service D
 Analysis Period (min) 15

Splits and Phases: 36: Elsworth St. & Cactus Av.

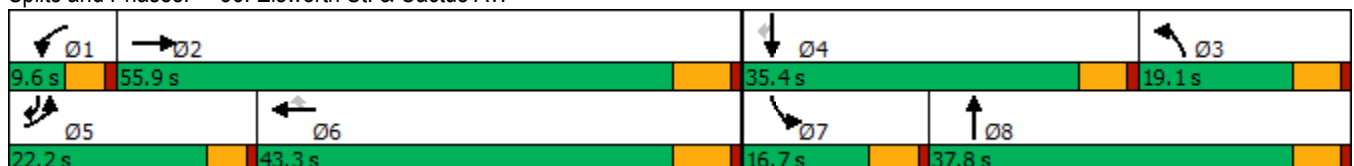

HCM 6th Signalized Intersection Summary
36: Elsworth St. & Cactus Av.

West Campus Upper Plateau (JN 14064)

09/19/2022



Movement	EBL	EBT	EBR	WBL	WBT	WBR	NBL	NBT	NBR	SBL	SBT	SBR
Lane Configurations	↗	↑↑↑	↖	↖	↑↑↑	↖	↖	↑		↖	↑	↖
Traffic Volume (veh/h)	188	1962	26	15	1227	83	191	64	74	201	13	197
Future Volume (veh/h)	188	1962	26	15	1227	83	191	64	74	201	13	197
Initial Q (Qb), veh	0	0	0	0	0	0	0	0	0	0	0	0
Ped-Bike Adj(A_pbT)	1.00		1.00	1.00		1.00	1.00		1.00	1.00		1.00
Parking Bus, Adj	1.00	1.00	1.00	1.00	1.00	1.00	1.00	1.00	1.00	1.00	1.00	1.00
Work Zone On Approach		No			No			No			No	
Adj Sat Flow, veh/h/ln	1856	1841	1781	1900	1841	1885	1885	1900	1885	1900	1900	1885
Adj Flow Rate, veh/h	196	2044	0	16	1278	50	199	67	53	209	14	98
Peak Hour Factor	0.96	0.96	0.96	0.96	0.96	0.96	0.96	0.96	0.96	0.96	0.96	0.96
Percent Heavy Veh, %	3	4	8	0	4	1	1	0	1	0	0	1
Cap, veh/h	231	2511		33	1945	618	236	115	91	227	211	386
Arrive On Green	0.13	0.50	0.00	0.02	0.39	0.39	0.13	0.12	0.12	0.13	0.11	0.11
Sat Flow, veh/h	1767	5025	1510	1810	5025	1598	1795	983	777	1810	1900	1598
Grp Volume(v), veh/h	196	2044	0	16	1278	50	199	0	120	209	14	98
Grp Sat Flow(s),veh/h/ln	1767	1675	1510	1810	1675	1598	1795	0	1760	1810	1900	1598
Q Serve(g_s), s	9.8	30.9	0.0	0.8	18.9	1.8	9.8	0.0	5.8	10.3	0.6	2.7
Cycle Q Clear(g_c), s	9.8	30.9	0.0	0.8	18.9	1.8	9.8	0.0	5.8	10.3	0.6	2.7
Prop In Lane	1.00		1.00	1.00		1.00	1.00		0.44	1.00		1.00
Lane Grp Cap(c), veh/h	231	2511		33	1945	618	236	0	206	227	211	386
V/C Ratio(X)	0.85	0.81		0.48	0.66	0.08	0.84	0.00	0.58	0.92	0.07	0.25
Avail Cap(c_a), veh/h	345	2770		100	2067	657	273	0	632	227	632	741
HCM Platoon Ratio	1.00	1.00	1.00	1.00	1.00	1.00	1.00	1.00	1.00	1.00	1.00	1.00
Upstream Filter(I)	1.00	1.00	0.00	1.00	1.00	1.00	1.00	0.00	1.00	1.00	1.00	1.00
Uniform Delay (d), s/veh	38.3	19.0	0.0	43.8	22.7	17.5	38.2	0.0	37.7	39.0	35.9	11.7
Incr Delay (d2), s/veh	7.9	1.8	0.0	4.0	0.7	0.1	18.6	0.0	2.6	38.9	0.1	0.3
Initial Q Delay(d3),s/veh	0.0	0.0	0.0	0.0	0.0	0.0	0.0	0.0	0.0	0.0	0.0	0.0
%ile BackOfQ(50%),veh/ln	4.5	10.5	0.0	0.4	6.7	0.7	5.5	0.0	2.7	6.8	0.3	1.2
Unsig. Movement Delay, s/veh												
LnGrp Delay(d),s/veh	46.2	20.8	0.0	47.8	23.4	17.5	56.8	0.0	40.3	77.9	36.0	12.1
LnGrp LOS	D	C		D	C	B	E	A	D	E	D	B
Approach Vol, veh/h		2240			1344			319			321	
Approach Delay, s/veh		23.1			23.5			50.6			56.0	
Approach LOS		C			C			D			E	
Timer - Assigned Phs	1	2	3	4	5	6	7	8				
Phs Duration (G+Y+Rc), s	6.3	51.3	17.3	15.4	16.4	41.1	16.7	16.0				
Change Period (Y+Rc), s	4.6	6.2	5.4	5.4	4.6	6.2	5.4	5.4				
Max Green Setting (Gmax), s	5.0	49.7	13.7	30.0	17.6	37.1	11.3	32.4				
Max Q Clear Time (g_c+I1), s	2.8	32.9	11.8	4.7	11.8	20.9	12.3	7.8				
Green Ext Time (p_c), s	0.0	12.1	0.1	0.3	0.1	7.6	0.0	0.7				

Intersection Summary

HCM 6th Ctrl Delay	27.8
HCM 6th LOS	C

Notes

- User approved pedestrian interval to be less than phase max green.
- User approved volume balancing among the lanes for turning movement.
- Unsignalized Delay for [EBR] is excluded from calculations of the approach delay and intersection delay.

Timings

3: Overlook Pkwy./Canyon Crest Dr. & Alessandro Bl/Alessandro Bl.



Lane Group	EBL	EBT	WBL	WBT	WBR	NBL	NBT	NBR	SBL	SBT
Lane Configurations	↙	↕↕↕↕	↙	↕↕↕↕	↗	↙	↕↕	↗	↙↙↙↙	↗
Traffic Volume (vph)	33	1256	24	1367	393	18	54	27	304	56
Future Volume (vph)	33	1256	24	1367	393	18	54	27	304	56
Turn Type	Prot	NA	Prot	NA	pm+ov	Perm	NA	Perm	Prot	NA
Protected Phases	5	2	1	6	7		8		7	4
Permitted Phases					6	8		8		
Detector Phase	5	2	1	6	7	8	8	8	7	4
Switch Phase										
Minimum Initial (s)	5.0	10.0	5.0	10.0	10.0	10.0	10.0	10.0	10.0	10.0
Minimum Split (s)	9.2	35.2	9.2	35.2	38.8	15.8	15.8	15.8	38.8	38.8
Total Split (s)	9.2	56.2	9.2	56.2	38.8	15.8	15.8	15.8	38.8	54.6
Total Split (%)	7.7%	46.8%	7.7%	46.8%	32.3%	13.2%	13.2%	13.2%	32.3%	45.5%
Yellow Time (s)	3.2	5.2	3.2	5.2	4.8	4.8	4.8	4.8	4.8	4.8
All-Red Time (s)	1.0	1.0	1.0	1.0	1.0	1.0	1.0	1.0	1.0	1.0
Lost Time Adjust (s)	0.0	0.0	0.0	0.0	0.0	0.0	0.0	0.0	0.0	0.0
Total Lost Time (s)	4.2	6.2	4.2	6.2	5.8	5.8	5.8	5.8	5.8	5.8
Lead/Lag	Lead	Lag	Lead	Lag	Lead	Lag	Lag	Lag	Lead	
Lead-Lag Optimize?	Yes	Yes	Yes	Yes	Yes	Yes	Yes	Yes	Yes	
Recall Mode	None	None	None	None	None	None	None	None	None	None
Act Effct Green (s)	5.7	30.4	5.7	28.6	52.9	11.4	11.4	11.4	14.9	26.8
Actuated g/C Ratio	0.08	0.41	0.08	0.39	0.72	0.15	0.15	0.15	0.20	0.36
v/c Ratio	0.26	0.56	0.17	0.64	0.32	0.09	0.10	0.08	0.30	0.12
Control Delay	48.2	19.2	46.4	21.5	1.3	40.7	37.6	0.4	29.0	15.2
Queue Delay	0.0	0.0	0.0	0.0	0.0	0.0	0.0	0.0	0.0	0.0
Total Delay	48.2	19.2	46.4	21.5	1.3	40.7	37.6	0.4	29.0	15.2
LOS	D	B	D	C	A	D	D	A	C	B
Approach Delay		19.9		17.3			27.8			26.3
Approach LOS		B		B			C			C

Intersection Summary

Cycle Length: 120
 Actuated Cycle Length: 73.8
 Natural Cycle: 100
 Control Type: Actuated-Uncoordinated
 Maximum v/c Ratio: 0.64
 Intersection Signal Delay: 19.5
 Intersection LOS: B
 Intersection Capacity Utilization 56.2%
 ICU Level of Service B
 Analysis Period (min) 15

Splits and Phases: 3: Overlook Pkwy./Canyon Crest Dr. & Alessandro Bl/Alessandro Bl.

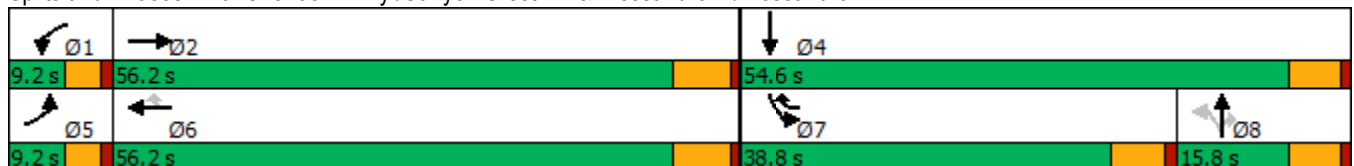

HCM 6th Signalized Intersection Summary

West Campus Upper Plateau (JN 14064)

3: Overlook Pkwy./Canyon Crest Dr. & Alessandro Bl/Alessandro Bl.

09/30/2022



Movement	EBL	EBT	EBR	WBL	WBT	WBR	NBL	NBT	NBR	SBL	SBT	SBR
Lane Configurations	↗	↑↑↑		↖	↑↑↑	↗	↖	↑↑	↗	↖↖↖	↖	
Traffic Volume (veh/h)	33	1256	21	24	1367	393	18	54	27	304	56	18
Future Volume (veh/h)	33	1256	21	24	1367	393	18	54	27	304	56	18
Initial Q (Qb), veh	0	0	0	0	0	0	0	0	0	0	0	0
Ped-Bike Adj(A_pbT)	1.00		1.00	1.00		1.00	1.00		1.00	1.00		1.00
Parking Bus, Adj	1.00	1.00	1.00	1.00	1.00	1.00	1.00	1.00	1.00	1.00	1.00	1.00
Work Zone On Approach		No			No			No				No
Adj Sat Flow, veh/h/ln	1811	1885	1811	1900	1885	1885	1781	1900	1900	1885	1767	1841
Adj Flow Rate, veh/h	34	1282	21	24	1395	393	18	55	20	310	57	9
Peak Hour Factor	0.98	0.98	0.98	0.98	0.98	0.98	0.98	0.98	0.98	0.98	0.98	0.98
Percent Heavy Veh, %	6	1	6	0	1	1	8	0	0	1	9	4
Cap, veh/h	59	2290	38	48	2291	862	262	468	209	682	510	81
Arrive On Green	0.03	0.41	0.41	0.03	0.41	0.41	0.13	0.13	0.13	0.13	0.34	0.34
Sat Flow, veh/h	1725	5548	91	1810	5656	1598	1272	3610	1610	5063	1489	235
Grp Volume(v), veh/h	34	871	432	24	1395	393	18	55	20	310	0	66
Grp Sat Flow(s),veh/h/ln	1725	1885	1869	1810	1885	1598	1272	1805	1610	1688	0	1724
Q Serve(g_s), s	1.4	13.1	13.1	1.0	14.5	11.1	0.9	1.0	0.8	4.2	0.0	1.9
Cycle Q Clear(g_c), s	1.4	13.1	13.1	1.0	14.5	11.1	0.9	1.0	0.8	4.2	0.0	1.9
Prop In Lane	1.00		0.05	1.00		1.00	1.00		1.00	1.00		0.14
Lane Grp Cap(c), veh/h	59	1556	771	48	2291	862	262	468	209	682	0	591
V/C Ratio(X)	0.58	0.56	0.56	0.50	0.61	0.46	0.07	0.12	0.10	0.45	0.00	0.11
Avail Cap(c_a), veh/h	116	2541	1259	122	3812	1292	268	487	217	2252	0	1134
HCM Platoon Ratio	1.00	1.00	1.00	1.00	1.00	1.00	1.00	1.00	1.00	1.00	1.00	1.00
Upstream Filter(I)	1.00	1.00	1.00	1.00	1.00	1.00	1.00	1.00	1.00	1.00	0.00	1.00
Uniform Delay (d), s/veh	35.3	16.6	16.6	35.6	17.4	10.4	28.5	28.5	28.4	29.6	0.0	16.7
Incr Delay (d2), s/veh	3.4	0.3	0.6	3.0	0.3	0.4	0.1	0.1	0.2	0.5	0.0	0.1
Initial Q Delay(d3),s/veh	0.0	0.0	0.0	0.0	0.0	0.0	0.0	0.0	0.0	0.0	0.0	0.0
%ile BackOfQ(50%),veh/ln	0.6	4.8	4.8	0.4	5.3	3.2	0.3	0.4	0.3	1.6	0.0	0.7
Unsig. Movement Delay, s/veh												
LnGrp Delay(d),s/veh	38.7	17.0	17.3	38.7	17.7	10.8	28.6	28.6	28.6	30.1	0.0	16.8
LnGrp LOS	D	B	B	D	B	B	C	C	C	C	A	B
Approach Vol, veh/h		1337			1812			93				376
Approach Delay, s/veh		17.6			16.5			28.6				27.7
Approach LOS		B			B			C				C
Timer - Assigned Phs	1	2		4	5	6	7	8				
Phs Duration (G+Y+Rc), s	6.2	36.8		31.2	6.7	36.3	15.8	15.4				
Change Period (Y+Rc), s	* 4.2	6.2		5.8	* 4.2	6.2	5.8	5.8				
Max Green Setting (Gmax), s	* 5	50.0		48.8	* 5	50.0	33.0	10.0				
Max Q Clear Time (g_c+1), s	3.0	15.1		3.9	3.4	16.5	6.2	3.0				
Green Ext Time (p_c), s	0.0	9.6		0.3	0.0	13.6	1.1	0.1				

Intersection Summary

HCM 6th Ctrl Delay	18.4
HCM 6th LOS	B

Notes

User approved pedestrian interval to be less than phase max green.
 * HCM 6th computational engine requires equal clearance times for the phases crossing the barrier.

Timings

14: Barton Rd. & Van Buren Bl.

09/30/2022

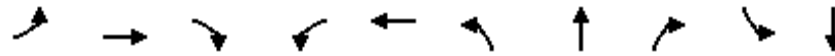

Lane Group	EBL	EBT	EBR	WBL	WBT	NBL	NBT	NBR	SBL	SBT
Lane Configurations	↙	↑↑	↗	↙	↑↑↑	↙↗	↑	↗	↙	↗
Traffic Volume (vph)	80	857	162	191	895	195	38	158	42	25
Future Volume (vph)	80	857	162	191	895	195	38	158	42	25
Turn Type	Prot	NA	pm+ov	Prot	NA	Prot	NA	Perm	Prot	NA
Protected Phases	5	2	3	1	6	3	8		7	4
Permitted Phases			2					8		
Detector Phase	5	2	3	1	6	3	8	8	7	4
Switch Phase										
Minimum Initial (s)	5.0	10.0	5.0	5.0	10.0	5.0	10.0	10.0	5.0	10.0
Minimum Split (s)	9.2	25.2	9.1	9.2	25.5	9.1	14.6	14.6	9.1	33.6
Total Split (s)	14.0	55.4	13.0	18.0	59.4	13.0	36.4	36.4	10.2	33.6
Total Split (%)	11.7%	46.2%	10.8%	15.0%	49.5%	10.8%	30.3%	30.3%	8.5%	28.0%
Yellow Time (s)	3.2	5.2	3.6	3.2	5.5	3.6	3.6	3.6	3.6	3.6
All-Red Time (s)	1.0	1.0	0.5	1.0	1.0	0.5	1.0	1.0	0.5	1.0
Lost Time Adjust (s)	0.0	0.0	0.0	0.0	0.0	0.0	0.0	0.0	0.0	0.0
Total Lost Time (s)	4.2	6.2	4.1	4.2	6.5	4.1	4.6	4.6	4.1	4.6
Lead/Lag	Lead	Lag	Lead	Lead	Lag	Lead	Lag	Lag	Lead	Lag
Lead-Lag Optimize?	Yes	Yes	Yes	Yes	Yes	Yes	Yes	Yes	Yes	Yes
Recall Mode	None	None	None	None	None	None	None	None	None	None
Act Effct Green (s)	8.2	27.8	39.0	14.2	35.7	9.1	20.5	20.5	6.1	13.1
Actuated g/C Ratio	0.10	0.33	0.47	0.17	0.43	0.11	0.24	0.24	0.07	0.16
v/c Ratio	0.50	0.82	0.24	0.71	0.49	0.57	0.09	0.35	0.36	0.36
Control Delay	49.7	32.3	8.3	50.3	19.4	45.1	29.3	7.0	49.9	14.3
Queue Delay	0.0	0.0	0.0	0.0	0.0	0.0	0.0	0.0	0.0	0.0
Total Delay	49.7	32.3	8.3	50.3	19.4	45.1	29.3	7.0	49.9	14.3
LOS	D	C	A	D	B	D	C	A	D	B
Approach Delay		30.1			24.6		28.2			24.2
Approach LOS		C			C		C			C

Intersection Summary

Cycle Length: 120
 Actuated Cycle Length: 83.8
 Natural Cycle: 90
 Control Type: Actuated-Uncoordinated
 Maximum v/c Ratio: 0.82
 Intersection Signal Delay: 27.2
 Intersection LOS: C
 Intersection Capacity Utilization 59.0%
 ICU Level of Service B
 Analysis Period (min) 15

Splits and Phases: 14: Barton Rd. & Van Buren Bl.

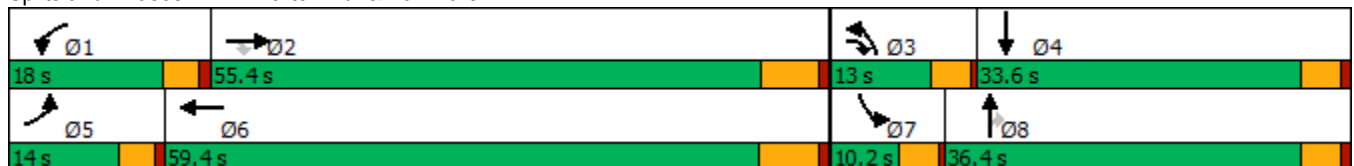

HCM 6th Signalized Intersection Summary
14: Barton Rd. & Van Buren Bl.

West Campus Upper Plateau (JN 14064)

09/30/2022



Movement	EBL	EBT	EBR	WBL	WBT	WBR	NBL	NBT	NBR	SBL	SBT	SBR
Lane Configurations												
Traffic Volume (veh/h)	80	857	162	191	895	50	195	38	158	42	25	85
Future Volume (veh/h)	80	857	162	191	895	50	195	38	158	42	25	85
Initial Q (Qb), veh	0	0	0	0	0	0	0	0	0	0	0	0
Ped-Bike Adj(A_pbT)	1.00		1.00	1.00		1.00	1.00		0.95	1.00		1.00
Parking Bus, Adj	1.00	1.00	1.00	1.00	1.00	1.00	1.00	1.00	1.00	1.00	1.00	1.00
Work Zone On Approach		No			No			No			No	
Adj Sat Flow, veh/h/ln	1900	1856	1870	1870	1870	1856	1900	1900	1885	1900	1885	1900
Adj Flow Rate, veh/h	89	952	149	212	994	45	217	42	44	47	28	32
Peak Hour Factor	0.90	0.90	0.90	0.90	0.90	0.90	0.90	0.90	0.90	0.90	0.90	0.90
Percent Heavy Veh, %	0	3	2	2	2	3	0	0	1	0	1	0
Cap, veh/h	115	1192	678	256	2094	95	317	361	289	78	115	131
Arrive On Green	0.06	0.34	0.34	0.14	0.42	0.42	0.09	0.19	0.19	0.04	0.14	0.14
Sat Flow, veh/h	1810	3526	1583	1781	5007	226	3510	1900	1522	1810	803	917
Grp Volume(v), veh/h	89	952	149	212	675	364	217	42	44	47	0	60
Grp Sat Flow(s),veh/h/ln	1810	1763	1583	1781	1702	1829	1755	1900	1522	1810	0	1720
Q Serve(g_s), s	3.3	16.7	4.0	7.9	9.8	9.8	4.1	1.2	1.6	1.7	0.0	2.1
Cycle Q Clear(g_c), s	3.3	16.7	4.0	7.9	9.8	9.8	4.1	1.2	1.6	1.7	0.0	2.1
Prop In Lane	1.00		1.00	1.00		0.12	1.00		1.00	1.00		0.53
Lane Grp Cap(c), veh/h	115	1192	678	256	1424	765	317	361	289	78	0	246
V/C Ratio(X)	0.77	0.80	0.22	0.83	0.47	0.48	0.68	0.12	0.15	0.60	0.00	0.24
Avail Cap(c_a), veh/h	260	2546	1286	361	2643	1420	459	887	711	162	0	732
HCM Platoon Ratio	1.00	1.00	1.00	1.00	1.00	1.00	1.00	1.00	1.00	1.00	1.00	1.00
Upstream Filter(I)	1.00	1.00	1.00	1.00	1.00	1.00	1.00	1.00	1.00	1.00	0.00	1.00
Uniform Delay (d), s/veh	31.4	20.5	12.3	28.3	14.4	14.4	30.0	22.8	23.0	32.0	0.0	25.9
Incr Delay (d2), s/veh	4.1	0.5	0.1	7.4	0.1	0.2	2.6	0.1	0.2	7.2	0.0	0.5
Initial Q Delay(d3),s/veh	0.0	0.0	0.0	0.0	0.0	0.0	0.0	0.0	0.0	0.0	0.0	0.0
%ile BackOfQ(50%),veh/ln	1.4	5.8	1.2	3.5	3.1	3.3	1.7	0.5	0.6	0.9	0.0	0.9
Unsig. Movement Delay, s/veh												
LnGrp Delay(d),s/veh	35.5	20.9	12.3	35.8	14.5	14.6	32.6	23.0	23.2	39.2	0.0	26.4
LnGrp LOS	D	C	B	D	B	B	C	C	C	D	A	C
Approach Vol, veh/h		1190			1251			303			107	
Approach Delay, s/veh		20.9			18.1			29.9			32.0	
Approach LOS		C			B			C			C	
Timer - Assigned Phs	1	2	3	4	5	6	7	8				
Phs Duration (G+Y+Rc), s	14.0	29.5	10.3	14.3	8.5	35.0	7.0	17.6				
Change Period (Y+Rc), s	* 4.2	* 6.5	4.1	4.6	* 4.2	6.5	4.1	4.6				
Max Green Setting (Gmax), s	* 14	* 49	8.9	29.0	* 9.8	52.9	6.1	31.8				
Max Q Clear Time (g_c+I1), s	9.9	18.7	6.1	4.1	5.3	11.8	3.7	3.6				
Green Ext Time (p_c), s	0.1	4.3	0.2	0.3	0.0	4.1	0.0	0.3				

Intersection Summary

HCM 6th Ctrl Delay	21.1
HCM 6th LOS	C

Notes

* HCM 6th computational engine requires equal clearance times for the phases crossing the barrier.

Timings
25: Sycamore Canyon Bl. & Cactus Av.

West Campus Upper Plateau (JN 14064)

09/30/2022



Lane Group	EBL	EBT	EBR	WBL	WBT	WBR	NBL	NBT	NBR	SBL	SBT	SBR
Lane Configurations	↘	↑↑↑	↗	↘↗	↑↑	↗	↘↗	↑↑	↗	↘↗	↑↑	↗
Traffic Volume (vph)	56	386	171	161	390	196	178	149	122	115	194	48
Future Volume (vph)	56	386	171	161	390	196	178	149	122	115	194	48
Turn Type	Prot	NA	Perm	Prot	NA	pm+ov	Prot	NA	Perm	Prot	NA	Perm
Protected Phases	7	4		3	8	1	5	2		1	6	
Permitted Phases			4			8			2			6
Detector Phase	7	4	4	3	8	1	5	2	2	1	6	6
Switch Phase												
Minimum Initial (s)	5.0	10.0	10.0	5.0	10.0	10.0	10.0	10.0	10.0	10.0	10.0	10.0
Minimum Split (s)	9.6	32.8	32.8	9.6	32.8	15.8	15.8	15.8	15.8	15.8	34.8	34.8
Total Split (s)	25.0	35.0	35.0	30.0	40.0	29.6	15.8	25.4	25.4	29.6	39.2	39.2
Total Split (%)	20.8%	29.2%	29.2%	25.0%	33.3%	24.7%	13.2%	21.2%	21.2%	24.7%	32.7%	32.7%
Yellow Time (s)	3.6	4.8	4.8	3.6	4.8	4.8	4.8	4.8	4.8	4.8	4.8	4.8
All-Red Time (s)	1.0	1.0	1.0	1.0	1.0	1.0	1.0	1.0	1.0	1.0	1.0	1.0
Lost Time Adjust (s)	0.0	0.0	0.0	0.0	0.0	0.0	0.0	0.0	0.0	0.0	0.0	0.0
Total Lost Time (s)	4.6	5.8	5.8	4.6	5.8	5.8	5.8	5.8	5.8	5.8	5.8	5.8
Lead/Lag	Lead	Lag	Lag	Lead	Lag	Lead	Lead	Lag	Lag	Lead	Lag	Lag
Lead-Lag Optimize?	Yes	Yes	Yes	Yes	Yes	Yes	Yes	Yes	Yes	Yes	Yes	Yes
Recall Mode	None	None	None	None	None	None	None	None	None	None	None	None
Act Effct Green (s)	7.1	13.9	13.9	8.2	19.6	36.2	10.4	13.0	13.0	10.6	13.1	13.1
Actuated g/C Ratio	0.10	0.20	0.20	0.12	0.29	0.53	0.15	0.19	0.19	0.15	0.19	0.19
v/c Ratio	0.32	0.37	0.36	0.42	0.42	0.22	0.36	0.24	0.28	0.22	0.31	0.12
Control Delay	37.3	25.0	4.6	33.9	23.6	2.9	31.9	25.4	1.5	30.6	25.7	0.6
Queue Delay	0.0	0.0	0.0	0.0	0.0	0.0	0.0	0.0	0.0	0.0	0.0	0.0
Total Delay	37.3	25.0	4.6	33.9	23.6	2.9	31.9	25.4	1.5	30.6	25.7	0.6
LOS	D	C	A	C	C	A	C	C	A	C	C	A
Approach Delay		20.4			20.4			21.4			23.9	
Approach LOS		C			C			C			C	

Intersection Summary

Cycle Length: 120
 Actuated Cycle Length: 68.5
 Natural Cycle: 95
 Control Type: Actuated-Uncoordinated
 Maximum v/c Ratio: 0.42
 Intersection Signal Delay: 21.2
 Intersection LOS: C
 Intersection Capacity Utilization 49.9%
 ICU Level of Service A
 Analysis Period (min) 15

Splits and Phases: 25: Sycamore Canyon Bl. & Cactus Av.

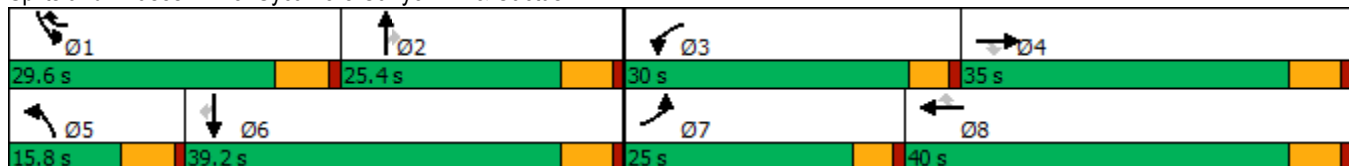

HCM 6th Signalized Intersection Summary
25: Sycamore Canyon Bl. & Cactus Av.

West Campus Upper Plateau (JN 14064)

09/30/2022



Movement	EBL	EBT	EBR	WBL	WBT	WBR	NBL	NBT	NBR	SBL	SBT	SBR
Lane Configurations												
Traffic Volume (veh/h)	56	386	171	161	390	196	178	149	122	115	194	48
Future Volume (veh/h)	56	386	171	161	390	196	178	149	122	115	194	48
Initial Q (Qb), veh	0	0	0	0	0	0	0	0	0	0	0	0
Ped-Bike Adj(A_pbT)	1.00		1.00	1.00		1.00	1.00		1.00	1.00		1.00
Parking Bus, Adj	1.00	1.00	1.00	1.00	1.00	1.00	1.00	1.00	1.00	1.00	1.00	1.00
Work Zone On Approach		No			No			No			No	
Adj Sat Flow, veh/h/ln	1841	1796	1856	1826	1796	1870	1856	1811	1781	1885	1796	1767
Adj Flow Rate, veh/h	58	402	-56	168	406	-38	185	155	34	120	202	50
Peak Hour Factor	0.96	0.96	0.96	0.96	0.96	0.96	0.96	0.96	0.96	0.96	0.96	0.96
Percent Heavy Veh, %	4	7	3	5	7	2	3	6	8	1	7	9
Cap, veh/h	93	951	278	277	702	606	605	607	267	615	603	264
Arrive On Green	0.05	0.18	0.00	0.08	0.21	0.00	0.18	0.18	0.18	0.18	0.18	0.18
Sat Flow, veh/h	1753	5389	1572	3374	3413	1585	3428	3441	1510	3483	3413	1497
Grp Volume(v), veh/h	58	402	-56	168	406	-38	185	155	34	120	202	50
Grp Sat Flow(s),veh/h/ln	1753	1796	1572	1687	1706	1585	1714	1721	1510	1742	1706	1497
Q Serve(g_s), s	1.8	3.8	0.0	2.7	6.1	0.0	2.7	2.2	1.1	1.7	2.9	1.6
Cycle Q Clear(g_c), s	1.8	3.8	0.0	2.7	6.1	0.0	2.7	2.2	1.1	1.7	2.9	1.6
Prop In Lane	1.00		1.00	1.00		1.00	1.00		1.00	1.00		1.00
Lane Grp Cap(c), veh/h	93	951	278	277	702	606	605	607	267	615	603	264
V/C Ratio(X)	0.63	0.42	-0.20	0.61	0.58	-0.06	0.31	0.26	0.13	0.20	0.34	0.19
Avail Cap(c_a), veh/h	631	2778	811	1513	2061	1237	605	1191	522	1464	2012	883
HCM Platoon Ratio	1.00	1.00	1.00	1.00	1.00	1.00	1.00	1.00	1.00	1.00	1.00	1.00
Upstream Filter(I)	1.00	1.00	0.00	1.00	1.00	0.00	1.00	1.00	1.00	1.00	1.00	1.00
Uniform Delay (d), s/veh	26.3	20.8	0.0	25.1	20.3	0.0	20.3	20.1	19.6	19.9	20.4	19.9
Incr Delay (d2), s/veh	2.6	0.3	0.0	0.8	0.8	0.0	0.3	0.2	0.2	0.2	0.3	0.3
Initial Q Delay(d3),s/veh	0.0	0.0	0.0	0.0	0.0	0.0	0.0	0.0	0.0	0.0	0.0	0.0
%ile BackOfQ(50%),veh/ln	0.8	1.4	0.0	1.0	2.1	0.0	0.9	0.8	0.3	0.6	1.0	0.5
Unsig. Movement Delay, s/veh												
LnGrp Delay(d),s/veh	28.9	21.1	0.0	25.9	21.0	0.0	20.6	20.3	19.9	20.0	20.7	20.2
LnGrp LOS	C	C	A	C	C	A	C	C	B	C	C	C
Approach Vol, veh/h		404			536			374			372	
Approach Delay, s/veh		25.1			24.1			20.4			20.4	
Approach LOS		C			C			C			C	
Timer - Assigned Phs	1	2	3	4	5	6	7	8				
Phs Duration (G+Y+Rc), s	15.8	15.8	9.2	15.8	15.8	15.8	7.6	17.5				
Change Period (Y+Rc), s	5.8	5.8	4.6	5.8	5.8	5.8	4.6	5.8				
Max Green Setting (Gmax), s	23.8	19.6	25.4	29.2	10.0	33.4	20.4	34.2				
Max Q Clear Time (g_c+1), s	3.7	4.2	4.7	5.8	4.7	4.9	3.8	8.1				
Green Ext Time (p_c), s	0.3	0.8	0.3	2.5	0.2	1.3	0.0	2.5				
Intersection Summary												
HCM 6th Ctrl Delay			22.7									
HCM 6th LOS			C									

Timings
29: I-215 NB Ramps & Alessandro Bl.

West Campus Upper Plateau (JN 14064)

09/30/2022

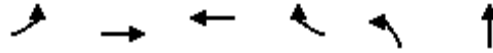

Lane Group	EBL	EBT	WBT	WBR	NBL	NBT
Lane Configurations						
Traffic Volume (vph)	208	755	875	137	503	9
Future Volume (vph)	208	755	875	137	503	9
Turn Type	Prot	NA	NA	Perm	Split	NA
Protected Phases	5	2	6		8	8
Permitted Phases				6		
Detector Phase	5	2	6	6	8	8
Switch Phase						
Minimum Initial (s)	5.0	5.0	5.0	5.0	5.0	5.0
Minimum Split (s)	9.5	10.5	33.5	33.5	10.0	10.0
Total Split (s)	24.6	67.0	42.4	42.4	43.0	43.0
Total Split (%)	22.4%	60.9%	38.5%	38.5%	39.1%	39.1%
Yellow Time (s)	3.5	4.5	4.5	4.5	4.0	4.0
All-Red Time (s)	1.0	1.0	1.0	1.0	1.0	1.0
Lost Time Adjust (s)	0.0	0.0	0.0	0.0	0.0	0.0
Total Lost Time (s)	4.5	5.5	5.5	5.5	5.0	5.0
Lead/Lag	Lead		Lag	Lag		
Lead-Lag Optimize?	Yes		Yes	Yes		
Recall Mode	None	Min	Min	Min	Max	Max
Act Effct Green (s)	15.6	44.2	24.1	24.1	38.4	38.4
Actuated g/C Ratio	0.17	0.47	0.26	0.26	0.41	0.41
v/c Ratio	0.74	0.32	0.69	0.35	0.35	0.41
Control Delay	53.3	15.1	34.2	18.5	21.4	10.8
Queue Delay	0.0	0.0	0.0	0.0	0.0	0.0
Total Delay	53.3	15.1	34.2	18.5	21.4	10.8
LOS	D	B	C	B	C	B
Approach Delay		23.4	32.1			17.4
Approach LOS		C	C			B

Intersection Summary

Cycle Length: 110
 Actuated Cycle Length: 93.2
 Natural Cycle: 65
 Control Type: Actuated-Uncoordinated
 Maximum v/c Ratio: 0.74
 Intersection Signal Delay: 25.0
 Intersection LOS: C
 Intersection Capacity Utilization 54.9%
 ICU Level of Service A
 Analysis Period (min) 15

Splits and Phases: 29: I-215 NB Ramps & Alessandro Bl.



HCM 6th Signalized Intersection Summary
 29: I-215 NB Ramps & Alessandro Bl.

West Campus Upper Plateau (JN 14064)

09/30/2022



Movement	EBL	EBT	EBR	WBL	WBT	WBR	NBL	NBT	NBR	SBL	SBT	SBR
Lane Configurations	↘	↑↑↑			↑↑↑	↗	↘↗	↕				
Traffic Volume (veh/h)	208	755	0	0	875	137	503	9	222	0	0	0
Future Volume (veh/h)	208	755	0	0	875	137	503	9	222	0	0	0
Initial Q (Qb), veh	0	0	0	0	0	0	0	0	0			
Ped-Bike Adj(A_pbT)	1.00		1.00	1.00		0.98	1.00		1.00			
Parking Bus, Adj	1.00	1.00	1.00	1.00	1.00	1.00	1.00	1.00	1.00			
Work Zone On Approach		No			No			No				
Adj Sat Flow, veh/h/ln	1841	1870	0	0	1870	1707	1870	1900	1870			
Adj Flow Rate, veh/h	214	778	0	0	902	115	484	58	145			
Peak Hour Factor	0.97	0.97	0.97	0.97	0.97	0.97	0.97	0.97	0.97			
Percent Heavy Veh, %	4	2	0	0	2	13	2	0	2			
Cap, veh/h	252	2276	0	0	1279	355	1547	209	522			
Arrive On Green	0.14	0.45	0.00	0.00	0.25	0.25	0.43	0.43	0.43			
Sat Flow, veh/h	1753	5274	0	0	5274	1416	3563	481	1203			
Grp Volume(v), veh/h	214	778	0	0	902	115	484	0	203			
Grp Sat Flow(s),veh/h/ln	1753	1702	0	0	1702	1416	1781	0	1684			
Q Serve(g_s), s	10.4	8.7	0.0	0.0	14.1	5.8	7.8	0.0	6.8			
Cycle Q Clear(g_c), s	10.4	8.7	0.0	0.0	14.1	5.8	7.8	0.0	6.8			
Prop In Lane	1.00		0.00	0.00		1.00	1.00		0.71			
Lane Grp Cap(c), veh/h	252	2276	0	0	1279	355	1547	0	731			
V/C Ratio(X)	0.85	0.34	0.00	0.00	0.70	0.32	0.31	0.00	0.28			
Avail Cap(c_a), veh/h	403	3588	0	0	2153	597	1547	0	731			
HCM Platoon Ratio	1.00	1.00	1.00	1.00	1.00	1.00	1.00	1.00	1.00			
Upstream Filter(I)	1.00	1.00	0.00	0.00	1.00	1.00	1.00	0.00	1.00			
Uniform Delay (d), s/veh	36.5	15.9	0.0	0.0	29.8	26.7	16.2	0.0	15.9			
Incr Delay (d2), s/veh	7.7	0.1	0.0	0.0	0.7	0.5	0.5	0.0	0.9			
Initial Q Delay(d3),s/veh	0.0	0.0	0.0	0.0	0.0	0.0	0.0	0.0	0.0			
%ile BackOfQ(50%),veh/ln	4.6	2.9	0.0	0.0	5.3	1.8	3.0	0.0	2.6			
Unsig. Movement Delay, s/veh												
LnGrp Delay(d),s/veh	44.2	15.9	0.0	0.0	30.6	27.3	16.7	0.0	16.9			
LnGrp LOS	D	B	A	A	C	C	B	A	B			
Approach Vol, veh/h		992			1017			687				
Approach Delay, s/veh		22.0			30.2			16.8				
Approach LOS		C			C			B				
Timer - Assigned Phs		2			5	6		8				
Phs Duration (G+Y+Rc), s		44.5			17.1	27.4		43.0				
Change Period (Y+Rc), s		5.5			4.5	5.5		5.0				
Max Green Setting (Gmax), s		61.5			20.1	36.9		38.0				
Max Q Clear Time (g_c+I1), s		10.7			12.4	16.1		9.8				
Green Ext Time (p_c), s		5.3			0.2	5.9		3.0				

Intersection Summary

HCM 6th Ctrl Delay	23.8
HCM 6th LOS	C

Notes

User approved volume balancing among the lanes for turning movement.

Timings

31: I-215 NB Ramps/Old 215 Frontage Rd. & Cactus Av.



Lane Group	EBL	EBT	EBR	WBT	NBL	NBT	NBR	SBL	SBT
Lane Configurations	↖	↗	↘	↙	↖	↗	↘	↙	↘
Traffic Volume (vph)	30	606	241	1018	119	61	3	101	1
Future Volume (vph)	30	606	241	1018	119	61	3	101	1
Turn Type	Perm	NA	Perm	NA	Prot	NA	Perm	Perm	NA
Protected Phases		2		6	3	8			4
Permitted Phases	2		2				8	4	
Detector Phase	2	2	2	6	3	8	8	4	4
Switch Phase									
Minimum Initial (s)	5.0	5.0	5.0	5.0	5.0	5.0	5.0	5.0	5.0
Minimum Split (s)	11.0	11.0	11.0	44.0	9.1	10.5	10.5	10.5	10.5
Total Split (s)	44.2	44.2	44.2	44.2	9.2	25.8	25.8	16.6	16.6
Total Split (%)	63.1%	63.1%	63.1%	63.1%	13.1%	36.9%	36.9%	23.7%	23.7%
Yellow Time (s)	5.0	5.0	5.0	5.0	3.6	4.5	4.5	4.5	4.5
All-Red Time (s)	1.0	1.0	1.0	1.0	0.5	1.0	1.0	1.0	1.0
Lost Time Adjust (s)	0.0	0.0	0.0	0.0	0.0	0.0	0.0	0.0	0.0
Total Lost Time (s)	6.0	6.0	6.0	6.0	4.1	5.5	5.5	5.5	5.5
Lead/Lag					Lead			Lag	Lag
Lead-Lag Optimize?					Yes			Yes	Yes
Recall Mode	Min	Min	Min	Min	None	None	None	None	None
Act Effct Green (s)	25.1	25.1	25.1	25.1	5.5	15.2	15.2	8.2	8.2
Actuated g/C Ratio	0.53	0.53	0.53	0.53	0.12	0.32	0.32	0.17	0.17
v/c Ratio	0.17	0.35	0.29	0.46	0.34	0.12	0.01	0.48	0.24
Control Delay	11.9	10.2	2.3	10.3	26.9	14.0	0.0	29.2	9.1
Queue Delay	0.0	0.0	0.0	0.0	0.0	0.0	0.0	0.0	0.0
Total Delay	11.9	10.2	2.3	10.3	26.9	14.0	0.0	29.2	9.1
LOS	B	B	A	B	C	B	A	C	A
Approach Delay		8.1		10.3		22.2			20.6
Approach LOS		A		B		C			C

Intersection Summary

Cycle Length: 70
 Actuated Cycle Length: 47.3
 Natural Cycle: 65
 Control Type: Actuated-Uncoordinated
 Maximum v/c Ratio: 0.48
 Intersection Signal Delay: 11.1
 Intersection LOS: B
 Intersection Capacity Utilization 46.8%
 ICU Level of Service A
 Analysis Period (min) 15

Splits and Phases: 31: I-215 NB Ramps/Old 215 Frontage Rd. & Cactus Av.



HCM 6th Signalized Intersection Summary

West Campus Upper Plateau (JN 14064)

31: I-215 NB Ramps/Old 215 Frontage Rd. & Cactus Av.

09/30/2022



Movement	EBL	EBT	EBR	WBL	WBT	WBR	NBL	NBT	NBR	SBL	SBT	SBR
Lane Configurations	↘	↑↑	↗		↑↑↑		↘↗	↑	↗	↘	↑	
Traffic Volume (veh/h)	30	606	241	0	1018	109	119	61	3	101	1	74
Future Volume (veh/h)	30	606	241	0	1018	109	119	61	3	101	1	74
Initial Q (Qb), veh	0	0	0	0	0	0	0	0	0	0	0	0
Ped-Bike Adj(A_pbT)	1.00		1.00	1.00		1.00	1.00		1.00	1.00		1.00
Parking Bus, Adj	1.00	1.00	1.00	1.00	1.00	1.00	1.00	1.00	1.00	1.00	1.00	1.00
Work Zone On Approach		No			No			No			No	
Adj Sat Flow, veh/h/ln	1856	1841	1767	0	1856	1885	1767	1856	1900	1841	1900	1885
Adj Flow Rate, veh/h	32	652	255	0	1095	68	128	66	0	109	1	53
Peak Hour Factor	0.93	0.93	0.93	0.93	0.93	0.93	0.93	0.93	0.93	0.93	0.93	0.93
Percent Heavy Veh, %	3	4	9	0	3	1	9	3	0	4	0	1
Cap, veh/h	280	1323	566	0	1844	114	324	604		347	4	195
Arrive On Green	0.38	0.38	0.38	0.00	0.38	0.38	0.10	0.33	0.00	0.12	0.12	0.12
Sat Flow, veh/h	479	3497	1497	0	5042	302	3365	1856	1610	1314	30	1585
Grp Volume(v), veh/h	32	652	255	0	758	405	128	66	0	109	0	54
Grp Sat Flow(s),veh/h/ln	479	1749	1497	0	1689	1800	1682	1856	1610	1314	0	1615
Q Serve(g_s), s	2.2	5.5	5.0	0.0	7.0	7.0	1.4	1.0	0.0	3.1	0.0	1.2
Cycle Q Clear(g_c), s	9.2	5.5	5.0	0.0	7.0	7.0	1.4	1.0	0.0	3.1	0.0	1.2
Prop In Lane	1.00		1.00	0.00		0.17	1.00		1.00	1.00		0.98
Lane Grp Cap(c), veh/h	280	1323	566	0	1278	681	324	604		347	0	199
V/C Ratio(X)	0.11	0.49	0.45	0.00	0.59	0.59	0.39	0.11		0.31	0.00	0.27
Avail Cap(c_a), veh/h	571	3443	1474	0	3325	1772	442	971		562	0	462
HCM Platoon Ratio	1.00	1.00	1.00	1.00	1.00	1.00	1.00	1.00	1.00	1.00	1.00	1.00
Upstream Filter(I)	1.00	1.00	1.00	0.00	1.00	1.00	1.00	1.00	0.00	1.00	0.00	1.00
Uniform Delay (d), s/veh	13.4	9.2	9.0	0.0	9.7	9.7	16.5	9.2	0.0	16.3	0.0	15.4
Incr Delay (d2), s/veh	0.1	0.1	0.2	0.0	0.2	0.3	0.8	0.0	0.0	0.2	0.0	0.3
Initial Q Delay(d3),s/veh	0.0	0.0	0.0	0.0	0.0	0.0	0.0	0.0	0.0	0.0	0.0	0.0
%ile BackOfQ(50%),veh/ln	0.2	1.3	1.0	0.0	1.6	1.7	0.4	0.3	0.0	0.7	0.0	0.3
Unsig. Movement Delay, s/veh												
LnGrp Delay(d),s/veh	13.4	9.3	9.2	0.0	9.8	10.0	17.2	9.2	0.0	16.5	0.0	15.7
LnGrp LOS	B	A	A	A	A	A	B	A		B	A	B
Approach Vol, veh/h		939			1163			194				163
Approach Delay, s/veh		9.4			9.9			14.5				16.2
Approach LOS		A			A			B				B
Timer - Assigned Phs		2	3	4		6		8				
Phs Duration (G+Y+Rc), s		20.7	7.8	10.3		20.7		18.1				
Change Period (Y+Rc), s		6.0	4.1	5.5		6.0		5.5				
Max Green Setting (Gmax), s		38.2	5.1	11.1		38.2		20.3				
Max Q Clear Time (g_c+I1), s		11.2	3.4	5.1		9.0		3.0				
Green Ext Time (p_c), s		3.5	0.1	0.1		5.0		0.1				

Intersection Summary

HCM 6th Ctrl Delay	10.5
HCM 6th LOS	B

Notes

User approved volume balancing among the lanes for turning movement.
 Unsignalized Delay for [NBR] is excluded from calculations of the approach delay and intersection delay.

Timings
36: Elsworth St. & Cactus Av.

West Campus Upper Plateau (JN 14064)

09/30/2022



Lane Group	EBL	EBT	EBR	WBL	WBT	WBR	NBL	NBT	SBL	SBT	SBR
Lane Configurations	↘	↑↑↑	↗	↘	↑↑↑	↗	↘	↗	↘	↑	↗
Traffic Volume (vph)	135	941	27	12	940	116	19	10	139	15	114
Future Volume (vph)	135	941	27	12	940	116	19	10	139	15	114
Turn Type	Prot	NA	Free	Prot	NA	Perm	Prot	NA	Prot	NA	pm+ov
Protected Phases	5	2		1	6		3	8	7	4	5
Permitted Phases			Free			6					4
Detector Phase	5	2		1	6	6	3	8	7	4	5
Switch Phase											
Minimum Initial (s)	5.0	10.0		5.0	10.0	10.0	5.0	10.0	5.0	10.0	5.0
Minimum Split (s)	9.6	36.2		9.6	36.2	36.2	15.4	35.4	15.4	35.4	9.6
Total Split (s)	22.2	55.9		9.6	43.3	43.3	19.1	37.8	16.7	35.4	22.2
Total Split (%)	18.5%	46.6%		8.0%	36.1%	36.1%	15.9%	31.5%	13.9%	29.5%	18.5%
Yellow Time (s)	3.6	5.2		3.6	5.2	5.2	4.4	4.4	4.4	4.4	3.6
All-Red Time (s)	1.0	1.0		1.0	1.0	1.0	1.0	1.0	1.0	1.0	1.0
Lost Time Adjust (s)	0.0	0.0		0.0	0.0	0.0	0.0	0.0	0.0	0.0	0.0
Total Lost Time (s)	4.6	6.2		4.6	6.2	6.2	5.4	5.4	5.4	5.4	4.6
Lead/Lag	Lead	Lag		Lead	Lag	Lag	Lag	Lag	Lead	Lead	Lead
Lead-Lag Optimize?	Yes	Yes		Yes	Yes	Yes	Yes	Yes	Yes	Yes	Yes
Recall Mode	None	None		None	None	None	None	None	None	None	None
Act Effct Green (s)	11.0	38.5	71.5	5.6	23.5	23.5	11.9	13.7	11.9	13.7	16.6
Actuated g/C Ratio	0.15	0.54	1.00	0.08	0.33	0.33	0.17	0.19	0.17	0.19	0.23
v/c Ratio	0.53	0.37	0.02	0.09	0.60	0.18	0.07	0.06	0.49	0.04	0.26
Control Delay	41.2	12.4	0.0	45.4	23.7	0.6	38.2	24.3	41.5	31.1	3.9
Queue Delay	0.0	0.0	0.0	0.0	0.0	0.0	0.0	0.0	0.0	0.0	0.0
Total Delay	41.2	12.4	0.0	45.4	23.7	0.6	38.2	24.3	41.5	31.1	3.9
LOS	D	B	A	D	C	A	D	C	D	C	A
Approach Delay		15.7			21.5			31.4		24.9	
Approach LOS		B			C			C		C	

Intersection Summary

Cycle Length: 120
 Actuated Cycle Length: 71.5
 Natural Cycle: 100
 Control Type: Actuated-Uncoordinated
 Maximum v/c Ratio: 0.60
 Intersection Signal Delay: 19.4
 Intersection LOS: B
 Intersection Capacity Utilization 53.5%
 ICU Level of Service A
 Analysis Period (min) 15

Splits and Phases: 36: Elsworth St. & Cactus Av.

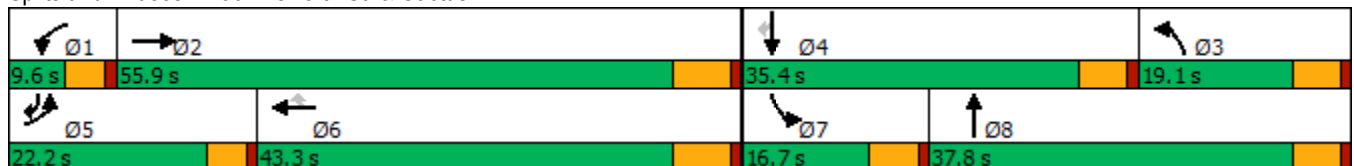

HCM 6th Signalized Intersection Summary
36: Elsworth St. & Cactus Av.

West Campus Upper Plateau (JN 14064)

09/30/2022



Movement	EBL	EBT	EBR	WBL	WBT	WBR	NBL	NBT	NBR	SBL	SBT	SBR
Lane Configurations	↶	↷↷↷	↷	↶	↷↷↷	↷	↶	↷		↶	↷	↷
Traffic Volume (veh/h)	135	941	27	12	940	116	19	10	8	139	15	114
Future Volume (veh/h)	135	941	27	12	940	116	19	10	8	139	15	114
Initial Q (Qb), veh	0	0	0	0	0	0	0	0	0	0	0	0
Ped-Bike Adj(A_pbT)	1.00		1.00	1.00		1.00	1.00		1.00	1.00		1.00
Parking Bus, Adj	1.00	1.00	1.00	1.00	1.00	1.00	1.00	1.00	1.00	1.00	1.00	1.00
Work Zone On Approach		No			No			No			No	
Adj Sat Flow, veh/h/ln	1856	1841	1781	1900	1841	1885	1885	1900	1885	1900	1900	1885
Adj Flow Rate, veh/h	142	991	0	13	989	85	20	11	-16	146	16	12
Peak Hour Factor	0.95	0.95	0.95	0.95	0.95	0.95	0.95	0.95	0.95	0.95	0.95	0.95
Percent Heavy Veh, %	3	4	8	0	4	1	1	0	1	0	0	1
Cap, veh/h	182	2014		29	1579	502	137	0	435	197	293	410
Arrive On Green	0.10	0.40	0.00	0.02	0.31	0.31	0.08	0.12	0.00	0.11	0.15	0.15
Sat Flow, veh/h	1767	5025	1510	1810	5025	1598	1795	1900	0	1810	1900	1598
Grp Volume(v), veh/h	142	991	0	13	989	85	20	-5	-5	146	16	12
Grp Sat Flow(s),veh/h/ln	1767	1675	1510	1810	1675	1598	1795	1900	1610	1810	1900	1598
Q Serve(g_s), s	4.8	9.0	0.0	0.4	10.3	2.4	0.6	0.0	0.0	4.8	0.4	0.2
Cycle Q Clear(g_c), s	4.8	9.0	0.0	0.4	10.3	2.4	0.6	0.0	0.0	4.8	0.4	0.2
Prop In Lane	1.00		1.00	1.00		1.00	1.00		0.00	1.00		1.00
Lane Grp Cap(c), veh/h	182	2014		29	1579	502	137	0	0	197	293	410
V/C Ratio(X)	0.78	0.49		0.44	0.63	0.17	0.15	0.00	0.00	0.74	0.05	0.03
Avail Cap(c_a), veh/h	508	4077		148	3043	968	402	0	0	334	930	947
HCM Platoon Ratio	1.00	1.00	1.00	1.00	1.00	1.00	1.00	1.00	1.00	1.00	1.00	1.00
Upstream Filter(I)	1.00	1.00	0.00	1.00	1.00	1.00	1.00	0.00	0.00	1.00	1.00	1.00
Uniform Delay (d), s/veh	26.8	13.7	0.0	29.9	17.9	15.2	26.4	0.0	0.0	26.5	22.1	6.2
Incr Delay (d2), s/veh	2.8	0.2	0.0	3.9	0.4	0.2	0.5	0.0	0.0	5.4	0.1	0.0
Initial Q Delay(d3),s/veh	0.0	0.0	0.0	0.0	0.0	0.0	0.0	0.0	0.0	0.0	0.0	0.0
%ile BackOfQ(50%),veh/ln	1.9	2.7	0.0	0.2	3.3	0.8	0.3	0.0	0.0	2.2	0.2	0.1
Unsig. Movement Delay, s/veh												
LnGrp Delay(d),s/veh	29.6	13.9	0.0	33.7	18.3	15.4	26.9	0.0	0.0	31.9	22.2	6.2
LnGrp LOS	C	B		C	B	B	C	A	A	C	C	A
Approach Vol, veh/h		1133			1087			10				174
Approach Delay, s/veh		15.9			18.3			53.8				29.2
Approach LOS		B			B			D				C
Timer - Assigned Phs	1	2	3	4	5	6	7	8				
Phs Duration (G+Y+Rc), s	5.6	30.8	10.1	14.8	10.9	25.4	12.1	12.8				
Change Period (Y+Rc), s	4.6	6.2	5.4	5.4	4.6	6.2	5.4	5.4				
Max Green Setting (Gmax), s	5.0	49.7	13.7	30.0	17.6	37.1	11.3	32.4				
Max Q Clear Time (g_c+I1), s	2.4	11.0	2.6	2.4	6.8	12.3	6.8	0.0				
Green Ext Time (p_c), s	0.0	7.3	0.0	0.1	0.1	7.0	0.1	0.0				

Intersection Summary

HCM 6th Ctrl Delay	18.1
HCM 6th LOS	B

Notes

- User approved pedestrian interval to be less than phase max green.
- User approved volume balancing among the lanes for turning movement.
- Unsignalized Delay for [EBR] is excluded from calculations of the approach delay and intersection delay.

APPENDIX 6.1:

EAP CONDITIONS INTERSECTION OPERATIONS ANALYSIS WORKSHEETS

This Page Intentionally Left Blank

Timings
1: Washington St & Van Buren Bl.



Lane Group	EBL	EBT	WBL	WBT	WBR	NBL	NBT	NBR	SBL	SBT
Lane Configurations	↙	↕↗	↙	↕↗	↗	↙↗	↕↗	↗	↙↗	↕↗
Traffic Volume (vph)	151	1157	113	1494	660	156	585	158	387	202
Future Volume (vph)	151	1157	113	1494	660	156	585	158	387	202
Turn Type	Prot	NA	Prot	NA	Perm	Prot	NA	Perm	Prot	NA
Protected Phases	5	2	1	6		3	8		7	4
Permitted Phases					6			8		
Detector Phase	5	2	1	6	6	3	8	8	7	4
Switch Phase										
Minimum Initial (s)	5.0	10.0	5.0	10.0	10.0	5.0	10.0	10.0	5.0	10.0
Minimum Split (s)	9.2	34.2	9.2	33.2	33.2	9.2	38.4	38.4	9.2	30.8
Total Split (s)	14.0	53.1	12.3	51.4	51.4	14.2	38.4	38.4	16.2	40.4
Total Split (%)	11.7%	44.3%	10.3%	42.8%	42.8%	11.8%	32.0%	32.0%	13.5%	33.7%
Yellow Time (s)	3.2	5.2	3.2	5.2	5.2	3.2	4.4	4.4	3.2	4.8
All-Red Time (s)	1.0	1.0	1.0	1.0	1.0	1.0	1.0	1.0	1.0	1.0
Lost Time Adjust (s)	0.0	0.0	0.0	0.0	0.0	0.0	0.0	0.0	0.0	0.0
Total Lost Time (s)	4.2	6.2	4.2	6.2	6.2	4.2	5.4	5.4	4.2	5.8
Lead/Lag	Lead	Lag	Lead	Lag	Lag	Lead	Lag	Lag	Lead	Lag
Lead-Lag Optimize?	Yes	Yes	Yes	Yes	Yes	Yes	Yes	Yes	Yes	Yes
Recall Mode	None	None	None	None	None	None	None	None	None	None
Act Effct Green (s)	9.8	47.0	8.1	45.3	45.3	9.0	26.5	26.5	12.0	29.1
Actuated g/C Ratio	0.09	0.41	0.07	0.40	0.40	0.08	0.23	0.23	0.11	0.26
v/c Ratio	1.03	0.94	0.94	1.10	0.88	0.62	0.74	0.35	1.12	0.33
Control Delay	133.1	46.3	121.7	91.1	34.1	62.1	46.1	9.3	131.4	30.0
Queue Delay	0.0	0.0	0.0	0.0	0.0	0.0	0.0	0.0	0.0	0.0
Total Delay	133.1	46.3	121.7	91.1	34.1	62.1	46.1	9.3	131.4	30.0
LOS	F	D	F	F	C	E	D	A	F	C
Approach Delay		55.4		76.0			42.4			89.5
Approach LOS		E		E			D			F

Intersection Summary

Cycle Length: 120
 Actuated Cycle Length: 113.7
 Natural Cycle: 125
 Control Type: Actuated-Uncoordinated
 Maximum v/c Ratio: 1.12
 Intersection Signal Delay: 66.3
 Intersection LOS: E
 Intersection Capacity Utilization 94.5%
 ICU Level of Service F
 Analysis Period (min) 15

Splits and Phases: 1: Washington St & Van Buren Bl.

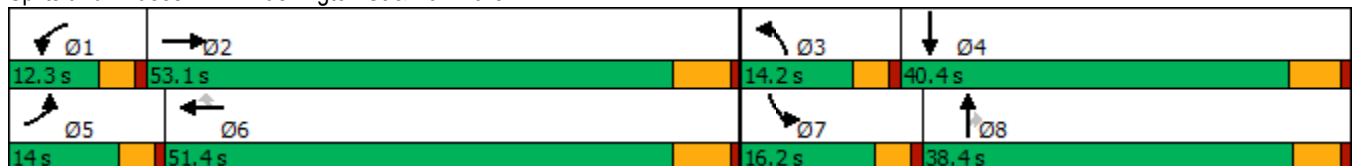

HCM 6th Signalized Intersection Summary
1: Washington St & Van Buren Bl.

West Campus Upper Plateau (JN 14064)

09/19/2022



Movement	EBL	EBT	EBR	WBL	WBT	WBR	NBL	NBT	NBR	SBL	SBT	SBR
Lane Configurations	↖	↕		↖	↕	↗	↖↗	↕	↗	↖↗	↕	↖↗
Traffic Volume (veh/h)	151	1157	137	113	1494	660	156	585	158	387	202	71
Future Volume (veh/h)	151	1157	137	113	1494	660	156	585	158	387	202	71
Initial Q (Qb), veh	0	0	0	0	0	0	0	0	0	0	0	0
Ped-Bike Adj(A_pbT)	1.00		0.99	1.00		0.98	1.00		1.00	1.00		1.00
Parking Bus, Adj	1.00	1.00	1.00	1.00	1.00	1.00	1.00	1.00	1.00	1.00	1.00	1.00
Work Zone On Approach		No			No			No			No	
Adj Sat Flow, veh/h/ln	1870	1856	1856	1856	1870	1885	1826	1870	1856	1856	1811	1826
Adj Flow Rate, veh/h	157	1205	120	118	1556	524	162	609	99	403	210	45
Peak Hour Factor	0.96	0.96	0.96	0.96	0.96	0.96	0.96	0.96	0.96	0.96	0.96	0.96
Percent Heavy Veh, %	2	3	3	3	2	1	5	2	3	3	6	5
Cap, veh/h	156	1357	135	128	1437	635	220	776	342	368	737	155
Arrive On Green	0.09	0.42	0.42	0.07	0.40	0.40	0.07	0.22	0.22	0.11	0.26	0.26
Sat Flow, veh/h	1781	3234	321	1767	3554	1569	3374	3554	1566	3428	2829	594
Grp Volume(v), veh/h	157	655	670	118	1556	524	162	609	99	403	126	129
Grp Sat Flow(s),veh/h/ln	1781	1763	1793	1767	1777	1569	1687	1777	1566	1714	1721	1703
Q Serve(g_s), s	9.8	38.4	38.7	7.4	45.2	33.4	5.3	18.1	5.9	12.0	6.5	6.8
Cycle Q Clear(g_c), s	9.8	38.4	38.7	7.4	45.2	33.4	5.3	18.1	5.9	12.0	6.5	6.8
Prop In Lane	1.00		0.18	1.00		1.00	1.00		1.00	1.00		0.35
Lane Grp Cap(c), veh/h	156	739	752	128	1437	635	220	776	342	368	448	443
V/C Ratio(X)	1.01	0.89	0.89	0.92	1.08	0.83	0.74	0.79	0.29	1.10	0.28	0.29
Avail Cap(c_a), veh/h	156	739	752	128	1437	635	302	1049	462	368	532	527
HCM Platoon Ratio	1.00	1.00	1.00	1.00	1.00	1.00	1.00	1.00	1.00	1.00	1.00	1.00
Upstream Filter(I)	1.00	1.00	1.00	1.00	1.00	1.00	1.00	1.00	1.00	1.00	1.00	1.00
Uniform Delay (d), s/veh	51.0	30.0	30.1	51.5	33.3	29.8	51.3	41.2	36.5	49.9	33.0	33.1
Incr Delay (d2), s/veh	73.5	12.8	13.0	55.2	49.7	9.1	3.3	2.8	0.5	75.0	0.3	0.4
Initial Q Delay(d3),s/veh	0.0	0.0	0.0	0.0	0.0	0.0	0.0	0.0	0.0	0.0	0.0	0.0
%ile BackOfQ(50%),veh/ln	7.4	17.5	18.0	5.1	27.7	14.1	2.3	8.3	2.3	9.0	2.8	2.8
Unsig. Movement Delay, s/veh												
LnGrp Delay(d),s/veh	124.5	42.8	43.1	106.7	83.0	38.9	54.6	44.0	36.9	124.9	33.3	33.4
LnGrp LOS	F	D	D	F	F	D	D	D	D	F	C	C
Approach Vol, veh/h		1482			2198			870				658
Approach Delay, s/veh		51.6			73.7			45.2				89.4
Approach LOS		D			E			D				F
Timer - Assigned Phs	1	2	3	4	5	6	7	8				
Phs Duration (G+Y+Rc), s	12.3	53.1	11.5	34.9	14.0	51.4	16.2	30.2				
Change Period (Y+Rc), s	* 4.2	6.2	* 4.2	5.8	* 4.2	6.2	* 4.2	* 5.8				
Max Green Setting (Gmax), s	* 8.1	46.9	* 10	34.6	* 9.8	45.2	* 12	* 33				
Max Q Clear Time (g_c+I1), s	9.4	40.7	7.3	8.8	11.8	47.2	14.0	20.1				
Green Ext Time (p_c), s	0.0	4.6	0.1	1.5	0.0	0.0	0.0	3.8				

Intersection Summary

HCM 6th Ctrl Delay	64.6
HCM 6th LOS	E

Notes

* HCM 6th computational engine requires equal clearance times for the phases crossing the barrier.

Timings
2: Central Ave & Arlington Ave/Chicago Ave

West Campus Upper Plateau (JN 14064)

09/19/2022



Lane Group	EBL	EBT	EBR	WBL	WBT	WBR	NBL	NBT	NBR	SBL	SBT
Lane Configurations	↖	↗	↘	↙	↕	↗	↙	↕	↘	↖	↗
Traffic Volume (vph)	47	564	708	234	932	370	1416	1756	523	259	712
Future Volume (vph)	47	564	708	234	932	370	1416	1756	523	259	712
Turn Type	Prot	NA	pm+ov	Prot	NA	pm+ov	Prot	NA	pm+ov	Prot	NA
Protected Phases	7	4	5	3	8	1	5	2	3	1	6
Permitted Phases			4			8			2		
Detector Phase	7	4	5	3	8	1	5	2	3	1	6
Switch Phase											
Minimum Initial (s)	5.0	10.0	10.0	5.0	10.0	10.0	10.0	10.0	5.0	10.0	10.0
Minimum Split (s)	9.6	35.2	15.8	9.6	38.8	15.8	15.8	38.8	9.6	15.8	38.8
Total Split (s)	9.6	35.6	42.0	12.8	38.8	15.9	42.0	65.7	12.8	15.9	39.6
Total Split (%)	7.4%	27.4%	32.3%	9.8%	29.8%	12.2%	32.3%	50.5%	9.8%	12.2%	30.5%
Yellow Time (s)	3.6	4.8	3.6	3.6	4.8	3.6	3.6	4.4	3.6	3.6	4.4
All-Red Time (s)	1.0	1.0	1.0	1.0	1.0	1.0	1.0	1.0	1.0	1.0	1.0
Lost Time Adjust (s)	0.0	0.0	0.0	0.0	0.0	0.0	0.0	0.0	0.0	0.0	0.0
Total Lost Time (s)	4.6	5.8	4.6	4.6	5.8	4.6	4.6	5.4	4.6	4.6	5.4
Lead/Lag	Lead	Lag	Lead	Lead	Lag	Lead	Lead	Lag	Lead	Lead	Lag
Lead-Lag Optimize?	Yes	Yes	Yes	Yes	Yes	Yes	Yes	Yes	Yes	Yes	Yes
Recall Mode	None	None	None	None	None	None	None	None	None	None	None
Act Effct Green (s)	5.0	27.8	71.0	8.2	33.0	50.2	37.4	60.4	69.4	11.3	34.2
Actuated g/C Ratio	0.04	0.22	0.55	0.06	0.26	0.39	0.29	0.47	0.54	0.09	0.27
v/c Ratio	0.71	0.79	0.48	1.19	1.08	0.58	1.49	1.11	0.63	0.91	0.60
Control Delay	108.9	55.6	16.9	173.4	97.2	26.9	258.1	91.4	19.5	91.5	43.0
Queue Delay	0.0	0.0	0.0	0.0	0.0	0.0	0.0	0.0	0.0	0.0	0.0
Total Delay	108.9	55.6	16.9	173.4	97.2	26.9	258.1	91.4	19.5	91.5	43.0
LOS	F	E	B	F	F	C	F	F	B	F	D
Approach Delay		36.7			91.9			145.1			55.3
Approach LOS		D			F			F			E

Intersection Summary

Cycle Length: 130
 Actuated Cycle Length: 128.1
 Natural Cycle: 125
 Control Type: Actuated-Uncoordinated
 Maximum v/c Ratio: 1.49
 Intersection Signal Delay: 103.3
 Intersection LOS: F
 Intersection Capacity Utilization 103.8%
 ICU Level of Service G
 Analysis Period (min) 15

Splits and Phases: 2: Central Ave & Arlington Ave/Chicago Ave



HCM 6th Signalized Intersection Summary
2: Central Ave & Arlington Ave/Chicago Ave

West Campus Upper Plateau (JN 14064)

09/19/2022



Movement	EBL	EBT	EBR	WBL	WBT	WBR	NBL	NBT	NBR	SBL	SBT	SBR
Lane Configurations	↖	↑↑	↗↖	↗↖	↑↑	↖	↗↖	↑↑	↖	↗↖	↑↑↗	
Traffic Volume (veh/h)	47	564	708	234	932	370	1416	1756	523	259	712	48
Future Volume (veh/h)	47	564	708	234	932	370	1416	1756	523	259	712	48
Initial Q (Qb), veh	0	0	0	0	0	0	0	0	0	0	0	0
Ped-Bike Adj(A_pbT)	1.00		1.00	1.00		1.00	1.00		0.99	1.00		1.00
Parking Bus, Adj	1.00	1.00	1.00	1.00	1.00	1.00	1.00	1.00	1.00	1.00	1.00	1.00
Work Zone On Approach		No			No			No			No	
Adj Sat Flow, veh/h/ln	1900	1856	1870	1796	1885	1885	1885	1885	1885	1870	1870	1870
Adj Flow Rate, veh/h	50	600	496	249	991	312	1506	1868	387	276	757	41
Peak Hour Factor	0.94	0.94	0.94	0.94	0.94	0.94	0.94	0.94	0.94	0.94	0.94	0.94
Percent Heavy Veh, %	0	3	2	7	1	1	1	1	1	2	2	2
Cap, veh/h	65	801	1438	210	912	546	1005	1666	834	301	1308	71
Arrive On Green	0.04	0.23	0.23	0.06	0.25	0.25	0.29	0.47	0.47	0.09	0.26	0.26
Sat Flow, veh/h	1810	3526	2790	3319	3582	1598	3483	3582	1577	3456	4959	268
Grp Volume(v), veh/h	50	600	496	249	991	312	1506	1868	387	276	519	279
Grp Sat Flow(s),veh/h/ln	1810	1763	1395	1659	1791	1598	1742	1791	1577	1728	1702	1822
Q Serve(g_s), s	3.6	20.6	13.6	8.2	33.0	20.7	37.4	60.3	19.9	10.3	17.2	17.3
Cycle Q Clear(g_c), s	3.6	20.6	13.6	8.2	33.0	20.7	37.4	60.3	19.9	10.3	17.2	17.3
Prop In Lane	1.00		1.00	1.00		1.00	1.00		1.00	1.00		0.15
Lane Grp Cap(c), veh/h	65	801	1438	210	912	546	1005	1666	834	301	898	481
V/C Ratio(X)	0.77	0.75	0.34	1.19	1.09	0.57	1.50	1.12	0.46	0.92	0.58	0.58
Avail Cap(c_a), veh/h	70	810	1446	210	912	546	1005	1666	834	301	898	481
HCM Platoon Ratio	1.00	1.00	1.00	1.00	1.00	1.00	1.00	1.00	1.00	1.00	1.00	1.00
Upstream Filter(I)	1.00	1.00	1.00	1.00	1.00	1.00	1.00	1.00	1.00	1.00	1.00	1.00
Uniform Delay (d), s/veh	62.0	46.7	18.5	60.7	48.3	34.9	46.1	34.7	19.1	58.7	41.4	41.5
Incr Delay (d2), s/veh	34.0	3.9	0.1	121.4	56.3	1.4	229.7	63.2	0.4	31.1	0.9	1.8
Initial Q Delay(d3),s/veh	0.0	0.0	0.0	0.0	0.0	0.0	0.0	0.0	0.0	0.0	0.0	0.0
%ile BackOfQ(50%),veh/ln	2.2	9.2	4.2	6.9	21.4	8.0	47.8	39.4	7.0	5.7	7.2	7.9
Unsig. Movement Delay, s/veh												
LnGrp Delay(d),s/veh	96.0	50.5	18.6	182.2	104.6	36.3	275.8	97.8	19.5	89.8	42.4	43.2
LnGrp LOS	F	D	B	F	F	D	F	F	B	F	D	D
Approach Vol, veh/h		1146			1552			3761			1074	
Approach Delay, s/veh		38.7			103.3			161.0			54.8	
Approach LOS		D			F			F			D	
Timer - Assigned Phs	1	2	3	4	5	6	7	8				
Phs Duration (G+Y+Rc), s	15.9	65.7	12.8	35.2	42.0	39.6	9.2	38.8				
Change Period (Y+Rc), s	4.6	5.4	4.6	5.8	4.6	5.4	4.6	5.8				
Max Green Setting (Gmax), s	11.3	60.3	8.2	29.8	37.4	34.2	5.0	33.0				
Max Q Clear Time (g_c+I1), s	12.3	62.3	10.2	22.6	39.4	19.3	5.6	35.0				
Green Ext Time (p_c), s	0.0	0.0	0.0	3.3	0.0	4.3	0.0	0.0				

Intersection Summary

HCM 6th Ctrl Delay	115.4
HCM 6th LOS	F

Timings

3: Overlook Pkwy./Canyon Crest Dr. & Alessandro Bl/Alessandro Bl.



Lane Group	EBL	EBT	WBL	WBT	WBR	NBL	NBT	NBR	SBL	SBT	SBR
Lane Configurations	↙	↕↕↕	↙	↕↕↕	↗	↙	↕↕	↗	↕↕	↕	↗
Traffic Volume (vph)	43	1508	28	3577	1167	9	35	11	515	83	57
Future Volume (vph)	43	1508	28	3577	1167	9	35	11	515	83	57
Turn Type	Prot	NA	Prot	NA	pm+ov	Split	NA	Perm	Split	NA	Perm
Protected Phases	5	2	1	6	4	8	8		4	4	
Permitted Phases					6			8			4
Detector Phase	5	2	1	6	4	8	8	8	4	4	4
Switch Phase											
Minimum Initial (s)	5.0	10.0	5.0	10.0	10.0	10.0	10.0	10.0	10.0	10.0	10.0
Minimum Split (s)	9.2	35.2	9.2	35.2	38.8	15.8	15.8	15.8	38.8	38.8	38.8
Total Split (s)	9.2	66.2	9.2	66.2	38.8	15.8	15.8	15.8	38.8	38.8	38.8
Total Split (%)	7.1%	50.9%	7.1%	50.9%	29.8%	12.2%	12.2%	12.2%	29.8%	29.8%	29.8%
Yellow Time (s)	3.2	5.2	3.2	5.2	4.8	4.8	4.8	4.8	4.8	4.8	4.8
All-Red Time (s)	1.0	1.0	1.0	1.0	1.0	1.0	1.0	1.0	1.0	1.0	1.0
Lost Time Adjust (s)	0.0	0.0	0.0	0.0	0.0	0.0	0.0	0.0	0.0	0.0	0.0
Total Lost Time (s)	4.2	6.2	4.2	6.2	5.8	5.8	5.8	5.8	5.8	5.8	5.8
Lead/Lag	Lead	Lag	Lead	Lag							
Lead-Lag Optimize?	Yes	Yes	Yes	Yes							
Recall Mode	None	None	None	None	None	None	None	None	None	None	None
Act Effct Green (s)	5.1	62.5	5.1	60.8	100.1	10.1	10.1	10.1	31.5	31.5	31.5
Actuated g/C Ratio	0.04	0.51	0.04	0.49	0.81	0.08	0.08	0.08	0.26	0.26	0.26
v/c Ratio	0.68	0.62	0.39	1.49	0.89	0.06	0.12	0.05	0.51	0.54	0.12
Control Delay	106.0	25.1	76.8	249.5	16.6	56.8	57.1	0.5	43.0	47.0	0.6
Queue Delay	0.0	0.0	0.0	0.0	0.0	0.0	0.0	0.0	0.0	0.0	0.0
Total Delay	106.0	25.1	76.8	249.5	16.6	56.8	57.1	0.5	43.0	47.0	0.6
LOS	F	C	E	F	B	E	E	A	D	D	A
Approach Delay		27.3		191.5			45.4			40.5	
Approach LOS		C		F			D			D	

Intersection Summary

Cycle Length: 130	
Actuated Cycle Length: 123.5	
Natural Cycle: 130	
Control Type: Actuated-Uncoordinated	
Maximum v/c Ratio: 1.49	
Intersection Signal Delay: 139.9	Intersection LOS: F
Intersection Capacity Utilization 100.6%	ICU Level of Service G
Analysis Period (min) 15	

Splits and Phases: 3: Overlook Pkwy./Canyon Crest Dr. & Alessandro Bl/Alessandro Bl.



HCM 6th Signalized Intersection Summary

West Campus Upper Plateau (JN 14064)

3: Overlook Pkwy./Canyon Crest Dr. & Alessandro Bl/Alessandro Bl.

09/19/2022



Movement	EBL	EBT	EBR	WBL	WBT	WBR	NBL	NBT	NBR	SBL	SBT	SBR
Lane Configurations	↗	↑↑↑		↖	↑↑↑	↗	↖	↑↑	↗	↖↗	↖	↗
Traffic Volume (veh/h)	43	1508	14	28	3577	1167	9	35	11	515	83	57
Future Volume (veh/h)	43	1508	14	28	3577	1167	9	35	11	515	83	57
Initial Q (Qb), veh	0	0	0	0	0	0	0	0	0	0	0	0
Ped-Bike Adj(A_pbT)	1.00		1.00	1.00		1.00	1.00		1.00	1.00		1.00
Parking Bus, Adj	1.00	1.00	1.00	1.00	1.00	1.00	1.00	1.00	1.00	1.00	1.00	1.00
Work Zone On Approach		No			No			No				No
Adj Sat Flow, veh/h/ln	1737	1870	1900	1900	1885	1885	1900	1900	1900	1856	1648	1870
Adj Flow Rate, veh/h	45	1587	15	29	3765	1065	9	37	10	481	173	43
Peak Hour Factor	0.95	0.95	0.95	0.95	0.95	0.95	0.95	0.95	0.95	0.95	0.95	0.95
Percent Heavy Veh, %	11	2	0	0	1	1	0	0	0	3	17	2
Cap, veh/h	56	2797	26	48	2721	1117	132	264	118	603	281	270
Arrive On Green	0.03	0.54	0.54	0.03	0.53	0.53	0.07	0.07	0.07	0.17	0.17	0.17
Sat Flow, veh/h	1654	5216	49	1810	5147	1598	1810	3610	1610	3534	1648	1585
Grp Volume(v), veh/h	45	1036	566	29	3765	1065	9	37	10	481	173	43
Grp Sat Flow(s),veh/h/ln	1654	1702	1861	1810	1716	1598	1810	1805	1610	1767	1648	1585
Q Serve(g_s), s	3.1	23.0	23.0	1.8	60.0	60.0	0.5	1.1	0.7	14.8	11.0	2.6
Cycle Q Clear(g_c), s	3.1	23.0	23.0	1.8	60.0	60.0	0.5	1.1	0.7	14.8	11.0	2.6
Prop In Lane	1.00		0.03	1.00		1.00	1.00		1.00	1.00		1.00
Lane Grp Cap(c), veh/h	56	1825	998	48	2721	1117	132	264	118	603	281	270
V/C Ratio(X)	0.80	0.57	0.57	0.61	1.38	0.95	0.07	0.14	0.09	0.80	0.62	0.16
Avail Cap(c_a), veh/h	73	1825	998	80	2721	1117	159	318	142	1028	479	461
HCM Platoon Ratio	1.00	1.00	1.00	1.00	1.00	1.00	1.00	1.00	1.00	1.00	1.00	1.00
Upstream Filter(I)	1.00	1.00	1.00	1.00	1.00	1.00	1.00	1.00	1.00	1.00	1.00	1.00
Uniform Delay (d), s/veh	54.4	17.5	17.5	54.7	26.7	14.2	49.0	49.3	49.1	45.2	43.6	40.1
Incr Delay (d2), s/veh	29.3	0.4	0.8	4.6	175.0	16.9	0.2	0.2	0.3	2.5	2.2	0.3
Initial Q Delay(d3),s/veh	0.0	0.0	0.0	0.0	0.0	0.0	0.0	0.0	0.0	0.0	0.0	0.0
%ile BackOfQ(50%),veh/ln	1.7	8.2	9.0	0.9	65.4	34.7	0.2	0.5	0.3	6.5	4.5	1.0
Unsig. Movement Delay, s/veh												
LnGrp Delay(d),s/veh	83.8	18.0	18.3	59.2	201.7	31.1	49.2	49.5	49.4	47.7	45.8	40.4
LnGrp LOS	F	B	B	E	F	C	D	D	D	D	D	D
Approach Vol, veh/h		1647			4859			56				697
Approach Delay, s/veh		19.9			163.4			49.4				46.8
Approach LOS		B			F			D				D
Timer - Assigned Phs	1	2		4	5	6		8				
Phs Duration (G+Y+Rc), s	7.2	67.0		25.1	8.0	66.2		14.1				
Change Period (Y+Rc), s	* 4.2	6.2		5.8	* 4.2	6.2		5.8				
Max Green Setting (Gmax), s	* 5	60.0		33.0	* 5	60.0		10.0				
Max Q Clear Time (g_c+I1), s	3.8	25.0		16.8	5.1	62.0		3.1				
Green Ext Time (p_c), s	0.0	12.9		2.5	0.0	0.0		0.1				

Intersection Summary

HCM 6th Ctrl Delay	118.8
HCM 6th LOS	F

Notes

- User approved pedestrian interval to be less than phase max green.
- User approved volume balancing among the lanes for turning movement.
- * HCM 6th computational engine requires equal clearance times for the phases crossing the barrier.

Timings

West Campus Upper Plateau (JN 14064)

4: Van Buren Bl. & Wood Rd.

09/19/2022

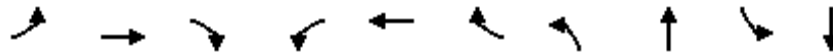

Lane Group	EBL	EBT	EBR	WBL	WBT	WBR	NBL	NBT	SBL	SBT
Lane Configurations	↘	↑↑	↗	↘↗	↑↑	↗	↘↗	↑↗	↘	↑↗
Traffic Volume (vph)	168	1021	364	512	1336	117	371	478	96	478
Future Volume (vph)	168	1021	364	512	1336	117	371	478	96	478
Turn Type	Prot	NA	pm+ov	Prot	NA	Perm	Prot	NA	Perm	NA
Protected Phases	5	2	3	1	6		3	8		4
Permitted Phases			2			6			4	
Detector Phase	5	2	3	1	6	6	3	8	4	4
Switch Phase										
Minimum Initial (s)	5.0	10.0	5.0	5.0	10.0	10.0	5.0	10.0	10.0	10.0
Minimum Split (s)	9.2	30.2	9.2	9.2	30.2	30.2	9.2	38.4	15.8	15.8
Total Split (s)	17.0	43.0	23.7	24.1	50.1	50.1	23.7	52.9	29.2	29.2
Total Split (%)	14.2%	35.8%	19.8%	20.1%	41.8%	41.8%	19.8%	44.1%	24.3%	24.3%
Yellow Time (s)	3.2	4.8	3.2	3.2	4.8	4.8	3.2	3.5	3.5	3.5
All-Red Time (s)	1.0	1.0	1.0	1.0	1.0	1.0	1.0	1.0	1.0	1.0
Lost Time Adjust (s)	0.0	0.0	0.0	0.0	0.0	0.0	0.0	0.0	0.0	0.0
Total Lost Time (s)	4.2	5.8	4.2	4.2	5.8	5.8	4.2	4.5	4.5	4.5
Lead/Lag	Lead	Lag	Lead	Lead	Lag	Lag	Lead		Lag	Lag
Lead-Lag Optimize?	Yes	Yes	Yes	Yes	Yes	Yes	Yes		Yes	Yes
Recall Mode	None	None	None	None	None	None	None	None	None	None
Act Effct Green (s)	12.8	37.2	56.4	19.9	44.3	44.3	17.5	46.4	24.7	24.7
Actuated g/C Ratio	0.11	0.31	0.48	0.17	0.38	0.38	0.15	0.39	0.21	0.21
v/c Ratio	1.01	1.05	0.53	1.00	1.15	0.21	0.82	0.69	0.96	1.01
Control Delay	120.9	81.0	17.3	85.9	113.1	10.4	62.6	26.4	123.9	78.8
Queue Delay	0.0	0.0	0.0	0.0	0.0	0.0	0.0	0.0	0.0	0.0
Total Delay	120.9	81.0	17.3	85.9	113.1	10.4	62.6	26.4	123.9	78.8
LOS	F	F	B	F	F	B	E	C	F	E
Approach Delay		70.4			99.9			37.6		84.5
Approach LOS		E			F			D		F

Intersection Summary

Cycle Length: 120
 Actuated Cycle Length: 118.1
 Natural Cycle: 110
 Control Type: Actuated-Uncoordinated
 Maximum v/c Ratio: 1.15
 Intersection Signal Delay: 75.8
 Intersection LOS: E
 Intersection Capacity Utilization 97.9%
 ICU Level of Service F
 Analysis Period (min) 15

Splits and Phases: 4: Van Buren Bl. & Wood Rd.

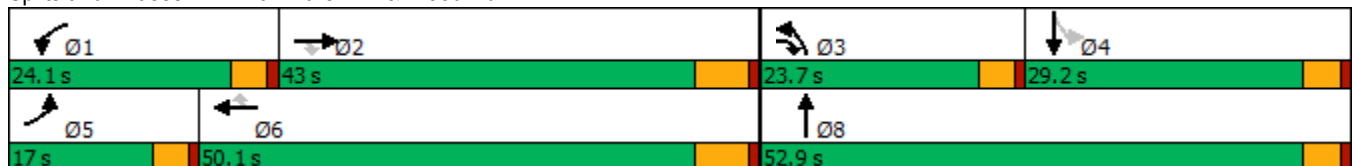

HCM 6th Signalized Intersection Summary
4: Van Buren Bl. & Wood Rd.

West Campus Upper Plateau (JN 14064)

09/19/2022

Movement	EBL	EBT	EBR	WBL	WBT	WBR	NBL	NBT	NBR	SBL	SBT	SBR
Lane Configurations												
Traffic Volume (veh/h)	168	1021	364	512	1336	117	371	478	350	96	478	186
Future Volume (veh/h)	168	1021	364	512	1336	117	371	478	350	96	478	186
Initial Q (Qb), veh	0	0	0	0	0	0	0	0	0	0	0	0
Ped-Bike Adj(A_pbT)	1.00		0.97	1.00		0.98	1.00		0.93	0.96		0.99
Parking Bus, Adj	1.00	1.00	1.00	1.00	1.00	1.00	1.00	1.00	1.00	1.00	1.00	1.00
Work Zone On Approach		No			No			No			No	
Adj Sat Flow, veh/h/ln	1856	1856	1856	1885	1856	1870	1885	1885	1885	1870	1900	1856
Adj Flow Rate, veh/h	191	1160	229	582	1518	83	422	543	255	109	543	116
Peak Hour Factor	0.88	0.88	0.88	0.88	0.88	0.88	0.88	0.88	0.88	0.88	0.88	0.88
Percent Heavy Veh, %	3	3	3	1	3	2	1	1	1	2	0	3
Cap, veh/h	196	1135	711	600	1351	598	484	877	410	185	606	129
Arrive On Green	0.11	0.32	0.32	0.17	0.38	0.38	0.14	0.38	0.38	0.21	0.21	0.21
Sat Flow, veh/h	1767	3526	1531	3483	3526	1560	3483	2305	1078	652	2954	628
Grp Volume(v), veh/h	191	1160	229	582	1518	83	422	422	376	109	331	328
Grp Sat Flow(s),veh/h/ln	1767	1763	1531	1742	1763	1560	1742	1791	1592	652	1805	1777
Q Serve(g_s), s	12.5	37.2	11.0	19.2	44.3	4.0	13.7	22.0	22.2	18.8	20.6	20.8
Cycle Q Clear(g_c), s	12.5	37.2	11.0	19.2	44.3	4.0	13.7	22.0	22.2	20.7	20.6	20.8
Prop In Lane	1.00		1.00	1.00		1.00	1.00		0.68	1.00		0.35
Lane Grp Cap(c), veh/h	196	1135	711	600	1351	598	484	681	606	185	370	364
V/C Ratio(X)	0.98	1.02	0.32	0.97	1.12	0.14	0.87	0.62	0.62	0.59	0.89	0.90
Avail Cap(c_a), veh/h	196	1135	711	600	1351	598	588	750	667	191	386	380
HCM Platoon Ratio	1.00	1.00	1.00	1.00	1.00	1.00	1.00	1.00	1.00	1.00	1.00	1.00
Upstream Filter(I)	1.00	1.00	1.00	1.00	1.00	1.00	1.00	1.00	1.00	1.00	1.00	1.00
Uniform Delay (d), s/veh	51.2	39.2	19.7	47.5	35.6	23.2	48.7	29.0	29.1	45.7	44.7	44.8
Incr Delay (d2), s/veh	56.9	32.5	0.4	29.2	65.7	0.1	10.3	1.3	1.5	4.5	21.9	23.1
Initial Q Delay(d3),s/veh	0.0	0.0	0.0	0.0	0.0	0.0	0.0	0.0	0.0	0.0	0.0	0.0
%ile BackOfQ(50%),veh/ln	8.4	20.2	3.8	10.4	29.9	1.4	6.5	9.4	8.4	3.2	11.2	11.3
Unsig. Movement Delay, s/veh												
LnGrp Delay(d),s/veh	108.1	71.6	20.1	76.7	101.3	23.4	59.1	30.3	30.6	50.1	66.6	67.9
LnGrp LOS	F	F	C	E	F	C	E	C	C	D	E	E
Approach Vol, veh/h		1580			2183			1220			768	
Approach Delay, s/veh		68.6			91.8			40.3			64.8	
Approach LOS		E			F			D			E	
Timer - Assigned Phs	1	2	3	4	5	6		8				
Phs Duration (G+Y+Rc), s	24.1	43.0	20.3	28.2	17.0	50.1		48.5				
Change Period (Y+Rc), s	* 4.2	5.8	* 4.2	4.5	* 4.2	5.8		4.5				
Max Green Setting (Gmax), s	* 20	37.2	* 20	24.7	* 13	44.3		48.4				
Max Q Clear Time (g_c+I1), s	21.2	39.2	15.7	22.8	14.5	46.3		24.2				
Green Ext Time (p_c), s	0.0	0.0	0.3	0.9	0.0	0.0		5.2				

Intersection Summary

HCM 6th Ctrl Delay	70.9
HCM 6th LOS	E

Notes

* HCM 6th computational engine requires equal clearance times for the phases crossing the barrier.

Timings
5: Trautwein Rd. & Alessandro Bl.

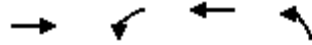

Lane Group	EBT	WBL	WBT	NBL
Lane Configurations	↑↑↑	↵↵	↑↑↑	↵↵↵
Traffic Volume (vph)	1280	180	3515	2121
Future Volume (vph)	1280	180	3515	2121
Turn Type	NA	Prot	NA	Prot
Protected Phases	2	1	6	8
Permitted Phases				
Detector Phase	2	1	6	8
Switch Phase				
Minimum Initial (s)	10.0	5.0	10.0	10.0
Minimum Split (s)	33.2	9.2	16.2	16.2
Total Split (s)	54.6	17.4	72.0	48.0
Total Split (%)	45.5%	14.5%	60.0%	40.0%
Yellow Time (s)	5.2	3.2	5.2	5.2
All-Red Time (s)	1.0	1.0	1.0	1.0
Lost Time Adjust (s)	0.0	0.0	0.0	0.0
Total Lost Time (s)	6.2	4.2	6.2	6.2
Lead/Lag	Lag	Lead		
Lead-Lag Optimize?	Yes	Yes		
Recall Mode	None	None	None	None
Act Effct Green (s)	50.6	11.0	65.8	41.8
Actuated g/C Ratio	0.42	0.09	0.55	0.35
v/c Ratio	0.66	0.64	1.37	1.34
Control Delay	29.9	61.9	195.9	191.8
Queue Delay	0.0	0.0	0.0	0.0
Total Delay	29.9	61.9	195.9	191.8
LOS	C	E	F	F
Approach Delay	29.9		189.3	191.8
Approach LOS	C		F	F

Intersection Summary

Cycle Length: 120
 Actuated Cycle Length: 120
 Natural Cycle: 130
 Control Type: Actuated-Uncoordinated
 Maximum v/c Ratio: 1.37
 Intersection Signal Delay: 161.3
 Intersection Capacity Utilization 118.8%
 Analysis Period (min) 15
 Intersection LOS: F
 ICU Level of Service H

Splits and Phases: 5: Trautwein Rd. & Alessandro Bl.

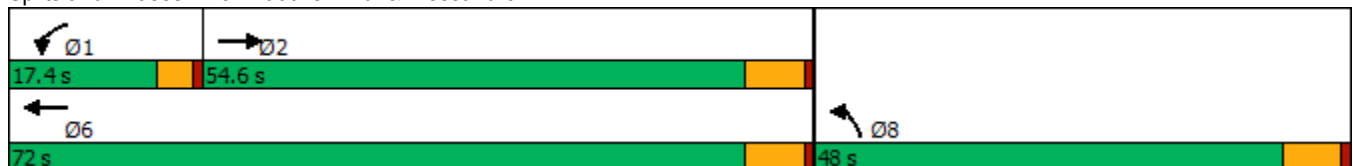

HCM 6th Signalized Intersection Summary
5: Trautwein Rd. & Alessandro Bl.

West Campus Upper Plateau (JN 14064)
09/19/2022

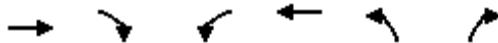

Movement	EBT	EBR	WBL	WBT	NBL	NBR
Lane Configurations	↑↑↑		↔	↑↑↑	↔	
Traffic Volume (veh/h)	1280	4	180	3515	2121	8
Future Volume (veh/h)	1280	4	180	3515	2121	8
Initial Q (Qb), veh	0	0	0	0	0	0
Ped-Bike Adj(A_pbT)		1.00	1.00		1.00	1.00
Parking Bus, Adj	1.00	1.00	1.00	1.00	1.00	1.00
Work Zone On Approach	No			No	No	
Adj Sat Flow, veh/h/ln	1870	1900	1856	1885	1870	1693
Adj Flow Rate, veh/h	1407	4	198	3863	2339	0
Peak Hour Factor	0.91	0.91	0.91	0.91	0.91	0.91
Percent Heavy Veh, %	2	0	3	1	2	14
Cap, veh/h	2307	7	255	2822	1861	500
Arrive On Green	0.44	0.44	0.07	0.55	0.35	0.00
Sat Flow, veh/h	5425	15	3428	5316	5344	1434
Grp Volume(v), veh/h	911	500	198	3863	2339	0
Grp Sat Flow(s),veh/h/ln	1702	1868	1714	1716	1781	1434
Q Serve(g_s), s	24.6	24.6	6.8	65.8	41.8	0.0
Cycle Q Clear(g_c), s	24.6	24.6	6.8	65.8	41.8	0.0
Prop In Lane		0.01	1.00		1.00	1.00
Lane Grp Cap(c), veh/h	1494	820	255	2822	1861	500
V/C Ratio(X)	0.61	0.61	0.78	1.37	1.26	0.00
Avail Cap(c_a), veh/h	1494	820	377	2822	1861	500
HCM Platoon Ratio	1.00	1.00	1.00	1.00	1.00	1.00
Upstream Filter(I)	1.00	1.00	1.00	1.00	1.00	0.00
Uniform Delay (d), s/veh	25.8	25.8	54.5	27.1	39.1	0.0
Incr Delay (d2), s/veh	0.9	1.6	3.0	168.3	120.0	0.0
Initial Q Delay(d3),s/veh	0.0	0.0	0.0	0.0	0.0	0.0
%ile BackOfQ(50%),veh/ln	9.5	10.5	2.9	67.0	37.7	0.0
Unsig. Movement Delay, s/veh						
LnGrp Delay(d),s/veh	26.7	27.4	57.5	195.4	159.1	0.0
LnGrp LOS	C	C	E	F	F	A
Approach Vol, veh/h	1411			4061	2339	
Approach Delay, s/veh	26.9			188.7	159.1	
Approach LOS	C			F	F	
Timer - Assigned Phs	1	2			6	8
Phs Duration (G+Y+Rc), s	13.1	58.9			72.0	48.0
Change Period (Y+Rc), s	* 4.2	6.2			6.2	6.2
Max Green Setting (Gmax), s	* 13	48.4			65.8	41.8
Max Q Clear Time (g_c+I1), s	8.8	26.6			67.8	43.8
Green Ext Time (p_c), s	0.1	12.2			0.0	0.0

Intersection Summary

HCM 6th Ctrl Delay	150.6
HCM 6th LOS	F

Notes

User approved volume balancing among the lanes for turning movement.
* HCM 6th computational engine requires equal clearance times for the phases crossing the barrier.

Timings
6: Trautwein Rd. & Grove Community Dr

West Campus Upper Plateau (JN 14064)

09/19/2022

Lane Group	WBL	WBR	NBT	NBR	SBL	SBT
Lane Configurations						
Traffic Volume (vph)	86	694	1641	26	237	1001
Future Volume (vph)	86	694	1641	26	237	1001
Turn Type	Prot	pm+ov	NA	Perm	Prot	NA
Protected Phases	8	1	2		1	6
Permitted Phases		8		2		
Detector Phase	8	1	2	2	1	6
Switch Phase						
Minimum Initial (s)	10.0	5.0	10.0	10.0	5.0	10.0
Minimum Split (s)	34.6	9.6	46.2	46.2	9.6	28.2
Total Split (s)	34.6	15.2	70.2	70.2	15.2	85.4
Total Split (%)	28.8%	12.7%	58.5%	58.5%	12.7%	71.2%
Yellow Time (s)	3.6	3.6	5.2	5.2	3.6	5.2
All-Red Time (s)	1.0	1.0	1.0	1.0	1.0	1.0
Lost Time Adjust (s)	0.0	0.0	0.0	0.0	0.0	0.0
Total Lost Time (s)	4.6	4.6	6.2	6.2	4.6	6.2
Lead/Lag		Lead	Lag	Lag	Lead	
Lead-Lag Optimize?		Yes	Yes	Yes	Yes	
Recall Mode	None	None	None	None	None	None
Act Effct Green (s)	14.0	24.7	64.3	64.3	10.6	79.5
Actuated g/C Ratio	0.13	0.24	0.62	0.62	0.10	0.76
v/c Ratio	0.43	1.26	0.91	0.03	0.82	0.45
Control Delay	46.4	161.6	26.0	6.6	66.2	5.9
Queue Delay	0.0	0.0	0.0	0.0	0.0	0.0
Total Delay	46.4	161.6	26.0	6.6	66.2	5.9
LOS	D	F	C	A	E	A
Approach Delay	148.9		25.7			17.4
Approach LOS	F		C			B

Intersection Summary

Cycle Length: 120	
Actuated Cycle Length: 104.4	
Natural Cycle: 125	
Control Type: Actuated-Uncoordinated	
Maximum v/c Ratio: 1.26	
Intersection Signal Delay: 49.0	Intersection LOS: D
Intersection Capacity Utilization 78.9%	ICU Level of Service D
Analysis Period (min) 15	

Splits and Phases: 6: Trautwein Rd. & Grove Community Dr



HCM 6th Signalized Intersection Summary
6: Trautwein Rd. & Grove Community Dr

West Campus Upper Plateau (JN 14064)
09/19/2022



Movement	WBL	WBR	NBT	NBR	SBL	SBT
Lane Configurations						
Traffic Volume (veh/h)	86	694	1641	26	237	1001
Future Volume (veh/h)	86	694	1641	26	237	1001
Initial Q (Qb), veh	0	0	0	0	0	0
Ped-Bike Adj(A_pbT)	1.00	1.00		0.97	1.00	
Parking Bus, Adj	1.00	1.00	1.00	1.00	1.00	1.00
Work Zone On Approach	No		No			No
Adj Sat Flow, veh/h/ln	1900	1885	1870	1900	1870	1856
Adj Flow Rate, veh/h	104	634	1977	23	286	1206
Peak Hour Factor	0.83	0.83	0.83	0.83	0.83	0.83
Percent Heavy Veh, %	0	1	2	0	2	3
Cap, veh/h	412	896	1951	862	314	2396
Arrive On Green	0.23	0.23	0.55	0.55	0.09	0.68
Sat Flow, veh/h	1810	2812	3647	1570	3456	3618
Grp Volume(v), veh/h	104	634	1977	23	286	1206
Grp Sat Flow(s),veh/h/ln	1810	1406	1777	1570	1728	1763
Q Serve(g_s), s	5.5	23.1	64.0	0.8	9.6	19.4
Cycle Q Clear(g_c), s	5.5	23.1	64.0	0.8	9.6	19.4
Prop In Lane	1.00	1.00		1.00	1.00	
Lane Grp Cap(c), veh/h	412	896	1951	862	314	2396
V/C Ratio(X)	0.25	0.71	1.01	0.03	0.91	0.50
Avail Cap(c_a), veh/h	466	979	1951	862	314	2396
HCM Platoon Ratio	1.00	1.00	1.00	1.00	1.00	1.00
Upstream Filter(I)	1.00	1.00	1.00	1.00	1.00	1.00
Uniform Delay (d), s/veh	36.9	34.9	26.3	12.0	52.5	9.1
Incr Delay (d2), s/veh	0.3	2.1	23.7	0.0	28.4	0.2
Initial Q Delay(d3),s/veh	0.0	0.0	0.0	0.0	0.0	0.0
%ile BackOfQ(50%),veh/ln	2.5	8.0	29.8	0.3	5.2	6.1
Unsig. Movement Delay, s/veh						
LnGrp Delay(d),s/veh	37.2	37.1	50.0	12.0	80.9	9.3
LnGrp LOS	D	D	F	B	F	A
Approach Vol, veh/h	738		2000			1492
Approach Delay, s/veh	37.1		49.5			23.0
Approach LOS	D		D			C
Timer - Assigned Phs	1	2			6	8
Phs Duration (G+Y+Rc), s	15.2	70.2			85.4	31.2
Change Period (Y+Rc), s	4.6	6.2			6.2	4.6
Max Green Setting (Gmax), s	10.6	64.0			79.2	30.0
Max Q Clear Time (g_c+I1), s	11.6	66.0			21.4	25.1
Green Ext Time (p_c), s	0.0	0.0			10.4	1.4

Intersection Summary

HCM 6th Ctrl Delay	38.0
HCM 6th LOS	D

Timings

West Campus Upper Plateau (JN 14064)

7: Trautwein Rd. & Orange Terrace Pkwy

09/19/2022



Lane Group	EBL	EBT	WBL	WBT	WBR	NBL	NBT	NBR	SBL	SBT	SBR
Lane Configurations											
Traffic Volume (vph)	77	73	331	114	557	56	1119	275	439	666	23
Future Volume (vph)	77	73	331	114	557	56	1119	275	439	666	23
Turn Type	Prot	NA	Prot	NA	pm+ov	Prot	NA	Perm	Prot	NA	Perm
Protected Phases	7	4	3	8	1	5	2		1	6	
Permitted Phases					8			2			6
Detector Phase	7	4	3	8	1	5	2	2	1	6	6
Switch Phase											
Minimum Initial (s)	5.0	10.0	5.0	10.0	5.0	5.0	10.0	10.0	5.0	10.0	10.0
Minimum Split (s)	9.6	38.6	9.6	34.6	9.6	9.6	47.5	47.5	9.6	24.2	24.2
Total Split (s)	16.9	38.6	24.0	45.7	18.0	14.3	49.4	49.4	18.0	53.1	53.1
Total Split (%)	13.0%	29.7%	18.5%	35.2%	13.8%	11.0%	38.0%	38.0%	13.8%	40.8%	40.8%
Yellow Time (s)	3.2	3.5	3.2	3.5	3.2	3.2	3.5	3.5	3.2	3.5	3.5
All-Red Time (s)	1.0	1.0	1.0	1.0	1.0	1.0	1.0	1.0	1.0	1.0	1.0
Lost Time Adjust (s)	0.0	0.0	0.0	0.0	0.0	0.0	0.0	0.0	0.0	0.0	0.0
Total Lost Time (s)	4.2	4.5	4.2	4.5	4.2	4.2	4.5	4.5	4.2	4.5	4.5
Lead/Lag	Lead	Lag	Lead	Lag	Lead	Lead	Lag	Lag	Lead	Lag	Lag
Lead-Lag Optimize?	Yes	Yes	Yes	Yes	Yes	Yes	Yes	Yes	Yes	Yes	Yes
Recall Mode	None	None	None	None	None	None	None	None	None	None	None
Act Effct Green (s)	9.5	14.9	19.9	25.3	39.5	8.1	45.2	45.2	13.9	52.9	52.9
Actuated g/C Ratio	0.09	0.13	0.18	0.23	0.35	0.07	0.41	0.41	0.12	0.47	0.47
v/c Ratio	0.60	0.42	1.24	0.32	0.63	0.52	0.94	0.45	1.24	0.48	0.04
Control Delay	66.7	45.2	169.3	38.0	23.9	66.3	45.8	14.2	166.0	23.2	0.1
Queue Delay	0.0	0.0	0.0	0.0	0.0	0.0	0.0	0.0	0.0	0.0	0.0
Total Delay	66.7	45.2	169.3	38.0	23.9	66.3	45.8	14.2	166.0	23.2	0.1
LOS	E	D	F	D	C	E	D	B	F	C	A
Approach Delay		55.3		73.5			40.6			78.3	
Approach LOS		E		E			D			E	

Intersection Summary

Cycle Length: 130
 Actuated Cycle Length: 111.4
 Natural Cycle: 130
 Control Type: Actuated-Uncoordinated
 Maximum v/c Ratio: 1.24
 Intersection Signal Delay: 61.4
 Intersection Capacity Utilization 79.8%
 Analysis Period (min) 15
 Intersection LOS: E
 ICU Level of Service D



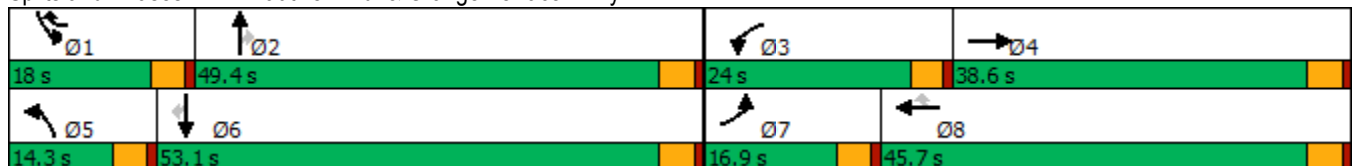



















Splits and Phases: 7: Trautwein Rd. & Orange Terrace Pkwy



HCM 6th Signalized Intersection Summary
7: Trautwein Rd. & Orange Terrace Pkwy

West Campus Upper Plateau (JN 14064)

09/19/2022

												
Movement	EBL	EBT	EBR	WBL	WBT	WBR	NBL	NBT	NBR	SBL	SBT	SBR
Lane Configurations												
Traffic Volume (veh/h)	77	73	14	331	114	557	56	1119	275	439	666	23
Future Volume (veh/h)	77	73	14	331	114	557	56	1119	275	439	666	23
Initial Q (Qb), veh	0	0	0	0	0	0	0	0	0	0	0	0
Ped-Bike Adj(A_pbT)	1.00		0.99	1.00		0.96	1.00		1.00	1.00		0.98
Parking Bus, Adj	1.00	1.00	1.00	1.00	1.00	1.00	1.00	1.00	1.00	1.00	1.00	1.00
Work Zone On Approach		No			No			No			No	
Adj Sat Flow, veh/h/ln	1900	1870	1900	1885	1885	1885	1870	1856	1870	1856	1856	1826
Adj Flow Rate, veh/h	92	87	12	394	136	418	67	1332	242	523	793	19
Peak Hour Factor	0.84	0.84	0.84	0.84	0.84	0.84	0.84	0.84	0.84	0.84	0.84	0.84
Percent Heavy Veh, %	0	2	0	1	1	1	2	3	2	3	3	5
Cap, veh/h	117	203	28	327	460	1018	86	1426	640	435	1703	730
Arrive On Green	0.06	0.13	0.13	0.18	0.24	0.24	0.05	0.40	0.40	0.13	0.48	0.48
Sat Flow, veh/h	1810	1606	221	1795	1885	2709	1781	3526	1583	3428	3526	1511
Grp Volume(v), veh/h	92	0	99	394	136	418	67	1332	242	523	793	19
Grp Sat Flow(s),veh/h/ln	1810	0	1827	1795	1885	1355	1781	1763	1583	1714	1763	1511
Q Serve(g_s), s	5.4	0.0	5.4	19.8	6.4	12.5	4.0	39.3	11.7	13.8	16.3	0.7
Cycle Q Clear(g_c), s	5.4	0.0	5.4	19.8	6.4	12.5	4.0	39.3	11.7	13.8	16.3	0.7
Prop In Lane	1.00		0.12	1.00		1.00	1.00		1.00	1.00		1.00
Lane Grp Cap(c), veh/h	117	0	231	327	460	1018	86	1426	640	435	1703	730
V/C Ratio(X)	0.79	0.00	0.43	1.21	0.30	0.41	0.78	0.93	0.38	1.20	0.47	0.03
Avail Cap(c_a), veh/h	211	0	573	327	714	1383	165	1456	654	435	1703	730
HCM Platoon Ratio	1.00	1.00	1.00	1.00	1.00	1.00	1.00	1.00	1.00	1.00	1.00	1.00
Upstream Filter(I)	1.00	0.00	1.00	1.00	1.00	1.00	1.00	1.00	1.00	1.00	1.00	1.00
Uniform Delay (d), s/veh	50.1	0.0	43.9	44.5	33.5	25.4	51.2	31.0	22.8	47.5	18.7	14.7
Incr Delay (d2), s/veh	4.4	0.0	1.3	117.6	0.4	0.3	5.5	11.2	0.4	111.0	0.2	0.0
Initial Q Delay(d3),s/veh	0.0	0.0	0.0	0.0	0.0	0.0	0.0	0.0	0.0	0.0	0.0	0.0
%ile BackOfQ(50%),veh/ln	2.6	0.0	2.5	19.1	2.9	3.9	1.9	17.4	4.2	12.3	6.1	0.2
Unsig. Movement Delay, s/veh												
LnGrp Delay(d),s/veh	54.5	0.0	45.1	162.1	33.9	25.7	56.7	42.2	23.1	158.5	18.9	14.7
LnGrp LOS	D	A	D	F	C	C	E	D	C	F	B	B
Approach Vol, veh/h		191			948			1641			1335	
Approach Delay, s/veh		49.6			83.6			40.0			73.5	
Approach LOS		D			F			D			E	
Timer - Assigned Phs	1	2	3	4	5	6	7	8				
Phs Duration (G+Y+Rc), s	18.0	48.5	24.0	18.2	9.5	57.0	11.2	31.0				
Change Period (Y+Rc), s	* 4.2	4.5	* 4.2	4.5	* 4.2	4.5	* 4.2	4.5				
Max Green Setting (Gmax), s	* 14	44.9	* 20	34.1	* 10	48.6	* 13	41.2				
Max Q Clear Time (g_c+I1), s	15.8	41.3	21.8	7.4	6.0	18.3	7.4	14.5				
Green Ext Time (p_c), s	0.0	2.7	0.0	0.5	0.0	5.4	0.0	2.4				

Intersection Summary

HCM 6th Ctrl Delay	61.4
HCM 6th LOS	E

Notes

* HCM 6th computational engine requires equal clearance times for the phases crossing the barrier.

Timings
8: Cole Av. & Van Buren Bl.

West Campus Upper Plateau (JN 14064)

09/19/2022



Lane Group	EBL	EBT	EBR	WBL	WBT	WBR	NBL	NBT	SBL	SBT	SBR
Lane Configurations	↖↗	↑↑	↗	↖	↑↑↑	↗	↖	↑↑	↖↗	↑↑	↗
Traffic Volume (vph)	346	1117	106	171	1424	382	247	615	202	378	260
Future Volume (vph)	346	1117	106	171	1424	382	247	615	202	378	260
Turn Type	Prot	NA	pm+ov	Prot	NA	pm+ov	Prot	NA	Prot	NA	pm+ov
Protected Phases	5	2	3	1	6	7	3	8	7	4	5
Permitted Phases			2			6					4
Detector Phase	5	2	3	1	6	7	3	8	7	4	5
Switch Phase											
Minimum Initial (s)	5.0	10.0	5.0	5.0	10.0	5.0	5.0	10.0	5.0	10.0	5.0
Minimum Split (s)	9.1	36.2	9.1	9.1	36.2	9.1	9.1	42.2	9.1	49.2	9.1
Total Split (s)	15.0	37.8	19.0	14.0	36.8	21.6	19.0	46.6	21.6	49.2	15.0
Total Split (%)	12.5%	31.5%	15.8%	11.7%	30.7%	18.0%	15.8%	38.8%	18.0%	41.0%	12.5%
Yellow Time (s)	3.2	5.2	3.2	3.2	5.2	3.2	3.2	5.2	3.2	5.2	3.2
All-Red Time (s)	0.5	1.0	0.5	0.5	1.0	0.5	0.5	1.0	0.5	1.0	0.5
Lost Time Adjust (s)	0.0	0.0	0.0	0.0	0.0	0.0	0.0	0.0	0.0	0.0	0.0
Total Lost Time (s)	3.7	6.2	3.7	3.7	6.2	3.7	3.7	6.2	3.7	6.2	3.7
Lead/Lag	Lead	Lag	Lead	Lead	Lag	Lead	Lead	Lag	Lead	Lag	Lead
Lead-Lag Optimize?	Yes	Yes	Yes	Yes	Yes	Yes	Yes	Yes	Yes	Yes	Yes
Recall Mode	None	None	None	None	None	None	None	None	None	None	None
Act Effct Green (s)	11.4	31.8	53.5	10.4	30.8	44.7	15.4	30.9	11.3	26.8	40.7
Actuated g/C Ratio	0.11	0.30	0.51	0.10	0.30	0.43	0.15	0.30	0.11	0.26	0.39
v/c Ratio	1.04	1.17	0.14	1.06	1.06	0.61	1.06	0.81	0.61	0.46	0.45
Control Delay	103.5	122.2	7.6	131.6	79.1	22.4	118.0	40.1	52.7	33.6	17.9
Queue Delay	0.0	0.0	0.0	0.0	0.0	0.0	0.0	0.0	0.0	0.0	0.0
Total Delay	103.5	122.2	7.6	131.6	79.1	22.4	118.0	40.1	52.7	33.6	17.9
LOS	F	F	A	F	E	C	F	D	D	C	B
Approach Delay		110.3			72.7			59.3		33.3	
Approach LOS		F			E			E		C	

Intersection Summary

Cycle Length: 120
 Actuated Cycle Length: 104.4
 Natural Cycle: 125
 Control Type: Actuated-Uncoordinated
 Maximum v/c Ratio: 1.17
 Intersection Signal Delay: 75.0
 Intersection LOS: E
 Intersection Capacity Utilization 84.9%
 ICU Level of Service E
 Analysis Period (min) 15



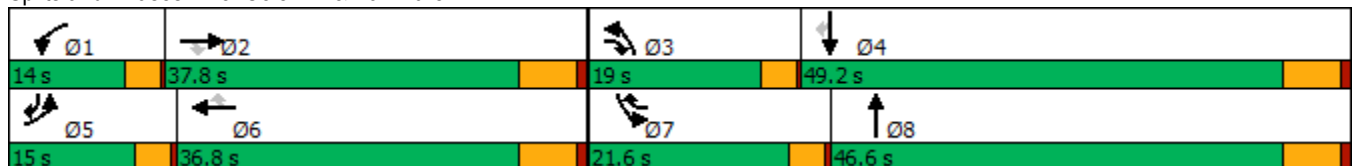



























Splits and Phases: 8: Cole Av. & Van Buren Bl.



HCM 6th Signalized Intersection Summary
8: Cole Av. & Van Buren Bl.

West Campus Upper Plateau (JN 14064)

09/19/2022

												
Movement	EBL	EBT	EBR	WBL	WBT	WBR	NBL	NBT	NBR	SBL	SBT	SBR
Lane Configurations	 	 			  			 		 	 	
Traffic Volume (veh/h)	346	1117	106	171	1424	382	247	615	140	202	378	260
Future Volume (veh/h)	346	1117	106	171	1424	382	247	615	140	202	378	260
Initial Q (Qb), veh	0	0	0	0	0	0	0	0	0	0	0	0
Ped-Bike Adj(A_pbT)	1.00		1.00	1.00		0.99	1.00		1.00	1.00		1.00
Parking Bus, Adj	1.00	1.00	1.00	1.00	1.00	1.00	1.00	1.00	1.00	1.00	1.00	1.00
Work Zone On Approach		No			No			No			No	
Adj Sat Flow, veh/h/ln	1856	1841	1841	1900	1856	1856	1856	1870	1856	1856	1870	1841
Adj Flow Rate, veh/h	384	1241	77	190	1582	334	274	683	147	224	420	217
Peak Hour Factor	0.90	0.90	0.90	0.90	0.90	0.90	0.90	0.90	0.90	0.90	0.90	0.90
Percent Heavy Veh, %	3	4	4	0	3	3	3	2	3	3	2	4
Cap, veh/h	394	1123	743	189	1575	619	275	833	179	297	773	518
Arrive On Green	0.11	0.32	0.32	0.10	0.31	0.31	0.16	0.29	0.29	0.09	0.22	0.22
Sat Flow, veh/h	3428	3497	1560	1810	5066	1552	1767	2908	625	3428	3554	1556
Grp Volume(v), veh/h	384	1241	77	190	1582	334	274	417	413	224	420	217
Grp Sat Flow(s),veh/h/ln	1714	1749	1560	1810	1689	1552	1767	1777	1757	1714	1777	1556
Q Serve(g_s), s	11.0	31.6	2.7	10.3	30.6	16.3	15.3	21.5	21.6	6.3	10.3	10.7
Cycle Q Clear(g_c), s	11.0	31.6	2.7	10.3	30.6	16.3	15.3	21.5	21.6	6.3	10.3	10.7
Prop In Lane	1.00		1.00	1.00		1.00	1.00		0.36	1.00		1.00
Lane Grp Cap(c), veh/h	394	1123	743	189	1575	619	275	509	503	297	773	518
V/C Ratio(X)	0.98	1.11	0.10	1.00	1.00	0.54	1.00	0.82	0.82	0.75	0.54	0.42
Avail Cap(c_a), veh/h	394	1123	743	189	1575	619	275	729	721	624	1553	859
HCM Platoon Ratio	1.00	1.00	1.00	1.00	1.00	1.00	1.00	1.00	1.00	1.00	1.00	1.00
Upstream Filter(I)	1.00	1.00	1.00	1.00	1.00	1.00	1.00	1.00	1.00	1.00	1.00	1.00
Uniform Delay (d), s/veh	43.4	33.4	14.2	44.1	33.9	22.8	41.5	32.7	32.8	43.9	34.2	25.5
Incr Delay (d2), s/veh	38.6	60.5	0.1	66.3	23.8	1.2	53.5	5.0	5.1	1.5	0.6	0.5
Initial Q Delay(d3),s/veh	0.0	0.0	0.0	0.0	0.0	0.0	0.0	0.0	0.0	0.0	0.0	0.0
%ile BackOfQ(50%),veh/ln	6.5	21.7	0.9	7.9	14.9	5.6	10.3	9.3	9.2	2.6	4.3	3.7
Unsig. Movement Delay, s/veh												
LnGrp Delay(d),s/veh	82.1	93.9	14.3	110.3	57.7	24.0	95.1	37.7	37.8	45.4	34.8	26.0
LnGrp LOS	F	F	B	F	F	C	F	D	D	D	C	C
Approach Vol, veh/h		1702			2106			1104			861	
Approach Delay, s/veh		87.6			57.1			52.0			35.3	
Approach LOS		F			E			D			D	
Timer - Assigned Phs	1	2	3	4	5	6	7	8				
Phs Duration (G+Y+Rc), s	14.0	37.8	19.0	27.6	15.0	36.8	12.2	34.4				
Change Period (Y+Rc), s	3.7	6.2	3.7	6.2	3.7	6.2	3.7	6.2				
Max Green Setting (Gmax), s	10.3	31.6	15.3	43.0	11.3	30.6	17.9	40.4				
Max Q Clear Time (g_c+I1), s	12.3	33.6	17.3	12.7	13.0	32.6	8.3	23.6				
Green Ext Time (p_c), s	0.0	0.0	0.0	3.3	0.0	0.0	0.3	4.3				
Intersection Summary												
HCM 6th Ctrl Delay			61.9									
HCM 6th LOS			E									

Intersection

Intersection Delay, s/veh	25.2
Intersection LOS	D

Movement	EBT	EBR	WBL	WBT	NBL	NBR
Lane Configurations	↔		↔	↑	↔	↔
Traffic Vol, veh/h	118	90	57	377	233	35
Future Vol, veh/h	118	90	57	377	233	35
Peak Hour Factor	0.76	0.76	0.76	0.76	0.76	0.76
Heavy Vehicles, %	2	1	2	2	0	0
Mvmt Flow	155	118	75	496	307	46
Number of Lanes	1	0	1	1	1	1

Approach	EB	WB	NB
Opposing Approach	WB	EB	
Opposing Lanes	2	1	0
Conflicting Approach Left		NB	EB
Conflicting Lanes Left	0	2	1
Conflicting Approach Right	NB		WB
Conflicting Lanes Right	2	0	2
HCM Control Delay	15	33.2	20.2
HCM LOS	B	D	C

Lane	NBLn1	NBLn2	EBLn1	WBLn1	WBLn2
Vol Left, %	100%	0%	0%	100%	0%
Vol Thru, %	0%	0%	57%	0%	100%
Vol Right, %	0%	100%	43%	0%	0%
Sign Control	Stop	Stop	Stop	Stop	Stop
Traffic Vol by Lane	233	35	208	57	377
LT Vol	233	0	0	57	0
Through Vol	0	0	118	0	377
RT Vol	0	35	90	0	0
Lane Flow Rate	307	46	274	75	496
Geometry Grp	7	7	4	7	7
Degree of Util (X)	0.627	0.079	0.477	0.141	0.863
Departure Headway (Hd)	7.367	6.145	6.277	6.775	6.266
Convergence, Y/N	Yes	Yes	Yes	Yes	Yes
Cap	487	580	569	527	575
Service Time	5.138	3.915	4.357	4.547	4.038
HCM Lane V/C Ratio	0.63	0.079	0.482	0.142	0.863
HCM Control Delay	21.8	9.4	15	10.7	36.6
HCM Lane LOS	C	A	B	B	E
HCM 95th-tile Q	4.2	0.3	2.6	0.5	9.5

Intersection

Intersection Delay, s/veh95.4

Intersection LOS F

Movement	EBL	EBT	EBR	WBL	WBT	WBR	NBL	NBT	NBR	SBL	SBT	SBR
Lane Configurations												
Traffic Vol, veh/h	252	481	47	4	620	58	179	44	7	94	35	42
Future Vol, veh/h	252	481	47	4	620	58	179	44	7	94	35	42
Peak Hour Factor	0.75	0.75	0.75	0.75	0.75	0.75	0.75	0.75	0.75	0.75	0.75	0.75
Heavy Vehicles, %	0	2	0	0	0	1	1	0	0	0	3	2
Mvmt Flow	336	641	63	5	827	77	239	59	9	125	47	56
Number of Lanes	1	2	0	1	2	0	0	1	0	0	1	0

Approach	EB	WB	NB	SB
Opposing Approach	WB	EB	SB	NB
Opposing Lanes	3	3	1	1
Conflicting Approach Left SB		NB	EB	WB
Conflicting Lanes Left	1	1	3	3
Conflicting Approach Right NB		SB	WB	EB
Conflicting Lanes Right	1	1	3	3
HCM Control Delay	62.2	160.8	59.7	34.1
HCM LOS	F	F	F	D

Lane	NBLn1	EBLn1	EBLn2	EBLn3	WBLn1	WBLn2	WBLn3	SBLn1
Vol Left, %		78%	100%	0%	0%	100%	0%	0%
Vol Thru, %		19%	0%	100%	77%	0%	100%	78%
Vol Right, %		3%	0%	0%	23%	0%	0%	22%
Sign Control		Stop	Stop	Stop	Stop	Stop	Stop	Stop
Traffic Vol by Lane		230	252	321	207	4	413	265
LT Vol		179	252	0	0	4	0	0
Through Vol		44	0	321	160	0	413	207
RT Vol		7	0	0	47	0	0	58
Lane Flow Rate		307	336	428	276	5	551	353
Geometry Grp		7	7	7	7	7	7	7
Degree of Util (X)		0.887	0.874	1.055	0.667	0.014	1.422	0.897
Departure Headway (Hd)		11.13	9.804	9.31	9.106	10.067	9.537	9.392
Convergence, Y/N		Yes	Yes	Yes	Yes	Yes	Yes	Yes
Cap		328	373	393	401	358	386	388
Service Time		8.83	7.504	7.01	6.806	7.767	7.237	7.092
HCM Lane V/C Ratio		0.936	0.901	1.089	0.688	0.014	1.427	0.91
HCM Control Delay		59.7	52.4	92	28.2	12.9	230.1	54.7
HCM Lane LOS		F	F	F	D	B	F	F
HCM 95th-tile Q		8.3	8.5	13.8	4.7	0	27.3	9.2

Timings

11: Barton St & Alessandro Bl.

09/19/2022



Lane Group	EBL	EBT	WBL	WBT	NBL	NBT	NBR	SBL	SBT	SBR
Lane Configurations	↙	↕↕↕	↙	↕↕↕		↕	↗		↕	↗
Traffic Volume (vph)	7	1668	41	2915	86	1	55	4	0	9
Future Volume (vph)	7	1668	41	2915	86	1	55	4	0	9
Turn Type	Prot	NA	Prot	NA	Perm	NA	Perm	Perm	NA	Perm
Protected Phases	5	2	1	6		8			4	
Permitted Phases					8		8	4		4
Detector Phase	5	2	1	6	8	8	8	4	4	4
Switch Phase										
Minimum Initial (s)	5.0	10.0	5.0	10.0	10.0	10.0	10.0	10.0	10.0	10.0
Minimum Split (s)	9.2	28.5	11.0	28.5	40.6	40.6	40.6	26.6	26.6	26.6
Total Split (s)	9.2	68.4	11.0	70.2	40.6	40.6	40.6	40.6	40.6	40.6
Total Split (%)	7.7%	57.0%	9.2%	58.5%	33.8%	33.8%	33.8%	33.8%	33.8%	33.8%
Yellow Time (s)	3.2	5.5	3.2	5.5	3.6	3.6	3.6	3.6	3.6	3.6
All-Red Time (s)	1.0	1.0	1.0	1.0	1.0	1.0	1.0	1.0	1.0	1.0
Lost Time Adjust (s)	0.0	0.0	0.0	0.0		0.0	0.0		0.0	0.0
Total Lost Time (s)	4.2	6.5	4.2	6.5		4.6	4.6		4.6	4.6
Lead/Lag	Lead	Lag	Lead	Lag						
Lead-Lag Optimize?	Yes	Yes	Yes	Yes						
Recall Mode	None	None	None	None	Max	Max	Max	Max	Max	Max
Act Effct Green (s)	5.0	59.9	6.2	66.7		36.0	36.0		36.0	36.0
Actuated g/C Ratio	0.04	0.52	0.05	0.58		0.31	0.31		0.31	0.31
v/c Ratio	0.10	0.68	0.44	1.04		0.21	0.11		0.02	0.02
Control Delay	58.7	22.7	68.5	52.3		32.0	5.6		30.0	0.1
Queue Delay	0.0	0.0	0.0	0.0		0.0	0.0		0.0	0.0
Total Delay	58.7	22.7	68.5	52.3		32.0	5.6		30.0	0.1
LOS	E	C	E	D		C	A		C	A
Approach Delay		22.9		52.5		21.8			9.3	
Approach LOS		C		D		C			A	

Intersection Summary

Cycle Length: 120
 Actuated Cycle Length: 115.6
 Natural Cycle: 125
 Control Type: Actuated-Uncoordinated
 Maximum v/c Ratio: 1.04
 Intersection Signal Delay: 40.9
 Intersection LOS: D
 Intersection Capacity Utilization 107.9%
 ICU Level of Service G
 Analysis Period (min) 15

Splits and Phases: 11: Barton St & Alessandro Bl.



HCM 6th Signalized Intersection Summary
11: Barton St & Alessandro Bl.

West Campus Upper Plateau (JN 14064)

09/19/2022



Movement	EBL	EBT	EBR	WBL	WBT	WBR	NBL	NBT	NBR	SBL	SBT	SBR
Lane Configurations	↖	↑↑↑		↖	↑↑↑			↑	↗		↑	↗
Traffic Volume (veh/h)	7	1668	51	41	2915	6	86	1	55	4	0	9
Future Volume (veh/h)	7	1668	51	41	2915	6	86	1	55	4	0	9
Initial Q (Qb), veh	0	0	0	0	0	0	0	0	0	0	0	0
Ped-Bike Adj(A_pbT)	1.00		0.98	1.00		1.00	1.00		1.00	1.00		1.00
Parking Bus, Adj	1.00	1.00	1.00	1.00	1.00	1.00	1.00	1.00	1.00	1.00	1.00	1.00
Work Zone On Approach		No			No			No			No	
Adj Sat Flow, veh/h/ln	1663	1870	1885	1900	1870	1604	1900	1900	1885	700	1900	1307
Adj Flow Rate, veh/h	7	1738	50	43	3036	6	90	1	27	4	0	4
Peak Hour Factor	0.96	0.96	0.96	0.96	0.96	0.96	0.96	0.96	0.96	0.96	0.96	0.96
Percent Heavy Veh, %	16	2	1	0	2	20	0	0	1	81	0	40
Cap, veh/h	14	2679	77	58	2889	6	62	0	495	62	0	344
Arrive On Green	0.01	0.53	0.53	0.03	0.55	0.55	0.31	0.31	0.31	0.31	0.00	0.31
Sat Flow, veh/h	1584	5098	147	1810	5262	10	0	1	1596	0	0	1108
Grp Volume(v), veh/h	7	1160	628	43	1963	1079	91	0	27	4	0	4
Grp Sat Flow(s),veh/h/ln	1584	1702	1840	1810	1702	1868	1	0	1596	0	0	1108
Q Serve(g_s), s	0.5	28.5	28.5	2.7	63.7	63.7	0.0	0.0	1.4	0.0	0.0	0.3
Cycle Q Clear(g_c), s	0.5	28.5	28.5	2.7	63.7	63.7	36.0	0.0	1.4	36.0	0.0	0.3
Prop In Lane	1.00		0.08	1.00		0.01	0.99		1.00	1.00		1.00
Lane Grp Cap(c), veh/h	14	1789	967	58	1869	1026	62	0	495	62	0	344
V/C Ratio(X)	0.51	0.65	0.65	0.74	1.05	1.05	1.47	0.00	0.05	0.06	0.00	0.01
Avail Cap(c_a), veh/h	68	1816	982	106	1869	1026	62	0	495	62	0	344
HCM Platoon Ratio	1.00	1.00	1.00	1.00	1.00	1.00	1.00	1.00	1.00	1.00	1.00	1.00
Upstream Filter(I)	1.00	1.00	1.00	1.00	1.00	1.00	1.00	0.00	1.00	1.00	0.00	1.00
Uniform Delay (d), s/veh	57.3	19.8	19.8	55.6	26.2	26.2	57.8	0.0	28.1	58.0	0.0	27.7
Incr Delay (d2), s/veh	10.3	0.9	1.7	6.5	35.5	42.6	278.3	0.0	0.2	2.0	0.0	0.1
Initial Q Delay(d3),s/veh	0.0	0.0	0.0	0.0	0.0	0.0	0.0	0.0	0.0	0.0	0.0	0.0
%ile BackOfQ(50%),veh/ln	0.2	10.2	11.2	1.4	33.4	38.7	6.6	0.0	0.6	0.2	0.0	0.1
Unsig. Movement Delay, s/veh												
LnGrp Delay(d),s/veh	67.6	20.7	21.5	62.1	61.6	68.8	336.1	0.0	28.3	60.0	0.0	27.8
LnGrp LOS	E	C	C	E	F	F	F	A	C	E	A	C
Approach Vol, veh/h		1795			3085			118				8
Approach Delay, s/veh		21.2			64.1			265.6				43.9
Approach LOS		C			E			F				D
Timer - Assigned Phs	1	2		4	5	6		8				
Phs Duration (G+Y+Rc), s	7.9	67.5		40.6	5.2	70.2		40.6				
Change Period (Y+Rc), s	* 4.2	6.5		4.6	* 4.2	6.5		4.6				
Max Green Setting (Gmax), s	* 6.8	61.9		36.0	* 5	63.7		36.0				
Max Q Clear Time (g_c+I1), s	4.7	30.5		38.0	2.5	65.7		38.0				
Green Ext Time (p_c), s	0.0	19.6		0.0	0.0	0.0		0.0				

Intersection Summary

HCM 6th Ctrl Delay	53.5
HCM 6th LOS	D

Notes

* HCM 6th computational engine requires equal clearance times for the phases crossing the barrier.

Intersection						
Int Delay, s/veh	1					
Movement	EBL	EBT	WBT	WBR	SBL	SBR
Lane Configurations						
Traffic Vol, veh/h	39	114	423	15	5	11
Future Vol, veh/h	39	114	423	15	5	11
Conflicting Peds, #/hr	0	0	0	5	0	1
Sign Control	Free	Free	Free	Free	Stop	Stop
RT Channelized	-	None	-	None	-	None
Storage Length	100	-	-	-	0	-
Veh in Median Storage, #	-	0	0	-	0	-
Grade, %	-	0	0	-	0	-
Peak Hour Factor	72	72	72	72	72	72
Heavy Vehicles, %	0	2	1	0	0	0
Mvmt Flow	54	158	588	21	7	15

Major/Minor	Major1	Major2	Minor2		
Conflicting Flow All	614	0	-	0	870 605
Stage 1	-	-	-	-	604 -
Stage 2	-	-	-	-	266 -
Critical Hdwy	4.1	-	-	-	6.4 6.2
Critical Hdwy Stg 1	-	-	-	-	5.4 -
Critical Hdwy Stg 2	-	-	-	-	5.4 -
Follow-up Hdwy	2.2	-	-	-	3.5 3.3
Pot Cap-1 Maneuver	975	-	-	-	325 501
Stage 1	-	-	-	-	550 -
Stage 2	-	-	-	-	783 -
Platoon blocked, %		-	-	-	
Mov Cap-1 Maneuver	970	-	-	-	304 498
Mov Cap-2 Maneuver	-	-	-	-	304 -
Stage 1	-	-	-	-	516 -
Stage 2	-	-	-	-	779 -

Approach	EB	WB	SB
HCM Control Delay, s	2.3	0	14.2
HCM LOS			B

Minor Lane/Major Mvmt	EBL	EBT	WBT	WBR	SBLn1
Capacity (veh/h)	970	-	-	-	415
HCM Lane V/C Ratio	0.056	-	-	-	0.054
HCM Control Delay (s)	8.9	-	-	-	14.2
HCM Lane LOS	A	-	-	-	B
HCM 95th %tile Q(veh)	0.2	-	-	-	0.2

Intersection						
Int Delay, s/veh	36.9					
Movement	EBT	EBR	WBL	WBT	NBL	NBR
Lane Configurations	↑↑		↖	↑↑	↘	
Traffic Vol, veh/h	308	273	51	455	226	38
Future Vol, veh/h	308	273	51	455	226	38
Conflicting Peds, #/hr	0	0	0	0	0	0
Sign Control	Free	Free	Free	Free	Stop	Stop
RT Channelized	-	None	-	None	-	None
Storage Length	-	-	125	-	0	-
Veh in Median Storage, #	0	-	-	0	0	-
Grade, %	0	-	-	0	0	-
Peak Hour Factor	80	80	80	80	80	80
Heavy Vehicles, %	3	0	2	1	0	0
Mvmt Flow	385	341	64	569	283	48

Major/Minor	Major1	Major2	Minor1		
Conflicting Flow All	0	0	726	0	969
Stage 1	-	-	-	-	556
Stage 2	-	-	-	-	413
Critical Hdwy	-	-	4.14	-	6.8
Critical Hdwy Stg 1	-	-	-	-	5.8
Critical Hdwy Stg 2	-	-	-	-	5.8
Follow-up Hdwy	-	-	2.22	-	3.5
Pot Cap-1 Maneuver	-	-	873	- ~	255
Stage 1	-	-	-	-	544
Stage 2	-	-	-	-	642
Platoon blocked, %	-	-	-	-	-
Mov Cap-1 Maneuver	-	-	873	- ~	236
Mov Cap-2 Maneuver	-	-	-	- ~	236
Stage 1	-	-	-	-	544
Stage 2	-	-	-	-	595

Approach	EB	WB	NB
HCM Control Delay, s	0	1	187
HCM LOS			F

Minor Lane/Major Mvmt	NBLn1	EBT	EBR	WBL	WBT
Capacity (veh/h)	260	-	-	873	-
HCM Lane V/C Ratio	1.269	-	-	0.073	-
HCM Control Delay (s)	187	-	-	9.4	-
HCM Lane LOS	F	-	-	A	-
HCM 95th %tile Q(veh)	16.3	-	-	0.2	-

Notes
 ~: Volume exceeds capacity \$: Delay exceeds 300s +: Computation Not Defined *: All major volume in platoon

Timings

14: Barton Rd. & Van Buren Bl.

09/19/2022



Lane Group	EBL	EBT	WBL	WBT	NBL	NBT	NBR	SBL	SBT
Lane Configurations	↙	↑↘	↙	↑↑↘	↙↘	↑	↗	↙	↘
Traffic Volume (vph)	155	1301	296	1454	411	83	421	77	109
Future Volume (vph)	155	1301	296	1454	411	83	421	77	109
Turn Type	Prot	NA	Prot	NA	Prot	NA	Perm	Prot	NA
Protected Phases	5	2	1	6	3	8		7	4
Permitted Phases							8		
Detector Phase	5	2	1	6	3	8	8	7	4
Switch Phase									
Minimum Initial (s)	5.0	10.0	5.0	10.0	5.0	10.0	10.0	5.0	10.0
Minimum Split (s)	9.2	25.2	9.2	25.5	9.1	14.6	14.6	9.1	33.6
Total Split (s)	18.5	47.4	22.0	50.9	17.0	37.5	37.5	13.1	33.6
Total Split (%)	15.4%	39.5%	18.3%	42.4%	14.2%	31.3%	31.3%	10.9%	28.0%
Yellow Time (s)	3.2	5.2	3.2	5.5	3.6	3.6	3.6	3.6	3.6
All-Red Time (s)	1.0	1.0	1.0	1.0	0.5	1.0	1.0	0.5	1.0
Lost Time Adjust (s)	0.0	0.0	0.0	0.0	0.0	0.0	0.0	0.0	0.0
Total Lost Time (s)	4.2	6.2	4.2	6.5	4.1	4.6	4.6	4.1	4.6
Lead/Lag	Lead	Lag	Lead	Lag	Lead	Lag	Lag	Lead	Lag
Lead-Lag Optimize?	Yes	Yes	Yes	Yes	Yes	Yes	Yes	Yes	Yes
Recall Mode	None	None	None	None	None	None	None	None	None
Act Effct Green (s)	13.7	41.2	17.8	45.0	12.9	33.2	33.2	8.7	29.0
Actuated g/C Ratio	0.11	0.34	0.15	0.38	0.11	0.28	0.28	0.07	0.24
v/c Ratio	0.86	1.36	1.30	0.91	1.29	0.18	0.75	0.68	1.00
Control Delay	88.1	199.2	200.1	44.2	193.5	34.4	24.9	80.4	75.8
Queue Delay	0.0	0.0	0.0	0.0	0.0	0.0	0.0	0.0	0.0
Total Delay	88.1	199.2	200.1	44.2	193.5	34.4	24.9	80.4	75.8
LOS	F	F	F	D	F	C	C	F	E
Approach Delay		188.3		70.0		101.5			76.5
Approach LOS		F		E		F			E

Intersection Summary

Cycle Length: 120
 Actuated Cycle Length: 120
 Natural Cycle: 130
 Control Type: Actuated-Uncoordinated
 Maximum v/c Ratio: 1.36
 Intersection Signal Delay: 115.7
 Intersection LOS: F
 Intersection Capacity Utilization 109.2%
 ICU Level of Service H
 Analysis Period (min) 15



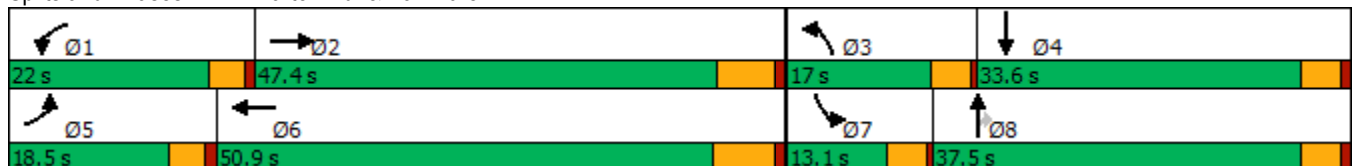



















Splits and Phases: 14: Barton Rd. & Van Buren Bl.



HCM 6th Signalized Intersection Summary
14: Barton Rd. & Van Buren Bl.

West Campus Upper Plateau (JN 14064)

09/19/2022

												
Movement	EBL	EBT	EBR	WBL	WBT	WBR	NBL	NBT	NBR	SBL	SBT	SBR
Lane Configurations												
Traffic Volume (veh/h)	155	1301	120	296	1454	36	411	83	421	77	109	320
Future Volume (veh/h)	155	1301	120	296	1454	36	411	83	421	77	109	320
Initial Q (Qb), veh	0	0	0	0	0	0	0	0	0	0	0	0
Ped-Bike Adj(A_pbT)	1.00		1.00	1.00		1.00	1.00		1.00	1.00		1.00
Parking Bus, Adj	1.00	1.00	1.00	1.00	1.00	1.00	1.00	1.00	1.00	1.00	1.00	1.00
Work Zone On Approach		No			No			No			No	
Adj Sat Flow, veh/h/ln	1900	1870	1841	1870	1856	1722	1856	1885	1885	1900	1870	1900
Adj Flow Rate, veh/h	178	1495	125	340	1671	35	472	95	268	89	125	246
Peak Hour Factor	0.87	0.87	0.87	0.87	0.87	0.87	0.87	0.87	0.87	0.87	0.87	0.87
Percent Heavy Veh, %	0	2	4	2	3	12	3	1	1	0	2	0
Cap, veh/h	205	1144	95	265	1941	41	370	532	451	112	133	262
Arrive On Green	0.11	0.34	0.34	0.15	0.38	0.38	0.11	0.28	0.28	0.06	0.24	0.24
Sat Flow, veh/h	1810	3322	276	1781	5106	107	3428	1885	1598	1810	563	1108
Grp Volume(v), veh/h	178	795	825	340	1105	601	472	95	268	89	0	371
Grp Sat Flow(s),veh/h/ln	1810	1777	1821	1781	1689	1836	1714	1885	1598	1810	0	1671
Q Serve(g_s), s	11.6	41.2	41.2	17.8	36.1	36.1	12.9	4.6	17.3	5.8	0.0	26.1
Cycle Q Clear(g_c), s	11.6	41.2	41.2	17.8	36.1	36.1	12.9	4.6	17.3	5.8	0.0	26.1
Prop In Lane	1.00		0.15	1.00		0.06	1.00		1.00	1.00		0.66
Lane Grp Cap(c), veh/h	205	612	627	265	1283	698	370	532	451	112	0	395
V/C Ratio(X)	0.87	1.30	1.31	1.28	0.86	0.86	1.28	0.18	0.59	0.79	0.00	0.94
Avail Cap(c_a), veh/h	216	612	627	265	1283	698	370	532	451	136	0	405
HCM Platoon Ratio	1.00	1.00	1.00	1.00	1.00	1.00	1.00	1.00	1.00	1.00	1.00	1.00
Upstream Filter(I)	1.00	1.00	1.00	1.00	1.00	1.00	1.00	1.00	1.00	1.00	0.00	1.00
Uniform Delay (d), s/veh	52.1	39.2	39.2	50.9	34.2	34.2	53.3	32.4	37.0	55.3	0.0	44.8
Incr Delay (d2), s/veh	26.8	146.5	152.8	152.8	5.9	10.2	143.8	0.2	2.1	22.6	0.0	29.3
Initial Q Delay(d3),s/veh	0.0	0.0	0.0	0.0	0.0	0.0	0.0	0.0	0.0	0.0	0.0	0.0
%ile BackOfQ(50%),veh/ln	6.6	41.7	43.8	18.9	14.9	17.0	12.8	2.1	6.8	3.4	0.0	14.0
Unsig. Movement Delay, s/veh												
LnGrp Delay(d),s/veh	79.0	185.7	192.0	203.7	40.1	44.4	197.2	32.6	39.1	78.0	0.0	74.1
LnGrp LOS	E	F	F	F	D	D	F	C	D	E	A	E
Approach Vol, veh/h		1798			2046			835			460	
Approach Delay, s/veh		178.0			68.5			127.7			74.8	
Approach LOS		F			E			F			E	
Timer - Assigned Phs	1	2	3	4	5	6	7	8				
Phs Duration (G+Y+Rc), s	22.0	47.7	17.0	32.9	17.8	51.9	11.5	38.4				
Change Period (Y+Rc), s	* 4.2	* 6.5	4.1	4.6	* 4.2	6.5	4.1	4.6				
Max Green Setting (Gmax), s	* 18	* 41	12.9	29.0	* 14	44.4	9.0	32.9				
Max Q Clear Time (g_c+I1), s	19.8	43.2	14.9	28.1	13.6	38.1	7.8	19.3				
Green Ext Time (p_c), s	0.0	0.0	0.0	0.2	0.0	3.7	0.0	1.1				

Intersection Summary

HCM 6th Ctrl Delay	117.0
HCM 6th LOS	F

Notes

* HCM 6th computational engine requires equal clearance times for the phases crossing the barrier.

Timings
15: Airman Dr & Cactus Av.



Lane Group	WBL	WBR	NBR	SBL	Ø6
Lane Configurations	↖	↗	↖	↖↗	
Traffic Volume (vph)	331	443	99	133	
Future Volume (vph)	331	443	99	133	
Turn Type	Prot	Perm	Perm	Prot	
Protected Phases	3			1	6
Permitted Phases		8	2		
Detector Phase	3	8	2	1	
Switch Phase					
Minimum Initial (s)	10.0	5.0	10.0	5.0	10.0
Minimum Split (s)	14.1	21.1	21.1	9.1	14.1
Total Split (s)	73.0	73.0	26.0	21.0	47.0
Total Split (%)	60.8%	60.8%	21.7%	17.5%	39%
Yellow Time (s)	3.6	3.6	3.6	3.6	3.6
All-Red Time (s)	0.5	0.5	0.5	0.5	0.5
Lost Time Adjust (s)	0.0	0.0	0.0	0.0	
Total Lost Time (s)	4.1	4.1	4.1	4.1	
Lead/Lag			Lag	Lead	
Lead-Lag Optimize?			Yes	Yes	
Recall Mode	None	None	Min	None	Min
Act Effct Green (s)	14.6	14.6	11.6	6.9	
Actuated g/C Ratio	0.34	0.34	0.27	0.16	
v/c Ratio	0.63	0.59	0.10	0.29	
Control Delay	18.8	5.0	0.2	20.7	
Queue Delay	0.0	0.0	0.0	0.0	
Total Delay	18.8	5.0	0.2	20.7	
LOS	B	A	A	C	
Approach Delay	10.9				
Approach LOS	B				

Intersection Summary

Cycle Length: 120
 Actuated Cycle Length: 43.3
 Natural Cycle: 55
 Control Type: Actuated-Uncoordinated
 Maximum v/c Ratio: 0.63
 Intersection Signal Delay: 11.1
 Intersection Capacity Utilization 33.5%
 Analysis Period (min) 15

Intersection LOS: B
 ICU Level of Service A



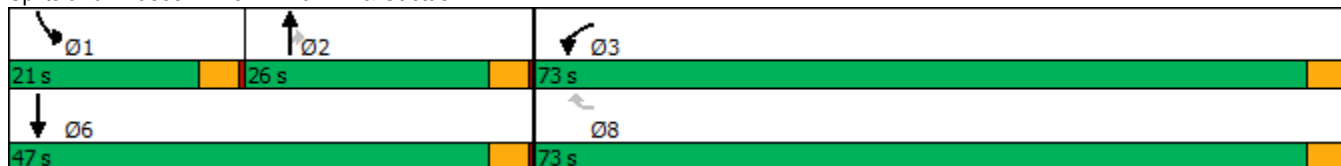









Splits and Phases: 15: Airman Dr & Cactus Av.



HCM 6th Signalized Intersection Summary
15: Airman Dr & Cactus Av.

West Campus Upper Plateau (JN 14064)

09/19/2022

						
Movement	WBL	WBR	NBT	NBR	SBL	SBT
Lane Configurations					 	
Traffic Volume (veh/h)	331	443	0	99	133	0
Future Volume (veh/h)	331	443	0	99	133	0
Initial Q (Qb), veh	0	0	0	0	0	0
Ped-Bike Adj(A_pbT)	1.00	1.00		1.00	1.00	
Parking Bus, Adj	1.00	1.00	1.00	1.00	1.00	1.00
Work Zone On Approach	No		No			No
Adj Sat Flow, veh/h/ln	1811	1752	1900	1811	1752	1900
Adj Flow Rate, veh/h	360	482	0	108	145	0
Peak Hour Factor	0.92	0.92	0.92	0.92	0.92	0.92
Percent Heavy Veh, %	6	10	0	6	10	0
Cap, veh/h	656	565	446	360	312	811
Arrive On Green	0.38	0.38	0.00	0.23	0.10	0.00
Sat Flow, veh/h	1725	1485	1900	1535	3237	1900
Grp Volume(v), veh/h	360	482	0	108	145	0
Grp Sat Flow(s),veh/h/ln	1725	1485	1900	1535	1618	1900
Q Serve(g_s), s	7.0	12.7	0.0	2.5	1.8	0.0
Cycle Q Clear(g_c), s	7.0	12.7	0.0	2.5	1.8	0.0
Prop In Lane	1.00	1.00		1.00	1.00	
Lane Grp Cap(c), veh/h	656	565	446	360	312	811
V/C Ratio(X)	0.55	0.85	0.00	0.30	0.47	0.00
Avail Cap(c_a), veh/h	2789	2400	976	789	1284	1913
HCM Platoon Ratio	1.00	1.00	1.00	1.00	1.00	1.00
Upstream Filter(I)	1.00	1.00	0.00	1.00	1.00	0.00
Uniform Delay (d), s/veh	10.3	12.1	0.0	13.4	18.2	0.0
Incr Delay (d2), s/veh	0.3	1.5	0.0	0.5	0.4	0.0
Initial Q Delay(d3),s/veh	0.0	0.0	0.0	0.0	0.0	0.0
%ile BackOfQ(50%),veh/ln	2.1	3.4	0.0	0.8	0.6	0.0
Unsig. Movement Delay, s/veh						
LnGrp Delay(d),s/veh	10.6	13.6	0.0	13.9	18.6	0.0
LnGrp LOS	B	B	A	B	B	A
Approach Vol, veh/h	842		108			145
Approach Delay, s/veh	12.3		13.9			18.6
Approach LOS	B		B			B
Timer - Assigned Phs	1	2			6	8
Phs Duration (G+Y+Rc), s	8.2	14.1			22.3	20.3
Change Period (Y+Rc), s	4.1	4.1			4.1	4.1
Max Green Setting (Gmax), s	16.9	21.9			42.9	68.9
Max Q Clear Time (g_c+11), s	3.8	4.5			0.0	14.7
Green Ext Time (p_c), s	0.2	0.3			0.0	1.5
Intersection Summary						
HCM 6th Ctrl Delay			13.3			
HCM 6th LOS			B			

Intersection

Intersection Delay, s/veh	13
Intersection LOS	B

Movement	EBT	EBR	WBL	WBT	NBL	NBR
Lane Configurations						
Traffic Vol, veh/h	66	59	106	270	155	70
Future Vol, veh/h	66	59	106	270	155	70
Peak Hour Factor	0.76	0.76	0.76	0.76	0.76	0.76
Heavy Vehicles, %	4	0	0	2	2	2
Mvmt Flow	87	78	139	355	204	92
Number of Lanes	1	0	1	1	1	0

Approach	EB	WB	NB
Opposing Approach	WB	EB	
Opposing Lanes	2	1	0
Conflicting Approach Left		NB	EB
Conflicting Lanes Left	0	1	1
Conflicting Approach Right	NB		WB
Conflicting Lanes Right	1	0	2
HCM Control Delay	10.1	13.9	13
HCM LOS	B	B	B

Lane	NBLn1	EBLn1	WBLn1	WBLn2
Vol Left, %	69%	0%	100%	0%
Vol Thru, %	0%	53%	0%	100%
Vol Right, %	31%	47%	0%	0%
Sign Control	Stop	Stop	Stop	Stop
Traffic Vol by Lane	225	125	106	270
LT Vol	155	0	106	0
Through Vol	0	66	0	270
RT Vol	70	59	0	0
Lane Flow Rate	296	164	139	355
Geometry Grp	2	5	7	7
Degree of Util (X)	0.454	0.243	0.236	0.555
Departure Headway (Hd)	5.525	5.326	6.091	5.62
Convergence, Y/N	Yes	Yes	Yes	Yes
Cap	657	674	590	643
Service Time	3.525	3.359	3.817	3.346
HCM Lane V/C Ratio	0.451	0.243	0.236	0.552
HCM Control Delay	13	10.1	10.7	15.2
HCM Lane LOS	B	B	B	C
HCM 95th-tile Q	2.4	0.9	0.9	3.4

Intersection

Intersection Delay, s/veh	15.7
Intersection LOS	C

Movement	EBL	EBT	WBT	WBR	SBL	SBR
Lane Configurations						
Traffic Vol, veh/h	129	185	346	100	84	120
Future Vol, veh/h	129	185	346	100	84	120
Peak Hour Factor	0.71	0.71	0.71	0.71	0.71	0.71
Heavy Vehicles, %	0	2	0	2	1	1
Mvmt Flow	182	261	487	141	118	169
Number of Lanes	1	2	2	0	1	0

Approach	EB	WB	SB
Opposing Approach	WB	EB	
Opposing Lanes	2	3	0
Conflicting Approach Left SB			WB
Conflicting Lanes Left	1	0	2
Conflicting Approach Right		SB	EB
Conflicting Lanes Right	0	1	3
HCM Control Delay	11.4	17.8	17.7
HCM LOS	B	C	C

Lane	EBLn1	EBLn2	EBLn3	WBLn1	WBLn2	SBLn1
Vol Left, %	100%	0%	0%	0%	0%	41%
Vol Thru, %	0%	100%	100%	100%	54%	0%
Vol Right, %	0%	0%	0%	0%	46%	59%
Sign Control	Stop	Stop	Stop	Stop	Stop	Stop
Traffic Vol by Lane	129	93	93	231	215	204
LT Vol	129	0	0	0	0	84
Through Vol	0	93	93	231	115	0
RT Vol	0	0	0	0	100	120
Lane Flow Rate	182	130	130	325	303	287
Geometry Grp	7	7	7	8	8	7
Degree of Util (X)	0.353	0.236	0.172	0.603	0.537	0.547
Departure Headway (Hd)	6.997	6.522	4.752	6.677	6.379	6.851
Convergence, Y/N	Yes	Yes	Yes	Yes	Yes	Yes
Cap	511	547	747	536	561	523
Service Time	4.779	4.303	2.532	4.459	4.162	4.626
HCM Lane V/C Ratio	0.356	0.238	0.174	0.606	0.54	0.549
HCM Control Delay	13.6	11.3	8.5	19.2	16.4	17.7
HCM Lane LOS	B	B	A	C	C	C
HCM 95th-tile Q	1.6	0.9	0.6	4	3.2	3.3

Timings
18: Linebacker Dr & Cactus Av.

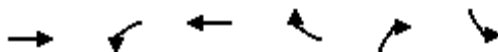

Lane Group	EBT	WBL	WBT	WBR	NBR	SBL	Ø3	Ø4	Ø5	Ø8
Lane Configurations	↑↑	↖	↑	↗	↗	↖↖				
Traffic Volume (vph)	232	277	774	277	84	84				
Future Volume (vph)	232	277	774	277	84	84				
Turn Type	NA	Prot	NA	Perm	pm+ov	Prot				
Protected Phases	2	1	6		1	7	3	4	5	8
Permitted Phases				6	8					
Detector Phase	2	1	6	6	1	7				
Switch Phase										
Minimum Initial (s)	10.0	5.0	10.0	10.0	5.0	5.0	5.0	10.0	5.0	10.0
Minimum Split (s)	27.0	9.6	27.0	27.0	9.6	9.6	9.6	27.0	9.6	27.0
Total Split (s)	27.4	16.0	33.8	33.8	16.0	9.6	9.6	27.0	9.6	27.0
Total Split (%)	34.3%	20.0%	42.3%	42.3%	20.0%	12.0%	12%	34%	12%	34%
Yellow Time (s)	4.0	3.6	4.0	4.0	3.6	3.6	3.6	4.0	3.6	4.0
All-Red Time (s)	1.0	1.0	1.0	1.0	1.0	1.0	1.0	1.0	1.0	1.0
Lost Time Adjust (s)	0.0	0.0	0.0	0.0	0.0	0.0				
Total Lost Time (s)	5.0	4.6	5.0	5.0	4.6	4.6				
Lead/Lag	Lag	Lead	Lag	Lag	Lead	Lead	Lead	Lag	Lead	Lag
Lead-Lag Optimize?	Yes	Yes	Yes	Yes	Yes	Yes	Yes	Yes	Yes	Yes
Recall Mode	None	None	None	None	None	None	None	None	None	None
Act Effct Green (s)	15.2	12.6	35.6	35.6	15.7	5.5				
Actuated g/C Ratio	0.32	0.27	0.76	0.76	0.34	0.12				
v/c Ratio	0.22	0.68	0.63	0.25	0.13	0.24				
Control Delay	15.0	31.7	12.5	2.3	0.4	26.0				
Queue Delay	0.0	0.0	0.0	0.0	0.0	0.0				
Total Delay	15.0	31.7	12.5	2.3	0.4	26.0				
LOS	B	C	B	A	A	C				
Approach Delay	15.0		14.4							
Approach LOS	B		B							

Intersection Summary

Cycle Length: 80
 Actuated Cycle Length: 46.8
 Natural Cycle: 90
 Control Type: Actuated-Uncoordinated
 Maximum v/c Ratio: 0.68
 Intersection Signal Delay: 14.3
 Intersection LOS: B
 Intersection Capacity Utilization 65.4%
 ICU Level of Service C
 Analysis Period (min) 15

Splits and Phases: 18: Linebacker Dr & Cactus Av.

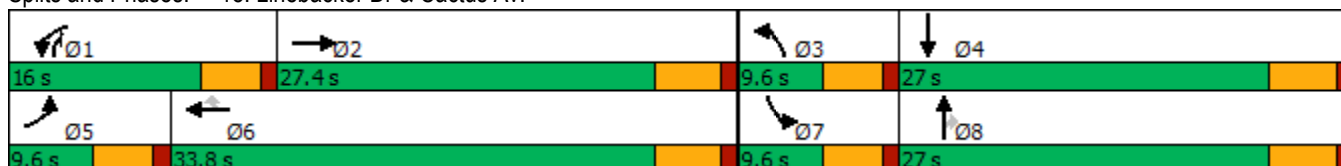

HCM 6th Signalized Intersection Summary
18: Linebacker Dr & Cactus Av.

West Campus Upper Plateau (JN 14064)

09/19/2022



Movement	EBL	EBT	EBR	WBL	WBT	WBR	NBL	NBT	NBR	SBL	SBT	SBR
Lane Configurations	↶	↷		↶	↷	↷	↶	↷	↷	↶	↷	↷
Traffic Volume (veh/h)	0	232	0	277	774	277	0	0	84	84	0	0
Future Volume (veh/h)	0	232	0	277	774	277	0	0	84	84	0	0
Initial Q (Qb), veh	0	0	0	0	0	0	0	0	0	0	0	0
Ped-Bike Adj(A_pbT)	1.00		1.00	1.00		1.00	1.00		1.00	1.00		1.00
Parking Bus, Adj	1.00	1.00	1.00	1.00	1.00	1.00	1.00	1.00	1.00	1.00	1.00	1.00
Work Zone On Approach		No			No			No			No	
Adj Sat Flow, veh/h/ln	1900	1767	1900	1752	1781	1752	1900	1900	1767	1752	1900	1900
Adj Flow Rate, veh/h	0	252	0	301	841	301	0	0	91	91	0	0
Peak Hour Factor	0.92	0.92	0.92	0.92	0.92	0.92	0.92	0.92	0.92	0.92	0.92	0.92
Percent Heavy Veh, %	0	9	0	10	8	10	0	0	9	10	0	0
Cap, veh/h	3	776	0	349	919	766	3	264	522	232	562	0
Arrive On Green	0.00	0.22	0.00	0.21	0.52	0.52	0.00	0.00	0.14	0.07	0.00	0.00
Sat Flow, veh/h	1810	3533	0	1668	1781	1485	1810	1900	1497	3337	1900	0
Grp Volume(v), veh/h	0	252	0	301	841	301	0	0	91	91	0	0
Grp Sat Flow(s),veh/h/ln	1810	1767	0	1668	1781	1485	1810	1900	1497	1668	1900	0
Q Serve(g_s), s	0.0	3.2	0.0	9.2	23.0	6.5	0.0	0.0	2.2	1.4	0.0	0.0
Cycle Q Clear(g_c), s	0.0	3.2	0.0	9.2	23.0	6.5	0.0	0.0	2.2	1.4	0.0	0.0
Prop In Lane	1.00		0.00	1.00		1.00	1.00		1.00	1.00		0.00
Lane Grp Cap(c), veh/h	3	776	0	349	919	766	3	264	522	232	562	0
V/C Ratio(X)	0.00	0.32	0.00	0.86	0.92	0.39	0.00	0.00	0.17	0.39	0.00	0.00
Avail Cap(c_a), veh/h	171	1492	0	359	967	806	171	788	935	315	788	0
HCM Platoon Ratio	1.00	1.00	1.00	1.00	1.00	1.00	1.00	1.00	1.00	1.00	1.00	1.00
Upstream Filter(I)	0.00	1.00	0.00	1.00	1.00	1.00	0.00	0.00	1.00	1.00	0.00	0.00
Uniform Delay (d), s/veh	0.0	17.4	0.0	20.2	11.8	7.8	0.0	0.0	12.0	23.6	0.0	0.0
Incr Delay (d2), s/veh	0.0	0.2	0.0	17.6	12.6	0.3	0.0	0.0	0.2	0.4	0.0	0.0
Initial Q Delay(d3),s/veh	0.0	0.0	0.0	0.0	0.0	0.0	0.0	0.0	0.0	0.0	0.0	0.0
%ile BackOfQ(50%),veh/ln	0.0	1.2	0.0	4.9	10.0	1.7	0.0	0.0	0.7	0.5	0.0	0.0
Unsig. Movement Delay, s/veh												
LnGrp Delay(d),s/veh	0.0	17.6	0.0	37.8	24.4	8.1	0.0	0.0	12.1	24.0	0.0	0.0
LnGrp LOS	A	B	A	D	C	A	A	A	B	C	A	A
Approach Vol, veh/h		252			1443			91			91	
Approach Delay, s/veh		17.6			23.8			12.1			24.0	
Approach LOS		B			C			B			C	
Timer - Assigned Phs	1	2	3	4	5	6	7	8				
Phs Duration (G+Y+Rc), s	15.7	16.7	0.0	20.7	0.0	32.4	8.3	12.4				
Change Period (Y+Rc), s	4.6	5.0	4.6	5.0	4.6	5.0	4.6	5.0				
Max Green Setting (Gmax), s	11.4	22.4	5.0	22.0	5.0	28.8	5.0	22.0				
Max Q Clear Time (g_c+I1), s	11.2	5.2	0.0	0.0	0.0	25.0	3.4	4.2				
Green Ext Time (p_c), s	0.0	1.4	0.0	0.0	0.0	2.4	0.0	0.2				

Intersection Summary

HCM 6th Ctrl Delay	22.4
HCM 6th LOS	C

Notes

User approved volume balancing among the lanes for turning movement.

Timings
19: Van Buren Bl. & Orange Terrace Pkwy.

West Campus Upper Plateau (JN 14064)

09/19/2022

Lane Group	EBL	EBT	EBR	WBL	WBT	WBR	NBL	NBT	NBR	SBL	SBT	SBR
Lane Configurations												
Traffic Volume (vph)	155	1580	47	40	1445	143	43	18	36	268	29	245
Future Volume (vph)	155	1580	47	40	1445	143	43	18	36	268	29	245
Turn Type	Prot	NA	Perm	Prot	NA	Perm	Prot	NA	Perm	Prot	NA	pm+ov
Protected Phases	5	2		1	6		3	8		7	4	5
Permitted Phases			2			6			8			4
Detector Phase	5	2	2	1	6	6	3	8	8	7	4	5
Switch Phase												
Minimum Initial (s)	5.0	10.0	10.0	5.0	10.0	10.0	5.0	5.0	5.0	10.0	10.0	5.0
Minimum Split (s)	9.2	25.2	25.2	9.1	25.2	25.2	9.1	26.1	26.1	15.8	24.8	9.2
Total Split (s)	16.0	62.8	62.8	9.1	55.9	55.9	9.1	26.1	26.1	22.0	39.0	16.0
Total Split (%)	13.3%	52.3%	52.3%	7.6%	46.6%	46.6%	7.6%	21.8%	21.8%	18.3%	32.5%	13.3%
Yellow Time (s)	3.2	5.2	5.2	3.6	5.2	5.2	3.6	3.6	3.6	4.8	4.8	3.2
All-Red Time (s)	1.0	1.0	1.0	0.5	1.0	1.0	0.5	0.5	0.5	1.0	1.0	1.0
Lost Time Adjust (s)	0.0	0.0	0.0	0.0	0.0	0.0	0.0	0.0	0.0	0.0	0.0	0.0
Total Lost Time (s)	4.2	6.2	6.2	4.1	6.2	6.2	4.1	4.1	4.1	5.8	5.8	4.2
Lead/Lag	Lead	Lag	Lag	Lead	Lag	Lag	Lead	Lag	Lag	Lead	Lag	Lead
Lead-Lag Optimize?	Yes	Yes	Yes	Yes	Yes	Yes	Yes	Yes	Yes	Yes	Yes	Yes
Recall Mode	None	None	None	None	None	None	None	None	None	None	None	None
Act Effct Green (s)	9.8	45.4	45.4	5.3	35.9	35.9	5.3	6.4	6.4	13.0	13.9	25.3
Actuated g/C Ratio	0.12	0.56	0.56	0.07	0.44	0.44	0.07	0.08	0.08	0.16	0.17	0.31
v/c Ratio	0.39	0.58	0.05	0.18	0.66	0.18	0.19	0.07	0.13	0.50	0.09	0.47
Control Delay	40.4	14.5	0.1	45.2	20.0	1.5	45.3	42.8	0.9	37.9	34.3	19.9
Queue Delay	0.0	0.0	0.0	0.0	0.0	0.0	0.0	0.0	0.0	0.0	0.0	0.0
Total Delay	40.4	14.5	0.1	45.2	20.0	1.5	45.3	42.8	0.9	37.9	34.3	19.9
LOS	D	B	A	D	C	A	D	D	A	D	C	B
Approach Delay		16.4			19.0			28.4			29.6	
Approach LOS		B			B			C			C	

Intersection Summary

Cycle Length: 120
 Actuated Cycle Length: 81.4
 Natural Cycle: 80
 Control Type: Actuated-Uncoordinated
 Maximum v/c Ratio: 0.66
 Intersection Signal Delay: 19.5
 Intersection LOS: B
 Intersection Capacity Utilization 62.6%
 ICU Level of Service B
 Analysis Period (min) 15

Splits and Phases: 19: Van Buren Bl. & Orange Terrace Pkwy.

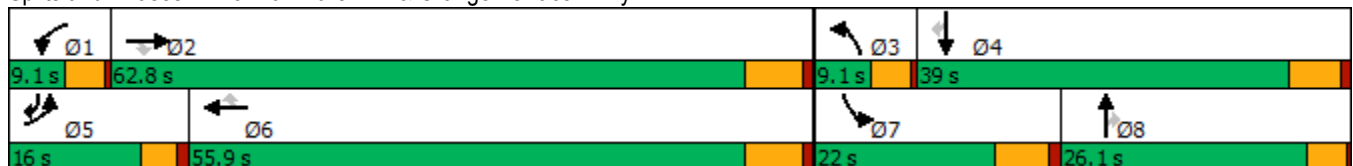

HCM 6th Signalized Intersection Summary
 19: Van Buren Bl. & Orange Terrace Pkwy.

West Campus Upper Plateau (JN 14064)

09/19/2022



Movement	EBL	EBT	EBR	WBL	WBT	WBR	NBL	NBT	NBR	SBL	SBT	SBR
Lane Configurations	↖↗	↑↑↑	↖	↖↗	↑↑↑	↖	↖↗	↑↑	↖	↖↗	↑	↖↗
Traffic Volume (veh/h)	155	1580	47	40	1445	143	43	18	36	268	29	245
Future Volume (veh/h)	155	1580	47	40	1445	143	43	18	36	268	29	245
Initial Q (Qb), veh	0	0	0	0	0	0	0	0	0	0	0	0
Ped-Bike Adj(A_pbT)	1.00		0.99	1.00		1.00	1.00		1.00	1.00		0.98
Parking Bus, Adj	1.00	1.00	1.00	1.00	1.00	1.00	1.00	1.00	1.00	1.00	1.00	1.00
Work Zone On Approach		No			No			No			No	
Adj Sat Flow, veh/h/ln	1885	1856	1796	1900	1870	1870	1900	1900	1707	1885	1900	1885
Adj Flow Rate, veh/h	160	1629	38	41	1490	106	44	19	10	276	30	140
Peak Hour Factor	0.97	0.97	0.97	0.97	0.97	0.97	0.97	0.97	0.97	0.97	0.97	0.97
Percent Heavy Veh, %	1	3	7	0	2	2	0	0	13	1	0	1
Cap, veh/h	245	2390	709	134	2238	695	140	238	96	463	345	397
Arrive On Green	0.07	0.47	0.47	0.04	0.44	0.44	0.04	0.07	0.07	0.13	0.18	0.18
Sat Flow, veh/h	3483	5066	1503	3510	5106	1585	3510	3610	1447	3483	1900	1569
Grp Volume(v), veh/h	160	1629	38	41	1490	106	44	19	10	276	30	140
Grp Sat Flow(s),veh/h/ln	1742	1689	1503	1755	1702	1585	1755	1805	1447	1742	1900	1569
Q Serve(g_s), s	3.4	18.8	1.0	0.9	17.4	3.0	0.9	0.4	0.5	5.6	1.0	5.5
Cycle Q Clear(g_c), s	3.4	18.8	1.0	0.9	17.4	3.0	0.9	0.4	0.5	5.6	1.0	5.5
Prop In Lane	1.00		1.00	1.00		1.00	1.00		1.00	1.00		1.00
Lane Grp Cap(c), veh/h	245	2390	709	134	2238	695	140	238	96	463	345	397
V/C Ratio(X)	0.65	0.68	0.05	0.31	0.67	0.15	0.31	0.08	0.10	0.60	0.09	0.35
Avail Cap(c_a), veh/h	546	3810	1131	233	3372	1047	233	1055	423	750	838	805
HCM Platoon Ratio	1.00	1.00	1.00	1.00	1.00	1.00	1.00	1.00	1.00	1.00	1.00	1.00
Upstream Filter(I)	1.00	1.00	1.00	1.00	1.00	1.00	1.00	1.00	1.00	1.00	1.00	1.00
Uniform Delay (d), s/veh	34.1	15.5	10.8	35.2	16.8	12.7	35.1	33.0	33.1	30.7	25.6	23.1
Incr Delay (d2), s/veh	1.1	0.3	0.0	1.3	0.3	0.1	1.3	0.1	0.5	1.2	0.1	0.5
Initial Q Delay(d3),s/veh	0.0	0.0	0.0	0.0	0.0	0.0	0.0	0.0	0.0	0.0	0.0	0.0
%ile BackOfQ(50%),veh/ln	1.3	5.9	0.3	0.4	5.6	1.0	0.4	0.2	0.2	2.3	0.4	2.0
Unsig. Movement Delay, s/veh												
LnGrp Delay(d),s/veh	35.2	15.8	10.8	36.5	17.1	12.8	36.4	33.1	33.5	32.0	25.7	23.6
LnGrp LOS	D	B	B	D	B	B	D	C	C	C	C	C
Approach Vol, veh/h		1827			1637			73			446	
Approach Delay, s/veh		17.4			17.3			35.1			28.9	
Approach LOS		B			B			D			C	
Timer - Assigned Phs	1	2	3	4	5	6	7	8				
Phs Duration (G+Y+Rc), s	7.0	41.7	7.1	19.5	9.5	39.2	15.8	10.8				
Change Period (Y+Rc), s	4.1	6.2	4.1	5.8	* 4.2	6.2	5.8	* 5.8				
Max Green Setting (Gmax), s	5.0	56.6	5.0	33.2	* 12	49.7	16.2	* 22				
Max Q Clear Time (g_c+I1), s	2.9	20.8	2.9	7.5	5.4	19.4	7.6	2.5				
Green Ext Time (p_c), s	0.0	14.7	0.0	0.5	0.1	12.5	0.6	0.1				

Intersection Summary

HCM 6th Ctrl Delay	19.0
HCM 6th LOS	B

Notes

* HCM 6th computational engine requires equal clearance times for the phases crossing the barrier.

Timings
20: Brown/San Gorgonio Dr & Alessandro Bl.

West Campus Upper Plateau (JN 14064)

09/19/2022



Lane Group	EBL	EBT	WBL	WBT	WBR	NBL	NBR	SBL	SBT	SBR	Ø8
Lane Configurations	↖	↕↕↕	↖	↕↕↕	↖	↖	↖	↖	↕	↖	
Traffic Volume (vph)	35	1509	207	2725	57	45	63	33	1	18	
Future Volume (vph)	35	1509	207	2725	57	45	63	33	1	18	
Turn Type	Prot	NA	Prot	NA	Perm	Prot	pm+ov	Prot	NA	pm+ov	
Protected Phases	5	2	1	6		3	1	7	4	5	8
Permitted Phases					6		8				4
Detector Phase	5	2	1	6	6	3	1	7	4	5	
Switch Phase											
Minimum Initial (s)	5.0	10.0	5.0	10.0	10.0	5.0	5.0	5.0	10.0	5.0	5.0
Minimum Split (s)	8.7	43.5	9.1	43.5	43.5	9.1	9.1	8.7	49.8	8.7	26.1
Total Split (s)	8.7	51.9	9.2	52.4	52.4	9.1	9.2	10.8	49.8	8.7	48.1
Total Split (%)	7.3%	43.3%	7.7%	43.7%	43.7%	7.6%	7.7%	9.0%	41.5%	7.3%	40%
Yellow Time (s)	3.2	5.5	3.6	5.5	5.5	3.6	3.6	3.2	4.8	3.2	3.6
All-Red Time (s)	0.5	1.0	0.5	1.0	1.0	0.5	0.5	0.5	1.0	0.5	0.5
Lost Time Adjust (s)	0.0	0.0	0.0	0.0	0.0	0.0	0.0	0.0	0.0	0.0	0.0
Total Lost Time (s)	3.7	6.5	4.1	6.5	6.5	4.1	4.1	3.7	5.8	3.7	
Lead/Lag	Lead	Lag	Lead	Lag	Lag	Lead	Lead	Lead	Lag	Lead	Lag
Lead-Lag Optimize?	Yes	Yes	Yes	Yes	Yes	Yes	Yes	Yes	Yes	Yes	Yes
Recall Mode	None	None	None	None	None	None	None	None	None	None	None
Act Effct Green (s)	5.5	44.9	5.6	53.9	53.9	5.8	13.5	6.3	15.1	11.6	
Actuated g/C Ratio	0.07	0.61	0.08	0.73	0.73	0.08	0.18	0.09	0.21	0.16	
v/c Ratio	0.28	0.57	1.73	0.76	0.05	0.33	0.20	0.26	0.00	0.06	
Control Delay	47.1	14.0	387.2	16.6	1.5	47.3	7.4	45.4	25.0	0.4	
Queue Delay	0.0	0.0	0.0	0.0	0.0	0.0	0.0	0.0	0.0	0.0	
Total Delay	47.1	14.0	387.2	16.6	1.5	47.3	7.4	45.4	25.0	0.4	
LOS	D	B	F	B	A	D	A	D	C	A	
Approach Delay		14.7		42.0					29.5		
Approach LOS		B		D					C		

Intersection Summary

Cycle Length: 120	
Actuated Cycle Length: 73.4	
Natural Cycle: 125	
Control Type: Actuated-Uncoordinated	
Maximum v/c Ratio: 1.73	
Intersection Signal Delay: 31.9	Intersection LOS: C
Intersection Capacity Utilization 78.9%	ICU Level of Service D
Analysis Period (min) 15	

Splits and Phases: 20: Brown/San Gorgonio Dr & Alessandro Bl.

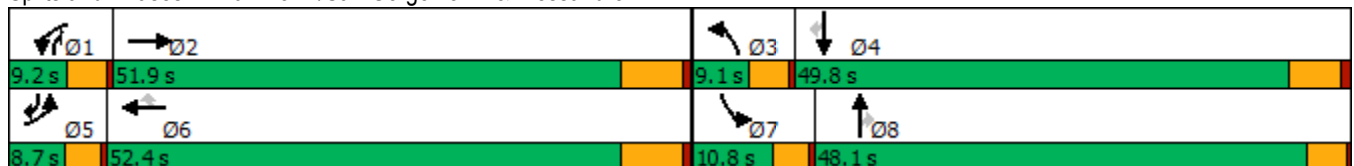

HCM 6th Signalized Intersection Summary
 20: Brown/San Gorgonio Dr & Alessandro Bl.

West Campus Upper Plateau (JN 14064)

09/19/2022



Movement	EBL	EBT	EBR	WBL	WBT	WBR	NBL	NBT	NBR	SBL	SBT	SBR
Lane Configurations	↖	↗↖↗		↖	↗↖↗	↖	↖	↗	↖	↖	↗	↖
Traffic Volume (veh/h)	35	1509	155	207	2725	57	45	0	63	33	1	18
Future Volume (veh/h)	35	1509	155	207	2725	57	45	0	63	33	1	18
Initial Q (Qb), veh	0	0	0	0	0	0	0	0	0	0	0	0
Ped-Bike Adj(A_pbT)	1.00		0.98	1.00		1.00	1.00		1.00	1.00		1.00
Parking Bus, Adj	1.00	1.00	1.00	1.00	1.00	1.00	1.00	1.00	1.00	1.00	1.00	1.00
Work Zone On Approach		No			No			No			No	
Adj Sat Flow, veh/h/ln	1900	1885	1900	1767	1885	1781	1900	1900	1752	1693	670	1900
Adj Flow Rate, veh/h	37	1588	163	218	2868	60	47	0	63	35	1	5
Peak Hour Factor	0.95	0.95	0.95	0.95	0.95	0.95	0.95	0.95	0.95	0.95	0.95	0.95
Percent Heavy Veh, %	0	1	0	9	1	8	0	0	10	14	83	0
Cap, veh/h	63	2521	258	106	2912	854	73	234	276	54	75	236
Arrive On Green	0.03	0.53	0.53	0.06	0.57	0.57	0.04	0.00	0.12	0.03	0.11	0.11
Sat Flow, veh/h	1810	4731	485	1682	5147	1510	1810	1900	1485	1612	670	1610
Grp Volume(v), veh/h	37	1151	600	218	2868	60	47	0	63	35	1	5
Grp Sat Flow(s),veh/h/ln	1810	1716	1785	1682	1716	1510	1810	1900	1485	1612	670	1610
Q Serve(g_s), s	1.6	19.1	19.2	5.1	44.4	1.5	2.1	0.0	2.9	1.7	0.1	0.2
Cycle Q Clear(g_c), s	1.6	19.1	19.2	5.1	44.4	1.5	2.1	0.0	2.9	1.7	0.1	0.2
Prop In Lane	1.00		0.27	1.00		1.00	1.00		1.00	1.00		1.00
Lane Grp Cap(c), veh/h	63	1828	951	106	2912	854	73	234	276	54	75	236
V/C Ratio(X)	0.59	0.63	0.63	2.06	0.99	0.07	0.65	0.00	0.23	0.65	0.01	0.02
Avail Cap(c_a), veh/h	112	1920	999	106	2912	854	112	1030	898	141	363	929
HCM Platoon Ratio	1.00	1.00	1.00	1.00	1.00	1.00	1.00	1.00	1.00	1.00	1.00	1.00
Upstream Filter(I)	1.00	1.00	1.00	1.00	1.00	1.00	1.00	0.00	1.00	1.00	1.00	1.00
Uniform Delay (d), s/veh	38.6	13.3	13.3	38.0	17.3	8.0	38.4	0.0	28.1	38.7	32.1	29.7
Incr Delay (d2), s/veh	3.2	0.7	1.4	508.6	13.4	0.0	9.2	0.0	0.4	4.7	0.1	0.0
Initial Q Delay(d3),s/veh	0.0	0.0	0.0	0.0	0.0	0.0	0.0	0.0	0.0	0.0	0.0	0.0
%ile BackOfQ(50%),veh/ln	0.7	5.8	6.3	17.0	18.5	0.4	1.1	0.0	1.0	0.7	0.0	0.1
Unsig. Movement Delay, s/veh												
LnGrp Delay(d),s/veh	41.8	14.1	14.8	546.6	30.6	8.0	47.5	0.0	28.5	43.4	32.1	29.7
LnGrp LOS	D	B	B	F	C	A	D	A	C	D	C	C
Approach Vol, veh/h		1788			3146			110			41	
Approach Delay, s/veh		14.9			66.0			36.6			41.5	
Approach LOS		B			E			D			D	
Timer - Assigned Phs	1	2	3	4	5	6	7	8				
Phs Duration (G+Y+Rc), s	9.2	49.7	7.4	14.8	6.5	52.4	6.4	15.8				
Change Period (Y+Rc), s	4.1	6.5	4.1	5.8	3.7	6.5	3.7	* 5.8				
Max Green Setting (Gmax), s	5.1	45.4	5.0	44.0	5.0	45.9	7.1	* 44				
Max Q Clear Time (g_c+I1), s	7.1	21.2	4.1	2.2	3.6	46.4	3.7	4.9				
Green Ext Time (p_c), s	0.0	16.2	0.0	0.0	0.0	0.0	0.0	0.2				

Intersection Summary

HCM 6th Ctrl Delay	47.2
HCM 6th LOS	D

Notes

* HCM 6th computational engine requires equal clearance times for the phases crossing the barrier.

Timings
21: Cactus Av. & Brown St



Lane Group	EBL	EBT	WBT	SBR
Lane Configurations	↖	↗↗	↗↖	↗
Traffic Volume (vph)	102	299	983	344
Future Volume (vph)	102	299	983	344
Turn Type	Prot	NA	NA	Perm
Protected Phases	7	4	8	
Permitted Phases				6
Detector Phase	7	4	8	6
Switch Phase				
Minimum Initial (s)	5.0	10.0	10.0	10.0
Minimum Split (s)	9.6	15.8	22.8	21.7
Total Split (s)	20.2	81.2	61.0	38.8
Total Split (%)	16.8%	67.7%	50.8%	32.3%
Yellow Time (s)	3.6	4.8	4.8	3.7
All-Red Time (s)	1.0	1.0	1.0	1.0
Lost Time Adjust (s)	0.0	0.0	0.0	0.0
Total Lost Time (s)	4.6	5.8	5.8	4.7
Lead/Lag	Lead		Lag	
Lead-Lag Optimize?	Yes		Yes	
Recall Mode	None	None	None	Min
Act Effct Green (s)	9.8	42.9	31.6	14.1
Actuated g/C Ratio	0.14	0.63	0.46	0.21
v/c Ratio	0.43	0.16	0.71	0.68
Control Delay	37.9	5.3	19.3	15.8
Queue Delay	0.0	0.0	0.0	0.0
Total Delay	37.9	5.3	19.3	15.8
LOS	D	A	B	B
Approach Delay		13.6	19.3	
Approach LOS		B	B	

Intersection Summary

Cycle Length: 120	
Actuated Cycle Length: 68.6	
Natural Cycle: 60	
Control Type: Actuated-Uncoordinated	
Maximum v/c Ratio: 0.71	
Intersection Signal Delay: 17.3	Intersection LOS: B
Intersection Capacity Utilization 57.2%	ICU Level of Service B
Analysis Period (min) 15	

Splits and Phases: 21: Cactus Av. & Brown St

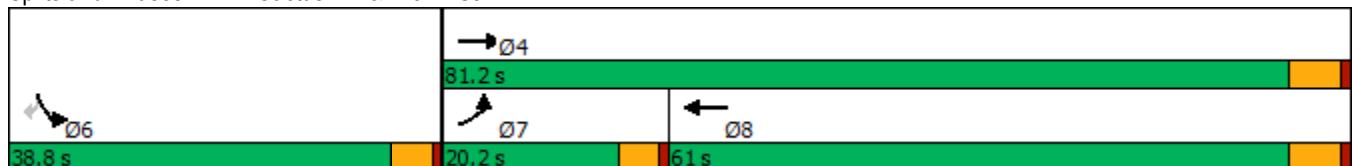

HCM 6th Signalized Intersection Summary
 21: Cactus Av. & Brown St

West Campus Upper Plateau (JN 14064)
 09/19/2022

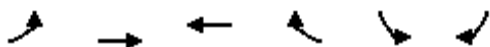

Movement	EBL	EBT	WBT	WBR	SBL	SBR	
Lane Configurations	↶	↷	↶		↶	↷	
Traffic Volume (veh/h)	102	299	983	0	0	344	
Future Volume (veh/h)	102	299	983	0	0	344	
Initial Q (Qb), veh	0	0	0	0	0	0	
Ped-Bike Adj(A_pbT)	1.00			1.00	1.00	1.00	
Parking Bus, Adj	1.00	1.00	1.00	1.00	1.00	1.00	
Work Zone On Approach		No	No		No		
Adj Sat Flow, veh/h/ln	1900	1737	1737	1900	1900	1900	
Adj Flow Rate, veh/h	111	325	1068	0	0	374	
Peak Hour Factor	0.92	0.92	0.92	0.92	0.92	0.92	
Percent Heavy Veh, %	0	11	11	0	0	0	
Cap, veh/h	144	1902	1415	0	486	433	
Arrive On Green	0.08	0.58	0.43	0.00	0.00	0.27	
Sat Flow, veh/h	1810	3387	3474	0	1810	1610	
Grp Volume(v), veh/h	111	325	1068	0	0	374	
Grp Sat Flow(s),veh/h/ln	1810	1650	1650	0	1810	1610	
Q Serve(g_s), s	4.1	3.1	18.5	0.0	0.0	15.0	
Cycle Q Clear(g_c), s	4.1	3.1	18.5	0.0	0.0	15.0	
Prop In Lane	1.00			0.00	1.00	1.00	
Lane Grp Cap(c), veh/h	144	1902	1415	0	486	433	
V/C Ratio(X)	0.77	0.17	0.75	0.00	0.00	0.86	
Avail Cap(c_a), veh/h	417	3674	2690	0	911	811	
HCM Platoon Ratio	1.00	1.00	1.00	1.00	1.00	1.00	
Upstream Filter(I)	1.00	1.00	1.00	0.00	0.00	1.00	
Uniform Delay (d), s/veh	30.6	6.7	16.3	0.0	0.0	23.6	
Incr Delay (d2), s/veh	3.3	0.0	0.8	0.0	0.0	5.3	
Initial Q Delay(d3),s/veh	0.0	0.0	0.0	0.0	0.0	0.0	
%ile BackOfQ(50%),veh/ln	1.8	0.8	5.8	0.0	0.0	0.6	
Unsig. Movement Delay, s/veh							
LnGrp Delay(d),s/veh	33.8	6.8	17.2	0.0	0.0	28.9	
LnGrp LOS	C	A	B	A	A	C	
Approach Vol, veh/h		436	1068		374		
Approach Delay, s/veh		13.7	17.2		28.9		
Approach LOS		B	B		C		
Timer - Assigned Phs				4	6	7	8
Phs Duration (G+Y+Rc), s				44.8	22.9	10.0	34.8
Change Period (Y+Rc), s				5.8	4.7	4.6	5.8
Max Green Setting (Gmax), s				75.4	34.1	15.6	55.2
Max Q Clear Time (g_c+I1), s				5.1	17.0	6.1	20.5
Green Ext Time (p_c), s				2.1	1.2	0.1	8.5
Intersection Summary							
HCM 6th Ctrl Delay			18.7				
HCM 6th LOS			B				

Timings
22: Sycamore Canyon Bl. & Eastridge Ave

West Campus Upper Plateau (JN 14064)

09/19/2022



Lane Group	EBL	EBT	EBR	WBL	WBT	WBR	NBL	NBT	NBR	SBL	SBT	SBR
Lane Configurations	↖↖	↑↑↑	↗	↖↖	↑↑	↗	↖↖	↑↑	↗	↖↖	↑↑	↗
Traffic Volume (vph)	53	43	19	117	202	525	77	828	97	81	225	44
Future Volume (vph)	53	43	19	117	202	525	77	828	97	81	225	44
Turn Type	Prot	NA	Perm	Prot	NA	pm+ov	Prot	NA	pm+ov	Prot	NA	pm+ov
Protected Phases	5	2		1	6	7	3	8	1	7	4	5
Permitted Phases			2			6			8			4
Detector Phase	5	2	2	1	6	7	3	8	1	7	4	5
Switch Phase												
Minimum Initial (s)	5.0	10.0	10.0	5.0	10.0	5.0	5.0	10.0	5.0	5.0	10.0	5.0
Minimum Split (s)	8.7	43.5	43.5	8.7	43.5	8.7	8.7	15.8	8.7	8.7	49.8	8.7
Total Split (s)	10.1	47.0	47.0	11.0	47.9	21.0	10.6	41.0	11.0	21.0	51.4	10.1
Total Split (%)	8.4%	39.2%	39.2%	9.2%	39.9%	17.5%	8.8%	34.2%	9.2%	17.5%	42.8%	8.4%
Yellow Time (s)	3.2	5.5	5.5	3.2	5.5	3.2	3.2	4.8	3.2	3.2	4.8	3.2
All-Red Time (s)	0.5	1.0	1.0	0.5	1.0	0.5	0.5	1.0	0.5	0.5	1.0	0.5
Lost Time Adjust (s)	0.0	0.0	0.0	0.0	0.0	0.0	0.0	0.0	0.0	0.0	0.0	0.0
Total Lost Time (s)	3.7	6.5	6.5	3.7	6.5	3.7	3.7	5.8	3.7	3.7	5.8	3.7
Lead/Lag	Lead	Lag	Lag	Lead	Lag	Lead	Lead	Lag	Lead	Lead	Lag	Lead
Lead-Lag Optimize?	Yes	Yes	Yes	Yes	Yes	Yes	Yes	Yes	Yes	Yes	Yes	Yes
Recall Mode	None	None	None	None	None	None	None	None	None	None	None	None
Act Effct Green (s)	6.1	14.9	14.9	9.3	15.7	38.1	6.5	32.6	44.1	15.6	44.3	52.6
Actuated g/C Ratio	0.07	0.17	0.17	0.11	0.18	0.43	0.07	0.37	0.50	0.18	0.50	0.60
v/c Ratio	0.32	0.08	0.06	0.43	0.41	0.87	0.37	0.76	0.14	0.16	0.15	0.06
Control Delay	49.3	32.6	0.4	48.4	35.5	36.1	48.7	31.2	4.9	35.5	14.9	2.4
Queue Delay	0.0	0.0	0.0	0.0	0.0	0.0	0.0	0.0	0.0	0.0	0.0	0.0
Total Delay	49.3	32.6	0.4	48.4	35.5	36.1	48.7	31.2	4.9	35.5	14.9	2.4
LOS	D	C	A	D	D	D	D	C	A	D	B	A
Approach Delay		35.0			37.6			30.0			18.1	
Approach LOS		C			D			C			B	

Intersection Summary

Cycle Length: 120
 Actuated Cycle Length: 88
 Natural Cycle: 115
 Control Type: Actuated-Uncoordinated
 Maximum v/c Ratio: 0.87
 Intersection Signal Delay: 31.2
 Intersection LOS: C
 Intersection Capacity Utilization 71.1%
 ICU Level of Service C
 Analysis Period (min) 15

Splits and Phases: 22: Sycamore Canyon Bl. & Eastridge Ave

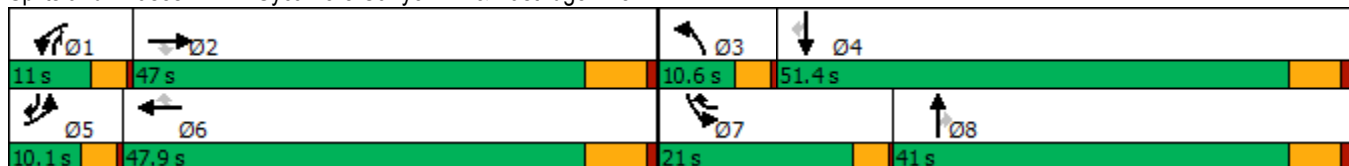

HCM 6th Signalized Intersection Summary
 22: Sycamore Canyon Bl. & Eastridge Ave

West Campus Upper Plateau (JN 14064)

09/19/2022



Movement	EBL	EBT	EBR	WBL	WBT	WBR	NBL	NBT	NBR	SBL	SBT	SBR
Lane Configurations	↖↗	↑↑↑	↖	↖↗	↑↑	↖	↖↗	↑↑	↖	↖↗	↑↑	↖
Traffic Volume (veh/h)	53	43	19	117	202	525	77	828	97	81	225	44
Future Volume (veh/h)	53	43	19	117	202	525	77	828	97	81	225	44
Initial Q (Qb), veh	0	0	0	0	0	0	0	0	0	0	0	0
Ped-Bike Adj(A_pbT)	1.00		1.00	1.00		1.00	1.00		0.99	1.00		0.99
Parking Bus, Adj	1.00	1.00	1.00	1.00	1.00	1.00	1.00	1.00	1.00	1.00	1.00	1.00
Work Zone On Approach		No			No			No			No	
Adj Sat Flow, veh/h/ln	1485	1352	1722	1618	1707	1811	1796	1796	1737	1767	1781	1589
Adj Flow Rate, veh/h	61	49	0	134	232	603	89	952	77	93	259	37
Peak Hour Factor	0.87	0.87	0.87	0.87	0.87	0.87	0.87	0.87	0.87	0.87	0.87	0.87
Percent Heavy Veh, %	28	37	12	19	13	6	7	7	11	9	8	21
Cap, veh/h	112	1386		187	1289	681	152	1086	555	151	1079	479
Arrive On Green	0.04	0.38	0.00	0.06	0.40	0.40	0.05	0.32	0.32	0.05	0.32	0.32
Sat Flow, veh/h	2744	3690	1459	2990	3244	1535	3319	3413	1453	3264	3385	1329
Grp Volume(v), veh/h	61	49	0	134	232	603	89	952	77	93	259	37
Grp Sat Flow(s),veh/h/ln	1372	1230	1459	1495	1622	1535	1659	1706	1453	1632	1692	1329
Q Serve(g_s), s	2.2	0.8	0.0	4.4	4.6	35.9	2.6	26.3	3.5	2.8	5.6	1.8
Cycle Q Clear(g_c), s	2.2	0.8	0.0	4.4	4.6	35.9	2.6	26.3	3.5	2.8	5.6	1.8
Prop In Lane	1.00		1.00	1.00		1.00	1.00		1.00	1.00		1.00
Lane Grp Cap(c), veh/h	112	1386		187	1289	681	152	1086	555	151	1079	479
V/C Ratio(X)	0.54	0.04		0.72	0.18	0.89	0.58	0.88	0.14	0.62	0.24	0.08
Avail Cap(c_a), veh/h	176	1497		219	1345	708	229	1204	605	566	1546	662
HCM Platoon Ratio	1.00	1.00	1.00	1.00	1.00	1.00	1.00	1.00	1.00	1.00	1.00	1.00
Upstream Filter(I)	1.00	1.00	0.00	1.00	1.00	1.00	1.00	1.00	1.00	1.00	1.00	1.00
Uniform Delay (d), s/veh	47.0	19.7	0.0	45.9	19.5	25.5	46.7	32.2	20.2	46.7	25.1	21.1
Incr Delay (d2), s/veh	1.5	0.0	0.0	6.6	0.1	13.0	1.3	7.0	0.1	1.5	0.1	0.1
Initial Q Delay(d3),s/veh	0.0	0.0	0.0	0.0	0.0	0.0	0.0	0.0	0.0	0.0	0.0	0.0
%ile BackOfQ(50%),veh/ln	0.7	0.2	0.0	1.7	1.6	14.2	1.1	11.2	1.1	1.1	2.2	0.5
Unsig. Movement Delay, s/veh												
LnGrp Delay(d),s/veh	48.5	19.7	0.0	52.5	19.6	38.5	48.0	39.2	20.3	48.2	25.2	21.1
LnGrp LOS	D	B		D	B	D	D	D	C	D	C	C
Approach Vol, veh/h		110			969			1118			389	
Approach Delay, s/veh		35.7			35.9			38.6			30.3	
Approach LOS		D			D			D			C	
Timer - Assigned Phs	1	2	3	4	5	6	7	8				
Phs Duration (G+Y+Rc), s	10.0	44.0	8.3	37.6	7.8	46.2	8.3	37.6				
Change Period (Y+Rc), s	3.7	6.5	3.7	5.8	3.7	6.5	3.7	5.8				
Max Green Setting (Gmax), s	7.3	40.5	6.9	45.6	6.4	41.4	17.3	35.2				
Max Q Clear Time (g_c+I1), s	6.4	2.8	4.6	7.6	4.2	37.9	4.8	28.3				
Green Ext Time (p_c), s	0.0	0.3	0.0	1.7	0.0	1.7	0.1	3.4				

Intersection Summary

HCM 6th Ctrl Delay	36.2
HCM 6th LOS	D

Notes

Unsignalized Delay for [EBR] is excluded from calculations of the approach delay and intersection delay.

Timings
23: Sycamore Canyon Bl. & Cottonwood Ave

West Campus Upper Plateau (JN 14064)

09/19/2022



Lane Group	WBL	WBR	NBT	SBL	SBT
Lane Configurations	↙	↗	↕↔	↙	↕↕
Traffic Volume (vph)	15	26	995	65	298
Future Volume (vph)	15	26	995	65	298
Turn Type	Prot	Perm	NA	Prot	NA
Protected Phases	8		2	1	6
Permitted Phases		8			
Detector Phase	8	8	2	1	6
Switch Phase					
Minimum Initial (s)	10.0	10.0	10.0	5.0	10.0
Minimum Split (s)	15.8	15.8	43.5	9.1	43.5
Total Split (s)	21.0	21.0	75.0	24.0	99.0
Total Split (%)	17.5%	17.5%	62.5%	20.0%	82.5%
Yellow Time (s)	4.8	4.8	5.5	3.6	5.5
All-Red Time (s)	1.0	1.0	1.0	0.5	1.0
Lost Time Adjust (s)	0.0	0.0	0.0	0.0	0.0
Total Lost Time (s)	5.8	5.8	6.5	4.1	6.5
Lead/Lag			Lag	Lead	
Lead-Lag Optimize?			Yes	Yes	
Recall Mode	None	None	None	None	None
Act Effct Green (s)	14.1	14.1	42.2	11.6	49.3
Actuated g/C Ratio	0.24	0.24	0.71	0.20	0.83
v/c Ratio	0.06	0.10	0.49	0.29	0.12
Control Delay	34.7	15.3	11.2	33.6	2.7
Queue Delay	0.0	0.0	0.0	0.0	0.0
Total Delay	34.7	15.3	11.2	33.6	2.7
LOS	C	B	B	C	A
Approach Delay	22.3		11.2		8.3
Approach LOS	C		B		A

Intersection Summary

Cycle Length: 120
 Actuated Cycle Length: 59.1
 Natural Cycle: 70
 Control Type: Actuated-Uncoordinated
 Maximum v/c Ratio: 0.49
 Intersection Signal Delay: 10.7
 Intersection LOS: B
 Intersection Capacity Utilization 54.4%
 ICU Level of Service A
 Analysis Period (min) 15

Splits and Phases: 23: Sycamore Canyon Bl. & Cottonwood Ave



HCM 6th Signalized Intersection Summary
 23: Sycamore Canyon Bl. & Cottonwood Ave

West Campus Upper Plateau (JN 14064)
 09/19/2022



Movement	WBL	WBR	NBT	NBR	SBL	SBT
Lane Configurations						
Traffic Volume (veh/h)	15	26	995	23	65	298
Future Volume (veh/h)	15	26	995	23	65	298
Initial Q (Qb), veh	0	0	0	0	0	0
Ped-Bike Adj(A_pbT)	1.00	1.00		0.98	1.00	
Parking Bus, Adj	1.00	1.00	1.00	1.00	1.00	1.00
Work Zone On Approach	No		No			No
Adj Sat Flow, veh/h/ln	1322	1307	1811	1752	1352	1811
Adj Flow Rate, veh/h	17	14	1157	26	76	347
Peak Hour Factor	0.86	0.86	0.86	0.86	0.86	0.86
Percent Heavy Veh, %	39	40	6	10	37	6
Cap, veh/h	87	77	1894	43	85	2393
Arrive On Green	0.07	0.07	0.55	0.55	0.07	0.70
Sat Flow, veh/h	1259	1108	3529	77	1287	3532
Grp Volume(v), veh/h	17	14	579	604	76	347
Grp Sat Flow(s),veh/h/ln	1259	1108	1721	1795	1287	1721
Q Serve(g_s), s	0.7	0.6	11.9	11.9	3.1	1.8
Cycle Q Clear(g_c), s	0.7	0.6	11.9	11.9	3.1	1.8
Prop In Lane	1.00	1.00		0.04	1.00	
Lane Grp Cap(c), veh/h	87	77	948	989	85	2393
V/C Ratio(X)	0.19	0.18	0.61	0.61	0.89	0.14
Avail Cap(c_a), veh/h	366	322	2253	2351	490	6084
HCM Platoon Ratio	1.00	1.00	1.00	1.00	1.00	1.00
Upstream Filter(I)	1.00	1.00	1.00	1.00	1.00	1.00
Uniform Delay (d), s/veh	23.0	22.9	8.0	8.0	24.2	2.7
Incr Delay (d2), s/veh	1.1	1.1	0.9	0.9	24.6	0.0
Initial Q Delay(d3),s/veh	0.0	0.0	0.0	0.0	0.0	0.0
%ile BackOfQ(50%),veh/ln	0.2	0.2	2.8	2.9	1.4	0.2
Unsig. Movement Delay, s/veh						
LnGrp Delay(d),s/veh	24.0	24.1	8.9	8.8	48.8	2.7
LnGrp LOS	C	C	A	A	D	A
Approach Vol, veh/h	31		1183			423
Approach Delay, s/veh	24.1		8.8			11.0
Approach LOS	C		A			B
Timer - Assigned Phs	1	2			6	8
Phs Duration (G+Y+Rc), s	7.6	35.3			42.9	9.4
Change Period (Y+Rc), s	4.1	6.5			6.5	5.8
Max Green Setting (Gmax), s	19.9	68.5			92.5	15.2
Max Q Clear Time (g_c+11), s	5.1	13.9			3.8	2.7
Green Ext Time (p_c), s	0.1	14.9			3.3	0.0

Intersection Summary

HCM 6th Ctrl Delay			9.7			
HCM 6th LOS			A			

Timings

West Campus Upper Plateau (JN 14064)

24: Sycamore Canyon Bl. & Alessandro Bl.

09/19/2022



Lane Group	EBL	EBT	EBR	WBL	WBT	WBR	NBL	NBT	NBR	SBL	SBT	SBR
Lane Configurations	↘	↑↑↑	↗	↘↗	↑↑↑	↗	↘↗	↑↑	↗↘	↘↗	↑↑	↗
Traffic Volume (vph)	161	1163	280	139	2422	614	672	681	82	100	161	145
Future Volume (vph)	161	1163	280	139	2422	614	672	681	82	100	161	145
Turn Type	Prot	NA	Perm	Prot	NA	Perm	Prot	NA	pm+ov	Prot	NA	Perm
Protected Phases	5	2		1	6		3	8	1	7	4	
Permitted Phases			2			6			8			4
Detector Phase	5	2	2	1	6	6	3	8	1	7	4	4
Switch Phase												
Minimum Initial (s)	5.0	10.0	10.0	5.0	10.0	10.0	5.0	10.0	5.0	5.0	10.0	10.0
Minimum Split (s)	8.7	43.5	43.5	8.7	43.5	43.5	8.7	15.8	8.7	8.7	49.8	49.8
Total Split (s)	10.0	47.0	47.0	9.2	46.2	46.2	14.0	52.5	9.2	11.3	49.8	49.8
Total Split (%)	8.3%	39.2%	39.2%	7.7%	38.5%	38.5%	11.7%	43.8%	7.7%	9.4%	41.5%	41.5%
Yellow Time (s)	3.2	5.5	5.5	3.2	5.5	5.5	3.2	4.8	3.2	3.2	4.8	4.8
All-Red Time (s)	0.5	1.0	1.0	0.5	1.0	1.0	0.5	1.0	0.5	0.5	1.0	1.0
Lost Time Adjust (s)	0.0	0.0	0.0	0.0	0.0	0.0	0.0	0.0	0.0	0.0	0.0	0.0
Total Lost Time (s)	3.7	6.5	6.5	3.7	6.5	6.5	3.7	5.8	3.7	3.7	5.8	5.8
Lead/Lag	Lead	Lag	Lag	Lead	Lag	Lag	Lead	Lag	Lead	Lead	Lag	Lag
Lead-Lag Optimize?	Yes	Yes	Yes	Yes	Yes	Yes	Yes	Yes	Yes	Yes	Yes	Yes
Recall Mode	None	C-Max	C-Max	None	C-Max	C-Max	None	None	None	None	None	None
Act Effct Green (s)	20.5	51.9	51.9	8.9	40.2	40.2	10.3	32.4	43.4	7.1	29.2	29.2
Actuated g/C Ratio	0.17	0.43	0.43	0.07	0.34	0.34	0.09	0.27	0.36	0.06	0.24	0.24
v/c Ratio	0.54	0.53	0.35	0.56	1.44	0.95	2.31	0.73	0.08	0.54	0.20	0.32
Control Delay	55.1	27.5	6.4	63.2	231.4	52.2	624.9	44.1	6.6	65.9	34.6	10.7
Queue Delay	0.0	0.0	0.0	0.0	0.0	0.0	0.0	0.0	0.0	0.0	0.0	0.0
Total Delay	55.1	27.5	6.4	63.2	231.4	52.2	624.9	44.1	6.6	65.9	34.6	10.7
LOS	E	C	A	E	F	D	F	D	A	E	C	B
Approach Delay		26.6			189.4			313.9			33.8	
Approach LOS		C			F			F			C	

Intersection Summary

Cycle Length: 120
 Actuated Cycle Length: 120
 Offset: 0 (0%), Referenced to phase 2:EBT and 6:WBT, Start of Yellow
 Natural Cycle: 125
 Control Type: Actuated-Coordinated
 Maximum v/c Ratio: 2.31
 Intersection Signal Delay: 167.4
 Intersection LOS: F
 Intersection Capacity Utilization 102.0%
 ICU Level of Service G
 Analysis Period (min) 15

Splits and Phases: 24: Sycamore Canyon Bl. & Alessandro Bl.

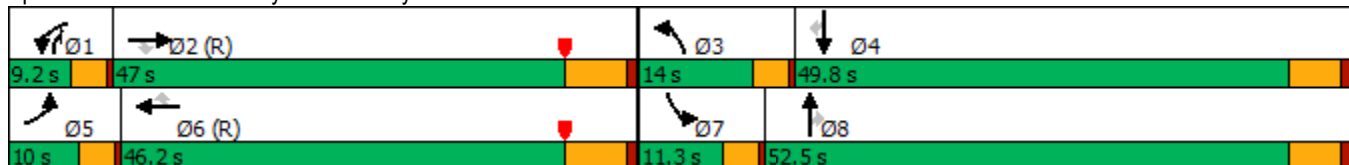

HCM 6th Signalized Intersection Summary
 24: Sycamore Canyon Bl. & Alessandro Bl.

West Campus Upper Plateau (JN 14064)

09/19/2022



Movement	EBL	EBT	EBR	WBL	WBT	WBR	NBL	NBT	NBR	SBL	SBT	SBR
Lane Configurations												
Traffic Volume (veh/h)	161	1163	280	139	2422	614	672	681	82	100	161	145
Future Volume (veh/h)	161	1163	280	139	2422	614	672	681	82	100	161	145
Initial Q (Qb), veh	0	0	0	0	0	0	0	0	0	0	0	0
Ped-Bike Adj(A_pbT)	1.00		1.00	1.00		1.00	1.00		1.00	1.00		1.00
Parking Bus, Adj	1.00	1.00	1.00	1.00	1.00	1.00	1.00	1.00	1.00	1.00	1.00	1.00
Work Zone On Approach		No			No			No			No	
Adj Sat Flow, veh/h/ln	1870	1885	1885	1841	1870	1856	1870	1841	1811	1737	1796	1856
Adj Flow Rate, veh/h	163	1175	201	140	2446	497	679	688	53	101	163	87
Peak Hour Factor	0.99	0.99	0.99	0.99	0.99	0.99	0.99	0.99	0.99	0.99	0.99	0.99
Percent Heavy Veh, %	2	1	1	4	2	3	2	4	6	11	7	3
Cap, veh/h	94	2589	803	156	2535	781	297	842	773	148	686	315
Arrive On Green	0.05	0.50	0.50	0.05	0.50	0.50	0.09	0.24	0.24	0.05	0.20	0.20
Sat Flow, veh/h	1781	5147	1596	3401	5106	1572	3456	3497	2698	3209	3413	1568
Grp Volume(v), veh/h	163	1175	201	140	2446	497	679	688	53	101	163	87
Grp Sat Flow(s),veh/h/ln	1781	1716	1596	1700	1702	1572	1728	1749	1349	1605	1706	1568
Q Serve(g_s), s	6.3	17.6	8.6	4.9	55.6	27.9	10.3	22.3	1.7	3.7	4.8	5.6
Cycle Q Clear(g_c), s	6.3	17.6	8.6	4.9	55.6	27.9	10.3	22.3	1.7	3.7	4.8	5.6
Prop In Lane	1.00		1.00	1.00		1.00	1.00		1.00	1.00		1.00
Lane Grp Cap(c), veh/h	94	2589	803	156	2535	781	297	842	773	148	686	315
V/C Ratio(X)	1.74	0.45	0.25	0.90	0.96	0.64	2.29	0.82	0.07	0.68	0.24	0.28
Avail Cap(c_a), veh/h	94	2589	803	156	2535	781	297	1361	1174	203	1251	575
HCM Platoon Ratio	1.00	1.00	1.00	1.00	1.00	1.00	1.00	1.00	1.00	1.00	1.00	1.00
Upstream Filter(I)	0.82	0.82	0.82	0.39	0.39	0.39	1.00	1.00	1.00	1.00	1.00	1.00
Uniform Delay (d), s/veh	56.8	19.2	16.9	57.0	29.2	22.2	54.8	43.1	31.2	56.4	40.2	40.6
Incr Delay (d2), s/veh	368.0	0.5	0.6	21.9	5.6	1.6	590.7	2.1	0.0	2.1	0.2	0.5
Initial Q Delay(d3),s/veh	0.0	0.0	0.0	0.0	0.0	0.0	0.0	0.0	0.0	0.0	0.0	0.0
%ile BackOfQ(50%),veh/ln	12.3	6.7	3.1	2.5	22.0	10.0	28.7	9.6	0.6	1.5	2.0	2.2
Unsig. Movement Delay, s/veh												
LnGrp Delay(d),s/veh	424.8	19.7	17.6	78.8	34.8	23.8	645.6	45.2	31.2	58.4	40.4	41.0
LnGrp LOS	F	B	B	E	C	C	F	D	C	E	D	D
Approach Vol, veh/h		1539			3083			1420			351	
Approach Delay, s/veh		62.3			35.0			331.7			45.7	
Approach LOS		E			D			F			D	
Timer - Assigned Phs	1	2	3	4	5	6	7	8				
Phs Duration (G+Y+Rc), s	9.2	66.9	14.0	29.9	10.0	66.1	9.2	34.7				
Change Period (Y+Rc), s	3.7	6.5	3.7	5.8	3.7	6.5	3.7	5.8				
Max Green Setting (Gmax), s	5.5	40.5	10.3	44.0	6.3	39.7	7.6	46.7				
Max Q Clear Time (g_c+I1), s	6.9	19.6	12.3	7.6	8.3	57.6	5.7	24.3				
Green Ext Time (p_c), s	0.0	11.5	0.0	1.2	0.0	0.0	0.0	4.6				

Intersection Summary

HCM 6th Ctrl Delay	108.1
HCM 6th LOS	F

Timings
25: Sycamore Canyon Bl. & Cactus Av.

West Campus Upper Plateau (JN 14064)

09/19/2022



Lane Group	EBL	EBT	EBR	WBL	WBT	WBR	NBL	NBT	NBR	SBL	SBT	SBR
Lane Configurations	↘	↑↑	↗	↘↗	↑↑	↗	↘↗	↑↑	↗	↘↗	↑↑	↗
Traffic Volume (vph)	26	202	83	419	661	1016	282	421	240	158	161	79
Future Volume (vph)	26	202	83	419	661	1016	282	421	240	158	161	79
Turn Type	Prot	NA	Perm	Prot	NA	Perm	Prot	NA	Perm	Prot	NA	Perm
Protected Phases	7	4		3	8		5	2		1	6	
Permitted Phases			4			8			2			6
Detector Phase	7	4	4	3	8	8	5	2	2	1	6	6
Switch Phase												
Minimum Initial (s)	5.0	10.0	10.0	5.0	10.0	10.0	5.0	10.0	10.0	5.0	10.0	10.0
Minimum Split (s)	9.6	32.8	32.8	9.6	32.8	32.8	9.6	34.8	34.8	9.6	34.8	34.8
Total Split (s)	9.6	45.6	45.6	27.0	63.0	63.0	9.6	36.4	36.4	11.0	37.8	37.8
Total Split (%)	8.0%	38.0%	38.0%	22.5%	52.5%	52.5%	8.0%	30.3%	30.3%	9.2%	31.5%	31.5%
Yellow Time (s)	3.6	4.8	4.8	3.6	4.8	4.8	3.6	4.8	4.8	3.6	4.8	4.8
All-Red Time (s)	1.0	1.0	1.0	1.0	1.0	1.0	1.0	1.0	1.0	1.0	1.0	1.0
Lost Time Adjust (s)	0.0	0.0	0.0	0.0	0.0	0.0	0.0	0.0	0.0	0.0	0.0	0.0
Total Lost Time (s)	4.6	5.8	5.8	4.6	5.8	5.8	4.6	5.8	5.8	4.6	5.8	5.8
Lead/Lag	Lead	Lag	Lag	Lead	Lag	Lag	Lead	Lag	Lag	Lead	Lag	Lag
Lead-Lag Optimize?	Yes	Yes	Yes	Yes	Yes	Yes	Yes	Yes	Yes	Yes	Yes	Yes
Recall Mode	None	None	None	None	None	None	None	None	None	None	None	None
Act Effct Green (s)	5.0	40.3	40.3	18.1	57.7	57.7	5.0	20.1	20.1	6.5	21.5	21.5
Actuated g/C Ratio	0.05	0.38	0.38	0.17	0.54	0.54	0.05	0.19	0.19	0.06	0.20	0.20
v/c Ratio	0.40	0.17	0.13	0.81	0.39	1.08	1.85	0.68	0.51	0.80	0.24	0.19
Control Delay	70.2	24.0	0.4	55.5	16.3	73.2	439.1	45.8	8.5	78.3	36.3	1.0
Queue Delay	0.0	0.0	0.0	0.0	0.0	6.4	0.0	0.0	0.0	0.0	0.0	0.0
Total Delay	70.2	24.0	0.4	55.5	16.3	79.6	439.1	45.8	8.5	78.3	36.3	1.0
LOS	E	C	A	E	B	E	F	D	A	E	D	A
Approach Delay		21.6			54.8			154.1			46.0	
Approach LOS		C			D			F			D	

Intersection Summary

Cycle Length: 120
 Actuated Cycle Length: 106
 Natural Cycle: 130
 Control Type: Actuated-Uncoordinated
 Maximum v/c Ratio: 1.85
 Intersection Signal Delay: 76.1
 Intersection LOS: E
 Intersection Capacity Utilization 92.2%
 ICU Level of Service F
 Analysis Period (min) 15

Splits and Phases: 25: Sycamore Canyon Bl. & Cactus Av.

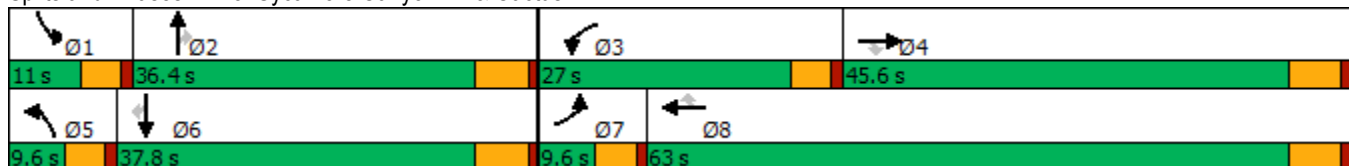

HCM 6th Signalized Intersection Summary
 25: Sycamore Canyon Bl. & Cactus Av.

West Campus Upper Plateau (JN 14064)

09/19/2022



Movement	EBL	EBT	EBR	WBL	WBT	WBR	NBL	NBT	NBR	SBL	SBT	SBR
Lane Configurations												
Traffic Volume (veh/h)	26	202	83	419	661	1016	282	421	240	158	161	79
Future Volume (veh/h)	26	202	83	419	661	1016	282	421	240	158	161	79
Initial Q (Qb), veh	0	0	0	0	0	0	0	0	0	0	0	0
Ped-Bike Adj(A_pbT)	1.00		1.00	1.00		0.99	1.00		1.00	1.00		0.99
Parking Bus, Adj	1.00	1.00	1.00	1.00	1.00	1.00	1.00	1.00	1.00	1.00	1.00	1.00
Work Zone On Approach		No			No			No			No	
Adj Sat Flow, veh/h/ln	1515	1693	1826	1722	1707	1856	1811	1796	1811	1841	1826	1796
Adj Flow Rate, veh/h	27	208	85	432	681	828	291	434	150	163	166	78
Peak Hour Factor	0.97	0.97	0.97	0.97	0.97	0.97	0.97	0.97	0.97	0.97	0.97	0.97
Percent Heavy Veh, %	26	14	5	12	13	3	6	7	6	4	5	7
Cap, veh/h	38	1336	643	498	1771	848	161	570	256	209	626	271
Arrive On Green	0.03	0.42	0.42	0.16	0.55	0.55	0.05	0.17	0.17	0.06	0.18	0.18
Sat Flow, veh/h	1443	3216	1547	3182	3244	1553	3346	3413	1535	3401	3469	1502
Grp Volume(v), veh/h	27	208	85	432	681	828	291	434	150	163	166	78
Grp Sat Flow(s),veh/h/ln	1443	1608	1547	1591	1622	1553	1673	1706	1535	1700	1735	1502
Q Serve(g_s), s	1.9	4.2	3.5	13.8	12.6	54.0	5.0	12.6	9.4	4.9	4.3	4.7
Cycle Q Clear(g_c), s	1.9	4.2	3.5	13.8	12.6	54.0	5.0	12.6	9.4	4.9	4.3	4.7
Prop In Lane	1.00		1.00	1.00		1.00	1.00		1.00	1.00		1.00
Lane Grp Cap(c), veh/h	38	1336	643	498	1771	848	161	570	256	209	626	271
V/C Ratio(X)	0.72	0.16	0.13	0.87	0.38	0.98	1.81	0.76	0.59	0.78	0.27	0.29
Avail Cap(c_a), veh/h	69	1336	643	684	1780	852	161	1002	451	209	1065	461
HCM Platoon Ratio	1.00	1.00	1.00	1.00	1.00	1.00	1.00	1.00	1.00	1.00	1.00	1.00
Upstream Filter(I)	1.00	1.00	1.00	1.00	1.00	1.00	1.00	1.00	1.00	1.00	1.00	1.00
Uniform Delay (d), s/veh	50.4	19.0	18.8	42.9	13.6	23.0	49.6	41.4	40.1	48.2	36.8	36.9
Incr Delay (d2), s/veh	9.2	0.1	0.1	6.8	0.1	25.0	389.2	2.1	2.1	15.8	0.2	0.6
Initial Q Delay(d3),s/veh	0.0	0.0	0.0	0.0	0.0	0.0	0.0	0.0	0.0	0.0	0.0	0.0
%ile BackOfQ(50%),veh/ln	0.8	1.5	1.2	5.7	4.2	22.9	10.7	5.3	3.6	2.5	1.8	1.7
Unsig. Movement Delay, s/veh												
LnGrp Delay(d),s/veh	59.6	19.1	18.9	49.7	13.7	48.1	438.8	43.6	42.2	64.0	37.0	37.5
LnGrp LOS	E	B	B	D	B	D	F	D	D	E	D	D
Approach Vol, veh/h		320			1941			875			407	
Approach Delay, s/veh		22.5			36.4			174.8			47.9	
Approach LOS		C			D			F			D	
Timer - Assigned Phs	1	2	3	4	5	6	7	8				
Phs Duration (G+Y+Rc), s	11.0	23.2	20.9	49.1	9.6	24.6	7.3	62.7				
Change Period (Y+Rc), s	4.6	5.8	4.6	5.8	4.6	5.8	4.6	5.8				
Max Green Setting (Gmax), s	6.4	30.6	22.4	39.8	5.0	32.0	5.0	57.2				
Max Q Clear Time (g_c+I1), s	6.9	14.6	15.8	6.2	7.0	6.7	3.9	56.0				
Green Ext Time (p_c), s	0.0	2.8	0.5	1.6	0.0	1.1	0.0	0.9				

Intersection Summary

HCM 6th Ctrl Delay	70.6
HCM 6th LOS	E

Timings

26: Sycamore Canyon Bl. & Van Buren Bl.

09/19/2022



Lane Group	EBL	EBT	EBR	WBL	WBT	WBR	NBL	NBT	SBL	SBT	SBR
Lane Configurations											
Traffic Volume (vph)	687	1317	3	53	1519	222	4	1	77	6	420
Future Volume (vph)	687	1317	3	53	1519	222	4	1	77	6	420
Turn Type	Prot	NA	Perm	Prot	NA	Perm	Perm	NA	Split	NA	Perm
Protected Phases	5	2		1	6			8	4	4	
Permitted Phases			2			6	8				4
Detector Phase	5	2	2	1	6	6	8	8	4	4	4
Switch Phase											
Minimum Initial (s)	5.0	10.0	10.0	5.0	10.0	10.0	10.0	10.0	10.0	10.0	10.0
Minimum Split (s)	9.6	29.2	29.2	9.6	29.2	29.2	14.6	14.6	50.8	50.8	50.8
Total Split (s)	25.0	50.9	50.9	13.7	39.6	39.6	14.6	14.6	50.8	50.8	50.8
Total Split (%)	19.2%	39.2%	39.2%	10.5%	30.5%	30.5%	11.2%	11.2%	39.1%	39.1%	39.1%
Yellow Time (s)	3.6	5.2	5.2	3.6	5.2	5.2	3.6	3.6	4.8	4.8	4.8
All-Red Time (s)	1.0	1.0	1.0	1.0	1.0	1.0	1.0	1.0	1.0	1.0	1.0
Lost Time Adjust (s)	0.0	0.0	0.0	0.0	0.0	0.0		0.0	0.0	0.0	0.0
Total Lost Time (s)	4.6	6.2	6.2	4.6	6.2	6.2		4.6	5.8	5.8	5.8
Lead/Lag	Lead	Lag	Lag	Lead	Lag	Lag					
Lead-Lag Optimize?	Yes	Yes	Yes	Yes	Yes	Yes					
Recall Mode	None	None	None	None	None	None	None	None	None	None	None
Act Effct Green (s)	21.2	50.9	50.9	7.1	34.6	34.6		10.4	15.4	15.4	15.4
Actuated g/C Ratio	0.23	0.56	0.56	0.08	0.38	0.38		0.12	0.17	0.17	0.17
v/c Ratio	0.93	0.40	0.00	0.41	0.69	0.34		0.02	0.17	0.02	0.71
Control Delay	54.3	15.6	0.0	53.1	27.5	6.3		35.4	31.5	29.5	9.5
Queue Delay	0.0	0.0	0.0	0.0	0.0	0.0		0.0	0.0	0.0	0.0
Total Delay	54.3	15.6	0.0	53.1	27.5	6.3		35.4	31.5	29.5	9.5
LOS	D	B	A	D	C	A		D	C	C	A
Approach Delay		28.8			25.7			35.4		13.1	
Approach LOS		C			C			D		B	

Intersection Summary

Cycle Length: 130
 Actuated Cycle Length: 90.4
 Natural Cycle: 125
 Control Type: Actuated-Uncoordinated
 Maximum v/c Ratio: 0.93
 Intersection Signal Delay: 25.7
 Intersection LOS: C
 Intersection Capacity Utilization 70.2%
 ICU Level of Service C
 Analysis Period (min) 15

Splits and Phases: 26: Sycamore Canyon Bl. & Van Buren Bl.

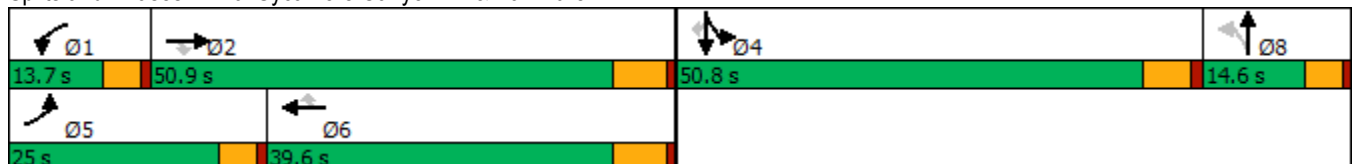

HCM 6th Signalized Intersection Summary
26: Sycamore Canyon Bl. & Van Buren Bl.

West Campus Upper Plateau (JN 14064)

09/19/2022



Movement	EBL	EBT	EBR	WBL	WBT	WBR	NBL	NBT	NBR	SBL	SBT	SBR
Lane Configurations												
Traffic Volume (veh/h)	687	1317	3	53	1519	222	4	1	4	77	6	420
Future Volume (veh/h)	687	1317	3	53	1519	222	4	1	4	77	6	420
Initial Q (Qb), veh	0	0	0	0	0	0	0	0	0	0	0	0
Ped-Bike Adj(A_pbT)	1.00		1.00	1.00		1.00	1.00		1.00	1.00		1.00
Parking Bus, Adj	1.00	1.00	1.00	1.00	1.00	1.00	1.00	1.00	1.00	1.00	1.00	1.00
Work Zone On Approach		No			No			No			No	
Adj Sat Flow, veh/h/ln	1870	1841	1900	1900	1841	1752	1900	1900	1900	1618	1900	1870
Adj Flow Rate, veh/h	747	1432	2	58	1651	216	4	1	2	84	7	0
Peak Hour Factor	0.92	0.92	0.92	0.92	0.92	0.92	0.92	0.92	0.92	0.92	0.92	0.92
Percent Heavy Veh, %	2	4	0	0	4	10	0	0	0	19	0	2
Cap, veh/h	829	3547	902	82	2317	543	33	10	20	326	207	
Arrive On Green	0.24	0.56	0.56	0.05	0.37	0.37	0.02	0.02	0.02	0.11	0.11	0.00
Sat Flow, veh/h	3456	6332	1610	1810	6332	1485	1810	565	1131	2990	1900	1585
Grp Volume(v), veh/h	747	1432	2	58	1651	216	4	0	3	84	7	0
Grp Sat Flow(s),veh/h/ln	1728	1583	1610	1810	1583	1485	1810	0	1696	1495	1900	1585
Q Serve(g_s), s	16.6	10.2	0.0	2.5	17.7	8.6	0.2	0.0	0.1	2.0	0.3	0.0
Cycle Q Clear(g_c), s	16.6	10.2	0.0	2.5	17.7	8.6	0.2	0.0	0.1	2.0	0.3	0.0
Prop In Lane	1.00		1.00	1.00		1.00	1.00		0.67	1.00		1.00
Lane Grp Cap(c), veh/h	829	3547	902	82	2317	543	33	0	31	326	207	
V/C Ratio(X)	0.90	0.40	0.00	0.70	0.71	0.40	0.12	0.00	0.10	0.26	0.03	
Avail Cap(c_a), veh/h	889	3568	907	208	2666	625	228	0	214	1696	1078	
HCM Platoon Ratio	1.00	1.00	1.00	1.00	1.00	1.00	1.00	1.00	1.00	1.00	1.00	1.00
Upstream Filter(I)	1.00	1.00	1.00	1.00	1.00	1.00	1.00	0.00	1.00	1.00	1.00	0.00
Uniform Delay (d), s/veh	29.2	9.9	7.7	37.3	21.6	18.7	38.3	0.0	38.3	32.4	31.6	0.0
Incr Delay (d2), s/veh	11.2	0.1	0.0	4.1	0.8	0.5	1.7	0.0	1.4	0.4	0.1	0.0
Initial Q Delay(d3),s/veh	0.0	0.0	0.0	0.0	0.0	0.0	0.0	0.0	0.0	0.0	0.0	0.0
%ile BackOfQ(50%),veh/ln	7.6	2.8	0.0	1.1	5.9	2.7	0.1	0.0	0.1	0.7	0.1	0.0
Unsig. Movement Delay, s/veh												
LnGrp Delay(d),s/veh	40.5	10.0	7.7	41.4	22.3	19.1	40.0	0.0	39.7	32.8	31.7	0.0
LnGrp LOS	D	A	A	D	C	B	D	A	D	C	C	
Approach Vol, veh/h		2181			1925			7			91	
Approach Delay, s/veh		20.4			22.6			39.9			32.7	
Approach LOS		C			C			D			C	
Timer - Assigned Phs	1	2		4	5	6		8				
Phs Duration (G+Y+Rc), s	8.2	50.6		14.5	23.6	35.2		6.0				
Change Period (Y+Rc), s	4.6	6.2		5.8	4.6	6.2		4.6				
Max Green Setting (Gmax), s	9.1	44.7		45.0	20.4	33.4		10.0				
Max Q Clear Time (g_c+I1), s	4.5	12.2		4.0	18.6	19.7		2.2				
Green Ext Time (p_c), s	0.0	12.1		0.3	0.4	9.3		0.0				

Intersection Summary

HCM 6th Ctrl Delay	21.7
HCM 6th LOS	C

Notes

Unsignalized Delay for [SBR] is excluded from calculations of the approach delay and intersection delay.

Timings
27: Innovation Dr. & Cactus Av.

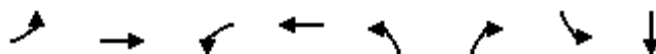

Lane Group	EBL	EBT	WBL	WBT	NBL	NBR	SBL	SBT
Lane Configurations	↖	↖↖↖	↖	↖↖↖	↖	↖	↖	↖
Traffic Volume (vph)	5	578	125	2086	8	23	5	0
Future Volume (vph)	5	578	125	2086	8	23	5	0
Turn Type	Prot	NA	Prot	NA	Perm	Perm	Perm	NA
Protected Phases	5	2	1	6				4
Permitted Phases					8	8	4	
Detector Phase	5	2	1	6	8	8	4	4
Switch Phase								
Minimum Initial (s)	5.0	10.0	5.0	10.0	10.0	10.0	10.0	10.0
Minimum Split (s)	9.2	26.8	9.2	26.8	31.1	31.1	31.1	31.1
Total Split (s)	12.0	57.0	31.0	76.0	32.0	32.0	32.0	32.0
Total Split (%)	10.0%	47.5%	25.8%	63.3%	26.7%	26.7%	26.7%	26.7%
Yellow Time (s)	3.2	4.8	3.2	4.8	4.1	4.1	4.1	4.1
All-Red Time (s)	1.0	1.0	1.0	1.0	1.0	1.0	1.0	1.0
Lost Time Adjust (s)	0.0	0.0	0.0	0.0	0.0	0.0	0.0	0.0
Total Lost Time (s)	4.2	5.8	4.2	5.8	5.1	5.1	5.1	5.1
Lead/Lag	Lead	Lag	Lead	Lag				
Lead-Lag Optimize?	Yes	Yes	Yes	Yes				
Recall Mode	None	None	None	None	None	None	None	None
Act Effct Green (s)	5.8	46.2	11.5	65.0	13.6	13.6	13.6	13.6
Actuated g/C Ratio	0.07	0.59	0.15	0.83	0.17	0.17	0.17	0.17
v/c Ratio	0.04	0.22	0.51	0.55	0.05	0.04	0.02	0.01
Control Delay	48.2	10.0	45.7	7.1	36.9	0.1	36.2	0.0
Queue Delay	0.0	0.0	0.0	0.0	0.0	0.0	0.0	0.0
Total Delay	48.2	10.0	45.7	7.1	36.9	0.1	36.2	0.0
LOS	D	A	D	A	D	A	D	A
Approach Delay		10.3		9.3				22.6
Approach LOS		B		A				C

Intersection Summary

Cycle Length: 120	
Actuated Cycle Length: 78.6	
Natural Cycle: 90	
Control Type: Actuated-Uncoordinated	
Maximum v/c Ratio: 0.55	
Intersection Signal Delay: 9.5	Intersection LOS: A
Intersection Capacity Utilization 66.6%	ICU Level of Service C
Analysis Period (min) 15	

Splits and Phases: 27: Innovation Dr. & Cactus Av.



HCM 6th Signalized Intersection Summary
27: Innovation Dr. & Cactus Av.

West Campus Upper Plateau (JN 14064)

09/19/2022



Movement	EBL	EBT	EBR	WBL	WBT	WBR	NBL	NBT	NBR	SBL	SBT	SBR
Lane Configurations	↖	↑↑↑		↖	↑↑↑		↖	↑	↗	↖	↗	
Traffic Volume (veh/h)	5	578	18	125	2086	53	8	0	23	5	0	3
Future Volume (veh/h)	5	578	18	125	2086	53	8	0	23	5	0	3
Initial Q (Qb), veh	0	0	0	0	0	0	0	0	0	0	0	0
Ped-Bike Adj(A_pbT)	1.00		1.00	1.00		1.00	1.00		1.00	1.00		1.00
Parking Bus, Adj	1.00	1.00	1.00	1.00	1.00	1.00	1.00	1.00	1.00	1.00	1.00	1.00
Work Zone On Approach		No			No			No			No	
Adj Sat Flow, veh/h/ln	1900	1752	1900	1811	1796	1870	1218	1900	1292	1559	1900	1900
Adj Flow Rate, veh/h	5	590	16	128	2129	54	8	0	10	5	0	2
Peak Hour Factor	0.98	0.98	0.98	0.98	0.98	0.98	0.98	0.98	0.98	0.98	0.98	0.98
Percent Heavy Veh, %	0	10	0	6	7	2	46	0	41	23	0	0
Cap, veh/h	12	3095	84	162	3610	91	147	103	60	161	0	88
Arrive On Green	0.01	0.65	0.65	0.09	0.73	0.73	0.05	0.00	0.05	0.05	0.00	0.05
Sat Flow, veh/h	1810	4787	129	1725	4919	124	922	1900	1095	1171	0	1610
Grp Volume(v), veh/h	5	392	214	128	1414	769	8	0	10	5	0	2
Grp Sat Flow(s),veh/h/ln	1810	1594	1729	1725	1635	1774	922	1900	1095	1171	0	1610
Q Serve(g_s), s	0.2	3.7	3.7	5.3	14.9	15.0	0.6	0.0	0.6	0.3	0.0	0.1
Cycle Q Clear(g_c), s	0.2	3.7	3.7	5.3	14.9	15.0	0.7	0.0	0.6	0.3	0.0	0.1
Prop In Lane	1.00		0.07	1.00		0.07	1.00		1.00	1.00		1.00
Lane Grp Cap(c), veh/h	12	2061	1117	162	2400	1302	147	103	60	161	0	88
V/C Ratio(X)	0.42	0.19	0.19	0.79	0.59	0.59	0.05	0.00	0.17	0.03	0.00	0.02
Avail Cap(c_a), veh/h	192	2216	1202	628	3116	1691	433	694	400	525	0	588
HCM Platoon Ratio	1.00	1.00	1.00	1.00	1.00	1.00	1.00	1.00	1.00	1.00	1.00	1.00
Upstream Filter(I)	1.00	1.00	1.00	1.00	1.00	1.00	1.00	0.00	1.00	1.00	0.00	1.00
Uniform Delay (d), s/veh	36.4	5.3	5.3	32.6	4.6	4.6	33.3	0.0	33.2	33.1	0.0	33.0
Incr Delay (d2), s/veh	8.4	0.1	0.1	3.2	0.3	0.6	0.2	0.0	1.3	0.1	0.0	0.1
Initial Q Delay(d3),s/veh	0.0	0.0	0.0	0.0	0.0	0.0	0.0	0.0	0.0	0.0	0.0	0.0
%ile BackOfQ(50%),veh/ln	0.1	0.8	0.9	2.2	2.4	2.8	0.1	0.0	0.2	0.1	0.0	0.0
Unsig. Movement Delay, s/veh												
LnGrp Delay(d),s/veh	44.9	5.3	5.4	35.8	4.9	5.2	33.5	0.0	34.5	33.1	0.0	33.1
LnGrp LOS	D	A	A	D	A	A	C	A	C	C	A	C
Approach Vol, veh/h		611			2311			18				7
Approach Delay, s/veh		5.7			6.7			34.1				33.1
Approach LOS		A			A			C				C
Timer - Assigned Phs	1	2		4	5	6		8				
Phs Duration (G+Y+Rc), s	11.1	53.4		9.1	4.7	59.9		9.1				
Change Period (Y+Rc), s	* 4.2	5.8		5.1	* 4.2	5.8		5.1				
Max Green Setting (Gmax), s	* 27	51.2		26.9	* 7.8	70.2		26.9				
Max Q Clear Time (g_c+I1), s	7.3	5.7		2.3	2.2	17.0		2.7				
Green Ext Time (p_c), s	0.1	5.8		0.0	0.0	37.1		0.0				

Intersection Summary

HCM 6th Ctrl Delay	6.7
HCM 6th LOS	A

Notes

* HCM 6th computational engine requires equal clearance times for the phases crossing the barrier.

Timings
28: I-215 SB Ramps & Alessandro Bl.

West Campus Upper Plateau (JN 14064)

09/19/2022

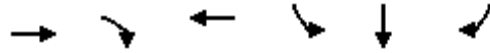

Lane Group	EBT	EBR	WBT	SBL	SBT	SBR
Lane Configurations	↑↑↑	↑	↑↑↑	↑	↔	↑
Traffic Volume (vph)	922	422	2767	197	0	409
Future Volume (vph)	922	422	2767	197	0	409
Turn Type	NA	Perm	NA	Split	NA	Perm
Protected Phases	2		6	4	4	
Permitted Phases		2				4
Detector Phase	2	2	6	4	4	4
Switch Phase						
Minimum Initial (s)	5.0	5.0	5.0	5.0	5.0	5.0
Minimum Split (s)	10.5	10.5	34.5	10.0	10.0	10.0
Total Split (s)	49.0	49.0	49.0	36.0	36.0	36.0
Total Split (%)	57.6%	57.6%	57.6%	42.4%	42.4%	42.4%
Yellow Time (s)	4.5	4.5	4.5	4.0	4.0	4.0
All-Red Time (s)	1.0	1.0	1.0	1.0	1.0	1.0
Lost Time Adjust (s)	0.0	0.0	0.0	0.0	0.0	0.0
Total Lost Time (s)	5.5	5.5	5.5	5.0	5.0	5.0
Lead/Lag						
Lead-Lag Optimize?						
Recall Mode	C-Min	C-Min	C-Min	None	None	None
Act Effct Green (s)	56.4	56.4	56.4	18.1	18.1	18.1
Actuated g/C Ratio	0.66	0.66	0.66	0.21	0.21	0.21
v/c Ratio	0.28	0.38	0.88	0.56	0.69	0.66
Control Delay	7.1	3.3	12.5	35.2	36.4	34.3
Queue Delay	0.0	0.0	0.0	0.0	0.0	0.0
Total Delay	7.1	3.3	12.5	35.2	36.4	34.3
LOS	A	A	B	D	D	C
Approach Delay	5.9		12.5		35.3	
Approach LOS	A		B		D	

Intersection Summary

Cycle Length: 85
 Actuated Cycle Length: 85
 Offset: 50 (59%), Referenced to phase 2:EBT and 6:WBT, Start of Yellow
 Natural Cycle: 60
 Control Type: Actuated-Coordinated
 Maximum v/c Ratio: 0.88
 Intersection Signal Delay: 13.5
 Intersection LOS: B
 Intersection Capacity Utilization 82.7%
 ICU Level of Service E
 Analysis Period (min) 15

Splits and Phases: 28: I-215 SB Ramps & Alessandro Bl.

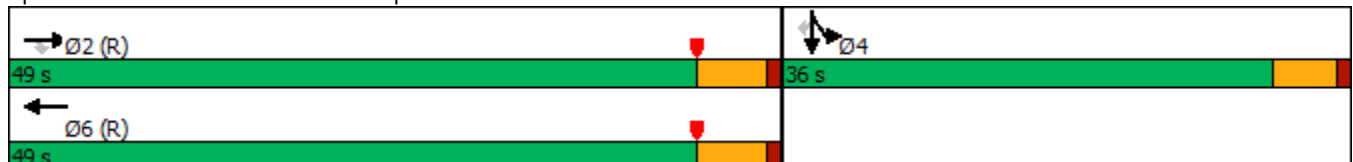

HCM 6th Signalized Intersection Summary
 28: I-215 SB Ramps & Alessandro Bl.

West Campus Upper Plateau (JN 14064)

09/19/2022



Movement	EBL	EBT	EBR	WBL	WBT	WBR	NBL	NBT	NBR	SBL	SBT	SBR
Lane Configurations		↑↑↑	↗		↑↑↑					↘	↔	↗
Traffic Volume (veh/h)	0	922	422	0	2767	164	0	0	0	197	0	409
Future Volume (veh/h)	0	922	422	0	2767	164	0	0	0	197	0	409
Initial Q (Qb), veh	0	0	0	0	0	0				0	0	0
Ped-Bike Adj(A_pbT)	1.00		1.00	1.00		1.00				1.00		1.00
Parking Bus, Adj	1.00	1.00	1.00	1.00	1.00	1.00				1.00	1.00	1.00
Work Zone On Approach		No			No						No	
Adj Sat Flow, veh/h/ln	0	1841	1841	0	1885	1826				1693	1900	1781
Adj Flow Rate, veh/h	0	931	426	0	2795	156				133	0	407
Peak Hour Factor	0.99	0.99	0.99	0.99	0.99	0.99				0.99	0.99	0.99
Percent Heavy Veh, %	0	4	4	0	1	5				14	0	8
Cap, veh/h	0	3529	1095	0	3507	192				281	0	526
Arrive On Green	0.00	0.70	0.70	0.00	0.47	0.47				0.17	0.00	0.17
Sat Flow, veh/h	0	5191	1559	0	5163	274				1612	0	3019
Grp Volume(v), veh/h	0	931	426	0	1905	1046				133	0	407
Grp Sat Flow(s),veh/h/ln	0	1675	1559	0	1716	1836				1612	0	1510
Q Serve(g_s), s	0.0	5.8	9.5	0.0	39.8	41.5				6.3	0.0	10.9
Cycle Q Clear(g_c), s	0.0	5.8	9.5	0.0	39.8	41.5				6.3	0.0	10.9
Prop In Lane	0.00		1.00	0.00		0.15				1.00		1.00
Lane Grp Cap(c), veh/h	0	3529	1095	0	2410	1289				281	0	526
V/C Ratio(X)	0.00	0.26	0.39	0.00	0.79	0.81				0.47	0.00	0.77
Avail Cap(c_a), veh/h	0	3529	1095	0	2410	1289				588	0	1101
HCM Platoon Ratio	1.00	1.00	1.00	1.00	0.67	0.67				1.00	1.00	1.00
Upstream Filter(I)	0.00	0.86	0.86	0.00	0.13	0.13				1.00	0.00	1.00
Uniform Delay (d), s/veh	0.0	4.6	5.2	0.0	17.2	17.7				31.6	0.0	33.5
Incr Delay (d2), s/veh	0.0	0.2	0.9	0.0	0.4	0.8				1.2	0.0	2.5
Initial Q Delay(d3),s/veh	0.0	0.0	0.0	0.0	0.0	0.0				0.0	0.0	0.0
%ile BackOfQ(50%),veh/ln	0.0	1.2	2.0	0.0	15.1	17.0				2.4	0.0	3.9
Unsig. Movement Delay, s/veh												
LnGrp Delay(d),s/veh	0.0	4.8	6.1	0.0	17.6	18.5				32.8	0.0	36.0
LnGrp LOS	A	A	A	A	B	B				C	A	D
Approach Vol, veh/h		1357			2951						540	
Approach Delay, s/veh		5.2			17.9						35.2	
Approach LOS		A			B						D	
Timer - Assigned Phs		2		4		6						
Phs Duration (G+Y+Rc), s		65.2		19.8		65.2						
Change Period (Y+Rc), s		5.5		5.0		5.5						
Max Green Setting (Gmax), s		43.5		31.0		43.5						
Max Q Clear Time (g_c+I1), s		11.5		12.9		43.5						
Green Ext Time (p_c), s		8.4		1.9		0.0						

Intersection Summary

HCM 6th Ctrl Delay	16.3
HCM 6th LOS	B

Notes

User approved volume balancing among the lanes for turning movement.

Timings
29: I-215 NB Ramps & Alessandro Bl.

West Campus Upper Plateau (JN 14064)

09/19/2022



Lane Group	EBL	EBT	WBT	WBR	NBL	NBT	NBR
Lane Configurations	↘	↑↑↑	↑↑↑	↗	↘	↕	↗
Traffic Volume (vph)	97	1023	1539	89	1392	0	182
Future Volume (vph)	97	1023	1539	89	1392	0	182
Turn Type	Prot	NA	NA	Perm	Split	NA	Perm
Protected Phases	5	2	6		8	8	
Permitted Phases				6			8
Detector Phase	5	2	6	6	8	8	8
Switch Phase							
Minimum Initial (s)	5.0	5.0	5.0	5.0	5.0	5.0	5.0
Minimum Split (s)	9.5	10.5	33.5	33.5	10.0	10.0	10.0
Total Split (s)	25.0	60.0	35.0	35.0	25.0	25.0	25.0
Total Split (%)	29.4%	70.6%	41.2%	41.2%	29.4%	29.4%	29.4%
Yellow Time (s)	3.5	4.5	4.5	4.5	4.0	4.0	4.0
All-Red Time (s)	1.0	1.0	1.0	1.0	1.0	1.0	1.0
Lost Time Adjust (s)	0.0	0.0	0.0	0.0	0.0	0.0	0.0
Total Lost Time (s)	4.5	5.5	5.5	5.5	5.0	5.0	5.0
Lead/Lag	Lead		Lag	Lag			
Lead-Lag Optimize?	Yes		Yes	Yes			
Recall Mode	None	C-Min	C-Min	C-Min	Max	Max	Max
Act Effct Green (s)	10.5	52.8	39.9	39.9	21.7	21.7	21.7
Actuated g/C Ratio	0.12	0.62	0.47	0.47	0.26	0.26	0.26
v/c Ratio	0.54	0.34	0.66	0.13	1.69	1.50	0.36
Control Delay	40.6	7.3	19.7	4.9	345.8	259.9	11.1
Queue Delay	0.0	0.0	0.0	0.0	0.0	0.0	0.0
Total Delay	40.6	7.3	19.7	4.9	345.8	259.9	11.1
LOS	D	A	B	A	F	F	B
Approach Delay		10.2	18.9			272.7	
Approach LOS		B	B			F	

Intersection Summary

Cycle Length: 85
 Actuated Cycle Length: 85
 Offset: 20 (24%), Referenced to phase 2:EBT and 6:WBT, Start of Yellow
 Natural Cycle: 90
 Control Type: Actuated-Coordinated
 Maximum v/c Ratio: 1.69
 Intersection Signal Delay: 109.1
 Intersection LOS: F
 Intersection Capacity Utilization 88.0%
 ICU Level of Service E
 Analysis Period (min) 15

Splits and Phases: 29: I-215 NB Ramps & Alessandro Bl.



HCM 6th Signalized Intersection Summary
 29: I-215 NB Ramps & Alessandro Bl.

West Campus Upper Plateau (JN 14064)

09/19/2022



Movement	EBL	EBT	EBR	WBL	WBT	WBR	NBL	NBT	NBR	SBL	SBT	SBR
Lane Configurations	↘	↑↑↑			↑↑↑	↗	↘	↕	↗			
Traffic Volume (veh/h)	97	1023	0	0	1539	89	1392	0	182	0	0	0
Future Volume (veh/h)	97	1023	0	0	1539	89	1392	0	182	0	0	0
Initial Q (Qb), veh	0	0	0	0	0	0	0	0	0			
Ped-Bike Adj(A_pbT)	1.00		1.00	1.00		1.00	1.00		1.00			
Parking Bus, Adj	1.00	1.00	1.00	1.00	1.00	1.00	1.00	1.00	1.00			
Work Zone On Approach		No			No			No				
Adj Sat Flow, veh/h/ln	1574	1841	0	0	1870	1707	1870	1900	1796			
Adj Flow Rate, veh/h	99	1044	0	0	1570	84	1453	0	72			
Peak Hour Factor	0.98	0.98	0.98	0.98	0.98	0.98	0.98	0.98	0.98			
Percent Heavy Veh, %	22	4	0	0	2	13	2	0	7			
Cap, veh/h	123	3222	0	0	2586	733	838	0	358			
Arrive On Green	0.03	0.21	0.00	0.00	0.51	0.51	0.24	0.00	0.24			
Sat Flow, veh/h	1499	5191	0	0	5274	1447	3563	0	1522			
Grp Volume(v), veh/h	99	1044	0	0	1570	84	1453	0	72			
Grp Sat Flow(s),veh/h/ln	1499	1675	0	0	1702	1447	1781	0	1522			
Q Serve(g_s), s	5.6	14.9	0.0	0.0	18.6	2.6	20.0	0.0	3.2			
Cycle Q Clear(g_c), s	5.6	14.9	0.0	0.0	18.6	2.6	20.0	0.0	3.2			
Prop In Lane	1.00		0.00	0.00		1.00	1.00		1.00			
Lane Grp Cap(c), veh/h	123	3222	0	0	2586	733	838	0	358			
V/C Ratio(X)	0.81	0.32	0.00	0.00	0.61	0.11	1.73	0.00	0.20			
Avail Cap(c_a), veh/h	362	3222	0	0	2586	733	838	0	358			
HCM Platoon Ratio	0.33	0.33	1.00	1.00	1.00	1.00	1.00	1.00	1.00			
Upstream Filter(I)	0.95	0.95	0.00	0.00	1.00	1.00	1.00	0.00	1.00			
Uniform Delay (d), s/veh	40.7	17.9	0.0	0.0	15.0	11.0	32.5	0.0	26.1			
Incr Delay (d2), s/veh	8.5	0.3	0.0	0.0	1.1	0.3	335.0	0.0	1.3			
Initial Q Delay(d3),s/veh	0.0	0.0	0.0	0.0	0.0	0.0	0.0	0.0	0.0			
%ile BackOfQ(50%),veh/ln	2.3	6.4	0.0	0.0	6.0	0.7	47.1	0.0	1.2			
Unsig. Movement Delay, s/veh												
LnGrp Delay(d),s/veh	49.2	18.2	0.0	0.0	16.0	11.3	367.5	0.0	27.3			
LnGrp LOS	D	B	A	A	B	B	F	A	C			
Approach Vol, veh/h		1143			1654			1525				
Approach Delay, s/veh		20.9			15.8			351.5				
Approach LOS		C			B			F				
Timer - Assigned Phs		2			5	6		8				
Phs Duration (G+Y+Rc), s		60.0			11.5	48.5		25.0				
Change Period (Y+Rc), s		5.5			4.5	5.5		5.0				
Max Green Setting (Gmax), s		54.5			20.5	29.5		20.0				
Max Q Clear Time (g_c+I1), s		16.9			7.6	20.6		22.0				
Green Ext Time (p_c), s		7.5			0.1	6.0		0.0				

Intersection Summary

HCM 6th Ctrl Delay	135.6
HCM 6th LOS	F

Notes

User approved volume balancing among the lanes for turning movement.

Timings
30: I-215 SB Ramps & Cactus Av.



Lane Group	EBT	EBR	WBL	WBT	NBR	SBR
Lane Configurations	↑↑	↑	↓	↑↑	↑	↓
Traffic Volume (vph)	533	73	665	1645	717	618
Future Volume (vph)	533	73	665	1645	717	618
Turn Type	NA	Perm	Prot	NA	Prot	Prot
Protected Phases	2		1	6	8	4
Permitted Phases		2				
Detector Phase	2	2	1	6	8	4
Switch Phase						
Minimum Initial (s)	5.0	5.0	5.0	5.0	5.0	5.0
Minimum Split (s)	11.0	11.0	9.5	23.0	9.5	9.5
Total Split (s)	23.0	23.0	54.0	77.0	28.0	28.0
Total Split (%)	21.9%	21.9%	51.4%	73.3%	26.7%	26.7%
Yellow Time (s)	5.0	5.0	3.5	5.0	3.5	3.5
All-Red Time (s)	1.0	1.0	1.0	1.0	1.0	1.0
Lost Time Adjust (s)	0.0	0.0	0.0	0.0	0.0	0.0
Total Lost Time (s)	6.0	6.0	4.5	6.0	4.5	4.5
Lead/Lag	Lag	Lag	Lead			
Lead-Lag Optimize?	Yes	Yes	Yes			
Recall Mode	Min	Min	None	Min	None	None
Act Effct Green (s)	17.0	17.0	47.5	69.0	23.5	23.5
Actuated g/C Ratio	0.16	0.16	0.46	0.67	0.23	0.23
v/c Ratio	1.07	0.26	0.97	0.78	0.82	1.82
Control Delay	101.4	11.2	54.0	14.7	10.7	402.9
Queue Delay	0.0	0.0	0.0	0.0	0.0	0.0
Total Delay	101.4	11.2	54.0	14.7	10.7	402.9
LOS	F	B	D	B	B	F
Approach Delay	90.5			26.0		
Approach LOS	F			C		

Intersection Summary

Cycle Length: 105
 Actuated Cycle Length: 103.1
 Natural Cycle: 120
 Control Type: Actuated-Uncoordinated
 Maximum v/c Ratio: 1.82
 Intersection Signal Delay: 87.4
 Intersection LOS: F
 Intersection Capacity Utilization 92.5%
 ICU Level of Service F
 Analysis Period (min) 15

Splits and Phases: 30: I-215 SB Ramps & Cactus Av.

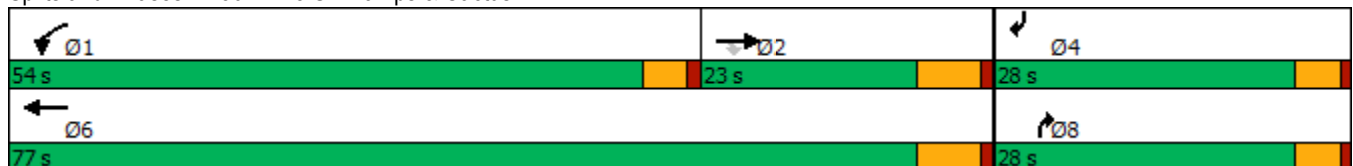

HCM 6th Signalized Intersection Summary
 30: I-215 SB Ramps & Cactus Av.

West Campus Upper Plateau (JN 14064)

09/19/2022



Movement	EBL	EBT	EBR	WBL	WBT	WBR	NBL	NBT	NBR	SBL	SBT	SBR
Lane Configurations		↑↑	↑	↑	↑↑				↑			↑
Traffic Volume (veh/h)	0	533	73	665	1645	0	0	0	717	0	0	618
Future Volume (veh/h)	0	533	73	665	1645	0	0	0	717	0	0	618
Initial Q (Qb), veh	0	0	0	0	0	0	0	0	0	0	0	0
Ped-Bike Adj(A_pbT)	1.00		1.00	1.00		1.00	1.00		1.00	1.00		1.00
Parking Bus, Adj	1.00	1.00	1.00	1.00	1.00	1.00	1.00	1.00	1.00	1.00	1.00	1.00
Work Zone On Approach		No			No			No			No	
Adj Sat Flow, veh/h/ln	0	1781	1781	1767	1856	0	0	0	1752	0	0	1633
Adj Flow Rate, veh/h	0	592	73	739	1828	0	0	0	0	0	0	586
Peak Hour Factor	0.90	0.90	0.90	0.90	0.90	0.90	0.90	0.90	0.90	0.90	0.90	0.90
Percent Heavy Veh, %	0	8	8	9	3	0	0	0	10	0	0	18
Cap, veh/h	0	855	381	814	2995	0	0	0	0	0	0	0
Arrive On Green	0.00	0.25	0.25	0.48	0.85	0.00	0.00	0.00	0.00	0.00	0.00	0.00
Sat Flow, veh/h	0	3474	1510	1682	3618	0		0			0	
Grp Volume(v), veh/h	0	592	73	739	1828	0		0.0			0.0	
Grp Sat Flow(s),veh/h/ln	0	1692	1510	1682	1763	0						
Q Serve(g_s), s	0.0	6.3	1.5	16.1	6.5	0.0						
Cycle Q Clear(g_c), s	0.0	6.3	1.5	16.1	6.5	0.0						
Prop In Lane	0.00		1.00	1.00		0.00						
Lane Grp Cap(c), veh/h	0	855	381	814	2995	0						
V/C Ratio(X)	0.00	0.69	0.19	0.91	0.61	0.00						
Avail Cap(c_a), veh/h	0	1444	644	2090	6282	0						
HCM Platoon Ratio	1.00	1.00	1.00	1.00	1.00	1.00						
Upstream Filter(I)	0.00	1.00	1.00	1.00	1.00	0.00						
Uniform Delay (d), s/veh	0.0	13.5	11.7	9.5	0.9	0.0						
Incr Delay (d2), s/veh	0.0	0.4	0.1	1.7	0.1	0.0						
Initial Q Delay(d3),s/veh	0.0	0.0	0.0	0.0	0.0	0.0						
%ile BackOfQ(50%),veh/ln	0.0	1.7	0.4	3.2	0.0	0.0						
Unsig. Movement Delay, s/veh												
LnGrp Delay(d),s/veh	0.0	13.9	11.8	11.1	1.0	0.0						
LnGrp LOS	A	B	B	B	A	A						
Approach Vol, veh/h		665			2567							
Approach Delay, s/veh		13.6			3.9							
Approach LOS		B			A							
Timer - Assigned Phs	1	2			6							
Phs Duration (G+Y+Rc), s	23.8	16.1			39.8							
Change Period (Y+Rc), s	4.5	6.0			6.0							
Max Green Setting (Gmax), s	49.5	17.0			71.0							
Max Q Clear Time (g_c+I1), s	18.1	8.3			8.5							
Green Ext Time (p_c), s	1.2	1.8			13.2							

Intersection Summary

HCM 6th Ctrl Delay			5.9			
HCM 6th LOS			A			

Notes

Unsignalized Delay for [NBR] is excluded from calculations of the approach delay and intersection delay.

Timings

31: I-215 NB Ramps/Old 215 Frontage Rd. & Cactus Av.

09/19/2022



Lane Group	EBL	EBT	WBT	NBL	NBT	NBR	SBL	SBT
Lane Configurations	↶	↶↷	↶↷	↶	↷	↷	↶	↷
Traffic Volume (vph)	32	1470	2792	464	335	13	56	0
Future Volume (vph)	32	1470	2792	464	335	13	56	0
Turn Type	Perm	NA	NA	Perm	NA	Perm	Perm	NA
Protected Phases		2	6		8			4
Permitted Phases	2			8		8	4	
Detector Phase	2	2	6	8	8	8	4	4
Switch Phase								
Minimum Initial (s)	5.0	5.0	5.0	5.0	5.0	5.0	5.0	5.0
Minimum Split (s)	11.0	11.0	44.0	10.5	10.5	10.5	10.5	10.5
Total Split (s)	88.0	88.0	88.0	32.0	32.0	32.0	32.0	32.0
Total Split (%)	73.3%	73.3%	73.3%	26.7%	26.7%	26.7%	26.7%	26.7%
Yellow Time (s)	5.0	5.0	5.0	4.5	4.5	4.5	4.5	4.5
All-Red Time (s)	1.0	1.0	1.0	1.0	1.0	1.0	1.0	1.0
Lost Time Adjust (s)	0.0	0.0	0.0	0.0	0.0	0.0	0.0	0.0
Total Lost Time (s)	6.0	6.0	6.0	5.5	5.5	5.5	5.5	5.5
Lead/Lag								
Lead-Lag Optimize?								
Recall Mode	Min	Min	Min	None	None	None	None	None
Act Effct Green (s)	82.0	82.0	82.0	26.5	26.5	26.5	26.5	26.5
Actuated g/C Ratio	0.68	0.68	0.68	0.22	0.22	0.22	0.22	0.22
v/c Ratio	0.62	0.76	1.32	2.25	1.01	0.04	1.00	0.55
Control Delay	62.5	15.2	168.7	598.9	96.2	5.4	165.4	42.4
Queue Delay	0.0	0.0	0.0	0.0	0.0	0.0	0.0	0.0
Total Delay	62.5	15.2	168.7	598.9	96.2	5.4	165.4	42.4
LOS	E	B	F	F	F	A	F	D
Approach Delay		16.1	168.7		382.3			75.2
Approach LOS		B	F		F			E

Intersection Summary

Cycle Length: 120
 Actuated Cycle Length: 120
 Natural Cycle: 110
 Control Type: Actuated-Uncoordinated
 Maximum v/c Ratio: 2.25
 Intersection Signal Delay: 150.7
 Intersection Capacity Utilization 131.7%
 Analysis Period (min) 15
 Intersection LOS: F
 ICU Level of Service H

Splits and Phases: 31: I-215 NB Ramps/Old 215 Frontage Rd. & Cactus Av.

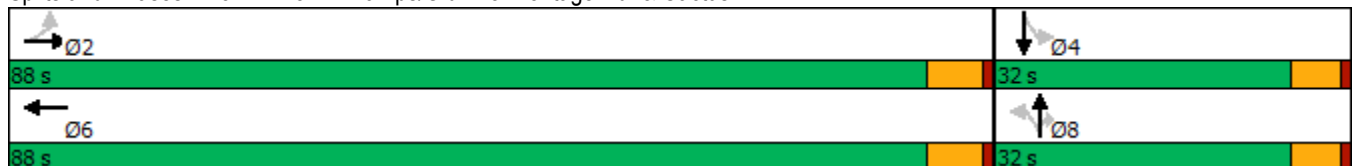

HCM 6th Signalized Intersection Summary

West Campus Upper Plateau (JN 14064)

31: I-215 NB Ramps/Old 215 Frontage Rd. & Cactus Av.

09/19/2022

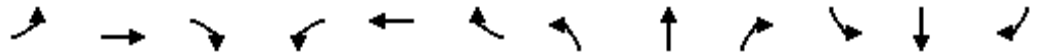

Movement	EBL	EBT	EBR	WBL	WBT	WBR	NBL	NBT	NBR	SBL	SBT	SBR
Lane Configurations	↗	↕			↕		↗	↕	↗	↗	↕	↕
Traffic Volume (veh/h)	32	1470	170	0	2792	158	464	335	13	56	0	155
Future Volume (veh/h)	32	1470	170	0	2792	158	464	335	13	56	0	155
Initial Q (Qb), veh	0	0	0	0	0	0	0	0	0	0	0	0
Ped-Bike Adj(A_pbT)	1.00		1.00	1.00		1.00	1.00		1.00	1.00		1.00
Parking Bus, Adj	1.00	1.00	1.00	1.00	1.00	1.00	1.00	1.00	1.00	1.00	1.00	1.00
Work Zone On Approach		No			No			No			No	
Adj Sat Flow, veh/h/ln	1678	1841	1515	0	1856	1841	1811	1722	1900	1841	1900	1485
Adj Flow Rate, veh/h	34	1564	176	0	2970	148	494	356	0	60	0	155
Peak Hour Factor	0.94	0.94	0.94	0.94	0.94	0.94	0.94	0.94	0.94	0.94	0.94	0.94
Percent Heavy Veh, %	15	4	26	0	3	4	6	12	0	4	0	28
Cap, veh/h	60	2168	241	0	2336	115	224	380		78	0	356
Arrive On Green	0.68	0.68	0.68	0.00	0.68	0.68	0.22	0.22	0.00	0.22	0.00	0.22
Sat Flow, veh/h	63	3173	353	0	3512	169	1193	1722	1610	1009	0	1610
Grp Volume(v), veh/h	34	854	886	0	1519	1599	494	356	0	60	0	155
Grp Sat Flow(s),veh/h/ln	63	1749	1777	0	1763	1825	1193	1722	1610	1009	0	1610
Q Serve(g_s), s	0.0	36.2	37.8	0.0	82.0	82.0	16.5	24.4	0.0	2.1	0.0	10.0
Cycle Q Clear(g_c), s	82.0	36.2	37.8	0.0	82.0	82.0	26.5	24.4	0.0	26.5	0.0	10.0
Prop In Lane	1.00		0.20	0.00		0.09	1.00		1.00	1.00		1.00
Lane Grp Cap(c), veh/h	60	1195	1214	0	1205	1247	224	380		78	0	356
V/C Ratio(X)	0.57	0.71	0.73	0.00	1.26	1.28	2.20	0.94		0.77	0.00	0.44
Avail Cap(c_a), veh/h	60	1195	1214	0	1205	1247	224	380		78	0	356
HCM Platoon Ratio	1.00	1.00	1.00	1.00	1.00	1.00	1.00	1.00	1.00	1.00	1.00	1.00
Upstream Filter(I)	1.00	1.00	1.00	0.00	1.00	1.00	1.00	1.00	0.00	1.00	0.00	1.00
Uniform Delay (d), s/veh	60.0	11.8	12.0	0.0	19.0	19.0	53.9	45.9	0.0	59.7	0.0	40.3
Incr Delay (d2), s/veh	7.7	1.8	2.0	0.0	124.3	133.2	554.9	30.0	0.0	33.6	0.0	0.3
Initial Q Delay(d3),s/veh	0.0	0.0	0.0	0.0	0.0	0.0	0.0	0.0	0.0	0.0	0.0	0.0
%ile BackOfQ(50%),veh/ln	1.1	12.2	13.0	0.0	68.2	73.7	41.3	13.2	0.0	2.5	0.0	3.8
Unsig. Movement Delay, s/veh												
LnGrp Delay(d),s/veh	67.7	13.5	14.0	0.0	143.3	152.2	608.8	75.9	0.0	93.3	0.0	40.6
LnGrp LOS	E	B	B	A	F	F	F	E		F	A	D
Approach Vol, veh/h		1774			3118			850				215
Approach Delay, s/veh		14.8			147.9			385.6				55.3
Approach LOS		B			F			F				E
Timer - Assigned Phs		2		4		6		8				
Phs Duration (G+Y+Rc), s		88.0		32.0		88.0		32.0				
Change Period (Y+Rc), s		6.0		5.5		6.0		5.5				
Max Green Setting (Gmax), s		82.0		26.5		82.0		26.5				
Max Q Clear Time (g_c+I1), s		84.0		28.5		84.0		28.5				
Green Ext Time (p_c), s		0.0		0.0		0.0		0.0				

Intersection Summary

HCM 6th Ctrl Delay	138.8
HCM 6th LOS	F

Notes

User approved volume balancing among the lanes for turning movement.
 Unsignalized Delay for [NBR] is excluded from calculations of the approach delay and intersection delay.

Timings
32: I-215 SB Ramps & Van Buren Bl.

West Campus Upper Plateau (JN 14064)

09/19/2022



Lane Group	EBT	EBR	WBL	WBT	SBT	SBR
Lane Configurations	↑↑	↑↑	↵	↑↑	↵	↑↑
Traffic Volume (vph)	582	777	3	1109	25	826
Future Volume (vph)	582	777	3	1109	25	826
Turn Type	NA	Perm	Prot	NA	NA	Perm
Protected Phases	6		5	2	8	
Permitted Phases		6				8
Detector Phase	6	6	5	2	8	8
Switch Phase						
Minimum Initial (s)	5.0	5.0	5.0	5.0	5.0	5.0
Minimum Split (s)	36.0	36.0	11.0	11.0	11.0	11.0
Total Split (s)	37.0	37.0	11.0	48.0	37.0	37.0
Total Split (%)	43.5%	43.5%	12.9%	56.5%	43.5%	43.5%
Yellow Time (s)	5.0	5.0	5.0	5.0	5.0	5.0
All-Red Time (s)	1.0	1.0	1.0	1.0	1.0	1.0
Lost Time Adjust (s)	0.0	0.0	0.0	0.0	0.0	0.0
Total Lost Time (s)	6.0	6.0	6.0	6.0	6.0	6.0
Lead/Lag	Lag	Lag	Lead			
Lead-Lag Optimize?	Yes	Yes	Yes			
Recall Mode	Min	Min	None	Min	Max	Max
Act Effct Green (s)	28.8	28.8	5.0	30.7	31.3	31.3
Actuated g/C Ratio	0.39	0.39	0.07	0.41	0.42	0.42
v/c Ratio	0.48	0.54	0.02	0.83	0.09	0.74
Control Delay	18.7	2.9	36.7	24.7	16.0	21.8
Queue Delay	0.0	0.0	0.0	0.0	0.0	0.0
Total Delay	18.7	2.9	36.7	24.7	16.0	21.8
LOS	B	A	D	C	B	C
Approach Delay	9.7			24.7	21.4	
Approach LOS	A			C	C	

Intersection Summary

Cycle Length: 85
 Actuated Cycle Length: 74.1
 Natural Cycle: 75
 Control Type: Actuated-Uncoordinated
 Maximum v/c Ratio: 0.83
 Intersection Signal Delay: 17.7
 Intersection LOS: B
 Intersection Capacity Utilization 69.6%
 ICU Level of Service C
 Analysis Period (min) 15

Splits and Phases: 32: I-215 SB Ramps & Van Buren Bl.

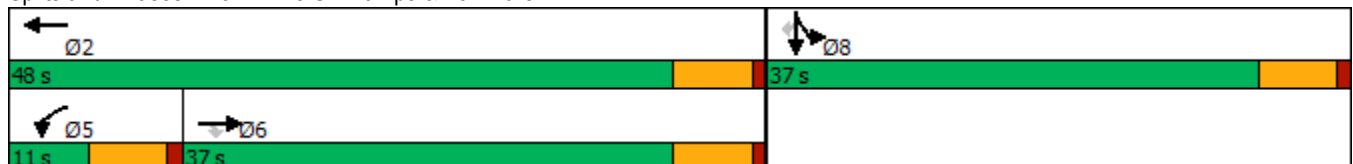

HCM 6th Signalized Intersection Summary
 32: I-215 SB Ramps & Van Buren Bl.

West Campus Upper Plateau (JN 14064)

09/19/2022



Movement	EBL	EBT	EBR	WBL	WBT	WBR	NBL	NBT	NBR	SBL	SBT	SBR
Lane Configurations		↑↑	↑↑	↑	↑↑						↑	↑↑
Traffic Volume (veh/h)	0	582	777	3	1109	0	0	0	0	25	25	826
Future Volume (veh/h)	0	582	777	3	1109	0	0	0	0	25	25	826
Initial Q (Qb), veh	0	0	0	0	0	0				0	0	0
Ped-Bike Adj(A_pbT)	1.00		1.00	1.00		1.00				1.00		1.00
Parking Bus, Adj	1.00	1.00	1.00	1.00	1.00	1.00				1.00	1.00	1.00
Work Zone On Approach		No			No						No	
Adj Sat Flow, veh/h/ln	0	1796	1781	1900	1841	0				1203	1559	1811
Adj Flow Rate, veh/h	0	626	741	3	1192	0				27	27	0
Peak Hour Factor	0.93	0.93	0.93	0.93	0.93	0.93				0.93	0.93	0.93
Percent Heavy Veh, %	0	7	8	0	4	0				47	23	6
Cap, veh/h	0	1103	859	113	1612	0				296	296	
Arrive On Green	0.00	0.32	0.32	0.06	0.46	0.00				0.39	0.39	0.00
Sat Flow, veh/h	0	3503	2657	1810	3589	0				761	761	2701
Grp Volume(v), veh/h	0	626	741	3	1192	0				54	0	0
Grp Sat Flow(s),veh/h/ln	0	1706	1329	1810	1749	0				1521	0	1351
Q Serve(g_s), s	0.0	12.1	20.9	0.1	22.2	0.0				1.8	0.0	0.0
Cycle Q Clear(g_c), s	0.0	12.1	20.9	0.1	22.2	0.0				1.8	0.0	0.0
Prop In Lane	0.00		1.00	1.00		0.00				0.50		1.00
Lane Grp Cap(c), veh/h	0	1103	859	113	1612	0				591	0	
V/C Ratio(X)	0.00	0.57	0.86	0.03	0.74	0.00				0.09	0.00	
Avail Cap(c_a), veh/h	0	1326	1032	113	1841	0				591	0	
HCM Platoon Ratio	1.00	1.00	1.00	1.00	1.00	1.00				1.00	1.00	1.00
Upstream Filter(I)	0.00	1.00	1.00	1.00	1.00	0.00				1.00	0.00	0.00
Uniform Delay (d), s/veh	0.0	22.4	25.3	35.1	17.6	0.0				15.5	0.0	0.0
Incr Delay (d2), s/veh	0.0	0.2	5.8	0.0	1.1	0.0				0.3	0.0	0.0
Initial Q Delay(d3),s/veh	0.0	0.0	0.0	0.0	0.0	0.0				0.0	0.0	0.0
%ile BackOfQ(50%),veh/ln	0.0	4.2	6.3	0.1	7.6	0.0				0.6	0.0	0.0
Unsig. Movement Delay, s/veh												
LnGrp Delay(d),s/veh	0.0	22.6	31.1	35.1	18.7	0.0				15.8	0.0	0.0
LnGrp LOS	A	C	C	D	B	A				B	A	
Approach Vol, veh/h		1367			1195							54
Approach Delay, s/veh		27.2			18.7							15.8
Approach LOS		C			B							B
Timer - Assigned Phs		2			5	6		8				
Phs Duration (G+Y+Rc), s		42.8			11.0	31.8		37.0				
Change Period (Y+Rc), s		6.0			6.0	6.0		6.0				
Max Green Setting (Gmax), s		42.0			5.0	31.0		31.0				
Max Q Clear Time (g_c+I1), s		24.2			2.1	22.9		3.8				
Green Ext Time (p_c), s		4.9			0.0	2.9		0.1				

Intersection Summary

HCM 6th Ctrl Delay	23.1
HCM 6th LOS	C

Notes

Unsignalized Delay for [SBR] is excluded from calculations of the approach delay and intersection delay.

Timings
33: I-215 NB On/Off Ramp & Van Buren Bl.



Lane Group	EBT	EBR	WBT	NBL	NBR
Lane Configurations	↑↑	↑↑	↑↑	↑↑	↑
Traffic Volume (vph)	37	641	30	1109	5
Future Volume (vph)	37	641	30	1109	5
Turn Type	NA	pm+ov	NA	Prot	Perm
Protected Phases	6	4	2	4	
Permitted Phases		6			4
Detector Phase	6	4	2	4	4
Switch Phase					
Minimum Initial (s)	5.0	5.0	5.0	5.0	5.0
Minimum Split (s)	11.0	42.0	11.0	42.0	42.0
Total Split (s)	15.0	55.0	15.0	55.0	55.0
Total Split (%)	21.4%	78.6%	21.4%	78.6%	78.6%
Yellow Time (s)	5.0	5.0	5.0	5.0	5.0
All-Red Time (s)	1.0	1.0	1.0	1.0	1.0
Lost Time Adjust (s)	0.0	0.0	0.0	0.0	0.0
Total Lost Time (s)	6.0	6.0	6.0	6.0	6.0
Lead/Lag					
Lead-Lag Optimize?					
Recall Mode	None	Min	None	Min	Min
Act Effct Green (s)	5.6	40.7	5.6	35.0	35.0
Actuated g/C Ratio	0.14	1.00	0.14	0.86	0.86
v/c Ratio	0.11	0.26	0.10	0.42	0.01
Control Delay	20.2	0.2	20.4	3.2	2.2
Queue Delay	0.0	0.0	0.0	0.0	0.0
Total Delay	20.2	0.2	20.4	3.2	2.2
LOS	C	A	C	A	A
Approach Delay	1.3		20.4	3.2	
Approach LOS	A		C	A	

Intersection Summary

Cycle Length: 70
 Actuated Cycle Length: 40.7
 Natural Cycle: 55
 Control Type: Actuated-Uncoordinated
 Maximum v/c Ratio: 0.42
 Intersection Signal Delay: 2.8
 Intersection Capacity Utilization 45.8%
 Analysis Period (min) 15

Intersection LOS: A
 ICU Level of Service A

Splits and Phases: 33: I-215 NB On/Off Ramp & Van Buren Bl.



HCM 6th Signalized Intersection Summary
 33: I-215 NB On/Off Ramp & Van Buren Bl.

West Campus Upper Plateau (JN 14064)

09/19/2022



Movement	EBT	EBR	WBL	WBT	NBL	NBR
Lane Configurations	↑↑	↑↑		↑↑	↑↑	↑
Traffic Volume (veh/h)	37	641	0	30	1109	5
Future Volume (veh/h)	37	641	0	30	1109	5
Initial Q (Qb), veh	0	0	0	0	0	0
Ped-Bike Adj(A_pbT)		1.00	1.00		1.00	1.00
Parking Bus, Adj	1.00	1.00	1.00	1.00	1.00	1.00
Work Zone On Approach	No			No	No	
Adj Sat Flow, veh/h/ln	1292	1826	0	1159	1826	1278
Adj Flow Rate, veh/h	40	682	0	33	1205	5
Peak Hour Factor	0.92	0.92	0.92	0.92	0.92	0.92
Percent Heavy Veh, %	41	5	0	50	5	42
Cap, veh/h	486	1752	0	436	1502	482
Arrive On Green	0.20	0.20	0.00	0.20	0.45	0.45
Sat Flow, veh/h	2520	2723	0	2318	3374	1083
Grp Volume(v), veh/h	40	682	0	33	1205	5
Grp Sat Flow(s),veh/h/ln	1228	1362	0	1101	1687	1083
Q Serve(g_s), s	0.4	4.0	0.0	0.4	10.4	0.1
Cycle Q Clear(g_c), s	0.4	4.0	0.0	0.4	10.4	0.1
Prop In Lane		1.00	0.00		1.00	1.00
Lane Grp Cap(c), veh/h	486	1752	0	436	1502	482
V/C Ratio(X)	0.08	0.39	0.00	0.08	0.80	0.01
Avail Cap(c_a), veh/h	657	1941	0	589	4915	1577
HCM Platoon Ratio	1.00	1.00	1.00	1.00	1.00	1.00
Upstream Filter(I)	1.00	1.00	0.00	1.00	1.00	1.00
Uniform Delay (d), s/veh	11.0	2.9	0.0	11.0	8.1	5.2
Incr Delay (d2), s/veh	0.0	0.1	0.0	0.0	0.4	0.0
Initial Q Delay(d3),s/veh	0.0	0.0	0.0	0.0	0.0	0.0
%ile BackOfQ(50%),veh/ln	0.1	1.7	0.0	0.1	1.6	0.0
Unsig. Movement Delay, s/veh						
LnGrp Delay(d),s/veh	11.0	2.9	0.0	11.0	8.4	5.2
LnGrp LOS	B	A	A	B	A	A
Approach Vol, veh/h	722			33	1210	
Approach Delay, s/veh	3.4			11.0	8.4	
Approach LOS	A			B	A	
Timer - Assigned Phs		2		4		6
Phs Duration (G+Y+Rc), s		12.7		21.0		12.7
Change Period (Y+Rc), s		6.0		6.0		6.0
Max Green Setting (Gmax), s		9.0		49.0		9.0
Max Q Clear Time (g_c+I1), s		2.4		12.4		6.0
Green Ext Time (p_c), s		0.0		2.6		0.7
Intersection Summary						
HCM 6th Ctrl Delay			6.6			
HCM 6th LOS			A			

Timings

West Campus Upper Plateau (JN 14064)

34: Old 215 Frontage Rd. & Alessandro Bl.

09/19/2022

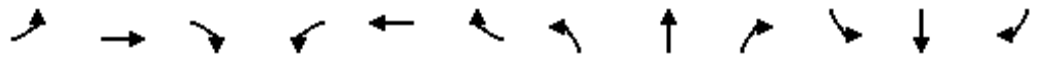

Lane Group	EBL	EBT	EBR	WBL	WBT	WBR	NBL	NBT	NBR	SBL	SBT	SBR
Lane Configurations	↖↗	↑↑↑	↖	↖	↑↑	↖	↖↗	↑↑	↖	↖	↑↑	↖
Traffic Volume (vph)	372	1059	48	11	1487	126	59	305	22	26	74	254
Future Volume (vph)	372	1059	48	11	1487	126	59	305	22	26	74	254
Turn Type	Prot	NA	Perm	Prot	NA	Perm	Prot	NA	Perm	Prot	NA	Perm
Protected Phases	5	2		1	6		3	8		7	4	
Permitted Phases			2			6			8			4
Detector Phase	5	2	2	1	6	6	3	8	8	7	4	4
Switch Phase												
Minimum Initial (s)	5.0	10.0	10.0	5.0	10.0	10.0	5.0	10.0	10.0	5.0	10.0	10.0
Minimum Split (s)	8.7	43.5	43.5	8.7	15.8	15.8	8.7	16.2	16.2	8.7	40.2	40.2
Total Split (s)	16.5	62.4	62.4	8.7	54.6	54.6	8.7	39.0	39.0	9.9	40.2	40.2
Total Split (%)	13.8%	52.0%	52.0%	7.3%	45.5%	45.5%	7.3%	32.5%	32.5%	8.3%	33.5%	33.5%
Yellow Time (s)	3.2	5.5	5.5	3.2	4.8	4.8	3.2	5.2	5.2	3.2	5.2	5.2
All-Red Time (s)	0.5	1.0	1.0	0.5	1.0	1.0	0.5	1.0	1.0	0.5	1.0	1.0
Lost Time Adjust (s)	0.0	0.0	0.0	0.0	0.0	0.0	0.0	0.0	0.0	0.0	0.0	0.0
Total Lost Time (s)	3.7	6.5	6.5	3.7	5.8	5.8	3.7	6.2	6.2	3.7	6.2	6.2
Lead/Lag	Lead	Lag	Lag	Lead	Lag	Lag	Lead	Lag	Lag	Lead	Lag	Lag
Lead-Lag Optimize?	Yes	Yes	Yes	Yes	Yes	Yes	Yes	Yes	Yes	Yes	Yes	Yes
Recall Mode	None	None	None	None	None	None	None	Max	Max	None	Max	Max
Act Effct Green (s)	12.8	63.0	63.0	5.0	48.9	48.9	5.0	35.0	35.0	5.8	34.0	34.0
Actuated g/C Ratio	0.11	0.53	0.53	0.04	0.41	0.41	0.04	0.30	0.30	0.05	0.29	0.29
v/c Ratio	1.01	0.40	0.07	0.23	1.04	0.19	0.46	0.31	0.04	0.32	0.08	0.45
Control Delay	102.6	17.7	0.3	67.8	68.8	4.4	67.9	34.1	0.1	65.3	31.8	14.1
Queue Delay	0.0	0.0	0.0	0.0	0.0	0.0	0.0	0.0	0.0	0.0	0.0	0.0
Total Delay	102.6	17.7	0.3	67.8	68.8	4.4	67.9	34.1	0.1	65.3	31.8	14.1
LOS	F	B	A	E	E	A	E	C	A	E	C	B
Approach Delay		38.5			63.7			37.3			21.6	
Approach LOS		D			E			D			C	

Intersection Summary

Cycle Length: 120
 Actuated Cycle Length: 118.3
 Natural Cycle: 125
 Control Type: Actuated-Uncoordinated
 Maximum v/c Ratio: 1.04
 Intersection Signal Delay: 47.5
 Intersection LOS: D
 Intersection Capacity Utilization 81.0%
 ICU Level of Service D
 Analysis Period (min) 15

Splits and Phases: 34: Old 215 Frontage Rd. & Alessandro Bl.



HCM 6th Signalized Intersection Summary
34: Old 215 Frontage Rd. & Alessandro Bl.

West Campus Upper Plateau (JN 14064)

09/19/2022



Movement	EBL	EBT	EBR	WBL	WBT	WBR	NBL	NBT	NBR	SBL	SBT	SBR
Lane Configurations	↖↗	↑↑↑	↖	↖	↑↑	↖	↖↗	↑↑	↖	↖	↑↑	↖
Traffic Volume (veh/h)	372	1059	48	11	1487	126	59	305	22	26	74	254
Future Volume (veh/h)	372	1059	48	11	1487	126	59	305	22	26	74	254
Initial Q (Qb), veh	0	0	0	0	0	0	0	0	0	0	0	0
Ped-Bike Adj(A_pbT)	1.00		1.00	1.00		1.00	1.00		1.00	1.00		1.00
Parking Bus, Adj	1.00	1.00	1.00	1.00	1.00	1.00	1.00	1.00	1.00	1.00	1.00	1.00
Work Zone On Approach		No			No			No			No	
Adj Sat Flow, veh/h/ln	1885	1856	1441	981	1870	1796	1693	1811	1752	1841	1811	1870
Adj Flow Rate, veh/h	380	1081	39	11	1517	0	60	311	14	27	76	0
Peak Hour Factor	0.98	0.98	0.98	0.98	0.98	0.98	0.98	0.98	0.98	0.98	0.98	0.98
Percent Heavy Veh, %	1	3	31	62	2	7	14	6	10	4	6	2
Cap, veh/h	371	2535	611	12	1445		113	1014	437	43	975	
Arrive On Green	0.11	0.50	0.50	0.01	0.41	0.00	0.04	0.29	0.29	0.02	0.28	0.00
Sat Flow, veh/h	3483	5066	1221	934	3554	1522	3127	3441	1485	1753	3441	1585
Grp Volume(v), veh/h	380	1081	39	11	1517	0	60	311	14	27	76	0
Grp Sat Flow(s),veh/h/ln	1742	1689	1221	934	1777	1522	1564	1721	1485	1753	1721	1585
Q Serve(g_s), s	12.8	16.3	2.0	1.4	48.8	0.0	2.3	8.4	0.8	1.8	1.9	0.0
Cycle Q Clear(g_c), s	12.8	16.3	2.0	1.4	48.8	0.0	2.3	8.4	0.8	1.8	1.9	0.0
Prop In Lane	1.00		1.00	1.00		1.00	1.00		1.00	1.00		1.00
Lane Grp Cap(c), veh/h	371	2535	611	12	1445		113	1014	437	43	975	
V/C Ratio(X)	1.02	0.43	0.06	0.92	1.05		0.53	0.31	0.03	0.62	0.08	
Avail Cap(c_a), veh/h	371	2535	611	39	1445		130	1014	437	91	975	
HCM Platoon Ratio	1.00	1.00	1.00	1.00	1.00	1.00	1.00	1.00	1.00	1.00	1.00	1.00
Upstream Filter(I)	1.00	1.00	1.00	1.00	1.00	0.00	1.00	1.00	1.00	1.00	1.00	0.00
Uniform Delay (d), s/veh	53.6	19.0	15.5	59.2	35.6	0.0	56.9	32.8	30.1	58.0	31.5	0.0
Incr Delay (d2), s/veh	52.7	0.1	0.0	55.1	38.0	0.0	1.5	0.8	0.1	5.3	0.2	0.0
Initial Q Delay(d3),s/veh	0.0	0.0	0.0	0.0	0.0	0.0	0.0	0.0	0.0	0.0	0.0	0.0
%ile BackOfQ(50%),veh/ln	8.1	5.8	0.5	0.5	27.4	0.0	0.9	3.5	0.3	0.9	0.8	0.0
Unsig. Movement Delay, s/veh												
LnGrp Delay(d),s/veh	106.3	19.2	15.5	114.3	73.6	0.0	58.3	33.6	30.3	63.3	31.7	0.0
LnGrp LOS	F	B	B	F	F		E	C	C	E	C	
Approach Vol, veh/h		1500			1528			385			103	
Approach Delay, s/veh		41.1			73.9			37.3			40.0	
Approach LOS		D			E			D			D	
Timer - Assigned Phs	1	2	3	4	5	6	7	8				
Phs Duration (G+Y+Rc), s	5.2	66.6	8.0	40.2	16.5	55.3	6.7	41.6				
Change Period (Y+Rc), s	3.7	6.5	3.7	6.2	3.7	* 6.5	3.7	6.2				
Max Green Setting (Gmax), s	5.0	55.9	5.0	34.0	12.8	* 49	6.2	32.8				
Max Q Clear Time (g_c+I1), s	3.4	18.3	4.3	3.9	14.8	50.8	3.8	10.4				
Green Ext Time (p_c), s	0.0	8.0	0.0	0.3	0.0	0.0	0.0	1.7				

Intersection Summary

HCM 6th Ctrl Delay	54.9
HCM 6th LOS	D

Notes

* HCM 6th computational engine requires equal clearance times for the phases crossing the barrier.
Unsignalized Delay for [WBR, SBR] is excluded from calculations of the approach delay and intersection delay.

Timings
35: Day St. & Alessandro Bl.

West Campus Upper Plateau (JN 14064)

09/19/2022



Lane Group	EBL	EBT	EBR	WBL	WBT	WBR	NBL	NBT	NBR	SBL	SBT
Lane Configurations	↖	↗↗↗	↖	↖	↗↗	↖	↖	↗	↖	↖	↗
Traffic Volume (vph)	167	741	11	11	1339	142	12	178	19	89	44
Future Volume (vph)	167	741	11	11	1339	142	12	178	19	89	44
Turn Type	Prot	NA	Perm	Prot	NA	Perm	Perm	NA	Perm	Perm	NA
Protected Phases	5	2		1	6			8			4
Permitted Phases			2			6	8		8	4	
Detector Phase	5	2	2	1	6	6	8	8	8	4	4
Switch Phase											
Minimum Initial (s)	5.0	10.0	10.0	5.0	10.0	10.0	10.0	10.0	10.0	10.0	10.0
Minimum Split (s)	9.1	30.8	30.8	9.1	30.8	30.8	42.4	42.4	42.4	41.6	41.6
Total Split (s)	21.0	68.5	68.5	9.1	56.6	56.6	42.4	42.4	42.4	42.4	42.4
Total Split (%)	17.5%	57.1%	57.1%	7.6%	47.2%	47.2%	35.3%	35.3%	35.3%	35.3%	35.3%
Yellow Time (s)	3.6	4.8	4.8	3.6	4.8	4.8	4.4	4.4	4.4	3.6	3.6
All-Red Time (s)	0.5	1.0	1.0	0.5	1.0	1.0	1.0	1.0	1.0	1.0	1.0
Lost Time Adjust (s)	0.0	0.0	0.0	0.0	0.0	0.0	0.0	0.0	0.0	0.0	0.0
Total Lost Time (s)	4.1	5.8	5.8	4.1	5.8	5.8	5.4	5.4	5.4	4.6	4.6
Lead/Lag	Lead	Lag	Lag	Lead	Lag	Lag					
Lead-Lag Optimize?	Yes	Yes	Yes	Yes	Yes	Yes					
Recall Mode	None	None	None	None	None	None	None	None	None	None	None
Act Effct Green (s)	13.8	63.4	63.4	5.2	46.8	46.8	17.6	17.6	17.6	18.4	18.4
Actuated g/C Ratio	0.15	0.67	0.67	0.06	0.50	0.50	0.19	0.19	0.19	0.20	0.20
v/c Ratio	0.70	0.23	0.02	0.13	0.82	0.18	0.11	0.54	0.06	0.54	0.37
Control Delay	56.5	7.7	0.1	53.9	26.5	7.6	34.6	41.4	0.3	46.8	16.3
Queue Delay	0.0	0.0	0.0	0.0	0.0	0.0	0.0	0.0	0.0	0.0	0.0
Total Delay	56.5	7.7	0.1	53.9	26.5	7.6	34.6	41.4	0.3	46.8	16.3
LOS	E	A	A	D	C	A	C	D	A	D	B
Approach Delay		16.5			24.9			37.3			28.3
Approach LOS		B			C			D			C

Intersection Summary

Cycle Length: 120
 Actuated Cycle Length: 94
 Natural Cycle: 105
 Control Type: Actuated-Uncoordinated
 Maximum v/c Ratio: 0.82
 Intersection Signal Delay: 23.3
 Intersection LOS: C
 Intersection Capacity Utilization 81.3%
 ICU Level of Service D
 Analysis Period (min) 15

Splits and Phases: 35: Day St. & Alessandro Bl.



HCM 6th Signalized Intersection Summary
35: Day St. & Alessandro Bl.

West Campus Upper Plateau (JN 14064)

09/19/2022

Movement	EBL	EBT	EBR	WBL	WBT	WBR	NBL	NBT	NBR	SBL	SBT	SBR
Lane Configurations												
Traffic Volume (veh/h)	167	741	11	11	1339	142	12	178	19	89	44	95
Future Volume (veh/h)	167	741	11	11	1339	142	12	178	19	89	44	95
Initial Q (Qb), veh	0	0	0	0	0	0	0	0	0	0	0	0
Ped-Bike Adj(A_pbT)	1.00		0.98	1.00		1.00	1.00		1.00	1.00		1.00
Parking Bus, Adj	1.00	1.00	1.00	1.00	1.00	1.00	1.00	1.00	1.00	1.00	1.00	1.00
Work Zone On Approach		No			No			No			No	
Adj Sat Flow, veh/h/ln	1856	1856	952	1737	1870	1870	922	1885	1722	1856	1900	1870
Adj Flow Rate, veh/h	180	797	11	12	1440	118	13	191	8	96	47	75
Peak Hour Factor	0.93	0.93	0.93	0.93	0.93	0.93	0.93	0.93	0.93	0.93	0.93	0.93
Percent Heavy Veh, %	3	3	64	11	2	2	66	1	12	3	0	2
Cap, veh/h	217	3036	473	24	1746	779	176	390	301	222	136	217
Arrive On Green	0.12	0.60	0.60	0.01	0.49	0.49	0.21	0.21	0.21	0.21	0.21	0.21
Sat Flow, veh/h	1767	5066	790	1654	3554	1585	626	1885	1457	1173	659	1052
Grp Volume(v), veh/h	180	797	11	12	1440	118	13	191	8	96	0	122
Grp Sat Flow(s),veh/h/ln	1767	1689	790	1654	1777	1585	626	1885	1457	1173	0	1711
Q Serve(g_s), s	8.5	6.4	0.5	0.6	29.5	3.5	1.5	7.6	0.4	6.7	0.0	5.2
Cycle Q Clear(g_c), s	8.5	6.4	0.5	0.6	29.5	3.5	6.7	7.6	0.4	14.3	0.0	5.2
Prop In Lane	1.00		1.00	1.00		1.00	1.00		1.00	1.00		0.61
Lane Grp Cap(c), veh/h	217	3036	473	24	1746	779	176	390	301	222	0	353
V/C Ratio(X)	0.83	0.26	0.02	0.50	0.82	0.15	0.07	0.49	0.03	0.43	0.00	0.35
Avail Cap(c_a), veh/h	351	3728	581	97	2119	945	318	819	633	500	0	759
HCM Platoon Ratio	1.00	1.00	1.00	1.00	1.00	1.00	1.00	1.00	1.00	1.00	1.00	1.00
Upstream Filter(I)	1.00	1.00	1.00	1.00	1.00	1.00	1.00	1.00	1.00	1.00	0.00	1.00
Uniform Delay (d), s/veh	36.5	8.1	6.9	41.7	18.5	11.9	31.8	29.8	27.0	36.2	0.0	28.9
Incr Delay (d2), s/veh	4.1	0.0	0.0	5.9	2.3	0.1	0.2	1.0	0.0	1.3	0.0	0.6
Initial Q Delay(d3),s/veh	0.0	0.0	0.0	0.0	0.0	0.0	0.0	0.0	0.0	0.0	0.0	0.0
%ile BackOfQ(50%),veh/ln	3.7	1.9	0.1	0.3	10.8	1.1	0.2	3.4	0.1	2.0	0.0	2.2
Unsig. Movement Delay, s/veh												
LnGrp Delay(d),s/veh	40.6	8.2	7.0	47.5	20.9	12.0	31.9	30.8	27.0	37.5	0.0	29.5
LnGrp LOS	D	A	A	D	C	B	C	C	C	D	A	C
Approach Vol, veh/h		988			1570			212				218
Approach Delay, s/veh		14.1			20.4			30.7				33.0
Approach LOS		B			C			C				C
Timer - Assigned Phs	1	2		4	5	6		8				
Phs Duration (G+Y+Rc), s	5.3	56.9		23.0	14.5	47.6		23.0				
Change Period (Y+Rc), s	4.1	5.8		* 5.4	4.1	5.8		5.4				
Max Green Setting (Gmax), s	5.0	62.7		* 38	16.9	50.8		37.0				
Max Q Clear Time (g_c+I1), s	2.6	8.4		16.3	10.5	31.5		9.6				
Green Ext Time (p_c), s	0.0	6.0		1.0	0.1	10.3		1.1				

Intersection Summary

HCM 6th Ctrl Delay	20.0
HCM 6th LOS	B

Notes

* HCM 6th computational engine requires equal clearance times for the phases crossing the barrier.

Timings
36: Elsworth St. & Cactus Av.

West Campus Upper Plateau (JN 14064)

09/19/2022



Lane Group	EBL	EBT	EBR	WBL	WBT	WBR	NBL	NBT	SBL	SBT	SBR
Lane Configurations	↘	↑↑↑	↗	↘	↑↑↑	↗	↘	↕	↘	↗	↗
Traffic Volume (vph)	213	1578	330	79	1959	138	26	12	94	66	206
Future Volume (vph)	213	1578	330	79	1959	138	26	12	94	66	206
Turn Type	Prot	NA	Perm	Prot	NA	Perm	Split	NA	Split	NA	pm+ov
Protected Phases	5	2		1	6		8	8	4	4	5
Permitted Phases			2			6					4
Detector Phase	5	2	2	1	6	6	8	8	4	4	5
Switch Phase											
Minimum Initial (s)	5.0	10.0	10.0	5.0	10.0	10.0	10.0	10.0	10.0	10.0	5.0
Minimum Split (s)	9.6	36.2	36.2	9.6	36.2	36.2	35.4	35.4	35.4	35.4	9.6
Total Split (s)	15.0	48.6	48.6	10.6	44.2	44.2	35.4	35.4	35.4	35.4	15.0
Total Split (%)	11.5%	37.4%	37.4%	8.2%	34.0%	34.0%	27.2%	27.2%	27.2%	27.2%	11.5%
Yellow Time (s)	3.6	5.2	5.2	3.6	5.2	5.2	4.4	4.4	4.4	4.4	3.6
All-Red Time (s)	1.0	1.0	1.0	1.0	1.0	1.0	1.0	1.0	1.0	1.0	1.0
Lost Time Adjust (s)	0.0	0.0	0.0	0.0	0.0	0.0	0.0	0.0	0.0	0.0	0.0
Total Lost Time (s)	4.6	6.2	6.2	4.6	6.2	6.2	5.4	5.4	5.4	5.4	4.6
Lead/Lag	Lead	Lag	Lag	Lead	Lag	Lag					Lead
Lead-Lag Optimize?	Yes	Yes	Yes	Yes	Yes	Yes					Yes
Recall Mode	None	None	None	None	None	None	Max	Max	Max	Max	None
Act Effct Green (s)	10.4	42.4	42.4	6.0	38.0	38.0	30.0	30.0	30.0	30.0	41.2
Actuated g/C Ratio	0.08	0.33	0.33	0.05	0.29	0.29	0.23	0.23	0.23	0.23	0.32
v/c Ratio	1.58	1.02	0.45	0.98	1.37	0.27	0.07	0.09	0.21	0.20	0.33
Control Delay	332.3	70.6	5.3	153.6	207.7	12.5	40.0	23.5	42.3	42.0	3.5
Queue Delay	0.0	0.0	0.0	0.0	0.0	0.0	0.0	0.0	0.0	0.0	0.0
Total Delay	332.3	70.6	5.3	153.6	207.7	12.5	40.0	23.5	42.3	42.0	3.5
LOS	F	E	A	F	F	B	D	C	D	D	A
Approach Delay		86.6			193.3			30.4		20.4	
Approach LOS		F			F			C		C	

Intersection Summary

Cycle Length: 130
 Actuated Cycle Length: 130
 Natural Cycle: 130
 Control Type: Actuated-Uncoordinated
 Maximum v/c Ratio: 1.58
 Intersection Signal Delay: 130.1
 Intersection LOS: F
 Intersection Capacity Utilization 74.2%
 ICU Level of Service D
 Analysis Period (min) 15



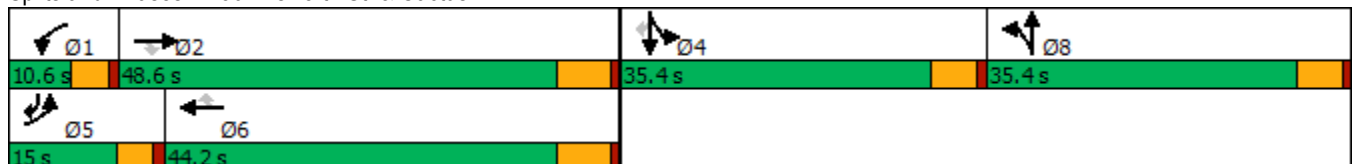

























Splits and Phases: 36: Elsworth St. & Cactus Av.



HCM 6th Signalized Intersection Summary
36: Elsworth St. & Cactus Av.

West Campus Upper Plateau (JN 14064)

09/19/2022

												
Movement	EBL	EBT	EBR	WBL	WBT	WBR	NBL	NBT	NBR	SBL	SBT	SBR
Lane Configurations		  			  			 			 	
Traffic Volume (veh/h)	213	1578	330	79	1959	138	26	12	18	94	66	206
Future Volume (veh/h)	213	1578	330	79	1959	138	26	12	18	94	66	206
Initial Q (Qb), veh	0	0	0	0	0	0	0	0	0	0	0	0
Ped-Bike Adj(A_pbT)	1.00		1.00	1.00		0.98	1.00		1.00	1.00		1.00
Parking Bus, Adj	1.00	1.00	1.00	1.00	1.00	1.00	1.00	1.00	1.00	1.00	1.00	1.00
Work Zone On Approach		No			No			No			No	
Adj Sat Flow, veh/h/ln	1826	1796	1885	1900	1841	1856	1633	1900	1900	1826	1900	1841
Adj Flow Rate, veh/h	217	1610	0	81	1999	93	24	16	10	82	87	143
Peak Hour Factor	0.98	0.98	0.98	0.98	0.98	0.98	0.98	0.98	0.98	0.98	0.98	0.98
Percent Heavy Veh, %	5	7	1	0	4	3	18	0	0	5	0	4
Cap, veh/h	139	1599		84	1469	450	359	252	158	401	438	485
Arrive On Green	0.08	0.33	0.00	0.05	0.29	0.29	0.23	0.23	0.23	0.23	0.23	0.23
Sat Flow, veh/h	1739	4904	1598	1810	5025	1539	1555	1094	683	1739	1900	1560
Grp Volume(v), veh/h	217	1610	0	81	1999	93	24	0	26	82	87	143
Grp Sat Flow(s),veh/h/ln	1739	1635	1598	1810	1675	1539	1555	0	1777	1739	1900	1560
Q Serve(g_s), s	10.4	42.4	0.0	5.8	38.0	5.9	1.6	0.0	1.5	4.9	4.8	9.0
Cycle Q Clear(g_c), s	10.4	42.4	0.0	5.8	38.0	5.9	1.6	0.0	1.5	4.9	4.8	9.0
Prop In Lane	1.00		1.00	1.00		1.00	1.00		0.38	1.00		1.00
Lane Grp Cap(c), veh/h	139	1599		84	1469	450	359	0	410	401	438	485
V/C Ratio(X)	1.56	1.01		0.97	1.36	0.21	0.07	0.00	0.06	0.20	0.20	0.29
Avail Cap(c_a), veh/h	139	1599		84	1469	450	359	0	410	401	438	485
HCM Platoon Ratio	1.00	1.00	1.00	1.00	1.00	1.00	1.00	1.00	1.00	1.00	1.00	1.00
Upstream Filter(I)	1.00	1.00	0.00	1.00	1.00	1.00	1.00	0.00	1.00	1.00	1.00	1.00
Uniform Delay (d), s/veh	59.8	43.8	0.0	61.9	46.0	34.6	39.1	0.0	39.0	40.4	40.3	34.0
Incr Delay (d2), s/veh	283.9	24.1	0.0	87.7	166.9	0.2	0.4	0.0	0.3	1.1	1.0	1.5
Initial Q Delay(d3),s/veh	0.0	0.0	0.0	0.0	0.0	0.0	0.0	0.0	0.0	0.0	0.0	0.0
%ile BackOfQ(50%),veh/ln	15.4	19.8	0.0	4.6	37.8	2.2	0.6	0.0	0.7	2.2	2.3	3.6
Unsig. Movement Delay, s/veh												
LnGrp Delay(d),s/veh	343.7	67.9	0.0	149.6	212.9	34.9	39.4	0.0	39.3	41.5	41.3	35.5
LnGrp LOS	F	F		F	F	C	D	A	D	D	D	D
Approach Vol, veh/h		1827			2173			50			312	
Approach Delay, s/veh		100.7			202.9			39.4			38.7	
Approach LOS		F			F			D			D	
Timer - Assigned Phs	1	2		4	5	6		8				
Phs Duration (G+Y+Rc), s	10.6	48.6		35.4	15.0	44.2		35.4				
Change Period (Y+Rc), s	4.6	6.2		5.4	4.6	6.2		5.4				
Max Green Setting (Gmax), s	6.0	42.4		30.0	10.4	38.0		30.0				
Max Q Clear Time (g_c+1), s	7.8	44.4		11.0	12.4	40.0		3.6				
Green Ext Time (p_c), s	0.0	0.0		1.0	0.0	0.0		0.1				

Intersection Summary

HCM 6th Ctrl Delay	146.5
HCM 6th LOS	F

Notes

- User approved pedestrian interval to be less than phase max green.
- User approved volume balancing among the lanes for turning movement.
- Unsignalized Delay for [EBR] is excluded from calculations of the approach delay and intersection delay.

Timings
37: Cactus Av. & Frederick St.

West Campus Upper Plateau (JN 14064)

09/19/2022

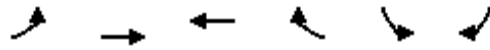

Lane Group	EBL	EBT	WBT	WBR	SBL	SBR
Lane Configurations	↖	↑↑↑	↑↑↑	↗	↖↗	↗
Traffic Volume (vph)	222	1385	2195	165	172	130
Future Volume (vph)	222	1385	2195	165	172	130
Turn Type	Prot	NA	NA	pm+ov	Prot	pm+ov
Protected Phases	5	2	6	4	4	5
Permitted Phases				6		4
Detector Phase	5	2	6	4	4	5
Switch Phase						
Minimum Initial (s)	5.0	10.0	10.0	10.0	10.0	5.0
Minimum Split (s)	9.2	28.2	29.2	36.4	36.4	9.2
Total Split (s)	23.0	83.6	60.6	36.4	36.4	23.0
Total Split (%)	19.2%	69.7%	50.5%	30.3%	30.3%	19.2%
Yellow Time (s)	3.2	5.2	5.2	4.4	4.4	3.2
All-Red Time (s)	1.0	1.0	1.0	1.0	1.0	1.0
Lost Time Adjust (s)	0.0	0.0	0.0	0.0	0.0	0.0
Total Lost Time (s)	4.2	6.2	6.2	5.4	5.4	4.2
Lead/Lag	Lead		Lag			Lead
Lead-Lag Optimize?	Yes		Yes			Yes
Recall Mode	None	None	None	Max	Max	None
Act Effct Green (s)	18.1	76.7	54.4	86.2	31.0	54.5
Actuated g/C Ratio	0.15	0.64	0.46	0.72	0.26	0.46
v/c Ratio	0.92	0.47	1.04	0.15	0.21	0.20
Control Delay	88.6	11.5	61.8	1.2	35.5	20.1
Queue Delay	0.0	0.0	0.0	0.0	0.0	0.0
Total Delay	88.6	11.5	61.8	1.2	35.5	20.1
LOS	F	B	E	A	D	C
Approach Delay		22.2	57.6		28.9	
Approach LOS		C	E		C	

Intersection Summary

Cycle Length: 120
 Actuated Cycle Length: 119.3
 Natural Cycle: 120
 Control Type: Actuated-Uncoordinated
 Maximum v/c Ratio: 1.04
 Intersection Signal Delay: 42.2
 Intersection LOS: D
 Intersection Capacity Utilization 76.2%
 ICU Level of Service D
 Analysis Period (min) 15

Splits and Phases: 37: Cactus Av. & Frederick St.



HCM 6th Signalized Intersection Summary
37: Cactus Av. & Frederick St.

West Campus Upper Plateau (JN 14064)

09/19/2022



Movement	EBL	EBT	WBT	WBR	SBL	SBR
Lane Configurations	↗	↑↑↑	↑↑↑	↖	↗↖	↖
Traffic Volume (veh/h)	222	1385	2195	165	172	130
Future Volume (veh/h)	222	1385	2195	165	172	130
Initial Q (Qb), veh	0	0	0	0	0	0
Ped-Bike Adj(A_pbT)	1.00			0.98	1.00	1.00
Parking Bus, Adj	1.00	1.00	1.00	1.00	1.00	1.00
Work Zone On Approach		No	No		No	
Adj Sat Flow, veh/h/ln	1826	1811	1841	1870	1856	1826
Adj Flow Rate, veh/h	239	1489	2360	123	185	99
Peak Hour Factor	0.93	0.93	0.93	0.93	0.93	0.93
Percent Heavy Veh, %	5	6	4	2	3	5
Cap, veh/h	264	3179	2291	1118	891	637
Arrive On Green	0.15	0.64	0.46	0.46	0.26	0.26
Sat Flow, veh/h	1739	5107	5191	1550	3428	1547
Grp Volume(v), veh/h	239	1489	2360	123	185	99
Grp Sat Flow(s),veh/h/ln	1739	1648	1675	1550	1714	1547
Q Serve(g_s), s	16.1	18.4	54.4	2.9	5.0	4.8
Cycle Q Clear(g_c), s	16.1	18.4	54.4	2.9	5.0	4.8
Prop In Lane	1.00			1.00	1.00	1.00
Lane Grp Cap(c), veh/h	264	3179	2291	1118	891	637
V/C Ratio(X)	0.90	0.47	1.03	0.11	0.21	0.16
Avail Cap(c_a), veh/h	274	3207	2291	1118	891	637
HCM Platoon Ratio	1.00	1.00	1.00	1.00	1.00	1.00
Upstream Filter(I)	1.00	1.00	1.00	1.00	1.00	1.00
Uniform Delay (d), s/veh	49.7	10.9	32.5	5.2	34.6	22.1
Incr Delay (d2), s/veh	29.3	0.1	27.1	0.0	0.5	0.5
Initial Q Delay(d3),s/veh	0.0	0.0	0.0	0.0	0.0	0.0
%ile BackOfQ(50%),veh/ln	8.9	5.7	25.7	1.9	2.1	0.1
Unsig. Movement Delay, s/veh						
LnGrp Delay(d),s/veh	79.0	11.0	59.6	5.3	35.1	22.6
LnGrp LOS	E	B	F	A	D	C
Approach Vol, veh/h		1728	2483		284	
Approach Delay, s/veh		20.4	56.9		30.7	
Approach LOS		C	E		C	
Timer - Assigned Phs		2		4	5	6
Phs Duration (G+Y+Rc), s		82.9		36.4	22.3	60.6
Change Period (Y+Rc), s		6.2		5.4	* 4.2	6.2
Max Green Setting (Gmax), s		77.4		31.0	* 19	54.4
Max Q Clear Time (g_c+I1), s		20.4		7.0	18.1	56.4
Green Ext Time (p_c), s		14.1		0.9	0.0	0.0

Intersection Summary

HCM 6th Ctrl Delay	41.2
HCM 6th LOS	D

Notes

* HCM 6th computational engine requires equal clearance times for the phases crossing the barrier.

Timings
38: Riverside Dr./Graham St. & Cactus Av.

West Campus Upper Plateau (JN 14064)

09/19/2022

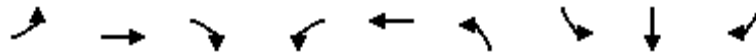

Lane Group	EBL	EBT	EBR	WBL	WBT	NBL	SBL	SBT	SBR	Ø2
Lane Configurations	↘	↑↑↑	↗	↘	↑↑↑	↘	↘	↑↑	↗	
Traffic Volume (vph)	71	1340	184	11	2218	11	96	52	132	
Future Volume (vph)	71	1340	184	11	2218	11	96	52	132	
Turn Type	Prot	NA	Perm	Prot	NA	Prot	Prot	NA	Perm	
Protected Phases	7	4		3	8	5	1	6		2
Permitted Phases			4						6	
Detector Phase	7	4	4	3	8	5	1	6	6	
Switch Phase										
Minimum Initial (s)	5.0	10.0	10.0	5.0	10.0	5.0	5.0	10.0	10.0	10.0
Minimum Split (s)	9.6	39.2	39.2	9.6	39.2	10.4	9.6	40.6	40.6	35.0
Total Split (s)	10.8	59.0	59.0	9.6	57.8	10.4	10.0	41.0	41.0	41.4
Total Split (%)	9.0%	49.2%	49.2%	8.0%	48.2%	8.7%	8.3%	34.2%	34.2%	35%
Yellow Time (s)	3.2	3.5	3.5	3.2	3.5	3.2	3.2	3.5	3.5	3.5
All-Red Time (s)	1.0	1.0	1.0	1.0	1.0	1.0	1.0	1.0	1.0	1.0
Lost Time Adjust (s)	0.0	0.0	0.0	0.0	0.0	0.0	0.0	0.0	0.0	
Total Lost Time (s)	4.2	4.5	4.5	4.2	4.5	4.2	4.2	4.5	4.5	
Lead/Lag	Lead	Lag	Lag	Lead	Lag	Lead	Lead	Lag	Lag	Lag
Lead-Lag Optimize?	Yes	Yes	Yes	Yes	Yes	Yes	Yes	Yes	Yes	Yes
Recall Mode	None	Min	Min	None	Min	None	None	None	None	None
Act Effct Green (s)	6.7	64.0	64.0	5.3	54.4	5.4	9.8	14.1	14.1	
Actuated g/C Ratio	0.07	0.71	0.71	0.06	0.60	0.06	0.11	0.16	0.16	
v/c Ratio	0.61	0.42	0.17	0.12	0.83	0.08	0.53	0.10	0.40	
Control Delay	65.3	9.2	2.4	48.5	19.6	46.7	52.6	32.0	9.1	
Queue Delay	0.0	0.0	0.0	0.0	0.0	0.0	0.0	0.0	0.0	
Total Delay	65.3	9.2	2.4	48.5	19.6	46.7	52.6	32.0	9.1	
LOS	E	A	A	D	B	D	D	C	A	
Approach Delay		10.9			19.8			28.3		
Approach LOS		B			B			C		

Intersection Summary

Cycle Length: 120
 Actuated Cycle Length: 90.4
 Natural Cycle: 130
 Control Type: Actuated-Uncoordinated
 Maximum v/c Ratio: 0.83
 Intersection Signal Delay: 17.0
 Intersection LOS: B
 Intersection Capacity Utilization 72.3%
 ICU Level of Service C
 Analysis Period (min) 15

Splits and Phases: 38: Riverside Dr./Graham St. & Cactus Av.

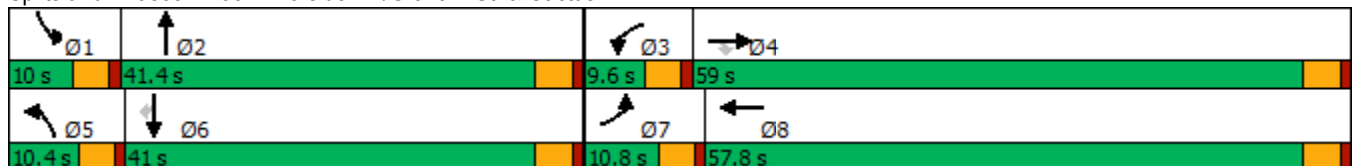

HCM 6th Signalized Intersection Summary
38: Riverside Dr./Graham St. & Cactus Av.

West Campus Upper Plateau (JN 14064)

09/19/2022



Movement	EBL	EBT	EBR	WBL	WBT	WBR	NBL	NBT	NBR	SBL	SBT	SBR
Lane Configurations	↘	↑↑↑	↗	↘	↑↑↑		↘↗	↑↗		↘	↑↑	↗
Traffic Volume (veh/h)	71	1340	184	11	2218	102	11	0	0	96	52	132
Future Volume (veh/h)	71	1340	184	11	2218	102	11	0	0	96	52	132
Initial Q (Qb), veh	0	0	0	0	0	0	0	0	0	0	0	0
Ped-Bike Adj(A_pbT)	1.00		1.00	1.00		1.00	1.00		1.00	1.00		1.00
Parking Bus, Adj	1.00	1.00	1.00	1.00	1.00	1.00	1.00	1.00	1.00	1.00	1.00	1.00
Work Zone On Approach		No			No			No			No	
Adj Sat Flow, veh/h/ln	1781	1796	1796	1900	1841	1870	1263	1900	1900	1870	1870	1796
Adj Flow Rate, veh/h	76	1426	149	12	2360	82	12	0	0	102	55	55
Peak Hour Factor	0.94	0.94	0.94	0.94	0.94	0.94	0.94	0.94	0.94	0.94	0.94	0.94
Percent Heavy Veh, %	8	7	7	0	4	2	43	0	0	2	2	7
Cap, veh/h	96	3119	968	26	2963	102	34	235	0	127	432	185
Arrive On Green	0.06	0.64	0.64	0.01	0.59	0.59	0.01	0.00	0.00	0.07	0.12	0.12
Sat Flow, veh/h	1697	4904	1522	1810	4987	172	2333	3705	0	1781	3554	1522
Grp Volume(v), veh/h	76	1426	149	12	1581	861	12	0	0	102	55	55
Grp Sat Flow(s),veh/h/ln	1697	1635	1522	1810	1675	1810	1167	1805	0	1781	1777	1522
Q Serve(g_s), s	3.6	12.2	3.2	0.5	29.6	30.0	0.4	0.0	0.0	4.6	1.1	2.7
Cycle Q Clear(g_c), s	3.6	12.2	3.2	0.5	29.6	30.0	0.4	0.0	0.0	4.6	1.1	2.7
Prop In Lane	1.00		1.00	1.00		0.10	1.00		0.00	1.00		1.00
Lane Grp Cap(c), veh/h	96	3119	968	26	1990	1075	34	235	0	127	432	185
V/C Ratio(X)	0.79	0.46	0.15	0.45	0.79	0.80	0.35	0.00	0.00	0.81	0.13	0.30
Avail Cap(c_a), veh/h	137	3275	1017	120	2188	1182	177	1632	0	127	1589	681
HCM Platoon Ratio	1.00	1.00	1.00	1.00	1.00	1.00	1.00	1.00	1.00	1.00	1.00	1.00
Upstream Filter(I)	1.00	1.00	1.00	1.00	1.00	1.00	1.00	0.00	0.00	1.00	1.00	1.00
Uniform Delay (d), s/veh	38.0	7.6	6.0	39.9	12.7	12.8	39.8	0.0	0.0	37.4	32.0	32.7
Incr Delay (d2), s/veh	11.4	0.1	0.1	4.5	1.9	3.7	2.3	0.0	0.0	28.6	0.1	0.9
Initial Q Delay(d3),s/veh	0.0	0.0	0.0	0.0	0.0	0.0	0.0	0.0	0.0	0.0	0.0	0.0
%ile BackOfQ(50%),veh/ln	1.7	3.0	0.8	0.3	8.7	10.0	0.1	0.0	0.0	2.9	0.5	1.0
Unsig. Movement Delay, s/veh												
LnGrp Delay(d),s/veh	49.5	7.7	6.1	44.4	14.7	16.5	42.1	0.0	0.0	65.9	32.1	33.6
LnGrp LOS	D	A	A	D	B	B	D	A	A	E	C	C
Approach Vol, veh/h		1651			2454			12			212	
Approach Delay, s/veh		9.5			15.5			42.1			48.8	
Approach LOS		A			B			D			D	
Timer - Assigned Phs	1	2	3	4	5	6	7	8				
Phs Duration (G+Y+Rc), s	10.0	9.8	5.4	56.4	5.4	14.4	8.8	53.0				
Change Period (Y+Rc), s	* 4.2	4.5	* 4.2	4.5	* 4.2	4.5	* 4.2	4.5				
Max Green Setting (Gmax), s	* 5.8	36.9	* 5.4	54.5	* 6.2	36.5	* 6.6	53.3				
Max Q Clear Time (g_c+I1), s	6.6	0.0	2.5	14.2	2.4	4.7	5.6	32.0				
Green Ext Time (p_c), s	0.0	0.0	0.0	13.2	0.0	0.4	0.0	16.4				

Intersection Summary

HCM 6th Ctrl Delay	14.9
HCM 6th LOS	B

Notes

* HCM 6th computational engine requires equal clearance times for the phases crossing the barrier.

Timings
1: Washington St & Van Buren Bl.



Lane Group	EBL	EBT	WBL	WBT	WBR	NBL	NBT	NBR	SBL	SBT
Lane Configurations	↘	↗	↘	↗	↗	↗	↗	↗	↗	↗
Traffic Volume (vph)	153	1485	233	1205	476	113	276	122	571	397
Future Volume (vph)	153	1485	233	1205	476	113	276	122	571	397
Turn Type	Prot	NA	Prot	NA	Perm	Prot	NA	Perm	Prot	NA
Protected Phases	5	2	1	6		3	8		7	4
Permitted Phases					6			8		
Detector Phase	5	2	1	6	6	3	8	8	7	4
Switch Phase										
Minimum Initial (s)	5.0	10.0	5.0	10.0	10.0	5.0	10.0	10.0	5.0	10.0
Minimum Split (s)	9.2	34.2	9.2	33.2	33.2	9.2	38.4	38.4	9.2	30.8
Total Split (s)	14.2	49.6	14.0	49.4	49.4	11.5	38.4	38.4	18.0	44.9
Total Split (%)	11.8%	41.3%	11.7%	41.2%	41.2%	9.6%	32.0%	32.0%	15.0%	37.4%
Yellow Time (s)	3.2	5.2	3.2	5.2	5.2	3.2	4.4	4.4	3.2	4.8
All-Red Time (s)	1.0	1.0	1.0	1.0	1.0	1.0	1.0	1.0	1.0	1.0
Lost Time Adjust (s)	0.0	0.0	0.0	0.0	0.0	0.0	0.0	0.0	0.0	0.0
Total Lost Time (s)	4.2	6.2	4.2	6.2	6.2	4.2	5.4	5.4	4.2	5.8
Lead/Lag	Lead	Lag	Lead	Lag	Lag	Lead	Lag	Lag	Lead	Lag
Lead-Lag Optimize?	Yes	Yes	Yes	Yes	Yes	Yes	Yes	Yes	Yes	Yes
Recall Mode	None	None	None	None	None	None	None	None	None	None
Act Effct Green (s)	10.0	43.6	9.8	43.4	43.4	6.8	16.3	16.3	13.9	22.9
Actuated g/C Ratio	0.10	0.42	0.09	0.42	0.42	0.07	0.16	0.16	0.13	0.22
v/c Ratio	0.89	1.09	1.37	0.82	0.60	0.50	0.51	0.34	1.25	0.65
Control Delay	92.5	81.4	237.9	33.5	15.2	56.2	42.6	6.4	166.0	38.2
Queue Delay	0.0	0.0	0.0	0.0	0.0	0.0	0.0	0.0	0.0	0.0
Total Delay	92.5	81.4	237.9	33.5	15.2	56.2	42.6	6.4	166.0	38.2
LOS	F	F	F	C	B	E	D	A	F	D
Approach Delay		82.4		53.8			37.0			106.2
Approach LOS		F		D			D			F

Intersection Summary

Cycle Length: 120
 Actuated Cycle Length: 103.7
 Natural Cycle: 115
 Control Type: Actuated-Uncoordinated
 Maximum v/c Ratio: 1.37
 Intersection Signal Delay: 72.4
 Intersection LOS: E
 Intersection Capacity Utilization 98.7%
 ICU Level of Service F
 Analysis Period (min) 15



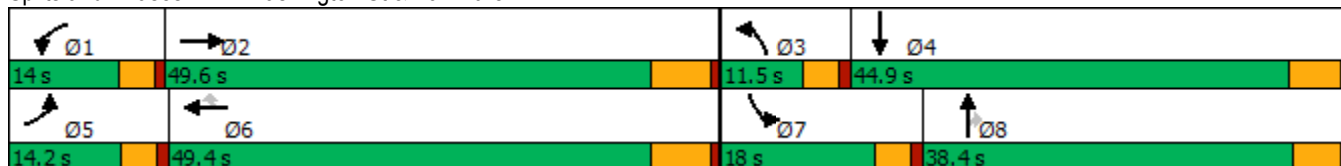



















Splits and Phases: 1: Washington St & Van Buren Bl.



HCM 6th Signalized Intersection Summary
1: Washington St & Van Buren Bl.

West Campus Upper Plateau (JN 14064)

09/19/2022

												
Movement	EBL	EBT	EBR	WBL	WBT	WBR	NBL	NBT	NBR	SBL	SBT	SBR
Lane Configurations												
Traffic Volume (veh/h)	153	1485	91	233	1205	476	113	276	122	571	397	105
Future Volume (veh/h)	153	1485	91	233	1205	476	113	276	122	571	397	105
Initial Q (Qb), veh	0	0	0	0	0	0	0	0	0	0	0	0
Ped-Bike Adj(A_pbT)	1.00		1.00	1.00		1.00	1.00		0.98	1.00		0.98
Parking Bus, Adj	1.00	1.00	1.00	1.00	1.00	1.00	1.00	1.00	1.00	1.00	1.00	1.00
Work Zone On Approach		No			No			No			No	
Adj Sat Flow, veh/h/ln	1900	1856	1856	1900	1870	1900	1885	1856	1870	1885	1885	1900
Adj Flow Rate, veh/h	155	1500	73	235	1217	388	114	279	84	577	401	60
Peak Hour Factor	0.99	0.99	0.99	0.99	0.99	0.99	0.99	0.99	0.99	0.99	0.99	0.99
Percent Heavy Veh, %	0	3	3	0	2	0	1	3	2	1	1	0
Cap, veh/h	181	1482	72	177	1532	693	175	450	199	480	672	100
Arrive On Green	0.10	0.43	0.43	0.10	0.43	0.43	0.05	0.13	0.13	0.14	0.22	0.22
Sat Flow, veh/h	1810	3422	166	1810	3554	1607	3483	3526	1554	3483	3120	463
Grp Volume(v), veh/h	155	770	803	235	1217	388	114	279	84	577	229	232
Grp Sat Flow(s),veh/h/ln	1810	1763	1826	1810	1777	1607	1742	1763	1554	1742	1791	1792
Q Serve(g_s), s	8.5	43.4	43.4	9.8	29.7	18.1	3.2	7.5	5.0	13.8	11.5	11.7
Cycle Q Clear(g_c), s	8.5	43.4	43.4	9.8	29.7	18.1	3.2	7.5	5.0	13.8	11.5	11.7
Prop In Lane	1.00		0.09	1.00		1.00	1.00		1.00	1.00		0.26
Lane Grp Cap(c), veh/h	181	764	791	177	1532	693	175	450	199	480	385	386
V/C Ratio(X)	0.86	1.01	1.02	1.33	0.79	0.56	0.65	0.62	0.42	1.20	0.59	0.60
Avail Cap(c_a), veh/h	181	764	791	177	1532	693	254	1161	512	480	699	699
HCM Platoon Ratio	1.00	1.00	1.00	1.00	1.00	1.00	1.00	1.00	1.00	1.00	1.00	1.00
Upstream Filter(I)	1.00	1.00	1.00	1.00	1.00	1.00	1.00	1.00	1.00	1.00	1.00	1.00
Uniform Delay (d), s/veh	44.4	28.4	28.4	45.2	24.7	21.4	46.7	41.4	40.3	43.2	35.4	35.4
Incr Delay (d2), s/veh	30.3	34.8	35.8	181.1	3.1	1.3	1.5	1.4	1.4	109.8	1.5	1.5
Initial Q Delay(d3),s/veh	0.0	0.0	0.0	0.0	0.0	0.0	0.0	0.0	0.0	0.0	0.0	0.0
%ile BackOfQ(50%),veh/ln	5.1	23.5	24.6	13.1	11.8	7.0	1.4	3.4	2.0	13.2	5.1	5.2
Unsig. Movement Delay, s/veh												
LnGrp Delay(d),s/veh	74.7	63.2	64.2	226.3	27.8	22.7	48.3	42.8	41.7	153.0	36.8	37.0
LnGrp LOS	E	F	F	F	C	C	D	D	D	F	D	D
Approach Vol, veh/h		1728			1840			477			1038	
Approach Delay, s/veh		64.7			52.1			43.9			101.4	
Approach LOS		E			D			D			F	
Timer - Assigned Phs	1	2	3	4	5	6	7	8				
Phs Duration (G+Y+Rc), s	14.0	49.6	9.2	27.4	14.2	49.4	18.0	18.6				
Change Period (Y+Rc), s	* 4.2	6.2	* 4.2	5.8	* 4.2	6.2	* 4.2	* 5.8				
Max Green Setting (Gmax), s	* 9.8	43.4	* 7.3	39.1	* 10	43.2	* 14	* 33				
Max Q Clear Time (g_c+I1), s	11.8	45.4	5.2	13.7	10.5	31.7	15.8	9.5				
Green Ext Time (p_c), s	0.0	0.0	0.0	2.9	0.0	8.4	0.0	2.2				

Intersection Summary

HCM 6th Ctrl Delay	65.7
HCM 6th LOS	E

Notes

* HCM 6th computational engine requires equal clearance times for the phases crossing the barrier.

Timings
2: Central Ave & Arlington Ave/Chicago Ave

West Campus Upper Plateau (JN 14064)

09/19/2022



Lane Group	EBL	EBT	EBR	WBL	WBT	WBR	NBL	NBT	NBR	SBL	SBT
Lane Configurations	↘	↑↑	↗↗	↘↘	↑↑	↗	↘↘	↑↑	↗	↘↘	↑↑↗
Traffic Volume (vph)	28	839	1174	622	754	241	947	1212	309	559	1882
Future Volume (vph)	28	839	1174	622	754	241	947	1212	309	559	1882
Turn Type	Prot	NA	pm+ov	Prot	NA	pm+ov	Prot	NA	pm+ov	Prot	NA
Protected Phases	7	4	5	3	8	1	5	2	3	1	6
Permitted Phases			4			8			2		
Detector Phase	7	4	5	3	8	1	5	2	3	1	6
Switch Phase											
Minimum Initial (s)	5.0	10.0	5.0	5.0	10.0	5.0	5.0	10.0	5.0	5.0	10.0
Minimum Split (s)	9.6	32.8	9.6	9.6	30.8	9.6	9.6	35.4	9.6	9.6	30.4
Total Split (s)	10.6	32.8	30.0	22.0	44.2	24.4	30.0	50.8	22.0	24.4	45.2
Total Split (%)	8.2%	25.2%	23.1%	16.9%	34.0%	18.8%	23.1%	39.1%	16.9%	18.8%	34.8%
Yellow Time (s)	3.6	4.8	3.6	3.6	4.8	3.6	3.6	4.4	3.6	3.6	4.4
All-Red Time (s)	1.0	1.0	1.0	1.0	1.0	1.0	1.0	1.0	1.0	1.0	1.0
Lost Time Adjust (s)	0.0	0.0	0.0	0.0	0.0	0.0	0.0	0.0	0.0	0.0	0.0
Total Lost Time (s)	4.6	5.8	4.6	4.6	5.8	4.6	4.6	5.4	4.6	4.6	5.4
Lead/Lag	Lead	Lag	Lead	Lead	Lag	Lead	Lead	Lag	Lead	Lead	Lag
Lead-Lag Optimize?	Yes	Yes	Yes	Yes	Yes	Yes	Yes	Yes	Yes	Yes	Yes
Recall Mode	None	None	None	None	None	None	None	None	None	None	None
Act Effct Green (s)	5.7	27.0	53.6	17.4	42.6	68.2	25.4	45.4	63.6	19.8	39.8
Actuated g/C Ratio	0.04	0.21	0.41	0.13	0.33	0.52	0.20	0.35	0.49	0.15	0.31
v/c Ratio	0.37	1.17	1.00	1.41	0.66	0.28	1.44	1.01	0.40	1.09	1.26
Control Delay	73.7	134.3	59.5	238.5	41.7	11.9	244.8	70.4	16.3	117.1	162.0
Queue Delay	0.0	0.0	0.0	0.0	0.0	0.0	0.0	0.0	0.0	0.0	0.0
Total Delay	73.7	134.3	59.5	238.5	41.7	11.9	244.8	70.4	16.3	117.1	162.0
LOS	E	F	E	F	D	B	F	E	B	F	F
Approach Delay		90.4			113.0			130.5			151.8
Approach LOS		F			F			F			F

Intersection Summary

Cycle Length: 130
 Actuated Cycle Length: 130
 Natural Cycle: 120
 Control Type: Actuated-Uncoordinated
 Maximum v/c Ratio: 1.44
 Intersection Signal Delay: 123.8
 Intersection LOS: F
 Intersection Capacity Utilization 121.8%
 ICU Level of Service H
 Analysis Period (min) 15

Splits and Phases: 2: Central Ave & Arlington Ave/Chicago Ave

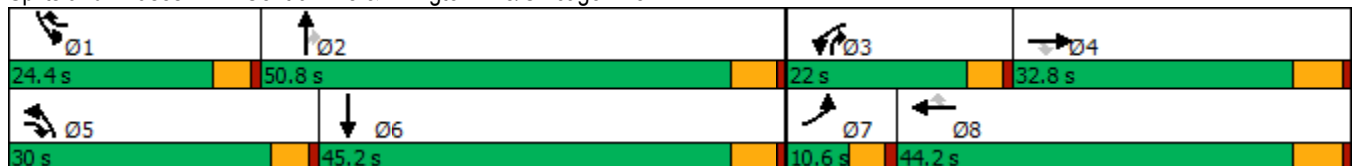

HCM 6th Signalized Intersection Summary
2: Central Ave & Arlington Ave/Chicago Ave

West Campus Upper Plateau (JN 14064)

09/19/2022



Movement	EBL	EBT	EBR	WBL	WBT	WBR	NBL	NBT	NBR	SBL	SBT	SBR
Lane Configurations												
Traffic Volume (veh/h)	28	839	1174	622	754	241	947	1212	309	559	1882	23
Future Volume (veh/h)	28	839	1174	622	754	241	947	1212	309	559	1882	23
Initial Q (Qb), veh	0	0	0	0	0	0	0	0	0	0	0	0
Ped-Bike Adj(A_pbT)	1.00		1.00	1.00		1.00	1.00		0.99	1.00		1.00
Parking Bus, Adj	1.00	1.00	1.00	1.00	1.00	1.00	1.00	1.00	1.00	1.00	1.00	1.00
Work Zone On Approach		No			No			No			No	
Adj Sat Flow, veh/h/ln	1900	1900	1900	1870	1900	1900	1900	1885	1870	1900	1885	1900
Adj Flow Rate, veh/h	29	874	826	648	785	164	986	1262	254	582	1960	22
Peak Hour Factor	0.96	0.96	0.96	0.96	0.96	0.96	0.96	0.96	0.96	0.96	0.96	0.96
Percent Heavy Veh, %	0	0	0	2	0	0	0	1	2	0	1	0
Cap, veh/h	45	750	1141	463	1143	755	686	1251	758	535	1606	18
Arrive On Green	0.02	0.21	0.21	0.13	0.32	0.32	0.20	0.35	0.35	0.15	0.31	0.31
Sat Flow, veh/h	1810	3610	2830	3456	3610	1610	3510	3582	1564	3510	5247	59
Grp Volume(v), veh/h	29	874	826	648	785	164	986	1262	254	582	1281	701
Grp Sat Flow(s),veh/h/ln	1810	1805	1415	1728	1805	1610	1755	1791	1564	1755	1716	1875
Q Serve(g_s), s	2.1	27.0	27.0	17.4	24.7	7.8	25.4	45.4	13.0	19.8	39.8	39.8
Cycle Q Clear(g_c), s	2.1	27.0	27.0	17.4	24.7	7.8	25.4	45.4	13.0	19.8	39.8	39.8
Prop In Lane	1.00		1.00	1.00		1.00	1.00		1.00	1.00		0.03
Lane Grp Cap(c), veh/h	45	750	1141	463	1143	755	686	1251	758	535	1050	574
V/C Ratio(X)	0.64	1.17	0.72	1.40	0.69	0.22	1.44	1.01	0.33	1.09	1.22	1.22
Avail Cap(c_a), veh/h	84	750	1141	463	1143	755	686	1251	758	535	1050	574
HCM Platoon Ratio	1.00	1.00	1.00	1.00	1.00	1.00	1.00	1.00	1.00	1.00	1.00	1.00
Upstream Filter(I)	1.00	1.00	1.00	1.00	1.00	1.00	1.00	1.00	1.00	1.00	1.00	1.00
Uniform Delay (d), s/veh	62.8	51.5	32.7	56.3	38.8	20.4	52.3	42.3	20.7	55.1	45.1	45.1
Incr Delay (d2), s/veh	5.5	88.8	2.3	193.1	1.7	0.1	205.2	27.6	0.3	65.1	107.7	114.4
Initial Q Delay(d3),s/veh	0.0	0.0	0.0	0.0	0.0	0.0	0.0	0.0	0.0	0.0	0.0	0.0
%ile BackOfQ(50%),veh/ln	1.0	21.1	10.9	19.8	10.9	2.9	30.5	24.2	4.6	13.4	32.2	36.2
Unsig. Movement Delay, s/veh												
LnGrp Delay(d),s/veh	68.3	140.3	35.0	249.4	40.5	20.6	257.5	69.9	21.0	120.2	152.8	159.5
LnGrp LOS	E	F	D	F	D	C	F	F	C	F	F	F
Approach Vol, veh/h		1729			1597			2502			2564	
Approach Delay, s/veh		88.8			123.2			138.9			147.2	
Approach LOS		F			F			F			F	
Timer - Assigned Phs	1	2	3	4	5	6	7	8				
Phs Duration (G+Y+Rc), s	24.4	50.8	22.0	32.8	30.0	45.2	7.8	47.0				
Change Period (Y+Rc), s	4.6	5.4	4.6	5.8	4.6	5.4	4.6	5.8				
Max Green Setting (Gmax), s	19.8	45.4	17.4	27.0	25.4	39.8	6.0	38.4				
Max Q Clear Time (g_c+I1), s	21.8	47.4	19.4	29.0	27.4	41.8	4.1	26.7				
Green Ext Time (p_c), s	0.0	0.0	0.0	0.0	0.0	0.0	0.0	4.3				

Intersection Summary

HCM 6th Ctrl Delay	128.1
HCM 6th LOS	F

Timings

3: Overlook Pkwy./Canyon Crest Dr. & Alessandro Bl/Alessandro Bl.



Lane Group	EBL	EBT	WBL	WBT	WBR	NBL	NBT	NBR	SBL	SBT	SBR
Lane Configurations	↘	↗↗↗	↘	↗↗↗	↗	↘	↗↗	↗	↗↗	↘	↗
Traffic Volume (vph)	60	3246	23	2416	688	39	151	57	628	65	26
Future Volume (vph)	60	3246	23	2416	688	39	151	57	628	65	26
Turn Type	Prot	NA	Prot	NA	pm+ov	Split	NA	Perm	Split	NA	Perm
Protected Phases	5	2	1	6	4	8	8		4	4	
Permitted Phases					6			8			4
Detector Phase	5	2	1	6	4	8	8	8	4	4	4
Switch Phase											
Minimum Initial (s)	5.0	10.0	5.0	10.0	10.0	10.0	10.0	10.0	10.0	10.0	10.0
Minimum Split (s)	9.2	35.2	9.2	35.2	38.8	38.8	38.8	38.8	38.8	38.8	38.8
Total Split (s)	9.2	43.2	9.2	43.2	38.8	38.8	38.8	38.8	38.8	38.8	38.8
Total Split (%)	7.1%	33.2%	7.1%	33.2%	29.8%	29.8%	29.8%	29.8%	29.8%	29.8%	29.8%
Yellow Time (s)	3.2	5.2	3.2	5.2	4.8	4.8	4.8	4.8	4.8	4.8	4.8
All-Red Time (s)	1.0	1.0	1.0	1.0	1.0	1.0	1.0	1.0	1.0	1.0	1.0
Lost Time Adjust (s)	0.0	0.0	0.0	0.0	0.0	0.0	0.0	0.0	0.0	0.0	0.0
Total Lost Time (s)	4.2	6.2	4.2	6.2	5.8	5.8	5.8	5.8	5.8	5.8	5.8
Lead/Lag	Lead	Lag	Lead	Lag							
Lead-Lag Optimize?	Yes	Yes	Yes	Yes							
Recall Mode	None	None	None	None	None	None	None	None	None	None	None
Act Effct Green (s)	5.0	43.0	5.0	37.2	69.2	10.7	10.7	10.7	25.8	25.8	25.8
Actuated g/C Ratio	0.05	0.43	0.05	0.37	0.69	0.11	0.11	0.11	0.26	0.26	0.26
v/c Ratio	0.75	1.56	0.27	1.33	0.58	0.23	0.41	0.22	0.57	0.59	0.06
Control Delay	96.2	278.7	56.6	180.7	4.7	46.8	46.8	2.4	35.4	39.1	0.2
Queue Delay	0.0	0.0	0.0	0.0	0.0	0.0	0.0	0.0	0.0	0.0	0.0
Total Delay	96.2	278.7	56.6	180.7	4.7	46.8	46.8	2.4	35.4	39.1	0.2
LOS	F	F	E	F	A	D	D	A	D	D	A
Approach Delay		275.4		141.0			36.6			35.3	
Approach LOS		F		F			D			D	

Intersection Summary

Cycle Length: 130
 Actuated Cycle Length: 100.8
 Natural Cycle: 125
 Control Type: Actuated-Uncoordinated
 Maximum v/c Ratio: 1.56
 Intersection Signal Delay: 187.6
 Intersection Capacity Utilization 99.2%
 Analysis Period (min) 15
 Intersection LOS: F
 ICU Level of Service F

Splits and Phases: 3: Overlook Pkwy./Canyon Crest Dr. & Alessandro Bl/Alessandro Bl.

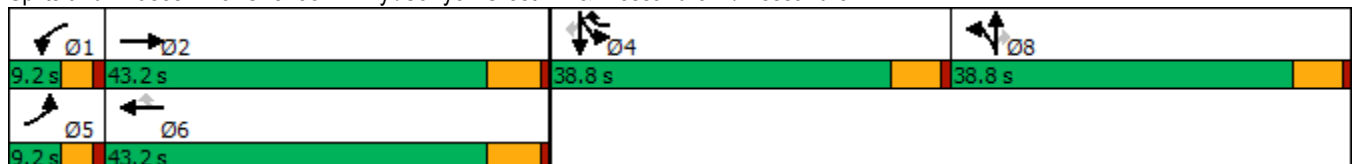

HCM 6th Signalized Intersection Summary

West Campus Upper Plateau (JN 14064)

3: Overlook Pkwy./Canyon Crest Dr. & Alessandro Bl/Alessandro Bl.

09/19/2022



Movement	EBL	EBT	EBR	WBL	WBT	WBR	NBL	NBT	NBR	SBL	SBT	SBR
Lane Configurations	↗	↑↑↑		↖	↑↑↑	↗	↖	↑↑	↗	↖↗	↖	↗
Traffic Volume (veh/h)	60	3246	27	23	2416	688	39	151	57	628	65	26
Future Volume (veh/h)	60	3246	27	23	2416	688	39	151	57	628	65	26
Initial Q (Qb), veh	0	0	0	0	0	0	0	0	0	0	0	0
Ped-Bike Adj(A_pbT)	1.00		1.00	1.00		1.00	1.00		1.00	1.00		1.00
Parking Bus, Adj	1.00	1.00	1.00	1.00	1.00	1.00	1.00	1.00	1.00	1.00	1.00	1.00
Work Zone On Approach		No			No			No			No	
Adj Sat Flow, veh/h/ln	1811	1885	1811	1900	1885	1885	1781	1900	1900	1885	1767	1841
Adj Flow Rate, veh/h	62	3381	28	24	2517	709	41	157	51	568	189	18
Peak Hour Factor	0.96	0.96	0.96	0.96	0.96	0.96	0.96	0.96	0.96	0.96	0.96	0.96
Percent Heavy Veh, %	6	1	6	0	1	1	8	0	0	1	9	4
Cap, veh/h	79	2230	18	45	2074	968	184	393	175	729	359	317
Arrive On Green	0.05	0.42	0.42	0.02	0.40	0.40	0.11	0.11	0.11	0.20	0.20	0.20
Sat Flow, veh/h	1725	5265	43	1810	5147	1598	1697	3610	1610	3591	1767	1560
Grp Volume(v), veh/h	62	2200	1209	24	2517	709	41	157	51	568	189	18
Grp Sat Flow(s),veh/h/ln	1725	1716	1877	1810	1716	1598	1697	1805	1610	1795	1767	1560
Q Serve(g_s), s	3.3	38.9	38.9	1.2	37.0	28.9	2.0	3.7	2.7	13.7	8.8	0.9
Cycle Q Clear(g_c), s	3.3	38.9	38.9	1.2	37.0	28.9	2.0	3.7	2.7	13.7	8.8	0.9
Prop In Lane	1.00		0.02	1.00		1.00	1.00		1.00	1.00		1.00
Lane Grp Cap(c), veh/h	79	1454	795	45	2074	968	184	393	175	729	359	317
V/C Ratio(X)	0.79	1.51	1.52	0.53	1.21	0.73	0.22	0.40	0.29	0.78	0.53	0.06
Avail Cap(c_a), veh/h	94	1454	795	99	2074	968	610	1298	579	1291	635	561
HCM Platoon Ratio	1.00	1.00	1.00	1.00	1.00	1.00	1.00	1.00	1.00	1.00	1.00	1.00
Upstream Filter(I)	1.00	1.00	1.00	1.00	1.00	1.00	1.00	1.00	1.00	1.00	1.00	1.00
Uniform Delay (d), s/veh	43.4	26.5	26.5	44.2	27.4	12.8	37.4	38.1	37.7	34.6	32.6	29.5
Incr Delay (d2), s/veh	25.3	234.7	240.4	3.6	100.8	2.9	0.6	0.7	0.9	1.8	1.2	0.1
Initial Q Delay(d3),s/veh	0.0	0.0	0.0	0.0	0.0	0.0	0.0	0.0	0.0	0.0	0.0	0.0
%ile BackOfQ(50%),veh/ln	1.9	61.2	68.2	0.6	32.6	15.4	0.8	1.6	1.1	5.8	3.7	0.3
Unsig. Movement Delay, s/veh												
LnGrp Delay(d),s/veh	68.7	261.2	266.9	47.8	128.2	15.7	38.0	38.8	38.6	36.5	33.8	29.6
LnGrp LOS	E	F	F	D	F	B	D	D	D	D	C	C
Approach Vol, veh/h		3471			3250			249			775	
Approach Delay, s/veh		259.7			103.1			38.6			35.7	
Approach LOS		F			F			D			D	
Timer - Assigned Phs	1	2		4	5	6		8				
Phs Duration (G+Y+Rc), s	6.5	45.1		24.4	8.4	43.2		15.8				
Change Period (Y+Rc), s	* 4.2	6.2		5.8	* 4.2	6.2		5.8				
Max Green Setting (Gmax), s	* 5	37.0		33.0	* 5	37.0		33.0				
Max Q Clear Time (g_c+I1), s	3.2	40.9		15.7	5.3	39.0		5.7				
Green Ext Time (p_c), s	0.0	0.0		2.9	0.0	0.0		1.1				

Intersection Summary

HCM 6th Ctrl Delay	164.5
HCM 6th LOS	F

Notes

- User approved pedestrian interval to be less than phase max green.
- User approved volume balancing among the lanes for turning movement.
- * HCM 6th computational engine requires equal clearance times for the phases crossing the barrier.

Timings

4: Van Buren Bl. & Wood Rd.

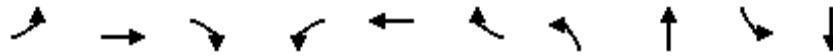

Lane Group	EBL	EBT	EBR	WBL	WBT	WBR	NBL	NBT	SBL	SBT
Lane Configurations	↘	↑↑	↗	↘↗	↑↑	↗	↘↗	↑↔	↘	↑↔
Traffic Volume (vph)	176	1542	226	290	1474	94	327	272	94	277
Future Volume (vph)	176	1542	226	290	1474	94	327	272	94	277
Turn Type	Prot	NA	pm+ov	Prot	NA	Perm	Prot	NA	Perm	NA
Protected Phases	5	2	3	1	6		3	8		4
Permitted Phases			2			6			4	
Detector Phase	5	2	3	1	6	6	3	8	4	4
Switch Phase										
Minimum Initial (s)	5.0	10.0	5.0	5.0	10.0	10.0	5.0	10.0	10.0	10.0
Minimum Split (s)	9.2	30.2	9.2	9.2	30.2	30.2	9.2	38.4	15.8	15.8
Total Split (s)	16.0	57.3	16.1	14.3	55.6	55.6	16.1	38.4	22.3	22.3
Total Split (%)	14.5%	52.1%	14.6%	13.0%	50.5%	50.5%	14.6%	34.9%	20.3%	20.3%
Yellow Time (s)	3.2	4.8	3.2	3.2	4.8	4.8	3.2	3.5	3.5	3.5
All-Red Time (s)	1.0	1.0	1.0	1.0	1.0	1.0	1.0	1.0	1.0	1.0
Lost Time Adjust (s)	0.0	0.0	0.0	0.0	0.0	0.0	0.0	0.0	0.0	0.0
Total Lost Time (s)	4.2	5.8	4.2	4.2	5.8	5.8	4.2	4.5	4.5	4.5
Lead/Lag	Lead	Lag	Lead	Lead	Lag	Lag	Lead		Lag	Lag
Lead-Lag Optimize?	Yes	Yes	Yes	Yes	Yes	Yes	Yes		Yes	Yes
Recall Mode	None	None	None	None	None	None	None	None	None	None
Act Effct Green (s)	11.8	51.5	65.0	10.1	49.8	49.8	11.9	32.8	16.7	16.7
Actuated g/C Ratio	0.11	0.47	0.60	0.09	0.46	0.46	0.11	0.30	0.15	0.15
v/c Ratio	1.00	1.02	0.26	0.99	1.00	0.13	0.96	0.49	0.80	0.84
Control Delay	114.5	57.4	7.3	98.9	52.9	4.4	86.2	21.5	86.4	45.0
Queue Delay	0.0	0.0	0.0	0.0	0.0	0.0	0.0	0.0	0.0	0.0
Total Delay	114.5	57.4	7.3	98.9	52.9	4.4	86.2	21.5	86.4	45.0
LOS	F	E	A	F	D	A	F	C	F	D
Approach Delay		56.8			57.6			47.0		51.7
Approach LOS		E			E			D		D

Intersection Summary

Cycle Length: 110
 Actuated Cycle Length: 108.9
 Natural Cycle: 110
 Control Type: Actuated-Uncoordinated
 Maximum v/c Ratio: 1.02
 Intersection Signal Delay: 54.9
 Intersection LOS: D
 Intersection Capacity Utilization 94.5%
 ICU Level of Service F
 Analysis Period (min) 15

Splits and Phases: 4: Van Buren Bl. & Wood Rd.



HCM 6th Signalized Intersection Summary
4: Van Buren Bl. & Wood Rd.

West Campus Upper Plateau (JN 14064)
09/19/2022



Movement	EBL	EBT	EBR	WBL	WBT	WBR	NBL	NBT	NBR	SBL	SBT	SBR
Lane Configurations	↘	↑↑	↗	↘↗	↑↑	↗	↘↗	↑↘		↘	↑↘	
Traffic Volume (veh/h)	176	1542	226	290	1474	94	327	272	231	94	277	212
Future Volume (veh/h)	176	1542	226	290	1474	94	327	272	231	94	277	212
Initial Q (Qb), veh	0	0	0	0	0	0	0	0	0	0	0	0
Ped-Bike Adj(A_pbT)	1.00		0.99	1.00		0.99	1.00		0.98	0.99		0.99
Parking Bus, Adj	1.00	1.00	1.00	1.00	1.00	1.00	1.00	1.00	1.00	1.00	1.00	1.00
Work Zone On Approach		No			No			No			No	
Adj Sat Flow, veh/h/ln	1885	1856	1870	1885	1870	1885	1870	1885	1870	1885	1885	1885
Adj Flow Rate, veh/h	193	1695	143	319	1620	56	359	299	173	103	304	158
Peak Hour Factor	0.91	0.91	0.91	0.91	0.91	0.91	0.91	0.91	0.91	0.91	0.91	0.91
Percent Heavy Veh, %	1	3	2	1	2	1	2	1	2	1	1	1
Cap, veh/h	194	1663	909	322	1621	718	377	663	372	209	356	180
Arrive On Green	0.11	0.47	0.47	0.09	0.46	0.46	0.11	0.30	0.30	0.16	0.16	0.16
Sat Flow, veh/h	1795	3526	1561	3483	3554	1575	3456	2189	1229	918	2290	1159
Grp Volume(v), veh/h	193	1695	143	319	1620	56	359	243	229	103	236	226
Grp Sat Flow(s),veh/h/ln	1795	1763	1561	1742	1777	1575	1728	1791	1628	918	1791	1658
Q Serve(g_s), s	11.7	51.5	4.6	10.0	49.7	2.2	11.3	11.9	12.5	11.7	14.0	14.6
Cycle Q Clear(g_c), s	11.7	51.5	4.6	10.0	49.7	2.2	11.3	11.9	12.5	11.7	14.0	14.6
Prop In Lane	1.00		1.00	1.00		1.00	1.00		0.76	1.00		0.70
Lane Grp Cap(c), veh/h	194	1663	909	322	1621	718	377	543	493	209	279	258
V/C Ratio(X)	0.99	1.02	0.16	0.99	1.00	0.08	0.95	0.45	0.46	0.49	0.85	0.88
Avail Cap(c_a), veh/h	194	1663	909	322	1621	718	377	556	505	216	292	270
HCM Platoon Ratio	1.00	1.00	1.00	1.00	1.00	1.00	1.00	1.00	1.00	1.00	1.00	1.00
Upstream Filter(I)	1.00	1.00	1.00	1.00	1.00	1.00	1.00	1.00	1.00	1.00	1.00	1.00
Uniform Delay (d), s/veh	48.7	28.8	10.6	49.5	29.7	16.7	48.4	30.7	30.9	43.9	44.8	45.1
Incr Delay (d2), s/veh	62.9	27.0	0.1	47.2	22.2	0.1	34.0	0.6	0.7	1.8	19.5	25.3
Initial Q Delay(d3),s/veh	0.0	0.0	0.0	0.0	0.0	0.0	0.0	0.0	0.0	0.0	0.0	0.0
%ile BackOfQ(50%),veh/ln	8.4	25.5	1.5	6.3	23.9	0.8	6.5	5.1	4.8	2.7	7.6	7.6
Unsig. Movement Delay, s/veh												
LnGrp Delay(d),s/veh	111.6	55.9	10.7	96.7	51.9	16.8	82.4	31.3	31.5	45.7	64.4	70.4
LnGrp LOS	F	F	B	F	D	B	F	C	C	D	E	E
Approach Vol, veh/h		2031			1995			831			565	
Approach Delay, s/veh		58.0			58.1			53.4			63.4	
Approach LOS		E			E			D			E	
Timer - Assigned Phs	1	2	3	4	5	6		8				
Phs Duration (G+Y+Rc), s	14.3	57.3	16.1	21.5	16.0	55.6		37.6				
Change Period (Y+Rc), s	* 4.2	5.8	* 4.2	4.5	* 4.2	5.8		4.5				
Max Green Setting (Gmax), s	* 10	51.5	* 12	17.8	* 12	49.8		33.9				
Max Q Clear Time (g_c+I1), s	12.0	53.5	13.3	16.6	13.7	51.7		14.5				
Green Ext Time (p_c), s	0.0	0.0	0.0	0.4	0.0	0.0		2.6				

Intersection Summary

HCM 6th Ctrl Delay	57.9
HCM 6th LOS	E

Notes

* HCM 6th computational engine requires equal clearance times for the phases crossing the barrier.

Timings
5: Trautwein Rd. & Alessandro Bl.

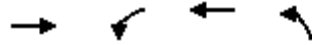

Lane Group	EBT	WBL	WBT	NBL
Lane Configurations	↑↑↑	↵↵	↑↑↑	↵↵↵
Traffic Volume (vph)	2125	269	2378	1026
Future Volume (vph)	2125	269	2378	1026
Turn Type	NA	Prot	NA	Prot
Protected Phases	2	1	6	8
Permitted Phases				
Detector Phase	2	1	6	8
Switch Phase				
Minimum Initial (s)	10.0	5.0	10.0	10.0
Minimum Split (s)	33.2	9.2	16.2	16.2
Total Split (s)	63.0	19.0	82.0	38.0
Total Split (%)	52.5%	15.8%	68.3%	31.7%
Yellow Time (s)	5.2	3.2	5.2	5.2
All-Red Time (s)	1.0	1.0	1.0	1.0
Lost Time Adjust (s)	0.0	0.0	0.0	0.0
Total Lost Time (s)	6.2	4.2	6.2	6.2
Lead/Lag	Lag	Lead		
Lead-Lag Optimize?	Yes	Yes		
Recall Mode	None	None	None	None
Act Effct Green (s)	57.5	13.1	74.8	29.8
Actuated g/C Ratio	0.49	0.11	0.64	0.25
v/c Ratio	0.90	0.73	0.76	0.86
Control Delay	33.4	62.3	17.1	49.6
Queue Delay	0.0	0.0	0.0	0.0
Total Delay	33.4	62.3	17.1	49.6
LOS	C	E	B	D
Approach Delay	33.4		21.7	49.6
Approach LOS	C		C	D

Intersection Summary

Cycle Length: 120
 Actuated Cycle Length: 117
 Natural Cycle: 90
 Control Type: Actuated-Uncoordinated
 Maximum v/c Ratio: 0.90
 Intersection Signal Delay: 31.0
 Intersection LOS: C
 Intersection Capacity Utilization 82.8%
 ICU Level of Service E
 Analysis Period (min) 15

Splits and Phases: 5: Trautwein Rd. & Alessandro Bl.



HCM 6th Signalized Intersection Summary
5: Trautwein Rd. & Alessandro Bl.

West Campus Upper Plateau (JN 14064)
09/19/2022

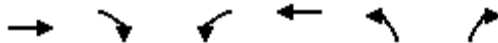

Movement	EBT	EBR	WBL	WBT	NBL	NBR
Lane Configurations	↑↑↑		↵↵	↑↑↑	↵↵↵	
Traffic Volume (veh/h)	2125	20	269	2378	1026	13
Future Volume (veh/h)	2125	20	269	2378	1026	13
Initial Q (Qb), veh	0	0	0	0	0	0
Ped-Bike Adj(A_pbT)		1.00	1.00		1.00	1.00
Parking Bus, Adj	1.00	1.00	1.00	1.00	1.00	1.00
Work Zone On Approach	No			No	No	
Adj Sat Flow, veh/h/ln	1885	1900	1885	1885	1870	1900
Adj Flow Rate, veh/h	2237	21	283	2503	1093	0
Peak Hour Factor	0.95	0.95	0.95	0.95	0.95	0.95
Percent Heavy Veh, %	1	0	1	1	2	0
Cap, veh/h	2666	25	348	3322	1286	388
Arrive On Green	0.51	0.51	0.10	0.65	0.24	0.00
Sat Flow, veh/h	5428	49	3483	5316	5344	1610
Grp Volume(v), veh/h	1459	799	283	2503	1093	0
Grp Sat Flow(s),veh/h/ln	1716	1876	1742	1716	1781	1610
Q Serve(g_s), s	39.7	39.8	8.7	36.6	21.3	0.0
Cycle Q Clear(g_c), s	39.7	39.8	8.7	36.6	21.3	0.0
Prop In Lane		0.03	1.00		1.00	1.00
Lane Grp Cap(c), veh/h	1740	952	348	3322	1286	388
V/C Ratio(X)	0.84	0.84	0.81	0.75	0.85	0.00
Avail Cap(c_a), veh/h	1788	978	473	3580	1559	470
HCM Platoon Ratio	1.00	1.00	1.00	1.00	1.00	1.00
Upstream Filter(I)	1.00	1.00	1.00	1.00	1.00	0.00
Uniform Delay (d), s/veh	23.0	23.1	48.1	13.3	39.5	0.0
Incr Delay (d2), s/veh	3.8	6.8	5.5	1.0	4.0	0.0
Initial Q Delay(d3),s/veh	0.0	0.0	0.0	0.0	0.0	0.0
%ile BackOfQ(50%),veh/ln	15.1	17.3	3.8	11.2	9.3	0.0
Unsig. Movement Delay, s/veh						
LnGrp Delay(d),s/veh	26.8	29.8	53.6	14.3	43.5	0.0
LnGrp LOS	C	C	D	B	D	A
Approach Vol, veh/h	2258			2786	1093	
Approach Delay, s/veh	27.9			18.3	43.5	
Approach LOS	C			B	D	
Timer - Assigned Phs	1	2			6	8
Phs Duration (G+Y+Rc), s	15.1	61.5			76.5	32.4
Change Period (Y+Rc), s	* 4.2	6.2			6.2	6.2
Max Green Setting (Gmax), s	* 15	56.8			75.8	31.8
Max Q Clear Time (g_c+I1), s	10.7	41.8			38.6	23.3
Green Ext Time (p_c), s	0.2	13.2			31.8	3.0

Intersection Summary

HCM 6th Ctrl Delay		26.3	
HCM 6th LOS		C	

Notes

User approved volume balancing among the lanes for turning movement.
* HCM 6th computational engine requires equal clearance times for the phases crossing the barrier.

Timings
6: Trautwein Rd. & Grove Community Dr

West Campus Upper Plateau (JN 14064)

09/19/2022



Lane Group	WBL	WBR	NBT	NBR	SBL	SBT
Lane Configurations	↙	↗↗	↕↕	↗	↗↗	↕↕
Traffic Volume (vph)	56	266	896	60	422	1563
Future Volume (vph)	56	266	896	60	422	1563
Turn Type	Prot	pm+ov	NA	Perm	Prot	NA
Protected Phases	8	1	2		1	6
Permitted Phases		8		2		
Detector Phase	8	1	2	2	1	6
Switch Phase						
Minimum Initial (s)	10.0	5.0	10.0	10.0	5.0	10.0
Minimum Split (s)	34.6	9.6	46.2	46.2	9.6	28.2
Total Split (s)	35.0	29.0	56.0	56.0	29.0	85.0
Total Split (%)	29.2%	24.2%	46.7%	46.7%	24.2%	70.8%
Yellow Time (s)	3.6	3.6	5.2	5.2	3.6	5.2
All-Red Time (s)	1.0	1.0	1.0	1.0	1.0	1.0
Lost Time Adjust (s)	0.0	0.0	0.0	0.0	0.0	0.0
Total Lost Time (s)	4.6	4.6	6.2	6.2	4.6	6.2
Lead/Lag		Lead	Lag	Lag	Lead	
Lead-Lag Optimize?		Yes	Yes	Yes	Yes	
Recall Mode	None	None	None	None	None	None
Act Effect Green (s)	14.0	21.4	26.0	26.0	14.3	50.0
Actuated g/C Ratio	0.22	0.34	0.42	0.42	0.23	0.80
v/c Ratio	0.14	0.26	0.62	0.09	0.54	0.56
Control Delay	27.3	8.5	18.8	7.0	28.0	7.2
Queue Delay	0.0	0.0	0.0	0.0	0.0	0.0
Total Delay	27.3	8.5	18.8	7.0	28.0	7.2
LOS	C	A	B	A	C	A
Approach Delay	11.8		18.1			11.6
Approach LOS	B		B			B

Intersection Summary

Cycle Length: 120
 Actuated Cycle Length: 62.5
 Natural Cycle: 95
 Control Type: Actuated-Uncoordinated
 Maximum v/c Ratio: 0.62
 Intersection Signal Delay: 13.5
 Intersection LOS: B
 Intersection Capacity Utilization 61.5%
 ICU Level of Service B
 Analysis Period (min) 15

Splits and Phases: 6: Trautwein Rd. & Grove Community Dr



HCM 6th Signalized Intersection Summary
6: Trautwein Rd. & Grove Community Dr

West Campus Upper Plateau (JN 14064)

09/19/2022



Movement	WBL	WBR	NBT	NBR	SBL	SBT
Lane Configurations						
Traffic Volume (veh/h)	56	266	896	60	422	1563
Future Volume (veh/h)	56	266	896	60	422	1563
Initial Q (Qb), veh	0	0	0	0	0	0
Ped-Bike Adj(A_pbT)	1.00	1.00		1.00	1.00	
Parking Bus, Adj	1.00	1.00	1.00	1.00	1.00	1.00
Work Zone On Approach	No		No			No
Adj Sat Flow, veh/h/ln	1900	1900	1885	1900	1900	1870
Adj Flow Rate, veh/h	57	92	914	56	431	1595
Peak Hour Factor	0.98	0.98	0.98	0.98	0.98	0.98
Percent Heavy Veh, %	0	0	1	0	0	2
Cap, veh/h	295	930	1407	632	580	2280
Arrive On Green	0.16	0.16	0.39	0.39	0.17	0.64
Sat Flow, veh/h	1810	2834	3676	1610	3510	3647
Grp Volume(v), veh/h	57	92	914	56	431	1595
Grp Sat Flow(s),veh/h/ln	1810	1417	1791	1610	1755	1777
Q Serve(g_s), s	1.5	1.2	11.5	1.2	6.4	16.1
Cycle Q Clear(g_c), s	1.5	1.2	11.5	1.2	6.4	16.1
Prop In Lane	1.00	1.00		1.00	1.00	
Lane Grp Cap(c), veh/h	295	930	1407	632	580	2280
V/C Ratio(X)	0.19	0.10	0.65	0.09	0.74	0.70
Avail Cap(c_a), veh/h	997	2030	3233	1453	1552	5075
HCM Platoon Ratio	1.00	1.00	1.00	1.00	1.00	1.00
Upstream Filter(I)	1.00	1.00	1.00	1.00	1.00	1.00
Uniform Delay (d), s/veh	20.0	12.9	13.7	10.5	21.9	6.4
Incr Delay (d2), s/veh	0.3	0.0	0.5	0.1	0.7	0.4
Initial Q Delay(d3),s/veh	0.0	0.0	0.0	0.0	0.0	0.0
%ile BackOfQ(50%),veh/ln	0.6	0.3	3.5	0.3	2.3	2.6
Unsig. Movement Delay, s/veh						
LnGrp Delay(d),s/veh	20.3	12.9	14.2	10.6	22.6	6.8
LnGrp LOS	C	B	B	B	C	A
Approach Vol, veh/h	149		970			2026
Approach Delay, s/veh	15.7		14.0			10.2
Approach LOS	B		B			B
Timer - Assigned Phs	1	2			6	8
Phs Duration (G+Y+Rc), s	13.7	27.9			41.6	13.6
Change Period (Y+Rc), s	4.6	6.2			6.2	4.6
Max Green Setting (Gmax), s	24.4	49.8			78.8	30.4
Max Q Clear Time (g_c+I1), s	8.4	13.5			18.1	3.5
Green Ext Time (p_c), s	0.7	6.8			17.3	0.5

Intersection Summary

HCM 6th Ctrl Delay	11.6
HCM 6th LOS	B

Timings

West Campus Upper Plateau (JN 14064)

7: Trautwein Rd. & Orange Terrace Pkwy

09/19/2022



Lane Group	EBL	EBT	WBL	WBT	WBR	NBL	NBT	NBR	SBL	SBT	SBR
Lane Configurations	↖	↗	↖	↗	↗↖	↖	↗↗	↗	↗↖	↗↗	↗
Traffic Volume (vph)	52	53	170	28	188	35	822	239	383	1206	46
Future Volume (vph)	52	53	170	28	188	35	822	239	383	1206	46
Turn Type	Prot	NA	Prot	NA	pm+ov	Prot	NA	Perm	Prot	NA	Perm
Protected Phases	7	4	3	8	1	5	2		1	6	
Permitted Phases					8			2			6
Detector Phase	7	4	3	8	1	5	2	2	1	6	6
Switch Phase											
Minimum Initial (s)	5.0	10.0	5.0	10.0	5.0	5.0	10.0	10.0	5.0	10.0	10.0
Minimum Split (s)	9.6	38.6	9.6	34.6	9.6	9.6	49.2	49.2	9.6	28.2	28.2
Total Split (s)	13.5	38.6	16.0	41.1	15.0	9.6	50.4	50.4	15.0	55.8	55.8
Total Split (%)	11.3%	32.2%	13.3%	34.3%	12.5%	8.0%	42.0%	42.0%	12.5%	46.5%	46.5%
Yellow Time (s)	3.6	3.6	3.6	3.6	3.6	3.6	5.2	5.2	3.6	5.2	5.2
All-Red Time (s)	1.0	1.0	1.0	1.0	1.0	1.0	1.0	1.0	1.0	1.0	1.0
Lost Time Adjust (s)	0.0	0.0	0.0	0.0	0.0	0.0	0.0	0.0	0.0	0.0	0.0
Total Lost Time (s)	4.6	4.6	4.6	4.6	4.6	4.6	6.2	6.2	4.6	6.2	6.2
Lead/Lag	Lead	Lag	Lead	Lag	Lead	Lead	Lag	Lag	Lead	Lag	Lag
Lead-Lag Optimize?	Yes	Yes	Yes	Yes	Yes	Yes	Yes	Yes	Yes	Yes	Yes
Recall Mode	None	None	None	None	None	None	None	None	None	None	None
Act Effct Green (s)	7.1	14.1	12.2	19.9	36.0	5.4	30.7	30.7	11.1	41.7	41.7
Actuated g/C Ratio	0.08	0.17	0.14	0.23	0.42	0.06	0.36	0.36	0.13	0.49	0.49
v/c Ratio	0.36	0.23	0.69	0.07	0.15	0.33	0.68	0.35	0.90	0.73	0.06
Control Delay	50.8	31.4	55.6	30.8	4.0	54.6	26.6	5.8	64.5	23.3	0.1
Queue Delay	0.0	0.0	0.0	0.0	0.0	0.0	0.0	0.0	0.0	0.0	0.0
Total Delay	50.8	31.4	55.6	30.8	4.0	54.6	26.6	5.8	64.5	23.3	0.1
LOS	D	C	E	C	A	D	C	A	E	C	A
Approach Delay		39.9		28.6			23.0			32.3	
Approach LOS		D		C			C			C	

Intersection Summary

Cycle Length: 120	
Actuated Cycle Length: 85	
Natural Cycle: 120	
Control Type: Actuated-Uncoordinated	
Maximum v/c Ratio: 0.90	
Intersection Signal Delay: 29.0	Intersection LOS: C
Intersection Capacity Utilization 66.4%	ICU Level of Service C
Analysis Period (min) 15	



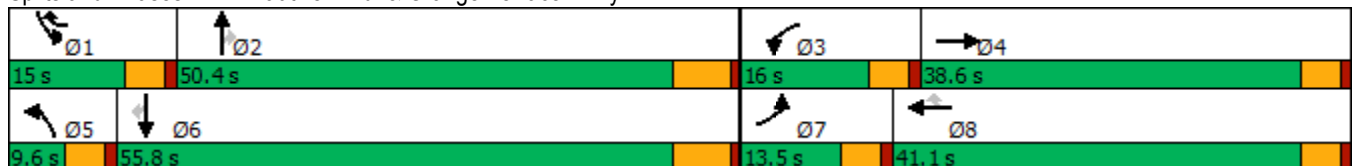



















Splits and Phases: 7: Trautwein Rd. & Orange Terrace Pkwy



HCM 6th Signalized Intersection Summary
7: Trautwein Rd. & Orange Terrace Pkwy

West Campus Upper Plateau (JN 14064)

09/19/2022

												
Movement	EBL	EBT	EBR	WBL	WBT	WBR	NBL	NBT	NBR	SBL	SBT	SBR
Lane Configurations												
Traffic Volume (veh/h)	52	53	14	170	28	188	35	822	239	383	1206	46
Future Volume (veh/h)	52	53	14	170	28	188	35	822	239	383	1206	46
Initial Q (Qb), veh	0	0	0	0	0	0	0	0	0	0	0	0
Ped-Bike Adj(A_pbT)	1.00		1.00	1.00		1.00	1.00		1.00	1.00		1.00
Parking Bus, Adj	1.00	1.00	1.00	1.00	1.00	1.00	1.00	1.00	1.00	1.00	1.00	1.00
Work Zone On Approach		No			No			No			No	
Adj Sat Flow, veh/h/ln	1900	1900	1900	1900	1900	1870	1900	1870	1885	1870	1870	1900
Adj Flow Rate, veh/h	55	56	13	179	29	79	37	865	175	403	1269	39
Peak Hour Factor	0.95	0.95	0.95	0.95	0.95	0.95	0.95	0.95	0.95	0.95	0.95	0.95
Percent Heavy Veh, %	0	0	0	0	0	2	0	2	1	2	2	0
Cap, veh/h	82	194	45	218	390	952	64	1252	563	470	1609	729
Arrive On Green	0.05	0.13	0.13	0.12	0.21	0.21	0.04	0.35	0.35	0.14	0.45	0.45
Sat Flow, veh/h	1810	1491	346	1810	1900	2790	1810	3554	1598	3456	3554	1610
Grp Volume(v), veh/h	55	0	69	179	29	79	37	865	175	403	1269	39
Grp Sat Flow(s),veh/h/ln	1810	0	1838	1810	1900	1395	1810	1777	1598	1728	1777	1610
Q Serve(g_s), s	2.3	0.0	2.6	7.4	0.9	1.5	1.5	15.9	6.1	8.7	23.3	1.0
Cycle Q Clear(g_c), s	2.3	0.0	2.6	7.4	0.9	1.5	1.5	15.9	6.1	8.7	23.3	1.0
Prop In Lane	1.00		0.19	1.00		1.00	1.00		1.00	1.00		1.00
Lane Grp Cap(c), veh/h	82	0	238	218	390	952	64	1252	563	470	1609	729
V/C Ratio(X)	0.67	0.00	0.29	0.82	0.07	0.08	0.57	0.69	0.31	0.86	0.79	0.05
Avail Cap(c_a), veh/h	211	0	817	270	907	1710	118	2053	923	470	2304	1044
HCM Platoon Ratio	1.00	1.00	1.00	1.00	1.00	1.00	1.00	1.00	1.00	1.00	1.00	1.00
Upstream Filter(I)	1.00	0.00	1.00	1.00	1.00	1.00	1.00	1.00	1.00	1.00	1.00	1.00
Uniform Delay (d), s/veh	36.0	0.0	30.1	32.8	24.5	17.1	36.3	21.2	18.0	32.3	17.8	11.7
Incr Delay (d2), s/veh	3.6	0.0	0.7	12.5	0.1	0.0	3.0	0.7	0.3	14.0	1.2	0.0
Initial Q Delay(d3),s/veh	0.0	0.0	0.0	0.0	0.0	0.0	0.0	0.0	0.0	0.0	0.0	0.0
%ile BackOfQ(50%),veh/ln	1.1	0.0	1.2	3.8	0.4	0.4	0.7	5.8	2.1	4.2	8.0	0.3
Unsig. Movement Delay, s/veh												
LnGrp Delay(d),s/veh	39.6	0.0	30.8	45.3	24.6	17.1	39.3	21.9	18.3	46.3	19.0	11.8
LnGrp LOS	D	A	C	D	C	B	D	C	B	D	B	B
Approach Vol, veh/h		124			287			1077			1711	
Approach Delay, s/veh		34.7			35.5			21.9			25.3	
Approach LOS		C			D			C			C	
Timer - Assigned Phs	1	2	3	4	5	6	7	8				
Phs Duration (G+Y+Rc), s	15.0	33.2	13.8	14.5	7.3	40.8	8.0	20.3				
Change Period (Y+Rc), s	4.6	6.2	4.6	4.6	4.6	6.2	4.6	4.6				
Max Green Setting (Gmax), s	10.4	44.2	11.4	34.0	5.0	49.6	8.9	36.5				
Max Q Clear Time (g_c+I1), s	10.7	17.9	9.4	4.6	3.5	25.3	4.3	3.5				
Green Ext Time (p_c), s	0.0	6.4	0.0	0.3	0.0	9.4	0.0	0.4				
Intersection Summary												
HCM 6th Ctrl Delay			25.4									
HCM 6th LOS			C									

Timings
8: Cole Av. & Van Buren Bl.

West Campus Upper Plateau (JN 14064)

09/19/2022



Lane Group	EBL	EBT	EBR	WBL	WBT	WBR	NBL	NBT	SBL	SBT	SBR
Lane Configurations	↔↔	↑↑	↗	↖	↑↑↑	↗	↖	↑↔	↖↔	↑↑	↗
Traffic Volume (vph)	364	1172	115	184	1329	285	102	326	330	584	247
Future Volume (vph)	364	1172	115	184	1329	285	102	326	330	584	247
Turn Type	Prot	NA	pm+ov	Prot	NA	pm+ov	Prot	NA	Prot	NA	pm+ov
Protected Phases	5	2	3	1	6	7	3	8	7	4	5
Permitted Phases			2			6					4
Detector Phase	5	2	3	1	6	7	3	8	7	4	5
Switch Phase											
Minimum Initial (s)	5.0	10.0	5.0	5.0	10.0	5.0	5.0	10.0	5.0	10.0	5.0
Minimum Split (s)	9.1	36.2	9.1	9.1	36.2	9.1	9.1	42.2	9.1	49.2	9.1
Total Split (s)	18.7	44.8	12.0	14.0	40.1	17.5	12.0	43.7	17.5	49.2	18.7
Total Split (%)	15.6%	37.3%	10.0%	11.7%	33.4%	14.6%	10.0%	36.4%	14.6%	41.0%	15.6%
Yellow Time (s)	3.2	5.2	3.2	3.2	5.2	3.2	3.2	5.2	3.2	5.2	3.2
All-Red Time (s)	0.5	1.0	0.5	0.5	1.0	0.5	0.5	1.0	0.5	1.0	0.5
Lost Time Adjust (s)	0.0	0.0	0.0	0.0	0.0	0.0	0.0	0.0	0.0	0.0	0.0
Total Lost Time (s)	3.7	6.2	3.7	3.7	6.2	3.7	3.7	6.2	3.7	6.2	3.7
Lead/Lag	Lead	Lag	Lead	Lead	Lag	Lead	Lead	Lag	Lead	Lag	Lead
Lead-Lag Optimize?	Yes	Yes	Yes	Yes	Yes	Yes	Yes	Yes	Yes	Yes	Yes
Recall Mode	None	None	None	None	None	None	None	None	None	None	None
Act Effct Green (s)	14.5	38.9	53.5	10.4	34.7	54.4	8.4	20.0	13.4	25.0	42.0
Actuated g/C Ratio	0.14	0.38	0.52	0.10	0.34	0.53	0.08	0.20	0.13	0.24	0.41
v/c Ratio	0.80	0.96	0.14	1.11	0.83	0.33	0.75	0.61	0.79	0.71	0.38
Control Delay	56.9	49.1	5.5	144.1	37.5	6.8	78.3	39.1	58.1	39.8	15.0
Queue Delay	0.0	0.0	0.0	0.0	0.0	0.0	0.0	0.0	0.0	0.0	0.0
Total Delay	56.9	49.1	5.5	144.1	37.5	6.8	78.3	39.1	58.1	39.8	15.0
LOS	E	D	A	F	D	A	E	D	E	D	B
Approach Delay		47.8			43.5			47.1		39.7	
Approach LOS		D			D			D		D	

Intersection Summary

Cycle Length: 120	
Actuated Cycle Length: 102.5	
Natural Cycle: 115	
Control Type: Actuated-Uncoordinated	
Maximum v/c Ratio: 1.11	
Intersection Signal Delay: 44.4	Intersection LOS: D
Intersection Capacity Utilization 82.7%	ICU Level of Service E
Analysis Period (min) 15	



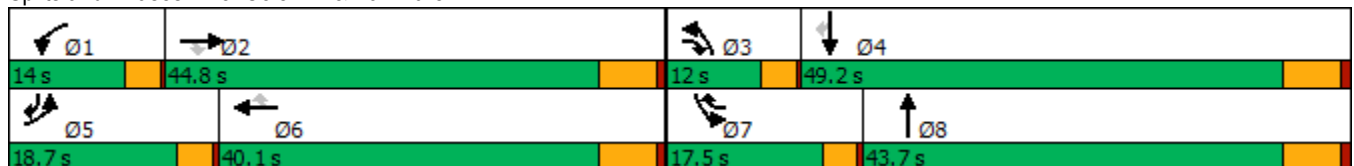





















Splits and Phases: 8: Cole Av. & Van Buren Bl.



HCM 6th Signalized Intersection Summary
8: Cole Av. & Van Buren Bl.

West Campus Upper Plateau (JN 14064)

09/19/2022

												
Movement	EBL	EBT	EBR	WBL	WBT	WBR	NBL	NBT	NBR	SBL	SBT	SBR
Lane Configurations												
Traffic Volume (veh/h)	364	1172	115	184	1329	285	102	326	70	330	584	247
Future Volume (veh/h)	364	1172	115	184	1329	285	102	326	70	330	584	247
Initial Q (Qb), veh	0	0	0	0	0	0	0	0	0	0	0	0
Ped-Bike Adj(A_pbT)	1.00		1.00	1.00		1.00	1.00		0.99	1.00		1.00
Parking Bus, Adj	1.00	1.00	1.00	1.00	1.00	1.00	1.00	1.00	1.00	1.00	1.00	1.00
Work Zone On Approach		No			No			No			No	
Adj Sat Flow, veh/h/ln	1870	1826	1856	1856	1856	1870	1885	1885	1870	1856	1885	1885
Adj Flow Rate, veh/h	387	1247	63	196	1414	213	109	347	67	351	621	163
Peak Hour Factor	0.94	0.94	0.94	0.94	0.94	0.94	0.94	0.94	0.94	0.94	0.94	0.94
Percent Heavy Veh, %	2	5	3	3	3	2	1	1	2	3	1	1
Cap, veh/h	455	1336	725	184	1812	760	136	565	108	418	840	584
Arrive On Green	0.13	0.39	0.39	0.10	0.36	0.36	0.08	0.19	0.19	0.12	0.23	0.23
Sat Flow, veh/h	3456	3469	1572	1767	5066	1585	1795	2997	572	3428	3582	1596
Grp Volume(v), veh/h	387	1247	63	196	1414	213	109	206	208	351	621	163
Grp Sat Flow(s),veh/h/ln	1728	1735	1572	1767	1689	1585	1795	1791	1778	1714	1791	1596
Q Serve(g_s), s	10.8	34.1	2.2	10.3	24.6	8.0	5.9	10.4	10.6	9.9	15.9	7.1
Cycle Q Clear(g_c), s	10.8	34.1	2.2	10.3	24.6	8.0	5.9	10.4	10.6	9.9	15.9	7.1
Prop In Lane	1.00		1.00	1.00		1.00	1.00		0.32	1.00		1.00
Lane Grp Cap(c), veh/h	455	1336	725	184	1812	760	136	338	335	418	840	584
V/C Ratio(X)	0.85	0.93	0.09	1.06	0.78	0.28	0.80	0.61	0.62	0.84	0.74	0.28
Avail Cap(c_a), veh/h	524	1354	733	184	1812	760	151	679	674	478	1557	904
HCM Platoon Ratio	1.00	1.00	1.00	1.00	1.00	1.00	1.00	1.00	1.00	1.00	1.00	1.00
Upstream Filter(I)	1.00	1.00	1.00	1.00	1.00	1.00	1.00	1.00	1.00	1.00	1.00	1.00
Uniform Delay (d), s/veh	42.0	29.2	15.0	44.3	28.3	15.5	44.9	36.8	36.9	42.5	35.1	22.1
Incr Delay (d2), s/veh	10.1	12.0	0.1	84.6	2.4	0.3	20.9	1.8	1.9	10.1	1.3	0.3
Initial Q Delay(d3),s/veh	0.0	0.0	0.0	0.0	0.0	0.0	0.0	0.0	0.0	0.0	0.0	0.0
%ile BackOfQ(50%),veh/ln	5.0	15.0	0.7	8.6	9.5	2.6	3.3	4.5	4.5	4.6	6.6	2.5
Unsig. Movement Delay, s/veh												
LnGrp Delay(d),s/veh	52.1	41.1	15.0	128.9	30.7	15.8	65.9	38.6	38.8	52.6	36.4	22.4
LnGrp LOS	D	D	B	F	C	B	E	D	D	D	D	C
Approach Vol, veh/h		1697			1823			523			1135	
Approach Delay, s/veh		42.7			39.5			44.3			39.4	
Approach LOS		D			D			D			D	
Timer - Assigned Phs	1	2	3	4	5	6	7	8				
Phs Duration (G+Y+Rc), s	14.0	44.3	11.2	29.4	16.7	41.6	15.8	24.8				
Change Period (Y+Rc), s	3.7	6.2	3.7	6.2	3.7	6.2	3.7	6.2				
Max Green Setting (Gmax), s	10.3	38.6	8.3	43.0	15.0	33.9	13.8	37.5				
Max Q Clear Time (g_c+I1), s	12.3	36.1	7.9	17.9	12.8	26.6	11.9	12.6				
Green Ext Time (p_c), s	0.0	2.0	0.0	4.4	0.2	5.8	0.1	2.1				
Intersection Summary												
HCM 6th Ctrl Delay			41.0									
HCM 6th LOS			D									

Intersection	
Intersection Delay, s/veh	9.9
Intersection LOS	A

Movement	EBT	EBR	WBL	WBT	NBL	NBR
Lane Configurations						
Traffic Vol, veh/h	242	21	25	176	31	41
Future Vol, veh/h	242	21	25	176	31	41
Peak Hour Factor	0.92	0.92	0.92	0.92	0.92	0.92
Heavy Vehicles, %	1	0	1	2	0	0
Mvmt Flow	263	23	27	191	34	45
Number of Lanes	1	0	1	1	1	1

Approach	EB	WB	NB
Opposing Approach	WB	EB	
Opposing Lanes	2	1	0
Conflicting Approach Left		NB	EB
Conflicting Lanes Left	0	2	1
Conflicting Approach Right	NB		WB
Conflicting Lanes Right	2	0	2
HCM Control Delay	10.6	9.4	8.6
HCM LOS	B	A	A

Lane	NBLn1	NBLn2	EBLn1	WBLn1	WBLn2
Vol Left, %	100%	0%	0%	100%	0%
Vol Thru, %	0%	0%	92%	0%	100%
Vol Right, %	0%	100%	8%	0%	0%
Sign Control	Stop	Stop	Stop	Stop	Stop
Traffic Vol by Lane	31	41	263	25	176
LT Vol	31	0	0	25	0
Through Vol	0	0	242	0	176
RT Vol	0	41	21	0	0
Lane Flow Rate	34	45	286	27	191
Geometry Grp	7	7	4	7	7
Degree of Util (X)	0.058	0.062	0.376	0.041	0.264
Departure Headway (Hd)	6.2	4.99	4.732	5.46	4.974
Convergence, Y/N	Yes	Yes	Yes	Yes	Yes
Cap	578	717	760	657	723
Service Time	3.937	2.727	2.756	3.185	2.699
HCM Lane V/C Ratio	0.059	0.063	0.376	0.041	0.264
HCM Control Delay	9.3	8.1	10.6	8.4	9.5
HCM Lane LOS	A	A	B	A	A
HCM 95th-tile Q	0.2	0.2	1.8	0.1	1.1

Intersection

Intersection Delay, s/veh	10.7
Intersection LOS	B

Movement	EBL	EBT	EBR	WBL	WBT	WBR	NBL	NBT	NBR	SBL	SBT	SBR
Lane Configurations	↙	↕		↙	↕			↕			↕	
Traffic Vol, veh/h	49	484	17	4	272	53	21	5	2	31	9	22
Future Vol, veh/h	49	484	17	4	272	53	21	5	2	31	9	22
Peak Hour Factor	0.96	0.96	0.96	0.96	0.96	0.96	0.96	0.96	0.96	0.96	0.96	0.96
Heavy Vehicles, %	3	2	7	0	1	0	6	0	0	0	0	0
Mvmt Flow	51	504	18	4	283	55	22	5	2	32	9	23
Number of Lanes	1	2	0	1	2	0	0	1	0	0	1	0

Approach	EB	WB	NB	SB
Opposing Approach	WB	EB	SB	NB
Opposing Lanes	3	3	1	1
Conflicting Approach Left	SB	NB	EB	WB
Conflicting Lanes Left	1	1	3	3
Conflicting Approach Right	NB	SB	WB	EB
Conflicting Lanes Right	1	1	3	3
HCM Control Delay	11.4	9.8	10.2	10.1
HCM LOS	B	A	B	B

Lane	NBLn1	EBLn1	EBLn2	EBLn3	WBLn1	WBLn2	WBLn3	SBLn1
Vol Left, %	75%	100%	0%	0%	100%	0%	0%	50%
Vol Thru, %	18%	0%	100%	90%	0%	100%	63%	15%
Vol Right, %	7%	0%	0%	10%	0%	0%	37%	35%
Sign Control	Stop	Stop	Stop	Stop	Stop	Stop	Stop	Stop
Traffic Vol by Lane	28	49	323	178	4	181	144	62
LT Vol	21	49	0	0	4	0	0	31
Through Vol	5	0	323	161	0	181	91	9
RT Vol	2	0	0	17	0	0	53	22
Lane Flow Rate	29	51	336	186	4	189	150	65
Geometry Grp	7	7	7	7	7	7	7	7
Degree of Util (X)	0.057	0.08	0.481	0.267	0.007	0.282	0.212	0.117
Departure Headway (Hd)	7.029	5.671	5.151	5.169	5.857	5.371	5.094	6.522
Convergence, Y/N	Yes	Yes	Yes	Yes	Yes	Yes	Yes	Yes
Cap	512	628	696	689	607	663	699	553
Service Time	4.732	3.441	2.921	2.939	3.633	3.147	2.87	4.224
HCM Lane V/C Ratio	0.057	0.081	0.483	0.27	0.007	0.285	0.215	0.118
HCM Control Delay	10.2	8.9	12.7	9.8	8.7	10.3	9.3	10.1
HCM Lane LOS	B	A	B	A	A	B	A	B
HCM 95th-tile Q	0.2	0.3	2.6	1.1	0	1.2	0.8	0.4

Timings
11: Barton St & Alessandro Bl.



Lane Group	EBL	EBT	WBL	WBT	NBL	NBT	NBR	SBL	SBT	SBR
Lane Configurations	↙	↕↕↕	↙	↕↕↕		↕	↗		↕	↗
Traffic Volume (vph)	6	2248	77	2620	78	1	38	10	0	14
Future Volume (vph)	6	2248	77	2620	78	1	38	10	0	14
Turn Type	Prot	NA	Prot	NA	Perm	NA	Perm	Perm	NA	Perm
Protected Phases	5	2	1	6		8			4	
Permitted Phases					8		8	4		4
Detector Phase	5	2	1	6	8	8	8	4	4	4
Switch Phase										
Minimum Initial (s)	5.0	10.0	5.0	10.0	10.0	10.0	10.0	10.0	10.0	10.0
Minimum Split (s)	9.2	28.5	11.0	28.5	40.6	40.6	40.6	26.6	26.6	26.6
Total Split (s)	9.2	65.4	14.0	70.2	40.6	40.6	40.6	40.6	40.6	40.6
Total Split (%)	7.7%	54.5%	11.7%	58.5%	33.8%	33.8%	33.8%	33.8%	33.8%	33.8%
Yellow Time (s)	3.2	5.5	3.2	5.5	3.6	3.6	3.6	3.6	3.6	3.6
All-Red Time (s)	1.0	1.0	1.0	1.0	1.0	1.0	1.0	1.0	1.0	1.0
Lost Time Adjust (s)	0.0	0.0	0.0	0.0		0.0	0.0		0.0	0.0
Total Lost Time (s)	4.2	6.5	4.2	6.5		4.6	4.6		4.6	4.6
Lead/Lag	Lead	Lag	Lead	Lag						
Lead-Lag Optimize?	Yes	Yes	Yes	Yes						
Recall Mode	None	None	None	None	None	None	None	None	None	None
Act Effct Green (s)	5.1	63.7	8.0	72.0		15.0	15.0		15.0	15.0
Actuated g/C Ratio	0.05	0.68	0.08	0.76		0.16	0.16		0.16	0.16
v/c Ratio	0.07	0.69	0.52	0.70		0.38	0.11		0.05	0.04
Control Delay	51.8	16.3	58.3	12.0		41.6	0.7		34.0	0.2
Queue Delay	0.0	0.0	0.0	0.0		0.0	0.0		0.0	0.0
Total Delay	51.8	16.3	58.3	12.0		41.6	0.7		34.0	0.2
LOS	D	B	E	B		D	A		C	A
Approach Delay		16.4		13.3		28.2			13.7	
Approach LOS		B		B		C			B	

Intersection Summary

Cycle Length: 120
 Actuated Cycle Length: 94.3
 Natural Cycle: 115
 Control Type: Actuated-Uncoordinated
 Maximum v/c Ratio: 0.70
 Intersection Signal Delay: 15.0
 Intersection Capacity Utilization 80.4%
 Analysis Period (min) 15
 Intersection LOS: B
 ICU Level of Service D

Splits and Phases: 11: Barton St & Alessandro Bl.



HCM 6th Signalized Intersection Summary
11: Barton St & Alessandro Bl.

West Campus Upper Plateau (JN 14064)

09/19/2022



Movement	EBL	EBT	EBR	WBL	WBT	WBR	NBL	NBT	NBR	SBL	SBT	SBR
Lane Configurations	↖	↑↑↑		↖	↑↑↑			↑	↗		↑	↗
Traffic Volume (veh/h)	6	2248	55	77	2620	3	78	1	38	10	0	14
Future Volume (veh/h)	6	2248	55	77	2620	3	78	1	38	10	0	14
Initial Q (Qb), veh	0	0	0	0	0	0	0	0	0	0	0	0
Ped-Bike Adj(A_pbT)	1.00		1.00	1.00		0.98	1.00		1.00	1.00		1.00
Parking Bus, Adj	1.00	1.00	1.00	1.00	1.00	1.00	1.00	1.00	1.00	1.00	1.00	1.00
Work Zone On Approach		No			No			No			No	
Adj Sat Flow, veh/h/ln	1604	1885	1900	1900	1870	1900	1900	1900	1900	1737	1900	1900
Adj Flow Rate, veh/h	6	2342	55	80	2729	3	81	1	14	10	0	5
Peak Hour Factor	0.96	0.96	0.96	0.96	0.96	0.96	0.96	0.96	0.96	0.96	0.96	0.96
Percent Heavy Veh, %	20	1	0	0	2	0	0	0	0	11	0	0
Cap, veh/h	12	2847	67	102	3155	3	76	1	400	76	0	400
Arrive On Green	0.01	0.55	0.55	0.06	0.60	0.60	0.25	0.25	0.25	0.25	0.00	0.25
Sat Flow, veh/h	1527	5173	121	1810	5267	6	30	2	1610	30	0	1610
Grp Volume(v), veh/h	6	1551	846	80	1763	969	82	0	14	10	0	5
Grp Sat Flow(s),veh/h/ln	1527	1716	1863	1810	1702	1869	33	0	1610	30	0	1610
Q Serve(g_s), s	0.4	39.0	39.4	4.6	45.4	45.4	0.6	0.0	0.7	0.6	0.0	0.2
Cycle Q Clear(g_c), s	0.4	39.0	39.4	4.6	45.4	45.4	26.1	0.0	0.7	26.1	0.0	0.2
Prop In Lane	1.00		0.06	1.00		0.00	0.99		1.00	1.00		1.00
Lane Grp Cap(c), veh/h	12	1888	1025	102	2039	1119	76	0	400	76	0	400
V/C Ratio(X)	0.52	0.82	0.83	0.79	0.86	0.87	1.08	0.00	0.04	0.13	0.00	0.01
Avail Cap(c_a), veh/h	73	1920	1043	169	2060	1131	211	0	551	209	0	551
HCM Platoon Ratio	1.00	1.00	1.00	1.00	1.00	1.00	1.00	1.00	1.00	1.00	1.00	1.00
Upstream Filter(I)	1.00	1.00	1.00	1.00	1.00	1.00	1.00	0.00	1.00	1.00	0.00	1.00
Uniform Delay (d), s/veh	52.0	19.4	19.5	49.0	17.6	17.6	52.4	0.0	30.0	52.4	0.0	29.8
Incr Delay (d2), s/veh	12.8	3.1	5.7	5.0	4.2	7.4	70.2	0.0	0.0	0.8	0.0	0.0
Initial Q Delay(d3),s/veh	0.0	0.0	0.0	0.0	0.0	0.0	0.0	0.0	0.0	0.0	0.0	0.0
%ile BackOfQ(50%),veh/ln	0.2	13.8	15.8	2.2	17.4	20.1	3.5	0.0	0.3	0.3	0.0	0.1
Unsig. Movement Delay, s/veh												
LnGrp Delay(d),s/veh	64.8	22.5	25.2	54.0	21.8	24.9	122.6	0.0	30.0	53.2	0.0	29.9
LnGrp LOS	E	C	C	D	C	C	F	A	C	D	A	C
Approach Vol, veh/h		2403			2812			96				15
Approach Delay, s/veh		23.6			23.8			109.1				45.4
Approach LOS		C			C			F				D
Timer - Assigned Phs	1	2		4	5	6		8				
Phs Duration (G+Y+Rc), s	10.1	64.4		31.3	5.0	69.6		31.3				
Change Period (Y+Rc), s	* 4.2	6.5		4.6	* 4.2	6.5		4.6				
Max Green Setting (Gmax), s	* 9.8	58.9		36.0	* 5	63.7		36.0				
Max Q Clear Time (g_c+I1), s	6.6	41.4		28.1	2.4	47.4		28.1				
Green Ext Time (p_c), s	0.0	15.6		0.0	0.0	15.7		0.2				

Intersection Summary

HCM 6th Ctrl Delay	25.3
HCM 6th LOS	C

Notes

* HCM 6th computational engine requires equal clearance times for the phases crossing the barrier.

Intersection						
Int Delay, s/veh	1.7					
Movement	EBL	EBT	WBT	WBR	SBL	SBR
Lane Configurations						
Traffic Vol, veh/h	45	239	146	23	2	54
Future Vol, veh/h	45	239	146	23	2	54
Conflicting Peds, #/hr	0	0	0	7	0	0
Sign Control	Free	Free	Free	Free	Stop	Stop
RT Channelized	-	None	-	None	-	None
Storage Length	100	-	-	-	0	-
Veh in Median Storage, #	-	0	0	-	0	-
Grade, %	-	0	0	-	0	-
Peak Hour Factor	94	94	94	94	94	94
Heavy Vehicles, %	0	0	1	0	0	0
Mvmt Flow	48	254	155	24	2	57

Major/Minor	Major1	Major2	Minor2		
Conflicting Flow All	186	0	-	0	524
Stage 1	-	-	-	-	174
Stage 2	-	-	-	-	350
Critical Hdwy	4.1	-	-	-	6.4
Critical Hdwy Stg 1	-	-	-	-	5.4
Critical Hdwy Stg 2	-	-	-	-	5.4
Follow-up Hdwy	2.2	-	-	-	3.5
Pot Cap-1 Maneuver	1401	-	-	-	517
Stage 1	-	-	-	-	861
Stage 2	-	-	-	-	718
Platoon blocked, %		-	-	-	
Mov Cap-1 Maneuver	1392	-	-	-	493
Mov Cap-2 Maneuver	-	-	-	-	493
Stage 1	-	-	-	-	826
Stage 2	-	-	-	-	713

Approach	EB	WB	SB
HCM Control Delay, s	1.2	0	9.6
HCM LOS			A

Minor Lane/Major Mvmt	EBL	EBT	WBT	WBR	SBLn1
Capacity (veh/h)	1392	-	-	-	846
HCM Lane V/C Ratio	0.034	-	-	-	0.07
HCM Control Delay (s)	7.7	-	-	-	9.6
HCM Lane LOS	A	-	-	-	A
HCM 95th %tile Q(veh)	0.1	-	-	-	0.2

Intersection						
Int Delay, s/veh	2.5					
Movement	EBT	EBR	WBL	WBT	NBL	NBR
Lane Configurations	↑↑		↖	↑↑	↘	
Traffic Vol, veh/h	425	92	47	254	75	45
Future Vol, veh/h	425	92	47	254	75	45
Conflicting Peds, #/hr	0	2	0	0	0	0
Sign Control	Free	Free	Free	Free	Stop	Stop
RT Channelized	-	None	-	None	-	None
Storage Length	-	-	125	-	0	-
Veh in Median Storage, #	0	-	-	0	0	-
Grade, %	0	-	-	0	0	-
Peak Hour Factor	97	97	97	97	97	97
Heavy Vehicles, %	1	1	0	0	0	0
Mvmt Flow	438	95	48	262	77	46

Major/Minor	Major1	Major2	Minor1		
Conflicting Flow All	0	0	535	0	715 269
Stage 1	-	-	-	-	488 -
Stage 2	-	-	-	-	227 -
Critical Hdwy	-	-	4.1	-	6.8 6.9
Critical Hdwy Stg 1	-	-	-	-	5.8 -
Critical Hdwy Stg 2	-	-	-	-	5.8 -
Follow-up Hdwy	-	-	2.2	-	3.5 3.3
Pot Cap-1 Maneuver	-	-	1043	-	370 735
Stage 1	-	-	-	-	588 -
Stage 2	-	-	-	-	795 -
Platoon blocked, %	-	-	-	-	-
Mov Cap-1 Maneuver	-	-	1041	-	352 734
Mov Cap-2 Maneuver	-	-	-	-	352 -
Stage 1	-	-	-	-	587 -
Stage 2	-	-	-	-	758 -

Approach	EB	WB	NB
HCM Control Delay, s	0	1.3	16.5
HCM LOS			C

Minor Lane/Major Mvmt	NBLn1	EBT	EBR	WBL	WBT
Capacity (veh/h)	437	-	-	1041	-
HCM Lane V/C Ratio	0.283	-	-	0.047	-
HCM Control Delay (s)	16.5	-	-	8.6	-
HCM Lane LOS	C	-	-	A	-
HCM 95th %tile Q(veh)	1.2	-	-	0.1	-

Timings

14: Barton Rd. & Van Buren Bl.

09/19/2022



Lane Group	EBL	EBT	WBL	WBT	NBL	NBT	NBR	SBL	SBT
Lane Configurations	↘	↗	↘	↗	↘	↗	↗	↘	↗
Traffic Volume (vph)	115	1351	341	1520	240	70	261	35	31
Future Volume (vph)	115	1351	341	1520	240	70	261	35	31
Turn Type	Prot	NA	Prot	NA	Prot	NA	Perm	Prot	NA
Protected Phases	5	2	1	6	3	8		7	4
Permitted Phases							8		
Detector Phase	5	2	1	6	3	8	8	7	4
Switch Phase									
Minimum Initial (s)	5.0	10.0	5.0	10.0	5.0	10.0	10.0	5.0	10.0
Minimum Split (s)	9.2	25.2	9.2	25.5	9.1	14.6	14.6	9.1	33.6
Total Split (s)	17.6	52.1	22.2	56.7	12.1	36.3	36.3	9.4	33.6
Total Split (%)	14.7%	43.4%	18.5%	47.3%	10.1%	30.3%	30.3%	7.8%	28.0%
Yellow Time (s)	3.2	5.2	3.2	5.5	3.6	3.6	3.6	3.6	3.6
All-Red Time (s)	1.0	1.0	1.0	1.0	0.5	1.0	1.0	0.5	1.0
Lost Time Adjust (s)	0.0	0.0	0.0	0.0	0.0	0.0	0.0	0.0	0.0
Total Lost Time (s)	4.2	6.2	4.2	6.5	4.1	4.6	4.6	4.1	4.6
Lead/Lag	Lead	Lag	Lead	Lag	Lead	Lag	Lag	Lead	Lag
Lead-Lag Optimize?	Yes	Yes	Yes	Yes	Yes	Yes	Yes	Yes	Yes
Recall Mode	None	None	None	None	None	None	None	None	None
Act Effct Green (s)	10.6	46.1	18.1	53.3	8.0	20.0	20.0	5.3	13.4
Actuated g/C Ratio	0.10	0.44	0.17	0.51	0.08	0.19	0.19	0.05	0.13
v/c Ratio	0.66	1.10	1.16	0.65	0.93	0.20	0.53	0.40	0.43
Control Delay	63.6	85.0	143.4	21.7	89.4	38.3	8.9	63.3	17.6
Queue Delay	0.0	0.0	0.0	0.0	0.0	0.0	0.0	0.0	0.0
Total Delay	63.6	85.0	143.4	21.7	89.4	38.3	8.9	63.3	17.6
LOS	E	F	F	C	F	D	A	E	B
Approach Delay		83.5		43.0		46.3			27.5
Approach LOS		F		D		D			C

Intersection Summary

Cycle Length: 120
 Actuated Cycle Length: 104.8
 Natural Cycle: 120
 Control Type: Actuated-Uncoordinated
 Maximum v/c Ratio: 1.16
 Intersection Signal Delay: 58.7
 Intersection LOS: E
 Intersection Capacity Utilization 95.3%
 ICU Level of Service F
 Analysis Period (min) 15

Splits and Phases: 14: Barton Rd. & Van Buren Bl.



HCM 6th Signalized Intersection Summary
14: Barton Rd. & Van Buren Bl.

West Campus Upper Plateau (JN 14064)

09/19/2022



Movement	EBL	EBT	EBR	WBL	WBT	WBR	NBL	NBT	NBR	SBL	SBT	SBR
Lane Configurations	↖	↗		↖	↗		↖	↗	↖	↗	↖	↗
Traffic Volume (veh/h)	115	1351	250	341	1520	85	240	70	261	35	31	94
Future Volume (veh/h)	115	1351	250	341	1520	85	240	70	261	35	31	94
Initial Q (Qb), veh	0	0	0	0	0	0	0	0	0	0	0	0
Ped-Bike Adj(A_pbT)	1.00		1.00	1.00		1.00	1.00		0.94	1.00		1.00
Parking Bus, Adj	1.00	1.00	1.00	1.00	1.00	1.00	1.00	1.00	1.00	1.00	1.00	1.00
Work Zone On Approach		No			No			No			No	
Adj Sat Flow, veh/h/ln	1900	1856	1870	1870	1870	1856	1900	1900	1885	1900	1885	1900
Adj Flow Rate, veh/h	120	1407	231	355	1583	79	250	73	148	36	32	40
Peak Hour Factor	0.96	0.96	0.96	0.96	0.96	0.96	0.96	0.96	0.96	0.96	0.96	0.96
Percent Heavy Veh, %	0	3	2	2	2	3	0	0	1	0	1	0
Cap, veh/h	149	1376	223	317	2731	136	277	278	220	57	75	94
Arrive On Green	0.08	0.45	0.45	0.18	0.55	0.55	0.08	0.15	0.15	0.03	0.10	0.10
Sat Flow, veh/h	1810	3037	492	1781	4981	248	3510	1900	1506	1810	762	952
Grp Volume(v), veh/h	120	809	829	355	1082	580	250	73	148	36	0	72
Grp Sat Flow(s),veh/h/ln	1810	1763	1766	1781	1702	1825	1755	1900	1506	1810	0	1714
Q Serve(g_s), s	6.6	45.9	45.9	18.0	21.3	21.3	7.2	3.5	9.4	2.0	0.0	4.0
Cycle Q Clear(g_c), s	6.6	45.9	45.9	18.0	21.3	21.3	7.2	3.5	9.4	2.0	0.0	4.0
Prop In Lane	1.00		0.28	1.00		0.14	1.00		1.00	1.00		0.56
Lane Grp Cap(c), veh/h	149	799	800	317	1866	1001	277	278	220	57	0	169
V/C Ratio(X)	0.80	1.01	1.04	1.12	0.58	0.58	0.90	0.26	0.67	0.63	0.00	0.43
Avail Cap(c_a), veh/h	239	799	800	317	1866	1001	277	595	471	95	0	491
HCM Platoon Ratio	1.00	1.00	1.00	1.00	1.00	1.00	1.00	1.00	1.00	1.00	1.00	1.00
Upstream Filter(I)	1.00	1.00	1.00	1.00	1.00	1.00	1.00	1.00	1.00	1.00	0.00	1.00
Uniform Delay (d), s/veh	45.7	27.7	27.7	41.6	15.1	15.2	46.3	38.4	40.9	48.5	0.0	42.9
Incr Delay (d2), s/veh	3.9	35.0	41.5	87.5	0.3	0.6	30.0	0.5	3.5	11.0	0.0	1.7
Initial Q Delay(d3),s/veh	0.0	0.0	0.0	0.0	0.0	0.0	0.0	0.0	0.0	0.0	0.0	0.0
%ile BackOfQ(50%),veh/ln	3.0	24.7	26.2	15.1	7.2	7.8	4.2	1.6	3.6	1.1	0.0	1.8
Unsig. Movement Delay, s/veh												
LnGrp Delay(d),s/veh	49.6	62.7	69.2	129.2	15.4	15.7	76.3	38.9	44.5	59.5	0.0	44.6
LnGrp LOS	D	F	F	F	B	B	E	D	D	E	A	D
Approach Vol, veh/h		1758			2017			471				108
Approach Delay, s/veh		64.9			35.5			60.5				49.6
Approach LOS		E			D			E				D
Timer - Assigned Phs	1	2	3	4	5	6	7	8				
Phs Duration (G+Y+Rc), s	22.2	52.4	12.1	14.6	12.6	62.0	7.3	19.4				
Change Period (Y+Rc), s	* 4.2	* 6.5	4.1	4.6	* 4.2	6.5	4.1	4.6				
Max Green Setting (Gmax), s	* 18	* 46	8.0	29.0	* 13	50.2	5.3	31.7				
Max Q Clear Time (g_c+I1), s	20.0	47.9	9.2	6.0	8.6	23.3	4.0	11.4				
Green Ext Time (p_c), s	0.0	0.0	0.0	0.3	0.1	7.6	0.0	0.8				

Intersection Summary

HCM 6th Ctrl Delay	50.4
HCM 6th LOS	D

Notes

* HCM 6th computational engine requires equal clearance times for the phases crossing the barrier.

Timings
15: Airman Dr & Cactus Av.



Lane Group	WBL	WBR	NBR	SBL	Ø6
Lane Configurations	↖	↖	↖	↖↗	
Traffic Volume (vph)	305	379	696	902	
Future Volume (vph)	305	379	696	902	
Turn Type	Prot	Perm	Perm	Prot	
Protected Phases	3			1	6
Permitted Phases		8	2		
Detector Phase	3	8	2	1	
Switch Phase					
Minimum Initial (s)	10.0	5.0	10.0	5.0	10.0
Minimum Split (s)	14.6	21.7	21.7	9.6	14.7
Total Split (s)	30.0	30.0	48.0	42.0	90.0
Total Split (%)	25.0%	25.0%	40.0%	35.0%	75%
Yellow Time (s)	3.6	3.7	3.7	3.6	3.7
All-Red Time (s)	1.0	1.0	1.0	1.0	1.0
Lost Time Adjust (s)	0.0	0.0	0.0	0.0	
Total Lost Time (s)	4.6	4.7	4.7	4.6	
Lead/Lag			Lag	Lead	
Lead-Lag Optimize?			Yes	Yes	
Recall Mode	None	None	Min	None	Min
Act Effct Green (s)	23.2	23.1	33.8	35.0	
Actuated g/C Ratio	0.22	0.22	0.32	0.33	
v/c Ratio	0.87	0.63	0.94	0.89	
Control Delay	66.0	8.7	35.1	47.3	
Queue Delay	0.0	0.0	0.0	0.0	
Total Delay	66.0	8.7	35.1	47.3	
LOS	E	A	D	D	
Approach Delay	34.3				
Approach LOS	C				

Intersection Summary

Cycle Length: 120
 Actuated Cycle Length: 106.4
 Natural Cycle: 80
 Control Type: Actuated-Uncoordinated
 Maximum v/c Ratio: 0.94
 Intersection Signal Delay: 39.7
 Intersection LOS: D
 Intersection Capacity Utilization 76.6%
 ICU Level of Service D
 Analysis Period (min) 15













Splits and Phases: 15: Airman Dr & Cactus Av.



HCM 6th Signalized Intersection Summary
15: Airman Dr & Cactus Av.

West Campus Upper Plateau (JN 14064)

09/19/2022

						
Movement	WBL	WBR	NBT	NBR	SBL	SBT
Lane Configurations						
Traffic Volume (veh/h)	305	379	0	696	902	0
Future Volume (veh/h)	305	379	0	696	902	0
Initial Q (Qb), veh	0	0	0	0	0	0
Ped-Bike Adj(A_pbT)	1.00	1.00		1.00	1.00	
Parking Bus, Adj	1.00	1.00	1.00	1.00	1.00	1.00
Work Zone On Approach	No		No			No
Adj Sat Flow, veh/h/ln	1856	1826	1900	1856	1826	1900
Adj Flow Rate, veh/h	332	222	0	431	980	0
Peak Hour Factor	0.92	0.92	0.92	0.92	0.92	0.92
Percent Heavy Veh, %	3	5	0	3	5	0
Cap, veh/h	374	328	574	475	1118	1301
Arrive On Green	0.21	0.21	0.00	0.30	0.33	0.00
Sat Flow, veh/h	1767	1547	1900	1572	3374	1900
Grp Volume(v), veh/h	332	222	0	431	980	0
Grp Sat Flow(s),veh/h/ln	1767	1547	1900	1572	1687	1900
Q Serve(g_s), s	16.4	11.9	0.0	23.7	24.6	0.0
Cycle Q Clear(g_c), s	16.4	11.9	0.0	23.7	24.6	0.0
Prop In Lane	1.00	1.00		1.00	1.00	
Lane Grp Cap(c), veh/h	374	328	574	475	1118	1301
V/C Ratio(X)	0.89	0.68	0.00	0.91	0.88	0.00
Avail Cap(c_a), veh/h	500	438	916	758	1404	1804
HCM Platoon Ratio	1.00	1.00	1.00	1.00	1.00	1.00
Upstream Filter(I)	1.00	1.00	0.00	1.00	1.00	0.00
Uniform Delay (d), s/veh	34.4	32.6	0.0	30.1	28.3	0.0
Incr Delay (d2), s/veh	11.8	1.1	0.0	9.7	5.5	0.0
Initial Q Delay(d3),s/veh	0.0	0.0	0.0	0.0	0.0	0.0
%ile BackOfQ(50%),veh/ln	8.1	4.4	0.0	9.9	10.4	0.0
Unsig. Movement Delay, s/veh						
LnGrp Delay(d),s/veh	46.1	33.7	0.0	39.8	33.8	0.0
LnGrp LOS	D	C	A	D	C	A
Approach Vol, veh/h	554		431			980
Approach Delay, s/veh	41.1		39.8			33.8
Approach LOS	D		D			C
Timer - Assigned Phs	1	2			6	8
Phs Duration (G+Y+Rc), s	34.4	31.8			66.2	23.6
Change Period (Y+Rc), s	4.6	* 4.7			* 4.7	4.6
Max Green Setting (Gmax), s	37.4	* 43			* 85	25.4
Max Q Clear Time (g_c+I1), s	26.6	25.7			0.0	18.4
Green Ext Time (p_c), s	3.2	1.5			0.0	0.6

Intersection Summary

HCM 6th Ctrl Delay	37.2
HCM 6th LOS	D

Notes

* HCM 6th computational engine requires equal clearance times for the phases crossing the barrier.

Intersection

Intersection Delay, s/veh	9.3
Intersection LOS	A

Movement	EBT	EBR	WBL	WBT	NBL	NBR
Lane Configurations						
Traffic Vol, veh/h	212	70	40	97	56	66
Future Vol, veh/h	212	70	40	97	56	66
Peak Hour Factor	0.94	0.94	0.94	0.94	0.94	0.94
Heavy Vehicles, %	1	2	3	1	2	0
Mvmt Flow	226	74	43	103	60	70
Number of Lanes	1	0	1	1	1	0

Approach	EB	WB	NB
Opposing Approach	WB	EB	
Opposing Lanes	2	1	0
Conflicting Approach Left		NB	EB
Conflicting Lanes Left	0	1	1
Conflicting Approach Right	NB		WB
Conflicting Lanes Right	1	0	2
HCM Control Delay	9.9	8.7	8.7
HCM LOS	A	A	A

Lane	NBLn1	EBLn1	WBLn1	WBLn2
Vol Left, %	46%	0%	100%	0%
Vol Thru, %	0%	75%	0%	100%
Vol Right, %	54%	25%	0%	0%
Sign Control	Stop	Stop	Stop	Stop
Traffic Vol by Lane	122	282	40	97
LT Vol	56	0	40	0
Through Vol	0	212	0	97
RT Vol	66	70	0	0
Lane Flow Rate	130	300	43	103
Geometry Grp	2	5	7	7
Degree of Util (X)	0.17	0.363	0.066	0.145
Departure Headway (Hd)	4.711	4.36	5.602	5.064
Convergence, Y/N	Yes	Yes	Yes	Yes
Cap	761	825	640	708
Service Time	2.742	2.386	3.332	2.795
HCM Lane V/C Ratio	0.171	0.364	0.067	0.145
HCM Control Delay	8.7	9.9	8.7	8.7
HCM Lane LOS	A	A	A	A
HCM 95th-tile Q	0.6	1.7	0.2	0.5

Intersection	
Intersection Delay, s/veh	8.9
Intersection LOS	A

Movement	EBL	EBT	WBT	WBR	SBL	SBR
Lane Configurations						
Traffic Vol, veh/h	130	320	229	37	28	42
Future Vol, veh/h	130	320	229	37	28	42
Peak Hour Factor	0.97	0.97	0.97	0.97	0.97	0.97
Heavy Vehicles, %	1	0	2	0	4	3
Mvmt Flow	134	330	236	38	29	43
Number of Lanes	1	2	2	0	1	0

Approach	EB	WB	SB
Opposing Approach	WB	EB	
Opposing Lanes	2	3	0
Conflicting Approach Left	SB		WB
Conflicting Lanes Left	1	0	2
Conflicting Approach Right		SB	EB
Conflicting Lanes Right	0	1	3
HCM Control Delay	8.4	9.7	9.4
HCM LOS	A	A	A

Lane	EBLn1	EBLn2	EBLn3	WBLn1	WBLn2	SBLn1
Vol Left, %	100%	0%	0%	0%	0%	40%
Vol Thru, %	0%	100%	100%	100%	67%	0%
Vol Right, %	0%	0%	0%	0%	33%	60%
Sign Control	Stop	Stop	Stop	Stop	Stop	Stop
Traffic Vol by Lane	130	160	160	153	113	70
LT Vol	130	0	0	0	0	28
Through Vol	0	160	160	153	76	0
RT Vol	0	0	0	0	37	42
Lane Flow Rate	134	165	165	157	117	72
Geometry Grp	7	7	7	8	8	7
Degree of Util (X)	0.204	0.228	0.15	0.242	0.171	0.117
Departure Headway (Hd)	5.492	4.973	3.265	5.541	5.277	5.853
Convergence, Y/N	Yes	Yes	Yes	Yes	Yes	Yes
Cap	654	721	1094	647	678	610
Service Time	3.225	2.706	0.997	3.29	3.026	3.614
HCM Lane V/C Ratio	0.205	0.229	0.151	0.243	0.173	0.118
HCM Control Delay	9.6	9.2	6.6	10.1	9.1	9.4
HCM Lane LOS	A	A	A	B	A	A
HCM 95th-tile Q	0.8	0.9	0.5	0.9	0.6	0.4

Timings
18: Linebacker Dr & Cactus Av.

West Campus Upper Plateau (JN 14064)

09/19/2022

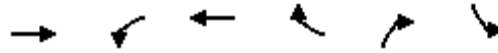

Lane Group	EBT	WBL	WBT	WBR	NBR	SBL	Ø3	Ø4	Ø5	Ø8
Lane Configurations	↑↑	↑	↑	↑	↑	↑↑				
Traffic Volume (vph)	1598	183	684	182	503	502				
Future Volume (vph)	1598	183	684	182	503	502				
Turn Type	NA	Prot	NA	Perm	pm+ov	Prot				
Protected Phases	2	1	6		1	7	3	4	5	8
Permitted Phases				6	8					
Detector Phase	2	1	6	6	1	7				
Switch Phase										
Minimum Initial (s)	10.0	5.0	10.0	10.0	5.0	5.0	5.0	10.0	5.0	10.0
Minimum Split (s)	27.0	9.6	27.0	27.0	9.6	9.6	9.6	27.0	9.6	27.0
Total Split (s)	56.0	15.0	61.4	61.4	15.0	20.0	9.6	39.4	9.6	29.0
Total Split (%)	46.7%	12.5%	51.2%	51.2%	12.5%	16.7%	8%	33%	8%	24%
Yellow Time (s)	4.0	3.6	4.0	4.0	3.6	3.6	3.6	4.0	3.6	4.0
All-Red Time (s)	1.0	1.0	1.0	1.0	1.0	1.0	1.0	1.0	1.0	1.0
Lost Time Adjust (s)	0.0	0.0	0.0	0.0	0.0	0.0				
Total Lost Time (s)	5.0	4.6	5.0	5.0	4.6	4.6				
Lead/Lag	Lead	Lag	Lag	Lag	Lag	Lag	Lag	Lead	Lead	Lead
Lead-Lag Optimize?	Yes	Yes	Yes	Yes	Yes	Yes	Yes	Yes	Yes	Yes
Recall Mode	None	None	None	None	None	None	None	None	None	None
Act Effct Green (s)	51.6	10.5	66.7	66.7	14.9	15.6				
Actuated g/C Ratio	0.54	0.11	0.69	0.69	0.15	0.16				
v/c Ratio	0.89	1.06	0.59	0.18	1.52	0.99				
Control Delay	28.3	127.0	12.2	2.5	268.7	76.5				
Queue Delay	0.0	0.0	0.0	0.0	0.0	0.0				
Total Delay	28.3	127.0	12.2	2.5	268.7	76.5				
LOS	C	F	B	A	F	E				
Approach Delay	28.3		30.5							
Approach LOS	C		C							

Intersection Summary

Cycle Length: 120
 Actuated Cycle Length: 96.4
 Natural Cycle: 120
 Control Type: Actuated-Uncoordinated
 Maximum v/c Ratio: 1.52
 Intersection Signal Delay: 68.7
 Intersection LOS: E
 Intersection Capacity Utilization 101.5%
 ICU Level of Service G
 Analysis Period (min) 15

Splits and Phases: 18: Linebacker Dr & Cactus Av.

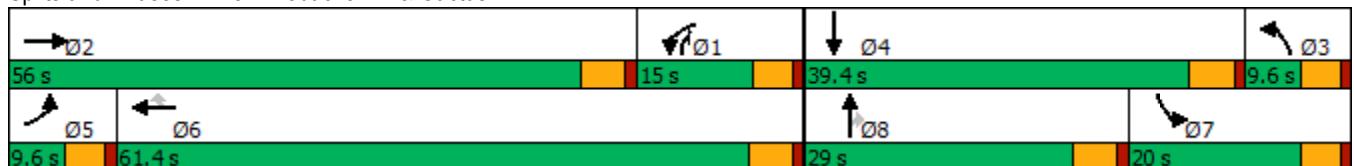

HCM 6th Signalized Intersection Summary
18: Linebacker Dr & Cactus Av.

West Campus Upper Plateau (JN 14064)

09/19/2022



Movement	EBL	EBT	EBR	WBL	WBT	WBR	NBL	NBT	NBR	SBL	SBT	SBR
Lane Configurations	↖	↗		↖	↗	↗	↖	↗	↗	↗	↗	↗
Traffic Volume (veh/h)	0	1598	0	183	684	182	0	0	503	502	0	0
Future Volume (veh/h)	0	1598	0	183	684	182	0	0	503	502	0	0
Initial Q (Qb), veh	0	0	0	0	0	0	0	0	0	0	0	0
Ped-Bike Adj(A_pbT)	1.00		1.00	1.00		1.00	1.00		1.00	1.00		1.00
Parking Bus, Adj	1.00	1.00	1.00	1.00	1.00	1.00	1.00	1.00	1.00	1.00	1.00	1.00
Work Zone On Approach		No			No			No			No	
Adj Sat Flow, veh/h/ln	1900	1841	1900	1826	1841	1826	1900	1900	1826	1826	1900	1900
Adj Flow Rate, veh/h	0	1737	0	199	743	198	0	0	248	546	0	0
Peak Hour Factor	0.92	0.92	0.92	0.92	0.92	0.92	0.92	0.92	0.92	0.92	0.92	0.92
Percent Heavy Veh, %	0	4	0	5	4	5	0	0	5	5	0	0
Cap, veh/h	2	1765	0	170	1149	966	517	178	297	503	2	0
Arrive On Green	0.00	0.48	0.00	0.10	0.62	0.62	0.00	0.00	0.09	0.14	0.00	0.00
Sat Flow, veh/h	1810	3681	0	1739	1841	1547	1810	1900	1547	3478	1900	0
Grp Volume(v), veh/h	0	1737	0	199	743	198	0	0	248	546	0	0
Grp Sat Flow(s),veh/h/ln	1810	1841	0	1739	1841	1547	1810	1900	1547	1739	1900	0
Q Serve(g_s), s	0.0	49.5	0.0	10.4	27.1	2.2	0.0	0.0	6.0	15.4	0.0	0.0
Cycle Q Clear(g_c), s	0.0	49.5	0.0	10.4	27.1	2.2	0.0	0.0	6.0	15.4	0.0	0.0
Prop In Lane	1.00		0.00	1.00		1.00	1.00		1.00	1.00		0.00
Lane Grp Cap(c), veh/h	2	1765	0	170	1149	966	517	178	297	503	2	0
V/C Ratio(X)	0.00	0.98	0.00	1.17	0.65	0.21	0.00	0.00	0.84	1.08	0.00	0.00
Avail Cap(c_a), veh/h	85	1765	0	170	1149	966	517	429	500	503	614	0
HCM Platoon Ratio	1.00	1.00	1.00	1.00	1.00	1.00	1.00	1.00	1.00	1.00	1.00	1.00
Upstream Filter(I)	0.00	1.00	0.00	1.00	1.00	1.00	0.00	0.00	1.00	1.00	0.00	0.00
Uniform Delay (d), s/veh	0.0	27.3	0.0	48.0	12.6	1.2	0.0	0.0	41.4	45.5	0.0	0.0
Incr Delay (d2), s/veh	0.0	17.8	0.0	122.4	1.3	0.1	0.0	0.0	6.2	64.9	0.0	0.0
Initial Q Delay(d3),s/veh	0.0	0.0	0.0	0.0	0.0	0.0	0.0	0.0	0.0	0.0	0.0	0.0
%ile BackOfQ(50%),veh/ln	0.0	24.9	0.0	10.3	10.6	1.7	0.0	0.0	6.7	11.1	0.0	0.0
Unsig. Movement Delay, s/veh												
LnGrp Delay(d),s/veh	0.0	45.1	0.0	170.4	13.9	1.3	0.0	0.0	47.6	110.4	0.0	0.0
LnGrp LOS	A	D	A	F	B	A	A	A	D	F	A	A
Approach Vol, veh/h		1737			1140			248			546	
Approach Delay, s/veh		45.1			39.0			47.6			110.4	
Approach LOS		D			D			D			F	
Timer - Assigned Phs	1	2	3	4	5	6	7	8				
Phs Duration (G+Y+Rc), s	15.4	56.0	35.0	0.0	0.0	71.4	20.0	15.0				
Change Period (Y+Rc), s	5.0	* 5	4.6	5.0	4.6	5.0	4.6	5.0				
Max Green Setting (Gmax), s	10.4	* 51	5.0	34.4	5.0	56.4	15.4	24.0				
Max Q Clear Time (g_c+I1), s	12.4	51.5	0.0	0.0	0.0	29.1	17.4	8.0				
Green Ext Time (p_c), s	0.0	0.0	0.0	0.0	0.0	6.8	0.0	0.7				

Intersection Summary

HCM 6th Ctrl Delay	53.1
HCM 6th LOS	D

Notes

* HCM 6th computational engine requires equal clearance times for the phases crossing the barrier.

Timings
19: Van Buren Bl. & Orange Terrace Pkwy.

West Campus Upper Plateau (JN 14064)

09/19/2022

Lane Group	EBL	EBT	EBR	WBL	WBT	WBR	NBL	NBT	NBR	SBL	SBT	SBR
Lane Configurations												
Traffic Volume (vph)	142	1522	88	54	1739	230	68	34	43	123	34	110
Future Volume (vph)	142	1522	88	54	1739	230	68	34	43	123	34	110
Turn Type	Prot	NA	Perm	Prot	NA	Perm	Prot	NA	Perm	Prot	NA	pm+ov
Protected Phases	5	2		1	6		3	8		7	4	5
Permitted Phases			2			6			8			4
Detector Phase	5	2	2	1	6	6	3	8	8	7	4	5
Switch Phase												
Minimum Initial (s)	5.0	10.0	10.0	5.0	10.0	10.0	5.0	5.0	5.0	10.0	10.0	5.0
Minimum Split (s)	9.2	25.2	25.2	9.1	25.2	25.2	9.1	26.1	26.1	15.8	24.8	9.2
Total Split (s)	16.0	63.0	63.0	11.0	58.0	58.0	12.0	27.0	27.0	19.0	34.0	16.0
Total Split (%)	13.3%	52.5%	52.5%	9.2%	48.3%	48.3%	10.0%	22.5%	22.5%	15.8%	28.3%	13.3%
Yellow Time (s)	3.2	5.2	5.2	3.6	5.2	5.2	3.6	3.6	3.6	4.8	4.8	3.2
All-Red Time (s)	1.0	1.0	1.0	0.5	1.0	1.0	0.5	0.5	0.5	1.0	1.0	1.0
Lost Time Adjust (s)	0.0	0.0	0.0	0.0	0.0	0.0	0.0	0.0	0.0	0.0	0.0	0.0
Total Lost Time (s)	4.2	6.2	6.2	4.1	6.2	6.2	4.1	4.1	4.1	5.8	5.8	4.2
Lead/Lag	Lead	Lag	Lag	Lead	Lag	Lag	Lead	Lag	Lag	Lead	Lag	Lead
Lead-Lag Optimize?	Yes	Yes	Yes	Yes	Yes	Yes	Yes	Yes	Yes	Yes	Yes	Yes
Recall Mode	None	None	None	None	None	None	None	None	None	None	None	None
Act Effct Green (s)	8.6	49.8	49.8	6.7	45.0	45.0	10.4	8.2	8.2	10.7	11.9	23.2
Actuated g/C Ratio	0.09	0.55	0.55	0.07	0.50	0.50	0.11	0.09	0.09	0.12	0.13	0.26
v/c Ratio	0.45	0.57	0.10	0.22	0.73	0.27	0.19	0.11	0.14	0.31	0.14	0.25
Control Delay	46.9	15.8	0.5	47.4	20.8	4.8	44.3	42.5	0.9	43.7	40.8	15.4
Queue Delay	0.0	0.0	0.0	0.0	0.0	0.0	0.0	0.0	0.0	0.0	0.0	0.0
Total Delay	46.9	15.8	0.5	47.4	20.8	4.8	44.3	42.5	0.9	43.7	40.8	15.4
LOS	D	B	A	D	C	A	D	D	A	D	D	B
Approach Delay		17.5			19.7			31.0				31.6
Approach LOS		B			B			C				C

Intersection Summary

Cycle Length: 120	
Actuated Cycle Length: 90.8	
Natural Cycle: 90	
Control Type: Actuated-Uncoordinated	
Maximum v/c Ratio: 0.73	
Intersection Signal Delay: 19.9	Intersection LOS: B
Intersection Capacity Utilization 61.4%	ICU Level of Service B
Analysis Period (min) 15	

Splits and Phases: 19: Van Buren Bl. & Orange Terrace Pkwy.

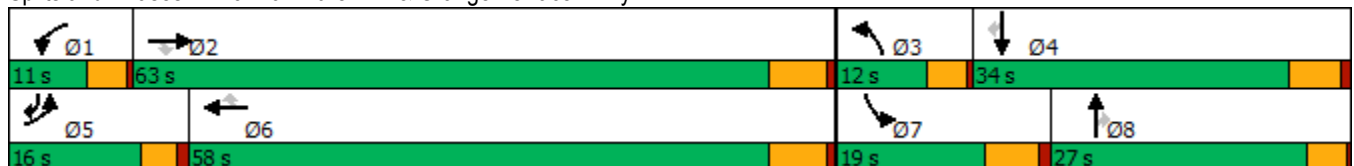

HCM 6th Signalized Intersection Summary
 19: Van Buren Bl. & Orange Terrace Pkwy.

West Campus Upper Plateau (JN 14064)

09/19/2022



Movement	EBL	EBT	EBR	WBL	WBT	WBR	NBL	NBT	NBR	SBL	SBT	SBR
Lane Configurations	↔↔	↑↑↑	↗	↔↔	↑↑↑	↗	↔↔	↑↑	↗	↔↔	↑	↗
Traffic Volume (veh/h)	142	1522	88	54	1739	230	68	34	43	123	34	110
Future Volume (veh/h)	142	1522	88	54	1739	230	68	34	43	123	34	110
Initial Q (Qb), veh	0	0	0	0	0	0	0	0	0	0	0	0
Ped-Bike Adj(A_pbT)	1.00		1.00	1.00		1.00	1.00		1.00	1.00		1.00
Parking Bus, Adj	1.00	1.00	1.00	1.00	1.00	1.00	1.00	1.00	1.00	1.00	1.00	1.00
Work Zone On Approach		No			No			No			No	
Adj Sat Flow, veh/h/ln	1885	1870	1811	1870	1856	1885	1796	1900	1856	1885	1900	1885
Adj Flow Rate, veh/h	148	1585	66	56	1811	181	71	35	14	128	35	42
Peak Hour Factor	0.96	0.96	0.96	0.96	0.96	0.96	0.96	0.96	0.96	0.96	0.96	0.96
Percent Heavy Veh, %	1	2	6	2	3	1	7	0	3	1	0	1
Cap, veh/h	225	2620	787	151	2486	784	161	215	94	419	288	346
Arrive On Green	0.06	0.51	0.51	0.04	0.49	0.49	0.05	0.06	0.06	0.12	0.15	0.15
Sat Flow, veh/h	3483	5106	1535	3456	5066	1598	3319	3610	1572	3483	1900	1598
Grp Volume(v), veh/h	148	1585	66	56	1811	181	71	35	14	128	35	42
Grp Sat Flow(s),veh/h/ln	1742	1702	1535	1728	1689	1598	1659	1805	1572	1742	1900	1598
Q Serve(g_s), s	3.4	18.2	1.8	1.3	23.5	5.4	1.7	0.8	0.7	2.8	1.3	1.8
Cycle Q Clear(g_c), s	3.4	18.2	1.8	1.3	23.5	5.4	1.7	0.8	0.7	2.8	1.3	1.8
Prop In Lane	1.00		1.00	1.00		1.00	1.00		1.00	1.00		1.00
Lane Grp Cap(c), veh/h	225	2620	787	151	2486	784	161	215	94	419	288	346
V/C Ratio(X)	0.66	0.61	0.08	0.37	0.73	0.23	0.44	0.16	0.15	0.31	0.12	0.12
Avail Cap(c_a), veh/h	495	3491	1049	287	3158	996	316	995	433	553	645	646
HCM Platoon Ratio	1.00	1.00	1.00	1.00	1.00	1.00	1.00	1.00	1.00	1.00	1.00	1.00
Upstream Filter(I)	1.00	1.00	1.00	1.00	1.00	1.00	1.00	1.00	1.00	1.00	1.00	1.00
Uniform Delay (d), s/veh	37.9	14.3	10.3	38.6	16.8	12.1	38.4	37.1	37.1	33.4	30.5	26.2
Incr Delay (d2), s/veh	1.2	0.2	0.0	1.5	0.6	0.1	1.9	0.4	0.7	0.4	0.2	0.2
Initial Q Delay(d3),s/veh	0.0	0.0	0.0	0.0	0.0	0.0	0.0	0.0	0.0	0.0	0.0	0.0
%ile BackOfQ(50%),veh/ln	1.4	5.8	0.6	0.6	7.7	1.8	0.7	0.3	0.3	1.1	0.6	0.7
Unsig. Movement Delay, s/veh												
LnGrp Delay(d),s/veh	39.2	14.5	10.3	40.1	17.4	12.3	40.3	37.5	37.8	33.8	30.6	26.4
LnGrp LOS	D	B	B	D	B	B	D	D	D	C	C	C
Approach Vol, veh/h		1799			2048			120			205	
Approach Delay, s/veh		16.4			17.6			39.2			31.7	
Approach LOS		B			B			D			C	
Timer - Assigned Phs	1	2	3	4	5	6	7	8				
Phs Duration (G+Y+Rc), s	7.7	48.8	8.1	18.4	9.6	47.0	15.8	10.7				
Change Period (Y+Rc), s	4.1	6.2	4.1	5.8	* 4.2	6.2	5.8	* 5.8				
Max Green Setting (Gmax), s	6.9	56.8	7.9	28.2	* 12	51.8	13.2	* 23				
Max Q Clear Time (g_c+I1), s	3.3	20.2	3.7	3.8	5.4	25.5	4.8	2.8				
Green Ext Time (p_c), s	0.0	14.4	0.1	0.2	0.1	15.2	0.2	0.2				

Intersection Summary

HCM 6th Ctrl Delay	18.4
HCM 6th LOS	B

Notes

* HCM 6th computational engine requires equal clearance times for the phases crossing the barrier.

Timings
20: Brown/San Gorgonio Dr & Alessandro Bl.

West Campus Upper Plateau (JN 14064)

09/19/2022



Lane Group	EBL	EBT	WBL	WBT	WBR	NBL	NBT	NBR	SBL	SBT	SBR
Lane Configurations	↖	↕↕↕	↖	↕↕↕	↖	↖	↕	↖	↖	↕	↖
Traffic Volume (vph)	30	2177	224	2060	33	386	2	471	124	1	78
Future Volume (vph)	30	2177	224	2060	33	386	2	471	124	1	78
Turn Type	Prot	NA	Prot	NA	Perm	Prot	NA	pm+ov	Prot	NA	pm+ov
Protected Phases	5	2	1	6		3	8	1	7	4	5
Permitted Phases					6			8			4
Detector Phase	5	2	1	6	6	3	8	1	7	4	5
Switch Phase											
Minimum Initial (s)	5.0	10.0	5.0	10.0	10.0	5.0	5.0	5.0	5.0	10.0	5.0
Minimum Split (s)	8.7	43.5	9.1	43.5	43.5	9.1	26.1	9.1	8.7	49.8	8.7
Total Split (s)	8.7	52.0	9.1	52.4	52.4	9.1	39.3	9.1	19.6	49.8	8.7
Total Split (%)	7.3%	43.3%	7.6%	43.7%	43.7%	7.6%	32.8%	7.6%	16.3%	41.5%	7.3%
Yellow Time (s)	3.2	5.5	3.6	5.5	5.5	3.6	3.6	3.6	3.2	4.8	3.2
All-Red Time (s)	0.5	1.0	0.5	1.0	1.0	0.5	0.5	0.5	0.5	1.0	0.5
Lost Time Adjust (s)	0.0	0.0	0.0	0.0	0.0	0.0	0.0	0.0	0.0	0.0	0.0
Total Lost Time (s)	3.7	6.5	4.1	6.5	6.5	4.1	4.1	4.1	3.7	5.8	3.7
Lead/Lag	Lead	Lag	Lead	Lag	Lag	Lead	Lag	Lead	Lead	Lag	Lead
Lead-Lag Optimize?	Yes	Yes	Yes	Yes	Yes	Yes	Yes	Yes	Yes	Yes	Yes
Recall Mode	None	None	None	None	None	None	None	None	None	None	None
Act Effct Green (s)	5.2	47.3	5.2	49.7	49.7	8.6	9.9	10.6	10.4	15.1	12.1
Actuated g/C Ratio	0.06	0.57	0.06	0.60	0.60	0.10	0.12	0.13	0.12	0.18	0.15
v/c Ratio	0.29	0.85	2.25	0.71	0.05	2.22	0.01	1.75	0.62	0.00	0.28
Control Delay	50.2	21.7	615.0	17.6	0.1	585.3	31.5	372.2	50.0	26.0	11.2
Queue Delay	0.0	0.0	0.0	0.0	0.0	0.0	0.0	0.0	0.0	0.0	0.0
Total Delay	50.2	21.7	615.0	17.6	0.1	585.3	31.5	372.2	50.0	26.0	11.2
LOS	D	C	F	B	A	F	C	F	D	C	B
Approach Delay		22.1		75.1			467.2			35.0	
Approach LOS		C		E			F			D	

Intersection Summary

Cycle Length: 120	
Actuated Cycle Length: 83.2	
Natural Cycle: 115	
Control Type: Actuated-Uncoordinated	
Maximum v/c Ratio: 2.25	
Intersection Signal Delay: 110.0	Intersection LOS: F
Intersection Capacity Utilization 99.0%	ICU Level of Service F
Analysis Period (min) 15	

Splits and Phases: 20: Brown/San Gorgonio Dr & Alessandro Bl.

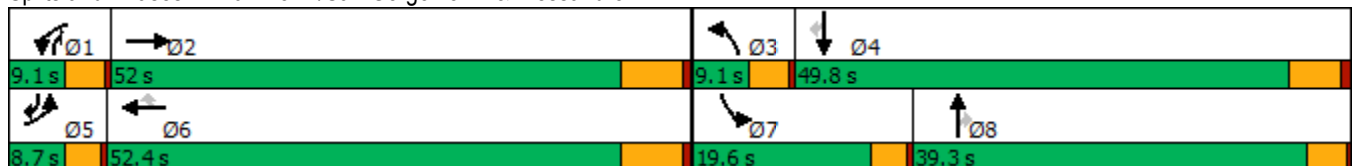

HCM 6th Signalized Intersection Summary
 20: Brown/San Gorgonio Dr & Alessandro Bl.

West Campus Upper Plateau (JN 14064)

09/19/2022



Movement	EBL	EBT	EBR	WBL	WBT	WBR	NBL	NBT	NBR	SBL	SBT	SBR
Lane Configurations	↖	↕↕↕		↖	↕↕↕	↖	↖	↕	↖	↖	↖	↖
Traffic Volume (veh/h)	30	2177	191	224	2060	33	386	2	471	124	1	78
Future Volume (veh/h)	30	2177	191	224	2060	33	386	2	471	124	1	78
Initial Q (Qb), veh	0	0	0	0	0	0	0	0	0	0	0	0
Ped-Bike Adj(A_pbT)	1.00		1.00	1.00		1.00	1.00		1.00	1.00		1.00
Parking Bus, Adj	1.00	1.00	1.00	1.00	1.00	1.00	1.00	1.00	1.00	1.00	1.00	1.00
Work Zone On Approach		No			No			No			No	
Adj Sat Flow, veh/h/ln	1900	1900	1900	1796	1885	1396	1885	1900	1811	1811	1900	1885
Adj Flow Rate, veh/h	32	2292	197	236	2168	31	406	2	483	131	1	34
Peak Hour Factor	0.95	0.95	0.95	0.95	0.95	0.95	0.95	0.95	0.95	0.95	0.95	0.95
Percent Heavy Veh, %	0	0	0	7	1	34	1	0	6	6	0	1
Cap, veh/h	50	1904	161	73	2108	485	77	575	530	157	660	599
Arrive On Green	0.03	0.39	0.39	0.04	0.41	0.41	0.04	0.30	0.30	0.09	0.35	0.35
Sat Flow, veh/h	1810	4871	413	1711	5147	1183	1795	1900	1535	1725	1900	1598
Grp Volume(v), veh/h	32	1618	871	236	2168	31	406	2	483	131	1	34
Grp Sat Flow(s),veh/h/ln	1810	1729	1826	1711	1716	1183	1795	1900	1535	1725	1900	1598
Q Serve(g_s), s	2.0	45.5	45.5	5.0	47.7	1.8	5.0	0.1	35.0	8.7	0.0	1.6
Cycle Q Clear(g_c), s	2.0	45.5	45.5	5.0	47.7	1.8	5.0	0.1	35.0	8.7	0.0	1.6
Prop In Lane	1.00		0.23	1.00		1.00	1.00		1.00	1.00		1.00
Lane Grp Cap(c), veh/h	50	1352	714	73	2108	485	77	575	530	157	660	599
V/C Ratio(X)	0.64	1.20	1.22	3.21	1.03	0.06	5.26	0.00	0.91	0.83	0.00	0.06
Avail Cap(c_a), veh/h	78	1352	714	73	2108	485	77	575	530	236	718	648
HCM Platoon Ratio	1.00	1.00	1.00	1.00	1.00	1.00	1.00	1.00	1.00	1.00	1.00	1.00
Upstream Filter(I)	1.00	1.00	1.00	1.00	1.00	1.00	1.00	1.00	1.00	1.00	1.00	1.00
Uniform Delay (d), s/veh	56.0	35.5	35.5	55.7	34.4	20.8	55.7	28.4	36.4	52.0	24.8	23.2
Incr Delay (d2), s/veh	4.9	96.1	111.8	1029.7	27.3	0.1	1947.6	0.0	20.0	9.3	0.0	0.0
Initial Q Delay(d3),s/veh	0.0	0.0	0.0	0.0	0.0	0.0	0.0	0.0	0.0	0.0	0.0	0.0
%ile BackOfQ(50%),veh/ln	1.0	35.5	40.5	23.2	24.6	0.5	44.0	0.0	15.8	4.2	0.0	0.6
Unsig. Movement Delay, s/veh												
LnGrp Delay(d),s/veh	61.0	131.6	147.2	1085.4	61.7	20.9	2003.3	28.4	56.4	61.4	24.8	23.3
LnGrp LOS	E	F	F	F	F	C	F	C	E	E	C	C
Approach Vol, veh/h		2521			2435			891				166
Approach Delay, s/veh		136.1			160.4			943.5				53.3
Approach LOS		F			F			F				D
Timer - Assigned Phs	1	2	3	4	5	6	7	8				
Phs Duration (G+Y+Rc), s	9.1	52.0	9.1	46.2	6.9	54.2	14.3	41.0				
Change Period (Y+Rc), s	4.1	6.5	4.1	5.8	3.7	6.5	3.7	* 5.8				
Max Green Setting (Gmax), s	5.0	45.5	5.0	44.0	5.0	45.9	15.9	* 35				
Max Q Clear Time (g_c+I1), s	7.0	47.5	7.0	3.6	4.0	49.7	10.7	37.0				
Green Ext Time (p_c), s	0.0	0.0	0.0	0.1	0.0	0.0	0.1	0.0				

Intersection Summary

HCM 6th Ctrl Delay	263.3
HCM 6th LOS	F

Notes

* HCM 6th computational engine requires equal clearance times for the phases crossing the barrier.

Timings
21: Cactus Av. & Brown St



Lane Group	EBL	EBT	WBT	SBR
Lane Configurations	↖	↑↑	↑↑	↗
Traffic Volume (vph)	815	1787	649	400
Future Volume (vph)	815	1787	649	400
Turn Type	Prot	NA	NA	Perm
Protected Phases	7	4	8	
Permitted Phases				6
Detector Phase	7	4	8	6
Switch Phase				
Minimum Initial (s)	5.0	10.0	10.0	10.0
Minimum Split (s)	9.6	15.8	22.8	21.7
Total Split (s)	65.0	97.0	32.0	23.0
Total Split (%)	54.2%	80.8%	26.7%	19.2%
Yellow Time (s)	3.6	4.8	4.8	3.7
All-Red Time (s)	1.0	1.0	1.0	1.0
Lost Time Adjust (s)	0.0	0.0	0.0	0.0
Total Lost Time (s)	4.6	5.8	5.8	4.7
Lead/Lag	Lead		Lag	
Lead-Lag Optimize?	Yes		Yes	
Recall Mode	None	None	None	Min
Act Effct Green (s)	58.2	88.4	25.6	11.3
Actuated g/C Ratio	0.53	0.80	0.23	0.10
v/c Ratio	0.93	0.71	0.89	0.51
Control Delay	42.1	7.1	56.4	2.2
Queue Delay	0.0	0.0	0.0	0.0
Total Delay	42.1	7.1	56.4	2.2
LOS	D	A	E	A
Approach Delay		18.1	56.4	
Approach LOS		B	E	

Intersection Summary

Cycle Length: 120
 Actuated Cycle Length: 110.3
 Natural Cycle: 110
 Control Type: Actuated-Uncoordinated
 Maximum v/c Ratio: 0.93
 Intersection Signal Delay: 23.1
 Intersection LOS: C
 Intersection Capacity Utilization 71.8%
 ICU Level of Service C
 Analysis Period (min) 15

Splits and Phases: 21: Cactus Av. & Brown St



HCM 6th Signalized Intersection Summary
21: Cactus Av. & Brown St

West Campus Upper Plateau (JN 14064)
09/19/2022

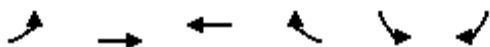

Movement	EBL	EBT	WBT	WBR	SBL	SBR	
Lane Configurations	↖	↑↑	↗		↙	↘	
Traffic Volume (veh/h)	815	1787	649	0	0	400	
Future Volume (veh/h)	815	1787	649	0	0	400	
Initial Q (Qb), veh	0	0	0	0	0	0	
Ped-Bike Adj(A_pbT)	1.00			1.00	1.00	1.00	
Parking Bus, Adj	1.00	1.00	1.00	1.00	1.00	1.00	
Work Zone On Approach		No	No		No		
Adj Sat Flow, veh/h/ln	1900	1811	1811	1900	1900	1900	
Adj Flow Rate, veh/h	886	1942	705	0	0	245	
Peak Hour Factor	0.92	0.92	0.92	0.92	0.92	0.92	
Percent Heavy Veh, %	0	6	6	0	0	0	
Cap, veh/h	904	2607	754	0	279	248	
Arrive On Green	0.50	0.76	0.22	0.00	0.00	0.15	
Sat Flow, veh/h	1810	3532	3622	0	1810	1610	
Grp Volume(v), veh/h	886	1942	705	0	0	245	
Grp Sat Flow(s),veh/h/ln	1810	1721	1721	0	1810	1610	
Q Serve(g_s), s	57.0	37.3	23.9	0.0	0.0	18.0	
Cycle Q Clear(g_c), s	57.0	37.3	23.9	0.0	0.0	18.0	
Prop In Lane	1.00			0.00	1.00	1.00	
Lane Grp Cap(c), veh/h	904	2607	754	0	279	248	
V/C Ratio(X)	0.98	0.74	0.93	0.00	0.00	0.99	
Avail Cap(c_a), veh/h	920	2641	759	0	279	248	
HCM Platoon Ratio	1.00	1.00	1.00	1.00	1.00	1.00	
Upstream Filter(I)	1.00	1.00	1.00	0.00	0.00	1.00	
Uniform Delay (d), s/veh	29.1	8.0	45.6	0.0	0.0	50.2	
Incr Delay (d2), s/veh	24.4	1.2	18.6	0.0	0.0	53.6	
Initial Q Delay(d3),s/veh	0.0	0.0	0.0	0.0	0.0	0.0	
%ile BackOfQ(50%),veh/ln	28.6	10.3	11.8	0.0	0.0	3.7	
Unsig. Movement Delay, s/veh							
LnGrp Delay(d),s/veh	53.6	9.2	64.2	0.0	0.0	103.8	
LnGrp LOS	D	A	E	A	A	F	
Approach Vol, veh/h		2828	705		245		
Approach Delay, s/veh		23.1	64.2		103.8		
Approach LOS		C	E		F		
Timer - Assigned Phs				4	6	7	8
Phs Duration (G+Y+Rc), s				95.8	23.0	64.0	31.8
Change Period (Y+Rc), s				5.8	4.7	4.6	5.8
Max Green Setting (Gmax), s				91.2	18.3	60.4	26.2
Max Q Clear Time (g_c+I1), s				39.3	20.0	59.0	25.9
Green Ext Time (p_c), s				25.3	0.0	0.4	0.1

Intersection Summary

HCM 6th Ctrl Delay	36.0
HCM 6th LOS	D

Timings
22: Sycamore Canyon Bl. & Eastridge Ave

West Campus Upper Plateau (JN 14064)

09/19/2022



Lane Group	EBL	EBT	EBR	WBL	WBT	WBR	NBL	NBT	NBR	SBL	SBT	SBR
Lane Configurations	↔↔	↑↑↑	↔	↔↔	↑↑	↔	↔↔	↑↑	↔	↔↔	↑↑	↔
Traffic Volume (vph)	94	99	53	189	69	366	33	747	154	288	390	20
Future Volume (vph)	94	99	53	189	69	366	33	747	154	288	390	20
Turn Type	Prot	NA	Perm	Prot	NA	pm+ov	Prot	NA	pm+ov	Prot	NA	pm+ov
Protected Phases	5	2		1	6	7	3	8	1	7	4	5
Permitted Phases			2			6			8			4
Detector Phase	5	2	2	1	6	7	3	8	1	7	4	5
Switch Phase												
Minimum Initial (s)	5.0	10.0	10.0	5.0	10.0	5.0	5.0	10.0	5.0	5.0	10.0	5.0
Minimum Split (s)	8.7	43.5	43.5	8.7	43.5	8.7	8.7	15.8	8.7	8.7	49.8	8.7
Total Split (s)	11.7	45.5	45.5	15.2	49.0	20.2	8.7	39.1	15.2	20.2	50.6	11.7
Total Split (%)	9.8%	37.9%	37.9%	12.7%	40.8%	16.8%	7.3%	32.6%	12.7%	16.8%	42.2%	9.8%
Yellow Time (s)	3.2	5.5	5.5	3.2	5.5	3.2	3.2	4.8	3.2	3.2	4.8	3.2
All-Red Time (s)	0.5	1.0	1.0	0.5	1.0	0.5	0.5	1.0	0.5	0.5	1.0	0.5
Lost Time Adjust (s)	0.0	0.0	0.0	0.0	0.0	0.0	0.0	0.0	0.0	0.0	0.0	0.0
Total Lost Time (s)	3.7	6.5	6.5	3.7	6.5	3.7	3.7	5.8	3.7	3.7	5.8	3.7
Lead/Lag	Lead	Lag	Lag	Lead	Lag	Lead	Lead	Lag	Lead	Lead	Lag	Lead
Lead-Lag Optimize?	Yes	Yes	Yes	Yes	Yes	Yes	Yes	Yes	Yes	Yes	Yes	Yes
Recall Mode	None	None	None	None	None	None	None	None	None	None	None	None
Act Effct Green (s)	7.1	13.6	13.6	9.6	18.4	33.9	5.2	27.9	39.7	12.6	39.6	48.8
Actuated g/C Ratio	0.08	0.16	0.16	0.11	0.22	0.40	0.06	0.33	0.47	0.15	0.47	0.58
v/c Ratio	0.42	0.16	0.17	0.55	0.13	0.64	0.20	0.75	0.22	0.64	0.27	0.03
Control Delay	46.1	32.1	1.0	43.8	30.1	21.6	46.5	31.3	4.9	42.2	16.0	0.1
Queue Delay	0.0	0.0	0.0	0.0	0.0	0.0	0.0	0.0	0.0	0.0	0.0	0.0
Total Delay	46.1	32.1	1.0	43.8	30.1	21.6	46.5	31.3	4.9	42.2	16.0	0.1
LOS	D	C	A	D	C	C	D	C	A	D	B	A
Approach Delay		30.7			29.2			27.5			26.4	
Approach LOS		C			C			C			C	

Intersection Summary

Cycle Length: 120
 Actuated Cycle Length: 84.1
 Natural Cycle: 115
 Control Type: Actuated-Uncoordinated
 Maximum v/c Ratio: 0.75
 Intersection Signal Delay: 27.9
 Intersection LOS: C
 Intersection Capacity Utilization 59.1%
 ICU Level of Service B
 Analysis Period (min) 15

Splits and Phases: 22: Sycamore Canyon Bl. & Eastridge Ave

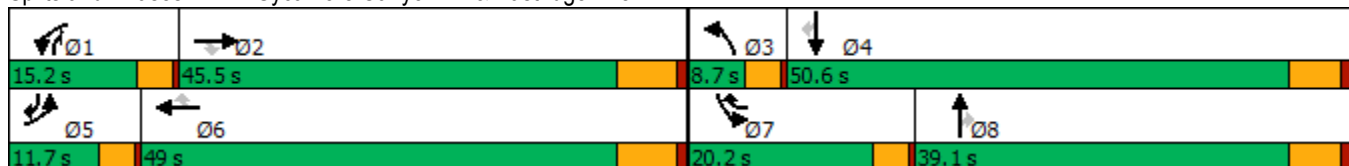

HCM 6th Signalized Intersection Summary
 22: Sycamore Canyon Bl. & Eastridge Ave

West Campus Upper Plateau (JN 14064)

09/19/2022



Movement	EBL	EBT	EBR	WBL	WBT	WBR	NBL	NBT	NBR	SBL	SBT	SBR
Lane Configurations	↔↔	↑↑↑	↔	↔↔	↑↑	↔	↔↔	↑↑	↔	↔↔	↑↑	↔
Traffic Volume (veh/h)	94	99	53	189	69	366	33	747	154	288	390	20
Future Volume (veh/h)	94	99	53	189	69	366	33	747	154	288	390	20
Initial Q (Qb), veh	0	0	0	0	0	0	0	0	0	0	0	0
Ped-Bike Adj(A_pbT)	1.00		1.00	1.00		1.00	1.00		0.99	1.00		0.99
Parking Bus, Adj	1.00	1.00	1.00	1.00	1.00	1.00	1.00	1.00	1.00	1.00	1.00	1.00
Work Zone On Approach		No			No			No			No	
Adj Sat Flow, veh/h/ln	1663	1604	1841	1856	1426	1796	1648	1796	1841	1841	1826	1559
Adj Flow Rate, veh/h	106	111	0	212	78	227	37	839	116	324	438	18
Peak Hour Factor	0.89	0.89	0.89	0.89	0.89	0.89	0.89	0.89	0.89	0.89	0.89	0.89
Percent Heavy Veh, %	16	20	4	3	32	7	17	7	4	4	5	23
Cap, veh/h	198	693		311	500	474	113	1121	647	434	1453	631
Arrive On Green	0.06	0.16	0.00	0.09	0.18	0.18	0.04	0.33	0.33	0.13	0.42	0.42
Sat Flow, veh/h	3072	4378	1560	3428	2709	1520	3045	3413	1540	3401	3469	1304
Grp Volume(v), veh/h	106	111	0	212	78	227	37	839	116	324	438	18
Grp Sat Flow(s),veh/h/ln	1536	1459	1560	1714	1354	1520	1522	1706	1540	1700	1735	1304
Q Serve(g_s), s	2.2	1.5	0.0	4.0	1.6	8.1	0.8	14.6	3.2	6.1	5.6	0.5
Cycle Q Clear(g_c), s	2.2	1.5	0.0	4.0	1.6	8.1	0.8	14.6	3.2	6.1	5.6	0.5
Prop In Lane	1.00		1.00	1.00		1.00	1.00		1.00	1.00		1.00
Lane Grp Cap(c), veh/h	198	693		311	500	474	113	1121	647	434	1453	631
V/C Ratio(X)	0.54	0.16		0.68	0.16	0.48	0.33	0.75	0.18	0.75	0.30	0.03
Avail Cap(c_a), veh/h	368	2557		591	1725	1162	228	1702	910	841	2328	960
HCM Platoon Ratio	1.00	1.00	1.00	1.00	1.00	1.00	1.00	1.00	1.00	1.00	1.00	1.00
Upstream Filter(I)	1.00	1.00	0.00	1.00	1.00	1.00	1.00	1.00	1.00	1.00	1.00	1.00
Uniform Delay (d), s/veh	30.3	24.3	0.0	29.4	22.9	18.6	31.3	20.0	12.2	28.1	12.9	9.0
Incr Delay (d2), s/veh	0.8	0.2	0.0	1.0	0.2	1.1	0.6	1.0	0.1	1.0	0.1	0.0
Initial Q Delay(d3),s/veh	0.0	0.0	0.0	0.0	0.0	0.0	0.0	0.0	0.0	0.0	0.0	0.0
%ile BackOfQ(50%),veh/ln	0.8	0.5	0.0	1.5	0.5	2.6	0.3	5.1	0.9	2.3	1.8	0.1
Unsig. Movement Delay, s/veh												
LnGrp Delay(d),s/veh	31.1	24.4	0.0	30.4	23.1	19.6	31.9	21.0	12.3	29.1	13.0	9.1
LnGrp LOS	C	C		C	C	B	C	C	B	C	B	A
Approach Vol, veh/h		217			517			992			780	
Approach Delay, s/veh		27.7			24.6			20.4			19.6	
Approach LOS		C			C			C			B	
Timer - Assigned Phs	1	2	3	4	5	6	7	8				
Phs Duration (G+Y+Rc), s	9.8	17.1	6.2	33.8	8.0	18.8	12.2	27.7				
Change Period (Y+Rc), s	3.7	6.5	3.7	5.8	3.7	6.5	3.7	5.8				
Max Green Setting (Gmax), s	11.5	39.0	5.0	44.8	8.0	42.5	16.5	33.3				
Max Q Clear Time (g_c+I1), s	6.0	3.5	2.8	7.6	4.2	10.1	8.1	16.6				
Green Ext Time (p_c), s	0.2	0.9	0.0	2.9	0.0	1.9	0.4	5.3				

Intersection Summary

HCM 6th Ctrl Delay	21.6
HCM 6th LOS	C

Notes

Unsignalized Delay for [EBR] is excluded from calculations of the approach delay and intersection delay.

Timings
23: Sycamore Canyon Bl. & Cottonwood Ave

West Campus Upper Plateau (JN 14064)

09/19/2022



Lane Group	WBL	WBR	NBT	SBL	SBT
Lane Configurations	↙	↗	↕↔	↙	↕↕
Traffic Volume (vph)	28	11	869	36	666
Future Volume (vph)	28	11	869	36	666
Turn Type	Prot	Perm	NA	Prot	NA
Protected Phases	8		2	1	6
Permitted Phases		8			
Detector Phase	8	8	2	1	6
Switch Phase					
Minimum Initial (s)	10.0	10.0	10.0	5.0	10.0
Minimum Split (s)	15.8	15.8	43.5	9.1	43.5
Total Split (s)	23.0	23.0	78.0	19.0	97.0
Total Split (%)	19.2%	19.2%	65.0%	15.8%	80.8%
Yellow Time (s)	4.8	4.8	5.5	3.6	5.5
All-Red Time (s)	1.0	1.0	1.0	0.5	1.0
Lost Time Adjust (s)	0.0	0.0	0.0	0.0	0.0
Total Lost Time (s)	5.8	5.8	6.5	4.1	6.5
Lead/Lag			Lag	Lead	
Lead-Lag Optimize?			Yes	Yes	
Recall Mode	None	None	None	None	None
Act Effct Green (s)	14.3	14.3	34.4	9.5	39.9
Actuated g/C Ratio	0.29	0.29	0.69	0.19	0.80
v/c Ratio	0.08	0.04	0.45	0.15	0.27
Control Delay	27.5	15.6	10.2	28.8	3.6
Queue Delay	0.0	0.0	0.0	0.0	0.0
Total Delay	27.5	15.6	10.2	28.8	3.6
LOS	C	B	B	C	A
Approach Delay	24.1		10.2		4.9
Approach LOS	C		B		A

Intersection Summary

Cycle Length: 120
 Actuated Cycle Length: 49.6
 Natural Cycle: 70
 Control Type: Actuated-Uncoordinated
 Maximum v/c Ratio: 0.45
 Intersection Signal Delay: 8.3
 Intersection Capacity Utilization 48.5%
 Analysis Period (min) 15
 Intersection LOS: A
 ICU Level of Service A

Splits and Phases: 23: Sycamore Canyon Bl. & Cottonwood Ave



HCM 6th Signalized Intersection Summary
 23: Sycamore Canyon Bl. & Cottonwood Ave

West Campus Upper Plateau (JN 14064)
 09/19/2022



Movement	WBL	WBR	NBT	NBR	SBL	SBT
Lane Configurations						
Traffic Volume (veh/h)	28	11	869	26	36	666
Future Volume (veh/h)	28	11	869	26	36	666
Initial Q (Qb), veh	0	0	0	0	0	0
Ped-Bike Adj(A_pbT)	1.00	1.00		0.98	1.00	
Parking Bus, Adj	1.00	1.00	1.00	1.00	1.00	1.00
Work Zone On Approach	No		No			No
Adj Sat Flow, veh/h/ln	1604	1129	1796	1767	1515	1870
Adj Flow Rate, veh/h	33	3	1010	29	42	774
Peak Hour Factor	0.86	0.86	0.86	0.86	0.86	0.86
Percent Heavy Veh, %	20	52	7	9	26	2
Cap, veh/h	123	77	1746	50	65	2312
Arrive On Green	0.08	0.08	0.52	0.52	0.05	0.65
Sat Flow, veh/h	1527	957	3475	97	1443	3647
Grp Volume(v), veh/h	33	3	509	530	42	774
Grp Sat Flow(s),veh/h/ln	1527	957	1706	1776	1443	1777
Q Serve(g_s), s	0.9	0.1	9.4	9.4	1.3	4.4
Cycle Q Clear(g_c), s	0.9	0.1	9.4	9.4	1.3	4.4
Prop In Lane	1.00	1.00		0.05	1.00	
Lane Grp Cap(c), veh/h	123	77	880	916	65	2312
V/C Ratio(X)	0.27	0.04	0.58	0.58	0.64	0.33
Avail Cap(c_a), veh/h	575	360	2669	2778	470	7035
HCM Platoon Ratio	1.00	1.00	1.00	1.00	1.00	1.00
Upstream Filter(I)	1.00	1.00	1.00	1.00	1.00	1.00
Uniform Delay (d), s/veh	19.8	19.4	7.6	7.6	21.5	3.6
Incr Delay (d2), s/veh	1.2	0.2	0.9	0.8	10.1	0.1
Initial Q Delay(d3),s/veh	0.0	0.0	0.0	0.0	0.0	0.0
%ile BackOfQ(50%),veh/ln	0.3	0.0	2.1	2.2	0.6	0.5
Unsig. Movement Delay, s/veh						
LnGrp Delay(d),s/veh	20.9	19.6	8.5	8.5	31.6	3.7
LnGrp LOS	C	B	A	A	C	A
Approach Vol, veh/h	36		1039			816
Approach Delay, s/veh	20.8		8.5			5.1
Approach LOS	C		A			A
Timer - Assigned Phs	1	2			6	8
Phs Duration (G+Y+Rc), s	6.2	30.1			36.2	9.5
Change Period (Y+Rc), s	4.1	6.5			6.5	5.8
Max Green Setting (Gmax), s	14.9	71.5			90.5	17.2
Max Q Clear Time (g_c+11), s	3.3	11.4			6.4	2.9
Green Ext Time (p_c), s	0.0	12.2			8.8	0.0

Intersection Summary

HCM 6th Ctrl Delay			7.3			
HCM 6th LOS			A			

Timings

West Campus Upper Plateau (JN 14064)

24: Sycamore Canyon Bl. & Alessandro Bl.

09/19/2022

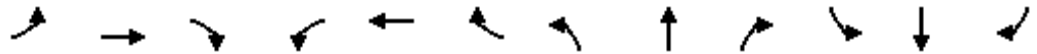

Lane Group	EBL	EBT	EBR	WBL	WBT	WBR	NBL	NBT	NBR	SBL	SBT	SBR
Lane Configurations	↘	↑↑↑	↗	↘↗	↑↑↑	↗	↘↗	↑↑	↗↘	↘↗	↑↑	↗
Traffic Volume (vph)	150	2006	617	359	1871	449	509	505	163	144	582	292
Future Volume (vph)	150	2006	617	359	1871	449	509	505	163	144	582	292
Turn Type	Prot	NA	Perm	Prot	NA	Perm	Prot	NA	pm+ov	Prot	NA	Perm
Protected Phases	5	2		1	6		3	8	1	7	4	
Permitted Phases			2			6			8			4
Detector Phase	5	2	2	1	6	6	3	8	1	7	4	4
Switch Phase												
Minimum Initial (s)	5.0	10.0	10.0	5.0	10.0	10.0	5.0	10.0	5.0	5.0	10.0	10.0
Minimum Split (s)	8.7	43.5	43.5	8.7	43.5	43.5	8.7	15.8	8.7	8.7	49.8	49.8
Total Split (s)	10.0	44.2	44.2	12.0	46.2	46.2	14.0	51.0	12.0	12.8	49.8	49.8
Total Split (%)	8.3%	36.8%	36.8%	10.0%	38.5%	38.5%	11.7%	42.5%	10.0%	10.7%	41.5%	41.5%
Yellow Time (s)	3.2	5.5	5.5	3.2	5.5	5.5	3.2	4.8	3.2	3.2	4.8	4.8
All-Red Time (s)	0.5	1.0	1.0	0.5	1.0	1.0	0.5	1.0	0.5	0.5	1.0	1.0
Lost Time Adjust (s)	0.0	0.0	0.0	0.0	0.0	0.0	0.0	0.0	0.0	0.0	0.0	0.0
Total Lost Time (s)	3.7	6.5	6.5	3.7	6.5	6.5	3.7	5.8	3.7	3.7	5.8	5.8
Lead/Lag	Lead	Lag	Lag	Lead	Lag	Lag	Lead	Lag	Lead	Lead	Lag	Lag
Lead-Lag Optimize?	Yes	Yes	Yes	Yes	Yes	Yes	Yes	Yes	Yes	Yes	Yes	Yes
Recall Mode	None	None	None	None	None	None	None	None	None	None	None	None
Act Effct Green (s)	6.3	38.0	38.0	8.4	40.0	40.0	10.4	28.5	42.7	8.1	26.3	26.3
Actuated g/C Ratio	0.06	0.37	0.37	0.08	0.39	0.39	0.10	0.28	0.42	0.08	0.26	0.26
v/c Ratio	1.38	1.08	0.83	1.42	0.96	0.66	1.50	0.53	0.14	0.56	0.68	0.60
Control Delay	255.7	78.1	29.2	245.2	43.9	21.9	273.4	33.3	11.0	55.8	38.0	22.9
Queue Delay	0.0	0.0	0.0	0.0	0.0	0.0	0.0	0.0	0.0	0.0	0.0	0.0
Total Delay	255.7	78.1	29.2	245.2	43.9	21.9	273.4	33.3	11.0	55.8	38.0	22.9
LOS	F	E	C	F	D	C	F	C	B	E	D	C
Approach Delay		76.8			67.2			134.1			36.2	
Approach LOS		E			E			F			D	

Intersection Summary

Cycle Length: 120
 Actuated Cycle Length: 102.8
 Natural Cycle: 115
 Control Type: Actuated-Uncoordinated
 Maximum v/c Ratio: 1.50
 Intersection Signal Delay: 76.8
 Intersection LOS: E
 Intersection Capacity Utilization 96.5%
 ICU Level of Service F
 Analysis Period (min) 15

Splits and Phases: 24: Sycamore Canyon Bl. & Alessandro Bl.

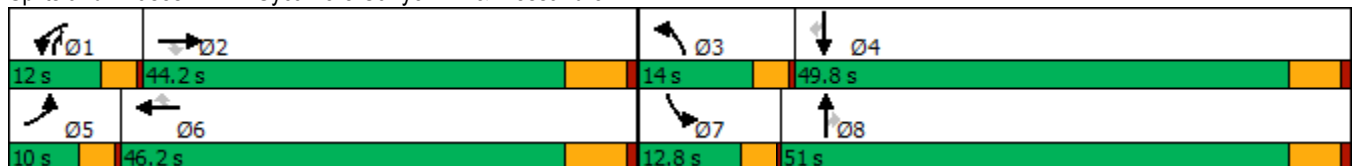

HCM 6th Signalized Intersection Summary
 24: Sycamore Canyon Bl. & Alessandro Bl.

West Campus Upper Plateau (JN 14064)

09/19/2022



Movement	EBL	EBT	EBR	WBL	WBT	WBR	NBL	NBT	NBR	SBL	SBT	SBR
Lane Configurations												
Traffic Volume (veh/h)	150	2006	617	359	1871	449	509	505	163	144	582	292
Future Volume (veh/h)	150	2006	617	359	1871	449	509	505	163	144	582	292
Initial Q (Qb), veh	0	0	0	0	0	0	0	0	0	0	0	0
Ped-Bike Adj(A_pbT)	1.00		1.00	1.00		0.99	1.00		1.00	1.00		1.00
Parking Bus, Adj	1.00	1.00	1.00	1.00	1.00	1.00	1.00	1.00	1.00	1.00	1.00	1.00
Work Zone On Approach		No			No			No			No	
Adj Sat Flow, veh/h/ln	1900	1885	1885	1752	1885	1796	1870	1841	1870	1826	1826	1870
Adj Flow Rate, veh/h	153	2047	439	366	1909	327	519	515	124	147	594	206
Peak Hour Factor	0.98	0.98	0.98	0.98	0.98	0.98	0.98	0.98	0.98	0.98	0.98	0.98
Percent Heavy Veh, %	0	1	1	10	1	7	2	4	2	5	5	2
Cap, veh/h	116	1975	613	273	2080	607	362	940	985	211	786	359
Arrive On Green	0.06	0.38	0.38	0.08	0.40	0.40	0.10	0.27	0.27	0.06	0.23	0.23
Sat Flow, veh/h	1810	5147	1598	3237	5147	1501	3456	3497	2790	3374	3469	1585
Grp Volume(v), veh/h	153	2047	439	366	1909	327	519	515	124	147	594	206
Grp Sat Flow(s),veh/h/ln	1810	1716	1598	1618	1716	1501	1728	1749	1395	1687	1735	1585
Q Serve(g_s), s	6.3	37.7	22.9	8.3	34.5	16.3	10.3	12.4	3.0	4.2	15.7	11.4
Cycle Q Clear(g_c), s	6.3	37.7	22.9	8.3	34.5	16.3	10.3	12.4	3.0	4.2	15.7	11.4
Prop In Lane	1.00		1.00	1.00		1.00	1.00		1.00	1.00		1.00
Lane Grp Cap(c), veh/h	116	1975	613	273	2080	607	362	940	985	211	786	359
V/C Ratio(X)	1.32	1.04	0.72	1.34	0.92	0.54	1.43	0.55	0.13	0.70	0.76	0.57
Avail Cap(c_a), veh/h	116	1975	613	273	2080	607	362	1609	1519	312	1554	710
HCM Platoon Ratio	1.00	1.00	1.00	1.00	1.00	1.00	1.00	1.00	1.00	1.00	1.00	1.00
Upstream Filter(I)	1.00	1.00	1.00	1.00	1.00	1.00	1.00	1.00	1.00	1.00	1.00	1.00
Uniform Delay (d), s/veh	46.0	30.3	25.7	45.0	27.7	22.3	44.0	30.8	21.5	45.1	35.5	33.8
Incr Delay (d2), s/veh	191.5	30.4	4.3	175.0	7.2	1.2	209.9	0.5	0.1	1.6	1.5	1.4
Initial Q Delay(d3),s/veh	0.0	0.0	0.0	0.0	0.0	0.0	0.0	0.0	0.0	0.0	0.0	0.0
%ile BackOfQ(50%),veh/ln	8.9	19.7	8.8	9.8	14.2	5.5	14.8	5.0	0.9	1.7	6.4	4.3
Unsig. Movement Delay, s/veh												
LnGrp Delay(d),s/veh	237.4	60.7	30.1	220.0	34.9	23.6	253.9	31.3	21.6	46.7	37.0	35.2
LnGrp LOS	F	F	C	F	C	C	F	C	C	D	D	D
Approach Vol, veh/h		2639			2602			1158			947	
Approach Delay, s/veh		65.9			59.5			130.0			38.1	
Approach LOS		E			E			F			D	
Timer - Assigned Phs	1	2	3	4	5	6	7	8				
Phs Duration (G+Y+Rc), s	12.0	44.2	14.0	28.1	10.0	46.2	9.8	32.2				
Change Period (Y+Rc), s	3.7	6.5	3.7	5.8	3.7	6.5	3.7	5.8				
Max Green Setting (Gmax), s	8.3	37.7	10.3	44.0	6.3	39.7	9.1	45.2				
Max Q Clear Time (g_c+I1), s	10.3	39.7	12.3	17.7	8.3	36.5	6.2	14.4				
Green Ext Time (p_c), s	0.0	0.0	0.0	4.5	0.0	3.0	0.1	3.8				
Intersection Summary												
HCM 6th Ctrl Delay				70.2								
HCM 6th LOS				E								

Timings
25: Sycamore Canyon Bl. & Cactus Av.

West Campus Upper Plateau (JN 14064)

09/19/2022



Lane Group	EBL	EBT	EBR	WBL	WBT	WBR	NBL	NBT	NBR	SBL	SBT	SBR
Lane Configurations	↘	↑↑	↗	↘↗	↑↑	↗	↘↗	↑↑	↗	↘↗	↑↑	↗
Traffic Volume (vph)	145	1161	530	799	433	571	186	377	254	572	965	52
Future Volume (vph)	145	1161	530	799	433	571	186	377	254	572	965	52
Turn Type	Prot	NA	Perm	Prot	NA	Perm	Prot	NA	Perm	Prot	NA	Perm
Protected Phases	7	4		3	8		5	2		1	6	
Permitted Phases			4			8			2			6
Detector Phase	7	4	4	3	8	8	5	2	2	1	6	6
Switch Phase												
Minimum Initial (s)	5.0	10.0	10.0	5.0	10.0	10.0	5.0	10.0	10.0	5.0	10.0	10.0
Minimum Split (s)	9.6	32.8	32.8	9.6	32.8	32.8	9.6	34.8	34.8	9.6	34.8	34.8
Total Split (s)	10.3	32.8	32.8	29.0	51.5	51.5	9.6	36.2	36.2	22.0	48.6	48.6
Total Split (%)	8.6%	27.3%	27.3%	24.2%	42.9%	42.9%	8.0%	30.2%	30.2%	18.3%	40.5%	40.5%
Yellow Time (s)	3.6	4.8	4.8	3.6	4.8	4.8	3.6	4.8	4.8	3.6	4.8	4.8
All-Red Time (s)	1.0	1.0	1.0	1.0	1.0	1.0	1.0	1.0	1.0	1.0	1.0	1.0
Lost Time Adjust (s)	0.0	0.0	0.0	0.0	0.0	0.0	0.0	0.0	0.0	0.0	0.0	0.0
Total Lost Time (s)	4.6	5.8	5.8	4.6	5.8	5.8	4.6	5.8	5.8	4.6	5.8	5.8
Lead/Lag	Lead	Lag	Lag	Lead	Lag	Lag	Lead	Lag	Lag	Lead	Lag	Lag
Lead-Lag Optimize?	Yes	Yes	Yes	Yes	Yes	Yes	Yes	Yes	Yes	Yes	Yes	Yes
Recall Mode	None	None	None	None	None	None	None	None	None	None	None	None
Act Effct Green (s)	5.7	27.0	27.0	24.4	45.7	45.7	5.0	29.6	29.6	17.4	42.0	42.0
Actuated g/C Ratio	0.05	0.23	0.23	0.20	0.38	0.38	0.04	0.25	0.25	0.15	0.35	0.35
v/c Ratio	2.04	1.77	1.22	1.36	0.39	0.80	1.52	0.52	0.50	1.31	0.95	0.10
Control Delay	538.6	379.6	144.7	208.9	27.9	23.5	305.2	41.2	7.2	195.8	53.7	0.3
Queue Delay	0.0	0.0	0.0	0.0	0.0	0.0	0.0	0.0	0.0	0.0	0.0	0.0
Total Delay	538.6	379.6	144.7	208.9	27.9	23.5	305.2	41.2	7.2	195.8	53.7	0.3
LOS	F	F	F	F	C	C	F	D	A	F	D	A
Approach Delay		324.4			106.7			90.7			103.1	
Approach LOS		F			F			F			F	

Intersection Summary

Cycle Length: 120
 Actuated Cycle Length: 119.2
 Natural Cycle: 120
 Control Type: Actuated-Uncoordinated
 Maximum v/c Ratio: 2.04
 Intersection Signal Delay: 169.7
 Intersection Capacity Utilization 104.2%
 Analysis Period (min) 15
 Intersection LOS: F
 ICU Level of Service G

Splits and Phases: 25: Sycamore Canyon Bl. & Cactus Av.

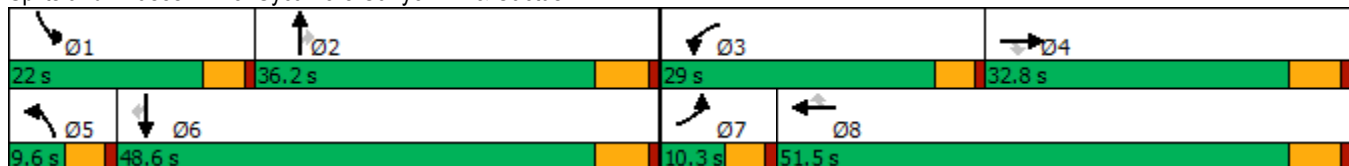

HCM 6th Signalized Intersection Summary
25: Sycamore Canyon Bl. & Cactus Av.

West Campus Upper Plateau (JN 14064)

09/19/2022



Movement	EBL	EBT	EBR	WBL	WBT	WBR	NBL	NBT	NBR	SBL	SBT	SBR
Lane Configurations	↘	↑↑	↗	↘↗	↑↑	↗	↘↗	↑↑	↗	↘↗	↑↑	↗
Traffic Volume (veh/h)	145	1161	530	799	433	571	186	377	254	572	965	52
Future Volume (veh/h)	145	1161	530	799	433	571	186	377	254	572	965	52
Initial Q (Qb), veh	0	0	0	0	0	0	0	0	0	0	0	0
Ped-Bike Adj(A_pbT)	1.00		1.00	1.00		1.00	1.00		1.00	1.00		1.00
Parking Bus, Adj	1.00	1.00	1.00	1.00	1.00	1.00	1.00	1.00	1.00	1.00	1.00	1.00
Work Zone On Approach		No			No			No			No	
Adj Sat Flow, veh/h/ln	1841	1796	1856	1826	1796	1870	1856	1811	1781	1885	1796	1767
Adj Flow Rate, veh/h	169	1350	606	929	503	394	216	438	192	665	1122	60
Peak Hour Factor	0.86	0.86	0.86	0.86	0.86	0.86	0.86	0.86	0.86	0.86	0.86	0.86
Percent Heavy Veh, %	4	7	3	5	7	2	3	6	8	1	7	9
Cap, veh/h	84	775	357	692	1311	609	144	849	373	509	1198	526
Arrive On Green	0.05	0.23	0.23	0.21	0.38	0.38	0.04	0.25	0.25	0.15	0.35	0.35
Sat Flow, veh/h	1753	3413	1572	3374	3413	1585	3428	3441	1510	3483	3413	1497
Grp Volume(v), veh/h	169	1350	606	929	503	394	216	438	192	665	1122	60
Grp Sat Flow(s),veh/h/ln	1753	1706	1572	1687	1706	1585	1714	1721	1510	1742	1706	1497
Q Serve(g_s), s	5.7	27.0	27.0	24.4	12.7	24.2	5.0	13.1	13.1	17.4	37.8	3.2
Cycle Q Clear(g_c), s	5.7	27.0	27.0	24.4	12.7	24.2	5.0	13.1	13.1	17.4	37.8	3.2
Prop In Lane	1.00		1.00	1.00		1.00	1.00		1.00	1.00		1.00
Lane Grp Cap(c), veh/h	84	775	357	692	1311	609	144	849	373	509	1198	526
V/C Ratio(X)	2.01	1.74	1.70	1.34	0.38	0.65	1.50	0.52	0.52	1.31	0.94	0.11
Avail Cap(c_a), veh/h	84	775	357	692	1311	609	144	879	386	509	1228	539
HCM Platoon Ratio	1.00	1.00	1.00	1.00	1.00	1.00	1.00	1.00	1.00	1.00	1.00	1.00
Upstream Filter(I)	1.00	1.00	1.00	1.00	1.00	1.00	1.00	1.00	1.00	1.00	1.00	1.00
Uniform Delay (d), s/veh	56.6	46.0	46.0	47.3	26.5	30.0	57.0	38.7	38.7	50.8	37.3	26.1
Incr Delay (d2), s/veh	494.6	339.6	325.9	163.8	0.2	2.4	257.3	0.5	1.1	151.1	13.1	0.1
Initial Q Delay(d3),s/veh	0.0	0.0	0.0	0.0	0.0	0.0	0.0	0.0	0.0	0.0	0.0	0.0
%ile BackOfQ(50%),veh/ln	14.0	47.7	42.5	25.6	5.0	9.2	7.3	5.4	4.8	18.0	17.1	1.1
Unsig. Movement Delay, s/veh												
LnGrp Delay(d),s/veh	551.2	385.6	371.9	211.0	26.6	32.4	314.3	39.2	39.8	201.9	50.4	26.2
LnGrp LOS	F	F	F	F	C	C	F	D	D	F	D	C
Approach Vol, veh/h		2125			1826			846			1847	
Approach Delay, s/veh		394.9			121.7			109.5			104.2	
Approach LOS		F			F			F			F	
Timer - Assigned Phs	1	2	3	4	5	6	7	8				
Phs Duration (G+Y+Rc), s	22.0	35.2	29.0	32.8	9.6	47.6	10.3	51.5				
Change Period (Y+Rc), s	4.6	5.8	4.6	5.8	4.6	5.8	4.6	5.8				
Max Green Setting (Gmax), s	17.4	30.4	24.4	27.0	5.0	42.8	5.7	45.7				
Max Q Clear Time (g_c+I1), s	19.4	15.1	26.4	29.0	7.0	39.8	7.7	26.2				
Green Ext Time (p_c), s	0.0	2.9	0.0	0.0	0.0	1.9	0.0	4.4				

Intersection Summary

HCM 6th Ctrl Delay	202.6
HCM 6th LOS	F

Timings

26: Sycamore Canyon Bl. & Van Buren Bl.

09/19/2022



Lane Group	EBL	EBT	EBR	WBL	WBT	WBR	NBL	NBT	SBL	SBT	SBR
Lane Configurations											
Traffic Volume (vph)	448	1496	1	8	1061	121	13	16	1070	15	1100
Future Volume (vph)	448	1496	1	8	1061	121	13	16	1070	15	1100
Turn Type	Prot	NA	Perm	Prot	NA	Perm	Perm	NA	Split	NA	Perm
Protected Phases	5	2		1	6			8	4	4	
Permitted Phases			2			6	8				4
Detector Phase	5	2	2	1	6	6	8	8	4	4	4
Switch Phase											
Minimum Initial (s)	5.0	10.0	10.0	5.0	10.0	10.0	10.0	10.0	10.0	10.0	10.0
Minimum Split (s)	9.6	29.2	29.2	9.6	29.2	29.2	14.6	14.6	50.8	50.8	50.8
Total Split (s)	22.0	47.8	47.8	9.6	35.4	35.4	14.6	14.6	58.0	58.0	58.0
Total Split (%)	16.9%	36.8%	36.8%	7.4%	27.2%	27.2%	11.2%	11.2%	44.6%	44.6%	44.6%
Yellow Time (s)	3.6	5.2	5.2	3.6	5.2	5.2	3.6	3.6	4.8	4.8	4.8
All-Red Time (s)	1.0	1.0	1.0	1.0	1.0	1.0	1.0	1.0	1.0	1.0	1.0
Lost Time Adjust (s)	0.0	0.0	0.0	0.0	0.0	0.0		0.0	0.0	0.0	0.0
Total Lost Time (s)	4.6	6.2	6.2	4.6	6.2	6.2		4.6	5.8	5.8	5.8
Lead/Lag	Lead	Lag	Lag	Lead	Lag	Lag					
Lead-Lag Optimize?	Yes	Yes	Yes	Yes	Yes	Yes					
Recall Mode	None	None	None	None	None	None	None	None	None	None	None
Act Effct Green (s)	17.5	48.4	48.4	5.0	28.2	28.2		10.0	52.4	52.4	52.4
Actuated g/C Ratio	0.14	0.38	0.38	0.04	0.22	0.22		0.08	0.42	0.42	0.42
v/c Ratio	1.05	0.68	0.00	0.15	0.84	0.29		0.27	0.83	0.02	1.32
Control Delay	109.1	35.1	0.0	65.8	53.9	7.6		31.3	40.2	23.7	174.2
Queue Delay	0.0	0.0	0.0	0.0	0.0	0.0		0.0	0.0	0.0	0.0
Total Delay	109.1	35.1	0.0	65.8	53.9	7.6		31.3	40.2	23.7	174.2
LOS	F	D	A	E	D	A		C	D	C	F
Approach Delay		52.1			49.3			31.3		107.6	
Approach LOS		D			D			C		F	

Intersection Summary

Cycle Length: 130
 Actuated Cycle Length: 126.1
 Natural Cycle: 115
 Control Type: Actuated-Uncoordinated
 Maximum v/c Ratio: 1.32
 Intersection Signal Delay: 73.7
 Intersection LOS: E
 Intersection Capacity Utilization 105.7%
 ICU Level of Service G
 Analysis Period (min) 15

Splits and Phases: 26: Sycamore Canyon Bl. & Van Buren Bl.

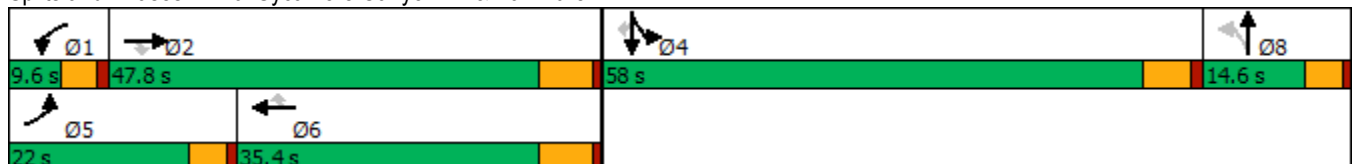

HCM 6th Signalized Intersection Summary
26: Sycamore Canyon Bl. & Van Buren Bl.

West Campus Upper Plateau (JN 14064)

09/19/2022



Movement	EBL	EBT	EBR	WBL	WBT	WBR	NBL	NBT	NBR	SBL	SBT	SBR
Lane Configurations	↔↔	↑↑↑	↗	↖	↑↑↑	↗		↔↔		↖↖	↑	↗
Traffic Volume (veh/h)	448	1496	1	8	1061	121	13	16	38	1070	15	1100
Future Volume (veh/h)	448	1496	1	8	1061	121	13	16	38	1070	15	1100
Initial Q (Qb), veh	0	0	0	0	0	0	0	0	0	0	0	0
Ped-Bike Adj(A_pbT)	1.00		1.00	1.00		0.99	1.00		0.99	1.00		1.00
Parking Bus, Adj	1.00	1.00	1.00	1.00	1.00	1.00	1.00	1.00	1.00	1.00	1.00	1.00
Work Zone On Approach		No			No			No			No	
Adj Sat Flow, veh/h/ln	1826	1826	1900	1693	1796	1841	1900	1900	1900	1841	1900	1856
Adj Flow Rate, veh/h	487	1626	1	9	1153	109	14	17	11	1163	16	0
Peak Hour Factor	0.92	0.92	0.92	0.92	0.92	0.92	0.92	0.92	0.92	0.92	0.92	0.92
Percent Heavy Veh, %	5	5	0	14	7	4	0	0	0	4	0	3
Cap, veh/h	505	2305	591	17	1409	351	75	92	60	1279	714	
Arrive On Green	0.15	0.37	0.37	0.01	0.23	0.23	0.06	0.06	0.06	0.38	0.38	0.00
Sat Flow, veh/h	3374	6281	1610	1612	6179	1540	1169	1441	945	3401	1900	1572
Grp Volume(v), veh/h	487	1626	1	9	1153	109	22	0	20	1163	16	0
Grp Sat Flow(s),veh/h/ln	1687	1570	1610	1612	1545	1540	1842	0	1713	1700	1900	1572
Q Serve(g_s), s	16.7	25.7	0.0	0.6	20.6	6.8	1.3	0.0	1.3	37.7	0.6	0.0
Cycle Q Clear(g_c), s	16.7	25.7	0.0	0.6	20.6	6.8	1.3	0.0	1.3	37.7	0.6	0.0
Prop In Lane	1.00		1.00	1.00		1.00	0.63		0.55	1.00		1.00
Lane Grp Cap(c), veh/h	505	2305	591	17	1409	351	118	0	109	1279	714	
V/C Ratio(X)	0.96	0.71	0.00	0.51	0.82	0.31	0.19	0.00	0.18	0.91	0.02	
Avail Cap(c_a), veh/h	505	2305	591	69	1552	387	158	0	147	1527	853	
HCM Platoon Ratio	1.00	1.00	1.00	1.00	1.00	1.00	1.00	1.00	1.00	1.00	1.00	1.00
Upstream Filter(I)	1.00	1.00	1.00	1.00	1.00	1.00	1.00	0.00	1.00	1.00	1.00	0.00
Uniform Delay (d), s/veh	49.1	31.4	23.3	57.2	42.6	37.3	51.6	0.0	51.5	34.4	22.8	0.0
Incr Delay (d2), s/veh	30.9	1.0	0.0	8.4	3.3	0.5	0.8	0.0	0.8	7.5	0.0	0.0
Initial Q Delay(d3),s/veh	0.0	0.0	0.0	0.0	0.0	0.0	0.0	0.0	0.0	0.0	0.0	0.0
%ile BackOfQ(50%),veh/ln	9.0	9.4	0.0	0.3	7.9	2.6	0.6	0.0	0.6	16.0	0.3	0.0
Unsig. Movement Delay, s/veh												
LnGrp Delay(d),s/veh	80.0	32.4	23.3	65.6	45.9	37.8	52.3	0.0	52.3	41.9	22.8	0.0
LnGrp LOS	E	C	C	E	D	D	D	A	D	D	C	
Approach Vol, veh/h		2114			1271			42			1179	
Approach Delay, s/veh		43.4			45.3			52.3			41.6	
Approach LOS		D			D			D			D	
Timer - Assigned Phs	1	2		4	5	6		8				
Phs Duration (G+Y+Rc), s	5.9	48.9		49.5	22.0	32.7		12.0				
Change Period (Y+Rc), s	4.6	6.2		5.8	4.6	6.2		4.6				
Max Green Setting (Gmax), s	5.0	41.6		52.2	17.4	29.2		10.0				
Max Q Clear Time (g_c+I1), s	2.6	27.7		39.7	18.7	22.6		3.3				
Green Ext Time (p_c), s	0.0	8.8		4.0	0.0	3.9		0.0				

Intersection Summary

HCM 6th Ctrl Delay	43.5
HCM 6th LOS	D

Notes

Unsignalized Delay for [SBR] is excluded from calculations of the approach delay and intersection delay.

Timings
27: Innovation Dr. & Cactus Av.

West Campus Upper Plateau (JN 14064)

09/19/2022

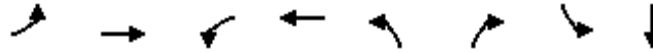

Lane Group	EBL	EBT	WBL	WBT	NBL	NBR	SBL	SBT
Lane Configurations	↶	↷	↶	↷	↶	↷	↶	↷
Traffic Volume (vph)	3	1978	56	1762	26	75	40	0
Future Volume (vph)	3	1978	56	1762	26	75	40	0
Turn Type	Prot	NA	Prot	NA	Perm	Perm	Perm	NA
Protected Phases	5	2	1	6				4
Permitted Phases					8	8	4	
Detector Phase	5	2	1	6	8	8	4	4
Switch Phase								
Minimum Initial (s)	5.0	10.0	5.0	10.0	10.0	10.0	10.0	10.0
Minimum Split (s)	9.2	26.8	9.2	26.8	31.1	31.1	31.1	31.1
Total Split (s)	12.0	63.0	22.0	73.0	35.0	35.0	35.0	35.0
Total Split (%)	10.0%	52.5%	18.3%	60.8%	29.2%	29.2%	29.2%	29.2%
Yellow Time (s)	3.2	4.8	3.2	4.8	4.1	4.1	4.1	4.1
All-Red Time (s)	1.0	1.0	1.0	1.0	1.0	1.0	1.0	1.0
Lost Time Adjust (s)	0.0	0.0	0.0	0.0	0.0	0.0	0.0	0.0
Total Lost Time (s)	4.2	5.8	4.2	5.8	5.1	5.1	5.1	5.1
Lead/Lag	Lead	Lag	Lead	Lag				
Lead-Lag Optimize?	Yes	Yes	Yes	Yes				
Recall Mode	None	None	None	None	None	None	None	None
Act Effct Green (s)	5.5	59.2	8.4	67.4	13.3	13.3	13.3	13.3
Actuated g/C Ratio	0.06	0.68	0.10	0.78	0.15	0.15	0.15	0.15
v/c Ratio	0.03	0.67	0.42	0.52	0.14	0.21	0.20	0.05
Control Delay	47.7	14.3	51.0	7.2	37.8	1.1	38.9	0.3
Queue Delay	0.0	0.1	0.0	0.1	0.0	0.0	0.0	0.0
Total Delay	47.7	14.4	51.0	7.3	37.8	1.1	38.9	0.3
LOS	D	B	D	A	D	A	D	A
Approach Delay		14.4		8.6				28.3
Approach LOS		B		A				C

Intersection Summary

Cycle Length: 120
 Actuated Cycle Length: 86.5
 Natural Cycle: 90
 Control Type: Actuated-Uncoordinated
 Maximum v/c Ratio: 0.67
 Intersection Signal Delay: 11.8
 Intersection Capacity Utilization 68.4%
 Analysis Period (min) 15
 Intersection LOS: B
 ICU Level of Service C

Splits and Phases: 27: Innovation Dr. & Cactus Av.



HCM 6th Signalized Intersection Summary
27: Innovation Dr. & Cactus Av.

West Campus Upper Plateau (JN 14064)
09/19/2022



Movement	EBL	EBT	EBR	WBL	WBT	WBR	NBL	NBT	NBR	SBL	SBT	SBR
Lane Configurations	↗	↑↑↑		↖	↑↑↑		↖	↑	↗	↖	↑	↗
Traffic Volume (veh/h)	3	1978	6	56	1762	15	26	0	75	40	0	15
Future Volume (veh/h)	3	1978	6	56	1762	15	26	0	75	40	0	15
Initial Q (Qb), veh	0	0	0	0	0	0	0	0	0	0	0	0
Ped-Bike Adj(A_pbT)	1.00		1.00	1.00		0.98	1.00		1.00	1.00		1.00
Parking Bus, Adj	1.00	1.00	1.00	1.00	1.00	1.00	1.00	1.00	1.00	1.00	1.00	1.00
Work Zone On Approach		No			No			No				No
Adj Sat Flow, veh/h/ln	1900	1811	1307	1663	1826	1900	1841	1900	1781	1900	1900	1781
Adj Flow Rate, veh/h	3	2222	7	63	1980	17	29	0	31	45	0	8
Peak Hour Factor	0.89	0.89	0.89	0.89	0.89	0.89	0.89	0.89	0.89	0.89	0.89	0.89
Percent Heavy Veh, %	0	6	40	16	5	0	4	0	8	0	0	8
Cap, veh/h	7	3268	10	77	3501	30	247	221	176	255	0	188
Arrive On Green	0.00	0.64	0.64	0.05	0.69	0.69	0.12	0.00	0.12	0.12	0.00	0.12
Sat Flow, veh/h	1810	5088	16	1584	5096	44	1385	1900	1510	1400	0	1610
Grp Volume(v), veh/h	3	1439	790	63	1291	706	29	0	31	45	0	8
Grp Sat Flow(s),veh/h/ln	1810	1648	1808	1584	1662	1817	1385	1900	1510	1400	0	1610
Q Serve(g_s), s	0.1	21.8	21.8	3.1	15.6	15.6	1.5	0.0	1.5	2.3	0.0	0.3
Cycle Q Clear(g_c), s	0.1	21.8	21.8	3.1	15.6	15.6	1.8	0.0	1.5	2.3	0.0	0.3
Prop In Lane	1.00		0.01	1.00		0.02	1.00		1.00	1.00		1.00
Lane Grp Cap(c), veh/h	7	2117	1161	77	2283	1248	247	221	176	255	0	188
V/C Ratio(X)	0.41	0.68	0.68	0.81	0.57	0.57	0.12	0.00	0.18	0.18	0.00	0.04
Avail Cap(c_a), veh/h	180	2402	1318	359	2845	1556	613	724	575	625	0	613
HCM Platoon Ratio	1.00	1.00	1.00	1.00	1.00	1.00	1.00	1.00	1.00	1.00	1.00	1.00
Upstream Filter(I)	1.00	1.00	1.00	1.00	1.00	1.00	1.00	0.00	1.00	1.00	0.00	1.00
Uniform Delay (d), s/veh	39.0	8.9	8.9	37.0	6.3	6.3	31.6	0.0	31.3	31.6	0.0	30.8
Incr Delay (d2), s/veh	13.2	0.8	1.5	7.5	0.3	0.6	0.2	0.0	0.5	0.3	0.0	0.1
Initial Q Delay(d3),s/veh	0.0	0.0	0.0	0.0	0.0	0.0	0.0	0.0	0.0	0.0	0.0	0.0
%ile BackOfQ(50%),veh/ln	0.1	5.6	6.4	1.3	3.5	4.0	0.5	0.0	0.5	0.8	0.0	0.1
Unsig. Movement Delay, s/veh												
LnGrp Delay(d),s/veh	52.1	9.7	10.4	44.5	6.6	6.9	31.8	0.0	31.7	32.0	0.0	30.9
LnGrp LOS	D	A	B	D	A	A	C	A	C	C	A	C
Approach Vol, veh/h		2232			2060			60				53
Approach Delay, s/veh		10.0			7.9			31.8				31.8
Approach LOS		B			A			C				C
Timer - Assigned Phs	1	2		4	5	6		8				
Phs Duration (G+Y+Rc), s	8.0	56.2		14.2	4.5	59.7		14.2				
Change Period (Y+Rc), s	* 4.2	5.8		5.1	* 4.2	5.8		5.1				
Max Green Setting (Gmax), s	* 18	57.2		29.9	* 7.8	67.2		29.9				
Max Q Clear Time (g_c+I1), s	5.1	23.8		4.3	2.1	17.6		3.8				
Green Ext Time (p_c), s	0.0	26.6		0.1	0.0	31.4		0.1				

Intersection Summary

HCM 6th Ctrl Delay	9.6
HCM 6th LOS	A

Notes

* HCM 6th computational engine requires equal clearance times for the phases crossing the barrier.

Timings
28: I-215 SB Ramps & Alessandro Bl.

West Campus Upper Plateau (JN 14064)

09/19/2022

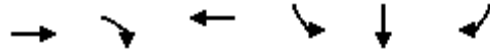

Lane Group	EBT	EBR	WBT	SBL	SBT	SBR
Lane Configurations	↑↑↑	↑	↑↑↑	↑	↔	↑
Traffic Volume (vph)	1769	544	2148	356	0	531
Future Volume (vph)	1769	544	2148	356	0	531
Turn Type	NA	Perm	NA	Split	NA	Perm
Protected Phases	2		6	4	4	
Permitted Phases		2				4
Detector Phase	2	2	6	4	4	4
Switch Phase						
Minimum Initial (s)	5.0	5.0	5.0	5.0	5.0	5.0
Minimum Split (s)	10.5	10.5	34.5	10.0	10.0	10.0
Total Split (s)	52.0	52.0	52.0	33.0	33.0	33.0
Total Split (%)	61.2%	61.2%	61.2%	38.8%	38.8%	38.8%
Yellow Time (s)	4.5	4.5	4.5	4.0	4.0	4.0
All-Red Time (s)	1.0	1.0	1.0	1.0	1.0	1.0
Lost Time Adjust (s)	0.0	0.0	0.0	0.0	0.0	0.0
Total Lost Time (s)	5.5	5.5	5.5	5.0	5.0	5.0
Lead/Lag						
Lead-Lag Optimize?						
Recall Mode	Min	Min	Min	None	None	None
Act Effct Green (s)	42.7	42.7	42.7	21.2	21.2	21.2
Actuated g/C Ratio	0.57	0.57	0.57	0.28	0.28	0.28
v/c Ratio	0.61	0.54	0.78	0.71	0.71	0.68
Control Delay	12.3	8.3	15.4	34.5	32.4	30.6
Queue Delay	0.0	0.0	0.0	0.0	0.0	0.0
Total Delay	12.3	8.3	15.4	34.5	32.4	30.6
LOS	B	A	B	C	C	C
Approach Delay	11.3		15.4		32.5	
Approach LOS	B		B		C	

Intersection Summary

Cycle Length: 85
 Actuated Cycle Length: 74.7
 Natural Cycle: 55
 Control Type: Actuated-Uncoordinated
 Maximum v/c Ratio: 0.78
 Intersection Signal Delay: 16.5
 Intersection LOS: B
 Intersection Capacity Utilization 73.7%
 ICU Level of Service D
 Analysis Period (min) 15

Splits and Phases: 28: I-215 SB Ramps & Alessandro Bl.

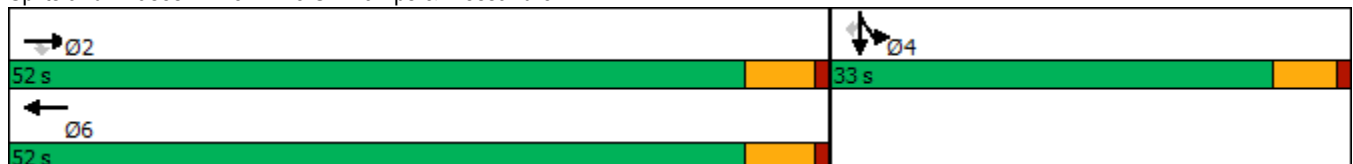

HCM 6th Signalized Intersection Summary
 28: I-215 SB Ramps & Alessandro Bl.

West Campus Upper Plateau (JN 14064)

09/19/2022



Movement	EBL	EBT	EBR	WBL	WBT	WBR	NBL	NBT	NBR	SBL	SBT	SBR
Lane Configurations		↑↑↑	↗		↑↑↑					↘	↔	↗
Traffic Volume (veh/h)	0	1769	544	0	2148	70	0	0	0	356	0	531
Future Volume (veh/h)	0	1769	544	0	2148	70	0	0	0	356	0	531
Initial Q (Qb), veh	0	0	0	0	0	0				0	0	0
Ped-Bike Adj(A_pbT)	1.00		1.00	1.00		0.98				1.00		1.00
Parking Bus, Adj	1.00	1.00	1.00	1.00	1.00	1.00				1.00	1.00	1.00
Work Zone On Approach		No			No						No	
Adj Sat Flow, veh/h/ln	0	1885	1885	0	1870	1781				1737	1900	1767
Adj Flow Rate, veh/h	0	1787	549	0	2170	63				533	0	306
Peak Hour Factor	0.99	0.99	0.99	0.99	0.99	0.99				0.99	0.99	0.99
Percent Heavy Veh, %	0	1	1	0	2	8				11	0	9
Cap, veh/h	0	2998	931	0	2969	86				859	0	389
Arrive On Green	0.00	0.58	0.58	0.00	0.58	0.58				0.26	0.00	0.26
Sat Flow, veh/h	0	5316	1598	0	5265	148				3309	0	1497
Grp Volume(v), veh/h	0	1787	549	0	1447	786				533	0	306
Grp Sat Flow(s),veh/h/ln	0	1716	1598	0	1702	1840				1654	0	1497
Q Serve(g_s), s	0.0	14.8	14.5	0.0	20.5	20.7				9.5	0.0	12.7
Cycle Q Clear(g_c), s	0.0	14.8	14.5	0.0	20.5	20.7				9.5	0.0	12.7
Prop In Lane	0.00		1.00	0.00		0.08				1.00		1.00
Lane Grp Cap(c), veh/h	0	2998	931	0	1983	1072				859	0	389
V/C Ratio(X)	0.00	0.60	0.59	0.00	0.73	0.73				0.62	0.00	0.79
Avail Cap(c_a), veh/h	0	3597	1117	0	2379	1286				1392	0	630
HCM Platoon Ratio	1.00	1.00	1.00	1.00	1.00	1.00				1.00	1.00	1.00
Upstream Filter(I)	0.00	1.00	1.00	0.00	1.00	1.00				1.00	0.00	1.00
Uniform Delay (d), s/veh	0.0	8.9	8.8	0.0	10.1	10.1				21.7	0.0	22.9
Incr Delay (d2), s/veh	0.0	0.2	0.6	0.0	0.9	1.8				0.7	0.0	3.6
Initial Q Delay(d3),s/veh	0.0	0.0	0.0	0.0	0.0	0.0				0.0	0.0	0.0
%ile BackOfQ(50%),veh/ln	0.0	3.4	3.3	0.0	4.9	5.6				3.3	0.0	4.3
Unsig. Movement Delay, s/veh												
LnGrp Delay(d),s/veh	0.0	9.1	9.4	0.0	11.0	11.9				22.5	0.0	26.5
LnGrp LOS	A	A	A	A	B	B				C	A	C
Approach Vol, veh/h		2336			2233						839	
Approach Delay, s/veh		9.2			11.3						23.9	
Approach LOS		A			B						C	
Timer - Assigned Phs		2		4		6						
Phs Duration (G+Y+Rc), s		44.3		22.3		44.3						
Change Period (Y+Rc), s		5.5		5.0		5.5						
Max Green Setting (Gmax), s		46.5		28.0		46.5						
Max Q Clear Time (g_c+I1), s		16.8		14.7		22.7						
Green Ext Time (p_c), s		17.8		2.6		16.0						

Intersection Summary

HCM 6th Ctrl Delay	12.3
HCM 6th LOS	B

Notes

User approved volume balancing among the lanes for turning movement.

Timings
29: I-215 NB Ramps & Alessandro Bl.

West Campus Upper Plateau (JN 14064)

09/19/2022



Lane Group	EBL	EBT	WBT	WBR	NBL	NBT	NBR
Lane Configurations	↶	↑↑↑	↶↶↶	↷	↶	↕	↷
Traffic Volume (vph)	231	1894	1181	129	1037	13	310
Future Volume (vph)	231	1894	1181	129	1037	13	310
Turn Type	Prot	NA	NA	Perm	Split	NA	Perm
Protected Phases	5	2	6		8	8	
Permitted Phases				6			8
Detector Phase	5	2	6	6	8	8	8
Switch Phase							
Minimum Initial (s)	5.0	5.0	5.0	5.0	5.0	5.0	5.0
Minimum Split (s)	9.5	10.5	33.5	33.5	10.0	10.0	10.0
Total Split (s)	13.0	48.0	35.0	35.0	37.0	37.0	37.0
Total Split (%)	15.3%	56.5%	41.2%	41.2%	43.5%	43.5%	43.5%
Yellow Time (s)	3.5	4.5	4.5	4.5	4.0	4.0	4.0
All-Red Time (s)	1.0	1.0	1.0	1.0	1.0	1.0	1.0
Lost Time Adjust (s)	0.0	0.0	0.0	0.0	0.0	0.0	0.0
Total Lost Time (s)	4.5	5.5	5.5	5.5	5.0	5.0	5.0
Lead/Lag	Lead		Lag	Lag			
Lead-Lag Optimize?	Yes		Yes	Yes			
Recall Mode	None	Min	Min	Min	Max	Max	Max
Act Effct Green (s)	8.5	40.9	27.9	27.9	32.1	32.1	32.1
Actuated g/C Ratio	0.10	0.49	0.33	0.33	0.38	0.38	0.38
v/c Ratio	1.40	0.81	0.74	0.26	0.89	0.93	0.47
Control Delay	240.7	21.1	27.6	10.4	43.3	49.7	16.4
Queue Delay	0.0	0.0	0.0	0.0	0.0	0.0	0.0
Total Delay	240.7	21.1	27.6	10.4	43.3	49.7	16.4
LOS	F	C	C	B	D	D	B
Approach Delay		45.0	25.9			40.3	
Approach LOS		D	C			D	

Intersection Summary

Cycle Length: 85
 Actuated Cycle Length: 83.5
 Natural Cycle: 90
 Control Type: Actuated-Uncoordinated
 Maximum v/c Ratio: 1.40
 Intersection Signal Delay: 38.4
 Intersection Capacity Utilization 80.3%
 Analysis Period (min) 15
 Intersection LOS: D
 ICU Level of Service D

Splits and Phases: 29: I-215 NB Ramps & Alessandro Bl.

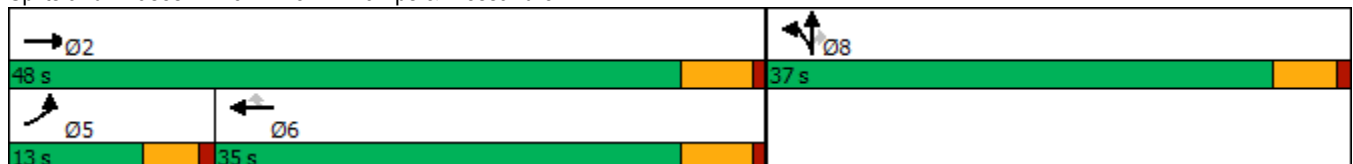

HCM 6th Signalized Intersection Summary
 29: I-215 NB Ramps & Alessandro Bl.

West Campus Upper Plateau (JN 14064)

09/19/2022



Movement	EBL	EBT	EBR	WBL	WBT	WBR	NBL	NBT	NBR	SBL	SBT	SBR
Lane Configurations	↗	↑↑↑			↑↑↑	↗	↗	↕	↗			
Traffic Volume (veh/h)	231	1894	0	0	1181	129	1037	13	310	0	0	0
Future Volume (veh/h)	231	1894	0	0	1181	129	1037	13	310	0	0	0
Initial Q (Qb), veh	0	0	0	0	0	0	0	0	0			
Ped-Bike Adj(A_pbT)	1.00		1.00	1.00		0.98	1.00		1.00			
Parking Bus, Adj	1.00	1.00	1.00	1.00	1.00	1.00	1.00	1.00	1.00			
Work Zone On Approach		No			No			No				
Adj Sat Flow, veh/h/ln	1841	1870	0	0	1870	1707	1870	1900	1870			
Adj Flow Rate, veh/h	246	2015	0	0	1256	110	1185	0	167			
Peak Hour Factor	0.94	0.94	0.94	0.94	0.94	0.94	0.94	0.94	0.94			
Percent Heavy Veh, %	4	2	0	0	2	13	2	0	2			
Cap, veh/h	182	2451	0	0	1639	455	1395	0	621			
Arrive On Green	0.10	0.48	0.00	0.00	0.32	0.32	0.39	0.00	0.39			
Sat Flow, veh/h	1753	5274	0	0	5274	1416	3563	0	1585			
Grp Volume(v), veh/h	246	2015	0	0	1256	110	1185	0	167			
Grp Sat Flow(s),veh/h/ln	1753	1702	0	0	1702	1416	1781	0	1585			
Q Serve(g_s), s	8.5	27.7	0.0	0.0	18.1	4.7	24.8	0.0	5.9			
Cycle Q Clear(g_c), s	8.5	27.7	0.0	0.0	18.1	4.7	24.8	0.0	5.9			
Prop In Lane	1.00		0.00	0.00		1.00	1.00		1.00			
Lane Grp Cap(c), veh/h	182	2451	0	0	1639	455	1395	0	621			
V/C Ratio(X)	1.35	0.82	0.00	0.00	0.77	0.24	0.85	0.00	0.27			
Avail Cap(c_a), veh/h	182	2655	0	0	1843	511	1395	0	621			
HCM Platoon Ratio	1.00	1.00	1.00	1.00	1.00	1.00	1.00	1.00	1.00			
Upstream Filter(I)	1.00	1.00	0.00	0.00	1.00	1.00	1.00	0.00	1.00			
Uniform Delay (d), s/veh	36.6	18.3	0.0	0.0	25.0	20.4	22.7	0.0	16.9			
Incr Delay (d2), s/veh	188.9	2.1	0.0	0.0	1.8	0.3	6.6	0.0	1.1			
Initial Q Delay(d3),s/veh	0.0	0.0	0.0	0.0	0.0	0.0	0.0	0.0	0.0			
%ile BackOfQ(50%),veh/ln	12.9	9.1	0.0	0.0	6.6	1.4	10.6	0.0	2.1			
Unsig. Movement Delay, s/veh												
LnGrp Delay(d),s/veh	225.5	20.3	0.0	0.0	26.8	20.7	29.3	0.0	18.0			
LnGrp LOS	F	C	A	A	C	C	C	A	B			
Approach Vol, veh/h		2261			1366			1352				
Approach Delay, s/veh		42.6			26.3			27.9				
Approach LOS		D			C			C				
Timer - Assigned Phs		2			5	6		8				
Phs Duration (G+Y+Rc), s		44.7			13.0	31.7		37.0				
Change Period (Y+Rc), s		5.5			4.5	5.5		5.0				
Max Green Setting (Gmax), s		42.5			8.5	29.5		32.0				
Max Q Clear Time (g_c+I1), s		29.7			10.5	20.1		26.8				
Green Ext Time (p_c), s		9.5			0.0	5.3		2.6				

Intersection Summary

HCM 6th Ctrl Delay	34.2
HCM 6th LOS	C

Notes

User approved volume balancing among the lanes for turning movement.

Timings
30: I-215 SB Ramps & Cactus Av.

West Campus Upper Plateau (JN 14064)

09/19/2022



Lane Group	EBT	EBR	WBL	WBT	NBR	SBR
Lane Configurations	↑↑	↑	↓	↑↑	↑	↑
Traffic Volume (vph)	1690	402	556	1290	627	543
Future Volume (vph)	1690	402	556	1290	627	543
Turn Type	NA	Perm	Prot	NA	Prot	Prot
Protected Phases	2		1	6	8	4
Permitted Phases		2				
Detector Phase	2	2	1	6	8	4
Switch Phase						
Minimum Initial (s)	5.0	5.0	5.0	5.0	5.0	5.0
Minimum Split (s)	11.0	11.0	9.5	23.0	9.1	9.5
Total Split (s)	35.0	35.0	43.0	78.0	27.0	27.0
Total Split (%)	33.3%	33.3%	41.0%	74.3%	25.7%	25.7%
Yellow Time (s)	5.0	5.0	3.5	5.0	3.6	3.5
All-Red Time (s)	1.0	1.0	1.0	1.0	0.5	1.0
Lost Time Adjust (s)	0.0	0.0	0.0	0.0	0.0	0.0
Total Lost Time (s)	6.0	6.0	4.5	6.0	4.1	4.5
Lead/Lag	Lag	Lag	Lead			
Lead-Lag Optimize?	Yes	Yes	Yes			
Recall Mode	Min	Min	None	Min	None	None
Act Effect Green (s)	29.0	29.0	35.8	69.4	22.9	22.5
Actuated g/C Ratio	0.28	0.28	0.35	0.68	0.22	0.22
v/c Ratio	1.83	0.70	0.95	0.57	0.80	1.48
Control Delay	401.4	21.8	58.1	9.7	12.7	258.0
Queue Delay	0.0	0.0	0.0	0.0	0.0	0.0
Total Delay	401.4	21.8	58.1	9.7	12.7	258.0
LOS	F	C	E	A	B	F
Approach Delay	328.5			24.3		
Approach LOS	F			C		

Intersection Summary

Cycle Length: 105
 Actuated Cycle Length: 102.4
 Natural Cycle: 120
 Control Type: Actuated-Uncoordinated
 Maximum v/c Ratio: 1.83
 Intersection Signal Delay: 172.3
 Intersection LOS: F
 Intersection Capacity Utilization 94.0%
 ICU Level of Service F
 Analysis Period (min) 15

Splits and Phases: 30: I-215 SB Ramps & Cactus Av.

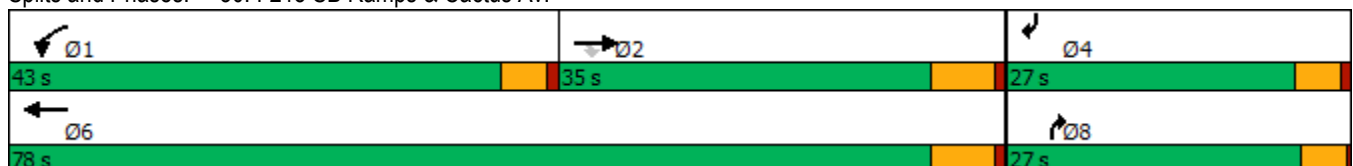

HCM 6th Signalized Intersection Summary
 30: I-215 SB Ramps & Cactus Av.

West Campus Upper Plateau (JN 14064)

09/19/2022



Movement	EBL	EBT	EBR	WBL	WBT	WBR	NBL	NBT	NBR	SBL	SBT	SBR
Lane Configurations		↑↑	↗	↖	↑↑				↗			↖
Traffic Volume (veh/h)	0	1690	402	556	1290	0	0	0	627	0	0	543
Future Volume (veh/h)	0	1690	402	556	1290	0	0	0	627	0	0	543
Initial Q (Qb), veh	0	0	0	0	0	0	0	0	0	0	0	0
Ped-Bike Adj(A_pbT)	1.00		1.00	1.00		1.00	1.00		1.00	1.00		1.00
Parking Bus, Adj	1.00	1.00	1.00	1.00	1.00	1.00	1.00	1.00	1.00	1.00	1.00	1.00
Work Zone On Approach		No			No			No			No	
Adj Sat Flow, veh/h/ln	0	1826	1811	1870	1870	0	0	0	1796	0	0	1737
Adj Flow Rate, veh/h	0	1779	395	585	1358	0	0	0	0	0	0	467
Peak Hour Factor	0.95	0.95	0.95	0.95	0.95	0.95	0.95	0.95	0.95	0.95	0.95	0.95
Percent Heavy Veh, %	0	5	6	2	2	0	0	0	7	0	0	11
Cap, veh/h	0	1632	722	640	3208	0	0	0	0	0	0	0
Arrive On Green	0.00	0.47	0.47	0.36	0.90	0.00	0.00	0.00	0.00	0.00	0.00	0.00
Sat Flow, veh/h	0	3561	1535	1781	3647	0		0			0	
Grp Volume(v), veh/h	0	1779	395	585	1358	0		0.0			0.0	
Grp Sat Flow(s),veh/h/ln	0	1735	1535	1781	1777	0						
Q Serve(g_s), s	0.0	29.0	11.3	19.3	3.7	0.0						
Cycle Q Clear(g_c), s	0.0	29.0	11.3	19.3	3.7	0.0						
Prop In Lane	0.00		1.00	1.00		0.00						
Lane Grp Cap(c), veh/h	0	1632	722	640	3208	0						
V/C Ratio(X)	0.00	1.09	0.55	0.91	0.42	0.00						
Avail Cap(c_a), veh/h	0	1632	722	1113	4152	0						
HCM Platoon Ratio	1.00	1.00	1.00	1.00	1.00	1.00						
Upstream Filter(I)	0.00	1.00	1.00	1.00	1.00	0.00						
Uniform Delay (d), s/veh	0.0	16.3	11.6	18.8	0.5	0.0						
Incr Delay (d2), s/veh	0.0	51.0	0.5	3.5	0.0	0.0						
Initial Q Delay(d3),s/veh	0.0	0.0	0.0	0.0	0.0	0.0						
%ile BackOfQ(50%),veh/ln	0.0	20.0	3.0	7.1	0.0	0.0						
Unsig. Movement Delay, s/veh												
LnGrp Delay(d),s/veh	0.0	67.3	12.1	22.4	0.5	0.0						
LnGrp LOS	A	F	B	C	A	A						
Approach Vol, veh/h		2174			1943							
Approach Delay, s/veh		57.3			7.1							
Approach LOS		E			A							
Timer - Assigned Phs	1	2			6							
Phs Duration (G+Y+Rc), s	26.6	35.0			61.6							
Change Period (Y+Rc), s	4.5	6.0			6.0							
Max Green Setting (Gmax), s	38.5	29.0			72.0							
Max Q Clear Time (g_c+I1), s	21.3	31.0			5.7							
Green Ext Time (p_c), s	0.8	0.0			7.5							

Intersection Summary

HCM 6th Ctrl Delay	33.6
HCM 6th LOS	C

Notes

Unsignalized Delay for [NBR] is excluded from calculations of the approach delay and intersection delay.

Timings

31: I-215 NB Ramps/Old 215 Frontage Rd. & Cactus Av.



Lane Group	EBL	EBT	WBT	NBL	NBT	NBR	SBL	SBT
Lane Configurations	↖	↗	↗	↖	↗	↗	↖	↗
Traffic Volume (vph)	105	1725	1961	224	250	4	191	3
Future Volume (vph)	105	1725	1961	224	250	4	191	3
Turn Type	Perm	NA	NA	Perm	NA	Perm	Perm	NA
Protected Phases		2	6		8			4
Permitted Phases	2			8		8	4	
Detector Phase	2	2	6	8	8	8	4	4
Switch Phase								
Minimum Initial (s)	5.0	5.0	5.0	5.0	5.0	5.0	5.0	5.0
Minimum Split (s)	11.0	11.0	44.0	10.5	10.5	10.5	10.5	10.5
Total Split (s)	57.4	57.4	57.4	27.6	27.6	27.6	27.6	27.6
Total Split (%)	67.5%	67.5%	67.5%	32.5%	32.5%	32.5%	32.5%	32.5%
Yellow Time (s)	5.0	5.0	5.0	4.5	4.5	4.5	4.5	4.5
All-Red Time (s)	1.0	1.0	1.0	1.0	1.0	1.0	1.0	1.0
Lost Time Adjust (s)	0.0	0.0	0.0	0.0	0.0	0.0	0.0	0.0
Total Lost Time (s)	6.0	6.0	6.0	5.5	5.5	5.5	5.5	5.5
Lead/Lag								
Lead-Lag Optimize?								
Recall Mode	Min	Min	Min	None	None	None	None	None
Act Effct Green (s)	51.4	51.4	51.4	22.1	22.1	22.1	22.1	22.1
Actuated g/C Ratio	0.60	0.60	0.60	0.26	0.26	0.26	0.26	0.26
v/c Ratio	1.25	1.27	1.07	0.94	0.57	0.01	0.96	0.50
Control Delay	203.7	144.3	58.3	78.6	33.2	0.0	88.3	30.2
Queue Delay	0.0	0.0	0.0	0.0	0.0	0.0	0.0	0.0
Total Delay	203.7	144.3	58.3	78.6	33.2	0.0	88.3	30.2
LOS	F	F	E	E	C	A	F	C
Approach Delay		146.7	58.3		54.2			58.4
Approach LOS		F	E		D			E

Intersection Summary

Cycle Length: 85	
Actuated Cycle Length: 85	
Natural Cycle: 55	
Control Type: Actuated-Uncoordinated	
Maximum v/c Ratio: 1.27	
Intersection Signal Delay: 98.7	Intersection LOS: F
Intersection Capacity Utilization 110.7%	ICU Level of Service H
Analysis Period (min) 15	

Splits and Phases: 31: I-215 NB Ramps/Old 215 Frontage Rd. & Cactus Av.

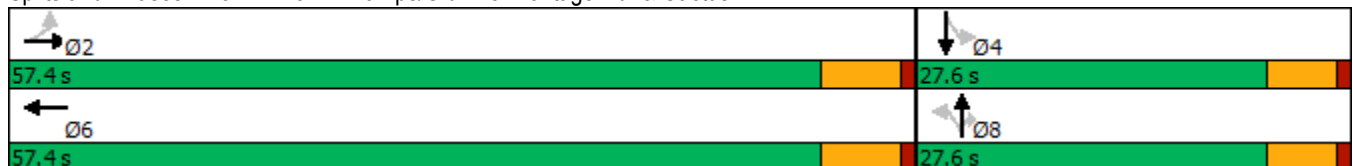

HCM 6th Signalized Intersection Summary

West Campus Upper Plateau (JN 14064)

31: I-215 NB Ramps/Old 215 Frontage Rd. & Cactus Av.

09/19/2022



Movement	EBL	EBT	EBR	WBL	WBT	WBR	NBL	NBT	NBR	SBL	SBT	SBR
Lane Configurations												
Traffic Volume (veh/h)	105	1725	749	0	1961	185	224	250	4	191	3	199
Future Volume (veh/h)	105	1725	749	0	1961	185	224	250	4	191	3	199
Initial Q (Qb), veh	0	0	0	0	0	0	0	0	0	0	0	0
Ped-Bike Adj(A_pbT)	1.00		1.00	1.00		1.00	1.00		1.00	1.00		1.00
Parking Bus, Adj	1.00	1.00	1.00	1.00	1.00	1.00	1.00	1.00	1.00	1.00	1.00	1.00
Work Zone On Approach		No			No			No			No	
Adj Sat Flow, veh/h/ln	1856	1841	1767	0	1856	1885	1767	1856	1900	1841	1900	1885
Adj Flow Rate, veh/h	109	1797	776	0	2043	145	233	260	0	199	3	181
Peak Hour Factor	0.96	0.96	0.96	0.96	0.96	0.96	0.96	0.96	0.96	0.96	0.96	0.96
Percent Heavy Veh, %	3	4	9	0	3	1	9	3	0	4	0	1
Cap, veh/h	85	1472	592	0	2021	142	271	482		238	7	413
Arrive On Green	0.60	0.60	0.60	0.00	0.60	0.60	0.26	0.26	0.00	0.26	0.26	0.26
Sat Flow, veh/h	178	2434	979	0	3434	234	1133	1856	1610	1102	26	1588
Grp Volume(v), veh/h	109	1254	1319	0	1066	1122	233	260	0	199	0	184
Grp Sat Flow(s),veh/h/ln	178	1749	1665	0	1763	1813	1133	1856	1610	1102	0	1614
Q Serve(g_s), s	0.0	51.4	51.4	0.0	51.4	51.4	14.0	10.2	0.0	11.9	0.0	8.1
Cycle Q Clear(g_c), s	51.4	51.4	51.4	0.0	51.4	51.4	22.1	10.2	0.0	22.1	0.0	8.1
Prop In Lane	1.00		0.59	0.00		0.13	1.00		1.00	1.00		0.98
Lane Grp Cap(c), veh/h	85	1057	1007	0	1066	1096	271	482		238	0	420
V/C Ratio(X)	1.29	1.19	1.31	0.00	1.00	1.02	0.86	0.54		0.84	0.00	0.44
Avail Cap(c_a), veh/h	85	1057	1007	0	1066	1096	271	482		238	0	420
HCM Platoon Ratio	1.00	1.00	1.00	1.00	1.00	1.00	1.00	1.00	1.00	1.00	1.00	1.00
Upstream Filter(I)	1.00	1.00	1.00	0.00	1.00	1.00	1.00	1.00	0.00	1.00	0.00	1.00
Uniform Delay (d), s/veh	42.5	16.8	16.8	0.0	16.8	16.8	36.9	27.1	0.0	37.9	0.0	26.3
Incr Delay (d2), s/veh	192.9	93.2	147.1	0.0	27.6	33.3	22.1	0.7	0.0	20.8	0.0	0.3
Initial Q Delay(d3),s/veh	0.0	0.0	0.0	0.0	0.0	0.0	0.0	0.0	0.0	0.0	0.0	0.0
%ile BackOfQ(50%),veh/ln	6.2	42.8	55.8	0.0	23.7	26.2	6.3	4.3	0.0	5.3	0.0	2.9
Unsig. Movement Delay, s/veh												
LnGrp Delay(d),s/veh	235.4	110.0	163.9	0.0	44.4	50.1	59.0	27.7	0.0	58.7	0.0	26.5
LnGrp LOS	F	F	F	A	D	F	E	C		E	A	C
Approach Vol, veh/h		2682			2188			493				383
Approach Delay, s/veh		141.6			47.3			42.5				43.3
Approach LOS		F			D			D				D
Timer - Assigned Phs		2		4		6		8				
Phs Duration (G+Y+Rc), s		57.4		27.6		57.4		27.6				
Change Period (Y+Rc), s		6.0		5.5		6.0		5.5				
Max Green Setting (Gmax), s		51.4		22.1		51.4		22.1				
Max Q Clear Time (g_c+I1), s		53.4		24.1		53.4		24.1				
Green Ext Time (p_c), s		0.0		0.0		0.0		0.0				

Intersection Summary

HCM 6th Ctrl Delay	90.6
HCM 6th LOS	F

Notes

User approved volume balancing among the lanes for turning movement.
 Unsignalized Delay for [NBR] is excluded from calculations of the approach delay and intersection delay.

Timings
32: I-215 SB Ramps & Van Buren Bl.



Lane Group	EBT	EBR	WBL	WBT	SBT	SBR
Lane Configurations	↑↑	↑↑	↵	↑↑	↵	↑↑
Traffic Volume (vph)	510	1972	3	963	98	221
Future Volume (vph)	510	1972	3	963	98	221
Turn Type	NA	Perm	Prot	NA	NA	Perm
Protected Phases	6		5	2	8	
Permitted Phases		6				8
Detector Phase	6	6	5	2	8	8
Switch Phase						
Minimum Initial (s)	5.0	5.0	5.0	5.0	5.0	5.0
Minimum Split (s)	36.0	36.0	11.0	11.0	11.0	11.0
Total Split (s)	60.0	60.0	11.0	71.0	14.0	14.0
Total Split (%)	70.6%	70.6%	12.9%	83.5%	16.5%	16.5%
Yellow Time (s)	5.0	5.0	5.0	5.0	5.0	5.0
All-Red Time (s)	1.0	1.0	1.0	1.0	1.0	1.0
Lost Time Adjust (s)	0.0	0.0	0.0	0.0	0.0	0.0
Total Lost Time (s)	6.0	6.0	6.0	6.0	6.0	6.0
Lead/Lag	Lag	Lag	Lead			
Lead-Lag Optimize?	Yes	Yes	Yes			
Recall Mode	Min	Min	None	Min	Max	Max
Act Effct Green (s)	54.2	54.2	5.0	56.1	8.0	8.0
Actuated g/C Ratio	0.71	0.71	0.07	0.74	0.10	0.10
v/c Ratio	0.23	0.95	0.03	0.41	0.64	0.51
Control Delay	4.5	18.2	36.3	4.3	51.3	9.3
Queue Delay	0.0	0.0	0.0	0.0	0.0	0.0
Total Delay	4.5	18.2	36.3	4.3	51.3	9.3
LOS	A	B	D	A	D	A
Approach Delay	15.4			4.4	23.3	
Approach LOS	B			A	C	

Intersection Summary

Cycle Length: 85
 Actuated Cycle Length: 76.2
 Natural Cycle: 90
 Control Type: Actuated-Uncoordinated
 Maximum v/c Ratio: 0.95
 Intersection Signal Delay: 13.3
 Intersection LOS: B
 Intersection Capacity Utilization 93.4%
 ICU Level of Service F
 Analysis Period (min) 15

Splits and Phases: 32: I-215 SB Ramps & Van Buren Bl.



HCM 6th Signalized Intersection Summary
 32: I-215 SB Ramps & Van Buren Bl.

West Campus Upper Plateau (JN 14064)

09/19/2022



Movement	EBL	EBT	EBR	WBL	WBT	WBR	NBL	NBT	NBR	SBL	SBT	SBR
Lane Configurations		↑↑	↑↑	↑	↑↑						↑	↑↑
Traffic Volume (veh/h)	0	510	1972	3	963	0	0	0	0	13	98	221
Future Volume (veh/h)	0	510	1972	3	963	0	0	0	0	13	98	221
Initial Q (Qb), veh	0	0	0	0	0	0				0	0	0
Ped-Bike Adj(A_pbT)	1.00		1.00	1.00		1.00				1.00		1.00
Parking Bus, Adj	1.00	1.00	1.00	1.00	1.00	1.00				1.00	1.00	1.00
Work Zone On Approach		No			No						No	
Adj Sat Flow, veh/h/ln	0	1767	1841	1411	1811	0				1500	1841	1663
Adj Flow Rate, veh/h	0	548	2021	3	1035	0				14	105	0
Peak Hour Factor	0.93	0.93	0.93	0.93	0.93	0.93				0.93	0.93	0.93
Percent Heavy Veh, %	0	9	4	33	6	0				27	4	16
Cap, veh/h	0	2132	1744	79	2631	0				20	152	
Arrive On Green	0.00	0.64	0.64	0.06	0.76	0.00				0.09	0.09	0.00
Sat Flow, veh/h	0	3445	2745	1344	3532	0				215	1615	2480
Grp Volume(v), veh/h	0	548	2021	3	1035	0				119	0	0
Grp Sat Flow(s),veh/h/ln	0	1678	1373	1344	1721	0				1830	0	1240
Q Serve(g_s), s	0.0	6.0	54.0	0.2	8.6	0.0				5.4	0.0	0.0
Cycle Q Clear(g_c), s	0.0	6.0	54.0	0.2	8.6	0.0				5.4	0.0	0.0
Prop In Lane	0.00		1.00	1.00		0.00				0.12		1.00
Lane Grp Cap(c), veh/h	0	2132	1744	79	2631	0				172	0	
V/C Ratio(X)	0.00	0.26	1.16	0.04	0.39	0.00				0.69	0.00	
Avail Cap(c_a), veh/h	0	2132	1744	79	2631	0				172	0	
HCM Platoon Ratio	1.00	1.00	1.00	1.00	1.00	1.00				1.00	1.00	1.00
Upstream Filter(I)	0.00	1.00	1.00	1.00	1.00	0.00				1.00	0.00	0.00
Uniform Delay (d), s/veh	0.0	6.8	15.5	37.7	3.4	0.0				37.3	0.0	0.0
Incr Delay (d2), s/veh	0.0	0.0	78.3	0.1	0.0	0.0				20.4	0.0	0.0
Initial Q Delay(d3),s/veh	0.0	0.0	0.0	0.0	0.0	0.0				0.0	0.0	0.0
%ile BackOfQ(50%),veh/ln	0.0	1.5	30.0	0.1	1.3	0.0				3.2	0.0	0.0
Unsig. Movement Delay, s/veh												
LnGrp Delay(d),s/veh	0.0	6.8	93.8	37.8	3.4	0.0				57.7	0.0	0.0
LnGrp LOS	A	A	F	D	A	A				E	A	
Approach Vol, veh/h		2569			1038							119
Approach Delay, s/veh		75.2			3.5							57.7
Approach LOS		E			A							E
Timer - Assigned Phs		2			5	6		8				
Phs Duration (G+Y+Rc), s		71.0			11.0	60.0		14.0				
Change Period (Y+Rc), s		6.0			6.0	6.0		6.0				
Max Green Setting (Gmax), s		65.0			5.0	54.0		8.0				
Max Q Clear Time (g_c+I1), s		10.6			2.2	56.0		7.4				
Green Ext Time (p_c), s		4.7			0.0	0.0		0.0				

Intersection Summary

HCM 6th Ctrl Delay	54.7
HCM 6th LOS	D

Notes

Unsignalized Delay for [SBR] is excluded from calculations of the approach delay and intersection delay.

Timings
33: I-215 NB On/Off Ramp & Van Buren Bl.



Lane Group	EBT	EBR	WBT	NBL	NBR
Lane Configurations	↑↑	↑↑	↑↑	↑↑	↑
Traffic Volume (vph)	5	571	24	872	5
Future Volume (vph)	5	571	24	872	5
Turn Type	NA	pm+ov	NA	Prot	Perm
Protected Phases	6	4	2	4	
Permitted Phases		6			4
Detector Phase	6	4	2	4	4
Switch Phase					
Minimum Initial (s)	5.0	5.0	5.0	5.0	5.0
Minimum Split (s)	11.0	42.0	11.0	42.0	42.0
Total Split (s)	15.0	55.0	15.0	55.0	55.0
Total Split (%)	21.4%	78.6%	21.4%	78.6%	78.6%
Yellow Time (s)	5.0	5.0	5.0	5.0	5.0
All-Red Time (s)	1.0	1.0	1.0	1.0	1.0
Lost Time Adjust (s)	0.0	0.0	0.0	0.0	0.0
Total Lost Time (s)	6.0	6.0	6.0	6.0	6.0
Lead/Lag					
Lead-Lag Optimize?					
Recall Mode	None	Min	None	Min	Min
Act Effct Green (s)	5.7	38.2	5.7	36.2	36.2
Actuated g/C Ratio	0.15	1.00	0.15	0.95	0.95
v/c Ratio	0.01	0.23	0.05	0.29	0.00
Control Delay	21.2	0.2	20.6	1.2	1.0
Queue Delay	0.0	0.0	0.0	0.0	0.0
Total Delay	21.2	0.2	20.6	1.2	1.0
LOS	C	A	C	A	A
Approach Delay	0.4		20.6	1.2	
Approach LOS	A		C	A	

Intersection Summary

Cycle Length: 70
 Actuated Cycle Length: 38.2
 Natural Cycle: 55
 Control Type: Actuated-Uncoordinated
 Maximum v/c Ratio: 0.29
 Intersection Signal Delay: 1.2
 Intersection LOS: A
 Intersection Capacity Utilization 39.0%
 ICU Level of Service A
 Analysis Period (min) 15

Splits and Phases: 33: I-215 NB On/Off Ramp & Van Buren Bl.



HCM 6th Signalized Intersection Summary
 33: I-215 NB On/Off Ramp & Van Buren Bl.

West Campus Upper Plateau (JN 14064)

09/19/2022



Movement	EBT	EBR	WBL	WBT	NBL	NBR
Lane Configurations	↑↑	↑↑		↑↑	↑↑	↑
Traffic Volume (veh/h)	5	571	0	24	872	5
Future Volume (veh/h)	5	571	0	24	872	5
Initial Q (Qb), veh	0	0	0	0	0	0
Ped-Bike Adj(A_pbT)		1.00	1.00		1.00	1.00
Parking Bus, Adj	1.00	1.00	1.00	1.00	1.00	1.00
Work Zone On Approach	No			No	No	
Adj Sat Flow, veh/h/ln	1900	1767	0	1752	1811	1159
Adj Flow Rate, veh/h	5	593	0	25	918	5
Peak Hour Factor	0.95	0.95	0.95	0.95	0.95	0.95
Percent Heavy Veh, %	0	9	0	10	6	50
Cap, veh/h	759	1533	0	699	1243	365
Arrive On Green	0.21	0.21	0.00	0.21	0.37	0.37
Sat Flow, veh/h	3705	2635	0	3504	3346	982
Grp Volume(v), veh/h	5	593	0	25	918	5
Grp Sat Flow(s),veh/h/ln	1805	1317	0	1664	1673	982
Q Serve(g_s), s	0.0	3.5	0.0	0.2	6.8	0.1
Cycle Q Clear(g_c), s	0.0	3.5	0.0	0.2	6.8	0.1
Prop In Lane		1.00	0.00		1.00	1.00
Lane Grp Cap(c), veh/h	759	1533	0	699	1243	365
V/C Ratio(X)	0.01	0.39	0.00	0.04	0.74	0.01
Avail Cap(c_a), veh/h	1133	1806	0	1044	5717	1678
HCM Platoon Ratio	1.00	1.00	1.00	1.00	1.00	1.00
Upstream Filter(I)	1.00	1.00	0.00	1.00	1.00	1.00
Uniform Delay (d), s/veh	9.0	3.2	0.0	9.0	7.8	5.7
Incr Delay (d2), s/veh	0.0	0.1	0.0	0.0	0.3	0.0
Initial Q Delay(d3),s/veh	0.0	0.0	0.0	0.0	0.0	0.0
%ile BackOfQ(50%),veh/ln	0.0	1.0	0.0	0.0	1.0	0.0
Unsig. Movement Delay, s/veh						
LnGrp Delay(d),s/veh	9.0	3.3	0.0	9.0	8.1	5.7
LnGrp LOS	A	A	A	A	A	A
Approach Vol, veh/h	598			25	923	
Approach Delay, s/veh	3.3			9.0	8.1	
Approach LOS	A			A	A	
Timer - Assigned Phs		2		4		6
Phs Duration (G+Y+Rc), s		12.0		16.7		12.0
Change Period (Y+Rc), s		6.0		6.0		6.0
Max Green Setting (Gmax), s		9.0		49.0		9.0
Max Q Clear Time (g_c+I1), s		2.2		8.8		5.5
Green Ext Time (p_c), s		0.0		1.8		0.6
Intersection Summary						
HCM 6th Ctrl Delay			6.3			
HCM 6th LOS			A			

Timings

West Campus Upper Plateau (JN 14064)

34: Old 215 Frontage Rd. & Alessandro Bl.

09/19/2022

Lane Group	EBL	EBT	EBR	WBL	WBT	WBR	NBL	NBT	NBR	SBL	SBT	SBR
Lane Configurations												
Traffic Volume (vph)	364	1693	111	15	1042	121	36	212	15	126	243	202
Future Volume (vph)	364	1693	111	15	1042	121	36	212	15	126	243	202
Turn Type	Prot	NA	Perm	Prot	NA	Perm	Prot	NA	Perm	Prot	NA	Perm
Protected Phases	5	2		1	6		3	8		7	4	
Permitted Phases			2			6			8			4
Detector Phase	5	2	2	1	6	6	3	8	8	7	4	4
Switch Phase												
Minimum Initial (s)	5.0	10.0	10.0	5.0	10.0	10.0	5.0	10.0	10.0	5.0	10.0	10.0
Minimum Split (s)	8.7	43.5	43.5	8.7	15.8	15.8	8.7	16.2	16.2	8.7	40.2	40.2
Total Split (s)	22.0	62.4	62.4	8.7	49.1	49.1	8.7	29.7	29.7	19.2	40.2	40.2
Total Split (%)	18.3%	52.0%	52.0%	7.3%	40.9%	40.9%	7.3%	24.8%	24.8%	16.0%	33.5%	33.5%
Yellow Time (s)	3.2	5.5	5.5	3.2	4.8	4.8	3.2	5.2	5.2	3.2	5.2	5.2
All-Red Time (s)	0.5	1.0	1.0	0.5	1.0	1.0	0.5	1.0	1.0	0.5	1.0	1.0
Lost Time Adjust (s)	0.0	0.0	0.0	0.0	0.0	0.0	0.0	0.0	0.0	0.0	0.0	0.0
Total Lost Time (s)	3.7	6.5	6.5	3.7	5.8	5.8	3.7	6.2	6.2	3.7	6.2	6.2
Lead/Lag	Lead	Lag	Lag	Lead	Lag	Lag	Lead	Lag	Lag	Lead	Lag	Lag
Lead-Lag Optimize?	Yes	Yes	Yes	Yes	Yes	Yes	Yes	Yes	Yes	Yes	Yes	Yes
Recall Mode	None	None	None	None	None	None	None	None	None	None	None	None
Act Effct Green (s)	14.7	50.6	50.6	5.2	35.7	35.7	5.2	13.4	13.4	11.5	24.1	24.1
Actuated g/C Ratio	0.15	0.53	0.53	0.05	0.37	0.37	0.05	0.14	0.14	0.12	0.25	0.25
v/c Ratio	0.70	0.63	0.14	0.18	0.81	0.18	0.25	0.44	0.05	0.63	0.30	0.37
Control Delay	48.2	18.5	2.7	56.3	33.6	2.2	54.4	42.7	0.3	57.5	32.6	6.8
Queue Delay	0.0	0.0	0.0	0.0	0.0	0.0	0.0	0.0	0.0	0.0	0.0	0.0
Total Delay	48.2	18.5	2.7	56.3	33.6	2.2	54.4	42.7	0.3	57.5	32.6	6.8
LOS	D	B	A	E	C	A	D	D	A	E	C	A
Approach Delay		22.7			30.7			42.0			29.0	
Approach LOS		C			C			D			C	

Intersection Summary

Cycle Length: 120
 Actuated Cycle Length: 95.5
 Natural Cycle: 105
 Control Type: Actuated-Uncoordinated
 Maximum v/c Ratio: 0.81
 Intersection Signal Delay: 27.0
 Intersection LOS: C
 Intersection Capacity Utilization 71.2%
 ICU Level of Service C
 Analysis Period (min) 15

Splits and Phases: 34: Old 215 Frontage Rd. & Alessandro Bl.

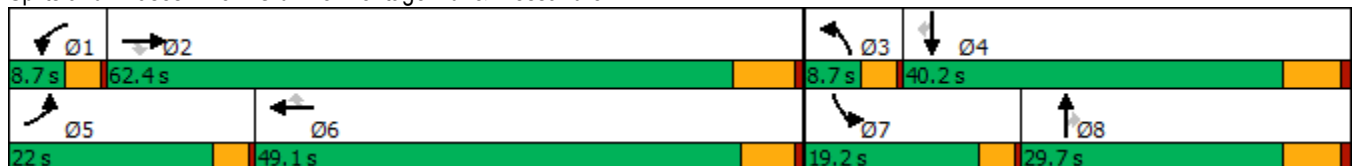

HCM 6th Signalized Intersection Summary
 34: Old 215 Frontage Rd. & Alessandro Bl.

West Campus Upper Plateau (JN 14064)

09/19/2022



Movement	EBL	EBT	EBR	WBL	WBT	WBR	NBL	NBT	NBR	SBL	SBT	SBR
Lane Configurations	↔↔	↑↑↑	↔	↔	↑↑	↔	↔↔	↑↑	↔	↔	↑↑	↔
Traffic Volume (veh/h)	364	1693	111	15	1042	121	36	212	15	126	243	202
Future Volume (veh/h)	364	1693	111	15	1042	121	36	212	15	126	243	202
Initial Q (Qb), veh	0	0	0	0	0	0	0	0	0	0	0	0
Ped-Bike Adj(A_pbT)	1.00		0.99	1.00		1.00	1.00		0.98	1.00		1.00
Parking Bus, Adj	1.00	1.00	1.00	1.00	1.00	1.00	1.00	1.00	1.00	1.00	1.00	1.00
Work Zone On Approach		No			No			No			No	
Adj Sat Flow, veh/h/ln	1870	1885	1678	1678	1856	1856	1515	1856	1559	1826	1752	1885
Adj Flow Rate, veh/h	371	1728	86	15	1063	0	37	216	5	129	248	0
Peak Hour Factor	0.98	0.98	0.98	0.98	0.98	0.98	0.98	0.98	0.98	0.98	0.98	0.98
Percent Heavy Veh, %	2	1	15	15	3	3	26	3	23	5	10	1
Cap, veh/h	468	2580	704	28	1352		99	454	168	162	621	
Arrive On Green	0.14	0.50	0.50	0.02	0.38	0.00	0.04	0.13	0.13	0.09	0.19	0.00
Sat Flow, veh/h	3456	5147	1404	1598	3526	1572	2799	3526	1301	1739	3328	1598
Grp Volume(v), veh/h	371	1728	86	15	1063	0	37	216	5	129	248	0
Grp Sat Flow(s),veh/h/ln	1728	1716	1404	1598	1763	1572	1399	1763	1301	1739	1664	1598
Q Serve(g_s), s	8.1	19.6	2.5	0.7	20.7	0.0	1.0	4.4	0.3	5.6	5.1	0.0
Cycle Q Clear(g_c), s	8.1	19.6	2.5	0.7	20.7	0.0	1.0	4.4	0.3	5.6	5.1	0.0
Prop In Lane	1.00		1.00	1.00		1.00	1.00		1.00	1.00		1.00
Lane Grp Cap(c), veh/h	468	2580	704	28	1352		99	454	168	162	621	
V/C Ratio(X)	0.79	0.67	0.12	0.53	0.79		0.37	0.48	0.03	0.79	0.40	
Avail Cap(c_a), veh/h	814	3705	1011	103	1966		180	1067	394	347	1457	
HCM Platoon Ratio	1.00	1.00	1.00	1.00	1.00	1.00	1.00	1.00	1.00	1.00	1.00	1.00
Upstream Filter(I)	1.00	1.00	1.00	1.00	1.00	0.00	1.00	1.00	1.00	1.00	1.00	0.00
Uniform Delay (d), s/veh	32.5	14.5	10.3	37.8	21.1	0.0	36.6	31.4	29.6	34.5	27.8	0.0
Incr Delay (d2), s/veh	1.2	0.3	0.1	5.5	1.3	0.0	0.9	0.8	0.1	3.3	0.4	0.0
Initial Q Delay(d3),s/veh	0.0	0.0	0.0	0.0	0.0	0.0	0.0	0.0	0.0	0.0	0.0	0.0
%ile BackOfQ(50%),veh/ln	3.1	5.9	0.7	0.3	7.7	0.0	0.3	1.8	0.1	2.3	1.9	0.0
Unsig. Movement Delay, s/veh												
LnGrp Delay(d),s/veh	33.7	14.8	10.4	43.3	22.5	0.0	37.5	32.2	29.7	37.8	28.2	0.0
LnGrp LOS	C	B	B	D	C		D	C	C	D	C	
Approach Vol, veh/h		2185			1078			258			377	
Approach Delay, s/veh		17.9			22.8			32.9			31.5	
Approach LOS		B			C			C			C	
Timer - Assigned Phs	1	2	3	4	5	6	7	8				
Phs Duration (G+Y+Rc), s	5.1	45.4	6.4	20.7	14.2	36.3	10.9	16.2				
Change Period (Y+Rc), s	3.7	6.5	3.7	6.2	3.7	* 6.5	3.7	6.2				
Max Green Setting (Gmax), s	5.0	55.9	5.0	34.0	18.3	* 43	15.5	23.5				
Max Q Clear Time (g_c+I1), s	2.7	21.6	3.0	7.1	10.1	22.7	7.6	6.4				
Green Ext Time (p_c), s	0.0	15.5	0.0	1.4	0.4	7.1	0.1	1.0				

Intersection Summary

HCM 6th Ctrl Delay	21.5
HCM 6th LOS	C

Notes

* HCM 6th computational engine requires equal clearance times for the phases crossing the barrier.
 Unsignalized Delay for [WBR, SBR] is excluded from calculations of the approach delay and intersection delay.

Timings
35: Day St. & Alessandro Bl.

West Campus Upper Plateau (JN 14064)

09/19/2022



Lane Group	EBL	EBT	EBR	WBL	WBT	WBR	NBL	NBT	NBR	SBL	SBT
Lane Configurations	↖	↗↗↗	↖	↖	↗↗	↖	↖	↗	↖	↖	↗
Traffic Volume (vph)	266	1624	24	14	970	199	17	154	13	231	152
Future Volume (vph)	266	1624	24	14	970	199	17	154	13	231	152
Turn Type	Prot	NA	Perm	Prot	NA	Perm	Perm	NA	Perm	Perm	NA
Protected Phases	5	2		1	6			8			4
Permitted Phases			2			6	8		8	4	
Detector Phase	5	2	2	1	6	6	8	8	8	4	4
Switch Phase											
Minimum Initial (s)	5.0	10.0	10.0	5.0	10.0	10.0	10.0	10.0	10.0	10.0	10.0
Minimum Split (s)	9.1	30.8	30.8	9.1	30.8	30.8	42.4	42.4	42.4	41.6	41.6
Total Split (s)	28.0	67.9	67.9	9.1	49.0	49.0	43.0	43.0	43.0	43.0	43.0
Total Split (%)	23.3%	56.6%	56.6%	7.6%	40.8%	40.8%	35.8%	35.8%	35.8%	35.8%	35.8%
Yellow Time (s)	3.6	4.8	4.8	3.6	4.8	4.8	4.4	4.4	4.4	3.6	3.6
All-Red Time (s)	0.5	1.0	1.0	0.5	1.0	1.0	1.0	1.0	1.0	1.0	1.0
Lost Time Adjust (s)	0.0	0.0	0.0	0.0	0.0	0.0	0.0	0.0	0.0	0.0	0.0
Total Lost Time (s)	4.1	5.8	5.8	4.1	5.8	5.8	5.4	5.4	5.4	4.6	4.6
Lead/Lag	Lead	Lag	Lag	Lead	Lag	Lag					
Lead-Lag Optimize?	Yes	Yes	Yes	Yes	Yes	Yes					
Recall Mode	None	None	None	None	None	None	None	None	None	None	None
Act Effct Green (s)	19.2	55.7	55.7	5.3	35.1	35.1	25.8	25.8	25.8	26.7	26.7
Actuated g/C Ratio	0.20	0.58	0.58	0.05	0.36	0.36	0.27	0.27	0.27	0.28	0.28
v/c Ratio	0.77	0.58	0.03	0.15	0.78	0.33	0.12	0.31	0.03	0.76	0.59
Control Delay	55.0	15.5	0.2	56.7	33.8	15.1	31.9	31.7	0.2	49.8	32.4
Queue Delay	0.0	0.0	0.0	0.0	0.0	0.0	0.0	0.0	0.0	0.0	0.0
Total Delay	55.0	15.5	0.2	56.7	33.8	15.1	31.9	31.7	0.2	49.8	32.4
LOS	E	B	A	E	C	B	C	C	A	D	C
Approach Delay		20.8			30.9			29.4			40.2
Approach LOS		C			C			C			D

Intersection Summary

Cycle Length: 120
 Actuated Cycle Length: 96.4
 Natural Cycle: 95
 Control Type: Actuated-Uncoordinated
 Maximum v/c Ratio: 0.78
 Intersection Signal Delay: 27.0
 Intersection LOS: C
 Intersection Capacity Utilization 82.8%
 ICU Level of Service E
 Analysis Period (min) 15





























Splits and Phases: 35: Day St. & Alessandro Bl.



HCM 6th Signalized Intersection Summary
35: Day St. & Alessandro Bl.

West Campus Upper Plateau (JN 14064)

09/19/2022

												
Movement	EBL	EBT	EBR	WBL	WBT	WBR	NBL	NBT	NBR	SBL	SBT	SBR
Lane Configurations		  			 						 	
Traffic Volume (veh/h)	266	1624	24	14	970	199	17	154	13	231	152	136
Future Volume (veh/h)	266	1624	24	14	970	199	17	154	13	231	152	136
Initial Q (Qb), veh	0	0	0	0	0	0	0	0	0	0	0	0
Ped-Bike Adj(A_pbT)	1.00		0.98	1.00		0.98	1.00		1.00	1.00		1.00
Parking Bus, Adj	1.00	1.00	1.00	1.00	1.00	1.00	1.00	1.00	1.00	1.00	1.00	1.00
Work Zone On Approach		No			No			No			No	
Adj Sat Flow, veh/h/ln	1900	1870	1618	1900	1870	1900	1500	1900	1767	1885	1870	1870
Adj Flow Rate, veh/h	277	1692	19	15	1010	139	18	160	9	241	158	111
Peak Hour Factor	0.96	0.96	0.96	0.96	0.96	0.96	0.96	0.96	0.96	0.96	0.96	0.96
Percent Heavy Veh, %	0	2	19	0	2	0	27	0	9	1	2	2
Cap, veh/h	315	2614	687	31	1262	559	233	569	448	369	306	215
Arrive On Green	0.17	0.51	0.51	0.02	0.36	0.36	0.30	0.30	0.30	0.30	0.30	0.30
Sat Flow, veh/h	1810	5106	1341	1810	3554	1575	890	1900	1497	1226	1023	718
Grp Volume(v), veh/h	277	1692	19	15	1010	139	18	160	9	241	0	269
Grp Sat Flow(s),veh/h/ln	1810	1702	1341	1810	1777	1575	890	1900	1497	1226	0	1741
Q Serve(g_s), s	13.3	21.6	0.6	0.7	22.9	5.6	1.5	5.8	0.4	16.7	0.0	11.4
Cycle Q Clear(g_c), s	13.3	21.6	0.6	0.7	22.9	5.6	13.0	5.8	0.4	22.5	0.0	11.4
Prop In Lane	1.00		1.00	1.00		1.00	1.00		1.00	1.00		0.41
Lane Grp Cap(c), veh/h	315	2614	687	31	1262	559	233	569	448	369	0	521
V/C Ratio(X)	0.88	0.65	0.03	0.48	0.80	0.25	0.08	0.28	0.02	0.65	0.00	0.52
Avail Cap(c_a), veh/h	484	3550	932	101	1719	761	341	800	630	529	0	748
HCM Platoon Ratio	1.00	1.00	1.00	1.00	1.00	1.00	1.00	1.00	1.00	1.00	1.00	1.00
Upstream Filter(I)	1.00	1.00	1.00	1.00	1.00	1.00	1.00	1.00	1.00	1.00	0.00	1.00
Uniform Delay (d), s/veh	36.0	15.9	10.8	43.5	26.0	20.4	31.3	23.9	22.1	32.5	0.0	25.9
Incr Delay (d2), s/veh	7.7	0.3	0.0	4.1	2.0	0.2	0.1	0.3	0.0	2.0	0.0	0.8
Initial Q Delay(d3),s/veh	0.0	0.0	0.0	0.0	0.0	0.0	0.0	0.0	0.0	0.0	0.0	0.0
%ile BackOfQ(50%),veh/ln	6.2	7.3	0.2	0.4	9.1	1.9	0.3	2.5	0.1	5.1	0.0	4.8
Unsig. Movement Delay, s/veh												
LnGrp Delay(d),s/veh	43.6	16.2	10.8	47.6	27.9	20.6	31.4	24.2	22.1	34.5	0.0	26.7
LnGrp LOS	D	B	B	D	C	C	C	C	C	C	A	C
Approach Vol, veh/h		1988			1164			187			510	
Approach Delay, s/veh		20.0			27.3			24.8			30.4	
Approach LOS		B			C			C			C	
Timer - Assigned Phs	1	2		4	5	6		8				
Phs Duration (G+Y+Rc), s	5.7	51.5		32.1	19.7	37.5		32.1				
Change Period (Y+Rc), s	4.1	5.8		* 5.4	4.1	5.8		5.4				
Max Green Setting (Gmax), s	5.0	62.1		* 38	23.9	43.2		37.6				
Max Q Clear Time (g_c+I1), s	2.7	23.6		24.5	15.3	24.9		15.0				
Green Ext Time (p_c), s	0.0	16.4		2.3	0.3	6.8		0.9				

Intersection Summary

HCM 6th Ctrl Delay	23.8
HCM 6th LOS	C

Notes

* HCM 6th computational engine requires equal clearance times for the phases crossing the barrier.

Timings
36: Elsworth St. & Cactus Av.

West Campus Upper Plateau (JN 14064)

09/19/2022



Lane Group	EBL	EBT	EBR	WBL	WBT	WBR	NBL	NBT	SBL	SBT	SBR
Lane Configurations	↘	↑↑↑	↗	↘	↑↑↑	↗	↘	↕	↘	↗	↗
Traffic Volume (vph)	209	2239	30	17	1405	95	219	73	231	15	224
Future Volume (vph)	209	2239	30	17	1405	95	219	73	231	15	224
Turn Type	Prot	NA	Perm	Prot	NA	Perm	Split	NA	Split	NA	pm+ov
Protected Phases	5	2		1	6		8	8	4	4	5
Permitted Phases			2			6					4
Detector Phase	5	2	2	1	6	6	8	8	4	4	5
Switch Phase											
Minimum Initial (s)	5.0	10.0	10.0	5.0	10.0	10.0	10.0	10.0	10.0	10.0	5.0
Minimum Split (s)	9.6	36.2	36.2	9.6	36.2	36.2	35.4	35.4	35.4	35.4	9.6
Total Split (s)	16.5	49.6	49.6	9.6	42.7	42.7	35.4	35.4	35.4	35.4	16.5
Total Split (%)	12.7%	38.2%	38.2%	7.4%	32.8%	32.8%	27.2%	27.2%	27.2%	27.2%	12.7%
Yellow Time (s)	3.6	5.2	5.2	3.6	5.2	5.2	4.4	4.4	4.4	4.4	3.6
All-Red Time (s)	1.0	1.0	1.0	1.0	1.0	1.0	1.0	1.0	1.0	1.0	1.0
Lost Time Adjust (s)	0.0	0.0	0.0	0.0	0.0	0.0	0.0	0.0	0.0	0.0	0.0
Total Lost Time (s)	4.6	6.2	6.2	4.6	6.2	6.2	5.4	5.4	5.4	5.4	4.6
Lead/Lag	Lead	Lag	Lag	Lead	Lag	Lag					Lead
Lead-Lag Optimize?	Yes	Yes	Yes	Yes	Yes	Yes					Yes
Recall Mode	None	None	None	None	None	None	Max	Max	Max	Max	None
Act Effct Green (s)	11.9	49.2	49.2	5.0	36.5	36.5	30.0	30.0	30.0	30.0	42.7
Actuated g/C Ratio	0.09	0.38	0.38	0.04	0.28	0.28	0.23	0.23	0.23	0.23	0.33
v/c Ratio	1.36	1.24	0.05	0.26	1.05	0.18	0.51	0.47	0.32	0.32	0.38
Control Delay	241.4	146.8	0.1	70.2	82.1	2.3	49.1	40.4	44.3	44.3	8.7
Queue Delay	0.0	0.0	0.0	0.0	0.0	0.0	0.0	0.0	0.0	0.0	0.0
Total Delay	241.4	146.8	0.1	70.2	82.1	2.3	49.1	40.4	44.3	44.3	8.7
LOS	F	F	A	E	F	A	D	D	D	D	A
Approach Delay		153.0			77.0			44.8		27.4	
Approach LOS		F			E			D		C	

Intersection Summary

Cycle Length: 130
 Actuated Cycle Length: 130
 Natural Cycle: 120
 Control Type: Actuated-Uncoordinated
 Maximum v/c Ratio: 1.36
 Intersection Signal Delay: 108.6
 Intersection Capacity Utilization 84.3%
 Analysis Period (min) 15
 Intersection LOS: F
 ICU Level of Service E

Splits and Phases: 36: Elsworth St. & Cactus Av.

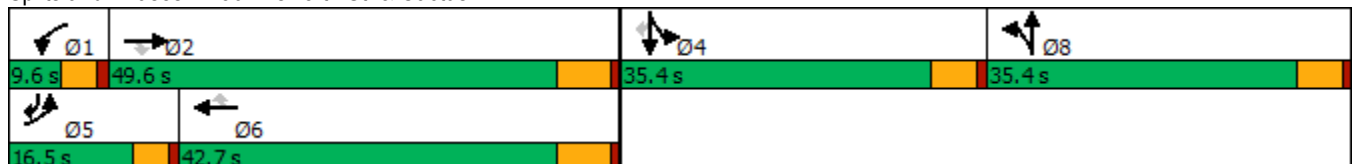

HCM 6th Signalized Intersection Summary
36: Elsworth St. & Cactus Av.

West Campus Upper Plateau (JN 14064)

09/19/2022



Movement	EBL	EBT	EBR	WBL	WBT	WBR	NBL	NBT	NBR	SBL	SBT	SBR
Lane Configurations	↗	↑↑↑	↖	↖	↑↑↑	↖	↖	↕		↖	↖	↖
Traffic Volume (veh/h)	209	2239	30	17	1405	95	219	73	85	231	15	224
Future Volume (veh/h)	209	2239	30	17	1405	95	219	73	85	231	15	224
Initial Q (Qb), veh	0	0	0	0	0	0	0	0	0	0	0	0
Ped-Bike Adj(A_pbT)	1.00		1.00	1.00		1.00	1.00		1.00	1.00		1.00
Parking Bus, Adj	1.00	1.00	1.00	1.00	1.00	1.00	1.00	1.00	1.00	1.00	1.00	1.00
Work Zone On Approach		No			No			No			No	
Adj Sat Flow, veh/h/ln	1856	1841	1781	1900	1841	1885	1885	1900	1885	1900	1900	1885
Adj Flow Rate, veh/h	218	2332	0	18	1464	63	185	137	65	252	0	126
Peak Hour Factor	0.96	0.96	0.96	0.96	0.96	0.96	0.96	0.96	0.96	0.96	0.96	0.96
Percent Heavy Veh, %	3	4	8	0	4	1	1	0	1	0	0	1
Cap, veh/h	162	1779		33	1411	449	414	281	133	835	0	515
Arrive On Green	0.09	0.35	0.00	0.02	0.28	0.28	0.23	0.23	0.23	0.23	0.00	0.23
Sat Flow, veh/h	1767	5025	1510	1810	5025	1598	1795	1218	578	3619	0	1598
Grp Volume(v), veh/h	218	2332	0	18	1464	63	185	0	202	252	0	126
Grp Sat Flow(s),veh/h/ln	1767	1675	1510	1810	1675	1598	1795	0	1796	1810	0	1598
Q Serve(g_s), s	11.9	46.0	0.0	1.3	36.5	3.8	11.5	0.0	12.7	7.5	0.0	7.5
Cycle Q Clear(g_c), s	11.9	46.0	0.0	1.3	36.5	3.8	11.5	0.0	12.7	7.5	0.0	7.5
Prop In Lane	1.00		1.00	1.00		1.00	1.00		0.32	1.00		1.00
Lane Grp Cap(c), veh/h	162	1779		33	1411	449	414	0	414	835	0	515
V/C Ratio(X)	1.35	1.31		0.54	1.04	0.14	0.45	0.00	0.49	0.30	0.00	0.24
Avail Cap(c_a), veh/h	162	1779		70	1411	449	414	0	414	835	0	515
HCM Platoon Ratio	1.00	1.00	1.00	1.00	1.00	1.00	1.00	1.00	1.00	1.00	1.00	1.00
Upstream Filter(I)	1.00	1.00	0.00	1.00	1.00	1.00	1.00	0.00	1.00	1.00	0.00	1.00
Uniform Delay (d), s/veh	59.0	42.0	0.0	63.3	46.8	35.0	42.9	0.0	43.3	41.3	0.0	32.4
Incr Delay (d2), s/veh	191.6	144.2	0.0	5.0	34.3	0.1	3.5	0.0	4.1	0.9	0.0	1.1
Initial Q Delay(d3),s/veh	0.0	0.0	0.0	0.0	0.0	0.0	0.0	0.0	0.0	0.0	0.0	0.0
%ile BackOfQ(50%),veh/ln	13.8	41.7	0.0	0.6	19.0	1.5	5.6	0.0	6.2	3.4	0.0	3.1
Unsig. Movement Delay, s/veh												
LnGrp Delay(d),s/veh	250.7	186.2	0.0	68.3	81.0	35.1	46.3	0.0	47.4	42.3	0.0	33.5
LnGrp LOS	F	F		E	F	D	D	A	D	D	A	C
Approach Vol, veh/h		2550			1545			387				378
Approach Delay, s/veh		191.7			79.0			46.9				39.4
Approach LOS		F			E			D				D
Timer - Assigned Phs	1	2		4	5	6		8				
Phs Duration (G+Y+Rc), s	7.0	52.2		35.4	16.5	42.7		35.4				
Change Period (Y+Rc), s	4.6	6.2		5.4	4.6	6.2		5.4				
Max Green Setting (Gmax), s	5.0	43.4		30.0	11.9	36.5		30.0				
Max Q Clear Time (g_c+I1), s	3.3	48.0		9.5	13.9	38.5		14.7				
Green Ext Time (p_c), s	0.0	0.0		1.2	0.0	0.0		1.6				

Intersection Summary

HCM 6th Ctrl Delay	132.5
HCM 6th LOS	F

Notes

- User approved pedestrian interval to be less than phase max green.
- User approved volume balancing among the lanes for turning movement.
- Unsignalized Delay for [EBR] is excluded from calculations of the approach delay and intersection delay.

Timings
37: Cactus Av. & Frederick St.

West Campus Upper Plateau (JN 14064)

09/19/2022



Lane Group	EBL	EBT	WBT	WBR	SBL	SBR
Lane Configurations	↖	↗↗↗	↖↖↖	↗	↖↖	↗
Traffic Volume (vph)	273	2253	1337	176	496	218
Future Volume (vph)	273	2253	1337	176	496	218
Turn Type	Prot	NA	NA	pm+ov	Prot	pm+ov
Protected Phases	5	2	6	4	4	5
Permitted Phases				6		4
Detector Phase	5	2	6	4	4	5
Switch Phase						
Minimum Initial (s)	5.0	10.0	10.0	10.0	10.0	5.0
Minimum Split (s)	9.2	28.2	29.2	36.4	36.4	9.2
Total Split (s)	31.0	81.0	50.0	39.0	39.0	31.0
Total Split (%)	25.8%	67.5%	41.7%	32.5%	32.5%	25.8%
Yellow Time (s)	3.2	5.2	5.2	4.4	4.4	3.2
All-Red Time (s)	1.0	1.0	1.0	1.0	1.0	1.0
Lost Time Adjust (s)	0.0	0.0	0.0	0.0	0.0	0.0
Total Lost Time (s)	4.2	6.2	6.2	5.4	5.4	4.2
Lead/Lag	Lead		Lag			Lead
Lead-Lag Optimize?	Yes		Yes			Yes
Recall Mode	None	None	None	None	None	None
Act Effct Green (s)	20.4	61.1	36.3	58.5	21.3	47.4
Actuated g/C Ratio	0.22	0.65	0.38	0.62	0.23	0.50
v/c Ratio	0.77	0.73	0.73	0.18	0.68	0.29
Control Delay	51.3	13.1	28.4	1.3	39.7	15.0
Queue Delay	0.0	0.0	0.0	0.0	0.0	0.0
Total Delay	51.3	13.1	28.4	1.3	39.7	15.0
LOS	D	B	C	A	D	B
Approach Delay		17.2	25.3		32.2	
Approach LOS		B	C		C	

Intersection Summary

Cycle Length: 120
 Actuated Cycle Length: 94.5
 Natural Cycle: 90
 Control Type: Actuated-Uncoordinated
 Maximum v/c Ratio: 0.77
 Intersection Signal Delay: 22.0
 Intersection LOS: C
 Intersection Capacity Utilization 68.3%
 ICU Level of Service C
 Analysis Period (min) 15

Splits and Phases: 37: Cactus Av. & Frederick St.



HCM 6th Signalized Intersection Summary
37: Cactus Av. & Frederick St.

West Campus Upper Plateau (JN 14064)

09/19/2022



Movement	EBL	EBT	WBT	WBR	SBL	SBR
Lane Configurations						
Traffic Volume (veh/h)	273	2253	1337	176	496	218
Future Volume (veh/h)	273	2253	1337	176	496	218
Initial Q (Qb), veh	0	0	0	0	0	0
Ped-Bike Adj(A_pbT)	1.00			0.98	1.00	1.00
Parking Bus, Adj	1.00	1.00	1.00	1.00	1.00	1.00
Work Zone On Approach		No	No		No	
Adj Sat Flow, veh/h/ln	1841	1856	1856	1870	1856	1856
Adj Flow Rate, veh/h	287	2372	1407	123	522	132
Peak Hour Factor	0.95	0.95	0.95	0.95	0.95	0.95
Percent Heavy Veh, %	4	3	3	2	3	3
Cap, veh/h	327	3383	2187	977	668	599
Arrive On Green	0.19	0.67	0.43	0.43	0.19	0.19
Sat Flow, veh/h	1753	5233	5233	1548	3428	1572
Grp Volume(v), veh/h	287	2372	1407	123	522	132
Grp Sat Flow(s),veh/h/ln	1753	1689	1689	1548	1714	1572
Q Serve(g_s), s	13.4	24.7	18.4	2.7	12.2	4.8
Cycle Q Clear(g_c), s	13.4	24.7	18.4	2.7	12.2	4.8
Prop In Lane	1.00			1.00	1.00	1.00
Lane Grp Cap(c), veh/h	327	3383	2187	977	668	599
V/C Ratio(X)	0.88	0.70	0.64	0.13	0.78	0.22
Avail Cap(c_a), veh/h	557	4490	2629	1112	1365	919
HCM Platoon Ratio	1.00	1.00	1.00	1.00	1.00	1.00
Upstream Filter(I)	1.00	1.00	1.00	1.00	1.00	1.00
Uniform Delay (d), s/veh	33.4	8.8	18.9	6.4	32.3	17.6
Incr Delay (d2), s/veh	4.0	0.3	0.4	0.1	2.0	0.2
Initial Q Delay(d3),s/veh	0.0	0.0	0.0	0.0	0.0	0.0
%ile BackOfQ(50%),veh/ln	5.6	6.1	6.3	1.3	5.0	5.0
Unsig. Movement Delay, s/veh						
LnGrp Delay(d),s/veh	37.5	9.1	19.3	6.5	34.3	17.8
LnGrp LOS	D	A	B	A	C	B
Approach Vol, veh/h		2659	1530		654	
Approach Delay, s/veh		12.1	18.2		31.0	
Approach LOS		B	B		C	
Timer - Assigned Phs		2		4	5	6
Phs Duration (G+Y+Rc), s		62.6		21.8	19.9	42.6
Change Period (Y+Rc), s		6.2		5.4	* 4.2	6.2
Max Green Setting (Gmax), s		74.8		33.6	* 27	43.8
Max Q Clear Time (g_c+I1), s		26.7		14.2	15.4	20.4
Green Ext Time (p_c), s		29.7		2.2	0.3	10.5

Intersection Summary

HCM 6th Ctrl Delay	16.6
HCM 6th LOS	B

Notes

* HCM 6th computational engine requires equal clearance times for the phases crossing the barrier.

Timings
38: Riverside Dr./Graham St. & Cactus Av.

West Campus Upper Plateau (JN 14064)

09/19/2022

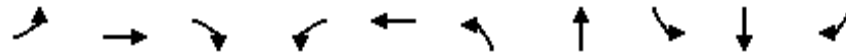

Lane Group	EBL	EBT	EBR	WBL	WBT	NBL	NBT	SBL	SBT	SBR
Lane Configurations	↘	↑↑↑	↗	↘	↑↑↑	↘↗	↑↗	↘	↑↑	↗
Traffic Volume (vph)	116	2448	406	19	1486	3	0	142	101	114
Future Volume (vph)	116	2448	406	19	1486	3	0	142	101	114
Turn Type	Prot	NA	Perm	Prot	NA	Prot	NA	Prot	NA	Perm
Protected Phases	7	4		3	8	5	2	1	6	
Permitted Phases			4							6
Detector Phase	7	4	4	3	8	5	2	1	6	6
Switch Phase										
Minimum Initial (s)	5.0	10.0	10.0	5.0	10.0	5.0	10.0	5.0	10.0	10.0
Minimum Split (s)	9.6	39.2	39.2	9.6	39.2	10.4	35.0	9.6	40.6	40.6
Total Split (s)	11.0	59.0	59.0	9.6	57.6	10.4	35.8	15.6	41.0	41.0
Total Split (%)	9.2%	49.2%	49.2%	8.0%	48.0%	8.7%	29.8%	13.0%	34.2%	34.2%
Yellow Time (s)	3.2	3.5	3.5	3.2	3.5	3.2	3.5	3.2	3.5	3.5
All-Red Time (s)	1.0	1.0	1.0	1.0	1.0	1.0	1.0	1.0	1.0	1.0
Lost Time Adjust (s)	0.0	0.0	0.0	0.0	0.0	0.0	0.0	0.0	0.0	0.0
Total Lost Time (s)	4.2	4.5	4.5	4.2	4.5	4.2	4.5	4.2	4.5	4.5
Lead/Lag	Lead	Lag	Lag	Lead	Lag	Lead	Lag	Lead	Lag	Lag
Lead-Lag Optimize?	Yes	Yes	Yes	Yes	Yes	Yes	Yes	Yes	Yes	Yes
Recall Mode	None	Min	Min	None	Min	None	None	None	None	None
Act Effct Green (s)	7.0	56.3	56.3	5.4	48.3	5.2	13.2	11.5	14.8	14.8
Actuated g/C Ratio	0.08	0.66	0.66	0.06	0.57	0.06	0.16	0.14	0.17	0.17
v/c Ratio	0.88	0.81	0.39	0.18	0.61	0.01	0.00	0.64	0.18	0.34
Control Delay	92.5	16.6	6.0	48.4	15.1	46.7	0.0	51.8	30.6	8.5
Queue Delay	0.0	0.0	0.0	0.0	0.0	0.0	0.0	0.0	0.0	0.0
Total Delay	92.5	16.6	6.0	48.4	15.1	46.7	0.0	51.8	30.6	8.5
LOS	F	B	A	D	B	D	A	D	C	A
Approach Delay		18.1			15.5		35.0		32.0	
Approach LOS		B			B		C		C	

Intersection Summary

Cycle Length: 120
 Actuated Cycle Length: 85.1
 Natural Cycle: 120
 Control Type: Actuated-Uncoordinated
 Maximum v/c Ratio: 0.88
 Intersection Signal Delay: 18.3
 Intersection LOS: B
 Intersection Capacity Utilization 77.0%
 ICU Level of Service D
 Analysis Period (min) 15

Splits and Phases: 38: Riverside Dr./Graham St. & Cactus Av.

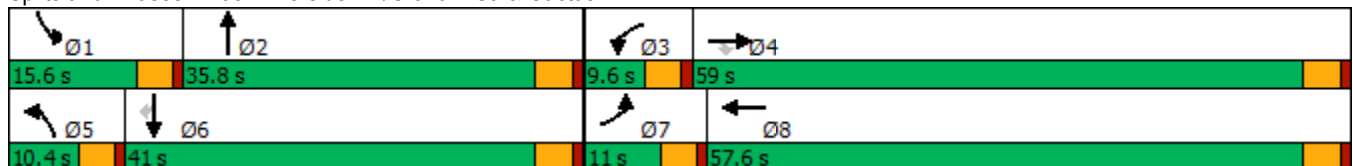

HCM 6th Signalized Intersection Summary
38: Riverside Dr./Graham St. & Cactus Av.

West Campus Upper Plateau (JN 14064)

09/19/2022



Movement	EBL	EBT	EBR	WBL	WBT	WBR	NBL	NBT	NBR	SBL	SBT	SBR
Lane Configurations	↗	↑↑↑	↖	↗	↑↑↑		↗↖	↑↖		↗	↑↑	↖
Traffic Volume (veh/h)	116	2448	406	19	1486	94	3	0	1	142	101	114
Future Volume (veh/h)	116	2448	406	19	1486	94	3	0	1	142	101	114
Initial Q (Qb), veh	0	0	0	0	0	0	0	0	0	0	0	0
Ped-Bike Adj(A_pbT)	1.00		1.00	1.00		0.99	1.00		1.00	1.00		1.00
Parking Bus, Adj	1.00	1.00	1.00	1.00	1.00	1.00	1.00	1.00	1.00	1.00	1.00	1.00
Work Zone On Approach		No			No			No			No	
Adj Sat Flow, veh/h/ln	1841	1841	1885	1900	1856	1900	1900	1900	1900	1870	1885	1826
Adj Flow Rate, veh/h	126	2661	393	21	1615	93	3	0	0	154	110	46
Peak Hour Factor	0.92	0.92	0.92	0.92	0.92	0.92	0.92	0.92	0.92	0.92	0.92	0.92
Percent Heavy Veh, %	4	4	1	0	3	0	0	0	0	2	1	5
Cap, veh/h	145	3212	1021	42	2837	163	14	70	0	189	436	188
Arrive On Green	0.08	0.64	0.64	0.02	0.58	0.58	0.00	0.00	0.00	0.11	0.12	0.12
Sat Flow, veh/h	1753	5025	1598	1810	4896	282	3510	3705	0	1781	3582	1547
Grp Volume(v), veh/h	126	2661	393	21	1114	594	3	0	0	154	110	46
Grp Sat Flow(s),veh/h/ln	1753	1675	1598	1810	1689	1801	1755	1805	0	1781	1791	1547
Q Serve(g_s), s	5.8	33.3	9.7	0.9	17.0	17.0	0.1	0.0	0.0	6.9	2.3	2.2
Cycle Q Clear(g_c), s	5.8	33.3	9.7	0.9	17.0	17.0	0.1	0.0	0.0	6.9	2.3	2.2
Prop In Lane	1.00		1.00	1.00		0.16	1.00		0.00	1.00		1.00
Lane Grp Cap(c), veh/h	145	3212	1021	42	1957	1043	14	70	0	189	436	188
V/C Ratio(X)	0.87	0.83	0.38	0.50	0.57	0.57	0.21	0.00	0.00	0.81	0.25	0.24
Avail Cap(c_a), veh/h	145	3336	1061	119	2184	1165	265	1376	0	247	1593	688
HCM Platoon Ratio	1.00	1.00	1.00	1.00	1.00	1.00	1.00	1.00	1.00	1.00	1.00	1.00
Upstream Filter(I)	1.00	1.00	1.00	1.00	1.00	1.00	1.00	0.00	0.00	1.00	1.00	1.00
Uniform Delay (d), s/veh	37.2	11.4	7.1	39.6	10.8	10.8	40.8	0.0	0.0	35.9	32.7	32.6
Incr Delay (d2), s/veh	37.7	1.8	0.2	3.4	0.3	0.5	2.7	0.0	0.0	11.2	0.3	0.7
Initial Q Delay(d3),s/veh	0.0	0.0	0.0	0.0	0.0	0.0	0.0	0.0	0.0	0.0	0.0	0.0
%ile BackOfQ(50%),veh/ln	3.8	9.0	2.4	0.4	4.9	5.3	0.0	0.0	0.0	3.5	1.0	0.8
Unsig. Movement Delay, s/veh												
LnGrp Delay(d),s/veh	74.9	13.2	7.3	43.0	11.1	11.4	43.5	0.0	0.0	47.1	33.0	33.3
LnGrp LOS	E	B	A	D	B	B	D	A	A	D	C	C
Approach Vol, veh/h		3180			1729			3			310	
Approach Delay, s/veh		14.9			11.6			43.5			40.0	
Approach LOS		B			B			D			D	
Timer - Assigned Phs	1	2	3	4	5	6	7	8				
Phs Duration (G+Y+Rc), s	12.9	6.1	6.1	57.0	4.5	14.5	11.0	52.1				
Change Period (Y+Rc), s	* 4.2	4.5	* 4.2	4.5	* 4.2	4.5	* 4.2	4.5				
Max Green Setting (Gmax), s	* 11	31.3	* 5.4	54.5	* 6.2	36.5	* 6.8	53.1				
Max Q Clear Time (g_c+I1), s	8.9	0.0	2.9	35.3	2.1	4.3	7.8	19.0				
Green Ext Time (p_c), s	0.0	0.0	0.0	17.1	0.0	0.8	0.0	14.2				

Intersection Summary

HCM 6th Ctrl Delay	15.3
HCM 6th LOS	B

Notes

* HCM 6th computational engine requires equal clearance times for the phases crossing the barrier.

Timings

1: Washington St & Van Buren Bl.

09/30/2022



Lane Group	EBL	EBT	WBL	WBT	WBR	NBL	NBT	NBR	SBL	SBT
Lane Configurations	↘	↗	↘	↗	↗	↗	↗	↗	↗	↗
Traffic Volume (vph)	126	877	122	851	234	146	219	139	332	191
Future Volume (vph)	126	877	122	851	234	146	219	139	332	191
Turn Type	Prot	NA	Prot	NA	Perm	Prot	NA	Perm	Prot	NA
Protected Phases	5	2	1	6		3	8		7	4
Permitted Phases					6			8		
Detector Phase	5	2	1	6	6	3	8	8	7	4
Switch Phase										
Minimum Initial (s)	5.0	10.0	5.0	10.0	10.0	5.0	10.0	10.0	5.0	10.0
Minimum Split (s)	9.2	34.2	9.2	33.2	33.2	9.2	38.4	38.4	9.2	30.8
Total Split (s)	14.2	49.6	14.0	49.4	49.4	11.5	38.4	38.4	18.0	44.9
Total Split (%)	11.8%	41.3%	11.7%	41.2%	41.2%	9.6%	32.0%	32.0%	15.0%	37.4%
Yellow Time (s)	3.2	5.2	3.2	5.2	5.2	3.2	4.4	4.4	3.2	4.8
All-Red Time (s)	1.0	1.0	1.0	1.0	1.0	1.0	1.0	1.0	1.0	1.0
Lost Time Adjust (s)	0.0	0.0	0.0	0.0	0.0	0.0	0.0	0.0	0.0	0.0
Total Lost Time (s)	4.2	6.2	4.2	6.2	6.2	4.2	5.4	5.4	4.2	5.8
Lead/Lag	Lead	Lag	Lead	Lag	Lag	Lead	Lag	Lag	Lead	Lag
Lead-Lag Optimize?	Yes	Yes	Yes	Yes	Yes	Yes	Yes	Yes	Yes	Yes
Recall Mode	None	None	None	None	None	None	None	None	None	None
Act Effct Green (s)	9.9	34.3	9.7	34.2	34.2	7.2	14.8	14.8	13.0	20.1
Actuated g/C Ratio	0.11	0.37	0.11	0.37	0.37	0.08	0.16	0.16	0.14	0.22
v/c Ratio	0.68	0.77	0.67	0.68	0.35	0.56	0.40	0.39	0.70	0.36
Control Delay	61.8	30.7	62.2	28.2	8.9	53.1	37.5	9.1	48.7	25.2
Queue Delay	0.0	0.0	0.0	0.0	0.0	0.0	0.0	0.0	0.0	0.0
Total Delay	61.8	30.7	62.2	28.2	8.9	53.1	37.5	9.1	48.7	25.2
LOS	E	C	E	C	A	D	D	A	D	C
Approach Delay		34.3		27.9			34.2			38.1
Approach LOS		C		C			C			D

Intersection Summary

Cycle Length: 120
 Actuated Cycle Length: 92.3
 Natural Cycle: 95
 Control Type: Actuated-Uncoordinated
 Maximum v/c Ratio: 0.77
 Intersection Signal Delay: 32.7
 Intersection LOS: C
 Intersection Capacity Utilization 68.6%
 ICU Level of Service C
 Analysis Period (min) 15



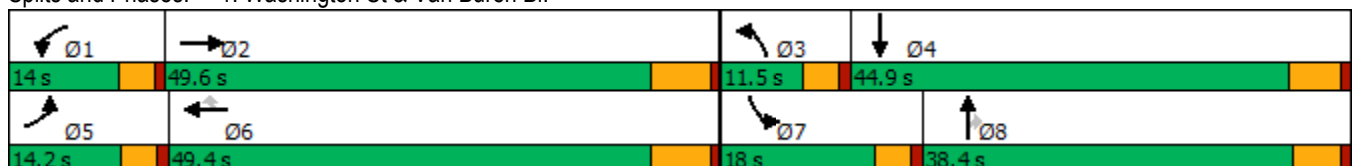



















Splits and Phases: 1: Washington St & Van Buren Bl.



HCM 6th Signalized Intersection Summary
1: Washington St & Van Buren Bl.

West Campus Upper Plateau (JN 14064)

09/30/2022

												
Movement	EBL	EBT	EBR	WBL	WBT	WBR	NBL	NBT	NBR	SBL	SBT	SBR
Lane Configurations												
Traffic Volume (veh/h)	126	877	78	122	851	234	146	219	139	332	191	83
Future Volume (veh/h)	126	877	78	122	851	234	146	219	139	332	191	83
Initial Q (Qb), veh	0	0	0	0	0	0	0	0	0	0	0	0
Ped-Bike Adj(A_pbT)	1.00		1.00	1.00		1.00	1.00		0.98	1.00		0.98
Parking Bus, Adj	1.00	1.00	1.00	1.00	1.00	1.00	1.00	1.00	1.00	1.00	1.00	1.00
Work Zone On Approach		No			No			No			No	
Adj Sat Flow, veh/h/ln	1900	1841	1856	1885	1856	1885	1885	1856	1870	1885	1885	1900
Adj Flow Rate, veh/h	130	904	60	126	877	146	151	226	103	342	197	39
Peak Hour Factor	0.97	0.97	0.97	0.97	0.97	0.97	0.97	0.97	0.97	0.97	0.97	0.97
Percent Heavy Veh, %	0	4	3	1	3	1	1	3	2	1	1	0
Cap, veh/h	165	1235	82	160	1301	588	232	509	225	438	607	118
Arrive On Green	0.09	0.37	0.37	0.09	0.37	0.37	0.07	0.14	0.14	0.13	0.20	0.20
Sat Flow, veh/h	1810	3329	221	1795	3526	1594	3483	3526	1556	3483	2982	578
Grp Volume(v), veh/h	130	475	489	126	877	146	151	226	103	342	117	119
Grp Sat Flow(s),veh/h/ln	1810	1749	1801	1795	1763	1594	1742	1763	1556	1742	1791	1769
Q Serve(g_s), s	5.3	17.7	17.7	5.2	15.8	4.8	3.2	4.4	4.6	7.2	4.2	4.4
Cycle Q Clear(g_c), s	5.3	17.7	17.7	5.2	15.8	4.8	3.2	4.4	4.6	7.2	4.2	4.4
Prop In Lane	1.00		0.12	1.00		1.00	1.00		1.00	1.00		0.33
Lane Grp Cap(c), veh/h	165	649	668	160	1301	588	232	509	225	438	365	360
V/C Ratio(X)	0.79	0.73	0.73	0.79	0.67	0.25	0.65	0.44	0.46	0.78	0.32	0.33
Avail Cap(c_a), veh/h	239	1004	1034	233	2014	911	336	1539	679	636	926	915
HCM Platoon Ratio	1.00	1.00	1.00	1.00	1.00	1.00	1.00	1.00	1.00	1.00	1.00	1.00
Upstream Filter(I)	1.00	1.00	1.00	1.00	1.00	1.00	1.00	1.00	1.00	1.00	1.00	1.00
Uniform Delay (d), s/veh	33.7	20.5	20.5	33.8	20.0	16.6	34.4	29.6	29.6	32.0	25.6	25.7
Incr Delay (d2), s/veh	6.2	2.3	2.2	6.2	0.9	0.3	1.2	0.6	1.5	2.2	0.5	0.5
Initial Q Delay(d3),s/veh	0.0	0.0	0.0	0.0	0.0	0.0	0.0	0.0	0.0	0.0	0.0	0.0
%ile BackOfQ(50%),veh/ln	2.4	6.5	6.7	2.4	5.7	1.7	1.4	1.9	1.8	3.1	1.8	1.8
Unsig. Movement Delay, s/veh												
LnGrp Delay(d),s/veh	39.8	22.8	22.7	40.0	20.9	16.9	35.6	30.2	31.1	34.2	26.1	26.2
LnGrp LOS	D	C	C	D	C	B	D	C	C	C	C	C
Approach Vol, veh/h		1094			1149			480			578	
Approach Delay, s/veh		24.8			22.5			32.1			30.9	
Approach LOS		C			C			C			C	
Timer - Assigned Phs	1	2	3	4	5	6	7	8				
Phs Duration (G+Y+Rc), s	10.9	34.3	9.2	21.2	11.1	34.1	13.7	16.7				
Change Period (Y+Rc), s	* 4.2	6.2	* 4.2	5.8	* 4.2	6.2	* 4.2	* 5.8				
Max Green Setting (Gmax), s	* 9.8	43.4	* 7.3	39.1	* 10	43.2	* 14	* 33				
Max Q Clear Time (g_c+I1), s	7.2	19.7	5.2	6.4	7.3	17.8	9.2	6.6				
Green Ext Time (p_c), s	0.0	8.3	0.1	1.4	0.0	9.2	0.3	1.9				
Intersection Summary												
HCM 6th Ctrl Delay				26.1								
HCM 6th LOS				C								
Notes												
* HCM 6th computational engine requires equal clearance times for the phases crossing the barrier.												

Timings
2: Central Ave & Arlington Ave/Chicago Ave

West Campus Upper Plateau (JN 14064)

09/30/2022



Lane Group	EBL	EBT	EBR	WBL	WBT	WBR	NBL	NBT	NBR	SBL	SBT
Lane Configurations	↘	↑↑	↗↗	↘↘	↑↑	↗	↘↘	↑↑	↗	↘↘	↑↑↗
Traffic Volume (vph)	24	363	591	202	485	185	724	767	199	244	879
Future Volume (vph)	24	363	591	202	485	185	724	767	199	244	879
Turn Type	Prot	NA	pm+ov	Prot	NA	pm+ov	Prot	NA	pm+ov	Prot	NA
Protected Phases	7	4	5	3	8	1	5	2	3	1	6
Permitted Phases			4			8			2		
Detector Phase	7	4	5	3	8	1	5	2	3	1	6
Switch Phase											
Minimum Initial (s)	5.0	10.0	5.0	5.0	10.0	5.0	5.0	10.0	5.0	5.0	10.0
Minimum Split (s)	9.6	32.8	9.6	9.6	30.8	9.6	9.6	35.4	9.6	9.6	30.4
Total Split (s)	10.6	32.8	30.0	22.0	44.2	24.4	30.0	50.8	22.0	24.4	45.2
Total Split (%)	8.2%	25.2%	23.1%	16.9%	34.0%	18.8%	23.1%	39.1%	16.9%	18.8%	34.8%
Yellow Time (s)	3.6	4.8	3.6	3.6	4.8	3.6	3.6	4.4	3.6	3.6	4.4
All-Red Time (s)	1.0	1.0	1.0	1.0	1.0	1.0	1.0	1.0	1.0	1.0	1.0
Lost Time Adjust (s)	0.0	0.0	0.0	0.0	0.0	0.0	0.0	0.0	0.0	0.0	0.0
Total Lost Time (s)	4.6	5.8	4.6	4.6	5.8	4.6	4.6	5.4	4.6	4.6	5.4
Lead/Lag	Lead	Lag	Lead	Lead	Lag	Lead	Lead	Lag	Lead	Lead	Lag
Lead-Lag Optimize?	Yes	Yes	Yes	Yes	Yes	Yes	Yes	Yes	Yes	Yes	Yes
Recall Mode	None	None	None	None	None	None	None	None	None	None	None
Act Effct Green (s)	5.6	16.5	43.6	10.6	28.0	45.6	25.9	39.5	50.9	11.7	25.3
Actuated g/C Ratio	0.06	0.17	0.44	0.11	0.28	0.46	0.26	0.40	0.51	0.12	0.26
v/c Ratio	0.24	0.61	0.46	0.56	0.48	0.23	0.81	0.54	0.24	0.60	0.70
Control Delay	56.0	43.6	15.8	50.0	32.6	7.6	44.4	26.1	6.4	49.5	36.9
Queue Delay	0.0	0.0	0.0	0.0	0.0	0.0	0.0	0.0	0.0	0.0	0.0
Total Delay	56.0	43.6	15.8	50.0	32.6	7.6	44.4	26.1	6.4	49.5	36.9
LOS	E	D	B	D	C	A	D	C	A	D	D
Approach Delay		27.1			31.3			31.6			39.6
Approach LOS		C			C			C			D

Intersection Summary

Cycle Length: 130
 Actuated Cycle Length: 99
 Natural Cycle: 100
 Control Type: Actuated-Uncoordinated
 Maximum v/c Ratio: 0.81
 Intersection Signal Delay: 32.6
 Intersection LOS: C
 Intersection Capacity Utilization 72.9%
 ICU Level of Service C
 Analysis Period (min) 15

Splits and Phases: 2: Central Ave & Arlington Ave/Chicago Ave

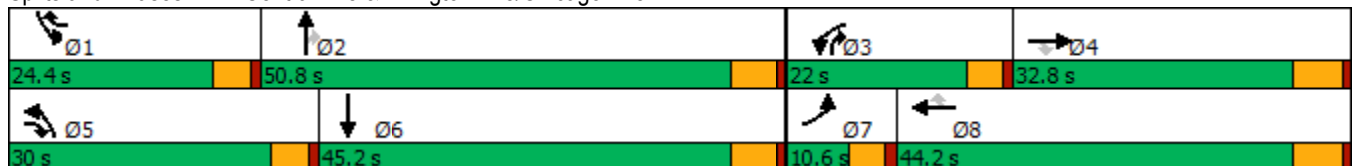

HCM 6th Signalized Intersection Summary
2: Central Ave & Arlington Ave/Chicago Ave

West Campus Upper Plateau (JN 14064)

09/30/2022



Movement	EBL	EBT	EBR	WBL	WBT	WBR	NBL	NBT	NBR	SBL	SBT	SBR
Lane Configurations	↘	↑↑	↗↗	↘↘	↑↑	↗	↘↘	↑↑	↗	↘↘	↑↑↘	
Traffic Volume (veh/h)	24	363	591	202	485	185	724	767	199	244	879	31
Future Volume (veh/h)	24	363	591	202	485	185	724	767	199	244	879	31
Initial Q (Qb), veh	0	0	0	0	0	0	0	0	0	0	0	0
Ped-Bike Adj(A_pbT)	1.00		1.00	1.00		1.00	1.00		0.99	1.00		1.00
Parking Bus, Adj	1.00	1.00	1.00	1.00	1.00	1.00	1.00	1.00	1.00	1.00	1.00	1.00
Work Zone On Approach		No			No			No			No	
Adj Sat Flow, veh/h/ln	1900	1900	1885	1870	1900	1885	1885	1885	1856	1900	1885	1900
Adj Flow Rate, veh/h	24	367	212	204	490	102	731	775	135	246	888	29
Peak Hour Factor	0.99	0.99	0.99	0.99	0.99	0.99	0.99	0.99	0.99	0.99	0.99	0.99
Percent Heavy Veh, %	0	0	1	2	0	1	1	1	3	0	1	0
Cap, veh/h	47	569	1119	294	782	502	837	1436	756	343	1322	43
Arrive On Green	0.03	0.16	0.16	0.08	0.22	0.22	0.24	0.40	0.40	0.10	0.26	0.26
Sat Flow, veh/h	1810	3610	2806	3456	3610	1598	3483	3582	1552	3510	5119	167
Grp Volume(v), veh/h	24	367	212	204	490	102	731	775	135	246	595	322
Grp Sat Flow(s),veh/h/ln	1810	1805	1403	1728	1805	1598	1742	1791	1552	1755	1716	1855
Q Serve(g_s), s	1.0	7.5	3.9	4.5	9.7	3.7	15.9	13.0	3.9	5.4	12.3	12.3
Cycle Q Clear(g_c), s	1.0	7.5	3.9	4.5	9.7	3.7	15.9	13.0	3.9	5.4	12.3	12.3
Prop In Lane	1.00		1.00	1.00		1.00	1.00		1.00	1.00		0.09
Lane Grp Cap(c), veh/h	47	569	1119	294	782	502	837	1436	756	343	886	479
V/C Ratio(X)	0.51	0.64	0.19	0.69	0.63	0.20	0.87	0.54	0.18	0.72	0.67	0.67
Avail Cap(c_a), veh/h	138	1236	1637	762	1758	934	1122	2062	1027	881	1731	936
HCM Platoon Ratio	1.00	1.00	1.00	1.00	1.00	1.00	1.00	1.00	1.00	1.00	1.00	1.00
Upstream Filter(I)	1.00	1.00	1.00	1.00	1.00	1.00	1.00	1.00	1.00	1.00	1.00	1.00
Uniform Delay (d), s/veh	37.9	31.1	15.5	35.1	28.0	19.8	28.8	18.1	11.4	34.5	26.2	26.3
Incr Delay (d2), s/veh	3.2	1.2	0.1	1.1	0.8	0.2	4.9	0.3	0.1	1.1	0.9	1.6
Initial Q Delay(d3),s/veh	0.0	0.0	0.0	0.0	0.0	0.0	0.0	0.0	0.0	0.0	0.0	0.0
%ile BackOfQ(50%),veh/ln	0.5	3.1	1.1	1.8	3.9	1.3	6.7	4.9	1.2	2.2	4.8	5.3
Unsig. Movement Delay, s/veh												
LnGrp Delay(d),s/veh	41.1	32.4	15.5	36.2	28.8	20.0	33.7	18.4	11.5	35.6	27.1	27.9
LnGrp LOS	D	C	B	D	C	B	C	B	B	D	C	C
Approach Vol, veh/h		603			796			1641			1163	
Approach Delay, s/veh		26.8			29.6			24.6			29.1	
Approach LOS		C			C			C			C	
Timer - Assigned Phs	1	2	3	4	5	6	7	8				
Phs Duration (G+Y+Rc), s	12.3	37.0	11.3	18.2	23.6	25.8	6.6	22.9				
Change Period (Y+Rc), s	4.6	5.4	4.6	5.8	4.6	5.4	4.6	5.8				
Max Green Setting (Gmax), s	19.8	45.4	17.4	27.0	25.4	39.8	6.0	38.4				
Max Q Clear Time (g_c+I1), s	7.4	15.0	6.5	9.5	17.9	14.3	3.0	11.7				
Green Ext Time (p_c), s	0.3	6.1	0.2	2.8	1.0	6.1	0.0	3.4				
Intersection Summary												
HCM 6th Ctrl Delay				27.1								
HCM 6th LOS				C								

Timings

3: Overlook Pkwy./Canyon Crest Dr. & Alessandro Bl/Alessandro Bl.



Lane Group	EBL	EBT	WBL	WBT	WBR	NBL	NBT	NBR	SBL	SBT	SBR
Lane Configurations	↙	↕↕↕	↙	↕↕↕	↗	↙	↕↕	↗	↕↕	↙	↗
Traffic Volume (vph)	38	1443	25	1570	451	19	55	29	349	57	21
Future Volume (vph)	38	1443	25	1570	451	19	55	29	349	57	21
Turn Type	Prot	NA	Prot	NA	pm+ov	Split	NA	Perm	Split	NA	Perm
Protected Phases	5	2	1	6	4	8	8		4	4	
Permitted Phases					6			8			4
Detector Phase	5	2	1	6	4	8	8	8	4	4	4
Switch Phase											
Minimum Initial (s)	5.0	10.0	5.0	10.0	10.0	10.0	10.0	10.0	10.0	10.0	10.0
Minimum Split (s)	9.2	35.2	9.2	35.2	38.8	38.8	38.8	38.8	38.8	38.8	38.8
Total Split (s)	9.2	43.2	9.2	43.2	38.8	38.8	38.8	38.8	38.8	38.8	38.8
Total Split (%)	7.1%	33.2%	7.1%	33.2%	29.8%	29.8%	29.8%	29.8%	29.8%	29.8%	29.8%
Yellow Time (s)	3.2	5.2	3.2	5.2	4.8	4.8	4.8	4.8	4.8	4.8	4.8
All-Red Time (s)	1.0	1.0	1.0	1.0	1.0	1.0	1.0	1.0	1.0	1.0	1.0
Lost Time Adjust (s)	0.0	0.0	0.0	0.0	0.0	0.0	0.0	0.0	0.0	0.0	0.0
Total Lost Time (s)	4.2	6.2	4.2	6.2	5.8	5.8	5.8	5.8	5.8	5.8	5.8
Lead/Lag	Lead	Lag	Lead	Lag							
Lead-Lag Optimize?	Yes	Yes	Yes	Yes							
Recall Mode	None	None	None	None	None	None	None	None	None	None	None
Act Effct Green (s)	5.2	42.1	5.2	38.5	64.1	10.4	10.4	10.4	17.4	17.4	17.4
Actuated g/C Ratio	0.06	0.48	0.06	0.44	0.74	0.12	0.12	0.12	0.20	0.20	0.20
v/c Ratio	0.40	0.62	0.24	0.72	0.36	0.10	0.13	0.10	0.43	0.44	0.06
Control Delay	57.1	21.4	50.7	25.6	1.3	41.7	40.6	0.7	33.1	36.2	0.3
Queue Delay	0.0	0.0	0.0	0.0	0.0	0.0	0.0	0.0	0.0	0.0	0.0
Total Delay	57.1	21.4	50.7	25.6	1.3	41.7	40.6	0.7	33.1	36.2	0.3
LOS	E	C	D	C	A	D	D	A	C	D	A
Approach Delay		22.3		20.6			29.6			32.5	
Approach LOS		C		C			C			C	

Intersection Summary

Cycle Length: 130
 Actuated Cycle Length: 87
 Natural Cycle: 125
 Control Type: Actuated-Uncoordinated
 Maximum v/c Ratio: 0.72
 Intersection Signal Delay: 22.7
 Intersection LOS: C
 Intersection Capacity Utilization 61.8%
 ICU Level of Service B
 Analysis Period (min) 15

Splits and Phases: 3: Overlook Pkwy./Canyon Crest Dr. & Alessandro Bl/Alessandro Bl.

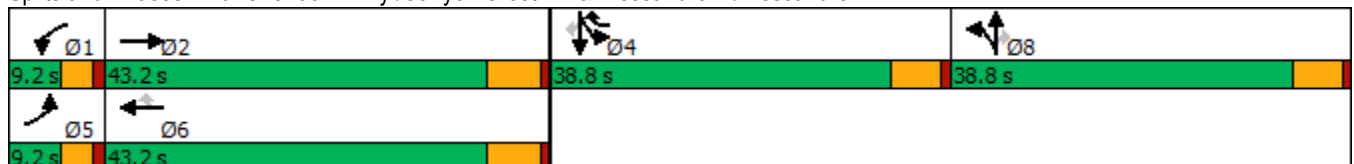

HCM 6th Signalized Intersection Summary

West Campus Upper Plateau (JN 14064)

3: Overlook Pkwy./Canyon Crest Dr. & Alessandro Bl/Alessandro Bl.

09/30/2022



Movement	EBL	EBT	EBR	WBL	WBT	WBR	NBL	NBT	NBR	SBL	SBT	SBR
Lane Configurations	↗	↑↑↑		↖	↑↑↑	↗	↖	↑↑	↗	↖↖	↖	↗
Traffic Volume (veh/h)	38	1443	23	25	1570	451	19	55	29	349	57	21
Future Volume (veh/h)	38	1443	23	25	1570	451	19	55	29	349	57	21
Initial Q (Qb), veh	0	0	0	0	0	0	0	0	0	0	0	0
Ped-Bike Adj(A_pbT)	1.00		1.00	1.00		1.00	1.00		1.00	1.00		1.00
Parking Bus, Adj	1.00	1.00	1.00	1.00	1.00	1.00	1.00	1.00	1.00	1.00	1.00	1.00
Work Zone On Approach		No			No			No			No	
Adj Sat Flow, veh/h/ln	1811	1885	1811	1900	1885	1870	1781	1900	1900	1885	1767	1841
Adj Flow Rate, veh/h	40	1503	24	26	1635	462	20	57	22	323	116	13
Peak Hour Factor	0.96	0.96	0.96	0.96	0.96	0.96	0.96	0.96	0.96	0.96	0.96	0.96
Percent Heavy Veh, %	6	1	6	0	1	2	8	0	0	1	9	4
Cap, veh/h	65	2272	36	50	2191	887	195	415	185	481	237	209
Arrive On Green	0.04	0.44	0.44	0.03	0.43	0.43	0.11	0.11	0.11	0.13	0.13	0.13
Sat Flow, veh/h	1725	5218	83	1810	5147	1585	1697	3610	1610	3591	1767	1560
Grp Volume(v), veh/h	40	988	539	26	1635	462	20	57	22	323	116	13
Grp Sat Flow(s),veh/h/ln	1725	1716	1870	1810	1716	1585	1697	1805	1610	1795	1767	1560
Q Serve(g_s), s	1.7	17.5	17.5	1.1	20.4	13.8	0.8	1.1	0.9	6.5	4.7	0.6
Cycle Q Clear(g_c), s	1.7	17.5	17.5	1.1	20.4	13.8	0.8	1.1	0.9	6.5	4.7	0.6
Prop In Lane	1.00		0.04	1.00		1.00	1.00		1.00	1.00		1.00
Lane Grp Cap(c), veh/h	65	1494	814	50	2191	887	195	415	185	481	237	209
V/C Ratio(X)	0.62	0.66	0.66	0.52	0.75	0.52	0.10	0.14	0.12	0.67	0.49	0.06
Avail Cap(c_a), veh/h	113	1661	906	118	2492	980	733	1559	695	1551	763	674
HCM Platoon Ratio	1.00	1.00	1.00	1.00	1.00	1.00	1.00	1.00	1.00	1.00	1.00	1.00
Upstream Filter(I)	1.00	1.00	1.00	1.00	1.00	1.00	1.00	1.00	1.00	1.00	1.00	1.00
Uniform Delay (d), s/veh	36.2	17.1	17.1	36.6	18.5	10.4	30.3	30.4	30.3	31.5	30.7	28.9
Incr Delay (d2), s/veh	3.6	0.9	1.6	3.0	1.1	0.5	0.2	0.1	0.3	1.6	1.6	0.1
Initial Q Delay(d3),s/veh	0.0	0.0	0.0	0.0	0.0	0.0	0.0	0.0	0.0	0.0	0.0	0.0
%ile BackOfQ(50%),veh/ln	0.7	5.9	6.5	0.5	6.9	5.6	0.3	0.4	0.4	2.7	1.9	0.2
Unsig. Movement Delay, s/veh												
LnGrp Delay(d),s/veh	39.8	18.0	18.7	39.7	19.6	10.9	30.5	30.6	30.6	33.1	32.2	29.0
LnGrp LOS	D	B	B	D	B	B	C	C	C	C	C	C
Approach Vol, veh/h		1567			2123			99			452	
Approach Delay, s/veh		18.8			17.9			30.6			32.8	
Approach LOS		B			B			C			C	
Timer - Assigned Phs	1	2		4	5	6		8				
Phs Duration (G+Y+Rc), s	6.3	39.5		16.0	7.1	38.7		14.6				
Change Period (Y+Rc), s	* 4.2	6.2		5.8	* 4.2	6.2		5.8				
Max Green Setting (Gmax), s	* 5	37.0		33.0	* 5	37.0		33.0				
Max Q Clear Time (g_c+I1), s	3.1	19.5		8.5	3.7	22.4		3.1				
Green Ext Time (p_c), s	0.0	8.9		1.7	0.0	10.1		0.4				

Intersection Summary

HCM 6th Ctrl Delay	20.1
HCM 6th LOS	C

Notes

- User approved pedestrian interval to be less than phase max green.
- User approved volume balancing among the lanes for turning movement.
- * HCM 6th computational engine requires equal clearance times for the phases crossing the barrier.

Timings
4: Van Buren Bl. & Wood Rd.

West Campus Upper Plateau (JN 14064)

09/30/2022

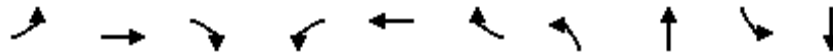

Lane Group	EBL	EBT	EBR	WBL	WBT	WBR	NBL	NBT	SBL	SBT
Lane Configurations	↘	↑↑	↗	↘↗	↑↑	↗	↘↗	↑↘	↘	↑↘
Traffic Volume (vph)	137	1098	187	194	1058	75	184	140	131	163
Future Volume (vph)	137	1098	187	194	1058	75	184	140	131	163
Turn Type	Prot	NA	pm+ov	Prot	NA	Perm	Prot	NA	Prot	NA
Protected Phases	5	2	3	1	6		3	8	7	4
Permitted Phases			2			6				
Detector Phase	5	2	3	1	6	6	3	8	7	4
Switch Phase										
Minimum Initial (s)	5.0	10.0	5.0	5.0	10.0	10.0	5.0	10.0	5.0	10.0
Minimum Split (s)	9.2	30.2	9.2	9.2	30.2	30.2	9.2	38.4	9.2	15.8
Total Split (s)	16.5	57.2	21.7	13.2	53.9	53.9	21.7	38.4	11.2	27.9
Total Split (%)	13.8%	47.7%	18.1%	11.0%	44.9%	44.9%	18.1%	32.0%	9.3%	23.3%
Yellow Time (s)	3.2	5.2	3.2	3.2	5.2	5.2	3.2	4.4	3.2	4.8
All-Red Time (s)	1.0	1.0	1.0	1.0	1.0	1.0	1.0	1.0	1.0	1.0
Lost Time Adjust (s)	0.0	0.0	0.0	0.0	0.0	0.0	0.0	0.0	0.0	0.0
Total Lost Time (s)	4.2	6.2	4.2	4.2	6.2	6.2	4.2	5.4	4.2	5.8
Lead/Lag	Lead	Lag	Lead	Lead	Lag	Lag	Lead	Lag	Lead	Lag
Lead-Lag Optimize?	Yes	Yes	Yes	Yes	Yes	Yes	Yes	Yes	Yes	Yes
Recall Mode	None	None	None	None	None	None	None	None	None	None
Act Effct Green (s)	11.6	43.1	55.6	8.9	40.4	40.4	10.5	17.1	7.2	13.4
Actuated g/C Ratio	0.12	0.45	0.57	0.09	0.42	0.42	0.11	0.18	0.07	0.14
v/c Ratio	0.71	0.77	0.21	0.67	0.79	0.11	0.55	0.42	1.09	0.58
Control Delay	63.0	27.4	1.8	56.9	29.9	0.6	49.3	20.5	150.3	24.6
Queue Delay	0.0	0.0	0.0	0.0	0.0	0.0	0.0	0.0	0.0	0.0
Total Delay	63.0	27.4	1.8	56.9	29.9	0.6	49.3	20.5	150.3	24.6
LOS	E	C	A	E	C	A	D	C	F	C
Approach Delay		27.5			32.2			32.3		61.3
Approach LOS		C			C			C		E

Intersection Summary

Cycle Length: 120
 Actuated Cycle Length: 96.8
 Natural Cycle: 110
 Control Type: Actuated-Uncoordinated
 Maximum v/c Ratio: 1.09
 Intersection Signal Delay: 34.0
 Intersection LOS: C
 Intersection Capacity Utilization 75.5%
 ICU Level of Service D
 Analysis Period (min) 15

Splits and Phases: 4: Van Buren Bl. & Wood Rd.



HCM 6th Signalized Intersection Summary
4: Van Buren Bl. & Wood Rd.

West Campus Upper Plateau (JN 14064)

09/30/2022

Movement	EBL	EBT	EBR	WBL	WBT	WBR	NBL	NBT	NBR	SBL	SBT	SBR
Lane Configurations												
Traffic Volume (veh/h)	137	1098	187	194	1058	75	184	140	124	131	163	155
Future Volume (veh/h)	137	1098	187	194	1058	75	184	140	124	131	163	155
Initial Q (Qb), veh	0	0	0	0	0	0	0	0	0	0	0	0
Ped-Bike Adj(A_pbT)	1.00		0.98	1.00		0.99	1.00		0.96	1.00		0.99
Parking Bus, Adj	1.00	1.00	1.00	1.00	1.00	1.00	1.00	1.00	1.00	1.00	1.00	1.00
Work Zone On Approach		No			No			No			No	
Adj Sat Flow, veh/h/ln	1885	1856	1870	1885	1870	1885	1856	1885	1870	1885	1885	1885
Adj Flow Rate, veh/h	151	1207	100	213	1163	35	202	154	55	144	179	95
Peak Hour Factor	0.91	0.91	0.91	0.91	0.91	0.91	0.91	0.91	0.91	0.91	0.91	0.91
Percent Heavy Veh, %	1	3	2	1	2	1	3	1	2	1	1	1
Cap, veh/h	185	1591	835	289	1532	679	283	392	134	144	341	172
Arrive On Green	0.10	0.45	0.45	0.08	0.43	0.43	0.08	0.15	0.15	0.08	0.15	0.15
Sat Flow, veh/h	1795	3526	1561	3483	3554	1574	3428	2593	884	1795	2292	1157
Grp Volume(v), veh/h	151	1207	100	213	1163	35	202	104	105	144	138	136
Grp Sat Flow(s),veh/h/ln	1795	1763	1561	1742	1777	1574	1714	1791	1686	1795	1791	1658
Q Serve(g_s), s	7.2	24.9	2.8	5.2	24.1	1.1	5.0	4.6	4.9	7.0	6.2	6.6
Cycle Q Clear(g_c), s	7.2	24.9	2.8	5.2	24.1	1.1	5.0	4.6	4.9	7.0	6.2	6.6
Prop In Lane	1.00		1.00	1.00		1.00	1.00		0.52	1.00		0.70
Lane Grp Cap(c), veh/h	185	1591	835	289	1532	679	283	271	255	144	267	247
V/C Ratio(X)	0.82	0.76	0.12	0.74	0.76	0.05	0.71	0.38	0.41	1.00	0.52	0.55
Avail Cap(c_a), veh/h	254	2064	1045	360	1946	862	689	679	639	144	454	421
HCM Platoon Ratio	1.00	1.00	1.00	1.00	1.00	1.00	1.00	1.00	1.00	1.00	1.00	1.00
Upstream Filter(I)	1.00	1.00	1.00	1.00	1.00	1.00	1.00	1.00	1.00	1.00	1.00	1.00
Uniform Delay (d), s/veh	38.2	19.9	10.1	39.0	21.0	14.4	38.9	33.3	33.5	40.0	34.2	34.4
Incr Delay (d2), s/veh	9.8	1.5	0.1	4.2	1.6	0.0	1.3	0.9	1.1	74.2	1.6	1.9
Initial Q Delay(d3),s/veh	0.0	0.0	0.0	0.0	0.0	0.0	0.0	0.0	0.0	0.0	0.0	0.0
%ile BackOfQ(50%),veh/ln	3.5	9.0	0.9	2.3	9.0	0.4	2.1	2.0	2.0	5.9	2.7	2.7
Unsig. Movement Delay, s/veh												
LnGrp Delay(d),s/veh	48.1	21.4	10.2	43.2	22.6	14.5	40.2	34.2	34.5	114.3	35.7	36.3
LnGrp LOS	D	C	B	D	C	B	D	C	C	F	D	D
Approach Vol, veh/h		1458			1411			411			418	
Approach Delay, s/veh		23.4			25.5			37.2			63.0	
Approach LOS		C			C			D			E	
Timer - Assigned Phs	1	2	3	4	5	6	7	8				
Phs Duration (G+Y+Rc), s	11.4	45.5	11.4	18.8	13.2	43.7	11.2	19.0				
Change Period (Y+Rc), s	* 4.2	6.2	* 4.2	5.8	* 4.2	6.2	* 4.2	* 5.8				
Max Green Setting (Gmax), s	* 9	51.0	* 18	22.1	* 12	47.7	* 7	* 33				
Max Q Clear Time (g_c+I1), s	7.2	26.9	7.0	8.6	9.2	26.1	9.0	6.9				
Green Ext Time (p_c), s	0.1	12.4	0.2	1.2	0.1	10.8	0.0	1.1				
Intersection Summary												
HCM 6th Ctrl Delay				30.2								
HCM 6th LOS				C								
Notes												
* HCM 6th computational engine requires equal clearance times for the phases crossing the barrier.												

Timings
5: Trautwein Rd. & Alessandro Bl.

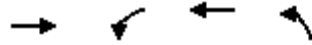

Lane Group	EBT	WBL	WBT	NBL
Lane Configurations	↑↑↑	↵↵	↑↑↑	↵↵↵
Traffic Volume (vph)	1179	195	1385	821
Future Volume (vph)	1179	195	1385	821
Turn Type	NA	Prot	NA	Prot
Protected Phases	2	1	6	8
Permitted Phases				
Detector Phase	2	1	6	8
Switch Phase				
Minimum Initial (s)	10.0	5.0	10.0	10.0
Minimum Split (s)	33.2	9.2	16.2	16.2
Total Split (s)	63.0	19.0	82.0	38.0
Total Split (%)	52.5%	15.8%	68.3%	31.7%
Yellow Time (s)	5.2	3.2	5.2	5.2
All-Red Time (s)	1.0	1.0	1.0	1.0
Lost Time Adjust (s)	0.0	0.0	0.0	0.0
Total Lost Time (s)	6.2	4.2	6.2	6.2
Lead/Lag	Lag	Lead		
Lead-Lag Optimize?	Yes	Yes		
Recall Mode	None	None	None	None
Act Effct Green (s)	32.4	9.6	46.4	20.5
Actuated g/C Ratio	0.41	0.12	0.58	0.26
v/c Ratio	0.59	0.49	0.48	0.67
Control Delay	20.2	39.6	10.4	30.4
Queue Delay	0.0	0.0	0.0	0.0
Total Delay	20.2	39.6	10.4	30.4
LOS	C	D	B	C
Approach Delay	20.2		14.0	30.4
Approach LOS	C		B	C

Intersection Summary

Cycle Length: 120	
Actuated Cycle Length: 79.7	
Natural Cycle: 60	
Control Type: Actuated-Uncoordinated	
Maximum v/c Ratio: 0.67	
Intersection Signal Delay: 19.9	Intersection LOS: B
Intersection Capacity Utilization 58.2%	ICU Level of Service B
Analysis Period (min) 15	

Splits and Phases: 5: Trautwein Rd. & Alessandro Bl.



HCM 6th Signalized Intersection Summary
5: Trautwein Rd. & Alessandro Bl.

West Campus Upper Plateau (JN 14064)

09/30/2022

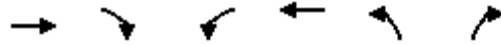

Movement	EBT	EBR	WBL	WBT	NBL	NBR
Lane Configurations	↑↑↑		↵↵	↑↑↑	↵↵↵	
Traffic Volume (veh/h)	1179	9	195	1385	821	11
Future Volume (veh/h)	1179	9	195	1385	821	11
Initial Q (Qb), veh	0	0	0	0	0	0
Ped-Bike Adj(A_pbT)		1.00	1.00		1.00	1.00
Parking Bus, Adj	1.00	1.00	1.00	1.00	1.00	1.00
Work Zone On Approach	No			No	No	
Adj Sat Flow, veh/h/ln	1885	1900	1885	1885	1870	1900
Adj Flow Rate, veh/h	1228	9	203	1443	865	0
Peak Hour Factor	0.96	0.96	0.96	0.96	0.96	0.96
Percent Heavy Veh, %	1	0	1	1	2	0
Cap, veh/h	2236	16	315	2983	1224	369
Arrive On Green	0.42	0.42	0.09	0.58	0.23	0.00
Sat Flow, veh/h	5440	39	3483	5316	5344	1610
Grp Volume(v), veh/h	799	438	203	1443	865	0
Grp Sat Flow(s),veh/h/ln	1716	1878	1742	1716	1781	1610
Q Serve(g_s), s	11.3	11.3	3.6	10.6	9.6	0.0
Cycle Q Clear(g_c), s	11.3	11.3	3.6	10.6	9.6	0.0
Prop In Lane		0.02	1.00		1.00	1.00
Lane Grp Cap(c), veh/h	1456	797	315	2983	1224	369
V/C Ratio(X)	0.55	0.55	0.64	0.48	0.71	0.00
Avail Cap(c_a), veh/h	3007	1646	795	6019	2622	790
HCM Platoon Ratio	1.00	1.00	1.00	1.00	1.00	1.00
Upstream Filter(I)	1.00	1.00	1.00	1.00	1.00	0.00
Uniform Delay (d), s/veh	14.0	14.0	28.5	8.0	23.0	0.0
Incr Delay (d2), s/veh	0.5	0.8	0.8	0.2	0.8	0.0
Initial Q Delay(d3),s/veh	0.0	0.0	0.0	0.0	0.0	0.0
%ile BackOfQ(50%),veh/ln	3.5	3.9	1.4	2.4	3.6	0.0
Unsig. Movement Delay, s/veh						
LnGrp Delay(d),s/veh	14.5	14.8	29.3	8.1	23.7	0.0
LnGrp LOS	B	B	C	A	C	A
Approach Vol, veh/h	1237			1646	865	
Approach Delay, s/veh	14.6			10.7	23.7	
Approach LOS	B			B	C	
Timer - Assigned Phs	1	2			6	8
Phs Duration (G+Y+Rc), s	10.1	33.7			43.8	21.0
Change Period (Y+Rc), s	* 4.2	6.2			6.2	6.2
Max Green Setting (Gmax), s	* 15	56.8			75.8	31.8
Max Q Clear Time (g_c+I1), s	5.6	13.3			12.6	11.6
Green Ext Time (p_c), s	0.2	14.2			20.5	3.2

Intersection Summary

HCM 6th Ctrl Delay	15.0
HCM 6th LOS	B

Notes

User approved volume balancing among the lanes for turning movement.

* HCM 6th computational engine requires equal clearance times for the phases crossing the barrier.

Timings
6: Trautwein Rd. & Grove Community Dr

West Campus Upper Plateau (JN 14064)

09/30/2022



Lane Group	WBL	WBR	NBT	NBR	SBL	SBT
Lane Configurations	↙	↗↗	↕↕	↗	↗↗	↕↕
Traffic Volume (vph)	114	426	785	91	383	702
Future Volume (vph)	114	426	785	91	383	702
Turn Type	Prot	pm+ov	NA	Perm	Prot	NA
Protected Phases	8	1	2		1	6
Permitted Phases		8		2		
Detector Phase	8	1	2	2	1	6
Switch Phase						
Minimum Initial (s)	10.0	5.0	10.0	10.0	5.0	10.0
Minimum Split (s)	34.6	9.6	46.2	46.2	9.6	28.2
Total Split (s)	35.0	29.0	56.0	56.0	29.0	85.0
Total Split (%)	29.2%	24.2%	46.7%	46.7%	24.2%	70.8%
Yellow Time (s)	3.6	3.6	5.2	5.2	3.6	5.2
All-Red Time (s)	1.0	1.0	1.0	1.0	1.0	1.0
Lost Time Adjust (s)	0.0	0.0	0.0	0.0	0.0	0.0
Total Lost Time (s)	4.6	4.6	6.2	6.2	4.6	6.2
Lead/Lag		Lead	Lag	Lag	Lead	
Lead-Lag Optimize?		Yes	Yes	Yes	Yes	
Recall Mode	None	None	None	None	None	None
Act Effct Green (s)	13.7	27.7	25.3	25.3	14.0	44.3
Actuated g/C Ratio	0.20	0.40	0.36	0.36	0.20	0.64
v/c Ratio	0.36	0.40	0.67	0.16	0.60	0.35
Control Delay	30.0	10.3	22.2	6.1	31.1	6.6
Queue Delay	0.0	0.0	0.0	0.0	0.0	0.0
Total Delay	30.0	10.3	22.2	6.1	31.1	6.6
LOS	C	B	C	A	C	A
Approach Delay	14.4		20.5			15.2
Approach LOS	B		C			B

Intersection Summary

Cycle Length: 120	
Actuated Cycle Length: 69.5	
Natural Cycle: 95	
Control Type: Actuated-Uncoordinated	
Maximum v/c Ratio: 0.67	
Intersection Signal Delay: 16.9	Intersection LOS: B
Intersection Capacity Utilization 54.8%	ICU Level of Service A
Analysis Period (min) 15	

Splits and Phases: 6: Trautwein Rd. & Grove Community Dr



HCM 6th Signalized Intersection Summary
6: Trautwein Rd. & Grove Community Dr

West Campus Upper Plateau (JN 14064)

09/30/2022



Movement	WBL	WBR	NBT	NBR	SBL	SBT
Lane Configurations						
Traffic Volume (veh/h)	114	426	785	91	383	702
Future Volume (veh/h)	114	426	785	91	383	702
Initial Q (Qb), veh	0	0	0	0	0	0
Ped-Bike Adj(A_pbT)	1.00	1.00		1.00	1.00	
Parking Bus, Adj	1.00	1.00	1.00	1.00	1.00	1.00
Work Zone On Approach	No		No			No
Adj Sat Flow, veh/h/ln	1900	1900	1885	1900	1900	1870
Adj Flow Rate, veh/h	127	279	872	95	426	780
Peak Hour Factor	0.90	0.90	0.90	0.90	0.90	0.90
Percent Heavy Veh, %	0	0	1	0	0	2
Cap, veh/h	335	992	1303	586	579	2182
Arrive On Green	0.19	0.19	0.36	0.36	0.16	0.61
Sat Flow, veh/h	1810	2834	3676	1610	3510	3647
Grp Volume(v), veh/h	127	279	872	95	426	780
Grp Sat Flow(s),veh/h/ln	1810	1417	1791	1610	1755	1777
Q Serve(g_s), s	3.3	3.8	11.0	2.1	6.2	5.8
Cycle Q Clear(g_c), s	3.3	3.8	11.0	2.1	6.2	5.8
Prop In Lane	1.00	1.00		1.00	1.00	
Lane Grp Cap(c), veh/h	335	992	1303	586	579	2182
V/C Ratio(X)	0.38	0.28	0.67	0.16	0.74	0.36
Avail Cap(c_a), veh/h	1022	2068	3314	1490	1591	5202
HCM Platoon Ratio	1.00	1.00	1.00	1.00	1.00	1.00
Upstream Filter(I)	1.00	1.00	1.00	1.00	1.00	1.00
Uniform Delay (d), s/veh	19.2	12.6	14.4	11.6	21.4	5.1
Incr Delay (d2), s/veh	0.7	0.2	0.6	0.1	0.7	0.1
Initial Q Delay(d3),s/veh	0.0	0.0	0.0	0.0	0.0	0.0
%ile BackOfQ(50%),veh/ln	1.3	1.0	3.4	0.6	2.2	1.0
Unsig. Movement Delay, s/veh						
LnGrp Delay(d),s/veh	19.9	12.8	15.0	11.7	22.1	5.2
LnGrp LOS	B	B	B	B	C	A
Approach Vol, veh/h	406		967			1206
Approach Delay, s/veh	15.0		14.7			11.2
Approach LOS	B		B			B
Timer - Assigned Phs	1	2			6	8
Phs Duration (G+Y+Rc), s	13.5	25.8			39.3	14.6
Change Period (Y+Rc), s	4.6	6.2			6.2	4.6
Max Green Setting (Gmax), s	24.4	49.8			78.8	30.4
Max Q Clear Time (g_c+I1), s	8.2	13.0			7.8	5.8
Green Ext Time (p_c), s	0.7	6.6			5.5	1.4

Intersection Summary

HCM 6th Ctrl Delay	13.1
HCM 6th LOS	B

Timings

7: Trautwein Rd. & Orange Terrace Pkwy

09/30/2022



Lane Group	EBL	EBT	WBL	WBT	WBR	NBL	NBT	NBR	SBL	SBT	SBR
Lane Configurations											
Traffic Volume (vph)	34	20	177	13	176	37	649	163	218	675	22
Future Volume (vph)	34	20	177	13	176	37	649	163	218	675	22
Turn Type	Prot	NA	Prot	NA	pm+ov	Prot	NA	Perm	Prot	NA	Perm
Protected Phases	7	4	3	8	1	5	2		1	6	
Permitted Phases					8			2			6
Detector Phase	7	4	3	8	1	5	2	2	1	6	6
Switch Phase											
Minimum Initial (s)	5.0	10.0	5.0	10.0	5.0	5.0	10.0	10.0	5.0	10.0	10.0
Minimum Split (s)	9.6	38.6	9.6	34.6	9.6	9.6	46.2	46.2	9.6	28.2	28.2
Total Split (s)	13.2	38.6	16.1	41.5	18.0	9.6	47.3	47.3	18.0	55.7	55.7
Total Split (%)	11.0%	32.2%	13.4%	34.6%	15.0%	8.0%	39.4%	39.4%	15.0%	46.4%	46.4%
Yellow Time (s)	3.6	3.6	3.6	3.6	3.6	3.6	5.2	5.2	3.6	5.2	5.2
All-Red Time (s)	1.0	1.0	1.0	1.0	1.0	1.0	1.0	1.0	1.0	1.0	1.0
Lost Time Adjust (s)	0.0	0.0	0.0	0.0	0.0	0.0	0.0	0.0	0.0	0.0	0.0
Total Lost Time (s)	4.6	4.6	4.6	4.6	4.6	4.6	6.2	6.2	4.6	6.2	6.2
Lead/Lag	Lead	Lag	Lead	Lag	Lead	Lead	Lag	Lag	Lead	Lag	Lag
Lead-Lag Optimize?	Yes	Yes	Yes	Yes	Yes	Yes	Yes	Yes	Yes	Yes	Yes
Recall Mode	None	None	None	None	None	None	None	None	None	None	None
Act Effct Green (s)	6.6	14.2	12.9	19.5	34.5	5.6	22.2	22.2	9.8	32.2	32.2
Actuated g/C Ratio	0.09	0.20	0.18	0.27	0.48	0.08	0.31	0.31	0.13	0.44	0.44
v/c Ratio	0.22	0.12	0.59	0.03	0.13	0.28	0.64	0.29	0.50	0.46	0.03
Control Delay	43.9	19.4	44.0	25.4	3.0	47.9	26.3	5.6	38.2	18.3	0.1
Queue Delay	0.0	0.0	0.0	0.0	0.0	0.0	0.0	0.0	0.0	0.0	0.0
Total Delay	43.9	19.4	44.0	25.4	3.0	47.9	26.3	5.6	38.2	18.3	0.1
LOS	D	B	D	C	A	D	C	A	D	B	A
Approach Delay		30.4		23.6			23.2			22.7	
Approach LOS		C		C			C			C	

Intersection Summary

Cycle Length: 120	
Actuated Cycle Length: 72.6	
Natural Cycle: 115	
Control Type: Actuated-Uncoordinated	
Maximum v/c Ratio: 0.64	
Intersection Signal Delay: 23.3	Intersection LOS: C
Intersection Capacity Utilization 53.5%	ICU Level of Service A
Analysis Period (min) 15	



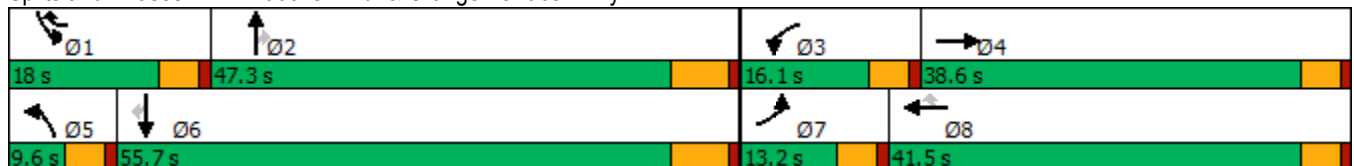



















Splits and Phases: 7: Trautwein Rd. & Orange Terrace Pkwy



HCM 6th Signalized Intersection Summary
7: Trautwein Rd. & Orange Terrace Pkwy

West Campus Upper Plateau (JN 14064)

09/30/2022

												
Movement	EBL	EBT	EBR	WBL	WBT	WBR	NBL	NBT	NBR	SBL	SBT	SBR
Lane Configurations												
Traffic Volume (veh/h)	34	20	22	177	13	176	37	649	163	218	675	22
Future Volume (veh/h)	34	20	22	177	13	176	37	649	163	218	675	22
Initial Q (Qb), veh	0	0	0	0	0	0	0	0	0	0	0	0
Ped-Bike Adj(A_pbT)	1.00		1.00	1.00		1.00	1.00		1.00	1.00		1.00
Parking Bus, Adj	1.00	1.00	1.00	1.00	1.00	1.00	1.00	1.00	1.00	1.00	1.00	1.00
Work Zone On Approach		No			No			No			No	
Adj Sat Flow, veh/h/ln	1900	1900	1900	1885	1900	1856	1900	1870	1870	1870	1870	1900
Adj Flow Rate, veh/h	36	21	21	188	14	67	39	690	95	232	718	13
Peak Hour Factor	0.94	0.94	0.94	0.94	0.94	0.94	0.94	0.94	0.94	0.94	0.94	0.94
Percent Heavy Veh, %	0	0	0	1	0	3	0	2	2	2	2	0
Cap, veh/h	68	134	134	234	469	959	72	1011	451	345	1224	555
Arrive On Green	0.04	0.15	0.15	0.13	0.25	0.25	0.04	0.28	0.28	0.10	0.34	0.34
Sat Flow, veh/h	1810	872	872	1795	1900	2768	1810	3554	1585	3456	3554	1610
Grp Volume(v), veh/h	36	0	42	188	14	67	39	690	95	232	718	13
Grp Sat Flow(s),veh/h/ln	1810	0	1743	1795	1900	1384	1810	1777	1585	1728	1777	1610
Q Serve(g_s), s	1.2	0.0	1.3	6.1	0.3	1.0	1.3	10.4	2.8	3.9	10.0	0.3
Cycle Q Clear(g_c), s	1.2	0.0	1.3	6.1	0.3	1.0	1.3	10.4	2.8	3.9	10.0	0.3
Prop In Lane	1.00		0.50	1.00		1.00	1.00		1.00	1.00		1.00
Lane Grp Cap(c), veh/h	68	0	269	234	469	959	72	1011	451	345	1224	555
V/C Ratio(X)	0.53	0.00	0.16	0.80	0.03	0.07	0.54	0.68	0.21	0.67	0.59	0.02
Avail Cap(c_a), veh/h	258	0	982	342	1161	1968	150	2419	1079	767	2914	1320
HCM Platoon Ratio	1.00	1.00	1.00	1.00	1.00	1.00	1.00	1.00	1.00	1.00	1.00	1.00
Upstream Filter(I)	1.00	0.00	1.00	1.00	1.00	1.00	1.00	1.00	1.00	1.00	1.00	1.00
Uniform Delay (d), s/veh	28.5	0.0	22.1	25.5	17.2	13.2	28.4	19.2	16.4	26.2	16.3	13.1
Incr Delay (d2), s/veh	2.4	0.0	0.3	5.1	0.0	0.0	2.3	0.8	0.2	0.9	0.4	0.0
Initial Q Delay(d3),s/veh	0.0	0.0	0.0	0.0	0.0	0.0	0.0	0.0	0.0	0.0	0.0	0.0
%ile BackOfQ(50%),veh/ln	0.5	0.0	0.5	2.6	0.1	0.3	0.5	3.6	0.9	1.4	3.3	0.1
Unsig. Movement Delay, s/veh												
LnGrp Delay(d),s/veh	30.9	0.0	22.4	30.6	17.3	13.2	30.8	20.0	16.7	27.1	16.7	13.1
LnGrp LOS	C	A	C	C	B	B	C	B	B	C	B	B
Approach Vol, veh/h		78			269			824			963	
Approach Delay, s/veh		26.3			25.6			20.1			19.2	
Approach LOS		C			C			C			B	
Timer - Assigned Phs	1	2	3	4	5	6	7	8				
Phs Duration (G+Y+Rc), s	10.6	23.4	12.5	13.9	7.0	27.0	6.9	19.5				
Change Period (Y+Rc), s	4.6	6.2	4.6	4.6	4.6	6.2	4.6	4.6				
Max Green Setting (Gmax), s	13.4	41.1	11.5	34.0	5.0	49.5	8.6	36.9				
Max Q Clear Time (g_c+I1), s	5.9	12.4	8.1	3.3	3.3	12.0	3.2	3.0				
Green Ext Time (p_c), s	0.2	4.8	0.1	0.2	0.0	4.9	0.0	0.3				
Intersection Summary												
HCM 6th Ctrl Delay				20.6								
HCM 6th LOS				C								

Timings
8: Cole Av. & Van Buren Bl.

West Campus Upper Plateau (JN 14064)

09/30/2022



Lane Group	EBL	EBT	EBR	WBL	WBT	WBR	NBL	NBT	SBL	SBT	SBR
Lane Configurations	↖↗	↑↑	↖	↖	↑↑↑	↖	↖	↑↑	↖↗	↑↑	↖
Traffic Volume (vph)	347	877	80	134	939	188	106	263	176	235	248
Future Volume (vph)	347	877	80	134	939	188	106	263	176	235	248
Turn Type	Prot	NA	pm+ov	Prot	NA	pm+ov	Prot	NA	Prot	NA	pm+ov
Protected Phases	5	2	3	1	6	7	3	8	7	4	5
Permitted Phases			2			6					4
Detector Phase	5	2	3	1	6	7	3	8	7	4	5
Switch Phase											
Minimum Initial (s)	5.0	10.0	5.0	5.0	10.0	5.0	5.0	10.0	5.0	10.0	5.0
Minimum Split (s)	9.1	36.2	9.1	9.1	36.2	9.1	9.1	42.2	9.1	49.2	9.1
Total Split (s)	18.7	44.8	12.0	14.0	40.1	17.5	12.0	43.7	17.5	49.2	18.7
Total Split (%)	15.6%	37.3%	10.0%	11.7%	33.4%	14.6%	10.0%	36.4%	14.6%	41.0%	15.6%
Yellow Time (s)	3.2	5.2	3.2	3.2	5.2	3.2	3.2	5.2	3.2	5.2	3.2
All-Red Time (s)	0.5	1.0	0.5	0.5	1.0	0.5	0.5	1.0	0.5	1.0	0.5
Lost Time Adjust (s)	0.0	0.0	0.0	0.0	0.0	0.0	0.0	0.0	0.0	0.0	0.0
Total Lost Time (s)	3.7	6.2	3.7	3.7	6.2	3.7	3.7	6.2	3.7	6.2	3.7
Lead/Lag	Lead	Lag	Lead	Lead	Lag	Lead	Lead	Lag	Lead	Lag	Lead
Lead-Lag Optimize?	Yes	Yes	Yes	Yes	Yes	Yes	Yes	Yes	Yes	Yes	Yes
Recall Mode	None	None	None	None	None	None	None	None	None	None	None
Act Effct Green (s)	13.7	31.0	46.0	10.5	27.9	43.8	8.6	17.0	9.5	17.9	34.2
Actuated g/C Ratio	0.15	0.35	0.52	0.12	0.32	0.49	0.10	0.19	0.11	0.20	0.39
v/c Ratio	0.69	0.76	0.10	0.67	0.62	0.22	0.64	0.50	0.50	0.34	0.40
Control Delay	45.3	31.3	3.0	58.5	29.0	3.1	60.9	32.4	45.0	31.1	14.3
Queue Delay	0.0	0.0	0.0	0.0	0.0	0.0	0.0	0.0	0.0	0.0	0.0
Total Delay	45.3	31.3	3.0	58.5	29.0	3.1	60.9	32.4	45.0	31.1	14.3
LOS	D	C	A	E	C	A	E	C	D	C	B
Approach Delay		33.3			28.3			39.3		28.5	
Approach LOS		C			C			D		C	

Intersection Summary

Cycle Length: 120
 Actuated Cycle Length: 88.5
 Natural Cycle: 105
 Control Type: Actuated-Uncoordinated
 Maximum v/c Ratio: 0.76
 Intersection Signal Delay: 31.4
 Intersection LOS: C
 Intersection Capacity Utilization 65.7%
 ICU Level of Service C
 Analysis Period (min) 15



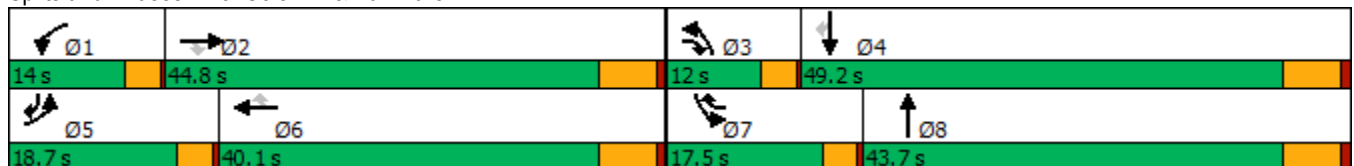



























Splits and Phases: 8: Cole Av. & Van Buren Bl.



HCM 6th Signalized Intersection Summary
8: Cole Av. & Van Buren Bl.

West Campus Upper Plateau (JN 14064)

09/30/2022

												
Movement	EBL	EBT	EBR	WBL	WBT	WBR	NBL	NBT	NBR	SBL	SBT	SBR
Lane Configurations	 	 			  			 		 	 	
Traffic Volume (veh/h)	347	877	80	134	939	188	106	263	66	176	235	248
Future Volume (veh/h)	347	877	80	134	939	188	106	263	66	176	235	248
Initial Q (Qb), veh	0	0	0	0	0	0	0	0	0	0	0	0
Ped-Bike Adj(A_pbT)	1.00		1.00	1.00		1.00	1.00		0.99	1.00		1.00
Parking Bus, Adj	1.00	1.00	1.00	1.00	1.00	1.00	1.00	1.00	1.00	1.00	1.00	1.00
Work Zone On Approach		No			No			No			No	
Adj Sat Flow, veh/h/ln	1856	1826	1856	1856	1856	1870	1885	1885	1870	1856	1885	1885
Adj Flow Rate, veh/h	361	914	26	140	978	107	110	274	62	183	245	160
Peak Hour Factor	0.96	0.96	0.96	0.96	0.96	0.96	0.96	0.96	0.96	0.96	0.96	0.96
Percent Heavy Veh, %	3	5	3	3	3	2	1	1	2	3	1	1
Cap, veh/h	465	1288	707	176	1698	660	141	472	105	277	590	479
Arrive On Green	0.14	0.37	0.37	0.10	0.34	0.34	0.08	0.16	0.16	0.08	0.16	0.16
Sat Flow, veh/h	3428	3469	1572	1767	5066	1585	1795	2907	647	3428	3582	1595
Grp Volume(v), veh/h	361	914	26	140	978	107	110	167	169	183	245	160
Grp Sat Flow(s),veh/h/ln	1714	1735	1572	1767	1689	1585	1795	1791	1763	1714	1791	1595
Q Serve(g_s), s	7.0	15.6	0.6	5.4	11.0	2.9	4.2	6.0	6.2	3.6	4.2	5.4
Cycle Q Clear(g_c), s	7.0	15.6	0.6	5.4	11.0	2.9	4.2	6.0	6.2	3.6	4.2	5.4
Prop In Lane	1.00		1.00	1.00		1.00	1.00		0.37	1.00		1.00
Lane Grp Cap(c), veh/h	465	1288	707	176	1698	660	141	291	286	277	590	479
V/C Ratio(X)	0.78	0.71	0.04	0.79	0.58	0.16	0.78	0.57	0.59	0.66	0.42	0.33
Avail Cap(c_a), veh/h	742	1933	1000	263	2479	904	215	969	954	683	2223	1207
HCM Platoon Ratio	1.00	1.00	1.00	1.00	1.00	1.00	1.00	1.00	1.00	1.00	1.00	1.00
Upstream Filter(I)	1.00	1.00	1.00	1.00	1.00	1.00	1.00	1.00	1.00	1.00	1.00	1.00
Uniform Delay (d), s/veh	28.9	18.6	10.7	30.5	19.0	12.7	31.3	26.8	26.9	30.9	26.0	18.8
Incr Delay (d2), s/veh	1.1	1.0	0.0	5.3	0.4	0.2	4.4	1.8	1.9	1.0	0.5	0.4
Initial Q Delay(d3),s/veh	0.0	0.0	0.0	0.0	0.0	0.0	0.0	0.0	0.0	0.0	0.0	0.0
%ile BackOfQ(50%),veh/ln	2.7	5.4	0.2	2.3	3.7	0.9	1.8	2.4	2.5	1.4	1.7	1.8
Unsig. Movement Delay, s/veh												
LnGrp Delay(d),s/veh	30.0	19.6	10.7	35.8	19.4	12.8	35.7	28.6	28.8	31.9	26.4	19.3
LnGrp LOS	C	B	B	D	B	B	D	C	C	C	C	B
Approach Vol, veh/h		1301			1225			446			588	
Approach Delay, s/veh		22.3			20.7			30.4			26.2	
Approach LOS		C			C			C			C	
Timer - Assigned Phs	1	2	3	4	5	6	7	8				
Phs Duration (G+Y+Rc), s	10.6	31.9	9.1	17.6	13.1	29.4	9.3	17.4				
Change Period (Y+Rc), s	3.7	6.2	3.7	6.2	3.7	6.2	3.7	6.2				
Max Green Setting (Gmax), s	10.3	38.6	8.3	43.0	15.0	33.9	13.8	37.5				
Max Q Clear Time (g_c+I1), s	7.4	17.6	6.2	7.4	9.0	13.0	5.6	8.2				
Green Ext Time (p_c), s	0.0	8.1	0.0	1.9	0.4	9.0	0.2	1.7				
Intersection Summary												
HCM 6th Ctrl Delay				23.4								
HCM 6th LOS				C								

Intersection	
Intersection Delay, s/veh	10.3
Intersection LOS	B

Movement	EBT	EBR	WBL	WBT	NBL	NBR
Lane Configurations	↶		↷	↶	↷	↷
Traffic Vol, veh/h	158	16	68	230	57	52
Future Vol, veh/h	158	16	68	230	57	52
Peak Hour Factor	0.82	0.82	0.82	0.82	0.82	0.82
Heavy Vehicles, %	2	0	5	2	0	0
Mvmt Flow	193	20	83	280	70	63
Number of Lanes	1	0	1	1	1	1

Approach	EB	WB	NB
Opposing Approach	WB	EB	
Opposing Lanes	2	1	0
Conflicting Approach Left		NB	EB
Conflicting Lanes Left	0	2	1
Conflicting Approach Right	NB		WB
Conflicting Lanes Right	2	0	2
HCM Control Delay	10.3	10.7	9.3
HCM LOS	B	B	A

Lane	NBLn1	NBLn2	EBLn1	WBLn1	WBLn2
Vol Left, %	100%	0%	0%	100%	0%
Vol Thru, %	0%	0%	91%	0%	100%
Vol Right, %	0%	100%	9%	0%	0%
Sign Control	Stop	Stop	Stop	Stop	Stop
Traffic Vol by Lane	57	52	174	68	230
LT Vol	57	0	0	68	0
Through Vol	0	0	158	0	230
RT Vol	0	52	16	0	0
Lane Flow Rate	70	63	212	83	280
Geometry Grp	7	7	4	7	7
Degree of Util (X)	0.123	0.091	0.299	0.13	0.397
Departure Headway (Hd)	6.383	5.171	5.066	5.654	5.1
Convergence, Y/N	Yes	Yes	Yes	Yes	Yes
Cap	560	689	707	633	704
Service Time	4.146	2.934	3.113	3.399	2.845
HCM Lane V/C Ratio	0.125	0.091	0.3	0.131	0.398
HCM Control Delay	10	8.5	10.3	9.2	11.2
HCM Lane LOS	A	A	B	A	B
HCM 95th-tile Q	0.4	0.3	1.3	0.4	1.9

Intersection												
Intersection Delay, s/veh	10.3											
Intersection LOS	B											

Movement	EBL	EBT	EBR	WBL	WBT	WBR	NBL	NBT	NBR	SBL	SBT	SBR
Lane Configurations	↵	↕		↵	↕			↕			↕	
Traffic Vol, veh/h	59	234	9	9	307	57	28	5	5	54	6	59
Future Vol, veh/h	59	234	9	9	307	57	28	5	5	54	6	59
Peak Hour Factor	0.90	0.90	0.90	0.90	0.90	0.90	0.90	0.90	0.90	0.90	0.90	0.90
Heavy Vehicles, %	5	2	7	0	1	0	6	0	0	0	0	0
Mvmt Flow	66	260	10	10	341	63	31	6	6	60	7	66
Number of Lanes	1	2	0	1	2	0	0	1	0	0	1	0

Approach	EB	WB	NB	SB
Opposing Approach	WB	EB	SB	NB
Opposing Lanes	3	3	1	1
Conflicting Approach Left	SB	NB	EB	WB
Conflicting Lanes Left	1	1	3	3
Conflicting Approach Right	NB	SB	WB	EB
Conflicting Lanes Right	1	1	3	3
HCM Control Delay	9.9	10.5	10.2	10.7
HCM LOS	A	B	B	B

Lane	NBLn1	EBLn1	EBLn2	EBLn3	WBLn1	WBLn2	WBLn3	SBLn1
Vol Left, %	74%	100%	0%	0%	100%	0%	0%	45%
Vol Thru, %	13%	0%	100%	90%	0%	100%	64%	5%
Vol Right, %	13%	0%	0%	10%	0%	0%	36%	50%
Sign Control	Stop	Stop	Stop	Stop	Stop	Stop	Stop	Stop
Traffic Vol by Lane	38	59	156	87	9	205	159	119
LT Vol	28	59	0	0	9	0	0	54
Through Vol	5	0	156	78	0	205	102	6
RT Vol	5	0	0	9	0	0	57	59
Lane Flow Rate	42	66	173	97	10	227	177	132
Geometry Grp	7	7	7	7	7	7	7	7
Degree of Util (X)	0.081	0.112	0.27	0.151	0.017	0.349	0.259	0.227
Departure Headway (Hd)	6.868	6.152	5.609	5.608	6.015	5.527	5.257	6.186
Convergence, Y/N	Yes	Yes	Yes	Yes	Yes	Yes	Yes	Yes
Cap	522	584	643	641	598	655	687	580
Service Time	4.605	3.877	3.32	3.333	3.719	3.231	2.96	3.919
HCM Lane V/C Ratio	0.08	0.113	0.269	0.151	0.017	0.347	0.258	0.228
HCM Control Delay	10.2	9.7	10.4	9.3	8.8	11.2	9.8	10.7
HCM Lane LOS	B	A	B	A	A	B	A	B
HCM 95th-tile Q	0.3	0.4	1.1	0.5	0.1	1.6	1	0.9

Timings
11: Barton St & Alessandro Bl.

West Campus Upper Plateau (JN 14064)

09/30/2022



Lane Group	EBL	EBT	WBL	WBT	NBL	NBT	NBR	SBL	SBT	SBR
Lane Configurations	↙	↕↕↕	↙	↕↕↕		↕	↗		↕	↗
Traffic Volume (vph)	5	1423	76	1596	61	1	38	5	0	3
Future Volume (vph)	5	1423	76	1596	61	1	38	5	0	3
Turn Type	Prot	NA	Prot	NA	Perm	NA	Perm	Perm	NA	Perm
Protected Phases	5	2	1	6		8			4	
Permitted Phases					8		8	4		4
Detector Phase	5	2	1	6	8	8	8	4	4	4
Switch Phase										
Minimum Initial (s)	5.0	10.0	5.0	10.0	10.0	10.0	10.0	10.0	10.0	10.0
Minimum Split (s)	9.2	28.5	11.0	28.5	40.6	40.6	40.6	26.6	26.6	26.6
Total Split (s)	9.2	65.4	14.0	70.2	40.6	40.6	40.6	40.6	40.6	40.6
Total Split (%)	7.7%	54.5%	11.7%	58.5%	33.8%	33.8%	33.8%	33.8%	33.8%	33.8%
Yellow Time (s)	3.2	5.5	3.2	5.5	3.6	3.6	3.6	3.6	3.6	3.6
All-Red Time (s)	1.0	1.0	1.0	1.0	1.0	1.0	1.0	1.0	1.0	1.0
Lost Time Adjust (s)	0.0	0.0	0.0	0.0		0.0	0.0		0.0	0.0
Total Lost Time (s)	4.2	6.5	4.2	6.5		4.6	4.6		4.6	4.6
Lead/Lag	Lead	Lag	Lead	Lag						
Lead-Lag Optimize?	Yes	Yes	Yes	Yes						
Recall Mode	None	None	None	None	None	None	None	None	None	None
Act Effct Green (s)	5.9	45.1	8.4	53.3		15.2	15.2		15.2	15.2
Actuated g/C Ratio	0.08	0.61	0.11	0.72		0.21	0.21		0.21	0.21
v/c Ratio	0.04	0.50	0.40	0.47		0.24	0.10		0.02	0.01
Control Delay	46.6	13.6	45.2	8.7		32.2	0.5		29.6	0.0
Queue Delay	0.0	0.0	0.0	0.0		0.0	0.0		0.0	0.0
Total Delay	46.6	13.6	45.2	8.7		32.2	0.5		29.6	0.0
LOS	D	B	D	A		C	A		C	A
Approach Delay		13.7		10.3		20.2			18.5	
Approach LOS		B		B		C			B	

Intersection Summary

Cycle Length: 120
 Actuated Cycle Length: 73.6
 Natural Cycle: 85
 Control Type: Actuated-Uncoordinated
 Maximum v/c Ratio: 0.50
 Intersection Signal Delay: 12.2
 Intersection LOS: B
 Intersection Capacity Utilization 60.7%
 ICU Level of Service B
 Analysis Period (min) 15

Splits and Phases: 11: Barton St & Alessandro Bl.



HCM 6th Signalized Intersection Summary
11: Barton St & Alessandro Bl.

West Campus Upper Plateau (JN 14064)

09/30/2022



Movement	EBL	EBT	EBR	WBL	WBT	WBR	NBL	NBT	NBR	SBL	SBT	SBR
Lane Configurations	↖	↑↑↑		↖	↑↑↑			↑	↗		↑	↗
Traffic Volume (veh/h)	5	1423	40	76	1596	5	61	1	38	5	0	3
Future Volume (veh/h)	5	1423	40	76	1596	5	61	1	38	5	0	3
Initial Q (Qb), veh	0	0	0	0	0	0	0	0	0	0	0	0
Ped-Bike Adj(A_pbT)	1.00		1.00	1.00		0.98	1.00		1.00	1.00		1.00
Parking Bus, Adj	1.00	1.00	1.00	1.00	1.00	1.00	1.00	1.00	1.00	1.00	1.00	1.00
Work Zone On Approach		No		No		No		No		No		No
Adj Sat Flow, veh/h/ln	1604	1885	1900	1900	1870	1900	1870	1900	1900	1737	1900	1900
Adj Flow Rate, veh/h	5	1530	41	82	1716	5	66	1	14	5	0	-8
Peak Hour Factor	0.93	0.93	0.93	0.93	0.93	0.93	0.93	0.93	0.93	0.93	0.93	0.93
Percent Heavy Veh, %	20	1	0	0	2	0	2	0	0	11	0	0
Cap, veh/h	10	3032	81	108	3370	10	288	4	187	228	0	187
Arrive On Green	0.01	0.59	0.59	0.06	0.64	0.64	0.12	0.12	0.12	0.12	0.00	0.00
Sat Flow, veh/h	1527	5153	138	1810	5256	15	1532	31	1610	1006	0	1610
Grp Volume(v), veh/h	5	1019	552	82	1111	610	67	0	14	5	0	-8
Grp Sat Flow(s),veh/h/ln	1527	1716	1860	1810	1702	1867	1562	0	1610	1006	0	1610
Q Serve(g_s), s	0.2	11.3	11.3	2.9	11.3	11.3	0.0	0.0	0.5	0.2	0.0	0.0
Cycle Q Clear(g_c), s	0.2	11.3	11.3	2.9	11.3	11.3	2.2	0.0	0.5	2.4	0.0	0.0
Prop In Lane	1.00		0.07	1.00		0.01	0.99		1.00	1.00		1.00
Lane Grp Cap(c), veh/h	10	2019	1094	108	2183	1197	292	0	187	228	0	187
V/C Ratio(X)	0.49	0.50	0.50	0.76	0.51	0.51	0.23	0.00	0.07	0.02	0.00	-0.04
Avail Cap(c_a), veh/h	118	3115	1689	273	3342	1833	926	0	893	851	0	893
HCM Platoon Ratio	1.00	1.00	1.00	1.00	1.00	1.00	1.00	1.00	1.00	1.00	1.00	1.00
Upstream Filter(I)	1.00	1.00	1.00	1.00	1.00	1.00	1.00	0.00	1.00	1.00	0.00	0.00
Uniform Delay (d), s/veh	32.1	7.8	7.8	30.1	6.2	6.2	26.3	0.0	25.6	27.4	0.0	0.0
Incr Delay (d2), s/veh	13.1	0.3	0.5	4.1	0.3	0.5	0.4	0.0	0.2	0.0	0.0	0.0
Initial Q Delay(d3),s/veh	0.0	0.0	0.0	0.0	0.0	0.0	0.0	0.0	0.0	0.0	0.0	0.0
%ile BackOfQ(50%),veh/ln	0.1	2.6	2.8	1.3	3.0	3.4	0.9	0.0	0.2	0.1	0.0	0.0
Unsig. Movement Delay, s/veh												
LnGrp Delay(d),s/veh	45.2	8.1	8.3	34.2	6.5	6.7	26.7	0.0	25.7	27.4	0.0	0.0
LnGrp LOS	D	A	A	C	A	A	C	A	C	C	A	A
Approach Vol, veh/h		1576			1803			81				-3
Approach Delay, s/veh		8.3			7.8			26.5				0.0
Approach LOS		A			A			C				A
Timer - Assigned Phs	1	2		4	5	6		8				
Phs Duration (G+Y+Rc), s	8.1	44.7		12.1	4.6	48.1		12.1				
Change Period (Y+Rc), s	* 4.2	6.5		4.6	* 4.2	6.5		4.6				
Max Green Setting (Gmax), s	* 9.8	58.9		36.0	* 5	63.7		36.0				
Max Q Clear Time (g_c+I1), s	4.9	13.3		4.4	2.2	13.3		4.2				
Green Ext Time (p_c), s	0.0	20.0		0.0	0.0	28.3		0.4				

Intersection Summary

HCM 6th Ctrl Delay	8.5
HCM 6th LOS	A

Notes

* HCM 6th computational engine requires equal clearance times for the phases crossing the barrier.

Intersection						
Int Delay, s/veh	2.5					
Movement	EBL	EBT	WBT	WBR	SBL	SBR
Lane Configurations						
Traffic Vol, veh/h	29	148	206	20	25	61
Future Vol, veh/h	29	148	206	20	25	61
Conflicting Peds, #/hr	0	0	0	7	0	0
Sign Control	Free	Free	Free	Free	Stop	Stop
RT Channelized	-	None	-	None	-	None
Storage Length	100	-	-	-	0	-
Veh in Median Storage, #	-	0	0	-	0	-
Grade, %	-	0	0	-	0	-
Peak Hour Factor	78	78	78	78	78	78
Heavy Vehicles, %	0	1	1	0	0	0
Mvmt Flow	37	190	264	26	32	78

Major/Minor	Major1	Major2	Minor2		
Conflicting Flow All	297	0	-	0	548 284
Stage 1	-	-	-	-	284 -
Stage 2	-	-	-	-	264 -
Critical Hdwy	4.1	-	-	-	6.4 6.2
Critical Hdwy Stg 1	-	-	-	-	5.4 -
Critical Hdwy Stg 2	-	-	-	-	5.4 -
Follow-up Hdwy	2.2	-	-	-	3.5 3.3
Pot Cap-1 Maneuver	1276	-	-	-	501 760
Stage 1	-	-	-	-	769 -
Stage 2	-	-	-	-	785 -
Platoon blocked, %		-	-	-	
Mov Cap-1 Maneuver	1267	-	-	-	479 755
Mov Cap-2 Maneuver	-	-	-	-	479 -
Stage 1	-	-	-	-	741 -
Stage 2	-	-	-	-	780 -

Approach	EB	WB	SB
HCM Control Delay, s	1.3	0	11.7
HCM LOS			B

Minor Lane/Major Mvmt	EBL	EBT	WBT	WBR	SBLn1
Capacity (veh/h)	1267	-	-	-	647
HCM Lane V/C Ratio	0.029	-	-	-	0.17
HCM Control Delay (s)	7.9	-	-	-	11.7
HCM Lane LOS	A	-	-	-	B
HCM 95th %tile Q(veh)	0.1	-	-	-	0.6

Intersection						
Int Delay, s/veh	22.3					
Movement	EBT	EBR	WBL	WBT	NBL	NBR
Lane Configurations	↑↑		↖	↑↑	↗	
Traffic Vol, veh/h	308	273	51	455	226	38
Future Vol, veh/h	308	273	51	455	226	38
Conflicting Peds, #/hr	0	2	0	0	0	0
Sign Control	Free	Free	Free	Free	Stop	Stop
RT Channelized	-	None	-	None	-	None
Storage Length	-	-	125	-	0	-
Veh in Median Storage, #	0	-	-	0	0	-
Grade, %	0	-	-	0	0	-
Peak Hour Factor	86	86	86	86	86	86
Heavy Vehicles, %	1	1	0	0	0	0
Mvmt Flow	358	317	59	529	263	44

Major/Minor	Major1	Major2	Minor1		
Conflicting Flow All	0	0	677	0	902 340
Stage 1	-	-	-	-	519 -
Stage 2	-	-	-	-	383 -
Critical Hdwy	-	-	4.1	-	6.8 6.9
Critical Hdwy Stg 1	-	-	-	-	5.8 -
Critical Hdwy Stg 2	-	-	-	-	5.8 -
Follow-up Hdwy	-	-	2.2	-	3.5 3.3
Pot Cap-1 Maneuver	-	-	924	-	281 662
Stage 1	-	-	-	-	568 -
Stage 2	-	-	-	-	665 -
Platoon blocked, %	-	-	-	-	-
Mov Cap-1 Maneuver	-	-	922	- ~	262 661
Mov Cap-2 Maneuver	-	-	-	- ~	262 -
Stage 1	-	-	-	-	567 -
Stage 2	-	-	-	-	622 -

Approach	EB	WB	NB
HCM Control Delay, s	0	0.9	112.5
HCM LOS			F

Minor Lane/Major Mvmt	NBLn1	EBT	EBR	WBL	WBT
Capacity (veh/h)	287	-	-	922	-
HCM Lane V/C Ratio	1.07	-	-	0.064	-
HCM Control Delay (s)	112.5	-	-	9.2	-
HCM Lane LOS	F	-	-	A	-
HCM 95th %tile Q(veh)	12.1	-	-	0.2	-

Notes
 ~: Volume exceeds capacity \$: Delay exceeds 300s +: Computation Not Defined *: All major volume in platoon

Timings

14: Barton Rd. & Van Buren Bl.

09/30/2022



Lane Group	EBL	EBT	WBL	WBT	NBL	NBT	NBR	SBL	SBT
Lane Configurations	↙	↕	↙	↕	↙	↕	↗	↙	↕
Traffic Volume (vph)	92	972	217	1016	224	44	179	46	29
Future Volume (vph)	92	972	217	1016	224	44	179	46	29
Turn Type	Prot	NA	Prot	NA	Prot	NA	Perm	Prot	NA
Protected Phases	5	2	1	6	3	8		7	4
Permitted Phases							8		
Detector Phase	5	2	1	6	3	8	8	7	4
Switch Phase									
Minimum Initial (s)	5.0	10.0	5.0	10.0	5.0	10.0	10.0	5.0	10.0
Minimum Split (s)	9.2	25.2	9.2	25.5	9.1	14.6	14.6	9.1	33.6
Total Split (s)	17.6	52.1	22.2	56.7	12.1	36.3	36.3	9.4	33.6
Total Split (%)	14.7%	43.4%	18.5%	47.3%	10.1%	30.3%	30.3%	7.8%	28.0%
Yellow Time (s)	3.2	5.2	3.2	5.5	3.6	3.6	3.6	3.6	3.6
All-Red Time (s)	1.0	1.0	1.0	1.0	0.5	1.0	1.0	0.5	1.0
Lost Time Adjust (s)	0.0	0.0	0.0	0.0	0.0	0.0	0.0	0.0	0.0
Total Lost Time (s)	4.2	6.2	4.2	6.5	4.1	4.6	4.6	4.1	4.6
Lead/Lag	Lead	Lag	Lead	Lag	Lead	Lag	Lag	Lead	Lag
Lead-Lag Optimize?	Yes	Yes	Yes	Yes	Yes	Yes	Yes	Yes	Yes
Recall Mode	None	None	None	None	None	None	None	None	None
Act Effct Green (s)	9.8	44.5	17.3	51.8	8.1	18.2	18.2	5.3	13.3
Actuated g/C Ratio	0.10	0.43	0.17	0.51	0.08	0.18	0.18	0.05	0.13
v/c Ratio	0.60	0.87	0.81	0.47	0.91	0.15	0.46	0.55	0.45
Control Delay	60.6	34.3	63.5	18.3	83.3	38.4	8.7	72.2	17.1
Queue Delay	0.0	0.0	0.0	0.0	0.0	0.0	0.0	0.0	0.0
Total Delay	60.6	34.3	63.5	18.3	83.3	38.4	8.7	72.2	17.1
LOS	E	C	E	B	F	D	A	E	B
Approach Delay		36.3		25.9		49.0			31.8
Approach LOS		D		C		D			C

Intersection Summary

Cycle Length: 120
 Actuated Cycle Length: 102.5
 Natural Cycle: 120
 Control Type: Actuated-Uncoordinated
 Maximum v/c Ratio: 0.91
 Intersection Signal Delay: 33.6
 Intersection LOS: C
 Intersection Capacity Utilization 75.5%
 ICU Level of Service D
 Analysis Period (min) 15



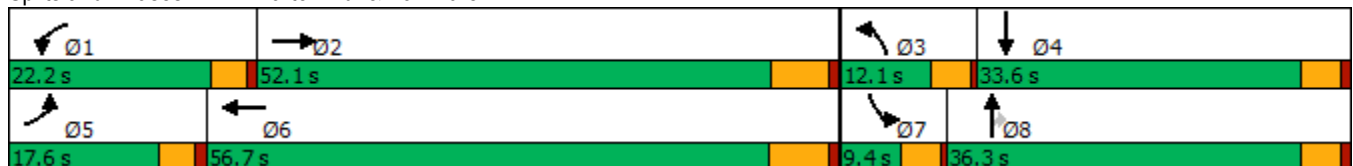





















Splits and Phases: 14: Barton Rd. & Van Buren Bl.



HCM 6th Signalized Intersection Summary
14: Barton Rd. & Van Buren Bl.

West Campus Upper Plateau (JN 14064)

09/30/2022

												
Movement	EBL	EBT	EBR	WBL	WBT	WBR	NBL	NBT	NBR	SBL	SBT	SBR
Lane Configurations		 			 						 	
Traffic Volume (veh/h)	92	972	186	217	1016	55	224	44	179	46	29	98
Future Volume (veh/h)	92	972	186	217	1016	55	224	44	179	46	29	98
Initial Q (Qb), veh	0	0	0	0	0	0	0	0	0	0	0	0
Ped-Bike Adj(A_pbT)	1.00		1.00	1.00		1.00	1.00		0.95	1.00		1.00
Parking Bus, Adj	1.00	1.00	1.00	1.00	1.00	1.00	1.00	1.00	1.00	1.00	1.00	1.00
Work Zone On Approach		No			No			No			No	
Adj Sat Flow, veh/h/ln	1900	1841	1870	1870	1856	1856	1900	1900	1885	1900	1841	1900
Adj Flow Rate, veh/h	102	1080	176	241	1129	50	249	49	67	51	32	47
Peak Hour Factor	0.90	0.90	0.90	0.90	0.90	0.90	0.90	0.90	0.90	0.90	0.90	0.90
Percent Heavy Veh, %	0	4	2	2	3	3	0	0	1	0	4	0
Cap, veh/h	131	1227	199	279	2444	108	325	319	255	74	79	115
Arrive On Green	0.07	0.41	0.41	0.16	0.49	0.49	0.09	0.17	0.17	0.04	0.12	0.12
Sat Flow, veh/h	1810	3011	490	1781	4973	220	3510	1900	1515	1810	673	989
Grp Volume(v), veh/h	102	626	630	241	767	412	249	49	67	51	0	79
Grp Sat Flow(s),veh/h/ln	1810	1749	1752	1781	1689	1816	1755	1900	1515	1810	0	1663
Q Serve(g_s), s	4.7	28.3	28.4	11.3	12.8	12.8	5.9	1.9	3.3	2.4	0.0	3.8
Cycle Q Clear(g_c), s	4.7	28.3	28.4	11.3	12.8	12.8	5.9	1.9	3.3	2.4	0.0	3.8
Prop In Lane	1.00		0.28	1.00		0.12	1.00		1.00	1.00		0.59
Lane Grp Cap(c), veh/h	131	712	714	279	1660	892	325	319	255	74	0	194
V/C Ratio(X)	0.78	0.88	0.88	0.86	0.46	0.46	0.77	0.15	0.26	0.69	0.00	0.41
Avail Cap(c_a), veh/h	284	939	941	375	1983	1066	329	705	562	112	0	564
HCM Platoon Ratio	1.00	1.00	1.00	1.00	1.00	1.00	1.00	1.00	1.00	1.00	1.00	1.00
Upstream Filter(I)	1.00	1.00	1.00	1.00	1.00	1.00	1.00	1.00	1.00	1.00	0.00	1.00
Uniform Delay (d), s/veh	39.0	23.4	23.4	35.2	14.3	14.3	37.9	30.4	30.9	40.4	0.0	35.0
Incr Delay (d2), s/veh	3.7	6.4	6.6	11.8	0.1	0.1	10.3	0.2	0.5	10.6	0.0	1.4
Initial Q Delay(d3),s/veh	0.0	0.0	0.0	0.0	0.0	0.0	0.0	0.0	0.0	0.0	0.0	0.0
%ile BackOfQ(50%),veh/ln	2.1	11.3	11.4	5.4	4.1	4.5	2.9	0.8	1.2	1.3	0.0	1.6
Unsig. Movement Delay, s/veh												
LnGrp Delay(d),s/veh	42.7	29.7	30.0	47.0	14.4	14.4	48.2	30.6	31.5	51.1	0.0	36.4
LnGrp LOS	D	C	C	D	B	B	D	C	C	D	A	D
Approach Vol, veh/h		1358			1420			365				130
Approach Delay, s/veh		30.9			19.9			42.8				42.2
Approach LOS		C			B			D				D
Timer - Assigned Phs	1	2	3	4	5	6	7	8				
Phs Duration (G+Y+Rc), s	17.6	41.3	12.0	14.6	10.4	48.5	7.6	19.0				
Change Period (Y+Rc), s	* 4.2	* 6.5	4.1	4.6	* 4.2	6.5	4.1	4.6				
Max Green Setting (Gmax), s	* 18	* 46	8.0	29.0	* 13	50.2	5.3	31.7				
Max Q Clear Time (g_c+I1), s	13.3	30.4	7.9	5.8	6.7	14.8	4.4	5.3				
Green Ext Time (p_c), s	0.1	4.4	0.0	0.4	0.1	4.9	0.0	0.4				

Intersection Summary

HCM 6th Ctrl Delay	27.9
HCM 6th LOS	C

Notes

* HCM 6th computational engine requires equal clearance times for the phases crossing the barrier.

Timings
15: Airman Dr & Cactus Av.



Lane Group	WBL	WBR	NBR	SBL	Ø6
Lane Configurations	↖	↗	↖	↖↗	
Traffic Volume (vph)	356	426	345	411	
Future Volume (vph)	356	426	345	411	
Turn Type	Prot	Perm	Perm	Prot	
Protected Phases	3			1	6
Permitted Phases		8	2		
Detector Phase	3	8	2	1	
Switch Phase					
Minimum Initial (s)	5.0	10.0	10.0	5.0	10.0
Minimum Split (s)	9.6	21.7	21.7	9.6	14.7
Total Split (s)	72.0	72.0	27.0	21.0	48.0
Total Split (%)	60.0%	60.0%	22.5%	17.5%	40%
Yellow Time (s)	3.6	3.7	3.7	3.6	3.7
All-Red Time (s)	1.0	1.0	1.0	1.0	1.0
Lost Time Adjust (s)	0.0	0.0	0.0	0.0	
Total Lost Time (s)	4.6	4.7	4.7	4.6	
Lead/Lag			Lag	Lead	
Lead-Lag Optimize?			Yes	Yes	
Recall Mode	None	None	Min	None	Min
Act Effect Green (s)	17.6	17.5	11.3	16.2	
Actuated g/C Ratio	0.30	0.30	0.19	0.27	
v/c Ratio	0.76	0.61	0.37	0.51	
Control Delay	29.8	5.8	1.1	22.2	
Queue Delay	0.0	0.0	0.0	0.0	
Total Delay	29.8	5.8	1.1	22.2	
LOS	C	A	A	C	
Approach Delay	16.7				
Approach LOS	B				

Intersection Summary

Cycle Length: 120	
Actuated Cycle Length: 59.2	
Natural Cycle: 60	
Control Type: Actuated-Uncoordinated	
Maximum v/c Ratio: 0.76	
Intersection Signal Delay: 14.7	Intersection LOS: B
Intersection Capacity Utilization 40.8%	ICU Level of Service A
Analysis Period (min) 15	

Splits and Phases: 15: Airman Dr & Cactus Av.

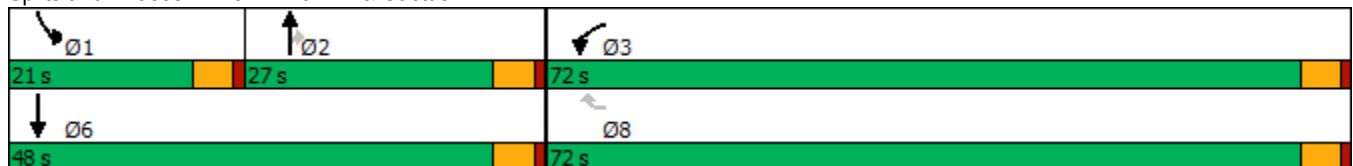

HCM 6th Signalized Intersection Summary
15: Airman Dr & Cactus Av.

West Campus Upper Plateau (JN 14064)

09/30/2022



Movement	WBL	WBR	NBT	NBR	SBL	SBT
Lane Configurations						
Traffic Volume (veh/h)	356	426	0	345	411	0
Future Volume (veh/h)	356	426	0	345	411	0
Initial Q (Qb), veh	0	0	0	0	0	0
Ped-Bike Adj(A_pbT)	1.00	1.00		1.00	1.00	
Parking Bus, Adj	1.00	1.00	1.00	1.00	1.00	1.00
Work Zone On Approach	No		No			No
Adj Sat Flow, veh/h/ln	1811	1752	1900	1811	1752	1900
Adj Flow Rate, veh/h	387	327	0	375	447	0
Peak Hour Factor	0.92	0.92	0.92	0.92	0.92	0.92
Percent Heavy Veh, %	6	10	0	6	10	0
Cap, veh/h	468	403	542	438	584	1050
Arrive On Green	0.27	0.27	0.00	0.29	0.18	0.00
Sat Flow, veh/h	1725	1485	1900	1535	3237	1900
Grp Volume(v), veh/h	387	327	0	375	447	0
Grp Sat Flow(s),veh/h/ln	1725	1485	1900	1535	1618	1900
Q Serve(g_s), s	11.2	10.9	0.0	12.2	7.0	0.0
Cycle Q Clear(g_c), s	11.2	10.9	0.0	12.2	7.0	0.0
Prop In Lane	1.00	1.00		1.00	1.00	
Lane Grp Cap(c), veh/h	468	403	542	438	584	1050
V/C Ratio(X)	0.83	0.81	0.00	0.86	0.77	0.00
Avail Cap(c_a), veh/h	2196	1890	800	647	1003	1554
HCM Platoon Ratio	1.00	1.00	1.00	1.00	1.00	1.00
Upstream Filter(I)	1.00	1.00	0.00	1.00	1.00	0.00
Uniform Delay (d), s/veh	18.1	18.0	0.0	17.9	20.6	0.0
Incr Delay (d2), s/veh	1.4	1.5	0.0	7.5	0.8	0.0
Initial Q Delay(d3),s/veh	0.0	0.0	0.0	0.0	0.0	0.0
%ile BackOfQ(50%),veh/ln	4.1	3.4	0.0	4.7	2.4	0.0
Unsig. Movement Delay, s/veh						
LnGrp Delay(d),s/veh	19.6	19.5	0.0	25.4	21.4	0.0
LnGrp LOS	B	B	A	C	C	A
Approach Vol, veh/h	714		375			447
Approach Delay, s/veh	19.5		25.4			21.4
Approach LOS	B		C			C
Timer - Assigned Phs	1	2			6	8
Phs Duration (G+Y+Rc), s	14.2	19.8			34.0	19.0
Change Period (Y+Rc), s	4.6	* 4.7			* 4.7	4.6
Max Green Setting (Gmax), s	16.4	* 22			* 43	67.4
Max Q Clear Time (g_c+11), s	9.0	14.2			0.0	13.2
Green Ext Time (p_c), s	0.6	0.9			0.0	1.2

Intersection Summary

HCM 6th Ctrl Delay	21.5
HCM 6th LOS	C

Notes

* HCM 6th computational engine requires equal clearance times for the phases crossing the barrier.

Intersection	
Intersection Delay, s/veh	8.8
Intersection LOS	A

Movement	EBT	EBR	WBL	WBT	NBL	NBR
Lane Configurations						
Traffic Vol, veh/h	102	79	40	136	76	37
Future Vol, veh/h	102	79	40	136	76	37
Peak Hour Factor	0.88	0.88	0.88	0.88	0.88	0.88
Heavy Vehicles, %	1	2	3	2	2	0
Mvmt Flow	116	90	45	155	86	42
Number of Lanes	1	0	1	1	1	0

Approach	EB	WB	NB
Opposing Approach	WB	EB	
Opposing Lanes	2	1	0
Conflicting Approach Left		NB	EB
Conflicting Lanes Left	0	1	1
Conflicting Approach Right	NB		WB
Conflicting Lanes Right	1	0	2
HCM Control Delay	8.7	9	8.8
HCM LOS	A	A	A

Lane	NBLn1	EBLn1	WBLn1	WBLn2
Vol Left, %	67%	0%	100%	0%
Vol Thru, %	0%	56%	0%	100%
Vol Right, %	33%	44%	0%	0%
Sign Control	Stop	Stop	Stop	Stop
Traffic Vol by Lane	113	181	40	136
LT Vol	76	0	40	0
Through Vol	0	102	0	136
RT Vol	37	79	0	0
Lane Flow Rate	128	206	45	155
Geometry Grp	2	5	7	7
Degree of Util (X)	0.171	0.246	0.07	0.215
Departure Headway (Hd)	4.795	4.31	5.53	5.01
Convergence, Y/N	Yes	Yes	Yes	Yes
Cap	749	833	649	717
Service Time	2.825	2.336	3.256	2.736
HCM Lane V/C Ratio	0.171	0.247	0.069	0.216
HCM Control Delay	8.8	8.7	8.7	9.1
HCM Lane LOS	A	A	A	A
HCM 95th-tile Q	0.6	1	0.2	0.8

Intersection	
Intersection Delay, s/veh	9.4
Intersection LOS	A

Movement	EBL	EBT	WBT	WBR	SBL	SBR
Lane Configurations						
Traffic Vol, veh/h	130	165	194	72	60	62
Future Vol, veh/h	130	165	194	72	60	62
Peak Hour Factor	0.90	0.90	0.90	0.90	0.90	0.90
Heavy Vehicles, %	1	0	2	0	4	3
Mvmt Flow	144	183	216	80	67	69
Number of Lanes	1	2	2	0	1	0

Approach	EB	WB	SB
Opposing Approach	WB	EB	
Opposing Lanes	2	3	0
Conflicting Approach Left	SB		WB
Conflicting Lanes Left	1	0	2
Conflicting Approach Right		SB	EB
Conflicting Lanes Right	0	1	3
HCM Control Delay	8.8	9.7	10.2
HCM LOS	A	A	B

Lane	EBLn1	EBLn2	EBLn3	WBLn1	WBLn2	SBLn1
Vol Left, %	100%	0%	0%	0%	0%	49%
Vol Thru, %	0%	100%	100%	100%	47%	0%
Vol Right, %	0%	0%	0%	0%	53%	51%
Sign Control	Stop	Stop	Stop	Stop	Stop	Stop
Traffic Vol by Lane	130	83	83	129	137	122
LT Vol	130	0	0	0	0	60
Through Vol	0	83	83	129	65	0
RT Vol	0	0	0	0	72	62
Lane Flow Rate	144	92	92	144	152	136
Geometry Grp	7	7	7	8	8	7
Degree of Util (X)	0.229	0.132	0.089	0.223	0.219	0.219
Departure Headway (Hd)	5.718	5.197	3.484	5.588	5.182	5.814
Convergence, Y/N	Yes	Yes	Yes	Yes	Yes	Yes
Cap	625	687	1017	638	688	613
Service Time	3.477	2.956	1.242	3.358	2.952	3.594
HCM Lane V/C Ratio	0.23	0.134	0.09	0.226	0.221	0.222
HCM Control Delay	10.2	8.8	6.6	10	9.4	10.2
HCM Lane LOS	B	A	A	A	A	B
HCM 95th-tile Q	0.9	0.5	0.3	0.8	0.8	0.8

Timings
18: Linebacker Dr & Cactus Av.

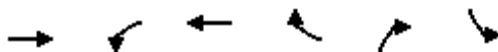

Lane Group	EBT	WBL	WBT	WBR	NBR	SBL	Ø3	Ø4	Ø5	Ø8
Lane Configurations	↑↑	↖	↑	↗	↗	↖↖				
Traffic Volume (vph)	756	169	782	168	159	159				
Future Volume (vph)	756	169	782	168	159	159				
Turn Type	NA	Prot	NA	Perm	pm+ov	Prot				
Protected Phases	2	1	6		1	7	3	4	5	8
Permitted Phases				6	8					
Detector Phase	2	1	6	6	1	7				
Switch Phase										
Minimum Initial (s)	10.0	5.0	10.0	10.0	5.0	5.0	5.0	10.0	5.0	10.0
Minimum Split (s)	27.0	9.6	27.0	27.0	9.6	9.6	9.6	27.0	9.6	27.0
Total Split (s)	27.4	16.0	33.8	33.8	16.0	9.6	9.6	27.0	9.6	27.0
Total Split (%)	34.3%	20.0%	42.3%	42.3%	20.0%	12.0%	12%	34%	12%	34%
Yellow Time (s)	4.0	3.6	4.0	4.0	3.6	3.6	3.6	4.0	3.6	4.0
All-Red Time (s)	1.0	1.0	1.0	1.0	1.0	1.0	1.0	1.0	1.0	1.0
Lost Time Adjust (s)	0.0	0.0	0.0	0.0	0.0	0.0				
Total Lost Time (s)	5.0	4.6	5.0	5.0	4.6	4.6				
Lead/Lag	Lag	Lead	Lag	Lag	Lead	Lead	Lead	Lag	Lead	Lag
Lead-Lag Optimize?	Yes	Yes	Yes	Yes	Yes	Yes	Yes	Yes	Yes	Yes
Recall Mode	None	None	None	None	None	None	None	None	None	None
Act Effct Green (s)	20.1	10.5	35.3	35.3	14.1	5.2				
Actuated g/C Ratio	0.37	0.19	0.65	0.65	0.26	0.10				
v/c Ratio	0.64	0.58	0.74	0.18	0.38	0.55				
Control Delay	19.3	32.8	15.3	2.4	10.5	35.9				
Queue Delay	0.0	0.0	0.0	0.0	0.0	0.0				
Total Delay	19.3	32.8	15.3	2.4	10.5	35.9				
LOS	B	C	B	A	B	D				
Approach Delay	19.3		16.0							
Approach LOS	B		B							

Intersection Summary

Cycle Length: 80
 Actuated Cycle Length: 54.3
 Natural Cycle: 100
 Control Type: Actuated-Uncoordinated
 Maximum v/c Ratio: 0.74
 Intersection Signal Delay: 18.2
 Intersection LOS: B
 Intersection Capacity Utilization 65.8%
 ICU Level of Service C
 Analysis Period (min) 15



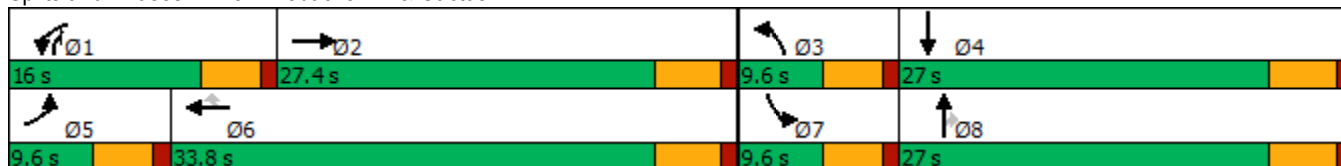





















Splits and Phases: 18: Linebacker Dr & Cactus Av.



HCM 6th Signalized Intersection Summary
18: Linebacker Dr & Cactus Av.

West Campus Upper Plateau (JN 14064)

09/30/2022

												
Movement	EBL	EBT	EBR	WBL	WBT	WBR	NBL	NBT	NBR	SBL	SBT	SBR
Lane Configurations		 								 		
Traffic Volume (veh/h)	0	756	0	169	782	168	0	0	159	159	0	0
Future Volume (veh/h)	0	756	0	169	782	168	0	0	159	159	0	0
Initial Q (Qb), veh	0	0	0	0	0	0	0	0	0	0	0	0
Ped-Bike Adj(A_pbT)	1.00		1.00	1.00		1.00	1.00		1.00	1.00		1.00
Parking Bus, Adj	1.00	1.00	1.00	1.00	1.00	1.00	1.00	1.00	1.00	1.00	1.00	1.00
Work Zone On Approach		No			No			No			No	
Adj Sat Flow, veh/h/ln	1900	1767	1900	1752	1781	1752	1900	1900	1767	1752	1900	1900
Adj Flow Rate, veh/h	0	822	0	184	850	183	0	0	173	173	0	0
Peak Hour Factor	0.92	0.92	0.92	0.92	0.92	0.92	0.92	0.92	0.92	0.92	0.92	0.92
Percent Heavy Veh, %	0	9	0	10	8	10	0	0	9	10	0	0
Cap, veh/h	3	1070	0	226	919	766	3	302	440	265	600	0
Arrive On Green	0.00	0.30	0.00	0.14	0.52	0.52	0.00	0.00	0.16	0.08	0.00	0.00
Sat Flow, veh/h	1810	3533	0	1668	1781	1485	1810	1900	1497	3337	1900	0
Grp Volume(v), veh/h	0	822	0	184	850	183	0	0	173	173	0	0
Grp Sat Flow(s),veh/h/ln	1810	1767	0	1668	1781	1485	1810	1900	1497	1668	1900	0
Q Serve(g_s), s	0.0	12.5	0.0	6.4	26.2	4.0	0.0	0.0	5.5	3.0	0.0	0.0
Cycle Q Clear(g_c), s	0.0	12.5	0.0	6.4	26.2	4.0	0.0	0.0	5.5	3.0	0.0	0.0
Prop In Lane	1.00		0.00	1.00		1.00	1.00		1.00	1.00		0.00
Lane Grp Cap(c), veh/h	3	1070	0	226	919	766	3	302	440	265	600	0
V/C Ratio(X)	0.00	0.77	0.00	0.81	0.93	0.24	0.00	0.00	0.39	0.65	0.00	0.00
Avail Cap(c_a), veh/h	152	1334	0	321	919	766	152	705	758	281	705	0
HCM Platoon Ratio	1.00	1.00	1.00	1.00	1.00	1.00	1.00	1.00	1.00	1.00	1.00	1.00
Upstream Filter(I)	0.00	1.00	0.00	1.00	1.00	1.00	0.00	0.00	1.00	1.00	0.00	0.00
Uniform Delay (d), s/veh	0.0	18.8	0.0	24.9	13.3	7.9	0.0	0.0	16.7	26.5	0.0	0.0
Incr Delay (d2), s/veh	0.0	2.2	0.0	7.0	14.8	0.2	0.0	0.0	0.6	3.6	0.0	0.0
Initial Q Delay(d3),s/veh	0.0	0.0	0.0	0.0	0.0	0.0	0.0	0.0	0.0	0.0	0.0	0.0
%ile BackOfQ(50%),veh/ln	0.0	4.9	0.0	2.8	12.1	1.1	0.0	0.0	1.8	1.3	0.0	0.0
Unsig. Movement Delay, s/veh												
LnGrp Delay(d),s/veh	0.0	21.0	0.0	31.9	28.2	8.1	0.0	0.0	17.3	30.2	0.0	0.0
LnGrp LOS	A	C	A	C	C	A	A	A	B	C	A	A
Approach Vol, veh/h		822			1217			173			173	
Approach Delay, s/veh		21.0			25.7			17.3			30.2	
Approach LOS		C			C			B			C	
Timer - Assigned Phs	1	2	3	4	5	6	7	8				
Phs Duration (G+Y+Rc), s	12.6	23.0	0.0	23.7	0.0	35.6	9.3	14.4				
Change Period (Y+Rc), s	4.6	5.0	4.6	5.0	4.6	5.0	4.6	5.0				
Max Green Setting (Gmax), s	11.4	22.4	5.0	22.0	5.0	28.8	5.0	22.0				
Max Q Clear Time (g_c+I1), s	8.4	14.5	0.0	0.0	0.0	28.2	5.0	7.5				
Green Ext Time (p_c), s	0.1	3.4	0.0	0.0	0.0	0.4	0.0	0.4				
Intersection Summary												
HCM 6th Ctrl Delay				23.8								
HCM 6th LOS				C								

Timings
19: Van Buren Bl. & Orange Terrace Pkwy.

West Campus Upper Plateau (JN 14064)

09/30/2022

Lane Group	EBL	EBT	EBR	WBL	WBT	WBR	NBL	NBT	NBR	SBL	SBT	SBR
Lane Configurations												
Traffic Volume (vph)	96	953	56	37	1213	277	60	53	44	211	41	79
Future Volume (vph)	96	953	56	37	1213	277	60	53	44	211	41	79
Turn Type	Prot	NA	Perm	Prot	NA	Perm	Prot	NA	Perm	Prot	NA	pm+ov
Protected Phases	5	2		1	6		3	8		7	4	5
Permitted Phases			2			6			8			4
Detector Phase	5	2	2	1	6	6	3	8	8	7	4	5
Switch Phase												
Minimum Initial (s)	5.0	10.0	10.0	5.0	10.0	10.0	5.0	5.0	5.0	10.0	10.0	5.0
Minimum Split (s)	9.2	25.2	25.2	9.1	25.2	25.2	9.1	26.1	26.1	15.8	24.8	9.2
Total Split (s)	16.0	63.0	63.0	11.0	58.0	58.0	12.0	27.0	27.0	19.0	34.0	16.0
Total Split (%)	13.3%	52.5%	52.5%	9.2%	48.3%	48.3%	10.0%	22.5%	22.5%	15.8%	28.3%	13.3%
Yellow Time (s)	3.2	5.2	5.2	3.6	5.2	5.2	3.6	3.6	3.6	4.8	4.8	3.2
All-Red Time (s)	1.0	1.0	1.0	0.5	1.0	1.0	0.5	0.5	0.5	1.0	1.0	1.0
Lost Time Adjust (s)	0.0	0.0	0.0	0.0	0.0	0.0	0.0	0.0	0.0	0.0	0.0	0.0
Total Lost Time (s)	4.2	6.2	6.2	4.1	6.2	6.2	4.1	4.1	4.1	5.8	5.8	4.2
Lead/Lag	Lead	Lag	Lag	Lead	Lag	Lag	Lead	Lag	Lag	Lead	Lag	Lead
Lead-Lag Optimize?	Yes	Yes	Yes	Yes	Yes	Yes	Yes	Yes	Yes	Yes	Yes	Yes
Recall Mode	None	None	None	None	None	None	None	None	None	None	None	None
Act Effct Green (s)	7.1	36.4	36.4	6.6	30.6	30.6	7.1	7.8	7.8	11.6	14.6	27.8
Actuated g/C Ratio	0.09	0.48	0.48	0.09	0.40	0.40	0.09	0.10	0.10	0.15	0.19	0.37
v/c Ratio	0.31	0.41	0.07	0.13	0.63	0.36	0.21	0.15	0.14	0.42	0.12	0.13
Control Delay	39.5	14.9	0.2	39.5	19.8	3.4	39.2	36.5	0.8	35.8	32.2	8.9
Queue Delay	0.0	0.0	0.0	0.0	0.0	0.0	0.0	0.0	0.0	0.0	0.0	0.0
Total Delay	39.5	14.9	0.2	39.5	19.8	3.4	39.2	36.5	0.8	35.8	32.2	8.9
LOS	D	B	A	D	B	A	D	D	A	D	C	A
Approach Delay		16.3			17.3			27.6			28.9	
Approach LOS		B			B			C			C	

Intersection Summary

Cycle Length: 120	
Actuated Cycle Length: 75.6	
Natural Cycle: 80	
Control Type: Actuated-Uncoordinated	
Maximum v/c Ratio: 0.63	
Intersection Signal Delay: 18.7	Intersection LOS: B
Intersection Capacity Utilization 53.8%	ICU Level of Service A
Analysis Period (min) 15	

































Splits and Phases: 19: Van Buren Bl. & Orange Terrace Pkwy.



HCM 6th Signalized Intersection Summary
 19: Van Buren Bl. & Orange Terrace Pkwy.

West Campus Upper Plateau (JN 14064)

09/30/2022

												
Movement	EBL	EBT	EBR	WBL	WBT	WBR	NBL	NBT	NBR	SBL	SBT	SBR
Lane Configurations	 	  		 	  		 	 		 		
Traffic Volume (veh/h)	96	953	56	37	1213	277	60	53	44	211	41	79
Future Volume (veh/h)	96	953	56	37	1213	277	60	53	44	211	41	79
Initial Q (Qb), veh	0	0	0	0	0	0	0	0	0	0	0	0
Ped-Bike Adj(A_pbT)	1.00		1.00	1.00		1.00	1.00		1.00	1.00		1.00
Parking Bus, Adj	1.00	1.00	1.00	1.00	1.00	1.00	1.00	1.00	1.00	1.00	1.00	1.00
Work Zone On Approach		No			No			No			No	
Adj Sat Flow, veh/h/ln	1885	1856	1811	1870	1856	1885	1796	1900	1856	1885	1900	1885
Adj Flow Rate, veh/h	101	1003	33	39	1277	232	63	56	14	222	43	9
Peak Hour Factor	0.95	0.95	0.95	0.95	0.95	0.95	0.95	0.95	0.95	0.95	0.95	0.95
Percent Heavy Veh, %	1	3	6	2	3	1	7	0	3	1	0	1
Cap, veh/h	217	2151	652	132	2021	637	169	256	112	508	362	404
Arrive On Green	0.06	0.42	0.42	0.04	0.40	0.40	0.05	0.07	0.07	0.15	0.19	0.19
Sat Flow, veh/h	3483	5066	1535	3456	5066	1598	3319	3610	1572	3483	1900	1598
Grp Volume(v), veh/h	101	1003	33	39	1277	232	63	56	14	222	43	9
Grp Sat Flow(s),veh/h/ln	1742	1689	1535	1728	1689	1598	1659	1805	1572	1742	1900	1598
Q Serve(g_s), s	1.9	9.7	0.9	0.8	13.9	7.0	1.3	1.0	0.6	4.0	1.3	0.3
Cycle Q Clear(g_c), s	1.9	9.7	0.9	0.8	13.9	7.0	1.3	1.0	0.6	4.0	1.3	0.3
Prop In Lane	1.00		1.00	1.00		1.00	1.00		1.00	1.00		1.00
Lane Grp Cap(c), veh/h	217	2151	652	132	2021	637	169	256	112	508	362	404
V/C Ratio(X)	0.46	0.47	0.05	0.29	0.63	0.36	0.37	0.22	0.13	0.44	0.12	0.02
Avail Cap(c_a), veh/h	601	4208	1275	349	3837	1210	383	1209	527	672	784	758
HCM Platoon Ratio	1.00	1.00	1.00	1.00	1.00	1.00	1.00	1.00	1.00	1.00	1.00	1.00
Upstream Filter(I)	1.00	1.00	1.00	1.00	1.00	1.00	1.00	1.00	1.00	1.00	1.00	1.00
Uniform Delay (d), s/veh	31.0	14.1	11.6	32.0	16.5	14.4	31.4	30.0	29.8	26.6	22.9	19.2
Incr Delay (d2), s/veh	0.6	0.2	0.0	1.2	0.3	0.3	1.4	0.4	0.5	0.6	0.1	0.0
Initial Q Delay(d3),s/veh	0.0	0.0	0.0	0.0	0.0	0.0	0.0	0.0	0.0	0.0	0.0	0.0
%ile BackOfQ(50%),veh/ln	0.7	3.0	0.3	0.3	4.4	0.1	0.5	0.4	0.2	1.5	0.5	0.1
Unsig. Movement Delay, s/veh												
LnGrp Delay(d),s/veh	31.5	14.3	11.6	33.2	16.8	14.8	32.7	30.4	30.3	27.2	23.1	19.2
LnGrp LOS	C	B	B	C	B	B	C	C	C	C	C	B
Approach Vol, veh/h		1137			1548			133			274	
Approach Delay, s/veh		15.7			16.9			31.5			26.3	
Approach LOS		B			B			C			C	
Timer - Assigned Phs	1	2	3	4	5	6	7	8				
Phs Duration (G+Y+Rc), s	6.7	35.2	7.6	18.8	8.5	33.5	15.8	10.7				
Change Period (Y+Rc), s	4.1	6.2	4.1	5.8	* 4.2	6.2	5.8	* 5.8				
Max Green Setting (Gmax), s	6.9	56.8	7.9	28.2	* 12	51.8	13.2	* 23				
Max Q Clear Time (g_c+I1), s	2.8	11.7	3.3	3.3	3.9	15.9	6.0	3.0				
Green Ext Time (p_c), s	0.0	7.7	0.0	0.2	0.1	11.4	0.4	0.3				
Intersection Summary												
HCM 6th Ctrl Delay			18.0									
HCM 6th LOS			B									
Notes												
* HCM 6th computational engine requires equal clearance times for the phases crossing the barrier.												

Timings
20: Brown/San Gorgonio Dr & Alessandro Bl.

West Campus Upper Plateau (JN 14064)

09/30/2022



Lane Group	EBL	EBT	WBL	WBT	WBR	NBL	NBR	SBL	SBR	Ø4	Ø8
Lane Configurations	↖	↕↕↕	↖	↕↕↕	↖	↖	↖	↖	↖		
Traffic Volume (vph)	33	1228	275	1413	36	241	266	41	38		
Future Volume (vph)	33	1228	275	1413	36	241	266	41	38		
Turn Type	Prot	NA	Prot	NA	Perm	Prot	pm+ov	Prot	pm+ov		
Protected Phases	5	2	1	6		3	1	7	5	4	8
Permitted Phases					6		8		4		
Detector Phase	5	2	1	6	6	3	1	7	5		
Switch Phase											
Minimum Initial (s)	5.0	10.0	5.0	10.0	10.0	5.0	5.0	5.0	5.0	10.0	5.0
Minimum Split (s)	8.7	43.5	9.1	43.5	43.5	9.1	9.1	8.7	8.7	49.8	26.1
Total Split (s)	8.7	52.0	9.1	52.4	52.4	9.1	9.1	19.6	8.7	49.8	39.3
Total Split (%)	7.3%	43.3%	7.6%	43.7%	43.7%	7.6%	7.6%	16.3%	7.3%	42%	33%
Yellow Time (s)	3.2	5.5	3.6	5.5	5.5	3.6	3.6	3.2	3.2	4.8	3.6
All-Red Time (s)	0.5	1.0	0.5	1.0	1.0	0.5	0.5	0.5	0.5	1.0	0.5
Lost Time Adjust (s)	0.0	0.0	0.0	0.0	0.0	0.0	0.0	0.0	0.0		
Total Lost Time (s)	3.7	6.5	4.1	6.5	6.5	4.1	4.1	3.7	3.7		
Lead/Lag	Lead	Lag	Lead	Lag	Lag	Lead	Lead	Lead	Lead	Lag	Lag
Lead-Lag Optimize?	Yes	Yes	Yes	Yes	Yes	Yes	Yes	Yes	Yes	Yes	Yes
Recall Mode	None	None	None	None	None	None	None	None	None	None	None
Act Effct Green (s)	5.5	39.1	5.5	42.1	42.1	6.3	16.1	7.0	11.5		
Actuated g/C Ratio	0.08	0.54	0.08	0.58	0.58	0.09	0.22	0.10	0.16		
v/c Ratio	0.26	0.58	3.08	0.51	0.05	1.79	0.76	0.27	0.13		
Control Delay	46.5	15.0	980.9	13.9	0.1	405.6	30.8	42.6	2.3		
Queue Delay	0.0	0.0	0.0	0.0	0.0	0.0	0.0	0.0	0.0		
Total Delay	46.5	15.0	980.9	13.9	0.1	405.6	30.8	42.6	2.3		
LOS	D	B	F	B	A	F	C	D	A		
Approach Delay		15.7		168.0							
Approach LOS		B		F							

Intersection Summary

Cycle Length: 120	
Actuated Cycle Length: 73	
Natural Cycle: 115	
Control Type: Actuated-Uncoordinated	
Maximum v/c Ratio: 3.08	
Intersection Signal Delay: 110.3	Intersection LOS: F
Intersection Capacity Utilization 76.7%	ICU Level of Service D
Analysis Period (min) 15	

Splits and Phases: 20: Brown/San Gorgonio Dr & Alessandro Bl.

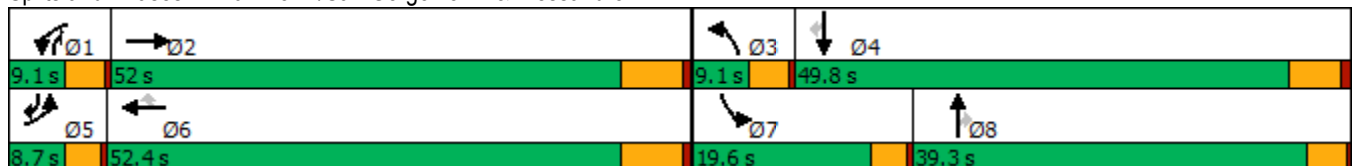

HCM 6th Signalized Intersection Summary
 20: Brown/San Gorgonio Dr & Alessandro Bl.

West Campus Upper Plateau (JN 14064)

09/30/2022



Movement	EBL	EBT	EBR	WBL	WBT	WBR	NBL	NBT	NBR	SBL	SBT	SBR
Lane Configurations	↖	↕	↗	↖	↕	↗	↖	↕	↗	↖	↕	↗
Traffic Volume (veh/h)	33	1228	246	275	1413	36	241	0	266	41	0	38
Future Volume (veh/h)	33	1228	246	275	1413	36	241	0	266	41	0	38
Initial Q (Qb), veh	0	0	0	0	0	0	0	0	0	0	0	0
Ped-Bike Adj(A_pbT)	1.00		1.00	1.00		1.00	1.00		1.00	1.00		1.00
Parking Bus, Adj	1.00	1.00	1.00	1.00	1.00	1.00	1.00	1.00	1.00	1.00	1.00	1.00
Work Zone On Approach		No			No			No			No	
Adj Sat Flow, veh/h/ln	1900	1900	1900	1307	1885	1396	1796	1900	1322	1796	1900	1885
Adj Flow Rate, veh/h	35	1320	261	296	1519	35	259	0	273	44	0	-8
Peak Hour Factor	0.93	0.93	0.93	0.93	0.93	0.93	0.93	0.93	0.93	0.93	0.93	0.93
Percent Heavy Veh, %	0	0	0	40	1	34	7	0	39	7	0	1
Cap, veh/h	59	1848	365	70	2335	537	97	482	348	64	438	420
Arrive On Green	0.03	0.43	0.43	0.06	0.45	0.45	0.06	0.00	0.25	0.04	0.00	0.00
Sat Flow, veh/h	1810	4345	859	1245	5147	1183	1711	1900	1120	1711	1900	1598
Grp Volume(v), veh/h	35	1050	531	296	1519	35	259	0	273	44	0	-8
Grp Sat Flow(s),veh/h/ln	1810	1729	1745	1245	1716	1183	1711	1900	1120	1711	1900	1598
Q Serve(g_s), s	1.7	22.2	22.2	5.0	20.3	1.5	5.0	0.0	19.7	2.3	0.0	0.0
Cycle Q Clear(g_c), s	1.7	22.2	22.2	5.0	20.3	1.5	5.0	0.0	19.7	2.3	0.0	0.0
Prop In Lane	1.00		0.49	1.00		1.00	1.00		1.00	1.00		1.00
Lane Grp Cap(c), veh/h	59	1471	742	70	2335	537	97	482	348	64	438	420
V/C Ratio(X)	0.59	0.71	0.71	4.21	0.65	0.07	2.68	0.00	0.79	0.69	0.00	-0.02
Avail Cap(c_a), veh/h	102	1776	897	70	2667	613	97	755	508	307	944	846
HCM Platoon Ratio	1.00	1.00	1.00	1.00	1.00	1.00	1.00	1.00	1.00	1.00	1.00	1.00
Upstream Filter(I)	1.00	1.00	1.00	1.00	1.00	1.00	1.00	0.00	1.00	1.00	0.00	0.00
Uniform Delay (d), s/veh	42.3	21.0	21.0	41.8	18.8	13.6	41.8	0.0	27.8	42.1	0.0	0.0
Incr Delay (d2), s/veh	3.5	1.3	2.6	1478.2	0.6	0.1	785.5	0.0	4.9	4.8	0.0	0.0
Initial Q Delay(d3),s/veh	0.0	0.0	0.0	0.0	0.0	0.0	0.0	0.0	0.0	0.0	0.0	0.0
%ile BackOfQ(50%),veh/ln	0.8	7.9	8.2	30.4	7.7	0.4	23.2	0.0	5.6	1.0	0.0	0.0
Unsig. Movement Delay, s/veh												
LnGrp Delay(d),s/veh	45.8	22.3	23.6	1520.0	19.3	13.7	827.3	0.0	32.8	47.0	0.0	0.0
LnGrp LOS	D	C	C	F	B	B	F	A	C	D	A	A
Approach Vol, veh/h		1616			1850			532				36
Approach Delay, s/veh		23.2			259.3			419.6				57.4
Approach LOS		C			F			F				E
Timer - Assigned Phs	1	2	3	4	5	6	7	8				
Phs Duration (G+Y+Rc), s	9.1	44.2	9.1	26.2	6.6	46.7	7.0	28.3				
Change Period (Y+Rc), s	4.1	6.5	4.1	5.8	3.7	6.5	3.7	* 5.8				
Max Green Setting (Gmax), s	5.0	45.5	5.0	44.0	5.0	45.9	15.9	* 35				
Max Q Clear Time (g_c+I1), s	7.0	24.2	7.0	0.0	3.7	22.3	4.3	21.7				
Green Ext Time (p_c), s	0.0	13.4	0.0	0.0	0.0	15.9	0.0	0.8				

Intersection Summary

HCM 6th Ctrl Delay	184.1
HCM 6th LOS	F

Notes

* HCM 6th computational engine requires equal clearance times for the phases crossing the barrier.

Timings
21: Cactus Av. & Brown St



Lane Group	EBL	EBT	WBT	SBR
Lane Configurations	↖	↗	↖↗	↖
Traffic Volume (vph)	507	567	601	518
Future Volume (vph)	507	567	601	518
Turn Type	Prot	NA	NA	Perm
Protected Phases	7	4	8	
Permitted Phases				6
Detector Phase	7	4	8	6
Switch Phase				
Minimum Initial (s)	5.0	10.0	10.0	10.0
Minimum Split (s)	9.6	15.8	27.8	26.7
Total Split (s)	50.0	86.0	36.0	34.0
Total Split (%)	41.7%	71.7%	30.0%	28.3%
Yellow Time (s)	3.6	4.8	4.8	3.7
All-Red Time (s)	1.0	1.0	1.0	1.0
Lost Time Adjust (s)	0.0	0.0	0.0	0.0
Total Lost Time (s)	4.6	5.8	5.8	4.7
Lead/Lag	Lead		Lag	
Lead-Lag Optimize?	Yes		Yes	
Recall Mode	None	None	None	Min
Act Effct Green (s)	30.5	58.4	23.1	12.2
Actuated g/C Ratio	0.37	0.71	0.28	0.15
v/c Ratio	0.82	0.26	0.71	0.70
Control Delay	35.1	4.4	32.7	5.9
Queue Delay	0.0	0.0	0.0	0.0
Total Delay	35.1	4.4	32.7	5.9
LOS	D	A	C	A
Approach Delay		18.9	32.7	
Approach LOS		B	C	

Intersection Summary

Cycle Length: 120	
Actuated Cycle Length: 81.7	
Natural Cycle: 90	
Control Type: Actuated-Uncoordinated	
Maximum v/c Ratio: 0.82	
Intersection Signal Delay: 19.6	Intersection LOS: B
Intersection Capacity Utilization 57.4%	ICU Level of Service B
Analysis Period (min) 15	

Splits and Phases: 21: Cactus Av. & Brown St



HCM 6th Signalized Intersection Summary
 21: Cactus Av. & Brown St

West Campus Upper Plateau (JN 14064)

09/30/2022

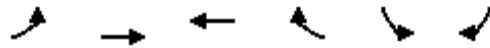

Movement	EBL	EBT	WBT	WBR	SBL	SBR	
Lane Configurations	↖	↑↑	↗		↖	↗	
Traffic Volume (veh/h)	507	567	601	0	0	518	
Future Volume (veh/h)	507	567	601	0	0	518	
Initial Q (Qb), veh	0	0	0	0	0	0	
Ped-Bike Adj(A_pbT)	1.00			1.00	1.00	1.00	
Parking Bus, Adj	1.00	1.00	1.00	1.00	1.00	1.00	
Work Zone On Approach		No	No		No		
Adj Sat Flow, veh/h/ln	1900	1737	1737	1900	1900	1900	
Adj Flow Rate, veh/h	551	616	653	0	0	405	
Peak Hour Factor	0.92	0.92	0.92	0.92	0.92	0.92	
Percent Heavy Veh, %	0	11	11	0	0	0	
Cap, veh/h	588	2029	794	0	494	439	
Arrive On Green	0.32	0.61	0.24	0.00	0.00	0.27	
Sat Flow, veh/h	1810	3387	3474	0	1810	1610	
Grp Volume(v), veh/h	551	616	653	0	0	405	
Grp Sat Flow(s),veh/h/ln	1810	1650	1650	0	1810	1610	
Q Serve(g_s), s	27.6	8.3	17.5	0.0	0.0	22.8	
Cycle Q Clear(g_c), s	27.6	8.3	17.5	0.0	0.0	22.8	
Prop In Lane	1.00			0.00	1.00	1.00	
Lane Grp Cap(c), veh/h	588	2029	794	0	494	439	
V/C Ratio(X)	0.94	0.30	0.82	0.00	0.00	0.92	
Avail Cap(c_a), veh/h	879	2833	1067	0	567	505	
HCM Platoon Ratio	1.00	1.00	1.00	1.00	1.00	1.00	
Upstream Filter(I)	1.00	1.00	1.00	0.00	0.00	1.00	
Uniform Delay (d), s/veh	30.6	8.5	33.6	0.0	0.0	33.0	
Incr Delay (d2), s/veh	10.4	0.1	3.9	0.0	0.0	21.0	
Initial Q Delay(d3),s/veh	0.0	0.0	0.0	0.0	0.0	0.0	
%ile BackOfQ(50%),veh/ln	12.8	2.5	7.0	0.0	0.0	2.6	
Unsig. Movement Delay, s/veh							
LnGrp Delay(d),s/veh	41.1	8.6	37.5	0.0	0.0	54.0	
LnGrp LOS	D	A	D	A	A	D	
Approach Vol, veh/h		1167	653		405		
Approach Delay, s/veh		23.9	37.5		54.0		
Approach LOS		C	D		D		
Timer - Assigned Phs				4	6	7	8
Phs Duration (G+Y+Rc), s				63.3	30.2	35.0	28.3
Change Period (Y+Rc), s				5.8	4.7	4.6	5.8
Max Green Setting (Gmax), s				80.2	29.3	45.4	30.2
Max Q Clear Time (g_c+11), s				10.3	24.8	29.6	19.5
Green Ext Time (p_c), s				4.3	0.6	0.7	3.0
Intersection Summary							
HCM 6th Ctrl Delay			33.4				
HCM 6th LOS			C				

Timings
22: Sycamore Canyon Bl. & Eastridge Ave

West Campus Upper Plateau (JN 14064)

09/30/2022



Lane Group	EBL	EBT	EBR	WBL	WBT	WBR	NBL	NBT	NBR	SBL	SBT	SBR
Lane Configurations	↖↖	↑↑↑	↗	↖↖	↑↑	↗	↖↖	↑↑	↗	↖↖	↑↑	↗
Traffic Volume (vph)	45	76	18	210	60	341	51	347	78	132	154	34
Future Volume (vph)	45	76	18	210	60	341	51	347	78	132	154	34
Turn Type	Prot	NA	Perm	Prot	NA	pm+ov	Prot	NA	pm+ov	Prot	NA	pm+ov
Protected Phases	5	2		1	6	7	3	8	1	7	4	5
Permitted Phases			2			6			8			4
Detector Phase	5	2	2	1	6	7	3	8	1	7	4	5
Switch Phase												
Minimum Initial (s)	5.0	10.0	10.0	5.0	10.0	5.0	5.0	10.0	5.0	5.0	10.0	5.0
Minimum Split (s)	8.7	43.5	43.5	8.7	43.5	8.7	8.7	15.8	8.7	8.7	49.8	8.7
Total Split (s)	11.7	45.5	45.5	15.2	49.0	20.2	8.7	39.1	15.2	20.2	50.6	11.7
Total Split (%)	9.8%	37.9%	37.9%	12.7%	40.8%	16.8%	7.3%	32.6%	12.7%	16.8%	42.2%	9.8%
Yellow Time (s)	3.2	5.5	5.5	3.2	5.5	3.2	3.2	4.8	3.2	3.2	4.8	3.2
All-Red Time (s)	0.5	1.0	1.0	0.5	1.0	0.5	0.5	1.0	0.5	0.5	1.0	0.5
Lost Time Adjust (s)	0.0	0.0	0.0	0.0	0.0	0.0	0.0	0.0	0.0	0.0	0.0	0.0
Total Lost Time (s)	3.7	6.5	6.5	3.7	6.5	3.7	3.7	5.8	3.7	3.7	5.8	3.7
Lead/Lag	Lead	Lag	Lag	Lead	Lag	Lead	Lead	Lag	Lead	Lead	Lag	Lead
Lead-Lag Optimize?	Yes	Yes	Yes	Yes	Yes	Yes	Yes	Yes	Yes	Yes	Yes	Yes
Recall Mode	None	None	None	None	None	None	None	None	None	None	None	None
Act Effct Green (s)	10.3	13.6	13.6	10.9	15.5	23.4	5.4	13.9	27.1	7.7	20.9	33.5
Actuated g/C Ratio	0.16	0.22	0.22	0.17	0.25	0.37	0.09	0.22	0.43	0.12	0.33	0.54
v/c Ratio	0.09	0.09	0.04	0.37	0.09	0.50	0.21	0.49	0.11	0.33	0.14	0.05
Control Delay	31.7	21.8	0.2	30.4	19.6	6.9	35.6	25.6	3.0	32.0	19.2	1.5
Queue Delay	0.0	0.0	0.0	0.0	0.0	0.0	0.0	0.0	0.0	0.0	0.0	0.0
Total Delay	31.7	21.8	0.2	30.4	19.6	6.9	35.6	25.6	3.0	32.0	19.2	1.5
LOS	C	C	A	C	B	A	D	C	A	C	B	A
Approach Delay		22.2			16.2			23.0			22.6	
Approach LOS		C			B			C			C	

Intersection Summary

Cycle Length: 120	
Actuated Cycle Length: 62.5	
Natural Cycle: 115	
Control Type: Actuated-Uncoordinated	
Maximum v/c Ratio: 0.50	
Intersection Signal Delay: 20.1	Intersection LOS: C
Intersection Capacity Utilization 46.5%	ICU Level of Service A
Analysis Period (min) 15	

Splits and Phases: 22: Sycamore Canyon Bl. & Eastridge Ave

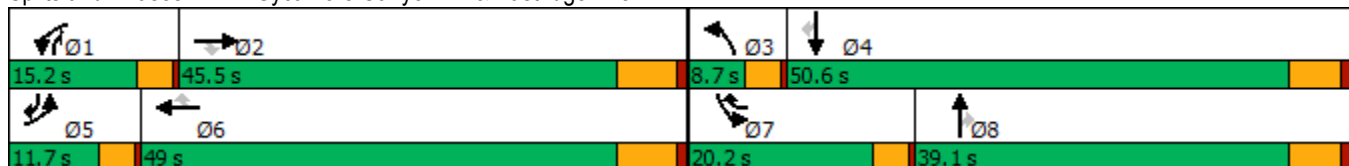

HCM 6th Signalized Intersection Summary
22: Sycamore Canyon Bl. & Eastridge Ave

West Campus Upper Plateau (JN 14064)

09/30/2022



Movement	EBL	EBT	EBR	WBL	WBT	WBR	NBL	NBT	NBR	SBL	SBT	SBR
Lane Configurations	↖↗	↑↑↑	↖	↖↗	↑↑	↖	↖↗	↑↑	↖	↖↗	↑↑	↖
Traffic Volume (veh/h)	45	76	18	210	60	341	51	347	78	132	154	34
Future Volume (veh/h)	45	76	18	210	60	341	51	347	78	132	154	34
Initial Q (Qb), veh	0	0	0	0	0	0	0	0	0	0	0	0
Ped-Bike Adj(A_pbT)	1.00		1.00	1.00		1.00	1.00		0.99	1.00		0.99
Parking Bus, Adj	1.00	1.00	1.00	1.00	1.00	1.00	1.00	1.00	1.00	1.00	1.00	1.00
Work Zone On Approach		No			No			No			No	
Adj Sat Flow, veh/h/ln	1648	1589	1826	1856	1396	1796	1618	1796	1826	1841	1826	1530
Adj Flow Rate, veh/h	47	80	0	221	63	186	54	365	28	139	162	32
Peak Hour Factor	0.95	0.95	0.95	0.95	0.95	0.95	0.95	0.95	0.95	0.95	0.95	0.95
Percent Heavy Veh, %	17	21	5	3	34	7	19	7	5	4	5	25
Cap, veh/h	147	904		348	694	529	159	694	467	294	821	365
Arrive On Green	0.05	0.21	0.00	0.10	0.26	0.26	0.05	0.20	0.20	0.09	0.24	0.24
Sat Flow, veh/h	3045	4337	1547	3428	2653	1521	2990	3413	1527	3401	3469	1278
Grp Volume(v), veh/h	47	80	0	221	63	186	54	365	28	139	162	32
Grp Sat Flow(s),veh/h/ln	1522	1446	1547	1714	1326	1521	1495	1706	1527	1700	1735	1278
Q Serve(g_s), s	0.7	0.7	0.0	3.0	0.9	4.5	0.9	4.7	0.6	1.9	1.8	0.9
Cycle Q Clear(g_c), s	0.7	0.7	0.0	3.0	0.9	4.5	0.9	4.7	0.6	1.9	1.8	0.9
Prop In Lane	1.00		1.00	1.00		1.00	1.00		1.00	1.00		1.00
Lane Grp Cap(c), veh/h	147	904		348	694	529	159	694	467	294	821	365
V/C Ratio(X)	0.32	0.09		0.64	0.09	0.35	0.34	0.53	0.06	0.47	0.20	0.09
Avail Cap(c_a), veh/h	495	3439		802	2292	1445	304	2311	1191	1141	3160	1226
HCM Platoon Ratio	1.00	1.00	1.00	1.00	1.00	1.00	1.00	1.00	1.00	1.00	1.00	1.00
Upstream Filter(I)	1.00	1.00	0.00	1.00	1.00	1.00	1.00	1.00	1.00	1.00	1.00	1.00
Uniform Delay (d), s/veh	22.6	15.7	0.0	21.2	13.7	11.9	22.5	17.5	12.1	21.4	15.0	12.9
Incr Delay (d2), s/veh	0.5	0.1	0.0	0.7	0.1	0.6	0.5	0.6	0.1	0.4	0.1	0.1
Initial Q Delay(d3),s/veh	0.0	0.0	0.0	0.0	0.0	0.0	0.0	0.0	0.0	0.0	0.0	0.0
%ile BackOfQ(50%),veh/ln	0.2	0.2	0.0	1.0	0.2	1.2	0.3	1.6	0.2	0.7	0.6	0.2
Unsig. Movement Delay, s/veh												
LnGrp Delay(d),s/veh	23.1	15.8	0.0	21.9	13.8	12.5	22.9	18.1	12.2	21.8	15.1	13.0
LnGrp LOS	C	B		C	B	B	C	B	B	C	B	B
Approach Vol, veh/h		127			470			447			333	
Approach Delay, s/veh		18.5			17.1			18.3			17.7	
Approach LOS		B			B			B			B	
Timer - Assigned Phs	1	2	3	4	5	6	7	8				
Phs Duration (G+Y+Rc), s	8.7	16.7	6.3	17.4	6.1	19.4	8.0	15.8				
Change Period (Y+Rc), s	3.7	6.5	3.7	5.8	3.7	6.5	3.7	5.8				
Max Green Setting (Gmax), s	11.5	39.0	5.0	44.8	8.0	42.5	16.5	33.3				
Max Q Clear Time (g_c+I1), s	5.0	2.7	2.9	3.8	2.7	6.5	3.9	6.7				
Green Ext Time (p_c), s	0.2	0.6	0.0	1.1	0.0	1.5	0.2	2.3				

Intersection Summary

HCM 6th Ctrl Delay	17.8
HCM 6th LOS	B

Notes

Unsignalized Delay for [EBR] is excluded from calculations of the approach delay and intersection delay.

Timings
23: Sycamore Canyon Bl. & Cottonwood Ave

West Campus Upper Plateau (JN 14064)

09/30/2022



Lane Group	WBL	WBR	NBT	SBL	SBT
Lane Configurations	↙	↗	↕	↙	↕
Traffic Volume (vph)	5	20	410	17	421
Future Volume (vph)	5	20	410	17	421
Turn Type	Prot	Perm	NA	Prot	NA
Protected Phases	8		2	1	6
Permitted Phases		8			
Detector Phase	8	8	2	1	6
Switch Phase					
Minimum Initial (s)	10.0	10.0	10.0	5.0	10.0
Minimum Split (s)	15.8	15.8	43.5	9.1	43.5
Total Split (s)	23.0	23.0	78.0	19.0	97.0
Total Split (%)	19.2%	19.2%	65.0%	15.8%	80.8%
Yellow Time (s)	4.8	4.8	5.5	3.6	5.5
All-Red Time (s)	1.0	1.0	1.0	0.5	1.0
Lost Time Adjust (s)	0.0	0.0	0.0	0.0	0.0
Total Lost Time (s)	5.8	5.8	6.5	4.1	6.5
Lead/Lag			Lag	Lead	
Lead-Lag Optimize?			Yes	Yes	
Recall Mode	None	None	None	None	None
Act Effect Green (s)	12.5	12.5	22.6	7.4	23.6
Actuated g/C Ratio	0.49	0.49	0.88	0.29	0.92
v/c Ratio	0.01	0.04	0.15	0.04	0.14
Control Delay	12.2	7.7	3.8	14.1	1.7
Queue Delay	0.0	0.0	0.0	0.0	0.0
Total Delay	12.2	7.7	3.8	14.1	1.7
LOS	B	A	A	B	A
Approach Delay	8.5		3.8		2.2
Approach LOS	A		A		A

Intersection Summary

Cycle Length: 120
 Actuated Cycle Length: 25.6
 Natural Cycle: 70
 Control Type: Actuated-Uncoordinated
 Maximum v/c Ratio: 0.15
 Intersection Signal Delay: 3.2
 Intersection LOS: A
 Intersection Capacity Utilization 32.7%
 ICU Level of Service A
 Analysis Period (min) 15

Splits and Phases: 23: Sycamore Canyon Bl. & Cottonwood Ave



HCM 6th Signalized Intersection Summary
 23: Sycamore Canyon Bl. & Cottonwood Ave

West Campus Upper Plateau (JN 14064)

09/30/2022



Movement	WBL	WBR	NBT	NBR	SBL	SBT
Lane Configurations	↶	↷	↕↔		↶	↕↕
Traffic Volume (veh/h)	5	20	410	7	17	421
Future Volume (veh/h)	5	20	410	7	17	421
Initial Q (Qb), veh	0	0	0	0	0	0
Ped-Bike Adj(A_pbT)	1.00	1.00		0.98	1.00	
Parking Bus, Adj	1.00	1.00	1.00	1.00	1.00	1.00
Work Zone On Approach	No		No			No
Adj Sat Flow, veh/h/ln	1574	1070	1796	1752	1485	1870
Adj Flow Rate, veh/h	5	12	441	7	18	453
Peak Hour Factor	0.93	0.93	0.93	0.93	0.93	0.93
Percent Heavy Veh, %	22	56	7	10	28	2
Cap, veh/h	66	40	1217	19	33	1855
Arrive On Green	0.04	0.04	0.35	0.35	0.02	0.52
Sat Flow, veh/h	1499	907	3527	55	1414	3647
Grp Volume(v), veh/h	5	12	219	229	18	453
Grp Sat Flow(s),veh/h/ln	1499	907	1706	1785	1414	1777
Q Serve(g_s), s	0.1	0.4	2.7	2.7	0.4	2.0
Cycle Q Clear(g_c), s	0.1	0.4	2.7	2.7	0.4	2.0
Prop In Lane	1.00	1.00		0.03	1.00	
Lane Grp Cap(c), veh/h	66	40	604	632	33	1855
V/C Ratio(X)	0.08	0.30	0.36	0.36	0.55	0.24
Avail Cap(c_a), veh/h	909	550	4302	4500	743	11341
HCM Platoon Ratio	1.00	1.00	1.00	1.00	1.00	1.00
Upstream Filter(I)	1.00	1.00	1.00	1.00	1.00	1.00
Uniform Delay (d), s/veh	13.0	13.1	6.8	6.8	13.7	3.7
Incr Delay (d2), s/veh	0.5	4.1	0.5	0.5	13.3	0.1
Initial Q Delay(d3),s/veh	0.0	0.0	0.0	0.0	0.0	0.0
%ile BackOfQ(50%),veh/ln	0.0	0.1	0.5	0.5	0.2	0.1
Unsig. Movement Delay, s/veh						
LnGrp Delay(d),s/veh	13.5	17.2	7.3	7.3	27.0	3.8
LnGrp LOS	B	B	A	A	C	A
Approach Vol, veh/h	17		448			471
Approach Delay, s/veh	16.1		7.3			4.7
Approach LOS	B		A			A
Timer - Assigned Phs	1	2			6	8
Phs Duration (G+Y+Rc), s	4.8	16.5			21.3	7.1
Change Period (Y+Rc), s	4.1	6.5			6.5	5.8
Max Green Setting (Gmax), s	14.9	71.5			90.5	17.2
Max Q Clear Time (g_c+I1), s	2.4	4.7			4.0	2.4
Green Ext Time (p_c), s	0.0	3.9			4.5	0.0
Intersection Summary						
HCM 6th Ctrl Delay			6.1			
HCM 6th LOS			A			

Timings

West Campus Upper Plateau (JN 14064)

24: Sycamore Canyon Bl. & Alessandro Bl.

09/30/2022



Lane Group	EBL	EBT	EBR	WBL	WBT	WBR	NBL	NBT	NBR	SBL	SBT	SBR
Lane Configurations	↖	↑↑↑	↗	↖↗	↑↑↑	↗	↖↗	↑↑	↖↗	↖↗	↑↑	↖↗
Traffic Volume (vph)	106	1274	105	85	1430	95	188	169	42	62	189	56
Future Volume (vph)	106	1274	105	85	1430	95	188	169	42	62	189	56
Turn Type	Prot	NA	Perm	Prot	NA	Perm	Prot	NA	pm+ov	Prot	NA	Perm
Protected Phases	5	2		1	6		3	8	1	7	4	
Permitted Phases			2			6			8			4
Detector Phase	5	2	2	1	6	6	3	8	1	7	4	4
Switch Phase												
Minimum Initial (s)	5.0	10.0	10.0	5.0	10.0	10.0	5.0	10.0	5.0	5.0	10.0	10.0
Minimum Split (s)	8.7	43.5	43.5	8.7	43.5	43.5	8.7	15.8	8.7	8.7	49.8	49.8
Total Split (s)	10.0	44.2	44.2	12.0	46.2	46.2	14.0	51.0	12.0	12.8	49.8	49.8
Total Split (%)	8.3%	36.8%	36.8%	10.0%	38.5%	38.5%	11.7%	42.5%	10.0%	10.7%	41.5%	41.5%
Yellow Time (s)	3.2	5.5	5.5	3.2	5.5	5.5	3.2	4.8	3.2	3.2	4.8	4.8
All-Red Time (s)	0.5	1.0	1.0	0.5	1.0	1.0	0.5	1.0	0.5	0.5	1.0	1.0
Lost Time Adjust (s)	0.0	0.0	0.0	0.0	0.0	0.0	0.0	0.0	0.0	0.0	0.0	0.0
Total Lost Time (s)	3.7	6.5	6.5	3.7	6.5	6.5	3.7	5.8	3.7	3.7	5.8	5.8
Lead/Lag	Lead	Lag	Lag	Lead	Lag	Lag	Lead	Lag	Lead	Lead	Lag	Lag
Lead-Lag Optimize?	Yes	Yes	Yes	Yes	Yes	Yes	Yes	Yes	Yes	Yes	Yes	Yes
Recall Mode	None	None	None	None	None	None	None	None	None	None	None	None
Act Effct Green (s)	6.5	40.0	40.0	6.8	38.2	38.2	9.1	20.5	33.2	6.4	15.7	15.7
Actuated g/C Ratio	0.07	0.45	0.45	0.08	0.43	0.43	0.10	0.23	0.37	0.07	0.18	0.18
v/c Ratio	0.86	0.58	0.15	0.37	0.69	0.15	0.57	0.22	0.04	0.27	0.33	0.16
Control Delay	94.9	22.8	7.4	47.9	24.7	6.3	48.0	29.4	2.0	46.6	33.2	2.2
Queue Delay	0.0	0.0	0.0	0.0	0.0	0.0	0.0	0.0	0.0	0.0	0.0	0.0
Total Delay	94.9	22.8	7.4	47.9	24.7	6.3	48.0	29.4	2.0	46.6	33.2	2.2
LOS	F	C	A	D	C	A	D	C	A	D	C	A
Approach Delay		26.9			24.9			35.3			30.2	
Approach LOS		C			C			D			C	

Intersection Summary

Cycle Length: 120
 Actuated Cycle Length: 89.7
 Natural Cycle: 115
 Control Type: Actuated-Uncoordinated
 Maximum v/c Ratio: 0.86
 Intersection Signal Delay: 27.2
 Intersection LOS: C
 Intersection Capacity Utilization 64.1%
 ICU Level of Service C
 Analysis Period (min) 15

Splits and Phases: 24: Sycamore Canyon Bl. & Alessandro Bl.

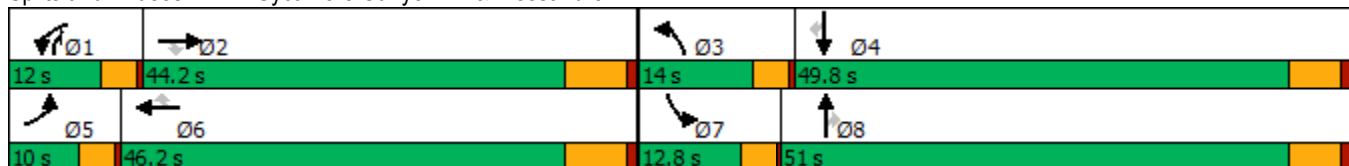

HCM 6th Signalized Intersection Summary
 24: Sycamore Canyon Bl. & Alessandro Bl.

West Campus Upper Plateau (JN 14064)

09/30/2022



Movement	EBL	EBT	EBR	WBL	WBT	WBR	NBL	NBT	NBR	SBL	SBT	SBR
Lane Configurations	↗	↑↑↑	↖	↗↖	↑↑↑	↖	↗↖	↑↑	↗↖	↗↖	↑↑	↖
Traffic Volume (veh/h)	106	1274	105	85	1430	95	188	169	42	62	189	56
Future Volume (veh/h)	106	1274	105	85	1430	95	188	169	42	62	189	56
Initial Q (Qb), veh	0	0	0	0	0	0	0	0	0	0	0	0
Ped-Bike Adj(A_pbT)	1.00		1.00	1.00		1.00	1.00		1.00	1.00		1.00
Parking Bus, Adj	1.00	1.00	1.00	1.00	1.00	1.00	1.00	1.00	1.00	1.00	1.00	1.00
Work Zone On Approach		No			No			No			No	
Adj Sat Flow, veh/h/ln	1900	1885	1885	1737	1885	1781	1870	1841	1841	1826	1826	1870
Adj Flow Rate, veh/h	112	1341	-86	89	1505	-35	198	178	1	65	199	-36
Peak Hour Factor	0.95	0.95	0.95	0.95	0.95	0.95	0.95	0.95	0.95	0.95	0.95	0.95
Percent Heavy Veh, %	0	1	1	11	1	8	2	4	4	5	5	2
Cap, veh/h	143	2368	735	182	2253	661	287	588	617	168	468	214
Arrive On Green	0.08	0.46	0.00	0.06	0.44	0.00	0.08	0.17	0.17	0.05	0.13	0.00
Sat Flow, veh/h	1810	5147	1598	3209	5147	1510	3456	3497	2745	3374	3469	1585
Grp Volume(v), veh/h	112	1341	-86	89	1505	-35	198	178	1	65	199	-36
Grp Sat Flow(s),veh/h/ln	1810	1716	1598	1605	1716	1510	1728	1749	1373	1687	1735	1585
Q Serve(g_s), s	4.5	14.1	0.0	2.0	17.2	0.0	4.1	3.3	0.0	1.4	3.9	0.0
Cycle Q Clear(g_c), s	4.5	14.1	0.0	2.0	17.2	0.0	4.1	3.3	0.0	1.4	3.9	0.0
Prop In Lane	1.00		1.00	1.00		1.00	1.00		1.00	1.00		1.00
Lane Grp Cap(c), veh/h	143	2368	735	182	2253	661	287	588	617	168	468	214
V/C Ratio(X)	0.78	0.57	-0.12	0.49	0.67	-0.05	0.69	0.30	0.00	0.39	0.43	-0.17
Avail Cap(c_a), veh/h	154	2615	812	359	2754	808	480	2131	1828	414	2058	940
HCM Platoon Ratio	1.00	1.00	1.00	1.00	1.00	1.00	1.00	1.00	1.00	1.00	1.00	1.00
Upstream Filter(I)	1.00	1.00	0.00	1.00	1.00	0.00	1.00	1.00	1.00	1.00	1.00	0.00
Uniform Delay (d), s/veh	33.5	14.6	0.0	34.0	16.6	0.0	33.1	27.1	22.3	34.2	29.5	0.0
Incr Delay (d2), s/veh	19.1	0.3	0.0	0.8	0.6	0.0	1.1	0.3	0.0	0.5	0.6	0.0
Initial Q Delay(d3),s/veh	0.0	0.0	0.0	0.0	0.0	0.0	0.0	0.0	0.0	0.0	0.0	0.0
%ile BackOfQ(50%),veh/ln	2.6	4.7	0.0	0.7	5.8	0.0	1.7	1.3	0.0	0.5	1.5	0.0
Unsig. Movement Delay, s/veh												
LnGrp Delay(d),s/veh	52.6	14.9	0.0	34.7	17.2	0.0	34.2	27.3	22.3	34.7	30.1	0.0
LnGrp LOS	D	B	A	C	B	A	C	C	C	C	C	A
Approach Vol, veh/h		1367			1559			377			228	
Approach Delay, s/veh		19.0			18.6			30.9			36.1	
Approach LOS		B			B			C			D	
Timer - Assigned Phs	1	2	3	4	5	6	7	8				
Phs Duration (G+Y+Rc), s	7.9	40.6	9.9	15.8	9.6	39.0	7.4	18.3				
Change Period (Y+Rc), s	3.7	6.5	3.7	5.8	3.7	6.5	3.7	5.8				
Max Green Setting (Gmax), s	8.3	37.7	10.3	44.0	6.3	39.7	9.1	45.2				
Max Q Clear Time (g_c+1), s	4.0	16.1	6.1	5.9	6.5	19.2	3.4	5.3				
Green Ext Time (p_c), s	0.0	12.3	0.1	1.2	0.0	13.2	0.0	1.1				
Intersection Summary												
HCM 6th Ctrl Delay			21.2									
HCM 6th LOS			C									

Timings
25: Sycamore Canyon Bl. & Cactus Av.

West Campus Upper Plateau (JN 14064)

09/30/2022



Lane Group	EBL	EBT	EBR	WBL	WBT	WBR	NBL	NBT	NBR	SBL	SBT	SBR
Lane Configurations	↘	↑↑	↗	↘↗	↑↑	↗	↘↗	↑↑	↗	↘↗	↑↑	↗
Traffic Volume (vph)	58	390	172	185	391	225	178	171	140	132	223	49
Future Volume (vph)	58	390	172	185	391	225	178	171	140	132	223	49
Turn Type	Prot	NA	Perm	Prot	NA	Perm	Prot	NA	Perm	Prot	NA	Perm
Protected Phases	7	4		3	8		5	2		1	6	
Permitted Phases			4			8			2			6
Detector Phase	7	4	4	3	8	8	5	2	2	1	6	6
Switch Phase												
Minimum Initial (s)	5.0	10.0	10.0	5.0	10.0	10.0	5.0	10.0	10.0	5.0	10.0	10.0
Minimum Split (s)	9.6	32.8	32.8	9.6	32.8	32.8	9.6	34.8	34.8	9.6	34.8	34.8
Total Split (s)	10.3	32.8	32.8	29.0	51.5	51.5	9.6	36.2	36.2	22.0	48.6	48.6
Total Split (%)	8.6%	27.3%	27.3%	24.2%	42.9%	42.9%	8.0%	30.2%	30.2%	18.3%	40.5%	40.5%
Yellow Time (s)	3.6	4.8	4.8	3.6	4.8	4.8	3.6	4.8	4.8	3.6	4.8	4.8
All-Red Time (s)	1.0	1.0	1.0	1.0	1.0	1.0	1.0	1.0	1.0	1.0	1.0	1.0
Lost Time Adjust (s)	0.0	0.0	0.0	0.0	0.0	0.0	0.0	0.0	0.0	0.0	0.0	0.0
Total Lost Time (s)	4.6	5.8	5.8	4.6	5.8	5.8	4.6	5.8	5.8	4.6	5.8	5.8
Lead/Lag	Lead	Lag	Lag	Lead	Lag	Lag	Lead	Lag	Lag	Lead	Lag	Lag
Lead-Lag Optimize?	Yes	Yes	Yes	Yes	Yes	Yes	Yes	Yes	Yes	Yes	Yes	Yes
Recall Mode	None	None	None	None	None	None	None	None	None	None	None	None
Act Effct Green (s)	6.0	15.5	15.5	8.8	20.9	20.9	5.3	13.1	13.1	7.6	15.4	15.4
Actuated g/C Ratio	0.09	0.23	0.23	0.13	0.31	0.31	0.08	0.20	0.20	0.11	0.23	0.23
v/c Ratio	0.40	0.56	0.36	0.44	0.39	0.36	0.67	0.27	0.33	0.35	0.30	0.15
Control Delay	43.6	26.9	5.9	32.9	20.6	4.9	47.8	25.2	3.7	33.6	22.7	0.9
Queue Delay	0.0	0.0	0.0	0.0	0.0	0.0	0.0	0.0	0.0	0.0	0.0	0.0
Total Delay	43.6	26.9	5.9	32.9	20.6	4.9	47.8	25.2	3.7	33.6	22.7	0.9
LOS	D	C	A	C	C	A	D	C	A	C	C	A
Approach Delay		22.6			19.0			27.2			23.6	
Approach LOS		C			B			C			C	

Intersection Summary

Cycle Length: 120
 Actuated Cycle Length: 66.9
 Natural Cycle: 90
 Control Type: Actuated-Uncoordinated
 Maximum v/c Ratio: 0.67
 Intersection Signal Delay: 22.5
 Intersection LOS: C
 Intersection Capacity Utilization 46.8%
 ICU Level of Service A
 Analysis Period (min) 15



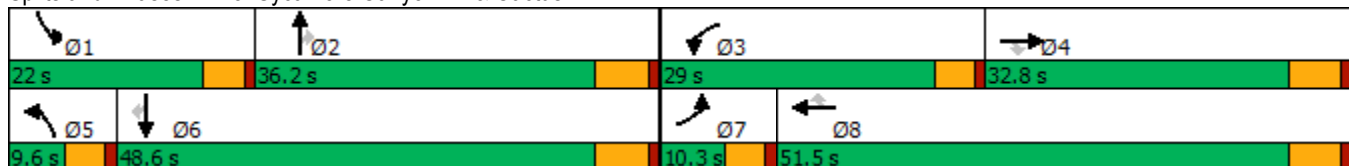





















Splits and Phases: 25: Sycamore Canyon Bl. & Cactus Av.



HCM 6th Signalized Intersection Summary
 25: Sycamore Canyon Bl. & Cactus Av.

West Campus Upper Plateau (JN 14064)

09/30/2022

												
Movement	EBL	EBT	EBR	WBL	WBT	WBR	NBL	NBT	NBR	SBL	SBT	SBR
Lane Configurations												
Traffic Volume (veh/h)	58	390	172	185	391	225	178	171	140	132	223	49
Future Volume (veh/h)	58	390	172	185	391	225	178	171	140	132	223	49
Initial Q (Qb), veh	0	0	0	0	0	0	0	0	0	0	0	0
Ped-Bike Adj(A_pbT)	1.00		1.00	1.00		1.00	1.00		1.00	1.00		1.00
Parking Bus, Adj	1.00	1.00	1.00	1.00	1.00	1.00	1.00	1.00	1.00	1.00	1.00	1.00
Work Zone On Approach		No			No			No			No	
Adj Sat Flow, veh/h/ln	1811	1678	1796	1826	1796	1870	1900	1811	1781	1885	1796	1011
Adj Flow Rate, veh/h	60	406	170	193	407	-8	185	178	53	138	232	51
Peak Hour Factor	0.96	0.96	0.96	0.96	0.96	0.96	0.96	0.96	0.96	0.96	0.96	0.96
Percent Heavy Veh, %	6	15	7	5	7	2	0	6	8	1	7	60
Cap, veh/h	97	676	323	315	851	395	319	698	306	293	669	168
Arrive On Green	0.06	0.21	0.21	0.09	0.25	0.00	0.09	0.20	0.20	0.08	0.20	0.20
Sat Flow, veh/h	1725	3188	1522	3374	3413	1585	3510	3441	1510	3483	3413	857
Grp Volume(v), veh/h	60	406	170	193	407	-8	185	178	53	138	232	51
Grp Sat Flow(s),veh/h/ln	1725	1594	1522	1687	1706	1585	1755	1721	1510	1742	1706	857
Q Serve(g_s), s	1.7	5.9	5.1	2.8	5.2	0.0	2.6	2.2	1.5	1.9	3.0	2.6
Cycle Q Clear(g_c), s	1.7	5.9	5.1	2.8	5.2	0.0	2.6	2.2	1.5	1.9	3.0	2.6
Prop In Lane	1.00		1.00	1.00		1.00	1.00		1.00	1.00		1.00
Lane Grp Cap(c), veh/h	97	676	323	315	851	395	319	698	306	293	669	168
V/C Ratio(X)	0.62	0.60	0.53	0.61	0.48	-0.02	0.58	0.26	0.17	0.47	0.35	0.30
Avail Cap(c_a), veh/h	193	1687	806	1613	3057	1420	344	2050	899	1188	2863	719
HCM Platoon Ratio	1.00	1.00	1.00	1.00	1.00	1.00	1.00	1.00	1.00	1.00	1.00	1.00
Upstream Filter(I)	1.00	1.00	1.00	1.00	1.00	0.00	1.00	1.00	1.00	1.00	1.00	1.00
Uniform Delay (d), s/veh	23.5	18.2	17.8	22.2	16.3	0.0	22.3	17.1	16.8	22.3	17.7	17.5
Incr Delay (d2), s/veh	2.4	0.9	1.3	0.7	0.4	0.0	1.2	0.2	0.3	0.4	0.3	1.0
Initial Q Delay(d3),s/veh	0.0	0.0	0.0	0.0	0.0	0.0	0.0	0.0	0.0	0.0	0.0	0.0
%ile BackOfQ(50%),veh/ln	0.7	1.9	1.6	1.0	1.7	0.0	1.0	0.7	0.4	0.7	1.0	0.5
Unsig. Movement Delay, s/veh												
LnGrp Delay(d),s/veh	25.9	19.0	19.2	23.0	16.7	0.0	23.4	17.3	17.1	22.7	18.0	18.5
LnGrp LOS	C	B	B	C	B	A	C	B	B	C	B	B
Approach Vol, veh/h		636			592			416			421	
Approach Delay, s/veh		19.7			19.0			20.0			19.6	
Approach LOS		B			B			B			B	
Timer - Assigned Phs	1	2	3	4	5	6	7	8				
Phs Duration (G+Y+Rc), s	8.9	16.1	9.4	16.6	9.2	15.8	7.5	18.5				
Change Period (Y+Rc), s	4.6	5.8	4.6	5.8	4.6	5.8	4.6	5.8				
Max Green Setting (Gmax), s	17.4	30.4	24.4	27.0	5.0	42.8	5.7	45.7				
Max Q Clear Time (g_c+I1), s	3.9	4.2	4.8	7.9	4.6	5.0	3.7	7.2				
Green Ext Time (p_c), s	0.2	1.1	0.3	2.9	0.0	1.6	0.0	2.6				
Intersection Summary												
HCM 6th Ctrl Delay				19.5								
HCM 6th LOS				B								

Timings

26: Sycamore Canyon Bl. & Van Buren Bl.

09/30/2022



Lane Group	EBL	EBT	EBR	WBL	WBT	WBR	NBL	NBT	SBL	SBT	SBR
Lane Configurations											
Traffic Volume (vph)	299	975	7	38	1060	72	8	7	99	10	503
Future Volume (vph)	299	975	7	38	1060	72	8	7	99	10	503
Turn Type	Prot	NA	Perm	Prot	NA	Perm	Perm	NA	Split	NA	Perm
Protected Phases	5	2		1	6			8	4	4	
Permitted Phases			2			6	8				4
Detector Phase	5	2	2	1	6	6	8	8	4	4	4
Switch Phase											
Minimum Initial (s)	5.0	10.0	10.0	5.0	10.0	10.0	10.0	10.0	10.0	10.0	10.0
Minimum Split (s)	9.6	29.2	29.2	9.6	29.2	29.2	14.6	14.6	50.8	50.8	50.8
Total Split (s)	22.0	47.8	47.8	9.6	35.4	35.4	14.6	14.6	58.0	58.0	58.0
Total Split (%)	16.9%	36.8%	36.8%	7.4%	27.2%	27.2%	11.2%	11.2%	44.6%	44.6%	44.6%
Yellow Time (s)	3.6	5.2	5.2	3.6	5.2	5.2	3.6	3.6	4.8	4.8	4.8
All-Red Time (s)	1.0	1.0	1.0	1.0	1.0	1.0	1.0	1.0	1.0	1.0	1.0
Lost Time Adjust (s)	0.0	0.0	0.0	0.0	0.0	0.0		0.0	0.0	0.0	0.0
Total Lost Time (s)	4.6	6.2	6.2	4.6	6.2	6.2		4.6	5.8	5.8	5.8
Lead/Lag	Lead	Lag	Lag	Lead	Lag	Lag					
Lead-Lag Optimize?	Yes	Yes	Yes	Yes	Yes	Yes					
Recall Mode	None	None	None	None	None	None	None	None	None	None	None
Act Effct Green (s)	12.6	36.6	36.6	5.6	23.6	23.6		11.2	17.6	17.6	17.6
Actuated g/C Ratio	0.16	0.46	0.46	0.07	0.30	0.30		0.14	0.22	0.22	0.22
v/c Ratio	0.60	0.36	0.01	0.36	0.62	0.14		0.09	0.14	0.03	0.76
Control Delay	41.2	18.5	0.0	56.1	28.7	0.5		26.4	27.7	27.5	13.6
Queue Delay	0.0	0.0	0.0	0.0	0.0	0.0		0.0	0.0	0.0	0.0
Total Delay	41.2	18.5	0.0	56.1	28.7	0.5		26.4	27.7	27.5	13.6
LOS	D	B	A	E	C	A		C	C	C	B
Approach Delay		23.7			27.8			26.4		16.1	
Approach LOS		C			C			C		B	

Intersection Summary

Cycle Length: 130	
Actuated Cycle Length: 79.8	
Natural Cycle: 105	
Control Type: Actuated-Uncoordinated	
Maximum v/c Ratio: 0.76	
Intersection Signal Delay: 23.8	Intersection LOS: C
Intersection Capacity Utilization 68.7%	ICU Level of Service C
Analysis Period (min) 15	

Splits and Phases: 26: Sycamore Canyon Bl. & Van Buren Bl.

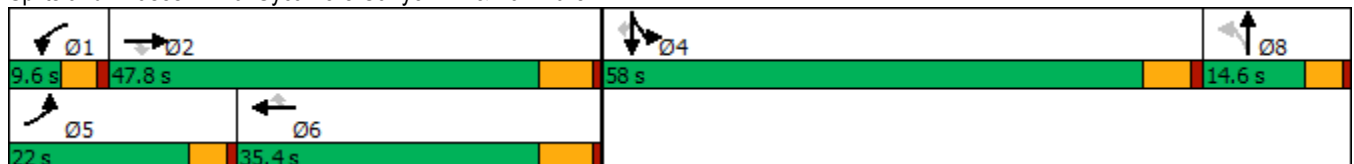

HCM 6th Signalized Intersection Summary
 26: Sycamore Canyon Bl. & Van Buren Bl.

West Campus Upper Plateau (JN 14064)

09/30/2022



Movement	EBL	EBT	EBR	WBL	WBT	WBR	NBL	NBT	NBR	SBL	SBT	SBR
Lane Configurations	↔↔	↑↑↑	↗	↖	↑↑↑	↗		↔↔		↖↖	↑	↗
Traffic Volume (veh/h)	299	975	7	38	1060	72	8	7	21	99	10	503
Future Volume (veh/h)	299	975	7	38	1060	72	8	7	21	99	10	503
Initial Q (Qb), veh	0	0	0	0	0	0	0	0	0	0	0	0
Ped-Bike Adj(A_pbT)	1.00		1.00	1.00		0.99	1.00		1.00	1.00		1.00
Parking Bus, Adj	1.00	1.00	1.00	1.00	1.00	1.00	1.00	1.00	1.00	1.00	1.00	1.00
Work Zone On Approach		No			No			No			No	
Adj Sat Flow, veh/h/ln	1811	1826	1900	1693	1796	1870	1900	1900	1900	1841	1900	1841
Adj Flow Rate, veh/h	315	1026	7	40	1116	54	8	7	-7	104	11	0
Peak Hour Factor	0.95	0.95	0.95	0.95	0.95	0.95	0.95	0.95	0.95	0.95	0.95	0.95
Percent Heavy Veh, %	6	5	0	14	7	2	0	0	0	4	0	4
Cap, veh/h	444	2566	658	67	1961	497	139	587	0	507	283	
Arrive On Green	0.13	0.41	0.41	0.04	0.32	0.32	0.02	0.02	0.00	0.15	0.15	0.00
Sat Flow, veh/h	3346	6281	1610	1612	6179	1565	1801	1909	0	3401	1900	1560
Grp Volume(v), veh/h	315	1026	7	40	1116	54	8	0	0	104	11	0
Grp Sat Flow(s),veh/h/ln	1673	1570	1610	1612	1545	1565	1810	1805	0	1700	1900	1560
Q Serve(g_s), s	5.0	6.4	0.1	1.4	8.4	1.4	0.0	0.0	0.0	1.5	0.3	0.0
Cycle Q Clear(g_c), s	5.0	6.4	0.1	1.4	8.4	1.4	0.0	0.0	0.0	1.5	0.3	0.0
Prop In Lane	1.00		1.00	1.00		1.00	0.99		0.00	1.00		1.00
Lane Grp Cap(c), veh/h	444	2566	658	67	1961	497	0	0	0	507	283	
V/C Ratio(X)	0.71	0.40	0.01	0.60	0.57	0.11	0.00	0.00	0.00	0.21	0.04	
Avail Cap(c_a), veh/h	1044	4684	1201	144	3234	819	0	0	0	3182	1778	
HCM Platoon Ratio	1.00	1.00	1.00	1.00	1.00	1.00	1.00	1.00	1.00	1.00	1.00	1.00
Upstream Filter(I)	1.00	1.00	1.00	1.00	1.00	1.00	1.00	0.00	0.00	1.00	1.00	0.00
Uniform Delay (d), s/veh	23.2	11.7	9.8	26.3	15.9	13.5	0.0	0.0	0.0	20.8	20.3	0.0
Incr Delay (d2), s/veh	0.8	0.1	0.0	3.2	0.3	0.1	0.0	0.0	0.0	0.2	0.1	0.0
Initial Q Delay(d3),s/veh	0.0	0.0	0.0	0.0	0.0	0.0	0.0	0.0	0.0	0.0	0.0	0.0
%ile BackOfQ(50%),veh/ln	1.8	1.7	0.0	0.5	2.4	0.4	0.0	0.0	0.0	0.5	0.1	0.0
Unsig. Movement Delay, s/veh												
LnGrp Delay(d),s/veh	24.0	11.8	9.8	29.5	16.1	13.6	0.0	0.0	0.0	21.0	20.4	0.0
LnGrp LOS	C	B	A	C	B	B	A	A	A	C	C	
Approach Vol, veh/h		1348			1210			8			115	
Approach Delay, s/veh		14.6			16.5			0.0			21.0	
Approach LOS		B			B			A			C	
Timer - Assigned Phs	1	2		4	5	6		8				
Phs Duration (G+Y+Rc), s	6.9	29.0		14.1	12.0	23.9		5.8				
Change Period (Y+Rc), s	4.6	6.2		5.8	4.6	6.2		4.6				
Max Green Setting (Gmax), s	5.0	41.6		52.2	17.4	29.2		10.0				
Max Q Clear Time (g_c+1), s	3.4	8.4		3.5	7.0	10.4		2.0				
Green Ext Time (p_c), s	0.0	7.8		0.4	0.4	7.3		0.0				

Intersection Summary

HCM 6th Ctrl Delay	15.7
HCM 6th LOS	B

Notes

Unsignalized Delay for [SBR] is excluded from calculations of the approach delay and intersection delay.

Timings
27: Innovation Dr. & Cactus Av.

West Campus Upper Plateau (JN 14064)

09/30/2022

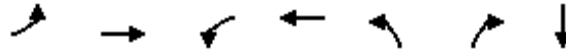

Lane Group	EBL	EBT	WBL	WBT	NBL	NBR	SBT
Lane Configurations	↖	↕↕↕	↖	↕↕↕	↖	↗	↘
Traffic Volume (vph)	1	661	25	801	1	24	0
Future Volume (vph)	1	661	25	801	1	24	0
Turn Type	Prot	NA	Prot	NA	Perm	Perm	NA
Protected Phases	5	2	1	6			4
Permitted Phases					8	8	
Detector Phase	5	2	1	6	8	8	4
Switch Phase							
Minimum Initial (s)	5.0	10.0	5.0	10.0	10.0	10.0	10.0
Minimum Split (s)	9.2	26.8	9.2	26.8	31.1	31.1	31.1
Total Split (s)	12.0	63.0	22.0	73.0	35.0	35.0	35.0
Total Split (%)	10.0%	52.5%	18.3%	60.8%	29.2%	29.2%	29.2%
Yellow Time (s)	3.2	4.8	3.2	4.8	4.1	4.1	4.1
All-Red Time (s)	1.0	1.0	1.0	1.0	1.0	1.0	1.0
Lost Time Adjust (s)	0.0	0.0	0.0	0.0	0.0	0.0	0.0
Total Lost Time (s)	4.2	5.8	4.2	5.8	5.1	5.1	5.1
Lead/Lag	Lead	Lag	Lead	Lag			
Lead-Lag Optimize?	Yes	Yes	Yes	Yes			
Recall Mode	None	None	None	None	None	None	None
Act Effct Green (s)	6.9	25.3	7.4	25.5	15.3	15.3	15.3
Actuated g/C Ratio	0.21	0.76	0.22	0.77	0.46	0.46	0.46
v/c Ratio	0.00	0.20	0.08	0.24	0.00	0.03	0.00
Control Delay	24.0	7.3	21.2	6.9	13.0	0.1	0.0
Queue Delay	0.0	0.0	0.0	0.0	0.0	0.0	0.0
Total Delay	24.0	7.3	21.2	6.9	13.0	0.1	0.0
LOS	C	A	C	A	B	A	A
Approach Delay		7.3		7.3			
Approach LOS		A		A			

Intersection Summary

Cycle Length: 120	
Actuated Cycle Length: 33.3	
Natural Cycle: 70	
Control Type: Actuated-Uncoordinated	
Maximum v/c Ratio: 0.24	
Intersection Signal Delay: 7.2	Intersection LOS: A
Intersection Capacity Utilization 38.2%	ICU Level of Service A
Analysis Period (min) 15	

Splits and Phases: 27: Innovation Dr. & Cactus Av.



HCM 6th Signalized Intersection Summary
27: Innovation Dr. & Cactus Av.

West Campus Upper Plateau (JN 14064)

09/30/2022



Movement	EBL	EBT	EBR	WBL	WBT	WBR	NBL	NBT	NBR	SBL	SBT	SBR
Lane Configurations	↗	↑↑↑		↗	↑↑↑		↗	↑	↗	↗	↗	↗
Traffic Volume (veh/h)	1	661	1	25	801	5	1	0	24	0	0	1
Future Volume (veh/h)	1	661	1	25	801	5	1	0	24	0	0	1
Initial Q (Qb), veh	0	0	0	0	0	0	0	0	0	0	0	0
Ped-Bike Adj(A_pbT)	1.00		1.00	1.00		0.98	1.00		1.00	1.00		1.00
Parking Bus, Adj	1.00	1.00	1.00	1.00	1.00	1.00	1.00	1.00	1.00	1.00	1.00	1.00
Work Zone On Approach		No			No			No			No	
Adj Sat Flow, veh/h/ln	1900	1826	1307	1663	1841	1900	1841	1900	1781	1900	1900	1781
Adj Flow Rate, veh/h	1	751	1	28	910	6	1	0	-26	0	0	-8
Peak Hour Factor	0.88	0.88	0.88	0.88	0.88	0.88	0.88	0.88	0.88	0.88	0.88	0.88
Percent Heavy Veh, %	0	5	40	16	4	0	4	0	8	0	0	8
Cap, veh/h	7	2625	3	56	2803	18	266	7	6	266	0	401
Arrive On Green	0.00	0.51	0.51	0.04	0.54	0.54	0.00	0.00	0.00	0.00	0.00	0.00
Sat Flow, veh/h	1810	5141	7	1584	5150	34	1753	1900	1510	1810	1900	0
Grp Volume(v), veh/h	1	485	267	28	592	324	1	0	-26	0	-8	-8
Grp Sat Flow(s),veh/h/ln	1810	1662	1825	1584	1675	1834	1753	1900	1510	1810	1900	1610
Q Serve(g_s), s	0.0	2.3	2.3	0.5	2.6	2.6	0.0	0.0	0.0	0.0	0.0	0.0
Cycle Q Clear(g_c), s	0.0	2.3	2.3	0.5	2.6	2.6	0.1	0.0	0.0	0.0	0.0	0.0
Prop In Lane	1.00		0.00	1.00		0.02	1.00		1.00	1.00		0.00
Lane Grp Cap(c), veh/h	7	1696	932	56	1823	998	266	7	6	266	0	0
V/C Ratio(X)	0.15	0.29	0.29	0.50	0.32	0.32	0.00	0.00	-4.66	0.00	0.00	0.00
Avail Cap(c_a), veh/h	522	7030	3860	1043	8326	4557	2387	2101	1669	2455	0	0
HCM Platoon Ratio	1.00	1.00	1.00	1.00	1.00	1.00	1.00	1.00	1.00	1.00	1.00	1.00
Upstream Filter(I)	1.00	1.00	1.00	1.00	1.00	1.00	1.00	0.00	0.00	0.00	0.00	0.00
Uniform Delay (d), s/veh	13.5	3.8	3.8	12.8	3.4	3.4	13.6	0.0	0.0	0.0	0.0	0.0
Incr Delay (d2), s/veh	3.8	0.1	0.2	2.6	0.1	0.3	0.0	0.0	0.0	0.0	0.0	0.0
Initial Q Delay(d3),s/veh	0.0	0.0	0.0	0.0	0.0	0.0	0.0	0.0	0.0	0.0	0.0	0.0
%ile BackOfQ(50%),veh/ln	0.0	0.1	0.1	0.1	0.0	0.1	0.0	0.0	0.0	0.0	0.0	0.0
Unsig. Movement Delay, s/veh												
LnGrp Delay(d),s/veh	17.2	3.9	4.0	15.4	3.6	3.7	13.6	0.0	0.0	0.0	0.0	0.0
LnGrp LOS	B	A	A	B	A	A	B	A	A	A	A	A
Approach Vol, veh/h		753			944			-25				-16
Approach Delay, s/veh		4.0			4.0			0.0				0.0
Approach LOS		A			A			A				A
Timer - Assigned Phs	1	2		4	5	6		8				
Phs Duration (G+Y+Rc), s	5.1	19.6		2.3	4.2	20.5		2.3				
Change Period (Y+Rc), s	* 4.2	5.8		5.1	* 4.2	5.8		5.1				
Max Green Setting (Gmax), s	* 18	57.2		29.9	* 7.8	67.2		29.9				
Max Q Clear Time (g_c+I1), s	2.5	4.3		0.0	2.0	4.6		2.1				
Green Ext Time (p_c), s	0.0	7.6		0.0	0.0	10.1		0.0				

Intersection Summary

HCM 6th Ctrl Delay	4.1
HCM 6th LOS	A

Notes

* HCM 6th computational engine requires equal clearance times for the phases crossing the barrier.

Timings
28: I-215 SB Ramps & Alessandro Bl.

West Campus Upper Plateau (JN 14064)

09/30/2022

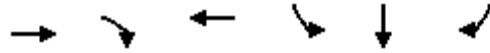

Lane Group	EBT	EBR	WBT	SBL	SBT	SBR
Lane Configurations	↑↑↑	↑	↑↑↑	↑	↔	↑
Traffic Volume (vph)	945	425	1228	144	0	334
Future Volume (vph)	945	425	1228	144	0	334
Turn Type	NA	Perm	NA	Split	NA	Perm
Protected Phases	2		6	4	4	
Permitted Phases		2				4
Detector Phase	2	2	6	4	4	4
Switch Phase						
Minimum Initial (s)	5.0	5.0	5.0	5.0	5.0	5.0
Minimum Split (s)	10.5	10.5	34.5	10.0	10.0	10.0
Total Split (s)	52.0	52.0	52.0	33.0	33.0	33.0
Total Split (%)	61.2%	61.2%	61.2%	38.8%	38.8%	38.8%
Yellow Time (s)	4.5	4.5	4.5	4.0	4.0	4.0
All-Red Time (s)	1.0	1.0	1.0	1.0	1.0	1.0
Lost Time Adjust (s)	0.0	0.0	0.0	0.0	0.0	0.0
Total Lost Time (s)	5.5	5.5	5.5	5.0	5.0	5.0
Lead/Lag						
Lead-Lag Optimize?						
Recall Mode	Min	Min	Min	None	None	None
Act Effct Green (s)	22.5	22.5	22.5	11.0	11.0	11.0
Actuated g/C Ratio	0.51	0.51	0.51	0.25	0.25	0.25
v/c Ratio	0.38	0.46	0.56	0.35	0.49	0.48
Control Delay	7.5	3.7	8.7	17.7	16.8	16.3
Queue Delay	0.0	0.0	0.0	0.0	0.0	0.0
Total Delay	7.5	3.7	8.7	17.7	16.8	16.3
LOS	A	A	A	B	B	B
Approach Delay	6.4		8.7		16.8	
Approach LOS	A		A		B	

Intersection Summary

Cycle Length: 85	
Actuated Cycle Length: 44.5	
Natural Cycle: 50	
Control Type: Actuated-Uncoordinated	
Maximum v/c Ratio: 0.56	
Intersection Signal Delay: 8.9	Intersection LOS: A
Intersection Capacity Utilization 49.1%	ICU Level of Service A
Analysis Period (min) 15	

Splits and Phases: 28: I-215 SB Ramps & Alessandro Bl.

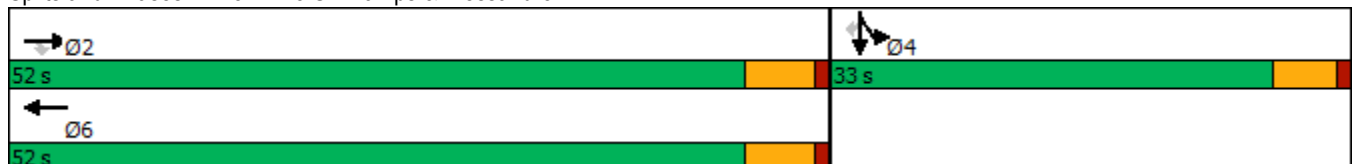

HCM 6th Signalized Intersection Summary
 28: I-215 SB Ramps & Alessandro Bl.

West Campus Upper Plateau (JN 14064)

09/30/2022



Movement	EBL	EBT	EBR	WBL	WBT	WBR	NBL	NBT	NBR	SBL	SBT	SBR
Lane Configurations		↑↑↑	↗		↑↑↑					↘	↔	↗
Traffic Volume (veh/h)	0	945	425	0	1228	128	0	0	0	144	0	334
Future Volume (veh/h)	0	945	425	0	1228	128	0	0	0	144	0	334
Initial Q (Qb), veh	0	0	0	0	0	0				0	0	0
Ped-Bike Adj(A_pbT)	1.00		1.00	1.00		0.98				1.00		1.00
Parking Bus, Adj	1.00	1.00	1.00	1.00	1.00	1.00				1.00	1.00	1.00
Work Zone On Approach		No			No						No	
Adj Sat Flow, veh/h/ln	0	1870	1870	0	1870	1781				1737	1900	1752
Adj Flow Rate, veh/h	0	984	443	0	1279	125				100	0	356
Peak Hour Factor	0.96	0.96	0.96	0.96	0.96	0.96				0.96	0.96	0.96
Percent Heavy Veh, %	0	2	2	0	2	8				11	0	10
Cap, veh/h	0	2634	818	0	2435	238				337	0	605
Arrive On Green	0.00	0.52	0.52	0.00	0.52	0.52				0.20	0.00	0.20
Sat Flow, veh/h	0	5274	1585	0	4887	461				1654	0	2969
Grp Volume(v), veh/h	0	984	443	0	923	481				100	0	356
Grp Sat Flow(s),veh/h/ln	0	1702	1585	0	1702	1776				1654	0	1485
Q Serve(g_s), s	0.0	4.3	7.0	0.0	6.7	6.7				1.9	0.0	4.1
Cycle Q Clear(g_c), s	0.0	4.3	7.0	0.0	6.7	6.7				1.9	0.0	4.1
Prop In Lane	0.00		1.00	0.00		0.26				1.00		1.00
Lane Grp Cap(c), veh/h	0	2634	818	0	1756	916				337	0	605
V/C Ratio(X)	0.00	0.37	0.54	0.00	0.53	0.53				0.30	0.00	0.59
Avail Cap(c_a), veh/h	0	6342	1969	0	4228	2206				1237	0	2220
HCM Platoon Ratio	1.00	1.00	1.00	1.00	1.00	1.00				1.00	1.00	1.00
Upstream Filter(I)	0.00	1.00	1.00	0.00	1.00	1.00				1.00	0.00	1.00
Uniform Delay (d), s/veh	0.0	5.4	6.1	0.0	6.0	6.0				12.6	0.0	13.5
Incr Delay (d2), s/veh	0.0	0.1	0.6	0.0	0.2	0.5				0.5	0.0	0.9
Initial Q Delay(d3),s/veh	0.0	0.0	0.0	0.0	0.0	0.0				0.0	0.0	0.0
%ile BackOfQ(50%),veh/ln	0.0	0.4	0.8	0.0	0.7	0.8				0.5	0.0	1.0
Unsig. Movement Delay, s/veh												
LnGrp Delay(d),s/veh	0.0	5.5	6.6	0.0	6.3	6.5				13.1	0.0	14.4
LnGrp LOS	A	A	A	A	A	A				B	A	B
Approach Vol, veh/h		1427			1404							456
Approach Delay, s/veh		5.9			6.3							14.1
Approach LOS		A			A							B
Timer - Assigned Phs		2		4		6						
Phs Duration (G+Y+Rc), s		24.8		12.6		24.8						
Change Period (Y+Rc), s		5.5		5.0		5.5						
Max Green Setting (Gmax), s		46.5		28.0		46.5						
Max Q Clear Time (g_c+I1), s		9.0		6.1		8.7						
Green Ext Time (p_c), s		9.3		1.6		10.6						
Intersection Summary												
HCM 6th Ctrl Delay			7.2									
HCM 6th LOS			A									
Notes												
User approved volume balancing among the lanes for turning movement.												

Timings
29: I-215 NB Ramps & Alessandro Bl.

West Campus Upper Plateau (JN 14064)

09/30/2022



Lane Group	EBL	EBT	WBT	WBR	NBL	NBT	NBR
Lane Configurations	↘	↑↑↑	↑↑↑	↗	↘	↕	↗
Traffic Volume (vph)	233	862	1000	157	566	10	255
Future Volume (vph)	233	862	1000	157	566	10	255
Turn Type	Prot	NA	NA	Perm	Split	NA	Perm
Protected Phases	5	2	6		8	8	
Permitted Phases				6			8
Detector Phase	5	2	6	6	8	8	8
Switch Phase							
Minimum Initial (s)	5.0	5.0	5.0	5.0	5.0	5.0	5.0
Minimum Split (s)	9.5	10.5	33.5	33.5	10.0	10.0	10.0
Total Split (s)	13.0	48.0	35.0	35.0	37.0	37.0	37.0
Total Split (%)	15.3%	56.5%	41.2%	41.2%	43.5%	43.5%	43.5%
Yellow Time (s)	3.5	4.5	4.5	4.5	4.0	4.0	4.0
All-Red Time (s)	1.0	1.0	1.0	1.0	1.0	1.0	1.0
Lost Time Adjust (s)	0.0	0.0	0.0	0.0	0.0	0.0	0.0
Total Lost Time (s)	4.5	5.5	5.5	5.5	5.0	5.0	5.0
Lead/Lag	Lead		Lag	Lag			
Lead-Lag Optimize?	Yes		Yes	Yes			
Recall Mode	None	Min	Min	Min	Max	Max	Max
Act Effct Green (s)	8.5	36.9	23.8	23.8	32.1	32.1	32.1
Actuated g/C Ratio	0.11	0.46	0.30	0.30	0.40	0.40	0.40
v/c Ratio	1.36	0.38	0.68	0.34	0.46	0.48	0.35
Control Delay	223.9	14.2	26.7	12.8	21.1	21.2	11.6
Queue Delay	0.0	0.0	0.0	0.0	0.0	0.0	0.0
Total Delay	223.9	14.2	26.7	12.8	21.1	21.2	11.6
LOS	F	B	C	B	C	C	B
Approach Delay		58.8	24.8			18.5	
Approach LOS		E	C			B	

Intersection Summary

Cycle Length: 85
 Actuated Cycle Length: 79.5
 Natural Cycle: 70
 Control Type: Actuated-Uncoordinated
 Maximum v/c Ratio: 1.36
 Intersection Signal Delay: 35.2
 Intersection LOS: D
 Intersection Capacity Utilization 63.3%
 ICU Level of Service B
 Analysis Period (min) 15

Splits and Phases: 29: I-215 NB Ramps & Alessandro Bl.

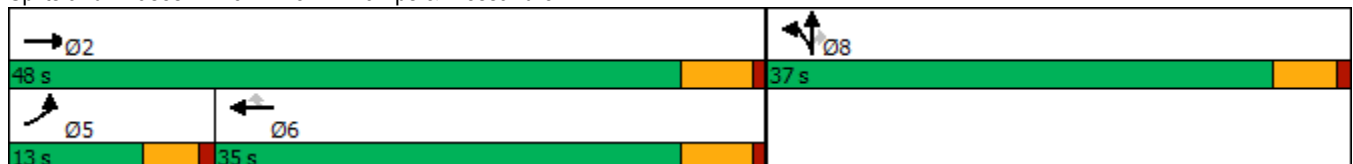

HCM 6th Signalized Intersection Summary
 29: I-215 NB Ramps & Alessandro Bl.

West Campus Upper Plateau (JN 14064)

09/30/2022



Movement	EBL	EBT	EBR	WBL	WBT	WBR	NBL	NBT	NBR	SBL	SBT	SBR
Lane Configurations	↘	↑↑↑			↑↑↑	↗	↘	↕	↗			
Traffic Volume (veh/h)	233	862	0	0	1000	157	566	10	255	0	0	0
Future Volume (veh/h)	233	862	0	0	1000	157	566	10	255	0	0	0
Initial Q (Qb), veh	0	0	0	0	0	0	0	0	0			
Ped-Bike Adj(A_pbT)	1.00		1.00	1.00		0.98	1.00		1.00			
Parking Bus, Adj	1.00	1.00	1.00	1.00	1.00	1.00	1.00	1.00	1.00			
Work Zone On Approach		No			No			No				
Adj Sat Flow, veh/h/ln	1767	1870	0	0	1870	1707	1856	1900	1870			
Adj Flow Rate, veh/h	240	889	0	0	1031	136	644	0	123			
Peak Hour Factor	0.97	0.97	0.97	0.97	0.97	0.97	0.97	0.97	0.97			
Percent Heavy Veh, %	9	2	0	0	2	13	3	0	2			
Cap, veh/h	185	2293	0	0	1432	397	1466	0	658			
Arrive On Green	0.11	0.45	0.00	0.00	0.28	0.28	0.41	0.00	0.41			
Sat Flow, veh/h	1682	5274	0	0	5274	1416	3534	0	1585			
Grp Volume(v), veh/h	240	889	0	0	1031	136	644	0	123			
Grp Sat Flow(s),veh/h/ln	1682	1702	0	0	1702	1416	1767	0	1585			
Q Serve(g_s), s	8.5	9.0	0.0	0.0	14.0	5.9	10.1	0.0	3.8			
Cycle Q Clear(g_c), s	8.5	9.0	0.0	0.0	14.0	5.9	10.1	0.0	3.8			
Prop In Lane	1.00		0.00	0.00		1.00	1.00		1.00			
Lane Grp Cap(c), veh/h	185	2293	0	0	1432	397	1466	0	658			
V/C Ratio(X)	1.29	0.39	0.00	0.00	0.72	0.34	0.44	0.00	0.19			
Avail Cap(c_a), veh/h	185	2813	0	0	1953	542	1466	0	658			
HCM Platoon Ratio	1.00	1.00	1.00	1.00	1.00	1.00	1.00	1.00	1.00			
Upstream Filter(I)	1.00	1.00	0.00	0.00	1.00	1.00	1.00	0.00	1.00			
Uniform Delay (d), s/veh	34.3	14.2	0.0	0.0	25.0	22.1	16.1	0.0	14.3			
Incr Delay (d2), s/veh	166.5	0.1	0.0	0.0	0.8	0.5	1.0	0.0	0.6			
Initial Q Delay(d3),s/veh	0.0	0.0	0.0	0.0	0.0	0.0	0.0	0.0	0.0			
%ile BackOfQ(50%),veh/ln	11.7	2.8	0.0	0.0	5.0	1.8	3.8	0.0	1.3			
Unsig. Movement Delay, s/veh												
LnGrp Delay(d),s/veh	200.8	14.3	0.0	0.0	25.9	22.6	17.1	0.0	14.9			
LnGrp LOS	F	B	A	A	C	C	B	A	B			
Approach Vol, veh/h		1129			1167			767				
Approach Delay, s/veh		53.9			25.5			16.8				
Approach LOS		D			C			B				
Timer - Assigned Phs		2			5	6		8				
Phs Duration (G+Y+Rc), s		40.1			13.0	27.1		37.0				
Change Period (Y+Rc), s		5.5			4.5	5.5		5.0				
Max Green Setting (Gmax), s		42.5			8.5	29.5		32.0				
Max Q Clear Time (g_c+I1), s		11.0			10.5	16.0		12.1				
Green Ext Time (p_c), s		5.9			0.0	5.6		2.7				

Intersection Summary

HCM 6th Ctrl Delay	33.8
HCM 6th LOS	C

Notes

User approved volume balancing among the lanes for turning movement.

Timings
30: I-215 SB Ramps & Cactus Av.

West Campus Upper Plateau (JN 14064)

09/30/2022



Lane Group	EBT	EBR	WBL	WBT	NBR	SBR
Lane Configurations	↑↑	↑	↓	↑↑	↑	↑
Traffic Volume (vph)	591	109	371	539	349	294
Future Volume (vph)	591	109	371	539	349	294
Turn Type	NA	Perm	Prot	NA	Prot	Prot
Protected Phases	2		1	6	8	4
Permitted Phases		2				
Detector Phase	2	2	1	6	8	4
Switch Phase						
Minimum Initial (s)	5.0	5.0	5.0	5.0	5.0	5.0
Minimum Split (s)	11.0	11.0	9.5	23.0	9.1	9.5
Total Split (s)	35.0	35.0	43.0	78.0	27.0	27.0
Total Split (%)	33.3%	33.3%	41.0%	74.3%	25.7%	25.7%
Yellow Time (s)	5.0	5.0	3.5	5.0	3.6	3.5
All-Red Time (s)	1.0	1.0	1.0	1.0	0.5	1.0
Lost Time Adjust (s)	0.0	0.0	0.0	0.0	0.0	0.0
Total Lost Time (s)	6.0	6.0	4.5	6.0	4.1	4.5
Lead/Lag	Lag	Lag	Lead			
Lead-Lag Optimize?	Yes	Yes	Yes			
Recall Mode	Min	Min	None	Min	None	None
Act Effct Green (s)	18.2	18.2	20.8	43.9	8.1	7.6
Actuated g/C Ratio	0.29	0.29	0.33	0.70	0.13	0.12
v/c Ratio	0.68	0.23	0.73	0.25	0.53	0.71
Control Delay	24.8	6.0	27.9	3.7	2.7	13.6
Queue Delay	0.0	0.0	0.0	0.0	0.0	0.0
Total Delay	24.8	6.0	27.9	3.7	2.7	13.6
LOS	C	A	C	A	A	B
Approach Delay	21.9			13.6		
Approach LOS	C			B		

Intersection Summary

Cycle Length: 105
 Actuated Cycle Length: 62.9
 Natural Cycle: 60
 Control Type: Actuated-Uncoordinated
 Maximum v/c Ratio: 0.73
 Intersection Signal Delay: 14.5
 Intersection LOS: B
 Intersection Capacity Utilization 46.4%
 ICU Level of Service A
 Analysis Period (min) 15

Splits and Phases: 30: I-215 SB Ramps & Cactus Av.

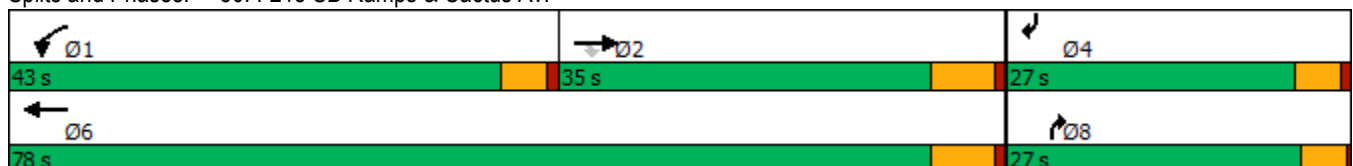

HCM 6th Signalized Intersection Summary
 30: I-215 SB Ramps & Cactus Av.

West Campus Upper Plateau (JN 14064)

09/30/2022



Movement	EBL	EBT	EBR	WBL	WBT	WBR	NBL	NBT	NBR	SBL	SBT	SBR
Lane Configurations		↑↑	↑	↑	↑↑				↑			↑
Traffic Volume (veh/h)	0	591	109	371	539	0	0	0	349	0	0	294
Future Volume (veh/h)	0	591	109	371	539	0	0	0	349	0	0	294
Initial Q (Qb), veh	0	0	0	0	0	0	0	0	0	0	0	0
Ped-Bike Adj(A_pbT)	1.00		1.00	1.00		1.00	1.00		1.00	1.00		1.00
Parking Bus, Adj	1.00	1.00	1.00	1.00	1.00	1.00	1.00	1.00	1.00	1.00	1.00	1.00
Work Zone On Approach		No			No			No			No	
Adj Sat Flow, veh/h/ln	0	1841	1826	1870	1870	0	0	0	1796	0	0	1707
Adj Flow Rate, veh/h	0	679	94	426	620	0	0	0	0	0	0	223
Peak Hour Factor	0.87	0.87	0.87	0.87	0.87	0.87	0.87	0.87	0.87	0.87	0.87	0.87
Percent Heavy Veh, %	0	4	5	2	2	0	0	0	7	0	0	13
Cap, veh/h	0	1160	513	534	2806	0	0	0	0	0	0	0
Arrive On Green	0.00	0.33	0.33	0.30	0.79	0.00	0.00	0.00	0.00	0.00	0.00	0.00
Sat Flow, veh/h	0	3589	1547	1781	3647	0		0			0	
Grp Volume(v), veh/h	0	679	94	426	620	0		0.0			0.0	
Grp Sat Flow(s),veh/h/ln	0	1749	1547	1781	1777	0						
Q Serve(g_s), s	0.0	4.6	1.2	6.3	1.3	0.0						
Cycle Q Clear(g_c), s	0.0	4.6	1.2	6.3	1.3	0.0						
Prop In Lane	0.00		1.00	1.00		0.00						
Lane Grp Cap(c), veh/h	0	1160	513	534	2806	0						
V/C Ratio(X)	0.00	0.59	0.18	0.80	0.22	0.00						
Avail Cap(c_a), veh/h	0	3558	1574	2406	8975	0						
HCM Platoon Ratio	1.00	1.00	1.00	1.00	1.00	1.00						
Upstream Filter(I)	0.00	1.00	1.00	1.00	1.00	0.00						
Uniform Delay (d), s/veh	0.0	7.9	6.8	9.2	0.8	0.0						
Incr Delay (d2), s/veh	0.0	0.2	0.1	1.1	0.0	0.0						
Initial Q Delay(d3),s/veh	0.0	0.0	0.0	0.0	0.0	0.0						
%ile BackOfQ(50%),veh/ln	0.0	0.8	0.2	1.3	0.0	0.0						
Unsig. Movement Delay, s/veh												
LnGrp Delay(d),s/veh	0.0	8.1	6.8	10.2	0.8	0.0						
LnGrp LOS	A	A	A	B	A	A						
Approach Vol, veh/h		773			1046							
Approach Delay, s/veh		7.9			4.6							
Approach LOS		A			A							
Timer - Assigned Phs	1	2				6						
Phs Duration (G+Y+Rc), s	13.0	15.5				28.5						
Change Period (Y+Rc), s	4.5	6.0				6.0						
Max Green Setting (Gmax), s	38.5	29.0				72.0						
Max Q Clear Time (g_c+I1), s	8.3	6.6				3.3						
Green Ext Time (p_c), s	0.6	2.9				2.6						

Intersection Summary

HCM 6th Ctrl Delay	6.0
HCM 6th LOS	A

Notes

Unsignalized Delay for [NBR] is excluded from calculations of the approach delay and intersection delay.

Timings

31: I-215 NB Ramps/Old 215 Frontage Rd. & Cactus Av.



Lane Group	EBL	EBT	WBT	NBL	NBT	NBR	SBL	SBT
Lane Configurations	↗	↕↗	↕↗	↖	↖	↖	↖	↖
Traffic Volume (vph)	32	689	1162	124	70	3	116	1
Future Volume (vph)	32	689	1162	124	70	3	116	1
Turn Type	Perm	NA	NA	Perm	NA	Perm	Perm	NA
Protected Phases		2	6		8			4
Permitted Phases	2			8		8	4	
Detector Phase	2	2	6	8	8	8	4	4
Switch Phase								
Minimum Initial (s)	5.0	5.0	5.0	5.0	5.0	5.0	5.0	5.0
Minimum Split (s)	11.0	11.0	44.0	10.5	10.5	10.5	10.5	10.5
Total Split (s)	57.4	57.4	57.4	27.6	27.6	27.6	27.6	27.6
Total Split (%)	67.5%	67.5%	67.5%	32.5%	32.5%	32.5%	32.5%	32.5%
Yellow Time (s)	5.0	5.0	5.0	4.5	4.5	4.5	4.5	4.5
All-Red Time (s)	1.0	1.0	1.0	1.0	1.0	1.0	1.0	1.0
Lost Time Adjust (s)	0.0	0.0	0.0	0.0	0.0	0.0	0.0	0.0
Total Lost Time (s)	6.0	6.0	6.0	5.5	5.5	5.5	5.5	5.5
Lead/Lag								
Lead-Lag Optimize?								
Recall Mode	Min	Min	Min	None	None	None	None	None
Act Effct Green (s)	32.4	32.4	32.4	10.8	10.8	10.8	10.7	10.7
Actuated g/C Ratio	0.64	0.64	0.64	0.21	0.21	0.21	0.21	0.21
v/c Ratio	0.21	0.50	0.63	0.53	0.20	0.01	0.46	0.23
Control Delay	10.6	7.4	9.5	27.8	19.7	0.0	25.2	9.6
Queue Delay	0.0	0.0	0.0	0.0	0.0	0.0	0.0	0.0
Total Delay	10.6	7.4	9.5	27.8	19.7	0.0	25.2	9.6
LOS	B	A	A	C	B	A	C	A
Approach Delay		7.5	9.5		24.5			18.7
Approach LOS		A	A		C			B

Intersection Summary

Cycle Length: 85
 Actuated Cycle Length: 50.5
 Natural Cycle: 60
 Control Type: Actuated-Uncoordinated
 Maximum v/c Ratio: 0.63
 Intersection Signal Delay: 10.6
 Intersection Capacity Utilization 59.2%
 Analysis Period (min) 15

Intersection LOS: B
 ICU Level of Service B

Splits and Phases: 31: I-215 NB Ramps/Old 215 Frontage Rd. & Cactus Av.

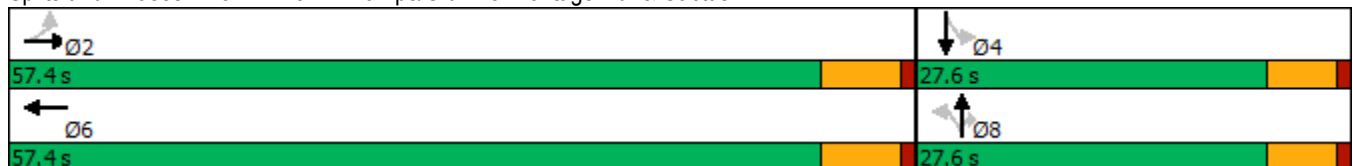

HCM 6th Signalized Intersection Summary

West Campus Upper Plateau (JN 14064)

31: I-215 NB Ramps/Old 215 Frontage Rd. & Cactus Av.

09/30/2022

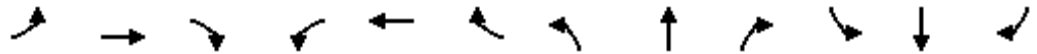

Movement	EBL	EBT	EBR	WBL	WBT	WBR	NBL	NBT	NBR	SBL	SBT	SBR
Lane Configurations	↗	↕			↕		↗	↕	↗	↗	↕	↕
Traffic Volume (veh/h)	32	689	245	0	1162	125	124	70	3	116	1	82
Future Volume (veh/h)	32	689	245	0	1162	125	124	70	3	116	1	82
Initial Q (Qb), veh	0	0	0	0	0	0	0	0	0	0	0	0
Ped-Bike Adj(A_pbT)	1.00		1.00	1.00		1.00	1.00		1.00	1.00		1.00
Parking Bus, Adj	1.00	1.00	1.00	1.00	1.00	1.00	1.00	1.00	1.00	1.00	1.00	1.00
Work Zone On Approach		No			No			No			No	
Adj Sat Flow, veh/h/ln	1796	1826	1366	0	1841	1885	1722	1856	1900	1841	1900	1885
Adj Flow Rate, veh/h	34	741	259	0	1249	85	133	75	0	125	1	61
Peak Hour Factor	0.93	0.93	0.93	0.93	0.93	0.93	0.93	0.93	0.93	0.93	0.93	0.93
Percent Heavy Veh, %	7	5	36	0	4	1	12	3	0	4	0	1
Cap, veh/h	272	1321	462	0	1741	118	374	353		382	5	302
Arrive On Green	0.52	0.52	0.52	0.00	0.52	0.52	0.19	0.19	0.00	0.19	0.19	0.19
Sat Flow, veh/h	394	2521	881	0	3415	226	1234	1856	1610	1304	26	1588
Grp Volume(v), veh/h	34	510	490	0	656	678	133	75	0	125	0	62
Grp Sat Flow(s),veh/h/ln	394	1735	1667	0	1749	1800	1234	1856	1610	1304	0	1614
Q Serve(g_s), s	2.9	8.0	8.0	0.0	11.5	11.6	4.1	1.4	0.0	3.6	0.0	1.3
Cycle Q Clear(g_c), s	14.5	8.0	8.0	0.0	11.5	11.6	5.4	1.4	0.0	5.0	0.0	1.3
Prop In Lane	1.00		0.53	0.00		0.13	1.00		1.00	1.00		0.98
Lane Grp Cap(c), veh/h	272	909	874	0	917	943	374	353		382	0	307
V/C Ratio(X)	0.13	0.56	0.56	0.00	0.72	0.72	0.36	0.21		0.33	0.00	0.20
Avail Cap(c_a), veh/h	568	2213	2128	0	2231	2296	816	1018		849	0	886
HCM Platoon Ratio	1.00	1.00	1.00	1.00	1.00	1.00	1.00	1.00	1.00	1.00	1.00	1.00
Upstream Filter(I)	1.00	1.00	1.00	0.00	1.00	1.00	1.00	1.00	0.00	1.00	0.00	1.00
Uniform Delay (d), s/veh	12.8	6.5	6.5	0.0	7.3	7.3	16.0	13.8	0.0	15.9	0.0	13.7
Incr Delay (d2), s/veh	0.1	0.2	0.2	0.0	0.4	0.4	0.2	0.1	0.0	0.2	0.0	0.1
Initial Q Delay(d3),s/veh	0.0	0.0	0.0	0.0	0.0	0.0	0.0	0.0	0.0	0.0	0.0	0.0
%ile BackOfQ(50%),veh/ln	0.2	1.3	1.3	0.0	2.0	2.0	0.9	0.4	0.0	0.8	0.0	0.4
Unsig. Movement Delay, s/veh												
LnGrp Delay(d),s/veh	12.9	6.7	6.7	0.0	7.7	7.7	16.2	13.9	0.0	16.0	0.0	13.8
LnGrp LOS	B	A	A	A	A	A	B	B		B	A	B
Approach Vol, veh/h		1034			1334			208				187
Approach Delay, s/veh		6.9			7.7			15.4				15.3
Approach LOS		A			A			B				B
Timer - Assigned Phs		2		4		6		8				
Phs Duration (G+Y+Rc), s		27.1		13.2		27.1		13.2				
Change Period (Y+Rc), s		6.0		5.5		6.0		5.5				
Max Green Setting (Gmax), s		51.4		22.1		51.4		22.1				
Max Q Clear Time (g_c+I1), s		16.5		7.0		13.6		7.4				
Green Ext Time (p_c), s		4.6		0.3		6.0		0.4				

Intersection Summary

HCM 6th Ctrl Delay	8.5
HCM 6th LOS	A

Notes

User approved volume balancing among the lanes for turning movement.
 Unsignalized Delay for [NBR] is excluded from calculations of the approach delay and intersection delay.

Timings
32: I-215 SB Ramps & Van Buren Bl.

West Campus Upper Plateau (JN 14064)

09/30/2022



Lane Group	EBT	EBR	WBL	WBT	SBT	SBR
Lane Configurations	↑↑	↑↑	↙	↑↑	↙	↑↑
Traffic Volume (vph)	481	642	14	612	0	564
Future Volume (vph)	481	642	14	612	0	564
Turn Type	NA	Perm	Prot	NA	NA	Perm
Protected Phases	6		5	2	8	
Permitted Phases		6				8
Detector Phase	6	6	5	2	8	8
Switch Phase						
Minimum Initial (s)	5.0	5.0	5.0	5.0	5.0	5.0
Minimum Split (s)	36.0	36.0	11.0	11.0	11.0	11.0
Total Split (s)	60.0	60.0	11.0	71.0	14.0	14.0
Total Split (%)	70.6%	70.6%	12.9%	83.5%	16.5%	16.5%
Yellow Time (s)	5.0	5.0	5.0	5.0	5.0	5.0
All-Red Time (s)	1.0	1.0	1.0	1.0	1.0	1.0
Lost Time Adjust (s)	0.0	0.0	0.0	0.0	0.0	0.0
Total Lost Time (s)	6.0	6.0	6.0	6.0	6.0	6.0
Lead/Lag	Lag	Lag	Lead			
Lead-Lag Optimize?	Yes	Yes	Yes			
Recall Mode	Min	Min	None	Min	Max	Max
Act Effct Green (s)	13.1	13.1	5.4	14.4	8.7	8.7
Actuated g/C Ratio	0.36	0.36	0.15	0.40	0.24	0.24
v/c Ratio	0.43	0.48	0.07	0.48	0.07	0.57
Control Delay	9.5	2.1	20.1	8.3	17.0	4.9
Queue Delay	0.0	0.0	0.0	0.0	0.0	0.0
Total Delay	9.5	2.1	20.1	8.3	17.0	4.9
LOS	A	A	C	A	B	A
Approach Delay	5.3			8.5	5.3	
Approach LOS	A			A	A	

Intersection Summary

Cycle Length: 85
 Actuated Cycle Length: 36.1
 Natural Cycle: 60
 Control Type: Actuated-Uncoordinated
 Maximum v/c Ratio: 0.57
 Intersection Signal Delay: 6.2
 Intersection LOS: A
 Intersection Capacity Utilization 46.6%
 ICU Level of Service A
 Analysis Period (min) 15

Splits and Phases: 32: I-215 SB Ramps & Van Buren Bl.



HCM 6th Signalized Intersection Summary
 32: I-215 SB Ramps & Van Buren Bl.

West Campus Upper Plateau (JN 14064)

09/30/2022



Movement	EBL	EBT	EBR	WBL	WBT	WBR	NBL	NBT	NBR	SBL	SBT	SBR
Lane Configurations		↑↑	↑↑	↑	↑↑						↑	↑↑
Traffic Volume (veh/h)	0	481	642	14	612	0	0	0	0	22	0	564
Future Volume (veh/h)	0	481	642	14	612	0	0	0	0	22	0	564
Initial Q (Qb), veh	0	0	0	0	0	0				0	0	0
Ped-Bike Adj(A_pbT)	1.00		1.00	1.00		1.00				1.00		1.00
Parking Bus, Adj	1.00	1.00	1.00	1.00	1.00	1.00				1.00	1.00	1.00
Work Zone On Approach		No			No						No	
Adj Sat Flow, veh/h/ln	0	1767	1856	1411	1811	0				1500	1841	1663
Adj Flow Rate, veh/h	0	512	585	15	651	0				23	0	0
Peak Hour Factor	0.94	0.94	0.94	0.94	0.94	0.94				0.94	0.94	0.94
Percent Heavy Veh, %	0	9	3	33	6	0				27	4	16
Cap, veh/h	0	1023	843	151	1898	0				315	0	
Arrive On Green	0.00	0.30	0.30	0.11	0.55	0.00				0.18	0.00	0.00
Sat Flow, veh/h	0	3445	2768	1344	3532	0				1753	0	2480
Grp Volume(v), veh/h	0	512	585	15	651	0				23	0	0
Grp Sat Flow(s),veh/h/ln	0	1678	1384	1344	1721	0				1753	0	1240
Q Serve(g_s), s	0.0	5.6	8.3	0.4	4.7	0.0				0.5	0.0	0.0
Cycle Q Clear(g_c), s	0.0	5.6	8.3	0.4	4.7	0.0				0.5	0.0	0.0
Prop In Lane	0.00		1.00	1.00		0.00				1.00		1.00
Lane Grp Cap(c), veh/h	0	1023	843	151	1898	0				315	0	
V/C Ratio(X)	0.00	0.50	0.69	0.10	0.34	0.00				0.07	0.00	
Avail Cap(c_a), veh/h	0	4065	3352	151	5016	0				315	0	
HCM Platoon Ratio	1.00	1.00	1.00	1.00	1.00	1.00				1.00	1.00	1.00
Upstream Filter(I)	0.00	1.00	1.00	1.00	1.00	0.00				1.00	0.00	0.00
Uniform Delay (d), s/veh	0.0	12.7	13.7	17.8	5.5	0.0				15.2	0.0	0.0
Incr Delay (d2), s/veh	0.0	0.1	0.4	0.1	0.0	0.0				0.5	0.0	0.0
Initial Q Delay(d3),s/veh	0.0	0.0	0.0	0.0	0.0	0.0				0.0	0.0	0.0
%ile BackOfQ(50%),veh/ln	0.0	1.4	1.7	0.1	0.7	0.0				0.2	0.0	0.0
Unsig. Movement Delay, s/veh												
LnGrp Delay(d),s/veh	0.0	12.9	14.1	17.9	5.6	0.0				15.7	0.0	0.0
LnGrp LOS	A	B	B	B	A	A				B	A	
Approach Vol, veh/h		1097			666							23
Approach Delay, s/veh		13.5			5.8							15.7
Approach LOS		B			A							B
Timer - Assigned Phs		2			5	6		8				
Phs Duration (G+Y+Rc), s		30.6			11.0	19.6		14.0				
Change Period (Y+Rc), s		6.0			6.0	6.0		6.0				
Max Green Setting (Gmax), s		65.0			5.0	54.0		8.0				
Max Q Clear Time (g_c+1), s		6.7			2.4	10.3		2.5				
Green Ext Time (p_c), s		2.6			0.0	3.3		0.0				

Intersection Summary

HCM 6th Ctrl Delay	10.7
HCM 6th LOS	B

Notes

Unsignalized Delay for [SBR] is excluded from calculations of the approach delay and intersection delay.

Timings
 33: I-215 NB On/Off Ramp & Van Buren Bl.

Lane Group	EBR	NBL	Ø2	Ø6
Lane Configurations	↖↖	↗↗		
Traffic Volume (vph)	17	1		
Future Volume (vph)	17	1		
Turn Type	pm+ov	Prot		
Protected Phases	4	4	2	6
Permitted Phases	6			
Detector Phase	4	4		
Switch Phase				
Minimum Initial (s)	5.0	5.0	5.0	5.0
Minimum Split (s)	42.0	42.0	11.0	11.0
Total Split (s)	55.0	55.0	15.0	15.0
Total Split (%)	78.6%	78.6%	21%	21%
Yellow Time (s)	5.0	5.0	5.0	5.0
All-Red Time (s)	1.0	1.0	1.0	1.0
Lost Time Adjust (s)	0.0	0.0		
Total Lost Time (s)	6.0	6.0		
Lead/Lag				
Lead-Lag Optimize?				
Recall Mode	Min	Min	None	None
Act Effct Green (s)	32.2	32.2		
Actuated g/C Ratio	1.00	1.00		
v/c Ratio	0.01	0.00		
Control Delay	0.0	0.0		
Queue Delay	0.0	0.0		
Total Delay	0.0	0.0		
LOS	A	A		
Approach Delay				
Approach LOS				

Intersection Summary

Cycle Length: 70
 Actuated Cycle Length: 32.2
 Natural Cycle: 55
 Control Type: Actuated-Uncoordinated
 Maximum v/c Ratio: 0.01
 Intersection Signal Delay: 0.0
 Intersection LOS: A
 Intersection Capacity Utilization 9.2%
 ICU Level of Service A
 Analysis Period (min) 15

Splits and Phases: 33: I-215 NB On/Off Ramp & Van Buren Bl.



HCM 6th Signalized Intersection Summary
 33: I-215 NB On/Off Ramp & Van Buren Bl.

West Campus Upper Plateau (JN 14064)

09/30/2022

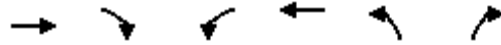

Movement	EBT	EBR	WBL	WBT	NBL	NBR
Lane Configurations	↑↑	↑↑		↑↑	↑↑	↑
Traffic Volume (veh/h)	0	17	0	0	1	0
Future Volume (veh/h)	0	17	0	0	1	0
Initial Q (Qb), veh	0	0	0	0	0	0
Ped-Bike Adj(A_pbT)		1.00	1.00		1.00	1.00
Parking Bus, Adj	1.00	1.00	1.00	1.00	1.00	1.00
Work Zone On Approach	No			No	No	
Adj Sat Flow, veh/h/ln	1900	1767	0	1752	1811	1159
Adj Flow Rate, veh/h	0	9	0	0	1	0
Peak Hour Factor	0.94	0.94	0.94	0.94	0.94	0.94
Percent Heavy Veh, %	0	9	0	10	6	50
Cap, veh/h	44	798	0	41	972	285
Arrive On Green	0.00	0.01	0.00	0.00	0.29	0.00
Sat Flow, veh/h	3705	2635	0	3504	3346	982
Grp Volume(v), veh/h	0	9	0	0	1	0
Grp Sat Flow(s),veh/h/ln	1805	1317	0	1664	1673	982
Q Serve(g_s), s	0.0	0.0	0.0	0.0	0.0	0.0
Cycle Q Clear(g_c), s	0.0	0.0	0.0	0.0	0.0	0.0
Prop In Lane		1.00	0.00		1.00	1.00
Lane Grp Cap(c), veh/h	44	798	0	41	972	285
V/C Ratio(X)	0.00	0.01	0.00	0.00	0.00	0.00
Avail Cap(c_a), veh/h	1888	2143	0	1741	9527	2796
HCM Platoon Ratio	1.00	1.00	1.00	1.00	1.00	1.00
Upstream Filter(I)	0.00	1.00	0.00	0.00	1.00	0.00
Uniform Delay (d), s/veh	0.0	4.2	0.0	0.0	4.3	0.0
Incr Delay (d2), s/veh	0.0	0.0	0.0	0.0	0.0	0.0
Initial Q Delay(d3),s/veh	0.0	0.0	0.0	0.0	0.0	0.0
%ile BackOfQ(50%),veh/ln	0.0	0.0	0.0	0.0	0.0	0.0
Unsig. Movement Delay, s/veh						
LnGrp Delay(d),s/veh	0.0	4.2	0.0	0.0	4.3	0.0
LnGrp LOS	A	A	A	A	A	A
Approach Vol, veh/h	9			0	1	
Approach Delay, s/veh	4.2			0.0	4.3	
Approach LOS	A				A	
Timer - Assigned Phs		2		4		6
Phs Duration (G+Y+Rc), s		6.2		11.0		6.2
Change Period (Y+Rc), s		6.0		6.0		6.0
Max Green Setting (Gmax), s		9.0		49.0		9.0
Max Q Clear Time (g_c+I1), s		0.0		2.0		2.0
Green Ext Time (p_c), s		0.0		0.0		0.0
Intersection Summary						
HCM 6th Ctrl Delay			4.2			
HCM 6th LOS			A			

Timings

West Campus Upper Plateau (JN 14064)

34: Old 215 Frontage Rd. & Alessandro Bl.

09/30/2022

Lane Group	EBL	EBT	EBR	WBL	WBT	WBR	NBL	NBT	NBR	SBL	SBT	SBR
Lane Configurations												
Traffic Volume (vph)	327	854	13	11	785	99	24	99	14	90	122	219
Future Volume (vph)	327	854	13	11	785	99	24	99	14	90	122	219
Turn Type	Prot	NA	Perm	Prot	NA	Perm	Prot	NA	Perm	Prot	NA	Perm
Protected Phases	5	2		1	6		3	8		7	4	
Permitted Phases			2			6			8			4
Detector Phase	5	2	2	1	6	6	3	8	8	7	4	4
Switch Phase												
Minimum Initial (s)	5.0	10.0	10.0	5.0	10.0	10.0	5.0	10.0	10.0	5.0	10.0	10.0
Minimum Split (s)	8.7	43.5	43.5	8.7	15.8	15.8	8.7	16.2	16.2	8.7	40.2	40.2
Total Split (s)	22.0	62.4	62.4	8.7	49.1	49.1	8.7	29.7	29.7	19.2	40.2	40.2
Total Split (%)	18.3%	52.0%	52.0%	7.3%	40.9%	40.9%	7.3%	24.8%	24.8%	16.0%	33.5%	33.5%
Yellow Time (s)	3.2	5.5	5.5	3.2	4.8	4.8	3.2	5.2	5.2	3.2	5.2	5.2
All-Red Time (s)	0.5	1.0	1.0	0.5	1.0	1.0	0.5	1.0	1.0	0.5	1.0	1.0
Lost Time Adjust (s)	0.0	0.0	0.0	0.0	0.0	0.0	0.0	0.0	0.0	0.0	0.0	0.0
Total Lost Time (s)	3.7	6.5	6.5	3.7	5.8	5.8	3.7	6.2	6.2	3.7	6.2	6.2
Lead/Lag	Lead	Lag	Lag	Lead	Lag	Lag	Lead	Lag	Lag	Lead	Lag	Lag
Lead-Lag Optimize?	Yes	Yes	Yes	Yes	Yes	Yes	Yes	Yes	Yes	Yes	Yes	Yes
Recall Mode	None	None	None	None	None	None	None	None	None	None	None	None
Act Effct Green (s)	13.1	42.3	42.3	5.4	27.2	27.2	5.4	12.6	12.6	9.5	20.4	20.4
Actuated g/C Ratio	0.16	0.53	0.53	0.07	0.34	0.34	0.07	0.16	0.16	0.12	0.25	0.25
v/c Ratio	0.61	0.33	0.02	0.10	0.69	0.16	0.13	0.19	0.04	0.47	0.15	0.40
Control Delay	39.7	12.7	0.1	48.5	27.7	1.1	46.6	35.3	0.2	46.4	27.0	6.7
Queue Delay	0.0	0.0	0.0	0.0	0.0	0.0	0.0	0.0	0.0	0.0	0.0	0.0
Total Delay	39.7	12.7	0.1	48.5	27.7	1.1	46.6	35.3	0.2	46.4	27.0	6.7
LOS	D	B	A	D	C	A	D	D	A	D	C	A
Approach Delay		20.0			25.0			33.6			20.8	
Approach LOS		B			C			C			C	

Intersection Summary

Cycle Length: 120
 Actuated Cycle Length: 80.4
 Natural Cycle: 105
 Control Type: Actuated-Uncoordinated
 Maximum v/c Ratio: 0.69
 Intersection Signal Delay: 22.5
 Intersection LOS: C
 Intersection Capacity Utilization 56.0%
 ICU Level of Service B
 Analysis Period (min) 15



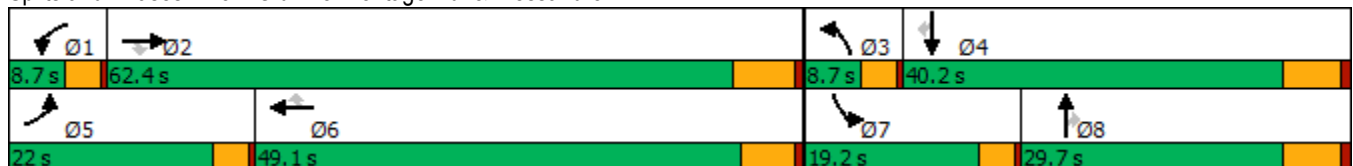





























Splits and Phases: 34: Old 215 Frontage Rd. & Alessandro Bl.



HCM 6th Signalized Intersection Summary
 34: Old 215 Frontage Rd. & Alessandro Bl.

West Campus Upper Plateau (JN 14064)

09/30/2022

												
Movement	EBL	EBT	EBR	WBL	WBT	WBR	NBL	NBT	NBR	SBL	SBT	SBR
Lane Configurations	 	  			 		 	 			 	 
Traffic Volume (veh/h)	327	854	13	11	785	99	24	99	14	90	122	219
Future Volume (veh/h)	327	854	13	11	785	99	24	99	14	90	122	219
Initial Q (Qb), veh	0	0	0	0	0	0	0	0	0	0	0	0
Ped-Bike Adj(A_pbT)	1.00		1.00	1.00		1.00	1.00		0.99	1.00		1.00
Parking Bus, Adj	1.00	1.00	1.00	1.00	1.00	1.00	1.00	1.00	1.00	1.00	1.00	1.00
Work Zone On Approach		No			No			No			No	
Adj Sat Flow, veh/h/ln	1870	1885	1678	1678	1856	1856	1515	1856	1559	1826	1737	1885
Adj Flow Rate, veh/h	341	890	-13	11	818	0	25	103	5	94	127	0
Peak Hour Factor	0.96	0.96	0.96	0.96	0.96	0.96	0.96	0.96	0.96	0.96	0.96	0.96
Percent Heavy Veh, %	2	1	15	15	3	3	26	3	23	5	11	1
Cap, veh/h	460	2286	632	22	1146		79	550	203	121	651	
Arrive On Green	0.13	0.44	0.00	0.01	0.32	0.00	0.03	0.16	0.16	0.07	0.20	0.00
Sat Flow, veh/h	3456	5147	1422	1598	3526	1572	2799	3526	1302	1739	3300	1598
Grp Volume(v), veh/h	341	890	-13	11	818	0	25	103	5	94	127	0
Grp Sat Flow(s),veh/h/ln	1728	1716	1422	1598	1763	1572	1399	1763	1302	1739	1650	1598
Q Serve(g_s), s	6.0	7.4	0.0	0.4	12.9	0.0	0.6	1.6	0.2	3.4	2.0	0.0
Cycle Q Clear(g_c), s	6.0	7.4	0.0	0.4	12.9	0.0	0.6	1.6	0.2	3.4	2.0	0.0
Prop In Lane	1.00		1.00	1.00		1.00	1.00		1.00	1.00		1.00
Lane Grp Cap(c), veh/h	460	2286	632	22	1146		79	550	203	121	651	
V/C Ratio(X)	0.74	0.39	-0.02	0.50	0.71		0.32	0.19	0.02	0.78	0.20	
Avail Cap(c_a), veh/h	996	4532	1252	126	2405		220	1305	482	425	1768	
HCM Platoon Ratio	1.00	1.00	1.00	1.00	1.00	1.00	1.00	1.00	1.00	1.00	1.00	1.00
Upstream Filter(I)	1.00	1.00	0.00	1.00	1.00	0.00	1.00	1.00	1.00	1.00	1.00	0.00
Uniform Delay (d), s/veh	26.5	11.9	0.0	31.1	18.8	0.0	30.2	23.3	22.7	29.1	21.3	0.0
Incr Delay (d2), s/veh	0.9	0.1	0.0	6.2	0.8	0.0	0.9	0.2	0.0	4.1	0.1	0.0
Initial Q Delay(d3),s/veh	0.0	0.0	0.0	0.0	0.0	0.0	0.0	0.0	0.0	0.0	0.0	0.0
%ile BackOfQ(50%),veh/ln	2.2	2.1	0.0	0.2	4.6	0.0	0.2	0.6	0.1	1.4	0.7	0.0
Unsig. Movement Delay, s/veh												
LnGrp Delay(d),s/veh	27.4	12.0	0.0	37.3	19.7	0.0	31.1	23.5	22.7	33.1	21.4	0.0
LnGrp LOS	C	B	A	D	B		C	C	C	C	C	
Approach Vol, veh/h		1218			829			133			221	
Approach Delay, s/veh		16.4			19.9			24.9			26.4	
Approach LOS		B			B			C			C	
Timer - Assigned Phs	1	2	3	4	5	6	7	8				
Phs Duration (G+Y+Rc), s	4.6	34.7	5.5	18.7	12.2	27.1	8.1	16.1				
Change Period (Y+Rc), s	3.7	6.5	3.7	6.2	3.7	* 6.5	3.7	6.2				
Max Green Setting (Gmax), s	5.0	55.9	5.0	34.0	18.3	* 43	15.5	23.5				
Max Q Clear Time (g_c+I1), s	2.4	9.4	2.6	4.0	8.0	14.9	5.4	3.6				
Green Ext Time (p_c), s	0.0	6.2	0.0	0.7	0.4	5.7	0.1	0.4				

Intersection Summary

HCM 6th Ctrl Delay	19.0
HCM 6th LOS	B

Notes

* HCM 6th computational engine requires equal clearance times for the phases crossing the barrier.
 Unsignalized Delay for [WBR, SBR] is excluded from calculations of the approach delay and intersection delay.

Timings
35: Day St. & Alessandro Bl.

West Campus Upper Plateau (JN 14064)

09/30/2022



Lane Group	EBL	EBT	EBR	WBL	WBT	WBR	NBL	NBT	NBR	SBL	SBT
Lane Configurations	↘	↑↑↑	↗	↘	↑↑	↗	↘	↑	↗	↘	↗
Traffic Volume (vph)	189	665	7	9	699	139	10	95	15	117	47
Future Volume (vph)	189	665	7	9	699	139	10	95	15	117	47
Turn Type	Prot	NA	Perm	Prot	NA	Perm	Perm	NA	Perm	Perm	NA
Protected Phases	5	2		1	6			8			4
Permitted Phases			2			6	8		8	4	
Detector Phase	5	2	2	1	6	6	8	8	8	4	4
Switch Phase											
Minimum Initial (s)	5.0	10.0	10.0	5.0	10.0	10.0	10.0	10.0	10.0	10.0	10.0
Minimum Split (s)	9.1	30.8	30.8	9.1	30.8	30.8	42.4	42.4	42.4	41.6	41.6
Total Split (s)	28.0	67.9	67.9	9.1	49.0	49.0	43.0	43.0	43.0	43.0	43.0
Total Split (%)	23.3%	56.6%	56.6%	7.6%	40.8%	40.8%	35.8%	35.8%	35.8%	35.8%	35.8%
Yellow Time (s)	3.6	4.8	4.8	3.6	4.8	4.8	4.4	4.4	4.4	3.6	3.6
All-Red Time (s)	0.5	1.0	1.0	0.5	1.0	1.0	1.0	1.0	1.0	1.0	1.0
Lost Time Adjust (s)	0.0	0.0	0.0	0.0	0.0	0.0	0.0	0.0	0.0	0.0	0.0
Total Lost Time (s)	4.1	5.8	5.8	4.1	5.8	5.8	5.4	5.4	5.4	4.6	4.6
Lead/Lag	Lead	Lag	Lag	Lead	Lag	Lag					
Lead-Lag Optimize?	Yes	Yes	Yes	Yes	Yes	Yes					
Recall Mode	None	None	None	None	None	None	None	None	None	None	None
Act Effct Green (s)	13.0	38.5	38.5	5.5	22.1	22.1	15.2	15.2	15.2	16.1	16.1
Actuated g/C Ratio	0.19	0.57	0.57	0.08	0.33	0.33	0.23	0.23	0.23	0.24	0.24
v/c Ratio	0.57	0.24	0.01	0.06	0.63	0.25	0.05	0.23	0.04	0.39	0.34
Control Delay	35.0	8.7	0.0	41.1	23.1	9.8	24.0	24.7	0.2	27.7	12.3
Queue Delay	0.0	0.0	0.0	0.0	0.0	0.0	0.0	0.0	0.0	0.0	0.0
Total Delay	35.0	8.7	0.0	41.1	23.1	9.8	24.0	24.7	0.2	27.7	12.3
LOS	D	A	A	D	C	A	C	C	A	C	B
Approach Delay		14.4			21.1			21.5			18.9
Approach LOS		B			C			C			B

Intersection Summary

Cycle Length: 120
 Actuated Cycle Length: 67.1
 Natural Cycle: 85
 Control Type: Actuated-Uncoordinated
 Maximum v/c Ratio: 0.63
 Intersection Signal Delay: 18.1
 Intersection LOS: B
 Intersection Capacity Utilization 55.0%
 ICU Level of Service B
 Analysis Period (min) 15





























Splits and Phases: 35: Day St. & Alessandro Bl.



HCM 6th Signalized Intersection Summary
35: Day St. & Alessandro Bl.

West Campus Upper Plateau (JN 14064)

09/30/2022

												
Movement	EBL	EBT	EBR	WBL	WBT	WBR	NBL	NBT	NBR	SBL	SBT	SBR
Lane Configurations		  			 						 	
Traffic Volume (veh/h)	189	665	7	9	699	139	10	95	15	117	47	108
Future Volume (veh/h)	189	665	7	9	699	139	10	95	15	117	47	108
Initial Q (Qb), veh	0	0	0	0	0	0	0	0	0	0	0	0
Ped-Bike Adj(A_pbT)	1.00		0.98	1.00		0.98	1.00		1.00	1.00		1.00
Parking Bus, Adj	1.00	1.00	1.00	1.00	1.00	1.00	1.00	1.00	1.00	1.00	1.00	1.00
Work Zone On Approach		No			No			No			No	
Adj Sat Flow, veh/h/ln	1885	1870	1618	1900	1870	1900	1500	1900	1767	1885	1870	1870
Adj Flow Rate, veh/h	197	693	1	9	728	77	10	99	11	122	49	81
Peak Hour Factor	0.96	0.96	0.96	0.96	0.96	0.96	0.96	0.96	0.96	0.96	0.96	0.96
Percent Heavy Veh, %	1	2	19	0	2	0	27	0	9	1	2	2
Cap, veh/h	254	2333	613	21	1164	516	296	397	313	366	133	219
Arrive On Green	0.14	0.46	0.46	0.01	0.33	0.33	0.21	0.21	0.21	0.21	0.21	0.21
Sat Flow, veh/h	1795	5106	1341	1810	3554	1574	1011	1900	1497	1293	634	1048
Grp Volume(v), veh/h	197	693	1	9	728	77	10	99	11	122	0	130
Grp Sat Flow(s),veh/h/ln	1795	1702	1341	1810	1777	1574	1011	1900	1497	1293	0	1682
Q Serve(g_s), s	5.0	4.0	0.0	0.2	8.2	1.6	0.4	2.1	0.3	4.1	0.0	3.1
Cycle Q Clear(g_c), s	5.0	4.0	0.0	0.2	8.2	1.6	3.6	2.1	0.3	6.2	0.0	3.1
Prop In Lane	1.00		1.00	1.00		1.00	1.00		1.00	1.00		0.62
Lane Grp Cap(c), veh/h	254	2333	613	21	1164	516	296	397	313	366	0	352
V/C Ratio(X)	0.78	0.30	0.00	0.42	0.63	0.15	0.03	0.25	0.04	0.33	0.00	0.37
Avail Cap(c_a), veh/h	904	6678	1753	191	3233	1432	885	1504	1185	1141	0	1360
HCM Platoon Ratio	1.00	1.00	1.00	1.00	1.00	1.00	1.00	1.00	1.00	1.00	1.00	1.00
Upstream Filter(I)	1.00	1.00	1.00	1.00	1.00	1.00	1.00	1.00	1.00	1.00	0.00	1.00
Uniform Delay (d), s/veh	19.7	8.1	7.0	23.3	13.5	11.3	17.6	15.7	15.0	18.3	0.0	16.1
Incr Delay (d2), s/veh	1.9	0.1	0.0	4.9	0.6	0.1	0.0	0.3	0.0	0.5	0.0	0.6
Initial Q Delay(d3),s/veh	0.0	0.0	0.0	0.0	0.0	0.0	0.0	0.0	0.0	0.0	0.0	0.0
%ile BackOfQ(50%),veh/ln	1.9	1.0	0.0	0.1	2.5	0.4	0.1	0.8	0.1	1.2	0.0	1.2
Unsig. Movement Delay, s/veh												
LnGrp Delay(d),s/veh	21.6	8.2	7.0	28.2	14.1	11.4	17.7	16.0	15.0	18.8	0.0	16.7
LnGrp LOS	C	A	A	C	B	B	B	B	B	B	A	B
Approach Vol, veh/h		891			814			120			252	
Approach Delay, s/veh		11.1			14.0			16.0			17.7	
Approach LOS		B			B			B			B	
Timer - Assigned Phs	1	2		4	5	6		8				
Phs Duration (G+Y+Rc), s	4.7	27.5		15.3	10.8	21.4		15.3				
Change Period (Y+Rc), s	4.1	5.8		* 5.4	4.1	5.8		5.4				
Max Green Setting (Gmax), s	5.0	62.1		* 38	23.9	43.2		37.6				
Max Q Clear Time (g_c+I1), s	2.2	6.0		8.2	7.0	10.2		5.6				
Green Ext Time (p_c), s	0.0	5.0		1.2	0.2	5.3		0.6				

Intersection Summary

HCM 6th Ctrl Delay	13.3
HCM 6th LOS	B

Notes

* HCM 6th computational engine requires equal clearance times for the phases crossing the barrier.

Timings
36: Elsworth St. & Cactus Av.

West Campus Upper Plateau (JN 14064)

09/30/2022



Lane Group	EBL	EBT	EBR	WBL	WBT	WBR	NBL	NBT	SBL	SBT	SBR
Lane Configurations											
Traffic Volume (vph)	153	1076	31	14	1075	133	22	11	160	17	128
Future Volume (vph)	153	1076	31	14	1075	133	22	11	160	17	128
Turn Type	Prot	NA	Perm	Prot	NA	Perm	Split	NA	Split	NA	pm+ov
Protected Phases	5	2		1	6		8	8	4	4	5
Permitted Phases			2			6					4
Detector Phase	5	2	2	1	6	6	8	8	4	4	5
Switch Phase											
Minimum Initial (s)	5.0	10.0	10.0	5.0	10.0	10.0	10.0	10.0	10.0	10.0	5.0
Minimum Split (s)	9.6	36.2	36.2	9.6	36.2	36.2	35.4	35.4	35.4	35.4	9.6
Total Split (s)	16.5	49.6	49.6	9.6	42.7	42.7	35.4	35.4	35.4	35.4	16.5
Total Split (%)	12.7%	38.2%	38.2%	7.4%	32.8%	32.8%	27.2%	27.2%	27.2%	27.2%	12.7%
Yellow Time (s)	3.6	5.2	5.2	3.6	5.2	5.2	4.4	4.4	4.4	4.4	3.6
All-Red Time (s)	1.0	1.0	1.0	1.0	1.0	1.0	1.0	1.0	1.0	1.0	1.0
Lost Time Adjust (s)	0.0	0.0	0.0	0.0	0.0	0.0	0.0	0.0	0.0	0.0	0.0
Total Lost Time (s)	4.6	6.2	6.2	4.6	6.2	6.2	5.4	5.4	5.4	5.4	4.6
Lead/Lag	Lead	Lag	Lag	Lead	Lag	Lag					Lead
Lead-Lag Optimize?	Yes	Yes	Yes	Yes	Yes	Yes					Yes
Recall Mode	None	None	None	None	None	None	Max	Max	Max	Max	None
Act Effct Green (s)	11.9	47.5	47.5	5.0	34.7	34.7	30.0	30.0	30.0	30.0	42.7
Actuated g/C Ratio	0.09	0.37	0.37	0.04	0.27	0.27	0.23	0.23	0.23	0.23	0.33
v/c Ratio	1.01	0.61	0.05	0.21	0.84	0.26	0.05	0.06	0.23	0.23	0.22
Control Delay	130.1	35.3	0.2	67.9	50.6	6.6	39.5	28.1	42.3	42.3	3.3
Queue Delay	0.0	0.0	0.0	0.0	0.0	0.0	0.0	0.0	0.0	0.0	0.0
Total Delay	130.1	35.3	0.2	67.9	50.6	6.6	39.5	28.1	42.3	42.3	3.3
LOS	F	D	A	E	D	A	D	C	D	D	A
Approach Delay		45.9			46.0			33.6		25.9	
Approach LOS		D			D			C		C	

Intersection Summary

Cycle Length: 130
 Actuated Cycle Length: 128.3
 Natural Cycle: 120
 Control Type: Actuated-Uncoordinated
 Maximum v/c Ratio: 1.01
 Intersection Signal Delay: 43.6
 Intersection LOS: D
 Intersection Capacity Utilization 54.3%
 ICU Level of Service A
 Analysis Period (min) 15

Splits and Phases: 36: Elsworth St. & Cactus Av.

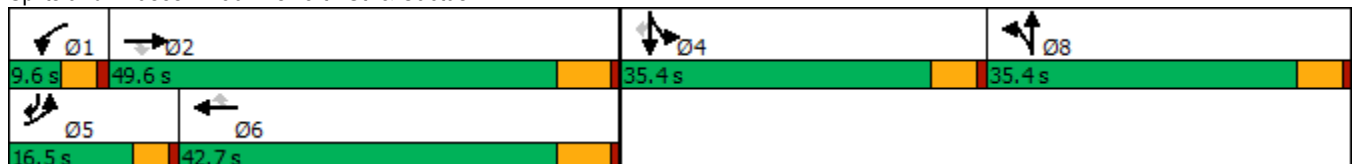

HCM 6th Signalized Intersection Summary
36: Elsworth St. & Cactus Av.

West Campus Upper Plateau (JN 14064)

09/30/2022



Movement	EBL	EBT	EBR	WBL	WBT	WBR	NBL	NBT	NBR	SBL	SBT	SBR
Lane Configurations	↗	↑↑↑	↖	↖	↑↑↑	↖	↖	↕		↖	↖	↖
Traffic Volume (veh/h)	153	1076	31	14	1075	133	22	11	9	160	17	128
Future Volume (veh/h)	153	1076	31	14	1075	133	22	11	9	160	17	128
Initial Q (Qb), veh	0	0	0	0	0	0	0	0	0	0	0	0
Ped-Bike Adj(A_pbT)	1.00		1.00	1.00		1.00	1.00		1.00	1.00		1.00
Parking Bus, Adj	1.00	1.00	1.00	1.00	1.00	1.00	1.00	1.00	1.00	1.00	1.00	1.00
Work Zone On Approach		No			No			No			No	
Adj Sat Flow, veh/h/ln	1841	1841	1781	1900	1841	1885	1885	1900	1885	1885	1900	1885
Adj Flow Rate, veh/h	161	1133	0	15	1132	103	17	0	0	181	0	27
Peak Hour Factor	0.95	0.95	0.95	0.95	0.95	0.95	0.95	0.95	0.95	0.95	0.95	0.95
Percent Heavy Veh, %	4	4	8	0	4	1	1	0	1	1	0	1
Cap, veh/h	165	1709		29	1319	419	850	450	0	850	0	528
Arrive On Green	0.09	0.34	0.00	0.02	0.26	0.26	0.24	0.00	0.00	0.24	0.00	0.24
Sat Flow, veh/h	1753	5025	1510	1810	5025	1598	3591	1900	0	3591	0	1598
Grp Volume(v), veh/h	161	1133	0	15	1132	103	17	0	0	181	0	27
Grp Sat Flow(s),veh/h/ln	1753	1675	1510	1810	1675	1598	1795	1900	0	1795	0	1598
Q Serve(g_s), s	11.6	24.4	0.0	1.0	27.2	6.4	0.5	0.0	0.0	5.1	0.0	1.5
Cycle Q Clear(g_c), s	11.6	24.4	0.0	1.0	27.2	6.4	0.5	0.0	0.0	5.1	0.0	1.5
Prop In Lane	1.00		1.00	1.00		1.00	1.00		0.00	1.00		1.00
Lane Grp Cap(c), veh/h	165	1709		29	1319	419	850	450	0	850	0	528
V/C Ratio(X)	0.98	0.66		0.51	0.86	0.25	0.02	0.00	0.00	0.21	0.00	0.05
Avail Cap(c_a), veh/h	165	1720		71	1447	460	850	450	0	850	0	528
HCM Platoon Ratio	1.00	1.00	1.00	1.00	1.00	1.00	1.00	1.00	1.00	1.00	1.00	1.00
Upstream Filter(I)	1.00	1.00	0.00	1.00	1.00	1.00	1.00	0.00	0.00	1.00	0.00	1.00
Uniform Delay (d), s/veh	57.3	35.6	0.0	61.9	44.5	36.9	37.1	0.0	0.0	38.9	0.0	28.9
Incr Delay (d2), s/veh	63.3	1.0	0.0	5.1	5.0	0.3	0.0	0.0	0.0	0.6	0.0	0.2
Initial Q Delay(d3),s/veh	0.0	0.0	0.0	0.0	0.0	0.0	0.0	0.0	0.0	0.0	0.0	0.0
%ile BackOfQ(50%),veh/ln	7.9	9.6	0.0	0.5	11.4	2.5	0.2	0.0	0.0	2.3	0.0	0.6
Unsig. Movement Delay, s/veh												
LnGrp Delay(d),s/veh	120.6	36.6	0.0	66.9	49.6	37.2	37.2	0.0	0.0	39.5	0.0	29.1
LnGrp LOS	F	D		E	D	D	D	A	A	D	A	C
Approach Vol, veh/h		1294			1250			17				208
Approach Delay, s/veh		47.0			48.7			37.2				38.1
Approach LOS		D			D			D				D
Timer - Assigned Phs	1	2		4	5	6		8				
Phs Duration (G+Y+Rc), s	6.7	49.3		35.4	16.5	39.5		35.4				
Change Period (Y+Rc), s	4.6	6.2		5.4	4.6	6.2		5.4				
Max Green Setting (Gmax), s	5.0	43.4		30.0	11.9	36.5		30.0				
Max Q Clear Time (g_c+I1), s	3.0	26.4		7.1	13.6	29.2		2.5				
Green Ext Time (p_c), s	0.0	6.7		0.6	0.0	4.1		0.0				

Intersection Summary

HCM 6th Ctrl Delay	47.1
HCM 6th LOS	D

Notes

- User approved pedestrian interval to be less than phase max green.
- User approved volume balancing among the lanes for turning movement.
- Unsignalized Delay for [EBR] is excluded from calculations of the approach delay and intersection delay.

Timings
37: Cactus Av. & Frederick St.

West Campus Upper Plateau (JN 14064)

09/30/2022

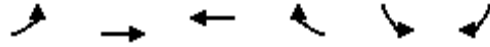

Lane Group	EBL	EBT	WBT	WBR	SBL	SBR
Lane Configurations	↖	↑↑↑	↑↑↑	↖	↘↘	↘
Traffic Volume (vph)	103	1169	1175	165	263	84
Future Volume (vph)	103	1169	1175	165	263	84
Turn Type	Prot	NA	NA	pm+ov	Prot	pm+ov
Protected Phases	5	2	6	4	4	5
Permitted Phases				6		4
Detector Phase	5	2	6	4	4	5
Switch Phase						
Minimum Initial (s)	5.0	10.0	10.0	10.0	10.0	5.0
Minimum Split (s)	9.2	28.2	29.2	36.4	36.4	9.2
Total Split (s)	31.0	81.0	50.0	39.0	39.0	31.0
Total Split (%)	25.8%	67.5%	41.7%	32.5%	32.5%	25.8%
Yellow Time (s)	3.2	5.2	5.2	4.4	4.4	3.2
All-Red Time (s)	1.0	1.0	1.0	1.0	1.0	1.0
Lost Time Adjust (s)	0.0	0.0	0.0	0.0	0.0	0.0
Total Lost Time (s)	4.2	6.2	6.2	5.4	5.4	4.2
Lead/Lag	Lead		Lag			Lead
Lead-Lag Optimize?	Yes		Yes			Yes
Recall Mode	None	None	None	None	None	None
Act Effct Green (s)	9.7	41.0	26.8	42.1	14.5	30.0
Actuated g/C Ratio	0.14	0.60	0.39	0.62	0.21	0.44
v/c Ratio	0.46	0.42	0.64	0.17	0.40	0.13
Control Delay	37.1	7.9	19.1	1.0	25.9	11.8
Queue Delay	0.0	0.0	0.0	0.0	0.0	0.0
Total Delay	37.1	7.9	19.1	1.0	25.9	11.8
LOS	D	A	B	A	C	B
Approach Delay		10.3	16.8		22.5	
Approach LOS		B	B		C	

Intersection Summary

Cycle Length: 120
 Actuated Cycle Length: 67.9
 Natural Cycle: 75
 Control Type: Actuated-Uncoordinated
 Maximum v/c Ratio: 0.64
 Intersection Signal Delay: 14.7
 Intersection Capacity Utilization 49.9%
 Analysis Period (min) 15
 Intersection LOS: B
 ICU Level of Service A

Splits and Phases: 37: Cactus Av. & Frederick St.



HCM 6th Signalized Intersection Summary
37: Cactus Av. & Frederick St.

West Campus Upper Plateau (JN 14064)

09/30/2022

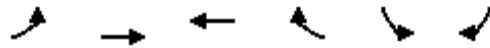

Movement	EBL	EBT	WBT	WBR	SBL	SBR
Lane Configurations						
Traffic Volume (veh/h)	103	1169	1175	165	263	84
Future Volume (veh/h)	103	1169	1175	165	263	84
Initial Q (Qb), veh	0	0	0	0	0	0
Ped-Bike Adj(A_pbT)	1.00			0.98	1.00	1.00
Parking Bus, Adj	1.00	1.00	1.00	1.00	1.00	1.00
Work Zone On Approach		No	No		No	
Adj Sat Flow, veh/h/ln	1826	1856	1856	1870	1856	1856
Adj Flow Rate, veh/h	112	1271	1277	115	286	-9
Peak Hour Factor	0.92	0.92	0.92	0.92	0.92	0.92
Percent Heavy Veh, %	5	3	3	2	3	3
Cap, veh/h	145	2999	2173	960	641	425
Arrive On Green	0.08	0.59	0.43	0.43	0.19	0.00
Sat Flow, veh/h	1739	5233	5233	1548	3428	1572
Grp Volume(v), veh/h	112	1271	1277	115	286	-9
Grp Sat Flow(s),veh/h/ln	1739	1689	1689	1548	1714	1572
Q Serve(g_s), s	3.3	7.2	10.1	1.6	3.9	0.0
Cycle Q Clear(g_c), s	3.3	7.2	10.1	1.6	3.9	0.0
Prop In Lane	1.00			1.00	1.00	1.00
Lane Grp Cap(c), veh/h	145	2999	2173	960	641	425
V/C Ratio(X)	0.77	0.42	0.59	0.12	0.45	-0.02
Avail Cap(c_a), veh/h	887	7215	4225	1587	2193	1137
HCM Platoon Ratio	1.00	1.00	1.00	1.00	1.00	1.00
Upstream Filter(I)	1.00	1.00	1.00	1.00	1.00	0.00
Uniform Delay (d), s/veh	23.6	5.8	11.5	4.2	18.9	0.0
Incr Delay (d2), s/veh	3.3	0.1	0.3	0.1	0.5	0.0
Initial Q Delay(d3),s/veh	0.0	0.0	0.0	0.0	0.0	0.0
%ile BackOfQ(50%),veh/ln	1.3	1.3	2.6	0.6	1.4	0.0
Unsig. Movement Delay, s/veh						
LnGrp Delay(d),s/veh	26.9	5.9	11.7	4.2	19.4	0.0
LnGrp LOS	C	A	B	A	B	A
Approach Vol, veh/h		1383	1392		277	
Approach Delay, s/veh		7.6	11.1		20.1	
Approach LOS		A	B		C	
Timer - Assigned Phs		2		4	5	6
Phs Duration (G+Y+Rc), s		37.3		15.2	8.6	28.7
Change Period (Y+Rc), s		6.2		5.4	* 4.2	6.2
Max Green Setting (Gmax), s		74.8		33.6	* 27	43.8
Max Q Clear Time (g_c+I1), s		9.2		5.9	5.3	12.1
Green Ext Time (p_c), s		11.0		1.0	0.1	10.4

Intersection Summary

HCM 6th Ctrl Delay	10.3
HCM 6th LOS	B

Notes

* HCM 6th computational engine requires equal clearance times for the phases crossing the barrier.

Timings
38: Riverside Dr./Graham St. & Cactus Av.

West Campus Upper Plateau (JN 14064)

09/30/2022

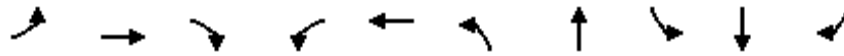

Lane Group	EBL	EBT	EBR	WBL	WBT	NBL	NBT	SBL	SBT	SBR
Lane Configurations	↘	↑↑↑	↗	↘	↑↑↑	↘	↑↑	↘	↑↑	↗
Traffic Volume (vph)	56	1095	173	20	1137	157	46	64	59	70
Future Volume (vph)	56	1095	173	20	1137	157	46	64	59	70
Turn Type	Prot	NA	Perm	Prot	NA	Prot	NA	Prot	NA	Perm
Protected Phases	7	4		3	8	5	2	1	6	
Permitted Phases			4							6
Detector Phase	7	4	4	3	8	5	2	1	6	6
Switch Phase										
Minimum Initial (s)	5.0	10.0	10.0	5.0	10.0	5.0	10.0	5.0	10.0	10.0
Minimum Split (s)	9.6	39.2	39.2	9.6	39.2	10.4	35.0	9.6	40.6	40.6
Total Split (s)	16.0	59.0	59.0	9.6	52.6	10.4	36.0	15.4	41.0	41.0
Total Split (%)	13.3%	49.2%	49.2%	8.0%	43.8%	8.7%	30.0%	12.8%	34.2%	34.2%
Yellow Time (s)	3.6	5.2	5.2	3.6	5.2	4.4	4.0	3.6	3.6	3.6
All-Red Time (s)	1.0	1.0	1.0	1.0	1.0	1.0	1.0	1.0	1.0	1.0
Lost Time Adjust (s)	0.0	0.0	0.0	0.0	0.0	0.0	0.0	0.0	0.0	0.0
Total Lost Time (s)	4.6	6.2	6.2	4.6	6.2	5.4	5.0	4.6	4.6	4.6
Lead/Lag	Lead	Lag	Lag	Lead	Lag	Lead	Lag	Lead	Lag	Lag
Lead-Lag Optimize?	Yes	Yes	Yes	Yes	Yes	Yes	Yes	Yes	Yes	Yes
Recall Mode	None	Min	Min	None	Min	None	None	None	None	None
Act Effct Green (s)	7.7	36.2	36.2	5.6	29.9	7.3	13.8	7.8	15.7	15.7
Actuated g/C Ratio	0.10	0.48	0.48	0.07	0.40	0.10	0.18	0.10	0.21	0.21
v/c Ratio	0.32	0.47	0.21	0.16	0.63	0.48	0.10	0.36	0.08	0.16
Control Delay	43.9	15.6	3.6	46.4	21.9	46.3	24.5	44.6	27.6	0.8
Queue Delay	0.0	0.0	0.0	0.0	0.0	0.0	0.0	0.0	0.0	0.0
Total Delay	43.9	15.6	3.6	46.4	21.9	46.3	24.5	44.6	27.6	0.8
LOS	D	B	A	D	C	D	C	D	C	A
Approach Delay		15.3			22.3		40.2		23.5	
Approach LOS		B			C		D		C	

Intersection Summary

Cycle Length: 120
 Actuated Cycle Length: 75.1
 Natural Cycle: 100
 Control Type: Actuated-Uncoordinated
 Maximum v/c Ratio: 0.63
 Intersection Signal Delay: 20.5
 Intersection LOS: C
 Intersection Capacity Utilization 51.9%
 ICU Level of Service A
 Analysis Period (min) 15

Splits and Phases: 38: Riverside Dr./Graham St. & Cactus Av.

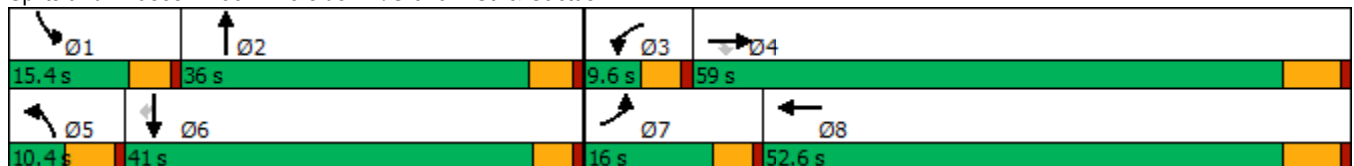

HCM 6th Signalized Intersection Summary
38: Riverside Dr./Graham St. & Cactus Av.

West Campus Upper Plateau (JN 14064)

09/30/2022



Movement	EBL	EBT	EBR	WBL	WBT	WBR	NBL	NBT	NBR	SBL	SBT	SBR
Lane Configurations	↘	↑↑↑	↗	↘	↑↑↑		↘↗	↑↗		↘	↑↑	↗
Traffic Volume (veh/h)	56	1095	173	20	1137	64	157	46	16	64	59	70
Future Volume (veh/h)	56	1095	173	20	1137	64	157	46	16	64	59	70
Initial Q (Qb), veh	0	0	0	0	0	0	0	0	0	0	0	0
Ped-Bike Adj(A_pbT)	1.00		1.00	1.00		0.99	1.00		1.00	1.00		1.00
Parking Bus, Adj	1.00	1.00	1.00	1.00	1.00	1.00	1.00	1.00	1.00	1.00	1.00	1.00
Work Zone On Approach		No			No			No			No	
Adj Sat Flow, veh/h/ln	1841	1841	1885	1900	1841	1900	1900	1900	1900	1870	1885	1826
Adj Flow Rate, veh/h	58	1129	133	21	1172	58	162	47	15	66	61	-2
Peak Hour Factor	0.97	0.97	0.97	0.97	0.97	0.97	0.97	0.97	0.97	0.97	0.97	0.97
Percent Heavy Veh, %	4	4	1	0	4	0	0	0	0	2	1	5
Cap, veh/h	90	2003	637	44	1823	90	268	518	158	98	559	241
Arrive On Green	0.05	0.40	0.40	0.02	0.37	0.37	0.08	0.19	0.19	0.05	0.16	0.00
Sat Flow, veh/h	1753	5025	1598	1810	4901	242	3510	2725	830	1781	3582	1547
Grp Volume(v), veh/h	58	1129	133	21	801	429	162	30	32	66	61	-2
Grp Sat Flow(s),veh/h/ln	1753	1675	1598	1810	1675	1793	1755	1805	1751	1781	1791	1547
Q Serve(g_s), s	2.0	10.7	3.4	0.7	12.1	12.1	2.7	0.9	0.9	2.2	0.9	0.0
Cycle Q Clear(g_c), s	2.0	10.7	3.4	0.7	12.1	12.1	2.7	0.9	0.9	2.2	0.9	0.0
Prop In Lane	1.00		1.00	1.00		0.14	1.00		0.47	1.00		1.00
Lane Grp Cap(c), veh/h	90	2003	637	44	1246	667	268	343	333	98	559	241
V/C Ratio(X)	0.65	0.56	0.21	0.47	0.64	0.64	0.61	0.09	0.10	0.67	0.11	-0.01
Avail Cap(c_a), veh/h	325	4315	1372	147	2528	1353	285	910	883	313	2120	916
HCM Platoon Ratio	1.00	1.00	1.00	1.00	1.00	1.00	1.00	1.00	1.00	1.00	1.00	1.00
Upstream Filter(I)	1.00	1.00	1.00	1.00	1.00	1.00	1.00	1.00	1.00	1.00	1.00	0.00
Uniform Delay (d), s/veh	28.6	14.3	12.1	29.6	15.9	15.9	27.5	20.5	20.5	28.5	22.3	0.0
Incr Delay (d2), s/veh	2.9	0.3	0.2	2.9	0.6	1.0	2.1	0.1	0.1	3.0	0.1	0.0
Initial Q Delay(d3),s/veh	0.0	0.0	0.0	0.0	0.0	0.0	0.0	0.0	0.0	0.0	0.0	0.0
%ile BackOfQ(50%),veh/ln	0.8	3.2	1.0	0.3	3.8	4.1	1.2	0.3	0.4	1.0	0.3	0.0
Unsig. Movement Delay, s/veh												
LnGrp Delay(d),s/veh	31.5	14.6	12.3	32.5	16.5	17.0	29.6	20.6	20.7	31.5	22.4	0.0
LnGrp LOS	C	B	B	C	B	B	C	C	C	C	C	A
Approach Vol, veh/h		1320			1251			224			125	
Approach Delay, s/veh		15.1			16.9			27.1			27.5	
Approach LOS		B			B			C			C	
Timer - Assigned Phs	1	2	3	4	5	6	7	8				
Phs Duration (G+Y+Rc), s	8.0	16.7	6.1	30.7	10.1	14.6	7.7	29.1				
Change Period (Y+Rc), s	4.6	5.0	4.6	6.2	5.4	* 5	4.6	6.2				
Max Green Setting (Gmax), s	10.8	31.0	5.0	52.8	5.0	* 36	11.4	46.4				
Max Q Clear Time (g_c+I1), s	4.2	2.9	2.7	12.7	4.7	2.9	4.0	14.1				
Green Ext Time (p_c), s	0.0	0.3	0.0	9.4	0.0	0.3	0.0	8.7				

Intersection Summary

HCM 6th Ctrl Delay	17.3
HCM 6th LOS	B

Notes

* HCM 6th computational engine requires equal clearance times for the phases crossing the barrier.

APPENDIX 6.2:

EAP CONDITIONS TRAFFIC SIGNAL WARRANT ANALYSIS WORKSHEETS

This Page Intentionally Left Blank

Figure 4C-3. Warrant 3, Peak Hour

Traffic Conditions = **EAP Conditions - Weekday AM Peak Hour**

Major Street Name = **Grove Community Dr.** Total of Both Approaches (VPH) = **642**
 Number of Approach Lanes on Major Street = **1**

Minor Street Name = **Deercreek Dr.** High Volume Approach (VPH) = **268**
 Number of Approach Lanes On Minor Street = **1**

SIGNAL WARRANT NOT SATISFIED

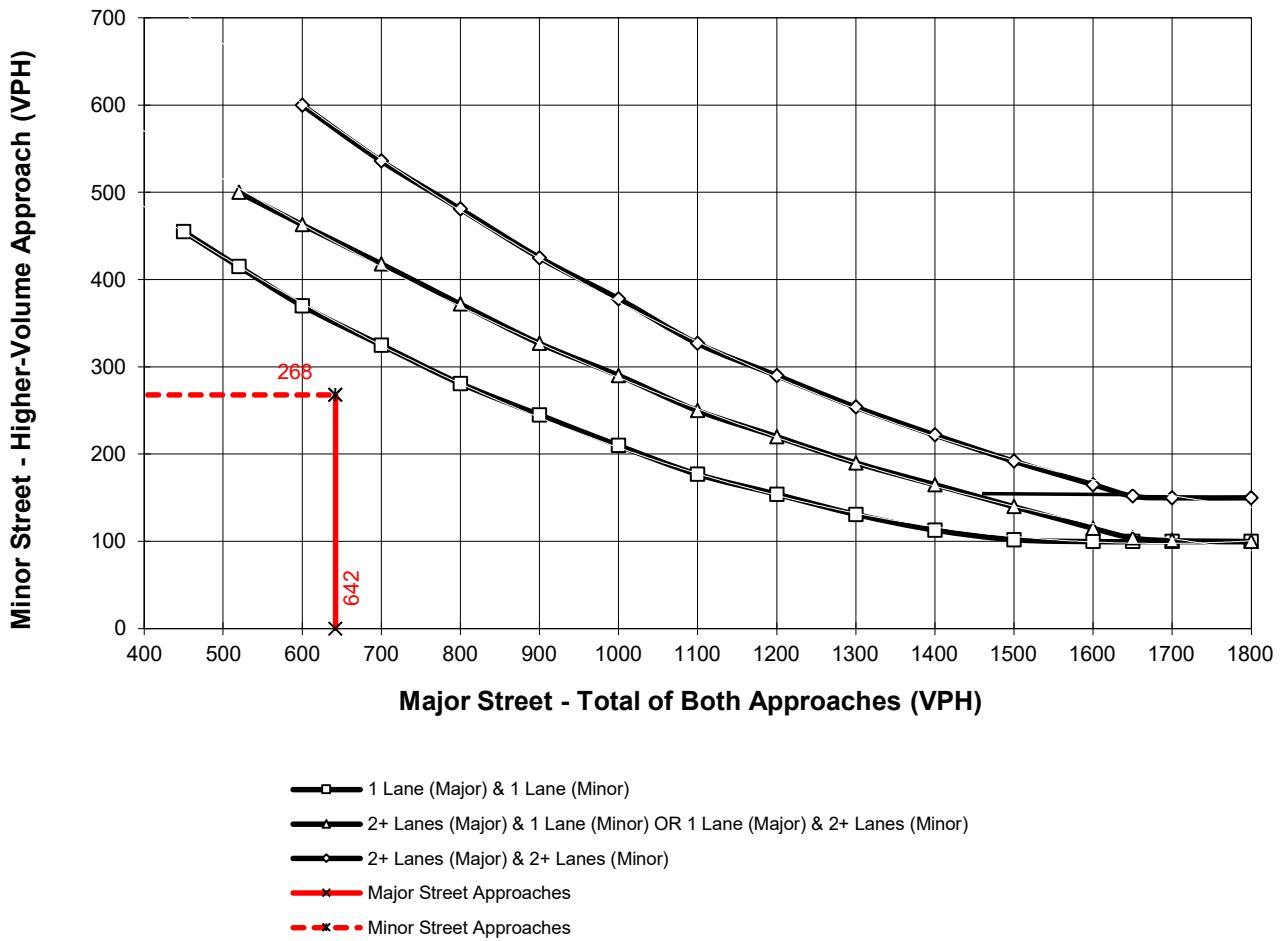

*Note: 150 vph applies as the lower threshold for a minor-street approach with two or more lanes and 100 vph applies as the lower threshold for a minor-street approach with one lane

Figure 4C-3. Warrant 3, Peak Hour

Traffic Conditions = **EAP Conditions - Weekday PM Peak Hour**

Major Street Name = **Grove Community Dr.** Total of Both Approaches (VPH) = **470**
 Number of Approach Lanes on Major Street = **1**

Minor Street Name = **Barton Rd.** High Volume Approach (VPH) = **57**
 Number of Approach Lanes On Minor Street = **1**

SIGNAL WARRANT NOT SATISFIED

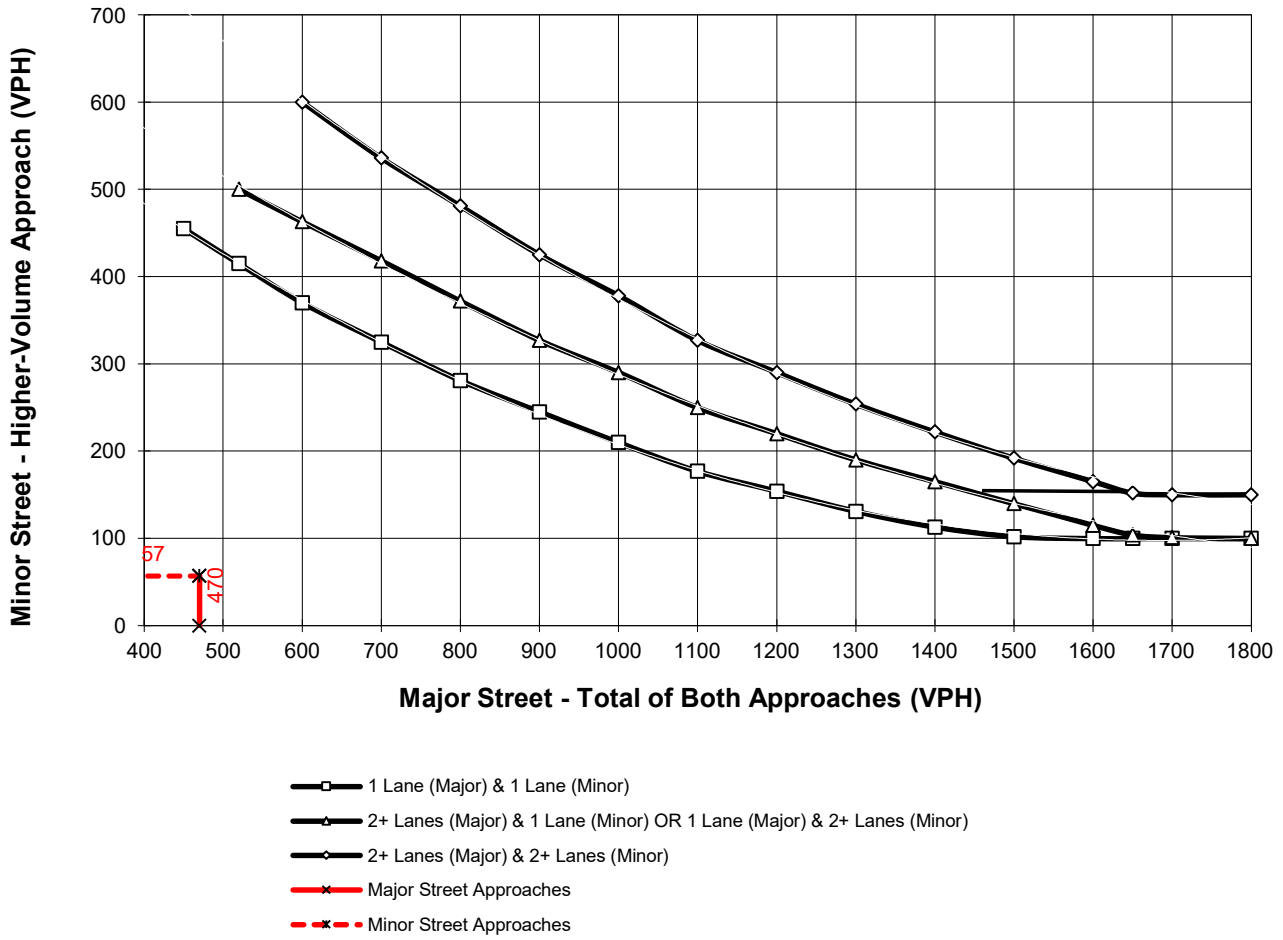

*Note: 150 vph applies as the lower threshold for a minor-street approach with two or more lanes and 100 vph applies as the lower threshold for a minor-street approach with one lane



Figure 4C-3. Warrant 3, Peak Hour

Traffic Conditions = **EAP Conditions - Weekday AM Peak Hour**

Major Street Name = **Grove Community Dr.** Total of Both Approaches (VPH) = **502**
 Number of Approach Lanes on Major Street = **1**

Minor Street Name = **Abrams Dr** High Volume Approach (VPH) = **225**
 Number of Approach Lanes On Minor Street = **1**

SIGNAL WARRANT NOT SATISFIED

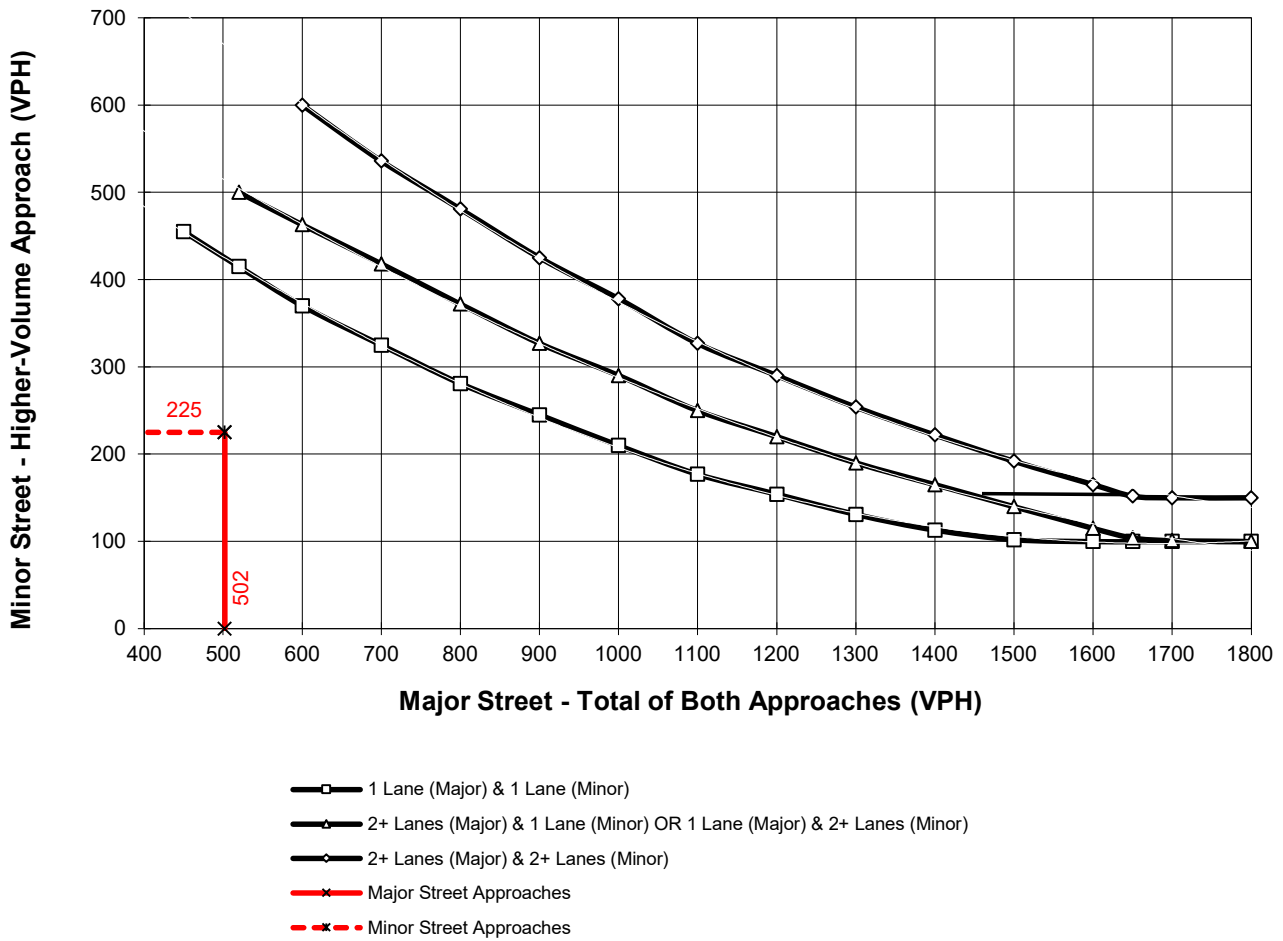

*Note: 150 vph applies as the lower threshold for a minor-street approach with two or more lanes and 100 vph applies as the lower threshold for a minor-street approach with one lane

Figure 4C-3. Warrant 3, Peak Hour

Traffic Conditions = **EAP Conditions - Weekday AM Peak Hour**

Major Street Name = **Orange Terrace Pkwy**

Total of Both Approaches (VPH) = **760**

Number of Approach Lanes on Major Street = **1**

Minor Street Name = **Abrams Dr.**

High Volume Approach (VPH) = **203**

Number of Approach Lanes On Minor Street = **1**

SIGNAL WARRANT NOT SATISFIED

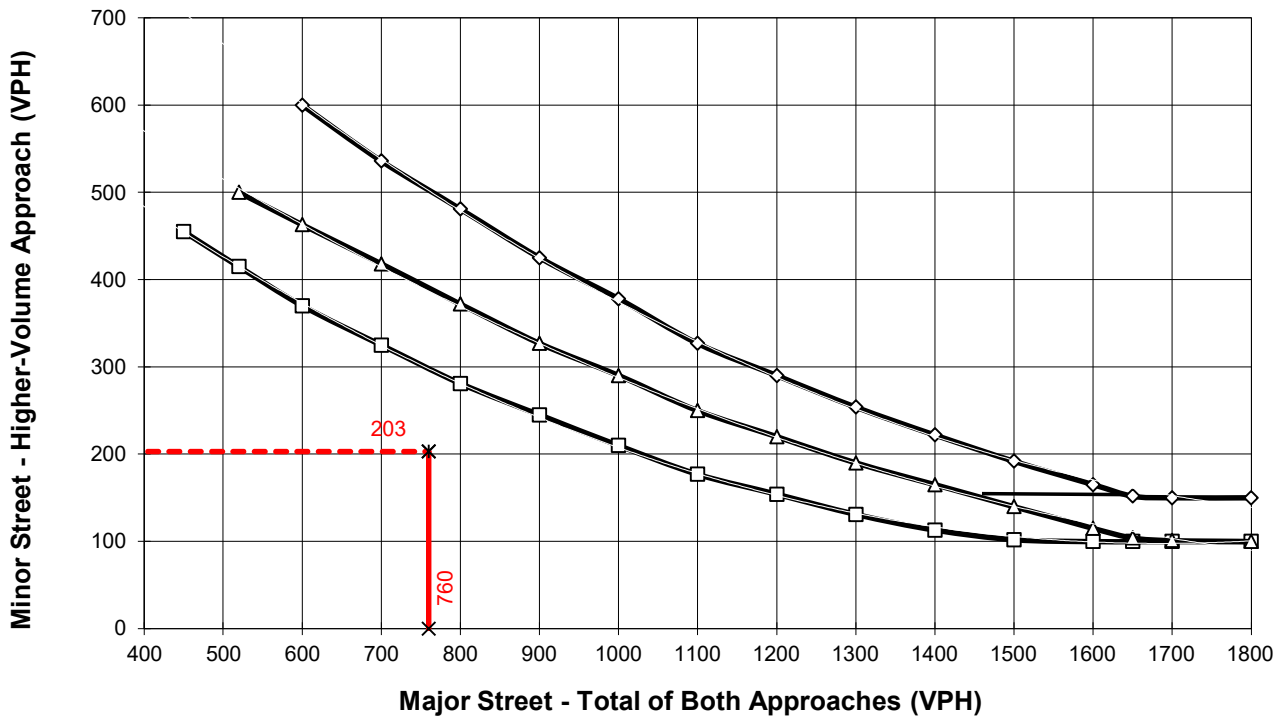

- 1 Lane (Major) & 1 Lane (Minor)
- △— 2+ Lanes (Major) & 1 Lane (Minor) OR 1 Lane (Major) & 2+ Lanes (Minor)
- ◇— 2+ Lanes (Major) & 2+ Lanes (Minor)
- x— Major Street Approaches
- - -x- - - Minor Street Approaches

*Note: 150 vph applies as the lower threshold for a minor-street approach with two or more lanes and 100 vph applies as the lower threshold for a minor-street approach with one lane

APPENDIX 6.3:

EAP CONDITIONS FREEWAY OFF-RAMP QUEUING ANALYSIS WORKSHEETS

This Page Intentionally Left Blank

Queues
28: I-215 SB Ramps & Alessandro Bl.

West Campus Upper Plateau (JN 14064)

09/19/2022

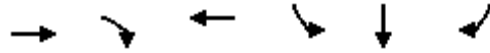

Lane Group	EBT	EBR	WBT	SBL	SBT	SBR
Lane Configurations	↑↑↑	↑	↑↑↑	↑	↔	↑
Traffic Volume (vph)	922	422	2767	197	0	409
Future Volume (vph)	922	422	2767	197	0	409
Lane Group Flow (vph)	931	426	2961	179	218	215
Turn Type	NA	Perm	NA	Split	NA	Perm
Protected Phases	2		6	4	4	
Permitted Phases		2				4
Detector Phase	2	2	6	4	4	4
Switch Phase						
Minimum Initial (s)	5.0	5.0	5.0	5.0	5.0	5.0
Minimum Split (s)	10.5	10.5	34.5	10.0	10.0	10.0
Total Split (s)	49.0	49.0	49.0	36.0	36.0	36.0
Total Split (%)	57.6%	57.6%	57.6%	42.4%	42.4%	42.4%
Yellow Time (s)	4.5	4.5	4.5	4.0	4.0	4.0
All-Red Time (s)	1.0	1.0	1.0	1.0	1.0	1.0
Lost Time Adjust (s)	0.0	0.0	0.0	0.0	0.0	0.0
Total Lost Time (s)	5.5	5.5	5.5	5.0	5.0	5.0
Lead/Lag						
Lead-Lag Optimize?						
Recall Mode	C-Min	C-Min	C-Min	None	None	None
v/c Ratio	0.28	0.38	0.88	0.56	0.69	0.66
Control Delay	7.1	3.3	12.5	35.2	36.4	34.3
Queue Delay	0.0	0.0	0.0	0.0	0.0	0.0
Total Delay	7.1	3.3	12.5	35.2	36.4	34.3
Queue Length 50th (ft)	65	17	397	90	101	94
Queue Length 95th (ft)	117	70	m275	136	159	148
Internal Link Dist (ft)	750		688		1585	
Turn Bay Length (ft)		50		525		525
Base Capacity (vph)	3308	1117	3376	548	519	538
Starvation Cap Reductn	0	0	0	0	0	0
Spillback Cap Reductn	0	0	0	0	0	0
Storage Cap Reductn	0	0	0	0	0	0
Reduced v/c Ratio	0.28	0.38	0.88	0.33	0.42	0.40

Intersection Summary

Cycle Length: 85
 Actuated Cycle Length: 85
 Offset: 50 (59%), Referenced to phase 2:EBT and 6:WBT, Start of Yellow
 Natural Cycle: 60
 Control Type: Actuated-Coordinated
 m Volume for 95th percentile queue is metered by upstream signal.

Splits and Phases: 28: I-215 SB Ramps & Alessandro Bl.

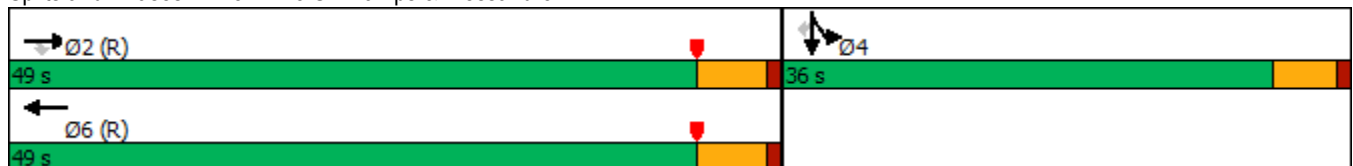

Queues

29: I-215 NB Ramps & Alessandro Bl.



Lane Group	EBL	EBT	WBT	WBR	NBL	NBT	NBR
Lane Configurations	↘	↑↑↑	↑↑↑	↗	↘	↕	↗
Traffic Volume (vph)	97	1023	1539	89	1392	0	182
Future Volume (vph)	97	1023	1539	89	1392	0	182
Lane Group Flow (vph)	99	1044	1570	91	724	715	167
Turn Type	Prot	NA	NA	Perm	Split	NA	Perm
Protected Phases	5	2	6		8	8	
Permitted Phases				6			8
Detector Phase	5	2	6	6	8	8	8
Switch Phase							
Minimum Initial (s)	5.0	5.0	5.0	5.0	5.0	5.0	5.0
Minimum Split (s)	9.5	10.5	33.5	33.5	10.0	10.0	10.0
Total Split (s)	25.0	60.0	35.0	35.0	25.0	25.0	25.0
Total Split (%)	29.4%	70.6%	41.2%	41.2%	29.4%	29.4%	29.4%
Yellow Time (s)	3.5	4.5	4.5	4.5	4.0	4.0	4.0
All-Red Time (s)	1.0	1.0	1.0	1.0	1.0	1.0	1.0
Lost Time Adjust (s)	0.0	0.0	0.0	0.0	0.0	0.0	0.0
Total Lost Time (s)	4.5	5.5	5.5	5.5	5.0	5.0	5.0
Lead/Lag	Lead		Lag	Lag			
Lead-Lag Optimize?	Yes		Yes	Yes			
Recall Mode	None	C-Min	C-Min	C-Min	Max	Max	Max
v/c Ratio	0.54	0.34	0.66	0.13	1.69	1.50	0.36
Control Delay	40.6	7.3	19.7	4.9	345.8	259.9	11.1
Queue Delay	0.0	0.0	0.0	0.0	0.0	0.0	0.0
Total Delay	40.6	7.3	19.7	4.9	345.8	259.9	11.1
Queue Length 50th (ft)	50	63	228	2	~623	~571	17
Queue Length 95th (ft)	96	115	311	30	#845	#806	72
Internal Link Dist (ft)		688	447			1005	
Turn Bay Length (ft)	200			50	400		400
Base Capacity (vph)	356	3198	2384	714	429	477	460
Starvation Cap Reductn	0	0	0	0	0	0	0
Spillback Cap Reductn	0	0	0	0	0	0	0
Storage Cap Reductn	0	0	0	0	0	0	0
Reduced v/c Ratio	0.28	0.33	0.66	0.13	1.69	1.50	0.36

Intersection Summary

Cycle Length: 85
 Actuated Cycle Length: 85
 Offset: 20 (24%), Referenced to phase 2:EBT and 6:WBT, Start of Yellow
 Natural Cycle: 90
 Control Type: Actuated-Coordinated
 ~ Volume exceeds capacity, queue is theoretically infinite.
 Queue shown is maximum after two cycles.
 # 95th percentile volume exceeds capacity, queue may be longer.
 Queue shown is maximum after two cycles.

Splits and Phases: 29: I-215 NB Ramps & Alessandro Bl.



Queues
30: I-215 SB Ramps & Cactus Av.

West Campus Upper Plateau (JN 14064)

09/19/2022



Lane Group	EBT	EBR	WBL	WBT	NBR	SBR
Lane Configurations	↑↑	↑	↓	↑↑	↑	↑
Traffic Volume (vph)	533	73	665	1645	717	618
Future Volume (vph)	533	73	665	1645	717	618
Lane Group Flow (vph)	592	81	739	1828	797	687
Turn Type	NA	Perm	Prot	NA	Prot	Prot
Protected Phases	2		1	6	8	4
Permitted Phases		2				
Detector Phase	2	2	1	6	8	4
Switch Phase						
Minimum Initial (s)	5.0	5.0	5.0	5.0	5.0	5.0
Minimum Split (s)	11.0	11.0	9.5	23.0	9.5	9.5
Total Split (s)	23.0	23.0	54.0	77.0	28.0	28.0
Total Split (%)	21.9%	21.9%	51.4%	73.3%	26.7%	26.7%
Yellow Time (s)	5.0	5.0	3.5	5.0	3.5	3.5
All-Red Time (s)	1.0	1.0	1.0	1.0	1.0	1.0
Lost Time Adjust (s)	0.0	0.0	0.0	0.0	0.0	0.0
Total Lost Time (s)	6.0	6.0	4.5	6.0	4.5	4.5
Lead/Lag	Lag	Lag	Lead			
Lead-Lag Optimize?	Yes	Yes	Yes			
Recall Mode	Min	Min	None	Min	None	None
v/c Ratio	1.07	0.26	0.97	0.78	0.82	1.82
Control Delay	101.4	11.2	54.0	14.7	10.7	402.9
Queue Delay	0.0	0.0	0.0	0.0	0.0	0.0
Total Delay	101.4	11.2	54.0	14.7	10.7	402.9
Queue Length 50th (ft)	~237	0	459	392	0	~667
Queue Length 95th (ft)	#348	42	#717	486	124	#894
Internal Link Dist (ft)	658			918		
Turn Bay Length (ft)						
Base Capacity (vph)	552	314	796	2418	969	378
Starvation Cap Reductn	0	0	0	0	0	0
Spillback Cap Reductn	0	0	0	0	0	0
Storage Cap Reductn	0	0	0	0	0	0
Reduced v/c Ratio	1.07	0.26	0.93	0.76	0.82	1.82

Intersection Summary

Cycle Length: 105

Actuated Cycle Length: 103.1

Natural Cycle: 120

Control Type: Actuated-Uncoordinated

~ Volume exceeds capacity, queue is theoretically infinite.

Queue shown is maximum after two cycles.

95th percentile volume exceeds capacity, queue may be longer.

Queue shown is maximum after two cycles.

Splits and Phases: 30: I-215 SB Ramps & Cactus Av.

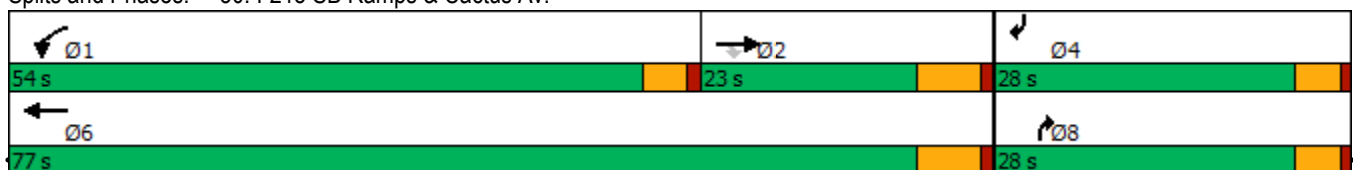

Queues

31: I-215 NB Ramps/Old 215 Frontage Rd. & Cactus Av.



Lane Group	EBL	EBT	WBT	NBL	NBT	NBR	SBL	SBT
Lane Configurations	↖	↕	↕	↖	↕	↗	↖	↕
Traffic Volume (vph)	32	1470	2792	464	335	13	56	0
Future Volume (vph)	32	1470	2792	464	335	13	56	0
Lane Group Flow (vph)	34	1745	3138	494	357	13	60	165
Turn Type	Perm	NA	NA	Perm	NA	Perm	Perm	NA
Protected Phases		2	6		8			4
Permitted Phases	2			8		8	4	
Detector Phase	2	2	6	8	8	8	4	4
Switch Phase								
Minimum Initial (s)	5.0	5.0	5.0	5.0	5.0	5.0	5.0	5.0
Minimum Split (s)	11.0	11.0	44.0	10.5	10.5	10.5	10.5	10.5
Total Split (s)	88.0	88.0	88.0	32.0	32.0	32.0	32.0	32.0
Total Split (%)	73.3%	73.3%	73.3%	26.7%	26.7%	26.7%	26.7%	26.7%
Yellow Time (s)	5.0	5.0	5.0	4.5	4.5	4.5	4.5	4.5
All-Red Time (s)	1.0	1.0	1.0	1.0	1.0	1.0	1.0	1.0
Lost Time Adjust (s)	0.0	0.0	0.0	0.0	0.0	0.0	0.0	0.0
Total Lost Time (s)	6.0	6.0	6.0	5.5	5.5	5.5	5.5	5.5
Lead/Lag								
Lead-Lag Optimize?								
Recall Mode	Min	Min	Min	None	None	None	None	None
v/c Ratio	0.62	0.76	1.32	2.25	1.01	0.04	1.00	0.55
Control Delay	62.5	15.2	168.7	598.9	96.2	5.4	165.4	42.4
Queue Delay	0.0	0.0	0.0	0.0	0.0	0.0	0.0	0.0
Total Delay	62.5	15.2	168.7	598.9	96.2	5.4	165.4	42.4
Queue Length 50th (ft)	13	420	~1662	~619	~294	0	47	95
Queue Length 95th (ft)	#81	513	#1784	#830	#502	9	#139	170
Internal Link Dist (ft)		310	1149		1221			746
Turn Bay Length (ft)	175			145			100	
Base Capacity (vph)	55	2290	2378	220	355	359	60	299
Starvation Cap Reductn	0	0	0	0	0	0	0	0
Spillback Cap Reductn	0	0	0	0	0	0	0	0
Storage Cap Reductn	0	0	0	0	0	0	0	0
Reduced v/c Ratio	0.62	0.76	1.32	2.25	1.01	0.04	1.00	0.55

Intersection Summary

Cycle Length: 120

Actuated Cycle Length: 120

Natural Cycle: 110

Control Type: Actuated-Uncoordinated

~ Volume exceeds capacity, queue is theoretically infinite.

Queue shown is maximum after two cycles.

95th percentile volume exceeds capacity, queue may be longer.

Queue shown is maximum after two cycles.

Splits and Phases: 31: I-215 NB Ramps/Old 215 Frontage Rd. & Cactus Av.

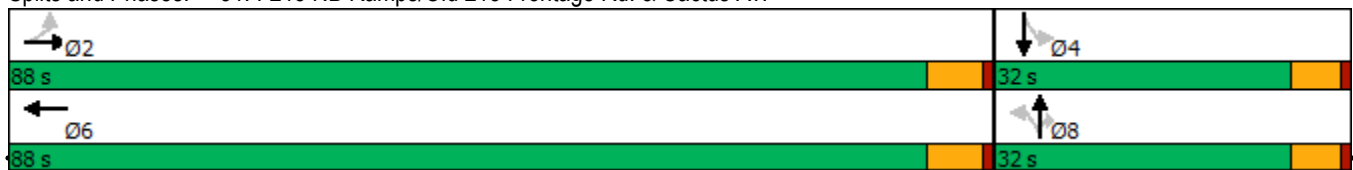

Queues
32: I-215 SB Ramps & Van Buren Bl.

West Campus Upper Plateau (JN 14064)

09/19/2022



Lane Group	EBT	EBR	WBL	WBT	SBT	SBR
Lane Configurations	↑↑	↑↑	↙	↑↑	↙	↑↑
Traffic Volume (vph)	582	777	3	1109	25	826
Future Volume (vph)	582	777	3	1109	25	826
Lane Group Flow (vph)	626	835	3	1192	54	888
Turn Type	NA	Perm	Prot	NA	NA	Perm
Protected Phases	6		5	2	8	
Permitted Phases		6				8
Detector Phase	6	6	5	2	8	8
Switch Phase						
Minimum Initial (s)	5.0	5.0	5.0	5.0	5.0	5.0
Minimum Split (s)	36.0	36.0	11.0	11.0	11.0	11.0
Total Split (s)	37.0	37.0	11.0	48.0	37.0	37.0
Total Split (%)	43.5%	43.5%	12.9%	56.5%	43.5%	43.5%
Yellow Time (s)	5.0	5.0	5.0	5.0	5.0	5.0
All-Red Time (s)	1.0	1.0	1.0	1.0	1.0	1.0
Lost Time Adjust (s)	0.0	0.0	0.0	0.0	0.0	0.0
Total Lost Time (s)	6.0	6.0	6.0	6.0	6.0	6.0
Lead/Lag	Lag	Lag	Lead			
Lead-Lag Optimize?	Yes	Yes	Yes			
Recall Mode	Min	Min	None	Min	Max	Max
v/c Ratio	0.48	0.54	0.02	0.83	0.09	0.74
Control Delay	18.7	2.9	36.7	24.7	16.0	21.8
Queue Delay	0.0	0.0	0.0	0.0	0.0	0.0
Total Delay	18.7	2.9	36.7	24.7	16.0	21.8
Queue Length 50th (ft)	103	0	1	245	14	160
Queue Length 95th (ft)	185	39	10	320	44	#334
Internal Link Dist (ft)	2745			429	1115	
Turn Bay Length (ft)			200			
Base Capacity (vph)	1458	1612	122	1985	580	1198
Starvation Cap Reductn	0	0	0	0	0	0
Spillback Cap Reductn	0	0	0	0	0	0
Storage Cap Reductn	0	0	0	0	0	0
Reduced v/c Ratio	0.43	0.52	0.02	0.60	0.09	0.74

Intersection Summary

Cycle Length: 85

Actuated Cycle Length: 74.1

Natural Cycle: 75

Control Type: Actuated-Uncoordinated

95th percentile volume exceeds capacity, queue may be longer.

Queue shown is maximum after two cycles.

Splits and Phases: 32: I-215 SB Ramps & Van Buren Bl.

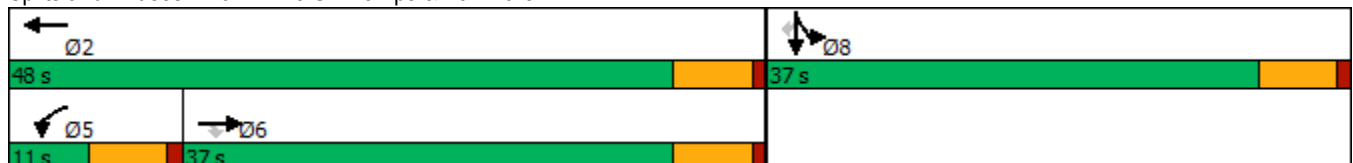

Queues
33: I-215 NB On/Off Ramp & Van Buren Bl.



Lane Group	EBT	EBR	WBT	NBL	NBR
Lane Configurations	↑↑	↑↑	↑↑	↑↑	↑
Traffic Volume (vph)	37	641	30	1109	5
Future Volume (vph)	37	641	30	1109	5
Lane Group Flow (vph)	40	697	33	1205	5
Turn Type	NA	pm+ov	NA	Prot	Perm
Protected Phases	6	4	2	4	
Permitted Phases		6			4
Detector Phase	6	4	2	4	4
Switch Phase					
Minimum Initial (s)	5.0	5.0	5.0	5.0	5.0
Minimum Split (s)	11.0	42.0	11.0	42.0	42.0
Total Split (s)	15.0	55.0	15.0	55.0	55.0
Total Split (%)	21.4%	78.6%	21.4%	78.6%	78.6%
Yellow Time (s)	5.0	5.0	5.0	5.0	5.0
All-Red Time (s)	1.0	1.0	1.0	1.0	1.0
Lost Time Adjust (s)	0.0	0.0	0.0	0.0	0.0
Total Lost Time (s)	6.0	6.0	6.0	6.0	6.0
Lead/Lag					
Lead-Lag Optimize?					
Recall Mode	None	Min	None	Min	Min
v/c Ratio	0.11	0.26	0.10	0.42	0.01
Control Delay	20.2	0.2	20.4	3.2	2.2
Queue Delay	0.0	0.0	0.0	0.0	0.0
Total Delay	20.2	0.2	20.4	3.2	2.2
Queue Length 50th (ft)	4	0	3	0	0
Queue Length 95th (ft)	18	0	16	122	2
Internal Link Dist (ft)	669		611	856	
Turn Bay Length (ft)		300			585
Base Capacity (vph)	597	2707	561	3256	1110
Starvation Cap Reductn	0	0	0	0	0
Spillback Cap Reductn	0	0	0	0	0
Storage Cap Reductn	0	0	0	0	0
Reduced v/c Ratio	0.07	0.26	0.06	0.37	0.00

Intersection Summary

Cycle Length: 70
 Actuated Cycle Length: 40.7
 Natural Cycle: 55
 Control Type: Actuated-Uncoordinated

Splits and Phases: 33: I-215 NB On/Off Ramp & Van Buren Bl.

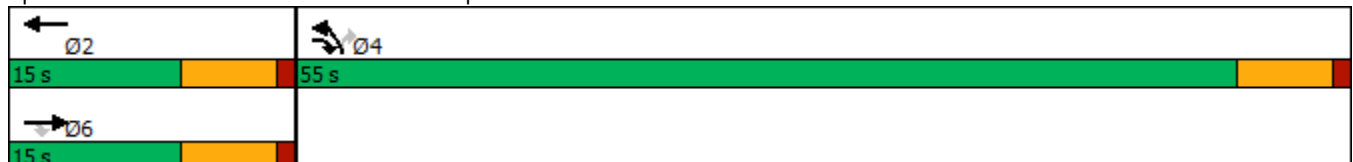

Queues
28: I-215 SB Ramps & Alessandro Bl.

West Campus Upper Plateau (JN 14064)

09/19/2022

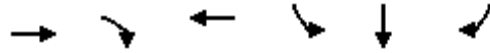

Lane Group	EBT	EBR	WBT	SBL	SBT	SBR
Lane Configurations	↑↑↑	↑	↑↑↑	↑	↔	↑
Traffic Volume (vph)	1769	544	2148	356	0	531
Future Volume (vph)	1769	544	2148	356	0	531
Lane Group Flow (vph)	1787	549	2241	313	294	289
Turn Type	NA	Perm	NA	Split	NA	Perm
Protected Phases	2		6	4	4	
Permitted Phases		2				4
Detector Phase	2	2	6	4	4	4
Switch Phase						
Minimum Initial (s)	5.0	5.0	5.0	5.0	5.0	5.0
Minimum Split (s)	10.5	10.5	34.5	10.0	10.0	10.0
Total Split (s)	52.0	52.0	52.0	33.0	33.0	33.0
Total Split (%)	61.2%	61.2%	61.2%	38.8%	38.8%	38.8%
Yellow Time (s)	4.5	4.5	4.5	4.0	4.0	4.0
All-Red Time (s)	1.0	1.0	1.0	1.0	1.0	1.0
Lost Time Adjust (s)	0.0	0.0	0.0	0.0	0.0	0.0
Total Lost Time (s)	5.5	5.5	5.5	5.0	5.0	5.0
Lead/Lag						
Lead-Lag Optimize?						
Recall Mode	Min	Min	Min	None	None	None
v/c Ratio	0.61	0.54	0.78	0.71	0.71	0.68
Control Delay	12.3	8.3	15.4	34.5	32.4	30.6
Queue Delay	0.0	0.0	0.0	0.0	0.0	0.0
Total Delay	12.3	8.3	15.4	34.5	32.4	30.6
Queue Length 50th (ft)	189	75	276	146	128	118
Queue Length 95th (ft)	274	181	399	237	224	207
Internal Link Dist (ft)	750		688		1585	
Turn Bay Length (ft)		50		525		525
Base Capacity (vph)	3293	1109	3240	596	549	563
Starvation Cap Reductn	0	0	0	0	0	0
Spillback Cap Reductn	0	0	0	0	0	0
Storage Cap Reductn	0	0	0	0	0	0
Reduced v/c Ratio	0.54	0.50	0.69	0.53	0.54	0.51

Intersection Summary

Cycle Length: 85
 Actuated Cycle Length: 74.7
 Natural Cycle: 55
 Control Type: Actuated-Uncoordinated

Splits and Phases: 28: I-215 SB Ramps & Alessandro Bl.

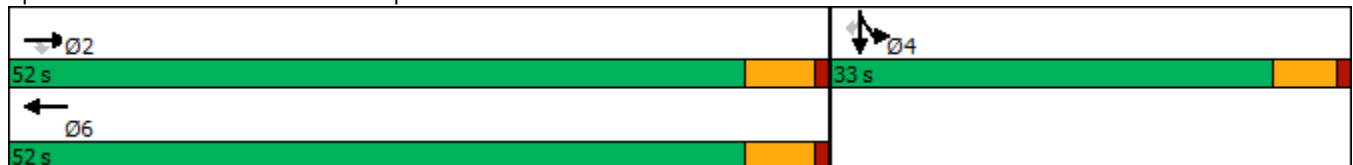

Queues
29: I-215 NB Ramps & Alessandro Bl.

West Campus Upper Plateau (JN 14064)

09/19/2022



Lane Group	EBL	EBT	WBT	WBR	NBL	NBT	NBR
Lane Configurations							
Traffic Volume (vph)	231	1894	1181	129	1037	13	310
Future Volume (vph)	231	1894	1181	129	1037	13	310
Lane Group Flow (vph)	246	2015	1256	137	574	576	297
Turn Type	Prot	NA	NA	Perm	Split	NA	Perm
Protected Phases	5	2	6		8	8	
Permitted Phases				6			8
Detector Phase	5	2	6	6	8	8	8
Switch Phase							
Minimum Initial (s)	5.0	5.0	5.0	5.0	5.0	5.0	5.0
Minimum Split (s)	9.5	10.5	33.5	33.5	10.0	10.0	10.0
Total Split (s)	13.0	48.0	35.0	35.0	37.0	37.0	37.0
Total Split (%)	15.3%	56.5%	41.2%	41.2%	43.5%	43.5%	43.5%
Yellow Time (s)	3.5	4.5	4.5	4.5	4.0	4.0	4.0
All-Red Time (s)	1.0	1.0	1.0	1.0	1.0	1.0	1.0
Lost Time Adjust (s)	0.0	0.0	0.0	0.0	0.0	0.0	0.0
Total Lost Time (s)	4.5	5.5	5.5	5.5	5.0	5.0	5.0
Lead/Lag	Lead		Lag	Lag			
Lead-Lag Optimize?	Yes		Yes	Yes			
Recall Mode	None	Min	Min	Min	Max	Max	Max
v/c Ratio	1.40	0.81	0.74	0.26	0.89	0.93	0.47
Control Delay	240.7	21.1	27.6	10.4	43.3	49.7	16.4
Queue Delay	0.0	0.0	0.0	0.0	0.0	0.0	0.0
Total Delay	240.7	21.1	27.6	10.4	43.3	49.7	16.4
Queue Length 50th (ft)	~179	309	210	19	298	319	83
Queue Length 95th (ft)	#322	373	261	59	#510	#554	160
Internal Link Dist (ft)		688	447			1005	
Turn Bay Length (ft)	200			50	400		400
Base Capacity (vph)	176	2593	1799	548	645	619	632
Starvation Cap Reductn	0	0	0	0	0	0	0
Spillback Cap Reductn	0	0	0	0	0	0	0
Storage Cap Reductn	0	0	0	0	0	0	0
Reduced v/c Ratio	1.40	0.78	0.70	0.25	0.89	0.93	0.47

Intersection Summary

Cycle Length: 85

Actuated Cycle Length: 83.5

Natural Cycle: 90

Control Type: Actuated-Uncoordinated

~ Volume exceeds capacity, queue is theoretically infinite.

Queue shown is maximum after two cycles.

95th percentile volume exceeds capacity, queue may be longer.

Queue shown is maximum after two cycles.

Splits and Phases: 29: I-215 NB Ramps & Alessandro Bl.

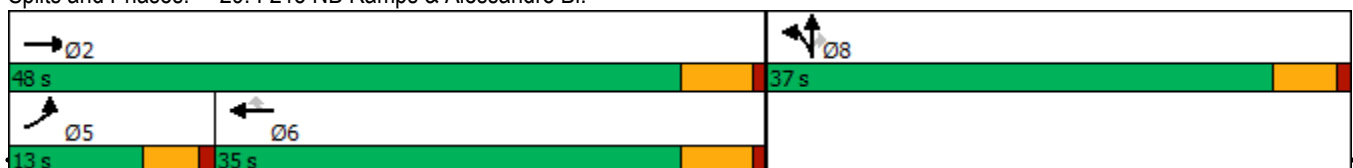

EAP (2028) - PM Peak Hour
Urban Crossroads, Inc.

Synchro 8 Report
Page 2

Queues
30: I-215 SB Ramps & Cactus Av.



Lane Group	EBT	EBR	WBL	WBT	NBR	SBR
Lane Configurations	↑↑	↑	↘	↑↑	↑	↑
Traffic Volume (vph)	1690	402	556	1290	627	543
Future Volume (vph)	1690	402	556	1290	627	543
Lane Group Flow (vph)	1779	423	585	1358	660	572
Turn Type	NA	Perm	Prot	NA	Prot	Prot
Protected Phases	2		1	6	8	4
Permitted Phases		2				
Detector Phase	2	2	1	6	8	4
Switch Phase						
Minimum Initial (s)	5.0	5.0	5.0	5.0	5.0	5.0
Minimum Split (s)	11.0	11.0	9.5	23.0	9.1	9.5
Total Split (s)	35.0	35.0	43.0	78.0	27.0	27.0
Total Split (%)	33.3%	33.3%	41.0%	74.3%	25.7%	25.7%
Yellow Time (s)	5.0	5.0	3.5	5.0	3.6	3.5
All-Red Time (s)	1.0	1.0	1.0	1.0	0.5	1.0
Lost Time Adjust (s)	0.0	0.0	0.0	0.0	0.0	0.0
Total Lost Time (s)	6.0	6.0	4.5	6.0	4.1	4.5
Lead/Lag	Lag	Lag	Lead			
Lead-Lag Optimize?	Yes	Yes	Yes			
Recall Mode	Min	Min	None	Min	None	None
v/c Ratio	1.83	0.70	0.95	0.57	0.80	1.48
Control Delay	401.4	21.8	58.1	9.7	12.7	258.0
Queue Delay	0.0	0.0	0.0	0.0	0.0	0.0
Total Delay	401.4	21.8	58.1	9.7	12.7	258.0
Queue Length 50th (ft)	~963	113	368	217	21	~498
Queue Length 95th (ft)	#1102	234	#578	269	164	#712
Internal Link Dist (ft)	658			918		
Turn Bay Length (ft)						
Base Capacity (vph)	974	600	666	2491	826	386
Starvation Cap Reductn	0	0	0	0	0	0
Spillback Cap Reductn	0	0	0	0	0	0
Storage Cap Reductn	0	0	0	0	0	0
Reduced v/c Ratio	1.83	0.70	0.88	0.55	0.80	1.48

Intersection Summary

Cycle Length: 105

Actuated Cycle Length: 102.4

Natural Cycle: 120

Control Type: Actuated-Uncoordinated

~ Volume exceeds capacity, queue is theoretically infinite.

Queue shown is maximum after two cycles.

95th percentile volume exceeds capacity, queue may be longer.

Queue shown is maximum after two cycles.

Splits and Phases: 30: I-215 SB Ramps & Cactus Av.

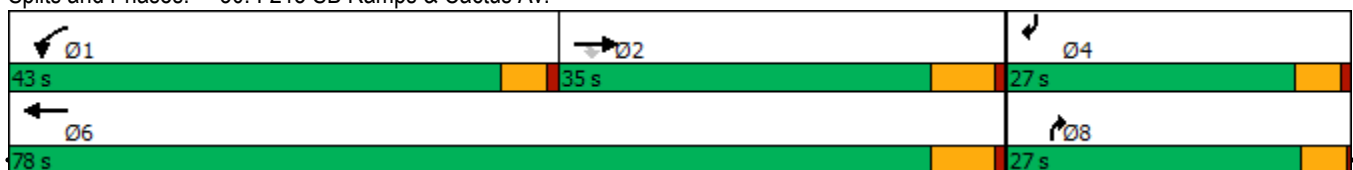

Queues

31: I-215 NB Ramps/Old 215 Frontage Rd. & Cactus Av.



Lane Group	EBL	EBT	WBT	NBL	NBT	NBR	SBL	SBT
Lane Configurations	↖	↗	↗	↖	↗	↗	↖	↗
Traffic Volume (vph)	105	1725	1961	224	250	4	191	3
Future Volume (vph)	105	1725	1961	224	250	4	191	3
Lane Group Flow (vph)	109	2577	2236	233	260	4	199	210
Turn Type	Perm	NA	NA	Perm	NA	Perm	Perm	NA
Protected Phases		2	6		8			4
Permitted Phases	2			8		8	4	
Detector Phase	2	2	6	8	8	8	4	4
Switch Phase								
Minimum Initial (s)	5.0	5.0	5.0	5.0	5.0	5.0	5.0	5.0
Minimum Split (s)	11.0	11.0	44.0	10.5	10.5	10.5	10.5	10.5
Total Split (s)	57.4	57.4	57.4	27.6	27.6	27.6	27.6	27.6
Total Split (%)	67.5%	67.5%	67.5%	32.5%	32.5%	32.5%	32.5%	32.5%
Yellow Time (s)	5.0	5.0	5.0	4.5	4.5	4.5	4.5	4.5
All-Red Time (s)	1.0	1.0	1.0	1.0	1.0	1.0	1.0	1.0
Lost Time Adjust (s)	0.0	0.0	0.0	0.0	0.0	0.0	0.0	0.0
Total Lost Time (s)	6.0	6.0	6.0	5.5	5.5	5.5	5.5	5.5
Lead/Lag								
Lead-Lag Optimize?								
Recall Mode	Min	Min	Min	None	None	None	None	None
v/c Ratio	1.25	1.27	1.07	0.94	0.57	0.01	0.96	0.50
Control Delay	203.7	144.3	58.3	78.6	33.2	0.0	88.3	30.2
Queue Delay	0.0	0.0	0.0	0.0	0.0	0.0	0.0	0.0
Total Delay	203.7	144.3	58.3	78.6	33.2	0.0	88.3	30.2
Queue Length 50th (ft)	~74	~914	~702	122	127	0	105	91
Queue Length 95th (ft)	#131	#1054	#843	#261	208	0	#238	158
Internal Link Dist (ft)		310	1149		1221			746
Turn Bay Length (ft)	175			145			100	
Base Capacity (vph)	87	2033	2099	247	455	427	207	424
Starvation Cap Reductn	0	0	0	0	0	0	0	0
Spillback Cap Reductn	0	0	0	0	0	0	0	0
Storage Cap Reductn	0	0	0	0	0	0	0	0
Reduced v/c Ratio	1.25	1.27	1.07	0.94	0.57	0.01	0.96	0.50

Intersection Summary

Cycle Length: 85

Actuated Cycle Length: 85

Natural Cycle: 55

Control Type: Actuated-Uncoordinated

~ Volume exceeds capacity, queue is theoretically infinite.

Queue shown is maximum after two cycles.

95th percentile volume exceeds capacity, queue may be longer.

Queue shown is maximum after two cycles.

Splits and Phases: 31: I-215 NB Ramps/Old 215 Frontage Rd. & Cactus Av.

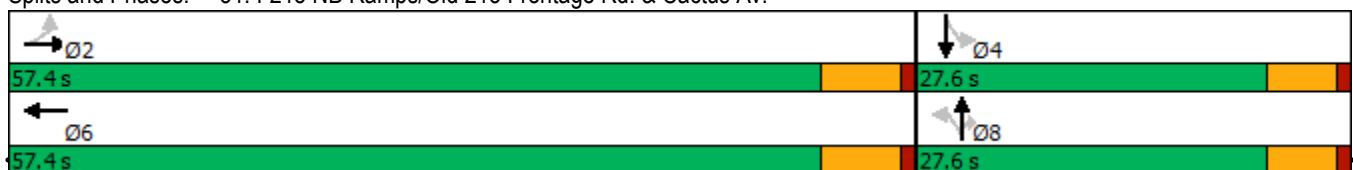

Queues
32: I-215 SB Ramps & Van Buren Bl.

West Campus Upper Plateau (JN 14064)

09/19/2022



Lane Group	EBT	EBR	WBL	WBT	SBT	SBR
Lane Configurations	↑↑	↑↑	↙	↑↑	↙	↑↑
Traffic Volume (vph)	510	1972	3	963	98	221
Future Volume (vph)	510	1972	3	963	98	221
Lane Group Flow (vph)	548	2120	3	1035	119	238
Turn Type	NA	Perm	Prot	NA	NA	Perm
Protected Phases	6		5	2	8	
Permitted Phases		6				8
Detector Phase	6	6	5	2	8	8
Switch Phase						
Minimum Initial (s)	5.0	5.0	5.0	5.0	5.0	5.0
Minimum Split (s)	36.0	36.0	11.0	11.0	11.0	11.0
Total Split (s)	60.0	60.0	11.0	71.0	14.0	14.0
Total Split (%)	70.6%	70.6%	12.9%	83.5%	16.5%	16.5%
Yellow Time (s)	5.0	5.0	5.0	5.0	5.0	5.0
All-Red Time (s)	1.0	1.0	1.0	1.0	1.0	1.0
Lost Time Adjust (s)	0.0	0.0	0.0	0.0	0.0	0.0
Total Lost Time (s)	6.0	6.0	6.0	6.0	6.0	6.0
Lead/Lag	Lag	Lag	Lead			
Lead-Lag Optimize?	Yes	Yes	Yes			
Recall Mode	Min	Min	None	Min	Max	Max
v/c Ratio	0.23	0.95	0.03	0.41	0.64	0.51
Control Delay	4.5	18.2	36.3	4.3	51.3	9.3
Queue Delay	0.0	0.0	0.0	0.0	0.0	0.0
Total Delay	4.5	18.2	36.3	4.3	51.3	9.3
Queue Length 50th (ft)	33	183	1	76	53	0
Queue Length 95th (ft)	84	#722	10	100	#145	36
Internal Link Dist (ft)	2745			429	1115	
Turn Bay Length (ft)			200			
Base Capacity (vph)	2354	2222	89	2914	186	471
Starvation Cap Reductn	0	0	0	0	0	0
Spillback Cap Reductn	0	0	0	0	0	0
Storage Cap Reductn	0	0	0	0	0	0
Reduced v/c Ratio	0.23	0.95	0.03	0.36	0.64	0.51

Intersection Summary

Cycle Length: 85

Actuated Cycle Length: 76.2

Natural Cycle: 90

Control Type: Actuated-Uncoordinated

95th percentile volume exceeds capacity, queue may be longer.

Queue shown is maximum after two cycles.

Splits and Phases: 32: I-215 SB Ramps & Van Buren Bl.



Queues
33: I-215 NB On/Off Ramp & Van Buren Bl.



Lane Group	EBT	EBR	WBT	NBL	NBR
Lane Configurations	↑↑	↑↑	↑↑	↑↑	↑
Traffic Volume (vph)	5	571	24	872	5
Future Volume (vph)	5	571	24	872	5
Lane Group Flow (vph)	5	601	25	918	5
Turn Type	NA	pm+ov	NA	Prot	Perm
Protected Phases	6	4	2	4	
Permitted Phases		6			4
Detector Phase	6	4	2	4	4
Switch Phase					
Minimum Initial (s)	5.0	5.0	5.0	5.0	5.0
Minimum Split (s)	11.0	42.0	11.0	42.0	42.0
Total Split (s)	15.0	55.0	15.0	55.0	55.0
Total Split (%)	21.4%	78.6%	21.4%	78.6%	78.6%
Yellow Time (s)	5.0	5.0	5.0	5.0	5.0
All-Red Time (s)	1.0	1.0	1.0	1.0	1.0
Lost Time Adjust (s)	0.0	0.0	0.0	0.0	0.0
Total Lost Time (s)	6.0	6.0	6.0	6.0	6.0
Lead/Lag					
Lead-Lag Optimize?					
Recall Mode	None	Min	None	Min	Min
v/c Ratio	0.01	0.23	0.05	0.29	0.00
Control Delay	21.2	0.2	20.6	1.2	1.0
Queue Delay	0.0	0.0	0.0	0.0	0.0
Total Delay	21.2	0.2	20.6	1.2	1.0
Queue Length 50th (ft)	0	0	1	0	0
Queue Length 95th (ft)	5	0	15	75	2
Internal Link Dist (ft)	669		611	856	
Turn Bay Length (ft)		300			585
Base Capacity (vph)	946	2608	860	3127	1020
Starvation Cap Reductn	0	0	0	0	0
Spillback Cap Reductn	0	0	0	0	0
Storage Cap Reductn	0	0	0	0	0
Reduced v/c Ratio	0.01	0.23	0.03	0.29	0.00

Intersection Summary

Cycle Length: 70
 Actuated Cycle Length: 38.2
 Natural Cycle: 55
 Control Type: Actuated-Uncoordinated

Splits and Phases: 33: I-215 NB On/Off Ramp & Van Buren Bl.

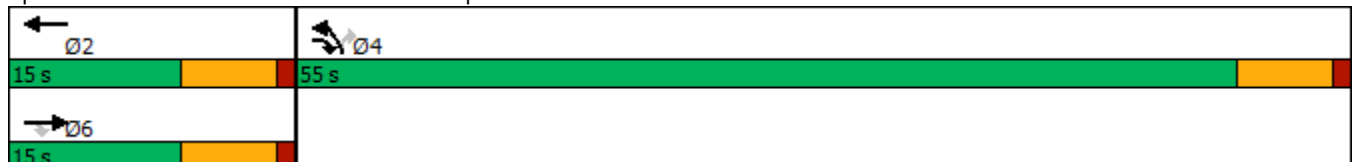

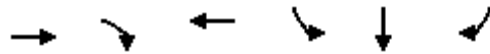

Lane Group	EBT	EBR	WBT	SBL	SBT	SBR
Lane Group Flow (vph)	984	443	1412	135	182	181
v/c Ratio	0.38	0.46	0.56	0.35	0.49	0.48
Control Delay	7.5	3.7	8.7	17.7	16.8	16.3
Queue Delay	0.0	0.0	0.0	0.0	0.0	0.0
Total Delay	7.5	3.7	8.7	17.7	16.8	16.3
Queue Length 50th (ft)	45	11	71	27	29	27
Queue Length 95th (ft)	97	58	149	82	96	90
Internal Link Dist (ft)	750		688		1585	
Turn Bay Length (ft)		50		525		525
Base Capacity (vph)	4777	1508	4678	1018	904	935
Starvation Cap Reductn	0	0	0	0	0	0
Spillback Cap Reductn	0	0	0	0	0	0
Storage Cap Reductn	0	0	0	0	0	0
Reduced v/c Ratio	0.21	0.29	0.30	0.13	0.20	0.19

Intersection Summary



Lane Group	EBL	EBT	WBT	WBR	NBL	NBT	NBR
Lane Group Flow (vph)	240	889	1031	162	310	310	237
v/c Ratio	1.36	0.38	0.68	0.34	0.46	0.48	0.35
Control Delay	223.9	14.2	26.7	12.8	21.1	21.2	11.6
Queue Delay	0.0	0.0	0.0	0.0	0.0	0.0	0.0
Total Delay	223.9	14.2	26.7	12.8	21.1	21.2	11.6
Queue Length 50th (ft)	~160	100	163	29	115	119	45
Queue Length 95th (ft)	#318	128	206	74	210	220	111
Internal Link Dist (ft)		688	447			1005	
Turn Bay Length (ft)	200			50	400		400
Base Capacity (vph)	177	2726	1892	572	672	645	668
Starvation Cap Reductn	0	0	0	0	0	0	0
Spillback Cap Reductn	0	0	0	0	0	0	0
Storage Cap Reductn	0	0	0	0	0	0	0
Reduced v/c Ratio	1.36	0.33	0.54	0.28	0.46	0.48	0.35

Intersection Summary

- ~ Volume exceeds capacity, queue is theoretically infinite.
Queue shown is maximum after two cycles.
- # 95th percentile volume exceeds capacity, queue may be longer.
Queue shown is maximum after two cycles.

Queues

30: I-215 SB Ramps & Cactus Av.



Lane Group	EBT	EBR	WBL	WBT	NBR	SBR
Lane Group Flow (vph)	679	125	426	620	401	338
v/c Ratio	0.68	0.23	0.73	0.25	0.53	0.71
Control Delay	24.8	6.0	27.9	3.7	2.7	13.6
Queue Delay	0.0	0.0	0.0	0.0	0.0	0.0
Total Delay	24.8	6.0	27.9	3.7	2.7	13.6
Queue Length 50th (ft)	103	0	122	26	0	0
Queue Length 95th (ft)	237	37	303	73	0	67
Internal Link Dist (ft)	658			918		
Turn Bay Length (ft)						
Base Capacity (vph)	1732	830	1173	3364	992	770
Starvation Cap Reductn	0	0	0	0	0	0
Spillback Cap Reductn	0	0	0	0	0	0
Storage Cap Reductn	0	0	0	0	0	0
Reduced v/c Ratio	0.39	0.15	0.36	0.18	0.40	0.44
Intersection Summary						

Queues

31: I-215 NB Ramps/Old 215 Frontage Rd. & Cactus Av.



Lane Group	EBL	EBT	WBT	NBL	NBT	NBR	SBL	SBT
Lane Group Flow (vph)	34	1004	1383	133	75	3	125	89
v/c Ratio	0.21	0.50	0.63	0.53	0.20	0.01	0.46	0.23
Control Delay	10.6	7.4	9.5	27.8	19.7	0.0	25.2	9.6
Queue Delay	0.0	0.0	0.0	0.0	0.0	0.0	0.0	0.0
Total Delay	10.6	7.4	9.5	27.8	19.7	0.0	25.2	9.6
Queue Length 50th (ft)	4	73	130	32	17	0	30	4
Queue Length 95th (ft)	24	161	268	100	61	0	93	39
Internal Link Dist (ft)		310	1149		1221			746
Turn Bay Length (ft)	175			145			100	
Base Capacity (vph)	238	2848	3170	549	811	731	597	779
Starvation Cap Reductn	0	0	0	0	0	0	0	0
Spillback Cap Reductn	0	0	0	0	0	0	0	0
Storage Cap Reductn	0	0	0	0	0	0	0	0
Reduced v/c Ratio	0.14	0.35	0.44	0.24	0.09	0.00	0.21	0.11

Intersection Summary

Queues

32: I-215 SB Ramps & Van Buren Bl.



Lane Group	EBT	EBR	WBL	WBT	SBT	SBR
Lane Group Flow (vph)	512	683	15	651	23	600
v/c Ratio	0.43	0.48	0.07	0.48	0.07	0.57
Control Delay	9.5	2.1	20.1	8.3	17.0	4.9
Queue Delay	0.0	0.0	0.0	0.0	0.0	0.0
Total Delay	9.5	2.1	20.1	8.3	17.0	4.9
Queue Length 50th (ft)	31	0	2	41	3	0
Queue Length 95th (ft)	83	24	21	60	26	44
Internal Link Dist (ft)	2745			429	1115	
Turn Bay Length (ft)			200			
Base Capacity (vph)	3236	2712	204	3406	342	1045
Starvation Cap Reductn	0	0	0	0	0	0
Spillback Cap Reductn	0	0	0	0	0	0
Storage Cap Reductn	0	0	0	0	0	0
Reduced v/c Ratio	0.16	0.25	0.07	0.19	0.07	0.57

Intersection Summary



Lane Group	EBR	NBL
Lane Group Flow (vph)	18	1
v/c Ratio	0.01	0.00
Control Delay	0.0	0.0
Queue Delay	0.0	0.0
Total Delay	0.0	0.0
Queue Length 50th (ft)	0	0
Queue Length 95th (ft)	0	0
Internal Link Dist (ft)		856
Turn Bay Length (ft)	300	
Base Capacity (vph)	2608	3303
Starvation Cap Reductn	0	0
Spillback Cap Reductn	0	0
Storage Cap Reductn	0	0
Reduced v/c Ratio	0.01	0.00
Intersection Summary		

APPENDIX 6.4:

**EAP CONDITIONS INTERSECTION OPERATIONS ANALYSIS WORKSHEETS WITH
IMPROVEMENTS**

This Page Intentionally Left Blank

Timings

1: Washington St & Van Buren Bl.

09/19/2022



Lane Group	EBL	EBT	EBR	WBL	WBT	WBR	NBL	NBT	NBR	SBL	SBT
Lane Configurations	↘	↑↑↑	↗	↘	↑↑↑	↗	↘↗	↑↑	↗	↘↗	↑↗
Traffic Volume (vph)	151	1157	137	113	1494	660	156	585	158	387	202
Future Volume (vph)	151	1157	137	113	1494	660	156	585	158	387	202
Turn Type	Prot	NA	Perm	Prot	NA	Perm	Prot	NA	Perm	Prot	NA
Protected Phases	5	2		1	6		3	8		7	4
Permitted Phases			2			6			8		
Detector Phase	5	2	2	1	6	6	3	8	8	7	4
Switch Phase											
Minimum Initial (s)	5.0	10.0	10.0	5.0	10.0	10.0	5.0	10.0	10.0	5.0	10.0
Minimum Split (s)	9.2	34.2	34.2	9.2	33.2	33.2	9.2	38.4	38.4	9.2	30.8
Total Split (s)	16.4	50.0	50.0	16.6	50.2	50.2	15.5	38.4	38.4	20.0	42.9
Total Split (%)	13.1%	40.0%	40.0%	13.3%	40.2%	40.2%	12.4%	30.7%	30.7%	16.0%	34.3%
Yellow Time (s)	3.2	5.2	5.2	3.2	5.2	5.2	3.2	4.4	4.4	3.2	4.8
All-Red Time (s)	1.0	1.0	1.0	1.0	1.0	1.0	1.0	1.0	1.0	1.0	1.0
Lost Time Adjust (s)	0.0	0.0	0.0	0.0	0.0	0.0	0.0	0.0	0.0	0.0	0.0
Total Lost Time (s)	4.2	6.2	6.2	4.2	6.2	6.2	4.2	5.4	5.4	4.2	5.8
Lead/Lag	Lead	Lag	Lag	Lead	Lag	Lag	Lead	Lag	Lag	Lead	Lag
Lead-Lag Optimize?	Yes	Yes	Yes	Yes	Yes	Yes	Yes	Yes	Yes	Yes	Yes
Recall Mode	None	None	None	None	None	None	None	None	None	None	None
Act Effct Green (s)	12.1	45.2	45.2	11.0	44.1	44.1	9.6	27.3	27.3	15.7	32.9
Actuated g/C Ratio	0.10	0.38	0.38	0.09	0.37	0.37	0.08	0.23	0.23	0.13	0.28
v/c Ratio	0.88	0.63	0.21	0.73	0.83	0.91	0.60	0.75	0.36	0.90	0.31
Control Delay	95.5	32.9	5.2	79.1	39.3	39.4	63.4	49.1	10.9	75.8	30.0
Queue Delay	0.0	0.0	0.0	0.0	0.0	0.0	0.0	0.0	0.0	0.0	0.0
Total Delay	95.5	32.9	5.2	79.1	39.3	39.4	63.4	49.1	10.9	75.8	30.0
LOS	F	C	A	E	D	D	E	D	B	E	C
Approach Delay		36.8			41.3			44.8			56.9
Approach LOS		D			D			D			E

Intersection Summary

Cycle Length: 125
 Actuated Cycle Length: 119.2
 Natural Cycle: 115
 Control Type: Actuated-Uncoordinated
 Maximum v/c Ratio: 0.91
 Intersection Signal Delay: 42.6
 Intersection LOS: D
 Intersection Capacity Utilization 82.1%
 ICU Level of Service E
 Analysis Period (min) 15

Splits and Phases: 1: Washington St & Van Buren Bl.

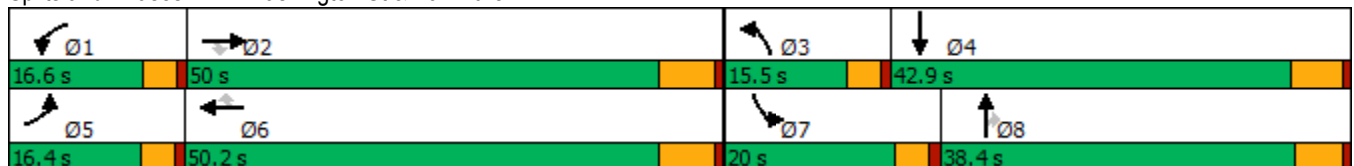

HCM 6th Signalized Intersection Summary
1: Washington St & Van Buren Bl.

West Campus Upper Plateau (JN 14064)

09/19/2022

Movement	EBL	EBT	EBR	WBL	WBT	WBR	NBL	NBT	NBR	SBL	SBT	SBR
Lane Configurations												
Traffic Volume (veh/h)	151	1157	137	113	1494	660	156	585	158	387	202	71
Future Volume (veh/h)	151	1157	137	113	1494	660	156	585	158	387	202	71
Initial Q (Qb), veh	0	0	0	0	0	0	0	0	0	0	0	0
Ped-Bike Adj(A_pbT)	1.00		0.99	1.00		0.98	1.00		1.00	1.00		1.00
Parking Bus, Adj	1.00	1.00	1.00	1.00	1.00	1.00	1.00	1.00	1.00	1.00	1.00	1.00
Work Zone On Approach		No			No			No			No	
Adj Sat Flow, veh/h/ln	1870	1856	1856	1856	1870	1885	1826	1870	1856	1856	1811	1826
Adj Flow Rate, veh/h	157	1205	120	118	1556	524	162	609	99	403	210	45
Peak Hour Factor	0.96	0.96	0.96	0.96	0.96	0.96	0.96	0.96	0.96	0.96	0.96	0.96
Percent Heavy Veh, %	2	3	3	3	2	1	5	2	3	3	6	5
Cap, veh/h	184	2001	613	144	1905	585	219	765	337	456	802	168
Arrive On Green	0.10	0.40	0.40	0.08	0.37	0.37	0.06	0.22	0.22	0.13	0.28	0.28
Sat Flow, veh/h	1781	5066	1553	1767	5106	1569	3374	3554	1566	3428	2829	594
Grp Volume(v), veh/h	157	1205	120	118	1556	524	162	609	99	403	126	129
Grp Sat Flow(s),veh/h/ln	1781	1689	1553	1767	1702	1569	1687	1777	1566	1714	1721	1703
Q Serve(g_s), s	10.1	22.0	5.9	7.7	32.0	36.6	5.5	18.9	6.2	13.4	6.6	6.8
Cycle Q Clear(g_c), s	10.1	22.0	5.9	7.7	32.0	36.6	5.5	18.9	6.2	13.4	6.6	6.8
Prop In Lane	1.00		1.00	1.00		1.00	1.00		1.00	1.00		0.35
Lane Grp Cap(c), veh/h	184	2001	613	144	1905	585	219	765	337	456	488	483
V/C Ratio(X)	0.85	0.60	0.20	0.82	0.82	0.90	0.74	0.80	0.29	0.88	0.26	0.27
Avail Cap(c_a), veh/h	187	2001	613	188	1930	593	328	1008	444	465	548	543
HCM Platoon Ratio	1.00	1.00	1.00	1.00	1.00	1.00	1.00	1.00	1.00	1.00	1.00	1.00
Upstream Filter(I)	1.00	1.00	1.00	1.00	1.00	1.00	1.00	1.00	1.00	1.00	1.00	1.00
Uniform Delay (d), s/veh	51.3	27.9	23.1	52.6	32.9	34.3	53.5	43.2	38.3	49.6	32.2	32.3
Incr Delay (d2), s/veh	28.3	0.6	0.2	15.1	3.0	16.4	1.9	3.4	0.5	17.0	0.3	0.3
Initial Q Delay(d3),s/veh	0.0	0.0	0.0	0.0	0.0	0.0	0.0	0.0	0.0	0.0	0.0	0.0
%ile BackOfQ(50%),veh/ln	5.8	8.4	2.2	3.9	12.8	16.5	2.4	8.7	2.4	6.8	2.8	2.9
Unsig. Movement Delay, s/veh												
LnGrp Delay(d),s/veh	79.6	28.6	23.3	67.8	35.9	50.7	55.3	46.6	38.7	66.6	32.5	32.6
LnGrp LOS	E	C	C	E	D	D	E	D	D	E	C	C
Approach Vol, veh/h		1482			2198			870			658	
Approach Delay, s/veh		33.5			41.1			47.3			53.4	
Approach LOS		C			D			D			D	
Timer - Assigned Phs	1	2	3	4	5	6	7	8				
Phs Duration (G+Y+Rc), s	13.7	52.2	11.7	38.8	16.2	49.6	19.7	30.9				
Change Period (Y+Rc), s	* 4.2	6.2	* 4.2	5.8	* 4.2	6.2	* 4.2	* 5.8				
Max Green Setting (Gmax), s	* 12	43.8	* 11	37.1	* 12	44.0	* 16	* 33				
Max Q Clear Time (g_c+I1), s	9.7	24.0	7.5	8.8	12.1	38.6	15.4	20.9				
Green Ext Time (p_c), s	0.0	10.8	0.1	1.5	0.0	4.8	0.0	3.7				

Intersection Summary

HCM 6th Ctrl Delay	41.5
HCM 6th LOS	D

Notes

* HCM 6th computational engine requires equal clearance times for the phases crossing the barrier.

Timings

3: Overlook Pkwy./Canyon Crest Dr. & Alessandro Bl/Alessandro Bl.



Lane Group	EBL	EBT	WBL	WBT	WBR	NBL	NBT	NBR	SBL	SBT
Lane Configurations	↙	↕↕↕↔	↙	↕↕↕	↗	↙	↕↕	↗	↙↙↙	↔
Traffic Volume (vph)	43	1508	28	3577	1167	9	35	11	515	83
Future Volume (vph)	43	1508	28	3577	1167	9	35	11	515	83
Turn Type	Prot	NA	Prot	NA	pm+ov	Prot	NA	Perm	Prot	NA
Protected Phases	5	2	1	6	7	3	8		7	4
Permitted Phases					6			8		
Detector Phase	5	2	1	6	7	3	8	8	7	4
Switch Phase										
Minimum Initial (s)	5.0	10.0	5.0	10.0	10.0	10.0	10.0	10.0	10.0	10.0
Minimum Split (s)	9.2	35.2	9.2	35.2	15.8	15.8	15.8	15.8	15.8	36.8
Total Split (s)	9.2	57.0	10.4	58.2	33.1	15.8	19.5	19.5	33.1	36.8
Total Split (%)	7.7%	47.5%	8.7%	48.5%	27.6%	13.2%	16.3%	16.3%	27.6%	30.7%
Yellow Time (s)	3.2	5.2	3.2	5.2	4.8	4.8	4.8	4.8	4.8	4.8
All-Red Time (s)	1.0	1.0	1.0	1.0	1.0	1.0	1.0	1.0	1.0	1.0
Lost Time Adjust (s)	0.0	0.0	0.0	0.0	0.0	0.0	0.0	0.0	0.0	0.0
Total Lost Time (s)	4.2	6.2	4.2	6.2	5.8	5.8	5.8	5.8	5.8	5.8
Lead/Lag	Lead	Lag	Lead	Lag	Lead	Lead	Lag	Lag	Lead	Lag
Lead-Lag Optimize?	Yes	Yes	Yes	Yes	Yes	Yes	Yes	Yes	Yes	Yes
Recall Mode	None	None	None	None	None	None	None	None	None	None
Act Effct Green (s)	5.1	54.1	5.8	52.7	87.3	10.1	10.8	10.8	26.8	33.4
Actuated g/C Ratio	0.05	0.50	0.05	0.49	0.81	0.09	0.10	0.10	0.25	0.31
v/c Ratio	0.60	0.57	0.30	1.37	0.87	0.05	0.10	0.04	0.42	0.29
Control Delay	85.7	22.4	61.8	194.7	14.6	50.8	48.5	0.2	36.7	25.6
Queue Delay	0.0	0.0	0.0	0.0	0.0	0.0	0.0	0.0	0.0	0.0
Total Delay	85.7	22.4	61.8	194.7	14.6	50.8	48.5	0.2	36.7	25.6
LOS	F	C	E	F	B	D	D	A	D	C
Approach Delay		24.1		149.9			38.9			34.3
Approach LOS		C		F			D			C

Intersection Summary

Cycle Length: 120
 Actuated Cycle Length: 108.2
 Natural Cycle: 130
 Control Type: Actuated-Uncoordinated
 Maximum v/c Ratio: 1.37
 Intersection Signal Delay: 110.4
 Intersection Capacity Utilization 97.9%
 Analysis Period (min) 15
 Intersection LOS: F
 ICU Level of Service F

Splits and Phases: 3: Overlook Pkwy./Canyon Crest Dr. & Alessandro Bl/Alessandro Bl.

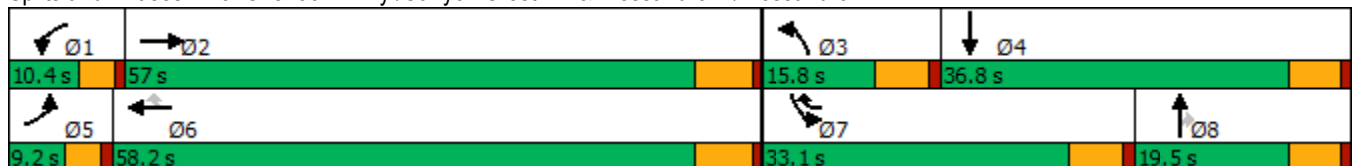

HCM 6th Signalized Intersection Summary

West Campus Upper Plateau (JN 14064)

3: Overlook Pkwy./Canyon Crest Dr. & Alessandro Bl/Alessandro Bl.

09/19/2022



Movement	EBL	EBT	EBR	WBL	WBT	WBR	NBL	NBT	NBR	SBL	SBT	SBR
Lane Configurations	↖	↖↖↖		↖	↖↖↖	↖	↖	↖↖	↖	↖↖↖	↖	↖
Traffic Volume (veh/h)	43	1508	14	28	3577	1167	9	35	11	515	83	57
Future Volume (veh/h)	43	1508	14	28	3577	1167	9	35	11	515	83	57
Initial Q (Qb), veh	0	0	0	0	0	0	0	0	0	0	0	0
Ped-Bike Adj(A_pbT)	1.00		1.00	1.00		1.00	1.00		1.00	1.00		1.00
Parking Bus, Adj	1.00	1.00	1.00	1.00	1.00	1.00	1.00	1.00	1.00	1.00	1.00	1.00
Work Zone On Approach		No			No			No				No
Adj Sat Flow, veh/h/ln	1737	1870	1900	1900	1885	1885	1900	1900	1900	1856	1648	1870
Adj Flow Rate, veh/h	45	1587	15	29	3765	1065	9	37	10	542	87	43
Peak Hour Factor	0.95	0.95	0.95	0.95	0.95	0.95	0.95	0.95	0.95	0.95	0.95	0.95
Percent Heavy Veh, %	11	2	0	0	1	1	0	0	0	3	17	2
Cap, veh/h	59	2893	27	50	2903	1037	179	354	158	720	141	70
Arrive On Green	0.04	0.52	0.52	0.03	0.51	0.51	0.10	0.10	0.10	0.14	0.14	0.14
Sat Flow, veh/h	1654	5549	52	1810	5656	1598	1810	3610	1610	5302	1041	514
Grp Volume(v), veh/h	45	1070	532	29	3765	1065	9	37	10	542	0	130
Grp Sat Flow(s),veh/h/ln	1654	1870	1861	1810	1885	1598	1810	1805	1610	1767	0	1555
Q Serve(g_s), s	2.7	19.4	19.4	1.6	52.0	52.0	0.5	0.9	0.6	10.0	0.0	8.0
Cycle Q Clear(g_c), s	2.7	19.4	19.4	1.6	52.0	52.0	0.5	0.9	0.6	10.0	0.0	8.0
Prop In Lane	1.00		0.03	1.00		1.00	1.00		1.00	1.00		0.33
Lane Grp Cap(c), veh/h	59	1950	970	50	2903	1037	179	354	158	720	0	210
V/C Ratio(X)	0.77	0.55	0.55	0.58	1.30	1.03	0.05	0.10	0.06	0.75	0.00	0.62
Avail Cap(c_a), veh/h	82	1950	970	111	2903	1037	179	488	218	1429	0	476
HCM Platoon Ratio	1.00	1.00	1.00	1.00	1.00	1.00	1.00	1.00	1.00	1.00	1.00	1.00
Upstream Filter(I)	1.00	1.00	1.00	1.00	1.00	1.00	1.00	1.00	1.00	1.00	0.00	1.00
Uniform Delay (d), s/veh	48.4	16.3	16.3	48.7	24.6	17.8	41.3	41.6	41.4	42.1	0.0	41.3
Incr Delay (d2), s/veh	15.4	0.3	0.7	4.0	136.2	35.0	0.1	0.1	0.2	1.6	0.0	2.9
Initial Q Delay(d3),s/veh	0.0	0.0	0.0	0.0	0.0	0.0	0.0	0.0	0.0	0.0	0.0	0.0
%ile BackOfQ(50%),veh/ln	1.3	7.3	7.4	0.7	56.3	28.7	0.2	0.4	0.2	4.3	0.0	3.1
Unsig. Movement Delay, s/veh												
LnGrp Delay(d),s/veh	63.8	16.6	16.9	52.6	160.8	52.8	41.5	41.7	41.6	43.8	0.0	44.3
LnGrp LOS	E	B	B	D	F	F	D	D	D	D	A	D
Approach Vol, veh/h		1647			4859			56				672
Approach Delay, s/veh		18.0			136.5			41.7				43.9
Approach LOS		B			F			D				D
Timer - Assigned Phs	1	2	3	4	5	6	7	8				
Phs Duration (G+Y+Rc), s	7.0	59.0	15.8	19.5	7.8	58.2	19.6	15.7				
Change Period (Y+Rc), s	* 4.2	6.2	5.8	5.8	* 4.2	6.2	5.8	5.8				
Max Green Setting (Gmax), s	* 6.2	50.8	10.0	31.0	* 5	52.0	27.3	13.7				
Max Q Clear Time (g_c+I1), s	3.6	21.4	2.5	10.0	4.7	54.0	12.0	2.9				
Green Ext Time (p_c), s	0.0	12.1	0.0	0.6	0.0	0.0	1.8	0.1				

Intersection Summary

HCM 6th Ctrl Delay	100.2
HCM 6th LOS	F

Notes

- User approved pedestrian interval to be less than phase max green.
- * HCM 6th computational engine requires equal clearance times for the phases crossing the barrier.

Timings
4: Van Buren Bl. & Wood Rd.

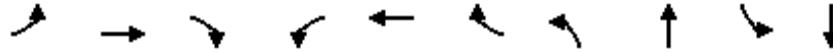

Lane Group	EBL	EBT	EBR	WBL	WBT	WBR	NBL	NBT	SBL	SBT
Lane Configurations	↘	↑↑↑	↗	↘↗	↑↑↑	↗	↘↗	↑↘	↘	↑↘
Traffic Volume (vph)	168	1021	364	512	1336	117	371	478	96	478
Future Volume (vph)	168	1021	364	512	1336	117	371	478	96	478
Turn Type	Prot	NA	pm+ov	Prot	NA	Perm	Prot	NA	Perm	NA
Protected Phases	5	2	3	1	6		3	8		4
Permitted Phases			2			6			4	
Detector Phase	5	2	3	1	6	6	3	8	4	4
Switch Phase										
Minimum Initial (s)	5.0	10.0	5.0	5.0	10.0	10.0	5.0	10.0	10.0	10.0
Minimum Split (s)	9.2	30.2	9.2	9.2	30.2	30.2	9.2	38.4	15.8	15.8
Total Split (s)	24.0	47.8	25.0	33.2	57.0	57.0	25.0	69.0	44.0	44.0
Total Split (%)	16.0%	31.9%	16.7%	22.1%	38.0%	38.0%	16.7%	46.0%	29.3%	29.3%
Yellow Time (s)	3.2	5.2	3.2	3.2	5.2	5.2	3.2	4.4	4.8	4.8
All-Red Time (s)	1.0	1.0	1.0	1.0	1.0	1.0	1.0	1.0	1.0	1.0
Lost Time Adjust (s)	0.0	0.0	0.0	0.0	0.0	0.0	0.0	0.0	0.0	0.0
Total Lost Time (s)	4.2	6.2	4.2	4.2	6.2	6.2	4.2	5.4	5.8	5.8
Lead/Lag	Lead	Lag	Lead	Lead	Lag	Lag	Lead		Lag	Lag
Lead-Lag Optimize?	Yes	Yes	Yes	Yes	Yes	Yes	Yes		Yes	Yes
Recall Mode	None	None	None	None	None	None	None	None	None	None
Act Effct Green (s)	18.1	40.9	62.7	26.8	49.6	49.6	19.8	59.6	35.1	35.1
Actuated g/C Ratio	0.13	0.29	0.44	0.19	0.35	0.35	0.14	0.42	0.25	0.25
v/c Ratio	0.86	0.81	0.58	0.90	0.87	0.22	0.88	0.67	0.84	0.87
Control Delay	95.5	53.5	26.2	74.8	51.0	12.7	81.3	30.7	99.3	61.5
Queue Delay	0.0	0.0	0.0	0.0	0.0	0.0	0.0	0.0	0.0	0.0
Total Delay	95.5	53.5	26.2	74.8	51.0	12.7	81.3	30.7	99.3	61.5
LOS	F	D	C	E	D	B	F	C	F	E
Approach Delay		51.6			54.9			46.4		66.3
Approach LOS		D			D			D		E

Intersection Summary

Cycle Length: 150
 Actuated Cycle Length: 143.2
 Natural Cycle: 90
 Control Type: Actuated-Uncoordinated
 Maximum v/c Ratio: 0.90
 Intersection Signal Delay: 53.7
 Intersection LOS: D
 Intersection Capacity Utilization 88.9%
 ICU Level of Service E
 Analysis Period (min) 15

Splits and Phases: 4: Van Buren Bl. & Wood Rd.

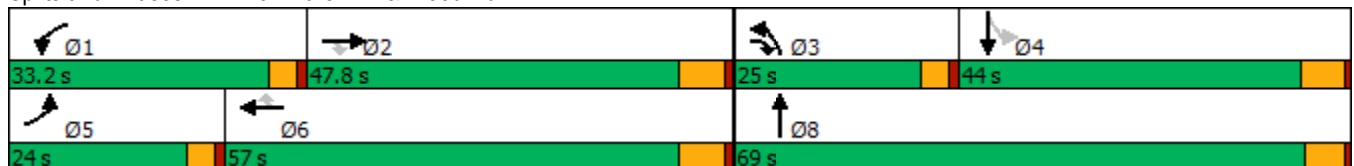

HCM 6th Signalized Intersection Summary
4: Van Buren Bl. & Wood Rd.

West Campus Upper Plateau (JN 14064)
09/19/2022



Movement	EBL	EBT	EBR	WBL	WBT	WBR	NBL	NBT	NBR	SBL	SBT	SBR
Lane Configurations	↘	↑↑↑	↗	↘↗	↑↑↑	↗	↘↗	↑↑		↘	↑↑	
Traffic Volume (veh/h)	168	1021	364	512	1336	117	371	478	350	96	478	186
Future Volume (veh/h)	168	1021	364	512	1336	117	371	478	350	96	478	186
Initial Q (Qb), veh	0	0	0	0	0	0	0	0	0	0	0	0
Ped-Bike Adj(A_pbT)	1.00		0.97	1.00		0.98	1.00		0.93	0.96		0.99
Parking Bus, Adj	1.00	1.00	1.00	1.00	1.00	1.00	1.00	1.00	1.00	1.00	1.00	1.00
Work Zone On Approach		No			No			No			No	
Adj Sat Flow, veh/h/ln	1856	1856	1856	1885	1856	1870	1885	1885	1885	1870	1900	1856
Adj Flow Rate, veh/h	191	1160	229	582	1518	83	422	543	255	109	543	116
Peak Hour Factor	0.88	0.88	0.88	0.88	0.88	0.88	0.88	0.88	0.88	0.88	0.88	0.88
Percent Heavy Veh, %	3	3	3	1	3	2	1	1	1	2	0	3
Cap, veh/h	216	1519	674	641	1832	564	476	905	423	189	660	140
Arrive On Green	0.12	0.30	0.30	0.18	0.36	0.36	0.14	0.39	0.39	0.22	0.22	0.22
Sat Flow, veh/h	1767	5066	1529	3483	5066	1560	3483	2307	1079	654	2954	628
Grp Volume(v), veh/h	191	1160	229	582	1518	83	422	421	377	109	331	328
Grp Sat Flow(s),veh/h/ln	1767	1689	1529	1742	1689	1560	1742	1791	1595	654	1805	1777
Q Serve(g_s), s	13.9	27.2	13.0	21.4	35.7	4.7	15.6	24.4	24.6	20.8	22.8	23.0
Cycle Q Clear(g_c), s	13.9	27.2	13.0	21.4	35.7	4.7	15.6	24.4	24.6	23.3	22.8	23.0
Prop In Lane	1.00		1.00	1.00		1.00	1.00		0.68	1.00		0.35
Lane Grp Cap(c), veh/h	216	1519	674	641	1832	564	476	703	626	189	403	397
V/C Ratio(X)	0.88	0.76	0.34	0.91	0.83	0.15	0.89	0.60	0.60	0.58	0.82	0.83
Avail Cap(c_a), veh/h	267	1611	701	772	1967	606	554	871	775	233	527	519
HCM Platoon Ratio	1.00	1.00	1.00	1.00	1.00	1.00	1.00	1.00	1.00	1.00	1.00	1.00
Upstream Filter(I)	1.00	1.00	1.00	1.00	1.00	1.00	1.00	1.00	1.00	1.00	1.00	1.00
Uniform Delay (d), s/veh	56.5	41.6	24.4	52.3	38.1	28.1	55.5	31.6	31.6	49.7	48.3	48.4
Incr Delay (d2), s/veh	21.4	2.3	0.4	11.8	3.1	0.2	13.2	0.8	0.9	2.8	7.7	8.2
Initial Q Delay(d3),s/veh	0.0	0.0	0.0	0.0	0.0	0.0	0.0	0.0	0.0	0.0	0.0	0.0
%ile BackOfQ(50%),veh/ln	7.3	11.2	4.7	10.1	14.6	1.7	7.6	10.5	9.4	3.5	10.9	10.9
Unsig. Movement Delay, s/veh												
LnGrp Delay(d),s/veh	77.9	43.9	24.8	64.1	41.2	28.3	68.7	32.4	32.6	52.5	56.0	56.6
LnGrp LOS	E	D	C	E	D	C	E	C	C	D	E	E
Approach Vol, veh/h		1580			2183			1220			768	
Approach Delay, s/veh		45.2			46.8			45.0			55.8	
Approach LOS		D			D			D			E	
Timer - Assigned Phs	1	2	3	4	5	6		8				
Phs Duration (G+Y+Rc), s	28.3	45.4	22.1	35.0	20.2	53.5		57.1				
Change Period (Y+Rc), s	* 4.2	6.2	* 4.2	5.8	* 4.2	6.2		* 5.8				
Max Green Setting (Gmax), s	* 29	41.6	* 21	38.2	* 20	50.8		* 64				
Max Q Clear Time (g_c+I1), s	23.4	29.2	17.6	25.3	15.9	37.7		26.6				
Green Ext Time (p_c), s	0.7	8.0	0.3	3.9	0.1	9.6		5.6				

Intersection Summary

HCM 6th Ctrl Delay	47.2
HCM 6th LOS	D

Notes

* HCM 6th computational engine requires equal clearance times for the phases crossing the barrier.

Timings

West Campus Upper Plateau (JN 14064)

7: Trautwein Rd. & Orange Terrace Pkwy

09/19/2022



Lane Group	EBL	EBT	WBL	WBT	WBR	NBL	NBT	NBR	SBL	SBT	SBR
Lane Configurations	↖	↗	↖↗	↖	↗	↖	↖↖	↗	↖↗	↖↖	↗
Traffic Volume (vph)	77	73	331	114	557	56	1119	275	439	666	23
Future Volume (vph)	77	73	331	114	557	56	1119	275	439	666	23
Turn Type	Prot	NA	Prot	NA	pm+ov	Prot	NA	pm+ov	Prot	NA	Perm
Protected Phases	7	4	3	8	1	5	2	3	1	6	
Permitted Phases					8			2			6
Detector Phase	7	4	3	8	1	5	2	3	1	6	6
Switch Phase											
Minimum Initial (s)	5.0	10.0	5.0	10.0	5.0	5.0	10.0	5.0	5.0	10.0	10.0
Minimum Split (s)	9.1	38.6	9.6	34.6	9.6	9.6	46.2	9.6	9.6	24.2	24.2
Total Split (s)	19.1	38.6	21.4	40.9	28.0	16.8	62.0	21.4	28.0	73.2	73.2
Total Split (%)	12.7%	25.7%	14.3%	27.3%	18.7%	11.2%	41.3%	14.3%	18.7%	48.8%	48.8%
Yellow Time (s)	3.6	3.6	3.6	3.6	3.6	3.6	5.2	3.6	3.6	5.2	5.2
All-Red Time (s)	0.5	1.0	1.0	1.0	1.0	1.0	1.0	1.0	1.0	1.0	1.0
Lost Time Adjust (s)	0.0	0.0	0.0	0.0	0.0	0.0	0.0	0.0	0.0	0.0	0.0
Total Lost Time (s)	4.1	4.6	4.6	4.6	4.6	4.6	6.2	4.6	4.6	6.2	6.2
Lead/Lag	Lead	Lag	Lead	Lag	Lead	Lead	Lag	Lead	Lead	Lag	Lag
Lead-Lag Optimize?	Yes	Yes	Yes	Yes	Yes	Yes	Yes	Yes	Yes	Yes	Yes
Recall Mode	None	None	None	None	None	None	None	None	None	None	None
Act Effct Green (s)	11.5	15.7	16.9	21.5	45.0	9.0	56.1	74.5	23.5	72.7	72.7
Actuated g/C Ratio	0.09	0.12	0.13	0.16	0.34	0.07	0.42	0.56	0.18	0.55	0.55
v/c Ratio	0.59	0.47	0.89	0.44	1.13	0.56	0.90	0.34	0.87	0.41	0.03
Control Delay	74.4	57.3	79.7	54.8	111.4	78.5	45.0	7.0	68.6	20.2	0.1
Queue Delay	0.0	0.0	0.0	0.0	0.0	0.0	0.0	0.0	0.0	0.0	0.0
Total Delay	74.4	57.3	79.7	54.8	111.4	78.5	45.0	7.0	68.6	20.2	0.1
LOS	E	E	E	D	F	E	D	A	E	C	A
Approach Delay		65.3		94.5			39.1			38.6	
Approach LOS		E		F			D			D	

Intersection Summary

Cycle Length: 150
 Actuated Cycle Length: 132.2
 Natural Cycle: 125
 Control Type: Actuated-Uncoordinated
 Maximum v/c Ratio: 1.13
 Intersection Signal Delay: 54.9
 Intersection LOS: D
 Intersection Capacity Utilization 82.9%
 ICU Level of Service E
 Analysis Period (min) 15



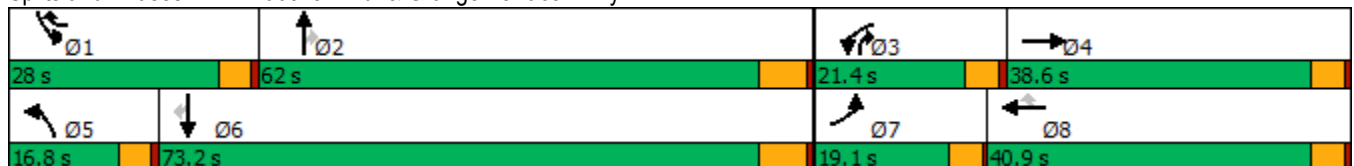























Splits and Phases: 7: Trautwein Rd. & Orange Terrace Pkwy



HCM 6th Signalized Intersection Summary
7: Trautwein Rd. & Orange Terrace Pkwy

West Campus Upper Plateau (JN 14064)

09/19/2022

												
Movement	EBL	EBT	EBR	WBL	WBT	WBR	NBL	NBT	NBR	SBL	SBT	SBR
Lane Configurations				 				 		 	 	
Traffic Volume (veh/h)	77	73	14	331	114	557	56	1119	275	439	666	23
Future Volume (veh/h)	77	73	14	331	114	557	56	1119	275	439	666	23
Initial Q (Qb), veh	0	0	0	0	0	0	0	0	0	0	0	0
Ped-Bike Adj(A_pbT)	1.00		0.99	1.00		0.98	1.00		1.00	1.00		0.98
Parking Bus, Adj	1.00	1.00	1.00	1.00	1.00	1.00	1.00	1.00	1.00	1.00	1.00	1.00
Work Zone On Approach		No			No			No			No	
Adj Sat Flow, veh/h/ln	1900	1870	1900	1885	1885	1885	1870	1856	1870	1856	1856	1826
Adj Flow Rate, veh/h	92	87	12	394	136	418	67	1332	242	523	793	19
Peak Hour Factor	0.84	0.84	0.84	0.84	0.84	0.84	0.84	0.84	0.84	0.84	0.84	0.84
Percent Heavy Veh, %	0	2	0	1	1	1	2	3	2	3	3	5
Cap, veh/h	114	286	39	417	449	636	85	1390	814	565	1803	773
Arrive On Green	0.06	0.18	0.18	0.12	0.24	0.24	0.05	0.39	0.39	0.16	0.51	0.51
Sat Flow, veh/h	1810	1607	222	3483	1885	1562	1781	3526	1583	3428	3526	1511
Grp Volume(v), veh/h	92	0	99	394	136	418	67	1332	242	523	793	19
Grp Sat Flow(s),veh/h/ln	1810	0	1828	1742	1885	1562	1781	1763	1583	1714	1763	1511
Q Serve(g_s), s	7.0	0.0	6.6	15.7	8.3	30.6	5.2	51.6	12.3	21.1	19.9	0.9
Cycle Q Clear(g_c), s	7.0	0.0	6.6	15.7	8.3	30.6	5.2	51.6	12.3	21.1	19.9	0.9
Prop In Lane	1.00		0.12	1.00		1.00	1.00		1.00	1.00		1.00
Lane Grp Cap(c), veh/h	114	0	326	417	449	636	85	1390	814	565	1803	773
V/C Ratio(X)	0.80	0.00	0.30	0.94	0.30	0.66	0.79	0.96	0.30	0.92	0.44	0.02
Avail Cap(c_a), veh/h	194	0	443	417	488	668	155	1403	820	572	1803	773
HCM Platoon Ratio	1.00	1.00	1.00	1.00	1.00	1.00	1.00	1.00	1.00	1.00	1.00	1.00
Upstream Filter(I)	1.00	0.00	1.00	1.00	1.00	1.00	1.00	1.00	1.00	1.00	1.00	1.00
Uniform Delay (d), s/veh	64.8	0.0	50.1	61.2	43.8	34.1	66.0	41.3	19.5	57.7	21.6	16.9
Incr Delay (d2), s/veh	12.2	0.0	0.5	30.2	0.4	2.2	5.9	15.1	0.2	20.5	0.2	0.0
Initial Q Delay(d3),s/veh	0.0	0.0	0.0	0.0	0.0	0.0	0.0	0.0	0.0	0.0	0.0	0.0
%ile BackOfQ(50%),veh/ln	3.6	0.0	3.1	8.6	3.9	11.6	2.5	24.1	4.4	10.5	7.8	0.3
Unsig. Movement Delay, s/veh												
LnGrp Delay(d),s/veh	77.0	0.0	50.6	91.4	44.2	36.3	71.9	56.4	19.7	78.2	21.8	17.0
LnGrp LOS	E	A	D	F	D	D	E	E	B	E	C	B
Approach Vol, veh/h		191			948			1641			1335	
Approach Delay, s/veh		63.3			60.3			51.7			43.8	
Approach LOS		E			E			D			D	
Timer - Assigned Phs	1	2	3	4	5	6	7	8				
Phs Duration (G+Y+Rc), s	27.7	61.5	21.4	29.6	11.3	77.9	13.0	38.0				
Change Period (Y+Rc), s	4.6	6.2	4.6	4.6	4.6	6.2	4.1	4.6				
Max Green Setting (Gmax), s	23.4	55.8	16.8	34.0	12.2	67.0	15.0	36.3				
Max Q Clear Time (g_c+I1), s	23.1	53.6	17.7	8.6	7.2	21.9	9.0	32.6				
Green Ext Time (p_c), s	0.1	1.7	0.0	0.5	0.0	5.7	0.1	0.9				
Intersection Summary												
HCM 6th Ctrl Delay			51.7									
HCM 6th LOS			D									

Timings
8: Cole Av. & Van Buren Bl.

West Campus Upper Plateau (JN 14064)

09/19/2022



Lane Group	EBL	EBT	EBR	WBL	WBT	WBR	NBL	NBT	SBL	SBT	SBR
Lane Configurations	↖↗	↑↑↑	↖	↖	↑↑↑	↖	↖	↑↑	↖↗	↑↑	↖
Traffic Volume (vph)	346	1117	106	171	1424	382	247	615	202	378	260
Future Volume (vph)	346	1117	106	171	1424	382	247	615	202	378	260
Turn Type	Prot	NA	pm+ov	Prot	NA	pm+ov	Prot	NA	Prot	NA	pm+ov
Protected Phases	5	2	3	1	6	7	3	8	7	4	5
Permitted Phases			2			6					4
Detector Phase	5	2	3	1	6	7	3	8	7	4	5
Switch Phase											
Minimum Initial (s)	5.0	10.0	5.0	5.0	10.0	5.0	5.0	10.0	5.0	10.0	5.0
Minimum Split (s)	9.1	36.2	9.1	9.1	36.2	9.1	9.1	42.2	9.1	49.2	9.1
Total Split (s)	14.0	38.8	17.0	15.0	39.8	17.6	17.0	48.6	17.6	49.2	14.0
Total Split (%)	11.7%	32.3%	14.2%	12.5%	33.2%	14.7%	14.2%	40.5%	14.7%	41.0%	11.7%
Yellow Time (s)	3.2	5.2	3.2	3.2	5.2	3.2	3.2	5.2	3.2	5.2	3.2
All-Red Time (s)	0.5	1.0	0.5	0.5	1.0	0.5	0.5	1.0	0.5	1.0	0.5
Lost Time Adjust (s)	0.0	0.0	0.0	0.0	0.0	0.0	0.0	0.0	0.0	0.0	0.0
Total Lost Time (s)	3.7	6.2	3.7	3.7	6.2	3.7	3.7	6.2	3.7	6.2	3.7
Lead/Lag	Lead	Lag	Lead	Lead	Lag	Lead	Lead	Lag	Lead	Lag	Lead
Lead-Lag Optimize?	Yes	Yes	Yes	Yes	Yes	Yes	Yes	Yes	Yes	Yes	Yes
Recall Mode	None	None	None	None	None	None	None	None	None	None	None
Act Effct Green (s)	10.4	32.8	52.5	11.4	33.8	47.5	13.4	31.8	11.1	29.5	42.4
Actuated g/C Ratio	0.10	0.31	0.49	0.11	0.32	0.44	0.13	0.30	0.10	0.28	0.40
v/c Ratio	1.17	0.81	0.14	0.99	0.99	0.58	1.25	0.81	0.64	0.43	0.45
Control Delay	147.2	40.6	5.2	113.7	59.0	21.3	185.6	40.5	55.8	32.5	18.0
Queue Delay	0.0	0.0	0.0	0.0	0.0	0.0	0.0	0.0	0.0	0.0	0.0
Total Delay	147.2	40.6	5.2	113.7	59.0	21.3	185.6	40.5	55.8	32.5	18.0
LOS	F	D	A	F	E	C	F	D	E	C	B
Approach Delay		61.6			56.4			76.2		33.6	
Approach LOS		E			E			E		C	

Intersection Summary

Cycle Length: 120
 Actuated Cycle Length: 107.1
 Natural Cycle: 125
 Control Type: Actuated-Uncoordinated
 Maximum v/c Ratio: 1.25
 Intersection Signal Delay: 58.1
 Intersection LOS: E
 Intersection Capacity Utilization 81.9%
 ICU Level of Service D
 Analysis Period (min) 15



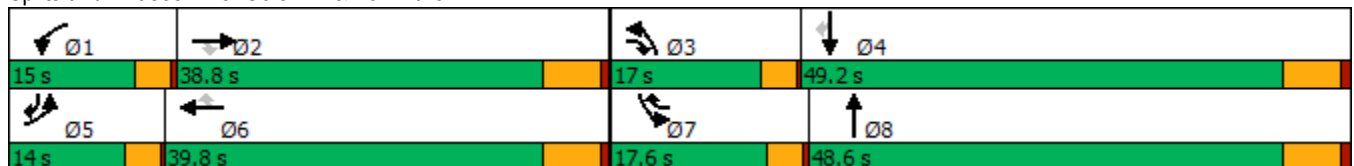



























Splits and Phases: 8: Cole Av. & Van Buren Bl.



HCM 6th Signalized Intersection Summary
8: Cole Av. & Van Buren Bl.

West Campus Upper Plateau (JN 14064)

09/19/2022

												
Movement	EBL	EBT	EBR	WBL	WBT	WBR	NBL	NBT	NBR	SBL	SBT	SBR
Lane Configurations	 	  			  			 		 	 	
Traffic Volume (veh/h)	346	1117	106	171	1424	382	247	615	140	202	378	260
Future Volume (veh/h)	346	1117	106	171	1424	382	247	615	140	202	378	260
Initial Q (Qb), veh	0	0	0	0	0	0	0	0	0	0	0	0
Ped-Bike Adj(A_pbT)	1.00		1.00	1.00		0.99	1.00		1.00	1.00		1.00
Parking Bus, Adj	1.00	1.00	1.00	1.00	1.00	1.00	1.00	1.00	1.00	1.00	1.00	1.00
Work Zone On Approach		No			No			No			No	
Adj Sat Flow, veh/h/ln	1856	1841	1841	1900	1856	1856	1856	1870	1856	1856	1870	1841
Adj Flow Rate, veh/h	384	1241	77	190	1582	334	274	683	147	224	420	217
Peak Hour Factor	0.90	0.90	0.90	0.90	0.90	0.90	0.90	0.90	0.90	0.90	0.90	0.90
Percent Heavy Veh, %	3	4	4	0	3	3	3	2	3	3	2	4
Cap, veh/h	349	1616	707	202	1679	649	232	831	179	293	852	532
Arrive On Green	0.10	0.32	0.32	0.11	0.33	0.33	0.13	0.29	0.29	0.09	0.24	0.24
Sat Flow, veh/h	3428	5025	1560	1810	5066	1553	1767	2908	625	3428	3554	1556
Grp Volume(v), veh/h	384	1241	77	190	1582	334	274	417	413	224	420	217
Grp Sat Flow(s),veh/h/ln	1714	1675	1560	1810	1689	1553	1767	1777	1757	1714	1777	1556
Q Serve(g_s), s	10.3	22.5	2.9	10.5	30.7	16.2	13.3	22.2	22.2	6.5	10.3	10.8
Cycle Q Clear(g_c), s	10.3	22.5	2.9	10.5	30.7	16.2	13.3	22.2	22.2	6.5	10.3	10.8
Prop In Lane	1.00		1.00	1.00		1.00	1.00		0.36	1.00		1.00
Lane Grp Cap(c), veh/h	349	1616	707	202	1679	649	232	508	502	293	852	532
V/C Ratio(X)	1.10	0.77	0.11	0.94	0.94	0.51	1.18	0.82	0.82	0.77	0.49	0.41
Avail Cap(c_a), veh/h	349	1619	708	202	1682	650	232	744	736	471	1510	820
HCM Platoon Ratio	1.00	1.00	1.00	1.00	1.00	1.00	1.00	1.00	1.00	1.00	1.00	1.00
Upstream Filter(I)	1.00	1.00	1.00	1.00	1.00	1.00	1.00	1.00	1.00	1.00	1.00	1.00
Uniform Delay (d), s/veh	45.4	30.9	15.9	44.6	32.9	21.9	43.9	33.7	33.7	45.3	33.2	25.5
Incr Delay (d2), s/veh	78.0	2.4	0.1	46.0	11.2	1.0	116.3	4.8	4.9	1.6	0.4	0.5
Initial Q Delay(d3),s/veh	0.0	0.0	0.0	0.0	0.0	0.0	0.0	0.0	0.0	0.0	0.0	0.0
%ile BackOfQ(50%),veh/ln	7.9	8.8	1.0	7.1	13.3	5.5	13.0	9.6	9.5	2.7	4.2	3.8
Unsig. Movement Delay, s/veh												
LnGrp Delay(d),s/veh	123.4	33.4	16.0	90.7	44.1	22.9	160.2	38.5	38.6	46.9	33.6	26.0
LnGrp LOS	F	C	B	F	D	C	F	D	D	D	C	C
Approach Vol, veh/h		1702			2106			1104			861	
Approach Delay, s/veh		52.9			45.0			68.7			35.1	
Approach LOS		D			D			E			D	
Timer - Assigned Phs	1	2	3	4	5	6	7	8				
Phs Duration (G+Y+Rc), s	15.0	38.7	17.0	30.5	14.0	39.7	12.3	35.1				
Change Period (Y+Rc), s	3.7	6.2	3.7	6.2	3.7	6.2	3.7	6.2				
Max Green Setting (Gmax), s	11.3	32.6	13.3	43.0	10.3	33.6	13.9	42.4				
Max Q Clear Time (g_c+I1), s	12.5	24.5	15.3	12.8	12.3	32.7	8.5	24.2				
Green Ext Time (p_c), s	0.0	5.6	0.0	3.3	0.0	0.8	0.2	4.4				
Intersection Summary												
HCM 6th Ctrl Delay			50.4									
HCM 6th LOS			D									

Timings
10: Orange Terrace Pkwy & Deercreek Dr

West Campus Upper Plateau (JN 14064)

09/19/2022



Lane Group	EBL	EBT	WBL	WBT	NBL	NBT	SBL	SBT
Lane Configurations	↖	↖↗	↖	↖↗		↕		↕
Traffic Volume (vph)	252	481	4	620	179	44	94	35
Future Volume (vph)	252	481	4	620	179	44	94	35
Turn Type	Perm	NA	Perm	NA	Perm	NA	Perm	NA
Protected Phases		4		8		2		6
Permitted Phases	4		8		2		6	
Detector Phase	4	4	8	8	2	2	6	6
Switch Phase								
Minimum Initial (s)	5.0	5.0	5.0	5.0	5.0	5.0	5.0	5.0
Minimum Split (s)	26.1	26.1	26.1	26.1	26.1	26.1	26.1	26.1
Total Split (s)	62.0	62.0	62.0	62.0	28.0	28.0	28.0	28.0
Total Split (%)	68.9%	68.9%	68.9%	68.9%	31.1%	31.1%	31.1%	31.1%
Yellow Time (s)	3.6	3.6	3.6	3.6	3.6	3.6	3.6	3.6
All-Red Time (s)	0.5	0.5	0.5	0.5	0.5	0.5	0.5	0.5
Lost Time Adjust (s)	0.0	0.0	0.0	0.0		0.0		0.0
Total Lost Time (s)	4.1	4.1	4.1	4.1		4.1		4.1
Lead/Lag								
Lead-Lag Optimize?								
Recall Mode	None	None	None	None	Min	Min	Min	Min
Act Effct Green (s)	57.9	57.9	57.9	57.9		23.9		23.9
Actuated g/C Ratio	0.64	0.64	0.64	0.64		0.27		0.27
v/c Ratio	1.00	0.31	0.01	0.39		0.98		0.59
Control Delay	70.0	7.3	6.0	8.1		80.6		33.9
Queue Delay	0.0	0.0	0.0	0.0		0.0		0.0
Total Delay	70.0	7.3	6.0	8.1		80.6		33.9
LOS	E	A	A	A		F		C
Approach Delay		27.6		8.0		80.6		33.9
Approach LOS		C		A		F		C

Intersection Summary

Cycle Length: 90	
Actuated Cycle Length: 90	
Natural Cycle: 80	
Control Type: Actuated-Uncoordinated	
Maximum v/c Ratio: 1.00	
Intersection Signal Delay: 27.6	Intersection LOS: C
Intersection Capacity Utilization 61.3%	ICU Level of Service B
Analysis Period (min) 15	

Splits and Phases: 10: Orange Terrace Pkwy & Deercreek Dr



HCM 6th Signalized Intersection Summary
10: Orange Terrace Pkwy & Deercreek Dr

West Campus Upper Plateau (JN 14064)

09/19/2022



Movement	EBL	EBT	EBR	WBL	WBT	WBR	NBL	NBT	NBR	SBL	SBT	SBR
Lane Configurations												
Traffic Volume (veh/h)	252	481	47	4	620	58	179	44	7	94	35	42
Future Volume (veh/h)	252	481	47	4	620	58	179	44	7	94	35	42
Initial Q (Qb), veh	0	0	0	0	0	0	0	0	0	0	0	0
Ped-Bike Adj(A_pbT)	1.00		0.97	1.00		1.00	1.00		0.99	0.99		0.97
Parking Bus, Adj	1.00	1.00	1.00	1.00	1.00	1.00	1.00	1.00	1.00	1.00	1.00	1.00
Work Zone On Approach		No			No			No			No	
Adj Sat Flow, veh/h/ln	1900	1870	1900	1900	1900	1885	1885	1900	1900	1900	1856	1870
Adj Flow Rate, veh/h	336	641	63	5	827	77	239	59	9	125	47	56
Peak Hour Factor	0.75	0.75	0.75	0.75	0.75	0.75	0.75	0.75	0.75	0.75	0.75	0.75
Percent Heavy Veh, %	0	2	0	0	0	1	1	0	0	0	3	2
Cap, veh/h	420	2134	209	511	2185	203	334	65	10	266	101	99
Arrive On Green	0.65	0.65	0.65	0.65	0.65	0.65	0.25	0.25	0.25	0.25	0.25	0.25
Sat Flow, veh/h	626	3259	320	754	3338	311	1035	256	39	804	401	392
Grp Volume(v), veh/h	336	349	355	5	447	457	307	0	0	228	0	0
Grp Sat Flow(s),veh/h/ln	626	1777	1802	754	1805	1844	1330	0	0	1597	0	0
Q Serve(g_s), s	47.0	7.5	7.5	0.3	10.1	10.1	9.2	0.0	0.0	0.0	0.0	0.0
Cycle Q Clear(g_c), s	57.0	7.5	7.5	7.7	10.1	10.1	20.0	0.0	0.0	10.8	0.0	0.0
Prop In Lane	1.00		0.18	1.00		0.17	0.78		0.03	0.55		0.25
Lane Grp Cap(c), veh/h	420	1163	1180	511	1182	1207	408	0	0	467	0	0
V/C Ratio(X)	0.80	0.30	0.30	0.01	0.38	0.38	0.75	0.00	0.00	0.49	0.00	0.00
Avail Cap(c_a), veh/h	420	1163	1180	511	1182	1207	433	0	0	492	0	0
HCM Platoon Ratio	1.00	1.00	1.00	1.00	1.00	1.00	1.00	1.00	1.00	1.00	1.00	1.00
Upstream Filter(I)	1.00	1.00	1.00	1.00	1.00	1.00	1.00	0.00	0.00	1.00	0.00	0.00
Uniform Delay (d), s/veh	20.1	6.6	6.6	8.2	7.0	7.0	32.4	0.0	0.0	28.7	0.0	0.0
Incr Delay (d2), s/veh	10.5	0.1	0.1	0.0	0.2	0.2	6.8	0.0	0.0	0.8	0.0	0.0
Initial Q Delay(d3),s/veh	0.0	0.0	0.0	0.0	0.0	0.0	0.0	0.0	0.0	0.0	0.0	0.0
%ile BackOfQ(50%),veh/ln	6.8	2.2	2.2	0.0	3.5	3.6	7.0	0.0	0.0	4.2	0.0	0.0
Unsig. Movement Delay, s/veh												
LnGrp Delay(d),s/veh	30.6	6.7	6.7	8.2	7.2	7.2	39.3	0.0	0.0	29.5	0.0	0.0
LnGrp LOS	C	A	A	A	A	A	D	A	A	C	A	A
Approach Vol, veh/h		1040			909			307			228	
Approach Delay, s/veh		14.4			7.2			39.3			29.5	
Approach LOS		B			A			D			C	
Timer - Assigned Phs		2		4		6		8				
Phs Duration (G+Y+Rc), s		26.4		62.0		26.4		62.0				
Change Period (Y+Rc), s		4.1		4.1		4.1		4.1				
Max Green Setting (Gmax), s		23.9		57.9		23.9		57.9				
Max Q Clear Time (g_c+I1), s		22.0		59.0		12.8		12.1				
Green Ext Time (p_c), s		0.3		0.0		1.0		7.6				
Intersection Summary												
HCM 6th Ctrl Delay				16.2								
HCM 6th LOS				B								

Timings
13: Barton Rd. & Orange Terrace Pkwy

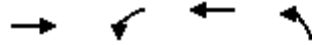

Lane Group	EBT	WBL	WBT	NBL
Lane Configurations	↑↑	↑	↑↑	↑
Traffic Volume (vph)	308	51	455	226
Future Volume (vph)	308	51	455	226
Turn Type	NA	Perm	NA	Prot
Protected Phases	4		8	2
Permitted Phases		8		
Detector Phase	4	8	8	2
Switch Phase				
Minimum Initial (s)	10.0	10.0	10.0	10.0
Minimum Split (s)	26.7	14.7	14.7	26.6
Total Split (s)	27.0	27.0	27.0	28.0
Total Split (%)	49.1%	49.1%	49.1%	50.9%
Yellow Time (s)	3.7	3.7	3.7	3.6
All-Red Time (s)	1.0	1.0	1.0	1.0
Lost Time Adjust (s)	0.0	0.0	0.0	0.0
Total Lost Time (s)	4.7	4.7	4.7	4.6
Lead/Lag				
Lead-Lag Optimize?				
Recall Mode	Min	Min	Min	None
Act Effect Green (s)	13.9	13.9	13.9	13.0
Actuated g/C Ratio	0.38	0.38	0.38	0.36
v/c Ratio	0.50	0.27	0.42	0.51
Control Delay	6.0	12.2	9.9	12.3
Queue Delay	0.0	0.0	0.0	0.0
Total Delay	6.0	12.2	9.9	12.3
LOS	A	B	A	B
Approach Delay	6.0		10.1	12.3
Approach LOS	A		B	B

Intersection Summary

Cycle Length: 55
 Actuated Cycle Length: 36.6
 Natural Cycle: 55
 Control Type: Actuated-Uncoordinated
 Maximum v/c Ratio: 0.51
 Intersection Signal Delay: 8.8
 Intersection LOS: A
 Intersection Capacity Utilization 52.1%
 ICU Level of Service A
 Analysis Period (min) 15

Splits and Phases: 13: Barton Rd. & Orange Terrace Pkwy

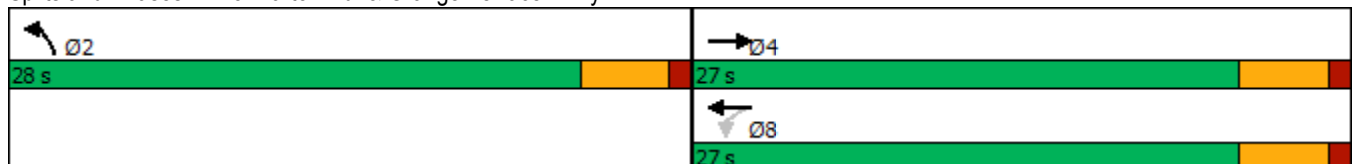

HCM 6th Signalized Intersection Summary
 13: Barton Rd. & Orange Terrace Pkwy

West Campus Upper Plateau (JN 14064)

09/19/2022

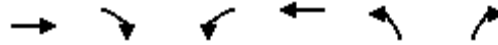

Movement	EBT	EBR	WBL	WBT	NBL	NBR
Lane Configurations	↑↑		↙	↑↑	↘	
Traffic Volume (veh/h)	308	273	51	455	226	38
Future Volume (veh/h)	308	273	51	455	226	38
Initial Q (Qb), veh	0	0	0	0	0	0
Ped-Bike Adj(A_pbT)		0.98	1.00		1.00	1.00
Parking Bus, Adj	1.00	1.00	1.00	1.00	1.00	1.00
Work Zone On Approach	No			No	No	
Adj Sat Flow, veh/h/ln	1856	1900	1870	1885	1900	1900
Adj Flow Rate, veh/h	385	341	64	569	282	48
Peak Hour Factor	0.80	0.80	0.80	0.80	0.80	0.80
Percent Heavy Veh, %	3	0	2	1	0	0
Cap, veh/h	727	634	404	1477	449	76
Arrive On Green	0.41	0.41	0.41	0.41	0.30	0.30
Sat Flow, veh/h	1856	1538	728	3676	1515	258
Grp Volume(v), veh/h	385	341	64	569	331	0
Grp Sat Flow(s),veh/h/ln	1763	1538	728	1791	1778	0
Q Serve(g_s), s	5.2	5.3	2.3	3.5	5.1	0.0
Cycle Q Clear(g_c), s	5.2	5.3	7.7	3.5	5.1	0.0
Prop In Lane		1.00	1.00		0.85	0.15
Lane Grp Cap(c), veh/h	727	634	404	1477	527	0
V/C Ratio(X)	0.53	0.54	0.16	0.39	0.63	0.00
Avail Cap(c_a), veh/h	1231	1074	612	2501	1303	0
HCM Platoon Ratio	1.00	1.00	1.00	1.00	1.00	1.00
Upstream Filter(I)	1.00	1.00	1.00	1.00	1.00	0.00
Uniform Delay (d), s/veh	7.1	7.1	10.0	6.6	9.7	0.0
Incr Delay (d2), s/veh	0.6	0.7	0.2	0.2	1.2	0.0
Initial Q Delay(d3),s/veh	0.0	0.0	0.0	0.0	0.0	0.0
%ile BackOfQ(50%),veh/ln	1.3	1.1	0.3	0.8	1.6	0.0
Unsig. Movement Delay, s/veh						
LnGrp Delay(d),s/veh	7.7	7.8	10.2	6.7	10.9	0.0
LnGrp LOS	A	A	B	A	B	A
Approach Vol, veh/h	726			633	331	
Approach Delay, s/veh	7.7			7.1	10.9	
Approach LOS	A			A	B	
Timer - Assigned Phs		2		4		8
Phs Duration (G+Y+Rc), s		14.1		17.9		17.9
Change Period (Y+Rc), s		4.6		* 4.7		* 4.7
Max Green Setting (Gmax), s		23.4		* 22		* 22
Max Q Clear Time (g_c+I1), s		7.1		7.3		9.7
Green Ext Time (p_c), s		0.9		4.3		3.5

Intersection Summary

HCM 6th Ctrl Delay	8.1
HCM 6th LOS	A

Notes

User approved volume balancing among the lanes for turning movement.
 * HCM 6th computational engine requires equal clearance times for the phases crossing the barrier.

Timings

14: Barton Rd. & Van Buren Bl.

09/19/2022

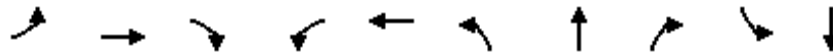

Lane Group	EBL	EBT	EBR	WBL	WBT	NBL	NBT	NBR	SBL	SBT
Lane Configurations	↙	↑↑↑	↘	↙	↑↑↑	↙	↑	↘	↙	↘
Traffic Volume (vph)	155	1301	120	296	1454	411	83	421	77	109
Future Volume (vph)	155	1301	120	296	1454	411	83	421	77	109
Turn Type	Prot	NA	pm+ov	Prot	NA	Prot	NA	Perm	Prot	NA
Protected Phases	5	2	3	1	6	3	8		7	4
Permitted Phases			2					8		
Detector Phase	5	2	3	1	6	3	8	8	7	4
Switch Phase										
Minimum Initial (s)	5.0	10.0	5.0	5.0	10.0	5.0	10.0	10.0	5.0	10.0
Minimum Split (s)	9.2	25.2	9.1	9.2	25.5	9.1	14.6	14.6	9.1	33.6
Total Split (s)	17.5	38.3	21.0	27.1	47.9	21.0	41.2	41.2	13.4	33.6
Total Split (%)	14.6%	31.9%	17.5%	22.6%	39.9%	17.5%	34.3%	34.3%	11.2%	28.0%
Yellow Time (s)	3.2	5.2	3.6	3.2	5.5	3.6	3.6	3.6	3.6	3.6
All-Red Time (s)	1.0	1.0	0.5	1.0	1.0	0.5	1.0	1.0	0.5	1.0
Lost Time Adjust (s)	0.0	0.0	0.0	0.0	0.0	0.0	0.0	0.0	0.0	0.0
Total Lost Time (s)	4.2	6.2	4.1	4.2	6.5	4.1	4.6	4.6	4.1	4.6
Lead/Lag	Lead	Lag	Lead	Lead	Lag	Lead	Lag	Lag	Lead	Lag
Lead-Lag Optimize?	Yes	Yes	Yes	Yes	Yes	Yes	Yes	Yes	Yes	Yes
Recall Mode	None	None	None	None	None	None	None	None	None	None
Act Effct Green (s)	13.1	32.1	55.2	22.9	41.6	16.9	37.0	37.0	8.9	29.0
Actuated g/C Ratio	0.11	0.27	0.46	0.19	0.35	0.14	0.31	0.31	0.07	0.24
v/c Ratio	0.91	1.00	0.18	1.01	0.90	0.99	0.16	0.64	0.67	1.00
Control Delay	96.9	67.5	7.8	99.9	44.4	89.8	31.4	12.3	78.3	75.8
Queue Delay	0.0	0.0	0.0	0.0	0.0	0.0	0.0	0.0	0.0	0.0
Total Delay	96.9	67.5	7.8	99.9	44.4	89.8	31.4	12.3	78.3	75.8
LOS	F	E	A	F	D	F	C	B	E	E
Approach Delay		65.8			53.6		48.9			76.2
Approach LOS		E			D		D			E

Intersection Summary

Cycle Length: 120
 Actuated Cycle Length: 120
 Natural Cycle: 120
 Control Type: Actuated-Uncoordinated
 Maximum v/c Ratio: 1.01
 Intersection Signal Delay: 59.1
 Intersection LOS: E
 Intersection Capacity Utilization 94.6%
 ICU Level of Service F
 Analysis Period (min) 15

Splits and Phases: 14: Barton Rd. & Van Buren Bl.

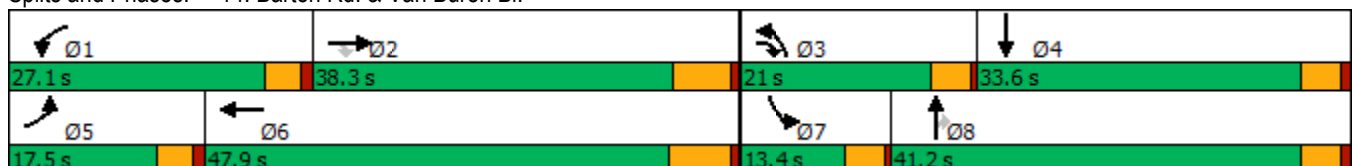

HCM 6th Signalized Intersection Summary
14: Barton Rd. & Van Buren Bl.

West Campus Upper Plateau (JN 14064)

09/19/2022



Movement	EBL	EBT	EBR	WBL	WBT	WBR	NBL	NBT	NBR	SBL	SBT	SBR
Lane Configurations												
Traffic Volume (veh/h)	155	1301	120	296	1454	36	411	83	421	77	109	320
Future Volume (veh/h)	155	1301	120	296	1454	36	411	83	421	77	109	320
Initial Q (Qb), veh	0	0	0	0	0	0	0	0	0	0	0	0
Ped-Bike Adj(A_pbT)	1.00		1.00	1.00		1.00	1.00		1.00	1.00		1.00
Parking Bus, Adj	1.00	1.00	1.00	1.00	1.00	1.00	1.00	1.00	1.00	1.00	1.00	1.00
Work Zone On Approach		No			No			No			No	
Adj Sat Flow, veh/h/ln	1900	1870	1841	1870	1856	1722	1856	1885	1885	1900	1870	1900
Adj Flow Rate, veh/h	178	1495	125	340	1671	35	472	95	268	89	125	246
Peak Hour Factor	0.87	0.87	0.87	0.87	0.87	0.87	0.87	0.87	0.87	0.87	0.87	0.87
Percent Heavy Veh, %	0	2	4	2	3	12	3	1	1	0	2	0
Cap, veh/h	201	1506	639	341	1894	40	484	595	505	112	133	262
Arrive On Green	0.11	0.27	0.27	0.19	0.35	0.35	0.14	0.32	0.32	0.06	0.24	0.24
Sat Flow, veh/h	1810	5611	1560	1781	5432	114	3428	1885	1598	1810	563	1108
Grp Volume(v), veh/h	178	1495	125	340	1141	565	472	95	268	89	0	371
Grp Sat Flow(s),veh/h/ln	1810	1870	1560	1781	1856	1835	1714	1885	1598	1810	0	1671
Q Serve(g_s), s	11.6	31.8	6.1	22.8	34.6	34.6	16.4	4.3	16.5	5.8	0.0	26.1
Cycle Q Clear(g_c), s	11.6	31.8	6.1	22.8	34.6	34.6	16.4	4.3	16.5	5.8	0.0	26.1
Prop In Lane	1.00		1.00	1.00		0.06	1.00		1.00	1.00		0.66
Lane Grp Cap(c), veh/h	201	1506	639	341	1294	640	484	595	505	112	0	395
V/C Ratio(X)	0.88	0.99	0.20	1.00	0.88	0.88	0.97	0.16	0.53	0.79	0.00	0.94
Avail Cap(c_a), veh/h	201	1506	639	341	1294	640	484	595	505	141	0	405
HCM Platoon Ratio	1.00	1.00	1.00	1.00	1.00	1.00	1.00	1.00	1.00	1.00	1.00	1.00
Upstream Filter(I)	1.00	1.00	1.00	1.00	1.00	1.00	1.00	1.00	1.00	1.00	0.00	1.00
Uniform Delay (d), s/veh	52.4	43.6	22.7	48.3	36.6	36.6	51.1	29.5	33.6	55.3	0.0	44.8
Incr Delay (d2), s/veh	33.0	21.4	0.1	47.8	7.2	13.2	34.2	0.1	1.1	21.2	0.0	29.3
Initial Q Delay(d3),s/veh	0.0	0.0	0.0	0.0	0.0	0.0	0.0	0.0	0.0	0.0	0.0	0.0
%ile BackOfQ(50%),veh/ln	6.9	16.9	2.2	14.2	16.0	16.9	9.1	1.9	6.3	3.3	0.0	14.0
Unsig. Movement Delay, s/veh												
LnGrp Delay(d),s/veh	85.4	65.0	22.7	96.1	43.8	49.9	85.3	29.6	34.7	76.5	0.0	74.1
LnGrp LOS	F	E	C	F	D	D	F	C	C	E	A	E
Approach Vol, veh/h		1798			2046			835				460
Approach Delay, s/veh		64.1			54.2			62.7				74.5
Approach LOS		E			D			E				E
Timer - Assigned Phs	1	2	3	4	5	6	7	8				
Phs Duration (G+Y+Rc), s	27.1	38.6	21.0	32.9	17.5	48.2	11.5	42.4				
Change Period (Y+Rc), s	* 4.2	* 6.5	4.1	4.6	* 4.2	6.5	4.1	4.6				
Max Green Setting (Gmax), s	* 23	* 32	16.9	29.0	* 13	41.4	9.3	36.6				
Max Q Clear Time (g_c+I1), s	24.8	33.8	18.4	28.1	13.6	36.6	7.8	18.5				
Green Ext Time (p_c), s	0.0	0.0	0.0	0.2	0.0	3.0	0.0	1.2				

Intersection Summary

HCM 6th Ctrl Delay	60.9
HCM 6th LOS	E

Notes

* HCM 6th computational engine requires equal clearance times for the phases crossing the barrier.

Timings
25: Sycamore Canyon Bl. & Cactus Av.

West Campus Upper Plateau (JN 14064)

09/19/2022



Lane Group	EBL	EBT	EBR	WBL	WBT	WBR	NBL	NBT	NBR	SBL	SBT	SBR
Lane Configurations	↘	↑↑	↗	↘↗	↑↑	↗	↘↗	↑↑	↗	↘↗	↑↑	↗
Traffic Volume (vph)	26	202	83	419	661	1016	282	421	240	158	161	79
Future Volume (vph)	26	202	83	419	661	1016	282	421	240	158	161	79
Turn Type	Prot	NA	Perm	Prot	NA	Perm	Prot	NA	Perm	Prot	NA	Perm
Protected Phases	7	4		3	8		5	2		1	6	
Permitted Phases			4			8			2			6
Detector Phase	7	4	4	3	8	8	5	2	2	1	6	6
Switch Phase												
Minimum Initial (s)	5.0	10.0	10.0	5.0	10.0	10.0	5.0	10.0	10.0	5.0	10.0	10.0
Minimum Split (s)	9.6	32.8	32.8	9.6	32.8	32.8	9.6	34.8	34.8	9.6	34.8	34.8
Total Split (s)	9.7	47.6	47.6	30.9	68.8	68.8	16.2	37.5	37.5	14.0	35.3	35.3
Total Split (%)	7.5%	36.6%	36.6%	23.8%	52.9%	52.9%	12.5%	28.8%	28.8%	10.8%	27.2%	27.2%
Yellow Time (s)	3.6	4.8	4.8	3.6	4.8	4.8	3.6	4.8	4.8	3.6	4.8	4.8
All-Red Time (s)	1.0	1.0	1.0	1.0	1.0	1.0	1.0	1.0	1.0	1.0	1.0	1.0
Lost Time Adjust (s)	0.0	0.0	0.0	0.0	0.0	0.0	0.0	0.0	0.0	0.0	0.0	0.0
Total Lost Time (s)	4.6	5.8	5.8	4.6	5.8	5.8	4.6	5.8	5.8	4.6	5.8	5.8
Lead/Lag	Lead	Lag	Lag	Lead	Lag	Lag	Lead	Lag	Lag	Lead	Lag	Lag
Lead-Lag Optimize?	Yes	Yes	Yes	Yes	Yes	Yes	Yes	Yes	Yes	Yes	Yes	Yes
Recall Mode	None	None	None	None	None	None	None	None	None	None	None	None
Act Effct Green (s)	5.1	44.5	44.5	19.9	63.6	63.6	11.7	21.7	21.7	8.7	18.6	18.6
Actuated g/C Ratio	0.04	0.38	0.38	0.17	0.55	0.55	0.10	0.19	0.19	0.08	0.16	0.16
v/c Ratio	0.43	0.17	0.13	0.80	0.39	1.04	0.87	0.69	0.51	0.64	0.30	0.23
Control Delay	78.3	26.2	1.1	58.8	17.4	57.8	78.5	50.2	8.8	66.3	44.0	1.8
Queue Delay	0.0	0.0	0.0	0.0	0.0	13.1	0.0	0.0	0.0	0.0	0.0	0.0
Total Delay	78.3	26.2	1.1	58.8	17.4	70.9	78.5	50.2	8.8	66.3	44.0	1.8
LOS	E	C	A	E	B	E	E	D	A	E	D	A
Approach Delay		23.8			51.6			48.1			44.5	
Approach LOS		C			D			D			D	

Intersection Summary

Cycle Length: 130
 Actuated Cycle Length: 115.7
 Natural Cycle: 130
 Control Type: Actuated-Uncoordinated
 Maximum v/c Ratio: 1.04
 Intersection Signal Delay: 47.7
 Intersection LOS: D
 Intersection Capacity Utilization 92.2%
 ICU Level of Service F
 Analysis Period (min) 15

Splits and Phases: 25: Sycamore Canyon Bl. & Cactus Av.

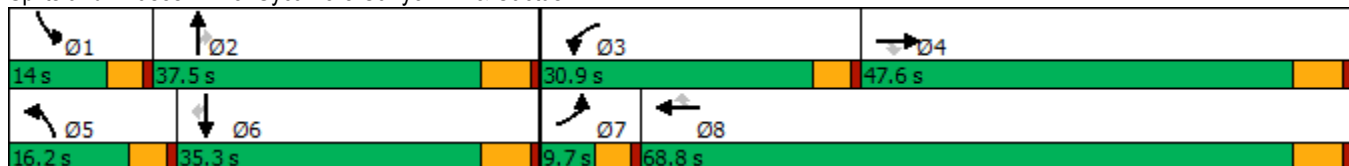

HCM 6th Signalized Intersection Summary
 25: Sycamore Canyon Bl. & Cactus Av.

West Campus Upper Plateau (JN 14064)

09/19/2022



Movement	EBL	EBT	EBR	WBL	WBT	WBR	NBL	NBT	NBR	SBL	SBT	SBR
Lane Configurations												
Traffic Volume (veh/h)	26	202	83	419	661	1016	282	421	240	158	161	79
Future Volume (veh/h)	26	202	83	419	661	1016	282	421	240	158	161	79
Initial Q (Qb), veh	0	0	0	0	0	0	0	0	0	0	0	0
Ped-Bike Adj(A_pbT)	1.00		1.00	1.00		0.99	1.00		1.00	1.00		0.99
Parking Bus, Adj	1.00	1.00	1.00	1.00	1.00	1.00	1.00	1.00	1.00	1.00	1.00	1.00
Work Zone On Approach		No			No			No			No	
Adj Sat Flow, veh/h/ln	1515	1693	1826	1722	1707	1856	1811	1796	1811	1841	1826	1796
Adj Flow Rate, veh/h	27	208	85	432	681	828	291	434	150	163	166	78
Peak Hour Factor	0.97	0.97	0.97	0.97	0.97	0.97	0.97	0.97	0.97	0.97	0.97	0.97
Percent Heavy Veh, %	26	14	5	12	13	3	6	7	6	4	5	7
Cap, veh/h	37	1366	657	497	1802	863	347	563	253	222	439	190
Arrive On Green	0.03	0.42	0.42	0.16	0.56	0.56	0.10	0.17	0.17	0.07	0.13	0.13
Sat Flow, veh/h	1443	3216	1547	3182	3244	1553	3346	3413	1535	3401	3469	1501
Grp Volume(v), veh/h	27	208	85	432	681	828	291	434	150	163	166	78
Grp Sat Flow(s),veh/h/ln	1443	1608	1547	1591	1622	1553	1673	1706	1535	1700	1735	1501
Q Serve(g_s), s	2.0	4.4	3.7	14.6	13.0	56.0	9.4	13.4	10.0	5.2	4.8	5.3
Cycle Q Clear(g_c), s	2.0	4.4	3.7	14.6	13.0	56.0	9.4	13.4	10.0	5.2	4.8	5.3
Prop In Lane	1.00		1.00	1.00		1.00	1.00		1.00	1.00		1.00
Lane Grp Cap(c), veh/h	37	1366	657	497	1802	863	347	563	253	222	439	190
V/C Ratio(X)	0.73	0.15	0.13	0.87	0.38	0.96	0.84	0.77	0.59	0.73	0.38	0.41
Avail Cap(c_a), veh/h	67	1366	657	759	1854	888	352	982	441	290	929	402
HCM Platoon Ratio	1.00	1.00	1.00	1.00	1.00	1.00	1.00	1.00	1.00	1.00	1.00	1.00
Upstream Filter(I)	1.00	1.00	1.00	1.00	1.00	1.00	1.00	1.00	1.00	1.00	1.00	1.00
Uniform Delay (d), s/veh	53.3	19.5	19.3	45.4	13.8	23.3	48.5	44.0	42.6	50.6	44.1	44.3
Incr Delay (d2), s/veh	10.0	0.1	0.1	4.6	0.1	20.8	15.2	2.3	2.2	4.2	0.5	1.4
Initial Q Delay(d3),s/veh	0.0	0.0	0.0	0.0	0.0	0.0	0.0	0.0	0.0	0.0	0.0	0.0
%ile BackOfQ(50%),veh/ln	0.8	1.6	1.3	5.9	4.4	22.8	4.5	5.6	3.8	2.3	2.1	2.0
Unsig. Movement Delay, s/veh												
LnGrp Delay(d),s/veh	63.3	19.6	19.4	50.0	13.9	44.1	63.7	46.3	44.8	54.8	44.7	45.7
LnGrp LOS	E	B	B	D	B	D	E	D	D	D	D	D
Approach Vol, veh/h		320			1941			875				407
Approach Delay, s/veh		23.2			34.8			51.8				48.9
Approach LOS		C			C			D				D
Timer - Assigned Phs	1	2	3	4	5	6	7	8				
Phs Duration (G+Y+Rc), s	11.8	24.0	21.8	52.6	16.0	19.8	7.4	67.0				
Change Period (Y+Rc), s	4.6	5.8	4.6	5.8	4.6	5.8	4.6	5.8				
Max Green Setting (Gmax), s	9.4	31.7	26.3	41.8	11.6	29.5	5.1	63.0				
Max Q Clear Time (g_c+1), s	7.2	15.4	16.6	6.4	11.4	7.3	4.0	58.0				
Green Ext Time (p_c), s	0.1	2.8	0.6	1.6	0.0	1.1	0.0	3.3				

Intersection Summary

HCM 6th Ctrl Delay	39.6
HCM 6th LOS	D

Timings
29: I-215 NB Ramps & Alessandro Bl.

West Campus Upper Plateau (JN 14064)

09/19/2022

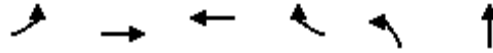

Lane Group	EBL	EBT	WBT	WBR	NBL	NBT
Lane Configurations	↶	↑↑↑	↑↑↑	↷	↶↷	↕
Traffic Volume (vph)	97	1023	1539	89	1392	0
Future Volume (vph)	97	1023	1539	89	1392	0
Turn Type	Prot	NA	NA	Perm	Split	NA
Protected Phases	5	2	6		8	8
Permitted Phases				6		
Detector Phase	5	2	6	6	8	8
Switch Phase						
Minimum Initial (s)	5.0	5.0	5.0	5.0	5.0	5.0
Minimum Split (s)	9.5	10.5	33.5	33.5	10.0	10.0
Total Split (s)	14.0	65.0	51.0	51.0	45.0	45.0
Total Split (%)	12.7%	59.1%	46.4%	46.4%	40.9%	40.9%
Yellow Time (s)	3.5	4.5	4.5	4.5	4.0	4.0
All-Red Time (s)	1.0	1.0	1.0	1.0	1.0	1.0
Lost Time Adjust (s)	0.0	0.0	0.0	0.0	0.0	0.0
Total Lost Time (s)	4.5	5.5	5.5	5.5	5.0	5.0
Lead/Lag	Lead		Lag	Lag		
Lead-Lag Optimize?	Yes		Yes	Yes		
Recall Mode	None	C-Min	C-Min	C-Min	None	None
Act Effct Green (s)	9.2	58.7	45.0	45.0	40.8	40.8
Actuated g/C Ratio	0.08	0.53	0.41	0.41	0.37	0.37
v/c Ratio	0.80	0.39	0.75	0.15	0.90	0.86
Control Delay	85.3	15.2	30.7	8.4	44.7	43.9
Queue Delay	0.0	0.0	0.0	0.0	0.0	0.0
Total Delay	85.3	15.2	30.7	8.4	44.7	43.9
LOS	F	B	C	A	D	D
Approach Delay		21.3	29.5			44.4
Approach LOS		C	C			D

Intersection Summary

Cycle Length: 110
 Actuated Cycle Length: 110
 Offset: 0 (0%), Referenced to phase 2:EBT and 6:WBT, Start of Yellow
 Natural Cycle: 80
 Control Type: Actuated-Coordinated
 Maximum v/c Ratio: 0.90
 Intersection Signal Delay: 32.8
 Intersection LOS: C
 Intersection Capacity Utilization 77.0%
 ICU Level of Service D
 Analysis Period (min) 15

Splits and Phases: 29: I-215 NB Ramps & Alessandro Bl.

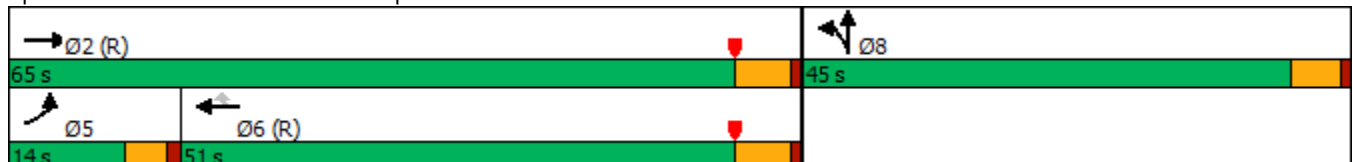

HCM 6th Signalized Intersection Summary
 29: I-215 NB Ramps & Alessandro Bl.

West Campus Upper Plateau (JN 14064)

09/19/2022



Movement	EBL	EBT	EBR	WBL	WBT	WBR	NBL	NBT	NBR	SBL	SBT	SBR
Lane Configurations	↗	↑↑↑			↑↑↑	↗	↗↗	↕				
Traffic Volume (veh/h)	97	1023	0	0	1539	89	1392	0	182	0	0	0
Future Volume (veh/h)	97	1023	0	0	1539	89	1392	0	182	0	0	0
Initial Q (Qb), veh	0	0	0	0	0	0	0	0	0			
Ped-Bike Adj(A_pbT)	1.00		1.00	1.00		1.00	1.00		1.00			
Parking Bus, Adj	1.00	1.00	1.00	1.00	1.00	1.00	1.00	1.00	1.00			
Work Zone On Approach		No			No			No				
Adj Sat Flow, veh/h/ln	1574	1841	0	0	1870	1707	1870	1900	1796			
Adj Flow Rate, veh/h	99	1044	0	0	1570	84	1520	0	0			
Peak Hour Factor	0.98	0.98	0.98	0.98	0.98	0.98	0.98	0.98	0.98			
Percent Heavy Veh, %	22	4	0	0	2	13	2	0	7			
Cap, veh/h	118	2912	0	0	2350	666	1737	618	0			
Arrive On Green	0.16	1.00	0.00	0.00	0.46	0.46	0.33	0.00	0.00			
Sat Flow, veh/h	1499	5191	0	0	5274	1447	5344	1900	0			
Grp Volume(v), veh/h	99	1044	0	0	1570	84	1520	0	0			
Grp Sat Flow(s),veh/h/ln	1499	1675	0	0	1702	1447	1781	1900	0			
Q Serve(g_s), s	7.1	0.0	0.0	0.0	26.4	3.7	29.5	0.0	0.0			
Cycle Q Clear(g_c), s	7.1	0.0	0.0	0.0	26.4	3.7	29.5	0.0	0.0			
Prop In Lane	1.00		0.00	0.00		1.00	1.00		0.00			
Lane Grp Cap(c), veh/h	118	2912	0	0	2350	666	1737	618	0			
V/C Ratio(X)	0.84	0.36	0.00	0.00	0.67	0.13	0.88	0.00	0.00			
Avail Cap(c_a), veh/h	129	2912	0	0	2350	666	1943	691	0			
HCM Platoon Ratio	2.00	2.00	1.00	1.00	1.00	1.00	1.00	1.00	1.00			
Upstream Filter(I)	0.96	0.96	0.00	0.00	1.00	1.00	1.00	0.00	0.00			
Uniform Delay (d), s/veh	45.7	0.0	0.0	0.0	23.1	17.0	35.0	0.0	0.0			
Incr Delay (d2), s/veh	32.6	0.3	0.0	0.0	1.5	0.4	4.4	0.0	0.0			
Initial Q Delay(d3),s/veh	0.0	0.0	0.0	0.0	0.0	0.0	0.0	0.0	0.0			
%ile BackOfQ(50%),veh/ln	3.4	0.1	0.0	0.0	9.8	1.2	13.0	0.0	0.0			
Unsig. Movement Delay, s/veh												
LnGrp Delay(d),s/veh	78.3	0.3	0.0	0.0	24.7	17.4	39.5	0.0	0.0			
LnGrp LOS	E	A	A	A	C	B	D	A	A			
Approach Vol, veh/h		1143			1654			1520				
Approach Delay, s/veh		7.1			24.3			39.5				
Approach LOS		A			C			D				
Timer - Assigned Phs		2			5	6		8				
Phs Duration (G+Y+Rc), s		69.2			13.1	56.1		40.8				
Change Period (Y+Rc), s		5.5			4.5	5.5		5.0				
Max Green Setting (Gmax), s		59.5			9.5	45.5		40.0				
Max Q Clear Time (g_c+I1), s		2.0			9.1	28.4		31.5				
Green Ext Time (p_c), s		7.8			0.0	9.6		4.2				

Intersection Summary

HCM 6th Ctrl Delay	25.1
HCM 6th LOS	C

Notes

User approved volume balancing among the lanes for turning movement.

Timings

31: I-215 NB Ramps/Old 215 Frontage Rd. & Cactus Av.



Lane Group	EBL	EBT	EBR	WBT	NBL	NBT	NBR	SBL	SBT
Lane Configurations	↶	↶↶	↶	↶↶↶	↶↶	↶	↶	↶	↶
Traffic Volume (vph)	32	1470	170	2792	464	335	13	56	0
Future Volume (vph)	32	1470	170	2792	464	335	13	56	0
Turn Type	Perm	NA	Perm	NA	Prot	NA	Perm	Perm	NA
Protected Phases		2		6	3	8			4
Permitted Phases	2		2				8	4	
Detector Phase	2	2	2	6	3	8	8	4	4
Switch Phase									
Minimum Initial (s)	5.0	5.0	5.0	5.0	5.0	5.0	5.0	5.0	5.0
Minimum Split (s)	11.0	11.0	11.0	44.0	9.1	10.5	10.5	10.5	10.5
Total Split (s)	88.0	88.0	88.0	88.0	25.0	42.0	42.0	17.0	17.0
Total Split (%)	67.7%	67.7%	67.7%	67.7%	19.2%	32.3%	32.3%	13.1%	13.1%
Yellow Time (s)	5.0	5.0	5.0	5.0	3.6	4.5	4.5	4.5	4.5
All-Red Time (s)	1.0	1.0	1.0	1.0	0.5	1.0	1.0	1.0	1.0
Lost Time Adjust (s)	0.0	0.0	0.0	0.0	0.0	0.0	0.0	0.0	0.0
Total Lost Time (s)	6.0	6.0	6.0	6.0	4.1	5.5	5.5	5.5	5.5
Lead/Lag					Lead			Lag	Lag
Lead-Lag Optimize?					Yes			Yes	Yes
Recall Mode	Min	Min	Min	Min	None	None	None	None	None
Act Effct Green (s)	82.0	82.0	82.0	82.0	20.8	36.4	36.4	11.5	11.5
Actuated g/C Ratio	0.63	0.63	0.63	0.63	0.16	0.28	0.28	0.09	0.09
v/c Ratio	0.67	0.71	0.21	0.99	0.93	0.79	0.03	0.70	0.99
Control Delay	77.6	18.4	1.9	38.6	79.4	57.2	5.5	95.8	105.8
Queue Delay	0.0	0.0	0.0	0.0	0.0	0.0	0.0	0.0	0.0
Total Delay	77.6	18.4	1.9	38.6	79.4	57.2	5.5	95.8	105.8
LOS	E	B	A	D	E	E	A	F	F
Approach Delay		17.9		38.6		69.1			103.2
Approach LOS		B		D		E			F

Intersection Summary

Cycle Length: 130
 Actuated Cycle Length: 129.9
 Natural Cycle: 120
 Control Type: Actuated-Uncoordinated
 Maximum v/c Ratio: 0.99
 Intersection Signal Delay: 39.3
 Intersection Capacity Utilization 93.7%
 Analysis Period (min) 15
 Intersection LOS: D
 ICU Level of Service F

Splits and Phases: 31: I-215 NB Ramps/Old 215 Frontage Rd. & Cactus Av.



HCM 6th Signalized Intersection Summary

West Campus Upper Plateau (JN 14064)

31: I-215 NB Ramps/Old 215 Frontage Rd. & Cactus Av.

09/19/2022



Movement	EBL	EBT	EBR	WBL	WBT	WBR	NBL	NBT	NBR	SBL	SBT	SBR
Lane Configurations												
Traffic Volume (veh/h)	32	1470	170	0	2792	158	464	335	13	56	0	155
Future Volume (veh/h)	32	1470	170	0	2792	158	464	335	13	56	0	155
Initial Q (Qb), veh	0	0	0	0	0	0	0	0	0	0	0	0
Ped-Bike Adj(A_pbT)	1.00		1.00	1.00		1.00	1.00		1.00	1.00		1.00
Parking Bus, Adj	1.00	1.00	1.00	1.00	1.00	1.00	1.00	1.00	1.00	1.00	1.00	1.00
Work Zone On Approach		No			No			No			No	
Adj Sat Flow, veh/h/ln	1678	1841	1515	0	1856	1841	1811	1722	1900	1841	1900	1485
Adj Flow Rate, veh/h	34	1564	176	0	2970	148	494	356	0	60	0	155
Peak Hour Factor	0.94	0.94	0.94	0.94	0.94	0.94	0.94	0.94	0.94	0.94	0.94	0.94
Percent Heavy Veh, %	15	4	26	0	3	4	6	12	0	4	0	28
Cap, veh/h	59	2215	813	0	3133	154	543	479		145	0	143
Arrive On Green	0.63	0.63	0.63	0.00	0.63	0.63	0.16	0.28	0.00	0.09	0.00	0.09
Sat Flow, veh/h	63	3497	1284	0	5113	243	3450	1722	1610	1009	0	1610
Grp Volume(v), veh/h	34	1564	176	0	2012	1106	494	356	0	60	0	155
Grp Sat Flow(s),veh/h/ln	63	1749	1284	0	1689	1812	1725	1722	1610	1009	0	1610
Q Serve(g_s), s	7.7	38.4	7.5	0.0	70.0	74.3	18.2	24.4	0.0	7.5	0.0	11.5
Cycle Q Clear(g_c), s	82.0	38.4	7.5	0.0	70.0	74.3	18.2	24.4	0.0	7.5	0.0	11.5
Prop In Lane	1.00		1.00	0.00		0.13	1.00		1.00	1.00		1.00
Lane Grp Cap(c), veh/h	59	2215	813	0	2139	1147	543	479		145	0	143
V/C Ratio(X)	0.57	0.71	0.22	0.00	0.94	0.96	0.91	0.74		0.41	0.00	1.08
Avail Cap(c_a), veh/h	59	2215	813	0	2139	1147	557	485		145	0	143
HCM Platoon Ratio	1.00	1.00	1.00	1.00	1.00	1.00	1.00	1.00	1.00	1.00	1.00	1.00
Upstream Filter(I)	1.00	1.00	1.00	0.00	1.00	1.00	1.00	1.00	0.00	1.00	0.00	1.00
Uniform Delay (d), s/veh	64.3	15.7	10.1	0.0	21.5	22.3	53.6	42.6	0.0	57.2	0.0	59.0
Incr Delay (d2), s/veh	8.4	0.9	0.0	0.0	8.9	18.3	18.8	5.3	0.0	0.7	0.0	99.5
Initial Q Delay(d3),s/veh	0.0	0.0	0.0	0.0	0.0	0.0	0.0	0.0	0.0	0.0	0.0	0.0
%ile BackOfQ(50%),veh/ln	1.2	13.9	2.0	0.0	26.6	33.2	9.1	10.8	0.0	1.9	0.0	8.5
Unsig. Movement Delay, s/veh												
LnGrp Delay(d),s/veh	72.7	16.6	10.1	0.0	30.5	40.6	72.4	47.9	0.0	57.8	0.0	158.5
LnGrp LOS	E	B	B	A	C	D	E	D		E	A	F
Approach Vol, veh/h		1774			3118			850				215
Approach Delay, s/veh		17.1			34.1			62.1				130.4
Approach LOS		B			C			E				F
Timer - Assigned Phs		2	3	4		6		8				
Phs Duration (G+Y+Rc), s		88.0	24.5	17.0		88.0		41.5				
Change Period (Y+Rc), s		6.0	4.1	5.5		6.0		5.5				
Max Green Setting (Gmax), s		82.0	20.9	11.5		82.0		36.5				
Max Q Clear Time (g_c+I1), s		84.0	20.2	13.5		76.3		26.4				
Green Ext Time (p_c), s		0.0	0.1	0.0		5.2		0.9				

Intersection Summary

HCM 6th Ctrl Delay	36.5
HCM 6th LOS	D

Notes

User approved volume balancing among the lanes for turning movement.
 Unsignalized Delay for [NBR] is excluded from calculations of the approach delay and intersection delay.

Timings
36: Elsworth St. & Cactus Av.

West Campus Upper Plateau (JN 14064)

09/19/2022



Lane Group	EBL	EBT	EBR	WBL	WBT	WBR	NBL	NBT	SBL	SBT	SBR
Lane Configurations	↖	↑↑↑	↗	↖	↑↑↑	↗	↖	↗	↖	↑	↗
Traffic Volume (vph)	213	1578	330	79	1959	138	26	12	94	66	206
Future Volume (vph)	213	1578	330	79	1959	138	26	12	94	66	206
Turn Type	Prot	NA	Perm	Prot	NA	Perm	Prot	NA	Prot	NA	pm+ov
Protected Phases	5	2		1	6		3	8	7	4	5
Permitted Phases			2			6					4
Detector Phase	5	2	2	1	6	6	3	8	7	4	5
Switch Phase											
Minimum Initial (s)	5.0	10.0	10.0	5.0	10.0	10.0	10.0	10.0	10.0	10.0	5.0
Minimum Split (s)	9.6	36.2	36.2	9.6	36.2	36.2	15.4	35.4	15.4	35.4	9.6
Total Split (s)	19.0	44.0	44.0	12.8	37.8	37.8	15.4	35.4	27.8	47.8	19.0
Total Split (%)	15.8%	36.7%	36.7%	10.7%	31.5%	31.5%	12.8%	29.5%	23.2%	39.8%	15.8%
Yellow Time (s)	3.6	5.2	5.2	3.6	5.2	5.2	4.4	4.4	4.4	4.4	3.6
All-Red Time (s)	1.0	1.0	1.0	1.0	1.0	1.0	1.0	1.0	1.0	1.0	1.0
Lost Time Adjust (s)	0.0	0.0	0.0	0.0	0.0	0.0	0.0	0.0	0.0	0.0	0.0
Total Lost Time (s)	4.6	6.2	6.2	4.6	6.2	6.2	5.4	5.4	5.4	5.4	4.6
Lead/Lag	Lead	Lag	Lag	Lead	Lag	Lag	Lag	Lag	Lead	Lead	Lead
Lead-Lag Optimize?	Yes	Yes	Yes	Yes	Yes	Yes	Yes	Yes	Yes	Yes	Yes
Recall Mode	None	None	None	None	None	None	None	None	None	None	None
Act Effct Green (s)	15.2	45.8	45.8	7.6	33.4	33.4	11.8	13.5	11.8	16.5	31.3
Actuated g/C Ratio	0.18	0.55	0.55	0.09	0.40	0.40	0.14	0.16	0.14	0.20	0.37
v/c Ratio	0.70	0.61	0.33	0.50	1.01	0.19	0.13	0.10	0.40	0.18	0.31
Control Delay	50.9	22.4	3.7	53.9	52.2	1.6	39.5	20.6	43.8	32.5	4.4
Queue Delay	0.0	0.0	0.0	0.0	0.0	0.0	0.0	0.0	0.0	0.0	0.0
Total Delay	50.9	22.4	3.7	53.9	52.2	1.6	39.5	20.6	43.8	32.5	4.4
LOS	D	C	A	D	D	A	D	C	D	C	A
Approach Delay		22.3			49.0			29.6		19.6	
Approach LOS		C			D			C		B	

Intersection Summary

Cycle Length: 120
 Actuated Cycle Length: 84
 Natural Cycle: 130
 Control Type: Actuated-Uncoordinated
 Maximum v/c Ratio: 1.01
 Intersection Signal Delay: 34.5
 Intersection LOS: C
 Intersection Capacity Utilization 75.0%
 ICU Level of Service D
 Analysis Period (min) 15

Splits and Phases: 36: Elsworth St. & Cactus Av.

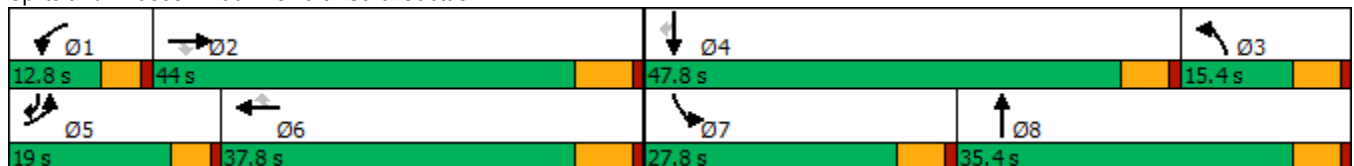

HCM 6th Signalized Intersection Summary
36: Elsworth St. & Cactus Av.

West Campus Upper Plateau (JN 14064)

09/19/2022



Movement	EBL	EBT	EBR	WBL	WBT	WBR	NBL	NBT	NBR	SBL	SBT	SBR
Lane Configurations	↗	↑↑↑	↘	↖	↑↑↑	↗	↖	↑		↘	↑	↗
Traffic Volume (veh/h)	213	1578	330	79	1959	138	26	12	18	94	66	206
Future Volume (veh/h)	213	1578	330	79	1959	138	26	12	18	94	66	206
Initial Q (Qb), veh	0	0	0	0	0	0	0	0	0	0	0	0
Ped-Bike Adj(A_pbT)	1.00		1.00	1.00		0.98	1.00		1.00	1.00		1.00
Parking Bus, Adj	1.00	1.00	1.00	1.00	1.00	1.00	1.00	1.00	1.00	1.00	1.00	1.00
Work Zone On Approach		No			No			No			No	
Adj Sat Flow, veh/h/ln	1826	1796	1885	1900	1841	1856	1633	1900	1900	1826	1900	1841
Adj Flow Rate, veh/h	217	1610	0	81	1999	93	27	12	10	96	67	143
Peak Hour Factor	0.98	0.98	0.98	0.98	0.98	0.98	0.98	0.98	0.98	0.98	0.98	0.98
Percent Heavy Veh, %	5	7	1	0	4	3	18	0	0	5	0	4
Cap, veh/h	252	2238		105	1855	568	181	112	93	203	222	409
Arrive On Green	0.15	0.46	0.00	0.06	0.37	0.37	0.12	0.12	0.12	0.12	0.12	0.12
Sat Flow, veh/h	1739	4904	1598	1810	5025	1539	1555	958	798	1739	1900	1560
Grp Volume(v), veh/h	217	1610	0	81	1999	93	27	0	22	96	67	143
Grp Sat Flow(s),veh/h/ln	1739	1635	1598	1810	1675	1539	1555	0	1756	1739	1900	1560
Q Serve(g_s), s	10.4	22.7	0.0	3.8	31.6	3.5	1.3	0.0	1.0	4.4	2.8	3.8
Cycle Q Clear(g_c), s	10.4	22.7	0.0	3.8	31.6	3.5	1.3	0.0	1.0	4.4	2.8	3.8
Prop In Lane	1.00		1.00	1.00		1.00	1.00		0.45	1.00		1.00
Lane Grp Cap(c), veh/h	252	2238		105	1855	568	181	0	205	203	222	409
V/C Ratio(X)	0.86	0.72		0.77	1.08	0.16	0.15	0.00	0.11	0.47	0.30	0.35
Avail Cap(c_a), veh/h	293	2238		173	1855	568	182	0	616	455	941	999
HCM Platoon Ratio	1.00	1.00	1.00	1.00	1.00	1.00	1.00	1.00	1.00	1.00	1.00	1.00
Upstream Filter(I)	1.00	1.00	0.00	1.00	1.00	1.00	1.00	0.00	1.00	1.00	1.00	1.00
Uniform Delay (d), s/veh	35.7	18.8	0.0	39.8	27.0	18.1	34.0	0.0	33.8	35.3	34.6	10.7
Incr Delay (d2), s/veh	17.9	1.1	0.0	4.5	45.3	0.1	0.4	0.0	0.2	1.7	0.8	0.5
Initial Q Delay(d3),s/veh	0.0	0.0	0.0	0.0	0.0	0.0	0.0	0.0	0.0	0.0	0.0	0.0
%ile BackOfQ(50%),veh/ln	5.4	7.6	0.0	1.7	18.8	1.2	0.5	0.0	0.4	1.9	1.3	1.6
Unsig. Movement Delay, s/veh												
LnGrp Delay(d),s/veh	53.6	20.0	0.0	44.3	72.3	18.3	34.4	0.0	34.1	37.0	35.4	11.2
LnGrp LOS	D	B		D	F	B	C	A	C	D	D	B
Approach Vol, veh/h		1827			2173			49			306	
Approach Delay, s/veh		24.0			68.9			34.2			24.6	
Approach LOS		C			E			C			C	
Timer - Assigned Phs	1	2	3	4	5	6	7	8				
Phs Duration (G+Y+Rc), s	9.5	45.3	15.4	15.4	17.0	37.8	15.4	15.4				
Change Period (Y+Rc), s	4.6	6.2	5.4	5.4	4.6	6.2	5.4	5.4				
Max Green Setting (Gmax), s	8.2	37.8	10.0	42.4	14.4	31.6	22.4	30.0				
Max Q Clear Time (g_c+I1), s	5.8	24.7	3.3	5.8	12.4	33.6	6.4	3.0				
Green Ext Time (p_c), s	0.0	8.2	0.0	0.8	0.1	0.0	0.2	0.1				

Intersection Summary

HCM 6th Ctrl Delay	46.6
HCM 6th LOS	D

Notes

User approved pedestrian interval to be less than phase max green.
Unsignalized Delay for [EBR] is excluded from calculations of the approach delay and intersection delay.

Timings

West Campus Upper Plateau (JN 14064)

1: Washington St & Van Buren Bl.

09/19/2022



Lane Group	EBL	EBT	EBR	WBL	WBT	WBR	NBL	NBT	NBR	SBL	SBT
Lane Configurations	↘	↑↑↑	↗	↘	↑↑↑	↗	↘↗	↑↑	↗	↘↗	↑↗
Traffic Volume (vph)	153	1485	91	233	1205	476	113	276	122	571	397
Future Volume (vph)	153	1485	91	233	1205	476	113	276	122	571	397
Turn Type	Prot	NA	Perm	Prot	NA	pm+ov	Prot	NA	Perm	Prot	NA
Protected Phases	5	2		1	6	7	3	8		7	4
Permitted Phases			2			6			8		
Detector Phase	5	2	2	1	6	7	3	8	8	7	4
Switch Phase											
Minimum Initial (s)	5.0	10.0	10.0	5.0	10.0	10.0	10.0	10.0	10.0	10.0	10.0
Minimum Split (s)	9.2	34.2	34.2	9.2	33.2	30.8	37.4	37.4	37.4	30.8	30.8
Total Split (s)	19.2	41.8	41.8	20.0	42.6	30.8	37.4	37.4	37.4	30.8	30.8
Total Split (%)	14.8%	32.2%	32.2%	15.4%	32.8%	23.7%	28.8%	28.8%	28.8%	23.7%	23.7%
Yellow Time (s)	3.2	5.2	5.2	3.2	5.2	4.8	4.4	4.4	4.4	4.8	4.8
All-Red Time (s)	1.0	1.0	1.0	1.0	1.0	1.0	1.0	1.0	1.0	1.0	1.0
Lost Time Adjust (s)	0.0	0.0	0.0	0.0	0.0	0.0	0.0	0.0	0.0	0.0	0.0
Total Lost Time (s)	4.2	6.2	6.2	4.2	6.2	5.8	5.4	5.4	5.4	5.8	5.8
Lead/Lag	Lead	Lag	Lag	Lead	Lag	Lead	Lead	Lag	Lag	Lead	Lag
Lead-Lag Optimize?	Yes	Yes	Yes	Yes	Yes	Yes	Yes	Yes	Yes	Yes	Yes
Recall Mode	None	None	None	None	None	None	None	None	None	None	None
Act Effct Green (s)	13.1	35.8	35.8	15.9	38.7	62.3	13.9	16.7	16.7	23.3	26.0
Actuated g/C Ratio	0.12	0.32	0.32	0.14	0.34	0.55	0.12	0.15	0.15	0.21	0.23
v/c Ratio	0.75	0.94	0.15	0.93	0.70	0.49	0.27	0.54	0.37	0.81	0.63
Control Delay	71.8	51.3	0.8	91.1	36.7	9.2	46.3	48.5	10.3	53.7	42.1
Queue Delay	0.0	0.0	0.0	0.0	0.0	0.0	0.0	0.0	0.0	0.0	0.0
Total Delay	71.8	51.3	0.8	91.1	36.7	9.2	46.3	48.5	10.3	53.7	42.1
LOS	E	D	A	F	D	A	D	D	B	D	D
Approach Delay		50.5			36.5			38.9			48.3
Approach LOS		D			D			D			D

Intersection Summary

Cycle Length: 130
 Actuated Cycle Length: 113.4
 Natural Cycle: 115
 Control Type: Actuated-Uncoordinated
 Maximum v/c Ratio: 0.94
 Intersection Signal Delay: 43.8
 Intersection LOS: D
 Intersection Capacity Utilization 84.8%
 ICU Level of Service E
 Analysis Period (min) 15

Splits and Phases: 1: Washington St & Van Buren Bl.

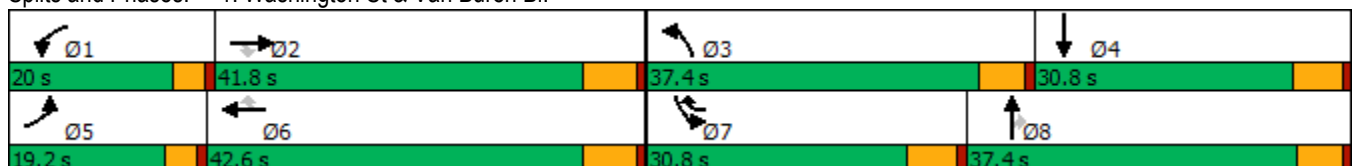

HCM 6th Signalized Intersection Summary
1: Washington St & Van Buren Bl.

West Campus Upper Plateau (JN 14064)

09/19/2022

Movement	EBL	EBT	EBR	WBL	WBT	WBR	NBL	NBT	NBR	SBL	SBT	SBR
Lane Configurations												
Traffic Volume (veh/h)	153	1485	91	233	1205	476	113	276	122	571	397	105
Future Volume (veh/h)	153	1485	91	233	1205	476	113	276	122	571	397	105
Initial Q (Qb), veh	0	0	0	0	0	0	0	0	0	0	0	0
Ped-Bike Adj(A_pbT)	1.00		1.00	1.00		1.00	1.00		0.98	1.00		0.98
Parking Bus, Adj	1.00	1.00	1.00	1.00	1.00	1.00	1.00	1.00	1.00	1.00	1.00	1.00
Work Zone On Approach		No			No			No			No	
Adj Sat Flow, veh/h/ln	1900	1856	1856	1900	1870	1900	1885	1856	1870	1885	1885	1900
Adj Flow Rate, veh/h	155	1500	73	235	1217	388	114	279	84	577	401	60
Peak Hour Factor	0.99	0.99	0.99	0.99	0.99	0.99	0.99	0.99	0.99	0.99	0.99	0.99
Percent Heavy Veh, %	0	3	3	0	2	0	1	3	2	1	1	0
Cap, veh/h	185	1673	519	265	1909	908	329	441	194	665	703	104
Arrive On Green	0.10	0.33	0.33	0.15	0.37	0.37	0.09	0.13	0.13	0.19	0.23	0.23
Sat Flow, veh/h	1810	5066	1572	1810	5106	1606	3483	3526	1554	3483	3120	463
Grp Volume(v), veh/h	155	1500	73	235	1217	388	114	279	84	577	229	232
Grp Sat Flow(s),veh/h/ln	1810	1689	1572	1810	1702	1606	1742	1763	1554	1742	1791	1792
Q Serve(g_s), s	8.9	29.9	3.5	13.5	20.8	14.7	3.2	8.0	5.3	17.0	12.0	12.2
Cycle Q Clear(g_c), s	8.9	29.9	3.5	13.5	20.8	14.7	3.2	8.0	5.3	17.0	12.0	12.2
Prop In Lane	1.00		1.00	1.00		1.00	1.00		1.00	1.00		0.26
Lane Grp Cap(c), veh/h	185	1673	519	265	1909	908	329	441	194	665	404	404
V/C Ratio(X)	0.84	0.90	0.14	0.89	0.64	0.43	0.35	0.63	0.43	0.87	0.57	0.57
Avail Cap(c_a), veh/h	256	1701	528	270	1909	908	1051	1064	469	821	422	423
HCM Platoon Ratio	1.00	1.00	1.00	1.00	1.00	1.00	1.00	1.00	1.00	1.00	1.00	1.00
Upstream Filter(I)	1.00	1.00	1.00	1.00	1.00	1.00	1.00	1.00	1.00	1.00	1.00	1.00
Uniform Delay (d), s/veh	46.7	33.8	24.9	44.4	27.3	13.2	44.9	44.1	42.9	41.6	36.5	36.5
Incr Delay (d2), s/veh	11.7	6.8	0.2	26.9	0.8	0.5	0.6	1.5	1.5	8.3	1.6	1.7
Initial Q Delay(d3),s/veh	0.0	0.0	0.0	0.0	0.0	0.0	0.0	0.0	0.0	0.0	0.0	0.0
%ile BackOfQ(50%),veh/ln	4.4	12.4	1.3	7.7	7.9	5.3	1.4	3.6	2.1	8.0	5.4	5.5
Unsig. Movement Delay, s/veh												
LnGrp Delay(d),s/veh	58.4	40.6	25.1	71.3	28.1	13.7	45.6	45.6	44.4	49.9	38.1	38.3
LnGrp LOS	E	D	C	E	C	B	D	D	D	D	D	D
Approach Vol, veh/h		1728			1840			477			1038	
Approach Delay, s/veh		41.5			30.6			45.4			44.7	
Approach LOS		D			C			D			D	
Timer - Assigned Phs	1	2	3	4	5	6	7	8				
Phs Duration (G+Y+Rc), s	19.7	41.2	15.4	29.7	15.1	45.8	26.0	19.1				
Change Period (Y+Rc), s	* 4.2	6.2	5.4	5.8	* 4.2	6.2	5.8	* 5.8				
Max Green Setting (Gmax), s	* 16	35.6	32.0	25.0	* 15	36.4	25.0	* 32				
Max Q Clear Time (g_c+I1), s	15.5	31.9	5.2	14.2	10.9	22.8	19.0	10.0				
Green Ext Time (p_c), s	0.0	3.1	0.4	2.0	0.1	9.4	1.2	2.1				

Intersection Summary

HCM 6th Ctrl Delay	38.6
HCM 6th LOS	D

Notes

* HCM 6th computational engine requires equal clearance times for the phases crossing the barrier.

Timings

3: Overlook Pkwy./Canyon Crest Dr. & Alessandro Bl/Alessandro Bl.



Lane Group	EBL	EBT	WBL	WBT	WBR	NBL	NBT	NBR	SBL	SBT
Lane Configurations	↖	↕↕↕↕	↖	↕↕↕	↗	↖	↕↕	↗	↖↖↖	↖
Traffic Volume (vph)	60	3246	23	2416	688	39	151	57	628	65
Future Volume (vph)	60	3246	23	2416	688	39	151	57	628	65
Turn Type	Prot	NA	Prot	NA	pm+ov	Prot	NA	Perm	Prot	NA
Protected Phases	5	2	1	6	7	3	8		7	4
Permitted Phases					6			8		
Detector Phase	5	2	1	6	7	3	8	8	7	4
Switch Phase										
Minimum Initial (s)	5.0	10.0	5.0	10.0	10.0	10.0	10.0	10.0	10.0	10.0
Minimum Split (s)	9.2	35.2	9.2	35.2	38.8	15.8	15.8	15.8	38.8	38.8
Total Split (s)	9.2	56.2	9.2	56.2	38.8	15.8	15.8	15.8	38.8	38.8
Total Split (%)	7.7%	46.8%	7.7%	46.8%	32.3%	13.2%	13.2%	13.2%	32.3%	32.3%
Yellow Time (s)	3.2	5.2	3.2	5.2	4.8	4.8	4.8	4.8	4.8	4.8
All-Red Time (s)	1.0	1.0	1.0	1.0	1.0	1.0	1.0	1.0	1.0	1.0
Lost Time Adjust (s)	0.0	0.0	0.0	0.0	0.0	0.0	0.0	0.0	0.0	0.0
Total Lost Time (s)	4.2	6.2	4.2	6.2	5.8	5.8	5.8	5.8	5.8	5.8
Lead/Lag	Lead	Lag	Lead	Lag	Lead	Lead	Lag	Lag	Lead	Lag
Lead-Lag Optimize?	Yes	Yes	Yes	Yes	Yes	Yes	Yes	Yes	Yes	Yes
Recall Mode	None	None	None	None	None	None	None	None	None	None
Act Effct Green (s)	5.0	55.9	5.0	50.2	78.3	10.0	10.0	10.0	21.9	28.6
Actuated g/C Ratio	0.05	0.51	0.05	0.46	0.72	0.09	0.09	0.09	0.20	0.26
v/c Ratio	0.81	1.18	0.29	0.97	0.61	0.27	0.47	0.19	0.61	0.21
Control Delay	113.2	112.3	62.1	41.8	8.8	53.3	53.5	1.4	41.9	29.4
Queue Delay	0.0	0.0	0.0	0.0	0.0	0.0	0.0	0.0	0.0	0.0
Total Delay	113.2	112.3	62.1	41.8	8.8	53.3	53.5	1.4	41.9	29.4
LOS	F	F	E	D	A	D	D	A	D	C
Approach Delay		112.3		34.7			41.5			40.3
Approach LOS		F		C			D			D

Intersection Summary

Cycle Length: 120	
Actuated Cycle Length: 109.2	
Natural Cycle: 120	
Control Type: Actuated-Uncoordinated	
Maximum v/c Ratio: 1.18	
Intersection Signal Delay: 70.3	Intersection LOS: E
Intersection Capacity Utilization 98.4%	ICU Level of Service F
Analysis Period (min) 15	

Splits and Phases: 3: Overlook Pkwy./Canyon Crest Dr. & Alessandro Bl/Alessandro Bl.

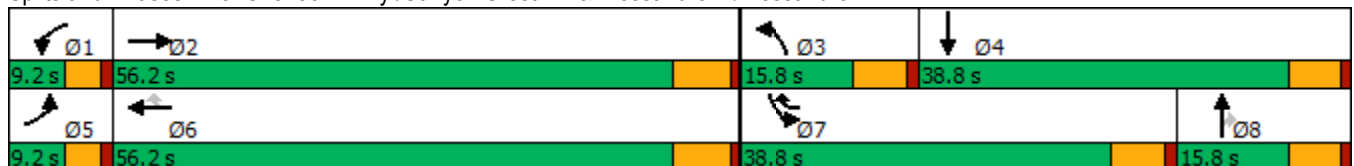

HCM 6th Signalized Intersection Summary

West Campus Upper Plateau (JN 14064)

3: Overlook Pkwy./Canyon Crest Dr. & Alessandro Bl/Alessandro Bl.

09/19/2022



Movement	EBL	EBT	EBR	WBL	WBT	WBR	NBL	NBT	NBR	SBL	SBT	SBR
Lane Configurations	↖	↗↖↗		↖	↗↖↗	↖	↖	↗↖	↖	↗↖↗	↗	
Traffic Volume (veh/h)	60	3246	27	23	2416	688	39	151	57	628	65	26
Future Volume (veh/h)	60	3246	27	23	2416	688	39	151	57	628	65	26
Initial Q (Qb), veh	0	0	0	0	0	0	0	0	0	0	0	0
Ped-Bike Adj(A_pbT)	1.00		1.00	1.00		1.00	1.00		1.00	1.00		1.00
Parking Bus, Adj	1.00	1.00	1.00	1.00	1.00	1.00	1.00	1.00	1.00	1.00	1.00	1.00
Work Zone On Approach		No			No			No			No	
Adj Sat Flow, veh/h/ln	1811	1885	1811	1900	1885	1885	1781	1900	1900	1885	1767	1841
Adj Flow Rate, veh/h	62	3381	28	24	2517	709	41	157	51	654	68	18
Peak Hour Factor	0.96	0.96	0.96	0.96	0.96	0.96	0.96	0.96	0.96	0.96	0.96	0.96
Percent Heavy Veh, %	6	1	6	0	1	1	8	0	0	1	9	4
Cap, veh/h	79	2834	23	44	2740	1027	165	351	157	853	213	56
Arrive On Green	0.05	0.51	0.51	0.02	0.48	0.48	0.10	0.10	0.10	0.16	0.16	0.16
Sat Flow, veh/h	1725	5601	46	1810	5656	1598	1697	3610	1610	5386	1346	356
Grp Volume(v), veh/h	62	2273	1136	24	2517	709	41	157	51	654	0	86
Grp Sat Flow(s),veh/h/ln	1725	1885	1877	1810	1885	1598	1697	1805	1610	1795	0	1702
Q Serve(g_s), s	3.7	52.0	52.0	1.3	42.5	29.3	2.3	4.2	3.0	11.9	0.0	4.6
Cycle Q Clear(g_c), s	3.7	52.0	52.0	1.3	42.5	29.3	2.3	4.2	3.0	11.9	0.0	4.6
Prop In Lane	1.00		0.02	1.00		1.00	1.00		1.00	1.00		0.21
Lane Grp Cap(c), veh/h	79	1908	950	44	2740	1027	165	351	157	853	0	270
V/C Ratio(X)	0.79	1.19	1.20	0.55	0.92	0.69	0.25	0.45	0.33	0.77	0.00	0.32
Avail Cap(c_a), veh/h	84	1908	950	88	2752	1031	165	351	157	1730	0	547
HCM Platoon Ratio	1.00	1.00	1.00	1.00	1.00	1.00	1.00	1.00	1.00	1.00	1.00	1.00
Upstream Filter(I)	1.00	1.00	1.00	1.00	1.00	1.00	1.00	1.00	1.00	1.00	0.00	1.00
Uniform Delay (d), s/veh	48.5	25.4	25.4	49.6	24.6	11.8	42.9	43.8	43.2	41.4	0.0	38.3
Incr Delay (d2), s/veh	32.7	91.6	98.8	4.0	5.6	2.0	0.8	0.9	1.2	1.5	0.0	0.7
Initial Q Delay(d3),s/veh	0.0	0.0	0.0	0.0	0.0	0.0	0.0	0.0	0.0	0.0	0.0	0.0
%ile BackOfQ(50%),veh/ln	2.2	44.2	45.9	0.6	17.9	9.0	1.0	1.9	1.2	5.2	0.0	1.9
Unsig. Movement Delay, s/veh												
LnGrp Delay(d),s/veh	81.2	117.0	124.2	53.5	30.2	13.7	43.7	44.6	44.4	42.9	0.0	39.0
LnGrp LOS	F	F	F	D	C	B	D	D	D	D	A	D
Approach Vol, veh/h		3471			3250			249			740	
Approach Delay, s/veh		118.7			26.8			44.4			42.4	
Approach LOS		F			C			D			D	
Timer - Assigned Phs	1	2	3	4	5	6	7	8				
Phs Duration (G+Y+Rc), s	6.7	58.2	15.8	22.1	8.9	56.0	22.1	15.8				
Change Period (Y+Rc), s	* 4.2	6.2	5.8	5.8	* 4.2	6.2	5.8	5.8				
Max Green Setting (Gmax), s	* 5	50.0	10.0	33.0	* 5	50.0	33.0	10.0				
Max Q Clear Time (g_c+I1), s	3.3	54.0	4.3	6.6	5.7	44.5	13.9	6.2				
Green Ext Time (p_c), s	0.0	0.0	0.0	0.4	0.0	5.3	2.3	0.3				

Intersection Summary

HCM 6th Ctrl Delay	70.2
HCM 6th LOS	E

Notes

- User approved pedestrian interval to be less than phase max green.
- * HCM 6th computational engine requires equal clearance times for the phases crossing the barrier.

Timings

4: Van Buren Bl. & Wood Rd.

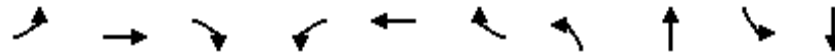

Lane Group	EBL	EBT	EBR	WBL	WBT	WBR	NBL	NBT	SBL	SBT
Lane Configurations	↘	↑↑↑	↗	↘↗	↑↑↑	↗	↘↗	↑↘	↘	↑↘
Traffic Volume (vph)	176	1542	226	290	1474	94	327	272	94	277
Future Volume (vph)	176	1542	226	290	1474	94	327	272	94	277
Turn Type	Prot	NA	pm+ov	Prot	NA	Perm	Prot	NA	Perm	NA
Protected Phases	5	2	3	1	6		3	8		4
Permitted Phases			2			6			4	
Detector Phase	5	2	3	1	6	6	3	8	4	4
Switch Phase										
Minimum Initial (s)	5.0	10.0	5.0	5.0	10.0	10.0	5.0	10.0	10.0	10.0
Minimum Split (s)	9.2	30.2	9.2	9.2	30.2	30.2	9.2	38.4	15.8	15.8
Total Split (s)	27.0	68.0	25.0	23.0	64.0	64.0	25.0	59.0	34.0	34.0
Total Split (%)	18.0%	45.3%	16.7%	15.3%	42.7%	42.7%	16.7%	39.3%	22.7%	22.7%
Yellow Time (s)	3.2	5.2	3.2	3.2	5.2	5.2	3.2	4.4	4.8	4.8
All-Red Time (s)	1.0	1.0	1.0	1.0	1.0	1.0	1.0	1.0	1.0	1.0
Lost Time Adjust (s)	0.0	0.0	0.0	0.0	0.0	0.0	0.0	0.0	0.0	0.0
Total Lost Time (s)	4.2	6.2	4.2	4.2	6.2	6.2	4.2	5.4	5.8	5.8
Lead/Lag	Lead	Lag	Lead	Lead	Lag	Lag	Lead		Lag	Lag
Lead-Lag Optimize?	Yes	Yes	Yes	Yes	Yes	Yes	Yes		Yes	Yes
Recall Mode	None	None	None	None	None	None	None	None	None	None
Act Effct Green (s)	18.5	57.6	77.6	16.2	55.3	55.3	17.9	46.0	23.4	23.4
Actuated g/C Ratio	0.14	0.42	0.57	0.12	0.41	0.41	0.13	0.34	0.17	0.17
v/c Ratio	0.79	0.79	0.27	0.77	0.78	0.15	0.79	0.46	0.72	0.81
Control Delay	82.1	38.3	9.1	73.1	39.6	9.6	72.4	25.9	83.0	53.3
Queue Delay	0.0	0.0	0.0	0.0	0.0	0.0	0.0	0.0	0.0	0.0
Total Delay	82.1	38.3	9.1	73.1	39.6	9.6	72.4	25.9	83.0	53.3
LOS	F	D	A	E	D	A	E	C	F	D
Approach Delay		38.9			43.3			44.2		58.1
Approach LOS		D			D			D		E

Intersection Summary

Cycle Length: 150
 Actuated Cycle Length: 135.9
 Natural Cycle: 90
 Control Type: Actuated-Uncoordinated
 Maximum v/c Ratio: 0.81
 Intersection Signal Delay: 43.4
 Intersection LOS: D
 Intersection Capacity Utilization 84.0%
 ICU Level of Service E
 Analysis Period (min) 15

Splits and Phases: 4: Van Buren Bl. & Wood Rd.



HCM 6th Signalized Intersection Summary
4: Van Buren Bl. & Wood Rd.

West Campus Upper Plateau (JN 14064)
09/19/2022

Movement	EBL	EBT	EBR	WBL	WBT	WBR	NBL	NBT	NBR	SBL	SBT	SBR
Lane Configurations												
Traffic Volume (veh/h)	176	1542	226	290	1474	94	327	272	231	94	277	212
Future Volume (veh/h)	176	1542	226	290	1474	94	327	272	231	94	277	212
Initial Q (Qb), veh	0	0	0	0	0	0	0	0	0	0	0	0
Ped-Bike Adj(A_pbT)	1.00		0.98	1.00		0.99	1.00		0.98	0.99		0.99
Parking Bus, Adj	1.00	1.00	1.00	1.00	1.00	1.00	1.00	1.00	1.00	1.00	1.00	1.00
Work Zone On Approach		No			No			No			No	
Adj Sat Flow, veh/h/ln	1885	1856	1870	1885	1870	1885	1870	1885	1870	1885	1885	1885
Adj Flow Rate, veh/h	193	1695	143	319	1620	56	359	299	173	103	304	158
Peak Hour Factor	0.91	0.91	0.91	0.91	0.91	0.91	0.91	0.91	0.91	0.91	0.91	0.91
Percent Heavy Veh, %	1	3	2	1	2	1	2	1	2	1	1	1
Cap, veh/h	221	2225	878	378	2169	669	419	704	395	211	381	193
Arrive On Green	0.12	0.44	0.44	0.11	0.42	0.42	0.12	0.32	0.32	0.17	0.17	0.17
Sat Flow, veh/h	1795	5066	1561	3483	5106	1574	3456	2190	1230	918	2290	1159
Grp Volume(v), veh/h	193	1695	143	319	1620	56	359	243	229	103	236	226
Grp Sat Flow(s),veh/h/ln	1795	1689	1561	1742	1702	1574	1728	1791	1629	918	1791	1658
Q Serve(g_s), s	13.1	34.9	5.5	11.1	33.1	2.6	12.6	13.2	13.7	13.0	15.7	16.3
Cycle Q Clear(g_c), s	13.1	34.9	5.5	11.1	33.1	2.6	12.6	13.2	13.7	13.0	15.7	16.3
Prop In Lane	1.00		1.00	1.00		1.00	1.00		0.76	1.00		0.70
Lane Grp Cap(c), veh/h	221	2225	878	378	2169	669	419	575	523	211	298	276
V/C Ratio(X)	0.88	0.76	0.16	0.84	0.75	0.08	0.86	0.42	0.44	0.49	0.79	0.82
Avail Cap(c_a), veh/h	331	2531	972	529	2386	736	581	776	706	268	408	378
HCM Platoon Ratio	1.00	1.00	1.00	1.00	1.00	1.00	1.00	1.00	1.00	1.00	1.00	1.00
Upstream Filter(I)	1.00	1.00	1.00	1.00	1.00	1.00	1.00	1.00	1.00	1.00	1.00	1.00
Uniform Delay (d), s/veh	53.3	29.2	13.2	54.1	30.0	21.2	53.3	33.0	33.2	48.4	49.5	49.8
Incr Delay (d2), s/veh	11.1	1.4	0.1	6.4	1.3	0.1	6.9	0.5	0.6	1.7	7.3	9.8
Initial Q Delay(d3),s/veh	0.0	0.0	0.0	0.0	0.0	0.0	0.0	0.0	0.0	0.0	0.0	0.0
%ile BackOfQ(50%),veh/ln	6.4	13.4	1.9	5.0	12.9	0.9	5.8	5.7	5.4	3.0	7.5	7.4
Unsig. Movement Delay, s/veh												
LnGrp Delay(d),s/veh	64.5	30.6	13.3	60.5	31.3	21.3	60.2	33.4	33.7	50.2	56.8	59.6
LnGrp LOS	E	C	B	E	C	C	E	C	C	D	E	E
Approach Vol, veh/h		2031			1995			831			565	
Approach Delay, s/veh		32.6			35.7			45.1			56.7	
Approach LOS		C			D			D			E	
Timer - Assigned Phs	1	2	3	4	5	6		8				
Phs Duration (G+Y+Rc), s	17.6	60.5	19.2	26.4	19.4	58.8		45.5				
Change Period (Y+Rc), s	* 4.2	6.2	* 4.2	5.8	* 4.2	6.2		* 5.8				
Max Green Setting (Gmax), s	* 19	61.8	* 21	28.2	* 23	57.8		* 54				
Max Q Clear Time (g_c+1), s	13.1	36.9	14.6	18.3	15.1	35.1		15.7				
Green Ext Time (p_c), s	0.3	17.4	0.4	2.3	0.1	15.3		2.9				
Intersection Summary												
HCM 6th Ctrl Delay				38.2								
HCM 6th LOS				D								
Notes												
* HCM 6th computational engine requires equal clearance times for the phases crossing the barrier.												

Timings

West Campus Upper Plateau (JN 14064)

7: Trautwein Rd. & Orange Terrace Pkwy

09/19/2022



Lane Group	EBL	EBT	WBL	WBT	WBR	NBL	NBT	NBR	SBL	SBT	SBR
Lane Configurations											
Traffic Volume (vph)	52	53	170	28	188	35	822	239	383	1206	46
Future Volume (vph)	52	53	170	28	188	35	822	239	383	1206	46
Turn Type	Prot	NA	Prot	NA	pm+ov	Prot	NA	pm+ov	Prot	NA	Perm
Protected Phases	7	4	3	8	1	5	2	3	1	6	
Permitted Phases					8			2			6
Detector Phase	7	4	3	8	1	5	2	3	1	6	6
Switch Phase											
Minimum Initial (s)	5.0	10.0	5.0	10.0	5.0	5.0	10.0	5.0	5.0	10.0	10.0
Minimum Split (s)	9.6	38.6	9.6	34.6	9.6	9.6	46.2	9.6	9.6	28.2	28.2
Total Split (s)	13.7	38.6	13.3	38.2	21.8	9.6	46.3	13.3	21.8	58.5	58.5
Total Split (%)	11.4%	32.2%	11.1%	31.8%	18.2%	8.0%	38.6%	11.1%	18.2%	48.8%	48.8%
Yellow Time (s)	3.6	3.6	3.6	3.6	3.6	3.6	5.2	3.6	3.6	5.2	5.2
All-Red Time (s)	1.0	1.0	1.0	1.0	1.0	1.0	1.0	1.0	1.0	1.0	1.0
Lost Time Adjust (s)	0.0	0.0	0.0	0.0	0.0	0.0	0.0	0.0	0.0	0.0	0.0
Total Lost Time (s)	4.6	4.6	4.6	4.6	4.6	4.6	6.2	4.6	4.6	6.2	6.2
Lead/Lag	Lead	Lag	Lead	Lag	Lead	Lead	Lag	Lead	Lead	Lag	Lag
Lead-Lag Optimize?	Yes	Yes	Yes	Yes	Yes	Yes	Yes	Yes	Yes	Yes	Yes
Recall Mode	None	None	None	None	None	None	None	None	None	None	None
Act Effct Green (s)	7.2	14.1	9.7	17.2	36.8	5.4	27.0	43.4	14.7	41.6	41.6
Actuated g/C Ratio	0.09	0.17	0.12	0.21	0.45	0.07	0.33	0.53	0.18	0.51	0.51
v/c Ratio	0.35	0.22	0.44	0.07	0.26	0.31	0.74	0.26	0.66	0.71	0.06
Control Delay	48.8	30.3	44.0	31.9	9.8	52.7	30.6	2.9	40.6	21.3	0.1
Queue Delay	0.0	0.0	0.0	0.0	0.0	0.0	0.0	0.0	0.0	0.0	0.0
Total Delay	48.8	30.3	44.0	31.9	9.8	52.7	30.6	2.9	40.6	21.3	0.1
LOS	D	C	D	C	A	D	C	A	D	C	A
Approach Delay		38.3		26.5			25.2			25.3	
Approach LOS		D		C			C			C	

Intersection Summary

Cycle Length: 120	
Actuated Cycle Length: 82.3	
Natural Cycle: 115	
Control Type: Actuated-Uncoordinated	
Maximum v/c Ratio: 0.74	
Intersection Signal Delay: 25.9	Intersection LOS: C
Intersection Capacity Utilization 61.9%	ICU Level of Service B
Analysis Period (min) 15	

Splits and Phases: 7: Trautwein Rd. & Orange Terrace Pkwy

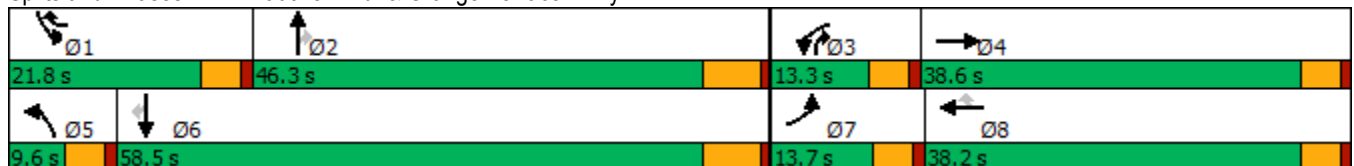

HCM 6th Signalized Intersection Summary
7: Trautwein Rd. & Orange Terrace Pkwy

West Campus Upper Plateau (JN 14064)

09/19/2022



Movement	EBL	EBT	EBR	WBL	WBT	WBR	NBL	NBT	NBR	SBL	SBT	SBR
Lane Configurations												
Traffic Volume (veh/h)	52	53	14	170	28	188	35	822	239	383	1206	46
Future Volume (veh/h)	52	53	14	170	28	188	35	822	239	383	1206	46
Initial Q (Qb), veh	0	0	0	0	0	0	0	0	0	0	0	0
Ped-Bike Adj(A_pbT)	1.00		1.00	1.00		1.00	1.00		1.00	1.00		1.00
Parking Bus, Adj	1.00	1.00	1.00	1.00	1.00	1.00	1.00	1.00	1.00	1.00	1.00	1.00
Work Zone On Approach		No			No			No			No	
Adj Sat Flow, veh/h/ln	1900	1900	1900	1900	1900	1870	1900	1870	1885	1870	1870	1900
Adj Flow Rate, veh/h	55	56	13	179	29	79	37	865	175	403	1269	39
Peak Hour Factor	0.95	0.95	0.95	0.95	0.95	0.95	0.95	0.95	0.95	0.95	0.95	0.95
Percent Heavy Veh, %	0	0	0	0	0	2	0	2	1	2	2	0
Cap, veh/h	84	208	48	269	322	502	66	1262	690	509	1656	750
Arrive On Green	0.05	0.14	0.14	0.08	0.17	0.17	0.04	0.36	0.36	0.15	0.47	0.47
Sat Flow, veh/h	1810	1491	346	3510	1900	1585	1810	3554	1598	3456	3554	1610
Grp Volume(v), veh/h	55	0	69	179	29	79	37	865	175	403	1269	39
Grp Sat Flow(s),veh/h/ln	1810	0	1838	1755	1900	1585	1810	1777	1598	1728	1777	1610
Q Serve(g_s), s	2.1	0.0	2.4	3.5	0.9	2.5	1.4	14.7	5.0	8.0	21.1	0.9
Cycle Q Clear(g_c), s	2.1	0.0	2.4	3.5	0.9	2.5	1.4	14.7	5.0	8.0	21.1	0.9
Prop In Lane	1.00		0.19	1.00		1.00	1.00		1.00	1.00		1.00
Lane Grp Cap(c), veh/h	84	0	256	269	322	502	66	1262	690	509	1656	750
V/C Ratio(X)	0.65	0.00	0.27	0.66	0.09	0.16	0.56	0.69	0.25	0.79	0.77	0.05
Avail Cap(c_a), veh/h	232	0	879	430	899	983	127	2006	1024	837	2616	1185
HCM Platoon Ratio	1.00	1.00	1.00	1.00	1.00	1.00	1.00	1.00	1.00	1.00	1.00	1.00
Upstream Filter(I)	1.00	0.00	1.00	1.00	1.00	1.00	1.00	1.00	1.00	1.00	1.00	1.00
Uniform Delay (d), s/veh	33.3	0.0	27.3	31.9	24.9	17.5	33.7	19.5	12.9	29.2	15.8	10.4
Incr Delay (d2), s/veh	3.1	0.0	0.6	1.1	0.1	0.1	2.8	0.7	0.2	1.1	0.8	0.0
Initial Q Delay(d3),s/veh	0.0	0.0	0.0	0.0	0.0	0.0	0.0	0.0	0.0	0.0	0.0	0.0
%ile BackOfQ(50%),veh/ln	1.0	0.0	1.0	1.4	0.4	0.8	0.6	5.2	1.5	3.0	6.8	0.3
Unsig. Movement Delay, s/veh												
LnGrp Delay(d),s/veh	36.4	0.0	27.9	33.0	25.0	17.6	36.4	20.2	13.1	30.3	16.5	10.4
LnGrp LOS	D	A	C	C	C	B	D	C	B	C	B	B
Approach Vol, veh/h		124			287			1077			1711	
Approach Delay, s/veh		31.7			27.9			19.6			19.6	
Approach LOS		C			C			B			B	
Timer - Assigned Phs	1	2	3	4	5	6	7	8				
Phs Duration (G+Y+Rc), s	15.1	31.4	10.0	14.5	7.2	39.3	7.9	16.6				
Change Period (Y+Rc), s	4.6	6.2	4.6	4.6	4.6	6.2	4.6	4.6				
Max Green Setting (Gmax), s	17.2	40.1	8.7	34.0	5.0	52.3	9.1	33.6				
Max Q Clear Time (g_c+I1), s	10.0	16.7	5.5	4.4	3.4	23.1	4.1	4.5				
Green Ext Time (p_c), s	0.5	6.2	0.1	0.3	0.0	10.0	0.0	0.3				

Intersection Summary

HCM 6th Ctrl Delay	20.8
HCM 6th LOS	C

Notes

User approved volume balancing among the lanes for turning movement.

Timings
8: Cole Av. & Van Buren Bl.

West Campus Upper Plateau (JN 14064)

09/19/2022



Lane Group	EBL	EBT	EBR	WBL	WBT	WBR	NBL	NBT	SBL	SBT	SBR
Lane Configurations	↖↗	↑↑↑	↖	↖	↑↑↑	↖	↖	↑↑	↖↗	↑↑	↖
Traffic Volume (vph)	364	1172	115	184	1329	285	102	326	330	584	247
Future Volume (vph)	364	1172	115	184	1329	285	102	326	330	584	247
Turn Type	Prot	NA	pm+ov	Prot	NA	pm+ov	Prot	NA	Prot	NA	pm+ov
Protected Phases	5	2	3	1	6	7	3	8	7	4	5
Permitted Phases			2			6					4
Detector Phase	5	2	3	1	6	7	3	8	7	4	5
Switch Phase											
Minimum Initial (s)	5.0	10.0	5.0	5.0	10.0	5.0	5.0	10.0	5.0	10.0	5.0
Minimum Split (s)	9.1	36.2	9.1	9.1	36.2	9.1	9.1	42.2	9.1	49.2	9.1
Total Split (s)	18.0	41.0	11.7	18.1	41.1	17.1	11.7	43.8	17.1	49.2	18.0
Total Split (%)	15.0%	34.2%	9.8%	15.1%	34.3%	14.3%	9.8%	36.5%	14.3%	41.0%	15.0%
Yellow Time (s)	3.2	5.2	3.2	3.2	5.2	3.2	3.2	5.2	3.2	5.2	3.2
All-Red Time (s)	0.5	1.0	0.5	0.5	1.0	0.5	0.5	1.0	0.5	1.0	0.5
Lost Time Adjust (s)	0.0	0.0	0.0	0.0	0.0	0.0	0.0	0.0	0.0	0.0	0.0
Total Lost Time (s)	3.7	6.2	3.7	3.7	6.2	3.7	3.7	6.2	3.7	6.2	3.7
Lead/Lag	Lead	Lag	Lead	Lead	Lag	Lead	Lead	Lag	Lead	Lag	Lead
Lead-Lag Optimize?	Yes	Yes	Yes	Yes	Yes	Yes	Yes	Yes	Yes	Yes	Yes
Recall Mode	None	None	None	None	None	None	None	None	None	None	None
Act Effct Green (s)	14.2	35.2	49.5	14.1	35.1	54.6	8.1	19.8	13.2	24.9	41.6
Actuated g/C Ratio	0.14	0.34	0.48	0.14	0.34	0.53	0.08	0.19	0.13	0.24	0.41
v/c Ratio	0.81	0.73	0.15	0.81	0.82	0.33	0.78	0.61	0.80	0.71	0.39
Control Delay	58.4	33.7	5.6	69.7	36.4	7.1	82.7	39.1	59.0	39.8	15.3
Queue Delay	0.0	0.0	0.0	0.0	0.0	0.0	0.0	0.0	0.0	0.0	0.0
Total Delay	58.4	33.7	5.6	69.7	36.4	7.1	82.7	39.1	59.0	39.8	15.3
LOS	E	C	A	E	D	A	F	D	E	D	B
Approach Delay		37.2			35.2			48.1		40.0	
Approach LOS		D			D			D		D	

Intersection Summary

Cycle Length: 120	
Actuated Cycle Length: 102.2	
Natural Cycle: 115	
Control Type: Actuated-Uncoordinated	
Maximum v/c Ratio: 0.82	
Intersection Signal Delay: 38.2	Intersection LOS: D
Intersection Capacity Utilization 76.1%	ICU Level of Service D
Analysis Period (min) 15	



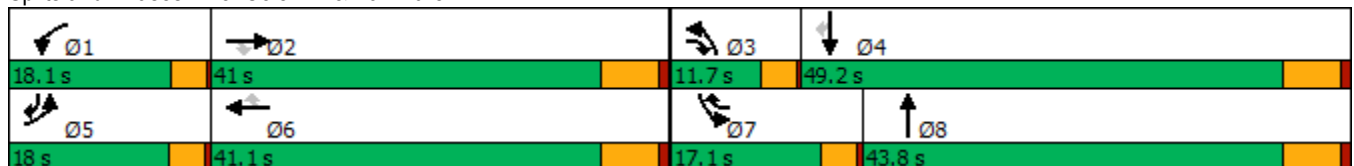



























Splits and Phases: 8: Cole Av. & Van Buren Bl.



HCM 6th Signalized Intersection Summary
8: Cole Av. & Van Buren Bl.

West Campus Upper Plateau (JN 14064)

09/19/2022

												
Movement	EBL	EBT	EBR	WBL	WBT	WBR	NBL	NBT	NBR	SBL	SBT	SBR
Lane Configurations	 	  			  			 		 	 	
Traffic Volume (veh/h)	364	1172	115	184	1329	285	102	326	70	330	584	247
Future Volume (veh/h)	364	1172	115	184	1329	285	102	326	70	330	584	247
Initial Q (Qb), veh	0	0	0	0	0	0	0	0	0	0	0	0
Ped-Bike Adj(A_pbT)	1.00		1.00	1.00		1.00	1.00		0.99	1.00		1.00
Parking Bus, Adj	1.00	1.00	1.00	1.00	1.00	1.00	1.00	1.00	1.00	1.00	1.00	1.00
Work Zone On Approach		No			No			No			No	
Adj Sat Flow, veh/h/ln	1870	1826	1856	1856	1856	1870	1885	1885	1870	1856	1885	1885
Adj Flow Rate, veh/h	387	1247	63	196	1414	213	109	347	67	351	621	163
Peak Hour Factor	0.94	0.94	0.94	0.94	0.94	0.94	0.94	0.94	0.94	0.94	0.94	0.94
Percent Heavy Veh, %	2	5	3	3	3	2	1	1	2	3	1	1
Cap, veh/h	457	1739	669	229	1753	743	137	572	109	420	849	590
Arrive On Green	0.13	0.35	0.35	0.13	0.35	0.35	0.08	0.19	0.19	0.12	0.24	0.24
Sat Flow, veh/h	3456	4985	1572	1767	5066	1585	1795	2997	572	3428	3582	1596
Grp Volume(v), veh/h	387	1247	63	196	1414	213	109	206	208	351	621	163
Grp Sat Flow(s),veh/h/ln	1728	1662	1572	1767	1689	1585	1795	1791	1778	1714	1791	1596
Q Serve(g_s), s	10.4	20.7	2.3	10.3	24.1	7.8	5.7	10.0	10.2	9.5	15.2	6.8
Cycle Q Clear(g_c), s	10.4	20.7	2.3	10.3	24.1	7.8	5.7	10.0	10.2	9.5	15.2	6.8
Prop In Lane	1.00		1.00	1.00		1.00	1.00		0.32	1.00		1.00
Lane Grp Cap(c), veh/h	457	1739	669	229	1753	743	137	342	339	420	849	590
V/C Ratio(X)	0.85	0.72	0.09	0.86	0.81	0.29	0.80	0.60	0.61	0.83	0.73	0.28
Avail Cap(c_a), veh/h	520	1824	695	268	1859	776	151	708	703	483	1620	933
HCM Platoon Ratio	1.00	1.00	1.00	1.00	1.00	1.00	1.00	1.00	1.00	1.00	1.00	1.00
Upstream Filter(I)	1.00	1.00	1.00	1.00	1.00	1.00	1.00	1.00	1.00	1.00	1.00	1.00
Uniform Delay (d), s/veh	40.3	26.9	16.4	40.5	28.2	15.5	43.2	35.2	35.3	40.8	33.5	21.1
Incr Delay (d2), s/veh	10.1	1.5	0.1	18.5	2.8	0.3	20.5	1.7	1.8	9.5	1.2	0.3
Initial Q Delay(d3),s/veh	0.0	0.0	0.0	0.0	0.0	0.0	0.0	0.0	0.0	0.0	0.0	0.0
%ile BackOfQ(50%),veh/ln	4.8	7.7	0.8	5.4	9.3	2.6	3.2	4.3	4.3	4.3	6.3	2.4
Unsig. Movement Delay, s/veh												
LnGrp Delay(d),s/veh	50.4	28.3	16.5	59.1	31.0	15.8	63.7	36.9	37.1	50.3	34.7	21.3
LnGrp LOS	D	C	B	E	C	B	E	D	D	D	C	C
Approach Vol, veh/h		1697			1823			523			1135	
Approach Delay, s/veh		32.9			32.2			42.5			37.6	
Approach LOS		C			C			D			D	
Timer - Assigned Phs	1	2	3	4	5	6	7	8				
Phs Duration (G+Y+Rc), s	16.0	39.4	10.9	28.7	16.3	39.1	15.4	24.3				
Change Period (Y+Rc), s	3.7	6.2	3.7	6.2	3.7	6.2	3.7	6.2				
Max Green Setting (Gmax), s	14.4	34.8	8.0	43.0	14.3	34.9	13.4	37.6				
Max Q Clear Time (g_c+I1), s	12.3	22.7	7.7	17.2	12.4	26.1	11.5	12.2				
Green Ext Time (p_c), s	0.1	7.8	0.0	4.4	0.2	6.8	0.1	2.1				
Intersection Summary												
HCM 6th Ctrl Delay				34.7								
HCM 6th LOS				C								

Timings
10: Orange Terrace Pkwy & Deercreek Dr

West Campus Upper Plateau (JN 14064)

09/19/2022



Lane Group	EBL	EBT	WBL	WBT	NBL	NBT	SBL	SBT
Lane Configurations	↖	↕	↖	↕		↕		↕
Traffic Volume (vph)	49	484	4	272	21	5	31	9
Future Volume (vph)	49	484	4	272	21	5	31	9
Turn Type	Perm	NA	Perm	NA	Perm	NA	Perm	NA
Protected Phases		4		8		2		6
Permitted Phases	4		8		2		6	
Detector Phase	4	4	8	8	2	2	6	6
Switch Phase								
Minimum Initial (s)	5.0	5.0	5.0	5.0	5.0	5.0	5.0	5.0
Minimum Split (s)	26.1	26.1	26.1	26.1	26.1	26.1	26.1	26.1
Total Split (s)	28.0	28.0	28.0	28.0	27.0	27.0	27.0	27.0
Total Split (%)	50.9%	50.9%	50.9%	50.9%	49.1%	49.1%	49.1%	49.1%
Yellow Time (s)	3.6	3.6	3.6	3.6	3.6	3.6	3.6	3.6
All-Red Time (s)	0.5	0.5	0.5	0.5	0.5	0.5	0.5	0.5
Lost Time Adjust (s)	0.0	0.0	0.0	0.0		0.0		0.0
Total Lost Time (s)	4.1	4.1	4.1	4.1		4.1		4.1
Lead/Lag								
Lead-Lag Optimize?								
Recall Mode	None	None	None	None	Min	Min	Min	Min
Act Effect Green (s)	11.0	11.0	11.0	11.0		8.4		8.4
Actuated g/C Ratio	0.38	0.38	0.38	0.38		0.29		0.29
v/c Ratio	0.13	0.39	0.01	0.25		0.07		0.14
Control Delay	7.8	7.6	7.2	6.0		8.0		6.6
Queue Delay	0.0	0.0	0.0	0.0		0.0		0.0
Total Delay	7.8	7.6	7.2	6.0		8.0		6.6
LOS	A	A	A	A		A		A
Approach Delay		7.7		6.0		8.0		6.6
Approach LOS		A		A		A		A

Intersection Summary

Cycle Length: 55
 Actuated Cycle Length: 28.6
 Natural Cycle: 55
 Control Type: Actuated-Uncoordinated
 Maximum v/c Ratio: 0.39
 Intersection Signal Delay: 7.1
 Intersection LOS: A
 Intersection Capacity Utilization 34.7%
 ICU Level of Service A
 Analysis Period (min) 15

Splits and Phases: 10: Orange Terrace Pkwy & Deercreek Dr

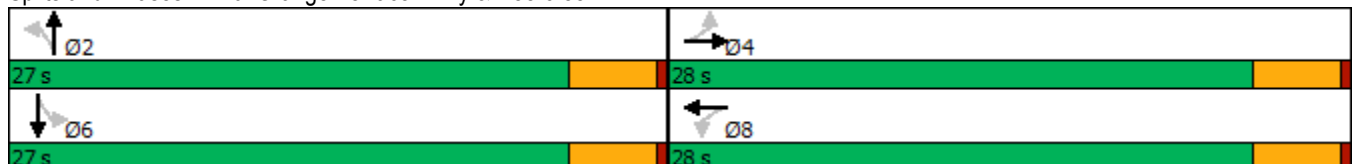

HCM 6th Signalized Intersection Summary
10: Orange Terrace Pkwy & Deercreek Dr

West Campus Upper Plateau (JN 14064)

09/19/2022



Movement	EBL	EBT	EBR	WBL	WBT	WBR	NBL	NBT	NBR	SBL	SBT	SBR
Lane Configurations	↗	↗↘		↗	↗↘			↕			↕	
Traffic Volume (veh/h)	49	484	17	4	272	53	21	5	2	31	9	22
Future Volume (veh/h)	49	484	17	4	272	53	21	5	2	31	9	22
Initial Q (Qb), veh	0	0	0	0	0	0	0	0	0	0	0	0
Ped-Bike Adj(A_pbT)	1.00		0.98	1.00		1.00	1.00		0.99	0.99		0.97
Parking Bus, Adj	1.00	1.00	1.00	1.00	1.00	1.00	1.00	1.00	1.00	1.00	1.00	1.00
Work Zone On Approach		No			No			No				No
Adj Sat Flow, veh/h/ln	1856	1870	1796	1900	1885	1900	1811	1900	1900	1900	1900	1900
Adj Flow Rate, veh/h	51	504	18	4	283	55	22	5	2	32	9	23
Peak Hour Factor	0.96	0.96	0.96	0.96	0.96	0.96	0.96	0.96	0.96	0.96	0.96	0.96
Percent Heavy Veh, %	3	2	7	0	1	0	6	0	0	0	0	0
Cap, veh/h	634	1216	43	559	1042	200	559	110	27	395	130	148
Arrive On Green	0.35	0.35	0.35	0.35	0.35	0.35	0.26	0.26	0.26	0.26	0.26	0.26
Sat Flow, veh/h	1032	3497	125	894	2997	574	989	428	105	523	504	576
Grp Volume(v), veh/h	51	256	266	4	167	171	29	0	0	64	0	0
Grp Sat Flow(s),veh/h/ln	1032	1777	1844	894	1791	1780	1522	0	0	1603	0	0
Q Serve(g_s), s	0.8	2.3	2.3	0.1	1.4	1.4	0.0	0.0	0.0	0.0	0.0	0.0
Cycle Q Clear(g_c), s	2.2	2.3	2.3	2.4	1.4	1.4	0.2	0.0	0.0	0.6	0.0	0.0
Prop In Lane	1.00		0.07	1.00		0.32	0.76		0.07	0.50		0.36
Lane Grp Cap(c), veh/h	634	618	642	559	623	619	696	0	0	673	0	0
V/C Ratio(X)	0.08	0.41	0.41	0.01	0.27	0.28	0.04	0.00	0.00	0.10	0.00	0.00
Avail Cap(c_a), veh/h	1463	2044	2122	1277	2061	2048	1943	0	0	1964	0	0
HCM Platoon Ratio	1.00	1.00	1.00	1.00	1.00	1.00	1.00	1.00	1.00	1.00	1.00	1.00
Upstream Filter(I)	1.00	1.00	1.00	1.00	1.00	1.00	1.00	0.00	0.00	1.00	0.00	0.00
Uniform Delay (d), s/veh	5.7	5.2	5.2	6.1	4.9	4.9	5.8	0.0	0.0	5.9	0.0	0.0
Incr Delay (d2), s/veh	0.1	0.4	0.4	0.0	0.2	0.2	0.0	0.0	0.0	0.1	0.0	0.0
Initial Q Delay(d3),s/veh	0.0	0.0	0.0	0.0	0.0	0.0	0.0	0.0	0.0	0.0	0.0	0.0
%ile BackOfQ(50%),veh/ln	0.0	0.1	0.1	0.0	0.2	0.2	0.0	0.0	0.0	0.1	0.0	0.0
Unsig. Movement Delay, s/veh												
LnGrp Delay(d),s/veh	5.7	5.6	5.6	6.1	5.1	5.1	5.8	0.0	0.0	6.0	0.0	0.0
LnGrp LOS	A	A	A	A	A	A	A	A	A	A	A	A
Approach Vol, veh/h		573			342			29				64
Approach Delay, s/veh		5.6			5.1			5.8				6.0
Approach LOS		A			A			A				A
Timer - Assigned Phs		2		4		6		8				
Phs Duration (G+Y+Rc), s		9.4		11.3		9.4		11.3				
Change Period (Y+Rc), s		4.1		4.1		4.1		4.1				
Max Green Setting (Gmax), s		22.9		23.9		22.9		23.9				
Max Q Clear Time (g_c+I1), s		2.2		4.3		2.6		4.4				
Green Ext Time (p_c), s		0.1		2.9		0.2		2.0				
Intersection Summary												
HCM 6th Ctrl Delay				5.5								
HCM 6th LOS				A								

Timings
13: Barton Rd. & Orange Terrace Pkwy

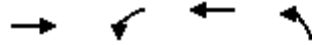

Lane Group	EBT	WBL	WBT	NBL
Lane Configurations	↑↑	↑	↑↑	↑
Traffic Volume (vph)	425	47	254	75
Future Volume (vph)	425	47	254	75
Turn Type	NA	Perm	NA	Prot
Protected Phases	4		8	2
Permitted Phases		8		
Detector Phase	4	8	8	2
Switch Phase				
Minimum Initial (s)	10.0	10.0	10.0	10.0
Minimum Split (s)	21.7	14.7	14.7	21.6
Total Split (s)	28.0	28.0	28.0	27.0
Total Split (%)	50.9%	50.9%	50.9%	49.1%
Yellow Time (s)	3.7	3.7	3.7	3.6
All-Red Time (s)	1.0	1.0	1.0	1.0
Lost Time Adjust (s)	0.0	0.0	0.0	0.0
Total Lost Time (s)	4.7	4.7	4.7	4.6
Lead/Lag				
Lead-Lag Optimize?				
Recall Mode	Min	Min	Min	None
Act Effct Green (s)	20.1	20.1	20.1	11.5
Actuated g/C Ratio	0.55	0.55	0.55	0.32
v/c Ratio	0.28	0.10	0.13	0.21
Control Delay	6.6	8.1	6.9	7.0
Queue Delay	0.0	0.0	0.0	0.0
Total Delay	6.6	8.1	6.9	7.0
LOS	A	A	A	A
Approach Delay	6.6		7.1	7.0
Approach LOS	A		A	A

Intersection Summary

Cycle Length: 55
 Actuated Cycle Length: 36.4
 Natural Cycle: 45
 Control Type: Actuated-Uncoordinated
 Maximum v/c Ratio: 0.28
 Intersection Signal Delay: 6.8
 Intersection LOS: A
 Intersection Capacity Utilization 43.1%
 ICU Level of Service A
 Analysis Period (min) 15

Splits and Phases: 13: Barton Rd. & Orange Terrace Pkwy

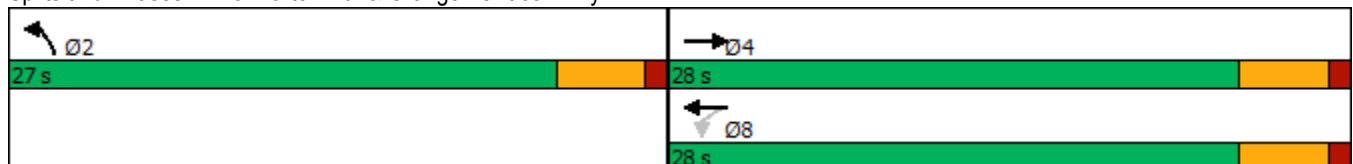

HCM 6th Signalized Intersection Summary
 13: Barton Rd. & Orange Terrace Pkwy

West Campus Upper Plateau (JN 14064)

09/19/2022

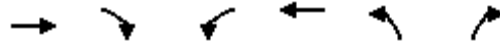

Movement	EBT	EBR	WBL	WBT	NBL	NBR
Lane Configurations	↑↑		↵	↑↑	↵	
Traffic Volume (veh/h)	425	92	47	254	75	45
Future Volume (veh/h)	425	92	47	254	75	45
Initial Q (Qb), veh	0	0	0	0	0	0
Ped-Bike Adj(A_pbT)		0.98	1.00		1.00	1.00
Parking Bus, Adj	1.00	1.00	1.00	1.00	1.00	1.00
Work Zone On Approach	No			No	No	
Adj Sat Flow, veh/h/ln	1885	1885	1900	1900	1900	1900
Adj Flow Rate, veh/h	438	95	48	262	77	46
Peak Hour Factor	0.97	0.97	0.97	0.97	0.97	0.97
Percent Heavy Veh, %	1	1	0	0	0	0
Cap, veh/h	1166	251	545	1443	248	148
Arrive On Green	0.40	0.40	0.40	0.40	0.23	0.23
Sat Flow, veh/h	3012	627	884	3705	1075	642
Grp Volume(v), veh/h	267	266	48	262	124	0
Grp Sat Flow(s),veh/h/ln	1791	1754	884	1805	1731	0
Q Serve(g_s), s	2.6	2.7	1.0	1.2	1.5	0.0
Cycle Q Clear(g_c), s	2.6	2.7	3.7	1.2	1.5	0.0
Prop In Lane		0.36	1.00		0.62	0.37
Lane Grp Cap(c), veh/h	716	701	545	1443	399	0
V/C Ratio(X)	0.37	0.38	0.09	0.18	0.31	0.00
Avail Cap(c_a), veh/h	1660	1625	1011	3345	1542	0
HCM Platoon Ratio	1.00	1.00	1.00	1.00	1.00	1.00
Upstream Filter(I)	1.00	1.00	1.00	1.00	1.00	0.00
Uniform Delay (d), s/veh	5.3	5.3	6.7	4.9	8.0	0.0
Incr Delay (d2), s/veh	0.3	0.3	0.1	0.1	0.4	0.0
Initial Q Delay(d3),s/veh	0.0	0.0	0.0	0.0	0.0	0.0
%ile BackOfQ(50%),veh/ln	0.5	0.5	0.1	0.2	0.4	0.0
Unsig. Movement Delay, s/veh						
LnGrp Delay(d),s/veh	5.6	5.7	6.7	4.9	8.5	0.0
LnGrp LOS	A	A	A	A	A	A
Approach Vol, veh/h	533			310	124	
Approach Delay, s/veh	5.7			5.2	8.5	
Approach LOS	A			A	A	

Timer - Assigned Phs	2	4	8
Phs Duration (G+Y+Rc), s	10.4	14.7	14.7
Change Period (Y+Rc), s	4.6	* 4.7	* 4.7
Max Green Setting (Gmax), s	22.4	* 23	* 23
Max Q Clear Time (g_c+I1), s	3.5	4.7	5.7
Green Ext Time (p_c), s	0.3	3.1	1.8

Intersection Summary

HCM 6th Ctrl Delay	5.9
HCM 6th LOS	A

Notes

User approved volume balancing among the lanes for turning movement.
 * HCM 6th computational engine requires equal clearance times for the phases crossing the barrier.

Timings

14: Barton Rd. & Van Buren Bl.

09/19/2022

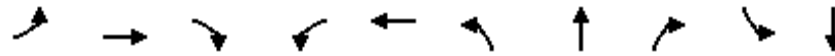

Lane Group	EBL	EBT	EBR	WBL	WBT	NBL	NBT	NBR	SBL	SBT
Lane Configurations	↘	↑↑↑	↗	↘	↑↑↑	↘	↑	↗	↘	↗
Traffic Volume (vph)	115	1351	250	341	1520	240	70	261	35	31
Future Volume (vph)	115	1351	250	341	1520	240	70	261	35	31
Turn Type	Prot	NA	pm+ov	Prot	NA	Prot	NA	Perm	Prot	NA
Protected Phases	5	2	3	1	6	3	8		7	4
Permitted Phases			2					8		
Detector Phase	5	2	3	1	6	3	8	8	7	4
Switch Phase										
Minimum Initial (s)	5.0	10.0	5.0	5.0	10.0	5.0	10.0	10.0	5.0	10.0
Minimum Split (s)	9.2	25.2	9.1	9.2	25.5	9.1	14.6	14.6	9.1	33.6
Total Split (s)	15.8	41.4	14.0	31.0	56.6	14.0	36.9	36.9	10.7	33.6
Total Split (%)	13.2%	34.5%	11.7%	25.8%	47.2%	11.7%	30.8%	30.8%	8.9%	28.0%
Yellow Time (s)	3.2	5.2	3.6	3.2	5.5	3.6	3.6	3.6	3.6	3.6
All-Red Time (s)	1.0	1.0	0.5	1.0	1.0	0.5	1.0	1.0	0.5	1.0
Lost Time Adjust (s)	0.0	0.0	0.0	0.0	0.0	0.0	0.0	0.0	0.0	0.0
Total Lost Time (s)	4.2	6.2	4.1	4.2	6.5	4.1	4.6	4.6	4.1	4.6
Lead/Lag	Lead	Lag	Lead	Lead	Lag	Lead	Lag	Lag	Lead	Lag
Lead-Lag Optimize?	Yes	Yes	Yes	Yes	Yes	Yes	Yes	Yes	Yes	Yes
Recall Mode	None	None	None	None	None	None	None	None	None	None
Act Effct Green (s)	10.2	30.5	42.7	24.1	44.1	10.1	21.5	21.5	6.4	13.3
Actuated g/C Ratio	0.10	0.31	0.44	0.25	0.45	0.10	0.22	0.22	0.07	0.14
v/c Ratio	0.64	0.81	0.35	0.81	0.67	0.69	0.17	0.49	0.30	0.42
Control Delay	60.7	36.0	12.6	51.6	22.9	55.6	36.3	7.7	55.2	17.2
Queue Delay	0.0	0.0	0.0	0.0	0.0	0.0	0.0	0.0	0.0	0.0
Total Delay	60.7	36.0	12.6	51.6	22.9	55.6	36.3	7.7	55.2	17.2
LOS	E	D	B	D	C	E	D	A	E	B
Approach Delay		34.3			27.9		31.3			25.5
Approach LOS		C			C		C			C

Intersection Summary

Cycle Length: 120
 Actuated Cycle Length: 97.4
 Natural Cycle: 100
 Control Type: Actuated-Uncoordinated
 Maximum v/c Ratio: 0.81
 Intersection Signal Delay: 30.7
 Intersection LOS: C
 Intersection Capacity Utilization 76.1%
 ICU Level of Service D
 Analysis Period (min) 15

Splits and Phases: 14: Barton Rd. & Van Buren Bl.

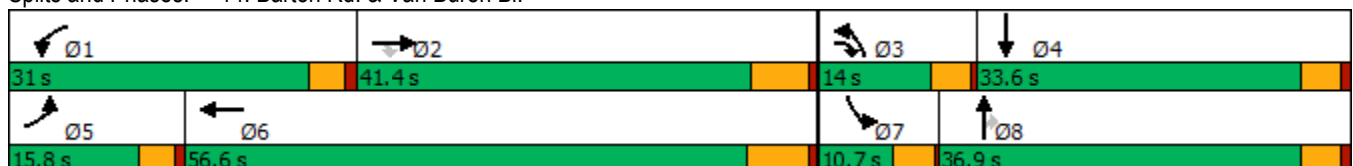

HCM 6th Signalized Intersection Summary
14: Barton Rd. & Van Buren Bl.

West Campus Upper Plateau (JN 14064)

09/19/2022



Movement	EBL	EBT	EBR	WBL	WBT	WBR	NBL	NBT	NBR	SBL	SBT	SBR
Lane Configurations												
Traffic Volume (veh/h)	115	1351	250	341	1520	85	240	70	261	35	31	94
Future Volume (veh/h)	115	1351	250	341	1520	85	240	70	261	35	31	94
Initial Q (Qb), veh	0	0	0	0	0	0	0	0	0	0	0	0
Ped-Bike Adj(A_pbT)	1.00		1.00	1.00		1.00	1.00		0.95	1.00		1.00
Parking Bus, Adj	1.00	1.00	1.00	1.00	1.00	1.00	1.00	1.00	1.00	1.00	1.00	1.00
Work Zone On Approach		No			No			No			No	
Adj Sat Flow, veh/h/ln	1900	1856	1870	1870	1870	1856	1900	1900	1885	1900	1885	1900
Adj Flow Rate, veh/h	120	1407	231	355	1583	79	250	73	148	36	32	40
Peak Hour Factor	0.96	0.96	0.96	0.96	0.96	0.96	0.96	0.96	0.96	0.96	0.96	0.96
Percent Heavy Veh, %	0	3	2	2	2	3	0	0	1	0	1	0
Cap, veh/h	152	1804	664	396	2448	122	336	348	279	62	93	116
Arrive On Green	0.08	0.32	0.32	0.22	0.46	0.46	0.10	0.18	0.18	0.03	0.12	0.12
Sat Flow, veh/h	1810	5567	1583	1781	5299	264	3510	1900	1520	1810	762	952
Grp Volume(v), veh/h	120	1407	231	355	1117	545	250	73	148	36	0	72
Grp Sat Flow(s),veh/h/ln	1810	1856	1583	1781	1870	1822	1755	1900	1520	1810	0	1714
Q Serve(g_s), s	5.3	18.8	8.1	15.9	18.8	18.8	5.7	2.7	7.2	1.6	0.0	3.2
Cycle Q Clear(g_c), s	5.3	18.8	8.1	15.9	18.8	18.8	5.7	2.7	7.2	1.6	0.0	3.2
Prop In Lane	1.00		1.00	1.00		0.15	1.00		1.00	1.00		0.56
Lane Grp Cap(c), veh/h	152	1804	664	396	1728	842	336	348	279	62	0	209
V/C Ratio(X)	0.79	0.78	0.35	0.90	0.65	0.65	0.75	0.21	0.53	0.58	0.00	0.34
Avail Cap(c_a), veh/h	256	2388	830	582	2284	1113	423	748	598	146	0	606
HCM Platoon Ratio	1.00	1.00	1.00	1.00	1.00	1.00	1.00	1.00	1.00	1.00	1.00	1.00
Upstream Filter(I)	1.00	1.00	1.00	1.00	1.00	1.00	1.00	1.00	1.00	1.00	0.00	1.00
Uniform Delay (d), s/veh	36.9	25.1	16.2	31.0	16.9	16.9	36.1	28.5	30.3	39.1	0.0	33.0
Incr Delay (d2), s/veh	3.4	0.9	0.1	9.3	0.2	0.3	5.4	0.3	1.6	8.4	0.0	1.0
Initial Q Delay(d3),s/veh	0.0	0.0	0.0	0.0	0.0	0.0	0.0	0.0	0.0	0.0	0.0	0.0
%ile BackOfQ(50%),veh/ln	2.3	7.4	2.6	7.2	6.8	6.7	2.5	1.2	2.6	0.9	0.0	1.4
Unsig. Movement Delay, s/veh												
LnGrp Delay(d),s/veh	40.3	25.9	16.3	40.3	17.1	17.2	41.5	28.8	31.9	47.5	0.0	34.0
LnGrp LOS	D	C	B	D	B	B	D	C	C	D	A	C
Approach Vol, veh/h		1758			2017			471				108
Approach Delay, s/veh		25.7			21.2			36.5				38.5
Approach LOS		C			C			D				D
Timer - Assigned Phs	1	2	3	4	5	6	7	8				
Phs Duration (G+Y+Rc), s	22.4	33.1	11.9	14.6	11.1	44.4	6.9	19.6				
Change Period (Y+Rc), s	* 4.2	* 6.5	4.1	4.6	* 4.2	6.5	4.1	4.6				
Max Green Setting (Gmax), s	* 27	* 35	9.9	29.0	* 12	50.1	6.6	32.3				
Max Q Clear Time (g_c+I1), s	17.9	20.8	7.7	5.2	7.3	20.8	3.6	9.2				
Green Ext Time (p_c), s	0.4	5.8	0.2	0.3	0.0	7.8	0.0	0.8				

Intersection Summary

HCM 6th Ctrl Delay	25.1
HCM 6th LOS	C

Notes

* HCM 6th computational engine requires equal clearance times for the phases crossing the barrier.

Timings
25: Sycamore Canyon Bl. & Cactus Av.

West Campus Upper Plateau (JN 14064)

09/19/2022



Lane Group	EBL	EBT	EBR	WBL	WBT	WBR	NBL	NBT	NBR	SBL	SBT	SBR
Lane Configurations	↘	↗	↘	↘↗	↗	↘	↘↗	↗	↘	↘↗	↗	↘
Traffic Volume (vph)	145	1161	530	799	433	571	186	377	254	572	965	52
Future Volume (vph)	145	1161	530	799	433	571	186	377	254	572	965	52
Turn Type	Prot	NA	Perm	Prot	NA	pm+ov	Prot	NA	Perm	Prot	NA	Perm
Protected Phases	7	4		3	8	1	5	2		1	6	
Permitted Phases			4			8			2			6
Detector Phase	7	4	4	3	8	1	5	2	2	1	6	6
Switch Phase												
Minimum Initial (s)	5.0	10.0	10.0	5.0	10.0	10.0	10.0	10.0	10.0	10.0	10.0	10.0
Minimum Split (s)	9.6	32.8	32.8	9.6	32.8	15.8	15.8	15.8	15.8	15.8	34.8	34.8
Total Split (s)	25.2	41.0	41.0	23.0	38.8	29.8	15.8	26.2	26.2	29.8	40.2	40.2
Total Split (%)	21.0%	34.2%	34.2%	19.2%	32.3%	24.8%	13.2%	21.8%	21.8%	24.8%	33.5%	33.5%
Yellow Time (s)	3.6	4.8	4.8	3.6	4.8	4.8	4.8	4.8	4.8	4.8	4.8	4.8
All-Red Time (s)	1.0	1.0	1.0	1.0	1.0	1.0	1.0	1.0	1.0	1.0	1.0	1.0
Lost Time Adjust (s)	0.0	0.0	0.0	0.0	0.0	0.0	0.0	0.0	0.0	0.0	0.0	0.0
Total Lost Time (s)	4.6	5.8	5.8	4.6	5.8	5.8	5.8	5.8	5.8	5.8	5.8	5.8
Lead/Lag	Lead	Lag	Lag	Lead	Lag	Lead	Lead	Lag	Lag	Lead	Lag	Lag
Lead-Lag Optimize?	Yes	Yes	Yes	Yes	Yes	Yes	Yes	Yes	Yes	Yes	Yes	Yes
Recall Mode	None	None	None	None	None	None	None	None	None	None	None	None
Act Effct Green (s)	15.7	35.2	35.2	18.4	37.9	67.7	10.0	20.4	20.4	24.0	34.4	34.4
Actuated g/C Ratio	0.13	0.29	0.29	0.15	0.32	0.56	0.08	0.17	0.17	0.20	0.29	0.29
v/c Ratio	0.75	1.37	1.03	1.82	0.47	0.69	0.76	0.76	0.59	0.96	1.16	0.12
Control Delay	69.5	205.3	74.4	406.0	35.6	18.9	71.8	56.8	10.7	73.4	122.7	0.5
Queue Delay	0.0	0.0	0.0	0.0	0.0	0.8	0.0	0.0	0.0	0.0	0.0	0.0
Total Delay	69.5	205.3	74.4	406.0	35.6	19.6	71.8	56.8	10.7	73.4	122.7	0.5
LOS	E	F	E	F	D	B	E	E	B	E	F	A
Approach Delay		156.8			194.7			45.9			101.0	
Approach LOS		F			F			D			F	

Intersection Summary

Cycle Length: 120	
Actuated Cycle Length: 120	
Natural Cycle: 115	
Control Type: Actuated-Uncoordinated	
Maximum v/c Ratio: 1.82	
Intersection Signal Delay: 138.4	Intersection LOS: F
Intersection Capacity Utilization 108.2%	ICU Level of Service G
Analysis Period (min) 15	



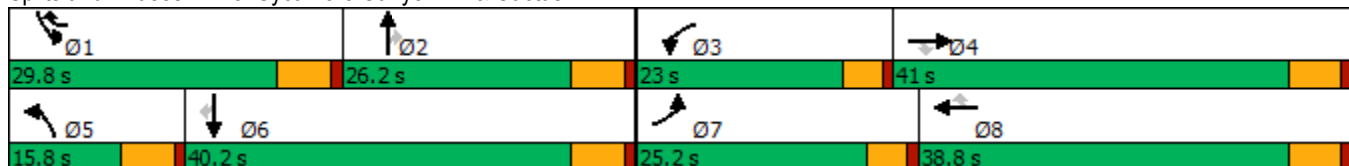





















Splits and Phases: 25: Sycamore Canyon Bl. & Cactus Av.



HCM 6th Signalized Intersection Summary
25: Sycamore Canyon Bl. & Cactus Av.

West Campus Upper Plateau (JN 14064)

09/19/2022

												
Movement	EBL	EBT	EBR	WBL	WBT	WBR	NBL	NBT	NBR	SBL	SBT	SBR
Lane Configurations												
Traffic Volume (veh/h)	145	1161	530	799	433	571	186	377	254	572	965	52
Future Volume (veh/h)	145	1161	530	799	433	571	186	377	254	572	965	52
Initial Q (Qb), veh	0	0	0	0	0	0	0	0	0	0	0	0
Ped-Bike Adj(A_pbT)	1.00		1.00	1.00		1.00	1.00		1.00	1.00		1.00
Parking Bus, Adj	1.00	1.00	1.00	1.00	1.00	1.00	1.00	1.00	1.00	1.00	1.00	1.00
Work Zone On Approach		No			No			No			No	
Adj Sat Flow, veh/h/ln	1841	1796	1856	1826	1796	1870	1856	1811	1781	1885	1796	1767
Adj Flow Rate, veh/h	169	1350	296	929	503	394	216	438	192	665	1122	60
Peak Hour Factor	0.86	0.86	0.86	0.86	0.86	0.86	0.86	0.86	0.86	0.86	0.86	0.86
Percent Heavy Veh, %	4	7	3	5	7	2	3	6	8	1	7	9
Cap, veh/h	196	1001	461	517	1142	847	286	585	257	697	978	429
Arrive On Green	0.11	0.29	0.29	0.15	0.33	0.33	0.08	0.17	0.17	0.20	0.29	0.29
Sat Flow, veh/h	1753	3413	1572	3374	3413	1585	3428	3441	1510	3483	3413	1497
Grp Volume(v), veh/h	169	1350	296	929	503	394	216	438	192	665	1122	60
Grp Sat Flow(s),veh/h/ln	1753	1706	1572	1687	1706	1585	1714	1721	1510	1742	1706	1497
Q Serve(g_s), s	11.4	35.2	19.7	18.4	13.8	18.5	7.4	14.5	14.5	22.7	34.4	3.6
Cycle Q Clear(g_c), s	11.4	35.2	19.7	18.4	13.8	18.5	7.4	14.5	14.5	22.7	34.4	3.6
Prop In Lane	1.00		1.00	1.00		1.00	1.00		1.00	1.00		1.00
Lane Grp Cap(c), veh/h	196	1001	461	517	1142	847	286	585	257	697	978	429
V/C Ratio(X)	0.86	1.35	0.64	1.80	0.44	0.46	0.76	0.75	0.75	0.95	1.15	0.14
Avail Cap(c_a), veh/h	301	1001	461	517	1142	847	286	585	257	697	978	429
HCM Platoon Ratio	1.00	1.00	1.00	1.00	1.00	1.00	1.00	1.00	1.00	1.00	1.00	1.00
Upstream Filter(I)	1.00	1.00	1.00	1.00	1.00	1.00	1.00	1.00	1.00	1.00	1.00	1.00
Uniform Delay (d), s/veh	52.4	42.4	36.9	50.8	31.2	17.3	53.8	47.4	47.4	47.5	42.8	31.8
Incr Delay (d2), s/veh	9.5	163.5	3.0	365.9	0.3	0.4	11.0	5.3	11.4	23.5	78.2	0.1
Initial Q Delay(d3),s/veh	0.0	0.0	0.0	0.0	0.0	0.0	0.0	0.0	0.0	0.0	0.0	0.0
%ile BackOfQ(50%),veh/ln	5.4	37.1	7.7	33.8	5.5	6.4	3.5	6.5	6.1	11.8	24.5	1.3
Unsig. Movement Delay, s/veh												
LnGrp Delay(d),s/veh	61.9	205.9	39.9	416.7	31.4	17.7	64.8	52.7	58.8	70.9	121.0	32.0
LnGrp LOS	E	F	D	F	C	B	E	D	E	E	F	C
Approach Vol, veh/h		1815			1826			846			1847	
Approach Delay, s/veh		165.4			224.5			57.2			100.1	
Approach LOS		F			F			E			F	
Timer - Assigned Phs	1	2	3	4	5	6	7	8				
Phs Duration (G+Y+Rc), s	29.8	26.2	23.0	41.0	15.8	40.2	18.0	46.0				
Change Period (Y+Rc), s	5.8	5.8	4.6	5.8	5.8	5.8	4.6	5.8				
Max Green Setting (Gmax), s	24.0	20.4	18.4	35.2	10.0	34.4	20.6	33.0				
Max Q Clear Time (g_c+I1), s	24.7	16.5	20.4	37.2	9.4	36.4	13.4	20.5				
Green Ext Time (p_c), s	0.0	1.2	0.0	0.0	0.0	0.0	0.1	3.7				
Intersection Summary												
HCM 6th Ctrl Delay			148.9									
HCM 6th LOS			F									

Timings
29: I-215 NB Ramps & Alessandro Bl.

West Campus Upper Plateau (JN 14064)

09/19/2022

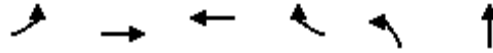

Lane Group	EBL	EBT	WBT	WBR	NBL	NBT
Lane Configurations	↶	↑↑↑	↑↑↑	↷	↶↷	↷
Traffic Volume (vph)	231	1894	1181	129	1037	13
Future Volume (vph)	231	1894	1181	129	1037	13
Turn Type	Prot	NA	NA	Perm	Split	NA
Protected Phases	5	2	6		8	8
Permitted Phases				6		
Detector Phase	5	2	6	6	8	8
Switch Phase						
Minimum Initial (s)	5.0	5.0	5.0	5.0	5.0	5.0
Minimum Split (s)	9.5	10.5	33.5	33.5	10.0	10.0
Total Split (s)	24.6	67.0	42.4	42.4	43.0	43.0
Total Split (%)	22.4%	60.9%	38.5%	38.5%	39.1%	39.1%
Yellow Time (s)	3.5	4.5	4.5	4.5	4.0	4.0
All-Red Time (s)	1.0	1.0	1.0	1.0	1.0	1.0
Lost Time Adjust (s)	0.0	0.0	0.0	0.0	0.0	0.0
Total Lost Time (s)	4.5	5.5	5.5	5.5	5.0	5.0
Lead/Lag	Lead		Lag	Lag		
Lead-Lag Optimize?	Yes		Yes	Yes		
Recall Mode	None	Min	Min	Min	Max	Max
Act Effct Green (s)	17.8	55.1	32.8	32.8	38.2	38.2
Actuated g/C Ratio	0.17	0.53	0.32	0.32	0.37	0.37
v/c Ratio	0.83	0.75	0.78	0.28	0.84	0.82
Control Delay	65.5	20.8	36.3	16.3	39.0	44.7
Queue Delay	0.0	0.0	0.0	0.0	0.0	0.0
Total Delay	65.5	20.8	36.3	16.3	39.0	44.7
LOS	E	C	D	B	D	D
Approach Delay		25.6	34.4			40.8
Approach LOS		C	C			D

Intersection Summary

Cycle Length: 110
 Actuated Cycle Length: 103.9
 Natural Cycle: 90
 Control Type: Actuated-Uncoordinated
 Maximum v/c Ratio: 0.84
 Intersection Signal Delay: 32.3
 Intersection LOS: C
 Intersection Capacity Utilization 73.8%
 ICU Level of Service D
 Analysis Period (min) 15

Splits and Phases: 29: I-215 NB Ramps & Alessandro Bl.



HCM 6th Signalized Intersection Summary
 29: I-215 NB Ramps & Alessandro Bl.

West Campus Upper Plateau (JN 14064)

09/19/2022

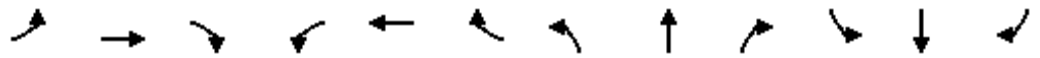

Movement	EBL	EBT	EBR	WBL	WBT	WBR	NBL	NBT	NBR	SBL	SBT	SBR
Lane Configurations	↘	↑↑↑			↑↑↑	↗	↘↗	↕				
Traffic Volume (veh/h)	231	1894	0	0	1181	129	1037	13	310	0	0	0
Future Volume (veh/h)	231	1894	0	0	1181	129	1037	13	310	0	0	0
Initial Q (Qb), veh	0	0	0	0	0	0	0	0	0			
Ped-Bike Adj(A_pbT)	1.00		1.00	1.00		0.98	1.00		1.00			
Parking Bus, Adj	1.00	1.00	1.00	1.00	1.00	1.00	1.00	1.00	1.00			
Work Zone On Approach		No			No			No				
Adj Sat Flow, veh/h/ln	1841	1870	0	0	1870	1707	1870	1900	1870			
Adj Flow Rate, veh/h	246	2015	0	0	1256	110	1005	151	244			
Peak Hour Factor	0.94	0.94	0.94	0.94	0.94	0.94	0.94	0.94	0.94			
Percent Heavy Veh, %	4	2	0	0	2	13	2	0	2			
Cap, veh/h	279	2622	0	0	1579	438	1358	249	403			
Arrive On Green	0.16	0.51	0.00	0.00	0.31	0.31	0.38	0.38	0.38			
Sat Flow, veh/h	1753	5274	0	0	5274	1416	3563	654	1056			
Grp Volume(v), veh/h	246	2015	0	0	1256	110	1005	0	395			
Grp Sat Flow(s),veh/h/ln	1753	1702	0	0	1702	1416	1781	0	1710			
Q Serve(g_s), s	13.7	31.6	0.0	0.0	22.5	5.8	24.2	0.0	18.5			
Cycle Q Clear(g_c), s	13.7	31.6	0.0	0.0	22.5	5.8	24.2	0.0	18.5			
Prop In Lane	1.00		0.00	0.00		1.00	1.00		0.62			
Lane Grp Cap(c), veh/h	279	2622	0	0	1579	438	1358	0	652			
V/C Ratio(X)	0.88	0.77	0.00	0.00	0.80	0.25	0.74	0.00	0.61			
Avail Cap(c_a), veh/h	353	3150	0	0	1890	524	1358	0	652			
HCM Platoon Ratio	1.00	1.00	1.00	1.00	1.00	1.00	1.00	1.00	1.00			
Upstream Filter(I)	1.00	1.00	0.00	0.00	1.00	1.00	1.00	0.00	1.00			
Uniform Delay (d), s/veh	41.0	19.5	0.0	0.0	31.5	25.8	26.6	0.0	24.8			
Incr Delay (d2), s/veh	17.7	1.0	0.0	0.0	2.1	0.3	3.7	0.0	4.2			
Initial Q Delay(d3),s/veh	0.0	0.0	0.0	0.0	0.0	0.0	0.0	0.0	0.0			
%ile BackOfQ(50%),veh/ln	6.9	10.8	0.0	0.0	8.7	1.8	10.3	0.0	7.8			
Unsig. Movement Delay, s/veh												
LnGrp Delay(d),s/veh	58.7	20.5	0.0	0.0	33.6	26.1	30.3	0.0	29.0			
LnGrp LOS	E	C	A	A	C	C	C	A	C			
Approach Vol, veh/h		2261			1366			1400				
Approach Delay, s/veh		24.6			33.0			29.9				
Approach LOS		C			C			C				
Timer - Assigned Phs		2			5	6		8				
Phs Duration (G+Y+Rc), s		56.7			20.4	36.3		43.0				
Change Period (Y+Rc), s		5.5			4.5	5.5		5.0				
Max Green Setting (Gmax), s		61.5			20.1	36.9		38.0				
Max Q Clear Time (g_c+I1), s		33.6			15.7	24.5		26.2				
Green Ext Time (p_c), s		16.6			0.2	6.4		5.2				

Intersection Summary

HCM 6th Ctrl Delay	28.4
HCM 6th LOS	C

Notes

User approved volume balancing among the lanes for turning movement.

Timings

31: I-215 NB Ramps/Old 215 Frontage Rd. & Cactus Av.



Lane Group	EBL	EBT	EBR	WBT	NBL	NBT	NBR	SBL	SBT
Lane Configurations	↘	↑↑	↗	↑↑↑	↘↗	↗	↗	↘	↗
Traffic Volume (vph)	105	1725	749	1961	224	250	4	191	3
Future Volume (vph)	105	1725	749	1961	224	250	4	191	3
Turn Type	Perm	NA	Perm	NA	Prot	NA	Perm	Perm	NA
Protected Phases		2		6	3	8			4
Permitted Phases	2		2				8	4	
Detector Phase	2	2	2	6	3	8	8	4	4
Switch Phase									
Minimum Initial (s)	5.0	5.0	5.0	5.0	5.0	5.0	5.0	5.0	5.0
Minimum Split (s)	11.0	11.0	11.0	44.0	9.1	10.5	10.5	10.5	10.5
Total Split (s)	64.0	64.0	64.0	64.0	14.0	36.0	36.0	22.0	22.0
Total Split (%)	64.0%	64.0%	64.0%	64.0%	14.0%	36.0%	36.0%	22.0%	22.0%
Yellow Time (s)	5.0	5.0	5.0	5.0	3.6	4.5	4.5	4.5	4.5
All-Red Time (s)	1.0	1.0	1.0	1.0	0.5	1.0	1.0	1.0	1.0
Lost Time Adjust (s)	0.0	0.0	0.0	0.0	0.0	0.0	0.0	0.0	0.0
Total Lost Time (s)	6.0	6.0	6.0	6.0	4.1	5.5	5.5	5.5	5.5
Lead/Lag					Lead			Lag	Lag
Lead-Lag Optimize?					Yes			Yes	Yes
Recall Mode	Min	Min	Min	Min	None	None	None	None	None
Act Effct Green (s)	58.0	58.0	58.0	58.0	9.8	30.4	30.4	16.5	16.5
Actuated g/C Ratio	0.58	0.58	0.58	0.58	0.10	0.30	0.30	0.17	0.17
v/c Ratio	1.49	0.89	0.66	0.77	0.74	0.49	0.01	1.12	0.76
Control Delay	303.6	25.4	3.8	18.1	59.1	32.2	0.0	142.6	56.0
Queue Delay	0.0	0.0	0.0	0.0	0.0	0.0	0.0	0.0	0.0
Total Delay	303.6	25.4	3.8	18.1	59.1	32.2	0.0	142.6	56.0
LOS	F	C	A	B	E	C	A	F	E
Approach Delay		30.4		18.1		44.6			98.2
Approach LOS		C		B		D			F

Intersection Summary

Cycle Length: 100
 Actuated Cycle Length: 99.9
 Natural Cycle: 70
 Control Type: Actuated-Uncoordinated
 Maximum v/c Ratio: 1.49
 Intersection Signal Delay: 31.6
 Intersection LOS: C
 Intersection Capacity Utilization 90.8%
 ICU Level of Service E
 Analysis Period (min) 15

Splits and Phases: 31: I-215 NB Ramps/Old 215 Frontage Rd. & Cactus Av.



HCM 6th Signalized Intersection Summary

West Campus Upper Plateau (JN 14064)

31: I-215 NB Ramps/Old 215 Frontage Rd. & Cactus Av.

09/19/2022

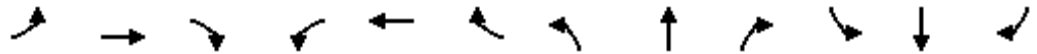

Movement	EBL	EBT	EBR	WBL	WBT	WBR	NBL	NBT	NBR	SBL	SBT	SBR
Lane Configurations	↘	↑↑	↗		↑↑↑		↘↗	↑	↗	↘	↑	↗
Traffic Volume (veh/h)	105	1725	749	0	1961	185	224	250	4	191	3	199
Future Volume (veh/h)	105	1725	749	0	1961	185	224	250	4	191	3	199
Initial Q (Qb), veh	0	0	0	0	0	0	0	0	0	0	0	0
Ped-Bike Adj(A_pbT)	1.00		1.00	1.00		1.00	1.00		1.00	1.00		1.00
Parking Bus, Adj	1.00	1.00	1.00	1.00	1.00	1.00	1.00	1.00	1.00	1.00	1.00	1.00
Work Zone On Approach		No			No			No			No	
Adj Sat Flow, veh/h/ln	1856	1841	1767	0	1856	1885	1767	1856	1900	1841	1900	1885
Adj Flow Rate, veh/h	109	1797	776	0	2043	145	233	260	0	199	3	181
Peak Hour Factor	0.96	0.96	0.96	0.96	0.96	0.96	0.96	0.96	0.96	0.96	0.96	0.96
Percent Heavy Veh, %	3	4	9	0	3	1	9	3	0	4	0	1
Cap, veh/h	123	2051	878	0	2833	200	299	551		257	4	265
Arrive On Green	0.59	0.59	0.59	0.00	0.59	0.59	0.09	0.30	0.00	0.17	0.17	0.17
Sat Flow, veh/h	178	3497	1497	0	4997	341	3365	1856	1610	1102	26	1588
Grp Volume(v), veh/h	109	1797	776	0	1425	763	233	260	0	199	0	184
Grp Sat Flow(s),veh/h/ln	178	1749	1497	0	1689	1794	1682	1856	1610	1102	0	1614
Q Serve(g_s), s	27.7	43.2	44.0	0.0	29.8	30.3	6.7	11.3	0.0	16.5	0.0	10.6
Cycle Q Clear(g_c), s	58.0	43.2	44.0	0.0	29.8	30.3	6.7	11.3	0.0	16.5	0.0	10.6
Prop In Lane	1.00		1.00	0.00		0.19	1.00		1.00	1.00		0.98
Lane Grp Cap(c), veh/h	123	2051	878	0	1981	1052	299	551		257	0	269
V/C Ratio(X)	0.89	0.88	0.88	0.00	0.72	0.73	0.78	0.47		0.78	0.00	0.68
Avail Cap(c_a), veh/h	123	2051	878	0	1981	1052	337	572		257	0	269
HCM Platoon Ratio	1.00	1.00	1.00	1.00	1.00	1.00	1.00	1.00	1.00	1.00	1.00	1.00
Upstream Filter(I)	1.00	1.00	1.00	0.00	1.00	1.00	1.00	1.00	0.00	1.00	0.00	1.00
Uniform Delay (d), s/veh	43.1	17.4	17.5	0.0	14.6	14.7	44.1	28.4	0.0	41.8	0.0	38.7
Incr Delay (d2), s/veh	47.9	4.4	10.2	0.0	1.1	2.2	10.0	0.2	0.0	12.6	0.0	5.8
Initial Q Delay(d3),s/veh	0.0	0.0	0.0	0.0	0.0	0.0	0.0	0.0	0.0	0.0	0.0	0.0
%ile BackOfQ(50%),veh/ln	4.2	15.7	15.1	0.0	9.9	11.0	3.1	4.8	0.0	5.5	0.0	4.4
Unsig. Movement Delay, s/veh												
LnGrp Delay(d),s/veh	91.0	21.8	27.8	0.0	15.7	16.9	54.1	28.6	0.0	54.4	0.0	44.5
LnGrp LOS	F	C	C	A	B	B	D	C		D	A	D
Approach Vol, veh/h		2682			2188			493				383
Approach Delay, s/veh		26.4			16.1			40.7				49.7
Approach LOS		C			B			D				D
Timer - Assigned Phs		2	3	4		6		8				
Phs Duration (G+Y+Rc), s		64.0	12.9	22.0		64.0		34.9				
Change Period (Y+Rc), s		6.0	4.1	5.5		6.0		5.5				
Max Green Setting (Gmax), s		58.0	9.9	16.5		58.0		30.5				
Max Q Clear Time (g_c+I1), s		60.0	8.7	18.5		32.3		13.3				
Green Ext Time (p_c), s		0.0	0.1	0.0		12.0		0.7				

Intersection Summary

HCM 6th Ctrl Delay	25.2
HCM 6th LOS	C

Notes

User approved volume balancing among the lanes for turning movement.
 Unsignalized Delay for [NBR] is excluded from calculations of the approach delay and intersection delay.

Timings
36: Elsworth St. & Cactus Av.

West Campus Upper Plateau (JN 14064)

09/19/2022



Lane Group	EBL	EBT	EBR	WBL	WBT	WBR	NBL	NBT	SBL	SBT	SBR
Lane Configurations	↘	↑↑↑	↗	↘	↑↑↑	↗	↘	↗	↘	↑	↗
Traffic Volume (vph)	209	2239	30	17	1405	95	219	73	231	15	224
Future Volume (vph)	209	2239	30	17	1405	95	219	73	231	15	224
Turn Type	Prot	NA	Perm	Prot	NA	Perm	Prot	NA	Prot	NA	pm+ov
Protected Phases	5	2		1	6		3	8	7	4	5
Permitted Phases			2			6					4
Detector Phase	5	2	2	1	6	6	3	8	7	4	5
Switch Phase											
Minimum Initial (s)	5.0	10.0	10.0	5.0	10.0	10.0	5.0	10.0	5.0	10.0	5.0
Minimum Split (s)	9.6	36.2	36.2	9.6	36.2	36.2	15.4	35.4	15.4	35.4	9.6
Total Split (s)	19.8	55.0	55.0	9.6	44.8	44.8	19.6	35.4	20.0	35.8	19.8
Total Split (%)	16.5%	45.8%	45.8%	8.0%	37.3%	37.3%	16.3%	29.5%	16.7%	29.8%	16.5%
Yellow Time (s)	3.6	5.2	5.2	3.6	5.2	5.2	4.4	4.4	4.4	4.4	3.6
All-Red Time (s)	1.0	1.0	1.0	1.0	1.0	1.0	1.0	1.0	1.0	1.0	1.0
Lost Time Adjust (s)	0.0	0.0	0.0	0.0	0.0	0.0	0.0	0.0	0.0	0.0	0.0
Total Lost Time (s)	4.6	6.2	6.2	4.6	6.2	6.2	5.4	5.4	5.4	5.4	4.6
Lead/Lag	Lead	Lead	Lead	Lag	Lag	Lag	Lag	Lag	Lead	Lead	Lead
Lead-Lag Optimize?	Yes	Yes	Yes	Yes	Yes	Yes	Yes	Yes	Yes	Yes	Yes
Recall Mode	None	None	None	None	None	None	None	None	None	None	None
Act Effct Green (s)	15.3	53.2	53.2	5.0	36.9	36.9	26.0	15.0	14.7	13.5	22.8
Actuated g/C Ratio	0.15	0.51	0.51	0.05	0.36	0.36	0.25	0.14	0.14	0.13	0.22
v/c Ratio	0.84	0.91	0.04	0.20	0.83	0.15	0.51	0.57	0.94	0.06	0.51
Control Delay	72.5	31.2	0.1	57.1	35.9	0.9	42.4	36.8	89.5	39.3	13.8
Queue Delay	0.0	0.0	0.0	0.0	0.0	0.0	0.0	0.0	0.0	0.0	0.0
Total Delay	72.5	31.2	0.1	57.1	35.9	0.9	42.4	36.8	89.5	39.3	13.8
LOS	E	C	A	E	D	A	D	D	F	D	B
Approach Delay		34.3			34.0			40.1		51.9	
Approach LOS		C			C			D		D	

Intersection Summary

Cycle Length: 120
 Actuated Cycle Length: 103.6
 Natural Cycle: 120
 Control Type: Actuated-Uncoordinated
 Maximum v/c Ratio: 0.94
 Intersection Signal Delay: 36.4
 Intersection LOS: D
 Intersection Capacity Utilization 87.3%
 ICU Level of Service E
 Analysis Period (min) 15

Splits and Phases: 36: Elsworth St. & Cactus Av.

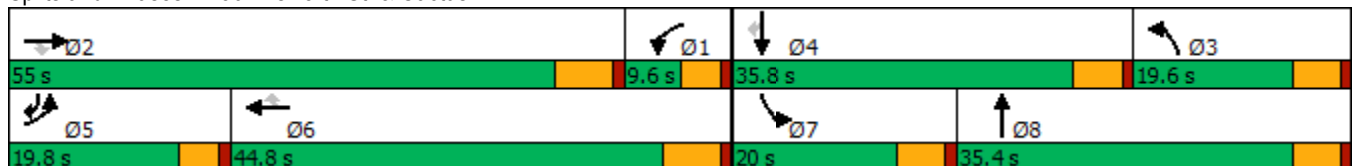

HCM 6th Signalized Intersection Summary
36: Elsworth St. & Cactus Av.

West Campus Upper Plateau (JN 14064)

09/19/2022



Movement	EBL	EBT	EBR	WBL	WBT	WBR	NBL	NBT	NBR	SBL	SBT	SBR
Lane Configurations	↗	↑↑↑	↖	↖	↑↑↑	↖	↖	↑		↖	↑	↖
Traffic Volume (veh/h)	209	2239	30	17	1405	95	219	73	85	231	15	224
Future Volume (veh/h)	209	2239	30	17	1405	95	219	73	85	231	15	224
Initial Q (Qb), veh	0	0	0	0	0	0	0	0	0	0	0	0
Ped-Bike Adj(A_pbT)	1.00		1.00	1.00		1.00	1.00		1.00	1.00		1.00
Parking Bus, Adj	1.00	1.00	1.00	1.00	1.00	1.00	1.00	1.00	1.00	1.00	1.00	1.00
Work Zone On Approach		No			No			No			No	
Adj Sat Flow, veh/h/ln	1856	1841	1781	1900	1841	1885	1885	1900	1885	1900	1900	1885
Adj Flow Rate, veh/h	218	2332	0	18	1464	63	228	76	65	241	16	126
Peak Hour Factor	0.96	0.96	0.96	0.96	0.96	0.96	0.96	0.96	0.96	0.96	0.96	0.96
Percent Heavy Veh, %	3	4	8	0	4	1	1	0	1	0	0	1
Cap, veh/h	249	2470		36	1941	617	274	100	86	268	192	387
Arrive On Green	0.14	0.49	0.00	0.02	0.39	0.39	0.15	0.11	0.11	0.15	0.10	0.10
Sat Flow, veh/h	1767	5025	1510	1810	5025	1598	1795	946	809	1810	1900	1598
Grp Volume(v), veh/h	218	2332	0	18	1464	63	228	0	141	241	16	126
Grp Sat Flow(s),veh/h/ln	1767	1675	1510	1810	1675	1598	1795	0	1754	1810	1900	1598
Q Serve(g_s), s	11.9	43.5	0.0	1.0	24.9	2.5	12.2	0.0	7.7	12.9	0.8	3.8
Cycle Q Clear(g_c), s	11.9	43.5	0.0	1.0	24.9	2.5	12.2	0.0	7.7	12.9	0.8	3.8
Prop In Lane	1.00		1.00	1.00		1.00	1.00		0.46	1.00		1.00
Lane Grp Cap(c), veh/h	249	2470		36	1941	617	274	0	186	268	192	387
V/C Ratio(X)	0.87	0.94		0.50	0.75	0.10	0.83	0.00	0.76	0.90	0.08	0.33
Avail Cap(c_a), veh/h	272	2484		92	1964	625	274	0	533	268	585	717
HCM Platoon Ratio	1.00	1.00	1.00	1.00	1.00	1.00	1.00	1.00	1.00	1.00	1.00	1.00
Upstream Filter(I)	1.00	1.00	0.00	1.00	1.00	1.00	1.00	0.00	1.00	1.00	1.00	1.00
Uniform Delay (d), s/veh	41.5	23.8	0.0	47.9	26.2	19.4	40.6	0.0	42.9	41.4	40.2	13.1
Incr Delay (d2), s/veh	22.7	8.4	0.0	4.0	1.7	0.1	19.2	0.0	6.2	30.6	0.2	0.5
Initial Q Delay(d3),s/veh	0.0	0.0	0.0	0.0	0.0	0.0	0.0	0.0	0.0	0.0	0.0	0.0
%ile BackOfQ(50%),veh/ln	6.5	16.7	0.0	0.5	9.3	0.9	6.8	0.0	3.7	7.8	0.4	1.7
Unsig. Movement Delay, s/veh												
LnGrp Delay(d),s/veh	64.2	32.2	0.0	52.0	27.9	19.4	59.9	0.0	49.1	72.0	40.4	13.6
LnGrp LOS	E	C		D	C	B	E	A	D	E	D	B
Approach Vol, veh/h		2550			1545			369			383	
Approach Delay, s/veh		34.9			27.9			55.8			51.4	
Approach LOS		C			C			E			D	
Timer - Assigned Phs	1	2	3	4	5	6	7	8				
Phs Duration (G+Y+Rc), s	8.1	54.7	20.5	15.4	18.5	44.3	20.0	15.9				
Change Period (Y+Rc), s	6.2	* 6.2	5.4	5.4	4.6	6.2	5.4	5.4				
Max Green Setting (Gmax), s	5.0	* 49	14.2	30.4	15.2	38.6	14.6	30.0				
Max Q Clear Time (g_c+I1), s	3.0	45.5	14.2	5.8	13.9	26.9	14.9	9.7				
Green Ext Time (p_c), s	0.0	3.1	0.0	0.4	0.0	7.0	0.0	0.7				

Intersection Summary

HCM 6th Ctrl Delay	35.6
HCM 6th LOS	D

Notes

- User approved pedestrian interval to be less than phase max green.
- User approved volume balancing among the lanes for turning movement.
- * HCM 6th computational engine requires equal clearance times for the phases crossing the barrier.

Timings

1: Washington St & Van Buren Bl.

09/30/2022



Lane Group	EBL	EBT	EBR	WBL	WBT	WBR	NBL	NBT	NBR	SBL	SBT
Lane Configurations	↘	↑↑↑	↗	↘	↑↑↑	↗	↘↗	↑↑	↗	↘↗	↑↗
Traffic Volume (vph)	126	877	78	122	851	234	146	219	139	332	191
Future Volume (vph)	126	877	78	122	851	234	146	219	139	332	191
Turn Type	Prot	NA	Perm	Prot	NA	pm+ov	Prot	NA	Perm	Prot	NA
Protected Phases	5	2		1	6	7	3	8		7	4
Permitted Phases			2			6			8		
Detector Phase	5	2	2	1	6	7	3	8	8	7	4
Switch Phase											
Minimum Initial (s)	5.0	10.0	10.0	5.0	10.0	10.0	10.0	10.0	10.0	10.0	10.0
Minimum Split (s)	9.2	34.2	34.2	9.2	33.2	30.8	37.4	37.4	37.4	30.8	30.8
Total Split (s)	19.2	41.8	41.8	20.0	42.6	30.8	37.4	37.4	37.4	30.8	30.8
Total Split (%)	14.8%	32.2%	32.2%	15.4%	32.8%	23.7%	28.8%	28.8%	28.8%	23.7%	23.7%
Yellow Time (s)	3.2	5.2	5.2	3.2	5.2	4.8	4.4	4.4	4.4	4.8	4.8
All-Red Time (s)	1.0	1.0	1.0	1.0	1.0	1.0	1.0	1.0	1.0	1.0	1.0
Lost Time Adjust (s)	0.0	0.0	0.0	0.0	0.0	0.0	0.0	0.0	0.0	0.0	0.0
Total Lost Time (s)	4.2	6.2	6.2	4.2	6.2	5.8	5.4	5.4	5.4	5.8	5.8
Lead/Lag	Lead	Lag	Lag	Lead	Lag	Lead	Lead	Lag	Lag	Lead	Lag
Lead-Lag Optimize?	Yes	Yes	Yes	Yes	Yes	Yes	Yes	Yes	Yes	Yes	Yes
Recall Mode	None	None	None	None	None	None	None	None	None	None	None
Act Effct Green (s)	11.0	26.2	26.2	11.0	26.1	42.0	13.8	14.8	14.8	15.5	16.4
Actuated g/C Ratio	0.12	0.29	0.29	0.12	0.29	0.47	0.15	0.16	0.16	0.17	0.18
v/c Ratio	0.59	0.62	0.14	0.58	0.60	0.28	0.28	0.39	0.38	0.57	0.43
Control Delay	53.7	31.2	0.5	53.0	30.7	2.7	37.6	37.5	9.7	40.7	31.2
Queue Delay	0.0	0.0	0.0	0.0	0.0	0.0	0.0	0.0	0.0	0.0	0.0
Total Delay	53.7	31.2	0.5	53.0	30.7	2.7	37.6	37.5	9.7	40.7	31.2
LOS	D	C	A	D	C	A	D	D	A	D	C
Approach Delay		31.6			27.6			29.9			36.4
Approach LOS		C			C			C			D

Intersection Summary

Cycle Length: 130
 Actuated Cycle Length: 90.2
 Natural Cycle: 115
 Control Type: Actuated-Uncoordinated
 Maximum v/c Ratio: 0.62
 Intersection Signal Delay: 30.8
 Intersection LOS: C
 Intersection Capacity Utilization 60.4%
 ICU Level of Service B
 Analysis Period (min) 15

Splits and Phases: 1: Washington St & Van Buren Bl.

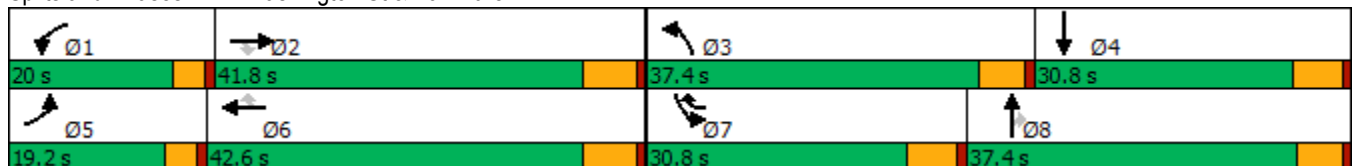

HCM 6th Signalized Intersection Summary
1: Washington St & Van Buren Bl.

West Campus Upper Plateau (JN 14064)

09/30/2022

Movement	EBL	EBT	EBR	WBL	WBT	WBR	NBL	NBT	NBR	SBL	SBT	SBR
Lane Configurations												
Traffic Volume (veh/h)	126	877	78	122	851	234	146	219	139	332	191	83
Future Volume (veh/h)	126	877	78	122	851	234	146	219	139	332	191	83
Initial Q (Qb), veh	0	0	0	0	0	0	0	0	0	0	0	0
Ped-Bike Adj(A_pbT)	1.00		1.00	1.00		1.00	1.00		0.98	1.00		0.98
Parking Bus, Adj	1.00	1.00	1.00	1.00	1.00	1.00	1.00	1.00	1.00	1.00	1.00	1.00
Work Zone On Approach		No			No			No			No	
Adj Sat Flow, veh/h/ln	1900	1856	1856	1900	1870	1900	1885	1856	1870	1885	1885	1900
Adj Flow Rate, veh/h	130	904	60	126	877	146	151	226	103	342	197	39
Peak Hour Factor	0.97	0.97	0.97	0.97	0.97	0.97	0.97	0.97	0.97	0.97	0.97	0.97
Percent Heavy Veh, %	0	3	3	0	2	0	1	3	2	1	1	0
Cap, veh/h	166	1538	478	162	1538	711	493	542	239	493	475	92
Arrive On Green	0.09	0.30	0.30	0.09	0.30	0.30	0.14	0.15	0.15	0.14	0.16	0.16
Sat Flow, veh/h	1810	5066	1572	1810	5106	1605	3483	3526	1556	3483	2981	578
Grp Volume(v), veh/h	130	904	60	126	877	146	151	226	103	342	117	119
Grp Sat Flow(s),veh/h/ln	1810	1689	1572	1810	1702	1605	1742	1763	1556	1742	1791	1768
Q Serve(g_s), s	5.0	10.7	2.0	4.8	10.2	3.9	2.7	4.1	4.2	6.6	4.1	4.3
Cycle Q Clear(g_c), s	5.0	10.7	2.0	4.8	10.2	3.9	2.7	4.1	4.2	6.6	4.1	4.3
Prop In Lane	1.00		1.00	1.00		1.00	1.00		1.00	1.00		0.33
Lane Grp Cap(c), veh/h	166	1538	478	162	1538	711	493	542	239	493	286	282
V/C Ratio(X)	0.78	0.59	0.13	0.78	0.57	0.21	0.31	0.42	0.43	0.69	0.41	0.42
Avail Cap(c_a), veh/h	384	2553	793	405	2631	1055	1578	1597	705	1233	634	626
HCM Platoon Ratio	1.00	1.00	1.00	1.00	1.00	1.00	1.00	1.00	1.00	1.00	1.00	1.00
Upstream Filter(I)	1.00	1.00	1.00	1.00	1.00	1.00	1.00	1.00	1.00	1.00	1.00	1.00
Uniform Delay (d), s/veh	31.4	20.8	17.8	31.5	20.8	12.1	27.2	27.0	27.1	28.9	26.7	26.8
Incr Delay (d2), s/veh	3.0	0.5	0.2	3.0	0.5	0.2	0.3	0.5	1.2	1.8	0.9	1.0
Initial Q Delay(d3),s/veh	0.0	0.0	0.0	0.0	0.0	0.0	0.0	0.0	0.0	0.0	0.0	0.0
%ile BackOfQ(50%),veh/ln	2.1	3.7	0.7	2.0	3.6	1.4	1.1	1.7	1.6	2.8	1.8	1.8
Unsig. Movement Delay, s/veh												
LnGrp Delay(d),s/veh	34.4	21.4	18.0	34.5	21.3	12.3	27.6	27.5	28.3	30.6	27.6	27.8
LnGrp LOS	C	C	B	C	C	B	C	C	C	C	C	C
Approach Vol, veh/h		1094			1149			480			578	
Approach Delay, s/veh		22.7			21.6			27.7			29.4	
Approach LOS		C			C			C			C	
Timer - Assigned Phs	1	2	3	4	5	6	7	8				
Phs Duration (G+Y+Rc), s	10.5	27.7	15.4	17.1	10.7	27.5	15.8	16.7				
Change Period (Y+Rc), s	* 4.2	6.2	5.4	5.8	* 4.2	6.2	5.8	* 5.8				
Max Green Setting (Gmax), s	* 16	35.6	32.0	25.0	* 15	36.4	25.0	* 32				
Max Q Clear Time (g_c+1), s	6.8	12.7	4.7	6.3	7.0	12.2	8.6	6.2				
Green Ext Time (p_c), s	0.1	8.4	0.5	1.2	0.1	8.9	1.1	1.9				
Intersection Summary												
HCM 6th Ctrl Delay			24.2									
HCM 6th LOS			C									
Notes												
* HCM 6th computational engine requires equal clearance times for the phases crossing the barrier.												

Timings

3: Overlook Pkwy./Canyon Crest Dr. & Alessandro Bl/Alessandro Bl.



Lane Group	EBL	EBT	WBL	WBT	WBR	NBL	NBT	NBR	SBL	SBT
Lane Configurations	↖	↕↕↕↕	↖	↕↕↕	↗	↖	↕↕	↗	↖↖↖	↗
Traffic Volume (vph)	38	1443	25	1570	451	19	55	29	349	57
Future Volume (vph)	38	1443	25	1570	451	19	55	29	349	57
Turn Type	Prot	NA	Prot	NA	pm+ov	Prot	NA	Perm	Prot	NA
Protected Phases	5	2	1	6	7	3	8		7	4
Permitted Phases					6			8		
Detector Phase	5	2	1	6	7	3	8	8	7	4
Switch Phase										
Minimum Initial (s)	5.0	10.0	5.0	10.0	10.0	10.0	10.0	10.0	10.0	10.0
Minimum Split (s)	9.2	35.2	9.2	35.2	38.8	15.8	15.8	15.8	38.8	38.8
Total Split (s)	9.2	56.2	9.2	56.2	38.8	15.8	15.8	15.8	38.8	38.8
Total Split (%)	7.7%	46.8%	7.7%	46.8%	32.3%	13.2%	13.2%	13.2%	32.3%	32.3%
Yellow Time (s)	3.2	5.2	3.2	5.2	4.8	4.8	4.8	4.8	4.8	4.8
All-Red Time (s)	1.0	1.0	1.0	1.0	1.0	1.0	1.0	1.0	1.0	1.0
Lost Time Adjust (s)	0.0	0.0	0.0	0.0	0.0	0.0	0.0	0.0	0.0	0.0
Total Lost Time (s)	4.2	6.2	4.2	6.2	5.8	5.8	5.8	5.8	5.8	5.8
Lead/Lag	Lead	Lag	Lead	Lag	Lead	Lead	Lag	Lag	Lead	Lag
Lead-Lag Optimize?	Yes	Yes	Yes	Yes	Yes	Yes	Yes	Yes	Yes	Yes
Recall Mode	None	None	None	None	None	None	None	None	None	None
Act Effct Green (s)	5.7	36.5	5.7	34.7	59.8	11.4	11.4	11.4	15.6	22.3
Actuated g/C Ratio	0.07	0.45	0.07	0.43	0.74	0.14	0.14	0.14	0.19	0.28
v/c Ratio	0.33	0.59	0.20	0.66	0.36	0.08	0.11	0.08	0.34	0.16
Control Delay	53.8	19.0	50.5	21.3	1.6	43.5	41.2	0.4	32.1	25.2
Queue Delay	0.0	0.0	0.0	0.0	0.0	0.0	0.0	0.0	0.0	0.0
Total Delay	53.8	19.0	50.5	21.3	1.6	43.5	41.2	0.4	32.1	25.2
LOS	D	B	D	C	A	D	D	A	C	C
Approach Delay		19.9		17.3			30.0			30.8
Approach LOS		B		B			C			C

Intersection Summary

Cycle Length: 120
 Actuated Cycle Length: 80.4
 Natural Cycle: 100
 Control Type: Actuated-Uncoordinated
 Maximum v/c Ratio: 0.66
 Intersection Signal Delay: 20.0
 Intersection LOS: B
 Intersection Capacity Utilization 59.9%
 ICU Level of Service B
 Analysis Period (min) 15

Splits and Phases: 3: Overlook Pkwy./Canyon Crest Dr. & Alessandro Bl/Alessandro Bl.

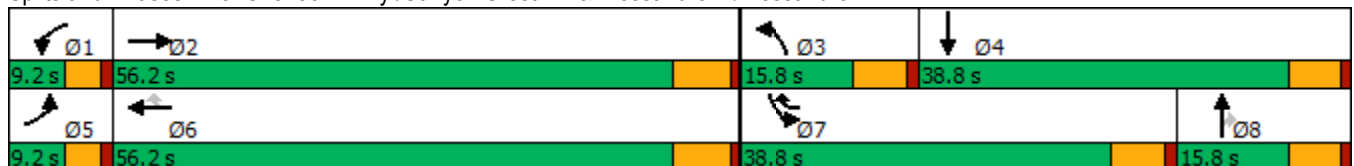

HCM 6th Signalized Intersection Summary

West Campus Upper Plateau (JN 14064)

3: Overlook Pkwy./Canyon Crest Dr. & Alessandro Bl/Alessandro Bl.

09/30/2022



Movement	EBL	EBT	EBR	WBL	WBT	WBR	NBL	NBT	NBR	SBL	SBT	SBR
Lane Configurations	↗	↑↑↑		↖	↑↑↑	↗	↖	↑↑	↗	↖↖↖	↖	
Traffic Volume (veh/h)	38	1443	23	25	1570	451	19	55	29	349	57	21
Future Volume (veh/h)	38	1443	23	25	1570	451	19	55	29	349	57	21
Initial Q (Qb), veh	0	0	0	0	0	0	0	0	0	0	0	0
Ped-Bike Adj(A_pbT)	1.00		1.00	1.00		1.00	1.00		1.00	1.00		1.00
Parking Bus, Adj	1.00	1.00	1.00	1.00	1.00	1.00	1.00	1.00	1.00	1.00	1.00	1.00
Work Zone On Approach		No			No			No				No
Adj Sat Flow, veh/h/ln	1811	1885	1811	1900	1885	1885	1781	1900	1900	1885	1767	1841
Adj Flow Rate, veh/h	39	1472	23	26	1602	452	19	56	22	356	58	12
Peak Hour Factor	0.98	0.98	0.98	0.98	0.98	0.98	0.98	0.98	0.98	0.98	0.98	0.98
Percent Heavy Veh, %	6	1	6	0	1	1	8	0	0	1	9	4
Cap, veh/h	62	2500	39	50	2497	904	211	449	200	670	177	37
Arrive On Green	0.04	0.45	0.45	0.03	0.44	0.44	0.12	0.12	0.12	0.12	0.12	0.12
Sat Flow, veh/h	1725	5553	87	1810	5656	1598	1697	3610	1610	5386	1420	294
Grp Volume(v), veh/h	39	999	496	26	1602	452	19	56	22	356	0	70
Grp Sat Flow(s),veh/h/ln	1725	1885	1869	1810	1885	1598	1697	1805	1610	1795	0	1714
Q Serve(g_s), s	1.8	15.9	15.9	1.1	17.7	13.8	0.8	1.1	1.0	5.0	0.0	3.0
Cycle Q Clear(g_c), s	1.8	15.9	15.9	1.1	17.7	13.8	0.8	1.1	1.0	5.0	0.0	3.0
Prop In Lane	1.00		0.05	1.00		1.00	1.00		1.00	1.00		0.17
Lane Grp Cap(c), veh/h	62	1698	842	50	2497	904	211	449	200	670	0	213
V/C Ratio(X)	0.63	0.59	0.59	0.52	0.64	0.50	0.09	0.12	0.11	0.53	0.00	0.33
Avail Cap(c_a), veh/h	107	2345	1163	113	3517	1192	211	449	200	2211	0	703
HCM Platoon Ratio	1.00	1.00	1.00	1.00	1.00	1.00	1.00	1.00	1.00	1.00	1.00	1.00
Upstream Filter(I)	1.00	1.00	1.00	1.00	1.00	1.00	1.00	1.00	1.00	1.00	0.00	1.00
Uniform Delay (d), s/veh	38.2	16.5	16.5	38.6	17.5	10.6	31.2	31.3	31.3	33.0	0.0	32.1
Incr Delay (d2), s/veh	3.8	0.3	0.7	3.2	0.3	0.4	0.2	0.1	0.2	0.7	0.0	0.9
Initial Q Delay(d3),s/veh	0.0	0.0	0.0	0.0	0.0	0.0	0.0	0.0	0.0	0.0	0.0	0.0
%ile BackOfQ(50%),veh/ln	0.8	5.9	5.9	0.5	6.5	4.0	0.3	0.5	0.4	2.1	0.0	1.2
Unsig. Movement Delay, s/veh												
LnGrp Delay(d),s/veh	42.0	16.9	17.2	41.8	17.8	11.0	31.4	31.4	31.5	33.7	0.0	33.0
LnGrp LOS	D	B	B	D	B	B	C	C	C	C	A	C
Approach Vol, veh/h		1534			2080			97				426
Approach Delay, s/veh		17.6			16.6			31.4				33.6
Approach LOS		B			B			C				C
Timer - Assigned Phs	1	2	3	4	5	6	7	8				
Phs Duration (G+Y+Rc), s	6.4	42.4	15.8	15.8	7.1	41.7	15.8	15.8				
Change Period (Y+Rc), s	* 4.2	6.2	5.8	5.8	* 4.2	6.2	5.8	5.8				
Max Green Setting (Gmax), s	* 5	50.0	10.0	33.0	* 5	50.0	33.0	10.0				
Max Q Clear Time (g_c+I1), s	3.1	17.9	2.8	5.0	3.8	19.7	7.0	3.1				
Green Ext Time (p_c), s	0.0	11.4	0.0	0.3	0.0	15.8	1.3	0.1				

Intersection Summary

HCM 6th Ctrl Delay	19.1
HCM 6th LOS	B

Notes

User approved pedestrian interval to be less than phase max green.
 * HCM 6th computational engine requires equal clearance times for the phases crossing the barrier.

Timings

4: Van Buren Bl. & Wood Rd.

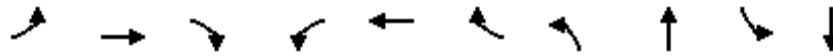

Lane Group	EBL	EBT	EBR	WBL	WBT	WBR	NBL	NBT	SBL	SBT
Lane Configurations	↘	↑↑↑	↗	↘↗	↑↑↑	↗	↘↗	↑↗	↘	↑↗
Traffic Volume (vph)	137	1098	187	194	1058	75	184	140	131	163
Future Volume (vph)	137	1098	187	194	1058	75	184	140	131	163
Turn Type	Prot	NA	pm+ov	Prot	NA	Perm	Prot	NA	Perm	NA
Protected Phases	5	2	3	1	6		3	8		4
Permitted Phases			2			6			4	
Detector Phase	5	2	3	1	6	6	3	8	4	4
Switch Phase										
Minimum Initial (s)	5.0	10.0	5.0	5.0	10.0	10.0	5.0	10.0	10.0	10.0
Minimum Split (s)	9.2	30.2	9.2	9.2	30.2	30.2	9.2	38.4	15.8	15.8
Total Split (s)	27.0	68.0	25.0	23.0	64.0	64.0	25.0	59.0	34.0	34.0
Total Split (%)	18.0%	45.3%	16.7%	15.3%	42.7%	42.7%	16.7%	39.3%	22.7%	22.7%
Yellow Time (s)	3.2	5.2	3.2	3.2	5.2	5.2	3.2	4.4	4.8	4.8
All-Red Time (s)	1.0	1.0	1.0	1.0	1.0	1.0	1.0	1.0	1.0	1.0
Lost Time Adjust (s)	0.0	0.0	0.0	0.0	0.0	0.0	0.0	0.0	0.0	0.0
Total Lost Time (s)	4.2	6.2	4.2	4.2	6.2	6.2	4.2	5.4	5.8	5.8
Lead/Lag	Lead	Lag	Lead	Lead	Lag	Lag	Lead		Lag	Lag
Lead-Lag Optimize?	Yes	Yes	Yes	Yes	Yes	Yes	Yes		Yes	Yes
Recall Mode	None	None	None	None	None	None	None	None	None	None
Act Effct Green (s)	13.2	36.9	49.8	10.9	34.6	34.6	10.7	34.1	18.5	18.5
Actuated g/C Ratio	0.13	0.37	0.50	0.11	0.35	0.35	0.11	0.35	0.19	0.19
v/c Ratio	0.60	0.61	0.22	0.53	0.62	0.13	0.51	0.23	0.66	0.45
Control Delay	55.4	27.1	2.5	50.7	29.2	6.2	50.8	13.5	57.1	23.6
Queue Delay	0.0	0.0	0.0	0.0	0.0	0.0	0.0	0.0	0.0	0.0
Total Delay	55.4	27.1	2.5	50.7	29.2	6.2	50.8	13.5	57.1	23.6
LOS	E	C	A	D	C	A	D	B	E	C
Approach Delay		26.6			31.0			28.8		33.4
Approach LOS		C			C			C		C

Intersection Summary































Cycle Length: 150
 Actuated Cycle Length: 98.7
 Natural Cycle: 80
 Control Type: Actuated-Uncoordinated
 Maximum v/c Ratio: 0.66
 Intersection Signal Delay: 29.3
 Intersection Capacity Utilization 69.1%
 Analysis Period (min) 15
 Intersection LOS: C
 ICU Level of Service C

Splits and Phases: 4: Van Buren Bl. & Wood Rd.



HCM 6th Signalized Intersection Summary
4: Van Buren Bl. & Wood Rd.

West Campus Upper Plateau (JN 14064)
09/30/2022

												
Movement	EBL	EBT	EBR	WBL	WBT	WBR	NBL	NBT	NBR	SBL	SBT	SBR
Lane Configurations		  		 	  		 	 			 	
Traffic Volume (veh/h)	137	1098	187	194	1058	75	184	140	124	131	163	155
Future Volume (veh/h)	137	1098	187	194	1058	75	184	140	124	131	163	155
Initial Q (Qb), veh	0	0	0	0	0	0	0	0	0	0	0	0
Ped-Bike Adj(A_pbT)	1.00		0.98	1.00		0.99	1.00		0.98	0.98		0.99
Parking Bus, Adj	1.00	1.00	1.00	1.00	1.00	1.00	1.00	1.00	1.00	1.00	1.00	1.00
Work Zone On Approach		No			No			No			No	
Adj Sat Flow, veh/h/ln	1885	1856	1870	1885	1870	1885	1870	1885	1870	1885	1885	1885
Adj Flow Rate, veh/h	143	1144	95	202	1102	33	192	146	52	136	170	90
Peak Hour Factor	0.96	0.96	0.96	0.96	0.96	0.96	0.96	0.96	0.96	0.96	0.96	0.96
Percent Heavy Veh, %	1	3	2	1	2	1	2	1	2	1	1	1
Cap, veh/h	181	2019	753	297	1955	603	286	779	266	285	368	185
Arrive On Green	0.10	0.40	0.40	0.09	0.38	0.38	0.08	0.30	0.30	0.16	0.16	0.16
Sat Flow, veh/h	1795	5066	1560	3483	5106	1574	3456	2603	887	1174	2296	1154
Grp Volume(v), veh/h	143	1144	95	202	1102	33	192	98	100	136	131	129
Grp Sat Flow(s),veh/h/ln	1795	1689	1560	1742	1702	1574	1728	1791	1699	1174	1791	1659
Q Serve(g_s), s	5.8	13.1	2.5	4.2	12.7	1.0	4.0	3.0	3.3	8.2	4.9	5.3
Cycle Q Clear(g_c), s	5.8	13.1	2.5	4.2	12.7	1.0	4.0	3.0	3.3	8.2	4.9	5.3
Prop In Lane	1.00		1.00	1.00		1.00	1.00		0.52	1.00		0.70
Lane Grp Cap(c), veh/h	181	2019	753	297	1955	603	286	536	509	285	287	266
V/C Ratio(X)	0.79	0.57	0.13	0.68	0.56	0.05	0.67	0.18	0.20	0.48	0.45	0.49
Avail Cap(c_a), veh/h	548	4189	1422	876	3949	1217	962	1285	1219	539	676	626
HCM Platoon Ratio	1.00	1.00	1.00	1.00	1.00	1.00	1.00	1.00	1.00	1.00	1.00	1.00
Upstream Filter(I)	1.00	1.00	1.00	1.00	1.00	1.00	1.00	1.00	1.00	1.00	1.00	1.00
Uniform Delay (d), s/veh	32.8	17.5	10.7	33.2	18.1	14.5	33.3	19.4	19.5	29.8	28.4	28.6
Incr Delay (d2), s/veh	2.9	0.4	0.1	1.0	0.4	0.1	1.0	0.2	0.2	1.2	1.1	1.4
Initial Q Delay(d3),s/veh	0.0	0.0	0.0	0.0	0.0	0.0	0.0	0.0	0.0	0.0	0.0	0.0
%ile BackOfQ(50%),veh/ln	2.5	4.3	0.8	1.7	4.3	0.3	1.6	1.2	1.2	2.3	2.1	2.1
Unsig. Movement Delay, s/veh												
LnGrp Delay(d),s/veh	35.7	17.8	10.8	34.2	18.5	14.6	34.3	19.6	19.7	31.0	29.5	29.9
LnGrp LOS	D	B	B	C	B	B	C	B	B	C	C	C
Approach Vol, veh/h		1382			1337			390			396	
Approach Delay, s/veh		19.2			20.8			26.9			30.2	
Approach LOS		B			C			C			C	
Timer - Assigned Phs	1	2	3	4	5	6		8				
Phs Duration (G+Y+Rc), s	10.6	36.0	10.4	17.8	11.7	34.8		28.2				
Change Period (Y+Rc), s	* 4.2	6.2	* 4.2	5.8	* 4.2	6.2		* 5.8				
Max Green Setting (Gmax), s	* 19	61.8	* 21	28.2	* 23	57.8		* 54				
Max Q Clear Time (g_c+I1), s	6.2	15.1	6.0	10.2	7.8	14.7		5.3				
Green Ext Time (p_c), s	0.3	14.7	0.3	1.8	0.1	13.1		1.1				

Intersection Summary

HCM 6th Ctrl Delay	21.9
HCM 6th LOS	C

Notes

* HCM 6th computational engine requires equal clearance times for the phases crossing the barrier.

Timings

7: Trautwein Rd. & Orange Terrace Pkwy

09/30/2022



Lane Group	EBL	EBT	WBL	WBT	WBR	NBL	NBT	NBR	SBL	SBT	SBR
Lane Configurations											
Traffic Volume (vph)	34	20	177	13	176	37	649	163	218	675	22
Future Volume (vph)	34	20	177	13	176	37	649	163	218	675	22
Turn Type	Prot	NA	Prot	NA	pm+ov	Prot	NA	pm+ov	Prot	NA	Perm
Protected Phases	7	4	3	8	1	5	2	3	1	6	
Permitted Phases					8			2			6
Detector Phase	7	4	3	8	1	5	2	3	1	6	6
Switch Phase											
Minimum Initial (s)	5.0	10.0	5.0	10.0	5.0	5.0	10.0	5.0	5.0	10.0	10.0
Minimum Split (s)	9.6	38.6	9.6	34.6	9.6	9.6	46.2	9.6	9.6	28.2	28.2
Total Split (s)	13.7	38.6	13.3	38.2	21.8	9.6	46.3	13.3	21.8	58.5	58.5
Total Split (%)	11.4%	32.2%	11.1%	31.8%	18.2%	8.0%	38.6%	11.1%	18.2%	48.8%	48.8%
Yellow Time (s)	3.6	3.6	3.6	3.6	3.6	3.6	5.2	3.6	3.6	5.2	5.2
All-Red Time (s)	1.0	1.0	1.0	1.0	1.0	1.0	1.0	1.0	1.0	1.0	1.0
Lost Time Adjust (s)	0.0	0.0	0.0	0.0	0.0	0.0	0.0	0.0	0.0	0.0	0.0
Total Lost Time (s)	4.6	4.6	4.6	4.6	4.6	4.6	6.2	4.6	4.6	6.2	6.2
Lead/Lag	Lead	Lag	Lead	Lag	Lead	Lead	Lag	Lead	Lead	Lag	Lag
Lead-Lag Optimize?	Yes	Yes	Yes	Yes	Yes	Yes	Yes	Yes	Yes	Yes	Yes
Recall Mode	None	None	None	None	None	None	None	None	None	None	None
Act Effct Green (s)	6.7	14.2	10.7	17.2	32.5	5.7	20.9	38.6	10.0	31.2	31.2
Actuated g/C Ratio	0.10	0.20	0.15	0.25	0.47	0.08	0.30	0.56	0.14	0.45	0.45
v/c Ratio	0.21	0.12	0.35	0.03	0.23	0.27	0.65	0.18	0.47	0.45	0.03
Control Delay	41.8	18.5	36.7	26.3	4.8	45.8	25.8	3.1	35.5	17.3	0.1
Queue Delay	0.0	0.0	0.0	0.0	0.0	0.0	0.0	0.0	0.0	0.0	0.0
Total Delay	41.8	18.5	36.7	26.3	4.8	45.8	25.8	3.1	35.5	17.3	0.1
LOS	D	B	D	C	A	D	C	A	D	B	A
Approach Delay		29.0		21.0			22.3			21.2	
Approach LOS		C		C			C			C	

Intersection Summary

Cycle Length: 120	
Actuated Cycle Length: 69.5	
Natural Cycle: 105	
Control Type: Actuated-Uncoordinated	
Maximum v/c Ratio: 0.65	
Intersection Signal Delay: 21.8	Intersection LOS: C
Intersection Capacity Utilization 48.7%	ICU Level of Service A
Analysis Period (min) 15	

Splits and Phases: 7: Trautwein Rd. & Orange Terrace Pkwy

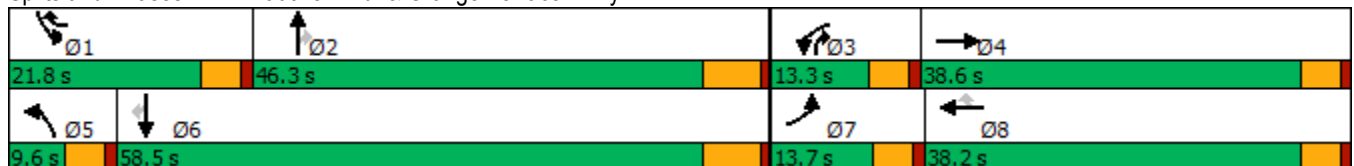

HCM 6th Signalized Intersection Summary
7: Trautwein Rd. & Orange Terrace Pkwy

West Campus Upper Plateau (JN 14064)

09/30/2022



Movement	EBL	EBT	EBR	WBL	WBT	WBR	NBL	NBT	NBR	SBL	SBT	SBR
Lane Configurations												
Traffic Volume (veh/h)	34	20	22	177	13	176	37	649	163	218	675	22
Future Volume (veh/h)	34	20	22	177	13	176	37	649	163	218	675	22
Initial Q (Qb), veh	0	0	0	0	0	0	0	0	0	0	0	0
Ped-Bike Adj(A_pbT)	1.00		1.00	1.00		1.00	1.00		1.00	1.00		1.00
Parking Bus, Adj	1.00	1.00	1.00	1.00	1.00	1.00	1.00	1.00	1.00	1.00	1.00	1.00
Work Zone On Approach		No			No			No			No	
Adj Sat Flow, veh/h/ln	1900	1900	1900	1900	1900	1870	1900	1870	1885	1870	1870	1900
Adj Flow Rate, veh/h	36	21	21	188	14	67	39	690	95	232	718	13
Peak Hour Factor	0.94	0.94	0.94	0.94	0.94	0.94	0.94	0.94	0.94	0.94	0.94	0.94
Percent Heavy Veh, %	0	0	0	0	0	2	0	2	1	2	2	0
Cap, veh/h	69	143	143	297	399	496	73	1036	601	355	1257	570
Arrive On Green	0.04	0.16	0.16	0.08	0.21	0.21	0.04	0.29	0.29	0.10	0.35	0.35
Sat Flow, veh/h	1810	872	872	3510	1900	1585	1810	3554	1598	3456	3554	1610
Grp Volume(v), veh/h	36	0	42	188	14	67	39	690	95	232	718	13
Grp Sat Flow(s),veh/h/ln	1810	0	1743	1755	1900	1585	1810	1777	1598	1728	1777	1610
Q Serve(g_s), s	1.1	0.0	1.2	2.9	0.3	1.7	1.2	9.6	2.2	3.6	9.2	0.3
Cycle Q Clear(g_c), s	1.1	0.0	1.2	2.9	0.3	1.7	1.2	9.6	2.2	3.6	9.2	0.3
Prop In Lane	1.00		0.50	1.00		1.00	1.00		1.00	1.00		1.00
Lane Grp Cap(c), veh/h	69	0	285	297	399	496	73	1036	601	355	1257	570
V/C Ratio(X)	0.52	0.00	0.15	0.63	0.04	0.14	0.53	0.67	0.16	0.65	0.57	0.02
Avail Cap(c_a), veh/h	294	0	1059	546	1141	1115	162	2546	1280	1062	3321	1505
HCM Platoon Ratio	1.00	1.00	1.00	1.00	1.00	1.00	1.00	1.00	1.00	1.00	1.00	1.00
Upstream Filter(I)	1.00	0.00	1.00	1.00	1.00	1.00	1.00	1.00	1.00	1.00	1.00	1.00
Uniform Delay (d), s/veh	26.4	0.0	20.1	24.8	17.6	13.8	26.3	17.4	11.6	24.1	14.6	11.8
Incr Delay (d2), s/veh	2.2	0.0	0.2	0.8	0.0	0.1	2.2	0.7	0.1	0.8	0.4	0.0
Initial Q Delay(d3),s/veh	0.0	0.0	0.0	0.0	0.0	0.0	0.0	0.0	0.0	0.0	0.0	0.0
%ile BackOfQ(50%),veh/ln	0.5	0.0	0.5	1.1	0.1	0.5	0.5	3.2	0.6	1.3	2.9	0.1
Unsig. Movement Delay, s/veh												
LnGrp Delay(d),s/veh	28.6	0.0	20.3	25.6	17.6	13.9	28.5	18.2	11.7	24.9	15.1	11.8
LnGrp LOS	C	A	C	C	B	B	C	B	B	C	B	B
Approach Vol, veh/h		78			269			824			963	
Approach Delay, s/veh		24.1			22.3			17.9			17.4	
Approach LOS		C			C			B			B	
Timer - Assigned Phs	1	2	3	4	5	6	7	8				
Phs Duration (G+Y+Rc), s	10.4	22.5	9.3	13.8	6.9	26.0	6.7	16.4				
Change Period (Y+Rc), s	4.6	6.2	4.6	4.6	4.6	6.2	4.6	4.6				
Max Green Setting (Gmax), s	17.2	40.1	8.7	34.0	5.0	52.3	9.1	33.6				
Max Q Clear Time (g_c+I1), s	5.6	11.6	4.9	3.2	3.2	11.2	3.1	3.7				
Green Ext Time (p_c), s	0.3	4.8	0.1	0.2	0.0	4.9	0.0	0.2				

Intersection Summary

HCM 6th Ctrl Delay	18.5
HCM 6th LOS	B

Notes

User approved volume balancing among the lanes for turning movement.

Timings
8: Cole Av. & Van Buren Bl.

West Campus Upper Plateau (JN 14064)

09/30/2022



Lane Group	EBL	EBT	EBR	WBL	WBT	WBR	NBL	NBT	SBL	SBT	SBR
Lane Configurations	↔↔	↑↑↑	↗	↖	↑↑↑	↗	↖	↑↑	↔↔	↑↑	↗
Traffic Volume (vph)	347	877	80	134	939	188	106	263	176	235	248
Future Volume (vph)	347	877	80	134	939	188	106	263	176	235	248
Turn Type	Prot	NA	pm+ov	Prot	NA	pm+ov	Prot	NA	Prot	NA	pm+ov
Protected Phases	5	2	3	1	6	7	3	8	7	4	5
Permitted Phases			2			6					4
Detector Phase	5	2	3	1	6	7	3	8	7	4	5
Switch Phase											
Minimum Initial (s)	5.0	10.0	5.0	5.0	10.0	5.0	5.0	10.0	5.0	10.0	5.0
Minimum Split (s)	9.1	36.2	9.1	9.1	36.2	9.1	9.1	42.2	9.1	49.2	9.1
Total Split (s)	18.0	41.0	11.7	18.1	41.1	17.1	11.7	43.8	17.1	49.2	18.0
Total Split (%)	15.0%	34.2%	9.8%	15.1%	34.3%	14.3%	9.8%	36.5%	14.3%	41.0%	15.0%
Yellow Time (s)	3.2	5.2	3.2	3.2	5.2	3.2	3.2	5.2	3.2	5.2	3.2
All-Red Time (s)	0.5	1.0	0.5	0.5	1.0	0.5	0.5	1.0	0.5	1.0	0.5
Lost Time Adjust (s)	0.0	0.0	0.0	0.0	0.0	0.0	0.0	0.0	0.0	0.0	0.0
Total Lost Time (s)	3.7	6.2	3.7	3.7	6.2	3.7	3.7	6.2	3.7	6.2	3.7
Lead/Lag	Lead	Lag	Lead	Lead	Lag	Lead	Lead	Lag	Lead	Lag	Lead
Lead-Lag Optimize?	Yes	Yes	Yes	Yes	Yes	Yes	Yes	Yes	Yes	Yes	Yes
Recall Mode	None	None	None	None	None	None	None	None	None	None	None
Act Effct Green (s)	13.5	28.3	43.0	11.3	26.1	41.9	8.3	16.8	9.3	17.9	33.9
Actuated g/C Ratio	0.16	0.33	0.50	0.13	0.30	0.49	0.10	0.19	0.11	0.21	0.39
v/c Ratio	0.67	0.57	0.10	0.61	0.64	0.23	0.64	0.49	0.50	0.33	0.39
Control Delay	44.2	27.0	3.5	51.2	29.3	3.1	60.6	31.4	44.2	30.1	13.9
Queue Delay	0.0	0.0	0.0	0.0	0.0	0.0	0.0	0.0	0.0	0.0	0.0
Total Delay	44.2	27.0	3.5	51.2	29.3	3.1	60.6	31.4	44.2	30.1	13.9
LOS	D	C	A	D	C	A	E	C	D	C	B
Approach Delay		30.1			27.7			38.5		27.8	
Approach LOS		C			C			D		C	

Intersection Summary

Cycle Length: 120	
Actuated Cycle Length: 86.3	
Natural Cycle: 105	
Control Type: Actuated-Uncoordinated	
Maximum v/c Ratio: 0.67	
Intersection Signal Delay: 29.9	Intersection LOS: C
Intersection Capacity Utilization 62.1%	ICU Level of Service B
Analysis Period (min) 15	



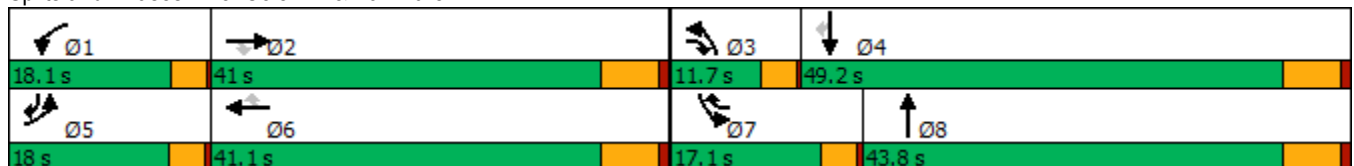



























Splits and Phases: 8: Cole Av. & Van Buren Bl.



HCM 6th Signalized Intersection Summary
8: Cole Av. & Van Buren Bl.

West Campus Upper Plateau (JN 14064)

09/30/2022

												
Movement	EBL	EBT	EBR	WBL	WBT	WBR	NBL	NBT	NBR	SBL	SBT	SBR
Lane Configurations	 	  			  			 		 	 	
Traffic Volume (veh/h)	347	877	80	134	939	188	106	263	66	176	235	248
Future Volume (veh/h)	347	877	80	134	939	188	106	263	66	176	235	248
Initial Q (Qb), veh	0	0	0	0	0	0	0	0	0	0	0	0
Ped-Bike Adj(A_pbT)	1.00		1.00	1.00		1.00	1.00		0.99	1.00		1.00
Parking Bus, Adj	1.00	1.00	1.00	1.00	1.00	1.00	1.00	1.00	1.00	1.00	1.00	1.00
Work Zone On Approach		No			No			No			No	
Adj Sat Flow, veh/h/ln	1870	1826	1856	1856	1856	1870	1885	1885	1870	1856	1885	1885
Adj Flow Rate, veh/h	361	914	26	140	978	107	110	274	62	183	245	160
Peak Hour Factor	0.96	0.96	0.96	0.96	0.96	0.96	0.96	0.96	0.96	0.96	0.96	0.96
Percent Heavy Veh, %	2	5	3	3	3	2	1	1	2	3	1	1
Cap, veh/h	468	1802	692	177	1655	647	141	480	107	278	601	484
Arrive On Green	0.14	0.36	0.36	0.10	0.33	0.33	0.08	0.17	0.17	0.08	0.17	0.17
Sat Flow, veh/h	3456	4985	1572	1767	5066	1585	1795	2907	647	3428	3582	1595
Grp Volume(v), veh/h	361	914	26	140	978	107	110	167	169	183	245	160
Grp Sat Flow(s),veh/h/ln	1728	1662	1572	1767	1689	1585	1795	1791	1763	1714	1791	1595
Q Serve(g_s), s	6.9	9.7	0.6	5.3	10.9	2.9	4.1	5.8	6.0	3.5	4.1	5.3
Cycle Q Clear(g_c), s	6.9	9.7	0.6	5.3	10.9	2.9	4.1	5.8	6.0	3.5	4.1	5.3
Prop In Lane	1.00		1.00	1.00		1.00	1.00		0.37	1.00		1.00
Lane Grp Cap(c), veh/h	468	1802	692	177	1655	647	141	296	291	278	601	484
V/C Ratio(X)	0.77	0.51	0.04	0.79	0.59	0.17	0.78	0.56	0.58	0.66	0.41	0.33
Avail Cap(c_a), veh/h	728	2554	929	375	2603	943	211	992	976	676	2268	1226
HCM Platoon Ratio	1.00	1.00	1.00	1.00	1.00	1.00	1.00	1.00	1.00	1.00	1.00	1.00
Upstream Filter(I)	1.00	1.00	1.00	1.00	1.00	1.00	1.00	1.00	1.00	1.00	1.00	1.00
Uniform Delay (d), s/veh	28.4	16.9	10.8	29.8	19.1	12.8	30.7	26.1	26.2	30.3	25.2	18.3
Incr Delay (d2), s/veh	1.0	0.3	0.0	2.9	0.5	0.2	5.0	1.7	1.8	1.0	0.4	0.4
Initial Q Delay(d3),s/veh	0.0	0.0	0.0	0.0	0.0	0.0	0.0	0.0	0.0	0.0	0.0	0.0
%ile BackOfQ(50%),veh/ln	2.6	3.1	0.2	2.1	3.7	0.9	1.8	2.3	2.4	1.3	1.6	1.7
Unsig. Movement Delay, s/veh												
LnGrp Delay(d),s/veh	29.4	17.3	10.9	32.8	19.6	12.9	35.7	27.8	28.0	31.3	25.7	18.7
LnGrp LOS	C	B	B	C	B	B	D	C	C	C	C	B
Approach Vol, veh/h		1301			1225			446			588	
Approach Delay, s/veh		20.5			20.5			29.8			25.5	
Approach LOS		C			C			C			C	
Timer - Assigned Phs	1	2	3	4	5	6	7	8				
Phs Duration (G+Y+Rc), s	10.5	30.8	9.0	17.6	12.9	28.4	9.2	17.4				
Change Period (Y+Rc), s	3.7	6.2	3.7	6.2	3.7	6.2	3.7	6.2				
Max Green Setting (Gmax), s	14.4	34.8	8.0	43.0	14.3	34.9	13.4	37.6				
Max Q Clear Time (g_c+I1), s	7.3	11.7	6.1	7.3	8.9	12.9	5.5	8.0				
Green Ext Time (p_c), s	0.1	8.4	0.0	1.9	0.3	9.2	0.2	1.7				
Intersection Summary												
HCM 6th Ctrl Delay			22.5									
HCM 6th LOS			C									

Timings
10: Orange Terrace Pkwy & Deercreek Dr

West Campus Upper Plateau (JN 14064)

09/30/2022



Lane Group	EBL	EBT	WBL	WBT	NBL	NBT	SBL	SBT
Lane Configurations	↖	↕	↖	↕		↕		↕
Traffic Volume (vph)	59	234	9	307	28	5	54	6
Future Volume (vph)	59	234	9	307	28	5	54	6
Turn Type	Perm	NA	Perm	NA	Perm	NA	Perm	NA
Protected Phases		4		8		2		6
Permitted Phases	4		8		2		6	
Detector Phase	4	4	8	8	2	2	6	6
Switch Phase								
Minimum Initial (s)	5.0	5.0	5.0	5.0	5.0	5.0	5.0	5.0
Minimum Split (s)	26.1	26.1	26.1	26.1	26.1	26.1	26.1	26.1
Total Split (s)	28.0	28.0	28.0	28.0	27.0	27.0	27.0	27.0
Total Split (%)	50.9%	50.9%	50.9%	50.9%	49.1%	49.1%	49.1%	49.1%
Yellow Time (s)	3.6	3.6	3.6	3.6	3.6	3.6	3.6	3.6
All-Red Time (s)	0.5	0.5	0.5	0.5	0.5	0.5	0.5	0.5
Lost Time Adjust (s)	0.0	0.0	0.0	0.0		0.0		0.0
Total Lost Time (s)	4.1	4.1	4.1	4.1		4.1		4.1
Lead/Lag								
Lead-Lag Optimize?								
Recall Mode	None	None	None	None	Min	Min	Min	Min
Act Effect Green (s)	10.0	10.0	10.0	10.0		8.7		8.7
Actuated g/C Ratio	0.36	0.36	0.36	0.36		0.31		0.31
v/c Ratio	0.20	0.22	0.03	0.32		0.10		0.26
Control Delay	8.8	7.0	7.3	6.8		7.5		6.1
Queue Delay	0.0	0.0	0.0	0.0		0.0		0.0
Total Delay	8.8	7.0	7.3	6.8		7.5		6.1
LOS	A	A	A	A		A		A
Approach Delay		7.3		6.8		7.5		6.1
Approach LOS		A		A		A		A

Intersection Summary

Cycle Length: 55
 Actuated Cycle Length: 28
 Natural Cycle: 55
 Control Type: Actuated-Uncoordinated
 Maximum v/c Ratio: 0.32
 Intersection Signal Delay: 6.9
 Intersection Capacity Utilization 33.1%
 Analysis Period (min) 15
 Intersection LOS: A
 ICU Level of Service A

Splits and Phases: 10: Orange Terrace Pkwy & Deercreek Dr

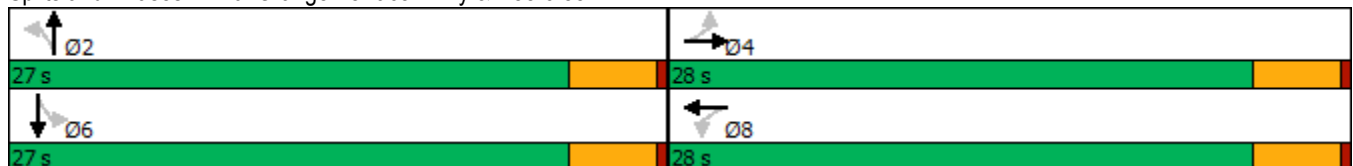

HCM 6th Signalized Intersection Summary
10: Orange Terrace Pkwy & Deercreek Dr

West Campus Upper Plateau (JN 14064)

09/30/2022



Movement	EBL	EBT	EBR	WBL	WBT	WBR	NBL	NBT	NBR	SBL	SBT	SBR
Lane Configurations												
Traffic Volume (veh/h)	59	234	9	9	307	57	28	5	5	54	6	59
Future Volume (veh/h)	59	234	9	9	307	57	28	5	5	54	6	59
Initial Q (Qb), veh	0	0	0	0	0	0	0	0	0	0	0	0
Ped-Bike Adj(A_pbT)	1.00		0.98	1.00		1.00	1.00		0.99	0.99		0.97
Parking Bus, Adj	1.00	1.00	1.00	1.00	1.00	1.00	1.00	1.00	1.00	1.00	1.00	1.00
Work Zone On Approach		No			No			No			No	
Adj Sat Flow, veh/h/ln	1856	1870	1796	1900	1885	1900	1811	1900	1900	1900	1900	1900
Adj Flow Rate, veh/h	66	260	10	10	341	63	31	6	6	60	7	66
Peak Hour Factor	0.90	0.90	0.90	0.90	0.90	0.90	0.90	0.90	0.90	0.90	0.90	0.90
Percent Heavy Veh, %	3	2	7	0	1	0	6	0	0	0	0	0
Cap, veh/h	588	1118	43	661	970	177	556	107	57	394	79	208
Arrive On Green	0.32	0.32	0.32	0.32	0.32	0.32	0.27	0.27	0.27	0.27	0.27	0.27
Sat Flow, veh/h	972	3486	134	1127	3022	552	914	401	213	494	296	778
Grp Volume(v), veh/h	66	132	138	10	201	203	43	0	0	133	0	0
Grp Sat Flow(s),veh/h/ln	972	1777	1843	1127	1791	1784	1528	0	0	1568	0	0
Q Serve(g_s), s	1.1	1.1	1.1	0.1	1.7	1.7	0.0	0.0	0.0	0.0	0.0	0.0
Cycle Q Clear(g_c), s	2.9	1.1	1.1	1.2	1.7	1.7	0.3	0.0	0.0	1.2	0.0	0.0
Prop In Lane	1.00		0.07	1.00		0.31	0.72		0.14	0.45		0.50
Lane Grp Cap(c), veh/h	588	570	591	661	575	572	720	0	0	682	0	0
V/C Ratio(X)	0.11	0.23	0.23	0.02	0.35	0.36	0.06	0.00	0.00	0.20	0.00	0.00
Avail Cap(c_a), veh/h	1442	2131	2210	1651	2148	2140	1985	0	0	2013	0	0
HCM Platoon Ratio	1.00	1.00	1.00	1.00	1.00	1.00	1.00	1.00	1.00	1.00	1.00	1.00
Upstream Filter(I)	1.00	1.00	1.00	1.00	1.00	1.00	1.00	0.00	0.00	1.00	0.00	0.00
Uniform Delay (d), s/veh	6.3	5.0	5.0	5.4	5.2	5.2	5.5	0.0	0.0	5.8	0.0	0.0
Incr Delay (d2), s/veh	0.1	0.2	0.2	0.0	0.4	0.4	0.0	0.0	0.0	0.1	0.0	0.0
Initial Q Delay(d3),s/veh	0.0	0.0	0.0	0.0	0.0	0.0	0.0	0.0	0.0	0.0	0.0	0.0
%ile BackOfQ(50%),veh/ln	0.1	0.1	0.1	0.0	0.3	0.3	0.1	0.0	0.0	0.2	0.0	0.0
Unsig. Movement Delay, s/veh												
LnGrp Delay(d),s/veh	6.4	5.2	5.2	5.4	5.5	5.6	5.5	0.0	0.0	5.9	0.0	0.0
LnGrp LOS	A	A	A	A	A	A	A	A	A	A	A	A
Approach Vol, veh/h		336			414			43				133
Approach Delay, s/veh		5.4			5.5			5.5				5.9
Approach LOS		A			A			A				A
Timer - Assigned Phs		2		4		6		8				
Phs Duration (G+Y+Rc), s		9.4		10.5		9.4		10.5				
Change Period (Y+Rc), s		4.1		4.1		4.1		4.1				
Max Green Setting (Gmax), s		22.9		23.9		22.9		23.9				
Max Q Clear Time (g_c+I1), s		2.3		4.9		3.2		3.7				
Green Ext Time (p_c), s		0.1		1.5		0.7		2.5				

Intersection Summary

HCM 6th Ctrl Delay	5.5
HCM 6th LOS	A

Timings
13: Barton Rd. & Orange Terrace Pkwy

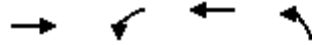

Lane Group	EBT	WBL	WBT	NBL
Lane Configurations	↑↑	↑	↑↑	↑
Traffic Volume (vph)	308	51	455	226
Future Volume (vph)	308	51	455	226
Turn Type	NA	Perm	NA	Prot
Protected Phases	4		8	2
Permitted Phases		8		
Detector Phase	4	8	8	2
Switch Phase				
Minimum Initial (s)	10.0	10.0	10.0	10.0
Minimum Split (s)	21.7	14.7	14.7	21.6
Total Split (s)	28.0	28.0	28.0	27.0
Total Split (%)	50.9%	50.9%	50.9%	49.1%
Yellow Time (s)	3.7	3.7	3.7	3.6
All-Red Time (s)	1.0	1.0	1.0	1.0
Lost Time Adjust (s)	0.0	0.0	0.0	0.0
Total Lost Time (s)	4.7	4.7	4.7	4.6
Lead/Lag				
Lead-Lag Optimize?				
Recall Mode	Min	Min	Min	None
Act Effct Green (s)	13.2	13.2	13.2	11.8
Actuated g/C Ratio	0.38	0.38	0.38	0.34
v/c Ratio	0.46	0.21	0.38	0.49
Control Delay	5.5	10.2	9.0	11.7
Queue Delay	0.0	0.0	0.0	0.0
Total Delay	5.5	10.2	9.0	11.7
LOS	A	B	A	B
Approach Delay	5.5		9.1	11.7
Approach LOS	A		A	B

Intersection Summary

Cycle Length: 55
 Actuated Cycle Length: 34.5
 Natural Cycle: 45
 Control Type: Actuated-Uncoordinated
 Maximum v/c Ratio: 0.49
 Intersection Signal Delay: 8.1
 Intersection Capacity Utilization 52.2%
 Analysis Period (min) 15

Intersection LOS: A
 ICU Level of Service A

Splits and Phases: 13: Barton Rd. & Orange Terrace Pkwy

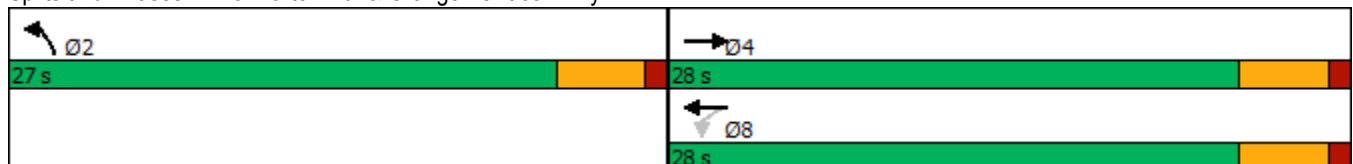

HCM 6th Signalized Intersection Summary
 13: Barton Rd. & Orange Terrace Pkwy

West Campus Upper Plateau (JN 14064)

09/30/2022

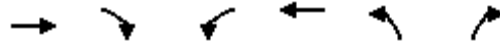

Movement	EBT	EBR	WBL	WBT	NBL	NBR
Lane Configurations	↑↑		↵	↑↑	↵	
Traffic Volume (veh/h)	308	273	51	455	226	38
Future Volume (veh/h)	308	273	51	455	226	38
Initial Q (Qb), veh	0	0	0	0	0	0
Ped-Bike Adj(A_pbT)		0.98	1.00		1.00	1.00
Parking Bus, Adj	1.00	1.00	1.00	1.00	1.00	1.00
Work Zone On Approach	No			No	No	
Adj Sat Flow, veh/h/ln	1885	1885	1900	1900	1900	1900
Adj Flow Rate, veh/h	358	317	59	529	263	44
Peak Hour Factor	0.86	0.86	0.86	0.86	0.86	0.86
Percent Heavy Veh, %	1	1	0	0	0	0
Cap, veh/h	707	615	421	1424	459	77
Arrive On Green	0.39	0.39	0.39	0.39	0.30	0.30
Sat Flow, veh/h	1885	1559	775	3705	1519	254
Grp Volume(v), veh/h	358	317	59	529	308	0
Grp Sat Flow(s),veh/h/ln	1791	1559	775	1805	1778	0
Q Serve(g_s), s	4.6	4.7	1.9	3.2	4.5	0.0
Cycle Q Clear(g_c), s	4.6	4.7	6.7	3.2	4.5	0.0
Prop In Lane		1.00	1.00		0.85	0.14
Lane Grp Cap(c), veh/h	707	615	421	1424	538	0
V/C Ratio(X)	0.51	0.52	0.14	0.37	0.57	0.00
Avail Cap(c_a), veh/h	1360	1184	704	2742	1299	0
HCM Platoon Ratio	1.00	1.00	1.00	1.00	1.00	1.00
Upstream Filter(I)	1.00	1.00	1.00	1.00	1.00	0.00
Uniform Delay (d), s/veh	7.0	7.1	9.6	6.6	9.0	0.0
Incr Delay (d2), s/veh	0.6	0.7	0.2	0.2	1.0	0.0
Initial Q Delay(d3),s/veh	0.0	0.0	0.0	0.0	0.0	0.0
%ile BackOfQ(50%),veh/ln	1.1	1.0	0.2	0.7	1.4	0.0
Unsig. Movement Delay, s/veh						
LnGrp Delay(d),s/veh	7.6	7.7	9.7	6.8	10.0	0.0
LnGrp LOS	A	A	A	A	A	A
Approach Vol, veh/h	675			588	308	
Approach Delay, s/veh	7.7			7.1	10.0	
Approach LOS	A			A	A	
Timer - Assigned Phs		2		4		8
Phs Duration (G+Y+Rc), s		13.9		16.8		16.8
Change Period (Y+Rc), s		4.6		* 4.7		* 4.7
Max Green Setting (Gmax), s		22.4		* 23		* 23
Max Q Clear Time (g_c+I1), s		6.5		6.7		8.7
Green Ext Time (p_c), s		0.9		4.1		3.4

Intersection Summary

HCM 6th Ctrl Delay	7.9
HCM 6th LOS	A

Notes

User approved volume balancing among the lanes for turning movement.
 * HCM 6th computational engine requires equal clearance times for the phases crossing the barrier.

Timings

14: Barton Rd. & Van Buren Bl.

09/30/2022

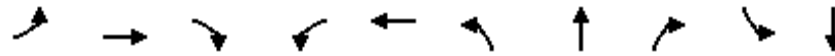

Lane Group	EBL	EBT	EBR	WBL	WBT	NBL	NBT	NBR	SBL	SBT
Lane Configurations	↖	↑↑↑	↗	↖	↑↑↑	↖↗	↑	↗	↖	↗
Traffic Volume (vph)	92	972	186	217	1016	224	44	179	46	29
Future Volume (vph)	92	972	186	217	1016	224	44	179	46	29
Turn Type	Prot	NA	pm+ov	Prot	NA	Prot	NA	Perm	Prot	NA
Protected Phases	5	2	3	1	6	3	8		7	4
Permitted Phases			2					8		
Detector Phase	5	2	3	1	6	3	8	8	7	4
Switch Phase										
Minimum Initial (s)	5.0	10.0	5.0	5.0	10.0	5.0	10.0	10.0	5.0	10.0
Minimum Split (s)	9.2	25.2	9.1	9.2	25.5	9.1	14.6	14.6	9.1	33.6
Total Split (s)	15.8	41.4	14.0	31.0	56.6	14.0	36.9	36.9	10.7	33.6
Total Split (%)	13.2%	34.5%	11.7%	25.8%	47.2%	11.7%	30.8%	30.8%	8.9%	28.0%
Yellow Time (s)	3.2	5.2	3.6	3.2	5.5	3.6	3.6	3.6	3.6	3.6
All-Red Time (s)	1.0	1.0	0.5	1.0	1.0	0.5	1.0	1.0	0.5	1.0
Lost Time Adjust (s)	0.0	0.0	0.0	0.0	0.0	0.0	0.0	0.0	0.0	0.0
Total Lost Time (s)	4.2	6.2	4.1	4.2	6.5	4.1	4.6	4.6	4.1	4.6
Lead/Lag	Lead	Lag	Lead	Lead	Lag	Lead	Lag	Lag	Lead	Lag
Lead-Lag Optimize?	Yes	Yes	Yes	Yes	Yes	Yes	Yes	Yes	Yes	Yes
Recall Mode	None	None	None	None	None	None	None	None	None	None
Act Effct Green (s)	9.0	22.3	34.7	16.1	31.7	10.2	21.6	21.6	6.6	13.1
Actuated g/C Ratio	0.11	0.27	0.42	0.20	0.39	0.12	0.26	0.26	0.08	0.16
v/c Ratio	0.52	0.72	0.29	0.69	0.55	0.57	0.10	0.36	0.35	0.39
Control Delay	48.7	30.6	10.0	43.5	21.3	43.4	29.5	6.9	49.1	14.6
Queue Delay	0.0	0.0	0.0	0.0	0.0	0.0	0.0	0.0	0.0	0.0
Total Delay	48.7	30.6	10.0	43.5	21.3	43.4	29.5	6.9	49.1	14.6
LOS	D	C	A	D	C	D	C	A	D	B
Approach Delay		28.8			25.0		27.4			23.7
Approach LOS		C			C		C			C

Intersection Summary

Cycle Length: 120
 Actuated Cycle Length: 81.7
 Natural Cycle: 90
 Control Type: Actuated-Uncoordinated
 Maximum v/c Ratio: 0.72
 Intersection Signal Delay: 26.8
 Intersection LOS: C
 Intersection Capacity Utilization 61.4%
 ICU Level of Service B
 Analysis Period (min) 15

Splits and Phases: 14: Barton Rd. & Van Buren Bl.

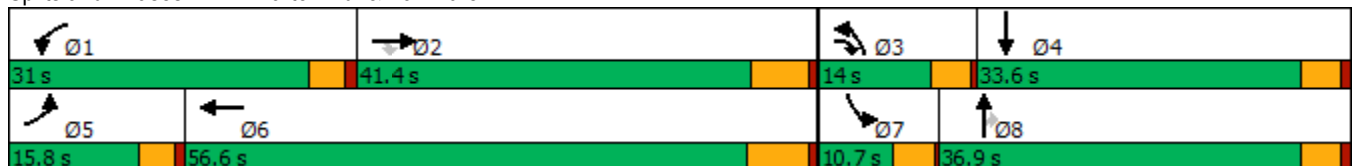

HCM 6th Signalized Intersection Summary
 14: Barton Rd. & Van Buren Bl.

West Campus Upper Plateau (JN 14064)

09/30/2022



Movement	EBL	EBT	EBR	WBL	WBT	WBR	NBL	NBT	NBR	SBL	SBT	SBR
Lane Configurations	↖	↑↑↑	↗	↖	↑↑↑		↖↗	↑	↗	↖	↗	
Traffic Volume (veh/h)	92	972	186	217	1016	55	224	44	179	46	29	98
Future Volume (veh/h)	92	972	186	217	1016	55	224	44	179	46	29	98
Initial Q (Qb), veh	0	0	0	0	0	0	0	0	0	0	0	0
Ped-Bike Adj(A_pbT)	1.00		1.00	1.00		1.00	1.00		0.96	1.00		1.00
Parking Bus, Adj	1.00	1.00	1.00	1.00	1.00	1.00	1.00	1.00	1.00	1.00	1.00	1.00
Work Zone On Approach		No			No			No			No	
Adj Sat Flow, veh/h/ln	1900	1856	1870	1870	1870	1856	1900	1900	1885	1900	1885	1900
Adj Flow Rate, veh/h	102	1080	176	241	1129	50	249	49	67	51	32	47
Peak Hour Factor	0.90	0.90	0.90	0.90	0.90	0.90	0.90	0.90	0.90	0.90	0.90	0.90
Percent Heavy Veh, %	0	3	2	2	2	3	0	0	1	0	1	0
Cap, veh/h	132	1560	606	292	1978	88	359	397	319	84	106	155
Arrive On Green	0.07	0.28	0.28	0.16	0.37	0.37	0.10	0.21	0.21	0.05	0.15	0.15
Sat Flow, veh/h	1810	5567	1582	1781	5332	236	3510	1900	1527	1810	690	1013
Grp Volume(v), veh/h	102	1080	176	241	792	387	249	49	67	51	0	79
Grp Sat Flow(s),veh/h/ln	1810	1856	1582	1781	1870	1828	1755	1900	1527	1810	0	1703
Q Serve(g_s), s	3.6	11.2	5.0	8.4	10.9	10.9	4.4	1.4	2.3	1.8	0.0	2.7
Cycle Q Clear(g_c), s	3.6	11.2	5.0	8.4	10.9	10.9	4.4	1.4	2.3	1.8	0.0	2.7
Prop In Lane	1.00		1.00	1.00		0.13	1.00		1.00	1.00		0.59
Lane Grp Cap(c), veh/h	132	1560	606	292	1387	678	359	397	319	84	0	261
V/C Ratio(X)	0.77	0.69	0.29	0.83	0.57	0.57	0.69	0.12	0.21	0.61	0.00	0.30
Avail Cap(c_a), veh/h	325	3036	1025	740	2904	1419	538	951	764	185	0	765
HCM Platoon Ratio	1.00	1.00	1.00	1.00	1.00	1.00	1.00	1.00	1.00	1.00	1.00	1.00
Upstream Filter(I)	1.00	1.00	1.00	1.00	1.00	1.00	1.00	1.00	1.00	1.00	0.00	1.00
Uniform Delay (d), s/veh	29.4	20.7	13.8	26.1	16.2	16.2	28.0	20.7	21.1	30.2	0.0	24.3
Incr Delay (d2), s/veh	3.6	0.2	0.1	2.3	0.1	0.3	2.4	0.1	0.3	6.9	0.0	0.6
Initial Q Delay(d3),s/veh	0.0	0.0	0.0	0.0	0.0	0.0	0.0	0.0	0.0	0.0	0.0	0.0
%ile BackOfQ(50%),veh/ln	1.5	4.1	1.5	3.3	3.8	3.7	1.8	0.5	0.8	0.9	0.0	1.1
Unsig. Movement Delay, s/veh												
LnGrp Delay(d),s/veh	32.9	21.0	13.9	28.4	16.3	16.5	30.4	20.9	21.4	37.1	0.0	24.9
LnGrp LOS	C	C	B	C	B	B	C	C	C	D	A	C
Approach Vol, veh/h		1358			1420			365				130
Approach Delay, s/veh		20.9			18.4			27.5				29.7
Approach LOS		C			B			C				C
Timer - Assigned Phs	1	2	3	4	5	6	7	8				
Phs Duration (G+Y+Rc), s	14.8	24.6	10.7	14.5	8.9	30.4	7.1	18.1				
Change Period (Y+Rc), s	* 4.2	* 6.5	4.1	4.6	* 4.2	6.5	4.1	4.6				
Max Green Setting (Gmax), s	* 27	* 35	9.9	29.0	* 12	50.1	6.6	32.3				
Max Q Clear Time (g_c+I1), s	10.4	13.2	6.4	4.7	5.6	12.9	3.8	4.3				
Green Ext Time (p_c), s	0.3	4.9	0.3	0.4	0.0	4.9	0.0	0.4				

Intersection Summary

HCM 6th Ctrl Delay	20.9
HCM 6th LOS	C

Notes

* HCM 6th computational engine requires equal clearance times for the phases crossing the barrier.

Timings
25: Sycamore Canyon Bl. & Cactus Av.

West Campus Upper Plateau (JN 14064)

09/30/2022



Lane Group	EBL	EBT	EBR	WBL	WBT	WBR	NBL	NBT	NBR	SBL	SBT	SBR
Lane Configurations	↘	↑↑	↗	↘↗	↑↑	↗	↘↗	↑↑	↗	↘↗	↑↑	↗
Traffic Volume (vph)	58	390	172	185	391	225	178	171	140	132	223	49
Future Volume (vph)	58	390	172	185	391	225	178	171	140	132	223	49
Turn Type	Prot	NA	Perm	Prot	NA	pm+ov	Prot	NA	Perm	Prot	NA	Perm
Protected Phases	7	4		3	8	1	5	2		1	6	
Permitted Phases			4			8			2			6
Detector Phase	7	4	4	3	8	1	5	2	2	1	6	6
Switch Phase												
Minimum Initial (s)	5.0	10.0	10.0	5.0	10.0	10.0	10.0	10.0	10.0	10.0	10.0	10.0
Minimum Split (s)	9.6	32.8	32.8	9.6	32.8	15.8	15.8	15.8	15.8	15.8	34.8	34.8
Total Split (s)	25.2	41.0	41.0	23.0	38.8	29.8	15.8	26.2	26.2	29.8	40.2	40.2
Total Split (%)	21.0%	34.2%	34.2%	19.2%	32.3%	24.8%	13.2%	21.8%	21.8%	24.8%	33.5%	33.5%
Yellow Time (s)	3.6	4.8	4.8	3.6	4.8	4.8	4.8	4.8	4.8	4.8	4.8	4.8
All-Red Time (s)	1.0	1.0	1.0	1.0	1.0	1.0	1.0	1.0	1.0	1.0	1.0	1.0
Lost Time Adjust (s)	0.0	0.0	0.0	0.0	0.0	0.0	0.0	0.0	0.0	0.0	0.0	0.0
Total Lost Time (s)	4.6	5.8	5.8	4.6	5.8	5.8	5.8	5.8	5.8	5.8	5.8	5.8
Lead/Lag	Lead	Lag	Lag	Lead	Lag	Lead	Lead	Lag	Lag	Lead	Lag	Lag
Lead-Lag Optimize?	Yes	Yes	Yes	Yes	Yes	Yes	Yes	Yes	Yes	Yes	Yes	Yes
Recall Mode	None	None	None	None	None	None	None	None	None	None	None	None
Act Effct Green (s)	7.3	15.3	15.3	8.8	21.7	38.3	10.4	13.1	13.1	10.6	13.4	13.4
Actuated g/C Ratio	0.10	0.22	0.22	0.12	0.31	0.54	0.15	0.19	0.19	0.15	0.19	0.19
v/c Ratio	0.34	0.56	0.37	0.46	0.39	0.24	0.37	0.28	0.35	0.27	0.36	0.14
Control Delay	38.7	28.5	7.0	35.0	23.0	2.8	33.4	26.9	5.6	31.9	27.3	0.8
Queue Delay	0.0	0.0	0.0	0.0	0.0	0.0	0.0	0.0	0.0	0.0	0.0	0.0
Total Delay	38.7	28.5	7.0	35.0	23.0	2.8	33.4	26.9	5.6	31.9	27.3	0.8
LOS	D	C	A	C	C	A	C	C	A	C	C	A
Approach Delay		23.4			20.1			23.2			25.6	
Approach LOS		C			C			C			C	

Intersection Summary

Cycle Length: 120
 Actuated Cycle Length: 70.8
 Natural Cycle: 95
 Control Type: Actuated-Uncoordinated
 Maximum v/c Ratio: 0.56
 Intersection Signal Delay: 22.6
 Intersection LOS: C
 Intersection Capacity Utilization 51.1%
 ICU Level of Service A
 Analysis Period (min) 15

Splits and Phases: 25: Sycamore Canyon Bl. & Cactus Av.

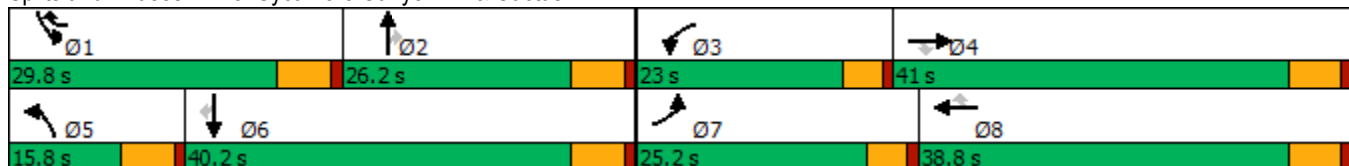

HCM 6th Signalized Intersection Summary
 25: Sycamore Canyon Bl. & Cactus Av.

West Campus Upper Plateau (JN 14064)

09/30/2022



Movement	EBL	EBT	EBR	WBL	WBT	WBR	NBL	NBT	NBR	SBL	SBT	SBR
Lane Configurations												
Traffic Volume (veh/h)	58	390	172	185	391	225	178	171	140	132	223	49
Future Volume (veh/h)	58	390	172	185	391	225	178	171	140	132	223	49
Initial Q (Qb), veh	0	0	0	0	0	0	0	0	0	0	0	0
Ped-Bike Adj(A_pbT)	1.00		1.00	1.00		1.00	1.00		1.00	1.00		1.00
Parking Bus, Adj	1.00	1.00	1.00	1.00	1.00	1.00	1.00	1.00	1.00	1.00	1.00	1.00
Work Zone On Approach		No			No			No			No	
Adj Sat Flow, veh/h/ln	1841	1796	1856	1826	1796	1870	1856	1811	1781	1885	1796	1767
Adj Flow Rate, veh/h	60	406	-107	193	407	-8	185	178	53	138	232	51
Peak Hour Factor	0.96	0.96	0.96	0.96	0.96	0.96	0.96	0.96	0.96	0.96	0.96	0.96
Percent Heavy Veh, %	4	7	3	5	7	2	3	6	8	1	7	9
Cap, veh/h	94	643	296	303	767	629	589	591	259	599	587	257
Arrive On Green	0.05	0.19	0.00	0.09	0.22	0.00	0.17	0.17	0.17	0.17	0.17	0.17
Sat Flow, veh/h	1753	3413	1572	3374	3413	1585	3428	3441	1510	3483	3413	1497
Grp Volume(v), veh/h	60	406	-107	193	407	-8	185	178	53	138	232	51
Grp Sat Flow(s),veh/h/ln	1753	1706	1572	1687	1706	1585	1714	1721	1510	1742	1706	1497
Q Serve(g_s), s	2.0	6.4	0.0	3.2	6.1	0.0	2.7	2.6	1.8	2.0	3.5	1.7
Cycle Q Clear(g_c), s	2.0	6.4	0.0	3.2	6.1	0.0	2.7	2.6	1.8	2.0	3.5	1.7
Prop In Lane	1.00		1.00	1.00		1.00	1.00		1.00	1.00		1.00
Lane Grp Cap(c), veh/h	94	643	296	303	767	629	589	591	259	599	587	257
V/C Ratio(X)	0.64	0.63	-0.36	0.64	0.53	-0.01	0.31	0.30	0.20	0.23	0.40	0.20
Avail Cap(c_a), veh/h	621	2065	951	1067	1936	1171	589	1207	529	1437	2018	885
HCM Platoon Ratio	1.00	1.00	1.00	1.00	1.00	1.00	1.00	1.00	1.00	1.00	1.00	1.00
Upstream Filter(I)	1.00	1.00	0.00	1.00	1.00	0.00	1.00	1.00	1.00	1.00	1.00	1.00
Uniform Delay (d), s/veh	27.0	21.8	0.0	25.6	19.8	0.0	21.1	21.0	20.7	20.8	21.4	20.7
Incr Delay (d2), s/veh	2.7	1.0	0.0	0.8	0.6	0.0	0.3	0.3	0.4	0.2	0.4	0.4
Initial Q Delay(d3),s/veh	0.0	0.0	0.0	0.0	0.0	0.0	0.0	0.0	0.0	0.0	0.0	0.0
%ile BackOfQ(50%),veh/ln	0.8	2.3	0.0	1.2	2.1	0.0	1.0	0.9	0.6	0.7	1.3	0.5
Unsig. Movement Delay, s/veh												
LnGrp Delay(d),s/veh	29.7	22.8	0.0	26.4	20.4	0.0	21.4	21.3	21.1	21.0	21.8	21.0
LnGrp LOS	C	C	A	C	C	A	C	C	C	C	C	C
Approach Vol, veh/h		359			592			416			421	
Approach Delay, s/veh		30.7			22.6			21.3			21.5	
Approach LOS		C			C			C			C	
Timer - Assigned Phs	1	2	3	4	5	6	7	8				
Phs Duration (G+Y+Rc), s	15.8	15.8	9.8	16.8	15.8	15.8	7.7	18.9				
Change Period (Y+Rc), s	5.8	5.8	4.6	5.8	5.8	5.8	4.6	5.8				
Max Green Setting (Gmax), s	24.0	20.4	18.4	35.2	10.0	34.4	20.6	33.0				
Max Q Clear Time (g_c+I1), s	4.0	4.6	5.2	8.4	4.7	5.5	4.0	8.1				
Green Ext Time (p_c), s	0.4	1.0	0.3	2.6	0.2	1.5	0.0	2.4				

Intersection Summary

HCM 6th Ctrl Delay	23.7
HCM 6th LOS	C

Timings
29: I-215 NB Ramps & Alessandro Bl.

West Campus Upper Plateau (JN 14064)

09/30/2022

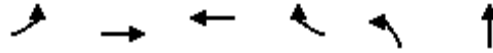

Lane Group	EBL	EBT	WBT	WBR	NBL	NBT
Lane Configurations	↶	↑↑↑	↑↑↑	↷	↶↷	↕
Traffic Volume (vph)	233	862	1000	157	566	10
Future Volume (vph)	233	862	1000	157	566	10
Turn Type	Prot	NA	NA	Perm	Split	NA
Protected Phases	5	2	6		8	8
Permitted Phases				6		
Detector Phase	5	2	6	6	8	8
Switch Phase						
Minimum Initial (s)	5.0	5.0	5.0	5.0	5.0	5.0
Minimum Split (s)	9.5	10.5	33.5	33.5	10.0	10.0
Total Split (s)	24.6	67.0	42.4	42.4	43.0	43.0
Total Split (%)	22.4%	60.9%	38.5%	38.5%	39.1%	39.1%
Yellow Time (s)	3.5	4.5	4.5	4.5	4.0	4.0
All-Red Time (s)	1.0	1.0	1.0	1.0	1.0	1.0
Lost Time Adjust (s)	0.0	0.0	0.0	0.0	0.0	0.0
Total Lost Time (s)	4.5	5.5	5.5	5.5	5.0	5.0
Lead/Lag	Lead		Lag	Lag		
Lead-Lag Optimize?	Yes		Yes	Yes		
Recall Mode	None	Min	Min	Min	Max	Max
Act Effct Green (s)	17.2	49.9	28.2	28.2	38.3	38.3
Actuated g/C Ratio	0.17	0.51	0.29	0.29	0.39	0.39
v/c Ratio	0.80	0.35	0.71	0.36	0.42	0.50
Control Delay	60.1	14.7	34.6	19.3	25.0	17.8
Queue Delay	0.0	0.0	0.0	0.0	0.0	0.0
Total Delay	60.1	14.7	34.6	19.3	25.0	17.8
LOS	E	B	C	B	C	B
Approach Delay		24.4	32.5			22.2
Approach LOS		C	C			C

Intersection Summary

Cycle Length: 110
 Actuated Cycle Length: 98.8
 Natural Cycle: 65
 Control Type: Actuated-Uncoordinated
 Maximum v/c Ratio: 0.80
 Intersection Signal Delay: 26.8
 Intersection LOS: C
 Intersection Capacity Utilization 60.6%
 ICU Level of Service B
 Analysis Period (min) 15

Splits and Phases: 29: I-215 NB Ramps & Alessandro Bl.



HCM 6th Signalized Intersection Summary
 29: I-215 NB Ramps & Alessandro Bl.

West Campus Upper Plateau (JN 14064)

09/30/2022



Movement	EBL	EBT	EBR	WBL	WBT	WBR	NBL	NBT	NBR	SBL	SBT	SBR
Lane Configurations	↘	↑↑↑			↑↑↑	↗	↘↗	↕				
Traffic Volume (veh/h)	233	862	0	0	1000	157	566	10	255	0	0	0
Future Volume (veh/h)	233	862	0	0	1000	157	566	10	255	0	0	0
Initial Q (Qb), veh	0	0	0	0	0	0	0	0	0			
Ped-Bike Adj(A_pbT)	1.00		1.00	1.00		0.98	1.00		1.00			
Parking Bus, Adj	1.00	1.00	1.00	1.00	1.00	1.00	1.00	1.00	1.00			
Work Zone On Approach		No			No			No				
Adj Sat Flow, veh/h/ln	1841	1870	0	0	1870	1707	1870	1900	1870			
Adj Flow Rate, veh/h	240	889	0	0	1031	136	550	58	179			
Peak Hour Factor	0.97	0.97	0.97	0.97	0.97	0.97	0.97	0.97	0.97			
Percent Heavy Veh, %	4	2	0	0	2	13	2	0	2			
Cap, veh/h	276	2449	0	0	1400	388	1452	167	515			
Arrive On Green	0.16	0.48	0.00	0.00	0.27	0.27	0.41	0.41	0.41			
Sat Flow, veh/h	1753	5274	0	0	5274	1416	3563	409	1263			
Grp Volume(v), veh/h	240	889	0	0	1031	136	550	0	237			
Grp Sat Flow(s),veh/h/ln	1753	1702	0	0	1702	1416	1781	0	1673			
Q Serve(g_s), s	12.5	10.2	0.0	0.0	17.1	7.2	10.1	0.0	9.1			
Cycle Q Clear(g_c), s	12.5	10.2	0.0	0.0	17.1	7.2	10.1	0.0	9.1			
Prop In Lane	1.00		0.00	0.00		1.00	1.00		0.76			
Lane Grp Cap(c), veh/h	276	2449	0	0	1400	388	1452	0	682			
V/C Ratio(X)	0.87	0.36	0.00	0.00	0.74	0.35	0.38	0.00	0.35			
Avail Cap(c_a), veh/h	378	3369	0	0	2021	561	1452	0	682			
HCM Platoon Ratio	1.00	1.00	1.00	1.00	1.00	1.00	1.00	1.00	1.00			
Upstream Filter(I)	1.00	1.00	0.00	0.00	1.00	1.00	1.00	0.00	1.00			
Uniform Delay (d), s/veh	38.3	15.3	0.0	0.0	30.8	27.2	19.3	0.0	19.0			
Incr Delay (d2), s/veh	13.7	0.1	0.0	0.0	0.8	0.5	0.8	0.0	1.4			
Initial Q Delay(d3),s/veh	0.0	0.0	0.0	0.0	0.0	0.0	0.0	0.0	0.0			
%ile BackOfQ(50%),veh/ln	6.0	3.4	0.0	0.0	6.5	2.3	4.1	0.0	3.6			
Unsig. Movement Delay, s/veh												
LnGrp Delay(d),s/veh	52.1	15.4	0.0	0.0	31.6	27.7	20.1	0.0	20.4			
LnGrp LOS	D	B	A	A	C	C	C	A	C			
Approach Vol, veh/h		1129			1167			787				
Approach Delay, s/veh		23.2			31.1			20.2				
Approach LOS		C			C			C				
Timer - Assigned Phs		2			5	6		8				
Phs Duration (G+Y+Rc), s		50.2			19.2	31.0		43.0				
Change Period (Y+Rc), s		5.5			4.5	5.5		5.0				
Max Green Setting (Gmax), s		61.5			20.1	36.9		38.0				
Max Q Clear Time (g_c+I1), s		12.2			14.5	19.1		12.1				
Green Ext Time (p_c), s		6.2			0.2	6.4		3.5				

Intersection Summary

HCM 6th Ctrl Delay	25.4
HCM 6th LOS	C

Notes

User approved volume balancing among the lanes for turning movement.

Timings

31: I-215 NB Ramps/Old 215 Frontage Rd. & Cactus Av.



Lane Group	EBL	EBT	EBR	WBT	NBL	NBT	NBR	SBL	SBT
Lane Configurations	↘	↑↑	↗	↑↑↑	↘↗	↗	↗	↘	↗
Traffic Volume (vph)	32	689	245	1162	124	70	3	116	1
Future Volume (vph)	32	689	245	1162	124	70	3	116	1
Turn Type	Perm	NA	Perm	NA	Prot	NA	Perm	Perm	NA
Protected Phases		2		6	3	8			4
Permitted Phases	2		2				8	4	
Detector Phase	2	2	2	6	3	8	8	4	4
Switch Phase									
Minimum Initial (s)	5.0	5.0	5.0	5.0	5.0	5.0	5.0	5.0	5.0
Minimum Split (s)	11.0	11.0	11.0	44.0	9.1	10.5	10.5	10.5	10.5
Total Split (s)	64.0	64.0	64.0	64.0	14.0	36.0	36.0	22.0	22.0
Total Split (%)	64.0%	64.0%	64.0%	64.0%	14.0%	36.0%	36.0%	22.0%	22.0%
Yellow Time (s)	5.0	5.0	5.0	5.0	3.6	4.5	4.5	4.5	4.5
All-Red Time (s)	1.0	1.0	1.0	1.0	0.5	1.0	1.0	1.0	1.0
Lost Time Adjust (s)	0.0	0.0	0.0	0.0	0.0	0.0	0.0	0.0	0.0
Total Lost Time (s)	6.0	6.0	6.0	6.0	4.1	5.5	5.5	5.5	5.5
Lead/Lag					Lead			Lag	Lag
Lead-Lag Optimize?					Yes			Yes	Yes
Recall Mode	Min	Min	Min	Min	None	None	None	None	None
Act Effct Green (s)	26.9	26.9	26.9	26.9	8.1	19.8	19.8	10.3	10.3
Actuated g/C Ratio	0.46	0.46	0.46	0.46	0.14	0.34	0.34	0.18	0.18
v/c Ratio	0.27	0.47	0.32	0.60	0.30	0.13	0.01	0.55	0.26
Control Delay	19.2	13.4	3.0	14.1	28.3	14.1	0.0	34.6	10.2
Queue Delay	0.0	0.0	0.0	0.0	0.0	0.0	0.0	0.0	0.0
Total Delay	19.2	13.4	3.0	14.1	28.3	14.1	0.0	34.6	10.2
LOS	B	B	A	B	C	B	A	C	B
Approach Delay		11.0		14.1		22.9			24.5
Approach LOS		B		B		C			C

Intersection Summary

Cycle Length: 100
 Actuated Cycle Length: 58.7
 Natural Cycle: 65
 Control Type: Actuated-Uncoordinated
 Maximum v/c Ratio: 0.60
 Intersection Signal Delay: 14.4
 Intersection LOS: B
 Intersection Capacity Utilization 49.3%
 ICU Level of Service A
 Analysis Period (min) 15

Splits and Phases: 31: I-215 NB Ramps/Old 215 Frontage Rd. & Cactus Av.



HCM 6th Signalized Intersection Summary

West Campus Upper Plateau (JN 14064)

31: I-215 NB Ramps/Old 215 Frontage Rd. & Cactus Av.

09/30/2022

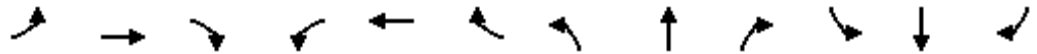

Movement	EBL	EBT	EBR	WBL	WBT	WBR	NBL	NBT	NBR	SBL	SBT	SBR
Lane Configurations	↘	↑↑	↗		↑↑↑		↘↗	↑	↗	↘	↑	↗
Traffic Volume (veh/h)	32	689	245	0	1162	125	124	70	3	116	1	82
Future Volume (veh/h)	32	689	245	0	1162	125	124	70	3	116	1	82
Initial Q (Qb), veh	0	0	0	0	0	0	0	0	0	0	0	0
Ped-Bike Adj(A_pbT)	1.00		1.00	1.00		1.00	1.00		1.00	1.00		1.00
Parking Bus, Adj	1.00	1.00	1.00	1.00	1.00	1.00	1.00	1.00	1.00	1.00	1.00	1.00
Work Zone On Approach		No			No			No			No	
Adj Sat Flow, veh/h/ln	1856	1841	1767	0	1856	1885	1767	1856	1900	1841	1900	1885
Adj Flow Rate, veh/h	34	741	259	0	1249	85	133	75	0	125	1	61
Peak Hour Factor	0.93	0.93	0.93	0.93	0.93	0.93	0.93	0.93	0.93	0.93	0.93	0.93
Percent Heavy Veh, %	3	4	9	0	3	1	9	3	0	4	0	1
Cap, veh/h	251	1454	623	0	2014	137	308	597		343	4	218
Arrive On Green	0.42	0.42	0.42	0.00	0.42	0.42	0.09	0.32	0.00	0.14	0.14	0.14
Sat Flow, veh/h	407	3497	1497	0	5010	330	3365	1856	1610	1304	26	1588
Grp Volume(v), veh/h	34	741	259	0	871	463	133	75	0	125	0	62
Grp Sat Flow(s),veh/h/ln	407	1749	1497	0	1689	1795	1682	1856	1610	1304	0	1614
Q Serve(g_s), s	3.1	6.9	5.4	0.0	8.9	8.9	1.6	1.3	0.0	4.0	0.0	1.5
Cycle Q Clear(g_c), s	12.1	6.9	5.4	0.0	8.9	8.9	1.6	1.3	0.0	4.0	0.0	1.5
Prop In Lane	1.00		1.00	0.00		0.18	1.00		1.00	1.00		0.98
Lane Grp Cap(c), veh/h	251	1454	623	0	1404	746	308	597		343	0	221
V/C Ratio(X)	0.14	0.51	0.42	0.00	0.62	0.62	0.43	0.13		0.36	0.00	0.28
Avail Cap(c_a), veh/h	620	4625	1980	0	4466	2374	760	1290		655	0	607
HCM Platoon Ratio	1.00	1.00	1.00	1.00	1.00	1.00	1.00	1.00	1.00	1.00	1.00	1.00
Upstream Filter(I)	1.00	1.00	1.00	0.00	1.00	1.00	1.00	1.00	0.00	1.00	0.00	1.00
Uniform Delay (d), s/veh	14.8	9.5	9.0	0.0	10.1	10.1	18.8	10.5	0.0	18.1	0.0	17.0
Incr Delay (d2), s/veh	0.1	0.1	0.2	0.0	0.2	0.3	1.0	0.0	0.0	0.2	0.0	0.3
Initial Q Delay(d3),s/veh	0.0	0.0	0.0	0.0	0.0	0.0	0.0	0.0	0.0	0.0	0.0	0.0
%ile BackOfQ(50%),veh/ln	0.2	1.7	1.1	0.0	2.1	2.3	0.6	0.4	0.0	1.0	0.0	0.4
Unsig. Movement Delay, s/veh												
LnGrp Delay(d),s/veh	14.9	9.6	9.2	0.0	10.3	10.4	19.8	10.5	0.0	18.3	0.0	17.2
LnGrp LOS	B	A	A	A	B	B	B	B		B	A	B
Approach Vol, veh/h		1034			1334			208				187
Approach Delay, s/veh		9.7			10.3			16.5				18.0
Approach LOS		A			B			B				B
Timer - Assigned Phs		2	3	4		6		8				
Phs Duration (G+Y+Rc), s		24.2	8.1	11.5		24.2		19.6				
Change Period (Y+Rc), s		6.0	4.1	5.5		6.0		5.5				
Max Green Setting (Gmax), s		58.0	9.9	16.5		58.0		30.5				
Max Q Clear Time (g_c+I1), s		14.1	3.6	6.0		10.9		3.3				
Green Ext Time (p_c), s		4.2	0.2	0.3		6.3		0.2				

Intersection Summary

HCM 6th Ctrl Delay	11.1
HCM 6th LOS	B

Notes

User approved volume balancing among the lanes for turning movement.
 Unsignalized Delay for [NBR] is excluded from calculations of the approach delay and intersection delay.

Timings
36: Elsworth St. & Cactus Av.

West Campus Upper Plateau (JN 14064)

09/30/2022



Lane Group	EBL	EBT	EBR	WBL	WBT	WBR	NBL	NBT	SBL	SBT	SBR
Lane Configurations	↖	↑↑↑	↗	↖	↑↑↑	↗	↖	↗	↖	↑	↗
Traffic Volume (vph)	153	1076	31	14	1075	133	22	11	160	17	128
Future Volume (vph)	153	1076	31	14	1075	133	22	11	160	17	128
Turn Type	Prot	NA	Perm	Prot	NA	Perm	Prot	NA	Prot	NA	pm+ov
Protected Phases	5	2		1	6		3	8	7	4	5
Permitted Phases			2			6					4
Detector Phase	5	2	2	1	6	6	3	8	7	4	5
Switch Phase											
Minimum Initial (s)	5.0	10.0	10.0	5.0	10.0	10.0	5.0	10.0	5.0	10.0	5.0
Minimum Split (s)	9.6	36.2	36.2	9.6	36.2	36.2	15.4	35.4	15.4	35.4	9.6
Total Split (s)	19.8	55.0	55.0	9.6	44.8	44.8	19.6	35.4	20.0	35.8	19.8
Total Split (%)	16.5%	45.8%	45.8%	8.0%	37.3%	37.3%	16.3%	29.5%	16.7%	29.8%	16.5%
Yellow Time (s)	3.6	5.2	5.2	3.6	5.2	5.2	4.4	4.4	4.4	4.4	3.6
All-Red Time (s)	1.0	1.0	1.0	1.0	1.0	1.0	1.0	1.0	1.0	1.0	1.0
Lost Time Adjust (s)	0.0	0.0	0.0	0.0	0.0	0.0	0.0	0.0	0.0	0.0	0.0
Total Lost Time (s)	4.6	6.2	6.2	4.6	6.2	6.2	5.4	5.4	5.4	5.4	4.6
Lead/Lag	Lead	Lead	Lead	Lag	Lag	Lag	Lag	Lag	Lead	Lead	Lead
Lead-Lag Optimize?	Yes	Yes	Yes	Yes	Yes	Yes	Yes	Yes	Yes	Yes	Yes
Recall Mode	None	None	None	None	None	None	None	None	None	None	None
Act Effct Green (s)	12.2	42.6	42.6	6.2	27.2	27.2	13.1	13.7	13.1	13.7	18.0
Actuated g/C Ratio	0.16	0.55	0.55	0.08	0.35	0.35	0.17	0.18	0.17	0.18	0.23
v/c Ratio	0.58	0.41	0.04	0.10	0.65	0.21	0.08	0.07	0.55	0.05	0.28
Control Delay	45.7	14.5	0.1	45.9	25.2	4.0	38.2	25.7	43.9	33.9	4.1
Queue Delay	0.0	0.0	0.0	0.0	0.0	0.0	0.0	0.0	0.0	0.0	0.0
Total Delay	45.7	14.5	0.1	45.9	25.2	4.0	38.2	25.7	43.9	33.9	4.1
LOS	D	B	A	D	C	A	D	C	D	C	A
Approach Delay		17.9			23.1			32.2		26.6	
Approach LOS		B			C			C		C	

Intersection Summary

Cycle Length: 120
 Actuated Cycle Length: 77.6
 Natural Cycle: 100
 Control Type: Actuated-Uncoordinated
 Maximum v/c Ratio: 0.65
 Intersection Signal Delay: 21.3
 Intersection LOS: C
 Intersection Capacity Utilization 58.3%
 ICU Level of Service B
 Analysis Period (min) 15

Splits and Phases: 36: Elsworth St. & Cactus Av.

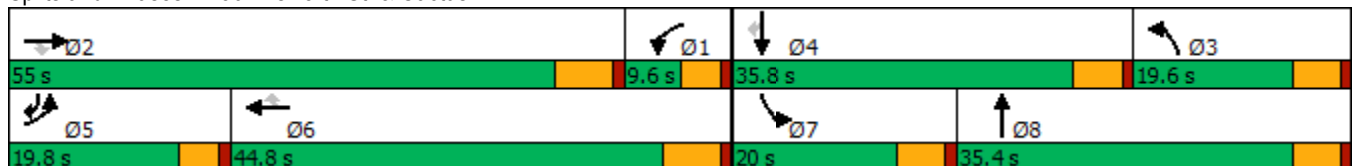

HCM 6th Signalized Intersection Summary
36: Elsworth St. & Cactus Av.

West Campus Upper Plateau (JN 14064)

09/30/2022



Movement	EBL	EBT	EBR	WBL	WBT	WBR	NBL	NBT	NBR	SBL	SBT	SBR
Lane Configurations	↗	↑↑↑	↖	↖	↑↑↑	↖	↖	↑		↖	↑	↖
Traffic Volume (veh/h)	153	1076	31	14	1075	133	22	11	9	160	17	128
Future Volume (veh/h)	153	1076	31	14	1075	133	22	11	9	160	17	128
Initial Q (Qb), veh	0	0	0	0	0	0	0	0	0	0	0	0
Ped-Bike Adj(A_pbT)	1.00		1.00	1.00		1.00	1.00		1.00	1.00		1.00
Parking Bus, Adj	1.00	1.00	1.00	1.00	1.00	1.00	1.00	1.00	1.00	1.00	1.00	1.00
Work Zone On Approach		No			No			No			No	
Adj Sat Flow, veh/h/ln	1856	1841	1781	1900	1841	1885	1885	1900	1885	1900	1900	1885
Adj Flow Rate, veh/h	161	1133	0	15	1132	103	23	12	-15	168	18	27
Peak Hour Factor	0.95	0.95	0.95	0.95	0.95	0.95	0.95	0.95	0.95	0.95	0.95	0.95
Percent Heavy Veh, %	3	4	8	0	4	1	1	0	1	0	0	1
Cap, veh/h	202	1748		154	1722	547	130	0	403	220	279	417
Arrive On Green	0.11	0.35	0.00	0.09	0.34	0.34	0.07	0.10	0.00	0.12	0.15	0.15
Sat Flow, veh/h	1767	5025	1510	1810	5025	1598	1795	1900	0	1810	1900	1598
Grp Volume(v), veh/h	161	1133	0	15	1132	103	23	-3	-3	168	18	27
Grp Sat Flow(s),veh/h/ln	1767	1675	1510	1810	1675	1598	1795	1900	1610	1810	1900	1598
Q Serve(g_s), s	5.9	12.7	0.0	0.5	12.8	3.0	0.8	0.0	0.0	6.0	0.5	0.5
Cycle Q Clear(g_c), s	5.9	12.7	0.0	0.5	12.8	3.0	0.8	0.0	0.0	6.0	0.5	0.5
Prop In Lane	1.00		1.00	1.00		1.00	1.00		0.00	1.00		1.00
Lane Grp Cap(c), veh/h	202	1748		154	1722	547	130	0	0	220	279	417
V/C Ratio(X)	0.80	0.65		0.10	0.66	0.19	0.18	0.00	0.00	0.76	0.06	0.06
Avail Cap(c_a), veh/h	402	3675		154	2907	924	382	0	0	396	865	910
HCM Platoon Ratio	1.00	1.00	1.00	1.00	1.00	1.00	1.00	1.00	1.00	1.00	1.00	1.00
Upstream Filter(I)	1.00	1.00	0.00	1.00	1.00	1.00	1.00	0.00	0.00	1.00	1.00	1.00
Uniform Delay (d), s/veh	28.8	18.3	0.0	28.2	18.6	15.4	29.1	0.0	0.0	28.4	24.5	7.2
Incr Delay (d2), s/veh	2.7	0.4	0.0	0.1	0.4	0.2	0.6	0.0	0.0	5.4	0.1	0.1
Initial Q Delay(d3),s/veh	0.0	0.0	0.0	0.0	0.0	0.0	0.0	0.0	0.0	0.0	0.0	0.0
%ile BackOfQ(50%),veh/ln	2.4	4.1	0.0	0.2	4.2	1.1	0.4	0.0	0.0	2.7	0.2	0.2
Unsig. Movement Delay, s/veh												
LnGrp Delay(d),s/veh	31.5	18.7	0.0	28.3	19.0	15.6	29.7	0.0	0.0	33.8	24.6	7.3
LnGrp LOS	C	B		C	B	B	C	A	A	C	C	A
Approach Vol, veh/h		1294			1250			17			213	
Approach Delay, s/veh		20.3			18.9			40.2			29.7	
Approach LOS		C			B			D			C	
Timer - Assigned Phs	1	2	3	4	5	6	7	8				
Phs Duration (G+Y+Rc), s	11.9	29.4	10.2	15.2	12.2	29.1	13.5	11.9				
Change Period (Y+Rc), s	6.2	* 6.2	5.4	5.4	4.6	6.2	5.4	5.4				
Max Green Setting (Gmax), s	5.0	* 49	14.2	30.4	15.2	38.6	14.6	30.0				
Max Q Clear Time (g_c+I1), s	2.5	14.7	2.8	2.5	7.9	14.8	8.0	0.0				
Green Ext Time (p_c), s	0.0	8.5	0.0	0.1	0.1	8.1	0.2	0.0				

Intersection Summary

HCM 6th Ctrl Delay	20.5
HCM 6th LOS	C

Notes

- User approved pedestrian interval to be less than phase max green.
- User approved volume balancing among the lanes for turning movement.
- * HCM 6th computational engine requires equal clearance times for the phases crossing the barrier.

APPENDIX 7.1:

**OPENING YEAR CUMULATIVE (2028) WITHOUT PROJECT CONDITIONS INTERSECTION
OPERATIONS ANALYSIS WORKSHEETS**

This Page Intentionally Left Blank

Timings
1: Washington St & Van Buren Bl.



Lane Group	EBL	EBT	WBL	WBT	WBR	NBL	NBT	NBR	SBL	SBT
Lane Configurations	↙	↕	↙	↕	↗	↙↗	↕	↗	↙↗	↕
Traffic Volume (vph)	151	1306	114	1706	763	156	585	145	444	202
Future Volume (vph)	151	1306	114	1706	763	156	585	145	444	202
Turn Type	Prot	NA	Prot	NA	Perm	Prot	NA	Perm	Prot	NA
Protected Phases	5	2	1	6		3	8		7	4
Permitted Phases					6			8		
Detector Phase	5	2	1	6	6	3	8	8	7	4
Switch Phase										
Minimum Initial (s)	5.0	10.0	5.0	10.0	10.0	5.0	10.0	10.0	5.0	10.0
Minimum Split (s)	9.2	34.2	9.2	33.2	33.2	9.2	38.4	38.4	9.2	30.8
Total Split (s)	14.0	53.1	12.3	51.4	51.4	14.2	38.4	38.4	16.2	40.4
Total Split (%)	11.7%	44.3%	10.3%	42.8%	42.8%	11.8%	32.0%	32.0%	13.5%	33.7%
Yellow Time (s)	3.2	5.2	3.2	5.2	5.2	3.2	4.4	4.4	3.2	4.8
All-Red Time (s)	1.0	1.0	1.0	1.0	1.0	1.0	1.0	1.0	1.0	1.0
Lost Time Adjust (s)	0.0	0.0	0.0	0.0	0.0	0.0	0.0	0.0	0.0	0.0
Total Lost Time (s)	4.2	6.2	4.2	6.2	6.2	4.2	5.4	5.4	4.2	5.8
Lead/Lag	Lead	Lag	Lead	Lag	Lag	Lead	Lag	Lag	Lead	Lag
Lead-Lag Optimize?	Yes	Yes	Yes	Yes	Yes	Yes	Yes	Yes	Yes	Yes
Recall Mode	None	None	None	None	None	None	None	None	None	None
Act Effct Green (s)	9.8	47.0	8.1	45.3	45.3	9.0	26.5	26.5	12.0	29.1
Actuated g/C Ratio	0.09	0.41	0.07	0.40	0.40	0.08	0.23	0.23	0.11	0.26
v/c Ratio	1.03	1.05	0.95	1.26	1.02	0.62	0.74	0.33	1.28	0.33
Control Delay	133.1	70.9	123.6	154.4	60.7	62.1	46.1	9.4	185.6	30.0
Queue Delay	0.0	0.0	0.0	0.0	0.0	0.0	0.0	0.0	0.0	0.0
Total Delay	133.1	70.9	123.6	154.4	60.7	62.1	46.1	9.4	185.6	30.0
LOS	F	E	F	F	E	E	D	A	F	C
Approach Delay		76.8		125.3			42.9			126.4
Approach LOS		E		F			D			F

Intersection Summary

Cycle Length: 120
 Actuated Cycle Length: 113.7
 Natural Cycle: 125
 Control Type: Actuated-Uncoordinated
 Maximum v/c Ratio: 1.28
 Intersection Signal Delay: 99.4
 Intersection LOS: F
 Intersection Capacity Utilization 102.0%
 ICU Level of Service G
 Analysis Period (min) 15

Splits and Phases: 1: Washington St & Van Buren Bl.

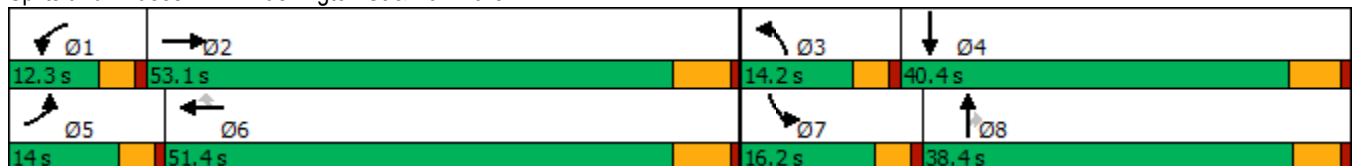

HCM 6th Signalized Intersection Summary
1: Washington St & Van Buren Bl.

West Campus Upper Plateau (JN 14064)

09/19/2022



Movement	EBL	EBT	EBR	WBL	WBT	WBR	NBL	NBT	NBR	SBL	SBT	SBR
Lane Configurations												
Traffic Volume (veh/h)	151	1306	137	114	1706	763	156	585	145	444	202	71
Future Volume (veh/h)	151	1306	137	114	1706	763	156	585	145	444	202	71
Initial Q (Qb), veh	0	0	0	0	0	0	0	0	0	0	0	0
Ped-Bike Adj(A_pbT)	1.00		0.99	1.00		0.98	1.00		1.00	1.00		1.00
Parking Bus, Adj	1.00	1.00	1.00	1.00	1.00	1.00	1.00	1.00	1.00	1.00	1.00	1.00
Work Zone On Approach		No			No			No			No	
Adj Sat Flow, veh/h/ln	1870	1856	1856	1856	1870	1885	1826	1870	1856	1870	1811	1826
Adj Flow Rate, veh/h	157	1360	120	119	1777	631	162	609	85	462	210	45
Peak Hour Factor	0.96	0.96	0.96	0.96	0.96	0.96	0.96	0.96	0.96	0.96	0.96	0.96
Percent Heavy Veh, %	2	3	3	3	2	1	5	2	3	2	6	5
Cap, veh/h	156	1374	121	128	1437	635	220	775	341	371	736	155
Arrive On Green	0.09	0.42	0.42	0.07	0.40	0.40	0.07	0.22	0.22	0.11	0.26	0.26
Sat Flow, veh/h	1781	3275	288	1767	3554	1569	3374	3554	1566	3456	2829	594
Grp Volume(v), veh/h	157	729	751	119	1777	631	162	609	85	462	126	129
Grp Sat Flow(s),veh/h/ln	1781	1763	1799	1767	1777	1569	1687	1777	1566	1728	1721	1703
Q Serve(g_s), s	9.8	45.8	46.4	7.5	45.2	44.8	5.3	18.1	5.0	12.0	6.5	6.8
Cycle Q Clear(g_c), s	9.8	45.8	46.4	7.5	45.2	44.8	5.3	18.1	5.0	12.0	6.5	6.8
Prop In Lane	1.00		0.16	1.00		1.00	1.00		1.00	1.00		0.35
Lane Grp Cap(c), veh/h	156	740	755	128	1437	635	220	775	341	371	447	443
V/C Ratio(X)	1.01	0.99	0.99	0.93	1.24	0.99	0.74	0.79	0.25	1.25	0.28	0.29
Avail Cap(c_a), veh/h	156	740	755	128	1437	635	302	1049	462	371	533	527
HCM Platoon Ratio	1.00	1.00	1.00	1.00	1.00	1.00	1.00	1.00	1.00	1.00	1.00	1.00
Upstream Filter(I)	1.00	1.00	1.00	1.00	1.00	1.00	1.00	1.00	1.00	1.00	1.00	1.00
Uniform Delay (d), s/veh	51.0	32.1	32.3	51.5	33.3	33.1	51.3	41.2	36.1	49.9	33.0	33.1
Incr Delay (d2), s/veh	73.4	29.5	31.2	57.3	112.6	34.2	3.3	2.8	0.4	131.0	0.3	0.4
Initial Q Delay(d3),s/veh	0.0	0.0	0.0	0.0	0.0	0.0	0.0	0.0	0.0	0.0	0.0	0.0
%ile BackOfQ(50%),veh/ln	7.4	23.8	24.9	5.2	40.2	22.7	2.3	8.2	2.0	11.9	2.8	2.8
Unsig. Movement Delay, s/veh												
LnGrp Delay(d),s/veh	124.3	61.6	63.5	108.8	145.8	67.3	54.6	44.1	36.5	180.9	33.4	33.5
LnGrp LOS	F	E	E	F	F	E	D	D	D	F	C	C
Approach Vol, veh/h		1637			2527			856				717
Approach Delay, s/veh		68.5			124.5			45.3				128.5
Approach LOS		E			F			D				F
Timer - Assigned Phs	1	2	3	4	5	6	7	8				
Phs Duration (G+Y+Rc), s	12.3	53.1	11.5	34.9	14.0	51.4	16.2	30.2				
Change Period (Y+Rc), s	* 4.2	6.2	* 4.2	5.8	* 4.2	6.2	* 4.2	* 5.8				
Max Green Setting (Gmax), s	* 8.1	46.9	* 10	34.6	* 9.8	45.2	* 12	* 33				
Max Q Clear Time (g_c+I1), s	9.5	48.4	7.3	8.8	11.8	47.2	14.0	20.1				
Green Ext Time (p_c), s	0.0	0.0	0.1	1.5	0.0	0.0	0.0	3.8				

Intersection Summary

HCM 6th Ctrl Delay	97.2
HCM 6th LOS	F

Notes

* HCM 6th computational engine requires equal clearance times for the phases crossing the barrier.

Timings
2: Central Ave & Arlington Ave/Chicago Ave

West Campus Upper Plateau (JN 14064)

09/19/2022



Lane Group	EBL	EBT	EBR	WBL	WBT	WBR	NBL	NBT	NBR	SBL	SBT
Lane Configurations	↘	↑↑	↗↗	↘↘	↑↑	↗	↘↘	↑↑	↗	↘↘	↑↑↗
Traffic Volume (vph)	47	564	739	247	932	370	1483	1853	580	259	769
Future Volume (vph)	47	564	739	247	932	370	1483	1853	580	259	769
Turn Type	Prot	NA	pm+ov	Prot	NA	pm+ov	Prot	NA	pm+ov	Prot	NA
Protected Phases	7	4	5	3	8	1	5	2	3	1	6
Permitted Phases			4			8			2		
Detector Phase	7	4	5	3	8	1	5	2	3	1	6
Switch Phase											
Minimum Initial (s)	5.0	10.0	10.0	5.0	10.0	10.0	10.0	10.0	5.0	10.0	10.0
Minimum Split (s)	9.6	35.2	15.8	9.6	38.8	15.8	15.8	38.8	9.6	15.8	38.8
Total Split (s)	9.6	35.6	42.0	12.8	38.8	15.9	42.0	65.7	12.8	15.9	39.6
Total Split (%)	7.4%	27.4%	32.3%	9.8%	29.8%	12.2%	32.3%	50.5%	9.8%	12.2%	30.5%
Yellow Time (s)	3.6	4.8	3.6	3.6	4.8	3.6	3.6	4.4	3.6	3.6	4.4
All-Red Time (s)	1.0	1.0	1.0	1.0	1.0	1.0	1.0	1.0	1.0	1.0	1.0
Lost Time Adjust (s)	0.0	0.0	0.0	0.0	0.0	0.0	0.0	0.0	0.0	0.0	0.0
Total Lost Time (s)	4.6	5.8	4.6	4.6	5.8	4.6	4.6	5.4	4.6	4.6	5.4
Lead/Lag	Lead	Lag	Lead	Lead	Lag	Lead	Lead	Lag	Lead	Lead	Lag
Lead-Lag Optimize?	Yes	Yes	Yes	Yes	Yes	Yes	Yes	Yes	Yes	Yes	Yes
Recall Mode	None	None	None	None	None	None	None	None	None	None	None
Act Effct Green (s)	5.0	27.8	71.0	8.2	33.0	50.2	37.4	60.4	69.4	11.3	34.2
Actuated g/C Ratio	0.04	0.22	0.55	0.06	0.26	0.39	0.29	0.47	0.54	0.09	0.27
v/c Ratio	0.71	0.79	0.50	1.26	1.08	0.58	1.56	1.17	0.70	0.91	0.64
Control Delay	108.9	55.6	17.3	196.2	97.2	26.9	288.4	115.8	22.0	91.5	44.1
Queue Delay	0.0	0.0	0.0	0.0	0.0	0.0	0.0	0.0	0.0	0.0	0.0
Total Delay	108.9	55.6	17.3	196.2	97.2	26.9	288.4	115.8	22.0	91.5	44.1
LOS	F	E	B	F	F	C	F	F	C	F	D
Approach Delay		36.5			96.2			167.3			55.5
Approach LOS		D			F			F			E

Intersection Summary

Cycle Length: 130
 Actuated Cycle Length: 128.1
 Natural Cycle: 125
 Control Type: Actuated-Uncoordinated
 Maximum v/c Ratio: 1.56
 Intersection Signal Delay: 115.7
 Intersection LOS: F
 Intersection Capacity Utilization 106.5%
 ICU Level of Service G
 Analysis Period (min) 15

Splits and Phases: 2: Central Ave & Arlington Ave/Chicago Ave



HCM 6th Signalized Intersection Summary
2: Central Ave & Arlington Ave/Chicago Ave

West Campus Upper Plateau (JN 14064)

09/19/2022



Movement	EBL	EBT	EBR	WBL	WBT	WBR	NBL	NBT	NBR	SBL	SBT	SBR
Lane Configurations	↘	↑↑	↗↗	↘↘	↑↑	↗	↘↘	↑↑	↗	↘↘	↑↑↘	
Traffic Volume (veh/h)	47	564	739	247	932	370	1483	1853	580	259	769	48
Future Volume (veh/h)	47	564	739	247	932	370	1483	1853	580	259	769	48
Initial Q (Qb), veh	0	0	0	0	0	0	0	0	0	0	0	0
Ped-Bike Adj(A_pbT)	1.00		1.00	1.00		1.00	1.00		0.99	1.00		1.00
Parking Bus, Adj	1.00	1.00	1.00	1.00	1.00	1.00	1.00	1.00	1.00	1.00	1.00	1.00
Work Zone On Approach		No			No			No			No	
Adj Sat Flow, veh/h/ln	1900	1856	1870	1796	1885	1885	1885	1885	1885	1870	1870	1870
Adj Flow Rate, veh/h	50	600	529	263	991	312	1578	1971	448	276	818	41
Peak Hour Factor	0.94	0.94	0.94	0.94	0.94	0.94	0.94	0.94	0.94	0.94	0.94	0.94
Percent Heavy Veh, %	0	3	2	7	1	1	1	1	1	2	2	2
Cap, veh/h	65	801	1438	210	912	546	1005	1666	834	301	1314	66
Arrive On Green	0.04	0.23	0.23	0.06	0.25	0.25	0.29	0.47	0.47	0.09	0.26	0.26
Sat Flow, veh/h	1810	3526	2790	3319	3582	1598	3483	3582	1577	3456	4981	249
Grp Volume(v), veh/h	50	600	529	263	991	312	1578	1971	448	276	558	301
Grp Sat Flow(s),veh/h/ln	1810	1763	1395	1659	1791	1598	1742	1791	1577	1728	1702	1826
Q Serve(g_s), s	3.6	20.6	14.7	8.2	33.0	20.7	37.4	60.3	24.3	10.3	18.7	18.8
Cycle Q Clear(g_c), s	3.6	20.6	14.7	8.2	33.0	20.7	37.4	60.3	24.3	10.3	18.7	18.8
Prop In Lane	1.00		1.00	1.00		1.00	1.00		1.00	1.00		0.14
Lane Grp Cap(c), veh/h	65	801	1438	210	912	546	1005	1666	834	301	898	482
V/C Ratio(X)	0.77	0.75	0.37	1.25	1.09	0.57	1.57	1.18	0.54	0.92	0.62	0.62
Avail Cap(c_a), veh/h	70	810	1446	210	912	546	1005	1666	834	301	898	482
HCM Platoon Ratio	1.00	1.00	1.00	1.00	1.00	1.00	1.00	1.00	1.00	1.00	1.00	1.00
Upstream Filter(I)	1.00	1.00	1.00	1.00	1.00	1.00	1.00	1.00	1.00	1.00	1.00	1.00
Uniform Delay (d), s/veh	62.0	46.7	18.8	60.7	48.3	34.9	46.1	34.7	20.1	58.7	42.0	42.1
Incr Delay (d2), s/veh	34.0	3.9	0.2	146.7	56.3	1.4	261.5	88.8	0.7	31.1	1.3	2.5
Initial Q Delay(d3),s/veh	0.0	0.0	0.0	0.0	0.0	0.0	0.0	0.0	0.0	0.0	0.0	0.0
%ile BackOfQ(50%),veh/ln	2.2	9.2	4.6	7.7	21.4	8.0	52.2	45.4	8.6	5.7	7.9	8.7
Unsig. Movement Delay, s/veh												
LnGrp Delay(d),s/veh	96.0	50.5	18.9	207.4	104.6	36.3	307.6	123.5	20.8	89.8	43.4	44.6
LnGrp LOS	F	D	B	F	F	D	F	F	C	F	D	D
Approach Vol, veh/h		1179			1566			3997			1135	
Approach Delay, s/veh		38.3			108.2			184.7			55.0	
Approach LOS		D			F			F			D	
Timer - Assigned Phs	1	2	3	4	5	6	7	8				
Phs Duration (G+Y+Rc), s	15.9	65.7	12.8	35.2	42.0	39.6	9.2	38.8				
Change Period (Y+Rc), s	4.6	5.4	4.6	5.8	4.6	5.4	4.6	5.8				
Max Green Setting (Gmax), s	11.3	60.3	8.2	29.8	37.4	34.2	5.0	33.0				
Max Q Clear Time (g_c+I1), s	12.3	62.3	10.2	22.6	39.4	20.8	5.6	35.0				
Green Ext Time (p_c), s	0.0	0.0	0.0	3.4	0.0	4.4	0.0	0.0				

Intersection Summary

HCM 6th Ctrl Delay	128.9
HCM 6th LOS	F

Timings

3: Overlook Pkwy./Canyon Crest Dr. & Alessandro Bl/Alessandro Bl.



Lane Group	EBL	EBT	WBT	WBR	NBL	NBT	NBR	SBL	SBT	SBR	Ø1
Lane Configurations											
Traffic Volume (vph)	75	1627	3666	1240	1	170	3	556	21	77	
Future Volume (vph)	75	1627	3666	1240	1	170	3	556	21	77	
Turn Type	Prot	NA	NA	pm+ov	Split	NA	Perm	Split	NA	Perm	
Protected Phases	5	2	6	4	8	8		4	4		1
Permitted Phases				6			8			4	
Detector Phase	5	2	6	4	8	8	8	4	4	4	
Switch Phase											
Minimum Initial (s)	5.0	10.0	10.0	10.0	10.0	10.0	10.0	10.0	10.0	10.0	5.0
Minimum Split (s)	9.2	35.2	35.2	38.8	15.8	15.8	15.8	38.8	38.8	38.8	9.2
Total Split (s)	9.2	66.2	66.2	38.8	15.8	15.8	15.8	38.8	38.8	38.8	9.2
Total Split (%)	7.1%	50.9%	50.9%	29.8%	12.2%	12.2%	12.2%	29.8%	29.8%	29.8%	7%
Yellow Time (s)	3.2	5.2	5.2	4.8	4.8	4.8	4.8	4.8	4.8	4.8	3.2
All-Red Time (s)	1.0	1.0	1.0	1.0	1.0	1.0	1.0	1.0	1.0	1.0	1.0
Lost Time Adjust (s)	0.0	0.0	0.0	0.0	0.0	0.0	0.0	0.0	0.0	0.0	0.0
Total Lost Time (s)	4.2	6.2	6.2	5.8	5.8	5.8	5.8	5.8	5.8	5.8	5.8
Lead/Lag	Lead	Lag	Lag								Lead
Lead-Lag Optimize?	Yes	Yes	Yes								Yes
Recall Mode	None	None	None	None	None	None	None	None	None	None	None
Act Effct Green (s)	5.0	69.2	60.0	99.2	10.0	10.0	10.0	33.0	33.0	33.0	
Actuated g/C Ratio	0.04	0.53	0.46	0.76	0.08	0.08	0.08	0.25	0.25	0.25	
v/c Ratio	1.22	0.63	1.63	1.06	0.01	0.65	0.01	0.50	0.50	0.17	
Control Delay	231.3	22.8	312.1	58.9	56.0	69.7	0.0	44.0	46.4	3.6	
Queue Delay	0.0	0.0	0.0	0.0	0.0	0.0	0.0	0.0	0.0	0.0	
Total Delay	231.3	22.8	312.1	58.9	56.0	69.7	0.0	44.0	46.4	3.6	
LOS	F	C	F	E	E	E	A	D	D	A	
Approach Delay		32.0	248.1			68.5			39.9		
Approach LOS		C	F			E			D		

Intersection Summary

Cycle Length: 130
 Actuated Cycle Length: 130
 Natural Cycle: 130
 Control Type: Actuated-Uncoordinated
 Maximum v/c Ratio: 1.63
 Intersection Signal Delay: 176.1
 Intersection LOS: F
 Intersection Capacity Utilization 104.6%
 ICU Level of Service G
 Analysis Period (min) 15

Splits and Phases: 3: Overlook Pkwy./Canyon Crest Dr. & Alessandro Bl/Alessandro Bl.

Ø1	Ø2	Ø4	Ø8
9.2 s	66.2 s	38.8 s	15.8 s
Ø5	Ø6		
9.2 s	66.2 s		

HCM 6th Signalized Intersection Summary

West Campus Upper Plateau (JN 14064)

3: Overlook Pkwy./Canyon Crest Dr. & Alessandro Bl/Alessandro Bl.

09/19/2022



Movement	EBL	EBT	EBR	WBL	WBT	WBR	NBL	NBT	NBR	SBL	SBT	SBR
Lane Configurations	↗	↑↑↑		↖	↑↑↑	↗	↖	↑↑	↗	↖↗	↖	↗
Traffic Volume (veh/h)	75	1627	0	0	3666	1240	1	170	3	556	21	77
Future Volume (veh/h)	75	1627	0	0	3666	1240	1	170	3	556	21	77
Initial Q (Qb), veh	0	0	0	0	0	0	0	0	0	0	0	0
Ped-Bike Adj(A_pbT)	1.00		1.00	1.00		1.00	1.00		1.00	1.00		1.00
Parking Bus, Adj	1.00	1.00	1.00	1.00	1.00	1.00	1.00	1.00	1.00	1.00	1.00	1.00
Work Zone On Approach		No			No			No			No	
Adj Sat Flow, veh/h/ln	1811	1870	1900	1900	1885	1885	1900	1900	1900	1856	1885	1885
Adj Flow Rate, veh/h	79	1713	0	0	3859	1142	1	179	1	601	0	64
Peak Hour Factor	0.95	0.95	0.95	0.95	0.95	0.95	0.95	0.95	0.95	0.95	0.95	0.95
Percent Heavy Veh, %	6	2	0	0	1	1	0	0	0	3	1	1
Cap, veh/h	76	3108	0	2	2716	1078	159	316	141	780	0	235
Arrive On Green	0.04	0.61	0.00	0.00	0.53	0.53	0.09	0.09	0.09	0.15	0.00	0.15
Sat Flow, veh/h	1725	5274	0	1810	5147	1598	1810	3610	1610	5302	0	1598
Grp Volume(v), veh/h	79	1713	0	0	3859	1142	1	179	1	601	0	64
Grp Sat Flow(s),veh/h/ln	1725	1702	0	1810	1716	1598	1810	1805	1610	1767	0	1598
Q Serve(g_s), s	5.0	22.5	0.0	0.0	60.0	60.0	0.1	5.4	0.1	12.4	0.0	4.0
Cycle Q Clear(g_c), s	5.0	22.5	0.0	0.0	60.0	60.0	0.1	5.4	0.1	12.4	0.0	4.0
Prop In Lane	1.00		0.00	1.00		1.00	1.00		1.00	1.00		1.00
Lane Grp Cap(c), veh/h	76	3108	0	2	2716	1078	159	316	141	780	0	235
V/C Ratio(X)	1.04	0.55	0.00	0.00	1.42	1.06	0.01	0.57	0.01	0.77	0.00	0.27
Avail Cap(c_a), veh/h	76	3108	0	80	2716	1078	159	318	142	1539	0	464
HCM Platoon Ratio	1.00	1.00	1.00	1.00	1.00	1.00	1.00	1.00	1.00	1.00	1.00	1.00
Upstream Filter(I)	1.00	1.00	0.00	0.00	1.00	1.00	1.00	1.00	1.00	1.00	0.00	1.00
Uniform Delay (d), s/veh	54.3	13.1	0.0	0.0	26.8	15.8	47.3	49.8	47.3	46.6	0.0	43.1
Incr Delay (d2), s/veh	115.2	0.2	0.0	0.0	191.6	44.5	0.0	2.3	0.0	1.7	0.0	0.6
Initial Q Delay(d3),s/veh	0.0	0.0	0.0	0.0	0.0	0.0	0.0	0.0	0.0	0.0	0.0	0.0
%ile BackOfQ(50%),veh/ln	4.5	7.4	0.0	0.0	69.5	43.3	0.0	2.5	0.0	5.4	0.0	1.6
Unsig. Movement Delay, s/veh												
LnGrp Delay(d),s/veh	169.5	13.3	0.0	0.0	218.4	60.3	47.4	52.1	47.4	48.3	0.0	43.7
LnGrp LOS	F	B	A	A	F	F	D	D	D	D	A	D
Approach Vol, veh/h		1792			5001			181				665
Approach Delay, s/veh		20.2			182.3			52.0				47.8
Approach LOS		C			F			D				D
Timer - Assigned Phs	1	2		4	5	6		8				
Phs Duration (G+Y+Rc), s	0.0	75.4		22.5	9.2	66.2		15.8				
Change Period (Y+Rc), s	* 4.2	6.2		5.8	* 4.2	6.2		5.8				
Max Green Setting (Gmax), s	* 5	60.0		33.0	* 5	60.0		10.0				
Max Q Clear Time (g_c+I1), s	0.0	24.5		14.4	7.0	62.0		7.4				
Green Ext Time (p_c), s	0.0	15.5		2.3	0.0	0.0		0.2				

Intersection Summary

HCM 6th Ctrl Delay	129.5
HCM 6th LOS	F

Notes

- User approved pedestrian interval to be less than phase max green.
- User approved volume balancing among the lanes for turning movement.
- * HCM 6th computational engine requires equal clearance times for the phases crossing the barrier.

Timings

West Campus Upper Plateau (JN 14064)

4: Van Buren Bl. & Wood Rd.

09/19/2022

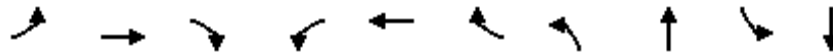

Lane Group	EBL	EBT	EBR	WBL	WBT	WBR	NBL	NBT	SBL	SBT
Lane Configurations	↘	↑↑	↗	↘↗	↑↑	↗	↘↗	↑↑	↘	↑↑
Traffic Volume (vph)	168	1266	377	516	1775	133	387	478	125	478
Future Volume (vph)	168	1266	377	516	1775	133	387	478	125	478
Turn Type	Prot	NA	pm+ov	Prot	NA	Perm	Prot	NA	Prot	NA
Protected Phases	5	2	3	1	6		3	8	7	4
Permitted Phases			2			6				
Detector Phase	5	2	3	1	6	6	3	8	7	4
Switch Phase										
Minimum Initial (s)	5.0	10.0	5.0	5.0	10.0	10.0	5.0	10.0	5.0	10.0
Minimum Split (s)	9.2	30.2	9.2	9.2	30.2	30.2	9.2	38.4	9.2	15.8
Total Split (s)	16.6	45.0	18.2	25.0	53.4	53.4	18.2	38.4	11.6	31.8
Total Split (%)	13.8%	37.5%	15.2%	20.8%	44.5%	44.5%	15.2%	32.0%	9.7%	26.5%
Yellow Time (s)	3.2	5.2	3.2	3.2	5.2	5.2	3.2	4.4	3.2	4.8
All-Red Time (s)	1.0	1.0	1.0	1.0	1.0	1.0	1.0	1.0	1.0	1.0
Lost Time Adjust (s)	0.0	0.0	0.0	0.0	0.0	0.0	0.0	0.0	0.0	0.0
Total Lost Time (s)	4.2	6.2	4.2	4.2	6.2	6.2	4.2	5.4	4.2	5.8
Lead/Lag	Lead	Lag	Lead	Lead	Lag	Lag	Lead	Lag	Lead	Lag
Lead-Lag Optimize?	Yes	Yes	Yes	Yes	Yes	Yes	Yes	Yes	Yes	Yes
Recall Mode	None	None	None	None	None	None	None	None	None	None
Act Effct Green (s)	12.4	38.8	54.8	20.8	47.2	47.2	14.0	33.0	7.4	26.0
Actuated g/C Ratio	0.10	0.32	0.46	0.17	0.39	0.39	0.12	0.28	0.06	0.22
v/c Ratio	1.06	1.27	0.57	0.98	1.45	0.22	1.09	0.95	1.30	0.97
Control Delay	133.8	163.8	19.1	81.0	236.3	5.5	120.2	54.6	231.7	70.9
Queue Delay	0.0	0.0	0.0	0.0	0.0	0.0	0.0	0.0	0.0	0.0
Total Delay	133.8	163.8	19.1	81.0	236.3	5.5	120.2	54.6	231.7	70.9
LOS	F	F	B	F	F	A	F	D	F	E
Approach Delay		130.9			190.6			75.6		96.4
Approach LOS		F			F			E		F

Intersection Summary

Cycle Length: 120
 Actuated Cycle Length: 120
 Natural Cycle: 130
 Control Type: Actuated-Uncoordinated
 Maximum v/c Ratio: 1.45
 Intersection Signal Delay: 139.0
 Intersection LOS: F
 Intersection Capacity Utilization 109.4%
 ICU Level of Service H
 Analysis Period (min) 15

Splits and Phases: 4: Van Buren Bl. & Wood Rd.

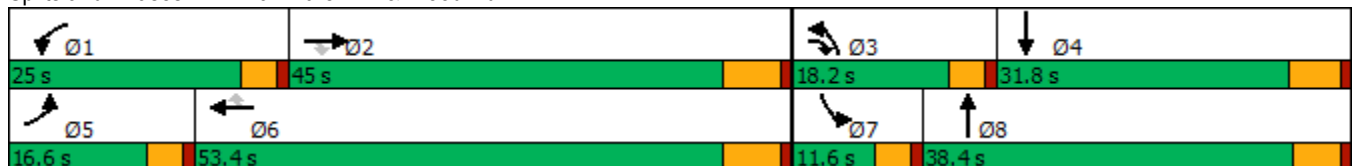

HCM 6th Signalized Intersection Summary
4: Van Buren Bl. & Wood Rd.

West Campus Upper Plateau (JN 14064)

09/19/2022

Movement	EBL	EBT	EBR	WBL	WBT	WBR	NBL	NBT	NBR	SBL	SBT	SBR
Lane Configurations												
Traffic Volume (veh/h)	168	1266	377	516	1775	133	387	478	346	125	478	186
Future Volume (veh/h)	168	1266	377	516	1775	133	387	478	346	125	478	186
Initial Q (Qb), veh	0	0	0	0	0	0	0	0	0	0	0	0
Ped-Bike Adj(A_pbT)	1.00		0.97	1.00		0.98	1.00		0.90	1.00		0.99
Parking Bus, Adj	1.00	1.00	1.00	1.00	1.00	1.00	1.00	1.00	1.00	1.00	1.00	1.00
Work Zone On Approach		No			No			No			No	
Adj Sat Flow, veh/h/ln	1856	1856	1856	1885	1870	1870	1885	1885	1885	1870	1900	1856
Adj Flow Rate, veh/h	191	1439	243	586	2017	101	440	543	250	142	543	116
Peak Hour Factor	0.88	0.88	0.88	0.88	0.88	0.88	0.88	0.88	0.88	0.88	0.88	0.88
Percent Heavy Veh, %	3	3	3	1	2	2	1	1	1	2	0	3
Cap, veh/h	183	1140	679	604	1398	614	406	623	285	110	639	136
Arrive On Green	0.10	0.32	0.32	0.17	0.39	0.39	0.12	0.27	0.27	0.06	0.22	0.22
Sat Flow, veh/h	1767	3526	1531	3483	3554	1560	3483	2295	1052	1781	2954	628
Grp Volume(v), veh/h	191	1439	243	586	2017	101	440	423	370	142	331	328
Grp Sat Flow(s),veh/h/ln	1767	1763	1531	1742	1777	1560	1742	1791	1555	1781	1805	1777
Q Serve(g_s), s	12.4	38.8	12.7	20.1	47.2	5.0	14.0	27.0	27.3	7.4	21.1	21.3
Cycle Q Clear(g_c), s	12.4	38.8	12.7	20.1	47.2	5.0	14.0	27.0	27.3	7.4	21.1	21.3
Prop In Lane	1.00		1.00	1.00		1.00	1.00		0.68	1.00		0.35
Lane Grp Cap(c), veh/h	183	1140	679	604	1398	614	406	486	422	110	391	385
V/C Ratio(X)	1.05	1.26	0.36	0.97	1.44	0.16	1.08	0.87	0.88	1.29	0.85	0.85
Avail Cap(c_a), veh/h	183	1140	679	604	1398	614	406	493	428	110	391	385
HCM Platoon Ratio	1.00	1.00	1.00	1.00	1.00	1.00	1.00	1.00	1.00	1.00	1.00	1.00
Upstream Filter(I)	1.00	1.00	1.00	1.00	1.00	1.00	1.00	1.00	1.00	1.00	1.00	1.00
Uniform Delay (d), s/veh	53.8	40.6	22.4	49.3	36.4	23.6	53.0	41.7	41.8	56.3	45.1	45.2
Incr Delay (d2), s/veh	79.1	125.1	0.5	29.0	203.3	0.2	68.6	15.3	17.9	183.5	15.7	16.6
Initial Q Delay(d3),s/veh	0.0	0.0	0.0	0.0	0.0	0.0	0.0	0.0	0.0	0.0	0.0	0.0
%ile BackOfQ(50%),veh/ln	9.3	35.6	4.5	10.8	58.4	1.9	9.9	13.7	12.3	8.9	10.9	10.9
Unsig. Movement Delay, s/veh												
LnGrp Delay(d),s/veh	132.9	165.7	22.8	78.3	239.7	23.8	121.6	57.0	59.7	239.8	60.8	61.8
LnGrp LOS	F	F	C	E	F	C	F	E	E	F	E	E
Approach Vol, veh/h		1873			2704			1233			801	
Approach Delay, s/veh		143.8			196.6			80.9			93.0	
Approach LOS		F			F			F			F	
Timer - Assigned Phs	1	2	3	4	5	6	7	8				
Phs Duration (G+Y+Rc), s	25.0	45.0	18.2	31.8	16.6	53.4	11.6	38.4				
Change Period (Y+Rc), s	* 4.2	6.2	* 4.2	5.8	* 4.2	6.2	* 4.2	* 5.8				
Max Green Setting (Gmax), s	* 21	38.8	* 14	26.0	* 12	47.2	* 7.4	* 33				
Max Q Clear Time (g_c+I1), s	22.1	40.8	16.0	23.3	14.4	49.2	9.4	29.3				
Green Ext Time (p_c), s	0.0	0.0	0.0	1.0	0.0	0.0	0.0	1.7				

Intersection Summary

HCM 6th Ctrl Delay	147.5
HCM 6th LOS	F

Notes

* HCM 6th computational engine requires equal clearance times for the phases crossing the barrier.

Timings
5: Trautwein Rd. & Alessandro Bl.

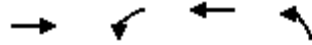

Lane Group	EBT	WBL	WBT	NBL
Lane Configurations	↑↑↑	↔↔	↑↑↑	↔↔↔
Traffic Volume (vph)	1244	261	3560	2257
Future Volume (vph)	1244	261	3560	2257
Turn Type	NA	Prot	NA	Prot
Protected Phases	2	1	6	8
Permitted Phases				
Detector Phase	2	1	6	8
Switch Phase				
Minimum Initial (s)	10.0	5.0	10.0	10.0
Minimum Split (s)	33.2	9.2	16.2	16.2
Total Split (s)	54.6	17.4	72.0	48.0
Total Split (%)	45.5%	14.5%	60.0%	40.0%
Yellow Time (s)	5.2	3.2	5.2	5.2
All-Red Time (s)	1.0	1.0	1.0	1.0
Lost Time Adjust (s)	0.0	0.0	0.0	0.0
Total Lost Time (s)	6.2	4.2	6.2	6.2
Lead/Lag	Lag	Lead		
Lead-Lag Optimize?	Yes	Yes		
Recall Mode	None	None	None	None
Act Effct Green (s)	49.0	12.6	65.8	41.8
Actuated g/C Ratio	0.41	0.10	0.55	0.35
v/c Ratio	0.80	0.80	1.39	1.47
Control Delay	34.9	69.2	203.5	246.2
Queue Delay	0.0	0.0	0.0	0.0
Total Delay	34.9	69.2	203.5	246.2
LOS	C	E	F	F
Approach Delay	34.9		194.3	246.2
Approach LOS	C		F	F

Intersection Summary

Cycle Length: 120
 Actuated Cycle Length: 120
 Natural Cycle: 130
 Control Type: Actuated-Uncoordinated
 Maximum v/c Ratio: 1.47
 Intersection Signal Delay: 179.5
 Intersection LOS: F
 Intersection Capacity Utilization 123.9%
 ICU Level of Service H
 Analysis Period (min) 15

Splits and Phases: 5: Trautwein Rd. & Alessandro Bl.

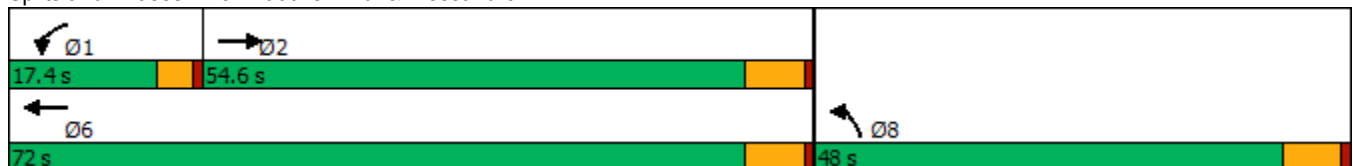

HCM 6th Signalized Intersection Summary
5: Trautwein Rd. & Alessandro Bl.

West Campus Upper Plateau (JN 14064)
09/19/2022

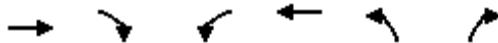

Movement	EBT	EBR	WBL	WBT	NBL	NBR
Lane Configurations	↑↑↑		↵↵	↑↑↑	↵↵↵	
Traffic Volume (veh/h)	1244	229	261	3560	2257	88
Future Volume (veh/h)	1244	229	261	3560	2257	88
Initial Q (Qb), veh	0	0	0	0	0	0
Ped-Bike Adj(A_pbT)		1.00	1.00		1.00	1.00
Parking Bus, Adj	1.00	1.00	1.00	1.00	1.00	1.00
Work Zone On Approach	No			No	No	
Adj Sat Flow, veh/h/ln	1870	1900	1870	1885	1885	1885
Adj Flow Rate, veh/h	1367	252	287	3912	2571	0
Peak Hour Factor	0.91	0.91	0.91	0.91	0.91	0.91
Percent Heavy Veh, %	2	0	2	1	1	1
Cap, veh/h	1795	331	342	2822	1876	557
Arrive On Green	0.41	0.41	0.10	0.55	0.35	0.00
Sat Flow, veh/h	4501	798	3456	5316	5386	1598
Grp Volume(v), veh/h	1074	545	287	3912	2571	0
Grp Sat Flow(s),veh/h/ln	1702	1727	1728	1716	1795	1598
Q Serve(g_s), s	32.4	32.4	9.8	65.8	41.8	0.0
Cycle Q Clear(g_c), s	32.4	32.4	9.8	65.8	41.8	0.0
Prop In Lane		0.46	1.00		1.00	1.00
Lane Grp Cap(c), veh/h	1410	715	342	2822	1876	557
V/C Ratio(X)	0.76	0.76	0.84	1.39	1.37	0.00
Avail Cap(c_a), veh/h	1410	715	380	2822	1876	557
HCM Platoon Ratio	1.00	1.00	1.00	1.00	1.00	1.00
Upstream Filter(I)	1.00	1.00	1.00	1.00	1.00	0.00
Uniform Delay (d), s/veh	30.1	30.1	53.1	27.1	39.1	0.0
Incr Delay (d2), s/veh	2.7	5.2	12.8	176.1	170.1	0.0
Initial Q Delay(d3),s/veh	0.0	0.0	0.0	0.0	0.0	0.0
%ile BackOfQ(50%),veh/ln	12.9	13.6	4.7	69.0	46.8	0.0
Unsig. Movement Delay, s/veh						
LnGrp Delay(d),s/veh	32.7	35.2	65.9	203.2	209.2	0.0
LnGrp LOS	C	D	E	F	F	A
Approach Vol, veh/h	1619			4199	2571	
Approach Delay, s/veh	33.6			193.8	209.2	
Approach LOS	C			F	F	
Timer - Assigned Phs	1	2			6	8
Phs Duration (G+Y+Rc), s	16.1	55.9			72.0	48.0
Change Period (Y+Rc), s	* 4.2	6.2			6.2	6.2
Max Green Setting (Gmax), s	* 13	48.4			65.8	41.8
Max Q Clear Time (g_c+I1), s	11.8	34.4			67.8	43.8
Green Ext Time (p_c), s	0.1	10.2			0.0	0.0

Intersection Summary

HCM 6th Ctrl Delay	167.6
HCM 6th LOS	F

Notes

User approved volume balancing among the lanes for turning movement.
* HCM 6th computational engine requires equal clearance times for the phases crossing the barrier.

Timings
6: Trautwein Rd. & Grove Community Dr

West Campus Upper Plateau (JN 14064)

09/19/2022

Lane Group	WBL	WBR	NBT	NBR	SBL	SBT
Lane Configurations						
Traffic Volume (vph)	88	698	1923	28	241	1510
Future Volume (vph)	88	698	1923	28	241	1510
Turn Type	Prot	pm+ov	NA	Perm	Prot	NA
Protected Phases	8	1	2		1	6
Permitted Phases		8		2		
Detector Phase	8	1	2	2	1	6
Switch Phase						
Minimum Initial (s)	10.0	5.0	10.0	10.0	5.0	10.0
Minimum Split (s)	34.6	9.6	46.2	46.2	9.6	28.2
Total Split (s)	34.6	15.2	70.2	70.2	15.2	85.4
Total Split (%)	28.8%	12.7%	58.5%	58.5%	12.7%	71.2%
Yellow Time (s)	3.6	3.6	5.2	5.2	3.6	5.2
All-Red Time (s)	1.0	1.0	1.0	1.0	1.0	1.0
Lost Time Adjust (s)	0.0	0.0	0.0	0.0	0.0	0.0
Total Lost Time (s)	4.6	4.6	6.2	6.2	4.6	6.2
Lead/Lag		Lead	Lag	Lag	Lead	
Lead-Lag Optimize?		Yes	Yes	Yes	Yes	
Recall Mode	None	None	None	None	None	None
Act Effct Green (s)	14.1	24.7	64.2	64.2	10.6	79.5
Actuated g/C Ratio	0.14	0.24	0.61	0.61	0.10	0.76
v/c Ratio	0.44	1.27	1.05	0.04	0.83	0.68
Control Delay	46.5	168.0	56.8	7.0	67.3	8.8
Queue Delay	0.0	0.0	0.0	0.0	0.0	0.0
Total Delay	46.5	168.0	56.8	7.0	67.3	8.8
LOS	D	F	E	A	E	A
Approach Delay	154.4		56.1			16.8
Approach LOS	F		E			B

Intersection Summary

Cycle Length: 120
 Actuated Cycle Length: 104.4
 Natural Cycle: 125
 Control Type: Actuated-Uncoordinated
 Maximum v/c Ratio: 1.27
 Intersection Signal Delay: 58.0
 Intersection LOS: E
 Intersection Capacity Utilization 86.8%
 ICU Level of Service E
 Analysis Period (min) 15

Splits and Phases: 6: Trautwein Rd. & Grove Community Dr



HCM 6th Signalized Intersection Summary
6: Trautwein Rd. & Grove Community Dr

West Campus Upper Plateau (JN 14064)

09/19/2022



Movement	WBL	WBR	NBT	NBR	SBL	SBT
Lane Configurations						
Traffic Volume (veh/h)	88	698	1923	28	241	1510
Future Volume (veh/h)	88	698	1923	28	241	1510
Initial Q (Qb), veh	0	0	0	0	0	0
Ped-Bike Adj(A_pbT)	1.00	1.00		0.97	1.00	
Parking Bus, Adj	1.00	1.00	1.00	1.00	1.00	1.00
Work Zone On Approach	No		No			No
Adj Sat Flow, veh/h/ln	1900	1885	1885	1900	1870	1870
Adj Flow Rate, veh/h	106	639	2317	26	290	1819
Peak Hour Factor	0.83	0.83	0.83	0.83	0.83	0.83
Percent Heavy Veh, %	0	1	1	0	2	2
Cap, veh/h	415	900	1963	860	314	2411
Arrive On Green	0.23	0.23	0.55	0.55	0.09	0.68
Sat Flow, veh/h	1810	2812	3676	1570	3456	3647
Grp Volume(v), veh/h	106	639	2317	26	290	1819
Grp Sat Flow(s),veh/h/ln	1810	1406	1791	1570	1728	1777
Q Serve(g_s), s	5.6	23.4	64.0	0.9	9.7	39.4
Cycle Q Clear(g_c), s	5.6	23.4	64.0	0.9	9.7	39.4
Prop In Lane	1.00	1.00		1.00	1.00	
Lane Grp Cap(c), veh/h	415	900	1963	860	314	2411
V/C Ratio(X)	0.26	0.71	1.18	0.03	0.92	0.75
Avail Cap(c_a), veh/h	465	978	1963	860	314	2411
HCM Platoon Ratio	1.00	1.00	1.00	1.00	1.00	1.00
Upstream Filter(I)	1.00	1.00	1.00	1.00	1.00	1.00
Uniform Delay (d), s/veh	36.8	34.9	26.4	12.1	52.7	12.4
Incr Delay (d2), s/veh	0.3	2.2	86.7	0.0	31.4	1.4
Initial Q Delay(d3),s/veh	0.0	0.0	0.0	0.0	0.0	0.0
%ile BackOfQ(50%),veh/ln	2.5	8.1	47.3	0.3	5.4	12.8
Unsig. Movement Delay, s/veh						
LnGrp Delay(d),s/veh	37.2	37.1	113.1	12.1	84.1	13.8
LnGrp LOS	D	D	F	B	F	B
Approach Vol, veh/h	745		2343			2109
Approach Delay, s/veh	37.1		111.9			23.4
Approach LOS	D		F			C
Timer - Assigned Phs	1	2			6	8
Phs Duration (G+Y+Rc), s	15.2	70.2			85.4	31.4
Change Period (Y+Rc), s	4.6	6.2			6.2	4.6
Max Green Setting (Gmax), s	10.6	64.0			79.2	30.0
Max Q Clear Time (g_c+11), s	11.7	66.0			41.4	25.4
Green Ext Time (p_c), s	0.0	0.0			18.8	1.4

Intersection Summary

HCM 6th Ctrl Delay	65.3
HCM 6th LOS	E

Timings

West Campus Upper Plateau (JN 14064)

7: Trautwein Rd. & Orange Terrace Pkwy

09/19/2022



Lane Group	EBL	EBT	WBL	WBT	WBR	NBL	NBT	NBR	SBL	SBT	SBR
Lane Configurations											
Traffic Volume (vph)	77	73	333	114	566	62	1388	277	447	1169	23
Future Volume (vph)	77	73	333	114	566	62	1388	277	447	1169	23
Turn Type	Prot	NA	Prot	NA	pm+ov	Prot	NA	Perm	Prot	NA	Perm
Protected Phases	7	4	3	8	1	5	2		1	6	
Permitted Phases					8			2			6
Detector Phase	7	4	3	8	1	5	2	2	1	6	6
Switch Phase											
Minimum Initial (s)	5.0	10.0	5.0	10.0	5.0	5.0	10.0	10.0	5.0	10.0	10.0
Minimum Split (s)	9.6	38.6	9.6	34.6	9.6	9.6	46.2	46.2	9.6	24.2	24.2
Total Split (s)	16.8	38.6	25.0	46.8	19.0	14.4	47.4	47.4	19.0	52.0	52.0
Total Split (%)	12.9%	29.7%	19.2%	36.0%	14.6%	11.1%	36.5%	36.5%	14.6%	40.0%	40.0%
Yellow Time (s)	3.6	3.6	3.6	3.6	3.6	3.6	5.2	5.2	3.6	5.2	5.2
All-Red Time (s)	1.0	1.0	1.0	1.0	1.0	1.0	1.0	1.0	1.0	1.0	1.0
Lost Time Adjust (s)	0.0	0.0	0.0	0.0	0.0	0.0	0.0	0.0	0.0	0.0	0.0
Total Lost Time (s)	4.6	4.6	4.6	4.6	4.6	4.6	6.2	6.2	4.6	6.2	6.2
Lead/Lag	Lead	Lag	Lead	Lag	Lead	Lead	Lag	Lag	Lead	Lag	Lag
Lead-Lag Optimize?	Yes	Yes	Yes	Yes	Yes	Yes	Yes	Yes	Yes	Yes	Yes
Recall Mode	None	None	None	None	None	None	None	None	None	None	None
Act Effct Green (s)	9.5	15.3	20.5	26.3	40.8	8.2	41.4	41.4	14.5	49.8	49.8
Actuated g/C Ratio	0.08	0.14	0.18	0.24	0.36	0.07	0.37	0.37	0.13	0.45	0.45
v/c Ratio	0.61	0.46	1.21	0.31	0.62	0.57	1.27	0.50	1.21	0.87	0.04
Control Delay	67.5	44.1	159.6	37.2	23.5	69.1	160.3	19.9	155.8	37.4	0.1
Queue Delay	0.0	0.0	0.0	0.0	0.0	0.0	0.0	0.0	0.0	0.0	0.0
Total Delay	67.5	44.1	159.6	37.2	23.5	69.1	160.3	19.9	155.8	37.4	0.1
LOS	E	D	F	D	C	E	F	B	F	D	A
Approach Delay		54.3		69.7			134.5			69.2	
Approach LOS		D		E			F			E	

Intersection Summary

Cycle Length: 130
 Actuated Cycle Length: 111.8
 Natural Cycle: 125
 Control Type: Actuated-Uncoordinated
 Maximum v/c Ratio: 1.27
 Intersection Signal Delay: 93.5
 Intersection LOS: F
 Intersection Capacity Utilization 89.1%
 ICU Level of Service E
 Analysis Period (min) 15



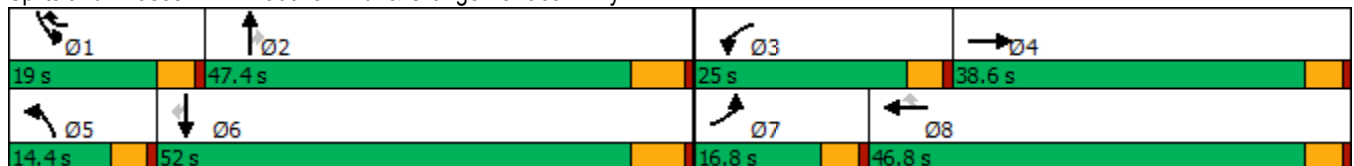



















Splits and Phases: 7: Trautwein Rd. & Orange Terrace Pkwy



HCM 6th Signalized Intersection Summary
7: Trautwein Rd. & Orange Terrace Pkwy

West Campus Upper Plateau (JN 14064)

09/19/2022

												
Movement	EBL	EBT	EBR	WBL	WBT	WBR	NBL	NBT	NBR	SBL	SBT	SBR
Lane Configurations												
Traffic Volume (veh/h)	77	73	27	333	114	566	62	1388	277	447	1169	23
Future Volume (veh/h)	77	73	27	333	114	566	62	1388	277	447	1169	23
Initial Q (Qb), veh	0	0	0	0	0	0	0	0	0	0	0	0
Ped-Bike Adj(A_pbT)	1.00		0.99	1.00		0.96	1.00		1.00	1.00		0.98
Parking Bus, Adj	1.00	1.00	1.00	1.00	1.00	1.00	1.00	1.00	1.00	1.00	1.00	1.00
Work Zone On Approach		No			No			No			No	
Adj Sat Flow, veh/h/ln	1900	1870	1900	1885	1885	1885	1870	1856	1870	1856	1885	1826
Adj Flow Rate, veh/h	92	87	27	396	136	429	74	1652	245	532	1392	19
Peak Hour Factor	0.84	0.84	0.84	0.84	0.84	0.84	0.84	0.84	0.84	0.84	0.84	0.84
Percent Heavy Veh, %	0	2	0	1	1	1	2	3	2	3	1	5
Cap, veh/h	117	171	53	334	465	1038	95	1323	594	450	1624	685
Arrive On Green	0.06	0.13	0.13	0.19	0.25	0.25	0.05	0.38	0.38	0.13	0.45	0.45
Sat Flow, veh/h	1810	1365	423	1795	1885	2710	1781	3526	1583	3428	3582	1510
Grp Volume(v), veh/h	92	0	114	396	136	429	74	1652	245	532	1392	19
Grp Sat Flow(s),veh/h/ln	1810	0	1788	1795	1885	1355	1781	1763	1583	1714	1791	1510
Q Serve(g_s), s	5.5	0.0	6.5	20.4	6.4	12.8	4.5	41.2	12.6	14.4	38.1	0.8
Cycle Q Clear(g_c), s	5.5	0.0	6.5	20.4	6.4	12.8	4.5	41.2	12.6	14.4	38.1	0.8
Prop In Lane	1.00		0.24	1.00		1.00	1.00		1.00	1.00		1.00
Lane Grp Cap(c), veh/h	117	0	224	334	465	1038	95	1323	594	450	1624	685
V/C Ratio(X)	0.79	0.00	0.51	1.19	0.29	0.41	0.78	1.25	0.41	1.18	0.86	0.03
Avail Cap(c_a), veh/h	201	0	554	334	725	1410	159	1323	594	450	1624	685
HCM Platoon Ratio	1.00	1.00	1.00	1.00	1.00	1.00	1.00	1.00	1.00	1.00	1.00	1.00
Upstream Filter(I)	1.00	0.00	1.00	1.00	1.00	1.00	1.00	1.00	1.00	1.00	1.00	1.00
Uniform Delay (d), s/veh	50.6	0.0	44.8	44.7	33.6	25.2	51.3	34.3	25.3	47.7	26.8	16.6
Incr Delay (d2), s/veh	4.4	0.0	1.8	110.2	0.3	0.3	5.2	118.3	0.5	103.0	4.8	0.0
Initial Q Delay(d3),s/veh	0.0	0.0	0.0	0.0	0.0	0.0	0.0	0.0	0.0	0.0	0.0	0.0
%ile BackOfQ(50%),veh/ln	2.6	0.0	3.0	18.9	2.9	4.0	2.1	37.9	4.6	12.3	15.8	0.3
Unsig. Movement Delay, s/veh												
LnGrp Delay(d),s/veh	55.0	0.0	46.6	154.9	33.9	25.5	56.5	152.6	25.8	150.7	31.6	16.6
LnGrp LOS	E	A	D	F	C	C	E	F	C	F	C	B
Approach Vol, veh/h		206			961			1971			1943	
Approach Delay, s/veh		50.4			80.0			133.2			64.1	
Approach LOS		D			F			F			E	
Timer - Assigned Phs	1	2	3	4	5	6	7	8				
Phs Duration (G+Y+Rc), s	19.0	47.4	25.0	18.4	10.4	56.0	11.7	31.7				
Change Period (Y+Rc), s	4.6	6.2	4.6	4.6	4.6	6.2	4.6	4.6				
Max Green Setting (Gmax), s	14.4	41.2	20.4	34.0	9.8	45.8	12.2	42.2				
Max Q Clear Time (g_c+I1), s	16.4	43.2	22.4	8.5	6.5	40.1	7.5	14.8				
Green Ext Time (p_c), s	0.0	0.0	0.0	0.6	0.0	3.9	0.0	2.5				
Intersection Summary												
HCM 6th Ctrl Delay			93.4									
HCM 6th LOS			F									

Timings
8: Cole Av. & Van Buren Bl.

West Campus Upper Plateau (JN 14064)

09/19/2022



Lane Group	EBL	EBT	EBR	WBL	WBT	WBR	NBL	NBT	SBL	SBT	SBR
Lane Configurations	↖↗	↑↑	↖	↖	↑↑↑	↖	↖	↑↑	↖↗	↑↑	↖
Traffic Volume (vph)	419	1299	106	175	1804	525	247	676	482	534	342
Future Volume (vph)	419	1299	106	175	1804	525	247	676	482	534	342
Turn Type	Prot	NA	pm+ov	Prot	NA	pm+ov	Prot	NA	Prot	NA	pm+ov
Protected Phases	5	2	3	1	6	7	3	8	7	4	5
Permitted Phases			2			6					4
Detector Phase	5	2	3	1	6	7	3	8	7	4	5
Switch Phase											
Minimum Initial (s)	5.0	10.0	5.0	5.0	10.0	5.0	5.0	10.0	5.0	10.0	5.0
Minimum Split (s)	9.1	36.2	9.1	9.1	36.2	9.1	9.1	42.2	9.1	49.2	9.1
Total Split (s)	15.0	37.8	19.0	14.0	36.8	21.6	19.0	46.6	21.6	49.2	15.0
Total Split (%)	12.5%	31.5%	15.8%	11.7%	30.7%	18.0%	15.8%	38.8%	18.0%	41.0%	12.5%
Yellow Time (s)	3.2	5.2	3.2	3.2	5.2	3.2	3.2	5.2	3.2	5.2	3.2
All-Red Time (s)	0.5	1.0	0.5	0.5	1.0	0.5	0.5	1.0	0.5	1.0	0.5
Lost Time Adjust (s)	0.0	0.0	0.0	0.0	0.0	0.0	0.0	0.0	0.0	0.0	0.0
Total Lost Time (s)	3.7	6.2	3.7	3.7	6.2	3.7	3.7	6.2	3.7	6.2	3.7
Lead/Lag	Lead	Lag	Lead	Lead	Lag	Lead	Lead	Lag	Lead	Lag	Lead
Lead-Lag Optimize?	Yes	Yes	Yes	Yes	Yes	Yes	Yes	Yes	Yes	Yes	Yes
Recall Mode	None	None	None	None	None	None	None	None	None	None	None
Act Effct Green (s)	11.3	31.7	53.2	10.3	30.7	51.1	15.3	34.9	17.9	37.5	51.4
Actuated g/C Ratio	0.10	0.28	0.46	0.09	0.27	0.45	0.13	0.30	0.16	0.33	0.45
v/c Ratio	1.39	1.49	0.16	1.20	1.47	0.79	1.17	0.85	0.99	0.51	0.52
Control Delay	231.6	258.8	10.1	179.5	249.9	32.4	157.5	44.9	85.2	32.6	19.3
Queue Delay	0.0	0.0	0.0	0.0	0.0	0.0	0.0	0.0	0.0	0.0	0.0
Total Delay	231.6	258.8	10.1	179.5	249.9	32.4	157.5	44.9	85.2	32.6	19.3
LOS	F	F	B	F	F	C	F	D	F	C	B
Approach Delay		238.1			199.4			71.2		47.9	
Approach LOS		F			F			E		D	

Intersection Summary

Cycle Length: 120
 Actuated Cycle Length: 114.7
 Natural Cycle: 125
 Control Type: Actuated-Uncoordinated
 Maximum v/c Ratio: 1.49
 Intersection Signal Delay: 159.2
 Intersection Capacity Utilization 100.8%
 Analysis Period (min) 15
 Intersection LOS: F
 ICU Level of Service G



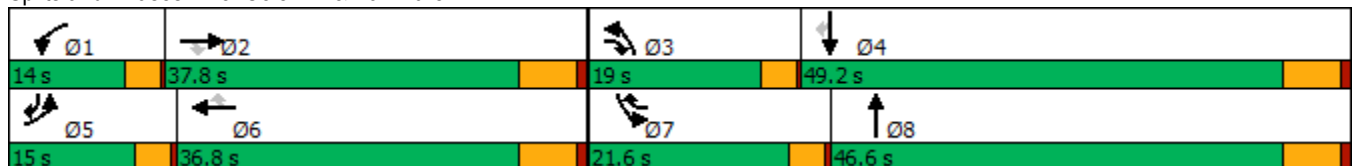



















Splits and Phases: 8: Cole Av. & Van Buren Bl.



HCM 6th Signalized Intersection Summary
8: Cole Av. & Van Buren Bl.

West Campus Upper Plateau (JN 14064)

09/19/2022

												
Movement	EBL	EBT	EBR	WBL	WBT	WBR	NBL	NBT	NBR	SBL	SBT	SBR
Lane Configurations												
Traffic Volume (veh/h)	419	1299	106	175	1804	525	247	676	136	482	534	342
Future Volume (veh/h)	419	1299	106	175	1804	525	247	676	136	482	534	342
Initial Q (Qb), veh	0	0	0	0	0	0	0	0	0	0	0	0
Ped-Bike Adj(A_pbT)	1.00		1.00	1.00		0.99	1.00		1.00	1.00		1.00
Parking Bus, Adj	1.00	1.00	1.00	1.00	1.00	1.00	1.00	1.00	1.00	1.00	1.00	1.00
Work Zone On Approach		No			No			No			No	
Adj Sat Flow, veh/h/ln	1856	1856	1841	1900	1870	1870	1856	1870	1870	1885	1885	1856
Adj Flow Rate, veh/h	466	1443	77	194	2004	493	274	751	142	536	593	308
Peak Hour Factor	0.90	0.90	0.90	0.90	0.90	0.90	0.90	0.90	0.90	0.90	0.90	0.90
Percent Heavy Veh, %	3	3	4	0	2	2	3	2	2	1	1	3
Cap, veh/h	344	991	650	166	1389	678	240	871	165	554	1130	653
Arrive On Green	0.10	0.28	0.28	0.09	0.27	0.27	0.14	0.29	0.29	0.16	0.32	0.32
Sat Flow, veh/h	3428	3526	1560	1810	5106	1565	1767	2981	564	3483	3582	1570
Grp Volume(v), veh/h	466	1443	77	194	2004	493	274	448	445	536	593	308
Grp Sat Flow(s),veh/h/ln	1714	1763	1560	1810	1702	1565	1767	1777	1768	1742	1791	1570
Q Serve(g_s), s	11.3	31.6	3.4	10.3	30.6	29.4	15.3	26.8	26.8	17.2	15.3	16.0
Cycle Q Clear(g_c), s	11.3	31.6	3.4	10.3	30.6	29.4	15.3	26.8	26.8	17.2	15.3	16.0
Prop In Lane	1.00		1.00	1.00		1.00	1.00		0.32	1.00		1.00
Lane Grp Cap(c), veh/h	344	991	650	166	1389	678	240	519	517	554	1130	653
V/C Ratio(X)	1.35	1.46	0.12	1.17	1.44	0.73	1.14	0.86	0.86	0.97	0.52	0.47
Avail Cap(c_a), veh/h	344	991	650	166	1389	678	240	638	635	554	1369	758
HCM Platoon Ratio	1.00	1.00	1.00	1.00	1.00	1.00	1.00	1.00	1.00	1.00	1.00	1.00
Upstream Filter(I)	1.00	1.00	1.00	1.00	1.00	1.00	1.00	1.00	1.00	1.00	1.00	1.00
Uniform Delay (d), s/veh	50.6	40.4	20.1	51.1	40.9	26.6	48.6	37.6	37.7	47.0	31.6	23.9
Incr Delay (d2), s/veh	176.8	211.2	0.1	123.2	203.3	4.3	100.9	9.9	10.0	29.7	0.4	0.5
Initial Q Delay(d3),s/veh	0.0	0.0	0.0	0.0	0.0	0.0	0.0	0.0	0.0	0.0	0.0	0.0
%ile BackOfQ(50%),veh/ln	13.1	41.9	1.2	10.2	38.2	10.9	13.2	12.4	12.3	9.4	6.3	5.6
Unsig. Movement Delay, s/veh												
LnGrp Delay(d),s/veh	227.4	251.6	20.2	174.3	244.2	30.8	149.5	47.6	47.6	76.7	32.0	24.4
LnGrp LOS	F	F	C	F	F	C	F	D	D	E	C	C
Approach Vol, veh/h		1986			2691			1167			1437	
Approach Delay, s/veh		237.0			200.1			71.5			47.0	
Approach LOS		F			F			E			D	
Timer - Assigned Phs	1	2	3	4	5	6	7	8				
Phs Duration (G+Y+Rc), s	14.0	37.8	19.0	41.7	15.0	36.8	21.6	39.1				
Change Period (Y+Rc), s	3.7	6.2	3.7	6.2	3.7	6.2	3.7	6.2				
Max Green Setting (Gmax), s	10.3	31.6	15.3	43.0	11.3	30.6	17.9	40.4				
Max Q Clear Time (g_c+I1), s	12.3	33.6	17.3	18.0	13.3	32.6	19.2	28.8				
Green Ext Time (p_c), s	0.0	0.0	0.0	4.8	0.0	0.0	0.0	3.9				
Intersection Summary												
HCM 6th Ctrl Delay			159.3									
HCM 6th LOS			F									

Intersection

Intersection Delay, s/veh	24.2
Intersection LOS	C

Movement	EBT	EBR	WBL	WBT	NBL	NBR
Lane Configurations	↔		↔	↑	↔	↔
Traffic Vol, veh/h	105	90	57	373	233	35
Future Vol, veh/h	105	90	57	373	233	35
Peak Hour Factor	0.76	0.76	0.76	0.76	0.76	0.76
Heavy Vehicles, %	2	1	2	2	0	0
Mvmt Flow	138	118	75	491	307	46
Number of Lanes	1	0	1	1	1	1

Approach	EB	WB	NB
Opposing Approach	WB	EB	
Opposing Lanes	2	1	0
Conflicting Approach Left		NB	EB
Conflicting Lanes Left	0	2	1
Conflicting Approach Right	NB		WB
Conflicting Lanes Right	2	0	2
HCM Control Delay	14.3	31.5	19.8
HCM LOS	B	D	C

Lane	NBLn1	NBLn2	EBLn1	WBLn1	WBLn2
Vol Left, %	100%	0%	0%	100%	0%
Vol Thru, %	0%	0%	54%	0%	100%
Vol Right, %	0%	100%	46%	0%	0%
Sign Control	Stop	Stop	Stop	Stop	Stop
Traffic Vol by Lane	233	35	195	57	373
LT Vol	233	0	0	57	0
Through Vol	0	0	105	0	373
RT Vol	0	35	90	0	0
Lane Flow Rate	307	46	257	75	491
Geometry Grp	7	7	4	7	7
Degree of Util (X)	0.622	0.078	0.445	0.14	0.849
Departure Headway (Hd)	7.303	6.082	6.237	6.735	6.227
Convergence, Y/N	Yes	Yes	Yes	Yes	Yes
Cap	494	586	575	530	579
Service Time	5.074	3.852	4.314	4.502	3.994
HCM Lane V/C Ratio	0.621	0.078	0.447	0.142	0.848
HCM Control Delay	21.4	9.4	14.3	10.6	34.7
HCM Lane LOS	C	A	B	B	D
HCM 95th-tile Q	4.2	0.3	2.3	0.5	9.1

Intersection

Intersection Delay, s/veh	101.5
Intersection LOS	F

Movement	EBL	EBT	EBR	WBL	WBT	WBR	NBL	NBT	NBR	SBL	SBT	SBR
Lane Configurations												
Traffic Vol, veh/h	252	501	47	4	634	58	179	44	7	94	35	42
Future Vol, veh/h	252	501	47	4	634	58	179	44	7	94	35	42
Peak Hour Factor	0.75	0.75	0.75	0.75	0.75	0.75	0.75	0.75	0.75	0.75	0.75	0.75
Heavy Vehicles, %	0	2	0	0	0	2	1	0	0	0	3	3
Mvmt Flow	336	668	63	5	845	77	239	59	9	125	47	56
Number of Lanes	1	2	0	1	2	0	0	1	0	0	1	0

Approach	EB	WB	NB	SB
Opposing Approach	WB	EB	SB	NB
Opposing Lanes	3	3	1	1
Conflicting Approach Left SB		NB	EB	WB
Conflicting Lanes Left	1	1	3	3
Conflicting Approach Right NB		SB	WB	EB
Conflicting Lanes Right	1	1	3	3
HCM Control Delay	69.1	168.5	60.7	34.7
HCM LOS	F	F	F	D

Lane	NBLn1	EBLn1	EBLn2	EBLn3	WBLn1	WBLn2	WBLn3	SBLn1
Vol Left, %		78%	100%	0%	0%	100%	0%	55%
Vol Thru, %		19%	0%	100%	78%	0%	100%	78%
Vol Right, %		3%	0%	0%	22%	0%	0%	22%
Sign Control		Stop	Stop	Stop	Stop	Stop	Stop	Stop
Traffic Vol by Lane		230	252	334	214	4	423	269
LT Vol		179	252	0	0	4	0	94
Through Vol		44	0	334	167	0	423	211
RT Vol		7	0	0	47	0	0	58
Lane Flow Rate		307	336	445	285	5	564	359
Geometry Grp		7	7	7	7	7	7	7
Degree of Util (X)		0.89	0.875	1.102	0.691	0.014	1.447	0.91
Departure Headway (Hd)		11.24	9.815	9.321	9.122	10.114	9.584	9.461
Convergence, Y/N		Yes	Yes	Yes	Yes	Yes	Yes	Yes
Cap		325	373	392	399	356	383	384
Service Time		8.94	7.515	7.021	6.822	7.814	7.284	7.161
HCM Lane V/C Ratio		0.945	0.901	1.135	0.714	0.014	1.473	0.935
HCM Control Delay		60.7	52.6	106.7	29.9	13	240.7	57.4
HCM Lane LOS		F	F	F	D	B	F	F
HCM 95th-tile Q		8.4	8.5	15.3	5	0	28.2	9.5

Timings

11: Barton St & Alessandro Bl.

09/19/2022



Lane Group	EBL	EBT	WBL	WBT	NBL	NBT	NBR	SBL	SBT	SBR
Lane Configurations	↙	↕↕↕	↙	↕↕↕		↕	↗		↕	↗
Traffic Volume (vph)	7	1652	41	2980	82	1	55	10	0	9
Future Volume (vph)	7	1652	41	2980	82	1	55	10	0	9
Turn Type	Prot	NA	Prot	NA	Perm	NA	Perm	Perm	NA	Perm
Protected Phases	5	2	1	6		8			4	
Permitted Phases					8		8	4		4
Detector Phase	5	2	1	6	8	8	8	4	4	4
Switch Phase										
Minimum Initial (s)	5.0	10.0	5.0	10.0	10.0	10.0	10.0	10.0	10.0	10.0
Minimum Split (s)	9.2	28.5	11.0	28.5	40.6	40.6	40.6	26.6	26.6	26.6
Total Split (s)	9.2	68.4	11.0	70.2	40.6	40.6	40.6	40.6	40.6	40.6
Total Split (%)	7.7%	57.0%	9.2%	58.5%	33.8%	33.8%	33.8%	33.8%	33.8%	33.8%
Yellow Time (s)	3.2	5.5	3.2	5.5	3.6	3.6	3.6	3.6	3.6	3.6
All-Red Time (s)	1.0	1.0	1.0	1.0	1.0	1.0	1.0	1.0	1.0	1.0
Lost Time Adjust (s)	0.0	0.0	0.0	0.0		0.0	0.0		0.0	0.0
Total Lost Time (s)	4.2	6.5	4.2	6.5		4.6	4.6		4.6	4.6
Lead/Lag	Lead	Lag	Lead	Lag						
Lead-Lag Optimize?	Yes	Yes	Yes	Yes						
Recall Mode	None	None	None	None	Max	Max	Max	Max	Max	Max
Act Effct Green (s)	5.0	59.6	6.2	66.4		36.1	36.1		36.1	36.1
Actuated g/C Ratio	0.04	0.52	0.05	0.58		0.31	0.31		0.31	0.31
v/c Ratio	0.10	0.67	0.44	1.06		0.20	0.11		0.03	0.02
Control Delay	58.6	22.5	68.3	61.7		31.6	5.6		29.8	0.1
Queue Delay	0.0	0.0	0.0	0.0		0.0	0.0		0.0	0.0
Total Delay	58.6	22.5	68.3	61.7		31.6	5.6		29.8	0.1
LOS	E	C	E	E		C	A		C	A
Approach Delay		22.7		61.8		21.3			15.7	
Approach LOS		C		E		C			B	

Intersection Summary

Cycle Length: 120
 Actuated Cycle Length: 115.3
 Natural Cycle: 125
 Control Type: Actuated-Uncoordinated
 Maximum v/c Ratio: 1.06
 Intersection Signal Delay: 46.9
 Intersection LOS: D
 Intersection Capacity Utilization 109.2%
 ICU Level of Service H
 Analysis Period (min) 15

Splits and Phases: 11: Barton St & Alessandro Bl.



HCM 6th Signalized Intersection Summary
11: Barton St & Alessandro Bl.

West Campus Upper Plateau (JN 14064)

09/19/2022



Movement	EBL	EBT	EBR	WBL	WBT	WBR	NBL	NBT	NBR	SBL	SBT	SBR
Lane Configurations	↖	↑↑↑		↖	↑↑↑			↑	↗		↑	↗
Traffic Volume (veh/h)	7	1652	38	41	2980	8	82	1	55	10	0	9
Future Volume (veh/h)	7	1652	38	41	2980	8	82	1	55	10	0	9
Initial Q (Qb), veh	0	0	0	0	0	0	0	0	0	0	0	0
Ped-Bike Adj(A_pbT)	1.00		0.98	1.00		1.00	1.00		1.00	1.00		1.00
Parking Bus, Adj	1.00	1.00	1.00	1.00	1.00	1.00	1.00	1.00	1.00	1.00	1.00	1.00
Work Zone On Approach		No			No			No			No	
Adj Sat Flow, veh/h/ln	1663	1870	1856	1900	1870	1678	1900	1900	1870	1426	1900	1307
Adj Flow Rate, veh/h	7	1721	37	43	3104	8	85	1	27	10	0	4
Peak Hour Factor	0.96	0.96	0.96	0.96	0.96	0.96	0.96	0.96	0.96	0.96	0.96	0.96
Percent Heavy Veh, %	16	2	3	0	2	15	0	0	2	32	0	40
Cap, veh/h	14	2702	58	58	2887	7	62	0	491	62	0	344
Arrive On Green	0.01	0.53	0.53	0.03	0.55	0.55	0.31	0.31	0.31	0.31	0.00	0.31
Sat Flow, veh/h	1584	5141	110	1810	5258	14	0	1	1584	0	0	1108
Grp Volume(v), veh/h	7	1139	619	43	2008	1104	86	0	27	10	0	4
Grp Sat Flow(s),veh/h/ln	1584	1702	1848	1810	1702	1868	1	0	1584	0	0	1108
Q Serve(g_s), s	0.5	27.7	27.7	2.7	63.7	63.7	0.0	0.0	1.4	0.0	0.0	0.3
Cycle Q Clear(g_c), s	0.5	27.7	27.7	2.7	63.7	63.7	36.0	0.0	1.4	36.0	0.0	0.3
Prop In Lane	1.00		0.06	1.00		0.01	0.99		1.00	1.00		1.00
Lane Grp Cap(c), veh/h	14	1789	971	58	1869	1026	62	0	491	62	0	344
V/C Ratio(X)	0.51	0.64	0.64	0.74	1.07	1.08	1.39	0.00	0.05	0.16	0.00	0.01
Avail Cap(c_a), veh/h	68	1816	986	106	1869	1026	62	0	491	62	0	344
HCM Platoon Ratio	1.00	1.00	1.00	1.00	1.00	1.00	1.00	1.00	1.00	1.00	1.00	1.00
Upstream Filter(I)	1.00	1.00	1.00	1.00	1.00	1.00	1.00	0.00	1.00	1.00	0.00	1.00
Uniform Delay (d), s/veh	57.3	19.6	19.6	55.6	26.2	26.2	57.8	0.0	28.1	58.0	0.0	27.7
Incr Delay (d2), s/veh	10.3	0.9	1.6	6.5	44.1	50.9	246.6	0.0	0.2	5.5	0.0	0.1
Initial Q Delay(d3),s/veh	0.0	0.0	0.0	0.0	0.0	0.0	0.0	0.0	0.0	0.0	0.0	0.0
%ile BackOfQ(50%),veh/ln	0.2	9.9	10.9	1.4	35.6	41.0	6.1	0.0	0.6	0.4	0.0	0.1
Unsig. Movement Delay, s/veh												
LnGrp Delay(d),s/veh	67.6	20.5	21.2	62.1	70.3	77.0	304.4	0.0	28.3	63.5	0.0	27.8
LnGrp LOS	E	C	C	E	F	F	F	A	C	E	A	C
Approach Vol, veh/h		1765			3155			113				14
Approach Delay, s/veh		20.9			72.5			238.4				53.3
Approach LOS		C			E			F				D
Timer - Assigned Phs	1	2		4	5	6		8				
Phs Duration (G+Y+Rc), s	7.9	67.5		40.6	5.2	70.2		40.6				
Change Period (Y+Rc), s	* 4.2	6.5		4.6	* 4.2	6.5		4.6				
Max Green Setting (Gmax), s	* 6.8	61.9		36.0	* 5	63.7		36.0				
Max Q Clear Time (g_c+I1), s	4.7	29.7		38.0	2.5	65.7		38.0				
Green Ext Time (p_c), s	0.0	19.5		0.0	0.0	0.0		0.0				

Intersection Summary

HCM 6th Ctrl Delay	58.1
HCM 6th LOS	E

Notes

* HCM 6th computational engine requires equal clearance times for the phases crossing the barrier.

Intersection						
Int Delay, s/veh	0.7					
Movement	EBL	EBT	WBT	WBR	SBL	SBR
Lane Configurations						
Traffic Vol, veh/h	26	114	423	15	5	7
Future Vol, veh/h	26	114	423	15	5	7
Conflicting Peds, #/hr	0	0	0	5	0	1
Sign Control	Free	Free	Free	Free	Stop	Stop
RT Channelized	-	None	-	None	-	None
Storage Length	100	-	-	-	0	-
Veh in Median Storage, #	-	0	0	-	0	-
Grade, %	-	0	0	-	0	-
Peak Hour Factor	72	72	72	72	72	72
Heavy Vehicles, %	0	2	1	0	0	0
Mvmt Flow	36	158	588	21	7	10

Major/Minor	Major1	Major2	Minor2		
Conflicting Flow All	614	0	-	0	834 605
Stage 1	-	-	-	-	604 -
Stage 2	-	-	-	-	230 -
Critical Hdwy	4.1	-	-	-	6.4 6.2
Critical Hdwy Stg 1	-	-	-	-	5.4 -
Critical Hdwy Stg 2	-	-	-	-	5.4 -
Follow-up Hdwy	2.2	-	-	-	3.5 3.3
Pot Cap-1 Maneuver	975	-	-	-	341 501
Stage 1	-	-	-	-	550 -
Stage 2	-	-	-	-	813 -
Platoon blocked, %		-	-	-	
Mov Cap-1 Maneuver	970	-	-	-	325 498
Mov Cap-2 Maneuver	-	-	-	-	325 -
Stage 1	-	-	-	-	527 -
Stage 2	-	-	-	-	809 -

Approach	EB	WB	SB
HCM Control Delay, s	1.6	0	14.2
HCM LOS			B

Minor Lane/Major Mvmt	EBL	EBT	WBT	WBR	SBLn1
Capacity (veh/h)	970	-	-	-	408
HCM Lane V/C Ratio	0.037	-	-	-	0.041
HCM Control Delay (s)	8.9	-	-	-	14.2
HCM Lane LOS	A	-	-	-	B
HCM 95th %tile Q(veh)	0.1	-	-	-	0.1

Intersection

Int Delay, s/veh	45.1					
Movement	EBT	EBR	WBL	WBT	NBL	NBR
Lane Configurations	↑↑		↘	↑↑	↘	
Traffic Vol, veh/h	312	289	51	459	236	38
Future Vol, veh/h	312	289	51	459	236	38
Conflicting Peds, #/hr	0	0	0	0	0	0
Sign Control	Free	Free	Free	Free	Stop	Stop
RT Channelized	-	None	-	None	-	None
Storage Length	-	-	125	-	0	-
Veh in Median Storage, #	0	-	-	0	0	-
Grade, %	0	-	-	0	0	-
Peak Hour Factor	80	80	80	80	80	80
Heavy Vehicles, %	3	0	2	1	0	0
Mvmt Flow	390	361	64	574	295	48

Major/Minor	Major1	Major2	Minor1		
Conflicting Flow All	0	0	751	0	986
Stage 1	-	-	-	-	571
Stage 2	-	-	-	-	415
Critical Hdwy	-	-	4.14	-	6.8
Critical Hdwy Stg 1	-	-	-	-	5.8
Critical Hdwy Stg 2	-	-	-	-	5.8
Follow-up Hdwy	-	-	2.22	-	3.5
Pot Cap-1 Maneuver	-	-	854	-	~ 248
Stage 1	-	-	-	-	534
Stage 2	-	-	-	-	641
Platoon blocked, %	-	-	-	-	-
Mov Cap-1 Maneuver	-	-	854	-	~ 229
Mov Cap-2 Maneuver	-	-	-	-	~ 229
Stage 1	-	-	-	-	534
Stage 2	-	-	-	-	593

Approach	EB	WB	NB
HCM Control Delay, s	0	1	226
HCM LOS			F

Minor Lane/Major Mvmt	NBLn1	EBT	EBR	WBL	WBT
Capacity (veh/h)	251	-	-	854	-
HCM Lane V/C Ratio	1.365	-	-	0.075	-
HCM Control Delay (s)	226	-	-	9.6	-
HCM Lane LOS	F	-	-	A	-
HCM 95th %tile Q(veh)	18.4	-	-	0.2	-

Notes
 ~: Volume exceeds capacity \$: Delay exceeds 300s +: Computation Not Defined *: All major volume in platoon

Timings
14: Barton Rd. & Van Buren Bl.

West Campus Upper Plateau (JN 14064)

09/19/2022



Lane Group	EBL	EBT	WBL	WBT	NBL	NBT	NBR	SBL	SBT
Lane Configurations	↘	↗	↘	↗	↘	↗	↗	↘	↗
Traffic Volume (vph)	175	1598	282	1962	469	83	379	40	129
Future Volume (vph)	175	1598	282	1962	469	83	379	40	129
Turn Type	Prot	NA	Prot	NA	Prot	NA	Perm	Prot	NA
Protected Phases	5	2	1	6	3	8		7	4
Permitted Phases							8		
Detector Phase	5	2	1	6	3	8	8	7	4
Switch Phase									
Minimum Initial (s)	5.0	10.0	5.0	10.0	5.0	10.0	10.0	5.0	10.0
Minimum Split (s)	9.2	25.2	9.2	25.5	9.1	14.6	14.6	9.1	33.6
Total Split (s)	18.5	47.4	22.0	50.9	17.0	37.5	37.5	13.1	33.6
Total Split (%)	15.4%	39.5%	18.3%	42.4%	14.2%	31.3%	31.3%	10.9%	28.0%
Yellow Time (s)	3.2	5.2	3.2	5.5	3.6	3.6	3.6	3.6	3.6
All-Red Time (s)	1.0	1.0	1.0	1.0	0.5	1.0	1.0	0.5	1.0
Lost Time Adjust (s)	0.0	0.0	0.0	0.0	0.0	0.0	0.0	0.0	0.0
Total Lost Time (s)	4.2	6.2	4.2	6.5	4.1	4.6	4.6	4.1	4.6
Lead/Lag	Lead	Lag	Lead	Lag	Lead	Lag	Lag	Lead	Lag
Lead-Lag Optimize?	Yes	Yes	Yes	Yes	Yes	Yes	Yes	Yes	Yes
Recall Mode	None	None	None	None	None	None	None	None	None
Act Effct Green (s)	14.3	41.2	17.8	44.4	12.9	36.0	36.0	7.8	29.0
Actuated g/C Ratio	0.12	0.34	0.15	0.37	0.11	0.30	0.30	0.06	0.24
v/c Ratio	0.93	1.74	1.24	1.22	1.46	0.17	0.62	0.39	1.13
Control Delay	99.4	361.9	177.6	137.2	259.8	33.6	15.1	63.4	116.6
Queue Delay	0.0	0.0	0.0	0.0	0.0	0.0	0.0	0.0	0.0
Total Delay	99.4	361.9	177.6	137.2	259.8	33.6	15.1	63.4	116.6
LOS	F	F	F	F	F	C	B	E	F
Approach Delay		338.8		142.2		140.0			112.5
Approach LOS		F		F		F			F

Intersection Summary

Cycle Length: 120
 Actuated Cycle Length: 120
 Natural Cycle: 130
 Control Type: Actuated-Uncoordinated
 Maximum v/c Ratio: 1.74
 Intersection Signal Delay: 207.6
 Intersection LOS: F
 Intersection Capacity Utilization 124.4%
 ICU Level of Service H
 Analysis Period (min) 15

Splits and Phases: 14: Barton Rd. & Van Buren Bl.

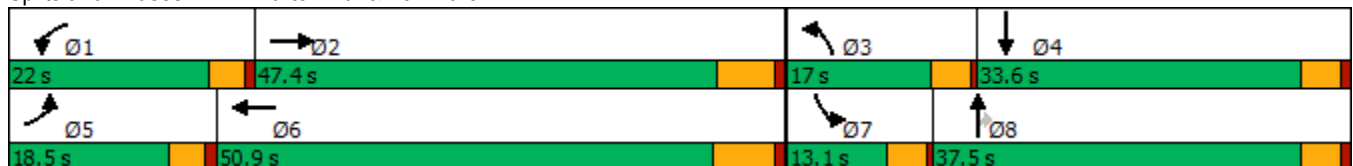

HCM 6th Signalized Intersection Summary
14: Barton Rd. & Van Buren Bl.

West Campus Upper Plateau (JN 14064)

09/19/2022



Movement	EBL	EBT	EBR	WBL	WBT	WBR	NBL	NBT	NBR	SBL	SBT	SBR
Lane Configurations	↗	↗↘		↗	↗↘↙		↗↘	↑	↗	↗	↘	↘
Traffic Volume (veh/h)	175	1598	215	282	1962	26	469	83	379	40	129	352
Future Volume (veh/h)	175	1598	215	282	1962	26	469	83	379	40	129	352
Initial Q (Qb), veh	0	0	0	0	0	0	0	0	0	0	0	0
Ped-Bike Adj(A_pbT)	1.00		1.00	1.00		1.00	1.00		1.00	1.00		1.00
Parking Bus, Adj	1.00	1.00	1.00	1.00	1.00	1.00	1.00	1.00	1.00	1.00	1.00	1.00
Work Zone On Approach		No			No			No			No	
Adj Sat Flow, veh/h/ln	1900	1870	1870	1870	1870	1752	1870	1885	1885	1900	1870	1900
Adj Flow Rate, veh/h	201	1837	234	324	2255	24	539	95	220	46	148	283
Peak Hour Factor	0.87	0.87	0.87	0.87	0.87	0.87	0.87	0.87	0.87	0.87	0.87	0.87
Percent Heavy Veh, %	0	2	2	2	2	10	2	1	1	0	2	0
Cap, veh/h	215	1089	136	264	1936	21	371	594	504	60	138	265
Arrive On Green	0.12	0.34	0.34	0.15	0.37	0.37	0.11	0.32	0.32	0.03	0.24	0.24
Sat Flow, veh/h	1810	3179	396	1781	5209	55	3456	1885	1598	1810	574	1098
Grp Volume(v), veh/h	201	1009	1062	324	1473	806	539	95	220	46	0	431
Grp Sat Flow(s),veh/h/ln	1810	1777	1799	1781	1702	1860	1728	1885	1598	1810	0	1673
Q Serve(g_s), s	13.2	41.2	41.2	17.8	44.7	44.7	12.9	4.4	13.2	3.0	0.0	29.0
Cycle Q Clear(g_c), s	13.2	41.2	41.2	17.8	44.7	44.7	12.9	4.4	13.2	3.0	0.0	29.0
Prop In Lane	1.00		0.22	1.00		0.03	1.00		1.00	1.00		0.66
Lane Grp Cap(c), veh/h	215	609	616	264	1265	691	371	594	504	60	0	403
V/C Ratio(X)	0.93	1.66	1.72	1.23	1.16	1.17	1.45	0.16	0.44	0.77	0.00	1.07
Avail Cap(c_a), veh/h	215	609	616	264	1265	691	371	594	504	135	0	403
HCM Platoon Ratio	1.00	1.00	1.00	1.00	1.00	1.00	1.00	1.00	1.00	1.00	1.00	1.00
Upstream Filter(I)	1.00	1.00	1.00	1.00	1.00	1.00	1.00	1.00	1.00	1.00	0.00	1.00
Uniform Delay (d), s/veh	52.5	39.6	39.6	51.3	37.8	37.8	53.7	29.7	32.7	57.7	0.0	45.7
Incr Delay (d2), s/veh	42.8	303.4	332.5	131.8	83.0	90.0	219.1	0.1	0.6	18.6	0.0	64.4
Initial Q Delay(d3),s/veh	0.0	0.0	0.0	0.0	0.0	0.0	0.0	0.0	0.0	0.0	0.0	0.0
%ile BackOfQ(50%),veh/ln	8.4	68.1	74.0	17.3	31.9	36.2	16.7	1.9	5.0	1.7	0.0	19.3
Unsig. Movement Delay, s/veh												
LnGrp Delay(d),s/veh	95.3	342.9	372.1	183.1	120.8	127.8	272.8	29.8	33.3	76.3	0.0	110.0
LnGrp LOS	F	F	F	F	F	F	F	C	C	E	A	F
Approach Vol, veh/h		2272			2603			854				477
Approach Delay, s/veh		334.6			130.7			184.0				106.8
Approach LOS		F			F			F				F
Timer - Assigned Phs	1	2	3	4	5	6	7	8				
Phs Duration (G+Y+Rc), s	22.0	47.7	17.0	33.6	18.5	51.2	8.1	42.5				
Change Period (Y+Rc), s	* 4.2	* 6.5	4.1	4.6	* 4.2	6.5	4.1	4.6				
Max Green Setting (Gmax), s	* 18	* 41	12.9	29.0	* 14	44.4	9.0	32.9				
Max Q Clear Time (g_c+I1), s	19.8	43.2	14.9	31.0	15.2	46.7	5.0	15.2				
Green Ext Time (p_c), s	0.0	0.0	0.0	0.0	0.0	0.0	0.0	1.1				

Intersection Summary

HCM 6th Ctrl Delay	210.9
HCM 6th LOS	F

Notes

* HCM 6th computational engine requires equal clearance times for the phases crossing the barrier.

Intersection

Intersection Delay, s/veh	12.3
Intersection LOS	B

Movement	EBT	EBR	WBL	WBT	NBL	NBR
Lane Configurations						
Traffic Vol, veh/h	58	59	106	245	155	70
Future Vol, veh/h	58	59	106	245	155	70
Peak Hour Factor	0.76	0.76	0.76	0.76	0.76	0.76
Heavy Vehicles, %	4	0	0	2	2	2
Mvmt Flow	76	78	139	322	204	92
Number of Lanes	1	0	1	1	1	0

Approach	EB	WB	NB
Opposing Approach	WB	EB	
Opposing Lanes	2	1	0
Conflicting Approach Left		NB	EB
Conflicting Lanes Left	0	1	1
Conflicting Approach Right	NB		WB
Conflicting Lanes Right	1	0	2
HCM Control Delay	9.8	12.8	12.7
HCM LOS	A	B	B

Lane	NBLn1	EBLn1	WBLn1	WBLn2
Vol Left, %	69%	0%	100%	0%
Vol Thru, %	0%	50%	0%	100%
Vol Right, %	31%	50%	0%	0%
Sign Control	Stop	Stop	Stop	Stop
Traffic Vol by Lane	225	117	106	245
LT Vol	155	0	106	0
Through Vol	0	58	0	245
RT Vol	70	59	0	0
Lane Flow Rate	296	154	139	322
Geometry Grp	2	5	7	7
Degree of Util (X)	0.446	0.224	0.235	0.5
Departure Headway (Hd)	5.42	5.249	6.06	5.589
Convergence, Y/N	Yes	Yes	Yes	Yes
Cap	669	685	594	645
Service Time	3.42	3.278	3.783	3.312
HCM Lane V/C Ratio	0.442	0.225	0.234	0.499
HCM Control Delay	12.7	9.8	10.6	13.8
HCM Lane LOS	B	A	B	B
HCM 95th-tile Q	2.3	0.9	0.9	2.8

Intersection

Intersection Delay, s/veh	15.9
Intersection LOS	C

Movement	EBL	EBT	WBT	WBR	SBL	SBR
Lane Configurations						
Traffic Vol, veh/h	129	189	350	100	84	120
Future Vol, veh/h	129	189	350	100	84	120
Peak Hour Factor	0.71	0.71	0.71	0.71	0.71	0.71
Heavy Vehicles, %	0	2	0	2	1	1
Mvmt Flow	182	266	493	141	118	169
Number of Lanes	1	2	2	0	1	0

Approach	EB	WB	SB
Opposing Approach	WB	EB	
Opposing Lanes	2	3	0
Conflicting Approach Left SB			WB
Conflicting Lanes Left	1	0	2
Conflicting Approach Right		SB	EB
Conflicting Lanes Right	0	1	3
HCM Control Delay	11.5	18.1	17.8
HCM LOS	B	C	C

Lane	EBLn1	EBLn2	EBLn3	WBLn1	WBLn2	SBLn1
Vol Left, %	100%	0%	0%	0%	0%	41%
Vol Thru, %	0%	100%	100%	100%	54%	0%
Vol Right, %	0%	0%	0%	0%	46%	59%
Sign Control	Stop	Stop	Stop	Stop	Stop	Stop
Traffic Vol by Lane	129	95	95	233	217	204
LT Vol	129	0	0	0	0	84
Through Vol	0	95	95	233	117	0
RT Vol	0	0	0	0	100	120
Lane Flow Rate	182	133	133	329	305	287
Geometry Grp	7	7	7	8	8	7
Degree of Util (X)	0.354	0.242	0.176	0.611	0.542	0.549
Departure Headway (Hd)	7.012	6.536	4.766	6.693	6.398	6.873
Convergence, Y/N	Yes	Yes	Yes	Yes	Yes	Yes
Cap	511	546	745	536	562	523
Service Time	4.794	4.318	2.546	4.476	4.181	4.65
HCM Lane V/C Ratio	0.356	0.244	0.179	0.614	0.543	0.549
HCM Control Delay	13.6	11.4	8.6	19.5	16.6	17.8
HCM Lane LOS	B	B	A	C	C	C
HCM 95th-tile Q	1.6	0.9	0.6	4.1	3.2	3.3

Timings
19: Van Buren Bl. & Orange Terrace Pkwy.

West Campus Upper Plateau (JN 14064)

09/19/2022

Lane Group	EBL	EBT	EBR	WBL	WBT	WBR	NBL	NBT	NBR	SBL	SBT	SBR
Lane Configurations												
Traffic Volume (vph)	173	1666	215	133	2110	145	125	24	81	276	41	275
Future Volume (vph)	173	1666	215	133	2110	145	125	24	81	276	41	275
Turn Type	Prot	NA	Perm	Prot	NA	Perm	Prot	NA	Perm	Prot	NA	pm+ov
Protected Phases	5	2		1	6		3	8		7	4	5
Permitted Phases			2			6			8			4
Detector Phase	5	2	2	1	6	6	3	8	8	7	4	5
Switch Phase												
Minimum Initial (s)	5.0	10.0	10.0	5.0	10.0	10.0	5.0	5.0	5.0	10.0	10.0	5.0
Minimum Split (s)	9.2	25.2	25.2	9.1	25.2	25.2	9.1	26.1	26.1	15.8	24.8	9.2
Total Split (s)	16.0	62.8	62.8	9.1	55.9	55.9	9.1	26.1	26.1	22.0	39.0	16.0
Total Split (%)	13.3%	52.3%	52.3%	7.6%	46.6%	46.6%	7.6%	21.8%	21.8%	18.3%	32.5%	13.3%
Yellow Time (s)	3.2	5.2	5.2	3.6	5.2	5.2	3.6	3.6	3.6	4.8	4.8	3.2
All-Red Time (s)	1.0	1.0	1.0	0.5	1.0	1.0	0.5	0.5	0.5	1.0	1.0	1.0
Lost Time Adjust (s)	0.0	0.0	0.0	0.0	0.0	0.0	0.0	0.0	0.0	0.0	0.0	0.0
Total Lost Time (s)	4.2	6.2	6.2	4.1	6.2	6.2	4.1	4.1	4.1	5.8	5.8	4.2
Lead/Lag	Lead	Lag	Lag	Lead	Lag	Lag	Lead	Lag	Lag	Lead	Lag	Lead
Lead-Lag Optimize?	Yes	Yes	Yes	Yes	Yes	Yes	Yes	Yes	Yes	Yes	Yes	Yes
Recall Mode	None	None	None	None	None	None	None	None	None	None	None	None
Act Effct Green (s)	10.8	55.8	55.8	5.0	50.0	50.0	10.2	6.3	6.3	13.2	13.9	21.3
Actuated g/C Ratio	0.11	0.57	0.57	0.05	0.51	0.51	0.10	0.06	0.06	0.13	0.14	0.22
v/c Ratio	0.47	0.60	0.23	0.77	0.85	0.17	0.36	0.11	0.30	0.61	0.16	0.72
Control Delay	46.8	15.9	4.8	75.5	26.4	1.4	48.5	46.3	2.7	46.9	38.8	34.9
Queue Delay	0.0	0.0	0.0	0.0	0.0	0.0	0.0	0.0	0.0	0.0	0.0	0.0
Total Delay	46.8	15.9	4.8	75.5	26.4	1.4	48.5	46.3	2.7	46.9	38.8	34.9
LOS	D	B	A	E	C	A	D	D	A	D	D	C
Approach Delay		17.4			27.6			32.1			40.8	
Approach LOS		B			C			C			D	

Intersection Summary

Cycle Length: 120
 Actuated Cycle Length: 98.5
 Natural Cycle: 100
 Control Type: Actuated-Uncoordinated
 Maximum v/c Ratio: 0.85
 Intersection Signal Delay: 25.3
 Intersection LOS: C
 Intersection Capacity Utilization 74.4%
 ICU Level of Service D
 Analysis Period (min) 15

Splits and Phases: 19: Van Buren Bl. & Orange Terrace Pkwy.



HCM 6th Signalized Intersection Summary
 19: Van Buren Bl. & Orange Terrace Pkwy.

West Campus Upper Plateau (JN 14064)

09/19/2022



Movement	EBL	EBT	EBR	WBL	WBT	WBR	NBL	NBT	NBR	SBL	SBT	SBR
Lane Configurations	↖↗	↑↑↑	↖	↖↗	↑↑↑	↖	↖↗	↑↑	↖	↖↗	↑	↖↗
Traffic Volume (veh/h)	173	1666	215	133	2110	145	125	24	81	276	41	275
Future Volume (veh/h)	173	1666	215	133	2110	145	125	24	81	276	41	275
Initial Q (Qb), veh	0	0	0	0	0	0	0	0	0	0	0	0
Ped-Bike Adj(A_pbT)	1.00		0.99	1.00		1.00	1.00		1.00	1.00		0.98
Parking Bus, Adj	1.00	1.00	1.00	1.00	1.00	1.00	1.00	1.00	1.00	1.00	1.00	1.00
Work Zone On Approach		No			No			No			No	
Adj Sat Flow, veh/h/ln	1885	1856	1870	1900	1856	1870	1900	1900	1826	1885	1900	1885
Adj Flow Rate, veh/h	178	1718	212	137	2175	108	129	25	57	285	42	171
Peak Hour Factor	0.97	0.97	0.97	0.97	0.97	0.97	0.97	0.97	0.97	0.97	0.97	0.97
Percent Heavy Veh, %	1	3	2	0	3	2	0	0	5	1	0	1
Cap, veh/h	253	2701	835	193	2607	816	193	218	93	384	255	326
Arrive On Green	0.07	0.53	0.53	0.06	0.51	0.51	0.06	0.06	0.06	0.11	0.13	0.13
Sat Flow, veh/h	3483	5066	1565	3510	5066	1585	3510	3610	1547	3483	1900	1565
Grp Volume(v), veh/h	178	1718	212	137	2175	108	129	25	57	285	42	171
Grp Sat Flow(s),veh/h/ln	1742	1689	1565	1755	1689	1585	1755	1805	1547	1742	1900	1565
Q Serve(g_s), s	4.5	21.7	6.6	3.5	33.2	3.2	3.3	0.6	3.3	7.2	1.8	8.8
Cycle Q Clear(g_c), s	4.5	21.7	6.6	3.5	33.2	3.2	3.3	0.6	3.3	7.2	1.8	8.8
Prop In Lane	1.00		1.00	1.00		1.00	1.00		1.00	1.00		1.00
Lane Grp Cap(c), veh/h	253	2701	835	193	2607	816	193	218	93	384	255	326
V/C Ratio(X)	0.70	0.64	0.25	0.71	0.83	0.13	0.67	0.11	0.61	0.74	0.16	0.52
Avail Cap(c_a), veh/h	453	3159	976	193	2774	868	193	875	375	622	695	688
HCM Platoon Ratio	1.00	1.00	1.00	1.00	1.00	1.00	1.00	1.00	1.00	1.00	1.00	1.00
Upstream Filter(I)	1.00	1.00	1.00	1.00	1.00	1.00	1.00	1.00	1.00	1.00	1.00	1.00
Uniform Delay (d), s/veh	41.1	15.0	11.4	42.2	18.7	11.5	42.1	40.4	41.6	39.1	34.8	32.1
Incr Delay (d2), s/veh	1.3	0.3	0.2	11.3	2.2	0.1	8.4	0.2	6.3	2.9	0.3	1.3
Initial Q Delay(d3),s/veh	0.0	0.0	0.0	0.0	0.0	0.0	0.0	0.0	0.0	0.0	0.0	0.0
%ile BackOfQ(50%),veh/ln	1.9	7.0	2.2	1.7	11.3	1.1	1.6	0.3	1.4	3.1	0.8	3.4
Unsig. Movement Delay, s/veh												
LnGrp Delay(d),s/veh	42.5	15.3	11.6	53.5	21.0	11.6	50.5	40.6	47.9	42.0	35.1	33.4
LnGrp LOS	D	B	B	D	C	B	D	D	D	D	D	C
Approach Vol, veh/h		2108			2420			211				498
Approach Delay, s/veh		17.2			22.4			48.6				38.5
Approach LOS		B			C			D				D
Timer - Assigned Phs	1	2	3	4	5	6	7	8				
Phs Duration (G+Y+Rc), s	9.1	54.6	9.1	18.0	10.8	52.9	15.8	11.3				
Change Period (Y+Rc), s	4.1	6.2	4.1	5.8	* 4.2	6.2	5.8	* 5.8				
Max Green Setting (Gmax), s	5.0	56.6	5.0	33.2	* 12	49.7	16.2	* 22				
Max Q Clear Time (g_c+I1), s	5.5	23.7	5.3	10.8	6.5	35.2	9.2	5.3				
Green Ext Time (p_c), s	0.0	16.3	0.0	0.7	0.1	11.6	0.5	0.2				

Intersection Summary

HCM 6th Ctrl Delay	22.9
HCM 6th LOS	C

Notes

* HCM 6th computational engine requires equal clearance times for the phases crossing the barrier.

Timings
20: Brown/San Gorgonio Dr & Alessandro Bl.

West Campus Upper Plateau (JN 14064)

09/19/2022



Lane Group	EBL	EBT	WBT	WBR	SBL	SBT	SBR	Ø1	Ø3	Ø8
Lane Configurations	↖	↖↖↖	↖↖↖	↖	↖	↖	↖			
Traffic Volume (vph)	35	1801	2915	57	33	1	18			
Future Volume (vph)	35	1801	2915	57	33	1	18			
Turn Type	Prot	NA	NA	Perm	Prot	NA	pm+ov			
Protected Phases	5	2	6		7	4	5	1	3	8
Permitted Phases				6			4			
Detector Phase	5	2	6	6	7	4	5			
Switch Phase										
Minimum Initial (s)	5.0	10.0	10.0	10.0	5.0	10.0	5.0	5.0	5.0	5.0
Minimum Split (s)	8.7	43.5	43.5	43.5	8.7	49.8	8.7	9.1	9.1	26.1
Total Split (s)	8.7	51.9	52.4	52.4	10.8	49.8	8.7	9.2	9.1	48.1
Total Split (%)	7.3%	43.3%	43.7%	43.7%	9.0%	41.5%	7.3%	8%	8%	40%
Yellow Time (s)	3.2	5.5	5.5	5.5	3.2	4.8	3.2	3.6	3.6	3.6
All-Red Time (s)	0.5	1.0	1.0	1.0	0.5	1.0	0.5	0.5	0.5	0.5
Lost Time Adjust (s)	0.0	0.0	0.0	0.0	0.0	0.0	0.0			
Total Lost Time (s)	3.7	6.5	6.5	6.5	3.7	5.8	3.7			
Lead/Lag	Lead	Lag	Lag	Lag	Lead	Lag	Lead	Lead	Lead	Lag
Lead-Lag Optimize?	Yes	Yes	Yes	Yes	Yes	Yes	Yes	Yes	Yes	Yes
Recall Mode	None	None	None	None	None	None	None	None	None	None
Act Effct Green (s)	5.4	59.4	53.2	53.2	7.2	15.2	14.7			
Actuated g/C Ratio	0.08	0.84	0.75	0.75	0.10	0.21	0.21			
v/c Ratio	0.27	0.44	0.81	0.05	0.22	0.00	0.05			
Control Delay	44.9	7.6	17.1	1.5	40.4	24.0	0.2			
Queue Delay	0.0	0.0	0.0	0.0	0.0	0.0	0.0			
Total Delay	44.9	7.6	17.1	1.5	40.4	24.0	0.2			
LOS	D	A	B	A	D	C	A			
Approach Delay		8.3	16.8			26.2				
Approach LOS		A	B			C				

Intersection Summary

Cycle Length: 120
 Actuated Cycle Length: 70.7
 Natural Cycle: 125
 Control Type: Actuated-Uncoordinated
 Maximum v/c Ratio: 0.81
 Intersection Signal Delay: 13.7
 Intersection LOS: B
 Intersection Capacity Utilization 74.9%
 ICU Level of Service D
 Analysis Period (min) 15

Splits and Phases: 20: Brown/San Gorgonio Dr & Alessandro Bl.

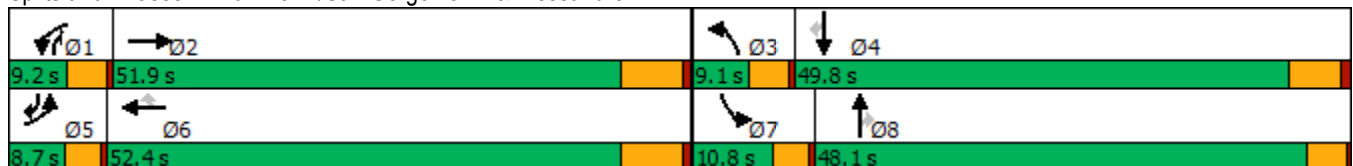

HCM 6th Signalized Intersection Summary
20: Brown/San Gorgonio Dr & Alessandro Bl.

West Campus Upper Plateau (JN 14064)

09/19/2022



Movement	EBL	EBT	EBR	WBL	WBT	WBR	NBL	NBT	NBR	SBL	SBT	SBR
Lane Configurations	↗	↑↑↑		↖	↑↑↑	↗	↖	↑	↗	↖	↑	↗
Traffic Volume (veh/h)	35	1801	3	0	2915	57	0	0	0	33	1	18
Future Volume (veh/h)	35	1801	3	0	2915	57	0	0	0	33	1	18
Initial Q (Qb), veh	0	0	0	0	0	0	0	0	0	0	0	0
Ped-Bike Adj(A_pbT)	1.00		0.98	1.00		1.00	1.00		1.00	1.00		1.00
Parking Bus, Adj	1.00	1.00	1.00	1.00	1.00	1.00	1.00	1.00	1.00	1.00	1.00	1.00
Work Zone On Approach		No			No			No			No	
Adj Sat Flow, veh/h/ln	1900	1870	1900	1707	1856	1781	1900	1900	1796	1693	670	1900
Adj Flow Rate, veh/h	37	1896	3	0	3068	60	0	0	-3	35	1	5
Peak Hour Factor	0.95	0.95	0.95	0.95	0.95	0.95	0.95	0.95	0.95	0.95	0.95	0.95
Percent Heavy Veh, %	0	2	0	13	3	8	0	0	7	14	83	0
Cap, veh/h	66	3941	6	2	3337	994	3	3	0	57	50	179
Arrive On Green	0.04	0.75	0.75	0.00	0.66	0.66	0.00	0.00	0.00	0.04	0.07	0.07
Sat Flow, veh/h	1810	5264	8	1626	5066	1510	1810	1900	1522	1612	670	1610
Grp Volume(v), veh/h	37	1226	673	0	3068	60	0	0	-3	35	1	5
Grp Sat Flow(s),veh/h/ln	1810	1702	1869	1626	1689	1510	1810	1900	1522	1612	670	1610
Q Serve(g_s), s	1.4	9.9	9.9	0.0	36.5	1.0	0.0	0.0	0.1	1.5	0.1	0.2
Cycle Q Clear(g_c), s	1.4	9.9	9.9	0.0	36.5	1.0	0.0	0.0	0.1	1.5	0.1	0.2
Prop In Lane	1.00		0.00	1.00		1.00	1.00		1.00	1.00		1.00
Lane Grp Cap(c), veh/h	66	2548	1399	2	3337	994	3	3	-87	57	50	179
V/C Ratio(X)	0.56	0.48	0.48	0.00	0.92	0.06	0.00	0.00	0.03	0.61	0.02	0.03
Avail Cap(c_a), veh/h	130	2548	1399	119	3340	996	130	1201	873	164	423	1077
HCM Platoon Ratio	1.00	1.00	1.00	1.00	1.00	1.00	1.00	1.00	1.00	1.00	1.00	1.00
Upstream Filter(I)	1.00	1.00	1.00	0.00	1.00	1.00	0.00	0.00	0.00	1.00	1.00	1.00
Uniform Delay (d), s/veh	33.0	3.4	3.4	0.0	10.3	4.2	0.0	0.0	0.0	33.1	29.8	27.6
Incr Delay (d2), s/veh	2.7	0.2	0.4	0.0	4.8	0.0	0.0	0.0	0.0	4.0	0.2	0.1
Initial Q Delay(d3),s/veh	0.0	0.0	0.0	0.0	0.0	0.0	0.0	0.0	0.0	0.0	0.0	0.0
%ile BackOfQ(50%),veh/ln	0.6	0.9	1.1	0.0	11.1	0.2	0.0	0.0	0.0	0.6	0.0	0.1
Unsig. Movement Delay, s/veh												
LnGrp Delay(d),s/veh	35.7	3.6	3.8	0.0	15.1	4.3	0.0	0.0	0.0	37.1	30.0	27.6
LnGrp LOS	D	A	A	A	B	A	A	A	A	D	C	C
Approach Vol, veh/h		1936			3128			-3				41
Approach Delay, s/veh		4.3			14.9			0.0				35.7
Approach LOS		A			B			A				D
Timer - Assigned Phs	1	2	3	4	5	6	7	8				
Phs Duration (G+Y+Rc), s	0.0	58.6	0.0	11.0	6.3	52.3	6.2	4.8				
Change Period (Y+Rc), s	4.1	6.5	4.1	5.8	3.7	6.5	3.7	* 5.8				
Max Green Setting (Gmax), s	5.1	45.4	5.0	44.0	5.0	45.9	7.1	* 44				
Max Q Clear Time (g_c+I1), s	0.0	11.9	0.0	2.2	3.4	38.5	3.5	0.0				
Green Ext Time (p_c), s	0.0	21.9	0.0	0.0	0.0	7.4	0.0	0.0				

Intersection Summary

HCM 6th Ctrl Delay	11.1
HCM 6th LOS	B

Notes

* HCM 6th computational engine requires equal clearance times for the phases crossing the barrier.

Timings
22: Sycamore Canyon Bl. & Eastridge Ave

West Campus Upper Plateau (JN 14064)

09/19/2022



Lane Group	EBL	EBT	EBR	WBL	WBT	WBR	NBL	NBT	NBR	SBL	SBT	SBR
Lane Configurations	↖↖	↑↑↑	↗	↖↖	↑↑	↗	↖↖	↑↑	↗	↖↖	↑↑	↗
Traffic Volume (vph)	53	43	19	165	202	525	77	850	109	81	245	44
Future Volume (vph)	53	43	19	165	202	525	77	850	109	81	245	44
Turn Type	Prot	NA	Perm	Prot	NA	pm+ov	Prot	NA	pm+ov	Prot	NA	pm+ov
Protected Phases	5	2		1	6	7	3	8	1	7	4	5
Permitted Phases			2			6			8			4
Detector Phase	5	2	2	1	6	7	3	8	1	7	4	5
Switch Phase												
Minimum Initial (s)	5.0	10.0	10.0	5.0	10.0	5.0	5.0	10.0	5.0	5.0	10.0	5.0
Minimum Split (s)	8.7	43.5	43.5	8.7	43.5	8.7	8.7	15.8	8.7	8.7	49.8	8.7
Total Split (s)	10.1	47.0	47.0	11.0	47.9	21.0	10.6	41.0	11.0	21.0	51.4	10.1
Total Split (%)	8.4%	39.2%	39.2%	9.2%	39.9%	17.5%	8.8%	34.2%	9.2%	17.5%	42.8%	8.4%
Yellow Time (s)	3.2	5.5	5.5	3.2	5.5	3.2	3.2	4.8	3.2	3.2	4.8	3.2
All-Red Time (s)	0.5	1.0	1.0	0.5	1.0	0.5	0.5	1.0	0.5	0.5	1.0	0.5
Lost Time Adjust (s)	0.0	0.0	0.0	0.0	0.0	0.0	0.0	0.0	0.0	0.0	0.0	0.0
Total Lost Time (s)	3.7	6.5	6.5	3.7	6.5	3.7	3.7	5.8	3.7	3.7	5.8	3.7
Lead/Lag	Lead	Lag	Lag	Lead	Lag	Lead	Lead	Lag	Lead	Lead	Lag	Lead
Lead-Lag Optimize?	Yes	Yes	Yes	Yes	Yes	Yes	Yes	Yes	Yes	Yes	Yes	Yes
Recall Mode	None	None	None	None	None	None	None	None	None	None	None	None
Act Effct Green (s)	6.1	14.9	14.9	9.2	15.7	38.0	6.4	33.6	45.0	15.6	45.3	53.5
Actuated g/C Ratio	0.07	0.17	0.17	0.10	0.18	0.43	0.07	0.38	0.51	0.18	0.51	0.60
v/c Ratio	0.33	0.08	0.06	0.73	0.41	0.88	0.38	0.76	0.17	0.17	0.16	0.06
Control Delay	49.5	32.7	0.4	61.5	35.7	37.5	49.0	31.0	5.7	35.6	14.8	2.4
Queue Delay	0.0	0.0	0.0	0.0	0.0	0.0	0.0	0.0	0.0	0.0	0.0	0.0
Total Delay	49.5	32.7	0.4	61.5	35.7	37.5	49.0	31.0	5.7	35.6	14.8	2.4
LOS	D	C	A	E	D	D	D	C	A	D	B	A
Approach Delay		35.1			41.5			29.7			17.8	
Approach LOS		D			D			C			B	

Intersection Summary

Cycle Length: 120
 Actuated Cycle Length: 88.9
 Natural Cycle: 115
 Control Type: Actuated-Uncoordinated
 Maximum v/c Ratio: 0.88
 Intersection Signal Delay: 32.5
 Intersection LOS: C
 Intersection Capacity Utilization 71.7%
 ICU Level of Service C
 Analysis Period (min) 15

Splits and Phases: 22: Sycamore Canyon Bl. & Eastridge Ave

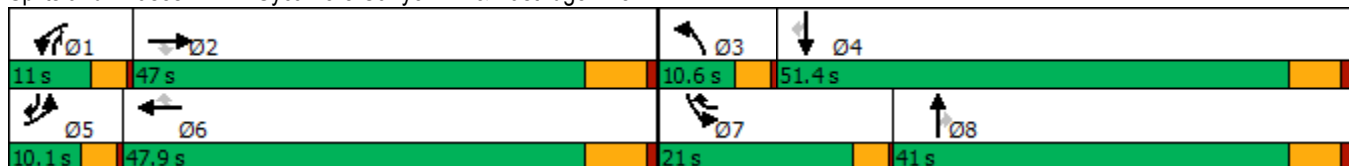

HCM 6th Signalized Intersection Summary
 22: Sycamore Canyon Bl. & Eastridge Ave

West Campus Upper Plateau (JN 14064)

09/19/2022



Movement	EBL	EBT	EBR	WBL	WBT	WBR	NBL	NBT	NBR	SBL	SBT	SBR
Lane Configurations	↖↗	↑↑↑	↖	↖↗	↑↑	↖	↖↗	↑↑	↖	↖↗	↑↑	↖
Traffic Volume (veh/h)	53	43	19	165	202	525	77	850	109	81	245	44
Future Volume (veh/h)	53	43	19	165	202	525	77	850	109	81	245	44
Initial Q (Qb), veh	0	0	0	0	0	0	0	0	0	0	0	0
Ped-Bike Adj(A_pbT)	1.00		1.00	1.00		1.00	1.00		0.99	1.00		0.99
Parking Bus, Adj	1.00	1.00	1.00	1.00	1.00	1.00	1.00	1.00	1.00	1.00	1.00	1.00
Work Zone On Approach		No			No			No			No	
Adj Sat Flow, veh/h/ln	1485	1352	1722	1337	1707	1811	1796	1811	1618	1767	1826	1589
Adj Flow Rate, veh/h	61	49	0	190	232	603	89	977	91	93	282	37
Peak Hour Factor	0.87	0.87	0.87	0.87	0.87	0.87	0.87	0.87	0.87	0.87	0.87	0.87
Percent Heavy Veh, %	28	37	12	38	13	6	7	6	19	9	5	21
Cap, veh/h	112	1344		179	1285	679	151	1105	535	150	1116	482
Arrive On Green	0.04	0.36	0.00	0.07	0.40	0.40	0.05	0.32	0.32	0.05	0.32	0.32
Sat Flow, veh/h	2744	3690	1459	2470	3244	1535	3319	3441	1354	3264	3469	1329
Grp Volume(v), veh/h	61	49	0	190	232	603	89	977	91	93	282	37
Grp Sat Flow(s),veh/h/ln	1372	1230	1459	1235	1622	1535	1659	1721	1354	1632	1735	1329
Q Serve(g_s), s	2.2	0.9	0.0	7.3	4.7	36.3	2.6	27.1	4.4	2.8	6.0	1.8
Cycle Q Clear(g_c), s	2.2	0.9	0.0	7.3	4.7	36.3	2.6	27.1	4.4	2.8	6.0	1.8
Prop In Lane	1.00		1.00	1.00		1.00	1.00		1.00	1.00		1.00
Lane Grp Cap(c), veh/h	112	1344		179	1285	679	151	1105	535	150	1116	482
V/C Ratio(X)	0.55	0.04		1.06	0.18	0.89	0.59	0.88	0.17	0.62	0.25	0.08
Avail Cap(c_a), veh/h	175	1486		179	1335	702	228	1204	573	561	1573	657
HCM Platoon Ratio	1.00	1.00	1.00	1.00	1.00	1.00	1.00	1.00	1.00	1.00	1.00	1.00
Upstream Filter(I)	1.00	1.00	0.00	1.00	1.00	1.00	1.00	1.00	1.00	1.00	1.00	1.00
Uniform Delay (d), s/veh	47.3	20.6	0.0	46.6	19.7	25.8	47.1	32.4	19.8	47.1	25.2	21.0
Incr Delay (d2), s/veh	1.5	0.0	0.0	84.0	0.1	13.4	1.4	7.6	0.1	1.6	0.1	0.1
Initial Q Delay(d3),s/veh	0.0	0.0	0.0	0.0	0.0	0.0	0.0	0.0	0.0	0.0	0.0	0.0
%ile BackOfQ(50%),veh/ln	0.7	0.2	0.0	4.2	1.7	14.5	1.1	11.7	1.3	1.1	2.4	0.6
Unsig. Movement Delay, s/veh												
LnGrp Delay(d),s/veh	48.9	20.6	0.0	130.7	19.8	39.2	48.4	40.0	20.0	48.7	25.3	21.1
LnGrp LOS	D	C		F	B	D	D	D	B	D	C	C
Approach Vol, veh/h		110			1025			1157			412	
Approach Delay, s/veh		36.3			51.8			39.1			30.2	
Approach LOS		D			D			D			C	
Timer - Assigned Phs	1	2	3	4	5	6	7	8				
Phs Duration (G+Y+Rc), s	11.0	43.2	8.3	38.2	7.8	46.4	8.3	38.1				
Change Period (Y+Rc), s	3.7	6.5	3.7	5.8	3.7	6.5	3.7	5.8				
Max Green Setting (Gmax), s	7.3	40.5	6.9	45.6	6.4	41.4	17.3	35.2				
Max Q Clear Time (g_c+I1), s	9.3	2.9	4.6	8.0	4.2	38.3	4.8	29.1				
Green Ext Time (p_c), s	0.0	0.3	0.0	1.9	0.0	1.6	0.1	3.2				

Intersection Summary

HCM 6th Ctrl Delay	42.4
HCM 6th LOS	D

Notes

Unsignalized Delay for [EBR] is excluded from calculations of the approach delay and intersection delay.

Timings
23: Sycamore Canyon Bl. & Cottonwood Ave

West Campus Upper Plateau (JN 14064)

09/19/2022



Lane Group	WBL	WBR	NBT	SBL	SBT
Lane Configurations	↙	↗	↕	↙	↕
Traffic Volume (vph)	25	39	1016	117	314
Future Volume (vph)	25	39	1016	117	314
Turn Type	Prot	Perm	NA	Prot	NA
Protected Phases	8		2	1	6
Permitted Phases		8			
Detector Phase	8	8	2	1	6
Switch Phase					
Minimum Initial (s)	10.0	10.0	10.0	5.0	10.0
Minimum Split (s)	15.8	15.8	43.5	9.1	43.5
Total Split (s)	21.0	21.0	75.0	24.0	99.0
Total Split (%)	17.5%	17.5%	62.5%	20.0%	82.5%
Yellow Time (s)	4.8	4.8	5.5	3.6	5.5
All-Red Time (s)	1.0	1.0	1.0	0.5	1.0
Lost Time Adjust (s)	0.0	0.0	0.0	0.0	0.0
Total Lost Time (s)	5.8	5.8	6.5	4.1	6.5
Lead/Lag			Lag	Lead	
Lead-Lag Optimize?			Yes	Yes	
Recall Mode	None	None	None	None	None
Act Effct Green (s)	11.4	11.4	43.2	15.7	66.2
Actuated g/C Ratio	0.14	0.14	0.52	0.19	0.80
v/c Ratio	0.17	0.24	0.72	0.62	0.13
Control Delay	43.5	17.0	18.6	50.0	3.0
Queue Delay	0.0	0.0	0.0	0.0	0.0
Total Delay	43.5	17.0	18.6	50.0	3.0
LOS	D	B	B	D	A
Approach Delay	27.4		18.6		15.7
Approach LOS	C		B		B

Intersection Summary

Cycle Length: 120
 Actuated Cycle Length: 82.5
 Natural Cycle: 75
 Control Type: Actuated-Uncoordinated
 Maximum v/c Ratio: 0.72
 Intersection Signal Delay: 18.2
 Intersection LOS: B
 Intersection Capacity Utilization 58.7%
 ICU Level of Service B
 Analysis Period (min) 15

Splits and Phases: 23: Sycamore Canyon Bl. & Cottonwood Ave



HCM 6th Signalized Intersection Summary
 23: Sycamore Canyon Bl. & Cottonwood Ave

West Campus Upper Plateau (JN 14064)

09/19/2022



Movement	WBL	WBR	NBT	NBR	SBL	SBT
Lane Configurations						
Traffic Volume (veh/h)	25	39	1016	66	117	314
Future Volume (veh/h)	25	39	1016	66	117	314
Initial Q (Qb), veh	0	0	0	0	0	0
Ped-Bike Adj(A_pbT)	1.00	1.00		0.98	1.00	
Parking Bus, Adj	1.00	1.00	1.00	1.00	1.00	1.00
Work Zone On Approach	No		No			No
Adj Sat Flow, veh/h/ln	1263	1115	1811	1366	1070	1841
Adj Flow Rate, veh/h	29	29	1181	76	136	365
Peak Hour Factor	0.86	0.86	0.86	0.86	0.86	0.86
Percent Heavy Veh, %	43	53	6	36	56	4
Cap, veh/h	115	91	1714	110	154	2558
Arrive On Green	0.10	0.10	0.52	0.52	0.15	0.73
Sat Flow, veh/h	1203	945	3368	211	1019	3589
Grp Volume(v), veh/h	29	29	619	638	136	365
Grp Sat Flow(s),veh/h/ln	1203	945	1721	1768	1019	1749
Q Serve(g_s), s	1.6	2.0	19.1	19.2	9.3	2.2
Cycle Q Clear(g_c), s	1.6	2.0	19.1	19.2	9.3	2.2
Prop In Lane	1.00	1.00		0.12	1.00	
Lane Grp Cap(c), veh/h	115	91	900	925	154	2558
V/C Ratio(X)	0.25	0.32	0.69	0.69	0.88	0.14
Avail Cap(c_a), veh/h	257	202	1655	1701	285	4544
HCM Platoon Ratio	1.00	1.00	1.00	1.00	1.00	1.00
Upstream Filter(I)	1.00	1.00	1.00	1.00	1.00	1.00
Uniform Delay (d), s/veh	29.8	30.0	12.7	12.7	29.6	2.9
Incr Delay (d2), s/veh	1.1	2.0	1.3	1.3	15.1	0.0
Initial Q Delay(d3),s/veh	0.0	0.0	0.0	0.0	0.0	0.0
%ile BackOfQ(50%),veh/ln	0.5	0.5	6.0	6.2	2.7	0.4
Unsig. Movement Delay, s/veh						
LnGrp Delay(d),s/veh	30.9	32.0	14.0	14.0	44.7	2.9
LnGrp LOS	C	C	B	B	D	A
Approach Vol, veh/h	58		1257			501
Approach Delay, s/veh	31.5		14.0			14.2
Approach LOS	C		B			B
Timer - Assigned Phs	1	2			6	8
Phs Duration (G+Y+Rc), s	14.8	43.7			58.6	12.6
Change Period (Y+Rc), s	4.1	6.5			6.5	5.8
Max Green Setting (Gmax), s	19.9	68.5			92.5	15.2
Max Q Clear Time (g_c+1), s	11.3	21.2			4.2	4.0
Green Ext Time (p_c), s	0.2	16.1			3.5	0.1

Intersection Summary

HCM 6th Ctrl Delay	14.6
HCM 6th LOS	B

Timings

West Campus Upper Plateau (JN 14064)

24: Sycamore Canyon Bl. & Alessandro Bl.

09/19/2022

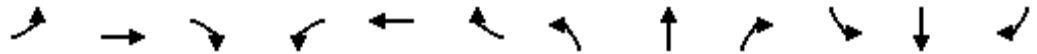

Lane Group	EBL	EBT	EBR	WBL	WBT	WBR	NBL	NBT	NBR	SBL	SBT	SBR
Lane Configurations	↖	↑↑↑	↗	↖↗	↑↑↑	↗	↖↗	↑↑	↖↗	↖↗	↑↑	↖
Traffic Volume (vph)	173	1253	401	211	2307	637	707	711	91	106	179	148
Future Volume (vph)	173	1253	401	211	2307	637	707	711	91	106	179	148
Turn Type	Prot	NA	Perm	Prot	NA	Perm	Prot	NA	pm+ov	Prot	NA	Perm
Protected Phases	5	2		1	6		3	8	1	7	4	
Permitted Phases			2			6			8			4
Detector Phase	5	2	2	1	6	6	3	8	1	7	4	4
Switch Phase												
Minimum Initial (s)	5.0	10.0	10.0	5.0	10.0	10.0	5.0	10.0	5.0	5.0	10.0	10.0
Minimum Split (s)	8.7	43.5	43.5	8.7	43.5	43.5	8.7	15.8	8.7	8.7	49.8	49.8
Total Split (s)	10.0	47.0	47.0	9.2	46.2	46.2	14.0	52.5	9.2	11.3	49.8	49.8
Total Split (%)	8.3%	39.2%	39.2%	7.7%	38.5%	38.5%	11.7%	43.8%	7.7%	9.4%	41.5%	41.5%
Yellow Time (s)	3.2	5.5	5.5	3.2	5.5	5.5	3.2	4.8	3.2	3.2	4.8	4.8
All-Red Time (s)	0.5	1.0	1.0	0.5	1.0	1.0	0.5	1.0	0.5	0.5	1.0	1.0
Lost Time Adjust (s)	0.0	0.0	0.0	0.0	0.0	0.0	0.0	0.0	0.0	0.0	0.0	0.0
Total Lost Time (s)	3.7	6.5	6.5	3.7	6.5	6.5	3.7	5.8	3.7	3.7	5.8	5.8
Lead/Lag	Lead	Lag	Lag	Lead	Lag	Lag	Lead	Lag	Lead	Lead	Lag	Lag
Lead-Lag Optimize?	Yes	Yes	Yes	Yes	Yes	Yes	Yes	Yes	Yes	Yes	Yes	Yes
Recall Mode	None	C-Max	C-Max	None	C-Max	C-Max	None	None	None	None	None	None
Act Effct Green (s)	20.1	45.6	45.6	14.2	39.7	39.7	10.3	33.2	49.6	7.2	30.2	30.2
Actuated g/C Ratio	0.17	0.38	0.38	0.12	0.33	0.33	0.09	0.28	0.41	0.06	0.25	0.25
v/c Ratio	0.59	0.66	0.51	0.53	1.41	1.01	2.43	0.75	0.08	0.59	0.21	0.31
Control Delay	57.1	33.3	8.9	56.1	221.6	64.7	676.9	44.0	6.8	68.5	34.3	10.8
Queue Delay	0.0	0.0	0.0	0.0	0.0	0.0	0.0	0.0	0.0	0.0	0.0	0.0
Total Delay	57.1	33.3	8.9	56.1	221.6	64.7	676.9	44.0	6.8	68.5	34.3	10.8
LOS	E	C	A	E	F	E	F	D	A	E	C	B
Approach Delay		30.2			178.9			338.3			34.7	
Approach LOS		C			F			F			C	

Intersection Summary

Cycle Length: 120
 Actuated Cycle Length: 120
 Offset: 0 (0%), Referenced to phase 2:EBT and 6:WBT, Start of Yellow
 Natural Cycle: 125
 Control Type: Actuated-Coordinated
 Maximum v/c Ratio: 2.43
 Intersection Signal Delay: 165.4
 Intersection LOS: F
 Intersection Capacity Utilization 101.4%
 ICU Level of Service G
 Analysis Period (min) 15

Splits and Phases: 24: Sycamore Canyon Bl. & Alessandro Bl.

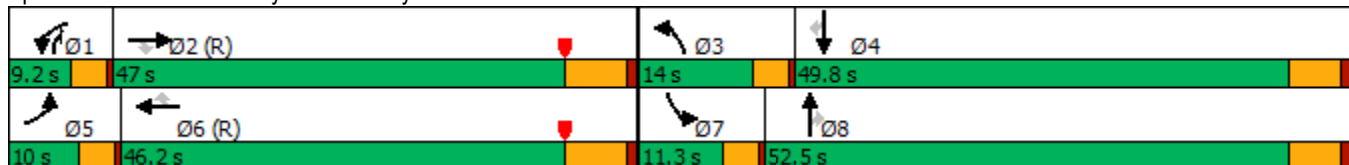

HCM 6th Signalized Intersection Summary
 24: Sycamore Canyon Bl. & Alessandro Bl.

West Campus Upper Plateau (JN 14064)

09/19/2022



Movement	EBL	EBT	EBR	WBL	WBT	WBR	NBL	NBT	NBR	SBL	SBT	SBR
Lane Configurations												
Traffic Volume (veh/h)	173	1253	401	211	2307	637	707	711	91	106	179	148
Future Volume (veh/h)	173	1253	401	211	2307	637	707	711	91	106	179	148
Initial Q (Qb), veh	0	0	0	0	0	0	0	0	0	0	0	0
Ped-Bike Adj(A_pbT)	1.00		1.00	1.00		1.00	1.00		1.00	1.00		1.00
Parking Bus, Adj	1.00	1.00	1.00	1.00	1.00	1.00	1.00	1.00	1.00	1.00	1.00	1.00
Work Zone On Approach		No			No			No			No	
Adj Sat Flow, veh/h/ln	1870	1870	1885	1856	1841	1796	1870	1841	1826	1663	1841	1856
Adj Flow Rate, veh/h	175	1266	323	213	2330	520	714	718	62	107	181	90
Peak Hour Factor	0.99	0.99	0.99	0.99	0.99	0.99	0.99	0.99	0.99	0.99	0.99	0.99
Percent Heavy Veh, %	2	2	1	3	4	7	2	4	5	16	4	3
Cap, veh/h	94	2503	782	157	2430	736	297	875	805	153	748	335
Arrive On Green	0.05	0.49	0.49	0.05	0.48	0.48	0.09	0.25	0.25	0.05	0.21	0.21
Sat Flow, veh/h	1781	5106	1596	3428	5025	1522	3456	3497	2720	3072	3497	1568
Grp Volume(v), veh/h	175	1266	323	213	2330	520	714	718	62	107	181	90
Grp Sat Flow(s),veh/h/ln	1781	1702	1596	1714	1675	1522	1728	1749	1360	1536	1749	1568
Q Serve(g_s), s	6.3	20.2	15.5	5.5	53.6	32.2	10.3	23.2	2.0	4.1	5.1	5.7
Cycle Q Clear(g_c), s	6.3	20.2	15.5	5.5	53.6	32.2	10.3	23.2	2.0	4.1	5.1	5.7
Prop In Lane	1.00		1.00	1.00		1.00	1.00		1.00	1.00		1.00
Lane Grp Cap(c), veh/h	94	2503	782	157	2430	736	297	875	805	153	748	335
V/C Ratio(X)	1.87	0.51	0.41	1.36	0.96	0.71	2.41	0.82	0.08	0.70	0.24	0.27
Avail Cap(c_a), veh/h	94	2503	782	157	2430	736	297	1361	1183	195	1282	575
HCM Platoon Ratio	1.00	1.00	1.00	1.00	1.00	1.00	1.00	1.00	1.00	1.00	1.00	1.00
Upstream Filter(I)	0.90	0.90	0.90	0.27	0.27	0.27	1.00	1.00	1.00	1.00	1.00	1.00
Uniform Delay (d), s/veh	56.8	20.7	19.6	57.3	29.8	24.3	54.8	42.5	30.4	56.1	39.1	39.3
Incr Delay (d2), s/veh	426.3	0.7	1.4	171.0	3.9	1.6	643.4	2.4	0.0	4.6	0.2	0.4
Initial Q Delay(d3),s/veh	0.0	0.0	0.0	0.0	0.0	0.0	0.0	0.0	0.0	0.0	0.0	0.0
%ile BackOfQ(50%),veh/ln	13.8	7.7	5.7	6.1	20.6	11.1	30.9	10.0	0.6	1.7	2.2	2.2
Unsig. Movement Delay, s/veh												
LnGrp Delay(d),s/veh	483.2	21.4	21.0	228.3	33.7	25.9	698.3	44.8	30.5	60.7	39.3	39.8
LnGrp LOS	F	C	C	F	C	C	F	D	C	E	D	D
Approach Vol, veh/h		1764			3063			1494			378	
Approach Delay, s/veh		67.1			45.9			356.5			45.5	
Approach LOS		E			D			F			D	
Timer - Assigned Phs	1	2	3	4	5	6	7	8				
Phs Duration (G+Y+Rc), s	9.2	65.3	14.0	31.5	10.0	64.5	9.7	35.8				
Change Period (Y+Rc), s	3.7	6.5	3.7	5.8	3.7	6.5	3.7	5.8				
Max Green Setting (Gmax), s	5.5	40.5	10.3	44.0	6.3	39.7	7.6	46.7				
Max Q Clear Time (g_c+I1), s	7.5	22.2	12.3	7.7	8.3	55.6	6.1	25.2				
Green Ext Time (p_c), s	0.0	11.9	0.0	1.3	0.0	0.0	0.0	4.8				

Intersection Summary

HCM 6th Ctrl Delay	120.7
HCM 6th LOS	F

Timings
25: Sycamore Canyon Bl. & Cactus Av.

West Campus Upper Plateau (JN 14064)

09/19/2022



Lane Group	EBL	EBT	EBR	WBL	WBT	WBR	NBT	NBR	SBL	SBT	SBR	Ø5
Lane Configurations	↘	↑↑	↗	↘↗	↑↑	↗	↑↑	↗	↘↗	↑↑	↗	
Traffic Volume (vph)	25	7	1	758	23	1055	483	301	197	312	7	
Future Volume (vph)	25	7	1	758	23	1055	483	301	197	312	7	
Turn Type	Prot	NA	Perm	Prot	NA	Perm	NA	Perm	Prot	NA	Perm	
Protected Phases	7	4		3	8		2		1	6		5
Permitted Phases			4			8		2			6	
Detector Phase	7	4	4	3	8	8	2	2	1	6	6	
Switch Phase												
Minimum Initial (s)	5.0	10.0	10.0	5.0	10.0	10.0	10.0	10.0	5.0	10.0	10.0	5.0
Minimum Split (s)	9.6	32.8	32.8	9.6	32.8	32.8	34.8	34.8	9.6	34.8	34.8	9.6
Total Split (s)	9.6	45.6	45.6	27.0	63.0	63.0	36.4	36.4	11.0	37.8	37.8	9.6
Total Split (%)	8.0%	38.0%	38.0%	22.5%	52.5%	52.5%	30.3%	30.3%	9.2%	31.5%	31.5%	8%
Yellow Time (s)	3.6	4.8	4.8	3.6	4.8	4.8	4.8	4.8	3.6	4.8	4.8	3.6
All-Red Time (s)	1.0	1.0	1.0	1.0	1.0	1.0	1.0	1.0	1.0	1.0	1.0	1.0
Lost Time Adjust (s)	0.0	0.0	0.0	0.0	0.0	0.0	0.0	0.0	0.0	0.0	0.0	0.0
Total Lost Time (s)	4.6	5.8	5.8	4.6	5.8	5.8	5.8	5.8	4.6	5.8	5.8	
Lead/Lag	Lead	Lag	Lag	Lead	Lag	Lag	Lag	Lag	Lead	Lag	Lag	Lead
Lead-Lag Optimize?	Yes	Yes	Yes	Yes	Yes	Yes	Yes	Yes	Yes	Yes	Yes	Yes
Recall Mode	None	None	None	None	None	None	None	None	None	None	None	None
Act Effct Green (s)	5.0	21.0	21.0	47.6	57.7	57.7	22.4	22.4	6.5	33.5	33.5	
Actuated g/C Ratio	0.05	0.19	0.19	0.44	0.53	0.53	0.21	0.21	0.06	0.31	0.31	
v/c Ratio	0.36	0.01	0.00	0.54	0.01	1.15	0.71	0.55	1.00	0.30	0.01	
Control Delay	67.9	29.4	0.0	31.4	15.2	102.3	46.0	8.0	117.0	29.4	0.0	
Queue Delay	0.0	0.0	0.0	0.0	0.0	0.1	0.0	0.0	0.0	0.0	0.0	
Total Delay	67.9	29.4	0.0	31.4	15.2	102.4	46.0	8.0	117.0	29.4	0.0	
LOS	E	C	A	C	B	F	D	A	F	C	A	
Approach Delay		58.0			72.0		31.4			62.4		
Approach LOS		E			E		C			E		

Intersection Summary

Cycle Length: 120
 Actuated Cycle Length: 108.3
 Natural Cycle: 130
 Control Type: Actuated-Uncoordinated
 Maximum v/c Ratio: 1.15
 Intersection Signal Delay: 60.3
 Intersection LOS: E
 Intersection Capacity Utilization 96.3%
 ICU Level of Service F
 Analysis Period (min) 15



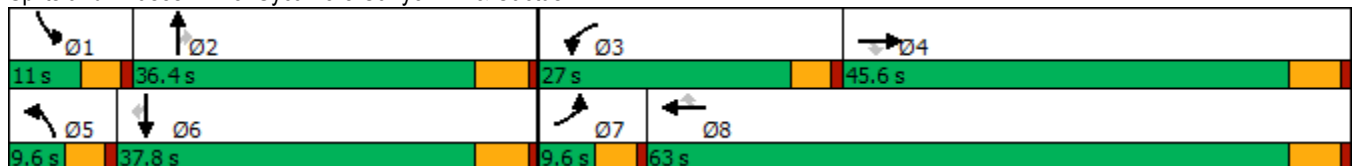





















Splits and Phases: 25: Sycamore Canyon Bl. & Cactus Av.



HCM 6th Signalized Intersection Summary
 25: Sycamore Canyon Bl. & Cactus Av.

West Campus Upper Plateau (JN 14064)

09/19/2022

												
Movement	EBL	EBT	EBR	WBL	WBT	WBR	NBL	NBT	NBR	SBL	SBT	SBR
Lane Configurations												
Traffic Volume (veh/h)	25	7	1	758	23	1055	0	483	301	197	312	7
Future Volume (veh/h)	25	7	1	758	23	1055	0	483	301	197	312	7
Initial Q (Qb), veh	0	0	0	0	0	0	0	0	0	0	0	0
Ped-Bike Adj(A_pbT)	1.00		1.00	1.00		0.99	1.00		1.00	1.00		0.99
Parking Bus, Adj	1.00	1.00	1.00	1.00	1.00	1.00	1.00	1.00	1.00	1.00	1.00	1.00
Work Zone On Approach		No			No			No			No	
Adj Sat Flow, veh/h/ln	1678	1203	1900	1796	1604	1856	1900	1811	1826	1856	1856	1752
Adj Flow Rate, veh/h	26	7	0	781	24	869	0	498	213	203	322	4
Peak Hour Factor	0.97	0.97	0.97	0.97	0.97	0.97	0.97	0.97	0.97	0.97	0.97	0.97
Percent Heavy Veh, %	15	47	0	7	20	3	0	6	5	3	3	10
Cap, veh/h	40	801	564	695	1629	830	3	640	288	205	1018	423
Arrive On Green	0.03	0.35	0.00	0.21	0.53	0.53	0.00	0.19	0.19	0.06	0.29	0.29
Sat Flow, veh/h	1598	2287	1610	3319	3047	1553	3510	3441	1547	3428	3526	1466
Grp Volume(v), veh/h	26	7	0	781	24	869	0	498	213	203	322	4
Grp Sat Flow(s),veh/h/ln	1598	1143	1610	1659	1523	1553	1755	1721	1547	1714	1763	1466
Q Serve(g_s), s	1.7	0.2	0.0	22.4	0.4	57.2	0.0	14.7	13.9	6.3	7.6	0.2
Cycle Q Clear(g_c), s	1.7	0.2	0.0	22.4	0.4	57.2	0.0	14.7	13.9	6.3	7.6	0.2
Prop In Lane	1.00		1.00	1.00		1.00	1.00		1.00	1.00		1.00
Lane Grp Cap(c), veh/h	40	801	564	695	1629	830	3	640	288	205	1018	423
V/C Ratio(X)	0.65	0.01	0.00	1.12	0.01	1.05	0.00	0.78	0.74	0.99	0.32	0.01
Avail Cap(c_a), veh/h	75	850	599	695	1629	830	164	984	443	205	1054	438
HCM Platoon Ratio	1.00	1.00	1.00	1.00	1.00	1.00	1.00	1.00	1.00	1.00	1.00	1.00
Upstream Filter(I)	1.00	1.00	0.00	1.00	1.00	1.00	0.00	1.00	1.00	1.00	1.00	1.00
Uniform Delay (d), s/veh	51.7	22.6	0.0	42.3	11.7	24.9	0.0	41.4	41.1	50.3	29.8	27.1
Incr Delay (d2), s/veh	6.3	0.0	0.0	73.7	0.0	44.2	0.0	2.2	3.7	59.7	0.2	0.0
Initial Q Delay(d3),s/veh	0.0	0.0	0.0	0.0	0.0	0.0	0.0	0.0	0.0	0.0	0.0	0.0
%ile BackOfQ(50%),veh/ln	0.7	0.1	0.0	15.9	0.1	28.5	0.0	6.2	5.4	4.3	3.1	0.1
Unsig. Movement Delay, s/veh												
LnGrp Delay(d),s/veh	58.0	22.7	0.0	116.0	11.7	69.1	0.0	43.6	44.8	110.0	30.0	27.1
LnGrp LOS	E	C	A	F	B	F	A	D	D	F	C	C
Approach Vol, veh/h		33			1674			711			529	
Approach Delay, s/veh		50.5			90.1			44.0			60.7	
Approach LOS		D			F			D			E	
Timer - Assigned Phs	1	2	3	4	5	6	7	8				
Phs Duration (G+Y+Rc), s	11.0	25.7	27.0	43.3	0.0	36.7	7.3	63.0				
Change Period (Y+Rc), s	4.6	5.8	4.6	5.8	4.6	5.8	4.6	5.8				
Max Green Setting (Gmax), s	6.4	30.6	22.4	39.8	5.0	32.0	5.0	57.2				
Max Q Clear Time (g_c+I1), s	8.3	16.7	24.4	2.2	0.0	9.6	3.7	59.2				
Green Ext Time (p_c), s	0.0	3.2	0.0	0.0	0.0	1.8	0.0	0.0				
Intersection Summary												
HCM 6th Ctrl Delay			73.3									
HCM 6th LOS			E									

Timings

West Campus Upper Plateau (JN 14064)

26: Sycamore Canyon Bl. & Van Buren Bl.

09/19/2022



Lane Group	EBL	EBT	EBR	WBL	WBT	WBR	NBL	NBT	SBL	SBT	SBR
Lane Configurations	↔↔	↑↑↑	↗	↖	↑↑↑	↗		↔↔	↔↔	↑	↗
Traffic Volume (vph)	579	2257	3	53	3354	157	4	1	99	6	527
Future Volume (vph)	579	2257	3	53	3354	157	4	1	99	6	527
Turn Type	Prot	NA	Perm	Prot	NA	Perm	Perm	NA	Split	NA	Perm
Protected Phases	5	2		1	6			8	4	4	
Permitted Phases			2			6	8				4
Detector Phase	5	2	2	1	6	6	8	8	4	4	4
Switch Phase											
Minimum Initial (s)	5.0	10.0	10.0	5.0	10.0	10.0	10.0	10.0	10.0	10.0	10.0
Minimum Split (s)	9.6	29.2	29.2	9.6	29.2	29.2	14.6	14.6	50.8	50.8	50.8
Total Split (s)	25.0	50.9	50.9	13.7	39.6	39.6	14.6	14.6	50.8	50.8	50.8
Total Split (%)	19.2%	39.2%	39.2%	10.5%	30.5%	30.5%	11.2%	11.2%	39.1%	39.1%	39.1%
Yellow Time (s)	3.6	5.2	5.2	3.6	5.2	5.2	3.6	3.6	4.8	4.8	4.8
All-Red Time (s)	1.0	1.0	1.0	1.0	1.0	1.0	1.0	1.0	1.0	1.0	1.0
Lost Time Adjust (s)	0.0	0.0	0.0	0.0	0.0	0.0		0.0	0.0	0.0	0.0
Total Lost Time (s)	4.6	6.2	6.2	4.6	6.2	6.2		4.6	5.8	5.8	5.8
Lead/Lag	Lead	Lag	Lag	Lead	Lag	Lag					
Lead-Lag Optimize?	Yes	Yes	Yes	Yes	Yes	Yes					
Recall Mode	None	None	None	None	None	None	None	None	None	None	None
Act Effct Green (s)	21.1	50.7	50.7	7.1	34.5	34.5		10.3	18.5	18.5	18.5
Actuated g/C Ratio	0.23	0.54	0.54	0.08	0.37	0.37		0.11	0.20	0.20	0.20
v/c Ratio	0.80	0.73	0.00	0.42	1.58	0.27		0.03	0.17	0.02	0.83
Control Delay	45.1	22.0	0.0	55.4	290.0	9.1		37.0	30.3	28.2	18.5
Queue Delay	0.0	0.0	0.0	0.0	0.0	0.0		0.0	0.0	0.0	0.0
Total Delay	45.1	22.0	0.0	55.4	290.0	9.1		37.0	30.3	28.2	18.5
LOS	D	C	A	E	F	A		D	C	C	B
Approach Delay		26.7			274.1			37.0		20.5	
Approach LOS		C			F			D		C	

Intersection Summary

Cycle Length: 130
 Actuated Cycle Length: 93.3
 Natural Cycle: 125
 Control Type: Actuated-Uncoordinated
 Maximum v/c Ratio: 1.58
 Intersection Signal Delay: 151.4
 Intersection Capacity Utilization 103.4%
 Analysis Period (min) 15

Intersection LOS: F
 ICU Level of Service G

Splits and Phases: 26: Sycamore Canyon Bl. & Van Buren Bl.

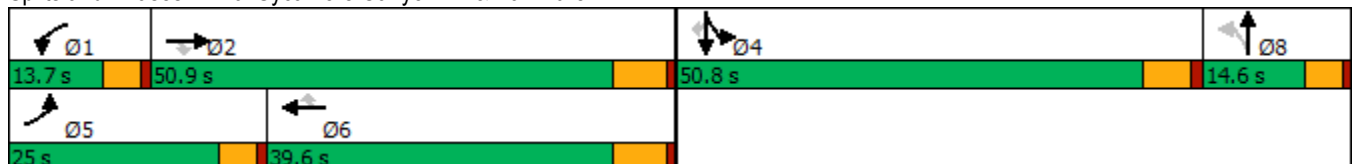

HCM 6th Signalized Intersection Summary
26: Sycamore Canyon Bl. & Van Buren Bl.

West Campus Upper Plateau (JN 14064)

09/19/2022



Movement	EBL	EBT	EBR	WBL	WBT	WBR	NBL	NBT	NBR	SBL	SBT	SBR
Lane Configurations												
Traffic Volume (veh/h)	579	2257	3	53	3354	157	4	1	4	99	6	527
Future Volume (veh/h)	579	2257	3	53	3354	157	4	1	4	99	6	527
Initial Q (Qb), veh	0	0	0	0	0	0	0	0	0	0	0	0
Ped-Bike Adj(A_pbT)	1.00		1.00	1.00		1.00	1.00		1.00	1.00		1.00
Parking Bus, Adj	1.00	1.00	1.00	1.00	1.00	1.00	1.00	1.00	1.00	1.00	1.00	1.00
Work Zone On Approach		No			No			No			No	
Adj Sat Flow, veh/h/ln	1885	1811	1900	1900	1826	1781	1900	1900	1900	1737	1900	1885
Adj Flow Rate, veh/h	629	2453	2	58	3646	146	4	1	2	108	7	0
Peak Hour Factor	0.92	0.92	0.92	0.92	0.92	0.92	0.92	0.92	0.92	0.92	0.92	0.92
Percent Heavy Veh, %	1	6	0	0	5	8	0	0	0	11	0	1
Cap, veh/h	719	3535	913	81	2547	612	33	10	20	362	214	
Arrive On Green	0.21	0.57	0.57	0.04	0.41	0.41	0.02	0.02	0.02	0.11	0.11	0.00
Sat Flow, veh/h	3483	6230	1610	1810	6281	1510	1810	565	1131	3209	1900	1598
Grp Volume(v), veh/h	629	2453	2	58	3646	146	4	0	3	108	7	0
Grp Sat Flow(s),veh/h/ln	1742	1558	1610	1810	1570	1510	1810	0	1696	1605	1900	1598
Q Serve(g_s), s	14.4	23.1	0.0	2.6	33.4	5.2	0.2	0.0	0.1	2.5	0.3	0.0
Cycle Q Clear(g_c), s	14.4	23.1	0.0	2.6	33.4	5.2	0.2	0.0	0.1	2.5	0.3	0.0
Prop In Lane	1.00		1.00	1.00		1.00	1.00		0.67	1.00		1.00
Lane Grp Cap(c), veh/h	719	3535	913	81	2547	612	33	0	30	362	214	
V/C Ratio(X)	0.88	0.69	0.00	0.72	1.43	0.24	0.12	0.00	0.10	0.30	0.03	
Avail Cap(c_a), veh/h	863	3535	913	200	2547	612	220	0	206	1754	1038	
HCM Platoon Ratio	1.00	1.00	1.00	1.00	1.00	1.00	1.00	1.00	1.00	1.00	1.00	1.00
Upstream Filter(I)	1.00	1.00	1.00	1.00	1.00	1.00	1.00	0.00	1.00	1.00	1.00	0.00
Uniform Delay (d), s/veh	31.7	12.7	7.7	38.8	24.5	16.1	39.8	0.0	39.8	33.5	32.5	0.0
Incr Delay (d2), s/veh	7.7	0.6	0.0	4.4	196.4	0.2	1.7	0.0	1.4	0.5	0.1	0.0
Initial Q Delay(d3),s/veh	0.0	0.0	0.0	0.0	0.0	0.0	0.0	0.0	0.0	0.0	0.0	0.0
%ile BackOfQ(50%),veh/ln	6.4	6.6	0.0	1.2	45.5	1.7	0.1	0.0	0.1	1.0	0.1	0.0
Unsig. Movement Delay, s/veh												
LnGrp Delay(d),s/veh	39.4	13.3	7.7	43.2	220.9	16.3	41.5	0.0	41.2	34.0	32.6	0.0
LnGrp LOS	D	B	A	D	F	B	D	A	D	C	C	
Approach Vol, veh/h		3084			3850			7			115	
Approach Delay, s/veh		18.6			210.4			41.3			33.9	
Approach LOS		B			F			D			C	
Timer - Assigned Phs	1	2		4	5	6		8				
Phs Duration (G+Y+Rc), s	8.3	52.9		15.1	21.6	39.6		6.1				
Change Period (Y+Rc), s	4.6	6.2		5.8	4.6	6.2		4.6				
Max Green Setting (Gmax), s	9.1	44.7		45.0	20.4	33.4		10.0				
Max Q Clear Time (g_c+I1), s	4.6	25.1		4.5	16.4	35.4		2.2				
Green Ext Time (p_c), s	0.0	16.2		0.4	0.6	0.0		0.0				

Intersection Summary

HCM 6th Ctrl Delay	123.6
HCM 6th LOS	F

Notes

Unsignalized Delay for [SBR] is excluded from calculations of the approach delay and intersection delay.

Timings
27: Innovation Dr. & Cactus Av.

West Campus Upper Plateau (JN 14064)

09/19/2022

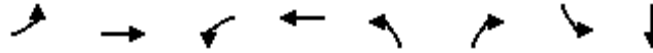

Lane Group	EBL	EBT	WBL	WBT	NBL	NBR	SBL	SBT
Lane Configurations	↖	↖↖↖	↖	↖↖↖	↖	↖	↖	↖
Traffic Volume (vph)	5	394	139	1491	13	39	5	0
Future Volume (vph)	5	394	139	1491	13	39	5	0
Turn Type	Prot	NA	Prot	NA	Perm	Perm	Perm	NA
Protected Phases	5	2	1	6				4
Permitted Phases					8	8	4	
Detector Phase	5	2	1	6	8	8	4	4
Switch Phase								
Minimum Initial (s)	5.0	10.0	5.0	10.0	10.0	10.0	10.0	10.0
Minimum Split (s)	9.2	26.8	9.2	26.8	31.1	31.1	31.1	31.1
Total Split (s)	12.0	57.0	31.0	76.0	32.0	32.0	32.0	32.0
Total Split (%)	10.0%	47.5%	25.8%	63.3%	26.7%	26.7%	26.7%	26.7%
Yellow Time (s)	3.2	4.8	3.2	4.8	4.1	4.1	4.1	4.1
All-Red Time (s)	1.0	1.0	1.0	1.0	1.0	1.0	1.0	1.0
Lost Time Adjust (s)	0.0	0.0	0.0	0.0	0.0	0.0	0.0	0.0
Total Lost Time (s)	4.2	5.8	4.2	5.8	5.1	5.1	5.1	5.1
Lead/Lag	Lead	Lag	Lead	Lag				
Lead-Lag Optimize?	Yes	Yes	Yes	Yes				
Recall Mode	None	None	None	None	None	None	None	None
Act Effct Green (s)	6.7	27.9	11.1	41.5	14.8	14.8	14.8	14.8
Actuated g/C Ratio	0.12	0.51	0.20	0.76	0.27	0.27	0.27	0.27
v/c Ratio	0.02	0.17	0.40	0.42	0.04	0.05	0.02	0.01
Control Delay	37.4	12.0	30.3	6.8	26.0	0.1	26.0	0.0
Queue Delay	0.0	0.0	0.0	0.0	0.0	0.0	0.0	0.0
Total Delay	37.4	12.0	30.3	6.8	26.0	0.1	26.0	0.0
LOS	D	B	C	A	C	A	C	A
Approach Delay		12.3		8.8				16.3
Approach LOS		B		A				B

Intersection Summary

Cycle Length: 120
 Actuated Cycle Length: 54.4
 Natural Cycle: 70
 Control Type: Actuated-Uncoordinated
 Maximum v/c Ratio: 0.42
 Intersection Signal Delay: 9.4
 Intersection Capacity Utilization 55.1%
 Analysis Period (min) 15
 Intersection LOS: A
 ICU Level of Service B

Splits and Phases: 27: Innovation Dr. & Cactus Av.



HCM 6th Signalized Intersection Summary
27: Innovation Dr. & Cactus Av.

West Campus Upper Plateau (JN 14064)

09/19/2022



Movement	EBL	EBT	EBR	WBL	WBT	WBR	NBL	NBT	NBR	SBL	SBT	SBR
Lane Configurations	↖	↑↑↑		↖	↑↑↑		↖	↑	↗	↖	↗	
Traffic Volume (veh/h)	5	394	18	139	1491	53	13	0	39	5	0	3
Future Volume (veh/h)	5	394	18	139	1491	53	13	0	39	5	0	3
Initial Q (Qb), veh	0	0	0	0	0	0	0	0	0	0	0	0
Ped-Bike Adj(A_pbT)	1.00		1.00	1.00		1.00	1.00		1.00	1.00		1.00
Parking Bus, Adj	1.00	1.00	1.00	1.00	1.00	1.00	1.00	1.00	1.00	1.00	1.00	1.00
Work Zone On Approach		No			No			No			No	
Adj Sat Flow, veh/h/ln	1900	1796	1900	1826	1841	1870	1500	1900	1559	1559	1900	1900
Adj Flow Rate, veh/h	5	402	16	142	1521	54	13	0	27	5	0	2
Peak Hour Factor	0.98	0.98	0.98	0.98	0.98	0.98	0.98	0.98	0.98	0.98	0.98	0.98
Percent Heavy Veh, %	0	7	0	5	4	2	27	0	23	23	0	0
Cap, veh/h	12	2562	101	183	3128	111	234	177	123	237	0	150
Arrive On Green	0.01	0.53	0.53	0.11	0.63	0.63	0.09	0.00	0.09	0.09	0.00	0.09
Sat Flow, veh/h	1810	4840	191	1739	4982	177	1135	1900	1321	1153	0	1610
Grp Volume(v), veh/h	5	271	147	142	1023	552	13	0	27	5	0	2
Grp Sat Flow(s),veh/h/ln	1810	1635	1762	1739	1675	1809	1135	1900	1321	1153	0	1610
Q Serve(g_s), s	0.2	2.4	2.4	4.4	9.1	9.1	0.6	0.0	1.0	0.2	0.0	0.1
Cycle Q Clear(g_c), s	0.2	2.4	2.4	4.4	9.1	9.1	0.6	0.0	1.0	0.2	0.0	0.1
Prop In Lane	1.00		0.11	1.00		0.10	1.00		1.00	1.00		1.00
Lane Grp Cap(c), veh/h	12	1730	933	183	2103	1136	234	177	123	237	0	150
V/C Ratio(X)	0.41	0.16	0.16	0.78	0.49	0.49	0.06	0.00	0.22	0.02	0.00	0.01
Avail Cap(c_a), veh/h	255	3022	1628	841	4246	2292	680	923	642	690	0	782
HCM Platoon Ratio	1.00	1.00	1.00	1.00	1.00	1.00	1.00	1.00	1.00	1.00	1.00	1.00
Upstream Filter(I)	1.00	1.00	1.00	1.00	1.00	1.00	1.00	0.00	1.00	1.00	0.00	1.00
Uniform Delay (d), s/veh	27.4	6.7	6.7	24.1	5.5	5.5	23.1	0.0	23.3	22.9	0.0	22.8
Incr Delay (d2), s/veh	8.2	0.1	0.1	2.7	0.2	0.5	0.1	0.0	0.9	0.0	0.0	0.0
Initial Q Delay(d3),s/veh	0.0	0.0	0.0	0.0	0.0	0.0	0.0	0.0	0.0	0.0	0.0	0.0
%ile BackOfQ(50%),veh/ln	0.1	0.6	0.6	1.7	1.7	1.9	0.1	0.0	0.3	0.1	0.0	0.0
Unsig. Movement Delay, s/veh												
LnGrp Delay(d),s/veh	35.6	6.8	6.8	26.8	5.8	6.0	23.2	0.0	24.2	22.9	0.0	22.9
LnGrp LOS	D	A	A	C	A	A	C	A	C	C	A	C
Approach Vol, veh/h		423			1717			40				7
Approach Delay, s/veh		7.1			7.6			23.8				22.9
Approach LOS		A			A			C				C
Timer - Assigned Phs	1	2		4	5	6		8				
Phs Duration (G+Y+Rc), s	10.0	35.1		10.2	4.6	40.6		10.2				
Change Period (Y+Rc), s	* 4.2	5.8		5.1	* 4.2	5.8		5.1				
Max Green Setting (Gmax), s	* 27	51.2		26.9	* 7.8	70.2		26.9				
Max Q Clear Time (g_c+I1), s	6.4	4.4		2.2	2.2	11.1		3.0				
Green Ext Time (p_c), s	0.2	3.8		0.0	0.0	23.7		0.1				

Intersection Summary

HCM 6th Ctrl Delay	7.8
HCM 6th LOS	A

Notes

* HCM 6th computational engine requires equal clearance times for the phases crossing the barrier.

Timings
28: I-215 SB Ramps & Alessandro Bl.

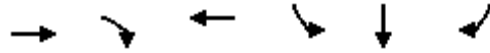

Lane Group	EBT	EBR	WBT	SBL	SBT	SBR
Lane Configurations	↑↑↑	↑	↑↑↑	↑	↔	↑
Traffic Volume (vph)	1043	407	2708	254	0	449
Future Volume (vph)	1043	407	2708	254	0	449
Turn Type	NA	Perm	NA	Split	NA	Perm
Protected Phases	2		6	4	4	
Permitted Phases		2				4
Detector Phase	2	2	6	4	4	4
Switch Phase						
Minimum Initial (s)	5.0	5.0	5.0	5.0	5.0	5.0
Minimum Split (s)	10.5	10.5	34.5	10.0	10.0	10.0
Total Split (s)	49.0	49.0	49.0	36.0	36.0	36.0
Total Split (%)	57.6%	57.6%	57.6%	42.4%	42.4%	42.4%
Yellow Time (s)	4.5	4.5	4.5	4.0	4.0	4.0
All-Red Time (s)	1.0	1.0	1.0	1.0	1.0	1.0
Lost Time Adjust (s)	0.0	0.0	0.0	0.0	0.0	0.0
Total Lost Time (s)	5.5	5.5	5.5	5.0	5.0	5.0
Lead/Lag						
Lead-Lag Optimize?						
Recall Mode	C-Min	C-Min	C-Min	None	None	None
Act Effct Green (s)	54.1	54.1	54.1	20.4	20.4	20.4
Actuated g/C Ratio	0.64	0.64	0.64	0.24	0.24	0.24
v/c Ratio	0.33	0.39	0.94	0.62	0.71	0.69
Control Delay	8.4	4.4	13.3	35.2	35.9	35.0
Queue Delay	0.0	0.0	0.0	0.0	0.0	0.0
Total Delay	8.4	4.4	13.3	35.2	35.9	35.0
LOS	A	A	B	D	D	C
Approach Delay	7.3		13.3		35.3	
Approach LOS	A		B		D	

Intersection Summary

Cycle Length: 85
 Actuated Cycle Length: 85
 Offset: 50 (59%), Referenced to phase 2:EBT and 6:WBT, Start of Yellow
 Natural Cycle: 75
 Control Type: Actuated-Coordinated
 Maximum v/c Ratio: 0.94
 Intersection Signal Delay: 14.6
 Intersection Capacity Utilization 85.0%
 Analysis Period (min) 15

Intersection LOS: B
 ICU Level of Service E

Splits and Phases: 28: I-215 SB Ramps & Alessandro Bl.

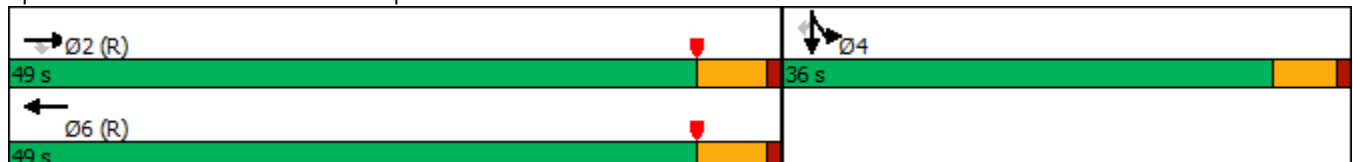

HCM 6th Signalized Intersection Summary
 28: I-215 SB Ramps & Alessandro Bl.

West Campus Upper Plateau (JN 14064)

09/19/2022



Movement	EBL	EBT	EBR	WBL	WBT	WBR	NBL	NBT	NBR	SBL	SBT	SBR
Lane Configurations		↑↑↑	↗		↑↑↑					↘	↔	↗
Traffic Volume (veh/h)	0	1043	407	0	2708	241	0	0	0	254	0	449
Future Volume (veh/h)	0	1043	407	0	2708	241	0	0	0	254	0	449
Initial Q (Qb), veh	0	0	0	0	0	0				0	0	0
Ped-Bike Adj(A_pbT)	1.00		1.00	1.00		1.00				1.00		1.00
Parking Bus, Adj	1.00	1.00	1.00	1.00	1.00	1.00				1.00	1.00	1.00
Work Zone On Approach		No			No						No	
Adj Sat Flow, veh/h/ln	0	1841	1811	0	1856	1796				1737	1900	1693
Adj Flow Rate, veh/h	0	1054	411	0	2735	233				171	0	469
Peak Hour Factor	0.99	0.99	0.99	0.99	0.99	0.99				0.99	0.99	0.99
Percent Heavy Veh, %	0	4	6	0	3	7				11	0	14
Cap, veh/h	0	3376	1030	0	3202	265				339	0	587
Arrive On Green	0.00	0.67	0.67	0.00	0.45	0.45				0.20	0.00	0.20
Sat Flow, veh/h	0	5191	1534	0	4933	395				1654	0	2869
Grp Volume(v), veh/h	0	1054	411	0	1916	1052				171	0	469
Grp Sat Flow(s),veh/h/ln	0	1675	1534	0	1689	1784				1654	0	1434
Q Serve(g_s), s	0.0	7.4	10.2	0.0	42.8	45.6				7.8	0.0	13.2
Cycle Q Clear(g_c), s	0.0	7.4	10.2	0.0	42.8	45.6				7.8	0.0	13.2
Prop In Lane	0.00		1.00	0.00		0.22				1.00		1.00
Lane Grp Cap(c), veh/h	0	3376	1030	0	2269	1199				339	0	587
V/C Ratio(X)	0.00	0.31	0.40	0.00	0.84	0.88				0.51	0.00	0.80
Avail Cap(c_a), veh/h	0	3376	1030	0	2269	1199				603	0	1046
HCM Platoon Ratio	1.00	1.00	1.00	1.00	0.67	0.67				1.00	1.00	1.00
Upstream Filter(I)	0.00	0.75	0.75	0.00	0.09	0.09				1.00	0.00	1.00
Uniform Delay (d), s/veh	0.0	5.8	6.3	0.0	19.4	20.2				30.0	0.0	32.1
Incr Delay (d2), s/veh	0.0	0.2	0.9	0.0	0.4	1.0				1.2	0.0	2.6
Initial Q Delay(d3),s/veh	0.0	0.0	0.0	0.0	0.0	0.0				0.0	0.0	0.0
%ile BackOfQ(50%),veh/ln	0.0	1.7	2.3	0.0	16.0	18.2				3.0	0.0	4.5
Unsig. Movement Delay, s/veh												
LnGrp Delay(d),s/veh	0.0	6.0	7.1	0.0	19.8	21.2				31.2	0.0	34.7
LnGrp LOS	A	A	A	A	B	C				C	A	C
Approach Vol, veh/h		1465			2968						640	
Approach Delay, s/veh		6.3			20.3						33.8	
Approach LOS		A			C						C	
Timer - Assigned Phs		2		4		6						
Phs Duration (G+Y+Rc), s		62.6		22.4		62.6						
Change Period (Y+Rc), s		5.5		5.0		5.5						
Max Green Setting (Gmax), s		43.5		31.0		43.5						
Max Q Clear Time (g_c+I1), s		12.2		15.2		47.6						
Green Ext Time (p_c), s		9.4		2.2		0.0						

Intersection Summary

HCM 6th Ctrl Delay	17.9
HCM 6th LOS	B

Notes

User approved volume balancing among the lanes for turning movement.

Timings
29: I-215 NB Ramps & Alessandro Bl.

West Campus Upper Plateau (JN 14064)

09/19/2022



Lane Group	EBL	EBT	WBT	WBR	NBL	NBT	NBR
Lane Configurations	↶	↷↷↷	↶↶↶	↷	↶	↷↷	↷
Traffic Volume (vph)	92	1246	1952	119	1316	0	248
Future Volume (vph)	92	1246	1952	119	1316	0	248
Turn Type	Prot	NA	NA	Perm	Split	NA	Perm
Protected Phases	5	2	6		8	8	
Permitted Phases				6			8
Detector Phase	5	2	6	6	8	8	8
Switch Phase							
Minimum Initial (s)	5.0	5.0	5.0	5.0	5.0	5.0	5.0
Minimum Split (s)	9.5	10.5	33.5	33.5	10.0	10.0	10.0
Total Split (s)	25.0	60.0	35.0	35.0	25.0	25.0	25.0
Total Split (%)	29.4%	70.6%	41.2%	41.2%	29.4%	29.4%	29.4%
Yellow Time (s)	3.5	4.5	4.5	4.5	4.0	4.0	4.0
All-Red Time (s)	1.0	1.0	1.0	1.0	1.0	1.0	1.0
Lost Time Adjust (s)	0.0	0.0	0.0	0.0	0.0	0.0	0.0
Total Lost Time (s)	4.5	5.5	5.5	5.5	5.0	5.0	5.0
Lead/Lag	Lead		Lag	Lag			
Lead-Lag Optimize?	Yes		Yes	Yes			
Recall Mode	None	C-Min	C-Min	C-Min	Max	Max	Max
Act Effct Green (s)	10.5	54.5	41.5	41.5	20.0	20.0	20.0
Actuated g/C Ratio	0.12	0.64	0.49	0.49	0.24	0.24	0.24
v/c Ratio	0.54	0.39	0.80	0.16	1.78	1.57	0.61
Control Delay	39.7	8.1	23.3	6.5	388.1	293.4	25.3
Queue Delay	0.0	0.0	0.0	0.0	0.0	0.0	0.0
Total Delay	39.7	8.1	23.3	6.5	388.1	293.4	25.3
LOS	D	A	C	A	F	F	C
Approach Delay		10.3	22.4			295.7	
Approach LOS		B	C			F	

Intersection Summary

Cycle Length: 85
 Actuated Cycle Length: 85
 Offset: 20 (24%), Referenced to phase 2:EBT and 6:WBT, Start of Yellow
 Natural Cycle: 110
 Control Type: Actuated-Coordinated
 Maximum v/c Ratio: 1.78
 Intersection Signal Delay: 105.1
 Intersection Capacity Utilization 94.3%
 Analysis Period (min) 15

Intersection LOS: F
 ICU Level of Service F

Splits and Phases: 29: I-215 NB Ramps & Alessandro Bl.

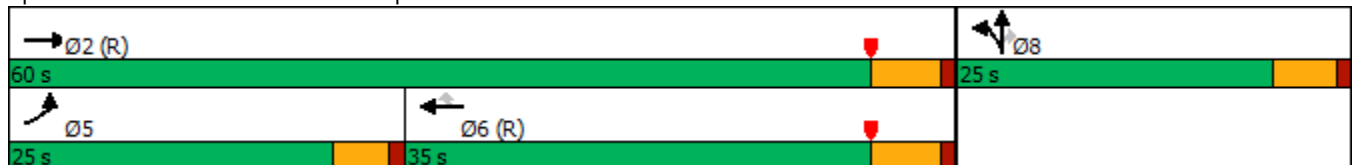

HCM 6th Signalized Intersection Summary
 29: I-215 NB Ramps & Alessandro Bl.

West Campus Upper Plateau (JN 14064)

09/19/2022



Movement	EBL	EBT	EBR	WBL	WBT	WBR	NBL	NBT	NBR	SBL	SBT	SBR
Lane Configurations	↘	↑↑↑			↑↑↑	↗	↘	↕	↗			
Traffic Volume (veh/h)	92	1246	0	0	1952	119	1316	0	248	0	0	0
Future Volume (veh/h)	92	1246	0	0	1952	119	1316	0	248	0	0	0
Initial Q (Qb), veh	0	0	0	0	0	0	0	0	0			
Ped-Bike Adj(A_pbT)	1.00		1.00	1.00		1.00	1.00		1.00			
Parking Bus, Adj	1.00	1.00	1.00	1.00	1.00	1.00	1.00	1.00	1.00			
Work Zone On Approach		No			No			No				
Adj Sat Flow, veh/h/ln	1470	1856	0	0	1870	1767	1826	1900	1618			
Adj Flow Rate, veh/h	94	1271	0	0	1992	114	1397	0	116			
Peak Hour Factor	0.98	0.98	0.98	0.98	0.98	0.98	0.98	0.98	0.98			
Percent Heavy Veh, %	29	3	0	0	2	9	5	0	19			
Cap, veh/h	114	3248	0	0	2587	758	818	0	323			
Arrive On Green	0.03	0.21	0.00	0.00	0.51	0.51	0.24	0.00	0.24			
Sat Flow, veh/h	1400	5233	0	0	5274	1497	3478	0	1372			
Grp Volume(v), veh/h	94	1271	0	0	1992	114	1397	0	116			
Grp Sat Flow(s),veh/h/ln	1400	1689	0	0	1702	1497	1739	0	1372			
Q Serve(g_s), s	5.7	18.3	0.0	0.0	26.8	3.5	20.0	0.0	6.0			
Cycle Q Clear(g_c), s	5.7	18.3	0.0	0.0	26.8	3.5	20.0	0.0	6.0			
Prop In Lane	1.00		0.00	0.00		1.00	1.00		1.00			
Lane Grp Cap(c), veh/h	114	3248	0	0	2587	758	818	0	323			
V/C Ratio(X)	0.82	0.39	0.00	0.00	0.77	0.15	1.71	0.00	0.36			
Avail Cap(c_a), veh/h	338	3248	0	0	2587	758	818	0	323			
HCM Platoon Ratio	0.33	0.33	1.00	1.00	1.00	1.00	1.00	1.00	1.00			
Upstream Filter(I)	0.93	0.93	0.00	0.00	1.00	1.00	1.00	0.00	1.00			
Uniform Delay (d), s/veh	40.7	19.3	0.0	0.0	17.0	11.2	32.5	0.0	27.1			
Incr Delay (d2), s/veh	9.7	0.3	0.0	0.0	2.3	0.4	323.4	0.0	3.1			
Initial Q Delay(d3),s/veh	0.0	0.0	0.0	0.0	0.0	0.0	0.0	0.0	0.0			
%ile BackOfQ(50%),veh/ln	2.2	8.1	0.0	0.0	8.9	1.0	44.6	0.0	2.1			
Unsig. Movement Delay, s/veh												
LnGrp Delay(d),s/veh	50.4	19.6	0.0	0.0	19.2	11.6	355.9	0.0	30.2			
LnGrp LOS	D	B	A	A	B	B	F	A	C			
Approach Vol, veh/h		1365			2106			1513				
Approach Delay, s/veh		21.7			18.8			331.0				
Approach LOS		C			B			F				
Timer - Assigned Phs		2			5	6		8				
Phs Duration (G+Y+Rc), s		60.0			11.4	48.6		25.0				
Change Period (Y+Rc), s		5.5			4.5	5.5		5.0				
Max Green Setting (Gmax), s		54.5			20.5	29.5		20.0				
Max Q Clear Time (g_c+I1), s		20.3			7.7	28.8		22.0				
Green Ext Time (p_c), s		9.6			0.1	0.6		0.0				

Intersection Summary

HCM 6th Ctrl Delay	114.4
HCM 6th LOS	F

Notes

User approved volume balancing among the lanes for turning movement.

Timings
30: I-215 SB Ramps & Cactus Av.

West Campus Upper Plateau (JN 14064)

09/19/2022



Lane Group	EBT	EBR	WBL	WBT	NBR	SBR
Lane Configurations	↑↑	↑	↓	↑↑	↑	↑
Traffic Volume (vph)	353	30	816	1402	838	225
Future Volume (vph)	353	30	816	1402	838	225
Turn Type	NA	Perm	Prot	NA	Prot	Prot
Protected Phases	2		1	6	8	4
Permitted Phases		2				
Detector Phase	2	2	1	6	8	4
Switch Phase						
Minimum Initial (s)	5.0	5.0	5.0	5.0	5.0	5.0
Minimum Split (s)	11.0	11.0	9.5	23.0	9.5	9.5
Total Split (s)	23.0	23.0	54.0	77.0	28.0	28.0
Total Split (%)	21.9%	21.9%	51.4%	73.3%	26.7%	26.7%
Yellow Time (s)	5.0	5.0	3.5	5.0	3.5	3.5
All-Red Time (s)	1.0	1.0	1.0	1.0	1.0	1.0
Lost Time Adjust (s)	0.0	0.0	0.0	0.0	0.0	0.0
Total Lost Time (s)	6.0	6.0	4.5	6.0	4.5	4.5
Lead/Lag	Lag	Lag	Lead			
Lead-Lag Optimize?	Yes	Yes	Yes			
Recall Mode	Min	Min	None	Min	None	None
Act Effct Green (s)	14.9	14.9	49.7	69.0	21.1	21.1
Actuated g/C Ratio	0.15	0.15	0.49	0.69	0.21	0.21
v/c Ratio	0.78	0.12	1.10	0.64	0.96	0.74
Control Delay	53.2	3.8	90.2	10.7	27.4	40.0
Queue Delay	0.0	0.0	0.0	0.0	0.0	0.0
Total Delay	53.2	3.8	90.2	10.7	27.4	40.0
LOS	D	A	F	B	C	D
Approach Delay	49.4			40.0		
Approach LOS	D			D		

Intersection Summary

Cycle Length: 105
 Actuated Cycle Length: 100.7
 Natural Cycle: 100
 Control Type: Actuated-Uncoordinated
 Maximum v/c Ratio: 1.10
 Intersection Signal Delay: 38.1
 Intersection LOS: D
 Intersection Capacity Utilization 70.4%
 ICU Level of Service C
 Analysis Period (min) 15

Splits and Phases: 30: I-215 SB Ramps & Cactus Av.

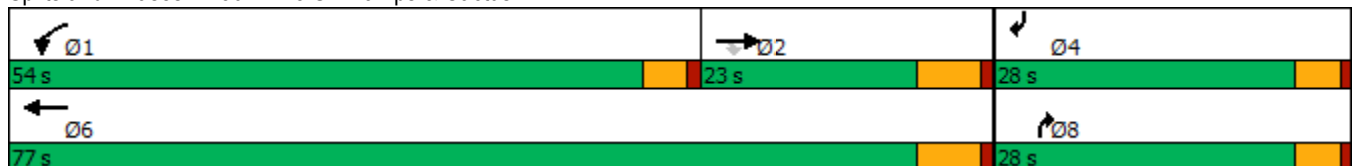

HCM 6th Signalized Intersection Summary
 30: I-215 SB Ramps & Cactus Av.

West Campus Upper Plateau (JN 14064)

09/19/2022



Movement	EBL	EBT	EBR	WBL	WBT	WBR	NBL	NBT	NBR	SBL	SBT	SBR
Lane Configurations		↑↑	↗	↖	↑↑				↗			↖
Traffic Volume (veh/h)	0	353	30	816	1402	0	0	0	838	0	0	225
Future Volume (veh/h)	0	353	30	816	1402	0	0	0	838	0	0	225
Initial Q (Qb), veh	0	0	0	0	0	0	0	0	0	0	0	0
Ped-Bike Adj(A_pbT)	1.00		1.00	1.00		1.00	1.00		1.00	1.00		1.00
Parking Bus, Adj	1.00	1.00	1.00	1.00	1.00	1.00	1.00	1.00	1.00	1.00	1.00	1.00
Work Zone On Approach		No			No			No			No	
Adj Sat Flow, veh/h/ln	0	1811	1841	1781	1870	0	0	0	1781	0	0	1530
Adj Flow Rate, veh/h	0	392	25	907	1558	0	0	0	0	0	0	149
Peak Hour Factor	0.90	0.90	0.90	0.90	0.90	0.90	0.90	0.90	0.90	0.90	0.90	0.90
Percent Heavy Veh, %	0	6	4	8	2	0	0	0	8	0	0	25
Cap, veh/h	0	618	280	973	3053	0	0	0	0	0	0	0
Arrive On Green	0.00	0.18	0.18	0.57	0.86	0.00	0.00	0.00	0.00	0.00	0.00	0.00
Sat Flow, veh/h	0	3532	1560	1697	3647	0		0			0	
Grp Volume(v), veh/h	0	392	25	907	1558	0		0.0			0.0	
Grp Sat Flow(s),veh/h/ln	0	1721	1560	1697	1777	0						
Q Serve(g_s), s	0.0	4.5	0.6	20.8	4.7	0.0						
Cycle Q Clear(g_c), s	0.0	4.5	0.6	20.8	4.7	0.0						
Prop In Lane	0.00		1.00	1.00		0.00						
Lane Grp Cap(c), veh/h	0	618	280	973	3053	0						
V/C Ratio(X)	0.00	0.63	0.09	0.93	0.51	0.00						
Avail Cap(c_a), veh/h	0	1375	623	1974	5930	0						
HCM Platoon Ratio	1.00	1.00	1.00	1.00	1.00	1.00						
Upstream Filter(I)	0.00	1.00	1.00	1.00	1.00	0.00						
Uniform Delay (d), s/veh	0.0	16.2	14.6	8.3	0.8	0.0						
Incr Delay (d2), s/veh	0.0	0.4	0.1	1.9	0.0	0.0						
Initial Q Delay(d3),s/veh	0.0	0.0	0.0	0.0	0.0	0.0						
%ile BackOfQ(50%),veh/ln	0.0	1.4	0.2	3.4	0.0	0.0						
Unsig. Movement Delay, s/veh												
LnGrp Delay(d),s/veh	0.0	16.6	14.6	10.2	0.8	0.0						
LnGrp LOS	A	B	B	B	A	A						
Approach Vol, veh/h		417			2465							
Approach Delay, s/veh		16.4			4.3							
Approach LOS		B			A							
Timer - Assigned Phs	1	2			6							
Phs Duration (G+Y+Rc), s	28.9	13.6			42.6							
Change Period (Y+Rc), s	4.5	6.0			6.0							
Max Green Setting (Gmax), s	49.5	17.0			71.0							
Max Q Clear Time (g_c+I1), s	22.8	6.5			6.7							
Green Ext Time (p_c), s	1.6	1.2			9.6							

Intersection Summary

HCM 6th Ctrl Delay	6.0
HCM 6th LOS	A

Notes

Unsignalized Delay for [NBR] is excluded from calculations of the approach delay and intersection delay.

Timings

31: I-215 NB Ramps/Old 215 Frontage Rd. & Cactus Av.



Lane Group	EBL	EBT	WBT	NBL	NBT	NBR	SBL	SBT
Lane Configurations	↶	↶↷	↶↷	↶	↷	↷	↶	↷
Traffic Volume (vph)	22	1634	3094	391	338	48	58	0
Future Volume (vph)	22	1634	3094	391	338	48	58	0
Turn Type	Perm	NA	NA	Perm	NA	Perm	Perm	NA
Protected Phases		2	6		8			4
Permitted Phases	2			8		8	4	
Detector Phase	2	2	6	8	8	8	4	4
Switch Phase								
Minimum Initial (s)	5.0	5.0	5.0	5.0	5.0	5.0	5.0	5.0
Minimum Split (s)	11.0	11.0	44.0	10.5	10.5	10.5	10.5	10.5
Total Split (s)	88.0	88.0	88.0	32.0	32.0	32.0	32.0	32.0
Total Split (%)	73.3%	73.3%	73.3%	26.7%	26.7%	26.7%	26.7%	26.7%
Yellow Time (s)	5.0	5.0	5.0	4.5	4.5	4.5	4.5	4.5
All-Red Time (s)	1.0	1.0	1.0	1.0	1.0	1.0	1.0	1.0
Lost Time Adjust (s)	0.0	0.0	0.0	0.0	0.0	0.0	0.0	0.0
Total Lost Time (s)	6.0	6.0	6.0	5.5	5.5	5.5	5.5	5.5
Lead/Lag								
Lead-Lag Optimize?								
Recall Mode	Min	Min	Min	None	None	None	None	None
Act Effct Green (s)	82.0	82.0	82.0	26.5	26.5	26.5	26.5	26.5
Actuated g/C Ratio	0.68	0.68	0.68	0.22	0.22	0.22	0.22	0.22
v/c Ratio	0.43	0.77	1.46	1.71	1.03	0.13	1.03	0.50
Control Delay	39.0	15.4	229.2	367.8	100.5	17.1	173.7	39.8
Queue Delay	0.0	0.0	0.0	0.0	0.0	0.0	0.0	0.0
Total Delay	39.0	15.4	229.2	367.8	100.5	17.1	173.7	39.8
LOS	D	B	F	F	F	B	F	D
Approach Delay		15.7	229.2		230.3			79.9
Approach LOS		B	F		F			E

Intersection Summary

Cycle Length: 120
 Actuated Cycle Length: 120
 Natural Cycle: 130
 Control Type: Actuated-Uncoordinated
 Maximum v/c Ratio: 1.71
 Intersection Signal Delay: 163.1
 Intersection Capacity Utilization 135.0%
 Analysis Period (min) 15

Intersection LOS: F
 ICU Level of Service H

Splits and Phases: 31: I-215 NB Ramps/Old 215 Frontage Rd. & Cactus Av.

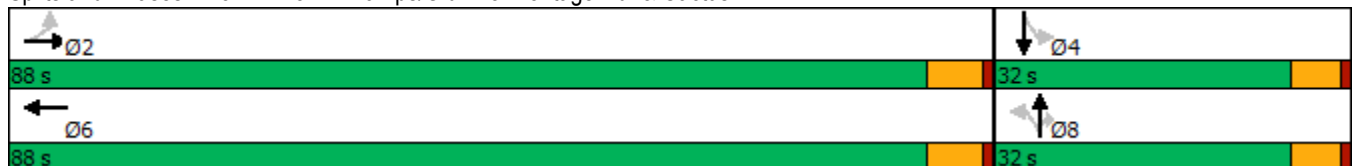

HCM 6th Signalized Intersection Summary

West Campus Upper Plateau (JN 14064)

31: I-215 NB Ramps/Old 215 Frontage Rd. & Cactus Av.

09/19/2022

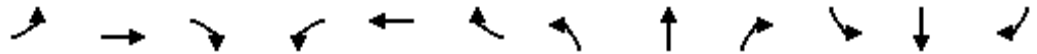

Movement	EBL	EBT	EBR	WBL	WBT	WBR	NBL	NBT	NBR	SBL	SBT	SBR
Lane Configurations												
Traffic Volume (veh/h)	22	1634	49	0	3094	163	391	338	48	58	0	136
Future Volume (veh/h)	22	1634	49	0	3094	163	391	338	48	58	0	136
Initial Q (Qb), veh	0	0	0	0	0	0	0	0	0	0	0	0
Ped-Bike Adj(A_pbT)	1.00		1.00	1.00		1.00	1.00		1.00	1.00		1.00
Parking Bus, Adj	1.00	1.00	1.00	1.00	1.00	1.00	1.00	1.00	1.00	1.00	1.00	1.00
Work Zone On Approach		No			No			No			No	
Adj Sat Flow, veh/h/ln	1604	1841	1174	0	1856	1841	1856	1722	1841	1841	1900	1426
Adj Flow Rate, veh/h	23	1738	47	0	3291	153	416	360	0	62	0	135
Peak Hour Factor	0.94	0.94	0.94	0.94	0.94	0.94	0.94	0.94	0.94	0.94	0.94	0.94
Percent Heavy Veh, %	20	4	49	0	3	4	3	12	4	4	0	32
Cap, veh/h	60	2377	64	0	2345	108	246	380		75	0	356
Arrive On Green	0.68	0.68	0.68	0.00	0.68	0.68	0.22	0.22	0.00	0.22	0.00	0.22
Sat Flow, veh/h	43	3479	94	0	3524	158	1244	1722	1560	1005	0	1610
Grp Volume(v), veh/h	23	871	914	0	1678	1766	416	360	0	62	0	135
Grp Sat Flow(s),veh/h/ln	43	1749	1824	0	1763	1827	1244	1722	1560	1005	0	1610
Q Serve(g_s), s	0.0	37.7	38.2	0.0	82.0	82.0	17.9	24.7	0.0	1.8	0.0	8.6
Cycle Q Clear(g_c), s	82.0	37.7	38.2	0.0	82.0	82.0	26.5	24.7	0.0	26.5	0.0	8.6
Prop In Lane	1.00		0.05	0.00		0.09	1.00		1.00	1.00		1.00
Lane Grp Cap(c), veh/h	60	1195	1246	0	1205	1248	246	380		75	0	356
V/C Ratio(X)	0.38	0.73	0.73	0.00	1.39	1.41	1.69	0.95		0.83	0.00	0.38
Avail Cap(c_a), veh/h	60	1195	1246	0	1205	1248	246	380		75	0	356
HCM Platoon Ratio	1.00	1.00	1.00	1.00	1.00	1.00	1.00	1.00	1.00	1.00	1.00	1.00
Upstream Filter(I)	1.00	1.00	1.00	0.00	1.00	1.00	1.00	1.00	0.00	1.00	0.00	1.00
Uniform Delay (d), s/veh	60.0	12.0	12.1	0.0	19.0	19.0	53.2	46.1	0.0	59.8	0.0	39.8
Incr Delay (d2), s/veh	1.5	2.0	2.0	0.0	182.0	191.4	327.7	32.3	0.0	48.2	0.0	0.2
Initial Q Delay(d3),s/veh	0.0	0.0	0.0	0.0	0.0	0.0	0.0	0.0	0.0	0.0	0.0	0.0
%ile BackOfQ(50%),veh/ln	0.7	12.8	13.5	0.0	87.5	93.9	29.7	13.6	0.0	2.8	0.0	3.3
Unsig. Movement Delay, s/veh												
LnGrp Delay(d),s/veh	61.5	14.0	14.1	0.0	201.0	210.4	380.9	78.3	0.0	108.0	0.0	40.0
LnGrp LOS	E	B	B	A	F	F	F	E		F	A	D
Approach Vol, veh/h		1808			3444			776				197
Approach Delay, s/veh		14.6			205.8			240.5				61.4
Approach LOS		B			F			F				E
Timer - Assigned Phs		2		4		6		8				
Phs Duration (G+Y+Rc), s		88.0		32.0		88.0		32.0				
Change Period (Y+Rc), s		6.0		5.5		6.0		5.5				
Max Green Setting (Gmax), s		82.0		26.5		82.0		26.5				
Max Q Clear Time (g_c+I1), s		84.0		28.5		84.0		28.5				
Green Ext Time (p_c), s		0.0		0.0		0.0		0.0				

Intersection Summary

HCM 6th Ctrl Delay	150.0
HCM 6th LOS	F

Notes

User approved volume balancing among the lanes for turning movement.
 Unsignalized Delay for [NBR] is excluded from calculations of the approach delay and intersection delay.

Timings
32: I-215 SB Ramps & Van Buren Bl.

West Campus Upper Plateau (JN 14064)

09/19/2022



Lane Group	EBT	EBR	WBL	WBT	SBT	SBR
Lane Configurations	↑↑	↑↑	↙	↑↑	↙	↑↑
Traffic Volume (vph)	1016	995	30	1515	25	1437
Future Volume (vph)	1016	995	30	1515	25	1437
Turn Type	NA	Perm	Prot	NA	NA	Perm
Protected Phases	6		5	2	8	
Permitted Phases		6				8
Detector Phase	6	6	5	2	8	8
Switch Phase						
Minimum Initial (s)	5.0	5.0	5.0	5.0	5.0	5.0
Minimum Split (s)	36.0	36.0	11.0	11.0	11.0	11.0
Total Split (s)	37.0	37.0	11.0	48.0	37.0	37.0
Total Split (%)	43.5%	43.5%	12.9%	56.5%	43.5%	43.5%
Yellow Time (s)	5.0	5.0	5.0	5.0	5.0	5.0
All-Red Time (s)	1.0	1.0	1.0	1.0	1.0	1.0
Lost Time Adjust (s)	0.0	0.0	0.0	0.0	0.0	0.0
Total Lost Time (s)	6.0	6.0	6.0	6.0	6.0	6.0
Lead/Lag	Lag	Lag	Lead			
Lead-Lag Optimize?	Yes	Yes	Yes			
Recall Mode	Min	Min	None	Min	Max	Max
Act Effect Green (s)	34.8	34.8	5.0	41.3	31.0	31.0
Actuated g/C Ratio	0.41	0.41	0.06	0.49	0.37	0.37
v/c Ratio	0.80	0.62	0.30	0.96	0.68	1.50
Control Delay	28.8	3.2	45.9	35.6	29.1	253.1
Queue Delay	0.0	0.0	0.0	0.0	0.0	0.0
Total Delay	28.8	3.2	45.9	35.6	29.1	253.1
LOS	C	A	D	D	C	F
Approach Delay	16.1			35.8	204.0	
Approach LOS	B			D	F	

Intersection Summary

Cycle Length: 85
 Actuated Cycle Length: 84.3
 Natural Cycle: 130
 Control Type: Actuated-Uncoordinated
 Maximum v/c Ratio: 1.50
 Intersection Signal Delay: 85.8
 Intersection LOS: F
 Intersection Capacity Utilization 101.7%
 ICU Level of Service G
 Analysis Period (min) 15

Splits and Phases: 32: I-215 SB Ramps & Van Buren Bl.

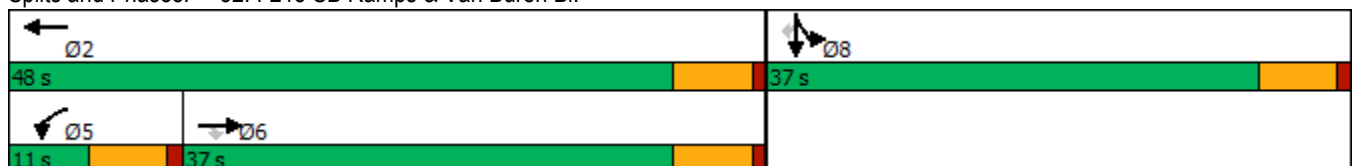

HCM 6th Signalized Intersection Summary
 32: I-215 SB Ramps & Van Buren Bl.

West Campus Upper Plateau (JN 14064)

09/19/2022



Movement	EBL	EBT	EBR	WBL	WBT	WBR	NBL	NBT	NBR	SBL	SBT	SBR
Lane Configurations		↑↑	↑↑	↑	↑↑						↑	↑↑
Traffic Volume (veh/h)	0	1016	995	30	1515	0	0	0	0	378	25	1437
Future Volume (veh/h)	0	1016	995	30	1515	0	0	0	0	378	25	1437
Initial Q (Qb), veh	0	0	0	0	0	0				0	0	0
Ped-Bike Adj(A_pbT)	1.00		1.00	1.00		1.00				1.00		1.00
Parking Bus, Adj	1.00	1.00	1.00	1.00	1.00	1.00				1.00	1.00	1.00
Work Zone On Approach		No			No						No	
Adj Sat Flow, veh/h/ln	0	1767	1781	1900	1841	0				1856	1559	1767
Adj Flow Rate, veh/h	0	1092	976	32	1629	0				406	27	0
Peak Hour Factor	0.93	0.93	0.93	0.93	0.93	0.93				0.93	0.93	0.93
Percent Heavy Veh, %	0	9	8	0	4	0				3	23	9
Cap, veh/h	0	1224	969	106	1728	0				509	34	
Arrive On Green	0.00	0.36	0.36	0.06	0.49	0.00				0.36	0.36	0.00
Sat Flow, veh/h	0	3445	2657	1810	3589	0				1396	93	2635
Grp Volume(v), veh/h	0	1092	976	32	1629	0				433	0	0
Grp Sat Flow(s),veh/h/ln	0	1678	1329	1810	1749	0				1489	0	1317
Q Serve(g_s), s	0.0	26.0	31.0	1.4	37.5	0.0				22.1	0.0	0.0
Cycle Q Clear(g_c), s	0.0	26.0	31.0	1.4	37.5	0.0				22.1	0.0	0.0
Prop In Lane	0.00		1.00	1.00		0.00				0.94		1.00
Lane Grp Cap(c), veh/h	0	1224	969	106	1728	0				543	0	
V/C Ratio(X)	0.00	0.89	1.01	0.30	0.94	0.00				0.80	0.00	
Avail Cap(c_a), veh/h	0	1224	969	106	1728	0				543	0	
HCM Platoon Ratio	1.00	1.00	1.00	1.00	1.00	1.00				1.00	1.00	1.00
Upstream Filter(I)	0.00	1.00	1.00	1.00	1.00	0.00				1.00	0.00	0.00
Uniform Delay (d), s/veh	0.0	25.4	27.0	38.3	20.4	0.0				24.2	0.0	0.0
Incr Delay (d2), s/veh	0.0	8.3	30.7	0.6	10.8	0.0				11.6	0.0	0.0
Initial Q Delay(d3),s/veh	0.0	0.0	0.0	0.0	0.0	0.0				0.0	0.0	0.0
%ile BackOfQ(50%),veh/ln	0.0	10.3	12.5	0.6	15.0	0.0				8.7	0.0	0.0
Unsig. Movement Delay, s/veh												
LnGrp Delay(d),s/veh	0.0	33.7	57.7	38.9	31.2	0.0				35.7	0.0	0.0
LnGrp LOS	A	C	F	D	C	A				D	A	
Approach Vol, veh/h		2068			1661							433
Approach Delay, s/veh		45.0			31.3							35.7
Approach LOS		D			C							D
Timer - Assigned Phs		2			5	6		8				
Phs Duration (G+Y+Rc), s		48.0			11.0	37.0		37.0				
Change Period (Y+Rc), s		6.0			6.0	6.0		6.0				
Max Green Setting (Gmax), s		42.0			5.0	31.0		31.0				
Max Q Clear Time (g_c+I1), s		39.5			3.4	33.0		24.1				
Green Ext Time (p_c), s		1.8			0.0	0.0		1.0				

Intersection Summary

HCM 6th Ctrl Delay	38.6
HCM 6th LOS	D

Notes

Unsignalized Delay for [SBR] is excluded from calculations of the approach delay and intersection delay.

Timings
33: I-215 NB On/Off Ramp & Van Buren Bl.



Lane Group	EBT	EBR	WBT	NBL	NBR
Lane Configurations	↑↑	↑↑	↑↑	↑↑	↑
Traffic Volume (vph)	517	948	173	1631	137
Future Volume (vph)	517	948	173	1631	137
Turn Type	NA	pm+ov	NA	Prot	Perm
Protected Phases	6	4	2	4	
Permitted Phases		6			4
Detector Phase	6	4	2	4	4
Switch Phase					
Minimum Initial (s)	5.0	5.0	5.0	5.0	5.0
Minimum Split (s)	11.0	42.0	11.0	42.0	42.0
Total Split (s)	15.0	55.0	15.0	55.0	55.0
Total Split (%)	21.4%	78.6%	21.4%	78.6%	78.6%
Yellow Time (s)	5.0	5.0	5.0	5.0	5.0
All-Red Time (s)	1.0	1.0	1.0	1.0	1.0
Lost Time Adjust (s)	0.0	0.0	0.0	0.0	0.0
Total Lost Time (s)	6.0	6.0	6.0	6.0	6.0
Lead/Lag					
Lead-Lag Optimize?					
Recall Mode	None	Min	None	Min	Min
Act Effct Green (s)	9.2	58.3	9.2	36.8	36.8
Actuated g/C Ratio	0.16	1.00	0.16	0.63	0.63
v/c Ratio	1.01	0.39	0.36	0.84	0.15
Control Delay	73.0	0.4	26.9	12.6	4.2
Queue Delay	0.0	0.0	0.0	0.0	0.0
Total Delay	73.0	0.4	26.9	12.6	4.2
LOS	E	A	C	B	A
Approach Delay	26.1		26.9	11.9	
Approach LOS	C		C	B	

Intersection Summary

Cycle Length: 70
 Actuated Cycle Length: 58.3
 Natural Cycle: 60
 Control Type: Actuated-Uncoordinated
 Maximum v/c Ratio: 1.01
 Intersection Signal Delay: 18.8
 Intersection LOS: B
 Intersection Capacity Utilization 70.8%
 ICU Level of Service C
 Analysis Period (min) 15

Splits and Phases: 33: I-215 NB On/Off Ramp & Van Buren Bl.



HCM 6th Signalized Intersection Summary
 33: I-215 NB On/Off Ramp & Van Buren Bl.

West Campus Upper Plateau (JN 14064)

09/19/2022

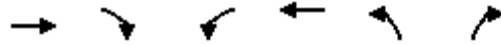

Movement	EBT	EBR	WBL	WBT	NBL	NBR
Lane Configurations	↑↑	↑↑		↑↑	↑↑	↑
Traffic Volume (veh/h)	517	948	0	173	1631	137
Future Volume (veh/h)	517	948	0	173	1631	137
Initial Q (Qb), veh	0	0	0	0	0	0
Ped-Bike Adj(A_pbT)		1.00	1.00		1.00	1.00
Parking Bus, Adj	1.00	1.00	1.00	1.00	1.00	1.00
Work Zone On Approach	No			No	No	
Adj Sat Flow, veh/h/ln	1856	1767	0	1781	1826	1870
Adj Flow Rate, veh/h	562	1015	0	188	1773	149
Peak Hour Factor	0.92	0.92	0.92	0.92	0.92	0.92
Percent Heavy Veh, %	3	9	0	8	5	2
Cap, veh/h	621	2016	0	596	1988	934
Arrive On Green	0.18	0.18	0.00	0.18	0.59	0.59
Sat Flow, veh/h	3618	2635	0	3563	3374	1585
Grp Volume(v), veh/h	562	1015	0	188	1773	149
Grp Sat Flow(s),veh/h/ln	1763	1317	0	1692	1687	1585
Q Serve(g_s), s	8.0	7.5	0.0	2.5	23.3	2.2
Cycle Q Clear(g_c), s	8.0	7.5	0.0	2.5	23.3	2.2
Prop In Lane		1.00	0.00		1.00	1.00
Lane Grp Cap(c), veh/h	621	2016	0	596	1988	934
V/C Ratio(X)	0.91	0.50	0.00	0.32	0.89	0.16
Avail Cap(c_a), veh/h	621	2016	0	596	3234	1519
HCM Platoon Ratio	1.00	1.00	1.00	1.00	1.00	1.00
Upstream Filter(I)	1.00	1.00	0.00	1.00	1.00	1.00
Uniform Delay (d), s/veh	20.6	2.3	0.0	18.4	9.1	4.8
Incr Delay (d2), s/veh	16.5	0.1	0.0	0.1	1.2	0.0
Initial Q Delay(d3),s/veh	0.0	0.0	0.0	0.0	0.0	0.0
%ile BackOfQ(50%),veh/ln	4.1	5.3	0.0	0.8	4.6	0.4
Unsig. Movement Delay, s/veh						
LnGrp Delay(d),s/veh	37.1	2.4	0.0	18.5	10.3	4.8
LnGrp LOS	D	A	A	B	B	A
Approach Vol, veh/h	1577			188	1922	
Approach Delay, s/veh	14.8			18.5	9.9	
Approach LOS	B			B	A	
Timer - Assigned Phs		2		4		6
Phs Duration (G+Y+Rc), s		15.0		36.1		15.0
Change Period (Y+Rc), s		6.0		6.0		6.0
Max Green Setting (Gmax), s		9.0		49.0		9.0
Max Q Clear Time (g_c+11), s		4.5		25.3		10.0
Green Ext Time (p_c), s		0.2		4.9		0.0
Intersection Summary						
HCM 6th Ctrl Delay			12.4			
HCM 6th LOS			B			

Timings

West Campus Upper Plateau (JN 14064)

34: Old 215 Frontage Rd. & Alessandro Bl.

09/19/2022

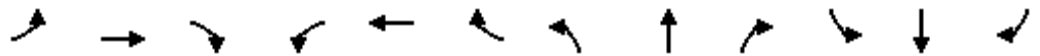

Lane Group	EBL	EBT	EBR	WBL	WBT	WBR	NBL	NBT	NBR	SBL	SBT	SBR
Lane Configurations	↖↗	↕↕↕	↖	↖	↕↕	↖	↖↗	↕↕	↖	↖	↕↕	↖
Traffic Volume (vph)	436	1230	52	11	1631	142	63	297	22	33	49	280
Future Volume (vph)	436	1230	52	11	1631	142	63	297	22	33	49	280
Turn Type	Prot	NA	Perm	Prot	NA	Perm	Prot	NA	Perm	Prot	NA	Perm
Protected Phases	5	2		1	6		3	8		7	4	
Permitted Phases			2			6			8			4
Detector Phase	5	2	2	1	6	6	3	8	8	7	4	4
Switch Phase												
Minimum Initial (s)	5.0	10.0	10.0	5.0	10.0	10.0	5.0	10.0	10.0	5.0	10.0	10.0
Minimum Split (s)	8.7	43.5	43.5	8.7	15.8	15.8	8.7	16.2	16.2	8.7	40.2	40.2
Total Split (s)	17.0	62.2	62.2	8.9	54.1	54.1	8.7	39.3	39.3	9.6	40.2	40.2
Total Split (%)	14.2%	51.8%	51.8%	7.4%	45.1%	45.1%	7.3%	32.8%	32.8%	8.0%	33.5%	33.5%
Yellow Time (s)	3.2	5.5	5.5	3.2	4.8	4.8	3.2	5.2	5.2	3.2	5.2	5.2
All-Red Time (s)	0.5	1.0	1.0	0.5	1.0	1.0	0.5	1.0	1.0	0.5	1.0	1.0
Lost Time Adjust (s)	0.0	0.0	0.0	0.0	0.0	0.0	0.0	0.0	0.0	0.0	0.0	0.0
Total Lost Time (s)	3.7	6.5	6.5	3.7	5.8	5.8	3.7	6.2	6.2	3.7	6.2	6.2
Lead/Lag	Lead	Lag	Lag	Lead	Lag	Lag	Lead	Lag	Lag	Lead	Lag	Lag
Lead-Lag Optimize?	Yes	Yes	Yes	Yes	Yes	Yes	Yes	Yes	Yes	Yes	Yes	Yes
Recall Mode	None	None	None	None	None	None	None	Max	Max	None	Max	Max
Act Effct Green (s)	13.3	62.9	62.9	5.1	48.4	48.4	5.0	35.2	35.2	5.7	34.0	34.0
Actuated g/C Ratio	0.11	0.53	0.53	0.04	0.41	0.41	0.04	0.30	0.30	0.05	0.29	0.29
v/c Ratio	1.23	0.47	0.07	0.23	1.15	0.21	0.49	0.30	0.04	0.41	0.05	0.50
Control Delay	169.9	18.7	0.7	67.0	109.5	4.4	69.1	33.8	0.1	70.1	31.6	16.2
Queue Delay	0.0	0.0	0.0	0.0	0.0	0.0	0.0	0.0	0.0	0.0	0.0	0.0
Total Delay	169.9	18.7	0.7	67.0	109.5	4.4	69.1	33.8	0.1	70.1	31.6	16.2
LOS	F	B	A	E	F	A	E	C	A	E	C	B
Approach Delay		56.5			100.9			37.7			23.2	
Approach LOS		E			F			D			C	

Intersection Summary

Cycle Length: 120
 Actuated Cycle Length: 118.3
 Natural Cycle: 125
 Control Type: Actuated-Uncoordinated
 Maximum v/c Ratio: 1.23
 Intersection Signal Delay: 70.6
 Intersection Capacity Utilization 86.7%
 Analysis Period (min) 15
 Intersection LOS: E
 ICU Level of Service E

Splits and Phases: 34: Old 215 Frontage Rd. & Alessandro Bl.

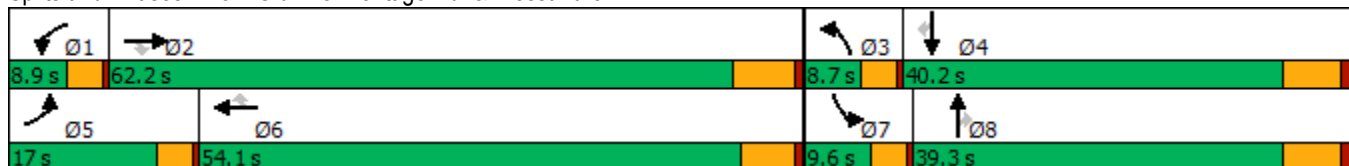

HCM 6th Signalized Intersection Summary
34: Old 215 Frontage Rd. & Alessandro Bl.

West Campus Upper Plateau (JN 14064)

09/19/2022



Movement	EBL	EBT	EBR	WBL	WBT	WBR	NBL	NBT	NBR	SBL	SBT	SBR
Lane Configurations	↖↗	↑↑↑	↖	↗	↑↑	↖	↖↗	↑↑	↖	↗	↑↑	↖
Traffic Volume (veh/h)	436	1230	52	11	1631	142	63	297	22	33	49	280
Future Volume (veh/h)	436	1230	52	11	1631	142	63	297	22	33	49	280
Initial Q (Qb), veh	0	0	0	0	0	0	0	0	0	0	0	0
Ped-Bike Adj(A_pbT)	1.00		1.00	1.00		1.00	1.00		1.00	1.00		1.00
Parking Bus, Adj	1.00	1.00	1.00	1.00	1.00	1.00	1.00	1.00	1.00	1.00	1.00	1.00
Work Zone On Approach		No			No			No			No	
Adj Sat Flow, veh/h/ln	1767	1856	1470	981	1870	1811	1707	1811	1752	1856	1767	1826
Adj Flow Rate, veh/h	445	1255	43	11	1664	0	64	303	14	34	50	0
Peak Hour Factor	0.98	0.98	0.98	0.98	0.98	0.98	0.98	0.98	0.98	0.98	0.98	0.98
Percent Heavy Veh, %	9	3	29	62	2	6	13	6	10	3	9	5
Cap, veh/h	361	2533	623	12	1429		116	1003	433	50	950	
Arrive On Green	0.11	0.50	0.50	0.01	0.40	0.00	0.04	0.29	0.29	0.03	0.28	0.00
Sat Flow, veh/h	3264	5066	1246	934	3554	1535	3155	3441	1485	1767	3357	1547
Grp Volume(v), veh/h	445	1255	43	11	1664	0	64	303	14	34	50	0
Grp Sat Flow(s),veh/h/ln	1632	1689	1246	934	1777	1535	1577	1721	1485	1767	1678	1547
Q Serve(g_s), s	13.3	19.8	2.1	1.4	48.3	0.0	2.4	8.2	0.8	2.3	1.3	0.0
Cycle Q Clear(g_c), s	13.3	19.8	2.1	1.4	48.3	0.0	2.4	8.2	0.8	2.3	1.3	0.0
Prop In Lane	1.00		1.00	1.00		1.00	1.00		1.00	1.00		1.00
Lane Grp Cap(c), veh/h	361	2533	623	12	1429		116	1003	433	50	950	
V/C Ratio(X)	1.23	0.50	0.07	0.92	1.16		0.55	0.30	0.03	0.68	0.05	
Avail Cap(c_a), veh/h	361	2533	623	40	1429		131	1003	433	87	950	
HCM Platoon Ratio	1.00	1.00	1.00	1.00	1.00	1.00	1.00	1.00	1.00	1.00	1.00	1.00
Upstream Filter(I)	1.00	1.00	1.00	1.00	1.00	0.00	1.00	1.00	1.00	1.00	1.00	0.00
Uniform Delay (d), s/veh	53.4	20.0	15.5	59.2	35.9	0.0	56.9	33.1	30.4	57.8	31.3	0.0
Incr Delay (d2), s/veh	125.9	0.2	0.0	55.1	82.0	0.0	1.5	0.8	0.1	5.9	0.1	0.0
Initial Q Delay(d3),s/veh	0.0	0.0	0.0	0.0	0.0	0.0	0.0	0.0	0.0	0.0	0.0	0.0
%ile BackOfQ(50%),veh/ln	11.5	7.1	0.6	0.5	35.9	0.0	1.0	3.4	0.3	1.1	0.5	0.0
Unsig. Movement Delay, s/veh												
LnGrp Delay(d),s/veh	179.4	20.1	15.6	114.3	117.9	0.0	58.4	33.8	30.6	63.8	31.4	0.0
LnGrp LOS	F	C	B	F	F		E	C	C	E	C	
Approach Vol, veh/h		1743			1675			381				84
Approach Delay, s/veh		60.6			117.9			37.8				44.5
Approach LOS		E			F			D				D
Timer - Assigned Phs	1	2	3	4	5	6	7	8				
Phs Duration (G+Y+Rc), s	5.2	66.6	8.1	40.2	17.0	54.8	7.1	41.2				
Change Period (Y+Rc), s	3.7	6.5	3.7	6.2	3.7	* 6.5	3.7	6.2				
Max Green Setting (Gmax), s	5.2	55.7	5.0	34.0	13.3	* 48	5.9	33.1				
Max Q Clear Time (g_c+I1), s	3.4	21.8	4.4	3.3	15.3	50.3	4.3	10.2				
Green Ext Time (p_c), s	0.0	9.7	0.0	0.2	0.0	0.0	0.0	1.7				

Intersection Summary

HCM 6th Ctrl Delay	82.8
HCM 6th LOS	F

Notes

* HCM 6th computational engine requires equal clearance times for the phases crossing the barrier.
Unsignalized Delay for [WBR, SBR] is excluded from calculations of the approach delay and intersection delay.

Timings
35: Day St. & Alessandro Bl.

West Campus Upper Plateau (JN 14064)

09/19/2022



Lane Group	EBL	EBT	EBR	WBL	WBT	WBR	NBL	NBT	NBR	SBL	SBT
Lane Configurations	↖	↗↗↗	↖	↖	↗↗	↖	↖	↗	↖	↖	↗
Traffic Volume (vph)	179	905	11	11	1495	157	12	184	19	105	74
Future Volume (vph)	179	905	11	11	1495	157	12	184	19	105	74
Turn Type	Prot	NA	Perm	Prot	NA	Perm	Perm	NA	Perm	Perm	NA
Protected Phases	5	2		1	6			8			4
Permitted Phases			2			6	8		8	4	
Detector Phase	5	2	2	1	6	6	8	8	8	4	4
Switch Phase											
Minimum Initial (s)	5.0	10.0	10.0	5.0	10.0	10.0	10.0	10.0	10.0	10.0	10.0
Minimum Split (s)	9.1	30.8	30.8	9.1	30.8	30.8	42.4	42.4	42.4	41.6	41.6
Total Split (s)	21.0	68.5	68.5	9.1	56.6	56.6	42.4	42.4	42.4	42.4	42.4
Total Split (%)	17.5%	57.1%	57.1%	7.6%	47.2%	47.2%	35.3%	35.3%	35.3%	35.3%	35.3%
Yellow Time (s)	3.6	4.8	4.8	3.6	4.8	4.8	4.4	4.4	4.4	3.6	3.6
All-Red Time (s)	0.5	1.0	1.0	0.5	1.0	1.0	1.0	1.0	1.0	1.0	1.0
Lost Time Adjust (s)	0.0	0.0	0.0	0.0	0.0	0.0	0.0	0.0	0.0	0.0	0.0
Total Lost Time (s)	4.1	5.8	5.8	4.1	5.8	5.8	5.4	5.4	5.4	4.6	4.6
Lead/Lag	Lead	Lag	Lag	Lead	Lag	Lag					
Lead-Lag Optimize?	Yes	Yes	Yes	Yes	Yes	Yes					
Recall Mode	None	None	None	None	None	None	None	None	None	None	None
Act Effct Green (s)	14.3	68.4	68.4	5.1	51.4	51.4	18.0	18.0	18.0	18.8	18.8
Actuated g/C Ratio	0.14	0.69	0.69	0.05	0.52	0.52	0.18	0.18	0.18	0.19	0.19
v/c Ratio	0.76	0.28	0.02	0.15	0.88	0.20	0.14	0.58	0.06	0.69	0.51
Control Delay	62.0	7.9	0.1	54.6	29.9	8.2	36.2	43.7	0.3	59.2	28.5
Queue Delay	0.0	0.0	0.0	0.0	0.0	0.0	0.0	0.0	0.0	0.0	0.0
Total Delay	62.0	7.9	0.1	54.6	29.9	8.2	36.2	43.7	0.3	59.2	28.5
LOS	E	A	A	D	C	A	D	D	A	E	C
Approach Delay		16.7			28.0			39.5			40.0
Approach LOS		B			C			D			D

Intersection Summary

Cycle Length: 120	
Actuated Cycle Length: 99.3	
Natural Cycle: 115	
Control Type: Actuated-Uncoordinated	
Maximum v/c Ratio: 0.88	
Intersection Signal Delay: 26.0	Intersection LOS: C
Intersection Capacity Utilization 86.5%	ICU Level of Service E
Analysis Period (min) 15	

Splits and Phases: 35: Day St. & Alessandro Bl.



HCM 6th Signalized Intersection Summary
35: Day St. & Alessandro Bl.

West Campus Upper Plateau (JN 14064)

09/19/2022

Movement	EBL	EBT	EBR	WBL	WBT	WBR	NBL	NBT	NBR	SBL	SBT	SBR
Lane Configurations												
Traffic Volume (veh/h)	179	905	11	11	1495	157	12	184	19	105	74	101
Future Volume (veh/h)	179	905	11	11	1495	157	12	184	19	105	74	101
Initial Q (Qb), veh	0	0	0	0	0	0	0	0	0	0	0	0
Ped-Bike Adj(A_pbT)	1.00		0.98	1.00		1.00	1.00		1.00	1.00		1.00
Parking Bus, Adj	1.00	1.00	1.00	1.00	1.00	1.00	1.00	1.00	1.00	1.00	1.00	1.00
Work Zone On Approach		No			No			No			No	
Adj Sat Flow, veh/h/ln	1856	1856	952	1737	1870	1870	922	1885	1722	1870	1900	1870
Adj Flow Rate, veh/h	192	973	11	12	1608	134	13	198	8	113	80	82
Peak Hour Factor	0.93	0.93	0.93	0.93	0.93	0.93	0.93	0.93	0.93	0.93	0.93	0.93
Percent Heavy Veh, %	3	3	64	11	2	2	66	1	12	2	0	2
Cap, veh/h	225	3090	482	24	1766	788	158	415	321	224	189	194
Arrive On Green	0.13	0.61	0.61	0.01	0.50	0.50	0.22	0.22	0.22	0.22	0.22	0.22
Sat Flow, veh/h	1767	5066	790	1654	3554	1585	603	1885	1457	1175	860	881
Grp Volume(v), veh/h	192	973	11	12	1608	134	13	198	8	113	0	162
Grp Sat Flow(s),veh/h/ln	1767	1689	790	1654	1777	1585	603	1885	1457	1175	0	1741
Q Serve(g_s), s	10.4	9.1	0.5	0.7	40.8	4.6	1.9	9.0	0.4	9.1	0.0	7.9
Cycle Q Clear(g_c), s	10.4	9.1	0.5	0.7	40.8	4.6	9.7	9.0	0.4	18.1	0.0	7.9
Prop In Lane	1.00		1.00	1.00		1.00	1.00		1.00	1.00		0.51
Lane Grp Cap(c), veh/h	225	3090	482	24	1766	788	158	415	321	224	0	383
V/C Ratio(X)	0.85	0.31	0.02	0.51	0.91	0.17	0.08	0.48	0.02	0.50	0.00	0.42
Avail Cap(c_a), veh/h	304	3236	504	84	1839	820	252	711	549	418	0	671
HCM Platoon Ratio	1.00	1.00	1.00	1.00	1.00	1.00	1.00	1.00	1.00	1.00	1.00	1.00
Upstream Filter(I)	1.00	1.00	1.00	1.00	1.00	1.00	1.00	1.00	1.00	1.00	0.00	1.00
Uniform Delay (d), s/veh	42.0	9.2	7.6	48.0	22.7	13.6	37.1	33.4	30.0	41.3	0.0	32.9
Incr Delay (d2), s/veh	12.7	0.1	0.0	6.2	7.1	0.1	0.2	0.9	0.0	1.7	0.0	0.7
Initial Q Delay(d3),s/veh	0.0	0.0	0.0	0.0	0.0	0.0	0.0	0.0	0.0	0.0	0.0	0.0
%ile BackOfQ(50%),veh/ln	5.1	2.8	0.1	0.3	16.6	1.5	0.3	4.1	0.1	2.7	0.0	3.4
Unsig. Movement Delay, s/veh												
LnGrp Delay(d),s/veh	54.6	9.3	7.6	54.3	29.7	13.7	37.3	34.2	30.1	43.0	0.0	33.7
LnGrp LOS	D	A	A	D	C	B	D	C	C	D	A	C
Approach Vol, veh/h		1176			1754			219				275
Approach Delay, s/veh		16.7			28.7			34.3				37.5
Approach LOS		B			C			C				D
Timer - Assigned Phs	1	2		4	5	6		8				
Phs Duration (G+Y+Rc), s	5.5	65.7		27.0	16.6	54.6		27.0				
Change Period (Y+Rc), s	4.1	5.8		* 5.4	4.1	5.8		5.4				
Max Green Setting (Gmax), s	5.0	62.7		* 38	16.9	50.8		37.0				
Max Q Clear Time (g_c+I1), s	2.7	11.1		20.1	12.4	42.8		11.7				
Green Ext Time (p_c), s	0.0	7.7		1.3	0.1	6.0		1.2				

Intersection Summary

HCM 6th Ctrl Delay	25.6
HCM 6th LOS	C

Notes

* HCM 6th computational engine requires equal clearance times for the phases crossing the barrier.

Timings
36: Elsworth St. & Cactus Av.

West Campus Upper Plateau (JN 14064)

09/19/2022



Lane Group	EBL	EBT	EBR	WBL	WBT	WBR	NBL	NBT	SBL	SBT	SBR
Lane Configurations	↘	↑↑↑	↗	↘	↑↑↑	↗	↘	↕	↘	↗	↗
Traffic Volume (vph)	293	1807	330	79	2201	219	26	12	169	66	273
Future Volume (vph)	293	1807	330	79	2201	219	26	12	169	66	273
Turn Type	Prot	NA	Perm	Prot	NA	Perm	Split	NA	Split	NA	pm+ov
Protected Phases	5	2		1	6		8	8	4	4	5
Permitted Phases			2			6					4
Detector Phase	5	2	2	1	6	6	8	8	4	4	5
Switch Phase											
Minimum Initial (s)	5.0	10.0	10.0	5.0	10.0	10.0	10.0	10.0	10.0	10.0	5.0
Minimum Split (s)	9.6	36.2	36.2	9.6	36.2	36.2	35.4	35.4	35.4	35.4	9.6
Total Split (s)	15.0	48.6	48.6	10.6	44.2	44.2	35.4	35.4	35.4	35.4	15.0
Total Split (%)	11.5%	37.4%	37.4%	8.2%	34.0%	34.0%	27.2%	27.2%	27.2%	27.2%	11.5%
Yellow Time (s)	3.6	5.2	5.2	3.6	5.2	5.2	4.4	4.4	4.4	4.4	3.6
All-Red Time (s)	1.0	1.0	1.0	1.0	1.0	1.0	1.0	1.0	1.0	1.0	1.0
Lost Time Adjust (s)	0.0	0.0	0.0	0.0	0.0	0.0	0.0	0.0	0.0	0.0	0.0
Total Lost Time (s)	4.6	6.2	6.2	4.6	6.2	6.2	5.4	5.4	5.4	5.4	4.6
Lead/Lag	Lead	Lag	Lag	Lead	Lag	Lag					Lead
Lead-Lag Optimize?	Yes	Yes	Yes	Yes	Yes	Yes					Yes
Recall Mode	None	None	None	None	None	None	Max	Max	Max	Max	None
Act Effct Green (s)	10.4	42.4	42.4	6.0	38.0	38.0	30.0	30.0	30.0	30.0	41.2
Actuated g/C Ratio	0.08	0.33	0.33	0.05	0.29	0.29	0.23	0.23	0.23	0.23	0.32
v/c Ratio	2.17	1.16	0.46	0.98	1.54	0.42	0.07	0.09	0.31	0.30	0.41
Control Delay	575.8	117.5	7.4	153.6	279.7	21.7	40.0	23.5	44.1	43.8	3.7
Queue Delay	0.0	0.0	0.0	0.0	0.0	0.0	0.0	0.0	0.0	0.0	0.0
Total Delay	575.8	117.5	7.4	153.6	279.7	21.7	40.0	23.5	44.1	43.8	3.7
LOS	F	F	A	F	F	C	D	C	D	D	A
Approach Delay		157.8			253.1			30.4		22.2	
Approach LOS		F			F			C		C	

Intersection Summary

Cycle Length: 130
 Actuated Cycle Length: 130
 Natural Cycle: 130
 Control Type: Actuated-Uncoordinated
 Maximum v/c Ratio: 2.17
 Intersection Signal Delay: 187.4
 Intersection LOS: F
 Intersection Capacity Utilization 85.3%
 ICU Level of Service E
 Analysis Period (min) 15

Splits and Phases: 36: Elsworth St. & Cactus Av.

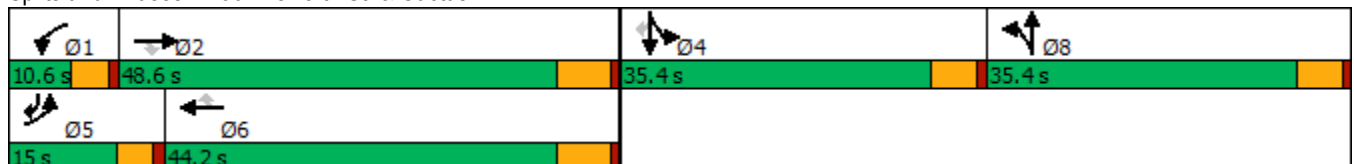

HCM 6th Signalized Intersection Summary
36: Elsworth St. & Cactus Av.

West Campus Upper Plateau (JN 14064)

09/19/2022



Movement	EBL	EBT	EBR	WBL	WBT	WBR	NBL	NBT	NBR	SBL	SBT	SBR
Lane Configurations	↗	↑↑↑	↖	↖	↑↑↑	↖	↖	↕		↖	↗	↖
Traffic Volume (veh/h)	293	1807	330	79	2201	219	26	12	18	169	66	273
Future Volume (veh/h)	293	1807	330	79	2201	219	26	12	18	169	66	273
Initial Q (Qb), veh	0	0	0	0	0	0	0	0	0	0	0	0
Ped-Bike Adj(A_pbT)	1.00		1.00	1.00		0.98	1.00		1.00	1.00		1.00
Parking Bus, Adj	1.00	1.00	1.00	1.00	1.00	1.00	1.00	1.00	1.00	1.00	1.00	1.00
Work Zone On Approach		No			No			No			No	
Adj Sat Flow, veh/h/ln	1841	1811	1885	1900	1841	1870	1633	1900	1900	1856	1900	1856
Adj Flow Rate, veh/h	299	1844	0	81	2246	175	24	16	10	120	140	212
Peak Hour Factor	0.98	0.98	0.98	0.98	0.98	0.98	0.98	0.98	0.98	0.98	0.98	0.98
Percent Heavy Veh, %	4	6	1	0	4	2	18	0	0	3	0	3
Cap, veh/h	140	1613		84	1469	453	359	252	158	408	438	489
Arrive On Green	0.08	0.33	0.00	0.05	0.29	0.29	0.23	0.23	0.23	0.23	0.23	0.23
Sat Flow, veh/h	1753	4944	1598	1810	5025	1551	1555	1094	683	1767	1900	1572
Grp Volume(v), veh/h	299	1844	0	81	2246	175	24	0	26	120	140	212
Grp Sat Flow(s),veh/h/ln	1753	1648	1598	1810	1675	1551	1555	0	1777	1767	1900	1572
Q Serve(g_s), s	10.4	42.4	0.0	5.8	38.0	11.7	1.6	0.0	1.5	7.3	8.0	14.0
Cycle Q Clear(g_c), s	10.4	42.4	0.0	5.8	38.0	11.7	1.6	0.0	1.5	7.3	8.0	14.0
Prop In Lane	1.00		1.00	1.00		1.00	1.00		0.38	1.00		1.00
Lane Grp Cap(c), veh/h	140	1613		84	1469	453	359	0	410	408	438	489
V/C Ratio(X)	2.13	1.14		0.97	1.53	0.39	0.07	0.00	0.06	0.29	0.32	0.43
Avail Cap(c_a), veh/h	140	1613		84	1469	453	359	0	410	408	438	489
HCM Platoon Ratio	1.00	1.00	1.00	1.00	1.00	1.00	1.00	1.00	1.00	1.00	1.00	1.00
Upstream Filter(I)	1.00	1.00	0.00	1.00	1.00	1.00	1.00	0.00	1.00	1.00	1.00	1.00
Uniform Delay (d), s/veh	59.8	43.8	0.0	61.9	46.0	36.7	39.1	0.0	39.0	41.3	41.5	35.7
Incr Delay (d2), s/veh	532.5	72.5	0.0	87.7	241.6	0.5	0.4	0.0	0.3	1.8	1.9	2.8
Initial Q Delay(d3),s/veh	0.0	0.0	0.0	0.0	0.0	0.0	0.0	0.0	0.0	0.0	0.0	0.0
%ile BackOfQ(50%),veh/ln	25.2	27.2	0.0	4.6	47.9	4.4	0.6	0.0	0.7	3.4	3.9	5.7
Unsig. Movement Delay, s/veh												
LnGrp Delay(d),s/veh	592.3	116.3	0.0	149.6	287.6	37.2	39.4	0.0	39.3	43.1	43.4	38.5
LnGrp LOS	F	F		F	F	D	D	A	D	D	D	D
Approach Vol, veh/h		2143			2502			50			472	
Approach Delay, s/veh		182.7			265.6			39.4			41.1	
Approach LOS		F			F			D			D	
Timer - Assigned Phs	1	2		4	5	6		8				
Phs Duration (G+Y+Rc), s	10.6	48.6		35.4	15.0	44.2		35.4				
Change Period (Y+Rc), s	4.6	6.2		5.4	4.6	6.2		5.4				
Max Green Setting (Gmax), s	6.0	42.4		30.0	10.4	38.0		30.0				
Max Q Clear Time (g_c+I1), s	7.8	44.4		16.0	12.4	40.0		3.6				
Green Ext Time (p_c), s	0.0	0.0		1.5	0.0	0.0		0.1				

Intersection Summary

HCM 6th Ctrl Delay	208.5
HCM 6th LOS	F

Notes

- User approved pedestrian interval to be less than phase max green.
- User approved volume balancing among the lanes for turning movement.
- Unsignalized Delay for [EBR] is excluded from calculations of the approach delay and intersection delay.

Timings
37: Cactus Av. & Frederick St.

West Campus Upper Plateau (JN 14064)

09/19/2022

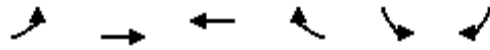

Lane Group	EBL	EBT	WBT	WBR	SBL	SBR
Lane Configurations	↘	↑↑↑	↑↑↑	↗	↘↗	↗
Traffic Volume (vph)	216	1543	2494	165	172	107
Future Volume (vph)	216	1543	2494	165	172	107
Turn Type	Prot	NA	NA	pm+ov	Prot	pm+ov
Protected Phases	5	2	6	4	4	5
Permitted Phases				6		4
Detector Phase	5	2	6	4	4	5
Switch Phase						
Minimum Initial (s)	5.0	10.0	10.0	10.0	10.0	5.0
Minimum Split (s)	9.2	28.2	29.2	36.4	36.4	9.2
Total Split (s)	23.0	83.6	60.6	36.4	36.4	23.0
Total Split (%)	19.2%	69.7%	50.5%	30.3%	30.3%	19.2%
Yellow Time (s)	3.2	5.2	5.2	4.4	4.4	3.2
All-Red Time (s)	1.0	1.0	1.0	1.0	1.0	1.0
Lost Time Adjust (s)	0.0	0.0	0.0	0.0	0.0	0.0
Total Lost Time (s)	4.2	6.2	6.2	5.4	5.4	4.2
Lead/Lag	Lead		Lag			Lead
Lead-Lag Optimize?	Yes		Yes			Yes
Recall Mode	None	None	None	Max	Max	None
Act Effct Green (s)	17.9	76.5	54.4	86.2	31.0	54.3
Actuated g/C Ratio	0.15	0.64	0.46	0.72	0.26	0.46
v/c Ratio	0.90	0.53	1.17	0.15	0.21	0.17
Control Delay	85.2	12.3	111.2	1.1	35.5	19.8
Queue Delay	0.0	0.0	0.0	0.0	0.0	0.0
Total Delay	85.2	12.3	111.2	1.1	35.5	19.8
LOS	F	B	F	A	D	B
Approach Delay		21.2	104.4		29.5	
Approach LOS		C	F		C	

Intersection Summary

Cycle Length: 120
 Actuated Cycle Length: 119.1
 Natural Cycle: 130
 Control Type: Actuated-Uncoordinated
 Maximum v/c Ratio: 1.17
 Intersection Signal Delay: 68.8
 Intersection LOS: E
 Intersection Capacity Utilization 81.7%
 ICU Level of Service D
 Analysis Period (min) 15

Splits and Phases: 37: Cactus Av. & Frederick St.



HCM 6th Signalized Intersection Summary
37: Cactus Av. & Frederick St.

West Campus Upper Plateau (JN 14064)

09/19/2022

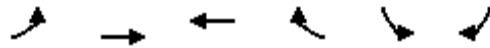

Movement	EBL	EBT	WBT	WBR	SBL	SBR
Lane Configurations	↖	↑↑↑	↑↑↑	↖	↖↖	↖
Traffic Volume (veh/h)	216	1543	2494	165	172	107
Future Volume (veh/h)	216	1543	2494	165	172	107
Initial Q (Qb), veh	0	0	0	0	0	0
Ped-Bike Adj(A_pbT)	1.00			0.98	1.00	1.00
Parking Bus, Adj	1.00	1.00	1.00	1.00	1.00	1.00
Work Zone On Approach		No	No		No	
Adj Sat Flow, veh/h/ln	1826	1811	1856	1870	1856	1811
Adj Flow Rate, veh/h	232	1659	2682	123	185	74
Peak Hour Factor	0.93	0.93	0.93	0.93	0.93	0.93
Percent Heavy Veh, %	5	6	3	2	3	6
Cap, veh/h	258	3172	2319	1123	894	628
Arrive On Green	0.15	0.64	0.46	0.46	0.26	0.26
Sat Flow, veh/h	1739	5107	5233	1550	3428	1535
Grp Volume(v), veh/h	232	1659	2682	123	185	74
Grp Sat Flow(s),veh/h/ln	1739	1648	1689	1550	1714	1535
Q Serve(g_s), s	15.6	21.5	54.4	2.9	5.0	3.6
Cycle Q Clear(g_c), s	15.6	21.5	54.4	2.9	5.0	3.6
Prop In Lane	1.00			1.00	1.00	1.00
Lane Grp Cap(c), veh/h	258	3172	2319	1123	894	628
V/C Ratio(X)	0.90	0.52	1.16	0.11	0.21	0.12
Avail Cap(c_a), veh/h	275	3221	2319	1123	894	628
HCM Platoon Ratio	1.00	1.00	1.00	1.00	1.00	1.00
Upstream Filter(I)	1.00	1.00	1.00	1.00	1.00	1.00
Uniform Delay (d), s/veh	49.7	11.5	32.2	5.1	34.3	21.8
Incr Delay (d2), s/veh	27.7	0.1	75.7	0.0	0.5	0.4
Initial Q Delay(d3),s/veh	0.0	0.0	0.0	0.0	0.0	0.0
%ile BackOfQ(50%),veh/ln	8.5	6.7	36.4	1.9	2.1	0.1
Unsig. Movement Delay, s/veh						
LnGrp Delay(d),s/veh	77.4	11.6	107.9	5.1	34.8	22.2
LnGrp LOS	E	B	F	A	C	C
Approach Vol, veh/h		1891	2805		259	
Approach Delay, s/veh		19.7	103.4		31.2	
Approach LOS		B	F		C	
Timer - Assigned Phs		2		4	5	6
Phs Duration (G+Y+Rc), s		82.4		36.4	21.8	60.6
Change Period (Y+Rc), s		6.2		5.4	* 4.2	6.2
Max Green Setting (Gmax), s		77.4		31.0	* 19	54.4
Max Q Clear Time (g_c+I1), s		23.5		7.0	17.6	56.4
Green Ext Time (p_c), s		16.9		0.8	0.0	0.0

Intersection Summary

HCM 6th Ctrl Delay	67.7
HCM 6th LOS	E

Notes

* HCM 6th computational engine requires equal clearance times for the phases crossing the barrier.

Timings
38: Riverside Dr./Graham St. & Cactus Av.

West Campus Upper Plateau (JN 14064)

09/19/2022

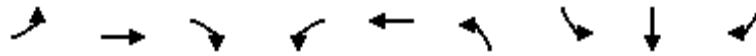

Lane Group	EBL	EBT	EBR	WBL	WBT	NBL	SBL	SBT	SBR	Ø2
Lane Configurations	↘	↑↑↑	↗	↘	↑↑↑	↗	↘	↑↑	↗	
Traffic Volume (vph)	104	1488	190	11	2543	24	96	52	190	
Future Volume (vph)	104	1488	190	11	2543	24	96	52	190	
Turn Type	Prot	NA	Perm	Prot	NA	Prot	Prot	NA	Perm	
Protected Phases	7	4		3	8	5	1	6		2
Permitted Phases			4						6	
Detector Phase	7	4	4	3	8	5	1	6	6	
Switch Phase										
Minimum Initial (s)	5.0	10.0	10.0	5.0	10.0	5.0	5.0	10.0	10.0	10.0
Minimum Split (s)	9.6	39.2	39.2	9.6	39.2	10.4	9.6	40.6	40.6	35.0
Total Split (s)	10.8	59.0	59.0	9.6	57.8	10.4	14.2	41.0	41.0	37.2
Total Split (%)	9.0%	49.2%	49.2%	8.0%	48.2%	8.7%	11.8%	34.2%	34.2%	31%
Yellow Time (s)	3.6	5.2	5.2	3.6	5.2	4.4	3.6	3.6	3.6	4.0
All-Red Time (s)	1.0	1.0	1.0	1.0	1.0	1.0	1.0	1.0	1.0	1.0
Lost Time Adjust (s)	0.0	0.0	0.0	0.0	0.0	0.0	0.0	0.0	0.0	
Total Lost Time (s)	4.6	6.2	6.2	4.6	6.2	5.4	4.6	4.6	4.6	
Lead/Lag	Lead	Lag	Lag	Lead	Lag	Lead	Lead	Lag	Lag	Lag
Lead-Lag Optimize?	Yes	Yes	Yes	Yes	Yes	Yes	Yes	Yes	Yes	Yes
Recall Mode	None	Min	Min	None	Min	None	None	None	None	None
Act Effct Green (s)	6.3	62.2	62.2	5.1	52.6	5.1	12.8	14.9	14.9	
Actuated g/C Ratio	0.07	0.67	0.67	0.05	0.56	0.05	0.14	0.16	0.16	
v/c Ratio	0.96	0.49	0.19	0.12	0.99	0.16	0.42	0.10	0.57	
Control Delay	119.5	11.7	3.3	51.5	38.1	49.9	45.7	33.2	20.6	
Queue Delay	0.0	0.0	0.0	0.0	0.0	0.0	0.0	0.0	0.0	
Total Delay	119.5	11.7	3.3	51.5	38.1	49.9	45.7	33.2	20.6	
LOS	F	B	A	D	D	D	D	C	C	
Approach Delay		17.1			38.1			29.7		
Approach LOS		B			D			C		

Intersection Summary

Cycle Length: 120
 Actuated Cycle Length: 93.2
 Natural Cycle: 130
 Control Type: Actuated-Uncoordinated
 Maximum v/c Ratio: 0.99
 Intersection Signal Delay: 29.8
 Intersection LOS: C
 Intersection Capacity Utilization 82.0%
 ICU Level of Service D
 Analysis Period (min) 15

Splits and Phases: 38: Riverside Dr./Graham St. & Cactus Av.

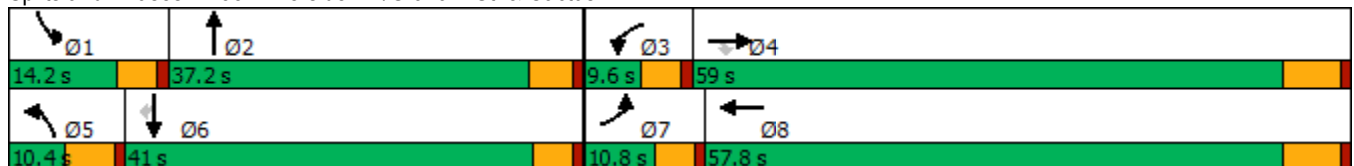

HCM 6th Signalized Intersection Summary
38: Riverside Dr./Graham St. & Cactus Av.

West Campus Upper Plateau (JN 14064)

09/19/2022



Movement	EBL	EBT	EBR	WBL	WBT	WBR	NBL	NBT	NBR	SBL	SBT	SBR
Lane Configurations	↖	↑↑↑	↗	↖	↑↑↑		↖↗	↑↗		↖	↑↑	↗
Traffic Volume (veh/h)	104	1488	190	11	2543	102	24	0	0	96	52	190
Future Volume (veh/h)	104	1488	190	11	2543	102	24	0	0	96	52	190
Initial Q (Qb), veh	0	0	0	0	0	0	0	0	0	0	0	0
Ped-Bike Adj(A_pbT)	1.00		1.00	1.00		1.00	1.00		1.00	1.00		1.00
Parking Bus, Adj	1.00	1.00	1.00	1.00	1.00	1.00	1.00	1.00	1.00	1.00	1.00	1.00
Work Zone On Approach		No			No			No			No	
Adj Sat Flow, veh/h/ln	1826	1811	1796	1900	1856	1870	1618	1900	1900	1870	1870	1826
Adj Flow Rate, veh/h	111	1583	190	12	2705	108	26	0	0	102	55	117
Peak Hour Factor	0.94	0.94	0.94	0.94	0.94	0.94	0.94	0.94	0.94	0.94	0.94	0.94
Percent Heavy Veh, %	5	6	7	0	3	2	19	0	0	2	2	5
Cap, veh/h	118	3054	940	26	2821	111	79	260	0	129	389	169
Arrive On Green	0.07	0.62	0.62	0.01	0.56	0.56	0.03	0.00	0.00	0.07	0.11	0.11
Sat Flow, veh/h	1739	4944	1522	1810	5000	197	2990	3705	0	1781	3554	1547
Grp Volume(v), veh/h	111	1583	190	12	1817	996	26	0	0	102	55	117
Grp Sat Flow(s),veh/h/ln	1739	1648	1522	1810	1689	1820	1495	1805	0	1781	1777	1547
Q Serve(g_s), s	5.8	16.4	5.0	0.6	46.4	48.1	0.8	0.0	0.0	5.1	1.3	6.7
Cycle Q Clear(g_c), s	5.8	16.4	5.0	0.6	46.4	48.1	0.8	0.0	0.0	5.1	1.3	6.7
Prop In Lane	1.00		1.00	1.00		0.11	1.00		0.00	1.00		1.00
Lane Grp Cap(c), veh/h	118	3054	940	26	1906	1027	79	260	0	129	389	169
V/C Ratio(X)	0.94	0.52	0.20	0.46	0.95	0.97	0.33	0.00	0.00	0.79	0.14	0.69
Avail Cap(c_a), veh/h	118	3054	940	99	1907	1028	164	1272	0	187	1416	617
HCM Platoon Ratio	1.00	1.00	1.00	1.00	1.00	1.00	1.00	1.00	1.00	1.00	1.00	1.00
Upstream Filter(I)	1.00	1.00	1.00	1.00	1.00	1.00	1.00	0.00	0.00	1.00	1.00	1.00
Uniform Delay (d), s/veh	42.4	9.8	7.6	44.7	18.8	19.1	43.7	0.0	0.0	41.7	36.8	39.2
Incr Delay (d2), s/veh	63.6	0.2	0.1	4.7	11.6	21.0	0.9	0.0	0.0	7.8	0.2	5.0
Initial Q Delay(d3),s/veh	0.0	0.0	0.0	0.0	0.0	0.0	0.0	0.0	0.0	0.0	0.0	0.0
%ile BackOfQ(50%),veh/ln	4.4	4.6	1.3	0.3	17.4	22.0	0.3	0.0	0.0	2.5	0.5	2.6
Unsig. Movement Delay, s/veh												
LnGrp Delay(d),s/veh	106.0	10.0	7.7	49.3	30.3	40.1	44.6	0.0	0.0	49.5	37.0	44.2
LnGrp LOS	F	A	A	D	C	D	D	A	A	D	D	D
Approach Vol, veh/h		1884			2825			26			274	
Approach Delay, s/veh		15.4			33.9			44.6			44.7	
Approach LOS		B			C			D			D	
Timer - Assigned Phs	1	2	3	4	5	6	7	8				
Phs Duration (G+Y+Rc), s	11.2	11.6	5.9	62.6	7.8	15.0	10.8	57.8				
Change Period (Y+Rc), s	4.6	5.0	4.6	6.2	5.4	* 5	4.6	6.2				
Max Green Setting (Gmax), s	9.6	32.2	5.0	52.8	5.0	* 36	6.2	51.6				
Max Q Clear Time (g_c+I1), s	7.1	0.0	2.6	18.4	2.8	8.7	7.8	50.1				
Green Ext Time (p_c), s	0.0	0.0	0.0	14.8	0.0	0.6	0.0	1.5				

Intersection Summary

HCM 6th Ctrl Delay	27.6
HCM 6th LOS	C

Notes

* HCM 6th computational engine requires equal clearance times for the phases crossing the barrier.

Timings
1: Washington St & Van Buren Bl.



Lane Group	EBL	EBT	WBL	WBT	WBR	NBL	NBT	NBR	SBL	SBT
Lane Configurations	↙	↕	↙	↕	↗	↗	↕	↗	↗	↕
Traffic Volume (vph)	153	1645	196	1354	521	113	276	115	653	397
Future Volume (vph)	153	1645	196	1354	521	113	276	115	653	397
Turn Type	Prot	NA	Prot	NA	Perm	Prot	NA	Perm	Prot	NA
Protected Phases	5	2	1	6		3	8		7	4
Permitted Phases					6			8		
Detector Phase	5	2	1	6	6	3	8	8	7	4
Switch Phase										
Minimum Initial (s)	5.0	10.0	5.0	10.0	10.0	5.0	10.0	10.0	5.0	10.0
Minimum Split (s)	9.2	34.2	9.2	33.2	33.2	9.2	38.4	38.4	9.2	30.8
Total Split (s)	14.2	49.6	14.0	49.4	49.4	11.5	38.4	38.4	18.0	44.9
Total Split (%)	11.8%	41.3%	11.7%	41.2%	41.2%	9.6%	32.0%	32.0%	15.0%	37.4%
Yellow Time (s)	3.2	5.2	3.2	5.2	5.2	3.2	4.4	4.4	3.2	4.8
All-Red Time (s)	1.0	1.0	1.0	1.0	1.0	1.0	1.0	1.0	1.0	1.0
Lost Time Adjust (s)	0.0	0.0	0.0	0.0	0.0	0.0	0.0	0.0	0.0	0.0
Total Lost Time (s)	4.2	6.2	4.2	6.2	6.2	4.2	5.4	5.4	4.2	5.8
Lead/Lag	Lead	Lag	Lead	Lag	Lag	Lead	Lag	Lag	Lead	Lag
Lead-Lag Optimize?	Yes	Yes	Yes	Yes	Yes	Yes	Yes	Yes	Yes	Yes
Recall Mode	None	None	None	None	None	None	None	None	None	None
Act Effct Green (s)	10.0	43.6	9.8	43.4	43.4	6.8	16.3	16.3	13.9	22.9
Actuated g/C Ratio	0.10	0.42	0.09	0.42	0.42	0.07	0.16	0.16	0.13	0.22
v/c Ratio	0.89	1.20	1.17	0.92	0.65	0.50	0.51	0.32	1.43	0.65
Control Delay	92.5	124.9	164.7	41.0	18.0	56.2	42.6	5.4	237.8	38.2
Queue Delay	0.0	0.0	0.0	0.0	0.0	0.0	0.0	0.0	0.0	0.0
Total Delay	92.5	124.9	164.7	41.0	18.0	56.2	42.6	5.4	237.8	38.2
LOS	F	F	F	D	B	E	D	A	F	D
Approach Delay		122.3		46.9			37.2			151.1
Approach LOS		F		D			D			F

Intersection Summary

Cycle Length: 120
 Actuated Cycle Length: 103.7
 Natural Cycle: 115
 Control Type: Actuated-Uncoordinated
 Maximum v/c Ratio: 1.43
 Intersection Signal Delay: 92.8
 Intersection LOS: F
 Intersection Capacity Utilization 103.5%
 ICU Level of Service G
 Analysis Period (min) 15

Splits and Phases: 1: Washington St & Van Buren Bl.

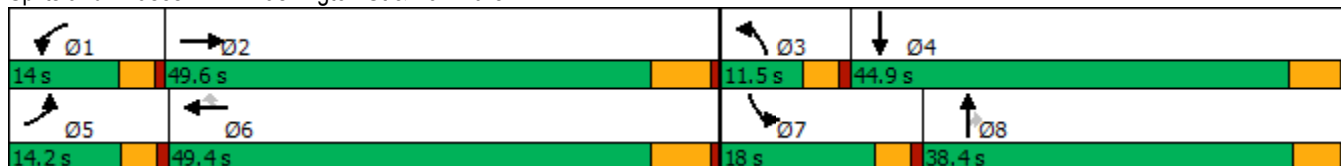

HCM 6th Signalized Intersection Summary
1: Washington St & Van Buren Bl.

West Campus Upper Plateau (JN 14064)

09/19/2022



Movement	EBL	EBT	EBR	WBL	WBT	WBR	NBL	NBT	NBR	SBL	SBT	SBR
Lane Configurations	↖	↕		↖	↕	↗	↖↗	↕	↗	↖↗	↕	↖↗
Traffic Volume (veh/h)	153	1645	91	196	1354	521	113	276	115	653	397	105
Future Volume (veh/h)	153	1645	91	196	1354	521	113	276	115	653	397	105
Initial Q (Qb), veh	0	0	0	0	0	0	0	0	0	0	0	0
Ped-Bike Adj(A_pbT)	1.00		1.00	1.00		1.00	1.00		0.98	1.00		0.98
Parking Bus, Adj	1.00	1.00	1.00	1.00	1.00	1.00	1.00	1.00	1.00	1.00	1.00	1.00
Work Zone On Approach		No			No			No			No	
Adj Sat Flow, veh/h/ln	1900	1856	1856	1885	1870	1900	1885	1856	1870	1885	1885	1900
Adj Flow Rate, veh/h	155	1662	73	198	1368	433	114	279	77	660	401	60
Peak Hour Factor	0.99	0.99	0.99	0.99	0.99	0.99	0.99	0.99	0.99	0.99	0.99	0.99
Percent Heavy Veh, %	0	3	3	1	2	0	1	3	2	1	1	0
Cap, veh/h	181	1491	65	176	1533	693	175	450	198	480	671	100
Arrive On Green	0.10	0.43	0.43	0.10	0.43	0.43	0.05	0.13	0.13	0.14	0.22	0.22
Sat Flow, veh/h	1810	3441	150	1795	3554	1607	3483	3526	1554	3483	3120	463
Grp Volume(v), veh/h	155	848	887	198	1368	433	114	279	77	660	229	232
Grp Sat Flow(s),veh/h/ln	1810	1763	1828	1795	1777	1607	1742	1763	1554	1742	1791	1792
Q Serve(g_s), s	8.4	43.4	43.4	9.8	35.7	21.0	3.2	7.5	4.6	13.8	11.5	11.7
Cycle Q Clear(g_c), s	8.4	43.4	43.4	9.8	35.7	21.0	3.2	7.5	4.6	13.8	11.5	11.7
Prop In Lane	1.00		0.08	1.00		1.00	1.00		1.00	1.00		0.26
Lane Grp Cap(c), veh/h	181	764	792	176	1533	693	175	450	198	480	385	385
V/C Ratio(X)	0.86	1.11	1.12	1.13	0.89	0.62	0.65	0.62	0.39	1.38	0.59	0.60
Avail Cap(c_a), veh/h	181	764	792	176	1533	693	254	1161	512	480	699	700
HCM Platoon Ratio	1.00	1.00	1.00	1.00	1.00	1.00	1.00	1.00	1.00	1.00	1.00	1.00
Upstream Filter(I)	1.00	1.00	1.00	1.00	1.00	1.00	1.00	1.00	1.00	1.00	1.00	1.00
Uniform Delay (d), s/veh	44.4	28.4	28.4	45.2	26.3	22.2	46.7	41.4	40.1	43.2	35.4	35.5
Incr Delay (d2), s/veh	30.2	67.1	70.3	106.2	7.2	2.1	1.5	1.4	1.2	181.7	1.5	1.5
Initial Q Delay(d3),s/veh	0.0	0.0	0.0	0.0	0.0	0.0	0.0	0.0	0.0	0.0	0.0	0.0
%ile BackOfQ(50%),veh/ln	5.1	30.4	32.2	9.3	14.9	8.2	1.4	3.4	1.8	18.0	5.1	5.2
Unsig. Movement Delay, s/veh												
LnGrp Delay(d),s/veh	74.6	95.5	98.7	151.4	33.6	24.2	48.2	42.8	41.4	224.9	36.8	37.0
LnGrp LOS	E	F	F	F	C	C	D	D	D	F	D	D
Approach Vol, veh/h		1890			1999			470			1121	
Approach Delay, s/veh		95.3			43.2			43.9			147.6	
Approach LOS		F			D			D			F	
Timer - Assigned Phs	1	2	3	4	5	6	7	8				
Phs Duration (G+Y+Rc), s	14.0	49.6	9.2	27.3	14.2	49.4	18.0	18.6				
Change Period (Y+Rc), s	* 4.2	6.2	* 4.2	5.8	* 4.2	6.2	* 4.2	* 5.8				
Max Green Setting (Gmax), s	* 9.8	43.4	* 7.3	39.1	* 10	43.2	* 14	* 33				
Max Q Clear Time (g_c+I1), s	11.8	45.4	5.2	13.7	10.4	37.7	15.8	9.5				
Green Ext Time (p_c), s	0.0	0.0	0.0	2.9	0.0	4.7	0.0	2.1				

Intersection Summary

HCM 6th Ctrl Delay	82.6
HCM 6th LOS	F

Notes

* HCM 6th computational engine requires equal clearance times for the phases crossing the barrier.

Timings
2: Central Ave & Arlington Ave/Chicago Ave

West Campus Upper Plateau (JN 14064)

09/19/2022



Lane Group	EBL	EBT	EBR	WBL	WBT	WBR	NBL	NBT	NBR	SBL	SBT
Lane Configurations	↘	↑↑	↗↗	↘↘	↑↑	↗	↘↘	↑↑	↗	↘↘	↑↑↗
Traffic Volume (vph)	28	839	1287	699	754	241	963	1244	286	559	2037
Future Volume (vph)	28	839	1287	699	754	241	963	1244	286	559	2037
Turn Type	Prot	NA	pm+ov	Prot	NA	pm+ov	Prot	NA	pm+ov	Prot	NA
Protected Phases	7	4	5	3	8	1	5	2	3	1	6
Permitted Phases			4			8			2		
Detector Phase	7	4	5	3	8	1	5	2	3	1	6
Switch Phase											
Minimum Initial (s)	5.0	10.0	5.0	5.0	10.0	5.0	5.0	10.0	5.0	5.0	10.0
Minimum Split (s)	9.6	32.8	9.6	9.6	30.8	9.6	9.6	35.4	9.6	9.6	30.4
Total Split (s)	10.6	32.8	30.0	22.0	44.2	24.4	30.0	50.8	22.0	24.4	45.2
Total Split (%)	8.2%	25.2%	23.1%	16.9%	34.0%	18.8%	23.1%	39.1%	16.9%	18.8%	34.8%
Yellow Time (s)	3.6	4.8	3.6	3.6	4.8	3.6	3.6	4.4	3.6	3.6	4.4
All-Red Time (s)	1.0	1.0	1.0	1.0	1.0	1.0	1.0	1.0	1.0	1.0	1.0
Lost Time Adjust (s)	0.0	0.0	0.0	0.0	0.0	0.0	0.0	0.0	0.0	0.0	0.0
Total Lost Time (s)	4.6	5.8	4.6	4.6	5.8	4.6	4.6	5.4	4.6	4.6	5.4
Lead/Lag	Lead	Lag	Lead	Lead	Lag	Lead	Lead	Lag	Lead	Lead	Lag
Lead-Lag Optimize?	Yes	Yes	Yes	Yes	Yes	Yes	Yes	Yes	Yes	Yes	Yes
Recall Mode	None	None	None	None	None	None	None	None	None	None	None
Act Effct Green (s)	5.7	27.0	53.6	17.4	42.6	68.2	25.4	45.4	63.6	19.8	39.8
Actuated g/C Ratio	0.04	0.21	0.41	0.13	0.33	0.52	0.20	0.35	0.49	0.15	0.31
v/c Ratio	0.37	1.17	1.10	1.59	0.66	0.28	1.47	1.04	0.37	1.09	1.37
Control Delay	73.7	134.3	89.6	310.3	41.7	11.9	255.2	77.3	15.6	117.1	205.1
Queue Delay	0.0	0.0	0.0	0.0	0.0	0.0	0.0	0.0	0.0	0.0	0.0
Total Delay	73.7	134.3	89.6	310.3	41.7	11.9	255.2	77.3	15.6	117.1	205.1
LOS	E	F	F	F	D	B	F	E	B	F	F
Approach Delay		106.8			148.3			138.9			186.4
Approach LOS		F			F			F			F

Intersection Summary

Cycle Length: 130
 Actuated Cycle Length: 130
 Natural Cycle: 120
 Control Type: Actuated-Uncoordinated
 Maximum v/c Ratio: 1.59
 Intersection Signal Delay: 146.8
 Intersection LOS: F
 Intersection Capacity Utilization 127.5%
 ICU Level of Service H
 Analysis Period (min) 15

Splits and Phases: 2: Central Ave & Arlington Ave/Chicago Ave

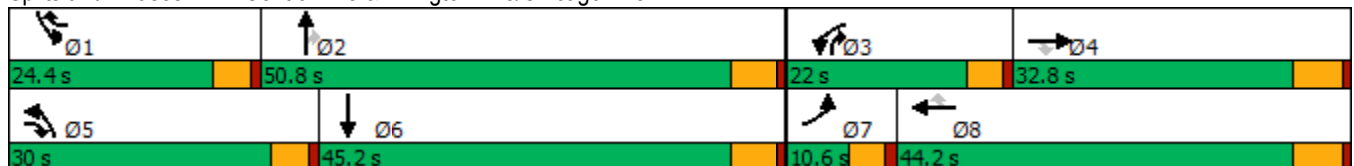

HCM 6th Signalized Intersection Summary
2: Central Ave & Arlington Ave/Chicago Ave

West Campus Upper Plateau (JN 14064)

09/19/2022



Movement	EBL	EBT	EBR	WBL	WBT	WBR	NBL	NBT	NBR	SBL	SBT	SBR
Lane Configurations	↵	↑↑	↗↘	↗↘	↑↑	↗	↗↘	↑↑	↗	↗↘	↑↑↘	
Traffic Volume (veh/h)	28	839	1287	699	754	241	963	1244	286	559	2037	23
Future Volume (veh/h)	28	839	1287	699	754	241	963	1244	286	559	2037	23
Initial Q (Qb), veh	0	0	0	0	0	0	0	0	0	0	0	0
Ped-Bike Adj(A_pbT)	1.00		1.00	1.00		1.00	1.00		0.99	1.00		1.00
Parking Bus, Adj	1.00	1.00	1.00	1.00	1.00	1.00	1.00	1.00	1.00	1.00	1.00	1.00
Work Zone On Approach		No			No			No			No	
Adj Sat Flow, veh/h/ln	1900	1900	1900	1870	1900	1900	1900	1885	1870	1900	1885	1900
Adj Flow Rate, veh/h	29	874	944	728	785	164	1003	1296	230	582	2122	22
Peak Hour Factor	0.96	0.96	0.96	0.96	0.96	0.96	0.96	0.96	0.96	0.96	0.96	0.96
Percent Heavy Veh, %	0	0	0	2	0	0	0	1	2	0	1	0
Cap, veh/h	45	750	1141	463	1143	755	686	1251	758	535	1608	17
Arrive On Green	0.02	0.21	0.21	0.13	0.32	0.32	0.20	0.35	0.35	0.15	0.31	0.31
Sat Flow, veh/h	1810	3610	2830	3456	3610	1610	3510	3582	1564	3510	5252	54
Grp Volume(v), veh/h	29	874	944	728	785	164	1003	1296	230	582	1386	758
Grp Sat Flow(s),veh/h/ln	1810	1805	1415	1728	1805	1610	1755	1791	1564	1755	1716	1875
Q Serve(g_s), s	2.1	27.0	27.0	17.4	24.7	7.8	25.4	45.4	11.6	19.8	39.8	39.8
Cycle Q Clear(g_c), s	2.1	27.0	27.0	17.4	24.7	7.8	25.4	45.4	11.6	19.8	39.8	39.8
Prop In Lane	1.00		1.00	1.00		1.00	1.00		1.00	1.00		0.03
Lane Grp Cap(c), veh/h	45	750	1141	463	1143	755	686	1251	758	535	1050	574
V/C Ratio(X)	0.64	1.17	0.83	1.57	0.69	0.22	1.46	1.04	0.30	1.09	1.32	1.32
Avail Cap(c_a), veh/h	84	750	1141	463	1143	755	686	1251	758	535	1050	574
HCM Platoon Ratio	1.00	1.00	1.00	1.00	1.00	1.00	1.00	1.00	1.00	1.00	1.00	1.00
Upstream Filter(I)	1.00	1.00	1.00	1.00	1.00	1.00	1.00	1.00	1.00	1.00	1.00	1.00
Uniform Delay (d), s/veh	62.8	51.5	34.8	56.3	38.8	20.4	52.3	42.3	20.4	55.1	45.1	45.1
Incr Delay (d2), s/veh	5.5	88.8	5.2	268.5	1.7	0.1	216.0	35.3	0.2	65.1	150.4	156.2
Initial Q Delay(d3),s/veh	0.0	0.0	0.0	0.0	0.0	0.0	0.0	0.0	0.0	0.0	0.0	0.0
%ile BackOfQ(50%),veh/ln	1.0	21.1	13.6	24.6	10.9	2.9	31.5	25.5	4.1	13.4	38.4	42.9
Unsig. Movement Delay, s/veh												
LnGrp Delay(d),s/veh	68.3	140.3	39.9	324.8	40.5	20.6	268.3	77.6	20.6	120.2	195.5	201.3
LnGrp LOS	E	F	D	F	D	C	F	F	C	F	F	F
Approach Vol, veh/h		1847			1677			2529			2726	
Approach Delay, s/veh		87.8			162.0			148.0			181.1	
Approach LOS		F			F			F			F	
Timer - Assigned Phs	1	2	3	4	5	6	7	8				
Phs Duration (G+Y+Rc), s	24.4	50.8	22.0	32.8	30.0	45.2	7.8	47.0				
Change Period (Y+Rc), s	4.6	5.4	4.6	5.8	4.6	5.4	4.6	5.8				
Max Green Setting (Gmax), s	19.8	45.4	17.4	27.0	25.4	39.8	6.0	38.4				
Max Q Clear Time (g_c+I1), s	21.8	47.4	19.4	29.0	27.4	41.8	4.1	26.7				
Green Ext Time (p_c), s	0.0	0.0	0.0	0.0	0.0	0.0	0.0	4.3				

Intersection Summary

HCM 6th Ctrl Delay	148.3
HCM 6th LOS	F

Timings

3: Overlook Pkwy./Canyon Crest Dr. & Alessandro Bl/Alessandro Bl.



Lane Group	EBL	EBT	WBL	WBT	WBR	NBR	SBL	SBT	SBR
Lane Configurations									
Traffic Volume (vph)	85	3395	6	2582	752	9	740	172	59
Future Volume (vph)	85	3395	6	2582	752	9	740	172	59
Turn Type	Prot	NA	Prot	NA	pm+ov	Perm	Split	NA	Perm
Protected Phases	5	2	1	6	4		4	4	
Permitted Phases					6	8			4
Detector Phase	5	2	1	6	4	8	4	4	4
Switch Phase									
Minimum Initial (s)	5.0	10.0	5.0	10.0	10.0	10.0	10.0	10.0	10.0
Minimum Split (s)	9.2	35.2	9.2	35.2	38.8	38.8	38.8	38.8	38.8
Total Split (s)	9.2	43.2	9.2	43.2	38.8	38.8	38.8	38.8	38.8
Total Split (%)	7.1%	33.2%	7.1%	33.2%	29.8%	29.8%	29.8%	29.8%	29.8%
Yellow Time (s)	3.2	5.2	3.2	5.2	4.8	4.8	4.8	4.8	4.8
All-Red Time (s)	1.0	1.0	1.0	1.0	1.0	1.0	1.0	1.0	1.0
Lost Time Adjust (s)	0.0	0.0	0.0	0.0	0.0	0.0	0.0	0.0	0.0
Total Lost Time (s)	4.2	6.2	4.2	6.2	5.8	5.8	5.8	5.8	5.8
Lead/Lag	Lead	Lag	Lead	Lag					
Lead-Lag Optimize?	Yes	Yes	Yes	Yes					
Recall Mode	None	None	None	None	None	None	None	None	None
Act Effct Green (s)	5.1	45.1	5.1	37.4	72.7	10.1	29.0	29.0	29.0
Actuated g/C Ratio	0.06	0.50	0.06	0.41	0.80	0.11	0.32	0.32	0.32
v/c Ratio	0.93	1.39	0.06	1.27	0.55	0.03	0.60	0.60	0.10
Control Delay	120.3	199.2	46.5	151.1	2.2	0.2	29.0	31.9	1.1
Queue Delay	0.0	0.0	0.0	0.0	0.0	0.0	0.0	0.0	0.0
Total Delay	120.3	199.2	46.5	151.1	2.2	0.2	29.0	31.9	1.1
LOS	F	F	D	F	A	A	C	C	A
Approach Delay		197.3		117.4				28.2	
Approach LOS		F		F				C	

Intersection Summary

Cycle Length: 130
 Actuated Cycle Length: 90.5
 Natural Cycle: 125
 Control Type: Actuated-Uncoordinated
 Maximum v/c Ratio: 1.39
 Intersection Signal Delay: 141.9
 Intersection Capacity Utilization 105.6%
 Analysis Period (min) 15

Intersection LOS: F
 ICU Level of Service G

Splits and Phases: 3: Overlook Pkwy./Canyon Crest Dr. & Alessandro Bl/Alessandro Bl.

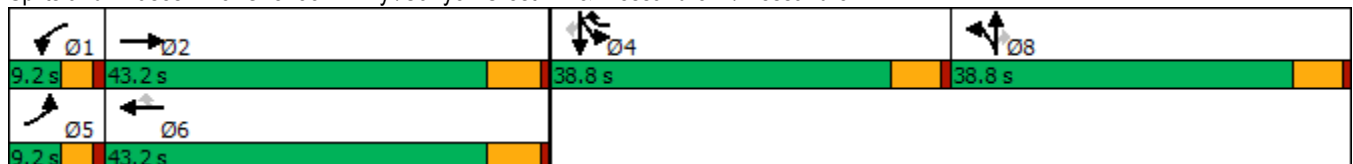

HCM 6th Signalized Intersection Summary

West Campus Upper Plateau (JN 14064)

3: Overlook Pkwy./Canyon Crest Dr. & Alessandro Bl/Alessandro Bl.

09/19/2022



Movement	EBL	EBT	EBR	WBL	WBT	WBR	NBL	NBT	NBR	SBL	SBT	SBR
Lane Configurations	↗	↑↑↑		↖	↑↑↑	↗	↖	↑↑	↗	↖↗	↖	↗
Traffic Volume (veh/h)	85	3395	9	6	2582	752	0	0	9	740	172	59
Future Volume (veh/h)	85	3395	9	6	2582	752	0	0	9	740	172	59
Initial Q (Qb), veh	0	0	0	0	0	0	0	0	0	0	0	0
Ped-Bike Adj(A_pbT)	1.00		1.00	1.00		1.00	1.00		1.00	1.00		1.00
Parking Bus, Adj	1.00	1.00	1.00	1.00	1.00	1.00	1.00	1.00	1.00	1.00	1.00	1.00
Work Zone On Approach		No			No			No				No
Adj Sat Flow, veh/h/ln	1841	1885	1811	1900	1885	1885	1781	1900	1900	1885	1900	1870
Adj Flow Rate, veh/h	89	3536	9	6	2690	775	0	0	1	702	275	52
Peak Hour Factor	0.96	0.96	0.96	0.96	0.96	0.96	0.96	0.96	0.96	0.96	0.96	0.96
Percent Heavy Veh, %	4	1	6	0	1	1	8	0	0	1	0	2
Cap, veh/h	102	2556	6	14	2221	1090	5	10	4	900	476	397
Arrive On Green	0.06	0.48	0.48	0.01	0.43	0.43	0.00	0.00	0.00	0.25	0.25	0.25
Sat Flow, veh/h	1753	5300	13	1810	5147	1598	1697	3610	1610	3591	1900	1585
Grp Volume(v), veh/h	89	2288	1257	6	2690	775	0	0	1	702	275	52
Grp Sat Flow(s),veh/h/ln	1753	1716	1883	1810	1716	1598	1697	1805	1610	1795	1900	1585
Q Serve(g_s), s	4.3	41.3	41.3	0.3	37.0	25.7	0.0	0.0	0.1	15.6	10.9	2.2
Cycle Q Clear(g_c), s	4.3	41.3	41.3	0.3	37.0	25.7	0.0	0.0	0.1	15.6	10.9	2.2
Prop In Lane	1.00		0.01	1.00		1.00	1.00		1.00	1.00		1.00
Lane Grp Cap(c), veh/h	102	1654	908	14	2221	1090	5	10	4	900	476	397
V/C Ratio(X)	0.87	1.38	1.38	0.43	1.21	0.71	0.00	0.00	0.23	0.78	0.58	0.13
Avail Cap(c_a), veh/h	102	1654	908	106	2221	1090	653	1390	620	1382	731	610
HCM Platoon Ratio	1.00	1.00	1.00	1.00	1.00	1.00	1.00	1.00	1.00	1.00	1.00	1.00
Upstream Filter(I)	1.00	1.00	1.00	1.00	1.00	1.00	0.00	0.00	1.00	1.00	1.00	1.00
Uniform Delay (d), s/veh	40.0	22.2	22.2	42.3	24.4	8.4	0.0	0.0	42.7	29.9	28.1	24.9
Incr Delay (d2), s/veh	48.9	176.1	180.0	7.4	99.4	2.2	0.0	0.0	24.1	1.6	1.1	0.1
Initial Q Delay(d3),s/veh	0.0	0.0	0.0	0.0	0.0	0.0	0.0	0.0	0.0	0.0	0.0	0.0
%ile BackOfQ(50%),veh/ln	3.1	54.1	60.3	0.1	33.1	15.3	0.0	0.0	0.0	6.4	4.7	0.8
Unsig. Movement Delay, s/veh												
LnGrp Delay(d),s/veh	89.0	198.3	202.2	49.8	123.7	10.6	0.0	0.0	66.7	31.5	29.3	25.0
LnGrp LOS	F	F	F	D	F	B	A	A	E	C	C	C
Approach Vol, veh/h		3634			3471			1			1029	
Approach Delay, s/veh		197.0			98.3			66.7			30.6	
Approach LOS		F			F			E			C	
Timer - Assigned Phs	1	2		4	5	6		8				
Phs Duration (G+Y+Rc), s	4.9	47.5		27.3	9.2	43.2		6.0				
Change Period (Y+Rc), s	* 4.2	6.2		5.8	* 4.2	6.2		5.8				
Max Green Setting (Gmax), s	* 5	37.0		33.0	* 5	37.0		33.0				
Max Q Clear Time (g_c+I1), s	2.3	43.3		17.6	6.3	39.0		2.1				
Green Ext Time (p_c), s	0.0	0.0		3.9	0.0	0.0		0.0				

Intersection Summary

HCM 6th Ctrl Delay	133.8
HCM 6th LOS	F

Notes

- User approved pedestrian interval to be less than phase max green.
- User approved volume balancing among the lanes for turning movement.
- * HCM 6th computational engine requires equal clearance times for the phases crossing the barrier.

Timings

4: Van Buren Bl. & Wood Rd.

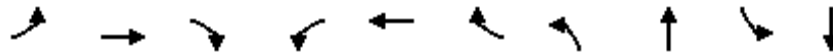

Lane Group	EBL	EBT	EBR	WBL	WBT	WBR	NBL	NBT	SBL	SBT
Lane Configurations	↘	↑↑	↗	↘↗	↑↑	↗	↘↗	↑↔	↘	↑↔
Traffic Volume (vph)	176	1874	241	285	1678	147	341	272	141	277
Future Volume (vph)	176	1874	241	285	1678	147	341	272	141	277
Turn Type	Prot	NA	pm+ov	Prot	NA	Perm	Prot	NA	Prot	NA
Protected Phases	5	2	3	1	6		3	8	7	4
Permitted Phases			2			6				
Detector Phase	5	2	3	1	6	6	3	8	7	4
Switch Phase										
Minimum Initial (s)	5.0	10.0	5.0	5.0	10.0	10.0	5.0	10.0	5.0	10.0
Minimum Split (s)	9.2	30.2	9.2	9.2	30.2	30.2	9.2	38.4	9.2	15.8
Total Split (s)	16.5	57.2	21.7	13.2	53.9	53.9	21.7	38.4	11.2	27.9
Total Split (%)	13.8%	47.7%	18.1%	11.0%	44.9%	44.9%	18.1%	32.0%	9.3%	23.3%
Yellow Time (s)	3.2	5.2	3.2	3.2	5.2	5.2	3.2	4.4	3.2	4.8
All-Red Time (s)	1.0	1.0	1.0	1.0	1.0	1.0	1.0	1.0	1.0	1.0
Lost Time Adjust (s)	0.0	0.0	0.0	0.0	0.0	0.0	0.0	0.0	0.0	0.0
Total Lost Time (s)	4.2	6.2	4.2	4.2	6.2	6.2	4.2	5.4	4.2	5.8
Lead/Lag	Lead	Lag	Lead	Lead	Lag	Lag	Lead	Lag	Lead	Lag
Lead-Lag Optimize?	Yes	Yes	Yes	Yes	Yes	Yes	Yes	Yes	Yes	Yes
Recall Mode	None	None	None	None	None	None	None	None	None	None
Act Effct Green (s)	12.3	51.2	68.9	9.0	47.8	47.8	15.7	27.8	7.0	18.7
Actuated g/C Ratio	0.11	0.44	0.60	0.08	0.42	0.42	0.14	0.24	0.06	0.16
v/c Ratio	1.01	1.31	0.27	1.15	1.24	0.22	0.80	0.64	1.42	0.81
Control Delay	119.9	173.3	7.1	149.8	145.8	6.2	62.2	31.1	276.6	44.5
Queue Delay	0.0	0.0	0.0	0.0	0.0	0.0	0.0	0.0	0.0	0.0
Total Delay	119.9	173.3	7.1	149.8	145.8	6.2	62.2	31.1	276.6	44.5
LOS	F	F	A	F	F	A	E	C	F	D
Approach Delay		151.7			136.6			43.3		96.5
Approach LOS		F			F			D		F

Intersection Summary





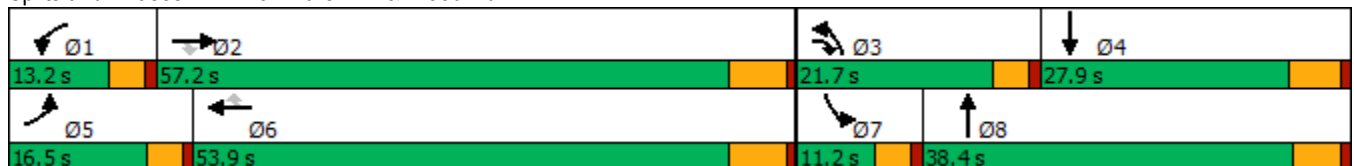



















Cycle Length: 120
 Actuated Cycle Length: 115.1
 Natural Cycle: 120
 Control Type: Actuated-Uncoordinated
 Maximum v/c Ratio: 1.42
 Intersection Signal Delay: 124.5
 Intersection LOS: F
 Intersection Capacity Utilization 104.4%
 ICU Level of Service G
 Analysis Period (min) 15

Splits and Phases: 4: Van Buren Bl. & Wood Rd.



HCM 6th Signalized Intersection Summary
4: Van Buren Bl. & Wood Rd.

West Campus Upper Plateau (JN 14064)
09/19/2022

												
Movement	EBL	EBT	EBR	WBL	WBT	WBR	NBL	NBT	NBR	SBL	SBT	SBR
Lane Configurations												
Traffic Volume (veh/h)	176	1874	241	285	1678	147	341	272	255	141	277	212
Future Volume (veh/h)	176	1874	241	285	1678	147	341	272	255	141	277	212
Initial Q (Qb), veh	0	0	0	0	0	0	0	0	0	0	0	0
Ped-Bike Adj(A_pbT)	1.00		0.98	1.00		0.99	1.00		0.97	1.00		0.99
Parking Bus, Adj	1.00	1.00	1.00	1.00	1.00	1.00	1.00	1.00	1.00	1.00	1.00	1.00
Work Zone On Approach		No			No			No			No	
Adj Sat Flow, veh/h/ln	1885	1870	1870	1885	1885	1885	1870	1885	1870	1885	1885	1885
Adj Flow Rate, veh/h	193	2059	160	313	1844	115	375	299	199	155	304	158
Peak Hour Factor	0.91	0.91	0.91	0.91	0.91	0.91	0.91	0.91	0.91	0.91	0.91	0.91
Percent Heavy Veh, %	1	2	2	1	1	1	2	1	2	1	1	1
Cap, veh/h	196	1607	906	278	1515	666	437	464	299	111	368	186
Arrive On Green	0.11	0.45	0.45	0.08	0.42	0.42	0.13	0.23	0.23	0.06	0.16	0.16
Sat Flow, veh/h	1795	3554	1561	3483	3582	1574	3456	2062	1329	1795	2290	1159
Grp Volume(v), veh/h	193	2059	160	313	1844	115	375	258	240	155	236	226
Grp Sat Flow(s),veh/h/ln	1795	1777	1561	1742	1791	1574	1728	1791	1600	1795	1791	1658
Q Serve(g_s), s	12.1	51.0	5.4	9.0	47.7	5.1	12.0	14.7	15.4	7.0	14.4	14.9
Cycle Q Clear(g_c), s	12.1	51.0	5.4	9.0	47.7	5.1	12.0	14.7	15.4	7.0	14.4	14.9
Prop In Lane	1.00		1.00	1.00		1.00	1.00		0.83	1.00		0.70
Lane Grp Cap(c), veh/h	196	1607	906	278	1515	666	437	403	360	111	288	266
V/C Ratio(X)	0.99	1.28	0.18	1.13	1.22	0.17	0.86	0.64	0.66	1.39	0.82	0.85
Avail Cap(c_a), veh/h	196	1607	906	278	1515	666	536	524	468	111	351	325
HCM Platoon Ratio	1.00	1.00	1.00	1.00	1.00	1.00	1.00	1.00	1.00	1.00	1.00	1.00
Upstream Filter(I)	1.00	1.00	1.00	1.00	1.00	1.00	1.00	1.00	1.00	1.00	1.00	1.00
Uniform Delay (d), s/veh	50.2	30.9	11.2	51.9	32.6	20.3	48.3	39.6	39.8	52.9	45.8	46.0
Incr Delay (d2), s/veh	59.9	131.6	0.1	92.4	104.1	0.2	9.6	1.7	2.3	221.7	12.1	16.0
Initial Q Delay(d3),s/veh	0.0	0.0	0.0	0.0	0.0	0.0	0.0	0.0	0.0	0.0	0.0	0.0
%ile BackOfQ(50%),veh/ln	8.5	49.0	1.8	7.3	40.7	1.9	5.6	6.5	6.1	10.0	7.2	7.2
Unsig. Movement Delay, s/veh												
LnGrp Delay(d),s/veh	110.1	162.5	11.3	144.3	136.7	20.4	57.9	41.3	42.1	274.6	57.8	62.0
LnGrp LOS	F	F	B	F	F	C	E	D	D	F	E	E
Approach Vol, veh/h		2412			2272			873			617	
Approach Delay, s/veh		148.3			131.8			48.6			113.8	
Approach LOS		F			F			D			F	
Timer - Assigned Phs	1	2	3	4	5	6	7	8				
Phs Duration (G+Y+Rc), s	13.2	57.2	18.5	23.9	16.5	53.9	11.2	31.2				
Change Period (Y+Rc), s	* 4.2	6.2	* 4.2	5.8	* 4.2	6.2	* 4.2	* 5.8				
Max Green Setting (Gmax), s	* 9	51.0	* 18	22.1	* 12	47.7	* 7	* 33				
Max Q Clear Time (g_c+1), s	11.0	53.0	14.0	16.9	14.1	49.7	9.0	17.4				
Green Ext Time (p_c), s	0.0	0.0	0.3	1.2	0.0	0.0	0.0	2.6				

Intersection Summary

HCM 6th Ctrl Delay	124.7
HCM 6th LOS	F

Notes

* HCM 6th computational engine requires equal clearance times for the phases crossing the barrier.

Timings

5: Trautwein Rd. & Alessandro Bl.

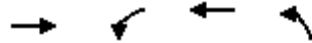

Lane Group	EBT	WBL	WBT	NBL
Lane Configurations	↑↑↑	↙↘	↑↑↑	↙↘↙↘
Traffic Volume (vph)	2107	368	2211	1331
Future Volume (vph)	2107	368	2211	1331
Turn Type	NA	Prot	NA	Prot
Protected Phases	2	1	6	8
Permitted Phases				
Detector Phase	2	1	6	8
Switch Phase				
Minimum Initial (s)	10.0	5.0	10.0	10.0
Minimum Split (s)	33.2	9.2	16.2	16.2
Total Split (s)	63.0	19.0	82.0	38.0
Total Split (%)	52.5%	15.8%	68.3%	31.7%
Yellow Time (s)	5.2	3.2	5.2	5.2
All-Red Time (s)	1.0	1.0	1.0	1.0
Lost Time Adjust (s)	0.0	0.0	0.0	0.0
Total Lost Time (s)	6.2	4.2	6.2	6.2
Lead/Lag	Lag	Lead		
Lead-Lag Optimize?	Yes	Yes		
Recall Mode	None	None	None	None
Act Effct Green (s)	56.8	14.7	75.7	31.8
Actuated g/C Ratio	0.47	0.12	0.63	0.27
v/c Ratio	1.05	0.91	0.72	1.14
Control Delay	63.3	78.8	16.5	112.5
Queue Delay	0.0	0.0	0.0	0.0
Total Delay	63.3	78.8	16.5	112.5
LOS	E	E	B	F
Approach Delay	63.3		25.4	112.5
Approach LOS	E		C	F

Intersection Summary

Cycle Length: 120	
Actuated Cycle Length: 119.9	
Natural Cycle: 120	
Control Type: Actuated-Uncoordinated	
Maximum v/c Ratio: 1.14	
Intersection Signal Delay: 59.1	Intersection LOS: E
Intersection Capacity Utilization 98.7%	ICU Level of Service F
Analysis Period (min) 15	

Splits and Phases: 5: Trautwein Rd. & Alessandro Bl.



HCM 6th Signalized Intersection Summary
5: Trautwein Rd. & Alessandro Bl.

West Campus Upper Plateau (JN 14064)
09/19/2022

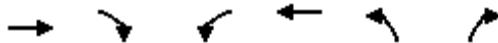

Movement	EBT	EBR	WBL	WBT	NBL	NBR
Lane Configurations	↑↑↑		↵↵	↑↑↑	↵↵↵	
Traffic Volume (veh/h)	2107	273	368	2211	1331	109
Future Volume (veh/h)	2107	273	368	2211	1331	109
Initial Q (Qb), veh	0	0	0	0	0	0
Ped-Bike Adj(A_pbT)		1.00	1.00		1.00	1.00
Parking Bus, Adj	1.00	1.00	1.00	1.00	1.00	1.00
Work Zone On Approach	No			No	No	
Adj Sat Flow, veh/h/ln	1885	1900	1885	1885	1885	1900
Adj Flow Rate, veh/h	2218	287	387	2327	1508	0
Peak Hour Factor	0.95	0.95	0.95	0.95	0.95	0.95
Percent Heavy Veh, %	1	0	1	1	1	0
Cap, veh/h	2189	277	430	3251	1427	427
Arrive On Green	0.47	0.47	0.12	0.63	0.27	0.00
Sat Flow, veh/h	4795	586	3483	5316	5386	1610
Grp Volume(v), veh/h	1633	872	387	2327	1508	0
Grp Sat Flow(s),veh/h/ln	1716	1780	1742	1716	1795	1610
Q Serve(g_s), s	56.8	56.8	13.1	36.5	31.8	0.0
Cycle Q Clear(g_c), s	56.8	56.8	13.1	36.5	31.8	0.0
Prop In Lane		0.33	1.00		1.00	1.00
Lane Grp Cap(c), veh/h	1624	842	430	3251	1427	427
V/C Ratio(X)	1.01	1.04	0.90	0.72	1.06	0.00
Avail Cap(c_a), veh/h	1624	842	430	3251	1427	427
HCM Platoon Ratio	1.00	1.00	1.00	1.00	1.00	1.00
Upstream Filter(I)	1.00	1.00	1.00	1.00	1.00	0.00
Uniform Delay (d), s/veh	31.6	31.6	51.9	14.9	44.1	0.0
Incr Delay (d2), s/veh	23.7	40.4	21.1	0.8	40.3	0.0
Initial Q Delay(d3),s/veh	0.0	0.0	0.0	0.0	0.0	0.0
%ile BackOfQ(50%),veh/ln	26.6	31.5	6.7	11.9	18.7	0.0
Unsig. Movement Delay, s/veh						
LnGrp Delay(d),s/veh	55.3	72.0	73.0	15.7	84.4	0.0
LnGrp LOS	F	F	E	B	F	A
Approach Vol, veh/h	2505			2714	1508	
Approach Delay, s/veh	61.1			23.9	84.4	
Approach LOS	E			C	F	
Timer - Assigned Phs	1	2			6	8
Phs Duration (G+Y+Rc), s	19.0	63.0			82.0	38.0
Change Period (Y+Rc), s	* 4.2	6.2			6.2	6.2
Max Green Setting (Gmax), s	* 15	56.8			75.8	31.8
Max Q Clear Time (g_c+I1), s	15.1	58.8			38.5	33.8
Green Ext Time (p_c), s	0.0	0.0			30.0	0.0

Intersection Summary

HCM 6th Ctrl Delay	51.3
HCM 6th LOS	D

Notes

User approved volume balancing among the lanes for turning movement.
* HCM 6th computational engine requires equal clearance times for the phases crossing the barrier.

Timings
6: Trautwein Rd. & Grove Community Dr

West Campus Upper Plateau (JN 14064)

09/19/2022



Lane Group	WBL	WBR	NBT	NBR	SBL	SBT
Lane Configurations						
Traffic Volume (vph)	58	270	1442	62	426	2076
Future Volume (vph)	58	270	1442	62	426	2076
Turn Type	Prot	pm+ov	NA	Perm	Prot	NA
Protected Phases	8	1	2		1	6
Permitted Phases		8		2		
Detector Phase	8	1	2	2	1	6
Switch Phase						
Minimum Initial (s)	10.0	5.0	10.0	10.0	5.0	10.0
Minimum Split (s)	34.6	9.6	46.2	46.2	9.6	28.2
Total Split (s)	35.0	29.0	56.0	56.0	29.0	85.0
Total Split (%)	29.2%	24.2%	46.7%	46.7%	24.2%	70.8%
Yellow Time (s)	3.6	3.6	5.2	5.2	3.6	5.2
All-Red Time (s)	1.0	1.0	1.0	1.0	1.0	1.0
Lost Time Adjust (s)	0.0	0.0	0.0	0.0	0.0	0.0
Total Lost Time (s)	4.6	4.6	6.2	6.2	4.6	6.2
Lead/Lag		Lead	Lag	Lag	Lead	
Lead-Lag Optimize?		Yes	Yes	Yes	Yes	
Recall Mode	None	None	None	None	None	None
Act Effct Green (s)	13.5	26.5	46.5	46.5	16.5	70.0
Actuated g/C Ratio	0.15	0.30	0.53	0.53	0.19	0.80
v/c Ratio	0.21	0.32	0.77	0.07	0.66	0.75
Control Delay	38.9	20.5	22.8	8.7	41.1	10.4
Queue Delay	0.0	0.0	0.0	0.0	0.0	0.0
Total Delay	38.9	20.5	22.8	8.7	41.1	10.4
LOS	D	C	C	A	D	B
Approach Delay	23.7		22.2			15.6
Approach LOS	C		C			B

Intersection Summary

Cycle Length: 120
 Actuated Cycle Length: 88
 Natural Cycle: 95
 Control Type: Actuated-Uncoordinated
 Maximum v/c Ratio: 0.77
 Intersection Signal Delay: 18.5
 Intersection LOS: B
 Intersection Capacity Utilization 75.7%
 ICU Level of Service D
 Analysis Period (min) 15

Splits and Phases: 6: Trautwein Rd. & Grove Community Dr



HCM 6th Signalized Intersection Summary
6: Trautwein Rd. & Grove Community Dr

West Campus Upper Plateau (JN 14064)

09/19/2022



Movement	WBL	WBR	NBT	NBR	SBL	SBT
Lane Configurations						
Traffic Volume (veh/h)	58	270	1442	62	426	2076
Future Volume (veh/h)	58	270	1442	62	426	2076
Initial Q (Qb), veh	0	0	0	0	0	0
Ped-Bike Adj(A_pbT)	1.00	1.00		1.00	1.00	
Parking Bus, Adj	1.00	1.00	1.00	1.00	1.00	1.00
Work Zone On Approach	No		No			No
Adj Sat Flow, veh/h/ln	1900	1900	1900	1900	1900	1870
Adj Flow Rate, veh/h	59	97	1471	58	435	2118
Peak Hour Factor	0.98	0.98	0.98	0.98	0.98	0.98
Percent Heavy Veh, %	0	0	0	0	0	2
Cap, veh/h	220	779	1918	855	538	2638
Arrive On Green	0.12	0.12	0.53	0.53	0.15	0.74
Sat Flow, veh/h	1810	2834	3705	1610	3510	3647
Grp Volume(v), veh/h	59	97	1471	58	435	2118
Grp Sat Flow(s),veh/h/ln	1810	1417	1805	1610	1755	1777
Q Serve(g_s), s	2.4	2.0	25.6	1.4	9.5	30.2
Cycle Q Clear(g_c), s	2.4	2.0	25.6	1.4	9.5	30.2
Prop In Lane	1.00	1.00		1.00	1.00	
Lane Grp Cap(c), veh/h	220	779	1918	855	538	2638
V/C Ratio(X)	0.27	0.12	0.77	0.07	0.81	0.80
Avail Cap(c_a), veh/h	692	1518	2262	1009	1078	3523
HCM Platoon Ratio	1.00	1.00	1.00	1.00	1.00	1.00
Upstream Filter(I)	1.00	1.00	1.00	1.00	1.00	1.00
Uniform Delay (d), s/veh	31.7	21.6	14.7	9.1	32.5	6.5
Incr Delay (d2), s/veh	0.6	0.1	1.4	0.0	1.1	1.0
Initial Q Delay(d3),s/veh	0.0	0.0	0.0	0.0	0.0	0.0
%ile BackOfQ(50%),veh/ln	1.0	0.7	8.5	0.4	3.8	5.4
Unsig. Movement Delay, s/veh						
LnGrp Delay(d),s/veh	32.3	21.7	16.1	9.1	33.6	7.6
LnGrp LOS	C	C	B	A	C	A
Approach Vol, veh/h	156		1529			2553
Approach Delay, s/veh	25.7		15.9			12.0
Approach LOS	C		B			B
Timer - Assigned Phs	1	2			6	8
Phs Duration (G+Y+Rc), s	16.8	48.4			65.2	14.3
Change Period (Y+Rc), s	4.6	6.2			6.2	4.6
Max Green Setting (Gmax), s	24.4	49.8			78.8	30.4
Max Q Clear Time (g_c+I1), s	11.5	27.6			32.2	4.4
Green Ext Time (p_c), s	0.7	10.9			26.8	0.5

Intersection Summary

HCM 6th Ctrl Delay			13.9			
HCM 6th LOS			B			

Timings

West Campus Upper Plateau (JN 14064)

7: Trautwein Rd. & Orange Terrace Pkwy

09/19/2022



Lane Group	EBL	EBT	WBL	WBT	WBR	NBL	NBT	NBR	SBL	SBT	SBR
Lane Configurations											
Traffic Volume (vph)	52	53	172	28	196	50	1347	241	392	1712	46
Future Volume (vph)	52	53	172	28	196	50	1347	241	392	1712	46
Turn Type	Prot	NA	Prot	NA	pm+ov	Prot	NA	Perm	Prot	NA	Perm
Protected Phases	7	4	3	8	1	5	2		1	6	
Permitted Phases					8			2			6
Detector Phase	7	4	3	8	1	5	2	2	1	6	6
Switch Phase											
Minimum Initial (s)	5.0	10.0	5.0	10.0	5.0	5.0	10.0	10.0	5.0	10.0	10.0
Minimum Split (s)	9.6	38.6	9.6	34.6	9.6	9.6	46.2	46.2	9.6	28.2	28.2
Total Split (s)	13.2	38.6	16.1	41.5	18.0	9.6	47.3	47.3	18.0	55.7	55.7
Total Split (%)	11.0%	32.2%	13.4%	34.6%	15.0%	8.0%	39.4%	39.4%	15.0%	46.4%	46.4%
Yellow Time (s)	3.6	3.6	3.6	3.6	3.6	3.6	5.2	5.2	3.6	5.2	5.2
All-Red Time (s)	1.0	1.0	1.0	1.0	1.0	1.0	1.0	1.0	1.0	1.0	1.0
Lost Time Adjust (s)	0.0	0.0	0.0	0.0	0.0	0.0	0.0	0.0	0.0	0.0	0.0
Total Lost Time (s)	4.6	4.6	4.6	4.6	4.6	4.6	6.2	6.2	4.6	6.2	6.2
Lead/Lag	Lead	Lag	Lead	Lag	Lead	Lead	Lag	Lag	Lead	Lag	Lag
Lead-Lag Optimize?	Yes	Yes	Yes	Yes	Yes	Yes	Yes	Yes	Yes	Yes	Yes
Recall Mode	None	None	None	None	None	None	None	None	None	None	None
Act Effct Green (s)	7.0	14.1	11.7	19.7	38.0	5.1	41.7	41.7	13.6	52.6	52.6
Actuated g/C Ratio	0.07	0.14	0.12	0.20	0.39	0.05	0.43	0.43	0.14	0.54	0.54
v/c Ratio	0.43	0.29	0.85	0.08	0.18	0.57	0.93	0.33	0.86	0.94	0.05
Control Delay	57.3	32.3	77.9	33.0	8.7	72.6	40.4	11.5	61.0	35.2	0.1
Queue Delay	0.0	0.0	0.0	0.0	0.0	0.0	0.0	0.0	0.0	0.0	0.0
Total Delay	57.3	32.3	77.9	33.0	8.7	72.6	40.4	11.5	61.0	35.2	0.1
LOS	E	C	E	C	A	E	D	B	E	D	A
Approach Delay		42.4		40.5			37.1			39.2	
Approach LOS		D		D			D			D	

Intersection Summary

Cycle Length: 120	
Actuated Cycle Length: 97.9	
Natural Cycle: 115	
Control Type: Actuated-Uncoordinated	
Maximum v/c Ratio: 0.94	
Intersection Signal Delay: 38.6	Intersection LOS: D
Intersection Capacity Utilization 80.5%	ICU Level of Service D
Analysis Period (min) 15	



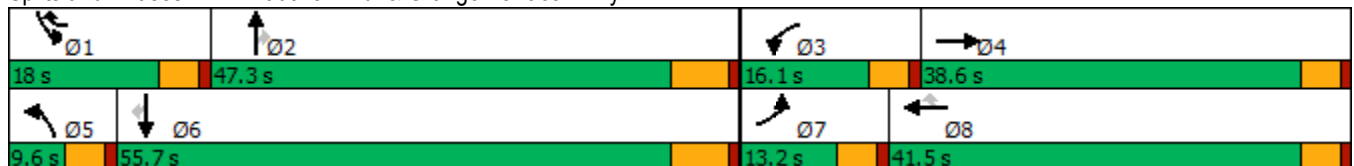



















Splits and Phases: 7: Trautwein Rd. & Orange Terrace Pkwy



HCM 6th Signalized Intersection Summary
7: Trautwein Rd. & Orange Terrace Pkwy

West Campus Upper Plateau (JN 14064)

09/19/2022

												
Movement	EBL	EBT	EBR	WBL	WBT	WBR	NBL	NBT	NBR	SBL	SBT	SBR
Lane Configurations												
Traffic Volume (veh/h)	52	53	24	172	28	196	50	1347	241	392	1712	46
Future Volume (veh/h)	52	53	24	172	28	196	50	1347	241	392	1712	46
Initial Q (Qb), veh	0	0	0	0	0	0	0	0	0	0	0	0
Ped-Bike Adj(A_pbT)	1.00		1.00	1.00		1.00	1.00		1.00	1.00		1.00
Parking Bus, Adj	1.00	1.00	1.00	1.00	1.00	1.00	1.00	1.00	1.00	1.00	1.00	1.00
Work Zone On Approach		No			No			No			No	
Adj Sat Flow, veh/h/ln	1900	1900	1900	1885	1900	1870	1900	1885	1885	1885	1885	1900
Adj Flow Rate, veh/h	55	56	23	181	29	87	53	1418	177	413	1802	39
Peak Hour Factor	0.95	0.95	0.95	0.95	0.95	0.95	0.95	0.95	0.95	0.95	0.95	0.95
Percent Heavy Veh, %	0	0	0	1	0	2	0	1	1	1	1	0
Cap, veh/h	73	135	56	214	350	898	72	1526	681	480	1877	844
Arrive On Green	0.04	0.11	0.11	0.12	0.18	0.18	0.04	0.43	0.43	0.14	0.52	0.52
Sat Flow, veh/h	1810	1280	526	1795	1900	2790	1810	3582	1598	3483	3582	1610
Grp Volume(v), veh/h	55	0	79	181	29	87	53	1418	177	413	1802	39
Grp Sat Flow(s),veh/h/ln	1810	0	1805	1795	1900	1395	1810	1791	1598	1742	1791	1610
Q Serve(g_s), s	2.8	0.0	3.9	9.3	1.2	2.1	2.7	35.5	6.8	11.0	45.5	1.1
Cycle Q Clear(g_c), s	2.8	0.0	3.9	9.3	1.2	2.1	2.7	35.5	6.8	11.0	45.5	1.1
Prop In Lane	1.00		0.29	1.00		1.00	1.00		1.00	1.00		1.00
Lane Grp Cap(c), veh/h	73	0	191	214	350	898	72	1526	681	480	1877	844
V/C Ratio(X)	0.75	0.00	0.41	0.85	0.08	0.10	0.74	0.93	0.26	0.86	0.96	0.05
Avail Cap(c_a), veh/h	165	0	650	219	742	1474	96	1558	695	494	1877	844
HCM Platoon Ratio	1.00	1.00	1.00	1.00	1.00	1.00	1.00	1.00	1.00	1.00	1.00	1.00
Upstream Filter(I)	1.00	0.00	1.00	1.00	1.00	1.00	1.00	1.00	1.00	1.00	1.00	1.00
Uniform Delay (d), s/veh	44.9	0.0	39.5	40.8	31.9	22.4	44.9	25.8	17.5	39.9	21.5	11.0
Incr Delay (d2), s/veh	5.7	0.0	1.4	23.8	0.1	0.0	11.4	10.1	0.2	13.4	12.7	0.0
Initial Q Delay(d3),s/veh	0.0	0.0	0.0	0.0	0.0	0.0	0.0	0.0	0.0	0.0	0.0	0.0
%ile BackOfQ(50%),veh/ln	1.4	0.0	1.8	5.4	0.5	0.6	1.4	15.4	2.3	5.3	19.1	0.4
Unsig. Movement Delay, s/veh												
LnGrp Delay(d),s/veh	50.6	0.0	40.9	64.6	32.0	22.5	56.3	35.9	17.7	53.2	34.3	11.0
LnGrp LOS	D	A	D	E	C	C	E	D	B	D	C	B
Approach Vol, veh/h		134			297			1648			2254	
Approach Delay, s/veh		44.9			49.1			34.6			37.3	
Approach LOS		D			D			C			D	
Timer - Assigned Phs	1	2	3	4	5	6	7	8				
Phs Duration (G+Y+Rc), s	17.6	46.4	15.8	14.6	8.4	55.7	8.4	22.0				
Change Period (Y+Rc), s	4.6	6.2	4.6	4.6	4.6	6.2	4.6	4.6				
Max Green Setting (Gmax), s	13.4	41.1	11.5	34.0	5.0	49.5	8.6	36.9				
Max Q Clear Time (g_c+I1), s	13.0	37.5	11.3	5.9	4.7	47.5	4.8	4.1				
Green Ext Time (p_c), s	0.0	2.7	0.0	0.4	0.0	1.7	0.0	0.4				
Intersection Summary												
HCM 6th Ctrl Delay				37.3								
HCM 6th LOS				D								

Timings
8: Cole Av. & Van Buren Bl.

West Campus Upper Plateau (JN 14064)

09/19/2022



Lane Group	EBL	EBT	EBR	WBL	WBT	WBR	NBL	NBT	SBL	SBT	SBR
Lane Configurations	↖↗	↑↑	↖	↖	↑↑↑	↖	↖	↑↑	↖↗	↑↑	↖
Traffic Volume (vph)	445	1485	115	165	1465	691	102	382	658	691	330
Future Volume (vph)	445	1485	115	165	1465	691	102	382	658	691	330
Turn Type	Prot	NA	pm+ov	Prot	NA	pm+ov	Prot	NA	Prot	NA	pm+ov
Protected Phases	5	2	3	1	6	7	3	8	7	4	5
Permitted Phases			2			6					4
Detector Phase	5	2	3	1	6	7	3	8	7	4	5
Switch Phase											
Minimum Initial (s)	5.0	10.0	5.0	5.0	10.0	5.0	5.0	10.0	5.0	10.0	5.0
Minimum Split (s)	9.1	36.2	9.1	9.1	36.2	9.1	9.1	42.2	9.1	49.2	9.1
Total Split (s)	18.7	44.8	12.0	14.0	40.1	17.5	12.0	43.7	17.5	49.2	18.7
Total Split (%)	15.6%	37.3%	10.0%	11.7%	33.4%	14.6%	10.0%	36.4%	14.6%	41.0%	15.6%
Yellow Time (s)	3.2	5.2	3.2	3.2	5.2	3.2	3.2	5.2	3.2	5.2	3.2
All-Red Time (s)	0.5	1.0	0.5	0.5	1.0	0.5	0.5	1.0	0.5	1.0	0.5
Lost Time Adjust (s)	0.0	0.0	0.0	0.0	0.0	0.0	0.0	0.0	0.0	0.0	0.0
Total Lost Time (s)	3.7	6.2	3.7	3.7	6.2	3.7	3.7	6.2	3.7	6.2	3.7
Lead/Lag	Lead	Lag	Lead	Lead	Lag	Lead	Lead	Lag	Lead	Lag	Lead
Lead-Lag Optimize?	Yes	Yes	Yes	Yes	Yes	Yes	Yes	Yes	Yes	Yes	Yes
Recall Mode	None	None	None	None	None	None	None	None	None	None	None
Act Effct Green (s)	15.1	38.8	53.4	10.4	34.1	54.2	8.3	22.9	13.9	28.4	46.0
Actuated g/C Ratio	0.14	0.37	0.50	0.10	0.32	0.51	0.08	0.22	0.13	0.27	0.43
v/c Ratio	0.97	1.24	0.15	1.02	0.95	0.82	0.78	0.68	1.56	0.77	0.48
Control Delay	80.0	146.8	5.7	123.1	49.6	27.8	83.8	39.8	294.0	41.1	17.4
Queue Delay	0.0	0.0	0.0	0.0	0.0	0.0	0.0	0.0	0.0	0.0	0.0
Total Delay	80.0	146.8	5.7	123.1	49.6	27.8	83.8	39.8	294.0	41.1	17.4
LOS	F	F	A	F	D	C	F	D	F	D	B
Approach Delay		124.4			48.4			47.4		135.5	
Approach LOS		F			D			D		F	

Intersection Summary

Cycle Length: 120	
Actuated Cycle Length: 105.8	
Natural Cycle: 115	
Control Type: Actuated-Uncoordinated	
Maximum v/c Ratio: 1.56	
Intersection Signal Delay: 93.7	Intersection LOS: F
Intersection Capacity Utilization 102.0%	ICU Level of Service G
Analysis Period (min) 15	



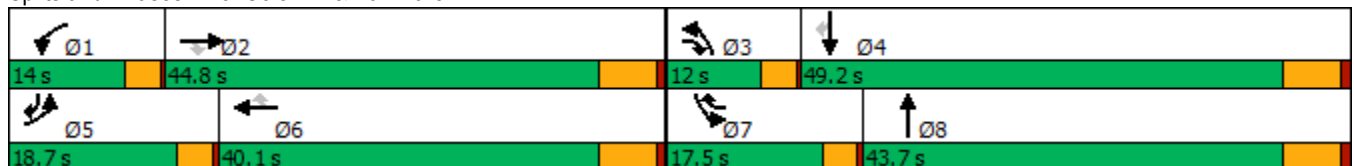





















Splits and Phases: 8: Cole Av. & Van Buren Bl.



HCM 6th Signalized Intersection Summary
8: Cole Av. & Van Buren Bl.

West Campus Upper Plateau (JN 14064)

09/19/2022

												
Movement	EBL	EBT	EBR	WBL	WBT	WBR	NBL	NBT	NBR	SBL	SBT	SBR
Lane Configurations												
Traffic Volume (veh/h)	445	1485	115	165	1465	691	102	382	108	658	691	330
Future Volume (veh/h)	445	1485	115	165	1465	691	102	382	108	658	691	330
Initial Q (Qb), veh	0	0	0	0	0	0	0	0	0	0	0	0
Ped-Bike Adj(A_pbT)	1.00		1.00	1.00		1.00	1.00		0.99	1.00		1.00
Parking Bus, Adj	1.00	1.00	1.00	1.00	1.00	1.00	1.00	1.00	1.00	1.00	1.00	1.00
Work Zone On Approach		No			No			No			No	
Adj Sat Flow, veh/h/ln	1870	1841	1856	1870	1870	1885	1885	1885	1885	1870	1885	1885
Adj Flow Rate, veh/h	473	1580	63	176	1559	645	109	406	108	700	735	251
Peak Hour Factor	0.94	0.94	0.94	0.94	0.94	0.94	0.94	0.94	0.94	0.94	0.94	0.94
Percent Heavy Veh, %	2	4	3	2	2	1	1	1	1	2	1	1
Cap, veh/h	497	1294	701	176	1659	730	136	586	154	457	953	654
Arrive On Green	0.14	0.37	0.37	0.10	0.32	0.32	0.08	0.21	0.21	0.13	0.27	0.27
Sat Flow, veh/h	3456	3497	1572	1781	5106	1598	1795	2801	737	3456	3582	1596
Grp Volume(v), veh/h	473	1580	63	176	1559	645	109	258	256	700	735	251
Grp Sat Flow(s),veh/h/ln	1728	1749	1572	1781	1702	1598	1795	1791	1747	1728	1791	1596
Q Serve(g_s), s	14.2	38.6	2.4	10.3	31.0	33.9	6.2	13.9	14.2	13.8	19.8	11.5
Cycle Q Clear(g_c), s	14.2	38.6	2.4	10.3	31.0	33.9	6.2	13.9	14.2	13.8	19.8	11.5
Prop In Lane	1.00		1.00	1.00		1.00	1.00		0.42	1.00		1.00
Lane Grp Cap(c), veh/h	497	1294	701	176	1659	730	136	375	366	457	953	654
V/C Ratio(X)	0.95	1.22	0.09	1.00	0.94	0.88	0.80	0.69	0.70	1.53	0.77	0.38
Avail Cap(c_a), veh/h	497	1294	701	176	1659	730	143	644	628	457	1476	887
HCM Platoon Ratio	1.00	1.00	1.00	1.00	1.00	1.00	1.00	1.00	1.00	1.00	1.00	1.00
Upstream Filter(I)	1.00	1.00	1.00	1.00	1.00	1.00	1.00	1.00	1.00	1.00	1.00	1.00
Uniform Delay (d), s/veh	44.3	32.9	16.7	47.0	34.2	25.8	47.5	38.1	38.2	45.3	35.4	21.6
Incr Delay (d2), s/veh	28.4	106.7	0.1	68.1	11.0	12.6	24.0	2.3	2.4	250.1	1.4	0.4
Initial Q Delay(d3),s/veh	0.0	0.0	0.0	0.0	0.0	0.0	0.0	0.0	0.0	0.0	0.0	0.0
%ile BackOfQ(50%),veh/ln	7.7	34.0	0.8	7.7	13.5	15.5	3.6	6.0	6.0	21.5	8.3	4.0
Unsig. Movement Delay, s/veh												
LnGrp Delay(d),s/veh	72.7	139.6	16.8	115.1	45.3	38.4	71.5	40.4	40.6	295.3	36.7	21.9
LnGrp LOS	E	F	B	F	D	D	E	D	D	F	D	C
Approach Vol, veh/h		2116			2380			623			1686	
Approach Delay, s/veh		121.0			48.6			45.9			141.9	
Approach LOS		F			D			D			F	
Timer - Assigned Phs	1	2	3	4	5	6	7	8				
Phs Duration (G+Y+Rc), s	14.0	44.8	11.6	34.0	18.7	40.1	17.5	28.0				
Change Period (Y+Rc), s	3.7	6.2	3.7	6.2	3.7	6.2	3.7	6.2				
Max Green Setting (Gmax), s	10.3	38.6	8.3	43.0	15.0	33.9	13.8	37.5				
Max Q Clear Time (g_c+I1), s	12.3	40.6	8.2	21.8	16.2	35.9	15.8	16.2				
Green Ext Time (p_c), s	0.0	0.0	0.0	5.4	0.0	0.0	0.0	2.6				
Intersection Summary												
HCM 6th Ctrl Delay			94.0									
HCM 6th LOS			F									

Intersection	
Intersection Delay, s/veh	9.7
Intersection LOS	A

Movement	EBT	EBR	WBL	WBT	NBL	NBR
Lane Configurations	↔		↔	↑	↔	↔
Traffic Vol, veh/h	233	21	25	152	31	41
Future Vol, veh/h	233	21	25	152	31	41
Peak Hour Factor	0.92	0.92	0.92	0.92	0.92	0.92
Heavy Vehicles, %	1	0	5	2	0	0
Mvmt Flow	253	23	27	165	34	45
Number of Lanes	1	0	1	1	1	1

Approach	EB	WB	NB
Opposing Approach	WB	EB	
Opposing Lanes	2	1	0
Conflicting Approach Left		NB	EB
Conflicting Lanes Left	0	2	1
Conflicting Approach Right	NB		WB
Conflicting Lanes Right	2	0	2
HCM Control Delay	10.4	9.1	8.5
HCM LOS	B	A	A

Lane	NBLn1	NBLn2	EBLn1	WBLn1	WBLn2
Vol Left, %	100%	0%	0%	100%	0%
Vol Thru, %	0%	0%	92%	0%	100%
Vol Right, %	0%	100%	8%	0%	0%
Sign Control	Stop	Stop	Stop	Stop	Stop
Traffic Vol by Lane	31	41	254	25	152
LT Vol	31	0	0	25	0
Through Vol	0	0	233	0	152
RT Vol	0	41	21	0	0
Lane Flow Rate	34	45	276	27	165
Geometry Grp	7	7	4	7	7
Degree of Util (X)	0.057	0.061	0.36	0.042	0.228
Departure Headway (Hd)	6.118	4.909	4.7	5.517	4.963
Convergence, Y/N	Yes	Yes	Yes	Yes	Yes
Cap	586	729	768	650	725
Service Time	3.851	2.641	2.72	3.239	2.685
HCM Lane V/C Ratio	0.058	0.062	0.359	0.042	0.228
HCM Control Delay	9.2	8	10.4	8.5	9.2
HCM Lane LOS	A	A	B	A	A
HCM 95th-tile Q	0.2	0.2	1.6	0.1	0.9

Intersection

Intersection Delay, s/veh 11.4
 Intersection LOS B

Movement	EBL	EBT	EBR	WBL	WBT	WBR	NBL	NBT	NBR	SBL	SBT	SBR
Lane Configurations	↖	↕		↖	↕			↕			↕	
Traffic Vol, veh/h	49	526	17	4	314	53	21	5	2	31	9	22
Future Vol, veh/h	49	526	17	4	314	53	21	5	2	31	9	22
Peak Hour Factor	0.96	0.96	0.96	0.96	0.96	0.96	0.96	0.96	0.96	0.96	0.96	0.96
Heavy Vehicles, %	5	2	7	0	1	0	6	0	0	0	0	0
Mvmt Flow	51	548	18	4	327	55	22	5	2	32	9	23
Number of Lanes	1	2	0	1	2	0	0	1	0	0	1	0

Approach	EB	WB	NB	SB
Opposing Approach	WB	EB	SB	NB
Opposing Lanes	3	3	1	1
Conflicting Approach Left SB		NB	EB	WB
Conflicting Lanes Left	1	1	3	3
Conflicting Approach Right NB		SB	WB	EB
Conflicting Lanes Right	1	1	3	3
HCM Control Delay	12.2	10.3	10.4	10.3
HCM LOS	B	B	B	B

Lane	NBLn1	EBLn1	EBLn2	EBLn3	WBLn1	WBLn2	WBLn3	SBLn1
Vol Left, %	75%	100%	0%	0%	100%	0%	0%	50%
Vol Thru, %	18%	0%	100%	91%	0%	100%	66%	15%
Vol Right, %	7%	0%	0%	9%	0%	0%	34%	35%
Sign Control	Stop	Stop	Stop	Stop	Stop	Stop	Stop	Stop
Traffic Vol by Lane	28	49	351	192	4	209	158	62
LT Vol	21	49	0	0	4	0	0	31
Through Vol	5	0	351	175	0	209	105	9
RT Vol	2	0	0	17	0	0	53	22
Lane Flow Rate	29	51	365	200	4	218	164	65
Geometry Grp	7	7	7	7	7	7	7	7
Degree of Util (X)	0.058	0.082	0.528	0.291	0.007	0.329	0.236	0.12
Departure Headway (Hd)	7.208	5.758	5.204	5.228	5.912	5.426	5.172	6.694
Convergence, Y/N	Yes	Yes	Yes	Yes	Yes	Yes	Yes	Yes
Cap	500	618	687	681	600	656	687	539
Service Time	4.911	3.536	2.982	3.005	3.699	3.213	2.959	4.395
HCM Lane V/C Ratio	0.058	0.083	0.531	0.294	0.007	0.332	0.239	0.121
HCM Control Delay	10.4	9.1	13.7	10.2	8.7	10.9	9.6	10.3
HCM Lane LOS	B	A	B	B	A	B	A	B
HCM 95th-tile Q	0.2	0.3	3.1	1.2	0	1.4	0.9	0.4

Timings

11: Barton St & Alessandro Bl.

09/19/2022



Lane Group	EBL	EBT	WBL	WBT	NBL	NBT	NBR	SBL	SBT	SBR
Lane Configurations	↙	↗↗↗	↙	↗↗↗		↖	↖		↖	↖
Traffic Volume (vph)	6	2241	77	2381	54	1	38	15	0	14
Future Volume (vph)	6	2241	77	2381	54	1	38	15	0	14
Turn Type	Prot	NA	Prot	NA	Perm	NA	Perm	Perm	NA	Perm
Protected Phases	5	2	1	6		8			4	
Permitted Phases					8		8	4		4
Detector Phase	5	2	1	6	8	8	8	4	4	4
Switch Phase										
Minimum Initial (s)	5.0	10.0	5.0	10.0	10.0	10.0	10.0	10.0	10.0	10.0
Minimum Split (s)	9.2	28.5	11.0	28.5	40.6	40.6	40.6	26.6	26.6	26.6
Total Split (s)	9.2	65.4	14.0	70.2	40.6	40.6	40.6	40.6	40.6	40.6
Total Split (%)	7.7%	54.5%	11.7%	58.5%	33.8%	33.8%	33.8%	33.8%	33.8%	33.8%
Yellow Time (s)	3.2	5.5	3.2	5.5	3.6	3.6	3.6	3.6	3.6	3.6
All-Red Time (s)	1.0	1.0	1.0	1.0	1.0	1.0	1.0	1.0	1.0	1.0
Lost Time Adjust (s)	0.0	0.0	0.0	0.0		0.0	0.0		0.0	0.0
Total Lost Time (s)	4.2	6.5	4.2	6.5		4.6	4.6		4.6	4.6
Lead/Lag	Lead	Lag	Lead	Lag						
Lead-Lag Optimize?	Yes	Yes	Yes	Yes						
Recall Mode	None	None	None	None	None	None	None	None	None	None
Act Effct Green (s)	5.1	63.7	8.0	72.1		14.5	14.5		14.5	14.5
Actuated g/C Ratio	0.05	0.68	0.09	0.77		0.15	0.15		0.15	0.15
v/c Ratio	0.07	0.69	0.52	0.64		0.28	0.12		0.08	0.04
Control Delay	51.3	15.8	57.7	10.6		39.4	0.7		35.1	0.2
Queue Delay	0.0	0.0	0.0	0.0		0.0	0.0		0.0	0.0
Total Delay	51.3	15.8	57.7	10.6		39.4	0.7		35.1	0.2
LOS	D	B	E	B		D	A		D	A
Approach Delay		15.9		12.1		23.5			18.2	
Approach LOS		B		B		C			B	

Intersection Summary

Cycle Length: 120
 Actuated Cycle Length: 93.8
 Natural Cycle: 105
 Control Type: Actuated-Uncoordinated
 Maximum v/c Ratio: 0.69
 Intersection Signal Delay: 14.1
 Intersection LOS: B
 Intersection Capacity Utilization 76.1%
 ICU Level of Service D
 Analysis Period (min) 15

Splits and Phases: 11: Barton St & Alessandro Bl.



HCM 6th Signalized Intersection Summary
11: Barton St & Alessandro Bl.

West Campus Upper Plateau (JN 14064)

09/19/2022



Movement	EBL	EBT	EBR	WBL	WBT	WBR	NBL	NBT	NBR	SBL	SBT	SBR
Lane Configurations	↗	↑↑↑		↖	↑↑↑			↑	↗		↑	↖
Traffic Volume (veh/h)	6	2241	46	77	2381	17	54	1	38	15	0	14
Future Volume (veh/h)	6	2241	46	77	2381	17	54	1	38	15	0	14
Initial Q (Qb), veh	0	0	0	0	0	0	0	0	0	0	0	0
Ped-Bike Adj(A_pbT)	1.00		1.00	1.00		0.98	1.00		1.00	1.00		1.00
Parking Bus, Adj	1.00	1.00	1.00	1.00	1.00	1.00	1.00	1.00	1.00	1.00	1.00	1.00
Work Zone On Approach		No			No			No			No	
Adj Sat Flow, veh/h/ln	1604	1885	1900	1900	1870	1900	1870	1900	1900	1796	1900	1900
Adj Flow Rate, veh/h	6	2334	46	80	2480	18	56	1	14	16	0	5
Peak Hour Factor	0.96	0.96	0.96	0.96	0.96	0.96	0.96	0.96	0.96	0.96	0.96	0.96
Percent Heavy Veh, %	20	1	0	0	2	0	2	0	0	7	0	0
Cap, veh/h	12	3119	61	103	3396	25	81	1	287	81	0	287
Arrive On Green	0.01	0.60	0.60	0.06	0.65	0.65	0.18	0.18	0.18	0.18	0.00	0.18
Sat Flow, veh/h	1527	5196	102	1810	5229	38	21	4	1610	21	0	1610
Grp Volume(v), veh/h	6	1539	841	80	1613	885	57	0	14	16	0	5
Grp Sat Flow(s),veh/h/ln	1527	1716	1867	1810	1702	1863	26	0	1610	21	0	1610
Q Serve(g_s), s	0.4	30.2	30.4	4.1	29.4	29.5	0.3	0.0	0.7	0.3	0.0	0.2
Cycle Q Clear(g_c), s	0.4	30.2	30.4	4.1	29.4	29.5	16.6	0.0	0.7	16.6	0.0	0.2
Prop In Lane	1.00		0.05	1.00		0.02	0.98		1.00	1.00		1.00
Lane Grp Cap(c), veh/h	12	2060	1121	103	2211	1210	81	0	287	81	0	287
V/C Ratio(X)	0.51	0.75	0.75	0.78	0.73	0.73	0.70	0.00	0.05	0.20	0.00	0.02
Avail Cap(c_a), veh/h	82	2174	1183	191	2332	1276	382	0	623	378	0	623
HCM Platoon Ratio	1.00	1.00	1.00	1.00	1.00	1.00	1.00	1.00	1.00	1.00	1.00	1.00
Upstream Filter(I)	1.00	1.00	1.00	1.00	1.00	1.00	1.00	0.00	1.00	1.00	0.00	1.00
Uniform Delay (d), s/veh	46.0	13.5	13.5	43.3	10.9	10.9	46.3	0.0	31.7	46.5	0.0	31.5
Incr Delay (d2), s/veh	12.2	1.5	2.8	4.7	1.2	2.3	10.4	0.0	0.1	1.2	0.0	0.0
Initial Q Delay(d3),s/veh	0.0	0.0	0.0	0.0	0.0	0.0	0.0	0.0	0.0	0.0	0.0	0.0
%ile BackOfQ(50%),veh/ln	0.2	9.2	10.5	1.9	9.8	11.1	1.5	0.0	0.3	0.4	0.0	0.1
Unsig. Movement Delay, s/veh												
LnGrp Delay(d),s/veh	58.2	15.0	16.3	48.0	12.1	13.2	56.7	0.0	31.7	47.6	0.0	31.5
LnGrp LOS	E	B	B	D	B	B	E	A	C	D	A	C
Approach Vol, veh/h		2386			2578			71				21
Approach Delay, s/veh		15.6			13.6			51.7				43.8
Approach LOS		B			B			D				D
Timer - Assigned Phs	1	2		4	5	6		8				
Phs Duration (G+Y+Rc), s	9.5	62.4		21.4	4.9	66.9		21.4				
Change Period (Y+Rc), s	* 4.2	6.5		4.6	* 4.2	6.5		4.6				
Max Green Setting (Gmax), s	* 9.8	58.9		36.0	* 5	63.7		36.0				
Max Q Clear Time (g_c+I1), s	6.1	32.4		18.6	2.4	31.5		18.6				
Green Ext Time (p_c), s	0.0	22.4		0.0	0.0	29.0		0.2				

Intersection Summary

HCM 6th Ctrl Delay	15.2
HCM 6th LOS	B

Notes

* HCM 6th computational engine requires equal clearance times for the phases crossing the barrier.

Intersection						
Int Delay, s/veh	1.2					
Movement	EBL	EBT	WBT	WBR	SBL	SBR
Lane Configurations						
Traffic Vol, veh/h	36	239	146	23	2	30
Future Vol, veh/h	36	239	146	23	2	30
Conflicting Peds, #/hr	0	0	0	7	0	0
Sign Control	Free	Free	Free	Free	Stop	Stop
RT Channelized	-	None	-	None	-	None
Storage Length	100	-	-	-	0	-
Veh in Median Storage, #	-	0	0	-	0	-
Grade, %	-	0	0	-	0	-
Peak Hour Factor	94	94	94	94	94	94
Heavy Vehicles, %	0	0	1	0	0	0
Mvmt Flow	38	254	155	24	2	32

Major/Minor	Major1	Major2	Minor2		
Conflicting Flow All	186	0	-	0	504
Stage 1	-	-	-	-	174
Stage 2	-	-	-	-	330
Critical Hdwy	4.1	-	-	-	6.4
Critical Hdwy Stg 1	-	-	-	-	5.4
Critical Hdwy Stg 2	-	-	-	-	5.4
Follow-up Hdwy	2.2	-	-	-	3.5
Pot Cap-1 Maneuver	1401	-	-	-	531
Stage 1	-	-	-	-	861
Stage 2	-	-	-	-	733
Platoon blocked, %		-	-	-	
Mov Cap-1 Maneuver	1392	-	-	-	509
Mov Cap-2 Maneuver	-	-	-	-	509
Stage 1	-	-	-	-	832
Stage 2	-	-	-	-	728

Approach	EB	WB	SB
HCM Control Delay, s	1	0	9.5
HCM LOS			A

Minor Lane/Major Mvmt	EBL	EBT	WBT	WBR	SBLn1
Capacity (veh/h)	1392	-	-	-	832
HCM Lane V/C Ratio	0.028	-	-	-	0.041
HCM Control Delay (s)	7.7	-	-	-	9.5
HCM Lane LOS	A	-	-	-	A
HCM 95th %tile Q(veh)	0.1	-	-	-	0.1

Intersection						
Int Delay, s/veh	3.5					
Movement	EBT	EBR	WBL	WBT	NBL	NBR
Lane Configurations	↑↑		↖	↑↑	↘	
Traffic Vol, veh/h	429	129	47	258	113	45
Future Vol, veh/h	429	129	47	258	113	45
Conflicting Peds, #/hr	0	2	0	0	0	0
Sign Control	Free	Free	Free	Free	Stop	Stop
RT Channelized	-	None	-	None	-	None
Storage Length	-	-	125	-	0	-
Veh in Median Storage, #	0	-	-	0	0	-
Grade, %	0	-	-	0	0	-
Peak Hour Factor	97	97	97	97	97	97
Heavy Vehicles, %	1	1	0	0	0	0
Mvmt Flow	442	133	48	266	116	46

Major/Minor	Major1	Major2	Minor1	Minor2	Minor3
Conflicting Flow All	0	0	577	0	740
Stage 1	-	-	-	-	511
Stage 2	-	-	-	-	229
Critical Hdwy	-	-	4.1	-	6.8
Critical Hdwy Stg 1	-	-	-	-	5.8
Critical Hdwy Stg 2	-	-	-	-	5.8
Follow-up Hdwy	-	-	2.2	-	3.5
Pot Cap-1 Maneuver	-	-	1006	-	357
Stage 1	-	-	-	-	573
Stage 2	-	-	-	-	793
Platoon blocked, %	-	-	-	-	-
Mov Cap-1 Maneuver	-	-	1004	-	339
Mov Cap-2 Maneuver	-	-	-	-	339
Stage 1	-	-	-	-	572
Stage 2	-	-	-	-	755

Approach	EB	WB	NB
HCM Control Delay, s	0	1.4	20.2
HCM LOS			C

Minor Lane/Major Mvmt	NBLn1	EBT	EBR	WBL	WBT
Capacity (veh/h)	398	-	-	1004	-
HCM Lane V/C Ratio	0.409	-	-	0.048	-
HCM Control Delay (s)	20.2	-	-	8.8	-
HCM Lane LOS	C	-	-	A	-
HCM 95th %tile Q(veh)	1.9	-	-	0.2	-

Timings

14: Barton Rd. & Van Buren Bl.

09/19/2022



Lane Group	EBL	EBT	WBL	WBT	NBL	NBT	NBR	SBL	SBT
Lane Configurations	↘	↕	↘	↕	↘	↕	↗	↘	↕
Traffic Volume (vph)	192	1945	271	1980	348	93	240	11	31
Future Volume (vph)	192	1945	271	1980	348	93	240	11	31
Turn Type	Prot	NA	Prot	NA	Prot	NA	Perm	Prot	NA
Protected Phases	5	2	1	6	3	8		7	4
Permitted Phases							8		
Detector Phase	5	2	1	6	3	8	8	7	4
Switch Phase									
Minimum Initial (s)	5.0	10.0	5.0	10.0	5.0	10.0	10.0	5.0	10.0
Minimum Split (s)	9.2	25.2	9.2	25.5	9.1	14.6	14.6	9.1	33.6
Total Split (s)	17.6	52.1	22.2	56.7	12.1	36.3	36.3	9.4	33.6
Total Split (%)	14.7%	43.4%	18.5%	47.3%	10.1%	30.3%	30.3%	7.8%	28.0%
Yellow Time (s)	3.2	5.2	3.2	5.5	3.6	3.6	3.6	3.6	3.6
All-Red Time (s)	1.0	1.0	1.0	1.0	0.5	1.0	1.0	0.5	1.0
Lost Time Adjust (s)	0.0	0.0	0.0	0.0	0.0	0.0	0.0	0.0	0.0
Total Lost Time (s)	4.2	6.2	4.2	6.5	4.1	4.6	4.6	4.1	4.6
Lead/Lag	Lead	Lag	Lead	Lag	Lead	Lag	Lag	Lead	Lag
Lead-Lag Optimize?	Yes	Yes	Yes	Yes	Yes	Yes	Yes	Yes	Yes
Recall Mode	None	None	None	None	None	None	None	None	None
Act Effct Green (s)	13.5	46.1	18.1	50.5	8.0	24.0	24.0	5.3	13.4
Actuated g/C Ratio	0.13	0.44	0.17	0.48	0.08	0.23	0.23	0.05	0.13
v/c Ratio	0.87	1.55	0.92	0.85	1.35	0.22	0.46	0.12	0.57
Control Delay	79.0	277.1	78.0	28.8	220.1	34.7	7.2	53.6	15.8
Queue Delay	0.0	0.0	0.0	0.0	0.0	0.0	0.0	0.0	0.0
Total Delay	79.0	277.1	78.0	28.8	220.1	34.7	7.2	53.6	15.8
LOS	E	F	E	C	F	C	A	D	B
Approach Delay		261.7		34.7		119.8			17.7
Approach LOS		F		C		F			B

Intersection Summary

Cycle Length: 120
 Actuated Cycle Length: 104.9
 Natural Cycle: 120
 Control Type: Actuated-Uncoordinated
 Maximum v/c Ratio: 1.55
 Intersection Signal Delay: 144.2
 Intersection LOS: F
 Intersection Capacity Utilization 117.2%
 ICU Level of Service H
 Analysis Period (min) 15

Splits and Phases: 14: Barton Rd. & Van Buren Bl.



HCM 6th Signalized Intersection Summary
14: Barton Rd. & Van Buren Bl.

West Campus Upper Plateau (JN 14064)

09/19/2022



Movement	EBL	EBT	EBR	WBL	WBT	WBR	NBL	NBT	NBR	SBL	SBT	SBR
Lane Configurations	↗	↗↘		↗	↗↘↙		↗↘	↑	↗	↗	↘	↘
Traffic Volume (veh/h)	192	1945	333	271	1980	6	348	93	240	11	31	168
Future Volume (veh/h)	192	1945	333	271	1980	6	348	93	240	11	31	168
Initial Q (Qb), veh	0	0	0	0	0	0	0	0	0	0	0	0
Ped-Bike Adj(A_pbT)	1.00		1.00	1.00		1.00	1.00		0.95	1.00		1.00
Parking Bus, Adj	1.00	1.00	1.00	1.00	1.00	1.00	1.00	1.00	1.00	1.00	1.00	1.00
Work Zone On Approach		No			No			No				No
Adj Sat Flow, veh/h/ln	1900	1870	1885	1885	1870	1870	1900	1900	1885	1900	1841	1900
Adj Flow Rate, veh/h	200	2026	318	282	2062	-4	362	97	126	11	32	117
Peak Hour Factor	0.96	0.96	0.96	0.96	0.96	0.96	0.96	0.96	0.96	0.96	0.96	0.96
Percent Heavy Veh, %	0	2	1	1	2	2	0	0	1	0	4	0
Cap, veh/h	231	1373	210	311	2504	0	272	344	275	24	40	148
Arrive On Green	0.13	0.44	0.44	0.17	0.49	0.00	0.08	0.18	0.18	0.01	0.12	0.12
Sat Flow, veh/h	1810	3089	472	1795	5274	0	3510	1900	1520	1810	346	1266
Grp Volume(v), veh/h	200	1142	1202	282	2058	0	362	97	126	11	0	149
Grp Sat Flow(s),veh/h/ln	1810	1777	1785	1795	1702	0	1755	1900	1520	1810	0	1613
Q Serve(g_s), s	11.2	45.9	45.9	15.9	35.5	0.0	8.0	4.5	7.6	0.6	0.0	9.3
Cycle Q Clear(g_c), s	11.2	45.9	45.9	15.9	35.5	0.0	8.0	4.5	7.6	0.6	0.0	9.3
Prop In Lane	1.00		0.26	1.00		0.00	1.00		1.00	1.00		0.79
Lane Grp Cap(c), veh/h	231	790	793	311	2504	0	272	344	275	24	0	188
V/C Ratio(X)	0.87	1.45	1.52	0.91	0.82	0.00	1.33	0.28	0.46	0.46	0.00	0.79
Avail Cap(c_a), veh/h	235	790	793	313	2504	0	272	583	466	93	0	453
HCM Platoon Ratio	1.00	1.00	1.00	1.00	1.00	1.00	1.00	1.00	1.00	1.00	1.00	1.00
Upstream Filter(I)	1.00	1.00	1.00	1.00	1.00	0.00	1.00	1.00	1.00	1.00	0.00	1.00
Uniform Delay (d), s/veh	44.2	28.7	28.7	41.9	22.5	0.0	47.6	36.5	37.7	50.6	0.0	44.4
Incr Delay (d2), s/veh	25.9	207.8	238.4	27.6	2.2	0.0	172.0	0.4	1.2	13.4	0.0	7.3
Initial Q Delay(d3),s/veh	0.0	0.0	0.0	0.0	0.0	0.0	0.0	0.0	0.0	0.0	0.0	0.0
%ile BackOfQ(50%),veh/ln	6.4	62.9	69.9	9.0	12.9	0.0	9.9	2.1	0.1	0.4	0.0	4.1
Unsig. Movement Delay, s/veh												
LnGrp Delay(d),s/veh	70.1	236.5	267.1	69.4	24.6	0.0	219.7	36.9	38.9	64.0	0.0	51.6
LnGrp LOS	E	F	F	E	C	A	F	D	D	E	A	D
Approach Vol, veh/h		2544			2340			585				160
Approach Delay, s/veh		237.9			30.0			150.4				52.5
Approach LOS		F			C			F				D
Timer - Assigned Phs	1	2	3	4	5	6	7	8				
Phs Duration (G+Y+Rc), s	22.1	52.4	12.1	16.7	17.4	57.1	5.5	23.3				
Change Period (Y+Rc), s	* 4.2	* 6.5	4.1	4.6	* 4.2	6.5	4.1	4.6				
Max Green Setting (Gmax), s	* 18	* 46	8.0	29.0	* 13	50.2	5.3	31.7				
Max Q Clear Time (g_c+I1), s	17.9	47.9	10.0	11.3	13.2	37.5	2.6	9.6				
Green Ext Time (p_c), s	0.0	0.0	0.0	0.8	0.0	7.7	0.0	0.8				

Intersection Summary

HCM 6th Ctrl Delay	137.1
HCM 6th LOS	F

Notes

* HCM 6th computational engine requires equal clearance times for the phases crossing the barrier.

Intersection

Intersection Delay, s/veh	8.8
Intersection LOS	A

Movement	EBT	EBR	WBL	WBT	NBL	NBR
Lane Configurations						
Traffic Vol, veh/h	164	70	40	80	56	66
Future Vol, veh/h	164	70	40	80	56	66
Peak Hour Factor	0.94	0.94	0.94	0.94	0.94	0.94
Heavy Vehicles, %	1	2	3	1	2	0
Mvmt Flow	174	74	43	85	60	70
Number of Lanes	1	0	1	1	1	0

Approach	EB	WB	NB
Opposing Approach	WB	EB	
Opposing Lanes	2	1	0
Conflicting Approach Left		NB	EB
Conflicting Lanes Left	0	1	1
Conflicting Approach Right	NB		WB
Conflicting Lanes Right	1	0	2
HCM Control Delay	9.1	8.5	8.5
HCM LOS	A	A	A

Lane	NBLn1	EBLn1	WBLn1	WBLn2
Vol Left, %	46%	0%	100%	0%
Vol Thru, %	0%	70%	0%	100%
Vol Right, %	54%	30%	0%	0%
Sign Control	Stop	Stop	Stop	Stop
Traffic Vol by Lane	122	234	40	80
LT Vol	56	0	40	0
Through Vol	0	164	0	80
RT Vol	66	70	0	0
Lane Flow Rate	130	249	43	85
Geometry Grp	2	5	7	7
Degree of Util (X)	0.164	0.297	0.066	0.119
Departure Headway (Hd)	4.555	4.3	5.551	5.014
Convergence, Y/N	Yes	Yes	Yes	Yes
Cap	788	836	646	716
Service Time	2.581	2.321	3.275	2.738
HCM Lane V/C Ratio	0.165	0.298	0.067	0.119
HCM Control Delay	8.5	9.1	8.7	8.4
HCM Lane LOS	A	A	A	A
HCM 95th-tile Q	0.6	1.2	0.2	0.4

Intersection	
Intersection Delay, s/veh	8.9
Intersection LOS	A

Movement	EBL	EBT	WBT	WBR	SBL	SBR
Lane Configurations						
Traffic Vol, veh/h	130	324	233	37	28	42
Future Vol, veh/h	130	324	233	37	28	42
Peak Hour Factor	0.97	0.97	0.97	0.97	0.97	0.97
Heavy Vehicles, %	1	0	2	0	4	3
Mvmt Flow	134	334	240	38	29	43
Number of Lanes	1	2	2	0	1	0

Approach	EB	WB	SB
Opposing Approach	WB	EB	
Opposing Lanes	2	3	0
Conflicting Approach Left	SB		WB
Conflicting Lanes Left	1	0	2
Conflicting Approach Right		SB	EB
Conflicting Lanes Right	0	1	3
HCM Control Delay	8.4	9.7	9.4
HCM LOS	A	A	A

Lane	EBLn1	EBLn2	EBLn3	WBLn1	WBLn2	SBLn1
Vol Left, %	100%	0%	0%	0%	0%	40%
Vol Thru, %	0%	100%	100%	100%	68%	0%
Vol Right, %	0%	0%	0%	0%	32%	60%
Sign Control	Stop	Stop	Stop	Stop	Stop	Stop
Traffic Vol by Lane	130	162	162	155	115	70
LT Vol	130	0	0	0	0	28
Through Vol	0	162	162	155	78	0
RT Vol	0	0	0	0	37	42
Lane Flow Rate	134	167	167	160	118	72
Geometry Grp	7	7	7	8	8	7
Degree of Util (X)	0.205	0.231	0.152	0.247	0.174	0.118
Departure Headway (Hd)	5.497	4.977	3.269	5.547	5.286	5.867
Convergence, Y/N	Yes	Yes	Yes	Yes	Yes	Yes
Cap	653	720	1092	645	676	608
Service Time	3.233	2.713	1.005	3.3	3.039	3.632
HCM Lane V/C Ratio	0.205	0.232	0.153	0.248	0.175	0.118
HCM Control Delay	9.7	9.2	6.6	10.1	9.2	9.4
HCM Lane LOS	A	A	A	B	A	A
HCM 95th-tile Q	0.8	0.9	0.5	1	0.6	0.4

Timings
19: Van Buren Bl. & Orange Terrace Pkwy.

West Campus Upper Plateau (JN 14064)

09/19/2022

Lane Group	EBL	EBT	EBR	WBL	WBT	WBR	NBL	NBT	NBR	SBL	SBT	SBR
Lane Configurations												
Traffic Volume (vph)	196	2103	295	177	1883	242	313	48	228	136	44	159
Future Volume (vph)	196	2103	295	177	1883	242	313	48	228	136	44	159
Turn Type	Prot	NA	Perm	Prot	NA	Perm	Prot	NA	Perm	Prot	NA	pm+ov
Protected Phases	5	2		1	6		3	8		7	4	5
Permitted Phases			2			6			8			4
Detector Phase	5	2	2	1	6	6	3	8	8	7	4	5
Switch Phase												
Minimum Initial (s)	5.0	10.0	10.0	5.0	10.0	10.0	5.0	5.0	5.0	10.0	10.0	5.0
Minimum Split (s)	9.2	25.2	25.2	9.1	25.2	25.2	9.1	26.1	26.1	15.8	24.8	9.2
Total Split (s)	16.0	63.0	63.0	11.0	58.0	58.0	12.0	27.0	27.0	19.0	34.0	16.0
Total Split (%)	13.3%	52.5%	52.5%	9.2%	48.3%	48.3%	10.0%	22.5%	22.5%	15.8%	28.3%	13.3%
Yellow Time (s)	3.2	5.2	5.2	3.6	5.2	5.2	3.6	3.6	3.6	4.8	4.8	3.2
All-Red Time (s)	1.0	1.0	1.0	0.5	1.0	1.0	0.5	0.5	0.5	1.0	1.0	1.0
Lost Time Adjust (s)	0.0	0.0	0.0	0.0	0.0	0.0	0.0	0.0	0.0	0.0	0.0	0.0
Total Lost Time (s)	4.2	6.2	6.2	4.1	6.2	6.2	4.1	4.1	4.1	5.8	5.8	4.2
Lead/Lag	Lead	Lag	Lag	Lead	Lag	Lag	Lead	Lag	Lag	Lead	Lag	Lead
Lead-Lag Optimize?	Yes	Yes	Yes	Yes	Yes	Yes	Yes	Yes	Yes	Yes	Yes	Yes
Recall Mode	None	None	None	None	None	None	None	None	None	None	None	None
Act Effct Green (s)	10.0	55.2	55.2	6.9	52.1	52.1	13.9	9.6	9.6	10.7	13.2	22.3
Actuated g/C Ratio	0.10	0.54	0.54	0.07	0.51	0.51	0.14	0.09	0.09	0.10	0.13	0.22
v/c Ratio	0.61	0.80	0.33	0.79	0.77	0.28	0.70	0.15	0.73	0.39	0.19	0.42
Control Delay	53.6	22.8	8.0	72.5	24.0	5.5	55.4	43.8	24.3	48.0	42.1	21.3
Queue Delay	0.0	0.0	0.0	0.0	0.0	0.0	0.0	0.0	0.0	0.0	0.0	0.0
Total Delay	53.6	22.8	8.0	72.5	24.0	5.5	55.4	43.8	24.3	48.0	42.1	21.3
LOS	D	C	A	E	C	A	E	D	C	D	D	C
Approach Delay		23.5			25.8			42.4			34.7	
Approach LOS		C			C			D			C	

Intersection Summary

Cycle Length: 120
 Actuated Cycle Length: 102.8
 Natural Cycle: 100
 Control Type: Actuated-Uncoordinated
 Maximum v/c Ratio: 0.80
 Intersection Signal Delay: 27.0
 Intersection LOS: C
 Intersection Capacity Utilization 76.5%
 ICU Level of Service D
 Analysis Period (min) 15

Splits and Phases: 19: Van Buren Bl. & Orange Terrace Pkwy.

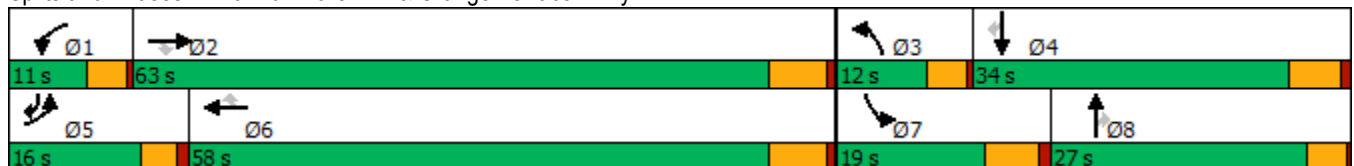

HCM 6th Signalized Intersection Summary
 19: Van Buren Bl. & Orange Terrace Pkwy.

West Campus Upper Plateau (JN 14064)

09/19/2022



Movement	EBL	EBT	EBR	WBL	WBT	WBR	NBL	NBT	NBR	SBL	SBT	SBR
Lane Configurations	↖↗	↑↑↑	↖	↖↗	↑↑↑	↖	↖↗	↑↑	↖	↖↗	↑	↖↗
Traffic Volume (veh/h)	196	2103	295	177	1883	242	313	48	228	136	44	159
Future Volume (veh/h)	196	2103	295	177	1883	242	313	48	228	136	44	159
Initial Q (Qb), veh	0	0	0	0	0	0	0	0	0	0	0	0
Ped-Bike Adj(A_pbT)	1.00		1.00	1.00		1.00	1.00		1.00	1.00		1.00
Parking Bus, Adj	1.00	1.00	1.00	1.00	1.00	1.00	1.00	1.00	1.00	1.00	1.00	1.00
Work Zone On Approach		No			No			No			No	
Adj Sat Flow, veh/h/ln	1885	1870	1870	1885	1856	1885	1885	1900	1900	1885	1900	1885
Adj Flow Rate, veh/h	204	2191	281	184	1961	193	326	50	207	142	46	93
Peak Hour Factor	0.96	0.96	0.96	0.96	0.96	0.96	0.96	0.96	0.96	0.96	0.96	0.96
Percent Heavy Veh, %	1	2	2	1	3	1	1	0	0	1	0	1
Cap, veh/h	267	2539	788	219	2445	771	251	537	240	318	349	415
Arrive On Green	0.08	0.50	0.50	0.06	0.48	0.48	0.07	0.15	0.15	0.09	0.18	0.18
Sat Flow, veh/h	3483	5106	1585	3483	5066	1598	3483	3610	1610	3483	1900	1598
Grp Volume(v), veh/h	204	2191	281	184	1961	193	326	50	207	142	46	93
Grp Sat Flow(s),veh/h/ln	1742	1702	1585	1742	1689	1598	1742	1805	1610	1742	1900	1598
Q Serve(g_s), s	6.3	41.4	11.9	5.7	35.8	7.8	7.9	1.3	13.8	4.2	2.2	5.0
Cycle Q Clear(g_c), s	6.3	41.4	11.9	5.7	35.8	7.8	7.9	1.3	13.8	4.2	2.2	5.0
Prop In Lane	1.00		1.00	1.00		1.00	1.00		1.00	1.00		1.00
Lane Grp Cap(c), veh/h	267	2539	788	219	2445	771	251	537	240	318	349	415
V/C Ratio(X)	0.76	0.86	0.36	0.84	0.80	0.25	1.30	0.09	0.86	0.45	0.13	0.22
Avail Cap(c_a), veh/h	375	2646	821	219	2445	771	251	754	336	419	489	533
HCM Platoon Ratio	1.00	1.00	1.00	1.00	1.00	1.00	1.00	1.00	1.00	1.00	1.00	1.00
Upstream Filter(I)	1.00	1.00	1.00	1.00	1.00	1.00	1.00	1.00	1.00	1.00	1.00	1.00
Uniform Delay (d), s/veh	49.6	24.3	16.8	50.8	23.9	16.7	50.9	40.3	45.6	47.2	37.4	31.9
Incr Delay (d2), s/veh	3.4	3.1	0.3	24.0	2.0	0.2	160.4	0.1	15.2	1.0	0.2	0.3
Initial Q Delay(d3),s/veh	0.0	0.0	0.0	0.0	0.0	0.0	0.0	0.0	0.0	0.0	0.0	0.0
%ile BackOfQ(50%),veh/ln	2.8	15.5	4.3	3.1	13.2	2.9	9.0	0.6	6.5	1.8	1.0	2.0
Unsig. Movement Delay, s/veh												
LnGrp Delay(d),s/veh	53.1	27.4	17.1	74.8	25.9	16.9	211.3	40.3	60.7	48.2	37.6	32.1
LnGrp LOS	D	C	B	E	C	B	F	D	E	D	D	C
Approach Vol, veh/h		2676			2338			583			281	
Approach Delay, s/veh		28.3			29.0			143.2			41.1	
Approach LOS		C			C			F			D	
Timer - Assigned Phs	1	2	3	4	5	6	7	8				
Phs Duration (G+Y+Rc), s	11.0	60.7	12.0	25.9	12.6	59.1	15.8	22.1				
Change Period (Y+Rc), s	4.1	6.2	4.1	5.8	* 4.2	6.2	5.8	* 5.8				
Max Green Setting (Gmax), s	6.9	56.8	7.9	28.2	* 12	51.8	13.2	* 23				
Max Q Clear Time (g_c+I1), s	7.7	43.4	9.9	7.0	8.3	37.8	6.2	15.8				
Green Ext Time (p_c), s	0.0	11.1	0.0	0.4	0.1	10.5	0.2	0.5				

Intersection Summary

HCM 6th Ctrl Delay	40.6
HCM 6th LOS	D

Notes

* HCM 6th computational engine requires equal clearance times for the phases crossing the barrier.

Timings
20: Brown/San Gorgonio Dr & Alessandro Bl.

West Campus Upper Plateau (JN 14064)

09/19/2022



Lane Group	EBL	EBT	WBT	WBR	NBL	NBT	NBR	SBL	SBT	SBR
Lane Configurations	↖	↗↗↗	↗↗↗	↖	↖	↗	↖	↖	↗	↖
Traffic Volume (vph)	30	2338	2573	33	16	2	26	124	1	78
Future Volume (vph)	30	2338	2573	33	16	2	26	124	1	78
Turn Type	Prot	NA	NA	Perm	Prot	NA	pm+ov	Prot	NA	pm+ov
Protected Phases	5	2	6		3	8	1	7	4	5
Permitted Phases				6			8			4
Detector Phase	5	2	6	6	3	8	1	7	4	5
Switch Phase										
Minimum Initial (s)	5.0	10.0	10.0	10.0	5.0	5.0	5.0	5.0	10.0	5.0
Minimum Split (s)	8.7	43.5	43.5	43.5	9.1	26.1	9.1	8.7	49.8	8.7
Total Split (s)	8.7	52.0	52.4	52.4	9.1	39.3	9.1	19.6	49.8	8.7
Total Split (%)	7.3%	43.3%	43.7%	43.7%	7.6%	32.8%	7.6%	16.3%	41.5%	7.3%
Yellow Time (s)	3.2	5.5	5.5	5.5	3.6	3.6	3.6	3.2	4.8	3.2
All-Red Time (s)	0.5	1.0	1.0	1.0	0.5	0.5	0.5	0.5	1.0	0.5
Lost Time Adjust (s)	0.0	0.0	0.0	0.0	0.0	0.0	0.0	0.0	0.0	0.0
Total Lost Time (s)	3.7	6.5	6.5	6.5	4.1	4.1	4.1	3.7	5.8	3.7
Lead/Lag	Lead	Lag	Lag	Lag	Lead	Lag	Lead	Lead	Lag	Lead
Lead-Lag Optimize?	Yes	Yes	Yes	Yes	Yes	Yes	Yes	Yes	Yes	Yes
Recall Mode	None	None	None	None	None	None	None	None	None	None
Act Effct Green (s)	5.2	51.4	47.7	47.7	5.2	9.9	10.7	13.1	15.1	26.4
Actuated g/C Ratio	0.06	0.61	0.57	0.57	0.06	0.12	0.13	0.16	0.18	0.32
v/c Ratio	0.29	0.79	0.93	0.05	0.16	0.01	0.11	0.49	0.00	0.15
Control Delay	50.6	18.6	26.0	0.1	48.1	31.5	1.0	43.2	26.0	7.4
Queue Delay	0.0	0.0	0.0	0.0	0.0	0.0	0.0	0.0	0.0	0.0
Total Delay	50.6	18.6	26.0	0.1	48.1	31.5	1.0	43.2	26.0	7.4
LOS	D	B	C	A	D	C	A	D	C	A
Approach Delay		19.0	25.6			19.7			29.4	
Approach LOS		B	C			B			C	

Intersection Summary

Cycle Length: 120
 Actuated Cycle Length: 83.8
 Natural Cycle: 115
 Control Type: Actuated-Uncoordinated
 Maximum v/c Ratio: 0.93
 Intersection Signal Delay: 22.7
 Intersection LOS: C
 Intersection Capacity Utilization 73.5%
 ICU Level of Service D
 Analysis Period (min) 15

Splits and Phases: 20: Brown/San Gorgonio Dr & Alessandro Bl.

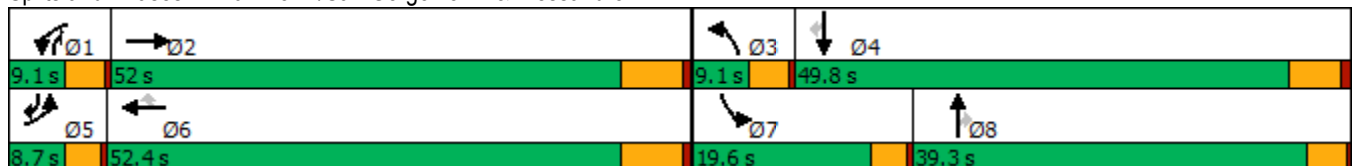

HCM 6th Signalized Intersection Summary
 20: Brown/San Gorgonio Dr & Alessandro Bl.

West Campus Upper Plateau (JN 14064)

09/19/2022

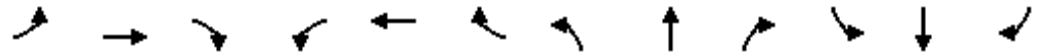

Movement	EBL	EBT	EBR	WBL	WBT	WBR	NBL	NBT	NBR	SBL	SBT	SBR
Lane Configurations	↗	↑↑↑		↖	↑↑↑	↗	↖	↑	↗	↖	↑	↗
Traffic Volume (veh/h)	30	2338	5	0	2573	33	16	2	26	124	1	78
Future Volume (veh/h)	30	2338	5	0	2573	33	16	2	26	124	1	78
Initial Q (Qb), veh	0	0	0	0	0	0	0	0	0	0	0	0
Ped-Bike Adj(A_pbT)	1.00		1.00	1.00		1.00	1.00		1.00	1.00		1.00
Parking Bus, Adj	1.00	1.00	1.00	1.00	1.00	1.00	1.00	1.00	1.00	1.00	1.00	1.00
Work Zone On Approach		No			No			No			No	
Adj Sat Flow, veh/h/ln	1900	1870	1900	1678	1885	1396	1796	1900	1322	1811	1900	1885
Adj Flow Rate, veh/h	32	2461	1	0	2708	31	17	2	14	131	1	34
Peak Hour Factor	0.95	0.95	0.95	0.95	0.95	0.95	0.95	0.95	0.95	0.95	0.95	0.95
Percent Heavy Veh, %	0	2	0	15	1	34	7	0	39	6	0	1
Cap, veh/h	57	3373	1	2	2896	666	34	131	21	164	265	273
Arrive On Green	0.03	0.64	0.64	0.00	0.56	0.56	0.02	0.07	0.07	0.09	0.14	0.14
Sat Flow, veh/h	1810	5272	2	1598	5147	1183	1711	1900	1120	1725	1900	1598
Grp Volume(v), veh/h	32	1589	873	0	2708	31	17	2	14	131	1	34
Grp Sat Flow(s),veh/h/ln	1810	1702	1870	1598	1716	1183	1711	1900	1120	1725	1900	1598
Q Serve(g_s), s	1.4	25.7	25.7	0.0	39.5	1.0	0.8	0.1	5.1	6.1	0.0	1.5
Cycle Q Clear(g_c), s	1.4	25.7	25.7	0.0	39.5	1.0	0.8	0.1	5.1	6.1	0.0	1.5
Prop In Lane	1.00		0.00	1.00		1.00	1.00		1.00	1.00		1.00
Lane Grp Cap(c), veh/h	57	2178	1196	2	2896	666	34	131	21	164	265	273
V/C Ratio(X)	0.56	0.73	0.73	0.00	0.93	0.05	0.51	0.02	0.68	0.80	0.00	0.12
Avail Cap(c_a), veh/h	111	2178	1196	98	2900	667	105	821	428	337	1026	913
HCM Platoon Ratio	1.00	1.00	1.00	1.00	1.00	1.00	1.00	1.00	1.00	1.00	1.00	1.00
Upstream Filter(I)	1.00	1.00	1.00	0.00	1.00	1.00	1.00	1.00	1.00	1.00	1.00	1.00
Uniform Delay (d), s/veh	38.9	9.9	9.9	0.0	16.4	8.0	39.5	35.4	369.9	36.1	30.2	28.6
Incr Delay (d2), s/veh	3.2	1.4	2.5	0.0	6.6	0.0	11.3	0.0	32.2	3.4	0.0	0.2
Initial Q Delay(d3),s/veh	0.0	0.0	0.0	0.0	0.0	0.0	0.0	0.0	0.0	0.0	0.0	0.0
%ile BackOfQ(50%),veh/ln	0.6	6.6	7.6	0.0	15.1	0.2	0.4	0.0	0.2	2.7	0.0	0.6
Unsig. Movement Delay, s/veh												
LnGrp Delay(d),s/veh	42.0	11.3	12.4	0.0	23.1	8.0	50.9	35.4	402.1	39.5	30.2	28.8
LnGrp LOS	D	B	B	A	C	A	D	D	F	D	C	C
Approach Vol, veh/h		2494			2739			33				166
Approach Delay, s/veh		12.1			22.9			199.0				37.3
Approach LOS		B			C			F				D
Timer - Assigned Phs	1	2	3	4	5	6	7	8				
Phs Duration (G+Y+Rc), s	0.0	58.6	5.7	17.1	6.3	52.3	11.4	11.4				
Change Period (Y+Rc), s	4.1	6.5	4.1	5.8	3.7	6.5	3.7	* 5.8				
Max Green Setting (Gmax), s	5.0	45.5	5.0	44.0	5.0	45.9	15.9	* 35				
Max Q Clear Time (g_c+I1), s	0.0	27.7	2.8	3.5	3.4	41.5	8.1	7.1				
Green Ext Time (p_c), s	0.0	16.0	0.0	0.1	0.0	4.3	0.1	0.0				

Intersection Summary

HCM 6th Ctrl Delay	19.4
HCM 6th LOS	B

Notes

* HCM 6th computational engine requires equal clearance times for the phases crossing the barrier.

Timings
22: Sycamore Canyon Bl. & Eastridge Ave

West Campus Upper Plateau (JN 14064)

09/19/2022



Lane Group	EBL	EBT	EBR	WBL	WBT	WBR	NBL	NBT	NBR	SBL	SBT	SBR
Lane Configurations	↖↗	↑↑↑	↖	↖↗	↑↑	↖	↖↗	↑↑	↖	↖↗	↑↑	↖
Traffic Volume (vph)	94	99	53	205	69	366	33	739	202	288	415	20
Future Volume (vph)	94	99	53	205	69	366	33	739	202	288	415	20
Turn Type	Prot	NA	Perm	Prot	NA	pm+ov	Prot	NA	pm+ov	Prot	NA	pm+ov
Protected Phases	5	2		1	6	7	3	8	1	7	4	5
Permitted Phases			2			6			8			4
Detector Phase	5	2	2	1	6	7	3	8	1	7	4	5
Switch Phase												
Minimum Initial (s)	5.0	10.0	10.0	5.0	10.0	5.0	5.0	10.0	5.0	5.0	10.0	5.0
Minimum Split (s)	8.7	43.5	43.5	8.7	43.5	8.7	8.7	15.8	8.7	8.7	49.8	8.7
Total Split (s)	11.7	45.5	45.5	15.2	49.0	20.2	8.7	39.1	15.2	20.2	50.6	11.7
Total Split (%)	9.8%	37.9%	37.9%	12.7%	40.8%	16.8%	7.3%	32.6%	12.7%	16.8%	42.2%	9.8%
Yellow Time (s)	3.2	5.5	5.5	3.2	5.5	3.2	3.2	4.8	3.2	3.2	4.8	3.2
All-Red Time (s)	0.5	1.0	1.0	0.5	1.0	0.5	0.5	1.0	0.5	0.5	1.0	0.5
Lost Time Adjust (s)	0.0	0.0	0.0	0.0	0.0	0.0	0.0	0.0	0.0	0.0	0.0	0.0
Total Lost Time (s)	3.7	6.5	6.5	3.7	6.5	3.7	3.7	5.8	3.7	3.7	5.8	3.7
Lead/Lag	Lead	Lag	Lag	Lead	Lag	Lead	Lead	Lag	Lead	Lead	Lag	Lead
Lead-Lag Optimize?	Yes	Yes	Yes	Yes	Yes	Yes	Yes	Yes	Yes	Yes	Yes	Yes
Recall Mode	None	None	None	None	None	None	None	None	None	None	None	None
Act Effct Green (s)	7.1	13.6	13.6	10.4	19.1	34.6	5.2	26.9	39.4	12.6	38.5	47.8
Actuated g/C Ratio	0.08	0.16	0.16	0.12	0.23	0.41	0.06	0.32	0.47	0.15	0.46	0.57
v/c Ratio	0.42	0.16	0.17	0.59	0.12	0.63	0.20	0.76	0.32	0.64	0.29	0.03
Control Delay	45.8	31.9	1.0	44.2	29.3	20.6	46.2	32.1	5.3	42.0	16.6	0.1
Queue Delay	0.0	0.0	0.0	0.0	0.0	0.0	0.0	0.0	0.0	0.0	0.0	0.0
Total Delay	45.8	31.9	1.0	44.2	29.3	20.6	46.2	32.1	5.3	42.0	16.6	0.1
LOS	D	C	A	D	C	C	D	C	A	D	B	A
Approach Delay		30.5			29.1			27.0			26.2	
Approach LOS		C			C			C			C	

Intersection Summary

Cycle Length: 120
 Actuated Cycle Length: 83.8
 Natural Cycle: 115
 Control Type: Actuated-Uncoordinated
 Maximum v/c Ratio: 0.76
 Intersection Signal Delay: 27.7
 Intersection LOS: C
 Intersection Capacity Utilization 58.9%
 ICU Level of Service B
 Analysis Period (min) 15

Splits and Phases: 22: Sycamore Canyon Bl. & Eastridge Ave

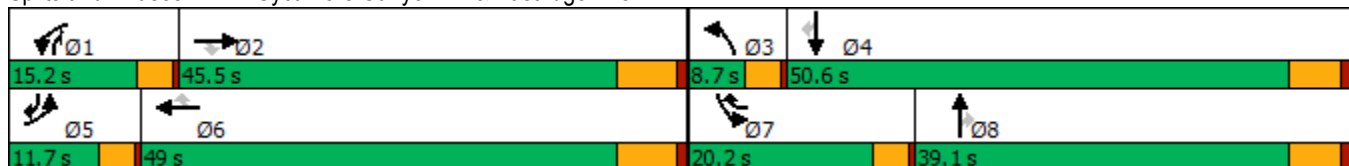

HCM 6th Signalized Intersection Summary
 22: Sycamore Canyon Bl. & Eastridge Ave

West Campus Upper Plateau (JN 14064)

09/19/2022



Movement	EBL	EBT	EBR	WBL	WBT	WBR	NBL	NBT	NBR	SBL	SBT	SBR
Lane Configurations	↖↗	↑↑↑	↖	↖↗	↑↑	↖	↖↗	↑↑	↖	↖↗	↑↑	↖
Traffic Volume (veh/h)	94	99	53	205	69	366	33	739	202	288	415	20
Future Volume (veh/h)	94	99	53	205	69	366	33	739	202	288	415	20
Initial Q (Qb), veh	0	0	0	0	0	0	0	0	0	0	0	0
Ped-Bike Adj(A_pbT)	1.00		1.00	1.00		1.00	1.00		0.99	1.00		0.99
Parking Bus, Adj	1.00	1.00	1.00	1.00	1.00	1.00	1.00	1.00	1.00	1.00	1.00	1.00
Work Zone On Approach		No			No			No			No	
Adj Sat Flow, veh/h/ln	1663	1604	1841	1752	1426	1796	1648	1811	1544	1841	1841	1559
Adj Flow Rate, veh/h	106	111	0	230	78	227	37	830	170	324	466	18
Peak Hour Factor	0.89	0.89	0.89	0.89	0.89	0.89	0.89	0.89	0.89	0.89	0.89	0.89
Percent Heavy Veh, %	16	20	4	10	32	7	17	6	24	4	4	23
Cap, veh/h	197	677		323	516	483	113	1120	551	433	1454	627
Arrive On Green	0.06	0.15	0.00	0.10	0.19	0.19	0.04	0.33	0.33	0.13	0.42	0.42
Sat Flow, veh/h	3072	4378	1560	3237	2709	1520	3045	3441	1292	3401	3497	1304
Grp Volume(v), veh/h	106	111	0	230	78	227	37	830	170	324	466	18
Grp Sat Flow(s),veh/h/ln	1536	1459	1560	1618	1354	1520	1522	1721	1292	1700	1749	1304
Q Serve(g_s), s	2.3	1.5	0.0	4.6	1.6	8.1	0.8	14.4	5.9	6.2	6.0	0.5
Cycle Q Clear(g_c), s	2.3	1.5	0.0	4.6	1.6	8.1	0.8	14.4	5.9	6.2	6.0	0.5
Prop In Lane	1.00		1.00	1.00		1.00	1.00		1.00	1.00		1.00
Lane Grp Cap(c), veh/h	197	677		323	516	483	113	1120	551	433	1454	627
V/C Ratio(X)	0.54	0.16		0.71	0.15	0.47	0.33	0.74	0.31	0.75	0.32	0.03
Avail Cap(c_a), veh/h	365	2536		553	1710	1153	226	1702	770	834	2328	952
HCM Platoon Ratio	1.00	1.00	1.00	1.00	1.00	1.00	1.00	1.00	1.00	1.00	1.00	1.00
Upstream Filter(I)	1.00	1.00	0.00	1.00	1.00	1.00	1.00	1.00	1.00	1.00	1.00	1.00
Uniform Delay (d), s/veh	30.5	24.7	0.0	29.4	22.7	18.4	31.6	20.2	12.8	28.3	13.3	9.2
Incr Delay (d2), s/veh	0.9	0.2	0.0	1.1	0.2	1.0	0.6	1.0	0.3	1.0	0.1	0.0
Initial Q Delay(d3),s/veh	0.0	0.0	0.0	0.0	0.0	0.0	0.0	0.0	0.0	0.0	0.0	0.0
%ile BackOfQ(50%),veh/ln	0.8	0.5	0.0	1.7	0.5	2.6	0.3	5.1	1.5	2.3	2.0	0.1
Unsig. Movement Delay, s/veh												
LnGrp Delay(d),s/veh	31.4	24.8	0.0	30.5	22.9	19.4	32.2	21.2	13.1	29.3	13.4	9.3
LnGrp LOS	C	C		C	C	B	C	C	B	C	B	A
Approach Vol, veh/h		217			535			1037			808	
Approach Delay, s/veh		28.0			24.7			20.2			19.7	
Approach LOS		C			C			C			B	
Timer - Assigned Phs	1	2	3	4	5	6	7	8				
Phs Duration (G+Y+Rc), s	10.4	16.9	6.2	33.8	8.0	19.3	12.3	27.7				
Change Period (Y+Rc), s	3.7	6.5	3.7	5.8	3.7	6.5	3.7	5.8				
Max Green Setting (Gmax), s	11.5	39.0	5.0	44.8	8.0	42.5	16.5	33.3				
Max Q Clear Time (g_c+I1), s	6.6	3.5	2.8	8.0	4.3	10.1	8.2	16.4				
Green Ext Time (p_c), s	0.2	0.9	0.0	3.1	0.0	1.9	0.4	5.5				

Intersection Summary

HCM 6th Ctrl Delay	21.6
HCM 6th LOS	C

Notes

Unsignalized Delay for [EBR] is excluded from calculations of the approach delay and intersection delay.

Timings
23: Sycamore Canyon Bl. & Cottonwood Ave

West Campus Upper Plateau (JN 14064)

09/19/2022



Lane Group	WBL	WBR	NBT	SBL	SBT
Lane Configurations	↙	↗	↕	↙	↕
Traffic Volume (vph)	71	63	857	53	690
Future Volume (vph)	71	63	857	53	690
Turn Type	Prot	Perm	NA	Prot	NA
Protected Phases	8		2	1	6
Permitted Phases		8			
Detector Phase	8	8	2	1	6
Switch Phase					
Minimum Initial (s)	10.0	10.0	10.0	5.0	10.0
Minimum Split (s)	15.8	15.8	43.5	9.1	43.5
Total Split (s)	23.0	23.0	78.0	19.0	97.0
Total Split (%)	19.2%	19.2%	65.0%	15.8%	80.8%
Yellow Time (s)	4.8	4.8	5.5	3.6	5.5
All-Red Time (s)	1.0	1.0	1.0	0.5	1.0
Lost Time Adjust (s)	0.0	0.0	0.0	0.0	0.0
Total Lost Time (s)	5.8	5.8	6.5	4.1	6.5
Lead/Lag			Lag	Lead	
Lead-Lag Optimize?			Yes	Yes	
Recall Mode	None	None	None	None	None
Act Effct Green (s)	13.6	13.6	36.6	10.1	43.8
Actuated g/C Ratio	0.22	0.22	0.60	0.16	0.71
v/c Ratio	0.29	0.28	0.52	0.30	0.32
Control Delay	32.4	11.8	13.3	34.8	5.2
Queue Delay	0.0	0.0	0.0	0.0	0.0
Total Delay	32.4	11.8	13.3	34.8	5.2
LOS	C	B	B	C	A
Approach Delay	22.7		13.3		7.4
Approach LOS	C		B		A

Intersection Summary

Cycle Length: 120
 Actuated Cycle Length: 61.3
 Natural Cycle: 70
 Control Type: Actuated-Uncoordinated
 Maximum v/c Ratio: 0.52
 Intersection Signal Delay: 11.5
 Intersection LOS: B
 Intersection Capacity Utilization 51.1%
 ICU Level of Service A
 Analysis Period (min) 15

Splits and Phases: 23: Sycamore Canyon Bl. & Cottonwood Ave



HCM 6th Signalized Intersection Summary
23: Sycamore Canyon Bl. & Cottonwood Ave

West Campus Upper Plateau (JN 14064)
09/19/2022



Movement	WBL	WBR	NBT	NBR	SBL	SBT
Lane Configurations						
Traffic Volume (veh/h)	71	63	857	40	53	690
Future Volume (veh/h)	71	63	857	40	53	690
Initial Q (Qb), veh	0	0	0	0	0	0
Ped-Bike Adj(A_pbT)	1.00	1.00		0.98	1.00	
Parking Bus, Adj	1.00	1.00	1.00	1.00	1.00	1.00
Work Zone On Approach	No		No			No
Adj Sat Flow, veh/h/ln	1337	818	1811	1544	1263	1870
Adj Flow Rate, veh/h	83	63	997	46	62	802
Peak Hour Factor	0.86	0.86	0.86	0.86	0.86	0.86
Percent Heavy Veh, %	38	73	6	24	43	2
Cap, veh/h	208	113	1608	74	67	2173
Arrive On Green	0.16	0.16	0.48	0.48	0.06	0.61
Sat Flow, veh/h	1273	693	3436	154	1203	3647
Grp Volume(v), veh/h	83	63	513	530	62	802
Grp Sat Flow(s),veh/h/ln	1273	693	1721	1779	1203	1777
Q Serve(g_s), s	3.2	4.6	12.0	12.0	2.8	6.2
Cycle Q Clear(g_c), s	3.2	4.6	12.0	12.0	2.8	6.2
Prop In Lane	1.00	1.00		0.09	1.00	
Lane Grp Cap(c), veh/h	208	113	827	855	67	2173
V/C Ratio(X)	0.40	0.56	0.62	0.62	0.92	0.37
Avail Cap(c_a), veh/h	401	218	2253	2330	328	5891
HCM Platoon Ratio	1.00	1.00	1.00	1.00	1.00	1.00
Upstream Filter(I)	1.00	1.00	1.00	1.00	1.00	1.00
Uniform Delay (d), s/veh	20.4	21.0	10.5	10.5	25.7	5.3
Incr Delay (d2), s/veh	1.2	4.2	1.1	1.1	34.8	0.1
Initial Q Delay(d3),s/veh	0.0	0.0	0.0	0.0	0.0	0.0
%ile BackOfQ(50%),veh/ln	0.9	0.8	3.4	3.5	1.4	1.3
Unsig. Movement Delay, s/veh						
LnGrp Delay(d),s/veh	21.7	25.3	11.6	11.5	60.5	5.5
LnGrp LOS	C	C	B	B	E	A
Approach Vol, veh/h	146		1043			864
Approach Delay, s/veh	23.2		11.6			9.4
Approach LOS	C		B			A
Timer - Assigned Phs	1	2			6	8
Phs Duration (G+Y+Rc), s	7.1	32.7			39.9	14.7
Change Period (Y+Rc), s	4.1	6.5			6.5	5.8
Max Green Setting (Gmax), s	14.9	71.5			90.5	17.2
Max Q Clear Time (g_c+I1), s	4.8	14.0			8.2	6.6
Green Ext Time (p_c), s	0.1	12.2			9.3	0.3

Intersection Summary

HCM 6th Ctrl Delay			11.5			
HCM 6th LOS			B			

Timings

West Campus Upper Plateau (JN 14064)

24: Sycamore Canyon Bl. & Alessandro Bl.

09/19/2022

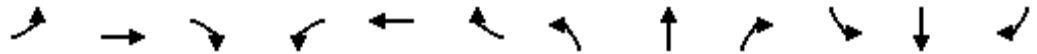

Lane Group	EBL	EBT	EBR	WBL	WBT	WBR	NBL	NBT	NBR	SBL	SBT	SBR
Lane Configurations	↖	↑↑↑	↗	↖↗	↑↑↑	↗	↖↗	↑↑	↖↗	↖↗	↑↑	↗
Traffic Volume (vph)	157	1706	680	369	1881	457	639	493	114	167	614	305
Future Volume (vph)	157	1706	680	369	1881	457	639	493	114	167	614	305
Turn Type	Prot	NA	Perm	Prot	NA	Perm	Prot	NA	pm+ov	Prot	NA	Perm
Protected Phases	5	2		1	6		3	8	1	7	4	
Permitted Phases			2			6			8			4
Detector Phase	5	2	2	1	6	6	3	8	1	7	4	4
Switch Phase												
Minimum Initial (s)	5.0	10.0	10.0	5.0	10.0	10.0	5.0	10.0	5.0	5.0	10.0	10.0
Minimum Split (s)	8.7	43.5	43.5	8.7	43.5	43.5	8.7	15.8	8.7	8.7	49.8	49.8
Total Split (s)	10.0	44.2	44.2	12.0	46.2	46.2	14.0	51.0	12.0	12.8	49.8	49.8
Total Split (%)	8.3%	36.8%	36.8%	10.0%	38.5%	38.5%	11.7%	42.5%	10.0%	10.7%	41.5%	41.5%
Yellow Time (s)	3.2	5.5	5.5	3.2	5.5	5.5	3.2	4.8	3.2	3.2	4.8	4.8
All-Red Time (s)	0.5	1.0	1.0	0.5	1.0	1.0	0.5	1.0	0.5	0.5	1.0	1.0
Lost Time Adjust (s)	0.0	0.0	0.0	0.0	0.0	0.0	0.0	0.0	0.0	0.0	0.0	0.0
Total Lost Time (s)	3.7	6.5	6.5	3.7	6.5	6.5	3.7	5.8	3.7	3.7	5.8	5.8
Lead/Lag	Lead	Lag	Lag	Lead	Lag	Lag	Lead	Lag	Lead	Lead	Lag	Lag
Lead-Lag Optimize?	Yes	Yes	Yes	Yes	Yes	Yes	Yes	Yes	Yes	Yes	Yes	Yes
Recall Mode	None	None	None	None	None	None	None	None	None	None	None	None
Act Effct Green (s)	6.3	37.9	37.9	8.4	40.0	40.0	10.4	28.8	43.0	8.7	27.2	27.2
Actuated g/C Ratio	0.06	0.37	0.37	0.08	0.39	0.39	0.10	0.28	0.41	0.08	0.26	0.26
v/c Ratio	1.45	0.95	0.93	1.47	0.98	0.69	1.88	0.52	0.10	0.67	0.69	0.61
Control Delay	285.3	45.9	42.1	267.8	48.7	23.2	436.7	33.1	8.6	61.7	38.1	23.7
Queue Delay	0.0	0.0	0.0	0.0	0.0	0.0	0.0	0.0	0.0	0.0	0.0	0.0
Total Delay	285.3	45.9	42.1	267.8	48.7	23.2	436.7	33.1	8.6	61.7	38.1	23.7
LOS	F	D	D	F	D	C	F	C	A	E	D	C
Approach Delay		59.7			74.3			237.9			37.7	
Approach LOS		E			E			F			D	

Intersection Summary

Cycle Length: 120
 Actuated Cycle Length: 103.7
 Natural Cycle: 115
 Control Type: Actuated-Uncoordinated
 Maximum v/c Ratio: 1.88
 Intersection Signal Delay: 91.0
 Intersection LOS: F
 Intersection Capacity Utilization 97.2%
 ICU Level of Service F
 Analysis Period (min) 15

Splits and Phases: 24: Sycamore Canyon Bl. & Alessandro Bl.

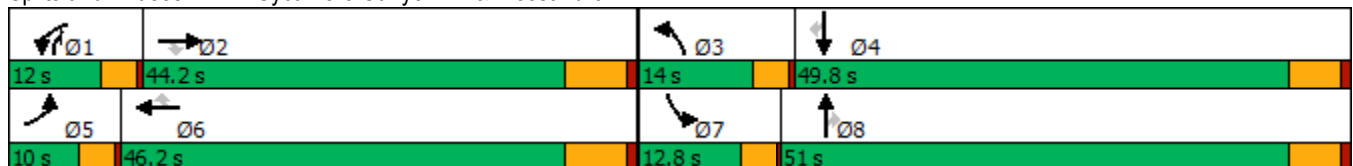

HCM 6th Signalized Intersection Summary
 24: Sycamore Canyon Bl. & Alessandro Bl.

West Campus Upper Plateau (JN 14064)

09/19/2022



Movement	EBL	EBT	EBR	WBL	WBT	WBR	NBL	NBT	NBR	SBL	SBT	SBR
Lane Configurations												
Traffic Volume (veh/h)	157	1706	680	369	1881	457	639	493	114	167	614	305
Future Volume (veh/h)	157	1706	680	369	1881	457	639	493	114	167	614	305
Initial Q (Qb), veh	0	0	0	0	0	0	0	0	0	0	0	0
Ped-Bike Adj(A_pbT)	1.00		1.00	1.00		0.99	1.00		1.00	1.00		1.00
Parking Bus, Adj	1.00	1.00	1.00	1.00	1.00	1.00	1.00	1.00	1.00	1.00	1.00	1.00
Work Zone On Approach		No			No			No			No	
Adj Sat Flow, veh/h/ln	1900	1841	1885	1752	1870	1767	1885	1856	1856	1648	1841	1870
Adj Flow Rate, veh/h	160	1741	503	377	1919	335	652	503	74	170	627	219
Peak Hour Factor	0.98	0.98	0.98	0.98	0.98	0.98	0.98	0.98	0.98	0.98	0.98	0.98
Percent Heavy Veh, %	0	4	1	10	2	9	1	3	3	17	4	2
Cap, veh/h	115	1903	605	270	2037	589	361	933	964	227	824	373
Arrive On Green	0.06	0.38	0.38	0.08	0.40	0.40	0.10	0.26	0.26	0.07	0.24	0.24
Sat Flow, veh/h	1810	5025	1598	3237	5106	1477	3483	3526	2768	3045	3497	1585
Grp Volume(v), veh/h	160	1741	503	377	1919	335	652	503	74	170	627	219
Grp Sat Flow(s),veh/h/ln	1810	1675	1598	1618	1702	1477	1742	1763	1384	1522	1749	1585
Q Serve(g_s), s	6.3	32.7	28.4	8.3	35.9	17.5	10.3	12.2	1.8	5.4	16.6	12.2
Cycle Q Clear(g_c), s	6.3	32.7	28.4	8.3	35.9	17.5	10.3	12.2	1.8	5.4	16.6	12.2
Prop In Lane	1.00		1.00	1.00		1.00	1.00		1.00	1.00		1.00
Lane Grp Cap(c), veh/h	115	1903	605	270	2037	589	361	933	964	227	824	373
V/C Ratio(X)	1.39	0.91	0.83	1.39	0.94	0.57	1.81	0.54	0.08	0.75	0.76	0.59
Avail Cap(c_a), veh/h	115	1907	606	270	2041	590	361	1604	1491	279	1549	702
HCM Platoon Ratio	1.00	1.00	1.00	1.00	1.00	1.00	1.00	1.00	1.00	1.00	1.00	1.00
Upstream Filter(I)	1.00	1.00	1.00	1.00	1.00	1.00	1.00	1.00	1.00	1.00	1.00	1.00
Uniform Delay (d), s/veh	46.5	29.3	28.0	45.5	28.7	23.2	44.5	31.3	21.7	45.0	35.4	33.7
Incr Delay (d2), s/veh	221.7	7.5	9.9	198.3	9.6	1.6	373.2	0.5	0.0	6.3	1.5	1.5
Initial Q Delay(d3),s/veh	0.0	0.0	0.0	0.0	0.0	0.0	0.0	0.0	0.0	0.0	0.0	0.0
%ile BackOfQ(50%),veh/ln	9.8	13.4	11.6	10.7	15.2	5.9	23.0	5.0	0.6	2.2	6.9	4.6
Unsig. Movement Delay, s/veh												
LnGrp Delay(d),s/veh	268.2	36.8	37.9	243.8	38.4	24.8	417.7	31.8	21.7	51.3	36.8	35.1
LnGrp LOS	F	D	D	F	D	C	F	C	C	D	D	D
Approach Vol, veh/h		2404			2631			1229			1016	
Approach Delay, s/veh		52.4			66.1			235.9			38.9	
Approach LOS		D			E			F			D	
Timer - Assigned Phs	1	2	3	4	5	6	7	8				
Phs Duration (G+Y+Rc), s	12.0	44.1	14.0	29.2	10.0	46.1	11.1	32.1				
Change Period (Y+Rc), s	3.7	6.5	3.7	5.8	3.7	6.5	3.7	5.8				
Max Green Setting (Gmax), s	8.3	37.7	10.3	44.0	6.3	39.7	9.1	45.2				
Max Q Clear Time (g_c+I1), s	10.3	34.7	12.3	18.6	8.3	37.9	7.4	14.2				
Green Ext Time (p_c), s	0.0	2.8	0.0	4.8	0.0	1.7	0.0	3.5				

Intersection Summary

HCM 6th Ctrl Delay	86.5
HCM 6th LOS	F

Timings
25: Sycamore Canyon Bl. & Cactus Av.

West Campus Upper Plateau (JN 14064)

09/19/2022



Lane Group	EBL	EBT	EBR	WBL	WBT	WBR	NBT	NBR	SBL	SBT	SBR	Ø5
Lane Configurations	↘	↑↑	↗	↘↗	↑↑	↗	↑↑	↗	↘↗	↑↑	↗	
Traffic Volume (vph)	46	15	16	964	16	616	539	369	743	1121	6	
Future Volume (vph)	46	15	16	964	16	616	539	369	743	1121	6	
Turn Type	Prot	NA	Perm	Prot	NA	Perm	NA	Perm	Prot	NA	Perm	
Protected Phases	7	4		3	8		2		1	6		5
Permitted Phases			4			8		2			6	
Detector Phase	7	4	4	3	8	8	2	2	1	6	6	
Switch Phase												
Minimum Initial (s)	5.0	10.0	10.0	5.0	10.0	10.0	10.0	10.0	5.0	10.0	10.0	5.0
Minimum Split (s)	9.6	32.8	32.8	9.6	32.8	32.8	34.8	34.8	9.6	34.8	34.8	9.6
Total Split (s)	10.3	32.8	32.8	29.0	51.5	51.5	36.2	36.2	22.0	48.6	48.6	9.6
Total Split (%)	8.6%	27.3%	27.3%	24.2%	42.9%	42.9%	30.2%	30.2%	18.3%	40.5%	40.5%	8%
Yellow Time (s)	3.6	4.8	4.8	3.6	4.8	4.8	4.8	4.8	3.6	4.8	4.8	3.6
All-Red Time (s)	1.0	1.0	1.0	1.0	1.0	1.0	1.0	1.0	1.0	1.0	1.0	1.0
Lost Time Adjust (s)	0.0	0.0	0.0	0.0	0.0	0.0	0.0	0.0	0.0	0.0	0.0	0.0
Total Lost Time (s)	4.6	5.8	5.8	4.6	5.8	5.8	5.8	5.8	4.6	5.8	5.8	
Lead/Lag	Lead	Lag	Lag	Lead	Lag	Lag	Lag	Lag	Lead	Lag	Lag	Lead
Lead-Lag Optimize?	Yes	Yes	Yes	Yes	Yes	Yes	Yes	Yes	Yes	Yes	Yes	Yes
Recall Mode	None	None	None	None	None	None	None	None	None	None	None	None
Act Effct Green (s)	5.7	18.9	18.9	29.3	37.4	37.4	26.8	26.8	17.9	49.4	49.4	
Actuated g/C Ratio	0.05	0.18	0.18	0.28	0.35	0.35	0.25	0.25	0.17	0.46	0.46	
v/c Ratio	0.56	0.03	0.04	1.21	0.02	0.92	0.72	0.61	1.48	0.82	0.01	
Control Delay	77.3	36.7	0.2	141.1	23.2	36.3	43.2	7.5	260.8	32.4	0.0	
Queue Delay	0.0	0.0	0.0	0.0	0.0	0.0	0.0	0.0	0.0	0.0	0.0	
Total Delay	77.3	36.7	0.2	141.1	23.2	36.3	43.2	7.5	260.8	32.4	0.0	
LOS	E	D	A	F	C	D	D	A	F	C	A	
Approach Delay		53.1			99.4		28.7			123.1		
Approach LOS		D			F		C			F		

Intersection Summary

Cycle Length: 120
 Actuated Cycle Length: 106.5
 Natural Cycle: 120
 Control Type: Actuated-Uncoordinated
 Maximum v/c Ratio: 1.48
 Intersection Signal Delay: 94.1
 Intersection LOS: F
 Intersection Capacity Utilization 83.8%
 ICU Level of Service E
 Analysis Period (min) 15



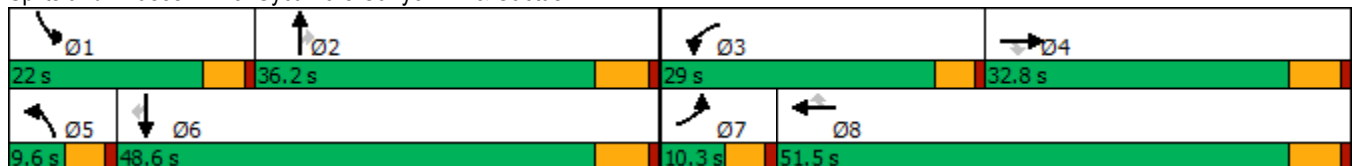





















Splits and Phases: 25: Sycamore Canyon Bl. & Cactus Av.



HCM 6th Signalized Intersection Summary
25: Sycamore Canyon Bl. & Cactus Av.

West Campus Upper Plateau (JN 14064)

09/19/2022

												
Movement	EBL	EBT	EBR	WBL	WBT	WBR	NBL	NBT	NBR	SBL	SBT	SBR
Lane Configurations												
Traffic Volume (veh/h)	46	15	16	964	16	616	0	539	369	743	1121	6
Future Volume (veh/h)	46	15	16	964	16	616	0	539	369	743	1121	6
Initial Q (Qb), veh	0	0	0	0	0	0	0	0	0	0	0	0
Ped-Bike Adj(A_pbT)	1.00		1.00	1.00		1.00	1.00		1.00	1.00		1.00
Parking Bus, Adj	1.00	1.00	1.00	1.00	1.00	1.00	1.00	1.00	1.00	1.00	1.00	1.00
Work Zone On Approach		No			No			No			No	
Adj Sat Flow, veh/h/ln	1870	1678	1796	1841	1796	1870	1900	1841	1826	1885	1811	1011
Adj Flow Rate, veh/h	53	17	9	1121	19	446	0	627	326	864	1303	7
Peak Hour Factor	0.86	0.86	0.86	0.86	0.86	0.86	0.86	0.86	0.86	0.86	0.86	0.86
Percent Heavy Veh, %	2	15	7	4	7	2	0	4	5	1	6	60
Cap, veh/h	70	327	156	852	1072	498	4	890	394	622	1653	411
Arrive On Green	0.04	0.10	0.10	0.25	0.31	0.31	0.00	0.25	0.25	0.18	0.48	0.48
Sat Flow, veh/h	1781	3188	1522	3401	3413	1585	3510	3497	1547	3483	3441	857
Grp Volume(v), veh/h	53	17	9	1121	19	446	0	627	326	864	1303	7
Grp Sat Flow(s),veh/h/ln	1781	1594	1522	1700	1706	1585	1755	1749	1547	1742	1721	857
Q Serve(g_s), s	2.9	0.5	0.5	24.4	0.4	26.1	0.0	15.9	19.4	17.4	30.8	0.4
Cycle Q Clear(g_c), s	2.9	0.5	0.5	24.4	0.4	26.1	0.0	15.9	19.4	17.4	30.8	0.4
Prop In Lane	1.00		1.00	1.00		1.00	1.00		1.00	1.00		1.00
Lane Grp Cap(c), veh/h	70	327	156	852	1072	498	4	890	394	622	1653	411
V/C Ratio(X)	0.76	0.05	0.06	1.32	0.02	0.90	0.00	0.70	0.83	1.39	0.79	0.02
Avail Cap(c_a), veh/h	104	884	422	852	1602	744	180	1092	483	622	1653	411
HCM Platoon Ratio	1.00	1.00	1.00	1.00	1.00	1.00	1.00	1.00	1.00	1.00	1.00	1.00
Upstream Filter(I)	1.00	1.00	1.00	1.00	1.00	1.00	0.00	1.00	1.00	1.00	1.00	1.00
Uniform Delay (d), s/veh	46.3	39.4	39.4	36.5	23.0	31.9	0.0	33.0	34.3	40.0	21.2	13.3
Incr Delay (d2), s/veh	7.3	0.1	0.2	150.3	0.0	9.6	0.0	1.6	9.6	184.5	2.6	0.0
Initial Q Delay(d3),s/veh	0.0	0.0	0.0	0.0	0.0	0.0	0.0	0.0	0.0	0.0	0.0	0.0
%ile BackOfQ(50%),veh/ln	1.4	0.2	0.2	27.3	0.1	10.6	0.0	6.5	7.9	23.0	11.6	0.1
Unsig. Movement Delay, s/veh												
LnGrp Delay(d),s/veh	53.7	39.5	39.6	186.7	23.0	41.5	0.0	34.6	43.9	224.5	23.8	13.3
LnGrp LOS	D	D	D	F	C	D	A	C	D	F	C	B
Approach Vol, veh/h		79			1586			953			2174	
Approach Delay, s/veh		49.0			143.9			37.8			103.5	
Approach LOS		D			F			D			F	
Timer - Assigned Phs	1	2	3	4	5	6	7	8				
Phs Duration (G+Y+Rc), s	22.0	30.6	29.0	15.8	0.0	52.6	8.4	36.4				
Change Period (Y+Rc), s	4.6	5.8	4.6	5.8	4.6	5.8	4.6	5.8				
Max Green Setting (Gmax), s	17.4	30.4	24.4	27.0	5.0	42.8	5.7	45.7				
Max Q Clear Time (g_c+I1), s	19.4	21.4	26.4	2.5	0.0	32.8	4.9	28.1				
Green Ext Time (p_c), s	0.0	3.4	0.0	0.1	0.0	5.8	0.0	1.5				
Intersection Summary												
HCM 6th Ctrl Delay				102.9								
HCM 6th LOS				F								

Timings

26: Sycamore Canyon Bl. & Van Buren Bl.

09/19/2022



Lane Group	EBL	EBT	EBR	WBL	WBT	WBR	NBL	NBT	SBL	SBT	SBR
Lane Configurations											
Traffic Volume (vph)	447	3907	1	8	2746	85	13	16	1024	15	692
Future Volume (vph)	447	3907	1	8	2746	85	13	16	1024	15	692
Turn Type	Prot	NA	Perm	Prot	NA	Perm	Perm	NA	Split	NA	Perm
Protected Phases	5	2		1	6			8	4	4	
Permitted Phases			2			6	8				4
Detector Phase	5	2	2	1	6	6	8	8	4	4	4
Switch Phase											
Minimum Initial (s)	5.0	10.0	10.0	5.0	10.0	10.0	10.0	10.0	10.0	10.0	10.0
Minimum Split (s)	9.6	29.2	29.2	9.6	29.2	29.2	14.6	14.6	50.8	50.8	50.8
Total Split (s)	22.0	47.8	47.8	9.6	35.4	35.4	14.6	14.6	58.0	58.0	58.0
Total Split (%)	16.9%	36.8%	36.8%	7.4%	27.2%	27.2%	11.2%	11.2%	44.6%	44.6%	44.6%
Yellow Time (s)	3.6	5.2	5.2	3.6	5.2	5.2	3.6	3.6	4.8	4.8	4.8
All-Red Time (s)	1.0	1.0	1.0	1.0	1.0	1.0	1.0	1.0	1.0	1.0	1.0
Lost Time Adjust (s)	0.0	0.0	0.0	0.0	0.0	0.0		0.0	0.0	0.0	0.0
Total Lost Time (s)	4.6	6.2	6.2	4.6	6.2	6.2		4.6	5.8	5.8	5.8
Lead/Lag	Lead	Lag	Lag	Lead	Lag	Lag					
Lead-Lag Optimize?	Yes	Yes	Yes	Yes	Yes	Yes					
Recall Mode	None	None	None	None	None	None	None	None	None	None	None
Act Effct Green (s)	17.6	50.0	50.0	5.1	29.5	29.5		10.1	48.6	48.6	48.6
Actuated g/C Ratio	0.14	0.40	0.40	0.04	0.24	0.24		0.08	0.39	0.39	0.39
v/c Ratio	1.01	1.67	0.00	0.14	2.01	0.19		0.26	0.84	0.02	0.85
Control Delay	98.3	331.8	0.0	65.5	482.6	2.5		31.4	41.2	23.7	24.9
Queue Delay	0.0	0.0	0.0	0.0	0.0	0.0		0.0	0.0	0.0	0.0
Total Delay	98.3	331.8	0.0	65.5	482.6	2.5		31.4	41.2	23.7	24.9
LOS	F	F	A	E	F	A		C	D	C	C
Approach Delay		307.8			467.1			31.4		34.6	
Approach LOS		F			F			C		C	

Intersection Summary

Cycle Length: 130	
Actuated Cycle Length: 123.7	
Natural Cycle: 115	
Control Type: Actuated-Uncoordinated	
Maximum v/c Ratio: 2.01	
Intersection Signal Delay: 303.5	Intersection LOS: F
Intersection Capacity Utilization 110.5%	ICU Level of Service H
Analysis Period (min) 15	

Splits and Phases: 26: Sycamore Canyon Bl. & Van Buren Bl.

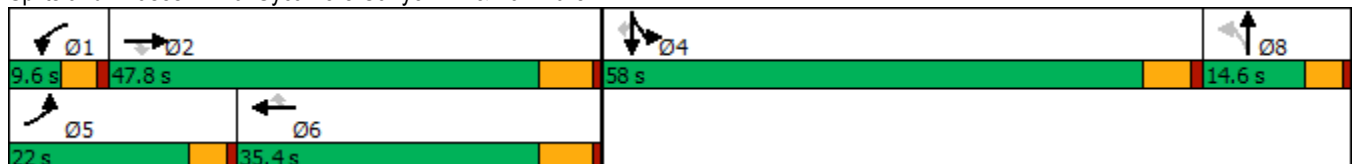

HCM 6th Signalized Intersection Summary
26: Sycamore Canyon Bl. & Van Buren Bl.

West Campus Upper Plateau (JN 14064)

09/19/2022



Movement	EBL	EBT	EBR	WBL	WBT	WBR	NBL	NBT	NBR	SBL	SBT	SBR
Lane Configurations												
Traffic Volume (veh/h)	447	3907	1	8	2746	85	13	16	38	1024	15	692
Future Volume (veh/h)	447	3907	1	8	2746	85	13	16	38	1024	15	692
Initial Q (Qb), veh	0	0	0	0	0	0	0	0	0	0	0	0
Ped-Bike Adj(A_pbT)	1.00		1.00	1.00		0.99	1.00		0.99	1.00		1.00
Parking Bus, Adj	1.00	1.00	1.00	1.00	1.00	1.00	1.00	1.00	1.00	1.00	1.00	1.00
Work Zone On Approach		No			No			No			No	
Adj Sat Flow, veh/h/ln	1841	1841	1900	1693	1826	1885	1900	1900	1900	1841	1900	1856
Adj Flow Rate, veh/h	486	4247	1	9	2985	69	14	17	11	1113	16	0
Peak Hour Factor	0.92	0.92	0.92	0.92	0.92	0.92	0.92	0.92	0.92	0.92	0.92	0.92
Percent Heavy Veh, %	4	4	0	14	5	1	0	0	0	4	0	3
Cap, veh/h	502	2436	619	17	1556	391	74	91	60	1229	686	
Arrive On Green	0.15	0.38	0.38	0.01	0.25	0.25	0.06	0.06	0.06	0.36	0.36	0.00
Sat Flow, veh/h	3401	6332	1610	1612	6281	1577	1169	1441	945	3401	1900	1572
Grp Volume(v), veh/h	486	4247	1	9	2985	69	22	0	20	1113	16	0
Grp Sat Flow(s),veh/h/ln	1700	1583	1610	1612	1570	1577	1842	0	1713	1700	1900	1572
Q Serve(g_s), s	16.7	45.3	0.0	0.7	29.2	4.1	1.3	0.0	1.3	36.6	0.6	0.0
Cycle Q Clear(g_c), s	16.7	45.3	0.0	0.7	29.2	4.1	1.3	0.0	1.3	36.6	0.6	0.0
Prop In Lane	1.00		1.00	1.00		1.00	0.63		0.55	1.00		1.00
Lane Grp Cap(c), veh/h	502	2436	619	17	1556	391	117	0	109	1229	686	
V/C Ratio(X)	0.97	1.74	0.00	0.52	1.92	0.18	0.19	0.00	0.18	0.91	0.02	
Avail Cap(c_a), veh/h	502	2436	619	68	1556	391	156	0	145	1507	842	
HCM Platoon Ratio	1.00	1.00	1.00	1.00	1.00	1.00	1.00	1.00	1.00	1.00	1.00	1.00
Upstream Filter(I)	1.00	1.00	1.00	1.00	1.00	1.00	1.00	0.00	1.00	1.00	1.00	0.00
Uniform Delay (d), s/veh	49.9	36.3	22.3	58.0	44.3	34.9	52.3	0.0	52.3	35.7	24.2	0.0
Incr Delay (d2), s/veh	31.7	336.4	0.0	8.5	415.4	0.2	0.8	0.0	0.8	7.1	0.0	0.0
Initial Q Delay(d3),s/veh	0.0	0.0	0.0	0.0	0.0	0.0	0.0	0.0	0.0	0.0	0.0	0.0
%ile BackOfQ(50%),veh/ln	9.1	73.3	0.0	0.3	55.8	1.5	0.6	0.0	0.6	15.6	0.3	0.0
Unsig. Movement Delay, s/veh												
LnGrp Delay(d),s/veh	81.7	372.7	22.3	66.5	459.7	35.1	53.1	0.0	53.1	42.9	24.3	0.0
LnGrp LOS	F	F	C	E	F	D	D	A	D	D	C	
Approach Vol, veh/h		4734			3063			42			1129	
Approach Delay, s/veh		342.7			449.0			53.1			42.6	
Approach LOS		F			F			D			D	
Timer - Assigned Phs	1	2		4	5	6		8				
Phs Duration (G+Y+Rc), s	5.9	51.5		48.4	22.0	35.4		12.1				
Change Period (Y+Rc), s	4.6	6.2		5.8	4.6	6.2		4.6				
Max Green Setting (Gmax), s	5.0	41.6		52.2	17.4	29.2		10.0				
Max Q Clear Time (g_c+I1), s	2.7	47.3		38.6	18.7	31.2		3.3				
Green Ext Time (p_c), s	0.0	0.0		3.9	0.0	0.0		0.0				

Intersection Summary

HCM 6th Ctrl Delay	339.9
HCM 6th LOS	F

Notes

Unsignalized Delay for [SBR] is excluded from calculations of the approach delay and intersection delay.

Timings
27: Innovation Dr. & Cactus Av.

West Campus Upper Plateau (JN 14064)

09/19/2022

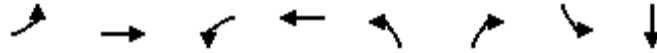

Lane Group	EBL	EBT	WBL	WBT	NBL	NBR	SBL	SBT
Lane Configurations	↖	↕↕↕	↖	↕↕↕	↖	↗	↖	↗
Traffic Volume (vph)	3	835	65	1346	51	145	40	0
Future Volume (vph)	3	835	65	1346	51	145	40	0
Turn Type	Prot	NA	Prot	NA	Perm	Perm	Perm	NA
Protected Phases	5	2	1	6				4
Permitted Phases					8	8	4	
Detector Phase	5	2	1	6	8	8	4	4
Switch Phase								
Minimum Initial (s)	5.0	10.0	5.0	10.0	10.0	10.0	10.0	10.0
Minimum Split (s)	9.2	26.8	9.2	26.8	31.1	31.1	31.1	31.1
Total Split (s)	12.0	63.0	22.0	73.0	35.0	35.0	35.0	35.0
Total Split (%)	10.0%	52.5%	18.3%	60.8%	29.2%	29.2%	29.2%	29.2%
Yellow Time (s)	3.2	4.8	3.2	4.8	4.1	4.1	4.1	4.1
All-Red Time (s)	1.0	1.0	1.0	1.0	1.0	1.0	1.0	1.0
Lost Time Adjust (s)	0.0	0.0	0.0	0.0	0.0	0.0	0.0	0.0
Total Lost Time (s)	4.2	5.8	4.2	5.8	5.1	5.1	5.1	5.1
Lead/Lag	Lead	Lag	Lead	Lag				
Lead-Lag Optimize?	Yes	Yes	Yes	Yes				
Recall Mode	None	None	None	None	None	None	None	None
Act Effct Green (s)	5.5	25.7	8.1	34.7	12.9	12.9	12.9	12.9
Actuated g/C Ratio	0.09	0.42	0.13	0.57	0.21	0.21	0.21	0.21
v/c Ratio	0.02	0.45	0.35	0.54	0.19	0.30	0.15	0.04
Control Delay	36.3	14.0	33.9	9.3	25.4	1.4	24.9	0.2
Queue Delay	0.0	0.0	0.0	0.0	0.0	0.0	0.0	0.0
Total Delay	36.3	14.0	33.9	9.3	25.4	1.4	24.9	0.2
LOS	D	B	C	A	C	A	C	A
Approach Delay		14.0		10.5				18.1
Approach LOS		B		B				B

Intersection Summary

Cycle Length: 120
 Actuated Cycle Length: 60.6
 Natural Cycle: 70
 Control Type: Actuated-Uncoordinated
 Maximum v/c Ratio: 0.54
 Intersection Signal Delay: 11.6
 Intersection Capacity Utilization 52.6%
 Analysis Period (min) 15
 Intersection LOS: B
 ICU Level of Service A

Splits and Phases: 27: Innovation Dr. & Cactus Av.



HCM 6th Signalized Intersection Summary
27: Innovation Dr. & Cactus Av.

West Campus Upper Plateau (JN 14064)
09/19/2022



Movement	EBL	EBT	EBR	WBL	WBT	WBR	NBL	NBT	NBR	SBL	SBT	SBR
Lane Configurations	↗	↑↑↑		↖	↑↑↑		↖	↑	↗	↖	↑	↗
Traffic Volume (veh/h)	3	835	6	65	1346	15	51	0	145	40	0	15
Future Volume (veh/h)	3	835	6	65	1346	15	51	0	145	40	0	15
Initial Q (Qb), veh	0	0	0	0	0	0	0	0	0	0	0	0
Ped-Bike Adj(A_pbT)	1.00		1.00	1.00		0.98	1.00		1.00	1.00		1.00
Parking Bus, Adj	1.00	1.00	1.00	1.00	1.00	1.00	1.00	1.00	1.00	1.00	1.00	1.00
Work Zone On Approach		No			No			No				No
Adj Sat Flow, veh/h/ln	1900	1826	1307	1693	1841	1900	1870	1900	1841	1900	1900	1781
Adj Flow Rate, veh/h	3	938	7	73	1512	17	57	0	110	45	0	8
Peak Hour Factor	0.89	0.89	0.89	0.89	0.89	0.89	0.89	0.89	0.89	0.89	0.89	0.89
Percent Heavy Veh, %	0	5	40	14	4	0	2	0	4	0	0	8
Cap, veh/h	7	2673	20	95	2963	33	345	311	255	334	0	263
Arrive On Green	0.00	0.52	0.52	0.06	0.58	0.58	0.16	0.00	0.16	0.16	0.00	0.16
Sat Flow, veh/h	1810	5104	38	1612	5121	58	1407	1900	1560	1304	0	1610
Grp Volume(v), veh/h	3	611	334	73	989	540	57	0	110	45	0	8
Grp Sat Flow(s),veh/h/ln	1810	1662	1819	1612	1675	1829	1407	1900	1560	1304	0	1610
Q Serve(g_s), s	0.1	6.4	6.4	2.7	10.5	10.5	2.1	0.0	3.8	1.8	0.0	0.2
Cycle Q Clear(g_c), s	0.1	6.4	6.4	2.7	10.5	10.5	2.4	0.0	3.8	1.8	0.0	0.2
Prop In Lane	1.00		0.02	1.00		0.03	1.00		1.00	1.00		1.00
Lane Grp Cap(c), veh/h	7	1740	953	95	1938	1058	345	311	255	334	0	263
V/C Ratio(X)	0.41	0.35	0.35	0.77	0.51	0.51	0.17	0.00	0.43	0.13	0.00	0.03
Avail Cap(c_a), veh/h	237	3194	1749	482	3783	2065	822	955	784	776	0	809
HCM Platoon Ratio	1.00	1.00	1.00	1.00	1.00	1.00	1.00	1.00	1.00	1.00	1.00	1.00
Upstream Filter(I)	1.00	1.00	1.00	1.00	1.00	1.00	1.00	0.00	1.00	1.00	0.00	1.00
Uniform Delay (d), s/veh	29.6	8.3	8.3	27.6	7.5	7.5	21.9	0.0	22.4	21.6	0.0	20.9
Incr Delay (d2), s/veh	12.9	0.2	0.3	4.8	0.3	0.5	0.2	0.0	1.1	0.2	0.0	0.0
Initial Q Delay(d3),s/veh	0.0	0.0	0.0	0.0	0.0	0.0	0.0	0.0	0.0	0.0	0.0	0.0
%ile BackOfQ(50%),veh/ln	0.1	1.7	1.8	1.0	2.5	2.8	0.7	0.0	1.3	0.5	0.0	0.1
Unsig. Movement Delay, s/veh												
LnGrp Delay(d),s/veh	42.5	8.4	8.6	32.4	7.8	8.0	22.1	0.0	23.5	21.7	0.0	21.0
LnGrp LOS	D	A	A	C	A	A	C	A	C	C	A	C
Approach Vol, veh/h		948			1602			167				53
Approach Delay, s/veh		8.6			9.0			23.1				21.6
Approach LOS		A			A			C				C
Timer - Assigned Phs	1	2		4	5	6		8				
Phs Duration (G+Y+Rc), s	7.7	37.0		14.8	4.4	40.2		14.8				
Change Period (Y+Rc), s	* 4.2	5.8		5.1	* 4.2	5.8		5.1				
Max Green Setting (Gmax), s	* 18	57.2		29.9	* 7.8	67.2		29.9				
Max Q Clear Time (g_c+I1), s	4.7	8.4		3.8	2.1	12.5		5.8				
Green Ext Time (p_c), s	0.1	10.3		0.1	0.0	21.9		0.5				

Intersection Summary

HCM 6th Ctrl Delay	10.0
HCM 6th LOS	A

Notes

* HCM 6th computational engine requires equal clearance times for the phases crossing the barrier.

Timings
28: I-215 SB Ramps & Alessandro Bl.

West Campus Upper Plateau (JN 14064)

09/19/2022

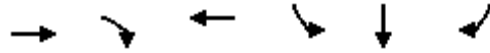

Lane Group	EBT	EBR	WBT	SBL	SBT	SBR
Lane Configurations	↑↑↑	↑	↑↑↑	↑	↔	↑
Traffic Volume (vph)	1641	365	2184	403	0	524
Future Volume (vph)	1641	365	2184	403	0	524
Turn Type	NA	Perm	NA	Split	NA	Perm
Protected Phases	2		6	4	4	
Permitted Phases		2				4
Detector Phase	2	2	6	4	4	4
Switch Phase						
Minimum Initial (s)	5.0	5.0	5.0	5.0	5.0	5.0
Minimum Split (s)	10.5	10.5	34.5	10.0	10.0	10.0
Total Split (s)	52.0	52.0	52.0	33.0	33.0	33.0
Total Split (%)	61.2%	61.2%	61.2%	38.8%	38.8%	38.8%
Yellow Time (s)	4.5	4.5	4.5	4.0	4.0	4.0
All-Red Time (s)	1.0	1.0	1.0	1.0	1.0	1.0
Lost Time Adjust (s)	0.0	0.0	0.0	0.0	0.0	0.0
Total Lost Time (s)	5.5	5.5	5.5	5.0	5.0	5.0
Lead/Lag						
Lead-Lag Optimize?						
Recall Mode	Min	Min	Min	None	None	None
Act Effct Green (s)	44.6	44.6	44.6	22.1	22.1	22.1
Actuated g/C Ratio	0.58	0.58	0.58	0.29	0.29	0.29
v/c Ratio	0.57	0.41	0.83	0.73	0.74	0.72
Control Delay	12.0	6.8	17.4	35.4	34.5	33.2
Queue Delay	0.0	0.0	0.0	0.0	0.0	0.0
Total Delay	12.0	6.8	17.4	35.4	34.5	33.2
LOS	B	A	B	D	C	C
Approach Delay	11.0		17.4		34.4	
Approach LOS	B		B		C	

Intersection Summary

Cycle Length: 85
 Actuated Cycle Length: 77.3
 Natural Cycle: 55
 Control Type: Actuated-Uncoordinated
 Maximum v/c Ratio: 0.83
 Intersection Signal Delay: 18.0
 Intersection LOS: B
 Intersection Capacity Utilization 76.2%
 ICU Level of Service D
 Analysis Period (min) 15

Splits and Phases: 28: I-215 SB Ramps & Alessandro Bl.

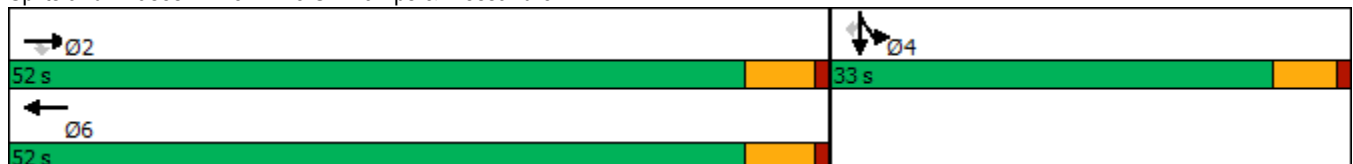

HCM 6th Signalized Intersection Summary
 28: I-215 SB Ramps & Alessandro Bl.

West Campus Upper Plateau (JN 14064)

09/19/2022



Movement	EBL	EBT	EBR	WBL	WBT	WBR	NBL	NBT	NBR	SBL	SBT	SBR
Lane Configurations		↑↑↑	↗		↑↑↑					↘	↔	↗
Traffic Volume (veh/h)	0	1641	365	0	2184	165	0	0	0	403	0	524
Future Volume (veh/h)	0	1641	365	0	2184	165	0	0	0	403	0	524
Initial Q (Qb), veh	0	0	0	0	0	0				0	0	0
Ped-Bike Adj(A_pbT)	1.00		1.00	1.00		0.98				1.00		1.00
Parking Bus, Adj	1.00	1.00	1.00	1.00	1.00	1.00				1.00	1.00	1.00
Work Zone On Approach		No			No						No	
Adj Sat Flow, veh/h/ln	0	1856	1722	0	1870	1544				1767	1900	1737
Adj Flow Rate, veh/h	0	1658	369	0	2206	159				570	0	310
Peak Hour Factor	0.99	0.99	0.99	0.99	0.99	0.99				0.99	0.99	0.99
Percent Heavy Veh, %	0	3	12	0	2	24				9	0	11
Cap, veh/h	0	2981	859	0	2858	204				884	0	387
Arrive On Green	0.00	0.59	0.59	0.00	0.59	0.59				0.26	0.00	0.26
Sat Flow, veh/h	0	5233	1459	0	5025	346				3365	0	1472
Grp Volume(v), veh/h	0	1658	369	0	1539	826				570	0	310
Grp Sat Flow(s),veh/h/ln	0	1689	1459	0	1702	1799				1682	0	1472
Q Serve(g_s), s	0.0	14.1	9.8	0.0	24.0	24.6				10.6	0.0	13.9
Cycle Q Clear(g_c), s	0.0	14.1	9.8	0.0	24.0	24.6				10.6	0.0	13.9
Prop In Lane	0.00		1.00	0.00		0.19				1.00		1.00
Lane Grp Cap(c), veh/h	0	2981	859	0	2003	1059				884	0	387
V/C Ratio(X)	0.00	0.56	0.43	0.00	0.77	0.78				0.64	0.00	0.80
Avail Cap(c_a), veh/h	0	3336	961	0	2241	1185				1334	0	584
HCM Platoon Ratio	1.00	1.00	1.00	1.00	1.00	1.00				1.00	1.00	1.00
Upstream Filter(I)	0.00	1.00	1.00	0.00	1.00	1.00				1.00	0.00	1.00
Uniform Delay (d), s/veh	0.0	8.9	8.0	0.0	10.9	11.0				23.1	0.0	24.3
Incr Delay (d2), s/veh	0.0	0.2	0.3	0.0	1.5	3.1				0.8	0.0	4.7
Initial Q Delay(d3),s/veh	0.0	0.0	0.0	0.0	0.0	0.0				0.0	0.0	0.0
%ile BackOfQ(50%),veh/ln	0.0	3.4	2.1	0.0	6.1	7.1				3.8	0.0	4.8
Unsig. Movement Delay, s/veh												
LnGrp Delay(d),s/veh	0.0	9.0	8.3	0.0	12.4	14.1				23.9	0.0	29.0
LnGrp LOS	A	A	A	A	B	B				C	A	C
Approach Vol, veh/h		2027			2365						880	
Approach Delay, s/veh		8.9			13.0						25.7	
Approach LOS		A			B						C	
Timer - Assigned Phs		2		4		6						
Phs Duration (G+Y+Rc), s		47.1		23.6		47.1						
Change Period (Y+Rc), s		5.5		5.0		5.5						
Max Green Setting (Gmax), s		46.5		28.0		46.5						
Max Q Clear Time (g_c+I1), s		16.1		15.9		26.6						
Green Ext Time (p_c), s		15.5		2.7		14.9						

Intersection Summary

HCM 6th Ctrl Delay	13.6
HCM 6th LOS	B

Notes

User approved volume balancing among the lanes for turning movement.

Timings
29: I-215 NB Ramps & Alessandro Bl.

West Campus Upper Plateau (JN 14064)

09/19/2022



Lane Group	EBL	EBT	WBT	WBR	NBL	NBT	NBR
Lane Configurations	↘	↑↑↑	↑↑↑	↗	↘	↕	↗
Traffic Volume (vph)	151	2259	1488	162	973	13	397
Future Volume (vph)	151	2259	1488	162	973	13	397
Turn Type	Prot	NA	NA	Perm	Split	NA	Perm
Protected Phases	5	2	6		8	8	
Permitted Phases				6			8
Detector Phase	5	2	6	6	8	8	8
Switch Phase							
Minimum Initial (s)	5.0	5.0	5.0	5.0	5.0	5.0	5.0
Minimum Split (s)	9.5	10.5	33.5	33.5	10.0	10.0	10.0
Total Split (s)	13.0	48.0	35.0	35.0	37.0	37.0	37.0
Total Split (%)	15.3%	56.5%	41.2%	41.2%	43.5%	43.5%	43.5%
Yellow Time (s)	3.5	4.5	4.5	4.5	4.0	4.0	4.0
All-Red Time (s)	1.0	1.0	1.0	1.0	1.0	1.0	1.0
Lost Time Adjust (s)	0.0	0.0	0.0	0.0	0.0	0.0	0.0
Total Lost Time (s)	4.5	5.5	5.5	5.5	5.0	5.0	5.0
Lead/Lag	Lead		Lag	Lag			
Lead-Lag Optimize?	Yes		Yes	Yes			
Recall Mode	None	Min	Min	Min	Max	Max	Max
Act Effct Green (s)	8.5	42.5	29.5	29.5	32.0	32.0	32.0
Actuated g/C Ratio	0.10	0.50	0.35	0.35	0.38	0.38	0.38
v/c Ratio	1.12	0.95	0.91	0.31	0.89	0.92	0.63
Control Delay	149.0	29.9	36.3	12.4	43.4	48.3	21.7
Queue Delay	0.0	0.0	0.0	0.0	0.0	0.0	0.0
Total Delay	149.0	29.9	36.3	12.4	43.4	48.3	21.7
LOS	F	C	D	B	D	D	C
Approach Delay		37.4	33.9			39.6	
Approach LOS		D	C			D	

Intersection Summary

Cycle Length: 85
 Actuated Cycle Length: 85
 Natural Cycle: 80
 Control Type: Actuated-Uncoordinated
 Maximum v/c Ratio: 1.12
 Intersection Signal Delay: 36.9
 Intersection LOS: D
 Intersection Capacity Utilization 83.7%
 ICU Level of Service E
 Analysis Period (min) 15

Splits and Phases: 29: I-215 NB Ramps & Alessandro Bl.

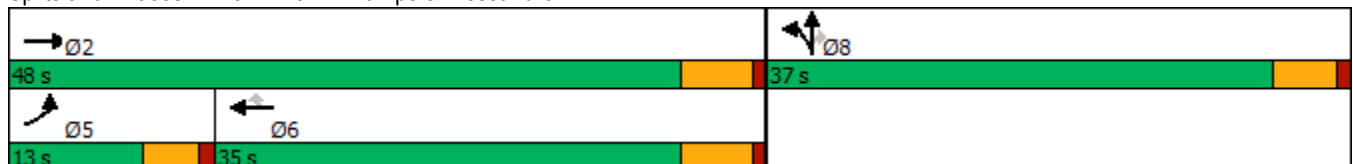

HCM 6th Signalized Intersection Summary
 29: I-215 NB Ramps & Alessandro Bl.

West Campus Upper Plateau (JN 14064)

09/19/2022



Movement	EBL	EBT	EBR	WBL	WBT	WBR	NBL	NBT	NBR	SBL	SBT	SBR
Lane Configurations	↗	↑↑↑			↑↑↑	↗	↗	↕	↗			
Traffic Volume (veh/h)	151	2259	0	0	1488	162	973	13	397	0	0	0
Future Volume (veh/h)	151	2259	0	0	1488	162	973	13	397	0	0	0
Initial Q (Qb), veh	0	0	0	0	0	0	0	0	0			
Ped-Bike Adj(A_pbT)	1.00		1.00	1.00		0.98	1.00		1.00			
Parking Bus, Adj	1.00	1.00	1.00	1.00	1.00	1.00	1.00	1.00	1.00			
Work Zone On Approach		No			No			No				
Adj Sat Flow, veh/h/ln	1530	1870	0	0	1841	1752	1841	1900	1826			
Adj Flow Rate, veh/h	161	2403	0	0	1583	145	1145	0	229			
Peak Hour Factor	0.94	0.94	0.94	0.94	0.94	0.94	0.94	0.94	0.94			
Percent Heavy Veh, %	25	2	0	0	4	10	4	0	5			
Cap, veh/h	146	2547	0	0	1737	502	1323	0	584			
Arrive On Green	0.10	0.50	0.00	0.00	0.35	0.35	0.38	0.00	0.38			
Sat Flow, veh/h	1457	5274	0	0	5191	1453	3506	0	1547			
Grp Volume(v), veh/h	161	2403	0	0	1583	145	1145	0	229			
Grp Sat Flow(s),veh/h/ln	1457	1702	0	0	1675	1453	1753	0	1547			
Q Serve(g_s), s	8.5	37.8	0.0	0.0	25.5	6.2	25.6	0.0	9.2			
Cycle Q Clear(g_c), s	8.5	37.8	0.0	0.0	25.5	6.2	25.6	0.0	9.2			
Prop In Lane	1.00		0.00	0.00		1.00	1.00		1.00			
Lane Grp Cap(c), veh/h	146	2547	0	0	1737	502	1323	0	584			
V/C Ratio(X)	1.10	0.94	0.00	0.00	0.91	0.29	0.87	0.00	0.39			
Avail Cap(c_a), veh/h	146	2559	0	0	1748	506	1323	0	584			
HCM Platoon Ratio	1.00	1.00	1.00	1.00	1.00	1.00	1.00	1.00	1.00			
Upstream Filter(I)	1.00	1.00	0.00	0.00	1.00	1.00	1.00	0.00	1.00			
Uniform Delay (d), s/veh	38.2	20.1	0.0	0.0	26.5	20.2	24.4	0.0	19.3			
Incr Delay (d2), s/veh	104.7	8.1	0.0	0.0	7.6	0.3	7.8	0.0	2.0			
Initial Q Delay(d3),s/veh	0.0	0.0	0.0	0.0	0.0	0.0	0.0	0.0	0.0			
%ile BackOfQ(50%),veh/ln	7.0	13.7	0.0	0.0	10.0	1.9	11.1	0.0	3.4			
Unsig. Movement Delay, s/veh												
LnGrp Delay(d),s/veh	142.8	28.2	0.0	0.0	34.1	20.5	32.2	0.0	21.3			
LnGrp LOS	F	C	A	A	C	C	C	A	C			
Approach Vol, veh/h		2564			1728			1374				
Approach Delay, s/veh		35.4			33.0			30.4				
Approach LOS		D			C			C				
Timer - Assigned Phs		2			5	6		8				
Phs Duration (G+Y+Rc), s		47.8			13.0	34.8		37.0				
Change Period (Y+Rc), s		5.5			4.5	5.5		5.0				
Max Green Setting (Gmax), s		42.5			8.5	29.5		32.0				
Max Q Clear Time (g_c+I1), s		39.8			10.5	27.5		27.6				
Green Ext Time (p_c), s		2.5			0.0	1.6		2.3				

Intersection Summary

HCM 6th Ctrl Delay	33.4
HCM 6th LOS	C

Notes

User approved volume balancing among the lanes for turning movement.

Timings
30: I-215 SB Ramps & Cactus Av.



Lane Group	EBT	EBR	WBL	WBT	NBR	SBR
Lane Configurations	↑↑	↑	↓	↑↑	↑	↑
Traffic Volume (vph)	800	149	805	1135	754	289
Future Volume (vph)	800	149	805	1135	754	289
Turn Type	NA	Perm	Prot	NA	Prot	Prot
Protected Phases	2		1	6	8	4
Permitted Phases		2				
Detector Phase	2	2	1	6	8	4
Switch Phase						
Minimum Initial (s)	5.0	5.0	5.0	5.0	5.0	5.0
Minimum Split (s)	11.0	11.0	9.5	23.0	9.1	9.5
Total Split (s)	35.0	35.0	43.0	78.0	27.0	27.0
Total Split (%)	33.3%	33.3%	41.0%	74.3%	25.7%	25.7%
Yellow Time (s)	5.0	5.0	3.5	5.0	3.6	3.5
All-Red Time (s)	1.0	1.0	1.0	1.0	0.5	1.0
Lost Time Adjust (s)	0.0	0.0	0.0	0.0	0.0	0.0
Total Lost Time (s)	6.0	6.0	4.5	6.0	4.1	4.5
Lead/Lag	Lag	Lag	Lead			
Lead-Lag Optimize?	Yes	Yes	Yes			
Recall Mode	Min	Min	None	Min	None	None
Act Effct Green (s)	27.1	27.1	38.6	70.3	21.4	21.0
Actuated g/C Ratio	0.27	0.27	0.38	0.69	0.21	0.21
v/c Ratio	0.91	0.30	1.25	0.49	0.96	0.79
Control Delay	51.3	6.4	154.4	8.4	33.9	40.3
Queue Delay	0.0	0.0	0.0	0.0	0.0	0.0
Total Delay	51.3	6.4	154.4	8.4	33.9	40.3
LOS	D	A	F	A	C	D
Approach Delay	44.3			69.0		
Approach LOS	D			E		

Intersection Summary

Cycle Length: 105
 Actuated Cycle Length: 101.8
 Natural Cycle: 110
 Control Type: Actuated-Uncoordinated
 Maximum v/c Ratio: 1.25
 Intersection Signal Delay: 54.2
 Intersection LOS: D
 Intersection Capacity Utilization 77.2%
 ICU Level of Service D
 Analysis Period (min) 15

Splits and Phases: 30: I-215 SB Ramps & Cactus Av.

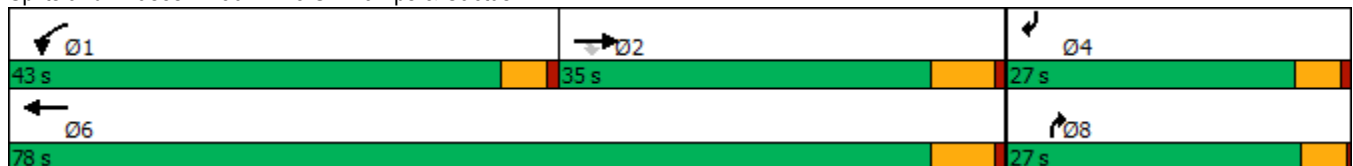

HCM 6th Signalized Intersection Summary
30: I-215 SB Ramps & Cactus Av.

West Campus Upper Plateau (JN 14064)

09/19/2022



Movement	EBL	EBT	EBR	WBL	WBT	WBR	NBL	NBT	NBR	SBL	SBT	SBR
Lane Configurations		↑↑	↗	↖	↑↑				↗			↖
Traffic Volume (veh/h)	0	800	149	805	1135	0	0	0	754	0	0	289
Future Volume (veh/h)	0	800	149	805	1135	0	0	0	754	0	0	289
Initial Q (Qb), veh	0	0	0	0	0	0	0	0	0	0	0	0
Ped-Bike Adj(A_pbT)	1.00		1.00	1.00		1.00	1.00		1.00	1.00		1.00
Parking Bus, Adj	1.00	1.00	1.00	1.00	1.00	1.00	1.00	1.00	1.00	1.00	1.00	1.00
Work Zone On Approach		No			No			No			No	
Adj Sat Flow, veh/h/ln	0	1841	1826	1885	1870	0	0	0	1811	0	0	1707
Adj Flow Rate, veh/h	0	842	129	847	1195	0	0	0	0	0	0	199
Peak Hour Factor	0.95	0.95	0.95	0.95	0.95	0.95	0.95	0.95	0.95	0.95	0.95	0.95
Percent Heavy Veh, %	0	4	5	1	2	0	0	0	6	0	0	13
Cap, veh/h	0	1093	484	901	3177	0	0	0	0	0	0	0
Arrive On Green	0.00	0.31	0.31	0.50	0.89	0.00	0.00	0.00	0.00	0.00	0.00	0.00
Sat Flow, veh/h	0	3589	1547	1795	3647	0		0			0	
Grp Volume(v), veh/h	0	842	129	847	1195	0		0.0			0.0	
Grp Sat Flow(s),veh/h/ln	0	1749	1547	1795	1777	0						
Q Serve(g_s), s	0.0	12.3	3.5	25.2	3.0	0.0						
Cycle Q Clear(g_c), s	0.0	12.3	3.5	25.2	3.0	0.0						
Prop In Lane	0.00		1.00	1.00		0.00						
Lane Grp Cap(c), veh/h	0	1093	484	901	3177	0						
V/C Ratio(X)	0.00	0.77	0.27	0.94	0.38	0.00						
Avail Cap(c_a), veh/h	0	1792	793	1221	4521	0						
HCM Platoon Ratio	1.00	1.00	1.00	1.00	1.00	1.00						
Upstream Filter(I)	0.00	1.00	1.00	1.00	1.00	0.00						
Uniform Delay (d), s/veh	0.0	17.6	14.6	13.3	0.5	0.0						
Incr Delay (d2), s/veh	0.0	0.4	0.1	9.9	0.0	0.0						
Initial Q Delay(d3),s/veh	0.0	0.0	0.0	0.0	0.0	0.0						
%ile BackOfQ(50%),veh/ln	0.0	4.1	1.0	9.3	0.0	0.0						
Unsig. Movement Delay, s/veh												
LnGrp Delay(d),s/veh	0.0	18.1	14.7	23.2	0.5	0.0						
LnGrp LOS	A	B	B	C	A	A						
Approach Vol, veh/h		971			2042							
Approach Delay, s/veh		17.6			9.9							
Approach LOS		B			A							
Timer - Assigned Phs	1	2			6							
Phs Duration (G+Y+Rc), s	32.9	23.7			56.6							
Change Period (Y+Rc), s	4.5	6.0			6.0							
Max Green Setting (Gmax), s	38.5	29.0			72.0							
Max Q Clear Time (g_c+I1), s	27.2	14.3			5.0							
Green Ext Time (p_c), s	1.2	3.3			6.1							

Intersection Summary

HCM 6th Ctrl Delay	12.4
HCM 6th LOS	B

Notes

Unsignalized Delay for [NBR] is excluded from calculations of the approach delay and intersection delay.

Timings

31: I-215 NB Ramps/Old 215 Frontage Rd. & Cactus Av.



Lane Group	EBL	EBT	WBT	NBL	NBT	NBR	SBL	SBT
Lane Configurations	↗	↕	↕	↖	↖	↗	↖	↖
Traffic Volume (vph)	57	1806	2465	124	252	86	196	3
Future Volume (vph)	57	1806	2465	124	252	86	196	3
Turn Type	Perm	NA	NA	Perm	NA	Perm	Perm	NA
Protected Phases		2	6		8			4
Permitted Phases	2			8		8	4	
Detector Phase	2	2	6	8	8	8	4	4
Switch Phase								
Minimum Initial (s)	5.0	5.0	5.0	5.0	5.0	5.0	5.0	5.0
Minimum Split (s)	11.0	11.0	44.0	10.5	10.5	10.5	10.5	10.5
Total Split (s)	57.4	57.4	57.4	27.6	27.6	27.6	27.6	27.6
Total Split (%)	67.5%	67.5%	67.5%	32.5%	32.5%	32.5%	32.5%	32.5%
Yellow Time (s)	5.0	5.0	5.0	4.5	4.5	4.5	4.5	4.5
All-Red Time (s)	1.0	1.0	1.0	1.0	1.0	1.0	1.0	1.0
Lost Time Adjust (s)	0.0	0.0	0.0	0.0	0.0	0.0	0.0	0.0
Total Lost Time (s)	6.0	6.0	6.0	5.5	5.5	5.5	5.5	5.5
Lead/Lag								
Lead-Lag Optimize?								
Recall Mode	Min	Min	Min	None	None	None	None	None
Act Effct Green (s)	51.4	51.4	51.4	22.1	22.1	22.1	22.1	22.1
Actuated g/C Ratio	0.60	0.60	0.60	0.26	0.26	0.26	0.26	0.26
v/c Ratio	0.70	0.93	1.31	0.50	0.60	0.19	1.04	0.46
Control Delay	59.6	25.2	165.6	34.6	33.8	15.9	108.4	30.3
Queue Delay	0.0	0.0	0.0	0.0	0.0	0.0	0.0	0.0
Total Delay	59.6	25.2	165.6	34.6	33.8	15.9	108.4	30.3
LOS	E	C	F	C	C	B	F	C
Approach Delay		26.2	165.6		31.0			70.4
Approach LOS		C	F		C			E

Intersection Summary

Cycle Length: 85
 Actuated Cycle Length: 85
 Natural Cycle: 60
 Control Type: Actuated-Uncoordinated
 Maximum v/c Ratio: 1.31
 Intersection Signal Delay: 98.1
 Intersection Capacity Utilization 114.1%
 Analysis Period (min) 15
 Intersection LOS: F
 ICU Level of Service H

Splits and Phases: 31: I-215 NB Ramps/Old 215 Frontage Rd. & Cactus Av.

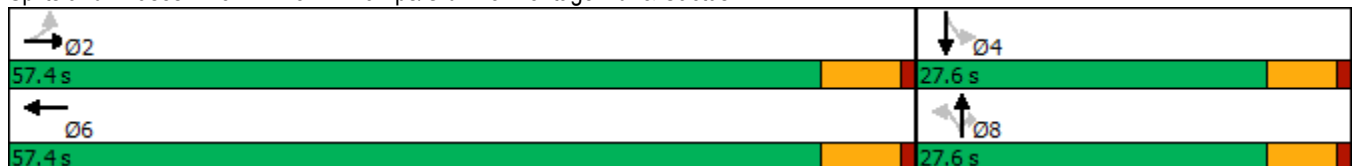

HCM 6th Signalized Intersection Summary

West Campus Upper Plateau (JN 14064)

31: I-215 NB Ramps/Old 215 Frontage Rd. & Cactus Av.

09/19/2022

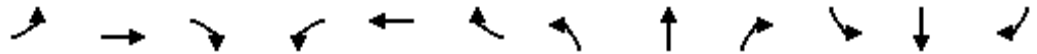

Movement	EBL	EBT	EBR	WBL	WBT	WBR	NBL	NBT	NBR	SBL	SBT	SBR
Lane Configurations												
Traffic Volume (veh/h)	57	1806	51	0	2465	187	124	252	86	196	3	182
Future Volume (veh/h)	57	1806	51	0	2465	187	124	252	86	196	3	182
Initial Q (Qb), veh	0	0	0	0	0	0	0	0	0	0	0	0
Ped-Bike Adj(A_pbT)	1.00		1.00	1.00		1.00	1.00		1.00	1.00		1.00
Parking Bus, Adj	1.00	1.00	1.00	1.00	1.00	1.00	1.00	1.00	1.00	1.00	1.00	1.00
Work Zone On Approach		No			No			No			No	
Adj Sat Flow, veh/h/ln	1811	1841	1426	0	1856	1885	1752	1856	1870	1841	1900	1885
Adj Flow Rate, veh/h	59	1881	49	0	2568	147	129	262	0	204	3	164
Peak Hour Factor	0.96	0.96	0.96	0.96	0.96	0.96	0.96	0.96	0.96	0.96	0.96	0.96
Percent Heavy Veh, %	6	4	32	0	3	1	10	3	2	4	0	1
Cap, veh/h	85	2106	55	0	2051	116	284	482		237	8	412
Arrive On Green	0.60	0.60	0.60	0.00	0.60	0.60	0.26	0.26	0.00	0.26	0.26	0.26
Sat Flow, veh/h	102	3483	90	0	3484	192	1141	1856	1585	1100	29	1586
Grp Volume(v), veh/h	59	940	990	0	1323	1392	129	262	0	204	0	167
Grp Sat Flow(s),veh/h/ln	102	1749	1824	0	1763	1821	1141	1856	1585	1100	0	1615
Q Serve(g_s), s	0.0	39.1	39.8	0.0	51.4	51.4	8.9	10.3	0.0	11.8	0.0	7.3
Cycle Q Clear(g_c), s	51.4	39.1	39.8	0.0	51.4	51.4	16.2	10.3	0.0	22.1	0.0	7.3
Prop In Lane	1.00		0.05	0.00		0.11	1.00		1.00	1.00		0.98
Lane Grp Cap(c), veh/h	85	1057	1103	0	1066	1101	284	482		237	0	420
V/C Ratio(X)	0.70	0.89	0.90	0.00	1.24	1.26	0.45	0.54		0.86	0.00	0.40
Avail Cap(c_a), veh/h	85	1057	1103	0	1066	1101	284	482		237	0	420
HCM Platoon Ratio	1.00	1.00	1.00	1.00	1.00	1.00	1.00	1.00	1.00	1.00	1.00	1.00
Upstream Filter(I)	1.00	1.00	1.00	0.00	1.00	1.00	1.00	1.00	0.00	1.00	0.00	1.00
Uniform Delay (d), s/veh	42.5	14.4	14.5	0.0	16.8	16.8	32.6	27.1	0.0	38.1	0.0	26.0
Incr Delay (d2), s/veh	18.9	9.2	9.5	0.0	116.5	126.5	0.4	0.7	0.0	25.1	0.0	0.2
Initial Q Delay(d3),s/veh	0.0	0.0	0.0	0.0	0.0	0.0	0.0	0.0	0.0	0.0	0.0	0.0
%ile BackOfQ(50%),veh/ln	1.6	14.5	15.4	0.0	50.0	54.7	2.4	4.3	0.0	5.7	0.0	2.6
Unsig. Movement Delay, s/veh												
LnGrp Delay(d),s/veh	61.4	23.6	24.1	0.0	133.3	143.3	33.1	27.8	0.0	63.2	0.0	26.2
LnGrp LOS	E	C	C	A	F	F	C	C		E	A	C
Approach Vol, veh/h		1989			2715			391				371
Approach Delay, s/veh		24.9			138.4			29.5				46.5
Approach LOS		C			F			C				D
Timer - Assigned Phs		2		4		6		8				
Phs Duration (G+Y+Rc), s		57.4		27.6		57.4		27.6				
Change Period (Y+Rc), s		6.0		5.5		6.0		5.5				
Max Green Setting (Gmax), s		51.4		22.1		51.4		22.1				
Max Q Clear Time (g_c+I1), s		53.4		24.1		53.4		18.2				
Green Ext Time (p_c), s		0.0		0.0		0.0		0.5				

Intersection Summary

HCM 6th Ctrl Delay	83.1
HCM 6th LOS	F

Notes

User approved volume balancing among the lanes for turning movement.
 Unsignalized Delay for [NBR] is excluded from calculations of the approach delay and intersection delay.

Timings
32: I-215 SB Ramps & Van Buren Bl.

West Campus Upper Plateau (JN 14064)

09/19/2022



Lane Group	EBT	EBR	WBL	WBT	SBT	SBR
Lane Configurations	↑↑	↑↑	↙	↑↑	↙	↑↑
Traffic Volume (vph)	1424	2327	184	1493	98	748
Future Volume (vph)	1424	2327	184	1493	98	748
Turn Type	NA	Perm	Prot	NA	NA	Perm
Protected Phases	6		5	2	8	
Permitted Phases		6				8
Detector Phase	6	6	5	2	8	8
Switch Phase						
Minimum Initial (s)	5.0	5.0	5.0	5.0	5.0	5.0
Minimum Split (s)	36.0	36.0	11.0	11.0	11.0	11.0
Total Split (s)	60.0	60.0	11.0	71.0	14.0	14.0
Total Split (%)	70.6%	70.6%	12.9%	83.5%	16.5%	16.5%
Yellow Time (s)	5.0	5.0	5.0	5.0	5.0	5.0
All-Red Time (s)	1.0	1.0	1.0	1.0	1.0	1.0
Lost Time Adjust (s)	0.0	0.0	0.0	0.0	0.0	0.0
Total Lost Time (s)	6.0	6.0	6.0	6.0	6.0	6.0
Lead/Lag	Lag	Lag	Lead			
Lead-Lag Optimize?	Yes	Yes	Yes			
Recall Mode	Min	Min	None	Min	Max	Max
Act Effct Green (s)	54.0	54.0	5.0	65.0	8.0	8.0
Actuated g/C Ratio	0.64	0.64	0.06	0.76	0.09	0.09
v/c Ratio	0.71	1.35	1.89	0.61	4.01	2.34
Control Delay	12.8	179.0	458.6	5.6	1380.3	633.1
Queue Delay	0.0	0.0	0.0	0.0	0.0	0.0
Total Delay	12.8	179.0	458.6	5.6	1380.3	633.1
LOS	B	F	F	A	F	F
Approach Delay	115.9			55.4	974.7	
Approach LOS	F			E	F	

Intersection Summary

Cycle Length: 85
 Actuated Cycle Length: 85
 Natural Cycle: 120
 Control Type: Actuated-Uncoordinated
 Maximum v/c Ratio: 4.01
 Intersection Signal Delay: 274.8
 Intersection Capacity Utilization 132.7%
 Analysis Period (min) 15
 Intersection LOS: F
 ICU Level of Service H

Splits and Phases: 32: I-215 SB Ramps & Van Buren Bl.



HCM 6th Signalized Intersection Summary
 32: I-215 SB Ramps & Van Buren Bl.

West Campus Upper Plateau (JN 14064)

09/19/2022



Movement	EBL	EBT	EBR	WBL	WBT	WBR	NBL	NBT	NBR	SBL	SBT	SBR
Lane Configurations		↑↑	↑↑	↑	↑↑						↑	↑↑
Traffic Volume (veh/h)	0	1424	2327	184	1493	0	0	0	0	532	98	748
Future Volume (veh/h)	0	1424	2327	184	1493	0	0	0	0	532	98	748
Initial Q (Qb), veh	0	0	0	0	0	0				0	0	0
Ped-Bike Adj(A_pbT)	1.00		1.00	1.00		1.00				1.00		1.00
Parking Bus, Adj	1.00	1.00	1.00	1.00	1.00	1.00				1.00	1.00	1.00
Work Zone On Approach		No			No						No	
Adj Sat Flow, veh/h/ln	0	1796	1856	1885	1826	0				1885	1841	1722
Adj Flow Rate, veh/h	0	1531	2403	198	1605	0				572	105	0
Peak Hour Factor	0.93	0.93	0.93	0.93	0.93	0.93				0.93	0.93	0.93
Percent Heavy Veh, %	0	7	3	1	5	0				1	4	12
Cap, veh/h	0	2168	1758	106	2653	0				140	26	
Arrive On Green	0.00	0.64	0.64	0.06	0.76	0.00				0.09	0.09	0.00
Sat Flow, veh/h	0	3503	2768	1795	3561	0				1492	274	2569
Grp Volume(v), veh/h	0	1531	2403	198	1605	0				677	0	0
Grp Sat Flow(s),veh/h/ln	0	1706	1384	1795	1735	0				1766	0	1284
Q Serve(g_s), s	0.0	25.2	54.0	5.0	17.2	0.0				8.0	0.0	0.0
Cycle Q Clear(g_c), s	0.0	25.2	54.0	5.0	17.2	0.0				8.0	0.0	0.0
Prop In Lane	0.00		1.00	1.00		0.00				0.84		1.00
Lane Grp Cap(c), veh/h	0	2168	1758	106	2653	0				166	0	
V/C Ratio(X)	0.00	0.71	1.37	1.87	0.60	0.00				4.07	0.00	
Avail Cap(c_a), veh/h	0	2168	1758	106	2653	0				166	0	
HCM Platoon Ratio	1.00	1.00	1.00	1.00	1.00	1.00				1.00	1.00	1.00
Upstream Filter(I)	0.00	1.00	1.00	1.00	1.00	0.00				1.00	0.00	0.00
Uniform Delay (d), s/veh	0.0	10.3	15.5	40.0	4.4	0.0				38.5	0.0	0.0
Incr Delay (d2), s/veh	0.0	0.9	168.8	427.3	0.3	0.0				1397.0	0.0	0.0
Initial Q Delay(d3),s/veh	0.0	0.0	0.0	0.0	0.0	0.0				0.0	0.0	0.0
%ile BackOfQ(50%),veh/ln	0.0	6.7	52.3	14.6	2.8	0.0				67.8	0.0	0.0
Unsig. Movement Delay, s/veh												
LnGrp Delay(d),s/veh	0.0	11.2	184.3	467.3	4.7	0.0				1435.5	0.0	0.0
LnGrp LOS	A	B	F	F	A	A				F	A	
Approach Vol, veh/h		3934			1803						677	
Approach Delay, s/veh		116.9			55.5						1435.5	
Approach LOS		F			E						F	
Timer - Assigned Phs		2			5	6		8				
Phs Duration (G+Y+Rc), s		71.0			11.0	60.0		14.0				
Change Period (Y+Rc), s		6.0			6.0	6.0		6.0				
Max Green Setting (Gmax), s		65.0			5.0	54.0		8.0				
Max Q Clear Time (g_c+I1), s		19.2			7.0	56.0		10.0				
Green Ext Time (p_c), s		9.4			0.0	0.0		0.0				

Intersection Summary

HCM 6th Ctrl Delay	238.8
HCM 6th LOS	F

Notes

Unsignalized Delay for [SBR] is excluded from calculations of the approach delay and intersection delay.

Timings
33: I-215 NB On/Off Ramp & Van Buren Bl.



Lane Group	EBT	EBR	WBT	NBL	NBR
Lane Configurations	↑↑	↑↑	↑↑	↑↑	↑
Traffic Volume (vph)	715	1294	888	1313	200
Future Volume (vph)	715	1294	888	1313	200
Turn Type	NA	pm+ov	NA	Prot	Perm
Protected Phases	6	4	2	4	
Permitted Phases		6			4
Detector Phase	6	4	2	4	4
Switch Phase					
Minimum Initial (s)	5.0	5.0	5.0	5.0	5.0
Minimum Split (s)	11.0	42.0	11.0	42.0	42.0
Total Split (s)	15.0	55.0	15.0	55.0	55.0
Total Split (%)	21.4%	78.6%	21.4%	78.6%	78.6%
Yellow Time (s)	5.0	5.0	5.0	5.0	5.0
All-Red Time (s)	1.0	1.0	1.0	1.0	1.0
Lost Time Adjust (s)	0.0	0.0	0.0	0.0	0.0
Total Lost Time (s)	6.0	6.0	6.0	6.0	6.0
Lead/Lag					
Lead-Lag Optimize?					
Recall Mode	None	Min	None	Min	Min
Act Effct Green (s)	9.2	49.8	9.2	28.2	28.2
Actuated g/C Ratio	0.18	1.00	0.18	0.57	0.57
v/c Ratio	1.12	0.52	1.40	0.74	0.23
Control Delay	100.4	0.7	211.0	10.3	5.5
Queue Delay	0.0	0.0	0.0	0.0	0.0
Total Delay	100.4	0.7	211.0	10.3	5.5
LOS	F	A	F	B	A
Approach Delay	36.2		211.0	9.7	
Approach LOS	D		F	A	

Intersection Summary

Cycle Length: 70
 Actuated Cycle Length: 49.8
 Natural Cycle: 65
 Control Type: Actuated-Uncoordinated
 Maximum v/c Ratio: 1.40
 Intersection Signal Delay: 62.3
 Intersection LOS: E
 Intersection Capacity Utilization 72.0%
 ICU Level of Service C
 Analysis Period (min) 15

Splits and Phases: 33: I-215 NB On/Off Ramp & Van Buren Bl.



HCM 6th Signalized Intersection Summary
 33: I-215 NB On/Off Ramp & Van Buren Bl.

West Campus Upper Plateau (JN 14064)

09/19/2022

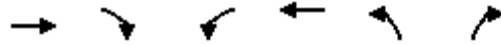

Movement	EBT	EBR	WBL	WBT	NBL	NBR
Lane Configurations	↑↑	↑↑		↑↑	↑↑	↑
Traffic Volume (veh/h)	715	1294	0	888	1313	200
Future Volume (veh/h)	715	1294	0	888	1313	200
Initial Q (Qb), veh	0	0	0	0	0	0
Ped-Bike Adj(A_pbT)		1.00	1.00		1.00	1.00
Parking Bus, Adj	1.00	1.00	1.00	1.00	1.00	1.00
Work Zone On Approach	No			No	No	
Adj Sat Flow, veh/h/ln	1900	1781	0	1900	1811	1885
Adj Flow Rate, veh/h	753	1354	0	935	1382	211
Peak Hour Factor	0.95	0.95	0.95	0.95	0.95	0.95
Percent Heavy Veh, %	0	8	0	0	6	1
Cap, veh/h	785	1886	0	785	1647	787
Arrive On Green	0.22	0.22	0.00	0.22	0.49	0.49
Sat Flow, veh/h	3705	2657	0	3800	3346	1598
Grp Volume(v), veh/h	753	1354	0	935	1382	211
Grp Sat Flow(s),veh/h/ln	1805	1329	0	1805	1673	1598
Q Serve(g_s), s	8.5	9.0	0.0	9.0	14.8	3.2
Cycle Q Clear(g_c), s	8.5	9.0	0.0	9.0	14.8	3.2
Prop In Lane		1.00	0.00		1.00	1.00
Lane Grp Cap(c), veh/h	785	1886	0	785	1647	787
V/C Ratio(X)	0.96	0.72	0.00	1.19	0.84	0.27
Avail Cap(c_a), veh/h	785	1886	0	785	3964	1892
HCM Platoon Ratio	1.00	1.00	1.00	1.00	1.00	1.00
Upstream Filter(I)	1.00	1.00	0.00	1.00	1.00	1.00
Uniform Delay (d), s/veh	16.0	3.0	0.0	16.2	9.1	6.1
Incr Delay (d2), s/veh	22.3	1.2	0.0	98.2	0.5	0.1
Initial Q Delay(d3),s/veh	0.0	0.0	0.0	0.0	0.0	0.0
%ile BackOfQ(50%),veh/ln	4.9	5.5	0.0	13.3	2.8	0.6
Unsig. Movement Delay, s/veh						
LnGrp Delay(d),s/veh	38.3	4.2	0.0	114.4	9.5	6.2
LnGrp LOS	D	A	A	F	A	A
Approach Vol, veh/h	2107			935	1593	
Approach Delay, s/veh	16.4			114.4	9.1	
Approach LOS	B			F	A	
Timer - Assigned Phs		2		4		6
Phs Duration (G+Y+Rc), s		15.0		26.4		15.0
Change Period (Y+Rc), s		6.0		6.0		6.0
Max Green Setting (Gmax), s		9.0		49.0		9.0
Max Q Clear Time (g_c+11), s		11.0		16.8		11.0
Green Ext Time (p_c), s		0.0		3.6		0.0
Intersection Summary						
HCM 6th Ctrl Delay			33.7			
HCM 6th LOS			C			

Timings

West Campus Upper Plateau (JN 14064)

34: Old 215 Frontage Rd. & Alessandro Bl.

09/19/2022

Lane Group	EBL	EBT	EBR	WBL	WBT	WBR	NBL	NBT	NBR	SBL	SBT	SBR
Lane Configurations												
Traffic Volume (vph)	398	1796	115	15	1247	128	42	164	16	143	226	269
Future Volume (vph)	398	1796	115	15	1247	128	42	164	16	143	226	269
Turn Type	Prot	NA	Perm	Prot	NA	Perm	Prot	NA	Perm	Prot	NA	Perm
Protected Phases	5	2		1	6		3	8		7	4	
Permitted Phases			2			6			8			4
Detector Phase	5	2	2	1	6	6	3	8	8	7	4	4
Switch Phase												
Minimum Initial (s)	5.0	10.0	10.0	5.0	10.0	10.0	5.0	10.0	10.0	5.0	10.0	10.0
Minimum Split (s)	8.7	43.5	43.5	8.7	15.8	15.8	8.7	16.2	16.2	8.7	40.2	40.2
Total Split (s)	22.0	62.4	62.4	8.7	49.1	49.1	8.7	29.7	29.7	19.2	40.2	40.2
Total Split (%)	18.3%	52.0%	52.0%	7.3%	40.9%	40.9%	7.3%	24.8%	24.8%	16.0%	33.5%	33.5%
Yellow Time (s)	3.2	5.5	5.5	3.2	4.8	4.8	3.2	5.2	5.2	3.2	5.2	5.2
All-Red Time (s)	0.5	1.0	1.0	0.5	1.0	1.0	0.5	1.0	1.0	0.5	1.0	1.0
Lost Time Adjust (s)	0.0	0.0	0.0	0.0	0.0	0.0	0.0	0.0	0.0	0.0	0.0	0.0
Total Lost Time (s)	3.7	6.5	6.5	3.7	5.8	5.8	3.7	6.2	6.2	3.7	6.2	6.2
Lead/Lag	Lead	Lag	Lag	Lead	Lag	Lag	Lead	Lag	Lag	Lead	Lag	Lag
Lead-Lag Optimize?	Yes	Yes	Yes	Yes	Yes	Yes	Yes	Yes	Yes	Yes	Yes	Yes
Recall Mode	None	None	None	None	None	None	None	None	None	None	None	None
Act Effct Green (s)	16.2	59.5	59.5	5.0	43.5	43.5	5.0	12.8	12.8	12.5	24.1	24.1
Actuated g/C Ratio	0.16	0.57	0.57	0.05	0.42	0.42	0.05	0.12	0.12	0.12	0.23	0.23
v/c Ratio	0.79	0.63	0.14	0.20	0.86	0.18	0.31	0.39	0.05	0.71	0.31	0.51
Control Delay	55.3	18.1	2.8	58.5	36.7	2.4	57.7	45.5	0.3	64.9	35.4	7.7
Queue Delay	0.0	0.0	0.0	0.0	0.0	0.0	0.0	0.0	0.0	0.0	0.0	0.0
Total Delay	55.3	18.1	2.8	58.5	36.7	2.4	57.7	45.5	0.3	64.9	35.4	7.7
LOS	E	B	A	E	D	A	E	D	A	E	D	A
Approach Delay		23.8			33.7			44.6			30.3	
Approach LOS		C			C			D			C	

Intersection Summary

Cycle Length: 120
 Actuated Cycle Length: 104.5
 Natural Cycle: 115
 Control Type: Actuated-Uncoordinated
 Maximum v/c Ratio: 0.86
 Intersection Signal Delay: 28.7
 Intersection LOS: C
 Intersection Capacity Utilization 78.7%
 ICU Level of Service D
 Analysis Period (min) 15

Splits and Phases: 34: Old 215 Frontage Rd. & Alessandro Bl.



HCM 6th Signalized Intersection Summary
 34: Old 215 Frontage Rd. & Alessandro Bl.

West Campus Upper Plateau (JN 14064)

09/19/2022



Movement	EBL	EBT	EBR	WBL	WBT	WBR	NBL	NBT	NBR	SBL	SBT	SBR
Lane Configurations	↖↗	↑↑↑	↖	↖	↑↑	↖	↖↗	↑↑	↖	↖	↑↑	↖
Traffic Volume (veh/h)	398	1796	115	15	1247	128	42	164	16	143	226	269
Future Volume (veh/h)	398	1796	115	15	1247	128	42	164	16	143	226	269
Initial Q (Qb), veh	0	0	0	0	0	0	0	0	0	0	0	0
Ped-Bike Adj(A_pbT)	1.00		0.99	1.00		1.00	1.00		0.98	1.00		1.00
Parking Bus, Adj	1.00	1.00	1.00	1.00	1.00	1.00	1.00	1.00	1.00	1.00	1.00	1.00
Work Zone On Approach		No			No			No			No	
Adj Sat Flow, veh/h/ln	1826	1885	1678	1678	1870	1856	1574	1856	1574	1826	1737	1693
Adj Flow Rate, veh/h	406	1833	90	15	1272	0	43	167	6	146	231	0
Peak Hour Factor	0.98	0.98	0.98	0.98	0.98	0.98	0.98	0.98	0.98	0.98	0.98	0.98
Percent Heavy Veh, %	5	1	15	15	2	3	22	3	22	5	11	14
Cap, veh/h	486	2807	766	28	1488		106	392	146	179	585	
Arrive On Green	0.14	0.55	0.55	0.02	0.42	0.00	0.04	0.11	0.11	0.10	0.18	0.00
Sat Flow, veh/h	3374	5147	1404	1598	3554	1572	2908	3526	1313	1739	3300	1434
Grp Volume(v), veh/h	406	1833	90	15	1272	0	43	167	6	146	231	0
Grp Sat Flow(s),veh/h/ln	1687	1716	1404	1598	1777	1572	1454	1763	1313	1739	1650	1434
Q Serve(g_s), s	10.5	22.6	2.8	0.8	29.1	0.0	1.3	4.0	0.4	7.4	5.6	0.0
Cycle Q Clear(g_c), s	10.5	22.6	2.8	0.8	29.1	0.0	1.3	4.0	0.4	7.4	5.6	0.0
Prop In Lane	1.00		1.00	1.00		1.00	1.00		1.00	1.00		1.00
Lane Grp Cap(c), veh/h	486	2807	766	28	1488		106	392	146	179	585	
V/C Ratio(X)	0.84	0.65	0.12	0.54	0.85		0.40	0.43	0.04	0.82	0.39	
Avail Cap(c_a), veh/h	686	3198	873	89	1711		162	921	343	300	1248	
HCM Platoon Ratio	1.00	1.00	1.00	1.00	1.00	1.00	1.00	1.00	1.00	1.00	1.00	1.00
Upstream Filter(I)	1.00	1.00	1.00	1.00	1.00	0.00	1.00	1.00	1.00	1.00	1.00	0.00
Uniform Delay (d), s/veh	37.5	14.4	9.9	43.8	23.7	0.0	42.4	37.3	35.7	39.5	32.7	0.0
Incr Delay (d2), s/veh	4.4	0.4	0.1	5.9	4.0	0.0	0.9	0.7	0.1	3.5	0.4	0.0
Initial Q Delay(d3),s/veh	0.0	0.0	0.0	0.0	0.0	0.0	0.0	0.0	0.0	0.0	0.0	0.0
%ile BackOfQ(50%),veh/ln	4.3	7.1	0.7	0.4	11.7	0.0	0.5	1.7	0.1	3.1	2.1	0.0
Unsig. Movement Delay, s/veh												
LnGrp Delay(d),s/veh	41.9	14.8	10.0	49.8	27.7	0.0	43.3	38.0	35.8	43.0	33.2	0.0
LnGrp LOS	D	B	B	D	C		D	D	D	D	C	
Approach Vol, veh/h		2329			1287			216			377	
Approach Delay, s/veh		19.4			27.9			39.0			37.0	
Approach LOS		B			C			D			D	
Timer - Assigned Phs	1	2	3	4	5	6	7	8				
Phs Duration (G+Y+Rc), s	5.3	55.5	7.0	22.1	16.6	44.2	12.9	16.2				
Change Period (Y+Rc), s	3.7	6.5	3.7	6.2	3.7	* 6.5	3.7	6.2				
Max Green Setting (Gmax), s	5.0	55.9	5.0	34.0	18.3	* 43	15.5	23.5				
Max Q Clear Time (g_c+I1), s	2.8	24.6	3.3	7.6	12.5	31.1	9.4	6.0				
Green Ext Time (p_c), s	0.0	16.1	0.0	1.3	0.4	6.5	0.1	0.8				

Intersection Summary

HCM 6th Ctrl Delay	24.6
HCM 6th LOS	C

Notes

* HCM 6th computational engine requires equal clearance times for the phases crossing the barrier.
 Unsignalized Delay for [WBR, SBR] is excluded from calculations of the approach delay and intersection delay.

Timings
35: Day St. & Alessandro Bl.

West Campus Upper Plateau (JN 14064)

09/19/2022



Lane Group	EBL	EBT	EBR	WBL	WBT	WBR	NBL	NBT	NBR	SBL	SBT
Lane Configurations	↖	↗↗↗	↖	↖	↗↗	↖	↖	↗	↖	↖	↗
Traffic Volume (vph)	234	1777	24	14	1177	216	17	184	13	248	160
Future Volume (vph)	234	1777	24	14	1177	216	17	184	13	248	160
Turn Type	Prot	NA	Perm	Prot	NA	Perm	Perm	NA	Perm	Perm	NA
Protected Phases	5	2		1	6			8			4
Permitted Phases			2			6	8		8	4	
Detector Phase	5	2	2	1	6	6	8	8	8	4	4
Switch Phase											
Minimum Initial (s)	5.0	10.0	10.0	5.0	10.0	10.0	10.0	10.0	10.0	10.0	10.0
Minimum Split (s)	9.1	30.8	30.8	9.1	30.8	30.8	42.4	42.4	42.4	41.6	41.6
Total Split (s)	28.0	67.9	67.9	9.1	49.0	49.0	43.0	43.0	43.0	43.0	43.0
Total Split (%)	23.3%	56.6%	56.6%	7.6%	40.8%	40.8%	35.8%	35.8%	35.8%	35.8%	35.8%
Yellow Time (s)	3.6	4.8	4.8	3.6	4.8	4.8	4.4	4.4	4.4	3.6	3.6
All-Red Time (s)	0.5	1.0	1.0	0.5	1.0	1.0	1.0	1.0	1.0	1.0	1.0
Lost Time Adjust (s)	0.0	0.0	0.0	0.0	0.0	0.0	0.0	0.0	0.0	0.0	0.0
Total Lost Time (s)	4.1	5.8	5.8	4.1	5.8	5.8	5.4	5.4	5.4	4.6	4.6
Lead/Lag	Lead	Lag	Lag	Lead	Lag	Lag					
Lead-Lag Optimize?	Yes	Yes	Yes	Yes	Yes	Yes					
Recall Mode	None	None	None	None	None	None	None	None	None	None	None
Act Effct Green (s)	18.2	60.9	60.9	5.1	41.6	41.6	29.7	29.7	29.7	30.5	30.5
Actuated g/C Ratio	0.17	0.58	0.58	0.05	0.40	0.40	0.28	0.28	0.28	0.29	0.29
v/c Ratio	0.78	0.63	0.03	0.17	0.88	0.33	0.13	0.36	0.03	0.85	0.60
Control Delay	61.2	17.6	0.2	59.0	39.7	15.8	31.9	32.9	0.1	62.2	33.5
Queue Delay	0.0	0.0	0.0	0.0	0.0	0.0	0.0	0.0	0.0	0.0	0.0
Total Delay	61.2	17.6	0.2	59.0	39.7	15.8	31.9	32.9	0.1	62.2	33.5
LOS	E	B	A	E	D	B	C	C	A	E	C
Approach Delay		22.4			36.2			30.8			46.3
Approach LOS		C			D			C			D

Intersection Summary

Cycle Length: 120
 Actuated Cycle Length: 105.3
 Natural Cycle: 95
 Control Type: Actuated-Uncoordinated
 Maximum v/c Ratio: 0.88
 Intersection Signal Delay: 30.6
 Intersection LOS: C
 Intersection Capacity Utilization 87.6%
 ICU Level of Service E
 Analysis Period (min) 15





























Splits and Phases: 35: Day St. & Alessandro Bl.



HCM 6th Signalized Intersection Summary
35: Day St. & Alessandro Bl.

West Campus Upper Plateau (JN 14064)

09/19/2022

												
Movement	EBL	EBT	EBR	WBL	WBT	WBR	NBL	NBT	NBR	SBL	SBT	SBR
Lane Configurations		  			 						 	
Traffic Volume (veh/h)	234	1777	24	14	1177	216	17	184	13	248	160	144
Future Volume (veh/h)	234	1777	24	14	1177	216	17	184	13	248	160	144
Initial Q (Qb), veh	0	0	0	0	0	0	0	0	0	0	0	0
Ped-Bike Adj(A_pbT)	1.00		0.98	1.00		0.98	1.00		1.00	1.00		1.00
Parking Bus, Adj	1.00	1.00	1.00	1.00	1.00	1.00	1.00	1.00	1.00	1.00	1.00	1.00
Work Zone On Approach		No			No			No			No	
Adj Sat Flow, veh/h/ln	1900	1870	1618	1900	1870	1900	1500	1900	1767	1885	1885	1870
Adj Flow Rate, veh/h	244	1851	19	15	1226	157	18	192	9	258	167	119
Peak Hour Factor	0.96	0.96	0.96	0.96	0.96	0.96	0.96	0.96	0.96	0.96	0.96	0.96
Percent Heavy Veh, %	0	2	19	0	2	0	27	0	9	1	1	2
Cap, veh/h	276	2654	697	30	1364	605	231	606	478	357	327	233
Arrive On Green	0.15	0.52	0.52	0.02	0.38	0.38	0.32	0.32	0.32	0.32	0.32	0.32
Sat Flow, veh/h	1810	5106	1341	1810	3554	1575	877	1900	1497	1191	1024	730
Grp Volume(v), veh/h	244	1851	19	15	1226	157	18	192	9	258	0	286
Grp Sat Flow(s),veh/h/ln	1810	1702	1341	1810	1777	1575	877	1900	1497	1191	0	1754
Q Serve(g_s), s	14.0	29.0	0.7	0.9	34.4	7.2	1.8	8.1	0.4	22.2	0.0	14.1
Cycle Q Clear(g_c), s	14.0	29.0	0.7	0.9	34.4	7.2	15.9	8.1	0.4	30.4	0.0	14.1
Prop In Lane	1.00		1.00	1.00		1.00	1.00		1.00	1.00		0.42
Lane Grp Cap(c), veh/h	276	2654	697	30	1364	605	231	606	478	357	0	560
V/C Ratio(X)	0.88	0.70	0.03	0.49	0.90	0.26	0.08	0.32	0.02	0.72	0.00	0.51
Avail Cap(c_a), veh/h	407	2987	785	85	1446	641	262	673	530	407	0	634
HCM Platoon Ratio	1.00	1.00	1.00	1.00	1.00	1.00	1.00	1.00	1.00	1.00	1.00	1.00
Upstream Filter(I)	1.00	1.00	1.00	1.00	1.00	1.00	1.00	1.00	1.00	1.00	0.00	1.00
Uniform Delay (d), s/veh	44.0	19.2	12.4	51.7	30.8	22.4	35.9	27.4	24.7	38.9	0.0	29.4
Incr Delay (d2), s/veh	10.7	0.6	0.0	4.5	7.6	0.2	0.1	0.3	0.0	5.4	0.0	0.7
Initial Q Delay(d3),s/veh	0.0	0.0	0.0	0.0	0.0	0.0	0.0	0.0	0.0	0.0	0.0	0.0
%ile BackOfQ(50%),veh/ln	6.9	10.4	0.2	0.4	15.1	2.6	0.4	3.6	0.2	7.0	0.0	6.1
Unsig. Movement Delay, s/veh												
LnGrp Delay(d),s/veh	54.7	19.8	12.4	56.2	38.4	22.6	36.0	27.7	24.8	44.2	0.0	30.1
LnGrp LOS	D	B	B	E	D	C	D	C	C	D	A	C
Approach Vol, veh/h		2114			1398			219			544	
Approach Delay, s/veh		23.8			36.8			28.2			36.8	
Approach LOS		C			D			C			D	
Timer - Assigned Phs	1	2		4	5	6		8				
Phs Duration (G+Y+Rc), s	5.9	61.0		39.3	20.3	46.6		39.3				
Change Period (Y+Rc), s	4.1	5.8		* 5.4	4.1	5.8		5.4				
Max Green Setting (Gmax), s	5.0	62.1		* 38	23.9	43.2		37.6				
Max Q Clear Time (g_c+I1), s	2.9	31.0		32.4	16.0	36.4		17.9				
Green Ext Time (p_c), s	0.0	16.9		1.5	0.2	4.3		1.0				

Intersection Summary

HCM 6th Ctrl Delay	29.9
HCM 6th LOS	C

Notes

* HCM 6th computational engine requires equal clearance times for the phases crossing the barrier.

Timings
36: Elsworth St. & Cactus Av.

West Campus Upper Plateau (JN 14064)

09/19/2022



Lane Group	EBL	EBT	EBR	WBL	WBT	WBR	NBL	NBT	SBL	SBT	SBR
Lane Configurations	↘	↑↑↑	↗	↘	↑↑↑	↗	↘	↕	↘	↗	↗
Traffic Volume (vph)	243	2493	30	17	1840	181	219	73	315	15	296
Future Volume (vph)	243	2493	30	17	1840	181	219	73	315	15	296
Turn Type	Prot	NA	Perm	Prot	NA	Perm	Split	NA	Split	NA	pm+ov
Protected Phases	5	2		1	6		8	8	4	4	5
Permitted Phases			2			6					4
Detector Phase	5	2	2	1	6	6	8	8	4	4	5
Switch Phase											
Minimum Initial (s)	5.0	10.0	10.0	5.0	10.0	10.0	10.0	10.0	10.0	10.0	5.0
Minimum Split (s)	9.6	36.2	36.2	9.6	36.2	36.2	35.4	35.4	35.4	35.4	9.6
Total Split (s)	16.5	49.6	49.6	9.6	42.7	42.7	35.4	35.4	35.4	35.4	16.5
Total Split (%)	12.7%	38.2%	38.2%	7.4%	32.8%	32.8%	27.2%	27.2%	27.2%	27.2%	12.7%
Yellow Time (s)	3.6	5.2	5.2	3.6	5.2	5.2	4.4	4.4	4.4	4.4	3.6
All-Red Time (s)	1.0	1.0	1.0	1.0	1.0	1.0	1.0	1.0	1.0	1.0	1.0
Lost Time Adjust (s)	0.0	0.0	0.0	0.0	0.0	0.0	0.0	0.0	0.0	0.0	0.0
Total Lost Time (s)	4.6	6.2	6.2	4.6	6.2	6.2	5.4	5.4	5.4	5.4	4.6
Lead/Lag	Lead	Lag	Lag	Lead	Lag	Lag					Lead
Lead-Lag Optimize?	Yes	Yes	Yes	Yes	Yes	Yes					Yes
Recall Mode	None	None	None	None	None	None	Max	Max	Max	Max	None
Act Effct Green (s)	11.9	49.2	49.2	5.0	36.5	36.5	30.0	30.0	30.0	30.0	42.7
Actuated g/C Ratio	0.09	0.38	0.38	0.04	0.28	0.28	0.23	0.23	0.23	0.23	0.33
v/c Ratio	1.56	1.38	0.05	0.26	1.36	0.34	0.51	0.47	0.43	0.43	0.50
Control Delay	318.6	206.2	0.1	70.2	202.2	12.3	49.1	40.4	46.8	46.8	12.4
Queue Delay	0.0	0.0	0.0	0.0	0.0	0.0	0.0	0.0	0.0	0.0	0.0
Total Delay	318.6	206.2	0.1	70.2	202.2	12.3	49.1	40.4	46.8	46.8	12.4
LOS	F	F	A	E	F	B	D	D	D	D	B
Approach Delay		213.9			184.2			44.8		30.6	
Approach LOS		F			F			D		C	

Intersection Summary

Cycle Length: 130
 Actuated Cycle Length: 130
 Natural Cycle: 120
 Control Type: Actuated-Uncoordinated
 Maximum v/c Ratio: 1.56
 Intersection Signal Delay: 172.7
 Intersection LOS: F
 Intersection Capacity Utilization 90.0%
 ICU Level of Service E
 Analysis Period (min) 15

Splits and Phases: 36: Elsworth St. & Cactus Av.

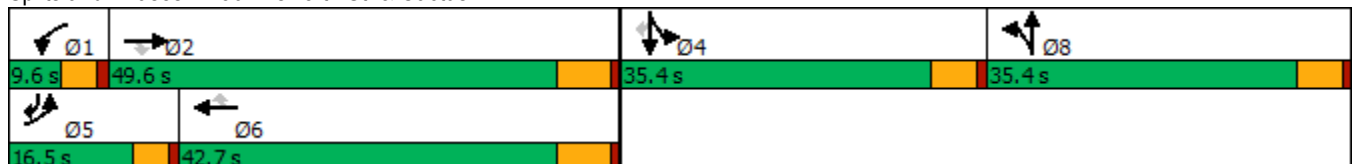

HCM 6th Signalized Intersection Summary
36: Elsworth St. & Cactus Av.

West Campus Upper Plateau (JN 14064)

09/19/2022



Movement	EBL	EBT	EBR	WBL	WBT	WBR	NBL	NBT	NBR	SBL	SBT	SBR
Lane Configurations												
Traffic Volume (veh/h)	243	2493	30	17	1840	181	219	73	85	315	15	296
Future Volume (veh/h)	243	2493	30	17	1840	181	219	73	85	315	15	296
Initial Q (Qb), veh	0	0	0	0	0	0	0	0	0	0	0	0
Ped-Bike Adj(A_pbT)	1.00		1.00	1.00		1.00	1.00		1.00	1.00		1.00
Parking Bus, Adj	1.00	1.00	1.00	1.00	1.00	1.00	1.00	1.00	1.00	1.00	1.00	1.00
Work Zone On Approach		No			No			No			No	
Adj Sat Flow, veh/h/ln	1870	1841	1781	1900	1856	1885	1885	1900	1885	1900	1900	1900
Adj Flow Rate, veh/h	253	2597	0	18	1917	153	185	137	65	339	0	201
Peak Hour Factor	0.96	0.96	0.96	0.96	0.96	0.96	0.96	0.96	0.96	0.96	0.96	0.96
Percent Heavy Veh, %	2	4	8	0	3	1	1	0	1	0	0	0
Cap, veh/h	163	1779		33	1422	449	414	281	133	835	0	519
Arrive On Green	0.09	0.35	0.00	0.02	0.28	0.28	0.23	0.23	0.23	0.23	0.00	0.23
Sat Flow, veh/h	1781	5025	1510	1810	5066	1598	1795	1218	578	3619	0	1610
Grp Volume(v), veh/h	253	2597	0	18	1917	153	185	0	202	339	0	201
Grp Sat Flow(s),veh/h/ln	1781	1675	1510	1810	1689	1598	1795	0	1796	1810	0	1610
Q Serve(g_s), s	11.9	46.0	0.0	1.3	36.5	9.9	11.5	0.0	12.7	10.3	0.0	12.6
Cycle Q Clear(g_c), s	11.9	46.0	0.0	1.3	36.5	9.9	11.5	0.0	12.7	10.3	0.0	12.6
Prop In Lane	1.00		1.00	1.00		1.00	1.00		0.32	1.00		1.00
Lane Grp Cap(c), veh/h	163	1779		33	1422	449	414	0	414	835	0	519
V/C Ratio(X)	1.55	1.46		0.54	1.35	0.34	0.45	0.00	0.49	0.41	0.00	0.39
Avail Cap(c_a), veh/h	163	1779		70	1422	449	414	0	414	835	0	519
HCM Platoon Ratio	1.00	1.00	1.00	1.00	1.00	1.00	1.00	1.00	1.00	1.00	1.00	1.00
Upstream Filter(I)	1.00	1.00	0.00	1.00	1.00	1.00	1.00	0.00	1.00	1.00	0.00	1.00
Uniform Delay (d), s/veh	59.1	42.0	0.0	63.3	46.7	37.2	42.9	0.0	43.3	42.4	0.0	34.1
Incr Delay (d2), s/veh	276.1	210.3	0.0	5.0	161.3	0.4	3.5	0.0	4.1	1.5	0.0	2.2
Initial Q Delay(d3),s/veh	0.0	0.0	0.0	0.0	0.0	0.0	0.0	0.0	0.0	0.0	0.0	0.0
%ile BackOfQ(50%),veh/ln	17.7	52.6	0.0	0.6	35.9	3.8	5.6	0.0	6.2	4.7	0.0	5.3
Unsig. Movement Delay, s/veh												
LnGrp Delay(d),s/veh	335.2	252.2	0.0	68.3	208.0	37.6	46.3	0.0	47.4	43.9	0.0	36.3
LnGrp LOS	F	F		E	F	D	D	A	D	D	A	D
Approach Vol, veh/h		2850			2088			387			540	
Approach Delay, s/veh		259.6			194.3			46.9			41.1	
Approach LOS		F			F			D			D	
Timer - Assigned Phs	1	2		4	5	6		8				
Phs Duration (G+Y+Rc), s	7.0	52.2		35.4	16.5	42.7		35.4				
Change Period (Y+Rc), s	4.6	6.2		5.4	4.6	6.2		5.4				
Max Green Setting (Gmax), s	5.0	43.4		30.0	11.9	36.5		30.0				
Max Q Clear Time (g_c+I1), s	3.3	48.0		14.6	13.9	38.5		14.7				
Green Ext Time (p_c), s	0.0	0.0		1.7	0.0	0.0		1.6				

Intersection Summary

HCM 6th Ctrl Delay	202.2
HCM 6th LOS	F

Notes

- User approved pedestrian interval to be less than phase max green.
- User approved volume balancing among the lanes for turning movement.
- Unsignalized Delay for [EBR] is excluded from calculations of the approach delay and intersection delay.

Timings
37: Cactus Av. & Frederick St.

West Campus Upper Plateau (JN 14064)

09/19/2022

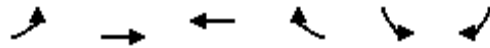

Lane Group	EBL	EBT	WBT	WBR	SBL	SBR
Lane Configurations	↖	↗↗↗	↖↖↖	↗	↖↖	↗
Traffic Volume (vph)	225	2532	1553	176	496	201
Future Volume (vph)	225	2532	1553	176	496	201
Turn Type	Prot	NA	NA	pm+ov	Prot	pm+ov
Protected Phases	5	2	6	4	4	5
Permitted Phases				6		4
Detector Phase	5	2	6	4	4	5
Switch Phase						
Minimum Initial (s)	5.0	10.0	10.0	10.0	10.0	5.0
Minimum Split (s)	9.2	28.2	29.2	36.4	36.4	9.2
Total Split (s)	31.0	81.0	50.0	39.0	39.0	31.0
Total Split (%)	25.8%	67.5%	41.7%	32.5%	32.5%	25.8%
Yellow Time (s)	3.2	5.2	5.2	4.4	4.4	3.2
All-Red Time (s)	1.0	1.0	1.0	1.0	1.0	1.0
Lost Time Adjust (s)	0.0	0.0	0.0	0.0	0.0	0.0
Total Lost Time (s)	4.2	6.2	6.2	5.4	5.4	4.2
Lead/Lag	Lead		Lag			Lead
Lead-Lag Optimize?	Yes		Yes			Yes
Recall Mode	None	None	None	None	None	None
Act Effct Green (s)	18.8	69.6	46.6	69.6	22.2	46.4
Actuated g/C Ratio	0.18	0.67	0.45	0.67	0.21	0.45
v/c Ratio	0.76	0.79	0.72	0.17	0.72	0.30
Control Delay	57.7	14.6	27.0	1.2	44.5	18.9
Queue Delay	0.0	0.0	0.0	0.0	0.0	0.0
Total Delay	57.7	14.6	27.0	1.2	44.5	18.9
LOS	E	B	C	A	D	B
Approach Delay		18.1	24.4		37.1	
Approach LOS		B	C		D	

Intersection Summary

Cycle Length: 120
 Actuated Cycle Length: 103.6
 Natural Cycle: 90
 Control Type: Actuated-Uncoordinated
 Maximum v/c Ratio: 0.79
 Intersection Signal Delay: 22.8
 Intersection LOS: C
 Intersection Capacity Utilization 72.7%
 ICU Level of Service C
 Analysis Period (min) 15

Splits and Phases: 37: Cactus Av. & Frederick St.



HCM 6th Signalized Intersection Summary
37: Cactus Av. & Frederick St.

West Campus Upper Plateau (JN 14064)

09/19/2022

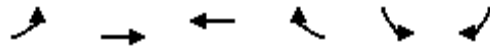

Movement	EBL	EBT	WBT	WBR	SBL	SBR
Lane Configurations	↗	↑↑↑	↑↑↑	↖	↗	↖
Traffic Volume (veh/h)	225	2532	1553	176	496	201
Future Volume (veh/h)	225	2532	1553	176	496	201
Initial Q (Qb), veh	0	0	0	0	0	0
Ped-Bike Adj(A_pbT)	1.00			0.98	1.00	1.00
Parking Bus, Adj	1.00	1.00	1.00	1.00	1.00	1.00
Work Zone On Approach		No	No		No	
Adj Sat Flow, veh/h/ln	1826	1856	1856	1870	1856	1856
Adj Flow Rate, veh/h	237	2665	1635	123	522	115
Peak Hour Factor	0.95	0.95	0.95	0.95	0.95	0.95
Percent Heavy Veh, %	5	3	3	2	3	3
Cap, veh/h	272	3488	2471	1055	649	543
Arrive On Green	0.16	0.69	0.49	0.49	0.19	0.19
Sat Flow, veh/h	1739	5233	5233	1549	3428	1572
Grp Volume(v), veh/h	237	2665	1635	123	522	115
Grp Sat Flow(s),veh/h/ln	1739	1689	1689	1549	1714	1572
Q Serve(g_s), s	12.6	32.8	23.2	2.6	13.8	4.9
Cycle Q Clear(g_c), s	12.6	32.8	23.2	2.6	13.8	4.9
Prop In Lane	1.00			1.00	1.00	1.00
Lane Grp Cap(c), veh/h	272	3488	2471	1055	649	543
V/C Ratio(X)	0.87	0.76	0.66	0.12	0.80	0.21
Avail Cap(c_a), veh/h	491	3995	2471	1055	1214	803
HCM Platoon Ratio	1.00	1.00	1.00	1.00	1.00	1.00
Upstream Filter(I)	1.00	1.00	1.00	1.00	1.00	1.00
Uniform Delay (d), s/veh	39.1	9.7	18.4	5.4	36.8	21.9
Incr Delay (d2), s/veh	3.4	0.8	0.7	0.0	2.4	0.2
Initial Q Delay(d3),s/veh	0.0	0.0	0.0	0.0	0.0	0.0
%ile BackOfQ(50%),veh/ln	5.3	8.5	7.9	1.3	5.8	5.0
Unsig. Movement Delay, s/veh						
LnGrp Delay(d),s/veh	42.5	10.5	19.0	5.4	39.2	22.1
LnGrp LOS	D	B	B	A	D	C
Approach Vol, veh/h		2902	1758		637	
Approach Delay, s/veh		13.1	18.1		36.1	
Approach LOS		B	B		D	
Timer - Assigned Phs		2		4	5	6
Phs Duration (G+Y+Rc), s		71.5		23.3	19.0	52.5
Change Period (Y+Rc), s		6.2		5.4	* 4.2	6.2
Max Green Setting (Gmax), s		74.8		33.6	* 27	43.8
Max Q Clear Time (g_c+I1), s		34.8		15.8	14.6	25.2
Green Ext Time (p_c), s		30.5		2.1	0.2	10.9

Intersection Summary

HCM 6th Ctrl Delay	17.5
HCM 6th LOS	B

Notes

* HCM 6th computational engine requires equal clearance times for the phases crossing the barrier.

Timings
38: Riverside Dr./Graham St. & Cactus Av.

West Campus Upper Plateau (JN 14064)

09/19/2022

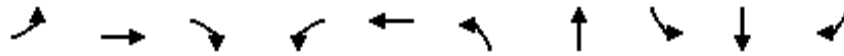

Lane Group	EBL	EBT	EBR	WBL	WBT	NBL	NBT	SBL	SBT	SBR
Lane Configurations	↘	↑↑↑	↗	↘	↑↑↑	↘↗	↑↗	↘	↑↑	↗
Traffic Volume (vph)	198	2839	421	19	1723	13	0	142	101	165
Future Volume (vph)	198	2839	421	19	1723	13	0	142	101	165
Turn Type	Prot	NA	Perm	Prot	NA	Prot	NA	Prot	NA	Perm
Protected Phases	7	4		3	8	5	2	1	6	
Permitted Phases			4							6
Detector Phase	7	4	4	3	8	5	2	1	6	6
Switch Phase										
Minimum Initial (s)	5.0	10.0	10.0	5.0	10.0	5.0	10.0	5.0	10.0	10.0
Minimum Split (s)	9.6	39.2	39.2	9.6	39.2	10.4	35.0	9.6	40.6	40.6
Total Split (s)	16.0	59.0	59.0	9.6	52.6	10.4	36.0	15.4	41.0	41.0
Total Split (%)	13.3%	49.2%	49.2%	8.0%	43.8%	8.7%	30.0%	12.8%	34.2%	34.2%
Yellow Time (s)	3.6	5.2	5.2	3.6	5.2	4.4	4.0	3.6	3.6	3.6
All-Red Time (s)	1.0	1.0	1.0	1.0	1.0	1.0	1.0	1.0	1.0	1.0
Lost Time Adjust (s)	0.0	0.0	0.0	0.0	0.0	0.0	0.0	0.0	0.0	0.0
Total Lost Time (s)	4.6	6.2	6.2	4.6	6.2	5.4	5.0	4.6	4.6	4.6
Lead/Lag	Lead	Lag	Lag	Lead	Lag	Lead	Lag	Lead	Lag	Lag
Lead-Lag Optimize?	Yes	Yes	Yes	Yes	Yes	Yes	Yes	Yes	Yes	Yes
Recall Mode	None	Min	Min	None	Min	None	None	None	None	None
Act Effct Green (s)	11.6	60.1	60.1	5.1	47.3	5.1	13.3	11.0	14.9	14.9
Actuated g/C Ratio	0.13	0.66	0.66	0.06	0.52	0.06	0.15	0.12	0.16	0.16
v/c Ratio	0.95	0.93	0.41	0.21	0.76	0.07	0.00	0.72	0.19	0.44
Control Delay	91.2	23.0	7.4	51.0	21.8	46.9	0.0	60.7	32.9	8.6
Queue Delay	0.0	0.0	0.0	0.0	0.0	0.0	0.0	0.0	0.0	0.0
Total Delay	91.2	23.0	7.4	51.0	21.8	46.9	0.0	60.7	32.9	8.6
LOS	F	C	A	D	C	D	A	E	C	A
Approach Delay		25.0			22.1		43.8		32.7	
Approach LOS		C			C		D		C	

Intersection Summary

Cycle Length: 120
 Actuated Cycle Length: 91.1
 Natural Cycle: 120
 Control Type: Actuated-Uncoordinated
 Maximum v/c Ratio: 0.95
 Intersection Signal Delay: 24.7
 Intersection LOS: C
 Intersection Capacity Utilization 86.4%
 ICU Level of Service E
 Analysis Period (min) 15

Splits and Phases: 38: Riverside Dr./Graham St. & Cactus Av.

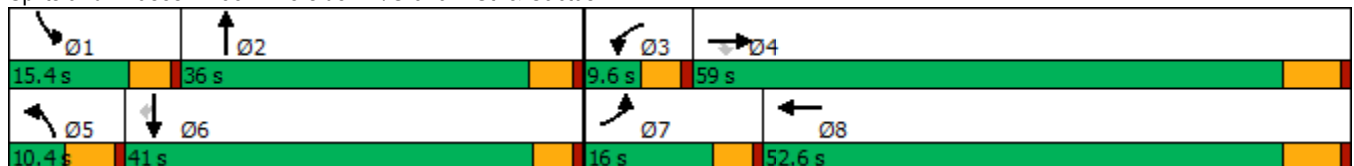

HCM 6th Signalized Intersection Summary
38: Riverside Dr./Graham St. & Cactus Av.

West Campus Upper Plateau (JN 14064)

09/19/2022



Movement	EBL	EBT	EBR	WBL	WBT	WBR	NBL	NBT	NBR	SBL	SBT	SBR
Lane Configurations	↘	↑↑↑	↗	↘	↑↑↑		↘↗	↑↗		↘	↑↑	↗
Traffic Volume (veh/h)	198	2839	421	19	1723	94	13	0	1	142	101	165
Future Volume (veh/h)	198	2839	421	19	1723	94	13	0	1	142	101	165
Initial Q (Qb), veh	0	0	0	0	0	0	0	0	0	0	0	0
Ped-Bike Adj(A_pbT)	1.00		1.00	1.00		0.99	1.00		1.00	1.00		1.00
Parking Bus, Adj	1.00	1.00	1.00	1.00	1.00	1.00	1.00	1.00	1.00	1.00	1.00	1.00
Work Zone On Approach		No			No			No			No	
Adj Sat Flow, veh/h/ln	1870	1856	1885	1900	1856	1900	1900	1900	1900	1870	1885	1856
Adj Flow Rate, veh/h	215	3086	410	21	1873	93	14	0	0	154	110	101
Peak Hour Factor	0.92	0.92	0.92	0.92	0.92	0.92	0.92	0.92	0.92	0.92	0.92	0.92
Percent Heavy Veh, %	2	3	1	0	3	0	0	0	0	2	1	3
Cap, veh/h	232	3059	965	41	2452	121	58	125	0	188	410	180
Arrive On Green	0.13	0.60	0.60	0.02	0.50	0.50	0.02	0.00	0.00	0.11	0.11	0.11
Sat Flow, veh/h	1781	5066	1598	1810	4940	245	3510	3705	0	1781	3582	1572
Grp Volume(v), veh/h	215	3086	410	21	1279	687	14	0	0	154	110	101
Grp Sat Flow(s),veh/h/ln	1781	1689	1598	1810	1689	1808	1755	1805	0	1781	1791	1572
Q Serve(g_s), s	10.4	52.8	12.0	1.0	26.9	27.0	0.3	0.0	0.0	7.4	2.5	5.3
Cycle Q Clear(g_c), s	10.4	52.8	12.0	1.0	26.9	27.0	0.3	0.0	0.0	7.4	2.5	5.3
Prop In Lane	1.00		1.00	1.00		0.14	1.00		0.00	1.00		1.00
Lane Grp Cap(c), veh/h	232	3059	965	41	1676	897	58	125	0	188	410	180
V/C Ratio(X)	0.93	1.01	0.42	0.51	0.76	0.77	0.24	0.00	0.00	0.82	0.27	0.56
Avail Cap(c_a), veh/h	232	3059	965	103	1792	959	201	1280	0	220	1491	655
HCM Platoon Ratio	1.00	1.00	1.00	1.00	1.00	1.00	1.00	1.00	1.00	1.00	1.00	1.00
Upstream Filter(I)	1.00	1.00	1.00	1.00	1.00	1.00	1.00	0.00	0.00	1.00	1.00	1.00
Uniform Delay (d), s/veh	37.6	17.3	9.2	42.2	17.9	17.9	42.5	0.0	0.0	38.3	35.4	36.6
Incr Delay (d2), s/veh	38.7	18.5	0.3	3.5	1.9	3.5	0.8	0.0	0.0	16.4	0.3	2.7
Initial Q Delay(d3),s/veh	0.0	0.0	0.0	0.0	0.0	0.0	0.0	0.0	0.0	0.0	0.0	0.0
%ile BackOfQ(50%),veh/ln	6.7	20.3	3.3	0.5	9.1	10.2	0.2	0.0	0.0	4.0	1.0	2.0
Unsig. Movement Delay, s/veh												
LnGrp Delay(d),s/veh	76.3	35.8	9.5	45.8	19.7	21.4	43.3	0.0	0.0	54.7	35.7	39.4
LnGrp LOS	E	F	A	D	B	C	D	A	A	D	D	D
Approach Vol, veh/h		3711			1987			14			365	
Approach Delay, s/veh		35.2			20.6			43.3			44.7	
Approach LOS		D			C			D			D	
Timer - Assigned Phs	1	2	3	4	5	6	7	8				
Phs Duration (G+Y+Rc), s	13.8	8.0	6.6	59.0	6.8	15.0	16.0	49.6				
Change Period (Y+Rc), s	4.6	5.0	4.6	6.2	5.4	* 5	4.6	6.2				
Max Green Setting (Gmax), s	10.8	31.0	5.0	52.8	5.0	* 36	11.4	46.4				
Max Q Clear Time (g_c+I1), s	9.4	0.0	3.0	54.8	2.3	7.3	12.4	29.0				
Green Ext Time (p_c), s	0.0	0.0	0.0	0.0	0.0	0.9	0.0	11.6				

Intersection Summary

HCM 6th Ctrl Delay	31.0
HCM 6th LOS	C

Notes

* HCM 6th computational engine requires equal clearance times for the phases crossing the barrier.

Timings
1: Washington St & Van Buren Bl.

West Campus Upper Plateau (JN 14064)

09/30/2022



Lane Group	EBL	EBT	WBL	WBT	WBR	NBL	NBT	NBR	SBL	SBT
Lane Configurations	↘	↗	↘	↗	↗	↗	↗	↗	↗	↗
Traffic Volume (vph)	126	974	125	947	291	146	219	142	389	191
Future Volume (vph)	126	974	125	947	291	146	219	142	389	191
Turn Type	Prot	NA	Prot	NA	Perm	Prot	NA	Perm	Prot	NA
Protected Phases	5	2	1	6		3	8		7	4
Permitted Phases					6			8		
Detector Phase	5	2	1	6	6	3	8	8	7	4
Switch Phase										
Minimum Initial (s)	5.0	10.0	5.0	10.0	10.0	5.0	10.0	10.0	5.0	10.0
Minimum Split (s)	9.2	34.2	9.2	33.2	33.2	9.2	38.4	38.4	9.2	30.8
Total Split (s)	14.2	49.6	14.0	49.4	49.4	11.5	38.4	38.4	18.0	44.9
Total Split (%)	11.8%	41.3%	11.7%	41.2%	41.2%	9.6%	32.0%	32.0%	15.0%	37.4%
Yellow Time (s)	3.2	5.2	3.2	5.2	5.2	3.2	4.4	4.4	3.2	4.8
All-Red Time (s)	1.0	1.0	1.0	1.0	1.0	1.0	1.0	1.0	1.0	1.0
Lost Time Adjust (s)	0.0	0.0	0.0	0.0	0.0	0.0	0.0	0.0	0.0	0.0
Total Lost Time (s)	4.2	6.2	4.2	6.2	6.2	4.2	5.4	5.4	4.2	5.8
Lead/Lag	Lead	Lag	Lead	Lag	Lag	Lead	Lag	Lag	Lead	Lag
Lead-Lag Optimize?	Yes	Yes	Yes	Yes	Yes	Yes	Yes	Yes	Yes	Yes
Recall Mode	None	None	None	None	None	None	None	None	None	None
Act Effct Green (s)	9.8	38.0	9.8	37.9	37.9	7.2	14.9	14.9	14.0	21.4
Actuated g/C Ratio	0.10	0.39	0.10	0.39	0.39	0.07	0.15	0.15	0.14	0.22
v/c Ratio	0.71	0.80	0.72	0.71	0.41	0.59	0.42	0.40	0.80	0.36
Control Delay	67.1	32.2	68.1	29.1	10.2	56.4	39.6	9.4	55.2	26.3
Queue Delay	0.0	0.0	0.0	0.0	0.0	0.0	0.0	0.0	0.0	0.0
Total Delay	67.1	32.2	68.1	29.1	10.2	56.4	39.6	9.4	55.2	26.3
LOS	E	C	E	C	B	E	D	A	E	C
Approach Delay		35.9		28.7			36.0			43.3
Approach LOS		D		C			D			D

Intersection Summary

Cycle Length: 120
 Actuated Cycle Length: 97
 Natural Cycle: 105
 Control Type: Actuated-Uncoordinated
 Maximum v/c Ratio: 0.80
 Intersection Signal Delay: 34.6
 Intersection LOS: C
 Intersection Capacity Utilization 73.0%
 ICU Level of Service D
 Analysis Period (min) 15



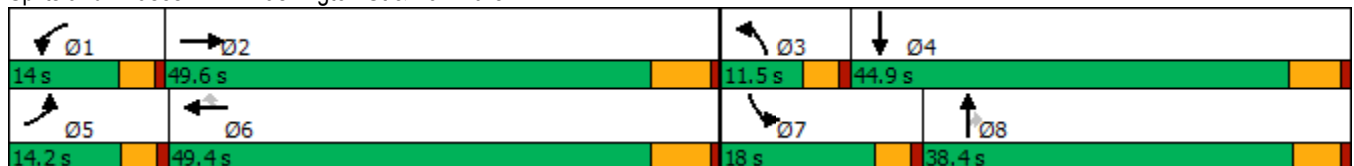



















Splits and Phases: 1: Washington St & Van Buren Bl.



HCM 6th Signalized Intersection Summary
1: Washington St & Van Buren Bl.

West Campus Upper Plateau (JN 14064)

09/30/2022

												
Movement	EBL	EBT	EBR	WBL	WBT	WBR	NBL	NBT	NBR	SBL	SBT	SBR
Lane Configurations												
Traffic Volume (veh/h)	126	974	78	125	947	291	146	219	142	389	191	83
Future Volume (veh/h)	126	974	78	125	947	291	146	219	142	389	191	83
Initial Q (Qb), veh	0	0	0	0	0	0	0	0	0	0	0	0
Ped-Bike Adj(A_pbT)	1.00		1.00	1.00		1.00	1.00		0.98	1.00		0.98
Parking Bus, Adj	1.00	1.00	1.00	1.00	1.00	1.00	1.00	1.00	1.00	1.00	1.00	1.00
Work Zone On Approach		No			No			No			No	
Adj Sat Flow, veh/h/ln	1900	1841	1856	1885	1856	1885	1885	1856	1870	1885	1885	1900
Adj Flow Rate, veh/h	130	1004	60	129	976	205	151	226	106	401	197	39
Peak Hour Factor	0.97	0.97	0.97	0.97	0.97	0.97	0.97	0.97	0.97	0.97	0.97	0.97
Percent Heavy Veh, %	0	4	3	1	3	1	1	3	2	1	1	0
Cap, veh/h	163	1307	78	162	1374	621	227	470	207	485	619	120
Arrive On Green	0.09	0.39	0.39	0.09	0.39	0.39	0.07	0.13	0.13	0.14	0.21	0.21
Sat Flow, veh/h	1810	3353	200	1795	3526	1594	3483	3526	1555	3483	2982	578
Grp Volume(v), veh/h	130	524	540	129	976	205	151	226	106	401	117	119
Grp Sat Flow(s),veh/h/ln	1810	1749	1805	1795	1763	1594	1742	1763	1555	1742	1791	1769
Q Serve(g_s), s	5.8	21.5	21.5	5.8	19.3	7.4	3.5	4.9	5.2	9.2	4.6	4.7
Cycle Q Clear(g_c), s	5.8	21.5	21.5	5.8	19.3	7.4	3.5	4.9	5.2	9.2	4.6	4.7
Prop In Lane	1.00		0.11	1.00		1.00	1.00		1.00	1.00		0.33
Lane Grp Cap(c), veh/h	163	682	704	162	1374	621	227	470	207	485	372	367
V/C Ratio(X)	0.80	0.77	0.77	0.80	0.71	0.33	0.67	0.48	0.51	0.83	0.31	0.33
Avail Cap(c_a), veh/h	219	920	950	213	1847	835	308	1411	622	583	849	839
HCM Platoon Ratio	1.00	1.00	1.00	1.00	1.00	1.00	1.00	1.00	1.00	1.00	1.00	1.00
Upstream Filter(I)	1.00	1.00	1.00	1.00	1.00	1.00	1.00	1.00	1.00	1.00	1.00	1.00
Uniform Delay (d), s/veh	36.8	21.9	21.9	36.8	21.2	17.6	37.7	33.1	33.2	34.5	27.7	27.8
Incr Delay (d2), s/veh	9.8	3.4	3.3	10.7	1.1	0.4	1.3	0.8	1.9	6.9	0.5	0.5
Initial Q Delay(d3),s/veh	0.0	0.0	0.0	0.0	0.0	0.0	0.0	0.0	0.0	0.0	0.0	0.0
%ile BackOfQ(50%),veh/ln	2.8	8.3	8.5	2.9	7.1	2.7	1.5	2.1	2.1	4.3	2.0	2.0
Unsig. Movement Delay, s/veh												
LnGrp Delay(d),s/veh	46.6	25.3	25.2	47.5	22.3	18.1	38.9	33.9	35.2	41.5	28.2	28.3
LnGrp LOS	D	C	C	D	C	B	D	C	D	D	C	C
Approach Vol, veh/h		1194			1310			483			637	
Approach Delay, s/veh		27.6			24.1			35.7			36.6	
Approach LOS		C			C			D			D	
Timer - Assigned Phs	1	2	3	4	5	6	7	8				
Phs Duration (G+Y+Rc), s	11.6	38.4	9.6	22.9	11.6	38.4	15.7	16.8				
Change Period (Y+Rc), s	* 4.2	6.2	* 4.2	5.8	* 4.2	6.2	* 4.2	* 5.8				
Max Green Setting (Gmax), s	* 9.8	43.4	* 7.3	39.1	* 10	43.2	* 14	* 33				
Max Q Clear Time (g_c+I1), s	7.8	23.5	5.5	6.7	7.8	21.3	11.2	7.2				
Green Ext Time (p_c), s	0.0	8.7	0.0	1.4	0.0	10.0	0.3	1.9				
Intersection Summary												
HCM 6th Ctrl Delay				29.0								
HCM 6th LOS				C								
Notes												
* HCM 6th computational engine requires equal clearance times for the phases crossing the barrier.												

Timings
2: Central Ave & Arlington Ave/Chicago Ave

West Campus Upper Plateau (JN 14064)

09/30/2022



Lane Group	EBL	EBT	EBR	WBL	WBT	WBR	NBL	NBT	NBR	SBL	SBT
Lane Configurations	↘	↑↑	↗↗	↘↘	↑↑	↗	↘↘	↑↑	↗	↘↘	↑↑↗
Traffic Volume (vph)	24	363	643	211	485	185	775	843	209	244	956
Future Volume (vph)	24	363	643	211	485	185	775	843	209	244	956
Turn Type	Prot	NA	pm+ov	Prot	NA	pm+ov	Prot	NA	pm+ov	Prot	NA
Protected Phases	7	4	5	3	8	1	5	2	3	1	6
Permitted Phases			4			8			2		
Detector Phase	7	4	5	3	8	1	5	2	3	1	6
Switch Phase											
Minimum Initial (s)	5.0	10.0	5.0	5.0	10.0	5.0	5.0	10.0	5.0	5.0	10.0
Minimum Split (s)	9.6	32.8	9.6	9.6	30.8	9.6	9.6	35.4	9.6	9.6	30.4
Total Split (s)	10.6	32.8	30.0	22.0	44.2	24.4	30.0	50.8	22.0	24.4	45.2
Total Split (%)	8.2%	25.2%	23.1%	16.9%	34.0%	18.8%	23.1%	39.1%	16.9%	18.8%	34.8%
Yellow Time (s)	3.6	4.8	3.6	3.6	4.8	3.6	3.6	4.4	3.6	3.6	4.4
All-Red Time (s)	1.0	1.0	1.0	1.0	1.0	1.0	1.0	1.0	1.0	1.0	1.0
Lost Time Adjust (s)	0.0	0.0	0.0	0.0	0.0	0.0	0.0	0.0	0.0	0.0	0.0
Total Lost Time (s)	4.6	5.8	4.6	4.6	5.8	4.6	4.6	5.4	4.6	4.6	5.4
Lead/Lag	Lead	Lag	Lead	Lead	Lag	Lead	Lead	Lag	Lead	Lead	Lag
Lead-Lag Optimize?	Yes	Yes	Yes	Yes	Yes	Yes	Yes	Yes	Yes	Yes	Yes
Recall Mode	None	None	None	None	None	None	None	None	None	None	None
Act Effct Green (s)	5.6	16.8	43.9	11.0	28.8	46.6	25.9	42.0	53.8	11.9	28.0
Actuated g/C Ratio	0.05	0.16	0.43	0.11	0.28	0.45	0.25	0.41	0.52	0.12	0.27
v/c Ratio	0.24	0.62	0.52	0.58	0.48	0.24	0.89	0.58	0.24	0.61	0.71
Control Delay	58.3	45.6	18.0	52.0	33.9	9.0	52.7	26.9	6.6	51.4	37.0
Queue Delay	0.0	0.0	0.0	0.0	0.0	0.0	0.0	0.0	0.0	0.0	0.0
Total Delay	58.3	45.6	18.0	52.0	33.9	9.0	52.7	26.9	6.6	51.4	37.0
LOS	E	D	B	D	C	A	D	C	A	D	D
Approach Delay		28.7			33.0			35.5			39.9
Approach LOS		C			C			D			D

Intersection Summary

Cycle Length: 130
 Actuated Cycle Length: 102.5
 Natural Cycle: 100
 Control Type: Actuated-Uncoordinated
 Maximum v/c Ratio: 0.89
 Intersection Signal Delay: 34.7
 Intersection LOS: C
 Intersection Capacity Utilization 75.8%
 ICU Level of Service D
 Analysis Period (min) 15

Splits and Phases: 2: Central Ave & Arlington Ave/Chicago Ave

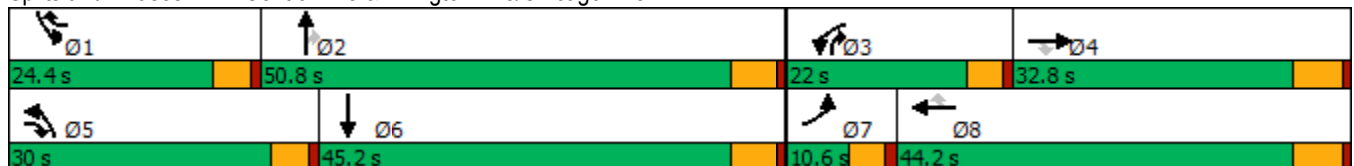

HCM 6th Signalized Intersection Summary
2: Central Ave & Arlington Ave/Chicago Ave

West Campus Upper Plateau (JN 14064)

09/30/2022



Movement	EBL	EBT	EBR	WBL	WBT	WBR	NBL	NBT	NBR	SBL	SBT	SBR
Lane Configurations	↘	↑↑	↗↗	↘↘	↑↑	↗	↘↘	↑↑	↗	↘↘	↑↑↑	
Traffic Volume (veh/h)	24	363	643	211	485	185	775	843	209	244	956	31
Future Volume (veh/h)	24	363	643	211	485	185	775	843	209	244	956	31
Initial Q (Qb), veh	0	0	0	0	0	0	0	0	0	0	0	0
Ped-Bike Adj(A_pbT)	1.00		1.00	1.00		1.00	1.00		0.99	1.00		1.00
Parking Bus, Adj	1.00	1.00	1.00	1.00	1.00	1.00	1.00	1.00	1.00	1.00	1.00	1.00
Work Zone On Approach		No			No			No			No	
Adj Sat Flow, veh/h/ln	1900	1900	1885	1870	1900	1885	1885	1885	1856	1900	1885	1900
Adj Flow Rate, veh/h	24	367	264	213	490	102	783	852	145	246	966	29
Peak Hour Factor	0.99	0.99	0.99	0.99	0.99	0.99	0.99	0.99	0.99	0.99	0.99	0.99
Percent Heavy Veh, %	0	0	1	2	0	1	1	1	3	0	1	0
Cap, veh/h	46	560	1142	297	779	497	874	1522	794	335	1382	41
Arrive On Green	0.03	0.16	0.16	0.09	0.22	0.22	0.25	0.42	0.42	0.10	0.27	0.27
Sat Flow, veh/h	1810	3610	2806	3456	3610	1598	3483	3582	1552	3510	5135	154
Grp Volume(v), veh/h	24	367	264	213	490	102	783	852	145	246	645	350
Grp Sat Flow(s),veh/h/ln	1810	1805	1403	1728	1805	1598	1742	1791	1552	1755	1716	1857
Q Serve(g_s), s	1.1	8.2	5.3	5.1	10.5	4.0	18.6	15.3	4.3	5.8	14.5	14.5
Cycle Q Clear(g_c), s	1.1	8.2	5.3	5.1	10.5	4.0	18.6	15.3	4.3	5.8	14.5	14.5
Prop In Lane	1.00		1.00	1.00		1.00	1.00		1.00	1.00		0.08
Lane Grp Cap(c), veh/h	46	560	1142	297	779	497	874	1522	794	335	924	500
V/C Ratio(X)	0.52	0.65	0.23	0.72	0.63	0.21	0.90	0.56	0.18	0.73	0.70	0.70
Avail Cap(c_a), veh/h	127	1140	1592	703	1621	870	1035	1902	959	813	1597	865
HCM Platoon Ratio	1.00	1.00	1.00	1.00	1.00	1.00	1.00	1.00	1.00	1.00	1.00	1.00
Upstream Filter(I)	1.00	1.00	1.00	1.00	1.00	1.00	1.00	1.00	1.00	1.00	1.00	1.00
Uniform Delay (d), s/veh	41.2	34.0	16.6	38.1	30.4	21.7	30.9	18.6	11.3	37.6	28.1	28.1
Incr Delay (d2), s/veh	3.4	1.3	0.1	1.2	0.8	0.2	8.3	0.3	0.1	1.2	1.0	1.8
Initial Q Delay(d3),s/veh	0.0	0.0	0.0	0.0	0.0	0.0	0.0	0.0	0.0	0.0	0.0	0.0
%ile BackOfQ(50%),veh/ln	0.5	3.5	1.5	2.1	4.4	1.4	8.3	5.8	1.3	2.5	5.7	6.3
Unsig. Movement Delay, s/veh												
LnGrp Delay(d),s/veh	44.5	35.3	16.7	39.3	31.3	21.9	39.2	18.9	11.4	38.8	29.1	29.9
LnGrp LOS	D	D	B	D	C	C	D	B	B	D	C	C
Approach Vol, veh/h		655			805			1780			1241	
Approach Delay, s/veh		28.1			32.2			27.2			31.2	
Approach LOS		C			C			C			C	
Timer - Assigned Phs	1	2	3	4	5	6	7	8				
Phs Duration (G+Y+Rc), s	12.8	41.7	11.9	19.1	26.1	28.4	6.8	24.2				
Change Period (Y+Rc), s	4.6	5.4	4.6	5.8	4.6	5.4	4.6	5.8				
Max Green Setting (Gmax), s	19.8	45.4	17.4	27.0	25.4	39.8	6.0	38.4				
Max Q Clear Time (g_c+I1), s	7.8	17.3	7.1	10.2	20.6	16.5	3.1	12.5				
Green Ext Time (p_c), s	0.3	6.8	0.3	2.9	0.9	6.5	0.0	3.4				
Intersection Summary												
HCM 6th Ctrl Delay			29.4									
HCM 6th LOS			C									

Timings

3: Overlook Pkwy./Canyon Crest Dr. & Alessandro Bl/Alessandro Bl.



Lane Group	EBL	EBT	WBL	WBT	WBR	NBL	NBT	NBR	SBL	SBT	SBR
Lane Configurations	↘	↗↗↗	↘	↗↗↗	↗	↘	↗↗	↗	↗↗	↘	↗
Traffic Volume (vph)	38	1443	77	1570	451	11	192	80	349	196	21
Future Volume (vph)	38	1443	77	1570	451	11	192	80	349	196	21
Turn Type	Prot	NA	Prot	NA	pm+ov	Split	NA	Perm	Split	NA	Perm
Protected Phases	5	2	1	6	4	8	8		4	4	
Permitted Phases					6			8			4
Detector Phase	5	2	1	6	4	8	8	8	4	4	4
Switch Phase											
Minimum Initial (s)	5.0	10.0	5.0	10.0	10.0	10.0	10.0	10.0	10.0	10.0	10.0
Minimum Split (s)	9.2	35.2	9.2	35.2	38.8	38.8	38.8	38.8	38.8	38.8	38.8
Total Split (s)	9.2	43.2	9.2	43.2	38.8	38.8	38.8	38.8	38.8	38.8	38.8
Total Split (%)	7.1%	33.2%	7.1%	33.2%	29.8%	29.8%	29.8%	29.8%	29.8%	29.8%	29.8%
Yellow Time (s)	3.2	5.2	3.2	5.2	4.8	4.8	4.8	4.8	4.8	4.8	4.8
All-Red Time (s)	1.0	1.0	1.0	1.0	1.0	1.0	1.0	1.0	1.0	1.0	1.0
Lost Time Adjust (s)	0.0	0.0	0.0	0.0	0.0	0.0	0.0	0.0	0.0	0.0	0.0
Total Lost Time (s)	4.2	6.2	4.2	6.2	5.8	5.8	5.8	5.8	5.8	5.8	5.8
Lead/Lag	Lead	Lag	Lead	Lag							
Lead-Lag Optimize?	Yes	Yes	Yes	Yes							
Recall Mode	None	None	None	None	None	None	None	None	None	None	None
Act Effct Green (s)	5.0	37.3	5.0	39.3	68.1	11.5	11.5	11.5	22.5	22.5	22.5
Actuated g/C Ratio	0.05	0.38	0.05	0.40	0.69	0.12	0.12	0.12	0.23	0.23	0.23
v/c Ratio	0.46	0.78	0.87	0.80	0.39	0.06	0.48	0.29	0.44	0.66	0.05
Control Delay	66.2	31.8	114.1	31.8	2.4	42.2	45.9	6.6	34.1	43.4	0.2
Queue Delay	0.0	0.0	0.0	0.0	0.0	0.0	0.0	0.0	0.0	0.0	0.0
Total Delay	66.2	31.8	114.1	31.8	2.4	42.2	45.9	6.6	34.1	43.4	0.2
LOS	E	C	F	C	A	D	D	A	C	D	A
Approach Delay		32.7		28.5			34.7			36.6	
Approach LOS		C		C			C			D	

Intersection Summary

Cycle Length: 130
 Actuated Cycle Length: 98.4
 Natural Cycle: 125
 Control Type: Actuated-Uncoordinated
 Maximum v/c Ratio: 0.87
 Intersection Signal Delay: 31.3
 Intersection LOS: C
 Intersection Capacity Utilization 71.5%
 ICU Level of Service C
 Analysis Period (min) 15

Splits and Phases: 3: Overlook Pkwy./Canyon Crest Dr. & Alessandro Bl/Alessandro Bl.

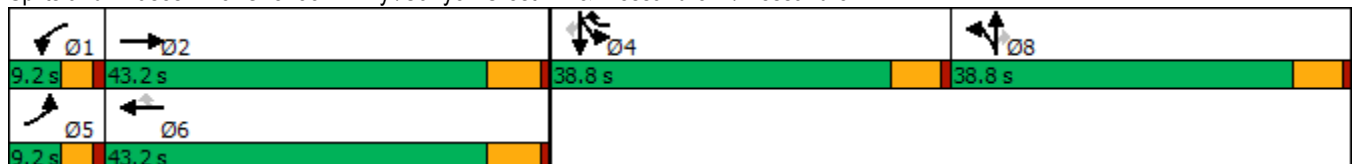

HCM 6th Signalized Intersection Summary

West Campus Upper Plateau (JN 14064)

3: Overlook Pkwy./Canyon Crest Dr. & Alessandro Bl/Alessandro Bl.

09/30/2022



Movement	EBL	EBT	EBR	WBL	WBT	WBR	NBL	NBT	NBR	SBL	SBT	SBR
Lane Configurations	↘	↑↑↑		↘	↑↑↑	↗	↘	↑↑	↗	↘↗	↘	↗
Traffic Volume (veh/h)	38	1443	15	77	1570	451	11	192	80	349	196	21
Future Volume (veh/h)	38	1443	15	77	1570	451	11	192	80	349	196	21
Initial Q (Qb), veh	0	0	0	0	0	0	0	0	0	0	0	0
Ped-Bike Adj(A_pbT)	1.00		1.00	1.00		1.00	1.00		1.00	1.00		1.00
Parking Bus, Adj	1.00	1.00	1.00	1.00	1.00	1.00	1.00	1.00	1.00	1.00	1.00	1.00
Work Zone On Approach		No			No			No			No	
Adj Sat Flow, veh/h/ln	1811	1885	1811	1900	1885	1870	1781	1900	1900	1885	1767	1841
Adj Flow Rate, veh/h	40	1503	16	80	1635	462	11	200	75	364	204	13
Peak Hour Factor	0.96	0.96	0.96	0.96	0.96	0.96	0.96	0.96	0.96	0.96	0.96	0.96
Percent Heavy Veh, %	6	1	6	0	1	2	8	0	0	1	9	4
Cap, veh/h	63	2043	22	103	2109	907	207	441	197	582	287	253
Arrive On Green	0.04	0.39	0.39	0.06	0.41	0.41	0.12	0.12	0.12	0.16	0.16	0.16
Sat Flow, veh/h	1725	5250	56	1810	5147	1585	1697	3610	1610	3591	1767	1560
Grp Volume(v), veh/h	40	982	537	80	1635	462	11	200	75	364	204	13
Grp Sat Flow(s),veh/h/ln	1725	1716	1875	1810	1716	1585	1697	1805	1610	1795	1767	1560
Q Serve(g_s), s	1.9	20.0	20.0	3.6	22.5	14.4	0.5	4.2	3.5	7.7	8.9	0.6
Cycle Q Clear(g_c), s	1.9	20.0	20.0	3.6	22.5	14.4	0.5	4.2	3.5	7.7	8.9	0.6
Prop In Lane	1.00		0.03	1.00		1.00	1.00		1.00	1.00		1.00
Lane Grp Cap(c), veh/h	63	1335	730	103	2109	907	207	441	197	582	287	253
V/C Ratio(X)	0.64	0.74	0.74	0.78	0.78	0.51	0.05	0.45	0.38	0.62	0.71	0.05
Avail Cap(c_a), veh/h	106	1554	849	111	2331	975	685	1458	651	1451	714	630
HCM Platoon Ratio	1.00	1.00	1.00	1.00	1.00	1.00	1.00	1.00	1.00	1.00	1.00	1.00
Upstream Filter(I)	1.00	1.00	1.00	1.00	1.00	1.00	1.00	1.00	1.00	1.00	1.00	1.00
Uniform Delay (d), s/veh	38.8	21.3	21.3	38.0	20.9	10.6	31.7	33.3	33.0	31.9	32.4	28.9
Incr Delay (d2), s/veh	3.9	1.6	2.8	23.8	1.5	0.4	0.1	0.7	1.2	1.1	3.3	0.1
Initial Q Delay(d3),s/veh	0.0	0.0	0.0	0.0	0.0	0.0	0.0	0.0	0.0	0.0	0.0	0.0
%ile BackOfQ(50%),veh/ln	0.8	7.2	8.1	2.2	8.0	6.4	0.2	1.8	1.4	3.2	3.8	0.2
Unsig. Movement Delay, s/veh												
LnGrp Delay(d),s/veh	42.7	22.9	24.2	61.8	22.4	11.0	31.8	34.0	34.2	33.0	35.7	29.0
LnGrp LOS	D	C	C	E	C	B	C	C	C	C	D	C
Approach Vol, veh/h		1559			2177			286			581	
Approach Delay, s/veh		23.9			21.4			34.0			33.9	
Approach LOS		C			C			C			C	
Timer - Assigned Phs	1	2		4	5	6		8				
Phs Duration (G+Y+Rc), s	8.9	38.0		19.0	7.2	39.7		15.8				
Change Period (Y+Rc), s	* 4.2	6.2		5.8	* 4.2	6.2		5.8				
Max Green Setting (Gmax), s	* 5	37.0		33.0	* 5	37.0		33.0				
Max Q Clear Time (g_c+I1), s	5.6	22.0		10.9	3.9	24.5		6.2				
Green Ext Time (p_c), s	0.0	8.0		2.3	0.0	9.0		1.4				

Intersection Summary

HCM 6th Ctrl Delay	24.6
HCM 6th LOS	C

Notes

- User approved pedestrian interval to be less than phase max green.
- User approved volume balancing among the lanes for turning movement.
- * HCM 6th computational engine requires equal clearance times for the phases crossing the barrier.

Timings

West Campus Upper Plateau (JN 14064)

4: Van Buren Bl. & Wood Rd.

09/30/2022

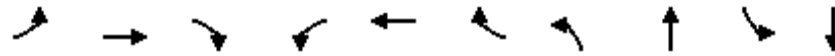

Lane Group	EBL	EBT	EBR	WBL	WBT	WBR	NBL	NBT	SBL	SBT
Lane Configurations	↘	↑↑	↗	↘↗	↑↑	↗	↘↗	↑↗	↘	↑↗
Traffic Volume (vph)	137	1472	218	219	1427	116	214	140	174	163
Future Volume (vph)	137	1472	218	219	1427	116	214	140	174	163
Turn Type	Prot	NA	pm+ov	Prot	NA	Perm	Prot	NA	Prot	NA
Protected Phases	5	2	3	1	6		3	8	7	4
Permitted Phases			2			6				
Detector Phase	5	2	3	1	6	6	3	8	7	4
Switch Phase										
Minimum Initial (s)	5.0	10.0	5.0	5.0	10.0	10.0	5.0	10.0	5.0	10.0
Minimum Split (s)	9.2	30.2	9.2	9.2	30.2	30.2	9.2	38.4	9.2	15.8
Total Split (s)	16.5	57.2	21.7	13.2	53.9	53.9	21.7	38.4	11.2	27.9
Total Split (%)	13.8%	47.7%	18.1%	11.0%	44.9%	44.9%	18.1%	32.0%	9.3%	23.3%
Yellow Time (s)	3.2	5.2	3.2	3.2	5.2	5.2	3.2	4.4	3.2	4.8
All-Red Time (s)	1.0	1.0	1.0	1.0	1.0	1.0	1.0	1.0	1.0	1.0
Lost Time Adjust (s)	0.0	0.0	0.0	0.0	0.0	0.0	0.0	0.0	0.0	0.0
Total Lost Time (s)	4.2	6.2	4.2	4.2	6.2	6.2	4.2	5.4	4.2	5.8
Lead/Lag	Lead	Lag	Lead	Lead	Lag	Lag	Lead	Lag	Lead	Lag
Lead-Lag Optimize?	Yes	Yes	Yes	Yes	Yes	Yes	Yes	Yes	Yes	Yes
Recall Mode	None	None	None	None	None	None	None	None	None	None
Act Effct Green (s)	11.7	51.3	65.0	9.0	48.6	48.6	11.7	18.4	7.0	13.3
Actuated g/C Ratio	0.11	0.48	0.61	0.09	0.46	0.46	0.11	0.17	0.07	0.13
v/c Ratio	0.77	0.95	0.23	0.81	0.96	0.16	0.63	0.46	1.62	0.62
Control Delay	72.2	40.8	2.0	70.4	44.6	3.4	53.3	20.5	344.7	27.4
Queue Delay	0.0	0.0	0.0	0.0	0.0	0.0	0.0	0.0	0.0	0.0
Total Delay	72.2	40.8	2.0	70.4	44.6	3.4	53.3	20.5	344.7	27.4
LOS	E	D	A	E	D	A	D	C	F	C
Approach Delay		38.5			45.1			34.4		139.6
Approach LOS		D			D			C		F

Intersection Summary

Cycle Length: 120
 Actuated Cycle Length: 105.8
 Natural Cycle: 120
 Control Type: Actuated-Uncoordinated
 Maximum v/c Ratio: 1.62
 Intersection Signal Delay: 51.4
 Intersection LOS: D
 Intersection Capacity Utilization 88.7%
 ICU Level of Service E
 Analysis Period (min) 15

Splits and Phases: 4: Van Buren Bl. & Wood Rd.

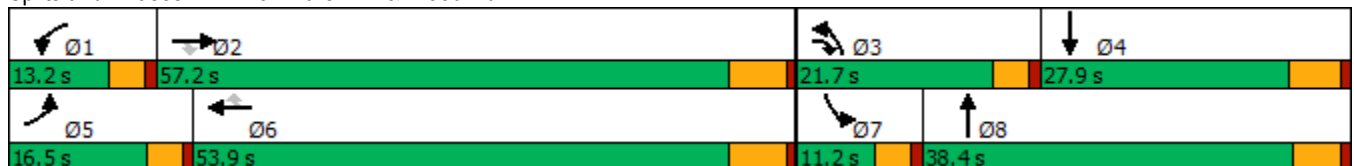

HCM 6th Signalized Intersection Summary
4: Van Buren Bl. & Wood Rd.

West Campus Upper Plateau (JN 14064)
09/30/2022

Movement	EBL	EBT	EBR	WBL	WBT	WBR	NBL	NBT	NBR	SBL	SBT	SBR
Lane Configurations												
Traffic Volume (veh/h)	137	1472	218	219	1427	116	214	140	150	174	163	155
Future Volume (veh/h)	137	1472	218	219	1427	116	214	140	150	174	163	155
Initial Q (Qb), veh	0	0	0	0	0	0	0	0	0	0	0	0
Ped-Bike Adj(A_pbT)	1.00		0.99	1.00		0.99	1.00		0.96	1.00		0.99
Parking Bus, Adj	1.00	1.00	1.00	1.00	1.00	1.00	1.00	1.00	1.00	1.00	1.00	1.00
Work Zone On Approach		No			No			No			No	
Adj Sat Flow, veh/h/ln	1885	1856	1870	1885	1870	1885	1856	1885	1870	1885	1885	1885
Adj Flow Rate, veh/h	151	1618	135	241	1568	80	235	154	84	191	179	95
Peak Hour Factor	0.91	0.91	0.91	0.91	0.91	0.91	0.91	0.91	0.91	0.91	0.91	0.91
Percent Heavy Veh, %	1	3	2	1	2	1	3	1	2	1	1	1
Cap, veh/h	182	1767	925	306	1733	768	307	308	157	126	268	135
Arrive On Green	0.10	0.50	0.50	0.09	0.49	0.49	0.09	0.14	0.14	0.07	0.12	0.12
Sat Flow, veh/h	1795	3526	1562	3483	3554	1575	3428	2259	1154	1795	2292	1157
Grp Volume(v), veh/h	151	1618	135	241	1568	80	235	120	118	191	138	136
Grp Sat Flow(s),veh/h/ln	1795	1763	1562	1742	1777	1575	1714	1791	1622	1795	1791	1658
Q Serve(g_s), s	8.2	42.2	3.9	6.8	40.4	2.7	6.7	6.2	6.8	7.0	7.4	7.9
Cycle Q Clear(g_c), s	8.2	42.2	3.9	6.8	40.4	2.7	6.7	6.2	6.8	7.0	7.4	7.9
Prop In Lane	1.00		1.00	1.00		1.00	1.00		0.71	1.00		0.70
Lane Grp Cap(c), veh/h	182	1767	925	306	1733	768	307	244	221	126	209	194
V/C Ratio(X)	0.83	0.92	0.15	0.79	0.90	0.10	0.76	0.49	0.53	1.52	0.66	0.70
Avail Cap(c_a), veh/h	221	1801	940	314	1733	768	601	592	536	126	397	367
HCM Platoon Ratio	1.00	1.00	1.00	1.00	1.00	1.00	1.00	1.00	1.00	1.00	1.00	1.00
Upstream Filter(I)	1.00	1.00	1.00	1.00	1.00	1.00	1.00	1.00	1.00	1.00	1.00	1.00
Uniform Delay (d), s/veh	44.0	22.9	9.1	44.6	23.4	13.8	44.4	39.9	40.1	46.4	42.2	42.4
Incr Delay (d2), s/veh	16.5	7.9	0.1	11.2	7.3	0.1	1.5	1.5	2.0	268.9	3.5	4.6
Initial Q Delay(d3),s/veh	0.0	0.0	0.0	0.0	0.0	0.0	0.0	0.0	0.0	0.0	0.0	0.0
%ile BackOfQ(50%),veh/ln	4.3	16.9	1.2	3.3	16.4	0.9	2.8	2.7	2.7	12.4	3.4	3.4
Unsig. Movement Delay, s/veh												
LnGrp Delay(d),s/veh	60.5	30.8	9.2	55.8	30.7	13.9	45.9	41.4	42.1	315.3	45.7	47.0
LnGrp LOS	E	C	A	E	C	B	D	D	D	F	D	D
Approach Vol, veh/h		1904			1889			473			465	
Approach Delay, s/veh		31.6			33.2			43.8			156.8	
Approach LOS		C			C			D			F	
Timer - Assigned Phs	1	2	3	4	5	6	7	8				
Phs Duration (G+Y+Rc), s	13.0	56.2	13.1	17.5	14.3	54.9	11.2	19.4				
Change Period (Y+Rc), s	* 4.2	6.2	* 4.2	5.8	* 4.2	6.2	* 4.2	* 5.8				
Max Green Setting (Gmax), s	* 9	51.0	* 18	22.1	* 12	47.7	* 7	* 33				
Max Q Clear Time (g_c+I1), s	8.8	44.2	8.7	9.9	10.2	42.4	9.0	8.8				
Green Ext Time (p_c), s	0.0	5.8	0.3	1.1	0.0	4.5	0.0	1.3				

Intersection Summary

HCM 6th Ctrl Delay	45.8
HCM 6th LOS	D

Notes

* HCM 6th computational engine requires equal clearance times for the phases crossing the barrier.

Timings
5: Trautwein Rd. & Alessandro Bl.

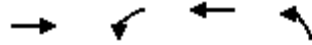

Lane Group	EBT	WBL	WBT	NBL
Lane Configurations	↑↑↑	↵↵	↑↑↑	↵↵↵
Traffic Volume (vph)	1106	195	1315	1072
Future Volume (vph)	1106	195	1315	1072
Turn Type	NA	Prot	NA	Prot
Protected Phases	2	1	6	8
Permitted Phases				
Detector Phase	2	1	6	8
Switch Phase				
Minimum Initial (s)	10.0	5.0	10.0	10.0
Minimum Split (s)	33.2	9.2	16.2	16.2
Total Split (s)	63.0	19.0	82.0	38.0
Total Split (%)	52.5%	15.8%	68.3%	31.7%
Yellow Time (s)	5.2	3.2	5.2	5.2
All-Red Time (s)	1.0	1.0	1.0	1.0
Lost Time Adjust (s)	0.0	0.0	0.0	0.0
Total Lost Time (s)	6.2	4.2	6.2	6.2
Lead/Lag	Lag	Lead		
Lead-Lag Optimize?	Yes	Yes		
Recall Mode	None	None	None	None
Act Effct Green (s)	42.5	10.4	57.2	27.5
Actuated g/C Ratio	0.44	0.11	0.59	0.28
v/c Ratio	0.66	0.55	0.45	0.80
Control Delay	23.6	49.7	11.8	38.8
Queue Delay	0.0	0.0	0.0	0.0
Total Delay	23.6	49.7	11.8	38.8
LOS	C	D	B	D
Approach Delay	23.6		16.7	38.8
Approach LOS	C		B	D

Intersection Summary

Cycle Length: 120	
Actuated Cycle Length: 97.5	
Natural Cycle: 65	
Control Type: Actuated-Uncoordinated	
Maximum v/c Ratio: 0.80	
Intersection Signal Delay: 25.1	Intersection LOS: C
Intersection Capacity Utilization 67.3%	ICU Level of Service C
Analysis Period (min) 15	

Splits and Phases: 5: Trautwein Rd. & Alessandro Bl.



HCM 6th Signalized Intersection Summary
5: Trautwein Rd. & Alessandro Bl.

West Campus Upper Plateau (JN 14064)
09/30/2022

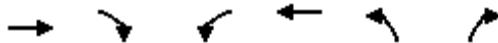

Movement	EBT	EBR	WBL	WBT	NBL	NBR
Lane Configurations	↑↑↑		↵↵	↑↑↑	↵↵↵	
Traffic Volume (veh/h)	1106	265	195	1315	1072	12
Future Volume (veh/h)	1106	265	195	1315	1072	12
Initial Q (Qb), veh	0	0	0	0	0	0
Ped-Bike Adj(A_pbT)		1.00	1.00		1.00	1.00
Parking Bus, Adj	1.00	1.00	1.00	1.00	1.00	1.00
Work Zone On Approach	No			No	No	
Adj Sat Flow, veh/h/ln	1885	1900	1885	1885	1870	1900
Adj Flow Rate, veh/h	1152	276	203	1370	1128	0
Peak Hour Factor	0.96	0.96	0.96	0.96	0.96	0.96
Percent Heavy Veh, %	1	0	1	1	2	0
Cap, veh/h	1844	442	292	2985	1432	432
Arrive On Green	0.44	0.44	0.08	0.58	0.27	0.00
Sat Flow, veh/h	4314	993	3483	5316	5344	1610
Grp Volume(v), veh/h	954	474	203	1370	1128	0
Grp Sat Flow(s),veh/h/ln	1716	1706	1742	1716	1781	1610
Q Serve(g_s), s	17.4	17.4	4.6	12.4	16.0	0.0
Cycle Q Clear(g_c), s	17.4	17.4	4.6	12.4	16.0	0.0
Prop In Lane		0.58	1.00		1.00	1.00
Lane Grp Cap(c), veh/h	1526	759	292	2985	1432	432
V/C Ratio(X)	0.62	0.62	0.70	0.46	0.79	0.00
Avail Cap(c_a), veh/h	2389	1188	632	4782	2083	628
HCM Platoon Ratio	1.00	1.00	1.00	1.00	1.00	1.00
Upstream Filter(I)	1.00	1.00	1.00	1.00	1.00	0.00
Uniform Delay (d), s/veh	17.4	17.4	36.4	9.8	27.7	0.0
Incr Delay (d2), s/veh	0.6	1.2	1.1	0.2	1.3	0.0
Initial Q Delay(d3),s/veh	0.0	0.0	0.0	0.0	0.0	0.0
%ile BackOfQ(50%),veh/ln	5.9	6.0	1.9	3.5	6.3	0.0
Unsig. Movement Delay, s/veh						
LnGrp Delay(d),s/veh	18.0	18.6	37.5	10.0	29.0	0.0
LnGrp LOS	B	B	D	A	C	A
Approach Vol, veh/h	1428			1573	1128	
Approach Delay, s/veh	18.2			13.5	29.0	
Approach LOS	B			B	C	
Timer - Assigned Phs	1	2			6	8
Phs Duration (G+Y+Rc), s	11.0	42.5			53.5	28.1
Change Period (Y+Rc), s	* 4.2	6.2			6.2	6.2
Max Green Setting (Gmax), s	* 15	56.8			75.8	31.8
Max Q Clear Time (g_c+I1), s	6.6	19.4			14.4	18.0
Green Ext Time (p_c), s	0.2	16.9			18.7	3.9

Intersection Summary

HCM 6th Ctrl Delay	19.4
HCM 6th LOS	B

Notes

User approved volume balancing among the lanes for turning movement.
* HCM 6th computational engine requires equal clearance times for the phases crossing the barrier.

Timings
6: Trautwein Rd. & Grove Community Dr

West Campus Upper Plateau (JN 14064)

09/30/2022



Lane Group	WBL	WBR	NBT	NBR	SBL	SBT
Lane Configurations	↙	↗↗	↕↕	↗	↗↗	↕↕
Traffic Volume (vph)	119	426	1079	97	383	1001
Future Volume (vph)	119	426	1079	97	383	1001
Turn Type	Prot	pm+ov	NA	Perm	Prot	NA
Protected Phases	8	1	2		1	6
Permitted Phases		8		2		
Detector Phase	8	1	2	2	1	6
Switch Phase						
Minimum Initial (s)	10.0	5.0	10.0	10.0	5.0	10.0
Minimum Split (s)	34.6	9.6	46.2	46.2	9.6	28.2
Total Split (s)	35.0	29.0	56.0	56.0	29.0	85.0
Total Split (%)	29.2%	24.2%	46.7%	46.7%	24.2%	70.8%
Yellow Time (s)	3.6	3.6	5.2	5.2	3.6	5.2
All-Red Time (s)	1.0	1.0	1.0	1.0	1.0	1.0
Lost Time Adjust (s)	0.0	0.0	0.0	0.0	0.0	0.0
Total Lost Time (s)	4.6	4.6	6.2	6.2	4.6	6.2
Lead/Lag		Lead	Lag	Lag	Lead	
Lead-Lag Optimize?		Yes	Yes	Yes	Yes	
Recall Mode	None	None	None	None	None	None
Act Effect Green (s)	14.3	30.0	35.9	35.9	15.7	56.4
Actuated g/C Ratio	0.17	0.36	0.44	0.44	0.19	0.69
v/c Ratio	0.42	0.45	0.77	0.15	0.64	0.46
Control Delay	37.6	17.1	24.5	7.8	37.4	6.9
Queue Delay	0.0	0.0	0.0	0.0	0.0	0.0
Total Delay	37.6	17.1	24.5	7.8	37.4	6.9
LOS	D	B	C	A	D	A
Approach Delay	21.6		23.1			15.3
Approach LOS	C		C			B

Intersection Summary

Cycle Length: 120	
Actuated Cycle Length: 82.2	
Natural Cycle: 95	
Control Type: Actuated-Uncoordinated	
Maximum v/c Ratio: 0.77	
Intersection Signal Delay: 19.4	Intersection LOS: B
Intersection Capacity Utilization 62.9%	ICU Level of Service B
Analysis Period (min) 15	

Splits and Phases: 6: Trautwein Rd. & Grove Community Dr



HCM 6th Signalized Intersection Summary
6: Trautwein Rd. & Grove Community Dr

West Campus Upper Plateau (JN 14064)

09/30/2022



Movement	WBL	WBR	NBT	NBR	SBL	SBT
Lane Configurations	↶	↶↶	↶↶	↶	↶↶	↶↶
Traffic Volume (veh/h)	119	426	1079	97	383	1001
Future Volume (veh/h)	119	426	1079	97	383	1001
Initial Q (Qb), veh	0	0	0	0	0	0
Ped-Bike Adj(A_pbT)	1.00	1.00		1.00	1.00	
Parking Bus, Adj	1.00	1.00	1.00	1.00	1.00	1.00
Work Zone On Approach	No		No			No
Adj Sat Flow, veh/h/ln	1900	1900	1885	1900	1900	1870
Adj Flow Rate, veh/h	132	279	1199	102	426	1112
Peak Hour Factor	0.90	0.90	0.90	0.90	0.90	0.90
Percent Heavy Veh, %	0	0	1	0	0	2
Cap, veh/h	277	880	1623	730	552	2420
Arrive On Green	0.15	0.15	0.45	0.45	0.16	0.68
Sat Flow, veh/h	1810	2834	3676	1610	3510	3647
Grp Volume(v), veh/h	132	279	1199	102	426	1112
Grp Sat Flow(s),veh/h/ln	1810	1417	1791	1610	1755	1777
Q Serve(g_s), s	4.3	4.9	17.9	2.4	7.6	9.5
Cycle Q Clear(g_c), s	4.3	4.9	17.9	2.4	7.6	9.5
Prop In Lane	1.00	1.00		1.00	1.00	
Lane Grp Cap(c), veh/h	277	880	1623	730	552	2420
V/C Ratio(X)	0.48	0.32	0.74	0.14	0.77	0.46
Avail Cap(c_a), veh/h	844	1767	2736	1230	1314	4295
HCM Platoon Ratio	1.00	1.00	1.00	1.00	1.00	1.00
Upstream Filter(I)	1.00	1.00	1.00	1.00	1.00	1.00
Uniform Delay (d), s/veh	25.2	17.2	14.6	10.4	26.3	4.8
Incr Delay (d2), s/veh	1.3	0.2	0.7	0.1	0.9	0.1
Initial Q Delay(d3),s/veh	0.0	0.0	0.0	0.0	0.0	0.0
%ile BackOfQ(50%),veh/ln	1.8	1.5	5.7	0.7	2.9	1.7
Unsig. Movement Delay, s/veh						
LnGrp Delay(d),s/veh	26.5	17.4	15.3	10.5	27.2	5.0
LnGrp LOS	C	B	B	B	C	A
Approach Vol, veh/h	411		1301			1538
Approach Delay, s/veh	20.3		14.9			11.1
Approach LOS	C		B			B
Timer - Assigned Phs	1	2			6	8
Phs Duration (G+Y+Rc), s	14.9	35.7			50.6	14.6
Change Period (Y+Rc), s	4.6	6.2			6.2	4.6
Max Green Setting (Gmax), s	24.4	49.8			78.8	30.4
Max Q Clear Time (g_c+11), s	9.6	19.9			11.5	6.9
Green Ext Time (p_c), s	0.7	9.6			9.2	1.4
Intersection Summary						
HCM 6th Ctrl Delay			13.8			
HCM 6th LOS			B			

Timings

West Campus Upper Plateau (JN 14064)

7: Trautwein Rd. & Orange Terrace Pkwy

09/30/2022



Lane Group	EBL	EBT	WBL	WBT	WBR	NBL	NBT	NBR	SBL	SBT	SBR
Lane Configurations											
Traffic Volume (vph)	34	20	182	13	176	37	949	169	218	979	22
Future Volume (vph)	34	20	182	13	176	37	949	169	218	979	22
Turn Type	Prot	NA	Prot	NA	pm+ov	Prot	NA	Perm	Prot	NA	Perm
Protected Phases	7	4	3	8	1	5	2		1	6	
Permitted Phases					8			2			6
Detector Phase	7	4	3	8	1	5	2	2	1	6	6
Switch Phase											
Minimum Initial (s)	5.0	10.0	5.0	10.0	5.0	5.0	10.0	10.0	5.0	10.0	10.0
Minimum Split (s)	9.6	38.6	9.6	34.6	9.6	9.6	46.2	46.2	9.6	28.2	28.2
Total Split (s)	13.2	38.6	16.1	41.5	18.0	9.6	47.3	47.3	18.0	55.7	55.7
Total Split (%)	11.0%	32.2%	13.4%	34.6%	15.0%	8.0%	39.4%	39.4%	15.0%	46.4%	46.4%
Yellow Time (s)	3.6	3.6	3.6	3.6	3.6	3.6	5.2	5.2	3.6	5.2	5.2
All-Red Time (s)	1.0	1.0	1.0	1.0	1.0	1.0	1.0	1.0	1.0	1.0	1.0
Lost Time Adjust (s)	0.0	0.0	0.0	0.0	0.0	0.0	0.0	0.0	0.0	0.0	0.0
Total Lost Time (s)	4.6	4.6	4.6	4.6	4.6	4.6	6.2	6.2	4.6	6.2	6.2
Lead/Lag	Lead	Lag	Lead	Lag	Lead	Lead	Lag	Lag	Lead	Lag	Lag
Lead-Lag Optimize?	Yes	Yes	Yes	Yes	Yes	Yes	Yes	Yes	Yes	Yes	Yes
Recall Mode	None	None	None	None	None	None	None	None	None	None	None
Act Effct Green (s)	10.5	14.2	12.6	16.2	28.9	5.5	30.4	30.4	10.4	41.0	41.0
Actuated g/C Ratio	0.13	0.18	0.16	0.20	0.36	0.07	0.38	0.38	0.13	0.51	0.51
v/c Ratio	0.15	0.13	0.70	0.04	0.17	0.32	0.76	0.26	0.53	0.58	0.03
Control Delay	42.4	21.2	53.8	31.1	3.4	53.4	28.4	8.0	42.4	19.1	0.0
Queue Delay	0.0	0.0	0.0	0.0	0.0	0.0	0.0	0.0	0.0	0.0	0.0
Total Delay	42.4	21.2	53.8	31.1	3.4	53.4	28.4	8.0	42.4	19.1	0.0
LOS	D	C	D	C	A	D	C	A	D	B	A
Approach Delay		30.8		29.1			26.2			22.9	
Approach LOS		C		C			C			C	

Intersection Summary

Cycle Length: 120	
Actuated Cycle Length: 80.9	
Natural Cycle: 115	
Control Type: Actuated-Uncoordinated	
Maximum v/c Ratio: 0.76	
Intersection Signal Delay: 25.3	Intersection LOS: C
Intersection Capacity Utilization 62.0%	ICU Level of Service B
Analysis Period (min) 15	



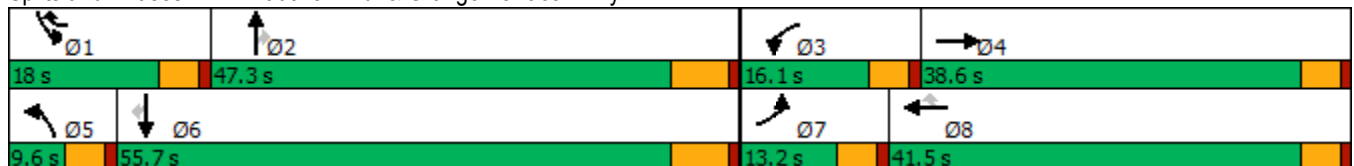



















Splits and Phases: 7: Trautwein Rd. & Orange Terrace Pkwy



HCM 6th Signalized Intersection Summary
7: Trautwein Rd. & Orange Terrace Pkwy

West Campus Upper Plateau (JN 14064)

09/30/2022

												
Movement	EBL	EBT	EBR	WBL	WBT	WBR	NBL	NBT	NBR	SBL	SBT	SBR
Lane Configurations												
Traffic Volume (veh/h)	34	20	22	182	13	176	37	949	169	218	979	22
Future Volume (veh/h)	34	20	22	182	13	176	37	949	169	218	979	22
Initial Q (Qb), veh	0	0	0	0	0	0	0	0	0	0	0	0
Ped-Bike Adj(A_pbT)	1.00		1.00	1.00		1.00	1.00		1.00	1.00		1.00
Parking Bus, Adj	1.00	1.00	1.00	1.00	1.00	1.00	1.00	1.00	1.00	1.00	1.00	1.00
Work Zone On Approach		No			No			No			No	
Adj Sat Flow, veh/h/ln	1900	1900	1900	1885	1900	1856	1900	1870	1870	1870	1870	1900
Adj Flow Rate, veh/h	36	21	21	194	14	67	39	1010	102	232	1041	13
Peak Hour Factor	0.94	0.94	0.94	0.94	0.94	0.94	0.94	0.94	0.94	0.94	0.94	0.94
Percent Heavy Veh, %	0	0	0	1	0	3	0	2	2	2	2	0
Cap, veh/h	64	114	114	235	430	888	68	1317	587	327	1520	689
Arrive On Green	0.04	0.13	0.13	0.13	0.23	0.23	0.04	0.37	0.37	0.09	0.43	0.43
Sat Flow, veh/h	1810	872	872	1795	1900	2768	1810	3554	1585	3456	3554	1610
Grp Volume(v), veh/h	36	0	42	194	14	67	39	1010	102	232	1041	13
Grp Sat Flow(s),veh/h/ln	1810	0	1743	1795	1900	1384	1810	1777	1585	1728	1777	1610
Q Serve(g_s), s	1.4	0.0	1.6	7.7	0.4	1.2	1.6	18.3	3.2	4.8	17.4	0.3
Cycle Q Clear(g_c), s	1.4	0.0	1.6	7.7	0.4	1.2	1.6	18.3	3.2	4.8	17.4	0.3
Prop In Lane	1.00		0.50	1.00		1.00	1.00		1.00	1.00		1.00
Lane Grp Cap(c), veh/h	64	0	229	235	430	888	68	1317	587	327	1520	689
V/C Ratio(X)	0.56	0.00	0.18	0.83	0.03	0.08	0.58	0.77	0.17	0.71	0.68	0.02
Avail Cap(c_a), veh/h	212	0	809	282	957	1656	123	1993	889	632	2401	1088
HCM Platoon Ratio	1.00	1.00	1.00	1.00	1.00	1.00	1.00	1.00	1.00	1.00	1.00	1.00
Upstream Filter(I)	1.00	0.00	1.00	1.00	1.00	1.00	1.00	1.00	1.00	1.00	1.00	1.00
Uniform Delay (d), s/veh	34.8	0.0	28.3	31.0	22.1	17.3	34.7	20.3	15.5	32.2	17.0	12.1
Incr Delay (d2), s/veh	2.8	0.0	0.4	13.3	0.0	0.0	2.9	1.0	0.1	1.1	0.6	0.0
Initial Q Delay(d3),s/veh	0.0	0.0	0.0	0.0	0.0	0.0	0.0	0.0	0.0	0.0	0.0	0.0
%ile BackOfQ(50%),veh/ln	0.7	0.0	0.7	3.9	0.2	0.4	0.7	6.6	1.0	1.9	5.9	0.1
Unsig. Movement Delay, s/veh												
LnGrp Delay(d),s/veh	37.6	0.0	28.7	44.4	22.1	17.3	37.6	21.3	15.6	33.3	17.5	12.1
LnGrp LOS	D	A	C	D	C	B	D	C	B	C	B	B
Approach Vol, veh/h		78			275			1151			1286	
Approach Delay, s/veh		32.8			36.7			21.3			20.3	
Approach LOS		C			D			C			C	
Timer - Assigned Phs	1	2	3	4	5	6	7	8				
Phs Duration (G+Y+Rc), s	11.5	33.4	14.2	14.2	7.3	37.5	7.2	21.2				
Change Period (Y+Rc), s	4.6	6.2	4.6	4.6	4.6	6.2	4.6	4.6				
Max Green Setting (Gmax), s	13.4	41.1	11.5	34.0	5.0	49.5	8.6	36.9				
Max Q Clear Time (g_c+I1), s	6.8	20.3	9.7	3.6	3.6	19.4	3.4	3.2				
Green Ext Time (p_c), s	0.2	6.8	0.0	0.2	0.0	7.6	0.0	0.3				
Intersection Summary												
HCM 6th Ctrl Delay				22.7								
HCM 6th LOS				C								

Timings
8: Cole Av. & Van Buren Bl.

West Campus Upper Plateau (JN 14064)

09/30/2022

Lane Group	EBL	EBT	EBR	WBL	WBT	WBR	NBL	NBT	SBL	SBT	SBR	
Lane Configurations												
Traffic Volume (vph)	487	1180	80	159	1237	354	106	263	348	235	385	
Future Volume (vph)	487	1180	80	159	1237	354	106	263	348	235	385	
Turn Type	Prot	NA	pm+ov	Prot	NA	pm+ov	Prot	NA	Prot	NA	pm+ov	
Protected Phases	5	2	3	1	6	7	3	8	7	4	5	
Permitted Phases			2			6					4	
Detector Phase	5	2	3	1	6	7	3	8	7	4	5	
Switch Phase												
Minimum Initial (s)	5.0	10.0	5.0	5.0	10.0	5.0	5.0	10.0	5.0	10.0	5.0	
Minimum Split (s)	9.1	36.2	9.1	9.1	36.2	9.1	9.1	42.2	9.1	49.2	9.1	
Total Split (s)	18.7	44.8	12.0	14.0	40.1	17.5	12.0	43.7	17.5	49.2	18.7	
Total Split (%)	15.6%	37.3%	10.0%	11.7%	33.4%	14.6%	10.0%	36.4%	14.6%	41.0%	15.6%	
Yellow Time (s)	3.2	5.2	3.2	3.2	5.2	3.2	3.2	5.2	3.2	5.2	3.2	
All-Red Time (s)	0.5	1.0	0.5	0.5	1.0	0.5	0.5	1.0	0.5	1.0	0.5	
Lost Time Adjust (s)	0.0	0.0	0.0	0.0	0.0	0.0	0.0	0.0	0.0	0.0	0.0	
Total Lost Time (s)	3.7	6.2	3.7	3.7	6.2	3.7	3.7	6.2	3.7	6.2	3.7	
Lead/Lag	Lead	Lag	Lead	Lead	Lag	Lead	Lead	Lag	Lead	Lag	Lead	
Lead-Lag Optimize?	Yes	Yes	Yes	Yes	Yes	Yes	Yes	Yes	Yes	Yes	Yes	
Recall Mode	None	None	None	None	None	None	None	None	None	None	None	
Act Effct Green (s)	15.1	38.9	53.5	10.4	34.2	54.0	8.4	17.5	13.6	22.7	40.3	
Actuated g/C Ratio	0.15	0.39	0.53	0.10	0.34	0.54	0.08	0.17	0.14	0.23	0.40	
v/c Ratio	0.99	0.92	0.09	0.92	0.75	0.38	0.74	0.59	0.79	0.30	0.59	
Control Delay	81.5	42.7	3.0	95.3	33.8	5.9	75.7	36.9	56.5	32.3	20.8	
Queue Delay	0.0	0.0	0.0	0.0	0.0	0.0	0.0	0.0	0.0	0.0	0.0	
Total Delay	81.5	42.7	3.0	95.3	33.8	5.9	75.7	36.9	56.5	32.3	20.8	
LOS	F	D	A	F	C	A	E	D	E	C	C	
Approach Delay		51.7			33.8			45.8		36.5		
Approach LOS		D			C			D		D		

Intersection Summary

Cycle Length: 120	
Actuated Cycle Length: 100.3	
Natural Cycle: 115	
Control Type: Actuated-Uncoordinated	
Maximum v/c Ratio: 0.99	
Intersection Signal Delay: 41.8	Intersection LOS: D
Intersection Capacity Utilization 81.1%	ICU Level of Service D
Analysis Period (min) 15	

Splits and Phases: 8: Cole Av. & Van Buren Bl.

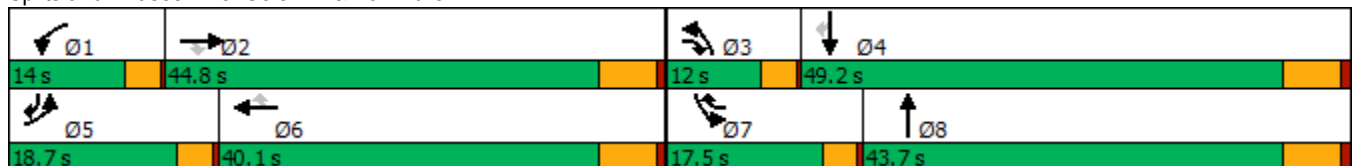

HCM 6th Signalized Intersection Summary
8: Cole Av. & Van Buren Bl.

West Campus Upper Plateau (JN 14064)

09/30/2022

Movement	EBL	EBT	EBR	WBL	WBT	WBR	NBL	NBT	NBR	SBL	SBT	SBR
Lane Configurations												
Traffic Volume (veh/h)	487	1180	80	159	1237	354	106	263	92	348	235	385
Future Volume (veh/h)	487	1180	80	159	1237	354	106	263	92	348	235	385
Initial Q (Qb), veh	0	0	0	0	0	0	0	0	0	0	0	0
Ped-Bike Adj(A_pbT)	1.00		1.00	1.00		1.00	1.00		0.99	1.00		1.00
Parking Bus, Adj	1.00	1.00	1.00	1.00	1.00	1.00	1.00	1.00	1.00	1.00	1.00	1.00
Work Zone On Approach		No			No			No			No	
Adj Sat Flow, veh/h/ln	1856	1826	1856	1856	1856	1870	1885	1885	1870	1856	1885	1885
Adj Flow Rate, veh/h	507	1229	26	166	1289	280	110	274	89	362	245	303
Peak Hour Factor	0.96	0.96	0.96	0.96	0.96	0.96	0.96	0.96	0.96	0.96	0.96	0.96
Percent Heavy Veh, %	3	5	3	3	3	2	1	1	2	3	1	1
Cap, veh/h	547	1372	743	194	1750	748	138	422	134	433	743	586
Arrive On Green	0.16	0.40	0.40	0.11	0.35	0.35	0.08	0.16	0.16	0.13	0.21	0.21
Sat Flow, veh/h	3428	3469	1572	1767	5066	1585	1795	2669	847	3428	3582	1595
Grp Volume(v), veh/h	507	1229	26	166	1289	280	110	182	181	362	245	303
Grp Sat Flow(s),veh/h/ln	1714	1735	1572	1767	1689	1585	1795	1791	1725	1714	1791	1595
Q Serve(g_s), s	13.7	31.2	0.8	8.7	21.0	10.7	5.7	8.9	9.3	9.7	5.5	13.9
Cycle Q Clear(g_c), s	13.7	31.2	0.8	8.7	21.0	10.7	5.7	8.9	9.3	9.7	5.5	13.9
Prop In Lane	1.00		1.00	1.00		1.00	1.00		0.49	1.00		1.00
Lane Grp Cap(c), veh/h	547	1372	743	194	1750	748	138	283	273	433	743	586
V/C Ratio(X)	0.93	0.90	0.04	0.86	0.74	0.37	0.80	0.64	0.66	0.84	0.33	0.52
Avail Cap(c_a), veh/h	547	1425	767	194	1827	772	159	715	688	503	1639	985
HCM Platoon Ratio	1.00	1.00	1.00	1.00	1.00	1.00	1.00	1.00	1.00	1.00	1.00	1.00
Upstream Filter(I)	1.00	1.00	1.00	1.00	1.00	1.00	1.00	1.00	1.00	1.00	1.00	1.00
Uniform Delay (d), s/veh	38.9	26.6	13.3	41.1	27.0	15.9	42.6	37.1	37.2	40.1	31.7	23.2
Incr Delay (d2), s/veh	21.7	7.8	0.0	28.5	1.7	0.4	18.5	2.4	2.8	9.1	0.3	0.7
Initial Q Delay(d3),s/veh	0.0	0.0	0.0	0.0	0.0	0.0	0.0	0.0	0.0	0.0	0.0	0.0
%ile BackOfQ(50%),veh/ln	7.0	12.9	0.3	5.1	7.9	3.5	3.1	3.9	3.9	4.4	2.2	4.9
Unsig. Movement Delay, s/veh												
LnGrp Delay(d),s/veh	60.6	34.4	13.3	69.6	28.7	16.4	61.1	39.5	40.0	49.3	31.9	24.0
LnGrp LOS	E	C	B	E	C	B	E	D	D	D	C	C
Approach Vol, veh/h		1762			1735			473			910	
Approach Delay, s/veh		41.7			30.6			44.7			36.2	
Approach LOS		D			C			D			D	
Timer - Assigned Phs	1	2	3	4	5	6	7	8				
Phs Duration (G+Y+Rc), s	14.0	43.4	10.9	25.7	18.7	38.7	15.6	21.1				
Change Period (Y+Rc), s	3.7	6.2	3.7	6.2	3.7	6.2	3.7	6.2				
Max Green Setting (Gmax), s	10.3	38.6	8.3	43.0	15.0	33.9	13.8	37.5				
Max Q Clear Time (g_c+1), s	10.7	33.2	7.7	15.9	15.7	23.0	11.7	11.3				
Green Ext Time (p_c), s	0.0	4.0	0.0	2.4	0.0	7.9	0.2	1.9				
Intersection Summary												
HCM 6th Ctrl Delay				37.0								
HCM 6th LOS				D								

Intersection	
Intersection Delay, s/veh	10.2
Intersection LOS	B

Movement	EBT	EBR	WBL	WBT	NBL	NBR
Lane Configurations	↶		↷	↶	↷	↷
Traffic Vol, veh/h	150	16	68	222	57	52
Future Vol, veh/h	150	16	68	222	57	52
Peak Hour Factor	0.82	0.82	0.82	0.82	0.82	0.82
Heavy Vehicles, %	2	0	5	2	0	0
Mvmt Flow	183	20	83	271	70	63
Number of Lanes	1	0	1	1	1	1

Approach	EB	WB	NB
Opposing Approach	WB	EB	
Opposing Lanes	2	1	0
Conflicting Approach Left		NB	EB
Conflicting Lanes Left	0	2	1
Conflicting Approach Right	NB		WB
Conflicting Lanes Right	2	0	2
HCM Control Delay	10.1	10.6	9.2
HCM LOS	B	B	A

Lane	NBLn1	NBLn2	EBLn1	WBLn1	WBLn2
Vol Left, %	100%	0%	0%	100%	0%
Vol Thru, %	0%	0%	90%	0%	100%
Vol Right, %	0%	100%	10%	0%	0%
Sign Control	Stop	Stop	Stop	Stop	Stop
Traffic Vol by Lane	57	52	166	68	222
LT Vol	57	0	0	68	0
Through Vol	0	0	150	0	222
RT Vol	0	52	16	0	0
Lane Flow Rate	70	63	202	83	271
Geometry Grp	7	7	4	7	7
Degree of Util (X)	0.122	0.09	0.284	0.13	0.383
Departure Headway (Hd)	6.339	5.128	5.05	5.643	5.089
Convergence, Y/N	Yes	Yes	Yes	Yes	Yes
Cap	564	695	709	634	707
Service Time	4.099	2.887	3.096	3.385	2.83
HCM Lane V/C Ratio	0.124	0.091	0.285	0.131	0.383
HCM Control Delay	10	8.4	10.1	9.2	11
HCM Lane LOS	A	A	B	A	B
HCM 95th-tile Q	0.4	0.3	1.2	0.4	1.8

Intersection												
Intersection Delay, s/veh	10.9											
Intersection LOS	B											

Movement	EBL	EBT	EBR	WBL	WBT	WBR	NBL	NBT	NBR	SBL	SBT	SBR
Lane Configurations	↵	↕		↵	↕			↕			↕	
Traffic Vol, veh/h	59	277	9	9	348	57	28	5	5	54	6	59
Future Vol, veh/h	59	277	9	9	348	57	28	5	5	54	6	59
Peak Hour Factor	0.90	0.90	0.90	0.90	0.90	0.90	0.90	0.90	0.90	0.90	0.90	0.90
Heavy Vehicles, %	5	2	7	0	1	0	6	0	0	0	0	0
Mvmt Flow	66	308	10	10	387	63	31	6	6	60	7	66
Number of Lanes	1	2	0	1	2	0	0	1	0	0	1	0

Approach	EB	WB	NB	SB
Opposing Approach	WB	EB	SB	NB
Opposing Lanes	3	3	1	1
Conflicting Approach Left	SB	NB	EB	WB
Conflicting Lanes Left	1	1	3	3
Conflicting Approach Right	NB	SB	WB	EB
Conflicting Lanes Right	1	1	3	3
HCM Control Delay	10.5	11.2	10.5	11.1
HCM LOS	B	B	B	B

Lane	NBLn1	EBLn1	EBLn2	EBLn3	WBLn1	WBLn2	WBLn3	SBLn1
Vol Left, %	74%	100%	0%	0%	100%	0%	0%	45%
Vol Thru, %	13%	0%	100%	91%	0%	100%	67%	5%
Vol Right, %	13%	0%	0%	9%	0%	0%	33%	50%
Sign Control	Stop	Stop	Stop	Stop	Stop	Stop	Stop	Stop
Traffic Vol by Lane	38	59	185	101	9	232	173	119
LT Vol	28	59	0	0	9	0	0	54
Through Vol	5	0	185	92	0	232	116	6
RT Vol	5	0	0	9	0	0	57	59
Lane Flow Rate	42	66	205	113	10	258	192	132
Geometry Grp	7	7	7	7	7	7	7	7
Degree of Util (X)	0.083	0.114	0.324	0.178	0.017	0.4	0.285	0.235
Departure Headway (Hd)	7.089	6.235	5.677	5.701	6.08	5.592	5.341	6.387
Convergence, Y/N	Yes	Yes	Yes	Yes	Yes	Yes	Yes	Yes
Cap	506	576	634	631	590	644	673	563
Service Time	4.829	3.961	3.404	3.427	3.806	3.318	3.067	4.121
HCM Lane V/C Ratio	0.083	0.115	0.323	0.179	0.017	0.401	0.285	0.234
HCM Control Delay	10.5	9.8	11.1	9.7	8.9	12	10.2	11.1
HCM Lane LOS	B	A	B	A	A	B	B	B
HCM 95th-tile Q	0.3	0.4	1.4	0.6	0.1	1.9	1.2	0.9

Timings
11: Barton St & Alessandro Bl.

West Campus Upper Plateau (JN 14064)

09/30/2022



Lane Group	EBL	EBT	WBL	WBT	NBL	NBT	NBR	SBL	SBT	SBR
Lane Configurations	↙	↕↕↕	↙	↕↕↕		↖	↖		↖	↖
Traffic Volume (vph)	5	1326	76	1502	53	1	38	5	0	3
Future Volume (vph)	5	1326	76	1502	53	1	38	5	0	3
Turn Type	Prot	NA	Prot	NA	Perm	NA	Perm	Perm	NA	Perm
Protected Phases	5	2	1	6		8			4	
Permitted Phases					8		8	4		4
Detector Phase	5	2	1	6	8	8	8	4	4	4
Switch Phase										
Minimum Initial (s)	5.0	10.0	5.0	10.0	10.0	10.0	10.0	10.0	10.0	10.0
Minimum Split (s)	9.2	28.5	11.0	28.5	40.6	40.6	40.6	26.6	26.6	26.6
Total Split (s)	9.2	65.4	14.0	70.2	40.6	40.6	40.6	40.6	40.6	40.6
Total Split (%)	7.7%	54.5%	11.7%	58.5%	33.8%	33.8%	33.8%	33.8%	33.8%	33.8%
Yellow Time (s)	3.2	5.5	3.2	5.5	3.6	3.6	3.6	3.6	3.6	3.6
All-Red Time (s)	1.0	1.0	1.0	1.0	1.0	1.0	1.0	1.0	1.0	1.0
Lost Time Adjust (s)	0.0	0.0	0.0	0.0		0.0	0.0		0.0	0.0
Total Lost Time (s)	4.2	6.5	4.2	6.5		4.6	4.6		4.6	4.6
Lead/Lag	Lead	Lag	Lead	Lag						
Lead-Lag Optimize?	Yes	Yes	Yes	Yes						
Recall Mode	None	None	None	None	None	None	None	None	None	None
Act Effct Green (s)	6.0	41.2	8.4	49.5		15.1	15.1		15.1	15.1
Actuated g/C Ratio	0.09	0.59	0.12	0.71		0.22	0.22		0.22	0.22
v/c Ratio	0.04	0.48	0.37	0.45		0.20	0.09		0.02	0.01
Control Delay	44.6	13.5	42.4	8.5		29.7	0.4		28.2	0.0
Queue Delay	0.0	0.0	0.0	0.0		0.0	0.0		0.0	0.0
Total Delay	44.6	13.5	42.4	8.5		29.7	0.4		28.2	0.0
LOS	D	B	D	A		C	A		C	A
Approach Delay		13.6		10.2		17.6			17.6	
Approach LOS		B		B		B			B	

Intersection Summary

Cycle Length: 120
 Actuated Cycle Length: 69.5
 Natural Cycle: 85
 Control Type: Actuated-Uncoordinated
 Maximum v/c Ratio: 0.48
 Intersection Signal Delay: 12.0
 Intersection LOS: B
 Intersection Capacity Utilization 58.9%
 ICU Level of Service B
 Analysis Period (min) 15

Splits and Phases: 11: Barton St & Alessandro Bl.



HCM 6th Signalized Intersection Summary
11: Barton St & Alessandro Bl.

West Campus Upper Plateau (JN 14064)

09/30/2022



Movement	EBL	EBT	EBR	WBL	WBT	WBR	NBL	NBT	NBR	SBL	SBT	SBR
Lane Configurations	↖	↑↑↑		↖	↑↑↑			↑	↗		↑	↗
Traffic Volume (veh/h)	5	1326	32	76	1502	5	53	1	38	5	0	3
Future Volume (veh/h)	5	1326	32	76	1502	5	53	1	38	5	0	3
Initial Q (Qb), veh	0	0	0	0	0	0	0	0	0	0	0	0
Ped-Bike Adj(A_pbT)	1.00		1.00	1.00		0.98	1.00		1.00	1.00		1.00
Parking Bus, Adj	1.00	1.00	1.00	1.00	1.00	1.00	1.00	1.00	1.00	1.00	1.00	1.00
Work Zone On Approach		No			No			No			No	
Adj Sat Flow, veh/h/ln	1604	1885	1900	1900	1870	1900	1870	1900	1900	1737	1900	1900
Adj Flow Rate, veh/h	5	1426	32	82	1615	5	57	1	14	5	0	-8
Peak Hour Factor	0.93	0.93	0.93	0.93	0.93	0.93	0.93	0.93	0.93	0.93	0.93	0.93
Percent Heavy Veh, %	20	1	0	0	2	0	2	0	0	11	0	0
Cap, veh/h	10	2972	67	111	3305	10	289	4	182	237	0	182
Arrive On Green	0.01	0.57	0.57	0.06	0.63	0.63	0.11	0.11	0.11	0.11	0.00	0.00
Sat Flow, veh/h	1527	5179	116	1810	5255	16	1515	36	1610	1052	0	1610
Grp Volume(v), veh/h	5	945	513	82	1046	574	58	0	14	5	0	-8
Grp Sat Flow(s),veh/h/ln	1527	1716	1864	1810	1702	1867	1551	0	1610	1052	0	1610
Q Serve(g_s), s	0.2	9.9	9.9	2.7	10.0	10.0	0.0	0.0	0.5	0.2	0.0	0.0
Cycle Q Clear(g_c), s	0.2	9.9	9.9	2.7	10.0	10.0	1.8	0.0	0.5	2.0	0.0	0.0
Prop In Lane	1.00		0.06	1.00		0.01	0.98		1.00	1.00		1.00
Lane Grp Cap(c), veh/h	10	1969	1070	111	2141	1174	293	0	182	237	0	182
V/C Ratio(X)	0.49	0.48	0.48	0.74	0.49	0.49	0.20	0.00	0.08	0.02	0.00	-0.04
Avail Cap(c_a), veh/h	125	3320	1804	291	3562	1954	984	0	952	917	0	952
HCM Platoon Ratio	1.00	1.00	1.00	1.00	1.00	1.00	1.00	1.00	1.00	1.00	1.00	1.00
Upstream Filter(I)	1.00	1.00	1.00	1.00	1.00	1.00	1.00	0.00	1.00	1.00	0.00	0.00
Uniform Delay (d), s/veh	30.1	7.6	7.6	28.1	6.1	6.1	24.7	0.0	24.2	25.6	0.0	0.0
Incr Delay (d2), s/veh	13.0	0.3	0.5	3.5	0.2	0.5	0.3	0.0	0.2	0.0	0.0	0.0
Initial Q Delay(d3),s/veh	0.0	0.0	0.0	0.0	0.0	0.0	0.0	0.0	0.0	0.0	0.0	0.0
%ile BackOfQ(50%),veh/ln	0.1	2.2	2.4	1.2	2.6	3.0	0.8	0.0	0.2	0.1	0.0	0.0
Unsig. Movement Delay, s/veh												
LnGrp Delay(d),s/veh	43.1	7.9	8.1	31.6	6.3	6.5	25.1	0.0	24.3	25.7	0.0	0.0
LnGrp LOS	D	A	A	C	A	A	C	A	C	C	A	A
Approach Vol, veh/h		1463			1702			72				-3
Approach Delay, s/veh		8.1			7.6			24.9				0.0
Approach LOS		A			A			C				A
Timer - Assigned Phs	1	2		4	5	6		8				
Phs Duration (G+Y+Rc), s	8.0	41.4		11.5	4.6	44.8		11.5				
Change Period (Y+Rc), s	* 4.2	6.5		4.6	* 4.2	6.5		4.6				
Max Green Setting (Gmax), s	* 9.8	58.9		36.0	* 5	63.7		36.0				
Max Q Clear Time (g_c+I1), s	4.7	11.9		4.0	2.2	12.0		3.8				
Green Ext Time (p_c), s	0.0	18.0		0.0	0.0	26.3		0.3				

Intersection Summary

HCM 6th Ctrl Delay	8.2
HCM 6th LOS	A

Notes

* HCM 6th computational engine requires equal clearance times for the phases crossing the barrier.

Intersection						
Int Delay, s/veh	2.3					
Movement	EBL	EBT	WBT	WBR	SBL	SBR
Lane Configurations						
Traffic Vol, veh/h	21	148	206	20	25	53
Future Vol, veh/h	21	148	206	20	25	53
Conflicting Peds, #/hr	0	0	0	7	0	0
Sign Control	Free	Free	Free	Free	Stop	Stop
RT Channelized	-	None	-	None	-	None
Storage Length	100	-	-	-	0	-
Veh in Median Storage, #	-	0	0	-	0	-
Grade, %	-	0	0	-	0	-
Peak Hour Factor	78	78	78	78	78	78
Heavy Vehicles, %	0	1	1	0	0	0
Mvmt Flow	27	190	264	26	32	68

Major/Minor	Major1	Major2	Minor2		
Conflicting Flow All	297	0	-	0	528 284
Stage 1	-	-	-	-	284 -
Stage 2	-	-	-	-	244 -
Critical Hdwy	4.1	-	-	-	6.4 6.2
Critical Hdwy Stg 1	-	-	-	-	5.4 -
Critical Hdwy Stg 2	-	-	-	-	5.4 -
Follow-up Hdwy	2.2	-	-	-	3.5 3.3
Pot Cap-1 Maneuver	1276	-	-	-	514 760
Stage 1	-	-	-	-	769 -
Stage 2	-	-	-	-	801 -
Platoon blocked, %		-	-	-	
Mov Cap-1 Maneuver	1267	-	-	-	496 755
Mov Cap-2 Maneuver	-	-	-	-	496 -
Stage 1	-	-	-	-	747 -
Stage 2	-	-	-	-	795 -

Approach	EB	WB	SB
HCM Control Delay, s	1	0	11.6
HCM LOS			B

Minor Lane/Major Mvmt	EBL	EBT	WBT	WBR	SBLn1
Capacity (veh/h)	1267	-	-	-	647
HCM Lane V/C Ratio	0.021	-	-	-	0.155
HCM Control Delay (s)	7.9	-	-	-	11.6
HCM Lane LOS	A	-	-	-	B
HCM 95th %tile Q(veh)	0.1	-	-	-	0.5

Intersection						
Int Delay, s/veh	42					
Movement	EBT	EBR	WBL	WBT	NBL	NBR
Lane Configurations	↑↑		↖	↑↑	↘	
Traffic Vol, veh/h	308	316	51	455	267	38
Future Vol, veh/h	308	316	51	455	267	38
Conflicting Peds, #/hr	0	2	0	0	0	0
Sign Control	Free	Free	Free	Free	Stop	Stop
RT Channelized	-	None	-	None	-	None
Storage Length	-	-	125	-	0	-
Veh in Median Storage, #	0	-	-	0	0	-
Grade, %	0	-	-	0	0	-
Peak Hour Factor	86	86	86	86	86	86
Heavy Vehicles, %	1	1	0	0	0	0
Mvmt Flow	358	367	59	529	310	44

Major/Minor	Major1	Major2	Minor1		
Conflicting Flow All	0	0	727	0	927
Stage 1	-	-	-	-	544
Stage 2	-	-	-	-	383
Critical Hdwy	-	-	4.1	-	6.8
Critical Hdwy Stg 1	-	-	-	-	5.8
Critical Hdwy Stg 2	-	-	-	-	5.8
Follow-up Hdwy	-	-	2.2	-	3.5
Pot Cap-1 Maneuver	-	-	886	- ~	271
Stage 1	-	-	-	-	551
Stage 2	-	-	-	-	665
Platoon blocked, %	-	-	-	-	-
Mov Cap-1 Maneuver	-	-	884	- ~	252
Mov Cap-2 Maneuver	-	-	-	- ~	252
Stage 1	-	-	-	-	550
Stage 2	-	-	-	-	620

Approach	EB	WB	NB
HCM Control Delay, s	0	0.9	196.1
HCM LOS			F

Minor Lane/Major Mvmt	NBLn1	EBT	EBR	WBL	WBT
Capacity (veh/h)	273	-	-	884	-
HCM Lane V/C Ratio	1.299	-	-	0.067	-
HCM Control Delay (s)	196.1	-	-	9.4	-
HCM Lane LOS	F	-	-	A	-
HCM 95th %tile Q(veh)	17.7	-	-	0.2	-

Notes
 ~: Volume exceeds capacity \$: Delay exceeds 300s +: Computation Not Defined *: All major volume in platoon

Timings
14: Barton Rd. & Van Buren Bl.



Lane Group	EBL	EBT	WBL	WBT	NBL	NBT	NBR	SBL	SBT
Lane Configurations	↘	↗	↘	↗	↘	↗	↗	↘	↗
Traffic Volume (vph)	175	1385	201	1448	254	44	162	29	29
Future Volume (vph)	175	1385	201	1448	254	44	162	29	29
Turn Type	Prot	NA	Prot	NA	Prot	NA	Perm	Prot	NA
Protected Phases	5	2	1	6	3	8		7	4
Permitted Phases							8		
Detector Phase	5	2	1	6	3	8	8	7	4
Switch Phase									
Minimum Initial (s)	5.0	10.0	5.0	10.0	5.0	10.0	10.0	5.0	10.0
Minimum Split (s)	9.2	25.2	9.2	25.5	9.1	14.6	14.6	9.1	33.6
Total Split (s)	17.6	52.1	22.2	56.7	12.1	36.3	36.3	9.4	33.6
Total Split (%)	14.7%	43.4%	18.5%	47.3%	10.1%	30.3%	30.3%	7.8%	28.0%
Yellow Time (s)	3.2	5.2	3.2	5.5	3.6	3.6	3.6	3.6	3.6
All-Red Time (s)	1.0	1.0	1.0	1.0	0.5	1.0	1.0	0.5	1.0
Lost Time Adjust (s)	0.0	0.0	0.0	0.0	0.0	0.0	0.0	0.0	0.0
Total Lost Time (s)	4.2	6.2	4.2	6.5	4.1	4.6	4.6	4.1	4.6
Lead/Lag	Lead	Lag	Lead	Lag	Lead	Lag	Lag	Lead	Lag
Lead-Lag Optimize?	Yes	Yes	Yes	Yes	Yes	Yes	Yes	Yes	Yes
Recall Mode	None	None	None	None	None	None	None	None	None
Act Effct Green (s)	13.5	46.2	16.4	48.8	8.1	20.2	20.2	5.3	13.5
Actuated g/C Ratio	0.13	0.45	0.16	0.47	0.08	0.20	0.20	0.05	0.13
v/c Ratio	0.83	1.16	0.80	0.70	1.04	0.13	0.40	0.34	0.60
Control Delay	72.9	109.6	64.0	24.1	111.8	37.2	8.3	60.9	15.4
Queue Delay	0.0	0.0	0.0	0.0	0.0	0.0	0.0	0.0	0.0
Total Delay	72.9	109.6	64.0	24.1	111.8	37.2	8.3	60.9	15.4
LOS	E	F	E	C	F	D	A	E	B
Approach Delay		106.0		28.9		68.2			20.8
Approach LOS		F		C		E			C

Intersection Summary
 Cycle Length: 120
 Actuated Cycle Length: 103.3
 Natural Cycle: 120
 Control Type: Actuated-Uncoordinated
 Maximum v/c Ratio: 1.16
 Intersection Signal Delay: 65.6
 Intersection LOS: E
 Intersection Capacity Utilization 92.4%
 ICU Level of Service F
 Analysis Period (min) 15

























Splits and Phases: 14: Barton Rd. & Van Buren Bl.



HCM 6th Signalized Intersection Summary
 14: Barton Rd. & Van Buren Bl.

West Campus Upper Plateau (JN 14064)

09/30/2022

												
Movement	EBL	EBT	EBR	WBL	WBT	WBR	NBL	NBT	NBR	SBL	SBT	SBR
Lane Configurations		 			 						 	
Traffic Volume (veh/h)	175	1385	217	201	1448	39	254	44	162	29	29	184
Future Volume (veh/h)	175	1385	217	201	1448	39	254	44	162	29	29	184
Initial Q (Qb), veh	0	0	0	0	0	0	0	0	0	0	0	0
Ped-Bike Adj(A_pbT)	1.00		1.00	1.00		1.00	1.00		0.95	1.00		1.00
Parking Bus, Adj	1.00	1.00	1.00	1.00	1.00	1.00	1.00	1.00	1.00	1.00	1.00	1.00
Work Zone On Approach		No			No			No			No	
Adj Sat Flow, veh/h/ln	1900	1841	1870	1870	1856	1856	1900	1900	1885	1900	1841	1900
Adj Flow Rate, veh/h	194	1539	210	223	1609	32	282	49	48	32	32	142
Peak Hour Factor	0.90	0.90	0.90	0.90	0.90	0.90	0.90	0.90	0.90	0.90	0.90	0.90
Percent Heavy Veh, %	0	4	2	2	3	3	0	0	1	0	4	0
Cap, veh/h	225	1402	189	255	2409	48	277	349	279	53	40	176
Arrive On Green	0.12	0.45	0.45	0.14	0.47	0.47	0.08	0.18	0.18	0.03	0.13	0.13
Sat Flow, veh/h	1810	3097	416	1781	5113	102	3510	1900	1520	1810	295	1310
Grp Volume(v), veh/h	194	859	890	223	1063	578	282	49	48	32	0	174
Grp Sat Flow(s),veh/h/ln	1810	1749	1765	1781	1689	1837	1755	1900	1520	1810	0	1605
Q Serve(g_s), s	10.7	45.9	45.9	12.4	24.6	24.6	8.0	2.2	2.7	1.8	0.0	10.7
Cycle Q Clear(g_c), s	10.7	45.9	45.9	12.4	24.6	24.6	8.0	2.2	2.7	1.8	0.0	10.7
Prop In Lane	1.00		0.24	1.00		0.06	1.00		1.00	1.00		0.82
Lane Grp Cap(c), veh/h	225	792	799	255	1591	866	277	349	279	53	0	215
V/C Ratio(X)	0.86	1.08	1.11	0.87	0.67	0.67	1.02	0.14	0.17	0.60	0.00	0.81
Avail Cap(c_a), veh/h	239	792	799	316	1672	910	277	594	475	95	0	459
HCM Platoon Ratio	1.00	1.00	1.00	1.00	1.00	1.00	1.00	1.00	1.00	1.00	1.00	1.00
Upstream Filter(I)	1.00	1.00	1.00	1.00	1.00	1.00	1.00	1.00	1.00	1.00	0.00	1.00
Uniform Delay (d), s/veh	43.5	27.7	27.7	42.6	20.7	20.7	46.7	34.7	34.9	48.6	0.0	42.6
Incr Delay (d2), s/veh	23.5	57.5	67.9	17.3	0.7	1.4	58.8	0.2	0.3	10.6	0.0	7.1
Initial Q Delay(d3),s/veh	0.0	0.0	0.0	0.0	0.0	0.0	0.0	0.0	0.0	0.0	0.0	0.0
%ile BackOfQ(50%),veh/ln	6.0	29.5	32.1	6.4	8.8	9.7	5.6	1.0	1.0	1.0	0.0	4.7
Unsig. Movement Delay, s/veh												
LnGrp Delay(d),s/veh	67.0	85.3	95.7	59.8	21.4	22.1	105.5	34.9	35.2	59.2	0.0	49.7
LnGrp LOS	E	F	F	E	C	C	F	C	D	E	A	D
Approach Vol, veh/h		1943			1864			379			206	
Approach Delay, s/veh		88.2			26.2			87.5			51.2	
Approach LOS		F			C			F			D	
Timer - Assigned Phs	1	2	3	4	5	6	7	8				
Phs Duration (G+Y+Rc), s	18.7	52.4	12.1	18.2	16.8	54.3	7.1	23.2				
Change Period (Y+Rc), s	* 4.2	* 6.5	4.1	4.6	* 4.2	6.5	4.1	4.6				
Max Green Setting (Gmax), s	* 18	* 46	8.0	29.0	* 13	50.2	5.3	31.7				
Max Q Clear Time (g_c+I1), s	14.4	47.9	10.0	12.7	12.7	26.6	3.8	4.7				
Green Ext Time (p_c), s	0.1	0.0	0.0	0.9	0.0	7.2	0.0	0.3				

Intersection Summary

HCM 6th Ctrl Delay	60.1
HCM 6th LOS	E

Notes

* HCM 6th computational engine requires equal clearance times for the phases crossing the barrier.

Intersection	
Intersection Delay, s/veh	8.7
Intersection LOS	A

Movement	EBT	EBR	WBL	WBT	NBL	NBR
Lane Configurations						
Traffic Vol, veh/h	86	79	40	119	76	37
Future Vol, veh/h	86	79	40	119	76	37
Peak Hour Factor	0.88	0.88	0.88	0.88	0.88	0.88
Heavy Vehicles, %	1	2	3	2	2	0
Mvmt Flow	98	90	45	135	86	42
Number of Lanes	1	0	1	1	1	0

Approach	EB	WB	NB
Opposing Approach	WB	EB	
Opposing Lanes	2	1	0
Conflicting Approach Left		NB	EB
Conflicting Lanes Left	0	1	1
Conflicting Approach Right	NB		WB
Conflicting Lanes Right	1	0	2
HCM Control Delay	8.5	8.8	8.7
HCM LOS	A	A	A

Lane	NBLn1	EBLn1	WBLn1	WBLn2
Vol Left, %	67%	0%	100%	0%
Vol Thru, %	0%	52%	0%	100%
Vol Right, %	33%	48%	0%	0%
Sign Control	Stop	Stop	Stop	Stop
Traffic Vol by Lane	113	165	40	119
LT Vol	76	0	40	0
Through Vol	0	86	0	119
RT Vol	37	79	0	0
Lane Flow Rate	128	188	45	135
Geometry Grp	2	5	7	7
Degree of Util (X)	0.168	0.222	0.07	0.187
Departure Headway (Hd)	4.711	4.259	5.511	4.991
Convergence, Y/N	Yes	Yes	Yes	Yes
Cap	761	844	651	719
Service Time	2.736	2.28	3.234	2.714
HCM Lane V/C Ratio	0.168	0.223	0.069	0.188
HCM Control Delay	8.7	8.5	8.7	8.9
HCM Lane LOS	A	A	A	A
HCM 95th-tile Q	0.6	0.8	0.2	0.7

Intersection	
Intersection Delay, s/veh	9.4
Intersection LOS	A

Movement	EBL	EBT	WBT	WBR	SBL	SBR
Lane Configurations						
Traffic Vol, veh/h	130	165	194	72	60	62
Future Vol, veh/h	130	165	194	72	60	62
Peak Hour Factor	0.90	0.90	0.90	0.90	0.90	0.90
Heavy Vehicles, %	1	0	2	0	4	3
Mvmt Flow	144	183	216	80	67	69
Number of Lanes	1	2	2	0	1	0

Approach	EB	WB	SB
Opposing Approach	WB	EB	
Opposing Lanes	2	3	0
Conflicting Approach Left	SB		WB
Conflicting Lanes Left	1	0	2
Conflicting Approach Right		SB	EB
Conflicting Lanes Right	0	1	3
HCM Control Delay	8.8	9.7	10.2
HCM LOS	A	A	B

Lane	EBLn1	EBLn2	EBLn3	WBLn1	WBLn2	SBLn1
Vol Left, %	100%	0%	0%	0%	0%	49%
Vol Thru, %	0%	100%	100%	100%	47%	0%
Vol Right, %	0%	0%	0%	0%	53%	51%
Sign Control	Stop	Stop	Stop	Stop	Stop	Stop
Traffic Vol by Lane	130	83	83	129	137	122
LT Vol	130	0	0	0	0	60
Through Vol	0	83	83	129	65	0
RT Vol	0	0	0	0	72	62
Lane Flow Rate	144	92	92	144	152	136
Geometry Grp	7	7	7	8	8	7
Degree of Util (X)	0.229	0.132	0.089	0.223	0.219	0.219
Departure Headway (Hd)	5.718	5.197	3.484	5.588	5.182	5.814
Convergence, Y/N	Yes	Yes	Yes	Yes	Yes	Yes
Cap	625	687	1017	638	688	613
Service Time	3.477	2.956	1.242	3.358	2.952	3.594
HCM Lane V/C Ratio	0.23	0.134	0.09	0.226	0.221	0.222
HCM Control Delay	10.2	8.8	6.6	10	9.4	10.2
HCM Lane LOS	B	A	A	A	A	B
HCM 95th-tile Q	0.9	0.5	0.3	0.8	0.8	0.8

Timings
19: Van Buren Bl. & Orange Terrace Pkwy.

West Campus Upper Plateau (JN 14064)

09/30/2022

Lane Group	EBL	EBT	EBR	WBL	WBT	WBR	NBL	NBT	NBR	SBL	SBT	SBR
Lane Configurations												
Traffic Volume (vph)	143	1266	56	37	1545	277	60	53	44	211	41	127
Future Volume (vph)	143	1266	56	37	1545	277	60	53	44	211	41	127
Turn Type	Prot	NA	Perm	Prot	NA	Perm	Prot	NA	Perm	Prot	NA	pm+ov
Protected Phases	5	2		1	6		3	8		7	4	5
Permitted Phases			2			6			8			4
Detector Phase	5	2	2	1	6	6	3	8	8	7	4	5
Switch Phase												
Minimum Initial (s)	5.0	10.0	10.0	5.0	10.0	10.0	5.0	5.0	5.0	10.0	10.0	5.0
Minimum Split (s)	9.2	25.2	25.2	9.1	25.2	25.2	9.1	26.1	26.1	15.8	24.8	9.2
Total Split (s)	16.0	63.0	63.0	11.0	58.0	58.0	12.0	27.0	27.0	19.0	34.0	16.0
Total Split (%)	13.3%	52.5%	52.5%	9.2%	48.3%	48.3%	10.0%	22.5%	22.5%	15.8%	28.3%	13.3%
Yellow Time (s)	3.2	5.2	5.2	3.6	5.2	5.2	3.6	3.6	3.6	4.8	4.8	3.2
All-Red Time (s)	1.0	1.0	1.0	0.5	1.0	1.0	0.5	0.5	0.5	1.0	1.0	1.0
Lost Time Adjust (s)	0.0	0.0	0.0	0.0	0.0	0.0	0.0	0.0	0.0	0.0	0.0	0.0
Total Lost Time (s)	4.2	6.2	6.2	4.1	6.2	6.2	4.1	4.1	4.1	5.8	5.8	4.2
Lead/Lag	Lead	Lag	Lag	Lead	Lag	Lag	Lead	Lag	Lag	Lead	Lag	Lead
Lead-Lag Optimize?	Yes	Yes	Yes	Yes	Yes	Yes	Yes	Yes	Yes	Yes	Yes	Yes
Recall Mode	None	None	None	None	None	None	None	None	None	None	None	None
Act Effct Green (s)	8.7	49.1	49.1	6.6	41.7	41.7	10.6	7.9	7.9	11.9	12.7	24.1
Actuated g/C Ratio	0.10	0.55	0.55	0.07	0.47	0.47	0.12	0.09	0.09	0.13	0.14	0.27
v/c Ratio	0.44	0.48	0.06	0.15	0.69	0.33	0.16	0.17	0.14	0.48	0.16	0.28
Control Delay	46.2	14.2	0.1	46.6	20.6	5.1	43.9	43.5	1.0	43.3	39.8	16.9
Queue Delay	0.0	0.0	0.0	0.0	0.0	0.0	0.0	0.0	0.0	0.0	0.0	0.0
Total Delay	46.2	14.2	0.1	46.6	20.6	5.1	43.9	43.5	1.0	43.3	39.8	16.9
LOS	D	B	A	D	C	A	D	D	A	D	D	B
Approach Delay		16.8			18.8			31.8			34.1	
Approach LOS		B			B			C			C	

Intersection Summary

Cycle Length: 120
 Actuated Cycle Length: 88.7
 Natural Cycle: 90
 Control Type: Actuated-Uncoordinated
 Maximum v/c Ratio: 0.69
 Intersection Signal Delay: 20.1
 Intersection LOS: C
 Intersection Capacity Utilization 60.2%
 ICU Level of Service B
 Analysis Period (min) 15

Splits and Phases: 19: Van Buren Bl. & Orange Terrace Pkwy.

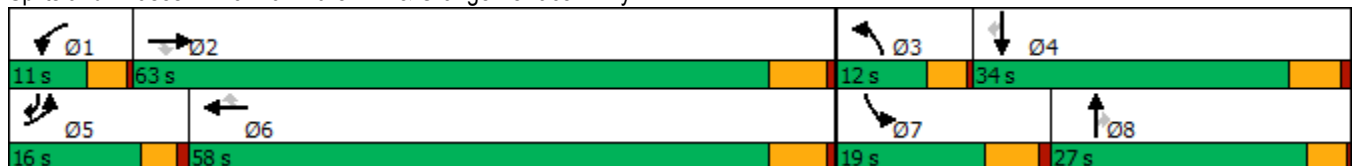

HCM 6th Signalized Intersection Summary
 19: Van Buren Bl. & Orange Terrace Pkwy.

West Campus Upper Plateau (JN 14064)

09/30/2022



Movement	EBL	EBT	EBR	WBL	WBT	WBR	NBL	NBT	NBR	SBL	SBT	SBR
Lane Configurations	↔↔	↑↑↑	↗	↔↔	↑↑↑	↗	↔↔	↑↑	↗	↔↔	↑	↗
Traffic Volume (veh/h)	143	1266	56	37	1545	277	60	53	44	211	41	127
Future Volume (veh/h)	143	1266	56	37	1545	277	60	53	44	211	41	127
Initial Q (Qb), veh	0	0	0	0	0	0	0	0	0	0	0	0
Ped-Bike Adj(A_pbT)	1.00		1.00	1.00		1.00	1.00		1.00	1.00		1.00
Parking Bus, Adj	1.00	1.00	1.00	1.00	1.00	1.00	1.00	1.00	1.00	1.00	1.00	1.00
Work Zone On Approach		No			No			No			No	
Adj Sat Flow, veh/h/ln	1885	1856	1811	1870	1856	1885	1796	1900	1856	1885	1900	1885
Adj Flow Rate, veh/h	151	1333	33	39	1626	232	63	56	14	222	43	60
Peak Hour Factor	0.95	0.95	0.95	0.95	0.95	0.95	0.95	0.95	0.95	0.95	0.95	0.95
Percent Heavy Veh, %	1	3	6	2	3	1	7	0	3	1	0	1
Cap, veh/h	232	2510	761	126	2351	741	158	228	99	442	312	369
Arrive On Green	0.07	0.50	0.50	0.04	0.46	0.46	0.05	0.06	0.06	0.13	0.16	0.16
Sat Flow, veh/h	3483	5066	1535	3456	5066	1598	3319	3610	1572	3483	1900	1598
Grp Volume(v), veh/h	151	1333	33	39	1626	232	63	56	14	222	43	60
Grp Sat Flow(s),veh/h/ln	1742	1689	1535	1728	1689	1598	1659	1805	1572	1742	1900	1598
Q Serve(g_s), s	3.3	14.2	0.9	0.9	20.0	7.2	1.5	1.2	0.7	4.7	1.5	2.4
Cycle Q Clear(g_c), s	3.3	14.2	0.9	0.9	20.0	7.2	1.5	1.2	0.7	4.7	1.5	2.4
Prop In Lane	1.00		1.00	1.00		1.00	1.00		1.00	1.00		1.00
Lane Grp Cap(c), veh/h	232	2510	761	126	2351	741	158	228	99	442	312	369
V/C Ratio(X)	0.65	0.53	0.04	0.31	0.69	0.31	0.40	0.25	0.14	0.50	0.14	0.16
Avail Cap(c_a), veh/h	522	3653	1107	303	3331	1051	333	1049	457	584	680	678
HCM Platoon Ratio	1.00	1.00	1.00	1.00	1.00	1.00	1.00	1.00	1.00	1.00	1.00	1.00
Upstream Filter(I)	1.00	1.00	1.00	1.00	1.00	1.00	1.00	1.00	1.00	1.00	1.00	1.00
Uniform Delay (d), s/veh	35.9	13.6	10.2	37.0	16.7	13.2	36.4	35.1	34.9	32.1	28.2	24.2
Incr Delay (d2), s/veh	1.2	0.2	0.0	1.4	0.4	0.2	1.6	0.6	0.6	0.9	0.2	0.2
Initial Q Delay(d3),s/veh	0.0	0.0	0.0	0.0	0.0	0.0	0.0	0.0	0.0	0.0	0.0	0.0
%ile BackOfQ(50%),veh/ln	1.3	4.4	0.3	0.4	6.4	2.4	0.6	0.5	0.3	1.9	0.7	0.9
Unsig. Movement Delay, s/veh												
LnGrp Delay(d),s/veh	37.0	13.8	10.3	38.4	17.0	13.5	38.1	35.7	35.5	32.9	28.4	24.4
LnGrp LOS	D	B	B	D	B	B	D	D	D	C	C	C
Approach Vol, veh/h		1517			1897			133			325	
Approach Delay, s/veh		16.0			17.0			36.8			30.8	
Approach LOS		B			B			D			C	
Timer - Assigned Phs	1	2	3	4	5	6	7	8				
Phs Duration (G+Y+Rc), s	7.0	45.2	7.8	18.7	9.4	42.8	15.8	10.8				
Change Period (Y+Rc), s	4.1	6.2	4.1	5.8	* 4.2	6.2	5.8	* 5.8				
Max Green Setting (Gmax), s	6.9	56.8	7.9	28.2	* 12	51.8	13.2	* 23				
Max Q Clear Time (g_c+I1), s	2.9	16.2	3.5	4.4	5.3	22.0	6.7	3.2				
Green Ext Time (p_c), s	0.0	11.3	0.0	0.3	0.1	14.6	0.4	0.3				

Intersection Summary

HCM 6th Ctrl Delay	18.5
HCM 6th LOS	B

Notes

* HCM 6th computational engine requires equal clearance times for the phases crossing the barrier.

Timings
20: Brown/San Gorgonio Dr & Alessandro Bl.

West Campus Upper Plateau (JN 14064)

09/30/2022

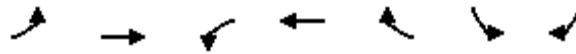

Lane Group	EBL	EBT	WBL	WBT	WBR	SBL	SBR	Ø3	Ø4	Ø8
Lane Configurations	↖	↕↕↕	↖	↕↕↕	↖	↖	↖			
Traffic Volume (vph)	33	1378	3	1565	36	41	38			
Future Volume (vph)	33	1378	3	1565	36	41	38			
Turn Type	Prot	NA	Prot	NA	Perm	Prot	pm+ov			
Protected Phases	5	2	1	6		7	5	3	4	8
Permitted Phases					6		4			
Detector Phase	5	2	1	6	6	7	5			
Switch Phase										
Minimum Initial (s)	5.0	10.0	5.0	10.0	10.0	5.0	5.0	5.0	10.0	5.0
Minimum Split (s)	8.7	43.5	9.1	43.5	43.5	8.7	8.7	9.1	49.8	26.1
Total Split (s)	8.7	52.0	9.1	52.4	52.4	19.6	8.7	9.1	49.8	39.3
Total Split (%)	7.3%	43.3%	7.6%	43.7%	43.7%	16.3%	7.3%	8%	42%	33%
Yellow Time (s)	3.2	5.5	3.6	5.5	5.5	3.2	3.2	3.6	4.8	3.6
All-Red Time (s)	0.5	1.0	0.5	1.0	1.0	0.5	0.5	0.5	1.0	0.5
Lost Time Adjust (s)	0.0	0.0	0.0	0.0	0.0	0.0	0.0			
Total Lost Time (s)	3.7	6.5	4.1	6.5	6.5	3.7	3.7			
Lead/Lag	Lead	Lag	Lead	Lag	Lag	Lead	Lead	Lead	Lag	Lag
Lead-Lag Optimize?	Yes	Yes	Yes	Yes	Yes	Yes	Yes	Yes	Yes	Yes
Recall Mode	None	None	None	None	None	None	None	None	None	None
Act Effct Green (s)	5.9	54.8	5.9	48.1	48.1	9.3	18.2			
Actuated g/C Ratio	0.08	0.77	0.08	0.67	0.67	0.13	0.25			
v/c Ratio	0.24	0.37	0.03	0.49	0.05	0.20	0.08			
Control Delay	45.6	9.4	44.3	12.6	0.1	38.4	0.3			
Queue Delay	0.0	0.0	0.0	0.0	0.0	0.0	0.0			
Total Delay	45.6	9.4	44.3	12.6	0.1	38.4	0.3			
LOS	D	A	D	B	A	D	A			
Approach Delay		10.2		12.3						
Approach LOS		B		B						

Intersection Summary

Cycle Length: 120
 Actuated Cycle Length: 71.6
 Natural Cycle: 115
 Control Type: Actuated-Uncoordinated
 Maximum v/c Ratio: 0.49
 Intersection Signal Delay: 11.6
 Intersection LOS: B
 Intersection Capacity Utilization 48.8%
 ICU Level of Service A
 Analysis Period (min) 15

Splits and Phases: 20: Brown/San Gorgonio Dr & Alessandro Bl.

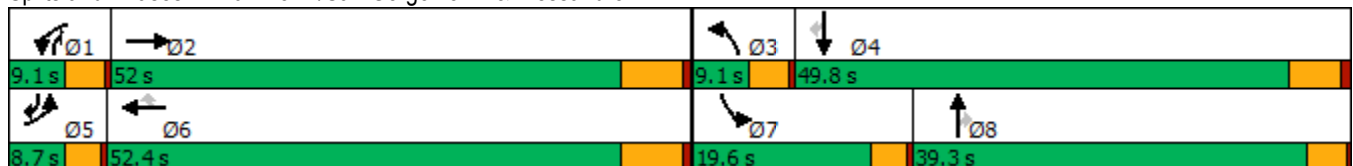

HCM 6th Signalized Intersection Summary
20: Brown/San Gorgonio Dr & Alessandro Bl.

West Campus Upper Plateau (JN 14064)

09/30/2022



Movement	EBL	EBT	EBR	WBL	WBT	WBR	NBL	NBT	NBR	SBL	SBT	SBR
Lane Configurations	↗	↑↑↑		↖	↑↑↑	↗	↖	↑	↗	↖	↑	↗
Traffic Volume (veh/h)	33	1378	0	3	1565	36	0	0	0	41	0	38
Future Volume (veh/h)	33	1378	0	3	1565	36	0	0	0	41	0	38
Initial Q (Qb), veh	0	0	0	0	0	0	0	0	0	0	0	0
Ped-Bike Adj(A_pbT)	1.00		1.00	1.00		1.00	1.00		1.00	1.00		1.00
Parking Bus, Adj	1.00	1.00	1.00	1.00	1.00	1.00	1.00	1.00	1.00	1.00	1.00	1.00
Work Zone On Approach		No			No			No			No	
Adj Sat Flow, veh/h/ln	1900	1900	1900	1307	1885	1396	1796	1900	1322	1796	1900	1885
Adj Flow Rate, veh/h	35	1482	-4	3	1683	35	0	0	-13	44	0	-8
Peak Hour Factor	0.93	0.93	0.93	0.93	0.93	0.93	0.93	0.93	0.93	0.93	0.93	0.93
Percent Heavy Veh, %	0	0	0	40	1	34	7	0	39	7	0	1
Cap, veh/h	69	3512	0	5	3348	770	3	4	7	77	9	69
Arrive On Green	0.04	0.68	0.00	0.00	0.65	0.65	0.00	0.00	0.00	0.05	0.00	0.00
Sat Flow, veh/h	1810	5358	0	1245	5147	1183	1711	1900	1120	1711	1900	1598
Grp Volume(v), veh/h	35	1478	0	3	1683	35	0	0	-13	44	0	-8
Grp Sat Flow(s),veh/h/ln	1810	1729	0	1245	1716	1183	1711	1900	1120	1711	1900	1598
Q Serve(g_s), s	1.0	6.7	0.0	0.1	8.9	0.6	0.0	0.0	0.0	1.3	0.0	0.0
Cycle Q Clear(g_c), s	1.0	6.7	0.0	0.1	8.9	0.6	0.0	0.0	0.0	1.3	0.0	0.0
Prop In Lane	1.00		0.00	1.00		1.00	1.00		1.00	1.00		1.00
Lane Grp Cap(c), veh/h	69	3512	0	5	3348	770	3	4	7	77	9	69
V/C Ratio(X)	0.51	0.42	0.00	0.59	0.50	0.05	0.00	0.00	-1.94	0.57	0.00	-0.12
Avail Cap(c_a), veh/h	173	4518	0	119	4522	1040	164	1280	760	521	1600	1407
HCM Platoon Ratio	1.00	1.00	1.00	1.00	1.00	1.00	1.00	1.00	1.00	1.00	1.00	1.00
Upstream Filter(I)	1.00	1.00	0.00	1.00	1.00	1.00	0.00	0.00	0.00	1.00	0.00	0.00
Uniform Delay (d), s/veh	24.6	3.8	0.0	26.0	4.7	3.3	0.0	0.0	0.0	24.4	0.0	0.0
Incr Delay (d2), s/veh	2.1	0.1	0.0	77.8	0.2	0.0	0.0	0.0	0.0	2.4	0.0	0.0
Initial Q Delay(d3),s/veh	0.0	0.0	0.0	0.0	0.0	0.0	0.0	0.0	0.0	0.0	0.0	0.0
%ile BackOfQ(50%),veh/ln	0.4	0.5	0.0	0.1	1.9	0.1	0.0	0.0	0.0	0.5	0.0	0.0
Unsig. Movement Delay, s/veh												
LnGrp Delay(d),s/veh	26.8	3.9	0.0	103.8	4.9	3.3	0.0	0.0	0.0	26.9	0.0	0.0
LnGrp LOS	C	A	A	F	A	A	A	A	A	C	A	A
Approach Vol, veh/h		1513			1721			-13				36
Approach Delay, s/veh		4.5			5.0			0.0				32.9
Approach LOS		A			A			A				C
Timer - Assigned Phs	1	2	3	4	5	6	7	8				
Phs Duration (G+Y+Rc), s	4.3	41.9	0.0	6.1	5.7	40.5	6.1	0.0				
Change Period (Y+Rc), s	4.1	6.5	4.1	5.8	3.7	6.5	3.7	* 5.8				
Max Green Setting (Gmax), s	5.0	45.5	5.0	44.0	5.0	45.9	15.9	* 35				
Max Q Clear Time (g_c+I1), s	2.1	8.7	0.0	0.0	3.0	10.9	3.3	0.0				
Green Ext Time (p_c), s	0.0	17.6	0.0	0.0	0.0	23.1	0.0	0.0				

Intersection Summary

HCM 6th Ctrl Delay	5.1
HCM 6th LOS	A

Notes

* HCM 6th computational engine requires equal clearance times for the phases crossing the barrier.

Timings
22: Sycamore Canyon Bl. & Eastridge Ave

West Campus Upper Plateau (JN 14064)

09/30/2022



Lane Group	EBL	EBT	EBR	WBL	WBT	WBR	NBL	NBT	NBR	SBL	SBT	SBR
Lane Configurations	↖↖	↑↑↑	↗	↖↖	↑↑	↗	↖↖	↑↑	↗	↖↖	↑↑	↗
Traffic Volume (vph)	45	76	18	213	60	341	51	331	79	132	138	34
Future Volume (vph)	45	76	18	213	60	341	51	331	79	132	138	34
Turn Type	Prot	NA	Perm	Prot	NA	pm+ov	Prot	NA	pm+ov	Prot	NA	pm+ov
Protected Phases	5	2		1	6	7	3	8	1	7	4	5
Permitted Phases			2			6			8			4
Detector Phase	5	2	2	1	6	7	3	8	1	7	4	5
Switch Phase												
Minimum Initial (s)	5.0	10.0	10.0	5.0	10.0	5.0	5.0	10.0	5.0	5.0	10.0	5.0
Minimum Split (s)	8.7	43.5	43.5	8.7	43.5	8.7	8.7	15.8	8.7	8.7	49.8	8.7
Total Split (s)	11.7	45.5	45.5	15.2	49.0	20.2	8.7	39.1	15.2	20.2	50.6	11.7
Total Split (%)	9.8%	37.9%	37.9%	12.7%	40.8%	16.8%	7.3%	32.6%	12.7%	16.8%	42.2%	9.8%
Yellow Time (s)	3.2	5.5	5.5	3.2	5.5	3.2	3.2	4.8	3.2	3.2	4.8	3.2
All-Red Time (s)	0.5	1.0	1.0	0.5	1.0	0.5	0.5	1.0	0.5	0.5	1.0	0.5
Lost Time Adjust (s)	0.0	0.0	0.0	0.0	0.0	0.0	0.0	0.0	0.0	0.0	0.0	0.0
Total Lost Time (s)	3.7	6.5	6.5	3.7	6.5	3.7	3.7	5.8	3.7	3.7	5.8	3.7
Lead/Lag	Lead	Lag	Lag	Lead	Lag	Lead	Lead	Lag	Lead	Lead	Lag	Lead
Lead-Lag Optimize?	Yes	Yes	Yes	Yes	Yes	Yes	Yes	Yes	Yes	Yes	Yes	Yes
Recall Mode	None	None	None	None	None	None	None	None	None	None	None	None
Act Effct Green (s)	10.4	13.6	13.6	10.9	15.6	23.3	5.4	13.7	26.9	7.6	20.5	33.2
Actuated g/C Ratio	0.17	0.22	0.22	0.18	0.25	0.37	0.09	0.22	0.43	0.12	0.33	0.53
v/c Ratio	0.09	0.09	0.04	0.38	0.09	0.50	0.21	0.47	0.12	0.34	0.13	0.05
Control Delay	31.7	21.7	0.2	30.2	19.5	6.3	35.5	25.4	3.1	32.0	19.4	1.5
Queue Delay	0.0	0.0	0.0	0.0	0.0	0.0	0.0	0.0	0.0	0.0	0.0	0.0
Total Delay	31.7	21.7	0.2	30.2	19.5	6.3	35.5	25.4	3.1	32.0	19.4	1.5
LOS	C	C	A	C	B	A	D	C	A	C	B	A
Approach Delay		22.1			15.9			22.7			22.9	
Approach LOS		C			B			C			C	

Intersection Summary

Cycle Length: 120
 Actuated Cycle Length: 62.2
 Natural Cycle: 115
 Control Type: Actuated-Uncoordinated
 Maximum v/c Ratio: 0.50
 Intersection Signal Delay: 19.9
 Intersection LOS: B
 Intersection Capacity Utilization 46.0%
 ICU Level of Service A
 Analysis Period (min) 15

Splits and Phases: 22: Sycamore Canyon Bl. & Eastridge Ave

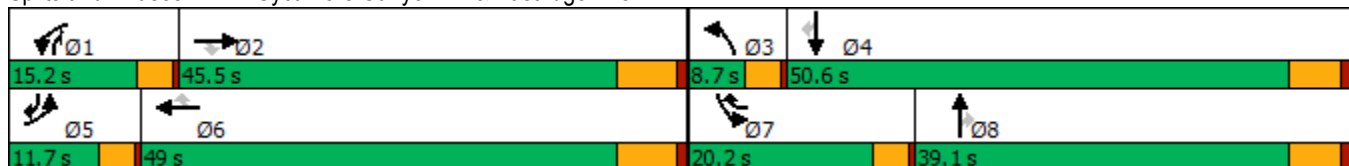

HCM 6th Signalized Intersection Summary
22: Sycamore Canyon Bl. & Eastridge Ave

West Campus Upper Plateau (JN 14064)

09/30/2022



Movement	EBL	EBT	EBR	WBL	WBT	WBR	NBL	NBT	NBR	SBL	SBT	SBR
Lane Configurations	↖↗	↑↑↑	↖	↖↗	↑↑	↖	↖↗	↑↑	↖	↖↗	↑↑	↖
Traffic Volume (veh/h)	45	76	18	213	60	341	51	331	79	132	138	34
Future Volume (veh/h)	45	76	18	213	60	341	51	331	79	132	138	34
Initial Q (Qb), veh	0	0	0	0	0	0	0	0	0	0	0	0
Ped-Bike Adj(A_pbT)	1.00		1.00	1.00		1.00	1.00		0.99	1.00		0.99
Parking Bus, Adj	1.00	1.00	1.00	1.00	1.00	1.00	1.00	1.00	1.00	1.00	1.00	1.00
Work Zone On Approach		No			No			No			No	
Adj Sat Flow, veh/h/ln	1648	1589	1826	1856	1396	1796	1618	1796	1826	1841	1826	1530
Adj Flow Rate, veh/h	47	80	0	224	63	186	54	348	29	139	145	32
Peak Hour Factor	0.95	0.95	0.95	0.95	0.95	0.95	0.95	0.95	0.95	0.95	0.95	0.95
Percent Heavy Veh, %	17	21	5	3	34	7	19	7	5	4	5	25
Cap, veh/h	147	903		351	696	530	159	693	469	294	820	364
Arrive On Green	0.05	0.21	0.00	0.10	0.26	0.26	0.05	0.20	0.20	0.09	0.24	0.24
Sat Flow, veh/h	3045	4337	1547	3428	2653	1521	2990	3413	1527	3401	3469	1278
Grp Volume(v), veh/h	47	80	0	224	63	186	54	348	29	139	145	32
Grp Sat Flow(s),veh/h/ln	1522	1446	1547	1714	1326	1521	1495	1706	1527	1700	1735	1278
Q Serve(g_s), s	0.7	0.7	0.0	3.1	0.9	4.5	0.9	4.5	0.7	1.9	1.6	0.9
Cycle Q Clear(g_c), s	0.7	0.7	0.0	3.1	0.9	4.5	0.9	4.5	0.7	1.9	1.6	0.9
Prop In Lane	1.00		1.00	1.00		1.00	1.00		1.00	1.00		1.00
Lane Grp Cap(c), veh/h	147	903		351	696	530	159	693	469	294	820	364
V/C Ratio(X)	0.32	0.09		0.64	0.09	0.35	0.34	0.50	0.06	0.47	0.18	0.09
Avail Cap(c_a), veh/h	495	3435		801	2289	1444	304	2308	1191	1140	3156	1225
HCM Platoon Ratio	1.00	1.00	1.00	1.00	1.00	1.00	1.00	1.00	1.00	1.00	1.00	1.00
Upstream Filter(I)	1.00	1.00	0.00	1.00	1.00	1.00	1.00	1.00	1.00	1.00	1.00	1.00
Uniform Delay (d), s/veh	22.7	15.7	0.0	21.2	13.7	11.9	22.5	17.4	12.1	21.4	15.0	12.9
Incr Delay (d2), s/veh	0.5	0.1	0.0	0.7	0.1	0.6	0.5	0.6	0.1	0.4	0.1	0.1
Initial Q Delay(d3),s/veh	0.0	0.0	0.0	0.0	0.0	0.0	0.0	0.0	0.0	0.0	0.0	0.0
%ile BackOfQ(50%),veh/ln	0.2	0.2	0.0	1.0	0.2	1.2	0.3	1.5	0.2	0.7	0.5	0.2
Unsig. Movement Delay, s/veh												
LnGrp Delay(d),s/veh	23.1	15.8	0.0	21.9	13.8	12.5	23.0	18.0	12.2	21.9	15.1	13.0
LnGrp LOS	C	B		C	B	B	C	B	B	C	B	B
Approach Vol, veh/h		127			473			431			316	
Approach Delay, s/veh		18.5			17.1			18.2			17.9	
Approach LOS		B			B			B			B	
Timer - Assigned Phs	1	2	3	4	5	6	7	8				
Phs Duration (G+Y+Rc), s	8.7	16.7	6.3	17.4	6.1	19.4	8.0	15.8				
Change Period (Y+Rc), s	3.7	6.5	3.7	5.8	3.7	6.5	3.7	5.8				
Max Green Setting (Gmax), s	11.5	39.0	5.0	44.8	8.0	42.5	16.5	33.3				
Max Q Clear Time (g_c+I1), s	5.1	2.7	2.9	3.6	2.7	6.5	3.9	6.5				
Green Ext Time (p_c), s	0.2	0.6	0.0	1.0	0.0	1.5	0.2	2.2				

Intersection Summary

HCM 6th Ctrl Delay	17.8
HCM 6th LOS	B

Notes

Unsignalized Delay for [EBR] is excluded from calculations of the approach delay and intersection delay.

Timings
23: Sycamore Canyon Bl. & Cottonwood Ave

West Campus Upper Plateau (JN 14064)

09/30/2022



Lane Group	WBL	WBR	NBT	SBL	SBT
Lane Configurations	↙	↗	↕	↘	↕
Traffic Volume (vph)	7	22	394	20	404
Future Volume (vph)	7	22	394	20	404
Turn Type	Prot	Perm	NA	Prot	NA
Protected Phases	8		2	1	6
Permitted Phases		8			
Detector Phase	8	8	2	1	6
Switch Phase					
Minimum Initial (s)	10.0	10.0	10.0	5.0	10.0
Minimum Split (s)	15.8	15.8	43.5	9.1	43.5
Total Split (s)	23.0	23.0	78.0	19.0	97.0
Total Split (%)	19.2%	19.2%	65.0%	15.8%	80.8%
Yellow Time (s)	4.8	4.8	5.5	3.6	5.5
All-Red Time (s)	1.0	1.0	1.0	0.5	1.0
Lost Time Adjust (s)	0.0	0.0	0.0	0.0	0.0
Total Lost Time (s)	5.8	5.8	6.5	4.1	6.5
Lead/Lag			Lag	Lead	
Lead-Lag Optimize?			Yes	Yes	
Recall Mode	None	None	None	None	None
Act Effct Green (s)	12.6	12.6	22.4	7.6	23.4
Actuated g/C Ratio	0.50	0.50	0.88	0.30	0.92
v/c Ratio	0.01	0.05	0.15	0.05	0.13
Control Delay	12.0	7.6	3.9	13.8	1.7
Queue Delay	0.0	0.0	0.0	0.0	0.0
Total Delay	12.0	7.6	3.9	13.8	1.7
LOS	B	A	A	B	A
Approach Delay	8.7		3.9		2.3
Approach LOS	A		A		A

Intersection Summary

Cycle Length: 120
 Actuated Cycle Length: 25.4
 Natural Cycle: 70
 Control Type: Actuated-Uncoordinated
 Maximum v/c Ratio: 0.15
 Intersection Signal Delay: 3.3
 Intersection LOS: A
 Intersection Capacity Utilization 35.2%
 ICU Level of Service A
 Analysis Period (min) 15

Splits and Phases: 23: Sycamore Canyon Bl. & Cottonwood Ave



HCM 6th Signalized Intersection Summary
 23: Sycamore Canyon Bl. & Cottonwood Ave

West Campus Upper Plateau (JN 14064)

09/30/2022



Movement	WBL	WBR	NBT	NBR	SBL	SBT
Lane Configurations						
Traffic Volume (veh/h)	7	22	394	12	20	404
Future Volume (veh/h)	7	22	394	12	20	404
Initial Q (Qb), veh	0	0	0	0	0	0
Ped-Bike Adj(A_pbT)	1.00	1.00		0.98	1.00	
Parking Bus, Adj	1.00	1.00	1.00	1.00	1.00	1.00
Work Zone On Approach	No		No			No
Adj Sat Flow, veh/h/ln	1574	1070	1796	1752	1485	1870
Adj Flow Rate, veh/h	8	14	424	12	22	434
Peak Hour Factor	0.93	0.93	0.93	0.93	0.93	0.93
Percent Heavy Veh, %	22	56	7	10	28	2
Cap, veh/h	84	51	1178	33	40	1841
Arrive On Green	0.06	0.06	0.35	0.35	0.03	0.52
Sat Flow, veh/h	1499	907	3477	96	1414	3647
Grp Volume(v), veh/h	8	14	213	223	22	434
Grp Sat Flow(s),veh/h/ln	1499	907	1706	1776	1414	1777
Q Serve(g_s), s	0.1	0.4	2.7	2.7	0.4	1.9
Cycle Q Clear(g_c), s	0.1	0.4	2.7	2.7	0.4	1.9
Prop In Lane	1.00	1.00		0.05	1.00	
Lane Grp Cap(c), veh/h	84	51	594	618	40	1841
V/C Ratio(X)	0.10	0.28	0.36	0.36	0.56	0.24
Avail Cap(c_a), veh/h	893	540	4226	4400	730	11140
HCM Platoon Ratio	1.00	1.00	1.00	1.00	1.00	1.00
Upstream Filter(I)	1.00	1.00	1.00	1.00	1.00	1.00
Uniform Delay (d), s/veh	12.9	13.1	7.0	7.0	13.9	3.8
Incr Delay (d2), s/veh	0.5	2.9	0.5	0.5	11.6	0.1
Initial Q Delay(d3),s/veh	0.0	0.0	0.0	0.0	0.0	0.0
%ile BackOfQ(50%),veh/ln	0.0	0.1	0.5	0.5	0.2	0.1
Unsig. Movement Delay, s/veh						
LnGrp Delay(d),s/veh	13.4	16.0	7.5	7.5	25.4	3.9
LnGrp LOS	B	B	A	A	C	A
Approach Vol, veh/h	22		436			456
Approach Delay, s/veh	15.0		7.5			5.0
Approach LOS	B		A			A
Timer - Assigned Phs	1	2			6	8
Phs Duration (G+Y+Rc), s	4.9	16.5			21.5	7.4
Change Period (Y+Rc), s	4.1	6.5			6.5	5.8
Max Green Setting (Gmax), s	14.9	71.5			90.5	17.2
Max Q Clear Time (g_c+11), s	2.4	4.7			3.9	2.4
Green Ext Time (p_c), s	0.0	3.8			4.3	0.0
Intersection Summary						
HCM 6th Ctrl Delay			6.4			
HCM 6th LOS			A			

Timings

West Campus Upper Plateau (JN 14064)

24: Sycamore Canyon Bl. & Alessandro Bl.

09/30/2022

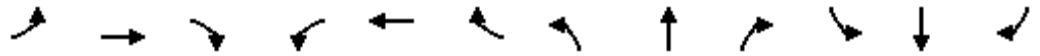

Lane Group	EBL	EBT	EBR	WBL	WBT	WBR	NBL	NBT	NBR	SBL	SBT	SBR
Lane Configurations	↖	↑↑↑	↗	↖↗	↑↑↑	↗	↖↗	↑↑	↖↗	↖↗	↑↑	↖↗
Traffic Volume (vph)	108	1156	105	59	1308	96	188	155	17	63	173	57
Future Volume (vph)	108	1156	105	59	1308	96	188	155	17	63	173	57
Turn Type	Prot	NA	Perm	Prot	NA	Perm	Prot	NA	pm+ov	Prot	NA	Perm
Protected Phases	5	2		1	6		3	8	1	7	4	
Permitted Phases			2			6			8			4
Detector Phase	5	2	2	1	6	6	3	8	1	7	4	4
Switch Phase												
Minimum Initial (s)	5.0	10.0	10.0	5.0	10.0	10.0	5.0	10.0	5.0	5.0	10.0	10.0
Minimum Split (s)	8.7	43.5	43.5	8.7	43.5	43.5	8.7	15.8	8.7	8.7	49.8	49.8
Total Split (s)	10.0	44.2	44.2	12.0	46.2	46.2	14.0	51.0	12.0	12.8	49.8	49.8
Total Split (%)	8.3%	36.8%	36.8%	10.0%	38.5%	38.5%	11.7%	42.5%	10.0%	10.7%	41.5%	41.5%
Yellow Time (s)	3.2	5.5	5.5	3.2	5.5	5.5	3.2	4.8	3.2	3.2	4.8	4.8
All-Red Time (s)	0.5	1.0	1.0	0.5	1.0	1.0	0.5	1.0	0.5	0.5	1.0	1.0
Lost Time Adjust (s)	0.0	0.0	0.0	0.0	0.0	0.0	0.0	0.0	0.0	0.0	0.0	0.0
Total Lost Time (s)	3.7	6.5	6.5	3.7	6.5	6.5	3.7	5.8	3.7	3.7	5.8	5.8
Lead/Lag	Lead	Lag	Lag	Lead	Lag	Lag	Lead	Lag	Lead	Lead	Lag	Lag
Lead-Lag Optimize?	Yes	Yes	Yes	Yes	Yes	Yes	Yes	Yes	Yes	Yes	Yes	Yes
Recall Mode	None	None	None	None	None	None	None	None	None	None	None	None
Act Effct Green (s)	6.5	37.9	37.9	6.3	35.5	35.5	9.1	20.3	32.7	6.4	15.4	15.4
Actuated g/C Ratio	0.07	0.44	0.44	0.07	0.41	0.41	0.10	0.23	0.38	0.07	0.18	0.18
v/c Ratio	0.84	0.54	0.15	0.27	0.66	0.15	0.55	0.20	0.02	0.27	0.30	0.17
Control Delay	90.0	22.0	7.4	46.2	24.2	6.5	46.5	28.5	0.0	45.7	32.0	2.2
Queue Delay	0.0	0.0	0.0	0.0	0.0	0.0	0.0	0.0	0.0	0.0	0.0	0.0
Total Delay	90.0	22.0	7.4	46.2	24.2	6.5	46.5	28.5	0.0	45.7	32.0	2.2
LOS	F	C	A	D	C	A	D	C	A	D	C	A
Approach Delay		26.2			23.9			36.5			29.1	
Approach LOS		C			C			D			C	

Intersection Summary

Cycle Length: 120	
Actuated Cycle Length: 87	
Natural Cycle: 115	
Control Type: Actuated-Uncoordinated	
Maximum v/c Ratio: 0.84	
Intersection Signal Delay: 26.6	Intersection LOS: C
Intersection Capacity Utilization 61.9%	ICU Level of Service B
Analysis Period (min) 15	



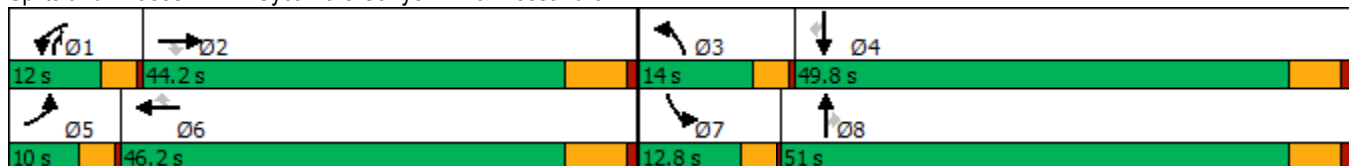





























Splits and Phases: 24: Sycamore Canyon Bl. & Alessandro Bl.



HCM 6th Signalized Intersection Summary
 24: Sycamore Canyon Bl. & Alessandro Bl.

West Campus Upper Plateau (JN 14064)

09/30/2022

												
Movement	EBL	EBT	EBR	WBL	WBT	WBR	NBL	NBT	NBR	SBL	SBT	SBR
Lane Configurations		  		 	  		 	 	 	 	 	
Traffic Volume (veh/h)	108	1156	105	59	1308	96	188	155	17	63	173	57
Future Volume (veh/h)	108	1156	105	59	1308	96	188	155	17	63	173	57
Initial Q (Qb), veh	0	0	0	0	0	0	0	0	0	0	0	0
Ped-Bike Adj(A_pbT)	1.00		1.00	1.00		1.00	1.00		1.00	1.00		1.00
Parking Bus, Adj	1.00	1.00	1.00	1.00	1.00	1.00	1.00	1.00	1.00	1.00	1.00	1.00
Work Zone On Approach		No			No			No			No	
Adj Sat Flow, veh/h/ln	1900	1885	1885	1737	1885	1781	1870	1841	1841	1826	1826	1870
Adj Flow Rate, veh/h	114	1217	-86	62	1377	-34	198	163	-25	66	182	-35
Peak Hour Factor	0.95	0.95	0.95	0.95	0.95	0.95	0.95	0.95	0.95	0.95	0.95	0.95
Percent Heavy Veh, %	0	1	1	11	1	8	2	4	4	5	5	2
Cap, veh/h	146	2324	721	159	2165	635	290	603	609	172	485	221
Arrive On Green	0.08	0.45	0.00	0.05	0.42	0.00	0.08	0.17	0.00	0.05	0.14	0.00
Sat Flow, veh/h	1810	5147	1598	3209	5147	1510	3456	3497	2745	3374	3469	1585
Grp Volume(v), veh/h	114	1217	-86	62	1377	-34	198	163	-25	66	182	-35
Grp Sat Flow(s),veh/h/ln	1810	1716	1598	1605	1716	1510	1728	1749	1373	1687	1735	1585
Q Serve(g_s), s	4.4	12.1	0.0	1.3	15.1	0.0	4.0	2.9	0.0	1.4	3.4	0.0
Cycle Q Clear(g_c), s	4.4	12.1	0.0	1.3	15.1	0.0	4.0	2.9	0.0	1.4	3.4	0.0
Prop In Lane	1.00		1.00	1.00		1.00	1.00		1.00	1.00		1.00
Lane Grp Cap(c), veh/h	146	2324	721	159	2165	635	290	603	609	172	485	221
V/C Ratio(X)	0.78	0.52	-0.12	0.39	0.64	-0.05	0.68	0.27	-0.04	0.38	0.38	-0.16
Avail Cap(c_a), veh/h	159	2713	842	372	2857	838	498	2210	1871	429	2134	975
HCM Platoon Ratio	1.00	1.00	1.00	1.00	1.00	1.00	1.00	1.00	1.00	1.00	1.00	1.00
Upstream Filter(I)	1.00	1.00	0.00	1.00	1.00	0.00	1.00	1.00	0.00	1.00	1.00	0.00
Uniform Delay (d), s/veh	32.3	14.1	0.0	32.9	16.4	0.0	31.8	25.7	0.0	32.8	27.9	0.0
Incr Delay (d2), s/veh	17.9	0.3	0.0	0.6	0.4	0.0	1.1	0.2	0.0	0.5	0.5	0.0
Initial Q Delay(d3),s/veh	0.0	0.0	0.0	0.0	0.0	0.0	0.0	0.0	0.0	0.0	0.0	0.0
%ile BackOfQ(50%),veh/ln	2.5	4.0	0.0	0.5	5.1	0.0	1.6	1.1	0.0	0.5	1.3	0.0
Unsig. Movement Delay, s/veh												
LnGrp Delay(d),s/veh	50.2	14.3	0.0	33.5	16.8	0.0	32.9	25.9	0.0	33.4	28.4	0.0
LnGrp LOS	D	B	A	C	B	A	C	C	A	C	C	A
Approach Vol, veh/h		1245			1405			336			213	
Approach Delay, s/veh		18.6			18.0			32.0			34.6	
Approach LOS		B			B			C			C	
Timer - Assigned Phs	1	2	3	4	5	6	7	8				
Phs Duration (G+Y+Rc), s	7.2	38.8	9.7	15.8	9.5	36.6	7.4	18.1				
Change Period (Y+Rc), s	3.7	6.5	3.7	5.8	3.7	6.5	3.7	5.8				
Max Green Setting (Gmax), s	8.3	37.7	10.3	44.0	6.3	39.7	9.1	45.2				
Max Q Clear Time (g_c+I1), s	3.3	14.1	6.0	5.4	6.4	17.1	3.4	4.9				
Green Ext Time (p_c), s	0.0	11.7	0.1	1.1	0.0	12.9	0.0	1.0				
Intersection Summary												
HCM 6th Ctrl Delay				20.8								
HCM 6th LOS				C								

Timings
25: Sycamore Canyon Bl. & Cactus Av.

West Campus Upper Plateau (JN 14064)

09/30/2022



Lane Group	EBL	EBT	EBR	WBL	WBT	WBR	NBL	NBT	NBR	SBL	SBT	SBR
Lane Configurations	↖	↗	↘	↖	↗	↘	↖	↗	↘	↖	↗	↘
Traffic Volume (vph)	17	32	5	185	10	225	1	172	140	132	224	6
Future Volume (vph)	17	32	5	185	10	225	1	172	140	132	224	6
Turn Type	Prot	NA	Perm	Prot	NA	Perm	Prot	NA	Perm	Prot	NA	Perm
Protected Phases	7	4		3	8		5	2		1	6	
Permitted Phases			4			8			2			6
Detector Phase	7	4	4	3	8	8	5	2	2	1	6	6
Switch Phase												
Minimum Initial (s)	5.0	10.0	10.0	5.0	10.0	10.0	5.0	10.0	10.0	5.0	10.0	10.0
Minimum Split (s)	9.6	32.8	32.8	9.6	32.8	32.8	9.6	34.8	34.8	9.6	34.8	34.8
Total Split (s)	10.3	32.8	32.8	29.0	51.5	51.5	9.6	36.2	36.2	22.0	48.6	48.6
Total Split (%)	8.6%	27.3%	27.3%	24.2%	42.9%	42.9%	8.0%	30.2%	30.2%	18.3%	40.5%	40.5%
Yellow Time (s)	3.6	4.8	4.8	3.6	4.8	4.8	3.6	4.8	4.8	3.6	4.8	4.8
All-Red Time (s)	1.0	1.0	1.0	1.0	1.0	1.0	1.0	1.0	1.0	1.0	1.0	1.0
Lost Time Adjust (s)	0.0	0.0	0.0	0.0	0.0	0.0	0.0	0.0	0.0	0.0	0.0	0.0
Total Lost Time (s)	4.6	5.8	5.8	4.6	5.8	5.8	4.6	5.8	5.8	4.6	5.8	5.8
Lead/Lag	Lead	Lag	Lag	Lead	Lag	Lag	Lead	Lag	Lag	Lead	Lag	Lag
Lead-Lag Optimize?	Yes	Yes	Yes	Yes	Yes	Yes	Yes	Yes	Yes	Yes	Yes	Yes
Recall Mode	None	None	None	None	None	None	None	None	None	None	None	None
Act Effct Green (s)	6.0	13.5	13.5	12.8	16.9	16.9	5.8	13.7	13.7	7.6	22.2	22.2
Actuated g/C Ratio	0.11	0.25	0.25	0.23	0.31	0.31	0.11	0.25	0.25	0.14	0.41	0.41
v/c Ratio	0.10	0.04	0.01	0.25	0.01	0.36	0.00	0.21	0.28	0.29	0.17	0.01
Control Delay	34.5	21.8	0.0	25.5	16.5	4.7	36.0	20.7	3.3	29.2	13.6	0.0
Queue Delay	0.0	0.0	0.0	0.0	0.0	0.0	0.0	0.0	0.0	0.0	0.0	0.0
Total Delay	34.5	21.8	0.0	25.5	16.5	4.7	36.0	20.7	3.3	29.2	13.6	0.0
LOS	C	C	A	C	B	A	D	C	A	C	B	A
Approach Delay		23.9			14.2			12.9			19.1	
Approach LOS		C			B			B			B	

Intersection Summary

Cycle Length: 120
 Actuated Cycle Length: 54.8
 Natural Cycle: 90
 Control Type: Actuated-Uncoordinated
 Maximum v/c Ratio: 0.36
 Intersection Signal Delay: 15.8
 Intersection LOS: B
 Intersection Capacity Utilization 39.9%
 ICU Level of Service A
 Analysis Period (min) 15

Splits and Phases: 25: Sycamore Canyon Bl. & Cactus Av.

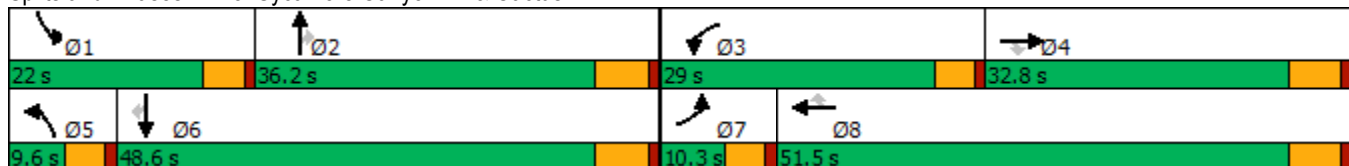

HCM 6th Signalized Intersection Summary
 25: Sycamore Canyon Bl. & Cactus Av.

West Campus Upper Plateau (JN 14064)

09/30/2022



Movement	EBL	EBT	EBR	WBL	WBT	WBR	NBL	NBT	NBR	SBL	SBT	SBR
Lane Configurations	↘	↑↑	↗	↘↗	↑↑	↗	↘↗	↑↑	↗	↘↗	↑↑	↗
Traffic Volume (veh/h)	17	32	5	185	10	225	1	172	140	132	224	6
Future Volume (veh/h)	17	32	5	185	10	225	1	172	140	132	224	6
Initial Q (Qb), veh	0	0	0	0	0	0	0	0	0	0	0	0
Ped-Bike Adj(A_pbT)	1.00		1.00	1.00		1.00	1.00		1.00	1.00		1.00
Parking Bus, Adj	1.00	1.00	1.00	1.00	1.00	1.00	1.00	1.00	1.00	1.00	1.00	1.00
Work Zone On Approach		No			No			No			No	
Adj Sat Flow, veh/h/ln	1811	1678	1796	1826	1796	1870	1900	1811	1781	1885	1796	1011
Adj Flow Rate, veh/h	18	33	-4	193	10	-8	1	179	53	138	233	6
Peak Hour Factor	0.96	0.96	0.96	0.96	0.96	0.96	0.96	0.96	0.96	0.96	0.96	0.96
Percent Heavy Veh, %	6	15	7	5	7	2	0	6	8	1	7	60
Cap, veh/h	39	412	197	339	708	329	8	757	332	317	1057	265
Arrive On Green	0.02	0.13	0.00	0.10	0.21	0.00	0.00	0.22	0.22	0.09	0.31	0.31
Sat Flow, veh/h	1725	3188	1522	3374	3413	1585	3510	3441	1510	3483	3413	857
Grp Volume(v), veh/h	18	33	-4	193	10	-8	1	179	53	138	233	6
Grp Sat Flow(s),veh/h/ln	1725	1594	1522	1687	1706	1585	1755	1721	1510	1742	1706	857
Q Serve(g_s), s	0.5	0.4	0.0	2.5	0.1	0.0	0.0	1.9	1.3	1.7	2.3	0.2
Cycle Q Clear(g_c), s	0.5	0.4	0.0	2.5	0.1	0.0	0.0	1.9	1.3	1.7	2.3	0.2
Prop In Lane	1.00		1.00	1.00		1.00	1.00		1.00	1.00		1.00
Lane Grp Cap(c), veh/h	39	412	197	339	708	329	8	757	332	317	1057	265
V/C Ratio(X)	0.47	0.08	-0.02	0.57	0.01	-0.02	0.13	0.24	0.16	0.44	0.22	0.02
Avail Cap(c_a), veh/h	217	1899	907	1817	3442	1599	387	2309	1013	1338	3224	809
HCM Platoon Ratio	1.00	1.00	1.00	1.00	1.00	1.00	1.00	1.00	1.00	1.00	1.00	1.00
Upstream Filter(I)	1.00	1.00	0.00	1.00	1.00	0.00	1.00	1.00	1.00	1.00	1.00	1.00
Uniform Delay (d), s/veh	21.9	17.4	0.0	19.4	14.3	0.0	22.6	14.5	14.3	19.5	11.6	10.9
Incr Delay (d2), s/veh	3.2	0.1	0.0	0.6	0.0	0.0	2.7	0.2	0.2	0.4	0.1	0.0
Initial Q Delay(d3),s/veh	0.0	0.0	0.0	0.0	0.0	0.0	0.0	0.0	0.0	0.0	0.0	0.0
%ile BackOfQ(50%),veh/ln	0.2	0.1	0.0	0.8	0.0	0.0	0.0	0.6	0.4	0.6	0.7	0.0
Unsig. Movement Delay, s/veh												
LnGrp Delay(d),s/veh	25.1	17.4	0.0	20.0	14.3	0.0	25.3	14.7	14.5	19.8	11.7	10.9
LnGrp LOS	C	B	A	B	B	A	C	B	B	B	B	B
Approach Vol, veh/h		47			195			233			377	
Approach Delay, s/veh		21.9			20.5			14.7			14.7	
Approach LOS		C			C			B			B	
Timer - Assigned Phs	1	2	3	4	5	6	7	8				
Phs Duration (G+Y+Rc), s	8.7	15.8	9.2	11.7	4.7	19.8	5.6	15.2				
Change Period (Y+Rc), s	4.6	5.8	4.6	5.8	4.6	5.8	4.6	5.8				
Max Green Setting (Gmax), s	17.4	30.4	24.4	27.0	5.0	42.8	5.7	45.7				
Max Q Clear Time (g_c+I1), s	3.7	3.9	4.5	2.4	2.0	4.3	2.5	2.1				
Green Ext Time (p_c), s	0.2	1.1	0.3	0.1	0.0	1.4	0.0	0.0				

Intersection Summary

HCM 6th Ctrl Delay	16.4
HCM 6th LOS	B

Timings
26: Sycamore Canyon Bl. & Van Buren Bl.

West Campus Upper Plateau (JN 14064)

09/30/2022



Lane Group	EBL	EBT	EBR	WBL	WBT	WBR	NBL	NBT	SBL	SBT	SBR
Lane Configurations											
Traffic Volume (vph)	165	1405	7	38	1503	30	8	7	60	10	376
Future Volume (vph)	165	1405	7	38	1503	30	8	7	60	10	376
Turn Type	Prot	NA	Perm	Prot	NA	Perm	Perm	NA	Split	NA	Perm
Protected Phases	5	2		1	6			8	4	4	
Permitted Phases			2			6	8				4
Detector Phase	5	2	2	1	6	6	8	8	4	4	4
Switch Phase											
Minimum Initial (s)	5.0	10.0	10.0	5.0	10.0	10.0	10.0	10.0	10.0	10.0	10.0
Minimum Split (s)	9.6	29.2	29.2	9.6	29.2	29.2	14.6	14.6	50.8	50.8	50.8
Total Split (s)	22.0	47.8	47.8	9.6	35.4	35.4	14.6	14.6	58.0	58.0	58.0
Total Split (%)	16.9%	36.8%	36.8%	7.4%	27.2%	27.2%	11.2%	11.2%	44.6%	44.6%	44.6%
Yellow Time (s)	3.6	5.2	5.2	3.6	5.2	5.2	3.6	3.6	4.8	4.8	4.8
All-Red Time (s)	1.0	1.0	1.0	1.0	1.0	1.0	1.0	1.0	1.0	1.0	1.0
Lost Time Adjust (s)	0.0	0.0	0.0	0.0	0.0	0.0		0.0	0.0	0.0	0.0
Total Lost Time (s)	4.6	6.2	6.2	4.6	6.2	6.2		4.6	5.8	5.8	5.8
Lead/Lag	Lead	Lag	Lag	Lead	Lag	Lag					
Lead-Lag Optimize?	Yes	Yes	Yes	Yes	Yes	Yes					
Recall Mode	None	None	None	None	None	None	None	None	None	None	None
Act Effct Green (s)	9.1	40.3	40.3	5.3	31.5	31.5		10.6	15.4	15.4	15.4
Actuated g/C Ratio	0.11	0.49	0.49	0.07	0.39	0.39		0.13	0.19	0.19	0.19
v/c Ratio	0.47	0.48	0.01	0.39	0.67	0.05		0.09	0.10	0.03	0.64
Control Delay	42.2	18.7	0.0	55.9	26.0	0.1		25.0	28.4	28.1	8.4
Queue Delay	0.0	0.0	0.0	0.0	0.0	0.0		0.0	0.0	0.0	0.0
Total Delay	42.2	18.7	0.0	55.9	26.0	0.1		25.0	28.4	28.1	8.4
LOS	D	B	A	E	C	A		C	C	C	A
Approach Delay		21.1			26.2			25.0		11.5	
Approach LOS		C			C			C		B	

Intersection Summary

Cycle Length: 130	
Actuated Cycle Length: 81.5	
Natural Cycle: 105	
Control Type: Actuated-Uncoordinated	
Maximum v/c Ratio: 0.67	
Intersection Signal Delay: 22.2	Intersection LOS: C
Intersection Capacity Utilization 67.2%	ICU Level of Service C
Analysis Period (min) 15	

Splits and Phases: 26: Sycamore Canyon Bl. & Van Buren Bl.

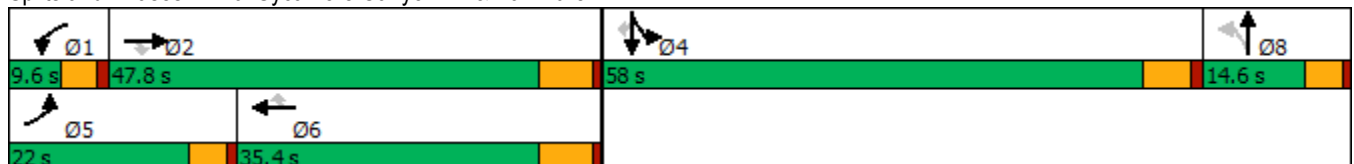

HCM 6th Signalized Intersection Summary
26: Sycamore Canyon Bl. & Van Buren Bl.

West Campus Upper Plateau (JN 14064)

09/30/2022



Movement	EBL	EBT	EBR	WBL	WBT	WBR	NBL	NBT	NBR	SBL	SBT	SBR
Lane Configurations	↔↔	↑↑↑	↔	↔	↑↑↑	↔		↔↔		↔↔	↑	↔
Traffic Volume (veh/h)	165	1405	7	38	1503	30	8	7	21	60	10	376
Future Volume (veh/h)	165	1405	7	38	1503	30	8	7	21	60	10	376
Initial Q (Qb), veh	0	0	0	0	0	0	0	0	0	0	0	0
Ped-Bike Adj(A_pbT)	1.00		1.00	1.00		0.99	1.00		1.00	1.00		1.00
Parking Bus, Adj	1.00	1.00	1.00	1.00	1.00	1.00	1.00	1.00	1.00	1.00	1.00	1.00
Work Zone On Approach		No			No			No			No	
Adj Sat Flow, veh/h/ln	1811	1826	1900	1693	1796	1870	1900	1900	1900	1841	1900	1841
Adj Flow Rate, veh/h	174	1479	7	40	1582	10	8	7	-7	63	11	0
Peak Hour Factor	0.95	0.95	0.95	0.95	0.95	0.95	0.95	0.95	0.95	0.95	0.95	0.95
Percent Heavy Veh, %	6	5	0	14	7	2	0	0	0	4	0	4
Cap, veh/h	279	2797	717	66	2490	631	139	587	0	412	230	
Arrive On Green	0.08	0.45	0.45	0.04	0.40	0.40	0.02	0.02	0.00	0.12	0.12	0.00
Sat Flow, veh/h	3346	6281	1610	1612	6179	1565	1801	1909	0	3401	1900	1560
Grp Volume(v), veh/h	174	1479	7	40	1582	10	8	0	0	63	11	0
Grp Sat Flow(s),veh/h/ln	1673	1570	1610	1612	1545	1565	1810	1805	0	1700	1900	1560
Q Serve(g_s), s	2.9	9.7	0.1	1.4	11.7	0.2	0.0	0.0	0.0	0.9	0.3	0.0
Cycle Q Clear(g_c), s	2.9	9.7	0.1	1.4	11.7	0.2	0.0	0.0	0.0	0.9	0.3	0.0
Prop In Lane	1.00		1.00	1.00		1.00	0.99		0.00	1.00		1.00
Lane Grp Cap(c), veh/h	279	2797	717	66	2490	631	0	0	0	412	230	
V/C Ratio(X)	0.62	0.53	0.01	0.60	0.64	0.02	0.00	0.00	0.00	0.15	0.05	
Avail Cap(c_a), veh/h	1021	4580	1174	141	3163	801	0	0	0	3112	1738	
HCM Platoon Ratio	1.00	1.00	1.00	1.00	1.00	1.00	1.00	1.00	1.00	1.00	1.00	1.00
Upstream Filter(I)	1.00	1.00	1.00	1.00	1.00	1.00	1.00	0.00	0.00	1.00	1.00	0.00
Uniform Delay (d), s/veh	25.3	11.5	8.8	26.9	13.7	10.2	0.0	0.0	0.0	22.5	22.2	0.0
Incr Delay (d2), s/veh	0.8	0.2	0.0	3.2	0.3	0.0	0.0	0.0	0.0	0.2	0.1	0.0
Initial Q Delay(d3),s/veh	0.0	0.0	0.0	0.0	0.0	0.0	0.0	0.0	0.0	0.0	0.0	0.0
%ile BackOfQ(50%),veh/ln	1.0	2.6	0.0	0.5	3.2	0.1	0.0	0.0	0.0	0.3	0.1	0.0
Unsig. Movement Delay, s/veh												
LnGrp Delay(d),s/veh	26.1	11.6	8.8	30.1	13.9	10.2	0.0	0.0	0.0	22.6	22.3	0.0
LnGrp LOS	C	B	A	C	B	B	A	A	A	C	C	
Approach Vol, veh/h		1660			1632			8			74	
Approach Delay, s/veh		13.1			14.3			0.0			22.6	
Approach LOS		B			B			A			C	
Timer - Assigned Phs	1	2		4	5	6		8				
Phs Duration (G+Y+Rc), s	6.9	31.6		12.7	9.4	29.2		5.8				
Change Period (Y+Rc), s	4.6	6.2		5.8	4.6	6.2		4.6				
Max Green Setting (Gmax), s	5.0	41.6		52.2	17.4	29.2		10.0				
Max Q Clear Time (g_c+I1), s	3.4	11.7		2.9	4.9	13.7		2.0				
Green Ext Time (p_c), s	0.0	12.3		0.2	0.2	9.3		0.0				

Intersection Summary

HCM 6th Ctrl Delay	13.9
HCM 6th LOS	B

Notes

Unsignalized Delay for [SBR] is excluded from calculations of the approach delay and intersection delay.

Timings
27: Innovation Dr. & Cactus Av.

West Campus Upper Plateau (JN 14064)

09/30/2022

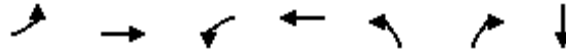

Lane Group	EBL	EBT	WBL	WBT	NBL	NBR	SBT
Lane Configurations	↖	↗↗↗	↖	↗↗↗	↖	↗	↘
Traffic Volume (vph)	1	303	25	420	1	24	0
Future Volume (vph)	1	303	25	420	1	24	0
Turn Type	Prot	NA	Prot	NA	Perm	Perm	NA
Protected Phases	5	2	1	6			4
Permitted Phases					8	8	
Detector Phase	5	2	1	6	8	8	4
Switch Phase							
Minimum Initial (s)	5.0	10.0	5.0	10.0	10.0	10.0	10.0
Minimum Split (s)	9.2	26.8	9.2	26.8	31.1	31.1	31.1
Total Split (s)	12.0	63.0	22.0	73.0	35.0	35.0	35.0
Total Split (%)	10.0%	52.5%	18.3%	60.8%	29.2%	29.2%	29.2%
Yellow Time (s)	3.2	4.8	3.2	4.8	4.1	4.1	4.1
All-Red Time (s)	1.0	1.0	1.0	1.0	1.0	1.0	1.0
Lost Time Adjust (s)	0.0	0.0	0.0	0.0	0.0	0.0	0.0
Total Lost Time (s)	4.2	5.8	4.2	5.8	5.1	5.1	5.1
Lead/Lag	Lead	Lag	Lead	Lag			
Lead-Lag Optimize?	Yes	Yes	Yes	Yes			
Recall Mode	None	None	None	None	None	None	None
Act Effct Green (s)	7.1	22.9	7.5	23.1	15.4	15.4	15.4
Actuated g/C Ratio	0.27	0.86	0.28	0.87	0.58	0.58	0.58
v/c Ratio	0.00	0.08	0.06	0.11	0.00	0.02	0.00
Control Delay	19.0	5.9	16.1	5.2	8.0	0.0	0.0
Queue Delay	0.0	0.0	0.0	0.0	0.0	0.0	0.0
Total Delay	19.0	5.9	16.1	5.2	8.0	0.0	0.0
LOS	B	A	B	A	A	A	A
Approach Delay		5.9		5.8			
Approach LOS		A		A			

Intersection Summary

Cycle Length: 120
 Actuated Cycle Length: 26.6
 Natural Cycle: 70
 Control Type: Actuated-Uncoordinated
 Maximum v/c Ratio: 0.11
 Intersection Signal Delay: 5.7
 Intersection LOS: A
 Intersection Capacity Utilization 33.4%
 ICU Level of Service A
 Analysis Period (min) 15

Splits and Phases: 27: Innovation Dr. & Cactus Av.



HCM 6th Signalized Intersection Summary
27: Innovation Dr. & Cactus Av.

West Campus Upper Plateau (JN 14064)

09/30/2022



Movement	EBL	EBT	EBR	WBL	WBT	WBR	NBL	NBT	NBR	SBL	SBT	SBR
Lane Configurations	↗	↑↑↑		↗	↑↑↑		↗	↑	↗	↗	↗	↗
Traffic Volume (veh/h)	1	303	1	25	420	5	1	0	24	0	0	1
Future Volume (veh/h)	1	303	1	25	420	5	1	0	24	0	0	1
Initial Q (Qb), veh	0	0	0	0	0	0	0	0	0	0	0	0
Ped-Bike Adj(A_pbT)	1.00		1.00	1.00		0.98	1.00		1.00	1.00		1.00
Parking Bus, Adj	1.00	1.00	1.00	1.00	1.00	1.00	1.00	1.00	1.00	1.00	1.00	1.00
Work Zone On Approach		No			No			No				No
Adj Sat Flow, veh/h/ln	1900	1826	1307	1663	1841	1900	1841	1900	1781	1900	1900	1781
Adj Flow Rate, veh/h	1	344	1	28	477	6	1	0	-26	0	0	-8
Peak Hour Factor	0.88	0.88	0.88	0.88	0.88	0.88	0.88	0.88	0.88	0.88	0.88	0.88
Percent Heavy Veh, %	0	5	40	16	4	0	4	0	8	0	0	8
Cap, veh/h	8	2175	6	56	2342	29	307	8	6	307	0	401
Arrive On Green	0.00	0.42	0.42	0.04	0.46	0.46	0.00	0.00	0.00	0.00	0.00	0.00
Sat Flow, veh/h	1810	5131	15	1584	5113	64	1753	1900	1510	1810	1900	0
Grp Volume(v), veh/h	1	223	122	28	312	171	1	0	-26	0	-8	-8
Grp Sat Flow(s),veh/h/ln	1810	1662	1823	1584	1675	1828	1753	1900	1510	1810	1900	1610
Q Serve(g_s), s	0.0	1.0	1.0	0.4	1.3	1.3	0.0	0.0	0.0	0.0	0.0	0.0
Cycle Q Clear(g_c), s	0.0	1.0	1.0	0.4	1.3	1.3	0.1	0.0	0.0	0.0	0.0	0.0
Prop In Lane	1.00		0.01	1.00		0.04	1.00		1.00	1.00		0.00
Lane Grp Cap(c), veh/h	8	1409	773	56	1534	837	307	8	6	307	0	0
V/C Ratio(X)	0.13	0.16	0.16	0.50	0.20	0.20	0.00	0.00	-4.04	0.00	0.00	0.00
Avail Cap(c_a), veh/h	601	8093	4440	1200	9585	5229	2718	2419	1922	2795	0	0
HCM Platoon Ratio	1.00	1.00	1.00	1.00	1.00	1.00	1.00	1.00	1.00	1.00	1.00	1.00
Upstream Filter(I)	1.00	1.00	1.00	1.00	1.00	1.00	1.00	0.00	0.00	0.00	0.00	0.00
Uniform Delay (d), s/veh	11.7	4.2	4.2	11.1	3.8	3.8	11.8	0.0	0.0	0.0	0.0	0.0
Incr Delay (d2), s/veh	2.8	0.1	0.1	2.5	0.1	0.2	0.0	0.0	0.0	0.0	0.0	0.0
Initial Q Delay(d3),s/veh	0.0	0.0	0.0	0.0	0.0	0.0	0.0	0.0	0.0	0.0	0.0	0.0
%ile BackOfQ(50%),veh/ln	0.0	0.0	0.1	0.1	0.0	0.0	0.0	0.0	0.0	0.0	0.0	0.0
Unsig. Movement Delay, s/veh												
LnGrp Delay(d),s/veh	14.5	4.3	4.3	13.6	3.9	4.0	11.8	0.0	0.0	0.0	0.0	0.0
LnGrp LOS	B	A	A	B	A	A	B	A	A	A	A	A
Approach Vol, veh/h		346			511			-25				-16
Approach Delay, s/veh		4.3			4.5			0.0				0.0
Approach LOS		A			A			A				A
Timer - Assigned Phs	1	2		4	5	6		8				
Phs Duration (G+Y+Rc), s	5.0	15.8		2.7	4.2	16.6		2.7				
Change Period (Y+Rc), s	* 4.2	5.8		5.1	* 4.2	5.8		5.1				
Max Green Setting (Gmax), s	* 18	57.2		29.9	* 7.8	67.2		29.9				
Max Q Clear Time (g_c+I1), s	2.4	3.0		0.0	2.0	3.3		2.1				
Green Ext Time (p_c), s	0.0	3.1		0.0	0.0	4.5		0.0				

Intersection Summary

HCM 6th Ctrl Delay	4.6
HCM 6th LOS	A

Notes

* HCM 6th computational engine requires equal clearance times for the phases crossing the barrier.

Timings
28: I-215 SB Ramps & Alessandro Bl.

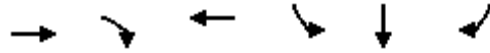

Lane Group	EBT	EBR	WBT	SBL	SBT	SBR
Lane Configurations	↑↑↑	↑	↑↑↑	↑	↔	↑
Traffic Volume (vph)	875	354	1120	144	0	294
Future Volume (vph)	875	354	1120	144	0	294
Turn Type	NA	Perm	NA	Split	NA	Perm
Protected Phases	2		6	4	4	
Permitted Phases		2				4
Detector Phase	2	2	6	4	4	4
Switch Phase						
Minimum Initial (s)	5.0	5.0	5.0	5.0	5.0	5.0
Minimum Split (s)	10.5	10.5	34.5	10.0	10.0	10.0
Total Split (s)	52.0	52.0	52.0	33.0	33.0	33.0
Total Split (%)	61.2%	61.2%	61.2%	38.8%	38.8%	38.8%
Yellow Time (s)	4.5	4.5	4.5	4.0	4.0	4.0
All-Red Time (s)	1.0	1.0	1.0	1.0	1.0	1.0
Lost Time Adjust (s)	0.0	0.0	0.0	0.0	0.0	0.0
Total Lost Time (s)	5.5	5.5	5.5	5.0	5.0	5.0
Lead/Lag						
Lead-Lag Optimize?						
Recall Mode	Min	Min	Min	None	None	None
Act Effct Green (s)	21.0	21.0	21.0	9.9	9.9	9.9
Actuated g/C Ratio	0.50	0.50	0.50	0.24	0.24	0.24
v/c Ratio	0.36	0.39	0.52	0.37	0.44	0.42
Control Delay	7.0	3.0	7.9	17.1	13.6	13.1
Queue Delay	0.0	0.0	0.0	0.0	0.0	0.0
Total Delay	7.0	3.0	7.9	17.1	13.6	13.1
LOS	A	A	A	B	B	B
Approach Delay	5.9		7.9		14.4	
Approach LOS	A		A		B	

Intersection Summary

Cycle Length: 85	
Actuated Cycle Length: 41.8	
Natural Cycle: 45	
Control Type: Actuated-Uncoordinated	
Maximum v/c Ratio: 0.52	
Intersection Signal Delay: 8.0	Intersection LOS: A
Intersection Capacity Utilization 45.4%	ICU Level of Service A
Analysis Period (min) 15	

Splits and Phases: 28: I-215 SB Ramps & Alessandro Bl.

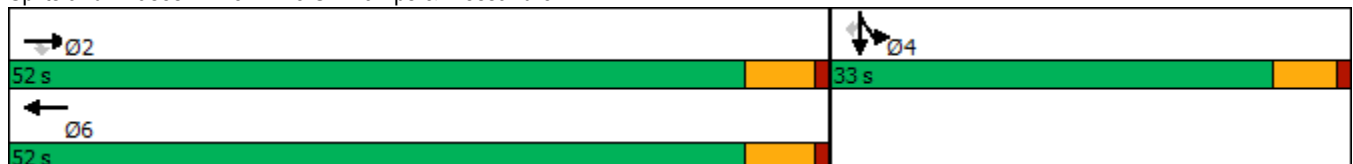

HCM 6th Signalized Intersection Summary
 28: I-215 SB Ramps & Alessandro Bl.

West Campus Upper Plateau (JN 14064)

09/30/2022



Movement	EBL	EBT	EBR	WBL	WBT	WBR	NBL	NBT	NBR	SBL	SBT	SBR
Lane Configurations		↑↑↑	↗		↑↑↑					↘	↔	↗
Traffic Volume (veh/h)	0	875	354	0	1120	130	0	0	0	144	0	294
Future Volume (veh/h)	0	875	354	0	1120	130	0	0	0	144	0	294
Initial Q (Qb), veh	0	0	0	0	0	0				0	0	0
Ped-Bike Adj(A_pbT)	1.00		1.00	1.00		0.98				1.00		1.00
Parking Bus, Adj	1.00	1.00	1.00	1.00	1.00	1.00				1.00	1.00	1.00
Work Zone On Approach		No			No						No	
Adj Sat Flow, veh/h/ln	0	1870	1870	0	1870	1781				1737	1900	1752
Adj Flow Rate, veh/h	0	911	369	0	1167	127				100	0	314
Peak Hour Factor	0.96	0.96	0.96	0.96	0.96	0.96				0.96	0.96	0.96
Percent Heavy Veh, %	0	2	2	0	2	8				11	0	10
Cap, veh/h	0	2557	794	0	2335	254				319	0	572
Arrive On Green	0.00	0.50	0.50	0.00	0.50	0.50				0.19	0.00	0.19
Sat Flow, veh/h	0	5274	1585	0	4832	507				1654	0	2969
Grp Volume(v), veh/h	0	911	369	0	852	442				100	0	314
Grp Sat Flow(s),veh/h/ln	0	1702	1585	0	1702	1766				1654	0	1485
Q Serve(g_s), s	0.0	3.7	5.2	0.0	5.7	5.7				1.8	0.0	3.3
Cycle Q Clear(g_c), s	0.0	3.7	5.2	0.0	5.7	5.7				1.8	0.0	3.3
Prop In Lane	0.00		1.00	0.00		0.29				1.00		1.00
Lane Grp Cap(c), veh/h	0	2557	794	0	1705	885				319	0	572
V/C Ratio(X)	0.00	0.36	0.46	0.00	0.50	0.50				0.31	0.00	0.55
Avail Cap(c_a), veh/h	0	6933	2152	0	4622	2398				1352	0	2427
HCM Platoon Ratio	1.00	1.00	1.00	1.00	1.00	1.00				1.00	1.00	1.00
Upstream Filter(I)	0.00	1.00	1.00	0.00	1.00	1.00				1.00	0.00	1.00
Uniform Delay (d), s/veh	0.0	5.2	5.6	0.0	5.7	5.7				11.9	0.0	12.5
Incr Delay (d2), s/veh	0.0	0.1	0.4	0.0	0.2	0.4				0.6	0.0	0.8
Initial Q Delay(d3),s/veh	0.0	0.0	0.0	0.0	0.0	0.0				0.0	0.0	0.0
%ile BackOfQ(50%),veh/ln	0.0	0.3	0.4	0.0	0.5	0.5				0.5	0.0	0.8
Unsig. Movement Delay, s/veh												
LnGrp Delay(d),s/veh	0.0	5.3	6.0	0.0	5.9	6.1				12.4	0.0	13.3
LnGrp LOS	A	A	A	A	A	A				B	A	B
Approach Vol, veh/h		1280			1294							414
Approach Delay, s/veh		5.5			6.0							13.1
Approach LOS		A			A							B
Timer - Assigned Phs		2		4		6						
Phs Duration (G+Y+Rc), s		22.7		11.6		22.7						
Change Period (Y+Rc), s		5.5		5.0		5.5						
Max Green Setting (Gmax), s		46.5		28.0		46.5						
Max Q Clear Time (g_c+I1), s		7.2		5.3		7.7						
Green Ext Time (p_c), s		8.1		1.5		9.4						

Intersection Summary

HCM 6th Ctrl Delay	6.8
HCM 6th LOS	A

Notes

User approved volume balancing among the lanes for turning movement.

Timings
29: I-215 NB Ramps & Alessandro Bl.

West Campus Upper Plateau (JN 14064)

09/30/2022



Lane Group	EBL	EBT	WBT	WBR	NBL	NBT	NBR
Lane Configurations	↔	↑↑↑	↑↑↑	↔	↔	↕	↔
Traffic Volume (vph)	193	830	969	157	492	10	259
Future Volume (vph)	193	830	969	157	492	10	259
Turn Type	Prot	NA	NA	Perm	Split	NA	Perm
Protected Phases	5	2	6		8	8	
Permitted Phases				6			8
Detector Phase	5	2	6	6	8	8	8
Switch Phase							
Minimum Initial (s)	5.0	5.0	5.0	5.0	5.0	5.0	5.0
Minimum Split (s)	9.5	10.5	33.5	33.5	10.0	10.0	10.0
Total Split (s)	13.0	48.0	35.0	35.0	37.0	37.0	37.0
Total Split (%)	15.3%	56.5%	41.2%	41.2%	43.5%	43.5%	43.5%
Yellow Time (s)	3.5	4.5	4.5	4.5	4.0	4.0	4.0
All-Red Time (s)	1.0	1.0	1.0	1.0	1.0	1.0	1.0
Lost Time Adjust (s)	0.0	0.0	0.0	0.0	0.0	0.0	0.0
Total Lost Time (s)	4.5	5.5	5.5	5.5	5.0	5.0	5.0
Lead/Lag	Lead		Lag	Lag			
Lead-Lag Optimize?	Yes		Yes	Yes			
Recall Mode	None	Min	Min	Min	Max	Max	Max
Act Effct Green (s)	8.5	36.2	23.2	23.2	32.1	32.1	32.1
Actuated g/C Ratio	0.11	0.46	0.29	0.29	0.41	0.41	0.41
v/c Ratio	1.11	0.37	0.67	0.34	0.40	0.41	0.35
Control Delay	138.6	14.2	26.7	12.6	19.9	19.6	10.9
Queue Delay	0.0	0.0	0.0	0.0	0.0	0.0	0.0
Total Delay	138.6	14.2	26.7	12.6	19.9	19.6	10.9
LOS	F	B	C	B	B	B	B
Approach Delay		37.6	24.7			17.1	
Approach LOS		D	C			B	

Intersection Summary

Cycle Length: 85
 Actuated Cycle Length: 78.9
 Natural Cycle: 65
 Control Type: Actuated-Uncoordinated
 Maximum v/c Ratio: 1.11
 Intersection Signal Delay: 27.3
 Intersection Capacity Utilization 58.4%
 Analysis Period (min) 15
 Intersection LOS: C
 ICU Level of Service B

Splits and Phases: 29: I-215 NB Ramps & Alessandro Bl.

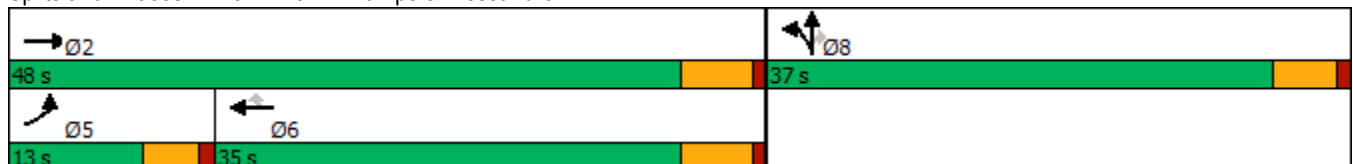

HCM 6th Signalized Intersection Summary
 29: I-215 NB Ramps & Alessandro Bl.

West Campus Upper Plateau (JN 14064)

09/30/2022



Movement	EBL	EBT	EBR	WBL	WBT	WBR	NBL	NBT	NBR	SBL	SBT	SBR
Lane Configurations	↘	↑↑↑			↑↑↑	↗	↘	↕	↗			
Traffic Volume (veh/h)	193	830	0	0	969	157	492	10	259	0	0	0
Future Volume (veh/h)	193	830	0	0	969	157	492	10	259	0	0	0
Initial Q (Qb), veh	0	0	0	0	0	0	0	0	0			
Ped-Bike Adj(A_pbT)	1.00		1.00	1.00		0.98	1.00		1.00			
Parking Bus, Adj	1.00	1.00	1.00	1.00	1.00	1.00	1.00	1.00	1.00			
Work Zone On Approach		No			No			No				
Adj Sat Flow, veh/h/ln	1767	1870	0	0	1870	1707	1856	1900	1870			
Adj Flow Rate, veh/h	199	856	0	0	999	136	568	0	126			
Peak Hour Factor	0.97	0.97	0.97	0.97	0.97	0.97	0.97	0.97	0.97			
Percent Heavy Veh, %	9	2	0	0	2	13	3	0	2			
Cap, veh/h	187	2271	0	0	1404	389	1478	0	663			
Arrive On Green	0.11	0.44	0.00	0.00	0.27	0.27	0.42	0.00	0.42			
Sat Flow, veh/h	1682	5274	0	0	5274	1416	3534	0	1585			
Grp Volume(v), veh/h	199	856	0	0	999	136	568	0	126			
Grp Sat Flow(s),veh/h/ln	1682	1702	0	0	1702	1416	1767	0	1585			
Q Serve(g_s), s	8.5	8.6	0.0	0.0	13.5	5.9	8.5	0.0	3.8			
Cycle Q Clear(g_c), s	8.5	8.6	0.0	0.0	13.5	5.9	8.5	0.0	3.8			
Prop In Lane	1.00		0.00	0.00		1.00	1.00		1.00			
Lane Grp Cap(c), veh/h	187	2271	0	0	1404	389	1478	0	663			
V/C Ratio(X)	1.07	0.38	0.00	0.00	0.71	0.35	0.38	0.00	0.19			
Avail Cap(c_a), veh/h	187	2835	0	0	1968	546	1478	0	663			
HCM Platoon Ratio	1.00	1.00	1.00	1.00	1.00	1.00	1.00	1.00	1.00			
Upstream Filter(I)	1.00	1.00	0.00	0.00	1.00	1.00	1.00	0.00	1.00			
Uniform Delay (d), s/veh	34.0	14.2	0.0	0.0	25.0	22.3	15.4	0.0	14.1			
Incr Delay (d2), s/veh	84.2	0.1	0.0	0.0	0.7	0.5	0.8	0.0	0.6			
Initial Q Delay(d3),s/veh	0.0	0.0	0.0	0.0	0.0	0.0	0.0	0.0	0.0			
%ile BackOfQ(50%),veh/ln	7.5	2.7	0.0	0.0	4.8	1.8	3.2	0.0	1.4			
Unsig. Movement Delay, s/veh												
LnGrp Delay(d),s/veh	118.2	14.3	0.0	0.0	25.7	22.8	16.2	0.0	14.7			
LnGrp LOS	F	B	A	A	C	C	B	A	B			
Approach Vol, veh/h		1055			1135			694				
Approach Delay, s/veh		33.9			25.4			15.9				
Approach LOS		C			C			B				
Timer - Assigned Phs		2			5	6		8				
Phs Duration (G+Y+Rc), s		39.5			13.0	26.5		37.0				
Change Period (Y+Rc), s		5.5			4.5	5.5		5.0				
Max Green Setting (Gmax), s		42.5			8.5	29.5		32.0				
Max Q Clear Time (g_c+I1), s		10.6			10.5	15.5		10.5				
Green Ext Time (p_c), s		5.7			0.0	5.5		2.4				

Intersection Summary

HCM 6th Ctrl Delay	26.2
HCM 6th LOS	C

Notes

User approved volume balancing among the lanes for turning movement.

Timings
30: I-215 SB Ramps & Cactus Av.

West Campus Upper Plateau (JN 14064)

09/30/2022



Lane Group	EBT	EBR	WBL	WBT	NBR	SBR
Lane Configurations	↑↑	↑	↓	↑↑	↑	↑
Traffic Volume (vph)	311	30	371	388	349	64
Future Volume (vph)	311	30	371	388	349	64
Turn Type	NA	Perm	Prot	NA	Prot	Prot
Protected Phases	2		1	6	8	4
Permitted Phases		2				
Detector Phase	2	2	1	6	8	4
Switch Phase						
Minimum Initial (s)	5.0	5.0	5.0	5.0	5.0	5.0
Minimum Split (s)	11.0	11.0	9.5	23.0	9.1	9.5
Total Split (s)	35.0	35.0	43.0	78.0	27.0	27.0
Total Split (%)	33.3%	33.3%	41.0%	74.3%	25.7%	25.7%
Yellow Time (s)	5.0	5.0	3.5	5.0	3.6	3.5
All-Red Time (s)	1.0	1.0	1.0	1.0	0.5	1.0
Lost Time Adjust (s)	0.0	0.0	0.0	0.0	0.0	0.0
Total Lost Time (s)	6.0	6.0	4.5	6.0	4.1	4.5
Lead/Lag	Lag	Lag	Lead			
Lead-Lag Optimize?	Yes	Yes	Yes			
Recall Mode	Min	Min	None	Min	None	None
Act Effct Green (s)	10.3	10.3	16.1	31.0	5.6	5.2
Actuated g/C Ratio	0.22	0.22	0.34	0.66	0.12	0.11
v/c Ratio	0.47	0.09	0.70	0.19	0.50	0.13
Control Delay	18.9	3.1	20.5	3.1	2.2	0.5
Queue Delay	0.0	0.0	0.0	0.0	0.0	0.0
Total Delay	18.9	3.1	20.5	3.1	2.2	0.5
LOS	B	A	C	A	A	A
Approach Delay	17.6			11.6		
Approach LOS	B			B		

Intersection Summary

Cycle Length: 105	
Actuated Cycle Length: 47	
Natural Cycle: 55	
Control Type: Actuated-Uncoordinated	
Maximum v/c Ratio: 0.70	
Intersection Signal Delay: 10.3	Intersection LOS: B
Intersection Capacity Utilization 38.6%	ICU Level of Service A
Analysis Period (min) 15	



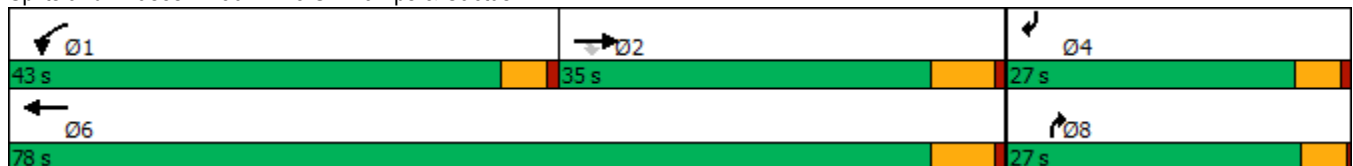









Splits and Phases: 30: I-215 SB Ramps & Cactus Av.



HCM 6th Signalized Intersection Summary
 30: I-215 SB Ramps & Cactus Av.

West Campus Upper Plateau (JN 14064)

09/30/2022

												
Movement	EBL	EBT	EBR	WBL	WBT	WBR	NBL	NBT	NBR	SBL	SBT	SBR
Lane Configurations		↑↑	↗	↖	↑↑				↗			↖
Traffic Volume (veh/h)	0	311	30	371	388	0	0	0	349	0	0	64
Future Volume (veh/h)	0	311	30	371	388	0	0	0	349	0	0	64
Initial Q (Qb), veh	0	0	0	0	0	0	0	0	0	0	0	0
Ped-Bike Adj(A_pbT)	1.00		1.00	1.00		1.00	1.00		1.00	1.00		1.00
Parking Bus, Adj	1.00	1.00	1.00	1.00	1.00	1.00	1.00	1.00	1.00	1.00	1.00	1.00
Work Zone On Approach		No			No			No			No	
Adj Sat Flow, veh/h/ln	0	1841	1826	1870	1870	0	0	0	1796	0	0	1707
Adj Flow Rate, veh/h	0	357	3	426	446	0	0	0	0	0	0	-41
Peak Hour Factor	0.87	0.87	0.87	0.87	0.87	0.87	0.87	0.87	0.87	0.87	0.87	0.87
Percent Heavy Veh, %	0	4	5	2	2	0	0	0	7	0	0	13
Cap, veh/h	0	815	361	549	2622	0	0	0	0	0	0	0
Arrive On Green	0.00	0.23	0.23	0.31	0.74	0.00	0.00	0.00	0.00	0.00	0.00	0.00
Sat Flow, veh/h	0	3589	1547	1781	3647	0		0			0	
Grp Volume(v), veh/h	0	357	3	426	446	0		0.0			0.0	
Grp Sat Flow(s),veh/h/ln	0	1749	1547	1781	1777	0						
Q Serve(g_s), s	0.0	2.0	0.0	5.0	0.9	0.0						
Cycle Q Clear(g_c), s	0.0	2.0	0.0	5.0	0.9	0.0						
Prop In Lane	0.00		1.00	1.00		0.00						
Lane Grp Cap(c), veh/h	0	815	361	549	2622	0						
V/C Ratio(X)	0.00	0.44	0.01	0.78	0.17	0.00						
Avail Cap(c_a), veh/h	0	4432	1961	2997	11181	0						
HCM Platoon Ratio	1.00	1.00	1.00	1.00	1.00	1.00						
Upstream Filter(I)	0.00	1.00	1.00	1.00	1.00	0.00						
Uniform Delay (d), s/veh	0.0	7.5	6.7	7.2	0.9	0.0						
Incr Delay (d2), s/veh	0.0	0.1	0.0	0.9	0.0	0.0						
Initial Q Delay(d3),s/veh	0.0	0.0	0.0	0.0	0.0	0.0						
%ile BackOfQ(50%),veh/ln	0.0	0.3	0.0	0.6	0.0	0.0						
Unsig. Movement Delay, s/veh												
LnGrp Delay(d),s/veh	0.0	7.6	6.7	8.1	0.9	0.0						
LnGrp LOS	A	A	A	A	A	A						
Approach Vol, veh/h		360			872							
Approach Delay, s/veh		7.6			4.4							
Approach LOS		A			A							
Timer - Assigned Phs	1	2				6						
Phs Duration (G+Y+Rc), s	11.6	11.3				22.9						
Change Period (Y+Rc), s	4.5	6.0				6.0						
Max Green Setting (Gmax), s	38.5	29.0				72.0						
Max Q Clear Time (g_c+I1), s	7.0	4.0				2.9						
Green Ext Time (p_c), s	0.6	1.3				1.8						

Intersection Summary

HCM 6th Ctrl Delay	5.4
HCM 6th LOS	A

Notes

Unsignalized Delay for [NBR] is excluded from calculations of the approach delay and intersection delay.

Timings

31: I-215 NB Ramps/Old 215 Frontage Rd. & Cactus Av.



Lane Group	EBL	EBT	WBT	NBL	NBT	NBR	SBL	SBT
Lane Configurations	↗	↗↘	↗↘	↖	↖	↖	↖	↖
Traffic Volume (vph)	16	641	1112	40	70	3	116	1
Future Volume (vph)	16	641	1112	40	70	3	116	1
Turn Type	Perm	NA	NA	Perm	NA	Perm	Perm	NA
Protected Phases		2	6		8			4
Permitted Phases	2			8		8	4	
Detector Phase	2	2	6	8	8	8	4	4
Switch Phase								
Minimum Initial (s)	5.0	5.0	5.0	5.0	5.0	5.0	5.0	5.0
Minimum Split (s)	11.0	11.0	44.0	10.5	10.5	10.5	10.5	10.5
Total Split (s)	57.4	57.4	57.4	27.6	27.6	27.6	27.6	27.6
Total Split (%)	67.5%	67.5%	67.5%	32.5%	32.5%	32.5%	32.5%	32.5%
Yellow Time (s)	5.0	5.0	5.0	4.5	4.5	4.5	4.5	4.5
All-Red Time (s)	1.0	1.0	1.0	1.0	1.0	1.0	1.0	1.0
Lost Time Adjust (s)	0.0	0.0	0.0	0.0	0.0	0.0	0.0	0.0
Total Lost Time (s)	6.0	6.0	6.0	5.5	5.5	5.5	5.5	5.5
Lead/Lag								
Lead-Lag Optimize?								
Recall Mode	Min	Min	Min	None	None	None	None	None
Act Effct Green (s)	29.5	29.5	29.5	9.5	9.5	9.5	9.6	9.6
Actuated g/C Ratio	0.64	0.64	0.64	0.21	0.21	0.21	0.21	0.21
v/c Ratio	0.09	0.33	0.61	0.17	0.21	0.01	0.47	0.18
Control Delay	7.4	6.4	8.8	19.4	18.9	0.0	24.6	7.2
Queue Delay	0.0	0.0	0.0	0.0	0.0	0.0	0.0	0.0
Total Delay	7.4	6.4	8.8	19.4	18.9	0.0	24.6	7.2
LOS	A	A	A	B	B	A	C	A
Approach Delay		6.4	8.8		18.6			18.3
Approach LOS		A	A		B			B

Intersection Summary

Cycle Length: 85	
Actuated Cycle Length: 46.3	
Natural Cycle: 60	
Control Type: Actuated-Uncoordinated	
Maximum v/c Ratio: 0.61	
Intersection Signal Delay: 9.4	Intersection LOS: A
Intersection Capacity Utilization 57.4%	ICU Level of Service B
Analysis Period (min) 15	

Splits and Phases: 31: I-215 NB Ramps/Old 215 Frontage Rd. & Cactus Av.

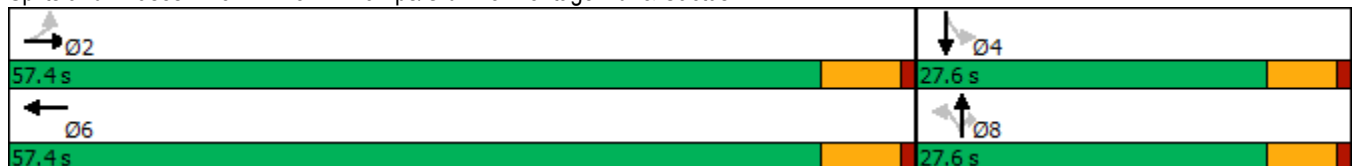

HCM 6th Signalized Intersection Summary

West Campus Upper Plateau (JN 14064)

31: I-215 NB Ramps/Old 215 Frontage Rd. & Cactus Av.

09/30/2022

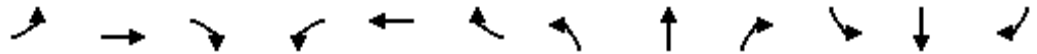

Movement	EBL	EBT	EBR	WBL	WBT	WBR	NBL	NBT	NBR	SBL	SBT	SBR
Lane Configurations	↗	↕			↕		↗	↕	↗	↗	↕	↕
Traffic Volume (veh/h)	16	641	29	0	1112	125	40	70	3	116	1	65
Future Volume (veh/h)	16	641	29	0	1112	125	40	70	3	116	1	65
Initial Q (Qb), veh	0	0	0	0	0	0	0	0	0	0	0	0
Ped-Bike Adj(A_pbT)	1.00		1.00	1.00		1.00	1.00		1.00	1.00		1.00
Parking Bus, Adj	1.00	1.00	1.00	1.00	1.00	1.00	1.00	1.00	1.00	1.00	1.00	1.00
Work Zone On Approach		No			No			No			No	
Adj Sat Flow, veh/h/ln	1796	1826	1366	0	1841	1885	1722	1856	1900	1841	1900	1885
Adj Flow Rate, veh/h	17	689	27	0	1196	85	43	75	0	125	1	43
Peak Hour Factor	0.93	0.93	0.93	0.93	0.93	0.93	0.93	0.93	0.93	0.93	0.93	0.93
Percent Heavy Veh, %	7	5	36	0	4	1	12	3	0	4	0	1
Cap, veh/h	292	1706	67	0	1660	118	395	330		387	7	280
Arrive On Green	0.50	0.50	0.50	0.00	0.50	0.50	0.18	0.18	0.00	0.18	0.18	0.18
Sat Flow, veh/h	414	3403	133	0	3404	235	1254	1856	1610	1304	37	1579
Grp Volume(v), veh/h	17	351	365	0	631	650	43	75	0	125	0	44
Grp Sat Flow(s),veh/h/ln	414	1735	1802	0	1749	1798	1254	1856	1610	1304	0	1616
Q Serve(g_s), s	1.2	4.5	4.5	0.0	10.1	10.1	1.1	1.2	0.0	3.3	0.0	0.8
Cycle Q Clear(g_c), s	11.3	4.5	4.5	0.0	10.1	10.1	1.9	1.2	0.0	4.5	0.0	0.8
Prop In Lane	1.00		0.07	0.00		0.13	1.00		1.00	1.00		0.98
Lane Grp Cap(c), veh/h	292	870	903	0	877	901	395	330		387	0	287
V/C Ratio(X)	0.06	0.40	0.40	0.00	0.72	0.72	0.11	0.23		0.32	0.00	0.15
Avail Cap(c_a), veh/h	679	2489	2586	0	2509	2580	946	1145		960	0	997
HCM Platoon Ratio	1.00	1.00	1.00	1.00	1.00	1.00	1.00	1.00	1.00	1.00	1.00	1.00
Upstream Filter(I)	1.00	1.00	1.00	0.00	1.00	1.00	1.00	1.00	0.00	1.00	0.00	1.00
Uniform Delay (d), s/veh	11.4	5.6	5.6	0.0	7.0	7.0	13.3	12.6	0.0	14.5	0.0	12.5
Incr Delay (d2), s/veh	0.0	0.1	0.1	0.0	0.4	0.4	0.0	0.1	0.0	0.2	0.0	0.1
Initial Q Delay(d3),s/veh	0.0	0.0	0.0	0.0	0.0	0.0	0.0	0.0	0.0	0.0	0.0	0.0
%ile BackOfQ(50%),veh/ln	0.1	0.6	0.7	0.0	1.5	1.5	0.2	0.4	0.0	0.7	0.0	0.2
Unsig. Movement Delay, s/veh												
LnGrp Delay(d),s/veh	11.4	5.7	5.7	0.0	7.4	7.4	13.3	12.8	0.0	14.7	0.0	12.5
LnGrp LOS	B	A	A	A	A	A	B	B		B	A	B
Approach Vol, veh/h		733			1281			118				169
Approach Delay, s/veh		5.8			7.4			13.0				14.2
Approach LOS		A			A			B				B
Timer - Assigned Phs		2		4		6		8				
Phs Duration (G+Y+Rc), s		24.0		11.9		24.0		11.9				
Change Period (Y+Rc), s		6.0		5.5		6.0		5.5				
Max Green Setting (Gmax), s		51.4		22.1		51.4		22.1				
Max Q Clear Time (g_c+I1), s		13.3		6.5		12.1		3.9				
Green Ext Time (p_c), s		2.8		0.3		5.6		0.2				

Intersection Summary

HCM 6th Ctrl Delay	7.7
HCM 6th LOS	A

Notes

User approved volume balancing among the lanes for turning movement.
 Unsignalized Delay for [NBR] is excluded from calculations of the approach delay and intersection delay.

Timings
32: I-215 SB Ramps & Van Buren Bl.



Lane Group	EBT	EBR	WBL	WBT	SBT	SBR
Lane Configurations	↑↑	↑↑	↘	↑↑	↙	↑↑
Traffic Volume (vph)	717	797	14	770	0	807
Future Volume (vph)	717	797	14	770	0	807
Turn Type	NA	Perm	Prot	NA	NA	Perm
Protected Phases	6		5	2	8	
Permitted Phases		6				8
Detector Phase	6	6	5	2	8	8
Switch Phase						
Minimum Initial (s)	5.0	5.0	5.0	5.0	5.0	5.0
Minimum Split (s)	36.0	36.0	11.0	11.0	11.0	11.0
Total Split (s)	60.0	60.0	11.0	71.0	14.0	14.0
Total Split (%)	70.6%	70.6%	12.9%	83.5%	16.5%	16.5%
Yellow Time (s)	5.0	5.0	5.0	5.0	5.0	5.0
All-Red Time (s)	1.0	1.0	1.0	1.0	1.0	1.0
Lost Time Adjust (s)	0.0	0.0	0.0	0.0	0.0	0.0
Total Lost Time (s)	6.0	6.0	6.0	6.0	6.0	6.0
Lead/Lag	Lag	Lag	Lead			
Lead-Lag Optimize?	Yes	Yes	Yes			
Recall Mode	Min	Min	None	Min	Max	Max
Act Effct Green (s)	16.9	16.9	5.3	18.3	8.5	8.5
Actuated g/C Ratio	0.43	0.43	0.13	0.46	0.22	0.22
v/c Ratio	0.54	0.51	0.08	0.52	0.08	0.95
Control Delay	10.0	2.0	21.5	8.0	18.3	33.0
Queue Delay	0.0	0.0	0.0	0.0	0.0	0.0
Total Delay	10.0	2.0	21.5	8.0	18.3	33.0
LOS	A	A	C	A	B	C
Approach Delay	5.8			8.2	32.6	
Approach LOS	A			A	C	

Intersection Summary

Cycle Length: 85
 Actuated Cycle Length: 39.5
 Natural Cycle: 75
 Control Type: Actuated-Uncoordinated
 Maximum v/c Ratio: 0.95
 Intersection Signal Delay: 13.5
 Intersection LOS: B
 Intersection Capacity Utilization 59.5%
 ICU Level of Service B
 Analysis Period (min) 15













Splits and Phases: 32: I-215 SB Ramps & Van Buren Bl.



HCM 6th Signalized Intersection Summary
32: I-215 SB Ramps & Van Buren Bl.

West Campus Upper Plateau (JN 14064)

09/30/2022

												
Movement	EBL	EBT	EBR	WBL	WBT	WBR	NBL	NBT	NBR	SBL	SBT	SBR
Lane Configurations		↑↑	↑↑	↑	↑↑						↑	↑↑
Traffic Volume (veh/h)	0	717	797	14	770	0	0	0	0	22	0	807
Future Volume (veh/h)	0	717	797	14	770	0	0	0	0	22	0	807
Initial Q (Qb), veh	0	0	0	0	0	0				0	0	0
Ped-Bike Adj(A_pbT)	1.00		1.00	1.00		1.00				1.00		1.00
Parking Bus, Adj	1.00	1.00	1.00	1.00	1.00	1.00				1.00	1.00	1.00
Work Zone On Approach		No			No						No	
Adj Sat Flow, veh/h/ln	0	1767	1856	1411	1811	0				1500	1841	1663
Adj Flow Rate, veh/h	0	763	750	15	819	0				23	0	0
Peak Hour Factor	0.94	0.94	0.94	0.94	0.94	0.94				0.94	0.94	0.94
Percent Heavy Veh, %	0	9	3	33	6	0				27	4	16
Cap, veh/h	0	1261	1040	135	2055	0				282	0	
Arrive On Green	0.00	0.38	0.38	0.10	0.60	0.00				0.16	0.00	0.00
Sat Flow, veh/h	0	3445	2768	1344	3532	0				1753	0	2480
Grp Volume(v), veh/h	0	763	750	15	819	0				23	0	0
Grp Sat Flow(s),veh/h/ln	0	1678	1384	1344	1721	0				1753	0	1240
Q Serve(g_s), s	0.0	9.1	11.5	0.5	6.2	0.0				0.6	0.0	0.0
Cycle Q Clear(g_c), s	0.0	9.1	11.5	0.5	6.2	0.0				0.6	0.0	0.0
Prop In Lane	0.00		1.00	1.00		0.00				1.00		1.00
Lane Grp Cap(c), veh/h	0	1261	1040	135	2055	0				282	0	
V/C Ratio(X)	0.00	0.61	0.72	0.11	0.40	0.00				0.08	0.00	
Avail Cap(c_a), veh/h	0	3651	3010	135	4505	0				282	0	
HCM Platoon Ratio	1.00	1.00	1.00	1.00	1.00	1.00				1.00	1.00	1.00
Upstream Filter(I)	0.00	1.00	1.00	1.00	1.00	0.00				1.00	0.00	0.00
Uniform Delay (d), s/veh	0.0	12.5	13.3	20.3	5.3	0.0				17.7	0.0	0.0
Incr Delay (d2), s/veh	0.0	0.2	0.4	0.1	0.0	0.0				0.6	0.0	0.0
Initial Q Delay(d3),s/veh	0.0	0.0	0.0	0.0	0.0	0.0				0.0	0.0	0.0
%ile BackOfQ(50%),veh/ln	0.0	2.3	2.4	0.1	0.9	0.0				0.2	0.0	0.0
Unsig. Movement Delay, s/veh												
LnGrp Delay(d),s/veh	0.0	12.7	13.6	20.4	5.3	0.0				18.3	0.0	0.0
LnGrp LOS	A	B	B	C	A	A				B	A	
Approach Vol, veh/h		1513			834							23
Approach Delay, s/veh		13.2			5.6							18.3
Approach LOS		B			A							B
Timer - Assigned Phs		2			5	6			8			
Phs Duration (G+Y+Rc), s		35.6			11.0	24.6			14.0			
Change Period (Y+Rc), s		6.0			6.0	6.0			6.0			
Max Green Setting (Gmax), s		65.0			5.0	54.0			8.0			
Max Q Clear Time (g_c+1), s		8.2			2.5	13.5			2.6			
Green Ext Time (p_c), s		3.5			0.0	5.1			0.0			
Intersection Summary												
HCM 6th Ctrl Delay				10.6								
HCM 6th LOS				B								
Notes												
Unsignalized Delay for [SBR] is excluded from calculations of the approach delay and intersection delay.												

Timings
33: I-215 NB On/Off Ramp & Van Buren Bl.

Lane Group	EBR	NBL	Ø2	Ø6
Lane Configurations	↔↔	↔↔		
Traffic Volume (vph)	17	1		
Future Volume (vph)	17	1		
Turn Type	pm+ov	Prot		
Protected Phases	4	4	2	6
Permitted Phases	6			
Detector Phase	4	4		
Switch Phase				
Minimum Initial (s)	5.0	5.0	5.0	5.0
Minimum Split (s)	42.0	42.0	11.0	11.0
Total Split (s)	55.0	55.0	15.0	15.0
Total Split (%)	78.6%	78.6%	21%	21%
Yellow Time (s)	5.0	5.0	5.0	5.0
All-Red Time (s)	1.0	1.0	1.0	1.0
Lost Time Adjust (s)	0.0	0.0		
Total Lost Time (s)	6.0	6.0		
Lead/Lag				
Lead-Lag Optimize?				
Recall Mode	Min	Min	None	None
Act Effct Green (s)	32.2	32.2		
Actuated g/C Ratio	1.00	1.00		
v/c Ratio	0.01	0.00		
Control Delay	0.0	0.0		
Queue Delay	0.0	0.0		
Total Delay	0.0	0.0		
LOS	A	A		
Approach Delay				
Approach LOS				

Intersection Summary

Cycle Length: 70
 Actuated Cycle Length: 32.2
 Natural Cycle: 55
 Control Type: Actuated-Uncoordinated
 Maximum v/c Ratio: 0.01
 Intersection Signal Delay: 0.0
 Intersection LOS: A
 Intersection Capacity Utilization 9.2%
 ICU Level of Service A
 Analysis Period (min) 15

Splits and Phases: 33: I-215 NB On/Off Ramp & Van Buren Bl.



HCM 6th Signalized Intersection Summary
 33: I-215 NB On/Off Ramp & Van Buren Bl.

West Campus Upper Plateau (JN 14064)

09/30/2022

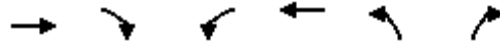

Movement	EBT	EBR	WBL	WBT	NBL	NBR
Lane Configurations	↑↑	↑↑		↑↑	↑↑	↑
Traffic Volume (veh/h)	0	17	0	0	1	0
Future Volume (veh/h)	0	17	0	0	1	0
Initial Q (Qb), veh	0	0	0	0	0	0
Ped-Bike Adj(A_pbT)		1.00	1.00		1.00	1.00
Parking Bus, Adj	1.00	1.00	1.00	1.00	1.00	1.00
Work Zone On Approach	No			No	No	
Adj Sat Flow, veh/h/ln	1900	1767	0	1752	1811	1159
Adj Flow Rate, veh/h	0	9	0	0	1	0
Peak Hour Factor	0.94	0.94	0.94	0.94	0.94	0.94
Percent Heavy Veh, %	0	9	0	10	6	50
Cap, veh/h	44	798	0	41	972	285
Arrive On Green	0.00	0.01	0.00	0.00	0.29	0.00
Sat Flow, veh/h	3705	2635	0	3504	3346	982
Grp Volume(v), veh/h	0	9	0	0	1	0
Grp Sat Flow(s),veh/h/ln	1805	1317	0	1664	1673	982
Q Serve(g_s), s	0.0	0.0	0.0	0.0	0.0	0.0
Cycle Q Clear(g_c), s	0.0	0.0	0.0	0.0	0.0	0.0
Prop In Lane		1.00	0.00		1.00	1.00
Lane Grp Cap(c), veh/h	44	798	0	41	972	285
V/C Ratio(X)	0.00	0.01	0.00	0.00	0.00	0.00
Avail Cap(c_a), veh/h	1888	2143	0	1741	9527	2796
HCM Platoon Ratio	1.00	1.00	1.00	1.00	1.00	1.00
Upstream Filter(I)	0.00	1.00	0.00	0.00	1.00	0.00
Uniform Delay (d), s/veh	0.0	4.2	0.0	0.0	4.3	0.0
Incr Delay (d2), s/veh	0.0	0.0	0.0	0.0	0.0	0.0
Initial Q Delay(d3),s/veh	0.0	0.0	0.0	0.0	0.0	0.0
%ile BackOfQ(50%),veh/ln	0.0	0.0	0.0	0.0	0.0	0.0
Unsig. Movement Delay, s/veh						
LnGrp Delay(d),s/veh	0.0	4.2	0.0	0.0	4.3	0.0
LnGrp LOS	A	A	A	A	A	A
Approach Vol, veh/h	9			0	1	
Approach Delay, s/veh	4.2			0.0	4.3	
Approach LOS	A				A	
Timer - Assigned Phs		2		4		6
Phs Duration (G+Y+Rc), s		6.2		11.0		6.2
Change Period (Y+Rc), s		6.0		6.0		6.0
Max Green Setting (Gmax), s		9.0		49.0		9.0
Max Q Clear Time (g_c+I1), s		0.0		2.0		2.0
Green Ext Time (p_c), s		0.0		0.0		0.0
Intersection Summary						
HCM 6th Ctrl Delay			4.2			
HCM 6th LOS			A			

Timings

West Campus Upper Plateau (JN 14064)

34: Old 215 Frontage Rd. & Alessandro Bl.

09/30/2022

Lane Group	EBL	EBT	EBR	WBL	WBT	WBR	NBL	NBT	NBR	SBL	SBT	SBR
Lane Configurations												
Traffic Volume (vph)	331	822	13	11	752	99	24	83	14	90	105	221
Future Volume (vph)	331	822	13	11	752	99	24	83	14	90	105	221
Turn Type	Prot	NA	Perm	Prot	NA	Perm	Prot	NA	Perm	Prot	NA	Perm
Protected Phases	5	2		1	6		3	8		7	4	
Permitted Phases			2			6			8			4
Detector Phase	5	2	2	1	6	6	3	8	8	7	4	4
Switch Phase												
Minimum Initial (s)	5.0	10.0	10.0	5.0	10.0	10.0	5.0	10.0	10.0	5.0	10.0	10.0
Minimum Split (s)	8.7	43.5	43.5	8.7	15.8	15.8	8.7	16.2	16.2	8.7	40.2	40.2
Total Split (s)	22.0	62.4	62.4	8.7	49.1	49.1	8.7	29.7	29.7	19.2	40.2	40.2
Total Split (%)	18.3%	52.0%	52.0%	7.3%	40.9%	40.9%	7.3%	24.8%	24.8%	16.0%	33.5%	33.5%
Yellow Time (s)	3.2	5.5	5.5	3.2	4.8	4.8	3.2	5.2	5.2	3.2	5.2	5.2
All-Red Time (s)	0.5	1.0	1.0	0.5	1.0	1.0	0.5	1.0	1.0	0.5	1.0	1.0
Lost Time Adjust (s)	0.0	0.0	0.0	0.0	0.0	0.0	0.0	0.0	0.0	0.0	0.0	0.0
Total Lost Time (s)	3.7	6.5	6.5	3.7	5.8	5.8	3.7	6.2	6.2	3.7	6.2	6.2
Lead/Lag	Lead	Lag	Lag	Lead	Lag	Lag	Lead	Lag	Lag	Lead	Lag	Lag
Lead-Lag Optimize?	Yes	Yes	Yes	Yes	Yes	Yes	Yes	Yes	Yes	Yes	Yes	Yes
Recall Mode	None	None	None	None	None	None	None	None	None	None	None	None
Act Effct Green (s)	12.9	40.4	40.4	5.4	25.4	25.4	5.4	12.7	12.7	9.4	20.4	20.4
Actuated g/C Ratio	0.16	0.51	0.51	0.07	0.32	0.32	0.07	0.16	0.16	0.12	0.26	0.26
v/c Ratio	0.61	0.32	0.02	0.10	0.69	0.17	0.13	0.15	0.04	0.46	0.13	0.39
Control Delay	39.0	12.9	0.1	47.5	28.0	1.2	45.6	34.1	0.2	45.4	26.2	6.5
Queue Delay	0.0	0.0	0.0	0.0	0.0	0.0	0.0	0.0	0.0	0.0	0.0	0.0
Total Delay	39.0	12.9	0.1	47.5	28.0	1.2	45.6	34.1	0.2	45.4	26.2	6.5
LOS	D	B	A	D	C	A	D	C	A	D	C	A
Approach Delay		20.2			25.2			32.4			19.9	
Approach LOS		C			C			C			B	

Intersection Summary

Cycle Length: 120	
Actuated Cycle Length: 78.6	
Natural Cycle: 105	
Control Type: Actuated-Uncoordinated	
Maximum v/c Ratio: 0.69	
Intersection Signal Delay: 22.4	Intersection LOS: C
Intersection Capacity Utilization 55.2%	ICU Level of Service B
Analysis Period (min) 15	

























Splits and Phases: 34: Old 215 Frontage Rd. & Alessandro Bl.



HCM 6th Signalized Intersection Summary
34: Old 215 Frontage Rd. & Alessandro Bl.

West Campus Upper Plateau (JN 14064)

09/30/2022

												
Movement	EBL	EBT	EBR	WBL	WBT	WBR	NBL	NBT	NBR	SBL	SBT	SBR
Lane Configurations												
Traffic Volume (veh/h)	331	822	13	11	752	99	24	83	14	90	105	221
Future Volume (veh/h)	331	822	13	11	752	99	24	83	14	90	105	221
Initial Q (Qb), veh	0	0	0	0	0	0	0	0	0	0	0	0
Ped-Bike Adj(A_pbT)	1.00		1.00	1.00		1.00	1.00		0.99	1.00		1.00
Parking Bus, Adj	1.00	1.00	1.00	1.00	1.00	1.00	1.00	1.00	1.00	1.00	1.00	1.00
Work Zone On Approach		No			No			No			No	
Adj Sat Flow, veh/h/ln	1870	1885	1678	1678	1856	1856	1515	1856	1559	1826	1737	1885
Adj Flow Rate, veh/h	345	856	-13	11	783	0	25	86	5	94	109	0
Peak Hour Factor	0.96	0.96	0.96	0.96	0.96	0.96	0.96	0.96	0.96	0.96	0.96	0.96
Percent Heavy Veh, %	2	1	15	15	3	3	26	3	23	5	11	1
Cap, veh/h	467	2244	620	22	1110		79	555	205	121	656	
Arrive On Green	0.14	0.44	0.00	0.01	0.31	0.00	0.03	0.16	0.16	0.07	0.20	0.00
Sat Flow, veh/h	3456	5147	1422	1598	3526	1572	2799	3526	1302	1739	3300	1598
Grp Volume(v), veh/h	345	856	-13	11	783	0	25	86	5	94	109	0
Grp Sat Flow(s),veh/h/ln	1728	1716	1422	1598	1763	1572	1399	1763	1302	1739	1650	1598
Q Serve(g_s), s	6.0	7.0	0.0	0.4	12.2	0.0	0.5	1.3	0.2	3.3	1.7	0.0
Cycle Q Clear(g_c), s	6.0	7.0	0.0	0.4	12.2	0.0	0.5	1.3	0.2	3.3	1.7	0.0
Prop In Lane	1.00		1.00	1.00		1.00	1.00		1.00	1.00		1.00
Lane Grp Cap(c), veh/h	467	2244	620	22	1110		79	555	205	121	656	
V/C Ratio(X)	0.74	0.38	-0.02	0.49	0.71		0.32	0.15	0.02	0.78	0.17	
Avail Cap(c_a), veh/h	1017	4627	1278	128	2455		225	1333	492	434	1805	
HCM Platoon Ratio	1.00	1.00	1.00	1.00	1.00	1.00	1.00	1.00	1.00	1.00	1.00	1.00
Upstream Filter(I)	1.00	1.00	0.00	1.00	1.00	0.00	1.00	1.00	1.00	1.00	1.00	0.00
Uniform Delay (d), s/veh	25.8	11.9	0.0	30.4	18.8	0.0	29.6	22.6	22.1	28.5	20.6	0.0
Incr Delay (d2), s/veh	0.9	0.1	0.0	6.2	0.8	0.0	0.8	0.1	0.0	4.1	0.1	0.0
Initial Q Delay(d3),s/veh	0.0	0.0	0.0	0.0	0.0	0.0	0.0	0.0	0.0	0.0	0.0	0.0
%ile BackOfQ(50%),veh/ln	2.1	2.0	0.0	0.2	4.3	0.0	0.2	0.5	0.1	1.4	0.6	0.0
Unsig. Movement Delay, s/veh												
LnGrp Delay(d),s/veh	26.7	12.0	0.0	36.6	19.6	0.0	30.5	22.7	22.2	32.5	20.8	0.0
LnGrp LOS	C	B	A	D	B		C	C	C	C	C	
Approach Vol, veh/h		1188			794			116			203	
Approach Delay, s/veh		16.4			19.8			24.4			26.2	
Approach LOS		B			B			C			C	
Timer - Assigned Phs	1	2	3	4	5	6	7	8				
Phs Duration (G+Y+Rc), s	4.6	33.6	5.5	18.6	12.1	26.1	8.0	16.0				
Change Period (Y+Rc), s	3.7	6.5	3.7	6.2	3.7	* 6.5	3.7	6.2				
Max Green Setting (Gmax), s	5.0	55.9	5.0	34.0	18.3	* 43	15.5	23.5				
Max Q Clear Time (g_c+I1), s	2.4	9.0	2.5	3.7	8.0	14.2	5.3	3.3				
Green Ext Time (p_c), s	0.0	5.9	0.0	0.5	0.5	5.4	0.1	0.4				

Intersection Summary

HCM 6th Ctrl Delay	18.8
HCM 6th LOS	B

Notes

* HCM 6th computational engine requires equal clearance times for the phases crossing the barrier.
Unsignalized Delay for [WBR, SBR] is excluded from calculations of the approach delay and intersection delay.

Timings
35: Day St. & Alessandro Bl.

West Campus Upper Plateau (JN 14064)

09/30/2022



Lane Group	EBL	EBT	EBR	WBL	WBT	WBR	NBL	NBT	NBR	SBL	SBT
Lane Configurations	↖	↗↗↗	↖	↖	↗↗	↖	↖	↗	↖	↖	↗
Traffic Volume (vph)	173	649	7	9	682	139	10	95	15	117	47
Future Volume (vph)	173	649	7	9	682	139	10	95	15	117	47
Turn Type	Prot	NA	Perm	Prot	NA	Perm	Perm	NA	Perm	Perm	NA
Protected Phases	5	2		1	6			8			4
Permitted Phases			2			6	8		8	4	
Detector Phase	5	2	2	1	6	6	8	8	8	4	4
Switch Phase											
Minimum Initial (s)	5.0	10.0	10.0	5.0	10.0	10.0	10.0	10.0	10.0	10.0	10.0
Minimum Split (s)	9.1	30.8	30.8	9.1	30.8	30.8	42.4	42.4	42.4	41.6	41.6
Total Split (s)	28.0	67.9	67.9	9.1	49.0	49.0	43.0	43.0	43.0	43.0	43.0
Total Split (%)	23.3%	56.6%	56.6%	7.6%	40.8%	40.8%	35.8%	35.8%	35.8%	35.8%	35.8%
Yellow Time (s)	3.6	4.8	4.8	3.6	4.8	4.8	4.4	4.4	4.4	3.6	3.6
All-Red Time (s)	0.5	1.0	1.0	0.5	1.0	1.0	1.0	1.0	1.0	1.0	1.0
Lost Time Adjust (s)	0.0	0.0	0.0	0.0	0.0	0.0	0.0	0.0	0.0	0.0	0.0
Total Lost Time (s)	4.1	5.8	5.8	4.1	5.8	5.8	5.4	5.4	5.4	4.6	4.6
Lead/Lag	Lead	Lag	Lag	Lead	Lag	Lag					
Lead-Lag Optimize?	Yes	Yes	Yes	Yes	Yes	Yes					
Recall Mode	None	None	None	None	None	None	None	None	None	None	None
Act Effct Green (s)	12.1	36.6	36.6	5.5	21.1	21.1	15.1	15.1	15.1	16.0	16.0
Actuated g/C Ratio	0.19	0.56	0.56	0.08	0.32	0.32	0.23	0.23	0.23	0.25	0.25
v/c Ratio	0.54	0.24	0.01	0.06	0.62	0.25	0.04	0.22	0.04	0.38	0.30
Control Delay	34.3	8.9	0.0	39.6	22.6	9.7	22.8	23.5	0.2	26.4	12.3
Queue Delay	0.0	0.0	0.0	0.0	0.0	0.0	0.0	0.0	0.0	0.0	0.0
Total Delay	34.3	8.9	0.0	39.6	22.6	9.7	22.8	23.5	0.2	26.4	12.3
LOS	C	A	A	D	C	A	C	C	A	C	B
Approach Delay		14.1			20.6			20.5			18.8
Approach LOS		B			C			C			B

Intersection Summary

Cycle Length: 120
 Actuated Cycle Length: 65.1
 Natural Cycle: 85
 Control Type: Actuated-Uncoordinated
 Maximum v/c Ratio: 0.62
 Intersection Signal Delay: 17.7
 Intersection LOS: B
 Intersection Capacity Utilization 53.7%
 ICU Level of Service A
 Analysis Period (min) 15

Splits and Phases: 35: Day St. & Alessandro Bl.



HCM 6th Signalized Intersection Summary
35: Day St. & Alessandro Bl.

West Campus Upper Plateau (JN 14064)

09/30/2022

Movement	EBL	EBT	EBR	WBL	WBT	WBR	NBL	NBT	NBR	SBL	SBT	SBR
Lane Configurations												
Traffic Volume (veh/h)	173	649	7	9	682	139	10	95	15	117	47	91
Future Volume (veh/h)	173	649	7	9	682	139	10	95	15	117	47	91
Initial Q (Qb), veh	0	0	0	0	0	0	0	0	0	0	0	0
Ped-Bike Adj(A_pbT)	1.00		0.98	1.00		0.98	1.00		1.00	1.00		1.00
Parking Bus, Adj	1.00	1.00	1.00	1.00	1.00	1.00	1.00	1.00	1.00	1.00	1.00	1.00
Work Zone On Approach		No			No			No			No	
Adj Sat Flow, veh/h/ln	1885	1870	1618	1900	1870	1900	1500	1900	1767	1885	1870	1870
Adj Flow Rate, veh/h	180	676	1	9	710	77	10	99	11	122	49	64
Peak Hour Factor	0.96	0.96	0.96	0.96	0.96	0.96	0.96	0.96	0.96	0.96	0.96	0.96
Percent Heavy Veh, %	1	2	19	0	2	0	27	0	9	1	2	2
Cap, veh/h	234	2260	593	21	1152	510	318	407	321	377	158	206
Arrive On Green	0.13	0.44	0.44	0.01	0.32	0.32	0.21	0.21	0.21	0.21	0.21	0.21
Sat Flow, veh/h	1795	5106	1341	1810	3554	1574	1026	1900	1497	1293	736	961
Grp Volume(v), veh/h	180	676	1	9	710	77	10	99	11	122	0	113
Grp Sat Flow(s),veh/h/ln	1795	1702	1341	1810	1777	1574	1026	1900	1497	1293	0	1697
Q Serve(g_s), s	4.5	3.9	0.0	0.2	7.8	1.6	0.4	2.0	0.3	4.0	0.0	2.6
Cycle Q Clear(g_c), s	4.5	3.9	0.0	0.2	7.8	1.6	3.0	2.0	0.3	6.0	0.0	2.6
Prop In Lane	1.00		1.00	1.00		1.00	1.00		1.00	1.00		0.57
Lane Grp Cap(c), veh/h	234	2260	593	21	1152	510	318	407	321	377	0	364
V/C Ratio(X)	0.77	0.30	0.00	0.42	0.62	0.15	0.03	0.24	0.03	0.32	0.00	0.31
Avail Cap(c_a), veh/h	929	6867	1803	196	3325	1473	934	1547	1219	1176	0	1411
HCM Platoon Ratio	1.00	1.00	1.00	1.00	1.00	1.00	1.00	1.00	1.00	1.00	1.00	1.00
Upstream Filter(I)	1.00	1.00	1.00	1.00	1.00	1.00	1.00	1.00	1.00	1.00	0.00	1.00
Uniform Delay (d), s/veh	19.4	8.3	7.2	22.7	13.2	11.1	16.5	15.0	14.4	17.5	0.0	15.3
Incr Delay (d2), s/veh	2.0	0.1	0.0	4.8	0.5	0.1	0.0	0.3	0.0	0.5	0.0	0.5
Initial Q Delay(d3),s/veh	0.0	0.0	0.0	0.0	0.0	0.0	0.0	0.0	0.0	0.0	0.0	0.0
%ile BackOfQ(50%),veh/ln	1.7	0.9	0.0	0.1	2.4	0.4	0.1	0.7	0.1	1.1	0.0	0.9
Unsig. Movement Delay, s/veh												
LnGrp Delay(d),s/veh	21.4	8.3	7.2	27.5	13.7	11.2	16.6	15.3	14.4	18.0	0.0	15.8
LnGrp LOS	C	A	A	C	B	B	B	B	B	B	A	B
Approach Vol, veh/h		857			796			120			235	
Approach Delay, s/veh		11.1			13.6			15.4			16.9	
Approach LOS		B			B			B			B	
Timer - Assigned Phs	1	2		4	5	6		8				
Phs Duration (G+Y+Rc), s	4.6	26.2		15.3	10.1	20.8		15.3				
Change Period (Y+Rc), s	4.1	5.8		* 5.4	4.1	5.8		5.4				
Max Green Setting (Gmax), s	5.0	62.1		* 38	23.9	43.2		37.6				
Max Q Clear Time (g_c+1), s	2.2	5.9		8.0	6.5	9.8		5.0				
Green Ext Time (p_c), s	0.0	4.8		1.1	0.2	5.2		0.6				

Intersection Summary

HCM 6th Ctrl Delay	13.0
HCM 6th LOS	B

Notes

* HCM 6th computational engine requires equal clearance times for the phases crossing the barrier.

Timings
36: Elsworth St. & Cactus Av.

West Campus Upper Plateau (JN 14064)

09/30/2022



Lane Group	EBL	EBT	EBR	WBL	WBT	WBR	NBL	NBT	SBL	SBT	SBR
Lane Configurations	↘	↑↑↑	↗	↘	↑↑↑	↗	↘	↕	↘	↗	↗
Traffic Volume (vph)	137	1044	31	14	1041	133	22	11	160	17	111
Future Volume (vph)	137	1044	31	14	1041	133	22	11	160	17	111
Turn Type	Prot	NA	Perm	Prot	NA	Perm	Split	NA	Split	NA	pm+ov
Protected Phases	5	2		1	6		8	8	4	4	5
Permitted Phases			2			6					4
Detector Phase	5	2	2	1	6	6	8	8	4	4	5
Switch Phase											
Minimum Initial (s)	5.0	10.0	10.0	5.0	10.0	10.0	10.0	10.0	10.0	10.0	5.0
Minimum Split (s)	9.6	36.2	36.2	9.6	36.2	36.2	35.4	35.4	35.4	35.4	9.6
Total Split (s)	16.5	49.6	49.6	9.6	42.7	42.7	35.4	35.4	35.4	35.4	16.5
Total Split (%)	12.7%	38.2%	38.2%	7.4%	32.8%	32.8%	27.2%	27.2%	27.2%	27.2%	12.7%
Yellow Time (s)	3.6	5.2	5.2	3.6	5.2	5.2	4.4	4.4	4.4	4.4	3.6
All-Red Time (s)	1.0	1.0	1.0	1.0	1.0	1.0	1.0	1.0	1.0	1.0	1.0
Lost Time Adjust (s)	0.0	0.0	0.0	0.0	0.0	0.0	0.0	0.0	0.0	0.0	0.0
Total Lost Time (s)	4.6	6.2	6.2	4.6	6.2	6.2	5.4	5.4	5.4	5.4	4.6
Lead/Lag	Lead	Lag	Lag	Lead	Lag	Lag					Lead
Lead-Lag Optimize?	Yes	Yes	Yes	Yes	Yes	Yes					Yes
Recall Mode	None	None	None	None	None	None	Max	Max	Max	Max	None
Act Effct Green (s)	11.8	46.8	46.8	5.0	34.1	34.1	30.0	30.0	30.0	30.0	42.6
Actuated g/C Ratio	0.09	0.37	0.37	0.04	0.27	0.27	0.24	0.24	0.24	0.24	0.33
v/c Ratio	0.90	0.60	0.05	0.21	0.82	0.26	0.05	0.06	0.23	0.23	0.19
Control Delay	106.3	35.0	0.2	67.9	49.8	6.6	39.5	28.1	42.1	42.1	3.4
Queue Delay	0.0	0.0	0.0	0.0	0.0	0.0	0.0	0.0	0.0	0.0	0.0
Total Delay	106.3	35.0	0.2	67.9	49.8	6.6	39.5	28.1	42.1	42.1	3.4
LOS	F	D	A	E	D	A	D	C	D	D	A
Approach Delay		42.2			45.2			33.6		27.2	
Approach LOS		D			D			C		C	

Intersection Summary

Cycle Length: 130
 Actuated Cycle Length: 127.6
 Natural Cycle: 120
 Control Type: Actuated-Uncoordinated
 Maximum v/c Ratio: 0.90
 Intersection Signal Delay: 41.8
 Intersection LOS: D
 Intersection Capacity Utilization 52.7%
 ICU Level of Service A
 Analysis Period (min) 15

Splits and Phases: 36: Elsworth St. & Cactus Av.

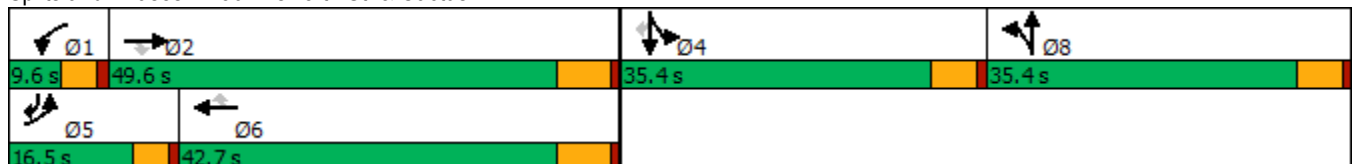

HCM 6th Signalized Intersection Summary
36: Elsworth St. & Cactus Av.

West Campus Upper Plateau (JN 14064)

09/30/2022



Movement	EBL	EBT	EBR	WBL	WBT	WBR	NBL	NBT	NBR	SBL	SBT	SBR
Lane Configurations	↗	↑↑↑	↖	↖	↑↑↑	↖	↖	↕		↖	↖	↖
Traffic Volume (veh/h)	137	1044	31	14	1041	133	22	11	9	160	17	111
Future Volume (veh/h)	137	1044	31	14	1041	133	22	11	9	160	17	111
Initial Q (Qb), veh	0	0	0	0	0	0	0	0	0	0	0	0
Ped-Bike Adj(A_pbT)	1.00		1.00	1.00		1.00	1.00		1.00	1.00		1.00
Parking Bus, Adj	1.00	1.00	1.00	1.00	1.00	1.00	1.00	1.00	1.00	1.00	1.00	1.00
Work Zone On Approach		No			No			No			No	
Adj Sat Flow, veh/h/ln	1841	1841	1781	1900	1841	1885	1885	1900	1885	1885	1900	1885
Adj Flow Rate, veh/h	144	1099	0	15	1096	103	17	0	0	181	0	9
Peak Hour Factor	0.95	0.95	0.95	0.95	0.95	0.95	0.95	0.95	0.95	0.95	0.95	0.95
Percent Heavy Veh, %	4	4	8	0	4	1	1	0	1	1	0	1
Cap, veh/h	166	1689		29	1296	412	855	452	0	855	0	531
Arrive On Green	0.09	0.34	0.00	0.02	0.26	0.26	0.24	0.00	0.00	0.24	0.00	0.24
Sat Flow, veh/h	1753	5025	1510	1810	5025	1598	3591	1900	0	3591	0	1598
Grp Volume(v), veh/h	144	1099	0	15	1096	103	17	0	0	181	0	9
Grp Sat Flow(s),veh/h/ln	1753	1675	1510	1810	1675	1598	1795	1900	0	1795	0	1598
Q Serve(g_s), s	10.2	23.4	0.0	1.0	26.1	6.4	0.5	0.0	0.0	5.1	0.0	0.5
Cycle Q Clear(g_c), s	10.2	23.4	0.0	1.0	26.1	6.4	0.5	0.0	0.0	5.1	0.0	0.5
Prop In Lane	1.00		1.00	1.00		1.00	1.00		0.00	1.00		1.00
Lane Grp Cap(c), veh/h	166	1689		29	1296	412	855	452	0	855	0	531
V/C Ratio(X)	0.87	0.65		0.51	0.85	0.25	0.02	0.00	0.00	0.21	0.00	0.02
Avail Cap(c_a), veh/h	166	1731		72	1456	463	855	452	0	855	0	531
HCM Platoon Ratio	1.00	1.00	1.00	1.00	1.00	1.00	1.00	1.00	1.00	1.00	1.00	1.00
Upstream Filter(l)	1.00	1.00	0.00	1.00	1.00	1.00	1.00	0.00	0.00	1.00	0.00	1.00
Uniform Delay (d), s/veh	56.3	35.5	0.0	61.5	44.4	37.1	36.7	0.0	0.0	38.5	0.0	28.2
Incr Delay (d2), s/veh	34.7	0.8	0.0	5.0	4.4	0.3	0.0	0.0	0.0	0.6	0.0	0.1
Initial Q Delay(d3),s/veh	0.0	0.0	0.0	0.0	0.0	0.0	0.0	0.0	0.0	0.0	0.0	0.0
%ile BackOfQ(50%),veh/ln	6.0	9.3	0.0	0.5	10.9	2.5	0.2	0.0	0.0	2.3	0.0	0.2
Unsig. Movement Delay, s/veh												
LnGrp Delay(d),s/veh	90.9	36.4	0.0	66.5	48.8	37.4	36.8	0.0	0.0	39.1	0.0	28.3
LnGrp LOS	F	D		E	D	D	D	A	A	D	A	C
Approach Vol, veh/h		1243			1214			17				190
Approach Delay, s/veh		42.7			48.0			36.8				38.6
Approach LOS		D			D			D				D
Timer - Assigned Phs	1	2		4	5	6		8				
Phs Duration (G+Y+Rc), s	6.6	48.5		35.4	16.5	38.7		35.4				
Change Period (Y+Rc), s	4.6	6.2		5.4	4.6	6.2		5.4				
Max Green Setting (Gmax), s	5.0	43.4		30.0	11.9	36.5		30.0				
Max Q Clear Time (g_c+1), s	3.0	25.4		7.1	12.2	28.1		2.5				
Green Ext Time (p_c), s	0.0	6.6		0.6	0.0	4.4		0.0				

Intersection Summary

HCM 6th Ctrl Delay	44.8
HCM 6th LOS	D

Notes

- User approved pedestrian interval to be less than phase max green.
- User approved volume balancing among the lanes for turning movement.
- Unsignalized Delay for [EBR] is excluded from calculations of the approach delay and intersection delay.

Timings
37: Cactus Av. & Frederick St.

West Campus Upper Plateau (JN 14064)

09/30/2022

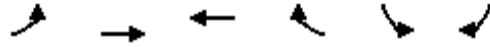

Lane Group	EBL	EBT	WBT	WBR	SBL	SBR
Lane Configurations	↗	↑↑↑	↑↑↑	↖	↖↗	↖
Traffic Volume (vph)	87	1153	1158	165	263	67
Future Volume (vph)	87	1153	1158	165	263	67
Turn Type	Prot	NA	NA	pm+ov	Prot	pm+ov
Protected Phases	5	2	6	4	4	5
Permitted Phases				6		4
Detector Phase	5	2	6	4	4	5
Switch Phase						
Minimum Initial (s)	5.0	10.0	10.0	10.0	10.0	5.0
Minimum Split (s)	9.2	28.2	29.2	36.4	36.4	9.2
Total Split (s)	31.0	81.0	50.0	39.0	39.0	31.0
Total Split (%)	25.8%	67.5%	41.7%	32.5%	32.5%	25.8%
Yellow Time (s)	3.2	5.2	5.2	4.4	4.4	3.2
All-Red Time (s)	1.0	1.0	1.0	1.0	1.0	1.0
Lost Time Adjust (s)	0.0	0.0	0.0	0.0	0.0	0.0
Total Lost Time (s)	4.2	6.2	6.2	5.4	5.4	4.2
Lead/Lag	Lead		Lag			Lead
Lead-Lag Optimize?	Yes		Yes			Yes
Recall Mode	None	None	None	None	None	None
Act Effct Green (s)	9.0	36.8	26.3	41.8	14.6	29.5
Actuated g/C Ratio	0.14	0.57	0.41	0.65	0.23	0.46
v/c Ratio	0.39	0.43	0.61	0.17	0.37	0.10
Control Delay	35.4	8.3	17.8	0.9	24.4	11.1
Queue Delay	0.0	0.0	0.0	0.0	0.0	0.0
Total Delay	35.4	8.3	17.8	0.9	24.4	11.1
LOS	D	A	B	A	C	B
Approach Delay		10.2	15.7		21.7	
Approach LOS		B	B		C	

Intersection Summary

Cycle Length: 120
 Actuated Cycle Length: 64.1
 Natural Cycle: 75
 Control Type: Actuated-Uncoordinated
 Maximum v/c Ratio: 0.61
 Intersection Signal Delay: 14.0
 Intersection LOS: B
 Intersection Capacity Utilization 48.7%
 ICU Level of Service A
 Analysis Period (min) 15

Splits and Phases: 37: Cactus Av. & Frederick St.



HCM 6th Signalized Intersection Summary
37: Cactus Av. & Frederick St.

West Campus Upper Plateau (JN 14064)
09/30/2022

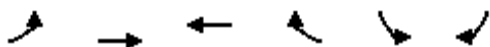

Movement	EBL	EBT	WBT	WBR	SBL	SBR
Lane Configurations						
Traffic Volume (veh/h)	87	1153	1158	165	263	67
Future Volume (veh/h)	87	1153	1158	165	263	67
Initial Q (Qb), veh	0	0	0	0	0	0
Ped-Bike Adj(A_pbT)	1.00			0.98	1.00	1.00
Parking Bus, Adj	1.00	1.00	1.00	1.00	1.00	1.00
Work Zone On Approach		No	No		No	
Adj Sat Flow, veh/h/ln	1826	1856	1856	1870	1856	1856
Adj Flow Rate, veh/h	95	1253	1259	115	286	-27
Peak Hour Factor	0.92	0.92	0.92	0.92	0.92	0.92
Percent Heavy Veh, %	5	3	3	2	3	3
Cap, veh/h	126	2953	2171	965	653	413
Arrive On Green	0.07	0.58	0.43	0.43	0.19	0.00
Sat Flow, veh/h	1739	5233	5233	1548	3428	1572
Grp Volume(v), veh/h	95	1253	1259	115	286	-27
Grp Sat Flow(s),veh/h/ln	1739	1689	1689	1548	1714	1572
Q Serve(g_s), s	2.7	7.0	9.7	1.6	3.8	0.0
Cycle Q Clear(g_c), s	2.7	7.0	9.7	1.6	3.8	0.0
Prop In Lane	1.00			1.00	1.00	1.00
Lane Grp Cap(c), veh/h	126	2953	2171	965	653	413
V/C Ratio(X)	0.75	0.42	0.58	0.12	0.44	-0.07
Avail Cap(c_a), veh/h	910	7402	4334	1626	2250	1146
HCM Platoon Ratio	1.00	1.00	1.00	1.00	1.00	1.00
Upstream Filter(I)	1.00	1.00	1.00	1.00	1.00	0.00
Uniform Delay (d), s/veh	23.3	5.9	11.1	4.0	18.3	0.0
Incr Delay (d2), s/veh	3.4	0.1	0.2	0.1	0.5	0.0
Initial Q Delay(d3),s/veh	0.0	0.0	0.0	0.0	0.0	0.0
%ile BackOfQ(50%),veh/ln	1.1	1.2	2.5	0.6	1.3	0.0
Unsig. Movement Delay, s/veh						
LnGrp Delay(d),s/veh	26.7	6.0	11.4	4.1	18.8	0.0
LnGrp LOS	C	A	B	A	B	A
Approach Vol, veh/h		1348	1374		259	
Approach Delay, s/veh		7.5	10.8		20.7	
Approach LOS		A	B		C	
Timer - Assigned Phs		2		4	5	6
Phs Duration (G+Y+Rc), s		36.0		15.1	7.9	28.1
Change Period (Y+Rc), s		6.2		5.4	* 4.2	6.2
Max Green Setting (Gmax), s		74.8		33.6	* 27	43.8
Max Q Clear Time (g_c+I1), s		9.0		5.8	4.7	11.7
Green Ext Time (p_c), s		10.7		1.0	0.1	10.3

Intersection Summary

HCM 6th Ctrl Delay	10.1
HCM 6th LOS	B

Notes

* HCM 6th computational engine requires equal clearance times for the phases crossing the barrier.

Timings
38: Riverside Dr./Graham St. & Cactus Av.

West Campus Upper Plateau (JN 14064)

09/30/2022

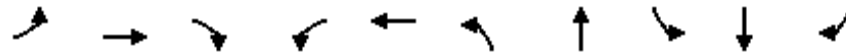

Lane Group	EBL	EBT	EBR	WBL	WBT	NBL	NBT	SBL	SBT	SBR
Lane Configurations	↘	↑↑↑	↗	↘	↑↑↑	↘	↑↑	↘	↑↑	↗
Traffic Volume (vph)	56	1079	173	20	1120	157	46	64	59	70
Future Volume (vph)	56	1079	173	20	1120	157	46	64	59	70
Turn Type	Prot	NA	Perm	Prot	NA	Prot	NA	Prot	NA	Perm
Protected Phases	7	4		3	8	5	2	1	6	
Permitted Phases			4							6
Detector Phase	7	4	4	3	8	5	2	1	6	6
Switch Phase										
Minimum Initial (s)	5.0	10.0	10.0	5.0	10.0	5.0	10.0	5.0	10.0	10.0
Minimum Split (s)	9.6	39.2	39.2	9.6	39.2	10.4	35.0	9.6	40.6	40.6
Total Split (s)	16.0	59.0	59.0	9.6	52.6	10.4	36.0	15.4	41.0	41.0
Total Split (%)	13.3%	49.2%	49.2%	8.0%	43.8%	8.7%	30.0%	12.8%	34.2%	34.2%
Yellow Time (s)	3.6	5.2	5.2	3.6	5.2	4.4	4.0	3.6	3.6	3.6
All-Red Time (s)	1.0	1.0	1.0	1.0	1.0	1.0	1.0	1.0	1.0	1.0
Lost Time Adjust (s)	0.0	0.0	0.0	0.0	0.0	0.0	0.0	0.0	0.0	0.0
Total Lost Time (s)	4.6	6.2	6.2	4.6	6.2	5.4	5.0	4.6	4.6	4.6
Lead/Lag	Lead	Lag	Lag	Lead	Lag	Lead	Lag	Lead	Lag	Lag
Lead-Lag Optimize?	Yes	Yes	Yes	Yes	Yes	Yes	Yes	Yes	Yes	Yes
Recall Mode	None	Min	Min	None	Min	None	None	None	None	None
Act Effct Green (s)	7.7	35.5	35.5	5.6	29.2	7.3	13.8	7.8	15.7	15.7
Actuated g/C Ratio	0.10	0.48	0.48	0.08	0.39	0.10	0.19	0.10	0.21	0.21
v/c Ratio	0.32	0.47	0.21	0.16	0.63	0.48	0.10	0.36	0.08	0.16
Control Delay	43.4	15.7	3.7	45.9	22.0	45.7	24.1	44.0	27.2	0.8
Queue Delay	0.0	0.0	0.0	0.0	0.0	0.0	0.0	0.0	0.0	0.0
Total Delay	43.4	15.7	3.7	45.9	22.0	45.7	24.1	44.0	27.2	0.8
LOS	D	B	A	D	C	D	C	D	C	A
Approach Delay		15.3			22.4		39.7		23.2	
Approach LOS		B			C		D		C	

Intersection Summary

Cycle Length: 120
 Actuated Cycle Length: 74.4
 Natural Cycle: 100
 Control Type: Actuated-Uncoordinated
 Maximum v/c Ratio: 0.63
 Intersection Signal Delay: 20.6
 Intersection LOS: C
 Intersection Capacity Utilization 51.5%
 ICU Level of Service A
 Analysis Period (min) 15

Splits and Phases: 38: Riverside Dr./Graham St. & Cactus Av.

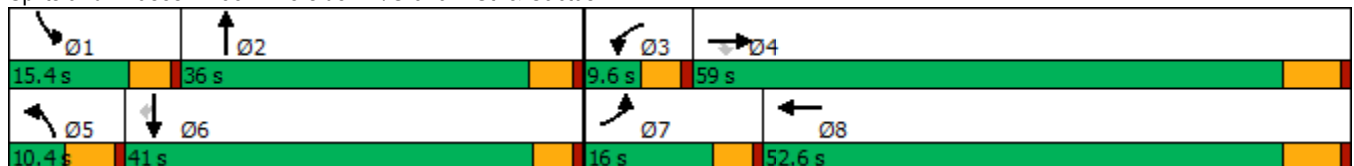

HCM 6th Signalized Intersection Summary
38: Riverside Dr./Graham St. & Cactus Av.

West Campus Upper Plateau (JN 14064)

09/30/2022



Movement	EBL	EBT	EBR	WBL	WBT	WBR	NBL	NBT	NBR	SBL	SBT	SBR
Lane Configurations	↘	↑↑↑	↗	↘	↑↑↑		↘↗	↑↗		↘	↑↑	↗
Traffic Volume (veh/h)	56	1079	173	20	1120	64	157	46	16	64	59	70
Future Volume (veh/h)	56	1079	173	20	1120	64	157	46	16	64	59	70
Initial Q (Qb), veh	0	0	0	0	0	0	0	0	0	0	0	0
Ped-Bike Adj(A_pbT)	1.00		1.00	1.00		0.99	1.00		1.00	1.00		1.00
Parking Bus, Adj	1.00	1.00	1.00	1.00	1.00	1.00	1.00	1.00	1.00	1.00	1.00	1.00
Work Zone On Approach		No			No			No			No	
Adj Sat Flow, veh/h/ln	1841	1841	1885	1900	1841	1900	1900	1900	1900	1870	1885	1826
Adj Flow Rate, veh/h	58	1112	133	21	1155	58	162	47	15	66	61	-2
Peak Hour Factor	0.97	0.97	0.97	0.97	0.97	0.97	0.97	0.97	0.97	0.97	0.97	0.97
Percent Heavy Veh, %	4	4	1	0	4	0	0	0	0	2	1	5
Cap, veh/h	90	1985	631	44	1803	91	269	522	159	98	562	243
Arrive On Green	0.05	0.39	0.39	0.02	0.37	0.37	0.08	0.19	0.19	0.06	0.16	0.00
Sat Flow, veh/h	1753	5025	1598	1810	4897	246	3510	2725	830	1781	3582	1547
Grp Volume(v), veh/h	58	1112	133	21	790	423	162	30	32	66	61	-2
Grp Sat Flow(s),veh/h/ln	1753	1675	1598	1810	1675	1793	1755	1805	1751	1781	1791	1547
Q Serve(g_s), s	2.0	10.5	3.4	0.7	11.9	11.9	2.7	0.8	0.9	2.2	0.9	0.0
Cycle Q Clear(g_c), s	2.0	10.5	3.4	0.7	11.9	11.9	2.7	0.8	0.9	2.2	0.9	0.0
Prop In Lane	1.00		1.00	1.00		0.14	1.00		0.47	1.00		1.00
Lane Grp Cap(c), veh/h	90	1985	631	44	1234	660	269	346	335	98	562	243
V/C Ratio(X)	0.65	0.56	0.21	0.47	0.64	0.64	0.60	0.09	0.09	0.67	0.11	-0.01
Avail Cap(c_a), veh/h	327	4344	1381	148	2545	1362	287	916	888	315	2134	922
HCM Platoon Ratio	1.00	1.00	1.00	1.00	1.00	1.00	1.00	1.00	1.00	1.00	1.00	1.00
Upstream Filter(I)	1.00	1.00	1.00	1.00	1.00	1.00	1.00	1.00	1.00	1.00	1.00	0.00
Uniform Delay (d), s/veh	28.4	14.4	12.2	29.4	16.0	16.0	27.3	20.3	20.3	28.3	22.1	0.0
Incr Delay (d2), s/veh	2.9	0.2	0.2	2.9	0.6	1.0	2.0	0.1	0.1	3.0	0.1	0.0
Initial Q Delay(d3),s/veh	0.0	0.0	0.0	0.0	0.0	0.0	0.0	0.0	0.0	0.0	0.0	0.0
%ile BackOfQ(50%),veh/ln	0.8	3.1	1.0	0.3	3.7	4.0	1.1	0.3	0.4	1.0	0.3	0.0
Unsig. Movement Delay, s/veh												
LnGrp Delay(d),s/veh	31.3	14.6	12.4	32.3	16.5	17.0	29.3	20.4	20.5	31.3	22.2	0.0
LnGrp LOS	C	B	B	C	B	B	C	C	C	C	C	A
Approach Vol, veh/h		1303			1234			224				125
Approach Delay, s/veh		15.1			16.9			26.8				27.3
Approach LOS		B			B			C				C
Timer - Assigned Phs	1	2	3	4	5	6	7	8				
Phs Duration (G+Y+Rc), s	8.0	16.7	6.1	30.3	10.1	14.6	7.7	28.7				
Change Period (Y+Rc), s	4.6	5.0	4.6	6.2	5.4	* 5	4.6	6.2				
Max Green Setting (Gmax), s	10.8	31.0	5.0	52.8	5.0	* 36	11.4	46.4				
Max Q Clear Time (g_c+I1), s	4.2	2.9	2.7	12.5	4.7	2.9	4.0	13.9				
Green Ext Time (p_c), s	0.0	0.3	0.0	9.2	0.0	0.3	0.0	8.6				

Intersection Summary

HCM 6th Ctrl Delay	17.3
HCM 6th LOS	B

Notes

* HCM 6th computational engine requires equal clearance times for the phases crossing the barrier.

APPENDIX 7.2:

**OPENING YEAR CUMULATIVE (2028) WITH PROJECT CONDITIONS INTERSECTION
OPERATIONS ANALYSIS WORKSHEETS**

This Page Intentionally Left Blank

Timings
1: Washington St & Van Buren Bl.



Lane Group	EBL	EBT	WBL	WBT	WBR	NBL	NBT	NBR	SBL	SBT
Lane Configurations	↘	↗	↘	↗	↗	↗	↗	↗	↗	↗
Traffic Volume (vph)	151	1331	122	1714	771	156	585	170	469	202
Future Volume (vph)	151	1331	122	1714	771	156	585	170	469	202
Turn Type	Prot	NA	Prot	NA	Perm	Prot	NA	Perm	Prot	NA
Protected Phases	5	2	1	6		3	8		7	4
Permitted Phases					6			8		
Detector Phase	5	2	1	6	6	3	8	8	7	4
Switch Phase										
Minimum Initial (s)	5.0	10.0	5.0	10.0	10.0	5.0	10.0	10.0	5.0	10.0
Minimum Split (s)	9.2	34.2	9.2	33.2	33.2	9.2	38.4	38.4	9.2	30.8
Total Split (s)	14.0	53.1	12.3	51.4	51.4	14.2	38.4	38.4	16.2	40.4
Total Split (%)	11.7%	44.3%	10.3%	42.8%	42.8%	11.8%	32.0%	32.0%	13.5%	33.7%
Yellow Time (s)	3.2	5.2	3.2	5.2	5.2	3.2	4.4	4.4	3.2	4.8
All-Red Time (s)	1.0	1.0	1.0	1.0	1.0	1.0	1.0	1.0	1.0	1.0
Lost Time Adjust (s)	0.0	0.0	0.0	0.0	0.0	0.0	0.0	0.0	0.0	0.0
Total Lost Time (s)	4.2	6.2	4.2	6.2	6.2	4.2	5.4	5.4	4.2	5.8
Lead/Lag	Lead	Lag	Lead	Lag	Lag	Lead	Lag	Lag	Lead	Lag
Lead-Lag Optimize?	Yes	Yes	Yes	Yes	Yes	Yes	Yes	Yes	Yes	Yes
Recall Mode	None	None	None	None	None	None	None	None	None	None
Act Effct Green (s)	9.8	47.0	8.1	45.3	45.3	9.0	26.5	26.5	12.0	29.1
Actuated g/C Ratio	0.09	0.41	0.07	0.40	0.40	0.08	0.23	0.23	0.11	0.26
v/c Ratio	1.03	1.07	1.02	1.27	1.03	0.62	0.74	0.38	1.35	0.33
Control Delay	133.1	76.8	139.3	156.8	63.5	62.1	46.1	11.1	213.4	30.0
Queue Delay	0.0	0.0	0.0	0.0	0.0	0.0	0.0	0.0	0.0	0.0
Total Delay	133.1	76.8	139.3	156.8	63.5	62.1	46.1	11.1	213.4	30.0
LOS	F	E	F	F	E	E	D	B	F	C
Approach Delay		82.1		128.4			42.3			146.0
Approach LOS		F		F			D			F

Intersection Summary

Cycle Length: 120
 Actuated Cycle Length: 113.7
 Natural Cycle: 125
 Control Type: Actuated-Uncoordinated
 Maximum v/c Ratio: 1.35
 Intersection Signal Delay: 104.5
 Intersection LOS: F
 Intersection Capacity Utilization 103.0%
 ICU Level of Service G
 Analysis Period (min) 15



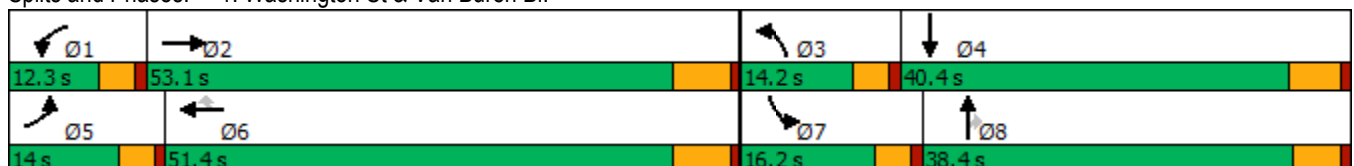



















Splits and Phases: 1: Washington St & Van Buren Bl.



HCM 6th Signalized Intersection Summary
1: Washington St & Van Buren Bl.

West Campus Upper Plateau (JN 14064)

09/19/2022

												
Movement	EBL	EBT	EBR	WBL	WBT	WBR	NBL	NBT	NBR	SBL	SBT	SBR
Lane Configurations												
Traffic Volume (veh/h)	151	1331	137	122	1714	771	156	585	170	469	202	71
Future Volume (veh/h)	151	1331	137	122	1714	771	156	585	170	469	202	71
Initial Q (Qb), veh	0	0	0	0	0	0	0	0	0	0	0	0
Ped-Bike Adj(A_pbT)	1.00		0.99	1.00		0.98	1.00		1.00	1.00		1.00
Parking Bus, Adj	1.00	1.00	1.00	1.00	1.00	1.00	1.00	1.00	1.00	1.00	1.00	1.00
Work Zone On Approach		No			No			No			No	
Adj Sat Flow, veh/h/ln	1870	1856	1856	1856	1870	1885	1826	1870	1856	1870	1811	1826
Adj Flow Rate, veh/h	157	1386	120	127	1785	639	162	609	111	489	210	45
Peak Hour Factor	0.96	0.96	0.96	0.96	0.96	0.96	0.96	0.96	0.96	0.96	0.96	0.96
Percent Heavy Veh, %	2	3	3	3	2	1	5	2	3	2	6	5
Cap, veh/h	156	1376	119	128	1436	634	220	777	342	371	737	155
Arrive On Green	0.09	0.42	0.42	0.07	0.40	0.40	0.07	0.22	0.22	0.11	0.26	0.26
Sat Flow, veh/h	1781	3281	283	1767	3554	1569	3374	3554	1566	3456	2829	594
Grp Volume(v), veh/h	157	742	764	127	1785	639	162	609	111	489	126	129
Grp Sat Flow(s),veh/h/ln	1781	1763	1800	1767	1777	1569	1687	1777	1566	1728	1721	1703
Q Serve(g_s), s	9.8	46.9	46.9	8.0	45.2	45.2	5.3	18.1	6.7	12.0	6.5	6.8
Cycle Q Clear(g_c), s	9.8	46.9	46.9	8.0	45.2	45.2	5.3	18.1	6.7	12.0	6.5	6.8
Prop In Lane	1.00		0.16	1.00		1.00	1.00		1.00	1.00		0.35
Lane Grp Cap(c), veh/h	156	739	755	128	1436	634	220	777	342	371	448	444
V/C Ratio(X)	1.01	1.00	1.01	0.99	1.24	1.01	0.74	0.78	0.32	1.32	0.28	0.29
Avail Cap(c_a), veh/h	156	739	755	128	1436	634	302	1049	462	371	532	527
HCM Platoon Ratio	1.00	1.00	1.00	1.00	1.00	1.00	1.00	1.00	1.00	1.00	1.00	1.00
Upstream Filter(I)	1.00	1.00	1.00	1.00	1.00	1.00	1.00	1.00	1.00	1.00	1.00	1.00
Uniform Delay (d), s/veh	51.0	32.5	32.5	51.8	33.3	33.3	51.3	41.2	36.8	49.9	33.0	33.1
Incr Delay (d2), s/veh	73.6	33.9	35.8	77.0	115.3	37.6	3.3	2.8	0.5	161.3	0.3	0.4
Initial Q Delay(d3),s/veh	0.0	0.0	0.0	0.0	0.0	0.0	0.0	0.0	0.0	0.0	0.0	0.0
%ile BackOfQ(50%),veh/ln	7.4	25.1	26.1	6.2	40.8	23.5	2.3	8.2	2.6	13.5	2.8	2.8
Unsig. Movement Delay, s/veh												
LnGrp Delay(d),s/veh	124.6	66.4	68.3	128.8	148.7	70.9	54.6	44.0	37.3	211.2	33.3	33.4
LnGrp LOS	F	F	F	F	F	F	D	D	D	F	C	C
Approach Vol, veh/h		1663			2551			882			744	
Approach Delay, s/veh		72.8			128.2			45.1			150.3	
Approach LOS		E			F			D			F	
Timer - Assigned Phs	1	2	3	4	5	6	7	8				
Phs Duration (G+Y+Rc), s	12.3	53.1	11.5	34.9	14.0	51.4	16.2	30.2				
Change Period (Y+Rc), s	* 4.2	6.2	* 4.2	5.8	* 4.2	6.2	* 4.2	* 5.8				
Max Green Setting (Gmax), s	* 8.1	46.9	* 10	34.6	* 9.8	45.2	* 12	* 33				
Max Q Clear Time (g_c+I1), s	10.0	48.9	7.3	8.8	11.8	47.2	14.0	20.1				
Green Ext Time (p_c), s	0.0	0.0	0.1	1.5	0.0	0.0	0.0	3.9				

Intersection Summary

HCM 6th Ctrl Delay	102.7
HCM 6th LOS	F

Notes

* HCM 6th computational engine requires equal clearance times for the phases crossing the barrier.

Timings
2: Central Ave & Arlington Ave/Chicago Ave

West Campus Upper Plateau (JN 14064)

09/19/2022



Lane Group	EBL	EBT	EBR	WBL	WBT	WBR	NBL	NBT	NBR	SBL	SBT
Lane Configurations	↘	↑↑	↗↗	↘↘	↑↑	↗	↘↘	↑↑	↗	↘↘	↑↑↗
Traffic Volume (vph)	47	564	764	272	932	370	1491	1861	588	259	794
Future Volume (vph)	47	564	764	272	932	370	1491	1861	588	259	794
Turn Type	Prot	NA	pm+ov	Prot	NA	pm+ov	Prot	NA	pm+ov	Prot	NA
Protected Phases	7	4	5	3	8	1	5	2	3	1	6
Permitted Phases			4			8			2		
Detector Phase	7	4	5	3	8	1	5	2	3	1	6
Switch Phase											
Minimum Initial (s)	5.0	10.0	10.0	5.0	10.0	10.0	10.0	10.0	5.0	10.0	10.0
Minimum Split (s)	9.6	35.2	15.8	9.6	38.8	15.8	15.8	38.8	9.6	15.8	38.8
Total Split (s)	9.6	35.6	42.0	12.8	38.8	15.9	42.0	65.7	12.8	15.9	39.6
Total Split (%)	7.4%	27.4%	32.3%	9.8%	29.8%	12.2%	32.3%	50.5%	9.8%	12.2%	30.5%
Yellow Time (s)	3.6	4.8	3.6	3.6	4.8	3.6	3.6	4.4	3.6	3.6	4.4
All-Red Time (s)	1.0	1.0	1.0	1.0	1.0	1.0	1.0	1.0	1.0	1.0	1.0
Lost Time Adjust (s)	0.0	0.0	0.0	0.0	0.0	0.0	0.0	0.0	0.0	0.0	0.0
Total Lost Time (s)	4.6	5.8	4.6	4.6	5.8	4.6	4.6	5.4	4.6	4.6	5.4
Lead/Lag	Lead	Lag	Lead	Lead	Lag	Lead	Lead	Lag	Lead	Lead	Lag
Lead-Lag Optimize?	Yes	Yes	Yes	Yes	Yes	Yes	Yes	Yes	Yes	Yes	Yes
Recall Mode	None	None	None	None	None	None	None	None	None	None	None
Act Effct Green (s)	5.0	27.8	71.0	8.2	33.0	50.2	37.4	60.4	69.4	11.3	34.2
Actuated g/C Ratio	0.04	0.22	0.55	0.06	0.26	0.39	0.29	0.47	0.54	0.09	0.27
v/c Ratio	0.71	0.79	0.51	1.37	1.08	0.58	1.57	1.18	0.71	0.91	0.66
Control Delay	108.9	55.6	17.5	236.7	97.2	26.9	291.8	118.0	22.4	91.5	44.6
Queue Delay	0.0	0.0	0.0	0.0	0.0	0.0	0.0	0.0	0.0	0.0	0.0
Total Delay	108.9	55.6	17.5	236.7	97.2	26.9	291.8	118.0	22.4	91.5	44.6
LOS	F	E	B	F	F	C	F	F	C	F	D
Approach Delay		36.3			104.7			169.5			55.6
Approach LOS		D			F			F			E

Intersection Summary

Cycle Length: 130
 Actuated Cycle Length: 128.1
 Natural Cycle: 125
 Control Type: Actuated-Uncoordinated
 Maximum v/c Ratio: 1.57
 Intersection Signal Delay: 118.1
 Intersection LOS: F
 Intersection Capacity Utilization 106.7%
 ICU Level of Service G
 Analysis Period (min) 15

Splits and Phases: 2: Central Ave & Arlington Ave/Chicago Ave



HCM 6th Signalized Intersection Summary
2: Central Ave & Arlington Ave/Chicago Ave

West Campus Upper Plateau (JN 14064)

09/19/2022



Movement	EBL	EBT	EBR	WBL	WBT	WBR	NBL	NBT	NBR	SBL	SBT	SBR
Lane Configurations	↘	↑↑	↗↘	↗↘	↑↑	↗	↗↘	↑↑	↗	↗↘	↑↑↘	
Traffic Volume (veh/h)	47	564	764	272	932	370	1491	1861	588	259	794	48
Future Volume (veh/h)	47	564	764	272	932	370	1491	1861	588	259	794	48
Initial Q (Qb), veh	0	0	0	0	0	0	0	0	0	0	0	0
Ped-Bike Adj(A_pbT)	1.00		1.00	1.00		1.00	1.00		0.99	1.00		1.00
Parking Bus, Adj	1.00	1.00	1.00	1.00	1.00	1.00	1.00	1.00	1.00	1.00	1.00	1.00
Work Zone On Approach		No			No			No			No	
Adj Sat Flow, veh/h/ln	1900	1856	1885	1811	1885	1885	1885	1885	1885	1870	1870	1870
Adj Flow Rate, veh/h	50	600	556	289	991	312	1586	1980	457	276	845	41
Peak Hour Factor	0.94	0.94	0.94	0.94	0.94	0.94	0.94	0.94	0.94	0.94	0.94	0.94
Percent Heavy Veh, %	0	3	1	6	1	1	1	1	1	2	2	2
Cap, veh/h	65	801	1450	212	912	546	1005	1666	834	301	1316	64
Arrive On Green	0.04	0.23	0.23	0.06	0.25	0.25	0.29	0.47	0.47	0.09	0.26	0.26
Sat Flow, veh/h	1810	3526	2812	3346	3582	1598	3483	3582	1577	3456	4989	241
Grp Volume(v), veh/h	50	600	556	289	991	312	1586	1980	457	276	576	310
Grp Sat Flow(s),veh/h/ln	1810	1763	1406	1673	1791	1598	1742	1791	1577	1728	1702	1827
Q Serve(g_s), s	3.6	20.6	15.5	8.2	33.0	20.7	37.4	60.3	25.0	10.3	19.4	19.5
Cycle Q Clear(g_c), s	3.6	20.6	15.5	8.2	33.0	20.7	37.4	60.3	25.0	10.3	19.4	19.5
Prop In Lane	1.00		1.00	1.00		1.00	1.00		1.00	1.00		0.13
Lane Grp Cap(c), veh/h	65	801	1450	212	912	546	1005	1666	834	301	898	482
V/C Ratio(X)	0.77	0.75	0.38	1.37	1.09	0.57	1.58	1.19	0.55	0.92	0.64	0.64
Avail Cap(c_a), veh/h	70	810	1458	212	912	546	1005	1666	834	301	898	482
HCM Platoon Ratio	1.00	1.00	1.00	1.00	1.00	1.00	1.00	1.00	1.00	1.00	1.00	1.00
Upstream Filter(I)	1.00	1.00	1.00	1.00	1.00	1.00	1.00	1.00	1.00	1.00	1.00	1.00
Uniform Delay (d), s/veh	62.0	46.7	19.0	60.7	48.3	34.9	46.1	34.7	20.3	58.7	42.3	42.3
Incr Delay (d2), s/veh	34.0	3.9	0.2	191.7	56.3	1.4	265.0	91.1	0.8	31.1	1.6	2.9
Initial Q Delay(d3),s/veh	0.0	0.0	0.0	0.0	0.0	0.0	0.0	0.0	0.0	0.0	0.0	0.0
%ile BackOfQ(50%),veh/ln	2.2	9.2	4.8	9.0	21.4	8.0	52.7	45.9	8.8	5.7	8.2	9.0
Unsig. Movement Delay, s/veh												
LnGrp Delay(d),s/veh	96.0	50.5	19.1	252.4	104.6	36.3	311.1	125.8	21.1	89.8	43.8	45.2
LnGrp LOS	F	D	B	F	F	D	F	F	C	F	D	D
Approach Vol, veh/h		1206			1592			4023			1162	
Approach Delay, s/veh		37.9			118.0			187.0			55.1	
Approach LOS		D			F			F			E	
Timer - Assigned Phs	1	2	3	4	5	6	7	8				
Phs Duration (G+Y+Rc), s	15.9	65.7	12.8	35.2	42.0	39.6	9.2	38.8				
Change Period (Y+Rc), s	4.6	5.4	4.6	5.8	4.6	5.4	4.6	5.8				
Max Green Setting (Gmax), s	11.3	60.3	8.2	29.8	37.4	34.2	5.0	33.0				
Max Q Clear Time (g_c+I1), s	12.3	62.3	10.2	22.6	39.4	21.5	5.6	35.0				
Green Ext Time (p_c), s	0.0	0.0	0.0	3.5	0.0	4.4	0.0	0.0				

Intersection Summary

HCM 6th Ctrl Delay	131.5
HCM 6th LOS	F

Timings

3: Overlook Pkwy./Canyon Crest Dr. & Alessandro Bl/Alessandro Bl.



Lane Group	EBL	EBT	WBL	WBT	WBR	NBL	NBT	NBR	SBL	SBT	SBR
Lane Configurations											
Traffic Volume (vph)	75	1627	9	3666	1240	5	193	11	556	97	77
Future Volume (vph)	75	1627	9	3666	1240	5	193	11	556	97	77
Turn Type	Prot	NA	Prot	NA	pm+ov	Split	NA	Perm	Split	NA	Perm
Protected Phases	5	2	1	6	4	8	8		4	4	
Permitted Phases					6			8			4
Detector Phase	5	2	1	6	4	8	8	8	4	4	4
Switch Phase											
Minimum Initial (s)	5.0	10.0	5.0	10.0	10.0	10.0	10.0	10.0	10.0	10.0	10.0
Minimum Split (s)	9.2	35.2	9.2	35.2	38.8	15.8	15.8	15.8	38.8	38.8	38.8
Total Split (s)	9.2	66.2	9.2	66.2	38.8	15.8	15.8	15.8	38.8	38.8	38.8
Total Split (%)	7.1%	50.9%	7.1%	50.9%	29.8%	12.2%	12.2%	12.2%	29.8%	29.8%	29.8%
Yellow Time (s)	3.2	5.2	3.2	5.2	4.8	4.8	4.8	4.8	4.8	4.8	4.8
All-Red Time (s)	1.0	1.0	1.0	1.0	1.0	1.0	1.0	1.0	1.0	1.0	1.0
Lost Time Adjust (s)	0.0	0.0	0.0	0.0	0.0	0.0	0.0	0.0	0.0	0.0	0.0
Total Lost Time (s)	4.2	6.2	4.2	6.2	5.8	5.8	5.8	5.8	5.8	5.8	5.8
Lead/Lag	Lead	Lag	Lead	Lag							
Lead-Lag Optimize?	Yes	Yes	Yes	Yes							
Recall Mode	None	None	None	None	None	None	None	None	None	None	None
Act Effct Green (s)	5.0	67.4	5.0	60.0	99.2	10.0	10.0	10.0	33.0	33.0	33.0
Actuated g/C Ratio	0.04	0.52	0.04	0.46	0.76	0.08	0.08	0.08	0.25	0.25	0.25
v/c Ratio	1.22	0.65	0.13	1.63	1.06	0.04	0.73	0.05	0.56	0.55	0.17
Control Delay	231.3	24.7	64.7	312.1	58.9	56.4	74.7	0.5	45.4	48.0	3.6
Queue Delay	0.0	0.0	0.0	0.0	0.0	0.0	0.0	0.0	0.0	0.0	0.0
Total Delay	231.3	24.7	64.7	312.1	58.9	56.4	74.7	0.5	45.4	48.0	3.6
LOS	F	C	E	F	E	E	E	A	D	D	A
Approach Delay		33.8		247.8			70.2			41.8	
Approach LOS		C		F			E			D	

Intersection Summary

Cycle Length: 130
 Actuated Cycle Length: 130
 Natural Cycle: 130
 Control Type: Actuated-Uncoordinated
 Maximum v/c Ratio: 1.63
 Intersection Signal Delay: 174.7
 Intersection LOS: F
 Intersection Capacity Utilization 106.0%
 ICU Level of Service G
 Analysis Period (min) 15

Splits and Phases: 3: Overlook Pkwy./Canyon Crest Dr. & Alessandro Bl/Alessandro Bl.



HCM 6th Signalized Intersection Summary

West Campus Upper Plateau (JN 14064)

3: Overlook Pkwy./Canyon Crest Dr. & Alessandro Bl/Alessandro Bl.

09/19/2022



Movement	EBL	EBT	EBR	WBL	WBT	WBR	NBL	NBT	NBR	SBL	SBT	SBR
Lane Configurations	↗	↗↗↗		↗	↗↗↗	↗	↗	↗↗	↗	↗↗	↗	↗
Traffic Volume (veh/h)	75	1627	1	9	3666	1240	5	193	11	556	97	77
Future Volume (veh/h)	75	1627	1	9	3666	1240	5	193	11	556	97	77
Initial Q (Qb), veh	0	0	0	0	0	0	0	0	0	0	0	0
Ped-Bike Adj(A_pbT)	1.00		1.00	1.00		1.00	1.00		1.00	1.00		1.00
Parking Bus, Adj	1.00	1.00	1.00	1.00	1.00	1.00	1.00	1.00	1.00	1.00	1.00	1.00
Work Zone On Approach		No			No			No				No
Adj Sat Flow, veh/h/ln	1811	1870	1900	1900	1885	1885	1900	1900	1900	1856	1885	1885
Adj Flow Rate, veh/h	79	1713	1	9	3859	1142	5	203	10	522	191	64
Peak Hour Factor	0.95	0.95	0.95	0.95	0.95	0.95	0.95	0.95	0.95	0.95	0.95	0.95
Percent Heavy Veh, %	6	2	0	0	1	1	0	0	0	3	1	1
Cap, veh/h	73	2834	2	20	2606	1099	153	304	136	642	342	290
Arrive On Green	0.04	0.54	0.54	0.01	0.51	0.51	0.08	0.08	0.08	0.18	0.18	0.18
Sat Flow, veh/h	1725	5271	3	1810	5147	1598	1810	3610	1610	3534	1885	1598
Grp Volume(v), veh/h	79	1106	608	9	3859	1142	5	203	10	522	191	64
Grp Sat Flow(s),veh/h/ln	1725	1702	1870	1810	1716	1598	1810	1805	1610	1767	1885	1598
Q Serve(g_s), s	5.0	26.4	26.4	0.6	60.0	60.0	0.3	6.5	0.7	16.8	10.9	4.0
Cycle Q Clear(g_c), s	5.0	26.4	26.4	0.6	60.0	60.0	0.3	6.5	0.7	16.8	10.9	4.0
Prop In Lane	1.00		0.00	1.00		1.00	1.00		1.00	1.00		1.00
Lane Grp Cap(c), veh/h	73	1830	1005	20	2606	1099	153	304	136	642	342	290
V/C Ratio(X)	1.09	0.60	0.60	0.46	1.48	1.04	0.03	0.67	0.07	0.81	0.56	0.22
Avail Cap(c_a), veh/h	73	1830	1005	76	2606	1099	153	305	136	984	525	445
HCM Platoon Ratio	1.00	1.00	1.00	1.00	1.00	1.00	1.00	1.00	1.00	1.00	1.00	1.00
Upstream Filter(I)	1.00	1.00	1.00	1.00	1.00	1.00	1.00	1.00	1.00	1.00	1.00	1.00
Uniform Delay (d), s/veh	56.8	18.8	18.8	58.3	29.3	15.1	49.8	52.6	50.0	46.6	44.2	41.3
Incr Delay (d2), s/veh	130.8	0.6	1.0	6.1	218.5	37.9	0.1	5.4	0.2	3.1	1.4	0.4
Initial Q Delay(d3),s/veh	0.0	0.0	0.0	0.0	0.0	0.0	0.0	0.0	0.0	0.0	0.0	0.0
%ile BackOfQ(50%),veh/ln	4.8	9.5	10.6	0.3	74.7	43.5	0.1	3.1	0.3	7.4	5.1	1.6
Unsig. Movement Delay, s/veh												
LnGrp Delay(d),s/veh	187.6	19.3	19.8	64.4	247.8	53.0	49.9	58.1	50.2	49.7	45.6	41.7
LnGrp LOS	F	B	B	E	F	F	D	E	D	D	D	D
Approach Vol, veh/h		1793			5010			218			777	
Approach Delay, s/veh		26.9			203.1			57.5			48.0	
Approach LOS		C			F			E			D	
Timer - Assigned Phs	1	2		4	5	6		8				
Phs Duration (G+Y+Rc), s	5.5	69.9		27.3	9.2	66.2		15.8				
Change Period (Y+Rc), s	* 4.2	6.2		5.8	* 4.2	6.2		5.8				
Max Green Setting (Gmax), s	* 5	60.0		33.0	* 5	60.0		10.0				
Max Q Clear Time (g_c+I1), s	2.6	28.4		18.8	7.0	62.0		8.5				
Green Ext Time (p_c), s	0.0	13.7		2.7	0.0	0.0		0.2				

Intersection Summary

HCM 6th Ctrl Delay	143.0
HCM 6th LOS	F

Notes

- User approved pedestrian interval to be less than phase max green.
- User approved volume balancing among the lanes for turning movement.
- * HCM 6th computational engine requires equal clearance times for the phases crossing the barrier.

Timings

4: Van Buren Bl. & Wood Rd.

09/19/2022

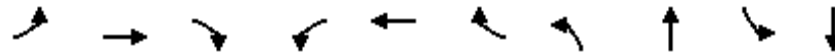

Lane Group	EBL	EBT	EBR	WBL	WBT	WBR	NBL	NBT	SBL	SBT
Lane Configurations	↘	↑↑	↗	↘↗	↑↑	↗	↘↗	↑↘	↘	↑↘
Traffic Volume (vph)	168	1342	377	524	1798	133	387	478	125	478
Future Volume (vph)	168	1342	377	524	1798	133	387	478	125	478
Turn Type	Prot	NA	pm+ov	Prot	NA	Perm	Prot	NA	Prot	NA
Protected Phases	5	2	3	1	6		3	8	7	4
Permitted Phases			2			6				
Detector Phase	5	2	3	1	6	6	3	8	7	4
Switch Phase										
Minimum Initial (s)	5.0	10.0	5.0	5.0	10.0	10.0	5.0	10.0	5.0	10.0
Minimum Split (s)	9.2	30.2	9.2	9.2	30.2	30.2	9.2	38.4	9.2	15.8
Total Split (s)	16.6	45.0	18.2	25.0	53.4	53.4	18.2	38.4	11.6	31.8
Total Split (%)	13.8%	37.5%	15.2%	20.8%	44.5%	44.5%	15.2%	32.0%	9.7%	26.5%
Yellow Time (s)	3.2	5.2	3.2	3.2	5.2	5.2	3.2	4.4	3.2	4.8
All-Red Time (s)	1.0	1.0	1.0	1.0	1.0	1.0	1.0	1.0	1.0	1.0
Lost Time Adjust (s)	0.0	0.0	0.0	0.0	0.0	0.0	0.0	0.0	0.0	0.0
Total Lost Time (s)	4.2	6.2	4.2	4.2	6.2	6.2	4.2	5.4	4.2	5.8
Lead/Lag	Lead	Lag	Lead	Lead	Lag	Lag	Lead	Lag	Lead	Lag
Lead-Lag Optimize?	Yes	Yes	Yes	Yes	Yes	Yes	Yes	Yes	Yes	Yes
Recall Mode	None	None	None	None	None	None	None	None	None	None
Act Effct Green (s)	12.4	38.8	54.8	20.8	47.2	47.2	14.0	33.0	7.4	26.0
Actuated g/C Ratio	0.10	0.32	0.46	0.17	0.39	0.39	0.12	0.28	0.06	0.22
v/c Ratio	1.06	1.35	0.57	0.99	1.47	0.22	1.09	0.97	1.30	0.97
Control Delay	133.8	195.5	19.1	84.5	244.3	5.5	120.2	59.0	231.7	70.9
Queue Delay	0.0	0.0	0.0	0.0	0.0	0.0	0.0	0.0	0.0	0.0
Total Delay	133.8	195.5	19.1	84.5	244.3	5.5	120.2	59.0	231.7	70.9
LOS	F	F	B	F	F	A	F	E	F	E
Approach Delay		154.8			197.3			78.2		96.4
Approach LOS		F			F			E		F

Intersection Summary

Cycle Length: 120
 Actuated Cycle Length: 120
 Natural Cycle: 130
 Control Type: Actuated-Uncoordinated
 Maximum v/c Ratio: 1.47
 Intersection Signal Delay: 149.1
 Intersection Capacity Utilization 110.2%
 Analysis Period (min) 15
 Intersection LOS: F
 ICU Level of Service H

Splits and Phases: 4: Van Buren Bl. & Wood Rd.

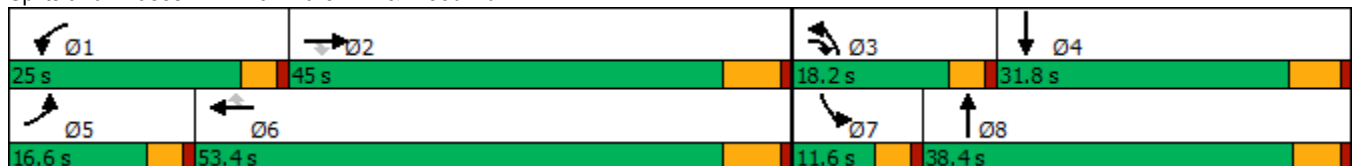

HCM 6th Signalized Intersection Summary
4: Van Buren Bl. & Wood Rd.

West Campus Upper Plateau (JN 14064)

09/19/2022



Movement	EBL	EBT	EBR	WBL	WBT	WBR	NBL	NBT	NBR	SBL	SBT	SBR
Lane Configurations	↘	↑↑	↗	↘↗	↑↑	↗	↘↗	↑↑		↘	↑↑	
Traffic Volume (veh/h)	168	1342	377	524	1798	133	387	478	371	125	478	186
Future Volume (veh/h)	168	1342	377	524	1798	133	387	478	371	125	478	186
Initial Q (Qb), veh	0	0	0	0	0	0	0	0	0	0	0	0
Ped-Bike Adj(A_pbT)	1.00		0.97	1.00		0.98	1.00		0.90	1.00		0.99
Parking Bus, Adj	1.00	1.00	1.00	1.00	1.00	1.00	1.00	1.00	1.00	1.00	1.00	1.00
Work Zone On Approach		No			No			No			No	
Adj Sat Flow, veh/h/ln	1856	1856	1856	1885	1870	1870	1885	1885	1885	1870	1900	1856
Adj Flow Rate, veh/h	191	1525	243	595	2043	101	440	543	279	142	543	116
Peak Hour Factor	0.88	0.88	0.88	0.88	0.88	0.88	0.88	0.88	0.88	0.88	0.88	0.88
Percent Heavy Veh, %	3	3	3	1	2	2	1	1	1	2	0	3
Cap, veh/h	182	1138	678	603	1396	613	406	600	307	110	643	137
Arrive On Green	0.10	0.32	0.32	0.17	0.39	0.39	0.12	0.27	0.27	0.06	0.22	0.22
Sat Flow, veh/h	1767	3526	1531	3483	3554	1560	3483	2198	1125	1781	2954	628
Grp Volume(v), veh/h	191	1525	243	595	2043	101	440	442	380	142	331	328
Grp Sat Flow(s),veh/h/ln	1767	1763	1531	1742	1777	1560	1742	1791	1533	1781	1805	1777
Q Serve(g_s), s	12.4	38.8	12.7	20.5	47.2	5.1	14.0	28.6	28.8	7.4	21.1	21.3
Cycle Q Clear(g_c), s	12.4	38.8	12.7	20.5	47.2	5.1	14.0	28.6	28.8	7.4	21.1	21.3
Prop In Lane	1.00		1.00	1.00		1.00	1.00		0.73	1.00		0.35
Lane Grp Cap(c), veh/h	182	1138	678	603	1396	613	406	488	418	110	393	387
V/C Ratio(X)	1.05	1.34	0.36	0.99	1.46	0.16	1.08	0.90	0.91	1.29	0.84	0.85
Avail Cap(c_a), veh/h	182	1138	678	603	1396	613	406	492	421	110	393	387
HCM Platoon Ratio	1.00	1.00	1.00	1.00	1.00	1.00	1.00	1.00	1.00	1.00	1.00	1.00
Upstream Filter(I)	1.00	1.00	1.00	1.00	1.00	1.00	1.00	1.00	1.00	1.00	1.00	1.00
Uniform Delay (d), s/veh	53.9	40.7	22.4	49.6	36.5	23.7	53.1	42.2	42.3	56.4	45.0	45.1
Incr Delay (d2), s/veh	79.7	158.9	0.5	33.2	212.7	0.2	69.2	20.1	23.3	184.4	15.1	16.0
Initial Q Delay(d3),s/veh	0.0	0.0	0.0	0.0	0.0	0.0	0.0	0.0	0.0	0.0	0.0	0.0
%ile BackOfQ(50%),veh/ln	9.4	40.9	4.5	11.3	60.2	1.9	9.9	15.0	13.3	8.9	10.9	10.9
Unsig. Movement Delay, s/veh												
LnGrp Delay(d),s/veh	133.6	199.6	22.9	82.7	249.1	23.9	122.3	62.3	65.5	240.8	60.1	61.1
LnGrp LOS	F	F	C	F	F	C	F	E	E	F	E	E
Approach Vol, veh/h		1959			2739			1262			801	
Approach Delay, s/veh		171.2			204.7			84.2			92.5	
Approach LOS		F			F			F			F	
Timer - Assigned Phs	1	2	3	4	5	6	7	8				
Phs Duration (G+Y+Rc), s	25.0	45.0	18.2	32.0	16.6	53.4	11.6	38.6				
Change Period (Y+Rc), s	* 4.2	6.2	* 4.2	5.8	* 4.2	6.2	* 4.2	* 5.8				
Max Green Setting (Gmax), s	* 21	38.8	* 14	26.0	* 12	47.2	* 7.4	* 33				
Max Q Clear Time (g_c+I1), s	22.5	40.8	16.0	23.3	14.4	49.2	9.4	30.8				
Green Ext Time (p_c), s	0.0	0.0	0.0	1.0	0.0	0.0	0.0	1.1				

Intersection Summary

HCM 6th Ctrl Delay	159.2
HCM 6th LOS	F

Notes

* HCM 6th computational engine requires equal clearance times for the phases crossing the barrier.

Timings
5: Trautwein Rd. & Alessandro Bl.

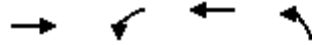

Lane Group	EBT	WBL	WBT	NBL
Lane Configurations	↑↑↑	↔↔	↑↑↑	↔↔↔
Traffic Volume (vph)	1358	261	3594	2257
Future Volume (vph)	1358	261	3594	2257
Turn Type	NA	Prot	NA	Prot
Protected Phases	2	1	6	8
Permitted Phases				
Detector Phase	2	1	6	8
Switch Phase				
Minimum Initial (s)	10.0	5.0	10.0	10.0
Minimum Split (s)	33.2	9.2	16.2	16.2
Total Split (s)	54.6	17.4	72.0	48.0
Total Split (%)	45.5%	14.5%	60.0%	40.0%
Yellow Time (s)	5.2	3.2	5.2	5.2
All-Red Time (s)	1.0	1.0	1.0	1.0
Lost Time Adjust (s)	0.0	0.0	0.0	0.0
Total Lost Time (s)	6.2	4.2	6.2	6.2
Lead/Lag	Lag	Lead		
Lead-Lag Optimize?	Yes	Yes		
Recall Mode	None	None	None	None
Act Effct Green (s)	49.0	12.6	65.8	41.8
Actuated g/C Ratio	0.41	0.10	0.55	0.35
v/c Ratio	0.86	0.80	1.40	1.47
Control Delay	37.7	69.2	209.3	246.2
Queue Delay	0.0	0.0	0.0	0.0
Total Delay	37.7	69.2	209.3	246.2
LOS	D	E	F	F
Approach Delay	37.7		199.8	246.2
Approach LOS	D		F	F

Intersection Summary

Cycle Length: 120
 Actuated Cycle Length: 120
 Natural Cycle: 130
 Control Type: Actuated-Uncoordinated
 Maximum v/c Ratio: 1.47
 Intersection Signal Delay: 180.7
 Intersection LOS: F
 Intersection Capacity Utilization 124.5%
 ICU Level of Service H
 Analysis Period (min) 15

Splits and Phases: 5: Trautwein Rd. & Alessandro Bl.

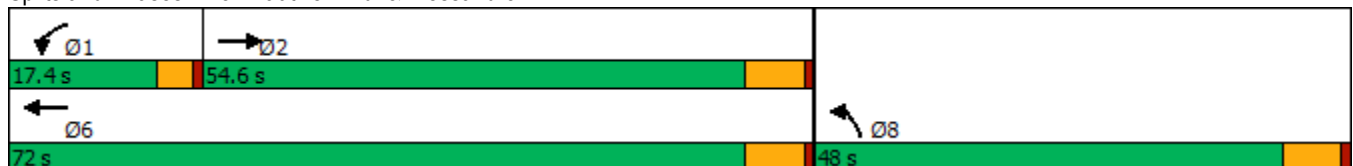

HCM 6th Signalized Intersection Summary
5: Trautwein Rd. & Alessandro Bl.

West Campus Upper Plateau (JN 14064)
09/19/2022

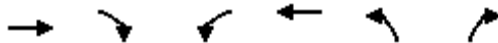

Movement	EBT	EBR	WBL	WBT	NBL	NBR
Lane Configurations	↑↑↑		↵↵	↑↑↑	↵↵↵	
Traffic Volume (veh/h)	1358	229	261	3594	2257	88
Future Volume (veh/h)	1358	229	261	3594	2257	88
Initial Q (Qb), veh	0	0	0	0	0	0
Ped-Bike Adj(A_pbT)		1.00	1.00		1.00	1.00
Parking Bus, Adj	1.00	1.00	1.00	1.00	1.00	1.00
Work Zone On Approach	No			No	No	
Adj Sat Flow, veh/h/ln	1870	1900	1870	1885	1885	1885
Adj Flow Rate, veh/h	1492	252	287	3949	2571	0
Peak Hour Factor	0.91	0.91	0.91	0.91	0.91	0.91
Percent Heavy Veh, %	2	0	2	1	1	1
Cap, veh/h	1823	307	342	2822	1876	557
Arrive On Green	0.41	0.41	0.10	0.55	0.35	0.00
Sat Flow, veh/h	4568	742	3456	5316	5386	1598
Grp Volume(v), veh/h	1154	590	287	3949	2571	0
Grp Sat Flow(s),veh/h/ln	1702	1737	1728	1716	1795	1598
Q Serve(g_s), s	36.0	36.2	9.8	65.8	41.8	0.0
Cycle Q Clear(g_c), s	36.0	36.2	9.8	65.8	41.8	0.0
Prop In Lane		0.43	1.00		1.00	1.00
Lane Grp Cap(c), veh/h	1410	720	342	2822	1876	557
V/C Ratio(X)	0.82	0.82	0.84	1.40	1.37	0.00
Avail Cap(c_a), veh/h	1410	720	380	2822	1876	557
HCM Platoon Ratio	1.00	1.00	1.00	1.00	1.00	1.00
Upstream Filter(I)	1.00	1.00	1.00	1.00	1.00	0.00
Uniform Delay (d), s/veh	31.1	31.2	53.1	27.1	39.1	0.0
Incr Delay (d2), s/veh	4.1	7.8	12.8	181.9	170.1	0.0
Initial Q Delay(d3),s/veh	0.0	0.0	0.0	0.0	0.0	0.0
%ile BackOfQ(50%),veh/ln	14.5	15.6	4.7	70.6	46.8	0.0
Unsig. Movement Delay, s/veh						
LnGrp Delay(d),s/veh	35.2	39.0	65.9	209.0	209.2	0.0
LnGrp LOS	D	D	E	F	F	A
Approach Vol, veh/h	1744			4236	2571	
Approach Delay, s/veh	36.5			199.3	209.2	
Approach LOS	D			F	F	
Timer - Assigned Phs	1	2			6	8
Phs Duration (G+Y+Rc), s	16.1	55.9			72.0	48.0
Change Period (Y+Rc), s	* 4.2	6.2			6.2	6.2
Max Green Setting (Gmax), s	* 13	48.4			65.8	41.8
Max Q Clear Time (g_c+I1), s	11.8	38.2			67.8	43.8
Green Ext Time (p_c), s	0.1	8.3			0.0	0.0

Intersection Summary

HCM 6th Ctrl Delay	169.1
HCM 6th LOS	F

















Notes

User approved volume balancing among the lanes for turning movement.
* HCM 6th computational engine requires equal clearance times for the phases crossing the barrier.

Timings
6: Trautwein Rd. & Grove Community Dr

West Campus Upper Plateau (JN 14064)

09/19/2022

						
Lane Group	WBL	WBR	NBT	NBR	SBL	SBT
Lane Configurations		 	 		 	 
Traffic Volume (vph)	88	698	1923	28	241	1510
Future Volume (vph)	88	698	1923	28	241	1510
Turn Type	Prot	pm+ov	NA	Perm	Prot	NA
Protected Phases	8	1	2		1	6
Permitted Phases		8		2		
Detector Phase	8	1	2	2	1	6
Switch Phase						
Minimum Initial (s)	10.0	5.0	10.0	10.0	5.0	10.0
Minimum Split (s)	34.6	9.6	46.2	46.2	9.6	28.2
Total Split (s)	34.6	15.2	70.2	70.2	15.2	85.4
Total Split (%)	28.8%	12.7%	58.5%	58.5%	12.7%	71.2%
Yellow Time (s)	3.6	3.6	5.2	5.2	3.6	5.2
All-Red Time (s)	1.0	1.0	1.0	1.0	1.0	1.0
Lost Time Adjust (s)	0.0	0.0	0.0	0.0	0.0	0.0
Total Lost Time (s)	4.6	4.6	6.2	6.2	4.6	6.2
Lead/Lag		Lead	Lag	Lag	Lead	
Lead-Lag Optimize?		Yes	Yes	Yes	Yes	
Recall Mode	None	None	None	None	None	None
Act Effct Green (s)	14.1	24.7	64.2	64.2	10.6	79.5
Actuated g/C Ratio	0.14	0.24	0.61	0.61	0.10	0.76
v/c Ratio	0.44	1.27	1.05	0.04	0.83	0.68
Control Delay	46.5	168.0	56.8	7.0	67.3	8.8
Queue Delay	0.0	0.0	0.0	0.0	0.0	0.0
Total Delay	46.5	168.0	56.8	7.0	67.3	8.8
LOS	D	F	E	A	E	A
Approach Delay	154.4		56.1			16.8
Approach LOS	F		E			B

Intersection Summary

Cycle Length: 120
 Actuated Cycle Length: 104.4
 Natural Cycle: 125
 Control Type: Actuated-Uncoordinated
 Maximum v/c Ratio: 1.27
 Intersection Signal Delay: 58.0
 Intersection LOS: E
 Intersection Capacity Utilization 86.8%
 ICU Level of Service E
 Analysis Period (min) 15

Splits and Phases: 6: Trautwein Rd. & Grove Community Dr



HCM 6th Signalized Intersection Summary
6: Trautwein Rd. & Grove Community Dr

West Campus Upper Plateau (JN 14064)

09/19/2022



Movement	WBL	WBR	NBT	NBR	SBL	SBT
Lane Configurations	↶	↶↶	↶↶	↶	↶↶	↶↶
Traffic Volume (veh/h)	88	698	1923	28	241	1510
Future Volume (veh/h)	88	698	1923	28	241	1510
Initial Q (Qb), veh	0	0	0	0	0	0
Ped-Bike Adj(A_pbT)	1.00	1.00		0.97	1.00	
Parking Bus, Adj	1.00	1.00	1.00	1.00	1.00	1.00
Work Zone On Approach	No		No			No
Adj Sat Flow, veh/h/ln	1900	1885	1885	1900	1870	1870
Adj Flow Rate, veh/h	106	639	2317	26	290	1819
Peak Hour Factor	0.83	0.83	0.83	0.83	0.83	0.83
Percent Heavy Veh, %	0	1	1	0	2	2
Cap, veh/h	415	900	1963	860	314	2411
Arrive On Green	0.23	0.23	0.55	0.55	0.09	0.68
Sat Flow, veh/h	1810	2812	3676	1570	3456	3647
Grp Volume(v), veh/h	106	639	2317	26	290	1819
Grp Sat Flow(s),veh/h/ln	1810	1406	1791	1570	1728	1777
Q Serve(g_s), s	5.6	23.4	64.0	0.9	9.7	39.4
Cycle Q Clear(g_c), s	5.6	23.4	64.0	0.9	9.7	39.4
Prop In Lane	1.00	1.00		1.00	1.00	
Lane Grp Cap(c), veh/h	415	900	1963	860	314	2411
V/C Ratio(X)	0.26	0.71	1.18	0.03	0.92	0.75
Avail Cap(c_a), veh/h	465	978	1963	860	314	2411
HCM Platoon Ratio	1.00	1.00	1.00	1.00	1.00	1.00
Upstream Filter(I)	1.00	1.00	1.00	1.00	1.00	1.00
Uniform Delay (d), s/veh	36.8	34.9	26.4	12.1	52.7	12.4
Incr Delay (d2), s/veh	0.3	2.2	86.7	0.0	31.4	1.4
Initial Q Delay(d3),s/veh	0.0	0.0	0.0	0.0	0.0	0.0
%ile BackOfQ(50%),veh/ln	2.5	8.1	47.3	0.3	5.4	12.8
Unsig. Movement Delay, s/veh						
LnGrp Delay(d),s/veh	37.2	37.1	113.1	12.1	84.1	13.8
LnGrp LOS	D	D	F	B	F	B
Approach Vol, veh/h	745		2343			2109
Approach Delay, s/veh	37.1		111.9			23.4
Approach LOS	D		F			C
Timer - Assigned Phs	1	2			6	8
Phs Duration (G+Y+Rc), s	15.2	70.2			85.4	31.4
Change Period (Y+Rc), s	4.6	6.2			6.2	4.6
Max Green Setting (Gmax), s	10.6	64.0			79.2	30.0
Max Q Clear Time (g_c+1), s	11.7	66.0			41.4	25.4
Green Ext Time (p_c), s	0.0	0.0			18.8	1.4

Intersection Summary

HCM 6th Ctrl Delay			65.3			
HCM 6th LOS			E			

Timings

West Campus Upper Plateau (JN 14064)

7: Trautwein Rd. & Orange Terrace Pkwy

09/19/2022



Lane Group	EBL	EBT	WBL	WBT	WBR	NBL	NBT	NBR	SBL	SBT	SBR
Lane Configurations											
Traffic Volume (vph)	77	73	333	114	566	62	1388	277	447	1169	23
Future Volume (vph)	77	73	333	114	566	62	1388	277	447	1169	23
Turn Type	Prot	NA	Prot	NA	pm+ov	Prot	NA	Perm	Prot	NA	Perm
Protected Phases	7	4	3	8	1	5	2		1	6	
Permitted Phases					8			2			6
Detector Phase	7	4	3	8	1	5	2	2	1	6	6
Switch Phase											
Minimum Initial (s)	5.0	10.0	5.0	10.0	5.0	5.0	10.0	10.0	5.0	10.0	10.0
Minimum Split (s)	9.6	38.6	9.6	34.6	9.6	9.6	46.2	46.2	9.6	24.2	24.2
Total Split (s)	17.2	38.6	25.4	46.8	19.0	14.4	47.0	47.0	19.0	51.6	51.6
Total Split (%)	13.2%	29.7%	19.5%	36.0%	14.6%	11.1%	36.2%	36.2%	14.6%	39.7%	39.7%
Yellow Time (s)	3.6	3.6	3.6	3.6	3.6	3.6	5.2	5.2	3.6	5.2	5.2
All-Red Time (s)	1.0	1.0	1.0	1.0	1.0	1.0	1.0	1.0	1.0	1.0	1.0
Lost Time Adjust (s)	0.0	0.0	0.0	0.0	0.0	0.0	0.0	0.0	0.0	0.0	0.0
Total Lost Time (s)	4.6	4.6	4.6	4.6	4.6	4.6	6.2	6.2	4.6	6.2	6.2
Lead/Lag	Lead	Lag	Lead	Lag	Lead	Lead	Lag	Lag	Lead	Lag	Lag
Lead-Lag Optimize?	Yes	Yes	Yes	Yes	Yes	Yes	Yes	Yes	Yes	Yes	Yes
Recall Mode	None	None	None	None	None	None	None	None	None	None	None
Act Effct Green (s)	9.5	15.3	20.9	26.6	41.1	8.2	41.0	41.0	14.5	49.4	49.4
Actuated g/C Ratio	0.08	0.14	0.19	0.24	0.37	0.07	0.37	0.37	0.13	0.44	0.44
v/c Ratio	0.60	0.46	1.19	0.30	0.62	0.57	1.28	0.50	1.21	0.88	0.04
Control Delay	67.0	44.1	150.5	36.9	22.8	69.1	165.6	20.2	155.8	38.2	0.1
Queue Delay	0.0	0.0	0.0	0.0	0.0	0.0	0.0	0.0	0.0	0.0	0.0
Total Delay	67.0	44.1	150.5	36.9	22.8	69.1	165.6	20.2	155.8	38.2	0.1
LOS	E	D	F	D	C	E	F	C	F	D	A
Approach Delay		54.1		66.3			138.8			69.7	
Approach LOS		D		E			F			E	

Intersection Summary

Cycle Length: 130
 Actuated Cycle Length: 111.8
 Natural Cycle: 125
 Control Type: Actuated-Uncoordinated
 Maximum v/c Ratio: 1.28
 Intersection Signal Delay: 94.5
 Intersection LOS: F
 Intersection Capacity Utilization 89.1%
 ICU Level of Service E
 Analysis Period (min) 15



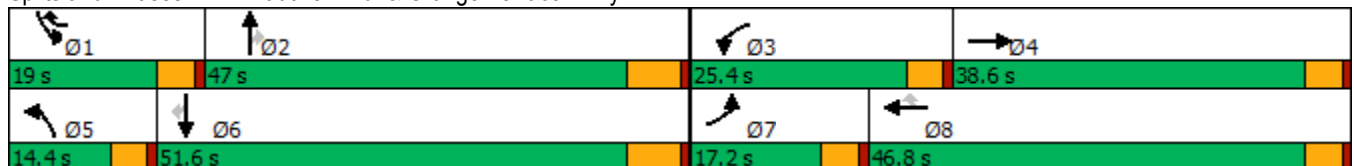



















Splits and Phases: 7: Trautwein Rd. & Orange Terrace Pkwy



HCM 6th Signalized Intersection Summary
7: Trautwein Rd. & Orange Terrace Pkwy

West Campus Upper Plateau (JN 14064)

09/19/2022

												
Movement	EBL	EBT	EBR	WBL	WBT	WBR	NBL	NBT	NBR	SBL	SBT	SBR
Lane Configurations												
Traffic Volume (veh/h)	77	73	27	333	114	566	62	1388	277	447	1169	23
Future Volume (veh/h)	77	73	27	333	114	566	62	1388	277	447	1169	23
Initial Q (Qb), veh	0	0	0	0	0	0	0	0	0	0	0	0
Ped-Bike Adj(A_pbT)	1.00		0.99	1.00		0.96	1.00		1.00	1.00		0.98
Parking Bus, Adj	1.00	1.00	1.00	1.00	1.00	1.00	1.00	1.00	1.00	1.00	1.00	1.00
Work Zone On Approach		No			No			No			No	
Adj Sat Flow, veh/h/ln	1900	1870	1900	1885	1885	1885	1870	1856	1870	1856	1885	1826
Adj Flow Rate, veh/h	92	87	27	396	136	489	74	1652	245	532	1392	19
Peak Hour Factor	0.84	0.84	0.84	0.84	0.84	0.84	0.84	0.84	0.84	0.84	0.84	0.84
Percent Heavy Veh, %	0	2	0	1	1	1	2	3	2	3	1	5
Cap, veh/h	117	171	53	340	472	1048	95	1310	588	450	1611	679
Arrive On Green	0.06	0.13	0.13	0.19	0.25	0.25	0.05	0.37	0.37	0.13	0.45	0.45
Sat Flow, veh/h	1810	1365	423	1795	1885	2710	1781	3526	1582	3428	3582	1510
Grp Volume(v), veh/h	92	0	114	396	136	489	74	1652	245	532	1392	19
Grp Sat Flow(s),veh/h/ln	1810	0	1788	1795	1885	1355	1781	1763	1582	1714	1791	1510
Q Serve(g_s), s	5.5	0.0	6.5	20.8	6.4	14.9	4.5	40.8	12.6	14.4	38.4	0.8
Cycle Q Clear(g_c), s	5.5	0.0	6.5	20.8	6.4	14.9	4.5	40.8	12.6	14.4	38.4	0.8
Prop In Lane	1.00		0.24	1.00		1.00	1.00		1.00	1.00		1.00
Lane Grp Cap(c), veh/h	117	0	224	340	472	1048	95	1310	588	450	1611	679
V/C Ratio(X)	0.79	0.00	0.51	1.16	0.29	0.47	0.78	1.26	0.42	1.18	0.86	0.03
Avail Cap(c_a), veh/h	208	0	554	340	725	1411	159	1310	588	450	1611	679
HCM Platoon Ratio	1.00	1.00	1.00	1.00	1.00	1.00	1.00	1.00	1.00	1.00	1.00	1.00
Upstream Filter(I)	1.00	0.00	1.00	1.00	1.00	1.00	1.00	1.00	1.00	1.00	1.00	1.00
Uniform Delay (d), s/veh	50.6	0.0	44.8	44.5	33.2	25.6	51.3	34.5	25.6	47.7	27.2	16.8
Incr Delay (d2), s/veh	4.4	0.0	1.8	101.2	0.3	0.3	5.2	123.6	0.5	103.0	5.2	0.0
Initial Q Delay(d3),s/veh	0.0	0.0	0.0	0.0	0.0	0.0	0.0	0.0	0.0	0.0	0.0	0.0
%ile BackOfQ(50%),veh/ln	2.6	0.0	3.0	18.4	2.9	4.6	2.1	38.5	4.6	12.3	16.0	0.3
Unsig. Movement Delay, s/veh												
LnGrp Delay(d),s/veh	55.0	0.0	46.6	145.7	33.6	25.9	56.5	158.1	26.1	150.7	32.4	16.9
LnGrp LOS	D	A	D	F	C	C	E	F	C	F	C	B
Approach Vol, veh/h		206			1021			1971			1943	
Approach Delay, s/veh		50.4			73.4			137.9			64.6	
Approach LOS		D			E			F			E	
Timer - Assigned Phs	1	2	3	4	5	6	7	8				
Phs Duration (G+Y+Rc), s	19.0	47.0	25.4	18.4	10.4	55.6	11.7	32.1				
Change Period (Y+Rc), s	4.6	6.2	4.6	4.6	4.6	6.2	4.6	4.6				
Max Green Setting (Gmax), s	14.4	40.8	20.8	34.0	9.8	45.4	12.6	42.2				
Max Q Clear Time (g_c+I1), s	16.4	42.8	22.8	8.5	6.5	40.4	7.5	16.9				
Green Ext Time (p_c), s	0.0	0.0	0.0	0.6	0.0	3.5	0.0	2.8				
Intersection Summary												
HCM 6th Ctrl Delay				93.9								
HCM 6th LOS				F								

Timings
8: Cole Av. & Van Buren Bl.

West Campus Upper Plateau (JN 14064)

09/19/2022



Lane Group	EBL	EBT	EBR	WBL	WBT	WBR	NBL	NBT	SBL	SBT	SBR
Lane Configurations	↔↔	↑↑	↗	↖	↑↑↑	↗	↖	↑↔	↗↖	↑↑	↗
Traffic Volume (vph)	419	1401	106	183	1834	525	247	676	482	534	342
Future Volume (vph)	419	1401	106	183	1834	525	247	676	482	534	342
Turn Type	Prot	NA	pm+ov	Prot	NA	pm+ov	Prot	NA	Prot	NA	pm+ov
Protected Phases	5	2	3	1	6	7	3	8	7	4	5
Permitted Phases			2			6					4
Detector Phase	5	2	3	1	6	7	3	8	7	4	5
Switch Phase											
Minimum Initial (s)	5.0	10.0	5.0	5.0	10.0	5.0	5.0	10.0	5.0	10.0	5.0
Minimum Split (s)	9.1	36.2	9.1	9.1	36.2	9.1	9.1	42.2	9.1	49.2	9.1
Total Split (s)	15.0	37.8	19.0	14.0	36.8	21.6	19.0	46.6	21.6	49.2	15.0
Total Split (%)	12.5%	31.5%	15.8%	11.7%	30.7%	18.0%	15.8%	38.8%	18.0%	41.0%	12.5%
Yellow Time (s)	3.2	5.2	3.2	3.2	5.2	3.2	3.2	5.2	3.2	5.2	3.2
All-Red Time (s)	0.5	1.0	0.5	0.5	1.0	0.5	0.5	1.0	0.5	1.0	0.5
Lost Time Adjust (s)	0.0	0.0	0.0	0.0	0.0	0.0	0.0	0.0	0.0	0.0	0.0
Total Lost Time (s)	3.7	6.2	3.7	3.7	6.2	3.7	3.7	6.2	3.7	6.2	3.7
Lead/Lag	Lead	Lag	Lead	Lead	Lag	Lead	Lead	Lag	Lead	Lag	Lead
Lead-Lag Optimize?	Yes	Yes	Yes	Yes	Yes	Yes	Yes	Yes	Yes	Yes	Yes
Recall Mode	None	None	None	None	None	None	None	None	None	None	None
Act Effct Green (s)	11.3	31.6	53.2	10.3	30.6	51.1	15.3	35.6	17.9	38.2	52.0
Actuated g/C Ratio	0.10	0.27	0.46	0.09	0.27	0.44	0.13	0.31	0.16	0.33	0.45
v/c Ratio	1.38	1.62	0.16	1.26	1.51	0.80	1.18	0.87	0.99	0.50	0.52
Control Delay	229.7	313.5	10.3	201.5	264.6	32.9	160.2	45.8	87.0	32.4	19.2
Queue Delay	0.0	0.0	0.0	0.0	0.0	0.0	0.0	0.0	0.0	0.0	0.0
Total Delay	229.7	313.5	10.3	201.5	264.6	32.9	160.2	45.8	87.0	32.4	19.2
LOS	F	F	B	F	F	C	F	D	F	C	B
Approach Delay		278.6			212.2			71.9		48.4	
Approach LOS		F			F			E		D	

Intersection Summary

Cycle Length: 120
 Actuated Cycle Length: 115.3
 Natural Cycle: 125
 Control Type: Actuated-Uncoordinated
 Maximum v/c Ratio: 1.62
 Intersection Signal Delay: 176.5
 Intersection LOS: F
 Intersection Capacity Utilization 103.7%
 ICU Level of Service G
 Analysis Period (min) 15



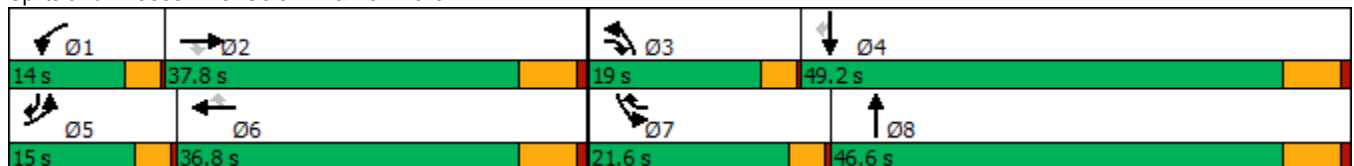



























Splits and Phases: 8: Cole Av. & Van Buren Bl.



HCM 6th Signalized Intersection Summary
8: Cole Av. & Van Buren Bl.

West Campus Upper Plateau (JN 14064)

09/19/2022

												
Movement	EBL	EBT	EBR	WBL	WBT	WBR	NBL	NBT	NBR	SBL	SBT	SBR
Lane Configurations	 	 			  			 		 	 	
Traffic Volume (veh/h)	419	1401	106	183	1834	525	247	676	161	482	534	342
Future Volume (veh/h)	419	1401	106	183	1834	525	247	676	161	482	534	342
Initial Q (Qb), veh	0	0	0	0	0	0	0	0	0	0	0	0
Ped-Bike Adj(A_pbT)	1.00		1.00	1.00		0.99	1.00		1.00	1.00		1.00
Parking Bus, Adj	1.00	1.00	1.00	1.00	1.00	1.00	1.00	1.00	1.00	1.00	1.00	1.00
Work Zone On Approach		No			No			No			No	
Adj Sat Flow, veh/h/ln	1870	1856	1841	1900	1870	1870	1856	1870	1870	1885	1885	1856
Adj Flow Rate, veh/h	466	1557	77	203	2038	493	274	751	170	536	593	308
Peak Hour Factor	0.90	0.90	0.90	0.90	0.90	0.90	0.90	0.90	0.90	0.90	0.90	0.90
Percent Heavy Veh, %	2	3	4	0	2	2	3	2	2	1	1	3
Cap, veh/h	344	981	644	164	1375	671	238	861	195	549	1154	662
Arrive On Green	0.10	0.28	0.28	0.09	0.27	0.27	0.13	0.30	0.30	0.16	0.32	0.32
Sat Flow, veh/h	3456	3526	1560	1810	5106	1565	1767	2878	651	3483	3582	1570
Grp Volume(v), veh/h	466	1557	77	203	2038	493	274	464	457	536	593	308
Grp Sat Flow(s),veh/h/ln	1728	1763	1560	1810	1702	1565	1767	1777	1752	1742	1791	1570
Q Serve(g_s), s	11.3	31.6	3.5	10.3	30.6	29.9	15.3	28.1	28.1	17.4	15.3	16.0
Cycle Q Clear(g_c), s	11.3	31.6	3.5	10.3	30.6	29.9	15.3	28.1	28.1	17.4	15.3	16.0
Prop In Lane	1.00		1.00	1.00		1.00	1.00		0.37	1.00		1.00
Lane Grp Cap(c), veh/h	344	981	644	164	1375	671	238	532	525	549	1154	662
V/C Ratio(X)	1.36	1.59	0.12	1.24	1.48	0.73	1.15	0.87	0.87	0.98	0.51	0.47
Avail Cap(c_a), veh/h	344	981	644	164	1375	671	238	632	623	549	1356	751
HCM Platoon Ratio	1.00	1.00	1.00	1.00	1.00	1.00	1.00	1.00	1.00	1.00	1.00	1.00
Upstream Filter(I)	1.00	1.00	1.00	1.00	1.00	1.00	1.00	1.00	1.00	1.00	1.00	1.00
Uniform Delay (d), s/veh	51.2	41.0	20.6	51.7	41.5	27.2	49.2	37.7	37.7	47.6	31.3	23.6
Incr Delay (d2), s/veh	178.0	269.3	0.1	148.1	220.8	4.5	105.3	11.2	11.4	32.3	0.4	0.5
Initial Q Delay(d3),s/veh	0.0	0.0	0.0	0.0	0.0	0.0	0.0	0.0	0.0	0.0	0.0	0.0
%ile BackOfQ(50%),veh/ln	13.2	49.6	1.2	11.2	40.2	11.1	13.4	13.1	13.0	9.7	6.3	5.6
Unsig. Movement Delay, s/veh												
LnGrp Delay(d),s/veh	229.2	310.3	20.7	199.7	262.3	31.8	154.4	49.0	49.1	79.9	31.6	24.1
LnGrp LOS	F	F	C	F	F	C	F	D	D	E	C	C
Approach Vol, veh/h		2100			2734			1195			1437	
Approach Delay, s/veh		281.7			216.0			73.2			48.0	
Approach LOS		F			F			E			D	
Timer - Assigned Phs	1	2	3	4	5	6	7	8				
Phs Duration (G+Y+Rc), s	14.0	37.8	19.0	42.8	15.0	36.8	21.6	40.2				
Change Period (Y+Rc), s	3.7	6.2	3.7	6.2	3.7	6.2	3.7	6.2				
Max Green Setting (Gmax), s	10.3	31.6	15.3	43.0	11.3	30.6	17.9	40.4				
Max Q Clear Time (g_c+I1), s	12.3	33.6	17.3	18.0	13.3	32.6	19.4	30.1				
Green Ext Time (p_c), s	0.0	0.0	0.0	4.8	0.0	0.0	0.0	3.8				
Intersection Summary												
HCM 6th Ctrl Delay				179.3								
HCM 6th LOS				F								

Intersection

Intersection Delay, s/veh	25.2
Intersection LOS	D

Movement	EBT	EBR	WBL	WBT	NBL	NBR
Lane Configurations	↻		↻	↻	↻	↻
Traffic Vol, veh/h	118	90	57	377	233	35
Future Vol, veh/h	118	90	57	377	233	35
Peak Hour Factor	0.76	0.76	0.76	0.76	0.76	0.76
Heavy Vehicles, %	2	1	2	2	0	0
Mvmt Flow	155	118	75	496	307	46
Number of Lanes	1	0	1	1	1	1

Approach	EB	WB	NB
Opposing Approach	WB	EB	
Opposing Lanes	2	1	0
Conflicting Approach Left		NB	EB
Conflicting Lanes Left	0	2	1
Conflicting Approach Right	NB		WB
Conflicting Lanes Right	2	0	2
HCM Control Delay	15	33.2	20.2
HCM LOS	B	D	C

Lane	NBLn1	NBLn2	EBLn1	WBLn1	WBLn2
Vol Left, %	100%	0%	0%	100%	0%
Vol Thru, %	0%	0%	57%	0%	100%
Vol Right, %	0%	100%	43%	0%	0%
Sign Control	Stop	Stop	Stop	Stop	Stop
Traffic Vol by Lane	233	35	208	57	377
LT Vol	233	0	0	57	0
Through Vol	0	0	118	0	377
RT Vol	0	35	90	0	0
Lane Flow Rate	307	46	274	75	496
Geometry Grp	7	7	4	7	7
Degree of Util (X)	0.627	0.079	0.477	0.141	0.863
Departure Headway (Hd)	7.367	6.145	6.277	6.775	6.266
Convergence, Y/N	Yes	Yes	Yes	Yes	Yes
Cap	487	580	569	527	575
Service Time	5.138	3.915	4.357	4.547	4.038
HCM Lane V/C Ratio	0.63	0.079	0.482	0.142	0.863
HCM Control Delay	21.8	9.4	15	10.7	36.6
HCM Lane LOS	C	A	B	B	E
HCM 95th-tile Q	4.2	0.3	2.6	0.5	9.5

Intersection

Intersection Delay, s/veh	101.4
Intersection LOS	F

Movement	EBL	EBT	EBR	WBL	WBT	WBR	NBL	NBT	NBR	SBL	SBT	SBR
Lane Configurations	↙	↕		↙	↕			↕			↕	
Traffic Vol, veh/h	252	501	47	4	634	58	179	44	7	94	35	42
Future Vol, veh/h	252	501	47	4	634	58	179	44	7	94	35	42
Peak Hour Factor	0.75	0.75	0.75	0.75	0.75	0.75	0.75	0.75	0.75	0.75	0.75	0.75
Heavy Vehicles, %	0	2	0	0	0	1	1	0	0	0	3	2
Mvmt Flow	336	668	63	5	845	77	239	59	9	125	47	56
Number of Lanes	1	2	0	1	2	0	0	1	0	0	1	0

Approach	EB	WB	NB	SB
Opposing Approach	WB	EB	SB	NB
Opposing Lanes	3	3	1	1
Conflicting Approach Left	SB	NB	EB	WB
Conflicting Lanes Left	1	1	3	3
Conflicting Approach Right	NB	SB	WB	EB
Conflicting Lanes Right	1	1	3	3
HCM Control Delay	69.1	168.3	60.7	34.7
HCM LOS	F	F	F	D

Lane	NBLn1	EBLn1	EBLn2	EBLn3	WBLn1	WBLn2	WBLn3	SBLn1
Vol Left, %	78%	100%	0%	0%	100%	0%	0%	55%
Vol Thru, %	19%	0%	100%	78%	0%	100%	78%	20%
Vol Right, %	3%	0%	0%	22%	0%	0%	22%	25%
Sign Control	Stop	Stop	Stop	Stop	Stop	Stop	Stop	Stop
Traffic Vol by Lane	230	252	334	214	4	423	269	171
LT Vol	179	252	0	0	4	0	0	94
Through Vol	44	0	334	167	0	423	211	35
RT Vol	7	0	0	47	0	0	58	42
Lane Flow Rate	307	336	445	285	5	564	359	228
Geometry Grp	7	7	7	7	7	7	7	7
Degree of Util (X)	0.89	0.875	1.102	0.691	0.014	1.447	0.908	0.67
Departure Headway (Hd)	11.239	9.817	9.322	9.123	10.114	9.584	9.443	11.487
Convergence, Y/N	Yes	Yes	Yes	Yes	Yes	Yes	Yes	Yes
Cap	325	373	392	399	356	383	388	317
Service Time	8.939	7.517	7.022	6.823	7.814	7.284	7.143	9.187
HCM Lane V/C Ratio	0.945	0.901	1.135	0.714	0.014	1.473	0.925	0.719
HCM Control Delay	60.7	52.6	106.7	29.9	13	240.7	56.9	34.7
HCM Lane LOS	F	F	F	D	B	F	F	D
HCM 95th-tile Q	8.4	8.5	15.3	5	0	28.2	9.4	4.5

Timings
11: Barton St & Alessandro Bl.

West Campus Upper Plateau (JN 14064)

09/19/2022



Lane Group	EBL	EBT	WBL	WBT	NBL	NBT	NBR	SBL	SBT	SBR
Lane Configurations	↙	↕	↙	↕		↕	↗		↕	↗
Traffic Volume (vph)	7	1804	41	3025	86	1	55	10	0	9
Future Volume (vph)	7	1804	41	3025	86	1	55	10	0	9
Turn Type	Prot	NA	Prot	NA	Perm	NA	Perm	Perm	NA	Perm
Protected Phases	5	2	1	6		8			4	
Permitted Phases					8		8	4		4
Detector Phase	5	2	1	6	8	8	8	4	4	4
Switch Phase										
Minimum Initial (s)	5.0	10.0	5.0	10.0	10.0	10.0	10.0	10.0	10.0	10.0
Minimum Split (s)	9.2	28.5	11.0	28.5	40.6	40.6	40.6	26.6	26.6	26.6
Total Split (s)	9.2	68.4	11.0	70.2	40.6	40.6	40.6	40.6	40.6	40.6
Total Split (%)	7.7%	57.0%	9.2%	58.5%	33.8%	33.8%	33.8%	33.8%	33.8%	33.8%
Yellow Time (s)	3.2	5.5	3.2	5.5	3.6	3.6	3.6	3.6	3.6	3.6
All-Red Time (s)	1.0	1.0	1.0	1.0	1.0	1.0	1.0	1.0	1.0	1.0
Lost Time Adjust (s)	0.0	0.0	0.0	0.0		0.0	0.0		0.0	0.0
Total Lost Time (s)	4.2	6.5	4.2	6.5		4.6	4.6		4.6	4.6
Lead/Lag	Lead	Lag	Lead	Lag						
Lead-Lag Optimize?	Yes	Yes	Yes	Yes						
Recall Mode	None	None	None	None	Max	Max	Max	Max	Max	Max
Act Effct Green (s)	5.0	61.6	6.3	68.4		36.0	36.0		36.0	36.0
Actuated g/C Ratio	0.04	0.53	0.05	0.58		0.31	0.31		0.31	0.31
v/c Ratio	0.11	0.73	0.45	1.07		0.21	0.11		0.03	0.02
Control Delay	59.0	23.7	69.6	62.6		32.7	5.6		30.3	0.1
Queue Delay	0.0	0.0	0.0	0.0		0.0	0.0		0.0	0.0
Total Delay	59.0	23.7	69.6	62.6		32.7	5.6		30.3	0.1
LOS	E	C	E	E		C	A		C	A
Approach Delay		23.8		62.7		22.3			16.0	
Approach LOS		C		E		C			B	

Intersection Summary

Cycle Length: 120
 Actuated Cycle Length: 117.3
 Natural Cycle: 125
 Control Type: Actuated-Uncoordinated
 Maximum v/c Ratio: 1.07
 Intersection Signal Delay: 47.2
 Intersection LOS: D
 Intersection Capacity Utilization 110.0%
 ICU Level of Service H
 Analysis Period (min) 15

Splits and Phases: 11: Barton St & Alessandro Bl.



HCM 6th Signalized Intersection Summary
11: Barton St & Alessandro Bl.

West Campus Upper Plateau (JN 14064)

09/19/2022



Movement	EBL	EBT	EBR	WBL	WBT	WBR	NBL	NBT	NBR	SBL	SBT	SBR
Lane Configurations	↖	↑↑↑		↖	↑↑↑			↑	↗		↑	↗
Traffic Volume (veh/h)	7	1804	51	41	3025	8	86	1	55	10	0	9
Future Volume (veh/h)	7	1804	51	41	3025	8	86	1	55	10	0	9
Initial Q (Qb), veh	0	0	0	0	0	0	0	0	0	0	0	0
Ped-Bike Adj(A_pbT)	1.00		0.98	1.00		1.00	1.00		1.00	1.00		1.00
Parking Bus, Adj	1.00	1.00	1.00	1.00	1.00	1.00	1.00	1.00	1.00	1.00	1.00	1.00
Work Zone On Approach		No			No			No			No	
Adj Sat Flow, veh/h/ln	1663	1870	1885	1900	1870	1678	1900	1900	1885	1426	1900	1307
Adj Flow Rate, veh/h	7	1879	50	43	3151	8	90	1	27	10	0	4
Peak Hour Factor	0.96	0.96	0.96	0.96	0.96	0.96	0.96	0.96	0.96	0.96	0.96	0.96
Percent Heavy Veh, %	16	2	1	0	2	15	0	0	1	32	0	40
Cap, veh/h	14	2685	71	58	2887	7	62	0	495	62	0	344
Arrive On Green	0.01	0.53	0.53	0.03	0.55	0.55	0.31	0.31	0.31	0.31	0.00	0.31
Sat Flow, veh/h	1584	5111	136	1810	5259	13	0	1	1596	0	0	1108
Grp Volume(v), veh/h	7	1251	678	43	2039	1120	91	0	27	10	0	4
Grp Sat Flow(s),veh/h/ln	1584	1702	1842	1810	1702	1868	1	0	1596	0	0	1108
Q Serve(g_s), s	0.5	32.0	32.1	2.7	63.7	63.7	0.0	0.0	1.4	0.0	0.0	0.3
Cycle Q Clear(g_c), s	0.5	32.0	32.1	2.7	63.7	63.7	36.0	0.0	1.4	36.0	0.0	0.3
Prop In Lane	1.00		0.07	1.00		0.01	0.99		1.00	1.00		1.00
Lane Grp Cap(c), veh/h	14	1789	968	58	1869	1026	62	0	495	62	0	344
V/C Ratio(X)	0.51	0.70	0.70	0.74	1.09	1.09	1.47	0.00	0.05	0.16	0.00	0.01
Avail Cap(c_a), veh/h	68	1816	983	106	1869	1026	62	0	495	62	0	344
HCM Platoon Ratio	1.00	1.00	1.00	1.00	1.00	1.00	1.00	1.00	1.00	1.00	1.00	1.00
Upstream Filter(I)	1.00	1.00	1.00	1.00	1.00	1.00	1.00	0.00	1.00	1.00	0.00	1.00
Uniform Delay (d), s/veh	57.3	20.6	20.7	55.6	26.2	26.2	57.8	0.0	28.1	58.0	0.0	27.7
Incr Delay (d2), s/veh	10.3	1.3	2.4	6.5	50.2	56.7	278.3	0.0	0.2	5.5	0.0	0.1
Initial Q Delay(d3),s/veh	0.0	0.0	0.0	0.0	0.0	0.0	0.0	0.0	0.0	0.0	0.0	0.0
%ile BackOfQ(50%),veh/ln	0.2	11.5	12.8	1.4	37.2	42.7	6.6	0.0	0.6	0.4	0.0	0.1
Unsig. Movement Delay, s/veh												
LnGrp Delay(d),s/veh	67.6	22.0	23.1	62.1	76.4	82.8	336.1	0.0	28.3	63.5	0.0	27.8
LnGrp LOS	E	C	C	E	F	F	F	A	C	E	A	C
Approach Vol, veh/h		1936			3202			118				14
Approach Delay, s/veh		22.5			78.5			265.6				53.3
Approach LOS		C			E			F				D
Timer - Assigned Phs	1	2		4	5	6		8				
Phs Duration (G+Y+Rc), s	7.9	67.5		40.6	5.2	70.2		40.6				
Change Period (Y+Rc), s	* 4.2	6.5		4.6	* 4.2	6.5		4.6				
Max Green Setting (Gmax), s	* 6.8	61.9		36.0	* 5	63.7		36.0				
Max Q Clear Time (g_c+I1), s	4.7	34.1		38.0	2.5	65.7		38.0				
Green Ext Time (p_c), s	0.0	19.6		0.0	0.0	0.0		0.0				

Intersection Summary

HCM 6th Ctrl Delay	62.0
HCM 6th LOS	E

Notes

* HCM 6th computational engine requires equal clearance times for the phases crossing the barrier.

Intersection

Int Delay, s/veh 1

Movement	EBL	EBT	WBT	WBR	SBL	SBR
Lane Configurations	↘	↑	↗		↘	
Traffic Vol, veh/h	39	114	423	15	5	11
Future Vol, veh/h	39	114	423	15	5	11
Conflicting Peds, #/hr	0	0	0	5	0	1
Sign Control	Free	Free	Free	Free	Stop	Stop
RT Channelized	-	None	-	None	-	None
Storage Length	100	-	-	-	0	-
Veh in Median Storage, #	-	0	0	-	0	-
Grade, %	-	0	0	-	0	-
Peak Hour Factor	72	72	72	72	72	72
Heavy Vehicles, %	0	2	1	0	0	0
Mvmt Flow	54	158	588	21	7	15

Major/Minor	Major1	Major2	Minor2
Conflicting Flow All	614	0	0
Stage 1	-	-	604
Stage 2	-	-	266
Critical Hdwy	4.1	-	6.4
Critical Hdwy Stg 1	-	-	5.4
Critical Hdwy Stg 2	-	-	5.4
Follow-up Hdwy	2.2	-	3.5
Pot Cap-1 Maneuver	975	-	325
Stage 1	-	-	550
Stage 2	-	-	783
Platoon blocked, %	-	-	-
Mov Cap-1 Maneuver	970	-	304
Mov Cap-2 Maneuver	-	-	304
Stage 1	-	-	516
Stage 2	-	-	779

Approach	EB	WB	SB
HCM Control Delay, s	2.3	0	14.2
HCM LOS			B

Minor Lane/Major Mvmt	EBL	EBT	WBT	WBR	SBLn1
Capacity (veh/h)	970	-	-	-	415
HCM Lane V/C Ratio	0.056	-	-	-	0.054
HCM Control Delay (s)	8.9	-	-	-	14.2
HCM Lane LOS	A	-	-	-	B
HCM 95th %tile Q(veh)	0.2	-	-	-	0.2

Intersection						
Int Delay, s/veh	45.1					
Movement	EBT	EBR	WBL	WBT	NBL	NBR
Lane Configurations	↑↑		↖	↑↑	↘	
Traffic Vol, veh/h	312	289	51	459	236	38
Future Vol, veh/h	312	289	51	459	236	38
Conflicting Peds, #/hr	0	0	0	0	0	0
Sign Control	Free	Free	Free	Free	Stop	Stop
RT Channelized	-	None	-	None	-	None
Storage Length	-	-	125	-	0	-
Veh in Median Storage, #	0	-	-	0	0	-
Grade, %	0	-	-	0	0	-
Peak Hour Factor	80	80	80	80	80	80
Heavy Vehicles, %	3	0	2	1	0	0
Mvmt Flow	390	361	64	574	295	48

Major/Minor	Major1	Major2	Minor1		
Conflicting Flow All	0	0	751	0	986
Stage 1	-	-	-	-	571
Stage 2	-	-	-	-	415
Critical Hdwy	-	-	4.14	-	6.8
Critical Hdwy Stg 1	-	-	-	-	5.8
Critical Hdwy Stg 2	-	-	-	-	5.8
Follow-up Hdwy	-	-	2.22	-	3.5
Pot Cap-1 Maneuver	-	-	854	- ~	248
Stage 1	-	-	-	-	534
Stage 2	-	-	-	-	641
Platoon blocked, %	-	-	-	-	-
Mov Cap-1 Maneuver	-	-	854	- ~	229
Mov Cap-2 Maneuver	-	-	-	- ~	229
Stage 1	-	-	-	-	534
Stage 2	-	-	-	-	593

Approach	EB	WB	NB
HCM Control Delay, s	0	1	226
HCM LOS			F

Minor Lane/Major Mvmt	NBLn1	EBT	EBR	WBL	WBT
Capacity (veh/h)	251	-	-	854	-
HCM Lane V/C Ratio	1.365	-	-	0.075	-
HCM Control Delay (s)	226	-	-	9.6	-
HCM Lane LOS	F	-	-	A	-
HCM 95th %tile Q(veh)	18.4	-	-	0.2	-

Notes
 ~: Volume exceeds capacity \$: Delay exceeds 300s +: Computation Not Defined *: All major volume in platoon

Timings

14: Barton Rd. & Van Buren Bl.

09/19/2022



Lane Group	EBL	EBT	WBL	WBT	NBL	NBT	NBR	SBL	SBT
Lane Configurations	↙	↑↔	↙	↑↑↔	↙↔	↑	↗	↙	↗
Traffic Volume (vph)	175	1725	290	2000	469	83	404	65	129
Future Volume (vph)	175	1725	290	2000	469	83	404	65	129
Turn Type	Prot	NA	Prot	NA	Prot	NA	Perm	Prot	NA
Protected Phases	5	2	1	6	3	8		7	4
Permitted Phases							8		
Detector Phase	5	2	1	6	3	8	8	7	4
Switch Phase									
Minimum Initial (s)	5.0	10.0	5.0	10.0	5.0	10.0	10.0	5.0	10.0
Minimum Split (s)	9.2	25.2	9.2	25.5	9.1	14.6	14.6	9.1	33.6
Total Split (s)	18.5	47.4	22.0	50.9	17.0	37.5	37.5	13.1	33.6
Total Split (%)	15.4%	39.5%	18.3%	42.4%	14.2%	31.3%	31.3%	10.9%	28.0%
Yellow Time (s)	3.2	5.2	3.2	5.5	3.6	3.6	3.6	3.6	3.6
All-Red Time (s)	1.0	1.0	1.0	1.0	0.5	1.0	1.0	0.5	1.0
Lost Time Adjust (s)	0.0	0.0	0.0	0.0	0.0	0.0	0.0	0.0	0.0
Total Lost Time (s)	4.2	6.2	4.2	6.5	4.1	4.6	4.6	4.1	4.6
Lead/Lag	Lead	Lag	Lead	Lag	Lead	Lag	Lag	Lead	Lag
Lead-Lag Optimize?	Yes	Yes	Yes	Yes	Yes	Yes	Yes	Yes	Yes
Recall Mode	None	None	None	None	None	None	None	None	None
Act Effct Green (s)	14.3	41.2	17.8	44.4	12.9	35.6	35.6	8.4	29.0
Actuated g/C Ratio	0.12	0.34	0.15	0.37	0.11	0.30	0.30	0.07	0.24
v/c Ratio	0.93	1.86	1.27	1.25	1.46	0.17	0.69	0.60	1.13
Control Delay	99.4	414.3	190.2	149.8	259.8	33.8	20.5	73.4	116.6
Queue Delay	0.0	0.0	0.0	0.0	0.0	0.0	0.0	0.0	0.0
Total Delay	99.4	414.3	190.2	149.8	259.8	33.8	20.5	73.4	116.6
LOS	F	F	F	F	F	C	C	E	F
Approach Delay		388.3		154.9		139.1			111.5
Approach LOS		F		F		F			F

Intersection Summary

Cycle Length: 120
 Actuated Cycle Length: 120
 Natural Cycle: 130
 Control Type: Actuated-Uncoordinated
 Maximum v/c Ratio: 1.86
 Intersection Signal Delay: 231.4
 Intersection Capacity Utilization 128.3%
 Analysis Period (min) 15
 Intersection LOS: F
 ICU Level of Service H



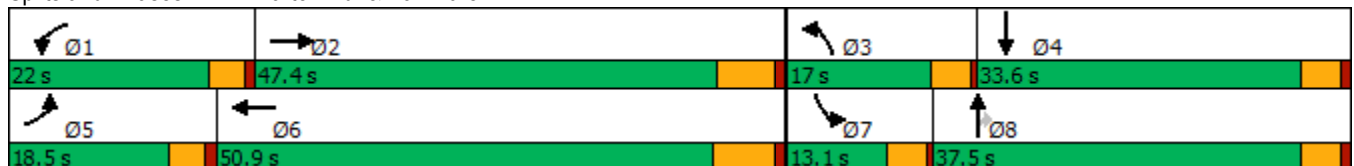



















Splits and Phases: 14: Barton Rd. & Van Buren Bl.



HCM 6th Signalized Intersection Summary
 14: Barton Rd. & Van Buren Bl.

West Campus Upper Plateau (JN 14064)

09/19/2022

												
Movement	EBL	EBT	EBR	WBL	WBT	WBR	NBL	NBT	NBR	SBL	SBT	SBR
Lane Configurations												
Traffic Volume (veh/h)	175	1725	215	290	2000	34	469	83	404	65	129	352
Future Volume (veh/h)	175	1725	215	290	2000	34	469	83	404	65	129	352
Initial Q (Qb), veh	0	0	0	0	0	0	0	0	0	0	0	0
Ped-Bike Adj(A_pbT)	1.00		1.00	1.00		1.00	1.00		1.00	1.00		1.00
Parking Bus, Adj	1.00	1.00	1.00	1.00	1.00	1.00	1.00	1.00	1.00	1.00	1.00	1.00
Work Zone On Approach		No			No			No			No	
Adj Sat Flow, veh/h/ln	1900	1870	1870	1870	1870	1752	1870	1885	1885	1900	1870	1900
Adj Flow Rate, veh/h	201	1983	234	333	2299	33	539	95	248	75	148	283
Peak Hour Factor	0.87	0.87	0.87	0.87	0.87	0.87	0.87	0.87	0.87	0.87	0.87	0.87
Percent Heavy Veh, %	0	2	2	2	2	10	2	1	1	0	2	0
Cap, veh/h	215	1099	127	264	1927	28	371	557	472	96	138	265
Arrive On Green	0.12	0.34	0.34	0.15	0.37	0.37	0.11	0.30	0.30	0.05	0.24	0.24
Sat Flow, veh/h	1810	3209	371	1781	5187	74	3456	1885	1598	1810	574	1098
Grp Volume(v), veh/h	201	1080	1137	333	1508	824	539	95	248	75	0	431
Grp Sat Flow(s),veh/h/ln	1810	1777	1804	1781	1702	1857	1728	1885	1598	1810	0	1673
Q Serve(g_s), s	13.2	41.2	41.2	17.8	44.7	44.7	12.9	4.5	15.6	4.9	0.0	29.0
Cycle Q Clear(g_c), s	13.2	41.2	41.2	17.8	44.7	44.7	12.9	4.5	15.6	4.9	0.0	29.0
Prop In Lane	1.00		0.21	1.00		0.04	1.00		1.00	1.00		0.66
Lane Grp Cap(c), veh/h	215	609	618	264	1265	690	371	557	472	96	0	403
V/C Ratio(X)	0.93	1.77	1.84	1.26	1.19	1.19	1.45	0.17	0.53	0.78	0.00	1.07
Avail Cap(c_a), veh/h	215	609	618	264	1265	690	371	557	472	135	0	403
HCM Platoon Ratio	1.00	1.00	1.00	1.00	1.00	1.00	1.00	1.00	1.00	1.00	1.00	1.00
Upstream Filter(I)	1.00	1.00	1.00	1.00	1.00	1.00	1.00	1.00	1.00	1.00	0.00	1.00
Uniform Delay (d), s/veh	52.5	39.6	39.6	51.3	37.8	37.8	53.7	31.5	35.4	56.3	0.0	45.7
Incr Delay (d2), s/veh	42.8	355.4	384.6	145.3	94.4	101.5	219.1	0.1	1.1	17.1	0.0	64.4
Initial Q Delay(d3),s/veh	0.0	0.0	0.0	0.0	0.0	0.0	0.0	0.0	0.0	0.0	0.0	0.0
%ile BackOfQ(50%),veh/ln	8.4	76.9	83.1	18.3	33.9	38.4	16.7	2.0	6.0	2.7	0.0	19.3
Unsig. Movement Delay, s/veh												
LnGrp Delay(d),s/veh	95.3	394.9	424.1	196.5	132.2	139.3	272.8	31.6	36.4	73.4	0.0	110.0
LnGrp LOS	F	F	F	F	F	F	F	C	D	E	A	F
Approach Vol, veh/h		2418			2665			882			506	
Approach Delay, s/veh		383.7			142.5			180.3			104.6	
Approach LOS		F			F			F			F	
Timer - Assigned Phs	1	2	3	4	5	6	7	8				
Phs Duration (G+Y+Rc), s	22.0	47.7	17.0	33.6	18.5	51.2	10.5	40.1				
Change Period (Y+Rc), s	* 4.2	* 6.5	4.1	4.6	* 4.2	6.5	4.1	4.6				
Max Green Setting (Gmax), s	* 18	* 41	12.9	29.0	* 14	44.4	9.0	32.9				
Max Q Clear Time (g_c+I1), s	19.8	43.2	14.9	31.0	15.2	46.7	6.9	17.6				
Green Ext Time (p_c), s	0.0	0.0	0.0	0.0	0.0	0.0	0.0	1.1				

Intersection Summary

HCM 6th Ctrl Delay	234.8
HCM 6th LOS	F

Notes

* HCM 6th computational engine requires equal clearance times for the phases crossing the barrier.

Timings
15: Airman Dr & Cactus Av.



Lane Group	WBL	WBR	NBR	SBL	Ø6
Lane Configurations	↖	↗	↖	↖↗	
Traffic Volume (vph)	331	443	99	133	
Future Volume (vph)	331	443	99	133	
Turn Type	Prot	Perm	Perm	Prot	
Protected Phases	3			1	6
Permitted Phases		8	2		
Detector Phase	3	8	2	1	
Switch Phase					
Minimum Initial (s)	5.0	10.0	10.0	5.0	10.0
Minimum Split (s)	9.6	26.7	26.7	9.6	14.7
Total Split (s)	68.0	68.0	32.0	20.0	52.0
Total Split (%)	56.7%	56.7%	26.7%	16.7%	43%
Yellow Time (s)	3.6	3.7	3.7	3.6	3.7
All-Red Time (s)	1.0	1.0	1.0	1.0	1.0
Lost Time Adjust (s)	0.0	0.0	0.0	0.0	
Total Lost Time (s)	4.6	4.7	4.7	4.6	
Lead/Lag			Lag	Lead	
Lead-Lag Optimize?			Yes	Yes	
Recall Mode	None	None	Min	None	Min
Act Effect Green (s)	16.4	16.3	12.4	7.2	
Actuated g/C Ratio	0.34	0.34	0.26	0.15	
v/c Ratio	0.62	0.59	0.10	0.30	
Control Delay	20.0	5.2	0.2	23.6	
Queue Delay	0.0	0.0	0.0	0.0	
Total Delay	20.0	5.2	0.2	23.6	
LOS	B	A	A	C	
Approach Delay	11.5				
Approach LOS	B				

Intersection Summary

Cycle Length: 120
 Actuated Cycle Length: 47.9
 Natural Cycle: 65
 Control Type: Actuated-Uncoordinated
 Maximum v/c Ratio: 0.62
 Intersection Signal Delay: 12.0
 Intersection LOS: B
 Intersection Capacity Utilization 34.4%
 ICU Level of Service A
 Analysis Period (min) 15



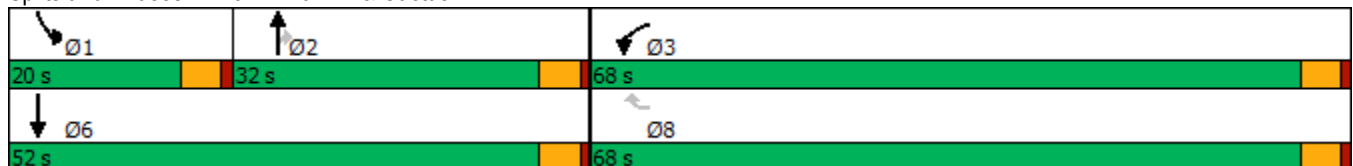









Splits and Phases: 15: Airman Dr & Cactus Av.



HCM 6th Signalized Intersection Summary
15: Airman Dr & Cactus Av.

West Campus Upper Plateau (JN 14064)

09/19/2022

						
Movement	WBL	WBR	NBT	NBR	SBL	SBT
Lane Configurations					 	
Traffic Volume (veh/h)	331	443	0	99	133	0
Future Volume (veh/h)	331	443	0	99	133	0
Initial Q (Qb), veh	0	0	0	0	0	0
Ped-Bike Adj(A_pbT)	1.00	1.00		1.00	1.00	
Parking Bus, Adj	1.00	1.00	1.00	1.00	1.00	1.00
Work Zone On Approach	No		No			No
Adj Sat Flow, veh/h/ln	1811	1752	1900	1811	1752	1900
Adj Flow Rate, veh/h	360	482	0	108	145	0
Peak Hour Factor	0.92	0.92	0.92	0.92	0.92	0.92
Percent Heavy Veh, %	6	10	0	6	10	0
Cap, veh/h	690	594	405	327	293	763
Arrive On Green	0.40	0.40	0.00	0.21	0.09	0.00
Sat Flow, veh/h	1725	1485	1900	1535	3237	1900
Grp Volume(v), veh/h	360	482	0	108	145	0
Grp Sat Flow(s),veh/h/ln	1725	1485	1900	1535	1618	1900
Q Serve(g_s), s	7.4	13.5	0.0	2.8	2.0	0.0
Cycle Q Clear(g_c), s	7.4	13.5	0.0	2.8	2.0	0.0
Prop In Lane	1.00	1.00		1.00	1.00	
Lane Grp Cap(c), veh/h	690	594	405	327	293	763
V/C Ratio(X)	0.52	0.81	0.00	0.33	0.50	0.00
Avail Cap(c_a), veh/h	2332	2007	1106	893	1063	1916
HCM Platoon Ratio	1.00	1.00	1.00	1.00	1.00	1.00
Upstream Filter(I)	1.00	1.00	0.00	1.00	1.00	0.00
Uniform Delay (d), s/veh	10.7	12.5	0.0	15.6	20.3	0.0
Incr Delay (d2), s/veh	0.6	2.7	0.0	0.6	0.5	0.0
Initial Q Delay(d3),s/veh	0.0	0.0	0.0	0.0	0.0	0.0
%ile BackOfQ(50%),veh/ln	2.4	4.0	0.0	0.9	0.7	0.0
Unsig. Movement Delay, s/veh						
LnGrp Delay(d),s/veh	11.3	15.2	0.0	16.2	20.8	0.0
LnGrp LOS	B	B	A	B	C	A
Approach Vol, veh/h	842		108			145
Approach Delay, s/veh	13.5		16.2			20.8
Approach LOS	B		B			C
Timer - Assigned Phs	1	2			6	8
Phs Duration (G+Y+Rc), s	8.8	14.7			23.5	23.4
Change Period (Y+Rc), s	4.6	* 4.7			* 4.7	4.6
Max Green Setting (Gmax), s	15.4	* 27			* 47	63.4
Max Q Clear Time (g_c+I1), s	4.0	4.8			0.0	15.5
Green Ext Time (p_c), s	0.2	0.3			0.0	3.2

Intersection Summary

HCM 6th Ctrl Delay	14.8
HCM 6th LOS	B

Notes

* HCM 6th computational engine requires equal clearance times for the phases crossing the barrier.

Intersection

Intersection Delay, s/veh	13
Intersection LOS	B

Movement	EBT	EBR	WBL	WBT	NBL	NBR
Lane Configurations						
Traffic Vol, veh/h	66	59	106	270	155	70
Future Vol, veh/h	66	59	106	270	155	70
Peak Hour Factor	0.76	0.76	0.76	0.76	0.76	0.76
Heavy Vehicles, %	4	0	0	2	2	2
Mvmt Flow	87	78	139	355	204	92
Number of Lanes	1	0	1	1	1	0

Approach	EB	WB	NB
Opposing Approach	WB	EB	
Opposing Lanes	2	1	0
Conflicting Approach Left		NB	EB
Conflicting Lanes Left	0	1	1
Conflicting Approach Right	NB		WB
Conflicting Lanes Right	1	0	2
HCM Control Delay	10.1	13.9	13
HCM LOS	B	B	B

Lane	NBLn1	EBLn1	WBLn1	WBLn2
Vol Left, %	69%	0%	100%	0%
Vol Thru, %	0%	53%	0%	100%
Vol Right, %	31%	47%	0%	0%
Sign Control	Stop	Stop	Stop	Stop
Traffic Vol by Lane	225	125	106	270
LT Vol	155	0	106	0
Through Vol	0	66	0	270
RT Vol	70	59	0	0
Lane Flow Rate	296	164	139	355
Geometry Grp	2	5	7	7
Degree of Util (X)	0.454	0.243	0.236	0.555
Departure Headway (Hd)	5.525	5.326	6.091	5.62
Convergence, Y/N	Yes	Yes	Yes	Yes
Cap	657	674	590	643
Service Time	3.525	3.359	3.817	3.346
HCM Lane V/C Ratio	0.451	0.243	0.236	0.552
HCM Control Delay	13	10.1	10.7	15.2
HCM Lane LOS	B	B	B	C
HCM 95th-tile Q	2.4	0.9	0.9	3.4

Intersection	
Intersection Delay, s/veh	15.9
Intersection LOS	C

Movement	EBL	EBT	WBT	WBR	SBL	SBR
Lane Configurations						
Traffic Vol, veh/h	129	189	350	100	84	120
Future Vol, veh/h	129	189	350	100	84	120
Peak Hour Factor	0.71	0.71	0.71	0.71	0.71	0.71
Heavy Vehicles, %	0	2	0	2	1	1
Mvmt Flow	182	266	493	141	118	169
Number of Lanes	1	2	2	0	1	0

Approach	EB	WB	SB
Opposing Approach	WB	EB	
Opposing Lanes	2	3	0
Conflicting Approach Left SB			WB
Conflicting Lanes Left	1	0	2
Conflicting Approach Right		SB	EB
Conflicting Lanes Right	0	1	3
HCM Control Delay	11.5	18.1	17.8
HCM LOS	B	C	C

Lane	EBLn1	EBLn2	EBLn3	WBLn1	WBLn2	SBLn1
Vol Left, %	100%	0%	0%	0%	0%	41%
Vol Thru, %	0%	100%	100%	100%	54%	0%
Vol Right, %	0%	0%	0%	0%	46%	59%
Sign Control	Stop	Stop	Stop	Stop	Stop	Stop
Traffic Vol by Lane	129	95	95	233	217	204
LT Vol	129	0	0	0	0	84
Through Vol	0	95	95	233	117	0
RT Vol	0	0	0	0	100	120
Lane Flow Rate	182	133	133	329	305	287
Geometry Grp	7	7	7	8	8	7
Degree of Util (X)	0.354	0.242	0.176	0.611	0.542	0.549
Departure Headway (Hd)	7.012	6.536	4.766	6.693	6.398	6.873
Convergence, Y/N	Yes	Yes	Yes	Yes	Yes	Yes
Cap	511	546	745	536	562	523
Service Time	4.794	4.318	2.546	4.476	4.181	4.65
HCM Lane V/C Ratio	0.356	0.244	0.179	0.614	0.543	0.549
HCM Control Delay	13.6	11.4	8.6	19.5	16.6	17.8
HCM Lane LOS	B	B	A	C	C	C
HCM 95th-tile Q	1.6	0.9	0.6	4.1	3.2	3.3

Timings
18: Linebacker Dr & Cactus Av.

West Campus Upper Plateau (JN 14064)

09/19/2022

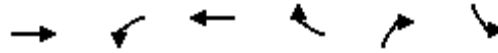

Lane Group	EBT	WBL	WBT	WBR	NBR	SBL	Ø3	Ø4	Ø5	Ø8
Lane Configurations	↑↑	↖	↑	↗	↗	↖↖				
Traffic Volume (vph)	232	277	774	277	84	84				
Future Volume (vph)	232	277	774	277	84	84				
Turn Type	NA	Prot	NA	Perm	pm+ov	Prot				
Protected Phases	2	1	6		1	7	3	4	5	8
Permitted Phases				6	8					
Detector Phase	2	1	6	6	1	7				
Switch Phase										
Minimum Initial (s)	10.0	5.0	10.0	10.0	5.0	5.0	5.0	10.0	5.0	10.0
Minimum Split (s)	27.0	9.6	26.1	26.1	9.6	9.6	9.6	27.0	9.6	27.0
Total Split (s)	27.4	16.0	33.8	33.8	16.0	9.6	9.6	27.0	9.6	27.0
Total Split (%)	34.3%	20.0%	42.3%	42.3%	20.0%	12.0%	12%	34%	12%	34%
Yellow Time (s)	4.0	3.6	4.0	4.0	3.6	3.6	3.6	4.0	3.6	4.0
All-Red Time (s)	1.0	1.0	1.0	1.0	1.0	1.0	1.0	1.0	1.0	1.0
Lost Time Adjust (s)	0.0	0.0	0.0	0.0	0.0	0.0				
Total Lost Time (s)	5.0	4.6	5.0	5.0	4.6	4.6				
Lead/Lag	Lag	Lead	Lag	Lag	Lead	Lead	Lead	Lag	Lead	Lag
Lead-Lag Optimize?	Yes	Yes	Yes	Yes	Yes	Yes	Yes	Yes	Yes	Yes
Recall Mode	None	None	None	None	None	None	None	None	None	None
Act Effct Green (s)	15.2	12.6	35.6	35.6	15.7	5.5				
Actuated g/C Ratio	0.32	0.27	0.76	0.76	0.34	0.12				
v/c Ratio	0.22	0.68	0.63	0.25	0.13	0.24				
Control Delay	15.0	31.7	12.5	2.3	0.4	26.0				
Queue Delay	0.0	0.0	0.0	0.0	0.0	0.0				
Total Delay	15.0	31.7	12.5	2.3	0.4	26.0				
LOS	B	C	B	A	A	C				
Approach Delay	15.0		14.4							
Approach LOS	B		B							

Intersection Summary

Cycle Length: 80
 Actuated Cycle Length: 46.8
 Natural Cycle: 90
 Control Type: Actuated-Uncoordinated
 Maximum v/c Ratio: 0.68
 Intersection Signal Delay: 14.3
 Intersection LOS: B
 Intersection Capacity Utilization 65.4%
 ICU Level of Service C
 Analysis Period (min) 15

Splits and Phases: 18: Linebacker Dr & Cactus Av.

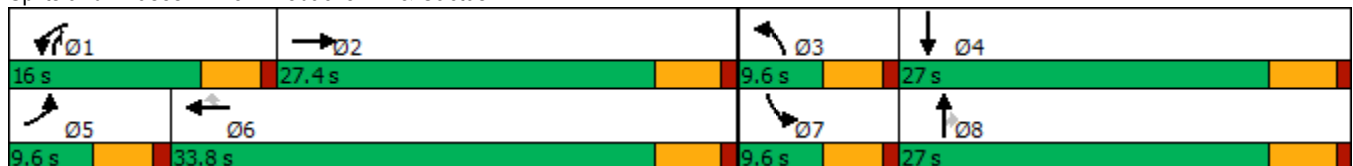

HCM 6th Signalized Intersection Summary
18: Linebacker Dr & Cactus Av.

West Campus Upper Plateau (JN 14064)

09/19/2022



Movement	EBL	EBT	EBR	WBL	WBT	WBR	NBL	NBT	NBR	SBL	SBT	SBR
Lane Configurations												
Traffic Volume (veh/h)	0	232	0	277	774	277	0	0	84	84	0	0
Future Volume (veh/h)	0	232	0	277	774	277	0	0	84	84	0	0
Initial Q (Qb), veh	0	0	0	0	0	0	0	0	0	0	0	0
Ped-Bike Adj(A_pbT)	1.00		1.00	1.00		1.00	1.00		1.00	1.00		1.00
Parking Bus, Adj	1.00	1.00	1.00	1.00	1.00	1.00	1.00	1.00	1.00	1.00	1.00	1.00
Work Zone On Approach		No			No			No			No	
Adj Sat Flow, veh/h/ln	1900	1767	1900	1752	1781	1752	1900	1900	1767	1752	1900	1900
Adj Flow Rate, veh/h	0	252	0	301	841	301	0	0	91	91	0	0
Peak Hour Factor	0.92	0.92	0.92	0.92	0.92	0.92	0.92	0.92	0.92	0.92	0.92	0.92
Percent Heavy Veh, %	0	9	0	10	8	10	0	0	9	10	0	0
Cap, veh/h	3	776	0	349	919	766	3	264	522	232	562	0
Arrive On Green	0.00	0.22	0.00	0.21	0.52	0.52	0.00	0.00	0.14	0.07	0.00	0.00
Sat Flow, veh/h	1810	3533	0	1668	1781	1485	1810	1900	1497	3337	1900	0
Grp Volume(v), veh/h	0	252	0	301	841	301	0	0	91	91	0	0
Grp Sat Flow(s),veh/h/ln	1810	1767	0	1668	1781	1485	1810	1900	1497	1668	1900	0
Q Serve(g_s), s	0.0	3.2	0.0	9.2	23.0	6.5	0.0	0.0	2.2	1.4	0.0	0.0
Cycle Q Clear(g_c), s	0.0	3.2	0.0	9.2	23.0	6.5	0.0	0.0	2.2	1.4	0.0	0.0
Prop In Lane	1.00		0.00	1.00		1.00	1.00		1.00	1.00		0.00
Lane Grp Cap(c), veh/h	3	776	0	349	919	766	3	264	522	232	562	0
V/C Ratio(X)	0.00	0.32	0.00	0.86	0.92	0.39	0.00	0.00	0.17	0.39	0.00	0.00
Avail Cap(c_a), veh/h	171	1492	0	359	967	806	171	788	935	315	788	0
HCM Platoon Ratio	1.00	1.00	1.00	1.00	1.00	1.00	1.00	1.00	1.00	1.00	1.00	1.00
Upstream Filter(I)	0.00	1.00	0.00	1.00	1.00	1.00	0.00	0.00	1.00	1.00	0.00	0.00
Uniform Delay (d), s/veh	0.0	17.4	0.0	20.2	11.8	7.8	0.0	0.0	12.0	23.6	0.0	0.0
Incr Delay (d2), s/veh	0.0	0.2	0.0	17.6	12.6	0.3	0.0	0.0	0.2	0.4	0.0	0.0
Initial Q Delay(d3),s/veh	0.0	0.0	0.0	0.0	0.0	0.0	0.0	0.0	0.0	0.0	0.0	0.0
%ile BackOfQ(50%),veh/ln	0.0	1.2	0.0	4.9	10.0	1.7	0.0	0.0	0.7	0.5	0.0	0.0
Unsig. Movement Delay, s/veh												
LnGrp Delay(d),s/veh	0.0	17.6	0.0	37.8	24.4	8.1	0.0	0.0	12.1	24.0	0.0	0.0
LnGrp LOS	A	B	A	D	C	A	A	A	B	C	A	A
Approach Vol, veh/h		252			1443			91			91	
Approach Delay, s/veh		17.6			23.8			12.1			24.0	
Approach LOS		B			C			B			C	
Timer - Assigned Phs	1	2	3	4	5	6	7	8				
Phs Duration (G+Y+Rc), s	15.7	16.7	0.0	20.7	0.0	32.4	8.3	12.4				
Change Period (Y+Rc), s	4.6	5.0	4.6	5.0	4.6	5.0	4.6	5.0				
Max Green Setting (Gmax), s	11.4	22.4	5.0	22.0	5.0	28.8	5.0	22.0				
Max Q Clear Time (g_c+I1), s	11.2	5.2	0.0	0.0	0.0	25.0	3.4	4.2				
Green Ext Time (p_c), s	0.0	1.4	0.0	0.0	0.0	2.4	0.0	0.2				

Intersection Summary

HCM 6th Ctrl Delay	22.4
HCM 6th LOS	C

Timings
19: Van Buren Bl. & Orange Terrace Pkwy.

West Campus Upper Plateau (JN 14064)

09/19/2022

Lane Group	EBL	EBT	EBR	WBL	WBT	WBR	NBL	NBT	NBR	SBL	SBT	SBR
Lane Configurations												
Traffic Volume (vph)	173	1844	215	133	2163	145	125	24	81	276	41	275
Future Volume (vph)	173	1844	215	133	2163	145	125	24	81	276	41	275
Turn Type	Prot	NA	Perm	Prot	NA	Perm	Prot	NA	Perm	Prot	NA	pm+ov
Protected Phases	5	2		1	6		3	8		7	4	5
Permitted Phases			2			6			8			4
Detector Phase	5	2	2	1	6	6	3	8	8	7	4	5
Switch Phase												
Minimum Initial (s)	5.0	10.0	10.0	5.0	10.0	10.0	5.0	5.0	5.0	10.0	10.0	5.0
Minimum Split (s)	9.2	25.2	25.2	9.1	25.2	25.2	9.1	26.1	26.1	15.8	24.8	9.2
Total Split (s)	16.0	62.8	62.8	9.1	55.9	55.9	9.1	26.1	26.1	22.0	39.0	16.0
Total Split (%)	13.3%	52.3%	52.3%	7.6%	46.6%	46.6%	7.6%	21.8%	21.8%	18.3%	32.5%	13.3%
Yellow Time (s)	3.2	5.2	5.2	3.6	5.2	5.2	3.6	3.6	3.6	4.8	4.8	3.2
All-Red Time (s)	1.0	1.0	1.0	0.5	1.0	1.0	0.5	0.5	0.5	1.0	1.0	1.0
Lost Time Adjust (s)	0.0	0.0	0.0	0.0	0.0	0.0	0.0	0.0	0.0	0.0	0.0	0.0
Total Lost Time (s)	4.2	6.2	6.2	4.1	6.2	6.2	4.1	4.1	4.1	5.8	5.8	4.2
Lead/Lag	Lead	Lag	Lag	Lead	Lag	Lag	Lead	Lag	Lag	Lead	Lag	Lead
Lead-Lag Optimize?	Yes	Yes	Yes	Yes	Yes	Yes	Yes	Yes	Yes	Yes	Yes	Yes
Recall Mode	None	None	None	None	None	None	None	None	None	None	None	None
Act Effct Green (s)	10.8	56.1	56.1	5.0	50.2	50.2	10.2	6.3	6.3	13.3	13.9	21.4
Actuated g/C Ratio	0.11	0.57	0.57	0.05	0.51	0.51	0.10	0.06	0.06	0.13	0.14	0.22
v/c Ratio	0.47	0.67	0.23	0.77	0.87	0.17	0.36	0.11	0.30	0.61	0.16	0.72
Control Delay	47.0	17.1	4.8	75.8	27.5	1.4	48.7	46.5	2.7	46.9	38.9	35.1
Queue Delay	0.0	0.0	0.0	0.0	0.0	0.0	0.0	0.0	0.0	0.0	0.0	0.0
Total Delay	47.0	17.1	4.8	75.8	27.5	1.4	48.7	46.5	2.7	46.9	38.9	35.1
LOS	D	B	A	E	C	A	D	D	A	D	D	D
Approach Delay		18.2			28.5			32.3			40.9	
Approach LOS		B			C			C			D	

Intersection Summary

Cycle Length: 120
 Actuated Cycle Length: 98.8
 Natural Cycle: 100
 Control Type: Actuated-Uncoordinated
 Maximum v/c Ratio: 0.87
 Intersection Signal Delay: 25.8
 Intersection LOS: C
 Intersection Capacity Utilization 75.4%
 ICU Level of Service D
 Analysis Period (min) 15

Splits and Phases: 19: Van Buren Bl. & Orange Terrace Pkwy.

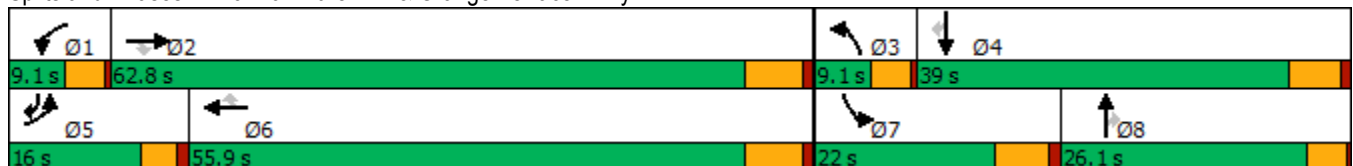

HCM 6th Signalized Intersection Summary
 19: Van Buren Bl. & Orange Terrace Pkwy.

West Campus Upper Plateau (JN 14064)

09/19/2022



Movement	EBL	EBT	EBR	WBL	WBT	WBR	NBL	NBT	NBR	SBL	SBT	SBR
Lane Configurations	↖↗	↑↑↑	↗	↖↗	↑↑↑	↗	↖↗	↑↑	↗	↖↗	↑	↗
Traffic Volume (veh/h)	173	1844	215	133	2163	145	125	24	81	276	41	275
Future Volume (veh/h)	173	1844	215	133	2163	145	125	24	81	276	41	275
Initial Q (Qb), veh	0	0	0	0	0	0	0	0	0	0	0	0
Ped-Bike Adj(A_pbT)	1.00		0.99	1.00		1.00	1.00		1.00	1.00		0.98
Parking Bus, Adj	1.00	1.00	1.00	1.00	1.00	1.00	1.00	1.00	1.00	1.00	1.00	1.00
Work Zone On Approach		No			No			No			No	
Adj Sat Flow, veh/h/ln	1885	1856	1870	1900	1856	1870	1900	1900	1826	1885	1900	1885
Adj Flow Rate, veh/h	178	1901	212	137	2230	108	129	25	57	285	42	171
Peak Hour Factor	0.97	0.97	0.97	0.97	0.97	0.97	0.97	0.97	0.97	0.97	0.97	0.97
Percent Heavy Veh, %	1	3	2	0	3	2	0	0	5	1	0	1
Cap, veh/h	252	2718	840	192	2623	821	192	217	93	381	253	324
Arrive On Green	0.07	0.54	0.54	0.05	0.52	0.52	0.05	0.06	0.06	0.11	0.13	0.13
Sat Flow, veh/h	3483	5066	1565	3510	5066	1585	3510	3610	1547	3483	1900	1565
Grp Volume(v), veh/h	178	1901	212	137	2230	108	129	25	57	285	42	171
Grp Sat Flow(s),veh/h/ln	1742	1689	1565	1755	1689	1585	1755	1805	1547	1742	1900	1565
Q Serve(g_s), s	4.6	25.5	6.6	3.5	34.7	3.2	3.3	0.6	3.3	7.3	1.8	8.9
Cycle Q Clear(g_c), s	4.6	25.5	6.6	3.5	34.7	3.2	3.3	0.6	3.3	7.3	1.8	8.9
Prop In Lane	1.00		1.00	1.00		1.00	1.00		1.00	1.00		1.00
Lane Grp Cap(c), veh/h	252	2718	840	192	2623	821	192	217	93	381	253	324
V/C Ratio(X)	0.71	0.70	0.25	0.71	0.85	0.13	0.67	0.12	0.61	0.75	0.17	0.53
Avail Cap(c_a), veh/h	449	3133	968	192	2751	861	192	868	372	617	689	684
HCM Platoon Ratio	1.00	1.00	1.00	1.00	1.00	1.00	1.00	1.00	1.00	1.00	1.00	1.00
Upstream Filter(I)	1.00	1.00	1.00	1.00	1.00	1.00	1.00	1.00	1.00	1.00	1.00	1.00
Uniform Delay (d), s/veh	41.5	15.7	11.4	42.6	19.0	11.4	42.5	40.7	42.0	39.5	35.1	32.4
Incr Delay (d2), s/veh	1.4	0.6	0.2	11.9	2.6	0.1	8.8	0.2	6.4	3.0	0.3	1.3
Initial Q Delay(d3),s/veh	0.0	0.0	0.0	0.0	0.0	0.0	0.0	0.0	0.0	0.0	0.0	0.0
%ile BackOfQ(50%),veh/ln	1.9	8.3	2.2	1.8	11.9	1.1	1.7	0.3	1.4	3.1	0.8	3.4
Unsig. Movement Delay, s/veh												
LnGrp Delay(d),s/veh	42.9	16.3	11.5	54.4	21.6	11.5	51.3	40.9	48.3	42.5	35.4	33.7
LnGrp LOS	D	B	B	D	C	B	D	D	D	D	D	C
Approach Vol, veh/h		2291			2475			211			498	
Approach Delay, s/veh		17.9			23.0			49.3			38.9	
Approach LOS		B			C			D			D	
Timer - Assigned Phs	1	2	3	4	5	6	7	8				
Phs Duration (G+Y+Rc), s	9.1	55.3	9.1	18.0	10.8	53.6	15.8	11.3				
Change Period (Y+Rc), s	4.1	6.2	4.1	5.8	* 4.2	6.2	5.8	* 5.8				
Max Green Setting (Gmax), s	5.0	56.6	5.0	33.2	* 12	49.7	16.2	* 22				
Max Q Clear Time (g_c+I1), s	5.5	27.5	5.3	10.9	6.6	36.7	9.3	5.3				
Green Ext Time (p_c), s	0.0	17.3	0.0	0.7	0.1	10.7	0.5	0.2				

Intersection Summary

HCM 6th Ctrl Delay	23.3
HCM 6th LOS	C

Notes

* HCM 6th computational engine requires equal clearance times for the phases crossing the barrier.

Timings
20: Brown/San Gorgonio Dr & Alessandro Bl.

West Campus Upper Plateau (JN 14064)

09/19/2022



Lane Group	EBL	EBT	WBL	WBT	WBR	NBL	NBR	SBL	SBT	SBR	Ø8
Lane Configurations	↖	↕	↖	↕	↖	↖	↖	↖	↕	↖	
Traffic Volume (vph)	35	1801	131	2915	57	45	51	33	1	18	
Future Volume (vph)	35	1801	131	2915	57	45	51	33	1	18	
Turn Type	Prot	NA	Prot	NA	Perm	Prot	pm+ov	Prot	NA	pm+ov	
Protected Phases	5	2	1	6		3	1	7	4	5	8
Permitted Phases					6		8				4
Detector Phase	5	2	1	6	6	3	1	7	4	5	
Switch Phase											
Minimum Initial (s)	5.0	10.0	5.0	10.0	10.0	5.0	5.0	5.0	10.0	5.0	5.0
Minimum Split (s)	8.7	43.5	9.1	43.5	43.5	9.1	9.1	8.7	49.8	8.7	26.1
Total Split (s)	8.7	51.9	9.2	52.4	52.4	9.1	9.2	10.8	49.8	8.7	48.1
Total Split (%)	7.3%	43.3%	7.7%	43.7%	43.7%	7.6%	7.7%	9.0%	41.5%	7.3%	40%
Yellow Time (s)	3.2	5.5	3.6	5.5	5.5	3.6	3.6	3.2	4.8	3.2	3.6
All-Red Time (s)	0.5	1.0	0.5	1.0	1.0	0.5	0.5	0.5	1.0	0.5	0.5
Lost Time Adjust (s)	0.0	0.0	0.0	0.0	0.0	0.0	0.0	0.0	0.0	0.0	0.0
Total Lost Time (s)	3.7	6.5	4.1	6.5	6.5	4.1	4.1	3.7	5.8	3.7	
Lead/Lag	Lead	Lag	Lead	Lag	Lag	Lead	Lead	Lead	Lag	Lead	Lag
Lead-Lag Optimize?	Yes	Yes	Yes	Yes	Yes	Yes	Yes	Yes	Yes	Yes	Yes
Recall Mode	None	None	None	None	None	None	None	None	None	None	None
Act Effct Green (s)	5.3	48.3	5.4	56.5	56.5	5.7	13.7	6.2	15.0	11.7	
Actuated g/C Ratio	0.07	0.63	0.07	0.73	0.73	0.07	0.18	0.08	0.20	0.15	
v/c Ratio	0.30	0.65	1.15	0.83	0.05	0.35	0.16	0.27	0.00	0.06	
Control Delay	48.3	15.2	166.9	18.2	1.5	48.6	5.1	46.2	25.0	0.4	
Queue Delay	0.0	0.0	0.0	0.0	0.0	0.0	0.0	0.0	0.0	0.0	
Total Delay	48.3	15.2	166.9	18.2	1.5	48.6	5.1	46.2	25.0	0.4	
LOS	D	B	F	B	A	D	A	D	C	A	
Approach Delay		15.8		24.2					30.0		
Approach LOS		B		C					C		

Intersection Summary

Cycle Length: 120
 Actuated Cycle Length: 76.9
 Natural Cycle: 125
 Control Type: Actuated-Uncoordinated
 Maximum v/c Ratio: 1.15
 Intersection Signal Delay: 21.1
 Intersection LOS: C
 Intersection Capacity Utilization 82.6%
 ICU Level of Service E
 Analysis Period (min) 15

Splits and Phases: 20: Brown/San Gorgonio Dr & Alessandro Bl.

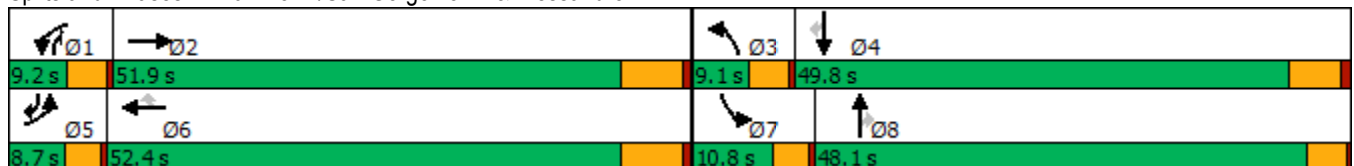

HCM 6th Signalized Intersection Summary
20: Brown/San Gorgonio Dr & Alessandro Bl.

West Campus Upper Plateau (JN 14064)

09/19/2022



Movement	EBL	EBT	EBR	WBL	WBT	WBR	NBL	NBT	NBR	SBL	SBT	SBR
Lane Configurations	↖	↕↕↕		↖	↕↕↕	↖	↖	↕	↖	↖	↕	↖
Traffic Volume (veh/h)	35	1801	155	131	2915	57	45	0	51	33	1	18
Future Volume (veh/h)	35	1801	155	131	2915	57	45	0	51	33	1	18
Initial Q (Qb), veh	0	0	0	0	0	0	0	0	0	0	0	0
Ped-Bike Adj(A_pbT)	1.00		0.98	1.00		1.00	1.00		1.00	1.00		1.00
Parking Bus, Adj	1.00	1.00	1.00	1.00	1.00	1.00	1.00	1.00	1.00	1.00	1.00	1.00
Work Zone On Approach		No			No			No			No	
Adj Sat Flow, veh/h/ln	1900	1870	1900	1811	1856	1781	1900	1900	1841	1693	670	1900
Adj Flow Rate, veh/h	37	1896	163	138	3068	60	47	0	51	35	1	5
Peak Hour Factor	0.95	0.95	0.95	0.95	0.95	0.95	0.95	0.95	0.95	0.95	0.95	0.95
Percent Heavy Veh, %	0	2	0	6	3	8	0	0	4	14	83	0
Cap, veh/h	63	2557	219	109	2877	857	73	227	285	54	72	230
Arrive On Green	0.03	0.53	0.53	0.06	0.57	0.57	0.04	0.00	0.12	0.03	0.11	0.11
Sat Flow, veh/h	1810	4781	409	1725	5066	1510	1810	1900	1560	1612	670	1610
Grp Volume(v), veh/h	37	1347	712	138	3068	60	47	0	51	35	1	5
Grp Sat Flow(s),veh/h/ln	1810	1702	1786	1725	1689	1510	1810	1900	1560	1612	670	1610
Q Serve(g_s), s	1.6	24.6	24.9	5.1	45.9	1.4	2.1	0.0	2.2	1.7	0.1	0.2
Cycle Q Clear(g_c), s	1.6	24.6	24.9	5.1	45.9	1.4	2.1	0.0	2.2	1.7	0.1	0.2
Prop In Lane	1.00		0.23	1.00		1.00	1.00		1.00	1.00		1.00
Lane Grp Cap(c), veh/h	63	1821	955	109	2877	857	73	227	285	54	72	230
V/C Ratio(X)	0.59	0.74	0.75	1.27	1.07	0.07	0.64	0.00	0.18	0.64	0.01	0.02
Avail Cap(c_a), veh/h	112	1912	1003	109	2877	857	112	1034	948	142	365	933
HCM Platoon Ratio	1.00	1.00	1.00	1.00	1.00	1.00	1.00	1.00	1.00	1.00	1.00	1.00
Upstream Filter(I)	1.00	1.00	1.00	1.00	1.00	1.00	1.00	0.00	1.00	1.00	1.00	1.00
Uniform Delay (d), s/veh	38.4	14.5	14.5	37.9	17.5	7.9	38.2	0.0	27.9	38.6	32.2	29.8
Incr Delay (d2), s/veh	3.2	1.6	3.2	174.5	37.8	0.0	9.1	0.0	0.3	4.7	0.1	0.0
Initial Q Delay(d3),s/veh	0.0	0.0	0.0	0.0	0.0	0.0	0.0	0.0	0.0	0.0	0.0	0.0
%ile BackOfQ(50%),veh/ln	0.7	7.6	8.4	7.4	25.2	0.4	1.1	0.0	0.8	0.7	0.0	0.1
Unsig. Movement Delay, s/veh												
LnGrp Delay(d),s/veh	41.6	16.1	17.8	212.4	55.2	7.9	47.3	0.0	28.2	43.3	32.3	29.8
LnGrp LOS	D	B	B	F	F	A	D	A	C	D	C	C
Approach Vol, veh/h		2096			3266			98				41
Approach Delay, s/veh		17.1			61.0			37.4				41.4
Approach LOS		B			E			D				D
Timer - Assigned Phs	1	2	3	4	5	6	7	8				
Phs Duration (G+Y+Rc), s	9.2	49.7	7.4	14.5	6.5	52.4	6.4	15.5				
Change Period (Y+Rc), s	4.1	6.5	4.1	5.8	3.7	6.5	3.7	* 5.8				
Max Green Setting (Gmax), s	5.1	45.4	5.0	44.0	5.0	45.9	7.1	* 44				
Max Q Clear Time (g_c+I1), s	7.1	26.9	4.1	2.2	3.6	47.9	3.7	4.2				
Green Ext Time (p_c), s	0.0	15.0	0.0	0.0	0.0	0.0	0.0	0.1				

Intersection Summary

HCM 6th Ctrl Delay	43.7
HCM 6th LOS	D

Notes

* HCM 6th computational engine requires equal clearance times for the phases crossing the barrier.

Timings
21: Cactus Av. & Brown St



Lane Group	EBL	EBT	WBT	SBR
Lane Configurations	↖	↑↑	↑↑	↗
Traffic Volume (vph)	102	299	983	344
Future Volume (vph)	102	299	983	344
Turn Type	Perm	NA	NA	Perm
Protected Phases		4	8	
Permitted Phases	4			6
Detector Phase	4	4	8	6
Switch Phase				
Minimum Initial (s)	5.0	5.0	5.0	5.0
Minimum Split (s)	26.1	26.1	26.1	26.1
Total Split (s)	26.1	26.1	26.1	26.1
Total Split (%)	50.0%	50.0%	50.0%	50.0%
Yellow Time (s)	3.6	3.6	3.6	3.6
All-Red Time (s)	0.5	0.5	0.5	0.5
Lost Time Adjust (s)	0.0	0.0	0.0	0.0
Total Lost Time (s)	4.1	4.1	4.1	4.1
Lead/Lag				
Lead-Lag Optimize?				
Recall Mode	None	None	None	Min
Act Effct Green (s)	19.1	19.1	19.1	14.3
Actuated g/C Ratio	0.45	0.45	0.45	0.34
v/c Ratio	0.62	0.22	0.72	0.65
Control Delay	31.0	8.2	13.8	16.9
Queue Delay	0.0	0.0	0.0	0.0
Total Delay	31.0	8.2	13.8	16.9
LOS	C	A	B	B
Approach Delay		14.0	13.8	
Approach LOS		B	B	

Intersection Summary

Cycle Length: 52.2
 Actuated Cycle Length: 42
 Natural Cycle: 60
 Control Type: Actuated-Uncoordinated
 Maximum v/c Ratio: 0.72
 Intersection Signal Delay: 14.4
 Intersection Capacity Utilization 55.3%
 Analysis Period (min) 15

Intersection LOS: B
 ICU Level of Service B

Splits and Phases: 21: Cactus Av. & Brown St

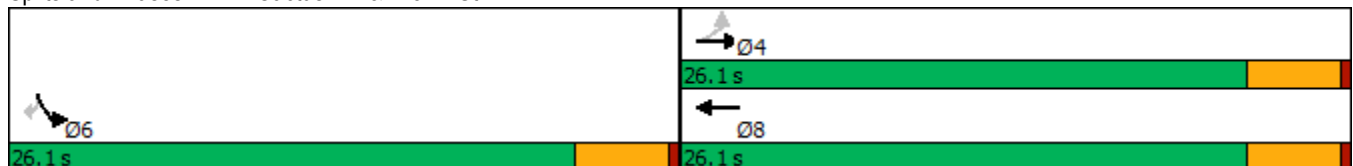

HCM 6th Signalized Intersection Summary
21: Cactus Av. & Brown St

West Campus Upper Plateau (JN 14064)
09/19/2022

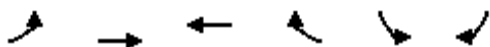

Movement	EBL	EBT	WBT	WBR	SBL	SBR
Lane Configurations	↖	↑↑	↗		↖	↗
Traffic Volume (veh/h)	102	299	983	0	0	344
Future Volume (veh/h)	102	299	983	0	0	344
Initial Q (Qb), veh	0	0	0	0	0	0
Ped-Bike Adj(A_pbT)	1.00			1.00	1.00	1.00
Parking Bus, Adj	1.00	1.00	1.00	1.00	1.00	1.00
Work Zone On Approach		No	No		No	
Adj Sat Flow, veh/h/ln	1900	1737	1737	1900	1900	1900
Adj Flow Rate, veh/h	111	325	1068	0	0	374
Peak Hour Factor	0.92	0.92	0.92	0.92	0.92	0.92
Percent Heavy Veh, %	0	11	11	0	0	0
Cap, veh/h	323	1657	1657	0	527	469
Arrive On Green	0.50	0.50	0.50	0.00	0.00	0.29
Sat Flow, veh/h	537	3387	3474	0	1810	1610
Grp Volume(v), veh/h	111	325	1068	0	0	374
Grp Sat Flow(s),veh/h/ln	537	1650	1650	0	1810	1610
Q Serve(g_s), s	7.6	2.2	9.4	0.0	0.0	8.5
Cycle Q Clear(g_c), s	17.1	2.2	9.4	0.0	0.0	8.5
Prop In Lane	1.00			0.00	1.00	1.00
Lane Grp Cap(c), veh/h	323	1657	1657	0	527	469
V/C Ratio(X)	0.34	0.20	0.64	0.00	0.00	0.80
Avail Cap(c_a), veh/h	351	1831	1831	0	1004	893
HCM Platoon Ratio	1.00	1.00	1.00	1.00	1.00	1.00
Upstream Filter(I)	1.00	1.00	1.00	0.00	0.00	1.00
Uniform Delay (d), s/veh	13.6	5.5	7.3	0.0	0.0	13.0
Incr Delay (d2), s/veh	0.6	0.1	0.7	0.0	0.0	3.2
Initial Q Delay(d3),s/veh	0.0	0.0	0.0	0.0	0.0	0.0
%ile BackOfQ(50%),veh/ln	0.7	0.4	1.7	0.0	0.0	2.8
Unsig. Movement Delay, s/veh						
LnGrp Delay(d),s/veh	14.2	5.5	8.0	0.0	0.0	16.1
LnGrp LOS	B	A	A	A	A	B
Approach Vol, veh/h		436	1068		374	
Approach Delay, s/veh		7.7	8.0		16.1	
Approach LOS		A	A		B	
Timer - Assigned Phs				4	6	8
Phs Duration (G+Y+Rc), s				24.0	15.7	24.0
Change Period (Y+Rc), s				4.1	4.1	4.1
Max Green Setting (Gmax), s				22.0	22.0	22.0
Max Q Clear Time (g_c+I1), s				19.1	10.5	11.4
Green Ext Time (p_c), s				0.8	1.0	5.0
Intersection Summary						
HCM 6th Ctrl Delay			9.5			
HCM 6th LOS			A			

Timings
22: Sycamore Canyon Bl. & Eastridge Ave

West Campus Upper Plateau (JN 14064)

09/19/2022



Lane Group	EBL	EBT	EBR	WBL	WBT	WBR	NBL	NBT	NBR	SBL	SBT	SBR
Lane Configurations	↖↖	↑↑↑	↗	↖↖	↑↑	↗	↖↖	↑↑	↗	↖↖	↑↑	↗
Traffic Volume (vph)	53	43	19	165	202	525	77	859	109	81	275	44
Future Volume (vph)	53	43	19	165	202	525	77	859	109	81	275	44
Turn Type	Prot	NA	Perm	Prot	NA	pm+ov	Prot	NA	pm+ov	Prot	NA	pm+ov
Protected Phases	5	2		1	6	7	3	8	1	7	4	5
Permitted Phases			2			6			8			4
Detector Phase	5	2	2	1	6	7	3	8	1	7	4	5
Switch Phase												
Minimum Initial (s)	5.0	10.0	10.0	5.0	10.0	5.0	5.0	10.0	5.0	5.0	10.0	5.0
Minimum Split (s)	8.7	43.5	43.5	8.7	43.5	8.7	8.7	15.8	8.7	8.7	49.8	8.7
Total Split (s)	9.9	47.0	47.0	11.0	48.1	21.0	10.5	41.0	11.0	21.0	51.5	9.9
Total Split (%)	8.3%	39.2%	39.2%	9.2%	40.1%	17.5%	8.8%	34.2%	9.2%	17.5%	42.9%	8.3%
Yellow Time (s)	3.2	5.5	5.5	3.2	5.5	3.2	3.2	4.8	3.2	3.2	4.8	3.2
All-Red Time (s)	0.5	1.0	1.0	0.5	1.0	0.5	0.5	1.0	0.5	0.5	1.0	0.5
Lost Time Adjust (s)	0.0	0.0	0.0	0.0	0.0	0.0	0.0	0.0	0.0	0.0	0.0	0.0
Total Lost Time (s)	3.7	6.5	6.5	3.7	6.5	3.7	3.7	5.8	3.7	3.7	5.8	3.7
Lead/Lag	Lead	Lag	Lag	Lead	Lag	Lead	Lead	Lag	Lead	Lead	Lag	Lead
Lead-Lag Optimize?	Yes	Yes	Yes	Yes	Yes	Yes	Yes	Yes	Yes	Yes	Yes	Yes
Recall Mode	None	None	None	None	None	None	None	None	None	None	None	None
Act Effct Green (s)	6.0	14.8	14.8	9.1	15.7	38.0	6.4	34.4	45.6	15.5	46.0	54.1
Actuated g/C Ratio	0.07	0.17	0.17	0.10	0.18	0.42	0.07	0.38	0.51	0.17	0.51	0.60
v/c Ratio	0.34	0.08	0.06	0.74	0.41	0.89	0.38	0.76	0.17	0.17	0.18	0.06
Control Delay	50.0	32.8	0.4	62.5	35.8	38.2	49.3	30.8	5.7	35.6	14.8	2.4
Queue Delay	0.0	0.0	0.0	0.0	0.0	0.0	0.0	0.0	0.0	0.0	0.0	0.0
Total Delay	50.0	32.8	0.4	62.5	35.8	38.2	49.3	30.8	5.7	35.6	14.8	2.4
LOS	D	C	A	E	D	D	D	C	A	D	B	A
Approach Delay		35.4			42.2			29.5			17.6	
Approach LOS		D			D			C			B	

Intersection Summary

Cycle Length: 120
 Actuated Cycle Length: 89.5
 Natural Cycle: 115
 Control Type: Actuated-Uncoordinated
 Maximum v/c Ratio: 0.89
 Intersection Signal Delay: 32.5
 Intersection LOS: C
 Intersection Capacity Utilization 71.9%
 ICU Level of Service C
 Analysis Period (min) 15

Splits and Phases: 22: Sycamore Canyon Bl. & Eastridge Ave

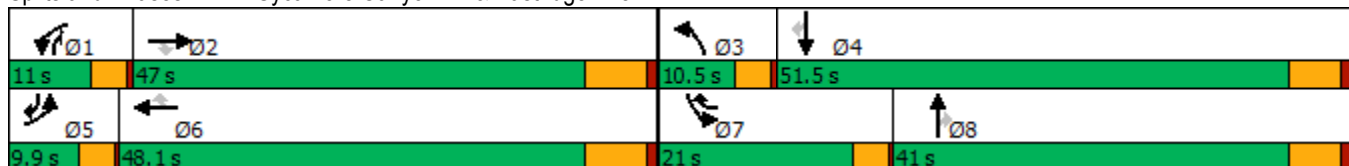

HCM 6th Signalized Intersection Summary
 22: Sycamore Canyon Bl. & Eastridge Ave

West Campus Upper Plateau (JN 14064)

09/19/2022



Movement	EBL	EBT	EBR	WBL	WBT	WBR	NBL	NBT	NBR	SBL	SBT	SBR
Lane Configurations	↖↗	↑↑↑	↖	↖↗	↑↑	↖	↖↗	↑↑	↖	↖↗	↑↑	↖
Traffic Volume (veh/h)	53	43	19	165	202	525	77	859	109	81	275	44
Future Volume (veh/h)	53	43	19	165	202	525	77	859	109	81	275	44
Initial Q (Qb), veh	0	0	0	0	0	0	0	0	0	0	0	0
Ped-Bike Adj(A_pbT)	1.00		1.00	1.00		1.00	1.00		0.99	1.00		0.99
Parking Bus, Adj	1.00	1.00	1.00	1.00	1.00	1.00	1.00	1.00	1.00	1.00	1.00	1.00
Work Zone On Approach		No			No			No			No	
Adj Sat Flow, veh/h/ln	1485	1352	1722	1337	1707	1811	1796	1811	1618	1767	1811	1589
Adj Flow Rate, veh/h	61	49	0	190	232	603	89	987	91	93	316	37
Peak Hour Factor	0.87	0.87	0.87	0.87	0.87	0.87	0.87	0.87	0.87	0.87	0.87	0.87
Percent Heavy Veh, %	28	37	12	38	13	6	7	6	19	9	6	21
Cap, veh/h	111	1345		178	1285	678	151	1110	536	150	1112	484
Arrive On Green	0.04	0.36	0.00	0.07	0.40	0.40	0.05	0.32	0.32	0.05	0.32	0.32
Sat Flow, veh/h	2744	3690	1459	2470	3244	1535	3319	3441	1354	3264	3441	1329
Grp Volume(v), veh/h	61	49	0	190	232	603	89	987	91	93	316	37
Grp Sat Flow(s),veh/h/ln	1372	1230	1459	1235	1622	1535	1659	1721	1354	1632	1721	1329
Q Serve(g_s), s	2.2	0.9	0.0	7.3	4.7	36.5	2.7	27.5	4.4	2.8	6.9	1.8
Cycle Q Clear(g_c), s	2.2	0.9	0.0	7.3	4.7	36.5	2.7	27.5	4.4	2.8	6.9	1.8
Prop In Lane	1.00		1.00	1.00		1.00	1.00		1.00	1.00		1.00
Lane Grp Cap(c), veh/h	111	1345		178	1285	678	151	1110	536	150	1112	484
V/C Ratio(X)	0.55	0.04		1.07	0.18	0.89	0.59	0.89	0.17	0.62	0.28	0.08
Avail Cap(c_a), veh/h	168	1478		178	1335	702	223	1198	570	558	1555	655
HCM Platoon Ratio	1.00	1.00	1.00	1.00	1.00	1.00	1.00	1.00	1.00	1.00	1.00	1.00
Upstream Filter(I)	1.00	1.00	0.00	1.00	1.00	1.00	1.00	1.00	1.00	1.00	1.00	1.00
Uniform Delay (d), s/veh	47.6	20.7	0.0	46.9	19.8	25.9	47.3	32.5	19.9	47.4	25.5	21.1
Incr Delay (d2), s/veh	1.6	0.0	0.0	85.8	0.1	13.5	1.4	8.1	0.1	1.6	0.1	0.1
Initial Q Delay(d3),s/veh	0.0	0.0	0.0	0.0	0.0	0.0	0.0	0.0	0.0	0.0	0.0	0.0
%ile BackOfQ(50%),veh/ln	0.7	0.2	0.0	4.3	1.7	14.6	1.1	11.9	1.3	1.1	2.7	0.6
Unsig. Movement Delay, s/veh												
LnGrp Delay(d),s/veh	49.2	20.7	0.0	132.8	19.9	39.4	48.7	40.6	20.0	49.0	25.7	21.1
LnGrp LOS	D	C		F	B	D	D	D	C	D	C	C
Approach Vol, veh/h		110			1025			1167			446	
Approach Delay, s/veh		36.5			52.3			39.6			30.1	
Approach LOS		D			D			D			C	
Timer - Assigned Phs	1	2	3	4	5	6	7	8				
Phs Duration (G+Y+Rc), s	11.0	43.4	8.3	38.5	7.8	46.6	8.3	38.4				
Change Period (Y+Rc), s	3.7	6.5	3.7	5.8	3.7	6.5	3.7	5.8				
Max Green Setting (Gmax), s	7.3	40.5	6.8	45.7	6.2	41.6	17.3	35.2				
Max Q Clear Time (g_c+I1), s	9.3	2.9	4.7	8.9	4.2	38.5	4.8	29.5				
Green Ext Time (p_c), s	0.0	0.3	0.0	2.1	0.0	1.6	0.1	3.1				

Intersection Summary

HCM 6th Ctrl Delay	42.7
HCM 6th LOS	D

Notes

Unsignalized Delay for [EBR] is excluded from calculations of the approach delay and intersection delay.

Timings
23: Sycamore Canyon Bl. & Cottonwood Ave

West Campus Upper Plateau (JN 14064)

09/19/2022



Lane Group	WBL	WBR	NBT	SBL	SBT
Lane Configurations	↙	↗	↕	↙	↕
Traffic Volume (vph)	25	39	1025	117	344
Future Volume (vph)	25	39	1025	117	344
Turn Type	Prot	Perm	NA	Prot	NA
Protected Phases	8		2	1	6
Permitted Phases		8			
Detector Phase	8	8	2	1	6
Switch Phase					
Minimum Initial (s)	10.0	10.0	10.0	5.0	10.0
Minimum Split (s)	15.8	15.8	43.5	9.1	43.5
Total Split (s)	55.0	55.0	52.0	13.0	65.0
Total Split (%)	45.8%	45.8%	43.3%	10.8%	54.2%
Yellow Time (s)	4.8	4.8	5.5	3.6	5.5
All-Red Time (s)	1.0	1.0	1.0	0.5	1.0
Lost Time Adjust (s)	0.0	0.0	0.0	0.0	0.0
Total Lost Time (s)	5.8	5.8	6.5	4.1	6.5
Lead/Lag			Lag	Lead	
Lead-Lag Optimize?			Yes	Yes	
Recall Mode	None	None	None	None	None
Act Effct Green (s)	10.2	10.2	43.8	9.1	58.9
Actuated g/C Ratio	0.13	0.13	0.58	0.12	0.78
v/c Ratio	0.17	0.25	0.66	0.98	0.15
Control Delay	34.5	14.4	13.7	112.2	3.3
Queue Delay	0.0	0.0	0.0	0.0	0.0
Total Delay	34.5	14.4	13.7	112.2	3.3
LOS	C	B	B	F	A
Approach Delay	22.3		13.7		31.0
Approach LOS	C		B		C

Intersection Summary

Cycle Length: 120
 Actuated Cycle Length: 75.6
 Natural Cycle: 75
 Control Type: Actuated-Uncoordinated
 Maximum v/c Ratio: 0.98
 Intersection Signal Delay: 19.0
 Intersection LOS: B
 Intersection Capacity Utilization 58.9%
 ICU Level of Service B
 Analysis Period (min) 15

Splits and Phases: 23: Sycamore Canyon Bl. & Cottonwood Ave

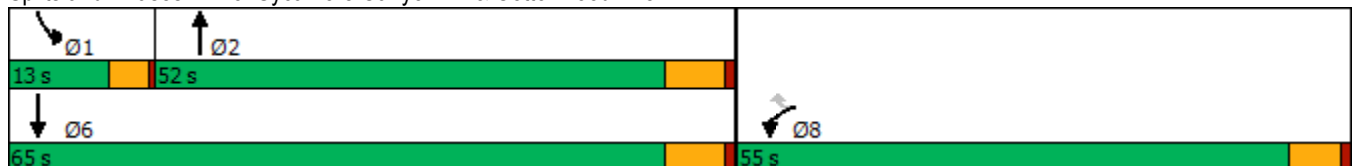

HCM 6th Signalized Intersection Summary
23: Sycamore Canyon Bl. & Cottonwood Ave

West Campus Upper Plateau (JN 14064)

09/19/2022



Movement	WBL	WBR	NBT	NBR	SBL	SBT
Lane Configurations	↶	↶	↷		↶	↷
Traffic Volume (veh/h)	25	39	1025	66	117	344
Future Volume (veh/h)	25	39	1025	66	117	344
Initial Q (Qb), veh	0	0	0	0	0	0
Ped-Bike Adj(A_pbT)	1.00	1.00		0.98	1.00	
Parking Bus, Adj	1.00	1.00	1.00	1.00	1.00	1.00
Work Zone On Approach	No		No			No
Adj Sat Flow, veh/h/ln	1263	1115	1811	1366	1070	1826
Adj Flow Rate, veh/h	29	29	1192	76	136	400
Peak Hour Factor	0.86	0.86	0.86	0.86	0.86	0.86
Percent Heavy Veh, %	43	53	6	36	56	5
Cap, veh/h	121	95	1664	106	141	2460
Arrive On Green	0.10	0.10	0.51	0.51	0.14	0.71
Sat Flow, veh/h	1203	945	3370	209	1019	3561
Grp Volume(v), veh/h	29	29	625	643	136	400
Grp Sat Flow(s),veh/h/ln	1203	945	1721	1768	1019	1735
Q Serve(g_s), s	1.4	1.8	18.1	18.2	8.6	2.4
Cycle Q Clear(g_c), s	1.4	1.8	18.1	18.2	8.6	2.4
Prop In Lane	1.00	1.00		0.12	1.00	
Lane Grp Cap(c), veh/h	121	95	873	897	141	2460
V/C Ratio(X)	0.24	0.31	0.72	0.72	0.97	0.16
Avail Cap(c_a), veh/h	918	721	1214	1248	141	3147
HCM Platoon Ratio	1.00	1.00	1.00	1.00	1.00	1.00
Upstream Filter(I)	1.00	1.00	1.00	1.00	1.00	1.00
Uniform Delay (d), s/veh	26.7	26.9	12.3	12.3	27.6	3.1
Incr Delay (d2), s/veh	1.0	1.8	1.7	1.7	65.6	0.0
Initial Q Delay(d3),s/veh	0.0	0.0	0.0	0.0	0.0	0.0
%ile BackOfQ(50%),veh/ln	0.4	0.4	5.6	5.7	4.4	0.4
Unsig. Movement Delay, s/veh						
LnGrp Delay(d),s/veh	27.8	28.7	14.0	13.9	93.2	3.1
LnGrp LOS	C	C	B	B	F	A
Approach Vol, veh/h	58		1268			536
Approach Delay, s/veh	28.3		14.0			26.0
Approach LOS	C		B			C
Timer - Assigned Phs	1	2			6	8
Phs Duration (G+Y+Rc), s	13.0	39.2			52.2	12.3
Change Period (Y+Rc), s	4.1	6.5			6.5	5.8
Max Green Setting (Gmax), s	8.9	45.5			58.5	49.2
Max Q Clear Time (g_c+I1), s	10.6	20.2			4.4	3.8
Green Ext Time (p_c), s	0.0	12.6			3.9	0.2

Intersection Summary

HCM 6th Ctrl Delay	17.9
HCM 6th LOS	B

Timings

West Campus Upper Plateau (JN 14064)

24: Sycamore Canyon Bl. & Alessandro Bl.

09/19/2022

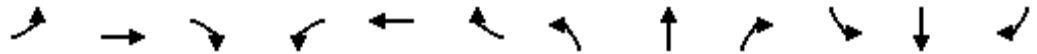

Lane Group	EBL	EBT	EBR	WBL	WBT	WBR	NBL	NBT	NBR	SBL	SBT	SBR
Lane Configurations	↘	↑↑↑	↗	↘↗	↑↑↑	↗	↘↗	↑↑	↗↘	↘↗	↑↑	↗
Traffic Volume (vph)	173	1310	401	251	2499	637	707	720	103	106	209	148
Future Volume (vph)	173	1310	401	251	2499	637	707	720	103	106	209	148
Turn Type	Prot	NA	Perm	Prot	NA	Perm	Prot	NA	pm+ov	Prot	NA	Perm
Protected Phases	5	2		1	6		3	8	1	7	4	
Permitted Phases			2			6			8			4
Detector Phase	5	2	2	1	6	6	3	8	1	7	4	4
Switch Phase												
Minimum Initial (s)	5.0	10.0	10.0	5.0	10.0	10.0	5.0	10.0	5.0	5.0	10.0	10.0
Minimum Split (s)	8.7	43.5	43.5	8.7	43.5	43.5	8.7	15.8	8.7	8.7	49.8	49.8
Total Split (s)	9.0	47.0	47.0	9.2	47.2	47.2	14.0	52.5	9.2	11.3	49.8	49.8
Total Split (%)	7.5%	39.2%	39.2%	7.7%	39.3%	39.3%	11.7%	43.8%	7.7%	9.4%	41.5%	41.5%
Yellow Time (s)	3.2	5.5	5.5	3.2	5.5	5.5	3.2	4.8	3.2	3.2	4.8	4.8
All-Red Time (s)	0.5	1.0	1.0	0.5	1.0	1.0	0.5	1.0	0.5	0.5	1.0	1.0
Lost Time Adjust (s)	0.0	0.0	0.0	0.0	0.0	0.0	0.0	0.0	0.0	0.0	0.0	0.0
Total Lost Time (s)	3.7	6.5	6.5	3.7	6.5	6.5	3.7	5.8	3.7	3.7	5.8	5.8
Lead/Lag	Lead	Lag	Lag	Lead	Lag	Lag	Lead	Lag	Lead	Lead	Lag	Lag
Lead-Lag Optimize?	Yes	Yes	Yes	Yes	Yes	Yes	Yes	Yes	Yes	Yes	Yes	Yes
Recall Mode	None	C-Max	C-Max	None	C-Max	C-Max	None	None	None	None	None	None
Act Effct Green (s)	18.9	42.5	42.5	17.1	40.7	40.7	10.3	33.5	52.7	7.2	30.4	30.4
Actuated g/C Ratio	0.16	0.35	0.35	0.14	0.34	0.34	0.09	0.28	0.44	0.06	0.25	0.25
v/c Ratio	0.63	0.73	0.53	0.52	1.48	1.00	2.43	0.75	0.08	0.59	0.24	0.32
Control Delay	60.0	37.0	10.4	53.5	249.5	64.5	676.9	44.0	7.6	68.5	34.7	11.9
Queue Delay	0.0	0.0	0.0	0.0	0.0	0.0	0.0	0.0	0.0	0.0	0.0	0.0
Total Delay	60.0	37.0	10.4	53.5	249.5	64.5	676.9	44.0	7.6	68.5	34.7	11.9
LOS	E	D	B	D	F	E	F	D	A	E	C	B
Approach Delay		33.4			200.1			334.1			35.2	
Approach LOS		C			F			F			D	

Intersection Summary

Cycle Length: 120
 Actuated Cycle Length: 120
 Offset: 0 (0%), Referenced to phase 2:EBT and 6:WBT, Start of Yellow
 Natural Cycle: 125
 Control Type: Actuated-Coordinated
 Maximum v/c Ratio: 2.43
 Intersection Signal Delay: 174.6
 Intersection LOS: F
 Intersection Capacity Utilization 105.1%
 ICU Level of Service G
 Analysis Period (min) 15

Splits and Phases: 24: Sycamore Canyon Bl. & Alessandro Bl.

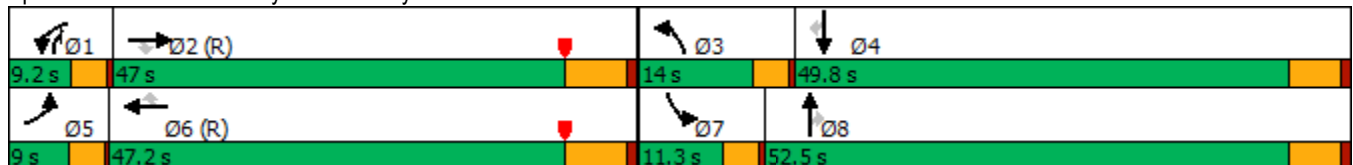

HCM 6th Signalized Intersection Summary
24: Sycamore Canyon Bl. & Alessandro Bl.

West Campus Upper Plateau (JN 14064)
09/19/2022



Movement	EBL	EBT	EBR	WBL	WBT	WBR	NBL	NBT	NBR	SBL	SBT	SBR
Lane Configurations												
Traffic Volume (veh/h)	173	1310	401	251	2499	637	707	720	103	106	209	148
Future Volume (veh/h)	173	1310	401	251	2499	637	707	720	103	106	209	148
Initial Q (Qb), veh	0	0	0	0	0	0	0	0	0	0	0	0
Ped-Bike Adj(A_pbT)	1.00		1.00	1.00		1.00	1.00		1.00	1.00		1.00
Parking Bus, Adj	1.00	1.00	1.00	1.00	1.00	1.00	1.00	1.00	1.00	1.00	1.00	1.00
Work Zone On Approach		No			No			No			No	
Adj Sat Flow, veh/h/ln	1870	1870	1885	1870	1856	1796	1870	1841	1841	1663	1826	1856
Adj Flow Rate, veh/h	175	1323	323	254	2524	520	714	727	74	107	211	90
Peak Hour Factor	0.99	0.99	0.99	0.99	0.99	0.99	0.99	0.99	0.99	0.99	0.99	0.99
Percent Heavy Veh, %	2	2	1	2	3	7	2	4	4	16	5	3
Cap, veh/h	79	2487	777	158	2476	744	297	885	820	153	753	340
Arrive On Green	0.04	0.49	0.49	0.05	0.49	0.49	0.09	0.25	0.25	0.05	0.22	0.22
Sat Flow, veh/h	1781	5106	1596	3456	5066	1522	3456	3497	2742	3072	3469	1568
Grp Volume(v), veh/h	175	1323	323	254	2524	520	714	727	74	107	211	90
Grp Sat Flow(s),veh/h/ln	1781	1702	1596	1728	1689	1522	1728	1749	1371	1536	1735	1568
Q Serve(g_s), s	5.3	21.5	15.6	5.5	58.7	31.8	10.3	23.5	2.3	4.1	6.1	5.7
Cycle Q Clear(g_c), s	5.3	21.5	15.6	5.5	58.7	31.8	10.3	23.5	2.3	4.1	6.1	5.7
Prop In Lane	1.00		1.00	1.00		1.00	1.00		1.00	1.00		1.00
Lane Grp Cap(c), veh/h	79	2487	777	158	2476	744	297	885	820	153	753	340
V/C Ratio(X)	2.22	0.53	0.42	1.60	1.02	0.70	2.41	0.82	0.09	0.70	0.28	0.26
Avail Cap(c_a), veh/h	79	2487	777	158	2476	744	297	1361	1193	195	1272	575
HCM Platoon Ratio	1.00	1.00	1.00	1.00	1.00	1.00	1.00	1.00	1.00	1.00	1.00	1.00
Upstream Filter(I)	0.73	0.73	0.73	0.10	0.10	0.10	1.00	1.00	1.00	1.00	1.00	1.00
Uniform Delay (d), s/veh	57.3	21.3	19.8	57.2	30.7	23.8	54.8	42.2	30.3	56.1	39.2	39.0
Incr Delay (d2), s/veh	579.8	0.6	1.2	274.6	11.6	0.6	643.4	2.4	0.0	4.6	0.2	0.4
Initial Q Delay(d3),s/veh	0.0	0.0	0.0	0.0	0.0	0.0	0.0	0.0	0.0	0.0	0.0	0.0
%ile BackOfQ(50%),veh/ln	15.0	8.2	5.7	8.4	24.4	10.8	30.9	10.1	0.8	1.7	2.6	2.2
Unsig. Movement Delay, s/veh												
LnGrp Delay(d),s/veh	637.2	21.9	21.0	331.9	42.3	24.4	698.3	44.7	30.3	60.7	39.4	39.4
LnGrp LOS	F	C	C	F	F	C	F	D	C	E	D	D
Approach Vol, veh/h		1821			3298			1515			408	
Approach Delay, s/veh		80.9			61.7			352.0			45.0	
Approach LOS		F			E			F			D	
Timer - Assigned Phs	1	2	3	4	5	6	7	8				
Phs Duration (G+Y+Rc), s	9.2	65.0	14.0	31.8	9.0	65.2	9.7	36.2				
Change Period (Y+Rc), s	3.7	6.5	3.7	5.8	3.7	6.5	3.7	5.8				
Max Green Setting (Gmax), s	5.5	40.5	10.3	44.0	5.3	40.7	7.6	46.7				
Max Q Clear Time (g_c+I1), s	7.5	23.5	12.3	8.1	7.3	60.7	6.1	25.5				
Green Ext Time (p_c), s	0.0	11.6	0.0	1.5	0.0	0.0	0.0	4.9				

Intersection Summary

HCM 6th Ctrl Delay	128.2
HCM 6th LOS	F

Notes

User approved pedestrian interval to be less than phase max green.

Timings
25: Sycamore Canyon Bl. & Cactus Av.

West Campus Upper Plateau (JN 14064)

09/19/2022



Lane Group	EBL	EBT	EBR	WBL	WBT	WBR	NBL	NBT	NBR	SBL	SBT	SBR
Lane Configurations	↘	↑↑	↗	↘↗	↑↑	↗	↘↗	↑↑	↗	↘↗	↑↑	↗
Traffic Volume (vph)	46	202	83	758	661	1055	188	483	301	197	312	76
Future Volume (vph)	46	202	83	758	661	1055	188	483	301	197	312	76
Turn Type	Prot	NA	Perm	Prot	NA	Perm	Prot	NA	Perm	Prot	NA	Perm
Protected Phases	7	4		3	8		5	2		1	6	
Permitted Phases			4			8			2			6
Detector Phase	7	4	4	3	8	8	5	2	2	1	6	6
Switch Phase												
Minimum Initial (s)	5.0	10.0	10.0	5.0	10.0	10.0	5.0	10.0	10.0	5.0	10.0	10.0
Minimum Split (s)	9.6	32.8	32.8	9.6	32.8	32.8	9.6	34.8	34.8	9.6	34.8	34.8
Total Split (s)	11.0	45.6	45.6	15.4	50.0	50.0	9.6	49.0	49.0	10.0	49.4	49.4
Total Split (%)	9.2%	38.0%	38.0%	12.8%	41.7%	41.7%	8.0%	40.8%	40.8%	8.3%	41.2%	41.2%
Yellow Time (s)	3.6	4.8	4.8	3.6	4.8	4.8	3.6	4.8	4.8	3.6	4.8	4.8
All-Red Time (s)	1.0	1.0	1.0	1.0	1.0	1.0	1.0	1.0	1.0	1.0	1.0	1.0
Lost Time Adjust (s)	0.0	0.0	0.0	0.0	0.0	0.0	0.0	0.0	0.0	0.0	0.0	0.0
Total Lost Time (s)	4.6	5.8	5.8	4.6	5.8	5.8	4.6	5.8	5.8	4.6	5.8	5.8
Lead/Lag	Lead	Lag	Lag	Lead	Lag	Lag	Lead	Lag	Lag	Lead	Lag	Lag
Lead-Lag Optimize?	Yes	Yes	Yes	Yes	Yes	Yes	Yes	Yes	Yes	Yes	Yes	Yes
Recall Mode	None	None	None	None	None	None	None	None	None	None	None	None
Act Effct Green (s)	6.1	37.5	37.5	10.9	44.7	44.7	5.1	20.7	20.7	5.5	21.1	21.1
Actuated g/C Ratio	0.06	0.39	0.39	0.11	0.47	0.47	0.05	0.22	0.22	0.06	0.22	0.22
v/c Ratio	0.46	0.17	0.13	2.09	0.46	1.25	1.10	0.68	0.54	1.05	0.42	0.19
Control Delay	60.9	20.1	3.0	525.3	20.0	141.9	143.2	39.4	7.4	125.1	33.7	3.6
Queue Delay	0.0	0.0	0.0	0.0	0.0	0.0	0.0	0.0	0.0	0.0	0.0	0.0
Total Delay	60.9	20.1	3.0	525.3	20.0	141.9	143.2	39.4	7.4	125.1	33.7	3.6
LOS	E	C	A	F	C	F	F	D	A	F	C	A
Approach Delay		21.4			226.8			49.6			60.5	
Approach LOS		C			F			D			E	

Intersection Summary

Cycle Length: 120
 Actuated Cycle Length: 95.6
 Natural Cycle: 130
 Control Type: Actuated-Uncoordinated
 Maximum v/c Ratio: 2.09
 Intersection Signal Delay: 149.4
 Intersection LOS: F
 Intersection Capacity Utilization 96.3%
 ICU Level of Service F
 Analysis Period (min) 15

Splits and Phases: 25: Sycamore Canyon Bl. & Cactus Av.

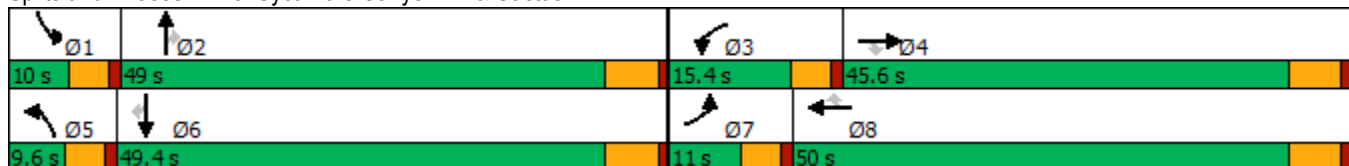

HCM 6th Signalized Intersection Summary
 25: Sycamore Canyon Bl. & Cactus Av.

West Campus Upper Plateau (JN 14064)

09/19/2022



Movement	EBL	EBT	EBR	WBL	WBT	WBR	NBL	NBT	NBR	SBL	SBT	SBR
Lane Configurations												
Traffic Volume (veh/h)	46	202	83	758	661	1055	188	483	301	197	312	76
Future Volume (veh/h)	46	202	83	758	661	1055	188	483	301	197	312	76
Initial Q (Qb), veh	0	0	0	0	0	0	0	0	0	0	0	0
Ped-Bike Adj(A_pbT)	1.00		1.00	1.00		0.99	1.00		1.00	1.00		0.99
Parking Bus, Adj	1.00	1.00	1.00	1.00	1.00	1.00	1.00	1.00	1.00	1.00	1.00	1.00
Work Zone On Approach		No			No			No			No	
Adj Sat Flow, veh/h/ln	1722	1693	1826	1796	1707	1856	1826	1811	1826	1856	1856	1796
Adj Flow Rate, veh/h	47	208	85	781	681	869	194	498	213	203	322	75
Peak Hour Factor	0.97	0.97	0.97	0.97	0.97	0.97	0.97	0.97	0.97	0.97	0.97	0.97
Percent Heavy Veh, %	12	14	5	7	13	3	5	6	5	3	3	7
Cap, veh/h	62	1285	618	388	1553	743	183	687	309	201	719	306
Arrive On Green	0.04	0.40	0.40	0.12	0.48	0.48	0.05	0.20	0.20	0.06	0.20	0.20
Sat Flow, veh/h	1640	3216	1547	3319	3244	1553	3374	3441	1547	3428	3526	1502
Grp Volume(v), veh/h	47	208	85	781	681	869	194	498	213	203	322	75
Grp Sat Flow(s),veh/h/ln	1640	1608	1547	1659	1622	1553	1687	1721	1547	1714	1763	1502
Q Serve(g_s), s	2.6	3.8	3.2	10.8	12.8	44.2	5.0	12.5	11.8	5.4	7.4	3.9
Cycle Q Clear(g_c), s	2.6	3.8	3.2	10.8	12.8	44.2	5.0	12.5	11.8	5.4	7.4	3.9
Prop In Lane	1.00		1.00	1.00		1.00	1.00		1.00	1.00		1.00
Lane Grp Cap(c), veh/h	62	1285	618	388	1553	743	183	687	309	201	719	306
V/C Ratio(X)	0.76	0.16	0.14	2.01	0.44	1.17	1.06	0.73	0.69	1.01	0.45	0.24
Avail Cap(c_a), veh/h	114	1386	667	388	1553	743	183	1610	724	201	1665	709
HCM Platoon Ratio	1.00	1.00	1.00	1.00	1.00	1.00	1.00	1.00	1.00	1.00	1.00	1.00
Upstream Filter(I)	1.00	1.00	1.00	1.00	1.00	1.00	1.00	1.00	1.00	1.00	1.00	1.00
Uniform Delay (d), s/veh	44.0	17.8	17.6	40.8	15.9	24.1	43.7	34.6	34.3	43.5	32.2	30.8
Incr Delay (d2), s/veh	6.8	0.1	0.1	464.3	0.2	90.1	83.9	1.5	2.7	66.8	0.4	0.4
Initial Q Delay(d3),s/veh	0.0	0.0	0.0	0.0	0.0	0.0	0.0	0.0	0.0	0.0	0.0	0.0
%ile BackOfQ(50%),veh/ln	1.1	1.4	1.1	29.2	4.3	32.6	4.1	5.1	4.4	4.1	3.0	1.4
Unsig. Movement Delay, s/veh												
LnGrp Delay(d),s/veh	50.7	17.8	17.7	505.1	16.1	114.2	127.6	36.1	37.0	110.3	32.6	31.2
LnGrp LOS	D	B	B	F	B	F	F	D	D	F	C	C
Approach Vol, veh/h		340			2331			905			600	
Approach Delay, s/veh		22.4			216.5			55.9			58.7	
Approach LOS		C			F			E			E	
Timer - Assigned Phs	1	2	3	4	5	6	7	8				
Phs Duration (G+Y+Rc), s	10.0	24.2	15.4	42.7	9.6	24.6	8.1	50.0				
Change Period (Y+Rc), s	4.6	5.8	4.6	5.8	4.6	5.8	4.6	5.8				
Max Green Setting (Gmax), s	5.4	43.2	10.8	39.8	5.0	43.6	6.4	44.2				
Max Q Clear Time (g_c+I1), s	7.4	14.5	12.8	5.8	7.0	9.4	4.6	46.2				
Green Ext Time (p_c), s	0.0	3.9	0.0	1.6	0.0	2.2	0.0	0.0				

Intersection Summary

HCM 6th Ctrl Delay	143.2
HCM 6th LOS	F

Timings

West Campus Upper Plateau (JN 14064)

26: Sycamore Canyon Bl. & Van Buren Bl.

09/19/2022



Lane Group	EBL	EBT	EBR	WBL	WBT	WBR	NBL	NBT	SBL	SBT	SBR
Lane Configurations											
Traffic Volume (vph)	782	2257	3	53	3354	229	4	1	121	6	587
Future Volume (vph)	782	2257	3	53	3354	229	4	1	121	6	587
Turn Type	Prot	NA	Perm	Prot	NA	Perm	Perm	NA	Split	NA	Perm
Protected Phases	5	2		1	6			8	4	4	
Permitted Phases			2			6	8				4
Detector Phase	5	2	2	1	6	6	8	8	4	4	4
Switch Phase											
Minimum Initial (s)	5.0	10.0	10.0	5.0	10.0	10.0	10.0	10.0	10.0	10.0	10.0
Minimum Split (s)	9.6	29.2	29.2	9.6	29.2	29.2	14.6	14.6	50.8	50.8	50.8
Total Split (s)	25.0	50.9	50.9	13.7	39.6	39.6	14.6	14.6	50.8	50.8	50.8
Total Split (%)	19.2%	39.2%	39.2%	10.5%	30.5%	30.5%	11.2%	11.2%	39.1%	39.1%	39.1%
Yellow Time (s)	3.6	5.2	5.2	3.6	5.2	5.2	3.6	3.6	4.8	4.8	4.8
All-Red Time (s)	1.0	1.0	1.0	1.0	1.0	1.0	1.0	1.0	1.0	1.0	1.0
Lost Time Adjust (s)	0.0	0.0	0.0	0.0	0.0	0.0		0.0	0.0	0.0	0.0
Total Lost Time (s)	4.6	6.2	6.2	4.6	6.2	6.2		4.6	5.8	5.8	5.8
Lead/Lag	Lead	Lag	Lag	Lead	Lag	Lag					
Lead-Lag Optimize?	Yes	Yes	Yes	Yes	Yes	Yes					
Recall Mode	None	None	None	None	None	None	None	None	None	None	None
Act Effct Green (s)	21.0	50.4	50.4	7.3	34.4	34.4		10.3	22.1	22.1	22.1
Actuated g/C Ratio	0.22	0.52	0.52	0.08	0.36	0.36		0.11	0.23	0.23	0.23
v/c Ratio	1.13	0.76	0.00	0.43	1.65	0.41		0.03	0.18	0.02	0.88
Control Delay	111.1	24.6	0.0	57.6	319.0	15.4		38.2	29.4	27.3	24.4
Queue Delay	0.0	0.0	0.0	0.0	0.0	0.0		0.0	0.0	0.0	0.0
Total Delay	111.1	24.6	0.0	57.6	319.0	15.4		38.2	29.4	27.3	24.4
LOS	F	C	A	E	F	B		D	C	C	C
Approach Delay		46.8			296.0			38.3		25.3	
Approach LOS		D			F			D		C	

Intersection Summary

Cycle Length: 130	
Actuated Cycle Length: 96.7	
Natural Cycle: 125	
Control Type: Actuated-Uncoordinated	
Maximum v/c Ratio: 1.65	
Intersection Signal Delay: 167.1	Intersection LOS: F
Intersection Capacity Utilization 107.1%	ICU Level of Service G
Analysis Period (min) 15	

Splits and Phases: 26: Sycamore Canyon Bl. & Van Buren Bl.

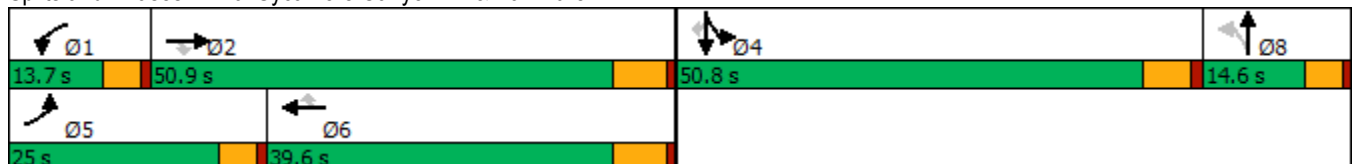

HCM 6th Signalized Intersection Summary
26: Sycamore Canyon Bl. & Van Buren Bl.

West Campus Upper Plateau (JN 14064)

09/19/2022



Movement	EBL	EBT	EBR	WBL	WBT	WBR	NBL	NBT	NBR	SBL	SBT	SBR
Lane Configurations												
Traffic Volume (veh/h)	782	2257	3	53	3354	229	4	1	4	121	6	587
Future Volume (veh/h)	782	2257	3	53	3354	229	4	1	4	121	6	587
Initial Q (Qb), veh	0	0	0	0	0	0	0	0	0	0	0	0
Ped-Bike Adj(A_pbT)	1.00		1.00	1.00		1.00	1.00		1.00	1.00		1.00
Parking Bus, Adj	1.00	1.00	1.00	1.00	1.00	1.00	1.00	1.00	1.00	1.00	1.00	1.00
Work Zone On Approach		No			No			No			No	
Adj Sat Flow, veh/h/ln	1885	1811	1900	1900	1826	1752	1900	1900	1900	1737	1900	1885
Adj Flow Rate, veh/h	850	2453	2	58	3646	224	4	1	2	132	7	0
Peak Hour Factor	0.92	0.92	0.92	0.92	0.92	0.92	0.92	0.92	0.92	0.92	0.92	0.92
Percent Heavy Veh, %	1	6	0	0	5	10	0	0	0	11	0	1
Cap, veh/h	824	3618	935	79	2434	575	32	10	20	359	213	
Arrive On Green	0.24	0.58	0.58	0.04	0.39	0.39	0.02	0.02	0.02	0.11	0.11	0.00
Sat Flow, veh/h	3483	6230	1610	1810	6281	1485	1810	565	1131	3209	1900	1598
Grp Volume(v), veh/h	850	2453	2	58	3646	224	4	0	3	132	7	0
Grp Sat Flow(s),veh/h/ln	1742	1558	1610	1810	1570	1485	1810	0	1696	1605	1900	1598
Q Serve(g_s), s	20.4	23.5	0.0	2.7	33.4	9.4	0.2	0.0	0.1	3.3	0.3	0.0
Cycle Q Clear(g_c), s	20.4	23.5	0.0	2.7	33.4	9.4	0.2	0.0	0.1	3.3	0.3	0.0
Prop In Lane	1.00		1.00	1.00		1.00	1.00		0.67	1.00		1.00
Lane Grp Cap(c), veh/h	824	3618	935	79	2434	575	32	0	30	359	213	
V/C Ratio(X)	1.03	0.68	0.00	0.74	1.50	0.39	0.12	0.00	0.10	0.37	0.03	
Avail Cap(c_a), veh/h	824	3618	935	191	2434	575	210	0	197	1676	992	
HCM Platoon Ratio	1.00	1.00	1.00	1.00	1.00	1.00	1.00	1.00	1.00	1.00	1.00	1.00
Upstream Filter(I)	1.00	1.00	1.00	1.00	1.00	1.00	1.00	0.00	1.00	1.00	1.00	0.00
Uniform Delay (d), s/veh	32.9	12.5	7.6	40.7	26.4	19.0	41.7	0.0	41.6	35.4	34.1	0.0
Incr Delay (d2), s/veh	39.6	0.5	0.0	4.9	226.2	0.4	1.7	0.0	1.4	0.6	0.1	0.0
Initial Q Delay(d3),s/veh	0.0	0.0	0.0	0.0	0.0	0.0	0.0	0.0	0.0	0.0	0.0	0.0
%ile BackOfQ(50%),veh/ln	12.5	6.7	0.0	1.3	49.3	3.0	0.1	0.0	0.1	1.3	0.1	0.0
Unsig. Movement Delay, s/veh												
LnGrp Delay(d),s/veh	72.4	13.0	7.6	45.6	252.6	19.5	43.3	0.0	43.0	36.1	34.2	0.0
LnGrp LOS	F	B	A	D	F	B	D	A	D	D	C	
Approach Vol, veh/h		3305			3928			7			139	
Approach Delay, s/veh		28.3			236.3			43.2			36.0	
Approach LOS		C			F			D			D	
Timer - Assigned Phs	1	2		4	5	6		8				
Phs Duration (G+Y+Rc), s	8.4	56.2		15.4	25.0	39.6		6.1				
Change Period (Y+Rc), s	4.6	6.2		5.8	4.6	6.2		4.6				
Max Green Setting (Gmax), s	9.1	44.7		45.0	20.4	33.4		10.0				
Max Q Clear Time (g_c+I1), s	4.7	25.5		5.3	22.4	35.4		2.2				
Green Ext Time (p_c), s	0.0	15.9		0.5	0.0	0.0		0.0				

Intersection Summary

HCM 6th Ctrl Delay	139.2
HCM 6th LOS	F

Notes

Unsignalized Delay for [SBR] is excluded from calculations of the approach delay and intersection delay.

Timings
27: Innovation Dr. & Cactus Av.

West Campus Upper Plateau (JN 14064)

09/19/2022

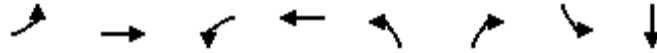

Lane Group	EBL	EBT	WBL	WBT	NBL	NBR	SBL	SBT
Lane Configurations	↖	↖↖↖	↖	↖↖↖	↖	↖	↖	↖
Traffic Volume (vph)	5	589	139	2129	13	39	5	0
Future Volume (vph)	5	589	139	2129	13	39	5	0
Turn Type	Prot	NA	Prot	NA	Perm	Perm	Perm	NA
Protected Phases	5	2	1	6				4
Permitted Phases					8	8	4	
Detector Phase	5	2	1	6	8	8	4	4
Switch Phase								
Minimum Initial (s)	5.0	10.0	5.0	10.0	10.0	10.0	10.0	10.0
Minimum Split (s)	9.2	26.8	9.2	26.8	31.1	31.1	31.1	31.1
Total Split (s)	12.0	38.0	31.0	57.0	51.0	51.0	51.0	51.0
Total Split (%)	10.0%	31.7%	25.8%	47.5%	42.5%	42.5%	42.5%	42.5%
Yellow Time (s)	3.2	4.8	3.2	4.8	4.1	4.1	4.1	4.1
All-Red Time (s)	1.0	1.0	1.0	1.0	1.0	1.0	1.0	1.0
Lost Time Adjust (s)	0.0	0.0	0.0	0.0	0.0	0.0	0.0	0.0
Total Lost Time (s)	4.2	5.8	4.2	5.8	5.1	5.1	5.1	5.1
Lead/Lag	Lead	Lag	Lead	Lag				
Lead-Lag Optimize?	Yes	Yes	Yes	Yes				
Recall Mode	None	None	None	None	None	None	None	None
Act Effct Green (s)	5.3	40.2	10.1	56.2	12.7	12.7	12.7	12.7
Actuated g/C Ratio	0.07	0.56	0.14	0.79	0.18	0.18	0.18	0.18
v/c Ratio	0.04	0.23	0.58	0.58	0.06	0.06	0.02	0.01
Control Delay	38.8	11.0	41.1	8.8	27.9	0.2	27.2	0.0
Queue Delay	0.0	0.0	0.0	0.0	0.0	0.0	0.0	0.0
Total Delay	38.8	11.0	41.1	8.8	27.9	0.2	27.2	0.0
LOS	D	B	D	A	C	A	C	A
Approach Delay		11.3		10.7				17.0
Approach LOS		B		B				B

Intersection Summary

Cycle Length: 120
 Actuated Cycle Length: 71.2
 Natural Cycle: 90
 Control Type: Actuated-Uncoordinated
 Maximum v/c Ratio: 0.58
 Intersection Signal Delay: 10.8
 Intersection LOS: B
 Intersection Capacity Utilization 67.4%
 ICU Level of Service C
 Analysis Period (min) 15

Splits and Phases: 27: Innovation Dr. & Cactus Av.

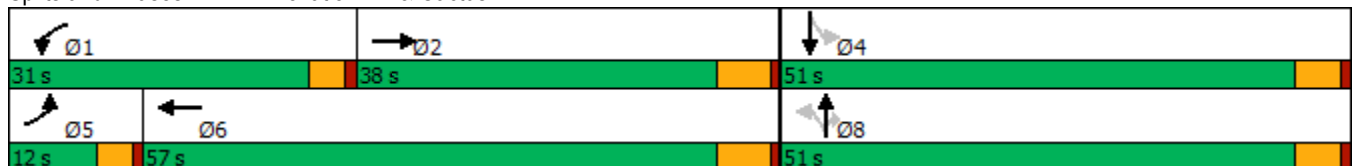

HCM 6th Signalized Intersection Summary
27: Innovation Dr. & Cactus Av.

West Campus Upper Plateau (JN 14064)
09/19/2022



Movement	EBL	EBT	EBR	WBL	WBT	WBR	NBL	NBT	NBR	SBL	SBT	SBR
Lane Configurations	↗	↑↑↑		↖	↑↑↑		↖	↑	↗	↖	↑	↗
Traffic Volume (veh/h)	5	589	18	139	2129	53	13	0	39	5	0	3
Future Volume (veh/h)	5	589	18	139	2129	53	13	0	39	5	0	3
Initial Q (Qb), veh	0	0	0	0	0	0	0	0	0	0	0	0
Ped-Bike Adj(A_pbT)	1.00		1.00	1.00		1.00	1.00		1.00	1.00		1.00
Parking Bus, Adj	1.00	1.00	1.00	1.00	1.00	1.00	1.00	1.00	1.00	1.00	1.00	1.00
Work Zone On Approach		No			No			No			No	
Adj Sat Flow, veh/h/ln	1900	1767	1900	1826	1796	1870	1500	1900	1559	1559	1900	1900
Adj Flow Rate, veh/h	5	601	16	142	2172	54	13	0	27	5	0	2
Peak Hour Factor	0.98	0.98	0.98	0.98	0.98	0.98	0.98	0.98	0.98	0.98	0.98	0.98
Percent Heavy Veh, %	0	9	0	5	7	2	27	0	23	23	0	0
Cap, veh/h	12	2803	74	181	3335	83	207	166	116	210	0	141
Arrive On Green	0.01	0.58	0.58	0.10	0.68	0.68	0.09	0.00	0.09	0.09	0.00	0.09
Sat Flow, veh/h	1810	4831	128	1739	4921	122	1135	1900	1321	1153	0	1610
Grp Volume(v), veh/h	5	399	218	142	1441	785	13	0	27	5	0	2
Grp Sat Flow(s),veh/h/ln	1810	1608	1744	1739	1635	1774	1135	1900	1321	1153	0	1610
Q Serve(g_s), s	0.2	3.9	4.0	5.3	16.8	16.9	0.7	0.0	1.3	0.3	0.0	0.1
Cycle Q Clear(g_c), s	0.2	3.9	4.0	5.3	16.8	16.9	0.8	0.0	1.3	0.3	0.0	0.1
Prop In Lane	1.00		0.07	1.00		0.07	1.00		1.00	1.00		1.00
Lane Grp Cap(c), veh/h	12	1866	1012	181	2215	1202	207	166	116	210	0	141
V/C Ratio(X)	0.42	0.21	0.22	0.79	0.65	0.65	0.06	0.00	0.23	0.02	0.00	0.01
Avail Cap(c_a), veh/h	213	1866	1012	705	2531	1374	895	1319	917	909	0	1118
HCM Platoon Ratio	1.00	1.00	1.00	1.00	1.00	1.00	1.00	1.00	1.00	1.00	1.00	1.00
Upstream Filter(I)	1.00	1.00	1.00	1.00	1.00	1.00	1.00	0.00	1.00	1.00	0.00	1.00
Uniform Delay (d), s/veh	32.7	6.7	6.7	28.9	6.1	6.2	27.9	0.0	28.1	27.7	0.0	27.6
Incr Delay (d2), s/veh	8.3	0.1	0.2	2.8	0.6	1.1	0.1	0.0	1.0	0.0	0.0	0.0
Initial Q Delay(d3),s/veh	0.0	0.0	0.0	0.0	0.0	0.0	0.0	0.0	0.0	0.0	0.0	0.0
%ile BackOfQ(50%),veh/ln	0.1	1.0	1.1	2.1	3.2	3.7	0.2	0.0	0.4	0.1	0.0	0.0
Unsig. Movement Delay, s/veh												
LnGrp Delay(d),s/veh	41.0	6.7	6.8	31.7	6.8	7.3	28.0	0.0	29.1	27.7	0.0	27.6
LnGrp LOS	D	A	A	C	A	A	C	A	C	C	A	C
Approach Vol, veh/h		622			2368			40				7
Approach Delay, s/veh		7.0			8.4			28.8				27.7
Approach LOS		A			A			C				C
Timer - Assigned Phs	1	2		4	5	6		8				
Phs Duration (G+Y+Rc), s	11.1	44.2		10.9	4.6	50.6		10.9				
Change Period (Y+Rc), s	* 4.2	5.8		5.1	* 4.2	5.8		5.1				
Max Green Setting (Gmax), s	* 27	32.2		45.9	* 7.8	51.2		45.9				
Max Q Clear Time (g_c+I1), s	7.3	6.0		2.3	2.2	18.9		3.3				
Green Ext Time (p_c), s	0.2	5.4		0.0	0.0	25.9		0.1				

Intersection Summary

HCM 6th Ctrl Delay	8.5
HCM 6th LOS	A

Notes

* HCM 6th computational engine requires equal clearance times for the phases crossing the barrier.

Timings
28: I-215 SB Ramps & Alessandro Bl.

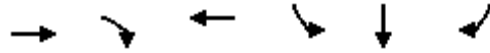

Lane Group	EBT	EBR	WBT	SBL	SBT	SBR
Lane Configurations	↑↑↑	↑	↑↑↑	↑	↔	↑
Traffic Volume (vph)	1077	441	2875	254	0	514
Future Volume (vph)	1077	441	2875	254	0	514
Turn Type	NA	Perm	NA	Split	NA	Perm
Protected Phases	2		6	4	4	
Permitted Phases		2				4
Detector Phase	2	2	6	4	4	4
Switch Phase						
Minimum Initial (s)	5.0	5.0	5.0	5.0	5.0	5.0
Minimum Split (s)	10.5	10.5	34.5	10.0	10.0	10.0
Total Split (s)	49.0	49.0	49.0	36.0	36.0	36.0
Total Split (%)	57.6%	57.6%	57.6%	42.4%	42.4%	42.4%
Yellow Time (s)	4.5	4.5	4.5	4.0	4.0	4.0
All-Red Time (s)	1.0	1.0	1.0	1.0	1.0	1.0
Lost Time Adjust (s)	0.0	0.0	0.0	0.0	0.0	0.0
Total Lost Time (s)	5.5	5.5	5.5	5.0	5.0	5.0
Lead/Lag						
Lead-Lag Optimize?						
Recall Mode	C-Min	C-Min	C-Min	None	None	None
Act Effct Green (s)	52.2	52.2	52.2	22.3	22.3	22.3
Actuated g/C Ratio	0.61	0.61	0.61	0.26	0.26	0.26
v/c Ratio	0.36	0.43	1.02	0.57	0.74	0.70
Control Delay	9.5	5.1	26.7	31.5	36.4	34.0
Queue Delay	0.0	0.0	0.0	0.0	0.0	0.0
Total Delay	9.5	5.1	26.7	31.5	36.4	34.0
LOS	A	A	C	C	D	C
Approach Delay	8.3		26.7		34.1	
Approach LOS	A		C		C	

Intersection Summary

Cycle Length: 85
 Actuated Cycle Length: 85
 Offset: 50 (59%), Referenced to phase 2:EBT and 6:WBT, Start of Yellow
 Natural Cycle: 80
 Control Type: Actuated-Coordinated
 Maximum v/c Ratio: 1.02
 Intersection Signal Delay: 22.6
 Intersection LOS: C
 Intersection Capacity Utilization 90.9%
 ICU Level of Service E
 Analysis Period (min) 15

Splits and Phases: 28: I-215 SB Ramps & Alessandro Bl.

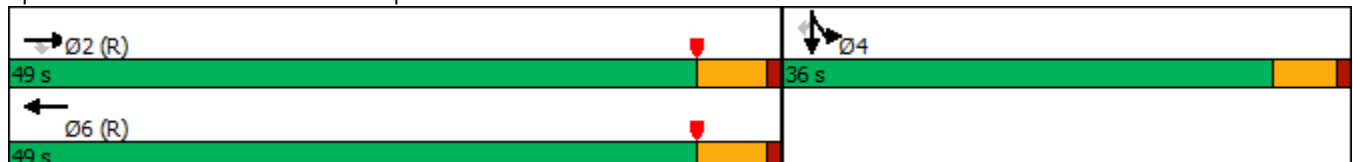

HCM 6th Signalized Intersection Summary
 28: I-215 SB Ramps & Alessandro Bl.

West Campus Upper Plateau (JN 14064)
 09/19/2022



Movement	EBL	EBT	EBR	WBL	WBT	WBR	NBL	NBT	NBR	SBL	SBT	SBR
Lane Configurations		↑↑↑	↗		↑↑↑					↘	↔	↗
Traffic Volume (veh/h)	0	1077	441	0	2875	241	0	0	0	254	0	514
Future Volume (veh/h)	0	1077	441	0	2875	241	0	0	0	254	0	514
Initial Q (Qb), veh	0	0	0	0	0	0				0	0	0
Ped-Bike Adj(A_pbT)	1.00		1.00	1.00		1.00				1.00		1.00
Parking Bus, Adj	1.00	1.00	1.00	1.00	1.00	1.00				1.00	1.00	1.00
Work Zone On Approach		No			No						No	
Adj Sat Flow, veh/h/ln	0	1841	1826	0	1870	1796				1737	1900	1722
Adj Flow Rate, veh/h	0	1088	445	0	2904	233				171	0	534
Peak Hour Factor	0.99	0.99	0.99	0.99	0.99	0.99				0.99	0.99	0.99
Percent Heavy Veh, %	0	4	5	0	2	7				11	0	12
Cap, veh/h	0	3274	1007	0	3146	246				372	0	657
Arrive On Green	0.00	0.65	0.65	0.00	0.44	0.44				0.22	0.00	0.22
Sat Flow, veh/h	0	5191	1546	0	4997	378				1654	0	2919
Grp Volume(v), veh/h	0	1088	445	0	2025	1112				171	0	534
Grp Sat Flow(s),veh/h/ln	0	1675	1546	0	1702	1802				1654	0	1459
Q Serve(g_s), s	0.0	8.2	12.0	0.0	47.4	50.4				7.6	0.0	14.8
Cycle Q Clear(g_c), s	0.0	8.2	12.0	0.0	47.4	50.4				7.6	0.0	14.8
Prop In Lane	0.00		1.00	0.00		0.21				1.00		1.00
Lane Grp Cap(c), veh/h	0	3274	1007	0	2218	1174				372	0	657
V/C Ratio(X)	0.00	0.33	0.44	0.00	0.91	0.95				0.46	0.00	0.81
Avail Cap(c_a), veh/h	0	3274	1007	0	2218	1174				603	0	1065
HCM Platoon Ratio	1.00	1.00	1.00	1.00	0.67	0.67				1.00	1.00	1.00
Upstream Filter(I)	0.00	0.68	0.68	0.00	0.09	0.09				1.00	0.00	1.00
Uniform Delay (d), s/veh	0.0	6.6	7.2	0.0	21.7	22.5				28.5	0.0	31.2
Incr Delay (d2), s/veh	0.0	0.2	1.0	0.0	0.8	2.3				0.9	0.0	2.5
Initial Q Delay(d3),s/veh	0.0	0.0	0.0	0.0	0.0	0.0				0.0	0.0	0.0
%ile BackOfQ(50%),veh/ln	0.0	2.0	2.9	0.0	18.2	20.9				2.9	0.0	5.0
Unsig. Movement Delay, s/veh												
LnGrp Delay(d),s/veh	0.0	6.8	8.2	0.0	22.4	24.8				29.4	0.0	33.8
LnGrp LOS	A	A	A	A	C	C				C	A	C
Approach Vol, veh/h		1533			3137						705	
Approach Delay, s/veh		7.2			23.3						32.7	
Approach LOS		A			C						C	
Timer - Assigned Phs		2		4		6						
Phs Duration (G+Y+Rc), s		60.9		24.1		60.9						
Change Period (Y+Rc), s		5.5		5.0		5.5						
Max Green Setting (Gmax), s		43.5		31.0		43.5						
Max Q Clear Time (g_c+I1), s		14.0		16.8		52.4						
Green Ext Time (p_c), s		9.8		2.4		0.0						

Intersection Summary

HCM 6th Ctrl Delay	19.9
HCM 6th LOS	B

Notes

User approved volume balancing among the lanes for turning movement.

Timings
29: I-215 NB Ramps & Alessandro Bl.

West Campus Upper Plateau (JN 14064)

09/19/2022



Lane Group	EBL	EBT	WBT	WBR	NBL	NBT	NBR
Lane Configurations	↶	↷↷↷	↶↶↶	↷	↶	↷↷	↷
Traffic Volume (vph)	111	1261	2003	119	1432	0	248
Future Volume (vph)	111	1261	2003	119	1432	0	248
Turn Type	Prot	NA	NA	Perm	Split	NA	Perm
Protected Phases	5	2	6		8	8	
Permitted Phases				6			8
Detector Phase	5	2	6	6	8	8	8
Switch Phase							
Minimum Initial (s)	5.0	5.0	5.0	5.0	5.0	5.0	5.0
Minimum Split (s)	9.5	10.5	33.5	33.5	10.0	10.0	10.0
Total Split (s)	25.0	60.0	35.0	35.0	25.0	25.0	25.0
Total Split (%)	29.4%	70.6%	41.2%	41.2%	29.4%	29.4%	29.4%
Yellow Time (s)	3.5	4.5	4.5	4.5	4.0	4.0	4.0
All-Red Time (s)	1.0	1.0	1.0	1.0	1.0	1.0	1.0
Lost Time Adjust (s)	0.0	0.0	0.0	0.0	0.0	0.0	0.0
Total Lost Time (s)	4.5	5.5	5.5	5.5	5.0	5.0	5.0
Lead/Lag	Lead		Lag	Lag			
Lead-Lag Optimize?	Yes		Yes	Yes			
Recall Mode	None	C-Min	C-Min	C-Min	Max	Max	Max
Act Effct Green (s)	11.5	54.5	40.7	40.7	20.0	20.0	20.0
Actuated g/C Ratio	0.14	0.64	0.48	0.48	0.24	0.24	0.24
v/c Ratio	0.58	0.40	0.84	0.16	1.94	1.71	0.61
Control Delay	39.1	9.4	25.5	6.8	456.1	351.4	25.3
Queue Delay	0.0	0.0	0.0	0.0	0.0	0.0	0.0
Total Delay	39.1	9.4	25.5	6.8	456.1	351.4	25.3
LOS	D	A	C	A	F	F	C
Approach Delay		11.8	24.5			353.6	
Approach LOS		B	C			F	

Intersection Summary

Cycle Length: 85
 Actuated Cycle Length: 85
 Offset: 20 (24%), Referenced to phase 2:EBT and 6:WBT, Start of Yellow
 Natural Cycle: 130
 Control Type: Actuated-Coordinated
 Maximum v/c Ratio: 1.94
 Intersection Signal Delay: 128.0
 Intersection Capacity Utilization 99.5%
 Analysis Period (min) 15

Intersection LOS: F
 ICU Level of Service F

Splits and Phases: 29: I-215 NB Ramps & Alessandro Bl.



HCM 6th Signalized Intersection Summary
 29: I-215 NB Ramps & Alessandro Bl.

West Campus Upper Plateau (JN 14064)
 09/19/2022



Movement	EBL	EBT	EBR	WBL	WBT	WBR	NBL	NBT	NBR	SBL	SBT	SBR
Lane Configurations	↘	↑↑↑			↑↑↑	↗	↘	↕	↗			
Traffic Volume (veh/h)	111	1261	0	0	2003	119	1432	0	248	0	0	0
Future Volume (veh/h)	111	1261	0	0	2003	119	1432	0	248	0	0	0
Initial Q (Qb), veh	0	0	0	0	0	0	0	0	0			
Ped-Bike Adj(A_pbT)	1.00		1.00	1.00		1.00	1.00		1.00			
Parking Bus, Adj	1.00	1.00	1.00	1.00	1.00	1.00	1.00	1.00	1.00			
Work Zone On Approach		No			No			No				
Adj Sat Flow, veh/h/ln	1530	1856	0	0	1870	1767	1826	1900	1618			
Adj Flow Rate, veh/h	113	1287	0	0	2044	114	1515	0	116			
Peak Hour Factor	0.98	0.98	0.98	0.98	0.98	0.98	0.98	0.98	0.98			
Percent Heavy Veh, %	25	3	0	0	2	9	5	0	19			
Cap, veh/h	139	3248	0	0	2518	738	818	0	323			
Arrive On Green	0.03	0.21	0.00	0.00	0.49	0.49	0.24	0.00	0.24			
Sat Flow, veh/h	1457	5233	0	0	5274	1497	3478	0	1372			
Grp Volume(v), veh/h	113	1287	0	0	2044	114	1515	0	116			
Grp Sat Flow(s),veh/h/ln	1457	1689	0	0	1702	1497	1739	0	1372			
Q Serve(g_s), s	6.6	18.6	0.0	0.0	28.8	3.6	20.0	0.0	6.0			
Cycle Q Clear(g_c), s	6.6	18.6	0.0	0.0	28.8	3.6	20.0	0.0	6.0			
Prop In Lane	1.00		0.00	0.00		1.00	1.00		1.00			
Lane Grp Cap(c), veh/h	139	3248	0	0	2518	738	818	0	323			
V/C Ratio(X)	0.82	0.40	0.00	0.00	0.81	0.15	1.85	0.00	0.36			
Avail Cap(c_a), veh/h	351	3248	0	0	2518	738	818	0	323			
HCM Platoon Ratio	0.33	0.33	1.00	1.00	1.00	1.00	1.00	1.00	1.00			
Upstream Filter(I)	0.93	0.93	0.00	0.00	1.00	1.00	1.00	0.00	1.00			
Uniform Delay (d), s/veh	40.4	19.3	0.0	0.0	18.2	11.8	32.5	0.0	27.1			
Incr Delay (d2), s/veh	7.8	0.3	0.0	0.0	3.0	0.4	387.8	0.0	3.1			
Initial Q Delay(d3),s/veh	0.0	0.0	0.0	0.0	0.0	0.0	0.0	0.0	0.0			
%ile BackOfQ(50%),veh/ln	2.6	8.2	0.0	0.0	9.7	1.1	52.0	0.0	2.1			
Unsig. Movement Delay, s/veh												
LnGrp Delay(d),s/veh	48.2	19.7	0.0	0.0	21.2	12.3	420.3	0.0	30.2			
LnGrp LOS	D	B	A	A	C	B	F	A	C			
Approach Vol, veh/h		1400			2158			1631				
Approach Delay, s/veh		22.0			20.7			392.6				
Approach LOS		C			C			F				
Timer - Assigned Phs		2			5	6		8				
Phs Duration (G+Y+Rc), s		60.0			12.6	47.4		25.0				
Change Period (Y+Rc), s		5.5			4.5	5.5		5.0				
Max Green Setting (Gmax), s		54.5			20.5	29.5		20.0				
Max Q Clear Time (g_c+I1), s		20.6			8.6	30.8		22.0				
Green Ext Time (p_c), s		9.8			0.1	0.0		0.0				

Intersection Summary

HCM 6th Ctrl Delay	137.9
HCM 6th LOS	F

Notes

User approved volume balancing among the lanes for turning movement.

Timings
30: I-215 SB Ramps & Cactus Av.

West Campus Upper Plateau (JN 14064)

09/19/2022



Lane Group	EBT	EBR	WBL	WBT	NBR	SBR
Lane Configurations	↑↑	↑	↓	↑↑	↑	↑
Traffic Volume (vph)	505	73	816	1647	838	618
Future Volume (vph)	505	73	816	1647	838	618
Turn Type	NA	Perm	Prot	NA	Prot	Prot
Protected Phases	2		1	6	8	4
Permitted Phases		2				
Detector Phase	2	2	1	6	8	4
Switch Phase						
Minimum Initial (s)	5.0	5.0	5.0	5.0	5.0	5.0
Minimum Split (s)	11.0	11.0	9.5	23.0	9.5	9.5
Total Split (s)	23.0	23.0	54.0	77.0	28.0	28.0
Total Split (%)	21.9%	21.9%	51.4%	73.3%	26.7%	26.7%
Yellow Time (s)	5.0	5.0	3.5	5.0	3.5	3.5
All-Red Time (s)	1.0	1.0	1.0	1.0	1.0	1.0
Lost Time Adjust (s)	0.0	0.0	0.0	0.0	0.0	0.0
Total Lost Time (s)	6.0	6.0	4.5	6.0	4.5	4.5
Lead/Lag	Lag	Lag	Lead			
Lead-Lag Optimize?	Yes	Yes	Yes			
Recall Mode	Min	Min	None	Min	None	None
Act Effct Green (s)	17.0	17.0	49.5	71.0	23.5	23.5
Actuated g/C Ratio	0.16	0.16	0.47	0.68	0.22	0.22
v/c Ratio	1.04	0.26	1.15	0.77	0.96	1.85
Control Delay	92.3	11.2	110.9	14.4	27.3	415.7
Queue Delay	0.0	0.0	0.0	0.0	0.0	0.0
Total Delay	92.3	11.2	110.9	14.4	27.3	415.7
LOS	F	B	F	B	C	F
Approach Delay	82.0			46.4		
Approach LOS	F			D		

Intersection Summary

Cycle Length: 105
 Actuated Cycle Length: 105
 Natural Cycle: 120
 Control Type: Actuated-Uncoordinated
 Maximum v/c Ratio: 1.85
 Intersection Signal Delay: 98.2
 Intersection LOS: F
 Intersection Capacity Utilization 92.5%
 ICU Level of Service F
 Analysis Period (min) 15

Splits and Phases: 30: I-215 SB Ramps & Cactus Av.

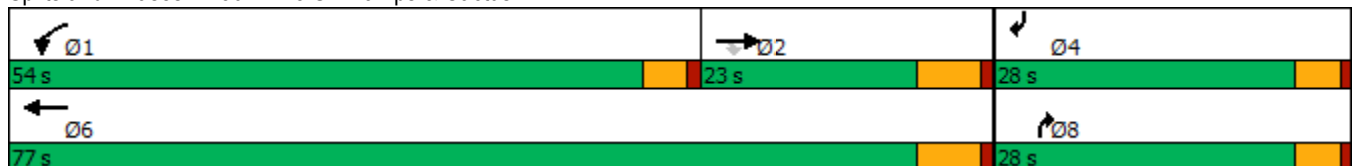

HCM 6th Signalized Intersection Summary
30: I-215 SB Ramps & Cactus Av.

West Campus Upper Plateau (JN 14064)

09/19/2022



Movement	EBL	EBT	EBR	WBL	WBT	WBR	NBL	NBT	NBR	SBL	SBT	SBR
Lane Configurations		↑↑	↗	↘	↑↑				↗			↗
Traffic Volume (veh/h)	0	505	73	816	1647	0	0	0	838	0	0	618
Future Volume (veh/h)	0	505	73	816	1647	0	0	0	838	0	0	618
Initial Q (Qb), veh	0	0	0	0	0	0	0	0	0	0	0	0
Ped-Bike Adj(A_pbT)	1.00		1.00	1.00		1.00	1.00		1.00	1.00		1.00
Parking Bus, Adj	1.00	1.00	1.00	1.00	1.00	1.00	1.00	1.00	1.00	1.00	1.00	1.00
Work Zone On Approach		No			No			No			No	
Adj Sat Flow, veh/h/ln	0	1781	1781	1781	1856	0	0	0	1781	0	0	1633
Adj Flow Rate, veh/h	0	561	73	907	1830	0	0	0	0	0	0	586
Peak Hour Factor	0.90	0.90	0.90	0.90	0.90	0.90	0.90	0.90	0.90	0.90	0.90	0.90
Percent Heavy Veh, %	0	8	8	8	3	0	0	0	8	0	0	18
Cap, veh/h	0	757	338	963	3105	0	0	0	0	0	0	0
Arrive On Green	0.00	0.22	0.22	0.57	0.88	0.00	0.00	0.00	0.00	0.00	0.00	0.00
Sat Flow, veh/h	0	3474	1510	1697	3618	0		0			0	
Grp Volume(v), veh/h	0	561	73	907	1830	0		0.0			0.0	
Grp Sat Flow(s),veh/h/ln	0	1692	1510	1697	1763	0						
Q Serve(g_s), s	0.0	7.8	2.0	25.0	6.5	0.0						
Cycle Q Clear(g_c), s	0.0	7.8	2.0	25.0	6.5	0.0						
Prop In Lane	0.00		1.00	1.00		0.00						
Lane Grp Cap(c), veh/h	0	757	338	963	3105	0						
V/C Ratio(X)	0.00	0.74	0.22	0.94	0.59	0.00						
Avail Cap(c_a), veh/h	0	1144	510	1670	4977	0						
HCM Platoon Ratio	1.00	1.00	1.00	1.00	1.00	1.00						
Upstream Filter(I)	0.00	1.00	1.00	1.00	1.00	0.00						
Uniform Delay (d), s/veh	0.0	18.2	15.9	10.1	0.7	0.0						
Incr Delay (d2), s/veh	0.0	0.5	0.1	4.2	0.1	0.0						
Initial Q Delay(d3),s/veh	0.0	0.0	0.0	0.0	0.0	0.0						
%ile BackOfQ(50%),veh/ln	0.0	2.5	0.6	6.0	0.0	0.0						
Unsig. Movement Delay, s/veh												
LnGrp Delay(d),s/veh	0.0	18.7	16.0	14.3	0.8	0.0						
LnGrp LOS	A	B	B	B	A	A						
Approach Vol, veh/h		634			2737							
Approach Delay, s/veh		18.4			5.3							
Approach LOS		B			A							
Timer - Assigned Phs	1	2			6							
Phs Duration (G+Y+Rc), s	33.0	17.3			50.3							
Change Period (Y+Rc), s	4.5	6.0			6.0							
Max Green Setting (Gmax), s	49.5	17.0			71.0							
Max Q Clear Time (g_c+I1), s	27.0	9.8			8.5							
Green Ext Time (p_c), s	1.6	1.5			13.3							

Intersection Summary

HCM 6th Ctrl Delay		7.7				
HCM 6th LOS		A				

Notes

Unsignalized Delay for [NBR] is excluded from calculations of the approach delay and intersection delay.

Timings

31: I-215 NB Ramps/Old 215 Frontage Rd. & Cactus Av.



Lane Group	EBL	EBT	WBT	NBL	NBT	NBR	SBL	SBT
Lane Configurations	↖	↕	↕	↖	↕	↗	↖	↕
Traffic Volume (vph)	30	1658	3173	532	338	48	58	0
Future Volume (vph)	30	1658	3173	532	338	48	58	0
Turn Type	Perm	NA	NA	Perm	NA	Perm	Perm	NA
Protected Phases		2	6		8			4
Permitted Phases	2			8		8	4	
Detector Phase	2	2	6	8	8	8	4	4
Switch Phase								
Minimum Initial (s)	5.0	5.0	5.0	5.0	5.0	5.0	5.0	5.0
Minimum Split (s)	11.0	11.0	44.0	10.5	10.5	10.5	10.5	10.5
Total Split (s)	88.0	88.0	88.0	32.0	32.0	32.0	32.0	32.0
Total Split (%)	73.3%	73.3%	73.3%	26.7%	26.7%	26.7%	26.7%	26.7%
Yellow Time (s)	5.0	5.0	5.0	4.5	4.5	4.5	4.5	4.5
All-Red Time (s)	1.0	1.0	1.0	1.0	1.0	1.0	1.0	1.0
Lost Time Adjust (s)	0.0	0.0	0.0	0.0	0.0	0.0	0.0	0.0
Total Lost Time (s)	6.0	6.0	6.0	5.5	5.5	5.5	5.5	5.5
Lead/Lag								
Lead-Lag Optimize?								
Recall Mode	Min	Min	Min	None	None	None	None	None
Act Effct Green (s)	82.0	82.0	82.0	26.5	26.5	26.5	26.5	26.5
Actuated g/C Ratio	0.68	0.68	0.68	0.22	0.22	0.22	0.22	0.22
v/c Ratio	0.58	0.85	1.49	2.61	1.03	0.13	1.03	0.57
Control Delay	56.9	18.7	245.1	758.0	100.5	18.1	173.7	43.2
Queue Delay	0.0	0.0	0.0	0.0	0.0	0.0	0.0	0.0
Total Delay	56.9	18.7	245.1	758.0	100.5	18.1	173.7	43.2
LOS	E	B	F	F	F	B	F	D
Approach Delay		19.3	245.1		477.5			77.9
Approach LOS		B	F		F			E

Intersection Summary

Cycle Length: 120	
Actuated Cycle Length: 120	
Natural Cycle: 110	
Control Type: Actuated-Uncoordinated	
Maximum v/c Ratio: 2.61	
Intersection Signal Delay: 206.7	Intersection LOS: F
Intersection Capacity Utilization 146.5%	ICU Level of Service H
Analysis Period (min) 15	

Splits and Phases: 31: I-215 NB Ramps/Old 215 Frontage Rd. & Cactus Av.



HCM 6th Signalized Intersection Summary

West Campus Upper Plateau (JN 14064)

31: I-215 NB Ramps/Old 215 Frontage Rd. & Cactus Av.

09/19/2022



Movement	EBL	EBT	EBR	WBL	WBT	WBR	NBL	NBT	NBR	SBL	SBT	SBR
Lane Configurations	↗	↗↘			↗↘		↗	↘	↗	↗	↘	↘
Traffic Volume (veh/h)	30	1658	170	0	3173	163	532	338	48	58	0	161
Future Volume (veh/h)	30	1658	170	0	3173	163	532	338	48	58	0	161
Initial Q (Qb), veh	0	0	0	0	0	0	0	0	0	0	0	0
Ped-Bike Adj(A_pbT)	1.00		1.00	1.00		1.00	1.00		1.00	1.00		1.00
Parking Bus, Adj	1.00	1.00	1.00	1.00	1.00	1.00	1.00	1.00	1.00	1.00	1.00	1.00
Work Zone On Approach		No			No			No			No	
Adj Sat Flow, veh/h/ln	1678	1841	1515	0	1856	1841	1826	1722	1841	1841	1900	1500
Adj Flow Rate, veh/h	32	1764	176	0	3376	153	566	360	0	62	0	161
Peak Hour Factor	0.94	0.94	0.94	0.94	0.94	0.94	0.94	0.94	0.94	0.94	0.94	0.94
Percent Heavy Veh, %	15	4	26	0	3	4	5	12	4	4	0	27
Cap, veh/h	60	2198	216	0	2348	106	221	380		75	0	356
Arrive On Green	0.68	0.68	0.68	0.00	0.68	0.68	0.22	0.22	0.00	0.22	0.00	0.22
Sat Flow, veh/h	41	3217	316	0	3529	155	1196	1722	1560	1005	0	1610
Grp Volume(v), veh/h	32	945	995	0	1719	1810	566	360	0	62	0	161
Grp Sat Flow(s),veh/h/ln	41	1749	1784	0	1763	1828	1196	1722	1560	1005	0	1610
Q Serve(g_s), s	0.0	44.7	47.9	0.0	82.0	82.0	16.1	24.7	0.0	1.8	0.0	10.4
Cycle Q Clear(g_c), s	82.0	44.7	47.9	0.0	82.0	82.0	26.5	24.7	0.0	26.5	0.0	10.4
Prop In Lane	1.00		0.18	0.00		0.08	1.00		1.00	1.00		1.00
Lane Grp Cap(c), veh/h	60	1195	1219	0	1205	1249	221	380		75	0	356
V/C Ratio(X)	0.53	0.79	0.82	0.00	1.43	1.45	2.57	0.95		0.83	0.00	0.45
Avail Cap(c_a), veh/h	60	1195	1219	0	1205	1249	221	380		75	0	356
HCM Platoon Ratio	1.00	1.00	1.00	1.00	1.00	1.00	1.00	1.00	1.00	1.00	1.00	1.00
Upstream Filter(I)	1.00	1.00	1.00	0.00	1.00	1.00	1.00	1.00	0.00	1.00	0.00	1.00
Uniform Delay (d), s/veh	60.0	13.1	13.6	0.0	19.0	19.0	54.1	46.1	0.0	59.8	0.0	40.5
Incr Delay (d2), s/veh	4.7	3.4	4.1	0.0	197.2	206.6	717.8	32.3	0.0	48.2	0.0	0.3
Initial Q Delay(d3),s/veh	0.0	0.0	0.0	0.0	0.0	0.0	0.0	0.0	0.0	0.0	0.0	0.0
%ile BackOfQ(50%),veh/ln	1.0	15.5	17.1	0.0	92.6	99.3	50.5	13.6	0.0	2.8	0.0	4.0
Unsig. Movement Delay, s/veh												
LnGrp Delay(d),s/veh	64.7	16.5	17.7	0.0	216.2	225.6	771.9	78.3	0.0	108.0	0.0	40.8
LnGrp LOS	E	B	B	A	F	F	F	E		F	A	D
Approach Vol, veh/h		1972			3529			926				223
Approach Delay, s/veh		17.9			221.0			502.3				59.5
Approach LOS		B			F			F				E
Timer - Assigned Phs		2		4		6		8				
Phs Duration (G+Y+Rc), s		88.0		32.0		88.0		32.0				
Change Period (Y+Rc), s		6.0		5.5		6.0		5.5				
Max Green Setting (Gmax), s		82.0		26.5		82.0		26.5				
Max Q Clear Time (g_c+I1), s		84.0		28.5		84.0		28.5				
Green Ext Time (p_c), s		0.0		0.0		0.0		0.0				

Intersection Summary

HCM 6th Ctrl Delay	194.5
HCM 6th LOS	F

Notes

User approved volume balancing among the lanes for turning movement.
 Unsignalized Delay for [NBR] is excluded from calculations of the approach delay and intersection delay.

Timings
32: I-215 SB Ramps & Van Buren Bl.

West Campus Upper Plateau (JN 14064)

09/19/2022



Lane Group	EBT	EBR	WBL	WBT	SBT	SBR
Lane Configurations	↑↑	↑↑	↙	↑↑	↙	↑↑
Traffic Volume (vph)	1016	1017	30	1587	25	1437
Future Volume (vph)	1016	1017	30	1587	25	1437
Turn Type	NA	Perm	Prot	NA	NA	Perm
Protected Phases	6		5	2	8	
Permitted Phases		6				8
Detector Phase	6	6	5	2	8	8
Switch Phase						
Minimum Initial (s)	5.0	5.0	5.0	5.0	5.0	5.0
Minimum Split (s)	36.0	36.0	11.0	11.0	11.0	11.0
Total Split (s)	37.0	37.0	11.0	48.0	37.0	37.0
Total Split (%)	43.5%	43.5%	12.9%	56.5%	43.5%	43.5%
Yellow Time (s)	5.0	5.0	5.0	5.0	5.0	5.0
All-Red Time (s)	1.0	1.0	1.0	1.0	1.0	1.0
Lost Time Adjust (s)	0.0	0.0	0.0	0.0	0.0	0.0
Total Lost Time (s)	6.0	6.0	6.0	6.0	6.0	6.0
Lead/Lag	Lag	Lag	Lead			
Lead-Lag Optimize?	Yes	Yes	Yes			
Recall Mode	Min	Min	None	Min	Max	Max
Act Effct Green (s)	35.4	35.4	5.0	42.0	31.0	31.0
Actuated g/C Ratio	0.42	0.42	0.06	0.49	0.36	0.36
v/c Ratio	0.79	0.63	0.30	1.00	0.68	1.51
Control Delay	28.4	3.2	46.0	45.8	29.5	258.0
Queue Delay	0.0	0.0	0.0	0.0	0.0	0.0
Total Delay	28.4	3.2	46.0	45.8	29.5	258.0
LOS	C	A	D	D	C	F
Approach Delay	15.8			45.8	207.9	
Approach LOS	B			D	F	

Intersection Summary

Cycle Length: 85
 Actuated Cycle Length: 85
 Natural Cycle: 130
 Control Type: Actuated-Uncoordinated
 Maximum v/c Ratio: 1.51
 Intersection Signal Delay: 89.0
 Intersection Capacity Utilization 102.5%
 Analysis Period (min) 15
 Intersection LOS: F
 ICU Level of Service G

Splits and Phases: 32: I-215 SB Ramps & Van Buren Bl.

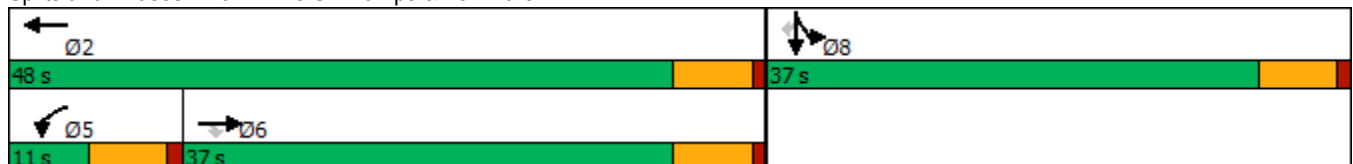

HCM 6th Signalized Intersection Summary
 32: I-215 SB Ramps & Van Buren Bl.

West Campus Upper Plateau (JN 14064)

09/19/2022



Movement	EBL	EBT	EBR	WBL	WBT	WBR	NBL	NBT	NBR	SBL	SBT	SBR
Lane Configurations		↑↑	↑↑	↑	↑↑						↑	↑↑
Traffic Volume (veh/h)	0	1016	1017	30	1587	0	0	0	0	378	25	1437
Future Volume (veh/h)	0	1016	1017	30	1587	0	0	0	0	378	25	1437
Initial Q (Qb), veh	0	0	0	0	0	0				0	0	0
Ped-Bike Adj(A_pbT)	1.00		1.00	1.00		1.00				1.00		1.00
Parking Bus, Adj	1.00	1.00	1.00	1.00	1.00	1.00				1.00	1.00	1.00
Work Zone On Approach		No			No						No	
Adj Sat Flow, veh/h/ln	0	1767	1781	1900	1826	0				1856	1559	1767
Adj Flow Rate, veh/h	0	1092	1000	32	1706	0				406	27	0
Peak Hour Factor	0.93	0.93	0.93	0.93	0.93	0.93				0.93	0.93	0.93
Percent Heavy Veh, %	0	9	8	0	5	0				3	23	9
Cap, veh/h	0	1224	969	106	1714	0				509	34	
Arrive On Green	0.00	0.36	0.36	0.06	0.49	0.00				0.36	0.36	0.00
Sat Flow, veh/h	0	3445	2657	1810	3561	0				1396	93	2635
Grp Volume(v), veh/h	0	1092	1000	32	1706	0				433	0	0
Grp Sat Flow(s),veh/h/ln	0	1678	1329	1810	1735	0				1489	0	1317
Q Serve(g_s), s	0.0	26.0	31.0	1.4	41.6	0.0				22.1	0.0	0.0
Cycle Q Clear(g_c), s	0.0	26.0	31.0	1.4	41.6	0.0				22.1	0.0	0.0
Prop In Lane	0.00		1.00	1.00		0.00				0.94		1.00
Lane Grp Cap(c), veh/h	0	1224	969	106	1714	0				543	0	
V/C Ratio(X)	0.00	0.89	1.03	0.30	1.00	0.00				0.80	0.00	
Avail Cap(c_a), veh/h	0	1224	969	106	1714	0				543	0	
HCM Platoon Ratio	1.00	1.00	1.00	1.00	1.00	1.00				1.00	1.00	1.00
Upstream Filter(I)	0.00	1.00	1.00	1.00	1.00	0.00				1.00	0.00	0.00
Uniform Delay (d), s/veh	0.0	25.4	27.0	38.3	21.4	0.0				24.2	0.0	0.0
Incr Delay (d2), s/veh	0.0	8.3	37.4	0.6	20.5	0.0				11.6	0.0	0.0
Initial Q Delay(d3),s/veh	0.0	0.0	0.0	0.0	0.0	0.0				0.0	0.0	0.0
%ile BackOfQ(50%),veh/ln	0.0	10.3	13.4	0.6	18.6	0.0				8.7	0.0	0.0
Unsig. Movement Delay, s/veh												
LnGrp Delay(d),s/veh	0.0	33.7	64.4	38.9	41.9	0.0				35.7	0.0	0.0
LnGrp LOS	A	C	F	D	D	A				D	A	
Approach Vol, veh/h		2092			1738							433
Approach Delay, s/veh		48.4			41.9							35.7
Approach LOS		D			D							D
Timer - Assigned Phs		2			5	6		8				
Phs Duration (G+Y+Rc), s		48.0			11.0	37.0		37.0				
Change Period (Y+Rc), s		6.0			6.0	6.0		6.0				
Max Green Setting (Gmax), s		42.0			5.0	31.0		31.0				
Max Q Clear Time (g_c+I1), s		43.6			3.4	33.0		24.1				
Green Ext Time (p_c), s		0.0			0.0	0.0		1.0				

Intersection Summary

HCM 6th Ctrl Delay	44.5
HCM 6th LOS	D

Notes

Unsignalized Delay for [SBR] is excluded from calculations of the approach delay and intersection delay.

Timings
33: I-215 NB On/Off Ramp & Van Buren Bl.



Lane Group	EBT	EBR	WBT	NBL	NBR
Lane Configurations	↑↑	↑↑	↑↑	↑↑	↑
Traffic Volume (vph)	517	948	173	1631	137
Future Volume (vph)	517	948	173	1631	137
Turn Type	NA	pm+ov	NA	Prot	Perm
Protected Phases	6	4	2	4	
Permitted Phases		6			4
Detector Phase	6	4	2	4	4
Switch Phase					
Minimum Initial (s)	5.0	5.0	5.0	5.0	5.0
Minimum Split (s)	11.0	42.0	11.0	42.0	42.0
Total Split (s)	15.0	55.0	15.0	55.0	55.0
Total Split (%)	21.4%	78.6%	21.4%	78.6%	78.6%
Yellow Time (s)	5.0	5.0	5.0	5.0	5.0
All-Red Time (s)	1.0	1.0	1.0	1.0	1.0
Lost Time Adjust (s)	0.0	0.0	0.0	0.0	0.0
Total Lost Time (s)	6.0	6.0	6.0	6.0	6.0
Lead/Lag					
Lead-Lag Optimize?					
Recall Mode	None	Min	None	Min	Min
Act Effct Green (s)	9.2	58.3	9.2	36.8	36.8
Actuated g/C Ratio	0.16	1.00	0.16	0.63	0.63
v/c Ratio	1.01	0.39	0.36	0.84	0.15
Control Delay	73.0	0.4	26.9	12.6	4.2
Queue Delay	0.0	0.0	0.0	0.0	0.0
Total Delay	73.0	0.4	26.9	12.6	4.2
LOS	E	A	C	B	A
Approach Delay	26.1		26.9	11.9	
Approach LOS	C		C	B	

Intersection Summary

Cycle Length: 70
 Actuated Cycle Length: 58.3
 Natural Cycle: 60
 Control Type: Actuated-Uncoordinated
 Maximum v/c Ratio: 1.01
 Intersection Signal Delay: 18.8
 Intersection LOS: B
 Intersection Capacity Utilization 70.8%
 ICU Level of Service C
 Analysis Period (min) 15

Splits and Phases: 33: I-215 NB On/Off Ramp & Van Buren Bl.



HCM 6th Signalized Intersection Summary
 33: I-215 NB On/Off Ramp & Van Buren Bl.

West Campus Upper Plateau (JN 14064)

09/19/2022

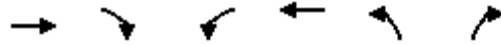

Movement	EBT	EBR	WBL	WBT	NBL	NBR
Lane Configurations	↑↑	↑↑		↑↑	↑↑	↑
Traffic Volume (veh/h)	517	948	0	173	1631	137
Future Volume (veh/h)	517	948	0	173	1631	137
Initial Q (Qb), veh	0	0	0	0	0	0
Ped-Bike Adj(A_pbT)		1.00	1.00		1.00	1.00
Parking Bus, Adj	1.00	1.00	1.00	1.00	1.00	1.00
Work Zone On Approach	No			No	No	
Adj Sat Flow, veh/h/ln	1856	1767	0	1781	1826	1870
Adj Flow Rate, veh/h	562	1015	0	188	1773	149
Peak Hour Factor	0.92	0.92	0.92	0.92	0.92	0.92
Percent Heavy Veh, %	3	9	0	8	5	2
Cap, veh/h	621	2016	0	596	1988	934
Arrive On Green	0.18	0.18	0.00	0.18	0.59	0.59
Sat Flow, veh/h	3618	2635	0	3563	3374	1585
Grp Volume(v), veh/h	562	1015	0	188	1773	149
Grp Sat Flow(s),veh/h/ln	1763	1317	0	1692	1687	1585
Q Serve(g_s), s	8.0	7.5	0.0	2.5	23.3	2.2
Cycle Q Clear(g_c), s	8.0	7.5	0.0	2.5	23.3	2.2
Prop In Lane		1.00	0.00		1.00	1.00
Lane Grp Cap(c), veh/h	621	2016	0	596	1988	934
V/C Ratio(X)	0.91	0.50	0.00	0.32	0.89	0.16
Avail Cap(c_a), veh/h	621	2016	0	596	3234	1519
HCM Platoon Ratio	1.00	1.00	1.00	1.00	1.00	1.00
Upstream Filter(I)	1.00	1.00	0.00	1.00	1.00	1.00
Uniform Delay (d), s/veh	20.6	2.3	0.0	18.4	9.1	4.8
Incr Delay (d2), s/veh	16.5	0.1	0.0	0.1	1.2	0.0
Initial Q Delay(d3),s/veh	0.0	0.0	0.0	0.0	0.0	0.0
%ile BackOfQ(50%),veh/ln	4.1	5.3	0.0	0.8	4.6	0.4
Unsig. Movement Delay, s/veh						
LnGrp Delay(d),s/veh	37.1	2.4	0.0	18.5	10.3	4.8
LnGrp LOS	D	A	A	B	B	A
Approach Vol, veh/h	1577			188	1922	
Approach Delay, s/veh	14.8			18.5	9.9	
Approach LOS	B			B	A	
Timer - Assigned Phs		2		4		6
Phs Duration (G+Y+Rc), s		15.0		36.1		15.0
Change Period (Y+Rc), s		6.0		6.0		6.0
Max Green Setting (Gmax), s		9.0		49.0		9.0
Max Q Clear Time (g_c+11), s		4.5		25.3		10.0
Green Ext Time (p_c), s		0.2		4.9		0.0
Intersection Summary						
HCM 6th Ctrl Delay			12.4			
HCM 6th LOS			B			

Timings

West Campus Upper Plateau (JN 14064)

34: Old 215 Frontage Rd. & Alessandro Bl.

09/19/2022

Lane Group	EBL	EBT	EBR	WBL	WBT	WBR	NBL	NBT	NBR	SBL	SBT	SBR
Lane Configurations												
Traffic Volume (vph)	436	1245	52	11	1682	142	63	305	22	33	74	280
Future Volume (vph)	436	1245	52	11	1682	142	63	305	22	33	74	280
Turn Type	Prot	NA	Perm	Prot	NA	Perm	Prot	NA	Perm	Prot	NA	Perm
Protected Phases	5	2		1	6		3	8		7	4	
Permitted Phases			2			6			8			4
Detector Phase	5	2	2	1	6	6	3	8	8	7	4	4
Switch Phase												
Minimum Initial (s)	5.0	10.0	10.0	5.0	10.0	10.0	5.0	10.0	10.0	5.0	10.0	10.0
Minimum Split (s)	8.7	43.5	43.5	8.7	15.8	15.8	8.7	16.2	16.2	8.7	40.2	40.2
Total Split (s)	18.0	66.0	66.0	8.7	56.7	56.7	8.7	39.0	39.0	10.3	40.6	40.6
Total Split (%)	14.5%	53.2%	53.2%	7.0%	45.7%	45.7%	7.0%	31.5%	31.5%	8.3%	32.7%	32.7%
Yellow Time (s)	3.2	5.5	5.5	3.2	4.8	4.8	3.2	5.2	5.2	3.2	5.2	5.2
All-Red Time (s)	0.5	1.0	1.0	0.5	1.0	1.0	0.5	1.0	1.0	0.5	1.0	1.0
Lost Time Adjust (s)	0.0	0.0	0.0	0.0	0.0	0.0	0.0	0.0	0.0	0.0	0.0	0.0
Total Lost Time (s)	3.7	6.5	6.5	3.7	5.8	5.8	3.7	6.2	6.2	3.7	6.2	6.2
Lead/Lag	Lead	Lag	Lag	Lead	Lag	Lag	Lead	Lag	Lag	Lead	Lag	Lag
Lead-Lag Optimize?	Yes	Yes	Yes	Yes	Yes	Yes	Yes	Yes	Yes	Yes	Yes	Yes
Recall Mode	None	None	None	None	None	None	None	Max	Max	None	Max	Max
Act Effct Green (s)	14.3	66.6	66.6	5.0	51.0	51.0	5.0	35.2	35.2	6.1	34.4	34.4
Actuated g/C Ratio	0.12	0.54	0.54	0.04	0.42	0.42	0.04	0.29	0.29	0.05	0.28	0.28
v/c Ratio	1.18	0.46	0.07	0.24	1.16	0.20	0.51	0.32	0.04	0.39	0.08	0.50
Control Delay	153.5	18.3	0.8	71.0	115.3	4.3	72.5	36.1	0.1	70.2	33.3	16.3
Queue Delay	0.0	0.0	0.0	0.0	0.0	0.0	0.0	0.0	0.0	0.0	0.0	0.0
Total Delay	153.5	18.3	0.8	71.0	115.3	4.3	72.5	36.1	0.1	70.2	33.3	16.3
LOS	F	B	A	E	F	A	E	D	A	E	C	B
Approach Delay		51.8			106.5			40.0			24.2	
Approach LOS		D			F			D			C	

Intersection Summary

Cycle Length: 124
 Actuated Cycle Length: 122.3
 Natural Cycle: 125
 Control Type: Actuated-Uncoordinated
 Maximum v/c Ratio: 1.18
 Intersection Signal Delay: 71.4
 Intersection LOS: E
 Intersection Capacity Utilization 88.2%
 ICU Level of Service E
 Analysis Period (min) 15

Splits and Phases: 34: Old 215 Frontage Rd. & Alessandro Bl.

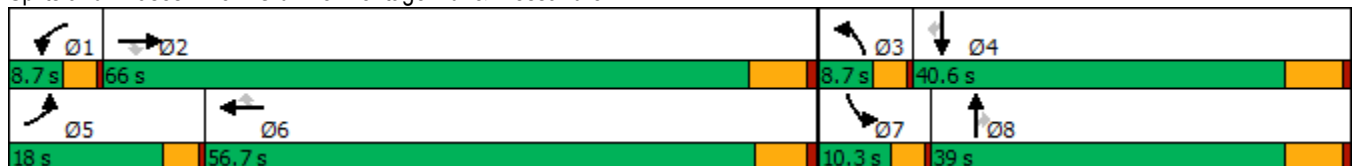

HCM 6th Signalized Intersection Summary
 34: Old 215 Frontage Rd. & Alessandro Bl.

West Campus Upper Plateau (JN 14064)

09/19/2022



Movement	EBL	EBT	EBR	WBL	WBT	WBR	NBL	NBT	NBR	SBL	SBT	SBR
Lane Configurations	↖↗	↑↑↑	↖	↖	↑↑	↖	↖↗	↑↑	↖	↖	↑↑	↖
Traffic Volume (veh/h)	436	1245	52	11	1682	142	63	305	22	33	74	280
Future Volume (veh/h)	436	1245	52	11	1682	142	63	305	22	33	74	280
Initial Q (Qb), veh	0	0	0	0	0	0	0	0	0	0	0	0
Ped-Bike Adj(A_pbT)	1.00		1.00	1.00		1.00	1.00		1.00	1.00		1.00
Parking Bus, Adj	1.00	1.00	1.00	1.00	1.00	1.00	1.00	1.00	1.00	1.00	1.00	1.00
Work Zone On Approach		No			No			No			No	
Adj Sat Flow, veh/h/ln	1767	1856	1470	981	1870	1811	1707	1811	1752	1856	1811	1826
Adj Flow Rate, veh/h	445	1270	43	11	1716	0	64	311	14	34	76	0
Peak Hour Factor	0.98	0.98	0.98	0.98	0.98	0.98	0.98	0.98	0.98	0.98	0.98	0.98
Percent Heavy Veh, %	9	3	29	62	2	6	13	6	10	3	6	5
Cap, veh/h	376	2596	638	12	1457		113	981	423	49	953	
Arrive On Green	0.12	0.51	0.51	0.01	0.41	0.00	0.04	0.29	0.29	0.03	0.28	0.00
Sat Flow, veh/h	3264	5066	1246	934	3554	1535	3155	3441	1485	1767	3441	1547
Grp Volume(v), veh/h	445	1270	43	11	1716	0	64	311	14	34	76	0
Grp Sat Flow(s),veh/h/ln	1632	1689	1246	934	1777	1535	1577	1721	1485	1767	1721	1547
Q Serve(g_s), s	14.3	20.3	2.2	1.5	50.9	0.0	2.5	8.8	0.8	2.4	2.0	0.0
Cycle Q Clear(g_c), s	14.3	20.3	2.2	1.5	50.9	0.0	2.5	8.8	0.8	2.4	2.0	0.0
Prop In Lane	1.00		1.00	1.00		1.00	1.00		1.00	1.00		1.00
Lane Grp Cap(c), veh/h	376	2596	638	12	1457		113	981	423	49	953	
V/C Ratio(X)	1.18	0.49	0.07	0.93	1.18		0.57	0.32	0.03	0.69	0.08	
Avail Cap(c_a), veh/h	376	2596	638	38	1457		127	981	423	94	953	
HCM Platoon Ratio	1.00	1.00	1.00	1.00	1.00	1.00	1.00	1.00	1.00	1.00	1.00	1.00
Upstream Filter(I)	1.00	1.00	1.00	1.00	1.00	0.00	1.00	1.00	1.00	1.00	1.00	0.00
Uniform Delay (d), s/veh	54.9	19.7	15.3	61.2	36.6	0.0	58.9	34.9	32.0	59.8	33.2	0.0
Incr Delay (d2), s/veh	106.6	0.1	0.0	56.4	87.5	0.0	1.8	0.8	0.1	6.3	0.2	0.0
Initial Q Delay(d3),s/veh	0.0	0.0	0.0	0.0	0.0	0.0	0.0	0.0	0.0	0.0	0.0	0.0
%ile BackOfQ(50%),veh/ln	11.2	7.3	0.6	0.5	38.4	0.0	1.0	3.7	0.3	1.1	0.8	0.0
Unsig. Movement Delay, s/veh												
LnGrp Delay(d),s/veh	161.5	19.8	15.3	117.6	124.1	0.0	60.7	35.7	32.2	66.1	33.3	0.0
LnGrp LOS	F	B	B	F	F		E	D	C	E	C	
Approach Vol, veh/h		1758			1727			389			110	
Approach Delay, s/veh		55.6			124.1			39.7			43.5	
Approach LOS		E			F			D			D	
Timer - Assigned Phs	1	2	3	4	5	6	7	8				
Phs Duration (G+Y+Rc), s	5.3	70.1	8.1	40.6	18.0	57.4	7.2	41.6				
Change Period (Y+Rc), s	3.7	6.5	3.7	6.2	3.7	* 6.5	3.7	6.2				
Max Green Setting (Gmax), s	5.0	59.5	5.0	34.4	14.3	* 51	6.6	32.8				
Max Q Clear Time (g_c+I1), s	3.5	22.3	4.5	4.0	16.3	52.9	4.4	10.8				
Green Ext Time (p_c), s	0.0	10.0	0.0	0.3	0.0	0.0	0.0	1.7				

Intersection Summary

HCM 6th Ctrl Delay	83.4
HCM 6th LOS	F

Notes

* HCM 6th computational engine requires equal clearance times for the phases crossing the barrier.
 Unsignalized Delay for [WBR, SBR] is excluded from calculations of the approach delay and intersection delay.

Timings
35: Day St. & Alessandro Bl.

West Campus Upper Plateau (JN 14064)

09/19/2022



Lane Group	EBL	EBT	EBR	WBL	WBT	WBR	NBL	NBT	NBR	SBL	SBT
Lane Configurations	↖	↗↗↗	↖	↖	↗↗	↖	↖	↗	↖	↖	↗
Traffic Volume (vph)	187	913	11	11	1520	157	12	184	19	105	74
Future Volume (vph)	187	913	11	11	1520	157	12	184	19	105	74
Turn Type	Prot	NA	Perm	Prot	NA	Perm	Perm	NA	Perm	Perm	NA
Protected Phases	5	2		1	6			8			4
Permitted Phases			2			6	8		8	4	
Detector Phase	5	2	2	1	6	6	8	8	8	4	4
Switch Phase											
Minimum Initial (s)	5.0	10.0	10.0	5.0	10.0	10.0	10.0	10.0	10.0	10.0	10.0
Minimum Split (s)	9.1	30.8	30.8	9.1	30.8	30.8	42.4	42.4	42.4	41.6	41.6
Total Split (s)	21.0	68.5	68.5	9.1	56.6	56.6	42.4	42.4	42.4	42.4	42.4
Total Split (%)	17.5%	57.1%	57.1%	7.6%	47.2%	47.2%	35.3%	35.3%	35.3%	35.3%	35.3%
Yellow Time (s)	3.6	4.8	4.8	3.6	4.8	4.8	4.4	4.4	4.4	3.6	3.6
All-Red Time (s)	0.5	1.0	1.0	0.5	1.0	1.0	1.0	1.0	1.0	1.0	1.0
Lost Time Adjust (s)	0.0	0.0	0.0	0.0	0.0	0.0	0.0	0.0	0.0	0.0	0.0
Total Lost Time (s)	4.1	5.8	5.8	4.1	5.8	5.8	5.4	5.4	5.4	4.6	4.6
Lead/Lag	Lead	Lag	Lag	Lead	Lag	Lag					
Lead-Lag Optimize?	Yes	Yes	Yes	Yes	Yes	Yes					
Recall Mode	None	None	None	None	None	None	None	None	None	None	None
Act Effct Green (s)	15.0	69.0	69.0	5.1	51.4	51.4	18.1	18.1	18.1	18.9	18.9
Actuated g/C Ratio	0.15	0.69	0.69	0.05	0.51	0.51	0.18	0.18	0.18	0.19	0.19
v/c Ratio	0.77	0.28	0.02	0.15	0.90	0.20	0.16	0.58	0.06	0.70	0.56
Control Delay	62.2	7.9	0.1	54.8	31.7	8.3	37.9	44.0	0.3	59.7	29.1
Queue Delay	0.0	0.0	0.0	0.0	0.0	0.0	0.0	0.0	0.0	0.0	0.0
Total Delay	62.2	7.9	0.1	54.8	31.7	8.3	37.9	44.0	0.3	59.7	29.1
LOS	E	A	A	D	C	A	D	D	A	E	C
Approach Delay		17.0			29.7			39.9			39.6
Approach LOS		B			C			D			D

Intersection Summary

Cycle Length: 120	
Actuated Cycle Length: 99.9	
Natural Cycle: 125	
Control Type: Actuated-Uncoordinated	
Maximum v/c Ratio: 0.90	
Intersection Signal Delay: 27.0	Intersection LOS: C
Intersection Capacity Utilization 88.9%	ICU Level of Service E
Analysis Period (min) 15	

Splits and Phases: 35: Day St. & Alessandro Bl.



HCM 6th Signalized Intersection Summary
35: Day St. & Alessandro Bl.

West Campus Upper Plateau (JN 14064)

09/19/2022

Movement	EBL	EBT	EBR	WBL	WBT	WBR	NBL	NBT	NBR	SBL	SBT	SBR
Lane Configurations												
Traffic Volume (veh/h)	187	913	11	11	1520	157	12	184	19	105	74	126
Future Volume (veh/h)	187	913	11	11	1520	157	12	184	19	105	74	126
Initial Q (Qb), veh	0	0	0	0	0	0	0	0	0	0	0	0
Ped-Bike Adj(A_pbT)	1.00		0.98	1.00		1.00	1.00		1.00	1.00		1.00
Parking Bus, Adj	1.00	1.00	1.00	1.00	1.00	1.00	1.00	1.00	1.00	1.00	1.00	1.00
Work Zone On Approach		No			No			No			No	
Adj Sat Flow, veh/h/ln	1856	1856	952	1737	1870	1870	922	1885	1722	1870	1900	1870
Adj Flow Rate, veh/h	201	982	11	12	1634	134	13	198	8	113	80	108
Peak Hour Factor	0.93	0.93	0.93	0.93	0.93	0.93	0.93	0.93	0.93	0.93	0.93	0.93
Percent Heavy Veh, %	3	3	64	11	2	2	66	1	12	2	0	2
Cap, veh/h	233	3103	484	23	1759	784	146	416	322	224	162	218
Arrive On Green	0.13	0.61	0.61	0.01	0.49	0.49	0.22	0.22	0.22	0.22	0.22	0.22
Sat Flow, veh/h	1767	5066	790	1654	3554	1585	589	1885	1457	1175	733	989
Grp Volume(v), veh/h	201	982	11	12	1634	134	13	198	8	113	0	188
Grp Sat Flow(s),veh/h/ln	1767	1689	790	1654	1777	1585	589	1885	1457	1175	0	1722
Q Serve(g_s), s	11.2	9.3	0.5	0.7	43.1	4.7	2.0	9.2	0.4	9.3	0.0	9.6
Cycle Q Clear(g_c), s	11.2	9.3	0.5	0.7	43.1	4.7	11.6	9.2	0.4	18.5	0.0	9.6
Prop In Lane	1.00		1.00	1.00		1.00	1.00		1.00	1.00		0.57
Lane Grp Cap(c), veh/h	233	3103	484	23	1759	784	146	416	322	224	0	380
V/C Ratio(X)	0.86	0.32	0.02	0.51	0.93	0.17	0.09	0.48	0.02	0.51	0.00	0.49
Avail Cap(c_a), veh/h	298	3168	494	83	1801	803	233	696	538	407	0	649
HCM Platoon Ratio	1.00	1.00	1.00	1.00	1.00	1.00	1.00	1.00	1.00	1.00	1.00	1.00
Upstream Filter(I)	1.00	1.00	1.00	1.00	1.00	1.00	1.00	1.00	1.00	1.00	0.00	1.00
Uniform Delay (d), s/veh	42.6	9.3	7.6	49.1	23.7	14.0	39.2	34.0	30.6	42.0	0.0	34.2
Incr Delay (d2), s/veh	15.6	0.1	0.0	6.3	9.0	0.1	0.3	0.8	0.0	1.8	0.0	1.0
Initial Q Delay(d3),s/veh	0.0	0.0	0.0	0.0	0.0	0.0	0.0	0.0	0.0	0.0	0.0	0.0
%ile BackOfQ(50%),veh/ln	5.7	2.9	0.1	0.3	18.1	1.6	0.3	4.2	0.2	2.8	0.0	4.1
Unsig. Movement Delay, s/veh												
LnGrp Delay(d),s/veh	58.2	9.4	7.7	55.4	32.6	14.1	39.5	34.9	30.6	43.8	0.0	35.2
LnGrp LOS	E	A	A	E	C	B	D	C	C	D	A	D
Approach Vol, veh/h		1194			1780			219			301	
Approach Delay, s/veh		17.6			31.4			35.0			38.4	
Approach LOS		B			C			C			D	
Timer - Assigned Phs	1	2		4	5	6		8				
Phs Duration (G+Y+Rc), s	5.5	67.2		27.5	17.3	55.4		27.5				
Change Period (Y+Rc), s	4.1	5.8		* 5.4	4.1	5.8		5.4				
Max Green Setting (Gmax), s	5.0	62.7		* 38	16.9	50.8		37.0				
Max Q Clear Time (g_c+I1), s	2.7	11.3		20.5	13.2	45.1		13.6				
Green Ext Time (p_c), s	0.0	7.8		1.5	0.1	4.5		1.1				

Intersection Summary

HCM 6th Ctrl Delay	27.5
HCM 6th LOS	C

Notes

* HCM 6th computational engine requires equal clearance times for the phases crossing the barrier.

Timings
36: Elsworth St. & Cactus Av.

West Campus Upper Plateau (JN 14064)

09/19/2022



Lane Group	EBL	EBT	EBR	WBL	WBT	WBR	NBL	NBT	SBL	SBT	SBR
Lane Configurations											
Traffic Volume (vph)	301	1823	330	79	2254	219	26	12	169	66	298
Future Volume (vph)	301	1823	330	79	2254	219	26	12	169	66	298
Turn Type	Prot	NA	Perm	Prot	NA	Perm	Split	NA	Split	NA	pm+ov
Protected Phases	5	2		1	6		8	8	4	4	5
Permitted Phases			2			6					4
Detector Phase	5	2	2	1	6	6	8	8	4	4	5
Switch Phase											
Minimum Initial (s)	5.0	10.0	10.0	5.0	10.0	10.0	10.0	10.0	10.0	10.0	5.0
Minimum Split (s)	9.6	36.2	36.2	9.6	36.2	36.2	35.4	35.4	35.4	35.4	9.6
Total Split (s)	15.0	48.6	48.6	10.6	44.2	44.2	35.4	35.4	35.4	35.4	15.0
Total Split (%)	11.5%	37.4%	37.4%	8.2%	34.0%	34.0%	27.2%	27.2%	27.2%	27.2%	11.5%
Yellow Time (s)	3.6	5.2	5.2	3.6	5.2	5.2	4.4	4.4	4.4	4.4	3.6
All-Red Time (s)	1.0	1.0	1.0	1.0	1.0	1.0	1.0	1.0	1.0	1.0	1.0
Lost Time Adjust (s)	0.0	0.0	0.0	0.0	0.0	0.0	0.0	0.0	0.0	0.0	0.0
Total Lost Time (s)	4.6	6.2	6.2	4.6	6.2	6.2	5.4	5.4	5.4	5.4	4.6
Lead/Lag	Lead	Lag	Lag	Lead	Lag	Lag					Lead
Lead-Lag Optimize?	Yes	Yes	Yes	Yes	Yes	Yes					Yes
Recall Mode	None	None	None	None	None	None	Max	Max	Max	Max	None
Act Effct Green (s)	10.4	42.4	42.4	6.0	38.0	38.0	30.0	30.0	30.0	30.0	41.2
Actuated g/C Ratio	0.08	0.33	0.33	0.05	0.29	0.29	0.23	0.23	0.23	0.23	0.32
v/c Ratio	2.22	1.17	0.47	0.98	1.58	0.42	0.07	0.09	0.31	0.30	0.43
Control Delay	600.8	121.5	7.6	153.6	295.6	22.0	40.0	23.5	44.1	43.8	3.7
Queue Delay	0.0	0.0	0.0	0.0	0.0	0.0	0.0	0.0	0.0	0.0	0.0
Total Delay	600.8	121.5	7.6	153.6	295.6	22.0	40.0	23.5	44.1	43.8	3.7
LOS	F	F	A	F	F	C	D	C	D	D	A
Approach Delay		164.9			267.8			30.4		21.4	
Approach LOS		F			F			C		C	

Intersection Summary

Cycle Length: 130
 Actuated Cycle Length: 130
 Natural Cycle: 130
 Control Type: Actuated-Uncoordinated
 Maximum v/c Ratio: 2.22
 Intersection Signal Delay: 196.8
 Intersection LOS: F
 Intersection Capacity Utilization 86.8%
 ICU Level of Service E
 Analysis Period (min) 15

Splits and Phases: 36: Elsworth St. & Cactus Av.

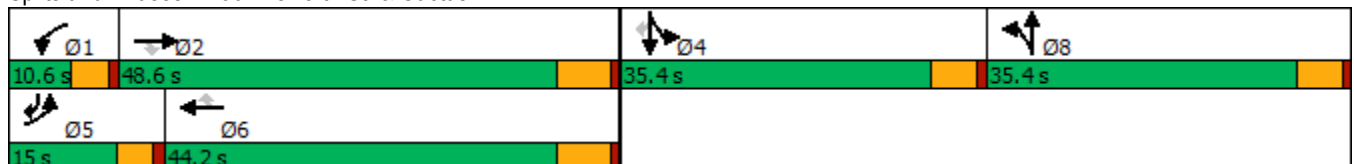

HCM 6th Signalized Intersection Summary
36: Elsworth St. & Cactus Av.

West Campus Upper Plateau (JN 14064)

09/19/2022



Movement	EBL	EBT	EBR	WBL	WBT	WBR	NBL	NBT	NBR	SBL	SBT	SBR
Lane Configurations	↗	↑↑↑	↖	↖	↑↑↑	↖	↖	↕		↖	↗	↖
Traffic Volume (veh/h)	301	1823	330	79	2254	219	26	12	18	169	66	298
Future Volume (veh/h)	301	1823	330	79	2254	219	26	12	18	169	66	298
Initial Q (Qb), veh	0	0	0	0	0	0	0	0	0	0	0	0
Ped-Bike Adj(A_pbT)	1.00		1.00	1.00		0.98	1.00		1.00	1.00		1.00
Parking Bus, Adj	1.00	1.00	1.00	1.00	1.00	1.00	1.00	1.00	1.00	1.00	1.00	1.00
Work Zone On Approach		No			No			No			No	
Adj Sat Flow, veh/h/ln	1841	1811	1885	1900	1841	1870	1633	1900	1900	1856	1900	1856
Adj Flow Rate, veh/h	307	1860	0	81	2300	175	24	16	10	120	140	237
Peak Hour Factor	0.98	0.98	0.98	0.98	0.98	0.98	0.98	0.98	0.98	0.98	0.98	0.98
Percent Heavy Veh, %	4	6	1	0	4	2	18	0	0	3	0	3
Cap, veh/h	140	1613		84	1469	453	359	252	158	408	438	489
Arrive On Green	0.08	0.33	0.00	0.05	0.29	0.29	0.23	0.23	0.23	0.23	0.23	0.23
Sat Flow, veh/h	1753	4944	1598	1810	5025	1551	1555	1094	683	1767	1900	1572
Grp Volume(v), veh/h	307	1860	0	81	2300	175	24	0	26	120	140	237
Grp Sat Flow(s),veh/h/ln	1753	1648	1598	1810	1675	1551	1555	0	1777	1767	1900	1572
Q Serve(g_s), s	10.4	42.4	0.0	5.8	38.0	11.7	1.6	0.0	1.5	7.3	8.0	15.9
Cycle Q Clear(g_c), s	10.4	42.4	0.0	5.8	38.0	11.7	1.6	0.0	1.5	7.3	8.0	15.9
Prop In Lane	1.00		1.00	1.00		1.00	1.00		0.38	1.00		1.00
Lane Grp Cap(c), veh/h	140	1613		84	1469	453	359	0	410	408	438	489
V/C Ratio(X)	2.19	1.15		0.97	1.57	0.39	0.07	0.00	0.06	0.29	0.32	0.48
Avail Cap(c_a), veh/h	140	1613		84	1469	453	359	0	410	408	438	489
HCM Platoon Ratio	1.00	1.00	1.00	1.00	1.00	1.00	1.00	1.00	1.00	1.00	1.00	1.00
Upstream Filter(I)	1.00	1.00	0.00	1.00	1.00	1.00	1.00	0.00	1.00	1.00	1.00	1.00
Uniform Delay (d), s/veh	59.8	43.8	0.0	61.9	46.0	36.7	39.1	0.0	39.0	41.3	41.5	36.4
Incr Delay (d2), s/veh	557.7	76.6	0.0	87.7	258.0	0.5	0.4	0.0	0.3	1.8	1.9	3.4
Initial Q Delay(d3),s/veh	0.0	0.0	0.0	0.0	0.0	0.0	0.0	0.0	0.0	0.0	0.0	0.0
%ile BackOfQ(50%),veh/ln	26.2	27.8	0.0	4.6	50.1	4.4	0.6	0.0	0.7	3.4	3.9	6.5
Unsig. Movement Delay, s/veh												
LnGrp Delay(d),s/veh	617.5	120.4	0.0	149.6	304.0	37.2	39.4	0.0	39.3	43.1	43.4	39.8
LnGrp LOS	F	F		F	F	D	D	A	D	D	D	D
Approach Vol, veh/h		2167			2556			50				497
Approach Delay, s/veh		190.8			280.8			39.4				41.6
Approach LOS		F			F			D				D
Timer - Assigned Phs	1	2		4	5	6		8				
Phs Duration (G+Y+Rc), s	10.6	48.6		35.4	15.0	44.2		35.4				
Change Period (Y+Rc), s	4.6	6.2		5.4	4.6	6.2		5.4				
Max Green Setting (Gmax), s	6.0	42.4		30.0	10.4	38.0		30.0				
Max Q Clear Time (g_c+I1), s	7.8	44.4		17.9	12.4	40.0		3.6				
Green Ext Time (p_c), s	0.0	0.0		1.5	0.0	0.0		0.1				

Intersection Summary

HCM 6th Ctrl Delay	219.0
HCM 6th LOS	F

Notes

- User approved pedestrian interval to be less than phase max green.
- User approved volume balancing among the lanes for turning movement.
- Unsignalized Delay for [EBR] is excluded from calculations of the approach delay and intersection delay.

Timings
37: Cactus Av. & Frederick St.

West Campus Upper Plateau (JN 14064)

09/19/2022

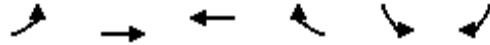

Lane Group	EBL	EBT	WBT	WBR	SBL	SBR
Lane Configurations	↖	↑↑↑	↑↑↑	↗	↖↗	↗
Traffic Volume (vph)	224	1551	2522	165	172	132
Future Volume (vph)	224	1551	2522	165	172	132
Turn Type	Prot	NA	NA	pm+ov	Prot	pm+ov
Protected Phases	5	2	6	4	4	5
Permitted Phases				6		4
Detector Phase	5	2	6	4	4	5
Switch Phase						
Minimum Initial (s)	5.0	10.0	10.0	10.0	10.0	5.0
Minimum Split (s)	9.2	28.2	29.2	36.4	36.4	9.2
Total Split (s)	22.0	83.6	61.6	36.4	36.4	22.0
Total Split (%)	18.3%	69.7%	51.3%	30.3%	30.3%	18.3%
Yellow Time (s)	3.2	5.2	5.2	4.4	4.4	3.2
All-Red Time (s)	1.0	1.0	1.0	1.0	1.0	1.0
Lost Time Adjust (s)	0.0	0.0	0.0	0.0	0.0	0.0
Total Lost Time (s)	4.2	6.2	6.2	5.4	5.4	4.2
Lead/Lag	Lead		Lag			Lead
Lead-Lag Optimize?	Yes		Yes			Yes
Recall Mode	None	None	None	Max	Max	None
Act Effct Green (s)	17.7	77.3	55.4	87.2	31.0	54.1
Actuated g/C Ratio	0.15	0.64	0.46	0.73	0.26	0.45
v/c Ratio	0.95	0.53	1.17	0.15	0.21	0.20
Control Delay	96.4	12.2	111.0	1.4	35.7	20.9
Queue Delay	0.0	0.0	0.0	0.0	0.0	0.0
Total Delay	96.4	12.2	111.0	1.4	35.7	20.9
LOS	F	B	F	A	D	C
Approach Delay		22.9	104.3		29.3	
Approach LOS		C	F		C	

Intersection Summary

Cycle Length: 120
 Actuated Cycle Length: 119.9
 Natural Cycle: 130
 Control Type: Actuated-Uncoordinated
 Maximum v/c Ratio: 1.17
 Intersection Signal Delay: 69.2
 Intersection LOS: E
 Intersection Capacity Utilization 82.6%
 ICU Level of Service E
 Analysis Period (min) 15

Splits and Phases: 37: Cactus Av. & Frederick St.



HCM 6th Signalized Intersection Summary
37: Cactus Av. & Frederick St.

West Campus Upper Plateau (JN 14064)

09/19/2022

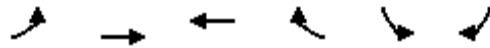

Movement	EBL	EBT	WBT	WBR	SBL	SBR
Lane Configurations	↖	↑↑↑	↑↑↑	↗	↙	↘
Traffic Volume (veh/h)	224	1551	2522	165	172	132
Future Volume (veh/h)	224	1551	2522	165	172	132
Initial Q (Qb), veh	0	0	0	0	0	0
Ped-Bike Adj(A_pbT)	1.00			0.98	1.00	1.00
Parking Bus, Adj	1.00	1.00	1.00	1.00	1.00	1.00
Work Zone On Approach		No	No		No	
Adj Sat Flow, veh/h/ln	1826	1811	1856	1870	1856	1826
Adj Flow Rate, veh/h	241	1668	2712	123	185	101
Peak Hour Factor	0.93	0.93	0.93	0.93	0.93	0.93
Percent Heavy Veh, %	5	6	3	2	3	5
Cap, veh/h	258	3189	2339	1125	886	629
Arrive On Green	0.15	0.65	0.46	0.46	0.26	0.26
Sat Flow, veh/h	1739	5107	5233	1550	3428	1547
Grp Volume(v), veh/h	241	1668	2712	123	185	101
Grp Sat Flow(s),veh/h/ln	1739	1648	1689	1550	1714	1547
Q Serve(g_s), s	16.4	21.7	55.4	2.9	5.1	5.0
Cycle Q Clear(g_c), s	16.4	21.7	55.4	2.9	5.1	5.0
Prop In Lane	1.00			1.00	1.00	1.00
Lane Grp Cap(c), veh/h	258	3189	2339	1125	886	629
V/C Ratio(X)	0.93	0.52	1.16	0.11	0.21	0.16
Avail Cap(c_a), veh/h	258	3189	2339	1125	886	629
HCM Platoon Ratio	1.00	1.00	1.00	1.00	1.00	1.00
Upstream Filter(I)	1.00	1.00	1.00	1.00	1.00	1.00
Uniform Delay (d), s/veh	50.5	11.4	32.3	5.1	34.9	22.6
Incr Delay (d2), s/veh	38.1	0.2	77.1	0.0	0.5	0.5
Initial Q Delay(d3),s/veh	0.0	0.0	0.0	0.0	0.0	0.0
%ile BackOfQ(50%),veh/ln	9.6	6.8	37.2	1.9	2.2	0.1
Unsig. Movement Delay, s/veh						
LnGrp Delay(d),s/veh	88.6	11.6	109.4	5.2	35.4	23.1
LnGrp LOS	F	B	F	A	D	C
Approach Vol, veh/h		1909	2835		286	
Approach Delay, s/veh		21.3	104.8		31.1	
Approach LOS		C	F		C	
Timer - Assigned Phs		2		4	5	6
Phs Duration (G+Y+Rc), s		83.6		36.4	22.0	61.6
Change Period (Y+Rc), s		6.2		5.4	* 4.2	6.2
Max Green Setting (Gmax), s		77.4		31.0	* 18	55.4
Max Q Clear Time (g_c+I1), s		23.7		7.1	18.4	57.4
Green Ext Time (p_c), s		17.0		0.9	0.0	0.0

Intersection Summary

HCM 6th Ctrl Delay	68.9
HCM 6th LOS	E

Notes

* HCM 6th computational engine requires equal clearance times for the phases crossing the barrier.

Timings
38: Riverside Dr./Graham St. & Cactus Av.

West Campus Upper Plateau (JN 14064)

09/19/2022

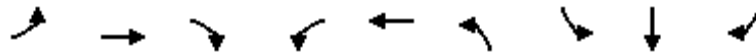

Lane Group	EBL	EBT	EBR	WBL	WBT	NBL	SBL	SBT	SBR	Ø2
Lane Configurations	↘	↑↑↑	↗	↘	↑↑↑	↗	↘	↑↑	↗	
Traffic Volume (vph)	104	1496	190	11	2571	24	96	52	190	
Future Volume (vph)	104	1496	190	11	2571	24	96	52	190	
Turn Type	Prot	NA	Perm	Prot	NA	Prot	Prot	NA	Perm	
Protected Phases	7	4		3	8	5	1	6		2
Permitted Phases			4						6	
Detector Phase	7	4	4	3	8	5	1	6	6	
Switch Phase										
Minimum Initial (s)	5.0	10.0	10.0	5.0	10.0	5.0	5.0	10.0	10.0	10.0
Minimum Split (s)	9.6	39.2	39.2	9.6	39.2	10.4	9.6	40.6	40.6	35.0
Total Split (s)	10.8	59.0	59.0	9.6	57.8	10.4	14.2	41.0	41.0	37.2
Total Split (%)	9.0%	49.2%	49.2%	8.0%	48.2%	8.7%	11.8%	34.2%	34.2%	31%
Yellow Time (s)	3.6	5.2	5.2	3.6	5.2	4.4	3.6	3.6	3.6	4.0
All-Red Time (s)	1.0	1.0	1.0	1.0	1.0	1.0	1.0	1.0	1.0	1.0
Lost Time Adjust (s)	0.0	0.0	0.0	0.0	0.0	0.0	0.0	0.0	0.0	
Total Lost Time (s)	4.6	6.2	6.2	4.6	6.2	5.4	4.6	4.6	4.6	
Lead/Lag	Lead	Lag	Lag	Lead	Lag	Lead	Lead	Lag	Lag	Lag
Lead-Lag Optimize?	Yes	Yes	Yes	Yes	Yes	Yes	Yes	Yes	Yes	Yes
Recall Mode	None	Min	Min	None	Min	None	None	None	None	None
Act Effct Green (s)	6.3	62.2	62.2	5.1	52.6	5.1	12.8	14.9	14.9	
Actuated g/C Ratio	0.07	0.67	0.67	0.05	0.56	0.05	0.14	0.16	0.16	
v/c Ratio	0.96	0.49	0.19	0.12	1.01	0.16	0.42	0.10	0.57	
Control Delay	119.5	11.8	3.4	51.5	40.6	49.9	45.7	33.2	20.6	
Queue Delay	0.0	0.0	0.0	0.0	0.0	0.0	0.0	0.0	0.0	
Total Delay	119.5	11.8	3.4	51.5	40.6	49.9	45.7	33.2	20.6	
LOS	F	B	A	D	D	D	D	C	C	
Approach Delay		17.1			40.7			29.7		
Approach LOS		B			D			C		

Intersection Summary

Cycle Length: 120
 Actuated Cycle Length: 93.2
 Natural Cycle: 130
 Control Type: Actuated-Uncoordinated
 Maximum v/c Ratio: 1.01
 Intersection Signal Delay: 31.2
 Intersection LOS: C
 Intersection Capacity Utilization 82.5%
 ICU Level of Service E
 Analysis Period (min) 15

Splits and Phases: 38: Riverside Dr./Graham St. & Cactus Av.

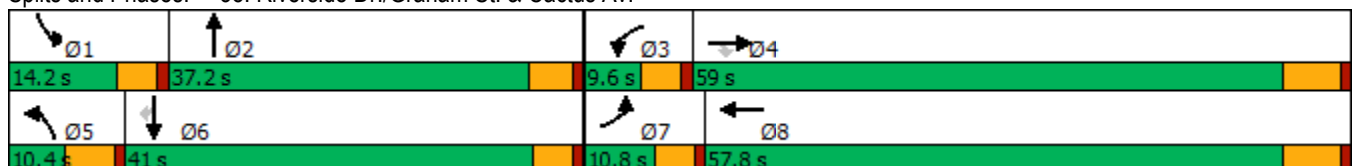

HCM 6th Signalized Intersection Summary
38: Riverside Dr./Graham St. & Cactus Av.

West Campus Upper Plateau (JN 14064)

09/19/2022



Movement	EBL	EBT	EBR	WBL	WBT	WBR	NBL	NBT	NBR	SBL	SBT	SBR
Lane Configurations	↖	↑↑↑	↗	↖	↑↑↑		↖↗	↑↗		↖	↑↑	↗
Traffic Volume (veh/h)	104	1496	190	11	2571	102	24	0	0	96	52	190
Future Volume (veh/h)	104	1496	190	11	2571	102	24	0	0	96	52	190
Initial Q (Qb), veh	0	0	0	0	0	0	0	0	0	0	0	0
Ped-Bike Adj(A_pbT)	1.00		1.00	1.00		1.00	1.00		1.00	1.00		1.00
Parking Bus, Adj	1.00	1.00	1.00	1.00	1.00	1.00	1.00	1.00	1.00	1.00	1.00	1.00
Work Zone On Approach		No			No			No			No	
Adj Sat Flow, veh/h/ln	1826	1811	1796	1900	1856	1870	1618	1900	1900	1870	1870	1826
Adj Flow Rate, veh/h	111	1591	190	12	2735	108	26	0	0	102	55	117
Peak Hour Factor	0.94	0.94	0.94	0.94	0.94	0.94	0.94	0.94	0.94	0.94	0.94	0.94
Percent Heavy Veh, %	5	6	7	0	3	2	19	0	0	2	2	5
Cap, veh/h	118	3055	941	26	2824	110	79	260	0	129	388	169
Arrive On Green	0.07	0.62	0.62	0.01	0.56	0.56	0.03	0.00	0.00	0.07	0.11	0.11
Sat Flow, veh/h	1739	4944	1522	1810	5002	195	2990	3705	0	1781	3554	1547
Grp Volume(v), veh/h	111	1591	190	12	1836	1007	26	0	0	102	55	117
Grp Sat Flow(s),veh/h/ln	1739	1648	1522	1810	1689	1820	1495	1805	0	1781	1777	1547
Q Serve(g_s), s	5.8	16.6	5.0	0.6	47.4	49.3	0.8	0.0	0.0	5.1	1.3	6.7
Cycle Q Clear(g_c), s	5.8	16.6	5.0	0.6	47.4	49.3	0.8	0.0	0.0	5.1	1.3	6.7
Prop In Lane	1.00		1.00	1.00		0.11	1.00		0.00	1.00		1.00
Lane Grp Cap(c), veh/h	118	3055	941	26	1906	1027	79	260	0	129	388	169
V/C Ratio(X)	0.94	0.52	0.20	0.46	0.96	0.98	0.33	0.00	0.00	0.79	0.14	0.69
Avail Cap(c_a), veh/h	118	3055	941	99	1907	1028	164	1272	0	187	1415	616
HCM Platoon Ratio	1.00	1.00	1.00	1.00	1.00	1.00	1.00	1.00	1.00	1.00	1.00	1.00
Upstream Filter(I)	1.00	1.00	1.00	1.00	1.00	1.00	1.00	0.00	0.00	1.00	1.00	1.00
Uniform Delay (d), s/veh	42.4	9.8	7.6	44.7	19.0	19.4	43.7	0.0	0.0	41.7	36.8	39.2
Incr Delay (d2), s/veh	63.8	0.2	0.1	4.7	13.0	23.2	0.9	0.0	0.0	7.9	0.2	5.0
Initial Q Delay(d3),s/veh	0.0	0.0	0.0	0.0	0.0	0.0	0.0	0.0	0.0	0.0	0.0	0.0
%ile BackOfQ(50%),veh/ln	4.4	4.7	1.3	0.3	18.1	23.1	0.3	0.0	0.0	2.5	0.5	2.6
Unsig. Movement Delay, s/veh												
LnGrp Delay(d),s/veh	106.2	10.0	7.7	49.4	32.0	42.6	44.6	0.0	0.0	49.5	37.0	44.2
LnGrp LOS	F	A	A	D	C	D	D	A	A	D	D	D
Approach Vol, veh/h		1892			2855			26			274	
Approach Delay, s/veh		15.4			35.8			44.6			44.7	
Approach LOS		B			D			D			D	
Timer - Assigned Phs	1	2	3	4	5	6	7	8				
Phs Duration (G+Y+Rc), s	11.2	11.6	5.9	62.7	7.8	15.0	10.8	57.8				
Change Period (Y+Rc), s	4.6	5.0	4.6	6.2	5.4	* 5	4.6	6.2				
Max Green Setting (Gmax), s	9.6	32.2	5.0	52.8	5.0	* 36	6.2	51.6				
Max Q Clear Time (g_c+I1), s	7.1	0.0	2.6	18.6	2.8	8.7	7.8	51.3				
Green Ext Time (p_c), s	0.0	0.0	0.0	14.9	0.0	0.6	0.0	0.3				

Intersection Summary

HCM 6th Ctrl Delay	28.7
HCM 6th LOS	C

Notes

* HCM 6th computational engine requires equal clearance times for the phases crossing the barrier.

Timings
1: Washington St & Van Buren Bl.



Lane Group	EBL	EBT	WBL	WBT	WBR	NBL	NBT	NBR	SBL	SBT
Lane Configurations	↘	↗	↘	↗	↗	↗	↗	↗	↗	↗
Traffic Volume (vph)	153	1662	244	1402	569	113	276	132	670	397
Future Volume (vph)	153	1662	244	1402	569	113	276	132	670	397
Turn Type	Prot	NA	Prot	NA	Perm	Prot	NA	Perm	Prot	NA
Protected Phases	5	2	1	6		3	8		7	4
Permitted Phases					6			8		
Detector Phase	5	2	1	6	6	3	8	8	7	4
Switch Phase										
Minimum Initial (s)	5.0	10.0	5.0	10.0	10.0	5.0	10.0	10.0	5.0	10.0
Minimum Split (s)	9.2	34.2	9.2	33.2	33.2	9.2	38.4	38.4	9.2	30.8
Total Split (s)	14.2	49.6	14.0	49.4	49.4	11.5	38.4	38.4	18.0	44.9
Total Split (%)	11.8%	41.3%	11.7%	41.2%	41.2%	9.6%	32.0%	32.0%	15.0%	37.4%
Yellow Time (s)	3.2	5.2	3.2	5.2	5.2	3.2	4.4	4.4	3.2	4.8
All-Red Time (s)	1.0	1.0	1.0	1.0	1.0	1.0	1.0	1.0	1.0	1.0
Lost Time Adjust (s)	0.0	0.0	0.0	0.0	0.0	0.0	0.0	0.0	0.0	0.0
Total Lost Time (s)	4.2	6.2	4.2	6.2	6.2	4.2	5.4	5.4	4.2	5.8
Lead/Lag	Lead	Lag	Lead	Lag	Lag	Lead	Lag	Lag	Lead	Lag
Lead-Lag Optimize?	Yes	Yes	Yes	Yes	Yes	Yes	Yes	Yes	Yes	Yes
Recall Mode	None	None	None	None	None	None	None	None	None	None
Act Effct Green (s)	10.0	43.6	9.8	43.4	43.4	6.8	16.3	16.3	13.9	22.9
Actuated g/C Ratio	0.10	0.42	0.09	0.42	0.42	0.07	0.16	0.16	0.13	0.22
v/c Ratio	0.89	1.21	1.44	0.96	0.71	0.50	0.51	0.36	1.46	0.65
Control Delay	92.5	129.7	263.0	45.5	20.0	56.2	42.6	7.8	253.0	38.2
Queue Delay	0.0	0.0	0.0	0.0	0.0	0.0	0.0	0.0	0.0	0.0
Total Delay	92.5	129.7	263.0	45.5	20.0	56.2	42.6	7.8	253.0	38.2
LOS	F	F	F	D	C	E	D	A	F	D
Approach Delay		126.7		62.9			36.8			161.0
Approach LOS		F		E			D			F

Intersection Summary

Cycle Length: 120
 Actuated Cycle Length: 103.7
 Natural Cycle: 115
 Control Type: Actuated-Uncoordinated
 Maximum v/c Ratio: 1.46
 Intersection Signal Delay: 101.3
 Intersection Capacity Utilization 107.1%
 Analysis Period (min) 15
 Intersection LOS: F
 ICU Level of Service G



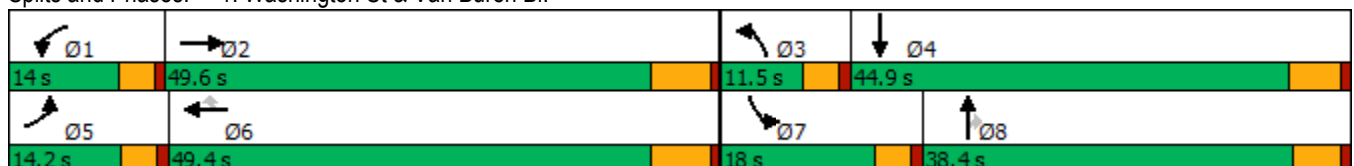



















Splits and Phases: 1: Washington St & Van Buren Bl.



HCM 6th Signalized Intersection Summary
 1: Washington St & Van Buren Bl.

West Campus Upper Plateau (JN 14064)

09/19/2022

												
Movement	EBL	EBT	EBR	WBL	WBT	WBR	NBL	NBT	NBR	SBL	SBT	SBR
Lane Configurations												
Traffic Volume (veh/h)	153	1662	91	244	1402	569	113	276	132	670	397	105
Future Volume (veh/h)	153	1662	91	244	1402	569	113	276	132	670	397	105
Initial Q (Qb), veh	0	0	0	0	0	0	0	0	0	0	0	0
Ped-Bike Adj(A_pbT)	1.00		1.00	1.00		1.00	1.00		0.98	1.00		0.98
Parking Bus, Adj	1.00	1.00	1.00	1.00	1.00	1.00	1.00	1.00	1.00	1.00	1.00	1.00
Work Zone On Approach		No			No			No			No	
Adj Sat Flow, veh/h/ln	1900	1856	1856	1900	1870	1900	1885	1856	1870	1885	1885	1900
Adj Flow Rate, veh/h	155	1679	73	246	1416	482	114	279	94	677	401	60
Peak Hour Factor	0.99	0.99	0.99	0.99	0.99	0.99	0.99	0.99	0.99	0.99	0.99	0.99
Percent Heavy Veh, %	0	3	3	0	2	0	1	3	2	1	1	0
Cap, veh/h	181	1491	64	177	1532	693	175	451	199	480	672	100
Arrive On Green	0.10	0.43	0.43	0.10	0.43	0.43	0.05	0.13	0.13	0.14	0.22	0.22
Sat Flow, veh/h	1810	3443	149	1810	3554	1607	3483	3526	1554	3483	3120	463
Grp Volume(v), veh/h	155	856	896	246	1416	482	114	279	94	677	229	232
Grp Sat Flow(s),veh/h/ln	1810	1763	1829	1810	1777	1607	1742	1763	1554	1742	1791	1792
Q Serve(g_s), s	8.5	43.4	43.4	9.8	37.8	24.4	3.2	7.5	5.6	13.8	11.5	11.7
Cycle Q Clear(g_c), s	8.5	43.4	43.4	9.8	37.8	24.4	3.2	7.5	5.6	13.8	11.5	11.7
Prop In Lane	1.00		0.08	1.00		1.00	1.00		1.00	1.00		0.26
Lane Grp Cap(c), veh/h	181	763	792	177	1532	693	175	451	199	480	386	386
V/C Ratio(X)	0.86	1.12	1.13	1.39	0.92	0.70	0.65	0.62	0.47	1.41	0.59	0.60
Avail Cap(c_a), veh/h	181	763	792	177	1532	693	254	1161	512	480	699	699
HCM Platoon Ratio	1.00	1.00	1.00	1.00	1.00	1.00	1.00	1.00	1.00	1.00	1.00	1.00
Upstream Filter(I)	1.00	1.00	1.00	1.00	1.00	1.00	1.00	1.00	1.00	1.00	1.00	1.00
Uniform Delay (d), s/veh	44.4	28.4	28.4	45.2	27.0	23.2	46.7	41.4	40.6	43.2	35.4	35.4
Incr Delay (d2), s/veh	30.3	71.3	74.8	206.5	10.0	3.4	1.5	1.4	1.7	197.4	1.5	1.5
Initial Q Delay(d3),s/veh	0.0	0.0	0.0	0.0	0.0	0.0	0.0	0.0	0.0	0.0	0.0	0.0
%ile BackOfQ(50%),veh/ln	5.1	31.3	33.2	14.3	16.3	9.7	1.4	3.4	2.3	19.0	5.1	5.2
Unsig. Movement Delay, s/veh												
LnGrp Delay(d),s/veh	74.8	99.7	103.2	251.8	36.9	26.5	48.3	42.8	42.3	240.6	36.8	36.9
LnGrp LOS	E	F	F	F	D	C	D	D	D	F	D	D
Approach Vol, veh/h		1907			2144			487			1138	
Approach Delay, s/veh		99.3			59.3			44.0			158.1	
Approach LOS		F			E			D			F	
Timer - Assigned Phs	1	2	3	4	5	6	7	8				
Phs Duration (G+Y+Rc), s	14.0	49.6	9.2	27.4	14.2	49.4	18.0	18.6				
Change Period (Y+Rc), s	* 4.2	6.2	* 4.2	5.8	* 4.2	6.2	* 4.2	* 5.8				
Max Green Setting (Gmax), s	* 9.8	43.4	* 7.3	39.1	* 10	43.2	* 14	* 33				
Max Q Clear Time (g_c+I1), s	11.8	45.4	5.2	13.7	10.5	39.8	15.8	9.5				
Green Ext Time (p_c), s	0.0	0.0	0.0	2.9	0.0	3.1	0.0	2.2				
Intersection Summary												
HCM 6th Ctrl Delay				91.2								
HCM 6th LOS				F								
Notes												
* HCM 6th computational engine requires equal clearance times for the phases crossing the barrier.												

Timings
2: Central Ave & Arlington Ave/Chicago Ave

West Campus Upper Plateau (JN 14064)

09/19/2022



Lane Group	EBL	EBT	EBR	WBL	WBT	WBR	NBL	NBT	NBR	SBL	SBT
Lane Configurations	↘	↑↑	↗↗	↘↘	↑↑	↗	↘↘	↑↑	↗	↘↘	↑↑↗
Traffic Volume (vph)	28	839	1304	716	754	241	1011	1292	334	559	2054
Future Volume (vph)	28	839	1304	716	754	241	1011	1292	334	559	2054
Turn Type	Prot	NA	pm+ov	Prot	NA	pm+ov	Prot	NA	pm+ov	Prot	NA
Protected Phases	7	4	5	3	8	1	5	2	3	1	6
Permitted Phases			4			8			2		
Detector Phase	7	4	5	3	8	1	5	2	3	1	6
Switch Phase											
Minimum Initial (s)	5.0	10.0	5.0	5.0	10.0	5.0	5.0	10.0	5.0	5.0	10.0
Minimum Split (s)	9.6	32.8	9.6	9.6	30.8	9.6	9.6	35.4	9.6	9.6	30.4
Total Split (s)	10.6	32.8	30.0	22.0	44.2	24.4	30.0	50.8	22.0	24.4	45.2
Total Split (%)	8.2%	25.2%	23.1%	16.9%	34.0%	18.8%	23.1%	39.1%	16.9%	18.8%	34.8%
Yellow Time (s)	3.6	4.8	3.6	3.6	4.8	3.6	3.6	4.4	3.6	3.6	4.4
All-Red Time (s)	1.0	1.0	1.0	1.0	1.0	1.0	1.0	1.0	1.0	1.0	1.0
Lost Time Adjust (s)	0.0	0.0	0.0	0.0	0.0	0.0	0.0	0.0	0.0	0.0	0.0
Total Lost Time (s)	4.6	5.8	4.6	4.6	5.8	4.6	4.6	5.4	4.6	4.6	5.4
Lead/Lag	Lead	Lag	Lead	Lead	Lag	Lead	Lead	Lag	Lead	Lead	Lag
Lead-Lag Optimize?	Yes	Yes	Yes	Yes	Yes	Yes	Yes	Yes	Yes	Yes	Yes
Recall Mode	None	None	None	None	None	None	None	None	None	None	None
Act Effct Green (s)	5.7	27.0	53.6	17.4	42.6	68.2	25.4	45.4	63.6	19.8	39.8
Actuated g/C Ratio	0.04	0.21	0.41	0.13	0.33	0.52	0.20	0.35	0.49	0.15	0.31
v/c Ratio	0.37	1.17	1.11	1.63	0.66	0.28	1.54	1.08	0.44	1.09	1.38
Control Delay	73.7	134.3	94.8	326.7	41.7	11.9	285.8	89.9	17.1	117.1	210.0
Queue Delay	0.0	0.0	0.0	0.0	0.0	0.0	0.0	0.0	0.0	0.0	0.0
Total Delay	73.7	134.3	94.8	326.7	41.7	11.9	285.8	89.9	17.1	117.1	210.0
LOS	E	F	F	F	D	B	F	F	B	F	F
Approach Delay		109.8			156.8			155.7			190.3
Approach LOS		F			F			F			F

Intersection Summary

Cycle Length: 130
 Actuated Cycle Length: 130
 Natural Cycle: 120
 Control Type: Actuated-Uncoordinated
 Maximum v/c Ratio: 1.63
 Intersection Signal Delay: 155.0
 Intersection LOS: F
 Intersection Capacity Utilization 129.7%
 ICU Level of Service H
 Analysis Period (min) 15

Splits and Phases: 2: Central Ave & Arlington Ave/Chicago Ave

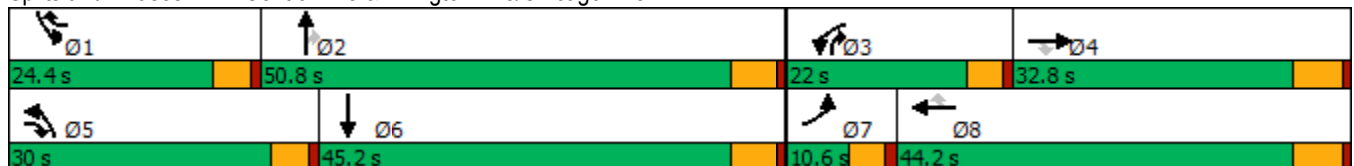

HCM 6th Signalized Intersection Summary
2: Central Ave & Arlington Ave/Chicago Ave

West Campus Upper Plateau (JN 14064)

09/19/2022



Movement	EBL	EBT	EBR	WBL	WBT	WBR	NBL	NBT	NBR	SBL	SBT	SBR
Lane Configurations	↘	↑↑	↗↘	↗↘	↑↑	↗	↗↘	↑↑	↗	↗↘	↑↑↘	
Traffic Volume (veh/h)	28	839	1304	716	754	241	1011	1292	334	559	2054	23
Future Volume (veh/h)	28	839	1304	716	754	241	1011	1292	334	559	2054	23
Initial Q (Qb), veh	0	0	0	0	0	0	0	0	0	0	0	0
Ped-Bike Adj(A_pbT)	1.00		1.00	1.00		1.00	1.00		0.99	1.00		1.00
Parking Bus, Adj	1.00	1.00	1.00	1.00	1.00	1.00	1.00	1.00	1.00	1.00	1.00	1.00
Work Zone On Approach		No			No			No			No	
Adj Sat Flow, veh/h/ln	1900	1900	1900	1870	1900	1900	1900	1885	1870	1900	1885	1900
Adj Flow Rate, veh/h	29	874	961	746	785	164	1053	1346	280	582	2140	22
Peak Hour Factor	0.96	0.96	0.96	0.96	0.96	0.96	0.96	0.96	0.96	0.96	0.96	0.96
Percent Heavy Veh, %	0	0	0	2	0	0	0	1	2	0	1	0
Cap, veh/h	45	750	1141	463	1143	755	686	1251	758	535	1608	17
Arrive On Green	0.02	0.21	0.21	0.13	0.32	0.32	0.20	0.35	0.35	0.15	0.31	0.31
Sat Flow, veh/h	1810	3610	2830	3456	3610	1610	3510	3582	1564	3510	5253	54
Grp Volume(v), veh/h	29	874	961	746	785	164	1053	1346	280	582	1397	765
Grp Sat Flow(s),veh/h/ln	1810	1805	1415	1728	1805	1610	1755	1791	1564	1755	1716	1875
Q Serve(g_s), s	2.1	27.0	27.0	17.4	24.7	7.8	25.4	45.4	14.7	19.8	39.8	39.8
Cycle Q Clear(g_c), s	2.1	27.0	27.0	17.4	24.7	7.8	25.4	45.4	14.7	19.8	39.8	39.8
Prop In Lane	1.00		1.00	1.00		1.00	1.00		1.00	1.00		0.03
Lane Grp Cap(c), veh/h	45	750	1141	463	1143	755	686	1251	758	535	1050	574
V/C Ratio(X)	0.64	1.17	0.84	1.61	0.69	0.22	1.54	1.08	0.37	1.09	1.33	1.33
Avail Cap(c_a), veh/h	84	750	1141	463	1143	755	686	1251	758	535	1050	574
HCM Platoon Ratio	1.00	1.00	1.00	1.00	1.00	1.00	1.00	1.00	1.00	1.00	1.00	1.00
Upstream Filter(I)	1.00	1.00	1.00	1.00	1.00	1.00	1.00	1.00	1.00	1.00	1.00	1.00
Uniform Delay (d), s/veh	62.8	51.5	35.1	56.3	38.8	20.4	52.3	42.3	21.2	55.1	45.1	45.1
Incr Delay (d2), s/veh	5.5	88.8	5.8	285.7	1.7	0.1	248.2	48.6	0.3	65.1	155.2	161.0
Initial Q Delay(d3),s/veh	0.0	0.0	0.0	0.0	0.0	0.0	0.0	0.0	0.0	0.0	0.0	0.0
%ile BackOfQ(50%),veh/ln	1.0	21.1	14.0	25.7	10.9	2.9	34.6	27.8	5.2	13.4	39.1	43.6
Unsig. Movement Delay, s/veh												
LnGrp Delay(d),s/veh	68.3	140.3	40.9	342.0	40.5	20.6	300.5	90.9	21.5	120.2	200.3	206.1
LnGrp LOS	E	F	D	F	D	C	F	F	C	F	F	F
Approach Vol, veh/h		1864			1695			2679			2744	
Approach Delay, s/veh		87.9			171.3			166.0			184.9	
Approach LOS		F			F			F			F	
Timer - Assigned Phs	1	2	3	4	5	6	7	8				
Phs Duration (G+Y+Rc), s	24.4	50.8	22.0	32.8	30.0	45.2	7.8	47.0				
Change Period (Y+Rc), s	4.6	5.4	4.6	5.8	4.6	5.4	4.6	5.8				
Max Green Setting (Gmax), s	19.8	45.4	17.4	27.0	25.4	39.8	6.0	38.4				
Max Q Clear Time (g_c+I1), s	21.8	47.4	19.4	29.0	27.4	41.8	4.1	26.7				
Green Ext Time (p_c), s	0.0	0.0	0.0	0.0	0.0	0.0	0.0	4.3				

Intersection Summary

HCM 6th Ctrl Delay	156.6
HCM 6th LOS	F

Timings

3: Overlook Pkwy./Canyon Crest Dr. & Alessandro Bl/Alessandro Bl.



Lane Group	EBL	EBT	WBL	WBT	WBR	NBL	NBT	NBR	SBL	SBT	SBR
Lane Configurations											
Traffic Volume (vph)	85	3395	23	2582	752	15	134	57	740	224	59
Future Volume (vph)	85	3395	23	2582	752	15	134	57	740	224	59
Turn Type	Prot	NA	Prot	NA	pm+ov	Split	NA	Perm	Split	NA	Perm
Protected Phases	5	2	1	6	4	8	8		4	4	
Permitted Phases					6			8			4
Detector Phase	5	2	1	6	4	8	8	8	4	4	4
Switch Phase											
Minimum Initial (s)	5.0	10.0	5.0	10.0	10.0	10.0	10.0	10.0	10.0	10.0	10.0
Minimum Split (s)	9.2	35.2	9.2	35.2	38.8	38.8	38.8	38.8	38.8	38.8	38.8
Total Split (s)	9.2	43.2	9.2	43.2	38.8	38.8	38.8	38.8	38.8	38.8	38.8
Total Split (%)	7.1%	33.2%	7.1%	33.2%	29.8%	29.8%	29.8%	29.8%	29.8%	29.8%	29.8%
Yellow Time (s)	3.2	5.2	3.2	5.2	4.8	4.8	4.8	4.8	4.8	4.8	4.8
All-Red Time (s)	1.0	1.0	1.0	1.0	1.0	1.0	1.0	1.0	1.0	1.0	1.0
Lost Time Adjust (s)	0.0	0.0	0.0	0.0	0.0	0.0	0.0	0.0	0.0	0.0	0.0
Total Lost Time (s)	4.2	6.2	4.2	6.2	5.8	5.8	5.8	5.8	5.8	5.8	5.8
Lead/Lag	Lead	Lag	Lead	Lag							
Lead-Lag Optimize?	Yes	Yes	Yes	Yes							
Recall Mode	None	None	None	None	None	None	None	None	None	None	None
Act Effct Green (s)	5.0	42.7	5.0	37.0	74.3	10.5	10.5	10.5	31.1	31.1	31.1
Actuated g/C Ratio	0.05	0.40	0.05	0.35	0.70	0.10	0.10	0.10	0.29	0.29	0.29
v/c Ratio	1.09	1.72	0.28	1.49	0.62	0.10	0.39	0.23	0.69	0.68	0.11
Control Delay	174.5	349.4	58.4	253.8	5.1	45.5	48.6	2.8	37.4	40.9	1.1
Queue Delay	0.0	0.0	0.0	0.0	0.0	0.0	0.0	0.0	0.0	0.0	0.0
Total Delay	174.5	349.4	58.4	253.8	5.1	45.5	48.6	2.8	37.4	40.9	1.1
LOS	F	F	E	F	A	D	D	A	D	D	A
Approach Delay		345.1		196.8			35.8			36.5	
Approach LOS		F		F			D			D	

Intersection Summary

Cycle Length: 130	
Actuated Cycle Length: 105.6	
Natural Cycle: 125	
Control Type: Actuated-Uncoordinated	
Maximum v/c Ratio: 1.72	
Intersection Signal Delay: 236.6	Intersection LOS: F
Intersection Capacity Utilization 111.4%	ICU Level of Service H
Analysis Period (min) 15	

Splits and Phases: 3: Overlook Pkwy./Canyon Crest Dr. & Alessandro Bl/Alessandro Bl.

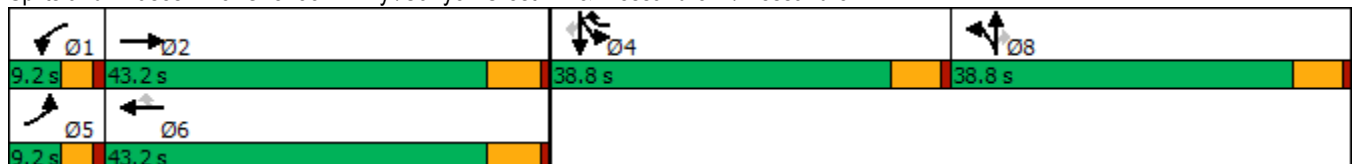

HCM 6th Signalized Intersection Summary

West Campus Upper Plateau (JN 14064)

3: Overlook Pkwy./Canyon Crest Dr. & Alessandro Bl/Alessandro Bl.

09/19/2022



Movement	EBL	EBT	EBR	WBL	WBT	WBR	NBL	NBT	NBR	SBL	SBT	SBR
Lane Configurations	↗	↑↑↑		↖	↑↑↑	↗	↖	↑↑	↗	↖↗	↖	↗
Traffic Volume (veh/h)	85	3395	18	23	2582	752	15	134	57	740	224	59
Future Volume (veh/h)	85	3395	18	23	2582	752	15	134	57	740	224	59
Initial Q (Qb), veh	0	0	0	0	0	0	0	0	0	0	0	0
Ped-Bike Adj(A_pbT)	1.00		1.00	1.00		1.00	1.00		1.00	1.00		1.00
Parking Bus, Adj	1.00	1.00	1.00	1.00	1.00	1.00	1.00	1.00	1.00	1.00	1.00	1.00
Work Zone On Approach		No			No			No			No	
Adj Sat Flow, veh/h/ln	1841	1885	1811	1900	1885	1885	1781	1900	1900	1885	1900	1870
Adj Flow Rate, veh/h	89	3536	19	24	2690	775	16	140	51	720	304	52
Peak Hour Factor	0.96	0.96	0.96	0.96	0.96	0.96	0.96	0.96	0.96	0.96	0.96	0.96
Percent Heavy Veh, %	4	1	6	0	1	1	8	0	0	1	0	2
Cap, veh/h	89	2128	11	44	1938	997	172	366	163	888	470	392
Arrive On Green	0.05	0.40	0.40	0.02	0.38	0.38	0.10	0.10	0.10	0.25	0.25	0.25
Sat Flow, veh/h	1753	5283	28	1810	5147	1598	1697	3610	1610	3591	1900	1585
Grp Volume(v), veh/h	89	2294	1261	24	2690	775	16	140	51	720	304	52
Grp Sat Flow(s),veh/h/ln	1753	1716	1880	1810	1716	1598	1697	1805	1610	1795	1900	1585
Q Serve(g_s), s	5.0	39.6	39.6	1.3	37.0	34.8	0.8	3.6	2.9	18.6	14.1	2.5
Cycle Q Clear(g_c), s	5.0	39.6	39.6	1.3	37.0	34.8	0.8	3.6	2.9	18.6	14.1	2.5
Prop In Lane	1.00		0.02	1.00		1.00	1.00		1.00	1.00		1.00
Lane Grp Cap(c), veh/h	89	1382	757	44	1938	997	172	366	163	888	470	392
V/C Ratio(X)	1.00	1.66	1.66	0.54	1.39	0.78	0.09	0.38	0.31	0.81	0.65	0.13
Avail Cap(c_a), veh/h	89	1382	757	92	1938	997	570	1212	541	1206	638	532
HCM Platoon Ratio	1.00	1.00	1.00	1.00	1.00	1.00	1.00	1.00	1.00	1.00	1.00	1.00
Upstream Filter(I)	1.00	1.00	1.00	1.00	1.00	1.00	1.00	1.00	1.00	1.00	1.00	1.00
Uniform Delay (d), s/veh	46.6	29.3	29.3	47.4	30.6	13.5	40.1	41.3	41.0	34.8	33.1	28.8
Incr Delay (d2), s/veh	94.5	300.1	304.8	3.8	178.0	4.0	0.2	0.7	1.1	3.1	1.5	0.2
Initial Q Delay(d3),s/veh	0.0	0.0	0.0	0.0	0.0	0.0	0.0	0.0	0.0	0.0	0.0	0.0
%ile BackOfQ(50%),veh/ln	4.4	72.1	80.0	0.6	45.7	19.3	0.4	1.6	1.2	8.0	6.3	0.9
Unsig. Movement Delay, s/veh												
LnGrp Delay(d),s/veh	141.2	329.5	334.1	51.2	208.6	17.5	40.3	41.9	42.1	37.9	34.6	28.9
LnGrp LOS	F	F	F	D	F	B	D	D	D	D	C	C
Approach Vol, veh/h		3644			3489			207			1076	
Approach Delay, s/veh		326.5			165.1			41.8			36.5	
Approach LOS		F			F			D			D	
Timer - Assigned Phs	1	2		4	5	6		8				
Phs Duration (G+Y+Rc), s	6.6	45.8		30.1	9.2	43.2		15.8				
Change Period (Y+Rc), s	* 4.2	6.2		5.8	* 4.2	6.2		5.8				
Max Green Setting (Gmax), s	* 5	37.0		33.0	* 5	37.0		33.0				
Max Q Clear Time (g_c+I1), s	3.3	41.6		20.6	7.0	39.0		5.6				
Green Ext Time (p_c), s	0.0	0.0		3.8	0.0	0.0		0.9				

Intersection Summary

HCM 6th Ctrl Delay	215.5
HCM 6th LOS	F

Notes

- User approved pedestrian interval to be less than phase max green.
- User approved volume balancing among the lanes for turning movement.
- * HCM 6th computational engine requires equal clearance times for the phases crossing the barrier.

Timings

West Campus Upper Plateau (JN 14064)

4: Van Buren Bl. & Wood Rd.

09/19/2022

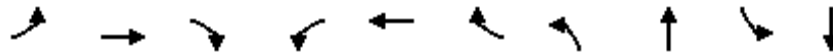

Lane Group	EBL	EBT	EBR	WBL	WBT	WBR	NBL	NBT	SBL	SBT
Lane Configurations	↘	↑↑	↗	↘↗	↑↑	↗	↘↗	↑↔	↘	↑↔
Traffic Volume (vph)	176	1926	241	333	1822	147	341	272	141	277
Future Volume (vph)	176	1926	241	333	1822	147	341	272	141	277
Turn Type	Prot	NA	pm+ov	Prot	NA	Perm	Prot	NA	Prot	NA
Protected Phases	5	2	3	1	6		3	8	7	4
Permitted Phases			2			6				
Detector Phase	5	2	3	1	6	6	3	8	7	4
Switch Phase										
Minimum Initial (s)	5.0	10.0	5.0	5.0	10.0	10.0	5.0	10.0	5.0	10.0
Minimum Split (s)	9.2	30.2	9.2	9.2	30.2	30.2	9.2	38.4	9.2	15.8
Total Split (s)	16.5	57.2	21.7	13.2	53.9	53.9	21.7	38.4	11.2	27.9
Total Split (%)	13.8%	47.7%	18.1%	11.0%	44.9%	44.9%	18.1%	32.0%	9.3%	23.3%
Yellow Time (s)	3.2	5.2	3.2	3.2	5.2	5.2	3.2	4.4	3.2	4.8
All-Red Time (s)	1.0	1.0	1.0	1.0	1.0	1.0	1.0	1.0	1.0	1.0
Lost Time Adjust (s)	0.0	0.0	0.0	0.0	0.0	0.0	0.0	0.0	0.0	0.0
Total Lost Time (s)	4.2	6.2	4.2	4.2	6.2	6.2	4.2	5.4	4.2	5.8
Lead/Lag	Lead	Lag	Lead	Lead	Lag	Lag	Lead	Lag	Lead	Lag
Lead-Lag Optimize?	Yes	Yes	Yes	Yes	Yes	Yes	Yes	Yes	Yes	Yes
Recall Mode	None	None	None	None	None	None	None	None	None	None
Act Effct Green (s)	12.3	51.2	68.9	9.0	47.8	47.8	15.7	27.8	7.0	18.7
Actuated g/C Ratio	0.11	0.44	0.60	0.08	0.42	0.42	0.14	0.24	0.06	0.16
v/c Ratio	1.01	1.35	0.27	1.35	1.35	0.22	0.80	0.66	1.42	0.81
Control Delay	119.9	188.9	7.1	220.1	191.0	6.2	62.2	32.0	276.6	44.5
Queue Delay	0.0	0.0	0.0	0.0	0.0	0.0	0.0	0.0	0.0	0.0
Total Delay	119.9	188.9	7.1	220.1	191.0	6.2	62.2	32.0	276.6	44.5
LOS	F	F	A	F	F	A	E	C	F	D
Approach Delay		165.0			183.4			43.6		96.5
Approach LOS		F			F			D		F

Intersection Summary

Cycle Length: 120
 Actuated Cycle Length: 115.1
 Natural Cycle: 120
 Control Type: Actuated-Uncoordinated
 Maximum v/c Ratio: 1.42
 Intersection Signal Delay: 147.4
 Intersection LOS: F
 Intersection Capacity Utilization 107.6%
 ICU Level of Service G
 Analysis Period (min) 15



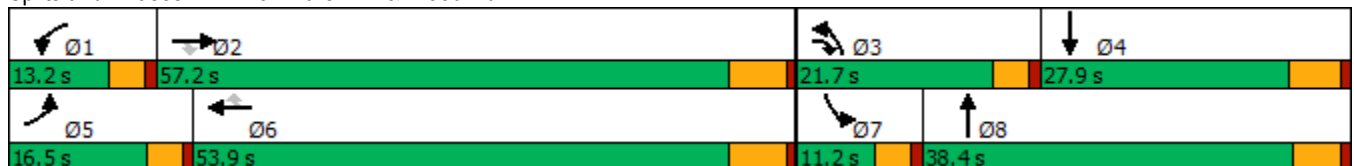





















Splits and Phases: 4: Van Buren Bl. & Wood Rd.



HCM 6th Signalized Intersection Summary
4: Van Buren Bl. & Wood Rd.

West Campus Upper Plateau (JN 14064)

09/19/2022

												
Movement	EBL	EBT	EBR	WBL	WBT	WBR	NBL	NBT	NBR	SBL	SBT	SBR
Lane Configurations												
Traffic Volume (veh/h)	176	1926	241	333	1822	147	341	272	272	141	277	212
Future Volume (veh/h)	176	1926	241	333	1822	147	341	272	272	141	277	212
Initial Q (Qb), veh	0	0	0	0	0	0	0	0	0	0	0	0
Ped-Bike Adj(A_pbT)	1.00		0.98	1.00		0.99	1.00		0.97	1.00		0.99
Parking Bus, Adj	1.00	1.00	1.00	1.00	1.00	1.00	1.00	1.00	1.00	1.00	1.00	1.00
Work Zone On Approach		No			No			No			No	
Adj Sat Flow, veh/h/ln	1885	1870	1870	1885	1885	1885	1870	1885	1870	1885	1885	1885
Adj Flow Rate, veh/h	193	2116	160	366	2002	115	375	299	218	155	304	158
Peak Hour Factor	0.91	0.91	0.91	0.91	0.91	0.91	0.91	0.91	0.91	0.91	0.91	0.91
Percent Heavy Veh, %	1	2	2	1	1	1	2	1	2	1	1	1
Cap, veh/h	196	1607	906	278	1515	666	437	446	315	111	368	186
Arrive On Green	0.11	0.45	0.45	0.08	0.42	0.42	0.13	0.23	0.23	0.06	0.16	0.16
Sat Flow, veh/h	1795	3554	1561	3483	3582	1574	3456	1979	1397	1795	2290	1159
Grp Volume(v), veh/h	193	2116	160	366	2002	115	375	270	247	155	236	226
Grp Sat Flow(s),veh/h/ln	1795	1777	1561	1742	1791	1574	1728	1791	1585	1795	1791	1658
Q Serve(g_s), s	12.1	51.0	5.4	9.0	47.7	5.1	12.0	15.5	16.2	7.0	14.4	14.9
Cycle Q Clear(g_c), s	12.1	51.0	5.4	9.0	47.7	5.1	12.0	15.5	16.2	7.0	14.4	14.9
Prop In Lane	1.00		1.00	1.00		1.00	1.00		0.88	1.00		0.70
Lane Grp Cap(c), veh/h	196	1607	906	278	1515	666	437	403	357	111	288	266
V/C Ratio(X)	0.99	1.32	0.18	1.32	1.32	0.17	0.86	0.67	0.69	1.39	0.82	0.85
Avail Cap(c_a), veh/h	196	1607	906	278	1515	666	536	524	464	111	351	325
HCM Platoon Ratio	1.00	1.00	1.00	1.00	1.00	1.00	1.00	1.00	1.00	1.00	1.00	1.00
Upstream Filter(I)	1.00	1.00	1.00	1.00	1.00	1.00	1.00	1.00	1.00	1.00	1.00	1.00
Uniform Delay (d), s/veh	50.2	30.9	11.2	51.9	32.6	20.3	48.3	39.9	40.1	52.9	45.8	46.0
Incr Delay (d2), s/veh	59.9	147.2	0.1	165.8	149.5	0.2	9.6	2.1	3.0	221.7	12.1	16.0
Initial Q Delay(d3),s/veh	0.0	0.0	0.0	0.0	0.0	0.0	0.0	0.0	0.0	0.0	0.0	0.0
%ile BackOfQ(50%),veh/ln	8.5	52.5	1.8	10.2	50.2	1.9	5.6	6.9	6.4	10.0	7.2	7.2
Unsig. Movement Delay, s/veh												
LnGrp Delay(d),s/veh	110.1	178.1	11.3	217.7	182.1	20.4	57.9	42.0	43.1	274.6	57.8	62.0
LnGrp LOS	F	F	B	F	F	C	E	D	D	F	E	E
Approach Vol, veh/h		2469			2483			892			617	
Approach Delay, s/veh		161.9			179.8			49.0			113.8	
Approach LOS		F			F			D			F	
Timer - Assigned Phs	1	2	3	4	5	6	7	8				
Phs Duration (G+Y+Rc), s	13.2	57.2	18.5	23.9	16.5	53.9	11.2	31.2				
Change Period (Y+Rc), s	* 4.2	6.2	* 4.2	5.8	* 4.2	6.2	* 4.2	* 5.8				
Max Green Setting (Gmax), s	* 9	51.0	* 18	22.1	* 12	47.7	* 7	* 33				
Max Q Clear Time (g_c+I1), s	11.0	53.0	14.0	16.9	14.1	49.7	9.0	18.2				
Green Ext Time (p_c), s	0.0	0.0	0.3	1.2	0.0	0.0	0.0	2.6				

Intersection Summary

HCM 6th Ctrl Delay	148.6
HCM 6th LOS	F

Notes

* HCM 6th computational engine requires equal clearance times for the phases crossing the barrier.

Timings

5: Trautwein Rd. & Alessandro Bl.

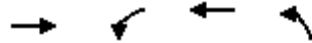

Lane Group	EBT	WBL	WBT	NBL
Lane Configurations	↑↑↑	↔↔	↑↑↑	↔↔↔
Traffic Volume (vph)	2185	368	2427	1331
Future Volume (vph)	2185	368	2427	1331
Turn Type	NA	Prot	NA	Prot
Protected Phases	2	1	6	8
Permitted Phases				
Detector Phase	2	1	6	8
Switch Phase				
Minimum Initial (s)	10.0	5.0	10.0	10.0
Minimum Split (s)	33.2	9.2	16.2	16.2
Total Split (s)	63.0	19.0	82.0	38.0
Total Split (%)	52.5%	15.8%	68.3%	31.7%
Yellow Time (s)	5.2	3.2	5.2	5.2
All-Red Time (s)	1.0	1.0	1.0	1.0
Lost Time Adjust (s)	0.0	0.0	0.0	0.0
Total Lost Time (s)	6.2	4.2	6.2	6.2
Lead/Lag	Lag	Lead		
Lead-Lag Optimize?	Yes	Yes		
Recall Mode	None	None	None	None
Act Effct Green (s)	56.9	14.7	75.8	31.8
Actuated g/C Ratio	0.47	0.12	0.63	0.26
v/c Ratio	1.08	0.91	0.79	1.14
Control Delay	75.3	78.7	18.5	112.9
Queue Delay	0.0	0.0	0.0	0.0
Total Delay	75.3	78.7	18.5	112.9
LOS	E	E	B	F
Approach Delay	75.3		26.4	112.9
Approach LOS	E		C	F

Intersection Summary

Cycle Length: 120
 Actuated Cycle Length: 120
 Natural Cycle: 120
 Control Type: Actuated-Uncoordinated
 Maximum v/c Ratio: 1.14
 Intersection Signal Delay: 63.0
 Intersection LOS: E
 Intersection Capacity Utilization 100.2%
 ICU Level of Service G
 Analysis Period (min) 15

Splits and Phases: 5: Trautwein Rd. & Alessandro Bl.



HCM 6th Signalized Intersection Summary
5: Trautwein Rd. & Alessandro Bl.

West Campus Upper Plateau (JN 14064)

09/19/2022

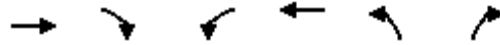

Movement	EBT	EBR	WBL	WBT	NBL	NBR
Lane Configurations	↑↑↑		↵↵	↑↑↑	↵↵↵	
Traffic Volume (veh/h)	2185	273	368	2427	1331	109
Future Volume (veh/h)	2185	273	368	2427	1331	109
Initial Q (Qb), veh	0	0	0	0	0	0
Ped-Bike Adj(A_pbT)		1.00	1.00		1.00	1.00
Parking Bus, Adj	1.00	1.00	1.00	1.00	1.00	1.00
Work Zone On Approach	No			No	No	
Adj Sat Flow, veh/h/ln	1885	1900	1885	1885	1885	1900
Adj Flow Rate, veh/h	2300	287	387	2555	1508	0
Peak Hour Factor	0.95	0.95	0.95	0.95	0.95	0.95
Percent Heavy Veh, %	1	0	1	1	1	0
Cap, veh/h	2200	268	430	3251	1427	427
Arrive On Green	0.47	0.47	0.12	0.63	0.27	0.00
Sat Flow, veh/h	4818	566	3483	5316	5386	1610
Grp Volume(v), veh/h	1683	904	387	2555	1508	0
Grp Sat Flow(s),veh/h/ln	1716	1783	1742	1716	1795	1610
Q Serve(g_s), s	56.8	56.8	13.1	43.6	31.8	0.0
Cycle Q Clear(g_c), s	56.8	56.8	13.1	43.6	31.8	0.0
Prop In Lane		0.32	1.00		1.00	1.00
Lane Grp Cap(c), veh/h	1624	844	430	3251	1427	427
V/C Ratio(X)	1.04	1.07	0.90	0.79	1.06	0.00
Avail Cap(c_a), veh/h	1624	844	430	3251	1427	427
HCM Platoon Ratio	1.00	1.00	1.00	1.00	1.00	1.00
Upstream Filter(I)	1.00	1.00	1.00	1.00	1.00	0.00
Uniform Delay (d), s/veh	31.6	31.6	51.9	16.2	44.1	0.0
Incr Delay (d2), s/veh	32.3	51.8	21.1	1.4	40.3	0.0
Initial Q Delay(d3),s/veh	0.0	0.0	0.0	0.0	0.0	0.0
%ile BackOfQ(50%),veh/ln	28.5	34.2	6.7	14.4	18.7	0.0
Unsig. Movement Delay, s/veh						
LnGrp Delay(d),s/veh	63.9	83.4	73.0	17.6	84.4	0.0
LnGrp LOS	F	F	E	B	F	A
Approach Vol, veh/h	2587			2942	1508	
Approach Delay, s/veh	70.7			24.9	84.4	
Approach LOS	E			C	F	
Timer - Assigned Phs	1	2			6	8
Phs Duration (G+Y+Rc), s	19.0	63.0			82.0	38.0
Change Period (Y+Rc), s	* 4.2	6.2			6.2	6.2
Max Green Setting (Gmax), s	* 15	56.8			75.8	31.8
Max Q Clear Time (g_c+I1), s	15.1	58.8			45.6	33.8
Green Ext Time (p_c), s	0.0	0.0			26.8	0.0

Intersection Summary

HCM 6th Ctrl Delay	54.5
HCM 6th LOS	D

Notes

User approved volume balancing among the lanes for turning movement.
* HCM 6th computational engine requires equal clearance times for the phases crossing the barrier.

Timings
6: Trautwein Rd. & Grove Community Dr

West Campus Upper Plateau (JN 14064)
09/19/2022



Lane Group	WBL	WBR	NBT	NBR	SBL	SBT
Lane Configurations	↙	↗↗	↕↕	↗	↗↗	↕↕
Traffic Volume (vph)	58	270	1442	62	426	2076
Future Volume (vph)	58	270	1442	62	426	2076
Turn Type	Prot	pm+ov	NA	Perm	Prot	NA
Protected Phases	8	1	2		1	6
Permitted Phases		8		2		
Detector Phase	8	1	2	2	1	6
Switch Phase						
Minimum Initial (s)	10.0	5.0	10.0	10.0	5.0	10.0
Minimum Split (s)	34.6	9.6	46.2	46.2	9.6	28.2
Total Split (s)	35.0	29.0	56.0	56.0	29.0	85.0
Total Split (%)	29.2%	24.2%	46.7%	46.7%	24.2%	70.8%
Yellow Time (s)	3.6	3.6	5.2	5.2	3.6	5.2
All-Red Time (s)	1.0	1.0	1.0	1.0	1.0	1.0
Lost Time Adjust (s)	0.0	0.0	0.0	0.0	0.0	0.0
Total Lost Time (s)	4.6	4.6	6.2	6.2	4.6	6.2
Lead/Lag		Lead	Lag	Lag	Lead	
Lead-Lag Optimize?		Yes	Yes	Yes	Yes	
Recall Mode	None	None	None	None	None	None
Act Effct Green (s)	13.5	26.5	46.5	46.5	16.5	70.0
Actuated g/C Ratio	0.15	0.30	0.53	0.53	0.19	0.80
v/c Ratio	0.21	0.32	0.77	0.07	0.66	0.75
Control Delay	38.9	20.5	22.8	8.7	41.1	10.4
Queue Delay	0.0	0.0	0.0	0.0	0.0	0.0
Total Delay	38.9	20.5	22.8	8.7	41.1	10.4
LOS	D	C	C	A	D	B
Approach Delay	23.7		22.2			15.6
Approach LOS	C		C			B

Intersection Summary

Cycle Length: 120
 Actuated Cycle Length: 88
 Natural Cycle: 95
 Control Type: Actuated-Uncoordinated
 Maximum v/c Ratio: 0.77
 Intersection Signal Delay: 18.5
 Intersection LOS: B
 Intersection Capacity Utilization 75.7%
 ICU Level of Service D
 Analysis Period (min) 15

Splits and Phases: 6: Trautwein Rd. & Grove Community Dr



HCM 6th Signalized Intersection Summary
6: Trautwein Rd. & Grove Community Dr

West Campus Upper Plateau (JN 14064)

09/19/2022



Movement	WBL	WBR	NBT	NBR	SBL	SBT
Lane Configurations						
Traffic Volume (veh/h)	58	270	1442	62	426	2076
Future Volume (veh/h)	58	270	1442	62	426	2076
Initial Q (Qb), veh	0	0	0	0	0	0
Ped-Bike Adj(A_pbT)	1.00	1.00		1.00	1.00	
Parking Bus, Adj	1.00	1.00	1.00	1.00	1.00	1.00
Work Zone On Approach	No		No			No
Adj Sat Flow, veh/h/ln	1900	1900	1900	1900	1900	1870
Adj Flow Rate, veh/h	59	97	1471	58	435	2118
Peak Hour Factor	0.98	0.98	0.98	0.98	0.98	0.98
Percent Heavy Veh, %	0	0	0	0	0	2
Cap, veh/h	220	779	1918	855	538	2638
Arrive On Green	0.12	0.12	0.53	0.53	0.15	0.74
Sat Flow, veh/h	1810	2834	3705	1610	3510	3647
Grp Volume(v), veh/h	59	97	1471	58	435	2118
Grp Sat Flow(s),veh/h/ln	1810	1417	1805	1610	1755	1777
Q Serve(g_s), s	2.4	2.0	25.6	1.4	9.5	30.2
Cycle Q Clear(g_c), s	2.4	2.0	25.6	1.4	9.5	30.2
Prop In Lane	1.00	1.00		1.00	1.00	
Lane Grp Cap(c), veh/h	220	779	1918	855	538	2638
V/C Ratio(X)	0.27	0.12	0.77	0.07	0.81	0.80
Avail Cap(c_a), veh/h	692	1518	2262	1009	1078	3523
HCM Platoon Ratio	1.00	1.00	1.00	1.00	1.00	1.00
Upstream Filter(I)	1.00	1.00	1.00	1.00	1.00	1.00
Uniform Delay (d), s/veh	31.7	21.6	14.7	9.1	32.5	6.5
Incr Delay (d2), s/veh	0.6	0.1	1.4	0.0	1.1	1.0
Initial Q Delay(d3),s/veh	0.0	0.0	0.0	0.0	0.0	0.0
%ile BackOfQ(50%),veh/ln	1.0	0.7	8.5	0.4	3.8	5.4
Unsig. Movement Delay, s/veh						
LnGrp Delay(d),s/veh	32.3	21.7	16.1	9.1	33.6	7.6
LnGrp LOS	C	C	B	A	C	A
Approach Vol, veh/h	156		1529			2553
Approach Delay, s/veh	25.7		15.9			12.0
Approach LOS	C		B			B
Timer - Assigned Phs	1	2			6	8
Phs Duration (G+Y+Rc), s	16.8	48.4			65.2	14.3
Change Period (Y+Rc), s	4.6	6.2			6.2	4.6
Max Green Setting (Gmax), s	24.4	49.8			78.8	30.4
Max Q Clear Time (g_c+I1), s	11.5	27.6			32.2	4.4
Green Ext Time (p_c), s	0.7	10.9			26.8	0.5

Intersection Summary

HCM 6th Ctrl Delay	13.9
HCM 6th LOS	B

Timings

West Campus Upper Plateau (JN 14064)

7: Trautwein Rd. & Orange Terrace Pkwy

09/19/2022



Lane Group	EBL	EBT	WBL	WBT	WBR	NBL	NBT	NBR	SBL	SBT	SBR
Lane Configurations											
Traffic Volume (vph)	52	53	172	28	196	50	1347	241	392	1712	46
Future Volume (vph)	52	53	172	28	196	50	1347	241	392	1712	46
Turn Type	Prot	NA	Prot	NA	pm+ov	Prot	NA	Perm	Prot	NA	Perm
Protected Phases	7	4	3	8	1	5	2		1	6	
Permitted Phases					8			2			6
Detector Phase	7	4	3	8	1	5	2	2	1	6	6
Switch Phase											
Minimum Initial (s)	5.0	10.0	5.0	10.0	5.0	5.0	10.0	10.0	5.0	10.0	10.0
Minimum Split (s)	9.6	38.6	9.6	34.6	9.6	9.6	46.2	46.2	9.6	28.2	28.2
Total Split (s)	13.5	38.6	16.4	41.5	18.0	9.6	47.0	47.0	18.0	55.4	55.4
Total Split (%)	11.3%	32.2%	13.7%	34.6%	15.0%	8.0%	39.2%	39.2%	15.0%	46.2%	46.2%
Yellow Time (s)	3.6	3.6	3.6	3.6	3.6	3.6	5.2	5.2	3.6	5.2	5.2
All-Red Time (s)	1.0	1.0	1.0	1.0	1.0	1.0	1.0	1.0	1.0	1.0	1.0
Lost Time Adjust (s)	0.0	0.0	0.0	0.0	0.0	0.0	0.0	0.0	0.0	0.0	0.0
Total Lost Time (s)	4.6	4.6	4.6	4.6	4.6	4.6	6.2	6.2	4.6	6.2	6.2
Lead/Lag	Lead	Lag	Lead	Lag	Lead	Lead	Lag	Lag	Lead	Lag	Lag
Lead-Lag Optimize?	Yes	Yes	Yes	Yes	Yes	Yes	Yes	Yes	Yes	Yes	Yes
Recall Mode	None	None	None	None	None	None	None	None	None	None	None
Act Effct Green (s)	7.0	14.1	12.0	19.9	38.2	5.1	41.4	41.4	13.6	52.3	52.3
Actuated g/C Ratio	0.07	0.14	0.12	0.20	0.39	0.05	0.42	0.42	0.14	0.53	0.53
v/c Ratio	0.43	0.29	0.82	0.08	0.18	0.57	0.94	0.34	0.86	0.94	0.05
Control Delay	57.0	32.3	73.1	32.8	8.0	72.6	41.6	11.6	61.0	36.1	0.1
Queue Delay	0.0	0.0	0.0	0.0	0.0	0.0	0.0	0.0	0.0	0.0	0.0
Total Delay	57.0	32.3	73.1	32.8	8.0	72.6	41.6	11.6	61.0	36.1	0.1
LOS	E	C	E	C	A	E	D	B	E	D	A
Approach Delay		42.3		38.0			38.1			39.9	
Approach LOS		D		D			D			D	

Intersection Summary

Cycle Length: 120	
Actuated Cycle Length: 97.9	
Natural Cycle: 115	
Control Type: Actuated-Uncoordinated	
Maximum v/c Ratio: 0.94	
Intersection Signal Delay: 39.1	Intersection LOS: D
Intersection Capacity Utilization 80.5%	ICU Level of Service D
Analysis Period (min) 15	



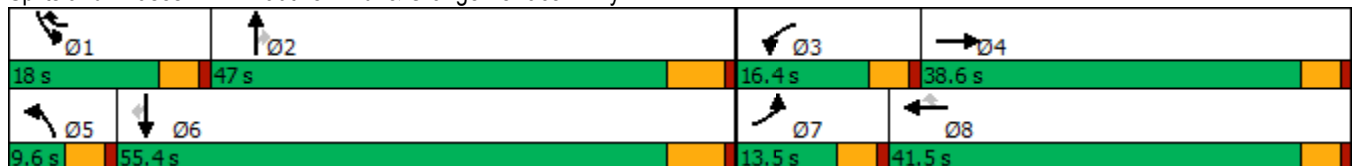



















Splits and Phases: 7: Trautwein Rd. & Orange Terrace Pkwy



HCM 6th Signalized Intersection Summary
7: Trautwein Rd. & Orange Terrace Pkwy

West Campus Upper Plateau (JN 14064)

09/19/2022

												
Movement	EBL	EBT	EBR	WBL	WBT	WBR	NBL	NBT	NBR	SBL	SBT	SBR
Lane Configurations												
Traffic Volume (veh/h)	52	53	24	172	28	196	50	1347	241	392	1712	46
Future Volume (veh/h)	52	53	24	172	28	196	50	1347	241	392	1712	46
Initial Q (Qb), veh	0	0	0	0	0	0	0	0	0	0	0	0
Ped-Bike Adj(A_pbT)	1.00		1.00	1.00		1.00	1.00		1.00	1.00		1.00
Parking Bus, Adj	1.00	1.00	1.00	1.00	1.00	1.00	1.00	1.00	1.00	1.00	1.00	1.00
Work Zone On Approach		No			No			No			No	
Adj Sat Flow, veh/h/ln	1900	1900	1900	1900	1900	1870	1900	1885	1885	1885	1885	1900
Adj Flow Rate, veh/h	55	56	23	181	29	87	53	1418	177	413	1802	39
Peak Hour Factor	0.95	0.95	0.95	0.95	0.95	0.95	0.95	0.95	0.95	0.95	0.95	0.95
Percent Heavy Veh, %	0	0	0	0	0	2	0	1	1	1	1	0
Cap, veh/h	73	136	56	214	350	898	72	1523	679	480	1874	842
Arrive On Green	0.04	0.11	0.11	0.12	0.18	0.18	0.04	0.43	0.43	0.14	0.52	0.52
Sat Flow, veh/h	1810	1280	526	1810	1900	2790	1810	3582	1598	3483	3582	1610
Grp Volume(v), veh/h	55	0	79	181	29	87	53	1418	177	413	1802	39
Grp Sat Flow(s),veh/h/ln	1810	0	1805	1810	1900	1395	1810	1791	1598	1742	1791	1610
Q Serve(g_s), s	2.8	0.0	3.8	9.2	1.2	2.1	2.7	35.4	6.7	10.9	45.4	1.1
Cycle Q Clear(g_c), s	2.8	0.0	3.8	9.2	1.2	2.1	2.7	35.4	6.7	10.9	45.4	1.1
Prop In Lane	1.00		0.29	1.00		1.00	1.00		1.00	1.00		1.00
Lane Grp Cap(c), veh/h	73	0	192	214	350	898	72	1523	679	480	1874	842
V/C Ratio(X)	0.75	0.00	0.41	0.85	0.08	0.10	0.74	0.93	0.26	0.86	0.96	0.05
Avail Cap(c_a), veh/h	171	0	652	227	745	1478	96	1553	693	496	1874	842
HCM Platoon Ratio	1.00	1.00	1.00	1.00	1.00	1.00	1.00	1.00	1.00	1.00	1.00	1.00
Upstream Filter(I)	1.00	0.00	1.00	1.00	1.00	1.00	1.00	1.00	1.00	1.00	1.00	1.00
Uniform Delay (d), s/veh	44.7	0.0	39.3	40.6	31.8	22.3	44.7	25.7	17.5	39.7	21.5	11.0
Incr Delay (d2), s/veh	5.6	0.0	1.4	21.9	0.1	0.0	11.1	10.3	0.2	13.2	12.9	0.0
Initial Q Delay(d3),s/veh	0.0	0.0	0.0	0.0	0.0	0.0	0.0	0.0	0.0	0.0	0.0	0.0
%ile BackOfQ(50%),veh/ln	1.4	0.0	1.8	5.2	0.5	0.6	1.4	15.4	2.3	5.3	19.1	0.4
Unsig. Movement Delay, s/veh												
LnGrp Delay(d),s/veh	50.3	0.0	40.7	62.6	31.9	22.4	55.8	36.1	17.7	52.9	34.5	11.0
LnGrp LOS	D	A	D	E	C	C	E	D	B	D	C	B
Approach Vol, veh/h		134			297			1648			2254	
Approach Delay, s/veh		44.7			47.8			34.7			37.4	
Approach LOS		D			D			C			D	
Timer - Assigned Phs	1	2	3	4	5	6	7	8				
Phs Duration (G+Y+Rc), s	17.6	46.2	15.7	14.6	8.3	55.4	8.4	21.9				
Change Period (Y+Rc), s	4.6	6.2	4.6	4.6	4.6	6.2	4.6	4.6				
Max Green Setting (Gmax), s	13.4	40.8	11.8	34.0	5.0	49.2	8.9	36.9				
Max Q Clear Time (g_c+I1), s	12.9	37.4	11.2	5.8	4.7	47.4	4.8	4.1				
Green Ext Time (p_c), s	0.1	2.6	0.0	0.4	0.0	1.5	0.0	0.4				
Intersection Summary												
HCM 6th Ctrl Delay				37.3								
HCM 6th LOS				D								

Timings
8: Cole Av. & Van Buren Bl.

West Campus Upper Plateau (JN 14064)

09/19/2022



Lane Group	EBL	EBT	EBR	WBL	WBT	WBR	NBL	NBT	SBL	SBT	SBR
Lane Configurations	↖↗	↑↑	↖	↖	↑↑↑	↖	↖	↑↑	↖↗	↑↑	↖
Traffic Volume (vph)	445	1555	115	213	1657	691	102	382	658	691	330
Future Volume (vph)	445	1555	115	213	1657	691	102	382	658	691	330
Turn Type	Prot	NA	pm+ov	Prot	NA	pm+ov	Prot	NA	Prot	NA	pm+ov
Protected Phases	5	2	3	1	6	7	3	8	7	4	5
Permitted Phases			2			6					4
Detector Phase	5	2	3	1	6	7	3	8	7	4	5
Switch Phase											
Minimum Initial (s)	5.0	10.0	5.0	5.0	10.0	5.0	5.0	10.0	5.0	10.0	5.0
Minimum Split (s)	9.1	36.2	9.1	9.1	36.2	9.1	9.1	42.2	9.1	49.2	9.1
Total Split (s)	18.7	44.8	12.0	14.0	40.1	17.5	12.0	43.7	17.5	49.2	18.7
Total Split (%)	15.6%	37.3%	10.0%	11.7%	33.4%	14.6%	10.0%	36.4%	14.6%	41.0%	15.6%
Yellow Time (s)	3.2	5.2	3.2	3.2	5.2	3.2	3.2	5.2	3.2	5.2	3.2
All-Red Time (s)	0.5	1.0	0.5	0.5	1.0	0.5	0.5	1.0	0.5	1.0	0.5
Lost Time Adjust (s)	0.0	0.0	0.0	0.0	0.0	0.0	0.0	0.0	0.0	0.0	0.0
Total Lost Time (s)	3.7	6.2	3.7	3.7	6.2	3.7	3.7	6.2	3.7	6.2	3.7
Lead/Lag	Lead	Lag	Lead	Lead	Lag	Lead	Lead	Lag	Lead	Lag	Lead
Lead-Lag Optimize?	Yes	Yes	Yes	Yes	Yes	Yes	Yes	Yes	Yes	Yes	Yes
Recall Mode	None	None	None	None	None	None	None	None	None	None	None
Act Effct Green (s)	15.1	38.8	53.3	10.3	34.0	54.1	8.3	23.0	13.9	28.5	46.1
Actuated g/C Ratio	0.14	0.37	0.50	0.10	0.32	0.51	0.08	0.22	0.13	0.27	0.44
v/c Ratio	0.97	1.30	0.15	1.32	1.08	0.83	0.78	0.70	1.56	0.76	0.48
Control Delay	80.2	171.8	5.7	216.4	81.9	27.9	83.8	40.1	294.6	41.0	17.3
Queue Delay	0.0	0.0	0.0	0.0	0.0	0.0	0.0	0.0	0.0	0.0	0.0
Total Delay	80.2	171.8	5.7	216.4	81.9	27.9	83.8	40.1	294.6	41.0	17.3
LOS	F	F	A	F	F	C	F	D	F	D	B
Approach Delay		143.5			78.5			47.4		135.7	
Approach LOS		F			E			D		F	

Intersection Summary

Cycle Length: 120	
Actuated Cycle Length: 105.8	
Natural Cycle: 115	
Control Type: Actuated-Uncoordinated	
Maximum v/c Ratio: 1.56	
Intersection Signal Delay: 109.3	Intersection LOS: F
Intersection Capacity Utilization 107.1%	ICU Level of Service G
Analysis Period (min) 15	



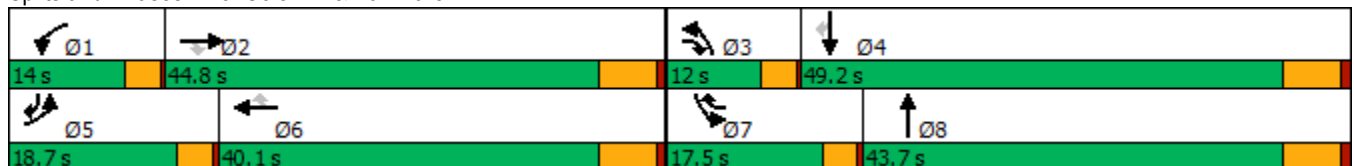





















Splits and Phases: 8: Cole Av. & Van Buren Bl.



HCM 6th Signalized Intersection Summary
8: Cole Av. & Van Buren Bl.

West Campus Upper Plateau (JN 14064)

09/19/2022

												
Movement	EBL	EBT	EBR	WBL	WBT	WBR	NBL	NBT	NBR	SBL	SBT	SBR
Lane Configurations												
Traffic Volume (veh/h)	445	1555	115	213	1657	691	102	382	125	658	691	330
Future Volume (veh/h)	445	1555	115	213	1657	691	102	382	125	658	691	330
Initial Q (Qb), veh	0	0	0	0	0	0	0	0	0	0	0	0
Ped-Bike Adj(A_pbT)	1.00		1.00	1.00		1.00	1.00		0.99	1.00		1.00
Parking Bus, Adj	1.00	1.00	1.00	1.00	1.00	1.00	1.00	1.00	1.00	1.00	1.00	1.00
Work Zone On Approach		No			No			No			No	
Adj Sat Flow, veh/h/ln	1870	1841	1856	1870	1870	1885	1885	1885	1885	1870	1885	1885
Adj Flow Rate, veh/h	473	1654	63	227	1763	645	109	406	126	700	735	251
Peak Hour Factor	0.94	0.94	0.94	0.94	0.94	0.94	0.94	0.94	0.94	0.94	0.94	0.94
Percent Heavy Veh, %	2	4	3	2	2	1	1	1	1	2	1	1
Cap, veh/h	497	1294	701	176	1659	730	136	564	173	457	953	654
Arrive On Green	0.14	0.37	0.37	0.10	0.32	0.32	0.08	0.21	0.21	0.13	0.27	0.27
Sat Flow, veh/h	3456	3497	1572	1781	5106	1598	1795	2695	827	3456	3582	1596
Grp Volume(v), veh/h	473	1654	63	227	1763	645	109	268	264	700	735	251
Grp Sat Flow(s),veh/h/ln	1728	1749	1572	1781	1702	1598	1795	1791	1731	1728	1791	1596
Q Serve(g_s), s	14.2	38.6	2.4	10.3	33.9	33.9	6.2	14.5	14.8	13.8	19.8	11.5
Cycle Q Clear(g_c), s	14.2	38.6	2.4	10.3	33.9	33.9	6.2	14.5	14.8	13.8	19.8	11.5
Prop In Lane	1.00		1.00	1.00		1.00	1.00		0.48	1.00		1.00
Lane Grp Cap(c), veh/h	497	1294	701	176	1659	730	136	375	362	457	953	654
V/C Ratio(X)	0.95	1.28	0.09	1.29	1.06	0.88	0.80	0.72	0.73	1.53	0.77	0.38
Avail Cap(c_a), veh/h	497	1294	701	176	1659	730	143	644	622	457	1476	887
HCM Platoon Ratio	1.00	1.00	1.00	1.00	1.00	1.00	1.00	1.00	1.00	1.00	1.00	1.00
Upstream Filter(I)	1.00	1.00	1.00	1.00	1.00	1.00	1.00	1.00	1.00	1.00	1.00	1.00
Uniform Delay (d), s/veh	44.3	32.9	16.7	47.0	35.2	25.8	47.5	38.4	38.5	45.3	35.4	21.6
Incr Delay (d2), s/veh	28.4	131.4	0.1	166.6	40.9	12.6	24.0	2.6	2.8	250.1	1.4	0.4
Initial Q Delay(d3),s/veh	0.0	0.0	0.0	0.0	0.0	0.0	0.0	0.0	0.0	0.0	0.0	0.0
%ile BackOfQ(50%),veh/ln	7.7	38.5	0.8	12.5	19.2	15.5	3.6	6.3	6.2	21.5	8.3	4.0
Unsig. Movement Delay, s/veh												
LnGrp Delay(d),s/veh	72.7	164.2	16.8	213.6	76.1	38.4	71.5	40.9	41.3	295.3	36.7	21.9
LnGrp LOS	E	F	B	F	F	D	E	D	D	F	D	C
Approach Vol, veh/h		2190			2635			641			1686	
Approach Delay, s/veh		140.2			78.7			46.3			141.9	
Approach LOS		F			E			D			F	
Timer - Assigned Phs	1	2	3	4	5	6	7	8				
Phs Duration (G+Y+Rc), s	14.0	44.8	11.6	34.0	18.7	40.1	17.5	28.0				
Change Period (Y+Rc), s	3.7	6.2	3.7	6.2	3.7	6.2	3.7	6.2				
Max Green Setting (Gmax), s	10.3	38.6	8.3	43.0	15.0	33.9	13.8	37.5				
Max Q Clear Time (g_c+I1), s	12.3	40.6	8.2	21.8	16.2	35.9	15.8	16.8				
Green Ext Time (p_c), s	0.0	0.0	0.0	5.4	0.0	0.0	0.0	2.7				
Intersection Summary												
HCM 6th Ctrl Delay				109.5								
HCM 6th LOS				F								

Intersection	
Intersection Delay, s/veh	9.9
Intersection LOS	A

Movement	EBT	EBR	WBL	WBT	NBL	NBR
Lane Configurations	↻		↻	↻	↻	↻
Traffic Vol, veh/h	242	21	25	176	31	41
Future Vol, veh/h	242	21	25	176	31	41
Peak Hour Factor	0.92	0.92	0.92	0.92	0.92	0.92
Heavy Vehicles, %	1	0	1	2	0	0
Mvmt Flow	263	23	27	191	34	45
Number of Lanes	1	0	1	1	1	1

Approach	EB	WB	NB
Opposing Approach	WB	EB	
Opposing Lanes	2	1	0
Conflicting Approach Left		NB	EB
Conflicting Lanes Left	0	2	1
Conflicting Approach Right	NB		WB
Conflicting Lanes Right	2	0	2
HCM Control Delay	10.6	9.4	8.6
HCM LOS	B	A	A

Lane	NBLn1	NBLn2	EBLn1	WBLn1	WBLn2
Vol Left, %	100%	0%	0%	100%	0%
Vol Thru, %	0%	0%	92%	0%	100%
Vol Right, %	0%	100%	8%	0%	0%
Sign Control	Stop	Stop	Stop	Stop	Stop
Traffic Vol by Lane	31	41	263	25	176
LT Vol	31	0	0	25	0
Through Vol	0	0	242	0	176
RT Vol	0	41	21	0	0
Lane Flow Rate	34	45	286	27	191
Geometry Grp	7	7	4	7	7
Degree of Util (X)	0.058	0.062	0.376	0.041	0.264
Departure Headway (Hd)	6.2	4.99	4.732	5.46	4.974
Convergence, Y/N	Yes	Yes	Yes	Yes	Yes
Cap	578	717	760	657	723
Service Time	3.937	2.727	2.756	3.185	2.699
HCM Lane V/C Ratio	0.059	0.063	0.376	0.041	0.264
HCM Control Delay	9.3	8.1	10.6	8.4	9.5
HCM Lane LOS	A	A	B	A	A
HCM 95th-tile Q	0.2	0.2	1.8	0.1	1.1

Intersection

Intersection Delay, s/veh 11.4

Intersection LOS B

Movement	EBL	EBT	EBR	WBL	WBT	WBR	NBL	NBT	NBR	SBL	SBT	SBR
Lane Configurations												
Traffic Vol, veh/h	49	526	17	4	314	53	21	5	2	31	9	22
Future Vol, veh/h	49	526	17	4	314	53	21	5	2	31	9	22
Peak Hour Factor	0.96	0.96	0.96	0.96	0.96	0.96	0.96	0.96	0.96	0.96	0.96	0.96
Heavy Vehicles, %	3	2	7	0	1	0	6	0	0	0	0	0
Mvmt Flow	51	548	18	4	327	55	22	5	2	32	9	23
Number of Lanes	1	2	0	1	2	0	0	1	0	0	1	0

Approach	EB	WB	NB	SB
Opposing Approach	WB	EB	SB	NB
Opposing Lanes	3	3	1	1
Conflicting Approach Left SB		NB	EB	WB
Conflicting Lanes Left	1	1	3	3
Conflicting Approach Right NB		SB	WB	EB
Conflicting Lanes Right	1	1	3	3
HCM Control Delay	12.2	10.3	10.4	10.3
HCM LOS	B	B	B	B

Lane	NBLn1	EBLn1	EBLn2	EBLn3	WBLn1	WBLn2	WBLn3	SBLn1
Vol Left, %		75%	100%	0%	0%	100%	0%	0%
Vol Thru, %		18%	0%	100%	91%	0%	100%	66%
Vol Right, %		7%	0%	0%	9%	0%	0%	34%
Sign Control		Stop	Stop	Stop	Stop	Stop	Stop	Stop
Traffic Vol by Lane		28	49	351	192	4	209	158
LT Vol		21	49	0	0	4	0	0
Through Vol		5	0	351	175	0	209	105
RT Vol		2	0	0	17	0	0	53
Lane Flow Rate		29	51	365	200	4	218	164
Geometry Grp		7	7	7	7	7	7	7
Degree of Util (X)		0.058	0.081	0.528	0.291	0.007	0.329	0.236
Departure Headway (Hd)		7.207	5.724	5.204	5.228	5.912	5.426	5.172
Convergence, Y/N		Yes	Yes	Yes	Yes	Yes	Yes	Yes
Cap		500	621	687	681	600	656	687
Service Time		4.91	3.502	2.982	3.005	3.698	3.212	2.958
HCM Lane V/C Ratio		0.058	0.082	0.531	0.294	0.007	0.332	0.239
HCM Control Delay		10.4	9	13.7	10.2	8.7	10.9	9.6
HCM Lane LOS		B	A	B	B	A	B	A
HCM 95th-tile Q		0.2	0.3	3.1	1.2	0	1.4	0.9

Timings

11: Barton St & Alessandro Bl.

09/19/2022



Lane Group	EBL	EBT	WBL	WBT	NBL	NBT	NBR	SBL	SBT	SBR
Lane Configurations	↙	↕↕↕	↙	↕↕↕		↕	↗		↕	↗
Traffic Volume (vph)	6	2345	77	2669	78	1	38	15	0	14
Future Volume (vph)	6	2345	77	2669	78	1	38	15	0	14
Turn Type	Prot	NA	Prot	NA	Perm	NA	Perm	Perm	NA	Perm
Protected Phases	5	2	1	6		8			4	
Permitted Phases					8		8	4		4
Detector Phase	5	2	1	6	8	8	8	4	4	4
Switch Phase										
Minimum Initial (s)	5.0	10.0	5.0	10.0	10.0	10.0	10.0	10.0	10.0	10.0
Minimum Split (s)	9.2	28.5	11.0	28.5	40.6	40.6	40.6	26.6	26.6	26.6
Total Split (s)	9.2	65.4	14.0	70.2	40.6	40.6	40.6	40.6	40.6	40.6
Total Split (%)	7.7%	54.5%	11.7%	58.5%	33.8%	33.8%	33.8%	33.8%	33.8%	33.8%
Yellow Time (s)	3.2	5.5	3.2	5.5	3.6	3.6	3.6	3.6	3.6	3.6
All-Red Time (s)	1.0	1.0	1.0	1.0	1.0	1.0	1.0	1.0	1.0	1.0
Lost Time Adjust (s)	0.0	0.0	0.0	0.0		0.0	0.0		0.0	0.0
Total Lost Time (s)	4.2	6.5	4.2	6.5		4.6	4.6		4.6	4.6
Lead/Lag	Lead	Lag	Lead	Lag						
Lead-Lag Optimize?	Yes	Yes	Yes	Yes						
Recall Mode	None	None	None	None	None	None	None	None	None	None
Act Effct Green (s)	5.1	63.7	8.0	72.0		15.1	15.1		15.1	15.1
Actuated g/C Ratio	0.05	0.68	0.08	0.76		0.16	0.16		0.16	0.16
v/c Ratio	0.07	0.72	0.52	0.72		0.38	0.11		0.08	0.04
Control Delay	51.8	17.0	58.3	12.3		41.6	0.7		34.7	0.2
Queue Delay	0.0	0.0	0.0	0.0		0.0	0.0		0.0	0.0
Total Delay	51.8	17.0	58.3	12.3		41.6	0.7		34.7	0.2
LOS	D	B	E	B		D	A		C	A
Approach Delay		17.0		13.6		28.2			18.0	
Approach LOS		B		B		C			B	

Intersection Summary

Cycle Length: 120
 Actuated Cycle Length: 94.3
 Natural Cycle: 115
 Control Type: Actuated-Uncoordinated
 Maximum v/c Ratio: 0.72
 Intersection Signal Delay: 15.5
 Intersection LOS: B
 Intersection Capacity Utilization 81.7%
 ICU Level of Service D
 Analysis Period (min) 15

Splits and Phases: 11: Barton St & Alessandro Bl.



HCM 6th Signalized Intersection Summary
11: Barton St & Alessandro Bl.

West Campus Upper Plateau (JN 14064)

09/19/2022



Movement	EBL	EBT	EBR	WBL	WBT	WBR	NBL	NBT	NBR	SBL	SBT	SBR
Lane Configurations	↖	↑↑↑		↖	↑↑↑			↑	↗		↑	↗
Traffic Volume (veh/h)	6	2345	55	77	2669	17	78	1	38	15	0	14
Future Volume (veh/h)	6	2345	55	77	2669	17	78	1	38	15	0	14
Initial Q (Qb), veh	0	0	0	0	0	0	0	0	0	0	0	0
Ped-Bike Adj(A_pbT)	1.00		1.00	1.00		0.98	1.00		1.00	1.00		1.00
Parking Bus, Adj	1.00	1.00	1.00	1.00	1.00	1.00	1.00	1.00	1.00	1.00	1.00	1.00
Work Zone On Approach		No			No			No			No	
Adj Sat Flow, veh/h/ln	1604	1885	1900	1900	1870	1900	1900	1900	1900	1796	1900	1900
Adj Flow Rate, veh/h	6	2443	55	80	2780	18	81	1	14	16	0	5
Peak Hour Factor	0.96	0.96	0.96	0.96	0.96	0.96	0.96	0.96	0.96	0.96	0.96	0.96
Percent Heavy Veh, %	20	1	0	0	2	0	0	0	0	7	0	0
Cap, veh/h	12	2796	63	101	3079	20	75	1	422	75	0	422
Arrive On Green	0.01	0.54	0.54	0.06	0.59	0.59	0.26	0.26	0.26	0.26	0.00	0.26
Sat Flow, veh/h	1527	5179	116	1810	5234	34	32	2	1610	32	0	1610
Grp Volume(v), veh/h	6	1615	883	80	1806	992	82	0	14	16	0	5
Grp Sat Flow(s),veh/h/ln	1527	1716	1864	1810	1702	1863	34	0	1610	32	0	1610
Q Serve(g_s), s	0.4	44.1	44.6	4.7	50.1	50.5	0.6	0.0	0.7	0.6	0.0	0.2
Cycle Q Clear(g_c), s	0.4	44.1	44.6	4.7	50.1	50.5	28.2	0.0	0.7	28.2	0.0	0.2
Prop In Lane	1.00		0.06	1.00		0.02	0.99		1.00	1.00		1.00
Lane Grp Cap(c), veh/h	12	1852	1006	101	2003	1096	75	0	422	75	0	422
V/C Ratio(X)	0.52	0.87	0.88	0.79	0.90	0.90	1.09	0.00	0.03	0.21	0.00	0.01
Avail Cap(c_a), veh/h	71	1876	1019	165	2013	1102	179	0	538	178	0	538
HCM Platoon Ratio	1.00	1.00	1.00	1.00	1.00	1.00	1.00	1.00	1.00	1.00	1.00	1.00
Upstream Filter(I)	1.00	1.00	1.00	1.00	1.00	1.00	1.00	0.00	1.00	1.00	0.00	1.00
Uniform Delay (d), s/veh	53.3	21.6	21.7	50.2	19.4	19.5	53.7	0.0	29.6	53.7	0.0	29.4
Incr Delay (d2), s/veh	12.9	4.9	9.0	5.0	6.2	10.7	74.1	0.0	0.0	1.4	0.0	0.0
Initial Q Delay(d3),s/veh	0.0	0.0	0.0	0.0	0.0	0.0	0.0	0.0	0.0	0.0	0.0	0.0
%ile BackOfQ(50%),veh/ln	0.2	16.2	18.9	2.3	19.9	23.3	3.6	0.0	0.3	0.5	0.0	0.1
Unsig. Movement Delay, s/veh												
LnGrp Delay(d),s/veh	66.1	26.5	30.6	55.3	25.7	30.3	127.8	0.0	29.6	55.1	0.0	29.4
LnGrp LOS	E	C	C	E	C	C	F	A	C	E	A	C
Approach Vol, veh/h		2504			2878			96				21
Approach Delay, s/veh		28.0			28.1			113.5				49.0
Approach LOS		C			C			F				D
Timer - Assigned Phs	1	2		4	5	6		8				
Phs Duration (G+Y+Rc), s	10.3	64.6		33.5	5.0	69.9		33.5				
Change Period (Y+Rc), s	* 4.2	6.5		4.6	* 4.2	6.5		4.6				
Max Green Setting (Gmax), s	* 9.8	58.9		36.0	* 5	63.7		36.0				
Max Q Clear Time (g_c+I1), s	6.7	46.6		30.2	2.4	52.5		30.2				
Green Ext Time (p_c), s	0.0	11.4		0.0	0.0	11.0		0.2				

Intersection Summary

HCM 6th Ctrl Delay	29.6
HCM 6th LOS	C

Notes

* HCM 6th computational engine requires equal clearance times for the phases crossing the barrier.

Intersection						
Int Delay, s/veh	1.7					
Movement	EBL	EBT	WBT	WBR	SBL	SBR
Lane Configurations						
Traffic Vol, veh/h	45	239	146	23	2	54
Future Vol, veh/h	45	239	146	23	2	54
Conflicting Peds, #/hr	0	0	0	7	0	0
Sign Control	Free	Free	Free	Free	Stop	Stop
RT Channelized	-	None	-	None	-	None
Storage Length	100	-	-	-	0	-
Veh in Median Storage, #	-	0	0	-	0	-
Grade, %	-	0	0	-	0	-
Peak Hour Factor	94	94	94	94	94	94
Heavy Vehicles, %	0	0	1	0	0	0
Mvmt Flow	48	254	155	24	2	57

Major/Minor	Major1	Major2	Minor2		
Conflicting Flow All	186	0	-	0	524 174
Stage 1	-	-	-	-	174 -
Stage 2	-	-	-	-	350 -
Critical Hdwy	4.1	-	-	-	6.4 6.2
Critical Hdwy Stg 1	-	-	-	-	5.4 -
Critical Hdwy Stg 2	-	-	-	-	5.4 -
Follow-up Hdwy	2.2	-	-	-	3.5 3.3
Pot Cap-1 Maneuver	1401	-	-	-	517 875
Stage 1	-	-	-	-	861 -
Stage 2	-	-	-	-	718 -
Platoon blocked, %		-	-	-	
Mov Cap-1 Maneuver	1392	-	-	-	493 869
Mov Cap-2 Maneuver	-	-	-	-	493 -
Stage 1	-	-	-	-	826 -
Stage 2	-	-	-	-	713 -

Approach	EB	WB	SB
HCM Control Delay, s	1.2	0	9.6
HCM LOS			A

Minor Lane/Major Mvmt	EBL	EBT	WBT	WBR	SBLn1
Capacity (veh/h)	1392	-	-	-	846
HCM Lane V/C Ratio	0.034	-	-	-	0.07
HCM Control Delay (s)	7.7	-	-	-	9.6
HCM Lane LOS	A	-	-	-	A
HCM 95th %tile Q(veh)	0.1	-	-	-	0.2

Intersection						
Int Delay, s/veh	3.5					
Movement	EBT	EBR	WBL	WBT	NBL	NBR
Lane Configurations	↑↑		↖	↑↑	↘	
Traffic Vol, veh/h	429	129	47	258	113	45
Future Vol, veh/h	429	129	47	258	113	45
Conflicting Peds, #/hr	0	2	0	0	0	0
Sign Control	Free	Free	Free	Free	Stop	Stop
RT Channelized	-	None	-	None	-	None
Storage Length	-	-	125	-	0	-
Veh in Median Storage, #	0	-	-	0	0	-
Grade, %	0	-	-	0	0	-
Peak Hour Factor	97	97	97	97	97	97
Heavy Vehicles, %	1	1	0	0	0	0
Mvmt Flow	442	133	48	266	116	46

Major/Minor	Major1	Major2	Minor1		
Conflicting Flow All	0	0	577	0	740 290
Stage 1	-	-	-	-	511 -
Stage 2	-	-	-	-	229 -
Critical Hdwy	-	-	4.1	-	6.8 6.9
Critical Hdwy Stg 1	-	-	-	-	5.8 -
Critical Hdwy Stg 2	-	-	-	-	5.8 -
Follow-up Hdwy	-	-	2.2	-	3.5 3.3
Pot Cap-1 Maneuver	-	-	1006	-	357 713
Stage 1	-	-	-	-	573 -
Stage 2	-	-	-	-	793 -
Platoon blocked, %	-	-	-	-	-
Mov Cap-1 Maneuver	-	-	1004	-	339 712
Mov Cap-2 Maneuver	-	-	-	-	339 -
Stage 1	-	-	-	-	572 -
Stage 2	-	-	-	-	755 -

Approach	EB	WB	NB
HCM Control Delay, s	0	1.4	20.2
HCM LOS			C

Minor Lane/Major Mvmt	NBLn1	EBT	EBR	WBL	WBT
Capacity (veh/h)	398	-	-	1004	-
HCM Lane V/C Ratio	0.409	-	-	0.048	-
HCM Control Delay (s)	20.2	-	-	8.8	-
HCM Lane LOS	C	-	-	A	-
HCM 95th %tile Q(veh)	1.9	-	-	0.2	-

Timings

14: Barton Rd. & Van Buren Bl.



Lane Group	EBL	EBT	WBL	WBT	NBL	NBT	NBR	SBL	SBT
Lane Configurations	↘	↗	↘	↗	↘	↗	↗	↘	↗
Traffic Volume (vph)	192	2032	319	2220	348	93	257	28	31
Future Volume (vph)	192	2032	319	2220	348	93	257	28	31
Turn Type	Prot	NA	Prot	NA	Prot	NA	Perm	Prot	NA
Protected Phases	5	2	1	6	3	8		7	4
Permitted Phases							8		
Detector Phase	5	2	1	6	3	8	8	7	4
Switch Phase									
Minimum Initial (s)	5.0	10.0	5.0	10.0	5.0	10.0	10.0	5.0	10.0
Minimum Split (s)	9.2	25.2	9.2	25.5	9.1	14.6	14.6	9.1	33.6
Total Split (s)	17.6	52.1	22.2	56.7	12.1	36.3	36.3	9.4	33.6
Total Split (%)	14.7%	43.4%	18.5%	47.3%	10.1%	30.3%	30.3%	7.8%	28.0%
Yellow Time (s)	3.2	5.2	3.2	5.5	3.6	3.6	3.6	3.6	3.6
All-Red Time (s)	1.0	1.0	1.0	1.0	0.5	1.0	1.0	0.5	1.0
Lost Time Adjust (s)	0.0	0.0	0.0	0.0	0.0	0.0	0.0	0.0	0.0
Total Lost Time (s)	4.2	6.2	4.2	6.5	4.1	4.6	4.6	4.1	4.6
Lead/Lag	Lead	Lag	Lead	Lag	Lead	Lag	Lag	Lead	Lag
Lead-Lag Optimize?	Yes	Yes	Yes	Yes	Yes	Yes	Yes	Yes	Yes
Recall Mode	None	None	None	None	None	None	None	None	None
Act Effct Green (s)	13.5	46.1	18.1	50.5	8.0	20.1	20.1	5.3	13.4
Actuated g/C Ratio	0.13	0.44	0.17	0.48	0.08	0.19	0.19	0.05	0.13
v/c Ratio	0.87	1.61	1.08	0.96	1.35	0.27	0.52	0.32	0.57
Control Delay	79.0	302.8	116.1	38.5	220.1	39.2	8.4	59.9	15.8
Queue Delay	0.0	0.0	0.0	0.0	0.0	0.0	0.0	0.0	0.0
Total Delay	79.0	302.8	116.1	38.5	220.1	39.2	8.4	59.9	15.8
LOS	E	F	F	D	F	D	A	E	B
Approach Delay		286.0		48.0		118.1			21.2
Approach LOS		F		D		F			C

Intersection Summary

Cycle Length: 120
 Actuated Cycle Length: 104.9
 Natural Cycle: 120
 Control Type: Actuated-Uncoordinated
 Maximum v/c Ratio: 1.61
 Intersection Signal Delay: 155.2
 Intersection LOS: F
 Intersection Capacity Utilization 122.3%
 ICU Level of Service H
 Analysis Period (min) 15

Splits and Phases: 14: Barton Rd. & Van Buren Bl.



HCM 6th Signalized Intersection Summary
 14: Barton Rd. & Van Buren Bl.

West Campus Upper Plateau (JN 14064)

09/19/2022



Movement	EBL	EBT	EBR	WBL	WBT	WBR	NBL	NBT	NBR	SBL	SBT	SBR
Lane Configurations	↗	↗↘		↗	↗↘↙		↗↘	↑	↗	↗	↘	↘
Traffic Volume (veh/h)	192	2032	333	319	2220	54	348	93	257	28	31	168
Future Volume (veh/h)	192	2032	333	319	2220	54	348	93	257	28	31	168
Initial Q (Qb), veh	0	0	0	0	0	0	0	0	0	0	0	0
Ped-Bike Adj(A_pbT)	1.00		1.00	1.00		1.00	1.00		0.95	1.00		1.00
Parking Bus, Adj	1.00	1.00	1.00	1.00	1.00	1.00	1.00	1.00	1.00	1.00	1.00	1.00
Work Zone On Approach		No			No			No				No
Adj Sat Flow, veh/h/ln	1900	1870	1885	1885	1885	1870	1900	1900	1885	1900	1885	1900
Adj Flow Rate, veh/h	200	2117	318	332	2312	46	362	97	144	29	32	117
Peak Hour Factor	0.96	0.96	0.96	0.96	0.96	0.96	0.96	0.96	0.96	0.96	0.96	0.96
Percent Heavy Veh, %	0	2	1	1	1	2	0	0	1	0	1	0
Cap, veh/h	231	1384	203	313	2556	51	272	313	250	50	41	149
Arrive On Green	0.13	0.45	0.45	0.17	0.49	0.49	0.08	0.16	0.16	0.03	0.11	0.11
Sat Flow, veh/h	1810	3109	455	1795	5194	103	3510	1900	1514	1810	355	1297
Grp Volume(v), veh/h	200	1186	1249	332	1525	833	362	97	144	29	0	149
Grp Sat Flow(s),veh/h/ln	1810	1777	1788	1795	1716	1866	1755	1900	1514	1810	0	1652
Q Serve(g_s), s	11.2	45.9	45.9	18.0	41.9	42.2	8.0	4.6	9.1	1.6	0.0	9.1
Cycle Q Clear(g_c), s	11.2	45.9	45.9	18.0	41.9	42.2	8.0	4.6	9.1	1.6	0.0	9.1
Prop In Lane	1.00		0.25	1.00		0.06	1.00		1.00	1.00		0.79
Lane Grp Cap(c), veh/h	231	791	796	313	1688	919	272	313	250	50	0	190
V/C Ratio(X)	0.87	1.50	1.57	1.06	0.90	0.91	1.33	0.31	0.58	0.59	0.00	0.79
Avail Cap(c_a), veh/h	235	791	796	313	1688	919	272	584	465	93	0	464
HCM Platoon Ratio	1.00	1.00	1.00	1.00	1.00	1.00	1.00	1.00	1.00	1.00	1.00	1.00
Upstream Filter(I)	1.00	1.00	1.00	1.00	1.00	1.00	1.00	1.00	1.00	1.00	0.00	1.00
Uniform Delay (d), s/veh	44.1	28.6	28.6	42.6	23.9	24.0	47.6	37.9	39.7	49.6	0.0	44.4
Incr Delay (d2), s/veh	25.8	231.7	262.3	67.4	7.0	12.2	171.3	0.6	2.1	10.5	0.0	7.0
Initial Q Delay(d3),s/veh	0.0	0.0	0.0	0.0	0.0	0.0	0.0	0.0	0.0	0.0	0.0	0.0
%ile BackOfQ(50%),veh/ln	6.4	68.2	75.3	13.4	16.4	19.3	9.9	2.1	3.4	0.9	0.0	4.1
Unsig. Movement Delay, s/veh												
LnGrp Delay(d),s/veh	69.9	260.3	290.9	110.0	31.0	36.2	218.9	38.4	41.8	60.1	0.0	51.5
LnGrp LOS	E	F	F	F	C	D	F	D	D	E	A	D
Approach Vol, veh/h		2635			2690			603				178
Approach Delay, s/veh		260.4			42.4			147.6				52.9
Approach LOS		F			D			F				D
Timer - Assigned Phs	1	2	3	4	5	6	7	8				
Phs Duration (G+Y+Rc), s	22.2	52.4	12.1	16.4	17.3	57.3	6.9	21.6				
Change Period (Y+Rc), s	* 4.2	* 6.5	4.1	4.6	* 4.2	6.5	4.1	4.6				
Max Green Setting (Gmax), s	* 18	* 46	8.0	29.0	* 13	50.2	5.3	31.7				
Max Q Clear Time (g_c+I1), s	20.0	47.9	10.0	11.1	13.2	44.2	3.6	11.1				
Green Ext Time (p_c), s	0.0	0.0	0.0	0.8	0.0	4.6	0.0	0.9				

Intersection Summary

HCM 6th Ctrl Delay	147.1
HCM 6th LOS	F

Notes

* HCM 6th computational engine requires equal clearance times for the phases crossing the barrier.

Timings
15: Airman Dr & Cactus Av.

Lane Group	WBL	WBR	NBR	SBL	Ø6
Lane Configurations					
Traffic Volume (vph)	305	379	696	902	
Future Volume (vph)	305	379	696	902	
Turn Type	Prot	Perm	Perm	Prot	
Protected Phases	3			1	6
Permitted Phases		8	2		
Detector Phase	3	8	2	1	
Switch Phase					
Minimum Initial (s)	5.0	10.0	10.0	5.0	10.0
Minimum Split (s)	9.6	26.7	26.7	9.7	14.6
Total Split (s)	30.0	30.0	30.0	60.0	90.0
Total Split (%)	25.0%	25.0%	25.0%	50.0%	75%
Yellow Time (s)	3.6	3.7	3.7	3.7	3.6
All-Red Time (s)	1.0	1.0	1.0	1.0	1.0
Lost Time Adjust (s)	0.0	0.0	0.0	0.0	
Total Lost Time (s)	4.6	4.7	4.7	4.7	
Lead/Lag			Lag	Lead	
Lead-Lag Optimize?			Yes	Yes	
Recall Mode	None	None	Min	None	Min
Act Effct Green (s)	22.8	22.7	25.6	32.6	
Actuated g/C Ratio	0.24	0.24	0.27	0.34	
v/c Ratio	0.79	0.60	1.08	0.86	
Control Delay	49.9	7.6	75.3	37.7	
Queue Delay	0.0	0.0	0.0	0.0	
Total Delay	49.9	7.6	75.3	37.7	
LOS	D	A	E	D	
Approach Delay	26.5				
Approach LOS	C				

Intersection Summary

Cycle Length: 120
 Actuated Cycle Length: 95.2
 Natural Cycle: 90
 Control Type: Actuated-Uncoordinated
 Maximum v/c Ratio: 1.08
 Intersection Signal Delay: 45.8
 Intersection LOS: D
 Intersection Capacity Utilization 76.6%
 ICU Level of Service D
 Analysis Period (min) 15



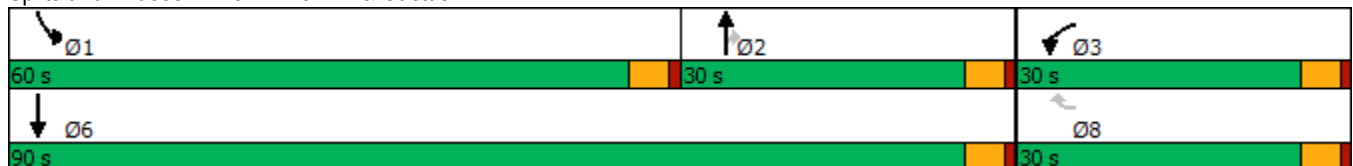









Splits and Phases: 15: Airman Dr & Cactus Av.



HCM 6th Signalized Intersection Summary
15: Airman Dr & Cactus Av.

West Campus Upper Plateau (JN 14064)

09/19/2022

						
Movement	WBL	WBR	NBT	NBR	SBL	SBT
Lane Configurations						
Traffic Volume (veh/h)	305	379	0	696	902	0
Future Volume (veh/h)	305	379	0	696	902	0
Initial Q (Qb), veh	0	0	0	0	0	0
Ped-Bike Adj(A_pbT)	1.00	1.00		1.00	1.00	
Parking Bus, Adj	1.00	1.00	1.00	1.00	1.00	1.00
Work Zone On Approach	No		No			No
Adj Sat Flow, veh/h/ln	1856	1826	1900	1856	1826	1900
Adj Flow Rate, veh/h	332	412	0	431	980	0
Peak Hour Factor	0.92	0.92	0.92	0.92	0.92	0.92
Percent Heavy Veh, %	3	5	0	3	5	0
Cap, veh/h	471	412	504	417	1084	1208
Arrive On Green	0.27	0.27	0.00	0.27	0.32	0.00
Sat Flow, veh/h	1767	1547	1900	1572	3374	1900
Grp Volume(v), veh/h	332	412	0	431	980	0
Grp Sat Flow(s),veh/h/ln	1767	1547	1900	1572	1687	1900
Q Serve(g_s), s	16.2	25.4	0.0	25.3	26.5	0.0
Cycle Q Clear(g_c), s	16.2	25.4	0.0	25.3	26.5	0.0
Prop In Lane	1.00	1.00		1.00	1.00	
Lane Grp Cap(c), veh/h	471	412	504	417	1084	1208
V/C Ratio(X)	0.71	1.00	0.00	1.03	0.90	0.00
Avail Cap(c_a), veh/h	471	412	504	417	1957	1702
HCM Platoon Ratio	1.00	1.00	1.00	1.00	1.00	1.00
Upstream Filter(I)	1.00	1.00	0.00	1.00	1.00	0.00
Uniform Delay (d), s/veh	31.6	35.0	0.0	35.0	30.9	0.0
Incr Delay (d2), s/veh	4.7	44.2	0.0	52.8	1.2	0.0
Initial Q Delay(d3),s/veh	0.0	0.0	0.0	0.0	0.0	0.0
%ile BackOfQ(50%),veh/ln	7.4	14.3	0.0	15.5	10.6	0.0
Unsig. Movement Delay, s/veh						
LnGrp Delay(d),s/veh	36.3	79.1	0.0	87.8	32.2	0.0
LnGrp LOS	D	E	A	F	C	A
Approach Vol, veh/h	744		431		980	
Approach Delay, s/veh	60.0		87.8		32.2	
Approach LOS	E		F		C	
Timer - Assigned Phs	1	2			6	8
Phs Duration (G+Y+Rc), s	35.3	30.0			65.3	30.0
Change Period (Y+Rc), s	* 4.7	* 4.7			* 4.7	4.6
Max Green Setting (Gmax), s	* 55	* 25			* 85	25.4
Max Q Clear Time (g_c+I1), s	28.5	27.3			0.0	27.4
Green Ext Time (p_c), s	2.2	0.0			0.0	0.0

Intersection Summary

HCM 6th Ctrl Delay	52.9
HCM 6th LOS	D

Notes

* HCM 6th computational engine requires equal clearance times for the phases crossing the barrier.

Intersection

Intersection Delay, s/veh	9.3
Intersection LOS	A

Movement	EBT	EBR	WBL	WBT	NBL	NBR
Lane Configurations						
Traffic Vol, veh/h	212	70	40	97	56	66
Future Vol, veh/h	212	70	40	97	56	66
Peak Hour Factor	0.94	0.94	0.94	0.94	0.94	0.94
Heavy Vehicles, %	1	2	3	1	2	0
Mvmt Flow	226	74	43	103	60	70
Number of Lanes	1	0	1	1	1	0

Approach	EB	WB	NB
Opposing Approach	WB	EB	
Opposing Lanes	2	1	0
Conflicting Approach Left		NB	EB
Conflicting Lanes Left	0	1	1
Conflicting Approach Right	NB		WB
Conflicting Lanes Right	1	0	2
HCM Control Delay	9.9	8.7	8.7
HCM LOS	A	A	A

Lane	NBLn1	EBLn1	WBLn1	WBLn2
Vol Left, %	46%	0%	100%	0%
Vol Thru, %	0%	75%	0%	100%
Vol Right, %	54%	25%	0%	0%
Sign Control	Stop	Stop	Stop	Stop
Traffic Vol by Lane	122	282	40	97
LT Vol	56	0	40	0
Through Vol	0	212	0	97
RT Vol	66	70	0	0
Lane Flow Rate	130	300	43	103
Geometry Grp	2	5	7	7
Degree of Util (X)	0.17	0.363	0.066	0.145
Departure Headway (Hd)	4.711	4.36	5.602	5.064
Convergence, Y/N	Yes	Yes	Yes	Yes
Cap	761	825	640	708
Service Time	2.742	2.386	3.332	2.795
HCM Lane V/C Ratio	0.171	0.364	0.067	0.145
HCM Control Delay	8.7	9.9	8.7	8.7
HCM Lane LOS	A	A	A	A
HCM 95th-tile Q	0.6	1.7	0.2	0.5

Intersection	
Intersection Delay, s/veh	8.9
Intersection LOS	A

Movement	EBL	EBT	WBT	WBR	SBL	SBR
Lane Configurations						
Traffic Vol, veh/h	130	324	233	37	28	42
Future Vol, veh/h	130	324	233	37	28	42
Peak Hour Factor	0.97	0.97	0.97	0.97	0.97	0.97
Heavy Vehicles, %	1	0	2	0	4	3
Mvmt Flow	134	334	240	38	29	43
Number of Lanes	1	2	2	0	1	0

Approach	EB	WB	SB
Opposing Approach	WB	EB	
Opposing Lanes	2	3	0
Conflicting Approach Left	SB		WB
Conflicting Lanes Left	1	0	2
Conflicting Approach Right		SB	EB
Conflicting Lanes Right	0	1	3
HCM Control Delay	8.4	9.7	9.4
HCM LOS	A	A	A

Lane	EBLn1	EBLn2	EBLn3	WBLn1	WBLn2	SBLn1
Vol Left, %	100%	0%	0%	0%	0%	40%
Vol Thru, %	0%	100%	100%	100%	68%	0%
Vol Right, %	0%	0%	0%	0%	32%	60%
Sign Control	Stop	Stop	Stop	Stop	Stop	Stop
Traffic Vol by Lane	130	162	162	155	115	70
LT Vol	130	0	0	0	0	28
Through Vol	0	162	162	155	78	0
RT Vol	0	0	0	0	37	42
Lane Flow Rate	134	167	167	160	118	72
Geometry Grp	7	7	7	8	8	7
Degree of Util (X)	0.205	0.231	0.152	0.247	0.174	0.118
Departure Headway (Hd)	5.497	4.977	3.269	5.547	5.286	5.867
Convergence, Y/N	Yes	Yes	Yes	Yes	Yes	Yes
Cap	653	720	1092	645	676	608
Service Time	3.233	2.713	1.005	3.3	3.039	3.632
HCM Lane V/C Ratio	0.205	0.232	0.153	0.248	0.175	0.118
HCM Control Delay	9.7	9.2	6.6	10.1	9.2	9.4
HCM Lane LOS	A	A	A	B	A	A
HCM 95th-tile Q	0.8	0.9	0.5	1	0.6	0.4

Timings
18: Linebacker Dr & Cactus Av.

West Campus Upper Plateau (JN 14064)

09/19/2022

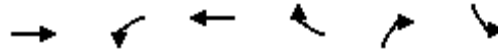

Lane Group	EBT	WBL	WBT	WBR	NBR	SBL	Ø3	Ø4	Ø5	Ø8
Lane Configurations	↑↑	↑	↑	↑	↑	↑↑				
Traffic Volume (vph)	1598	183	684	182	503	502				
Future Volume (vph)	1598	183	684	182	503	502				
Turn Type	NA	Prot	NA	Perm	pm+ov	Prot				
Protected Phases	2	1	6		1	7	3	4	5	8
Permitted Phases				6	8					
Detector Phase	2	1	6	6	1	7				
Switch Phase										
Minimum Initial (s)	10.0	5.0	10.0	10.0	5.0	5.0	5.0	10.0	5.0	10.0
Minimum Split (s)	27.0	9.6	27.0	27.0	9.6	9.6	9.6	27.0	9.6	27.0
Total Split (s)	56.0	17.0	63.4	63.4	17.0	20.0	9.6	37.4	9.6	27.0
Total Split (%)	46.7%	14.2%	52.8%	52.8%	14.2%	16.7%	8%	31%	8%	23%
Yellow Time (s)	4.0	3.6	4.0	4.0	3.6	3.6	3.6	4.0	3.6	4.0
All-Red Time (s)	1.0	1.0	1.0	1.0	1.0	1.0	1.0	1.0	1.0	1.0
Lost Time Adjust (s)	0.0	0.0	0.0	0.0	0.0	0.0				
Total Lost Time (s)	5.0	4.6	5.0	5.0	4.6	4.6				
Lead/Lag	Lead	Lag	Lag	Lag	Lag	Lag	Lag	Lead	Lead	Lead
Lead-Lag Optimize?	Yes	Yes	Yes	Yes	Yes	Yes	Yes	Yes	Yes	Yes
Recall Mode	None	None	None	None	None	None	None	None	None	None
Act Effct Green (s)	51.5	12.5	68.7	68.7	17.0	15.6				
Actuated g/C Ratio	0.52	0.13	0.70	0.70	0.17	0.16				
v/c Ratio	0.91	0.91	0.58	0.18	1.42	1.01				
Control Delay	30.8	86.0	11.9	2.3	226.8	82.4				
Queue Delay	0.0	0.0	0.0	0.0	0.0	0.0				
Total Delay	30.8	86.0	11.9	2.3	226.8	82.4				
LOS	C	F	B	A	F	F				
Approach Delay	30.8		23.2							
Approach LOS	C		C							

Intersection Summary

Cycle Length: 120
 Actuated Cycle Length: 98.4
 Natural Cycle: 120
 Control Type: Actuated-Uncoordinated
 Maximum v/c Ratio: 1.42
 Intersection Signal Delay: 62.7
 Intersection LOS: E
 Intersection Capacity Utilization 101.5%
 ICU Level of Service G
 Analysis Period (min) 15

Splits and Phases: 18: Linebacker Dr & Cactus Av.

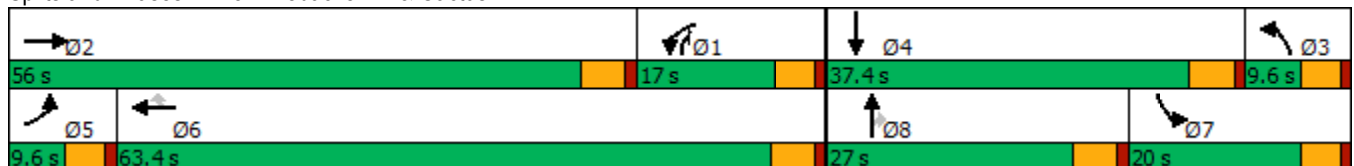

HCM 6th Signalized Intersection Summary
18: Linebacker Dr & Cactus Av.

West Campus Upper Plateau (JN 14064)

09/19/2022



Movement	EBL	EBT	EBR	WBL	WBT	WBR	NBL	NBT	NBR	SBL	SBT	SBR
Lane Configurations	↶	↷		↶	↷	↷	↶	↷	↷	↷	↷	↷
Traffic Volume (veh/h)	0	1598	0	183	684	182	0	0	503	502	0	0
Future Volume (veh/h)	0	1598	0	183	684	182	0	0	503	502	0	0
Initial Q (Qb), veh	0	0	0	0	0	0	0	0	0	0	0	0
Ped-Bike Adj(A_pbT)	1.00		1.00	1.00		1.00	1.00		1.00	1.00		1.00
Parking Bus, Adj	1.00	1.00	1.00	1.00	1.00	1.00	1.00	1.00	1.00	1.00	1.00	1.00
Work Zone On Approach		No			No			No			No	
Adj Sat Flow, veh/h/ln	1900	1841	1900	1826	1841	1826	1900	1900	1826	1826	1900	1900
Adj Flow Rate, veh/h	0	1737	0	199	743	198	0	0	286	546	0	0
Peak Hour Factor	0.92	0.92	0.92	0.92	0.92	0.92	0.92	0.92	0.92	0.92	0.92	0.92
Percent Heavy Veh, %	0	4	0	5	4	5	0	0	5	5	0	0
Cap, veh/h	2	1732	0	199	1162	976	507	175	320	494	2	0
Arrive On Green	0.00	0.47	0.00	0.11	0.63	0.63	0.00	0.00	0.09	0.14	0.00	0.00
Sat Flow, veh/h	1810	3681	0	1739	1841	1547	1810	1900	1547	3478	1900	0
Grp Volume(v), veh/h	0	1737	0	199	743	198	0	0	286	546	0	0
Grp Sat Flow(s),veh/h/ln	1810	1841	0	1739	1841	1547	1810	1900	1547	1739	1900	0
Q Serve(g_s), s	0.0	51.0	0.0	12.4	27.1	2.2	0.0	0.0	7.1	15.4	0.0	0.0
Cycle Q Clear(g_c), s	0.0	51.0	0.0	12.4	27.1	2.2	0.0	0.0	7.1	15.4	0.0	0.0
Prop In Lane	1.00		0.00	1.00		1.00	1.00		1.00	1.00		0.00
Lane Grp Cap(c), veh/h	2	1732	0	199	1162	976	507	175	320	494	2	0
V/C Ratio(X)	0.00	1.00	0.00	1.00	0.64	0.20	0.00	0.00	0.89	1.11	0.00	0.00
Avail Cap(c_a), veh/h	83	1732	0	199	1162	976	507	386	491	494	568	0
HCM Platoon Ratio	1.00	1.00	1.00	1.00	1.00	1.00	1.00	1.00	1.00	1.00	1.00	1.00
Upstream Filter(I)	0.00	1.00	0.00	1.00	1.00	1.00	0.00	0.00	1.00	1.00	0.00	0.00
Uniform Delay (d), s/veh	0.0	28.7	0.0	48.0	12.4	1.2	0.0	0.0	41.9	46.5	0.0	0.0
Incr Delay (d2), s/veh	0.0	22.3	0.0	63.9	1.2	0.1	0.0	0.0	12.9	72.3	0.0	0.0
Initial Q Delay(d3),s/veh	0.0	0.0	0.0	0.0	0.0	0.0	0.0	0.0	0.0	0.0	0.0	0.0
%ile BackOfQ(50%),veh/ln	0.0	26.7	0.0	8.9	10.6	1.7	0.0	0.0	8.5	11.6	0.0	0.0
Unsig. Movement Delay, s/veh												
LnGrp Delay(d),s/veh	0.0	51.0	0.0	111.9	13.6	1.3	0.0	0.0	54.8	118.8	0.0	0.0
LnGrp LOS	A	F	A	F	B	A	A	A	D	F	A	A
Approach Vol, veh/h		1737			1140			286			546	
Approach Delay, s/veh		51.0			28.6			54.8			118.8	
Approach LOS		D			C			D			F	
Timer - Assigned Phs	1	2	3	4	5	6	7	8				
Phs Duration (G+Y+Rc), s	17.4	56.0	35.0	0.0	0.0	73.4	20.0	15.0				
Change Period (Y+Rc), s	5.0	* 5	4.6	5.0	4.6	5.0	4.6	5.0				
Max Green Setting (Gmax), s	12.4	* 51	5.0	32.4	5.0	58.4	15.4	22.0				
Max Q Clear Time (g_c+I1), s	14.4	53.0	0.0	0.0	0.0	29.1	17.4	9.1				
Green Ext Time (p_c), s	0.0	0.0	0.0	0.0	0.0	6.9	0.0	0.8				

Intersection Summary

HCM 6th Ctrl Delay	54.4
HCM 6th LOS	D

Notes

User approved volume balancing among the lanes for turning movement.
* HCM 6th computational engine requires equal clearance times for the phases crossing the barrier.

Timings
19: Van Buren Bl. & Orange Terrace Pkwy.

West Campus Upper Plateau (JN 14064)

09/19/2022

Lane Group	EBL	EBT	EBR	WBL	WBT	WBR	NBL	NBT	NBR	SBL	SBT	SBR
Lane Configurations												
Traffic Volume (vph)	196	2225	295	177	2219	242	313	48	228	136	44	159
Future Volume (vph)	196	2225	295	177	2219	242	313	48	228	136	44	159
Turn Type	Prot	NA	Perm	Prot	NA	Perm	Prot	NA	Perm	Prot	NA	pm+ov
Protected Phases	5	2		1	6		3	8		7	4	5
Permitted Phases			2			6			8			4
Detector Phase	5	2	2	1	6	6	3	8	8	7	4	5
Switch Phase												
Minimum Initial (s)	5.0	10.0	10.0	5.0	10.0	10.0	5.0	5.0	5.0	10.0	10.0	5.0
Minimum Split (s)	9.2	25.2	25.2	9.1	25.2	25.2	9.1	26.1	26.1	15.8	24.8	9.2
Total Split (s)	16.0	63.0	63.0	11.0	58.0	58.0	12.0	27.0	27.0	19.0	34.0	16.0
Total Split (%)	13.3%	52.5%	52.5%	9.2%	48.3%	48.3%	10.0%	22.5%	22.5%	15.8%	28.3%	13.3%
Yellow Time (s)	3.2	5.2	5.2	3.6	5.2	5.2	3.6	3.6	3.6	4.8	4.8	3.2
All-Red Time (s)	1.0	1.0	1.0	0.5	1.0	1.0	0.5	0.5	0.5	1.0	1.0	1.0
Lost Time Adjust (s)	0.0	0.0	0.0	0.0	0.0	0.0	0.0	0.0	0.0	0.0	0.0	0.0
Total Lost Time (s)	4.2	6.2	6.2	4.1	6.2	6.2	4.1	4.1	4.1	5.8	5.8	4.2
Lead/Lag	Lead	Lag	Lag	Lead	Lag	Lag	Lead	Lag	Lag	Lead	Lag	Lead
Lead-Lag Optimize?	Yes	Yes	Yes	Yes	Yes	Yes	Yes	Yes	Yes	Yes	Yes	Yes
Recall Mode	None	None	None	None	None	None	None	None	None	None	None	None
Act Effct Green (s)	10.0	57.0	57.0	6.9	53.8	53.8	13.7	9.7	9.7	10.7	13.3	22.5
Actuated g/C Ratio	0.10	0.55	0.55	0.07	0.51	0.51	0.13	0.09	0.09	0.10	0.13	0.22
v/c Ratio	0.61	0.84	0.33	0.80	0.89	0.28	0.72	0.15	0.73	0.40	0.19	0.42
Control Delay	54.3	24.2	8.0	74.7	29.4	5.5	56.9	43.8	24.4	48.4	42.2	21.3
Queue Delay	0.0	0.0	0.0	0.0	0.0	0.0	0.0	0.0	0.0	0.0	0.0	0.0
Total Delay	54.3	24.2	8.0	74.7	29.4	5.5	56.9	43.8	24.4	48.4	42.2	21.3
LOS	D	C	A	E	C	A	E	D	C	D	D	C
Approach Delay		24.6			30.3			43.2			34.9	
Approach LOS		C			C			D			C	

Intersection Summary

Cycle Length: 120
 Actuated Cycle Length: 104.5
 Natural Cycle: 110
 Control Type: Actuated-Uncoordinated
 Maximum v/c Ratio: 0.89
 Intersection Signal Delay: 29.3
 Intersection LOS: C
 Intersection Capacity Utilization 78.9%
 ICU Level of Service D
 Analysis Period (min) 15



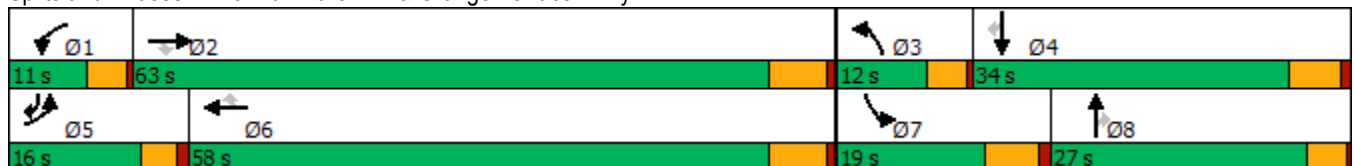





























Splits and Phases: 19: Van Buren Bl. & Orange Terrace Pkwy.



HCM 6th Signalized Intersection Summary
 19: Van Buren Bl. & Orange Terrace Pkwy.

West Campus Upper Plateau (JN 14064)

09/19/2022

												
Movement	EBL	EBT	EBR	WBL	WBT	WBR	NBL	NBT	NBR	SBL	SBT	SBR
Lane Configurations	 	  		 	  		 	 		 		
Traffic Volume (veh/h)	196	2225	295	177	2219	242	313	48	228	136	44	159
Future Volume (veh/h)	196	2225	295	177	2219	242	313	48	228	136	44	159
Initial Q (Qb), veh	0	0	0	0	0	0	0	0	0	0	0	0
Ped-Bike Adj(A_pbT)	1.00		1.00	1.00		1.00	1.00		1.00	1.00		1.00
Parking Bus, Adj	1.00	1.00	1.00	1.00	1.00	1.00	1.00	1.00	1.00	1.00	1.00	1.00
Work Zone On Approach		No			No			No			No	
Adj Sat Flow, veh/h/ln	1885	1870	1870	1885	1856	1885	1885	1900	1900	1885	1900	1885
Adj Flow Rate, veh/h	204	2318	281	184	2311	193	326	50	207	142	46	93
Peak Hour Factor	0.96	0.96	0.96	0.96	0.96	0.96	0.96	0.96	0.96	0.96	0.96	0.96
Percent Heavy Veh, %	1	2	2	1	3	1	1	0	0	1	0	1
Cap, veh/h	266	2565	796	216	2468	778	248	536	239	313	347	414
Arrive On Green	0.08	0.50	0.50	0.06	0.49	0.49	0.07	0.15	0.15	0.09	0.18	0.18
Sat Flow, veh/h	3483	5106	1585	3483	5066	1598	3483	3610	1610	3483	1900	1598
Grp Volume(v), veh/h	204	2318	281	184	2311	193	326	50	207	142	46	93
Grp Sat Flow(s),veh/h/ln	1742	1702	1585	1742	1689	1598	1742	1805	1610	1742	1900	1598
Q Serve(g_s), s	6.4	46.0	11.9	5.8	47.8	7.8	7.9	1.3	14.0	4.3	2.3	5.1
Cycle Q Clear(g_c), s	6.4	46.0	11.9	5.8	47.8	7.8	7.9	1.3	14.0	4.3	2.3	5.1
Prop In Lane	1.00		1.00	1.00		1.00	1.00		1.00	1.00		1.00
Lane Grp Cap(c), veh/h	266	2565	796	216	2468	778	248	536	239	313	347	414
V/C Ratio(X)	0.77	0.90	0.35	0.85	0.94	0.25	1.32	0.09	0.87	0.45	0.13	0.22
Avail Cap(c_a), veh/h	370	2610	810	216	2468	778	248	744	332	414	482	527
HCM Platoon Ratio	1.00	1.00	1.00	1.00	1.00	1.00	1.00	1.00	1.00	1.00	1.00	1.00
Upstream Filter(I)	1.00	1.00	1.00	1.00	1.00	1.00	1.00	1.00	1.00	1.00	1.00	1.00
Uniform Delay (d), s/veh	50.4	25.2	16.7	51.6	26.9	16.6	51.6	40.9	46.2	48.0	38.0	32.4
Incr Delay (d2), s/veh	3.8	4.9	0.3	26.1	7.6	0.2	168.0	0.1	15.8	1.0	0.2	0.3
Initial Q Delay(d3),s/veh	0.0	0.0	0.0	0.0	0.0	0.0	0.0	0.0	0.0	0.0	0.0	0.0
%ile BackOfQ(50%),veh/ln	2.8	17.5	4.3	3.2	18.8	2.9	9.2	0.6	6.6	1.9	1.0	2.0
Unsig. Movement Delay, s/veh												
LnGrp Delay(d),s/veh	54.1	30.1	17.0	77.7	34.5	16.8	219.6	40.9	62.1	49.0	38.2	32.7
LnGrp LOS	D	C	B	E	C	B	F	D	E	D	D	C
Approach Vol, veh/h		2803			2688			583			281	
Approach Delay, s/veh		30.5			36.2			148.4			41.8	
Approach LOS		C			D			F			D	
Timer - Assigned Phs	1	2	3	4	5	6	7	8				
Phs Duration (G+Y+Rc), s	11.0	62.0	12.0	26.1	12.7	60.3	15.8	22.3				
Change Period (Y+Rc), s	4.1	6.2	4.1	5.8	* 4.2	6.2	5.8	* 5.8				
Max Green Setting (Gmax), s	6.9	56.8	7.9	28.2	* 12	51.8	13.2	* 23				
Max Q Clear Time (g_c+I1), s	7.8	48.0	9.9	7.1	8.4	49.8	6.3	16.0				
Green Ext Time (p_c), s	0.0	7.9	0.0	0.4	0.1	1.9	0.2	0.5				

Intersection Summary

HCM 6th Ctrl Delay	44.2
HCM 6th LOS	D

Notes

* HCM 6th computational engine requires equal clearance times for the phases crossing the barrier.

Timings
20: Brown/San Gorgonio Dr & Alessandro Bl.

West Campus Upper Plateau (JN 14064)

09/19/2022



Lane Group	EBL	EBT	WBL	WBT	WBR	NBL	NBT	NBR	SBL	SBT	SBR
Lane Configurations	↖	↕	↖	↕	↖	↖	↕	↖	↖	↕	↖
Traffic Volume (vph)	30	2256	77	2491	33	386	2	471	124	1	78
Future Volume (vph)	30	2256	77	2491	33	386	2	471	124	1	78
Turn Type	Prot	NA	Prot	NA	Perm	Prot	NA	pm+ov	Prot	NA	pm+ov
Protected Phases	5	2	1	6		3	8	1	7	4	5
Permitted Phases					6			8			4
Detector Phase	5	2	1	6	6	3	8	1	7	4	5
Switch Phase											
Minimum Initial (s)	5.0	10.0	5.0	10.0	10.0	5.0	5.0	5.0	5.0	10.0	5.0
Minimum Split (s)	8.7	43.5	9.1	43.5	43.5	9.1	26.1	9.1	8.7	49.8	8.7
Total Split (s)	8.7	52.0	9.1	52.4	52.4	9.1	39.3	9.1	19.6	49.8	8.7
Total Split (%)	7.3%	43.3%	7.6%	43.7%	43.7%	7.6%	32.8%	7.6%	16.3%	41.5%	7.3%
Yellow Time (s)	3.2	5.5	3.6	5.5	5.5	3.6	3.6	3.6	3.2	4.8	3.2
All-Red Time (s)	0.5	1.0	0.5	1.0	1.0	0.5	0.5	0.5	0.5	1.0	0.5
Lost Time Adjust (s)	0.0	0.0	0.0	0.0	0.0	0.0	0.0	0.0	0.0	0.0	0.0
Total Lost Time (s)	3.7	6.5	4.1	6.5	6.5	4.1	4.1	4.1	3.7	5.8	3.7
Lead/Lag	Lead	Lag	Lead	Lag	Lag	Lead	Lag	Lead	Lead	Lag	Lead
Lead-Lag Optimize?	Yes	Yes	Yes	Yes	Yes	Yes	Yes	Yes	Yes	Yes	Yes
Recall Mode	None	None	None	None	None	None	None	None	None	None	None
Act Effct Green (s)	5.2	47.3	5.2	49.7	49.7	8.6	9.9	10.6	10.4	15.1	12.1
Actuated g/C Ratio	0.06	0.57	0.06	0.60	0.60	0.10	0.12	0.13	0.12	0.18	0.15
v/c Ratio	0.29	0.90	0.76	0.85	0.05	2.22	0.01	1.75	0.62	0.00	0.28
Control Delay	50.2	23.9	84.0	21.2	0.1	585.3	31.5	372.2	50.0	26.0	11.2
Queue Delay	0.0	0.0	0.0	0.0	0.0	0.0	0.0	0.0	0.0	0.0	0.0
Total Delay	50.2	23.9	84.0	21.2	0.1	585.3	31.5	372.2	50.0	26.0	11.2
LOS	D	C	F	C	A	F	C	F	D	C	B
Approach Delay		24.2		22.8			467.2			35.0	
Approach LOS		C		C			F			D	

Intersection Summary

Cycle Length: 120	
Actuated Cycle Length: 83.2	
Natural Cycle: 115	
Control Type: Actuated-Uncoordinated	
Maximum v/c Ratio: 2.22	
Intersection Signal Delay: 85.9	Intersection LOS: F
Intersection Capacity Utilization 96.0%	ICU Level of Service F
Analysis Period (min) 15	

Splits and Phases: 20: Brown/San Gorgonio Dr & Alessandro Bl.

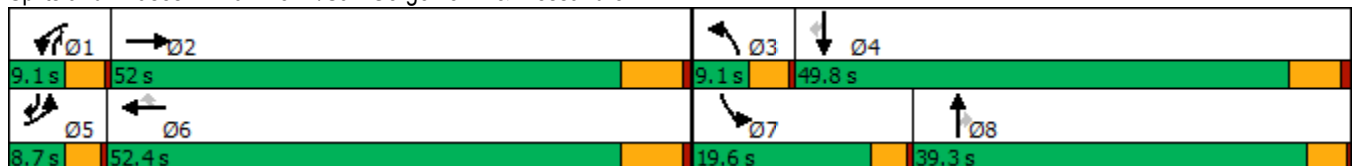

HCM 6th Signalized Intersection Summary
 20: Brown/San Gorgonio Dr & Alessandro Bl.

West Campus Upper Plateau (JN 14064)

09/19/2022



Movement	EBL	EBT	EBR	WBL	WBT	WBR	NBL	NBT	NBR	SBL	SBT	SBR
Lane Configurations	↖	↕↕↕		↖	↕↕↕	↖	↖	↕	↖	↖	↖	↖
Traffic Volume (veh/h)	30	2256	191	77	2491	33	386	2	471	124	1	78
Future Volume (veh/h)	30	2256	191	77	2491	33	386	2	471	124	1	78
Initial Q (Qb), veh	0	0	0	0	0	0	0	0	0	0	0	0
Ped-Bike Adj(A_pbT)	1.00		1.00	1.00		1.00	1.00		1.00	1.00		1.00
Parking Bus, Adj	1.00	1.00	1.00	1.00	1.00	1.00	1.00	1.00	1.00	1.00	1.00	1.00
Work Zone On Approach		No			No			No			No	
Adj Sat Flow, veh/h/ln	1900	1870	1900	1811	1885	1396	1885	1900	1811	1811	1900	1885
Adj Flow Rate, veh/h	32	2375	197	81	2622	31	406	2	483	131	1	34
Peak Hour Factor	0.95	0.95	0.95	0.95	0.95	0.95	0.95	0.95	0.95	0.95	0.95	0.95
Percent Heavy Veh, %	0	2	0	6	1	34	1	0	6	6	0	1
Cap, veh/h	50	1880	154	74	2108	485	77	575	530	157	660	599
Arrive On Green	0.03	0.39	0.39	0.04	0.41	0.41	0.04	0.30	0.30	0.09	0.35	0.35
Sat Flow, veh/h	1810	4811	393	1725	5147	1183	1795	1900	1535	1725	1900	1598
Grp Volume(v), veh/h	32	1670	902	81	2622	31	406	2	483	131	1	34
Grp Sat Flow(s),veh/h/ln	1810	1702	1800	1725	1716	1183	1795	1900	1535	1725	1900	1598
Q Serve(g_s), s	2.0	45.5	45.5	5.0	47.7	1.8	5.0	0.1	35.0	8.7	0.0	1.6
Cycle Q Clear(g_c), s	2.0	45.5	45.5	5.0	47.7	1.8	5.0	0.1	35.0	8.7	0.0	1.6
Prop In Lane	1.00		0.22	1.00		1.00	1.00		1.00	1.00		1.00
Lane Grp Cap(c), veh/h	50	1330	703	74	2108	485	77	575	530	157	660	599
V/C Ratio(X)	0.64	1.25	1.28	1.09	1.24	0.06	5.26	0.00	0.91	0.83	0.00	0.06
Avail Cap(c_a), veh/h	78	1330	703	74	2108	485	77	575	530	236	718	648
HCM Platoon Ratio	1.00	1.00	1.00	1.00	1.00	1.00	1.00	1.00	1.00	1.00	1.00	1.00
Upstream Filter(I)	1.00	1.00	1.00	1.00	1.00	1.00	1.00	1.00	1.00	1.00	1.00	1.00
Uniform Delay (d), s/veh	56.0	35.5	35.5	55.7	34.4	20.8	55.7	28.4	36.4	52.0	24.8	23.2
Incr Delay (d2), s/veh	4.9	121.0	138.1	132.3	114.0	0.1	1947.6	0.0	20.0	9.3	0.0	0.0
Initial Q Delay(d3),s/veh	0.0	0.0	0.0	0.0	0.0	0.0	0.0	0.0	0.0	0.0	0.0	0.0
%ile BackOfQ(50%),veh/ln	1.0	39.5	45.1	4.9	41.5	0.5	44.0	0.0	15.8	4.2	0.0	0.6
Unsig. Movement Delay, s/veh												
LnGrp Delay(d),s/veh	61.0	156.4	173.5	188.0	148.3	20.9	2003.3	28.4	56.4	61.4	24.8	23.3
LnGrp LOS	E	F	F	F	F	C	F	C	E	E	C	C
Approach Vol, veh/h		2604			2734			891				166
Approach Delay, s/veh		161.2			148.1			943.5				53.3
Approach LOS		F			F			F				D
Timer - Assigned Phs	1	2	3	4	5	6	7	8				
Phs Duration (G+Y+Rc), s	9.1	52.0	9.1	46.2	6.9	54.2	14.3	41.0				
Change Period (Y+Rc), s	4.1	6.5	4.1	5.8	3.7	6.5	3.7	* 5.8				
Max Green Setting (Gmax), s	5.0	45.5	5.0	44.0	5.0	45.9	15.9	* 35				
Max Q Clear Time (g_c+I1), s	7.0	47.5	7.0	3.6	4.0	49.7	10.7	37.0				
Green Ext Time (p_c), s	0.0	0.0	0.0	0.1	0.0	0.0	0.1	0.0				

Intersection Summary

HCM 6th Ctrl Delay	261.8
HCM 6th LOS	F

Notes

* HCM 6th computational engine requires equal clearance times for the phases crossing the barrier.

Timings
21: Cactus Av. & Brown St



Lane Group	EBL	EBT	WBT	SBR
Lane Configurations	↘	↑↑	↑↑	↗
Traffic Volume (vph)	815	1787	649	400
Future Volume (vph)	815	1787	649	400
Turn Type	Prot	NA	NA	Perm
Protected Phases	7	4	8	
Permitted Phases				6
Detector Phase	7	4	8	6
Switch Phase				
Minimum Initial (s)	5.0	10.0	10.0	10.0
Minimum Split (s)	9.6	15.8	27.8	26.7
Total Split (s)	62.0	92.4	30.4	27.6
Total Split (%)	51.7%	77.0%	25.3%	23.0%
Yellow Time (s)	3.6	4.8	4.8	3.7
All-Red Time (s)	1.0	1.0	1.0	1.0
Lost Time Adjust (s)	0.0	0.0	0.0	0.0
Total Lost Time (s)	4.6	5.8	5.8	4.7
Lead/Lag	Lead		Lag	
Lead-Lag Optimize?	Yes		Yes	
Recall Mode	None	None	None	Min
Act Effct Green (s)	57.5	86.8	24.6	12.2
Actuated g/C Ratio	0.53	0.79	0.22	0.11
v/c Ratio	0.94	0.72	0.92	0.51
Control Delay	42.9	8.1	60.3	2.1
Queue Delay	0.0	0.0	0.0	0.0
Total Delay	42.9	8.1	60.3	2.1
LOS	D	A	E	A
Approach Delay		19.0	60.3	
Approach LOS		B	E	

Intersection Summary

Cycle Length: 120	
Actuated Cycle Length: 109.5	
Natural Cycle: 120	
Control Type: Actuated-Uncoordinated	
Maximum v/c Ratio: 0.94	
Intersection Signal Delay: 24.5	Intersection LOS: C
Intersection Capacity Utilization 71.8%	ICU Level of Service C
Analysis Period (min) 15	

Splits and Phases: 21: Cactus Av. & Brown St



HCM 6th Signalized Intersection Summary
21: Cactus Av. & Brown St

West Campus Upper Plateau (JN 14064)
09/19/2022

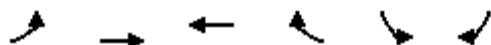

Movement	EBL	EBT	WBT	WBR	SBL	SBR	
Lane Configurations							
Traffic Volume (veh/h)	815	1787	649	0	0	400	
Future Volume (veh/h)	815	1787	649	0	0	400	
Initial Q (Qb), veh	0	0	0	0	0	0	
Ped-Bike Adj(A_pbT)	1.00			1.00	1.00	1.00	
Parking Bus, Adj	1.00	1.00	1.00	1.00	1.00	1.00	
Work Zone On Approach		No	No		No		
Adj Sat Flow, veh/h/ln	1900	1811	1811	1900	1900	1900	
Adj Flow Rate, veh/h	886	1942	705	0	0	218	
Peak Hour Factor	0.92	0.92	0.92	0.92	0.92	0.92	
Percent Heavy Veh, %	0	6	6	0	0	0	
Cap, veh/h	903	2598	741	0	277	246	
Arrive On Green	0.50	0.75	0.22	0.00	0.00	0.15	
Sat Flow, veh/h	1810	3532	3622	0	1810	1610	
Grp Volume(v), veh/h	886	1942	705	0	0	218	
Grp Sat Flow(s),veh/h/ln	1810	1721	1721	0	1810	1610	
Q Serve(g_s), s	54.9	36.2	23.1	0.0	0.0	15.1	
Cycle Q Clear(g_c), s	54.9	36.2	23.1	0.0	0.0	15.1	
Prop In Lane	1.00			0.00	1.00	1.00	
Lane Grp Cap(c), veh/h	903	2598	741	0	277	246	
V/C Ratio(X)	0.98	0.75	0.95	0.00	0.00	0.88	
Avail Cap(c_a), veh/h	910	2610	741	0	363	323	
HCM Platoon Ratio	1.00	1.00	1.00	1.00	1.00	1.00	
Upstream Filter(I)	1.00	1.00	1.00	0.00	0.00	1.00	
Uniform Delay (d), s/veh	28.1	7.9	44.2	0.0	0.0	47.4	
Incr Delay (d2), s/veh	24.9	1.2	21.8	0.0	0.0	19.9	
Initial Q Delay(d3),s/veh	0.0	0.0	0.0	0.0	0.0	0.0	
%ile BackOfQ(50%),veh/ln	27.6	9.8	11.7	0.0	0.0	14.1	
Unsig. Movement Delay, s/veh							
LnGrp Delay(d),s/veh	53.0	9.1	66.0	0.0	0.0	67.2	
LnGrp LOS	D	A	E	A	A	E	
Approach Vol, veh/h		2828	705		218		
Approach Delay, s/veh		22.8	66.0		67.2		
Approach LOS		C	E		E		
Timer - Assigned Phs				4	6	7	8
Phs Duration (G+Y+Rc), s				92.0	22.2	61.6	30.4
Change Period (Y+Rc), s				5.8	4.7	4.6	5.8
Max Green Setting (Gmax), s				86.6	22.9	57.4	24.6
Max Q Clear Time (g_c+I1), s				38.2	17.1	56.9	25.1
Green Ext Time (p_c), s				24.5	0.3	0.2	0.0
Intersection Summary							
HCM 6th Ctrl Delay			33.5				
HCM 6th LOS			C				

Timings
22: Sycamore Canyon Bl. & Eastridge Ave

West Campus Upper Plateau (JN 14064)

09/19/2022



Lane Group	EBL	EBT	EBR	WBL	WBT	WBR	NBL	NBT	NBR	SBL	SBT	SBR
Lane Configurations	↖↗	↑↑↑	↖	↖↗	↑↑	↖	↖↗	↑↑	↖	↖↗	↑↑	↖
Traffic Volume (vph)	94	99	53	205	69	366	33	791	202	288	434	20
Future Volume (vph)	94	99	53	205	69	366	33	791	202	288	434	20
Turn Type	Prot	NA	Perm	Prot	NA	pm+ov	Prot	NA	pm+ov	Prot	NA	pm+ov
Protected Phases	5	2		1	6	7	3	8	1	7	4	5
Permitted Phases			2			6			8			4
Detector Phase	5	2	2	1	6	7	3	8	1	7	4	5
Switch Phase												
Minimum Initial (s)	5.0	10.0	10.0	5.0	10.0	5.0	5.0	10.0	5.0	5.0	10.0	5.0
Minimum Split (s)	8.7	43.5	43.5	8.7	43.5	8.7	8.7	15.8	8.7	8.7	49.8	8.7
Total Split (s)	11.7	45.5	45.5	15.2	49.0	20.2	8.7	39.1	15.2	20.2	50.6	11.7
Total Split (%)	9.8%	37.9%	37.9%	12.7%	40.8%	16.8%	7.3%	32.6%	12.7%	16.8%	42.2%	9.8%
Yellow Time (s)	3.2	5.5	5.5	3.2	5.5	3.2	3.2	4.8	3.2	3.2	4.8	3.2
All-Red Time (s)	0.5	1.0	1.0	0.5	1.0	0.5	0.5	1.0	0.5	0.5	1.0	0.5
Lost Time Adjust (s)	0.0	0.0	0.0	0.0	0.0	0.0	0.0	0.0	0.0	0.0	0.0	0.0
Total Lost Time (s)	3.7	6.5	6.5	3.7	6.5	3.7	3.7	5.8	3.7	3.7	5.8	3.7
Lead/Lag	Lead	Lag	Lag	Lead	Lag	Lead	Lead	Lag	Lead	Lead	Lag	Lead
Lead-Lag Optimize?	Yes	Yes	Yes	Yes	Yes	Yes	Yes	Yes	Yes	Yes	Yes	Yes
Recall Mode	None	None	None	None	None	None	None	None	None	None	None	None
Act Effct Green (s)	7.1	13.7	13.7	10.4	19.2	34.7	5.1	29.9	42.5	12.6	41.5	50.7
Actuated g/C Ratio	0.08	0.16	0.16	0.12	0.22	0.40	0.06	0.34	0.49	0.15	0.48	0.58
v/c Ratio	0.43	0.16	0.17	0.60	0.13	0.65	0.21	0.76	0.32	0.66	0.29	0.03
Control Delay	47.4	33.0	1.1	46.1	30.4	22.3	47.5	31.7	5.7	44.0	16.3	0.1
Queue Delay	0.0	0.0	0.0	0.0	0.0	0.0	0.0	0.0	0.0	0.0	0.0	0.0
Total Delay	47.4	33.0	1.1	46.1	30.4	22.3	47.5	31.7	5.7	44.0	16.3	0.1
LOS	D	C	A	D	C	C	D	C	A	D	B	A
Approach Delay		31.6			30.8			27.1			26.6	
Approach LOS		C			C			C			C	

Intersection Summary

Cycle Length: 120	
Actuated Cycle Length: 86.8	
Natural Cycle: 115	
Control Type: Actuated-Uncoordinated	
Maximum v/c Ratio: 0.76	
Intersection Signal Delay: 28.3	Intersection LOS: C
Intersection Capacity Utilization 60.3%	ICU Level of Service B
Analysis Period (min) 15	

Splits and Phases: 22: Sycamore Canyon Bl. & Eastridge Ave

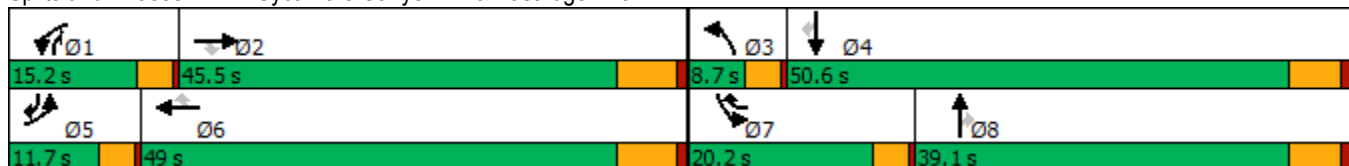

HCM 6th Signalized Intersection Summary
 22: Sycamore Canyon Bl. & Eastridge Ave

West Campus Upper Plateau (JN 14064)

09/19/2022



Movement	EBL	EBT	EBR	WBL	WBT	WBR	NBL	NBT	NBR	SBL	SBT	SBR
Lane Configurations	↖↗	↑↑↑	↖	↖↗	↑↑	↖	↖↗	↑↑	↖	↖↗	↑↑	↖
Traffic Volume (veh/h)	94	99	53	205	69	366	33	791	202	288	434	20
Future Volume (veh/h)	94	99	53	205	69	366	33	791	202	288	434	20
Initial Q (Qb), veh	0	0	0	0	0	0	0	0	0	0	0	0
Ped-Bike Adj(A_pbT)	1.00		1.00	1.00		1.00	1.00		0.99	1.00		0.99
Parking Bus, Adj	1.00	1.00	1.00	1.00	1.00	1.00	1.00	1.00	1.00	1.00	1.00	1.00
Work Zone On Approach		No			No			No			No	
Adj Sat Flow, veh/h/ln	1663	1604	1841	1752	1426	1796	1648	1811	1544	1841	1841	1559
Adj Flow Rate, veh/h	106	111	0	230	78	227	37	889	170	324	488	18
Peak Hour Factor	0.89	0.89	0.89	0.89	0.89	0.89	0.89	0.89	0.89	0.89	0.89	0.89
Percent Heavy Veh, %	16	20	4	10	32	7	17	6	24	4	4	23
Cap, veh/h	193	659		321	506	476	112	1170	569	429	1502	643
Arrive On Green	0.06	0.15	0.00	0.10	0.19	0.19	0.04	0.34	0.34	0.13	0.43	0.43
Sat Flow, veh/h	3072	4378	1560	3237	2709	1520	3045	3441	1292	3401	3497	1304
Grp Volume(v), veh/h	106	111	0	230	78	227	37	889	170	324	488	18
Grp Sat Flow(s),veh/h/ln	1536	1459	1560	1618	1354	1520	1522	1721	1292	1700	1749	1304
Q Serve(g_s), s	2.3	1.5	0.0	4.8	1.7	8.4	0.8	15.9	5.9	6.4	6.4	0.5
Cycle Q Clear(g_c), s	2.3	1.5	0.0	4.8	1.7	8.4	0.8	15.9	5.9	6.4	6.4	0.5
Prop In Lane	1.00		1.00	1.00		1.00	1.00		1.00	1.00		1.00
Lane Grp Cap(c), veh/h	193	659		321	506	476	112	1170	569	429	1502	643
V/C Ratio(X)	0.55	0.17		0.72	0.15	0.48	0.33	0.76	0.30	0.75	0.32	0.03
Avail Cap(c_a), veh/h	355	2463		537	1661	1124	220	1653	750	810	2260	926
HCM Platoon Ratio	1.00	1.00	1.00	1.00	1.00	1.00	1.00	1.00	1.00	1.00	1.00	1.00
Upstream Filter(I)	1.00	1.00	0.00	1.00	1.00	1.00	1.00	1.00	1.00	1.00	1.00	1.00
Uniform Delay (d), s/veh	31.5	25.7	0.0	30.3	23.6	19.2	32.6	20.4	12.6	29.2	13.1	9.1
Incr Delay (d2), s/veh	0.9	0.2	0.0	1.1	0.2	1.1	0.6	1.3	0.3	1.0	0.1	0.0
Initial Q Delay(d3),s/veh	0.0	0.0	0.0	0.0	0.0	0.0	0.0	0.0	0.0	0.0	0.0	0.0
%ile BackOfQ(50%),veh/ln	0.8	0.5	0.0	1.7	0.5	2.7	0.3	5.7	1.5	2.4	2.1	0.1
Unsig. Movement Delay, s/veh												
LnGrp Delay(d),s/veh	32.4	25.8	0.0	31.4	23.8	20.3	33.2	21.7	12.8	30.3	13.2	9.1
LnGrp LOS	C	C		C	C	C	C	C	B	C	B	A
Approach Vol, veh/h		217			535			1096			830	
Approach Delay, s/veh		29.1			25.6			20.7			19.8	
Approach LOS		C			C			C			B	
Timer - Assigned Phs	1	2	3	4	5	6	7	8				
Phs Duration (G+Y+Rc), s	10.6	16.9	6.2	35.6	8.1	19.4	12.5	29.4				
Change Period (Y+Rc), s	3.7	6.5	3.7	5.8	3.7	6.5	3.7	5.8				
Max Green Setting (Gmax), s	11.5	39.0	5.0	44.8	8.0	42.5	16.5	33.3				
Max Q Clear Time (g_c+I1), s	6.8	3.5	2.8	8.4	4.3	10.4	8.4	17.9				
Green Ext Time (p_c), s	0.2	0.9	0.0	3.2	0.0	1.9	0.4	5.6				

Intersection Summary

HCM 6th Ctrl Delay	22.1
HCM 6th LOS	C

Notes

Unsignalized Delay for [EBR] is excluded from calculations of the approach delay and intersection delay.

Timings
23: Sycamore Canyon Bl. & Cottonwood Ave

West Campus Upper Plateau (JN 14064)

09/19/2022



Lane Group	WBL	WBR	NBT	SBL	SBT
Lane Configurations	↙	↗	↕	↙	↕
Traffic Volume (vph)	71	63	909	53	709
Future Volume (vph)	71	63	909	53	709
Turn Type	Prot	Perm	NA	Prot	NA
Protected Phases	8		2	1	6
Permitted Phases		8			
Detector Phase	8	8	2	1	6
Switch Phase					
Minimum Initial (s)	10.0	10.0	10.0	5.0	10.0
Minimum Split (s)	15.8	15.8	43.5	9.1	43.5
Total Split (s)	23.0	23.0	78.0	19.0	97.0
Total Split (%)	19.2%	19.2%	65.0%	15.8%	80.8%
Yellow Time (s)	4.8	4.8	5.5	3.6	5.5
All-Red Time (s)	1.0	1.0	1.0	0.5	1.0
Lost Time Adjust (s)	0.0	0.0	0.0	0.0	0.0
Total Lost Time (s)	5.8	5.8	6.5	4.1	6.5
Lead/Lag			Lag	Lead	
Lead-Lag Optimize?			Yes	Yes	
Recall Mode	None	None	None	None	None
Act Effct Green (s)	13.6	13.6	39.3	10.1	46.6
Actuated g/C Ratio	0.21	0.21	0.61	0.16	0.73
v/c Ratio	0.30	0.29	0.54	0.31	0.32
Control Delay	34.2	12.3	13.3	36.8	5.1
Queue Delay	0.0	0.0	0.0	0.0	0.0
Total Delay	34.2	12.3	13.3	36.8	5.1
LOS	C	B	B	D	A
Approach Delay	24.0		13.3		7.4
Approach LOS	C		B		A

Intersection Summary

Cycle Length: 120
 Actuated Cycle Length: 64.2
 Natural Cycle: 70
 Control Type: Actuated-Uncoordinated
 Maximum v/c Ratio: 0.54
 Intersection Signal Delay: 11.6
 Intersection Capacity Utilization 52.6%
 Analysis Period (min) 15
 Intersection LOS: B
 ICU Level of Service A

Splits and Phases: 23: Sycamore Canyon Bl. & Cottonwood Ave



HCM 6th Signalized Intersection Summary
23: Sycamore Canyon Bl. & Cottonwood Ave

West Campus Upper Plateau (JN 14064)
09/19/2022



Movement	WBL	WBR	NBT	NBR	SBL	SBT
Lane Configurations						
Traffic Volume (veh/h)	71	63	909	40	53	709
Future Volume (veh/h)	71	63	909	40	53	709
Initial Q (Qb), veh	0	0	0	0	0	0
Ped-Bike Adj(A_pbT)	1.00	1.00		0.98	1.00	
Parking Bus, Adj	1.00	1.00	1.00	1.00	1.00	1.00
Work Zone On Approach	No		No			No
Adj Sat Flow, veh/h/ln	1337	818	1811	1544	1263	1870
Adj Flow Rate, veh/h	83	63	1057	46	62	824
Peak Hour Factor	0.86	0.86	0.86	0.86	0.86	0.86
Percent Heavy Veh, %	38	73	6	24	43	2
Cap, veh/h	201	110	1676	73	66	2225
Arrive On Green	0.16	0.16	0.50	0.50	0.05	0.63
Sat Flow, veh/h	1273	693	3446	146	1203	3647
Grp Volume(v), veh/h	83	63	542	561	62	824
Grp Sat Flow(s),veh/h/ln	1273	693	1721	1781	1203	1777
Q Serve(g_s), s	3.3	4.8	13.1	13.1	2.9	6.4
Cycle Q Clear(g_c), s	3.3	4.8	13.1	13.1	2.9	6.4
Prop In Lane	1.00	1.00		0.08	1.00	
Lane Grp Cap(c), veh/h	201	110	859	889	66	2225
V/C Ratio(X)	0.41	0.57	0.63	0.63	0.94	0.37
Avail Cap(c_a), veh/h	384	209	2158	2234	314	5642
HCM Platoon Ratio	1.00	1.00	1.00	1.00	1.00	1.00
Upstream Filter(I)	1.00	1.00	1.00	1.00	1.00	1.00
Uniform Delay (d), s/veh	21.6	22.2	10.4	10.4	26.8	5.2
Incr Delay (d2), s/veh	1.4	4.7	1.1	1.1	38.2	0.1
Initial Q Delay(d3),s/veh	0.0	0.0	0.0	0.0	0.0	0.0
%ile BackOfQ(50%),veh/ln	1.0	0.9	3.7	3.8	1.4	1.3
Unsig. Movement Delay, s/veh						
LnGrp Delay(d),s/veh	23.0	26.9	11.5	11.5	65.0	5.3
LnGrp LOS	C	C	B	B	E	A
Approach Vol, veh/h	146		1103			886
Approach Delay, s/veh	24.7		11.5			9.5
Approach LOS	C		B			A
Timer - Assigned Phs	1	2			6	8
Phs Duration (G+Y+Rc), s	7.2	35.0			42.2	14.8
Change Period (Y+Rc), s	4.1	6.5			6.5	5.8
Max Green Setting (Gmax), s	14.9	71.5			90.5	17.2
Max Q Clear Time (g_c+11), s	4.9	15.1			8.4	6.8
Green Ext Time (p_c), s	0.1	13.3			9.6	0.3

Intersection Summary

HCM 6th Ctrl Delay	11.6
HCM 6th LOS	B

Timings

West Campus Upper Plateau (JN 14064)

24: Sycamore Canyon Bl. & Alessandro Bl.

09/19/2022

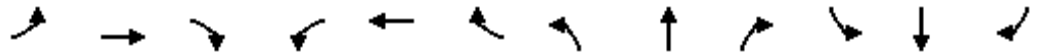

Lane Group	EBL	EBT	EBR	WBL	WBT	WBR	NBL	NBT	NBR	SBL	SBT	SBR
Lane Configurations	↘	↑↑↑	↗	↘↗	↑↑↑	↗	↘↗	↑↑	↗↘	↘↗	↑↑	↗
Traffic Volume (vph)	157	2069	680	396	2012	457	639	545	189	167	633	305
Future Volume (vph)	157	2069	680	396	2012	457	639	545	189	167	633	305
Turn Type	Prot	NA	Perm	Prot	NA	Perm	Prot	NA	pm+ov	Prot	NA	Perm
Protected Phases	5	2		1	6		3	8	1	7	4	
Permitted Phases			2			6			8			4
Detector Phase	5	2	2	1	6	6	3	8	1	7	4	4
Switch Phase												
Minimum Initial (s)	5.0	10.0	10.0	5.0	10.0	10.0	5.0	10.0	5.0	5.0	10.0	10.0
Minimum Split (s)	8.7	43.5	43.5	8.7	43.5	43.5	8.7	15.8	8.7	8.7	49.8	49.8
Total Split (s)	10.0	44.2	44.2	12.0	46.2	46.2	14.0	51.0	12.0	12.8	49.8	49.8
Total Split (%)	8.3%	36.8%	36.8%	10.0%	38.5%	38.5%	11.7%	42.5%	10.0%	10.7%	41.5%	41.5%
Yellow Time (s)	3.2	5.5	5.5	3.2	5.5	5.5	3.2	4.8	3.2	3.2	4.8	4.8
All-Red Time (s)	0.5	1.0	1.0	0.5	1.0	1.0	0.5	1.0	0.5	0.5	1.0	1.0
Lost Time Adjust (s)	0.0	0.0	0.0	0.0	0.0	0.0	0.0	0.0	0.0	0.0	0.0	0.0
Total Lost Time (s)	3.7	6.5	6.5	3.7	6.5	6.5	3.7	5.8	3.7	3.7	5.8	5.8
Lead/Lag	Lead	Lag	Lag	Lead	Lag	Lag	Lead	Lag	Lead	Lead	Lag	Lag
Lead-Lag Optimize?	Yes	Yes	Yes	Yes	Yes	Yes	Yes	Yes	Yes	Yes	Yes	Yes
Recall Mode	None	None	None	None	None	None	None	None	None	None	None	None
Act Effct Green (s)	6.3	37.9	37.9	8.4	39.9	39.9	10.4	29.5	43.7	8.7	27.9	27.9
Actuated g/C Ratio	0.06	0.36	0.36	0.08	0.38	0.38	0.10	0.28	0.42	0.08	0.27	0.27
v/c Ratio	1.47	1.15	0.94	1.57	1.06	0.70	1.90	0.57	0.16	0.68	0.70	0.60
Control Delay	288.7	107.9	44.2	309.7	69.3	24.7	442.6	33.9	12.2	62.5	38.2	23.3
Queue Delay	0.0	0.0	0.0	0.0	0.0	0.0	0.0	0.0	0.0	0.0	0.0	0.0
Total Delay	288.7	107.9	44.2	309.7	69.3	24.7	442.6	33.9	12.2	62.5	38.2	23.3
LOS	F	F	D	F	E	C	F	C	B	E	D	C
Approach Delay		102.8			95.4			221.1			37.7	
Approach LOS		F			F			F			D	

Intersection Summary

Cycle Length: 120
 Actuated Cycle Length: 104.4
 Natural Cycle: 115
 Control Type: Actuated-Uncoordinated
 Maximum v/c Ratio: 1.90
 Intersection Signal Delay: 111.2
 Intersection LOS: F
 Intersection Capacity Utilization 103.9%
 ICU Level of Service G
 Analysis Period (min) 15

Splits and Phases: 24: Sycamore Canyon Bl. & Alessandro Bl.

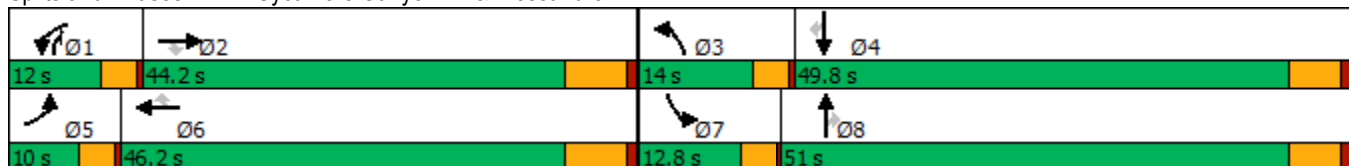

HCM 6th Signalized Intersection Summary
 24: Sycamore Canyon Bl. & Alessandro Bl.

West Campus Upper Plateau (JN 14064)

09/19/2022



Movement	EBL	EBT	EBR	WBL	WBT	WBR	NBL	NBT	NBR	SBL	SBT	SBR
Lane Configurations												
Traffic Volume (veh/h)	157	2069	680	396	2012	457	639	545	189	167	633	305
Future Volume (veh/h)	157	2069	680	396	2012	457	639	545	189	167	633	305
Initial Q (Qb), veh	0	0	0	0	0	0	0	0	0	0	0	0
Ped-Bike Adj(A_pbT)	1.00		1.00	1.00		0.99	1.00		1.00	1.00		1.00
Parking Bus, Adj	1.00	1.00	1.00	1.00	1.00	1.00	1.00	1.00	1.00	1.00	1.00	1.00
Work Zone On Approach		No			No			No			No	
Adj Sat Flow, veh/h/ln	1900	1856	1885	1767	1870	1767	1885	1841	1870	1648	1841	1870
Adj Flow Rate, veh/h	160	2111	503	404	2053	335	652	556	151	170	646	219
Peak Hour Factor	0.98	0.98	0.98	0.98	0.98	0.98	0.98	0.98	0.98	0.98	0.98	0.98
Percent Heavy Veh, %	0	3	1	9	2	9	1	4	2	17	4	2
Cap, veh/h	114	1907	601	270	2024	585	358	943	983	227	844	382
Arrive On Green	0.06	0.38	0.38	0.08	0.40	0.40	0.10	0.27	0.27	0.07	0.24	0.24
Sat Flow, veh/h	1810	5066	1598	3264	5106	1477	3483	3497	2790	3045	3497	1585
Grp Volume(v), veh/h	160	2111	503	404	2053	335	652	556	151	170	646	219
Grp Sat Flow(s),veh/h/ln	1810	1689	1598	1632	1702	1477	1742	1749	1395	1522	1749	1585
Q Serve(g_s), s	6.3	37.7	28.7	8.3	39.7	17.7	10.3	13.8	3.7	5.5	17.2	12.2
Cycle Q Clear(g_c), s	6.3	37.7	28.7	8.3	39.7	17.7	10.3	13.8	3.7	5.5	17.2	12.2
Prop In Lane	1.00		1.00	1.00		1.00	1.00		1.00	1.00		1.00
Lane Grp Cap(c), veh/h	114	1907	601	270	2024	585	358	943	983	227	844	382
V/C Ratio(X)	1.41	1.11	0.84	1.49	1.01	0.57	1.82	0.59	0.15	0.75	0.77	0.57
Avail Cap(c_a), veh/h	114	1907	601	270	2024	585	358	1578	1490	277	1536	696
HCM Platoon Ratio	1.00	1.00	1.00	1.00	1.00	1.00	1.00	1.00	1.00	1.00	1.00	1.00
Upstream Filter(I)	1.00	1.00	1.00	1.00	1.00	1.00	1.00	1.00	1.00	1.00	1.00	1.00
Uniform Delay (d), s/veh	46.9	31.2	28.4	45.9	30.2	23.6	44.9	31.8	22.2	45.4	35.4	33.5
Incr Delay (d2), s/veh	226.7	56.5	10.4	240.7	23.6	1.7	380.0	0.6	0.1	6.5	1.5	1.4
Initial Q Delay(d3),s/veh	0.0	0.0	0.0	0.0	0.0	0.0	0.0	0.0	0.0	0.0	0.0	0.0
%ile BackOfQ(50%),veh/ln	9.9	24.0	11.9	12.3	19.2	6.0	23.2	5.6	1.2	2.2	7.1	4.6
Unsig. Movement Delay, s/veh												
LnGrp Delay(d),s/veh	273.6	87.8	38.8	286.6	53.9	25.3	424.9	32.4	22.3	52.0	36.9	34.8
LnGrp LOS	F	F	D	F	F	C	F	C	C	D	D	C
Approach Vol, veh/h		2774			2792			1359			1035	
Approach Delay, s/veh		89.6			84.1			219.6			38.9	
Approach LOS		F			F			F			D	
Timer - Assigned Phs	1	2	3	4	5	6	7	8				
Phs Duration (G+Y+Rc), s	12.0	44.2	14.0	30.0	10.0	46.2	11.2	32.8				
Change Period (Y+Rc), s	3.7	6.5	3.7	5.8	3.7	6.5	3.7	5.8				
Max Green Setting (Gmax), s	8.3	37.7	10.3	44.0	6.3	39.7	9.1	45.2				
Max Q Clear Time (g_c+I1), s	10.3	39.7	12.3	19.2	8.3	41.7	7.5	15.8				
Green Ext Time (p_c), s	0.0	0.0	0.0	4.9	0.0	0.0	0.0	4.2				

Intersection Summary

HCM 6th Ctrl Delay	103.3
HCM 6th LOS	F

Timings
25: Sycamore Canyon Bl. & Cactus Av.

West Campus Upper Plateau (JN 14064)

09/19/2022



Lane Group	EBL	EBT	EBR	WBL	WBT	WBR	NBL	NBT	NBR	SBL	SBT	SBR
Lane Configurations	↘	↑↑	↗	↘↗	↑↑	↗	↘↗	↑↑	↗	↘↗	↑↑	↗
Traffic Volume (vph)	173	1161	530	964	433	616	186	539	369	743	1121	52
Future Volume (vph)	173	1161	530	964	433	616	186	539	369	743	1121	52
Turn Type	Prot	NA	Perm	Prot	NA	Perm	Prot	NA	Perm	Prot	NA	Perm
Protected Phases	7	4		3	8		5	2		1	6	
Permitted Phases			4			8			2			6
Detector Phase	7	4	4	3	8	8	5	2	2	1	6	6
Switch Phase												
Minimum Initial (s)	5.0	10.0	10.0	5.0	10.0	10.0	5.0	10.0	10.0	5.0	10.0	10.0
Minimum Split (s)	9.6	32.8	32.8	9.6	32.8	32.8	9.6	34.8	34.8	9.6	34.8	34.8
Total Split (s)	10.3	32.8	32.8	29.0	51.5	51.5	9.6	36.2	36.2	22.0	48.6	48.6
Total Split (%)	8.6%	27.3%	27.3%	24.2%	42.9%	42.9%	8.0%	30.2%	30.2%	18.3%	40.5%	40.5%
Yellow Time (s)	3.6	4.8	4.8	3.6	4.8	4.8	3.6	4.8	4.8	3.6	4.8	4.8
All-Red Time (s)	1.0	1.0	1.0	1.0	1.0	1.0	1.0	1.0	1.0	1.0	1.0	1.0
Lost Time Adjust (s)	0.0	0.0	0.0	0.0	0.0	0.0	0.0	0.0	0.0	0.0	0.0	0.0
Total Lost Time (s)	4.6	5.8	5.8	4.6	5.8	5.8	4.6	5.8	5.8	4.6	5.8	5.8
Lead/Lag	Lead	Lag	Lag	Lead	Lag	Lag	Lead	Lag	Lag	Lead	Lag	Lag
Lead-Lag Optimize?	Yes	Yes	Yes	Yes	Yes	Yes	Yes	Yes	Yes	Yes	Yes	Yes
Recall Mode	None	None	None	None	None	None	None	None	None	None	None	None
Act Effct Green (s)	5.7	27.0	27.0	24.4	45.7	45.7	5.0	30.4	30.4	17.4	42.8	42.8
Actuated g/C Ratio	0.05	0.22	0.22	0.20	0.38	0.38	0.04	0.25	0.25	0.14	0.36	0.36
v/c Ratio	2.42	1.78	1.23	1.64	0.39	0.90	1.53	0.71	0.65	1.72	1.07	0.10
Control Delay	699.1	385.2	146.9	326.2	28.2	35.6	309.8	46.1	12.3	364.8	85.3	0.3
Queue Delay	0.0	0.0	0.0	0.0	0.0	0.0	0.0	0.0	0.0	0.0	0.0	0.0
Total Delay	699.1	385.2	146.9	326.2	28.2	35.6	309.8	46.1	12.3	364.8	85.3	0.3
LOS	F	F	F	F	C	D	F	D	B	F	F	A
Approach Delay		346.6			173.2			79.5			191.4	
Approach LOS		F			F			E			F	

Intersection Summary

Cycle Length: 120
 Actuated Cycle Length: 120
 Natural Cycle: 120
 Control Type: Actuated-Uncoordinated
 Maximum v/c Ratio: 2.42
 Intersection Signal Delay: 210.3
 Intersection Capacity Utilization 113.2%
 Analysis Period (min) 15
 Intersection LOS: F
 ICU Level of Service H

Splits and Phases: 25: Sycamore Canyon Bl. & Cactus Av.

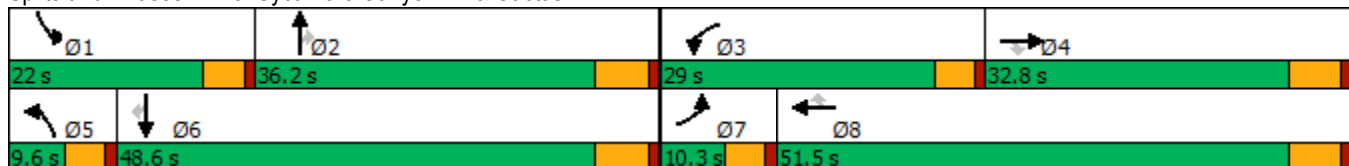

HCM 6th Signalized Intersection Summary
25: Sycamore Canyon Bl. & Cactus Av.

West Campus Upper Plateau (JN 14064)
09/19/2022



Movement	EBL	EBT	EBR	WBL	WBT	WBR	NBL	NBT	NBR	SBL	SBT	SBR
Lane Configurations	↘	↑↑	↗	↘↗	↑↑	↗	↘↗	↑↑	↗	↘↗	↑↑	↗
Traffic Volume (veh/h)	173	1161	530	964	433	616	186	539	369	743	1121	52
Future Volume (veh/h)	173	1161	530	964	433	616	186	539	369	743	1121	52
Initial Q (Qb), veh	0	0	0	0	0	0	0	0	0	0	0	0
Ped-Bike Adj(A_pbT)	1.00		1.00	1.00		1.00	1.00		1.00	1.00		1.00
Parking Bus, Adj	1.00	1.00	1.00	1.00	1.00	1.00	1.00	1.00	1.00	1.00	1.00	1.00
Work Zone On Approach		No			No			No			No	
Adj Sat Flow, veh/h/ln	1856	1796	1856	1841	1796	1870	1856	1841	1826	1885	1811	1767
Adj Flow Rate, veh/h	201	1350	606	1121	503	446	216	627	326	864	1303	60
Peak Hour Factor	0.86	0.86	0.86	0.86	0.86	0.86	0.86	0.86	0.86	0.86	0.86	0.86
Percent Heavy Veh, %	3	7	3	4	7	2	3	4	5	1	6	9
Cap, veh/h	84	768	354	692	1300	604	143	886	392	505	1227	534
Arrive On Green	0.05	0.22	0.22	0.20	0.38	0.38	0.04	0.25	0.25	0.14	0.36	0.36
Sat Flow, veh/h	1767	3413	1572	3401	3413	1585	3428	3497	1547	3483	3441	1497
Grp Volume(v), veh/h	201	1350	606	1121	503	446	216	627	326	864	1303	60
Grp Sat Flow(s),veh/h/ln	1767	1706	1572	1700	1706	1585	1714	1749	1547	1742	1721	1497
Q Serve(g_s), s	5.7	27.0	27.0	24.4	12.8	29.1	5.0	19.6	23.9	17.4	42.8	3.2
Cycle Q Clear(g_c), s	5.7	27.0	27.0	24.4	12.8	29.1	5.0	19.6	23.9	17.4	42.8	3.2
Prop In Lane	1.00		1.00	1.00		1.00	1.00		1.00	1.00		1.00
Lane Grp Cap(c), veh/h	84	768	354	692	1300	604	143	886	392	505	1227	534
V/C Ratio(X)	2.39	1.76	1.71	1.62	0.39	0.74	1.51	0.71	0.83	1.71	1.06	0.11
Avail Cap(c_a), veh/h	84	768	354	692	1300	604	143	886	392	505	1227	534
HCM Platoon Ratio	1.00	1.00	1.00	1.00	1.00	1.00	1.00	1.00	1.00	1.00	1.00	1.00
Upstream Filter(I)	1.00	1.00	1.00	1.00	1.00	1.00	1.00	1.00	1.00	1.00	1.00	1.00
Uniform Delay (d), s/veh	57.2	46.5	46.5	47.8	27.0	32.0	57.5	40.8	42.4	51.3	38.6	25.9
Incr Delay (d2), s/veh	662.4	346.5	332.5	286.1	0.2	4.8	263.0	2.6	14.1	328.2	43.8	0.1
Initial Q Delay(d3),s/veh	0.0	0.0	0.0	0.0	0.0	0.0	0.0	0.0	0.0	0.0	0.0	0.0
%ile BackOfQ(50%),veh/ln	17.9	48.1	42.8	37.4	5.1	11.4	7.3	8.5	10.3	30.4	24.5	1.1
Unsig. Movement Delay, s/veh												
LnGrp Delay(d),s/veh	719.6	393.0	379.0	333.9	27.2	36.8	320.5	43.4	56.5	379.5	82.4	26.0
LnGrp LOS	F	F	F	F	C	D	F	D	E	F	F	C
Approach Vol, veh/h		2157			2070			1169			2227	
Approach Delay, s/veh		419.5			195.4			98.2			196.1	
Approach LOS		F			F			F			F	
Timer - Assigned Phs	1	2	3	4	5	6	7	8				
Phs Duration (G+Y+Rc), s	22.0	36.2	29.0	32.8	9.6	48.6	10.3	51.5				
Change Period (Y+Rc), s	4.6	5.8	4.6	5.8	4.6	5.8	4.6	5.8				
Max Green Setting (Gmax), s	17.4	30.4	24.4	27.0	5.0	42.8	5.7	45.7				
Max Q Clear Time (g_c+I1), s	19.4	25.9	26.4	29.0	7.0	44.8	7.7	31.1				
Green Ext Time (p_c), s	0.0	2.1	0.0	0.0	0.0	0.0	0.0	4.1				
Intersection Summary												
HCM 6th Ctrl Delay			244.1									
HCM 6th LOS			F									

Timings

West Campus Upper Plateau (JN 14064)

26: Sycamore Canyon Bl. & Van Buren Bl.

09/19/2022



Lane Group	EBL	EBT	EBR	WBL	WBT	WBR	NBL	NBT	SBL	SBT	SBR
Lane Configurations											
Traffic Volume (vph)	586	3907	1	8	2746	132	13	16	1154	15	1076
Future Volume (vph)	586	3907	1	8	2746	132	13	16	1154	15	1076
Turn Type	Prot	NA	Perm	Prot	NA	Perm	Perm	NA	Split	NA	Perm
Protected Phases	5	2		1	6			8	4	4	
Permitted Phases			2			6	8				4
Detector Phase	5	2	2	1	6	6	8	8	4	4	4
Switch Phase											
Minimum Initial (s)	5.0	10.0	10.0	5.0	10.0	10.0	10.0	10.0	10.0	10.0	10.0
Minimum Split (s)	9.6	29.2	29.2	9.6	29.2	29.2	14.6	14.6	50.8	50.8	50.8
Total Split (s)	22.0	47.8	47.8	9.6	35.4	35.4	14.6	14.6	58.0	58.0	58.0
Total Split (%)	16.9%	36.8%	36.8%	7.4%	27.2%	27.2%	11.2%	11.2%	44.6%	44.6%	44.6%
Yellow Time (s)	3.6	5.2	5.2	3.6	5.2	5.2	3.6	3.6	4.8	4.8	4.8
All-Red Time (s)	1.0	1.0	1.0	1.0	1.0	1.0	1.0	1.0	1.0	1.0	1.0
Lost Time Adjust (s)	0.0	0.0	0.0	0.0	0.0	0.0		0.0	0.0	0.0	0.0
Total Lost Time (s)	4.6	6.2	6.2	4.6	6.2	6.2		4.6	5.8	5.8	5.8
Lead/Lag	Lead	Lag	Lag	Lead	Lag	Lag					
Lead-Lag Optimize?	Yes	Yes	Yes	Yes	Yes	Yes					
Recall Mode	None	None	None	None	None	None	None	None	None	None	None
Act Effct Green (s)	17.4	49.4	49.4	5.0	29.3	29.3		10.0	52.3	52.3	52.3
Actuated g/C Ratio	0.14	0.39	0.39	0.04	0.23	0.23		0.08	0.41	0.41	0.41
v/c Ratio	1.37	1.74	0.00	0.15	2.08	0.31		0.27	0.91	0.02	1.30
Control Delay	219.0	360.9	0.0	65.9	515.7	9.0		31.2	46.1	23.7	164.8
Queue Delay	0.0	0.0	0.0	0.0	0.0	0.0		0.0	0.0	0.0	0.0
Total Delay	219.0	360.9	0.0	65.9	515.7	9.0		31.2	46.1	23.7	164.8
LOS	F	F	A	E	F	A		C	D	C	F
Approach Delay		342.3			491.3			31.2		102.9	
Approach LOS		F			F			C		F	

Intersection Summary

Cycle Length: 130	
Actuated Cycle Length: 127.1	
Natural Cycle: 115	
Control Type: Actuated-Uncoordinated	
Maximum v/c Ratio: 2.08	
Intersection Signal Delay: 329.1	Intersection LOS: F
Intersection Capacity Utilization 128.6%	ICU Level of Service H
Analysis Period (min) 15	

Splits and Phases: 26: Sycamore Canyon Bl. & Van Buren Bl.

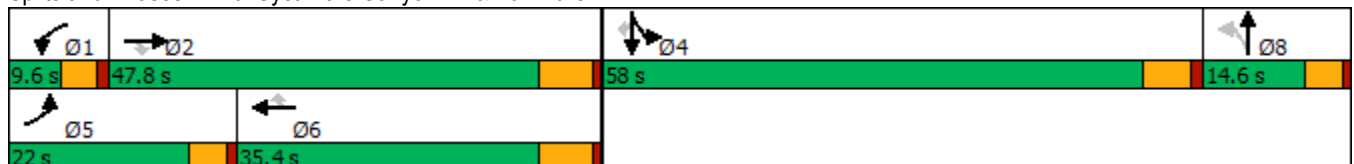

HCM 6th Signalized Intersection Summary
 26: Sycamore Canyon Bl. & Van Buren Bl.

West Campus Upper Plateau (JN 14064)

09/19/2022



Movement	EBL	EBT	EBR	WBL	WBT	WBR	NBL	NBT	NBR	SBL	SBT	SBR
Lane Configurations	↔↔	↑↑↑	↗	↖	↑↑↑	↗		↔↔		↖↖	↑	↗
Traffic Volume (veh/h)	586	3907	1	8	2746	132	13	16	38	1154	15	1076
Future Volume (veh/h)	586	3907	1	8	2746	132	13	16	38	1154	15	1076
Initial Q (Qb), veh	0	0	0	0	0	0	0	0	0	0	0	0
Ped-Bike Adj(A_pbT)	1.00		1.00	1.00		0.99	1.00		0.99	1.00		1.00
Parking Bus, Adj	1.00	1.00	1.00	1.00	1.00	1.00	1.00	1.00	1.00	1.00	1.00	1.00
Work Zone On Approach		No			No			No			No	
Adj Sat Flow, veh/h/ln	1856	1841	1900	1693	1826	1856	1900	1900	1900	1841	1900	1856
Adj Flow Rate, veh/h	637	4247	1	9	2985	120	14	17	11	1254	16	0
Peak Hour Factor	0.92	0.92	0.92	0.92	0.92	0.92	0.92	0.92	0.92	0.92	0.92	0.92
Percent Heavy Veh, %	3	4	0	14	5	3	0	0	0	4	0	3
Cap, veh/h	480	2304	586	17	1475	364	72	89	58	1338	747	
Arrive On Green	0.14	0.36	0.36	0.01	0.23	0.23	0.06	0.06	0.06	0.39	0.39	0.00
Sat Flow, veh/h	3428	6332	1610	1612	6281	1552	1169	1441	945	3401	1900	1572
Grp Volume(v), veh/h	637	4247	1	9	2985	120	22	0	20	1254	16	0
Grp Sat Flow(s),veh/h/ln	1714	1583	1610	1612	1570	1552	1842	0	1713	1700	1900	1572
Q Serve(g_s), s	17.4	45.3	0.0	0.7	29.2	8.0	1.4	0.0	1.4	44.1	0.6	0.0
Cycle Q Clear(g_c), s	17.4	45.3	0.0	0.7	29.2	8.0	1.4	0.0	1.4	44.1	0.6	0.0
Prop In Lane	1.00		1.00	1.00		1.00	0.63		0.55	1.00		1.00
Lane Grp Cap(c), veh/h	480	2304	586	17	1475	364	113	0	105	1338	747	
V/C Ratio(X)	1.33	1.84	0.00	0.52	2.02	0.33	0.19	0.00	0.19	0.94	0.02	
Avail Cap(c_a), veh/h	480	2304	586	65	1475	364	148	0	138	1427	797	
HCM Platoon Ratio	1.00	1.00	1.00	1.00	1.00	1.00	1.00	1.00	1.00	1.00	1.00	1.00
Upstream Filter(I)	1.00	1.00	1.00	1.00	1.00	1.00	1.00	0.00	1.00	1.00	1.00	0.00
Uniform Delay (d), s/veh	53.5	39.6	25.2	61.2	47.6	39.5	55.4	0.0	55.4	36.3	23.1	0.0
Incr Delay (d2), s/veh	161.6	381.1	0.0	8.7	463.4	0.5	0.8	0.0	0.9	11.6	0.0	0.0
Initial Q Delay(d3),s/veh	0.0	0.0	0.0	0.0	0.0	0.0	0.0	0.0	0.0	0.0	0.0	0.0
%ile BackOfQ(50%),veh/ln	18.1	77.7	0.0	0.3	58.5	3.0	0.7	0.0	0.6	19.4	0.3	0.0
Unsig. Movement Delay, s/veh												
LnGrp Delay(d),s/veh	215.1	420.7	25.2	69.9	511.0	40.0	56.3	0.0	56.3	47.8	23.1	0.0
LnGrp LOS	F	F	C	E	F	D	E	A	E	D	C	
Approach Vol, veh/h		4885			3114			42			1270	
Approach Delay, s/veh		393.8			491.5			56.3			47.5	
Approach LOS		F			F			E			D	
Timer - Assigned Phs	1	2		4	5	6		8				
Phs Duration (G+Y+Rc), s	5.9	51.5		54.7	22.0	35.4		12.3				
Change Period (Y+Rc), s	4.6	6.2		5.8	4.6	6.2		4.6				
Max Green Setting (Gmax), s	5.0	41.6		52.2	17.4	29.2		10.0				
Max Q Clear Time (g_c+I1), s	2.7	47.3		46.1	19.4	31.2		3.4				
Green Ext Time (p_c), s	0.0	0.0		2.9	0.0	0.0		0.0				

Intersection Summary

HCM 6th Ctrl Delay	377.7
HCM 6th LOS	F

Notes

Unsignalized Delay for [SBR] is excluded from calculations of the approach delay and intersection delay.

Timings
27: Innovation Dr. & Cactus Av.

West Campus Upper Plateau (JN 14064)

09/19/2022

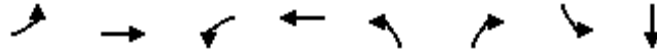

Lane Group	EBL	EBT	WBL	WBT	NBL	NBR	SBL	SBT
Lane Configurations	↶	↷	↶	↷	↶	↷	↶	↷
Traffic Volume (vph)	3	1981	65	1763	51	145	40	0
Future Volume (vph)	3	1981	65	1763	51	145	40	0
Turn Type	Prot	NA	Prot	NA	Perm	Perm	Perm	NA
Protected Phases	5	2	1	6				4
Permitted Phases					8	8	4	
Detector Phase	5	2	1	6	8	8	4	4
Switch Phase								
Minimum Initial (s)	5.0	10.0	5.0	10.0	10.0	10.0	10.0	10.0
Minimum Split (s)	9.2	26.8	9.2	26.8	31.1	31.1	31.1	31.1
Total Split (s)	12.0	63.0	22.0	73.0	35.0	35.0	35.0	35.0
Total Split (%)	10.0%	52.5%	18.3%	60.8%	29.2%	29.2%	29.2%	29.2%
Yellow Time (s)	3.2	4.8	3.2	4.8	4.1	4.1	4.1	4.1
All-Red Time (s)	1.0	1.0	1.0	1.0	1.0	1.0	1.0	1.0
Lost Time Adjust (s)	0.0	0.0	0.0	0.0	0.0	0.0	0.0	0.0
Total Lost Time (s)	4.2	5.8	4.2	5.8	5.1	5.1	5.1	5.1
Lead/Lag	Lead	Lag	Lead	Lag				
Lead-Lag Optimize?	Yes	Yes	Yes	Yes				
Recall Mode	None	None	None	None	None	None	None	None
Act Effct Green (s)	5.2	57.3	8.7	66.4	12.9	12.9	12.9	12.9
Actuated g/C Ratio	0.06	0.62	0.09	0.72	0.14	0.14	0.14	0.14
v/c Ratio	0.03	0.73	0.49	0.56	0.29	0.41	0.22	0.05
Control Delay	48.0	16.0	53.6	8.0	41.2	5.0	39.5	0.3
Queue Delay	0.0	0.1	0.0	0.1	0.0	0.0	0.0	0.0
Total Delay	48.0	16.1	53.6	8.1	41.2	5.0	39.5	0.3
LOS	D	B	D	A	D	A	D	A
Approach Delay		16.2		9.7				28.7
Approach LOS		B		A				C

Intersection Summary

Cycle Length: 120
 Actuated Cycle Length: 92
 Natural Cycle: 90
 Control Type: Actuated-Uncoordinated
 Maximum v/c Ratio: 0.73
 Intersection Signal Delay: 13.3
 Intersection LOS: B
 Intersection Capacity Utilization 69.1%
 ICU Level of Service C
 Analysis Period (min) 15

Splits and Phases: 27: Innovation Dr. & Cactus Av.



HCM 6th Signalized Intersection Summary
27: Innovation Dr. & Cactus Av.

West Campus Upper Plateau (JN 14064)
09/19/2022



Movement	EBL	EBT	EBR	WBL	WBT	WBR	NBL	NBT	NBR	SBL	SBT	SBR
Lane Configurations	↗	↑↑↑		↖	↑↑↑		↖	↑	↗	↖	↑	↗
Traffic Volume (veh/h)	3	1981	6	65	1763	15	51	0	145	40	0	15
Future Volume (veh/h)	3	1981	6	65	1763	15	51	0	145	40	0	15
Initial Q (Qb), veh	0	0	0	0	0	0	0	0	0	0	0	0
Ped-Bike Adj(A_pbT)	1.00		1.00	1.00		0.98	1.00		1.00	1.00		1.00
Parking Bus, Adj	1.00	1.00	1.00	1.00	1.00	1.00	1.00	1.00	1.00	1.00	1.00	1.00
Work Zone On Approach		No			No			No			No	
Adj Sat Flow, veh/h/ln	1900	1811	1307	1693	1826	1900	1870	1900	1841	1900	1900	1781
Adj Flow Rate, veh/h	3	2226	7	73	1981	17	57	0	110	45	0	8
Peak Hour Factor	0.89	0.89	0.89	0.89	0.89	0.89	0.89	0.89	0.89	0.89	0.89	0.89
Percent Heavy Veh, %	0	6	40	14	5	0	2	0	4	0	0	8
Cap, veh/h	7	3218	10	91	3490	30	257	234	193	250	0	199
Arrive On Green	0.00	0.63	0.63	0.06	0.68	0.68	0.12	0.00	0.12	0.12	0.00	0.12
Sat Flow, veh/h	1810	5088	16	1612	5096	44	1407	1900	1560	1304	0	1610
Grp Volume(v), veh/h	3	1442	791	73	1291	707	57	0	110	45	0	8
Grp Sat Flow(s),veh/h/ln	1810	1648	1808	1612	1662	1817	1407	1900	1560	1304	0	1610
Q Serve(g_s), s	0.1	23.0	23.0	3.6	16.1	16.1	3.0	0.0	5.3	2.5	0.0	0.4
Cycle Q Clear(g_c), s	0.1	23.0	23.0	3.6	16.1	16.1	3.3	0.0	5.3	2.5	0.0	0.4
Prop In Lane	1.00		0.01	1.00		0.02	1.00		1.00	1.00		1.00
Lane Grp Cap(c), veh/h	7	2084	1143	91	2276	1244	257	234	193	250	0	199
V/C Ratio(X)	0.41	0.69	0.69	0.80	0.57	0.57	0.22	0.00	0.57	0.18	0.00	0.04
Avail Cap(c_a), veh/h	175	2344	1286	357	2776	1518	606	706	580	574	0	599
HCM Platoon Ratio	1.00	1.00	1.00	1.00	1.00	1.00	1.00	1.00	1.00	1.00	1.00	1.00
Upstream Filter(I)	1.00	1.00	1.00	1.00	1.00	1.00	1.00	0.00	1.00	1.00	0.00	1.00
Uniform Delay (d), s/veh	40.0	9.7	9.7	37.5	6.5	6.5	32.5	0.0	33.2	32.0	0.0	31.1
Incr Delay (d2), s/veh	13.2	0.9	1.6	6.0	0.3	0.6	0.4	0.0	2.7	0.3	0.0	0.1
Initial Q Delay(d3),s/veh	0.0	0.0	0.0	0.0	0.0	0.0	0.0	0.0	0.0	0.0	0.0	0.0
%ile BackOfQ(50%),veh/ln	0.1	6.2	7.0	1.5	3.8	4.2	1.0	0.0	2.1	0.8	0.0	0.1
Unsig. Movement Delay, s/veh												
LnGrp Delay(d),s/veh	53.1	10.6	11.3	43.5	6.9	7.1	33.0	0.0	35.9	32.3	0.0	31.1
LnGrp LOS	D	B	B	D	A	A	C	A	D	C	A	C
Approach Vol, veh/h		2236			2071			167				53
Approach Delay, s/veh		10.9			8.2			34.9				32.2
Approach LOS		B			A			C				C
Timer - Assigned Phs	1	2		4	5	6		8				
Phs Duration (G+Y+Rc), s	8.7	56.7		15.0	4.5	60.9		15.0				
Change Period (Y+Rc), s	* 4.2	5.8		5.1	* 4.2	5.8		5.1				
Max Green Setting (Gmax), s	* 18	57.2		29.9	* 7.8	67.2		29.9				
Max Q Clear Time (g_c+I1), s	5.6	25.0		4.5	2.1	18.1		7.3				
Green Ext Time (p_c), s	0.1	25.9		0.1	0.0	31.2		0.5				

Intersection Summary

HCM 6th Ctrl Delay	10.8
HCM 6th LOS	B

Notes

* HCM 6th computational engine requires equal clearance times for the phases crossing the barrier.

Timings
28: I-215 SB Ramps & Alessandro Bl.

West Campus Upper Plateau (JN 14064)

09/19/2022

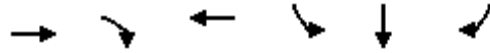

Lane Group	EBT	EBR	WBT	SBL	SBT	SBR
Lane Configurations	↑↑↑	↑	↑↑↑	↑	↔	↑
Traffic Volume (vph)	1860	584	2298	403	0	568
Future Volume (vph)	1860	584	2298	403	0	568
Turn Type	NA	Perm	NA	Split	NA	Perm
Protected Phases	2		6	4	4	
Permitted Phases		2				4
Detector Phase	2	2	6	4	4	4
Switch Phase						
Minimum Initial (s)	5.0	5.0	5.0	5.0	5.0	5.0
Minimum Split (s)	10.5	10.5	34.5	10.0	10.0	10.0
Total Split (s)	52.0	52.0	52.0	33.0	33.0	33.0
Total Split (%)	61.2%	61.2%	61.2%	38.8%	38.8%	38.8%
Yellow Time (s)	4.5	4.5	4.5	4.0	4.0	4.0
All-Red Time (s)	1.0	1.0	1.0	1.0	1.0	1.0
Lost Time Adjust (s)	0.0	0.0	0.0	0.0	0.0	0.0
Total Lost Time (s)	5.5	5.5	5.5	5.0	5.0	5.0
Lead/Lag						
Lead-Lag Optimize?						
Recall Mode	Min	Min	Min	None	None	None
Act Effct Green (s)	45.6	45.6	45.6	22.6	22.6	22.6
Actuated g/C Ratio	0.58	0.58	0.58	0.29	0.29	0.29
v/c Ratio	0.65	0.61	0.87	0.76	0.78	0.75
Control Delay	13.2	10.0	19.2	37.3	36.8	34.7
Queue Delay	0.0	0.0	0.0	0.0	0.0	0.0
Total Delay	13.2	10.0	19.2	37.3	36.8	34.7
LOS	B	A	B	D	D	C
Approach Delay	12.4		19.2		36.3	
Approach LOS	B		B		D	

Intersection Summary

Cycle Length: 85
 Actuated Cycle Length: 78.8
 Natural Cycle: 60
 Control Type: Actuated-Uncoordinated
 Maximum v/c Ratio: 0.87
 Intersection Signal Delay: 19.2
 Intersection LOS: B
 Intersection Capacity Utilization 80.3%
 ICU Level of Service D
 Analysis Period (min) 15

Splits and Phases: 28: I-215 SB Ramps & Alessandro Bl.

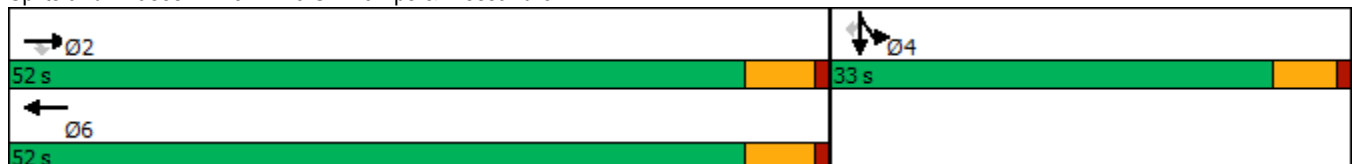

HCM 6th Signalized Intersection Summary
 28: I-215 SB Ramps & Alessandro Bl.

West Campus Upper Plateau (JN 14064)

09/19/2022



Movement	EBL	EBT	EBR	WBL	WBT	WBR	NBL	NBT	NBR	SBL	SBT	SBR
Lane Configurations		↑↑↑	↗		↑↑↑					↘	↔	↗
Traffic Volume (veh/h)	0	1860	584	0	2298	165	0	0	0	403	0	568
Future Volume (veh/h)	0	1860	584	0	2298	165	0	0	0	403	0	568
Initial Q (Qb), veh	0	0	0	0	0	0				0	0	0
Ped-Bike Adj(A_pbT)	1.00		1.00	1.00		0.98				1.00		1.00
Parking Bus, Adj	1.00	1.00	1.00	1.00	1.00	1.00				1.00	1.00	1.00
Work Zone On Approach		No			No						No	
Adj Sat Flow, veh/h/ln	0	1856	1781	0	1870	1544				1767	1900	1752
Adj Flow Rate, veh/h	0	1879	590	0	2321	159				591	0	333
Peak Hour Factor	0.99	0.99	0.99	0.99	0.99	0.99				0.99	0.99	0.99
Percent Heavy Veh, %	0	3	8	0	2	24				9	0	10
Cap, veh/h	0	2968	885	0	2858	193				918	0	405
Arrive On Green	0.00	0.59	0.59	0.00	0.59	0.59				0.27	0.00	0.27
Sat Flow, veh/h	0	5233	1510	0	5045	330				3365	0	1485
Grp Volume(v), veh/h	0	1879	590	0	1611	869				591	0	333
Grp Sat Flow(s),veh/h/ln	0	1689	1510	0	1702	1803				1682	0	1485
Q Serve(g_s), s	0.0	18.1	19.7	0.0	27.6	28.6				11.5	0.0	15.6
Cycle Q Clear(g_c), s	0.0	18.1	19.7	0.0	27.6	28.6				11.5	0.0	15.6
Prop In Lane	0.00		1.00	0.00		0.18				1.00		1.00
Lane Grp Cap(c), veh/h	0	2968	885	0	1995	1056				918	0	405
V/C Ratio(X)	0.00	0.63	0.67	0.00	0.81	0.82				0.64	0.00	0.82
Avail Cap(c_a), veh/h	0	3171	945	0	2131	1128				1268	0	560
HCM Platoon Ratio	1.00	1.00	1.00	1.00	1.00	1.00				1.00	1.00	1.00
Upstream Filter(I)	0.00	1.00	1.00	0.00	1.00	1.00				1.00	0.00	1.00
Uniform Delay (d), s/veh	0.0	10.1	10.5	0.0	12.1	12.3				23.8	0.0	25.3
Incr Delay (d2), s/veh	0.0	0.4	1.7	0.0	2.3	4.8				0.8	0.0	6.9
Initial Q Delay(d3),s/veh	0.0	0.0	0.0	0.0	0.0	0.0				0.0	0.0	0.0
%ile BackOfQ(50%),veh/ln	0.0	4.6	4.8	0.0	7.6	9.0				4.2	0.0	5.7
Unsig. Movement Delay, s/veh												
LnGrp Delay(d),s/veh	0.0	10.5	12.1	0.0	14.4	17.0				24.6	0.0	32.3
LnGrp LOS	A	B	B	A	B	B				C	A	C
Approach Vol, veh/h		2469			2480						924	
Approach Delay, s/veh		10.9			15.3						27.4	
Approach LOS		B			B						C	
Timer - Assigned Phs		2		4		6						
Phs Duration (G+Y+Rc), s		49.0		25.3		49.0						
Change Period (Y+Rc), s		5.5		5.0		5.5						
Max Green Setting (Gmax), s		46.5		28.0		46.5						
Max Q Clear Time (g_c+I1), s		21.7		17.6		30.6						
Green Ext Time (p_c), s		16.9		2.6		12.9						

Intersection Summary

HCM 6th Ctrl Delay	15.3
HCM 6th LOS	B

Notes

User approved volume balancing among the lanes for turning movement.

Timings
29: I-215 NB Ramps & Alessandro Bl.

West Campus Upper Plateau (JN 14064)

09/19/2022



Lane Group	EBL	EBT	WBT	WBR	NBL	NBT	NBR
Lane Configurations	↶	↑↑↑	↑↑↑	↷	↶	↕	↷
Traffic Volume (vph)	274	2355	1523	162	1052	13	397
Future Volume (vph)	274	2355	1523	162	1052	13	397
Turn Type	Prot	NA	NA	Perm	Split	NA	Perm
Protected Phases	5	2	6		8	8	
Permitted Phases				6			8
Detector Phase	5	2	6	6	8	8	8
Switch Phase							
Minimum Initial (s)	5.0	5.0	5.0	5.0	5.0	5.0	5.0
Minimum Split (s)	9.5	10.5	33.5	33.5	10.0	10.0	10.0
Total Split (s)	13.0	48.0	35.0	35.0	37.0	37.0	37.0
Total Split (%)	15.3%	56.5%	41.2%	41.2%	43.5%	43.5%	43.5%
Yellow Time (s)	3.5	4.5	4.5	4.5	4.0	4.0	4.0
All-Red Time (s)	1.0	1.0	1.0	1.0	1.0	1.0	1.0
Lost Time Adjust (s)	0.0	0.0	0.0	0.0	0.0	0.0	0.0
Total Lost Time (s)	4.5	5.5	5.5	5.5	5.0	5.0	5.0
Lead/Lag	Lead		Lag	Lag			
Lead-Lag Optimize?	Yes		Yes	Yes			
Recall Mode	None	Min	Min	Min	Max	Max	Max
Act Effct Green (s)	8.5	42.5	29.5	29.5	32.0	32.0	32.0
Actuated g/C Ratio	0.10	0.50	0.35	0.35	0.38	0.38	0.38
v/c Ratio	1.84	0.99	0.94	0.31	0.95	0.97	0.63
Control Delay	428.5	36.7	38.6	12.4	52.8	59.0	21.7
Queue Delay	0.0	0.0	0.0	0.0	0.0	0.0	0.0
Total Delay	428.5	36.7	38.6	12.4	52.8	59.0	21.7
LOS	F	D	D	B	D	E	C
Approach Delay		77.4	36.1			47.5	
Approach LOS		E	D			D	

Intersection Summary

Cycle Length: 85
 Actuated Cycle Length: 85
 Natural Cycle: 110
 Control Type: Actuated-Uncoordinated
 Maximum v/c Ratio: 1.84
 Intersection Signal Delay: 57.8
 Intersection LOS: E
 Intersection Capacity Utilization 90.6%
 ICU Level of Service E
 Analysis Period (min) 15

Splits and Phases: 29: I-215 NB Ramps & Alessandro Bl.

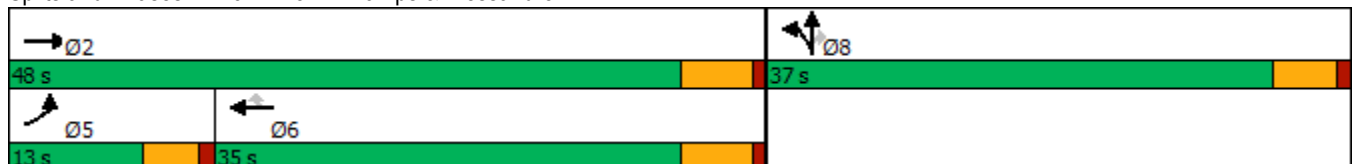

HCM 6th Signalized Intersection Summary
 29: I-215 NB Ramps & Alessandro Bl.

West Campus Upper Plateau (JN 14064)

09/19/2022



Movement	EBL	EBT	EBR	WBL	WBT	WBR	NBL	NBT	NBR	SBL	SBT	SBR
Lane Configurations	↗	↑↑↑			↑↑↑	↗	↗	↕	↗			
Traffic Volume (veh/h)	274	2355	0	0	1523	162	1052	13	397	0	0	0
Future Volume (veh/h)	274	2355	0	0	1523	162	1052	13	397	0	0	0
Initial Q (Qb), veh	0	0	0	0	0	0	0	0	0			
Ped-Bike Adj(A_pbT)	1.00		1.00	1.00		0.98	1.00		1.00			
Parking Bus, Adj	1.00	1.00	1.00	1.00	1.00	1.00	1.00	1.00	1.00			
Work Zone On Approach		No			No			No				
Adj Sat Flow, veh/h/ln	1693	1870	0	0	1841	1752	1856	1900	1826			
Adj Flow Rate, veh/h	291	2505	0	0	1620	145	1229	0	229			
Peak Hour Factor	0.94	0.94	0.94	0.94	0.94	0.94	0.94	0.94	0.94			
Percent Heavy Veh, %	14	2	0	0	4	10	3	0	5			
Cap, veh/h	161	2553	0	0	1744	504	1331	0	583			
Arrive On Green	0.10	0.50	0.00	0.00	0.35	0.35	0.38	0.00	0.38			
Sat Flow, veh/h	1612	5274	0	0	5191	1453	3534	0	1547			
Grp Volume(v), veh/h	291	2505	0	0	1620	145	1229	0	229			
Grp Sat Flow(s),veh/h/ln	1612	1702	0	0	1675	1453	1767	0	1547			
Q Serve(g_s), s	8.5	40.9	0.0	0.0	26.4	6.2	28.3	0.0	9.2			
Cycle Q Clear(g_c), s	8.5	40.9	0.0	0.0	26.4	6.2	28.3	0.0	9.2			
Prop In Lane	1.00		0.00	0.00		1.00	1.00		1.00			
Lane Grp Cap(c), veh/h	161	2553	0	0	1744	504	1331	0	583			
V/C Ratio(X)	1.81	0.98	0.00	0.00	0.93	0.29	0.92	0.00	0.39			
Avail Cap(c_a), veh/h	161	2553	0	0	1744	504	1331	0	583			
HCM Platoon Ratio	1.00	1.00	1.00	1.00	1.00	1.00	1.00	1.00	1.00			
Upstream Filter(I)	1.00	1.00	0.00	0.00	1.00	1.00	1.00	0.00	1.00			
Uniform Delay (d), s/veh	38.2	20.9	0.0	0.0	26.7	20.1	25.3	0.0	19.4			
Incr Delay (d2), s/veh	385.9	13.7	0.0	0.0	9.3	0.3	12.1	0.0	2.0			
Initial Q Delay(d3),s/veh	0.0	0.0	0.0	0.0	0.0	0.0	0.0	0.0	0.0			
%ile BackOfQ(50%),veh/ln	20.4	16.0	0.0	0.0	10.6	1.9	13.0	0.0	3.4			
Unsig. Movement Delay, s/veh												
LnGrp Delay(d),s/veh	424.1	34.5	0.0	0.0	36.0	20.4	37.4	0.0	21.4			
LnGrp LOS	F	C	A	A	D	C	D	A	C			
Approach Vol, veh/h		2796			1765			1458				
Approach Delay, s/veh		75.1			34.7			34.9				
Approach LOS		E			C			C				
Timer - Assigned Phs		2			5	6		8				
Phs Duration (G+Y+Rc), s		48.0			13.0	35.0		37.0				
Change Period (Y+Rc), s		5.5			4.5	5.5		5.0				
Max Green Setting (Gmax), s		42.5			8.5	29.5		32.0				
Max Q Clear Time (g_c+I1), s		42.9			10.5	28.4		30.3				
Green Ext Time (p_c), s		0.0			0.0	0.9		1.1				

Intersection Summary

HCM 6th Ctrl Delay	53.5
HCM 6th LOS	D

Notes

User approved volume balancing among the lanes for turning movement.

Timings
30: I-215 SB Ramps & Cactus Av.

West Campus Upper Plateau (JN 14064)

09/19/2022



Lane Group	EBT	EBR	WBL	WBT	NBR	SBR
Lane Configurations	↑↑	↑	↓	↑↑	↑	↑
Traffic Volume (vph)	1693	402	805	1298	754	543
Future Volume (vph)	1693	402	805	1298	754	543
Turn Type	NA	Perm	Prot	NA	Prot	Prot
Protected Phases	2		1	6	8	4
Permitted Phases		2				
Detector Phase	2	2	1	6	8	4
Switch Phase						
Minimum Initial (s)	5.0	5.0	5.0	5.0	5.0	5.0
Minimum Split (s)	11.0	11.0	9.5	23.0	9.1	9.5
Total Split (s)	50.0	50.0	43.0	93.0	27.0	27.0
Total Split (%)	41.7%	41.7%	35.8%	77.5%	22.5%	22.5%
Yellow Time (s)	5.0	5.0	3.5	5.0	3.6	3.5
All-Red Time (s)	1.0	1.0	1.0	1.0	0.5	1.0
Lost Time Adjust (s)	0.0	0.0	0.0	0.0	0.0	0.0
Total Lost Time (s)	6.0	6.0	4.5	6.0	4.1	4.5
Lead/Lag	Lag	Lag	Lead			
Lead-Lag Optimize?	Yes	Yes	Yes			
Recall Mode	Min	Min	None	Min	None	None
Act Effect Green (s)	44.0	44.0	38.5	87.0	22.9	22.5
Actuated g/C Ratio	0.37	0.37	0.32	0.72	0.19	0.19
v/c Ratio	1.41	0.60	1.48	0.53	1.12	1.63
Control Delay	222.6	16.9	256.3	8.3	89.1	326.0
Queue Delay	0.0	0.0	0.0	0.0	0.0	0.0
Total Delay	222.6	16.9	256.3	8.3	89.1	326.0
LOS	F	B	F	A	F	F
Approach Delay	183.1			103.2		
Approach LOS	F			F		

Intersection Summary

Cycle Length: 120
 Actuated Cycle Length: 120
 Natural Cycle: 120
 Control Type: Actuated-Uncoordinated
 Maximum v/c Ratio: 1.63
 Intersection Signal Delay: 153.8
 Intersection LOS: F
 Intersection Capacity Utilization 101.9%
 ICU Level of Service G
 Analysis Period (min) 15

Splits and Phases: 30: I-215 SB Ramps & Cactus Av.



HCM 6th Signalized Intersection Summary
 30: I-215 SB Ramps & Cactus Av.

West Campus Upper Plateau (JN 14064)

09/19/2022



Movement	EBL	EBT	EBR	WBL	WBT	WBR	NBL	NBT	NBR	SBL	SBT	SBR
Lane Configurations		↑↑	↗	↖	↑↑				↗			↗
Traffic Volume (veh/h)	0	1693	402	805	1298	0	0	0	754	0	0	543
Future Volume (veh/h)	0	1693	402	805	1298	0	0	0	754	0	0	543
Initial Q (Qb), veh	0	0	0	0	0	0	0	0	0	0	0	0
Ped-Bike Adj(A_pbT)	1.00		1.00	1.00		1.00	1.00		1.00	1.00		1.00
Parking Bus, Adj	1.00	1.00	1.00	1.00	1.00	1.00	1.00	1.00	1.00	1.00	1.00	1.00
Work Zone On Approach		No			No			No			No	
Adj Sat Flow, veh/h/ln	0	1826	1811	1885	1870	0	0	0	1811	0	0	1737
Adj Flow Rate, veh/h	0	1782	395	847	1366	0	0	0	0	0	0	467
Peak Hour Factor	0.95	0.95	0.95	0.95	0.95	0.95	0.95	0.95	0.95	0.95	0.95	0.95
Percent Heavy Veh, %	0	5	6	1	2	0	0	0	6	0	0	11
Cap, veh/h	0	1641	726	743	3324	0	0	0	0	0	0	0
Arrive On Green	0.00	0.47	0.47	0.41	0.94	0.00	0.00	0.00	0.00	0.00	0.00	0.00
Sat Flow, veh/h	0	3561	1535	1795	3647	0		0			0	
Grp Volume(v), veh/h	0	1782	395	847	1366	0		0.0			0.0	
Grp Sat Flow(s),veh/h/ln	0	1735	1535	1795	1777	0						
Q Serve(g_s), s	0.0	44.0	17.0	38.5	3.7	0.0						
Cycle Q Clear(g_c), s	0.0	44.0	17.0	38.5	3.7	0.0						
Prop In Lane	0.00		1.00	1.00		0.00						
Lane Grp Cap(c), veh/h	0	1641	726	743	3324	0						
V/C Ratio(X)	0.00	1.09	0.54	1.14	0.41	0.00						
Avail Cap(c_a), veh/h	0	1641	726	743	3324	0						
HCM Platoon Ratio	1.00	1.00	1.00	1.00	1.00	1.00						
Upstream Filter(I)	0.00	1.00	1.00	1.00	1.00	0.00						
Uniform Delay (d), s/veh	0.0	24.5	17.4	27.3	0.3	0.0						
Incr Delay (d2), s/veh	0.0	49.4	0.5	78.6	0.0	0.0						
Initial Q Delay(d3),s/veh	0.0	0.0	0.0	0.0	0.0	0.0						
%ile BackOfQ(50%),veh/ln	0.0	26.9	5.4	30.9	0.0	0.0						
Unsig. Movement Delay, s/veh												
LnGrp Delay(d),s/veh	0.0	73.9	17.9	105.9	0.3	0.0						
LnGrp LOS	A	F	B	F	A	A						
Approach Vol, veh/h		2177			2213							
Approach Delay, s/veh		63.7			40.7							
Approach LOS		E			D							
Timer - Assigned Phs	1	2					6					
Phs Duration (G+Y+Rc), s	43.0	50.0					93.0					
Change Period (Y+Rc), s	4.5	6.0					6.0					
Max Green Setting (Gmax), s	38.5	44.0					87.0					
Max Q Clear Time (g_c+I1), s	40.5	46.0					5.7					
Green Ext Time (p_c), s	0.0	0.0					7.6					

Intersection Summary

HCM 6th Ctrl Delay	52.1
HCM 6th LOS	D

Notes

Unsignalized Delay for [NBR] is excluded from calculations of the approach delay and intersection delay.

Timings

31: I-215 NB Ramps/Old 215 Frontage Rd. & Cactus Av.



Lane Group	EBL	EBT	WBT	NBL	NBT	NBR	SBL	SBT
Lane Configurations	↗	↕	↕	↖	↖	↗	↖	↖
Traffic Volume (vph)	105	1953	2518	216	252	86	196	3
Future Volume (vph)	105	1953	2518	216	252	86	196	3
Turn Type	Perm	NA	NA	Perm	NA	Perm	Perm	NA
Protected Phases		2	6		8			4
Permitted Phases	2			8		8	4	
Detector Phase	2	2	6	8	8	8	4	4
Switch Phase								
Minimum Initial (s)	5.0	5.0	5.0	5.0	5.0	5.0	5.0	5.0
Minimum Split (s)	11.0	11.0	44.0	10.5	10.5	10.5	10.5	10.5
Total Split (s)	57.4	57.4	57.4	27.6	27.6	27.6	27.6	27.6
Total Split (%)	67.5%	67.5%	67.5%	32.5%	32.5%	32.5%	32.5%	32.5%
Yellow Time (s)	5.0	5.0	5.0	4.5	4.5	4.5	4.5	4.5
All-Red Time (s)	1.0	1.0	1.0	1.0	1.0	1.0	1.0	1.0
Lost Time Adjust (s)	0.0	0.0	0.0	0.0	0.0	0.0	0.0	0.0
Total Lost Time (s)	6.0	6.0	6.0	5.5	5.5	5.5	5.5	5.5
Lead/Lag								
Lead-Lag Optimize?								
Recall Mode	Min	Min	Min	None	None	None	None	None
Act Effct Green (s)	51.4	51.4	51.4	22.1	22.1	22.1	22.1	22.1
Actuated g/C Ratio	0.60	0.60	0.60	0.26	0.26	0.26	0.26	0.26
v/c Ratio	1.25	1.39	1.34	0.91	0.60	0.19	1.04	0.50
Control Delay	203.7	196.9	176.6	71.8	33.8	15.9	108.4	31.5
Queue Delay	0.0	0.0	0.0	0.0	0.0	0.0	0.0	0.0
Total Delay	203.7	196.9	176.6	71.8	33.8	15.9	108.4	31.5
LOS	F	F	F	E	C	B	F	C
Approach Delay		197.1	176.6		46.1			69.4
Approach LOS		F	F		D			E

Intersection Summary

Cycle Length: 85
 Actuated Cycle Length: 85
 Natural Cycle: 55
 Control Type: Actuated-Uncoordinated
 Maximum v/c Ratio: 1.39
 Intersection Signal Delay: 167.7
 Intersection LOS: F
 Intersection Capacity Utilization 126.4%
 ICU Level of Service H
 Analysis Period (min) 15

Splits and Phases: 31: I-215 NB Ramps/Old 215 Frontage Rd. & Cactus Av.

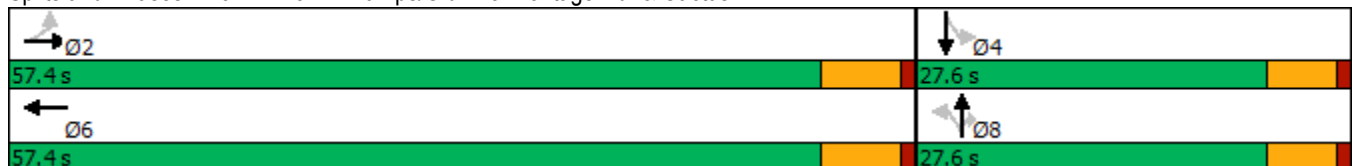

HCM 6th Signalized Intersection Summary

West Campus Upper Plateau (JN 14064)

31: I-215 NB Ramps/Old 215 Frontage Rd. & Cactus Av.

09/19/2022

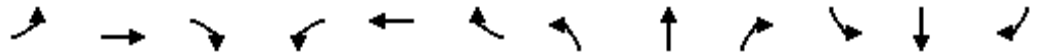

Movement	EBL	EBT	EBR	WBL	WBT	WBR	NBL	NBT	NBR	SBL	SBT	SBR
Lane Configurations	↶	↷			↷		↶	↷	↷	↶	↷	
Traffic Volume (veh/h)	105	1953	749	0	2518	187	216	252	86	196	3	199
Future Volume (veh/h)	105	1953	749	0	2518	187	216	252	86	196	3	199
Initial Q (Qb), veh	0	0	0	0	0	0	0	0	0	0	0	0
Ped-Bike Adj(A_pbT)	1.00		1.00	1.00		1.00	1.00		1.00	1.00		1.00
Parking Bus, Adj	1.00	1.00	1.00	1.00	1.00	1.00	1.00	1.00	1.00	1.00	1.00	1.00
Work Zone On Approach		No			No			No			No	
Adj Sat Flow, veh/h/ln	1856	1841	1767	0	1856	1885	1767	1856	1870	1841	1900	1885
Adj Flow Rate, veh/h	109	2034	776	0	2623	147	225	262	0	204	3	181
Peak Hour Factor	0.96	0.96	0.96	0.96	0.96	0.96	0.96	0.96	0.96	0.96	0.96	0.96
Percent Heavy Veh, %	3	4	9	0	3	1	9	3	2	4	0	1
Cap, veh/h	85	1526	546	0	2053	114	271	482		237	7	413
Arrive On Green	0.60	0.60	0.60	0.00	0.60	0.60	0.26	0.26	0.00	0.26	0.26	0.26
Sat Flow, veh/h	99	2523	904	0	3488	188	1133	1856	1585	1100	26	1588
Grp Volume(v), veh/h	109	1369	1441	0	1349	1421	225	262	0	204	0	184
Grp Sat Flow(s),veh/h/ln	99	1749	1678	0	1763	1821	1133	1856	1585	1100	0	1614
Q Serve(g_s), s	0.0	51.4	51.4	0.0	51.4	51.4	14.0	10.3	0.0	11.8	0.0	8.1
Cycle Q Clear(g_c), s	51.4	51.4	51.4	0.0	51.4	51.4	22.1	10.3	0.0	22.1	0.0	8.1
Prop In Lane	1.00		0.54	0.00		0.10	1.00		1.00	1.00		0.98
Lane Grp Cap(c), veh/h	85	1057	1015	0	1066	1101	271	482		237	0	420
V/C Ratio(X)	1.29	1.29	1.42	0.00	1.27	1.29	0.83	0.54		0.86	0.00	0.44
Avail Cap(c_a), veh/h	85	1057	1015	0	1066	1101	271	482		237	0	420
HCM Platoon Ratio	1.00	1.00	1.00	1.00	1.00	1.00	1.00	1.00	1.00	1.00	1.00	1.00
Upstream Filter(I)	1.00	1.00	1.00	0.00	1.00	1.00	1.00	1.00	0.00	1.00	0.00	1.00
Uniform Delay (d), s/veh	42.5	16.8	16.8	0.0	16.8	16.8	36.7	27.1	0.0	38.1	0.0	26.3
Incr Delay (d2), s/veh	192.9	139.7	194.9	0.0	127.3	137.3	17.9	0.7	0.0	25.1	0.0	0.3
Initial Q Delay(d3),s/veh	0.0	0.0	0.0	0.0	0.0	0.0	0.0	0.0	0.0	0.0	0.0	0.0
%ile BackOfQ(50%),veh/ln	6.2	56.4	69.7	0.0	53.2	58.1	5.8	4.3	0.0	5.7	0.0	2.9
Unsig. Movement Delay, s/veh												
LnGrp Delay(d),s/veh	235.4	156.5	211.7	0.0	144.1	154.1	54.5	27.8	0.0	63.2	0.0	26.5
LnGrp LOS	F	F	F	A	F	F	D	C		E	A	C
Approach Vol, veh/h		2919			2770			487				388
Approach Delay, s/veh		186.7			149.2			40.2				45.8
Approach LOS		F			F			D				D
Timer - Assigned Phs		2		4		6		8				
Phs Duration (G+Y+Rc), s		57.4		27.6		57.4		27.6				
Change Period (Y+Rc), s		6.0		5.5		6.0		5.5				
Max Green Setting (Gmax), s		51.4		22.1		51.4		22.1				
Max Q Clear Time (g_c+I1), s		53.4		24.1		53.4		24.1				
Green Ext Time (p_c), s		0.0		0.0		0.0		0.0				

Intersection Summary

HCM 6th Ctrl Delay	151.7
HCM 6th LOS	F

Notes

User approved volume balancing among the lanes for turning movement.
 Unsignalized Delay for [NBR] is excluded from calculations of the approach delay and intersection delay.

Timings
32: I-215 SB Ramps & Van Buren Bl.

West Campus Upper Plateau (JN 14064)

09/19/2022



Lane Group	EBT	EBR	WBL	WBT	SBT	SBR
Lane Configurations	↑↑	↑↑	↙	↑↑	↙	↑↑
Traffic Volume (vph)	1424	2457	184	1540	98	748
Future Volume (vph)	1424	2457	184	1540	98	748
Turn Type	NA	Perm	Prot	NA	NA	Perm
Protected Phases	6		5	2	8	
Permitted Phases		6				8
Detector Phase	6	6	5	2	8	8
Switch Phase						
Minimum Initial (s)	5.0	5.0	5.0	5.0	5.0	5.0
Minimum Split (s)	36.0	36.0	11.0	11.0	11.0	11.0
Total Split (s)	60.0	60.0	11.0	71.0	14.0	14.0
Total Split (%)	70.6%	70.6%	12.9%	83.5%	16.5%	16.5%
Yellow Time (s)	5.0	5.0	5.0	5.0	5.0	5.0
All-Red Time (s)	1.0	1.0	1.0	1.0	1.0	1.0
Lost Time Adjust (s)	0.0	0.0	0.0	0.0	0.0	0.0
Total Lost Time (s)	6.0	6.0	6.0	6.0	6.0	6.0
Lead/Lag	Lag	Lag	Lead			
Lead-Lag Optimize?	Yes	Yes	Yes			
Recall Mode	Min	Min	None	Min	Max	Max
Act Effct Green (s)	54.0	54.0	5.0	65.0	8.0	8.0
Actuated g/C Ratio	0.64	0.64	0.06	0.76	0.09	0.09
v/c Ratio	0.71	1.42	1.89	0.63	4.01	2.34
Control Delay	12.8	212.8	458.6	5.9	1380.3	633.1
Queue Delay	0.0	0.0	0.0	0.0	0.0	0.0
Total Delay	12.8	212.8	458.6	5.9	1380.3	633.1
LOS	B	F	F	A	F	F
Approach Delay	139.4			54.2	974.7	
Approach LOS	F			D	F	

Intersection Summary

Cycle Length: 85
 Actuated Cycle Length: 85
 Natural Cycle: 120
 Control Type: Actuated-Uncoordinated
 Maximum v/c Ratio: 4.01
 Intersection Signal Delay: 283.1
 Intersection Capacity Utilization 137.2%
 Analysis Period (min) 15
 Intersection LOS: F
 ICU Level of Service H

Splits and Phases: 32: I-215 SB Ramps & Van Buren Bl.



HCM 6th Signalized Intersection Summary
 32: I-215 SB Ramps & Van Buren Bl.

West Campus Upper Plateau (JN 14064)

09/19/2022



Movement	EBL	EBT	EBR	WBL	WBT	WBR	NBL	NBT	NBR	SBL	SBT	SBR
Lane Configurations		↑↑	↑↑	↑	↑↑						↑	↑↑
Traffic Volume (veh/h)	0	1424	2457	184	1540	0	0	0	0	532	98	748
Future Volume (veh/h)	0	1424	2457	184	1540	0	0	0	0	532	98	748
Initial Q (Qb), veh	0	0	0	0	0	0				0	0	0
Ped-Bike Adj(A_pbT)	1.00		1.00	1.00		1.00				1.00		1.00
Parking Bus, Adj	1.00	1.00	1.00	1.00	1.00	1.00				1.00	1.00	1.00
Work Zone On Approach		No			No						No	
Adj Sat Flow, veh/h/ln	0	1796	1856	1885	1826	0				1885	1841	1722
Adj Flow Rate, veh/h	0	1531	2543	198	1656	0				572	105	0
Peak Hour Factor	0.93	0.93	0.93	0.93	0.93	0.93				0.93	0.93	0.93
Percent Heavy Veh, %	0	7	3	1	5	0				1	4	12
Cap, veh/h	0	2168	1758	106	2653	0				140	26	
Arrive On Green	0.00	0.64	0.64	0.06	0.76	0.00				0.09	0.09	0.00
Sat Flow, veh/h	0	3503	2768	1795	3561	0				1492	274	2569
Grp Volume(v), veh/h	0	1531	2543	198	1656	0				677	0	0
Grp Sat Flow(s),veh/h/ln	0	1706	1384	1795	1735	0				1766	0	1284
Q Serve(g_s), s	0.0	25.2	54.0	5.0	18.3	0.0				8.0	0.0	0.0
Cycle Q Clear(g_c), s	0.0	25.2	54.0	5.0	18.3	0.0				8.0	0.0	0.0
Prop In Lane	0.00		1.00	1.00		0.00				0.84		1.00
Lane Grp Cap(c), veh/h	0	2168	1758	106	2653	0				166	0	
V/C Ratio(X)	0.00	0.71	1.45	1.87	0.62	0.00				4.07	0.00	
Avail Cap(c_a), veh/h	0	2168	1758	106	2653	0				166	0	
HCM Platoon Ratio	1.00	1.00	1.00	1.00	1.00	1.00				1.00	1.00	1.00
Upstream Filter(I)	0.00	1.00	1.00	1.00	1.00	0.00				1.00	0.00	0.00
Uniform Delay (d), s/veh	0.0	10.3	15.5	40.0	4.5	0.0				38.5	0.0	0.0
Incr Delay (d2), s/veh	0.0	0.9	204.1	427.3	0.3	0.0				1397.0	0.0	0.0
Initial Q Delay(d3),s/veh	0.0	0.0	0.0	0.0	0.0	0.0				0.0	0.0	0.0
%ile BackOfQ(50%),veh/ln	0.0	6.7	60.9	14.6	2.9	0.0				67.8	0.0	0.0
Unsig. Movement Delay, s/veh												
LnGrp Delay(d),s/veh	0.0	11.2	219.6	467.3	4.8	0.0				1435.5	0.0	0.0
LnGrp LOS	A	B	F	F	A	A				F	A	
Approach Vol, veh/h		4074			1854							677
Approach Delay, s/veh		141.3			54.2							1435.5
Approach LOS		F			D							F
Timer - Assigned Phs		2			5	6		8				
Phs Duration (G+Y+Rc), s		71.0			11.0	60.0		14.0				
Change Period (Y+Rc), s		6.0			6.0	6.0		6.0				
Max Green Setting (Gmax), s		65.0			5.0	54.0		8.0				
Max Q Clear Time (g_c+I1), s		20.3			7.0	56.0		10.0				
Green Ext Time (p_c), s		9.9			0.0	0.0		0.0				

Intersection Summary

HCM 6th Ctrl Delay	249.5
HCM 6th LOS	F

Notes

Unsignalized Delay for [SBR] is excluded from calculations of the approach delay and intersection delay.

Timings
33: I-215 NB On/Off Ramp & Van Buren Bl.



Lane Group	EBT	EBR	WBT	NBL	NBR
Lane Configurations	↑↑	↑↑	↑↑	↑↑	↑
Traffic Volume (vph)	715	1294	888	1313	200
Future Volume (vph)	715	1294	888	1313	200
Turn Type	NA	pm+ov	NA	Prot	Perm
Protected Phases	6	4	2	4	
Permitted Phases		6			4
Detector Phase	6	4	2	4	4
Switch Phase					
Minimum Initial (s)	5.0	5.0	5.0	5.0	5.0
Minimum Split (s)	11.0	42.0	11.0	42.0	42.0
Total Split (s)	15.0	55.0	15.0	55.0	55.0
Total Split (%)	21.4%	78.6%	21.4%	78.6%	78.6%
Yellow Time (s)	5.0	5.0	5.0	5.0	5.0
All-Red Time (s)	1.0	1.0	1.0	1.0	1.0
Lost Time Adjust (s)	0.0	0.0	0.0	0.0	0.0
Total Lost Time (s)	6.0	6.0	6.0	6.0	6.0
Lead/Lag					
Lead-Lag Optimize?					
Recall Mode	None	Min	None	Min	Min
Act Effct Green (s)	9.2	49.8	9.2	28.2	28.2
Actuated g/C Ratio	0.18	1.00	0.18	0.57	0.57
v/c Ratio	1.12	0.52	1.40	0.74	0.23
Control Delay	100.4	0.7	211.0	10.3	5.5
Queue Delay	0.0	0.0	0.0	0.0	0.0
Total Delay	100.4	0.7	211.0	10.3	5.5
LOS	F	A	F	B	A
Approach Delay	36.2		211.0	9.7	
Approach LOS	D		F	A	

Intersection Summary

Cycle Length: 70
 Actuated Cycle Length: 49.8
 Natural Cycle: 65
 Control Type: Actuated-Uncoordinated
 Maximum v/c Ratio: 1.40
 Intersection Signal Delay: 62.3
 Intersection LOS: E
 Intersection Capacity Utilization 72.0%
 ICU Level of Service C
 Analysis Period (min) 15

Splits and Phases: 33: I-215 NB On/Off Ramp & Van Buren Bl.



HCM 6th Signalized Intersection Summary
33: I-215 NB On/Off Ramp & Van Buren Bl.

West Campus Upper Plateau (JN 14064)

09/19/2022

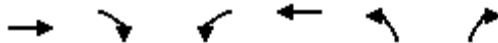

Movement	EBT	EBR	WBL	WBT	NBL	NBR
Lane Configurations	↑↑	↑↑		↑↑	↑↑	↑
Traffic Volume (veh/h)	715	1294	0	888	1313	200
Future Volume (veh/h)	715	1294	0	888	1313	200
Initial Q (Qb), veh	0	0	0	0	0	0
Ped-Bike Adj(A_pbT)		1.00	1.00		1.00	1.00
Parking Bus, Adj	1.00	1.00	1.00	1.00	1.00	1.00
Work Zone On Approach	No			No	No	
Adj Sat Flow, veh/h/ln	1900	1781	0	1900	1811	1885
Adj Flow Rate, veh/h	753	1354	0	935	1382	211
Peak Hour Factor	0.95	0.95	0.95	0.95	0.95	0.95
Percent Heavy Veh, %	0	8	0	0	6	1
Cap, veh/h	785	1886	0	785	1647	787
Arrive On Green	0.22	0.22	0.00	0.22	0.49	0.49
Sat Flow, veh/h	3705	2657	0	3800	3346	1598
Grp Volume(v), veh/h	753	1354	0	935	1382	211
Grp Sat Flow(s),veh/h/ln	1805	1329	0	1805	1673	1598
Q Serve(g_s), s	8.5	9.0	0.0	9.0	14.8	3.2
Cycle Q Clear(g_c), s	8.5	9.0	0.0	9.0	14.8	3.2
Prop In Lane		1.00	0.00		1.00	1.00
Lane Grp Cap(c), veh/h	785	1886	0	785	1647	787
V/C Ratio(X)	0.96	0.72	0.00	1.19	0.84	0.27
Avail Cap(c_a), veh/h	785	1886	0	785	3964	1892
HCM Platoon Ratio	1.00	1.00	1.00	1.00	1.00	1.00
Upstream Filter(I)	1.00	1.00	0.00	1.00	1.00	1.00
Uniform Delay (d), s/veh	16.0	3.0	0.0	16.2	9.1	6.1
Incr Delay (d2), s/veh	22.3	1.2	0.0	98.2	0.5	0.1
Initial Q Delay(d3),s/veh	0.0	0.0	0.0	0.0	0.0	0.0
%ile BackOfQ(50%),veh/ln	4.9	5.5	0.0	13.3	2.8	0.6
Unsig. Movement Delay, s/veh						
LnGrp Delay(d),s/veh	38.3	4.2	0.0	114.4	9.5	6.2
LnGrp LOS	D	A	A	F	A	A
Approach Vol, veh/h	2107			935	1593	
Approach Delay, s/veh	16.4			114.4	9.1	
Approach LOS	B			F	A	
Timer - Assigned Phs		2		4		6
Phs Duration (G+Y+Rc), s		15.0		26.4		15.0
Change Period (Y+Rc), s		6.0		6.0		6.0
Max Green Setting (Gmax), s		9.0		49.0		9.0
Max Q Clear Time (g_c+11), s		11.0		16.8		11.0
Green Ext Time (p_c), s		0.0		3.6		0.0
Intersection Summary						
HCM 6th Ctrl Delay			33.7			
HCM 6th LOS			C			

Timings

West Campus Upper Plateau (JN 14064)

34: Old 215 Frontage Rd. & Alessandro Bl.

09/19/2022

Lane Group	EBL	EBT	EBR	WBL	WBT	WBR	NBL	NBT	NBR	SBL	SBT	SBR
Lane Configurations												
Traffic Volume (vph)	398	1892	115	15	1282	128	42	212	16	143	243	269
Future Volume (vph)	398	1892	115	15	1282	128	42	212	16	143	243	269
Turn Type	Prot	NA	Perm	Prot	NA	Perm	Prot	NA	Perm	Prot	NA	Perm
Protected Phases	5	2		1	6		3	8		7	4	
Permitted Phases			2			6			8			4
Detector Phase	5	2	2	1	6	6	3	8	8	7	4	4
Switch Phase												
Minimum Initial (s)	5.0	10.0	10.0	5.0	10.0	10.0	5.0	10.0	10.0	5.0	10.0	10.0
Minimum Split (s)	8.7	43.5	43.5	8.7	15.8	15.8	8.7	16.2	16.2	8.7	40.2	40.2
Total Split (s)	22.0	62.4	62.4	8.7	49.1	49.1	8.7	29.7	29.7	19.2	40.2	40.2
Total Split (%)	18.3%	52.0%	52.0%	7.3%	40.9%	40.9%	7.3%	24.8%	24.8%	16.0%	33.5%	33.5%
Yellow Time (s)	3.2	5.5	5.5	3.2	4.8	4.8	3.2	5.2	5.2	3.2	5.2	5.2
All-Red Time (s)	0.5	1.0	1.0	0.5	1.0	1.0	0.5	1.0	1.0	0.5	1.0	1.0
Lost Time Adjust (s)	0.0	0.0	0.0	0.0	0.0	0.0	0.0	0.0	0.0	0.0	0.0	0.0
Total Lost Time (s)	3.7	6.5	6.5	3.7	5.8	5.8	3.7	6.2	6.2	3.7	6.2	6.2
Lead/Lag	Lead	Lag	Lag	Lead	Lag	Lag	Lead	Lag	Lag	Lead	Lag	Lag
Lead-Lag Optimize?	Yes	Yes	Yes	Yes	Yes	Yes	Yes	Yes	Yes	Yes	Yes	Yes
Recall Mode	None	None	None	None	None	None	None	None	None	None	None	None
Act Effct Green (s)	16.2	59.7	59.7	5.0	43.6	43.6	5.0	13.6	13.6	12.5	24.9	24.9
Actuated g/C Ratio	0.15	0.57	0.57	0.05	0.41	0.41	0.05	0.13	0.13	0.12	0.24	0.24
v/c Ratio	0.79	0.66	0.14	0.20	0.89	0.18	0.32	0.48	0.05	0.72	0.32	0.50
Control Delay	56.1	19.3	2.8	59.0	39.4	2.4	58.3	46.8	0.3	65.8	35.3	7.6
Queue Delay	0.0	0.0	0.0	0.0	0.0	0.0	0.0	0.0	0.0	0.0	0.0	0.0
Total Delay	56.1	19.3	2.8	59.0	39.4	2.4	58.3	46.8	0.3	65.8	35.3	7.6
LOS	E	B	A	E	D	A	E	D	A	E	D	A
Approach Delay		24.6			36.2			45.9			30.6	
Approach LOS		C			D			D			C	

Intersection Summary

Cycle Length: 120
 Actuated Cycle Length: 105.5
 Natural Cycle: 115
 Control Type: Actuated-Uncoordinated
 Maximum v/c Ratio: 0.89
 Intersection Signal Delay: 30.1
 Intersection LOS: C
 Intersection Capacity Utilization 79.7%
 ICU Level of Service D
 Analysis Period (min) 15

Splits and Phases: 34: Old 215 Frontage Rd. & Alessandro Bl.



HCM 6th Signalized Intersection Summary
34: Old 215 Frontage Rd. & Alessandro Bl.

West Campus Upper Plateau (JN 14064)

09/19/2022



Movement	EBL	EBT	EBR	WBL	WBT	WBR	NBL	NBT	NBR	SBL	SBT	SBR
Lane Configurations	↗↘	↑↑↑	↗	↘	↑↑	↗	↗↘	↑↑	↗	↘	↑↑	↗
Traffic Volume (veh/h)	398	1892	115	15	1282	128	42	212	16	143	243	269
Future Volume (veh/h)	398	1892	115	15	1282	128	42	212	16	143	243	269
Initial Q (Qb), veh	0	0	0	0	0	0	0	0	0	0	0	0
Ped-Bike Adj(A_pbT)	1.00		0.99	1.00		1.00	1.00		0.98	1.00		1.00
Parking Bus, Adj	1.00	1.00	1.00	1.00	1.00	1.00	1.00	1.00	1.00	1.00	1.00	1.00
Work Zone On Approach		No			No			No			No	
Adj Sat Flow, veh/h/ln	1826	1885	1678	1678	1870	1856	1574	1856	1574	1826	1752	1693
Adj Flow Rate, veh/h	406	1931	90	15	1308	0	43	216	6	146	248	0
Peak Hour Factor	0.98	0.98	0.98	0.98	0.98	0.98	0.98	0.98	0.98	0.98	0.98	0.98
Percent Heavy Veh, %	5	1	15	15	2	3	22	3	22	5	10	14
Cap, veh/h	484	2833	773	28	1508		106	386	144	178	585	
Arrive On Green	0.14	0.55	0.55	0.02	0.42	0.00	0.04	0.11	0.11	0.10	0.18	0.00
Sat Flow, veh/h	3374	5147	1404	1598	3554	1572	2908	3526	1312	1739	3328	1434
Grp Volume(v), veh/h	406	1931	90	15	1308	0	43	216	6	146	248	0
Grp Sat Flow(s),veh/h/ln	1687	1716	1404	1598	1777	1572	1454	1763	1312	1739	1664	1434
Q Serve(g_s), s	10.7	24.6	2.8	0.9	30.6	0.0	1.3	5.3	0.4	7.5	6.1	0.0
Cycle Q Clear(g_c), s	10.7	24.6	2.8	0.9	30.6	0.0	1.3	5.3	0.4	7.5	6.1	0.0
Prop In Lane	1.00		1.00	1.00		1.00	1.00		1.00	1.00		1.00
Lane Grp Cap(c), veh/h	484	2833	773	28	1508		106	386	144	178	585	
V/C Ratio(X)	0.84	0.68	0.12	0.54	0.87		0.41	0.56	0.04	0.82	0.42	
Avail Cap(c_a), veh/h	676	3151	860	87	1685		159	907	338	295	1239	
HCM Platoon Ratio	1.00	1.00	1.00	1.00	1.00	1.00	1.00	1.00	1.00	1.00	1.00	1.00
Upstream Filter(I)	1.00	1.00	1.00	1.00	1.00	0.00	1.00	1.00	1.00	1.00	1.00	0.00
Uniform Delay (d), s/veh	38.1	14.8	9.9	44.5	23.9	0.0	43.0	38.6	36.4	40.1	33.5	0.0
Incr Delay (d2), s/veh	4.8	0.5	0.1	6.0	4.7	0.0	0.9	1.3	0.1	3.5	0.5	0.0
Initial Q Delay(d3),s/veh	0.0	0.0	0.0	0.0	0.0	0.0	0.0	0.0	0.0	0.0	0.0	0.0
%ile BackOfQ(50%),veh/ln	4.4	7.8	0.7	0.4	12.4	0.0	0.5	2.2	0.1	3.2	2.3	0.0
Unsig. Movement Delay, s/veh												
LnGrp Delay(d),s/veh	42.9	15.3	9.9	50.5	28.6	0.0	44.0	39.8	36.5	43.7	34.0	0.0
LnGrp LOS	D	B	A	D	C		D	D	D	D	C	
Approach Vol, veh/h		2427			1323			265			394	
Approach Delay, s/veh		19.7			28.9			40.4			37.6	
Approach LOS		B			C			D			D	
Timer - Assigned Phs	1	2	3	4	5	6	7	8				
Phs Duration (G+Y+Rc), s	5.3	56.8	7.0	22.2	16.8	45.2	13.1	16.2				
Change Period (Y+Rc), s	3.7	6.5	3.7	6.2	3.7	* 6.5	3.7	6.2				
Max Green Setting (Gmax), s	5.0	55.9	5.0	34.0	18.3	* 43	15.5	23.5				
Max Q Clear Time (g_c+I1), s	2.9	26.6	3.3	8.1	12.7	32.6	9.5	7.3				
Green Ext Time (p_c), s	0.0	16.6	0.0	1.4	0.4	6.1	0.1	1.0				

Intersection Summary

HCM 6th Ctrl Delay	25.3
HCM 6th LOS	C

Notes

* HCM 6th computational engine requires equal clearance times for the phases crossing the barrier.
Unsignalized Delay for [WBR, SBR] is excluded from calculations of the approach delay and intersection delay.

Timings
35: Day St. & Alessandro Bl.

West Campus Upper Plateau (JN 14064)

09/19/2022



Lane Group	EBL	EBT	EBR	WBL	WBT	WBR	NBL	NBT	NBR	SBL	SBT
Lane Configurations	↖	↗↗↗	↖	↖	↗↗	↖	↖	↗	↖	↖	↗
Traffic Volume (vph)	282	1825	24	14	1194	216	17	184	13	248	160
Future Volume (vph)	282	1825	24	14	1194	216	17	184	13	248	160
Turn Type	Prot	NA	Perm	Prot	NA	Perm	Perm	NA	Perm	Perm	NA
Protected Phases	5	2		1	6			8			4
Permitted Phases			2			6	8		8	4	
Detector Phase	5	2	2	1	6	6	8	8	8	4	4
Switch Phase											
Minimum Initial (s)	5.0	10.0	10.0	5.0	10.0	10.0	10.0	10.0	10.0	10.0	10.0
Minimum Split (s)	9.1	30.8	30.8	9.1	30.8	30.8	42.4	42.4	42.4	41.6	41.6
Total Split (s)	28.0	67.9	67.9	9.1	49.0	49.0	43.0	43.0	43.0	43.0	43.0
Total Split (%)	23.3%	56.6%	56.6%	7.6%	40.8%	40.8%	35.8%	35.8%	35.8%	35.8%	35.8%
Yellow Time (s)	3.6	4.8	4.8	3.6	4.8	4.8	4.4	4.4	4.4	3.6	3.6
All-Red Time (s)	0.5	1.0	1.0	0.5	1.0	1.0	1.0	1.0	1.0	1.0	1.0
Lost Time Adjust (s)	0.0	0.0	0.0	0.0	0.0	0.0	0.0	0.0	0.0	0.0	0.0
Total Lost Time (s)	4.1	5.8	5.8	4.1	5.8	5.8	5.4	5.4	5.4	4.6	4.6
Lead/Lag	Lead	Lag	Lag	Lead	Lag	Lag					
Lead-Lag Optimize?	Yes	Yes	Yes	Yes	Yes	Yes					
Recall Mode	None	None	None	None	None	None	None	None	None	None	None
Act Effct Green (s)	20.9	64.0	64.0	5.1	42.2	42.2	30.5	30.5	30.5	31.3	31.3
Actuated g/C Ratio	0.19	0.59	0.59	0.05	0.39	0.39	0.28	0.28	0.28	0.29	0.29
v/c Ratio	0.85	0.64	0.03	0.18	0.91	0.34	0.14	0.36	0.03	0.87	0.63
Control Delay	67.3	17.9	0.2	60.2	44.2	16.4	33.1	33.9	0.1	66.1	35.3
Queue Delay	0.0	0.0	0.0	0.0	0.0	0.0	0.0	0.0	0.0	0.0	0.0
Total Delay	67.3	17.9	0.2	60.2	44.2	16.4	33.1	33.9	0.1	66.1	35.3
LOS	E	B	A	E	D	B	C	C	A	E	D
Approach Delay		24.3			40.1			31.7			48.7
Approach LOS		C			D			C			D

Intersection Summary

Cycle Length: 120
 Actuated Cycle Length: 109.2
 Natural Cycle: 105
 Control Type: Actuated-Uncoordinated
 Maximum v/c Ratio: 0.91
 Intersection Signal Delay: 33.0
 Intersection LOS: C
 Intersection Capacity Utilization 91.8%
 ICU Level of Service F
 Analysis Period (min) 15



























Splits and Phases: 35: Day St. & Alessandro Bl.



HCM 6th Signalized Intersection Summary
35: Day St. & Alessandro Bl.

West Campus Upper Plateau (JN 14064)

09/19/2022

												
Movement	EBL	EBT	EBR	WBL	WBT	WBR	NBL	NBT	NBR	SBL	SBT	SBR
Lane Configurations		  			 							
Traffic Volume (veh/h)	282	1825	24	14	1194	216	17	184	13	248	160	161
Future Volume (veh/h)	282	1825	24	14	1194	216	17	184	13	248	160	161
Initial Q (Qb), veh	0	0	0	0	0	0	0	0	0	0	0	0
Ped-Bike Adj(A_pbT)	1.00		0.98	1.00		0.98	1.00		1.00	1.00		1.00
Parking Bus, Adj	1.00	1.00	1.00	1.00	1.00	1.00	1.00	1.00	1.00	1.00	1.00	1.00
Work Zone On Approach		No			No			No			No	
Adj Sat Flow, veh/h/ln	1900	1870	1618	1900	1870	1900	1500	1900	1767	1885	1885	1885
Adj Flow Rate, veh/h	294	1901	19	15	1244	157	18	192	9	258	167	137
Peak Hour Factor	0.96	0.96	0.96	0.96	0.96	0.96	0.96	0.96	0.96	0.96	0.96	0.96
Percent Heavy Veh, %	0	2	19	0	2	0	27	0	9	1	1	1
Cap, veh/h	323	2729	717	30	1324	587	210	598	471	346	302	247
Arrive On Green	0.18	0.53	0.53	0.02	0.37	0.37	0.31	0.31	0.31	0.31	0.31	0.31
Sat Flow, veh/h	1810	5106	1341	1810	3554	1575	862	1900	1497	1191	958	786
Grp Volume(v), veh/h	294	1901	19	15	1244	157	18	192	9	258	0	304
Grp Sat Flow(s),veh/h/ln	1810	1702	1341	1810	1777	1575	862	1900	1497	1191	0	1744
Q Serve(g_s), s	18.2	31.5	0.8	0.9	38.5	7.9	2.0	8.8	0.5	24.0	0.0	16.5
Cycle Q Clear(g_c), s	18.2	31.5	0.8	0.9	38.5	7.9	18.5	8.8	0.5	32.8	0.0	16.5
Prop In Lane	1.00		1.00	1.00		1.00	1.00		1.00	1.00		0.45
Lane Grp Cap(c), veh/h	323	2729	717	30	1324	587	210	598	471	346	0	549
V/C Ratio(X)	0.91	0.70	0.03	0.50	0.94	0.27	0.09	0.32	0.02	0.75	0.00	0.55
Avail Cap(c_a), veh/h	379	2782	731	79	1347	597	223	627	494	373	0	588
HCM Platoon Ratio	1.00	1.00	1.00	1.00	1.00	1.00	1.00	1.00	1.00	1.00	1.00	1.00
Upstream Filter(I)	1.00	1.00	1.00	1.00	1.00	1.00	1.00	1.00	1.00	1.00	0.00	1.00
Uniform Delay (d), s/veh	45.9	19.7	12.5	55.6	34.5	24.9	40.1	29.8	26.9	42.3	0.0	32.4
Incr Delay (d2), s/veh	21.7	0.8	0.0	4.7	12.7	0.2	0.2	0.3	0.0	7.4	0.0	1.0
Initial Q Delay(d3),s/veh	0.0	0.0	0.0	0.0	0.0	0.0	0.0	0.0	0.0	0.0	0.0	0.0
%ile BackOfQ(50%),veh/ln	9.8	11.5	0.2	0.5	17.9	2.9	0.4	4.0	0.2	7.8	0.0	7.2
Unsig. Movement Delay, s/veh												
LnGrp Delay(d),s/veh	67.6	20.4	12.5	60.3	47.2	25.2	40.3	30.1	26.9	49.7	0.0	33.4
LnGrp LOS	E	C	B	E	D	C	D	C	C	D	A	C
Approach Vol, veh/h		2214			1416			219				562
Approach Delay, s/veh		26.6			44.9			30.8				40.9
Approach LOS		C			D			C				D
Timer - Assigned Phs	1	2		4	5	6		8				
Phs Duration (G+Y+Rc), s	6.0	66.7		41.3	24.4	48.3		41.3				
Change Period (Y+Rc), s	4.1	5.8		* 5.4	4.1	5.8		5.4				
Max Green Setting (Gmax), s	5.0	62.1		* 38	23.9	43.2		37.6				
Max Q Clear Time (g_c+I1), s	2.9	33.5		34.8	20.2	40.5		20.5				
Green Ext Time (p_c), s	0.0	16.6		1.1	0.2	2.0		1.0				

Intersection Summary

HCM 6th Ctrl Delay	34.5
HCM 6th LOS	C

Notes

* HCM 6th computational engine requires equal clearance times for the phases crossing the barrier.

Timings
36: Elsworth St. & Cactus Av.

West Campus Upper Plateau (JN 14064)

09/19/2022



Lane Group	EBL	EBT	EBR	WBL	WBT	WBR	NBL	NBT	SBL	SBT	SBR
Lane Configurations	↘	↑↑↑	↗	↘	↑↑↑	↗	↘	↕	↘	↗	↗
Traffic Volume (vph)	291	2592	30	17	1876	181	219	73	315	15	313
Future Volume (vph)	291	2592	30	17	1876	181	219	73	315	15	313
Turn Type	Prot	NA	Perm	Prot	NA	Perm	Split	NA	Split	NA	pm+ov
Protected Phases	5	2		1	6		8	8	4	4	5
Permitted Phases			2			6					4
Detector Phase	5	2	2	1	6	6	8	8	4	4	5
Switch Phase											
Minimum Initial (s)	5.0	10.0	10.0	5.0	10.0	10.0	10.0	10.0	10.0	10.0	5.0
Minimum Split (s)	9.6	36.2	36.2	9.6	36.2	36.2	35.4	35.4	35.4	35.4	9.6
Total Split (s)	16.5	49.6	49.6	9.6	42.7	42.7	35.4	35.4	35.4	35.4	16.5
Total Split (%)	12.7%	38.2%	38.2%	7.4%	32.8%	32.8%	27.2%	27.2%	27.2%	27.2%	12.7%
Yellow Time (s)	3.6	5.2	5.2	3.6	5.2	5.2	4.4	4.4	4.4	4.4	3.6
All-Red Time (s)	1.0	1.0	1.0	1.0	1.0	1.0	1.0	1.0	1.0	1.0	1.0
Lost Time Adjust (s)	0.0	0.0	0.0	0.0	0.0	0.0	0.0	0.0	0.0	0.0	0.0
Total Lost Time (s)	4.6	6.2	6.2	4.6	6.2	6.2	5.4	5.4	5.4	5.4	4.6
Lead/Lag	Lead	Lag	Lag	Lead	Lag	Lag					Lead
Lead-Lag Optimize?	Yes	Yes	Yes	Yes	Yes	Yes					Yes
Recall Mode	None	None	None	None	None	None	Max	Max	Max	Max	None
Act Effct Green (s)	11.9	49.2	49.2	5.0	36.5	36.5	30.0	30.0	30.0	30.0	42.7
Actuated g/C Ratio	0.09	0.38	0.38	0.04	0.28	0.28	0.23	0.23	0.23	0.23	0.33
v/c Ratio	1.87	1.43	0.05	0.26	1.38	0.34	0.51	0.47	0.43	0.43	0.52
Control Delay	446.0	229.6	0.1	70.2	213.2	12.3	49.1	40.4	46.8	46.8	13.3
Queue Delay	0.0	0.0	0.0	0.0	0.0	0.0	0.0	0.0	0.0	0.0	0.0
Total Delay	446.0	229.6	0.1	70.2	213.2	12.3	49.1	40.4	46.8	46.8	13.3
LOS	F	F	A	E	F	B	D	D	D	D	B
Approach Delay		248.9			194.5			44.8		30.5	
Approach LOS		F			F			D		C	

Intersection Summary

Cycle Length: 130
 Actuated Cycle Length: 130
 Natural Cycle: 120
 Control Type: Actuated-Uncoordinated
 Maximum v/c Ratio: 1.87
 Intersection Signal Delay: 193.9
 Intersection Capacity Utilization 91.9%
 Analysis Period (min) 15
 Intersection LOS: F
 ICU Level of Service F

Splits and Phases: 36: Elsworth St. & Cactus Av.

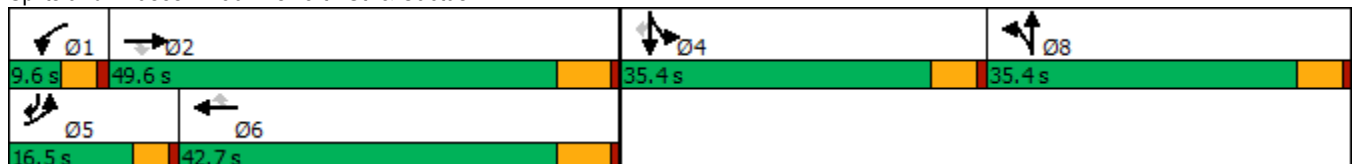

HCM 6th Signalized Intersection Summary
36: Elsworth St. & Cactus Av.

West Campus Upper Plateau (JN 14064)

09/19/2022



Movement	EBL	EBT	EBR	WBL	WBT	WBR	NBL	NBT	NBR	SBL	SBT	SBR
Lane Configurations	↖	↑↑↑	↗	↖	↑↑↑	↗	↖	↕		↖	↗	↖
Traffic Volume (veh/h)	291	2592	30	17	1876	181	219	73	85	315	15	313
Future Volume (veh/h)	291	2592	30	17	1876	181	219	73	85	315	15	313
Initial Q (Qb), veh	0	0	0	0	0	0	0	0	0	0	0	0
Ped-Bike Adj(A_pbT)	1.00		1.00	1.00		1.00	1.00		1.00	1.00		1.00
Parking Bus, Adj	1.00	1.00	1.00	1.00	1.00	1.00	1.00	1.00	1.00	1.00	1.00	1.00
Work Zone On Approach		No			No			No			No	
Adj Sat Flow, veh/h/ln	1870	1841	1781	1900	1856	1885	1885	1900	1885	1900	1900	1900
Adj Flow Rate, veh/h	303	2700	0	18	1954	153	185	137	65	339	0	219
Peak Hour Factor	0.96	0.96	0.96	0.96	0.96	0.96	0.96	0.96	0.96	0.96	0.96	0.96
Percent Heavy Veh, %	2	4	8	0	3	1	1	0	1	0	0	0
Cap, veh/h	163	1779		33	1422	449	414	281	133	835	0	519
Arrive On Green	0.09	0.35	0.00	0.02	0.28	0.28	0.23	0.23	0.23	0.23	0.00	0.23
Sat Flow, veh/h	1781	5025	1510	1810	5066	1598	1795	1218	578	3619	0	1610
Grp Volume(v), veh/h	303	2700	0	18	1954	153	185	0	202	339	0	219
Grp Sat Flow(s),veh/h/ln	1781	1675	1510	1810	1689	1598	1795	0	1796	1810	0	1610
Q Serve(g_s), s	11.9	46.0	0.0	1.3	36.5	9.9	11.5	0.0	12.7	10.3	0.0	13.9
Cycle Q Clear(g_c), s	11.9	46.0	0.0	1.3	36.5	9.9	11.5	0.0	12.7	10.3	0.0	13.9
Prop In Lane	1.00		1.00	1.00		1.00	1.00		0.32	1.00		1.00
Lane Grp Cap(c), veh/h	163	1779		33	1422	449	414	0	414	835	0	519
V/C Ratio(X)	1.86	1.52		0.54	1.37	0.34	0.45	0.00	0.49	0.41	0.00	0.42
Avail Cap(c_a), veh/h	163	1779		70	1422	449	414	0	414	835	0	519
HCM Platoon Ratio	1.00	1.00	1.00	1.00	1.00	1.00	1.00	1.00	1.00	1.00	1.00	1.00
Upstream Filter(l)	1.00	1.00	0.00	1.00	1.00	1.00	1.00	0.00	1.00	1.00	0.00	1.00
Uniform Delay (d), s/veh	59.1	42.0	0.0	63.3	46.7	37.2	42.9	0.0	43.3	42.4	0.0	34.6
Incr Delay (d2), s/veh	408.8	236.1	0.0	5.0	172.8	0.4	3.5	0.0	4.1	1.5	0.0	2.5
Initial Q Delay(d3),s/veh	0.0	0.0	0.0	0.0	0.0	0.0	0.0	0.0	0.0	0.0	0.0	0.0
%ile BackOfQ(50%),veh/ln	23.7	56.8	0.0	0.6	37.4	3.8	5.6	0.0	6.2	4.7	0.0	5.9
Unsig. Movement Delay, s/veh												
LnGrp Delay(d),s/veh	467.8	278.1	0.0	68.3	219.5	37.6	46.3	0.0	47.4	43.9	0.0	37.1
LnGrp LOS	F	F		E	F	D	D	A	D	D	A	D
Approach Vol, veh/h		3003			2125			387				558
Approach Delay, s/veh		297.2			205.1			46.9				41.2
Approach LOS		F			F			D				D
Timer - Assigned Phs	1	2		4	5	6		8				
Phs Duration (G+Y+Rc), s	7.0	52.2		35.4	16.5	42.7		35.4				
Change Period (Y+Rc), s	4.6	6.2		5.4	4.6	6.2		5.4				
Max Green Setting (Gmax), s	5.0	43.4		30.0	11.9	36.5		30.0				
Max Q Clear Time (g_c+1), s	3.3	48.0		15.9	13.9	38.5		14.7				
Green Ext Time (p_c), s	0.0	0.0		1.7	0.0	0.0		1.6				

Intersection Summary

HCM 6th Ctrl Delay	225.5
HCM 6th LOS	F

Notes

- User approved pedestrian interval to be less than phase max green.
- User approved volume balancing among the lanes for turning movement.
- Unsignalized Delay for [EBR] is excluded from calculations of the approach delay and intersection delay.

Timings
37: Cactus Av. & Frederick St.

West Campus Upper Plateau (JN 14064)

09/19/2022

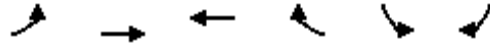

Lane Group	EBL	EBT	WBT	WBR	SBL	SBR
Lane Configurations	↗	↑↑↑	↑↑↑	↖	↘↘	↘
Traffic Volume (vph)	273	2583	1571	176	496	218
Future Volume (vph)	273	2583	1571	176	496	218
Turn Type	Prot	NA	NA	pm+ov	Prot	pm+ov
Protected Phases	5	2	6	4	4	5
Permitted Phases				6		4
Detector Phase	5	2	6	4	4	5
Switch Phase						
Minimum Initial (s)	5.0	10.0	10.0	10.0	10.0	5.0
Minimum Split (s)	9.2	28.2	29.2	36.4	36.4	9.2
Total Split (s)	31.0	81.0	50.0	39.0	39.0	31.0
Total Split (%)	25.8%	67.5%	41.7%	32.5%	32.5%	25.8%
Yellow Time (s)	3.2	5.2	5.2	4.4	4.4	3.2
All-Red Time (s)	1.0	1.0	1.0	1.0	1.0	1.0
Lost Time Adjust (s)	0.0	0.0	0.0	0.0	0.0	0.0
Total Lost Time (s)	4.2	6.2	6.2	5.4	5.4	4.2
Lead/Lag	Lead		Lag			Lead
Lead-Lag Optimize?	Yes		Yes			Yes
Recall Mode	None	None	None	None	None	None
Act Effct Green (s)	21.3	71.0	45.4	68.5	22.3	49.0
Actuated g/C Ratio	0.20	0.68	0.43	0.65	0.21	0.47
v/c Ratio	0.82	0.80	0.76	0.17	0.72	0.31
Control Delay	59.8	14.9	29.4	1.3	45.3	18.2
Queue Delay	0.0	0.0	0.0	0.0	0.0	0.0
Total Delay	59.8	14.9	29.4	1.3	45.3	18.2
LOS	E	B	C	A	D	B
Approach Delay		19.2	26.5		37.0	
Approach LOS		B	C		D	

Intersection Summary

Cycle Length: 120
 Actuated Cycle Length: 105
 Natural Cycle: 90
 Control Type: Actuated-Uncoordinated
 Maximum v/c Ratio: 0.82
 Intersection Signal Delay: 24.0
 Intersection LOS: C
 Intersection Capacity Utilization 73.7%
 ICU Level of Service D
 Analysis Period (min) 15

Splits and Phases: 37: Cactus Av. & Frederick St.

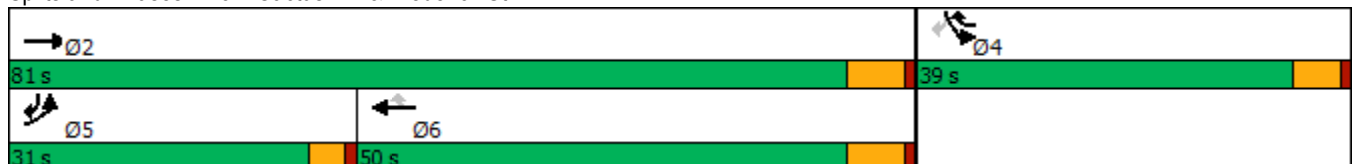

HCM 6th Signalized Intersection Summary
37: Cactus Av. & Frederick St.

West Campus Upper Plateau (JN 14064)

09/19/2022



Movement	EBL	EBT	WBT	WBR	SBL	SBR
Lane Configurations	↖	↑↑↑	↑↑↑	↗	↙	↘
Traffic Volume (veh/h)	273	2583	1571	176	496	218
Future Volume (veh/h)	273	2583	1571	176	496	218
Initial Q (Qb), veh	0	0	0	0	0	0
Ped-Bike Adj(A_pbT)	1.00			0.98	1.00	1.00
Parking Bus, Adj	1.00	1.00	1.00	1.00	1.00	1.00
Work Zone On Approach		No	No		No	
Adj Sat Flow, veh/h/ln	1841	1856	1856	1870	1856	1856
Adj Flow Rate, veh/h	287	2719	1654	123	522	132
Peak Hour Factor	0.95	0.95	0.95	0.95	0.95	0.95
Percent Heavy Veh, %	4	3	3	2	3	3
Cap, veh/h	321	3499	2350	1018	648	586
Arrive On Green	0.18	0.69	0.46	0.46	0.19	0.19
Sat Flow, veh/h	1753	5233	5233	1548	3428	1572
Grp Volume(v), veh/h	287	2719	1654	123	522	132
Grp Sat Flow(s),veh/h/ln	1753	1689	1689	1548	1714	1572
Q Serve(g_s), s	15.4	34.6	25.1	2.9	14.1	5.6
Cycle Q Clear(g_c), s	15.4	34.6	25.1	2.9	14.1	5.6
Prop In Lane	1.00			1.00	1.00	1.00
Lane Grp Cap(c), veh/h	321	3499	2350	1018	648	586
V/C Ratio(X)	0.89	0.78	0.70	0.12	0.81	0.23
Avail Cap(c_a), veh/h	487	3926	2350	1018	1194	836
HCM Platoon Ratio	1.00	1.00	1.00	1.00	1.00	1.00
Upstream Filter(I)	1.00	1.00	1.00	1.00	1.00	1.00
Uniform Delay (d), s/veh	38.5	10.0	20.6	6.3	37.4	20.8
Incr Delay (d2), s/veh	9.5	0.9	1.0	0.1	2.4	0.2
Initial Q Delay(d3),s/veh	0.0	0.0	0.0	0.0	0.0	0.0
%ile BackOfQ(50%),veh/ln	7.1	9.1	8.9	1.4	5.9	0.0
Unsig. Movement Delay, s/veh						
LnGrp Delay(d),s/veh	48.0	10.9	21.6	6.4	39.9	20.9
LnGrp LOS	D	B	C	A	D	C
Approach Vol, veh/h		3006	1777		654	
Approach Delay, s/veh		14.4	20.5		36.0	
Approach LOS		B	C		D	
Timer - Assigned Phs		2		4	5	6
Phs Duration (G+Y+Rc), s		72.9		23.6	21.9	51.0
Change Period (Y+Rc), s		6.2		5.4	* 4.2	6.2
Max Green Setting (Gmax), s		74.8		33.6	* 27	43.8
Max Q Clear Time (g_c+I1), s		36.6		16.1	17.4	27.1
Green Ext Time (p_c), s		30.1		2.2	0.3	10.3

Intersection Summary

HCM 6th Ctrl Delay	19.0
HCM 6th LOS	B

Notes

* HCM 6th computational engine requires equal clearance times for the phases crossing the barrier.

Timings
38: Riverside Dr./Graham St. & Cactus Av.

West Campus Upper Plateau (JN 14064)

09/19/2022

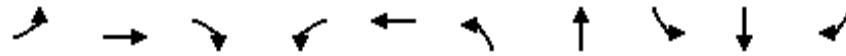

Lane Group	EBL	EBT	EBR	WBL	WBT	NBL	NBT	SBL	SBT	SBR
Lane Configurations	↘	↑↑↑	↗	↘	↑↑↑	↘↗	↑↗	↘	↑↑	↗
Traffic Volume (vph)	198	2890	421	19	1741	13	0	142	101	165
Future Volume (vph)	198	2890	421	19	1741	13	0	142	101	165
Turn Type	Prot	NA	Perm	Prot	NA	Prot	NA	Prot	NA	Perm
Protected Phases	7	4		3	8	5	2	1	6	
Permitted Phases			4							6
Detector Phase	7	4	4	3	8	5	2	1	6	6
Switch Phase										
Minimum Initial (s)	5.0	10.0	10.0	5.0	10.0	5.0	10.0	5.0	10.0	10.0
Minimum Split (s)	9.6	39.2	39.2	9.6	39.2	10.4	35.0	9.6	40.6	40.6
Total Split (s)	15.0	59.0	59.0	9.6	53.6	10.4	35.4	16.0	41.0	41.0
Total Split (%)	12.5%	49.2%	49.2%	8.0%	44.7%	8.7%	29.5%	13.3%	34.2%	34.2%
Yellow Time (s)	3.6	5.2	5.2	3.6	5.2	4.4	4.0	3.6	3.6	3.6
All-Red Time (s)	1.0	1.0	1.0	1.0	1.0	1.0	1.0	1.0	1.0	1.0
Lost Time Adjust (s)	0.0	0.0	0.0	0.0	0.0	0.0	0.0	0.0	0.0	0.0
Total Lost Time (s)	4.6	6.2	6.2	4.6	6.2	5.4	5.0	4.6	4.6	4.6
Lead/Lag	Lead	Lag	Lag	Lead	Lag	Lead	Lag	Lead	Lag	Lag
Lead-Lag Optimize?	Yes	Yes	Yes	Yes	Yes	Yes	Yes	Yes	Yes	Yes
Recall Mode	None	Min	Min	None	Min	None	None	None	None	None
Act Effct Green (s)	10.6	60.1	60.1	5.1	48.3	5.1	13.3	11.4	15.1	15.1
Actuated g/C Ratio	0.12	0.66	0.66	0.06	0.53	0.06	0.15	0.12	0.17	0.17
v/c Ratio	1.05	0.95	0.41	0.21	0.75	0.07	0.00	0.70	0.19	0.45
Control Delay	118.3	25.1	7.6	51.2	21.2	47.1	0.0	58.4	32.7	9.5
Queue Delay	0.0	0.0	0.0	0.0	0.0	0.0	0.0	0.0	0.0	0.0
Total Delay	118.3	25.1	7.6	51.2	21.2	47.1	0.0	58.4	32.7	9.5
LOS	F	C	A	D	C	D	A	E	C	A
Approach Delay		28.3			21.6		43.9		32.3	
Approach LOS		C			C		D		C	

Intersection Summary

Cycle Length: 120
 Actuated Cycle Length: 91.4
 Natural Cycle: 120
 Control Type: Actuated-Uncoordinated
 Maximum v/c Ratio: 1.05
 Intersection Signal Delay: 26.4
 Intersection LOS: C
 Intersection Capacity Utilization 87.4%
 ICU Level of Service E
 Analysis Period (min) 15

Splits and Phases: 38: Riverside Dr./Graham St. & Cactus Av.

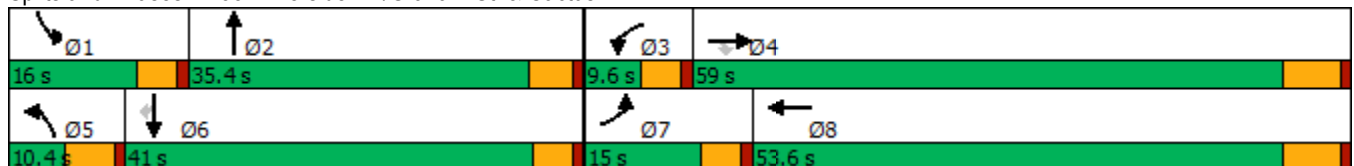

HCM 6th Signalized Intersection Summary
38: Riverside Dr./Graham St. & Cactus Av.

West Campus Upper Plateau (JN 14064)

09/19/2022



Movement	EBL	EBT	EBR	WBL	WBT	WBR	NBL	NBT	NBR	SBL	SBT	SBR
Lane Configurations	↗	↑↑↑	↘	↗	↑↑↑		↗↘	↑↘		↗	↑↑	↘
Traffic Volume (veh/h)	198	2890	421	19	1741	94	13	0	1	142	101	165
Future Volume (veh/h)	198	2890	421	19	1741	94	13	0	1	142	101	165
Initial Q (Qb), veh	0	0	0	0	0	0	0	0	0	0	0	0
Ped-Bike Adj(A_pbT)	1.00		1.00	1.00		0.99	1.00		1.00	1.00		1.00
Parking Bus, Adj	1.00	1.00	1.00	1.00	1.00	1.00	1.00	1.00	1.00	1.00	1.00	1.00
Work Zone On Approach		No			No			No			No	
Adj Sat Flow, veh/h/ln	1870	1856	1885	1900	1856	1900	1900	1900	1900	1870	1885	1856
Adj Flow Rate, veh/h	215	3141	410	21	1892	93	14	0	0	154	110	101
Peak Hour Factor	0.92	0.92	0.92	0.92	0.92	0.92	0.92	0.92	0.92	0.92	0.92	0.92
Percent Heavy Veh, %	2	3	1	0	3	0	0	0	0	2	1	3
Cap, veh/h	212	3059	965	41	2510	123	58	125	0	188	410	180
Arrive On Green	0.12	0.60	0.60	0.02	0.51	0.51	0.02	0.00	0.00	0.11	0.11	0.11
Sat Flow, veh/h	1781	5066	1598	1810	4943	242	3510	3705	0	1781	3582	1572
Grp Volume(v), veh/h	215	3141	410	21	1291	694	14	0	0	154	110	101
Grp Sat Flow(s),veh/h/ln	1781	1689	1598	1810	1689	1808	1755	1805	0	1781	1791	1572
Q Serve(g_s), s	10.4	52.8	12.0	1.0	26.6	26.8	0.3	0.0	0.0	7.4	2.5	5.3
Cycle Q Clear(g_c), s	10.4	52.8	12.0	1.0	26.6	26.8	0.3	0.0	0.0	7.4	2.5	5.3
Prop In Lane	1.00		1.00	1.00		0.13	1.00		0.00	1.00		1.00
Lane Grp Cap(c), veh/h	212	3059	965	41	1715	918	58	125	0	188	410	180
V/C Ratio(X)	1.01	1.03	0.42	0.51	0.75	0.76	0.24	0.00	0.00	0.82	0.27	0.56
Avail Cap(c_a), veh/h	212	3059	965	103	1831	980	201	1255	0	232	1491	655
HCM Platoon Ratio	1.00	1.00	1.00	1.00	1.00	1.00	1.00	1.00	1.00	1.00	1.00	1.00
Upstream Filter(I)	1.00	1.00	1.00	1.00	1.00	1.00	1.00	0.00	0.00	1.00	1.00	1.00
Uniform Delay (d), s/veh	38.5	17.3	9.2	42.2	17.2	17.2	42.5	0.0	0.0	38.3	35.4	36.6
Incr Delay (d2), s/veh	65.7	23.6	0.3	3.5	1.7	3.2	0.8	0.0	0.0	14.2	0.3	2.7
Initial Q Delay(d3),s/veh	0.0	0.0	0.0	0.0	0.0	0.0	0.0	0.0	0.0	0.0	0.0	0.0
%ile BackOfQ(50%),veh/ln	8.1	21.7	3.3	0.5	8.9	10.0	0.2	0.0	0.0	3.8	1.0	2.0
Unsig. Movement Delay, s/veh												
LnGrp Delay(d),s/veh	104.2	40.9	9.5	45.8	18.8	20.4	43.3	0.0	0.0	52.5	35.7	39.4
LnGrp LOS	F	F	A	D	B	C	D	A	A	D	D	D
Approach Vol, veh/h		3766			2006			14			365	
Approach Delay, s/veh		41.1			19.7			43.3			43.8	
Approach LOS		D			B			D			D	
Timer - Assigned Phs	1	2	3	4	5	6	7	8				
Phs Duration (G+Y+Rc), s	13.8	8.0	6.6	59.0	6.8	15.0	15.0	50.6				
Change Period (Y+Rc), s	4.6	5.0	4.6	6.2	5.4	* 5	4.6	6.2				
Max Green Setting (Gmax), s	11.4	30.4	5.0	52.8	5.0	* 36	10.4	47.4				
Max Q Clear Time (g_c+I1), s	9.4	0.0	3.0	54.8	2.3	7.3	12.4	28.8				
Green Ext Time (p_c), s	0.0	0.0	0.0	0.0	0.0	0.9	0.0	12.3				

Intersection Summary

HCM 6th Ctrl Delay	34.3
HCM 6th LOS	C

Notes

* HCM 6th computational engine requires equal clearance times for the phases crossing the barrier.

Timings
1: Washington St & Van Buren Bl.

West Campus Upper Plateau (JN 14064)

09/30/2022



Lane Group	EBL	EBT	WBL	WBT	WBR	NBL	NBT	NBR	SBL	SBT
Lane Configurations	↙	↕	↙	↕	↗	↙	↕	↗	↙	↕
Traffic Volume (vph)	126	991	141	963	307	146	219	159	406	191
Future Volume (vph)	126	991	141	963	307	146	219	159	406	191
Turn Type	Prot	NA	Prot	NA	Perm	Prot	NA	Perm	Prot	NA
Protected Phases	5	2	1	6		3	8		7	4
Permitted Phases					6			8		
Detector Phase	5	2	1	6	6	3	8	8	7	4
Switch Phase										
Minimum Initial (s)	5.0	10.0	5.0	10.0	10.0	5.0	10.0	10.0	5.0	10.0
Minimum Split (s)	9.2	34.2	9.2	33.2	33.2	9.2	38.4	38.4	9.2	30.8
Total Split (s)	14.2	49.6	14.0	49.4	49.4	11.5	38.4	38.4	18.0	44.9
Total Split (%)	11.8%	41.3%	11.7%	41.2%	41.2%	9.6%	32.0%	32.0%	15.0%	37.4%
Yellow Time (s)	3.2	5.2	3.2	5.2	5.2	3.2	4.4	4.4	3.2	4.8
All-Red Time (s)	1.0	1.0	1.0	1.0	1.0	1.0	1.0	1.0	1.0	1.0
Lost Time Adjust (s)	0.0	0.0	0.0	0.0	0.0	0.0	0.0	0.0	0.0	0.0
Total Lost Time (s)	4.2	6.2	4.2	6.2	6.2	4.2	5.4	5.4	4.2	5.8
Lead/Lag	Lead	Lag	Lead	Lag	Lag	Lead	Lag	Lag	Lead	Lag
Lead-Lag Optimize?	Yes	Yes	Yes	Yes	Yes	Yes	Yes	Yes	Yes	Yes
Recall Mode	None	None	None	None	None	None	None	None	None	None
Act Effct Green (s)	9.8	38.5	9.9	38.6	38.6	7.2	14.9	14.9	14.0	21.4
Actuated g/C Ratio	0.10	0.39	0.10	0.40	0.40	0.07	0.15	0.15	0.14	0.22
v/c Ratio	0.72	0.81	0.80	0.72	0.43	0.59	0.42	0.44	0.84	0.36
Control Delay	67.9	32.6	76.3	29.2	10.5	56.8	39.9	9.4	59.0	26.5
Queue Delay	0.0	0.0	0.0	0.0	0.0	0.0	0.0	0.0	0.0	0.0
Total Delay	67.9	32.6	76.3	29.2	10.5	56.8	39.9	9.4	59.0	26.5
LOS	E	C	E	C	B	E	D	A	E	C
Approach Delay		36.3		29.8			35.4			45.9
Approach LOS		D		C			D			D

Intersection Summary

Cycle Length: 120
 Actuated Cycle Length: 97.7
 Natural Cycle: 115
 Control Type: Actuated-Uncoordinated
 Maximum v/c Ratio: 0.84
 Intersection Signal Delay: 35.5
 Intersection LOS: D
 Intersection Capacity Utilization 74.9%
 ICU Level of Service D
 Analysis Period (min) 15



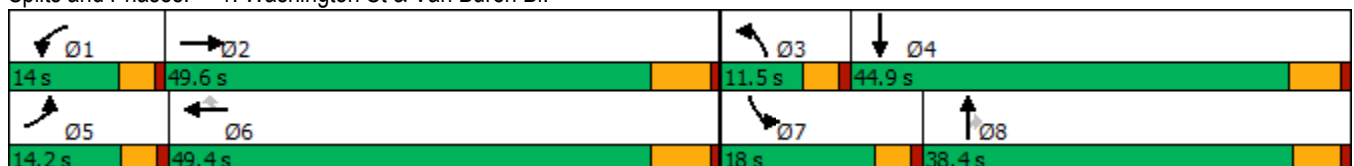



















Splits and Phases: 1: Washington St & Van Buren Bl.



HCM 6th Signalized Intersection Summary
1: Washington St & Van Buren Bl.

West Campus Upper Plateau (JN 14064)

09/30/2022

												
Movement	EBL	EBT	EBR	WBL	WBT	WBR	NBL	NBT	NBR	SBL	SBT	SBR
Lane Configurations												
Traffic Volume (veh/h)	126	991	78	141	963	307	146	219	159	406	191	83
Future Volume (veh/h)	126	991	78	141	963	307	146	219	159	406	191	83
Initial Q (Qb), veh	0	0	0	0	0	0	0	0	0	0	0	0
Ped-Bike Adj(A_pbT)	1.00		1.00	1.00		1.00	1.00		0.98	1.00		0.98
Parking Bus, Adj	1.00	1.00	1.00	1.00	1.00	1.00	1.00	1.00	1.00	1.00	1.00	1.00
Work Zone On Approach		No			No			No			No	
Adj Sat Flow, veh/h/ln	1900	1841	1856	1885	1856	1885	1885	1856	1870	1885	1885	1900
Adj Flow Rate, veh/h	130	1022	60	145	993	221	151	226	124	419	197	39
Peak Hour Factor	0.97	0.97	0.97	0.97	0.97	0.97	0.97	0.97	0.97	0.97	0.97	0.97
Percent Heavy Veh, %	0	4	3	1	3	1	1	3	2	1	1	0
Cap, veh/h	162	1305	77	178	1404	635	224	468	206	497	630	122
Arrive On Green	0.09	0.39	0.39	0.10	0.40	0.40	0.06	0.13	0.13	0.14	0.21	0.21
Sat Flow, veh/h	1810	3357	197	1795	3526	1594	3483	3526	1555	3483	2982	578
Grp Volume(v), veh/h	130	532	550	145	993	221	151	226	124	419	117	119
Grp Sat Flow(s),veh/h/ln	1810	1749	1805	1795	1763	1594	1742	1763	1555	1742	1791	1769
Q Serve(g_s), s	6.1	23.1	23.1	6.8	20.3	8.4	3.7	5.1	6.5	10.1	4.7	4.9
Cycle Q Clear(g_c), s	6.1	23.1	23.1	6.8	20.3	8.4	3.7	5.1	6.5	10.1	4.7	4.9
Prop In Lane	1.00		0.11	1.00		1.00	1.00		1.00	1.00		0.33
Lane Grp Cap(c), veh/h	162	680	702	178	1404	635	224	468	206	497	378	373
V/C Ratio(X)	0.80	0.78	0.78	0.81	0.71	0.35	0.67	0.48	0.60	0.84	0.31	0.32
Avail Cap(c_a), veh/h	210	880	909	204	1766	799	295	1349	595	557	812	802
HCM Platoon Ratio	1.00	1.00	1.00	1.00	1.00	1.00	1.00	1.00	1.00	1.00	1.00	1.00
Upstream Filter(I)	1.00	1.00	1.00	1.00	1.00	1.00	1.00	1.00	1.00	1.00	1.00	1.00
Uniform Delay (d), s/veh	38.5	23.2	23.2	38.0	21.7	18.1	39.5	34.6	35.2	36.0	28.7	28.8
Incr Delay (d2), s/veh	11.8	4.2	4.0	17.1	1.2	0.5	1.7	0.8	2.8	9.4	0.5	0.5
Initial Q Delay(d3),s/veh	0.0	0.0	0.0	0.0	0.0	0.0	0.0	0.0	0.0	0.0	0.0	0.0
%ile BackOfQ(50%),veh/ln	3.1	9.1	9.4	3.6	7.6	3.1	1.6	2.2	2.6	4.8	2.0	2.1
Unsig. Movement Delay, s/veh												
LnGrp Delay(d),s/veh	50.3	27.3	27.2	55.1	22.9	18.6	41.1	35.4	38.0	45.4	29.2	29.3
LnGrp LOS	D	C	C	E	C	B	D	D	D	D	C	C
Approach Vol, veh/h		1212			1359			501			655	
Approach Delay, s/veh		29.7			25.7			37.8			39.6	
Approach LOS		C			C			D			D	
Timer - Assigned Phs	1	2	3	4	5	6	7	8				
Phs Duration (G+Y+Rc), s	12.8	39.7	9.7	24.0	11.9	40.5	16.5	17.3				
Change Period (Y+Rc), s	* 4.2	6.2	* 4.2	5.8	* 4.2	6.2	* 4.2	* 5.8				
Max Green Setting (Gmax), s	* 9.8	43.4	* 7.3	39.1	* 10	43.2	* 14	* 33				
Max Q Clear Time (g_c+I1), s	8.8	25.1	5.7	6.9	8.1	22.3	12.1	8.5				
Green Ext Time (p_c), s	0.0	8.4	0.0	1.4	0.0	10.0	0.2	1.9				
Intersection Summary												
HCM 6th Ctrl Delay				31.1								
HCM 6th LOS				C								
Notes												
* HCM 6th computational engine requires equal clearance times for the phases crossing the barrier.												

Timings
2: Central Ave & Arlington Ave/Chicago Ave

West Campus Upper Plateau (JN 14064)

09/30/2022



Lane Group	EBL	EBT	EBR	WBL	WBT	WBR	NBL	NBT	NBR	SBL	SBT
Lane Configurations	↘	↑↑	↗↗	↘↘	↑↑	↗	↘↘	↑↑	↗	↘↘	↑↑↗
Traffic Volume (vph)	24	363	660	228	485	185	791	859	225	244	973
Future Volume (vph)	24	363	660	228	485	185	791	859	225	244	973
Turn Type	Prot	NA	pm+ov	Prot	NA	pm+ov	Prot	NA	pm+ov	Prot	NA
Protected Phases	7	4	5	3	8	1	5	2	3	1	6
Permitted Phases			4			8			2		
Detector Phase	7	4	5	3	8	1	5	2	3	1	6
Switch Phase											
Minimum Initial (s)	5.0	10.0	5.0	5.0	10.0	5.0	5.0	10.0	5.0	5.0	10.0
Minimum Split (s)	9.6	32.8	9.6	9.6	30.8	9.6	9.6	35.4	9.6	9.6	30.4
Total Split (s)	10.6	32.8	30.0	22.0	44.2	24.4	30.0	50.8	22.0	24.4	45.2
Total Split (%)	8.2%	25.2%	23.1%	16.9%	34.0%	18.8%	23.1%	39.1%	16.9%	18.8%	34.8%
Yellow Time (s)	3.6	4.8	3.6	3.6	4.8	3.6	3.6	4.4	3.6	3.6	4.4
All-Red Time (s)	1.0	1.0	1.0	1.0	1.0	1.0	1.0	1.0	1.0	1.0	1.0
Lost Time Adjust (s)	0.0	0.0	0.0	0.0	0.0	0.0	0.0	0.0	0.0	0.0	0.0
Total Lost Time (s)	4.6	5.8	4.6	4.6	5.8	4.6	4.6	5.4	4.6	4.6	5.4
Lead/Lag	Lead	Lag	Lead	Lead	Lag	Lead	Lead	Lag	Lead	Lead	Lag
Lead-Lag Optimize?	Yes	Yes	Yes	Yes	Yes	Yes	Yes	Yes	Yes	Yes	Yes
Recall Mode	None	None	None	None	None	None	None	None	None	None	None
Act Effct Green (s)	5.6	16.9	44.0	11.6	29.5	47.4	25.9	42.5	55.0	12.0	28.6
Actuated g/C Ratio	0.05	0.16	0.42	0.11	0.28	0.46	0.25	0.41	0.53	0.12	0.28
v/c Ratio	0.25	0.63	0.54	0.60	0.48	0.24	0.92	0.59	0.26	0.61	0.72
Control Delay	59.3	46.4	18.9	52.5	33.9	9.2	57.0	27.5	7.0	52.2	37.5
Queue Delay	0.0	0.0	0.0	0.0	0.0	0.0	0.0	0.0	0.0	0.0	0.0
Total Delay	59.3	46.4	18.9	52.5	33.9	9.2	57.0	27.5	7.0	52.2	37.5
LOS	E	D	B	D	C	A	E	C	A	D	D
Approach Delay		29.4			33.5			37.5			40.3
Approach LOS		C			C			D			D

Intersection Summary

Cycle Length: 130
 Actuated Cycle Length: 103.8
 Natural Cycle: 100
 Control Type: Actuated-Uncoordinated
 Maximum v/c Ratio: 0.92
 Intersection Signal Delay: 35.8
 Intersection LOS: D
 Intersection Capacity Utilization 76.6%
 ICU Level of Service D
 Analysis Period (min) 15

Splits and Phases: 2: Central Ave & Arlington Ave/Chicago Ave

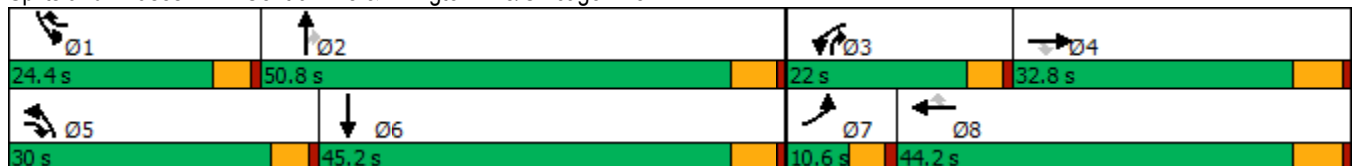

HCM 6th Signalized Intersection Summary
2: Central Ave & Arlington Ave/Chicago Ave

West Campus Upper Plateau (JN 14064)

09/30/2022



Movement	EBL	EBT	EBR	WBL	WBT	WBR	NBL	NBT	NBR	SBL	SBT	SBR
Lane Configurations	↖	↗	↘	↙	↕	↗	↖	↕	↗	↖	↗	↘
Traffic Volume (veh/h)	24	363	660	228	485	185	791	859	225	244	973	31
Future Volume (veh/h)	24	363	660	228	485	185	791	859	225	244	973	31
Initial Q (Qb), veh	0	0	0	0	0	0	0	0	0	0	0	0
Ped-Bike Adj(A_pbT)	1.00		1.00	1.00		1.00	1.00		0.99	1.00		1.00
Parking Bus, Adj	1.00	1.00	1.00	1.00	1.00	1.00	1.00	1.00	1.00	1.00	1.00	1.00
Work Zone On Approach		No			No			No			No	
Adj Sat Flow, veh/h/ln	1900	1900	1885	1870	1900	1885	1885	1885	1856	1900	1885	1900
Adj Flow Rate, veh/h	24	367	282	230	490	102	799	868	161	246	983	29
Peak Hour Factor	0.99	0.99	0.99	0.99	0.99	0.99	0.99	0.99	0.99	0.99	0.99	0.99
Percent Heavy Veh, %	0	0	1	2	0	1	1	1	3	0	1	0
Cap, veh/h	46	557	1146	312	792	502	884	1538	808	332	1388	41
Arrive On Green	0.03	0.15	0.15	0.09	0.22	0.22	0.25	0.43	0.43	0.09	0.27	0.27
Sat Flow, veh/h	1810	3610	2806	3456	3610	1598	3483	3582	1552	3510	5138	151
Grp Volume(v), veh/h	24	367	282	230	490	102	799	868	161	246	656	356
Grp Sat Flow(s),veh/h/ln	1810	1805	1403	1728	1805	1598	1742	1791	1552	1755	1716	1858
Q Serve(g_s), s	1.2	8.4	5.8	5.7	10.8	4.1	19.6	16.1	4.9	6.0	15.2	15.2
Cycle Q Clear(g_c), s	1.2	8.4	5.8	5.7	10.8	4.1	19.6	16.1	4.9	6.0	15.2	15.2
Prop In Lane	1.00		1.00	1.00		1.00	1.00		1.00	1.00		0.08
Lane Grp Cap(c), veh/h	46	557	1146	312	792	502	884	1538	808	332	927	502
V/C Ratio(X)	0.53	0.66	0.25	0.74	0.62	0.20	0.90	0.56	0.20	0.74	0.71	0.71
Avail Cap(c_a), veh/h	123	1106	1573	682	1573	847	1004	1845	941	789	1549	839
HCM Platoon Ratio	1.00	1.00	1.00	1.00	1.00	1.00	1.00	1.00	1.00	1.00	1.00	1.00
Upstream Filter(I)	1.00	1.00	1.00	1.00	1.00	1.00	1.00	1.00	1.00	1.00	1.00	1.00
Uniform Delay (d), s/veh	42.4	35.1	17.2	39.1	31.1	22.2	31.9	18.9	11.3	38.8	29.0	29.0
Incr Delay (d2), s/veh	3.5	1.3	0.1	1.3	0.8	0.2	9.8	0.3	0.1	1.2	1.0	1.9
Initial Q Delay(d3),s/veh	0.0	0.0	0.0	0.0	0.0	0.0	0.0	0.0	0.0	0.0	0.0	0.0
%ile BackOfQ(50%),veh/ln	0.5	3.6	1.7	2.4	4.5	1.5	8.9	6.2	1.5	2.5	6.0	6.7
Unsig. Movement Delay, s/veh												
LnGrp Delay(d),s/veh	45.9	36.4	17.3	40.3	31.9	22.3	41.6	19.3	11.5	40.1	30.0	30.9
LnGrp LOS	D	D	B	D	C	C	D	B	B	D	C	C
Approach Vol, veh/h		673			822			1828			1258	
Approach Delay, s/veh		28.7			33.1			28.4			32.2	
Approach LOS		C			C			C			C	
Timer - Assigned Phs	1	2	3	4	5	6	7	8				
Phs Duration (G+Y+Rc), s	12.9	43.2	12.6	19.4	27.0	29.2	6.8	25.1				
Change Period (Y+Rc), s	4.6	5.4	4.6	5.8	4.6	5.4	4.6	5.8				
Max Green Setting (Gmax), s	19.8	45.4	17.4	27.0	25.4	39.8	6.0	38.4				
Max Q Clear Time (g_c+I1), s	8.0	18.1	7.7	10.4	21.6	17.2	3.2	12.8				
Green Ext Time (p_c), s	0.3	7.0	0.3	3.0	0.8	6.6	0.0	3.3				
Intersection Summary												
HCM 6th Ctrl Delay			30.3									
HCM 6th LOS			C									

Timings

3: Overlook Pkwy./Canyon Crest Dr. & Alessandro Bl/Alessandro Bl.



Lane Group	EBL	EBT	WBL	WBT	WBR	NBL	NBT	NBR	SBL	SBT	SBR
Lane Configurations	↖	↖↖↖	↖	↖↖↖	↖	↖	↖↖	↖	↖↖	↖	↖
Traffic Volume (vph)	38	1443	94	1570	451	19	240	96	349	246	21
Future Volume (vph)	38	1443	94	1570	451	19	240	96	349	246	21
Turn Type	Prot	NA	Prot	NA	pm+ov	Split	NA	Perm	Split	NA	Perm
Protected Phases	5	2	1	6	4	8	8		4	4	
Permitted Phases					6			8			4
Detector Phase	5	2	1	6	4	8	8	8	4	4	4
Switch Phase											
Minimum Initial (s)	5.0	10.0	5.0	10.0	10.0	10.0	10.0	10.0	10.0	10.0	10.0
Minimum Split (s)	9.2	35.2	9.2	35.2	38.8	38.8	38.8	38.8	38.8	38.8	38.8
Total Split (s)	9.2	43.2	9.2	43.2	38.8	38.8	38.8	38.8	38.8	38.8	38.8
Total Split (%)	7.1%	33.2%	7.1%	33.2%	29.8%	29.8%	29.8%	29.8%	29.8%	29.8%	29.8%
Yellow Time (s)	3.2	5.2	3.2	5.2	4.8	4.8	4.8	4.8	4.8	4.8	4.8
All-Red Time (s)	1.0	1.0	1.0	1.0	1.0	1.0	1.0	1.0	1.0	1.0	1.0
Lost Time Adjust (s)	0.0	0.0	0.0	0.0	0.0	0.0	0.0	0.0	0.0	0.0	0.0
Total Lost Time (s)	4.2	6.2	4.2	6.2	5.8	5.8	5.8	5.8	5.8	5.8	5.8
Lead/Lag	Lead	Lag	Lead	Lag							
Lead-Lag Optimize?	Yes	Yes	Yes	Yes							
Recall Mode	None	None	None	None	None	None	None	None	None	None	None
Act Effct Green (s)	5.0	37.3	5.0	39.4	71.6	13.0	13.0	13.0	26.0	26.0	26.0
Actuated g/C Ratio	0.05	0.36	0.05	0.38	0.69	0.13	0.13	0.13	0.25	0.25	0.25
v/c Ratio	0.49	0.83	1.13	0.84	0.40	0.10	0.55	0.33	0.40	0.73	0.05
Control Delay	71.1	36.1	180.4	36.0	3.6	42.9	48.2	10.0	33.6	47.2	0.2
Queue Delay	0.0	0.0	0.0	0.0	0.0	0.0	0.0	0.0	0.0	0.0	0.0
Total Delay	71.1	36.1	180.4	36.0	3.6	42.9	48.2	10.0	33.6	47.2	0.2
LOS	E	D	F	D	A	D	D	A	C	D	A
Approach Delay		37.0		35.5			37.6			38.6	
Approach LOS		D		D			D			D	

Intersection Summary

Cycle Length: 130	
Actuated Cycle Length: 103.4	
Natural Cycle: 125	
Control Type: Actuated-Uncoordinated	
Maximum v/c Ratio: 1.13	
Intersection Signal Delay: 36.6	Intersection LOS: D
Intersection Capacity Utilization 74.1%	ICU Level of Service D
Analysis Period (min) 15	

Splits and Phases: 3: Overlook Pkwy./Canyon Crest Dr. & Alessandro Bl/Alessandro Bl.

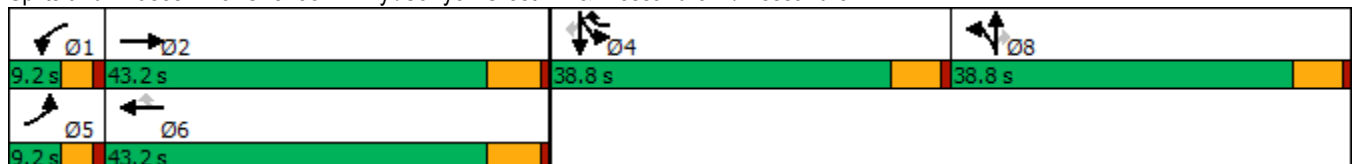

HCM 6th Signalized Intersection Summary

West Campus Upper Plateau (JN 14064)

3: Overlook Pkwy./Canyon Crest Dr. & Alessandro Bl/Alessandro Bl.

09/30/2022



Movement	EBL	EBT	EBR	WBL	WBT	WBR	NBL	NBT	NBR	SBL	SBT	SBR
Lane Configurations	↗	↑↑↑		↖	↑↑↑	↗	↖	↑↑	↗	↖↗	↖	↗
Traffic Volume (veh/h)	38	1443	23	94	1570	451	19	240	96	349	246	21
Future Volume (veh/h)	38	1443	23	94	1570	451	19	240	96	349	246	21
Initial Q (Qb), veh	0	0	0	0	0	0	0	0	0	0	0	0
Ped-Bike Adj(A_pbT)	1.00		1.00	1.00		1.00	1.00		1.00	1.00		1.00
Parking Bus, Adj	1.00	1.00	1.00	1.00	1.00	1.00	1.00	1.00	1.00	1.00	1.00	1.00
Work Zone On Approach		No			No			No			No	
Adj Sat Flow, veh/h/ln	1811	1885	1811	1900	1885	1870	1781	1900	1900	1885	1767	1841
Adj Flow Rate, veh/h	40	1503	24	98	1635	462	20	250	92	364	256	13
Peak Hour Factor	0.96	0.96	0.96	0.96	0.96	0.96	0.96	0.96	0.96	0.96	0.96	0.96
Percent Heavy Veh, %	6	1	6	0	1	2	8	0	0	1	9	4
Cap, veh/h	62	1964	31	106	2054	934	199	423	188	684	336	297
Arrive On Green	0.04	0.38	0.38	0.06	0.40	0.40	0.12	0.12	0.12	0.19	0.19	0.19
Sat Flow, veh/h	1725	5218	83	1810	5147	1585	1697	3610	1610	3591	1767	1560
Grp Volume(v), veh/h	40	988	539	98	1635	462	20	250	92	364	256	13
Grp Sat Flow(s),veh/h/ln	1725	1716	1870	1810	1716	1585	1697	1805	1610	1795	1767	1560
Q Serve(g_s), s	2.0	21.5	21.5	4.6	23.9	14.4	0.9	5.6	4.6	7.8	11.7	0.6
Cycle Q Clear(g_c), s	2.0	21.5	21.5	4.6	23.9	14.4	0.9	5.6	4.6	7.8	11.7	0.6
Prop In Lane	1.00		0.04	1.00		1.00	1.00		1.00	1.00		1.00
Lane Grp Cap(c), veh/h	62	1291	704	106	2054	934	199	423	188	684	336	297
V/C Ratio(X)	0.65	0.77	0.77	0.93	0.80	0.49	0.10	0.59	0.49	0.53	0.76	0.04
Avail Cap(c_a), veh/h	101	1486	810	106	2230	989	656	1395	622	1387	683	603
HCM Platoon Ratio	1.00	1.00	1.00	1.00	1.00	1.00	1.00	1.00	1.00	1.00	1.00	1.00
Upstream Filter(I)	1.00	1.00	1.00	1.00	1.00	1.00	1.00	1.00	1.00	1.00	1.00	1.00
Uniform Delay (d), s/veh	40.6	23.3	23.3	40.0	22.6	10.2	33.7	35.8	35.3	31.1	32.7	28.2
Incr Delay (d2), s/veh	4.2	2.1	3.8	63.0	2.0	0.4	0.2	1.3	2.0	0.6	3.6	0.1
Initial Q Delay(d3),s/veh	0.0	0.0	0.0	0.0	0.0	0.0	0.0	0.0	0.0	0.0	0.0	0.0
%ile BackOfQ(50%),veh/ln	0.9	8.0	9.1	3.8	8.7	6.9	0.4	2.4	1.8	3.2	5.0	0.2
Unsig. Movement Delay, s/veh												
LnGrp Delay(d),s/veh	44.8	25.4	27.1	103.0	24.6	10.6	33.9	37.1	37.3	31.8	36.3	28.3
LnGrp LOS	D	C	C	F	C	B	C	D	D	C	D	C
Approach Vol, veh/h		1567			2195			362			633	
Approach Delay, s/veh		26.5			25.1			37.0			33.5	
Approach LOS		C			C			D			C	
Timer - Assigned Phs	1	2		4	5	6		8				
Phs Duration (G+Y+Rc), s	9.2	38.3		22.1	7.3	40.3		15.8				
Change Period (Y+Rc), s	* 4.2	6.2		5.8	* 4.2	6.2		5.8				
Max Green Setting (Gmax), s	* 5	37.0		33.0	* 5	37.0		33.0				
Max Q Clear Time (g_c+1), s	6.6	23.5		13.7	4.0	25.9		7.6				
Green Ext Time (p_c), s	0.0	7.5		2.5	0.0	8.2		1.8				

Intersection Summary

HCM 6th Ctrl Delay	27.6
HCM 6th LOS	C

Notes

- User approved pedestrian interval to be less than phase max green.
- User approved volume balancing among the lanes for turning movement.
- * HCM 6th computational engine requires equal clearance times for the phases crossing the barrier.

Timings
4: Van Buren Bl. & Wood Rd.

West Campus Upper Plateau (JN 14064)

09/30/2022

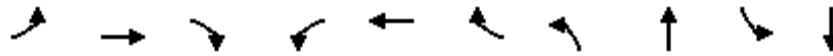

Lane Group	EBL	EBT	EBR	WBL	WBT	WBR	NBL	NBT	SBL	SBT
Lane Configurations	↘	↑↑	↗	↘↗	↑↑	↗	↘↗	↑↔	↘	↑↔
Traffic Volume (vph)	137	1522	218	235	1475	116	214	140	174	163
Future Volume (vph)	137	1522	218	235	1475	116	214	140	174	163
Turn Type	Prot	NA	pm+ov	Prot	NA	Perm	Prot	NA	Prot	NA
Protected Phases	5	2	3	1	6		3	8	7	4
Permitted Phases			2			6				
Detector Phase	5	2	3	1	6	6	3	8	7	4
Switch Phase										
Minimum Initial (s)	5.0	10.0	5.0	5.0	10.0	10.0	5.0	10.0	5.0	10.0
Minimum Split (s)	9.2	30.2	9.2	9.2	30.2	30.2	9.2	38.4	9.2	15.8
Total Split (s)	16.5	57.2	21.7	13.2	53.9	53.9	21.7	38.4	11.2	27.9
Total Split (%)	13.8%	47.7%	18.1%	11.0%	44.9%	44.9%	18.1%	32.0%	9.3%	23.3%
Yellow Time (s)	3.2	5.2	3.2	3.2	5.2	5.2	3.2	4.4	3.2	4.8
All-Red Time (s)	1.0	1.0	1.0	1.0	1.0	1.0	1.0	1.0	1.0	1.0
Lost Time Adjust (s)	0.0	0.0	0.0	0.0	0.0	0.0	0.0	0.0	0.0	0.0
Total Lost Time (s)	4.2	6.2	4.2	4.2	6.2	6.2	4.2	5.4	4.2	5.8
Lead/Lag	Lead	Lag	Lead	Lead	Lag	Lag	Lead	Lag	Lead	Lag
Lead-Lag Optimize?	Yes	Yes	Yes	Yes	Yes	Yes	Yes	Yes	Yes	Yes
Recall Mode	None	None	None	None	None	None	None	None	None	None
Act Effct Green (s)	11.7	51.3	65.0	9.0	48.6	48.6	11.7	18.4	7.0	13.3
Actuated g/C Ratio	0.11	0.48	0.61	0.09	0.46	0.46	0.11	0.17	0.07	0.13
v/c Ratio	0.77	0.99	0.23	0.87	1.00	0.16	0.63	0.49	1.62	0.62
Control Delay	72.2	46.8	2.0	77.2	51.5	3.4	53.3	22.2	344.7	27.6
Queue Delay	0.0	0.0	0.0	0.0	0.0	0.0	0.0	0.0	0.0	0.0
Total Delay	72.2	46.8	2.0	77.2	51.5	3.4	53.3	22.2	344.7	27.6
LOS	E	D	A	E	D	A	D	C	F	C
Approach Delay		43.5			51.8			34.9		139.7
Approach LOS		D			D			C		F

Intersection Summary

Cycle Length: 120
 Actuated Cycle Length: 105.8
 Natural Cycle: 120
 Control Type: Actuated-Uncoordinated
 Maximum v/c Ratio: 1.62
 Intersection Signal Delay: 55.8
 Intersection LOS: E
 Intersection Capacity Utilization 90.8%
 ICU Level of Service E
 Analysis Period (min) 15

Splits and Phases: 4: Van Buren Bl. & Wood Rd.

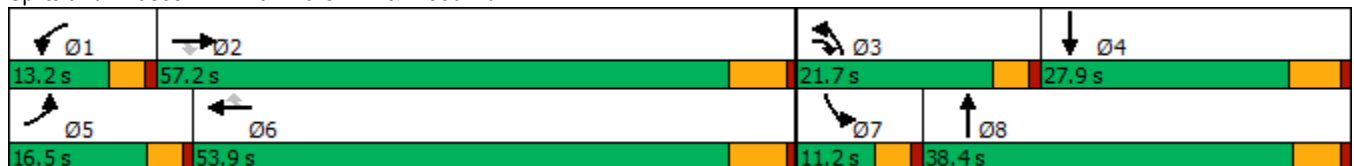

HCM 6th Signalized Intersection Summary
4: Van Buren Bl. & Wood Rd.

West Campus Upper Plateau (JN 14064)

09/30/2022

Movement	EBL	EBT	EBR	WBL	WBT	WBR	NBL	NBT	NBR	SBL	SBT	SBR
Lane Configurations												
Traffic Volume (veh/h)	137	1522	218	235	1475	116	214	140	167	174	163	155
Future Volume (veh/h)	137	1522	218	235	1475	116	214	140	167	174	163	155
Initial Q (Qb), veh	0	0	0	0	0	0	0	0	0	0	0	0
Ped-Bike Adj(A_pbT)	1.00		0.99	1.00		0.99	1.00		0.96	1.00		0.99
Parking Bus, Adj	1.00	1.00	1.00	1.00	1.00	1.00	1.00	1.00	1.00	1.00	1.00	1.00
Work Zone On Approach		No			No			No			No	
Adj Sat Flow, veh/h/ln	1885	1856	1870	1885	1870	1885	1856	1885	1870	1885	1885	1885
Adj Flow Rate, veh/h	151	1673	135	258	1621	80	235	154	103	191	179	95
Peak Hour Factor	0.91	0.91	0.91	0.91	0.91	0.91	0.91	0.91	0.91	0.91	0.91	0.91
Percent Heavy Veh, %	1	3	2	1	2	1	3	1	2	1	1	1
Cap, veh/h	182	1761	922	309	1731	767	306	296	184	124	279	141
Arrive On Green	0.10	0.50	0.50	0.09	0.49	0.49	0.09	0.14	0.14	0.07	0.12	0.12
Sat Flow, veh/h	1795	3526	1562	3483	3554	1575	3428	2087	1295	1795	2292	1157
Grp Volume(v), veh/h	151	1673	135	258	1621	80	235	130	127	191	138	136
Grp Sat Flow(s),veh/h/ln	1795	1763	1562	1742	1777	1575	1714	1791	1591	1795	1791	1658
Q Serve(g_s), s	8.4	45.9	3.9	7.4	43.7	2.8	6.8	6.8	7.5	7.0	7.4	8.0
Cycle Q Clear(g_c), s	8.4	45.9	3.9	7.4	43.7	2.8	6.8	6.8	7.5	7.0	7.4	8.0
Prop In Lane	1.00		1.00	1.00		1.00	1.00		0.81	1.00		0.70
Lane Grp Cap(c), veh/h	182	1761	922	309	1731	767	306	254	226	124	218	202
V/C Ratio(X)	0.83	0.95	0.15	0.84	0.94	0.10	0.77	0.51	0.56	1.54	0.63	0.68
Avail Cap(c_a), veh/h	218	1771	926	309	1731	767	591	582	517	124	390	361
HCM Platoon Ratio	1.00	1.00	1.00	1.00	1.00	1.00	1.00	1.00	1.00	1.00	1.00	1.00
Upstream Filter(I)	1.00	1.00	1.00	1.00	1.00	1.00	1.00	1.00	1.00	1.00	1.00	1.00
Uniform Delay (d), s/veh	44.8	24.2	9.4	45.5	24.6	14.1	45.2	40.3	40.6	47.3	42.4	42.7
Incr Delay (d2), s/veh	17.4	11.8	0.1	16.8	10.3	0.1	1.5	1.6	2.2	280.2	3.0	3.9
Initial Q Delay(d3),s/veh	0.0	0.0	0.0	0.0	0.0	0.0	0.0	0.0	0.0	0.0	0.0	0.0
%ile BackOfQ(50%),veh/ln	4.4	19.3	1.2	3.8	18.4	1.0	2.9	3.0	3.0	12.7	3.4	3.4
Unsig. Movement Delay, s/veh												
LnGrp Delay(d),s/veh	62.2	36.0	9.5	62.3	34.8	14.2	46.7	41.9	42.8	327.5	45.5	46.6
LnGrp LOS	E	D	A	E	C	B	D	D	D	F	D	D
Approach Vol, veh/h		1959			1959			492			465	
Approach Delay, s/veh		36.2			37.6			44.4			161.6	
Approach LOS		D			D			D			F	
Timer - Assigned Phs	1	2	3	4	5	6	7	8				
Phs Duration (G+Y+Rc), s	13.2	56.9	13.3	18.1	14.5	55.6	11.2	20.2				
Change Period (Y+Rc), s	* 4.2	6.2	* 4.2	5.8	* 4.2	6.2	* 4.2	* 5.8				
Max Green Setting (Gmax), s	* 9	51.0	* 18	22.1	* 12	47.7	* 7	* 33				
Max Q Clear Time (g_c+I1), s	9.4	47.9	8.8	10.0	10.4	45.7	9.0	9.5				
Green Ext Time (p_c), s	0.0	2.8	0.3	1.1	0.0	1.8	0.0	1.4				
Intersection Summary												
HCM 6th Ctrl Delay			49.6									
HCM 6th LOS			D									
Notes												
* HCM 6th computational engine requires equal clearance times for the phases crossing the barrier.												

Timings
5: Trautwein Rd. & Alessandro Bl.

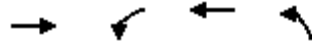

Lane Group	EBT	WBL	WBT	NBL
Lane Configurations	↑↑↑	↵↵	↑↑↑	↵↵↵
Traffic Volume (vph)	1181	195	1386	1072
Future Volume (vph)	1181	195	1386	1072
Turn Type	NA	Prot	NA	Prot
Protected Phases	2	1	6	8
Permitted Phases				
Detector Phase	2	1	6	8
Switch Phase				
Minimum Initial (s)	10.0	5.0	10.0	10.0
Minimum Split (s)	33.2	9.2	16.2	16.2
Total Split (s)	63.0	19.0	82.0	38.0
Total Split (%)	52.5%	15.8%	68.3%	31.7%
Yellow Time (s)	5.2	3.2	5.2	5.2
All-Red Time (s)	1.0	1.0	1.0	1.0
Lost Time Adjust (s)	0.0	0.0	0.0	0.0
Total Lost Time (s)	6.2	4.2	6.2	6.2
Lead/Lag	Lag	Lead		
Lead-Lag Optimize?	Yes	Yes		
Recall Mode	None	None	None	None
Act Effct Green (s)	45.1	10.6	59.9	27.9
Actuated g/C Ratio	0.45	0.11	0.60	0.28
v/c Ratio	0.67	0.56	0.47	0.81
Control Delay	23.9	51.4	12.0	40.6
Queue Delay	0.0	0.0	0.0	0.0
Total Delay	23.9	51.4	12.0	40.6
LOS	C	D	B	D
Approach Delay	23.9		16.8	40.6
Approach LOS	C		B	D

Intersection Summary

Cycle Length: 120	
Actuated Cycle Length: 100.6	
Natural Cycle: 65	
Control Type: Actuated-Uncoordinated	
Maximum v/c Ratio: 0.81	
Intersection Signal Delay: 25.6	Intersection LOS: C
Intersection Capacity Utilization 68.8%	ICU Level of Service C
Analysis Period (min) 15	

Splits and Phases: 5: Trautwein Rd. & Alessandro Bl.



HCM 6th Signalized Intersection Summary
5: Trautwein Rd. & Alessandro Bl.

West Campus Upper Plateau (JN 14064)

09/30/2022

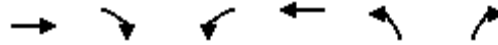

Movement	EBT	EBR	WBL	WBT	NBL	NBR
Lane Configurations	↑↑↑		↵↵	↑↑↑	↵↵↵	
Traffic Volume (veh/h)	1181	265	195	1386	1072	12
Future Volume (veh/h)	1181	265	195	1386	1072	12
Initial Q (Qb), veh	0	0	0	0	0	0
Ped-Bike Adj(A_pbT)		1.00	1.00		1.00	1.00
Parking Bus, Adj	1.00	1.00	1.00	1.00	1.00	1.00
Work Zone On Approach	No			No	No	
Adj Sat Flow, veh/h/ln	1885	1900	1885	1885	1870	1900
Adj Flow Rate, veh/h	1230	276	203	1444	1128	0
Peak Hour Factor	0.96	0.96	0.96	0.96	0.96	0.96
Percent Heavy Veh, %	1	0	1	1	2	0
Cap, veh/h	1920	431	288	3031	1416	427
Arrive On Green	0.46	0.46	0.08	0.59	0.26	0.00
Sat Flow, veh/h	4373	943	3483	5316	5344	1610
Grp Volume(v), veh/h	1004	502	203	1444	1128	0
Grp Sat Flow(s),veh/h/ln	1716	1715	1742	1716	1781	1610
Q Serve(g_s), s	19.1	19.1	4.8	13.6	16.7	0.0
Cycle Q Clear(g_c), s	19.1	19.1	4.8	13.6	16.7	0.0
Prop In Lane		0.55	1.00		1.00	1.00
Lane Grp Cap(c), veh/h	1567	784	288	3031	1416	427
V/C Ratio(X)	0.64	0.64	0.70	0.48	0.80	0.00
Avail Cap(c_a), veh/h	2296	1148	607	4595	2002	603
HCM Platoon Ratio	1.00	1.00	1.00	1.00	1.00	1.00
Upstream Filter(I)	1.00	1.00	1.00	1.00	1.00	0.00
Uniform Delay (d), s/veh	17.7	17.7	37.9	10.0	29.1	0.0
Incr Delay (d2), s/veh	0.6	1.3	1.2	0.2	1.5	0.0
Initial Q Delay(d3),s/veh	0.0	0.0	0.0	0.0	0.0	0.0
%ile BackOfQ(50%),veh/ln	6.6	6.7	1.9	3.8	6.7	0.0
Unsig. Movement Delay, s/veh						
LnGrp Delay(d),s/veh	18.3	19.0	39.1	10.1	30.6	0.0
LnGrp LOS	B	B	D	B	C	A
Approach Vol, veh/h	1506			1647	1128	
Approach Delay, s/veh	18.5			13.7	30.6	
Approach LOS	B			B	C	
Timer - Assigned Phs	1	2			6	8
Phs Duration (G+Y+Rc), s	11.2	45.0			56.2	28.7
Change Period (Y+Rc), s	* 4.2	6.2			6.2	6.2
Max Green Setting (Gmax), s	* 15	56.8			75.8	31.8
Max Q Clear Time (g_c+I1), s	6.8	21.1			15.6	18.7
Green Ext Time (p_c), s	0.2	17.7			20.3	3.8

Intersection Summary

HCM 6th Ctrl Delay	19.9
HCM 6th LOS	B

Notes

User approved volume balancing among the lanes for turning movement.
* HCM 6th computational engine requires equal clearance times for the phases crossing the barrier.

Timings
6: Trautwein Rd. & Grove Community Dr

West Campus Upper Plateau (JN 14064)

09/30/2022



Lane Group	WBL	WBR	NBT	NBR	SBL	SBT
Lane Configurations	↙	↗↗	↕↕	↗	↗↗	↕↕
Traffic Volume (vph)	119	426	1079	97	383	1001
Future Volume (vph)	119	426	1079	97	383	1001
Turn Type	Prot	pm+ov	NA	Perm	Prot	NA
Protected Phases	8	1	2		1	6
Permitted Phases		8		2		
Detector Phase	8	1	2	2	1	6
Switch Phase						
Minimum Initial (s)	10.0	5.0	10.0	10.0	5.0	10.0
Minimum Split (s)	34.6	9.6	46.2	46.2	9.6	28.2
Total Split (s)	35.0	29.0	56.0	56.0	29.0	85.0
Total Split (%)	29.2%	24.2%	46.7%	46.7%	24.2%	70.8%
Yellow Time (s)	3.6	3.6	5.2	5.2	3.6	5.2
All-Red Time (s)	1.0	1.0	1.0	1.0	1.0	1.0
Lost Time Adjust (s)	0.0	0.0	0.0	0.0	0.0	0.0
Total Lost Time (s)	4.6	4.6	6.2	6.2	4.6	6.2
Lead/Lag		Lead	Lag	Lag	Lead	
Lead-Lag Optimize?		Yes	Yes	Yes	Yes	
Recall Mode	None	None	None	None	None	None
Act Effct Green (s)	14.3	30.0	35.9	35.9	15.7	56.4
Actuated g/C Ratio	0.17	0.36	0.44	0.44	0.19	0.69
v/c Ratio	0.42	0.45	0.77	0.15	0.64	0.46
Control Delay	37.6	17.1	24.5	7.8	37.4	6.9
Queue Delay	0.0	0.0	0.0	0.0	0.0	0.0
Total Delay	37.6	17.1	24.5	7.8	37.4	6.9
LOS	D	B	C	A	D	A
Approach Delay	21.6		23.1			15.3
Approach LOS	C		C			B

Intersection Summary

Cycle Length: 120
 Actuated Cycle Length: 82.2
 Natural Cycle: 95
 Control Type: Actuated-Uncoordinated
 Maximum v/c Ratio: 0.77
 Intersection Signal Delay: 19.4
 Intersection LOS: B
 Intersection Capacity Utilization 62.9%
 ICU Level of Service B
 Analysis Period (min) 15

Splits and Phases: 6: Trautwein Rd. & Grove Community Dr



HCM 6th Signalized Intersection Summary
6: Trautwein Rd. & Grove Community Dr

West Campus Upper Plateau (JN 14064)

09/30/2022



Movement	WBL	WBR	NBT	NBR	SBL	SBT
Lane Configurations						
Traffic Volume (veh/h)	119	426	1079	97	383	1001
Future Volume (veh/h)	119	426	1079	97	383	1001
Initial Q (Qb), veh	0	0	0	0	0	0
Ped-Bike Adj(A_pbT)	1.00	1.00		1.00	1.00	
Parking Bus, Adj	1.00	1.00	1.00	1.00	1.00	1.00
Work Zone On Approach	No		No			No
Adj Sat Flow, veh/h/ln	1900	1900	1885	1900	1900	1870
Adj Flow Rate, veh/h	132	279	1199	102	426	1112
Peak Hour Factor	0.90	0.90	0.90	0.90	0.90	0.90
Percent Heavy Veh, %	0	0	1	0	0	2
Cap, veh/h	277	880	1623	730	552	2420
Arrive On Green	0.15	0.15	0.45	0.45	0.16	0.68
Sat Flow, veh/h	1810	2834	3676	1610	3510	3647
Grp Volume(v), veh/h	132	279	1199	102	426	1112
Grp Sat Flow(s),veh/h/ln	1810	1417	1791	1610	1755	1777
Q Serve(g_s), s	4.3	4.9	17.9	2.4	7.6	9.5
Cycle Q Clear(g_c), s	4.3	4.9	17.9	2.4	7.6	9.5
Prop In Lane	1.00	1.00		1.00	1.00	
Lane Grp Cap(c), veh/h	277	880	1623	730	552	2420
V/C Ratio(X)	0.48	0.32	0.74	0.14	0.77	0.46
Avail Cap(c_a), veh/h	844	1767	2736	1230	1314	4295
HCM Platoon Ratio	1.00	1.00	1.00	1.00	1.00	1.00
Upstream Filter(I)	1.00	1.00	1.00	1.00	1.00	1.00
Uniform Delay (d), s/veh	25.2	17.2	14.6	10.4	26.3	4.8
Incr Delay (d2), s/veh	1.3	0.2	0.7	0.1	0.9	0.1
Initial Q Delay(d3),s/veh	0.0	0.0	0.0	0.0	0.0	0.0
%ile BackOfQ(50%),veh/ln	1.8	1.5	5.7	0.7	2.9	1.7
Unsig. Movement Delay, s/veh						
LnGrp Delay(d),s/veh	26.5	17.4	15.3	10.5	27.2	5.0
LnGrp LOS	C	B	B	B	C	A
Approach Vol, veh/h	411		1301			1538
Approach Delay, s/veh	20.3		14.9			11.1
Approach LOS	C		B			B
Timer - Assigned Phs	1	2			6	8
Phs Duration (G+Y+Rc), s	14.9	35.7			50.6	14.6
Change Period (Y+Rc), s	4.6	6.2			6.2	4.6
Max Green Setting (Gmax), s	24.4	49.8			78.8	30.4
Max Q Clear Time (g_c+11), s	9.6	19.9			11.5	6.9
Green Ext Time (p_c), s	0.7	9.6			9.2	1.4
Intersection Summary						
HCM 6th Ctrl Delay			13.8			
HCM 6th LOS			B			

Timings

7: Trautwein Rd. & Orange Terrace Pkwy

09/30/2022



Lane Group	EBL	EBT	WBL	WBT	WBR	NBL	NBT	NBR	SBL	SBT	SBR
Lane Configurations											
Traffic Volume (vph)	34	20	182	13	176	37	949	169	218	979	22
Future Volume (vph)	34	20	182	13	176	37	949	169	218	979	22
Turn Type	Prot	NA	Prot	NA	pm+ov	Prot	NA	Perm	Prot	NA	Perm
Protected Phases	7	4	3	8	1	5	2		1	6	
Permitted Phases					8			2			6
Detector Phase	7	4	3	8	1	5	2	2	1	6	6
Switch Phase											
Minimum Initial (s)	5.0	10.0	5.0	10.0	5.0	5.0	10.0	10.0	5.0	10.0	10.0
Minimum Split (s)	9.6	38.6	9.6	34.6	9.6	9.6	46.2	46.2	9.6	28.2	28.2
Total Split (s)	13.2	38.6	16.1	41.5	18.0	9.6	47.3	47.3	18.0	55.7	55.7
Total Split (%)	11.0%	32.2%	13.4%	34.6%	15.0%	8.0%	39.4%	39.4%	15.0%	46.4%	46.4%
Yellow Time (s)	3.6	3.6	3.6	3.6	3.6	3.6	5.2	5.2	3.6	5.2	5.2
All-Red Time (s)	1.0	1.0	1.0	1.0	1.0	1.0	1.0	1.0	1.0	1.0	1.0
Lost Time Adjust (s)	0.0	0.0	0.0	0.0	0.0	0.0	0.0	0.0	0.0	0.0	0.0
Total Lost Time (s)	4.6	4.6	4.6	4.6	4.6	4.6	6.2	6.2	4.6	6.2	6.2
Lead/Lag	Lead	Lag	Lead	Lag	Lead	Lead	Lag	Lag	Lead	Lag	Lag
Lead-Lag Optimize?	Yes	Yes	Yes	Yes	Yes	Yes	Yes	Yes	Yes	Yes	Yes
Recall Mode	None	None	None	None	None	None	None	None	None	None	None
Act Effct Green (s)	10.5	14.2	12.6	16.2	28.9	5.5	30.4	30.4	10.4	41.0	41.0
Actuated g/C Ratio	0.13	0.18	0.16	0.20	0.36	0.07	0.38	0.38	0.13	0.51	0.51
v/c Ratio	0.15	0.13	0.70	0.04	0.17	0.32	0.76	0.26	0.53	0.58	0.03
Control Delay	42.4	21.2	53.8	31.1	3.4	53.4	28.4	8.0	42.4	19.1	0.0
Queue Delay	0.0	0.0	0.0	0.0	0.0	0.0	0.0	0.0	0.0	0.0	0.0
Total Delay	42.4	21.2	53.8	31.1	3.4	53.4	28.4	8.0	42.4	19.1	0.0
LOS	D	C	D	C	A	D	C	A	D	B	A
Approach Delay		30.8		29.1			26.2			22.9	
Approach LOS		C		C			C			C	

Intersection Summary

Cycle Length: 120	
Actuated Cycle Length: 80.9	
Natural Cycle: 115	
Control Type: Actuated-Uncoordinated	
Maximum v/c Ratio: 0.76	
Intersection Signal Delay: 25.3	Intersection LOS: C
Intersection Capacity Utilization 62.0%	ICU Level of Service B
Analysis Period (min) 15	



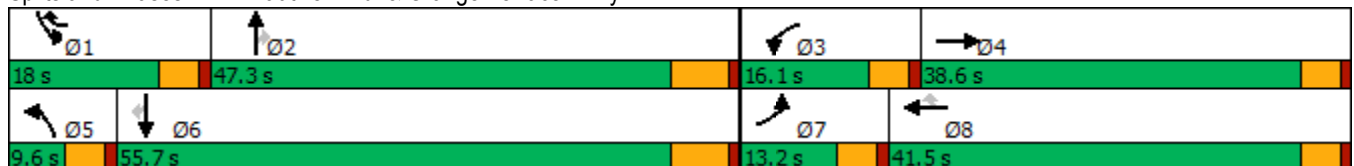



















Splits and Phases: 7: Trautwein Rd. & Orange Terrace Pkwy



HCM 6th Signalized Intersection Summary
7: Trautwein Rd. & Orange Terrace Pkwy

West Campus Upper Plateau (JN 14064)

09/30/2022

												
Movement	EBL	EBT	EBR	WBL	WBT	WBR	NBL	NBT	NBR	SBL	SBT	SBR
Lane Configurations												
Traffic Volume (veh/h)	34	20	22	182	13	176	37	949	169	218	979	22
Future Volume (veh/h)	34	20	22	182	13	176	37	949	169	218	979	22
Initial Q (Qb), veh	0	0	0	0	0	0	0	0	0	0	0	0
Ped-Bike Adj(A_pbT)	1.00		1.00	1.00		1.00	1.00		1.00	1.00		1.00
Parking Bus, Adj	1.00	1.00	1.00	1.00	1.00	1.00	1.00	1.00	1.00	1.00	1.00	1.00
Work Zone On Approach		No			No			No			No	
Adj Sat Flow, veh/h/ln	1900	1900	1900	1885	1900	1856	1900	1870	1870	1870	1870	1900
Adj Flow Rate, veh/h	36	21	21	194	14	67	39	1010	102	232	1041	13
Peak Hour Factor	0.94	0.94	0.94	0.94	0.94	0.94	0.94	0.94	0.94	0.94	0.94	0.94
Percent Heavy Veh, %	0	0	0	1	0	3	0	2	2	2	2	0
Cap, veh/h	64	114	114	235	430	888	68	1317	587	327	1520	689
Arrive On Green	0.04	0.13	0.13	0.13	0.23	0.23	0.04	0.37	0.37	0.09	0.43	0.43
Sat Flow, veh/h	1810	872	872	1795	1900	2768	1810	3554	1585	3456	3554	1610
Grp Volume(v), veh/h	36	0	42	194	14	67	39	1010	102	232	1041	13
Grp Sat Flow(s),veh/h/ln	1810	0	1743	1795	1900	1384	1810	1777	1585	1728	1777	1610
Q Serve(g_s), s	1.4	0.0	1.6	7.7	0.4	1.2	1.6	18.3	3.2	4.8	17.4	0.3
Cycle Q Clear(g_c), s	1.4	0.0	1.6	7.7	0.4	1.2	1.6	18.3	3.2	4.8	17.4	0.3
Prop In Lane	1.00		0.50	1.00		1.00	1.00		1.00	1.00		1.00
Lane Grp Cap(c), veh/h	64	0	229	235	430	888	68	1317	587	327	1520	689
V/C Ratio(X)	0.56	0.00	0.18	0.83	0.03	0.08	0.58	0.77	0.17	0.71	0.68	0.02
Avail Cap(c_a), veh/h	212	0	809	282	957	1656	123	1993	889	632	2401	1088
HCM Platoon Ratio	1.00	1.00	1.00	1.00	1.00	1.00	1.00	1.00	1.00	1.00	1.00	1.00
Upstream Filter(I)	1.00	0.00	1.00	1.00	1.00	1.00	1.00	1.00	1.00	1.00	1.00	1.00
Uniform Delay (d), s/veh	34.8	0.0	28.3	31.0	22.1	17.3	34.7	20.3	15.5	32.2	17.0	12.1
Incr Delay (d2), s/veh	2.8	0.0	0.4	13.3	0.0	0.0	2.9	1.0	0.1	1.1	0.6	0.0
Initial Q Delay(d3),s/veh	0.0	0.0	0.0	0.0	0.0	0.0	0.0	0.0	0.0	0.0	0.0	0.0
%ile BackOfQ(50%),veh/ln	0.7	0.0	0.7	3.9	0.2	0.4	0.7	6.6	1.0	1.9	5.9	0.1
Unsig. Movement Delay, s/veh												
LnGrp Delay(d),s/veh	37.6	0.0	28.7	44.4	22.1	17.3	37.6	21.3	15.6	33.3	17.5	12.1
LnGrp LOS	D	A	C	D	C	B	D	C	B	C	B	B
Approach Vol, veh/h		78			275			1151			1286	
Approach Delay, s/veh		32.8			36.7			21.3			20.3	
Approach LOS		C			D			C			C	
Timer - Assigned Phs	1	2	3	4	5	6	7	8				
Phs Duration (G+Y+Rc), s	11.5	33.4	14.2	14.2	7.3	37.5	7.2	21.2				
Change Period (Y+Rc), s	4.6	6.2	4.6	4.6	4.6	6.2	4.6	4.6				
Max Green Setting (Gmax), s	13.4	41.1	11.5	34.0	5.0	49.5	8.6	36.9				
Max Q Clear Time (g_c+I1), s	6.8	20.3	9.7	3.6	3.6	19.4	3.4	3.2				
Green Ext Time (p_c), s	0.2	6.8	0.0	0.2	0.0	7.6	0.0	0.3				
Intersection Summary												
HCM 6th Ctrl Delay				22.7								
HCM 6th LOS				C								

Timings
8: Cole Av. & Van Buren Bl.

West Campus Upper Plateau (JN 14064)

09/30/2022



Lane Group	EBL	EBT	EBR	WBL	WBT	WBR	NBL	NBT	SBL	SBT	SBR
Lane Configurations	↖↗	↑↑	↗	↖	↑↑↑	↗	↖	↑↑	↖↗	↑↑	↗
Traffic Volume (vph)	487	1247	80	175	1301	354	106	263	348	235	385
Future Volume (vph)	487	1247	80	175	1301	354	106	263	348	235	385
Turn Type	Prot	NA	pm+ov	Prot	NA	pm+ov	Prot	NA	Prot	NA	pm+ov
Protected Phases	5	2	3	1	6	7	3	8	7	4	5
Permitted Phases			2			6					4
Detector Phase	5	2	3	1	6	7	3	8	7	4	5
Switch Phase											
Minimum Initial (s)	5.0	10.0	5.0	5.0	10.0	5.0	5.0	10.0	5.0	10.0	5.0
Minimum Split (s)	9.1	36.2	9.1	9.1	36.2	9.1	9.1	42.2	9.1	49.2	9.1
Total Split (s)	18.7	44.8	12.0	14.0	40.1	17.5	12.0	43.7	17.5	49.2	18.7
Total Split (%)	15.6%	37.3%	10.0%	11.7%	33.4%	14.6%	10.0%	36.4%	14.6%	41.0%	15.6%
Yellow Time (s)	3.2	5.2	3.2	3.2	5.2	3.2	3.2	5.2	3.2	5.2	3.2
All-Red Time (s)	0.5	1.0	0.5	0.5	1.0	0.5	0.5	1.0	0.5	1.0	0.5
Lost Time Adjust (s)	0.0	0.0	0.0	0.0	0.0	0.0	0.0	0.0	0.0	0.0	0.0
Total Lost Time (s)	3.7	6.2	3.7	3.7	6.2	3.7	3.7	6.2	3.7	6.2	3.7
Lead/Lag	Lead	Lag	Lead	Lead	Lag	Lead	Lead	Lag	Lead	Lag	Lead
Lead-Lag Optimize?	Yes	Yes	Yes	Yes	Yes	Yes	Yes	Yes	Yes	Yes	Yes
Recall Mode	None	None	None	None	None	None	None	None	None	None	None
Act Effct Green (s)	15.1	38.9	53.5	10.4	34.2	54.0	8.4	17.7	13.6	22.9	40.5
Actuated g/C Ratio	0.15	0.39	0.53	0.10	0.34	0.54	0.08	0.18	0.14	0.23	0.40
v/c Ratio	0.99	0.98	0.09	1.01	0.79	0.38	0.74	0.61	0.79	0.30	0.59
Control Delay	82.2	51.5	3.0	116.7	35.2	6.0	75.9	36.0	56.6	32.2	20.8
Queue Delay	0.0	0.0	0.0	0.0	0.0	0.0	0.0	0.0	0.0	0.0	0.0
Total Delay	82.2	51.5	3.0	116.7	35.2	6.0	75.9	36.0	56.6	32.2	20.8
LOS	F	D	A	F	D	A	E	D	E	C	C
Approach Delay		57.6			37.3			44.9		36.5	
Approach LOS		E			D			D		D	

Intersection Summary

Cycle Length: 120	
Actuated Cycle Length: 100.5	
Natural Cycle: 115	
Control Type: Actuated-Uncoordinated	
Maximum v/c Ratio: 1.01	
Intersection Signal Delay: 45.1	Intersection LOS: D
Intersection Capacity Utilization 84.4%	ICU Level of Service E
Analysis Period (min) 15	



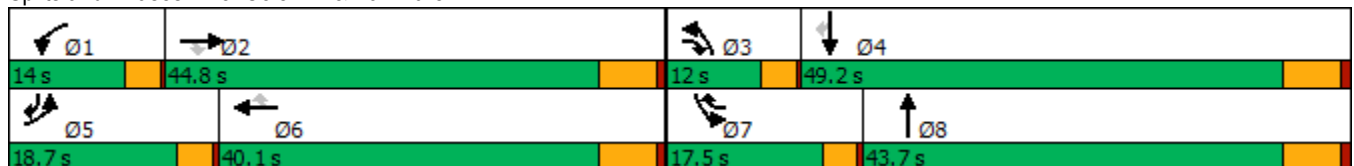



























Splits and Phases: 8: Cole Av. & Van Buren Bl.



HCM 6th Signalized Intersection Summary
8: Cole Av. & Van Buren Bl.

West Campus Upper Plateau (JN 14064)

09/30/2022

												
Movement	EBL	EBT	EBR	WBL	WBT	WBR	NBL	NBT	NBR	SBL	SBT	SBR
Lane Configurations	 	 			  			 		 	 	
Traffic Volume (veh/h)	487	1247	80	175	1301	354	106	263	109	348	235	385
Future Volume (veh/h)	487	1247	80	175	1301	354	106	263	109	348	235	385
Initial Q (Qb), veh	0	0	0	0	0	0	0	0	0	0	0	0
Ped-Bike Adj(A_pbT)	1.00		1.00	1.00		1.00	1.00		0.99	1.00		1.00
Parking Bus, Adj	1.00	1.00	1.00	1.00	1.00	1.00	1.00	1.00	1.00	1.00	1.00	1.00
Work Zone On Approach		No			No			No			No	
Adj Sat Flow, veh/h/ln	1856	1826	1856	1856	1856	1870	1885	1885	1870	1856	1885	1885
Adj Flow Rate, veh/h	507	1299	26	182	1355	280	110	274	107	362	245	303
Peak Hour Factor	0.96	0.96	0.96	0.96	0.96	0.96	0.96	0.96	0.96	0.96	0.96	0.96
Percent Heavy Veh, %	3	5	3	3	3	2	1	1	2	3	1	1
Cap, veh/h	537	1383	748	190	1772	754	138	408	155	431	753	585
Arrive On Green	0.16	0.40	0.40	0.11	0.35	0.35	0.08	0.16	0.16	0.13	0.21	0.21
Sat Flow, veh/h	3428	3469	1572	1767	5066	1585	1795	2531	963	3428	3582	1595
Grp Volume(v), veh/h	507	1299	26	182	1355	280	110	192	189	362	245	303
Grp Sat Flow(s),veh/h/ln	1714	1735	1572	1767	1689	1585	1795	1791	1703	1714	1791	1595
Q Serve(g_s), s	14.0	34.5	0.8	9.8	22.7	10.8	5.8	9.6	10.0	9.9	5.6	14.2
Cycle Q Clear(g_c), s	14.0	34.5	0.8	9.8	22.7	10.8	5.8	9.6	10.0	9.9	5.6	14.2
Prop In Lane	1.00		1.00	1.00		1.00	1.00		0.57	1.00		1.00
Lane Grp Cap(c), veh/h	537	1383	748	190	1772	754	138	289	275	431	753	585
V/C Ratio(X)	0.94	0.94	0.03	0.96	0.76	0.37	0.80	0.66	0.69	0.84	0.33	0.52
Avail Cap(c_a), veh/h	537	1398	754	190	1793	760	156	701	667	494	1608	966
HCM Platoon Ratio	1.00	1.00	1.00	1.00	1.00	1.00	1.00	1.00	1.00	1.00	1.00	1.00
Upstream Filter(I)	1.00	1.00	1.00	1.00	1.00	1.00	1.00	1.00	1.00	1.00	1.00	1.00
Uniform Delay (d), s/veh	40.0	27.7	13.4	42.5	27.6	16.0	43.5	37.7	37.9	40.9	32.1	23.7
Incr Delay (d2), s/veh	25.4	12.4	0.0	52.6	2.1	0.4	19.5	2.6	3.1	9.8	0.2	0.7
Initial Q Delay(d3),s/veh	0.0	0.0	0.0	0.0	0.0	0.0	0.0	0.0	0.0	0.0	0.0	0.0
%ile BackOfQ(50%),veh/ln	7.4	15.1	0.3	6.8	8.7	3.5	3.2	4.2	4.2	4.5	2.3	5.0
Unsig. Movement Delay, s/veh												
LnGrp Delay(d),s/veh	65.4	40.1	13.4	95.1	29.8	16.4	63.0	40.4	41.0	50.7	32.3	24.4
LnGrp LOS	E	D	B	F	C	B	E	D	D	D	C	C
Approach Vol, veh/h		1832			1817			491			910	
Approach Delay, s/veh		46.7			34.3			45.7			37.0	
Approach LOS		D			C			D			D	
Timer - Assigned Phs	1	2	3	4	5	6	7	8				
Phs Duration (G+Y+Rc), s	14.0	44.4	11.1	26.3	18.7	39.7	15.7	21.6				
Change Period (Y+Rc), s	3.7	6.2	3.7	6.2	3.7	6.2	3.7	6.2				
Max Green Setting (Gmax), s	10.3	38.6	8.3	43.0	15.0	33.9	13.8	37.5				
Max Q Clear Time (g_c+I1), s	11.8	36.5	7.8	16.2	16.0	24.7	11.9	12.0				
Green Ext Time (p_c), s	0.0	1.7	0.0	2.4	0.0	7.0	0.2	2.0				
Intersection Summary												
HCM 6th Ctrl Delay			40.4									
HCM 6th LOS			D									

Intersection	
Intersection Delay, s/veh	10.3
Intersection LOS	B

Movement	EBT	EBR	WBL	WBT	NBL	NBR
Lane Configurations	↶		↷	↶	↷	↷
Traffic Vol, veh/h	158	16	68	230	57	52
Future Vol, veh/h	158	16	68	230	57	52
Peak Hour Factor	0.82	0.82	0.82	0.82	0.82	0.82
Heavy Vehicles, %	2	0	5	2	0	0
Mvmt Flow	193	20	83	280	70	63
Number of Lanes	1	0	1	1	1	1

Approach	EB	WB	NB
Opposing Approach	WB	EB	
Opposing Lanes	2	1	0
Conflicting Approach Left		NB	EB
Conflicting Lanes Left	0	2	1
Conflicting Approach Right	NB		WB
Conflicting Lanes Right	2	0	2
HCM Control Delay	10.3	10.7	9.3
HCM LOS	B	B	A

Lane	NBLn1	NBLn2	EBLn1	WBLn1	WBLn2
Vol Left, %	100%	0%	0%	100%	0%
Vol Thru, %	0%	0%	91%	0%	100%
Vol Right, %	0%	100%	9%	0%	0%
Sign Control	Stop	Stop	Stop	Stop	Stop
Traffic Vol by Lane	57	52	174	68	230
LT Vol	57	0	0	68	0
Through Vol	0	0	158	0	230
RT Vol	0	52	16	0	0
Lane Flow Rate	70	63	212	83	280
Geometry Grp	7	7	4	7	7
Degree of Util (X)	0.123	0.091	0.299	0.13	0.397
Departure Headway (Hd)	6.383	5.171	5.066	5.654	5.1
Convergence, Y/N	Yes	Yes	Yes	Yes	Yes
Cap	560	689	707	633	704
Service Time	4.146	2.934	3.113	3.399	2.845
HCM Lane V/C Ratio	0.125	0.091	0.3	0.131	0.398
HCM Control Delay	10	8.5	10.3	9.2	11.2
HCM Lane LOS	A	A	B	A	B
HCM 95th-tile Q	0.4	0.3	1.3	0.4	1.9

Intersection

Intersection Delay, s/veh 10.9

Intersection LOS B

Movement	EBL	EBT	EBR	WBL	WBT	WBR	NBL	NBT	NBR	SBL	SBT	SBR
Lane Configurations	↙	↑↑		↙	↑↑			↕			↕	
Traffic Vol, veh/h	59	277	9	9	348	57	28	5	5	54	6	59
Future Vol, veh/h	59	277	9	9	348	57	28	5	5	54	6	59
Peak Hour Factor	0.90	0.90	0.90	0.90	0.90	0.90	0.90	0.90	0.90	0.90	0.90	0.90
Heavy Vehicles, %	5	2	7	0	1	0	6	0	0	0	0	0
Mvmt Flow	66	308	10	10	387	63	31	6	6	60	7	66
Number of Lanes	1	2	0	1	2	0	0	1	0	0	1	0

Approach	EB	WB	NB	SB
Opposing Approach	WB	EB	SB	NB
Opposing Lanes	3	3	1	1
Conflicting Approach Left SB		NB	EB	WB
Conflicting Lanes Left	1	1	3	3
Conflicting Approach Right NB		SB	WB	EB
Conflicting Lanes Right	1	1	3	3
HCM Control Delay	10.5	11.2	10.5	11.1
HCM LOS	B	B	B	B

Lane	NBLn1	EBLn1	EBLn2	EBLn3	WBLn1	WBLn2	WBLn3	SBLn1	
Vol Left, %		74%	100%	0%	0%	100%	0%	0%	45%
Vol Thru, %		13%	0%	100%	91%	0%	100%	67%	5%
Vol Right, %		13%	0%	0%	9%	0%	0%	33%	50%
Sign Control		Stop	Stop	Stop	Stop	Stop	Stop	Stop	Stop
Traffic Vol by Lane		38	59	185	101	9	232	173	119
LT Vol		28	59	0	0	9	0	0	54
Through Vol		5	0	185	92	0	232	116	6
RT Vol		5	0	0	9	0	0	57	59
Lane Flow Rate		42	66	205	113	10	258	192	132
Geometry Grp		7	7	7	7	7	7	7	7
Degree of Util (X)		0.083	0.114	0.324	0.178	0.017	0.4	0.285	0.235
Departure Headway (Hd)		7.089	6.235	5.677	5.701	6.08	5.592	5.341	6.387
Convergence, Y/N		Yes	Yes	Yes	Yes	Yes	Yes	Yes	Yes
Cap		506	576	634	631	590	644	673	563
Service Time		4.829	3.961	3.404	3.427	3.806	3.318	3.067	4.121
HCM Lane V/C Ratio		0.083	0.115	0.323	0.179	0.017	0.401	0.285	0.234
HCM Control Delay		10.5	9.8	11.1	9.7	8.9	12	10.2	11.1
HCM Lane LOS		B	A	B	A	A	B	B	B
HCM 95th-tile Q		0.3	0.4	1.4	0.6	0.1	1.9	1.2	0.9

Timings
11: Barton St & Alessandro Bl.

West Campus Upper Plateau (JN 14064)

09/30/2022



Lane Group	EBL	EBT	WBL	WBT	NBL	NBT	NBR	SBL	SBT	SBR
Lane Configurations	↙	↕↕↕	↙	↕↕↕		↕	↗		↕	↗
Traffic Volume (vph)	5	1426	76	1597	61	1	38	5	0	3
Future Volume (vph)	5	1426	76	1597	61	1	38	5	0	3
Turn Type	Prot	NA	Prot	NA	Perm	NA	Perm	Perm	NA	Perm
Protected Phases	5	2	1	6		8			4	
Permitted Phases					8		8	4		4
Detector Phase	5	2	1	6	8	8	8	4	4	4
Switch Phase										
Minimum Initial (s)	5.0	10.0	5.0	10.0	10.0	10.0	10.0	10.0	10.0	10.0
Minimum Split (s)	9.2	28.5	11.0	28.5	40.6	40.6	40.6	26.6	26.6	26.6
Total Split (s)	9.2	65.4	14.0	70.2	40.6	40.6	40.6	40.6	40.6	40.6
Total Split (%)	7.7%	54.5%	11.7%	58.5%	33.8%	33.8%	33.8%	33.8%	33.8%	33.8%
Yellow Time (s)	3.2	5.5	3.2	5.5	3.6	3.6	3.6	3.6	3.6	3.6
All-Red Time (s)	1.0	1.0	1.0	1.0	1.0	1.0	1.0	1.0	1.0	1.0
Lost Time Adjust (s)	0.0	0.0	0.0	0.0		0.0	0.0		0.0	0.0
Total Lost Time (s)	4.2	6.5	4.2	6.5		4.6	4.6		4.6	4.6
Lead/Lag	Lead	Lag	Lead	Lag						
Lead-Lag Optimize?	Yes	Yes	Yes	Yes						
Recall Mode	None	None	None	None	None	None	None	None	None	None
Act Effct Green (s)	5.9	45.3	8.4	53.5		15.2	15.2		15.2	15.2
Actuated g/C Ratio	0.08	0.61	0.11	0.72		0.21	0.21		0.21	0.21
v/c Ratio	0.04	0.50	0.40	0.47		0.24	0.10		0.02	0.01
Control Delay	46.6	13.6	45.4	8.7		32.4	0.5		29.8	0.0
Queue Delay	0.0	0.0	0.0	0.0		0.0	0.0		0.0	0.0
Total Delay	46.6	13.6	45.4	8.7		32.4	0.5		29.8	0.0
LOS	D	B	D	A		C	A		C	A
Approach Delay		13.7		10.3		20.3			18.6	
Approach LOS		B		B		C			B	

Intersection Summary

Cycle Length: 120
 Actuated Cycle Length: 73.8
 Natural Cycle: 85
 Control Type: Actuated-Uncoordinated
 Maximum v/c Ratio: 0.50
 Intersection Signal Delay: 12.2
 Intersection LOS: B
 Intersection Capacity Utilization 60.7%
 ICU Level of Service B
 Analysis Period (min) 15

Splits and Phases: 11: Barton St & Alessandro Bl.



HCM 6th Signalized Intersection Summary
11: Barton St & Alessandro Bl.

West Campus Upper Plateau (JN 14064)

09/30/2022



Movement	EBL	EBT	EBR	WBL	WBT	WBR	NBL	NBT	NBR	SBL	SBT	SBR
Lane Configurations	↖	↑↑↑		↖	↑↑↑			↑	↗		↑	↗
Traffic Volume (veh/h)	5	1426	40	76	1597	5	61	1	38	5	0	3
Future Volume (veh/h)	5	1426	40	76	1597	5	61	1	38	5	0	3
Initial Q (Qb), veh	0	0	0	0	0	0	0	0	0	0	0	0
Ped-Bike Adj(A_pbT)	1.00		1.00	1.00		0.98	1.00		1.00	1.00		1.00
Parking Bus, Adj	1.00	1.00	1.00	1.00	1.00	1.00	1.00	1.00	1.00	1.00	1.00	1.00
Work Zone On Approach		No			No			No			No	
Adj Sat Flow, veh/h/ln	1604	1885	1900	1900	1870	1900	1870	1900	1900	1737	1900	1900
Adj Flow Rate, veh/h	5	1533	41	82	1717	5	66	1	14	5	0	-8
Peak Hour Factor	0.93	0.93	0.93	0.93	0.93	0.93	0.93	0.93	0.93	0.93	0.93	0.93
Percent Heavy Veh, %	20	1	0	0	2	0	2	0	0	11	0	0
Cap, veh/h	10	3033	81	108	3371	10	288	4	187	228	0	187
Arrive On Green	0.01	0.59	0.59	0.06	0.64	0.64	0.12	0.12	0.12	0.12	0.00	0.00
Sat Flow, veh/h	1527	5153	138	1810	5256	15	1532	31	1610	1006	0	1610
Grp Volume(v), veh/h	5	1021	553	82	1112	610	67	0	14	5	0	-8
Grp Sat Flow(s),veh/h/ln	1527	1716	1860	1810	1702	1867	1562	0	1610	1006	0	1610
Q Serve(g_s), s	0.2	11.3	11.3	2.9	11.3	11.3	0.0	0.0	0.5	0.2	0.0	0.0
Cycle Q Clear(g_c), s	0.2	11.3	11.3	2.9	11.3	11.3	2.2	0.0	0.5	2.4	0.0	0.0
Prop In Lane	1.00		0.07	1.00		0.01	0.99		1.00	1.00		1.00
Lane Grp Cap(c), veh/h	10	2019	1095	108	2183	1198	292	0	187	228	0	187
V/C Ratio(X)	0.49	0.51	0.51	0.76	0.51	0.51	0.23	0.00	0.07	0.02	0.00	-0.04
Avail Cap(c_a), veh/h	118	3113	1688	273	3341	1832	925	0	893	851	0	893
HCM Platoon Ratio	1.00	1.00	1.00	1.00	1.00	1.00	1.00	1.00	1.00	1.00	1.00	1.00
Upstream Filter(I)	1.00	1.00	1.00	1.00	1.00	1.00	1.00	0.00	1.00	1.00	0.00	0.00
Uniform Delay (d), s/veh	32.1	7.8	7.8	30.1	6.2	6.2	26.3	0.0	25.6	27.4	0.0	0.0
Incr Delay (d2), s/veh	13.1	0.3	0.5	4.1	0.3	0.5	0.4	0.0	0.2	0.0	0.0	0.0
Initial Q Delay(d3),s/veh	0.0	0.0	0.0	0.0	0.0	0.0	0.0	0.0	0.0	0.0	0.0	0.0
%ile BackOfQ(50%),veh/ln	0.1	2.6	2.8	1.3	3.0	3.4	0.9	0.0	0.2	0.1	0.0	0.0
Unsig. Movement Delay, s/veh												
LnGrp Delay(d),s/veh	45.2	8.1	8.3	34.2	6.5	6.7	26.7	0.0	25.7	27.5	0.0	0.0
LnGrp LOS	D	A	A	C	A	A	C	A	C	C	A	A
Approach Vol, veh/h		1579			1804			81				-3
Approach Delay, s/veh		8.3			7.8			26.5				0.0
Approach LOS		A			A			C				A
Timer - Assigned Phs	1	2		4	5	6		8				
Phs Duration (G+Y+Rc), s	8.1	44.7		12.1	4.6	48.1		12.1				
Change Period (Y+Rc), s	* 4.2	6.5		4.6	* 4.2	6.5		4.6				
Max Green Setting (Gmax), s	* 9.8	58.9		36.0	* 5	63.7		36.0				
Max Q Clear Time (g_c+I1), s	4.9	13.3		4.4	2.2	13.3		4.2				
Green Ext Time (p_c), s	0.0	20.1		0.0	0.0	28.3		0.4				

Intersection Summary

HCM 6th Ctrl Delay	8.5
HCM 6th LOS	A

Notes

* HCM 6th computational engine requires equal clearance times for the phases crossing the barrier.

Intersection						
Int Delay, s/veh	2.5					
Movement	EBL	EBT	WBT	WBR	SBL	SBR
Lane Configurations						
Traffic Vol, veh/h	29	148	206	20	25	61
Future Vol, veh/h	29	148	206	20	25	61
Conflicting Peds, #/hr	0	0	0	7	0	0
Sign Control	Free	Free	Free	Free	Stop	Stop
RT Channelized	-	None	-	None	-	None
Storage Length	100	-	-	-	0	-
Veh in Median Storage, #	-	0	0	-	0	-
Grade, %	-	0	0	-	0	-
Peak Hour Factor	78	78	78	78	78	78
Heavy Vehicles, %	0	1	1	0	0	0
Mvmt Flow	37	190	264	26	32	78

Major/Minor	Major1	Major2	Minor2		
Conflicting Flow All	297	0	-	0	548
Stage 1	-	-	-	-	284
Stage 2	-	-	-	-	264
Critical Hdwy	4.1	-	-	-	6.4
Critical Hdwy Stg 1	-	-	-	-	5.4
Critical Hdwy Stg 2	-	-	-	-	5.4
Follow-up Hdwy	2.2	-	-	-	3.5
Pot Cap-1 Maneuver	1276	-	-	-	501
Stage 1	-	-	-	-	769
Stage 2	-	-	-	-	785
Platoon blocked, %		-	-	-	
Mov Cap-1 Maneuver	1267	-	-	-	479
Mov Cap-2 Maneuver	-	-	-	-	479
Stage 1	-	-	-	-	741
Stage 2	-	-	-	-	780

Approach	EB	WB	SB
HCM Control Delay, s	1.3	0	11.7
HCM LOS			B

Minor Lane/Major Mvmt	EBL	EBT	WBT	WBR	SBLn1
Capacity (veh/h)	1267	-	-	-	647
HCM Lane V/C Ratio	0.029	-	-	-	0.17
HCM Control Delay (s)	7.9	-	-	-	11.7
HCM Lane LOS	A	-	-	-	B
HCM 95th %tile Q(veh)	0.1	-	-	-	0.6

Intersection						
Int Delay, s/veh	42					
Movement	EBT	EBR	WBL	WBT	NBL	NBR
Lane Configurations	↑↑		↖	↑↑	↘	
Traffic Vol, veh/h	308	316	51	455	267	38
Future Vol, veh/h	308	316	51	455	267	38
Conflicting Peds, #/hr	0	2	0	0	0	0
Sign Control	Free	Free	Free	Free	Stop	Stop
RT Channelized	-	None	-	None	-	None
Storage Length	-	-	125	-	0	-
Veh in Median Storage, #	0	-	-	0	0	-
Grade, %	0	-	-	0	0	-
Peak Hour Factor	86	86	86	86	86	86
Heavy Vehicles, %	1	1	0	0	0	0
Mvmt Flow	358	367	59	529	310	44

Major/Minor	Major1	Major2	Minor1		
Conflicting Flow All	0	0	727	0	927
Stage 1	-	-	-	-	544
Stage 2	-	-	-	-	383
Critical Hdwy	-	-	4.1	-	6.8
Critical Hdwy Stg 1	-	-	-	-	5.8
Critical Hdwy Stg 2	-	-	-	-	5.8
Follow-up Hdwy	-	-	2.2	-	3.5
Pot Cap-1 Maneuver	-	-	886	- ~	271
Stage 1	-	-	-	-	551
Stage 2	-	-	-	-	665
Platoon blocked, %	-	-	-	-	-
Mov Cap-1 Maneuver	-	-	884	- ~	252
Mov Cap-2 Maneuver	-	-	-	- ~	252
Stage 1	-	-	-	-	550
Stage 2	-	-	-	-	620

Approach	EB	WB	NB
HCM Control Delay, s	0	0.9	196.1
HCM LOS			F

Minor Lane/Major Mvmt	NBLn1	EBT	EBR	WBL	WBT
Capacity (veh/h)	273	-	-	884	-
HCM Lane V/C Ratio	1.299	-	-	0.067	-
HCM Control Delay (s)	196.1	-	-	9.4	-
HCM Lane LOS	F	-	-	A	-
HCM 95th %tile Q(veh)	17.7	-	-	0.2	-

Notes
~: Volume exceeds capacity \$: Delay exceeds 300s +: Computation Not Defined *: All major volume in platoon

Timings
14: Barton Rd. & Van Buren Bl.

West Campus Upper Plateau (JN 14064)

09/30/2022



Lane Group	EBL	EBT	WBL	WBT	NBL	NBT	NBR	SBL	SBT
Lane Configurations	↘	↗	↘	↗	↘	↗	↗	↘	↗
Traffic Volume (vph)	175	1469	217	1527	254	44	179	46	29
Future Volume (vph)	175	1469	217	1527	254	44	179	46	29
Turn Type	Prot	NA	Prot	NA	Prot	NA	Perm	Prot	NA
Protected Phases	5	2	1	6	3	8		7	4
Permitted Phases							8		
Detector Phase	5	2	1	6	3	8	8	7	4
Switch Phase									
Minimum Initial (s)	5.0	10.0	5.0	10.0	5.0	10.0	10.0	5.0	10.0
Minimum Split (s)	9.2	25.2	9.2	25.5	9.1	14.6	14.6	9.1	33.6
Total Split (s)	17.6	52.1	22.2	56.7	12.1	36.3	36.3	9.4	33.6
Total Split (%)	14.7%	43.4%	18.5%	47.3%	10.1%	30.3%	30.3%	7.8%	28.0%
Yellow Time (s)	3.2	5.2	3.2	5.5	3.6	3.6	3.6	3.6	3.6
All-Red Time (s)	1.0	1.0	1.0	1.0	0.5	1.0	1.0	0.5	1.0
Lost Time Adjust (s)	0.0	0.0	0.0	0.0	0.0	0.0	0.0	0.0	0.0
Total Lost Time (s)	4.2	6.2	4.2	6.5	4.1	4.6	4.6	4.1	4.6
Lead/Lag	Lead	Lag	Lead	Lag	Lead	Lag	Lag	Lead	Lag
Lead-Lag Optimize?	Yes	Yes	Yes	Yes	Yes	Yes	Yes	Yes	Yes
Recall Mode	None	None	None	None	None	None	None	None	None
Act Effct Green (s)	13.5	46.1	17.3	49.7	8.0	18.2	18.2	5.3	13.5
Actuated g/C Ratio	0.13	0.44	0.17	0.48	0.08	0.17	0.17	0.05	0.13
v/c Ratio	0.83	1.24	0.82	0.74	1.04	0.15	0.46	0.55	0.61
Control Delay	74.4	139.8	65.6	25.0	114.8	38.4	8.8	73.4	15.5
Queue Delay	0.0	0.0	0.0	0.0	0.0	0.0	0.0	0.0	0.0
Total Delay	74.4	139.8	65.6	25.0	114.8	38.4	8.8	73.4	15.5
LOS	E	F	E	C	F	D	A	E	B
Approach Delay		133.7		29.9		67.9			25.8
Approach LOS		F		C		E			C

Intersection Summary

Cycle Length: 120
 Actuated Cycle Length: 104.2
 Natural Cycle: 120
 Control Type: Actuated-Uncoordinated
 Maximum v/c Ratio: 1.24
 Intersection Signal Delay: 77.7
 Intersection LOS: E
 Intersection Capacity Utilization 95.6%
 ICU Level of Service F
 Analysis Period (min) 15

























Splits and Phases: 14: Barton Rd. & Van Buren Bl.



HCM 6th Signalized Intersection Summary
 14: Barton Rd. & Van Buren Bl.

West Campus Upper Plateau (JN 14064)

09/30/2022

												
Movement	EBL	EBT	EBR	WBL	WBT	WBR	NBL	NBT	NBR	SBL	SBT	SBR
Lane Configurations		 			 						 	
Traffic Volume (veh/h)	175	1469	217	217	1527	55	254	44	179	46	29	184
Future Volume (veh/h)	175	1469	217	217	1527	55	254	44	179	46	29	184
Initial Q (Qb), veh	0	0	0	0	0	0	0	0	0	0	0	0
Ped-Bike Adj(A_pbT)	1.00		1.00	1.00		1.00	1.00		0.95	1.00		1.00
Parking Bus, Adj	1.00	1.00	1.00	1.00	1.00	1.00	1.00	1.00	1.00	1.00	1.00	1.00
Work Zone On Approach		No			No			No			No	
Adj Sat Flow, veh/h/ln	1900	1841	1870	1870	1856	1856	1900	1900	1885	1900	1841	1900
Adj Flow Rate, veh/h	194	1632	210	241	1697	50	282	49	67	51	32	142
Peak Hour Factor	0.90	0.90	0.90	0.90	0.90	0.90	0.90	0.90	0.90	0.90	0.90	0.90
Percent Heavy Veh, %	0	4	2	2	3	3	0	0	1	0	4	0
Cap, veh/h	225	1396	176	272	2403	71	273	331	264	68	39	175
Arrive On Green	0.12	0.45	0.45	0.15	0.48	0.48	0.08	0.17	0.17	0.04	0.13	0.13
Sat Flow, veh/h	1810	3123	395	1781	5057	149	3510	1900	1517	1810	295	1310
Grp Volume(v), veh/h	194	901	941	241	1133	614	282	49	67	51	0	174
Grp Sat Flow(s),veh/h/ln	1810	1749	1769	1781	1689	1829	1755	1900	1517	1810	0	1605
Q Serve(g_s), s	10.8	45.9	45.9	13.6	27.2	27.2	8.0	2.2	3.9	2.9	0.0	10.8
Cycle Q Clear(g_c), s	10.8	45.9	45.9	13.6	27.2	27.2	8.0	2.2	3.9	2.9	0.0	10.8
Prop In Lane	1.00		0.22	1.00		0.08	1.00		1.00	1.00		0.82
Lane Grp Cap(c), veh/h	225	781	791	272	1605	869	273	331	264	68	0	215
V/C Ratio(X)	0.86	1.15	1.19	0.89	0.71	0.71	1.03	0.15	0.25	0.76	0.00	0.81
Avail Cap(c_a), veh/h	236	781	791	312	1651	894	273	586	468	93	0	453
HCM Platoon Ratio	1.00	1.00	1.00	1.00	1.00	1.00	1.00	1.00	1.00	1.00	1.00	1.00
Upstream Filter(I)	1.00	1.00	1.00	1.00	1.00	1.00	1.00	1.00	1.00	1.00	0.00	1.00
Uniform Delay (d), s/veh	44.1	28.4	28.4	42.6	21.3	21.3	47.4	35.9	36.6	49.0	0.0	43.2
Incr Delay (d2), s/veh	24.2	83.3	98.0	21.1	1.1	2.1	62.8	0.2	0.5	20.1	0.0	7.2
Initial Q Delay(d3),s/veh	0.0	0.0	0.0	0.0	0.0	0.0	0.0	0.0	0.0	0.0	0.0	0.0
%ile BackOfQ(50%),veh/ln	6.1	35.0	38.7	7.3	9.8	10.8	5.8	1.0	1.4	1.7	0.0	4.7
Unsig. Movement Delay, s/veh												
LnGrp Delay(d),s/veh	68.4	111.7	126.4	63.8	22.4	23.4	110.1	36.2	37.1	69.0	0.0	50.4
LnGrp LOS	E	F	F	E	C	C	F	D	D	E	A	D
Approach Vol, veh/h		2036			1988			398			225	
Approach Delay, s/veh		114.4			27.7			88.7			54.6	
Approach LOS		F			C			F			D	
Timer - Assigned Phs	1	2	3	4	5	6	7	8				
Phs Duration (G+Y+Rc), s	19.9	52.4	12.1	18.3	17.0	55.3	7.9	22.5				
Change Period (Y+Rc), s	* 4.2	* 6.5	4.1	4.6	* 4.2	6.5	4.1	4.6				
Max Green Setting (Gmax), s	* 18	* 46	8.0	29.0	* 13	50.2	5.3	31.7				
Max Q Clear Time (g_c+I1), s	15.6	47.9	10.0	12.8	12.8	29.2	4.9	5.9				
Green Ext Time (p_c), s	0.1	0.0	0.0	0.9	0.0	7.6	0.0	0.4				

Intersection Summary

HCM 6th Ctrl Delay	72.2
HCM 6th LOS	E

Notes

* HCM 6th computational engine requires equal clearance times for the phases crossing the barrier.

Timings
15: Airman Dr & Cactus Av.



Lane Group	WBL	WBR	NBR	SBL	Ø6
Lane Configurations	↖	↗	↖	↖↗	
Traffic Volume (vph)	356	426	345	411	
Future Volume (vph)	356	426	345	411	
Turn Type	Prot	Perm	Perm	Prot	
Protected Phases	3			1	6
Permitted Phases		8	2		
Detector Phase	3	8	2	1	
Switch Phase					
Minimum Initial (s)	5.0	10.0	10.0	5.0	10.0
Minimum Split (s)	9.6	21.7	21.7	9.6	14.7
Total Split (s)	72.0	72.0	27.0	21.0	48.0
Total Split (%)	60.0%	60.0%	22.5%	17.5%	40%
Yellow Time (s)	3.6	3.7	3.7	3.6	3.7
All-Red Time (s)	1.0	1.0	1.0	1.0	1.0
Lost Time Adjust (s)	0.0	0.0	0.0	0.0	
Total Lost Time (s)	4.6	4.7	4.7	4.6	
Lead/Lag			Lag	Lead	
Lead-Lag Optimize?			Yes	Yes	
Recall Mode	None	None	Min	None	Min
Act Effect Green (s)	17.6	17.5	11.3	16.2	
Actuated g/C Ratio	0.30	0.30	0.19	0.27	
v/c Ratio	0.76	0.61	0.37	0.51	
Control Delay	29.8	5.8	1.1	22.2	
Queue Delay	0.0	0.0	0.0	0.0	
Total Delay	29.8	5.8	1.1	22.2	
LOS	C	A	A	C	
Approach Delay	16.7				
Approach LOS	B				

Intersection Summary

Cycle Length: 120	
Actuated Cycle Length: 59.2	
Natural Cycle: 60	
Control Type: Actuated-Uncoordinated	
Maximum v/c Ratio: 0.76	
Intersection Signal Delay: 14.7	Intersection LOS: B
Intersection Capacity Utilization 40.8%	ICU Level of Service A
Analysis Period (min) 15	



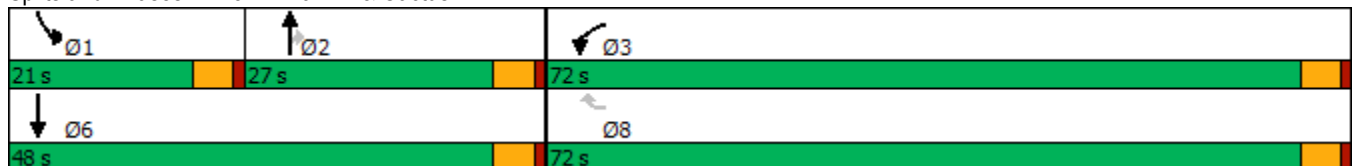









Splits and Phases: 15: Airman Dr & Cactus Av.



HCM 6th Signalized Intersection Summary
15: Airman Dr & Cactus Av.

West Campus Upper Plateau (JN 14064)

09/30/2022

						
Movement	WBL	WBR	NBT	NBR	SBL	SBT
Lane Configurations						
Traffic Volume (veh/h)	356	426	0	345	411	0
Future Volume (veh/h)	356	426	0	345	411	0
Initial Q (Qb), veh	0	0	0	0	0	0
Ped-Bike Adj(A_pbT)	1.00	1.00		1.00	1.00	
Parking Bus, Adj	1.00	1.00	1.00	1.00	1.00	1.00
Work Zone On Approach	No		No			No
Adj Sat Flow, veh/h/ln	1811	1752	1900	1811	1752	1900
Adj Flow Rate, veh/h	387	327	0	375	447	0
Peak Hour Factor	0.92	0.92	0.92	0.92	0.92	0.92
Percent Heavy Veh, %	6	10	0	6	10	0
Cap, veh/h	468	403	542	438	584	1050
Arrive On Green	0.27	0.27	0.00	0.29	0.18	0.00
Sat Flow, veh/h	1725	1485	1900	1535	3237	1900
Grp Volume(v), veh/h	387	327	0	375	447	0
Grp Sat Flow(s),veh/h/ln	1725	1485	1900	1535	1618	1900
Q Serve(g_s), s	11.2	10.9	0.0	12.2	7.0	0.0
Cycle Q Clear(g_c), s	11.2	10.9	0.0	12.2	7.0	0.0
Prop In Lane	1.00	1.00		1.00	1.00	
Lane Grp Cap(c), veh/h	468	403	542	438	584	1050
V/C Ratio(X)	0.83	0.81	0.00	0.86	0.77	0.00
Avail Cap(c_a), veh/h	2196	1890	800	647	1003	1554
HCM Platoon Ratio	1.00	1.00	1.00	1.00	1.00	1.00
Upstream Filter(I)	1.00	1.00	0.00	1.00	1.00	0.00
Uniform Delay (d), s/veh	18.1	18.0	0.0	17.9	20.6	0.0
Incr Delay (d2), s/veh	1.4	1.5	0.0	7.5	0.8	0.0
Initial Q Delay(d3),s/veh	0.0	0.0	0.0	0.0	0.0	0.0
%ile BackOfQ(50%),veh/ln	4.1	3.4	0.0	4.7	2.4	0.0
Unsig. Movement Delay, s/veh						
LnGrp Delay(d),s/veh	19.6	19.5	0.0	25.4	21.4	0.0
LnGrp LOS	B	B	A	C	C	A
Approach Vol, veh/h	714		375			447
Approach Delay, s/veh	19.5		25.4			21.4
Approach LOS	B		C			C
Timer - Assigned Phs	1	2			6	8
Phs Duration (G+Y+Rc), s	14.2	19.8			34.0	19.0
Change Period (Y+Rc), s	4.6	* 4.7			* 4.7	4.6
Max Green Setting (Gmax), s	16.4	* 22			* 43	67.4
Max Q Clear Time (g_c+11), s	9.0	14.2			0.0	13.2
Green Ext Time (p_c), s	0.6	0.9			0.0	1.2

Intersection Summary

HCM 6th Ctrl Delay	21.5
HCM 6th LOS	C

Notes

* HCM 6th computational engine requires equal clearance times for the phases crossing the barrier.

Intersection	
Intersection Delay, s/veh	8.8
Intersection LOS	A

Movement	EBT	EBR	WBL	WBT	NBL	NBR
Lane Configurations						
Traffic Vol, veh/h	102	79	40	136	76	37
Future Vol, veh/h	102	79	40	136	76	37
Peak Hour Factor	0.88	0.88	0.88	0.88	0.88	0.88
Heavy Vehicles, %	1	2	3	2	2	0
Mvmt Flow	116	90	45	155	86	42
Number of Lanes	1	0	1	1	1	0

Approach	EB	WB	NB
Opposing Approach	WB	EB	
Opposing Lanes	2	1	0
Conflicting Approach Left		NB	EB
Conflicting Lanes Left	0	1	1
Conflicting Approach Right	NB		WB
Conflicting Lanes Right	1	0	2
HCM Control Delay	8.7	9	8.8
HCM LOS	A	A	A

Lane	NBLn1	EBLn1	WBLn1	WBLn2
Vol Left, %	67%	0%	100%	0%
Vol Thru, %	0%	56%	0%	100%
Vol Right, %	33%	44%	0%	0%
Sign Control	Stop	Stop	Stop	Stop
Traffic Vol by Lane	113	181	40	136
LT Vol	76	0	40	0
Through Vol	0	102	0	136
RT Vol	37	79	0	0
Lane Flow Rate	128	206	45	155
Geometry Grp	2	5	7	7
Degree of Util (X)	0.171	0.246	0.07	0.215
Departure Headway (Hd)	4.795	4.31	5.53	5.01
Convergence, Y/N	Yes	Yes	Yes	Yes
Cap	749	833	649	717
Service Time	2.825	2.336	3.256	2.736
HCM Lane V/C Ratio	0.171	0.247	0.069	0.216
HCM Control Delay	8.8	8.7	8.7	9.1
HCM Lane LOS	A	A	A	A
HCM 95th-tile Q	0.6	1	0.2	0.8

Intersection	
Intersection Delay, s/veh	9.4
Intersection LOS	A

Movement	EBL	EBT	WBT	WBR	SBL	SBR
Lane Configurations						
Traffic Vol, veh/h	130	165	194	72	60	62
Future Vol, veh/h	130	165	194	72	60	62
Peak Hour Factor	0.90	0.90	0.90	0.90	0.90	0.90
Heavy Vehicles, %	1	0	2	0	4	3
Mvmt Flow	144	183	216	80	67	69
Number of Lanes	1	2	2	0	1	0

Approach	EB	WB	SB
Opposing Approach	WB	EB	
Opposing Lanes	2	3	0
Conflicting Approach Left	SB		WB
Conflicting Lanes Left	1	0	2
Conflicting Approach Right		SB	EB
Conflicting Lanes Right	0	1	3
HCM Control Delay	8.8	9.7	10.2
HCM LOS	A	A	B

Lane	EBLn1	EBLn2	EBLn3	WBLn1	WBLn2	SBLn1
Vol Left, %	100%	0%	0%	0%	0%	49%
Vol Thru, %	0%	100%	100%	100%	47%	0%
Vol Right, %	0%	0%	0%	0%	53%	51%
Sign Control	Stop	Stop	Stop	Stop	Stop	Stop
Traffic Vol by Lane	130	83	83	129	137	122
LT Vol	130	0	0	0	0	60
Through Vol	0	83	83	129	65	0
RT Vol	0	0	0	0	72	62
Lane Flow Rate	144	92	92	144	152	136
Geometry Grp	7	7	7	8	8	7
Degree of Util (X)	0.229	0.132	0.089	0.223	0.219	0.219
Departure Headway (Hd)	5.718	5.197	3.484	5.588	5.182	5.814
Convergence, Y/N	Yes	Yes	Yes	Yes	Yes	Yes
Cap	625	687	1017	638	688	613
Service Time	3.477	2.956	1.242	3.358	2.952	3.594
HCM Lane V/C Ratio	0.23	0.134	0.09	0.226	0.221	0.222
HCM Control Delay	10.2	8.8	6.6	10	9.4	10.2
HCM Lane LOS	B	A	A	A	A	B
HCM 95th-tile Q	0.9	0.5	0.3	0.8	0.8	0.8

Timings
18: Linebacker Dr & Cactus Av.

West Campus Upper Plateau (JN 14064)

09/30/2022

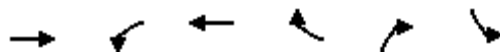

Lane Group	EBT	WBL	WBT	WBR	NBR	SBL	Ø3	Ø4	Ø5	Ø8
Lane Configurations	↑↑	↖	↑	↗	↗	↖↖				
Traffic Volume (vph)	756	169	782	168	159	159				
Future Volume (vph)	756	169	782	168	159	159				
Turn Type	NA	Prot	NA	Perm	pm+ov	Prot				
Protected Phases	2	1	6		1	7	3	4	5	8
Permitted Phases				6	8					
Detector Phase	2	1	6	6	1	7				
Switch Phase										
Minimum Initial (s)	10.0	5.0	10.0	10.0	5.0	5.0	5.0	10.0	5.0	10.0
Minimum Split (s)	27.0	9.6	27.0	27.0	9.6	9.6	9.6	27.0	9.6	27.0
Total Split (s)	27.4	16.0	33.8	33.8	16.0	9.6	9.6	27.0	9.6	27.0
Total Split (%)	34.3%	20.0%	42.3%	42.3%	20.0%	12.0%	12%	34%	12%	34%
Yellow Time (s)	4.0	3.6	4.0	4.0	3.6	3.6	3.6	4.0	3.6	4.0
All-Red Time (s)	1.0	1.0	1.0	1.0	1.0	1.0	1.0	1.0	1.0	1.0
Lost Time Adjust (s)	0.0	0.0	0.0	0.0	0.0	0.0				
Total Lost Time (s)	5.0	4.6	5.0	5.0	4.6	4.6				
Lead/Lag	Lag	Lead	Lag	Lag	Lead	Lead	Lead	Lag	Lead	Lag
Lead-Lag Optimize?	Yes	Yes	Yes	Yes	Yes	Yes	Yes	Yes	Yes	Yes
Recall Mode	None	None	None	None	None	None	None	None	None	None
Act Effct Green (s)	20.1	10.5	35.3	35.3	14.1	5.2				
Actuated g/C Ratio	0.37	0.19	0.65	0.65	0.26	0.10				
v/c Ratio	0.64	0.58	0.74	0.18	0.38	0.55				
Control Delay	19.3	32.8	15.3	2.4	10.5	35.9				
Queue Delay	0.0	0.0	0.0	0.0	0.0	0.0				
Total Delay	19.3	32.8	15.3	2.4	10.5	35.9				
LOS	B	C	B	A	B	D				
Approach Delay	19.3		16.0							
Approach LOS	B		B							

Intersection Summary

Cycle Length: 80
 Actuated Cycle Length: 54.3
 Natural Cycle: 100
 Control Type: Actuated-Uncoordinated
 Maximum v/c Ratio: 0.74
 Intersection Signal Delay: 18.2
 Intersection LOS: B
 Intersection Capacity Utilization 65.8%
 ICU Level of Service C
 Analysis Period (min) 15



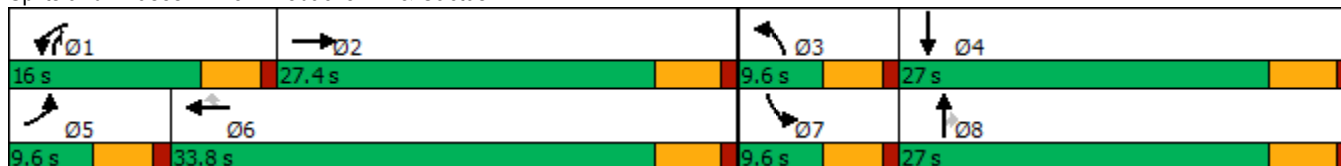





















Splits and Phases: 18: Linebacker Dr & Cactus Av.



HCM 6th Signalized Intersection Summary
18: Linebacker Dr & Cactus Av.

West Campus Upper Plateau (JN 14064)

09/30/2022

												
Movement	EBL	EBT	EBR	WBL	WBT	WBR	NBL	NBT	NBR	SBL	SBT	SBR
Lane Configurations		 								 		
Traffic Volume (veh/h)	0	756	0	169	782	168	0	0	159	159	0	0
Future Volume (veh/h)	0	756	0	169	782	168	0	0	159	159	0	0
Initial Q (Qb), veh	0	0	0	0	0	0	0	0	0	0	0	0
Ped-Bike Adj(A_pbT)	1.00		1.00	1.00		1.00	1.00		1.00	1.00		1.00
Parking Bus, Adj	1.00	1.00	1.00	1.00	1.00	1.00	1.00	1.00	1.00	1.00	1.00	1.00
Work Zone On Approach		No			No			No			No	
Adj Sat Flow, veh/h/ln	1900	1767	1900	1752	1781	1752	1900	1900	1767	1752	1900	1900
Adj Flow Rate, veh/h	0	822	0	184	850	183	0	0	173	173	0	0
Peak Hour Factor	0.92	0.92	0.92	0.92	0.92	0.92	0.92	0.92	0.92	0.92	0.92	0.92
Percent Heavy Veh, %	0	9	0	10	8	10	0	0	9	10	0	0
Cap, veh/h	3	1070	0	226	919	766	3	302	440	265	600	0
Arrive On Green	0.00	0.30	0.00	0.14	0.52	0.52	0.00	0.00	0.16	0.08	0.00	0.00
Sat Flow, veh/h	1810	3533	0	1668	1781	1485	1810	1900	1497	3337	1900	0
Grp Volume(v), veh/h	0	822	0	184	850	183	0	0	173	173	0	0
Grp Sat Flow(s),veh/h/ln	1810	1767	0	1668	1781	1485	1810	1900	1497	1668	1900	0
Q Serve(g_s), s	0.0	12.5	0.0	6.4	26.2	4.0	0.0	0.0	5.5	3.0	0.0	0.0
Cycle Q Clear(g_c), s	0.0	12.5	0.0	6.4	26.2	4.0	0.0	0.0	5.5	3.0	0.0	0.0
Prop In Lane	1.00		0.00	1.00		1.00	1.00		1.00	1.00		0.00
Lane Grp Cap(c), veh/h	3	1070	0	226	919	766	3	302	440	265	600	0
V/C Ratio(X)	0.00	0.77	0.00	0.81	0.93	0.24	0.00	0.00	0.39	0.65	0.00	0.00
Avail Cap(c_a), veh/h	152	1334	0	321	919	766	152	705	758	281	705	0
HCM Platoon Ratio	1.00	1.00	1.00	1.00	1.00	1.00	1.00	1.00	1.00	1.00	1.00	1.00
Upstream Filter(I)	0.00	1.00	0.00	1.00	1.00	1.00	0.00	0.00	1.00	1.00	0.00	0.00
Uniform Delay (d), s/veh	0.0	18.8	0.0	24.9	13.3	7.9	0.0	0.0	16.7	26.5	0.0	0.0
Incr Delay (d2), s/veh	0.0	2.2	0.0	7.0	14.8	0.2	0.0	0.0	0.6	3.6	0.0	0.0
Initial Q Delay(d3),s/veh	0.0	0.0	0.0	0.0	0.0	0.0	0.0	0.0	0.0	0.0	0.0	0.0
%ile BackOfQ(50%),veh/ln	0.0	4.9	0.0	2.8	12.1	1.1	0.0	0.0	1.8	1.3	0.0	0.0
Unsig. Movement Delay, s/veh												
LnGrp Delay(d),s/veh	0.0	21.0	0.0	31.9	28.2	8.1	0.0	0.0	17.3	30.2	0.0	0.0
LnGrp LOS	A	C	A	C	C	A	A	A	B	C	A	A
Approach Vol, veh/h		822			1217			173			173	
Approach Delay, s/veh		21.0			25.7			17.3			30.2	
Approach LOS		C			C			B			C	
Timer - Assigned Phs	1	2	3	4	5	6	7	8				
Phs Duration (G+Y+Rc), s	12.6	23.0	0.0	23.7	0.0	35.6	9.3	14.4				
Change Period (Y+Rc), s	4.6	5.0	4.6	5.0	4.6	5.0	4.6	5.0				
Max Green Setting (Gmax), s	11.4	22.4	5.0	22.0	5.0	28.8	5.0	22.0				
Max Q Clear Time (g_c+I1), s	8.4	14.5	0.0	0.0	0.0	28.2	5.0	7.5				
Green Ext Time (p_c), s	0.1	3.4	0.0	0.0	0.0	0.4	0.0	0.4				
Intersection Summary												
HCM 6th Ctrl Delay				23.8								
HCM 6th LOS				C								

Timings
19: Van Buren Bl. & Orange Terrace Pkwy.

West Campus Upper Plateau (JN 14064)

09/30/2022

Lane Group	EBL	EBT	EBR	WBL	WBT	WBR	NBL	NBT	NBR	SBL	SBT	SBR
Lane Configurations												
Traffic Volume (vph)	143	1383	56	37	1656	277	60	53	44	211	41	127
Future Volume (vph)	143	1383	56	37	1656	277	60	53	44	211	41	127
Turn Type	Prot	NA	Perm	Prot	NA	Perm	Prot	NA	Perm	Prot	NA	pm+ov
Protected Phases	5	2		1	6		3	8		7	4	5
Permitted Phases			2			6			8			4
Detector Phase	5	2	2	1	6	6	3	8	8	7	4	5
Switch Phase												
Minimum Initial (s)	5.0	10.0	10.0	5.0	10.0	10.0	5.0	5.0	5.0	10.0	10.0	5.0
Minimum Split (s)	9.2	25.2	25.2	9.1	25.2	25.2	9.1	26.1	26.1	15.8	24.8	9.2
Total Split (s)	16.0	63.0	63.0	11.0	58.0	58.0	12.0	27.0	27.0	19.0	34.0	16.0
Total Split (%)	13.3%	52.5%	52.5%	9.2%	48.3%	48.3%	10.0%	22.5%	22.5%	15.8%	28.3%	13.3%
Yellow Time (s)	3.2	5.2	5.2	3.6	5.2	5.2	3.6	3.6	3.6	4.8	4.8	3.2
All-Red Time (s)	1.0	1.0	1.0	0.5	1.0	1.0	0.5	0.5	0.5	1.0	1.0	1.0
Lost Time Adjust (s)	0.0	0.0	0.0	0.0	0.0	0.0	0.0	0.0	0.0	0.0	0.0	0.0
Total Lost Time (s)	4.2	6.2	6.2	4.1	6.2	6.2	4.1	4.1	4.1	5.8	5.8	4.2
Lead/Lag	Lead	Lag	Lag	Lead	Lag	Lag	Lead	Lag	Lag	Lead	Lag	Lead
Lead-Lag Optimize?	Yes	Yes	Yes	Yes	Yes	Yes	Yes	Yes	Yes	Yes	Yes	Yes
Recall Mode	None	None	None	None	None	None	None	None	None	None	None	None
Act Effct Green (s)	8.7	51.9	51.9	6.5	44.6	44.6	10.5	7.9	7.9	11.9	12.7	24.2
Actuated g/C Ratio	0.10	0.57	0.57	0.07	0.49	0.49	0.11	0.09	0.09	0.13	0.14	0.26
v/c Ratio	0.46	0.51	0.06	0.16	0.71	0.33	0.17	0.18	0.15	0.49	0.16	0.29
Control Delay	47.4	14.4	0.1	47.5	21.0	5.6	44.7	44.4	1.0	44.6	40.6	17.4
Queue Delay	0.0	0.0	0.0	0.0	0.0	0.0	0.0	0.0	0.0	0.0	0.0	0.0
Total Delay	47.4	14.4	0.1	47.5	21.0	5.6	44.7	44.4	1.0	44.6	40.6	17.4
LOS	D	B	A	D	C	A	D	D	A	D	D	B
Approach Delay		16.9			19.4			32.4			35.1	
Approach LOS		B			B			C			D	

Intersection Summary

Cycle Length: 120	
Actuated Cycle Length: 91.5	
Natural Cycle: 90	
Control Type: Actuated-Uncoordinated	
Maximum v/c Ratio: 0.71	
Intersection Signal Delay: 20.4	Intersection LOS: C
Intersection Capacity Utilization 62.3%	ICU Level of Service B
Analysis Period (min) 15	

Splits and Phases: 19: Van Buren Bl. & Orange Terrace Pkwy.

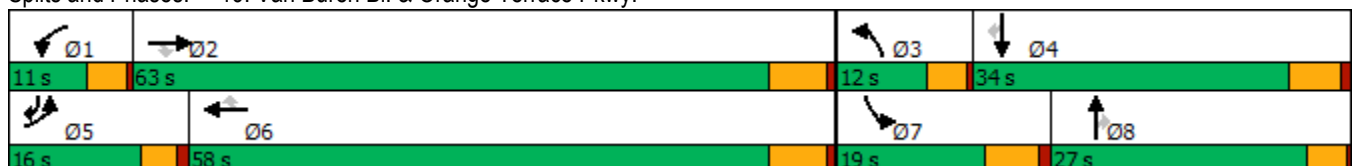

HCM 6th Signalized Intersection Summary
 19: Van Buren Bl. & Orange Terrace Pkwy.

West Campus Upper Plateau (JN 14064)

09/30/2022



Movement	EBL	EBT	EBR	WBL	WBT	WBR	NBL	NBT	NBR	SBL	SBT	SBR
Lane Configurations	↖↗	↑↑↑	↖	↖↗	↑↑↑	↖	↖↗	↑↑	↖	↖↗	↑	↖↗
Traffic Volume (veh/h)	143	1383	56	37	1656	277	60	53	44	211	41	127
Future Volume (veh/h)	143	1383	56	37	1656	277	60	53	44	211	41	127
Initial Q (Qb), veh	0	0	0	0	0	0	0	0	0	0	0	0
Ped-Bike Adj(A_pbT)	1.00		1.00	1.00		1.00	1.00		1.00	1.00		1.00
Parking Bus, Adj	1.00	1.00	1.00	1.00	1.00	1.00	1.00	1.00	1.00	1.00	1.00	1.00
Work Zone On Approach		No			No			No			No	
Adj Sat Flow, veh/h/ln	1885	1856	1811	1870	1856	1885	1796	1900	1856	1885	1900	1885
Adj Flow Rate, veh/h	151	1456	33	39	1743	232	63	56	14	222	43	60
Peak Hour Factor	0.95	0.95	0.95	0.95	0.95	0.95	0.95	0.95	0.95	0.95	0.95	0.95
Percent Heavy Veh, %	1	3	6	2	3	1	7	0	3	1	0	1
Cap, veh/h	230	2601	788	124	2443	770	154	220	96	426	299	357
Arrive On Green	0.07	0.51	0.51	0.04	0.48	0.48	0.05	0.06	0.06	0.12	0.16	0.16
Sat Flow, veh/h	3483	5066	1535	3456	5066	1598	3319	3610	1572	3483	1900	1598
Grp Volume(v), veh/h	151	1456	33	39	1743	232	63	56	14	222	43	60
Grp Sat Flow(s),veh/h/ln	1742	1689	1535	1728	1689	1598	1659	1805	1572	1742	1900	1598
Q Serve(g_s), s	3.5	16.1	0.9	0.9	22.2	7.2	1.5	1.2	0.7	4.9	1.6	2.5
Cycle Q Clear(g_c), s	3.5	16.1	0.9	0.9	22.2	7.2	1.5	1.2	0.7	4.9	1.6	2.5
Prop In Lane	1.00		1.00	1.00		1.00	1.00		1.00	1.00		1.00
Lane Grp Cap(c), veh/h	230	2601	788	124	2443	770	154	220	96	426	299	357
V/C Ratio(X)	0.66	0.56	0.04	0.31	0.71	0.30	0.41	0.26	0.15	0.52	0.14	0.17
Avail Cap(c_a), veh/h	502	3516	1065	291	3206	1011	320	1010	440	562	655	656
HCM Platoon Ratio	1.00	1.00	1.00	1.00	1.00	1.00	1.00	1.00	1.00	1.00	1.00	1.00
Upstream Filter(I)	1.00	1.00	1.00	1.00	1.00	1.00	1.00	1.00	1.00	1.00	1.00	1.00
Uniform Delay (d), s/veh	37.3	13.6	9.9	38.5	16.7	12.8	37.9	36.7	36.4	33.7	29.7	25.7
Incr Delay (d2), s/veh	1.2	0.2	0.0	1.4	0.5	0.2	1.7	0.6	0.7	1.0	0.2	0.2
Initial Q Delay(d3),s/veh	0.0	0.0	0.0	0.0	0.0	0.0	0.0	0.0	0.0	0.0	0.0	0.0
%ile BackOfQ(50%),veh/ln	1.4	5.0	0.3	0.4	7.2	2.5	0.6	0.5	0.3	2.0	0.7	0.9
Unsig. Movement Delay, s/veh												
LnGrp Delay(d),s/veh	38.5	13.8	9.9	39.9	17.2	13.1	39.6	37.3	37.1	34.7	30.0	25.9
LnGrp LOS	D	B	A	D	B	B	D	D	D	C	C	C
Approach Vol, veh/h		1640			2014			133			325	
Approach Delay, s/veh		16.0			17.2			38.4			32.4	
Approach LOS		B			B			D			C	
Timer - Assigned Phs	1	2	3	4	5	6	7	8				
Phs Duration (G+Y+Rc), s	7.0	48.2	7.9	18.7	9.6	45.7	15.8	10.8				
Change Period (Y+Rc), s	4.1	6.2	4.1	5.8	* 4.2	6.2	5.8	* 5.8				
Max Green Setting (Gmax), s	6.9	56.8	7.9	28.2	* 12	51.8	13.2	* 23				
Max Q Clear Time (g_c+I1), s	2.9	18.1	3.5	4.5	5.5	24.2	6.9	3.2				
Green Ext Time (p_c), s	0.0	12.7	0.0	0.3	0.1	15.2	0.4	0.3				

Intersection Summary

HCM 6th Ctrl Delay	18.6
HCM 6th LOS	B

Notes

* HCM 6th computational engine requires equal clearance times for the phases crossing the barrier.

Timings
20: Brown/San Gorgonio Dr & Alessandro Bl.

West Campus Upper Plateau (JN 14064)

09/30/2022



Lane Group	EBL	EBT	WBL	WBT	WBR	NBL	NBR	SBL	SBR	Ø4	Ø8
Lane Configurations	↖	↕	↖	↕	↖	↖	↖	↖	↖		
Traffic Volume (vph)	33	1232	275	1419	36	241	266	41	38		
Future Volume (vph)	33	1232	275	1419	36	241	266	41	38		
Turn Type	Prot	NA	Prot	NA	Perm	Prot	pm+ov	Prot	pm+ov		
Protected Phases	5	2	1	6		3	1	7	5	4	8
Permitted Phases					6		8		4		
Detector Phase	5	2	1	6	6	3	1	7	5		
Switch Phase											
Minimum Initial (s)	5.0	10.0	5.0	10.0	10.0	5.0	5.0	5.0	5.0	10.0	5.0
Minimum Split (s)	8.7	43.5	9.1	43.5	43.5	9.1	9.1	8.7	8.7	49.8	26.1
Total Split (s)	8.7	52.0	9.1	52.4	52.4	9.1	9.1	19.6	8.7	49.8	39.3
Total Split (%)	7.3%	43.3%	7.6%	43.7%	43.7%	7.6%	7.6%	16.3%	7.3%	42%	33%
Yellow Time (s)	3.2	5.5	3.6	5.5	5.5	3.6	3.6	3.2	3.2	4.8	3.6
All-Red Time (s)	0.5	1.0	0.5	1.0	1.0	0.5	0.5	0.5	0.5	1.0	0.5
Lost Time Adjust (s)	0.0	0.0	0.0	0.0	0.0	0.0	0.0	0.0	0.0		
Total Lost Time (s)	3.7	6.5	4.1	6.5	6.5	4.1	4.1	3.7	3.7		
Lead/Lag	Lead	Lag	Lead	Lag	Lag	Lead	Lead	Lead	Lead	Lag	Lag
Lead-Lag Optimize?	Yes	Yes	Yes	Yes	Yes	Yes	Yes	Yes	Yes	Yes	Yes
Recall Mode	None	None	None	None	None	None	None	None	None	None	None
Act Effct Green (s)	5.5	39.6	5.5	42.6	42.6	6.3	16.1	7.0	11.6		
Actuated g/C Ratio	0.07	0.54	0.07	0.58	0.58	0.09	0.22	0.10	0.16		
v/c Ratio	0.26	0.58	3.12	0.51	0.05	1.80	0.76	0.27	0.13		
Control Delay	46.7	15.0	992.6	13.8	0.1	411.1	31.1	42.8	2.4		
Queue Delay	0.0	0.0	0.0	0.0	0.0	0.0	0.0	0.0	0.0		
Total Delay	46.7	15.0	992.6	13.8	0.1	411.1	31.1	42.8	2.4		
LOS	D	B	F	B	A	F	C	D	A		
Approach Delay		15.7		169.2							
Approach LOS		B		F							

Intersection Summary

Cycle Length: 120
 Actuated Cycle Length: 73.5
 Natural Cycle: 115
 Control Type: Actuated-Uncoordinated
 Maximum v/c Ratio: 3.12
 Intersection Signal Delay: 111.2
 Intersection Capacity Utilization 76.8%
 Analysis Period (min) 15
 Intersection LOS: F
 ICU Level of Service D

Splits and Phases: 20: Brown/San Gorgonio Dr & Alessandro Bl.

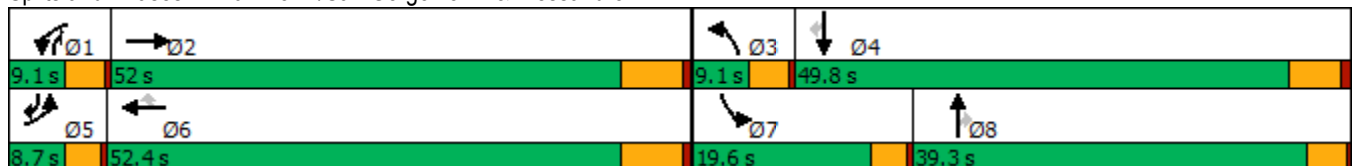

HCM 6th Signalized Intersection Summary
 20: Brown/San Gorgonio Dr & Alessandro Bl.

West Campus Upper Plateau (JN 14064)

09/30/2022

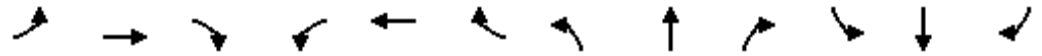

Movement	EBL	EBT	EBR	WBL	WBT	WBR	NBL	NBT	NBR	SBL	SBT	SBR
Lane Configurations	↗	↑↑↑		↖	↑↑↑	↗	↖	↑	↗	↖	↑	↗
Traffic Volume (veh/h)	33	1232	246	275	1419	36	241	0	266	41	0	38
Future Volume (veh/h)	33	1232	246	275	1419	36	241	0	266	41	0	38
Initial Q (Qb), veh	0	0	0	0	0	0	0	0	0	0	0	0
Ped-Bike Adj(A_pbT)	1.00		1.00	1.00		1.00	1.00		1.00	1.00		1.00
Parking Bus, Adj	1.00	1.00	1.00	1.00	1.00	1.00	1.00	1.00	1.00	1.00	1.00	1.00
Work Zone On Approach		No			No			No			No	
Adj Sat Flow, veh/h/ln	1900	1900	1900	1307	1885	1396	1796	1900	1322	1796	1900	1885
Adj Flow Rate, veh/h	35	1325	261	296	1526	35	259	0	273	44	0	-8
Peak Hour Factor	0.93	0.93	0.93	0.93	0.93	0.93	0.93	0.93	0.93	0.93	0.93	0.93
Percent Heavy Veh, %	0	0	0	40	1	34	7	0	39	7	0	1
Cap, veh/h	59	1852	365	70	2337	537	96	482	348	64	438	420
Arrive On Green	0.03	0.43	0.43	0.06	0.45	0.45	0.06	0.00	0.25	0.04	0.00	0.00
Sat Flow, veh/h	1810	4348	856	1245	5147	1183	1711	1900	1120	1711	1900	1598
Grp Volume(v), veh/h	35	1054	532	296	1526	35	259	0	273	44	0	-8
Grp Sat Flow(s),veh/h/ln	1810	1729	1746	1245	1716	1183	1711	1900	1120	1711	1900	1598
Q Serve(g_s), s	1.7	22.3	22.3	5.0	20.4	1.5	5.0	0.0	19.7	2.3	0.0	0.0
Cycle Q Clear(g_c), s	1.7	22.3	22.3	5.0	20.4	1.5	5.0	0.0	19.7	2.3	0.0	0.0
Prop In Lane	1.00		0.49	1.00		1.00	1.00		1.00	1.00		1.00
Lane Grp Cap(c), veh/h	59	1473	744	70	2337	537	96	482	348	64	438	420
V/C Ratio(X)	0.59	0.72	0.72	4.22	0.65	0.07	2.69	0.00	0.79	0.69	0.00	-0.02
Avail Cap(c_a), veh/h	102	1773	895	70	2663	612	96	754	508	307	942	844
HCM Platoon Ratio	1.00	1.00	1.00	1.00	1.00	1.00	1.00	1.00	1.00	1.00	1.00	1.00
Upstream Filter(I)	1.00	1.00	1.00	1.00	1.00	1.00	1.00	0.00	1.00	1.00	0.00	0.00
Uniform Delay (d), s/veh	42.3	21.0	21.0	41.9	18.8	13.6	41.9	0.0	27.9	42.2	0.0	0.0
Incr Delay (d2), s/veh	3.5	1.3	2.6	1481.3	0.6	0.1	787.5	0.0	5.0	4.9	0.0	0.0
Initial Q Delay(d3),s/veh	0.0	0.0	0.0	0.0	0.0	0.0	0.0	0.0	0.0	0.0	0.0	0.0
%ile BackOfQ(50%),veh/ln	0.8	8.0	8.3	30.4	7.8	0.4	23.2	0.0	5.6	1.0	0.0	0.0
Unsig. Movement Delay, s/veh												
LnGrp Delay(d),s/veh	45.9	22.4	23.7	1523.1	19.4	13.7	829.4	0.0	32.9	47.1	0.0	0.0
LnGrp LOS	D	C	C	F	B	B	F	A	C	D	A	A
Approach Vol, veh/h		1621			1857			532				36
Approach Delay, s/veh		23.3			259.0			420.6				57.5
Approach LOS		C			F			F				E
Timer - Assigned Phs	1	2	3	4	5	6	7	8				
Phs Duration (G+Y+Rc), s	9.1	44.3	9.1	26.2	6.6	46.8	7.0	28.3				
Change Period (Y+Rc), s	4.1	6.5	4.1	5.8	3.7	6.5	3.7	* 5.8				
Max Green Setting (Gmax), s	5.0	45.5	5.0	44.0	5.0	45.9	15.9	* 35				
Max Q Clear Time (g_c+I1), s	7.0	24.3	7.0	0.0	3.7	22.4	4.3	21.7				
Green Ext Time (p_c), s	0.0	13.4	0.0	0.0	0.0	15.9	0.0	0.8				

Intersection Summary

HCM 6th Ctrl Delay	184.0
HCM 6th LOS	F

Notes

* HCM 6th computational engine requires equal clearance times for the phases crossing the barrier.

Timings
21: Cactus Av. & Brown St



Lane Group	EBL	EBT	WBT	SBR
Lane Configurations	↖	↗↗	↗↖	↗
Traffic Volume (vph)	507	567	601	518
Future Volume (vph)	507	567	601	518
Turn Type	Prot	NA	NA	Perm
Protected Phases	7	4	8	
Permitted Phases				6
Detector Phase	7	4	8	6
Switch Phase				
Minimum Initial (s)	5.0	10.0	10.0	10.0
Minimum Split (s)	9.6	15.8	27.8	26.7
Total Split (s)	50.0	86.0	36.0	34.0
Total Split (%)	41.7%	71.7%	30.0%	28.3%
Yellow Time (s)	3.6	4.8	4.8	3.7
All-Red Time (s)	1.0	1.0	1.0	1.0
Lost Time Adjust (s)	0.0	0.0	0.0	0.0
Total Lost Time (s)	4.6	5.8	5.8	4.7
Lead/Lag	Lead		Lag	
Lead-Lag Optimize?	Yes		Yes	
Recall Mode	None	None	None	Min
Act Effct Green (s)	30.5	58.4	23.1	12.2
Actuated g/C Ratio	0.37	0.71	0.28	0.15
v/c Ratio	0.82	0.26	0.71	0.70
Control Delay	35.1	4.4	32.7	5.9
Queue Delay	0.0	0.0	0.0	0.0
Total Delay	35.1	4.4	32.7	5.9
LOS	D	A	C	A
Approach Delay		18.9	32.7	
Approach LOS		B	C	

Intersection Summary

Cycle Length: 120	
Actuated Cycle Length: 81.7	
Natural Cycle: 90	
Control Type: Actuated-Uncoordinated	
Maximum v/c Ratio: 0.82	
Intersection Signal Delay: 19.6	Intersection LOS: B
Intersection Capacity Utilization 57.4%	ICU Level of Service B
Analysis Period (min) 15	

Splits and Phases: 21: Cactus Av. & Brown St



HCM 6th Signalized Intersection Summary
21: Cactus Av. & Brown St

West Campus Upper Plateau (JN 14064)
09/30/2022



Movement	EBL	EBT	WBT	WBR	SBL	SBR	
Lane Configurations	↖	↑↑	↗		↖	↗	
Traffic Volume (veh/h)	507	567	601	0	0	518	
Future Volume (veh/h)	507	567	601	0	0	518	
Initial Q (Qb), veh	0	0	0	0	0	0	
Ped-Bike Adj(A_pbT)	1.00			1.00	1.00	1.00	
Parking Bus, Adj	1.00	1.00	1.00	1.00	1.00	1.00	
Work Zone On Approach		No	No		No		
Adj Sat Flow, veh/h/ln	1900	1737	1737	1900	1900	1900	
Adj Flow Rate, veh/h	551	616	653	0	0	405	
Peak Hour Factor	0.92	0.92	0.92	0.92	0.92	0.92	
Percent Heavy Veh, %	0	11	11	0	0	0	
Cap, veh/h	588	2029	794	0	494	439	
Arrive On Green	0.32	0.61	0.24	0.00	0.00	0.27	
Sat Flow, veh/h	1810	3387	3474	0	1810	1610	
Grp Volume(v), veh/h	551	616	653	0	0	405	
Grp Sat Flow(s),veh/h/ln	1810	1650	1650	0	1810	1610	
Q Serve(g_s), s	27.6	8.3	17.5	0.0	0.0	22.8	
Cycle Q Clear(g_c), s	27.6	8.3	17.5	0.0	0.0	22.8	
Prop In Lane	1.00			0.00	1.00	1.00	
Lane Grp Cap(c), veh/h	588	2029	794	0	494	439	
V/C Ratio(X)	0.94	0.30	0.82	0.00	0.00	0.92	
Avail Cap(c_a), veh/h	879	2833	1067	0	567	505	
HCM Platoon Ratio	1.00	1.00	1.00	1.00	1.00	1.00	
Upstream Filter(I)	1.00	1.00	1.00	0.00	0.00	1.00	
Uniform Delay (d), s/veh	30.6	8.5	33.6	0.0	0.0	33.0	
Incr Delay (d2), s/veh	10.4	0.1	3.9	0.0	0.0	21.0	
Initial Q Delay(d3),s/veh	0.0	0.0	0.0	0.0	0.0	0.0	
%ile BackOfQ(50%),veh/ln	12.8	2.5	7.0	0.0	0.0	2.6	
Unsig. Movement Delay, s/veh							
LnGrp Delay(d),s/veh	41.1	8.6	37.5	0.0	0.0	54.0	
LnGrp LOS	D	A	D	A	A	D	
Approach Vol, veh/h		1167	653		405		
Approach Delay, s/veh		23.9	37.5		54.0		
Approach LOS		C	D		D		
Timer - Assigned Phs				4	6	7	8
Phs Duration (G+Y+Rc), s				63.3	30.2	35.0	28.3
Change Period (Y+Rc), s				5.8	4.7	4.6	5.8
Max Green Setting (Gmax), s				80.2	29.3	45.4	30.2
Max Q Clear Time (g_c+11), s				10.3	24.8	29.6	19.5
Green Ext Time (p_c), s				4.3	0.6	0.7	3.0
Intersection Summary							
HCM 6th Ctrl Delay			33.4				
HCM 6th LOS			C				

Timings
22: Sycamore Canyon Bl. & Eastridge Ave

West Campus Upper Plateau (JN 14064)

09/30/2022



Lane Group	EBL	EBT	EBR	WBL	WBT	WBR	NBL	NBT	NBR	SBL	SBT	SBR
Lane Configurations	↖↖	↑↑↑	↗	↖↖	↑↑	↗	↖↖	↑↑	↗	↖↖	↑↑	↗
Traffic Volume (vph)	45	76	18	213	60	341	51	347	79	132	155	34
Future Volume (vph)	45	76	18	213	60	341	51	347	79	132	155	34
Turn Type	Prot	NA	Perm	Prot	NA	pm+ov	Prot	NA	pm+ov	Prot	NA	pm+ov
Protected Phases	5	2		1	6	7	3	8	1	7	4	5
Permitted Phases			2			6			8			4
Detector Phase	5	2	2	1	6	7	3	8	1	7	4	5
Switch Phase												
Minimum Initial (s)	5.0	10.0	10.0	5.0	10.0	5.0	5.0	10.0	5.0	5.0	10.0	5.0
Minimum Split (s)	8.7	43.5	43.5	8.7	43.5	8.7	8.7	15.8	8.7	8.7	49.8	8.7
Total Split (s)	11.7	45.5	45.5	15.2	49.0	20.2	8.7	39.1	15.2	20.2	50.6	11.7
Total Split (%)	9.8%	37.9%	37.9%	12.7%	40.8%	16.8%	7.3%	32.6%	12.7%	16.8%	42.2%	9.8%
Yellow Time (s)	3.2	5.5	5.5	3.2	5.5	3.2	3.2	4.8	3.2	3.2	4.8	3.2
All-Red Time (s)	0.5	1.0	1.0	0.5	1.0	0.5	0.5	1.0	0.5	0.5	1.0	0.5
Lost Time Adjust (s)	0.0	0.0	0.0	0.0	0.0	0.0	0.0	0.0	0.0	0.0	0.0	0.0
Total Lost Time (s)	3.7	6.5	6.5	3.7	6.5	3.7	3.7	5.8	3.7	3.7	5.8	3.7
Lead/Lag	Lead	Lag	Lag	Lead	Lag	Lead	Lead	Lag	Lead	Lead	Lag	Lead
Lead-Lag Optimize?	Yes	Yes	Yes	Yes	Yes	Yes	Yes	Yes	Yes	Yes	Yes	Yes
Recall Mode	None	None	None	None	None	None	None	None	None	None	None	None
Act Effct Green (s)	10.4	13.6	13.6	10.9	15.6	23.5	5.4	13.9	27.1	7.8	20.9	33.5
Actuated g/C Ratio	0.17	0.22	0.22	0.17	0.25	0.38	0.09	0.22	0.43	0.12	0.33	0.54
v/c Ratio	0.09	0.09	0.04	0.38	0.09	0.50	0.21	0.49	0.12	0.33	0.14	0.05
Control Delay	31.8	21.8	0.2	30.4	19.6	6.9	35.6	25.6	3.1	32.1	19.2	1.5
Queue Delay	0.0	0.0	0.0	0.0	0.0	0.0	0.0	0.0	0.0	0.0	0.0	0.0
Total Delay	31.8	21.8	0.2	30.4	19.6	6.9	35.6	25.6	3.1	32.1	19.2	1.5
LOS	C	C	A	C	B	A	D	C	A	C	B	A
Approach Delay		22.2			16.3			23.0			22.6	
Approach LOS		C			B			C			C	

Intersection Summary

Cycle Length: 120	
Actuated Cycle Length: 62.6	
Natural Cycle: 115	
Control Type: Actuated-Uncoordinated	
Maximum v/c Ratio: 0.50	
Intersection Signal Delay: 20.2	Intersection LOS: C
Intersection Capacity Utilization 46.5%	ICU Level of Service A
Analysis Period (min) 15	

Splits and Phases: 22: Sycamore Canyon Bl. & Eastridge Ave

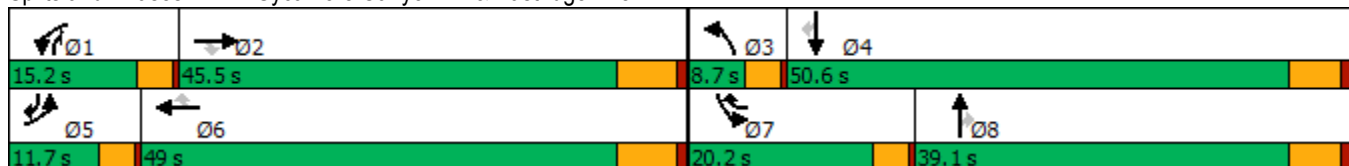

HCM 6th Signalized Intersection Summary
22: Sycamore Canyon Bl. & Eastridge Ave

West Campus Upper Plateau (JN 14064)

09/30/2022



Movement	EBL	EBT	EBR	WBL	WBT	WBR	NBL	NBT	NBR	SBL	SBT	SBR
Lane Configurations	↖↗	↑↑↑	↖	↖↗	↑↑	↖	↖↗	↑↑	↖	↖↗	↑↑	↖
Traffic Volume (veh/h)	45	76	18	213	60	341	51	347	79	132	155	34
Future Volume (veh/h)	45	76	18	213	60	341	51	347	79	132	155	34
Initial Q (Qb), veh	0	0	0	0	0	0	0	0	0	0	0	0
Ped-Bike Adj(A_pbT)	1.00		1.00	1.00		1.00	1.00		0.99	1.00		0.99
Parking Bus, Adj	1.00	1.00	1.00	1.00	1.00	1.00	1.00	1.00	1.00	1.00	1.00	1.00
Work Zone On Approach		No			No			No			No	
Adj Sat Flow, veh/h/ln	1648	1589	1826	1856	1396	1796	1618	1796	1826	1841	1826	1530
Adj Flow Rate, veh/h	47	80	0	224	63	186	54	365	29	139	163	32
Peak Hour Factor	0.95	0.95	0.95	0.95	0.95	0.95	0.95	0.95	0.95	0.95	0.95	0.95
Percent Heavy Veh, %	17	21	5	3	34	7	19	7	5	4	5	25
Cap, veh/h	147	903		351	696	530	159	693	469	294	820	364
Arrive On Green	0.05	0.21	0.00	0.10	0.26	0.26	0.05	0.20	0.20	0.09	0.24	0.24
Sat Flow, veh/h	3045	4337	1547	3428	2653	1521	2990	3413	1527	3401	3469	1278
Grp Volume(v), veh/h	47	80	0	224	63	186	54	365	29	139	163	32
Grp Sat Flow(s),veh/h/ln	1522	1446	1547	1714	1326	1521	1495	1706	1527	1700	1735	1278
Q Serve(g_s), s	0.7	0.7	0.0	3.1	0.9	4.5	0.9	4.7	0.7	1.9	1.9	0.9
Cycle Q Clear(g_c), s	0.7	0.7	0.0	3.1	0.9	4.5	0.9	4.7	0.7	1.9	1.9	0.9
Prop In Lane	1.00		1.00	1.00		1.00	1.00		1.00	1.00		1.00
Lane Grp Cap(c), veh/h	147	903		351	696	530	159	693	469	294	820	364
V/C Ratio(X)	0.32	0.09		0.64	0.09	0.35	0.34	0.53	0.06	0.47	0.20	0.09
Avail Cap(c_a), veh/h	495	3435		801	2289	1444	304	2308	1191	1140	3156	1225
HCM Platoon Ratio	1.00	1.00	1.00	1.00	1.00	1.00	1.00	1.00	1.00	1.00	1.00	1.00
Upstream Filter(I)	1.00	1.00	0.00	1.00	1.00	1.00	1.00	1.00	1.00	1.00	1.00	1.00
Uniform Delay (d), s/veh	22.7	15.7	0.0	21.2	13.7	11.9	22.5	17.5	12.1	21.4	15.1	12.9
Incr Delay (d2), s/veh	0.5	0.1	0.0	0.7	0.1	0.6	0.5	0.6	0.1	0.4	0.1	0.1
Initial Q Delay(d3),s/veh	0.0	0.0	0.0	0.0	0.0	0.0	0.0	0.0	0.0	0.0	0.0	0.0
%ile BackOfQ(50%),veh/ln	0.2	0.2	0.0	1.0	0.2	1.2	0.3	1.6	0.2	0.7	0.6	0.2
Unsig. Movement Delay, s/veh												
LnGrp Delay(d),s/veh	23.1	15.8	0.0	21.9	13.8	12.5	23.0	18.1	12.2	21.9	15.2	13.0
LnGrp LOS	C	B		C	B	B	C	B	B	C	B	B
Approach Vol, veh/h		127			473			448			334	
Approach Delay, s/veh		18.5			17.1			18.3			17.8	
Approach LOS		B			B			B			B	
Timer - Assigned Phs	1	2	3	4	5	6	7	8				
Phs Duration (G+Y+Rc), s	8.7	16.7	6.3	17.4	6.1	19.4	8.0	15.8				
Change Period (Y+Rc), s	3.7	6.5	3.7	5.8	3.7	6.5	3.7	5.8				
Max Green Setting (Gmax), s	11.5	39.0	5.0	44.8	8.0	42.5	16.5	33.3				
Max Q Clear Time (g_c+I1), s	5.1	2.7	2.9	3.9	2.7	6.5	3.9	6.7				
Green Ext Time (p_c), s	0.2	0.6	0.0	1.1	0.0	1.5	0.2	2.3				

Intersection Summary

HCM 6th Ctrl Delay	17.8
HCM 6th LOS	B

Notes

Unsignalized Delay for [EBR] is excluded from calculations of the approach delay and intersection delay.

Timings
23: Sycamore Canyon Bl. & Cottonwood Ave

West Campus Upper Plateau (JN 14064)

09/30/2022



Lane Group	WBL	WBR	NBT	SBL	SBT
Lane Configurations	↙	↗	↕↔	↘	↕↕
Traffic Volume (vph)	7	22	410	20	421
Future Volume (vph)	7	22	410	20	421
Turn Type	Prot	Perm	NA	Prot	NA
Protected Phases	8		2	1	6
Permitted Phases		8			
Detector Phase	8	8	2	1	6
Switch Phase					
Minimum Initial (s)	10.0	10.0	10.0	5.0	10.0
Minimum Split (s)	15.8	15.8	43.5	9.1	43.5
Total Split (s)	23.0	23.0	78.0	19.0	97.0
Total Split (%)	19.2%	19.2%	65.0%	15.8%	80.8%
Yellow Time (s)	4.8	4.8	5.5	3.6	5.5
All-Red Time (s)	1.0	1.0	1.0	0.5	1.0
Lost Time Adjust (s)	0.0	0.0	0.0	0.0	0.0
Total Lost Time (s)	5.8	5.8	6.5	4.1	6.5
Lead/Lag			Lag	Lead	
Lead-Lag Optimize?			Yes	Yes	
Recall Mode	None	None	None	None	None
Act Effct Green (s)	12.5	12.5	22.6	7.5	23.7
Actuated g/C Ratio	0.49	0.49	0.88	0.29	0.92
v/c Ratio	0.01	0.05	0.15	0.05	0.14
Control Delay	12.1	7.6	3.9	14.0	1.7
Queue Delay	0.0	0.0	0.0	0.0	0.0
Total Delay	12.1	7.6	3.9	14.0	1.7
LOS	B	A	A	B	A
Approach Delay	8.7		3.9		2.3
Approach LOS	A		A		A

Intersection Summary

Cycle Length: 120
 Actuated Cycle Length: 25.7
 Natural Cycle: 70
 Control Type: Actuated-Uncoordinated
 Maximum v/c Ratio: 0.15
 Intersection Signal Delay: 3.3
 Intersection LOS: A
 Intersection Capacity Utilization 35.2%
 ICU Level of Service A
 Analysis Period (min) 15

Splits and Phases: 23: Sycamore Canyon Bl. & Cottonwood Ave



HCM 6th Signalized Intersection Summary
23: Sycamore Canyon Bl. & Cottonwood Ave

West Campus Upper Plateau (JN 14064)
09/30/2022



Movement	WBL	WBR	NBT	NBR	SBL	SBT
Lane Configurations						
Traffic Volume (veh/h)	7	22	410	12	20	421
Future Volume (veh/h)	7	22	410	12	20	421
Initial Q (Qb), veh	0	0	0	0	0	0
Ped-Bike Adj(A_pbT)	1.00	1.00		0.98	1.00	
Parking Bus, Adj	1.00	1.00	1.00	1.00	1.00	1.00
Work Zone On Approach	No		No			No
Adj Sat Flow, veh/h/ln	1574	1070	1796	1752	1485	1870
Adj Flow Rate, veh/h	8	14	441	12	22	453
Peak Hour Factor	0.93	0.93	0.93	0.93	0.93	0.93
Percent Heavy Veh, %	22	56	7	10	28	2
Cap, veh/h	84	51	1180	32	40	1841
Arrive On Green	0.06	0.06	0.35	0.35	0.03	0.52
Sat Flow, veh/h	1499	907	3481	92	1414	3647
Grp Volume(v), veh/h	8	14	222	231	22	453
Grp Sat Flow(s),veh/h/ln	1499	907	1706	1777	1414	1777
Q Serve(g_s), s	0.1	0.4	2.8	2.8	0.4	2.0
Cycle Q Clear(g_c), s	0.1	0.4	2.8	2.8	0.4	2.0
Prop In Lane	1.00	1.00		0.05	1.00	
Lane Grp Cap(c), veh/h	84	51	594	618	40	1841
V/C Ratio(X)	0.10	0.28	0.37	0.37	0.56	0.25
Avail Cap(c_a), veh/h	893	540	4226	4401	730	11139
HCM Platoon Ratio	1.00	1.00	1.00	1.00	1.00	1.00
Upstream Filter(I)	1.00	1.00	1.00	1.00	1.00	1.00
Uniform Delay (d), s/veh	12.9	13.1	7.1	7.1	13.9	3.8
Incr Delay (d2), s/veh	0.5	2.9	0.6	0.5	11.6	0.1
Initial Q Delay(d3),s/veh	0.0	0.0	0.0	0.0	0.0	0.0
%ile BackOfQ(50%),veh/ln	0.0	0.1	0.5	0.5	0.2	0.1
Unsig. Movement Delay, s/veh						
LnGrp Delay(d),s/veh	13.4	16.0	7.6	7.6	25.4	3.9
LnGrp LOS	B	B	A	A	C	A
Approach Vol, veh/h	22		453			475
Approach Delay, s/veh	15.0		7.6			4.9
Approach LOS	B		A			A
Timer - Assigned Phs	1	2			6	8
Phs Duration (G+Y+Rc), s	4.9	16.5			21.5	7.4
Change Period (Y+Rc), s	4.1	6.5			6.5	5.8
Max Green Setting (Gmax), s	14.9	71.5			90.5	17.2
Max Q Clear Time (g_c+I1), s	2.4	4.8			4.0	2.4
Green Ext Time (p_c), s	0.0	4.0			4.5	0.0
Intersection Summary						
HCM 6th Ctrl Delay			6.4			
HCM 6th LOS			A			

Timings

West Campus Upper Plateau (JN 14064)

24: Sycamore Canyon Bl. & Alessandro Bl.

09/30/2022

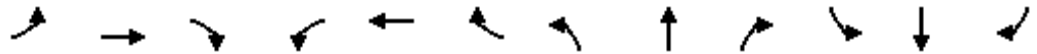

Lane Group	EBL	EBT	EBR	WBL	WBT	WBR	NBL	NBT	NBR	SBL	SBT	SBR
Lane Configurations	↖	↑↑↑	↗	↖↗	↑↑↑	↗	↖↗	↑↑	↖↗	↖↗	↑↑	↖↗
Traffic Volume (vph)	108	1276	105	85	1434	96	188	171	42	63	190	57
Future Volume (vph)	108	1276	105	85	1434	96	188	171	42	63	190	57
Turn Type	Prot	NA	Perm	Prot	NA	Perm	Prot	NA	pm+ov	Prot	NA	Perm
Protected Phases	5	2		1	6		3	8	1	7	4	
Permitted Phases			2			6			8			4
Detector Phase	5	2	2	1	6	6	3	8	1	7	4	4
Switch Phase												
Minimum Initial (s)	5.0	10.0	10.0	5.0	10.0	10.0	5.0	10.0	5.0	5.0	10.0	10.0
Minimum Split (s)	8.7	43.5	43.5	8.7	43.5	43.5	8.7	15.8	8.7	8.7	49.8	49.8
Total Split (s)	10.0	44.2	44.2	12.0	46.2	46.2	14.0	51.0	12.0	12.8	49.8	49.8
Total Split (%)	8.3%	36.8%	36.8%	10.0%	38.5%	38.5%	11.7%	42.5%	10.0%	10.7%	41.5%	41.5%
Yellow Time (s)	3.2	5.5	5.5	3.2	5.5	5.5	3.2	4.8	3.2	3.2	4.8	4.8
All-Red Time (s)	0.5	1.0	1.0	0.5	1.0	1.0	0.5	1.0	0.5	0.5	1.0	1.0
Lost Time Adjust (s)	0.0	0.0	0.0	0.0	0.0	0.0	0.0	0.0	0.0	0.0	0.0	0.0
Total Lost Time (s)	3.7	6.5	6.5	3.7	6.5	6.5	3.7	5.8	3.7	3.7	5.8	5.8
Lead/Lag	Lead	Lag	Lag	Lead	Lag	Lag	Lead	Lag	Lead	Lead	Lag	Lag
Lead-Lag Optimize?	Yes	Yes	Yes	Yes	Yes	Yes	Yes	Yes	Yes	Yes	Yes	Yes
Recall Mode	None	None	None	None	None	None	None	None	None	None	None	None
Act Effct Green (s)	6.5	40.1	40.1	6.8	38.3	38.3	9.1	20.5	33.3	6.4	15.7	15.7
Actuated g/C Ratio	0.07	0.45	0.45	0.08	0.43	0.43	0.10	0.23	0.37	0.07	0.17	0.17
v/c Ratio	0.88	0.59	0.15	0.37	0.69	0.15	0.57	0.23	0.04	0.28	0.33	0.17
Control Delay	98.1	22.8	7.4	48.0	24.8	6.5	48.1	29.4	2.0	46.6	33.2	2.2
Queue Delay	0.0	0.0	0.0	0.0	0.0	0.0	0.0	0.0	0.0	0.0	0.0	0.0
Total Delay	98.1	22.8	7.4	48.0	24.8	6.5	48.1	29.4	2.0	46.6	33.2	2.2
LOS	F	C	A	D	C	A	D	C	A	D	C	A
Approach Delay		27.2			24.9			35.3			30.2	
Approach LOS		C			C			D			C	

Intersection Summary

Cycle Length: 120
 Actuated Cycle Length: 89.8
 Natural Cycle: 115
 Control Type: Actuated-Uncoordinated
 Maximum v/c Ratio: 0.88
 Intersection Signal Delay: 27.3
 Intersection LOS: C
 Intersection Capacity Utilization 64.3%
 ICU Level of Service C
 Analysis Period (min) 15



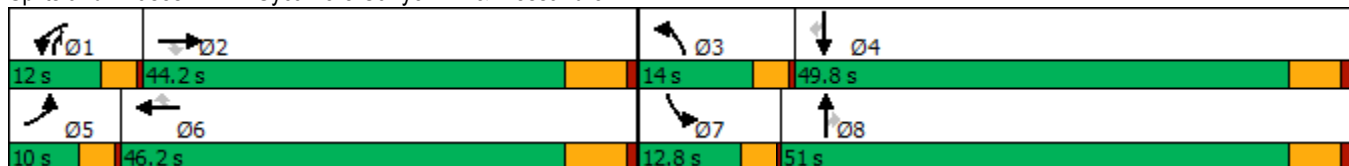































Splits and Phases: 24: Sycamore Canyon Bl. & Alessandro Bl.



HCM 6th Signalized Intersection Summary
 24: Sycamore Canyon Bl. & Alessandro Bl.

West Campus Upper Plateau (JN 14064)

09/30/2022

												
Movement	EBL	EBT	EBR	WBL	WBT	WBR	NBL	NBT	NBR	SBL	SBT	SBR
Lane Configurations		  		 	  		 	 	 	 	 	
Traffic Volume (veh/h)	108	1276	105	85	1434	96	188	171	42	63	190	57
Future Volume (veh/h)	108	1276	105	85	1434	96	188	171	42	63	190	57
Initial Q (Qb), veh	0	0	0	0	0	0	0	0	0	0	0	0
Ped-Bike Adj(A_pbT)	1.00		1.00	1.00		1.00	1.00		1.00	1.00		1.00
Parking Bus, Adj	1.00	1.00	1.00	1.00	1.00	1.00	1.00	1.00	1.00	1.00	1.00	1.00
Work Zone On Approach		No			No			No			No	
Adj Sat Flow, veh/h/ln	1900	1885	1885	1737	1885	1781	1870	1841	1841	1826	1826	1870
Adj Flow Rate, veh/h	114	1343	-86	89	1509	-34	198	180	1	66	200	-35
Peak Hour Factor	0.95	0.95	0.95	0.95	0.95	0.95	0.95	0.95	0.95	0.95	0.95	0.95
Percent Heavy Veh, %	0	1	1	11	1	8	2	4	4	5	5	2
Cap, veh/h	145	2375	737	181	2252	661	287	585	614	169	466	213
Arrive On Green	0.08	0.46	0.00	0.06	0.44	0.00	0.08	0.17	0.17	0.05	0.13	0.00
Sat Flow, veh/h	1810	5147	1598	3209	5147	1510	3456	3497	2745	3374	3469	1585
Grp Volume(v), veh/h	114	1343	-86	89	1509	-34	198	180	1	66	200	-35
Grp Sat Flow(s),veh/h/ln	1810	1716	1598	1605	1716	1510	1728	1749	1373	1687	1735	1585
Q Serve(g_s), s	4.6	14.1	0.0	2.0	17.4	0.0	4.1	3.4	0.0	1.4	3.9	0.0
Cycle Q Clear(g_c), s	4.6	14.1	0.0	2.0	17.4	0.0	4.1	3.4	0.0	1.4	3.9	0.0
Prop In Lane	1.00		1.00	1.00		1.00	1.00		1.00	1.00		1.00
Lane Grp Cap(c), veh/h	145	2375	737	181	2252	661	287	585	614	169	466	213
V/C Ratio(X)	0.78	0.57	-0.12	0.49	0.67	-0.05	0.69	0.31	0.00	0.39	0.43	-0.16
Avail Cap(c_a), veh/h	153	2607	809	358	2746	805	478	2124	1823	413	2051	937
HCM Platoon Ratio	1.00	1.00	1.00	1.00	1.00	1.00	1.00	1.00	1.00	1.00	1.00	1.00
Upstream Filter(I)	1.00	1.00	0.00	1.00	1.00	0.00	1.00	1.00	1.00	1.00	1.00	0.00
Uniform Delay (d), s/veh	33.6	14.6	0.0	34.1	16.6	0.0	33.2	27.2	22.4	34.2	29.6	0.0
Incr Delay (d2), s/veh	19.8	0.3	0.0	0.8	0.6	0.0	1.1	0.3	0.0	0.5	0.6	0.0
Initial Q Delay(d3),s/veh	0.0	0.0	0.0	0.0	0.0	0.0	0.0	0.0	0.0	0.0	0.0	0.0
%ile BackOfQ(50%),veh/ln	2.7	4.6	0.0	0.7	5.9	0.0	1.7	1.3	0.0	0.6	1.6	0.0
Unsig. Movement Delay, s/veh												
LnGrp Delay(d),s/veh	53.4	14.9	0.0	34.8	17.3	0.0	34.3	27.5	22.4	34.8	30.2	0.0
LnGrp LOS	D	B	A	C	B	A	C	C	C	C	C	A
Approach Vol, veh/h		1371			1564			379			231	
Approach Delay, s/veh		19.1			18.6			31.0			36.1	
Approach LOS		B			B			C			D	
Timer - Assigned Phs	1	2	3	4	5	6	7	8				
Phs Duration (G+Y+Rc), s	7.9	40.8	9.9	15.8	9.7	39.1	7.4	18.2				
Change Period (Y+Rc), s	3.7	6.5	3.7	5.8	3.7	6.5	3.7	5.8				
Max Green Setting (Gmax), s	8.3	37.7	10.3	44.0	6.3	39.7	9.1	45.2				
Max Q Clear Time (g_c+I1), s	4.0	16.1	6.1	5.9	6.6	19.4	3.4	5.4				
Green Ext Time (p_c), s	0.0	12.3	0.1	1.2	0.0	13.2	0.0	1.1				
Intersection Summary												
HCM 6th Ctrl Delay				21.3								
HCM 6th LOS				C								

Timings
25: Sycamore Canyon Bl. & Cactus Av.

West Campus Upper Plateau (JN 14064)

09/30/2022



Lane Group	EBL	EBT	EBR	WBL	WBT	WBR	NBL	NBT	NBR	SBL	SBT	SBR
Lane Configurations	↘	↑↑	↗	↘↗	↑↑	↗	↘↗	↑↑	↗	↘↗	↑↑	↗
Traffic Volume (vph)	58	390	172	185	391	225	178	172	140	132	224	49
Future Volume (vph)	58	390	172	185	391	225	178	172	140	132	224	49
Turn Type	Prot	NA	Perm	Prot	NA	Perm	Prot	NA	Perm	Prot	NA	Perm
Protected Phases	7	4		3	8		5	2		1	6	
Permitted Phases			4			8			2			6
Detector Phase	7	4	4	3	8	8	5	2	2	1	6	6
Switch Phase												
Minimum Initial (s)	5.0	10.0	10.0	5.0	10.0	10.0	5.0	10.0	10.0	5.0	10.0	10.0
Minimum Split (s)	9.6	32.8	32.8	9.6	32.8	32.8	9.6	34.8	34.8	9.6	34.8	34.8
Total Split (s)	10.3	32.8	32.8	29.0	51.5	51.5	9.6	36.2	36.2	22.0	48.6	48.6
Total Split (%)	8.6%	27.3%	27.3%	24.2%	42.9%	42.9%	8.0%	30.2%	30.2%	18.3%	40.5%	40.5%
Yellow Time (s)	3.6	4.8	4.8	3.6	4.8	4.8	3.6	4.8	4.8	3.6	4.8	4.8
All-Red Time (s)	1.0	1.0	1.0	1.0	1.0	1.0	1.0	1.0	1.0	1.0	1.0	1.0
Lost Time Adjust (s)	0.0	0.0	0.0	0.0	0.0	0.0	0.0	0.0	0.0	0.0	0.0	0.0
Total Lost Time (s)	4.6	5.8	5.8	4.6	5.8	5.8	4.6	5.8	5.8	4.6	5.8	5.8
Lead/Lag	Lead	Lag	Lag	Lead	Lag	Lag	Lead	Lag	Lag	Lead	Lag	Lag
Lead-Lag Optimize?	Yes	Yes	Yes	Yes	Yes	Yes	Yes	Yes	Yes	Yes	Yes	Yes
Recall Mode	None	None	None	None	None	None	None	None	None	None	None	None
Act Effct Green (s)	6.0	15.5	15.5	8.8	20.9	20.9	5.3	13.1	13.1	7.6	15.4	15.4
Actuated g/C Ratio	0.09	0.23	0.23	0.13	0.31	0.31	0.08	0.20	0.20	0.11	0.23	0.23
v/c Ratio	0.40	0.56	0.36	0.44	0.39	0.36	0.67	0.27	0.33	0.35	0.30	0.15
Control Delay	43.6	26.9	5.9	32.9	20.6	4.9	47.8	25.2	3.7	33.6	22.7	0.9
Queue Delay	0.0	0.0	0.0	0.0	0.0	0.0	0.0	0.0	0.0	0.0	0.0	0.0
Total Delay	43.6	26.9	5.9	32.9	20.6	4.9	47.8	25.2	3.7	33.6	22.7	0.9
LOS	D	C	A	C	C	A	D	C	A	C	C	A
Approach Delay		22.6			19.0			27.2			23.7	
Approach LOS		C			B			C			C	

Intersection Summary

Cycle Length: 120
 Actuated Cycle Length: 66.9
 Natural Cycle: 90
 Control Type: Actuated-Uncoordinated
 Maximum v/c Ratio: 0.67
 Intersection Signal Delay: 22.5
 Intersection LOS: C
 Intersection Capacity Utilization 46.8%
 ICU Level of Service A
 Analysis Period (min) 15



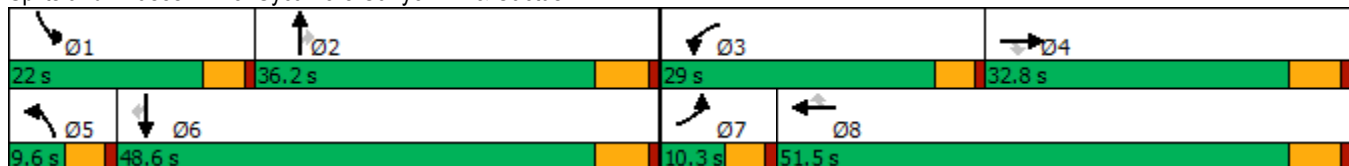





















Splits and Phases: 25: Sycamore Canyon Bl. & Cactus Av.



HCM 6th Signalized Intersection Summary
 25: Sycamore Canyon Bl. & Cactus Av.

West Campus Upper Plateau (JN 14064)

09/30/2022

												
Movement	EBL	EBT	EBR	WBL	WBT	WBR	NBL	NBT	NBR	SBL	SBT	SBR
Lane Configurations												
Traffic Volume (veh/h)	58	390	172	185	391	225	178	172	140	132	224	49
Future Volume (veh/h)	58	390	172	185	391	225	178	172	140	132	224	49
Initial Q (Qb), veh	0	0	0	0	0	0	0	0	0	0	0	0
Ped-Bike Adj(A_pbT)	1.00		1.00	1.00		1.00	1.00		1.00	1.00		1.00
Parking Bus, Adj	1.00	1.00	1.00	1.00	1.00	1.00	1.00	1.00	1.00	1.00	1.00	1.00
Work Zone On Approach		No			No			No			No	
Adj Sat Flow, veh/h/ln	1811	1678	1796	1826	1796	1870	1900	1811	1781	1885	1796	1011
Adj Flow Rate, veh/h	60	406	170	193	407	-8	185	179	53	138	233	51
Peak Hour Factor	0.96	0.96	0.96	0.96	0.96	0.96	0.96	0.96	0.96	0.96	0.96	0.96
Percent Heavy Veh, %	6	15	7	5	7	2	0	6	8	1	7	60
Cap, veh/h	97	676	323	315	851	395	319	698	306	293	669	168
Arrive On Green	0.06	0.21	0.21	0.09	0.25	0.00	0.09	0.20	0.20	0.08	0.20	0.20
Sat Flow, veh/h	1725	3188	1522	3374	3413	1585	3510	3441	1510	3483	3413	857
Grp Volume(v), veh/h	60	406	170	193	407	-8	185	179	53	138	233	51
Grp Sat Flow(s),veh/h/ln	1725	1594	1522	1687	1706	1585	1755	1721	1510	1742	1706	857
Q Serve(g_s), s	1.7	5.9	5.1	2.8	5.2	0.0	2.6	2.2	1.5	1.9	3.0	2.6
Cycle Q Clear(g_c), s	1.7	5.9	5.1	2.8	5.2	0.0	2.6	2.2	1.5	1.9	3.0	2.6
Prop In Lane	1.00		1.00	1.00		1.00	1.00		1.00	1.00		1.00
Lane Grp Cap(c), veh/h	97	676	323	315	851	395	319	698	306	293	669	168
V/C Ratio(X)	0.62	0.60	0.53	0.61	0.48	-0.02	0.58	0.26	0.17	0.47	0.35	0.30
Avail Cap(c_a), veh/h	193	1687	806	1613	3057	1420	344	2050	899	1188	2863	719
HCM Platoon Ratio	1.00	1.00	1.00	1.00	1.00	1.00	1.00	1.00	1.00	1.00	1.00	1.00
Upstream Filter(I)	1.00	1.00	1.00	1.00	1.00	0.00	1.00	1.00	1.00	1.00	1.00	1.00
Uniform Delay (d), s/veh	23.5	18.2	17.8	22.2	16.3	0.0	22.3	17.1	16.8	22.3	17.7	17.5
Incr Delay (d2), s/veh	2.4	0.9	1.3	0.7	0.4	0.0	1.2	0.2	0.3	0.4	0.3	1.0
Initial Q Delay(d3),s/veh	0.0	0.0	0.0	0.0	0.0	0.0	0.0	0.0	0.0	0.0	0.0	0.0
%ile BackOfQ(50%),veh/ln	0.7	1.9	1.6	1.0	1.7	0.0	1.0	0.7	0.4	0.7	1.0	0.5
Unsig. Movement Delay, s/veh												
LnGrp Delay(d),s/veh	25.9	19.0	19.2	23.0	16.7	0.0	23.4	17.3	17.1	22.7	18.0	18.5
LnGrp LOS	C	B	B	C	B	A	C	B	B	C	B	B
Approach Vol, veh/h		636			592			417			422	
Approach Delay, s/veh		19.7			19.0			20.0			19.6	
Approach LOS		B			B			B			B	
Timer - Assigned Phs	1	2	3	4	5	6	7	8				
Phs Duration (G+Y+Rc), s	8.9	16.1	9.4	16.6	9.2	15.8	7.5	18.5				
Change Period (Y+Rc), s	4.6	5.8	4.6	5.8	4.6	5.8	4.6	5.8				
Max Green Setting (Gmax), s	17.4	30.4	24.4	27.0	5.0	42.8	5.7	45.7				
Max Q Clear Time (g_c+I1), s	3.9	4.2	4.8	7.9	4.6	5.0	3.7	7.2				
Green Ext Time (p_c), s	0.2	1.1	0.3	2.9	0.0	1.6	0.0	2.6				
Intersection Summary												
HCM 6th Ctrl Delay				19.5								
HCM 6th LOS				B								

Timings

West Campus Upper Plateau (JN 14064)

26: Sycamore Canyon Bl. & Van Buren Bl.

09/30/2022



Lane Group	EBL	EBT	EBR	WBL	WBT	WBR	NBL	NBT	SBL	SBT	SBR
Lane Configurations											
Traffic Volume (vph)	299	1405	7	38	1503	73	8	7	100	10	503
Future Volume (vph)	299	1405	7	38	1503	73	8	7	100	10	503
Turn Type	Prot	NA	Perm	Prot	NA	Perm	Perm	NA	Split	NA	Perm
Protected Phases	5	2		1	6			8	4	4	
Permitted Phases			2			6	8				4
Detector Phase	5	2	2	1	6	6	8	8	4	4	4
Switch Phase											
Minimum Initial (s)	5.0	10.0	10.0	5.0	10.0	10.0	10.0	10.0	10.0	10.0	10.0
Minimum Split (s)	9.6	29.2	29.2	9.6	29.2	29.2	14.6	14.6	50.8	50.8	50.8
Total Split (s)	22.0	47.8	47.8	9.6	35.4	35.4	14.6	14.6	58.0	58.0	58.0
Total Split (%)	16.9%	36.8%	36.8%	7.4%	27.2%	27.2%	11.2%	11.2%	44.6%	44.6%	44.6%
Yellow Time (s)	3.6	5.2	5.2	3.6	5.2	5.2	3.6	3.6	4.8	4.8	4.8
All-Red Time (s)	1.0	1.0	1.0	1.0	1.0	1.0	1.0	1.0	1.0	1.0	1.0
Lost Time Adjust (s)	0.0	0.0	0.0	0.0	0.0	0.0		0.0	0.0	0.0	0.0
Total Lost Time (s)	4.6	6.2	6.2	4.6	6.2	6.2		4.6	5.8	5.8	5.8
Lead/Lag	Lead	Lag	Lag	Lead	Lag	Lag					
Lead-Lag Optimize?	Yes	Yes	Yes	Yes	Yes	Yes					
Recall Mode	None	None	None	None	None	None	None	None	None	None	None
Act Effct Green (s)	12.4	43.1	43.1	5.3	30.9	30.9		10.6	17.5	17.5	17.5
Actuated g/C Ratio	0.14	0.50	0.50	0.06	0.36	0.36		0.12	0.20	0.20	0.20
v/c Ratio	0.67	0.47	0.01	0.41	0.72	0.12		0.10	0.15	0.03	0.78
Control Delay	45.2	19.5	0.0	60.4	29.9	0.4		26.5	29.0	28.0	14.8
Queue Delay	0.0	0.0	0.0	0.0	0.0	0.0		0.0	0.0	0.0	0.0
Total Delay	45.2	19.5	0.0	60.4	29.9	0.4		26.5	29.0	28.0	14.8
LOS	D	B	A	E	C	A		C	C	C	B
Approach Delay		23.9			29.3			26.5		17.3	
Approach LOS		C			C			C		B	

Intersection Summary

Cycle Length: 130	
Actuated Cycle Length: 86.1	
Natural Cycle: 115	
Control Type: Actuated-Uncoordinated	
Maximum v/c Ratio: 0.78	
Intersection Signal Delay: 25.1	Intersection LOS: C
Intersection Capacity Utilization 75.1%	ICU Level of Service D
Analysis Period (min) 15	

Splits and Phases: 26: Sycamore Canyon Bl. & Van Buren Bl.

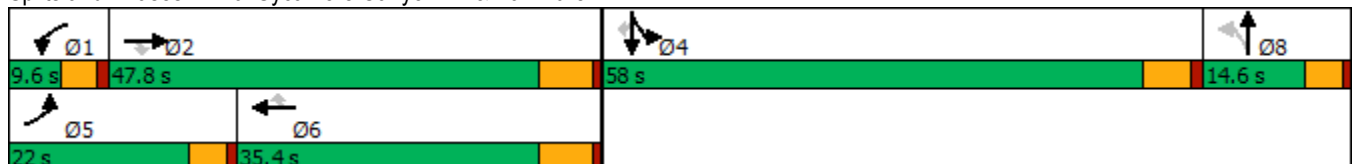

HCM 6th Signalized Intersection Summary
26: Sycamore Canyon Bl. & Van Buren Bl.

West Campus Upper Plateau (JN 14064)

09/30/2022



Movement	EBL	EBT	EBR	WBL	WBT	WBR	NBL	NBT	NBR	SBL	SBT	SBR
Lane Configurations	↔↔	↑↑↑	↗	↖	↑↑↑↑	↗		↔↔		↖↖	↑	↗
Traffic Volume (veh/h)	299	1405	7	38	1503	73	8	7	21	100	10	503
Future Volume (veh/h)	299	1405	7	38	1503	73	8	7	21	100	10	503
Initial Q (Qb), veh	0	0	0	0	0	0	0	0	0	0	0	0
Ped-Bike Adj(A_pbT)	1.00		1.00	1.00		0.99	1.00		1.00	1.00		1.00
Parking Bus, Adj	1.00	1.00	1.00	1.00	1.00	1.00	1.00	1.00	1.00	1.00	1.00	1.00
Work Zone On Approach		No			No			No			No	
Adj Sat Flow, veh/h/ln	1811	1826	1900	1693	1796	1870	1900	1900	1900	1841	1900	1841
Adj Flow Rate, veh/h	315	1479	7	40	1582	55	8	7	-7	105	11	0
Peak Hour Factor	0.95	0.95	0.95	0.95	0.95	0.95	0.95	0.95	0.95	0.95	0.95	0.95
Percent Heavy Veh, %	6	5	0	14	7	2	0	0	0	4	0	4
Cap, veh/h	429	2943	754	64	2350	595	139	587	0	466	261	
Arrive On Green	0.13	0.47	0.47	0.04	0.38	0.38	0.02	0.02	0.00	0.14	0.14	0.00
Sat Flow, veh/h	3346	6281	1610	1612	6179	1565	1801	1909	0	3401	1900	1560
Grp Volume(v), veh/h	315	1479	7	40	1582	55	8	0	0	105	11	0
Grp Sat Flow(s),veh/h/ln	1673	1570	1610	1612	1545	1565	1810	1805	0	1700	1900	1560
Q Serve(g_s), s	5.8	10.4	0.1	1.6	13.5	1.4	0.0	0.0	0.0	1.7	0.3	0.0
Cycle Q Clear(g_c), s	5.8	10.4	0.1	1.6	13.5	1.4	0.0	0.0	0.0	1.7	0.3	0.0
Prop In Lane	1.00		1.00	1.00		1.00	0.99		0.00	1.00		1.00
Lane Grp Cap(c), veh/h	429	2943	754	64	2350	595	0	0	0	466	261	
V/C Ratio(X)	0.73	0.50	0.01	0.62	0.67	0.09	0.00	0.00	0.00	0.23	0.04	
Avail Cap(c_a), veh/h	917	4114	1055	127	2841	720	0	0	0	2795	1562	
HCM Platoon Ratio	1.00	1.00	1.00	1.00	1.00	1.00	1.00	1.00	1.00	1.00	1.00	1.00
Upstream Filter(I)	1.00	1.00	1.00	1.00	1.00	1.00	1.00	0.00	0.00	1.00	1.00	0.00
Uniform Delay (d), s/veh	26.6	11.7	9.0	30.0	16.4	12.6	0.0	0.0	0.0	24.4	23.8	0.0
Incr Delay (d2), s/veh	0.9	0.1	0.0	3.6	0.5	0.1	0.0	0.0	0.0	0.2	0.1	0.0
Initial Q Delay(d3),s/veh	0.0	0.0	0.0	0.0	0.0	0.0	0.0	0.0	0.0	0.0	0.0	0.0
%ile BackOfQ(50%),veh/ln	2.1	2.8	0.0	0.6	4.0	0.4	0.0	0.0	0.0	0.6	0.1	0.0
Unsig. Movement Delay, s/veh												
LnGrp Delay(d),s/veh	27.6	11.9	9.0	33.7	16.9	12.7	0.0	0.0	0.0	24.6	23.8	0.0
LnGrp LOS	C	B	A	C	B	B	A	A	A	C	C	
Approach Vol, veh/h		1801			1677			8			116	
Approach Delay, s/veh		14.6			17.1			0.0			24.6	
Approach LOS		B			B			A			C	
Timer - Assigned Phs	1	2		4	5	6		8				
Phs Duration (G+Y+Rc), s	7.1	36.0		14.5	12.7	30.3		5.9				
Change Period (Y+Rc), s	4.6	6.2		5.8	4.6	6.2		4.6				
Max Green Setting (Gmax), s	5.0	41.6		52.2	17.4	29.2		10.0				
Max Q Clear Time (g_c+I1), s	3.6	12.4		3.7	7.8	15.5		2.0				
Green Ext Time (p_c), s	0.0	12.1		0.4	0.4	8.6		0.0				

Intersection Summary

HCM 6th Ctrl Delay	16.1
HCM 6th LOS	B

Notes

Unsignalized Delay for [SBR] is excluded from calculations of the approach delay and intersection delay.

Timings
27: Innovation Dr. & Cactus Av.

West Campus Upper Plateau (JN 14064)

09/30/2022

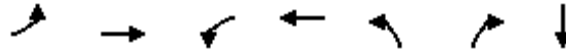

Lane Group	EBL	EBT	WBL	WBT	NBL	NBR	SBT
Lane Configurations	↶	↷	↶	↷	↶	↷	↷
Traffic Volume (vph)	1	661	25	801	1	24	0
Future Volume (vph)	1	661	25	801	1	24	0
Turn Type	Prot	NA	Prot	NA	Perm	Perm	NA
Protected Phases	5	2	1	6			4
Permitted Phases					8	8	
Detector Phase	5	2	1	6	8	8	4
Switch Phase							
Minimum Initial (s)	5.0	10.0	5.0	10.0	10.0	10.0	10.0
Minimum Split (s)	9.2	26.8	9.2	26.8	31.1	31.1	31.1
Total Split (s)	12.0	63.0	22.0	73.0	35.0	35.0	35.0
Total Split (%)	10.0%	52.5%	18.3%	60.8%	29.2%	29.2%	29.2%
Yellow Time (s)	3.2	4.8	3.2	4.8	4.1	4.1	4.1
All-Red Time (s)	1.0	1.0	1.0	1.0	1.0	1.0	1.0
Lost Time Adjust (s)	0.0	0.0	0.0	0.0	0.0	0.0	0.0
Total Lost Time (s)	4.2	5.8	4.2	5.8	5.1	5.1	5.1
Lead/Lag	Lead	Lag	Lead	Lag			
Lead-Lag Optimize?	Yes	Yes	Yes	Yes			
Recall Mode	None	None	None	None	None	None	None
Act Effct Green (s)	6.9	25.3	7.4	25.5	15.3	15.3	15.3
Actuated g/C Ratio	0.21	0.76	0.22	0.77	0.46	0.46	0.46
v/c Ratio	0.00	0.20	0.08	0.24	0.00	0.03	0.00
Control Delay	24.0	7.3	21.2	6.9	13.0	0.1	0.0
Queue Delay	0.0	0.0	0.0	0.0	0.0	0.0	0.0
Total Delay	24.0	7.3	21.2	6.9	13.0	0.1	0.0
LOS	C	A	C	A	B	A	A
Approach Delay		7.3		7.3			
Approach LOS		A		A			

Intersection Summary

Cycle Length: 120	
Actuated Cycle Length: 33.3	
Natural Cycle: 70	
Control Type: Actuated-Uncoordinated	
Maximum v/c Ratio: 0.24	
Intersection Signal Delay: 7.2	Intersection LOS: A
Intersection Capacity Utilization 38.2%	ICU Level of Service A
Analysis Period (min) 15	

Splits and Phases: 27: Innovation Dr. & Cactus Av.



HCM 6th Signalized Intersection Summary
27: Innovation Dr. & Cactus Av.

West Campus Upper Plateau (JN 14064)

09/30/2022



Movement	EBL	EBT	EBR	WBL	WBT	WBR	NBL	NBT	NBR	SBL	SBT	SBR
Lane Configurations	↗	↑↑↑		↖	↑↑↑		↖	↑	↗	↖	↑	↗
Traffic Volume (veh/h)	1	661	1	25	801	5	1	0	24	0	0	1
Future Volume (veh/h)	1	661	1	25	801	5	1	0	24	0	0	1
Initial Q (Qb), veh	0	0	0	0	0	0	0	0	0	0	0	0
Ped-Bike Adj(A_pbT)	1.00		1.00	1.00		0.98	1.00		1.00	1.00		1.00
Parking Bus, Adj	1.00	1.00	1.00	1.00	1.00	1.00	1.00	1.00	1.00	1.00	1.00	1.00
Work Zone On Approach		No			No			No			No	
Adj Sat Flow, veh/h/ln	1900	1826	1307	1663	1841	1900	1841	1900	1781	1900	1900	1781
Adj Flow Rate, veh/h	1	751	1	28	910	6	1	0	-26	0	0	-8
Peak Hour Factor	0.88	0.88	0.88	0.88	0.88	0.88	0.88	0.88	0.88	0.88	0.88	0.88
Percent Heavy Veh, %	0	5	40	16	4	0	4	0	8	0	0	8
Cap, veh/h	7	2625	3	56	2803	18	266	7	6	266	0	401
Arrive On Green	0.00	0.51	0.51	0.04	0.54	0.54	0.00	0.00	0.00	0.00	0.00	0.00
Sat Flow, veh/h	1810	5141	7	1584	5150	34	1753	1900	1510	1810	1900	0
Grp Volume(v), veh/h	1	485	267	28	592	324	1	0	-26	0	-8	-8
Grp Sat Flow(s),veh/h/ln	1810	1662	1825	1584	1675	1834	1753	1900	1510	1810	1900	1610
Q Serve(g_s), s	0.0	2.3	2.3	0.5	2.6	2.6	0.0	0.0	0.0	0.0	0.0	0.0
Cycle Q Clear(g_c), s	0.0	2.3	2.3	0.5	2.6	2.6	0.1	0.0	0.0	0.0	0.0	0.0
Prop In Lane	1.00		0.00	1.00		0.02	1.00		1.00	1.00		0.00
Lane Grp Cap(c), veh/h	7	1696	932	56	1823	998	266	7	6	266	0	0
V/C Ratio(X)	0.15	0.29	0.29	0.50	0.32	0.32	0.00	0.00	-4.66	0.00	0.00	0.00
Avail Cap(c_a), veh/h	522	7030	3860	1043	8326	4557	2387	2101	1669	2455	0	0
HCM Platoon Ratio	1.00	1.00	1.00	1.00	1.00	1.00	1.00	1.00	1.00	1.00	1.00	1.00
Upstream Filter(I)	1.00	1.00	1.00	1.00	1.00	1.00	1.00	0.00	0.00	0.00	0.00	0.00
Uniform Delay (d), s/veh	13.5	3.8	3.8	12.8	3.4	3.4	13.6	0.0	0.0	0.0	0.0	0.0
Incr Delay (d2), s/veh	3.8	0.1	0.2	2.6	0.1	0.3	0.0	0.0	0.0	0.0	0.0	0.0
Initial Q Delay(d3),s/veh	0.0	0.0	0.0	0.0	0.0	0.0	0.0	0.0	0.0	0.0	0.0	0.0
%ile BackOfQ(50%),veh/ln	0.0	0.1	0.1	0.1	0.0	0.1	0.0	0.0	0.0	0.0	0.0	0.0
Unsig. Movement Delay, s/veh												
LnGrp Delay(d),s/veh	17.2	3.9	4.0	15.4	3.6	3.7	13.6	0.0	0.0	0.0	0.0	0.0
LnGrp LOS	B	A	A	B	A	A	B	A	A	A	A	A
Approach Vol, veh/h		753			944			-25				-16
Approach Delay, s/veh		4.0			4.0			0.0				0.0
Approach LOS		A			A			A				A
Timer - Assigned Phs	1	2		4	5	6		8				
Phs Duration (G+Y+Rc), s	5.1	19.6		2.3	4.2	20.5		2.3				
Change Period (Y+Rc), s	* 4.2	5.8		5.1	* 4.2	5.8		5.1				
Max Green Setting (Gmax), s	* 18	57.2		29.9	* 7.8	67.2		29.9				
Max Q Clear Time (g_c+I1), s	2.5	4.3		0.0	2.0	4.6		2.1				
Green Ext Time (p_c), s	0.0	7.6		0.0	0.0	10.1		0.0				

Intersection Summary

HCM 6th Ctrl Delay	4.1
HCM 6th LOS	A

Notes

* HCM 6th computational engine requires equal clearance times for the phases crossing the barrier.

Timings
28: I-215 SB Ramps & Alessandro Bl.

West Campus Upper Plateau (JN 14064)

09/30/2022

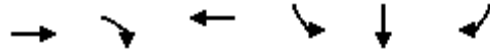

Lane Group	EBT	EBR	WBT	SBL	SBT	SBR
Lane Configurations	↑↑↑	↑	↑↑↑	↑	↔	↑
Traffic Volume (vph)	947	426	1230	144	0	337
Future Volume (vph)	947	426	1230	144	0	337
Turn Type	NA	Perm	NA	Split	NA	Perm
Protected Phases	2		6	4	4	
Permitted Phases		2				4
Detector Phase	2	2	6	4	4	4
Switch Phase						
Minimum Initial (s)	5.0	5.0	5.0	5.0	5.0	5.0
Minimum Split (s)	10.5	10.5	34.5	10.0	10.0	10.0
Total Split (s)	52.0	52.0	52.0	33.0	33.0	33.0
Total Split (%)	61.2%	61.2%	61.2%	38.8%	38.8%	38.8%
Yellow Time (s)	4.5	4.5	4.5	4.0	4.0	4.0
All-Red Time (s)	1.0	1.0	1.0	1.0	1.0	1.0
Lost Time Adjust (s)	0.0	0.0	0.0	0.0	0.0	0.0
Total Lost Time (s)	5.5	5.5	5.5	5.0	5.0	5.0
Lead/Lag						
Lead-Lag Optimize?						
Recall Mode	Min	Min	Min	None	None	None
Act Effct Green (s)	22.8	22.8	22.8	11.1	11.1	11.1
Actuated g/C Ratio	0.51	0.51	0.51	0.25	0.25	0.25
v/c Ratio	0.38	0.46	0.56	0.35	0.50	0.48
Control Delay	7.5	3.7	8.7	17.8	17.0	16.5
Queue Delay	0.0	0.0	0.0	0.0	0.0	0.0
Total Delay	7.5	3.7	8.7	17.8	17.0	16.5
LOS	A	A	A	B	B	B
Approach Delay	6.4		8.7		17.0	
Approach LOS	A		A		B	

Intersection Summary

Cycle Length: 85
 Actuated Cycle Length: 44.8
 Natural Cycle: 50
 Control Type: Actuated-Uncoordinated
 Maximum v/c Ratio: 0.56
 Intersection Signal Delay: 8.9
 Intersection LOS: A
 Intersection Capacity Utilization 49.3%
 ICU Level of Service A
 Analysis Period (min) 15

Splits and Phases: 28: I-215 SB Ramps & Alessandro Bl.

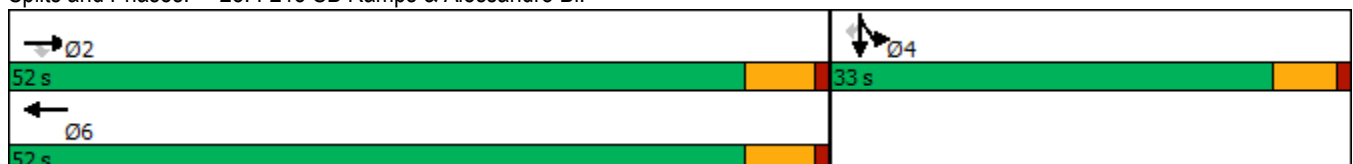

HCM 6th Signalized Intersection Summary
 28: I-215 SB Ramps & Alessandro Bl.

West Campus Upper Plateau (JN 14064)

09/30/2022



Movement	EBL	EBT	EBR	WBL	WBT	WBR	NBL	NBT	NBR	SBL	SBT	SBR
Lane Configurations		↑↑↑	↗		↑↑↑					↘	↔	↗
Traffic Volume (veh/h)	0	947	426	0	1230	130	0	0	0	144	0	337
Future Volume (veh/h)	0	947	426	0	1230	130	0	0	0	144	0	337
Initial Q (Qb), veh	0	0	0	0	0	0				0	0	0
Ped-Bike Adj(A_pbT)	1.00		1.00	1.00		0.98				1.00		1.00
Parking Bus, Adj	1.00	1.00	1.00	1.00	1.00	1.00				1.00	1.00	1.00
Work Zone On Approach		No			No						No	
Adj Sat Flow, veh/h/ln	0	1870	1870	0	1870	1781				1737	1900	1752
Adj Flow Rate, veh/h	0	986	444	0	1281	127				100	0	359
Peak Hour Factor	0.96	0.96	0.96	0.96	0.96	0.96				0.96	0.96	0.96
Percent Heavy Veh, %	0	2	2	0	2	8				11	0	10
Cap, veh/h	0	2636	818	0	2433	241				338	0	607
Arrive On Green	0.00	0.52	0.52	0.00	0.52	0.52				0.20	0.00	0.20
Sat Flow, veh/h	0	5274	1585	0	4880	467				1654	0	2969
Grp Volume(v), veh/h	0	986	444	0	925	483				100	0	359
Grp Sat Flow(s),veh/h/ln	0	1702	1585	0	1702	1775				1654	0	1485
Q Serve(g_s), s	0.0	4.4	7.1	0.0	6.8	6.8				1.9	0.0	4.1
Cycle Q Clear(g_c), s	0.0	4.4	7.1	0.0	6.8	6.8				1.9	0.0	4.1
Prop In Lane	0.00		1.00	0.00		0.26				1.00		1.00
Lane Grp Cap(c), veh/h	0	2636	818	0	1757	916				338	0	607
V/C Ratio(X)	0.00	0.37	0.54	0.00	0.53	0.53				0.30	0.00	0.59
Avail Cap(c_a), veh/h	0	6314	1960	0	4209	2194				1232	0	2211
HCM Platoon Ratio	1.00	1.00	1.00	1.00	1.00	1.00				1.00	1.00	1.00
Upstream Filter(I)	0.00	1.00	1.00	0.00	1.00	1.00				1.00	0.00	1.00
Uniform Delay (d), s/veh	0.0	5.5	6.1	0.0	6.0	6.0				12.7	0.0	13.5
Incr Delay (d2), s/veh	0.0	0.1	0.6	0.0	0.2	0.5				0.5	0.0	0.9
Initial Q Delay(d3),s/veh	0.0	0.0	0.0	0.0	0.0	0.0				0.0	0.0	0.0
%ile BackOfQ(50%),veh/ln	0.0	0.4	0.8	0.0	0.7	0.8				0.6	0.0	1.0
Unsig. Movement Delay, s/veh												
LnGrp Delay(d),s/veh	0.0	5.5	6.7	0.0	6.3	6.5				13.1	0.0	14.5
LnGrp LOS	A	A	A	A	A	A				B	A	B
Approach Vol, veh/h		1430			1408							459
Approach Delay, s/veh		5.9			6.4							14.2
Approach LOS		A			A							B
Timer - Assigned Phs		2		4		6						
Phs Duration (G+Y+Rc), s		24.9		12.7		24.9						
Change Period (Y+Rc), s		5.5		5.0		5.5						
Max Green Setting (Gmax), s		46.5		28.0		46.5						
Max Q Clear Time (g_c+I1), s		9.1		6.1		8.8						
Green Ext Time (p_c), s		9.3		1.6		10.6						

Intersection Summary

HCM 6th Ctrl Delay	7.2
HCM 6th LOS	A

Notes

User approved volume balancing among the lanes for turning movement.

Timings
29: I-215 NB Ramps & Alessandro Bl.

West Campus Upper Plateau (JN 14064)

09/30/2022



Lane Group	EBL	EBT	WBT	WBR	NBL	NBT	NBR
Lane Configurations	↶	↑↑↑	↑↑↑	↷	↶	↕	↷
Traffic Volume (vph)	234	862	1002	157	568	10	259
Future Volume (vph)	234	862	1002	157	568	10	259
Turn Type	Prot	NA	NA	Perm	Split	NA	Perm
Protected Phases	5	2	6		8	8	
Permitted Phases				6			8
Detector Phase	5	2	6	6	8	8	8
Switch Phase							
Minimum Initial (s)	5.0	5.0	5.0	5.0	5.0	5.0	5.0
Minimum Split (s)	9.5	10.5	33.5	33.5	10.0	10.0	10.0
Total Split (s)	13.0	48.0	35.0	35.0	37.0	37.0	37.0
Total Split (%)	15.3%	56.5%	41.2%	41.2%	43.5%	43.5%	43.5%
Yellow Time (s)	3.5	4.5	4.5	4.5	4.0	4.0	4.0
All-Red Time (s)	1.0	1.0	1.0	1.0	1.0	1.0	1.0
Lost Time Adjust (s)	0.0	0.0	0.0	0.0	0.0	0.0	0.0
Total Lost Time (s)	4.5	5.5	5.5	5.5	5.0	5.0	5.0
Lead/Lag	Lead		Lag	Lag			
Lead-Lag Optimize?	Yes		Yes	Yes			
Recall Mode	None	Min	Min	Min	Max	Max	Max
Act Effct Green (s)	8.5	36.9	23.8	23.8	32.1	32.1	32.1
Actuated g/C Ratio	0.11	0.46	0.30	0.30	0.40	0.40	0.40
v/c Ratio	1.36	0.38	0.68	0.34	0.46	0.48	0.36
Control Delay	226.1	14.2	26.7	12.8	21.2	21.3	11.7
Queue Delay	0.0	0.0	0.0	0.0	0.0	0.0	0.0
Total Delay	226.1	14.2	26.7	12.8	21.2	21.3	11.7
LOS	F	B	C	B	C	C	B
Approach Delay		59.4	24.9			18.6	
Approach LOS		E	C			B	

Intersection Summary

Cycle Length: 85
 Actuated Cycle Length: 79.5
 Natural Cycle: 70
 Control Type: Actuated-Uncoordinated
 Maximum v/c Ratio: 1.36
 Intersection Signal Delay: 35.4
 Intersection LOS: D
 Intersection Capacity Utilization 63.5%
 ICU Level of Service B
 Analysis Period (min) 15

Splits and Phases: 29: I-215 NB Ramps & Alessandro Bl.

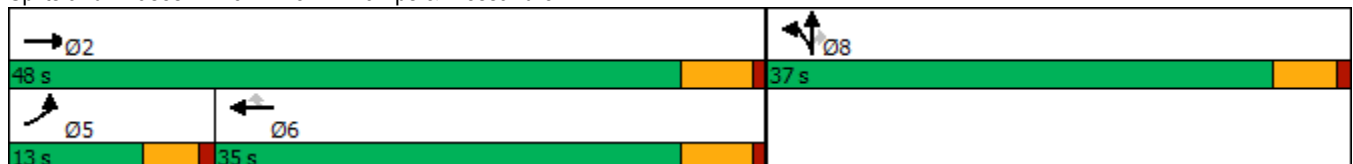

HCM 6th Signalized Intersection Summary
 29: I-215 NB Ramps & Alessandro Bl.

West Campus Upper Plateau (JN 14064)

09/30/2022



Movement	EBL	EBT	EBR	WBL	WBT	WBR	NBL	NBT	NBR	SBL	SBT	SBR
Lane Configurations	↗	↑↑↑			↑↑↑	↗	↗	↕	↗			
Traffic Volume (veh/h)	234	862	0	0	1002	157	568	10	259	0	0	0
Future Volume (veh/h)	234	862	0	0	1002	157	568	10	259	0	0	0
Initial Q (Qb), veh	0	0	0	0	0	0	0	0	0			
Ped-Bike Adj(A_pbT)	1.00		1.00	1.00		0.98	1.00		1.00			
Parking Bus, Adj	1.00	1.00	1.00	1.00	1.00	1.00	1.00	1.00	1.00			
Work Zone On Approach		No			No			No				
Adj Sat Flow, veh/h/ln	1767	1870	0	0	1870	1707	1856	1900	1870			
Adj Flow Rate, veh/h	241	889	0	0	1033	136	647	0	126			
Peak Hour Factor	0.97	0.97	0.97	0.97	0.97	0.97	0.97	0.97	0.97			
Percent Heavy Veh, %	9	2	0	0	2	13	3	0	2			
Cap, veh/h	185	2294	0	0	1434	398	1466	0	657			
Arrive On Green	0.11	0.45	0.00	0.00	0.28	0.28	0.41	0.00	0.41			
Sat Flow, veh/h	1682	5274	0	0	5274	1416	3534	0	1585			
Grp Volume(v), veh/h	241	889	0	0	1033	136	647	0	126			
Grp Sat Flow(s),veh/h/ln	1682	1702	0	0	1702	1416	1767	0	1585			
Q Serve(g_s), s	8.5	9.0	0.0	0.0	14.1	5.9	10.1	0.0	3.9			
Cycle Q Clear(g_c), s	8.5	9.0	0.0	0.0	14.1	5.9	10.1	0.0	3.9			
Prop In Lane	1.00		0.00	0.00		1.00	1.00		1.00			
Lane Grp Cap(c), veh/h	185	2294	0	0	1434	398	1466	0	657			
V/C Ratio(X)	1.30	0.39	0.00	0.00	0.72	0.34	0.44	0.00	0.19			
Avail Cap(c_a), veh/h	185	2812	0	0	1952	541	1466	0	657			
HCM Platoon Ratio	1.00	1.00	1.00	1.00	1.00	1.00	1.00	1.00	1.00			
Upstream Filter(I)	1.00	1.00	0.00	0.00	1.00	1.00	1.00	0.00	1.00			
Uniform Delay (d), s/veh	34.3	14.2	0.0	0.0	25.0	22.1	16.2	0.0	14.4			
Incr Delay (d2), s/veh	168.9	0.1	0.0	0.0	0.8	0.5	1.0	0.0	0.6			
Initial Q Delay(d3),s/veh	0.0	0.0	0.0	0.0	0.0	0.0	0.0	0.0	0.0			
%ile BackOfQ(50%),veh/ln	11.8	2.8	0.0	0.0	5.0	1.8	3.8	0.0	1.4			
Unsig. Movement Delay, s/veh												
LnGrp Delay(d),s/veh	203.2	14.3	0.0	0.0	25.9	22.6	17.2	0.0	15.0			
LnGrp LOS	F	B	A	A	C	C	B	A	B			
Approach Vol, veh/h		1130			1169			773				
Approach Delay, s/veh		54.6			25.5			16.8				
Approach LOS		D			C			B				
Timer - Assigned Phs		2			5	6		8				
Phs Duration (G+Y+Rc), s		40.2			13.0	27.2		37.0				
Change Period (Y+Rc), s		5.5			4.5	5.5		5.0				
Max Green Setting (Gmax), s		42.5			8.5	29.5		32.0				
Max Q Clear Time (g_c+I1), s		11.0			10.5	16.1		12.1				
Green Ext Time (p_c), s		5.9			0.0	5.6		2.7				

Intersection Summary

HCM 6th Ctrl Delay	34.0
HCM 6th LOS	C

Notes

User approved volume balancing among the lanes for turning movement.

Timings
30: I-215 SB Ramps & Cactus Av.

West Campus Upper Plateau (JN 14064)

09/30/2022



Lane Group	EBT	EBR	WBL	WBT	NBR	SBR
Lane Configurations	↑↑	↑	↓	↑↑	↑	↑
Traffic Volume (vph)	591	109	371	539	349	294
Future Volume (vph)	591	109	371	539	349	294
Turn Type	NA	Perm	Prot	NA	Prot	Prot
Protected Phases	2		1	6	8	4
Permitted Phases		2				
Detector Phase	2	2	1	6	8	4
Switch Phase						
Minimum Initial (s)	5.0	5.0	5.0	5.0	5.0	5.0
Minimum Split (s)	11.0	11.0	9.5	23.0	9.1	9.5
Total Split (s)	35.0	35.0	43.0	78.0	27.0	27.0
Total Split (%)	33.3%	33.3%	41.0%	74.3%	25.7%	25.7%
Yellow Time (s)	5.0	5.0	3.5	5.0	3.6	3.5
All-Red Time (s)	1.0	1.0	1.0	1.0	0.5	1.0
Lost Time Adjust (s)	0.0	0.0	0.0	0.0	0.0	0.0
Total Lost Time (s)	6.0	6.0	4.5	6.0	4.1	4.5
Lead/Lag	Lag	Lag	Lead			
Lead-Lag Optimize?	Yes	Yes	Yes			
Recall Mode	Min	Min	None	Min	None	None
Act Effct Green (s)	18.2	18.2	20.8	43.9	8.1	7.6
Actuated g/C Ratio	0.29	0.29	0.33	0.70	0.13	0.12
v/c Ratio	0.68	0.23	0.73	0.25	0.53	0.71
Control Delay	24.8	6.0	27.9	3.7	2.7	13.6
Queue Delay	0.0	0.0	0.0	0.0	0.0	0.0
Total Delay	24.8	6.0	27.9	3.7	2.7	13.6
LOS	C	A	C	A	A	B
Approach Delay	21.9			13.6		
Approach LOS	C			B		

Intersection Summary

Cycle Length: 105
 Actuated Cycle Length: 62.9
 Natural Cycle: 60
 Control Type: Actuated-Uncoordinated
 Maximum v/c Ratio: 0.73
 Intersection Signal Delay: 14.5
 Intersection LOS: B
 Intersection Capacity Utilization 46.4%
 ICU Level of Service A
 Analysis Period (min) 15

Splits and Phases: 30: I-215 SB Ramps & Cactus Av.

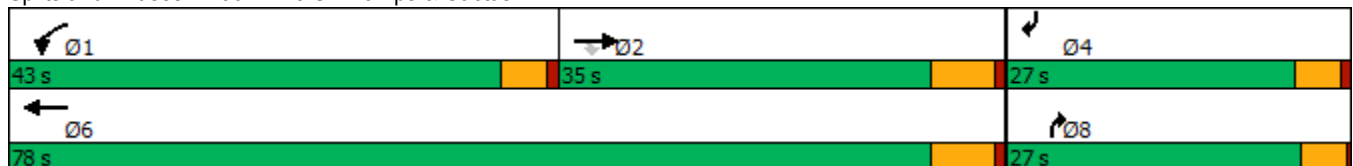

HCM 6th Signalized Intersection Summary
30: I-215 SB Ramps & Cactus Av.

West Campus Upper Plateau (JN 14064)
09/30/2022



Movement	EBL	EBT	EBR	WBL	WBT	WBR	NBL	NBT	NBR	SBL	SBT	SBR
Lane Configurations		↑↑	↑	↑	↑↑				↑			↑
Traffic Volume (veh/h)	0	591	109	371	539	0	0	0	349	0	0	294
Future Volume (veh/h)	0	591	109	371	539	0	0	0	349	0	0	294
Initial Q (Qb), veh	0	0	0	0	0	0	0	0	0	0	0	0
Ped-Bike Adj(A_pbT)	1.00		1.00	1.00		1.00	1.00		1.00	1.00		1.00
Parking Bus, Adj	1.00	1.00	1.00	1.00	1.00	1.00	1.00	1.00	1.00	1.00	1.00	1.00
Work Zone On Approach		No			No			No			No	
Adj Sat Flow, veh/h/ln	0	1841	1826	1870	1870	0	0	0	1796	0	0	1707
Adj Flow Rate, veh/h	0	679	94	426	620	0	0	0	0	0	0	223
Peak Hour Factor	0.87	0.87	0.87	0.87	0.87	0.87	0.87	0.87	0.87	0.87	0.87	0.87
Percent Heavy Veh, %	0	4	5	2	2	0	0	0	7	0	0	13
Cap, veh/h	0	1160	513	534	2806	0	0	0	0	0	0	0
Arrive On Green	0.00	0.33	0.33	0.30	0.79	0.00	0.00	0.00	0.00	0.00	0.00	0.00
Sat Flow, veh/h	0	3589	1547	1781	3647	0		0			0	
Grp Volume(v), veh/h	0	679	94	426	620	0		0.0			0.0	
Grp Sat Flow(s),veh/h/ln	0	1749	1547	1781	1777	0						
Q Serve(g_s), s	0.0	4.6	1.2	6.3	1.3	0.0						
Cycle Q Clear(g_c), s	0.0	4.6	1.2	6.3	1.3	0.0						
Prop In Lane	0.00		1.00	1.00		0.00						
Lane Grp Cap(c), veh/h	0	1160	513	534	2806	0						
V/C Ratio(X)	0.00	0.59	0.18	0.80	0.22	0.00						
Avail Cap(c_a), veh/h	0	3558	1574	2406	8975	0						
HCM Platoon Ratio	1.00	1.00	1.00	1.00	1.00	1.00						
Upstream Filter(I)	0.00	1.00	1.00	1.00	1.00	0.00						
Uniform Delay (d), s/veh	0.0	7.9	6.8	9.2	0.8	0.0						
Incr Delay (d2), s/veh	0.0	0.2	0.1	1.1	0.0	0.0						
Initial Q Delay(d3),s/veh	0.0	0.0	0.0	0.0	0.0	0.0						
%ile BackOfQ(50%),veh/ln	0.0	0.8	0.2	1.3	0.0	0.0						
Unsig. Movement Delay, s/veh												
LnGrp Delay(d),s/veh	0.0	8.1	6.8	10.2	0.8	0.0						
LnGrp LOS	A	A	A	B	A	A						
Approach Vol, veh/h		773			1046							
Approach Delay, s/veh		7.9			4.6							
Approach LOS		A			A							
Timer - Assigned Phs	1	2				6						
Phs Duration (G+Y+Rc), s	13.0	15.5				28.5						
Change Period (Y+Rc), s	4.5	6.0				6.0						
Max Green Setting (Gmax), s	38.5	29.0				72.0						
Max Q Clear Time (g_c+I1), s	8.3	6.6				3.3						
Green Ext Time (p_c), s	0.6	2.9				2.6						

Intersection Summary

HCM 6th Ctrl Delay			6.0									
HCM 6th LOS			A									

Notes

Unsignalized Delay for [NBR] is excluded from calculations of the approach delay and intersection delay.

Timings

31: I-215 NB Ramps/Old 215 Frontage Rd. & Cactus Av.



Lane Group	EBL	EBT	WBT	NBL	NBT	NBR	SBL	SBT
Lane Configurations	↖	↕	↕	↖	↕	↗	↖	↕
Traffic Volume (vph)	32	689	1162	124	70	3	116	1
Future Volume (vph)	32	689	1162	124	70	3	116	1
Turn Type	Perm	NA	NA	Perm	NA	Perm	Perm	NA
Protected Phases		2	6		8			4
Permitted Phases	2			8		8	4	
Detector Phase	2	2	6	8	8	8	4	4
Switch Phase								
Minimum Initial (s)	5.0	5.0	5.0	5.0	5.0	5.0	5.0	5.0
Minimum Split (s)	11.0	11.0	44.0	10.5	10.5	10.5	10.5	10.5
Total Split (s)	57.4	57.4	57.4	27.6	27.6	27.6	27.6	27.6
Total Split (%)	67.5%	67.5%	67.5%	32.5%	32.5%	32.5%	32.5%	32.5%
Yellow Time (s)	5.0	5.0	5.0	4.5	4.5	4.5	4.5	4.5
All-Red Time (s)	1.0	1.0	1.0	1.0	1.0	1.0	1.0	1.0
Lost Time Adjust (s)	0.0	0.0	0.0	0.0	0.0	0.0	0.0	0.0
Total Lost Time (s)	6.0	6.0	6.0	5.5	5.5	5.5	5.5	5.5
Lead/Lag								
Lead-Lag Optimize?								
Recall Mode	Min	Min	Min	None	None	None	None	None
Act Effct Green (s)	32.4	32.4	32.4	10.8	10.8	10.8	10.7	10.7
Actuated g/C Ratio	0.64	0.64	0.64	0.21	0.21	0.21	0.21	0.21
v/c Ratio	0.21	0.50	0.63	0.53	0.20	0.01	0.46	0.23
Control Delay	10.6	7.4	9.5	27.8	19.7	0.0	25.2	9.6
Queue Delay	0.0	0.0	0.0	0.0	0.0	0.0	0.0	0.0
Total Delay	10.6	7.4	9.5	27.8	19.7	0.0	25.2	9.6
LOS	B	A	A	C	B	A	C	A
Approach Delay		7.5	9.5		24.5			18.7
Approach LOS		A	A		C			B

Intersection Summary

Cycle Length: 85
 Actuated Cycle Length: 50.5
 Natural Cycle: 60
 Control Type: Actuated-Uncoordinated
 Maximum v/c Ratio: 0.63
 Intersection Signal Delay: 10.6
 Intersection Capacity Utilization 59.2%
 Analysis Period (min) 15
 Intersection LOS: B
 ICU Level of Service B

Splits and Phases: 31: I-215 NB Ramps/Old 215 Frontage Rd. & Cactus Av.

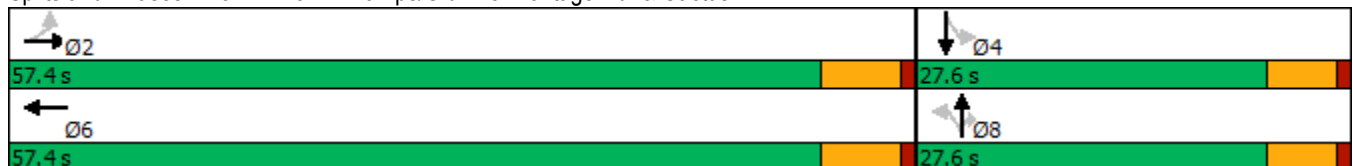

HCM 6th Signalized Intersection Summary

West Campus Upper Plateau (JN 14064)

31: I-215 NB Ramps/Old 215 Frontage Rd. & Cactus Av.

09/30/2022



Movement	EBL	EBT	EBR	WBL	WBT	WBR	NBL	NBT	NBR	SBL	SBT	SBR
Lane Configurations	↗	↕			↕		↗	↕	↗	↗	↕	↕
Traffic Volume (veh/h)	32	689	245	0	1162	125	124	70	3	116	1	82
Future Volume (veh/h)	32	689	245	0	1162	125	124	70	3	116	1	82
Initial Q (Qb), veh	0	0	0	0	0	0	0	0	0	0	0	0
Ped-Bike Adj(A_pbT)	1.00		1.00	1.00		1.00	1.00		1.00	1.00		1.00
Parking Bus, Adj	1.00	1.00	1.00	1.00	1.00	1.00	1.00	1.00	1.00	1.00	1.00	1.00
Work Zone On Approach		No			No			No			No	
Adj Sat Flow, veh/h/ln	1796	1826	1366	0	1841	1885	1722	1856	1900	1841	1900	1885
Adj Flow Rate, veh/h	34	741	259	0	1249	85	133	75	0	125	1	61
Peak Hour Factor	0.93	0.93	0.93	0.93	0.93	0.93	0.93	0.93	0.93	0.93	0.93	0.93
Percent Heavy Veh, %	7	5	36	0	4	1	12	3	0	4	0	1
Cap, veh/h	272	1321	462	0	1741	118	374	353		382	5	302
Arrive On Green	0.52	0.52	0.52	0.00	0.52	0.52	0.19	0.19	0.00	0.19	0.19	0.19
Sat Flow, veh/h	394	2521	881	0	3415	226	1234	1856	1610	1304	26	1588
Grp Volume(v), veh/h	34	510	490	0	656	678	133	75	0	125	0	62
Grp Sat Flow(s),veh/h/ln	394	1735	1667	0	1749	1800	1234	1856	1610	1304	0	1614
Q Serve(g_s), s	2.9	8.0	8.0	0.0	11.5	11.6	4.1	1.4	0.0	3.6	0.0	1.3
Cycle Q Clear(g_c), s	14.5	8.0	8.0	0.0	11.5	11.6	5.4	1.4	0.0	5.0	0.0	1.3
Prop In Lane	1.00		0.53	0.00		0.13	1.00		1.00	1.00		0.98
Lane Grp Cap(c), veh/h	272	909	874	0	917	943	374	353		382	0	307
V/C Ratio(X)	0.13	0.56	0.56	0.00	0.72	0.72	0.36	0.21		0.33	0.00	0.20
Avail Cap(c_a), veh/h	568	2213	2128	0	2231	2296	816	1018		849	0	886
HCM Platoon Ratio	1.00	1.00	1.00	1.00	1.00	1.00	1.00	1.00	1.00	1.00	1.00	1.00
Upstream Filter(I)	1.00	1.00	1.00	0.00	1.00	1.00	1.00	1.00	0.00	1.00	0.00	1.00
Uniform Delay (d), s/veh	12.8	6.5	6.5	0.0	7.3	7.3	16.0	13.8	0.0	15.9	0.0	13.7
Incr Delay (d2), s/veh	0.1	0.2	0.2	0.0	0.4	0.4	0.2	0.1	0.0	0.2	0.0	0.1
Initial Q Delay(d3),s/veh	0.0	0.0	0.0	0.0	0.0	0.0	0.0	0.0	0.0	0.0	0.0	0.0
%ile BackOfQ(50%),veh/ln	0.2	1.3	1.3	0.0	2.0	2.0	0.9	0.4	0.0	0.8	0.0	0.4
Unsig. Movement Delay, s/veh												
LnGrp Delay(d),s/veh	12.9	6.7	6.7	0.0	7.7	7.7	16.2	13.9	0.0	16.0	0.0	13.8
LnGrp LOS	B	A	A	A	A	A	B	B		B	A	B
Approach Vol, veh/h		1034			1334			208				187
Approach Delay, s/veh		6.9			7.7			15.4				15.3
Approach LOS		A			A			B				B
Timer - Assigned Phs		2		4		6		8				
Phs Duration (G+Y+Rc), s		27.1		13.2		27.1		13.2				
Change Period (Y+Rc), s		6.0		5.5		6.0		5.5				
Max Green Setting (Gmax), s		51.4		22.1		51.4		22.1				
Max Q Clear Time (g_c+I1), s		16.5		7.0		13.6		7.4				
Green Ext Time (p_c), s		4.6		0.3		6.0		0.4				

Intersection Summary

HCM 6th Ctrl Delay	8.5
HCM 6th LOS	A

Notes

User approved volume balancing among the lanes for turning movement.
 Unsignalized Delay for [NBR] is excluded from calculations of the approach delay and intersection delay.

Timings
32: I-215 SB Ramps & Van Buren Bl.



Lane Group	EBT	EBR	WBL	WBT	SBT	SBR
Lane Configurations	↑↑	↑↑	↙	↑↑	↙	↑↑
Traffic Volume (vph)	717	837	14	813	0	807
Future Volume (vph)	717	837	14	813	0	807
Turn Type	NA	Perm	Prot	NA	NA	Perm
Protected Phases	6		5	2	8	
Permitted Phases		6				8
Detector Phase	6	6	5	2	8	8
Switch Phase						
Minimum Initial (s)	5.0	5.0	5.0	5.0	5.0	5.0
Minimum Split (s)	36.0	36.0	11.0	11.0	11.0	11.0
Total Split (s)	60.0	60.0	11.0	71.0	14.0	14.0
Total Split (%)	70.6%	70.6%	12.9%	83.5%	16.5%	16.5%
Yellow Time (s)	5.0	5.0	5.0	5.0	5.0	5.0
All-Red Time (s)	1.0	1.0	1.0	1.0	1.0	1.0
Lost Time Adjust (s)	0.0	0.0	0.0	0.0	0.0	0.0
Total Lost Time (s)	6.0	6.0	6.0	6.0	6.0	6.0
Lead/Lag	Lag	Lag	Lead			
Lead-Lag Optimize?	Yes	Yes	Yes			
Recall Mode	Min	Min	None	Min	Max	Max
Act Effct Green (s)	16.9	16.9	5.3	18.3	8.5	8.5
Actuated g/C Ratio	0.43	0.43	0.13	0.46	0.22	0.22
v/c Ratio	0.54	0.53	0.08	0.55	0.08	0.99
Control Delay	10.0	2.0	21.5	8.3	18.3	40.7
Queue Delay	0.0	0.0	0.0	0.0	0.0	0.0
Total Delay	10.0	2.0	21.5	8.3	18.3	40.7
LOS	A	A	C	A	B	D
Approach Delay	5.7			8.5	40.2	
Approach LOS	A			A	D	

Intersection Summary

Cycle Length: 85
 Actuated Cycle Length: 39.5
 Natural Cycle: 75
 Control Type: Actuated-Uncoordinated
 Maximum v/c Ratio: 0.99
 Intersection Signal Delay: 15.3
 Intersection Capacity Utilization 60.7%
 Analysis Period (min) 15
 Intersection LOS: B
 ICU Level of Service B

Splits and Phases: 32: I-215 SB Ramps & Van Buren Bl.



HCM 6th Signalized Intersection Summary
 32: I-215 SB Ramps & Van Buren Bl.

West Campus Upper Plateau (JN 14064)

09/30/2022



Movement	EBL	EBT	EBR	WBL	WBT	WBR	NBL	NBT	NBR	SBL	SBT	SBR
Lane Configurations		↑↑	↑↑	↑	↑↑						↑	↑↑
Traffic Volume (veh/h)	0	717	837	14	813	0	0	0	0	22	0	807
Future Volume (veh/h)	0	717	837	14	813	0	0	0	0	22	0	807
Initial Q (Qb), veh	0	0	0	0	0	0				0	0	0
Ped-Bike Adj(A_pbT)	1.00		1.00	1.00		1.00				1.00		1.00
Parking Bus, Adj	1.00	1.00	1.00	1.00	1.00	1.00				1.00	1.00	1.00
Work Zone On Approach		No			No						No	
Adj Sat Flow, veh/h/ln	0	1767	1856	1411	1811	0				1500	1841	1663
Adj Flow Rate, veh/h	0	763	792	15	865	0				23	0	0
Peak Hour Factor	0.94	0.94	0.94	0.94	0.94	0.94				0.94	0.94	0.94
Percent Heavy Veh, %	0	9	3	33	6	0				27	4	16
Cap, veh/h	0	1304	1076	133	2084	0				277	0	
Arrive On Green	0.00	0.39	0.39	0.10	0.61	0.00				0.16	0.00	0.00
Sat Flow, veh/h	0	3445	2768	1344	3532	0				1753	0	2480
Grp Volume(v), veh/h	0	763	792	15	865	0				23	0	0
Grp Sat Flow(s),veh/h/ln	0	1678	1384	1344	1721	0				1753	0	1240
Q Serve(g_s), s	0.0	9.1	12.4	0.5	6.7	0.0				0.6	0.0	0.0
Cycle Q Clear(g_c), s	0.0	9.1	12.4	0.5	6.7	0.0				0.6	0.0	0.0
Prop In Lane	0.00		1.00	1.00		0.00				1.00		1.00
Lane Grp Cap(c), veh/h	0	1304	1076	133	2084	0				277	0	
V/C Ratio(X)	0.00	0.58	0.74	0.11	0.42	0.00				0.08	0.00	
Avail Cap(c_a), veh/h	0	3575	2947	133	4411	0				277	0	
HCM Platoon Ratio	1.00	1.00	1.00	1.00	1.00	1.00				1.00	1.00	1.00
Upstream Filter(I)	0.00	1.00	1.00	1.00	1.00	0.00				1.00	0.00	0.00
Uniform Delay (d), s/veh	0.0	12.3	13.3	20.8	5.3	0.0				18.2	0.0	0.0
Incr Delay (d2), s/veh	0.0	0.2	0.4	0.1	0.0	0.0				0.6	0.0	0.0
Initial Q Delay(d3),s/veh	0.0	0.0	0.0	0.0	0.0	0.0				0.0	0.0	0.0
%ile BackOfQ(50%),veh/ln	0.0	2.3	2.6	0.1	1.0	0.0				0.2	0.0	0.0
Unsig. Movement Delay, s/veh												
LnGrp Delay(d),s/veh	0.0	12.4	13.6	21.0	5.3	0.0				18.8	0.0	0.0
LnGrp LOS	A	B	B	C	A	A				B	A	
Approach Vol, veh/h		1555			880							23
Approach Delay, s/veh		13.0			5.6							18.8
Approach LOS		B			A							B
Timer - Assigned Phs		2			5	6		8				
Phs Duration (G+Y+Rc), s		36.7			11.0	25.7		14.0				
Change Period (Y+Rc), s		6.0			6.0	6.0		6.0				
Max Green Setting (Gmax), s		65.0			5.0	54.0		8.0				
Max Q Clear Time (g_c+I1), s		8.7			2.5	14.4		2.6				
Green Ext Time (p_c), s		3.7			0.0	5.3		0.0				

Intersection Summary

HCM 6th Ctrl Delay	10.4
HCM 6th LOS	B

Notes

Unsignalized Delay for [SBR] is excluded from calculations of the approach delay and intersection delay.

Timings
33: I-215 NB On/Off Ramp & Van Buren Bl.

Lane Group	EBR	NBL	Ø2	Ø6
Lane Configurations	↔↔	↔↔		
Traffic Volume (vph)	17	1		
Future Volume (vph)	17	1		
Turn Type	pm+ov	Prot		
Protected Phases	4	4	2	6
Permitted Phases	6			
Detector Phase	4	4		
Switch Phase				
Minimum Initial (s)	5.0	5.0	5.0	5.0
Minimum Split (s)	42.0	42.0	11.0	11.0
Total Split (s)	55.0	55.0	15.0	15.0
Total Split (%)	78.6%	78.6%	21%	21%
Yellow Time (s)	5.0	5.0	5.0	5.0
All-Red Time (s)	1.0	1.0	1.0	1.0
Lost Time Adjust (s)	0.0	0.0		
Total Lost Time (s)	6.0	6.0		
Lead/Lag				
Lead-Lag Optimize?				
Recall Mode	Min	Min	None	None
Act Effct Green (s)	32.2	32.2		
Actuated g/C Ratio	1.00	1.00		
v/c Ratio	0.01	0.00		
Control Delay	0.0	0.0		
Queue Delay	0.0	0.0		
Total Delay	0.0	0.0		
LOS	A	A		
Approach Delay				
Approach LOS				

Intersection Summary

Cycle Length: 70
 Actuated Cycle Length: 32.2
 Natural Cycle: 55
 Control Type: Actuated-Uncoordinated
 Maximum v/c Ratio: 0.01
 Intersection Signal Delay: 0.0
 Intersection LOS: A
 Intersection Capacity Utilization 9.2%
 ICU Level of Service A
 Analysis Period (min) 15

Splits and Phases: 33: I-215 NB On/Off Ramp & Van Buren Bl.



HCM 6th Signalized Intersection Summary
33: I-215 NB On/Off Ramp & Van Buren Bl.

West Campus Upper Plateau (JN 14064)
09/30/2022



Movement	EBT	EBR	WBL	WBT	NBL	NBR
Lane Configurations	↑↑	↑↑		↑↑	↑↑	↑
Traffic Volume (veh/h)	0	17	0	0	1	0
Future Volume (veh/h)	0	17	0	0	1	0
Initial Q (Qb), veh	0	0	0	0	0	0
Ped-Bike Adj(A_pbT)		1.00	1.00		1.00	1.00
Parking Bus, Adj	1.00	1.00	1.00	1.00	1.00	1.00
Work Zone On Approach	No			No	No	
Adj Sat Flow, veh/h/ln	1900	1767	0	1752	1811	1159
Adj Flow Rate, veh/h	0	9	0	0	1	0
Peak Hour Factor	0.94	0.94	0.94	0.94	0.94	0.94
Percent Heavy Veh, %	0	9	0	10	6	50
Cap, veh/h	44	798	0	41	972	285
Arrive On Green	0.00	0.01	0.00	0.00	0.29	0.00
Sat Flow, veh/h	3705	2635	0	3504	3346	982
Grp Volume(v), veh/h	0	9	0	0	1	0
Grp Sat Flow(s),veh/h/ln	1805	1317	0	1664	1673	982
Q Serve(g_s), s	0.0	0.0	0.0	0.0	0.0	0.0
Cycle Q Clear(g_c), s	0.0	0.0	0.0	0.0	0.0	0.0
Prop In Lane		1.00	0.00		1.00	1.00
Lane Grp Cap(c), veh/h	44	798	0	41	972	285
V/C Ratio(X)	0.00	0.01	0.00	0.00	0.00	0.00
Avail Cap(c_a), veh/h	1888	2143	0	1741	9527	2796
HCM Platoon Ratio	1.00	1.00	1.00	1.00	1.00	1.00
Upstream Filter(I)	0.00	1.00	0.00	0.00	1.00	0.00
Uniform Delay (d), s/veh	0.0	4.2	0.0	0.0	4.3	0.0
Incr Delay (d2), s/veh	0.0	0.0	0.0	0.0	0.0	0.0
Initial Q Delay(d3),s/veh	0.0	0.0	0.0	0.0	0.0	0.0
%ile BackOfQ(50%),veh/ln	0.0	0.0	0.0	0.0	0.0	0.0
Unsig. Movement Delay, s/veh						
LnGrp Delay(d),s/veh	0.0	4.2	0.0	0.0	4.3	0.0
LnGrp LOS	A	A	A	A	A	A
Approach Vol, veh/h	9			0	1	
Approach Delay, s/veh	4.2			0.0	4.3	
Approach LOS	A				A	
Timer - Assigned Phs		2		4		6
Phs Duration (G+Y+Rc), s		6.2		11.0		6.2
Change Period (Y+Rc), s		6.0		6.0		6.0
Max Green Setting (Gmax), s		9.0		49.0		9.0
Max Q Clear Time (g_c+I1), s		0.0		2.0		2.0
Green Ext Time (p_c), s		0.0		0.0		0.0
Intersection Summary						
HCM 6th Ctrl Delay			4.2			
HCM 6th LOS			A			

Timings

West Campus Upper Plateau (JN 14064)

34: Old 215 Frontage Rd. & Alessandro Bl.

09/30/2022

Lane Group	EBL	EBT	EBR	WBL	WBT	WBR	NBL	NBT	NBR	SBL	SBT	SBR
Lane Configurations												
Traffic Volume (vph)	331	854	13	11	785	99	24	99	14	90	122	221
Future Volume (vph)	331	854	13	11	785	99	24	99	14	90	122	221
Turn Type	Prot	NA	Perm	Prot	NA	Perm	Prot	NA	Perm	Prot	NA	Perm
Protected Phases	5	2		1	6		3	8		7	4	
Permitted Phases			2			6			8			4
Detector Phase	5	2	2	1	6	6	3	8	8	7	4	4
Switch Phase												
Minimum Initial (s)	5.0	10.0	10.0	5.0	10.0	10.0	5.0	10.0	10.0	5.0	10.0	10.0
Minimum Split (s)	8.7	43.5	43.5	8.7	15.8	15.8	8.7	16.2	16.2	8.7	40.2	40.2
Total Split (s)	22.0	62.4	62.4	8.7	49.1	49.1	8.7	29.7	29.7	19.2	40.2	40.2
Total Split (%)	18.3%	52.0%	52.0%	7.3%	40.9%	40.9%	7.3%	24.8%	24.8%	16.0%	33.5%	33.5%
Yellow Time (s)	3.2	5.5	5.5	3.2	4.8	4.8	3.2	5.2	5.2	3.2	5.2	5.2
All-Red Time (s)	0.5	1.0	1.0	0.5	1.0	1.0	0.5	1.0	1.0	0.5	1.0	1.0
Lost Time Adjust (s)	0.0	0.0	0.0	0.0	0.0	0.0	0.0	0.0	0.0	0.0	0.0	0.0
Total Lost Time (s)	3.7	6.5	6.5	3.7	5.8	5.8	3.7	6.2	6.2	3.7	6.2	6.2
Lead/Lag	Lead	Lag	Lag	Lead	Lag	Lag	Lead	Lag	Lag	Lead	Lag	Lag
Lead-Lag Optimize?	Yes	Yes	Yes	Yes	Yes	Yes	Yes	Yes	Yes	Yes	Yes	Yes
Recall Mode	None	None	None	None	None	None	None	None	None	None	None	None
Act Effct Green (s)	13.2	42.4	42.4	5.4	27.2	27.2	5.4	12.6	12.6	9.5	20.4	20.4
Actuated g/C Ratio	0.16	0.53	0.53	0.07	0.34	0.34	0.07	0.16	0.16	0.12	0.25	0.25
v/c Ratio	0.61	0.33	0.02	0.10	0.69	0.16	0.13	0.19	0.04	0.46	0.15	0.40
Control Delay	39.8	12.7	0.1	48.6	27.8	1.1	46.6	35.4	0.2	46.4	27.1	6.7
Queue Delay	0.0	0.0	0.0	0.0	0.0	0.0	0.0	0.0	0.0	0.0	0.0	0.0
Total Delay	39.8	12.7	0.1	48.6	27.8	1.1	46.6	35.4	0.2	46.4	27.1	6.7
LOS	D	B	A	D	C	A	D	D	A	D	C	A
Approach Delay		20.1			25.1			33.6			20.7	
Approach LOS		C			C			C			C	

Intersection Summary

Cycle Length: 120
 Actuated Cycle Length: 80.5
 Natural Cycle: 105
 Control Type: Actuated-Uncoordinated
 Maximum v/c Ratio: 0.69
 Intersection Signal Delay: 22.6
 Intersection LOS: C
 Intersection Capacity Utilization 56.1%
 ICU Level of Service B
 Analysis Period (min) 15



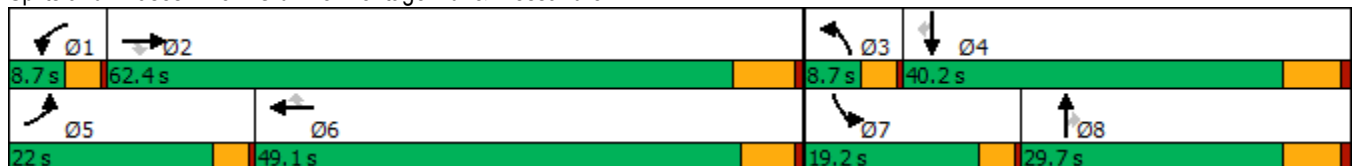



























Splits and Phases: 34: Old 215 Frontage Rd. & Alessandro Bl.



HCM 6th Signalized Intersection Summary
34: Old 215 Frontage Rd. & Alessandro Bl.

West Campus Upper Plateau (JN 14064)

09/30/2022

												
Movement	EBL	EBT	EBR	WBL	WBT	WBR	NBL	NBT	NBR	SBL	SBT	SBR
Lane Configurations	 	  			 		 	 			 	
Traffic Volume (veh/h)	331	854	13	11	785	99	24	99	14	90	122	221
Future Volume (veh/h)	331	854	13	11	785	99	24	99	14	90	122	221
Initial Q (Qb), veh	0	0	0	0	0	0	0	0	0	0	0	0
Ped-Bike Adj(A_pbT)	1.00		1.00	1.00		1.00	1.00		0.99	1.00		1.00
Parking Bus, Adj	1.00	1.00	1.00	1.00	1.00	1.00	1.00	1.00	1.00	1.00	1.00	1.00
Work Zone On Approach		No			No			No			No	
Adj Sat Flow, veh/h/ln	1870	1885	1678	1678	1856	1856	1515	1856	1559	1826	1737	1885
Adj Flow Rate, veh/h	345	890	-13	11	818	0	25	103	5	94	127	0
Peak Hour Factor	0.96	0.96	0.96	0.96	0.96	0.96	0.96	0.96	0.96	0.96	0.96	0.96
Percent Heavy Veh, %	2	1	15	15	3	3	26	3	23	5	11	1
Cap, veh/h	464	2291	633	22	1145		79	549	203	121	650	
Arrive On Green	0.13	0.45	0.00	0.01	0.32	0.00	0.03	0.16	0.16	0.07	0.20	0.00
Sat Flow, veh/h	3456	5147	1422	1598	3526	1572	2799	3526	1302	1739	3300	1598
Grp Volume(v), veh/h	345	890	-13	11	818	0	25	103	5	94	127	0
Grp Sat Flow(s),veh/h/ln	1728	1716	1422	1598	1763	1572	1399	1763	1302	1739	1650	1598
Q Serve(g_s), s	6.1	7.4	0.0	0.4	13.0	0.0	0.6	1.6	0.2	3.4	2.0	0.0
Cycle Q Clear(g_c), s	6.1	7.4	0.0	0.4	13.0	0.0	0.6	1.6	0.2	3.4	2.0	0.0
Prop In Lane	1.00		1.00	1.00		1.00	1.00		1.00	1.00		1.00
Lane Grp Cap(c), veh/h	464	2291	633	22	1145		79	549	203	121	650	
V/C Ratio(X)	0.74	0.39	-0.02	0.50	0.71		0.32	0.19	0.02	0.78	0.20	
Avail Cap(c_a), veh/h	994	4523	1250	126	2400		220	1303	481	424	1764	
HCM Platoon Ratio	1.00	1.00	1.00	1.00	1.00	1.00	1.00	1.00	1.00	1.00	1.00	1.00
Upstream Filter(I)	1.00	1.00	0.00	1.00	1.00	0.00	1.00	1.00	1.00	1.00	1.00	0.00
Uniform Delay (d), s/veh	26.5	11.8	0.0	31.1	18.9	0.0	30.3	23.4	22.8	29.1	21.3	0.0
Incr Delay (d2), s/veh	0.9	0.1	0.0	6.2	0.8	0.0	0.9	0.2	0.0	4.1	0.1	0.0
Initial Q Delay(d3),s/veh	0.0	0.0	0.0	0.0	0.0	0.0	0.0	0.0	0.0	0.0	0.0	0.0
%ile BackOfQ(50%),veh/ln	2.2	2.1	0.0	0.2	4.6	0.0	0.2	0.6	0.1	1.4	0.7	0.0
Unsig. Movement Delay, s/veh												
LnGrp Delay(d),s/veh	27.4	11.9	0.0	37.4	19.7	0.0	31.2	23.5	22.8	33.2	21.5	0.0
LnGrp LOS	C	B	A	D	B		C	C	C	C	C	
Approach Vol, veh/h		1222			829			133			221	
Approach Delay, s/veh		16.4			20.0			24.9			26.5	
Approach LOS		B			B			C			C	
Timer - Assigned Phs	1	2	3	4	5	6	7	8				
Phs Duration (G+Y+Rc), s	4.6	34.8	5.5	18.7	12.2	27.2	8.1	16.1				
Change Period (Y+Rc), s	3.7	6.5	3.7	6.2	3.7	* 6.5	3.7	6.2				
Max Green Setting (Gmax), s	5.0	55.9	5.0	34.0	18.3	* 43	15.5	23.5				
Max Q Clear Time (g_c+I1), s	2.4	9.4	2.6	4.0	8.1	15.0	5.4	3.6				
Green Ext Time (p_c), s	0.0	6.2	0.0	0.7	0.5	5.7	0.1	0.4				

Intersection Summary

HCM 6th Ctrl Delay	19.0
HCM 6th LOS	B

Notes

* HCM 6th computational engine requires equal clearance times for the phases crossing the barrier.
Unsignalized Delay for [WBR, SBR] is excluded from calculations of the approach delay and intersection delay.

Timings
35: Day St. & Alessandro Bl.

West Campus Upper Plateau (JN 14064)

09/30/2022



Lane Group	EBL	EBT	EBR	WBL	WBT	WBR	NBL	NBT	NBR	SBL	SBT
Lane Configurations	↖	↗↗↗	↖	↖	↗↗	↖	↖	↗	↖	↖	↗
Traffic Volume (vph)	189	665	7	9	699	139	10	95	15	117	47
Future Volume (vph)	189	665	7	9	699	139	10	95	15	117	47
Turn Type	Prot	NA	Perm	Prot	NA	Perm	Perm	NA	Perm	Perm	NA
Protected Phases	5	2		1	6			8			4
Permitted Phases			2			6	8		8	4	
Detector Phase	5	2	2	1	6	6	8	8	8	4	4
Switch Phase											
Minimum Initial (s)	5.0	10.0	10.0	5.0	10.0	10.0	10.0	10.0	10.0	10.0	10.0
Minimum Split (s)	9.1	30.8	30.8	9.1	30.8	30.8	42.4	42.4	42.4	41.6	41.6
Total Split (s)	28.0	67.9	67.9	9.1	49.0	49.0	43.0	43.0	43.0	43.0	43.0
Total Split (%)	23.3%	56.6%	56.6%	7.6%	40.8%	40.8%	35.8%	35.8%	35.8%	35.8%	35.8%
Yellow Time (s)	3.6	4.8	4.8	3.6	4.8	4.8	4.4	4.4	4.4	3.6	3.6
All-Red Time (s)	0.5	1.0	1.0	0.5	1.0	1.0	1.0	1.0	1.0	1.0	1.0
Lost Time Adjust (s)	0.0	0.0	0.0	0.0	0.0	0.0	0.0	0.0	0.0	0.0	0.0
Total Lost Time (s)	4.1	5.8	5.8	4.1	5.8	5.8	5.4	5.4	5.4	4.6	4.6
Lead/Lag	Lead	Lag	Lag	Lead	Lag	Lag					
Lead-Lag Optimize?	Yes	Yes	Yes	Yes	Yes	Yes					
Recall Mode	None	None	None	None	None	None	None	None	None	None	None
Act Effct Green (s)	13.0	38.5	38.5	5.5	22.1	22.1	15.2	15.2	15.2	16.1	16.1
Actuated g/C Ratio	0.19	0.57	0.57	0.08	0.33	0.33	0.23	0.23	0.23	0.24	0.24
v/c Ratio	0.57	0.24	0.01	0.06	0.63	0.25	0.05	0.23	0.04	0.39	0.34
Control Delay	35.0	8.7	0.0	41.1	23.1	9.8	24.0	24.7	0.2	27.7	12.3
Queue Delay	0.0	0.0	0.0	0.0	0.0	0.0	0.0	0.0	0.0	0.0	0.0
Total Delay	35.0	8.7	0.0	41.1	23.1	9.8	24.0	24.7	0.2	27.7	12.3
LOS	D	A	A	D	C	A	C	C	A	C	B
Approach Delay		14.4			21.1			21.5			18.9
Approach LOS		B			C			C			B

Intersection Summary

Cycle Length: 120
 Actuated Cycle Length: 67.1
 Natural Cycle: 85
 Control Type: Actuated-Uncoordinated
 Maximum v/c Ratio: 0.63
 Intersection Signal Delay: 18.1
 Intersection LOS: B
 Intersection Capacity Utilization 55.0%
 ICU Level of Service B
 Analysis Period (min) 15





























Splits and Phases: 35: Day St. & Alessandro Bl.



HCM 6th Signalized Intersection Summary
35: Day St. & Alessandro Bl.

West Campus Upper Plateau (JN 14064)

09/30/2022

												
Movement	EBL	EBT	EBR	WBL	WBT	WBR	NBL	NBT	NBR	SBL	SBT	SBR
Lane Configurations		  			 						 	
Traffic Volume (veh/h)	189	665	7	9	699	139	10	95	15	117	47	108
Future Volume (veh/h)	189	665	7	9	699	139	10	95	15	117	47	108
Initial Q (Qb), veh	0	0	0	0	0	0	0	0	0	0	0	0
Ped-Bike Adj(A_pbT)	1.00		0.98	1.00		0.98	1.00		1.00	1.00		1.00
Parking Bus, Adj	1.00	1.00	1.00	1.00	1.00	1.00	1.00	1.00	1.00	1.00	1.00	1.00
Work Zone On Approach		No			No			No			No	
Adj Sat Flow, veh/h/ln	1885	1870	1618	1900	1870	1900	1500	1900	1767	1885	1870	1870
Adj Flow Rate, veh/h	197	693	1	9	728	77	10	99	11	122	49	81
Peak Hour Factor	0.96	0.96	0.96	0.96	0.96	0.96	0.96	0.96	0.96	0.96	0.96	0.96
Percent Heavy Veh, %	1	2	19	0	2	0	27	0	9	1	2	2
Cap, veh/h	254	2333	613	21	1164	516	296	397	313	366	133	219
Arrive On Green	0.14	0.46	0.46	0.01	0.33	0.33	0.21	0.21	0.21	0.21	0.21	0.21
Sat Flow, veh/h	1795	5106	1341	1810	3554	1574	1011	1900	1497	1293	634	1048
Grp Volume(v), veh/h	197	693	1	9	728	77	10	99	11	122	0	130
Grp Sat Flow(s),veh/h/ln	1795	1702	1341	1810	1777	1574	1011	1900	1497	1293	0	1682
Q Serve(g_s), s	5.0	4.0	0.0	0.2	8.2	1.6	0.4	2.1	0.3	4.1	0.0	3.1
Cycle Q Clear(g_c), s	5.0	4.0	0.0	0.2	8.2	1.6	3.6	2.1	0.3	6.2	0.0	3.1
Prop In Lane	1.00		1.00	1.00		1.00	1.00		1.00	1.00		0.62
Lane Grp Cap(c), veh/h	254	2333	613	21	1164	516	296	397	313	366	0	352
V/C Ratio(X)	0.78	0.30	0.00	0.42	0.63	0.15	0.03	0.25	0.04	0.33	0.00	0.37
Avail Cap(c_a), veh/h	904	6678	1753	191	3233	1432	885	1504	1185	1141	0	1360
HCM Platoon Ratio	1.00	1.00	1.00	1.00	1.00	1.00	1.00	1.00	1.00	1.00	1.00	1.00
Upstream Filter(I)	1.00	1.00	1.00	1.00	1.00	1.00	1.00	1.00	1.00	1.00	0.00	1.00
Uniform Delay (d), s/veh	19.7	8.1	7.0	23.3	13.5	11.3	17.6	15.7	15.0	18.3	0.0	16.1
Incr Delay (d2), s/veh	1.9	0.1	0.0	4.9	0.6	0.1	0.0	0.3	0.0	0.5	0.0	0.6
Initial Q Delay(d3),s/veh	0.0	0.0	0.0	0.0	0.0	0.0	0.0	0.0	0.0	0.0	0.0	0.0
%ile BackOfQ(50%),veh/ln	1.9	1.0	0.0	0.1	2.5	0.4	0.1	0.8	0.1	1.2	0.0	1.2
Unsig. Movement Delay, s/veh												
LnGrp Delay(d),s/veh	21.6	8.2	7.0	28.2	14.1	11.4	17.7	16.0	15.0	18.8	0.0	16.7
LnGrp LOS	C	A	A	C	B	B	B	B	B	B	A	B
Approach Vol, veh/h		891			814			120			252	
Approach Delay, s/veh		11.1			14.0			16.0			17.7	
Approach LOS		B			B			B			B	
Timer - Assigned Phs	1	2		4	5	6		8				
Phs Duration (G+Y+Rc), s	4.7	27.5		15.3	10.8	21.4		15.3				
Change Period (Y+Rc), s	4.1	5.8		* 5.4	4.1	5.8		5.4				
Max Green Setting (Gmax), s	5.0	62.1		* 38	23.9	43.2		37.6				
Max Q Clear Time (g_c+I1), s	2.2	6.0		8.2	7.0	10.2		5.6				
Green Ext Time (p_c), s	0.0	5.0		1.2	0.2	5.3		0.6				

Intersection Summary

HCM 6th Ctrl Delay	13.3
HCM 6th LOS	B

Notes

* HCM 6th computational engine requires equal clearance times for the phases crossing the barrier.

Timings
36: Elsworth St. & Cactus Av.

West Campus Upper Plateau (JN 14064)

09/30/2022



Lane Group	EBL	EBT	EBR	WBL	WBT	WBR	NBL	NBT	SBL	SBT	SBR
Lane Configurations	↘	↑↑↑	↗	↘	↑↑↑	↗	↘	↕	↘	↗	↗
Traffic Volume (vph)	153	1076	31	14	1075	133	22	11	160	17	128
Future Volume (vph)	153	1076	31	14	1075	133	22	11	160	17	128
Turn Type	Prot	NA	Perm	Prot	NA	Perm	Split	NA	Split	NA	pm+ov
Protected Phases	5	2		1	6		8	8	4	4	5
Permitted Phases			2			6					4
Detector Phase	5	2	2	1	6	6	8	8	4	4	5
Switch Phase											
Minimum Initial (s)	5.0	10.0	10.0	5.0	10.0	10.0	10.0	10.0	10.0	10.0	5.0
Minimum Split (s)	9.6	36.2	36.2	9.6	36.2	36.2	35.4	35.4	35.4	35.4	9.6
Total Split (s)	16.5	49.6	49.6	9.6	42.7	42.7	35.4	35.4	35.4	35.4	16.5
Total Split (%)	12.7%	38.2%	38.2%	7.4%	32.8%	32.8%	27.2%	27.2%	27.2%	27.2%	12.7%
Yellow Time (s)	3.6	5.2	5.2	3.6	5.2	5.2	4.4	4.4	4.4	4.4	3.6
All-Red Time (s)	1.0	1.0	1.0	1.0	1.0	1.0	1.0	1.0	1.0	1.0	1.0
Lost Time Adjust (s)	0.0	0.0	0.0	0.0	0.0	0.0	0.0	0.0	0.0	0.0	0.0
Total Lost Time (s)	4.6	6.2	6.2	4.6	6.2	6.2	5.4	5.4	5.4	5.4	4.6
Lead/Lag	Lead	Lag	Lag	Lead	Lag	Lag					Lead
Lead-Lag Optimize?	Yes	Yes	Yes	Yes	Yes	Yes					Yes
Recall Mode	None	None	None	None	None	None	Max	Max	Max	Max	None
Act Effct Green (s)	11.9	47.5	47.5	5.0	34.7	34.7	30.0	30.0	30.0	30.0	42.7
Actuated g/C Ratio	0.09	0.37	0.37	0.04	0.27	0.27	0.23	0.23	0.23	0.23	0.33
v/c Ratio	1.01	0.61	0.05	0.21	0.84	0.26	0.05	0.06	0.23	0.23	0.22
Control Delay	130.1	35.3	0.2	67.9	50.6	6.6	39.5	28.1	42.3	42.3	3.3
Queue Delay	0.0	0.0	0.0	0.0	0.0	0.0	0.0	0.0	0.0	0.0	0.0
Total Delay	130.1	35.3	0.2	67.9	50.6	6.6	39.5	28.1	42.3	42.3	3.3
LOS	F	D	A	E	D	A	D	C	D	D	A
Approach Delay		45.9			46.0			33.6		25.9	
Approach LOS		D			D			C		C	

Intersection Summary

Cycle Length: 130
 Actuated Cycle Length: 128.3
 Natural Cycle: 120
 Control Type: Actuated-Uncoordinated
 Maximum v/c Ratio: 1.01
 Intersection Signal Delay: 43.6
 Intersection LOS: D
 Intersection Capacity Utilization 54.3%
 ICU Level of Service A
 Analysis Period (min) 15

Splits and Phases: 36: Elsworth St. & Cactus Av.

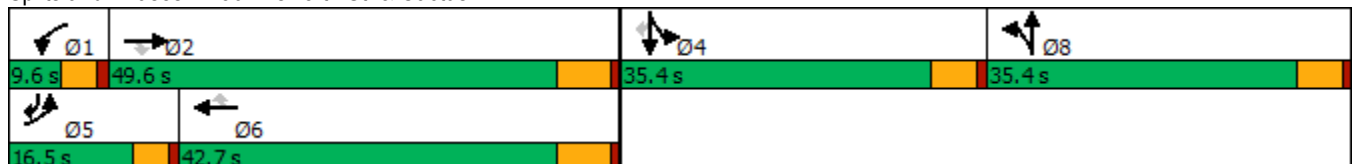

HCM 6th Signalized Intersection Summary
36: Elsworth St. & Cactus Av.

West Campus Upper Plateau (JN 14064)

09/30/2022



Movement	EBL	EBT	EBR	WBL	WBT	WBR	NBL	NBT	NBR	SBL	SBT	SBR
Lane Configurations	↖	↑↑↑	↗	↖	↑↑↑	↗	↖	↕		↖	↗	↗
Traffic Volume (veh/h)	153	1076	31	14	1075	133	22	11	9	160	17	128
Future Volume (veh/h)	153	1076	31	14	1075	133	22	11	9	160	17	128
Initial Q (Qb), veh	0	0	0	0	0	0	0	0	0	0	0	0
Ped-Bike Adj(A_pbT)	1.00		1.00	1.00		1.00	1.00		1.00	1.00		1.00
Parking Bus, Adj	1.00	1.00	1.00	1.00	1.00	1.00	1.00	1.00	1.00	1.00	1.00	1.00
Work Zone On Approach		No			No			No			No	
Adj Sat Flow, veh/h/ln	1841	1841	1781	1900	1841	1885	1885	1900	1885	1885	1900	1885
Adj Flow Rate, veh/h	161	1133	0	15	1132	103	17	0	0	181	0	27
Peak Hour Factor	0.95	0.95	0.95	0.95	0.95	0.95	0.95	0.95	0.95	0.95	0.95	0.95
Percent Heavy Veh, %	4	4	8	0	4	1	1	0	1	1	0	1
Cap, veh/h	165	1709		29	1319	419	850	450	0	850	0	528
Arrive On Green	0.09	0.34	0.00	0.02	0.26	0.26	0.24	0.00	0.00	0.24	0.00	0.24
Sat Flow, veh/h	1753	5025	1510	1810	5025	1598	3591	1900	0	3591	0	1598
Grp Volume(v), veh/h	161	1133	0	15	1132	103	17	0	0	181	0	27
Grp Sat Flow(s),veh/h/ln	1753	1675	1510	1810	1675	1598	1795	1900	0	1795	0	1598
Q Serve(g_s), s	11.6	24.4	0.0	1.0	27.2	6.4	0.5	0.0	0.0	5.1	0.0	1.5
Cycle Q Clear(g_c), s	11.6	24.4	0.0	1.0	27.2	6.4	0.5	0.0	0.0	5.1	0.0	1.5
Prop In Lane	1.00		1.00	1.00		1.00	1.00		0.00	1.00		1.00
Lane Grp Cap(c), veh/h	165	1709		29	1319	419	850	450	0	850	0	528
V/C Ratio(X)	0.98	0.66		0.51	0.86	0.25	0.02	0.00	0.00	0.21	0.00	0.05
Avail Cap(c_a), veh/h	165	1720		71	1447	460	850	450	0	850	0	528
HCM Platoon Ratio	1.00	1.00	1.00	1.00	1.00	1.00	1.00	1.00	1.00	1.00	1.00	1.00
Upstream Filter(I)	1.00	1.00	0.00	1.00	1.00	1.00	1.00	0.00	0.00	1.00	0.00	1.00
Uniform Delay (d), s/veh	57.3	35.6	0.0	61.9	44.5	36.9	37.1	0.0	0.0	38.9	0.0	28.9
Incr Delay (d2), s/veh	63.3	1.0	0.0	5.1	5.0	0.3	0.0	0.0	0.0	0.6	0.0	0.2
Initial Q Delay(d3),s/veh	0.0	0.0	0.0	0.0	0.0	0.0	0.0	0.0	0.0	0.0	0.0	0.0
%ile BackOfQ(50%),veh/ln	7.9	9.6	0.0	0.5	11.4	2.5	0.2	0.0	0.0	2.3	0.0	0.6
Unsig. Movement Delay, s/veh												
LnGrp Delay(d),s/veh	120.6	36.6	0.0	66.9	49.6	37.2	37.2	0.0	0.0	39.5	0.0	29.1
LnGrp LOS	F	D		E	D	D	D	A	A	D	A	C
Approach Vol, veh/h		1294			1250			17				208
Approach Delay, s/veh		47.0			48.7			37.2				38.1
Approach LOS		D			D			D				D
Timer - Assigned Phs	1	2		4	5	6		8				
Phs Duration (G+Y+Rc), s	6.7	49.3		35.4	16.5	39.5		35.4				
Change Period (Y+Rc), s	4.6	6.2		5.4	4.6	6.2		5.4				
Max Green Setting (Gmax), s	5.0	43.4		30.0	11.9	36.5		30.0				
Max Q Clear Time (g_c+1), s	3.0	26.4		7.1	13.6	29.2		2.5				
Green Ext Time (p_c), s	0.0	6.7		0.6	0.0	4.1		0.0				

Intersection Summary

HCM 6th Ctrl Delay	47.1
HCM 6th LOS	D

Notes

- User approved pedestrian interval to be less than phase max green.
- User approved volume balancing among the lanes for turning movement.
- Unsignalized Delay for [EBR] is excluded from calculations of the approach delay and intersection delay.

Timings
37: Cactus Av. & Frederick St.

West Campus Upper Plateau (JN 14064)

09/30/2022

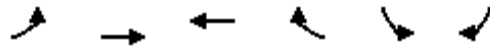

Lane Group	EBL	EBT	WBT	WBR	SBL	SBR
Lane Configurations	↖	↑↑↑	↑↑↑	↗	↖↗	↗
Traffic Volume (vph)	103	1169	1175	165	263	84
Future Volume (vph)	103	1169	1175	165	263	84
Turn Type	Prot	NA	NA	pm+ov	Prot	pm+ov
Protected Phases	5	2	6	4	4	5
Permitted Phases				6		4
Detector Phase	5	2	6	4	4	5
Switch Phase						
Minimum Initial (s)	5.0	10.0	10.0	10.0	10.0	5.0
Minimum Split (s)	9.2	28.2	29.2	36.4	36.4	9.2
Total Split (s)	31.0	81.0	50.0	39.0	39.0	31.0
Total Split (%)	25.8%	67.5%	41.7%	32.5%	32.5%	25.8%
Yellow Time (s)	3.2	5.2	5.2	4.4	4.4	3.2
All-Red Time (s)	1.0	1.0	1.0	1.0	1.0	1.0
Lost Time Adjust (s)	0.0	0.0	0.0	0.0	0.0	0.0
Total Lost Time (s)	4.2	6.2	6.2	5.4	5.4	4.2
Lead/Lag	Lead		Lag			Lead
Lead-Lag Optimize?	Yes		Yes			Yes
Recall Mode	None	None	None	None	None	None
Act Effct Green (s)	9.7	41.0	26.8	42.1	14.5	30.0
Actuated g/C Ratio	0.14	0.60	0.39	0.62	0.21	0.44
v/c Ratio	0.46	0.42	0.64	0.17	0.40	0.13
Control Delay	37.1	7.9	19.1	1.0	25.9	11.8
Queue Delay	0.0	0.0	0.0	0.0	0.0	0.0
Total Delay	37.1	7.9	19.1	1.0	25.9	11.8
LOS	D	A	B	A	C	B
Approach Delay		10.3	16.8		22.5	
Approach LOS		B	B		C	

Intersection Summary

Cycle Length: 120
 Actuated Cycle Length: 67.9
 Natural Cycle: 75
 Control Type: Actuated-Uncoordinated
 Maximum v/c Ratio: 0.64
 Intersection Signal Delay: 14.7
 Intersection LOS: B
 Intersection Capacity Utilization 49.9%
 ICU Level of Service A
 Analysis Period (min) 15

Splits and Phases: 37: Cactus Av. & Frederick St.



HCM 6th Signalized Intersection Summary
37: Cactus Av. & Frederick St.

West Campus Upper Plateau (JN 14064)
09/30/2022



Movement	EBL	EBT	WBT	WBR	SBL	SBR
Lane Configurations						
Traffic Volume (veh/h)	103	1169	1175	165	263	84
Future Volume (veh/h)	103	1169	1175	165	263	84
Initial Q (Qb), veh	0	0	0	0	0	0
Ped-Bike Adj(A_pbT)	1.00			0.98	1.00	1.00
Parking Bus, Adj	1.00	1.00	1.00	1.00	1.00	1.00
Work Zone On Approach		No	No		No	
Adj Sat Flow, veh/h/ln	1826	1856	1856	1870	1856	1856
Adj Flow Rate, veh/h	112	1271	1277	115	286	-9
Peak Hour Factor	0.92	0.92	0.92	0.92	0.92	0.92
Percent Heavy Veh, %	5	3	3	2	3	3
Cap, veh/h	145	2999	2173	960	641	425
Arrive On Green	0.08	0.59	0.43	0.43	0.19	0.00
Sat Flow, veh/h	1739	5233	5233	1548	3428	1572
Grp Volume(v), veh/h	112	1271	1277	115	286	-9
Grp Sat Flow(s),veh/h/ln	1739	1689	1689	1548	1714	1572
Q Serve(g_s), s	3.3	7.2	10.1	1.6	3.9	0.0
Cycle Q Clear(g_c), s	3.3	7.2	10.1	1.6	3.9	0.0
Prop In Lane	1.00			1.00	1.00	1.00
Lane Grp Cap(c), veh/h	145	2999	2173	960	641	425
V/C Ratio(X)	0.77	0.42	0.59	0.12	0.45	-0.02
Avail Cap(c_a), veh/h	887	7215	4225	1587	2193	1137
HCM Platoon Ratio	1.00	1.00	1.00	1.00	1.00	1.00
Upstream Filter(I)	1.00	1.00	1.00	1.00	1.00	0.00
Uniform Delay (d), s/veh	23.6	5.8	11.5	4.2	18.9	0.0
Incr Delay (d2), s/veh	3.3	0.1	0.3	0.1	0.5	0.0
Initial Q Delay(d3),s/veh	0.0	0.0	0.0	0.0	0.0	0.0
%ile BackOfQ(50%),veh/ln	1.3	1.3	2.6	0.6	1.4	0.0
Unsig. Movement Delay, s/veh						
LnGrp Delay(d),s/veh	26.9	5.9	11.7	4.2	19.4	0.0
LnGrp LOS	C	A	B	A	B	A
Approach Vol, veh/h		1383	1392		277	
Approach Delay, s/veh		7.6	11.1		20.1	
Approach LOS		A	B		C	
Timer - Assigned Phs		2		4	5	6
Phs Duration (G+Y+Rc), s		37.3		15.2	8.6	28.7
Change Period (Y+Rc), s		6.2		5.4	* 4.2	6.2
Max Green Setting (Gmax), s		74.8		33.6	* 27	43.8
Max Q Clear Time (g_c+11), s		9.2		5.9	5.3	12.1
Green Ext Time (p_c), s		11.0		1.0	0.1	10.4

Intersection Summary

HCM 6th Ctrl Delay	10.3
HCM 6th LOS	B

Notes

* HCM 6th computational engine requires equal clearance times for the phases crossing the barrier.

Timings
38: Riverside Dr./Graham St. & Cactus Av.

West Campus Upper Plateau (JN 14064)

09/30/2022

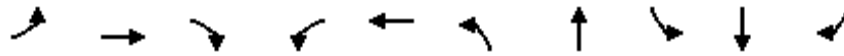

Lane Group	EBL	EBT	EBR	WBL	WBT	NBL	NBT	SBL	SBT	SBR
Lane Configurations	↘	↑↑↑	↗	↘	↑↑↑	↘	↑↑	↘	↑↑	↗
Traffic Volume (vph)	56	1095	173	20	1137	157	46	64	59	70
Future Volume (vph)	56	1095	173	20	1137	157	46	64	59	70
Turn Type	Prot	NA	Perm	Prot	NA	Prot	NA	Prot	NA	Perm
Protected Phases	7	4		3	8	5	2	1	6	
Permitted Phases			4							6
Detector Phase	7	4	4	3	8	5	2	1	6	6
Switch Phase										
Minimum Initial (s)	5.0	10.0	10.0	5.0	10.0	5.0	10.0	5.0	10.0	10.0
Minimum Split (s)	9.6	39.2	39.2	9.6	39.2	10.4	35.0	9.6	40.6	40.6
Total Split (s)	16.0	59.0	59.0	9.6	52.6	10.4	36.0	15.4	41.0	41.0
Total Split (%)	13.3%	49.2%	49.2%	8.0%	43.8%	8.7%	30.0%	12.8%	34.2%	34.2%
Yellow Time (s)	3.6	5.2	5.2	3.6	5.2	4.4	4.0	3.6	3.6	3.6
All-Red Time (s)	1.0	1.0	1.0	1.0	1.0	1.0	1.0	1.0	1.0	1.0
Lost Time Adjust (s)	0.0	0.0	0.0	0.0	0.0	0.0	0.0	0.0	0.0	0.0
Total Lost Time (s)	4.6	6.2	6.2	4.6	6.2	5.4	5.0	4.6	4.6	4.6
Lead/Lag	Lead	Lag	Lag	Lead	Lag	Lead	Lag	Lead	Lag	Lag
Lead-Lag Optimize?	Yes	Yes	Yes	Yes	Yes	Yes	Yes	Yes	Yes	Yes
Recall Mode	None	Min	Min	None	Min	None	None	None	None	None
Act Effct Green (s)	7.7	36.2	36.2	5.6	29.9	7.3	13.8	7.8	15.7	15.7
Actuated g/C Ratio	0.10	0.48	0.48	0.07	0.40	0.10	0.18	0.10	0.21	0.21
v/c Ratio	0.32	0.47	0.21	0.16	0.63	0.48	0.10	0.36	0.08	0.16
Control Delay	43.9	15.6	3.6	46.4	21.9	46.3	24.5	44.6	27.6	0.8
Queue Delay	0.0	0.0	0.0	0.0	0.0	0.0	0.0	0.0	0.0	0.0
Total Delay	43.9	15.6	3.6	46.4	21.9	46.3	24.5	44.6	27.6	0.8
LOS	D	B	A	D	C	D	C	D	C	A
Approach Delay		15.3			22.3		40.2		23.5	
Approach LOS		B			C		D		C	

Intersection Summary

Cycle Length: 120
 Actuated Cycle Length: 75.1
 Natural Cycle: 100
 Control Type: Actuated-Uncoordinated
 Maximum v/c Ratio: 0.63
 Intersection Signal Delay: 20.5
 Intersection LOS: C
 Intersection Capacity Utilization 51.9%
 ICU Level of Service A
 Analysis Period (min) 15

Splits and Phases: 38: Riverside Dr./Graham St. & Cactus Av.

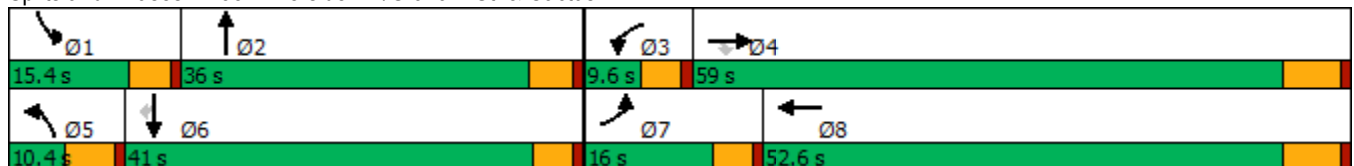

HCM 6th Signalized Intersection Summary
38: Riverside Dr./Graham St. & Cactus Av.

West Campus Upper Plateau (JN 14064)

09/30/2022



Movement	EBL	EBT	EBR	WBL	WBT	WBR	NBL	NBT	NBR	SBL	SBT	SBR
Lane Configurations	↘	↑↑↑	↗	↘	↑↑↑		↘↗	↑↗		↘	↑↑	↗
Traffic Volume (veh/h)	56	1095	173	20	1137	64	157	46	16	64	59	70
Future Volume (veh/h)	56	1095	173	20	1137	64	157	46	16	64	59	70
Initial Q (Qb), veh	0	0	0	0	0	0	0	0	0	0	0	0
Ped-Bike Adj(A_pbT)	1.00		1.00	1.00		0.99	1.00		1.00	1.00		1.00
Parking Bus, Adj	1.00	1.00	1.00	1.00	1.00	1.00	1.00	1.00	1.00	1.00	1.00	1.00
Work Zone On Approach		No			No			No			No	
Adj Sat Flow, veh/h/ln	1841	1841	1885	1900	1841	1900	1900	1900	1900	1870	1885	1826
Adj Flow Rate, veh/h	58	1129	133	21	1172	58	162	47	15	66	61	-2
Peak Hour Factor	0.97	0.97	0.97	0.97	0.97	0.97	0.97	0.97	0.97	0.97	0.97	0.97
Percent Heavy Veh, %	4	4	1	0	4	0	0	0	0	2	1	5
Cap, veh/h	90	2003	637	44	1823	90	268	518	158	98	559	241
Arrive On Green	0.05	0.40	0.40	0.02	0.37	0.37	0.08	0.19	0.19	0.05	0.16	0.00
Sat Flow, veh/h	1753	5025	1598	1810	4901	242	3510	2725	830	1781	3582	1547
Grp Volume(v), veh/h	58	1129	133	21	801	429	162	30	32	66	61	-2
Grp Sat Flow(s),veh/h/ln	1753	1675	1598	1810	1675	1793	1755	1805	1751	1781	1791	1547
Q Serve(g_s), s	2.0	10.7	3.4	0.7	12.1	12.1	2.7	0.9	0.9	2.2	0.9	0.0
Cycle Q Clear(g_c), s	2.0	10.7	3.4	0.7	12.1	12.1	2.7	0.9	0.9	2.2	0.9	0.0
Prop In Lane	1.00		1.00	1.00		0.14	1.00		0.47	1.00		1.00
Lane Grp Cap(c), veh/h	90	2003	637	44	1246	667	268	343	333	98	559	241
V/C Ratio(X)	0.65	0.56	0.21	0.47	0.64	0.64	0.61	0.09	0.10	0.67	0.11	-0.01
Avail Cap(c_a), veh/h	325	4315	1372	147	2528	1353	285	910	883	313	2120	916
HCM Platoon Ratio	1.00	1.00	1.00	1.00	1.00	1.00	1.00	1.00	1.00	1.00	1.00	1.00
Upstream Filter(I)	1.00	1.00	1.00	1.00	1.00	1.00	1.00	1.00	1.00	1.00	1.00	0.00
Uniform Delay (d), s/veh	28.6	14.3	12.1	29.6	15.9	15.9	27.5	20.5	20.5	28.5	22.3	0.0
Incr Delay (d2), s/veh	2.9	0.3	0.2	2.9	0.6	1.0	2.1	0.1	0.1	3.0	0.1	0.0
Initial Q Delay(d3),s/veh	0.0	0.0	0.0	0.0	0.0	0.0	0.0	0.0	0.0	0.0	0.0	0.0
%ile BackOfQ(50%),veh/ln	0.8	3.2	1.0	0.3	3.8	4.1	1.2	0.3	0.4	1.0	0.3	0.0
Unsig. Movement Delay, s/veh												
LnGrp Delay(d),s/veh	31.5	14.6	12.3	32.5	16.5	17.0	29.6	20.6	20.7	31.5	22.4	0.0
LnGrp LOS	C	B	B	C	B	B	C	C	C	C	C	A
Approach Vol, veh/h		1320			1251			224			125	
Approach Delay, s/veh		15.1			16.9			27.1			27.5	
Approach LOS		B			B			C			C	
Timer - Assigned Phs	1	2	3	4	5	6	7	8				
Phs Duration (G+Y+Rc), s	8.0	16.7	6.1	30.7	10.1	14.6	7.7	29.1				
Change Period (Y+Rc), s	4.6	5.0	4.6	6.2	5.4	* 5	4.6	6.2				
Max Green Setting (Gmax), s	10.8	31.0	5.0	52.8	5.0	* 36	11.4	46.4				
Max Q Clear Time (g_c+I1), s	4.2	2.9	2.7	12.7	4.7	2.9	4.0	14.1				
Green Ext Time (p_c), s	0.0	0.3	0.0	9.4	0.0	0.3	0.0	8.7				

Intersection Summary

HCM 6th Ctrl Delay	17.3
HCM 6th LOS	B

Notes

* HCM 6th computational engine requires equal clearance times for the phases crossing the barrier.

APPENDIX 7.3:

**OPENING YEAR CUMULATIVE (2028) WITHOUT PROJECT CONDITIONS TRAFFIC
SIGNAL WARRANT ANALYSIS WORKSHEETS**

This Page Intentionally Left Blank

Figure 4C-3. Warrant 3, Peak Hour

Traffic Conditions = **2025 Without Project Conditions - Weekday AM Peak Hour**

Major Street Name = **Grove Community Dr.** Total of Both Approaches (VPH) = **625**
 Number of Approach Lanes on Major Street = **1**

Minor Street Name = **Deercreek Dr.** High Volume Approach (VPH) = **268**
 Number of Approach Lanes On Minor Street = **1**

SIGNAL WARRANT NOT SATISFIED

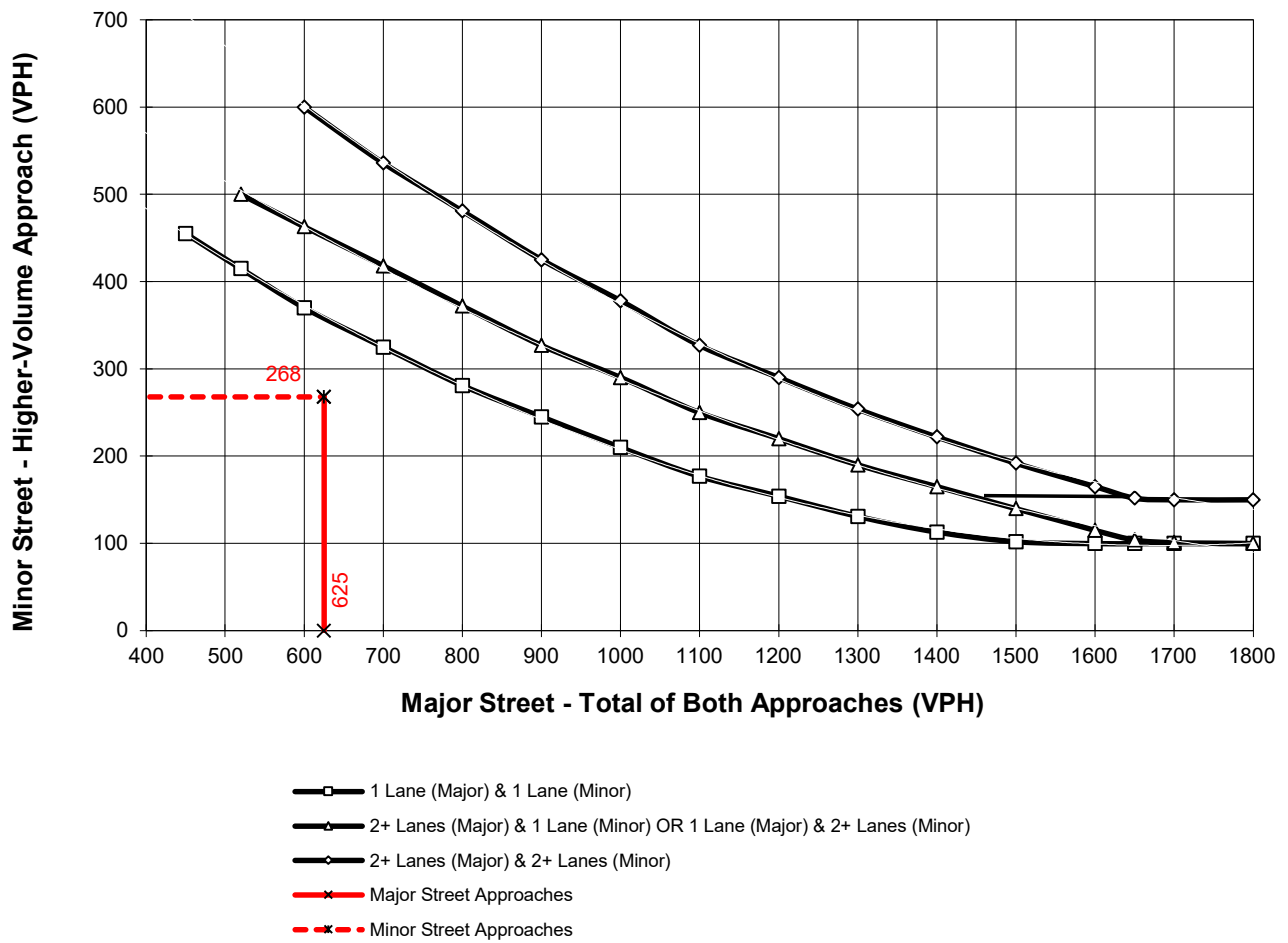

*Note: 150 vph applies as the lower threshold for a minor-street approach with two or more lanes and 100 vph applies as the lower threshold for a minor-street approach with one lane

Figure 4C-3. Warrant 3, Peak Hour

Traffic Conditions = **2025 Without Project Conditions - Weekday PM Peak Hour**

Major Street Name = **Grove Community Dr.** Total of Both Approaches (VPH) = **553**
 Number of Approach Lanes on Major Street = **1**

Minor Street Name = **Barton Rd.** High Volume Approach (VPH) = **12**
 Number of Approach Lanes On Minor Street = **1**

SIGNAL WARRANT NOT SATISFIED

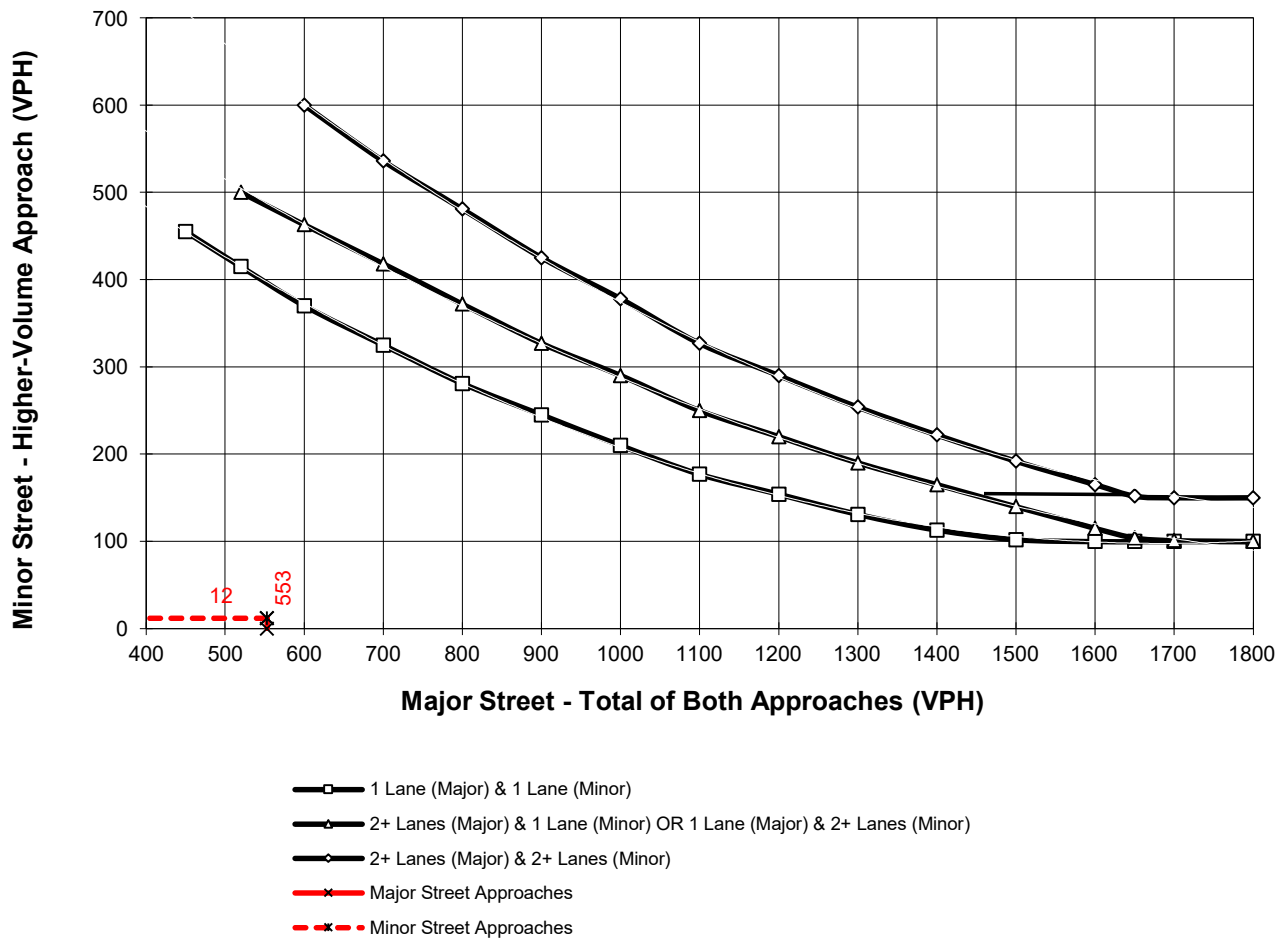

*Note: 150 vph applies as the lower threshold for a minor-street approach with two or more lanes and 100 vph applies as the lower threshold for a minor-street approach with one lane

Figure 4C-3. Warrant 3, Peak Hour

Traffic Conditions = **2025 Without Project Conditions - Weekday AM Peak Hour**

Major Street Name = **Grove Community Dr.** Total of Both Approaches (VPH) = **469**
 Number of Approach Lanes on Major Street = **1**

Minor Street Name = **Abrams Dr** High Volume Approach (VPH) = **225**
 Number of Approach Lanes On Minor Street = **1**

SIGNAL WARRANT NOT SATISFIED

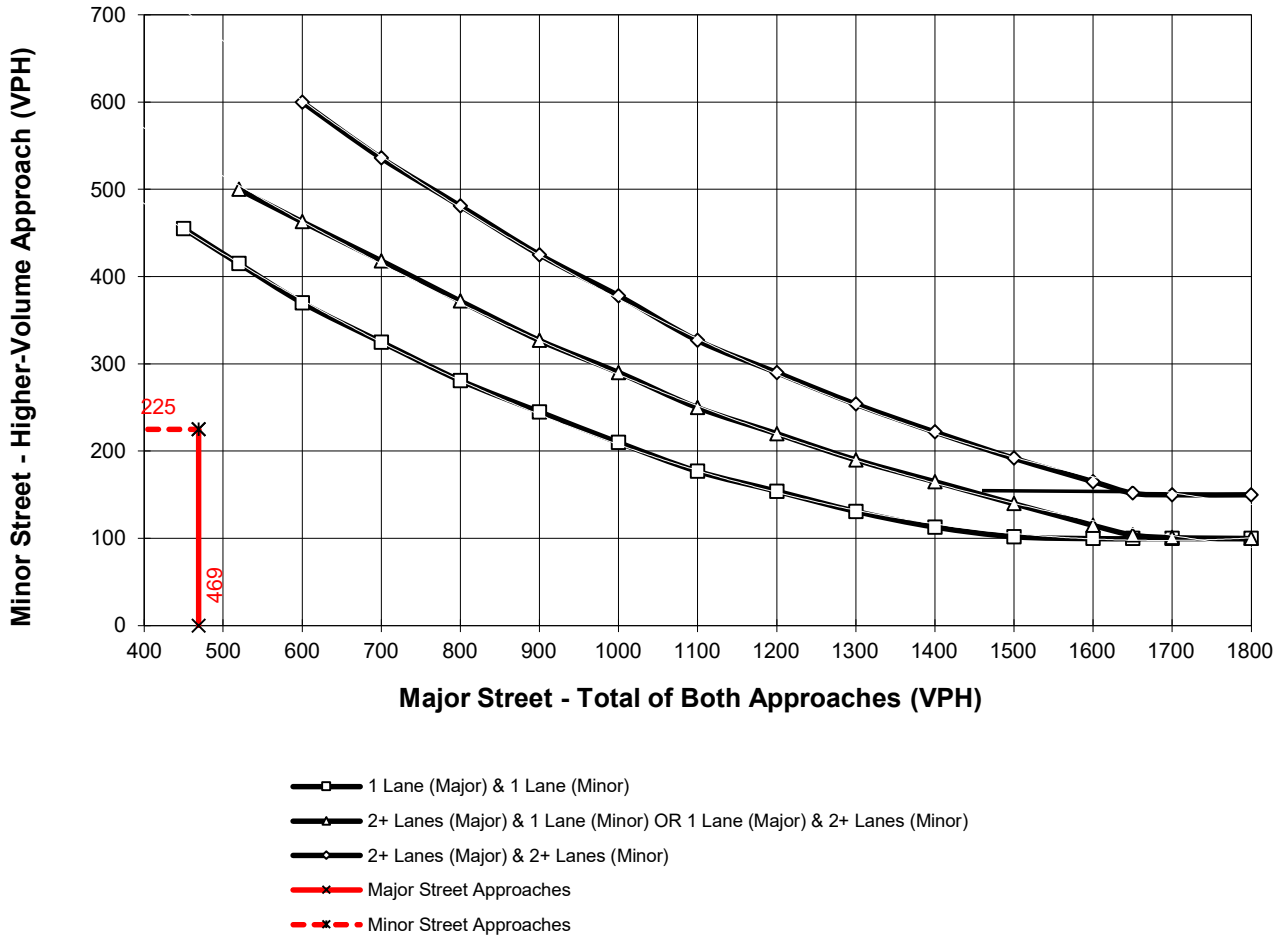

*Note: 150 vph applies as the lower threshold for a minor-street approach with two or more lanes and 100 vph applies as the lower threshold for a minor-street approach with one lane



Figure 4C-3. Warrant 3, Peak Hour

Traffic Conditions = **2025 Without Project Conditions - Weekday AM Peak Hour**

Major Street Name = **Orange Terrace Pkwy**

Total of Both Approaches (VPH) = **768**

Number of Approach Lanes on Major Street = **1**

Minor Street Name = **Abrams Dr.**

High Volume Approach (VPH) = **203**

Number of Approach Lanes On Minor Street = **1**

SIGNAL WARRANT NOT SATISFIED

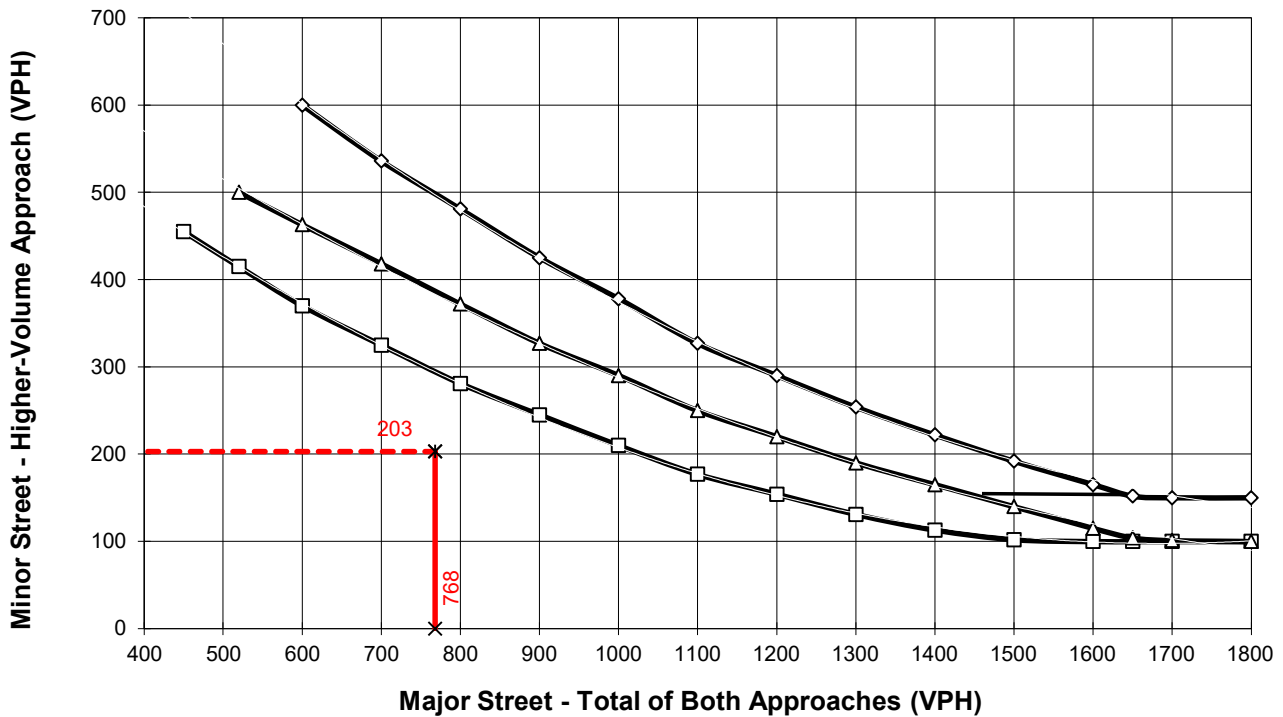

- 1 Lane (Major) & 1 Lane (Minor)
- △— 2+ Lanes (Major) & 1 Lane (Minor) OR 1 Lane (Major) & 2+ Lanes (Minor)
- ◇— 2+ Lanes (Major) & 2+ Lanes (Minor)
- x— Major Street Approaches
- x- Minor Street Approaches

*Note: 150 vph applies as the lower threshold for a minor-street approach with two or more lanes and 100 vph applies as the lower threshold for a minor-street approach with one lane

APPENDIX 7.4:

**OPENING YEAR CUMULATIVE (2028) WITH PROJECT CONDITIONS TRAFFIC SIGNAL
WARRANT ANALYSIS WORKSHEETS**

This Page Intentionally Left Blank

Figure 4C-3. Warrant 3, Peak Hour

Traffic Conditions = **2025 With Project Conditions - Weekday AM Peak Hour**

Major Street Name = **Grove Community Dr.** Total of Both Approaches (VPH) = **642**
 Number of Approach Lanes on Major Street = **1**

Minor Street Name = **Deercreek Dr.** High Volume Approach (VPH) = **268**
 Number of Approach Lanes On Minor Street = **1**

SIGNAL WARRANT NOT SATISFIED

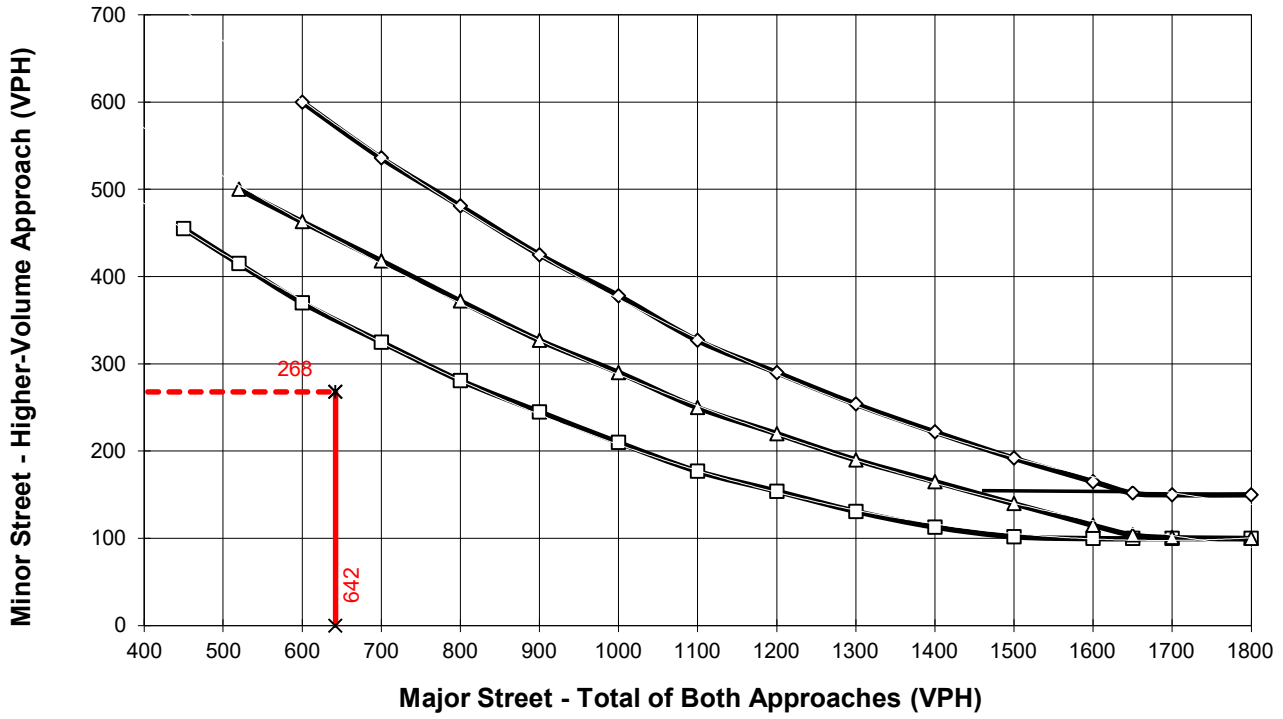

- 1 Lane (Major) & 1 Lane (Minor)
- △— 2+ Lanes (Major) & 1 Lane (Minor) OR 1 Lane (Major) & 2+ Lanes (Minor)
- ◇— 2+ Lanes (Major) & 2+ Lanes (Minor)
- x— Major Street Approaches
- x- Minor Street Approaches

*Note: 150 vph applies as the lower threshold for a minor-street approach with two or more lanes and 100 vph applies as the lower threshold for a minor-street approach with one lane



Figure 4C-3. Warrant 3, Peak Hour

Traffic Conditions = **2025 With Project Conditions - Weekday PM Peak Hour**

Major Street Name = **Grove Community Dr.** Total of Both Approaches (VPH) = **453**
 Number of Approach Lanes on Major Street = **1**

Minor Street Name = **Barton Rd.** High Volume Approach (VPH) = **57**
 Number of Approach Lanes On Minor Street = **1**

SIGNAL WARRANT NOT SATISFIED

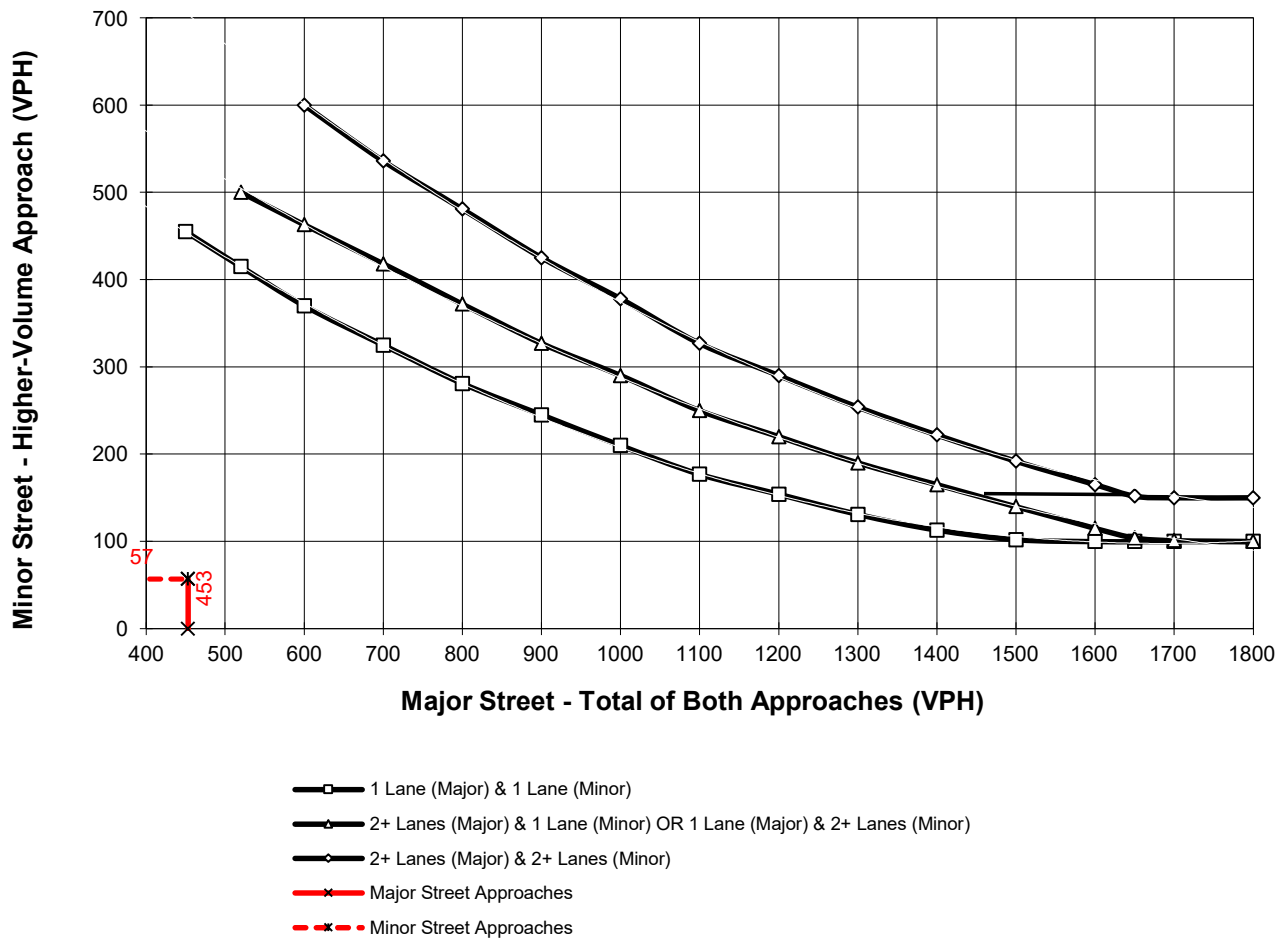

*Note: 150 vph applies as the lower threshold for a minor-street approach with two or more lanes and 100 vph applies as the lower threshold for a minor-street approach with one lane

Figure 4C-3. Warrant 3, Peak Hour

Traffic Conditions = **2025 With Project Conditions - Weekday AM Peak Hour**

Major Street Name = **Grove Community Dr.** Total of Both Approaches (VPH) = **502**
 Number of Approach Lanes on Major Street = **1**

Minor Street Name = **Abrams Dr** High Volume Approach (VPH) = **225**
 Number of Approach Lanes On Minor Street = **1**

SIGNAL WARRANT NOT SATISFIED

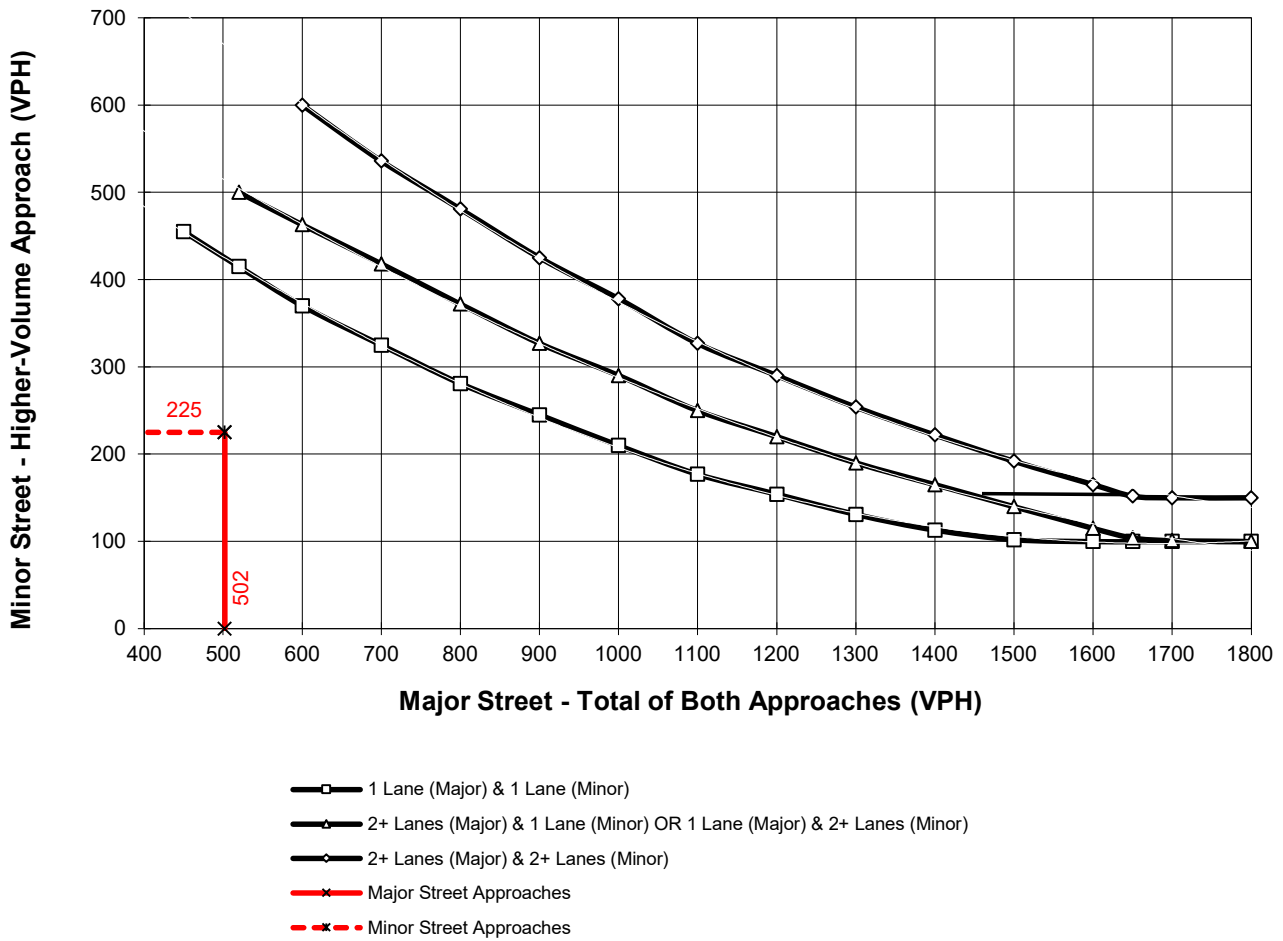

*Note: 150 vph applies as the lower threshold for a minor-street approach with two or more lanes and 100 vph applies as the lower threshold for a minor-street approach with one lane

Figure 4C-3. Warrant 3, Peak Hour

Traffic Conditions = **2025 With Project Conditions - Weekday AM Peak Hour**

Major Street Name = **Orange Terrace Pkwy**

Total of Both Approaches (VPH) = **768**

Number of Approach Lanes on Major Street = **1**

Minor Street Name = **Abrams Dr.**

High Volume Approach (VPH) = **203**

Number of Approach Lanes On Minor Street = **1**

SIGNAL WARRANT NOT SATISFIED

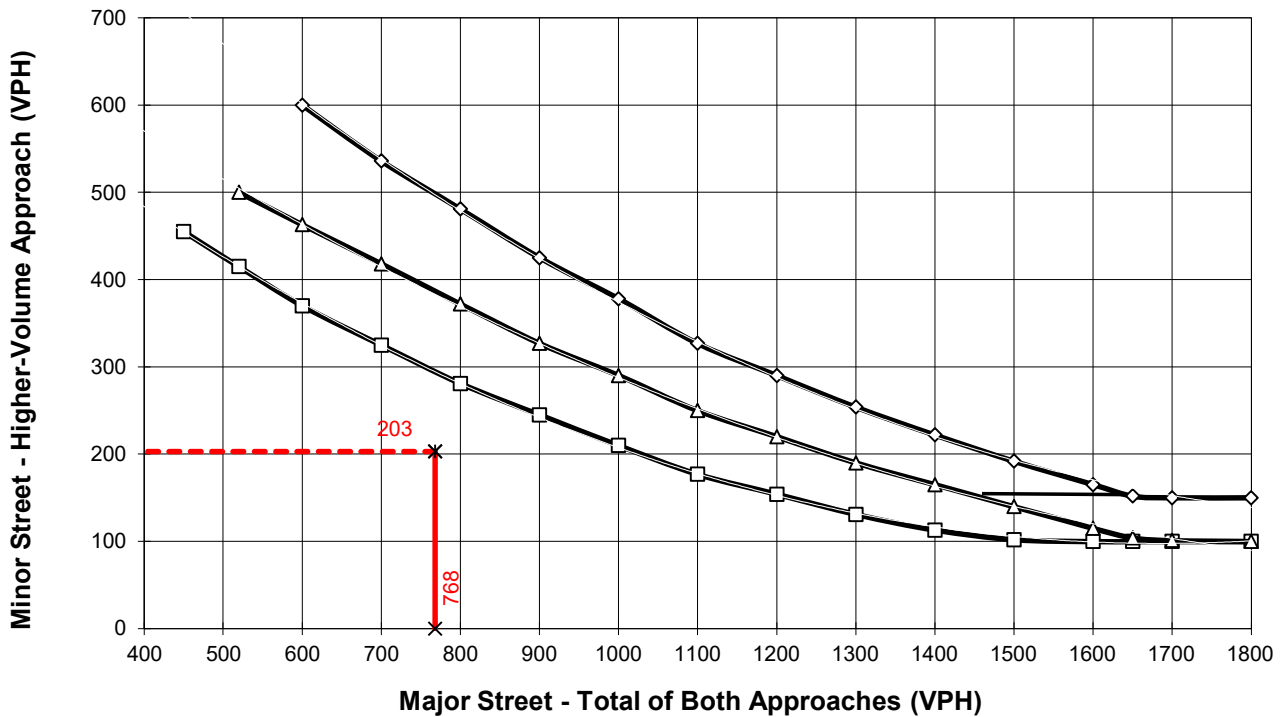

- 1 Lane (Major) & 1 Lane (Minor)
- △— 2+ Lanes (Major) & 1 Lane (Minor) OR 1 Lane (Major) & 2+ Lanes (Minor)
- ◇— 2+ Lanes (Major) & 2+ Lanes (Minor)
- x— Major Street Approaches
- x- Minor Street Approaches

*Note: 150 vph applies as the lower threshold for a minor-street approach with two or more lanes and 100 vph applies as the lower threshold for a minor-street approach with one lane

APPENDIX 7.5:

**OPENING YEAR CUMULATIVE (2028) WITHOUT PROJECT OFF-RAMP QUEUING
ANALYSIS WORKSHEETS**

This Page Intentionally Left Blank

Queues
28: I-215 SB Ramps & Alessandro Bl.

West Campus Upper Plateau (JN 14064)

09/19/2022

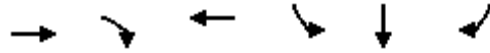

Lane Group	EBT	EBR	WBT	SBL	SBT	SBR
Lane Group Flow (vph)	1054	411	2978	231	239	241
v/c Ratio	0.33	0.39	0.94	0.62	0.71	0.69
Control Delay	8.4	4.4	13.3	35.2	35.9	35.0
Queue Delay	0.0	0.0	0.0	0.0	0.0	0.0
Total Delay	8.4	4.4	13.3	35.2	35.9	35.0
Queue Length 50th (ft)	83	25	420	116	112	108
Queue Length 95th (ft)	148	93	m387	164	170	162
Internal Link Dist (ft)	750		688		1585	
Turn Bay Length (ft)		50		525		525
Base Capacity (vph)	3175	1050	3167	563	498	511
Starvation Cap Reductn	0	0	0	0	0	0
Spillback Cap Reductn	0	0	0	0	0	0
Storage Cap Reductn	0	0	0	0	0	0
Reduced v/c Ratio	0.33	0.39	0.94	0.41	0.48	0.47

Intersection Summary

m Volume for 95th percentile queue is metered by upstream signal.

Queues

West Campus Upper Plateau (JN 14064)

29: I-215 NB Ramps & Alessandro Bl.

09/19/2022



Lane Group	EBL	EBT	WBT	WBR	NBL	NBT	NBR
Lane Group Flow (vph)	94	1271	1992	121	685	683	228
v/c Ratio	0.54	0.39	0.80	0.16	1.78	1.57	0.61
Control Delay	39.7	8.1	23.3	6.5	388.1	293.4	25.3
Queue Delay	0.0	0.0	0.0	0.0	0.0	0.0	0.0
Total Delay	39.7	8.1	23.3	6.5	388.1	293.4	25.3
Queue Length 50th (ft)	46	76	328	11	~584	~538	67
Queue Length 95th (ft)	85	180	#489	45	#802	#772	149
Internal Link Dist (ft)		688	447			1005	
Turn Bay Length (ft)	200			50	400		400
Base Capacity (vph)	337	3228	2482	766	384	434	372
Starvation Cap Reductn	0	0	0	0	0	0	0
Spillback Cap Reductn	0	0	0	0	0	0	0
Storage Cap Reductn	0	0	0	0	0	0	0
Reduced v/c Ratio	0.28	0.39	0.80	0.16	1.78	1.57	0.61

Intersection Summary

~ Volume exceeds capacity, queue is theoretically infinite.

Queue shown is maximum after two cycles.

95th percentile volume exceeds capacity, queue may be longer.

Queue shown is maximum after two cycles.



Lane Group	EBT	EBR	WBL	WBT	NBR	SBR
Lane Group Flow (vph)	392	33	907	1558	931	250
v/c Ratio	0.78	0.12	1.10	0.64	0.96	0.74
Control Delay	53.2	3.8	90.2	10.7	27.4	40.0
Queue Delay	0.0	0.0	0.0	0.0	0.0	0.0
Total Delay	53.2	3.8	90.2	10.7	27.4	40.0
Queue Length 50th (ft)	132	0	~710	285	60	106
Queue Length 95th (ft)	185	10	#959	352	#398	#208
Internal Link Dist (ft)	658		918			
Turn Bay Length (ft)						
Base Capacity (vph)	576	314	823	2503	986	367
Starvation Cap Reductn	0	0	0	0	0	0
Spillback Cap Reductn	0	0	0	0	0	0
Storage Cap Reductn	0	0	0	0	0	0
Reduced v/c Ratio	0.68	0.11	1.10	0.62	0.94	0.68

Intersection Summary

~ Volume exceeds capacity, queue is theoretically infinite.

Queue shown is maximum after two cycles.

95th percentile volume exceeds capacity, queue may be longer.

Queue shown is maximum after two cycles.

Queues

West Campus Upper Plateau (JN 14064)

31: I-215 NB Ramps/Old 215 Frontage Rd. & Cactus Av.

09/19/2022



Lane Group	EBL	EBT	WBT	NBL	NBT	NBR	SBL	SBT
Lane Group Flow (vph)	23	1790	3464	416	365	46	62	145
v/c Ratio	0.43	0.77	1.46	1.71	1.03	0.13	1.03	0.50
Control Delay	39.0	15.4	229.2	367.8	100.5	17.1	173.7	39.8
Queue Delay	0.0	0.0	0.0	0.0	0.0	0.0	0.0	0.0
Total Delay	39.0	15.4	229.2	367.8	100.5	17.1	173.7	39.8
Queue Length 50th (ft)	7	438	~1943	~475	~316	7	~50	80
Queue Length 95th (ft)	#52	533	#2056	#674	#520	41	#144	149
Internal Link Dist (ft)		310	1149		1221			746
Turn Bay Length (ft)	175			145			100	
Base Capacity (vph)	53	2334	2380	243	356	353	60	291
Starvation Cap Reductn	0	0	0	0	0	0	0	0
Spillback Cap Reductn	0	0	0	0	0	0	0	0
Storage Cap Reductn	0	0	0	0	0	0	0	0
Reduced v/c Ratio	0.43	0.77	1.46	1.71	1.03	0.13	1.03	0.50

Intersection Summary

~ Volume exceeds capacity, queue is theoretically infinite.

Queue shown is maximum after two cycles.

95th percentile volume exceeds capacity, queue may be longer.

Queue shown is maximum after two cycles.



Lane Group	EBT	EBR	WBL	WBT	SBT	SBR
Lane Group Flow (vph)	1092	1070	32	1629	433	1545
v/c Ratio	0.80	0.62	0.30	0.96	0.68	1.50
Control Delay	28.8	3.2	45.9	35.6	29.1	253.1
Queue Delay	0.0	0.0	0.0	0.0	0.0	0.0
Total Delay	28.8	3.2	45.9	35.6	29.1	253.1
Queue Length 50th (ft)	285	0	17	415	192	~643
Queue Length 95th (ft)	#413	42	45	#591	298	#790
Internal Link Dist (ft)	2745			429	1115	
Turn Bay Length (ft)			200			
Base Capacity (vph)	1365	1713	107	1729	639	1031
Starvation Cap Reductn	0	0	0	0	0	0
Spillback Cap Reductn	0	0	0	0	0	0
Storage Cap Reductn	0	0	0	0	0	0
Reduced v/c Ratio	0.80	0.62	0.30	0.94	0.68	1.50

Intersection Summary

~ Volume exceeds capacity, queue is theoretically infinite.

Queue shown is maximum after two cycles.

95th percentile volume exceeds capacity, queue may be longer.

Queue shown is maximum after two cycles.



Lane Group	EBT	EBR	WBT	NBL	NBR
Lane Group Flow (vph)	562	1030	188	1773	149
v/c Ratio	1.01	0.39	0.36	0.84	0.15
Control Delay	73.0	0.4	26.9	12.6	4.2
Queue Delay	0.0	0.0	0.0	0.0	0.0
Total Delay	73.0	0.4	26.9	12.6	4.2
Queue Length 50th (ft)	~110	0	31	203	17
Queue Length 95th (ft)	#257	0	70	284	33
Internal Link Dist (ft)	669		611	856	
Turn Bay Length (ft)		300			585
Base Capacity (vph)	554	2559	528	2815	1336
Starvation Cap Reductn	0	0	0	0	0
Spillback Cap Reductn	0	0	0	0	0
Storage Cap Reductn	0	0	0	0	0
Reduced v/c Ratio	1.01	0.40	0.36	0.63	0.11

Intersection Summary

~ Volume exceeds capacity, queue is theoretically infinite.

Queue shown is maximum after two cycles.

95th percentile volume exceeds capacity, queue may be longer.

Queue shown is maximum after two cycles.

Queues

28: I-215 SB Ramps & Alessandro Bl.

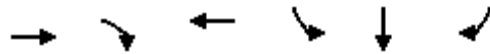

Lane Group	EBT	EBR	WBT	SBL	SBT	SBR
Lane Group Flow (vph)	1658	369	2373	326	308	302
v/c Ratio	0.57	0.41	0.83	0.73	0.74	0.72
Control Delay	12.0	6.8	17.4	35.4	34.5	33.2
Queue Delay	0.0	0.0	0.0	0.0	0.0	0.0
Total Delay	12.0	6.8	17.4	35.4	34.5	33.2
Queue Length 50th (ft)	179	45	327	153	136	127
Queue Length 95th (ft)	249	111	450	247	236	221
Internal Link Dist (ft)	750		688		1585	
Turn Bay Length (ft)		50		525		525
Base Capacity (vph)	3084	949	3039	580	526	529
Starvation Cap Reductn	0	0	0	0	0	0
Spillback Cap Reductn	0	0	0	0	0	0
Storage Cap Reductn	0	0	0	0	0	0
Reduced v/c Ratio	0.54	0.39	0.78	0.56	0.59	0.57

Intersection Summary

Queues
29: I-215 NB Ramps & Alessandro Bl.



Lane Group	EBL	EBT	WBT	WBR	NBL	NBT	NBR
Lane Group Flow (vph)	161	2403	1583	172	549	542	380
v/c Ratio	1.12	0.95	0.91	0.31	0.89	0.92	0.63
Control Delay	149.0	29.9	36.3	12.4	43.4	48.3	21.7
Queue Delay	0.0	0.0	0.0	0.0	0.0	0.0	0.0
Total Delay	149.0	29.9	36.3	12.4	43.4	48.3	21.7
Queue Length 50th (ft)	~100	423	292	33	283	296	129
Queue Length 95th (ft)	#219	#562	#388	81	#485	#517	231
Internal Link Dist (ft)		688	447			1005	
Turn Bay Length (ft)	200			50	400		400
Base Capacity (vph)	144	2542	1731	552	620	592	606
Starvation Cap Reductn	0	0	0	0	0	0	0
Spillback Cap Reductn	0	0	0	0	0	0	0
Storage Cap Reductn	0	0	0	0	0	0	0
Reduced v/c Ratio	1.12	0.95	0.91	0.31	0.89	0.92	0.63

Intersection Summary

~ Volume exceeds capacity, queue is theoretically infinite.

Queue shown is maximum after two cycles.

95th percentile volume exceeds capacity, queue may be longer.

Queue shown is maximum after two cycles.

Queues
30: I-215 SB Ramps & Cactus Av.



Lane Group	EBT	EBR	WBL	WBT	NBR	SBR
Lane Group Flow (vph)	842	157	847	1195	794	304
v/c Ratio	0.91	0.30	1.25	0.49	0.96	0.79
Control Delay	51.3	6.4	154.4	8.4	33.9	40.3
Queue Delay	0.0	0.0	0.0	0.0	0.0	0.0
Total Delay	51.3	6.4	154.4	8.4	33.9	40.3
Queue Length 50th (ft)	284	0	~729	178	125	125
Queue Length 95th (ft)	#391	48	#963	222	#407	#256
Internal Link Dist (ft)	658			918		
Turn Bay Length (ft)						
Base Capacity (vph)	992	551	678	2511	837	407
Starvation Cap Reductn	0	0	0	0	0	0
Spillback Cap Reductn	0	0	0	0	0	0
Storage Cap Reductn	0	0	0	0	0	0
Reduced v/c Ratio	0.85	0.28	1.25	0.48	0.95	0.75

Intersection Summary

~ Volume exceeds capacity, queue is theoretically infinite.

Queue shown is maximum after two cycles.

95th percentile volume exceeds capacity, queue may be longer.

Queue shown is maximum after two cycles.

Queues

31: I-215 NB Ramps/Old 215 Frontage Rd. & Cactus Av.



Lane Group	EBL	EBT	WBT	NBL	NBT	NBR	SBL	SBT
Lane Group Flow (vph)	59	1934	2763	129	272	81	204	193
v/c Ratio	0.70	0.93	1.31	0.50	0.60	0.19	1.04	0.46
Control Delay	59.6	25.2	165.6	34.6	33.8	15.9	108.4	30.3
Queue Delay	0.0	0.0	0.0	0.0	0.0	0.0	0.0	0.0
Total Delay	59.6	25.2	165.6	34.6	33.8	15.9	108.4	30.3
Queue Length 50th (ft)	20	446	~1021	59	132	17	~119	85
Queue Length 95th (ft)	#95	#667	#1161	115	217	54	#250	149
Internal Link Dist (ft)		310	1149		1221			746
Turn Bay Length (ft)	175			145			100	
Base Capacity (vph)	84	2077	2102	259	454	419	197	419
Starvation Cap Reductn	0	0	0	0	0	0	0	0
Spillback Cap Reductn	0	0	0	0	0	0	0	0
Storage Cap Reductn	0	0	0	0	0	0	0	0
Reduced v/c Ratio	0.70	0.93	1.31	0.50	0.60	0.19	1.04	0.46

Intersection Summary

~ Volume exceeds capacity, queue is theoretically infinite.

Queue shown is maximum after two cycles.

95th percentile volume exceeds capacity, queue may be longer.

Queue shown is maximum after two cycles.

Queues

32: I-215 SB Ramps & Van Buren Bl.



Lane Group	EBT	EBR	WBL	WBT	SBT	SBR
Lane Group Flow (vph)	1531	2502	198	1605	677	804
v/c Ratio	0.71	1.35	1.89	0.61	4.01	2.34
Control Delay	12.8	179.0	458.6	5.6	1380.3	633.1
Queue Delay	0.0	0.0	0.0	0.0	0.0	0.0
Total Delay	12.8	179.0	458.6	5.6	1380.3	633.1
Queue Length 50th (ft)	256	~981	~164	154	~667	~376
Queue Length 95th (ft)	334	#1133	#294	201	#873	#502
Internal Link Dist (ft)	2745			429	1115	
Turn Bay Length (ft)			200			
Base Capacity (vph)	2143	1856	105	2629	169	343
Starvation Cap Reductn	0	0	0	0	0	0
Spillback Cap Reductn	0	0	0	0	0	0
Storage Cap Reductn	0	0	0	0	0	0
Reduced v/c Ratio	0.71	1.35	1.89	0.61	4.01	2.34

Intersection Summary

~ Volume exceeds capacity, queue is theoretically infinite.

Queue shown is maximum after two cycles.

95th percentile volume exceeds capacity, queue may be longer.

Queue shown is maximum after two cycles.



Lane Group	EBT	EBR	WBT	NBL	NBR
Lane Group Flow (vph)	753	1362	935	1382	211
v/c Ratio	1.12	0.52	1.40	0.74	0.23
Control Delay	100.4	0.7	211.0	10.3	5.5
Queue Delay	0.0	0.0	0.0	0.0	0.0
Total Delay	100.4	0.7	211.0	10.3	5.5
Queue Length 50th (ft)	~135	0	~194	127	25
Queue Length 95th (ft)	#314	0	#400	179	47
Internal Link Dist (ft)	669		611	856	
Turn Bay Length (ft)		300			585
Base Capacity (vph)	670	2588	670	3100	1500
Starvation Cap Reductn	0	0	0	0	0
Spillback Cap Reductn	0	0	0	0	0
Storage Cap Reductn	0	0	0	0	0
Reduced v/c Ratio	1.12	0.53	1.40	0.45	0.14

Intersection Summary

~ Volume exceeds capacity, queue is theoretically infinite.

Queue shown is maximum after two cycles.

95th percentile volume exceeds capacity, queue may be longer.

Queue shown is maximum after two cycles.

Queues
28: I-215 SB Ramps & Alessandro Bl.

West Campus Upper Plateau (JN 14064)

09/30/2022

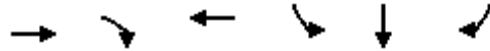

Lane Group	EBT	EBR	WBT	SBL	SBT	SBR
Lane Group Flow (vph)	911	369	1302	135	162	159
v/c Ratio	0.36	0.39	0.52	0.37	0.44	0.42
Control Delay	7.0	3.0	7.9	17.1	13.6	13.1
Queue Delay	0.0	0.0	0.0	0.0	0.0	0.0
Total Delay	7.0	3.0	7.9	17.1	13.6	13.1
Queue Length 50th (ft)	38	6	58	25	18	17
Queue Length 95th (ft)	80	43	120	76	72	67
Internal Link Dist (ft)	750		688		1585	
Turn Bay Length (ft)		50		525		525
Base Capacity (vph)	4918	1541	4802	1067	952	983
Starvation Cap Reductn	0	0	0	0	0	0
Spillback Cap Reductn	0	0	0	0	0	0
Storage Cap Reductn	0	0	0	0	0	0
Reduced v/c Ratio	0.19	0.24	0.27	0.13	0.17	0.16

Intersection Summary

Queues

West Campus Upper Plateau (JN 14064)

29: I-215 NB Ramps & Alessandro Bl.

09/30/2022



Lane Group	EBL	EBT	WBT	WBR	NBL	NBT	NBR
Lane Group Flow (vph)	199	856	999	162	274	270	240
v/c Ratio	1.11	0.37	0.67	0.34	0.40	0.41	0.35
Control Delay	138.6	14.2	26.7	12.6	19.9	19.6	10.9
Queue Delay	0.0	0.0	0.0	0.0	0.0	0.0	0.0
Total Delay	138.6	14.2	26.7	12.6	19.9	19.6	10.9
Queue Length 50th (ft)	~115	95	156	28	98	98	42
Queue Length 95th (ft)	#261	123	198	73	184	187	108
Internal Link Dist (ft)		688	447			1005	
Turn Bay Length (ft)	200			50	400		400
Base Capacity (vph)	179	2749	1908	578	677	651	679
Starvation Cap Reductn	0	0	0	0	0	0	0
Spillback Cap Reductn	0	0	0	0	0	0	0
Storage Cap Reductn	0	0	0	0	0	0	0
Reduced v/c Ratio	1.11	0.31	0.52	0.28	0.40	0.41	0.35

Intersection Summary

~ Volume exceeds capacity, queue is theoretically infinite.

Queue shown is maximum after two cycles.

95th percentile volume exceeds capacity, queue may be longer.

Queue shown is maximum after two cycles.

Queues

30: I-215 SB Ramps & Cactus Av.



Lane Group	EBT	EBR	WBL	WBT	NBR	SBR
Lane Group Flow (vph)	357	34	426	446	401	74
v/c Ratio	0.47	0.09	0.70	0.19	0.50	0.13
Control Delay	18.9	3.1	20.5	3.1	2.2	0.5
Queue Delay	0.0	0.0	0.0	0.0	0.0	0.0
Total Delay	18.9	3.1	20.5	3.1	2.2	0.5
Queue Length 50th (ft)	43	0	94	17	0	0
Queue Length 95th (ft)	85	9	182	26	0	0
Internal Link Dist (ft)	658			918		
Turn Bay Length (ft)						
Base Capacity (vph)	2191	993	1474	3539	1121	953
Starvation Cap Reductn	0	0	0	0	0	0
Spillback Cap Reductn	0	0	0	0	0	0
Storage Cap Reductn	0	0	0	0	0	0
Reduced v/c Ratio	0.16	0.03	0.29	0.13	0.36	0.08

Intersection Summary

Queues

West Campus Upper Plateau (JN 14064)

31: I-215 NB Ramps/Old 215 Frontage Rd. & Cactus Av.

09/30/2022



Lane Group	EBL	EBT	WBT	NBL	NBT	NBR	SBL	SBT
Lane Group Flow (vph)	17	720	1330	43	75	3	125	71
v/c Ratio	0.09	0.33	0.61	0.17	0.21	0.01	0.47	0.18
Control Delay	7.4	6.4	8.8	19.4	18.9	0.0	24.6	7.2
Queue Delay	0.0	0.0	0.0	0.0	0.0	0.0	0.0	0.0
Total Delay	7.4	6.4	8.8	19.4	18.9	0.0	24.6	7.2
Queue Length 50th (ft)	2	48	114	9	16	0	28	0
Queue Length 95th (ft)	11	100	228	37	56	0	87	28
Internal Link Dist (ft)		310	1149		1221			746
Turn Bay Length (ft)	175			145			100	
Base Capacity (vph)	269	3228	3272	611	888	797	654	847
Starvation Cap Reductn	0	0	0	0	0	0	0	0
Spillback Cap Reductn	0	0	0	0	0	0	0	0
Storage Cap Reductn	0	0	0	0	0	0	0	0
Reduced v/c Ratio	0.06	0.22	0.41	0.07	0.08	0.00	0.19	0.08

Intersection Summary

Queues

32: I-215 SB Ramps & Van Buren Bl.



Lane Group	EBT	EBR	WBL	WBT	SBT	SBR
Lane Group Flow (vph)	763	848	15	819	23	859
v/c Ratio	0.54	0.51	0.08	0.52	0.08	0.95
Control Delay	10.0	2.0	21.5	8.0	18.3	33.0
Queue Delay	0.0	0.0	0.0	0.0	0.0	0.0
Total Delay	10.0	2.0	21.5	8.0	18.3	33.0
Queue Length 50th (ft)	51	0	3	55	4	38
Queue Length 95th (ft)	131	26	21	78	26	#238
Internal Link Dist (ft)	2745		429		1115	
Turn Bay Length (ft)	200					
Base Capacity (vph)	3236	2716	182	3406	305	900
Starvation Cap Reductn	0	0	0	0	0	0
Spillback Cap Reductn	0	0	0	0	0	0
Storage Cap Reductn	0	0	0	0	0	0
Reduced v/c Ratio	0.24	0.31	0.08	0.24	0.08	0.95

Intersection Summary

95th percentile volume exceeds capacity, queue may be longer.
 Queue shown is maximum after two cycles.



Lane Group	EBR	NBL
Lane Group Flow (vph)	18	1
v/c Ratio	0.01	0.00
Control Delay	0.0	0.0
Queue Delay	0.0	0.0
Total Delay	0.0	0.0
Queue Length 50th (ft)	0	0
Queue Length 95th (ft)	0	0
Internal Link Dist (ft)		856
Turn Bay Length (ft)	300	
Base Capacity (vph)	2608	3303
Starvation Cap Reductn	0	0
Spillback Cap Reductn	0	0
Storage Cap Reductn	0	0
Reduced v/c Ratio	0.01	0.00
Intersection Summary		

APPENDIX 7.6:

**OPENING YEAR CUMULATIVE (2028) WITH PROJECT CONDITIONS OFF-RAMP
QUEUING ANALYSIS WORKSHEETS**

This Page Intentionally Left Blank

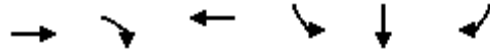

Lane Group	EBT	EBR	WBT	SBL	SBT	SBR
Lane Group Flow (vph)	1088	445	3147	231	275	270
v/c Ratio	0.36	0.43	1.02	0.57	0.74	0.70
Control Delay	9.5	5.1	26.7	31.5	36.4	34.0
Queue Delay	0.0	0.0	0.0	0.0	0.0	0.0
Total Delay	9.5	5.1	26.7	31.5	36.4	34.0
Queue Length 50th (ft)	97	33	~487	111	129	120
Queue Length 95th (ft)	158	109	m#404	162	196	181
Internal Link Dist (ft)	750		688		1585	
Turn Bay Length (ft)		50		525		525
Base Capacity (vph)	3062	1036	3081	563	504	519
Starvation Cap Reductn	0	0	0	0	0	0
Spillback Cap Reductn	0	0	0	0	0	0
Storage Cap Reductn	0	0	0	0	0	0
Reduced v/c Ratio	0.36	0.43	1.02	0.41	0.55	0.52

Intersection Summary

- ~ Volume exceeds capacity, queue is theoretically infinite.
Queue shown is maximum after two cycles.
- # 95th percentile volume exceeds capacity, queue may be longer.
Queue shown is maximum after two cycles.
- m Volume for 95th percentile queue is metered by upstream signal.



Lane Group	EBL	EBT	WBT	WBR	NBL	NBT	NBR
Lane Group Flow (vph)	113	1287	2044	121	745	741	228
v/c Ratio	0.58	0.40	0.84	0.16	1.94	1.71	0.61
Control Delay	39.1	9.4	25.5	6.8	456.1	351.4	25.3
Queue Delay	0.0	0.0	0.0	0.0	0.0	0.0	0.0
Total Delay	39.1	9.4	25.5	6.8	456.1	351.4	25.3
Queue Length 50th (ft)	56	77	352	11	~654	~612	67
Queue Length 95th (ft)	100	195	#526	46	#877	#850	149
Internal Link Dist (ft)		688	447			1005	
Turn Bay Length (ft)	200			50	400		400
Base Capacity (vph)	348	3228	2433	752	384	434	372
Starvation Cap Reductn	0	0	0	0	0	0	0
Spillback Cap Reductn	0	0	0	0	0	0	0
Storage Cap Reductn	0	0	0	0	0	0	0
Reduced v/c Ratio	0.32	0.40	0.84	0.16	1.94	1.71	0.61

Intersection Summary

~ Volume exceeds capacity, queue is theoretically infinite.

Queue shown is maximum after two cycles.

95th percentile volume exceeds capacity, queue may be longer.

Queue shown is maximum after two cycles.



Lane Group	EBT	EBR	WBL	WBT	NBR	SBR
Lane Group Flow (vph)	561	81	907	1830	931	687
v/c Ratio	1.04	0.26	1.15	0.77	0.96	1.85
Control Delay	92.3	11.2	110.9	14.4	27.3	415.7
Queue Delay	0.0	0.0	0.0	0.0	0.0	0.0
Total Delay	92.3	11.2	110.9	14.4	27.3	415.7
Queue Length 50th (ft)	~214	0	~720	392	72	~667
Queue Length 95th (ft)	#324	42	#959	487	#409	#894
Internal Link Dist (ft)	658			918		
Turn Bay Length (ft)						
Base Capacity (vph)	541	309	787	2370	972	372
Starvation Cap Reductn	0	0	0	0	0	0
Spillback Cap Reductn	0	0	0	0	0	0
Storage Cap Reductn	0	0	0	0	0	0
Reduced v/c Ratio	1.04	0.26	1.15	0.77	0.96	1.85

Intersection Summary

- ~ Volume exceeds capacity, queue is theoretically infinite.
Queue shown is maximum after two cycles.
- # 95th percentile volume exceeds capacity, queue may be longer.
Queue shown is maximum after two cycles.



Lane Group	EBL	EBT	WBT	NBL	NBT	NBR	SBL	SBT
Lane Group Flow (vph)	32	1945	3549	566	365	46	62	171
v/c Ratio	0.58	0.85	1.49	2.61	1.03	0.13	1.03	0.57
Control Delay	56.9	18.7	245.1	758.0	100.5	18.1	173.7	43.2
Queue Delay	0.0	0.0	0.0	0.0	0.0	0.0	0.0	0.0
Total Delay	56.9	18.7	245.1	758.0	100.5	18.1	173.7	43.2
Queue Length 50th (ft)	12	535	~2016	~737	~316	8	~50	100
Queue Length 95th (ft)	#76	655	#2126	#957	#520	42	#144	177
Internal Link Dist (ft)		310	1149		1221			746
Turn Bay Length (ft)	175			145			100	
Base Capacity (vph)	55	2299	2380	217	356	351	60	301
Starvation Cap Reductn	0	0	0	0	0	0	0	0
Spillback Cap Reductn	0	0	0	0	0	0	0	0
Storage Cap Reductn	0	0	0	0	0	0	0	0
Reduced v/c Ratio	0.58	0.85	1.49	2.61	1.03	0.13	1.03	0.57

Intersection Summary

~ Volume exceeds capacity, queue is theoretically infinite.

Queue shown is maximum after two cycles.

95th percentile volume exceeds capacity, queue may be longer.

Queue shown is maximum after two cycles.



Lane Group	EBT	EBR	WBL	WBT	SBT	SBR
Lane Group Flow (vph)	1092	1094	32	1706	433	1545
v/c Ratio	0.79	0.63	0.30	1.00	0.68	1.51
Control Delay	28.4	3.2	46.0	45.8	29.5	258.0
Queue Delay	0.0	0.0	0.0	0.0	0.0	0.0
Total Delay	28.4	3.2	46.0	45.8	29.5	258.0
Queue Length 50th (ft)	285	0	17	~462	192	~643
Queue Length 95th (ft)	#413	43	45	#642	298	#790
Internal Link Dist (ft)	2745			429	1115	
Turn Bay Length (ft)			200			
Base Capacity (vph)	1379	1734	106	1698	634	1024
Starvation Cap Reductn	0	0	0	0	0	0
Spillback Cap Reductn	0	0	0	0	0	0
Storage Cap Reductn	0	0	0	0	0	0
Reduced v/c Ratio	0.79	0.63	0.30	1.00	0.68	1.51

Intersection Summary

~ Volume exceeds capacity, queue is theoretically infinite.

Queue shown is maximum after two cycles.

95th percentile volume exceeds capacity, queue may be longer.

Queue shown is maximum after two cycles.



Lane Group	EBT	EBR	WBT	NBL	NBR
Lane Group Flow (vph)	562	1030	188	1773	149
v/c Ratio	1.01	0.39	0.36	0.84	0.15
Control Delay	73.0	0.4	26.9	12.6	4.2
Queue Delay	0.0	0.0	0.0	0.0	0.0
Total Delay	73.0	0.4	26.9	12.6	4.2
Queue Length 50th (ft)	~110	0	31	203	17
Queue Length 95th (ft)	#257	0	70	284	33
Internal Link Dist (ft)	669		611	856	
Turn Bay Length (ft)		300			585
Base Capacity (vph)	554	2559	528	2815	1336
Starvation Cap Reductn	0	0	0	0	0
Spillback Cap Reductn	0	0	0	0	0
Storage Cap Reductn	0	0	0	0	0
Reduced v/c Ratio	1.01	0.40	0.36	0.63	0.11

Intersection Summary

~ Volume exceeds capacity, queue is theoretically infinite.

Queue shown is maximum after two cycles.

95th percentile volume exceeds capacity, queue may be longer.

Queue shown is maximum after two cycles.

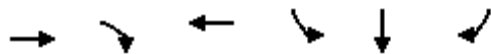

Lane Group	EBT	EBR	WBT	SBL	SBT	SBR
Lane Group Flow (vph)	1879	590	2488	342	323	316
v/c Ratio	0.65	0.61	0.87	0.76	0.78	0.75
Control Delay	13.2	10.0	19.2	37.3	36.8	34.7
Queue Delay	0.0	0.0	0.0	0.0	0.0	0.0
Total Delay	13.2	10.0	19.2	37.3	36.8	34.7
Queue Length 50th (ft)	225	101	371	163	146	135
Queue Length 95th (ft)	300	222	494	262	252	231
Internal Link Dist (ft)	750		688		1585	
Turn Bay Length (ft)		50		525		525
Base Capacity (vph)	3002	989	2963	564	513	521
Starvation Cap Reductn	0	0	0	0	0	0
Spillback Cap Reductn	0	0	0	0	0	0
Storage Cap Reductn	0	0	0	0	0	0
Reduced v/c Ratio	0.63	0.60	0.84	0.61	0.63	0.61
Intersection Summary						

Queues
29: I-215 NB Ramps & Alessandro Bl.

West Campus Upper Plateau (JN 14064)

09/19/2022



Lane Group	EBL	EBT	WBT	WBR	NBL	NBT	NBR
Lane Group Flow (vph)	291	2505	1620	172	593	582	380
v/c Ratio	1.84	0.99	0.94	0.31	0.95	0.97	0.63
Control Delay	428.5	36.7	38.6	12.4	52.8	59.0	21.7
Queue Delay	0.0	0.0	0.0	0.0	0.0	0.0	0.0
Total Delay	428.5	36.7	38.6	12.4	52.8	59.0	21.7
Queue Length 50th (ft)	~238	458	302	33	316	329	129
Queue Length 95th (ft)	#392	#604	#404	81	#540	#569	231
Internal Link Dist (ft)		688	447			1005	
Turn Bay Length (ft)	200			50	400		400
Base Capacity (vph)	158	2542	1731	552	626	598	606
Starvation Cap Reductn	0	0	0	0	0	0	0
Spillback Cap Reductn	0	0	0	0	0	0	0
Storage Cap Reductn	0	0	0	0	0	0	0
Reduced v/c Ratio	1.84	0.99	0.94	0.31	0.95	0.97	0.63

Intersection Summary

- ~ Volume exceeds capacity, queue is theoretically infinite.
Queue shown is maximum after two cycles.
- # 95th percentile volume exceeds capacity, queue may be longer.
Queue shown is maximum after two cycles.



Lane Group	EBT	EBR	WBL	WBT	NBR	SBR
Lane Group Flow (vph)	1782	423	847	1366	794	572
v/c Ratio	1.41	0.60	1.48	0.53	1.12	1.63
Control Delay	222.6	16.9	256.3	8.3	89.1	326.0
Queue Delay	0.0	0.0	0.0	0.0	0.0	0.0
Total Delay	222.6	16.9	256.3	8.3	89.1	326.0
Queue Length 50th (ft)	~976	113	~903	220	~367	~586
Queue Length 95th (ft)	#1116	222	#1147	266	#612	#809
Internal Link Dist (ft)	658			918		
Turn Bay Length (ft)						
Base Capacity (vph)	1260	707	573	2565	708	350
Starvation Cap Reductn	0	0	0	0	0	0
Spillback Cap Reductn	0	0	0	0	0	0
Storage Cap Reductn	0	0	0	0	0	0
Reduced v/c Ratio	1.41	0.60	1.48	0.53	1.12	1.63

Intersection Summary

- ~ Volume exceeds capacity, queue is theoretically infinite.
Queue shown is maximum after two cycles.
- # 95th percentile volume exceeds capacity, queue may be longer.
Queue shown is maximum after two cycles.



Lane Group	EBL	EBT	WBT	NBL	NBT	NBR	SBL	SBT
Lane Group Flow (vph)	109	2814	2818	225	272	81	204	210
v/c Ratio	1.25	1.39	1.34	0.91	0.60	0.19	1.04	0.50
Control Delay	203.7	196.9	176.6	71.8	33.8	15.9	108.4	31.5
Queue Delay	0.0	0.0	0.0	0.0	0.0	0.0	0.0	0.0
Total Delay	203.7	196.9	176.6	71.8	33.8	15.9	108.4	31.5
Queue Length 50th (ft)	~74	~1062	~1054	117	132	17	~119	94
Queue Length 95th (ft)	#131	#1201	#1193	#251	217	54	#250	163
Internal Link Dist (ft)		310	1149		1221			746
Turn Bay Length (ft)	175			145			100	
Base Capacity (vph)	87	2031	2104	247	454	419	197	418
Starvation Cap Reductn	0	0	0	0	0	0	0	0
Spillback Cap Reductn	0	0	0	0	0	0	0	0
Storage Cap Reductn	0	0	0	0	0	0	0	0
Reduced v/c Ratio	1.25	1.39	1.34	0.91	0.60	0.19	1.04	0.50

Intersection Summary

~ Volume exceeds capacity, queue is theoretically infinite.

Queue shown is maximum after two cycles.

95th percentile volume exceeds capacity, queue may be longer.

Queue shown is maximum after two cycles.

Queues

32: I-215 SB Ramps & Van Buren Bl.



Lane Group	EBT	EBR	WBL	WBT	SBT	SBR
Lane Group Flow (vph)	1531	2642	198	1656	677	804
v/c Ratio	0.71	1.42	1.89	0.63	4.01	2.34
Control Delay	12.8	212.8	458.6	5.9	1380.3	633.1
Queue Delay	0.0	0.0	0.0	0.0	0.0	0.0
Total Delay	12.8	212.8	458.6	5.9	1380.3	633.1
Queue Length 50th (ft)	256	~1073	~164	163	~667	~376
Queue Length 95th (ft)	334	#1225	#294	213	#873	#502
Internal Link Dist (ft)	2745			429	1115	
Turn Bay Length (ft)			200			
Base Capacity (vph)	2143	1856	105	2629	169	343
Starvation Cap Reductn	0	0	0	0	0	0
Spillback Cap Reductn	0	0	0	0	0	0
Storage Cap Reductn	0	0	0	0	0	0
Reduced v/c Ratio	0.71	1.42	1.89	0.63	4.01	2.34

Intersection Summary

~ Volume exceeds capacity, queue is theoretically infinite.

Queue shown is maximum after two cycles.

95th percentile volume exceeds capacity, queue may be longer.

Queue shown is maximum after two cycles.

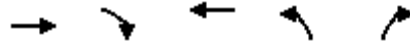

Lane Group	EBT	EBR	WBT	NBL	NBR
Lane Group Flow (vph)	753	1362	935	1382	211
v/c Ratio	1.12	0.52	1.40	0.74	0.23
Control Delay	100.4	0.7	211.0	10.3	5.5
Queue Delay	0.0	0.0	0.0	0.0	0.0
Total Delay	100.4	0.7	211.0	10.3	5.5
Queue Length 50th (ft)	~135	0	~194	127	25
Queue Length 95th (ft)	#314	0	#400	179	47
Internal Link Dist (ft)	669		611	856	
Turn Bay Length (ft)		300			585
Base Capacity (vph)	670	2588	670	3100	1500
Starvation Cap Reductn	0	0	0	0	0
Spillback Cap Reductn	0	0	0	0	0
Storage Cap Reductn	0	0	0	0	0
Reduced v/c Ratio	1.12	0.53	1.40	0.45	0.14

Intersection Summary

~ Volume exceeds capacity, queue is theoretically infinite.

Queue shown is maximum after two cycles.

95th percentile volume exceeds capacity, queue may be longer.

Queue shown is maximum after two cycles.

Queues
28: I-215 SB Ramps & Alessandro Bl.

West Campus Upper Plateau (JN 14064)

09/30/2022

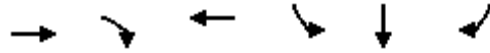

Lane Group	EBT	EBR	WBT	SBL	SBT	SBR
Lane Group Flow (vph)	986	444	1416	135	183	183
v/c Ratio	0.38	0.46	0.56	0.35	0.50	0.48
Control Delay	7.5	3.7	8.7	17.8	17.0	16.5
Queue Delay	0.0	0.0	0.0	0.0	0.0	0.0
Total Delay	7.5	3.7	8.7	17.8	17.0	16.5
Queue Length 50th (ft)	45	11	71	28	29	28
Queue Length 95th (ft)	98	59	150	82	97	92
Internal Link Dist (ft)	750		688		1585	
Turn Bay Length (ft)		50		525		525
Base Capacity (vph)	4773	1507	4673	1010	897	928
Starvation Cap Reductn	0	0	0	0	0	0
Spillback Cap Reductn	0	0	0	0	0	0
Storage Cap Reductn	0	0	0	0	0	0
Reduced v/c Ratio	0.21	0.29	0.30	0.13	0.20	0.20
Intersection Summary						

Queues
29: I-215 NB Ramps & Alessandro Bl.

West Campus Upper Plateau (JN 14064)

09/30/2022



Lane Group	EBL	EBT	WBT	WBR	NBL	NBT	NBR
Lane Group Flow (vph)	241	889	1033	162	311	312	240
v/c Ratio	1.36	0.38	0.68	0.34	0.46	0.48	0.36
Control Delay	226.1	14.2	26.7	12.8	21.2	21.3	11.7
Queue Delay	0.0	0.0	0.0	0.0	0.0	0.0	0.0
Total Delay	226.1	14.2	26.7	12.8	21.2	21.3	11.7
Queue Length 50th (ft)	~161	100	163	29	116	120	46
Queue Length 95th (ft)	#319	128	206	74	211	223	112
Internal Link Dist (ft)		688	447			1005	
Turn Bay Length (ft)	200			50	400		400
Base Capacity (vph)	177	2726	1892	572	671	645	668
Starvation Cap Reductn	0	0	0	0	0	0	0
Spillback Cap Reductn	0	0	0	0	0	0	0
Storage Cap Reductn	0	0	0	0	0	0	0
Reduced v/c Ratio	1.36	0.33	0.55	0.28	0.46	0.48	0.36

Intersection Summary

~ Volume exceeds capacity, queue is theoretically infinite.

Queue shown is maximum after two cycles.

95th percentile volume exceeds capacity, queue may be longer.

Queue shown is maximum after two cycles.

Queues

30: I-215 SB Ramps & Cactus Av.



Lane Group	EBT	EBR	WBL	WBT	NBR	SBR
Lane Group Flow (vph)	679	125	426	620	401	338
v/c Ratio	0.68	0.23	0.73	0.25	0.53	0.71
Control Delay	24.8	6.0	27.9	3.7	2.7	13.6
Queue Delay	0.0	0.0	0.0	0.0	0.0	0.0
Total Delay	24.8	6.0	27.9	3.7	2.7	13.6
Queue Length 50th (ft)	103	0	122	26	0	0
Queue Length 95th (ft)	237	37	303	73	0	67
Internal Link Dist (ft)	658			918		
Turn Bay Length (ft)						
Base Capacity (vph)	1732	830	1173	3364	992	770
Starvation Cap Reductn	0	0	0	0	0	0
Spillback Cap Reductn	0	0	0	0	0	0
Storage Cap Reductn	0	0	0	0	0	0
Reduced v/c Ratio	0.39	0.15	0.36	0.18	0.40	0.44
Intersection Summary						

Queues

31: I-215 NB Ramps/Old 215 Frontage Rd. & Cactus Av.



Lane Group	EBL	EBT	WBT	NBL	NBT	NBR	SBL	SBT
Lane Group Flow (vph)	34	1004	1383	133	75	3	125	89
v/c Ratio	0.21	0.50	0.63	0.53	0.20	0.01	0.46	0.23
Control Delay	10.6	7.4	9.5	27.8	19.7	0.0	25.2	9.6
Queue Delay	0.0	0.0	0.0	0.0	0.0	0.0	0.0	0.0
Total Delay	10.6	7.4	9.5	27.8	19.7	0.0	25.2	9.6
Queue Length 50th (ft)	4	73	130	32	17	0	30	4
Queue Length 95th (ft)	24	161	268	100	61	0	93	39
Internal Link Dist (ft)		310	1149		1221			746
Turn Bay Length (ft)	175			145			100	
Base Capacity (vph)	238	2848	3170	549	811	731	597	779
Starvation Cap Reductn	0	0	0	0	0	0	0	0
Spillback Cap Reductn	0	0	0	0	0	0	0	0
Storage Cap Reductn	0	0	0	0	0	0	0	0
Reduced v/c Ratio	0.14	0.35	0.44	0.24	0.09	0.00	0.21	0.11

Intersection Summary

Queues

32: I-215 SB Ramps & Van Buren Bl.



Lane Group	EBT	EBR	WBL	WBT	SBT	SBR
Lane Group Flow (vph)	763	890	15	865	23	859
v/c Ratio	0.54	0.53	0.08	0.55	0.08	0.99
Control Delay	10.0	2.0	21.5	8.3	18.3	40.7
Queue Delay	0.0	0.0	0.0	0.0	0.0	0.0
Total Delay	10.0	2.0	21.5	8.3	18.3	40.7
Queue Length 50th (ft)	51	0	3	59	4	42
Queue Length 95th (ft)	131	27	21	84	26	#253
Internal Link Dist (ft)	2745		429		1115	
Turn Bay Length (ft)	200					
Base Capacity (vph)	3236	2717	182	3406	305	871
Starvation Cap Reductn	0	0	0	0	0	0
Spillback Cap Reductn	0	0	0	0	0	0
Storage Cap Reductn	0	0	0	0	0	0
Reduced v/c Ratio	0.24	0.33	0.08	0.25	0.08	0.99

Intersection Summary

95th percentile volume exceeds capacity, queue may be longer.
 Queue shown is maximum after two cycles.

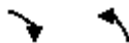

Lane Group	EBR	NBL
Lane Group Flow (vph)	18	1
v/c Ratio	0.01	0.00
Control Delay	0.0	0.0
Queue Delay	0.0	0.0
Total Delay	0.0	0.0
Queue Length 50th (ft)	0	0
Queue Length 95th (ft)	0	0
Internal Link Dist (ft)		856
Turn Bay Length (ft)	300	
Base Capacity (vph)	2608	3303
Starvation Cap Reductn	0	0
Spillback Cap Reductn	0	0
Storage Cap Reductn	0	0
Reduced v/c Ratio	0.01	0.00
Intersection Summary		

APPENDIX 7.7:

**OPENING YEAR CUMULATIVE (2028) WITH PROJECT CONDITIONS INTERSECTION
OPERATIONS ANALYSIS WORKSHEETS WITH IMPROVEMENTS**

This Page Intentionally Left Blank

Timings

West Campus Upper Plateau (JN 14064)

1: Washington St & Van Buren Bl.

09/19/2022



Lane Group	EBL	EBT	EBR	WBL	WBT	WBR	NBL	NBT	NBR	SBL	SBT
Lane Configurations	↘	↑↑↑	↗	↘	↑↑↑	↗	↘↗	↑↑	↗	↘↗	↑↗
Traffic Volume (vph)	151	1331	137	122	1714	771	156	585	170	469	202
Future Volume (vph)	151	1331	137	122	1714	771	156	585	170	469	202
Turn Type	Prot	NA	Perm	Prot	NA	Perm	Prot	NA	Perm	Prot	NA
Protected Phases	5	2		1	6		3	8		7	4
Permitted Phases			2			6			8		
Detector Phase	5	2	2	1	6	6	3	8	8	7	4
Switch Phase											
Minimum Initial (s)	5.0	10.0	10.0	5.0	10.0	10.0	5.0	10.0	10.0	5.0	10.0
Minimum Split (s)	9.2	34.2	34.2	9.2	33.2	33.2	9.2	38.4	38.4	9.2	30.8
Total Split (s)	15.1	49.0	49.0	16.2	50.1	50.1	14.7	38.4	38.4	21.4	45.1
Total Split (%)	12.1%	39.2%	39.2%	13.0%	40.1%	40.1%	11.8%	30.7%	30.7%	17.1%	36.1%
Yellow Time (s)	3.2	5.2	5.2	3.2	5.2	5.2	3.2	4.4	4.4	3.2	4.8
All-Red Time (s)	1.0	1.0	1.0	1.0	1.0	1.0	1.0	1.0	1.0	1.0	1.0
Lost Time Adjust (s)	0.0	0.0	0.0	0.0	0.0	0.0	0.0	0.0	0.0	0.0	0.0
Total Lost Time (s)	4.2	6.2	6.2	4.2	6.2	6.2	4.2	5.4	5.4	4.2	5.8
Lead/Lag	Lead	Lag	Lag	Lead	Lag	Lag	Lead	Lag	Lag	Lead	Lag
Lead-Lag Optimize?	Yes	Yes	Yes	Yes	Yes	Yes	Yes	Yes	Yes	Yes	Yes
Recall Mode	None	None	None	None	None	None	None	None	None	None	None
Act Effct Green (s)	10.9	43.8	43.8	11.1	44.0	44.0	9.3	27.3	27.3	17.2	34.8
Actuated g/C Ratio	0.09	0.37	0.37	0.09	0.37	0.37	0.08	0.23	0.23	0.14	0.29
v/c Ratio	0.98	0.75	0.22	0.78	0.95	1.05	0.63	0.75	0.38	0.99	0.29
Control Delay	119.5	37.0	6.2	84.8	49.8	71.2	65.1	49.3	10.9	89.3	28.6
Queue Delay	0.0	0.0	0.0	0.0	0.0	0.0	0.0	0.0	0.0	0.0	0.0
Total Delay	119.5	37.0	6.2	84.8	49.8	71.2	65.1	49.3	10.9	89.3	28.6
LOS	F	D	A	F	D	E	E	D	B	F	C
Approach Delay		42.1			57.8			44.8			67.0
Approach LOS		D			E			D			E

Intersection Summary

Cycle Length: 125
 Actuated Cycle Length: 119.4
 Natural Cycle: 125
 Control Type: Actuated-Uncoordinated
 Maximum v/c Ratio: 1.05
 Intersection Signal Delay: 52.6
 Intersection LOS: D
 Intersection Capacity Utilization 88.7%
 ICU Level of Service E
 Analysis Period (min) 15

Splits and Phases: 1: Washington St & Van Buren Bl.

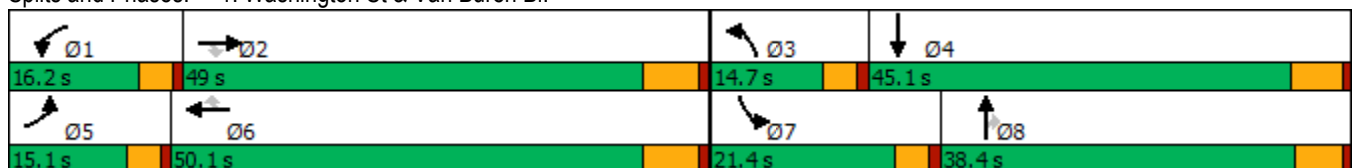

HCM 6th Signalized Intersection Summary
1: Washington St & Van Buren Bl.

West Campus Upper Plateau (JN 14064)

09/19/2022

Movement	EBL	EBT	EBR	WBL	WBT	WBR	NBL	NBT	NBR	SBL	SBT	SBR
Lane Configurations												
Traffic Volume (veh/h)	151	1331	137	122	1714	771	156	585	170	469	202	71
Future Volume (veh/h)	151	1331	137	122	1714	771	156	585	170	469	202	71
Initial Q (Qb), veh	0	0	0	0	0	0	0	0	0	0	0	0
Ped-Bike Adj(A_pbT)	1.00		0.99	1.00		0.98	1.00		1.00	1.00		1.00
Parking Bus, Adj	1.00	1.00	1.00	1.00	1.00	1.00	1.00	1.00	1.00	1.00	1.00	1.00
Work Zone On Approach		No			No			No			No	
Adj Sat Flow, veh/h/ln	1870	1856	1856	1856	1870	1885	1826	1870	1856	1870	1811	1826
Adj Flow Rate, veh/h	157	1386	120	127	1785	639	162	609	111	489	210	45
Peak Hour Factor	0.96	0.96	0.96	0.96	0.96	0.96	0.96	0.96	0.96	0.96	0.96	0.96
Percent Heavy Veh, %	2	3	3	3	2	1	5	2	3	2	6	5
Cap, veh/h	165	1921	589	153	1905	585	218	763	336	505	839	176
Arrive On Green	0.09	0.38	0.38	0.09	0.37	0.37	0.06	0.21	0.21	0.15	0.30	0.30
Sat Flow, veh/h	1781	5066	1553	1767	5106	1569	3374	3554	1566	3456	2830	594
Grp Volume(v), veh/h	157	1386	120	127	1785	639	162	609	111	489	126	129
Grp Sat Flow(s),veh/h/ln	1781	1689	1553	1767	1702	1569	1687	1777	1566	1728	1721	1703
Q Serve(g_s), s	10.3	27.5	6.1	8.3	39.6	43.9	5.6	19.1	7.0	16.6	6.5	6.8
Cycle Q Clear(g_c), s	10.3	27.5	6.1	8.3	39.6	43.9	5.6	19.1	7.0	16.6	6.5	6.8
Prop In Lane	1.00		1.00	1.00		1.00	1.00		1.00	1.00		0.35
Lane Grp Cap(c), veh/h	165	1921	589	153	1905	585	218	763	336	505	510	505
V/C Ratio(X)	0.95	0.72	0.20	0.83	0.94	1.09	0.74	0.80	0.33	0.97	0.25	0.26
Avail Cap(c_a), veh/h	165	1921	589	180	1905	585	301	997	439	505	575	569
HCM Platoon Ratio	1.00	1.00	1.00	1.00	1.00	1.00	1.00	1.00	1.00	1.00	1.00	1.00
Upstream Filter(I)	1.00	1.00	1.00	1.00	1.00	1.00	1.00	1.00	1.00	1.00	1.00	1.00
Uniform Delay (d), s/veh	53.1	31.2	24.6	52.9	35.6	36.9	54.1	43.8	39.0	50.0	31.4	31.5
Incr Delay (d2), s/veh	55.2	1.5	0.2	20.7	9.6	64.7	3.5	3.5	0.6	31.7	0.3	0.3
Initial Q Delay(d3),s/veh	0.0	0.0	0.0	0.0	0.0	0.0	0.0	0.0	0.0	0.0	0.0	0.0
%ile BackOfQ(50%),veh/ln	7.7	15.4	6.4	5.0	21.1	41.6	2.8	10.3	6.5	10.2	4.2	4.2
Unsig. Movement Delay, s/veh												
LnGrp Delay(d),s/veh	108.3	32.7	24.8	73.6	45.1	101.6	57.6	47.3	39.6	81.7	31.7	31.8
LnGrp LOS	F	C	C	E	D	F	E	D	D	F	C	C
Approach Vol, veh/h		1663			2551			882			744	
Approach Delay, s/veh		39.3			60.7			48.2			64.6	
Approach LOS		D			E			D			E	
Timer - Assigned Phs	1	2	3	4	5	6	7	8				
Phs Duration (G+Y+Rc), s	14.4	50.8	11.8	40.7	15.1	50.1	21.4	31.1				
Change Period (Y+Rc), s	* 4.2	6.2	* 4.2	5.8	* 4.2	6.2	* 4.2	* 5.8				
Max Green Setting (Gmax), s	* 12	42.8	* 11	39.3	* 11	43.9	* 17	* 33				
Max Q Clear Time (g_c+1), s	10.3	29.5	7.6	8.8	12.3	45.9	18.6	21.1				
Green Ext Time (p_c), s	0.0	9.2	0.1	1.5	0.0	0.0	0.0	3.7				
Intersection Summary												
HCM 6th Ctrl Delay			53.2									
HCM 6th LOS			D									
Notes												
* HCM 6th computational engine requires equal clearance times for the phases crossing the barrier.												

Timings

3: Overlook Pkwy./Canyon Crest Dr. & Alessandro Bl/Alessandro Bl.



Lane Group	EBL	EBT	WBL	WBT	WBR	NBL	NBT	NBR	SBL	SBT
Lane Configurations	↙	↕↕↕↕	↙	↕↕↕↕	↗	↙	↕↕	↗	↙↙↙↙	↘
Traffic Volume (vph)	75	1627	9	3666	1240	5	193	11	556	97
Future Volume (vph)	75	1627	9	3666	1240	5	193	11	556	97
Turn Type	Prot	NA	Prot	NA	pm+ov	Split	NA	Perm	Split	NA
Protected Phases	5	2	1	6	4	8	8		4	4
Permitted Phases					6			8		
Detector Phase	5	2	1	6	4	8	8	8	4	4
Switch Phase										
Minimum Initial (s)	5.0	10.0	5.0	10.0	10.0	10.0	10.0	10.0	10.0	10.0
Minimum Split (s)	9.2	35.2	9.2	35.2	38.8	15.8	15.8	15.8	38.8	38.8
Total Split (s)	9.2	66.2	9.2	66.2	38.8	15.8	15.8	15.8	38.8	38.8
Total Split (%)	7.1%	50.9%	7.1%	50.9%	29.8%	12.2%	12.2%	12.2%	29.8%	29.8%
Yellow Time (s)	3.2	5.2	3.2	5.2	4.8	4.8	4.8	4.8	4.8	4.8
All-Red Time (s)	1.0	1.0	1.0	1.0	1.0	1.0	1.0	1.0	1.0	1.0
Lost Time Adjust (s)	0.0	0.0	0.0	0.0	0.0	0.0	0.0	0.0	0.0	0.0
Total Lost Time (s)	4.2	6.2	4.2	6.2	5.8	5.8	5.8	5.8	5.8	5.8
Lead/Lag	Lead	Lag	Lead	Lag						
Lead-Lag Optimize?	Yes	Yes	Yes	Yes						
Recall Mode	None	None	None	None	None	None	None	None	None	None
Act Effct Green (s)	5.0	67.4	5.0	60.0	99.2	10.0	10.0	10.0	33.0	33.0
Actuated g/C Ratio	0.04	0.52	0.04	0.46	0.76	0.08	0.08	0.08	0.25	0.25
v/c Ratio	1.22	0.65	0.13	1.63	1.06	0.04	0.73	0.05	0.47	0.39
Control Delay	231.3	24.7	64.7	312.1	58.9	56.4	74.7	0.5	42.5	36.5
Queue Delay	0.0	0.0	0.0	0.0	0.0	0.0	0.0	0.0	0.0	0.0
Total Delay	231.3	24.7	64.7	312.1	58.9	56.4	74.7	0.5	42.5	36.5
LOS	F	C	E	F	E	E	E	A	D	D
Approach Delay		33.8		247.8			70.2			41.1
Approach LOS		C		F			E			D

Intersection Summary

Cycle Length: 130
 Actuated Cycle Length: 130
 Natural Cycle: 130
 Control Type: Actuated-Uncoordinated
 Maximum v/c Ratio: 1.63
 Intersection Signal Delay: 174.7
 Intersection LOS: F
 Intersection Capacity Utilization 104.6%
 ICU Level of Service G
 Analysis Period (min) 15

Splits and Phases: 3: Overlook Pkwy./Canyon Crest Dr. & Alessandro Bl/Alessandro Bl.



HCM 6th Signalized Intersection Summary

West Campus Upper Plateau (JN 14064)

3: Overlook Pkwy./Canyon Crest Dr. & Alessandro Bl/Alessandro Bl.

09/19/2022



Movement	EBL	EBT	EBR	WBL	WBT	WBR	NBL	NBT	NBR	SBL	SBT	SBR
Lane Configurations	↖	↑↑↑		↖	↑↑↑	↖	↖	↑↑	↖	↖↖↖	↖	↖
Traffic Volume (veh/h)	75	1627	1	9	3666	1240	5	193	11	556	97	77
Future Volume (veh/h)	75	1627	1	9	3666	1240	5	193	11	556	97	77
Initial Q (Qb), veh	0	0	0	0	0	0	0	0	0	0	0	0
Ped-Bike Adj(A_pbT)	1.00		1.00	1.00		1.00	1.00		1.00	1.00		1.00
Parking Bus, Adj	1.00	1.00	1.00	1.00	1.00	1.00	1.00	1.00	1.00	1.00	1.00	1.00
Work Zone On Approach		No			No			No				No
Adj Sat Flow, veh/h/ln	1811	1870	1900	1900	1885	1885	1900	1900	1900	1856	1885	1885
Adj Flow Rate, veh/h	79	1713	1	9	3859	1142	5	203	10	585	102	64
Peak Hour Factor	0.95	0.95	0.95	0.95	0.95	0.95	0.95	0.95	0.95	0.95	0.95	0.95
Percent Heavy Veh, %	6	2	0	0	1	1	0	0	0	3	1	1
Cap, veh/h	75	2927	2	20	2689	1083	157	314	140	774	168	106
Arrive On Green	0.04	0.56	0.56	0.01	0.52	0.52	0.09	0.09	0.09	0.16	0.16	0.16
Sat Flow, veh/h	1725	5271	3	1810	5147	1598	1810	3610	1610	4983	1083	680
Grp Volume(v), veh/h	79	1106	608	9	3859	1142	5	203	10	585	0	166
Grp Sat Flow(s),veh/h/ln	1725	1702	1870	1810	1716	1598	1810	1805	1610	1661	0	1763
Q Serve(g_s), s	5.0	24.6	24.6	0.6	60.0	60.0	0.3	6.2	0.7	12.9	0.0	10.1
Cycle Q Clear(g_c), s	5.0	24.6	24.6	0.6	60.0	60.0	0.3	6.2	0.7	12.9	0.0	10.1
Prop In Lane	1.00		0.00	1.00		1.00	1.00		1.00	1.00		0.39
Lane Grp Cap(c), veh/h	75	1890	1038	20	2689	1083	157	314	140	774	0	274
V/C Ratio(X)	1.05	0.59	0.59	0.46	1.43	1.05	0.03	0.65	0.07	0.76	0.00	0.61
Avail Cap(c_a), veh/h	75	1890	1038	79	2689	1083	158	314	140	1432	0	507
HCM Platoon Ratio	1.00	1.00	1.00	1.00	1.00	1.00	1.00	1.00	1.00	1.00	1.00	1.00
Upstream Filter(I)	1.00	1.00	1.00	1.00	1.00	1.00	1.00	1.00	1.00	1.00	0.00	1.00
Uniform Delay (d), s/veh	54.9	16.8	16.8	56.5	27.4	15.6	48.0	50.7	48.2	46.4	0.0	45.2
Incr Delay (d2), s/veh	118.8	0.5	0.9	6.1	197.9	42.9	0.1	4.5	0.2	1.5	0.0	2.2
Initial Q Delay(d3),s/veh	0.0	0.0	0.0	0.0	0.0	0.0	0.0	0.0	0.0	0.0	0.0	0.0
%ile BackOfQ(50%),veh/ln	2.5	0.1	0.2	0.0	49.3	12.9	0.0	0.2	0.0	0.1	0.0	0.2
Unsig. Movement Delay, s/veh												
LnGrp Delay(d),s/veh	173.7	17.3	17.7	62.5	225.3	58.5	48.1	55.2	48.4	47.9	0.0	47.4
LnGrp LOS	F	B	B	E	F	F	D	E	D	D	A	D
Approach Vol, veh/h		1793			5010			218			751	
Approach Delay, s/veh		24.3			187.0			54.8			47.8	
Approach LOS		C			F			D			D	
Timer - Assigned Phs	1	2		4	5	6		8				
Phs Duration (G+Y+Rc), s	5.4	70.0		23.6	9.2	66.2		15.8				
Change Period (Y+Rc), s	* 4.2	6.2		5.8	* 4.2	6.2		5.8				
Max Green Setting (Gmax), s	* 5	60.0		33.0	* 5	60.0		10.0				
Max Q Clear Time (g_c+I1), s	2.6	26.6		14.9	7.0	62.0		8.2				
Green Ext Time (p_c), s	0.0	14.0		2.9	0.0	0.0		0.2				

Intersection Summary

HCM 6th Ctrl Delay	132.3
HCM 6th LOS	F

Notes

User approved pedestrian interval to be less than phase max green.
 * HCM 6th computational engine requires equal clearance times for the phases crossing the barrier.

Timings

4: Van Buren Bl. & Wood Rd.

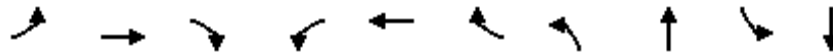

Lane Group	EBL	EBT	EBR	WBL	WBT	WBR	NBL	NBT	SBL	SBT
Lane Configurations	↘	↑↑↑	↗	↘↗	↑↑↑	↗	↘↗	↑↗	↘	↑↗
Traffic Volume (vph)	168	1342	377	524	1798	133	387	478	125	478
Future Volume (vph)	168	1342	377	524	1798	133	387	478	125	478
Turn Type	Prot	NA	pm+ov	Prot	NA	Perm	Prot	NA	Prot	NA
Protected Phases	5	2	3	1	6		3	8	7	4
Permitted Phases			2			6				
Detector Phase	5	2	3	1	6	6	3	8	7	4
Switch Phase										
Minimum Initial (s)	5.0	10.0	5.0	5.0	10.0	10.0	5.0	10.0	5.0	10.0
Minimum Split (s)	9.2	30.2	9.2	9.2	30.2	30.2	9.2	38.4	9.2	15.8
Total Split (s)	16.3	44.5	19.9	23.7	51.9	51.9	19.9	38.4	13.4	31.9
Total Split (%)	13.6%	37.1%	16.6%	19.8%	43.3%	43.3%	16.6%	32.0%	11.2%	26.6%
Yellow Time (s)	3.2	5.2	3.2	3.2	5.2	5.2	3.2	4.4	3.2	4.8
All-Red Time (s)	1.0	1.0	1.0	1.0	1.0	1.0	1.0	1.0	1.0	1.0
Lost Time Adjust (s)	0.0	0.0	0.0	0.0	0.0	0.0	0.0	0.0	0.0	0.0
Total Lost Time (s)	4.2	6.2	4.2	4.2	6.2	6.2	4.2	5.4	4.2	5.8
Lead/Lag	Lead	Lag	Lead	Lead	Lag	Lag	Lead	Lag	Lead	Lag
Lead-Lag Optimize?	Yes	Yes	Yes	Yes	Yes	Yes	Yes	Yes	Yes	Yes
Recall Mode	None	None	None	None	None	None	None	None	None	None
Act Effct Green (s)	12.1	38.3	56.0	19.5	45.7	45.7	15.7	33.0	9.2	26.1
Actuated g/C Ratio	0.10	0.32	0.47	0.16	0.38	0.38	0.13	0.28	0.08	0.22
v/c Ratio	1.09	0.95	0.56	1.06	1.06	0.22	0.97	0.97	1.05	0.97
Control Delay	142.8	53.4	18.3	102.0	73.2	5.7	87.9	59.0	145.1	70.3
Queue Delay	0.0	0.0	0.0	0.0	0.0	0.0	0.0	0.0	0.0	0.0
Total Delay	142.8	53.4	18.3	102.0	73.2	5.7	87.9	59.0	145.1	70.3
LOS	F	D	B	F	E	A	F	E	F	E
Approach Delay		54.3			75.7			68.1		82.1
Approach LOS		D			E			E		F

Intersection Summary

Cycle Length: 120
 Actuated Cycle Length: 120
 Natural Cycle: 130
 Control Type: Actuated-Uncoordinated
 Maximum v/c Ratio: 1.09
 Intersection Signal Delay: 68.7
 Intersection LOS: E
 Intersection Capacity Utilization 95.3%
 ICU Level of Service F
 Analysis Period (min) 15

Splits and Phases: 4: Van Buren Bl. & Wood Rd.

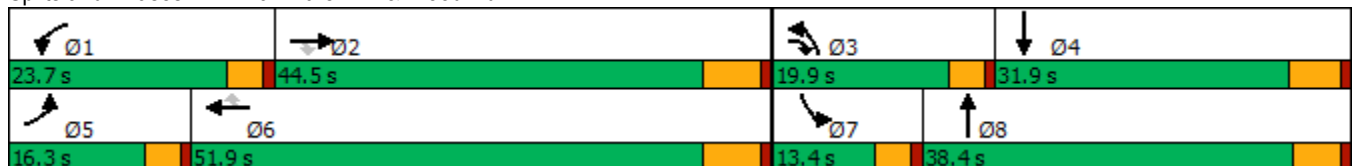

HCM 6th Signalized Intersection Summary
4: Van Buren Bl. & Wood Rd.

West Campus Upper Plateau (JN 14064)
09/19/2022



Movement	EBL	EBT	EBR	WBL	WBT	WBR	NBL	NBT	NBR	SBL	SBT	SBR
Lane Configurations	↖	↑↑↑	↗	↖↗	↑↑↑	↗	↖↗	↑↑		↖	↑↑	
Traffic Volume (veh/h)	168	1342	377	524	1798	133	387	478	371	125	478	186
Future Volume (veh/h)	168	1342	377	524	1798	133	387	478	371	125	478	186
Initial Q (Qb), veh	0	0	0	0	0	0	0	0	0	0	0	0
Ped-Bike Adj(A_pbT)	1.00		0.97	1.00		0.98	1.00		0.90	1.00		0.99
Parking Bus, Adj	1.00	1.00	1.00	1.00	1.00	1.00	1.00	1.00	1.00	1.00	1.00	1.00
Work Zone On Approach		No			No			No			No	
Adj Sat Flow, veh/h/ln	1856	1856	1856	1885	1870	1870	1885	1885	1885	1870	1900	1856
Adj Flow Rate, veh/h	191	1525	243	595	2043	101	440	543	279	142	543	116
Peak Hour Factor	0.88	0.88	0.88	0.88	0.88	0.88	0.88	0.88	0.88	0.88	0.88	0.88
Percent Heavy Veh, %	3	3	3	1	2	2	1	1	1	2	0	3
Cap, veh/h	178	1614	693	565	1942	593	455	600	307	136	646	137
Arrive On Green	0.10	0.32	0.32	0.16	0.38	0.38	0.13	0.27	0.27	0.08	0.22	0.22
Sat Flow, veh/h	1767	5066	1531	3483	5106	1560	3483	2198	1125	1781	2954	628
Grp Volume(v), veh/h	191	1525	243	595	2043	101	440	442	380	142	331	328
Grp Sat Flow(s),veh/h/ln	1767	1689	1531	1742	1702	1560	1742	1791	1533	1781	1805	1777
Q Serve(g_s), s	12.1	35.3	12.5	19.5	45.7	5.2	15.1	28.6	28.8	9.2	21.1	21.3
Cycle Q Clear(g_c), s	12.1	35.3	12.5	19.5	45.7	5.2	15.1	28.6	28.8	9.2	21.1	21.3
Prop In Lane	1.00		1.00	1.00		1.00	1.00		0.73	1.00		0.35
Lane Grp Cap(c), veh/h	178	1614	693	565	1942	593	455	488	418	136	395	389
V/C Ratio(X)	1.07	0.94	0.35	1.05	1.05	0.17	0.97	0.90	0.91	1.04	0.84	0.84
Avail Cap(c_a), veh/h	178	1614	693	565	1942	593	455	492	421	136	395	389
HCM Platoon Ratio	1.00	1.00	1.00	1.00	1.00	1.00	1.00	1.00	1.00	1.00	1.00	1.00
Upstream Filter(I)	1.00	1.00	1.00	1.00	1.00	1.00	1.00	1.00	1.00	1.00	1.00	1.00
Uniform Delay (d), s/veh	54.0	39.9	21.7	50.3	37.2	24.7	52.0	42.2	42.3	55.5	44.9	45.0
Incr Delay (d2), s/veh	88.3	11.9	0.4	52.5	35.7	0.2	33.4	20.1	23.3	88.5	14.7	15.6
Initial Q Delay(d3),s/veh	0.0	0.0	0.0	0.0	0.0	0.0	0.0	0.0	0.0	0.0	0.0	0.0
%ile BackOfQ(50%),veh/ln	10.3	18.7	12.7	13.5	28.0	5.5	9.5	17.5	15.4	7.9	12.7	12.6
Unsig. Movement Delay, s/veh												
LnGrp Delay(d),s/veh	142.4	51.8	22.1	102.8	73.0	24.9	85.4	62.3	65.5	144.0	59.7	60.5
LnGrp LOS	F	D	C	F	F	C	F	E	E	F	E	E
Approach Vol, veh/h		1959			2739			1262			801	
Approach Delay, s/veh		56.9			77.7			71.3			75.0	
Approach LOS		E			E			E			E	
Timer - Assigned Phs	1	2	3	4	5	6	7	8				
Phs Duration (G+Y+Rc), s	23.7	44.5	19.9	32.1	16.3	51.9	13.4	38.6				
Change Period (Y+Rc), s	* 4.2	6.2	* 4.2	5.8	* 4.2	6.2	* 4.2	* 5.8				
Max Green Setting (Gmax), s	* 20	38.3	* 16	26.1	* 12	45.7	* 9.2	* 33				
Max Q Clear Time (g_c+I1), s	21.5	37.3	17.1	23.3	14.1	47.7	11.2	30.8				
Green Ext Time (p_c), s	0.0	0.9	0.0	1.1	0.0	0.0	0.0	1.1				

Intersection Summary

HCM 6th Ctrl Delay	70.2
HCM 6th LOS	E

Notes

* HCM 6th computational engine requires equal clearance times for the phases crossing the barrier.

Timings
8: Cole Av. & Van Buren Bl.

West Campus Upper Plateau (JN 14064)

09/19/2022



Lane Group	EBL	EBT	EBR	WBL	WBT	WBR	NBL	NBT	SBL	SBT	SBR
Lane Configurations	↖↗	↑↑↑	↗	↖	↑↑↑	↗	↖	↑↑	↖↗	↑↑	↗
Traffic Volume (vph)	419	1401	106	183	1834	525	247	676	482	534	342
Future Volume (vph)	419	1401	106	183	1834	525	247	676	482	534	342
Turn Type	Prot	NA	pm+ov	Prot	NA	pm+ov	Prot	NA	Prot	NA	pm+ov
Protected Phases	5	2	3	1	6	7	3	8	7	4	5
Permitted Phases			2			6					4
Detector Phase	5	2	3	1	6	7	3	8	7	4	5
Switch Phase											
Minimum Initial (s)	5.0	10.0	5.0	5.0	10.0	5.0	5.0	10.0	5.0	10.0	5.0
Minimum Split (s)	9.1	36.2	9.1	9.1	36.2	9.1	9.1	42.2	9.1	49.2	9.1
Total Split (s)	14.0	44.8	14.0	12.0	42.8	20.7	14.0	42.5	20.7	49.2	14.0
Total Split (%)	11.7%	37.3%	11.7%	10.0%	35.7%	17.3%	11.7%	35.4%	17.3%	41.0%	11.7%
Yellow Time (s)	3.2	5.2	3.2	3.2	5.2	3.2	3.2	5.2	3.2	5.2	3.2
All-Red Time (s)	0.5	1.0	0.5	0.5	1.0	0.5	0.5	1.0	0.5	1.0	0.5
Lost Time Adjust (s)	0.0	0.0	0.0	0.0	0.0	0.0	0.0	0.0	0.0	0.0	0.0
Total Lost Time (s)	3.7	6.2	3.7	3.7	6.2	3.7	3.7	6.2	3.7	6.2	3.7
Lead/Lag	Lead	Lag	Lead	Lead	Lag	Lead	Lead	Lag	Lead	Lag	Lead
Lead-Lag Optimize?	Yes	Yes	Yes	Yes	Yes	Yes	Yes	Yes	Yes	Yes	Yes
Recall Mode	None	None	None	None	None	None	None	None	None	None	None
Act Effct Green (s)	10.3	38.6	55.1	8.3	36.6	56.1	10.3	34.8	17.0	41.5	54.3
Actuated g/C Ratio	0.09	0.33	0.46	0.07	0.31	0.47	0.09	0.29	0.14	0.35	0.46
v/c Ratio	1.56	0.95	0.15	1.61	1.30	0.75	1.80	0.91	1.08	0.47	0.51
Control Delay	305.4	52.5	5.9	345.1	173.6	27.9	417.5	52.8	110.8	31.4	19.3
Queue Delay	0.0	0.0	0.0	0.0	0.0	0.0	0.0	0.0	0.0	0.0	0.0
Total Delay	305.4	52.5	5.9	345.1	173.6	27.9	417.5	52.8	110.8	31.4	19.3
LOS	F	D	A	F	F	C	F	D	F	C	B
Approach Delay		105.0			155.9			135.8		56.6	
Approach LOS		F			F			F		E	

Intersection Summary

Cycle Length: 120
 Actuated Cycle Length: 118.5
 Natural Cycle: 125
 Control Type: Actuated-Uncoordinated
 Maximum v/c Ratio: 1.80
 Intersection Signal Delay: 119.0
 Intersection Capacity Utilization 102.2%
 Analysis Period (min) 15
 Intersection LOS: F
 ICU Level of Service G



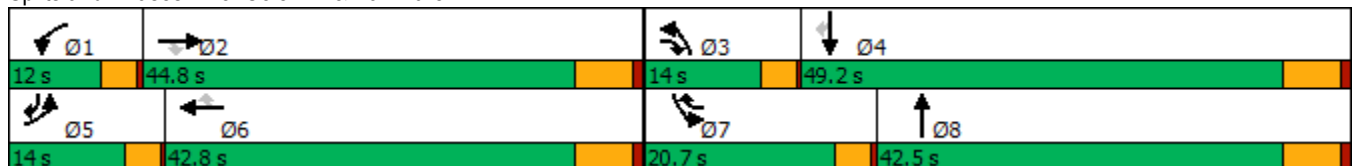



























Splits and Phases: 8: Cole Av. & Van Buren Bl.



HCM 6th Signalized Intersection Summary
8: Cole Av. & Van Buren Bl.

West Campus Upper Plateau (JN 14064)

09/19/2022

												
Movement	EBL	EBT	EBR	WBL	WBT	WBR	NBL	NBT	NBR	SBL	SBT	SBR
Lane Configurations	 	  			  			 		 	 	
Traffic Volume (veh/h)	419	1401	106	183	1834	525	247	676	161	482	534	342
Future Volume (veh/h)	419	1401	106	183	1834	525	247	676	161	482	534	342
Initial Q (Qb), veh	0	0	0	0	0	0	0	0	0	0	0	0
Ped-Bike Adj(A_pbT)	1.00		1.00	1.00		0.99	1.00		1.00	1.00		1.00
Parking Bus, Adj	1.00	1.00	1.00	1.00	1.00	1.00	1.00	1.00	1.00	1.00	1.00	1.00
Work Zone On Approach		No			No			No			No	
Adj Sat Flow, veh/h/ln	1870	1856	1841	1900	1870	1870	1856	1870	1870	1885	1885	1856
Adj Flow Rate, veh/h	466	1557	77	203	2038	493	274	751	170	536	593	308
Peak Hour Factor	0.90	0.90	0.90	0.90	0.90	0.90	0.90	0.90	0.90	0.90	0.90	0.90
Percent Heavy Veh, %	2	3	4	0	2	2	3	2	2	1	1	3
Cap, veh/h	303	1663	649	128	1590	716	155	829	188	504	1236	679
Arrive On Green	0.09	0.33	0.33	0.07	0.31	0.31	0.09	0.29	0.29	0.14	0.35	0.35
Sat Flow, veh/h	3456	5066	1560	1810	5106	1565	1767	2878	651	3483	3582	1570
Grp Volume(v), veh/h	466	1557	77	203	2038	493	274	464	457	536	593	308
Grp Sat Flow(s),veh/h/ln	1728	1689	1560	1810	1702	1565	1767	1777	1752	1742	1791	1570
Q Serve(g_s), s	10.3	35.0	3.6	8.3	36.6	29.4	10.3	29.6	29.6	17.0	15.3	16.3
Cycle Q Clear(g_c), s	10.3	35.0	3.6	8.3	36.6	29.4	10.3	29.6	29.6	17.0	15.3	16.3
Prop In Lane	1.00		1.00	1.00		1.00	1.00		0.37	1.00		1.00
Lane Grp Cap(c), veh/h	303	1663	649	128	1590	716	155	512	505	504	1236	679
V/C Ratio(X)	1.54	0.94	0.12	1.59	1.28	0.69	1.77	0.91	0.91	1.06	0.48	0.45
Avail Cap(c_a), veh/h	303	1663	649	128	1590	716	155	549	541	504	1310	712
HCM Platoon Ratio	1.00	1.00	1.00	1.00	1.00	1.00	1.00	1.00	1.00	1.00	1.00	1.00
Upstream Filter(I)	1.00	1.00	1.00	1.00	1.00	1.00	1.00	1.00	1.00	1.00	1.00	1.00
Uniform Delay (d), s/veh	53.6	38.3	21.1	54.6	40.5	25.4	53.6	40.3	40.3	50.3	30.2	23.5
Incr Delay (d2), s/veh	258.6	10.6	0.1	298.8	131.9	3.1	371.3	18.0	18.2	58.3	0.3	0.5
Initial Q Delay(d3),s/veh	0.0	0.0	0.0	0.0	0.0	0.0	0.0	0.0	0.0	0.0	0.0	0.0
%ile BackOfQ(50%),veh/ln	15.8	18.6	4.0	14.8	36.7	25.5	21.0	17.7	17.5	12.3	9.7	15.8
Unsig. Movement Delay, s/veh												
LnGrp Delay(d),s/veh	312.2	48.9	21.2	353.4	172.4	28.5	425.0	58.3	58.5	108.6	30.5	24.0
LnGrp LOS	F	D	C	F	F	C	F	E	E	F	C	C
Approach Vol, veh/h		2100			2734			1195			1437	
Approach Delay, s/veh		106.3			159.9			142.5			58.2	
Approach LOS		F			F			F			E	
Timer - Assigned Phs	1	2	3	4	5	6	7	8				
Phs Duration (G+Y+Rc), s	12.0	44.8	14.0	46.8	14.0	42.8	20.7	40.1				
Change Period (Y+Rc), s	3.7	6.2	3.7	6.2	3.7	6.2	3.7	6.2				
Max Green Setting (Gmax), s	8.3	38.6	10.3	43.0	10.3	36.6	17.0	36.3				
Max Q Clear Time (g_c+I1), s	10.3	37.0	12.3	18.3	12.3	38.6	19.0	31.6				
Green Ext Time (p_c), s	0.0	1.4	0.0	4.7	0.0	0.0	0.0	2.2				
Intersection Summary												
HCM 6th Ctrl Delay	122.5											
HCM 6th LOS	F											

Timings
10: Orange Terrace Pkwy & Deercreek Dr

West Campus Upper Plateau (JN 14064)

09/19/2022

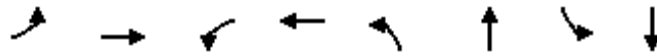

Lane Group	EBL	EBT	WBL	WBT	NBL	NBT	SBL	SBT
Lane Configurations	↖	↕	↖	↕		↕		↕
Traffic Volume (vph)	252	501	4	634	179	44	94	35
Future Volume (vph)	252	501	4	634	179	44	94	35
Turn Type	Perm	NA	Perm	NA	Perm	NA	Perm	NA
Protected Phases		4		8		2		6
Permitted Phases	4		8		2		6	
Detector Phase	4	4	8	8	2	2	6	6
Switch Phase								
Minimum Initial (s)	5.0	5.0	5.0	5.0	5.0	5.0	5.0	5.0
Minimum Split (s)	26.1	26.1	26.1	26.1	26.1	26.1	26.1	26.1
Total Split (s)	63.4	63.4	63.4	63.4	26.6	26.6	26.6	26.6
Total Split (%)	70.4%	70.4%	70.4%	70.4%	29.6%	29.6%	29.6%	29.6%
Yellow Time (s)	3.6	3.6	3.6	3.6	3.6	3.6	3.6	3.6
All-Red Time (s)	0.5	0.5	0.5	0.5	0.5	0.5	0.5	0.5
Lost Time Adjust (s)	0.0	0.0	0.0	0.0		0.0		0.0
Total Lost Time (s)	4.1	4.1	4.1	4.1		4.1		4.1
Lead/Lag								
Lead-Lag Optimize?								
Recall Mode	None	None	None	None	Min	Min	Min	Min
Act Effct Green (s)	59.3	59.3	59.3	59.3		22.5		22.5
Actuated g/C Ratio	0.66	0.66	0.66	0.66		0.25		0.25
v/c Ratio	0.99	0.32	0.01	0.39		1.04		0.62
Control Delay	65.1	6.8	5.5	7.5		98.7		36.2
Queue Delay	0.0	0.0	0.0	0.0		0.0		0.0
Total Delay	65.1	6.8	5.5	7.5		98.7		36.2
LOS	E	A	A	A		F		D
Approach Delay		25.2		7.4		98.7		36.2
Approach LOS		C		A		F		D

Intersection Summary

Cycle Length: 90
 Actuated Cycle Length: 90
 Natural Cycle: 90
 Control Type: Actuated-Uncoordinated
 Maximum v/c Ratio: 1.04
 Intersection Signal Delay: 28.6
 Intersection LOS: C
 Intersection Capacity Utilization 61.7%
 ICU Level of Service B
 Analysis Period (min) 15

Splits and Phases: 10: Orange Terrace Pkwy & Deercreek Dr



HCM 6th Signalized Intersection Summary
 10: Orange Terrace Pkwy & Deercreek Dr

West Campus Upper Plateau (JN 14064)

09/19/2022



Movement	EBL	EBT	EBR	WBL	WBT	WBR	NBL	NBT	NBR	SBL	SBT	SBR
Lane Configurations												
Traffic Volume (veh/h)	252	501	47	4	634	58	179	44	7	94	35	42
Future Volume (veh/h)	252	501	47	4	634	58	179	44	7	94	35	42
Initial Q (Qb), veh	0	0	0	0	0	0	0	0	0	0	0	0
Ped-Bike Adj(A_pbT)	1.00		0.97	1.00		1.00	1.00		0.99	1.00		0.97
Parking Bus, Adj	1.00	1.00	1.00	1.00	1.00	1.00	1.00	1.00	1.00	1.00	1.00	1.00
Work Zone On Approach		No			No			No				No
Adj Sat Flow, veh/h/ln	1900	1870	1900	1900	1900	1885	1885	1900	1900	1900	1856	1870
Adj Flow Rate, veh/h	336	668	63	5	845	77	239	59	9	125	47	56
Peak Hour Factor	0.75	0.75	0.75	0.75	0.75	0.75	0.75	0.75	0.75	0.75	0.75	0.75
Percent Heavy Veh, %	0	2	0	0	0	1	1	0	0	0	3	2
Cap, veh/h	415	2157	203	500	2205	201	329	64	10	263	100	98
Arrive On Green	0.66	0.66	0.66	0.66	0.66	0.66	0.25	0.25	0.25	0.25	0.25	0.25
Sat Flow, veh/h	616	3273	308	735	3345	305	1033	255	39	806	401	393
Grp Volume(v), veh/h	336	362	369	5	456	466	307	0	0	228	0	0
Grp Sat Flow(s),veh/h/ln	616	1777	1805	735	1805	1845	1326	0	0	1600	0	0
Q Serve(g_s), s	48.9	7.9	7.9	0.3	10.4	10.4	9.5	0.0	0.0	0.0	0.0	0.0
Cycle Q Clear(g_c), s	59.3	7.9	7.9	8.1	10.4	10.4	20.5	0.0	0.0	11.0	0.0	0.0
Prop In Lane	1.00		0.17	1.00		0.17	0.78		0.03	0.55		0.25
Lane Grp Cap(c), veh/h	415	1171	1189	500	1190	1216	403	0	0	462	0	0
V/C Ratio(X)	0.81	0.31	0.31	0.01	0.38	0.38	0.76	0.00	0.00	0.49	0.00	0.00
Avail Cap(c_a), veh/h	415	1171	1189	500	1190	1216	403	0	0	462	0	0
HCM Platoon Ratio	1.00	1.00	1.00	1.00	1.00	1.00	1.00	1.00	1.00	1.00	1.00	1.00
Upstream Filter(I)	1.00	1.00	1.00	1.00	1.00	1.00	1.00	0.00	0.00	1.00	0.00	0.00
Uniform Delay (d), s/veh	20.6	6.6	6.6	8.3	7.0	7.0	33.3	0.0	0.0	29.4	0.0	0.0
Incr Delay (d2), s/veh	11.4	0.1	0.1	0.0	0.2	0.2	8.4	0.0	0.0	0.8	0.0	0.0
Initial Q Delay(d3),s/veh	0.0	0.0	0.0	0.0	0.0	0.0	0.0	0.0	0.0	0.0	0.0	0.0
%ile BackOfQ(50%),veh/ln	9.7	9.1	9.3	0.1	11.5	11.7	8.6	0.0	0.0	5.8	0.0	0.0
Unsig. Movement Delay, s/veh												
LnGrp Delay(d),s/veh	32.0	6.7	6.7	8.3	7.2	7.2	41.6	0.0	0.0	30.2	0.0	0.0
LnGrp LOS	C	A	A	A	A	A	D	A	A	C	A	A
Approach Vol, veh/h		1067			927			307				228
Approach Delay, s/veh		14.7			7.2			41.6				30.2
Approach LOS		B			A			D				C
Timer - Assigned Phs		2		4		6		8				
Phs Duration (G+Y+Rc), s		26.6		63.4		26.6		63.4				
Change Period (Y+Rc), s		4.1		4.1		4.1		4.1				
Max Green Setting (Gmax), s		22.5		59.3		22.5		59.3				
Max Q Clear Time (g_c+I1), s		22.5		61.3		13.0		12.4				
Green Ext Time (p_c), s		0.0		0.0		0.9		7.9				

Intersection Summary

HCM 6th Ctrl Delay	16.6
HCM 6th LOS	B

Timings

11: Barton St & Alessandro Bl.

09/19/2022

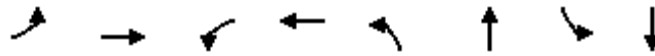

Lane Group	EBL	EBT	WBL	WBT	NBL	NBT	SBL	SBT
Lane Configurations	↖	↗	↖	↗	↖	↗	↖	↗
Traffic Volume (vph)	7	1804	41	3025	86	1	10	0
Future Volume (vph)	7	1804	41	3025	86	1	10	0
Turn Type	Prot	NA	Prot	NA	Perm	NA	Perm	NA
Protected Phases	5	2	1	6		8		4
Permitted Phases					8		4	
Detector Phase	5	2	1	6	8	8	4	4
Switch Phase								
Minimum Initial (s)	5.0	10.0	5.0	10.0	10.0	10.0	10.0	10.0
Minimum Split (s)	9.2	28.5	11.0	28.5	40.6	40.6	26.6	26.6
Total Split (s)	9.2	61.4	18.0	70.2	40.6	40.6	40.6	40.6
Total Split (%)	7.7%	51.2%	15.0%	58.5%	33.8%	33.8%	33.8%	33.8%
Yellow Time (s)	3.2	5.5	3.2	5.5	3.6	3.6	3.6	3.6
All-Red Time (s)	1.0	1.0	1.0	1.0	1.0	1.0	1.0	1.0
Lost Time Adjust (s)	0.0	0.0	0.0	0.0	0.0	0.0	0.0	0.0
Total Lost Time (s)	4.2	6.5	4.2	6.5	4.6	4.6	4.6	4.6
Lead/Lag	Lead	Lag	Lead	Lag				
Lead-Lag Optimize?	Yes	Yes	Yes	Yes				
Recall Mode	None	None	None	None	Max	Max	Max	Max
Act Effct Green (s)	5.0	57.4	7.3	65.2	36.0	36.0	36.0	36.0
Actuated g/C Ratio	0.04	0.50	0.06	0.57	0.32	0.32	0.32	0.32
v/c Ratio	0.10	0.76	0.37	1.09	0.20	0.11	0.03	0.02
Control Delay	57.4	25.8	60.8	70.9	30.9	8.4	28.9	0.1
Queue Delay	0.0	0.0	0.0	0.0	0.0	0.0	0.0	0.0
Total Delay	57.4	25.8	60.8	70.9	30.9	8.4	28.9	0.1
LOS	E	C	E	E	C	A	C	A
Approach Delay		25.9		70.8		22.1		15.3
Approach LOS		C		E		C		B

Intersection Summary

Cycle Length: 120
 Actuated Cycle Length: 114.1
 Natural Cycle: 125
 Control Type: Actuated-Uncoordinated
 Maximum v/c Ratio: 1.09
 Intersection Signal Delay: 52.9
 Intersection LOS: D
 Intersection Capacity Utilization 97.9%
 ICU Level of Service F
 Analysis Period (min) 15

Splits and Phases: 11: Barton St & Alessandro Bl.



HCM 6th Signalized Intersection Summary
11: Barton St & Alessandro Bl.

West Campus Upper Plateau (JN 14064)

09/19/2022



Movement	EBL	EBT	EBR	WBL	WBT	WBR	NBL	NBT	NBR	SBL	SBT	SBR
Lane Configurations	↖	↑↑↑		↖	↑↑↑		↖	↑		↖	↑	
Traffic Volume (veh/h)	7	1804	51	41	3025	8	86	1	55	10	0	9
Future Volume (veh/h)	7	1804	51	41	3025	8	86	1	55	10	0	9
Initial Q (Qb), veh	0	0	0	0	0	0	0	0	0	0	0	0
Ped-Bike Adj(A_pbT)	1.00		0.98	1.00		1.00	1.00		1.00	1.00		1.00
Parking Bus, Adj	1.00	1.00	1.00	1.00	1.00	1.00	1.00	1.00	1.00	1.00	1.00	1.00
Work Zone On Approach		No			No			No			No	
Adj Sat Flow, veh/h/ln	1663	1870	1885	1900	1870	1678	1900	1900	1885	1426	1900	1307
Adj Flow Rate, veh/h	7	1879	50	43	3151	8	90	1	27	10	0	4
Peak Hour Factor	0.96	0.96	0.96	0.96	0.96	0.96	0.96	0.96	0.96	0.96	0.96	0.96
Percent Heavy Veh, %	16	2	1	0	2	15	0	0	1	32	0	40
Cap, veh/h	14	2685	71	58	2887	7	505	18	484	376	0	500
Arrive On Green	0.01	0.53	0.53	0.03	0.55	0.55	0.31	0.31	0.31	0.31	0.00	0.31
Sat Flow, veh/h	1584	5111	136	1810	5259	13	1435	58	1560	1053	0	1610
Grp Volume(v), veh/h	7	1251	678	43	2039	1120	90	0	28	10	0	4
Grp Sat Flow(s),veh/h/ln	1584	1702	1842	1810	1702	1868	1435	0	1617	1053	0	1610
Q Serve(g_s), s	0.5	32.0	32.1	2.7	63.7	63.7	5.4	0.0	1.4	0.8	0.0	0.2
Cycle Q Clear(g_c), s	0.5	32.0	32.1	2.7	63.7	63.7	5.6	0.0	1.4	2.2	0.0	0.2
Prop In Lane	1.00		0.07	1.00		0.01	1.00		0.96	1.00		1.00
Lane Grp Cap(c), veh/h	14	1789	968	58	1869	1026	505	0	502	376	0	500
V/C Ratio(X)	0.51	0.70	0.70	0.74	1.09	1.09	0.18	0.00	0.06	0.03	0.00	0.01
Avail Cap(c_a), veh/h	68	1789	968	215	1869	1026	505	0	502	376	0	500
HCM Platoon Ratio	1.00	1.00	1.00	1.00	1.00	1.00	1.00	1.00	1.00	1.00	1.00	1.00
Upstream Filter(I)	1.00	1.00	1.00	1.00	1.00	1.00	1.00	0.00	1.00	1.00	0.00	1.00
Uniform Delay (d), s/veh	57.3	20.6	20.7	55.6	26.2	26.2	29.6	0.0	28.1	28.8	0.0	27.7
Incr Delay (d2), s/veh	10.3	1.4	2.5	6.5	50.2	56.7	0.8	0.0	0.2	0.1	0.0	0.0
Initial Q Delay(d3),s/veh	0.0	0.0	0.0	0.0	0.0	0.0	0.0	0.0	0.0	0.0	0.0	0.0
%ile BackOfQ(50%),veh/ln	0.0	0.3	0.7	0.1	13.0	16.2	0.1	0.0	0.0	0.0	0.0	0.0
Unsig. Movement Delay, s/veh												
LnGrp Delay(d),s/veh	67.6	22.0	23.2	62.1	76.4	82.8	30.4	0.0	28.3	29.0	0.0	27.7
LnGrp LOS	E	C	C	E	F	F	C	A	C	C	A	C
Approach Vol, veh/h		1936			3202			118				14
Approach Delay, s/veh		22.6			78.5			29.9				28.6
Approach LOS		C			E			C				C
Timer - Assigned Phs	1	2		4	5	6		8				
Phs Duration (G+Y+Rc), s	7.9	67.5		40.6	5.2	70.2		40.6				
Change Period (Y+Rc), s	* 4.2	6.5		4.6	* 4.2	6.5		4.6				
Max Green Setting (Gmax), s	* 14	54.9		36.0	* 5	63.7		36.0				
Max Q Clear Time (g_c+I1), s	4.7	34.1		4.2	2.5	65.7		7.6				
Green Ext Time (p_c), s	0.0	15.7		0.0	0.0	0.0		0.4				

Intersection Summary

HCM 6th Ctrl Delay	56.7
HCM 6th LOS	E

Notes

* HCM 6th computational engine requires equal clearance times for the phases crossing the barrier.

Timings
13: Barton Rd. & Orange Terrace Pkwy

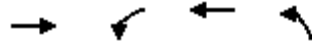

Lane Group	EBT	WBL	WBT	NBL
Lane Configurations	↑↑	↑	↑↑	↑
Traffic Volume (vph)	312	51	459	236
Future Volume (vph)	312	51	459	236
Turn Type	NA	Perm	NA	Prot
Protected Phases	4		8	2
Permitted Phases		8		
Detector Phase	4	8	8	2
Switch Phase				
Minimum Initial (s)	5.0	5.0	5.0	5.0
Minimum Split (s)	26.1	26.1	26.1	26.1
Total Split (s)	27.0	27.0	27.0	28.0
Total Split (%)	49.1%	49.1%	49.1%	50.9%
Yellow Time (s)	3.6	3.6	3.6	3.6
All-Red Time (s)	0.5	0.5	0.5	0.5
Lost Time Adjust (s)	0.0	0.0	0.0	0.0
Total Lost Time (s)	4.1	4.1	4.1	4.1
Lead/Lag				
Lead-Lag Optimize?				
Recall Mode	Max	Max	Max	Max
Act Effct Green (s)	22.9	22.9	22.9	23.9
Actuated g/C Ratio	0.42	0.42	0.42	0.43
v/c Ratio	0.48	0.29	0.39	0.44
Control Delay	6.9	15.0	12.1	12.4
Queue Delay	0.0	0.0	0.0	0.0
Total Delay	6.9	15.0	12.1	12.4
LOS	A	B	B	B
Approach Delay	6.9		12.4	12.4
Approach LOS	A		B	B

Intersection Summary

Cycle Length: 55
 Actuated Cycle Length: 55
 Offset: 0 (0%), Referenced to phase 2:NBL and 6:, Start of Yellow
 Natural Cycle: 55
 Control Type: Pretimed
 Maximum v/c Ratio: 0.48
 Intersection Signal Delay: 10.0
 Intersection Capacity Utilization 47.7%
 Analysis Period (min) 15

Intersection LOS: B
 ICU Level of Service A

Splits and Phases: 13: Barton Rd. & Orange Terrace Pkwy

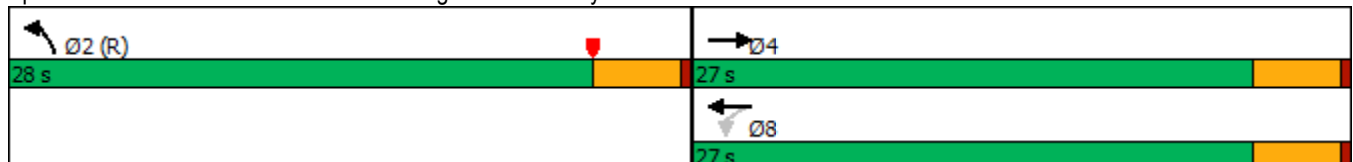

HCM 6th Signalized Intersection Summary
 13: Barton Rd. & Orange Terrace Pkwy

West Campus Upper Plateau (JN 14064)

09/19/2022

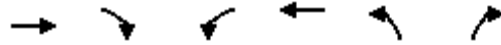

Movement	EBT	EBR	WBL	WBT	NBL	NBR
Lane Configurations	↑↑		↵	↑↑	↵	
Traffic Volume (veh/h)	312	289	51	459	236	38
Future Volume (veh/h)	312	289	51	459	236	38
Initial Q (Qb), veh	0	0	0	0	0	0
Ped-Bike Adj(A_pbT)		0.98	1.00		1.00	1.00
Parking Bus, Adj	1.00	1.00	1.00	1.00	1.00	1.00
Work Zone On Approach	No			No	No	
Adj Sat Flow, veh/h/ln	1856	1900	1870	1885	1900	1900
Adj Flow Rate, veh/h	390	361	64	574	295	48
Peak Hour Factor	0.80	0.80	0.80	0.80	0.80	0.80
Percent Heavy Veh, %	3	0	2	1	0	0
Cap, veh/h	734	640	300	1491	663	108
Arrive On Green	0.42	0.42	0.42	0.42	0.43	0.43
Sat Flow, veh/h	1856	1538	712	3676	1526	248
Grp Volume(v), veh/h	390	361	64	574	344	0
Grp Sat Flow(s),veh/h/ln	1763	1538	712	1791	1779	0
Q Serve(g_s), s	9.1	9.8	4.1	6.1	7.5	0.0
Cycle Q Clear(g_c), s	9.1	9.8	14.0	6.1	7.5	0.0
Prop In Lane		1.00	1.00		0.86	0.14
Lane Grp Cap(c), veh/h	734	640	300	1491	773	0
V/C Ratio(X)	0.53	0.56	0.21	0.38	0.44	0.00
Avail Cap(c_a), veh/h	734	640	300	1491	773	0
HCM Platoon Ratio	1.00	1.00	1.00	1.00	1.00	1.00
Upstream Filter(I)	1.00	1.00	1.00	1.00	1.00	0.00
Uniform Delay (d), s/veh	12.0	12.2	17.6	11.2	10.9	0.0
Incr Delay (d2), s/veh	2.7	3.6	1.6	0.8	1.9	0.0
Initial Q Delay(d3),s/veh	0.0	0.0	0.0	0.0	0.0	0.0
%ile BackOfQ(50%),veh/ln	6.5	6.1	1.1	4.5	5.6	0.0
Unsig. Movement Delay, s/veh						
LnGrp Delay(d),s/veh	14.8	15.8	19.2	11.9	12.8	0.0
LnGrp LOS	B	B	B	B	B	A
Approach Vol, veh/h	751			638	344	
Approach Delay, s/veh	15.3			12.6	12.8	
Approach LOS	B			B	B	
Timer - Assigned Phs		2		4		8
Phs Duration (G+Y+Rc), s		28.0		27.0		27.0
Change Period (Y+Rc), s		4.1		4.1		4.1
Max Green Setting (Gmax), s		23.9		22.9		22.9
Max Q Clear Time (g_c+I1), s		9.5		11.8		16.0
Green Ext Time (p_c), s		0.9		3.8		2.4

Intersection Summary

HCM 6th Ctrl Delay	13.8
HCM 6th LOS	B

Notes

User approved volume balancing among the lanes for turning movement.

Timings
14: Barton Rd. & Van Buren Bl.

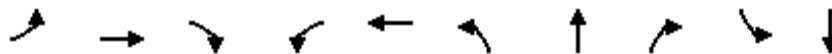

Lane Group	EBL	EBT	EBR	WBL	WBT	NBL	NBT	NBR	SBL	SBT
Lane Configurations	↙	↑↑↑	↗	↙↗	↑↑↑	↙↗	↑	↗	↙	↘
Traffic Volume (vph)	175	1725	215	290	2000	469	83	404	65	129
Future Volume (vph)	175	1725	215	290	2000	469	83	404	65	129
Turn Type	Prot	NA	pm+ov	Prot	NA	Prot	NA	Perm	Prot	NA
Protected Phases	5	2	3	1	6	3	8		7	4
Permitted Phases			2					8		
Detector Phase	5	2	3	1	6	3	8	8	7	4
Switch Phase										
Minimum Initial (s)	5.0	10.0	5.0	5.0	10.0	5.0	10.0	10.0	5.0	10.0
Minimum Split (s)	9.2	25.2	9.1	9.2	25.5	9.1	14.6	14.6	9.1	33.6
Total Split (s)	16.0	50.4	20.0	16.0	50.4	20.0	42.0	42.0	11.6	33.6
Total Split (%)	13.3%	42.0%	16.7%	13.3%	42.0%	16.7%	35.0%	35.0%	9.7%	28.0%
Yellow Time (s)	3.2	5.2	3.6	3.2	5.5	3.6	3.6	3.6	3.6	3.6
All-Red Time (s)	1.0	1.0	0.5	1.0	1.0	0.5	1.0	1.0	0.5	1.0
Lost Time Adjust (s)	0.0	0.0	0.0	0.0	0.0	0.0	0.0	0.0	0.0	0.0
Total Lost Time (s)	4.2	6.2	4.1	4.2	6.5	4.1	4.6	4.6	4.1	4.6
Lead/Lag	Lead	Lag	Lead	Lead	Lag	Lead	Lag	Lag	Lead	Lag
Lead-Lag Optimize?	Yes	Yes	Yes	Yes	Yes	Yes	Yes	Yes	Yes	Yes
Recall Mode	None	None	None	None	None	None	None	None	None	None
Act Effct Green (s)	11.8	44.2	66.3	11.8	43.9	15.9	39.7	39.7	7.4	29.0
Actuated g/C Ratio	0.10	0.37	0.55	0.10	0.37	0.13	0.33	0.33	0.06	0.24
v/c Ratio	1.14	0.96	0.27	0.99	1.15	1.19	0.15	0.68	0.68	1.13
Control Delay	157.2	50.3	10.4	100.4	108.6	149.4	30.4	23.1	84.9	116.6
Queue Delay	0.0	0.0	0.0	0.0	0.0	0.0	0.0	0.0	0.0	0.0
Total Delay	157.2	50.3	10.4	100.4	108.6	149.4	30.4	23.1	84.9	116.6
LOS	F	D	B	F	F	F	C	C	F	F
Approach Delay		55.1			107.5		85.8			112.8
Approach LOS		E			F		F			F

Intersection Summary

Cycle Length: 120
 Actuated Cycle Length: 120
 Natural Cycle: 130
 Control Type: Actuated-Uncoordinated
 Maximum v/c Ratio: 1.19
 Intersection Signal Delay: 85.8
 Intersection LOS: F
 Intersection Capacity Utilization 107.1%
 ICU Level of Service G
 Analysis Period (min) 15

Splits and Phases: 14: Barton Rd. & Van Buren Bl.

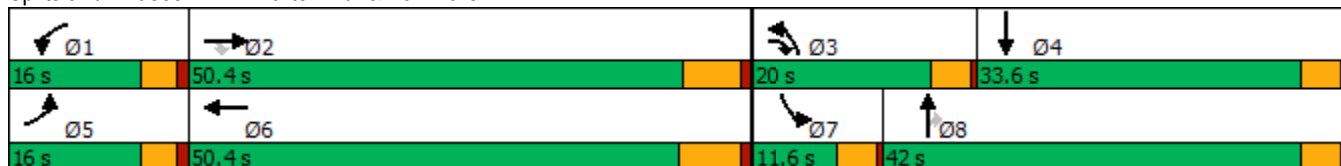

HCM 6th Signalized Intersection Summary
14: Barton Rd. & Van Buren Bl.

West Campus Upper Plateau (JN 14064)

09/19/2022



Movement	EBL	EBT	EBR	WBL	WBT	WBR	NBL	NBT	NBR	SBL	SBT	SBR
Lane Configurations	↘	↑↑↑	↗	↘↗	↑↑↑		↘↗	↑	↗	↘	↗	↘
Traffic Volume (veh/h)	175	1725	215	290	2000	34	469	83	404	65	129	352
Future Volume (veh/h)	175	1725	215	290	2000	34	469	83	404	65	129	352
Initial Q (Qb), veh	0	0	0	0	0	0	0	0	0	0	0	0
Ped-Bike Adj(A_pbT)	1.00		1.00	1.00		1.00	1.00		1.00	1.00		1.00
Parking Bus, Adj	1.00	1.00	1.00	1.00	1.00	1.00	1.00	1.00	1.00	1.00	1.00	1.00
Work Zone On Approach		No			No			No			No	
Adj Sat Flow, veh/h/ln	1900	1870	1870	1870	1870	1752	1870	1885	1885	1900	1870	1900
Adj Flow Rate, veh/h	201	1983	234	333	2299	33	539	95	248	75	148	238
Peak Hour Factor	0.87	0.87	0.87	0.87	0.87	0.87	0.87	0.87	0.87	0.87	0.87	0.87
Percent Heavy Veh, %	0	2	2	2	2	10	2	1	1	0	2	0
Cap, veh/h	178	2059	791	339	2025	29	457	604	512	96	156	250
Arrive On Green	0.10	0.37	0.37	0.10	0.37	0.37	0.13	0.32	0.32	0.05	0.24	0.24
Sat Flow, veh/h	1810	5611	1585	3456	5518	79	3456	1885	1598	1810	645	1038
Grp Volume(v), veh/h	201	1983	234	333	1557	775	539	95	248	75	0	386
Grp Sat Flow(s),veh/h/ln	1810	1870	1585	1728	1870	1856	1728	1885	1598	1810	0	1684
Q Serve(g_s), s	11.8	41.6	10.4	11.6	44.1	44.1	15.9	4.3	15.0	4.9	0.0	27.1
Cycle Q Clear(g_c), s	11.8	41.6	10.4	11.6	44.1	44.1	15.9	4.3	15.0	4.9	0.0	27.1
Prop In Lane	1.00		1.00	1.00		0.04	1.00		1.00	1.00		0.62
Lane Grp Cap(c), veh/h	178	2059	791	339	1373	681	457	604	512	96	0	406
V/C Ratio(X)	1.13	0.96	0.30	0.98	1.13	1.14	1.18	0.16	0.48	0.78	0.00	0.95
Avail Cap(c_a), veh/h	178	2063	792	339	1373	681	457	604	512	113	0	406
HCM Platoon Ratio	1.00	1.00	1.00	1.00	1.00	1.00	1.00	1.00	1.00	1.00	1.00	1.00
Upstream Filter(I)	1.00	1.00	1.00	1.00	1.00	1.00	1.00	1.00	1.00	1.00	0.00	1.00
Uniform Delay (d), s/veh	54.2	37.3	17.7	54.1	38.0	38.1	52.2	29.2	32.8	56.2	0.0	44.9
Incr Delay (d2), s/veh	107.3	12.2	0.1	43.6	70.1	79.0	101.3	0.1	0.7	25.5	0.0	32.1
Initial Q Delay(d3),s/veh	0.0	0.0	0.0	0.0	0.0	0.0	0.0	0.0	0.0	0.0	0.0	0.0
%ile BackOfQ(50%),veh/ln	5.3	2.3	0.0	2.1	13.4	15.0	6.4	0.0	0.1	0.7	0.0	3.6
Unsig. Movement Delay, s/veh												
LnGrp Delay(d),s/veh	161.5	49.5	17.8	97.7	108.1	117.1	153.4	29.3	33.6	81.7	0.0	77.0
LnGrp LOS	F	D	B	F	F	F	F	C	C	F	A	E
Approach Vol, veh/h		2418			2665			882				461
Approach Delay, s/veh		55.7			109.4			106.4				77.8
Approach LOS		E			F			F				E
Timer - Assigned Phs	1	2	3	4	5	6	7	8				
Phs Duration (G+Y+Rc), s	16.0	50.6	20.0	33.6	16.0	50.6	10.5	43.1				
Change Period (Y+Rc), s	* 4.2	* 6.5	4.1	4.6	* 4.2	6.5	4.1	4.6				
Max Green Setting (Gmax), s	* 12	* 44	15.9	29.0	* 12	43.9	7.5	37.4				
Max Q Clear Time (g_c+I1), s	13.6	43.6	17.9	29.1	13.8	46.1	6.9	17.0				
Green Ext Time (p_c), s	0.0	0.5	0.0	0.0	0.0	0.0	0.0	1.2				

Intersection Summary

HCM 6th Ctrl Delay	86.5
HCM 6th LOS	F

Notes

* HCM 6th computational engine requires equal clearance times for the phases crossing the barrier.

Timings
25: Sycamore Canyon Bl. & Cactus Av.

West Campus Upper Plateau (JN 14064)

09/19/2022



Lane Group	EBL	EBT	WBL	WBT	WBR	NBL	NBT	NBR	SBL	SBT	SBR
Lane Configurations	↘	↗↗↗	↘↘	↗↗	↗	↘↘	↗↗	↗	↘↘	↗↗	↗
Traffic Volume (vph)	46	202	758	661	1055	188	483	301	197	312	76
Future Volume (vph)	46	202	758	661	1055	188	483	301	197	312	76
Turn Type	Prot	NA	Prot	NA	Perm	Prot	NA	Perm	Prot	NA	Perm
Protected Phases	7	4	3	8		5	2		1	6	
Permitted Phases					8			2			6
Detector Phase	7	4	3	8	8	5	2	2	1	6	6
Switch Phase											
Minimum Initial (s)	5.0	10.0	5.0	10.0	10.0	5.0	10.0	10.0	5.0	10.0	10.0
Minimum Split (s)	9.6	32.8	9.6	32.8	32.8	9.6	34.8	34.8	9.6	34.8	34.8
Total Split (s)	9.9	43.5	47.4	81.0	81.0	13.4	35.7	35.7	13.4	35.7	35.7
Total Split (%)	7.1%	31.1%	33.9%	57.9%	57.9%	9.6%	25.5%	25.5%	9.6%	25.5%	25.5%
Yellow Time (s)	3.6	4.8	3.6	4.8	4.8	3.6	4.8	4.8	3.6	4.8	4.8
All-Red Time (s)	1.0	1.0	1.0	1.0	1.0	1.0	1.0	1.0	1.0	1.0	1.0
Lost Time Adjust (s)	0.0	0.0	0.0	0.0	0.0	0.0	0.0	0.0	0.0	0.0	0.0
Total Lost Time (s)	4.6	5.8	4.6	5.8	5.8	4.6	5.8	5.8	4.6	5.8	5.8
Lead/Lag	Lead	Lag	Lead	Lag	Lag	Lead	Lag	Lag	Lead	Lag	Lag
Lead-Lag Optimize?	Yes	Yes	Yes	Yes	Yes	Yes	Yes	Yes	Yes	Yes	Yes
Recall Mode	None	None	None	None	None	None	None	None	None	None	None
Act Effct Green (s)	5.3	43.0	35.6	75.5	75.5	8.8	25.1	25.1	8.8	25.1	25.1
Actuated g/C Ratio	0.04	0.32	0.27	0.57	0.57	0.07	0.19	0.19	0.07	0.19	0.19
v/c Ratio	0.73	0.20	0.90	0.38	1.09	0.88	0.78	0.57	0.90	0.49	0.20
Control Delay	118.8	26.4	60.9	17.7	80.0	98.4	60.7	9.3	101.8	51.1	1.9
Queue Delay	0.0	0.0	0.0	0.0	3.4	0.0	0.0	0.0	0.0	0.0	0.0
Total Delay	118.8	26.4	60.9	17.7	83.4	98.4	60.7	9.3	101.8	51.1	1.9
LOS	F	C	E	B	F	F	E	A	F	D	A
Approach Delay		39.1		59.0			52.1			61.8	
Approach LOS		D		E			D			E	

Intersection Summary

Cycle Length: 140
 Actuated Cycle Length: 133.4
 Natural Cycle: 130
 Control Type: Actuated-Uncoordinated
 Maximum v/c Ratio: 1.09
 Intersection Signal Delay: 56.3
 Intersection LOS: E
 Intersection Capacity Utilization 96.3%
 ICU Level of Service F
 Analysis Period (min) 15

Splits and Phases: 25: Sycamore Canyon Bl. & Cactus Av.

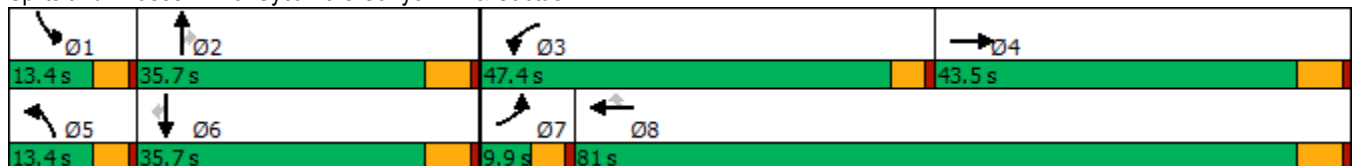

HCM 6th Signalized Intersection Summary
25: Sycamore Canyon Bl. & Cactus Av.

West Campus Upper Plateau (JN 14064)

09/19/2022



Movement	EBL	EBT	EBR	WBL	WBT	WBR	NBL	NBT	NBR	SBL	SBT	SBR
Lane Configurations												
Traffic Volume (veh/h)	46	202	83	758	661	1055	188	483	301	197	312	76
Future Volume (veh/h)	46	202	83	758	661	1055	188	483	301	197	312	76
Initial Q (Qb), veh	0	0	0	0	0	0	0	0	0	0	0	0
Ped-Bike Adj(A_pbT)	1.00		1.00	1.00		0.99	1.00		1.00	1.00		0.99
Parking Bus, Adj	1.00	1.00	1.00	1.00	1.00	1.00	1.00	1.00	1.00	1.00	1.00	1.00
Work Zone On Approach		No			No			No			No	
Adj Sat Flow, veh/h/ln	1722	1693	1826	1796	1707	1856	1826	1811	1826	1856	1856	1796
Adj Flow Rate, veh/h	47	208	85	781	681	869	194	498	213	203	322	75
Peak Hour Factor	0.97	0.97	0.97	0.97	0.97	0.97	0.97	0.97	0.97	0.97	0.97	0.97
Percent Heavy Veh, %	12	14	5	7	13	3	5	6	5	3	3	7
Cap, veh/h	59	1151	433	844	1838	880	224	600	270	227	615	262
Arrive On Green	0.04	0.35	0.35	0.25	0.57	0.57	0.07	0.17	0.17	0.07	0.17	0.17
Sat Flow, veh/h	1640	3305	1244	3319	3244	1553	3374	3441	1547	3428	3526	1502
Grp Volume(v), veh/h	47	193	100	781	681	869	194	498	213	203	322	75
Grp Sat Flow(s),veh/h/ln	1640	1540	1469	1659	1622	1553	1687	1721	1547	1714	1763	1502
Q Serve(g_s), s	3.8	5.8	6.3	30.4	15.3	73.0	7.6	18.5	17.5	7.8	11.0	5.8
Cycle Q Clear(g_c), s	3.8	5.8	6.3	30.4	15.3	73.0	7.6	18.5	17.5	7.8	11.0	5.8
Prop In Lane	1.00		0.85	1.00		1.00	1.00		1.00	1.00		1.00
Lane Grp Cap(c), veh/h	59	1073	511	844	1838	880	224	600	270	227	615	262
V/C Ratio(X)	0.80	0.18	0.20	0.93	0.37	0.99	0.87	0.83	0.79	0.89	0.52	0.29
Avail Cap(c_a), veh/h	66	1073	511	1071	1839	880	224	776	349	227	795	339
HCM Platoon Ratio	1.00	1.00	1.00	1.00	1.00	1.00	1.00	1.00	1.00	1.00	1.00	1.00
Upstream Filter(I)	1.00	1.00	1.00	1.00	1.00	1.00	1.00	1.00	1.00	1.00	1.00	1.00
Uniform Delay (d), s/veh	63.5	30.1	30.2	48.2	15.8	28.3	61.3	52.9	52.4	61.5	49.8	47.6
Incr Delay (d2), s/veh	40.5	0.1	0.2	10.2	0.1	27.2	27.2	6.0	8.9	31.8	0.7	0.6
Initial Q Delay(d3),s/veh	0.0	0.0	0.0	0.0	0.0	0.0	0.0	0.0	0.0	0.0	0.0	0.0
%ile BackOfQ(50%),veh/ln	0.7	0.0	0.0	1.2	0.0	6.6	0.8	0.5	0.7	1.0	0.1	0.0
Unsig. Movement Delay, s/veh												
LnGrp Delay(d),s/veh	104.0	30.1	30.4	58.4	15.9	55.4	88.5	58.8	61.3	93.3	50.4	48.2
LnGrp LOS	F	C	C	E	B	E	F	E	E	F	D	D
Approach Vol, veh/h		340			2331			905			600	
Approach Delay, s/veh		40.4			44.9			65.8			64.6	
Approach LOS		D			D			E			E	
Timer - Assigned Phs	1	2	3	4	5	6	7	8				
Phs Duration (G+Y+Rc), s	13.4	28.9	38.3	52.0	13.4	28.9	9.4	81.0				
Change Period (Y+Rc), s	4.6	5.8	4.6	5.8	4.6	5.8	4.6	5.8				
Max Green Setting (Gmax), s	8.8	29.9	42.8	37.7	8.8	29.9	5.3	75.2				
Max Q Clear Time (g_c+I1), s	9.8	20.5	32.4	8.3	9.6	13.0	5.8	75.0				
Green Ext Time (p_c), s	0.0	2.6	1.3	1.8	0.0	1.9	0.0	0.1				

Intersection Summary

HCM 6th Ctrl Delay	51.9
HCM 6th LOS	D

Timings

26: Sycamore Canyon Bl. & Van Buren Bl.

09/19/2022



Lane Group	EBL	EBT	EBR	WBL	WBT	WBR	NBL	NBT	SBL	SBT	SBR
Lane Configurations											
Traffic Volume (vph)	782	2257	3	53	3354	229	4	1	121	6	587
Future Volume (vph)	782	2257	3	53	3354	229	4	1	121	6	587
Turn Type	Prot	NA	Perm	Prot	NA	Perm	Perm	NA	Split	NA	pm+ov
Protected Phases	5	2		1	6			8	4	4	5
Permitted Phases			2			6	8				4
Detector Phase	5	2	2	1	6	6	8	8	4	4	5
Switch Phase											
Minimum Initial (s)	5.0	10.0	10.0	5.0	10.0	10.0	10.0	10.0	10.0	10.0	5.0
Minimum Split (s)	9.6	29.2	29.2	9.6	29.2	29.2	14.6	14.6	50.8	50.8	9.6
Total Split (s)	15.0	45.0	45.0	9.6	39.6	39.6	14.6	14.6	50.8	50.8	15.0
Total Split (%)	12.5%	37.5%	37.5%	8.0%	33.0%	33.0%	12.2%	12.2%	42.3%	42.3%	12.5%
Yellow Time (s)	3.6	5.2	5.2	3.6	5.2	5.2	3.6	3.6	4.8	4.8	3.6
All-Red Time (s)	1.0	1.0	1.0	1.0	1.0	1.0	1.0	1.0	1.0	1.0	1.0
Lost Time Adjust (s)	0.0	0.0	0.0	0.0	0.0	0.0		0.0	0.0	0.0	0.0
Total Lost Time (s)	4.6	6.2	6.2	4.6	6.2	6.2		4.6	5.8	5.8	4.6
Lead/Lag	Lead	Lag	Lag	Lead	Lag	Lag					Lead
Lead-Lag Optimize?	Yes	Yes	Yes	Yes	Yes	Yes					Yes
Recall Mode	None	None	None	None	None	None	None	None	None	None	None
Act Effct Green (s)	10.9	42.8	42.8	5.2	34.9	34.9		10.5	15.1	15.1	31.5
Actuated g/C Ratio	0.14	0.53	0.53	0.06	0.43	0.43		0.13	0.19	0.19	0.39
v/c Ratio	1.76	0.64	0.00	0.50	1.16	0.34		0.02	0.19	0.60	0.42
Control Delay	375.0	18.3	0.0	56.1	98.4	10.3		31.8	26.9	9.0	5.8
Queue Delay	0.0	0.0	0.0	0.0	0.0	0.0		0.0	0.0	0.0	0.0
Total Delay	375.0	18.3	0.0	56.1	98.4	10.3		31.8	26.9	9.0	5.8
LOS	F	B	A	E	F	B		C	C	A	A
Approach Delay		110.0			92.3			31.8		10.4	
Approach LOS		F			F			C		B	

Intersection Summary

Cycle Length: 120	
Actuated Cycle Length: 80.3	
Natural Cycle: 125	
Control Type: Actuated-Uncoordinated	
Maximum v/c Ratio: 1.76	
Intersection Signal Delay: 91.6	Intersection LOS: F
Intersection Capacity Utilization 97.8%	ICU Level of Service F
Analysis Period (min) 15	

Splits and Phases: 26: Sycamore Canyon Bl. & Van Buren Bl.

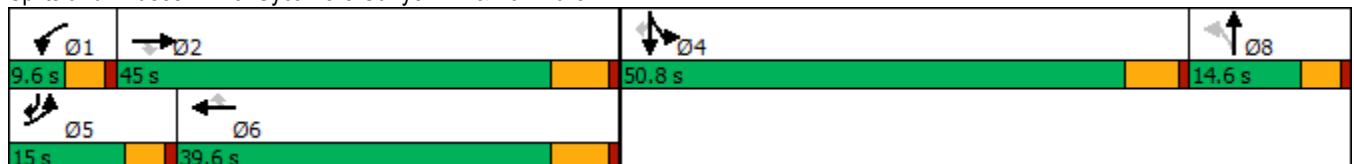

HCM 6th Signalized Intersection Summary
26: Sycamore Canyon Bl. & Van Buren Bl.

West Campus Upper Plateau (JN 14064)

09/19/2022



Movement	EBL	EBT	EBR	WBL	WBT	WBR	NBL	NBT	NBR	SBL	SBT	SBR
Lane Configurations												
Traffic Volume (veh/h)	782	2257	3	53	3354	229	4	1	4	121	6	587
Future Volume (veh/h)	782	2257	3	53	3354	229	4	1	4	121	6	587
Initial Q (Qb), veh	0	0	0	0	0	0	0	0	0	0	0	0
Ped-Bike Adj(A_pbT)	1.00		1.00	1.00		1.00	1.00		1.00	1.00		1.00
Parking Bus, Adj	1.00	1.00	1.00	1.00	1.00	1.00	1.00	1.00	1.00	1.00	1.00	1.00
Work Zone On Approach		No			No			No			No	
Adj Sat Flow, veh/h/ln	1885	1811	1900	1900	1826	1752	1900	1900	1900	1737	1900	1885
Adj Flow Rate, veh/h	850	2453	2	58	3646	224	4	1	2	108	0	0
Peak Hour Factor	0.92	0.92	0.92	0.92	0.92	0.92	0.92	0.92	0.92	0.92	0.92	0.92
Percent Heavy Veh, %	1	6	0	0	5	10	0	0	0	11	0	1
Cap, veh/h	496	3875	861	84	3239	658	33	10	20	393	0	
Arrive On Green	0.14	0.53	0.53	0.05	0.44	0.44	0.02	0.02	0.02	0.12	0.00	0.00
Sat Flow, veh/h	3591	7244	1610	1810	7304	1485	1810	565	1131	3309	0	3195
Grp Volume(v), veh/h	850	2453	2	58	3646	224	4	0	3	108	0	0
Grp Sat Flow(s),veh/h/ln	1795	1811	1610	1810	1826	1485	1810	0	1696	1654	0	1598
Q Serve(g_s), s	10.4	17.9	0.0	2.4	33.4	7.4	0.2	0.0	0.1	2.2	0.0	0.0
Cycle Q Clear(g_c), s	10.4	17.9	0.0	2.4	33.4	7.4	0.2	0.0	0.1	2.2	0.0	0.0
Prop In Lane	1.00		1.00	1.00		1.00	1.00		0.67	1.00		1.00
Lane Grp Cap(c), veh/h	496	3875	861	84	3239	658	33	0	31	393	0	
V/C Ratio(X)	1.71	0.63	0.00	0.69	1.13	0.34	0.12	0.00	0.10	0.27	0.00	
Avail Cap(c_a), veh/h	496	3875	861	120	3239	658	240	0	225	1977	0	
HCM Platoon Ratio	1.00	1.00	1.00	1.00	1.00	1.00	1.00	1.00	1.00	1.00	1.00	1.00
Upstream Filter(I)	1.00	1.00	1.00	1.00	1.00	1.00	1.00	0.00	1.00	1.00	0.00	0.00
Uniform Delay (d), s/veh	32.5	12.3	8.2	35.4	21.0	13.7	36.4	0.0	36.4	30.2	0.0	0.0
Incr Delay (d2), s/veh	329.9	0.3	0.0	3.7	61.2	0.3	1.6	0.0	1.4	0.4	0.0	0.0
Initial Q Delay(d3),s/veh	0.0	0.0	0.0	0.0	0.0	0.0	0.0	0.0	0.0	0.0	0.0	0.0
%ile BackOfQ(50%),veh/ln	22.7	0.1	0.0	0.1	13.8	0.1	0.0	0.0	0.0	0.0	0.0	0.0
Unsig. Movement Delay, s/veh												
LnGrp Delay(d),s/veh	362.4	12.7	8.2	39.0	82.1	14.0	38.0	0.0	37.7	30.6	0.0	0.0
LnGrp LOS	F	B	A	D	F	B	D	A	D	C	A	
Approach Vol, veh/h		3305			3928			7			108	
Approach Delay, s/veh		102.6			77.6			37.9			30.6	
Approach LOS		F			E			D			C	
Timer - Assigned Phs	1	2		4	5	6		8				
Phs Duration (G+Y+Rc), s	8.1	46.5		14.8	15.0	39.6		6.0				
Change Period (Y+Rc), s	4.6	6.2		5.8	4.6	6.2		4.6				
Max Green Setting (Gmax), s	5.0	38.8		45.0	10.4	33.4		10.0				
Max Q Clear Time (g_c+I1), s	4.4	19.9		4.2	12.4	35.4		2.2				
Green Ext Time (p_c), s	0.0	15.7		0.3	0.0	0.0		0.0				

Intersection Summary

HCM 6th Ctrl Delay	88.1
HCM 6th LOS	F

Notes

User approved volume balancing among the lanes for turning movement.
Unsignalized Delay for [SBR] is excluded from calculations of the approach delay and intersection delay.

Timings
29: I-215 NB Ramps & Alessandro Bl.

West Campus Upper Plateau (JN 14064)

09/19/2022

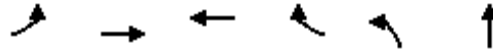

Lane Group	EBL	EBT	WBT	WBR	NBL	NBT
Lane Configurations	↘	↑↑↑	↑↑↑	↗	↗↘	↕
Traffic Volume (vph)	111	1261	2003	119	1432	0
Future Volume (vph)	111	1261	2003	119	1432	0
Turn Type	Prot	NA	NA	Perm	Split	NA
Protected Phases	5	2	6		8	8
Permitted Phases				6		
Detector Phase	5	2	6	6	8	8
Switch Phase						
Minimum Initial (s)	5.0	5.0	5.0	5.0	5.0	5.0
Minimum Split (s)	9.5	10.5	33.5	33.5	10.0	10.0
Total Split (s)	14.0	65.0	51.0	51.0	45.0	45.0
Total Split (%)	12.7%	59.1%	46.4%	46.4%	40.9%	40.9%
Yellow Time (s)	3.5	4.5	4.5	4.5	4.0	4.0
All-Red Time (s)	1.0	1.0	1.0	1.0	1.0	1.0
Lost Time Adjust (s)	0.0	0.0	0.0	0.0	0.0	0.0
Total Lost Time (s)	4.5	5.5	5.5	5.5	5.0	5.0
Lead/Lag	Lead		Lag	Lag		
Lead-Lag Optimize?	Yes		Yes	Yes		
Recall Mode	None	C-Min	C-Min	C-Min	None	None
Act Effct Green (s)	9.5	59.5	45.5	45.5	40.0	40.0
Actuated g/C Ratio	0.09	0.54	0.41	0.41	0.36	0.36
v/c Ratio	0.91	0.47	0.97	0.19	1.03	0.98
Control Delay	103.7	15.0	46.1	11.0	69.3	65.8
Queue Delay	0.0	0.0	10.6	0.0	0.0	0.4
Total Delay	103.7	15.0	56.7	11.0	69.3	66.2
LOS	F	B	E	B	E	E
Approach Delay		22.1	54.2			68.3
Approach LOS		C	D			E

Intersection Summary

Cycle Length: 110
 Actuated Cycle Length: 110
 Offset: 0 (0%), Referenced to phase 2:EBT and 6:WBT, Start of Yellow
 Natural Cycle: 110
 Control Type: Actuated-Coordinated
 Maximum v/c Ratio: 1.03
 Intersection Signal Delay: 50.3
 Intersection LOS: D
 Intersection Capacity Utilization 88.8%
 ICU Level of Service E
 Analysis Period (min) 15

Splits and Phases: 29: I-215 NB Ramps & Alessandro Bl.

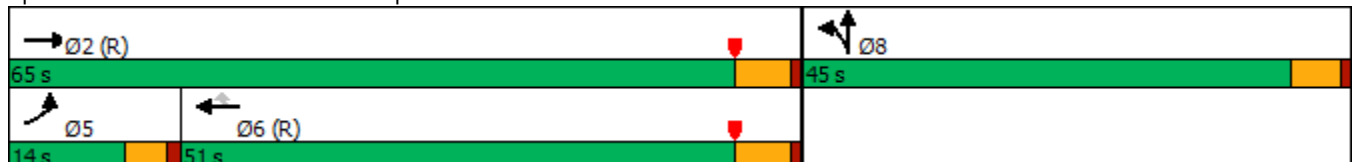

HCM 6th Signalized Intersection Summary
 29: I-215 NB Ramps & Alessandro Bl.

West Campus Upper Plateau (JN 14064)

09/19/2022



Movement	EBL	EBT	EBR	WBL	WBT	WBR	NBL	NBT	NBR	SBL	SBT	SBR
Lane Configurations	↘	↑↑↑			↑↑↑	↗	↘↗	↕				
Traffic Volume (veh/h)	111	1261	0	0	2003	119	1432	0	248	0	0	0
Future Volume (veh/h)	111	1261	0	0	2003	119	1432	0	248	0	0	0
Initial Q (Qb), veh	0	0	0	0	0	0	0	0	0			
Ped-Bike Adj(A_pbT)	1.00		1.00	1.00		1.00	1.00		1.00			
Parking Bus, Adj	1.00	1.00	1.00	1.00	1.00	1.00	1.00	1.00	1.00			
Work Zone On Approach		No			No			No				
Adj Sat Flow, veh/h/ln	1530	1856	0	0	1870	1767	1826	1900	1618			
Adj Flow Rate, veh/h	113	1287	0	0	2044	114	1276	259	174			
Peak Hour Factor	0.98	0.98	0.98	0.98	0.98	0.98	0.98	0.98	0.98			
Percent Heavy Veh, %	25	3	0	0	2	9	5	0	19			
Cap, veh/h	126	2740	0	0	2112	619	1265	385	259			
Arrive On Green	0.17	1.00	0.00	0.00	0.41	0.41	0.36	0.36	0.36			
Sat Flow, veh/h	1457	5233	0	0	5274	1497	3478	1060	712			
Grp Volume(v), veh/h	113	1287	0	0	2044	114	1276	0	433			
Grp Sat Flow(s),veh/h/ln	1457	1689	0	0	1702	1497	1739	0	1772			
Q Serve(g_s), s	8.4	0.0	0.0	0.0	43.1	5.3	40.0	0.0	22.6			
Cycle Q Clear(g_c), s	8.4	0.0	0.0	0.0	43.1	5.3	40.0	0.0	22.6			
Prop In Lane	1.00		0.00	0.00		1.00	1.00		0.40			
Lane Grp Cap(c), veh/h	126	2740	0	0	2112	619	1265	0	644			
V/C Ratio(X)	0.90	0.47	0.00	0.00	0.97	0.18	1.01	0.00	0.67			
Avail Cap(c_a), veh/h	126	2740	0	0	2112	619	1265	0	644			
HCM Platoon Ratio	2.00	2.00	1.00	1.00	1.00	1.00	1.00	1.00	1.00			
Upstream Filter(I)	0.93	0.93	0.00	0.00	1.00	1.00	1.00	0.00	1.00			
Uniform Delay (d), s/veh	45.0	0.0	0.0	0.0	31.5	20.5	35.0	0.0	29.5			
Incr Delay (d2), s/veh	47.7	0.5	0.0	0.0	13.3	0.7	27.5	0.0	2.7			
Initial Q Delay(d3),s/veh	0.0	0.0	0.0	0.0	0.0	0.0	0.0	0.0	0.0			
%ile BackOfQ(50%),veh/ln	5.1	13.2	0.0	0.0	23.4	3.6	24.1	0.0	13.7			
Unsig. Movement Delay, s/veh												
LnGrp Delay(d),s/veh	92.7	0.5	0.0	0.0	44.9	21.1	62.5	0.0	32.2			
LnGrp LOS	F	A	A	A	D	C	F	A	C			
Approach Vol, veh/h		1400			2158			1709				
Approach Delay, s/veh		8.0			43.6			54.8				
Approach LOS		A			D			D				
Timer - Assigned Phs		2			5	6		8				
Phs Duration (G+Y+Rc), s		65.0			14.0	51.0		45.0				
Change Period (Y+Rc), s		5.5			4.5	5.5		5.0				
Max Green Setting (Gmax), s		59.5			9.5	45.5		40.0				
Max Q Clear Time (g_c+I1), s		2.0			10.4	45.1		42.0				
Green Ext Time (p_c), s		10.6			0.0	0.4		0.0				

Intersection Summary

HCM 6th Ctrl Delay	37.8
HCM 6th LOS	D

Notes

User approved volume balancing among the lanes for turning movement.

Timings

31: I-215 NB Ramps/Old 215 Frontage Rd. & Cactus Av.



Lane Group	EBL	EBT	EBR	WBT	NBL	NBT	NBR	SBL	SBT
Lane Configurations	↶	↶↶	↶	↶↶↶	↶↶	↶	↶	↶	↶
Traffic Volume (vph)	30	1658	170	3173	532	338	48	58	0
Future Volume (vph)	30	1658	170	3173	532	338	48	58	0
Turn Type	Perm	NA	Perm	NA	Prot	NA	Perm	Perm	NA
Protected Phases		2		6	3	8			4
Permitted Phases	2		2				8	4	
Detector Phase	2	2	2	6	3	8	8	4	4
Switch Phase									
Minimum Initial (s)	5.0	5.0	5.0	5.0	5.0	5.0	5.0	5.0	5.0
Minimum Split (s)	11.0	11.0	11.0	44.0	9.1	10.5	10.5	10.5	10.5
Total Split (s)	90.0	90.0	90.0	90.0	24.0	40.0	40.0	16.0	16.0
Total Split (%)	69.2%	69.2%	69.2%	69.2%	18.5%	30.8%	30.8%	12.3%	12.3%
Yellow Time (s)	5.0	5.0	5.0	5.0	3.6	4.5	4.5	4.5	4.5
All-Red Time (s)	1.0	1.0	1.0	1.0	0.5	1.0	1.0	1.0	1.0
Lost Time Adjust (s)	0.0	0.0	0.0	0.0	0.0	0.0	0.0	0.0	0.0
Total Lost Time (s)	6.0	6.0	6.0	6.0	4.1	5.5	5.5	5.5	5.5
Lead/Lag					Lead			Lag	Lag
Lead-Lag Optimize?					Yes			Yes	Yes
Recall Mode	Min	Min	Min	Min	None	None	None	None	None
Act Effct Green (s)	84.0	84.0	84.0	84.0	19.9	34.5	34.5	10.5	10.5
Actuated g/C Ratio	0.65	0.65	0.65	0.65	0.15	0.27	0.27	0.08	0.08
v/c Ratio	0.63	0.79	0.20	1.10	1.11	0.85	0.11	0.79	1.09
Control Delay	70.1	19.8	2.1	73.4	123.3	64.8	19.8	114.8	133.1
Queue Delay	0.0	0.0	0.0	0.0	0.0	0.0	0.0	0.0	0.0
Total Delay	70.1	19.8	2.1	73.4	123.3	64.8	19.8	114.8	133.1
LOS	E	B	A	E	F	E	B	F	F
Approach Delay		19.0		73.4		96.6			128.2
Approach LOS		B		E		F			F

Intersection Summary

Cycle Length: 130
 Actuated Cycle Length: 130
 Natural Cycle: 130
 Control Type: Actuated-Uncoordinated
 Maximum v/c Ratio: 1.11
 Intersection Signal Delay: 62.7
 Intersection Capacity Utilization 103.1%
 Analysis Period (min) 15
 Intersection LOS: E
 ICU Level of Service G

Splits and Phases: 31: I-215 NB Ramps/Old 215 Frontage Rd. & Cactus Av.



HCM 6th Signalized Intersection Summary

West Campus Upper Plateau (JN 14064)

31: I-215 NB Ramps/Old 215 Frontage Rd. & Cactus Av.

09/19/2022

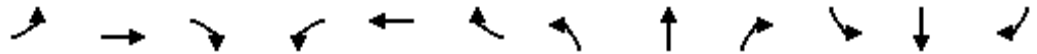

Movement	EBL	EBT	EBR	WBL	WBT	WBR	NBL	NBT	NBR	SBL	SBT	SBR
Lane Configurations												
Traffic Volume (veh/h)	30	1658	170	0	3173	163	532	338	48	58	0	161
Future Volume (veh/h)	30	1658	170	0	3173	163	532	338	48	58	0	161
Initial Q (Qb), veh	0	0	0	0	0	0	0	0	0	0	0	0
Ped-Bike Adj(A_pbT)	1.00		1.00	1.00		1.00	1.00		1.00	1.00		1.00
Parking Bus, Adj	1.00	1.00	1.00	1.00	1.00	1.00	1.00	1.00	1.00	1.00	1.00	1.00
Work Zone On Approach		No			No			No			No	
Adj Sat Flow, veh/h/ln	1678	1841	1515	0	1856	1841	1826	1722	1841	1841	1900	1500
Adj Flow Rate, veh/h	32	1764	176	0	3376	104	566	360	0	62	0	161
Peak Hour Factor	0.94	0.94	0.94	0.94	0.94	0.94	0.94	0.94	0.94	0.94	0.94	0.94
Percent Heavy Veh, %	15	4	26	0	3	4	5	12	4	4	0	27
Cap, veh/h	55	2260	829	0	3264	100	532	457		127	0	130
Arrive On Green	0.65	0.65	0.65	0.00	0.65	0.65	0.15	0.27	0.00	0.08	0.00	0.08
Sat Flow, veh/h	44	3497	1284	0	5218	154	3478	1722	1560	1005	0	1610
Grp Volume(v), veh/h	32	1764	176	0	2246	1234	566	360	0	62	0	161
Grp Sat Flow(s),veh/h/ln	44	1749	1284	0	1689	1828	1739	1722	1560	1005	0	1610
Q Serve(g_s), s	0.0	46.8	7.3	0.0	84.0	84.0	19.9	25.2	0.0	7.9	0.0	10.5
Cycle Q Clear(g_c), s	84.0	46.8	7.3	0.0	84.0	84.0	19.9	25.2	0.0	9.2	0.0	10.5
Prop In Lane	1.00		1.00	0.00		0.08	1.00		1.00	1.00		1.00
Lane Grp Cap(c), veh/h	55	2260	829	0	2182	1181	532	457		127	0	130
V/C Ratio(X)	0.58	0.78	0.21	0.00	1.03	1.04	1.06	0.79		0.49	0.00	1.24
Avail Cap(c_a), veh/h	55	2260	829	0	2182	1181	532	457		127	0	130
HCM Platoon Ratio	1.00	1.00	1.00	1.00	1.00	1.00	1.00	1.00	1.00	1.00	1.00	1.00
Upstream Filter(I)	1.00	1.00	1.00	0.00	1.00	1.00	1.00	1.00	0.00	1.00	0.00	1.00
Uniform Delay (d), s/veh	65.0	16.4	9.4	0.0	23.0	23.0	55.1	44.3	0.0	59.8	0.0	59.8
Incr Delay (d2), s/veh	9.5	1.7	0.0	0.0	27.2	38.7	56.9	8.2	0.0	1.1	0.0	156.4
Initial Q Delay(d3),s/veh	0.0	0.0	0.0	0.0	0.0	0.0	0.0	0.0	0.0	0.0	0.0	0.0
%ile BackOfQ(50%),veh/ln	1.3	32.3	8.6	0.0	47.6	55.3	13.8	14.0	0.0	2.3	0.0	10.3
Unsig. Movement Delay, s/veh												
LnGrp Delay(d),s/veh	74.5	18.1	9.5	0.0	50.2	61.7	111.9	52.5	0.0	60.8	0.0	216.1
LnGrp LOS	E	B	A	A	F	F	F	D		E	A	F
Approach Vol, veh/h		1972			3480			926				223
Approach Delay, s/veh		18.2			54.3			88.8				173.0
Approach LOS		B			D			F				F
Timer - Assigned Phs		2	3	4		6		8				
Phs Duration (G+Y+Rc), s		90.0	24.0	16.0		90.0		40.0				
Change Period (Y+Rc), s		6.0	4.1	5.5		6.0		5.5				
Max Green Setting (Gmax), s		84.0	19.9	10.5		84.0		34.5				
Max Q Clear Time (g_c+I1), s		86.0	21.9	12.5		86.0		27.2				
Green Ext Time (p_c), s		0.0	0.0	0.0		0.0		0.7				

Intersection Summary

HCM 6th Ctrl Delay	52.4
HCM 6th LOS	D

Notes

User approved volume balancing among the lanes for turning movement.
 Unsignalized Delay for [NBR] is excluded from calculations of the approach delay and intersection delay.

Timings
32: I-215 SB Ramps & Van Buren Bl.

West Campus Upper Plateau (JN 14064)

09/19/2022

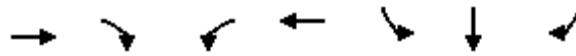

Lane Group	EBT	EBR	WBL	WBT	SBL	SBT	SBR
Lane Configurations	↑↑	↑	↵	↑↑	↵	↕	↵
Traffic Volume (vph)	1016	1017	30	1587	378	25	1437
Future Volume (vph)	1016	1017	30	1587	378	25	1437
Turn Type	NA	Perm	Prot	NA	Split	NA	Perm
Protected Phases	6		5	2	8	8	
Permitted Phases		6					8
Detector Phase	6	6	5	2	8	8	8
Switch Phase							
Minimum Initial (s)	5.0	5.0	5.0	5.0	5.0	5.0	5.0
Minimum Split (s)	36.0	36.0	11.0	11.0	11.0	11.0	11.0
Total Split (s)	50.0	50.0	12.0	62.0	68.0	68.0	68.0
Total Split (%)	38.5%	38.5%	9.2%	47.7%	52.3%	52.3%	52.3%
Yellow Time (s)	5.0	5.0	5.0	5.0	5.0	5.0	5.0
All-Red Time (s)	1.0	1.0	1.0	1.0	1.0	1.0	1.0
Lost Time Adjust (s)	0.0	0.0	0.0	0.0	0.0	0.0	0.0
Total Lost Time (s)	6.0	6.0	6.0	6.0	6.0	6.0	6.0
Lead/Lag	Lag	Lag	Lead				
Lead-Lag Optimize?	Yes	Yes	Yes				
Recall Mode	None	None	None	None	None	None	None
Act Effct Green (s)	48.8	48.8	5.7	56.0	62.0	62.0	62.0
Actuated g/C Ratio	0.38	0.38	0.04	0.43	0.48	0.48	0.48
v/c Ratio	0.88	0.99	0.41	1.15	0.46	1.24	1.13
Control Delay	48.0	33.5	75.6	111.6	25.2	153.0	105.3
Queue Delay	0.0	0.0	0.0	0.0	0.0	0.0	0.0
Total Delay	48.0	33.5	75.6	111.6	25.2	153.0	105.3
LOS	D	C	E	F	C	F	F
Approach Delay	40.8			111.0		110.0	
Approach LOS	D			F		F	

Intersection Summary

Cycle Length: 130
 Actuated Cycle Length: 130
 Natural Cycle: 120
 Control Type: Actuated-Uncoordinated
 Maximum v/c Ratio: 1.24
 Intersection Signal Delay: 84.6
 Intersection LOS: F
 Intersection Capacity Utilization 113.2%
 ICU Level of Service H
 Analysis Period (min) 15

Splits and Phases: 32: I-215 SB Ramps & Van Buren Bl.

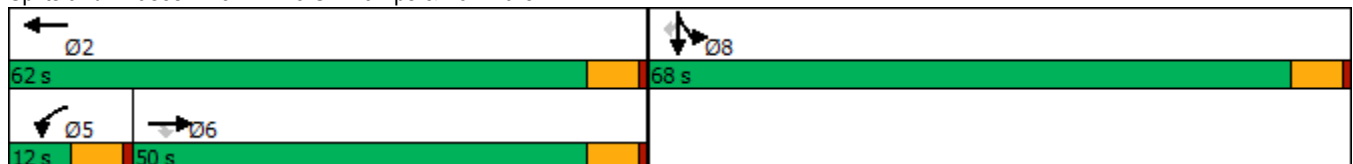

HCM 6th Signalized Intersection Summary
32: I-215 SB Ramps & Van Buren Bl.

West Campus Upper Plateau (JN 14064)

09/19/2022



Movement	EBL	EBT	EBR	WBL	WBT	WBR	NBL	NBT	NBR	SBL	SBT	SBR
Lane Configurations		↑↑	↗	↖	↑↑					↘	↕	↗
Traffic Volume (veh/h)	0	1016	1017	30	1587	0	0	0	0	378	25	1437
Future Volume (veh/h)	0	1016	1017	30	1587	0	0	0	0	378	25	1437
Initial Q (Qb), veh	0	0	0	0	0	0				0	0	0
Ped-Bike Adj(A_pbT)	1.00		1.00	1.00		1.00				1.00		1.00
Parking Bus, Adj	1.00	1.00	1.00	1.00	1.00	1.00				1.00	1.00	1.00
Work Zone On Approach		No			No						No	
Adj Sat Flow, veh/h/ln	0	1767	1781	1900	1826	0				1856	1559	1767
Adj Flow Rate, veh/h	0	1092	0	32	1706	0				280	0	0
Peak Hour Factor	0.93	0.93	0.93	0.93	0.93	0.93				0.93	0.93	0.93
Percent Heavy Veh, %	0	9	8	0	5	0				3	23	9
Cap, veh/h	0	1357		159	2073	0				338	0	
Arrive On Green	0.00	0.40	0.00	0.09	0.60	0.00				0.19	0.00	0.00
Sat Flow, veh/h	0	3445	1510	1810	3561	0				1767	0	2994
Grp Volume(v), veh/h	0	1092	0	32	1706	0				280	0	0
Grp Sat Flow(s),veh/h/ln	0	1678	1510	1810	1735	0				1767	0	1497
Q Serve(g_s), s	0.0	16.3	0.0	0.9	22.2	0.0				8.7	0.0	0.0
Cycle Q Clear(g_c), s	0.0	16.3	0.0	0.9	22.2	0.0				8.7	0.0	0.0
Prop In Lane	0.00		1.00	1.00		0.00				1.00		1.00
Lane Grp Cap(c), veh/h	0	1357		159	2073	0				338	0	
V/C Ratio(X)	0.00	0.80		0.20	0.82	0.00				0.83	0.00	
Avail Cap(c_a), veh/h	0	2596		191	3415	0				1926	0	
HCM Platoon Ratio	1.00	1.00	1.00	1.00	1.00	1.00				1.00	1.00	1.00
Upstream Filter(I)	0.00	1.00	0.00	1.00	1.00	0.00				1.00	0.00	0.00
Uniform Delay (d), s/veh	0.0	15.0	0.0	24.1	9.1	0.0				22.1	0.0	0.0
Incr Delay (d2), s/veh	0.0	0.4	0.0	0.2	0.3	0.0				2.0	0.0	0.0
Initial Q Delay(d3),s/veh	0.0	0.0	0.0	0.0	0.0	0.0				0.0	0.0	0.0
%ile BackOfQ(50%),veh/ln	0.0	8.7	0.0	0.5	13.6	0.0				4.6	0.0	0.0
Unsig. Movement Delay, s/veh												
LnGrp Delay(d),s/veh	0.0	15.4	0.0	24.3	9.4	0.0				24.1	0.0	0.0
LnGrp LOS	A	B		C	A	A				C	A	
Approach Vol, veh/h		1092			1738						280	
Approach Delay, s/veh		15.4			9.7						24.1	
Approach LOS		B			A						C	
Timer - Assigned Phs		2			5	6		8				
Phs Duration (G+Y+Rc), s		40.0			11.0	29.0		16.9				
Change Period (Y+Rc), s		6.0			6.0	6.0		6.0				
Max Green Setting (Gmax), s		56.0			6.0	44.0		62.0				
Max Q Clear Time (g_c+I1), s		24.2			2.9	18.3		10.7				
Green Ext Time (p_c), s		9.8			0.0	4.6		0.4				

Intersection Summary

HCM 6th Ctrl Delay	13.0
HCM 6th LOS	B

Notes

User approved volume balancing among the lanes for turning movement.
Unsignalized Delay for [EBR, SBR] is excluded from calculations of the approach delay and intersection delay.

Timings

West Campus Upper Plateau (JN 14064)

34: Old 215 Frontage Rd. & Alessandro Bl.

09/19/2022

Lane Group	EBL	EBT	EBR	WBL	WBT	WBR	NBL	NBT	NBR	SBL	SBT	SBR
Lane Configurations												
Traffic Volume (vph)	436	1245	52	11	1682	142	63	305	22	33	74	280
Future Volume (vph)	436	1245	52	11	1682	142	63	305	22	33	74	280
Turn Type	Prot	NA	Perm	Prot	NA	Perm	Prot	NA	Perm	Prot	NA	Perm
Protected Phases	5	2		1	6		3	8		7	4	
Permitted Phases			2			6			8			4
Detector Phase	5	2	2	1	6	6	3	8	8	7	4	4
Switch Phase												
Minimum Initial (s)	5.0	10.0	10.0	5.0	10.0	10.0	5.0	10.0	10.0	5.0	10.0	10.0
Minimum Split (s)	8.7	43.5	43.5	8.7	15.8	15.8	8.7	16.2	16.2	8.7	40.2	40.2
Total Split (s)	22.0	62.4	62.4	8.7	49.1	49.1	8.7	38.7	38.7	10.2	40.2	40.2
Total Split (%)	18.3%	52.0%	52.0%	7.3%	40.9%	40.9%	7.3%	32.3%	32.3%	8.5%	33.5%	33.5%
Yellow Time (s)	3.2	5.5	5.5	3.2	4.8	4.8	3.2	5.2	5.2	3.2	5.2	5.2
All-Red Time (s)	0.5	1.0	1.0	0.5	1.0	1.0	0.5	1.0	1.0	0.5	1.0	1.0
Lost Time Adjust (s)	0.0	0.0	0.0	0.0	0.0	0.0	0.0	0.0	0.0	0.0	0.0	0.0
Total Lost Time (s)	3.7	6.5	6.5	3.7	5.8	5.8	3.7	6.2	6.2	3.7	6.2	6.2
Lead/Lag	Lead	Lag	Lag	Lead	Lag	Lag	Lead	Lag	Lag	Lead	Lag	Lag
Lead-Lag Optimize?	Yes	Yes	Yes	Yes	Yes	Yes	Yes	Yes	Yes	Yes	Yes	Yes
Recall Mode	None	None	None	None	None	None	None	None	None	None	None	None
Act Effct Green (s)	17.2	60.6	60.6	5.1	41.7	41.7	5.1	17.8	17.8	6.0	16.8	16.8
Actuated g/C Ratio	0.17	0.62	0.62	0.05	0.42	0.42	0.05	0.18	0.18	0.06	0.17	0.17
v/c Ratio	0.79	0.41	0.07	0.19	0.80	0.20	0.40	0.50	0.06	0.32	0.13	0.59
Control Delay	52.4	12.3	0.7	59.5	29.8	4.8	58.0	40.2	0.3	57.9	35.8	10.9
Queue Delay	0.0	0.0	0.0	0.0	0.0	0.0	0.0	0.0	0.0	0.0	0.0	0.0
Total Delay	52.4	12.3	0.7	59.5	29.8	4.8	58.0	40.2	0.3	57.9	35.8	10.9
LOS	D	B	A	E	C	A	E	D	A	E	D	B
Approach Delay		22.1			28.1			40.8			19.7	
Approach LOS		C			C			D			B	

Intersection Summary

Cycle Length: 120
 Actuated Cycle Length: 98.5
 Natural Cycle: 115
 Control Type: Actuated-Uncoordinated
 Maximum v/c Ratio: 0.80
 Intersection Signal Delay: 26.1
 Intersection LOS: C
 Intersection Capacity Utilization 74.2%
 ICU Level of Service D
 Analysis Period (min) 15



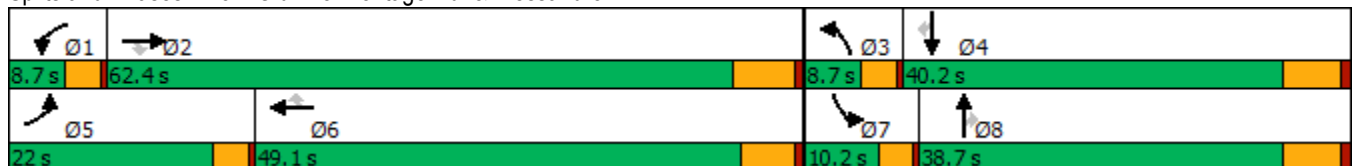





























Splits and Phases: 34: Old 215 Frontage Rd. & Alessandro Bl.



HCM 6th Signalized Intersection Summary
34: Old 215 Frontage Rd. & Alessandro Bl.

West Campus Upper Plateau (JN 14064)

09/19/2022

												
Movement	EBL	EBT	EBR	WBL	WBT	WBR	NBL	NBT	NBR	SBL	SBT	SBR
Lane Configurations	 	  			  		 	 			 	
Traffic Volume (veh/h)	436	1245	52	11	1682	142	63	305	22	33	74	280
Future Volume (veh/h)	436	1245	52	11	1682	142	63	305	22	33	74	280
Initial Q (Qb), veh	0	0	0	0	0	0	0	0	0	0	0	0
Ped-Bike Adj(A_pbT)	1.00		1.00	1.00		1.00	1.00		1.00	1.00		1.00
Parking Bus, Adj	1.00	1.00	1.00	1.00	1.00	1.00	1.00	1.00	1.00	1.00	1.00	1.00
Work Zone On Approach		No			No			No			No	
Adj Sat Flow, veh/h/ln	1767	1856	1470	981	1870	1811	1707	1811	1752	1856	1811	1826
Adj Flow Rate, veh/h	445	1270	43	11	1716	0	64	311	14	34	76	0
Peak Hour Factor	0.98	0.98	0.98	0.98	0.98	0.98	0.98	0.98	0.98	0.98	0.98	0.98
Percent Heavy Veh, %	9	3	29	62	2	6	13	6	10	3	6	5
Cap, veh/h	526	2958	727	13	2226		145	454	196	58	408	
Arrive On Green	0.16	0.58	0.58	0.01	0.44	0.00	0.05	0.13	0.13	0.03	0.12	0.00
Sat Flow, veh/h	3264	5066	1246	934	5106	1535	3155	3441	1485	1767	3441	1547
Grp Volume(v), veh/h	445	1270	43	11	1716	0	64	311	14	34	76	0
Grp Sat Flow(s),veh/h/ln	1632	1689	1246	934	1702	1535	1577	1721	1485	1767	1721	1547
Q Serve(g_s), s	11.2	11.8	1.3	1.0	24.1	0.0	1.7	7.3	0.7	1.6	1.7	0.0
Cycle Q Clear(g_c), s	11.2	11.8	1.3	1.0	24.1	0.0	1.7	7.3	0.7	1.6	1.7	0.0
Prop In Lane	1.00		1.00	1.00		1.00	1.00		1.00	1.00		1.00
Lane Grp Cap(c), veh/h	526	2958	727	13	2226		145	454	196	58	408	
V/C Ratio(X)	0.85	0.43	0.06	0.87	0.77		0.44	0.68	0.07	0.59	0.19	
Avail Cap(c_a), veh/h	708	3355	825	55	2620		187	1325	572	136	1386	
HCM Platoon Ratio	1.00	1.00	1.00	1.00	1.00	1.00	1.00	1.00	1.00	1.00	1.00	1.00
Upstream Filter(I)	1.00	1.00	1.00	1.00	1.00	0.00	1.00	1.00	1.00	1.00	1.00	0.00
Uniform Delay (d), s/veh	34.4	9.8	7.6	41.6	20.2	0.0	39.2	35.0	32.1	40.3	33.5	0.0
Incr Delay (d2), s/veh	5.5	0.1	0.0	44.6	1.2	0.0	0.8	1.8	0.2	3.6	0.2	0.0
Initial Q Delay(d3),s/veh	0.0	0.0	0.0	0.0	0.0	0.0	0.0	0.0	0.0	0.0	0.0	0.0
%ile BackOfQ(50%),veh/ln	5.6	9.9	1.4	0.4	13.6	0.0	0.8	3.8	0.6	0.9	0.9	0.0
Unsig. Movement Delay, s/veh												
LnGrp Delay(d),s/veh	39.9	9.9	7.6	86.2	21.4	0.0	40.0	36.8	32.2	43.8	33.7	0.0
LnGrp LOS	D	A	A	F	C		D	D	C	D	C	
Approach Vol, veh/h		1758			1727			389			110	
Approach Delay, s/veh		17.4			21.9			37.2			36.9	
Approach LOS		B			C			D			D	
Timer - Assigned Phs	1	2	3	4	5	6	7	8				
Phs Duration (G+Y+Rc), s	4.8	55.8	7.6	16.2	17.3	43.3	6.4	17.3				
Change Period (Y+Rc), s	3.7	6.5	3.7	6.2	3.7	* 6.5	3.7	6.2				
Max Green Setting (Gmax), s	5.0	55.9	5.0	34.0	18.3	* 43	6.5	32.5				
Max Q Clear Time (g_c+I1), s	3.0	13.8	3.7	3.7	13.2	26.1	3.6	9.3				
Green Ext Time (p_c), s	0.0	10.3	0.0	0.3	0.4	10.7	0.0	1.7				

Intersection Summary

HCM 6th Ctrl Delay	21.8
HCM 6th LOS	C

Notes

* HCM 6th computational engine requires equal clearance times for the phases crossing the barrier.
Unsignalized Delay for [WBR, SBR] is excluded from calculations of the approach delay and intersection delay.

Timings
36: Elsworth St. & Cactus Av.

West Campus Upper Plateau (JN 14064)

09/19/2022



Lane Group	EBL	EBT	EBR	WBL	WBT	WBR	NBL	NBT	SBL	SBT	SBR
Lane Configurations	↘	↑↑↑	↗	↘	↑↑↑	↗	↘	↗	↘	↑	↗
Traffic Volume (vph)	301	1823	330	79	2254	219	26	12	169	66	298
Future Volume (vph)	301	1823	330	79	2254	219	26	12	169	66	298
Turn Type	Prot	NA	Perm	Prot	NA	Perm	Prot	NA	Prot	NA	pm+ov
Protected Phases	5	2		1	6		3	8	7	4	5
Permitted Phases			2			6					4
Detector Phase	5	2	2	1	6	6	3	8	7	4	5
Switch Phase											
Minimum Initial (s)	5.0	10.0	10.0	5.0	10.0	10.0	10.0	10.0	10.0	10.0	5.0
Minimum Split (s)	9.6	36.2	36.2	9.6	36.2	36.2	15.4	35.4	15.4	35.4	9.6
Total Split (s)	19.0	52.4	52.4	16.2	49.6	49.6	15.4	35.4	16.0	36.0	19.0
Total Split (%)	15.8%	43.7%	43.7%	13.5%	41.3%	41.3%	12.8%	29.5%	13.3%	30.0%	15.8%
Yellow Time (s)	3.6	5.2	5.2	3.6	5.2	5.2	4.4	4.4	4.4	4.4	3.6
All-Red Time (s)	1.0	1.0	1.0	1.0	1.0	1.0	1.0	1.0	1.0	1.0	1.0
Lost Time Adjust (s)	0.0	0.0	0.0	0.0	0.0	0.0	0.0	0.0	0.0	0.0	0.0
Total Lost Time (s)	4.6	6.2	6.2	4.6	6.2	6.2	5.4	5.4	5.4	5.4	4.6
Lead/Lag	Lead	Lag	Lag	Lead	Lag	Lag	Lag	Lag	Lead	Lead	Lead
Lead-Lag Optimize?	Yes	Yes	Yes	Yes	Yes	Yes	Yes	Yes	Yes	Yes	Yes
Recall Mode	None	None	None	None	None	None	None	None	None	None	None
Act Effct Green (s)	14.6	52.6	52.6	8.4	44.1	44.1	10.5	13.4	10.8	16.7	31.6
Actuated g/C Ratio	0.15	0.54	0.54	0.09	0.45	0.45	0.11	0.14	0.11	0.17	0.32
v/c Ratio	1.19	0.56	0.33	0.52	1.02	0.28	0.16	0.12	0.90	0.21	0.51
Control Delay	154.0	19.4	3.4	57.9	53.6	7.9	47.6	22.9	88.6	37.4	13.2
Queue Delay	0.0	0.0	0.0	0.0	0.0	0.0	0.0	0.0	0.0	0.0	0.0
Total Delay	154.0	19.4	3.4	57.9	53.6	7.9	47.6	22.9	88.6	37.4	13.2
LOS	F	B	A	E	D	A	D	C	F	D	B
Approach Delay		33.7			49.8			34.6		40.1	
Approach LOS		C			D			C		D	

Intersection Summary

Cycle Length: 120
 Actuated Cycle Length: 97.8
 Natural Cycle: 130
 Control Type: Actuated-Uncoordinated
 Maximum v/c Ratio: 1.19
 Intersection Signal Delay: 41.7
 Intersection LOS: D
 Intersection Capacity Utilization 89.8%
 ICU Level of Service E
 Analysis Period (min) 15

Splits and Phases: 36: Elsworth St. & Cactus Av.

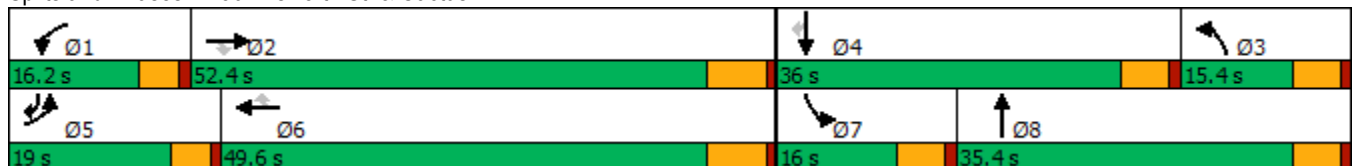

HCM 6th Signalized Intersection Summary
36: Elsworth St. & Cactus Av.

West Campus Upper Plateau (JN 14064)

09/19/2022



Movement	EBL	EBT	EBR	WBL	WBT	WBR	NBL	NBT	NBR	SBL	SBT	SBR
Lane Configurations												
Traffic Volume (veh/h)	301	1823	330	79	2254	219	26	12	18	169	66	298
Future Volume (veh/h)	301	1823	330	79	2254	219	26	12	18	169	66	298
Initial Q (Qb), veh	0	0	0	0	0	0	0	0	0	0	0	0
Ped-Bike Adj(A_pbT)	1.00		1.00	1.00		0.98	1.00		1.00	1.00		1.00
Parking Bus, Adj	1.00	1.00	1.00	1.00	1.00	1.00	1.00	1.00	1.00	1.00	1.00	1.00
Work Zone On Approach		No			No			No			No	
Adj Sat Flow, veh/h/ln	1841	1811	1885	1900	1841	1870	1633	1900	1900	1856	1900	1856
Adj Flow Rate, veh/h	307	1860	0	81	2300	175	27	12	10	172	67	237
Peak Hour Factor	0.98	0.98	0.98	0.98	0.98	0.98	0.98	0.98	0.98	0.98	0.98	0.98
Percent Heavy Veh, %	4	6	1	0	4	2	18	0	0	3	0	3
Cap, veh/h	249	3199		104	2155	665	153	106	88	185	222	408
Arrive On Green	0.14	0.51	0.00	0.06	0.43	0.43	0.10	0.11	0.11	0.10	0.12	0.12
Sat Flow, veh/h	1753	6230	1598	1810	5025	1552	1555	958	798	1767	1900	1572
Grp Volume(v), veh/h	307	1860	0	81	2300	175	27	0	22	172	67	237
Grp Sat Flow(s),veh/h/ln	1753	1558	1598	1810	1675	1552	1555	0	1756	1767	1900	1572
Q Serve(g_s), s	14.4	21.0	0.0	4.5	43.4	7.3	1.6	0.0	1.1	9.8	3.3	8.8
Cycle Q Clear(g_c), s	14.4	21.0	0.0	4.5	43.4	7.3	1.6	0.0	1.1	9.8	3.3	8.8
Prop In Lane	1.00		1.00	1.00		1.00	1.00		0.45	1.00		1.00
Lane Grp Cap(c), veh/h	249	3199		104	2155	665	153	0	195	185	222	408
V/C Ratio(X)	1.23	0.58		0.78	1.07	0.26	0.18	0.00	0.11	0.93	0.30	0.58
Avail Cap(c_a), veh/h	249	3199		207	2155	665	154	0	521	185	574	699
HCM Platoon Ratio	1.00	1.00	1.00	1.00	1.00	1.00	1.00	1.00	1.00	1.00	1.00	1.00
Upstream Filter(I)	1.00	1.00	0.00	1.00	1.00	1.00	1.00	0.00	1.00	1.00	1.00	1.00
Uniform Delay (d), s/veh	43.4	17.1	0.0	47.1	28.9	18.6	41.8	0.0	40.5	44.9	40.9	15.7
Incr Delay (d2), s/veh	133.8	0.3	0.0	4.6	40.3	0.2	0.5	0.0	0.3	46.3	0.8	1.3
Initial Q Delay(d3),s/veh	0.0	0.0	0.0	0.0	0.0	0.0	0.0	0.0	0.0	0.0	0.0	0.0
%ile BackOfQ(50%),veh/ln	9.3	0.1	0.0	0.1	8.0	0.0	0.0	0.0	0.0	2.4	0.0	0.1
Unsig. Movement Delay, s/veh												
LnGrp Delay(d),s/veh	177.2	17.4	0.0	51.7	69.2	18.8	42.4	0.0	40.8	91.3	41.7	17.0
LnGrp LOS	F	B		D	F	B	D	A	D	F	D	B
Approach Vol, veh/h		2167			2556			49			476	
Approach Delay, s/veh		40.0			65.2			41.7			47.3	
Approach LOS		D			E			D			D	
Timer - Assigned Phs	1	2	3	4	5	6	7	8				
Phs Duration (G+Y+Rc), s	10.4	58.2	15.4	17.2	19.0	49.6	16.0	16.6				
Change Period (Y+Rc), s	4.6	6.2	5.4	5.4	4.6	6.2	5.4	5.4				
Max Green Setting (Gmax), s	11.6	46.2	10.0	30.6	14.4	43.4	10.6	30.0				
Max Q Clear Time (g_c+I1), s	6.5	23.0	3.6	10.8	16.4	45.4	11.8	3.1				
Green Ext Time (p_c), s	0.0	13.9	0.0	1.0	0.0	0.0	0.0	0.1				

Intersection Summary

HCM 6th Ctrl Delay	53.0
HCM 6th LOS	D

Notes

User approved pedestrian interval to be less than phase max green.
Unsignalized Delay for [EBR] is excluded from calculations of the approach delay and intersection delay.

Timings

West Campus Upper Plateau (JN 14064)

1: Washington St & Van Buren Bl.

09/19/2022



Lane Group	EBL	EBT	EBR	WBL	WBT	WBR	NBL	NBT	NBR	SBL	SBT
Lane Configurations	↘	↑↑↑	↗	↘	↑↑↑	↗	↘↗	↑↑	↗	↘↗	↑↗
Traffic Volume (vph)	153	1662	91	244	1402	569	113	276	132	670	397
Future Volume (vph)	153	1662	91	244	1402	569	113	276	132	670	397
Turn Type	Prot	NA	Perm	Prot	NA	pm+ov	Prot	NA	Perm	Prot	NA
Protected Phases	5	2		1	6	7	3	8		7	4
Permitted Phases			2			6			8		
Detector Phase	5	2	2	1	6	7	3	8	8	7	4
Switch Phase											
Minimum Initial (s)	5.0	10.0	10.0	5.0	10.0	10.0	10.0	10.0	10.0	10.0	10.0
Minimum Split (s)	9.2	34.2	34.2	9.2	33.2	30.8	37.4	37.4	37.4	30.8	30.8
Total Split (s)	15.6	43.8	43.8	18.0	46.2	30.8	37.4	37.4	37.4	30.8	30.8
Total Split (%)	12.0%	33.7%	33.7%	13.8%	35.5%	23.7%	28.8%	28.8%	28.8%	23.7%	23.7%
Yellow Time (s)	3.2	5.2	5.2	3.2	5.2	4.8	4.4	4.4	4.4	4.8	4.8
All-Red Time (s)	1.0	1.0	1.0	1.0	1.0	1.0	1.0	1.0	1.0	1.0	1.0
Lost Time Adjust (s)	0.0	0.0	0.0	0.0	0.0	0.0	0.0	0.0	0.0	0.0	0.0
Total Lost Time (s)	4.2	6.2	6.2	4.2	6.2	5.8	5.4	5.4	5.4	5.8	5.8
Lead/Lag	Lead	Lag	Lag	Lead	Lag	Lead	Lead	Lag	Lag	Lead	Lag
Lead-Lag Optimize?	Yes	Yes	Yes	Yes	Yes	Yes	Yes	Yes	Yes	Yes	Yes
Recall Mode	None	None	None	None	None	None	None	None	None	None	None
Act Effct Green (s)	11.5	37.8	37.8	13.9	40.2	65.7	14.0	16.8	16.8	25.1	27.9
Actuated g/C Ratio	0.10	0.33	0.33	0.12	0.35	0.57	0.12	0.15	0.15	0.22	0.24
v/c Ratio	0.87	1.02	0.15	1.13	0.80	0.58	0.27	0.55	0.39	0.90	0.59
Control Delay	91.9	65.3	0.8	148.2	38.8	11.2	46.7	49.2	10.2	60.2	41.1
Queue Delay	0.0	0.0	0.0	0.0	0.0	0.0	0.0	0.0	0.0	0.0	0.0
Total Delay	91.9	65.3	0.8	148.2	38.8	11.2	46.7	49.2	10.2	60.2	41.1
LOS	F	E	A	F	D	B	D	D	B	E	D
Approach Delay		64.4			43.7			38.8			52.0
Approach LOS		E			D			D			D

Intersection Summary

Cycle Length: 130
 Actuated Cycle Length: 115.2
 Natural Cycle: 115
 Control Type: Actuated-Uncoordinated
 Maximum v/c Ratio: 1.13
 Intersection Signal Delay: 51.7
 Intersection LOS: D
 Intersection Capacity Utilization 91.7%
 ICU Level of Service F
 Analysis Period (min) 15

Splits and Phases: 1: Washington St & Van Buren Bl.

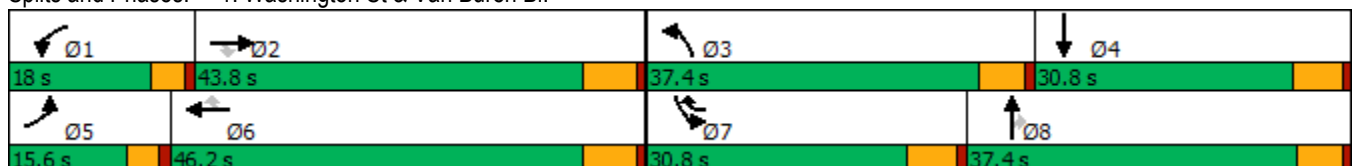

HCM 6th Signalized Intersection Summary
1: Washington St & Van Buren Bl.

West Campus Upper Plateau (JN 14064)

09/19/2022

Movement	EBL	EBT	EBR	WBL	WBT	WBR	NBL	NBT	NBR	SBL	SBT	SBR
Lane Configurations												
Traffic Volume (veh/h)	153	1662	91	244	1402	569	113	276	132	670	397	105
Future Volume (veh/h)	153	1662	91	244	1402	569	113	276	132	670	397	105
Initial Q (Qb), veh	0	0	0	0	0	0	0	0	0	0	0	0
Ped-Bike Adj(A_pbT)	1.00		1.00	1.00		1.00	1.00		0.98	1.00		0.98
Parking Bus, Adj	1.00	1.00	1.00	1.00	1.00	1.00	1.00	1.00	1.00	1.00	1.00	1.00
Work Zone On Approach		No			No			No			No	
Adj Sat Flow, veh/h/ln	1900	1856	1856	1900	1870	1900	1885	1856	1870	1885	1885	1900
Adj Flow Rate, veh/h	155	1679	73	246	1416	482	114	279	94	677	401	60
Peak Hour Factor	0.99	0.99	0.99	0.99	0.99	0.99	0.99	0.99	0.99	0.99	0.99	0.99
Percent Heavy Veh, %	0	3	3	0	2	0	1	3	2	1	1	0
Cap, veh/h	183	1720	534	226	1853	927	315	436	192	743	781	116
Arrive On Green	0.10	0.34	0.34	0.12	0.36	0.36	0.09	0.12	0.12	0.21	0.25	0.25
Sat Flow, veh/h	1810	5066	1572	1810	5106	1606	3483	3526	1554	3483	3120	463
Grp Volume(v), veh/h	155	1679	73	246	1416	482	114	279	94	677	229	232
Grp Sat Flow(s),veh/h/ln	1810	1689	1572	1810	1702	1606	1742	1763	1554	1742	1791	1793
Q Serve(g_s), s	9.3	36.2	3.6	13.8	27.1	20.1	3.4	8.3	6.2	21.0	12.2	12.3
Cycle Q Clear(g_c), s	9.3	36.2	3.6	13.8	27.1	20.1	3.4	8.3	6.2	21.0	12.2	12.3
Prop In Lane	1.00		1.00	1.00		1.00	1.00		1.00	1.00		0.26
Lane Grp Cap(c), veh/h	183	1720	534	226	1853	927	315	436	192	743	448	449
V/C Ratio(X)	0.84	0.98	0.14	1.09	0.76	0.52	0.36	0.64	0.49	0.91	0.51	0.52
Avail Cap(c_a), veh/h	186	1720	534	226	1853	927	1007	1019	449	787	448	449
HCM Platoon Ratio	1.00	1.00	1.00	1.00	1.00	1.00	1.00	1.00	1.00	1.00	1.00	1.00
Upstream Filter(I)	1.00	1.00	1.00	1.00	1.00	1.00	1.00	1.00	1.00	1.00	1.00	1.00
Uniform Delay (d), s/veh	48.9	36.1	25.3	48.5	31.1	14.2	47.4	46.2	45.3	42.5	35.7	35.7
Incr Delay (d2), s/veh	26.7	16.3	0.2	86.2	2.1	0.7	0.7	1.6	1.9	14.3	1.0	1.0
Initial Q Delay(d3),s/veh	0.0	0.0	0.0	0.0	0.0	0.0	0.0	0.0	0.0	0.0	0.0	0.0
%ile BackOfQ(50%),veh/ln	5.4	16.4	1.4	11.4	10.7	7.3	1.5	3.8	2.5	10.4	5.4	5.5
Unsig. Movement Delay, s/veh												
LnGrp Delay(d),s/veh	75.6	52.4	25.5	134.6	33.2	14.9	48.1	47.7	47.2	56.8	36.6	36.8
LnGrp LOS	E	D	C	F	C	B	D	D	D	E	D	D
Approach Vol, veh/h		1907			2144			487			1138	
Approach Delay, s/veh		53.3			40.7			47.7			48.6	
Approach LOS		D			D			D			D	
Timer - Assigned Phs	1	2	3	4	5	6	7	8				
Phs Duration (G+Y+Rc), s	18.0	43.8	15.4	33.5	15.4	46.4	29.4	19.5				
Change Period (Y+Rc), s	* 4.2	6.2	5.4	5.8	* 4.2	6.2	5.8	* 5.8				
Max Green Setting (Gmax), s	* 14	37.6	32.0	25.0	* 11	40.0	25.0	* 32				
Max Q Clear Time (g_c+I1), s	15.8	38.2	5.4	14.3	11.3	29.1	23.0	10.3				
Green Ext Time (p_c), s	0.0	0.0	0.4	2.0	0.0	8.8	0.6	2.2				

Intersection Summary

HCM 6th Ctrl Delay	47.1
HCM 6th LOS	D

Notes

* HCM 6th computational engine requires equal clearance times for the phases crossing the barrier.

Timings

3: Overlook Pkwy./Canyon Crest Dr. & Alessandro Bl/Alessandro Bl.



Lane Group	EBL	EBT	WBL	WBT	WBR	NBL	NBT	NBR	SBL	SBT
Lane Configurations	↘	↗↗↗	↘	↗↗↗	↗	↘	↗↗	↗	↗↗↗	↘
Traffic Volume (vph)	85	3395	23	2582	752	15	134	57	740	224
Future Volume (vph)	85	3395	23	2582	752	15	134	57	740	224
Turn Type	Prot	NA	Prot	NA	pm+ov	Split	NA	Perm	Split	NA
Protected Phases	5	2	1	6	4	8	8		4	4
Permitted Phases					6			8		
Detector Phase	5	2	1	6	4	8	8	8	4	4
Switch Phase										
Minimum Initial (s)	5.0	10.0	5.0	10.0	10.0	10.0	10.0	10.0	10.0	10.0
Minimum Split (s)	9.2	35.2	9.2	35.2	38.8	38.8	38.8	38.8	38.8	38.8
Total Split (s)	9.2	43.2	9.2	43.2	38.8	38.8	38.8	38.8	38.8	38.8
Total Split (%)	7.1%	33.2%	7.1%	33.2%	29.8%	29.8%	29.8%	29.8%	29.8%	29.8%
Yellow Time (s)	3.2	5.2	3.2	5.2	4.8	4.8	4.8	4.8	4.8	4.8
All-Red Time (s)	1.0	1.0	1.0	1.0	1.0	1.0	1.0	1.0	1.0	1.0
Lost Time Adjust (s)	0.0	0.0	0.0	0.0	0.0	0.0	0.0	0.0	0.0	0.0
Total Lost Time (s)	4.2	6.2	4.2	6.2	5.8	5.8	5.8	5.8	5.8	5.8
Lead/Lag	Lead	Lag	Lead	Lag						
Lead-Lag Optimize?	Yes	Yes	Yes	Yes						
Recall Mode	None	None	None	None	None	None	None	None	None	None
Act Effct Green (s)	5.0	42.8	5.0	37.1	72.7	10.5	10.5	10.5	29.4	29.4
Actuated g/C Ratio	0.05	0.41	0.05	0.36	0.70	0.10	0.10	0.10	0.28	0.28
v/c Ratio	1.07	1.69	0.28	1.47	0.62	0.10	0.39	0.23	0.54	0.56
Control Delay	169.3	335.9	58.0	242.9	5.2	45.4	48.0	2.7	33.0	35.1
Queue Delay	0.0	0.0	0.0	0.0	0.0	0.0	0.0	0.0	0.0	0.0
Total Delay	169.3	335.9	58.0	242.9	5.2	45.4	48.0	2.7	33.0	35.1
LOS	F	F	E	F	A	D	D	A	C	D
Approach Delay		331.8		188.4			35.4			33.6
Approach LOS		F		F			D			C

Intersection Summary

Cycle Length: 130
 Actuated Cycle Length: 104
 Natural Cycle: 125
 Control Type: Actuated-Uncoordinated
 Maximum v/c Ratio: 1.69
 Intersection Signal Delay: 227.0
 Intersection Capacity Utilization 109.2%
 Analysis Period (min) 15
 Intersection LOS: F
 ICU Level of Service H

Splits and Phases: 3: Overlook Pkwy./Canyon Crest Dr. & Alessandro Bl/Alessandro Bl.

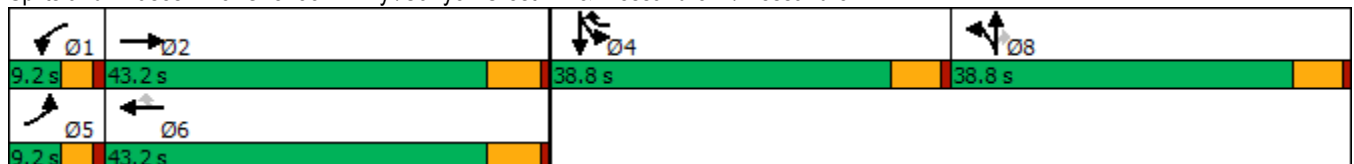

HCM 6th Signalized Intersection Summary

West Campus Upper Plateau (JN 14064)

3: Overlook Pkwy./Canyon Crest Dr. & Alessandro Bl/Alessandro Bl.

09/19/2022



Movement	EBL	EBT	EBR	WBL	WBT	WBR	NBL	NBT	NBR	SBL	SBT	SBR
Lane Configurations	↗	↑↑↑		↖	↑↑↑	↗	↖	↑↑	↗	↖↖↖	↖	↗
Traffic Volume (veh/h)	85	3395	18	23	2582	752	15	134	57	740	224	59
Future Volume (veh/h)	85	3395	18	23	2582	752	15	134	57	740	224	59
Initial Q (Qb), veh	0	0	0	0	0	0	0	0	0	0	0	0
Ped-Bike Adj(A_pbT)	1.00		1.00	1.00		1.00	1.00		1.00	1.00		1.00
Parking Bus, Adj	1.00	1.00	1.00	1.00	1.00	1.00	1.00	1.00	1.00	1.00	1.00	1.00
Work Zone On Approach		No			No			No			No	
Adj Sat Flow, veh/h/ln	1841	1885	1811	1900	1885	1885	1781	1900	1900	1885	1900	1870
Adj Flow Rate, veh/h	89	3536	19	24	2690	775	16	140	51	771	233	52
Peak Hour Factor	0.96	0.96	0.96	0.96	0.96	0.96	0.96	0.96	0.96	0.96	0.96	0.96
Percent Heavy Veh, %	4	1	6	0	1	1	8	0	0	1	0	2
Cap, veh/h	93	2234	12	45	2030	968	180	383	171	1072	319	71
Arrive On Green	0.05	0.42	0.42	0.02	0.39	0.39	0.11	0.11	0.11	0.21	0.21	0.21
Sat Flow, veh/h	1753	5283	28	1810	5147	1598	1697	3610	1610	5063	1504	336
Grp Volume(v), veh/h	89	2294	1261	24	2690	775	16	140	51	771	0	285
Grp Sat Flow(s),veh/h/ln	1753	1716	1880	1810	1716	1598	1697	1805	1610	1688	0	1840
Q Serve(g_s), s	4.8	39.7	39.7	1.2	37.0	34.8	0.8	3.4	2.7	13.3	0.0	13.6
Cycle Q Clear(g_c), s	4.8	39.7	39.7	1.2	37.0	34.8	0.8	3.4	2.7	13.3	0.0	13.6
Prop In Lane	1.00		0.02	1.00		1.00	1.00		1.00	1.00		0.18
Lane Grp Cap(c), veh/h	93	1451	795	45	2030	968	180	383	171	1072	0	390
V/C Ratio(X)	0.95	1.58	1.59	0.54	1.33	0.80	0.09	0.37	0.30	0.72	0.00	0.73
Avail Cap(c_a), veh/h	93	1451	795	96	2030	968	597	1270	566	1781	0	647
HCM Platoon Ratio	1.00	1.00	1.00	1.00	1.00	1.00	1.00	1.00	1.00	1.00	1.00	1.00
Upstream Filter(I)	1.00	1.00	1.00	1.00	1.00	1.00	1.00	1.00	1.00	1.00	0.00	1.00
Uniform Delay (d), s/veh	44.3	27.1	27.1	45.2	28.4	14.1	37.8	39.0	38.7	34.4	0.0	34.5
Incr Delay (d2), s/veh	76.8	265.0	269.6	3.6	150.0	4.9	0.2	0.6	1.0	0.9	0.0	2.7
Initial Q Delay(d3),s/veh	0.0	0.0	0.0	0.0	0.0	0.0	0.0	0.0	0.0	0.0	0.0	0.0
%ile BackOfQ(50%),veh/ln	4.0	67.5	75.0	0.6	41.6	18.5	0.3	1.5	1.1	5.2	0.0	6.0
Unsig. Movement Delay, s/veh												
LnGrp Delay(d),s/veh	121.1	292.0	296.6	48.9	178.4	19.0	38.1	39.6	39.7	35.3	0.0	37.2
LnGrp LOS	F	F	F	D	F	B	D	D	D	D	A	D
Approach Vol, veh/h		3644			3489			207			1056	
Approach Delay, s/veh		289.5			142.1			39.5			35.8	
Approach LOS		F			F			D			D	
Timer - Assigned Phs	1	2		4	5	6		8				
Phs Duration (G+Y+Rc), s	6.5	45.9		25.7	9.2	43.2		15.8				
Change Period (Y+Rc), s	* 4.2	6.2		5.8	* 4.2	6.2		5.8				
Max Green Setting (Gmax), s	* 5	37.0		33.0	* 5	37.0		33.0				
Max Q Clear Time (g_c+I1), s	3.2	41.7		15.6	6.8	39.0		5.4				
Green Ext Time (p_c), s	0.0	0.0		4.3	0.0	0.0		0.9				

Intersection Summary

HCM 6th Ctrl Delay	190.1
HCM 6th LOS	F

Notes

- User approved pedestrian interval to be less than phase max green.
- User approved volume balancing among the lanes for turning movement.
- * HCM 6th computational engine requires equal clearance times for the phases crossing the barrier.

Timings
4: Van Buren Bl. & Wood Rd.

West Campus Upper Plateau (JN 14064)

09/19/2022

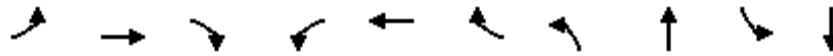

Lane Group	EBL	EBT	EBR	WBL	WBT	WBR	NBL	NBT	SBL	SBT
Lane Configurations	↘	↑↑↑	↗	↘↗	↑↑↑	↗	↘↗	↑↔	↘	↑↔
Traffic Volume (vph)	176	1926	241	333	1822	147	341	272	141	277
Future Volume (vph)	176	1926	241	333	1822	147	341	272	141	277
Turn Type	Prot	NA	pm+ov	Prot	NA	Perm	Prot	NA	Prot	NA
Protected Phases	5	2	3	1	6		3	8	7	4
Permitted Phases			2			6				
Detector Phase	5	2	3	1	6	6	3	8	7	4
Switch Phase										
Minimum Initial (s)	5.0	10.0	5.0	5.0	10.0	10.0	5.0	10.0	5.0	10.0
Minimum Split (s)	9.2	30.2	9.2	9.2	30.2	30.2	9.2	38.4	9.2	15.8
Total Split (s)	16.8	51.3	23.4	16.1	50.6	50.6	23.4	38.4	14.2	29.2
Total Split (%)	14.0%	42.8%	19.5%	13.4%	42.2%	42.2%	19.5%	32.0%	11.8%	24.3%
Yellow Time (s)	3.2	5.2	3.2	3.2	5.2	5.2	3.2	4.4	3.2	4.8
All-Red Time (s)	1.0	1.0	1.0	1.0	1.0	1.0	1.0	1.0	1.0	1.0
Lost Time Adjust (s)	0.0	0.0	0.0	0.0	0.0	0.0	0.0	0.0	0.0	0.0
Total Lost Time (s)	4.2	6.2	4.2	4.2	6.2	6.2	4.2	5.4	4.2	5.8
Lead/Lag	Lead	Lag	Lead	Lead	Lag	Lag	Lead	Lag	Lead	Lag
Lead-Lag Optimize?	Yes	Yes	Yes	Yes	Yes	Yes	Yes	Yes	Yes	Yes
Recall Mode	None	None	None	None	None	None	None	None	None	None
Act Effct Green (s)	12.7	45.3	63.3	12.0	44.6	44.6	16.0	25.3	10.0	18.9
Actuated g/C Ratio	0.11	0.40	0.56	0.11	0.40	0.40	0.14	0.22	0.09	0.17
v/c Ratio	0.96	1.04	0.29	1.00	0.99	0.23	0.77	0.67	0.97	0.79
Control Delay	106.5	63.8	8.0	97.7	51.5	6.8	58.1	28.8	118.5	41.9
Queue Delay	0.0	0.0	0.0	0.0	0.0	0.0	0.0	0.0	0.0	0.0
Total Delay	106.5	63.8	8.0	97.7	51.5	6.8	58.1	28.8	118.5	41.9
LOS	F	E	A	F	D	A	E	C	F	D
Approach Delay		61.3			55.3			40.1		59.1
Approach LOS		E			E			D		E

Intersection Summary

Cycle Length: 120
 Actuated Cycle Length: 112.7
 Natural Cycle: 120
 Control Type: Actuated-Uncoordinated
 Maximum v/c Ratio: 1.04
 Intersection Signal Delay: 55.8
 Intersection LOS: E
 Intersection Capacity Utilization 91.6%
 ICU Level of Service F
 Analysis Period (min) 15

Splits and Phases: 4: Van Buren Bl. & Wood Rd.

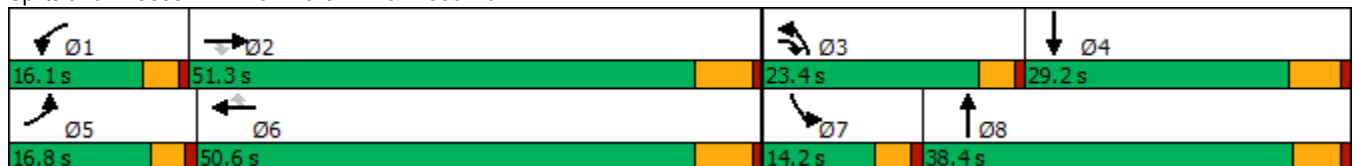

HCM 6th Signalized Intersection Summary
4: Van Buren Bl. & Wood Rd.

West Campus Upper Plateau (JN 14064)
09/19/2022



Movement	EBL	EBT	EBR	WBL	WBT	WBR	NBL	NBT	NBR	SBL	SBT	SBR
Lane Configurations	↶	↑↑↑	↷	↶↷	↑↑↑	↷	↶↷	↑↷		↶	↑↷	
Traffic Volume (veh/h)	176	1926	241	333	1822	147	341	272	272	141	277	212
Future Volume (veh/h)	176	1926	241	333	1822	147	341	272	272	141	277	212
Initial Q (Qb), veh	0	0	0	0	0	0	0	0	0	0	0	0
Ped-Bike Adj(A_pbT)	1.00		0.98	1.00		0.99	1.00		0.97	1.00		0.99
Parking Bus, Adj	1.00	1.00	1.00	1.00	1.00	1.00	1.00	1.00	1.00	1.00	1.00	1.00
Work Zone On Approach		No			No			No			No	
Adj Sat Flow, veh/h/ln	1885	1870	1870	1885	1885	1885	1870	1885	1870	1885	1885	1885
Adj Flow Rate, veh/h	193	2116	160	366	2002	115	375	299	218	155	304	158
Peak Hour Factor	0.91	0.91	0.91	0.91	0.91	0.91	0.91	0.91	0.91	0.91	0.91	0.91
Percent Heavy Veh, %	1	2	2	1	1	1	2	1	2	1	1	1
Cap, veh/h	205	2088	841	376	2072	634	442	410	290	163	390	198
Arrive On Green	0.11	0.41	0.41	0.11	0.40	0.40	0.13	0.21	0.21	0.09	0.17	0.17
Sat Flow, veh/h	1795	5106	1561	3483	5147	1574	3456	1978	1396	1795	2290	1159
Grp Volume(v), veh/h	193	2116	160	366	2002	115	375	270	247	155	236	226
Grp Sat Flow(s),veh/h/ln	1795	1702	1561	1742	1716	1574	1728	1791	1583	1795	1791	1658
Q Serve(g_s), s	11.8	45.1	5.8	11.6	41.9	5.2	11.7	15.5	16.2	9.5	13.9	14.4
Cycle Q Clear(g_c), s	11.8	45.1	5.8	11.6	41.9	5.2	11.7	15.5	16.2	9.5	13.9	14.4
Prop In Lane	1.00		1.00	1.00		1.00	1.00		0.88	1.00		0.70
Lane Grp Cap(c), veh/h	205	2088	841	376	2072	634	442	372	328	163	305	283
V/C Ratio(X)	0.94	1.01	0.19	0.97	0.97	0.18	0.85	0.73	0.75	0.95	0.77	0.80
Avail Cap(c_a), veh/h	205	2088	841	376	2072	634	602	536	474	163	380	352
HCM Platoon Ratio	1.00	1.00	1.00	1.00	1.00	1.00	1.00	1.00	1.00	1.00	1.00	1.00
Upstream Filter(I)	1.00	1.00	1.00	1.00	1.00	1.00	1.00	1.00	1.00	1.00	1.00	1.00
Uniform Delay (d), s/veh	48.5	32.6	13.2	49.0	32.2	21.2	47.1	40.8	41.0	49.9	43.7	43.9
Incr Delay (d2), s/veh	45.8	23.1	0.2	39.2	12.8	0.2	6.4	2.8	4.0	55.8	7.6	10.1
Initial Q Delay(d3),s/veh	0.0	0.0	0.0	0.0	0.0	0.0	0.0	0.0	0.0	0.0	0.0	0.0
%ile BackOfQ(50%),veh/ln	7.7	21.3	2.0	6.9	18.3	1.9	5.3	6.9	6.5	6.7	6.6	6.6
Unsig. Movement Delay, s/veh												
LnGrp Delay(d),s/veh	94.2	55.7	13.3	88.2	45.0	21.4	53.5	43.6	45.1	105.7	51.3	54.0
LnGrp LOS	F	F	B	F	D	C	D	D	D	F	D	D
Approach Vol, veh/h		2469			2483			892				617
Approach Delay, s/veh		55.9			50.3			48.2				66.0
Approach LOS		E			D			D				E
Timer - Assigned Phs	1	2	3	4	5	6	7	8				
Phs Duration (G+Y+Rc), s	16.1	51.3	18.3	24.6	16.8	50.6	14.2	28.7				
Change Period (Y+Rc), s	* 4.2	6.2	* 4.2	5.8	* 4.2	6.2	* 4.2	* 5.8				
Max Green Setting (Gmax), s	* 12	45.1	* 19	23.4	* 13	44.4	* 10	* 33				
Max Q Clear Time (g_c+I1), s	13.6	47.1	13.7	16.4	13.8	43.9	11.5	18.2				
Green Ext Time (p_c), s	0.0	0.0	0.4	1.5	0.0	0.4	0.0	2.6				

Intersection Summary

HCM 6th Ctrl Delay	53.7
HCM 6th LOS	D

Notes

* HCM 6th computational engine requires equal clearance times for the phases crossing the barrier.

Timings
8: Cole Av. & Van Buren Bl.

West Campus Upper Plateau (JN 14064)

09/19/2022



Lane Group	EBL	EBT	EBR	WBL	WBT	WBR	NBL	NBT	SBL	SBT	SBR
Lane Configurations	↖↗	↑↑↑	↖	↖	↑↑↑	↖	↖	↑↑	↖↗	↑↑	↖
Traffic Volume (vph)	445	1555	115	213	1657	691	102	382	658	691	330
Future Volume (vph)	445	1555	115	213	1657	691	102	382	658	691	330
Turn Type	Prot	NA	pm+ov	Prot	NA	pm+ov	Prot	NA	Prot	NA	pm+ov
Protected Phases	5	2	3	1	6	7	3	8	7	4	5
Permitted Phases			2			6					4
Detector Phase	5	2	3	1	6	7	3	8	7	4	5
Switch Phase											
Minimum Initial (s)	5.0	10.0	5.0	5.0	10.0	5.0	5.0	10.0	5.0	10.0	5.0
Minimum Split (s)	9.1	36.2	9.1	9.1	36.2	9.1	9.1	42.2	9.1	49.2	9.1
Total Split (s)	15.0	44.8	11.4	14.0	43.8	19.0	11.4	42.2	19.0	49.8	15.0
Total Split (%)	12.5%	37.3%	9.5%	11.7%	36.5%	15.8%	9.5%	35.2%	15.8%	41.5%	12.5%
Yellow Time (s)	3.2	5.2	3.2	3.2	5.2	3.2	3.2	5.2	3.2	5.2	3.2
All-Red Time (s)	0.5	1.0	0.5	0.5	1.0	0.5	0.5	1.0	0.5	1.0	0.5
Lost Time Adjust (s)	0.0	0.0	0.0	0.0	0.0	0.0	0.0	0.0	0.0	0.0	0.0
Total Lost Time (s)	3.7	6.2	3.7	3.7	6.2	3.7	3.7	6.2	3.7	6.2	3.7
Lead/Lag	Lead	Lag	Lead	Lead	Lag	Lead	Lead	Lag	Lead	Lag	Lead
Lead-Lag Optimize?	Yes	Yes	Yes	Yes	Yes	Yes	Yes	Yes	Yes	Yes	Yes
Recall Mode	None	None	None	None	None	None	None	None	None	None	None
Act Effct Green (s)	11.3	38.8	52.7	10.3	37.8	59.4	7.7	22.3	15.4	30.0	43.8
Actuated g/C Ratio	0.11	0.36	0.49	0.10	0.35	0.56	0.07	0.21	0.14	0.28	0.41
v/c Ratio	1.30	0.91	0.15	1.33	0.98	0.77	0.84	0.72	1.42	0.73	0.51
Control Delay	191.7	42.0	5.9	220.8	52.0	22.8	97.5	41.9	234.7	39.1	19.3
Queue Delay	0.0	0.0	0.0	0.0	0.0	0.0	0.0	0.0	0.0	0.0	0.0
Total Delay	191.7	42.0	5.9	220.8	52.0	22.8	97.5	41.9	234.7	39.1	19.3
LOS	F	D	A	F	D	C	F	D	F	D	B
Approach Delay		71.5			58.2			51.2		111.9	
Approach LOS		E			E			D		F	

Intersection Summary

Cycle Length: 120	
Actuated Cycle Length: 106.7	
Natural Cycle: 115	
Control Type: Actuated-Uncoordinated	
Maximum v/c Ratio: 1.42	
Intersection Signal Delay: 74.6	Intersection LOS: E
Intersection Capacity Utilization 97.1%	ICU Level of Service F
Analysis Period (min) 15	



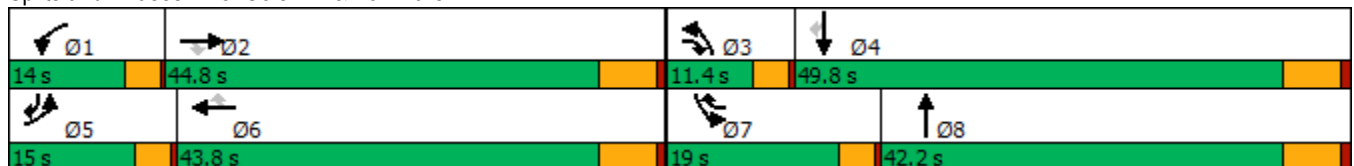



























Splits and Phases: 8: Cole Av. & Van Buren Bl.



HCM 6th Signalized Intersection Summary
8: Cole Av. & Van Buren Bl.

West Campus Upper Plateau (JN 14064)

09/19/2022

												
Movement	EBL	EBT	EBR	WBL	WBT	WBR	NBL	NBT	NBR	SBL	SBT	SBR
Lane Configurations	 	  			  			 		 	 	
Traffic Volume (veh/h)	445	1555	115	213	1657	691	102	382	125	658	691	330
Future Volume (veh/h)	445	1555	115	213	1657	691	102	382	125	658	691	330
Initial Q (Qb), veh	0	0	0	0	0	0	0	0	0	0	0	0
Ped-Bike Adj(A_pbT)	1.00		1.00	1.00		1.00	1.00		0.99	1.00		1.00
Parking Bus, Adj	1.00	1.00	1.00	1.00	1.00	1.00	1.00	1.00	1.00	1.00	1.00	1.00
Work Zone On Approach		No			No			No			No	
Adj Sat Flow, veh/h/ln	1870	1841	1856	1870	1870	1885	1885	1885	1885	1870	1885	1885
Adj Flow Rate, veh/h	473	1654	63	227	1763	645	109	406	126	700	735	251
Peak Hour Factor	0.94	0.94	0.94	0.94	0.94	0.94	0.94	0.94	0.94	0.94	0.94	0.94
Percent Heavy Veh, %	2	4	3	2	2	1	1	1	1	2	1	1
Cap, veh/h	372	1849	694	175	1830	805	132	537	165	504	974	606
Arrive On Green	0.11	0.37	0.37	0.10	0.36	0.36	0.07	0.20	0.20	0.15	0.27	0.27
Sat Flow, veh/h	3456	5025	1572	1781	5106	1598	1795	2695	827	3456	3582	1596
Grp Volume(v), veh/h	473	1654	63	227	1763	645	109	268	264	700	735	251
Grp Sat Flow(s),veh/h/ln	1728	1675	1572	1781	1702	1598	1795	1791	1730	1728	1791	1596
Q Serve(g_s), s	11.3	32.5	2.4	10.3	35.5	35.2	6.3	14.8	15.1	15.3	19.7	12.1
Cycle Q Clear(g_c), s	11.3	32.5	2.4	10.3	35.5	35.2	6.3	14.8	15.1	15.3	19.7	12.1
Prop In Lane	1.00		1.00	1.00		1.00	1.00		0.48	1.00		1.00
Lane Grp Cap(c), veh/h	372	1849	694	175	1830	805	132	357	345	504	974	606
V/C Ratio(X)	1.27	0.89	0.09	1.30	0.96	0.80	0.83	0.75	0.76	1.39	0.75	0.41
Avail Cap(c_a), veh/h	372	1849	694	175	1830	806	132	614	594	504	1488	835
HCM Platoon Ratio	1.00	1.00	1.00	1.00	1.00	1.00	1.00	1.00	1.00	1.00	1.00	1.00
Upstream Filter(I)	1.00	1.00	1.00	1.00	1.00	1.00	1.00	1.00	1.00	1.00	1.00	1.00
Uniform Delay (d), s/veh	46.8	31.2	17.1	47.3	33.0	21.6	48.0	39.5	39.7	44.8	35.0	24.0
Incr Delay (d2), s/veh	141.4	6.2	0.1	169.6	13.5	6.1	31.7	3.2	3.5	187.0	1.2	0.5
Initial Q Delay(d3),s/veh	0.0	0.0	0.0	0.0	0.0	0.0	0.0	0.0	0.0	0.0	0.0	0.0
%ile BackOfQ(50%),veh/ln	11.9	13.1	0.8	12.6	15.7	12.9	3.9	6.5	6.4	19.3	8.2	4.3
Unsig. Movement Delay, s/veh												
LnGrp Delay(d),s/veh	188.3	37.5	17.1	216.9	46.5	27.7	79.7	42.7	43.2	231.8	36.2	24.4
LnGrp LOS	F	D	B	F	D	C	E	D	D	F	D	C
Approach Vol, veh/h		2190			2635			641			1686	
Approach Delay, s/veh		69.5			56.6			49.2			115.7	
Approach LOS		E			E			D			F	
Timer - Assigned Phs	1	2	3	4	5	6	7	8				
Phs Duration (G+Y+Rc), s	14.0	44.8	11.4	34.7	15.0	43.8	19.0	27.1				
Change Period (Y+Rc), s	3.7	6.2	3.7	6.2	3.7	6.2	3.7	6.2				
Max Green Setting (Gmax), s	10.3	38.6	7.7	43.6	11.3	37.6	15.3	36.0				
Max Q Clear Time (g_c+I1), s	12.3	34.5	8.3	21.7	13.3	37.5	17.3	17.1				
Green Ext Time (p_c), s	0.0	3.5	0.0	5.4	0.0	0.1	0.0	2.7				
Intersection Summary												
HCM 6th Ctrl Delay				73.8								
HCM 6th LOS				E								

Timings
10: Orange Terrace Pkwy & Deercreek Dr

West Campus Upper Plateau (JN 14064)

09/19/2022



Lane Group	EBL	EBT	WBL	WBT	NBL	NBT	SBL	SBT
Lane Configurations	↖	↕	↖	↕		↕		↕
Traffic Volume (vph)	49	526	4	314	21	5	31	9
Future Volume (vph)	49	526	4	314	21	5	31	9
Turn Type	Perm	NA	Perm	NA	Perm	NA	Perm	NA
Protected Phases		4		8		2		6
Permitted Phases	4		8		2		6	
Detector Phase	4	4	8	8	2	2	6	6
Switch Phase								
Minimum Initial (s)	5.0	5.0	5.0	5.0	5.0	5.0	5.0	5.0
Minimum Split (s)	26.1	26.1	26.1	26.1	26.1	26.1	26.1	26.1
Total Split (s)	27.0	27.0	27.0	27.0	28.0	28.0	28.0	28.0
Total Split (%)	49.1%	49.1%	49.1%	49.1%	50.9%	50.9%	50.9%	50.9%
Yellow Time (s)	3.6	3.6	3.6	3.6	3.6	3.6	3.6	3.6
All-Red Time (s)	0.5	0.5	0.5	0.5	0.5	0.5	0.5	0.5
Lost Time Adjust (s)	0.0	0.0	0.0	0.0		0.0		0.0
Total Lost Time (s)	4.1	4.1	4.1	4.1		4.1		4.1
Lead/Lag								
Lead-Lag Optimize?								
Recall Mode	None	None	None	None	Min	Min	Min	Min
Act Effct Green (s)	11.2	11.2	11.2	11.2		8.4		8.4
Actuated g/C Ratio	0.39	0.39	0.39	0.39		0.29		0.29
v/c Ratio	0.14	0.41	0.01	0.28		0.07		0.14
Control Delay	7.8	7.8	7.2	6.4		8.1		6.7
Queue Delay	0.0	0.0	0.0	0.0		0.0		0.0
Total Delay	7.8	7.8	7.2	6.4		8.1		6.7
LOS	A	A	A	A		A		A
Approach Delay		7.8		6.4		8.1		6.7
Approach LOS		A		A		A		A

Intersection Summary

Cycle Length: 55
 Actuated Cycle Length: 28.8
 Natural Cycle: 55
 Control Type: Actuated-Uncoordinated
 Maximum v/c Ratio: 0.41
 Intersection Signal Delay: 7.2
 Intersection LOS: A
 Intersection Capacity Utilization 35.8%
 ICU Level of Service A
 Analysis Period (min) 15

Splits and Phases: 10: Orange Terrace Pkwy & Deercreek Dr

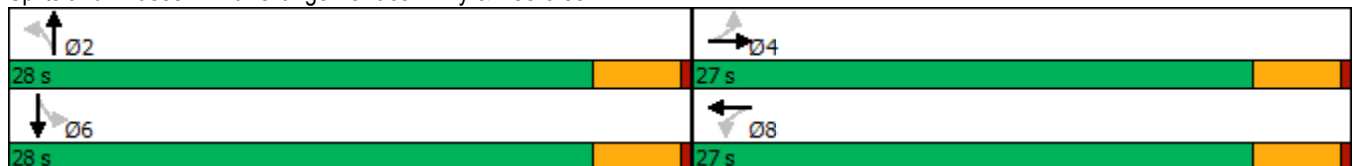

HCM 6th Signalized Intersection Summary
 10: Orange Terrace Pkwy & Deercreek Dr

West Campus Upper Plateau (JN 14064)

09/19/2022



Movement	EBL	EBT	EBR	WBL	WBT	WBR	NBL	NBT	NBR	SBL	SBT	SBR
Lane Configurations												
Traffic Volume (veh/h)	49	526	17	4	314	53	21	5	2	31	9	22
Future Volume (veh/h)	49	526	17	4	314	53	21	5	2	31	9	22
Initial Q (Qb), veh	0	0	0	0	0	0	0	0	0	0	0	0
Ped-Bike Adj(A_pbT)	1.00		0.98	1.00		1.00	1.00		0.99	0.99		0.97
Parking Bus, Adj	1.00	1.00	1.00	1.00	1.00	1.00	1.00	1.00	1.00	1.00	1.00	1.00
Work Zone On Approach		No			No			No			No	
Adj Sat Flow, veh/h/ln	1856	1870	1796	1900	1885	1900	1811	1900	1900	1900	1900	1900
Adj Flow Rate, veh/h	51	548	18	4	327	55	22	5	2	32	9	23
Peak Hour Factor	0.96	0.96	0.96	0.96	0.96	0.96	0.96	0.96	0.96	0.96	0.96	0.96
Percent Heavy Veh, %	3	2	7	0	1	0	6	0	0	0	0	0
Cap, veh/h	621	1269	42	548	1111	185	547	108	26	386	127	145
Arrive On Green	0.36	0.36	0.36	0.36	0.36	0.36	0.25	0.25	0.25	0.25	0.25	0.25
Sat Flow, veh/h	992	3508	115	858	3071	511	989	428	105	523	504	576
Grp Volume(v), veh/h	51	277	289	4	189	193	29	0	0	64	0	0
Grp Sat Flow(s),veh/h/ln	992	1777	1846	858	1791	1792	1521	0	0	1603	0	0
Q Serve(g_s), s	0.8	2.5	2.5	0.1	1.6	1.6	0.0	0.0	0.0	0.0	0.0	0.0
Cycle Q Clear(g_c), s	2.5	2.5	2.5	2.6	1.6	1.6	0.2	0.0	0.0	0.6	0.0	0.0
Prop In Lane	1.00		0.06	1.00		0.29	0.76		0.07	0.50		0.36
Lane Grp Cap(c), veh/h	621	643	668	548	648	648	682	0	0	658	0	0
V/C Ratio(X)	0.08	0.43	0.43	0.01	0.29	0.30	0.04	0.00	0.00	0.10	0.00	0.00
Avail Cap(c_a), veh/h	1332	1916	1991	1163	1931	1932	1970	0	0	1993	0	0
HCM Platoon Ratio	1.00	1.00	1.00	1.00	1.00	1.00	1.00	1.00	1.00	1.00	1.00	1.00
Upstream Filter(I)	1.00	1.00	1.00	1.00	1.00	1.00	1.00	0.00	0.00	1.00	0.00	0.00
Uniform Delay (d), s/veh	5.7	5.1	5.1	6.1	4.8	4.8	6.0	0.0	0.0	6.2	0.0	0.0
Incr Delay (d2), s/veh	0.1	0.5	0.4	0.0	0.2	0.3	0.0	0.0	0.0	0.1	0.0	0.0
Initial Q Delay(d3),s/veh	0.0	0.0	0.0	0.0	0.0	0.0	0.0	0.0	0.0	0.0	0.0	0.0
%ile BackOfQ(50%),veh/ln	0.0	0.1	0.1	0.0	0.3	0.3	0.0	0.0	0.0	0.1	0.0	0.0
Unsig. Movement Delay, s/veh												
LnGrp Delay(d),s/veh	5.8	5.6	5.6	6.1	5.1	5.1	6.1	0.0	0.0	6.2	0.0	0.0
LnGrp LOS	A	A	A	A	A	A	A	A	A	A	A	A
Approach Vol, veh/h		617			386			29				64
Approach Delay, s/veh		5.6			5.1			6.1				6.2
Approach LOS		A			A			A				A
Timer - Assigned Phs		2		4		6		8				
Phs Duration (G+Y+Rc), s		9.5		11.8		9.5		11.8				
Change Period (Y+Rc), s		4.1		4.1		4.1		4.1				
Max Green Setting (Gmax), s		23.9		22.9		23.9		22.9				
Max Q Clear Time (g_c+I1), s		2.2		4.5		2.6		4.6				
Green Ext Time (p_c), s		0.1		3.1		0.3		2.2				
Intersection Summary												
HCM 6th Ctrl Delay				5.5								
HCM 6th LOS				A								

Timings
11: Barton St & Alessandro Bl.

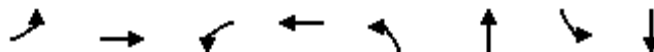

Lane Group	EBL	EBT	WBL	WBT	NBL	NBT	SBL	SBT
Lane Configurations	↙	↗↗↗	↙	↗↗↗	↙	↗	↙	↗
Traffic Volume (vph)	6	2345	77	2669	78	1	15	0
Future Volume (vph)	6	2345	77	2669	78	1	15	0
Turn Type	Prot	NA	Prot	NA	Perm	NA	Perm	NA
Protected Phases	5	2	1	6		8		4
Permitted Phases					8		4	
Detector Phase	5	2	1	6	8	8	4	4
Switch Phase								
Minimum Initial (s)	5.0	10.0	5.0	10.0	10.0	10.0	10.0	10.0
Minimum Split (s)	9.2	28.5	11.0	28.5	40.6	40.6	26.6	26.6
Total Split (s)	9.2	60.2	14.0	65.0	40.8	40.8	40.8	40.8
Total Split (%)	8.0%	52.3%	12.2%	56.5%	35.5%	35.5%	35.5%	35.5%
Yellow Time (s)	3.2	5.5	3.2	5.5	3.6	3.6	3.6	3.6
All-Red Time (s)	1.0	1.0	1.0	1.0	1.0	1.0	1.0	1.0
Lost Time Adjust (s)	0.0	0.0	0.0	0.0	0.0	0.0	0.0	0.0
Total Lost Time (s)	4.2	6.5	4.2	6.5	4.6	4.6	4.6	4.6
Lead/Lag	Lead	Lag	Lead	Lag				
Lead-Lag Optimize?	Yes	Yes	Yes	Yes				
Recall Mode	None	None	None	None	None	None	None	None
Act Effct Green (s)	5.2	58.6	7.9	66.9	14.8	14.8	14.8	14.8
Actuated g/C Ratio	0.06	0.66	0.09	0.75	0.17	0.17	0.17	0.17
v/c Ratio	0.07	0.74	0.50	0.73	0.34	0.13	0.07	0.04
Control Delay	49.0	17.7	54.1	12.8	37.8	11.0	32.1	0.2
Queue Delay	0.0	0.0	0.0	0.0	0.0	0.0	0.0	0.0
Total Delay	49.0	17.7	54.1	12.8	37.8	11.0	32.1	0.2
LOS	D	B	D	B	D	B	C	A
Approach Delay		17.8		13.9		28.8		16.7
Approach LOS		B		B		C		B

Intersection Summary

Cycle Length: 115
 Actuated Cycle Length: 88.8
 Natural Cycle: 115
 Control Type: Actuated-Uncoordinated
 Maximum v/c Ratio: 0.74
 Intersection Signal Delay: 16.0
 Intersection LOS: B
 Intersection Capacity Utilization 79.9%
 ICU Level of Service D
 Analysis Period (min) 15

Splits and Phases: 11: Barton St & Alessandro Bl.



HCM 6th Signalized Intersection Summary
11: Barton St & Alessandro Bl.

West Campus Upper Plateau (JN 14064)

09/19/2022



Movement	EBL	EBT	EBR	WBL	WBT	WBR	NBL	NBT	NBR	SBL	SBT	SBR
Lane Configurations	↖	↑↑↑		↖	↑↑↑		↖	↑		↖	↑	
Traffic Volume (veh/h)	6	2345	55	77	2669	17	78	1	38	15	0	14
Future Volume (veh/h)	6	2345	55	77	2669	17	78	1	38	15	0	14
Initial Q (Qb), veh	0	0	0	0	0	0	0	0	0	0	0	0
Ped-Bike Adj(A_pbT)	1.00		1.00	1.00		0.98	1.00		1.00	1.00		1.00
Parking Bus, Adj	1.00	1.00	1.00	1.00	1.00	1.00	1.00	1.00	1.00	1.00	1.00	1.00
Work Zone On Approach		No			No			No			No	
Adj Sat Flow, veh/h/ln	1604	1885	1900	1900	1870	1900	1900	1900	1900	1796	1900	1900
Adj Flow Rate, veh/h	6	2443	55	80	2780	18	81	1	14	16	0	5
Peak Hour Factor	0.96	0.96	0.96	0.96	0.96	0.96	0.96	0.96	0.96	0.96	0.96	0.96
Percent Heavy Veh, %	20	1	0	0	2	0	0	0	0	7	0	0
Cap, veh/h	12	3336	75	104	3630	23	245	12	172	228	0	182
Arrive On Green	0.01	0.64	0.64	0.06	0.69	0.69	0.11	0.11	0.11	0.11	0.00	0.11
Sat Flow, veh/h	1527	5179	116	1810	5234	34	1434	108	1518	1343	0	1610
Grp Volume(v), veh/h	6	1615	883	80	1806	992	81	0	15	16	0	5
Grp Sat Flow(s),veh/h/ln	1527	1716	1864	1810	1702	1863	1434	0	1627	1343	0	1610
Q Serve(g_s), s	0.3	26.1	26.4	3.6	28.5	28.7	4.4	0.0	0.7	0.9	0.0	0.2
Cycle Q Clear(g_c), s	0.3	26.1	26.4	3.6	28.5	28.7	4.6	0.0	0.7	1.6	0.0	0.2
Prop In Lane	1.00		0.06	1.00		0.02	1.00		0.93	1.00		1.00
Lane Grp Cap(c), veh/h	12	2210	1201	104	2361	1292	245	0	184	228	0	182
V/C Ratio(X)	0.50	0.73	0.74	0.77	0.77	0.77	0.33	0.00	0.08	0.07	0.00	0.03
Avail Cap(c_a), veh/h	93	2236	1215	215	2417	1323	713	0	715	666	0	707
HCM Platoon Ratio	1.00	1.00	1.00	1.00	1.00	1.00	1.00	1.00	1.00	1.00	1.00	1.00
Upstream Filter(I)	1.00	1.00	1.00	1.00	1.00	1.00	1.00	0.00	1.00	1.00	0.00	1.00
Uniform Delay (d), s/veh	40.7	9.9	9.9	38.3	8.2	8.3	34.6	0.0	32.7	33.4	0.0	32.5
Incr Delay (d2), s/veh	11.7	1.3	2.5	4.5	1.6	2.9	0.8	0.0	0.2	0.1	0.0	0.1
Initial Q Delay(d3),s/veh	0.0	0.0	0.0	0.0	0.0	0.0	0.0	0.0	0.0	0.0	0.0	0.0
%ile BackOfQ(50%),veh/ln	0.2	6.7	7.8	1.7	8.5	9.8	1.6	0.0	0.3	0.3	0.0	0.1
Unsig. Movement Delay, s/veh												
LnGrp Delay(d),s/veh	52.5	11.2	12.4	42.8	9.8	11.2	35.4	0.0	32.9	33.5	0.0	32.6
LnGrp LOS	D	B	B	D	A	B	D	A	C	C	A	C
Approach Vol, veh/h		2504			2878			96				21
Approach Delay, s/veh		11.7			11.2			35.0				33.3
Approach LOS		B			B			C				C
Timer - Assigned Phs	1	2		4	5	6		8				
Phs Duration (G+Y+Rc), s	8.9	59.6		13.9	4.8	63.7		13.9				
Change Period (Y+Rc), s	* 4.2	6.5		4.6	* 4.2	6.5		4.6				
Max Green Setting (Gmax), s	* 9.8	53.7		36.2	* 5	58.5		36.2				
Max Q Clear Time (g_c+1), s	5.6	28.4		3.6	2.3	30.7		6.6				
Green Ext Time (p_c), s	0.0	22.2		0.0	0.0	26.4		0.3				

Intersection Summary

HCM 6th Ctrl Delay	12.0
HCM 6th LOS	B

Notes

* HCM 6th computational engine requires equal clearance times for the phases crossing the barrier.

Timings
13: Barton Rd. & Orange Terrace Pkwy

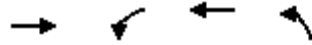

Lane Group	EBT	WBL	WBT	NBL
Lane Configurations	↑↑	↑	↑↑	↑
Traffic Volume (vph)	429	47	258	113
Future Volume (vph)	429	47	258	113
Turn Type	NA	Perm	NA	Prot
Protected Phases	4		8	2
Permitted Phases		8		
Detector Phase	4	8	8	2
Switch Phase				
Minimum Initial (s)	5.0	5.0	5.0	5.0
Minimum Split (s)	26.1	26.1	26.1	26.1
Total Split (s)	27.0	27.0	27.0	28.0
Total Split (%)	49.1%	49.1%	49.1%	50.9%
Yellow Time (s)	3.6	3.6	3.6	3.6
All-Red Time (s)	0.5	0.5	0.5	0.5
Lost Time Adjust (s)	0.0	0.0	0.0	0.0
Total Lost Time (s)	4.1	4.1	4.1	4.1
Lead/Lag				
Lead-Lag Optimize?				
Recall Mode	Max	Max	Max	Max
Act Effct Green (s)	22.9	22.9	22.9	23.9
Actuated g/C Ratio	0.42	0.42	0.42	0.43
v/c Ratio	0.39	0.16	0.18	0.20
Control Delay	10.3	11.7	10.5	7.8
Queue Delay	0.0	0.0	0.0	0.0
Total Delay	10.3	11.7	10.5	7.8
LOS	B	B	B	A
Approach Delay	10.3		10.7	7.8
Approach LOS	B		B	A

Intersection Summary

Cycle Length: 55
 Actuated Cycle Length: 55
 Offset: 0 (0%), Referenced to phase 2:NBL and 6:, Start of Yellow
 Natural Cycle: 55
 Control Type: Pretimed
 Maximum v/c Ratio: 0.39
 Intersection Signal Delay: 10.0
 Intersection LOS: B
 Intersection Capacity Utilization 41.8%
 ICU Level of Service A
 Analysis Period (min) 15

Splits and Phases: 13: Barton Rd. & Orange Terrace Pkwy

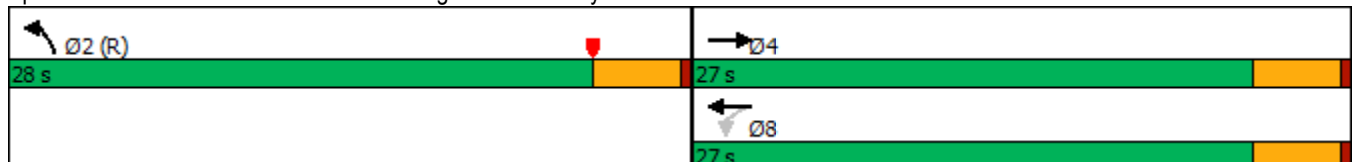

HCM 6th Signalized Intersection Summary
 13: Barton Rd. & Orange Terrace Pkwy

West Campus Upper Plateau (JN 14064)

09/19/2022

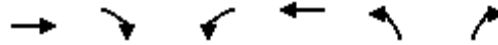

Movement	EBT	EBR	WBL	WBT	NBL	NBR
Lane Configurations	↑↑		↵	↑↑	↵	
Traffic Volume (veh/h)	429	129	47	258	113	45
Future Volume (veh/h)	429	129	47	258	113	45
Initial Q (Qb), veh	0	0	0	0	0	0
Ped-Bike Adj(A_pbT)		0.98	1.00		1.00	1.00
Parking Bus, Adj	1.00	1.00	1.00	1.00	1.00	1.00
Work Zone On Approach	No			No	No	
Adj Sat Flow, veh/h/ln	1885	1885	1900	1900	1900	1900
Adj Flow Rate, veh/h	442	133	48	266	116	46
Peak Hour Factor	0.97	0.97	0.97	0.97	0.97	0.97
Percent Heavy Veh, %	1	1	0	0	0	0
Cap, veh/h	1125	335	387	1503	541	214
Arrive On Green	0.42	0.42	0.42	0.42	0.43	0.43
Sat Flow, veh/h	2797	805	850	3705	1245	494
Grp Volume(v), veh/h	291	284	48	266	163	0
Grp Sat Flow(s),veh/h/ln	1791	1717	850	1805	1749	0
Q Serve(g_s), s	6.2	6.4	2.3	2.6	3.2	0.0
Cycle Q Clear(g_c), s	6.2	6.4	8.7	2.6	3.2	0.0
Prop In Lane		0.47	1.00		0.71	0.28
Lane Grp Cap(c), veh/h	746	715	387	1503	760	0
V/C Ratio(X)	0.39	0.40	0.12	0.18	0.21	0.00
Avail Cap(c_a), veh/h	746	715	387	1503	760	0
HCM Platoon Ratio	1.00	1.00	1.00	1.00	1.00	1.00
Upstream Filter(I)	1.00	1.00	1.00	1.00	1.00	0.00
Uniform Delay (d), s/veh	11.2	11.2	14.2	10.1	9.7	0.0
Incr Delay (d2), s/veh	1.5	1.6	0.7	0.3	0.6	0.0
Initial Q Delay(d3),s/veh	0.0	0.0	0.0	0.0	0.0	0.0
%ile BackOfQ(50%),veh/ln	2.4	2.4	0.5	0.9	1.2	0.0
Unsig. Movement Delay, s/veh						
LnGrp Delay(d),s/veh	12.7	12.9	14.9	10.4	10.3	0.0
LnGrp LOS	B	B	B	B	B	A
Approach Vol, veh/h	575			314	163	
Approach Delay, s/veh	12.8			11.1	10.3	
Approach LOS	B			B	B	
Timer - Assigned Phs		2		4		8
Phs Duration (G+Y+Rc), s		28.0		27.0		27.0
Change Period (Y+Rc), s		4.1		4.1		4.1
Max Green Setting (Gmax), s		23.9		22.9		22.9
Max Q Clear Time (g_c+I1), s		5.2		8.4		10.7
Green Ext Time (p_c), s		0.4		3.1		1.5

Intersection Summary

HCM 6th Ctrl Delay	11.9
HCM 6th LOS	B

Notes

User approved volume balancing among the lanes for turning movement.

Timings
14: Barton Rd. & Van Buren Bl.

West Campus Upper Plateau (JN 14064)

09/19/2022

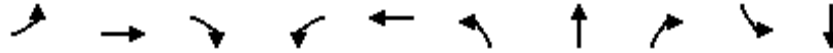

Lane Group	EBL	EBT	EBR	WBL	WBT	NBL	NBT	NBR	SBL	SBT
Lane Configurations	↘	↑↑↑	↗	↘↗	↑↑↑	↘↗	↑	↗	↘	↗
Traffic Volume (vph)	192	2032	333	319	2220	348	93	257	28	31
Future Volume (vph)	192	2032	333	319	2220	348	93	257	28	31
Turn Type	Prot	NA	pm+ov	Prot	NA	Prot	NA	Perm	Prot	NA
Protected Phases	5	2	3	1	6	3	8		7	4
Permitted Phases			2					8		
Detector Phase	5	2	3	1	6	3	8	8	7	4
Switch Phase										
Minimum Initial (s)	5.0	10.0	5.0	5.0	10.0	5.0	10.0	10.0	5.0	10.0
Minimum Split (s)	9.2	25.2	9.1	9.2	25.5	9.1	14.6	14.6	9.1	33.6
Total Split (s)	17.4	54.3	16.0	16.1	53.0	16.0	39.4	39.4	10.2	33.6
Total Split (%)	14.5%	45.3%	13.3%	13.4%	44.2%	13.3%	32.8%	32.8%	8.5%	28.0%
Yellow Time (s)	3.2	5.2	3.6	3.2	5.5	3.6	3.6	3.6	3.6	3.6
All-Red Time (s)	1.0	1.0	0.5	1.0	1.0	0.5	1.0	1.0	0.5	1.0
Lost Time Adjust (s)	0.0	0.0	0.0	0.0	0.0	0.0	0.0	0.0	0.0	0.0
Total Lost Time (s)	4.2	6.2	4.1	4.2	6.5	4.1	4.6	4.6	4.1	4.6
Lead/Lag	Lead	Lag	Lead	Lead	Lag	Lead	Lag	Lag	Lead	Lag
Lead-Lag Optimize?	Yes	Yes	Yes	Yes	Yes	Yes	Yes	Yes	Yes	Yes
Recall Mode	None	None	None	None	None	None	None	None	None	None
Act Effct Green (s)	13.3	48.3	62.4	12.0	46.7	12.0	23.5	23.5	6.0	13.4
Actuated g/C Ratio	0.13	0.46	0.59	0.11	0.45	0.11	0.22	0.22	0.06	0.13
v/c Ratio	0.88	0.82	0.36	0.84	0.95	0.91	0.23	0.50	0.28	0.57
Control Delay	81.7	28.7	8.4	65.7	37.8	74.4	35.9	9.0	56.8	15.8
Queue Delay	0.0	0.0	0.0	0.0	0.0	0.0	0.0	0.0	0.0	0.0
Total Delay	81.7	28.7	8.4	65.7	37.8	74.4	35.9	9.0	56.8	15.8
LOS	F	C	A	E	D	E	D	A	E	B
Approach Delay		30.1			41.2		45.2			20.8
Approach LOS		C			D		D			C

Intersection Summary

Cycle Length: 120
 Actuated Cycle Length: 104.9
 Natural Cycle: 120
 Control Type: Actuated-Uncoordinated
 Maximum v/c Ratio: 0.95
 Intersection Signal Delay: 36.2
 Intersection LOS: D
 Intersection Capacity Utilization 92.8%
 ICU Level of Service F
 Analysis Period (min) 15



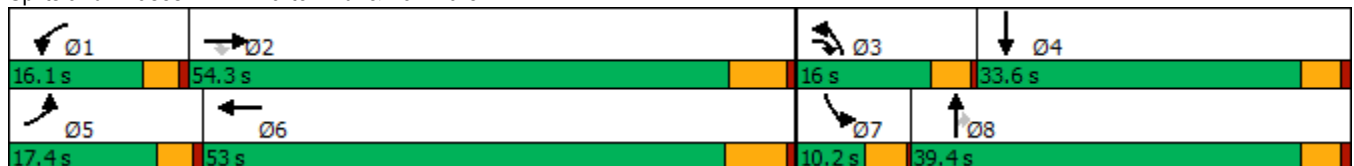



























Splits and Phases: 14: Barton Rd. & Van Buren Bl.



HCM 6th Signalized Intersection Summary
14: Barton Rd. & Van Buren Bl.

West Campus Upper Plateau (JN 14064)

09/19/2022

												
Movement	EBL	EBT	EBR	WBL	WBT	WBR	NBL	NBT	NBR	SBL	SBT	SBR
Lane Configurations		  		  	  		 					
Traffic Volume (veh/h)	192	2032	333	319	2220	54	348	93	257	28	31	168
Future Volume (veh/h)	192	2032	333	319	2220	54	348	93	257	28	31	168
Initial Q (Qb), veh	0	0	0	0	0	0	0	0	0	0	0	0
Ped-Bike Adj(A_pbT)	1.00		1.00	1.00		1.00	1.00		0.96	1.00		1.00
Parking Bus, Adj	1.00	1.00	1.00	1.00	1.00	1.00	1.00	1.00	1.00	1.00	1.00	1.00
Work Zone On Approach		No			No			No			No	
Adj Sat Flow, veh/h/ln	1900	1870	1885	1885	1885	1870	1900	1900	1885	1900	1885	1900
Adj Flow Rate, veh/h	200	2117	318	332	2312	46	362	97	144	29	32	117
Peak Hour Factor	0.96	0.96	0.96	0.96	0.96	0.96	0.96	0.96	0.96	0.96	0.96	0.96
Percent Heavy Veh, %	0	2	1	1	1	2	0	0	1	0	1	0
Cap, veh/h	231	2602	927	395	2484	49	411	389	312	50	41	149
Arrive On Green	0.13	0.46	0.46	0.11	0.45	0.45	0.12	0.20	0.20	0.03	0.12	0.12
Sat Flow, veh/h	1810	5611	1597	3483	5526	110	3510	1900	1526	1810	355	1297
Grp Volume(v), veh/h	200	2117	318	332	1575	783	362	97	144	29	0	149
Grp Sat Flow(s),veh/h/ln	1810	1870	1597	1742	1885	1865	1755	1900	1526	1810	0	1652
Q Serve(g_s), s	11.0	33.0	10.6	9.5	40.2	40.5	10.3	4.4	8.4	1.6	0.0	8.9
Cycle Q Clear(g_c), s	11.0	33.0	10.6	9.5	40.2	40.5	10.3	4.4	8.4	1.6	0.0	8.9
Prop In Lane	1.00		1.00	1.00		0.06	1.00		1.00	1.00		0.79
Lane Grp Cap(c), veh/h	231	2602	927	395	1695	838	411	389	312	50	0	190
V/C Ratio(X)	0.87	0.81	0.34	0.84	0.93	0.93	0.88	0.25	0.46	0.58	0.00	0.78
Avail Cap(c_a), veh/h	235	2654	942	408	1724	853	411	650	522	109	0	471
HCM Platoon Ratio	1.00	1.00	1.00	1.00	1.00	1.00	1.00	1.00	1.00	1.00	1.00	1.00
Upstream Filter(I)	1.00	1.00	1.00	1.00	1.00	1.00	1.00	1.00	1.00	1.00	0.00	1.00
Uniform Delay (d), s/veh	43.5	23.5	11.2	44.2	26.5	26.6	44.2	33.9	35.5	48.9	0.0	43.8
Incr Delay (d2), s/veh	25.6	1.9	0.1	13.4	9.2	16.5	19.4	0.3	1.1	10.4	0.0	6.9
Initial Q Delay(d3),s/veh	0.0	0.0	0.0	0.0	0.0	0.0	0.0	0.0	0.0	0.0	0.0	0.0
%ile BackOfQ(50%),veh/ln	6.3	13.3	3.3	4.6	18.1	19.7	5.4	2.0	3.1	0.9	0.0	4.0
Unsig. Movement Delay, s/veh												
LnGrp Delay(d),s/veh	69.1	25.3	11.2	57.5	35.6	43.0	63.6	34.2	36.6	59.2	0.0	50.7
LnGrp LOS	E	C	B	E	D	D	E	C	D	E	A	D
Approach Vol, veh/h		2635			2690			603				178
Approach Delay, s/veh		27.0			40.5			52.4				52.1
Approach LOS		C			D			D				D
Timer - Assigned Phs	1	2	3	4	5	6	7	8				
Phs Duration (G+Y+Rc), s	15.7	53.7	16.0	16.3	17.2	52.2	6.9	25.4				
Change Period (Y+Rc), s	* 4.2	* 6.5	4.1	4.6	* 4.2	6.5	4.1	4.6				
Max Green Setting (Gmax), s	* 12	* 48	11.9	29.0	* 13	46.5	6.1	34.8				
Max Q Clear Time (g_c+I1), s	11.5	35.0	12.3	10.9	13.0	42.5	3.6	10.4				
Green Ext Time (p_c), s	0.0	8.5	0.0	0.8	0.0	3.2	0.0	0.9				

Intersection Summary

HCM 6th Ctrl Delay	36.2
HCM 6th LOS	D

Notes

* HCM 6th computational engine requires equal clearance times for the phases crossing the barrier.

Timings
25: Sycamore Canyon Bl. & Cactus Av.

West Campus Upper Plateau (JN 14064)

09/19/2022



Lane Group	EBL	EBT	WBL	WBT	WBR	NBL	NBT	NBR	SBL	SBT	SBR
Lane Configurations	↖	↕↕↕	↖↖	↕↕	↖	↖↖	↕↕	↖	↖↖	↕↕	↖
Traffic Volume (vph)	173	1161	964	433	616	186	539	369	743	1121	52
Future Volume (vph)	173	1161	964	433	616	186	539	369	743	1121	52
Turn Type	Prot	NA	Prot	NA	pm+ov	Prot	NA	Perm	Prot	NA	Perm
Protected Phases	7	4	3	8	1	5	2		1	6	
Permitted Phases					8			2			6
Detector Phase	7	4	3	8	1	5	2	2	1	6	6
Switch Phase											
Minimum Initial (s)	5.0	10.0	5.0	10.0	10.0	10.0	10.0	10.0	10.0	10.0	10.0
Minimum Split (s)	9.6	32.8	9.6	32.8	15.8	15.8	15.8	15.8	15.8	34.8	34.8
Total Split (s)	32.1	49.0	34.0	50.9	30.0	15.8	37.0	37.0	30.0	51.2	51.2
Total Split (%)	21.4%	32.7%	22.7%	33.9%	20.0%	10.5%	24.7%	24.7%	20.0%	34.1%	34.1%
Yellow Time (s)	3.6	4.8	3.6	4.8	4.8	4.8	4.8	4.8	4.8	4.8	4.8
All-Red Time (s)	1.0	1.0	1.0	1.0	1.0	1.0	1.0	1.0	1.0	1.0	1.0
Lost Time Adjust (s)	0.0	0.0	0.0	0.0	0.0	0.0	0.0	0.0	0.0	0.0	0.0
Total Lost Time (s)	4.6	5.8	4.6	5.8	5.8	5.8	5.8	5.8	5.8	5.8	5.8
Lead/Lag	Lead	Lag	Lead	Lag	Lead	Lead	Lag	Lag	Lead	Lag	Lag
Lead-Lag Optimize?	Yes	Yes	Yes	Yes	Yes	Yes	Yes	Yes	Yes	Yes	Yes
Recall Mode	None	None	None	None	None	None	None	None	None	None	None
Act Effct Green (s)	21.2	43.2	29.4	51.4	81.4	10.0	31.2	31.2	24.2	45.4	45.4
Actuated g/C Ratio	0.14	0.29	0.20	0.34	0.54	0.07	0.21	0.21	0.16	0.30	0.30
v/c Ratio	0.81	1.40	1.70	0.44	0.78	0.96	0.87	0.73	1.55	1.27	0.12
Control Delay	86.1	223.7	357.3	40.5	29.8	117.9	71.1	20.4	294.3	169.7	2.1
Queue Delay	0.0	0.0	0.0	0.0	5.2	0.0	0.0	0.0	0.0	0.0	0.0
Total Delay	86.1	223.7	357.3	40.5	35.0	117.9	71.1	20.4	294.3	169.7	2.1
LOS	F	F	F	D	D	F	E	C	F	F	A
Approach Delay		211.0		190.6			61.9			213.5	
Approach LOS		F		F			E			F	

Intersection Summary

Cycle Length: 150
 Actuated Cycle Length: 150
 Natural Cycle: 115
 Control Type: Actuated-Uncoordinated
 Maximum v/c Ratio: 1.70
 Intersection Signal Delay: 182.1
 Intersection LOS: F
 Intersection Capacity Utilization 119.4%
 ICU Level of Service H
 Analysis Period (min) 15



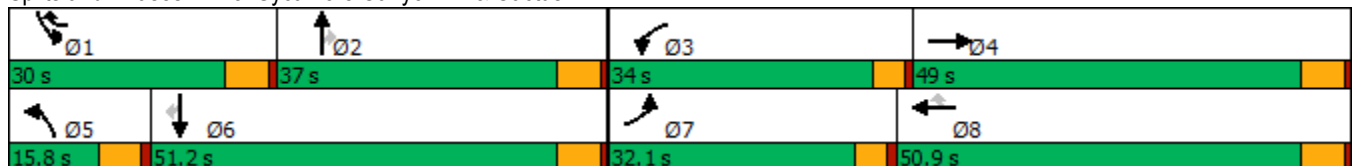



























Splits and Phases: 25: Sycamore Canyon Bl. & Cactus Av.



HCM 6th Signalized Intersection Summary
 25: Sycamore Canyon Bl. & Cactus Av.

West Campus Upper Plateau (JN 14064)

09/19/2022

												
Movement	EBL	EBT	EBR	WBL	WBT	WBR	NBL	NBT	NBR	SBL	SBT	SBR
Lane Configurations		 		 	 		 	 		 	 	 
Traffic Volume (veh/h)	173	1161	530	964	433	616	186	539	369	743	1121	52
Future Volume (veh/h)	173	1161	530	964	433	616	186	539	369	743	1121	52
Initial Q (Qb), veh	0	0	0	0	0	0	0	0	0	0	0	0
Ped-Bike Adj(A_pbT)	1.00		1.00	1.00		1.00	1.00		1.00	1.00		1.00
Parking Bus, Adj	1.00	1.00	1.00	1.00	1.00	1.00	1.00	1.00	1.00	1.00	1.00	1.00
Work Zone On Approach		No			No			No			No	
Adj Sat Flow, veh/h/ln	1856	1796	1856	1841	1796	1870	1856	1841	1826	1885	1811	1767
Adj Flow Rate, veh/h	201	1350	383	1121	503	446	216	627	284	864	1303	60
Peak Hour Factor	0.86	0.86	0.86	0.86	0.86	0.86	0.86	0.86	0.86	0.86	0.86	0.86
Percent Heavy Veh, %	3	7	3	4	7	2	3	4	5	1	6	9
Cap, veh/h	224	1094	309	667	1220	822	229	727	322	562	1041	453
Arrive On Green	0.13	0.29	0.29	0.20	0.36	0.36	0.07	0.21	0.21	0.16	0.30	0.30
Sat Flow, veh/h	1767	3798	1074	3401	3413	1585	3428	3497	1547	3483	3441	1497
Grp Volume(v), veh/h	201	1161	572	1121	503	446	216	627	284	864	1303	60
Grp Sat Flow(s),veh/h/ln	1767	1635	1603	1700	1706	1585	1714	1749	1547	1742	1721	1497
Q Serve(g_s), s	16.8	43.2	43.2	29.4	16.7	28.3	9.4	26.0	26.7	24.2	45.4	4.4
Cycle Q Clear(g_c), s	16.8	43.2	43.2	29.4	16.7	28.3	9.4	26.0	26.7	24.2	45.4	4.4
Prop In Lane	1.00		0.67	1.00		1.00	1.00		1.00	1.00		1.00
Lane Grp Cap(c), veh/h	224	942	462	667	1220	822	229	727	322	562	1041	453
V/C Ratio(X)	0.90	1.23	1.24	1.68	0.41	0.54	0.95	0.86	0.88	1.54	1.25	0.13
Avail Cap(c_a), veh/h	324	942	462	667	1220	822	229	727	322	562	1041	453
HCM Platoon Ratio	1.00	1.00	1.00	1.00	1.00	1.00	1.00	1.00	1.00	1.00	1.00	1.00
Upstream Filter(I)	1.00	1.00	1.00	1.00	1.00	1.00	1.00	1.00	1.00	1.00	1.00	1.00
Uniform Delay (d), s/veh	64.6	53.4	53.4	60.3	36.3	24.2	69.7	57.3	57.6	62.9	52.3	38.0
Incr Delay (d2), s/veh	16.0	114.4	124.6	313.3	0.2	0.7	44.3	10.4	23.7	250.7	121.0	0.1
Initial Q Delay(d3),s/veh	0.0	0.0	0.0	0.0	0.0	0.0	0.0	0.0	0.0	0.0	0.0	0.0
%ile BackOfQ(50%),veh/ln	8.5	32.4	33.0	41.4	6.9	10.4	5.5	12.3	12.4	30.1	36.5	1.6
Unsig. Movement Delay, s/veh												
LnGrp Delay(d),s/veh	80.5	167.8	178.0	373.6	36.5	24.9	114.1	67.7	81.3	313.6	173.3	38.1
LnGrp LOS	F	F	F	F	D	C	F	E	F	F	F	D
Approach Vol, veh/h		1934			2070			1127			2227	
Approach Delay, s/veh		161.7			216.6			80.0			224.1	
Approach LOS		F			F			E			F	
Timer - Assigned Phs	1	2	3	4	5	6	7	8				
Phs Duration (G+Y+Rc), s	30.0	37.0	34.0	49.0	15.8	51.2	23.6	59.4				
Change Period (Y+Rc), s	5.8	5.8	4.6	5.8	5.8	5.8	4.6	5.8				
Max Green Setting (Gmax), s	24.2	31.2	29.4	43.2	10.0	45.4	27.5	45.1				
Max Q Clear Time (g_c+I1), s	26.2	28.7	31.4	45.2	11.4	47.4	18.8	30.3				
Green Ext Time (p_c), s	0.0	1.2	0.0	0.0	0.0	0.0	0.2	4.2				
Intersection Summary												
HCM 6th Ctrl Delay			183.5									
HCM 6th LOS			F									

Timings
26: Sycamore Canyon Bl. & Van Buren Bl.

West Campus Upper Plateau (JN 14064)

09/19/2022

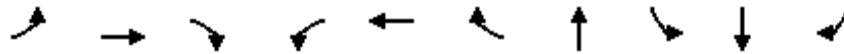

Lane Group	EBL	EBT	EBR	WBL	WBT	WBR	NBT	SBL	SBT	SBR
Lane Configurations										
Traffic Volume (vph)	586	3907	1	8	2746	132	16	1154	15	1076
Future Volume (vph)	586	3907	1	8	2746	132	16	1154	15	1076
Turn Type	Prot	NA	Perm	Prot	NA	Perm	NA	Split	NA	Perm
Protected Phases	5	2		1	6		8	4	4	
Permitted Phases			2			6				4
Detector Phase	5	2	2	1	6	6	8	4	4	4
Switch Phase										
Minimum Initial (s)	5.0	10.0	10.0	5.0	10.0	10.0	10.0	10.0	10.0	10.0
Minimum Split (s)	9.6	29.2	29.2	9.6	29.2	29.2	14.6	50.8	50.8	50.8
Total Split (s)	15.0	45.0	45.0	9.6	39.6	39.6	14.6	50.8	50.8	50.8
Total Split (%)	12.5%	37.5%	37.5%	8.0%	33.0%	33.0%	12.2%	42.3%	42.3%	42.3%
Yellow Time (s)	3.6	5.2	5.2	3.6	5.2	5.2	3.6	4.8	4.8	4.8
All-Red Time (s)	1.0	1.0	1.0	1.0	1.0	1.0	1.0	1.0	1.0	1.0
Lost Time Adjust (s)	0.0	0.0	0.0	0.0	0.0	0.0	0.0	0.0	0.0	0.0
Total Lost Time (s)	4.6	6.2	6.2	4.6	6.2	6.2	4.6	5.8	5.8	5.8
Lead/Lag	Lead	Lag	Lag	Lead	Lag	Lag				
Lead-Lag Optimize?	Yes	Yes	Yes	Yes	Yes	Yes				
Recall Mode	None	None	None	None	None	None	None	None	None	None
Act Effct Green (s)	10.4	46.7	46.7	5.0	33.5	33.5	10.0	44.4	44.4	44.4
Actuated g/C Ratio	0.09	0.40	0.40	0.04	0.29	0.29	0.09	0.38	0.38	0.38
v/c Ratio	2.03	1.45	0.00	0.13	1.43	0.26	0.23	0.85	0.92	0.82
Control Delay	502.3	232.6	0.0	60.0	229.7	5.8	28.3	41.1	45.2	26.5
Queue Delay	0.0	0.0	0.0	0.0	0.0	0.0	0.0	0.0	0.0	0.0
Total Delay	502.3	232.6	0.0	60.0	229.7	5.8	28.3	41.1	45.2	26.5
LOS	F	F	A	E	F	A	C	D	D	C
Approach Delay		267.7			219.0		28.3		38.4	
Approach LOS		F			F		C		D	

Intersection Summary

Cycle Length: 120
 Actuated Cycle Length: 116.4
 Natural Cycle: 115
 Control Type: Actuated-Uncoordinated
 Maximum v/c Ratio: 2.03
 Intersection Signal Delay: 198.5
 Intersection Capacity Utilization 110.2%
 Analysis Period (min) 15
 Intersection LOS: F
 ICU Level of Service H

Splits and Phases: 26: Sycamore Canyon Bl. & Van Buren Bl.

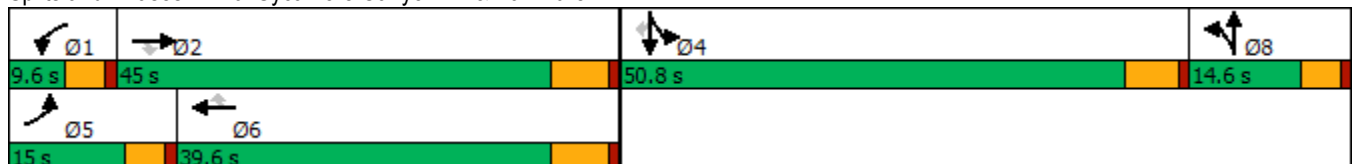

HCM 6th Signalized Intersection Summary
 26: Sycamore Canyon Bl. & Van Buren Bl.

West Campus Upper Plateau (JN 14064)

09/19/2022



Movement	EBL	EBT	EBR	WBL	WBT	WBR	NBL	NBT	NBR	SBL	SBT	SBR
Lane Configurations												
Traffic Volume (veh/h)	586	3907	1	8	2746	132	13	16	38	1154	15	1076
Future Volume (veh/h)	586	3907	1	8	2746	132	13	16	38	1154	15	1076
Initial Q (Qb), veh	0	0	0	0	0	0	0	0	0	0	0	0
Ped-Bike Adj(A_pbT)	1.00		1.00	1.00		0.99	1.00		0.99	1.00		1.00
Parking Bus, Adj	1.00	1.00	1.00	1.00	1.00	1.00	1.00	1.00	1.00	1.00	1.00	1.00
Work Zone On Approach		No			No			No			No	
Adj Sat Flow, veh/h/ln	1856	1841	1900	1693	1826	1856	1900	1900	1900	1841	1900	1856
Adj Flow Rate, veh/h	637	4247	1	9	2985	132	14	17	11	1010	0	0
Peak Hour Factor	0.92	0.92	0.92	0.92	0.92	0.92	0.92	0.92	0.92	0.92	0.92	0.92
Percent Heavy Veh, %	3	4	0	14	5	3	0	0	0	4	0	3
Cap, veh/h	344	2940	643	18	2285	486	78	96	63	1138	0	
Arrive On Green	0.10	0.60	0.40	0.01	0.47	0.31	0.07	0.07	0.07	0.32	0.00	0.00
Sat Flow, veh/h	3534	7363	1610	1612	7304	1553	1169	1441	945	3506	0	3145
Grp Volume(v), veh/h	637	4247	1	9	2985	132	22	0	20	1010	0	0
Grp Sat Flow(s),veh/h/ln	1767	1841	1610	1612	1826	1553	1842	0	1714	1753	0	1572
Q Serve(g_s), s	10.4	42.6	0.0	0.6	33.4	6.8	1.2	0.0	1.2	29.2	0.0	0.0
Cycle Q Clear(g_c), s	10.4	42.6	0.0	0.6	33.4	6.8	1.2	0.0	1.2	29.2	0.0	0.0
Prop In Lane	1.00		1.00	1.00		1.00	0.63		0.55	1.00		1.00
Lane Grp Cap(c), veh/h	344	2940	643	18	2285	486	123	0	114	1138	0	
V/C Ratio(X)	1.85	1.44	0.00	0.51	1.31	0.27	0.18	0.00	0.17	0.89	0.00	
Avail Cap(c_a), veh/h	344	2940	643	75	2285	486	172	0	160	1478	0	
HCM Platoon Ratio	1.00	1.50	1.00	1.00	1.50	1.00	1.00	1.00	1.00	1.00	1.00	1.00
Upstream Filter(I)	1.00	1.00	1.00	1.00	1.00	1.00	1.00	0.00	1.00	1.00	0.00	0.00
Uniform Delay (d), s/veh	48.2	21.4	19.3	52.5	28.3	27.6	47.1	0.0	47.1	34.2	0.0	0.0
Incr Delay (d2), s/veh	393.7	202.1	0.0	8.2	141.2	0.3	0.7	0.0	0.7	5.7	0.0	0.0
Initial Q Delay(d3),s/veh	0.0	0.0	0.0	0.0	0.0	0.0	0.0	0.0	0.0	0.0	0.0	0.0
%ile BackOfQ(50%),veh/ln	23.3	53.3	0.0	0.3	33.6	2.5	0.6	0.0	0.5	12.6	0.0	0.0
Unsig. Movement Delay, s/veh												
LnGrp Delay(d),s/veh	441.9	223.5	19.3	60.7	169.6	27.9	47.8	0.0	47.8	39.9	0.0	0.0
LnGrp LOS	F	F	B	E	F	C	D	A	D	D	A	
Approach Vol, veh/h		4885			3126			42			1010	
Approach Delay, s/veh		252.0			163.3			47.8			39.9	
Approach LOS		F			F			D			D	
Timer - Assigned Phs	1	2		4	5	6		8				
Phs Duration (G+Y+Rc), s	5.8	48.8		40.5	15.0	39.6		11.7				
Change Period (Y+Rc), s	4.6	6.2		5.8	4.6	6.2		4.6				
Max Green Setting (Gmax), s	5.0	38.8		45.0	10.4	33.4		10.0				
Max Q Clear Time (g_c+I1), s	2.6	44.6		31.2	12.4	35.4		3.2				
Green Ext Time (p_c), s	0.0	0.0		3.5	0.0	0.0		0.0				

Intersection Summary

HCM 6th Ctrl Delay	196.8
HCM 6th LOS	F

Notes

User approved volume balancing among the lanes for turning movement.
 Unsignalized Delay for [SBR] is excluded from calculations of the approach delay and intersection delay.

Timings
29: I-215 NB Ramps & Alessandro Bl.

West Campus Upper Plateau (JN 14064)

09/19/2022

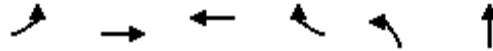

Lane Group	EBL	EBT	WBT	WBR	NBL	NBT
Lane Configurations						
Traffic Volume (vph)	274	2355	1523	162	1052	13
Future Volume (vph)	274	2355	1523	162	1052	13
Turn Type	Prot	NA	NA	Perm	Split	NA
Protected Phases	5	2	6		8	8
Permitted Phases				6		
Detector Phase	5	2	6	6	8	8
Switch Phase						
Minimum Initial (s)	5.0	5.0	5.0	5.0	5.0	5.0
Minimum Split (s)	9.5	10.5	33.5	33.5	10.0	10.0
Total Split (s)	24.6	67.0	42.4	42.4	43.0	43.0
Total Split (%)	22.4%	60.9%	38.5%	38.5%	39.1%	39.1%
Yellow Time (s)	3.5	4.5	4.5	4.5	4.0	4.0
All-Red Time (s)	1.0	1.0	1.0	1.0	1.0	1.0
Lost Time Adjust (s)	0.0	0.0	0.0	0.0	0.0	0.0
Total Lost Time (s)	4.5	5.5	5.5	5.5	5.0	5.0
Lead/Lag	Lead		Lag	Lag		
Lead-Lag Optimize?	Yes		Yes	Yes		
Recall Mode	None	Min	Min	Min	Max	Max
Act Effct Green (s)	20.1	61.5	36.9	36.9	38.0	38.0
Actuated g/C Ratio	0.18	0.56	0.34	0.34	0.35	0.35
v/c Ratio	1.01	0.88	0.97	0.33	0.91	1.09
Control Delay	100.5	25.8	52.1	18.8	48.1	103.3
Queue Delay	0.0	0.6	0.0	0.0	0.0	0.0
Total Delay	100.5	26.4	52.1	18.8	48.1	103.3
LOS	F	C	D	B	D	F
Approach Delay		34.1	48.9			67.6
Approach LOS		C	D			E

Intersection Summary

Cycle Length: 110
 Actuated Cycle Length: 110
 Natural Cycle: 100
 Control Type: Actuated-Uncoordinated
 Maximum v/c Ratio: 1.09
 Intersection Signal Delay: 46.9
 Intersection LOS: D
 Intersection Capacity Utilization 84.8%
 ICU Level of Service E
 Analysis Period (min) 15

Splits and Phases: 29: I-215 NB Ramps & Alessandro Bl.



HCM 6th Signalized Intersection Summary
 29: I-215 NB Ramps & Alessandro Bl.

West Campus Upper Plateau (JN 14064)

09/19/2022



Movement	EBL	EBT	EBR	WBL	WBT	WBR	NBL	NBT	NBR	SBL	SBT	SBR
Lane Configurations	↗	↑↑↑			↑↑↑	↗	↗↗	↕				
Traffic Volume (veh/h)	274	2355	0	0	1523	162	1052	13	397	0	0	0
Future Volume (veh/h)	274	2355	0	0	1523	162	1052	13	397	0	0	0
Initial Q (Qb), veh	0	0	0	0	0	0	0	0	0			
Ped-Bike Adj(A_pbT)	1.00		1.00	1.00		0.98	1.00		1.00			
Parking Bus, Adj	1.00	1.00	1.00	1.00	1.00	1.00	1.00	1.00	1.00			
Work Zone On Approach		No			No			No				
Adj Sat Flow, veh/h/ln	1693	1870	0	0	1841	1752	1856	1900	1826			
Adj Flow Rate, veh/h	291	2505	0	0	1620	145	1049	112	336			
Peak Hour Factor	0.94	0.94	0.94	0.94	0.94	0.94	0.94	0.94	0.94			
Percent Heavy Veh, %	14	2	0	0	4	10	3	0	5			
Cap, veh/h	295	2854	0	0	1685	487	1221	145	434			
Arrive On Green	0.18	0.56	0.00	0.00	0.34	0.34	0.35	0.35	0.35			
Sat Flow, veh/h	1612	5274	0	0	5191	1453	3534	419	1256			
Grp Volume(v), veh/h	291	2505	0	0	1620	145	1049	0	448			
Grp Sat Flow(s),veh/h/ln	1612	1702	0	0	1675	1453	1767	0	1674			
Q Serve(g_s), s	19.8	46.7	0.0	0.0	34.8	8.1	30.4	0.0	26.3			
Cycle Q Clear(g_c), s	19.8	46.7	0.0	0.0	34.8	8.1	30.4	0.0	26.3			
Prop In Lane	1.00		0.00	0.00		1.00	1.00		0.75			
Lane Grp Cap(c), veh/h	295	2854	0	0	1685	487	1221	0	578			
V/C Ratio(X)	0.99	0.88	0.00	0.00	0.96	0.30	0.86	0.00	0.77			
Avail Cap(c_a), veh/h	295	2855	0	0	1686	488	1221	0	578			
HCM Platoon Ratio	1.00	1.00	1.00	1.00	1.00	1.00	1.00	1.00	1.00			
Upstream Filter(I)	1.00	1.00	0.00	0.00	1.00	1.00	1.00	0.00	1.00			
Uniform Delay (d), s/veh	44.8	21.0	0.0	0.0	35.9	27.0	33.5	0.0	32.2			
Incr Delay (d2), s/veh	48.9	3.4	0.0	0.0	13.9	0.3	8.0	0.0	9.8			
Initial Q Delay(d3),s/veh	0.0	0.0	0.0	0.0	0.0	0.0	0.0	0.0	0.0			
%ile BackOfQ(50%),veh/ln	11.4	16.4	0.0	0.0	15.1	2.7	13.8	0.0	11.8			
Unsig. Movement Delay, s/veh												
LnGrp Delay(d),s/veh	93.7	24.4	0.0	0.0	49.7	27.3	41.5	0.0	41.9			
LnGrp LOS	F	C	A	A	D	C	D	A	D			
Approach Vol, veh/h		2796			1765			1497				
Approach Delay, s/veh		31.6			47.9			41.6				
Approach LOS		C			D			D				
Timer - Assigned Phs		2			5	6		8				
Phs Duration (G+Y+Rc), s		67.0			24.6	42.4		43.0				
Change Period (Y+Rc), s		5.5			4.5	5.5		5.0				
Max Green Setting (Gmax), s		61.5			20.1	36.9		38.0				
Max Q Clear Time (g_c+I1), s		48.7			21.8	36.8		32.4				
Green Ext Time (p_c), s		11.0			0.0	0.1		3.4				

Intersection Summary

HCM 6th Ctrl Delay	38.8
HCM 6th LOS	D

Notes

User approved volume balancing among the lanes for turning movement.

Timings

West Campus Upper Plateau (JN 14064)

31: I-215 NB Ramps/Old 215 Frontage Rd. & Cactus Av.

09/19/2022



Lane Group	EBL	EBT	EBR	WBT	NBL	NBT	NBR	SBL	SBT
Lane Configurations	↶	↶↶	↶	↶↶↶	↶↶	↶	↶	↶	↶
Traffic Volume (vph)	105	1953	749	2518	216	252	86	196	3
Future Volume (vph)	105	1953	749	2518	216	252	86	196	3
Turn Type	Perm	NA	Perm	NA	Prot	NA	Perm	Perm	NA
Protected Phases		2		6	3	8			4
Permitted Phases	2		2				8	4	
Detector Phase	2	2	2	6	3	8	8	4	4
Switch Phase									
Minimum Initial (s)	5.0	5.0	5.0	5.0	5.0	5.0	5.0	5.0	5.0
Minimum Split (s)	11.0	11.0	11.0	44.0	9.1	10.5	10.5	10.5	10.5
Total Split (s)	64.0	64.0	64.0	64.0	14.0	36.0	36.0	22.0	22.0
Total Split (%)	64.0%	64.0%	64.0%	64.0%	14.0%	36.0%	36.0%	22.0%	22.0%
Yellow Time (s)	5.0	5.0	5.0	5.0	3.6	4.5	4.5	4.5	4.5
All-Red Time (s)	1.0	1.0	1.0	1.0	0.5	1.0	1.0	1.0	1.0
Lost Time Adjust (s)	0.0	0.0	0.0	0.0	0.0	0.0	0.0	0.0	0.0
Total Lost Time (s)	6.0	6.0	6.0	6.0	4.1	5.5	5.5	5.5	5.5
Lead/Lag					Lead			Lag	Lag
Lead-Lag Optimize?					Yes			Yes	Yes
Recall Mode	Min	Min	Min	Min	None	None	None	None	None
Act Effct Green (s)	58.0	58.0	58.0	58.0	9.7	30.3	30.3	16.5	16.5
Actuated g/C Ratio	0.58	0.58	0.58	0.58	0.10	0.30	0.30	0.17	0.17
v/c Ratio	1.49	1.01	0.68	0.97	0.72	0.51	0.17	1.16	0.77
Control Delay	303.6	44.0	5.2	31.7	57.8	32.5	17.3	155.9	58.2
Queue Delay	0.0	0.0	0.0	0.0	0.0	0.0	0.0	0.0	0.0
Total Delay	303.6	44.0	5.2	31.7	57.8	32.5	17.3	155.9	58.2
LOS	F	D	A	C	E	C	B	F	E
Approach Delay		43.3		31.7		40.2			106.4
Approach LOS		D		C		D			F

Intersection Summary

Cycle Length: 100
 Actuated Cycle Length: 99.8
 Natural Cycle: 110
 Control Type: Actuated-Uncoordinated
 Maximum v/c Ratio: 1.49
 Intersection Signal Delay: 42.0
 Intersection LOS: D
 Intersection Capacity Utilization 103.7%
 ICU Level of Service G
 Analysis Period (min) 15

Splits and Phases: 31: I-215 NB Ramps/Old 215 Frontage Rd. & Cactus Av.



HCM 6th Signalized Intersection Summary

West Campus Upper Plateau (JN 14064)

31: I-215 NB Ramps/Old 215 Frontage Rd. & Cactus Av.

09/19/2022



Movement	EBL	EBT	EBR	WBL	WBT	WBR	NBL	NBT	NBR	SBL	SBT	SBR
Lane Configurations	↘	↑↑	↗		↑↑↑		↘↗	↑	↗	↘	↑	↗
Traffic Volume (veh/h)	105	1953	749	0	2518	187	216	252	86	196	3	199
Future Volume (veh/h)	105	1953	749	0	2518	187	216	252	86	196	3	199
Initial Q (Qb), veh	0	0	0	0	0	0	0	0	0	0	0	0
Ped-Bike Adj(A_pbT)	1.00		1.00	1.00		1.00	1.00		1.00	1.00		1.00
Parking Bus, Adj	1.00	1.00	1.00	1.00	1.00	1.00	1.00	1.00	1.00	1.00	1.00	1.00
Work Zone On Approach		No			No			No			No	
Adj Sat Flow, veh/h/ln	1856	1841	1767	0	1856	1885	1767	1856	1870	1841	1900	1885
Adj Flow Rate, veh/h	109	2034	776	0	2623	147	225	262	0	204	3	181
Peak Hour Factor	0.96	0.96	0.96	0.96	0.96	0.96	0.96	0.96	0.96	0.96	0.96	0.96
Percent Heavy Veh, %	3	4	9	0	3	1	9	3	2	4	0	1
Cap, veh/h	83	2056	880	0	2888	159	291	548		257	4	266
Arrive On Green	0.59	0.59	0.59	0.00	0.59	0.59	0.09	0.30	0.00	0.17	0.17	0.17
Sat Flow, veh/h	99	3497	1497	0	5079	271	3365	1856	1585	1100	26	1588
Grp Volume(v), veh/h	109	2034	776	0	1791	979	225	262	0	204	0	184
Grp Sat Flow(s),veh/h/ln	99	1749	1497	0	1689	1806	1682	1856	1585	1100	0	1614
Q Serve(g_s), s	9.9	56.5	43.7	0.0	45.9	48.1	6.5	11.4	0.0	16.5	0.0	10.6
Cycle Q Clear(g_c), s	58.0	56.5	43.7	0.0	45.9	48.1	6.5	11.4	0.0	16.5	0.0	10.6
Prop In Lane	1.00		1.00	0.00		0.15	1.00		1.00	1.00		0.98
Lane Grp Cap(c), veh/h	83	2056	880	0	1986	1062	291	548		257	0	270
V/C Ratio(X)	1.31	0.99	0.88	0.00	0.90	0.92	0.77	0.48		0.79	0.00	0.68
Avail Cap(c_a), veh/h	83	2056	880	0	1986	1062	338	574		257	0	270
HCM Platoon Ratio	1.00	1.00	1.00	1.00	1.00	1.00	1.00	1.00	1.00	1.00	1.00	1.00
Upstream Filter(I)	1.00	1.00	1.00	0.00	1.00	1.00	1.00	1.00	0.00	1.00	0.00	1.00
Uniform Delay (d), s/veh	48.7	20.0	17.4	0.0	17.8	18.3	44.1	28.5	0.0	41.9	0.0	38.6
Incr Delay (d2), s/veh	204.1	17.2	10.0	0.0	6.0	12.6	9.1	0.2	0.0	14.5	0.0	5.7
Initial Q Delay(d3),s/veh	0.0	0.0	0.0	0.0	0.0	0.0	0.0	0.0	0.0	0.0	0.0	0.0
%ile BackOfQ(50%),veh/ln	6.7	23.7	14.9	0.0	16.4	20.2	3.0	4.8	0.0	5.8	0.0	4.4
Unsig. Movement Delay, s/veh												
LnGrp Delay(d),s/veh	252.8	37.3	27.4	0.0	23.8	30.9	53.2	28.7	0.0	56.4	0.0	44.3
LnGrp LOS	F	D	C	A	C	C	D	C		E	A	D
Approach Vol, veh/h		2919			2770			487				388
Approach Delay, s/veh		42.7			26.3			40.1				50.6
Approach LOS		D			C			D				D
Timer - Assigned Phs		2	3	4		6		8				
Phs Duration (G+Y+Rc), s		64.0	12.6	22.0		64.0		34.6				
Change Period (Y+Rc), s		6.0	4.1	5.5		6.0		5.5				
Max Green Setting (Gmax), s		58.0	9.9	16.5		58.0		30.5				
Max Q Clear Time (g_c+I1), s		60.0	8.5	18.5		50.1		13.4				
Green Ext Time (p_c), s		0.0	0.1	0.0		6.6		0.7				

Intersection Summary

HCM 6th Ctrl Delay	36.1
HCM 6th LOS	D

Notes

User approved volume balancing among the lanes for turning movement.
 Unsignalized Delay for [NBR] is excluded from calculations of the approach delay and intersection delay.

Timings
32: I-215 SB Ramps & Van Buren Bl.

West Campus Upper Plateau (JN 14064)

09/19/2022

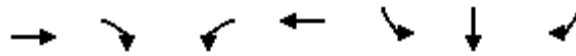

Lane Group	EBT	EBR	WBL	WBT	SBL	SBT	SBR
Lane Configurations	↑↑	↑	↵	↑↑	↵	↕	↑
Traffic Volume (vph)	1424	2457	184	1540	532	98	748
Future Volume (vph)	1424	2457	184	1540	532	98	748
Turn Type	NA	Perm	Prot	NA	Split	NA	Perm
Protected Phases	6		5	2	8	8	
Permitted Phases		6					8
Detector Phase	6	6	5	2	8	8	8
Switch Phase							
Minimum Initial (s)	5.0	5.0	5.0	5.0	5.0	5.0	5.0
Minimum Split (s)	36.0	36.0	11.0	11.0	11.0	11.0	11.0
Total Split (s)	80.0	80.0	15.0	95.0	25.0	25.0	25.0
Total Split (%)	66.7%	66.7%	12.5%	79.2%	20.8%	20.8%	20.8%
Yellow Time (s)	5.0	5.0	5.0	5.0	5.0	5.0	5.0
All-Red Time (s)	1.0	1.0	1.0	1.0	1.0	1.0	1.0
Lost Time Adjust (s)	0.0	0.0	0.0	0.0	0.0	0.0	0.0
Total Lost Time (s)	6.0	6.0	6.0	6.0	6.0	6.0	6.0
Lead/Lag	Lag	Lag	Lead				
Lead-Lag Optimize?	Yes	Yes	Yes				
Recall Mode	None	None	None	None	None	None	None
Act Effect Green (s)	74.0	74.0	9.0	89.0	19.0	19.0	19.0
Actuated g/C Ratio	0.62	0.62	0.08	0.74	0.16	0.16	0.16
v/c Ratio	0.74	2.42	1.48	0.65	1.90	1.84	1.66
Control Delay	18.9	659.8	289.1	9.2	447.3	417.8	340.9
Queue Delay	0.0	0.0	0.0	0.0	0.0	0.0	0.0
Total Delay	18.9	659.8	289.1	9.2	447.3	417.8	340.9
LOS	B	F	F	A	F	F	F
Approach Delay	424.7			39.1		403.3	
Approach LOS	F			D		F	

Intersection Summary

Cycle Length: 120
 Actuated Cycle Length: 120
 Natural Cycle: 120
 Control Type: Actuated-Uncoordinated
 Maximum v/c Ratio: 2.42
 Intersection Signal Delay: 325.3
 Intersection Capacity Utilization 199.7%
 Analysis Period (min) 15
 Intersection LOS: F
 ICU Level of Service H

Splits and Phases: 32: I-215 SB Ramps & Van Buren Bl.



HCM 6th Signalized Intersection Summary
 32: I-215 SB Ramps & Van Buren Bl.

West Campus Upper Plateau (JN 14064)

09/19/2022



Movement	EBL	EBT	EBR	WBL	WBT	WBR	NBL	NBT	NBR	SBL	SBT	SBR
Lane Configurations		↑↑	↗	↖	↑↑					↘	↕	↗
Traffic Volume (veh/h)	0	1424	2457	184	1540	0	0	0	0	532	98	748
Future Volume (veh/h)	0	1424	2457	184	1540	0	0	0	0	532	98	748
Initial Q (Qb), veh	0	0	0	0	0	0				0	0	0
Ped-Bike Adj(A_pbT)	1.00		1.00	1.00		1.00				1.00		1.00
Parking Bus, Adj	1.00	1.00	1.00	1.00	1.00	1.00				1.00	1.00	1.00
Work Zone On Approach		No			No						No	
Adj Sat Flow, veh/h/ln	0	1796	1856	1885	1826	0				1885	1841	1722
Adj Flow Rate, veh/h	0	1531	0	198	1656	0				416	0	0
Peak Hour Factor	0.93	0.93	0.93	0.93	0.93	0.93				0.93	0.93	0.93
Percent Heavy Veh, %	0	7	3	1	5	0				1	4	12
Cap, veh/h	0	1732		173	2318	0				365	0	
Arrive On Green	0.00	0.51	0.00	0.10	0.67	0.00				0.20	0.00	0.00
Sat Flow, veh/h	0	3503	1572	1795	3561	0				1795	0	2919
Grp Volume(v), veh/h	0	1531	0	198	1656	0				416	0	0
Grp Sat Flow(s),veh/h/ln	0	1706	1572	1795	1735	0				1795	0	1459
Q Serve(g_s), s	0.0	37.4	0.0	9.0	28.3	0.0				19.0	0.0	0.0
Cycle Q Clear(g_c), s	0.0	37.4	0.0	9.0	28.3	0.0				19.0	0.0	0.0
Prop In Lane	0.00		1.00	1.00		0.00				1.00		1.00
Lane Grp Cap(c), veh/h	0	1732		173	2318	0				365	0	
V/C Ratio(X)	0.00	0.88		1.14	0.71	0.00				1.14	0.00	
Avail Cap(c_a), veh/h	0	2704		173	3306	0				365	0	
HCM Platoon Ratio	1.00	1.00	1.00	1.00	1.00	1.00				1.00	1.00	1.00
Upstream Filter(I)	0.00	1.00	0.00	1.00	1.00	0.00				1.00	0.00	0.00
Uniform Delay (d), s/veh	0.0	20.5	0.0	42.2	9.8	0.0				37.2	0.0	0.0
Incr Delay (d2), s/veh	0.0	1.6	0.0	112.5	0.2	0.0				90.4	0.0	0.0
Initial Q Delay(d3),s/veh	0.0	0.0	0.0	0.0	0.0	0.0				0.0	0.0	0.0
%ile BackOfQ(50%),veh/ln	0.0	12.6	0.0	9.2	7.7	0.0				17.0	0.0	0.0
Unsig. Movement Delay, s/veh												
LnGrp Delay(d),s/veh	0.0	22.1	0.0	154.7	10.0	0.0				127.6	0.0	0.0
LnGrp LOS	A	C		F	B	A				F	A	
Approach Vol, veh/h		1531			1854						416	
Approach Delay, s/veh		22.1			25.5						127.6	
Approach LOS		C			C						F	
Timer - Assigned Phs		2			5	6		8				
Phs Duration (G+Y+Rc), s		68.4			15.0	53.4		25.0				
Change Period (Y+Rc), s		6.0			6.0	6.0		6.0				
Max Green Setting (Gmax), s		89.0			9.0	74.0		19.0				
Max Q Clear Time (g_c+I1), s		30.3			11.0	39.4		21.0				
Green Ext Time (p_c), s		10.2			0.0	8.0		0.0				

Intersection Summary

HCM 6th Ctrl Delay	35.3
HCM 6th LOS	D

Notes

User approved volume balancing among the lanes for turning movement.
 Unsignalized Delay for [EBR, SBR] is excluded from calculations of the approach delay and intersection delay.

Timings

West Campus Upper Plateau (JN 14064)

34: Old 215 Frontage Rd. & Alessandro Bl.

09/19/2022



Lane Group	EBL	EBT	EBR	WBL	WBT	WBR	NBL	NBT	NBR	SBL	SBT	SBR
Lane Configurations	↖↗	↑↑↑	↖	↖	↑↑↑	↖	↖↗	↑↑	↖	↖	↑↑	↖
Traffic Volume (vph)	398	1892	115	15	1282	128	42	212	16	143	243	269
Future Volume (vph)	398	1892	115	15	1282	128	42	212	16	143	243	269
Turn Type	Prot	NA	Perm	Prot	NA	Perm	Prot	NA	Perm	Prot	NA	Perm
Protected Phases	5	2		1	6		3	8		7	4	
Permitted Phases			2			6			8			4
Detector Phase	5	2	2	1	6	6	3	8	8	7	4	4
Switch Phase												
Minimum Initial (s)	5.0	10.0	10.0	5.0	10.0	10.0	5.0	10.0	10.0	5.0	10.0	10.0
Minimum Split (s)	8.7	43.5	43.5	8.7	15.8	15.8	8.7	16.2	16.2	8.7	40.2	40.2
Total Split (s)	25.0	62.4	62.4	8.7	46.1	46.1	8.7	26.9	26.9	22.0	40.2	40.2
Total Split (%)	20.8%	52.0%	52.0%	7.3%	38.4%	38.4%	7.3%	22.4%	22.4%	18.3%	33.5%	33.5%
Yellow Time (s)	3.2	5.5	5.5	3.2	4.8	4.8	3.2	5.2	5.2	3.2	5.2	5.2
All-Red Time (s)	0.5	1.0	1.0	0.5	1.0	1.0	0.5	1.0	1.0	0.5	1.0	1.0
Lost Time Adjust (s)	0.0	0.0	0.0	0.0	0.0	0.0	0.0	0.0	0.0	0.0	0.0	0.0
Total Lost Time (s)	3.7	6.5	6.5	3.7	5.8	5.8	3.7	6.2	6.2	3.7	6.2	6.2
Lead/Lag	Lead	Lag	Lag	Lead	Lag	Lag	Lead	Lag	Lag	Lead	Lag	Lag
Lead-Lag Optimize?	Yes	Yes	Yes	Yes	Yes	Yes	Yes	Yes	Yes	Yes	Yes	Yes
Recall Mode	None	None	None	None	None	None	None	None	None	None	None	None
Act Effct Green (s)	16.2	50.6	50.6	5.2	34.2	34.2	5.2	13.0	13.0	12.7	24.9	24.9
Actuated g/C Ratio	0.17	0.53	0.53	0.05	0.36	0.36	0.05	0.14	0.14	0.13	0.26	0.26
v/c Ratio	0.72	0.71	0.15	0.18	0.72	0.20	0.28	0.46	0.05	0.65	0.29	0.48
Control Delay	47.8	20.6	2.9	56.7	30.5	2.8	55.3	44.2	0.3	56.4	32.3	7.2
Queue Delay	0.0	0.0	0.0	0.0	0.0	0.0	0.0	0.0	0.0	0.0	0.0	0.0
Total Delay	47.8	20.6	2.9	56.7	30.5	2.8	55.3	44.2	0.3	56.4	32.3	7.2
LOS	D	C	A	E	C	A	E	D	A	E	C	A
Approach Delay		24.3			28.3			43.4			27.3	
Approach LOS		C			C			D			C	

Intersection Summary

Cycle Length: 120
 Actuated Cycle Length: 96.2
 Natural Cycle: 105
 Control Type: Actuated-Uncoordinated
 Maximum v/c Ratio: 0.72
 Intersection Signal Delay: 27.0
 Intersection LOS: C
 Intersection Capacity Utilization 74.2%
 ICU Level of Service D
 Analysis Period (min) 15

Splits and Phases: 34: Old 215 Frontage Rd. & Alessandro Bl.

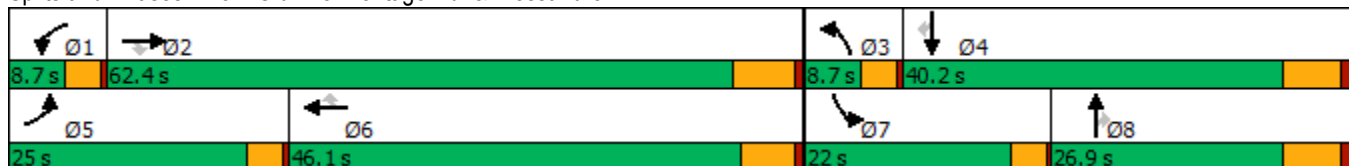

HCM 6th Signalized Intersection Summary
34: Old 215 Frontage Rd. & Alessandro Bl.

West Campus Upper Plateau (JN 14064)

09/19/2022



Movement	EBL	EBT	EBR	WBL	WBT	WBR	NBL	NBT	NBR	SBL	SBT	SBR
Lane Configurations	↔↔	↑↑↑	↗	↖	↑↑↑	↗	↔↔	↑↑	↗	↖	↑↑	↗
Traffic Volume (veh/h)	398	1892	115	15	1282	128	42	212	16	143	243	269
Future Volume (veh/h)	398	1892	115	15	1282	128	42	212	16	143	243	269
Initial Q (Qb), veh	0	0	0	0	0	0	0	0	0	0	0	0
Ped-Bike Adj(A_pbT)	1.00		0.99	1.00		1.00	1.00		0.98	1.00		1.00
Parking Bus, Adj	1.00	1.00	1.00	1.00	1.00	1.00	1.00	1.00	1.00	1.00	1.00	1.00
Work Zone On Approach		No			No			No			No	
Adj Sat Flow, veh/h/ln	1826	1885	1678	1678	1870	1856	1574	1856	1574	1826	1752	1693
Adj Flow Rate, veh/h	406	1931	90	15	1308	0	43	216	6	146	248	0
Peak Hour Factor	0.98	0.98	0.98	0.98	0.98	0.98	0.98	0.98	0.98	0.98	0.98	0.98
Percent Heavy Veh, %	5	1	15	15	2	3	22	3	22	5	10	14
Cap, veh/h	497	2657	725	28	1974		110	424	158	181	620	
Arrive On Green	0.15	0.52	0.52	0.02	0.39	0.00	0.04	0.12	0.12	0.10	0.19	0.00
Sat Flow, veh/h	3374	5147	1404	1598	5106	1572	2908	3526	1313	1739	3328	1434
Grp Volume(v), veh/h	406	1931	90	15	1308	0	43	216	6	146	248	0
Grp Sat Flow(s),veh/h/ln	1687	1716	1404	1598	1702	1572	1454	1763	1313	1739	1664	1434
Q Serve(g_s), s	9.7	24.1	2.8	0.8	17.6	0.0	1.2	4.8	0.3	6.8	5.4	0.0
Cycle Q Clear(g_c), s	9.7	24.1	2.8	0.8	17.6	0.0	1.2	4.8	0.3	6.8	5.4	0.0
Prop In Lane	1.00		1.00	1.00		1.00	1.00		1.00	1.00		1.00
Lane Grp Cap(c), veh/h	497	2657	725	28	1974		110	424	158	181	620	
V/C Ratio(X)	0.82	0.73	0.12	0.53	0.66		0.39	0.51	0.04	0.81	0.40	
Avail Cap(c_a), veh/h	865	3462	945	96	2476		175	878	327	383	1362	
HCM Platoon Ratio	1.00	1.00	1.00	1.00	1.00	1.00	1.00	1.00	1.00	1.00	1.00	1.00
Upstream Filter(I)	1.00	1.00	1.00	1.00	1.00	0.00	1.00	1.00	1.00	1.00	1.00	0.00
Uniform Delay (d), s/veh	34.3	15.6	10.4	40.5	21.0	0.0	39.0	34.2	32.3	36.4	29.7	0.0
Incr Delay (d2), s/veh	1.3	0.5	0.1	5.7	0.5	0.0	0.8	0.9	0.1	3.3	0.4	0.0
Initial Q Delay(d3),s/veh	0.0	0.0	0.0	0.0	0.0	0.0	0.0	0.0	0.0	0.0	0.0	0.0
%ile BackOfQ(50%),veh/ln	3.7	7.5	0.7	0.3	6.3	0.0	0.4	2.0	0.1	2.9	2.0	0.0
Unsig. Movement Delay, s/veh												
LnGrp Delay(d),s/veh	35.6	16.1	10.5	46.2	21.5	0.0	39.9	35.2	32.4	39.7	30.1	0.0
LnGrp LOS	D	B	B	D	C		D	D	C	D	C	
Approach Vol, veh/h		2427			1323			265			394	
Approach Delay, s/veh		19.2			21.8			35.9			33.7	
Approach LOS		B			C			D			C	
Timer - Assigned Phs	1	2	3	4	5	6	7	8				
Phs Duration (G+Y+Rc), s	5.2	49.4	6.8	21.7	15.9	38.6	12.3	16.2				
Change Period (Y+Rc), s	3.7	6.5	3.7	6.2	3.7	* 6.5	3.7	6.2				
Max Green Setting (Gmax), s	5.0	55.9	5.0	34.0	21.3	* 40	18.3	20.7				
Max Q Clear Time (g_c+I1), s	2.8	26.1	3.2	7.4	11.7	19.6	8.8	6.8				
Green Ext Time (p_c), s	0.0	16.8	0.0	1.4	0.5	8.9	0.1	0.9				

Intersection Summary

HCM 6th Ctrl Delay	22.2
HCM 6th LOS	C

Notes

* HCM 6th computational engine requires equal clearance times for the phases crossing the barrier.
Unsignalized Delay for [WBR, SBR] is excluded from calculations of the approach delay and intersection delay.

Timings
36: Elsworth St. & Cactus Av.

West Campus Upper Plateau (JN 14064)

09/19/2022



Lane Group	EBL	EBT	EBR	WBL	WBT	WBR	NBL	NBT	SBL	SBT	SBR
Lane Configurations	↖	↑↑↑	↗	↖	↑↑↑	↗	↖	↗	↖	↑	↗
Traffic Volume (vph)	291	2592	30	17	1876	181	219	73	315	15	313
Future Volume (vph)	291	2592	30	17	1876	181	219	73	315	15	313
Turn Type	Prot	NA	Perm	Prot	NA	Perm	Prot	NA	Prot	NA	pm+ov
Protected Phases	5	2		1	6		3	8	7	4	5
Permitted Phases			2			6					4
Detector Phase	5	2	2	1	6	6	3	8	7	4	5
Switch Phase											
Minimum Initial (s)	5.0	10.0	10.0	5.0	10.0	10.0	5.0	10.0	5.0	10.0	5.0
Minimum Split (s)	9.6	36.2	36.2	9.6	36.2	36.2	15.4	35.4	15.4	35.4	9.6
Total Split (s)	18.0	54.0	54.0	9.6	45.6	45.6	20.9	35.4	21.0	35.5	18.0
Total Split (%)	15.0%	45.0%	45.0%	8.0%	38.0%	38.0%	17.4%	29.5%	17.5%	29.6%	15.0%
Yellow Time (s)	3.6	5.2	5.2	3.6	5.2	5.2	4.4	4.4	4.4	4.4	3.6
All-Red Time (s)	1.0	1.0	1.0	1.0	1.0	1.0	1.0	1.0	1.0	1.0	1.0
Lost Time Adjust (s)	0.0	0.0	0.0	0.0	0.0	0.0	0.0	0.0	0.0	0.0	0.0
Total Lost Time (s)	4.6	6.2	6.2	4.6	6.2	6.2	5.4	5.4	5.4	5.4	4.6
Lead/Lag	Lead	Lead	Lead	Lag	Lag	Lag	Lag	Lag	Lead	Lead	Lead
Lead-Lag Optimize?	Yes	Yes	Yes	Yes	Yes	Yes	Yes	Yes	Yes	Yes	Yes
Recall Mode	None	None	None	None	None	None	None	None	None	None	None
Act Effct Green (s)	13.5	54.1	54.1	5.0	39.6	39.6	26.8	15.0	15.7	13.6	21.1
Actuated g/C Ratio	0.13	0.51	0.51	0.05	0.38	0.38	0.25	0.14	0.15	0.13	0.20
v/c Ratio	1.35	0.84	0.04	0.21	1.03	0.27	0.50	0.57	1.22	0.07	0.76
Control Delay	218.6	26.8	0.1	57.3	63.3	7.0	41.9	37.3	169.4	39.3	28.1
Queue Delay	0.0	0.0	0.0	0.0	0.0	0.0	0.0	0.0	0.0	0.0	0.0
Total Delay	218.6	26.8	0.1	57.3	63.3	7.0	41.9	37.3	169.4	39.3	28.1
LOS	F	C	A	E	E	A	D	D	F	D	C
Approach Delay		45.7			58.3			40.0		97.5	
Approach LOS		D			E			D		F	

Intersection Summary

Cycle Length: 120
 Actuated Cycle Length: 105.5
 Natural Cycle: 120
 Control Type: Actuated-Uncoordinated
 Maximum v/c Ratio: 1.35
 Intersection Signal Delay: 55.2
 Intersection LOS: E
 Intersection Capacity Utilization 96.9%
 ICU Level of Service F
 Analysis Period (min) 15

Splits and Phases: 36: Elsworth St. & Cactus Av.

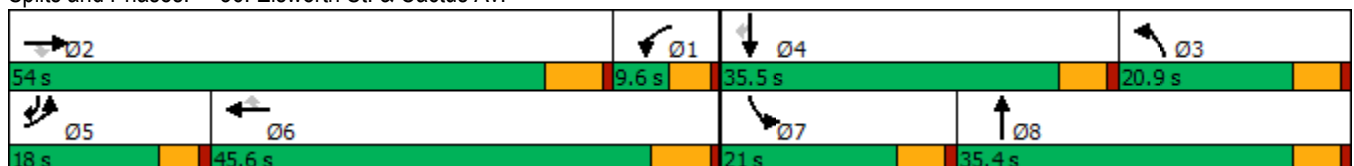

HCM 6th Signalized Intersection Summary
36: Elsworth St. & Cactus Av.

West Campus Upper Plateau (JN 14064)

09/19/2022



Movement	EBL	EBT	EBR	WBL	WBT	WBR	NBL	NBT	NBR	SBL	SBT	SBR
Lane Configurations												
Traffic Volume (veh/h)	291	2592	30	17	1876	181	219	73	85	315	15	313
Future Volume (veh/h)	291	2592	30	17	1876	181	219	73	85	315	15	313
Initial Q (Qb), veh	0	0	0	0	0	0	0	0	0	0	0	0
Ped-Bike Adj(A_pbT)	1.00		1.00	1.00		1.00	1.00		1.00	1.00		1.00
Parking Bus, Adj	1.00	1.00	1.00	1.00	1.00	1.00	1.00	1.00	1.00	1.00	1.00	1.00
Work Zone On Approach		No			No			No			No	
Adj Sat Flow, veh/h/ln	1870	1841	1781	1900	1856	1885	1885	1900	1885	1900	1900	1900
Adj Flow Rate, veh/h	303	2700	0	18	1954	153	228	76	65	328	16	219
Peak Hour Factor	0.96	0.96	0.96	0.96	0.96	0.96	0.96	0.96	0.96	0.96	0.96	0.96
Percent Heavy Veh, %	2	4	8	0	3	1	1	0	1	0	0	0
Cap, veh/h	237	2985		68	1984	626	289	100	85	281	189	375
Arrive On Green	0.13	0.47	0.00	0.04	0.39	0.39	0.16	0.11	0.11	0.16	0.10	0.10
Sat Flow, veh/h	1781	6332	1510	1810	5066	1598	1795	946	809	1810	1900	1610
Grp Volume(v), veh/h	303	2700	0	18	1954	153	228	0	141	328	16	219
Grp Sat Flow(s),veh/h/ln	1781	1583	1510	1810	1689	1598	1795	0	1754	1810	1900	1610
Q Serve(g_s), s	13.4	39.5	0.0	1.0	38.4	6.5	12.3	0.0	7.9	15.6	0.8	7.2
Cycle Q Clear(g_c), s	13.4	39.5	0.0	1.0	38.4	6.5	12.3	0.0	7.9	15.6	0.8	7.2
Prop In Lane	1.00		1.00	1.00		1.00	1.00		0.46	1.00		1.00
Lane Grp Cap(c), veh/h	237	2985		68	1984	626	289	0	185	281	189	375
V/C Ratio(X)	1.28	0.90		0.27	0.98	0.24	0.79	0.00	0.76	1.17	0.08	0.58
Avail Cap(c_a), veh/h	237	3009		90	1984	626	289	0	523	281	568	696
HCM Platoon Ratio	1.00	1.00	1.00	1.00	1.00	1.00	1.00	1.00	1.00	1.00	1.00	1.00
Upstream Filter(I)	1.00	1.00	0.00	1.00	1.00	1.00	1.00	0.00	1.00	1.00	1.00	1.00
Uniform Delay (d), s/veh	43.6	24.5	0.0	47.1	30.3	20.6	40.6	0.0	43.8	42.5	41.1	14.6
Incr Delay (d2), s/veh	153.2	4.4	0.0	0.8	16.7	0.2	13.6	0.0	6.4	107.4	0.2	1.5
Initial Q Delay(d3),s/veh	0.0	0.0	0.0	0.0	0.0	0.0	0.0	0.0	0.0	0.0	0.0	0.0
%ile BackOfQ(50%),veh/ln	15.7	13.8	0.0	0.4	17.1	2.5	6.5	0.0	3.8	15.1	0.4	2.7
Unsig. Movement Delay, s/veh												
LnGrp Delay(d),s/veh	196.8	28.9	0.0	47.8	47.0	20.8	54.1	0.0	50.1	149.9	41.3	16.1
LnGrp LOS	F	C		D	D	C	D	A	D	F	D	B
Approach Vol, veh/h		3003			2125			369				563
Approach Delay, s/veh		45.8			45.1			52.6				94.8
Approach LOS		D			D			D				F
Timer - Assigned Phs	1	2	3	4	5	6	7	8				
Phs Duration (G+Y+Rc), s	10.0	53.6	21.6	15.4	18.0	45.6	21.0	16.0				
Change Period (Y+Rc), s	6.2	* 6.2	5.4	5.4	4.6	6.2	5.4	5.4				
Max Green Setting (Gmax), s	5.0	* 48	15.5	30.1	13.4	39.4	15.6	30.0				
Max Q Clear Time (g_c+I1), s	3.0	41.5	14.3	9.2	15.4	40.4	17.6	9.9				
Green Ext Time (p_c), s	0.0	5.9	0.1	0.7	0.0	0.0	0.0	0.7				

Intersection Summary

HCM 6th Ctrl Delay	50.5
HCM 6th LOS	D

Notes

- User approved pedestrian interval to be less than phase max green.
- User approved volume balancing among the lanes for turning movement.
- * HCM 6th computational engine requires equal clearance times for the phases crossing the barrier.

Timings

West Campus Upper Plateau (JN 14064)

1: Washington St & Van Buren Bl.

09/30/2022



Lane Group	EBL	EBT	EBR	WBL	WBT	WBR	NBL	NBT	NBR	SBL	SBT
Lane Configurations	↘	↑↑↑	↗	↘	↑↑↑	↗	↘↗	↑↑	↗	↘↗	↑↗
Traffic Volume (vph)	126	991	78	141	963	307	146	219	159	406	191
Future Volume (vph)	126	991	78	141	963	307	146	219	159	406	191
Turn Type	Prot	NA	Perm	Prot	NA	pm+ov	Prot	NA	Perm	Prot	NA
Protected Phases	5	2		1	6	7	3	8		7	4
Permitted Phases			2			6			8		
Detector Phase	5	2	2	1	6	7	3	8	8	7	4
Switch Phase											
Minimum Initial (s)	5.0	10.0	10.0	5.0	10.0	10.0	10.0	10.0	10.0	10.0	10.0
Minimum Split (s)	9.2	34.2	34.2	9.2	33.2	30.8	37.4	37.4	37.4	30.8	30.8
Total Split (s)	15.6	43.8	43.8	18.0	46.2	30.8	37.4	37.4	37.4	30.8	30.8
Total Split (%)	12.0%	33.7%	33.7%	13.8%	35.5%	23.7%	28.8%	28.8%	28.8%	23.7%	23.7%
Yellow Time (s)	3.2	5.2	5.2	3.2	5.2	4.8	4.4	4.4	4.4	4.8	4.8
All-Red Time (s)	1.0	1.0	1.0	1.0	1.0	1.0	1.0	1.0	1.0	1.0	1.0
Lost Time Adjust (s)	0.0	0.0	0.0	0.0	0.0	0.0	0.0	0.0	0.0	0.0	0.0
Total Lost Time (s)	4.2	6.2	6.2	4.2	6.2	5.8	5.4	5.4	5.4	5.8	5.8
Lead/Lag	Lead	Lag	Lag	Lead	Lag	Lead	Lead	Lag	Lag	Lead	Lag
Lead-Lag Optimize?	Yes	Yes	Yes	Yes	Yes	Yes	Yes	Yes	Yes	Yes	Yes
Recall Mode	None	None	None	None	None	None	None	None	None	None	None
Act Effct Green (s)	10.9	30.1	30.1	12.0	31.2	49.6	13.9	15.1	15.1	18.0	19.1
Actuated g/C Ratio	0.11	0.31	0.31	0.12	0.32	0.51	0.14	0.15	0.15	0.18	0.20
v/c Ratio	0.65	0.66	0.14	0.66	0.61	0.33	0.31	0.42	0.43	0.66	0.40
Control Delay	62.0	32.9	0.5	59.6	30.8	3.3	41.1	41.1	9.9	44.2	32.0
Queue Delay	0.0	0.0	0.0	0.0	0.0	0.0	0.0	0.0	0.0	0.0	0.0
Total Delay	62.0	32.9	0.5	59.6	30.8	3.3	41.1	41.1	9.9	44.2	32.0
LOS	E	C	A	E	C	A	D	D	A	D	C
Approach Delay		33.9			27.7			31.6			39.3
Approach LOS		C			C			C			D

Intersection Summary

Cycle Length: 130
 Actuated Cycle Length: 97.6
 Natural Cycle: 115
 Control Type: Actuated-Uncoordinated
 Maximum v/c Ratio: 0.66
 Intersection Signal Delay: 32.2
 Intersection LOS: C
 Intersection Capacity Utilization 65.5%
 ICU Level of Service C
 Analysis Period (min) 15

Splits and Phases: 1: Washington St & Van Buren Bl.

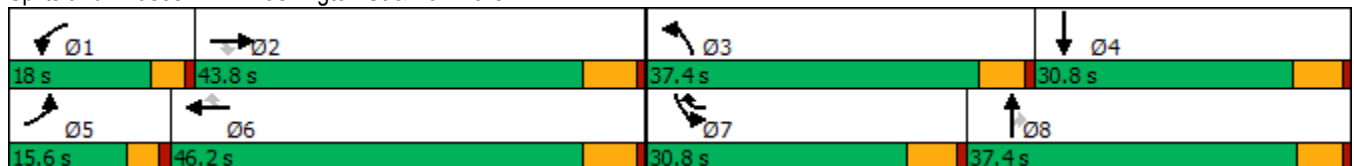

HCM 6th Signalized Intersection Summary
1: Washington St & Van Buren Bl.

West Campus Upper Plateau (JN 14064)

09/30/2022

Movement	EBL	EBT	EBR	WBL	WBT	WBR	NBL	NBT	NBR	SBL	SBT	SBR
Lane Configurations												
Traffic Volume (veh/h)	126	991	78	141	963	307	146	219	159	406	191	83
Future Volume (veh/h)	126	991	78	141	963	307	146	219	159	406	191	83
Initial Q (Qb), veh	0	0	0	0	0	0	0	0	0	0	0	0
Ped-Bike Adj(A_pbT)	1.00		1.00	1.00		1.00	1.00		0.98	1.00		0.98
Parking Bus, Adj	1.00	1.00	1.00	1.00	1.00	1.00	1.00	1.00	1.00	1.00	1.00	1.00
Work Zone On Approach		No			No			No			No	
Adj Sat Flow, veh/h/ln	1900	1856	1856	1900	1870	1900	1885	1856	1870	1885	1885	1900
Adj Flow Rate, veh/h	130	1022	60	145	993	221	151	226	124	419	197	39
Peak Hour Factor	0.97	0.97	0.97	0.97	0.97	0.97	0.97	0.97	0.97	0.97	0.97	0.97
Percent Heavy Veh, %	0	3	3	0	2	0	1	3	2	1	1	0
Cap, veh/h	164	1621	503	182	1683	783	446	495	218	549	521	101
Arrive On Green	0.09	0.32	0.32	0.10	0.33	0.33	0.13	0.14	0.14	0.16	0.17	0.17
Sat Flow, veh/h	1810	5066	1572	1810	5106	1606	3483	3526	1555	3483	2982	578
Grp Volume(v), veh/h	130	1022	60	145	993	221	151	226	124	419	117	119
Grp Sat Flow(s),veh/h/ln	1810	1689	1572	1810	1702	1606	1742	1763	1555	1742	1791	1768
Q Serve(g_s), s	5.5	13.4	2.1	6.1	12.6	6.4	3.1	4.6	5.8	9.0	4.5	4.7
Cycle Q Clear(g_c), s	5.5	13.4	2.1	6.1	12.6	6.4	3.1	4.6	5.8	9.0	4.5	4.7
Prop In Lane	1.00		1.00	1.00		1.00	1.00		1.00	1.00		0.33
Lane Grp Cap(c), veh/h	164	1621	503	182	1683	783	446	495	218	549	313	309
V/C Ratio(X)	0.79	0.63	0.12	0.80	0.59	0.28	0.34	0.46	0.57	0.76	0.37	0.39
Avail Cap(c_a), veh/h	264	2440	757	320	2616	1076	1428	1445	638	1115	574	566
HCM Platoon Ratio	1.00	1.00	1.00	1.00	1.00	1.00	1.00	1.00	1.00	1.00	1.00	1.00
Upstream Filter(I)	1.00	1.00	1.00	1.00	1.00	1.00	1.00	1.00	1.00	1.00	1.00	1.00
Uniform Delay (d), s/veh	34.8	22.6	18.8	34.3	21.8	11.9	31.0	30.8	31.3	31.5	28.4	28.5
Incr Delay (d2), s/veh	3.2	0.6	0.1	3.0	0.5	0.3	0.4	0.7	2.3	2.2	0.7	0.8
Initial Q Delay(d3),s/veh	0.0	0.0	0.0	0.0	0.0	0.0	0.0	0.0	0.0	0.0	0.0	0.0
%ile BackOfQ(50%),veh/ln	2.4	4.8	0.8	2.6	4.5	0.1	1.3	2.0	2.3	3.8	1.9	2.0
Unsig. Movement Delay, s/veh												
LnGrp Delay(d),s/veh	38.0	23.2	18.9	37.4	22.3	12.2	31.5	31.5	33.7	33.7	29.2	29.3
LnGrp LOS	D	C	B	D	C	B	C	C	C	C	C	C
Approach Vol, veh/h		1212			1359			501			655	
Approach Delay, s/veh		24.6			22.2			32.0			32.1	
Approach LOS		C			C			C			C	
Timer - Assigned Phs	1	2	3	4	5	6	7	8				
Phs Duration (G+Y+Rc), s	12.0	31.2	15.4	19.4	11.3	31.9	18.1	16.8				
Change Period (Y+Rc), s	* 4.2	6.2	5.4	5.8	* 4.2	6.2	5.8	* 5.8				
Max Green Setting (Gmax), s	* 14	37.6	32.0	25.0	* 11	40.0	25.0	* 32				
Max Q Clear Time (g_c+I1), s	8.1	15.4	5.1	6.7	7.5	14.6	11.0	7.8				
Green Ext Time (p_c), s	0.1	9.5	0.5	1.2	0.0	10.8	1.3	1.9				

Intersection Summary

HCM 6th Ctrl Delay	26.0
HCM 6th LOS	C

Notes

* HCM 6th computational engine requires equal clearance times for the phases crossing the barrier.

Timings

3: Overlook Pkwy./Canyon Crest Dr. & Alessandro Bl/Alessandro Bl.



Lane Group	EBL	EBT	WBL	WBT	WBR	NBL	NBT	NBR	SBL	SBT
Lane Configurations	↘	↗↗↗	↘	↗↗↗	↗	↘	↗↗	↗	↗↗↗	↗
Traffic Volume (vph)	38	1443	94	1570	451	19	240	96	349	246
Future Volume (vph)	38	1443	94	1570	451	19	240	96	349	246
Turn Type	Prot	NA	Prot	NA	pm+ov	Split	NA	Perm	Split	NA
Protected Phases	5	2	1	6	4	8	8		4	4
Permitted Phases					6			8		
Detector Phase	5	2	1	6	4	8	8	8	4	4
Switch Phase										
Minimum Initial (s)	5.0	10.0	5.0	10.0	10.0	10.0	10.0	10.0	10.0	10.0
Minimum Split (s)	9.2	35.2	9.2	35.2	38.8	38.8	38.8	38.8	38.8	38.8
Total Split (s)	9.2	43.2	9.2	43.2	38.8	38.8	38.8	38.8	38.8	38.8
Total Split (%)	7.1%	33.2%	7.1%	33.2%	29.8%	29.8%	29.8%	29.8%	29.8%	29.8%
Yellow Time (s)	3.2	5.2	3.2	5.2	4.8	4.8	4.8	4.8	4.8	4.8
All-Red Time (s)	1.0	1.0	1.0	1.0	1.0	1.0	1.0	1.0	1.0	1.0
Lost Time Adjust (s)	0.0	0.0	0.0	0.0	0.0	0.0	0.0	0.0	0.0	0.0
Total Lost Time (s)	4.2	6.2	4.2	6.2	5.8	5.8	5.8	5.8	5.8	5.8
Lead/Lag	Lead	Lag	Lead	Lag						
Lead-Lag Optimize?	Yes	Yes	Yes	Yes						
Recall Mode	None	None	None	None	None	None	None	None	None	None
Act Effct Green (s)	5.0	37.3	5.0	39.4	68.5	12.8	12.8	12.8	22.9	22.9
Actuated g/C Ratio	0.05	0.37	0.05	0.39	0.68	0.13	0.13	0.13	0.23	0.23
v/c Ratio	0.46	0.80	1.09	0.81	0.40	0.09	0.54	0.33	0.32	0.65
Control Delay	67.2	33.4	168.7	33.2	3.6	41.7	46.5	9.9	32.6	42.0
Queue Delay	0.0	0.0	0.0	0.0	0.0	0.0	0.0	0.0	0.0	0.0
Total Delay	67.2	33.4	168.7	33.2	3.6	41.7	46.5	9.9	32.6	42.0
LOS	E	C	F	C	A	D	D	A	C	D
Approach Delay		34.3		32.9			36.4			36.6
Approach LOS		C		C			D			D

Intersection Summary

Cycle Length: 130
 Actuated Cycle Length: 100.2
 Natural Cycle: 125
 Control Type: Actuated-Uncoordinated
 Maximum v/c Ratio: 1.09
 Intersection Signal Delay: 34.1
 Intersection LOS: C
 Intersection Capacity Utilization 75.4%
 ICU Level of Service D
 Analysis Period (min) 15

Splits and Phases: 3: Overlook Pkwy./Canyon Crest Dr. & Alessandro Bl/Alessandro Bl.

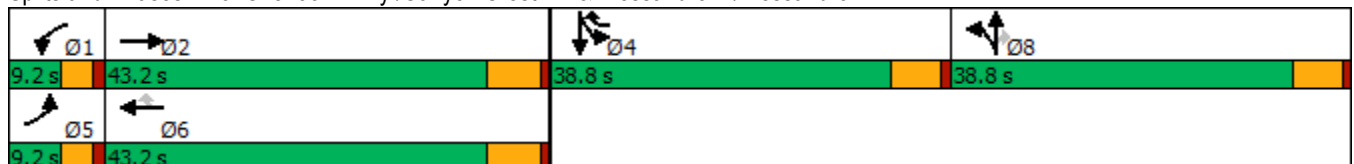

HCM 6th Signalized Intersection Summary

West Campus Upper Plateau (JN 14064)

3: Overlook Pkwy./Canyon Crest Dr. & Alessandro Bl/Alessandro Bl.

09/30/2022

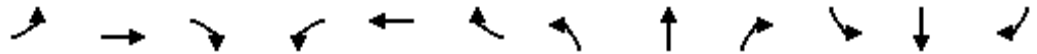

Movement	EBL	EBT	EBR	WBL	WBT	WBR	NBL	NBT	NBR	SBL	SBT	SBR
Lane Configurations	↗	↑↑↑		↖	↑↑↑	↗	↖	↑↑	↗	↖↖↖	↖	
Traffic Volume (veh/h)	38	1443	23	94	1570	451	19	240	96	349	246	21
Future Volume (veh/h)	38	1443	23	94	1570	451	19	240	96	349	246	21
Initial Q (Qb), veh	0	0	0	0	0	0	0	0	0	0	0	0
Ped-Bike Adj(A_pbT)	1.00		1.00	1.00		1.00	1.00		1.00	1.00		1.00
Parking Bus, Adj	1.00	1.00	1.00	1.00	1.00	1.00	1.00	1.00	1.00	1.00	1.00	1.00
Work Zone On Approach		No			No			No				No
Adj Sat Flow, veh/h/ln	1841	1885	1811	1900	1885	1885	1781	1900	1900	1885	1900	1870
Adj Flow Rate, veh/h	40	1503	24	98	1635	462	20	250	92	364	256	13
Peak Hour Factor	0.96	0.96	0.96	0.96	0.96	0.96	0.96	0.96	0.96	0.96	0.96	0.96
Percent Heavy Veh, %	4	1	6	0	1	1	8	0	0	1	0	2
Cap, veh/h	63	1965	31	106	2055	941	199	423	189	960	340	17
Arrive On Green	0.04	0.38	0.38	0.06	0.40	0.40	0.12	0.12	0.12	0.19	0.19	0.19
Sat Flow, veh/h	1753	5218	83	1810	5147	1598	1697	3610	1610	5063	1793	91
Grp Volume(v), veh/h	40	988	539	98	1635	462	20	250	92	364	0	269
Grp Sat Flow(s),veh/h/ln	1753	1716	1870	1810	1716	1598	1697	1805	1610	1688	0	1884
Q Serve(g_s), s	1.9	21.5	21.5	4.6	23.9	14.3	0.9	5.6	4.6	5.4	0.0	11.5
Cycle Q Clear(g_c), s	1.9	21.5	21.5	4.6	23.9	14.3	0.9	5.6	4.6	5.4	0.0	11.5
Prop In Lane	1.00		0.04	1.00		1.00	1.00		1.00	1.00		0.05
Lane Grp Cap(c), veh/h	63	1292	704	106	2055	941	199	423	189	960	0	357
V/C Ratio(X)	0.64	0.76	0.76	0.92	0.80	0.49	0.10	0.59	0.49	0.38	0.00	0.75
Avail Cap(c_a), veh/h	103	1489	811	106	2233	996	656	1397	623	1959	0	729
HCM Platoon Ratio	1.00	1.00	1.00	1.00	1.00	1.00	1.00	1.00	1.00	1.00	1.00	1.00
Upstream Filter(I)	1.00	1.00	1.00	1.00	1.00	1.00	1.00	1.00	1.00	1.00	0.00	1.00
Uniform Delay (d), s/veh	40.6	23.3	23.3	40.0	22.5	10.1	33.6	35.7	35.2	30.2	0.0	32.7
Incr Delay (d2), s/veh	3.9	2.1	3.8	62.6	1.9	0.4	0.2	1.3	1.9	0.2	0.0	3.2
Initial Q Delay(d3),s/veh	0.0	0.0	0.0	0.0	0.0	0.0	0.0	0.0	0.0	0.0	0.0	0.0
%ile BackOfQ(50%),veh/ln	0.8	8.0	9.1	3.8	8.7	6.9	0.4	2.4	1.8	2.1	0.0	5.2
Unsig. Movement Delay, s/veh												
LnGrp Delay(d),s/veh	44.5	25.4	27.1	102.5	24.5	10.5	33.8	37.0	37.2	30.4	0.0	35.9
LnGrp LOS	D	C	C	F	C	B	C	D	D	C	A	D
Approach Vol, veh/h		1567			2195			362				633
Approach Delay, s/veh		26.4			25.0			36.9				32.8
Approach LOS		C			C			D				C
Timer - Assigned Phs	1	2		4	5	6		8				
Phs Duration (G+Y+Rc), s	9.2	38.3		22.0	7.3	40.3		15.8				
Change Period (Y+Rc), s	* 4.2	6.2		5.8	* 4.2	6.2		5.8				
Max Green Setting (Gmax), s	* 5	37.0		33.0	* 5	37.0		33.0				
Max Q Clear Time (g_c+1), s	6.6	23.5		13.5	3.9	25.9		7.6				
Green Ext Time (p_c), s	0.0	7.6		2.6	0.0	8.2		1.8				

Intersection Summary

HCM 6th Ctrl Delay	27.4
HCM 6th LOS	C

Notes

- User approved pedestrian interval to be less than phase max green.
- User approved volume balancing among the lanes for turning movement.
- * HCM 6th computational engine requires equal clearance times for the phases crossing the barrier.

Timings
4: Van Buren Bl. & Wood Rd.

West Campus Upper Plateau (JN 14064)

09/30/2022

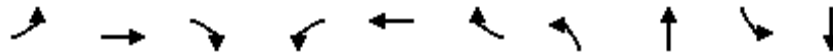

Lane Group	EBL	EBT	EBR	WBL	WBT	WBR	NBL	NBT	SBL	SBT
Lane Configurations	↘	↑↑↑	↗	↘↗	↑↑↑	↗	↘↗	↑↘	↘	↑↘
Traffic Volume (vph)	137	1522	218	235	1475	116	214	140	174	163
Future Volume (vph)	137	1522	218	235	1475	116	214	140	174	163
Turn Type	Prot	NA	pm+ov	Prot	NA	Perm	Prot	NA	Prot	NA
Protected Phases	5	2	3	1	6		3	8	7	4
Permitted Phases			2			6				
Detector Phase	5	2	3	1	6	6	3	8	7	4
Switch Phase										
Minimum Initial (s)	5.0	10.0	5.0	5.0	10.0	10.0	5.0	10.0	5.0	10.0
Minimum Split (s)	9.2	30.2	9.2	9.2	30.2	30.2	9.2	38.4	9.2	15.8
Total Split (s)	16.8	51.3	23.4	16.1	50.6	50.6	23.4	38.4	14.2	29.2
Total Split (%)	14.0%	42.8%	19.5%	13.4%	42.2%	42.2%	19.5%	32.0%	11.8%	24.3%
Yellow Time (s)	3.2	5.2	3.2	3.2	5.2	5.2	3.2	4.4	3.2	4.8
All-Red Time (s)	1.0	1.0	1.0	1.0	1.0	1.0	1.0	1.0	1.0	1.0
Lost Time Adjust (s)	0.0	0.0	0.0	0.0	0.0	0.0	0.0	0.0	0.0	0.0
Total Lost Time (s)	4.2	6.2	4.2	4.2	6.2	6.2	4.2	5.4	4.2	5.8
Lead/Lag	Lead	Lag	Lead	Lead	Lag	Lag	Lead	Lag	Lead	Lag
Lead-Lag Optimize?	Yes	Yes	Yes	Yes	Yes	Yes	Yes	Yes	Yes	Yes
Recall Mode	None	None	None	None	None	None	None	None	None	None
Act Effct Green (s)	11.3	42.3	55.3	10.7	41.6	41.6	11.0	15.3	10.2	14.1
Actuated g/C Ratio	0.11	0.43	0.56	0.11	0.42	0.42	0.11	0.15	0.10	0.14
v/c Ratio	0.70	0.73	0.23	0.66	0.71	0.16	0.58	0.50	0.99	0.54
Control Delay	63.5	26.9	2.1	53.3	26.8	3.3	49.8	19.6	111.1	23.9
Queue Delay	0.0	0.0	0.0	0.0	0.0	0.0	0.0	0.0	0.0	0.0
Total Delay	63.5	26.9	2.1	53.3	26.8	3.3	49.8	19.6	111.1	23.9
LOS	E	C	A	D	C	A	D	B	F	C
Approach Delay		26.7			28.7			32.0		54.7
Approach LOS		C			C			C		D

Intersection Summary

Cycle Length: 120
 Actuated Cycle Length: 98.8
 Natural Cycle: 100
 Control Type: Actuated-Uncoordinated
 Maximum v/c Ratio: 0.99
 Intersection Signal Delay: 31.0
 Intersection LOS: C
 Intersection Capacity Utilization 78.1%
 ICU Level of Service D
 Analysis Period (min) 15

Splits and Phases: 4: Van Buren Bl. & Wood Rd.

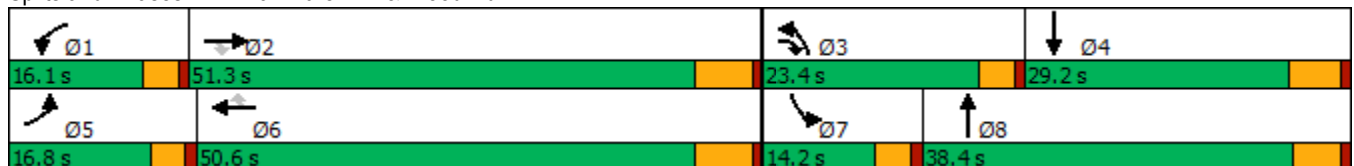

HCM 6th Signalized Intersection Summary
4: Van Buren Bl. & Wood Rd.

West Campus Upper Plateau (JN 14064)
09/30/2022

Movement	EBL	EBT	EBR	WBL	WBT	WBR	NBL	NBT	NBR	SBL	SBT	SBR
Lane Configurations												
Traffic Volume (veh/h)	137	1522	218	235	1475	116	214	140	167	174	163	155
Future Volume (veh/h)	137	1522	218	235	1475	116	214	140	167	174	163	155
Initial Q (Qb), veh	0	0	0	0	0	0	0	0	0	0	0	0
Ped-Bike Adj(A_pbT)	1.00		0.98	1.00		0.99	1.00		0.96	1.00		0.99
Parking Bus, Adj	1.00	1.00	1.00	1.00	1.00	1.00	1.00	1.00	1.00	1.00	1.00	1.00
Work Zone On Approach		No			No			No			No	
Adj Sat Flow, veh/h/ln	1885	1870	1870	1885	1885	1885	1870	1885	1870	1885	1885	1885
Adj Flow Rate, veh/h	143	1585	127	245	1536	76	223	146	97	181	170	90
Peak Hour Factor	0.96	0.96	0.96	0.96	0.96	0.96	0.96	0.96	0.96	0.96	0.96	0.96
Percent Heavy Veh, %	1	2	2	1	1	1	2	1	2	1	1	1
Cap, veh/h	176	2192	809	321	2180	667	303	305	188	197	384	193
Arrive On Green	0.10	0.43	0.43	0.09	0.42	0.42	0.09	0.15	0.15	0.11	0.17	0.17
Sat Flow, veh/h	1795	5106	1561	3483	5147	1574	3456	2096	1289	1795	2296	1154
Grp Volume(v), veh/h	143	1585	127	245	1536	76	223	123	120	181	131	129
Grp Sat Flow(s),veh/h/ln	1795	1702	1561	1742	1716	1574	1728	1791	1594	1795	1791	1659
Q Serve(g_s), s	7.1	23.5	3.9	6.3	22.4	2.7	5.7	5.8	6.4	9.1	6.0	6.4
Cycle Q Clear(g_c), s	7.1	23.5	3.9	6.3	22.4	2.7	5.7	5.8	6.4	9.1	6.0	6.4
Prop In Lane	1.00		1.00	1.00		1.00	1.00		0.81	1.00		0.70
Lane Grp Cap(c), veh/h	176	2192	809	321	2180	667	303	261	232	197	300	278
V/C Ratio(X)	0.81	0.72	0.16	0.76	0.70	0.11	0.74	0.47	0.52	0.92	0.44	0.47
Avail Cap(c_a), veh/h	248	2521	910	454	2502	765	726	647	576	197	459	425
HCM Platoon Ratio	1.00	1.00	1.00	1.00	1.00	1.00	1.00	1.00	1.00	1.00	1.00	1.00
Upstream Filter(I)	1.00	1.00	1.00	1.00	1.00	1.00	1.00	1.00	1.00	1.00	1.00	1.00
Uniform Delay (d), s/veh	40.4	21.6	11.6	40.5	21.6	15.9	40.6	35.8	36.0	40.3	34.1	34.3
Incr Delay (d2), s/veh	9.0	1.0	0.1	2.7	0.9	0.1	1.3	1.3	1.8	41.8	1.0	1.2
Initial Q Delay(d3),s/veh	0.0	0.0	0.0	0.0	0.0	0.0	0.0	0.0	0.0	0.0	0.0	0.0
%ile BackOfQ(50%),veh/ln	3.4	8.4	1.3	2.7	8.1	0.9	2.4	2.5	2.5	6.2	2.6	2.6
Unsig. Movement Delay, s/veh												
LnGrp Delay(d),s/veh	49.4	22.6	11.7	43.2	22.5	16.0	41.9	37.1	37.8	82.1	35.1	35.5
LnGrp LOS	D	C	B	D	C	B	D	D	D	F	D	D
Approach Vol, veh/h		1855			1857			466			441	
Approach Delay, s/veh		23.9			25.0			39.6			54.5	
Approach LOS		C			C			D			D	
Timer - Assigned Phs	1	2	3	4	5	6	7	8				
Phs Duration (G+Y+Rc), s	12.6	45.4	12.2	21.1	13.1	44.9	14.2	19.1				
Change Period (Y+Rc), s	* 4.2	6.2	* 4.2	5.8	* 4.2	6.2	* 4.2	* 5.8				
Max Green Setting (Gmax), s	* 12	45.1	* 19	23.4	* 13	44.4	* 10	* 33				
Max Q Clear Time (g_c+I1), s	8.3	25.5	7.7	8.4	9.1	24.4	11.1	8.4				
Green Ext Time (p_c), s	0.2	13.8	0.3	1.2	0.1	13.4	0.0	1.3				

Intersection Summary

HCM 6th Ctrl Delay	28.9
HCM 6th LOS	C

Notes

* HCM 6th computational engine requires equal clearance times for the phases crossing the barrier.

Timings
8: Cole Av. & Van Buren Bl.

West Campus Upper Plateau (JN 14064)

09/30/2022



Lane Group	EBL	EBT	EBR	WBL	WBT	WBR	NBL	NBT	SBL	SBT	SBR
Lane Configurations	↖↗	↑↑↑	↖	↖	↑↑↑	↖	↖	↑↑	↖↗	↑↑	↖
Traffic Volume (vph)	487	1247	80	175	1301	354	106	263	348	235	385
Future Volume (vph)	487	1247	80	175	1301	354	106	263	348	235	385
Turn Type	Prot	NA	pm+ov	Prot	NA	pm+ov	Prot	NA	Prot	NA	pm+ov
Protected Phases	5	2	3	1	6	7	3	8	7	4	5
Permitted Phases			2			6					4
Detector Phase	5	2	3	1	6	7	3	8	7	4	5
Switch Phase											
Minimum Initial (s)	5.0	10.0	5.0	5.0	10.0	5.0	5.0	10.0	5.0	10.0	5.0
Minimum Split (s)	9.1	36.2	9.1	9.1	36.2	9.1	9.1	42.2	9.1	49.2	9.1
Total Split (s)	15.0	44.8	11.4	14.0	43.8	19.0	11.4	42.2	19.0	49.8	15.0
Total Split (%)	12.5%	37.3%	9.5%	11.7%	36.5%	15.8%	9.5%	35.2%	15.8%	41.5%	12.5%
Yellow Time (s)	3.2	5.2	3.2	3.2	5.2	3.2	3.2	5.2	3.2	5.2	3.2
All-Red Time (s)	0.5	1.0	0.5	0.5	1.0	0.5	0.5	1.0	0.5	1.0	0.5
Lost Time Adjust (s)	0.0	0.0	0.0	0.0	0.0	0.0	0.0	0.0	0.0	0.0	0.0
Total Lost Time (s)	3.7	6.2	3.7	3.7	6.2	3.7	3.7	6.2	3.7	6.2	3.7
Lead/Lag	Lead	Lag	Lead	Lead	Lag	Lead	Lead	Lag	Lead	Lag	Lead
Lead-Lag Optimize?	Yes	Yes	Yes	Yes	Yes	Yes	Yes	Yes	Yes	Yes	Yes
Recall Mode	None	None	None	None	None	None	None	None	None	None	None
Act Effct Green (s)	11.5	36.4	50.5	10.5	35.4	55.7	7.8	17.6	14.0	23.8	37.9
Actuated g/C Ratio	0.12	0.37	0.51	0.11	0.36	0.56	0.08	0.18	0.14	0.24	0.38
v/c Ratio	1.27	0.71	0.10	0.97	0.74	0.36	0.78	0.60	0.74	0.28	0.62
Control Delay	177.3	30.2	3.2	106.5	31.8	5.5	82.3	35.6	52.5	30.7	22.6
Queue Delay	0.0	0.0	0.0	0.0	0.0	0.0	0.0	0.0	0.0	0.0	0.0
Total Delay	177.3	30.2	3.2	106.5	31.8	5.5	82.3	35.6	52.5	30.7	22.6
LOS	F	C	A	F	C	A	F	D	D	C	C
Approach Delay		68.5			33.8			45.9		35.3	
Approach LOS		E			C			D		D	

Intersection Summary

Cycle Length: 120
 Actuated Cycle Length: 98.7
 Natural Cycle: 115
 Control Type: Actuated-Uncoordinated
 Maximum v/c Ratio: 1.27
 Intersection Signal Delay: 47.6
 Intersection LOS: D
 Intersection Capacity Utilization 79.2%
 ICU Level of Service D
 Analysis Period (min) 15



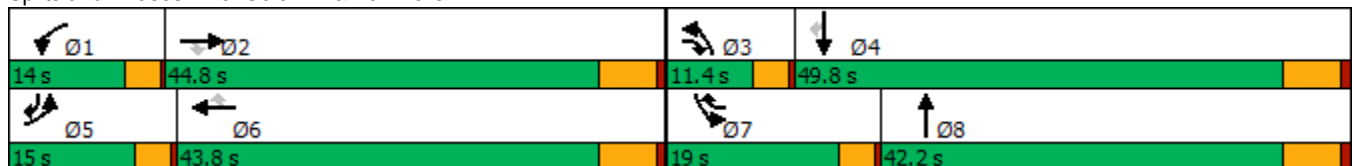



























Splits and Phases: 8: Cole Av. & Van Buren Bl.



HCM 6th Signalized Intersection Summary
8: Cole Av. & Van Buren Bl.

West Campus Upper Plateau (JN 14064)

09/30/2022

												
Movement	EBL	EBT	EBR	WBL	WBT	WBR	NBL	NBT	NBR	SBL	SBT	SBR
Lane Configurations	 	  			  			 		 	 	
Traffic Volume (veh/h)	487	1247	80	175	1301	354	106	263	109	348	235	385
Future Volume (veh/h)	487	1247	80	175	1301	354	106	263	109	348	235	385
Initial Q (Qb), veh	0	0	0	0	0	0	0	0	0	0	0	0
Ped-Bike Adj(A_pbT)	1.00		1.00	1.00		1.00	1.00		0.99	1.00		1.00
Parking Bus, Adj	1.00	1.00	1.00	1.00	1.00	1.00	1.00	1.00	1.00	1.00	1.00	1.00
Work Zone On Approach		No			No			No			No	
Adj Sat Flow, veh/h/ln	1870	1841	1856	1870	1870	1885	1885	1885	1885	1870	1885	1885
Adj Flow Rate, veh/h	507	1299	26	182	1355	280	110	274	107	362	245	303
Peak Hour Factor	0.96	0.96	0.96	0.96	0.96	0.96	0.96	0.96	0.96	0.96	0.96	0.96
Percent Heavy Veh, %	2	4	3	2	2	1	1	1	1	2	1	1
Cap, veh/h	430	1890	713	202	1865	787	139	418	159	440	771	542
Arrive On Green	0.12	0.38	0.38	0.11	0.37	0.37	0.08	0.17	0.17	0.13	0.22	0.22
Sat Flow, veh/h	3456	5025	1572	1781	5106	1598	1795	2531	963	3456	3582	1595
Grp Volume(v), veh/h	507	1299	26	182	1355	280	110	192	189	362	245	303
Grp Sat Flow(s),veh/h/ln	1728	1675	1572	1781	1702	1598	1795	1791	1703	1728	1791	1595
Q Serve(g_s), s	11.3	19.8	0.8	9.2	20.8	9.8	5.5	9.1	9.5	9.3	5.2	14.1
Cycle Q Clear(g_c), s	11.3	19.8	0.8	9.2	20.8	9.8	5.5	9.1	9.5	9.3	5.2	14.1
Prop In Lane	1.00		1.00	1.00		1.00	1.00		0.57	1.00		1.00
Lane Grp Cap(c), veh/h	430	1890	713	202	1865	787	139	296	281	440	771	542
V/C Ratio(X)	1.18	0.69	0.04	0.90	0.73	0.36	0.79	0.65	0.67	0.82	0.32	0.56
Avail Cap(c_a), veh/h	430	2135	790	202	2114	865	152	710	675	582	1719	965
HCM Platoon Ratio	1.00	1.00	1.00	1.00	1.00	1.00	1.00	1.00	1.00	1.00	1.00	1.00
Upstream Filter(I)	1.00	1.00	1.00	1.00	1.00	1.00	1.00	1.00	1.00	1.00	1.00	1.00
Uniform Delay (d), s/veh	39.8	23.8	13.8	39.8	24.9	14.2	41.2	35.4	35.6	38.6	30.0	24.4
Incr Delay (d2), s/veh	102.4	1.0	0.0	36.5	1.3	0.4	20.2	2.4	2.8	5.4	0.2	0.9
Initial Q Delay(d3),s/veh	0.0	0.0	0.0	0.0	0.0	0.0	0.0	0.0	0.0	0.0	0.0	0.0
%ile BackOfQ(50%),veh/ln	10.6	7.1	0.3	5.8	7.7	3.1	3.1	3.9	3.9	4.0	2.1	4.9
Unsig. Movement Delay, s/veh												
LnGrp Delay(d),s/veh	142.2	24.8	13.8	76.3	26.2	14.6	61.4	37.8	38.4	44.1	30.3	25.3
LnGrp LOS	F	C	B	E	C	B	E	D	D	D	C	C
Approach Vol, veh/h		1832			1817			491			910	
Approach Delay, s/veh		57.1			29.4			43.3			34.1	
Approach LOS		E			C			D			C	
Timer - Assigned Phs	1	2	3	4	5	6	7	8				
Phs Duration (G+Y+Rc), s	14.0	40.4	10.7	25.8	15.0	39.4	15.3	21.2				
Change Period (Y+Rc), s	3.7	6.2	3.7	6.2	3.7	6.2	3.7	6.2				
Max Green Setting (Gmax), s	10.3	38.6	7.7	43.6	11.3	37.6	15.3	36.0				
Max Q Clear Time (g_c+I1), s	11.2	21.8	7.5	16.1	13.3	22.8	11.3	11.5				
Green Ext Time (p_c), s	0.0	10.0	0.0	2.4	0.0	10.3	0.3	2.0				
Intersection Summary												
HCM 6th Ctrl Delay			41.7									
HCM 6th LOS			D									

Timings
10: Orange Terrace Pkwy & Deercreek Dr

West Campus Upper Plateau (JN 14064)

09/30/2022

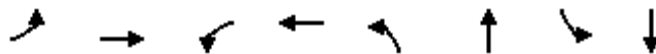

Lane Group	EBL	EBT	WBL	WBT	NBL	NBT	SBL	SBT
Lane Configurations	↖	↕	↖	↕		↕		↕
Traffic Volume (vph)	59	277	9	348	28	5	54	6
Future Volume (vph)	59	277	9	348	28	5	54	6
Turn Type	Perm	NA	Perm	NA	Perm	NA	Perm	NA
Protected Phases		4		8		2		6
Permitted Phases	4		8		2		6	
Detector Phase	4	4	8	8	2	2	6	6
Switch Phase								
Minimum Initial (s)	5.0	5.0	5.0	5.0	5.0	5.0	5.0	5.0
Minimum Split (s)	26.1	26.1	26.1	26.1	26.1	26.1	26.1	26.1
Total Split (s)	27.0	27.0	27.0	27.0	28.0	28.0	28.0	28.0
Total Split (%)	49.1%	49.1%	49.1%	49.1%	50.9%	50.9%	50.9%	50.9%
Yellow Time (s)	3.6	3.6	3.6	3.6	3.6	3.6	3.6	3.6
All-Red Time (s)	0.5	0.5	0.5	0.5	0.5	0.5	0.5	0.5
Lost Time Adjust (s)	0.0	0.0	0.0	0.0		0.0		0.0
Total Lost Time (s)	4.1	4.1	4.1	4.1		4.1		4.1
Lead/Lag								
Lead-Lag Optimize?								
Recall Mode	None	None	None	None	Min	Min	Min	Min
Act Effct Green (s)	10.4	10.4	10.4	10.4		8.7		8.7
Actuated g/C Ratio	0.37	0.37	0.37	0.37		0.31		0.31
v/c Ratio	0.20	0.25	0.03	0.34		0.10		0.26
Control Delay	8.8	7.1	7.3	7.1		7.6		6.2
Queue Delay	0.0	0.0	0.0	0.0		0.0		0.0
Total Delay	8.8	7.1	7.3	7.1		7.6		6.2
LOS	A	A	A	A		A		A
Approach Delay		7.4		7.1		7.6		6.2
Approach LOS		A		A		A		A

Intersection Summary

Cycle Length: 55
 Actuated Cycle Length: 28.4
 Natural Cycle: 55
 Control Type: Actuated-Uncoordinated
 Maximum v/c Ratio: 0.34
 Intersection Signal Delay: 7.1
 Intersection Capacity Utilization 34.1%
 Analysis Period (min) 15
 Intersection LOS: A
 ICU Level of Service A

Splits and Phases: 10: Orange Terrace Pkwy & Deercreek Dr

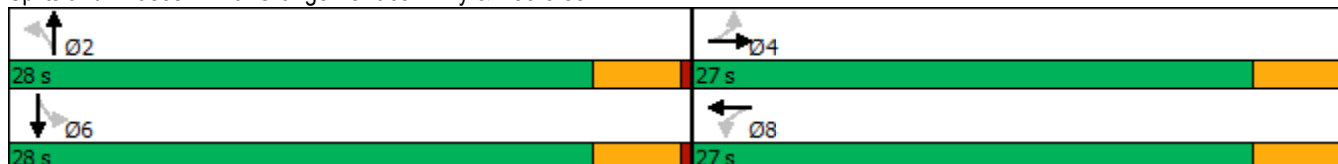

HCM 6th Signalized Intersection Summary
 10: Orange Terrace Pkwy & Deercreek Dr

West Campus Upper Plateau (JN 14064)

09/30/2022



Movement	EBL	EBT	EBR	WBL	WBT	WBR	NBL	NBT	NBR	SBL	SBT	SBR
Lane Configurations												
Traffic Volume (veh/h)	59	277	9	9	348	57	28	5	5	54	6	59
Future Volume (veh/h)	59	277	9	9	348	57	28	5	5	54	6	59
Initial Q (Qb), veh	0	0	0	0	0	0	0	0	0	0	0	0
Ped-Bike Adj(A_pbT)	1.00		0.98	1.00		1.00	1.00		0.99	0.99		0.97
Parking Bus, Adj	1.00	1.00	1.00	1.00	1.00	1.00	1.00	1.00	1.00	1.00	1.00	1.00
Work Zone On Approach		No			No			No			No	
Adj Sat Flow, veh/h/ln	1856	1870	1796	1900	1885	1900	1811	1900	1900	1900	1900	1900
Adj Flow Rate, veh/h	66	308	10	10	387	63	31	6	6	60	7	66
Peak Hour Factor	0.90	0.90	0.90	0.90	0.90	0.90	0.90	0.90	0.90	0.90	0.90	0.90
Percent Heavy Veh, %	3	2	7	0	1	0	6	0	0	0	0	0
Cap, veh/h	578	1191	39	649	1048	169	541	104	56	384	76	203
Arrive On Green	0.34	0.34	0.34	0.34	0.34	0.34	0.26	0.26	0.26	0.26	0.26	0.26
Sat Flow, veh/h	932	3510	114	1078	3086	498	917	401	214	496	293	778
Grp Volume(v), veh/h	66	155	163	10	223	227	43	0	0	133	0	0
Grp Sat Flow(s),veh/h/ln	932	1777	1847	1078	1791	1794	1532	0	0	1567	0	0
Q Serve(g_s), s	1.2	1.3	1.3	0.1	1.9	2.0	0.0	0.0	0.0	0.0	0.0	0.0
Cycle Q Clear(g_c), s	3.1	1.3	1.3	1.4	1.9	2.0	0.4	0.0	0.0	1.3	0.0	0.0
Prop In Lane	1.00		0.06	1.00		0.28	0.72		0.14	0.45		0.50
Lane Grp Cap(c), veh/h	578	603	627	649	608	609	701	0	0	663	0	0
V/C Ratio(X)	0.11	0.26	0.26	0.02	0.37	0.37	0.06	0.00	0.00	0.20	0.00	0.00
Avail Cap(c_a), veh/h	1303	1985	2063	1487	2001	2004	2000	0	0	2030	0	0
HCM Platoon Ratio	1.00	1.00	1.00	1.00	1.00	1.00	1.00	1.00	1.00	1.00	1.00	1.00
Upstream Filter(I)	1.00	1.00	1.00	1.00	1.00	1.00	1.00	0.00	0.00	1.00	0.00	0.00
Uniform Delay (d), s/veh	6.3	4.9	4.9	5.4	5.1	5.1	5.7	0.0	0.0	6.1	0.0	0.0
Incr Delay (d2), s/veh	0.1	0.2	0.2	0.0	0.4	0.4	0.0	0.0	0.0	0.1	0.0	0.0
Initial Q Delay(d3),s/veh	0.0	0.0	0.0	0.0	0.0	0.0	0.0	0.0	0.0	0.0	0.0	0.0
%ile BackOfQ(50%),veh/ln	0.1	0.1	0.1	0.0	0.3	0.3	0.1	0.0	0.0	0.2	0.0	0.0
Unsig. Movement Delay, s/veh												
LnGrp Delay(d),s/veh	6.4	5.1	5.1	5.4	5.5	5.5	5.8	0.0	0.0	6.2	0.0	0.0
LnGrp LOS	A	A	A	A	A	A	A	A	A	A	A	A
Approach Vol, veh/h		384			460			43				133
Approach Delay, s/veh		5.3			5.5			5.8				6.2
Approach LOS		A			A			A				A
Timer - Assigned Phs		2		4		6		8				
Phs Duration (G+Y+Rc), s		9.4		11.1		9.4		11.1				
Change Period (Y+Rc), s		4.1		4.1		4.1		4.1				
Max Green Setting (Gmax), s		23.9		22.9		23.9		22.9				
Max Q Clear Time (g_c+I1), s		2.4		5.1		3.3		4.0				
Green Ext Time (p_c), s		0.1		1.8		0.7		2.7				

Intersection Summary

HCM 6th Ctrl Delay	5.5
HCM 6th LOS	A

Timings
11: Barton St & Alessandro Bl.

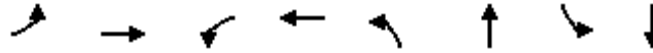

Lane Group	EBL	EBT	WBL	WBT	NBL	NBT	SBL	SBT
Lane Configurations	↙	↕↕↕↕	↙	↕↕↕↕	↙	↕	↙	↕
Traffic Volume (vph)	5	1426	76	1597	61	1	5	0
Future Volume (vph)	5	1426	76	1597	61	1	5	0
Turn Type	Prot	NA	Prot	NA	Perm	NA	Perm	NA
Protected Phases	5	2	1	6		8		4
Permitted Phases					8		4	
Detector Phase	5	2	1	6	8	8	4	4
Switch Phase								
Minimum Initial (s)	5.0	10.0	5.0	10.0	10.0	10.0	10.0	10.0
Minimum Split (s)	9.2	28.5	11.0	28.5	40.6	40.6	26.6	26.6
Total Split (s)	9.2	60.2	14.0	65.0	40.8	40.8	40.8	40.8
Total Split (%)	8.0%	52.3%	12.2%	56.5%	35.5%	35.5%	35.5%	35.5%
Yellow Time (s)	3.2	5.5	3.2	5.5	3.6	3.6	3.6	3.6
All-Red Time (s)	1.0	1.0	1.0	1.0	1.0	1.0	1.0	1.0
Lost Time Adjust (s)	0.0	0.0	0.0	0.0	0.0	0.0	0.0	0.0
Total Lost Time (s)	4.2	6.5	4.2	6.5	4.6	4.6	4.6	4.6
Lead/Lag	Lead	Lag	Lead	Lag				
Lead-Lag Optimize?	Yes	Yes	Yes	Yes				
Recall Mode	None	None	None	None	None	None	None	None
Act Effct Green (s)	5.9	44.3	8.3	52.4	15.2	15.2	15.2	15.2
Actuated g/C Ratio	0.08	0.61	0.11	0.72	0.21	0.21	0.21	0.21
v/c Ratio	0.04	0.51	0.40	0.47	0.22	0.11	0.02	0.01
Control Delay	45.2	13.8	44.3	8.9	30.9	10.5	28.4	0.0
Queue Delay	0.0	0.0	0.0	0.0	0.0	0.0	0.0	0.0
Total Delay	45.2	13.8	44.3	8.9	30.9	10.5	28.4	0.0
LOS	D	B	D	A	C	B	C	A
Approach Delay		13.9		10.5		23.0		17.8
Approach LOS		B		B		C		B

Intersection Summary

Cycle Length: 115
 Actuated Cycle Length: 72.7
 Natural Cycle: 85
 Control Type: Actuated-Uncoordinated
 Maximum v/c Ratio: 0.51
 Intersection Signal Delay: 12.5
 Intersection LOS: B
 Intersection Capacity Utilization 57.9%
 ICU Level of Service B
 Analysis Period (min) 15

Splits and Phases: 11: Barton St & Alessandro Bl.



HCM 6th Signalized Intersection Summary
11: Barton St & Alessandro Bl.

West Campus Upper Plateau (JN 14064)

09/30/2022



Movement	EBL	EBT	EBR	WBL	WBT	WBR	NBL	NBT	NBR	SBL	SBT	SBR
Lane Configurations	↖	↗↖↗		↖	↗↖↗		↖	↗		↖	↗	
Traffic Volume (veh/h)	5	1426	40	76	1597	5	61	1	38	5	0	3
Future Volume (veh/h)	5	1426	40	76	1597	5	61	1	38	5	0	3
Initial Q (Qb), veh	0	0	0	0	0	0	0	0	0	0	0	0
Ped-Bike Adj(A_pbT)	1.00		1.00	1.00		0.98	1.00		1.00	1.00		1.00
Parking Bus, Adj	1.00	1.00	1.00	1.00	1.00	1.00	1.00	1.00	1.00	1.00	1.00	1.00
Work Zone On Approach		No			No			No			No	
Adj Sat Flow, veh/h/ln	1604	1885	1900	1900	1870	1900	1900	1900	1900	1796	1900	1900
Adj Flow Rate, veh/h	5	1533	41	82	1717	5	66	1	14	5	0	-8
Peak Hour Factor	0.93	0.93	0.93	0.93	0.93	0.93	0.93	0.93	0.93	0.93	0.93	0.93
Percent Heavy Veh, %	20	1	0	0	2	0	0	0	0	7	0	0
Cap, veh/h	10	2983	80	109	3325	10	328	13	179	262	0	507
Arrive On Green	0.01	0.58	0.58	0.06	0.63	0.63	0.12	0.12	0.12	0.12	0.00	0.00
Sat Flow, veh/h	1527	5153	138	1810	5256	15	1810	108	1518	1343	1900	0
Grp Volume(v), veh/h	5	1021	553	82	1112	610	66	0	15	5	-8	-8
Grp Sat Flow(s),veh/h/ln	1527	1716	1860	1810	1702	1867	1810	0	1627	1343	1900	1610
Q Serve(g_s), s	0.2	11.2	11.2	2.8	11.2	11.2	2.1	0.0	0.5	0.2	0.0	0.0
Cycle Q Clear(g_c), s	0.2	11.2	11.2	2.8	11.2	11.2	2.1	0.0	0.5	0.7	0.0	0.0
Prop In Lane	1.00		0.07	1.00		0.01	1.00		0.93	1.00		0.00
Lane Grp Cap(c), veh/h	10	1986	1077	109	2154	1181	328	0	192	262	0	0
V/C Ratio(X)	0.49	0.51	0.51	0.75	0.52	0.52	0.20	0.00	0.08	0.02	0.00	0.00
Avail Cap(c_a), veh/h	121	2921	1584	281	3157	1732	1153	0	934	874	0	0
HCM Platoon Ratio	1.00	1.00	1.00	1.00	1.00	1.00	1.00	1.00	1.00	1.00	1.00	1.00
Upstream Filter(I)	1.00	1.00	1.00	1.00	1.00	1.00	1.00	0.00	1.00	1.00	0.00	0.00
Uniform Delay (d), s/veh	31.2	8.0	8.0	29.2	6.3	6.3	25.5	0.0	24.8	25.1	0.0	0.0
Incr Delay (d2), s/veh	13.1	0.3	0.5	3.8	0.3	0.5	0.3	0.0	0.2	0.0	0.0	0.0
Initial Q Delay(d3),s/veh	0.0	0.0	0.0	0.0	0.0	0.0	0.0	0.0	0.0	0.0	0.0	0.0
%ile BackOfQ(50%),veh/ln	0.1	2.5	2.8	1.3	3.0	3.4	0.9	0.0	0.2	0.1	0.0	0.0
Unsig. Movement Delay, s/veh												
LnGrp Delay(d),s/veh	44.3	8.3	8.5	33.0	6.6	6.8	25.8	0.0	24.9	25.1	0.0	0.0
LnGrp LOS	D	A	A	C	A	A	C	A	C	C	A	A
Approach Vol, veh/h		1579			1804			81				-11
Approach Delay, s/veh		8.5			7.9			25.6				0.0
Approach LOS		A			A			C				A
Timer - Assigned Phs	1	2		4	5	6		8				
Phs Duration (G+Y+Rc), s	8.0	43.0		12.1	4.6	46.4		12.1				
Change Period (Y+Rc), s	* 4.2	6.5		4.6	* 4.2	6.5		4.6				
Max Green Setting (Gmax), s	* 9.8	53.7		36.2	* 5	58.5		36.2				
Max Q Clear Time (g_c+I1), s	4.8	13.2		2.7	2.2	13.2		4.1				
Green Ext Time (p_c), s	0.0	19.1		0.0	0.0	26.7		0.2				

Intersection Summary

HCM 6th Ctrl Delay	8.6
HCM 6th LOS	A

Notes

* HCM 6th computational engine requires equal clearance times for the phases crossing the barrier.

Timings
13: Barton Rd. & Orange Terrace Pkwy

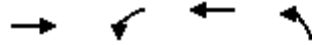

Lane Group	EBT	WBL	WBT	NBL
Lane Configurations	↑↑	↑	↑↑	↑
Traffic Volume (vph)	308	51	455	267
Future Volume (vph)	308	51	455	267
Turn Type	NA	Perm	NA	Prot
Protected Phases	4		8	2
Permitted Phases		8		
Detector Phase	4	8	8	2
Switch Phase				
Minimum Initial (s)	5.0	5.0	5.0	5.0
Minimum Split (s)	26.1	26.1	26.1	26.1
Total Split (s)	27.0	27.0	27.0	28.0
Total Split (%)	49.1%	49.1%	49.1%	50.9%
Yellow Time (s)	3.6	3.6	3.6	3.6
All-Red Time (s)	0.5	0.5	0.5	0.5
Lost Time Adjust (s)	0.0	0.0	0.0	0.0
Total Lost Time (s)	4.1	4.1	4.1	4.1
Lead/Lag				
Lead-Lag Optimize?				
Recall Mode	Max	Max	Max	Max
Act Effct Green (s)	22.9	22.9	22.9	23.9
Actuated g/C Ratio	0.42	0.42	0.42	0.43
v/c Ratio	0.46	0.25	0.35	0.45
Control Delay	6.5	13.9	11.8	12.7
Queue Delay	0.0	0.0	0.0	0.0
Total Delay	6.5	13.9	11.8	12.7
LOS	A	B	B	B
Approach Delay	6.5		12.0	12.7
Approach LOS	A		B	B

Intersection Summary

Cycle Length: 55
 Actuated Cycle Length: 55
 Offset: 0 (0%), Referenced to phase 2:NBL and 6:, Start of Yellow
 Natural Cycle: 55
 Control Type: Pretimed
 Maximum v/c Ratio: 0.46
 Intersection Signal Delay: 9.8
 Intersection Capacity Utilization 50.3%
 Analysis Period (min) 15

Intersection LOS: A
 ICU Level of Service A

Splits and Phases: 13: Barton Rd. & Orange Terrace Pkwy

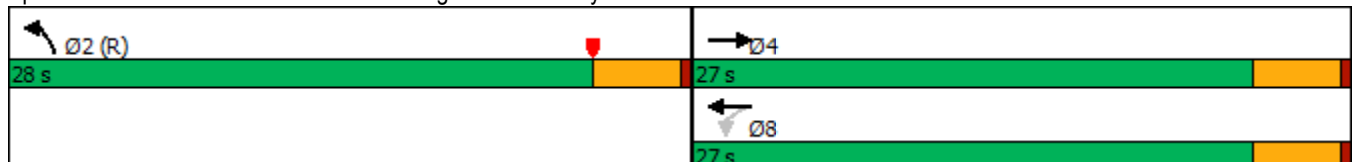

HCM 6th Signalized Intersection Summary
 13: Barton Rd. & Orange Terrace Pkwy

West Campus Upper Plateau (JN 14064)

09/30/2022

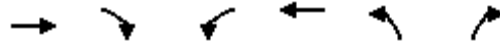

Movement	EBT	EBR	WBL	WBT	NBL	NBR
Lane Configurations	↑↑		↵	↑↑	↵	
Traffic Volume (veh/h)	308	316	51	455	267	38
Future Volume (veh/h)	308	316	51	455	267	38
Initial Q (Qb), veh	0	0	0	0	0	0
Ped-Bike Adj(A_pbT)		0.98	1.00		1.00	1.00
Parking Bus, Adj	1.00	1.00	1.00	1.00	1.00	1.00
Work Zone On Approach	No			No	No	
Adj Sat Flow, veh/h/ln	1885	1885	1900	1900	1900	1900
Adj Flow Rate, veh/h	358	367	59	529	310	44
Peak Hour Factor	0.86	0.86	0.86	0.86	0.86	0.86
Percent Heavy Veh, %	1	1	0	0	0	0
Cap, veh/h	746	649	306	1503	676	96
Arrive On Green	0.42	0.42	0.42	0.42	0.43	0.43
Sat Flow, veh/h	1885	1559	740	3705	1556	221
Grp Volume(v), veh/h	358	367	59	529	355	0
Grp Sat Flow(s),veh/h/ln	1791	1559	740	1805	1782	0
Q Serve(g_s), s	8.0	9.9	3.6	5.5	7.7	0.0
Cycle Q Clear(g_c), s	8.0	9.9	13.5	5.5	7.7	0.0
Prop In Lane		1.00	1.00		0.87	0.12
Lane Grp Cap(c), veh/h	746	649	306	1503	775	0
V/C Ratio(X)	0.48	0.57	0.19	0.35	0.46	0.00
Avail Cap(c_a), veh/h	746	649	306	1503	775	0
HCM Platoon Ratio	1.00	1.00	1.00	1.00	1.00	1.00
Upstream Filter(I)	1.00	1.00	1.00	1.00	1.00	0.00
Uniform Delay (d), s/veh	11.7	12.3	17.4	11.0	11.0	0.0
Incr Delay (d2), s/veh	2.2	3.5	1.4	0.6	2.0	0.0
Initial Q Delay(d3),s/veh	0.0	0.0	0.0	0.0	0.0	0.0
%ile BackOfQ(50%),veh/ln	3.2	3.5	0.7	2.0	3.1	0.0
Unsig. Movement Delay, s/veh						
LnGrp Delay(d),s/veh	13.9	15.8	18.8	11.6	12.9	0.0
LnGrp LOS	B	B	B	B	B	A
Approach Vol, veh/h	725			588	355	
Approach Delay, s/veh	14.9			12.3	12.9	
Approach LOS	B			B	B	
Timer - Assigned Phs		2		4		8
Phs Duration (G+Y+Rc), s		28.0		27.0		27.0
Change Period (Y+Rc), s		4.1		4.1		4.1
Max Green Setting (Gmax), s		23.9		22.9		22.9
Max Q Clear Time (g_c+I1), s		9.7		11.9		15.5
Green Ext Time (p_c), s		1.0		3.6		2.3

Intersection Summary

HCM 6th Ctrl Delay	13.6
HCM 6th LOS	B

Notes

User approved volume balancing among the lanes for turning movement.

Timings

14: Barton Rd. & Van Buren Bl.

09/30/2022

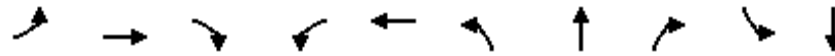

Lane Group	EBL	EBT	EBR	WBL	WBT	NBL	NBT	NBR	SBL	SBT
Lane Configurations	↘	↑↑↑	↗	↘↗	↑↑↑	↘↗	↑	↗	↘	↗
Traffic Volume (vph)	175	1469	217	217	1527	254	44	179	46	29
Future Volume (vph)	175	1469	217	217	1527	254	44	179	46	29
Turn Type	Prot	NA	pm+ov	Prot	NA	Prot	NA	Perm	Prot	NA
Protected Phases	5	2	3	1	6	3	8		7	4
Permitted Phases			2					8		
Detector Phase	5	2	3	1	6	3	8	8	7	4
Switch Phase										
Minimum Initial (s)	5.0	10.0	5.0	5.0	10.0	5.0	10.0	10.0	5.0	10.0
Minimum Split (s)	9.2	25.2	9.1	9.2	25.5	9.1	14.6	14.6	9.1	33.6
Total Split (s)	17.4	54.3	16.0	16.1	53.0	16.0	39.4	39.4	10.2	33.6
Total Split (%)	14.5%	45.3%	13.3%	13.4%	44.2%	13.3%	32.8%	32.8%	8.5%	28.0%
Yellow Time (s)	3.2	5.2	3.6	3.2	5.5	3.6	3.6	3.6	3.6	3.6
All-Red Time (s)	1.0	1.0	0.5	1.0	1.0	0.5	1.0	1.0	0.5	1.0
Lost Time Adjust (s)	0.0	0.0	0.0	0.0	0.0	0.0	0.0	0.0	0.0	0.0
Total Lost Time (s)	4.2	6.2	4.1	4.2	6.5	4.1	4.6	4.6	4.1	4.6
Lead/Lag	Lead	Lag	Lead	Lead	Lag	Lead	Lag	Lag	Lead	Lag
Lead-Lag Optimize?	Yes	Yes	Yes	Yes	Yes	Yes	Yes	Yes	Yes	Yes
Recall Mode	None	None	None	None	None	None	None	None	None	None
Act Effct Green (s)	13.4	39.6	53.4	10.5	36.4	11.6	21.2	21.2	6.1	13.4
Actuated g/C Ratio	0.14	0.42	0.56	0.11	0.38	0.12	0.22	0.22	0.06	0.14
v/c Ratio	0.76	0.70	0.26	0.63	0.81	0.65	0.12	0.40	0.44	0.58
Control Delay	61.3	25.2	7.1	49.9	29.9	49.6	32.6	7.3	59.3	14.9
Queue Delay	0.0	0.0	0.0	0.0	0.0	0.0	0.0	0.0	0.0	0.0
Total Delay	61.3	25.2	7.1	49.9	29.9	49.6	32.6	7.3	59.3	14.9
LOS	E	C	A	D	C	D	C	A	E	B
Approach Delay		26.5			32.3		32.1			22.8
Approach LOS		C			C		C			C

Intersection Summary

Cycle Length: 120
 Actuated Cycle Length: 94.6
 Natural Cycle: 100
 Control Type: Actuated-Uncoordinated
 Maximum v/c Ratio: 0.81
 Intersection Signal Delay: 29.3
 Intersection LOS: C
 Intersection Capacity Utilization 76.7%
 ICU Level of Service D
 Analysis Period (min) 15

Splits and Phases: 14: Barton Rd. & Van Buren Bl.

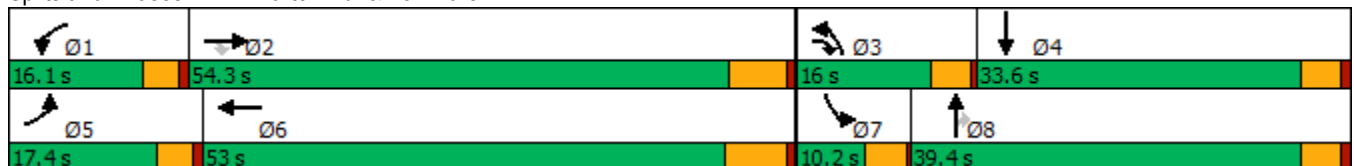

HCM 6th Signalized Intersection Summary
14: Barton Rd. & Van Buren Bl.

West Campus Upper Plateau (JN 14064)

09/30/2022

Movement	EBL	EBT	EBR	WBL	WBT	WBR	NBL	NBT	NBR	SBL	SBT	SBR
Lane Configurations												
Traffic Volume (veh/h)	175	1469	217	217	1527	55	254	44	179	46	29	184
Future Volume (veh/h)	175	1469	217	217	1527	55	254	44	179	46	29	184
Initial Q (Qb), veh	0	0	0	0	0	0	0	0	0	0	0	0
Ped-Bike Adj(A_pbT)	1.00		1.00	1.00		1.00	1.00		0.96	1.00		1.00
Parking Bus, Adj	1.00	1.00	1.00	1.00	1.00	1.00	1.00	1.00	1.00	1.00	1.00	1.00
Work Zone On Approach		No			No			No			No	
Adj Sat Flow, veh/h/ln	1900	1870	1885	1885	1885	1870	1900	1900	1885	1900	1885	1900
Adj Flow Rate, veh/h	194	1632	210	241	1697	50	282	49	67	51	32	142
Peak Hour Factor	0.90	0.90	0.90	0.90	0.90	0.90	0.90	0.90	0.90	0.90	0.90	0.90
Percent Heavy Veh, %	0	2	1	1	1	2	0	0	1	0	1	0
Cap, veh/h	232	2394	851	325	2142	63	372	384	309	76	42	185
Arrive On Green	0.13	0.43	0.43	0.09	0.39	0.39	0.11	0.20	0.20	0.04	0.14	0.14
Sat Flow, veh/h	1810	5611	1596	3483	5465	161	3510	1900	1526	1810	302	1341
Grp Volume(v), veh/h	194	1632	210	241	1170	577	282	49	67	51	0	174
Grp Sat Flow(s),veh/h/ln	1810	1870	1596	1742	1885	1856	1755	1900	1526	1810	0	1644
Q Serve(g_s), s	8.6	19.3	5.8	5.5	22.5	22.5	6.4	1.7	3.0	2.3	0.0	8.4
Cycle Q Clear(g_c), s	8.6	19.3	5.8	5.5	22.5	22.5	6.4	1.7	3.0	2.3	0.0	8.4
Prop In Lane	1.00		1.00	1.00		0.09	1.00		1.00	1.00		0.82
Lane Grp Cap(c), veh/h	232	2394	851	325	1478	727	372	384	309	76	0	227
V/C Ratio(X)	0.84	0.68	0.25	0.74	0.79	0.79	0.76	0.13	0.22	0.67	0.00	0.77
Avail Cap(c_a), veh/h	290	3280	1103	504	2131	1049	508	804	645	134	0	579
HCM Platoon Ratio	1.00	1.00	1.00	1.00	1.00	1.00	1.00	1.00	1.00	1.00	1.00	1.00
Upstream Filter(I)	1.00	1.00	1.00	1.00	1.00	1.00	1.00	1.00	1.00	1.00	0.00	1.00
Uniform Delay (d), s/veh	35.0	19.1	10.3	36.3	22.1	22.1	35.8	26.9	27.4	38.9	0.0	34.2
Incr Delay (d2), s/veh	13.1	0.1	0.1	1.3	0.8	1.6	4.4	0.1	0.3	9.9	0.0	5.4
Initial Q Delay(d3),s/veh	0.0	0.0	0.0	0.0	0.0	0.0	0.0	0.0	0.0	0.0	0.0	0.0
%ile BackOfQ(50%),veh/ln	4.4	7.2	1.7	2.2	8.8	8.8	2.8	0.8	1.1	1.2	0.0	3.7
Unsig. Movement Delay, s/veh												
LnGrp Delay(d),s/veh	48.1	19.2	10.4	37.6	22.9	23.7	40.2	27.0	27.7	48.8	0.0	39.5
LnGrp LOS	D	B	B	D	C	C	D	C	C	D	A	D
Approach Vol, veh/h		2036			1988			398			225	
Approach Delay, s/veh		21.0			24.9			36.4			41.6	
Approach LOS		C			C			D			D	
Timer - Assigned Phs	1	2	3	4	5	6	7	8				
Phs Duration (G+Y+Rc), s	11.9	41.6	12.8	16.0	14.8	38.7	7.5	21.2				
Change Period (Y+Rc), s	* 4.2	* 6.5	4.1	4.6	* 4.2	6.5	4.1	4.6				
Max Green Setting (Gmax), s	* 12	* 48	11.9	29.0	* 13	46.5	6.1	34.8				
Max Q Clear Time (g_c+I1), s	7.5	21.3	8.4	10.4	10.6	24.5	4.3	5.0				
Green Ext Time (p_c), s	0.2	8.8	0.3	1.0	0.1	7.7	0.0	0.4				
Intersection Summary												
HCM 6th Ctrl Delay			25.0									
HCM 6th LOS			C									
Notes												
* HCM 6th computational engine requires equal clearance times for the phases crossing the barrier.												

Timings
25: Sycamore Canyon Bl. & Cactus Av.

West Campus Upper Plateau (JN 14064)

09/30/2022



Lane Group	EBL	EBT	WBL	WBT	WBR	NBL	NBT	NBR	SBL	SBT	SBR
Lane Configurations	↖	↕↕↕	↖↖	↕↕	↖	↖↖	↕↕	↖	↖↖	↕↕	↖
Traffic Volume (vph)	58	390	185	391	225	178	172	140	132	224	49
Future Volume (vph)	58	390	185	391	225	178	172	140	132	224	49
Turn Type	Prot	NA	Prot	NA	pm+ov	Prot	NA	Perm	Prot	NA	Perm
Protected Phases	7	4	3	8	1	5	2		1	6	
Permitted Phases					8			2			6
Detector Phase	7	4	3	8	1	5	2	2	1	6	6
Switch Phase											
Minimum Initial (s)	5.0	10.0	5.0	10.0	10.0	10.0	10.0	10.0	10.0	10.0	10.0
Minimum Split (s)	9.6	32.8	9.6	32.8	15.8	15.8	15.8	15.8	15.8	34.8	34.8
Total Split (s)	32.1	49.0	34.0	50.9	30.0	15.8	37.0	37.0	30.0	51.2	51.2
Total Split (%)	21.4%	32.7%	22.7%	33.9%	20.0%	10.5%	24.7%	24.7%	20.0%	34.1%	34.1%
Yellow Time (s)	3.6	4.8	3.6	4.8	4.8	4.8	4.8	4.8	4.8	4.8	4.8
All-Red Time (s)	1.0	1.0	1.0	1.0	1.0	1.0	1.0	1.0	1.0	1.0	1.0
Lost Time Adjust (s)	0.0	0.0	0.0	0.0	0.0	0.0	0.0	0.0	0.0	0.0	0.0
Total Lost Time (s)	4.6	5.8	4.6	5.8	5.8	5.8	5.8	5.8	5.8	5.8	5.8
Lead/Lag	Lead	Lag	Lead	Lag	Lead	Lead	Lag	Lag	Lead	Lag	Lag
Lead-Lag Optimize?	Yes	Yes	Yes	Yes	Yes	Yes	Yes	Yes	Yes	Yes	Yes
Recall Mode	None	None	None	None	None	None	None	None	None	None	None
Act Effct Green (s)	7.3	15.1	9.0	19.1	35.7	10.4	13.2	13.2	10.6	13.4	13.4
Actuated g/C Ratio	0.10	0.21	0.13	0.27	0.50	0.15	0.19	0.19	0.15	0.19	0.19
v/c Ratio	0.33	0.55	0.45	0.45	0.26	0.37	0.28	0.36	0.27	0.36	0.14
Control Delay	38.6	24.0	34.6	24.8	2.8	33.2	26.6	7.9	31.8	27.1	1.8
Queue Delay	0.0	0.0	0.0	0.0	0.0	0.0	0.0	0.0	0.0	0.0	0.0
Total Delay	38.6	24.0	34.6	24.8	2.8	33.2	26.6	7.9	31.8	27.1	1.8
LOS	D	C	C	C	A	C	C	A	C	C	A
Approach Delay		25.4		20.9			23.7			25.6	
Approach LOS		C		C			C			C	

Intersection Summary

Cycle Length: 150
 Actuated Cycle Length: 70.7
 Natural Cycle: 95
 Control Type: Actuated-Uncoordinated
 Maximum v/c Ratio: 0.55
 Intersection Signal Delay: 23.5
 Intersection LOS: C
 Intersection Capacity Utilization 51.7%
 ICU Level of Service A
 Analysis Period (min) 15

Splits and Phases: 25: Sycamore Canyon Bl. & Cactus Av.

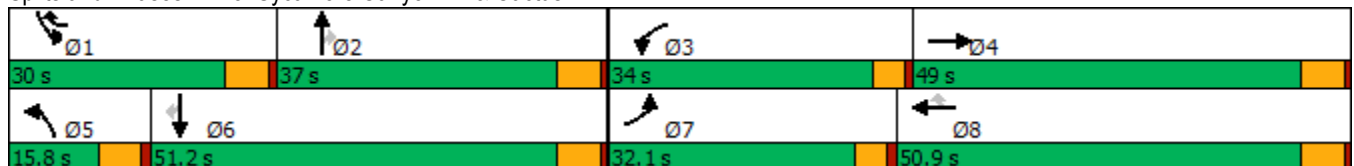

HCM 6th Signalized Intersection Summary
 25: Sycamore Canyon Bl. & Cactus Av.

West Campus Upper Plateau (JN 14064)

09/30/2022



Movement	EBL	EBT	EBR	WBL	WBT	WBR	NBL	NBT	NBR	SBL	SBT	SBR
Lane Configurations												
Traffic Volume (veh/h)	58	390	172	185	391	225	178	172	140	132	224	49
Future Volume (veh/h)	58	390	172	185	391	225	178	172	140	132	224	49
Initial Q (Qb), veh	0	0	0	0	0	0	0	0	0	0	0	0
Ped-Bike Adj(A_pbT)	1.00		1.00	1.00		1.00	1.00		1.00	1.00		1.00
Parking Bus, Adj	1.00	1.00	1.00	1.00	1.00	1.00	1.00	1.00	1.00	1.00	1.00	1.00
Work Zone On Approach		No			No			No			No	
Adj Sat Flow, veh/h/ln	1856	1796	1856	1841	1796	1870	1856	1841	1826	1885	1811	1767
Adj Flow Rate, veh/h	60	406	-29	193	407	-8	185	179	16	138	233	51
Peak Hour Factor	0.96	0.96	0.96	0.96	0.96	0.96	0.96	0.96	0.96	0.96	0.96	0.96
Percent Heavy Veh, %	3	7	3	4	7	2	3	4	5	1	6	9
Cap, veh/h	95	858	0	308	723	613	599	612	271	609	602	262
Arrive On Green	0.05	0.17	0.00	0.09	0.21	0.00	0.17	0.17	0.17	0.17	0.17	0.17
Sat Flow, veh/h	1767	5065	0	3401	3413	1585	3428	3497	1547	3483	3441	1497
Grp Volume(v), veh/h	60	377	0	193	407	-8	185	179	16	138	233	51
Grp Sat Flow(s),veh/h/ln	1767	1635	0	1700	1706	1585	1714	1749	1547	1742	1721	1497
Q Serve(g_s), s	1.9	3.9	0.0	3.1	6.1	0.0	2.7	2.5	0.5	1.9	3.4	1.7
Cycle Q Clear(g_c), s	1.9	3.9	0.0	3.1	6.1	0.0	2.7	2.5	0.5	1.9	3.4	1.7
Prop In Lane	1.00		0.00	1.00		1.00	1.00		1.00	1.00		1.00
Lane Grp Cap(c), veh/h	95	858	0	308	723	613	599	612	271	609	602	262
V/C Ratio(X)	0.63	0.44	0.00	0.63	0.56	-0.01	0.31	0.29	0.06	0.23	0.39	0.19
Avail Cap(c_a), veh/h	850	3705	0	1749	2692	1527	600	1908	844	1474	2732	1189
HCM Platoon Ratio	1.00	1.00	1.00	1.00	1.00	1.00	1.00	1.00	1.00	1.00	1.00	1.00
Upstream Filter(I)	1.00	1.00	0.00	1.00	1.00	0.00	1.00	1.00	1.00	1.00	1.00	1.00
Uniform Delay (d), s/veh	26.5	21.1	0.0	25.1	20.2	0.0	20.6	20.5	19.7	20.3	20.9	20.2
Incr Delay (d2), s/veh	2.6	0.4	0.0	0.8	0.7	0.0	0.3	0.3	0.1	0.2	0.4	0.4
Initial Q Delay(d3),s/veh	0.0	0.0	0.0	0.0	0.0	0.0	0.0	0.0	0.0	0.0	0.0	0.0
%ile BackOfQ(50%),veh/ln	0.8	1.4	0.0	1.1	2.1	0.0	1.0	0.9	0.2	0.7	1.2	0.5
Unsig. Movement Delay, s/veh												
LnGrp Delay(d),s/veh	29.1	21.4	0.0	25.8	20.9	0.0	20.9	20.8	19.8	20.5	21.3	20.5
LnGrp LOS	C	C	A	C	C	A	C	C	B	C	C	C
Approach Vol, veh/h		437			592			380			422	
Approach Delay, s/veh		22.5			22.8			20.8			20.9	
Approach LOS		C			C			C			C	
Timer - Assigned Phs	1	2	3	4	5	6	7	8				
Phs Duration (G+Y+Rc), s	15.8	15.8	9.8	15.8	15.8	15.8	7.7	17.9				
Change Period (Y+Rc), s	5.8	5.8	4.6	5.8	5.8	5.8	4.6	5.8				
Max Green Setting (Gmax), s	24.2	31.2	29.4	43.2	10.0	45.4	27.5	45.1				
Max Q Clear Time (g_c+I1), s	3.9	4.5	5.1	5.9	4.7	5.4	3.9	8.1				
Green Ext Time (p_c), s	0.4	1.0	0.3	2.6	0.2	1.6	0.1	2.6				

Intersection Summary

HCM 6th Ctrl Delay	21.9
HCM 6th LOS	C

Timings

West Campus Upper Plateau (JN 14064)

26: Sycamore Canyon Bl. & Van Buren Bl.

09/30/2022

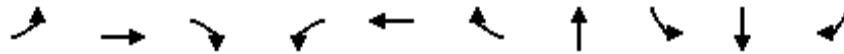

Lane Group	EBL	EBT	EBR	WBL	WBT	WBR	NBT	SBL	SBT	SBR
Lane Configurations										
Traffic Volume (vph)	299	1405	7	38	1503	73	7	100	10	503
Future Volume (vph)	299	1405	7	38	1503	73	7	100	10	503
Turn Type	Prot	NA	Perm	Prot	NA	Perm	NA	Split	NA	Perm
Protected Phases	5	2		1	6		8	4	4	
Permitted Phases			2			6				4
Detector Phase	5	2	2	1	6	6	8	4	4	4
Switch Phase										
Minimum Initial (s)	5.0	10.0	10.0	5.0	10.0	10.0	10.0	10.0	10.0	10.0
Minimum Split (s)	9.6	29.2	29.2	9.6	29.2	29.2	14.6	50.8	50.8	50.8
Total Split (s)	15.0	45.0	45.0	9.6	39.6	39.6	14.6	50.8	50.8	50.8
Total Split (%)	12.5%	37.5%	37.5%	8.0%	33.0%	33.0%	12.2%	42.3%	42.3%	42.3%
Yellow Time (s)	3.6	5.2	5.2	3.6	5.2	5.2	3.6	4.8	4.8	4.8
All-Red Time (s)	1.0	1.0	1.0	1.0	1.0	1.0	1.0	1.0	1.0	1.0
Lost Time Adjust (s)	0.0	0.0	0.0	0.0	0.0	0.0	0.0	0.0	0.0	0.0
Total Lost Time (s)	4.6	6.2	6.2	4.6	6.2	6.2	4.6	5.8	5.8	5.8
Lead/Lag	Lead	Lag	Lag	Lead	Lag	Lag				
Lead-Lag Optimize?	Yes	Yes	Yes	Yes	Yes	Yes				
Recall Mode	None	None	None	None	None	None	None	None	None	None
Act Effct Green (s)	11.2	40.0	40.0	5.4	28.9	28.9	10.7	15.8	15.8	15.8
Actuated g/C Ratio	0.14	0.49	0.49	0.07	0.36	0.36	0.13	0.19	0.19	0.19
v/c Ratio	0.65	0.41	0.01	0.38	0.62	0.12	0.08	0.14	0.54	0.52
Control Delay	45.2	17.8	0.0	56.4	24.9	0.4	25.4	29.0	9.3	7.4
Queue Delay	0.0	0.0	0.0	0.0	0.0	0.0	0.0	0.0	0.0	0.0
Total Delay	45.2	17.8	0.0	56.4	24.9	0.4	25.4	29.0	9.3	7.4
LOS	D	B	A	E	C	A	C	C	A	A
Approach Delay		22.5			24.5		25.4		11.4	
Approach LOS		C			C		C		B	

Intersection Summary

Cycle Length: 120
 Actuated Cycle Length: 81.3
 Natural Cycle: 105
 Control Type: Actuated-Uncoordinated
 Maximum v/c Ratio: 0.65
 Intersection Signal Delay: 21.6
 Intersection Capacity Utilization 64.7%
 Analysis Period (min) 15

Intersection LOS: C
 ICU Level of Service C

Splits and Phases: 26: Sycamore Canyon Bl. & Van Buren Bl.

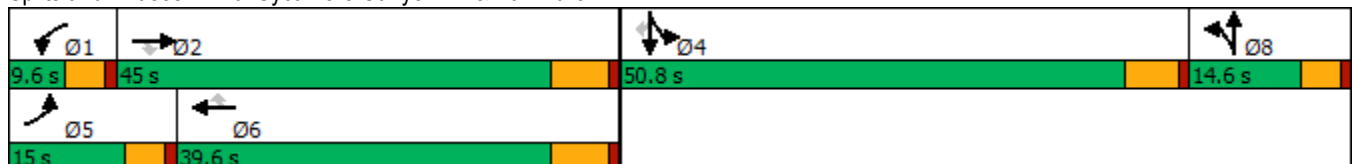

HCM 6th Signalized Intersection Summary
26: Sycamore Canyon Bl. & Van Buren Bl.

West Campus Upper Plateau (JN 14064)

09/30/2022



Movement	EBL	EBT	EBR	WBL	WBT	WBR	NBL	NBT	NBR	SBL	SBT	SBR
Lane Configurations												
Traffic Volume (veh/h)	299	1405	7	38	1503	73	8	7	21	100	10	503
Future Volume (veh/h)	299	1405	7	38	1503	73	8	7	21	100	10	503
Initial Q (Qb), veh	0	0	0	0	0	0	0	0	0	0	0	0
Ped-Bike Adj(A_pbT)	1.00		1.00	1.00		0.99	1.00		1.00	1.00		1.00
Parking Bus, Adj	1.00	1.00	1.00	1.00	1.00	1.00	1.00	1.00	1.00	1.00	1.00	1.00
Work Zone On Approach		No			No			No			No	
Adj Sat Flow, veh/h/ln	1856	1841	1900	1693	1826	1856	1900	1900	1900	1841	1900	1856
Adj Flow Rate, veh/h	315	1479	7	40	1582	66	8	7	-7	88	0	0
Peak Hour Factor	0.95	0.95	0.95	0.95	0.95	0.95	0.95	0.95	0.95	0.95	0.95	0.95
Percent Heavy Veh, %	3	4	0	14	5	3	0	0	0	4	0	3
Cap, veh/h	431	3358	734	65	2736	582	151	636	0	450	0	
Arrive On Green	0.12	0.68	0.46	0.04	0.56	0.37	0.02	0.02	0.00	0.13	0.00	0.00
Sat Flow, veh/h	3534	7363	1610	1612	7304	1553	1801	1909	0	3506	0	3145
Grp Volume(v), veh/h	315	1479	7	40	1582	66	8	0	0	88	0	0
Grp Sat Flow(s),veh/h/ln	1767	1841	1610	1612	1826	1553	1810	1805	0	1753	0	1572
Q Serve(g_s), s	5.1	5.4	0.1	1.5	8.4	1.7	0.0	0.0	0.0	1.3	0.0	0.0
Cycle Q Clear(g_c), s	5.1	5.4	0.1	1.5	8.4	1.7	0.0	0.0	0.0	1.3	0.0	0.0
Prop In Lane	1.00		1.00	1.00		1.00	0.99		0.00	1.00		1.00
Lane Grp Cap(c), veh/h	431	3358	734	65	2736	582	0	0	0	450	0	
V/C Ratio(X)	0.73	0.44	0.01	0.61	0.58	0.11	0.00	0.00	0.00	0.20	0.00	
Avail Cap(c_a), veh/h	614	4772	1044	135	4075	866	0	0	0	2636	0	
HCM Platoon Ratio	1.00	1.50	1.00	1.00	1.50	1.00	1.00	1.00	1.00	1.00	1.00	1.00
Upstream Filter(I)	1.00	1.00	1.00	1.00	1.00	1.00	1.00	0.00	0.00	1.00	0.00	0.00
Uniform Delay (d), s/veh	25.3	6.0	8.9	28.3	10.0	12.2	0.0	0.0	0.0	23.3	0.0	0.0
Incr Delay (d2), s/veh	1.2	0.1	0.0	3.4	0.2	0.1	0.0	0.0	0.0	0.2	0.0	0.0
Initial Q Delay(d3),s/veh	0.0	0.0	0.0	0.0	0.0	0.0	0.0	0.0	0.0	0.0	0.0	0.0
%ile BackOfQ(50%),veh/ln	2.0	1.4	0.0	0.6	2.3	0.5	0.0	0.0	0.0	0.5	0.0	0.0
Unsig. Movement Delay, s/veh												
LnGrp Delay(d),s/veh	26.5	6.1	8.9	31.7	10.2	12.3	0.0	0.0	0.0	23.5	0.0	0.0
LnGrp LOS	C	A	A	C	B	B	A	A	A	C	A	
Approach Vol, veh/h		1801			1688			8				88
Approach Delay, s/veh		9.7			10.8			0.0				23.5
Approach LOS		A			B			A				C
Timer - Assigned Phs	1	2		4	5	6		8				
Phs Duration (G+Y+Rc), s	7.0	33.5		13.5	11.9	28.6		5.8				
Change Period (Y+Rc), s	4.6	6.2		5.8	4.6	6.2		4.6				
Max Green Setting (Gmax), s	5.0	38.8		45.0	10.4	33.4		10.0				
Max Q Clear Time (g_c+I1), s	3.5	7.4		3.3	7.1	10.4		2.0				
Green Ext Time (p_c), s	0.0	12.5		0.3	0.2	12.0		0.0				

Intersection Summary

HCM 6th Ctrl Delay	10.5
HCM 6th LOS	B

Notes

User approved volume balancing among the lanes for turning movement.
Unsignalized Delay for [SBR] is excluded from calculations of the approach delay and intersection delay.

Timings
29: I-215 NB Ramps & Alessandro Bl.

West Campus Upper Plateau (JN 14064)

09/30/2022

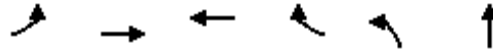

Lane Group	EBL	EBT	WBT	WBR	NBL	NBT
Lane Configurations	↶	↑↑↑	↑↑↑	↷	↶↷	↕
Traffic Volume (vph)	234	862	1002	157	568	10
Future Volume (vph)	234	862	1002	157	568	10
Turn Type	Prot	NA	NA	Perm	Split	NA
Protected Phases	5	2	6		8	8
Permitted Phases				6		
Detector Phase	5	2	6	6	8	8
Switch Phase						
Minimum Initial (s)	5.0	5.0	5.0	5.0	5.0	5.0
Minimum Split (s)	9.5	10.5	33.5	33.5	10.0	10.0
Total Split (s)	24.6	67.0	42.4	42.4	43.0	43.0
Total Split (%)	22.4%	60.9%	38.5%	38.5%	39.1%	39.1%
Yellow Time (s)	3.5	4.5	4.5	4.5	4.0	4.0
All-Red Time (s)	1.0	1.0	1.0	1.0	1.0	1.0
Lost Time Adjust (s)	0.0	0.0	0.0	0.0	0.0	0.0
Total Lost Time (s)	4.5	5.5	5.5	5.5	5.0	5.0
Lead/Lag	Lead		Lag	Lag		
Lead-Lag Optimize?	Yes		Yes	Yes		
Recall Mode	None	Min	Min	Min	Max	Max
Act Effct Green (s)	18.2	51.6	28.8	28.8	38.3	38.3
Actuated g/C Ratio	0.18	0.51	0.29	0.29	0.38	0.38
v/c Ratio	0.84	0.34	0.72	0.35	0.43	0.53
Control Delay	65.9	14.5	35.3	19.2	25.7	18.8
Queue Delay	0.0	0.0	0.0	0.0	0.0	0.0
Total Delay	65.9	14.5	35.3	19.2	25.7	18.8
LOS	E	B	D	B	C	B
Approach Delay		25.5	33.1			23.1
Approach LOS		C	C			C

Intersection Summary

Cycle Length: 110
 Actuated Cycle Length: 100.4
 Natural Cycle: 70
 Control Type: Actuated-Uncoordinated
 Maximum v/c Ratio: 0.84
 Intersection Signal Delay: 27.7
 Intersection LOS: C
 Intersection Capacity Utilization 60.8%
 ICU Level of Service B
 Analysis Period (min) 15

Splits and Phases: 29: I-215 NB Ramps & Alessandro Bl.



HCM 6th Signalized Intersection Summary
 29: I-215 NB Ramps & Alessandro Bl.

West Campus Upper Plateau (JN 14064)

09/30/2022

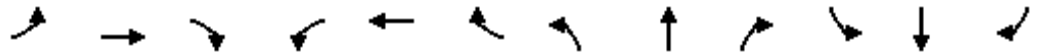

Movement	EBL	EBT	EBR	WBL	WBT	WBR	NBL	NBT	NBR	SBL	SBT	SBR
Lane Configurations	↘	↑↑↑			↑↑↑	↗	↘↗	↕				
Traffic Volume (veh/h)	234	862	0	0	1002	157	568	10	259	0	0	0
Future Volume (veh/h)	234	862	0	0	1002	157	568	10	259	0	0	0
Initial Q (Qb), veh	0	0	0	0	0	0	0	0	0			
Ped-Bike Adj(A_pbT)	1.00		1.00	1.00		0.98	1.00		1.00			
Parking Bus, Adj	1.00	1.00	1.00	1.00	1.00	1.00	1.00	1.00	1.00			
Work Zone On Approach		No			No			No				
Adj Sat Flow, veh/h/ln	1693	1870	0	0	1841	1752	1856	1900	1826			
Adj Flow Rate, veh/h	241	889	0	0	1033	136	553	56	183			
Peak Hour Factor	0.97	0.97	0.97	0.97	0.97	0.97	0.97	0.97	0.97			
Percent Heavy Veh, %	14	2	0	0	4	10	3	0	5			
Cap, veh/h	272	2507	0	0	1382	400	1409	156	510			
Arrive On Green	0.17	0.49	0.00	0.00	0.27	0.27	0.40	0.40	0.40			
Sat Flow, veh/h	1612	5274	0	0	5191	1453	3534	391	1279			
Grp Volume(v), veh/h	241	889	0	0	1033	136	553	0	239			
Grp Sat Flow(s),veh/h/ln	1612	1702	0	0	1675	1453	1767	0	1670			
Q Serve(g_s), s	13.9	10.2	0.0	0.0	17.9	7.1	10.6	0.0	9.6			
Cycle Q Clear(g_c), s	13.9	10.2	0.0	0.0	17.9	7.1	10.6	0.0	9.6			
Prop In Lane	1.00		0.00	0.00		1.00	1.00		0.77			
Lane Grp Cap(c), veh/h	272	2507	0	0	1382	400	1409	0	666			
V/C Ratio(X)	0.89	0.35	0.00	0.00	0.75	0.34	0.39	0.00	0.36			
Avail Cap(c_a), veh/h	340	3296	0	0	1946	563	1409	0	666			
HCM Platoon Ratio	1.00	1.00	1.00	1.00	1.00	1.00	1.00	1.00	1.00			
Upstream Filter(I)	1.00	1.00	0.00	0.00	1.00	1.00	1.00	0.00	1.00			
Uniform Delay (d), s/veh	38.7	14.9	0.0	0.0	31.5	27.6	20.4	0.0	20.1			
Incr Delay (d2), s/veh	19.1	0.1	0.0	0.0	1.0	0.5	0.8	0.0	1.5			
Initial Q Delay(d3),s/veh	0.0	0.0	0.0	0.0	0.0	0.0	0.0	0.0	0.0			
%ile BackOfQ(50%),veh/ln	6.5	3.4	0.0	0.0	6.7	2.3	4.3	0.0	3.8			
Unsig. Movement Delay, s/veh												
LnGrp Delay(d),s/veh	57.8	15.0	0.0	0.0	32.5	28.1	21.2	0.0	21.6			
LnGrp LOS	E	B	A	A	C	C	C	A	C			
Approach Vol, veh/h		1130			1169			792				
Approach Delay, s/veh		24.2			32.0			21.3				
Approach LOS		C			C			C				
Timer - Assigned Phs		2			5	6		8				
Phs Duration (G+Y+Rc), s		52.3			20.6	31.7		43.0				
Change Period (Y+Rc), s		5.5			4.5	5.5		5.0				
Max Green Setting (Gmax), s		61.5			20.1	36.9		38.0				
Max Q Clear Time (g_c+I1), s		12.2			15.9	19.9		12.6				
Green Ext Time (p_c), s		6.2			0.2	6.3		3.5				

Intersection Summary

HCM 6th Ctrl Delay	26.4
HCM 6th LOS	C

Notes

User approved volume balancing among the lanes for turning movement.

Timings

West Campus Upper Plateau (JN 14064)

31: I-215 NB Ramps/Old 215 Frontage Rd. & Cactus Av.

09/30/2022



Lane Group	EBL	EBT	EBR	WBT	NBL	NBT	NBR	SBL	SBT
Lane Configurations	↶	↶↶	↶	↶↶↶	↶↶	↶	↶	↶	↶
Traffic Volume (vph)	32	689	245	1162	124	70	3	116	1
Future Volume (vph)	32	689	245	1162	124	70	3	116	1
Turn Type	Perm	NA	Perm	NA	Prot	NA	Perm	Perm	NA
Protected Phases		2		6	3	8			4
Permitted Phases	2		2				8	4	
Detector Phase	2	2	2	6	3	8	8	4	4
Switch Phase									
Minimum Initial (s)	5.0	5.0	5.0	5.0	5.0	5.0	5.0	5.0	5.0
Minimum Split (s)	11.0	11.0	11.0	44.0	9.1	10.5	10.5	10.5	10.5
Total Split (s)	64.0	64.0	64.0	64.0	14.0	36.0	36.0	22.0	22.0
Total Split (%)	64.0%	64.0%	64.0%	64.0%	14.0%	36.0%	36.0%	22.0%	22.0%
Yellow Time (s)	5.0	5.0	5.0	5.0	3.6	4.5	4.5	4.5	4.5
All-Red Time (s)	1.0	1.0	1.0	1.0	0.5	1.0	1.0	1.0	1.0
Lost Time Adjust (s)	0.0	0.0	0.0	0.0	0.0	0.0	0.0	0.0	0.0
Total Lost Time (s)	6.0	6.0	6.0	6.0	4.1	5.5	5.5	5.5	5.5
Lead/Lag					Lead			Lag	Lag
Lead-Lag Optimize?					Yes			Yes	Yes
Recall Mode	Min	Min	Min	Min	None	None	None	None	None
Act Effct Green (s)	26.9	26.9	26.9	26.9	8.1	19.8	19.8	10.3	10.3
Actuated g/C Ratio	0.46	0.46	0.46	0.46	0.14	0.34	0.34	0.18	0.18
v/c Ratio	0.27	0.47	0.32	0.60	0.30	0.13	0.01	0.55	0.26
Control Delay	19.2	13.4	3.0	14.1	28.3	14.1	0.0	34.6	10.2
Queue Delay	0.0	0.0	0.0	0.0	0.0	0.0	0.0	0.0	0.0
Total Delay	19.2	13.4	3.0	14.1	28.3	14.1	0.0	34.6	10.2
LOS	B	B	A	B	C	B	A	C	B
Approach Delay		11.0		14.1		22.9			24.5
Approach LOS		B		B		C			C

Intersection Summary

Cycle Length: 100
 Actuated Cycle Length: 58.7
 Natural Cycle: 65
 Control Type: Actuated-Uncoordinated
 Maximum v/c Ratio: 0.60
 Intersection Signal Delay: 14.4
 Intersection LOS: B
 Intersection Capacity Utilization 49.3%
 ICU Level of Service A
 Analysis Period (min) 15

Splits and Phases: 31: I-215 NB Ramps/Old 215 Frontage Rd. & Cactus Av.

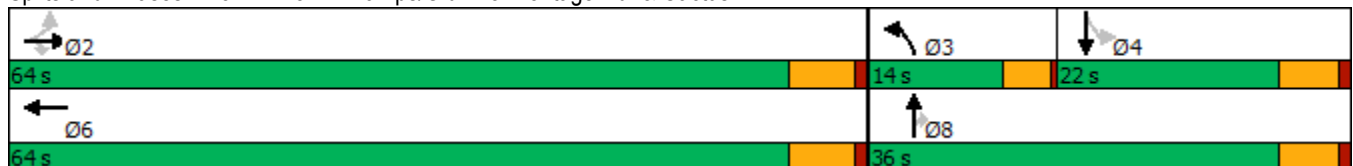

HCM 6th Signalized Intersection Summary

West Campus Upper Plateau (JN 14064)

31: I-215 NB Ramps/Old 215 Frontage Rd. & Cactus Av.

09/30/2022

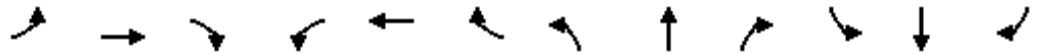

Movement	EBL	EBT	EBR	WBL	WBT	WBR	NBL	NBT	NBR	SBL	SBT	SBR
Lane Configurations												
Traffic Volume (veh/h)	32	689	245	0	1162	125	124	70	3	116	1	82
Future Volume (veh/h)	32	689	245	0	1162	125	124	70	3	116	1	82
Initial Q (Qb), veh	0	0	0	0	0	0	0	0	0	0	0	0
Ped-Bike Adj(A_pbT)	1.00		1.00	1.00		1.00	1.00		1.00	1.00		1.00
Parking Bus, Adj	1.00	1.00	1.00	1.00	1.00	1.00	1.00	1.00	1.00	1.00	1.00	1.00
Work Zone On Approach		No			No			No			No	
Adj Sat Flow, veh/h/ln	1856	1841	1767	0	1856	1885	1767	1856	1870	1841	1900	1885
Adj Flow Rate, veh/h	34	741	259	0	1249	85	133	75	0	125	1	61
Peak Hour Factor	0.93	0.93	0.93	0.93	0.93	0.93	0.93	0.93	0.93	0.93	0.93	0.93
Percent Heavy Veh, %	3	4	9	0	3	1	9	3	2	4	0	1
Cap, veh/h	251	1454	623	0	2014	137	308	597		343	4	218
Arrive On Green	0.42	0.42	0.42	0.00	0.42	0.42	0.09	0.32	0.00	0.14	0.14	0.14
Sat Flow, veh/h	407	3497	1497	0	5010	330	3365	1856	1585	1304	26	1588
Grp Volume(v), veh/h	34	741	259	0	871	463	133	75	0	125	0	62
Grp Sat Flow(s),veh/h/ln	407	1749	1497	0	1689	1795	1682	1856	1585	1304	0	1614
Q Serve(g_s), s	3.1	6.9	5.4	0.0	8.9	8.9	1.6	1.3	0.0	4.0	0.0	1.5
Cycle Q Clear(g_c), s	12.1	6.9	5.4	0.0	8.9	8.9	1.6	1.3	0.0	4.0	0.0	1.5
Prop In Lane	1.00		1.00	0.00		0.18	1.00		1.00	1.00		0.98
Lane Grp Cap(c), veh/h	251	1454	623	0	1404	746	308	597		343	0	221
V/C Ratio(X)	0.14	0.51	0.42	0.00	0.62	0.62	0.43	0.13		0.36	0.00	0.28
Avail Cap(c_a), veh/h	620	4625	1980	0	4466	2374	760	1290		655	0	607
HCM Platoon Ratio	1.00	1.00	1.00	1.00	1.00	1.00	1.00	1.00	1.00	1.00	1.00	1.00
Upstream Filter(I)	1.00	1.00	1.00	0.00	1.00	1.00	1.00	1.00	0.00	1.00	0.00	1.00
Uniform Delay (d), s/veh	14.8	9.5	9.0	0.0	10.1	10.1	18.8	10.5	0.0	18.1	0.0	17.0
Incr Delay (d2), s/veh	0.1	0.1	0.2	0.0	0.2	0.3	1.0	0.0	0.0	0.2	0.0	0.3
Initial Q Delay(d3),s/veh	0.0	0.0	0.0	0.0	0.0	0.0	0.0	0.0	0.0	0.0	0.0	0.0
%ile BackOfQ(50%),veh/ln	0.2	1.7	1.1	0.0	2.1	2.3	0.6	0.4	0.0	1.0	0.0	0.4
Unsig. Movement Delay, s/veh												
LnGrp Delay(d),s/veh	14.9	9.6	9.2	0.0	10.3	10.4	19.8	10.5	0.0	18.3	0.0	17.2
LnGrp LOS	B	A	A	A	B	B	B	B		B	A	B
Approach Vol, veh/h		1034			1334			208				187
Approach Delay, s/veh		9.7			10.3			16.5				18.0
Approach LOS		A			B			B				B
Timer - Assigned Phs		2	3	4		6		8				
Phs Duration (G+Y+Rc), s		24.2	8.1	11.5		24.2		19.6				
Change Period (Y+Rc), s		6.0	4.1	5.5		6.0		5.5				
Max Green Setting (Gmax), s		58.0	9.9	16.5		58.0		30.5				
Max Q Clear Time (g_c+I1), s		14.1	3.6	6.0		10.9		3.3				
Green Ext Time (p_c), s		4.2	0.2	0.3		6.3		0.2				

Intersection Summary

HCM 6th Ctrl Delay	11.1
HCM 6th LOS	B

Notes

User approved volume balancing among the lanes for turning movement.
 Unsignalized Delay for [NBR] is excluded from calculations of the approach delay and intersection delay.

Timings
32: I-215 SB Ramps & Van Buren Bl.

West Campus Upper Plateau (JN 14064)

09/30/2022

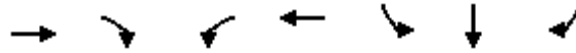

Lane Group	EBT	EBR	WBL	WBT	SBL	SBT	SBR
Lane Configurations	↑↑	↑	↵	↑↑	↵	↕	↑
Traffic Volume (vph)	717	837	14	813	22	0	807
Future Volume (vph)	717	837	14	813	22	0	807
Turn Type	NA	Perm	Prot	NA	Split	NA	Perm
Protected Phases	6		5	2	8	8	
Permitted Phases		6					8
Detector Phase	6	6	5	2	8	8	8
Switch Phase							
Minimum Initial (s)	5.0	5.0	5.0	5.0	5.0	5.0	5.0
Minimum Split (s)	36.0	36.0	11.0	11.0	11.0	11.0	11.0
Total Split (s)	80.0	80.0	15.0	95.0	25.0	25.0	25.0
Total Split (%)	66.7%	66.7%	12.5%	79.2%	20.8%	20.8%	20.8%
Yellow Time (s)	5.0	5.0	5.0	5.0	5.0	5.0	5.0
All-Red Time (s)	1.0	1.0	1.0	1.0	1.0	1.0	1.0
Lost Time Adjust (s)	0.0	0.0	0.0	0.0	0.0	0.0	0.0
Total Lost Time (s)	6.0	6.0	6.0	6.0	6.0	6.0	6.0
Lead/Lag	Lag	Lag	Lead				
Lead-Lag Optimize?	Yes	Yes	Yes				
Recall Mode	None	None	None	None	None	None	None
Act Effct Green (s)	20.4	20.4	5.4	22.2	19.7	19.7	19.7
Actuated g/C Ratio	0.38	0.38	0.10	0.41	0.36	0.36	0.36
v/c Ratio	0.60	0.78	0.08	0.62	0.03	0.69	0.66
Control Delay	15.8	6.8	28.4	13.9	16.8	16.5	15.3
Queue Delay	0.0	0.0	0.0	0.0	0.0	0.0	0.0
Total Delay	15.8	6.8	28.4	13.9	16.8	16.5	15.3
LOS	B	A	C	B	B	B	B
Approach Delay	11.0			14.1		15.9	
Approach LOS	B			B		B	

Intersection Summary

Cycle Length: 120
 Actuated Cycle Length: 54.3
 Natural Cycle: 75
 Control Type: Actuated-Uncoordinated
 Maximum v/c Ratio: 0.78
 Intersection Signal Delay: 13.0
 Intersection LOS: B
 Intersection Capacity Utilization 79.9%
 ICU Level of Service D
 Analysis Period (min) 15

Splits and Phases: 32: I-215 SB Ramps & Van Buren Bl.



HCM 6th Signalized Intersection Summary
 32: I-215 SB Ramps & Van Buren Bl.

West Campus Upper Plateau (JN 14064)

09/30/2022



Movement	EBL	EBT	EBR	WBL	WBT	WBR	NBL	NBT	NBR	SBL	SBT	SBR
Lane Configurations		↑↑	↗	↖	↑↑					↘	↕	↗
Traffic Volume (veh/h)	0	717	837	14	813	0	0	0	0	22	0	807
Future Volume (veh/h)	0	717	837	14	813	0	0	0	0	22	0	807
Initial Q (Qb), veh	0	0	0	0	0	0				0	0	0
Ped-Bike Adj(A_pbT)	1.00		1.00	1.00		1.00				1.00		1.00
Parking Bus, Adj	1.00	1.00	1.00	1.00	1.00	1.00				1.00	1.00	1.00
Work Zone On Approach		No			No						No	
Adj Sat Flow, veh/h/ln	0	1796	1856	1885	1826	0				1885	1841	1722
Adj Flow Rate, veh/h	0	763	0	15	865	0				15	0	0
Peak Hour Factor	0.94	0.94	0.94	0.94	0.94	0.94				0.94	0.94	0.94
Percent Heavy Veh, %	0	7	3	1	5	0				1	4	12
Cap, veh/h	0	1138		253	2231	0				35	0	
Arrive On Green	0.00	0.33	0.00	0.14	0.64	0.00				0.02	0.00	0.00
Sat Flow, veh/h	0	3503	1572	1795	3561	0				1795	0	2919
Grp Volume(v), veh/h	0	763	0	15	865	0				15	0	0
Grp Sat Flow(s),veh/h/ln	0	1706	1572	1795	1735	0				1795	0	1459
Q Serve(g_s), s	0.0	6.8	0.0	0.3	4.2	0.0				0.3	0.0	0.0
Cycle Q Clear(g_c), s	0.0	6.8	0.0	0.3	4.2	0.0				0.3	0.0	0.0
Prop In Lane	0.00		1.00	1.00		0.00				1.00		1.00
Lane Grp Cap(c), veh/h	0	1138		253	2231	0				35	0	
V/C Ratio(X)	0.00	0.67		0.06	0.39	0.00				0.43	0.00	
Avail Cap(c_a), veh/h	0	7105		455	8687	0				960	0	
HCM Platoon Ratio	1.00	1.00	1.00	1.00	1.00	1.00				1.00	1.00	1.00
Upstream Filter(I)	0.00	1.00	0.00	1.00	1.00	0.00				1.00	0.00	0.00
Uniform Delay (d), s/veh	0.0	10.2	0.0	13.2	3.0	0.0				17.2	0.0	0.0
Incr Delay (d2), s/veh	0.0	0.3	0.0	0.0	0.0	0.0				3.1	0.0	0.0
Initial Q Delay(d3),s/veh	0.0	0.0	0.0	0.0	0.0	0.0				0.0	0.0	0.0
%ile BackOfQ(50%),veh/ln	0.0	1.3	0.0	0.1	0.0	0.0				0.1	0.0	0.0
Unsig. Movement Delay, s/veh												
LnGrp Delay(d),s/veh	0.0	10.4	0.0	13.3	3.1	0.0				20.3	0.0	0.0
LnGrp LOS	A	B		B	A	A				C	A	
Approach Vol, veh/h		763			880							15
Approach Delay, s/veh		10.4			3.2							20.3
Approach LOS		B			A							C
Timer - Assigned Phs		2			5	6		8				
Phs Duration (G+Y+Rc), s		28.9			11.0	17.9		6.7				
Change Period (Y+Rc), s		6.0			6.0	6.0		6.0				
Max Green Setting (Gmax), s		89.0			9.0	74.0		19.0				
Max Q Clear Time (g_c+I1), s		6.2			2.3	8.8		2.3				
Green Ext Time (p_c), s		3.7			0.0	3.0		0.0				

Intersection Summary

HCM 6th Ctrl Delay	6.7
HCM 6th LOS	A

Notes

User approved volume balancing among the lanes for turning movement.
 Unsignalized Delay for [EBR, SBR] is excluded from calculations of the approach delay and intersection delay.

Timings

West Campus Upper Plateau (JN 14064)

34: Old 215 Frontage Rd. & Alessandro Bl.

09/30/2022

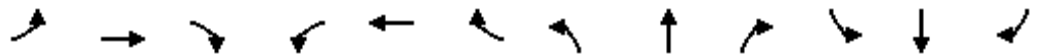

Lane Group	EBL	EBT	EBR	WBL	WBT	WBR	NBL	NBT	NBR	SBL	SBT	SBR
Lane Configurations	↖↗	↑↑↑	↖	↖	↑↑↑	↖	↖↗	↑↑	↖	↖	↑↑	↖
Traffic Volume (vph)	331	854	13	11	785	99	24	99	14	90	122	221
Future Volume (vph)	331	854	13	11	785	99	24	99	14	90	122	221
Turn Type	Prot	NA	Perm	Prot	NA	Perm	Prot	NA	Perm	Prot	NA	Perm
Protected Phases	5	2		1	6		3	8		7	4	
Permitted Phases			2			6			8			4
Detector Phase	5	2	2	1	6	6	3	8	8	7	4	4
Switch Phase												
Minimum Initial (s)	5.0	10.0	10.0	5.0	10.0	10.0	5.0	10.0	10.0	5.0	10.0	10.0
Minimum Split (s)	8.7	43.5	43.5	8.7	15.8	15.8	8.7	16.2	16.2	8.7	40.2	40.2
Total Split (s)	25.0	62.4	62.4	8.7	46.1	46.1	8.7	26.9	26.9	22.0	40.2	40.2
Total Split (%)	20.8%	52.0%	52.0%	7.3%	38.4%	38.4%	7.3%	22.4%	22.4%	18.3%	33.5%	33.5%
Yellow Time (s)	3.2	5.5	5.5	3.2	4.8	4.8	3.2	5.2	5.2	3.2	5.2	5.2
All-Red Time (s)	0.5	1.0	1.0	0.5	1.0	1.0	0.5	1.0	1.0	0.5	1.0	1.0
Lost Time Adjust (s)	0.0	0.0	0.0	0.0	0.0	0.0	0.0	0.0	0.0	0.0	0.0	0.0
Total Lost Time (s)	3.7	6.5	6.5	3.7	5.8	5.8	3.7	6.2	6.2	3.7	6.2	6.2
Lead/Lag	Lead	Lag	Lag	Lead	Lag	Lag	Lead	Lag	Lag	Lead	Lag	Lag
Lead-Lag Optimize?	Yes	Yes	Yes	Yes	Yes	Yes	Yes	Yes	Yes	Yes	Yes	Yes
Recall Mode	None	None	None	None	None	None	None	None	None	None	None	None
Act Effct Green (s)	12.8	35.2	35.2	5.4	20.3	20.3	5.4	12.7	12.7	9.1	20.1	20.1
Actuated g/C Ratio	0.18	0.48	0.48	0.07	0.28	0.28	0.07	0.17	0.17	0.12	0.28	0.28
v/c Ratio	0.59	0.36	0.02	0.10	0.58	0.19	0.12	0.17	0.04	0.44	0.14	0.41
Control Delay	34.8	14.0	0.1	43.3	25.9	1.6	41.6	30.4	0.2	41.3	23.0	6.5
Queue Delay	0.0	0.0	0.0	0.0	0.0	0.0	0.0	0.0	0.0	0.0	0.0	0.0
Total Delay	34.8	14.0	0.1	43.3	25.9	1.6	41.6	30.4	0.2	41.3	23.0	6.5
LOS	C	B	A	D	C	A	D	C	A	D	C	A
Approach Delay		19.6			23.4			29.2			18.4	
Approach LOS		B			C			C			B	

Intersection Summary

Cycle Length: 120
 Actuated Cycle Length: 72.9
 Natural Cycle: 105
 Control Type: Actuated-Uncoordinated
 Maximum v/c Ratio: 0.59
 Intersection Signal Delay: 21.2
 Intersection LOS: C
 Intersection Capacity Utilization 49.6%
 ICU Level of Service A
 Analysis Period (min) 15

Splits and Phases: 34: Old 215 Frontage Rd. & Alessandro Bl.

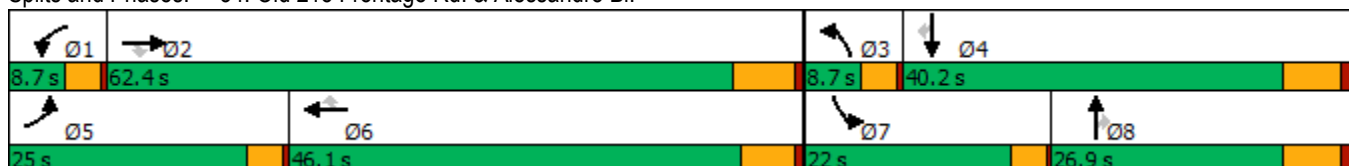

HCM 6th Signalized Intersection Summary
34: Old 215 Frontage Rd. & Alessandro Bl.

West Campus Upper Plateau (JN 14064)

09/30/2022



Movement	EBL	EBT	EBR	WBL	WBT	WBR	NBL	NBT	NBR	SBL	SBT	SBR
Lane Configurations	↖↗	↑↑↑	↖	↖	↑↑↑	↖	↖↗	↑↑	↖	↖	↑↑	↖
Traffic Volume (veh/h)	331	854	13	11	785	99	24	99	14	90	122	221
Future Volume (veh/h)	331	854	13	11	785	99	24	99	14	90	122	221
Initial Q (Qb), veh	0	0	0	0	0	0	0	0	0	0	0	0
Ped-Bike Adj(A_pbT)	1.00		1.00	1.00		1.00	1.00		0.99	1.00		1.00
Parking Bus, Adj	1.00	1.00	1.00	1.00	1.00	1.00	1.00	1.00	1.00	1.00	1.00	1.00
Work Zone On Approach		No			No			No			No	
Adj Sat Flow, veh/h/ln	1826	1885	1678	1678	1870	1856	1574	1856	1574	1826	1752	1693
Adj Flow Rate, veh/h	345	890	-13	11	818	0	25	103	5	94	127	0
Peak Hour Factor	0.96	0.96	0.96	0.96	0.96	0.96	0.96	0.96	0.96	0.96	0.96	0.96
Percent Heavy Veh, %	5	1	15	15	2	3	22	3	22	5	10	14
Cap, veh/h	475	2054	567	22	1391		83	600	224	121	702	
Arrive On Green	0.14	0.40	0.00	0.01	0.27	0.00	0.03	0.17	0.17	0.07	0.21	0.00
Sat Flow, veh/h	3374	5147	1422	1598	5106	1572	2908	3526	1314	1739	3328	1434
Grp Volume(v), veh/h	345	890	-13	11	818	0	25	103	5	94	127	0
Grp Sat Flow(s),veh/h/ln	1687	1716	1422	1598	1702	1572	1454	1763	1314	1739	1664	1434
Q Serve(g_s), s	5.7	7.3	0.0	0.4	8.0	0.0	0.5	1.4	0.2	3.1	1.8	0.0
Cycle Q Clear(g_c), s	5.7	7.3	0.0	0.4	8.0	0.0	0.5	1.4	0.2	3.1	1.8	0.0
Prop In Lane	1.00		1.00	1.00		1.00	1.00		1.00	1.00		1.00
Lane Grp Cap(c), veh/h	475	2054	567	22	1391		83	600	224	121	702	
V/C Ratio(X)	0.73	0.43	-0.02	0.49	0.59		0.30	0.17	0.02	0.78	0.18	
Avail Cap(c_a), veh/h	1242	4972	1374	138	3556		251	1261	470	550	1956	
HCM Platoon Ratio	1.00	1.00	1.00	1.00	1.00	1.00	1.00	1.00	1.00	1.00	1.00	1.00
Upstream Filter(I)	1.00	1.00	0.00	1.00	1.00	0.00	1.00	1.00	1.00	1.00	1.00	0.00
Uniform Delay (d), s/veh	23.8	12.6	0.0	28.3	18.2	0.0	27.5	20.5	20.0	26.5	18.7	0.0
Incr Delay (d2), s/veh	0.8	0.1	0.0	6.1	0.4	0.0	0.7	0.1	0.0	4.1	0.1	0.0
Initial Q Delay(d3),s/veh	0.0	0.0	0.0	0.0	0.0	0.0	0.0	0.0	0.0	0.0	0.0	0.0
%ile BackOfQ(50%),veh/ln	1.9	2.0	0.0	0.2	2.7	0.0	0.2	0.5	0.1	1.2	0.6	0.0
Unsig. Movement Delay, s/veh												
LnGrp Delay(d),s/veh	24.6	12.8	0.0	34.4	18.6	0.0	28.3	20.7	20.0	30.5	18.8	0.0
LnGrp LOS	C	B	A	C	B		C	C	C	C	B	
Approach Vol, veh/h		1222			829			133			221	
Approach Delay, s/veh		16.3			18.8			22.1			23.8	
Approach LOS		B			B			C			C	
Timer - Assigned Phs	1	2	3	4	5	6	7	8				
Phs Duration (G+Y+Rc), s	4.5	29.6	5.4	18.4	11.8	22.3	7.7	16.0				
Change Period (Y+Rc), s	3.7	6.5	3.7	6.2	3.7	* 6.5	3.7	6.2				
Max Green Setting (Gmax), s	5.0	55.9	5.0	34.0	21.3	* 40	18.3	20.7				
Max Q Clear Time (g_c+I1), s	2.4	9.3	2.5	3.8	7.7	10.0	5.1	3.4				
Green Ext Time (p_c), s	0.0	6.2	0.0	0.7	0.5	5.7	0.1	0.4				

Intersection Summary

HCM 6th Ctrl Delay	18.2
HCM 6th LOS	B

Notes

* HCM 6th computational engine requires equal clearance times for the phases crossing the barrier.
Unsignalized Delay for [WBR, SBR] is excluded from calculations of the approach delay and intersection delay.

Timings
36: Elsworth St. & Cactus Av.

West Campus Upper Plateau (JN 14064)

09/30/2022



Lane Group	EBL	EBT	EBR	WBL	WBT	WBR	NBL	NBT	SBL	SBT	SBR
Lane Configurations	↘	↑↑↑	↗	↘	↑↑↑	↗	↘	↗	↘	↑	↗
Traffic Volume (vph)	153	1076	31	14	1075	133	22	11	160	17	128
Future Volume (vph)	153	1076	31	14	1075	133	22	11	160	17	128
Turn Type	Prot	NA	Perm	Prot	NA	Perm	Prot	NA	Prot	NA	pm+ov
Protected Phases	5	2		1	6		3	8	7	4	5
Permitted Phases			2			6					4
Detector Phase	5	2	2	1	6	6	3	8	7	4	5
Switch Phase											
Minimum Initial (s)	5.0	10.0	10.0	5.0	10.0	10.0	5.0	10.0	5.0	10.0	5.0
Minimum Split (s)	9.6	36.2	36.2	9.6	36.2	36.2	15.4	35.4	15.4	35.4	9.6
Total Split (s)	18.0	54.0	54.0	9.6	45.6	45.6	20.9	35.4	21.0	35.5	18.0
Total Split (%)	15.0%	45.0%	45.0%	8.0%	38.0%	38.0%	17.4%	29.5%	17.5%	29.6%	15.0%
Yellow Time (s)	3.6	5.2	5.2	3.6	5.2	5.2	4.4	4.4	4.4	4.4	3.6
All-Red Time (s)	1.0	1.0	1.0	1.0	1.0	1.0	1.0	1.0	1.0	1.0	1.0
Lost Time Adjust (s)	0.0	0.0	0.0	0.0	0.0	0.0	0.0	0.0	0.0	0.0	0.0
Total Lost Time (s)	4.6	6.2	6.2	4.6	6.2	6.2	5.4	5.4	5.4	5.4	4.6
Lead/Lag	Lead	Lead	Lead	Lag	Lag	Lag	Lag	Lag	Lead	Lead	Lead
Lead-Lag Optimize?	Yes	Yes	Yes	Yes	Yes	Yes	Yes	Yes	Yes	Yes	Yes
Recall Mode	None	None	None	None	None	None	None	None	None	None	None
Act Effct Green (s)	12.3	41.8	41.8	6.9	27.0	27.0	13.1	13.6	13.1	13.6	18.0
Actuated g/C Ratio	0.16	0.54	0.54	0.09	0.35	0.35	0.17	0.18	0.17	0.18	0.23
v/c Ratio	0.57	0.33	0.04	0.09	0.64	0.21	0.08	0.07	0.55	0.05	0.28
Control Delay	45.8	14.8	0.1	43.0	24.9	3.9	37.4	25.6	43.2	33.7	4.2
Queue Delay	0.0	0.0	0.0	0.0	0.0	0.0	0.0	0.0	0.0	0.0	0.0
Total Delay	45.8	14.8	0.1	43.0	24.9	3.9	37.4	25.6	43.2	33.7	4.2
LOS	D	B	A	D	C	A	D	C	D	C	A
Approach Delay		18.2			22.9			31.7		26.3	
Approach LOS		B			C			C		C	

Intersection Summary

Cycle Length: 120
 Actuated Cycle Length: 77.4
 Natural Cycle: 100
 Control Type: Actuated-Uncoordinated
 Maximum v/c Ratio: 0.64
 Intersection Signal Delay: 21.3
 Intersection LOS: C
 Intersection Capacity Utilization 58.3%
 ICU Level of Service B
 Analysis Period (min) 15

Splits and Phases: 36: Elsworth St. & Cactus Av.

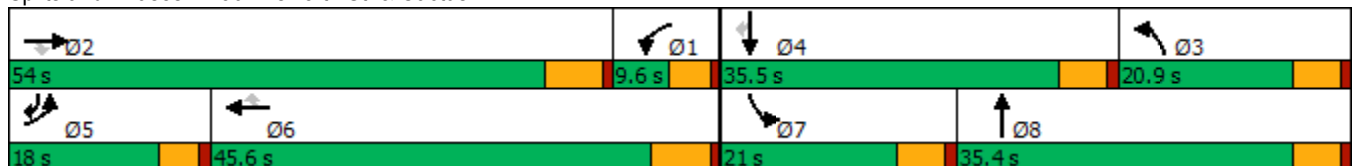

HCM 6th Signalized Intersection Summary
36: Elsworth St. & Cactus Av.

West Campus Upper Plateau (JN 14064)

09/30/2022



Movement	EBL	EBT	EBR	WBL	WBT	WBR	NBL	NBT	NBR	SBL	SBT	SBR
Lane Configurations												
Traffic Volume (veh/h)	153	1076	31	14	1075	133	22	11	9	160	17	128
Future Volume (veh/h)	153	1076	31	14	1075	133	22	11	9	160	17	128
Initial Q (Qb), veh	0	0	0	0	0	0	0	0	0	0	0	0
Ped-Bike Adj(A_pbT)	1.00		1.00	1.00		1.00	1.00		1.00	1.00		1.00
Parking Bus, Adj	1.00	1.00	1.00	1.00	1.00	1.00	1.00	1.00	1.00	1.00	1.00	1.00
Work Zone On Approach		No			No			No			No	
Adj Sat Flow, veh/h/ln	1870	1841	1781	1900	1856	1885	1885	1900	1885	1900	1900	1900
Adj Flow Rate, veh/h	161	1133	0	15	1132	103	23	12	-15	168	18	27
Peak Hour Factor	0.95	0.95	0.95	0.95	0.95	0.95	0.95	0.95	0.95	0.95	0.95	0.95
Percent Heavy Veh, %	2	4	8	0	3	1	1	0	1	0	0	0
Cap, veh/h	202	1963		221	1735	547	131	0	403	221	279	419
Arrive On Green	0.11	0.31	0.00	0.12	0.34	0.34	0.07	0.10	0.00	0.12	0.15	0.15
Sat Flow, veh/h	1781	6332	1510	1810	5066	1598	1795	1900	0	1810	1900	1610
Grp Volume(v), veh/h	161	1133	0	15	1132	103	23	-3	-3	168	18	27
Grp Sat Flow(s),veh/h/ln	1781	1583	1510	1810	1689	1598	1795	1900	1610	1810	1900	1610
Q Serve(g_s), s	5.9	10.0	0.0	0.5	12.6	3.0	0.8	0.0	0.0	6.0	0.5	0.5
Cycle Q Clear(g_c), s	5.9	10.0	0.0	0.5	12.6	3.0	0.8	0.0	0.0	6.0	0.5	0.5
Prop In Lane	1.00		1.00	1.00		1.00	1.00		0.00	1.00		1.00
Lane Grp Cap(c), veh/h	202	1963		221	1735	547	131	0	0	221	279	419
V/C Ratio(X)	0.80	0.58		0.07	0.65	0.19	0.18	0.00	0.00	0.76	0.06	0.06
Avail Cap(c_a), veh/h	358	4544		221	2996	945	418	0	0	424	859	910
HCM Platoon Ratio	1.00	1.00	1.00	1.00	1.00	1.00	1.00	1.00	1.00	1.00	1.00	1.00
Upstream Filter(I)	1.00	1.00	0.00	1.00	1.00	1.00	1.00	0.00	0.00	1.00	1.00	1.00
Uniform Delay (d), s/veh	28.8	19.3	0.0	25.9	18.5	15.4	29.0	0.0	0.0	28.3	24.5	7.2
Incr Delay (d2), s/veh	2.7	0.3	0.0	0.0	0.4	0.2	0.6	0.0	0.0	5.4	0.1	0.1
Initial Q Delay(d3),s/veh	0.0	0.0	0.0	0.0	0.0	0.0	0.0	0.0	0.0	0.0	0.0	0.0
%ile BackOfQ(50%),veh/ln	2.4	3.1	0.0	0.2	4.1	1.1	0.4	0.0	0.0	2.7	0.2	0.2
Unsig. Movement Delay, s/veh												
LnGrp Delay(d),s/veh	31.5	19.6	0.0	25.9	19.0	15.6	29.6	0.0	0.0	33.7	24.6	7.3
LnGrp LOS	C	B		C	B	B	C	A	A	C	C	A
Approach Vol, veh/h		1294			1250			17			213	
Approach Delay, s/veh		21.1			18.8			40.1			29.6	
Approach LOS		C			B			D			C	
Timer - Assigned Phs	1	2	3	4	5	6	7	8				
Phs Duration (G+Y+Rc), s	14.3	26.8	10.2	15.2	12.2	29.0	13.5	11.9				
Change Period (Y+Rc), s	6.2	* 6.2	5.4	5.4	4.6	6.2	5.4	5.4				
Max Green Setting (Gmax), s	5.0	* 48	15.5	30.1	13.4	39.4	15.6	30.0				
Max Q Clear Time (g_c+I1), s	2.5	12.0	2.8	2.5	7.9	14.6	8.0	0.0				
Green Ext Time (p_c), s	0.0	8.6	0.0	0.1	0.1	8.2	0.2	0.0				

Intersection Summary

HCM 6th Ctrl Delay	20.8
HCM 6th LOS	C

Notes

- User approved pedestrian interval to be less than phase max green.
- User approved volume balancing among the lanes for turning movement.
- * HCM 6th computational engine requires equal clearance times for the phases crossing the barrier.

APPENDIX 8.1:

**HORIZON YEAR (2045) WITHOUT PROJECT CONDITIONS INTERSECTION OPERATIONS
ANALYSIS WORKSHEETS**

This Page Intentionally Left Blank

Timings
1: Washington St & Van Buren Bl.

West Campus Upper Plateau (JN 14064)

09/20/2022



Lane Group	EBL	EBT	WBL	WBT	WBR	NBL	NBT	NBR	SBL	SBT
Lane Configurations	↙	↕↗	↙	↕↗	↗	↙↗	↕↗	↗	↙↗	↕↗
Traffic Volume (vph)	175	1522	134	1984	888	328	1169	199	521	235
Future Volume (vph)	175	1522	134	1984	888	328	1169	199	521	235
Turn Type	Prot	NA	Prot	NA	Perm	Prot	NA	Perm	Prot	NA
Protected Phases	5	2	1	6		3	8		7	4
Permitted Phases					6			8		
Detector Phase	5	2	1	6	6	3	8	8	7	4
Switch Phase										
Minimum Initial (s)	5.0	10.0	5.0	10.0	10.0	5.0	10.0	10.0	5.0	10.0
Minimum Split (s)	9.2	34.2	9.2	33.2	33.2	9.2	38.4	38.4	9.2	30.8
Total Split (s)	14.0	53.1	12.3	51.4	51.4	14.2	38.4	38.4	16.2	40.4
Total Split (%)	11.7%	44.3%	10.3%	42.8%	42.8%	11.8%	32.0%	32.0%	13.5%	33.7%
Yellow Time (s)	3.2	5.2	3.2	5.2	5.2	3.2	4.4	4.4	3.2	4.8
All-Red Time (s)	1.0	1.0	1.0	1.0	1.0	1.0	1.0	1.0	1.0	1.0
Lost Time Adjust (s)	0.0	0.0	0.0	0.0	0.0	0.0	0.0	0.0	0.0	0.0
Total Lost Time (s)	4.2	6.2	4.2	6.2	6.2	4.2	5.4	5.4	4.2	5.8
Lead/Lag	Lead	Lag	Lead	Lag	Lag	Lead	Lag	Lag	Lead	Lag
Lead-Lag Optimize?	Yes	Yes	Yes	Yes	Yes	Yes	Yes	Yes	Yes	Yes
Recall Mode	None	None	None	None	None	None	None	None	None	None
Act Effct Green (s)	9.8	46.9	8.1	45.2	45.2	10.0	33.0	33.0	12.0	34.6
Actuated g/C Ratio	0.08	0.39	0.07	0.38	0.38	0.08	0.28	0.28	0.10	0.29
v/c Ratio	1.26	1.30	1.19	1.55	1.27	1.21	1.24	0.41	1.58	0.34
Control Delay	203.7	171.2	189.3	280.8	157.8	168.4	154.5	19.9	311.4	30.5
Queue Delay	0.0	0.0	0.0	0.0	0.0	0.0	0.0	0.0	0.0	0.0
Total Delay	203.7	171.2	189.3	280.8	157.8	168.4	154.5	19.9	311.4	30.5
LOS	F	F	F	F	F	F	F	B	F	C
Approach Delay		174.3		240.4			141.4			205.0
Approach LOS		F		F			F			F

Intersection Summary

Cycle Length: 120
 Actuated Cycle Length: 120
 Natural Cycle: 125
 Control Type: Actuated-Uncoordinated
 Maximum v/c Ratio: 1.58
 Intersection Signal Delay: 197.1
 Intersection LOS: F
 Intersection Capacity Utilization 128.4%
 ICU Level of Service H
 Analysis Period (min) 15

Splits and Phases: 1: Washington St & Van Buren Bl.

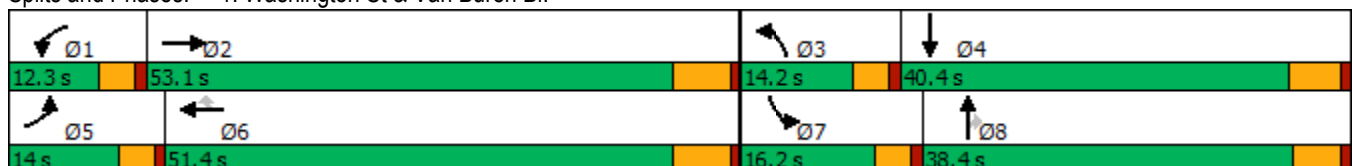

HCM 6th Signalized Intersection Summary
1: Washington St & Van Buren Bl.

West Campus Upper Plateau (JN 14064)

09/20/2022



Movement	EBL	EBT	EBR	WBL	WBT	WBR	NBL	NBT	NBR	SBL	SBT	SBR
Lane Configurations												
Traffic Volume (veh/h)	175	1522	165	134	1984	888	328	1169	199	521	235	83
Future Volume (veh/h)	175	1522	165	134	1984	888	328	1169	199	521	235	83
Initial Q (Qb), veh	0	0	0	0	0	0	0	0	0	0	0	0
Ped-Bike Adj(A_pbT)	1.00		0.99	1.00		0.98	1.00		1.00	1.00		1.00
Parking Bus, Adj	1.00	1.00	1.00	1.00	1.00	1.00	1.00	1.00	1.00	1.00	1.00	1.00
Work Zone On Approach		No			No			No			No	
Adj Sat Flow, veh/h/ln	1885	1856	1870	1856	1870	1885	1856	1885	1856	1870	1811	1826
Adj Flow Rate, veh/h	182	1585	149	140	2067	761	342	1218	141	543	245	57
Peak Hour Factor	0.96	0.96	0.96	0.96	0.96	0.96	0.96	0.96	0.96	0.96	0.96	0.96
Percent Heavy Veh, %	1	3	2	3	2	1	3	1	3	2	6	5
Cap, veh/h	146	1268	118	119	1334	589	285	982	430	344	809	185
Arrive On Green	0.08	0.39	0.39	0.07	0.38	0.38	0.08	0.27	0.27	0.10	0.29	0.29
Sat Flow, veh/h	1795	3256	303	1767	3554	1569	3428	3582	1567	3456	2781	635
Grp Volume(v), veh/h	182	850	884	140	2067	761	342	1218	141	543	150	152
Grp Sat Flow(s),veh/h/ln	1795	1763	1796	1767	1777	1569	1714	1791	1567	1728	1721	1696
Q Serve(g_s), s	9.8	46.9	46.9	8.1	45.2	45.2	10.0	33.0	8.6	12.0	8.1	8.4
Cycle Q Clear(g_c), s	9.8	46.9	46.9	8.1	45.2	45.2	10.0	33.0	8.6	12.0	8.1	8.4
Prop In Lane	1.00		0.17	1.00		1.00	1.00		1.00	1.00		0.37
Lane Grp Cap(c), veh/h	146	687	700	119	1334	589	285	982	430	344	500	493
V/C Ratio(X)	1.25	1.24	1.26	1.18	1.55	1.29	1.20	1.24	0.33	1.58	0.30	0.31
Avail Cap(c_a), veh/h	146	687	700	119	1334	589	285	982	430	344	500	493
HCM Platoon Ratio	1.00	1.00	1.00	1.00	1.00	1.00	1.00	1.00	1.00	1.00	1.00	1.00
Upstream Filter(I)	1.00	1.00	1.00	1.00	1.00	1.00	1.00	1.00	1.00	1.00	1.00	1.00
Uniform Delay (d), s/veh	55.3	36.7	36.8	56.1	37.6	37.6	55.2	43.7	34.9	54.2	33.2	33.3
Incr Delay (d2), s/veh	155.0	119.4	129.6	138.0	251.0	143.8	119.2	117.0	0.4	273.0	0.3	0.4
Initial Q Delay(d3),s/veh	0.0	0.0	0.0	0.0	0.0	0.0	0.0	0.0	0.0	0.0	0.0	0.0
%ile BackOfQ(50%),veh/ln	10.6	41.5	44.2	8.1	64.8	40.7	9.1	30.6	3.4	18.3	3.5	3.5
Unsig. Movement Delay, s/veh												
LnGrp Delay(d),s/veh	210.3	156.2	166.3	194.2	288.6	181.4	174.4	160.7	35.3	327.2	33.5	33.6
LnGrp LOS	F	F	F	F	F	F	F	F	D	F	C	C
Approach Vol, veh/h		1916			2968			1701			845	
Approach Delay, s/veh		166.0			256.6			153.1			222.3	
Approach LOS		F			F			F			F	
Timer - Assigned Phs	1	2	3	4	5	6	7	8				
Phs Duration (G+Y+Rc), s	12.3	53.1	14.2	40.8	14.0	51.4	16.2	38.8				
Change Period (Y+Rc), s	* 4.2	6.2	* 4.2	5.8	* 4.2	6.2	* 4.2	* 5.8				
Max Green Setting (Gmax), s	* 8.1	46.9	* 10	34.6	* 9.8	45.2	* 12	* 33				
Max Q Clear Time (g_c+I1), s	10.1	48.9	12.0	10.4	11.8	47.2	14.0	35.0				
Green Ext Time (p_c), s	0.0	0.0	0.0	1.8	0.0	0.0	0.0	0.0				

Intersection Summary

HCM 6th Ctrl Delay	205.6
HCM 6th LOS	F

Notes

* HCM 6th computational engine requires equal clearance times for the phases crossing the barrier.

Timings
2: Central Ave & Arlington Ave/Chicago Ave

West Campus Upper Plateau (JN 14064)

09/20/2022



Lane Group	EBL	EBT	EBR	WBL	WBT	WBR	NBL	NBT	NBR	SBL	SBT
Lane Configurations											
Traffic Volume (vph)	55	656	862	292	1083	431	1725	2155	675	301	898
Future Volume (vph)	55	656	862	292	1083	431	1725	2155	675	301	898
Turn Type	Prot	NA	pm+ov	Prot	NA	pm+ov	Prot	NA	pm+ov	Prot	NA
Protected Phases	7	4	5	3	8	1	5	2	3	1	6
Permitted Phases			4			8			2		
Detector Phase	7	4	5	3	8	1	5	2	3	1	6
Switch Phase											
Minimum Initial (s)	5.0	10.0	10.0	5.0	10.0	10.0	10.0	10.0	5.0	10.0	10.0
Minimum Split (s)	9.6	35.2	15.8	9.6	38.8	15.8	15.8	38.8	9.6	15.8	38.8
Total Split (s)	9.6	35.6	42.0	12.8	38.8	15.9	42.0	65.7	12.8	15.9	39.6
Total Split (%)	7.4%	27.4%	32.3%	9.8%	29.8%	12.2%	32.3%	50.5%	9.8%	12.2%	30.5%
Yellow Time (s)	3.6	4.8	3.6	3.6	4.8	3.6	3.6	4.4	3.6	3.6	4.4
All-Red Time (s)	1.0	1.0	1.0	1.0	1.0	1.0	1.0	1.0	1.0	1.0	1.0
Lost Time Adjust (s)	0.0	0.0	0.0	0.0	0.0	0.0	0.0	0.0	0.0	0.0	0.0
Total Lost Time (s)	4.6	5.8	4.6	4.6	5.8	4.6	4.6	5.4	4.6	4.6	5.4
Lead/Lag	Lead	Lag	Lead	Lead	Lag	Lead	Lead	Lag	Lead	Lead	Lag
Lead-Lag Optimize?	Yes	Yes	Yes	Yes	Yes	Yes	Yes	Yes	Yes	Yes	Yes
Recall Mode	None	None	None	None	None	None	None	None	None	None	None
Act Effct Green (s)	5.0	29.8	73.0	8.2	33.0	50.1	37.4	60.3	69.3	11.3	34.2
Actuated g/C Ratio	0.04	0.23	0.56	0.06	0.25	0.39	0.29	0.46	0.53	0.09	0.26
v/c Ratio	0.86	0.87	0.58	1.51	1.27	0.68	1.84	1.38	0.83	1.07	0.76
Control Delay	134.5	60.8	18.9	292.9	170.3	31.8	410.7	206.8	29.5	128.2	48.3
Queue Delay	0.0	0.0	0.0	0.0	0.0	0.0	0.0	0.0	0.0	0.0	0.0
Total Delay	134.5	60.8	18.9	292.9	170.3	31.8	410.7	206.8	29.5	128.2	48.3
LOS	F	E	B	F	F	C	F	F	C	F	D
Approach Delay		40.4			157.1			257.7			67.4
Approach LOS		D			F			F			E

Intersection Summary

Cycle Length: 130
 Actuated Cycle Length: 130
 Natural Cycle: 125
 Control Type: Actuated-Uncoordinated
 Maximum v/c Ratio: 1.84
 Intersection Signal Delay: 174.8
 Intersection LOS: F
 Intersection Capacity Utilization 119.3%
 ICU Level of Service H
 Analysis Period (min) 15

Splits and Phases: 2: Central Ave & Arlington Ave/Chicago Ave



HCM 6th Signalized Intersection Summary
2: Central Ave & Arlington Ave/Chicago Ave

West Campus Upper Plateau (JN 14064)

09/20/2022



Movement	EBL	EBT	EBR	WBL	WBT	WBR	NBL	NBT	NBR	SBL	SBT	SBR
Lane Configurations												
Traffic Volume (veh/h)	55	656	862	292	1083	431	1725	2155	675	301	898	56
Future Volume (veh/h)	55	656	862	292	1083	431	1725	2155	675	301	898	56
Initial Q (Qb), veh	0	0	0	0	0	0	0	0	0	0	0	0
Ped-Bike Adj(A_pbT)	1.00		1.00	1.00		1.00	1.00		0.99	1.00		1.00
Parking Bus, Adj	1.00	1.00	1.00	1.00	1.00	1.00	1.00	1.00	1.00	1.00	1.00	1.00
Work Zone On Approach		No			No			No			No	
Adj Sat Flow, veh/h/ln	1900	1856	1870	1796	1885	1885	1885	1885	1885	1870	1870	1870
Adj Flow Rate, veh/h	59	698	660	311	1152	377	1835	2293	549	320	955	50
Peak Hour Factor	0.94	0.94	0.94	0.94	0.94	0.94	0.94	0.94	0.94	0.94	0.94	0.94
Percent Heavy Veh, %	0	3	2	7	1	1	1	1	1	2	2	2
Cap, veh/h	70	808	1442	209	909	544	1002	1661	832	300	1307	68
Arrive On Green	0.04	0.23	0.23	0.06	0.25	0.25	0.29	0.46	0.46	0.09	0.26	0.26
Sat Flow, veh/h	1810	3526	2790	3319	3582	1598	3483	3582	1577	3456	4968	260
Grp Volume(v), veh/h	59	698	660	311	1152	377	1835	2293	549	320	654	351
Grp Sat Flow(s),veh/h/ln	1810	1763	1395	1659	1791	1598	1742	1791	1577	1728	1702	1824
Q Serve(g_s), s	4.2	24.7	19.5	8.2	33.0	26.5	37.4	60.3	32.9	11.3	22.8	22.8
Cycle Q Clear(g_c), s	4.2	24.7	19.5	8.2	33.0	26.5	37.4	60.3	32.9	11.3	22.8	22.8
Prop In Lane	1.00		1.00	1.00		1.00	1.00		1.00	1.00		0.14
Lane Grp Cap(c), veh/h	70	808	1442	209	909	544	1002	1661	832	300	896	480
V/C Ratio(X)	0.85	0.86	0.46	1.49	1.27	0.69	1.83	1.38	0.66	1.07	0.73	0.73
Avail Cap(c_a), veh/h	70	808	1442	209	909	544	1002	1661	832	300	896	480
HCM Platoon Ratio	1.00	1.00	1.00	1.00	1.00	1.00	1.00	1.00	1.00	1.00	1.00	1.00
Upstream Filter(I)	1.00	1.00	1.00	1.00	1.00	1.00	1.00	1.00	1.00	1.00	1.00	1.00
Uniform Delay (d), s/veh	62.1	48.1	19.9	60.9	48.5	37.0	46.3	34.8	22.3	59.4	43.7	43.7
Incr Delay (d2), s/veh	56.7	9.6	0.2	242.3	128.9	3.8	378.0	174.9	1.9	70.3	3.1	5.7
Initial Q Delay(d3),s/veh	0.0	0.0	0.0	0.0	0.0	0.0	0.0	0.0	0.0	0.0	0.0	0.0
%ile BackOfQ(50%),veh/ln	3.0	11.6	6.0	10.4	30.5	10.6	68.3	65.2	11.8	7.8	9.8	10.9
Unsig. Movement Delay, s/veh												
LnGrp Delay(d),s/veh	118.8	57.7	20.1	303.2	177.4	40.7	424.3	209.8	24.3	129.6	46.8	49.4
LnGrp LOS	F	E	C	F	F	D	F	F	C	F	D	D
Approach Vol, veh/h		1417			1840			4677			1325	
Approach Delay, s/veh		42.8			170.7			272.1			67.5	
Approach LOS		D			F			F			E	
Timer - Assigned Phs	1	2	3	4	5	6	7	8				
Phs Duration (G+Y+Rc), s	15.9	65.7	12.8	35.6	42.0	39.6	9.6	38.8				
Change Period (Y+Rc), s	4.6	5.4	4.6	5.8	4.6	5.4	4.6	5.8				
Max Green Setting (Gmax), s	11.3	60.3	8.2	29.8	37.4	34.2	5.0	33.0				
Max Q Clear Time (g_c+I1), s	13.3	62.3	10.2	26.7	39.4	24.8	6.2	35.0				
Green Ext Time (p_c), s	0.0	0.0	0.0	2.0	0.0	4.2	0.0	0.0				

Intersection Summary

HCM 6th Ctrl Delay	187.6
HCM 6th LOS	F

Timings

3: Overlook Pkwy./Canyon Crest Dr. & Alessandro Bl/Alessandro Bl.



Lane Group	EBL	EBT	WBL	WBT	WBR	NBL	NBT	NBR	SBL	SBT	SBR
Lane Configurations											
Traffic Volume (vph)	79	1891	66	4261	1302	24	179	72	584	25	80
Future Volume (vph)	79	1891	66	4261	1302	24	179	72	584	25	80
Turn Type	Prot	NA	Prot	NA	pm+ov	Split	NA	Perm	Split	NA	Perm
Protected Phases	5	2	1	6	4	8	8		4	4	
Permitted Phases					6			8			4
Detector Phase	5	2	1	6	4	8	8	8	4	4	4
Switch Phase											
Minimum Initial (s)	5.0	10.0	5.0	10.0	10.0	10.0	10.0	10.0	10.0	10.0	10.0
Minimum Split (s)	9.2	35.2	9.2	35.2	38.8	15.8	15.8	15.8	38.8	38.8	38.8
Total Split (s)	9.2	66.2	9.2	66.2	38.8	15.8	15.8	15.8	38.8	38.8	38.8
Total Split (%)	7.1%	50.9%	7.1%	50.9%	29.8%	12.2%	12.2%	12.2%	29.8%	29.8%	29.8%
Yellow Time (s)	3.2	5.2	3.2	5.2	4.8	4.8	4.8	4.8	4.8	4.8	4.8
All-Red Time (s)	1.0	1.0	1.0	1.0	1.0	1.0	1.0	1.0	1.0	1.0	1.0
Lost Time Adjust (s)	0.0	0.0	0.0	0.0	0.0	0.0	0.0	0.0	0.0	0.0	0.0
Total Lost Time (s)	4.2	6.2	4.2	6.2	5.8	5.8	5.8	5.8	5.8	5.8	5.8
Lead/Lag	Lead	Lag	Lead	Lag							
Lead-Lag Optimize?	Yes	Yes	Yes	Yes							
Recall Mode	None	None	None	None	None	None	None	None	None	None	None
Act Effct Green (s)	5.0	60.0	5.0	60.0	99.2	10.0	10.0	10.0	33.0	33.0	33.0
Actuated g/C Ratio	0.04	0.46	0.04	0.46	0.76	0.08	0.08	0.08	0.25	0.25	0.25
v/c Ratio	1.30	0.85	1.00	1.89	1.11	0.18	0.68	0.34	0.52	0.53	0.17
Control Delay	258.7	35.4	170.1	427.9	79.2	59.6	71.4	7.5	44.5	47.4	3.9
Queue Delay	0.0	0.0	0.0	0.0	0.0	0.0	0.0	0.0	0.0	0.0	0.0
Total Delay	258.7	35.4	170.1	427.9	79.2	59.6	71.4	7.5	44.5	47.4	3.9
LOS	F	D	F	F	E	E	E	A	D	D	A
Approach Delay		44.3		344.2			53.6			40.7	
Approach LOS		D		F			D			D	

Intersection Summary

Cycle Length: 130	
Actuated Cycle Length: 130	
Natural Cycle: 130	
Control Type: Actuated-Uncoordinated	
Maximum v/c Ratio: 1.89	
Intersection Signal Delay: 241.5	Intersection LOS: F
Intersection Capacity Utilization 116.7%	ICU Level of Service H
Analysis Period (min) 15	

Splits and Phases: 3: Overlook Pkwy./Canyon Crest Dr. & Alessandro Bl/Alessandro Bl.

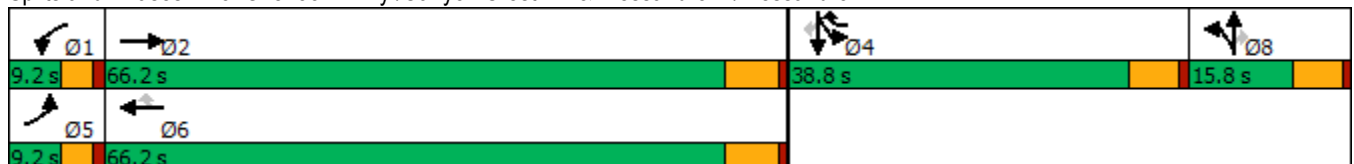

HCM 6th Signalized Intersection Summary

West Campus Upper Plateau (JN 14064)

3: Overlook Pkwy./Canyon Crest Dr. & Alessandro Bl/Alessandro Bl.

09/20/2022

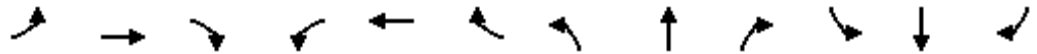

Movement	EBL	EBT	EBR	WBL	WBT	WBR	NBL	NBT	NBR	SBL	SBT	SBR
Lane Configurations	↗	↑↑↑		↖	↑↑↑	↗	↖	↑↑	↗	↖↖	↖	↗
Traffic Volume (veh/h)	79	1891	0	66	4261	1302	24	179	72	584	25	80
Future Volume (veh/h)	79	1891	0	66	4261	1302	24	179	72	584	25	80
Initial Q (Qb), veh	0	0	0	0	0	0	0	0	0	0	0	0
Ped-Bike Adj(A_pbT)	1.00		1.00	1.00		1.00	1.00		1.00	1.00		1.00
Parking Bus, Adj	1.00	1.00	1.00	1.00	1.00	1.00	1.00	1.00	1.00	1.00	1.00	1.00
Work Zone On Approach		No			No			No			No	
Adj Sat Flow, veh/h/ln	1796	1870	1900	1900	1885	1885	1900	1900	1900	1856	1885	1870
Adj Flow Rate, veh/h	83	1991	0	69	4485	1208	25	188	74	634	0	67
Peak Hour Factor	0.95	0.95	0.95	0.95	0.95	0.95	0.95	0.95	0.95	0.95	0.95	0.95
Percent Heavy Veh, %	7	2	0	0	1	1	0	0	0	3	1	2
Cap, veh/h	75	2673	0	79	2694	1082	158	315	140	815	0	244
Arrive On Green	0.04	0.52	0.00	0.04	0.52	0.52	0.09	0.09	0.09	0.15	0.00	0.15
Sat Flow, veh/h	1711	5274	0	1810	5147	1598	1810	3610	1610	5302	0	1585
Grp Volume(v), veh/h	83	1991	0	69	4485	1208	25	188	74	634	0	67
Grp Sat Flow(s),veh/h/ln	1711	1702	0	1810	1716	1598	1810	1805	1610	1767	0	1585
Q Serve(g_s), s	5.0	34.9	0.0	4.3	60.0	60.0	1.5	5.7	5.0	13.2	0.0	4.3
Cycle Q Clear(g_c), s	5.0	34.9	0.0	4.3	60.0	60.0	1.5	5.7	5.0	13.2	0.0	4.3
Prop In Lane	1.00		0.00	1.00		1.00	1.00		1.00	1.00		1.00
Lane Grp Cap(c), veh/h	75	2673	0	79	2694	1082	158	315	140	815	0	244
V/C Ratio(X)	1.11	0.74	0.00	0.87	1.66	1.12	0.16	0.60	0.53	0.78	0.00	0.28
Avail Cap(c_a), veh/h	75	2673	0	79	2694	1082	158	315	140	1526	0	456
HCM Platoon Ratio	1.00	1.00	1.00	1.00	1.00	1.00	1.00	1.00	1.00	1.00	1.00	1.00
Upstream Filter(I)	1.00	1.00	0.00	1.00	1.00	1.00	1.00	1.00	1.00	1.00	0.00	1.00
Uniform Delay (d), s/veh	54.8	21.3	0.0	54.5	27.3	15.7	48.4	50.4	50.0	46.6	0.0	42.9
Incr Delay (d2), s/veh	138.0	1.2	0.0	59.4	300.8	65.3	0.5	3.1	3.6	1.6	0.0	0.6
Initial Q Delay(d3),s/veh	0.0	0.0	0.0	0.0	0.0	0.0	0.0	0.0	0.0	0.0	0.0	0.0
%ile BackOfQ(50%),veh/ln	4.9	12.7	0.0	3.2	96.5	49.9	0.7	2.7	2.1	5.7	0.0	1.7
Unsig. Movement Delay, s/veh												
LnGrp Delay(d),s/veh	192.8	22.5	0.0	113.9	328.1	80.9	48.9	53.4	53.7	48.3	0.0	43.5
LnGrp LOS	F	C	A	F	F	F	D	D	D	D	A	D
Approach Vol, veh/h		2074			5762			287			701	
Approach Delay, s/veh		29.3			273.7			53.1			47.8	
Approach LOS		C			F			D			D	
Timer - Assigned Phs	1	2		4	5	6		8				
Phs Duration (G+Y+Rc), s	9.2	66.2		23.4	9.2	66.2		15.8				
Change Period (Y+Rc), s	* 4.2	6.2		5.8	* 4.2	6.2		5.8				
Max Green Setting (Gmax), s	* 5	60.0		33.0	* 5	60.0		10.0				
Max Q Clear Time (g_c+I1), s	6.3	36.9		15.2	7.0	62.0		7.7				
Green Ext Time (p_c), s	0.0	14.9		2.4	0.0	0.0		0.3				

Intersection Summary

HCM 6th Ctrl Delay	191.1
HCM 6th LOS	F

Notes

- User approved pedestrian interval to be less than phase max green.
- User approved volume balancing among the lanes for turning movement.
- * HCM 6th computational engine requires equal clearance times for the phases crossing the barrier.

Timings

4: Van Buren Bl. & Wood Rd.

09/20/2022

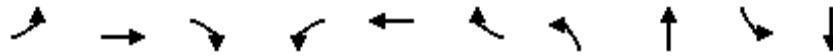

Lane Group	EBL	EBT	EBR	WBL	WBT	WBR	NBL	NBT	SBL	SBT
Lane Configurations	↘	↑↑	↗	↘↗	↑↑	↗	↘↗	↑↘	↘	↑↘
Traffic Volume (vph)	181	1484	438	601	2067	139	450	502	133	550
Future Volume (vph)	181	1484	438	601	2067	139	450	502	133	550
Turn Type	Prot	NA	pm+ov	Prot	NA	Perm	Prot	NA	Prot	NA
Protected Phases	5	2	3	1	6		3	8	7	4
Permitted Phases			2			6				
Detector Phase	5	2	3	1	6	6	3	8	7	4
Switch Phase										
Minimum Initial (s)	5.0	10.0	5.0	5.0	10.0	10.0	5.0	10.0	5.0	10.0
Minimum Split (s)	9.2	30.2	9.2	9.2	30.2	30.2	9.2	38.4	9.2	15.8
Total Split (s)	16.6	45.0	18.2	25.0	53.4	53.4	18.2	38.4	11.6	31.8
Total Split (%)	13.8%	37.5%	15.2%	20.8%	44.5%	44.5%	15.2%	32.0%	9.7%	26.5%
Yellow Time (s)	3.2	5.2	3.2	3.2	5.2	5.2	3.2	4.4	3.2	4.8
All-Red Time (s)	1.0	1.0	1.0	1.0	1.0	1.0	1.0	1.0	1.0	1.0
Lost Time Adjust (s)	0.0	0.0	0.0	0.0	0.0	0.0	0.0	0.0	0.0	0.0
Total Lost Time (s)	4.2	6.2	4.2	4.2	6.2	6.2	4.2	5.4	4.2	5.8
Lead/Lag	Lead	Lag	Lead	Lead	Lag	Lag	Lead	Lag	Lead	Lag
Lead-Lag Optimize?	Yes	Yes	Yes	Yes	Yes	Yes	Yes	Yes	Yes	Yes
Recall Mode	None	None	None	None	None	None	None	None	None	None
Act Effct Green (s)	12.4	38.8	54.8	20.8	47.2	47.2	14.0	33.0	7.4	26.0
Actuated g/C Ratio	0.10	0.32	0.46	0.17	0.39	0.39	0.12	0.28	0.06	0.22
v/c Ratio	1.09	1.42	0.63	1.09	1.61	0.22	1.21	0.99	1.33	1.12
Control Delay	142.6	228.4	21.3	109.5	307.9	5.5	160.5	63.7	241.5	111.4
Queue Delay	0.0	0.0	0.0	0.0	0.0	0.0	0.0	0.0	0.0	0.0
Total Delay	142.6	228.4	21.3	109.5	307.9	5.5	160.5	63.7	241.5	111.4
LOS	F	F	C	F	F	A	F	E	F	F
Approach Delay		177.9			250.4			95.7		129.9
Approach LOS		F			F			F		F

Intersection Summary

Cycle Length: 120
 Actuated Cycle Length: 120
 Natural Cycle: 130
 Control Type: Actuated-Uncoordinated
 Maximum v/c Ratio: 1.61
 Intersection Signal Delay: 184.4
 Intersection Capacity Utilization 120.7%
 Analysis Period (min) 15
 Intersection LOS: F
 ICU Level of Service H

Splits and Phases: 4: Van Buren Bl. & Wood Rd.

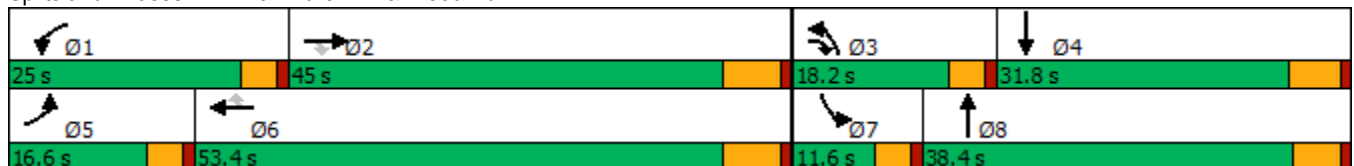

HCM 6th Signalized Intersection Summary
4: Van Buren Bl. & Wood Rd.

West Campus Upper Plateau (JN 14064)

09/20/2022



Movement	EBL	EBT	EBR	WBL	WBT	WBR	NBL	NBT	NBR	SBL	SBT	SBR
Lane Configurations	↖	↗	↘	↖	↗	↘	↖	↗	↘	↖	↗	↘
Traffic Volume (veh/h)	181	1484	438	601	2067	139	450	502	407	133	550	257
Future Volume (veh/h)	181	1484	438	601	2067	139	450	502	407	133	550	257
Initial Q (Qb), veh	0	0	0	0	0	0	0	0	0	0	0	0
Ped-Bike Adj(A_pbT)	1.00		0.97	1.00		0.98	1.00		0.90	1.00		0.99
Parking Bus, Adj	1.00	1.00	1.00	1.00	1.00	1.00	1.00	1.00	1.00	1.00	1.00	1.00
Work Zone On Approach		No			No			No			No	
Adj Sat Flow, veh/h/ln	1856	1856	1856	1885	1870	1870	1885	1885	1885	1870	1900	1870
Adj Flow Rate, veh/h	197	1613	299	653	2247	103	489	546	305	145	598	188
Peak Hour Factor	0.92	0.92	0.92	0.92	0.92	0.92	0.92	0.92	0.92	0.92	0.92	0.92
Percent Heavy Veh, %	3	3	3	1	2	2	1	1	1	2	0	2
Cap, veh/h	182	1137	677	602	1394	612	405	581	324	110	590	185
Arrive On Green	0.10	0.32	0.32	0.17	0.39	0.39	0.12	0.27	0.27	0.06	0.22	0.22
Sat Flow, veh/h	1767	3526	1531	3483	3554	1560	3483	2123	1183	1781	2694	845
Grp Volume(v), veh/h	197	1613	299	653	2247	103	489	460	391	145	400	386
Grp Sat Flow(s),veh/h/ln	1767	1763	1531	1742	1777	1560	1742	1791	1516	1781	1805	1735
Q Serve(g_s), s	12.4	38.8	16.4	20.8	47.2	5.2	14.0	30.2	30.4	7.4	26.3	26.3
Cycle Q Clear(g_c), s	12.4	38.8	16.4	20.8	47.2	5.2	14.0	30.2	30.4	7.4	26.3	26.3
Prop In Lane	1.00		1.00	1.00		1.00	1.00		0.78	1.00		0.49
Lane Grp Cap(c), veh/h	182	1137	677	602	1394	612	405	490	415	110	395	380
V/C Ratio(X)	1.08	1.42	0.44	1.08	1.61	0.17	1.21	0.94	0.94	1.32	1.01	1.02
Avail Cap(c_a), veh/h	182	1137	677	602	1394	612	405	491	416	110	395	380
HCM Platoon Ratio	1.00	1.00	1.00	1.00	1.00	1.00	1.00	1.00	1.00	1.00	1.00	1.00
Upstream Filter(I)	1.00	1.00	1.00	1.00	1.00	1.00	1.00	1.00	1.00	1.00	1.00	1.00
Uniform Delay (d), s/veh	54.0	40.8	23.6	49.8	36.6	23.8	53.2	42.7	42.8	56.5	47.0	47.0
Incr Delay (d2), s/veh	90.2	193.8	0.6	61.7	278.8	0.2	114.2	26.1	29.8	195.7	48.6	50.3
Initial Q Delay(d3),s/veh	0.0	0.0	0.0	0.0	0.0	0.0	0.0	0.0	0.0	0.0	0.0	0.0
%ile BackOfQ(50%),veh/ln	9.9	46.4	5.8	13.8	72.9	1.9	12.4	16.5	14.4	9.2	16.8	16.4
Unsig. Movement Delay, s/veh												
LnGrp Delay(d),s/veh	144.2	234.5	24.2	111.5	315.4	24.0	167.3	68.8	72.5	252.2	95.6	97.3
LnGrp LOS	F	F	C	F	F	C	F	E	E	F	F	F
Approach Vol, veh/h		2109			3003			1340			931	
Approach Delay, s/veh		196.3			261.1			105.9			120.7	
Approach LOS		F			F			F			F	
Timer - Assigned Phs	1	2	3	4	5	6	7	8				
Phs Duration (G+Y+Rc), s	25.0	45.0	18.2	32.1	16.6	53.4	11.6	38.7				
Change Period (Y+Rc), s	* 4.2	6.2	* 4.2	5.8	* 4.2	6.2	* 4.2	* 5.8				
Max Green Setting (Gmax), s	* 21	38.8	* 14	26.0	* 12	47.2	* 7.4	* 33				
Max Q Clear Time (g_c+I1), s	22.8	40.8	16.0	28.3	14.4	49.2	9.4	32.4				
Green Ext Time (p_c), s	0.0	0.0	0.0	0.0	0.0	0.0	0.0	0.4				

Intersection Summary

HCM 6th Ctrl Delay	196.7
HCM 6th LOS	F

Notes

* HCM 6th computational engine requires equal clearance times for the phases crossing the barrier.

Timings
5: Trautwein Rd. & Alessandro Bl.

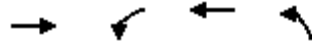

Lane Group	EBT	WBL	WBT	NBL
Lane Configurations	↑↑↑	↵↵	↑↑↑	↵↵↵
Traffic Volume (vph)	1465	303	4144	2370
Future Volume (vph)	1465	303	4144	2370
Turn Type	NA	Prot	NA	Prot
Protected Phases	2	1	6	8
Permitted Phases				
Detector Phase	2	1	6	8
Switch Phase				
Minimum Initial (s)	10.0	5.0	10.0	10.0
Minimum Split (s)	33.2	9.2	16.2	16.2
Total Split (s)	54.6	17.4	72.0	48.0
Total Split (%)	45.5%	14.5%	60.0%	40.0%
Yellow Time (s)	5.2	3.2	5.2	5.2
All-Red Time (s)	1.0	1.0	1.0	1.0
Lost Time Adjust (s)	0.0	0.0	0.0	0.0
Total Lost Time (s)	6.2	4.2	6.2	6.2
Lead/Lag	Lag	Lead		
Lead-Lag Optimize?	Yes	Yes		
Recall Mode	None	None	None	None
Act Effct Green (s)	48.6	13.0	65.8	41.8
Actuated g/C Ratio	0.40	0.11	0.55	0.35
v/c Ratio	0.93	0.88	1.60	1.55
Control Delay	44.0	77.8	296.1	280.1
Queue Delay	0.0	0.0	0.0	0.0
Total Delay	44.0	77.8	296.1	280.1
LOS	D	E	F	F
Approach Delay	44.0		281.2	280.1
Approach LOS	D		F	F

Intersection Summary

Cycle Length: 120
 Actuated Cycle Length: 120
 Natural Cycle: 130
 Control Type: Actuated-Uncoordinated
 Maximum v/c Ratio: 1.60
 Intersection Signal Delay: 233.4
 Intersection LOS: F
 Intersection Capacity Utilization 137.6%
 ICU Level of Service H
 Analysis Period (min) 15

Splits and Phases: 5: Trautwein Rd. & Alessandro Bl.

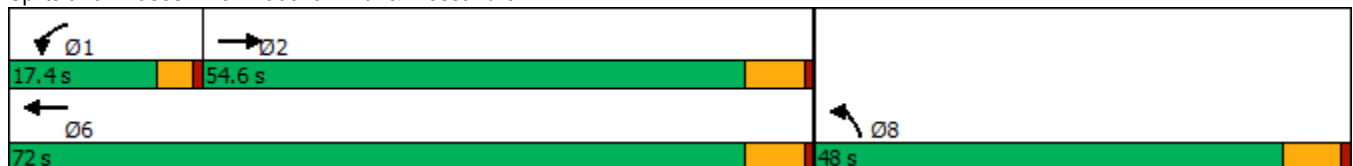

HCM 6th Signalized Intersection Summary
5: Trautwein Rd. & Alessandro Bl.

West Campus Upper Plateau (JN 14064)

09/20/2022

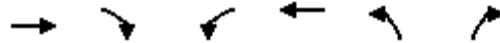

Movement	EBT	EBR	WBL	WBT	NBL	NBR
Lane Configurations	↑↑↑		↵↵	↑↑↑	↵↵↵	
Traffic Volume (veh/h)	1465	266	303	4144	2370	103
Future Volume (veh/h)	1465	266	303	4144	2370	103
Initial Q (Qb), veh	0	0	0	0	0	0
Ped-Bike Adj(A_pbT)		1.00	1.00		1.00	1.00
Parking Bus, Adj	1.00	1.00	1.00	1.00	1.00	1.00
Work Zone On Approach	No			No	No	
Adj Sat Flow, veh/h/ln	1870	1900	1870	1885	1870	1885
Adj Flow Rate, veh/h	1592	289	329	4504	2681	0
Peak Hour Factor	0.92	0.92	0.92	0.92	0.92	0.92
Percent Heavy Veh, %	2	0	2	1	2	1
Cap, veh/h	1754	317	380	2822	1861	557
Arrive On Green	0.40	0.40	0.11	0.55	0.35	0.00
Sat Flow, veh/h	4516	785	3456	5316	5344	1598
Grp Volume(v), veh/h	1245	636	329	4504	2681	0
Grp Sat Flow(s),veh/h/ln	1702	1729	1728	1716	1781	1598
Q Serve(g_s), s	41.3	41.7	11.2	65.8	41.8	0.0
Cycle Q Clear(g_c), s	41.3	41.7	11.2	65.8	41.8	0.0
Prop In Lane		0.45	1.00		1.00	1.00
Lane Grp Cap(c), veh/h	1373	697	380	2822	1861	557
V/C Ratio(X)	0.91	0.91	0.87	1.60	1.44	0.00
Avail Cap(c_a), veh/h	1373	697	380	2822	1861	557
HCM Platoon Ratio	1.00	1.00	1.00	1.00	1.00	1.00
Upstream Filter(I)	1.00	1.00	1.00	1.00	1.00	0.00
Uniform Delay (d), s/veh	33.7	33.8	52.5	27.1	39.1	0.0
Incr Delay (d2), s/veh	9.1	16.6	17.7	269.9	201.2	0.0
Initial Q Delay(d3),s/veh	0.0	0.0	0.0	0.0	0.0	0.0
%ile BackOfQ(50%),veh/ln	17.5	19.4	5.6	93.5	51.7	0.0
Unsig. Movement Delay, s/veh						
LnGrp Delay(d),s/veh	42.8	50.4	70.3	297.0	240.3	0.0
LnGrp LOS	D	D	E	F	F	A
Approach Vol, veh/h	1881			4833	2681	
Approach Delay, s/veh	45.4			281.6	240.3	
Approach LOS	D			F	F	
Timer - Assigned Phs	1	2			6	8
Phs Duration (G+Y+Rc), s	17.4	54.6			72.0	48.0
Change Period (Y+Rc), s	* 4.2	6.2			6.2	6.2
Max Green Setting (Gmax), s	* 13	48.4			65.8	41.8
Max Q Clear Time (g_c+I1), s	13.2	43.7			67.8	43.8
Green Ext Time (p_c), s	0.0	4.2			0.0	0.0

Intersection Summary

HCM 6th Ctrl Delay	222.5
HCM 6th LOS	F

Notes

User approved volume balancing among the lanes for turning movement.
* HCM 6th computational engine requires equal clearance times for the phases crossing the barrier.

Timings
6: Trautwein Rd. & Grove Community Dr

West Campus Upper Plateau (JN 14064)

09/20/2022



Lane Group	WBL	WBR	NBT	NBR	SBL	SBT
Lane Configurations	↙	↗↗	↕↕	↗	↗↗	↕↕
Traffic Volume (vph)	93	733	2235	29	253	1755
Future Volume (vph)	93	733	2235	29	253	1755
Turn Type	Prot	pm+ov	NA	Perm	Prot	NA
Protected Phases	8	1	2		1	6
Permitted Phases		8		2		
Detector Phase	8	1	2	2	1	6
Switch Phase						
Minimum Initial (s)	10.0	5.0	10.0	10.0	5.0	10.0
Minimum Split (s)	34.6	9.6	46.2	46.2	9.6	28.2
Total Split (s)	34.6	15.2	70.2	70.2	15.2	85.4
Total Split (%)	28.8%	12.7%	58.5%	58.5%	12.7%	71.2%
Yellow Time (s)	3.6	3.6	5.2	5.2	3.6	5.2
All-Red Time (s)	1.0	1.0	1.0	1.0	1.0	1.0
Lost Time Adjust (s)	0.0	0.0	0.0	0.0	0.0	0.0
Total Lost Time (s)	4.6	4.6	6.2	6.2	4.6	6.2
Lead/Lag		Lead	Lag	Lag	Lead	
Lead-Lag Optimize?		Yes	Yes	Yes	Yes	
Recall Mode	None	None	None	None	None	None
Act Effct Green (s)	13.9	24.6	64.3	64.3	10.6	79.5
Actuated g/C Ratio	0.13	0.24	0.62	0.62	0.10	0.76
v/c Ratio	0.42	1.21	1.10	0.03	0.79	0.71
Control Delay	46.1	144.1	75.7	7.0	64.0	9.4
Queue Delay	0.0	0.0	0.0	0.0	0.0	0.0
Total Delay	46.1	144.1	75.7	7.0	64.0	9.4
LOS	D	F	E	A	E	A
Approach Delay	133.0		74.8			16.3
Approach LOS	F		E			B

Intersection Summary

Cycle Length: 120
 Actuated Cycle Length: 104.3
 Natural Cycle: 125
 Control Type: Actuated-Uncoordinated
 Maximum v/c Ratio: 1.21
 Intersection Signal Delay: 61.2
 Intersection LOS: E
 Intersection Capacity Utilization 96.6%
 ICU Level of Service F
 Analysis Period (min) 15

Splits and Phases: 6: Trautwein Rd. & Grove Community Dr



HCM 6th Signalized Intersection Summary
6: Trautwein Rd. & Grove Community Dr

West Campus Upper Plateau (JN 14064)

09/20/2022



Movement	WBL	WBR	NBT	NBR	SBL	SBT
Lane Configurations						
Traffic Volume (veh/h)	93	733	2235	29	253	1755
Future Volume (veh/h)	93	733	2235	29	253	1755
Initial Q (Qb), veh	0	0	0	0	0	0
Ped-Bike Adj(A_pbT)	1.00	1.00		0.97	1.00	
Parking Bus, Adj	1.00	1.00	1.00	1.00	1.00	1.00
Work Zone On Approach	No		No			No
Adj Sat Flow, veh/h/ln	1900	1885	1885	1900	1856	1870
Adj Flow Rate, veh/h	101	614	2429	24	275	1908
Peak Hour Factor	0.92	0.92	0.92	0.92	0.92	0.92
Percent Heavy Veh, %	0	1	1	0	3	2
Cap, veh/h	403	883	1980	868	314	2431
Arrive On Green	0.22	0.22	0.55	0.55	0.09	0.68
Sat Flow, veh/h	1810	2812	3676	1570	3428	3647
Grp Volume(v), veh/h	101	614	2429	24	275	1908
Grp Sat Flow(s),veh/h/ln	1810	1406	1791	1570	1714	1777
Q Serve(g_s), s	5.3	22.2	64.0	0.8	9.2	42.4
Cycle Q Clear(g_c), s	5.3	22.2	64.0	0.8	9.2	42.4
Prop In Lane	1.00	1.00		1.00	1.00	
Lane Grp Cap(c), veh/h	403	883	1980	868	314	2431
V/C Ratio(X)	0.25	0.70	1.23	0.03	0.88	0.78
Avail Cap(c_a), veh/h	469	986	1980	868	314	2431
HCM Platoon Ratio	1.00	1.00	1.00	1.00	1.00	1.00
Upstream Filter(I)	1.00	1.00	1.00	1.00	1.00	1.00
Uniform Delay (d), s/veh	37.1	34.8	25.9	11.8	51.9	12.5
Incr Delay (d2), s/veh	0.3	1.9	106.7	0.0	22.3	1.8
Initial Q Delay(d3),s/veh	0.0	0.0	0.0	0.0	0.0	0.0
%ile BackOfQ(50%),veh/ln	2.4	7.7	52.8	0.3	4.8	13.7
Unsig. Movement Delay, s/veh						
LnGrp Delay(d),s/veh	37.4	36.7	132.5	11.8	74.3	14.2
LnGrp LOS	D	D	F	B	E	B
Approach Vol, veh/h	715		2453			2183
Approach Delay, s/veh	36.8		131.4			21.8
Approach LOS	D		F			C
Timer - Assigned Phs	1	2			6	8
Phs Duration (G+Y+Rc), s	15.2	70.2			85.4	30.4
Change Period (Y+Rc), s	4.6	6.2			6.2	4.6
Max Green Setting (Gmax), s	10.6	64.0			79.2	30.0
Max Q Clear Time (g_c+I1), s	11.2	66.0			44.4	24.2
Green Ext Time (p_c), s	0.0	0.0			19.4	1.6

Intersection Summary

HCM 6th Ctrl Delay	74.0
HCM 6th LOS	E

Timings

7: Trautwein Rd. & Orange Terrace Pkwy

09/20/2022



Lane Group	EBL	EBT	WBL	WBT	WBR	NBL	NBT	NBR	SBL	SBT	SBR
Lane Configurations											
Traffic Volume (vph)	81	85	350	129	831	65	1613	291	469	1358	25
Future Volume (vph)	81	85	350	129	831	65	1613	291	469	1358	25
Turn Type	Prot	NA	Prot	NA	pm+ov	Prot	NA	Perm	Prot	NA	Perm
Protected Phases	7	4	3	8	1	5	2		1	6	
Permitted Phases					8			2			6
Detector Phase	7	4	3	8	1	5	2	2	1	6	6
Switch Phase											
Minimum Initial (s)	5.0	10.0	5.0	10.0	5.0	5.0	10.0	10.0	5.0	10.0	10.0
Minimum Split (s)	9.6	38.6	9.6	34.6	9.6	9.6	46.2	46.2	9.6	24.2	24.2
Total Split (s)	16.8	38.6	25.0	46.8	19.0	14.4	47.4	47.4	19.0	52.0	52.0
Total Split (%)	12.9%	29.7%	19.2%	36.0%	14.6%	11.1%	36.5%	36.5%	14.6%	40.0%	40.0%
Yellow Time (s)	3.6	3.6	3.6	3.6	3.6	3.6	5.2	5.2	3.6	5.2	5.2
All-Red Time (s)	1.0	1.0	1.0	1.0	1.0	1.0	1.0	1.0	1.0	1.0	1.0
Lost Time Adjust (s)	0.0	0.0	0.0	0.0	0.0	0.0	0.0	0.0	0.0	0.0	0.0
Total Lost Time (s)	4.6	4.6	4.6	4.6	4.6	4.6	6.2	6.2	4.6	6.2	6.2
Lead/Lag	Lead	Lag	Lead	Lag	Lead	Lead	Lag	Lag	Lead	Lag	Lag
Lead-Lag Optimize?	Yes	Yes	Yes	Yes	Yes	Yes	Yes	Yes	Yes	Yes	Yes
Recall Mode	None	None	None	None	None	None	None	None	None	None	None
Act Effct Green (s)	9.3	15.4	20.5	26.6	41.1	8.2	41.4	41.4	14.5	49.9	49.9
Actuated g/C Ratio	0.08	0.14	0.18	0.24	0.37	0.07	0.37	0.37	0.13	0.45	0.45
v/c Ratio	0.59	0.48	1.16	0.31	0.83	0.55	1.35	0.48	1.16	0.93	0.04
Control Delay	66.9	45.0	143.0	37.1	32.0	68.3	194.2	19.4	138.5	42.3	0.1
Queue Delay	0.0	0.0	0.0	0.0	0.0	0.0	0.0	0.0	0.0	0.0	0.0
Total Delay	66.9	45.0	143.0	37.1	32.0	68.3	194.2	19.4	138.5	42.3	0.1
LOS	E	D	F	D	C	E	F	B	F	D	A
Approach Delay		54.1		62.1			164.2			66.1	
Approach LOS		D		E			F			E	

Intersection Summary

Cycle Length: 130
 Actuated Cycle Length: 112
 Natural Cycle: 125
 Control Type: Actuated-Uncoordinated
 Maximum v/c Ratio: 1.35
 Intersection Signal Delay: 101.0
 Intersection Capacity Utilization 105.4%
 Analysis Period (min) 15
 Intersection LOS: F
 ICU Level of Service G



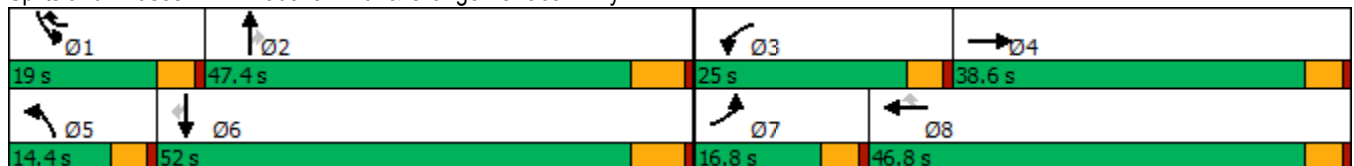



















Splits and Phases: 7: Trautwein Rd. & Orange Terrace Pkwy



HCM 6th Signalized Intersection Summary
7: Trautwein Rd. & Orange Terrace Pkwy

West Campus Upper Plateau (JN 14064)

09/20/2022

												
Movement	EBL	EBT	EBR	WBL	WBT	WBR	NBL	NBT	NBR	SBL	SBT	SBR
Lane Configurations												
Traffic Volume (veh/h)	81	85	29	350	129	831	65	1613	291	469	1358	25
Future Volume (veh/h)	81	85	29	350	129	831	65	1613	291	469	1358	25
Initial Q (Qb), veh	0	0	0	0	0	0	0	0	0	0	0	0
Ped-Bike Adj(A_pbT)	1.00		0.99	1.00		0.96	1.00		1.00	1.00		0.98
Parking Bus, Adj	1.00	1.00	1.00	1.00	1.00	1.00	1.00	1.00	1.00	1.00	1.00	1.00
Work Zone On Approach		No			No			No			No	
Adj Sat Flow, veh/h/ln	1900	1885	1900	1885	1885	1885	1870	1856	1870	1856	1885	1826
Adj Flow Rate, veh/h	88	92	28	380	140	679	71	1753	239	510	1476	19
Peak Hour Factor	0.92	0.92	0.92	0.92	0.92	0.92	0.92	0.92	0.92	0.92	0.92	0.92
Percent Heavy Veh, %	0	1	0	1	1	1	2	3	2	3	1	5
Cap, veh/h	112	186	57	330	484	1061	91	1309	588	445	1612	680
Arrive On Green	0.06	0.13	0.13	0.18	0.26	0.26	0.05	0.37	0.37	0.13	0.45	0.45
Sat Flow, veh/h	1810	1383	421	1795	1885	2711	1781	3526	1582	3428	3582	1510
Grp Volume(v), veh/h	88	0	120	380	140	679	71	1753	239	510	1476	19
Grp Sat Flow(s),veh/h/ln	1810	0	1804	1795	1885	1356	1781	1763	1582	1714	1791	1510
Q Serve(g_s), s	5.3	0.0	6.8	20.4	6.6	22.7	4.4	41.2	12.4	14.4	42.8	0.8
Cycle Q Clear(g_c), s	5.3	0.0	6.8	20.4	6.6	22.7	4.4	41.2	12.4	14.4	42.8	0.8
Prop In Lane	1.00		0.23	1.00		1.00	1.00		1.00	1.00		1.00
Lane Grp Cap(c), veh/h	112	0	243	330	484	1061	91	1309	588	445	1612	680
V/C Ratio(X)	0.79	0.00	0.49	1.15	0.29	0.64	0.78	1.34	0.41	1.15	0.92	0.03
Avail Cap(c_a), veh/h	199	0	553	330	717	1396	157	1309	588	445	1612	680
HCM Platoon Ratio	1.00	1.00	1.00	1.00	1.00	1.00	1.00	1.00	1.00	1.00	1.00	1.00
Upstream Filter(I)	1.00	0.00	1.00	1.00	1.00	1.00	1.00	1.00	1.00	1.00	1.00	1.00
Uniform Delay (d), s/veh	51.3	0.0	44.5	45.3	33.1	27.9	52.0	34.9	25.8	48.3	28.5	17.0
Incr Delay (d2), s/veh	4.5	0.0	1.6	97.1	0.3	0.6	5.3	157.8	0.5	89.2	8.6	0.0
Initial Q Delay(d3),s/veh	0.0	0.0	0.0	0.0	0.0	0.0	0.0	0.0	0.0	0.0	0.0	0.0
%ile BackOfQ(50%),veh/ln	2.5	0.0	3.2	17.6	3.0	7.0	2.0	44.9	4.5	11.4	18.4	0.3
Unsig. Movement Delay, s/veh												
LnGrp Delay(d),s/veh	55.8	0.0	46.0	142.3	33.4	28.5	57.4	192.7	26.3	137.4	37.1	17.0
LnGrp LOS	E	A	D	F	C	C	E	F	C	F	D	B
Approach Vol, veh/h		208			1199			2063			2005	
Approach Delay, s/veh		50.2			65.2			168.7			62.4	
Approach LOS		D			E			F			E	
Timer - Assigned Phs	1	2	3	4	5	6	7	8				
Phs Duration (G+Y+Rc), s	19.0	47.4	25.0	19.5	10.3	56.1	11.5	33.1				
Change Period (Y+Rc), s	4.6	6.2	4.6	4.6	4.6	6.2	4.6	4.6				
Max Green Setting (Gmax), s	14.4	41.2	20.4	34.0	9.8	45.8	12.2	42.2				
Max Q Clear Time (g_c+I1), s	16.4	43.2	22.4	8.8	6.4	44.8	7.3	24.7				
Green Ext Time (p_c), s	0.0	0.0	0.0	0.6	0.0	0.8	0.0	3.4				
Intersection Summary												
HCM 6th Ctrl Delay				102.6								
HCM 6th LOS				F								

Timings
8: Cole Av. & Van Buren Bl.

West Campus Upper Plateau (JN 14064)

09/20/2022



Lane Group	EBL	EBT	EBR	WBL	WBT	WBR	NBL	NBT	SBL	SBT	SBR
Lane Configurations	↖↗	↑↑	↖	↖	↑↑↑	↖	↖	↑↑	↖↗	↑↑	↖
Traffic Volume (vph)	487	1527	130	194	2102	610	259	710	560	560	397
Future Volume (vph)	487	1527	130	194	2102	610	259	710	560	560	397
Turn Type	Prot	NA	pm+ov	Prot	NA	pm+ov	Prot	NA	Prot	NA	pm+ov
Protected Phases	5	2	3	1	6	7	3	8	7	4	5
Permitted Phases			2			6					4
Detector Phase	5	2	3	1	6	7	3	8	7	4	5
Switch Phase											
Minimum Initial (s)	5.0	10.0	5.0	5.0	10.0	5.0	5.0	10.0	5.0	10.0	5.0
Minimum Split (s)	9.1	36.2	9.1	9.1	36.2	9.1	9.1	42.2	9.1	49.2	9.1
Total Split (s)	15.0	37.8	19.0	14.0	36.8	21.6	19.0	46.6	21.6	49.2	15.0
Total Split (%)	12.5%	31.5%	15.8%	11.7%	30.7%	18.0%	15.8%	38.8%	18.0%	41.0%	12.5%
Yellow Time (s)	3.2	5.2	3.2	3.2	5.2	3.2	3.2	5.2	3.2	5.2	3.2
All-Red Time (s)	0.5	1.0	0.5	0.5	1.0	0.5	0.5	1.0	0.5	1.0	0.5
Lost Time Adjust (s)	0.0	0.0	0.0	0.0	0.0	0.0	0.0	0.0	0.0	0.0	0.0
Total Lost Time (s)	3.7	6.2	3.7	3.7	6.2	3.7	3.7	6.2	3.7	6.2	3.7
Lead/Lag	Lead	Lag	Lead	Lead	Lag	Lead	Lead	Lag	Lead	Lag	Lead
Lead-Lag Optimize?	Yes	Yes	Yes	Yes	Yes	Yes	Yes	Yes	Yes	Yes	Yes
Recall Mode	None	None	None	None	None	None	None	None	None	None	None
Act Effct Green (s)	11.3	31.7	53.2	10.3	30.7	51.1	15.3	35.7	17.9	38.3	52.2
Actuated g/C Ratio	0.10	0.27	0.46	0.09	0.27	0.44	0.13	0.31	0.15	0.33	0.45
v/c Ratio	1.59	1.73	0.19	1.31	1.69	0.91	1.22	0.87	1.13	0.52	0.59
Control Delay	313.3	361.0	11.3	220.1	344.6	44.1	172.4	46.3	125.1	32.7	21.2
Queue Delay	0.0	0.0	0.0	0.0	0.0	0.0	0.0	0.0	0.0	0.0	0.0
Total Delay	313.3	361.0	11.3	220.1	344.6	44.1	172.4	46.3	125.1	32.7	21.2
LOS	F	F	B	F	F	D	F	D	F	C	C
Approach Delay		329.0			273.2			75.6		63.8	
Approach LOS		F			F			E		E	

Intersection Summary

Cycle Length: 120
 Actuated Cycle Length: 115.5
 Natural Cycle: 125
 Control Type: Actuated-Uncoordinated
 Maximum v/c Ratio: 1.73
 Intersection Signal Delay: 218.7
 Intersection LOS: F
 Intersection Capacity Utilization 111.9%
 ICU Level of Service H
 Analysis Period (min) 15



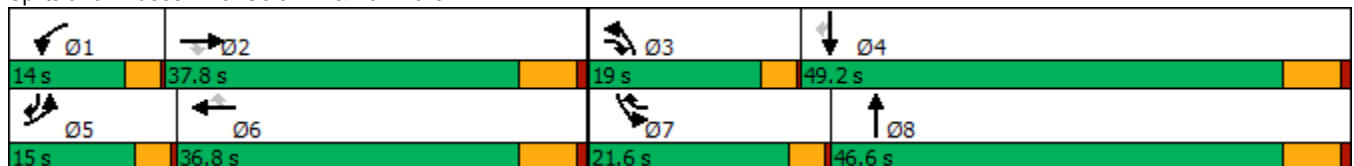



























Splits and Phases: 8: Cole Av. & Van Buren Bl.



HCM 6th Signalized Intersection Summary
8: Cole Av. & Van Buren Bl.

West Campus Upper Plateau (JN 14064)

09/20/2022

												
Movement	EBL	EBT	EBR	WBL	WBT	WBR	NBL	NBT	NBR	SBL	SBT	SBR
Lane Configurations	 	 			  			 		 	 	
Traffic Volume (veh/h)	487	1527	130	194	2102	610	259	710	144	560	560	397
Future Volume (veh/h)	487	1527	130	194	2102	610	259	710	144	560	560	397
Initial Q (Qb), veh	0	0	0	0	0	0	0	0	0	0	0	0
Ped-Bike Adj(A_pbT)	1.00		1.00	1.00		0.99	1.00		1.00	1.00		1.00
Parking Bus, Adj	1.00	1.00	1.00	1.00	1.00	1.00	1.00	1.00	1.00	1.00	1.00	1.00
Work Zone On Approach		No			No			No			No	
Adj Sat Flow, veh/h/ln	1856	1856	1841	1900	1870	1870	1856	1856	1870	1885	1870	1856
Adj Flow Rate, veh/h	529	1660	101	211	2285	575	282	772	148	609	609	361
Peak Hour Factor	0.92	0.92	0.92	0.92	0.92	0.92	0.92	0.92	0.92	0.92	0.92	0.92
Percent Heavy Veh, %	3	3	4	0	2	2	3	3	2	1	2	3
Cap, veh/h	341	980	644	164	1375	671	238	884	170	548	1146	663
Arrive On Green	0.10	0.28	0.28	0.09	0.27	0.27	0.13	0.30	0.30	0.16	0.32	0.32
Sat Flow, veh/h	3428	3526	1560	1810	5106	1565	1767	2950	566	3483	3554	1570
Grp Volume(v), veh/h	529	1660	101	211	2285	575	282	461	459	609	609	361
Grp Sat Flow(s),veh/h/ln	1714	1763	1560	1810	1702	1565	1767	1763	1753	1742	1777	1570
Q Serve(g_s), s	11.3	31.6	4.6	10.3	30.6	30.6	15.3	28.2	28.2	17.9	15.9	19.6
Cycle Q Clear(g_c), s	11.3	31.6	4.6	10.3	30.6	30.6	15.3	28.2	28.2	17.9	15.9	19.6
Prop In Lane	1.00		1.00	1.00		1.00	1.00		0.32	1.00		1.00
Lane Grp Cap(c), veh/h	341	980	644	164	1375	671	238	528	525	548	1146	663
V/C Ratio(X)	1.55	1.69	0.16	1.29	1.66	0.86	1.19	0.87	0.87	1.11	0.53	0.54
Avail Cap(c_a), veh/h	341	980	644	164	1375	671	238	627	623	548	1344	750
HCM Platoon Ratio	1.00	1.00	1.00	1.00	1.00	1.00	1.00	1.00	1.00	1.00	1.00	1.00
Upstream Filter(I)	1.00	1.00	1.00	1.00	1.00	1.00	1.00	1.00	1.00	1.00	1.00	1.00
Uniform Delay (d), s/veh	51.2	41.0	21.0	51.7	41.5	29.5	49.2	37.7	37.8	47.9	31.5	24.7
Incr Delay (d2), s/veh	262.5	316.6	0.2	167.1	301.3	11.0	117.8	11.4	11.5	72.3	0.4	0.7
Initial Q Delay(d3),s/veh	0.0	0.0	0.0	0.0	0.0	0.0	0.0	0.0	0.0	0.0	0.0	0.0
%ile BackOfQ(50%),veh/ln	17.1	56.0	1.6	12.1	50.4	15.1	14.2	13.1	13.0	12.9	6.5	6.9
Unsig. Movement Delay, s/veh												
LnGrp Delay(d),s/veh	313.7	357.6	21.1	218.8	342.8	40.6	167.0	49.2	49.3	120.2	31.9	25.4
LnGrp LOS	F	F	C	F	F	D	F	D	D	F	C	C
Approach Vol, veh/h		2290			3071			1202			1579	
Approach Delay, s/veh		332.6			277.7			76.8			64.4	
Approach LOS		F			F			E			E	
Timer - Assigned Phs	1	2	3	4	5	6	7	8				
Phs Duration (G+Y+Rc), s	14.0	37.8	19.0	42.9	15.0	36.8	21.6	40.3				
Change Period (Y+Rc), s	3.7	6.2	3.7	6.2	3.7	6.2	3.7	6.2				
Max Green Setting (Gmax), s	10.3	31.6	15.3	43.0	11.3	30.6	17.9	40.4				
Max Q Clear Time (g_c+I1), s	12.3	33.6	17.3	21.6	13.3	32.6	19.9	30.2				
Green Ext Time (p_c), s	0.0	0.0	0.0	4.9	0.0	0.0	0.0	3.8				
Intersection Summary												
HCM 6th Ctrl Delay			222.1									
HCM 6th LOS			F									

Intersection	
Intersection Delay, s/veh	21.5
Intersection LOS	C

Movement	EBT	EBR	WBL	WBT	NBL	NBR
Lane Configurations	↔		↔	↑	↔	↔
Traffic Vol, veh/h	122	105	66	434	271	41
Future Vol, veh/h	122	105	66	434	271	41
Peak Hour Factor	0.92	0.92	0.92	0.92	0.92	0.92
Heavy Vehicles, %	2	1	2	2	0	0
Mvmt Flow	133	114	72	472	295	45
Number of Lanes	1	0	1	1	1	1

Approach	EB	WB	NB
Opposing Approach	WB	EB	
Opposing Lanes	2	1	0
Conflicting Approach Left		NB	EB
Conflicting Lanes Left	0	2	1
Conflicting Approach Right	NB		WB
Conflicting Lanes Right	2	0	2
HCM Control Delay	13.6	27	18.5
HCM LOS	B	D	C

Lane	NBLn1	NBLn2	EBLn1	WBLn1	WBLn2
Vol Left, %	100%	0%	0%	100%	0%
Vol Thru, %	0%	0%	54%	0%	100%
Vol Right, %	0%	100%	46%	0%	0%
Sign Control	Stop	Stop	Stop	Stop	Stop
Traffic Vol by Lane	271	41	227	66	434
LT Vol	271	0	0	66	0
Through Vol	0	0	122	0	434
RT Vol	0	41	105	0	0
Lane Flow Rate	295	45	247	72	472
Geometry Grp	7	7	4	7	7
Degree of Util (X)	0.59	0.074	0.42	0.132	0.804
Departure Headway (Hd)	7.205	5.985	6.126	6.643	6.136
Convergence, Y/N	Yes	Yes	Yes	Yes	Yes
Cap	501	596	585	538	590
Service Time	4.966	3.746	4.195	4.403	3.895
HCM Lane V/C Ratio	0.589	0.076	0.422	0.134	0.8
HCM Control Delay	19.9	9.2	13.6	10.4	29.5
HCM Lane LOS	C	A	B	B	D
HCM 95th-tile Q	3.8	0.2	2.1	0.5	7.9

Intersection

Intersection Delay, s/veh 81.7
 Intersection LOS F

Movement	EBL	EBT	EBR	WBL	WBT	WBR	NBL	NBT	NBR	SBL	SBT	SBR
Lane Configurations												
Traffic Vol, veh/h	293	583	55	5	736	67	208	52	8	110	41	49
Future Vol, veh/h	293	583	55	5	736	67	208	52	8	110	41	49
Peak Hour Factor	0.92	0.92	0.92	0.92	0.92	0.92	0.92	0.92	0.92	0.92	0.92	0.92
Heavy Vehicles, %	0	2	0	0	0	2	1	0	0	0	3	3
Mvmt Flow	318	634	60	5	800	73	226	57	9	120	45	53
Number of Lanes	1	2	0	1	2	0	0	1	0	0	1	0

Approach	EB	WB	NB	SB
Opposing Approach	WB	EB	SB	NB
Opposing Lanes	3	3	1	1
Conflicting Approach Left SB		NB	EB	WB
Conflicting Lanes Left	1	1	3	3
Conflicting Approach Right NB		SB	WB	EB
Conflicting Lanes Right	1	1	3	3
HCM Control Delay	54.1	137.1	49	30.1
HCM LOS	F	F	E	D

Lane	NBLn1	EBLn1	EBLn2	EBLn3	WBLn1	WBLn2	WBLn3	SBLn1	
Vol Left, %		78%	100%	0%	0%	100%	0%	0%	55%
Vol Thru, %		19%	0%	100%	78%	0%	100%	79%	20%
Vol Right, %		3%	0%	0%	22%	0%	0%	21%	24%
Sign Control		Stop	Stop	Stop	Stop	Stop	Stop	Stop	Stop
Traffic Vol by Lane		268	293	389	249	5	491	312	200
LT Vol		208	293	0	0	5	0	0	110
Through Vol		52	0	389	194	0	491	245	41
RT Vol		8	0	0	55	0	0	67	49
Lane Flow Rate		291	318	422	271	5	533	339	217
Geometry Grp		7	7	7	7	7	7	7	7
Degree of Util (X)		0.827	0.81	1.019	0.639	0.014	1.343	0.844	0.622
Departure Headway (Hd)		10.813	9.596	9.103	8.904	9.811	9.283	9.161	10.962
Convergence, Y/N		Yes	Yes	Yes	Yes	Yes	Yes	Yes	Yes
Cap		338	379	401	409	367	395	397	333
Service Time		8.513	7.296	6.803	6.604	7.511	6.983	6.861	8.662
HCM Lane V/C Ratio		0.861	0.839	1.052	0.663	0.014	1.349	0.854	0.652
HCM Control Delay		49	42.5	80.8	26.1	12.7	196.7	45.4	30.1
HCM Lane LOS		E	E	F	D	B	F	E	D
HCM 95th-tile Q		7.2	7.1	12.8	4.3	0	24.6	8	3.9

Timings

11: Barton St & Alessandro Bl.

09/20/2022



Lane Group	EBL	EBT	WBL	WBT	NBL	NBT	NBR	SBL	SBT	SBR
Lane Configurations	↙	↕↕↕	↙	↕↕↕		↕	↗		↕	↗
Traffic Volume (vph)	8	1945	48	3471	97	2	64	12	0	10
Future Volume (vph)	8	1945	48	3471	97	2	64	12	0	10
Turn Type	Prot	NA	Prot	NA	Perm	NA	Perm	Perm	NA	Perm
Protected Phases	5	2	1	6		8			4	
Permitted Phases					8		8	4		4
Detector Phase	5	2	1	6	8	8	8	4	4	4
Switch Phase										
Minimum Initial (s)	5.0	10.0	5.0	10.0	10.0	10.0	10.0	10.0	10.0	10.0
Minimum Split (s)	9.2	28.5	11.0	28.5	40.6	40.6	40.6	26.6	26.6	26.6
Total Split (s)	9.2	68.4	11.0	70.2	40.6	40.6	40.6	40.6	40.6	40.6
Total Split (%)	7.7%	57.0%	9.2%	58.5%	33.8%	33.8%	33.8%	33.8%	33.8%	33.8%
Yellow Time (s)	3.2	5.5	3.2	5.5	3.6	3.6	3.6	3.6	3.6	3.6
All-Red Time (s)	1.0	1.0	1.0	1.0	1.0	1.0	1.0	1.0	1.0	1.0
Lost Time Adjust (s)	0.0	0.0	0.0	0.0		0.0	0.0		0.0	0.0
Total Lost Time (s)	4.2	6.5	4.2	6.5		4.6	4.6		4.6	4.6
Lead/Lag	Lead	Lag	Lead	Lag						
Lead-Lag Optimize?	Yes	Yes	Yes	Yes						
Recall Mode	None	None	None	None	Max	Max	Max	Max	Max	Max
Act Effct Green (s)	5.0	62.4	6.3	69.1		36.0	36.0		36.0	36.0
Actuated g/C Ratio	0.04	0.53	0.05	0.59		0.30	0.30		0.30	0.30
v/c Ratio	0.12	0.78	0.52	1.22		0.24	0.13		0.04	0.02
Control Delay	59.6	25.3	74.1	126.7		33.5	7.3		30.5	0.1
Queue Delay	0.0	0.0	0.0	0.0		0.0	0.0		0.0	0.0
Total Delay	59.6	25.3	74.1	126.7		33.5	7.3		30.5	0.1
LOS	E	C	E	F		C	A		C	A
Approach Delay		25.4		126.0		23.2			17.3	
Approach LOS		C		F		C			B	

Intersection Summary

Cycle Length: 120
 Actuated Cycle Length: 118.1
 Natural Cycle: 125
 Control Type: Actuated-Uncoordinated
 Maximum v/c Ratio: 1.22
 Intersection Signal Delay: 87.4
 Intersection Capacity Utilization 118.7%
 Analysis Period (min) 15
 Intersection LOS: F
 ICU Level of Service H

Splits and Phases: 11: Barton St & Alessandro Bl.



HCM 6th Signalized Intersection Summary
11: Barton St & Alessandro Bl.

West Campus Upper Plateau (JN 14064)

09/20/2022



Movement	EBL	EBT	EBR	WBL	WBT	WBR	NBL	NBT	NBR	SBL	SBT	SBR
Lane Configurations	↖	↑↑↑		↖	↑↑↑			↑	↗		↑	↗
Traffic Volume (veh/h)	8	1945	47	48	3471	9	97	2	64	12	0	10
Future Volume (veh/h)	8	1945	47	48	3471	9	97	2	64	12	0	10
Initial Q (Qb), veh	0	0	0	0	0	0	0	0	0	0	0	0
Ped-Bike Adj(A_pbT)	1.00		0.98	1.00		1.00	1.00		1.00	1.00		1.00
Parking Bus, Adj	1.00	1.00	1.00	1.00	1.00	1.00	1.00	1.00	1.00	1.00	1.00	1.00
Work Zone On Approach		No			No			No			No	
Adj Sat Flow, veh/h/ln	1663	1870	1870	1900	1870	1678	1900	1900	1870	1426	1900	1307
Adj Flow Rate, veh/h	8	2026	46	50	3616	9	101	2	37	12	0	5
Peak Hour Factor	0.96	0.96	0.96	0.96	0.96	0.96	0.96	0.96	0.96	0.96	0.96	0.96
Percent Heavy Veh, %	16	2	2	0	2	15	0	0	2	32	0	40
Cap, veh/h	16	2683	61	65	2884	7	61	1	491	62	0	343
Arrive On Green	0.01	0.52	0.52	0.04	0.55	0.55	0.31	0.31	0.31	0.31	0.00	0.31
Sat Flow, veh/h	1584	5134	116	1810	5259	13	0	2	1584	0	0	1108
Grp Volume(v), veh/h	8	1342	730	50	2340	1285	103	0	37	12	0	5
Grp Sat Flow(s),veh/h/ln	1584	1702	1846	1810	1702	1868	2	0	1584	0	0	1108
Q Serve(g_s), s	0.6	36.1	36.2	3.2	63.7	63.7	0.0	0.0	1.9	0.0	0.0	0.4
Cycle Q Clear(g_c), s	0.6	36.1	36.2	3.2	63.7	63.7	36.0	0.0	1.9	36.0	0.0	0.4
Prop In Lane	1.00		0.06	1.00		0.01	0.98		1.00	1.00		1.00
Lane Grp Cap(c), veh/h	16	1779	965	65	1867	1025	62	0	491	62	0	343
V/C Ratio(X)	0.52	0.75	0.76	0.77	1.25	1.25	1.66	0.00	0.08	0.19	0.00	0.01
Avail Cap(c_a), veh/h	68	1814	984	106	1867	1025	62	0	491	62	0	343
HCM Platoon Ratio	1.00	1.00	1.00	1.00	1.00	1.00	1.00	1.00	1.00	1.00	1.00	1.00
Upstream Filter(I)	1.00	1.00	1.00	1.00	1.00	1.00	1.00	0.00	1.00	1.00	0.00	1.00
Uniform Delay (d), s/veh	57.2	21.9	21.9	55.5	26.2	26.2	57.7	0.0	28.3	58.1	0.0	27.8
Incr Delay (d2), s/veh	9.5	2.0	3.6	7.1	118.5	122.7	357.7	0.0	0.3	6.8	0.0	0.1
Initial Q Delay(d3),s/veh	0.0	0.0	0.0	0.0	0.0	0.0	0.0	0.0	0.0	0.0	0.0	0.0
%ile BackOfQ(50%),veh/ln	0.3	13.1	14.7	1.6	54.9	61.4	8.0	0.0	0.8	0.5	0.0	0.1
Unsig. Movement Delay, s/veh												
LnGrp Delay(d),s/veh	66.7	23.8	25.5	62.6	144.7	148.9	415.4	0.0	28.6	64.9	0.0	27.9
LnGrp LOS	E	C	C	E	F	F	F	A	C	E	A	C
Approach Vol, veh/h		2080			3675			140				17
Approach Delay, s/veh		24.6			145.0			313.2				54.0
Approach LOS		C			F			F				D
Timer - Assigned Phs	1	2		4	5	6		8				
Phs Duration (G+Y+Rc), s	8.4	67.2		40.6	5.3	70.2		40.6				
Change Period (Y+Rc), s	* 4.2	6.5		4.6	* 4.2	6.5		4.6				
Max Green Setting (Gmax), s	* 6.8	61.9		36.0	* 5	63.7		36.0				
Max Q Clear Time (g_c+I1), s	5.2	38.2		38.0	2.6	65.7		38.0				
Green Ext Time (p_c), s	0.0	18.4		0.0	0.0	0.0		0.0				

Intersection Summary

HCM 6th Ctrl Delay	106.4
HCM 6th LOS	F

Notes

* HCM 6th computational engine requires equal clearance times for the phases crossing the barrier.

Intersection						
Int Delay, s/veh	0.7					
Movement	EBL	EBT	WBT	WBR	SBL	SBR
Lane Configurations						
Traffic Vol, veh/h	30	133	492	17	6	8
Future Vol, veh/h	30	133	492	17	6	8
Conflicting Peds, #/hr	0	0	0	5	0	1
Sign Control	Free	Free	Free	Free	Stop	Stop
RT Channelized	-	None	-	None	-	None
Storage Length	100	-	-	-	0	-
Veh in Median Storage, #	-	0	0	-	0	-
Grade, %	-	0	0	-	0	-
Peak Hour Factor	92	92	92	92	92	92
Heavy Vehicles, %	0	2	1	0	0	0
Mvmt Flow	33	145	535	18	7	9

Major/Minor	Major1	Major2	Minor2		
Conflicting Flow All	558	0	-	0	760
Stage 1	-	-	-	-	549
Stage 2	-	-	-	-	211
Critical Hdwy	4.1	-	-	-	6.4
Critical Hdwy Stg 1	-	-	-	-	5.4
Critical Hdwy Stg 2	-	-	-	-	5.4
Follow-up Hdwy	2.2	-	-	-	3.5
Pot Cap-1 Maneuver	1023	-	-	-	377
Stage 1	-	-	-	-	583
Stage 2	-	-	-	-	829
Platoon blocked, %		-	-	-	
Mov Cap-1 Maneuver	1018	-	-	-	361
Mov Cap-2 Maneuver	-	-	-	-	361
Stage 1	-	-	-	-	561
Stage 2	-	-	-	-	825

Approach	EB	WB	SB
HCM Control Delay, s	1.6	0	13.4
HCM LOS			B

Minor Lane/Major Mvmt	EBL	EBT	WBT	WBR	SBLn1
Capacity (veh/h)	1018	-	-	-	444
HCM Lane V/C Ratio	0.032	-	-	-	0.034
HCM Control Delay (s)	8.7	-	-	-	13.4
HCM Lane LOS	A	-	-	-	B
HCM 95th %tile Q(veh)	0.1	-	-	-	0.1

Intersection						
Int Delay, s/veh	47.5					
Movement	EBT	EBR	WBL	WBT	NBL	NBR
Lane Configurations	↑↑		↖	↑↑	↘	
Traffic Vol, veh/h	363	336	59	530	275	44
Future Vol, veh/h	363	336	59	530	275	44
Conflicting Peds, #/hr	0	0	0	0	0	0
Sign Control	Free	Free	Free	Free	Stop	Stop
RT Channelized	-	None	-	None	-	None
Storage Length	-	-	125	-	0	-
Veh in Median Storage, #	0	-	-	0	0	-
Grade, %	0	-	-	0	0	-
Peak Hour Factor	92	92	92	92	92	92
Heavy Vehicles, %	3	0	2	1	0	0
Mvmt Flow	395	365	64	576	299	48

Major/Minor	Major1	Major2	Minor1		
Conflicting Flow All	0	0	760	0	994 380
Stage 1	-	-	-	-	578 -
Stage 2	-	-	-	-	416 -
Critical Hdwy	-	-	4.14	-	6.8 6.9
Critical Hdwy Stg 1	-	-	-	-	5.8 -
Critical Hdwy Stg 2	-	-	-	-	5.8 -
Follow-up Hdwy	-	-	2.22	-	3.5 3.3
Pot Cap-1 Maneuver	-	-	848	-	~ 245 624
Stage 1	-	-	-	-	530 -
Stage 2	-	-	-	-	640 -
Platoon blocked, %	-	-	-	-	-
Mov Cap-1 Maneuver	-	-	848	-	~ 227 624
Mov Cap-2 Maneuver	-	-	-	-	~ 227 -
Stage 1	-	-	-	-	530 -
Stage 2	-	-	-	-	592 -

Approach	EB	WB	NB
HCM Control Delay, s	0	1	237.6
HCM LOS			F

Minor Lane/Major Mvmt	NBLn1	EBT	EBR	WBL	WBT
Capacity (veh/h)	249	-	-	848	-
HCM Lane V/C Ratio	1.393	-	-	0.076	-
HCM Control Delay (s)	237.6	-	-	9.6	-
HCM Lane LOS	F	-	-	A	-
HCM 95th %tile Q(veh)	19	-	-	0.2	-

Notes
 ~: Volume exceeds capacity \$: Delay exceeds 300s +: Computation Not Defined *: All major volume in platoon

Timings

14: Barton Rd. & Van Buren Bl.

09/20/2022



Lane Group	EBL	EBT	WBL	WBT	NBL	NBT	NBR	SBL	SBT
Lane Configurations	↙	↕↗	↙	↕↗	↙↗	↕	↗	↙	↗
Traffic Volume (vph)	203	1878	329	2287	606	97	445	51	150
Future Volume (vph)	203	1878	329	2287	606	97	445	51	150
Turn Type	Prot	NA	Prot	NA	Prot	NA	Perm	Prot	NA
Protected Phases	5	2	1	6	3	8		7	4
Permitted Phases							8		
Detector Phase	5	2	1	6	3	8	8	7	4
Switch Phase									
Minimum Initial (s)	5.0	10.0	5.0	10.0	5.0	10.0	10.0	5.0	10.0
Minimum Split (s)	9.2	25.2	9.2	25.5	9.1	14.6	14.6	9.1	33.6
Total Split (s)	18.5	47.4	22.0	50.9	17.0	37.5	37.5	13.1	33.6
Total Split (%)	15.4%	39.5%	18.3%	42.4%	14.2%	31.3%	31.3%	10.9%	28.0%
Yellow Time (s)	3.2	5.2	3.2	5.5	3.6	3.6	3.6	3.6	3.6
All-Red Time (s)	1.0	1.0	1.0	1.0	0.5	1.0	1.0	0.5	1.0
Lost Time Adjust (s)	0.0	0.0	0.0	0.0	0.0	0.0	0.0	0.0	0.0
Total Lost Time (s)	4.2	6.2	4.2	6.5	4.1	4.6	4.6	4.1	4.6
Lead/Lag	Lead	Lag	Lead	Lag	Lead	Lag	Lag	Lead	Lag
Lead-Lag Optimize?	Yes	Yes	Yes	Yes	Yes	Yes	Yes	Yes	Yes
Recall Mode	None	None	None	None	None	None	None	None	None
Act Effct Green (s)	14.3	41.2	17.8	44.4	12.9	35.8	35.8	8.1	29.0
Actuated g/C Ratio	0.12	0.34	0.15	0.37	0.11	0.30	0.30	0.07	0.24
v/c Ratio	1.03	1.93	1.37	1.34	1.79	0.19	0.70	0.45	1.25
Control Delay	120.7	448.9	226.6	190.4	396.0	34.0	20.5	65.7	159.3
Queue Delay	0.0	0.0	0.0	0.0	0.0	0.0	0.0	0.0	0.0
Total Delay	120.7	448.9	226.6	190.4	396.0	34.0	20.5	65.7	159.3
LOS	F	F	F	F	F	C	C	E	F
Approach Delay		420.4		194.9		219.9			151.5
Approach LOS		F		F		F			F

Intersection Summary

Cycle Length: 120
 Actuated Cycle Length: 120
 Natural Cycle: 130
 Control Type: Actuated-Uncoordinated
 Maximum v/c Ratio: 1.93
 Intersection Signal Delay: 273.5
 Intersection LOS: F
 Intersection Capacity Utilization 144.7%
 ICU Level of Service H
 Analysis Period (min) 15

Splits and Phases: 14: Barton Rd. & Van Buren Bl.

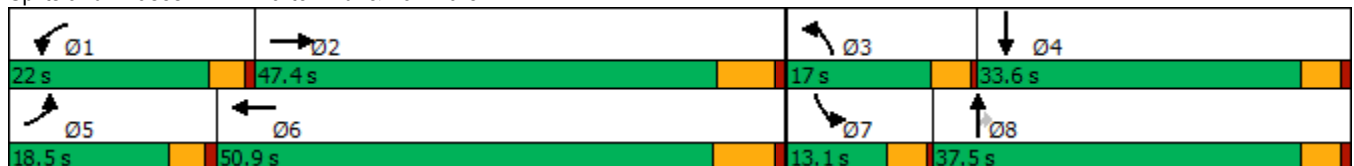

HCM 6th Signalized Intersection Summary
14: Barton Rd. & Van Buren Bl.

West Campus Upper Plateau (JN 14064)

09/20/2022

Movement	EBL	EBT	EBR	WBL	WBT	WBR	NBL	NBT	NBR	SBL	SBT	SBR
Lane Configurations												
Traffic Volume (veh/h)	203	1878	261	329	2287	32	606	97	445	51	150	409
Future Volume (veh/h)	203	1878	261	329	2287	32	606	97	445	51	150	409
Initial Q (Qb), veh	0	0	0	0	0	0	0	0	0	0	0	0
Ped-Bike Adj(A_pbT)	1.00		1.00	1.00		1.00	1.00		1.00	1.00		1.00
Parking Bus, Adj	1.00	1.00	1.00	1.00	1.00	1.00	1.00	1.00	1.00	1.00	1.00	1.00
Work Zone On Approach		No			No			No			No	
Adj Sat Flow, veh/h/ln	1900	1870	1870	1870	1870	1752	1870	1885	1885	1900	1870	1900
Adj Flow Rate, veh/h	221	2041	272	358	2486	30	659	105	280	55	163	330
Peak Hour Factor	0.92	0.92	0.92	0.92	0.92	0.92	0.92	0.92	0.92	0.92	0.92	0.92
Percent Heavy Veh, %	0	2	2	2	2	10	2	1	1	0	2	0
Cap, veh/h	215	1083	141	264	1932	23	371	582	493	71	133	269
Arrive On Green	0.12	0.34	0.34	0.15	0.37	0.37	0.11	0.31	0.31	0.04	0.24	0.24
Sat Flow, veh/h	1810	3161	412	1781	5201	63	3456	1885	1598	1810	552	1117
Grp Volume(v), veh/h	221	1127	1186	358	1625	891	659	105	280	55	0	493
Grp Sat Flow(s),veh/h/ln	1810	1777	1796	1781	1702	1859	1728	1885	1598	1810	0	1669
Q Serve(g_s), s	14.3	41.2	41.2	17.8	44.7	44.7	12.9	4.9	17.7	3.6	0.0	29.0
Cycle Q Clear(g_c), s	14.3	41.2	41.2	17.8	44.7	44.7	12.9	4.9	17.7	3.6	0.0	29.0
Prop In Lane	1.00		0.23	1.00		0.03	1.00		1.00	1.00		0.67
Lane Grp Cap(c), veh/h	215	609	615	264	1265	691	371	582	493	71	0	402
V/C Ratio(X)	1.03	1.85	1.93	1.36	1.29	1.29	1.78	0.18	0.57	0.77	0.00	1.23
Avail Cap(c_a), veh/h	215	609	615	264	1265	691	371	582	493	135	0	402
HCM Platoon Ratio	1.00	1.00	1.00	1.00	1.00	1.00	1.00	1.00	1.00	1.00	1.00	1.00
Upstream Filter(I)	1.00	1.00	1.00	1.00	1.00	1.00	1.00	1.00	1.00	1.00	0.00	1.00
Uniform Delay (d), s/veh	53.0	39.6	39.6	51.3	37.8	37.8	53.7	30.4	34.8	57.2	0.0	45.7
Incr Delay (d2), s/veh	68.7	389.6	423.7	183.9	134.4	140.9	361.0	0.1	1.5	15.8	0.0	121.6
Initial Q Delay(d3),s/veh	0.0	0.0	0.0	0.0	0.0	0.0	0.0	0.0	0.0	0.0	0.0	0.0
%ile BackOfQ(50%),veh/ln	10.4	82.7	89.4	21.1	40.9	45.9	24.0	2.2	6.8	2.0	0.0	25.6
Unsig. Movement Delay, s/veh												
LnGrp Delay(d),s/veh	121.7	429.2	463.2	235.2	172.2	178.7	414.7	30.6	36.4	73.1	0.0	167.3
LnGrp LOS	F	F	F	F	F	F	F	C	D	E	A	F
Approach Vol, veh/h		2534			2874			1044			548	
Approach Delay, s/veh		418.3			182.1			274.6			157.8	
Approach LOS		F			F			F			F	
Timer - Assigned Phs	1	2	3	4	5	6	7	8				
Phs Duration (G+Y+Rc), s	22.0	47.7	17.0	33.6	18.5	51.2	8.8	41.8				
Change Period (Y+Rc), s	* 4.2	* 6.5	4.1	4.6	* 4.2	6.5	4.1	4.6				
Max Green Setting (Gmax), s	* 18	* 41	12.9	29.0	* 14	44.4	9.0	32.9				
Max Q Clear Time (g_c+I1), s	19.8	43.2	14.9	31.0	16.3	46.7	5.6	19.7				
Green Ext Time (p_c), s	0.0	0.0	0.0	0.0	0.0	0.0	0.0	1.2				

Intersection Summary

HCM 6th Ctrl Delay	279.5
HCM 6th LOS	F

Notes

* HCM 6th computational engine requires equal clearance times for the phases crossing the barrier.

Intersection

Intersection Delay, s/veh	11.7
Intersection LOS	B

Movement	EBT	EBR	WBL	WBT	NBL	NBR
Lane Configurations						
Traffic Vol, veh/h	67	69	124	285	180	81
Future Vol, veh/h	67	69	124	285	180	81
Peak Hour Factor	0.92	0.92	0.92	0.92	0.92	0.92
Heavy Vehicles, %	4	0	0	2	2	2
Mvmt Flow	73	75	135	310	196	88
Number of Lanes	1	0	1	1	1	0

Approach	EB	WB	NB
Opposing Approach	WB	EB	
Opposing Lanes	2	1	0
Conflicting Approach Left		NB	EB
Conflicting Lanes Left	0	1	1
Conflicting Approach Right	NB		WB
Conflicting Lanes Right	1	0	2
HCM Control Delay	9.6	12.2	12.1
HCM LOS	A	B	B

Lane	NBLn1	EBLn1	WBLn1	WBLn2
Vol Left, %	69%	0%	100%	0%
Vol Thru, %	0%	49%	0%	100%
Vol Right, %	31%	51%	0%	0%
Sign Control	Stop	Stop	Stop	Stop
Traffic Vol by Lane	261	136	124	285
LT Vol	180	0	124	0
Through Vol	0	67	0	285
RT Vol	81	69	0	0
Lane Flow Rate	284	148	135	310
Geometry Grp	2	5	7	7
Degree of Util (X)	0.415	0.212	0.221	0.468
Departure Headway (Hd)	5.26	5.174	5.91	5.44
Convergence, Y/N	Yes	Yes	Yes	Yes
Cap	678	698	601	654
Service Time	3.345	3.174	3.706	3.236
HCM Lane V/C Ratio	0.419	0.212	0.225	0.474
HCM Control Delay	12.1	9.6	10.4	13
HCM Lane LOS	B	A	B	B
HCM 95th-tile Q	2	0.8	0.8	2.5

Intersection

Intersection Delay, s/veh	13.6
Intersection LOS	B

Movement	EBL	EBT	WBT	WBR	SBL	SBR
Lane Configurations						
Traffic Vol, veh/h	150	219	407	116	97	139
Future Vol, veh/h	150	219	407	116	97	139
Peak Hour Factor	0.92	0.92	0.92	0.92	0.92	0.92
Heavy Vehicles, %	0	2	0	2	1	1
Mvmt Flow	163	238	442	126	105	151
Number of Lanes	1	2	2	0	1	0

Approach	EB	WB	SB
Opposing Approach	WB	EB	
Opposing Lanes	2	3	0
Conflicting Approach Left SB			WB
Conflicting Lanes Left	1	0	2
Conflicting Approach Right		SB	EB
Conflicting Lanes Right	0	1	3
HCM Control Delay	10.6	15.1	15.2
HCM LOS	B	C	C

Lane	EBLn1	EBLn2	EBLn3	WBLn1	WBLn2	SBLn1
Vol Left, %	100%	0%	0%	0%	0%	41%
Vol Thru, %	0%	100%	100%	100%	54%	0%
Vol Right, %	0%	0%	0%	0%	46%	59%
Sign Control	Stop	Stop	Stop	Stop	Stop	Stop
Traffic Vol by Lane	150	110	110	271	252	236
LT Vol	150	0	0	0	0	97
Through Vol	0	110	110	271	136	0
RT Vol	0	0	0	0	116	139
Lane Flow Rate	163	119	119	295	274	257
Geometry Grp	7	7	7	8	8	7
Degree of Util (X)	0.304	0.207	0.148	0.524	0.464	0.471
Departure Headway (Hd)	6.72	6.246	4.481	6.401	6.107	6.607
Convergence, Y/N	Yes	Yes	Yes	Yes	Yes	Yes
Cap	533	572	794	560	588	544
Service Time	4.482	4.007	2.242	4.162	3.868	4.366
HCM Lane V/C Ratio	0.306	0.208	0.15	0.527	0.466	0.472
HCM Control Delay	12.4	10.6	8	16.1	14.1	15.2
HCM Lane LOS	B	B	A	C	B	C
HCM 95th-tile Q	1.3	0.8	0.5	3	2.4	2.5

Timings
19: Van Buren Bl. & Orange Terrace Pkwy.

West Campus Upper Plateau (JN 14064)

09/20/2022

Lane Group	EBL	EBT	EBR	WBL	WBT	WBR	NBL	NBT	NBR	SBL	SBT	SBR
Lane Configurations												
Traffic Volume (vph)	181	1965	225	140	2461	153	131	25	86	290	43	289
Future Volume (vph)	181	1965	225	140	2461	153	131	25	86	290	43	289
Turn Type	Prot	NA	Perm	Prot	NA	Perm	Prot	NA	Perm	Prot	NA	pm+ov
Protected Phases	5	2		1	6		3	8		7	4	5
Permitted Phases			2			6			8			4
Detector Phase	5	2	2	1	6	6	3	8	8	7	4	5
Switch Phase												
Minimum Initial (s)	5.0	10.0	10.0	5.0	10.0	10.0	5.0	5.0	5.0	10.0	10.0	5.0
Minimum Split (s)	9.2	25.2	25.2	9.1	25.2	25.2	9.1	26.1	26.1	15.8	24.8	9.2
Total Split (s)	16.0	62.8	62.8	9.1	55.9	55.9	9.1	26.1	26.1	22.0	39.0	16.0
Total Split (%)	13.3%	52.3%	52.3%	7.6%	46.6%	46.6%	7.6%	21.8%	21.8%	18.3%	32.5%	13.3%
Yellow Time (s)	3.2	5.2	5.2	3.6	5.2	5.2	3.6	3.6	3.6	4.8	4.8	3.2
All-Red Time (s)	1.0	1.0	1.0	0.5	1.0	1.0	0.5	0.5	0.5	1.0	1.0	1.0
Lost Time Adjust (s)	0.0	0.0	0.0	0.0	0.0	0.0	0.0	0.0	0.0	0.0	0.0	0.0
Total Lost Time (s)	4.2	6.2	6.2	4.1	6.2	6.2	4.1	4.1	4.1	5.8	5.8	4.2
Lead/Lag	Lead	Lag	Lag	Lead	Lag	Lag	Lead	Lag	Lag	Lead	Lag	Lead
Lead-Lag Optimize?	Yes	Yes	Yes	Yes	Yes	Yes	Yes	Yes	Yes	Yes	Yes	Yes
Recall Mode	None	None	None	None	None	None	None	None	None	None	None	None
Act Effct Green (s)	11.1	56.7	56.7	5.0	50.5	50.5	10.3	6.4	6.4	13.6	14.1	21.9
Actuated g/C Ratio	0.11	0.57	0.57	0.05	0.51	0.51	0.10	0.06	0.06	0.14	0.14	0.22
v/c Ratio	0.48	0.71	0.24	0.82	1.00	0.18	0.37	0.11	0.32	0.63	0.16	0.75
Control Delay	47.5	18.2	5.1	82.2	42.7	1.8	49.3	46.9	3.0	47.8	39.2	37.1
Queue Delay	0.0	0.0	0.0	0.0	0.0	0.0	0.0	0.0	0.0	0.0	0.0	0.0
Total Delay	47.5	18.2	5.1	82.2	42.7	1.8	49.3	46.9	3.0	47.8	39.2	37.1
LOS	D	B	A	F	D	A	D	D	A	D	D	D
Approach Delay		19.2			42.5			32.6			42.2	
Approach LOS		B			D			C			D	

Intersection Summary

Cycle Length: 120
 Actuated Cycle Length: 99.7
 Natural Cycle: 120
 Control Type: Actuated-Uncoordinated
 Maximum v/c Ratio: 1.00
 Intersection Signal Delay: 32.8
 Intersection LOS: C
 Intersection Capacity Utilization 82.0%
 ICU Level of Service E
 Analysis Period (min) 15

Splits and Phases: 19: Van Buren Bl. & Orange Terrace Pkwy.

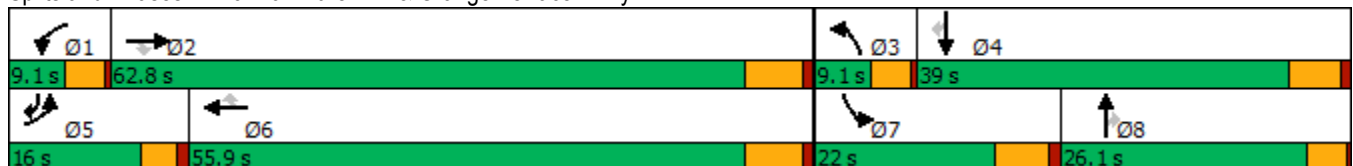

HCM 6th Signalized Intersection Summary
 19: Van Buren Bl. & Orange Terrace Pkwy.

West Campus Upper Plateau (JN 14064)

09/20/2022



Movement	EBL	EBT	EBR	WBL	WBT	WBR	NBL	NBT	NBR	SBL	SBT	SBR
Lane Configurations	↖↗	↑↑↑	↖	↖↗	↑↑↑	↖	↖↗	↑↑	↖	↖↗	↑	↖↗
Traffic Volume (veh/h)	181	1965	225	140	2461	153	131	25	86	290	43	289
Future Volume (veh/h)	181	1965	225	140	2461	153	131	25	86	290	43	289
Initial Q (Qb), veh	0	0	0	0	0	0	0	0	0	0	0	0
Ped-Bike Adj(A_pbT)	1.00		0.99	1.00		1.00	1.00		1.00	1.00		0.98
Parking Bus, Adj	1.00	1.00	1.00	1.00	1.00	1.00	1.00	1.00	1.00	1.00	1.00	1.00
Work Zone On Approach		No			No			No			No	
Adj Sat Flow, veh/h/ln	1885	1856	1870	1900	1856	1870	1900	1900	1811	1885	1900	1885
Adj Flow Rate, veh/h	187	2026	222	144	2537	117	135	26	62	299	44	185
Peak Hour Factor	0.97	0.97	0.97	0.97	0.97	0.97	0.97	0.97	0.97	0.97	0.97	0.97
Percent Heavy Veh, %	1	3	2	0	3	2	0	0	6	1	0	1
Cap, veh/h	259	2757	852	184	2641	826	184	227	97	384	263	335
Arrive On Green	0.07	0.54	0.54	0.05	0.52	0.52	0.05	0.06	0.06	0.11	0.14	0.14
Sat Flow, veh/h	3483	5066	1565	3510	5066	1585	3510	3610	1535	3483	1900	1566
Grp Volume(v), veh/h	187	2026	222	144	2537	117	135	26	62	299	44	185
Grp Sat Flow(s),veh/h/ln	1742	1689	1565	1755	1689	1585	1755	1805	1535	1742	1900	1566
Q Serve(g_s), s	5.0	28.9	7.2	3.9	45.7	3.6	3.6	0.6	3.8	8.0	1.9	10.0
Cycle Q Clear(g_c), s	5.0	28.9	7.2	3.9	45.7	3.6	3.6	0.6	3.8	8.0	1.9	10.0
Prop In Lane	1.00		1.00	1.00		1.00	1.00		1.00	1.00		1.00
Lane Grp Cap(c), veh/h	259	2757	852	184	2641	826	184	227	97	384	263	335
V/C Ratio(X)	0.72	0.73	0.26	0.78	0.96	0.14	0.73	0.11	0.64	0.78	0.17	0.55
Avail Cap(c_a), veh/h	432	3013	931	184	2646	828	184	835	355	593	663	665
HCM Platoon Ratio	1.00	1.00	1.00	1.00	1.00	1.00	1.00	1.00	1.00	1.00	1.00	1.00
Upstream Filter(I)	1.00	1.00	1.00	1.00	1.00	1.00	1.00	1.00	1.00	1.00	1.00	1.00
Uniform Delay (d), s/veh	43.1	16.5	11.5	44.5	21.8	11.8	44.4	42.1	43.5	41.2	36.2	33.4
Incr Delay (d2), s/veh	1.4	0.9	0.2	19.1	9.9	0.1	13.8	0.2	6.9	3.6	0.3	1.4
Initial Q Delay(d3),s/veh	0.0	0.0	0.0	0.0	0.0	0.0	0.0	0.0	0.0	0.0	0.0	0.0
%ile BackOfQ(50%),veh/ln	2.1	9.5	2.4	2.1	17.5	1.2	1.9	0.3	1.6	3.4	0.9	3.9
Unsig. Movement Delay, s/veh												
LnGrp Delay(d),s/veh	44.5	17.3	11.7	63.6	31.8	11.8	58.3	42.3	50.5	44.8	36.5	34.9
LnGrp LOS	D	B	B	E	C	B	E	D	D	D	D	C
Approach Vol, veh/h		2435			2798			223			528	
Approach Delay, s/veh		18.9			32.6			54.2			40.6	
Approach LOS		B			C			D			D	
Timer - Assigned Phs	1	2	3	4	5	6	7	8				
Phs Duration (G+Y+Rc), s	9.1	58.0	9.1	19.0	11.3	55.8	16.3	11.8				
Change Period (Y+Rc), s	4.1	6.2	4.1	5.8	* 4.2	6.2	5.8	* 5.8				
Max Green Setting (Gmax), s	5.0	56.6	5.0	33.2	* 12	49.7	16.2	* 22				
Max Q Clear Time (g_c+I1), s	5.9	30.9	5.6	12.0	7.0	47.7	10.0	5.8				
Green Ext Time (p_c), s	0.0	17.2	0.0	0.7	0.1	1.9	0.5	0.2				

Intersection Summary

HCM 6th Ctrl Delay	28.5
HCM 6th LOS	C

Notes

* HCM 6th computational engine requires equal clearance times for the phases crossing the barrier.

Timings
20: Brown/San Gorgonio Dr & Alessandro Bl.

West Campus Upper Plateau (JN 14064)

09/20/2022



Lane Group	EBL	EBT	WBT	WBR	NBL	NBT	SBL	SBT	SBR	Ø1
Lane Configurations	↖	↕↕↕	↕↕↕	↗	↖	↕	↖	↕	↗	
Traffic Volume (vph)	40	2100	3388	66	10	5	39	5	21	
Future Volume (vph)	40	2100	3388	66	10	5	39	5	21	
Turn Type	Prot	NA	NA	Perm	Prot	NA	Prot	NA	pm+ov	
Protected Phases	5	2	6		3	8	7	4	5	1
Permitted Phases				6						4
Detector Phase	5	2	6	6	3	8	7	4	5	
Switch Phase										
Minimum Initial (s)	5.0	10.0	10.0	10.0	5.0	5.0	5.0	10.0	5.0	5.0
Minimum Split (s)	8.7	43.5	43.5	43.5	9.1	26.1	8.7	49.8	8.7	9.1
Total Split (s)	8.7	51.9	52.4	52.4	9.1	48.1	10.8	49.8	8.7	9.2
Total Split (%)	7.3%	43.3%	43.7%	43.7%	7.6%	40.1%	9.0%	41.5%	7.3%	8%
Yellow Time (s)	3.2	5.5	5.5	5.5	3.6	3.6	3.2	4.8	3.2	3.6
All-Red Time (s)	0.5	1.0	1.0	1.0	0.5	0.5	0.5	1.0	0.5	0.5
Lost Time Adjust (s)	0.0	0.0	0.0	0.0	0.0	0.0	0.0	0.0	0.0	
Total Lost Time (s)	3.7	6.5	6.5	6.5	4.1	4.1	3.7	5.8	3.7	
Lead/Lag	Lead	Lag	Lag	Lag	Lead	Lag	Lead	Lag	Lead	Lead
Lead-Lag Optimize?	Yes	Yes	Yes	Yes	Yes	Yes	Yes	Yes	Yes	Yes
Recall Mode	None	None	None	None	None	None	None	None	None	None
Act Effct Green (s)	5.4	60.1	51.6	51.6	5.4	11.0	8.6	15.2	18.2	
Actuated g/C Ratio	0.07	0.78	0.67	0.67	0.07	0.14	0.11	0.20	0.23	
v/c Ratio	0.33	0.56	1.06	0.07	0.09	0.02	0.23	0.02	0.05	
Control Delay	50.7	11.3	56.7	2.4	46.4	28.4	42.8	26.8	0.2	
Queue Delay	0.0	0.0	0.0	0.0	0.0	0.0	0.0	0.0	0.0	
Total Delay	50.7	11.3	56.7	2.4	46.4	28.4	42.8	26.8	0.2	
LOS	D	B	E	A	D	C	D	C	A	
Approach Delay		12.0	55.6			40.8		27.8		
Approach LOS		B	E			D		C		

Intersection Summary

Cycle Length: 120
 Actuated Cycle Length: 77.5
 Natural Cycle: 125
 Control Type: Actuated-Uncoordinated
 Maximum v/c Ratio: 1.06
 Intersection Signal Delay: 38.8
 Intersection LOS: D
 Intersection Capacity Utilization 86.0%
 ICU Level of Service E
 Analysis Period (min) 15

Splits and Phases: 20: Brown/San Gorgonio Dr & Alessandro Bl.

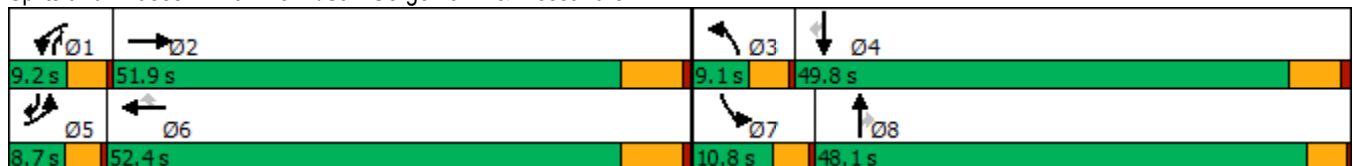

HCM 6th Signalized Intersection Summary
20: Brown/San Gorgonio Dr & Alessandro Bl.

West Campus Upper Plateau (JN 14064)

09/20/2022



Movement	EBL	EBT	EBR	WBL	WBT	WBR	NBL	NBT	NBR	SBL	SBT	SBR
Lane Configurations	↗	↑↑↑		↖	↑↑↑	↗	↖	↑	↗	↖	↑	↗
Traffic Volume (veh/h)	40	2100	5	0	3388	66	10	5	0	39	5	21
Future Volume (veh/h)	40	2100	5	0	3388	66	10	5	0	39	5	21
Initial Q (Qb), veh	0	0	0	0	0	0	0	0	0	0	0	0
Ped-Bike Adj(A_pbT)	1.00		0.98	1.00		1.00	1.00		1.00	1.00		1.00
Parking Bus, Adj	1.00	1.00	1.00	1.00	1.00	1.00	1.00	1.00	1.00	1.00	1.00	1.00
Work Zone On Approach		No			No			No			No	
Adj Sat Flow, veh/h/ln	1900	1870	1900	1707	1856	1781	1900	1900	1796	1693	1530	1900
Adj Flow Rate, veh/h	42	2211	5	0	3566	69	11	5	-3	41	5	8
Peak Hour Factor	0.95	0.95	0.95	0.95	0.95	0.95	0.95	0.95	0.95	0.95	0.95	0.95
Percent Heavy Veh, %	0	2	0	13	3	8	0	0	7	14	25	0
Cap, veh/h	70	3591	8	2	3020	900	25	136	28	61	139	208
Arrive On Green	0.04	0.68	0.68	0.00	0.60	0.60	0.01	0.07	0.00	0.04	0.09	0.09
Sat Flow, veh/h	1810	5260	12	1626	5066	1510	1810	1900	1522	1612	1530	1610
Grp Volume(v), veh/h	42	1431	785	0	3566	69	11	5	-3	41	5	8
Grp Sat Flow(s),veh/h/ln	1810	1702	1868	1626	1689	1510	1810	1900	1522	1612	1530	1610
Q Serve(g_s), s	1.8	17.7	17.7	0.0	45.9	1.5	0.5	0.2	3.9	1.9	0.2	0.3
Cycle Q Clear(g_c), s	1.8	17.7	17.7	0.0	45.9	1.5	0.5	0.2	3.9	1.9	0.2	0.3
Prop In Lane	1.00		0.01	1.00		1.00	1.00		1.00	1.00		1.00
Lane Grp Cap(c), veh/h	70	2324	1275	2	3020	900	25	136	28	61	139	208
V/C Ratio(X)	0.60	0.62	0.62	0.00	1.18	0.08	0.45	0.04	-0.11	0.67	0.04	0.04
Avail Cap(c_a), veh/h	118	2324	1275	108	3020	900	118	1086	789	149	874	982
HCM Platoon Ratio	1.00	1.00	1.00	1.00	1.00	1.00	1.00	1.00	1.00	1.00	1.00	1.00
Upstream Filter(I)	1.00	1.00	1.00	0.00	1.00	1.00	1.00	1.00	0.00	1.00	1.00	1.00
Uniform Delay (d), s/veh	36.4	6.7	6.7	0.0	15.5	6.6	37.7	33.3	0.0	36.6	31.9	29.3
Incr Delay (d2), s/veh	3.1	0.6	1.1	0.0	85.1	0.1	12.1	0.1	0.0	4.7	0.1	0.1
Initial Q Delay(d3),s/veh	0.0	0.0	0.0	0.0	0.0	0.0	0.0	0.0	0.0	0.0	0.0	0.0
%ile BackOfQ(50%),veh/ln	0.8	3.6	4.2	0.0	38.1	0.4	0.3	0.1	0.0	0.8	0.1	0.1
Unsig. Movement Delay, s/veh												
LnGrp Delay(d),s/veh	39.5	7.3	7.7	0.0	100.6	6.6	49.8	33.4	0.0	41.2	32.0	29.4
LnGrp LOS	D	A	A	A	F	A	D	C	A	D	C	C
Approach Vol, veh/h		2258			3635			13				54
Approach Delay, s/veh		8.0			98.9			55.0				38.6
Approach LOS		A			F			E				D
Timer - Assigned Phs	1	2	3	4	5	6	7	8				
Phs Duration (G+Y+Rc), s	0.0	59.1	5.1	12.8	6.7	52.4	6.6	11.3				
Change Period (Y+Rc), s	4.1	6.5	4.1	5.8	3.7	6.5	3.7	* 5.8				
Max Green Setting (Gmax), s	5.1	45.4	5.0	44.0	5.0	45.9	7.1	* 44				
Max Q Clear Time (g_c+I1), s	0.0	19.7	2.5	2.3	3.8	47.9	3.9	5.9				
Green Ext Time (p_c), s	0.0	20.7	0.0	0.0	0.0	0.0	0.0	0.0				

Intersection Summary

HCM 6th Ctrl Delay	63.8
HCM 6th LOS	E

Notes

* HCM 6th computational engine requires equal clearance times for the phases crossing the barrier.

Timings
22: Sycamore Canyon Bl. & Eastridge Ave

West Campus Upper Plateau (JN 14064)

09/20/2022



Lane Group	EBL	EBT	EBR	WBL	WBT	WBR	NBL	NBT	NBR	SBL	SBT	SBR
Lane Configurations	↖↖	↑↑↑	↗	↖↖	↑↑	↗	↖↖	↑↑	↗	↖↖	↑↑	↗
Traffic Volume (vph)	61	50	22	192	235	611	89	989	127	94	290	52
Future Volume (vph)	61	50	22	192	235	611	89	989	127	94	290	52
Turn Type	Prot	NA	Perm	Prot	NA	pm+ov	Prot	NA	pm+ov	Prot	NA	pm+ov
Protected Phases	5	2		1	6	7	3	8	1	7	4	5
Permitted Phases			2			6			8			4
Detector Phase	5	2	2	1	6	7	3	8	1	7	4	5
Switch Phase												
Minimum Initial (s)	5.0	10.0	10.0	5.0	10.0	5.0	5.0	10.0	5.0	5.0	10.0	5.0
Minimum Split (s)	8.7	43.5	43.5	8.7	43.5	8.7	8.7	15.8	8.7	8.7	49.8	8.7
Total Split (s)	10.1	47.0	47.0	11.0	47.9	21.0	10.6	41.0	11.0	21.0	51.4	10.1
Total Split (%)	8.4%	39.2%	39.2%	9.2%	39.9%	17.5%	8.8%	34.2%	9.2%	17.5%	42.8%	8.4%
Yellow Time (s)	3.2	5.5	5.5	3.2	5.5	3.2	3.2	4.8	3.2	3.2	4.8	3.2
All-Red Time (s)	0.5	1.0	1.0	0.5	1.0	0.5	0.5	1.0	0.5	0.5	1.0	0.5
Lost Time Adjust (s)	0.0	0.0	0.0	0.0	0.0	0.0	0.0	0.0	0.0	0.0	0.0	0.0
Total Lost Time (s)	3.7	6.5	6.5	3.7	6.5	3.7	3.7	5.8	3.7	3.7	5.8	3.7
Lead/Lag	Lead	Lag	Lag	Lead	Lag	Lead	Lead	Lag	Lead	Lead	Lag	Lead
Lead-Lag Optimize?	Yes	Yes	Yes	Yes	Yes	Yes	Yes	Yes	Yes	Yes	Yes	Yes
Recall Mode	None	None	None	None	None	None	None	None	None	None	None	None
Act Effct Green (s)	6.0	15.2	15.2	8.8	16.1	39.1	6.4	35.8	46.8	16.4	48.0	56.2
Actuated g/C Ratio	0.07	0.16	0.16	0.10	0.17	0.42	0.07	0.39	0.51	0.18	0.52	0.61
v/c Ratio	0.37	0.09	0.07	0.86	0.46	0.98	0.43	0.81	0.19	0.18	0.18	0.07
Control Delay	51.1	32.8	0.4	77.5	36.9	54.4	50.3	33.5	6.3	35.8	14.9	2.8
Queue Delay	0.0	0.0	0.0	0.0	0.0	0.0	0.0	0.0	0.0	0.0	0.0	0.0
Total Delay	51.1	32.8	0.4	77.5	36.9	54.4	50.3	33.5	6.3	35.8	14.9	2.8
LOS	D	C	A	E	D	D	D	C	A	D	B	A
Approach Delay		35.8			54.7			31.8			17.9	
Approach LOS		D			D			C			B	

Intersection Summary

Cycle Length: 120
 Actuated Cycle Length: 92.2
 Natural Cycle: 115
 Control Type: Actuated-Uncoordinated
 Maximum v/c Ratio: 0.98
 Intersection Signal Delay: 38.3
 Intersection LOS: D
 Intersection Capacity Utilization 80.8%
 ICU Level of Service D
 Analysis Period (min) 15

Splits and Phases: 22: Sycamore Canyon Bl. & Eastridge Ave

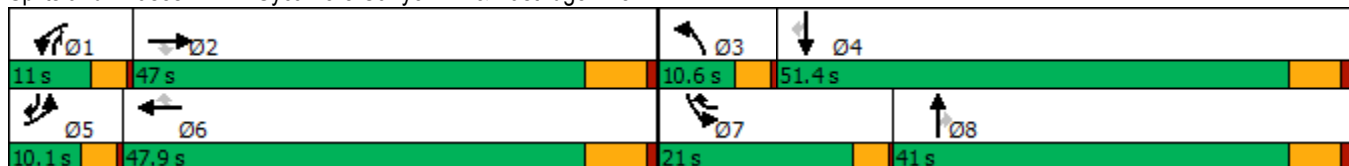

HCM 6th Signalized Intersection Summary
22: Sycamore Canyon Bl. & Eastridge Ave

West Campus Upper Plateau (JN 14064)

09/20/2022



Movement	EBL	EBT	EBR	WBL	WBT	WBR	NBL	NBT	NBR	SBL	SBT	SBR
Lane Configurations	↖↗	↑↑↑	↖	↖↗	↑↑	↖	↖↗	↑↑	↖	↖↗	↑↑	↖
Traffic Volume (veh/h)	61	50	22	192	235	611	89	989	127	94	290	52
Future Volume (veh/h)	61	50	22	192	235	611	89	989	127	94	290	52
Initial Q (Qb), veh	0	0	0	0	0	0	0	0	0	0	0	0
Ped-Bike Adj(A_pbT)	1.00		1.00	1.00		1.00	1.00		0.99	1.00		0.99
Parking Bus, Adj	1.00	1.00	1.00	1.00	1.00	1.00	1.00	1.00	1.00	1.00	1.00	1.00
Work Zone On Approach		No			No			No			No	
Adj Sat Flow, veh/h/ln	1485	1352	1722	1337	1707	1811	1796	1811	1618	1767	1826	1589
Adj Flow Rate, veh/h	66	54	0	209	255	664	97	1075	105	102	315	44
Peak Hour Factor	0.92	0.92	0.92	0.92	0.92	0.92	0.92	0.92	0.92	0.92	0.92	0.92
Percent Heavy Veh, %	28	37	12	38	13	6	7	6	19	9	5	21
Cap, veh/h	111	1345		171	1276	678	150	1138	543	157	1158	498
Arrive On Green	0.04	0.36	0.00	0.07	0.39	0.39	0.05	0.33	0.33	0.05	0.33	0.33
Sat Flow, veh/h	2744	3690	1459	2470	3244	1535	3319	3441	1354	3264	3469	1329
Grp Volume(v), veh/h	66	54	0	209	255	664	97	1075	105	102	315	44
Grp Sat Flow(s),veh/h/ln	1372	1230	1459	1235	1622	1535	1659	1721	1354	1632	1735	1329
Q Serve(g_s), s	2.5	1.0	0.0	7.3	5.4	41.4	3.0	32.0	5.3	3.2	7.0	2.3
Cycle Q Clear(g_c), s	2.5	1.0	0.0	7.3	5.4	41.4	3.0	32.0	5.3	3.2	7.0	2.3
Prop In Lane	1.00		1.00	1.00		1.00	1.00		1.00	1.00		1.00
Lane Grp Cap(c), veh/h	111	1345		171	1276	678	150	1138	543	157	1158	498
V/C Ratio(X)	0.59	0.04		1.22	0.20	0.98	0.65	0.94	0.19	0.65	0.27	0.09
Avail Cap(c_a), veh/h	167	1420		171	1276	678	218	1151	548	536	1503	631
HCM Platoon Ratio	1.00	1.00	1.00	1.00	1.00	1.00	1.00	1.00	1.00	1.00	1.00	1.00
Upstream Filter(I)	1.00	1.00	0.00	1.00	1.00	1.00	1.00	1.00	1.00	1.00	1.00	1.00
Uniform Delay (d), s/veh	49.6	21.6	0.0	49.0	21.0	28.9	49.4	34.3	20.5	49.2	25.7	21.3
Incr Delay (d2), s/veh	1.9	0.0	0.0	140.2	0.1	29.6	1.8	15.0	0.2	1.7	0.1	0.1
Initial Q Delay(d3),s/veh	0.0	0.0	0.0	0.0	0.0	0.0	0.0	0.0	0.0	0.0	0.0	0.0
%ile BackOfQ(50%),veh/ln	0.8	0.3	0.0	5.5	1.9	20.5	1.3	14.9	1.6	1.3	2.8	0.7
Unsig. Movement Delay, s/veh												
LnGrp Delay(d),s/veh	51.5	21.6	0.0	189.2	21.1	58.5	51.2	49.3	20.7	50.9	25.8	21.4
LnGrp LOS	D	C		F	C	E	D	D	C	D	C	C
Approach Vol, veh/h		120			1128			1277			461	
Approach Delay, s/veh		38.0			74.3			47.1			30.9	
Approach LOS		D			E			D			C	
Timer - Assigned Phs	1	2	3	4	5	6	7	8				
Phs Duration (G+Y+Rc), s	11.0	44.9	8.5	40.9	8.0	47.9	8.8	40.6				
Change Period (Y+Rc), s	3.7	6.5	3.7	5.8	3.7	6.5	3.7	5.8				
Max Green Setting (Gmax), s	7.3	40.5	6.9	45.6	6.4	41.4	17.3	35.2				
Max Q Clear Time (g_c+I1), s	9.3	3.0	5.0	9.0	4.5	43.4	5.2	34.0				
Green Ext Time (p_c), s	0.0	0.4	0.0	2.1	0.0	0.0	0.1	0.8				

Intersection Summary

HCM 6th Ctrl Delay	54.5
HCM 6th LOS	D

Notes

Unsignalized Delay for [EBR] is excluded from calculations of the approach delay and intersection delay.

Timings
23: Sycamore Canyon Bl. & Cottonwood Ave

West Campus Upper Plateau (JN 14064)

09/20/2022



Lane Group	WBL	WBR	NBT	SBL	SBT
Lane Configurations	↙	↗	↕↔	↙	↕↕
Traffic Volume (vph)	29	45	1182	136	370
Future Volume (vph)	29	45	1182	136	370
Turn Type	Prot	Perm	NA	Prot	NA
Protected Phases	8		2	1	6
Permitted Phases		8			
Detector Phase	8	8	2	1	6
Switch Phase					
Minimum Initial (s)	10.0	10.0	10.0	5.0	10.0
Minimum Split (s)	15.8	15.8	43.5	9.1	43.5
Total Split (s)	21.0	21.0	75.0	24.0	99.0
Total Split (%)	17.5%	17.5%	62.5%	20.0%	82.5%
Yellow Time (s)	4.8	4.8	5.5	3.6	5.5
All-Red Time (s)	1.0	1.0	1.0	0.5	1.0
Lost Time Adjust (s)	0.0	0.0	0.0	0.0	0.0
Total Lost Time (s)	5.8	5.8	6.5	4.1	6.5
Lead/Lag			Lag	Lead	
Lead-Lag Optimize?			Yes	Yes	
Recall Mode	None	None	None	None	None
Act Effct Green (s)	11.4	11.4	49.4	17.0	73.5
Actuated g/C Ratio	0.13	0.13	0.55	0.19	0.82
v/c Ratio	0.20	0.28	0.75	0.68	0.14
Control Delay	47.9	18.0	19.3	56.9	2.8
Queue Delay	0.0	0.0	0.0	0.0	0.0
Total Delay	47.9	18.0	19.3	56.9	2.8
LOS	D	B	B	E	A
Approach Delay	29.8		19.3		17.3
Approach LOS	C		B		B

Intersection Summary

Cycle Length: 120
 Actuated Cycle Length: 89.9
 Natural Cycle: 75
 Control Type: Actuated-Uncoordinated
 Maximum v/c Ratio: 0.75
 Intersection Signal Delay: 19.2
 Intersection LOS: B
 Intersection Capacity Utilization 64.7%
 ICU Level of Service C
 Analysis Period (min) 15

Splits and Phases: 23: Sycamore Canyon Bl. & Cottonwood Ave



HCM 6th Signalized Intersection Summary
23: Sycamore Canyon Bl. & Cottonwood Ave

West Campus Upper Plateau (JN 14064)
09/20/2022



Movement	WBL	WBR	NBT	NBR	SBL	SBT
Lane Configurations	↶	↶	↕	↶	↷	↷
Traffic Volume (veh/h)	29	45	1182	77	136	370
Future Volume (veh/h)	29	45	1182	77	136	370
Initial Q (Qb), veh	0	0	0	0	0	0
Ped-Bike Adj(A_pbT)	1.00	1.00		0.98	1.00	
Parking Bus, Adj	1.00	1.00	1.00	1.00	1.00	1.00
Work Zone On Approach	No		No			No
Adj Sat Flow, veh/h/ln	1263	1115	1811	1366	1070	1841
Adj Flow Rate, veh/h	32	34	1285	83	148	402
Peak Hour Factor	0.92	0.92	0.92	0.92	0.92	0.92
Percent Heavy Veh, %	43	53	6	36	56	4
Cap, veh/h	114	90	1771	114	166	2636
Arrive On Green	0.10	0.10	0.54	0.54	0.16	0.75
Sat Flow, veh/h	1203	945	3368	211	1019	3589
Grp Volume(v), veh/h	32	34	673	695	148	402
Grp Sat Flow(s),veh/h/ln	1203	945	1721	1768	1019	1749
Q Serve(g_s), s	2.0	2.8	24.1	24.2	11.6	2.6
Cycle Q Clear(g_c), s	2.0	2.8	24.1	24.2	11.6	2.6
Prop In Lane	1.00	1.00		0.12	1.00	
Lane Grp Cap(c), veh/h	114	90	930	955	166	2636
V/C Ratio(X)	0.28	0.38	0.72	0.73	0.89	0.15
Avail Cap(c_a), veh/h	224	176	1447	1486	249	3971
HCM Platoon Ratio	1.00	1.00	1.00	1.00	1.00	1.00
Upstream Filter(I)	1.00	1.00	1.00	1.00	1.00	1.00
Uniform Delay (d), s/veh	34.3	34.6	14.1	14.2	33.4	2.8
Incr Delay (d2), s/veh	1.3	2.6	1.5	1.5	22.1	0.0
Initial Q Delay(d3),s/veh	0.0	0.0	0.0	0.0	0.0	0.0
%ile BackOfQ(50%),veh/ln	0.6	0.7	8.0	8.2	3.7	0.5
Unsig. Movement Delay, s/veh						
LnGrp Delay(d),s/veh	35.6	37.2	15.7	15.7	55.5	2.8
LnGrp LOS	D	D	B	B	E	A
Approach Vol, veh/h	66		1368			550
Approach Delay, s/veh	36.4		15.7			17.0
Approach LOS	D		B			B
Timer - Assigned Phs	1	2			6	8
Phs Duration (G+Y+Rc), s	17.4	50.5			67.9	13.6
Change Period (Y+Rc), s	4.1	6.5			6.5	5.8
Max Green Setting (Gmax), s	19.9	68.5			92.5	15.2
Max Q Clear Time (g_c+1), s	13.6	26.2			4.6	4.8
Green Ext Time (p_c), s	0.2	17.8			3.9	0.1

Intersection Summary

HCM 6th Ctrl Delay	16.7
HCM 6th LOS	B

Timings

West Campus Upper Plateau (JN 14064)

24: Sycamore Canyon Bl. & Alessandro Bl.

09/20/2022

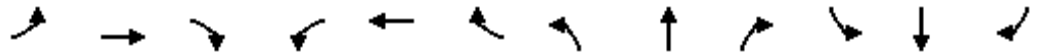

Lane Group	EBL	EBT	EBR	WBL	WBT	WBR	NBL	NBT	NBR	SBL	SBT	SBR
Lane Configurations	↖	↑↑↑	↗	↖↗	↑↑↑	↗	↖↗	↑↑	↖↗	↖↗	↑↑	↖↗
Traffic Volume (vph)	201	1466	466	252	2713	741	822	828	108	123	213	172
Future Volume (vph)	201	1466	466	252	2713	741	822	828	108	123	213	172
Turn Type	Prot	NA	Perm	Prot	NA	Perm	Prot	NA	pm+ov	Prot	NA	Perm
Protected Phases	5	2		1	6		3	8	1	7	4	
Permitted Phases			2			6			8			4
Detector Phase	5	2	2	1	6	6	3	8	1	7	4	4
Switch Phase												
Minimum Initial (s)	5.0	10.0	10.0	5.0	10.0	10.0	5.0	10.0	5.0	5.0	10.0	10.0
Minimum Split (s)	8.7	43.5	43.5	8.7	43.5	43.5	8.7	15.8	8.7	8.7	49.8	49.8
Total Split (s)	10.0	47.0	47.0	9.2	46.2	46.2	14.0	52.5	9.2	11.3	49.8	49.8
Total Split (%)	8.3%	39.2%	39.2%	7.7%	38.5%	38.5%	11.7%	43.8%	7.7%	9.4%	41.5%	41.5%
Yellow Time (s)	3.2	5.5	5.5	3.2	5.5	5.5	3.2	4.8	3.2	3.2	4.8	4.8
All-Red Time (s)	0.5	1.0	1.0	0.5	1.0	1.0	0.5	1.0	0.5	0.5	1.0	1.0
Lost Time Adjust (s)	0.0	0.0	0.0	0.0	0.0	0.0	0.0	0.0	0.0	0.0	0.0	0.0
Total Lost Time (s)	3.7	6.5	6.5	3.7	6.5	6.5	3.7	5.8	3.7	3.7	5.8	5.8
Lead/Lag	Lead	Lag	Lag	Lead	Lag	Lag	Lead	Lag	Lead	Lead	Lag	Lag
Lead-Lag Optimize?	Yes	Yes	Yes	Yes	Yes	Yes	Yes	Yes	Yes	Yes	Yes	Yes
Recall Mode	None	C-Max	C-Max	None	C-Max	C-Max	None	None	None	None	None	None
Act Effct Green (s)	16.4	40.5	40.5	15.6	39.7	39.7	10.3	36.8	54.5	7.4	33.9	33.9
Actuated g/C Ratio	0.14	0.34	0.34	0.13	0.33	0.33	0.09	0.31	0.45	0.06	0.28	0.28
v/c Ratio	0.84	0.86	0.63	0.58	1.66	1.19	2.82	0.78	0.09	0.67	0.22	0.34
Control Delay	80.3	43.5	14.2	56.3	328.9	128.9	850.4	43.2	7.7	73.1	32.2	13.1
Queue Delay	0.0	0.0	0.0	0.0	0.0	0.0	0.0	0.0	0.0	0.0	0.0	0.0
Total Delay	80.3	43.5	14.2	56.3	328.9	128.9	850.4	43.2	7.7	73.1	32.2	13.1
LOS	F	D	B	E	F	F	F	D	A	E	C	B
Approach Delay		40.6			270.4			418.5			35.6	
Approach LOS		D			F			F			D	

Intersection Summary

Cycle Length: 120
 Actuated Cycle Length: 120
 Offset: 0 (0%), Referenced to phase 2:EBT and 6:WBT, Start of Yellow
 Natural Cycle: 125
 Control Type: Actuated-Coordinated
 Maximum v/c Ratio: 2.82
 Intersection Signal Delay: 227.3
 Intersection LOS: F
 Intersection Capacity Utilization 114.1%
 ICU Level of Service H
 Analysis Period (min) 15



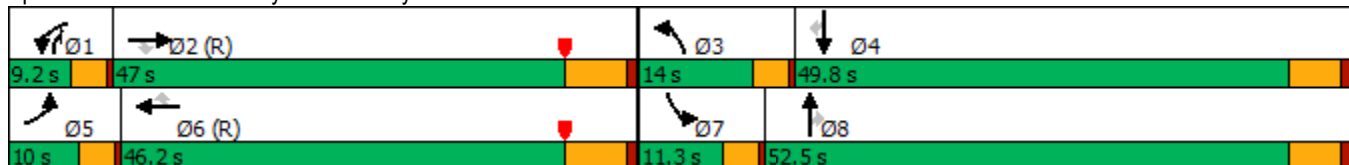































Splits and Phases: 24: Sycamore Canyon Bl. & Alessandro Bl.



HCM 6th Signalized Intersection Summary
 24: Sycamore Canyon Bl. & Alessandro Bl.

West Campus Upper Plateau (JN 14064)

09/20/2022

												
Movement	EBL	EBT	EBR	WBL	WBT	WBR	NBL	NBT	NBR	SBL	SBT	SBR
Lane Configurations		  		 	  		 	 	 	 	 	
Traffic Volume (veh/h)	201	1466	466	252	2713	741	822	828	108	123	213	172
Future Volume (veh/h)	201	1466	466	252	2713	741	822	828	108	123	213	172
Initial Q (Qb), veh	0	0	0	0	0	0	0	0	0	0	0	0
Ped-Bike Adj(A_pbT)	1.00		1.00	1.00		1.00	1.00		1.00	1.00		1.00
Parking Bus, Adj	1.00	1.00	1.00	1.00	1.00	1.00	1.00	1.00	1.00	1.00	1.00	1.00
Work Zone On Approach		No			No			No			No	
Adj Sat Flow, veh/h/ln	1870	1870	1885	1856	1841	1796	1870	1841	1826	1663	1841	1856
Adj Flow Rate, veh/h	203	1481	389	255	2740	625	830	836	79	124	215	115
Peak Hour Factor	0.99	0.99	0.99	0.99	0.99	0.99	0.99	0.99	0.99	0.99	0.99	0.99
Percent Heavy Veh, %	2	2	1	3	4	7	2	4	5	16	4	3
Cap, veh/h	94	2291	716	157	2222	673	297	999	902	171	893	401
Arrive On Green	0.05	0.45	0.45	0.05	0.44	0.44	0.09	0.29	0.29	0.06	0.26	0.26
Sat Flow, veh/h	1781	5106	1595	3428	5025	1522	3456	3497	2721	3072	3497	1569
Grp Volume(v), veh/h	203	1481	389	255	2740	625	830	836	79	124	215	115
Grp Sat Flow(s),veh/h/ln	1781	1702	1595	1714	1675	1522	1728	1749	1360	1536	1749	1569
Q Serve(g_s), s	6.3	27.0	21.3	5.5	53.1	46.6	10.3	26.9	2.4	4.8	5.9	7.1
Cycle Q Clear(g_c), s	6.3	27.0	21.3	5.5	53.1	46.6	10.3	26.9	2.4	4.8	5.9	7.1
Prop In Lane	1.00		1.00	1.00		1.00	1.00		1.00	1.00		1.00
Lane Grp Cap(c), veh/h	94	2291	716	157	2222	673	297	999	902	171	893	401
V/C Ratio(X)	2.17	0.65	0.54	1.62	1.23	0.93	2.80	0.84	0.09	0.73	0.24	0.29
Avail Cap(c_a), veh/h	94	2291	716	157	2222	673	297	1361	1184	195	1282	575
HCM Platoon Ratio	1.00	1.00	1.00	1.00	1.00	1.00	1.00	1.00	1.00	1.00	1.00	1.00
Upstream Filter(I)	0.81	0.81	0.81	0.09	0.09	0.09	1.00	1.00	1.00	1.00	1.00	1.00
Uniform Delay (d), s/veh	56.8	25.7	24.1	57.3	33.5	31.7	54.8	40.2	27.6	55.8	35.4	35.9
Incr Delay (d2), s/veh	554.3	1.2	2.4	282.9	105.4	2.9	818.5	3.5	0.0	8.7	0.1	0.4
Initial Q Delay(d3),s/veh	0.0	0.0	0.0	0.0	0.0	0.0	0.0	0.0	0.0	0.0	0.0	0.0
%ile BackOfQ(50%),veh/ln	17.2	10.5	8.1	8.5	41.7	16.5	38.1	11.6	0.8	2.0	2.5	2.7
Unsig. Movement Delay, s/veh												
LnGrp Delay(d),s/veh	611.1	26.8	26.5	340.2	138.9	34.6	873.4	43.7	27.7	64.4	35.6	36.3
LnGrp LOS	F	C	C	F	F	C	F	D	C	E	D	D
Approach Vol, veh/h		2073			3620			1745			454	
Approach Delay, s/veh		84.0			135.0			437.6			43.6	
Approach LOS		F			F			F			D	
Timer - Assigned Phs	1	2	3	4	5	6	7	8				
Phs Duration (G+Y+Rc), s	9.2	60.4	14.0	36.4	10.0	59.6	10.4	40.1				
Change Period (Y+Rc), s	3.7	6.5	3.7	5.8	3.7	6.5	3.7	5.8				
Max Green Setting (Gmax), s	5.5	40.5	10.3	44.0	6.3	39.7	7.6	46.7				
Max Q Clear Time (g_c+I1), s	7.5	29.0	12.3	9.1	8.3	55.1	6.8	28.9				
Green Ext Time (p_c), s	0.0	9.2	0.0	1.6	0.0	0.0	0.0	5.3				
Intersection Summary												
HCM 6th Ctrl Delay				183.3								
HCM 6th LOS				F								

Timings
25: Sycamore Canyon Bl. & Cactus Av.

West Campus Upper Plateau (JN 14064)

09/20/2022



Lane Group	EBL	EBT	EBR	WBL	WBT	WBR	NBT	NBR	SBL	SBT	SBR	Ø5
Lane Configurations	↘	↑↑	↗	↘↗	↑↑	↗	↑↑	↗	↘↗	↑↑	↗	
Traffic Volume (vph)	32	28	15	898	145	1250	561	327	214	362	19	
Future Volume (vph)	32	28	15	898	145	1250	561	327	214	362	19	
Turn Type	Prot	NA	Perm	Prot	NA	Perm	NA	Perm	Prot	NA	Perm	
Protected Phases	7	4		3	8		2		1	6		5
Permitted Phases			4			8		2			6	
Detector Phase	7	4	4	3	8	8	2	2	1	6	6	
Switch Phase												
Minimum Initial (s)	5.0	10.0	10.0	5.0	10.0	10.0	10.0	10.0	5.0	10.0	10.0	5.0
Minimum Split (s)	9.6	32.8	32.8	9.6	32.8	32.8	34.8	34.8	9.6	34.8	34.8	9.6
Total Split (s)	9.6	45.6	45.6	27.0	63.0	63.0	36.4	36.4	11.0	37.8	37.8	9.6
Total Split (%)	8.0%	38.0%	38.0%	22.5%	52.5%	52.5%	30.3%	30.3%	9.2%	31.5%	31.5%	8%
Yellow Time (s)	3.6	4.8	4.8	3.6	4.8	4.8	4.8	4.8	3.6	4.8	4.8	3.6
All-Red Time (s)	1.0	1.0	1.0	1.0	1.0	1.0	1.0	1.0	1.0	1.0	1.0	1.0
Lost Time Adjust (s)	0.0	0.0	0.0	0.0	0.0	0.0	0.0	0.0	0.0	0.0	0.0	0.0
Total Lost Time (s)	4.6	5.8	5.8	4.6	5.8	5.8	5.8	5.8	4.6	5.8	5.8	
Lead/Lag	Lead	Lag	Lag	Lead	Lag	Lag	Lag	Lag	Lead	Lag	Lag	Lead
Lead-Lag Optimize?	Yes	Yes	Yes	Yes	Yes	Yes	Yes	Yes	Yes	Yes	Yes	Yes
Recall Mode	None	None	None	None	None	None	None	None	None	None	None	None
Act Effct Green (s)	5.0	26.8	26.8	38.6	57.6	57.6	25.0	25.0	6.4	36.1	36.1	
Actuated g/C Ratio	0.05	0.24	0.24	0.35	0.52	0.52	0.23	0.23	0.06	0.33	0.33	
v/c Ratio	0.46	0.04	0.03	0.81	0.09	1.42	0.75	0.55	1.13	0.33	0.03	
Control Delay	75.7	28.1	0.1	45.4	15.4	215.9	47.0	7.6	152.1	29.3	0.1	
Queue Delay	0.0	0.0	0.0	0.0	0.0	0.0	0.0	0.0	0.0	0.0	0.0	
Total Delay	75.7	28.1	0.1	45.4	15.4	216.0	47.0	7.6	152.1	29.3	0.1	
LOS	E	C	A	D	B	F	D	A	F	C	A	
Approach Delay		43.0			136.5		32.5			72.5		
Approach LOS		D			F		C			E		

Intersection Summary

Cycle Length: 120
 Actuated Cycle Length: 110.8
 Natural Cycle: 130
 Control Type: Actuated-Uncoordinated
 Maximum v/c Ratio: 1.42
 Intersection Signal Delay: 100.8
 Intersection Capacity Utilization 110.6%
 Analysis Period (min) 15
 Intersection LOS: F
 ICU Level of Service H

Splits and Phases: 25: Sycamore Canyon Bl. & Cactus Av.

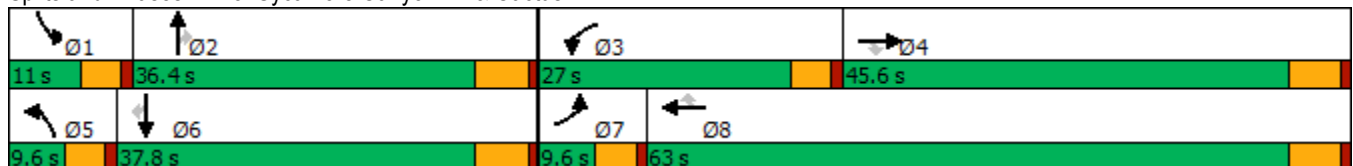

HCM 6th Signalized Intersection Summary
 25: Sycamore Canyon Bl. & Cactus Av.

West Campus Upper Plateau (JN 14064)

09/20/2022



Movement	EBL	EBT	EBR	WBL	WBT	WBR	NBL	NBT	NBR	SBL	SBT	SBR
Lane Configurations												
Traffic Volume (veh/h)	32	28	15	898	145	1250	0	561	327	214	362	19
Future Volume (veh/h)	32	28	15	898	145	1250	0	561	327	214	362	19
Initial Q (Qb), veh	0	0	0	0	0	0	0	0	0	0	0	0
Ped-Bike Adj(A_pbT)	1.00		1.00	1.00		0.99	1.00		1.00	1.00		0.99
Parking Bus, Adj	1.00	1.00	1.00	1.00	1.00	1.00	1.00	1.00	1.00	1.00	1.00	1.00
Work Zone On Approach		No			No			No			No	
Adj Sat Flow, veh/h/ln	1693	1396	1841	1796	1722	1856	1870	1811	1826	1841	1856	1781
Adj Flow Rate, veh/h	33	29	14	926	149	1070	0	578	240	221	373	17
Peak Hour Factor	0.97	0.97	0.97	0.97	0.97	0.97	0.97	0.97	0.97	0.97	0.97	0.97
Percent Heavy Veh, %	14	34	4	7	12	3	2	6	5	4	3	8
Cap, veh/h	46	911	536	672	1693	803	3	715	322	197	1084	458
Arrive On Green	0.03	0.34	0.34	0.20	0.52	0.52	0.00	0.21	0.21	0.06	0.31	0.31
Sat Flow, veh/h	1612	2653	1560	3319	3272	1553	3456	3441	1547	3401	3526	1490
Grp Volume(v), veh/h	33	29	14	926	149	1070	0	578	240	221	373	17
Grp Sat Flow(s),veh/h/ln	1612	1326	1560	1659	1636	1553	1728	1721	1547	1700	1763	1490
Q Serve(g_s), s	2.2	0.8	0.7	22.4	2.5	57.2	0.0	17.7	16.1	6.4	9.1	0.9
Cycle Q Clear(g_c), s	2.2	0.8	0.7	22.4	2.5	57.2	0.0	17.7	16.1	6.4	9.1	0.9
Prop In Lane	1.00		1.00	1.00		1.00	1.00		1.00	1.00		1.00
Lane Grp Cap(c), veh/h	46	911	536	672	1693	803	3	715	322	197	1084	458
V/C Ratio(X)	0.71	0.03	0.03	1.38	0.09	1.33	0.00	0.81	0.75	1.12	0.34	0.04
Avail Cap(c_a), veh/h	73	955	561	672	1693	803	156	952	428	197	1084	458
HCM Platoon Ratio	1.00	1.00	1.00	1.00	1.00	1.00	1.00	1.00	1.00	1.00	1.00	1.00
Upstream Filter(I)	1.00	1.00	1.00	1.00	1.00	1.00	0.00	1.00	1.00	1.00	1.00	1.00
Uniform Delay (d), s/veh	53.2	24.1	24.0	44.1	13.5	26.7	0.0	41.7	41.1	52.1	29.7	26.8
Incr Delay (d2), s/veh	7.2	0.0	0.0	179.1	0.0	157.9	0.0	3.9	4.9	101.0	0.2	0.0
Initial Q Delay(d3),s/veh	0.0	0.0	0.0	0.0	0.0	0.0	0.0	0.0	0.0	0.0	0.0	0.0
%ile BackOfQ(50%),veh/ln	1.0	0.2	0.2	25.5	0.9	54.0	0.0	7.6	6.3	5.4	3.7	0.3
Unsig. Movement Delay, s/veh												
LnGrp Delay(d),s/veh	60.5	24.1	24.1	223.1	13.5	184.6	0.0	45.6	46.0	153.1	29.8	26.9
LnGrp LOS	E	C	C	F	B	F	A	D	D	F	C	C
Approach Vol, veh/h		76			2145			818				611
Approach Delay, s/veh		39.9			189.3			45.7				74.3
Approach LOS		D			F			D				E
Timer - Assigned Phs	1	2	3	4	5	6	7	8				
Phs Duration (G+Y+Rc), s	11.0	28.8	27.0	43.8	0.0	39.8	7.8	63.0				
Change Period (Y+Rc), s	4.6	5.8	4.6	5.8	4.6	5.8	4.6	5.8				
Max Green Setting (Gmax), s	6.4	30.6	22.4	39.8	5.0	32.0	5.0	57.2				
Max Q Clear Time (g_c+I1), s	8.4	19.7	24.4	2.8	0.0	11.1	4.2	59.2				
Green Ext Time (p_c), s	0.0	3.3	0.0	0.2	0.0	2.2	0.0	0.0				

Intersection Summary

HCM 6th Ctrl Delay	134.8
HCM 6th LOS	F

Timings

26: Sycamore Canyon Bl. & Van Buren Bl.

09/20/2022



Lane Group	EBL	EBT	EBR	WBL	WBT	WBR	NBL	NBT	SBL	SBT	SBR
Lane Configurations	↔↔	↑↑↑	↔	↔	↑↑↑	↔		↔↔	↔↔	↑	↔
Traffic Volume (vph)	706	2623	31	55	3898	195	5	4	119	11	622
Future Volume (vph)	706	2623	31	55	3898	195	5	4	119	11	622
Turn Type	Prot	NA	Perm	Prot	NA	Perm	Perm	NA	Split	NA	Perm
Protected Phases	5	2		1	6			8	4	4	
Permitted Phases			2			6	8				4
Detector Phase	5	2	2	1	6	6	8	8	4	4	4
Switch Phase											
Minimum Initial (s)	5.0	10.0	10.0	5.0	10.0	10.0	10.0	10.0	10.0	10.0	10.0
Minimum Split (s)	9.6	29.2	29.2	9.6	29.2	29.2	14.6	14.6	50.8	50.8	50.8
Total Split (s)	25.0	50.9	50.9	13.7	39.6	39.6	14.6	14.6	50.8	50.8	50.8
Total Split (%)	19.2%	39.2%	39.2%	10.5%	30.5%	30.5%	11.2%	11.2%	39.1%	39.1%	39.1%
Yellow Time (s)	3.6	5.2	5.2	3.6	5.2	5.2	3.6	3.6	4.8	4.8	4.8
All-Red Time (s)	1.0	1.0	1.0	1.0	1.0	1.0	1.0	1.0	1.0	1.0	1.0
Lost Time Adjust (s)	0.0	0.0	0.0	0.0	0.0	0.0		0.0	0.0	0.0	0.0
Total Lost Time (s)	4.6	6.2	6.2	4.6	6.2	6.2		4.6	5.8	5.8	5.8
Lead/Lag	Lead	Lag	Lag	Lead	Lag	Lag					
Lead-Lag Optimize?	Yes	Yes	Yes	Yes	Yes	Yes					
Recall Mode	None	None	None	None	None	None	None	None	None	None	None
Act Effct Green (s)	21.1	50.8	50.8	7.4	34.6	34.6		10.4	25.4	25.4	25.4
Actuated g/C Ratio	0.20	0.49	0.49	0.07	0.34	0.34		0.10	0.25	0.25	0.25
v/c Ratio	1.08	0.94	0.04	0.47	2.03	0.36		0.04	0.17	0.03	0.91
Control Delay	97.6	36.1	0.1	63.7	487.0	14.4		43.2	30.0	28.5	29.3
Queue Delay	0.0	0.0	0.0	0.0	0.0	0.0		0.0	0.0	0.0	0.0
Total Delay	97.6	36.1	0.1	63.7	487.0	14.4		43.2	30.0	28.5	29.3
LOS	F	D	A	E	F	B		D	C	C	C
Approach Delay		48.7			459.2			43.2		29.4	
Approach LOS		D			F			D		C	

Intersection Summary

Cycle Length: 130	
Actuated Cycle Length: 103.1	
Natural Cycle: 125	
Control Type: Actuated-Uncoordinated	
Maximum v/c Ratio: 2.03	
Intersection Signal Delay: 252.8	Intersection LOS: F
Intersection Capacity Utilization 117.2%	ICU Level of Service H
Analysis Period (min) 15	

Splits and Phases: 26: Sycamore Canyon Bl. & Van Buren Bl.

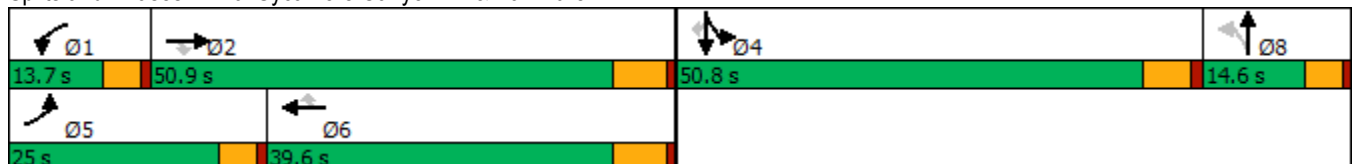

HCM 6th Signalized Intersection Summary
26: Sycamore Canyon Bl. & Van Buren Bl.

West Campus Upper Plateau (JN 14064)

09/20/2022



Movement	EBL	EBT	EBR	WBL	WBT	WBR	NBL	NBT	NBR	SBL	SBT	SBR
Lane Configurations	↔↔	↑↑↑	↔	↔	↑↑↑↑	↔		↔↔		↔↔	↑	↔
Traffic Volume (veh/h)	706	2623	31	55	3898	195	5	4	4	119	11	622
Future Volume (veh/h)	706	2623	31	55	3898	195	5	4	4	119	11	622
Initial Q (Qb), veh	0	0	0	0	0	0	0	0	0	0	0	0
Ped-Bike Adj(A_pbT)	1.00		1.00	1.00		1.00	1.00		1.00	1.00		1.00
Parking Bus, Adj	1.00	1.00	1.00	1.00	1.00	1.00	1.00	1.00	1.00	1.00	1.00	1.00
Work Zone On Approach		No			No			No			No	
Adj Sat Flow, veh/h/ln	1885	1811	1900	1900	1826	1781	1900	1900	1900	1737	1900	1885
Adj Flow Rate, veh/h	767	2851	33	60	4237	187	5	4	2	129	12	0
Peak Hour Factor	0.92	0.92	0.92	0.92	0.92	0.92	0.92	0.92	0.92	0.92	0.92	0.92
Percent Heavy Veh, %	1	6	0	0	5	8	0	0	0	11	0	1
Cap, veh/h	817	3578	925	80	2411	580	42	36	18	357	211	
Arrive On Green	0.23	0.57	0.57	0.04	0.38	0.38	0.03	0.03	0.03	0.11	0.11	0.00
Sat Flow, veh/h	3483	6230	1610	1810	6281	1510	1581	1340	679	3209	1900	1598
Grp Volume(v), veh/h	767	2851	33	60	4237	187	6	0	5	129	12	0
Grp Sat Flow(s),veh/h/ln	1742	1558	1610	1810	1570	1510	1821	0	1778	1605	1900	1598
Q Serve(g_s), s	18.8	31.2	0.8	2.9	33.4	7.6	0.3	0.0	0.3	3.2	0.5	0.0
Cycle Q Clear(g_c), s	18.8	31.2	0.8	2.9	33.4	7.6	0.3	0.0	0.3	3.2	0.5	0.0
Prop In Lane	1.00		1.00	1.00		1.00	0.87		0.38	1.00		1.00
Lane Grp Cap(c), veh/h	817	3578	925	80	2411	580	49	0	48	357	211	
V/C Ratio(X)	0.94	0.80	0.04	0.75	1.76	0.32	0.12	0.00	0.11	0.36	0.06	
Avail Cap(c_a), veh/h	817	3578	925	189	2411	580	209	0	204	1660	983	
HCM Platoon Ratio	1.00	1.00	1.00	1.00	1.00	1.00	1.00	1.00	1.00	1.00	1.00	1.00
Upstream Filter(I)	1.00	1.00	1.00	1.00	1.00	1.00	1.00	0.00	1.00	1.00	1.00	0.00
Uniform Delay (d), s/veh	32.7	14.5	8.0	41.1	26.8	18.8	41.3	0.0	41.3	35.8	34.6	0.0
Incr Delay (d2), s/veh	18.2	1.3	0.0	5.3	342.4	0.3	1.1	0.0	1.0	0.6	0.1	0.0
Initial Q Delay(d3),s/veh	0.0	0.0	0.0	0.0	0.0	0.0	0.0	0.0	0.0	0.0	0.0	0.0
%ile BackOfQ(50%),veh/ln	9.4	9.2	0.2	1.3	68.4	2.5	0.1	0.0	0.1	1.2	0.2	0.0
Unsig. Movement Delay, s/veh												
LnGrp Delay(d),s/veh	50.9	15.9	8.1	46.4	369.2	19.2	42.4	0.0	42.3	36.4	34.7	0.0
LnGrp LOS	D	B	A	D	F	B	D	A	D	D	C	
Approach Vol, veh/h		3651			4484			11			141	
Approach Delay, s/veh		23.1			350.3			42.4			36.3	
Approach LOS		C			F			D			D	
Timer - Assigned Phs	1	2		4	5	6		8				
Phs Duration (G+Y+Rc), s	8.4	56.2		15.5	25.0	39.6		6.9				
Change Period (Y+Rc), s	4.6	6.2		5.8	4.6	6.2		4.6				
Max Green Setting (Gmax), s	9.1	44.7		45.0	20.4	33.4		10.0				
Max Q Clear Time (g_c+I1), s	4.9	33.2		5.2	20.8	35.4		2.3				
Green Ext Time (p_c), s	0.0	10.8		0.5	0.0	0.0		0.0				

Intersection Summary

HCM 6th Ctrl Delay	200.4
HCM 6th LOS	F

Notes

Unsignalized Delay for [SBR] is excluded from calculations of the approach delay and intersection delay.

Timings
27: Innovation Dr. & Cactus Av.

West Campus Upper Plateau (JN 14064)

09/20/2022

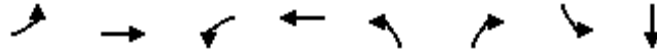

Lane Group	EBL	EBT	WBL	WBT	NBL	NBR	SBL	SBT
Lane Configurations	↖	↖↖↖	↖	↖↖↖	↖	↖	↖	↖
Traffic Volume (vph)	5	489	146	2228	13	41	5	0
Future Volume (vph)	5	489	146	2228	13	41	5	0
Turn Type	Prot	NA	Prot	NA	Perm	Perm	Perm	NA
Protected Phases	5	2	1	6				4
Permitted Phases					8	8	4	
Detector Phase	5	2	1	6	8	8	4	4
Switch Phase								
Minimum Initial (s)	5.0	10.0	5.0	10.0	10.0	10.0	10.0	10.0
Minimum Split (s)	9.2	26.8	9.2	26.8	31.1	31.1	31.1	31.1
Total Split (s)	12.0	57.0	31.0	76.0	32.0	32.0	32.0	32.0
Total Split (%)	10.0%	47.5%	25.8%	63.3%	26.7%	26.7%	26.7%	26.7%
Yellow Time (s)	3.2	4.8	3.2	4.8	4.1	4.1	4.1	4.1
All-Red Time (s)	1.0	1.0	1.0	1.0	1.0	1.0	1.0	1.0
Lost Time Adjust (s)	0.0	0.0	0.0	0.0	0.0	0.0	0.0	0.0
Total Lost Time (s)	4.2	5.8	4.2	5.8	5.1	5.1	5.1	5.1
Lead/Lag	Lead	Lag	Lead	Lag				
Lead-Lag Optimize?	Yes	Yes	Yes	Yes				
Recall Mode	None	None	None	None	None	None	None	None
Act Effct Green (s)	5.6	49.2	12.3	68.2	13.2	13.2	13.2	13.2
Actuated g/C Ratio	0.07	0.60	0.15	0.83	0.16	0.16	0.16	0.16
v/c Ratio	0.04	0.18	0.58	0.57	0.07	0.07	0.03	0.01
Control Delay	48.4	10.1	47.2	7.3	37.5	0.2	36.4	0.0
Queue Delay	0.0	0.0	0.0	0.1	0.0	0.0	0.0	0.0
Total Delay	48.4	10.1	47.2	7.3	37.5	0.2	36.4	0.0
LOS	D	B	D	A	D	A	D	A
Approach Delay		10.4		9.7				22.8
Approach LOS		B		A				C

Intersection Summary

Cycle Length: 120
 Actuated Cycle Length: 82.3
 Natural Cycle: 90
 Control Type: Actuated-Uncoordinated
 Maximum v/c Ratio: 0.58
 Intersection Signal Delay: 9.9
 Intersection Capacity Utilization 69.4%
 Analysis Period (min) 15
 Intersection LOS: A
 ICU Level of Service C

Splits and Phases: 27: Innovation Dr. & Cactus Av.



HCM 6th Signalized Intersection Summary
27: Innovation Dr. & Cactus Av.

West Campus Upper Plateau (JN 14064)

09/20/2022



Movement	EBL	EBT	EBR	WBL	WBT	WBR	NBL	NBT	NBR	SBL	SBT	SBR
Lane Configurations	↗	↑↑↑		↖	↑↑↑		↖	↑	↗	↖	↑	↗
Traffic Volume (veh/h)	5	489	19	146	2228	56	13	0	41	5	0	3
Future Volume (veh/h)	5	489	19	146	2228	56	13	0	41	5	0	3
Initial Q (Qb), veh	0	0	0	0	0	0	0	0	0	0	0	0
Ped-Bike Adj(A_pbT)	1.00		1.00	1.00		1.00	1.00		1.00	1.00		1.00
Parking Bus, Adj	1.00	1.00	1.00	1.00	1.00	1.00	1.00	1.00	1.00	1.00	1.00	1.00
Work Zone On Approach		No			No			No			No	
Adj Sat Flow, veh/h/ln	1900	1781	1900	1826	1841	1870	1455	1900	1515	1530	1900	1900
Adj Flow Rate, veh/h	5	499	17	149	2273	57	13	0	29	5	0	2
Peak Hour Factor	0.98	0.98	0.98	0.98	0.98	0.98	0.98	0.98	0.98	0.98	0.98	0.98
Percent Heavy Veh, %	0	8	0	5	4	2	30	0	26	25	0	0
Cap, veh/h	12	3013	102	185	3649	91	179	157	106	183	0	133
Arrive On Green	0.01	0.62	0.62	0.11	0.72	0.72	0.08	0.00	0.08	0.08	0.00	0.08
Sat Flow, veh/h	1810	4830	164	1739	5042	126	1101	1900	1284	1129	0	1610
Grp Volume(v), veh/h	5	334	182	149	1508	822	13	0	29	5	0	2
Grp Sat Flow(s),veh/h/ln	1810	1621	1752	1739	1675	1818	1101	1900	1284	1129	0	1610
Q Serve(g_s), s	0.2	3.5	3.5	6.8	18.3	18.4	0.9	0.0	1.7	0.3	0.0	0.1
Cycle Q Clear(g_c), s	0.2	3.5	3.5	6.8	18.3	18.4	1.0	0.0	1.7	0.3	0.0	0.1
Prop In Lane	1.00		0.09	1.00		0.07	1.00		1.00	1.00		1.00
Lane Grp Cap(c), veh/h	12	2022	1093	185	2424	1316	179	157	106	183	0	133
V/C Ratio(X)	0.42	0.17	0.17	0.80	0.62	0.62	0.07	0.00	0.27	0.03	0.00	0.02
Avail Cap(c_a), veh/h	175	2057	1112	578	2914	1582	455	633	428	466	0	537
HCM Platoon Ratio	1.00	1.00	1.00	1.00	1.00	1.00	1.00	1.00	1.00	1.00	1.00	1.00
Upstream Filter(I)	1.00	1.00	1.00	1.00	1.00	1.00	1.00	0.00	1.00	1.00	0.00	1.00
Uniform Delay (d), s/veh	39.9	6.4	6.4	35.2	5.6	5.6	34.4	0.0	34.7	34.1	0.0	34.0
Incr Delay (d2), s/veh	8.5	0.1	0.1	3.1	0.4	0.8	0.2	0.0	1.4	0.1	0.0	0.0
Initial Q Delay(d3),s/veh	0.0	0.0	0.0	0.0	0.0	0.0	0.0	0.0	0.0	0.0	0.0	0.0
%ile BackOfQ(50%),veh/ln	0.1	0.9	1.0	2.8	3.7	4.2	0.2	0.0	0.6	0.1	0.0	0.0
Unsig. Movement Delay, s/veh												
LnGrp Delay(d),s/veh	48.5	6.4	6.5	38.3	6.0	6.4	34.6	0.0	36.1	34.2	0.0	34.0
LnGrp LOS	D	A	A	D	A	A	C	A	D	C	A	C
Approach Vol, veh/h		521			2479			42				7
Approach Delay, s/veh		6.8			8.1			35.7				34.1
Approach LOS		A			A			D				C
Timer - Assigned Phs	1	2		4	5	6		8				
Phs Duration (G+Y+Rc), s	12.8	56.1		11.8	4.7	64.2		11.8				
Change Period (Y+Rc), s	* 4.2	5.8		5.1	* 4.2	5.8		5.1				
Max Green Setting (Gmax), s	* 27	51.2		26.9	* 7.8	70.2		26.9				
Max Q Clear Time (g_c+I1), s	8.8	5.5		2.3	2.2	20.4		3.7				
Green Ext Time (p_c), s	0.2	4.8		0.0	0.0	38.0		0.1				

Intersection Summary

HCM 6th Ctrl Delay	8.3
HCM 6th LOS	A

Notes

* HCM 6th computational engine requires equal clearance times for the phases crossing the barrier.

Timings
28: I-215 SB Ramps & Alessandro Bl.

West Campus Upper Plateau (JN 14064)

09/20/2022

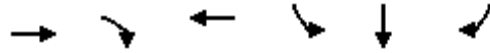

Lane Group	EBT	EBR	WBT	SBL	SBT	SBR
Lane Configurations	↑↑↑	↑	↑↑↑	↑	↔	↑
Traffic Volume (vph)	1193	479	3175	453	0	532
Future Volume (vph)	1193	479	3175	453	0	532
Turn Type	NA	Perm	NA	Split	NA	Perm
Protected Phases	2		6	4	4	
Permitted Phases		2				4
Detector Phase	2	2	6	4	4	4
Switch Phase						
Minimum Initial (s)	5.0	5.0	5.0	5.0	5.0	5.0
Minimum Split (s)	10.5	10.5	34.5	10.0	10.0	10.0
Total Split (s)	49.0	49.0	49.0	36.0	36.0	36.0
Total Split (%)	57.6%	57.6%	57.6%	42.4%	42.4%	42.4%
Yellow Time (s)	4.5	4.5	4.5	4.0	4.0	4.0
All-Red Time (s)	1.0	1.0	1.0	1.0	1.0	1.0
Lost Time Adjust (s)	0.0	0.0	0.0	0.0	0.0	0.0
Total Lost Time (s)	5.5	5.5	5.5	5.0	5.0	5.0
Lead/Lag						
Lead-Lag Optimize?						
Recall Mode	C-Min	C-Min	C-Min	None	None	None
Act Effct Green (s)	49.4	49.4	49.4	25.1	25.1	25.1
Actuated g/C Ratio	0.58	0.58	0.58	0.30	0.30	0.30
v/c Ratio	0.42	0.49	1.21	0.74	0.77	0.75
Control Delay	11.2	6.6	110.4	36.0	36.3	35.0
Queue Delay	0.0	0.0	0.0	0.0	0.0	0.0
Total Delay	11.2	6.6	110.4	36.0	36.3	35.0
LOS	B	A	F	D	D	D
Approach Delay	9.9		110.4		35.8	
Approach LOS	A		F		D	

Intersection Summary

Cycle Length: 85
 Actuated Cycle Length: 85
 Offset: 50 (59%), Referenced to phase 2:EBT and 6:WBT, Start of Yellow
 Natural Cycle: 130
 Control Type: Actuated-Coordinated
 Maximum v/c Ratio: 1.21
 Intersection Signal Delay: 70.9
 Intersection LOS: E
 Intersection Capacity Utilization 98.3%
 ICU Level of Service F
 Analysis Period (min) 15

Splits and Phases: 28: I-215 SB Ramps & Alessandro Bl.

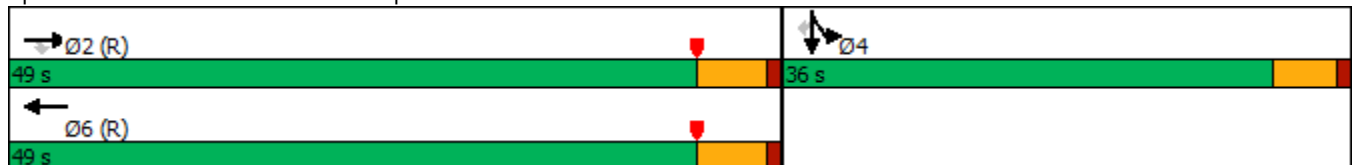

HCM 6th Signalized Intersection Summary
 28: I-215 SB Ramps & Alessandro Bl.

West Campus Upper Plateau (JN 14064)

09/20/2022



Movement	EBL	EBT	EBR	WBL	WBT	WBR	NBL	NBT	NBR	SBL	SBT	SBR
Lane Configurations		↑↑↑	↗		↑↑↑					↘	↔	↗
Traffic Volume (veh/h)	0	1193	479	0	3175	280	0	0	0	453	0	532
Future Volume (veh/h)	0	1193	479	0	3175	280	0	0	0	453	0	532
Initial Q (Qb), veh	0	0	0	0	0	0				0	0	0
Ped-Bike Adj(A_pbT)	1.00		1.00	1.00		1.00				1.00		1.00
Parking Bus, Adj	1.00	1.00	1.00	1.00	1.00	1.00				1.00	1.00	1.00
Work Zone On Approach		No			No						No	
Adj Sat Flow, veh/h/ln	0	1841	1826	0	1856	1796				1796	1900	1707
Adj Flow Rate, veh/h	0	1205	484	0	3207	273				602	0	306
Peak Hour Factor	0.99	0.99	0.99	0.99	0.99	0.99				0.99	0.99	0.99
Percent Heavy Veh, %	0	4	5	0	3	7				7	0	13
Cap, veh/h	0	3120	960	0	2960	245				875	0	370
Arrive On Green	0.00	0.62	0.62	0.00	0.20	0.20				0.26	0.00	0.26
Sat Flow, veh/h	0	5191	1546	0	4934	395				3421	0	1447
Grp Volume(v), veh/h	0	1205	484	0	2246	1234				602	0	306
Grp Sat Flow(s),veh/h/ln	0	1675	1546	0	1689	1784				1711	0	1447
Q Serve(g_s), s	0.0	10.2	14.7	0.0	52.8	52.8				13.5	0.0	17.0
Cycle Q Clear(g_c), s	0.0	10.2	14.7	0.0	52.8	52.8				13.5	0.0	17.0
Prop In Lane	0.00		1.00	0.00		0.22				1.00		1.00
Lane Grp Cap(c), veh/h	0	3120	960	0	2097	1108				875	0	370
V/C Ratio(X)	0.00	0.39	0.50	0.00	1.07	1.11				0.69	0.00	0.83
Avail Cap(c_a), veh/h	0	3120	960	0	2097	1108				1248	0	528
HCM Platoon Ratio	1.00	1.00	1.00	1.00	0.33	0.33				1.00	1.00	1.00
Upstream Filter(I)	0.00	0.50	0.50	0.00	0.09	0.09				1.00	0.00	1.00
Uniform Delay (d), s/veh	0.0	8.0	8.9	0.0	33.8	33.8				28.6	0.0	29.9
Incr Delay (d2), s/veh	0.0	0.2	0.9	0.0	33.2	52.6				1.0	0.0	7.3
Initial Q Delay(d3),s/veh	0.0	0.0	0.0	0.0	0.0	0.0				0.0	0.0	0.0
%ile BackOfQ(50%),veh/ln	0.0	2.7	3.7	0.0	32.7	40.6				5.2	0.0	6.2
Unsig. Movement Delay, s/veh												
LnGrp Delay(d),s/veh	0.0	8.2	9.8	0.0	66.9	86.4				29.6	0.0	37.1
LnGrp LOS	A	A	A	A	F	F				C	A	D
Approach Vol, veh/h		1689			3480						908	
Approach Delay, s/veh		8.7			73.8						32.1	
Approach LOS		A			E						C	
Timer - Assigned Phs		2		4		6						
Phs Duration (G+Y+Rc), s		58.3		26.7		58.3						
Change Period (Y+Rc), s		5.5		5.0		5.5						
Max Green Setting (Gmax), s		43.5		31.0		43.5						
Max Q Clear Time (g_c+I1), s		16.7		19.0		54.8						
Green Ext Time (p_c), s		10.8		2.8		0.0						

Intersection Summary

HCM 6th Ctrl Delay	49.5
HCM 6th LOS	D

Notes

User approved volume balancing among the lanes for turning movement.

Timings
29: I-215 NB Ramps & Alessandro Bl.

West Campus Upper Plateau (JN 14064)

09/20/2022



Lane Group	EBL	EBT	WBT	WBR	NBL	NBT	NBR
Lane Configurations	↶	↷↷↷	↶↶↶	↷	↶	↷↷	↷
Traffic Volume (vph)	118	1547	2149	189	1307	0	496
Future Volume (vph)	118	1547	2149	189	1307	0	496
Turn Type	Prot	NA	NA	Perm	Split	NA	Perm
Protected Phases	5	2	6		8	8	
Permitted Phases				6			8
Detector Phase	5	2	6	6	8	8	8
Switch Phase							
Minimum Initial (s)	5.0	5.0	5.0	5.0	5.0	5.0	5.0
Minimum Split (s)	9.5	10.5	33.5	33.5	10.0	10.0	10.0
Total Split (s)	25.0	60.0	35.0	35.0	25.0	25.0	25.0
Total Split (%)	29.4%	70.6%	41.2%	41.2%	29.4%	29.4%	29.4%
Yellow Time (s)	3.5	4.5	4.5	4.5	4.0	4.0	4.0
All-Red Time (s)	1.0	1.0	1.0	1.0	1.0	1.0	1.0
Lost Time Adjust (s)	0.0	0.0	0.0	0.0	0.0	0.0	0.0
Total Lost Time (s)	4.5	5.5	5.5	5.5	5.0	5.0	5.0
Lead/Lag	Lead		Lag	Lag			
Lead-Lag Optimize?	Yes		Yes	Yes			
Recall Mode	None	C-Min	C-Min	C-Min	Max	Max	Max
Act Effct Green (s)	12.0	54.5	40.2	40.2	20.0	20.0	20.0
Actuated g/C Ratio	0.14	0.64	0.47	0.47	0.24	0.24	0.24
v/c Ratio	0.60	0.49	0.91	0.25	1.83	1.61	1.15
Control Delay	38.3	10.5	30.2	10.3	406.6	307.8	121.6
Queue Delay	0.0	0.0	0.0	0.0	0.0	0.0	0.0
Total Delay	38.3	10.5	30.2	10.3	406.6	307.8	121.6
LOS	D	B	C	B	F	F	F
Approach Delay		12.5	28.6			299.0	
Approach LOS		B	C			F	

Intersection Summary

Cycle Length: 85
 Actuated Cycle Length: 85
 Offset: 20 (24%), Referenced to phase 2:EBT and 6:WBT, Start of Yellow
 Natural Cycle: 110
 Control Type: Actuated-Coordinated
 Maximum v/c Ratio: 1.83
 Intersection Signal Delay: 108.0
 Intersection LOS: F
 Intersection Capacity Utilization 101.8%
 ICU Level of Service G
 Analysis Period (min) 15

Splits and Phases: 29: I-215 NB Ramps & Alessandro Bl.



HCM 6th Signalized Intersection Summary
 29: I-215 NB Ramps & Alessandro Bl.

West Campus Upper Plateau (JN 14064)

09/20/2022



Movement	EBL	EBT	EBR	WBL	WBT	WBR	NBL	NBT	NBR	SBL	SBT	SBR
Lane Configurations	↘	↑↑↑			↑↑↑	↗	↘	↕	↗			
Traffic Volume (veh/h)	118	1547	0	0	2149	189	1307	0	496	0	0	0
Future Volume (veh/h)	118	1547	0	0	2149	189	1307	0	496	0	0	0
Initial Q (Qb), veh	0	0	0	0	0	0	0	0	0			
Ped-Bike Adj(A_pbT)	1.00		1.00	1.00		1.00	1.00		1.00			
Parking Bus, Adj	1.00	1.00	1.00	1.00	1.00	1.00	1.00	1.00	1.00			
Work Zone On Approach		No			No			No				
Adj Sat Flow, veh/h/ln	1500	1856	0	0	1870	1796	1811	1900	1737			
Adj Flow Rate, veh/h	120	1579	0	0	2193	186	1467	0	285			
Peak Hour Factor	0.98	0.98	0.98	0.98	0.98	0.98	0.98	0.98	0.98			
Percent Heavy Veh, %	27	3	0	0	2	7	6	0	11			
Cap, veh/h	146	3248	0	0	2481	740	812	0	346			
Arrive On Green	0.03	0.21	0.00	0.00	0.49	0.49	0.24	0.00	0.24			
Sat Flow, veh/h	1428	5233	0	0	5274	1522	3450	0	1472			
Grp Volume(v), veh/h	120	1579	0	0	2193	186	1467	0	285			
Grp Sat Flow(s),veh/h/ln	1428	1689	0	0	1702	1522	1725	0	1472			
Q Serve(g_s), s	7.1	23.3	0.0	0.0	32.9	6.1	20.0	0.0	15.6			
Cycle Q Clear(g_c), s	7.1	23.3	0.0	0.0	32.9	6.1	20.0	0.0	15.6			
Prop In Lane	1.00		0.00	0.00		1.00	1.00		1.00			
Lane Grp Cap(c), veh/h	146	3248	0	0	2481	740	812	0	346			
V/C Ratio(X)	0.82	0.49	0.00	0.00	0.88	0.25	1.81	0.00	0.82			
Avail Cap(c_a), veh/h	345	3248	0	0	2481	740	812	0	346			
HCM Platoon Ratio	0.33	0.33	1.00	1.00	1.00	1.00	1.00	1.00	1.00			
Upstream Filter(I)	0.87	0.87	0.00	0.00	1.00	1.00	1.00	0.00	1.00			
Uniform Delay (d), s/veh	40.3	21.2	0.0	0.0	19.7	12.8	32.5	0.0	30.8			
Incr Delay (d2), s/veh	7.2	0.5	0.0	0.0	5.0	0.8	368.2	0.0	19.4			
Initial Q Delay(d3),s/veh	0.0	0.0	0.0	0.0	0.0	0.0	0.0	0.0	0.0			
%ile BackOfQ(50%),veh/ln	2.7	10.3	0.0	0.0	11.6	1.9	49.3	0.0	7.1			
Unsig. Movement Delay, s/veh												
LnGrp Delay(d),s/veh	47.5	21.7	0.0	0.0	24.7	13.6	400.7	0.0	50.2			
LnGrp LOS	D	C	A	A	C	B	F	A	D			
Approach Vol, veh/h		1699			2379			1752				
Approach Delay, s/veh		23.5			23.9			343.7				
Approach LOS		C			C			F				
Timer - Assigned Phs		2			5	6		8				
Phs Duration (G+Y+Rc), s		60.0			13.2	46.8		25.0				
Change Period (Y+Rc), s		5.5			4.5	5.5		5.0				
Max Green Setting (Gmax), s		54.5			20.5	29.5		20.0				
Max Q Clear Time (g_c+I1), s		25.3			9.1	34.9		22.0				
Green Ext Time (p_c), s		12.4			0.1	0.0		0.0				

Intersection Summary

HCM 6th Ctrl Delay	119.9
HCM 6th LOS	F

Notes

User approved volume balancing among the lanes for turning movement.

Timings
30: I-215 SB Ramps & Cactus Av.

West Campus Upper Plateau (JN 14064)

09/20/2022



Lane Group	EBT	EBR	WBL	WBT	NBR	SBR
Lane Configurations	↑↑	↑	↓	↑↑	↑	↑
Traffic Volume (vph)	505	18	948	2040	974	325
Future Volume (vph)	505	18	948	2040	974	325
Turn Type	NA	Perm	Prot	NA	Prot	Prot
Protected Phases	2		1	6	8	4
Permitted Phases		2				
Detector Phase	2	2	1	6	8	4
Switch Phase						
Minimum Initial (s)	5.0	5.0	5.0	5.0	5.0	5.0
Minimum Split (s)	11.0	11.0	9.5	23.0	9.5	9.5
Total Split (s)	23.0	23.0	54.0	77.0	28.0	28.0
Total Split (%)	21.9%	21.9%	51.4%	73.3%	26.7%	26.7%
Yellow Time (s)	5.0	5.0	3.5	5.0	3.5	3.5
All-Red Time (s)	1.0	1.0	1.0	1.0	1.0	1.0
Lost Time Adjust (s)	0.0	0.0	0.0	0.0	0.0	0.0
Total Lost Time (s)	6.0	6.0	4.5	6.0	4.5	4.5
Lead/Lag	Lag	Lag	Lead			
Lead-Lag Optimize?	Yes	Yes	Yes			
Recall Mode	Min	Min	None	Min	None	None
Act Effct Green (s)	17.0	17.0	49.5	71.0	23.5	23.5
Actuated g/C Ratio	0.16	0.16	0.47	0.68	0.22	0.22
v/c Ratio	1.00	0.07	1.31	0.92	1.09	0.98
Control Delay	82.3	0.5	175.0	22.3	66.6	76.5
Queue Delay	0.0	0.0	0.0	0.0	0.0	0.0
Total Delay	82.3	0.5	175.0	22.3	66.6	76.5
LOS	F	A	F	C	E	E
Approach Delay	79.4			70.7		
Approach LOS	E			E		

Intersection Summary

Cycle Length: 105
 Actuated Cycle Length: 105
 Natural Cycle: 130
 Control Type: Actuated-Uncoordinated
 Maximum v/c Ratio: 1.31
 Intersection Signal Delay: 71.2
 Intersection LOS: E
 Intersection Capacity Utilization 85.3%
 ICU Level of Service E
 Analysis Period (min) 15

Splits and Phases: 30: I-215 SB Ramps & Cactus Av.

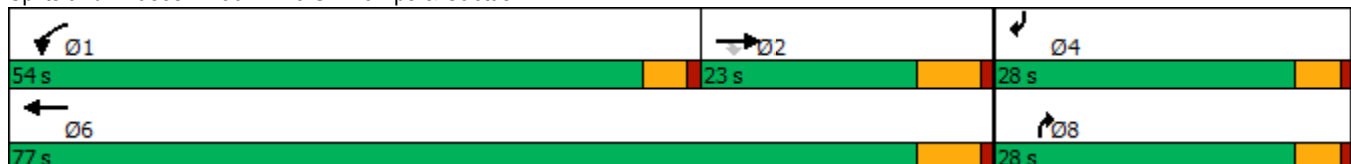

HCM 6th Signalized Intersection Summary
 30: I-215 SB Ramps & Cactus Av.

West Campus Upper Plateau (JN 14064)

09/20/2022



Movement	EBL	EBT	EBR	WBL	WBT	WBR	NBL	NBT	NBR	SBL	SBT	SBR
Lane Configurations		↑↑	↑	↑	↑↑				↑			↑
Traffic Volume (veh/h)	0	505	18	948	2040	0	0	0	974	0	0	325
Future Volume (veh/h)	0	505	18	948	2040	0	0	0	974	0	0	325
Initial Q (Qb), veh	0	0	0	0	0	0	0	0	0	0	0	0
Ped-Bike Adj(A_pbT)	1.00		1.00	1.00		1.00	1.00		1.00	1.00		1.00
Parking Bus, Adj	1.00	1.00	1.00	1.00	1.00	1.00	1.00	1.00	1.00	1.00	1.00	1.00
Work Zone On Approach		No			No			No			No	
Adj Sat Flow, veh/h/ln	0	1811	1693	1781	1885	0	0	0	1781	0	0	1559
Adj Flow Rate, veh/h	0	549	12	1030	2217	0	0	0	0	0	0	254
Peak Hour Factor	0.92	0.92	0.92	0.92	0.92	0.92	0.92	0.92	0.92	0.92	0.92	0.92
Percent Heavy Veh, %	0	6	14	8	1	0	0	0	8	0	0	23
Cap, veh/h	0	694	289	1070	3239	0	0	0	0	0	0	0
Arrive On Green	0.00	0.20	0.20	0.63	0.90	0.00	0.00	0.00	0.00	0.00	0.00	0.00
Sat Flow, veh/h	0	3532	1434	1697	3676	0		0			0	
Grp Volume(v), veh/h	0	549	12	1030	2217	0		0.0			0.0	
Grp Sat Flow(s),veh/h/ln	0	1721	1434	1697	1791	0						
Q Serve(g_s), s	0.0	9.5	0.4	35.7	9.7	0.0						
Cycle Q Clear(g_c), s	0.0	9.5	0.4	35.7	9.7	0.0						
Prop In Lane	0.00		1.00	1.00		0.00						
Lane Grp Cap(c), veh/h	0	694	289	1070	3239	0						
V/C Ratio(X)	0.00	0.79	0.04	0.96	0.68	0.00						
Avail Cap(c_a), veh/h	0	934	389	1341	4061	0						
HCM Platoon Ratio	1.00	1.00	1.00	1.00	1.00	1.00						
Upstream Filter(I)	0.00	1.00	1.00	1.00	1.00	0.00						
Uniform Delay (d), s/veh	0.0	23.7	20.1	10.9	0.8	0.0						
Incr Delay (d2), s/veh	0.0	2.3	0.0	13.7	0.2	0.0						
Initial Q Delay(d3),s/veh	0.0	0.0	0.0	0.0	0.0	0.0						
%ile BackOfQ(50%),veh/ln	0.0	3.6	0.1	11.6	0.1	0.0						
Unsig. Movement Delay, s/veh												
LnGrp Delay(d),s/veh	0.0	26.0	20.1	24.6	1.0	0.0						
LnGrp LOS	A	C	C	C	A	A						
Approach Vol, veh/h		561			3247							
Approach Delay, s/veh		25.9			8.5							
Approach LOS		C			A							
Timer - Assigned Phs	1	2			6							
Phs Duration (G+Y+Rc), s	44.0	18.6			62.6							
Change Period (Y+Rc), s	4.5	6.0			6.0							
Max Green Setting (Gmax), s	49.5	17.0			71.0							
Max Q Clear Time (g_c+I1), s	37.7	11.5			11.7							
Green Ext Time (p_c), s	1.7	1.1			20.2							

Intersection Summary

HCM 6th Ctrl Delay	11.0
HCM 6th LOS	B

Notes

Unsignalized Delay for [NBR] is excluded from calculations of the approach delay and intersection delay.

Timings

31: I-215 NB Ramps/Old 215 Frontage Rd. & Cactus Av.



Lane Group	EBL	EBT	WBT	NBL	NBT	NBR	SBL	SBT
Lane Configurations	↗	↕	↕	↖	↕	↗	↖	↕
Traffic Volume (vph)	26	2239	3609	563	393	56	67	0
Future Volume (vph)	26	2239	3609	563	393	56	67	0
Turn Type	Perm	NA	NA	Perm	NA	Perm	Perm	NA
Protected Phases		2	6		8			4
Permitted Phases	2			8		8	4	
Detector Phase	2	2	6	8	8	8	4	4
Switch Phase								
Minimum Initial (s)	5.0	5.0	5.0	5.0	5.0	5.0	5.0	5.0
Minimum Split (s)	11.0	11.0	44.0	10.5	10.5	10.5	10.5	10.5
Total Split (s)	88.0	88.0	88.0	32.0	32.0	32.0	32.0	32.0
Total Split (%)	73.3%	73.3%	73.3%	26.7%	26.7%	26.7%	26.7%	26.7%
Yellow Time (s)	5.0	5.0	5.0	4.5	4.5	4.5	4.5	4.5
All-Red Time (s)	1.0	1.0	1.0	1.0	1.0	1.0	1.0	1.0
Lost Time Adjust (s)	0.0	0.0	0.0	0.0	0.0	0.0	0.0	0.0
Total Lost Time (s)	6.0	6.0	6.0	5.5	5.5	5.5	5.5	5.5
Lead/Lag								
Lead-Lag Optimize?								
Recall Mode	Min	Min	Min	None	None	None	None	None
Act Effct Green (s)	82.0	82.0	82.0	26.5	26.5	26.5	26.5	26.5
Actuated g/C Ratio	0.68	0.68	0.68	0.22	0.22	0.22	0.22	0.22
v/c Ratio	0.53	1.05	1.70	2.70	1.19	0.16	1.18	0.59
Control Delay	50.7	51.9	337.0	797.3	151.5	23.4	216.7	44.3
Queue Delay	0.0	0.0	0.0	0.0	0.0	0.0	0.0	0.0
Total Delay	50.7	51.9	337.0	797.3	151.5	23.4	216.7	44.3
LOS	D	D	F	F	F	C	F	D
Approach Delay		51.9	337.0		504.2			94.7
Approach LOS		D	F		F			F

Intersection Summary

Cycle Length: 120
 Actuated Cycle Length: 120
 Natural Cycle: 110
 Control Type: Actuated-Uncoordinated
 Maximum v/c Ratio: 2.70
 Intersection Signal Delay: 262.0
 Intersection Capacity Utilization 161.2%
 Analysis Period (min) 15

Intersection LOS: F
 ICU Level of Service H

Splits and Phases: 31: I-215 NB Ramps/Old 215 Frontage Rd. & Cactus Av.



HCM 6th Signalized Intersection Summary

West Campus Upper Plateau (JN 14064)

31: I-215 NB Ramps/Old 215 Frontage Rd. & Cactus Av.

09/20/2022



Movement	EBL	EBT	EBR	WBL	WBT	WBR	NBL	NBT	NBR	SBL	SBT	SBR
Lane Configurations	↗	↗↘			↗↘		↗	↘	↗	↗	↘	↘
Traffic Volume (veh/h)	26	2239	76	0	3609	190	563	393	56	67	0	162
Future Volume (veh/h)	26	2239	76	0	3609	190	563	393	56	67	0	162
Initial Q (Qb), veh	0	0	0	0	0	0	0	0	0	0	0	0
Ped-Bike Adj(A_pbT)	1.00		1.00	1.00		1.00	1.00		1.00	1.00		1.00
Parking Bus, Adj	1.00	1.00	1.00	1.00	1.00	1.00	1.00	1.00	1.00	1.00	1.00	1.00
Work Zone On Approach		No			No			No			No	
Adj Sat Flow, veh/h/ln	1618	1856	1278	0	1856	1841	1870	1722	1841	1841	1900	1441
Adj Flow Rate, veh/h	28	2382	76	0	3839	182	599	418	0	71	0	162
Peak Hour Factor	0.94	0.94	0.94	0.94	0.94	0.94	0.94	0.94	0.94	0.94	0.94	0.94
Percent Heavy Veh, %	19	3	42	0	3	4	2	12	4	4	0	31
Cap, veh/h	60	2383	76	0	2343	110	224	380		60	0	356
Arrive On Green	0.68	0.68	0.68	0.00	0.68	0.68	0.22	0.22	0.00	0.22	0.00	0.22
Sat Flow, veh/h	24	3488	111	0	3521	161	1224	1722	1560	953	0	1610
Grp Volume(v), veh/h	28	1197	1261	0	1959	2062	599	418	0	71	0	162
Grp Sat Flow(s),veh/h/ln	24	1763	1836	0	1763	1827	1224	1722	1560	953	0	1610
Q Serve(g_s), s	0.0	80.5	82.0	0.0	82.0	82.0	16.0	26.5	0.0	0.0	0.0	10.5
Cycle Q Clear(g_c), s	82.0	80.5	82.0	0.0	82.0	82.0	26.5	26.5	0.0	26.5	0.0	10.5
Prop In Lane	1.00		0.06	0.00		0.09	1.00		1.00	1.00		1.00
Lane Grp Cap(c), veh/h	60	1205	1254	0	1205	1248	224	380		60	0	356
V/C Ratio(X)	0.47	0.99	1.00	0.00	1.63	1.65	2.68	1.10		1.18	0.00	0.46
Avail Cap(c_a), veh/h	60	1205	1254	0	1205	1248	224	380		60	0	356
HCM Platoon Ratio	1.00	1.00	1.00	1.00	1.00	1.00	1.00	1.00	1.00	1.00	1.00	1.00
Upstream Filter(I)	1.00	1.00	1.00	0.00	1.00	1.00	1.00	1.00	0.00	1.00	0.00	1.00
Uniform Delay (d), s/veh	60.0	18.8	19.0	0.0	19.0	19.0	54.1	46.8	0.0	60.0	0.0	40.5
Incr Delay (d2), s/veh	2.1	24.4	26.6	0.0	285.7	297.1	768.0	75.6	0.0	174.2	0.0	0.3
Initial Q Delay(d3),s/veh	0.0	0.0	0.0	0.0	0.0	0.0	0.0	0.0	0.0	0.0	0.0	0.0
%ile BackOfQ(50%),veh/ln	0.9	34.3	37.0	0.0	122.2	130.6	54.4	18.9	0.0	4.7	0.0	4.0
Unsig. Movement Delay, s/veh												
LnGrp Delay(d),s/veh	62.1	43.2	45.6	0.0	304.7	316.1	822.2	122.3	0.0	234.2	0.0	40.8
LnGrp LOS	E	D	F	A	F	F	F	F		F	A	D
Approach Vol, veh/h		2486			4021			1017				233
Approach Delay, s/veh		44.6			310.5			534.5				99.8
Approach LOS		D			F			F				F
Timer - Assigned Phs		2		4		6		8				
Phs Duration (G+Y+Rc), s		88.0		32.0		88.0		32.0				
Change Period (Y+Rc), s		6.0		5.5		6.0		5.5				
Max Green Setting (Gmax), s		82.0		26.5		82.0		26.5				
Max Q Clear Time (g_c+I1), s		84.0		28.5		84.0		28.5				
Green Ext Time (p_c), s		0.0		0.0		0.0		0.0				

Intersection Summary

HCM 6th Ctrl Delay	248.3
HCM 6th LOS	F

Notes

User approved volume balancing among the lanes for turning movement.
 Unsignalized Delay for [NBR] is excluded from calculations of the approach delay and intersection delay.

Timings
32: I-215 SB Ramps & Van Buren Bl.

West Campus Upper Plateau (JN 14064)

09/20/2022



Lane Group	EBT	EBR	WBL	WBT	SBT	SBR
Lane Configurations	↑↑	↑↑	↙	↑↑	↙	↑↑
Traffic Volume (vph)	1181	1160	34	1772	39	1670
Future Volume (vph)	1181	1160	34	1772	39	1670
Turn Type	NA	Perm	Prot	NA	NA	Perm
Protected Phases	6		5	2	8	
Permitted Phases		6				8
Detector Phase	6	6	5	2	8	8
Switch Phase						
Minimum Initial (s)	5.0	5.0	5.0	5.0	5.0	5.0
Minimum Split (s)	36.0	36.0	11.0	11.0	11.0	11.0
Total Split (s)	37.0	37.0	11.0	48.0	37.0	37.0
Total Split (%)	43.5%	43.5%	12.9%	56.5%	43.5%	43.5%
Yellow Time (s)	5.0	5.0	5.0	5.0	5.0	5.0
All-Red Time (s)	1.0	1.0	1.0	1.0	1.0	1.0
Lost Time Adjust (s)	0.0	0.0	0.0	0.0	0.0	0.0
Total Lost Time (s)	6.0	6.0	6.0	6.0	6.0	6.0
Lead/Lag	Lag	Lag	Lead			
Lead-Lag Optimize?	Yes	Yes	Yes			
Recall Mode	Min	Min	None	Min	Max	Max
Act Effct Green (s)	35.4	35.4	5.0	42.0	31.0	31.0
Actuated g/C Ratio	0.42	0.42	0.06	0.49	0.36	0.36
v/c Ratio	0.92	0.68	0.35	1.11	0.81	1.75
Control Delay	38.0	3.5	47.9	81.9	36.2	365.8
Queue Delay	0.0	0.0	0.0	0.0	0.0	0.0
Total Delay	38.0	3.5	47.9	81.9	36.2	365.8
LOS	D	A	D	F	D	F
Approach Delay	20.9			81.3	292.4	
Approach LOS	C			F	F	

Intersection Summary

Cycle Length: 85
 Actuated Cycle Length: 85
 Natural Cycle: 120
 Control Type: Actuated-Uncoordinated
 Maximum v/c Ratio: 1.75
 Intersection Signal Delay: 130.9
 Intersection Capacity Utilization 115.7%
 Analysis Period (min) 15
 Intersection LOS: F
 ICU Level of Service H

Splits and Phases: 32: I-215 SB Ramps & Van Buren Bl.

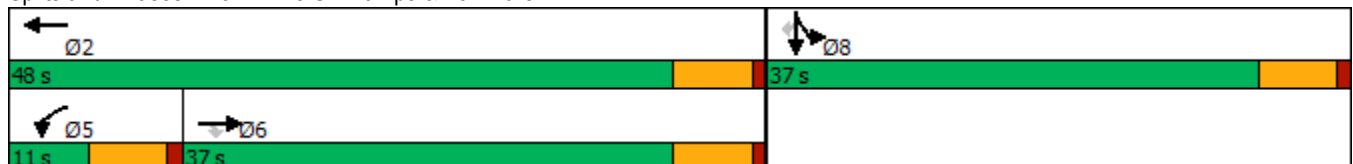

HCM 6th Signalized Intersection Summary
 32: I-215 SB Ramps & Van Buren Bl.

West Campus Upper Plateau (JN 14064)

09/20/2022



Movement	EBL	EBT	EBR	WBL	WBT	WBR	NBL	NBT	NBR	SBL	SBT	SBR
Lane Configurations		↑↑	↑↑	↑	↑↑						↑	↑↑
Traffic Volume (veh/h)	0	1181	1160	34	1772	0	0	0	0	439	39	1670
Future Volume (veh/h)	0	1181	1160	34	1772	0	0	0	0	439	39	1670
Initial Q (Qb), veh	0	0	0	0	0	0				0	0	0
Ped-Bike Adj(A_pbT)	1.00		1.00	1.00		1.00				1.00		1.00
Parking Bus, Adj	1.00	1.00	1.00	1.00	1.00	1.00				1.00	1.00	1.00
Work Zone On Approach		No			No						No	
Adj Sat Flow, veh/h/ln	0	1767	1781	1900	1841	0				1856	1663	1767
Adj Flow Rate, veh/h	0	1270	1153	37	1905	0				472	42	0
Peak Hour Factor	0.93	0.93	0.93	0.93	0.93	0.93				0.93	0.93	0.93
Percent Heavy Veh, %	0	9	8	0	4	0				3	16	9
Cap, veh/h	0	1224	969	106	1728	0				532	47	
Arrive On Green	0.00	0.36	0.36	0.06	0.49	0.00				0.36	0.36	0.00
Sat Flow, veh/h	0	3445	2657	1810	3589	0				1460	130	2635
Grp Volume(v), veh/h	0	1270	1153	37	1905	0				514	0	0
Grp Sat Flow(s),veh/h/ln	0	1678	1329	1810	1749	0				1590	0	1317
Q Serve(g_s), s	0.0	31.0	31.0	1.7	42.0	0.0				25.8	0.0	0.0
Cycle Q Clear(g_c), s	0.0	31.0	31.0	1.7	42.0	0.0				25.8	0.0	0.0
Prop In Lane	0.00		1.00	1.00		0.00				0.92		1.00
Lane Grp Cap(c), veh/h	0	1224	969	106	1728	0				580	0	
V/C Ratio(X)	0.00	1.04	1.19	0.35	1.10	0.00				0.89	0.00	
Avail Cap(c_a), veh/h	0	1224	969	106	1728	0				580	0	
HCM Platoon Ratio	1.00	1.00	1.00	1.00	1.00	1.00				1.00	1.00	1.00
Upstream Filter(I)	0.00	1.00	1.00	1.00	1.00	0.00				1.00	0.00	0.00
Uniform Delay (d), s/veh	0.0	27.0	27.0	38.4	21.5	0.0				25.3	0.0	0.0
Incr Delay (d2), s/veh	0.0	35.9	95.8	0.7	55.4	0.0				17.9	0.0	0.0
Initial Q Delay(d3),s/veh	0.0	0.0	0.0	0.0	0.0	0.0				0.0	0.0	0.0
%ile BackOfQ(50%),veh/ln	0.0	16.7	21.3	0.7	27.2	0.0				11.6	0.0	0.0
Unsig. Movement Delay, s/veh												
LnGrp Delay(d),s/veh	0.0	62.9	122.8	39.2	76.9	0.0				43.3	0.0	0.0
LnGrp LOS	A	F	F	D	F	A				D	A	
Approach Vol, veh/h		2423			1942							514
Approach Delay, s/veh		91.4			76.2							43.3
Approach LOS		F			E							D
Timer - Assigned Phs		2			5	6			8			
Phs Duration (G+Y+Rc), s		48.0			11.0	37.0			37.0			
Change Period (Y+Rc), s		6.0			6.0	6.0			6.0			
Max Green Setting (Gmax), s		42.0			5.0	31.0			31.0			
Max Q Clear Time (g_c+I1), s		44.0			3.7	33.0			27.8			
Green Ext Time (p_c), s		0.0			0.0	0.0			0.7			

Intersection Summary

HCM 6th Ctrl Delay	80.3
HCM 6th LOS	F

Notes

Unsignalized Delay for [SBR] is excluded from calculations of the approach delay and intersection delay.

Timings
33: I-215 NB On/Off Ramp & Van Buren Bl.



Lane Group	EBT	EBR	WBT	NBL	NBR
Lane Configurations	↑↑	↑↑	↑↑	↑↑	↑
Traffic Volume (vph)	600	1265	687	1712	160
Future Volume (vph)	600	1265	687	1712	160
Turn Type	NA	pm+ov	NA	Prot	Perm
Protected Phases	6	4	2	4	
Permitted Phases		6			4
Detector Phase	6	4	2	4	4
Switch Phase					
Minimum Initial (s)	5.0	5.0	5.0	5.0	5.0
Minimum Split (s)	11.0	42.0	11.0	42.0	42.0
Total Split (s)	15.0	55.0	15.0	55.0	55.0
Total Split (%)	21.4%	78.6%	21.4%	78.6%	78.6%
Yellow Time (s)	5.0	5.0	5.0	5.0	5.0
All-Red Time (s)	1.0	1.0	1.0	1.0	1.0
Lost Time Adjust (s)	0.0	0.0	0.0	0.0	0.0
Total Lost Time (s)	6.0	6.0	6.0	6.0	6.0
Lead/Lag					
Lead-Lag Optimize?					
Recall Mode	None	Min	None	Min	Min
Act Effct Green (s)	9.2	62.3	9.2	40.9	40.9
Actuated g/C Ratio	0.15	1.00	0.15	0.66	0.66
v/c Ratio	1.27	0.52	1.43	0.86	0.17
Control Delay	162.5	0.7	233.0	13.1	4.2
Queue Delay	0.0	0.0	0.0	0.0	0.0
Total Delay	162.5	0.7	233.0	13.1	4.2
LOS	F	A	F	B	A
Approach Delay	52.8		233.0	12.3	
Approach LOS	D		F	B	

Intersection Summary

Cycle Length: 70
 Actuated Cycle Length: 62.3
 Natural Cycle: 80
 Control Type: Actuated-Uncoordinated
 Maximum v/c Ratio: 1.43
 Intersection Signal Delay: 63.6
 Intersection LOS: E
 Intersection Capacity Utilization 77.8%
 ICU Level of Service D
 Analysis Period (min) 15

Splits and Phases: 33: I-215 NB On/Off Ramp & Van Buren Bl.



HCM 6th Signalized Intersection Summary
 33: I-215 NB On/Off Ramp & Van Buren Bl.

West Campus Upper Plateau (JN 14064)

09/20/2022



Movement	EBT	EBR	WBL	WBT	NBL	NBR
Lane Configurations	↑↑	↑↑		↑↑	↑↑	↑
Traffic Volume (veh/h)	600	1265	0	687	1712	160
Future Volume (veh/h)	600	1265	0	687	1712	160
Initial Q (Qb), veh	0	0	0	0	0	0
Ped-Bike Adj(A_pbT)		1.00	1.00		1.00	1.00
Parking Bus, Adj	1.00	1.00	1.00	1.00	1.00	1.00
Work Zone On Approach	No			No	No	
Adj Sat Flow, veh/h/ln	1856	1781	0	1870	1811	1870
Adj Flow Rate, veh/h	652	1360	0	747	1861	174
Peak Hour Factor	0.92	0.92	0.92	0.92	0.92	0.92
Percent Heavy Veh, %	3	8	0	2	6	2
Cap, veh/h	582	2072	0	587	2057	974
Arrive On Green	0.17	0.17	0.00	0.17	0.61	0.61
Sat Flow, veh/h	3618	2657	0	3741	3346	1585
Grp Volume(v), veh/h	652	1360	0	747	1861	174
Grp Sat Flow(s),veh/h/ln	1763	1329	0	1777	1673	1585
Q Serve(g_s), s	9.0	9.0	0.0	9.0	26.3	2.6
Cycle Q Clear(g_c), s	9.0	9.0	0.0	9.0	26.3	2.6
Prop In Lane		1.00	0.00		1.00	1.00
Lane Grp Cap(c), veh/h	582	2072	0	587	2057	974
V/C Ratio(X)	1.12	0.66	0.00	1.27	0.90	0.18
Avail Cap(c_a), veh/h	582	2072	0	587	3008	1425
HCM Platoon Ratio	1.00	1.00	1.00	1.00	1.00	1.00
Upstream Filter(I)	1.00	1.00	0.00	1.00	1.00	1.00
Uniform Delay (d), s/veh	22.8	2.3	0.0	22.8	9.1	4.5
Incr Delay (d2), s/veh	74.8	0.6	0.0	135.8	2.4	0.0
Initial Q Delay(d3),s/veh	0.0	0.0	0.0	0.0	0.0	0.0
%ile BackOfQ(50%),veh/ln	9.1	7.9	0.0	14.2	5.4	0.4
Unsig. Movement Delay, s/veh						
LnGrp Delay(d),s/veh	97.6	2.9	0.0	158.5	11.5	4.6
LnGrp LOS	F	A	A	F	B	A
Approach Vol, veh/h	2012			747	2035	
Approach Delay, s/veh	33.6			158.5	10.9	
Approach LOS	C			F	B	
Timer - Assigned Phs		2		4		6
Phs Duration (G+Y+Rc), s		15.0		39.5		15.0
Change Period (Y+Rc), s		6.0		6.0		6.0
Max Green Setting (Gmax), s		9.0		49.0		9.0
Max Q Clear Time (g_c+11), s		11.0		28.3		11.0
Green Ext Time (p_c), s		0.0		5.2		0.0
Intersection Summary						
HCM 6th Ctrl Delay			43.4			
HCM 6th LOS			D			

Timings

West Campus Upper Plateau (JN 14064)

34: Old 215 Frontage Rd. & Alessandro Bl.

09/20/2022



Lane Group	EBL	EBT	EBR	WBL	WBT	WBR	NBL	NBT	NBR	SBL	SBT	SBR
Lane Configurations	↖↗	↑↑↑	↖	↖	↑↑	↖	↖↗	↑↑	↖	↖	↑↑	↖
Traffic Volume (vph)	507	1669	60	13	1945	214	73	346	26	53	62	325
Future Volume (vph)	507	1669	60	13	1945	214	73	346	26	53	62	325
Turn Type	Prot	NA	Perm	Prot	NA	Perm	Prot	NA	Perm	Prot	NA	Perm
Protected Phases	5	2		1	6		3	8		7	4	
Permitted Phases			2			6			8			4
Detector Phase	5	2	2	1	6	6	3	8	8	7	4	4
Switch Phase												
Minimum Initial (s)	5.0	10.0	10.0	5.0	10.0	10.0	5.0	10.0	10.0	5.0	10.0	10.0
Minimum Split (s)	8.7	43.5	43.5	8.7	15.8	15.8	8.7	16.2	16.2	8.7	40.2	40.2
Total Split (s)	17.0	62.2	62.2	8.9	54.1	54.1	8.7	39.3	39.3	9.6	40.2	40.2
Total Split (%)	14.2%	51.8%	51.8%	7.4%	45.1%	45.1%	7.3%	32.8%	32.8%	8.0%	33.5%	33.5%
Yellow Time (s)	3.2	5.5	5.5	3.2	4.8	4.8	3.2	5.2	5.2	3.2	5.2	5.2
All-Red Time (s)	0.5	1.0	1.0	0.5	1.0	1.0	0.5	1.0	1.0	0.5	1.0	1.0
Lost Time Adjust (s)	0.0	0.0	0.0	0.0	0.0	0.0	0.0	0.0	0.0	0.0	0.0	0.0
Total Lost Time (s)	3.7	6.5	6.5	3.7	5.8	5.8	3.7	6.2	6.2	3.7	6.2	6.2
Lead/Lag	Lead	Lag	Lag	Lead	Lag	Lag	Lead	Lag	Lag	Lead	Lag	Lag
Lead-Lag Optimize?	Yes	Yes	Yes	Yes	Yes	Yes	Yes	Yes	Yes	Yes	Yes	Yes
Recall Mode	None	None	None	None	None	None	None	Max	Max	None	Max	Max
Act Effct Green (s)	13.3	61.2	61.2	5.1	48.4	48.4	5.0	33.3	33.3	5.7	34.0	34.0
Actuated g/C Ratio	0.11	0.52	0.52	0.04	0.41	0.41	0.04	0.28	0.28	0.05	0.29	0.29
v/c Ratio	1.43	0.65	0.09	0.27	1.36	0.29	0.56	0.37	0.05	0.64	0.07	0.58
Control Delay	247.3	23.2	1.4	69.7	196.7	4.1	73.2	35.9	0.2	87.3	31.7	21.2
Queue Delay	0.0	0.0	0.0	0.0	0.0	0.0	0.0	0.0	0.0	0.0	0.0	0.0
Total Delay	247.3	23.2	1.4	69.7	196.7	4.1	73.2	35.9	0.2	87.3	31.7	21.2
LOS	F	C	A	E	F	A	E	D	A	F	C	C
Approach Delay		73.4			177.0			39.8			30.6	
Approach LOS		E			F			D			C	

Intersection Summary

Cycle Length: 120	
Actuated Cycle Length: 118.3	
Natural Cycle: 125	
Control Type: Actuated-Uncoordinated	
Maximum v/c Ratio: 1.43	
Intersection Signal Delay: 109.5	Intersection LOS: F
Intersection Capacity Utilization 98.6%	ICU Level of Service F
Analysis Period (min) 15	

Splits and Phases: 34: Old 215 Frontage Rd. & Alessandro Bl.



HCM 6th Signalized Intersection Summary
 34: Old 215 Frontage Rd. & Alessandro Bl.

West Campus Upper Plateau (JN 14064)

09/20/2022



Movement	EBL	EBT	EBR	WBL	WBT	WBR	NBL	NBT	NBR	SBL	SBT	SBR
Lane Configurations	↔↔	↑↑↑	↔	↔	↑↑	↔	↔↔	↑↑	↔	↔	↑↑	↔
Traffic Volume (veh/h)	507	1669	60	13	1945	214	73	346	26	53	62	325
Future Volume (veh/h)	507	1669	60	13	1945	214	73	346	26	53	62	325
Initial Q (Qb), veh	0	0	0	0	0	0	0	0	0	0	0	0
Ped-Bike Adj(A_pbT)	1.00		1.00	1.00		1.00	1.00		1.00	1.00		1.00
Parking Bus, Adj	1.00	1.00	1.00	1.00	1.00	1.00	1.00	1.00	1.00	1.00	1.00	1.00
Work Zone On Approach		No			No			No			No	
Adj Sat Flow, veh/h/ln	1767	1870	1470	981	1885	1826	1707	1811	1752	1870	1767	1826
Adj Flow Rate, veh/h	517	1703	51	13	1985	0	74	353	19	54	63	0
Peak Hour Factor	0.98	0.98	0.98	0.98	0.98	0.98	0.98	0.98	0.98	0.98	0.98	0.98
Percent Heavy Veh, %	9	2	29	62	1	5	13	6	10	2	9	5
Cap, veh/h	361	2540	620	14	1438		120	969	418	69	949	
Arrive On Green	0.11	0.50	0.50	0.01	0.40	0.00	0.04	0.28	0.28	0.04	0.28	0.00
Sat Flow, veh/h	3264	5106	1246	934	3582	1547	3155	3441	1485	1781	3357	1547
Grp Volume(v), veh/h	517	1703	51	13	1985	0	74	353	19	54	63	0
Grp Sat Flow(s),veh/h/ln	1632	1702	1246	934	1791	1547	1577	1721	1485	1781	1678	1547
Q Serve(g_s), s	13.3	30.2	2.6	1.7	48.3	0.0	2.8	9.9	1.1	3.6	1.7	0.0
Cycle Q Clear(g_c), s	13.3	30.2	2.6	1.7	48.3	0.0	2.8	9.9	1.1	3.6	1.7	0.0
Prop In Lane	1.00		1.00	1.00		1.00	1.00		1.00	1.00		1.00
Lane Grp Cap(c), veh/h	361	2540	620	14	1438		120	969	418	69	949	
V/C Ratio(X)	1.43	0.67	0.08	0.95	1.38		0.62	0.36	0.05	0.78	0.07	
Avail Cap(c_a), veh/h	361	2540	620	40	1438		131	969	418	87	949	
HCM Platoon Ratio	1.00	1.00	1.00	1.00	1.00	1.00	1.00	1.00	1.00	1.00	1.00	1.00
Upstream Filter(I)	1.00	1.00	1.00	1.00	1.00	0.00	1.00	1.00	1.00	1.00	1.00	0.00
Uniform Delay (d), s/veh	53.5	22.8	15.8	59.2	36.0	0.0	57.0	34.6	31.4	57.3	31.5	0.0
Incr Delay (d2), s/veh	209.9	0.7	0.1	56.8	175.4	0.0	4.7	1.1	0.2	22.1	0.1	0.0
Initial Q Delay(d3),s/veh	0.0	0.0	0.0	0.0	0.0	0.0	0.0	0.0	0.0	0.0	0.0	0.0
%ile BackOfQ(50%),veh/ln	15.7	11.0	0.7	0.6	54.8	0.0	1.2	4.1	0.4	2.0	0.7	0.0
Unsig. Movement Delay, s/veh												
LnGrp Delay(d),s/veh	263.4	23.5	15.9	116.1	211.4	0.0	61.6	35.6	31.6	79.3	31.7	0.0
LnGrp LOS	F	C	B	F	F		E	D	C	E	C	
Approach Vol, veh/h		2271			1998			446			117	
Approach Delay, s/veh		77.9			210.8			39.8			53.7	
Approach LOS		E			F			D			D	
Timer - Assigned Phs	1	2	3	4	5	6	7	8				
Phs Duration (G+Y+Rc), s	5.5	66.3	8.3	40.2	17.0	54.8	8.4	40.1				
Change Period (Y+Rc), s	3.7	6.5	3.7	6.2	3.7	* 6.5	3.7	6.2				
Max Green Setting (Gmax), s	5.2	55.7	5.0	34.0	13.3	* 48	5.9	33.1				
Max Q Clear Time (g_c+I1), s	3.7	32.2	4.8	3.7	15.3	50.3	5.6	11.9				
Green Ext Time (p_c), s	0.0	12.4	0.0	0.3	0.0	0.0	0.0	2.0				

Intersection Summary

HCM 6th Ctrl Delay	128.8
HCM 6th LOS	F

Notes

* HCM 6th computational engine requires equal clearance times for the phases crossing the barrier.
 Unsignalized Delay for [WBR, SBR] is excluded from calculations of the approach delay and intersection delay.

Timings
35: Day St. & Alessandro Bl.

West Campus Upper Plateau (JN 14064)

09/20/2022



Lane Group	EBL	EBT	EBR	WBL	WBT	WBR	NBL	NBT	NBR	SBL	SBT
Lane Configurations	↖	↗↗↗	↖	↖	↗↗	↖	↖	↗	↖	↖	↗
Traffic Volume (vph)	285	1583	31	13	1977	182	95	214	32	122	87
Future Volume (vph)	285	1583	31	13	1977	182	95	214	32	122	87
Turn Type	Prot	NA	Perm	Prot	NA	Perm	Perm	NA	Perm	Perm	NA
Protected Phases	5	2		1	6			8			4
Permitted Phases			2			6	8		8	4	
Detector Phase	5	2	2	1	6	6	8	8	8	4	4
Switch Phase											
Minimum Initial (s)	5.0	10.0	10.0	5.0	10.0	10.0	10.0	10.0	10.0	10.0	10.0
Minimum Split (s)	9.1	30.8	30.8	9.1	30.8	30.8	42.4	42.4	42.4	41.6	41.6
Total Split (s)	21.0	68.5	68.5	9.1	56.6	56.6	42.4	42.4	42.4	42.4	42.4
Total Split (%)	17.5%	57.1%	57.1%	7.6%	47.2%	47.2%	35.3%	35.3%	35.3%	35.3%	35.3%
Yellow Time (s)	3.6	4.8	4.8	3.6	4.8	4.8	4.4	4.4	4.4	3.6	3.6
All-Red Time (s)	0.5	1.0	1.0	0.5	1.0	1.0	1.0	1.0	1.0	1.0	1.0
Lost Time Adjust (s)	0.0	0.0	0.0	0.0	0.0	0.0	0.0	0.0	0.0	0.0	0.0
Total Lost Time (s)	4.1	5.8	5.8	4.1	5.8	5.8	5.4	5.4	5.4	4.6	4.6
Lead/Lag	Lead	Lag	Lag	Lead	Lag	Lag					
Lead-Lag Optimize?	Yes	Yes	Yes	Yes	Yes	Yes					
Recall Mode	None	None	None	None	None	None	None	None	None	None	None
Act Effct Green (s)	17.0	69.0	69.0	5.0	51.2	51.2	27.1	27.1	27.1	27.9	27.9
Actuated g/C Ratio	0.15	0.62	0.62	0.05	0.46	0.46	0.24	0.24	0.24	0.25	0.25
v/c Ratio	1.12	0.54	0.04	0.19	1.29	0.25	1.44	0.50	0.08	0.62	0.74
Control Delay	136.8	14.8	1.2	60.8	162.0	11.4	290.8	39.0	0.3	48.7	32.5
Queue Delay	0.0	0.0	0.0	0.0	0.0	0.0	0.0	0.0	0.0	0.0	0.0
Total Delay	136.8	14.8	1.2	60.8	162.0	11.4	290.8	39.0	0.3	48.7	32.5
LOS	F	B	A	E	F	B	F	D	A	D	C
Approach Delay		32.9			148.7			105.6			36.6
Approach LOS		C			F			F			D

Intersection Summary

Cycle Length: 120
 Actuated Cycle Length: 110.7
 Natural Cycle: 125
 Control Type: Actuated-Uncoordinated
 Maximum v/c Ratio: 1.44
 Intersection Signal Delay: 89.8
 Intersection LOS: F
 Intersection Capacity Utilization 116.5%
 ICU Level of Service H
 Analysis Period (min) 15





























Splits and Phases: 35: Day St. & Alessandro Bl.



HCM 6th Signalized Intersection Summary
35: Day St. & Alessandro Bl.

West Campus Upper Plateau (JN 14064)

09/20/2022

												
Movement	EBL	EBT	EBR	WBL	WBT	WBR	NBL	NBT	NBR	SBL	SBT	SBR
Lane Configurations		  			 						 	
Traffic Volume (veh/h)	285	1583	31	13	1977	182	95	214	32	122	87	270
Future Volume (veh/h)	285	1583	31	13	1977	182	95	214	32	122	87	270
Initial Q (Qb), veh	0	0	0	0	0	0	0	0	0	0	0	0
Ped-Bike Adj(A_pbT)	1.00		0.98	1.00		1.00	1.00		1.00	1.00		1.00
Parking Bus, Adj	1.00	1.00	1.00	1.00	1.00	1.00	1.00	1.00	1.00	1.00	1.00	1.00
Work Zone On Approach		No			No			No			No	
Adj Sat Flow, veh/h/ln	1870	1870	1544	1752	1885	1870	1767	1885	1781	1870	1900	1885
Adj Flow Rate, veh/h	306	1702	32	14	2126	161	102	230	22	131	94	263
Peak Hour Factor	0.93	0.93	0.93	0.93	0.93	0.93	0.93	0.93	0.93	0.93	0.93	0.93
Percent Heavy Veh, %	2	2	24	10	1	2	9	1	8	2	0	1
Cap, veh/h	251	2804	704	26	1518	672	177	580	464	298	136	380
Arrive On Green	0.14	0.55	0.55	0.02	0.42	0.42	0.31	0.31	0.31	0.31	0.31	0.31
Sat Flow, veh/h	1781	5106	1282	1668	3582	1585	968	1885	1508	1127	442	1236
Grp Volume(v), veh/h	306	1702	32	14	2126	161	102	230	22	131	0	357
Grp Sat Flow(s),veh/h/ln	1781	1702	1282	1668	1791	1585	968	1885	1508	1127	0	1678
Q Serve(g_s), s	16.9	27.0	1.4	1.0	50.8	7.8	12.4	11.5	1.2	12.4	0.0	22.4
Cycle Q Clear(g_c), s	16.9	27.0	1.4	1.0	50.8	7.8	34.9	11.5	1.2	24.0	0.0	22.4
Prop In Lane	1.00		1.00	1.00		1.00	1.00		1.00	1.00		0.74
Lane Grp Cap(c), veh/h	251	2804	704	26	1518	672	177	580	464	298	0	516
V/C Ratio(X)	1.22	0.61	0.05	0.54	1.40	0.24	0.58	0.40	0.05	0.44	0.00	0.69
Avail Cap(c_a), veh/h	251	2804	704	70	1518	672	178	582	465	307	0	529
HCM Platoon Ratio	1.00	1.00	1.00	1.00	1.00	1.00	1.00	1.00	1.00	1.00	1.00	1.00
Upstream Filter(I)	1.00	1.00	1.00	1.00	1.00	1.00	1.00	1.00	1.00	1.00	0.00	1.00
Uniform Delay (d), s/veh	51.5	18.3	12.5	58.6	34.5	22.2	51.8	32.7	29.2	42.2	0.0	36.5
Incr Delay (d2), s/veh	128.9	0.4	0.0	6.3	184.4	0.2	4.5	0.4	0.0	1.0	0.0	3.7
Initial Q Delay(d3),s/veh	0.0	0.0	0.0	0.0	0.0	0.0	0.0	0.0	0.0	0.0	0.0	0.0
%ile BackOfQ(50%),veh/ln	16.3	9.9	0.4	0.5	59.4	2.8	3.2	5.2	0.4	3.6	0.0	9.8
Unsig. Movement Delay, s/veh												
LnGrp Delay(d),s/veh	180.4	18.7	12.5	64.9	219.0	22.3	56.3	33.2	29.2	43.2	0.0	40.2
LnGrp LOS	F	B	B	E	F	C	E	C	C	D	A	D
Approach Vol, veh/h		2040			2301			354				488
Approach Delay, s/veh		42.8			204.3			39.6				41.0
Approach LOS		D			F			D				D
Timer - Assigned Phs	1	2		4	5	6		8				
Phs Duration (G+Y+Rc), s	6.0	71.6		42.3	21.0	56.6		42.3				
Change Period (Y+Rc), s	4.1	5.8		* 5.4	4.1	5.8		5.4				
Max Green Setting (Gmax), s	5.0	62.7		* 38	16.9	50.8		37.0				
Max Q Clear Time (g_c+I1), s	3.0	29.0		26.0	18.9	52.8		36.9				
Green Ext Time (p_c), s	0.0	15.7		2.4	0.0	0.0		0.0				

Intersection Summary

HCM 6th Ctrl Delay	114.1
HCM 6th LOS	F

Notes

* HCM 6th computational engine requires equal clearance times for the phases crossing the barrier.

Timings
36: Elsworth St. & Cactus Av.

West Campus Upper Plateau (JN 14064)

09/20/2022



Lane Group	EBL	EBT	EBR	WBL	WBT	WBR	NBL	NBT	SBL	SBT	SBR
Lane Configurations											
Traffic Volume (vph)	437	2103	683	92	2567	254	90	49	196	131	321
Future Volume (vph)	437	2103	683	92	2567	254	90	49	196	131	321
Turn Type	Prot	NA	Perm	Prot	NA	Perm	Split	NA	Split	NA	pm+ov
Protected Phases	5	2		1	6		8	8	4	4	5
Permitted Phases			2			6					4
Detector Phase	5	2	2	1	6	6	8	8	4	4	5
Switch Phase											
Minimum Initial (s)	5.0	10.0	10.0	5.0	10.0	10.0	10.0	10.0	10.0	10.0	5.0
Minimum Split (s)	9.6	36.2	36.2	9.6	36.2	36.2	35.4	35.4	35.4	35.4	9.6
Total Split (s)	15.0	48.6	48.6	10.6	44.2	44.2	35.4	35.4	35.4	35.4	15.0
Total Split (%)	11.5%	37.4%	37.4%	8.2%	34.0%	34.0%	27.2%	27.2%	27.2%	27.2%	11.5%
Yellow Time (s)	3.6	5.2	5.2	3.6	5.2	5.2	4.4	4.4	4.4	4.4	3.6
All-Red Time (s)	1.0	1.0	1.0	1.0	1.0	1.0	1.0	1.0	1.0	1.0	1.0
Lost Time Adjust (s)	0.0	0.0	0.0	0.0	0.0	0.0	0.0	0.0	0.0	0.0	0.0
Total Lost Time (s)	4.6	6.2	6.2	4.6	6.2	6.2	5.4	5.4	5.4	5.4	4.6
Lead/Lag	Lead	Lag	Lag	Lead	Lag	Lag					Lead
Lead-Lag Optimize?	Yes	Yes	Yes	Yes	Yes	Yes					Yes
Recall Mode	None	None	None	None	None	None	Max	Max	Max	Max	None
Act Effct Green (s)	10.4	42.4	42.4	6.0	38.0	38.0	30.0	30.0	30.0	30.0	41.2
Actuated g/C Ratio	0.08	0.33	0.33	0.05	0.29	0.29	0.23	0.23	0.23	0.23	0.32
v/c Ratio	3.19	1.35	0.79	1.13	1.80	0.49	0.22	0.24	0.43	0.42	0.47
Control Delay	1020.8	195.4	16.1	193.2	390.1	25.4	42.5	32.7	46.8	46.2	5.3
Queue Delay	0.0	0.0	0.0	0.0	0.0	0.0	0.0	0.0	0.0	0.0	0.0
Total Delay	1020.8	195.4	16.1	193.2	390.1	25.4	42.5	32.7	46.8	46.2	5.3
LOS	F	F	B	F	F	C	D	C	D	D	A
Approach Delay		269.3			352.1			37.2		26.1	
Approach LOS		F			F			D		C	

Intersection Summary

Cycle Length: 130
 Actuated Cycle Length: 130
 Natural Cycle: 130
 Control Type: Actuated-Uncoordinated
 Maximum v/c Ratio: 3.19
 Intersection Signal Delay: 275.4
 Intersection Capacity Utilization 109.0%
 Analysis Period (min) 15
 Intersection LOS: F
 ICU Level of Service H



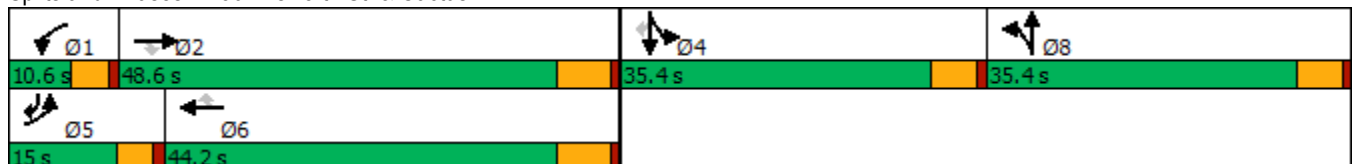





















Splits and Phases: 36: Elsworth St. & Cactus Av.



HCM 6th Signalized Intersection Summary
36: Elsworth St. & Cactus Av.

West Campus Upper Plateau (JN 14064)

09/20/2022

												
Movement	EBL	EBT	EBR	WBL	WBT	WBR	NBL	NBT	NBR	SBL	SBT	SBR
Lane Configurations												
Traffic Volume (veh/h)	437	2103	683	92	2567	254	90	49	37	196	131	321
Future Volume (veh/h)	437	2103	683	92	2567	254	90	49	37	196	131	321
Initial Q (Qb), veh	0	0	0	0	0	0	0	0	0	0	0	0
Ped-Bike Adj(A_pbT)	1.00		1.00	1.00		0.98	1.00		1.00	1.00		1.00
Parking Bus, Adj	1.00	1.00	1.00	1.00	1.00	1.00	1.00	1.00	1.00	1.00	1.00	1.00
Work Zone On Approach		No			No			No			No	
Adj Sat Flow, veh/h/ln	1856	1811	1885	1900	1841	1870	1811	1900	1900	1856	1900	1856
Adj Flow Rate, veh/h	446	2146	0	94	2619	211	86	59	30	167	180	261
Peak Hour Factor	0.98	0.98	0.98	0.98	0.98	0.98	0.98	0.98	0.98	0.98	0.98	0.98
Percent Heavy Veh, %	3	6	1	0	4	2	6	0	0	3	0	3
Cap, veh/h	141	1613		84	1469	453	398	274	139	408	438	489
Arrive On Green	0.08	0.33	0.00	0.05	0.29	0.29	0.23	0.23	0.23	0.23	0.23	0.23
Sat Flow, veh/h	1767	4944	1598	1810	5025	1551	1725	1188	604	1767	1900	1572
Grp Volume(v), veh/h	446	2146	0	94	2619	211	86	0	89	167	180	261
Grp Sat Flow(s),veh/h/ln	1767	1648	1598	1810	1675	1551	1725	0	1791	1767	1900	1572
Q Serve(g_s), s	10.4	42.4	0.0	6.0	38.0	14.5	5.2	0.0	5.2	10.4	10.5	17.8
Cycle Q Clear(g_c), s	10.4	42.4	0.0	6.0	38.0	14.5	5.2	0.0	5.2	10.4	10.5	17.8
Prop In Lane	1.00		1.00	1.00		1.00	1.00		0.34	1.00		1.00
Lane Grp Cap(c), veh/h	141	1613		84	1469	453	398	0	413	408	438	489
V/C Ratio(X)	3.15	1.33		1.13	1.78	0.47	0.22	0.00	0.22	0.41	0.41	0.53
Avail Cap(c_a), veh/h	141	1613		84	1469	453	398	0	413	408	438	489
HCM Platoon Ratio	1.00	1.00	1.00	1.00	1.00	1.00	1.00	1.00	1.00	1.00	1.00	1.00
Upstream Filter(I)	1.00	1.00	0.00	1.00	1.00	1.00	1.00	0.00	1.00	1.00	1.00	1.00
Uniform Delay (d), s/veh	59.8	43.8	0.0	62.0	46.0	37.7	40.5	0.0	40.5	42.5	42.5	37.0
Incr Delay (d2), s/veh	987.9	153.2	0.0	136.5	355.1	0.7	1.2	0.0	1.2	3.0	2.8	4.1
Initial Q Delay(d3),s/veh	0.0	0.0	0.0	0.0	0.0	0.0	0.0	0.0	0.0	0.0	0.0	0.0
%ile BackOfQ(50%),veh/ln	43.3	39.3	0.0	5.8	63.4	5.4	2.3	0.0	2.4	4.8	5.2	7.3
Unsig. Movement Delay, s/veh												
LnGrp Delay(d),s/veh	1047.7	197.0	0.0	198.5	401.1	38.4	41.7	0.0	41.7	45.5	45.3	41.2
LnGrp LOS	F	F		F	F	D	D	A	D	D	D	D
Approach Vol, veh/h		2592			2924			175			608	
Approach Delay, s/veh		343.4			368.4			41.7			43.6	
Approach LOS		F			F			D			D	
Timer - Assigned Phs	1	2		4	5	6		8				
Phs Duration (G+Y+Rc), s	10.6	48.6		35.4	15.0	44.2		35.4				
Change Period (Y+Rc), s	4.6	6.2		5.4	4.6	6.2		5.4				
Max Green Setting (Gmax), s	6.0	42.4		30.0	10.4	38.0		30.0				
Max Q Clear Time (g_c+I1), s	8.0	44.4		19.8	12.4	40.0		7.2				
Green Ext Time (p_c), s	0.0	0.0		1.8	0.0	0.0		0.6				

Intersection Summary

HCM 6th Ctrl Delay	317.7
HCM 6th LOS	F

Notes

- User approved pedestrian interval to be less than phase max green.
- User approved volume balancing among the lanes for turning movement.
- Unsignalized Delay for [EBR] is excluded from calculations of the approach delay and intersection delay.

Timings
37: Cactus Av. & Frederick St.

West Campus Upper Plateau (JN 14064)

09/20/2022



Lane Group	EBL	EBT	WBT	WBR	SBL	SBR
Lane Configurations	↗	↑↑↑	↑↑↑	↖	↗↖	↖
Traffic Volume (vph)	252	1794	2903	192	199	128
Future Volume (vph)	252	1794	2903	192	199	128
Turn Type	Prot	NA	NA	pm+ov	Prot	pm+ov
Protected Phases	5	2	6	4	4	5
Permitted Phases				6		4
Detector Phase	5	2	6	4	4	5
Switch Phase						
Minimum Initial (s)	5.0	10.0	10.0	10.0	10.0	5.0
Minimum Split (s)	9.2	28.2	29.2	36.4	36.4	9.2
Total Split (s)	23.0	83.6	60.6	36.4	36.4	23.0
Total Split (%)	19.2%	69.7%	50.5%	30.3%	30.3%	19.2%
Yellow Time (s)	3.2	5.2	5.2	4.4	4.4	3.2
All-Red Time (s)	1.0	1.0	1.0	1.0	1.0	1.0
Lost Time Adjust (s)	0.0	0.0	0.0	0.0	0.0	0.0
Total Lost Time (s)	4.2	6.2	6.2	5.4	5.4	4.2
Lead/Lag	Lead		Lag			Lead
Lead-Lag Optimize?	Yes		Yes			Yes
Recall Mode	None	None	None	Max	Max	None
Act Effct Green (s)	18.8	77.4	54.4	86.2	31.0	55.2
Actuated g/C Ratio	0.16	0.64	0.45	0.72	0.26	0.46
v/c Ratio	1.01	0.61	1.37	0.18	0.24	0.20
Control Delay	107.5	13.5	197.8	2.2	36.1	20.2
Queue Delay	0.0	0.0	0.0	0.0	0.0	0.0
Total Delay	107.5	13.5	197.8	2.2	36.1	20.2
LOS	F	B	F	A	D	C
Approach Delay		25.1	185.7		29.9	
Approach LOS		C	F		C	

Intersection Summary

Cycle Length: 120
 Actuated Cycle Length: 120
 Natural Cycle: 130
 Control Type: Actuated-Uncoordinated
 Maximum v/c Ratio: 1.37
 Intersection Signal Delay: 116.3
 Intersection Capacity Utilization 91.6%
 Analysis Period (min) 15
 Intersection LOS: F
 ICU Level of Service F

Splits and Phases: 37: Cactus Av. & Frederick St.



HCM 6th Signalized Intersection Summary
37: Cactus Av. & Frederick St.

West Campus Upper Plateau (JN 14064)
09/20/2022



Movement	EBL	EBT	WBT	WBR	SBL	SBR
Lane Configurations						
Traffic Volume (veh/h)	252	1794	2903	192	199	128
Future Volume (veh/h)	252	1794	2903	192	199	128
Initial Q (Qb), veh	0	0	0	0	0	0
Ped-Bike Adj(A_pbT)	1.00			0.98	1.00	1.00
Parking Bus, Adj	1.00	1.00	1.00	1.00	1.00	1.00
Work Zone On Approach		No	No		No	
Adj Sat Flow, veh/h/ln	1826	1811	1856	1870	1856	1811
Adj Flow Rate, veh/h	271	1929	3122	152	214	97
Peak Hour Factor	0.93	0.93	0.93	0.93	0.93	0.93
Percent Heavy Veh, %	5	6	3	2	3	6
Cap, veh/h	272	3189	2296	1112	886	637
Arrive On Green	0.16	0.65	0.45	0.45	0.26	0.26
Sat Flow, veh/h	1739	5107	5233	1550	3428	1535
Grp Volume(v), veh/h	271	1929	3122	152	214	97
Grp Sat Flow(s),veh/h/ln	1739	1648	1689	1550	1714	1535
Q Serve(g_s), s	18.7	27.3	54.4	3.8	5.9	4.7
Cycle Q Clear(g_c), s	18.7	27.3	54.4	3.8	5.9	4.7
Prop In Lane	1.00			1.00	1.00	1.00
Lane Grp Cap(c), veh/h	272	3189	2296	1112	886	637
V/C Ratio(X)	0.99	0.60	1.36	0.14	0.24	0.15
Avail Cap(c_a), veh/h	272	3189	2296	1112	886	637
HCM Platoon Ratio	1.00	1.00	1.00	1.00	1.00	1.00
Upstream Filter(I)	1.00	1.00	1.00	1.00	1.00	1.00
Uniform Delay (d), s/veh	50.6	12.4	32.8	5.5	35.2	21.9
Incr Delay (d2), s/veh	52.9	0.3	164.7	0.1	0.6	0.5
Initial Q Delay(d3),s/veh	0.0	0.0	0.0	0.0	0.0	0.0
%ile BackOfQ(50%),veh/ln	11.8	8.6	55.3	2.5	2.5	0.1
Unsig. Movement Delay, s/veh						
LnGrp Delay(d),s/veh	103.5	12.7	197.5	5.6	35.8	22.4
LnGrp LOS	F	B	F	A	D	C
Approach Vol, veh/h		2200	3274		311	
Approach Delay, s/veh		23.9	188.6		31.7	
Approach LOS		C	F		C	
Timer - Assigned Phs		2		4	5	6
Phs Duration (G+Y+Rc), s		83.6		36.4	23.0	60.6
Change Period (Y+Rc), s		6.2		5.4	* 4.2	6.2
Max Green Setting (Gmax), s		77.4		31.0	* 19	54.4
Max Q Clear Time (g_c+I1), s		29.3		7.9	20.7	56.4
Green Ext Time (p_c), s		21.2		1.0	0.0	0.0

Intersection Summary

HCM 6th Ctrl Delay	117.5
HCM 6th LOS	F

Notes

* HCM 6th computational engine requires equal clearance times for the phases crossing the barrier.

Timings
38: Riverside Dr./Graham St. & Cactus Av.

West Campus Upper Plateau (JN 14064)

09/20/2022

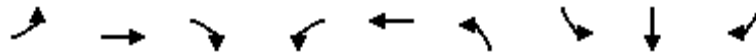

Lane Group	EBL	EBT	EBR	WBL	WBT	NBL	SBL	SBT	SBR	Ø2
Lane Configurations	↘	↑↑↑	↗	↘	↑↑↑	↗	↘	↑↑	↗	
Traffic Volume (vph)	222	1730	414	28	2961	50	355	458	338	
Future Volume (vph)	222	1730	414	28	2961	50	355	458	338	
Turn Type	Prot	NA	Perm	Prot	NA	Prot	Prot	NA	Perm	
Protected Phases	7	4		3	8	5	1	6		2
Permitted Phases			4						6	
Detector Phase	7	4	4	3	8	5	1	6	6	
Switch Phase										
Minimum Initial (s)	5.0	10.0	10.0	5.0	10.0	5.0	5.0	10.0	10.0	10.0
Minimum Split (s)	9.6	39.2	39.2	9.6	39.2	10.4	9.6	40.6	40.6	35.0
Total Split (s)	10.8	59.0	59.0	9.6	57.8	10.4	14.2	41.0	41.0	37.2
Total Split (%)	9.0%	49.2%	49.2%	8.0%	48.2%	8.7%	11.8%	34.2%	34.2%	31%
Yellow Time (s)	3.6	5.2	5.2	3.6	5.2	4.4	3.6	3.6	3.6	4.0
All-Red Time (s)	1.0	1.0	1.0	1.0	1.0	1.0	1.0	1.0	1.0	1.0
Lost Time Adjust (s)	0.0	0.0	0.0	0.0	0.0	0.0	0.0	0.0	0.0	
Total Lost Time (s)	4.6	6.2	6.2	4.6	6.2	5.4	4.6	4.6	4.6	
Lead/Lag	Lead	Lag	Lag	Lead	Lag	Lead	Lead	Lag	Lag	Lag
Lead-Lag Optimize?	Yes	Yes	Yes	Yes	Yes	Yes	Yes	Yes	Yes	Yes
Recall Mode	None	None	None	None	None	None	None	Max	Max	Max
Act Effct Green (s)	6.2	56.6	56.6	5.0	51.6	5.0	9.6	38.5	38.5	
Actuated g/C Ratio	0.05	0.47	0.47	0.04	0.43	0.04	0.08	0.32	0.32	
v/c Ratio	2.62	0.80	0.50	0.40	1.66	0.40	2.66	0.42	0.62	
Control Delay	783.4	30.8	10.0	71.8	324.6	65.3	789.5	34.0	28.5	
Queue Delay	0.0	0.0	0.0	0.0	0.0	0.0	0.0	0.0	0.0	
Total Delay	783.4	30.8	10.0	71.8	324.6	65.3	789.5	34.0	28.5	
LOS	F	C	B	E	F	E	F	C	C	
Approach Delay		97.8			322.5			265.5		
Approach LOS		F			F			F		

Intersection Summary

Cycle Length: 120
 Actuated Cycle Length: 120
 Natural Cycle: 130
 Control Type: Actuated-Uncoordinated
 Maximum v/c Ratio: 2.66
 Intersection Signal Delay: 234.5
 Intersection LOS: F
 Intersection Capacity Utilization 117.1%
 ICU Level of Service H
 Analysis Period (min) 15

Splits and Phases: 38: Riverside Dr./Graham St. & Cactus Av.

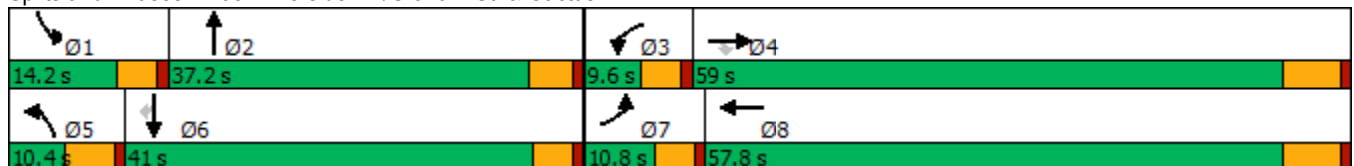

HCM 6th Signalized Intersection Summary
38: Riverside Dr./Graham St. & Cactus Av.

West Campus Upper Plateau (JN 14064)

09/20/2022



Movement	EBL	EBT	EBR	WBL	WBT	WBR	NBL	NBT	NBR	SBL	SBT	SBR
Lane Configurations	↖	↑↑↑	↗	↖	↑↑↑		↖↗	↑↗		↖	↑↑	↗
Traffic Volume (veh/h)	222	1730	414	28	2961	378	50	0	0	355	458	338
Future Volume (veh/h)	222	1730	414	28	2961	378	50	0	0	355	458	338
Initial Q (Qb), veh	0	0	0	0	0	0	0	0	0	0	0	0
Ped-Bike Adj(A_pbT)	1.00		1.00	1.00		1.00	1.00		1.00	1.00		1.00
Parking Bus, Adj	1.00	1.00	1.00	1.00	1.00	1.00	1.00	1.00	1.00	1.00	1.00	1.00
Work Zone On Approach		No			No			No			No	
Adj Sat Flow, veh/h/ln	1856	1811	1856	1900	1856	1885	1752	1900	1900	1885	1900	1856
Adj Flow Rate, veh/h	236	1840	428	30	3150	401	53	0	0	378	487	275
Peak Hour Factor	0.94	0.94	0.94	0.94	0.94	0.94	0.94	0.94	0.94	0.94	0.94	0.94
Percent Heavy Veh, %	3	6	3	0	3	1	10	0	0	1	0	3
Cap, veh/h	91	2251	716	48	1966	240	112	969	0	144	1109	483
Arrive On Green	0.05	0.46	0.46	0.03	0.43	0.43	0.03	0.00	0.00	0.08	0.31	0.31
Sat Flow, veh/h	1767	4944	1572	1810	4573	559	3237	3705	0	1795	3610	1572
Grp Volume(v), veh/h	236	1840	428	30	2292	1259	53	0	0	378	487	275
Grp Sat Flow(s),veh/h/ln	1767	1648	1572	1810	1689	1755	1618	1805	0	1795	1805	1572
Q Serve(g_s), s	6.2	38.7	24.4	2.0	51.6	51.6	1.9	0.0	0.0	9.6	13.0	17.6
Cycle Q Clear(g_c), s	6.2	38.7	24.4	2.0	51.6	51.6	1.9	0.0	0.0	9.6	13.0	17.6
Prop In Lane	1.00		1.00	1.00		0.32	1.00		0.00	1.00		1.00
Lane Grp Cap(c), veh/h	91	2251	716	48	1452	754	112	969	0	144	1109	483
V/C Ratio(X)	2.58	0.82	0.60	0.63	1.58	1.67	0.47	0.00	0.00	2.63	0.44	0.57
Avail Cap(c_a), veh/h	91	2251	716	75	1452	754	135	969	0	144	1109	483
HCM Platoon Ratio	1.00	1.00	1.00	1.00	1.00	1.00	1.00	1.00	1.00	1.00	1.00	1.00
Upstream Filter(I)	1.00	1.00	1.00	1.00	1.00	1.00	1.00	0.00	0.00	1.00	1.00	1.00
Uniform Delay (d), s/veh	56.9	28.4	24.5	57.8	34.2	34.2	56.9	0.0	0.0	55.2	33.3	34.9
Incr Delay (d2), s/veh	744.0	2.5	1.4	5.0	263.5	306.9	1.2	0.0	0.0	754.0	1.3	4.8
Initial Q Delay(d3),s/veh	0.0	0.0	0.0	0.0	0.0	0.0	0.0	0.0	0.0	0.0	0.0	0.0
%ile BackOfQ(50%),veh/ln	21.5	14.6	8.7	0.9	72.5	84.4	0.8	0.0	0.0	34.3	5.8	7.1
Unsig. Movement Delay, s/veh												
LnGrp Delay(d),s/veh	800.9	30.8	25.8	62.8	297.7	341.1	58.0	0.0	0.0	809.2	34.6	39.7
LnGrp LOS	F	C	C	E	F	F	E	A	A	F	C	D
Approach Vol, veh/h		2504			3581			53			1140	
Approach Delay, s/veh		102.5			311.0			58.0			292.6	
Approach LOS		F			F			E			F	
Timer - Assigned Phs	1	2	3	4	5	6	7	8				
Phs Duration (G+Y+Rc), s	14.2	37.2	7.8	60.8	9.5	41.9	10.8	57.8				
Change Period (Y+Rc), s	4.6	5.0	4.6	6.2	5.4	* 5	4.6	6.2				
Max Green Setting (Gmax), s	9.6	32.2	5.0	52.8	5.0	* 36	6.2	51.6				
Max Q Clear Time (g_c+I1), s	11.6	0.0	4.0	40.7	3.9	19.6	8.2	53.6				
Green Ext Time (p_c), s	0.0	0.0	0.0	9.4	0.0	3.7	0.0	0.0				

Intersection Summary

HCM 6th Ctrl Delay	234.6
HCM 6th LOS	F

Notes

* HCM 6th computational engine requires equal clearance times for the phases crossing the barrier.

Timings
1: Washington St & Van Buren Bl.

West Campus Upper Plateau (JN 14064)

09/20/2022



Lane Group	EBL	EBT	WBL	WBT	WBR	NBL	NBT	NBR	SBL	SBT
Lane Configurations	↙	↕	↙	↕	↗	↙↗	↕	↗	↙↗	↕
Traffic Volume (vph)	178	1915	236	1582	613	146	323	137	761	587
Future Volume (vph)	178	1915	236	1582	613	146	323	137	761	587
Turn Type	Prot	NA	Prot	NA	Perm	Prot	NA	Perm	Prot	NA
Protected Phases	5	2	1	6		3	8		7	4
Permitted Phases					6			8		
Detector Phase	5	2	1	6	6	3	8	8	7	4
Switch Phase										
Minimum Initial (s)	5.0	10.0	5.0	10.0	10.0	5.0	10.0	10.0	5.0	10.0
Minimum Split (s)	9.2	34.2	9.2	33.2	33.2	9.2	38.4	38.4	9.2	30.8
Total Split (s)	14.2	49.6	14.0	49.4	49.4	11.5	38.4	38.4	18.0	44.9
Total Split (%)	11.8%	41.3%	11.7%	41.2%	41.2%	9.6%	32.0%	32.0%	15.0%	37.4%
Yellow Time (s)	3.2	5.2	3.2	5.2	5.2	3.2	4.4	4.4	3.2	4.8
All-Red Time (s)	1.0	1.0	1.0	1.0	1.0	1.0	1.0	1.0	1.0	1.0
Lost Time Adjust (s)	0.0	0.0	0.0	0.0	0.0	0.0	0.0	0.0	0.0	0.0
Total Lost Time (s)	4.2	6.2	4.2	6.2	6.2	4.2	5.4	5.4	4.2	5.8
Lead/Lag	Lead	Lag	Lead	Lag	Lag	Lead	Lag	Lag	Lead	Lag
Lead-Lag Optimize?	Yes	Yes	Yes	Yes	Yes	Yes	Yes	Yes	Yes	Yes
Recall Mode	None	None	None	None	None	None	None	None	None	None
Act Effct Green (s)	10.0	43.6	9.8	43.4	43.4	7.1	22.5	22.5	13.8	28.8
Actuated g/C Ratio	0.09	0.40	0.09	0.40	0.40	0.06	0.20	0.20	0.13	0.26
v/c Ratio	1.09	1.52	1.49	1.14	0.80	0.65	0.45	0.32	1.76	0.77
Control Delay	145.1	266.5	287.1	106.0	27.5	65.7	39.8	7.2	381.3	42.2
Queue Delay	0.0	0.0	0.0	0.0	0.0	0.0	0.0	0.0	0.0	0.0
Total Delay	145.1	266.5	287.1	106.0	27.5	65.7	39.8	7.2	381.3	42.2
LOS	F	F	F	F	C	E	D	A	F	D
Approach Delay		256.9		103.7			38.7			217.8
Approach LOS		F		F			D			F

Intersection Summary

Cycle Length: 120
 Actuated Cycle Length: 109.8
 Natural Cycle: 115
 Control Type: Actuated-Uncoordinated
 Maximum v/c Ratio: 1.76
 Intersection Signal Delay: 173.8
 Intersection LOS: F
 Intersection Capacity Utilization 119.1%
 ICU Level of Service H
 Analysis Period (min) 15

Splits and Phases: 1: Washington St & Van Buren Bl.

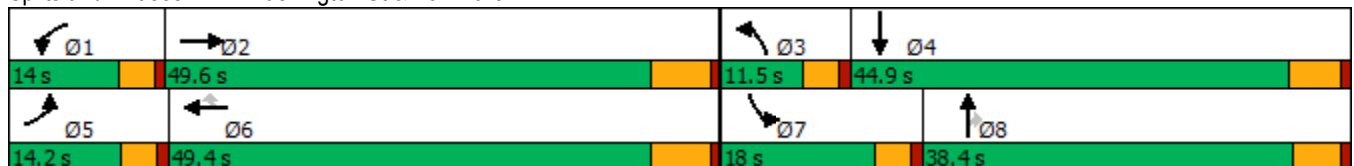

HCM 6th Signalized Intersection Summary
1: Washington St & Van Buren Bl.

West Campus Upper Plateau (JN 14064)

09/20/2022

Movement	EBL	EBT	EBR	WBL	WBT	WBR	NBL	NBT	NBR	SBL	SBT	SBR
Lane Configurations												
Traffic Volume (veh/h)	178	1915	163	236	1582	613	146	323	137	761	587	122
Future Volume (veh/h)	178	1915	163	236	1582	613	146	323	137	761	587	122
Initial Q (Qb), veh	0	0	0	0	0	0	0	0	0	0	0	0
Ped-Bike Adj(A_pbT)	1.00		1.00	1.00		1.00	1.00		0.98	1.00		0.98
Parking Bus, Adj	1.00	1.00	1.00	1.00	1.00	1.00	1.00	1.00	1.00	1.00	1.00	1.00
Work Zone On Approach		No			No			No			No	
Adj Sat Flow, veh/h/ln	1900	1856	1870	1885	1870	1900	1885	1856	1870	1885	1885	1900
Adj Flow Rate, veh/h	180	1934	146	238	1598	526	147	326	99	769	593	77
Peak Hour Factor	0.99	0.99	0.99	0.99	0.99	0.99	0.99	0.99	0.99	0.99	0.99	0.99
Percent Heavy Veh, %	0	3	2	1	2	0	1	3	2	1	1	0
Cap, veh/h	174	1384	103	169	1472	666	209	571	252	461	745	97
Arrive On Green	0.10	0.42	0.42	0.09	0.41	0.41	0.06	0.16	0.16	0.13	0.23	0.23
Sat Flow, veh/h	1810	3326	248	1795	3554	1607	3483	3526	1557	3483	3182	412
Grp Volume(v), veh/h	180	1013	1067	238	1598	526	147	326	99	769	333	337
Grp Sat Flow(s),veh/h/ln	1810	1763	1811	1795	1777	1607	1742	1763	1557	1742	1791	1803
Q Serve(g_s), s	10.0	43.4	43.4	9.8	43.2	29.7	4.3	8.9	5.9	13.8	18.3	18.3
Cycle Q Clear(g_c), s	10.0	43.4	43.4	9.8	43.2	29.7	4.3	8.9	5.9	13.8	18.3	18.3
Prop In Lane	1.00		0.14	1.00		1.00	1.00		1.00	1.00		0.23
Lane Grp Cap(c), veh/h	174	734	754	169	1472	666	209	571	252	461	420	422
V/C Ratio(X)	1.04	1.38	1.42	1.41	1.09	0.79	0.70	0.57	0.39	1.67	0.79	0.80
Avail Cap(c_a), veh/h	174	734	754	169	1472	666	244	1116	493	461	671	676
HCM Platoon Ratio	1.00	1.00	1.00	1.00	1.00	1.00	1.00	1.00	1.00	1.00	1.00	1.00
Upstream Filter(I)	1.00	1.00	1.00	1.00	1.00	1.00	1.00	1.00	1.00	1.00	1.00	1.00
Uniform Delay (d), s/veh	47.1	30.4	30.4	47.2	30.5	26.6	48.1	40.4	39.1	45.2	37.6	37.6
Incr Delay (d2), s/veh	78.5	180.0	194.7	216.1	50.3	6.8	5.3	0.9	1.0	310.2	3.4	3.5
Initial Q Delay(d3),s/veh	0.0	0.0	0.0	0.0	0.0	0.0	0.0	0.0	0.0	0.0	0.0	0.0
%ile BackOfQ(50%),veh/ln	8.1	53.2	57.7	14.3	26.9	12.4	2.0	4.0	2.4	25.8	8.3	8.4
Unsig. Movement Delay, s/veh												
LnGrp Delay(d),s/veh	125.6	210.5	225.1	263.3	80.9	33.3	53.4	41.3	40.1	355.5	41.0	41.1
LnGrp LOS	F	F	F	F	F	C	D	D	D	F	D	D
Approach Vol, veh/h		2260			2362			572			1439	
Approach Delay, s/veh		210.6			88.7			44.2			209.1	
Approach LOS		F			F			D			F	
Timer - Assigned Phs	1	2	3	4	5	6	7	8				
Phs Duration (G+Y+Rc), s	14.0	49.6	10.5	30.2	14.2	49.4	18.0	22.7				
Change Period (Y+Rc), s	* 4.2	6.2	* 4.2	5.8	* 4.2	6.2	* 4.2	* 5.8				
Max Green Setting (Gmax), s	* 9.8	43.4	* 7.3	39.1	* 10	43.2	* 14	* 33				
Max Q Clear Time (g_c+I1), s	11.8	45.4	6.3	20.3	12.0	45.2	15.8	10.9				
Green Ext Time (p_c), s	0.0	0.0	0.0	4.0	0.0	0.0	0.0	2.5				

Intersection Summary

HCM 6th Ctrl Delay	152.5
HCM 6th LOS	F

Notes

* HCM 6th computational engine requires equal clearance times for the phases crossing the barrier.

Timings
2: Central Ave & Arlington Ave/Chicago Ave

West Campus Upper Plateau (JN 14064)

09/20/2022



Lane Group	EBL	EBT	EBR	WBL	WBT	WBR	NBL	NBT	NBR	SBL	SBT
Lane Configurations	↘	↑↑	↗↗	↘↘	↑↑	↗	↘↘	↑↑	↗	↘↘	↑↑↗
Traffic Volume (vph)	33	976	1499	815	876	281	1128	1453	340	649	2370
Future Volume (vph)	33	976	1499	815	876	281	1128	1453	340	649	2370
Turn Type	Prot	NA	pm+ov	Prot	NA	pm+ov	Prot	NA	pm+ov	Prot	NA
Protected Phases	7	4	5	3	8	1	5	2	3	1	6
Permitted Phases			4			8			2		
Detector Phase	7	4	5	3	8	1	5	2	3	1	6
Switch Phase											
Minimum Initial (s)	5.0	10.0	5.0	5.0	10.0	5.0	5.0	10.0	5.0	5.0	10.0
Minimum Split (s)	9.6	32.8	9.6	9.6	30.8	9.6	9.6	35.4	9.6	9.6	30.4
Total Split (s)	10.6	32.8	30.0	22.0	44.2	24.4	30.0	50.8	22.0	24.4	45.2
Total Split (%)	8.2%	25.2%	23.1%	16.9%	34.0%	18.8%	23.1%	39.1%	16.9%	18.8%	34.8%
Yellow Time (s)	3.6	4.8	3.6	3.6	4.8	3.6	3.6	4.4	3.6	3.6	4.4
All-Red Time (s)	1.0	1.0	1.0	1.0	1.0	1.0	1.0	1.0	1.0	1.0	1.0
Lost Time Adjust (s)	0.0	0.0	0.0	0.0	0.0	0.0	0.0	0.0	0.0	0.0	0.0
Total Lost Time (s)	4.6	5.8	4.6	4.6	5.8	4.6	4.6	5.4	4.6	4.6	5.4
Lead/Lag	Lead	Lag	Lead	Lead	Lag	Lead	Lead	Lag	Lead	Lead	Lag
Lead-Lag Optimize?	Yes	Yes	Yes	Yes	Yes	Yes	Yes	Yes	Yes	Yes	Yes
Recall Mode	None	None	None	None	None	None	None	None	None	None	None
Act Effct Green (s)	5.7	27.0	53.6	17.4	42.6	68.2	25.4	45.4	63.6	19.8	39.8
Actuated g/C Ratio	0.04	0.21	0.41	0.13	0.33	0.52	0.20	0.35	0.49	0.15	0.31
v/c Ratio	0.43	1.36	1.28	1.85	0.77	0.33	1.72	1.21	0.44	1.27	1.59
Control Delay	76.9	209.2	162.6	422.1	45.4	13.3	361.5	140.9	17.3	179.2	300.6
Queue Delay	0.0	0.0	0.0	0.0	0.0	0.0	0.0	0.0	0.0	0.0	0.0
Total Delay	76.9	209.2	162.6	422.1	45.4	13.3	361.5	140.9	17.3	179.2	300.6
LOS	E	F	F	F	D	B	F	F	B	F	F
Approach Delay		179.6			196.5			211.7			274.7
Approach LOS		F			F			F			F

Intersection Summary

Cycle Length: 130
 Actuated Cycle Length: 130
 Natural Cycle: 120
 Control Type: Actuated-Uncoordinated
 Maximum v/c Ratio: 1.85
 Intersection Signal Delay: 219.5
 Intersection LOS: F
 Intersection Capacity Utilization 145.8%
 ICU Level of Service H
 Analysis Period (min) 15

Splits and Phases: 2: Central Ave & Arlington Ave/Chicago Ave

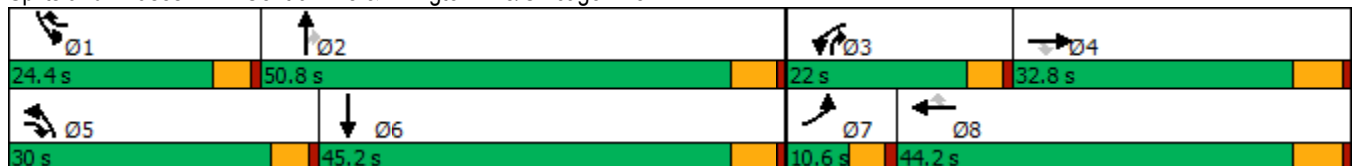

HCM 6th Signalized Intersection Summary
2: Central Ave & Arlington Ave/Chicago Ave

West Campus Upper Plateau (JN 14064)

09/20/2022



Movement	EBL	EBT	EBR	WBL	WBT	WBR	NBL	NBT	NBR	SBL	SBT	SBR
Lane Configurations	↘	↑↑	↗↗	↘↘	↑↑	↗	↘↘	↑↑	↗	↘↘	↑↑↑	
Traffic Volume (veh/h)	33	976	1499	815	876	281	1128	1453	340	649	2370	27
Future Volume (veh/h)	33	976	1499	815	876	281	1128	1453	340	649	2370	27
Initial Q (Qb), veh	0	0	0	0	0	0	0	0	0	0	0	0
Ped-Bike Adj(A_pbT)	1.00		1.00	1.00		1.00	1.00		0.99	1.00		1.00
Parking Bus, Adj	1.00	1.00	1.00	1.00	1.00	1.00	1.00	1.00	1.00	1.00	1.00	1.00
Work Zone On Approach		No			No			No			No	
Adj Sat Flow, veh/h/ln	1900	1900	1900	1870	1900	1900	1900	1885	1870	1900	1885	1900
Adj Flow Rate, veh/h	34	1017	1164	849	912	206	1175	1514	286	676	2469	26
Peak Hour Factor	0.96	0.96	0.96	0.96	0.96	0.96	0.96	0.96	0.96	0.96	0.96	0.96
Percent Heavy Veh, %	0	0	0	2	0	0	0	1	2	0	1	0
Cap, veh/h	49	750	1141	463	1135	751	686	1251	758	535	1608	17
Arrive On Green	0.03	0.21	0.21	0.13	0.31	0.31	0.20	0.35	0.35	0.15	0.31	0.31
Sat Flow, veh/h	1810	3610	2830	3456	3610	1610	3510	3582	1564	3510	5251	55
Grp Volume(v), veh/h	34	1017	1164	849	912	206	1175	1514	286	676	1612	883
Grp Sat Flow(s),veh/h/ln	1810	1805	1415	1728	1805	1610	1755	1791	1564	1755	1716	1875
Q Serve(g_s), s	2.4	27.0	27.0	17.4	30.1	10.2	25.4	45.4	15.0	19.8	39.8	39.8
Cycle Q Clear(g_c), s	2.4	27.0	27.0	17.4	30.1	10.2	25.4	45.4	15.0	19.8	39.8	39.8
Prop In Lane	1.00		1.00	1.00		1.00	1.00		1.00	1.00		0.03
Lane Grp Cap(c), veh/h	49	750	1141	463	1135	751	686	1251	758	535	1050	574
V/C Ratio(X)	0.69	1.36	1.02	1.84	0.80	0.27	1.71	1.21	0.38	1.26	1.53	1.54
Avail Cap(c_a), veh/h	84	750	1141	463	1135	751	686	1251	758	535	1050	574
HCM Platoon Ratio	1.00	1.00	1.00	1.00	1.00	1.00	1.00	1.00	1.00	1.00	1.00	1.00
Upstream Filter(I)	1.00	1.00	1.00	1.00	1.00	1.00	1.00	1.00	1.00	1.00	1.00	1.00
Uniform Delay (d), s/veh	62.7	51.5	38.8	56.3	40.9	21.2	52.3	42.3	21.3	55.1	45.1	45.1
Incr Delay (d2), s/veh	6.3	169.1	31.7	384.4	4.3	0.2	327.1	102.3	0.3	133.3	245.3	251.0
Initial Q Delay(d3),s/veh	0.0	0.0	0.0	0.0	0.0	0.0	0.0	0.0	0.0	0.0	0.0	0.0
%ile BackOfQ(50%),veh/ln	1.2	29.4	22.2	32.1	13.6	3.7	42.1	37.1	5.3	18.5	52.2	58.0
Unsig. Movement Delay, s/veh												
LnGrp Delay(d),s/veh	69.0	220.6	70.5	440.7	45.2	21.4	379.4	144.6	21.6	188.4	290.4	296.1
LnGrp LOS	E	F	F	F	D	C	F	F	C	F	F	F
Approach Vol, veh/h		2215			1967			2975			3171	
Approach Delay, s/veh		139.4			213.4			225.5			270.2	
Approach LOS		F			F			F			F	
Timer - Assigned Phs	1	2	3	4	5	6	7	8				
Phs Duration (G+Y+Rc), s	24.4	50.8	22.0	32.8	30.0	45.2	8.1	46.7				
Change Period (Y+Rc), s	4.6	5.4	4.6	5.8	4.6	5.4	4.6	5.8				
Max Green Setting (Gmax), s	19.8	45.4	17.4	27.0	25.4	39.8	6.0	38.4				
Max Q Clear Time (g_c+I1), s	21.8	47.4	19.4	29.0	27.4	41.8	4.4	32.1				
Green Ext Time (p_c), s	0.0	0.0	0.0	0.0	0.0	0.0	0.0	3.3				

Intersection Summary

HCM 6th Ctrl Delay	218.5
HCM 6th LOS	F

Timings

3: Overlook Pkwy./Canyon Crest Dr. & Alessandro Bl/Alessandro Bl.



Lane Group	EBL	EBT	WBL	WBT	WBR	NBL	NBR	SBL	SBT	SBR
Lane Configurations	↖	↕↕↕	↖	↕↕↕	↖	↖	↖	↖↖	↖	↖
Traffic Volume (vph)	89	3946	132	3001	790	63	192	860	183	69
Future Volume (vph)	89	3946	132	3001	790	63	192	860	183	69
Turn Type	Prot	NA	Prot	NA	pm+ov	Split	Perm	Split	NA	Perm
Protected Phases	5	2	1	6	4	8		4	4	
Permitted Phases					6		8			4
Detector Phase	5	2	1	6	4	8	8	4	4	4
Switch Phase										
Minimum Initial (s)	5.0	10.0	5.0	10.0	10.0	10.0	10.0	10.0	10.0	10.0
Minimum Split (s)	9.2	35.2	9.2	35.2	38.8	38.8	38.8	38.8	38.8	38.8
Total Split (s)	9.2	43.2	9.2	43.2	38.8	38.8	38.8	38.8	38.8	38.8
Total Split (%)	7.1%	33.2%	7.1%	33.2%	29.8%	29.8%	29.8%	29.8%	29.8%	29.8%
Yellow Time (s)	3.2	5.2	3.2	5.2	4.8	4.8	4.8	4.8	4.8	4.8
All-Red Time (s)	1.0	1.0	1.0	1.0	1.0	1.0	1.0	1.0	1.0	1.0
Lost Time Adjust (s)	0.0	0.0	0.0	0.0	0.0	0.0	0.0	0.0	0.0	0.0
Total Lost Time (s)	4.2	6.2	4.2	6.2	5.8	5.8	5.8	5.8	5.8	5.8
Lead/Lag	Lead	Lag	Lead	Lag						
Lead-Lag Optimize?	Yes	Yes	Yes	Yes						
Recall Mode	None	None	None	None	None	None	None	None	None	None
Act Effct Green (s)	5.0	37.1	5.0	37.1	75.3	13.0	13.0	32.1	32.1	32.1
Actuated g/C Ratio	0.05	0.34	0.05	0.34	0.69	0.12	0.12	0.29	0.29	0.29
v/c Ratio	1.18	2.43	1.68	1.79	0.64	0.31	0.69	0.75	0.76	0.13
Control Delay	203.4	664.9	383.9	385.5	4.6	47.9	33.9	41.1	46.6	2.4
Queue Delay	0.0	0.0	0.0	0.0	0.0	0.0	0.0	0.0	0.0	0.0
Total Delay	203.4	664.9	383.9	385.5	4.6	47.9	33.9	41.1	46.6	2.4
LOS	F	F	F	F	A	D	C	D	D	A
Approach Delay		654.9		308.8					40.5	
Approach LOS		F		F					D	

Intersection Summary

Cycle Length: 130
 Actuated Cycle Length: 109.2
 Natural Cycle: 125
 Control Type: Actuated-Uncoordinated
 Maximum v/c Ratio: 2.43
 Intersection Signal Delay: 421.6
 Intersection Capacity Utilization 131.6%
 Analysis Period (min) 15
 Intersection LOS: F
 ICU Level of Service H

Splits and Phases: 3: Overlook Pkwy./Canyon Crest Dr. & Alessandro Bl/Alessandro Bl.

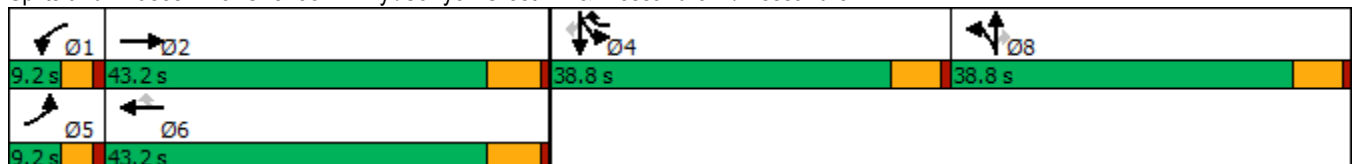

HCM 6th Signalized Intersection Summary

West Campus Upper Plateau (JN 14064)

3: Overlook Pkwy./Canyon Crest Dr. & Alessandro Bl/Alessandro Bl.

09/20/2022



Movement	EBL	EBT	EBR	WBL	WBT	WBR	NBL	NBT	NBR	SBL	SBT	SBR
Lane Configurations	↗	↑↑↑		↖	↑↑↑	↗	↖	↑↑	↗	↖↗	↖	↗
Traffic Volume (veh/h)	89	3946	102	132	3001	790	63	0	192	860	183	69
Future Volume (veh/h)	89	3946	102	132	3001	790	63	0	192	860	183	69
Initial Q (Qb), veh	0	0	0	0	0	0	0	0	0	0	0	0
Ped-Bike Adj(A_pbT)	1.00		1.00	1.00		1.00	1.00		1.00	1.00		1.00
Parking Bus, Adj	1.00	1.00	1.00	1.00	1.00	1.00	1.00	1.00	1.00	1.00	1.00	1.00
Work Zone On Approach		No			No			No			No	
Adj Sat Flow, veh/h/ln	1841	1885	1885	1900	1885	1870	1885	1900	1900	1885	1885	1870
Adj Flow Rate, veh/h	93	4110	106	138	3126	815	66	0	192	810	311	63
Peak Hour Factor	0.96	0.96	0.96	0.96	0.96	0.96	0.96	0.96	0.96	0.96	0.96	0.96
Percent Heavy Veh, %	4	1	1	0	1	2	1	0	0	1	1	2
Cap, veh/h	82	1776	45	84	1771	963	254	510	228	945	496	417
Arrive On Green	0.05	0.34	0.34	0.05	0.34	0.34	0.14	0.00	0.14	0.26	0.26	0.26
Sat Flow, veh/h	1753	5160	132	1810	5147	1585	1795	3610	1610	3591	1885	1585
Grp Volume(v), veh/h	93	2721	1495	138	3126	815	66	0	192	810	311	63
Grp Sat Flow(s),veh/h/ln	1753	1716	1861	1810	1716	1585	1795	1805	1610	1795	1885	1585
Q Serve(g_s), s	5.0	37.0	37.0	5.0	37.0	37.0	3.5	0.0	12.5	23.1	15.6	3.3
Cycle Q Clear(g_c), s	5.0	37.0	37.0	5.0	37.0	37.0	3.5	0.0	12.5	23.1	15.6	3.3
Prop In Lane	1.00		0.07	1.00		1.00	1.00		1.00	1.00		1.00
Lane Grp Cap(c), veh/h	82	1181	641	84	1771	963	254	510	228	945	496	417
V/C Ratio(X)	1.14	2.30	2.33	1.64	1.76	0.85	0.26	0.00	0.84	0.86	0.63	0.15
Avail Cap(c_a), veh/h	82	1181	641	84	1771	963	551	1108	494	1102	579	487
HCM Platoon Ratio	1.00	1.00	1.00	1.00	1.00	1.00	1.00	1.00	1.00	1.00	1.00	1.00
Upstream Filter(I)	1.00	1.00	1.00	1.00	1.00	1.00	1.00	0.00	1.00	1.00	1.00	1.00
Uniform Delay (d), s/veh	51.2	35.2	35.2	51.2	35.2	15.5	41.1	0.0	45.0	37.7	34.9	30.4
Incr Delay (d2), s/veh	142.7	589.5	605.1	334.9	346.4	7.1	0.5	0.0	8.3	6.1	1.7	0.2
Initial Q Delay(d3),s/veh	0.0	0.0	0.0	0.0	0.0	0.0	0.0	0.0	0.0	0.0	0.0	0.0
%ile BackOfQ(50%),veh/ln	5.3	110.9	123.1	10.0	71.0	23.1	1.6	0.0	5.3	10.4	7.1	1.2
Unsig. Movement Delay, s/veh												
LnGrp Delay(d),s/veh	193.9	624.7	640.3	386.2	381.7	22.6	41.7	0.0	53.2	43.7	36.6	30.5
LnGrp LOS	F	F	F	F	F	C	D	A	D	D	D	C
Approach Vol, veh/h		4309			4079			258			1184	
Approach Delay, s/veh		620.8			310.1			50.3			41.2	
Approach LOS		F			F			D			D	
Timer - Assigned Phs	1	2		4	5	6		8				
Phs Duration (G+Y+Rc), s	9.2	43.2		34.1	9.2	43.2		21.0				
Change Period (Y+Rc), s	* 4.2	6.2		5.8	* 4.2	6.2		5.8				
Max Green Setting (Gmax), s	* 5	37.0		33.0	* 5	37.0		33.0				
Max Q Clear Time (g_c+I1), s	7.0	39.0		25.1	7.0	39.0		14.5				
Green Ext Time (p_c), s	0.0	0.0		3.2	0.0	0.0		0.7				

Intersection Summary

HCM 6th Ctrl Delay	407.1
HCM 6th LOS	F

Notes

- User approved pedestrian interval to be less than phase max green.
- User approved volume balancing among the lanes for turning movement.
- * HCM 6th computational engine requires equal clearance times for the phases crossing the barrier.

Timings

West Campus Upper Plateau (JN 14064)

4: Van Buren Bl. & Wood Rd.

09/20/2022

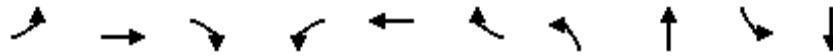

Lane Group	EBL	EBT	EBR	WBL	WBT	WBR	NBL	NBT	SBL	SBT
Lane Configurations	↘	↑↑	↗	↘↗	↑↑	↗	↘↗	↑↔	↘	↑↔
Traffic Volume (vph)	236	2186	280	339	1973	154	397	322	148	303
Future Volume (vph)	236	2186	280	339	1973	154	397	322	148	303
Turn Type	Prot	NA	pm+ov	Prot	NA	Perm	Prot	NA	Prot	NA
Protected Phases	5	2	3	1	6		3	8	7	4
Permitted Phases			2			6				
Detector Phase	5	2	3	1	6	6	3	8	7	4
Switch Phase										
Minimum Initial (s)	5.0	10.0	5.0	5.0	10.0	10.0	5.0	10.0	5.0	10.0
Minimum Split (s)	9.2	30.2	9.2	9.2	30.2	30.2	9.2	38.4	9.2	15.8
Total Split (s)	16.5	57.2	21.7	13.2	53.9	53.9	21.7	38.4	11.2	27.9
Total Split (%)	13.8%	47.7%	18.1%	11.0%	44.9%	44.9%	18.1%	32.0%	9.3%	23.3%
Yellow Time (s)	3.2	5.2	3.2	3.2	5.2	5.2	3.2	4.4	3.2	4.8
All-Red Time (s)	1.0	1.0	1.0	1.0	1.0	1.0	1.0	1.0	1.0	1.0
Lost Time Adjust (s)	0.0	0.0	0.0	0.0	0.0	0.0	0.0	0.0	0.0	0.0
Total Lost Time (s)	4.2	6.2	4.2	4.2	6.2	6.2	4.2	5.4	4.2	5.8
Lead/Lag	Lead	Lag	Lead	Lead	Lag	Lag	Lead	Lag	Lead	Lag
Lead-Lag Optimize?	Yes	Yes	Yes	Yes	Yes	Yes	Yes	Yes	Yes	Yes
Recall Mode	None	None	None	None	None	None	None	None	None	None
Act Effct Green (s)	12.3	51.1	69.9	9.0	47.8	47.8	16.8	30.3	7.0	20.1
Actuated g/C Ratio	0.10	0.44	0.60	0.08	0.41	0.41	0.14	0.26	0.06	0.17
v/c Ratio	1.37	1.54	0.32	1.38	1.48	0.23	0.88	0.71	1.52	0.86
Control Delay	237.7	275.6	8.6	234.6	247.0	6.6	69.3	34.2	312.0	49.1
Queue Delay	0.0	0.0	0.0	0.0	0.0	0.0	0.0	0.0	0.0	0.0
Total Delay	237.7	275.6	8.6	234.6	247.0	6.6	69.3	34.2	312.0	49.1
LOS	F	F	A	F	F	A	E	C	F	D
Approach Delay		244.6			230.4			47.9		105.4
Approach LOS		F			F			D		F

Intersection Summary

Cycle Length: 120
 Actuated Cycle Length: 117.4
 Natural Cycle: 120
 Control Type: Actuated-Uncoordinated
 Maximum v/c Ratio: 1.54
 Intersection Signal Delay: 196.4
 Intersection LOS: F
 Intersection Capacity Utilization 116.8%
 ICU Level of Service H
 Analysis Period (min) 15



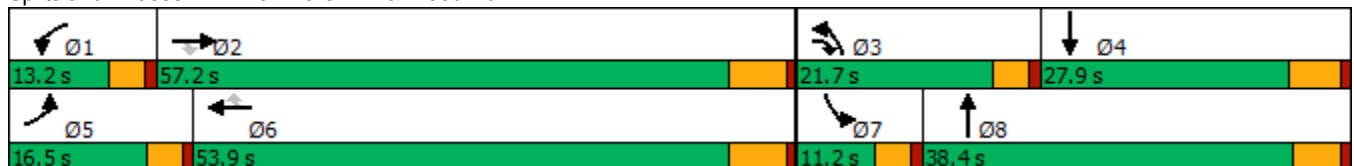





















Splits and Phases: 4: Van Buren Bl. & Wood Rd.



HCM 6th Signalized Intersection Summary
4: Van Buren Bl. & Wood Rd.

West Campus Upper Plateau (JN 14064)

09/20/2022

												
Movement	EBL	EBT	EBR	WBL	WBT	WBR	NBL	NBT	NBR	SBL	SBT	SBR
Lane Configurations												
Traffic Volume (veh/h)	236	2186	280	339	1973	154	397	322	299	148	303	240
Future Volume (veh/h)	236	2186	280	339	1973	154	397	322	299	148	303	240
Initial Q (Qb), veh	0	0	0	0	0	0	0	0	0	0	0	0
Ped-Bike Adj(A_pbT)	1.00		0.98	1.00		0.99	1.00		0.97	1.00		0.99
Parking Bus, Adj	1.00	1.00	1.00	1.00	1.00	1.00	1.00	1.00	1.00	1.00	1.00	1.00
Work Zone On Approach		No			No			No			No	
Adj Sat Flow, veh/h/ln	1885	1870	1870	1885	1885	1885	1870	1885	1870	1885	1885	1885
Adj Flow Rate, veh/h	257	2376	200	368	2145	120	432	350	245	161	329	187
Peak Hour Factor	0.92	0.92	0.92	0.92	0.92	0.92	0.92	0.92	0.92	0.92	0.92	0.92
Percent Heavy Veh, %	1	2	2	1	1	1	2	1	2	1	1	1
Cap, veh/h	189	1547	903	268	1459	641	487	509	349	107	381	212
Arrive On Green	0.11	0.44	0.44	0.08	0.41	0.41	0.14	0.25	0.25	0.06	0.17	0.17
Sat Flow, veh/h	1795	3554	1561	3483	3582	1574	3456	2008	1376	1795	2209	1227
Grp Volume(v), veh/h	257	2376	200	368	2145	120	432	311	284	161	265	251
Grp Sat Flow(s),veh/h/ln	1795	1777	1561	1742	1791	1574	1728	1791	1593	1795	1791	1645
Q Serve(g_s), s	12.3	51.0	7.3	9.0	47.7	5.7	14.4	18.4	18.9	7.0	16.9	17.4
Cycle Q Clear(g_c), s	12.3	51.0	7.3	9.0	47.7	5.7	14.4	18.4	18.9	7.0	16.9	17.4
Prop In Lane	1.00		1.00	1.00		1.00	1.00		0.86	1.00		0.75
Lane Grp Cap(c), veh/h	189	1547	903	268	1459	641	487	454	404	107	309	284
V/C Ratio(X)	1.36	1.54	0.22	1.37	1.47	0.19	0.89	0.69	0.70	1.50	0.86	0.88
Avail Cap(c_a), veh/h	189	1547	903	268	1459	641	516	505	449	107	338	310
HCM Platoon Ratio	1.00	1.00	1.00	1.00	1.00	1.00	1.00	1.00	1.00	1.00	1.00	1.00
Upstream Filter(I)	1.00	1.00	1.00	1.00	1.00	1.00	1.00	1.00	1.00	1.00	1.00	1.00
Uniform Delay (d), s/veh	52.4	33.1	12.1	54.1	34.7	22.3	49.4	39.5	39.7	55.1	47.1	47.3
Incr Delay (d2), s/veh	193.6	244.2	0.2	190.5	215.5	0.2	15.6	3.4	4.3	267.5	18.2	23.2
Initial Q Delay(d3),s/veh	0.0	0.0	0.0	0.0	0.0	0.0	0.0	0.0	0.0	0.0	0.0	0.0
%ile BackOfQ(50%),veh/ln	15.5	72.5	2.4	10.9	62.7	2.1	7.1	8.3	7.7	11.1	8.9	8.8
Unsig. Movement Delay, s/veh												
LnGrp Delay(d),s/veh	246.0	277.3	12.2	244.6	250.2	22.5	64.9	42.8	44.0	322.6	65.2	70.5
LnGrp LOS	F	F	B	F	F	C	E	D	D	F	E	E
Approach Vol, veh/h		2833			2633			1027			677	
Approach Delay, s/veh		255.7			239.0			52.4			128.4	
Approach LOS		F			F			D			F	
Timer - Assigned Phs	1	2	3	4	5	6	7	8				
Phs Duration (G+Y+Rc), s	13.2	57.2	20.7	26.0	16.5	53.9	11.2	35.5				
Change Period (Y+Rc), s	* 4.2	6.2	* 4.2	5.8	* 4.2	6.2	* 4.2	* 5.8				
Max Green Setting (Gmax), s	* 9	51.0	* 18	22.1	* 12	47.7	* 7	* 33				
Max Q Clear Time (g_c+I1), s	11.0	53.0	16.4	19.4	14.3	49.7	9.0	20.9				
Green Ext Time (p_c), s	0.0	0.0	0.1	0.8	0.0	0.0	0.0	2.8				

Intersection Summary

HCM 6th Ctrl Delay	208.5
HCM 6th LOS	F

Notes

* HCM 6th computational engine requires equal clearance times for the phases crossing the barrier.

Timings
5: Trautwein Rd. & Alessandro Bl.

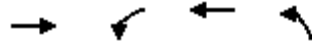

Lane Group	EBT	WBL	WBT	NBL
Lane Configurations	↑↑↑	↰↱	↑↑↑	↰↱↰↱
Traffic Volume (vph)	2462	427	2605	1397
Future Volume (vph)	2462	427	2605	1397
Turn Type	NA	Prot	NA	Prot
Protected Phases	2	1	6	8
Permitted Phases				
Detector Phase	2	1	6	8
Switch Phase				
Minimum Initial (s)	10.0	5.0	10.0	10.0
Minimum Split (s)	33.2	9.2	16.2	16.2
Total Split (s)	63.0	19.0	82.0	38.0
Total Split (%)	52.5%	15.8%	68.3%	31.7%
Yellow Time (s)	5.2	3.2	5.2	5.2
All-Red Time (s)	1.0	1.0	1.0	1.0
Lost Time Adjust (s)	0.0	0.0	0.0	0.0
Total Lost Time (s)	6.2	4.2	6.2	6.2
Lead/Lag	Lag	Lead		
Lead-Lag Optimize?	Yes	Yes		
Recall Mode	None	None	None	None
Act Effct Green (s)	56.8	14.8	75.8	31.8
Actuated g/C Ratio	0.47	0.12	0.63	0.26
v/c Ratio	1.22	1.05	0.85	1.21
Control Delay	134.5	108.2	20.7	139.6
Queue Delay	0.0	0.0	0.0	0.0
Total Delay	134.5	108.2	20.7	139.6
LOS	F	F	C	F
Approach Delay	134.5		33.0	139.6
Approach LOS	F		C	F

Intersection Summary

Cycle Length: 120
 Actuated Cycle Length: 120
 Natural Cycle: 120
 Control Type: Actuated-Uncoordinated
 Maximum v/c Ratio: 1.22
 Intersection Signal Delay: 93.6
 Intersection LOS: F
 Intersection Capacity Utilization 109.8%
 ICU Level of Service H
 Analysis Period (min) 15

Splits and Phases: 5: Trautwein Rd. & Alessandro Bl.



HCM 6th Signalized Intersection Summary
5: Trautwein Rd. & Alessandro Bl.

West Campus Upper Plateau (JN 14064)
09/20/2022

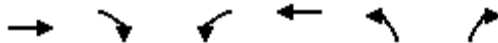

Movement	EBT	EBR	WBL	WBT	NBL	NBR
Lane Configurations	↑↑↑		↵↵	↑↑↑	↵↵↵	
Traffic Volume (veh/h)	2462	317	427	2605	1397	126
Future Volume (veh/h)	2462	317	427	2605	1397	126
Initial Q (Qb), veh	0	0	0	0	0	0
Ped-Bike Adj(A_pbT)		1.00	1.00		1.00	1.00
Parking Bus, Adj	1.00	1.00	1.00	1.00	1.00	1.00
Work Zone On Approach	No			No	No	
Adj Sat Flow, veh/h/ln	1885	1900	1885	1885	1885	1900
Adj Flow Rate, veh/h	2592	334	449	2742	1595	0
Peak Hour Factor	0.95	0.95	0.95	0.95	0.95	0.95
Percent Heavy Veh, %	1	0	1	1	1	0
Cap, veh/h	2196	272	430	3251	1427	427
Arrive On Green	0.47	0.47	0.12	0.63	0.27	0.00
Sat Flow, veh/h	4809	574	3483	5316	5386	1610
Grp Volume(v), veh/h	1888	1038	449	2742	1595	0
Grp Sat Flow(s),veh/h/ln	1716	1782	1742	1716	1795	1610
Q Serve(g_s), s	56.8	56.8	14.8	50.4	31.8	0.0
Cycle Q Clear(g_c), s	56.8	56.8	14.8	50.4	31.8	0.0
Prop In Lane		0.32	1.00		1.00	1.00
Lane Grp Cap(c), veh/h	1624	843	430	3251	1427	427
V/C Ratio(X)	1.16	1.23	1.05	0.84	1.12	0.00
Avail Cap(c_a), veh/h	1624	843	430	3251	1427	427
HCM Platoon Ratio	1.00	1.00	1.00	1.00	1.00	1.00
Upstream Filter(I)	1.00	1.00	1.00	1.00	1.00	0.00
Uniform Delay (d), s/veh	31.6	31.6	52.6	17.4	44.1	0.0
Incr Delay (d2), s/veh	80.5	113.9	55.7	2.3	62.9	0.0
Initial Q Delay(d3),s/veh	0.0	0.0	0.0	0.0	0.0	0.0
%ile BackOfQ(50%),veh/ln	39.4	48.7	9.5	16.8	21.7	0.0
Unsig. Movement Delay, s/veh						
LnGrp Delay(d),s/veh	112.1	145.5	108.3	19.7	107.0	0.0
LnGrp LOS	F	F	F	B	F	A
Approach Vol, veh/h	2926			3191	1595	
Approach Delay, s/veh	123.9			32.2	107.0	
Approach LOS	F			C	F	
Timer - Assigned Phs	1	2			6	8
Phs Duration (G+Y+Rc), s	19.0	63.0			82.0	38.0
Change Period (Y+Rc), s	* 4.2	6.2			6.2	6.2
Max Green Setting (Gmax), s	* 15	56.8			75.8	31.8
Max Q Clear Time (g_c+I1), s	16.8	58.8			52.4	33.8
Green Ext Time (p_c), s	0.0	0.0			21.9	0.0

Intersection Summary

HCM 6th Ctrl Delay	82.5
HCM 6th LOS	F

Notes

User approved volume balancing among the lanes for turning movement.
* HCM 6th computational engine requires equal clearance times for the phases crossing the barrier.

Timings
6: Trautwein Rd. & Grove Community Dr

West Campus Upper Plateau (JN 14064)

09/20/2022



Lane Group	WBL	WBR	NBT	NBR	SBL	SBT
Lane Configurations	↙	↗↗	↕↕	↗	↗↗	↕↕
Traffic Volume (vph)	61	283	1676	65	447	2413
Future Volume (vph)	61	283	1676	65	447	2413
Turn Type	Prot	pm+ov	NA	Perm	Prot	NA
Protected Phases	8	1	2		1	6
Permitted Phases		8		2		
Detector Phase	8	1	2	2	1	6
Switch Phase						
Minimum Initial (s)	10.0	5.0	10.0	10.0	5.0	10.0
Minimum Split (s)	34.6	9.6	46.2	46.2	9.6	28.2
Total Split (s)	35.0	29.0	56.0	56.0	29.0	85.0
Total Split (%)	29.2%	24.2%	46.7%	46.7%	24.2%	70.8%
Yellow Time (s)	3.6	3.6	5.2	5.2	3.6	5.2
All-Red Time (s)	1.0	1.0	1.0	1.0	1.0	1.0
Lost Time Adjust (s)	0.0	0.0	0.0	0.0	0.0	0.0
Total Lost Time (s)	4.6	4.6	6.2	6.2	4.6	6.2
Lead/Lag		Lead	Lag	Lag	Lead	
Lead-Lag Optimize?		Yes	Yes	Yes	Yes	
Recall Mode	None	None	None	None	None	None
Act Effect Green (s)	13.2	27.9	57.9	57.9	17.1	81.1
Actuated g/C Ratio	0.13	0.28	0.58	0.58	0.17	0.81
v/c Ratio	0.26	0.37	0.82	0.07	0.77	0.86
Control Delay	42.5	25.3	24.4	9.4	49.3	14.0
Queue Delay	0.0	0.0	0.0	0.0	0.0	0.0
Total Delay	42.5	25.3	24.4	9.4	49.3	14.0
LOS	D	C	C	A	D	B
Approach Delay	28.4		23.8			19.5
Approach LOS	C		C			B

Intersection Summary

Cycle Length: 120
 Actuated Cycle Length: 100.3
 Natural Cycle: 115
 Control Type: Actuated-Uncoordinated
 Maximum v/c Ratio: 0.86
 Intersection Signal Delay: 21.6
 Intersection LOS: C
 Intersection Capacity Utilization 85.0%
 ICU Level of Service E
 Analysis Period (min) 15

Splits and Phases: 6: Trautwein Rd. & Grove Community Dr



HCM 6th Signalized Intersection Summary
6: Trautwein Rd. & Grove Community Dr

West Campus Upper Plateau (JN 14064)

09/20/2022



Movement	WBL	WBR	NBT	NBR	SBL	SBT
Lane Configurations						
Traffic Volume (veh/h)	61	283	1676	65	447	2413
Future Volume (veh/h)	61	283	1676	65	447	2413
Initial Q (Qb), veh	0	0	0	0	0	0
Ped-Bike Adj(A_pbT)	1.00	1.00		1.00	1.00	
Parking Bus, Adj	1.00	1.00	1.00	1.00	1.00	1.00
Work Zone On Approach	No		No			No
Adj Sat Flow, veh/h/ln	1900	1900	1900	1900	1900	1870
Adj Flow Rate, veh/h	62	110	1710	61	456	2462
Peak Hour Factor	0.98	0.98	0.98	0.98	0.98	0.98
Percent Heavy Veh, %	0	0	0	0	0	2
Cap, veh/h	191	738	2075	926	543	2767
Arrive On Green	0.11	0.11	0.57	0.57	0.15	0.78
Sat Flow, veh/h	1810	2834	3705	1610	3510	3647
Grp Volume(v), veh/h	62	110	1710	61	456	2462
Grp Sat Flow(s),veh/h/ln	1810	1417	1805	1610	1755	1777
Q Serve(g_s), s	3.0	2.8	35.8	1.6	11.8	46.6
Cycle Q Clear(g_c), s	3.0	2.8	35.8	1.6	11.8	46.6
Prop In Lane	1.00	1.00		1.00	1.00	
Lane Grp Cap(c), veh/h	191	738	2075	926	543	2767
V/C Ratio(X)	0.32	0.15	0.82	0.07	0.84	0.89
Avail Cap(c_a), veh/h	589	1360	2075	926	917	2997
HCM Platoon Ratio	1.00	1.00	1.00	1.00	1.00	1.00
Upstream Filter(I)	1.00	1.00	1.00	1.00	1.00	1.00
Uniform Delay (d), s/veh	38.7	26.6	16.0	8.8	38.4	7.5
Incr Delay (d2), s/veh	1.0	0.1	2.8	0.0	1.4	3.5
Initial Q Delay(d3),s/veh	0.0	0.0	0.0	0.0	0.0	0.0
%ile BackOfQ(50%),veh/ln	1.3	0.9	12.6	0.5	4.9	9.2
Unsig. Movement Delay, s/veh						
LnGrp Delay(d),s/veh	39.7	26.7	18.9	8.8	39.7	11.0
LnGrp LOS	D	C	B	A	D	B
Approach Vol, veh/h	172		1771			2918
Approach Delay, s/veh	31.4		18.5			15.5
Approach LOS	C		B			B
Timer - Assigned Phs	1	2			6	8
Phs Duration (G+Y+Rc), s	19.0	59.9			79.0	14.5
Change Period (Y+Rc), s	4.6	6.2			6.2	4.6
Max Green Setting (Gmax), s	24.4	49.8			78.8	30.4
Max Q Clear Time (g_c+I1), s	13.8	37.8			48.6	5.0
Green Ext Time (p_c), s	0.7	8.5			24.1	0.5

Intersection Summary

HCM 6th Ctrl Delay	17.2
HCM 6th LOS	B

Timings

7: Trautwein Rd. & Orange Terrace Pkwy

09/20/2022



Lane Group	EBL	EBT	WBL	WBT	WBR	NBL	NBT	NBR	SBL	SBT	SBR
Lane Configurations											
Traffic Volume (vph)	55	77	268	55	322	53	1566	397	576	1990	48
Future Volume (vph)	55	77	268	55	322	53	1566	397	576	1990	48
Turn Type	Prot	NA	Prot	NA	pm+ov	Prot	NA	Perm	Prot	NA	Perm
Protected Phases	7	4	3	8	1	5	2		1	6	
Permitted Phases					8			2			6
Detector Phase	7	4	3	8	1	5	2	2	1	6	6
Switch Phase											
Minimum Initial (s)	5.0	10.0	5.0	10.0	5.0	5.0	10.0	10.0	5.0	10.0	10.0
Minimum Split (s)	9.6	38.6	9.6	34.6	9.6	9.6	46.2	46.2	9.6	28.2	28.2
Total Split (s)	13.2	38.6	16.1	41.5	18.0	9.6	47.3	47.3	18.0	55.7	55.7
Total Split (%)	11.0%	32.2%	13.4%	34.6%	15.0%	8.0%	39.4%	39.4%	15.0%	46.4%	46.4%
Yellow Time (s)	3.6	3.6	3.6	3.6	3.6	3.6	5.2	5.2	3.6	5.2	5.2
All-Red Time (s)	1.0	1.0	1.0	1.0	1.0	1.0	1.0	1.0	1.0	1.0	1.0
Lost Time Adjust (s)	0.0	0.0	0.0	0.0	0.0	0.0	0.0	0.0	0.0	0.0	0.0
Total Lost Time (s)	4.6	4.6	4.6	4.6	4.6	4.6	6.2	6.2	4.6	6.2	6.2
Lead/Lag	Lead	Lag	Lead	Lag	Lead	Lead	Lag	Lag	Lead	Lag	Lag
Lead-Lag Optimize?	Yes	Yes	Yes	Yes	Yes	Yes	Yes	Yes	Yes	Yes	Yes
Recall Mode	None	None	None	None	None	None	None	None	None	None	None
Act Effct Green (s)	7.2	14.6	11.6	21.0	39.1	5.0	41.4	41.4	13.5	51.9	51.9
Actuated g/C Ratio	0.07	0.14	0.11	0.21	0.39	0.05	0.41	0.41	0.13	0.51	0.51
v/c Ratio	0.45	0.39	1.38	0.15	0.29	0.62	1.13	0.55	1.31	1.14	0.06
Control Delay	58.6	37.4	234.6	34.7	14.7	79.0	96.3	16.1	191.6	97.6	0.4
Queue Delay	0.0	0.0	0.0	0.0	0.0	0.0	0.0	0.0	0.0	0.0	0.0
Total Delay	58.6	37.4	234.6	34.7	14.7	79.0	96.3	16.1	191.6	97.6	0.4
LOS	E	D	F	C	B	E	F	B	F	F	A
Approach Delay		44.9		107.8			80.0			116.5	
Approach LOS		D		F			F			F	

Intersection Summary

Cycle Length: 120	
Actuated Cycle Length: 101.2	
Natural Cycle: 115	
Control Type: Actuated-Uncoordinated	
Maximum v/c Ratio: 1.38	
Intersection Signal Delay: 99.9	Intersection LOS: F
Intersection Capacity Utilization 94.1%	ICU Level of Service F
Analysis Period (min) 15	

Splits and Phases: 7: Trautwein Rd. & Orange Terrace Pkwy

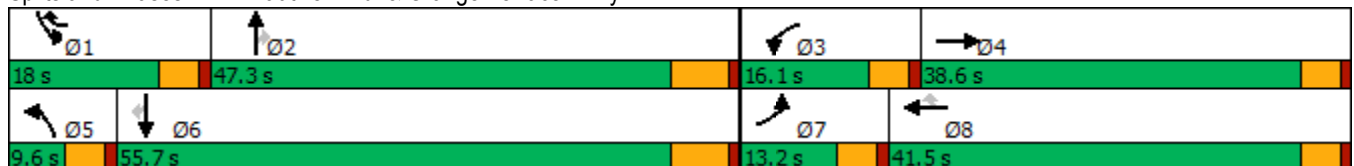

HCM 6th Signalized Intersection Summary
7: Trautwein Rd. & Orange Terrace Pkwy

West Campus Upper Plateau (JN 14064)

09/20/2022



Movement	EBL	EBT	EBR	WBL	WBT	WBR	NBL	NBT	NBR	SBL	SBT	SBR
Lane Configurations												
Traffic Volume (veh/h)	55	77	25	268	55	322	53	1566	397	576	1990	48
Future Volume (veh/h)	55	77	25	268	55	322	53	1566	397	576	1990	48
Initial Q (Qb), veh	0	0	0	0	0	0	0	0	0	0	0	0
Ped-Bike Adj(A_pbT)	1.00		1.00	1.00		1.00	1.00		1.00	1.00		1.00
Parking Bus, Adj	1.00	1.00	1.00	1.00	1.00	1.00	1.00	1.00	1.00	1.00	1.00	1.00
Work Zone On Approach		No			No			No			No	
Adj Sat Flow, veh/h/ln	1900	1900	1900	1885	1900	1870	1900	1885	1885	1885	1885	1900
Adj Flow Rate, veh/h	58	81	24	282	58	220	56	1648	341	606	2095	42
Peak Hour Factor	0.95	0.95	0.95	0.95	0.95	0.95	0.95	0.95	0.95	0.95	0.95	0.95
Percent Heavy Veh, %	0	0	0	1	0	2	0	1	1	1	1	0
Cap, veh/h	75	147	43	215	347	898	73	1533	684	486	1889	849
Arrive On Green	0.04	0.10	0.10	0.12	0.18	0.18	0.04	0.43	0.43	0.14	0.53	0.53
Sat Flow, veh/h	1810	1408	417	1795	1900	2790	1810	3582	1598	3483	3582	1610
Grp Volume(v), veh/h	58	0	105	282	58	220	56	1648	341	606	2095	42
Grp Sat Flow(s),veh/h/ln	1810	0	1825	1795	1900	1395	1810	1791	1598	1742	1791	1610
Q Serve(g_s), s	3.0	0.0	5.3	11.5	2.5	5.6	2.9	41.1	14.9	13.4	50.6	1.2
Cycle Q Clear(g_c), s	3.0	0.0	5.3	11.5	2.5	5.6	2.9	41.1	14.9	13.4	50.6	1.2
Prop In Lane	1.00		0.23	1.00		1.00	1.00		1.00	1.00		1.00
Lane Grp Cap(c), veh/h	75	0	190	215	347	898	73	1533	684	486	1889	849
V/C Ratio(X)	0.77	0.00	0.55	1.31	0.17	0.24	0.77	1.07	0.50	1.25	1.11	0.05
Avail Cap(c_a), veh/h	162	0	646	215	730	1462	94	1533	684	486	1889	849
HCM Platoon Ratio	1.00	1.00	1.00	1.00	1.00	1.00	1.00	1.00	1.00	1.00	1.00	1.00
Upstream Filter(I)	1.00	0.00	1.00	1.00	1.00	1.00	1.00	1.00	1.00	1.00	1.00	1.00
Uniform Delay (d), s/veh	45.6	0.0	40.9	42.2	33.1	24.0	45.6	27.4	20.0	41.3	22.7	11.0
Incr Delay (d2), s/veh	6.2	0.0	2.5	169.2	0.2	0.1	17.5	46.0	0.6	127.2	57.4	0.0
Initial Q Delay(d3),s/veh	0.0	0.0	0.0	0.0	0.0	0.0	0.0	0.0	0.0	0.0	0.0	0.0
%ile BackOfQ(50%),veh/ln	1.5	0.0	2.5	15.0	1.1	1.7	1.6	25.1	5.2	14.0	32.7	0.4
Unsig. Movement Delay, s/veh												
LnGrp Delay(d),s/veh	51.7	0.0	43.4	211.5	33.3	24.1	63.2	73.4	20.5	168.5	80.1	11.0
LnGrp LOS	D	A	D	F	C	C	E	F	C	F	F	B
Approach Vol, veh/h		163			560			2045			2743	
Approach Delay, s/veh		46.3			119.4			64.3			98.6	
Approach LOS		D			F			E			F	
Timer - Assigned Phs	1	2	3	4	5	6	7	8				
Phs Duration (G+Y+Rc), s	18.0	47.3	16.1	14.6	8.5	56.8	8.6	22.1				
Change Period (Y+Rc), s	4.6	6.2	4.6	4.6	4.6	6.2	4.6	4.6				
Max Green Setting (Gmax), s	13.4	41.1	11.5	34.0	5.0	49.5	8.6	36.9				
Max Q Clear Time (g_c+I1), s	15.4	43.1	13.5	7.3	4.9	52.6	5.0	7.6				
Green Ext Time (p_c), s	0.0	0.0	0.0	0.5	0.0	0.0	0.0	1.1				

Intersection Summary

HCM 6th Ctrl Delay	86.4
HCM 6th LOS	F

Timings
8: Cole Av. & Van Buren Bl.

West Campus Upper Plateau (JN 14064)

09/20/2022



Lane Group	EBL	EBT	EBR	WBL	WBT	WBR	NBL	NBT	SBL	SBT	SBR
Lane Configurations	↖↗	↑↑	↖	↖	↑↑↑	↖	↖	↑↑	↖↗	↑↑	↖
Traffic Volume (vph)	517	1737	121	175	1734	803	107	401	764	725	384
Future Volume (vph)	517	1737	121	175	1734	803	107	401	764	725	384
Turn Type	Prot	NA	pm+ov	Prot	NA	pm+ov	Prot	NA	Prot	NA	pm+ov
Protected Phases	5	2	3	1	6	7	3	8	7	4	5
Permitted Phases			2			6					4
Detector Phase	5	2	3	1	6	7	3	8	7	4	5
Switch Phase											
Minimum Initial (s)	5.0	10.0	5.0	5.0	10.0	5.0	5.0	10.0	5.0	10.0	5.0
Minimum Split (s)	9.1	36.2	9.1	9.1	36.2	9.1	9.1	42.2	9.1	49.2	9.1
Total Split (s)	18.7	44.8	12.0	14.0	40.1	17.5	12.0	43.7	17.5	49.2	18.7
Total Split (%)	15.6%	37.3%	10.0%	11.7%	33.4%	14.6%	10.0%	36.4%	14.6%	41.0%	15.6%
Yellow Time (s)	3.2	5.2	3.2	3.2	5.2	3.2	3.2	5.2	3.2	5.2	3.2
All-Red Time (s)	0.5	1.0	0.5	0.5	1.0	0.5	0.5	1.0	0.5	1.0	0.5
Lost Time Adjust (s)	0.0	0.0	0.0	0.0	0.0	0.0	0.0	0.0	0.0	0.0	0.0
Total Lost Time (s)	3.7	6.2	3.7	3.7	6.2	3.7	3.7	6.2	3.7	6.2	3.7
Lead/Lag	Lead	Lag	Lead	Lead	Lag	Lead	Lead	Lag	Lead	Lag	Lead
Lead-Lag Optimize?	Yes	Yes	Yes	Yes	Yes	Yes	Yes	Yes	Yes	Yes	Yes
Recall Mode	None	None	None	None	None	None	None	None	None	None	None
Act Effct Green (s)	15.1	38.8	53.3	10.3	34.0	54.1	8.3	24.3	13.9	29.8	47.3
Actuated g/C Ratio	0.14	0.36	0.50	0.10	0.32	0.51	0.08	0.23	0.13	0.28	0.44
v/c Ratio	1.14	1.47	0.16	1.09	1.14	0.98	0.82	0.68	1.83	0.78	0.56
Control Delay	127.8	245.3	6.2	142.6	106.4	49.0	91.2	39.8	412.1	41.2	19.2
Queue Delay	0.0	0.0	0.0	0.0	0.0	0.0	0.0	0.0	0.0	0.0	0.0
Total Delay	127.8	245.3	6.2	142.6	106.4	49.0	91.2	39.8	412.1	41.2	19.2
LOS	F	F	A	F	F	D	F	D	F	D	B
Approach Delay		207.5			91.8			48.6		188.0	
Approach LOS		F			F			D		F	

Intersection Summary

Cycle Length: 120	
Actuated Cycle Length: 107.1	
Natural Cycle: 115	
Control Type: Actuated-Uncoordinated	
Maximum v/c Ratio: 1.83	
Intersection Signal Delay: 148.3	Intersection LOS: F
Intersection Capacity Utilization 113.2%	ICU Level of Service H
Analysis Period (min) 15	



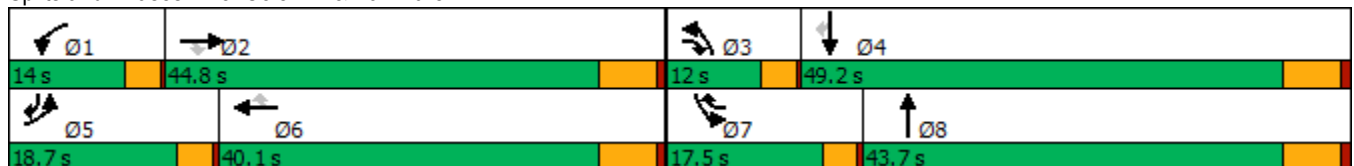



























Splits and Phases: 8: Cole Av. & Van Buren Bl.



HCM 6th Signalized Intersection Summary
8: Cole Av. & Van Buren Bl.

West Campus Upper Plateau (JN 14064)

09/20/2022

												
Movement	EBL	EBT	EBR	WBL	WBT	WBR	NBL	NBT	NBR	SBL	SBT	SBR
Lane Configurations	 	 			  			 		 	 	
Traffic Volume (veh/h)	517	1737	121	175	1734	803	107	401	114	764	725	384
Future Volume (veh/h)	517	1737	121	175	1734	803	107	401	114	764	725	384
Initial Q (Qb), veh	0	0	0	0	0	0	0	0	0	0	0	0
Ped-Bike Adj(A_pbT)	1.00		1.00	1.00		1.00	1.00		0.99	1.00		1.00
Parking Bus, Adj	1.00	1.00	1.00	1.00	1.00	1.00	1.00	1.00	1.00	1.00	1.00	1.00
Work Zone On Approach		No			No			No			No	
Adj Sat Flow, veh/h/ln	1870	1841	1856	1870	1870	1885	1885	1885	1885	1870	1885	1885
Adj Flow Rate, veh/h	550	1848	70	186	1845	764	114	427	114	813	771	309
Peak Hour Factor	0.94	0.94	0.94	0.94	0.94	0.94	0.94	0.94	0.94	0.94	0.94	0.94
Percent Heavy Veh, %	2	4	3	2	2	1	1	1	1	2	1	1
Cap, veh/h	487	1269	693	172	1627	716	140	628	166	448	989	666
Arrive On Green	0.14	0.36	0.36	0.10	0.32	0.32	0.08	0.22	0.22	0.13	0.28	0.28
Sat Flow, veh/h	3456	3497	1572	1781	5106	1598	1795	2798	740	3456	3582	1596
Grp Volume(v), veh/h	550	1848	70	186	1845	764	114	272	269	813	771	309
Grp Sat Flow(s),veh/h/ln	1728	1749	1572	1781	1702	1598	1795	1791	1747	1728	1791	1596
Q Serve(g_s), s	15.0	38.6	2.8	10.3	33.9	33.9	6.6	14.8	15.0	13.8	21.1	14.9
Cycle Q Clear(g_c), s	15.0	38.6	2.8	10.3	33.9	33.9	6.6	14.8	15.0	13.8	21.1	14.9
Prop In Lane	1.00		1.00	1.00		1.00	1.00		0.42	1.00		1.00
Lane Grp Cap(c), veh/h	487	1269	693	172	1627	716	140	402	392	448	989	666
V/C Ratio(X)	1.13	1.46	0.10	1.08	1.13	1.07	0.81	0.68	0.69	1.81	0.78	0.46
Avail Cap(c_a), veh/h	487	1269	693	172	1627	716	140	631	616	448	1448	870
HCM Platoon Ratio	1.00	1.00	1.00	1.00	1.00	1.00	1.00	1.00	1.00	1.00	1.00	1.00
Upstream Filter(I)	1.00	1.00	1.00	1.00	1.00	1.00	1.00	1.00	1.00	1.00	1.00	1.00
Uniform Delay (d), s/veh	45.7	33.9	17.4	48.0	36.2	29.3	48.3	37.7	37.8	46.3	35.5	22.4
Incr Delay (d2), s/veh	81.0	209.7	0.1	90.9	68.5	52.7	27.7	2.0	2.1	374.8	1.7	0.5
Initial Q Delay(d3),s/veh	0.0	0.0	0.0	0.0	0.0	0.0	0.0	0.0	0.0	0.0	0.0	0.0
%ile BackOfQ(50%),veh/ln	11.6	51.9	0.9	8.7	23.3	26.8	3.9	6.3	6.3	29.0	8.9	5.2
Unsig. Movement Delay, s/veh												
LnGrp Delay(d),s/veh	126.7	243.6	17.5	139.0	104.7	82.1	76.0	39.7	40.0	421.1	37.2	22.9
LnGrp LOS	F	F	B	F	F	F	E	D	D	F	D	C
Approach Vol, veh/h		2468			2795			655			1893	
Approach Delay, s/veh		211.1			100.8			46.1			199.7	
Approach LOS		F			F			D			F	
Timer - Assigned Phs	1	2	3	4	5	6	7	8				
Phs Duration (G+Y+Rc), s	14.0	44.8	12.0	35.6	18.7	40.1	17.5	30.1				
Change Period (Y+Rc), s	3.7	6.2	3.7	6.2	3.7	6.2	3.7	6.2				
Max Green Setting (Gmax), s	10.3	38.6	8.3	43.0	15.0	33.9	13.8	37.5				
Max Q Clear Time (g_c+I1), s	12.3	40.6	8.6	23.1	17.0	35.9	15.8	17.0				
Green Ext Time (p_c), s	0.0	0.0	0.0	5.7	0.0	0.0	0.0	2.8				
Intersection Summary												
HCM 6th Ctrl Delay			155.0									
HCM 6th LOS			F									

Intersection

Intersection Delay, s/veh	10.3
Intersection LOS	B

Movement	EBT	EBR	WBL	WBT	NBL	NBR
Lane Configurations	↔		↔	↑	↔	↔
Traffic Vol, veh/h	272	24	28	177	36	47
Future Vol, veh/h	272	24	28	177	36	47
Peak Hour Factor	0.92	0.92	0.92	0.92	0.92	0.92
Heavy Vehicles, %	1	0	5	2	0	0
Mvmt Flow	296	26	30	192	39	51
Number of Lanes	1	0	1	1	1	1

Approach	EB	WB	NB
Opposing Approach	WB	EB	
Opposing Lanes	2	1	0
Conflicting Approach Left		NB	EB
Conflicting Lanes Left	0	2	1
Conflicting Approach Right	NB		WB
Conflicting Lanes Right	2	0	2
HCM Control Delay	11.3	9.5	8.8
HCM LOS	B	A	A

Lane	NBLn1	NBLn2	EBLn1	WBLn1	WBLn2
Vol Left, %	100%	0%	0%	100%	0%
Vol Thru, %	0%	0%	92%	0%	100%
Vol Right, %	0%	100%	8%	0%	0%
Sign Control	Stop	Stop	Stop	Stop	Stop
Traffic Vol by Lane	36	47	296	28	177
LT Vol	36	0	0	28	0
Through Vol	0	0	272	0	177
RT Vol	0	47	24	0	0
Lane Flow Rate	39	51	322	30	192
Geometry Grp	7	7	4	7	7
Degree of Util (X)	0.068	0.072	0.427	0.047	0.27
Departure Headway (Hd)	6.297	5.086	4.777	5.599	5.044
Convergence, Y/N	Yes	Yes	Yes	Yes	Yes
Cap	568	702	753	640	712
Service Time	4.045	2.833	2.803	3.329	2.775
HCM Lane V/C Ratio	0.069	0.073	0.428	0.047	0.27
HCM Control Delay	9.5	8.2	11.3	8.6	9.6
HCM Lane LOS	A	A	B	A	A
HCM 95th-tile Q	0.2	0.2	2.1	0.1	1.1

Intersection

Intersection Delay, s/veh 13.4

Intersection LOS B

Movement	EBL	EBT	EBR	WBL	WBT	WBR	NBL	NBT	NBR	SBL	SBT	SBR
Lane Configurations												
Traffic Vol, veh/h	57	618	20	4	365	61	24	6	3	36	10	26
Future Vol, veh/h	57	618	20	4	365	61	24	6	3	36	10	26
Peak Hour Factor	0.96	0.96	0.96	0.96	0.96	0.96	0.96	0.96	0.96	0.96	0.96	0.96
Heavy Vehicles, %	5	2	7	0	1	0	6	0	0	0	0	0
Mvmt Flow	59	644	21	4	380	64	25	6	3	38	10	27
Number of Lanes	1	2	0	1	2	0	0	1	0	0	1	0

Approach	EB	WB	NB	SB
Opposing Approach	WB	EB	SB	NB
Opposing Lanes	3	3	1	1
Conflicting Approach Left SB		NB	EB	WB
Conflicting Lanes Left	1	1	3	3
Conflicting Approach Right NB		SB	WB	EB
Conflicting Lanes Right	1	1	3	3
HCM Control Delay	15	11.5	10.9	11
HCM LOS	B	B	B	B

Lane	NBLn1	EBLn1	EBLn2	EBLn3	WBLn1	WBLn2	WBLn3	SBLn1
Vol Left, %		73%	100%	0%	0%	100%	0%	0%
Vol Thru, %		18%	0%	100%	91%	0%	100%	67%
Vol Right, %		9%	0%	0%	9%	0%	0%	33%
Sign Control		Stop	Stop	Stop	Stop	Stop	Stop	Stop
Traffic Vol by Lane		33	57	412	226	4	243	183
LT Vol		24	57	0	0	4	0	0
Through Vol		6	0	412	206	0	243	122
RT Vol		3	0	0	20	0	0	61
Lane Flow Rate		34	59	429	235	4	253	190
Geometry Grp		7	7	7	7	7	7	7
Degree of Util (X)		0.072	0.099	0.653	0.359	0.007	0.404	0.29
Departure Headway (Hd)		7.554	6.029	5.474	5.497	6.228	5.741	5.488
Convergence, Y/N		Yes	Yes	Yes	Yes	Yes	Yes	Yes
Cap		474	598	665	659	575	626	655
Service Time		5.302	3.729	3.174	3.197	3.962	3.475	3.222
HCM Lane V/C Ratio		0.072	0.099	0.645	0.357	0.007	0.404	0.29
HCM Control Delay		10.9	9.4	17.9	11.2	9	12.3	10.5
HCM Lane LOS		B	A	C	B	A	B	B
HCM 95th-tile Q		0.2	0.3	4.8	1.6	0	2	1.2

Timings

11: Barton St & Alessandro Bl.

09/20/2022



Lane Group	EBL	EBT	WBL	WBT	NBL	NBT	NBR	SBL	SBT	SBR
Lane Configurations	↙	↕↕↕	↙	↕↕↕		↕	↗		↕	↗
Traffic Volume (vph)	7	2621	90	2814	67	1	44	18	0	16
Future Volume (vph)	7	2621	90	2814	67	1	44	18	0	16
Turn Type	Prot	NA	Prot	NA	Perm	NA	Perm	Perm	NA	Perm
Protected Phases	5	2	1	6		8			4	
Permitted Phases					8		8	4		4
Detector Phase	5	2	1	6	8	8	8	4	4	4
Switch Phase										
Minimum Initial (s)	5.0	10.0	5.0	10.0	10.0	10.0	10.0	10.0	10.0	10.0
Minimum Split (s)	9.2	28.5	11.0	28.5	40.6	40.6	40.6	26.6	26.6	26.6
Total Split (s)	9.2	65.4	14.0	70.2	40.6	40.6	40.6	40.6	40.6	40.6
Total Split (%)	7.7%	54.5%	11.7%	58.5%	33.8%	33.8%	33.8%	33.8%	33.8%	33.8%
Yellow Time (s)	3.2	5.5	3.2	5.5	3.6	3.6	3.6	3.6	3.6	3.6
All-Red Time (s)	1.0	1.0	1.0	1.0	1.0	1.0	1.0	1.0	1.0	1.0
Lost Time Adjust (s)	0.0	0.0	0.0	0.0		0.0	0.0		0.0	0.0
Total Lost Time (s)	4.2	6.5	4.2	6.5		4.6	4.6		4.6	4.6
Lead/Lag	Lead	Lag	Lead	Lag						
Lead-Lag Optimize?	Yes	Yes	Yes	Yes						
Recall Mode	None	None	None	None	None	None	None	None	None	None
Act Effct Green (s)	5.1	63.7	8.6	72.5		14.7	14.7		14.7	14.7
Actuated g/C Ratio	0.05	0.67	0.09	0.77		0.16	0.16		0.16	0.16
v/c Ratio	0.09	0.81	0.57	0.76		0.34	0.13		0.10	0.05
Control Delay	52.0	19.2	59.7	12.9		41.0	0.8		35.4	0.2
Queue Delay	0.0	0.0	0.0	0.0		0.0	0.0		0.0	0.0
Total Delay	52.0	19.2	59.7	12.9		41.0	0.8		35.4	0.2
LOS	D	B	E	B		D	A		D	A
Approach Delay		19.3		14.3		25.2			18.8	
Approach LOS		B		B		C			B	

Intersection Summary

Cycle Length: 120
 Actuated Cycle Length: 94.4
 Natural Cycle: 115
 Control Type: Actuated-Uncoordinated
 Maximum v/c Ratio: 0.81
 Intersection Signal Delay: 16.9
 Intersection LOS: B
 Intersection Capacity Utilization 84.6%
 ICU Level of Service E
 Analysis Period (min) 15

Splits and Phases: 11: Barton St & Alessandro Bl.



HCM 6th Signalized Intersection Summary
11: Barton St & Alessandro Bl.

West Campus Upper Plateau (JN 14064)

09/20/2022



Movement	EBL	EBT	EBR	WBL	WBT	WBR	NBL	NBT	NBR	SBL	SBT	SBR
Lane Configurations	↗	↑↑↑		↖	↑↑↑			↑	↗		↑	↖
Traffic Volume (veh/h)	7	2621	55	90	2814	20	67	1	44	18	0	16
Future Volume (veh/h)	7	2621	55	90	2814	20	67	1	44	18	0	16
Initial Q (Qb), veh	0	0	0	0	0	0	0	0	0	0	0	0
Ped-Bike Adj(A_pbT)	1.00		1.00	1.00		0.98	1.00		1.00	1.00		1.00
Parking Bus, Adj	1.00	1.00	1.00	1.00	1.00	1.00	1.00	1.00	1.00	1.00	1.00	1.00
Work Zone On Approach		No			No			No			No	
Adj Sat Flow, veh/h/ln	1604	1885	1900	1900	1870	1900	1885	1900	1900	1796	1900	1900
Adj Flow Rate, veh/h	7	2730	55	94	2931	21	70	1	20	19	0	7
Peak Hour Factor	0.96	0.96	0.96	0.96	0.96	0.96	0.96	0.96	0.96	0.96	0.96	0.96
Percent Heavy Veh, %	20	1	0	0	2	0	1	0	0	7	0	0
Cap, veh/h	13	2803	56	117	3117	22	74	1	411	74	0	411
Arrive On Green	0.01	0.54	0.54	0.06	0.60	0.60	0.26	0.26	0.26	0.26	0.00	0.26
Sat Flow, veh/h	1527	5193	104	1810	5229	37	33	2	1610	33	0	1610
Grp Volume(v), veh/h	7	1799	986	94	1905	1047	71	0	20	19	0	7
Grp Sat Flow(s),veh/h/ln	1527	1716	1866	1810	1702	1863	36	0	1610	33	0	1610
Q Serve(g_s), s	0.5	55.3	56.3	5.6	56.0	56.5	0.7	0.0	1.0	0.7	0.0	0.4
Cycle Q Clear(g_c), s	0.5	55.3	56.3	5.6	56.0	56.5	27.8	0.0	1.0	27.8	0.0	0.4
Prop In Lane	1.00		0.06	1.00		0.02	0.99		1.00	1.00		1.00
Lane Grp Cap(c), veh/h	13	1852	1007	117	2029	1110	75	0	411	74	0	411
V/C Ratio(X)	0.53	0.97	0.98	0.80	0.94	0.94	0.95	0.00	0.05	0.26	0.00	0.02
Avail Cap(c_a), veh/h	70	1853	1008	163	2029	1110	182	0	532	181	0	532
HCM Platoon Ratio	1.00	1.00	1.00	1.00	1.00	1.00	1.00	1.00	1.00	1.00	1.00	1.00
Upstream Filter(I)	1.00	1.00	1.00	1.00	1.00	1.00	1.00	0.00	1.00	1.00	0.00	1.00
Uniform Delay (d), s/veh	53.8	24.3	24.5	50.3	20.2	20.3	54.3	0.0	30.6	54.4	0.0	30.4
Incr Delay (d2), s/veh	11.7	14.7	23.4	12.1	9.3	15.4	37.5	0.0	0.0	1.8	0.0	0.0
Initial Q Delay(d3),s/veh	0.0	0.0	0.0	0.0	0.0	0.0	0.0	0.0	0.0	0.0	0.0	0.0
%ile BackOfQ(50%),veh/ln	0.2	22.5	27.3	2.9	22.9	27.1	2.7	0.0	0.4	0.6	0.0	0.1
Unsig. Movement Delay, s/veh												
LnGrp Delay(d),s/veh	65.5	39.0	47.9	62.4	29.5	35.7	91.8	0.0	30.7	56.2	0.0	30.4
LnGrp LOS	E	D	D	E	C	D	F	A	C	E	A	C
Approach Vol, veh/h		2792			3046			91				26
Approach Delay, s/veh		42.2			32.7			78.4				49.2
Approach LOS		D			C			E				D
Timer - Assigned Phs	1	2		4	5	6		8				
Phs Duration (G+Y+Rc), s	11.3	65.4		33.1	5.1	71.6		33.1				
Change Period (Y+Rc), s	* 4.2	6.5		4.6	* 4.2	6.5		4.6				
Max Green Setting (Gmax), s	* 9.8	58.9		36.0	* 5	63.7		36.0				
Max Q Clear Time (g_c+I1), s	7.6	58.3		29.8	2.5	58.5		29.8				
Green Ext Time (p_c), s	0.0	0.6		0.0	0.0	5.1		0.1				

Intersection Summary

HCM 6th Ctrl Delay	37.9
HCM 6th LOS	D

Notes

* HCM 6th computational engine requires equal clearance times for the phases crossing the barrier.

Intersection						
Int Delay, s/veh	1.3					
Movement	EBL	EBT	WBT	WBR	SBL	SBR
Lane Configurations						
Traffic Vol, veh/h	41	278	169	27	3	35
Future Vol, veh/h	41	278	169	27	3	35
Conflicting Peds, #/hr	0	0	0	7	0	0
Sign Control	Free	Free	Free	Free	Stop	Stop
RT Channelized	-	None	-	None	-	None
Storage Length	100	-	-	-	0	-
Veh in Median Storage, #	-	0	0	-	0	-
Grade, %	-	0	0	-	0	-
Peak Hour Factor	94	94	94	94	94	94
Heavy Vehicles, %	0	0	1	0	0	0
Mvmt Flow	44	296	180	29	3	37

Major/Minor	Major1	Major2	Minor2		
Conflicting Flow All	216	0	-	0	586 202
Stage 1	-	-	-	-	202 -
Stage 2	-	-	-	-	384 -
Critical Hdwy	4.1	-	-	-	6.4 6.2
Critical Hdwy Stg 1	-	-	-	-	5.4 -
Critical Hdwy Stg 2	-	-	-	-	5.4 -
Follow-up Hdwy	2.2	-	-	-	3.5 3.3
Pot Cap-1 Maneuver	1366	-	-	-	476 844
Stage 1	-	-	-	-	837 -
Stage 2	-	-	-	-	693 -
Platoon blocked, %		-	-	-	
Mov Cap-1 Maneuver	1357	-	-	-	454 838
Mov Cap-2 Maneuver	-	-	-	-	454 -
Stage 1	-	-	-	-	804 -
Stage 2	-	-	-	-	688 -

Approach	EB	WB	SB
HCM Control Delay, s	1	0	9.8
HCM LOS			A

Minor Lane/Major Mvmt	EBL	EBT	WBT	WBR	SBLn1
Capacity (veh/h)	1357	-	-	-	786
HCM Lane V/C Ratio	0.032	-	-	-	0.051
HCM Control Delay (s)	7.7	-	-	-	9.8
HCM Lane LOS	A	-	-	-	A
HCM 95th %tile Q(veh)	0.1	-	-	-	0.2

Intersection						
Int Delay, s/veh	4.9					
Movement	EBT	EBR	WBL	WBT	NBL	NBR
Lane Configurations	↑↑		↖	↑↑	↘	
Traffic Vol, veh/h	499	150	54	297	131	53
Future Vol, veh/h	499	150	54	297	131	53
Conflicting Peds, #/hr	0	2	0	0	0	0
Sign Control	Free	Free	Free	Free	Stop	Stop
RT Channelized	-	None	-	None	-	None
Storage Length	-	-	125	-	0	-
Veh in Median Storage, #	0	-	-	0	0	-
Grade, %	0	-	-	0	0	-
Peak Hour Factor	97	97	97	97	97	97
Heavy Vehicles, %	1	1	0	0	0	0
Mvmt Flow	514	155	56	306	135	55

Major/Minor	Major1	Major2	Minor1		
Conflicting Flow All	0	0	671	0	859 337
Stage 1	-	-	-	-	594 -
Stage 2	-	-	-	-	265 -
Critical Hdwy	-	-	4.1	-	6.8 6.9
Critical Hdwy Stg 1	-	-	-	-	5.8 -
Critical Hdwy Stg 2	-	-	-	-	5.8 -
Follow-up Hdwy	-	-	2.2	-	3.5 3.3
Pot Cap-1 Maneuver	-	-	929	-	299 665
Stage 1	-	-	-	-	520 -
Stage 2	-	-	-	-	761 -
Platoon blocked, %	-	-	-	-	-
Mov Cap-1 Maneuver	-	-	927	-	280 664
Mov Cap-2 Maneuver	-	-	-	-	280 -
Stage 1	-	-	-	-	519 -
Stage 2	-	-	-	-	715 -

Approach	EB	WB	NB
HCM Control Delay, s	0	1.4	28.7
HCM LOS			D

Minor Lane/Major Mvmt	NBLn1	EBT	EBR	WBL	WBT
Capacity (veh/h)	336	-	-	927	-
HCM Lane V/C Ratio	0.565	-	-	0.06	-
HCM Control Delay (s)	28.7	-	-	9.1	-
HCM Lane LOS	D	-	-	A	-
HCM 95th %tile Q(veh)	3.3	-	-	0.2	-

Timings

14: Barton Rd. & Van Buren Bl.

09/20/2022



Lane Group	EBL	EBT	WBL	WBT	NBL	NBT	NBR	SBL	SBT
Lane Configurations	↘	↗	↘	↗	↘	↗	↗	↘	↗
Traffic Volume (vph)	223	2274	323	2340	405	108	281	16	36
Future Volume (vph)	223	2274	323	2340	405	108	281	16	36
Turn Type	Prot	NA	Prot	NA	Prot	NA	Perm	Prot	NA
Protected Phases	5	2	1	6	3	8		7	4
Permitted Phases							8		
Detector Phase	5	2	1	6	3	8	8	7	4
Switch Phase									
Minimum Initial (s)	5.0	10.0	5.0	10.0	5.0	10.0	10.0	5.0	10.0
Minimum Split (s)	9.2	25.2	9.2	25.5	9.1	14.6	14.6	9.1	33.6
Total Split (s)	17.6	52.1	22.2	56.7	12.1	36.3	36.3	9.4	33.6
Total Split (%)	14.7%	43.4%	18.5%	47.3%	10.1%	30.3%	30.3%	7.8%	28.0%
Yellow Time (s)	3.2	5.2	3.2	5.5	3.6	3.6	3.6	3.6	3.6
All-Red Time (s)	1.0	1.0	1.0	1.0	0.5	1.0	1.0	0.5	1.0
Lost Time Adjust (s)	0.0	0.0	0.0	0.0	0.0	0.0	0.0	0.0	0.0
Total Lost Time (s)	4.2	6.2	4.2	6.5	4.1	4.6	4.6	4.1	4.6
Lead/Lag	Lead	Lag	Lead	Lag	Lead	Lag	Lag	Lead	Lag
Lead-Lag Optimize?	Yes	Yes	Yes	Yes	Yes	Yes	Yes	Yes	Yes
Recall Mode	None	None	None	None	None	None	None	None	None
Act Effct Green (s)	13.5	46.1	18.1	50.4	8.0	22.2	22.2	5.3	13.6
Actuated g/C Ratio	0.13	0.44	0.17	0.48	0.08	0.21	0.21	0.05	0.13
v/c Ratio	1.00	1.82	1.09	1.01	1.57	0.28	0.53	0.19	0.62
Control Delay	107.8	393.3	120.4	47.7	310.2	37.7	8.5	55.5	16.3
Queue Delay	0.0	0.0	0.0	0.0	0.0	0.0	0.0	0.0	0.0
Total Delay	107.8	393.3	120.4	47.7	310.2	37.7	8.5	55.5	16.3
LOS	F	F	F	D	F	D	A	E	B
Approach Delay		371.2		56.4		166.3			18.9
Approach LOS		F		E		F			B

Intersection Summary

Cycle Length: 120
 Actuated Cycle Length: 105
 Natural Cycle: 120
 Control Type: Actuated-Uncoordinated
 Maximum v/c Ratio: 1.82
 Intersection Signal Delay: 205.7
 Intersection LOS: F
 Intersection Capacity Utilization 134.5%
 ICU Level of Service H
 Analysis Period (min) 15























Splits and Phases: 14: Barton Rd. & Van Buren Bl.



HCM 6th Signalized Intersection Summary
14: Barton Rd. & Van Buren Bl.

West Campus Upper Plateau (JN 14064)

09/20/2022

												
Movement	EBL	EBT	EBR	WBL	WBT	WBR	NBL	NBT	NBR	SBL	SBT	SBR
Lane Configurations												
Traffic Volume (veh/h)	223	2274	388	323	2340	14	405	108	281	16	36	195
Future Volume (veh/h)	223	2274	388	323	2340	14	405	108	281	16	36	195
Initial Q (Qb), veh	0	0	0	0	0	0	0	0	0	0	0	0
Ped-Bike Adj(A_pbT)	1.00		1.00	1.00		1.00	1.00		0.95	1.00		1.00
Parking Bus, Adj	1.00	1.00	1.00	1.00	1.00	1.00	1.00	1.00	1.00	1.00	1.00	1.00
Work Zone On Approach		No			No			No			No	
Adj Sat Flow, veh/h/ln	1900	1870	1885	1885	1870	1870	1900	1900	1885	1900	1856	1900
Adj Flow Rate, veh/h	232	2369	375	336	2438	5	422	112	169	17	38	145
Peak Hour Factor	0.96	0.96	0.96	0.96	0.96	0.96	0.96	0.96	0.96	0.96	0.96	0.96
Percent Heavy Veh, %	0	2	1	1	2	2	0	0	1	0	3	0
Cap, veh/h	229	1338	206	305	2511	5	265	369	296	34	46	177
Arrive On Green	0.13	0.43	0.43	0.17	0.48	0.48	0.08	0.19	0.19	0.02	0.14	0.14
Sat Flow, veh/h	1810	3086	475	1795	5262	11	3510	1900	1524	1810	337	1287
Grp Volume(v), veh/h	232	1337	1407	336	1577	866	422	112	169	17	0	183
Grp Sat Flow(s),veh/h/ln	1810	1777	1784	1795	1702	1868	1755	1900	1524	1810	0	1624
Q Serve(g_s), s	13.4	45.9	45.9	18.0	47.8	47.8	8.0	5.3	10.6	1.0	0.0	11.6
Cycle Q Clear(g_c), s	13.4	45.9	45.9	18.0	47.8	47.8	8.0	5.3	10.6	1.0	0.0	11.6
Prop In Lane	1.00		0.27	1.00		0.01	1.00		1.00	1.00		0.79
Lane Grp Cap(c), veh/h	229	771	774	305	1624	892	265	369	296	34	0	223
V/C Ratio(X)	1.01	1.73	1.82	1.10	0.97	0.97	1.59	0.30	0.57	0.51	0.00	0.82
Avail Cap(c_a), veh/h	229	771	774	305	1624	892	265	569	456	91	0	445
HCM Platoon Ratio	1.00	1.00	1.00	1.00	1.00	1.00	1.00	1.00	1.00	1.00	1.00	1.00
Upstream Filter(I)	1.00	1.00	1.00	1.00	1.00	1.00	1.00	1.00	1.00	1.00	0.00	1.00
Uniform Delay (d), s/veh	46.2	30.0	30.0	43.9	27.0	27.0	48.9	36.5	38.6	51.5	0.0	44.4
Incr Delay (d2), s/veh	62.7	336.1	373.5	81.1	15.8	23.2	282.8	0.5	1.7	11.3	0.0	7.3
Initial Q Delay(d3),s/veh	0.0	0.0	0.0	0.0	0.0	0.0	0.0	0.0	0.0	0.0	0.0	0.0
%ile BackOfQ(50%),veh/ln	9.7	89.4	97.9	14.5	20.6	24.5	13.8	2.4	4.0	0.6	0.0	5.1
Unsig. Movement Delay, s/veh												
LnGrp Delay(d),s/veh	109.0	366.0	403.4	125.1	42.8	50.1	331.7	37.0	40.4	62.7	0.0	51.7
LnGrp LOS	F	F	F	F	D	D	F	D	D	E	A	D
Approach Vol, veh/h		2976			2779			703			200	
Approach Delay, s/veh		363.7			55.0			214.7			52.6	
Approach LOS		F			E			F			D	
Timer - Assigned Phs	1	2	3	4	5	6	7	8				
Phs Duration (G+Y+Rc), s	22.2	52.4	12.1	19.1	17.6	57.0	6.1	25.2				
Change Period (Y+Rc), s	* 4.2	* 6.5	4.1	4.6	* 4.2	6.5	4.1	4.6				
Max Green Setting (Gmax), s	* 18	* 46	8.0	29.0	* 13	50.2	5.3	31.7				
Max Q Clear Time (g_c+I1), s	20.0	47.9	10.0	13.6	15.4	49.8	3.0	12.6				
Green Ext Time (p_c), s	0.0	0.0	0.0	0.9	0.0	0.4	0.0	1.0				

Intersection Summary

HCM 6th Ctrl Delay	209.8
HCM 6th LOS	F

Notes

* HCM 6th computational engine requires equal clearance times for the phases crossing the barrier.

Intersection

Intersection Delay, s/veh	9.3
Intersection LOS	A

Movement	EBT	EBR	WBL	WBT	NBL	NBR
Lane Configurations						
Traffic Vol, veh/h	191	81	47	93	66	77
Future Vol, veh/h	191	81	47	93	66	77
Peak Hour Factor	0.94	0.94	0.94	0.94	0.94	0.94
Heavy Vehicles, %	1	2	3	1	2	0
Mvmt Flow	203	86	50	99	70	82
Number of Lanes	1	0	1	1	1	0

Approach	EB	WB	NB
Opposing Approach	WB	EB	
Opposing Lanes	2	1	0
Conflicting Approach Left		NB	EB
Conflicting Lanes Left	0	1	1
Conflicting Approach Right	NB		WB
Conflicting Lanes Right	1	0	2
HCM Control Delay	9.8	8.8	8.9
HCM LOS	A	A	A

Lane	NBLn1	EBLn1	WBLn1	WBLn2
Vol Left, %	46%	0%	100%	0%
Vol Thru, %	0%	70%	0%	100%
Vol Right, %	54%	30%	0%	0%
Sign Control	Stop	Stop	Stop	Stop
Traffic Vol by Lane	143	272	47	93
LT Vol	66	0	47	0
Through Vol	0	191	0	93
RT Vol	77	81	0	0
Lane Flow Rate	152	289	50	99
Geometry Grp	2	5	7	7
Degree of Util (X)	0.199	0.353	0.079	0.141
Departure Headway (Hd)	4.701	4.391	5.654	5.117
Convergence, Y/N	Yes	Yes	Yes	Yes
Cap	762	819	634	700
Service Time	2.739	2.423	3.391	2.853
HCM Lane V/C Ratio	0.199	0.353	0.079	0.141
HCM Control Delay	8.9	9.8	8.9	8.7
HCM Lane LOS	A	A	A	A
HCM 95th-tile Q	0.7	1.6	0.3	0.5

Intersection	
Intersection Delay, s/veh	9.4
Intersection LOS	A

Movement	EBL	EBT	WBT	WBR	SBL	SBR
Lane Configurations						
Traffic Vol, veh/h	151	376	271	43	33	48
Future Vol, veh/h	151	376	271	43	33	48
Peak Hour Factor	0.97	0.97	0.97	0.97	0.97	0.97
Heavy Vehicles, %	1	0	2	0	4	3
Mvmt Flow	156	388	279	44	34	49
Number of Lanes	1	2	2	0	1	0

Approach	EB	WB	SB
Opposing Approach	WB	EB	
Opposing Lanes	2	3	0
Conflicting Approach Left	SB		WB
Conflicting Lanes Left	1	0	2
Conflicting Approach Right		SB	EB
Conflicting Lanes Right	0	1	3
HCM Control Delay	8.8	10.4	9.9
HCM LOS	A	B	A

Lane	EBLn1	EBLn2	EBLn3	WBLn1	WBLn2	SBLn1
Vol Left, %	100%	0%	0%	0%	0%	41%
Vol Thru, %	0%	100%	100%	100%	68%	0%
Vol Right, %	0%	0%	0%	0%	32%	59%
Sign Control	Stop	Stop	Stop	Stop	Stop	Stop
Traffic Vol by Lane	151	188	188	181	133	81
LT Vol	151	0	0	0	0	33
Through Vol	0	188	188	181	90	0
RT Vol	0	0	0	0	43	48
Lane Flow Rate	156	194	194	186	137	84
Geometry Grp	7	7	7	8	8	7
Degree of Util (X)	0.242	0.273	0.181	0.296	0.208	0.142
Departure Headway (Hd)	5.598	5.078	3.368	5.719	5.458	6.104
Convergence, Y/N	Yes	Yes	Yes	Yes	Yes	Yes
Cap	640	705	1056	626	654	584
Service Time	3.348	2.827	1.117	3.486	3.225	3.884
HCM Lane V/C Ratio	0.244	0.275	0.184	0.297	0.209	0.144
HCM Control Delay	10.1	9.7	6.9	10.9	9.7	9.9
HCM Lane LOS	B	A	A	B	A	A
HCM 95th-tile Q	0.9	1.1	0.7	1.2	0.8	0.5

Timings
19: Van Buren Bl. & Orange Terrace Pkwy.

West Campus Upper Plateau (JN 14064)

09/20/2022

Lane Group	EBL	EBT	EBR	WBL	WBT	WBR	NBL	NBT	NBR	SBL	SBT	SBR
Lane Configurations												
Traffic Volume (vph)	206	2464	310	186	2243	254	328	51	239	143	47	167
Future Volume (vph)	206	2464	310	186	2243	254	328	51	239	143	47	167
Turn Type	Prot	NA	Perm	Prot	NA	Perm	Prot	NA	Perm	Prot	NA	pm+ov
Protected Phases	5	2		1	6		3	8		7	4	5
Permitted Phases			2			6			8			4
Detector Phase	5	2	2	1	6	6	3	8	8	7	4	5
Switch Phase												
Minimum Initial (s)	5.0	10.0	10.0	5.0	10.0	10.0	5.0	5.0	5.0	10.0	10.0	5.0
Minimum Split (s)	9.2	25.2	25.2	9.1	25.2	25.2	9.1	26.1	26.1	15.8	24.8	9.2
Total Split (s)	16.0	63.0	63.0	11.0	58.0	58.0	12.0	27.0	27.0	19.0	34.0	16.0
Total Split (%)	13.3%	52.5%	52.5%	9.2%	48.3%	48.3%	10.0%	22.5%	22.5%	15.8%	28.3%	13.3%
Yellow Time (s)	3.2	5.2	5.2	3.6	5.2	5.2	3.6	3.6	3.6	4.8	4.8	3.2
All-Red Time (s)	1.0	1.0	1.0	0.5	1.0	1.0	0.5	0.5	0.5	1.0	1.0	1.0
Lost Time Adjust (s)	0.0	0.0	0.0	0.0	0.0	0.0	0.0	0.0	0.0	0.0	0.0	0.0
Total Lost Time (s)	4.2	6.2	6.2	4.1	6.2	6.2	4.1	4.1	4.1	5.8	5.8	4.2
Lead/Lag	Lead	Lag	Lag	Lead	Lag	Lag	Lead	Lag	Lag	Lead	Lag	Lead
Lead-Lag Optimize?	Yes	Yes	Yes	Yes	Yes	Yes	Yes	Yes	Yes	Yes	Yes	Yes
Recall Mode	None	None	None	None	None	None	None	None	None	None	None	None
Act Effct Green (s)	10.2	57.0	57.0	6.9	53.6	53.6	10.8	10.7	10.7	10.8	14.0	26.7
Actuated g/C Ratio	0.10	0.54	0.54	0.07	0.51	0.51	0.10	0.10	0.10	0.10	0.13	0.25
v/c Ratio	0.64	0.94	0.35	0.86	0.91	0.29	0.98	0.15	0.74	0.42	0.19	0.38
Control Delay	55.8	31.4	8.8	82.3	31.9	6.2	93.4	43.4	25.8	49.2	41.8	20.1
Queue Delay	0.0	0.0	0.0	0.0	0.0	0.0	0.0	0.0	0.0	0.0	0.0	0.0
Total Delay	55.8	31.4	8.8	82.3	31.9	6.2	93.4	43.4	25.8	49.2	41.8	20.1
LOS	E	C	A	F	C	A	F	D	C	D	D	C
Approach Delay		30.7			32.9			63.2			34.6	
Approach LOS		C			C			E			C	

Intersection Summary

Cycle Length: 120
 Actuated Cycle Length: 105.6
 Natural Cycle: 120
 Control Type: Actuated-Uncoordinated
 Maximum v/c Ratio: 0.98
 Intersection Signal Delay: 34.8
 Intersection LOS: C
 Intersection Capacity Utilization 84.2%
 ICU Level of Service E
 Analysis Period (min) 15

Splits and Phases: 19: Van Buren Bl. & Orange Terrace Pkwy.

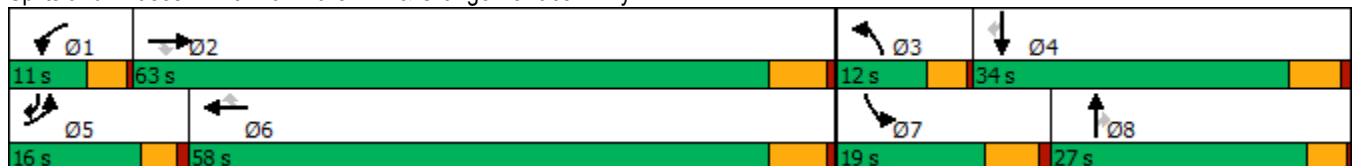

HCM 6th Signalized Intersection Summary
 19: Van Buren Bl. & Orange Terrace Pkwy.

West Campus Upper Plateau (JN 14064)

09/20/2022



Movement	EBL	EBT	EBR	WBL	WBT	WBR	NBL	NBT	NBR	SBL	SBT	SBR
Lane Configurations	↔↔	↑↑↑	↔	↔↔	↑↑↑	↔	↔↔	↑↑	↔	↔↔	↑	↔↔
Traffic Volume (veh/h)	206	2464	310	186	2243	254	328	51	239	143	47	167
Future Volume (veh/h)	206	2464	310	186	2243	254	328	51	239	143	47	167
Initial Q (Qb), veh	0	0	0	0	0	0	0	0	0	0	0	0
Ped-Bike Adj(A_pbT)	1.00		1.00	1.00		1.00	1.00		1.00	1.00		1.00
Parking Bus, Adj	1.00	1.00	1.00	1.00	1.00	1.00	1.00	1.00	1.00	1.00	1.00	1.00
Work Zone On Approach		No			No			No			No	
Adj Sat Flow, veh/h/ln	1885	1870	1870	1885	1856	1885	1870	1900	1885	1885	1900	1885
Adj Flow Rate, veh/h	215	2567	297	194	2336	206	342	53	218	149	49	101
Peak Hour Factor	0.96	0.96	0.96	0.96	0.96	0.96	0.96	0.96	0.96	0.96	0.96	0.96
Percent Heavy Veh, %	1	2	2	1	3	1	2	0	1	1	0	1
Cap, veh/h	276	2562	795	212	2445	771	241	562	249	308	359	429
Arrive On Green	0.08	0.50	0.50	0.06	0.48	0.48	0.07	0.16	0.16	0.09	0.19	0.19
Sat Flow, veh/h	3483	5106	1585	3483	5066	1598	3456	3610	1598	3483	1900	1598
Grp Volume(v), veh/h	215	2567	297	194	2336	206	342	53	218	149	49	101
Grp Sat Flow(s),veh/h/ln	1742	1702	1585	1742	1689	1598	1728	1805	1598	1742	1900	1598
Q Serve(g_s), s	6.9	56.8	13.0	6.3	50.1	8.7	7.9	1.4	15.1	4.6	2.4	5.6
Cycle Q Clear(g_c), s	6.9	56.8	13.0	6.3	50.1	8.7	7.9	1.4	15.1	4.6	2.4	5.6
Prop In Lane	1.00		1.00	1.00		1.00	1.00		1.00	1.00		1.00
Lane Grp Cap(c), veh/h	276	2562	795	212	2445	771	241	562	249	308	359	429
V/C Ratio(X)	0.78	1.00	0.37	0.91	0.96	0.27	1.42	0.09	0.88	0.48	0.14	0.24
Avail Cap(c_a), veh/h	363	2562	795	212	2445	771	241	730	323	406	473	524
HCM Platoon Ratio	1.00	1.00	1.00	1.00	1.00	1.00	1.00	1.00	1.00	1.00	1.00	1.00
Upstream Filter(I)	1.00	1.00	1.00	1.00	1.00	1.00	1.00	1.00	1.00	1.00	1.00	1.00
Uniform Delay (d), s/veh	51.2	28.2	17.3	52.9	28.1	17.4	52.7	41.0	46.7	49.2	38.2	32.4
Incr Delay (d2), s/veh	5.5	18.3	0.3	38.9	9.8	0.2	210.8	0.1	18.9	1.2	0.2	0.3
Initial Q Delay(d3),s/veh	0.0	0.0	0.0	0.0	0.0	0.0	0.0	0.0	0.0	0.0	0.0	0.0
%ile BackOfQ(50%),veh/ln	3.1	24.7	4.7	3.8	20.3	3.2	10.5	0.6	7.3	2.0	1.1	2.2
Unsig. Movement Delay, s/veh												
LnGrp Delay(d),s/veh	56.7	46.5	17.6	91.7	38.0	17.6	263.5	41.0	65.6	50.3	38.4	32.6
LnGrp LOS	E	F	B	F	D	B	F	D	E	D	D	C
Approach Vol, veh/h		3079			2736			613			299	
Approach Delay, s/veh		44.4			40.2			173.9			42.4	
Approach LOS		D			D			F			D	
Timer - Assigned Phs	1	2	3	4	5	6	7	8				
Phs Duration (G+Y+Rc), s	11.0	63.0	12.0	27.2	13.2	60.8	15.8	23.4				
Change Period (Y+Rc), s	4.1	6.2	4.1	5.8	* 4.2	6.2	5.8	* 5.8				
Max Green Setting (Gmax), s	6.9	56.8	7.9	28.2	* 12	51.8	13.2	* 23				
Max Q Clear Time (g_c+I1), s	8.3	58.8	9.9	7.6	8.9	52.1	6.6	17.1				
Green Ext Time (p_c), s	0.0	0.0	0.0	0.5	0.1	0.0	0.2	0.5				

Intersection Summary

HCM 6th Ctrl Delay	54.4
HCM 6th LOS	D

Notes

* HCM 6th computational engine requires equal clearance times for the phases crossing the barrier.

Timings
20: Brown/San Gorgonio Dr & Alessandro Bl.

West Campus Upper Plateau (JN 14064)

09/20/2022



Lane Group	EBL	EBT	WBT	WBR	NBL	NBT	NBR	SBL	SBT	SBR
Lane Configurations	↖	↗↗↗	↗↗↗	↖	↖	↗	↖	↖	↗	↖
Traffic Volume (vph)	35	2831	2991	39	19	5	32	150	5	91
Future Volume (vph)	35	2831	2991	39	19	5	32	150	5	91
Turn Type	Prot	NA	NA	Perm	Prot	NA	pm+ov	Prot	NA	pm+ov
Protected Phases	5	2	6		3	8	1	7	4	5
Permitted Phases				6			8			4
Detector Phase	5	2	6	6	3	8	1	7	4	5
Switch Phase										
Minimum Initial (s)	5.0	10.0	10.0	10.0	5.0	5.0	5.0	5.0	10.0	5.0
Minimum Split (s)	8.7	43.5	43.5	43.5	9.1	26.1	9.1	8.7	49.8	8.7
Total Split (s)	8.7	52.0	52.4	52.4	9.1	39.3	9.1	19.6	49.8	8.7
Total Split (%)	7.3%	43.3%	43.7%	43.7%	7.6%	32.8%	7.6%	16.3%	41.5%	7.3%
Yellow Time (s)	3.2	5.5	5.5	5.5	3.6	3.6	3.6	3.2	4.8	3.2
All-Red Time (s)	0.5	1.0	1.0	1.0	0.5	0.5	0.5	0.5	1.0	0.5
Lost Time Adjust (s)	0.0	0.0	0.0	0.0	0.0	0.0	0.0	0.0	0.0	0.0
Total Lost Time (s)	3.7	6.5	6.5	6.5	4.1	4.1	4.1	3.7	5.8	3.7
Lead/Lag	Lead	Lag	Lag	Lag	Lead	Lag	Lead	Lead	Lag	Lead
Lead-Lag Optimize?	Yes	Yes	Yes	Yes	Yes	Yes	Yes	Yes	Yes	Yes
Recall Mode	None	None	None	None	None	None	None	None	None	None
Act Effct Green (s)	5.2	49.4	47.7	47.7	5.2	10.0	10.7	13.4	15.5	26.7
Actuated g/C Ratio	0.06	0.59	0.57	0.57	0.06	0.12	0.13	0.16	0.18	0.32
v/c Ratio	0.33	1.00	1.08	0.06	0.19	0.02	0.14	0.58	0.01	0.17
Control Delay	52.3	37.1	64.2	0.2	48.9	32.0	1.2	45.9	26.6	8.7
Queue Delay	0.0	0.0	0.0	0.0	0.0	0.0	0.0	0.0	0.0	0.0
Total Delay	52.3	37.1	64.2	0.2	48.9	32.0	1.2	45.9	26.6	8.7
LOS	D	D	E	A	D	C	A	D	C	A
Approach Delay		37.2	63.4			20.0			31.7	
Approach LOS		D	E			C			C	

Intersection Summary

Cycle Length: 120
 Actuated Cycle Length: 84.1
 Natural Cycle: 115
 Control Type: Actuated-Uncoordinated
 Maximum v/c Ratio: 1.08
 Intersection Signal Delay: 49.6
 Intersection LOS: D
 Intersection Capacity Utilization 83.0%
 ICU Level of Service E
 Analysis Period (min) 15

Splits and Phases: 20: Brown/San Gorgonio Dr & Alessandro Bl.

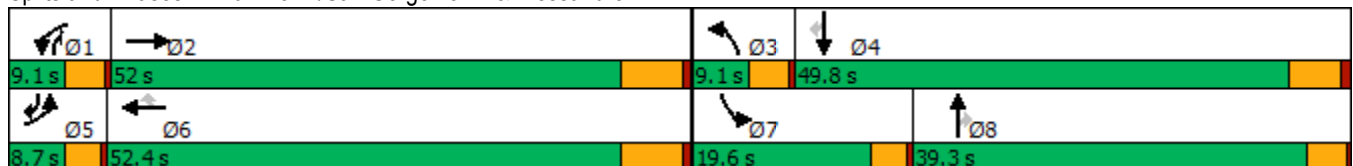

HCM 6th Signalized Intersection Summary
20: Brown/San Gorgonio Dr & Alessandro Bl.

West Campus Upper Plateau (JN 14064)

09/20/2022



Movement	EBL	EBT	EBR	WBL	WBT	WBR	NBL	NBT	NBR	SBL	SBT	SBR
Lane Configurations	↗	↑↑↑		↖	↑↑↑	↗	↖	↑	↗	↖	↑	↗
Traffic Volume (veh/h)	35	2831	5	0	2991	39	19	5	32	150	5	91
Future Volume (veh/h)	35	2831	5	0	2991	39	19	5	32	150	5	91
Initial Q (Qb), veh	0	0	0	0	0	0	0	0	0	0	0	0
Ped-Bike Adj(A_pbT)	1.00		1.00	1.00		1.00	1.00		1.00	1.00		1.00
Parking Bus, Adj	1.00	1.00	1.00	1.00	1.00	1.00	1.00	1.00	1.00	1.00	1.00	1.00
Work Zone On Approach		No			No			No			No	
Adj Sat Flow, veh/h/ln	1900	1870	1900	1678	1885	1396	1796	1900	1337	1811	1900	1885
Adj Flow Rate, veh/h	37	2980	1	0	3148	37	20	5	21	158	5	48
Peak Hour Factor	0.95	0.95	0.95	0.95	0.95	0.95	0.95	0.95	0.95	0.95	0.95	0.95
Percent Heavy Veh, %	0	2	0	15	1	34	7	0	38	6	0	1
Cap, veh/h	62	3259	1	2	2781	639	38	156	38	193	317	321
Arrive On Green	0.03	0.62	0.62	0.00	0.54	0.54	0.02	0.08	0.08	0.11	0.17	0.17
Sat Flow, veh/h	1810	5272	2	1598	5147	1183	1711	1900	1133	1725	1900	1598
Grp Volume(v), veh/h	37	1924	1057	0	3148	37	20	5	21	158	5	48
Grp Sat Flow(s),veh/h/ln	1810	1702	1870	1598	1716	1183	1711	1900	1133	1725	1900	1598
Q Serve(g_s), s	1.7	42.2	42.2	0.0	45.9	1.3	1.0	0.2	5.7	7.6	0.2	2.1
Cycle Q Clear(g_c), s	1.7	42.2	42.2	0.0	45.9	1.3	1.0	0.2	5.7	7.6	0.2	2.1
Prop In Lane	1.00		0.00	1.00		1.00	1.00		1.00	1.00		1.00
Lane Grp Cap(c), veh/h	62	2104	1156	2	2781	639	38	156	38	193	317	321
V/C Ratio(X)	0.60	0.91	0.91	0.00	1.13	0.06	0.53	0.03	0.55	0.82	0.02	0.15
Avail Cap(c_a), veh/h	106	2104	1156	94	2781	639	101	787	415	323	984	882
HCM Platoon Ratio	1.00	1.00	1.00	1.00	1.00	1.00	1.00	1.00	1.00	1.00	1.00	1.00
Upstream Filter(I)	1.00	1.00	1.00	0.00	1.00	1.00	1.00	1.00	1.00	1.00	1.00	1.00
Uniform Delay (d), s/veh	40.4	14.2	14.3	0.0	19.5	9.3	41.1	35.9	259.4	36.9	29.6	28.0
Incr Delay (d2), s/veh	3.4	6.8	11.3	0.0	64.6	0.1	10.9	0.1	11.8	3.3	0.0	0.2
Initial Q Delay(d3),s/veh	0.0	0.0	0.0	0.0	0.0	0.0	0.0	0.0	0.0	0.0	0.0	0.0
%ile BackOfQ(50%),veh/ln	0.8	13.1	15.8	0.0	32.7	0.3	0.5	0.1	0.1	3.3	0.1	0.8
Unsig. Movement Delay, s/veh												
LnGrp Delay(d),s/veh	43.8	21.1	25.6	0.0	84.1	9.3	52.0	36.0	271.2	40.2	29.6	28.2
LnGrp LOS	D	C	C	A	F	A	D	D	F	D	C	C
Approach Vol, veh/h		3018			3185			46			211	
Approach Delay, s/veh		22.9			83.2			150.3			37.2	
Approach LOS		C			F			F			D	
Timer - Assigned Phs	1	2	3	4	5	6	7	8				
Phs Duration (G+Y+Rc), s	0.0	59.0	6.0	20.0	6.6	52.4	13.2	12.8				
Change Period (Y+Rc), s	4.1	6.5	4.1	5.8	3.7	6.5	3.7	* 5.8				
Max Green Setting (Gmax), s	5.0	45.5	5.0	44.0	5.0	45.9	15.9	* 35				
Max Q Clear Time (g_c+I1), s	0.0	44.2	3.0	4.1	3.7	47.9	9.6	7.7				
Green Ext Time (p_c), s	0.0	1.3	0.0	0.2	0.0	0.0	0.1	0.1				

Intersection Summary

HCM 6th Ctrl Delay	54.0
HCM 6th LOS	D

Notes

* HCM 6th computational engine requires equal clearance times for the phases crossing the barrier.

Timings
22: Sycamore Canyon Bl. & Eastridge Ave

West Campus Upper Plateau (JN 14064)

09/20/2022



Lane Group	EBL	EBT	EBR	WBL	WBT	WBR	NBL	NBT	NBR	SBL	SBT	SBR
Lane Configurations	↔↔	↑↑↑	↔	↔↔	↑↑	↔	↔↔	↑↑	↔	↔↔	↑↑	↔
Traffic Volume (vph)	110	125	61	238	80	426	38	867	235	335	486	23
Future Volume (vph)	110	125	61	238	80	426	38	867	235	335	486	23
Turn Type	Prot	NA	Perm	Prot	NA	pm+ov	Prot	NA	pm+ov	Prot	NA	pm+ov
Protected Phases	5	2		1	6	7	3	8	1	7	4	5
Permitted Phases			2			6			8			4
Detector Phase	5	2	2	1	6	7	3	8	1	7	4	5
Switch Phase												
Minimum Initial (s)	5.0	10.0	10.0	5.0	10.0	5.0	5.0	10.0	5.0	5.0	10.0	5.0
Minimum Split (s)	8.7	43.5	43.5	8.7	43.5	8.7	8.7	15.8	8.7	8.7	49.8	8.7
Total Split (s)	11.7	45.5	45.5	15.2	49.0	20.2	8.7	39.1	15.2	20.2	50.6	11.7
Total Split (%)	9.8%	37.9%	37.9%	12.7%	40.8%	16.8%	7.3%	32.6%	12.7%	16.8%	42.2%	9.8%
Yellow Time (s)	3.2	5.5	5.5	3.2	5.5	3.2	3.2	4.8	3.2	3.2	4.8	3.2
All-Red Time (s)	0.5	1.0	1.0	0.5	1.0	0.5	0.5	1.0	0.5	0.5	1.0	0.5
Lost Time Adjust (s)	0.0	0.0	0.0	0.0	0.0	0.0	0.0	0.0	0.0	0.0	0.0	0.0
Total Lost Time (s)	3.7	6.5	6.5	3.7	6.5	3.7	3.7	5.8	3.7	3.7	5.8	3.7
Lead/Lag	Lead	Lag	Lag	Lead	Lag	Lead	Lead	Lag	Lead	Lead	Lag	Lead
Lead-Lag Optimize?	Yes	Yes	Yes	Yes	Yes	Yes	Yes	Yes	Yes	Yes	Yes	Yes
Recall Mode	None	None	None	None	None	None	None	None	None	None	None	None
Act Effct Green (s)	11.7	13.7	13.7	11.0	16.7	32.1	5.1	33.1	46.2	15.3	47.1	60.9
Actuated g/C Ratio	0.13	0.15	0.15	0.12	0.18	0.34	0.05	0.36	0.50	0.16	0.51	0.65
v/c Ratio	0.32	0.21	0.20	0.69	0.18	0.84	0.25	0.78	0.35	0.66	0.30	0.03
Control Delay	44.7	35.0	1.3	51.1	32.1	35.2	49.5	33.5	6.3	44.1	16.0	0.0
Queue Delay	0.0	0.0	0.0	0.0	0.0	0.0	0.0	0.0	0.0	0.0	0.0	0.0
Total Delay	44.7	35.0	1.3	51.1	32.1	35.2	49.5	33.5	6.3	44.1	16.0	0.0
LOS	D	C	A	D	C	D	D	C	A	D	B	A
Approach Delay		31.7			39.9			28.4			26.7	
Approach LOS		C			D			C			C	

Intersection Summary

Cycle Length: 120
 Actuated Cycle Length: 93.1
 Natural Cycle: 115
 Control Type: Actuated-Uncoordinated
 Maximum v/c Ratio: 0.84
 Intersection Signal Delay: 31.1
 Intersection LOS: C
 Intersection Capacity Utilization 66.2%
 ICU Level of Service C
 Analysis Period (min) 15

Splits and Phases: 22: Sycamore Canyon Bl. & Eastridge Ave

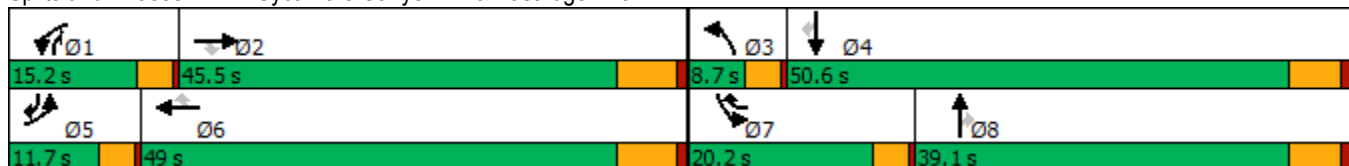

HCM 6th Signalized Intersection Summary
 22: Sycamore Canyon Bl. & Eastridge Ave

West Campus Upper Plateau (JN 14064)

09/20/2022



Movement	EBL	EBT	EBR	WBL	WBT	WBR	NBL	NBT	NBR	SBL	SBT	SBR
Lane Configurations	↔↔	↑↑↑	↔	↔↔	↑↑	↔	↔↔	↑↑	↔	↔↔	↑↑	↔
Traffic Volume (veh/h)	110	125	61	238	80	426	38	867	235	335	486	23
Future Volume (veh/h)	110	125	61	238	80	426	38	867	235	335	486	23
Initial Q (Qb), veh	0	0	0	0	0	0	0	0	0	0	0	0
Ped-Bike Adj(A_pbT)	1.00		1.00	1.00		1.00	1.00		0.99	1.00		0.99
Parking Bus, Adj	1.00	1.00	1.00	1.00	1.00	1.00	1.00	1.00	1.00	1.00	1.00	1.00
Work Zone On Approach		No			No			No			No	
Adj Sat Flow, veh/h/ln	1663	1648	1841	1752	1426	1796	1648	1811	1544	1841	1841	1559
Adj Flow Rate, veh/h	120	136	0	259	87	285	41	942	200	364	528	21
Peak Hour Factor	0.92	0.92	0.92	0.92	0.92	0.92	0.92	0.92	0.92	0.92	0.92	0.92
Percent Heavy Veh, %	16	17	4	10	32	7	17	6	24	4	4	23
Cap, veh/h	183	743		341	571	525	115	1177	580	458	1534	651
Arrive On Green	0.06	0.17	0.00	0.11	0.21	0.21	0.04	0.34	0.34	0.13	0.44	0.44
Sat Flow, veh/h	3072	4499	1560	3237	2709	1520	3045	3441	1292	3401	3497	1304
Grp Volume(v), veh/h	120	136	0	259	87	285	41	942	200	364	528	21
Grp Sat Flow(s),veh/h/ln	1536	1500	1560	1618	1354	1520	1522	1721	1292	1700	1749	1304
Q Serve(g_s), s	3.0	2.0	0.0	6.1	2.0	11.8	1.0	19.3	7.9	8.1	7.8	0.6
Cycle Q Clear(g_c), s	3.0	2.0	0.0	6.1	2.0	11.8	1.0	19.3	7.9	8.1	7.8	0.6
Prop In Lane	1.00		1.00	1.00		1.00	1.00		1.00	1.00		1.00
Lane Grp Cap(c), veh/h	183	743		341	571	525	115	1177	580	458	1534	651
V/C Ratio(X)	0.65	0.18		0.76	0.15	0.54	0.36	0.80	0.35	0.80	0.34	0.03
Avail Cap(c_a), veh/h	316	2256		478	1480	1035	196	1473	691	721	2014	830
HCM Platoon Ratio	1.00	1.00	1.00	1.00	1.00	1.00	1.00	1.00	1.00	1.00	1.00	1.00
Upstream Filter(I)	1.00	1.00	0.00	1.00	1.00	1.00	1.00	1.00	1.00	1.00	1.00	1.00
Uniform Delay (d), s/veh	35.8	28.0	0.0	33.9	25.0	20.5	36.5	23.2	14.1	32.6	14.4	9.9
Incr Delay (d2), s/veh	1.5	0.2	0.0	2.6	0.2	1.2	0.7	2.6	0.4	1.3	0.1	0.0
Initial Q Delay(d3),s/veh	0.0	0.0	0.0	0.0	0.0	0.0	0.0	0.0	0.0	0.0	0.0	0.0
%ile BackOfQ(50%),veh/ln	1.1	0.7	0.0	2.3	0.6	3.9	0.4	7.3	2.0	3.2	2.7	0.2
Unsig. Movement Delay, s/veh												
LnGrp Delay(d),s/veh	37.3	28.1	0.0	36.4	25.2	21.8	37.2	25.8	14.4	34.0	14.6	10.0
LnGrp LOS	D	C		D	C	C	D	C	B	C	B	A
Approach Vol, veh/h		256			631			1183			913	
Approach Delay, s/veh		32.4			28.3			24.3			22.2	
Approach LOS		C			C			C			C	
Timer - Assigned Phs	1	2	3	4	5	6	7	8				
Phs Duration (G+Y+Rc), s	11.9	19.3	6.6	39.9	8.3	22.9	14.2	32.4				
Change Period (Y+Rc), s	3.7	6.5	3.7	5.8	3.7	6.5	3.7	5.8				
Max Green Setting (Gmax), s	11.5	39.0	5.0	44.8	8.0	42.5	16.5	33.3				
Max Q Clear Time (g_c+I1), s	8.1	4.0	3.0	9.8	5.0	13.8	10.1	21.3				
Green Ext Time (p_c), s	0.2	1.1	0.0	3.5	0.0	2.3	0.4	5.3				

Intersection Summary

HCM 6th Ctrl Delay	25.2
HCM 6th LOS	C

Notes

Unsignalized Delay for [EBR] is excluded from calculations of the approach delay and intersection delay.

Timings
23: Sycamore Canyon Bl. & Cottonwood Ave

West Campus Upper Plateau (JN 14064)

09/20/2022



Lane Group	WBL	WBR	NBT	SBL	SBT
Lane Configurations	↙	↗	↕↔	↘	↕↕
Traffic Volume (vph)	83	73	1005	61	805
Future Volume (vph)	83	73	1005	61	805
Turn Type	Prot	Perm	NA	Prot	NA
Protected Phases	8		2	1	6
Permitted Phases		8			
Detector Phase	8	8	2	1	6
Switch Phase					
Minimum Initial (s)	10.0	10.0	10.0	5.0	10.0
Minimum Split (s)	15.8	15.8	43.5	9.1	43.5
Total Split (s)	23.0	23.0	78.0	19.0	97.0
Total Split (%)	19.2%	19.2%	65.0%	15.8%	80.8%
Yellow Time (s)	4.8	4.8	5.5	3.6	5.5
All-Red Time (s)	1.0	1.0	1.0	0.5	1.0
Lost Time Adjust (s)	0.0	0.0	0.0	0.0	0.0
Total Lost Time (s)	5.8	5.8	6.5	4.1	6.5
Lead/Lag			Lag	Lead	
Lead-Lag Optimize?			Yes	Yes	
Recall Mode	None	None	None	None	None
Act Effct Green (s)	14.1	14.1	41.3	10.5	51.7
Actuated g/C Ratio	0.20	0.20	0.60	0.15	0.75
v/c Ratio	0.34	0.31	0.57	0.35	0.33
Control Delay	36.8	12.5	15.0	39.5	5.1
Queue Delay	0.0	0.0	0.0	0.0	0.0
Total Delay	36.8	12.5	15.0	39.5	5.1
LOS	D	B	B	D	A
Approach Delay	25.4		15.0		7.5
Approach LOS	C		B		A

Intersection Summary

Cycle Length: 120
 Actuated Cycle Length: 69.2
 Natural Cycle: 70
 Control Type: Actuated-Uncoordinated
 Maximum v/c Ratio: 0.57
 Intersection Signal Delay: 12.6
 Intersection LOS: B
 Intersection Capacity Utilization 55.4%
 ICU Level of Service B
 Analysis Period (min) 15

Splits and Phases: 23: Sycamore Canyon Bl. & Cottonwood Ave



HCM 6th Signalized Intersection Summary
23: Sycamore Canyon Bl. & Cottonwood Ave

West Campus Upper Plateau (JN 14064)
09/20/2022



Movement	WBL	WBR	NBT	NBR	SBL	SBT
Lane Configurations						
Traffic Volume (veh/h)	83	73	1005	46	61	805
Future Volume (veh/h)	83	73	1005	46	61	805
Initial Q (Qb), veh	0	0	0	0	0	0
Ped-Bike Adj(A_pbT)	1.00	1.00		0.98	1.00	
Parking Bus, Adj	1.00	1.00	1.00	1.00	1.00	1.00
Work Zone On Approach	No		No			No
Adj Sat Flow, veh/h/ln	1337	818	1811	1544	1263	1870
Adj Flow Rate, veh/h	90	69	1092	49	66	875
Peak Hour Factor	0.92	0.92	0.92	0.92	0.92	0.92
Percent Heavy Veh, %	38	73	6	24	43	2
Cap, veh/h	199	108	1704	76	71	2263
Arrive On Green	0.16	0.16	0.51	0.51	0.06	0.64
Sat Flow, veh/h	1273	693	3441	150	1203	3647
Grp Volume(v), veh/h	90	69	561	580	66	875
Grp Sat Flow(s),veh/h/ln	1273	693	1721	1780	1203	1777
Q Serve(g_s), s	3.8	5.5	14.1	14.1	3.2	7.0
Cycle Q Clear(g_c), s	3.8	5.5	14.1	14.1	3.2	7.0
Prop In Lane	1.00	1.00		0.08	1.00	
Lane Grp Cap(c), veh/h	199	108	875	905	71	2263
V/C Ratio(X)	0.45	0.64	0.64	0.64	0.92	0.39
Avail Cap(c_a), veh/h	369	201	2070	2142	302	5412
HCM Platoon Ratio	1.00	1.00	1.00	1.00	1.00	1.00
Upstream Filter(I)	1.00	1.00	1.00	1.00	1.00	1.00
Uniform Delay (d), s/veh	22.8	23.5	10.6	10.6	27.8	5.2
Incr Delay (d2), s/veh	1.6	6.1	1.1	1.1	33.3	0.2
Initial Q Delay(d3),s/veh	0.0	0.0	0.0	0.0	0.0	0.0
%ile BackOfQ(50%),veh/ln	1.2	1.0	4.1	4.2	1.5	1.4
Unsig. Movement Delay, s/veh						
LnGrp Delay(d),s/veh	24.4	29.6	11.8	11.7	61.1	5.4
LnGrp LOS	C	C	B	B	E	A
Approach Vol, veh/h	159		1141			941
Approach Delay, s/veh	26.6		11.8			9.3
Approach LOS	C		B			A
Timer - Assigned Phs	1	2			6	8
Phs Duration (G+Y+Rc), s	7.6	36.7			44.4	15.1
Change Period (Y+Rc), s	4.1	6.5			6.5	5.8
Max Green Setting (Gmax), s	14.9	71.5			90.5	17.2
Max Q Clear Time (g_c+I1), s	5.2	16.1			9.0	7.5
Green Ext Time (p_c), s	0.1	14.1			10.5	0.3

Intersection Summary

HCM 6th Ctrl Delay	11.8
HCM 6th LOS	B

Timings

West Campus Upper Plateau (JN 14064)

24: Sycamore Canyon Bl. & Alessandro Bl.

09/20/2022



Lane Group	EBL	EBT	EBR	WBL	WBT	WBR	NBL	NBT	NBR	SBL	SBT	SBR
Lane Configurations	↘	↑↑↑	↗	↘↗	↑↑↑	↗	↘↗	↑↑	↗↘	↘↗	↑↑	↗
Traffic Volume (vph)	183	2041	790	433	2210	531	743	581	145	194	717	354
Future Volume (vph)	183	2041	790	433	2210	531	743	581	145	194	717	354
Turn Type	Prot	NA	Perm	Prot	NA	Perm	Prot	NA	pm+ov	Prot	NA	Perm
Protected Phases	5	2		1	6		3	8	1	7	4	
Permitted Phases			2			6			8			4
Detector Phase	5	2	2	1	6	6	3	8	1	7	4	4
Switch Phase												
Minimum Initial (s)	5.0	10.0	10.0	5.0	10.0	10.0	5.0	10.0	5.0	5.0	10.0	10.0
Minimum Split (s)	8.7	43.5	43.5	8.7	43.5	43.5	8.7	15.8	8.7	8.7	49.8	49.8
Total Split (s)	10.0	44.2	44.2	12.0	46.2	46.2	14.0	51.0	12.0	12.8	49.8	49.8
Total Split (%)	8.3%	36.8%	36.8%	10.0%	38.5%	38.5%	11.7%	42.5%	10.0%	10.7%	41.5%	41.5%
Yellow Time (s)	3.2	5.5	5.5	3.2	5.5	5.5	3.2	4.8	3.2	3.2	4.8	4.8
All-Red Time (s)	0.5	1.0	1.0	0.5	1.0	1.0	0.5	1.0	0.5	0.5	1.0	1.0
Lost Time Adjust (s)	0.0	0.0	0.0	0.0	0.0	0.0	0.0	0.0	0.0	0.0	0.0	0.0
Total Lost Time (s)	3.7	6.5	6.5	3.7	6.5	6.5	3.7	5.8	3.7	3.7	5.8	5.8
Lead/Lag	Lead	Lag	Lag	Lead	Lag	Lag	Lead	Lag	Lead	Lead	Lag	Lag
Lead-Lag Optimize?	Yes	Yes	Yes	Yes	Yes	Yes	Yes	Yes	Yes	Yes	Yes	Yes
Recall Mode	None	None	None	None	None	None	None	None	None	None	None	None
Act Effct Green (s)	6.3	37.9	37.9	8.3	39.9	39.9	10.4	32.4	46.6	9.1	31.1	31.1
Actuated g/C Ratio	0.06	0.35	0.35	0.08	0.37	0.37	0.10	0.30	0.43	0.08	0.29	0.29
v/c Ratio	1.76	1.19	1.14	1.78	1.20	0.83	2.28	0.56	0.12	0.79	0.73	0.66
Control Delay	412.0	122.2	104.1	395.6	125.2	33.2	607.3	33.3	10.0	71.7	38.6	26.6
Queue Delay	0.0	0.0	0.0	0.0	0.0	0.0	0.0	0.0	0.0	0.0	0.0	0.0
Total Delay	412.0	122.2	104.1	395.6	125.2	33.2	607.3	33.3	10.0	71.7	38.6	26.6
LOS	F	F	F	F	F	C	F	C	A	E	D	C
Approach Delay		135.1			146.7			321.3			40.3	
Approach LOS		F			F			F			D	

Intersection Summary

Cycle Length: 120
 Actuated Cycle Length: 107.5
 Natural Cycle: 115
 Control Type: Actuated-Uncoordinated
 Maximum v/c Ratio: 2.28
 Intersection Signal Delay: 156.4
 Intersection LOS: F
 Intersection Capacity Utilization 110.8%
 ICU Level of Service H
 Analysis Period (min) 15

Splits and Phases: 24: Sycamore Canyon Bl. & Alessandro Bl.

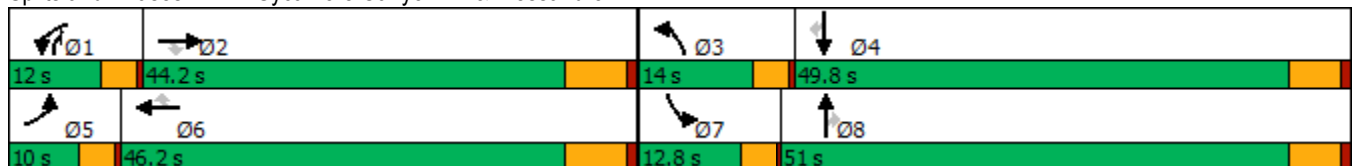

HCM 6th Signalized Intersection Summary
 24: Sycamore Canyon Bl. & Alessandro Bl.

West Campus Upper Plateau (JN 14064)

09/20/2022



Movement	EBL	EBT	EBR	WBL	WBT	WBR	NBL	NBT	NBR	SBL	SBT	SBR
Lane Configurations												
Traffic Volume (veh/h)	183	2041	790	433	2210	531	743	581	145	194	717	354
Future Volume (veh/h)	183	2041	790	433	2210	531	743	581	145	194	717	354
Initial Q (Qb), veh	0	0	0	0	0	0	0	0	0	0	0	0
Ped-Bike Adj(A_pbT)	1.00		1.00	1.00		0.99	1.00		1.00	1.00		1.00
Parking Bus, Adj	1.00	1.00	1.00	1.00	1.00	1.00	1.00	1.00	1.00	1.00	1.00	1.00
Work Zone On Approach		No			No			No			No	
Adj Sat Flow, veh/h/ln	1900	1841	1885	1767	1870	1767	1885	1856	1856	1648	1841	1870
Adj Flow Rate, veh/h	187	2083	615	442	2255	411	758	593	106	198	732	269
Peak Hour Factor	0.98	0.98	0.98	0.98	0.98	0.98	0.98	0.98	0.98	0.98	0.98	0.98
Percent Heavy Veh, %	0	4	1	9	2	9	1	3	3	17	4	2
Cap, veh/h	110	1826	580	261	1954	565	346	1001	1007	253	936	424
Arrive On Green	0.06	0.36	0.36	0.08	0.38	0.38	0.10	0.28	0.28	0.08	0.27	0.27
Sat Flow, veh/h	1810	5025	1598	3264	5106	1477	3483	3526	2768	3045	3497	1585
Grp Volume(v), veh/h	187	2083	615	442	2255	411	758	593	106	198	732	269
Grp Sat Flow(s),veh/h/ln	1810	1675	1598	1632	1702	1477	1742	1763	1384	1522	1749	1585
Q Serve(g_s), s	6.3	37.7	37.7	8.3	39.7	24.7	10.3	15.0	2.6	6.6	20.1	15.5
Cycle Q Clear(g_c), s	6.3	37.7	37.7	8.3	39.7	24.7	10.3	15.0	2.6	6.6	20.1	15.5
Prop In Lane	1.00		1.00	1.00		1.00	1.00		1.00	1.00		1.00
Lane Grp Cap(c), veh/h	110	1826	580	261	1954	565	346	1001	1007	253	936	424
V/C Ratio(X)	1.70	1.14	1.06	1.69	1.15	0.73	2.19	0.59	0.11	0.78	0.78	0.63
Avail Cap(c_a), veh/h	110	1826	580	261	1954	565	346	1536	1427	267	1483	672
HCM Platoon Ratio	1.00	1.00	1.00	1.00	1.00	1.00	1.00	1.00	1.00	1.00	1.00	1.00
Upstream Filter(I)	1.00	1.00	1.00	1.00	1.00	1.00	1.00	1.00	1.00	1.00	1.00	1.00
Uniform Delay (d), s/veh	48.7	33.0	33.0	47.7	32.0	27.4	46.7	32.0	21.8	46.7	35.2	33.5
Incr Delay (d2), s/veh	351.6	70.6	54.1	327.8	75.7	5.1	546.0	0.6	0.0	12.1	1.5	1.6
Initial Q Delay(d3),s/veh	0.0	0.0	0.0	0.0	0.0	0.0	0.0	0.0	0.0	0.0	0.0	0.0
%ile BackOfQ(50%),veh/ln	13.5	26.1	22.2	15.1	28.7	8.9	30.5	6.2	0.8	2.8	8.3	5.9
Unsig. Movement Delay, s/veh												
LnGrp Delay(d),s/veh	400.3	103.6	87.1	375.5	107.8	32.5	592.7	32.6	21.9	58.7	36.7	35.1
LnGrp LOS	F	F	F	F	F	C	F	C	C	E	D	D
Approach Vol, veh/h		2885			3108			1457			1199	
Approach Delay, s/veh		119.3			135.9			323.2			40.0	
Approach LOS		F			F			F			D	
Timer - Assigned Phs	1	2	3	4	5	6	7	8				
Phs Duration (G+Y+Rc), s	12.0	44.2	14.0	33.6	10.0	46.2	12.3	35.3				
Change Period (Y+Rc), s	3.7	6.5	3.7	5.8	3.7	6.5	3.7	5.8				
Max Green Setting (Gmax), s	8.3	37.7	10.3	44.0	6.3	39.7	9.1	45.2				
Max Q Clear Time (g_c+I1), s	10.3	39.7	12.3	22.1	8.3	41.7	8.6	17.0				
Green Ext Time (p_c), s	0.0	0.0	0.0	5.6	0.0	0.0	0.0	4.3				

Intersection Summary

HCM 6th Ctrl Delay	148.6
HCM 6th LOS	F

Timings
25: Sycamore Canyon Bl. & Cactus Av.

West Campus Upper Plateau (JN 14064)

09/20/2022



Lane Group	EBL	EBT	EBR	WBL	WBT	WBR	NBL	NBT	NBR	SBL	SBT	SBR
Lane Configurations	↘	↑↑	↗	↘↗	↑↑	↗	↘↗	↑↑	↗	↘↗	↑↑	↗
Traffic Volume (vph)	75	33	102	1070	65	684	30	626	376	757	1303	14
Future Volume (vph)	75	33	102	1070	65	684	30	626	376	757	1303	14
Turn Type	Prot	NA	Perm	Prot	NA	Perm	Prot	NA	Perm	Prot	NA	Perm
Protected Phases	7	4		3	8		5	2		1	6	
Permitted Phases			4			8			2			6
Detector Phase	7	4	4	3	8	8	5	2	2	1	6	6
Switch Phase												
Minimum Initial (s)	5.0	10.0	10.0	5.0	10.0	10.0	5.0	10.0	10.0	5.0	10.0	10.0
Minimum Split (s)	9.6	32.8	32.8	9.6	32.8	32.8	9.6	34.8	34.8	9.6	34.8	34.8
Total Split (s)	10.3	32.8	32.8	29.0	51.5	51.5	9.6	36.2	36.2	22.0	48.6	48.6
Total Split (%)	8.6%	27.3%	27.3%	24.2%	42.9%	42.9%	8.0%	30.2%	30.2%	18.3%	40.5%	40.5%
Yellow Time (s)	3.6	4.8	4.8	3.6	4.8	4.8	3.6	4.8	4.8	3.6	4.8	4.8
All-Red Time (s)	1.0	1.0	1.0	1.0	1.0	1.0	1.0	1.0	1.0	1.0	1.0	1.0
Lost Time Adjust (s)	0.0	0.0	0.0	0.0	0.0	0.0	0.0	0.0	0.0	0.0	0.0	0.0
Total Lost Time (s)	4.6	5.8	5.8	4.6	5.8	5.8	4.6	5.8	5.8	4.6	5.8	5.8
Lead/Lag	Lead	Lag	Lag	Lead	Lag	Lag	Lead	Lag	Lag	Lead	Lag	Lag
Lead-Lag Optimize?	Yes	Yes	Yes	Yes	Yes	Yes	Yes	Yes	Yes	Yes	Yes	Yes
Recall Mode	None	None	None	None	None	None	None	None	None	None	None	None
Act Effct Green (s)	5.8	22.3	22.3	24.6	41.2	41.2	5.0	27.7	27.7	17.6	44.5	44.5
Actuated g/C Ratio	0.05	0.20	0.20	0.22	0.36	0.36	0.04	0.24	0.24	0.16	0.39	0.39
v/c Ratio	0.92	0.08	0.24	1.59	0.06	0.96	0.22	0.80	0.60	1.53	1.06	0.03
Control Delay	133.4	37.2	1.2	302.9	23.7	44.1	58.9	48.8	7.6	282.5	76.6	0.1
Queue Delay	0.0	0.0	0.0	0.0	0.0	0.0	0.0	0.0	0.0	0.0	0.0	0.0
Total Delay	133.4	37.2	1.2	302.9	23.7	44.1	58.9	48.8	7.6	282.5	76.6	0.1
LOS	F	D	A	F	C	D	E	D	A	F	E	A
Approach Delay		54.2			195.6			34.0			151.3	
Approach LOS		D			F			C			F	

Intersection Summary

Cycle Length: 120
 Actuated Cycle Length: 113.2
 Natural Cycle: 120
 Control Type: Actuated-Uncoordinated
 Maximum v/c Ratio: 1.59
 Intersection Signal Delay: 139.4
 Intersection LOS: F
 Intersection Capacity Utilization 90.9%
 ICU Level of Service E
 Analysis Period (min) 15

Splits and Phases: 25: Sycamore Canyon Bl. & Cactus Av.

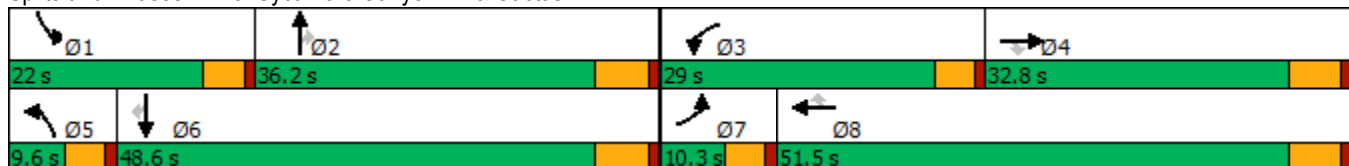

HCM 6th Signalized Intersection Summary
25: Sycamore Canyon Bl. & Cactus Av.

West Campus Upper Plateau (JN 14064)

09/20/2022



Movement	EBL	EBT	EBR	WBL	WBT	WBR	NBL	NBT	NBR	SBL	SBT	SBR
Lane Configurations												
Traffic Volume (veh/h)	75	33	102	1070	65	684	30	626	376	757	1303	14
Future Volume (veh/h)	75	33	102	1070	65	684	30	626	376	757	1303	14
Initial Q (Qb), veh	0	0	0	0	0	0	0	0	0	0	0	0
Ped-Bike Adj(A_pbT)	1.00		1.00	1.00		1.00	1.00		1.00	1.00		1.00
Parking Bus, Adj	1.00	1.00	1.00	1.00	1.00	1.00	1.00	1.00	1.00	1.00	1.00	1.00
Work Zone On Approach		No			No			No			No	
Adj Sat Flow, veh/h/ln	1856	1144	1841	1841	1767	1870	1856	1841	1811	1885	1811	1455
Adj Flow Rate, veh/h	82	36	101	1163	71	491	33	680	312	823	1416	15
Peak Hour Factor	0.92	0.92	0.92	0.92	0.92	0.92	0.92	0.92	0.92	0.92	0.92	0.92
Percent Heavy Veh, %	3	51	4	4	9	2	3	4	6	1	6	30
Cap, veh/h	93	351	252	763	1119	528	99	919	403	558	1355	486
Arrive On Green	0.05	0.16	0.16	0.22	0.33	0.33	0.03	0.26	0.26	0.16	0.39	0.39
Sat Flow, veh/h	1767	2174	1560	3401	3357	1585	3428	3497	1535	3483	3441	1233
Grp Volume(v), veh/h	82	36	101	1163	71	491	33	680	312	823	1416	15
Grp Sat Flow(s),veh/h/ln	1767	1087	1560	1700	1678	1585	1714	1749	1535	1742	1721	1233
Q Serve(g_s), s	5.0	1.5	6.3	24.4	1.6	32.5	1.0	19.3	20.4	17.4	42.8	0.8
Cycle Q Clear(g_c), s	5.0	1.5	6.3	24.4	1.6	32.5	1.0	19.3	20.4	17.4	42.8	0.8
Prop In Lane	1.00		1.00	1.00		1.00	1.00		1.00	1.00		1.00
Lane Grp Cap(c), veh/h	93	351	252	763	1119	528	99	919	403	558	1355	486
V/C Ratio(X)	0.88	0.10	0.40	1.52	0.06	0.93	0.33	0.74	0.77	1.48	1.04	0.03
Avail Cap(c_a), veh/h	93	540	388	763	1411	666	158	978	429	558	1355	486
HCM Platoon Ratio	1.00	1.00	1.00	1.00	1.00	1.00	1.00	1.00	1.00	1.00	1.00	1.00
Upstream Filter(I)	1.00	1.00	1.00	1.00	1.00	1.00	1.00	1.00	1.00	1.00	1.00	1.00
Uniform Delay (d), s/veh	51.2	38.9	40.9	42.1	24.7	35.0	51.7	36.7	37.1	45.6	32.9	20.2
Incr Delay (d2), s/veh	56.3	0.1	1.0	242.1	0.0	17.1	0.7	2.8	8.1	223.8	37.1	0.0
Initial Q Delay(d3),s/veh	0.0	0.0	0.0	0.0	0.0	0.0	0.0	0.0	0.0	0.0	0.0	0.0
%ile BackOfQ(50%),veh/ln	3.6	0.4	2.4	35.4	0.6	14.3	0.4	8.3	8.2	24.6	23.4	0.2
Unsig. Movement Delay, s/veh												
LnGrp Delay(d),s/veh	107.5	39.0	41.9	284.3	24.7	52.1	52.5	39.5	45.2	269.4	70.0	20.2
LnGrp LOS	F	D	D	F	C	D	D	D	D	F	F	C
Approach Vol, veh/h		219			1725			1025			2254	
Approach Delay, s/veh		66.0			207.5			41.7			142.5	
Approach LOS		E			F			D			F	
Timer - Assigned Phs	1	2	3	4	5	6	7	8				
Phs Duration (G+Y+Rc), s	22.0	34.4	29.0	23.3	7.8	48.6	10.3	42.0				
Change Period (Y+Rc), s	4.6	5.8	4.6	5.8	4.6	5.8	4.6	5.8				
Max Green Setting (Gmax), s	17.4	30.4	24.4	27.0	5.0	42.8	5.7	45.7				
Max Q Clear Time (g_c+I1), s	19.4	22.4	26.4	8.3	3.0	44.8	7.0	34.5				
Green Ext Time (p_c), s	0.0	3.3	0.0	0.4	0.0	0.0	0.0	1.7				

Intersection Summary

HCM 6th Ctrl Delay	141.0
HCM 6th LOS	F

Timings

West Campus Upper Plateau (JN 14064)

26: Sycamore Canyon Bl. & Van Buren Bl.

09/20/2022



Lane Group	EBL	EBT	EBR	WBL	WBT	WBR	NBL	NBT	SBL	SBT	SBR
Lane Configurations											
Traffic Volume (vph)	542	4541	6	8	3192	106	27	18	1211	16	866
Future Volume (vph)	542	4541	6	8	3192	106	27	18	1211	16	866
Turn Type	Prot	NA	Perm	Prot	NA	Perm	Perm	NA	Split	NA	Perm
Protected Phases	5	2		1	6			8	4	4	
Permitted Phases			2			6	8				4
Detector Phase	5	2	2	1	6	6	8	8	4	4	4
Switch Phase											
Minimum Initial (s)	5.0	10.0	10.0	5.0	10.0	10.0	10.0	10.0	10.0	10.0	10.0
Minimum Split (s)	9.6	29.2	29.2	9.6	29.2	29.2	14.6	14.6	50.8	50.8	50.8
Total Split (s)	22.0	47.8	47.8	9.6	35.4	35.4	14.6	14.6	58.0	58.0	58.0
Total Split (%)	16.9%	36.8%	36.8%	7.4%	27.2%	27.2%	11.2%	11.2%	44.6%	44.6%	44.6%
Yellow Time (s)	3.6	5.2	5.2	3.6	5.2	5.2	3.6	3.6	4.8	4.8	4.8
All-Red Time (s)	1.0	1.0	1.0	1.0	1.0	1.0	1.0	1.0	1.0	1.0	1.0
Lost Time Adjust (s)	0.0	0.0	0.0	0.0	0.0	0.0		0.0	0.0	0.0	0.0
Total Lost Time (s)	4.6	6.2	6.2	4.6	6.2	6.2		4.6	5.8	5.8	5.8
Lead/Lag	Lead	Lag	Lag	Lead	Lag	Lag					
Lead-Lag Optimize?	Yes	Yes	Yes	Yes	Yes	Yes					
Recall Mode	None	None	None	None	None	None	None	None	None	None	None
Act Effct Green (s)	17.4	49.3	49.3	5.0	29.2	29.2		10.0	52.2	52.2	52.2
Actuated g/C Ratio	0.13	0.38	0.38	0.04	0.22	0.22		0.08	0.40	0.40	0.40
v/c Ratio	1.31	2.07	0.01	0.15	2.48	0.25		0.35	0.97	0.02	1.09
Control Delay	197.9	508.2	0.0	66.4	691.7	5.1		36.1	57.4	23.8	78.7
Queue Delay	0.0	0.0	0.0	0.0	0.0	0.0		0.0	0.0	0.0	0.0
Total Delay	197.9	508.2	0.0	66.4	691.7	5.1		36.1	57.4	23.8	78.7
LOS	F	F	A	E	F	A		D	E	C	E
Approach Delay		474.5			668.2			36.1		66.0	
Approach LOS		F			F			D		E	

Intersection Summary

Cycle Length: 130	
Actuated Cycle Length: 130	
Natural Cycle: 115	
Control Type: Actuated-Uncoordinated	
Maximum v/c Ratio: 2.48	
Intersection Signal Delay: 450.7	Intersection LOS: F
Intersection Capacity Utilization 125.0%	ICU Level of Service H
Analysis Period (min) 15	

Splits and Phases: 26: Sycamore Canyon Bl. & Van Buren Bl.

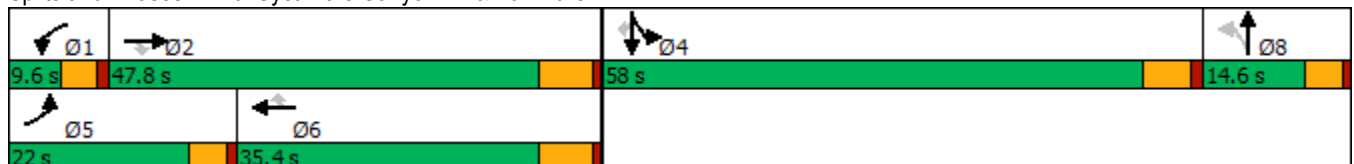

HCM 6th Signalized Intersection Summary
26: Sycamore Canyon Bl. & Van Buren Bl.

West Campus Upper Plateau (JN 14064)

09/20/2022



Movement	EBL	EBT	EBR	WBL	WBT	WBR	NBL	NBT	NBR	SBL	SBT	SBR
Lane Configurations												
Traffic Volume (veh/h)	542	4541	6	8	3192	106	27	18	40	1211	16	866
Future Volume (veh/h)	542	4541	6	8	3192	106	27	18	40	1211	16	866
Initial Q (Qb), veh	0	0	0	0	0	0	0	0	0	0	0	0
Ped-Bike Adj(A_pbT)	1.00		1.00	1.00		0.99	1.00		0.99	1.00		1.00
Parking Bus, Adj	1.00	1.00	1.00	1.00	1.00	1.00	1.00	1.00	1.00	1.00	1.00	1.00
Work Zone On Approach		No			No			No			No	
Adj Sat Flow, veh/h/ln	1841	1841	1900	1663	1826	1870	1900	1900	1900	1841	1900	1856
Adj Flow Rate, veh/h	589	4936	7	9	3470	92	29	20	13	1316	17	0
Peak Hour Factor	0.92	0.92	0.92	0.92	0.92	0.92	0.92	0.92	0.92	0.92	0.92	0.92
Percent Heavy Veh, %	4	4	0	16	5	2	0	0	0	4	0	3
Cap, veh/h	462	2234	568	17	1431	356	113	82	54	1366	763	
Arrive On Green	0.14	0.35	0.35	0.01	0.23	0.23	0.07	0.07	0.07	0.40	0.40	0.00
Sat Flow, veh/h	3401	6332	1610	1584	6281	1564	1621	1174	771	3401	1900	1572
Grp Volume(v), veh/h	589	4936	7	9	3470	92	33	0	29	1316	17	0
Grp Sat Flow(s),veh/h/ln	1700	1583	1610	1584	1570	1564	1819	0	1747	1700	1900	1572
Q Serve(g_s), s	17.4	45.2	0.4	0.7	29.2	6.2	2.2	0.0	2.0	48.4	0.7	0.0
Cycle Q Clear(g_c), s	17.4	45.2	0.4	0.7	29.2	6.2	2.2	0.0	2.0	48.4	0.7	0.0
Prop In Lane	1.00		1.00	1.00		1.00	0.89		0.44	1.00		1.00
Lane Grp Cap(c), veh/h	462	2234	568	17	1431	356	126	0	121	1366	763	
V/C Ratio(X)	1.28	2.21	0.01	0.53	2.43	0.26	0.26	0.00	0.24	0.96	0.02	
Avail Cap(c_a), veh/h	462	2234	568	62	1431	356	142	0	136	1385	774	
HCM Platoon Ratio	1.00	1.00	1.00	1.00	1.00	1.00	1.00	1.00	1.00	1.00	1.00	1.00
Upstream Filter(I)	1.00	1.00	1.00	1.00	1.00	1.00	1.00	0.00	1.00	1.00	1.00	0.00
Uniform Delay (d), s/veh	55.4	41.5	27.0	63.1	49.5	40.6	56.5	0.0	56.5	37.4	23.2	0.0
Incr Delay (d2), s/veh	140.1	545.7	0.0	9.3	643.5	0.4	1.1	0.0	1.0	16.1	0.0	0.0
Initial Q Delay(d3),s/veh	0.0	0.0	0.0	0.0	0.0	0.0	0.0	0.0	0.0	0.0	0.0	0.0
%ile BackOfQ(50%),veh/ln	16.2	101.5	0.1	0.3	75.0	2.4	1.0	0.0	0.9	22.1	0.3	0.0
Unsig. Movement Delay, s/veh												
LnGrp Delay(d),s/veh	195.5	587.1	27.0	72.4	693.0	41.0	57.6	0.0	57.5	53.6	23.2	0.0
LnGrp LOS	F	F	C	E	F	D	E	A	E	D	C	
Approach Vol, veh/h		5532			3571			62			1333	
Approach Delay, s/veh		544.7			674.6			57.5			53.2	
Approach LOS		F			F			E			D	
Timer - Assigned Phs	1	2		4	5	6		8				
Phs Duration (G+Y+Rc), s	6.0	51.4		57.3	22.0	35.4		13.5				
Change Period (Y+Rc), s	4.6	6.2		5.8	4.6	6.2		4.6				
Max Green Setting (Gmax), s	5.0	41.6		52.2	17.4	29.2		10.0				
Max Q Clear Time (g_c+I1), s	2.7	47.2		50.4	19.4	31.2		4.2				
Green Ext Time (p_c), s	0.0	0.0		1.1	0.0	0.0		0.1				

Intersection Summary

HCM 6th Ctrl Delay	523.6
HCM 6th LOS	F

Notes

Unsignalized Delay for [SBR] is excluded from calculations of the approach delay and intersection delay.

Timings
27: Innovation Dr. & Cactus Av.

West Campus Upper Plateau (JN 14064)

09/20/2022

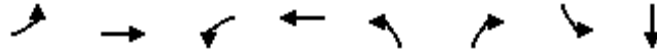

Lane Group	EBL	EBT	WBL	WBT	NBL	NBR	SBL	SBT
Lane Configurations	↖	↕↕↕	↖	↕↕↕	↖	↗	↖	↗
Traffic Volume (vph)	4	1156	69	1749	54	152	42	0
Future Volume (vph)	4	1156	69	1749	54	152	42	0
Turn Type	Prot	NA	Prot	NA	Perm	Perm	Perm	NA
Protected Phases	5	2	1	6				4
Permitted Phases					8	8	4	
Detector Phase	5	2	1	6	8	8	4	4
Switch Phase								
Minimum Initial (s)	5.0	10.0	5.0	10.0	10.0	10.0	10.0	10.0
Minimum Split (s)	9.2	26.8	9.2	26.8	31.1	31.1	31.1	31.1
Total Split (s)	12.0	63.0	22.0	73.0	35.0	35.0	35.0	35.0
Total Split (%)	10.0%	52.5%	18.3%	60.8%	29.2%	29.2%	29.2%	29.2%
Yellow Time (s)	3.2	4.8	3.2	4.8	4.1	4.1	4.1	4.1
All-Red Time (s)	1.0	1.0	1.0	1.0	1.0	1.0	1.0	1.0
Lost Time Adjust (s)	0.0	0.0	0.0	0.0	0.0	0.0	0.0	0.0
Total Lost Time (s)	4.2	5.8	4.2	5.8	5.1	5.1	5.1	5.1
Lead/Lag	Lead	Lag	Lead	Lag				
Lead-Lag Optimize?	Yes	Yes	Yes	Yes				
Recall Mode	None	None	None	None	None	None	None	None
Act Effct Green (s)	5.4	40.6	8.7	49.9	12.8	12.8	12.8	12.8
Actuated g/C Ratio	0.07	0.54	0.11	0.66	0.17	0.17	0.17	0.17
v/c Ratio	0.03	0.48	0.41	0.58	0.25	0.36	0.19	0.05
Control Delay	44.0	12.7	43.4	8.9	34.3	3.3	33.3	0.2
Queue Delay	0.0	0.0	0.0	0.0	0.0	0.0	0.0	0.0
Total Delay	44.0	12.7	43.4	8.9	34.3	3.3	33.3	0.2
LOS	D	B	D	A	C	A	C	A
Approach Delay		12.8		10.2				24.4
Approach LOS		B		B				C

Intersection Summary

Cycle Length: 120
 Actuated Cycle Length: 75.7
 Natural Cycle: 80
 Control Type: Actuated-Uncoordinated
 Maximum v/c Ratio: 0.58
 Intersection Signal Delay: 11.4
 Intersection LOS: B
 Intersection Capacity Utilization 60.6%
 ICU Level of Service B
 Analysis Period (min) 15

Splits and Phases: 27: Innovation Dr. & Cactus Av.



HCM 6th Signalized Intersection Summary
27: Innovation Dr. & Cactus Av.

West Campus Upper Plateau (JN 14064)

09/20/2022



Movement	EBL	EBT	EBR	WBL	WBT	WBR	NBL	NBT	NBR	SBL	SBT	SBR
Lane Configurations	↖	↑↑↑		↖	↑↑↑		↖	↑	↗	↖	↗	
Traffic Volume (veh/h)	4	1156	6	69	1749	16	54	0	152	42	0	16
Future Volume (veh/h)	4	1156	6	69	1749	16	54	0	152	42	0	16
Initial Q (Qb), veh	0	0	0	0	0	0	0	0	0	0	0	0
Ped-Bike Adj(A_pbT)	1.00		1.00	1.00		0.98	1.00		1.00	1.00		1.00
Parking Bus, Adj	1.00	1.00	1.00	1.00	1.00	1.00	1.00	1.00	1.00	1.00	1.00	1.00
Work Zone On Approach		No			No			No			No	
Adj Sat Flow, veh/h/ln	1900	1826	1248	1678	1841	1900	1870	1900	1841	1900	1900	1767
Adj Flow Rate, veh/h	4	1257	7	75	1901	17	59	0	114	46	0	8
Peak Hour Factor	0.92	0.92	0.92	0.92	0.92	0.92	0.92	0.92	0.92	0.92	0.92	0.92
Percent Heavy Veh, %	0	5	44	15	4	0	2	0	4	0	0	9
Cap, veh/h	10	3048	17	93	3332	30	286	260	214	278	0	221
Arrive On Green	0.01	0.60	0.60	0.06	0.65	0.65	0.14	0.00	0.14	0.14	0.00	0.14
Sat Flow, veh/h	1810	5115	28	1598	5136	46	1407	1900	1560	1299	0	1610
Grp Volume(v), veh/h	4	817	447	75	1240	678	59	0	114	46	0	8
Grp Sat Flow(s),veh/h/ln	1810	1662	1821	1598	1675	1831	1407	1900	1560	1299	0	1610
Q Serve(g_s), s	0.2	9.5	9.5	3.4	14.9	14.9	2.7	0.0	4.9	2.3	0.0	0.3
Cycle Q Clear(g_c), s	0.2	9.5	9.5	3.4	14.9	14.9	3.1	0.0	4.9	2.3	0.0	0.3
Prop In Lane	1.00		0.02	1.00		0.03	1.00		1.00	1.00		1.00
Lane Grp Cap(c), veh/h	10	1980	1085	93	2173	1188	286	260	214	278	0	221
V/C Ratio(X)	0.41	0.41	0.41	0.81	0.57	0.57	0.21	0.00	0.53	0.17	0.00	0.04
Avail Cap(c_a), veh/h	195	2631	1441	394	3116	1703	676	786	646	637	0	666
HCM Platoon Ratio	1.00	1.00	1.00	1.00	1.00	1.00	1.00	1.00	1.00	1.00	1.00	1.00
Upstream Filter(I)	1.00	1.00	1.00	1.00	1.00	1.00	1.00	0.00	1.00	1.00	0.00	1.00
Uniform Delay (d), s/veh	35.8	7.8	7.8	33.6	7.1	7.1	28.4	0.0	29.0	27.9	0.0	27.0
Incr Delay (d2), s/veh	10.2	0.2	0.4	6.0	0.3	0.6	0.4	0.0	2.1	0.3	0.0	0.1
Initial Q Delay(d3),s/veh	0.0	0.0	0.0	0.0	0.0	0.0	0.0	0.0	0.0	0.0	0.0	0.0
%ile BackOfQ(50%),veh/ln	0.1	2.5	2.8	1.4	3.5	4.0	0.9	0.0	1.9	0.7	0.0	0.1
Unsig. Movement Delay, s/veh												
LnGrp Delay(d),s/veh	46.0	8.0	8.2	39.7	7.4	7.7	28.7	0.0	31.1	28.2	0.0	27.1
LnGrp LOS	D	A	A	D	A	A	C	A	C	C	A	C
Approach Vol, veh/h		1268			1993			173				54
Approach Delay, s/veh		8.2			8.7			30.3				28.0
Approach LOS		A			A			C				C
Timer - Assigned Phs	1	2		4	5	6		8				
Phs Duration (G+Y+Rc), s	8.4	48.9		15.0	4.6	52.7		15.0				
Change Period (Y+Rc), s	* 4.2	5.8		5.1	* 4.2	5.8		5.1				
Max Green Setting (Gmax), s	* 18	57.2		29.9	* 7.8	67.2		29.9				
Max Q Clear Time (g_c+I1), s	5.4	11.5		4.3	2.2	16.9		6.9				
Green Ext Time (p_c), s	0.1	15.4		0.1	0.0	29.9		0.5				

Intersection Summary

HCM 6th Ctrl Delay	9.9
HCM 6th LOS	A

Notes

* HCM 6th computational engine requires equal clearance times for the phases crossing the barrier.

Timings
28: I-215 SB Ramps & Alessandro Bl.

West Campus Upper Plateau (JN 14064)

09/20/2022

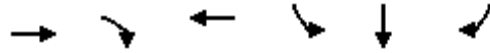

Lane Group	EBT	EBR	WBT	SBL	SBT	SBR
Lane Configurations	↑↑↑	↑	↑↑↑	↑	↔	↑
Traffic Volume (vph)	1922	454	2557	469	0	616
Future Volume (vph)	1922	454	2557	469	0	616
Turn Type	NA	Perm	NA	Split	NA	Perm
Protected Phases	2		6	4	4	
Permitted Phases		2				4
Detector Phase	2	2	6	4	4	4
Switch Phase						
Minimum Initial (s)	5.0	5.0	5.0	5.0	5.0	5.0
Minimum Split (s)	10.5	10.5	34.5	10.0	10.0	10.0
Total Split (s)	52.0	52.0	52.0	33.0	33.0	33.0
Total Split (%)	61.2%	61.2%	61.2%	38.8%	38.8%	38.8%
Yellow Time (s)	4.5	4.5	4.5	4.0	4.0	4.0
All-Red Time (s)	1.0	1.0	1.0	1.0	1.0	1.0
Lost Time Adjust (s)	0.0	0.0	0.0	0.0	0.0	0.0
Total Lost Time (s)	5.5	5.5	5.5	5.0	5.0	5.0
Lead/Lag						
Lead-Lag Optimize?						
Recall Mode	Min	Min	Min	None	None	None
Act Effect Green (s)	46.7	46.7	46.7	24.5	24.5	24.5
Actuated g/C Ratio	0.57	0.57	0.57	0.30	0.30	0.30
v/c Ratio	0.67	0.51	0.98	0.80	0.84	0.81
Control Delay	14.3	8.9	31.5	40.5	42.2	40.0
Queue Delay	0.0	0.0	0.0	0.0	0.0	0.0
Total Delay	14.3	8.9	31.5	40.5	42.2	40.0
LOS	B	A	C	D	D	D
Approach Delay	13.3		31.5		40.9	
Approach LOS	B		C		D	

Intersection Summary

Cycle Length: 85
 Actuated Cycle Length: 81.7
 Natural Cycle: 75
 Control Type: Actuated-Uncoordinated
 Maximum v/c Ratio: 0.98
 Intersection Signal Delay: 26.2
 Intersection LOS: C
 Intersection Capacity Utilization 87.9%
 ICU Level of Service E
 Analysis Period (min) 15

Splits and Phases: 28: I-215 SB Ramps & Alessandro Bl.

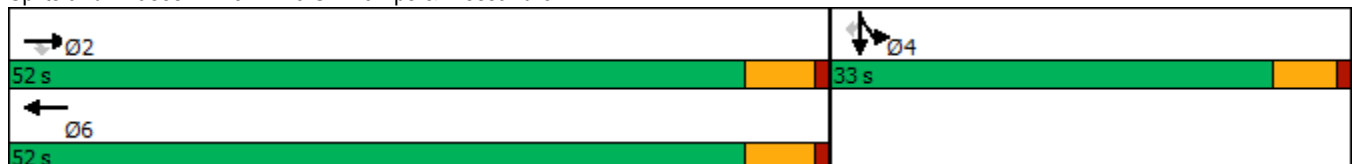

HCM 6th Signalized Intersection Summary
 28: I-215 SB Ramps & Alessandro Bl.

West Campus Upper Plateau (JN 14064)

09/20/2022



Movement	EBL	EBT	EBR	WBL	WBT	WBR	NBL	NBT	NBR	SBL	SBT	SBR
Lane Configurations		↑↑↑	↗		↑↑↑					↘	↔	↗
Traffic Volume (veh/h)	0	1922	454	0	2557	192	0	0	0	469	0	616
Future Volume (veh/h)	0	1922	454	0	2557	192	0	0	0	469	0	616
Initial Q (Qb), veh	0	0	0	0	0	0				0	0	0
Ped-Bike Adj(A_pbT)	1.00		1.00	1.00		0.98				1.00		1.00
Parking Bus, Adj	1.00	1.00	1.00	1.00	1.00	1.00				1.00	1.00	1.00
Work Zone On Approach		No			No						No	
Adj Sat Flow, veh/h/ln	0	1856	1737	0	1870	1544				1767	1900	1737
Adj Flow Rate, veh/h	0	1941	459	0	2583	186				670	0	368
Peak Hour Factor	0.99	0.99	0.99	0.99	0.99	0.99				0.99	0.99	0.99
Percent Heavy Veh, %	0	3	11	0	2	24				9	0	11
Cap, veh/h	0	2925	850	0	2808	198				981	0	429
Arrive On Green	0.00	0.58	0.58	0.00	0.58	0.58				0.29	0.00	0.29
Sat Flow, veh/h	0	5233	1472	0	5030	343				3365	0	1472
Grp Volume(v), veh/h	0	1941	459	0	1792	977				670	0	368
Grp Sat Flow(s),veh/h/ln	0	1689	1472	0	1702	1800				1682	0	1472
Q Serve(g_s), s	0.0	21.0	15.3	0.0	37.6	40.2				14.1	0.0	18.9
Cycle Q Clear(g_c), s	0.0	21.0	15.3	0.0	37.6	40.2				14.1	0.0	18.9
Prop In Lane	0.00		1.00	0.00		0.19				1.00		1.00
Lane Grp Cap(c), veh/h	0	2925	850	0	1966	1040				981	0	429
V/C Ratio(X)	0.00	0.66	0.54	0.00	0.91	0.94				0.68	0.00	0.86
Avail Cap(c_a), veh/h	0	2940	854	0	1976	1045				1176	0	515
HCM Platoon Ratio	1.00	1.00	1.00	1.00	1.00	1.00				1.00	1.00	1.00
Upstream Filter(I)	0.00	1.00	1.00	0.00	1.00	1.00				1.00	0.00	1.00
Uniform Delay (d), s/veh	0.0	11.6	10.4	0.0	15.1	15.6				25.1	0.0	26.8
Incr Delay (d2), s/veh	0.0	0.6	0.7	0.0	6.9	15.5				1.3	0.0	11.8
Initial Q Delay(d3),s/veh	0.0	0.0	0.0	0.0	0.0	0.0				0.0	0.0	0.0
%ile BackOfQ(50%),veh/ln	0.0	5.8	3.8	0.0	12.1	16.0				5.3	0.0	7.4
Unsig. Movement Delay, s/veh												
LnGrp Delay(d),s/veh	0.0	12.2	11.1	0.0	22.0	31.1				26.4	0.0	38.6
LnGrp LOS	A	B	B	A	C	C				C	A	D
Approach Vol, veh/h		2400			2769						1038	
Approach Delay, s/veh		11.9			25.2						30.7	
Approach LOS		B			C						C	
Timer - Assigned Phs		2		4		6						
Phs Duration (G+Y+Rc), s		51.8		28.3		51.8						
Change Period (Y+Rc), s		5.5		5.0		5.5						
Max Green Setting (Gmax), s		46.5		28.0		46.5						
Max Q Clear Time (g_c+I1), s		23.0		20.9		42.2						
Green Ext Time (p_c), s		16.1		2.4		4.1						

Intersection Summary

HCM 6th Ctrl Delay	21.0
HCM 6th LOS	C

Notes

User approved volume balancing among the lanes for turning movement.

Timings
29: I-215 NB Ramps & Alessandro Bl.

West Campus Upper Plateau (JN 14064)

09/20/2022



Lane Group	EBL	EBT	WBT	WBR	NBL	NBT	NBR
Lane Configurations	↶	↑↑↑	↶↑↑	↷	↶	↕	↷
Traffic Volume (vph)	150	2256	1730	218	1022	15	462
Future Volume (vph)	150	2256	1730	218	1022	15	462
Turn Type	Prot	NA	NA	Perm	Split	NA	Perm
Protected Phases	5	2	6		8	8	
Permitted Phases				6			8
Detector Phase	5	2	6	6	8	8	8
Switch Phase							
Minimum Initial (s)	5.0	5.0	5.0	5.0	5.0	5.0	5.0
Minimum Split (s)	9.5	10.5	33.5	33.5	10.0	10.0	10.0
Total Split (s)	13.0	48.0	35.0	35.0	37.0	37.0	37.0
Total Split (%)	15.3%	56.5%	41.2%	41.2%	43.5%	43.5%	43.5%
Yellow Time (s)	3.5	4.5	4.5	4.5	4.0	4.0	4.0
All-Red Time (s)	1.0	1.0	1.0	1.0	1.0	1.0	1.0
Lost Time Adjust (s)	0.0	0.0	0.0	0.0	0.0	0.0	0.0
Total Lost Time (s)	4.5	5.5	5.5	5.5	5.0	5.0	5.0
Lead/Lag	Lead		Lag	Lag			
Lead-Lag Optimize?	Yes		Yes	Yes			
Recall Mode	None	Min	Min	Min	Max	Max	Max
Act Effct Green (s)	8.5	42.5	29.5	29.5	32.0	32.0	32.0
Actuated g/C Ratio	0.10	0.50	0.35	0.35	0.38	0.38	0.38
v/c Ratio	1.15	0.94	1.06	0.41	0.93	0.97	0.73
Control Delay	160.6	29.7	69.1	15.9	49.7	59.1	26.3
Queue Delay	0.0	0.0	0.0	0.0	0.0	0.0	0.0
Total Delay	160.6	29.7	69.1	15.9	49.7	59.1	26.3
LOS	F	C	E	B	D	E	C
Approach Delay		37.9	63.1			46.6	
Approach LOS		D	E			D	

Intersection Summary

Cycle Length: 85
 Actuated Cycle Length: 85
 Natural Cycle: 100
 Control Type: Actuated-Uncoordinated
 Maximum v/c Ratio: 1.15
 Intersection Signal Delay: 48.5
 Intersection LOS: D
 Intersection Capacity Utilization 87.6%
 ICU Level of Service E
 Analysis Period (min) 15

Splits and Phases: 29: I-215 NB Ramps & Alessandro Bl.

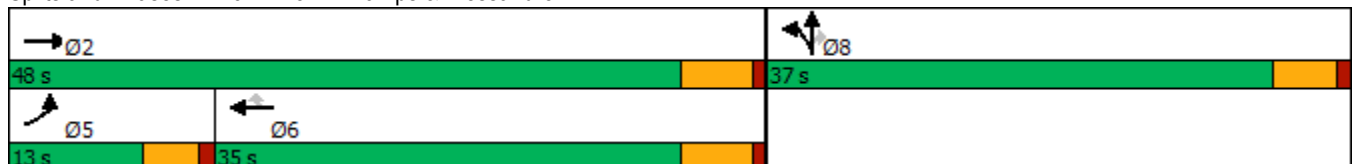

HCM 6th Signalized Intersection Summary
 29: I-215 NB Ramps & Alessandro Bl.

West Campus Upper Plateau (JN 14064)

09/20/2022



Movement	EBL	EBT	EBR	WBL	WBT	WBR	NBL	NBT	NBR	SBL	SBT	SBR
Lane Configurations												
Traffic Volume (veh/h)	150	2256	0	0	1730	218	1022	15	462	0	0	0
Future Volume (veh/h)	150	2256	0	0	1730	218	1022	15	462	0	0	0
Initial Q (Qb), veh	0	0	0	0	0	0	0	0	0			
Ped-Bike Adj(A_pbT)	1.00		1.00	1.00		0.98	1.00		1.00			
Parking Bus, Adj	1.00	1.00	1.00	1.00	1.00	1.00	1.00	1.00	1.00			
Work Zone On Approach		No			No			No				
Adj Sat Flow, veh/h/ln	1470	1870	0	0	1841	1781	1841	1900	1826			
Adj Flow Rate, veh/h	160	2400	0	0	1840	205	1219	0	275			
Peak Hour Factor	0.94	0.94	0.94	0.94	0.94	0.94	0.94	0.94	0.94			
Percent Heavy Veh, %	29	2	0	0	4	8	4	0	5			
Cap, veh/h	140	2553	0	0	1744	513	1320	0	583			
Arrive On Green	0.10	0.50	0.00	0.00	0.35	0.35	0.38	0.00	0.38			
Sat Flow, veh/h	1400	5274	0	0	5191	1478	3506	0	1547			
Grp Volume(v), veh/h	160	2400	0	0	1840	205	1219	0	275			
Grp Sat Flow(s),veh/h/ln	1400	1702	0	0	1675	1478	1753	0	1547			
Q Serve(g_s), s	8.5	37.7	0.0	0.0	29.5	8.9	28.2	0.0	11.5			
Cycle Q Clear(g_c), s	8.5	37.7	0.0	0.0	29.5	8.9	28.2	0.0	11.5			
Prop In Lane	1.00		0.00	0.00		1.00	1.00		1.00			
Lane Grp Cap(c), veh/h	140	2553	0	0	1744	513	1320	0	583			
V/C Ratio(X)	1.14	0.94	0.00	0.00	1.06	0.40	0.92	0.00	0.47			
Avail Cap(c_a), veh/h	140	2553	0	0	1744	513	1320	0	583			
HCM Platoon Ratio	1.00	1.00	1.00	1.00	1.00	1.00	1.00	1.00	1.00			
Upstream Filter(I)	1.00	1.00	0.00	0.00	1.00	1.00	1.00	0.00	1.00			
Uniform Delay (d), s/veh	38.3	20.0	0.0	0.0	27.7	21.0	25.3	0.0	20.1			
Incr Delay (d2), s/veh	119.5	7.8	0.0	0.0	37.7	0.5	12.2	0.0	2.7			
Initial Q Delay(d3),s/veh	0.0	0.0	0.0	0.0	0.0	0.0	0.0	0.0	0.0			
%ile BackOfQ(50%),veh/ln	7.3	13.6	0.0	0.0	16.3	2.8	12.9	0.0	4.2			
Unsig. Movement Delay, s/veh												
LnGrp Delay(d),s/veh	157.8	27.8	0.0	0.0	65.5	21.5	37.5	0.0	22.8			
LnGrp LOS	F	C	A	A	F	C	D	A	C			
Approach Vol, veh/h		2560			2045			1494				
Approach Delay, s/veh		35.9			61.1			34.8				
Approach LOS		D			E			C				
Timer - Assigned Phs		2			5	6		8				
Phs Duration (G+Y+Rc), s		48.0			13.0	35.0		37.0				
Change Period (Y+Rc), s		5.5			4.5	5.5		5.0				
Max Green Setting (Gmax), s		42.5			8.5	29.5		32.0				
Max Q Clear Time (g_c+I1), s		39.7			10.5	31.5		30.2				
Green Ext Time (p_c), s		2.6			0.0	0.0		1.1				

Intersection Summary

HCM 6th Ctrl Delay	44.1
HCM 6th LOS	D

Notes

User approved volume balancing among the lanes for turning movement.

Timings
30: I-215 SB Ramps & Cactus Av.



Lane Group	EBT	EBR	WBL	WBT	NBR	SBR
Lane Configurations	↑↑	↑	↓	↑↑	↑	↑
Traffic Volume (vph)	1124	227	936	1359	877	378
Future Volume (vph)	1124	227	936	1359	877	378
Turn Type	NA	Perm	Prot	NA	Prot	Prot
Protected Phases	2		1	6	8	4
Permitted Phases		2				
Detector Phase	2	2	1	6	8	4
Switch Phase						
Minimum Initial (s)	5.0	5.0	5.0	5.0	5.0	5.0
Minimum Split (s)	11.0	11.0	9.5	23.0	9.1	9.5
Total Split (s)	35.0	35.0	43.0	78.0	27.0	27.0
Total Split (%)	33.3%	33.3%	41.0%	74.3%	25.7%	25.7%
Yellow Time (s)	5.0	5.0	3.5	5.0	3.6	3.5
All-Red Time (s)	1.0	1.0	1.0	1.0	0.5	1.0
Lost Time Adjust (s)	0.0	0.0	0.0	0.0	0.0	0.0
Total Lost Time (s)	6.0	6.0	4.5	6.0	4.1	4.5
Lead/Lag	Lag	Lag	Lead			
Lead-Lag Optimize?	Yes	Yes	Yes			
Recall Mode	Min	Min	None	Min	None	None
Act Effct Green (s)	29.0	29.0	38.5	72.0	22.9	22.5
Actuated g/C Ratio	0.28	0.28	0.37	0.69	0.22	0.21
v/c Ratio	1.23	0.42	1.50	0.59	1.12	1.07
Control Delay	149.0	9.4	262.7	9.9	83.4	99.5
Queue Delay	0.0	0.0	0.0	0.0	0.0	0.0
Total Delay	149.0	9.4	262.7	9.9	83.4	99.5
LOS	F	A	F	A	F	F
Approach Delay	125.5			113.0		
Approach LOS	F			F		

Intersection Summary

Cycle Length: 105
 Actuated Cycle Length: 105
 Natural Cycle: 120
 Control Type: Actuated-Uncoordinated
 Maximum v/c Ratio: 1.50
 Intersection Signal Delay: 110.1
 Intersection Capacity Utilization 93.8%
 Analysis Period (min) 15
 Intersection LOS: F
 ICU Level of Service F

Splits and Phases: 30: I-215 SB Ramps & Cactus Av.

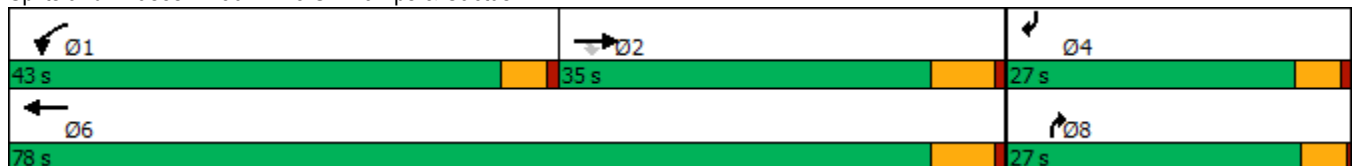

HCM 6th Signalized Intersection Summary
30: I-215 SB Ramps & Cactus Av.

West Campus Upper Plateau (JN 14064)

09/20/2022



Movement	EBL	EBT	EBR	WBL	WBT	WBR	NBL	NBT	NBR	SBL	SBT	SBR
Lane Configurations		↑↑	↗	↖	↑↑				↗			↗
Traffic Volume (veh/h)	0	1124	227	936	1359	0	0	0	877	0	0	378
Future Volume (veh/h)	0	1124	227	936	1359	0	0	0	877	0	0	378
Initial Q (Qb), veh	0	0	0	0	0	0	0	0	0	0	0	0
Ped-Bike Adj(A_pbT)	1.00		1.00	1.00		1.00	1.00		1.00	1.00		1.00
Parking Bus, Adj	1.00	1.00	1.00	1.00	1.00	1.00	1.00	1.00	1.00	1.00	1.00	1.00
Work Zone On Approach		No			No			No			No	
Adj Sat Flow, veh/h/ln	0	1841	1826	1885	1870	0	0	0	1811	0	0	1707
Adj Flow Rate, veh/h	0	1183	211	985	1431	0	0	0	0	0	0	293
Peak Hour Factor	0.95	0.95	0.95	0.95	0.95	0.95	0.95	0.95	0.95	0.95	0.95	0.95
Percent Heavy Veh, %	0	4	5	1	2	0	0	0	6	0	0	13
Cap, veh/h	0	1278	566	895	3278	0	0	0	0	0	0	0
Arrive On Green	0.00	0.37	0.37	0.50	0.92	0.00	0.00	0.00	0.00	0.00	0.00	0.00
Sat Flow, veh/h	0	3589	1547	1795	3647	0		0			0	
Grp Volume(v), veh/h	0	1183	211	985	1431	0		0.0			0.0	
Grp Sat Flow(s),veh/h/ln	0	1749	1547	1795	1777	0						
Q Serve(g_s), s	0.0	25.0	7.7	38.5	4.0	0.0						
Cycle Q Clear(g_c), s	0.0	25.0	7.7	38.5	4.0	0.0						
Prop In Lane	0.00		1.00	1.00		0.00						
Lane Grp Cap(c), veh/h	0	1278	566	895	3278	0						
V/C Ratio(X)	0.00	0.93	0.37	1.10	0.44	0.00						
Avail Cap(c_a), veh/h	0	1313	581	895	3313	0						
HCM Platoon Ratio	1.00	1.00	1.00	1.00	1.00	1.00						
Upstream Filter(I)	0.00	1.00	1.00	1.00	1.00	0.00						
Uniform Delay (d), s/veh	0.0	23.5	18.0	19.4	0.4	0.0						
Incr Delay (d2), s/veh	0.0	10.8	0.2	61.5	0.0	0.0						
Initial Q Delay(d3),s/veh	0.0	0.0	0.0	0.0	0.0	0.0						
%ile BackOfQ(50%),veh/ln	0.0	10.9	2.5	28.1	0.0	0.0						
Unsig. Movement Delay, s/veh												
LnGrp Delay(d),s/veh	0.0	34.3	18.1	80.8	0.4	0.0						
LnGrp LOS	A	C	B	F	A	A						
Approach Vol, veh/h		1394			2416							
Approach Delay, s/veh		31.8			33.2							
Approach LOS		C			C							
Timer - Assigned Phs	1	2			6							
Phs Duration (G+Y+Rc), s	43.0	34.2			77.2							
Change Period (Y+Rc), s	4.5	6.0			6.0							
Max Green Setting (Gmax), s	38.5	29.0			72.0							
Max Q Clear Time (g_c+I1), s	40.5	27.0			6.0							
Green Ext Time (p_c), s	0.0	1.2			8.2							

Intersection Summary

HCM 6th Ctrl Delay	32.7
HCM 6th LOS	C

Notes

Unsignalized Delay for [NBR] is excluded from calculations of the approach delay and intersection delay.

Timings

31: I-215 NB Ramps/Old 215 Frontage Rd. & Cactus Av.



Lane Group	EBL	EBT	WBT	NBL	NBT	NBR	SBL	SBT
Lane Configurations	↖	↗	↗	↖	↗	↗	↖	↗
Traffic Volume (vph)	74	2123	2873	346	298	100	227	3
Future Volume (vph)	74	2123	2873	346	298	100	227	3
Turn Type	Perm	NA	NA	Perm	NA	Perm	Perm	NA
Protected Phases		2	6		8			4
Permitted Phases	2			8		8	4	
Detector Phase	2	2	6	8	8	8	4	4
Switch Phase								
Minimum Initial (s)	5.0	5.0	5.0	5.0	5.0	5.0	5.0	5.0
Minimum Split (s)	11.0	11.0	44.0	10.5	10.5	10.5	10.5	10.5
Total Split (s)	57.4	57.4	57.4	27.6	27.6	27.6	27.6	27.6
Total Split (%)	67.5%	67.5%	67.5%	32.5%	32.5%	32.5%	32.5%	32.5%
Yellow Time (s)	5.0	5.0	5.0	4.5	4.5	4.5	4.5	4.5
All-Red Time (s)	1.0	1.0	1.0	1.0	1.0	1.0	1.0	1.0
Lost Time Adjust (s)	0.0	0.0	0.0	0.0	0.0	0.0	0.0	0.0
Total Lost Time (s)	6.0	6.0	6.0	5.5	5.5	5.5	5.5	5.5
Lead/Lag								
Lead-Lag Optimize?								
Recall Mode	Min	Min	Min	None	None	None	None	None
Act Effct Green (s)	51.4	51.4	51.4	22.1	22.1	22.1	22.1	22.1
Actuated g/C Ratio	0.60	0.60	0.60	0.26	0.26	0.26	0.26	0.26
v/c Ratio	0.91	1.16	1.53	1.48	0.70	0.22	1.50	0.54
Control Delay	99.3	96.3	262.5	262.6	38.1	17.2	284.5	32.7
Queue Delay	0.0	0.0	0.0	0.0	0.0	0.0	0.0	0.0
Total Delay	99.3	96.3	262.5	262.6	38.1	17.2	284.5	32.7
LOS	F	F	F	F	D	B	F	C
Approach Delay		96.4	262.5		140.0			161.3
Approach LOS		F	F		F			F

Intersection Summary

Cycle Length: 85
 Actuated Cycle Length: 85
 Natural Cycle: 110
 Control Type: Actuated-Uncoordinated
 Maximum v/c Ratio: 1.53
 Intersection Signal Delay: 182.9
 Intersection Capacity Utilization 133.1%
 Analysis Period (min) 15

Intersection LOS: F
 ICU Level of Service H

Splits and Phases: 31: I-215 NB Ramps/Old 215 Frontage Rd. & Cactus Av.

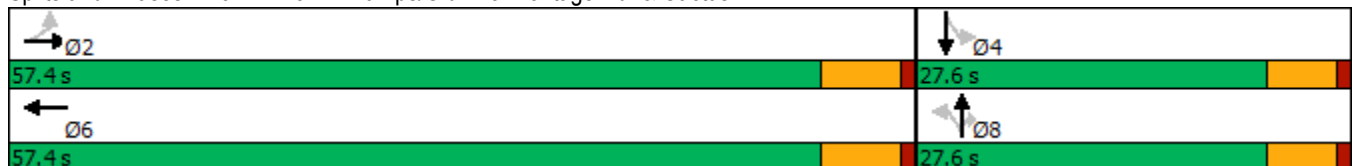

HCM 6th Signalized Intersection Summary

West Campus Upper Plateau (JN 14064)

31: I-215 NB Ramps/Old 215 Frontage Rd. & Cactus Av.

09/20/2022

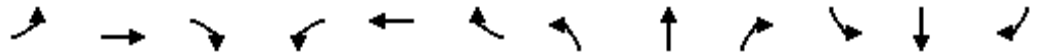

Movement	EBL	EBT	EBR	WBL	WBT	WBR	NBL	NBT	NBR	SBL	SBT	SBR
Lane Configurations												
Traffic Volume (veh/h)	74	2123	172	0	2873	218	346	298	100	227	3	214
Future Volume (veh/h)	74	2123	172	0	2873	218	346	298	100	227	3	214
Initial Q (Qb), veh	0	0	0	0	0	0	0	0	0	0	0	0
Ped-Bike Adj(A_pbT)	1.00		1.00	1.00		1.00	1.00		1.00	1.00		1.00
Parking Bus, Adj	1.00	1.00	1.00	1.00	1.00	1.00	1.00	1.00	1.00	1.00	1.00	1.00
Work Zone On Approach		No			No			No			No	
Adj Sat Flow, veh/h/ln	1826	1841	1663	0	1856	1885	1826	1856	1870	1841	1900	1885
Adj Flow Rate, veh/h	77	2211	175	0	2993	179	360	310	0	236	3	197
Peak Hour Factor	0.96	0.96	0.96	0.96	0.96	0.96	0.96	0.96	0.96	0.96	0.96	0.96
Percent Heavy Veh, %	5	4	16	0	3	1	5	3	2	4	0	1
Cap, veh/h	85	1987	155	0	2045	121	264	482		202	6	413
Arrive On Green	0.60	0.60	0.60	0.00	0.60	0.60	0.26	0.26	0.00	0.26	0.26	0.26
Sat Flow, veh/h	65	3287	257	0	3474	200	1154	1856	1585	1052	24	1590
Grp Volume(v), veh/h	77	1162	1224	0	1545	1627	360	310	0	236	0	200
Grp Sat Flow(s),veh/h/ln	65	1749	1795	0	1763	1819	1154	1856	1585	1052	0	1614
Q Serve(g_s), s	0.0	51.4	51.4	0.0	51.4	51.4	13.2	12.6	0.0	9.5	0.0	8.9
Cycle Q Clear(g_c), s	51.4	51.4	51.4	0.0	51.4	51.4	22.1	12.6	0.0	22.1	0.0	8.9
Prop In Lane	1.00		0.14	0.00		0.11	1.00		1.00	1.00		0.99
Lane Grp Cap(c), veh/h	85	1057	1085	0	1066	1100	264	482		202	0	420
V/C Ratio(X)	0.91	1.10	1.13	0.00	1.45	1.48	1.36	0.64		1.17	0.00	0.48
Avail Cap(c_a), veh/h	85	1057	1085	0	1066	1100	264	482		202	0	420
HCM Platoon Ratio	1.00	1.00	1.00	1.00	1.00	1.00	1.00	1.00	1.00	1.00	1.00	1.00
Upstream Filter(I)	1.00	1.00	1.00	0.00	1.00	1.00	1.00	1.00	0.00	1.00	0.00	1.00
Uniform Delay (d), s/veh	42.5	16.8	16.8	0.0	16.8	16.8	38.0	27.9	0.0	39.7	0.0	26.6
Incr Delay (d2), s/veh	67.0	59.0	69.5	0.0	207.7	220.4	186.1	2.3	0.0	115.8	0.0	0.3
Initial Q Delay(d3),s/veh	0.0	0.0	0.0	0.0	0.0	0.0	0.0	0.0	0.0	0.0	0.0	0.0
%ile BackOfQ(50%),veh/ln	3.1	32.7	36.8	0.0	77.0	83.4	18.9	5.5	0.0	10.5	0.0	3.2
Unsig. Movement Delay, s/veh												
LnGrp Delay(d),s/veh	109.5	75.8	86.3	0.0	224.5	237.2	224.1	30.2	0.0	155.5	0.0	26.9
LnGrp LOS	F	F	F	A	F	F	F	C		F	A	C
Approach Vol, veh/h		2463			3172			670				436
Approach Delay, s/veh		82.1			231.0			134.4				96.5
Approach LOS		F			F			F				F
Timer - Assigned Phs		2		4		6		8				
Phs Duration (G+Y+Rc), s		57.4		27.6		57.4		27.6				
Change Period (Y+Rc), s		6.0		5.5		6.0		5.5				
Max Green Setting (Gmax), s		51.4		22.1		51.4		22.1				
Max Q Clear Time (g_c+I1), s		53.4		24.1		53.4		24.1				
Green Ext Time (p_c), s		0.0		0.0		0.0		0.0				

Intersection Summary

HCM 6th Ctrl Delay	158.3
HCM 6th LOS	F

Notes

User approved volume balancing among the lanes for turning movement.
 Unsignalized Delay for [NBR] is excluded from calculations of the approach delay and intersection delay.

Timings
32: I-215 SB Ramps & Van Buren Bl.



Lane Group	EBT	EBR	WBL	WBT	SBT	SBR
Lane Configurations	↑↑	↑↑	↙	↑↑	↙	↑↑
Traffic Volume (vph)	1655	2726	214	1742	136	869
Future Volume (vph)	1655	2726	214	1742	136	869
Turn Type	NA	Perm	Prot	NA	NA	Perm
Protected Phases	6		5	2	8	
Permitted Phases		6				8
Detector Phase	6	6	5	2	8	8
Switch Phase						
Minimum Initial (s)	5.0	5.0	5.0	5.0	5.0	5.0
Minimum Split (s)	36.0	36.0	11.0	11.0	11.0	11.0
Total Split (s)	60.0	60.0	11.0	71.0	14.0	14.0
Total Split (%)	70.6%	70.6%	12.9%	83.5%	16.5%	16.5%
Yellow Time (s)	5.0	5.0	5.0	5.0	5.0	5.0
All-Red Time (s)	1.0	1.0	1.0	1.0	1.0	1.0
Lost Time Adjust (s)	0.0	0.0	0.0	0.0	0.0	0.0
Total Lost Time (s)	6.0	6.0	6.0	6.0	6.0	6.0
Lead/Lag	Lag	Lag	Lead			
Lead-Lag Optimize?	Yes	Yes	Yes			
Recall Mode	Min	Min	None	Min	Max	Max
Act Effct Green (s)	54.0	54.0	5.0	65.0	8.0	8.0
Actuated g/C Ratio	0.64	0.64	0.06	0.76	0.09	0.09
v/c Ratio	0.83	1.62	2.19	0.71	4.80	2.72
Control Delay	16.4	301.2	588.8	7.1	1734.4	800.9
Queue Delay	0.0	0.0	0.0	0.0	0.0	0.0
Total Delay	16.4	301.2	588.8	7.1	1734.4	800.9
LOS	B	F	F	A	F	F
Approach Delay	193.6			70.7	1234.8	
Approach LOS	F			E	F	

Intersection Summary

Cycle Length: 85
 Actuated Cycle Length: 85
 Natural Cycle: 120
 Control Type: Actuated-Uncoordinated
 Maximum v/c Ratio: 4.80
 Intersection Signal Delay: 375.7
 Intersection Capacity Utilization 153.4%
 Analysis Period (min) 15
 Intersection LOS: F
 ICU Level of Service H

Splits and Phases: 32: I-215 SB Ramps & Van Buren Bl.



HCM 6th Signalized Intersection Summary
 32: I-215 SB Ramps & Van Buren Bl.

West Campus Upper Plateau (JN 14064)

09/20/2022



Movement	EBL	EBT	EBR	WBL	WBT	WBR	NBL	NBT	NBR	SBL	SBT	SBR
Lane Configurations		↑↑	↑↑	↑	↑↑						↑	↑↑
Traffic Volume (veh/h)	0	1655	2726	214	1742	0	0	0	0	618	136	869
Future Volume (veh/h)	0	1655	2726	214	1742	0	0	0	0	618	136	869
Initial Q (Qb), veh	0	0	0	0	0	0				0	0	0
Ped-Bike Adj(A_pbT)	1.00		1.00	1.00		1.00				1.00		1.00
Parking Bus, Adj	1.00	1.00	1.00	1.00	1.00	1.00				1.00	1.00	1.00
Work Zone On Approach		No			No						No	
Adj Sat Flow, veh/h/ln	0	1796	1856	1885	1826	0				1885	1856	1722
Adj Flow Rate, veh/h	0	1780	2832	230	1873	0				665	146	0
Peak Hour Factor	0.93	0.93	0.93	0.93	0.93	0.93				0.93	0.93	0.93
Percent Heavy Veh, %	0	7	3	1	5	0				1	3	12
Cap, veh/h	0	2168	1758	106	2653	0				138	30	
Arrive On Green	0.00	0.64	0.64	0.06	0.76	0.00				0.09	0.09	0.00
Sat Flow, veh/h	0	3503	2768	1795	3561	0				1462	321	2569
Grp Volume(v), veh/h	0	1780	2832	230	1873	0				811	0	0
Grp Sat Flow(s),veh/h/ln	0	1706	1384	1795	1735	0				1782	0	1284
Q Serve(g_s), s	0.0	33.8	54.0	5.0	23.5	0.0				8.0	0.0	0.0
Cycle Q Clear(g_c), s	0.0	33.8	54.0	5.0	23.5	0.0				8.0	0.0	0.0
Prop In Lane	0.00		1.00	1.00		0.00				0.82		1.00
Lane Grp Cap(c), veh/h	0	2168	1758	106	2653	0				168	0	
V/C Ratio(X)	0.00	0.82	1.61	2.18	0.71	0.00				4.83	0.00	
Avail Cap(c_a), veh/h	0	2168	1758	106	2653	0				168	0	
HCM Platoon Ratio	1.00	1.00	1.00	1.00	1.00	1.00				1.00	1.00	1.00
Upstream Filter(I)	0.00	1.00	1.00	1.00	1.00	0.00				1.00	0.00	0.00
Uniform Delay (d), s/veh	0.0	11.8	15.5	40.0	5.1	0.0				38.5	0.0	0.0
Incr Delay (d2), s/veh	0.0	2.5	277.5	559.8	0.7	0.0				1738.8	0.0	0.0
Initial Q Delay(d3),s/veh	0.0	0.0	0.0	0.0	0.0	0.0				0.0	0.0	0.0
%ile BackOfQ(50%),veh/ln	0.0	9.3	78.9	18.5	3.9	0.0				84.3	0.0	0.0
Unsig. Movement Delay, s/veh												
LnGrp Delay(d),s/veh	0.0	14.3	293.0	599.8	5.9	0.0				1777.3	0.0	0.0
LnGrp LOS	A	B	F	F	A	A				F	A	
Approach Vol, veh/h		4612			2103							811
Approach Delay, s/veh		185.4			70.8							1777.3
Approach LOS		F			E							F
Timer - Assigned Phs		2			5	6		8				
Phs Duration (G+Y+Rc), s		71.0			11.0	60.0		14.0				
Change Period (Y+Rc), s		6.0			6.0	6.0		6.0				
Max Green Setting (Gmax), s		65.0			5.0	54.0		8.0				
Max Q Clear Time (g_c+I1), s		25.5			7.0	56.0		10.0				
Green Ext Time (p_c), s		12.2			0.0	0.0		0.0				

Intersection Summary

HCM 6th Ctrl Delay	324.9
HCM 6th LOS	F

Notes

Unsignalized Delay for [SBR] is excluded from calculations of the approach delay and intersection delay.

Timings
33: I-215 NB On/Off Ramp & Van Buren Bl.



Lane Group	EBT	EBR	WBT	NBL	NBR
Lane Configurations	↑↑	↑↑	↑↑	↑↑	↑
Traffic Volume (vph)	831	1359	1032	1378	232
Future Volume (vph)	831	1359	1032	1378	232
Turn Type	NA	pm+ov	NA	Prot	Perm
Protected Phases	6	4	2	4	
Permitted Phases		6			4
Detector Phase	6	4	2	4	4
Switch Phase					
Minimum Initial (s)	5.0	5.0	5.0	5.0	5.0
Minimum Split (s)	11.0	42.0	11.0	42.0	42.0
Total Split (s)	18.0	52.0	18.0	52.0	52.0
Total Split (%)	25.7%	74.3%	25.7%	74.3%	74.3%
Yellow Time (s)	5.0	5.0	5.0	5.0	5.0
All-Red Time (s)	1.0	1.0	1.0	1.0	1.0
Lost Time Adjust (s)	0.0	0.0	0.0	0.0	0.0
Total Lost Time (s)	6.0	6.0	6.0	6.0	6.0
Lead/Lag					
Lead-Lag Optimize?					
Recall Mode	None	Min	None	Min	Min
Act Effct Green (s)	12.3	57.6	12.3	33.1	33.1
Actuated g/C Ratio	0.21	1.00	0.21	0.57	0.57
v/c Ratio	1.14	0.54	1.41	0.77	0.27
Control Delay	105.2	0.8	218.7	12.2	6.4
Queue Delay	0.0	0.0	0.0	0.0	0.0
Total Delay	105.2	0.8	218.7	12.2	6.4
LOS	F	A	F	B	A
Approach Delay	40.4		218.7	11.4	
Approach LOS	D		F	B	

Intersection Summary

Cycle Length: 70
 Actuated Cycle Length: 57.6
 Natural Cycle: 70
 Control Type: Actuated-Uncoordinated
 Maximum v/c Ratio: 1.41
 Intersection Signal Delay: 68.8
 Intersection LOS: E
 Intersection Capacity Utilization 77.8%
 ICU Level of Service D
 Analysis Period (min) 15

Splits and Phases: 33: I-215 NB On/Off Ramp & Van Buren Bl.

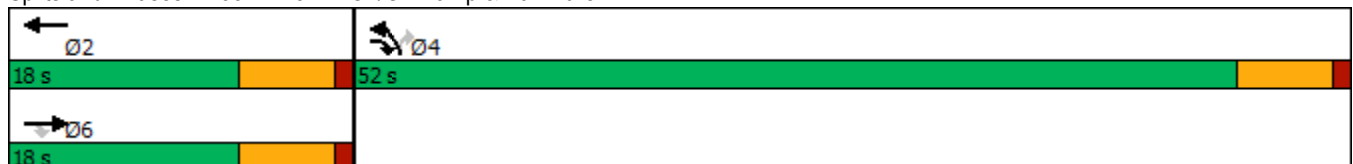

HCM 6th Signalized Intersection Summary
 33: I-215 NB On/Off Ramp & Van Buren Bl.

West Campus Upper Plateau (JN 14064)

09/20/2022



Movement	EBT	EBR	WBL	WBT	NBL	NBR
Lane Configurations	↑↑	↑↑		↑↑	↑↑	↑
Traffic Volume (veh/h)	831	1359	0	1032	1378	232
Future Volume (veh/h)	831	1359	0	1032	1378	232
Initial Q (Qb), veh	0	0	0	0	0	0
Ped-Bike Adj(A_pbT)		1.00	1.00		1.00	1.00
Parking Bus, Adj	1.00	1.00	1.00	1.00	1.00	1.00
Work Zone On Approach	No			No	No	
Adj Sat Flow, veh/h/ln	1900	1781	0	1900	1796	1885
Adj Flow Rate, veh/h	875	1423	0	1086	1451	244
Peak Hour Factor	0.95	0.95	0.95	0.95	0.95	0.95
Percent Heavy Veh, %	0	8	0	0	7	1
Cap, veh/h	893	2000	0	893	1677	807
Arrive On Green	0.25	0.25	0.00	0.25	0.51	0.51
Sat Flow, veh/h	3705	2657	0	3800	3319	1598
Grp Volume(v), veh/h	875	1423	0	1086	1451	244
Grp Sat Flow(s),veh/h/ln	1805	1329	0	1805	1659	1598
Q Serve(g_s), s	11.7	12.0	0.0	12.0	18.6	4.3
Cycle Q Clear(g_c), s	11.7	12.0	0.0	12.0	18.6	4.3
Prop In Lane		1.00	0.00		1.00	1.00
Lane Grp Cap(c), veh/h	893	2000	0	893	1677	807
V/C Ratio(X)	0.98	0.71	0.00	1.22	0.87	0.30
Avail Cap(c_a), veh/h	893	2000	0	893	3146	1515
HCM Platoon Ratio	1.00	1.00	1.00	1.00	1.00	1.00
Upstream Filter(I)	1.00	1.00	0.00	1.00	1.00	1.00
Uniform Delay (d), s/veh	18.1	3.0	0.0	18.3	10.5	7.0
Incr Delay (d2), s/veh	25.1	1.0	0.0	107.6	0.5	0.1
Initial Q Delay(d3),s/veh	0.0	0.0	0.0	0.0	0.0	0.0
%ile BackOfQ(50%),veh/ln	6.8	7.1	0.0	17.1	4.1	0.9
Unsig. Movement Delay, s/veh						
LnGrp Delay(d),s/veh	43.3	4.0	0.0	125.9	11.1	7.1
LnGrp LOS	D	A	A	F	B	A
Approach Vol, veh/h	2298			1086	1695	
Approach Delay, s/veh	18.9			125.9	10.5	
Approach LOS	B			F	B	
Timer - Assigned Phs		2		4		6
Phs Duration (G+Y+Rc), s		18.0		30.5		18.0
Change Period (Y+Rc), s		6.0		6.0		6.0
Max Green Setting (Gmax), s		12.0		46.0		12.0
Max Q Clear Time (g_c+I1), s		14.0		20.6		14.0
Green Ext Time (p_c), s		0.0		3.9		0.0
Intersection Summary						
HCM 6th Ctrl Delay			39.0			
HCM 6th LOS			D			

Timings

West Campus Upper Plateau (JN 14064)

34: Old 215 Frontage Rd. & Alessandro Bl.

09/20/2022

Lane Group	EBL	EBT	EBR	WBL	WBT	WBR	NBL	NBT	NBR	SBL	SBT	SBR
Lane Configurations												
Traffic Volume (vph)	463	2103	134	17	1538	299	48	199	19	322	266	313
Future Volume (vph)	463	2103	134	17	1538	299	48	199	19	322	266	313
Turn Type	Prot	NA	Perm	Prot	NA	Perm	Prot	NA	Perm	Prot	NA	Perm
Protected Phases	5	2		1	6		3	8		7	4	
Permitted Phases			2			6			8			4
Detector Phase	5	2	2	1	6	6	3	8	8	7	4	4
Switch Phase												
Minimum Initial (s)	5.0	10.0	10.0	5.0	10.0	10.0	5.0	10.0	10.0	5.0	10.0	10.0
Minimum Split (s)	8.7	43.5	43.5	8.7	15.8	15.8	8.7	16.2	16.2	8.7	40.2	40.2
Total Split (s)	22.0	62.4	62.4	8.7	49.1	49.1	8.7	29.7	29.7	19.2	40.2	40.2
Total Split (%)	18.3%	52.0%	52.0%	7.3%	40.9%	40.9%	7.3%	24.8%	24.8%	16.0%	33.5%	33.5%
Yellow Time (s)	3.2	5.5	5.5	3.2	4.8	4.8	3.2	5.2	5.2	3.2	5.2	5.2
All-Red Time (s)	0.5	1.0	1.0	0.5	1.0	1.0	0.5	1.0	1.0	0.5	1.0	1.0
Lost Time Adjust (s)	0.0	0.0	0.0	0.0	0.0	0.0	0.0	0.0	0.0	0.0	0.0	0.0
Total Lost Time (s)	3.7	6.5	6.5	3.7	5.8	5.8	3.7	6.2	6.2	3.7	6.2	6.2
Lead/Lag	Lead	Lag	Lag	Lead	Lag	Lag	Lead	Lag	Lag	Lead	Lag	Lag
Lead-Lag Optimize?	Yes	Yes	Yes	Yes	Yes	Yes	Yes	Yes	Yes	Yes	Yes	Yes
Recall Mode	None	None	None	None	None	None	None	None	None	None	None	None
Act Effct Green (s)	17.9	61.0	61.0	5.0	43.4	43.4	5.0	13.4	13.4	15.5	25.8	25.8
Actuated g/C Ratio	0.16	0.56	0.56	0.05	0.40	0.40	0.05	0.12	0.12	0.14	0.24	0.24
v/c Ratio	0.87	0.75	0.17	0.24	1.12	0.37	0.37	0.47	0.06	1.32	0.36	0.59
Control Delay	62.6	22.2	3.8	61.1	96.9	4.2	61.0	48.3	0.4	205.5	37.0	11.5
Queue Delay	0.0	0.0	0.0	0.0	0.0	0.0	0.0	0.0	0.0	0.0	0.0	0.0
Total Delay	62.6	22.2	3.8	61.1	96.9	4.2	61.0	48.3	0.4	205.5	37.0	11.5
LOS	E	C	A	E	F	A	E	D	A	F	D	B
Approach Delay		28.2			81.6			47.2			88.5	
Approach LOS		C			F			D			F	

Intersection Summary

Cycle Length: 120
 Actuated Cycle Length: 109.7
 Natural Cycle: 115
 Control Type: Actuated-Uncoordinated
 Maximum v/c Ratio: 1.32
 Intersection Signal Delay: 55.9
 Intersection LOS: E
 Intersection Capacity Utilization 98.6%
 ICU Level of Service F
 Analysis Period (min) 15

Splits and Phases: 34: Old 215 Frontage Rd. & Alessandro Bl.



HCM 6th Signalized Intersection Summary
34: Old 215 Frontage Rd. & Alessandro Bl.

West Campus Upper Plateau (JN 14064)

09/20/2022



Movement	EBL	EBT	EBR	WBL	WBT	WBR	NBL	NBT	NBR	SBL	SBT	SBR
Lane Configurations	↖↗	↑↑↑	↖	↖	↑↑	↖	↖↗	↑↑	↖	↖	↑↑	↖
Traffic Volume (veh/h)	463	2103	134	17	1538	299	48	199	19	322	266	313
Future Volume (veh/h)	463	2103	134	17	1538	299	48	199	19	322	266	313
Initial Q (Qb), veh	0	0	0	0	0	0	0	0	0	0	0	0
Ped-Bike Adj(A_pbT)	1.00		0.99	1.00		1.00	1.00		0.98	1.00		1.00
Parking Bus, Adj	1.00	1.00	1.00	1.00	1.00	1.00	1.00	1.00	1.00	1.00	1.00	1.00
Work Zone On Approach		No			No			No			No	
Adj Sat Flow, veh/h/ln	1826	1885	1678	1678	1870	1885	1574	1856	1574	1870	1737	1693
Adj Flow Rate, veh/h	472	2146	110	17	1569	0	49	203	9	329	271	0
Peak Hour Factor	0.98	0.98	0.98	0.98	0.98	0.98	0.98	0.98	0.98	0.98	0.98	0.98
Percent Heavy Veh, %	5	1	15	15	2	1	22	3	22	2	11	14
Cap, veh/h	533	2828	772	30	1457		105	334	124	262	678	
Arrive On Green	0.16	0.55	0.55	0.02	0.41	0.00	0.04	0.09	0.09	0.15	0.21	0.00
Sat Flow, veh/h	3374	5147	1404	1598	3554	1598	2908	3526	1312	1781	3300	1434
Grp Volume(v), veh/h	472	2146	110	17	1569	0	49	203	9	329	271	0
Grp Sat Flow(s),veh/h/ln	1687	1716	1404	1598	1777	1598	1454	1763	1312	1781	1650	1434
Q Serve(g_s), s	14.5	34.0	4.0	1.1	43.3	0.0	1.7	5.8	0.7	15.5	7.5	0.0
Cycle Q Clear(g_c), s	14.5	34.0	4.0	1.1	43.3	0.0	1.7	5.8	0.7	15.5	7.5	0.0
Prop In Lane	1.00		1.00	1.00		1.00	1.00		1.00	1.00		1.00
Lane Grp Cap(c), veh/h	533	2828	772	30	1457		105	334	124	262	678	
V/C Ratio(X)	0.89	0.76	0.14	0.57	1.08		0.47	0.61	0.07	1.26	0.40	
Avail Cap(c_a), veh/h	585	2828	772	76	1457		138	785	292	262	1063	
HCM Platoon Ratio	1.00	1.00	1.00	1.00	1.00	1.00	1.00	1.00	1.00	1.00	1.00	1.00
Upstream Filter(I)	1.00	1.00	1.00	1.00	1.00	0.00	1.00	1.00	1.00	1.00	1.00	0.00
Uniform Delay (d), s/veh	43.5	18.4	11.6	51.4	31.1	0.0	49.9	45.9	43.6	45.0	36.3	0.0
Incr Delay (d2), s/veh	13.4	1.2	0.1	6.3	47.1	0.0	1.2	1.8	0.2	143.3	0.4	0.0
Initial Q Delay(d3),s/veh	0.0	0.0	0.0	0.0	0.0	0.0	0.0	0.0	0.0	0.0	0.0	0.0
%ile BackOfQ(50%),veh/ln	6.7	11.6	1.1	0.5	26.5	0.0	0.6	2.5	0.2	16.9	2.9	0.0
Unsig. Movement Delay, s/veh												
LnGrp Delay(d),s/veh	56.9	19.6	11.7	57.7	78.3	0.0	51.1	47.7	43.8	188.4	36.7	0.0
LnGrp LOS	E	B	B	E	F		D	D	D	F	D	
Approach Vol, veh/h		2728			1586			261			600	
Approach Delay, s/veh		25.7			78.1			48.2			119.9	
Approach LOS		C			E			D			F	
Timer - Assigned Phs	1	2	3	4	5	6	7	8				
Phs Duration (G+Y+Rc), s	5.7	64.5	7.5	27.9	20.4	49.8	19.2	16.2				
Change Period (Y+Rc), s	3.7	6.5	3.7	6.2	3.7	* 6.5	3.7	6.2				
Max Green Setting (Gmax), s	5.0	55.9	5.0	34.0	18.3	* 43	15.5	23.5				
Max Q Clear Time (g_c+I1), s	3.1	36.0	3.7	9.5	16.5	45.3	17.5	7.8				
Green Ext Time (p_c), s	0.0	14.4	0.0	1.5	0.2	0.0	0.0	0.9				

Intersection Summary

HCM 6th Ctrl Delay	53.8
HCM 6th LOS	D

Notes

* HCM 6th computational engine requires equal clearance times for the phases crossing the barrier.
Unsignalized Delay for [WBR, SBR] is excluded from calculations of the approach delay and intersection delay.

Timings
35: Day St. & Alessandro Bl.

West Campus Upper Plateau (JN 14064)

09/20/2022



Lane Group	EBL	EBT	EBR	WBL	WBT	WBR	NBL	NBT	NBR	SBL	SBT
Lane Configurations	↘	↑↑↑	↗	↘	↑↑	↗	↘	↑	↗	↘	↗
Traffic Volume (vph)	280	2073	79	36	1636	251	76	214	32	288	186
Future Volume (vph)	280	2073	79	36	1636	251	76	214	32	288	186
Turn Type	Prot	NA	Perm	Prot	NA	Perm	Perm	NA	Perm	Perm	NA
Protected Phases	5	2		1	6			8			4
Permitted Phases			2			6	8		8	4	
Detector Phase	5	2	2	1	6	6	8	8	8	4	4
Switch Phase											
Minimum Initial (s)	5.0	10.0	10.0	5.0	10.0	10.0	10.0	10.0	10.0	10.0	10.0
Minimum Split (s)	9.1	30.8	30.8	9.1	30.8	30.8	42.4	42.4	42.4	41.6	41.6
Total Split (s)	28.0	67.9	67.9	9.1	49.0	49.0	43.0	43.0	43.0	43.0	43.0
Total Split (%)	23.3%	56.6%	56.6%	7.6%	40.8%	40.8%	35.8%	35.8%	35.8%	35.8%	35.8%
Yellow Time (s)	3.6	4.8	4.8	3.6	4.8	4.8	4.4	4.4	4.4	3.6	3.6
All-Red Time (s)	0.5	1.0	1.0	0.5	1.0	1.0	1.0	1.0	1.0	1.0	1.0
Lost Time Adjust (s)	0.0	0.0	0.0	0.0	0.0	0.0	0.0	0.0	0.0	0.0	0.0
Total Lost Time (s)	4.1	5.8	5.8	4.1	5.8	5.8	5.4	5.4	5.4	4.6	4.6
Lead/Lag	Lead	Lag	Lag	Lead	Lag	Lag					
Lead-Lag Optimize?	Yes	Yes	Yes	Yes	Yes	Yes					
Recall Mode	None	None	None	None	None	None	None	None	None	None	None
Act Effct Green (s)	21.6	62.4	62.4	5.0	43.8	43.8	37.0	37.0	37.0	37.8	37.8
Actuated g/C Ratio	0.18	0.53	0.53	0.04	0.37	0.37	0.31	0.31	0.31	0.32	0.32
v/c Ratio	0.88	0.80	0.10	0.49	1.28	0.40	0.81	0.37	0.06	0.96	0.79
Control Delay	74.0	26.1	6.0	78.1	165.7	19.5	91.9	34.0	0.2	82.2	42.7
Queue Delay	0.0	0.0	0.0	0.0	0.0	0.0	0.0	0.0	0.0	0.0	0.0
Total Delay	74.0	26.1	6.0	78.1	165.7	19.5	91.9	34.0	0.2	82.2	42.7
LOS	E	C	A	E	F	B	F	C	A	F	D
Approach Delay		30.9			145.0			44.3			58.1
Approach LOS		C			F			D			E

Intersection Summary

Cycle Length: 120
 Actuated Cycle Length: 117.7
 Natural Cycle: 115
 Control Type: Actuated-Uncoordinated
 Maximum v/c Ratio: 1.28
 Intersection Signal Delay: 76.0
 Intersection LOS: E
 Intersection Capacity Utilization 111.6%
 ICU Level of Service H
 Analysis Period (min) 15





























Splits and Phases: 35: Day St. & Alessandro Bl.



HCM 6th Signalized Intersection Summary
35: Day St. & Alessandro Bl.

West Campus Upper Plateau (JN 14064)

09/20/2022

												
Movement	EBL	EBT	EBR	WBL	WBT	WBR	NBL	NBT	NBR	SBL	SBT	SBR
Lane Configurations		  			 						 	
Traffic Volume (veh/h)	280	2073	79	36	1636	251	76	214	32	288	186	264
Future Volume (veh/h)	280	2073	79	36	1636	251	76	214	32	288	186	264
Initial Q (Qb), veh	0	0	0	0	0	0	0	0	0	0	0	0
Ped-Bike Adj(A_pbT)	1.00		0.98	1.00		0.98	1.00		1.00	1.00		1.00
Parking Bus, Adj	1.00	1.00	1.00	1.00	1.00	1.00	1.00	1.00	1.00	1.00	1.00	1.00
Work Zone On Approach		No			No			No			No	
Adj Sat Flow, veh/h/ln	1900	1870	1811	1900	1885	1900	1796	1900	1841	1885	1885	1885
Adj Flow Rate, veh/h	292	2159	76	38	1704	193	79	223	28	300	194	244
Peak Hour Factor	0.96	0.96	0.96	0.96	0.96	0.96	0.96	0.96	0.96	0.96	0.96	0.96
Percent Heavy Veh, %	0	2	6	0	1	0	7	0	4	1	1	1
Cap, veh/h	320	2622	771	55	1315	578	148	620	509	330	248	311
Arrive On Green	0.18	0.51	0.51	0.03	0.37	0.37	0.33	0.33	0.33	0.33	0.33	0.33
Sat Flow, veh/h	1810	5106	1501	1810	3582	1575	913	1900	1560	1138	759	954
Grp Volume(v), veh/h	292	2159	76	38	1704	193	79	223	28	300	0	438
Grp Sat Flow(s),veh/h/ln	1810	1702	1501	1810	1791	1575	913	1900	1560	1138	0	1713
Q Serve(g_s), s	18.6	41.9	3.1	2.4	43.2	10.4	10.1	10.5	1.4	27.9	0.0	27.2
Cycle Q Clear(g_c), s	18.6	41.9	3.1	2.4	43.2	10.4	37.3	10.5	1.4	38.4	0.0	27.2
Prop In Lane	1.00		1.00	1.00		1.00	1.00		1.00	1.00		0.56
Lane Grp Cap(c), veh/h	320	2622	771	55	1315	578	148	620	509	330	0	559
V/C Ratio(X)	0.91	0.82	0.10	0.69	1.30	0.33	0.53	0.36	0.06	0.91	0.00	0.78
Avail Cap(c_a), veh/h	367	2694	792	77	1315	578	148	620	509	330	0	559
HCM Platoon Ratio	1.00	1.00	1.00	1.00	1.00	1.00	1.00	1.00	1.00	1.00	1.00	1.00
Upstream Filter(I)	1.00	1.00	1.00	1.00	1.00	1.00	1.00	1.00	1.00	1.00	0.00	1.00
Uniform Delay (d), s/veh	47.6	24.1	14.7	56.5	37.2	26.9	52.8	30.3	27.2	46.3	0.0	35.9
Incr Delay (d2), s/veh	23.2	2.1	0.1	5.8	139.0	0.3	3.7	0.4	0.0	27.6	0.0	7.2
Initial Q Delay(d3),s/veh	0.0	0.0	0.0	0.0	0.0	0.0	0.0	0.0	0.0	0.0	0.0	0.0
%ile BackOfQ(50%),veh/ln	10.2	15.9	1.0	1.2	43.2	3.8	2.4	4.8	0.5	11.5	0.0	12.5
Unsig. Movement Delay, s/veh												
LnGrp Delay(d),s/veh	70.8	26.3	14.7	62.3	176.2	27.2	56.5	30.6	27.2	73.9	0.0	43.1
LnGrp LOS	E	C	B	E	F	C	E	C	C	E	A	D
Approach Vol, veh/h		2527			1935			330				738
Approach Delay, s/veh		31.1			159.1			36.5				55.6
Approach LOS		C			F			D				E
Timer - Assigned Phs	1	2		4	5	6		8				
Phs Duration (G+Y+Rc), s	7.7	66.2		43.8	24.9	49.0		43.8				
Change Period (Y+Rc), s	4.1	5.8		* 5.4	4.1	5.8		5.4				
Max Green Setting (Gmax), s	5.0	62.1		* 38	23.9	43.2		37.6				
Max Q Clear Time (g_c+I1), s	4.4	43.9		40.4	20.6	45.2		39.3				
Green Ext Time (p_c), s	0.0	13.9		0.0	0.1	0.0		0.0				

Intersection Summary

HCM 6th Ctrl Delay	79.5
HCM 6th LOS	E

Notes

* HCM 6th computational engine requires equal clearance times for the phases crossing the barrier.

Timings
36: Elsworth St. & Cactus Av.

West Campus Upper Plateau (JN 14064)

09/20/2022



Lane Group	EBL	EBT	EBR	WBL	WBT	WBR	NBL	NBT	SBL	SBT	SBR
Lane Configurations	↘	↑↑↑	↗	↘	↑↑↑	↗	↘	↕	↘	↗	↗
Traffic Volume (vph)	291	2914	121	36	2144	211	556	177	366	73	405
Future Volume (vph)	291	2914	121	36	2144	211	556	177	366	73	405
Turn Type	Prot	NA	Perm	Prot	NA	Perm	Split	NA	Split	NA	pm+ov
Protected Phases	5	2		1	6		8	8	4	4	5
Permitted Phases			2			6					4
Detector Phase	5	2	2	1	6	6	8	8	4	4	5
Switch Phase											
Minimum Initial (s)	5.0	10.0	10.0	5.0	10.0	10.0	10.0	10.0	10.0	10.0	5.0
Minimum Split (s)	9.6	36.2	36.2	9.6	36.2	36.2	35.4	35.4	35.4	35.4	9.6
Total Split (s)	16.5	49.6	49.6	9.6	42.7	42.7	35.4	35.4	35.4	35.4	16.5
Total Split (%)	12.7%	38.2%	38.2%	7.4%	32.8%	32.8%	27.2%	27.2%	27.2%	27.2%	12.7%
Yellow Time (s)	3.6	5.2	5.2	3.6	5.2	5.2	4.4	4.4	4.4	4.4	3.6
All-Red Time (s)	1.0	1.0	1.0	1.0	1.0	1.0	1.0	1.0	1.0	1.0	1.0
Lost Time Adjust (s)	0.0	0.0	0.0	0.0	0.0	0.0	0.0	0.0	0.0	0.0	0.0
Total Lost Time (s)	4.6	6.2	6.2	4.6	6.2	6.2	5.4	5.4	5.4	5.4	4.6
Lead/Lag	Lead	Lag	Lag	Lead	Lag	Lag					Lead
Lead-Lag Optimize?	Yes	Yes	Yes	Yes	Yes	Yes					Yes
Recall Mode	None	None	None	None	None	None	Max	Max	Max	Max	None
Act Effct Green (s)	11.9	45.3	45.3	5.0	36.5	36.5	30.0	30.0	30.0	30.0	42.7
Actuated g/C Ratio	0.09	0.35	0.35	0.04	0.28	0.28	0.23	0.23	0.23	0.23	0.33
v/c Ratio	1.87	1.75	0.20	0.55	1.58	0.40	1.14	1.11	0.57	0.58	0.73
Control Delay	446.0	366.5	9.1	89.9	297.2	15.8	135.5	121.3	50.8	51.0	26.6
Queue Delay	0.0	0.0	0.0	0.0	0.0	0.0	0.0	0.0	0.0	0.0	0.0
Total Delay	446.0	366.5	9.1	89.9	297.2	15.8	135.5	121.3	50.8	51.0	26.6
LOS	F	F	A	F	F	B	F	F	D	D	C
Approach Delay		360.4			269.2			128.5		39.2	
Approach LOS		F			F			F		D	

Intersection Summary

Cycle Length: 130
 Actuated Cycle Length: 130
 Natural Cycle: 120
 Control Type: Actuated-Uncoordinated
 Maximum v/c Ratio: 1.87
 Intersection Signal Delay: 267.6
 Intersection LOS: F
 Intersection Capacity Utilization 114.5%
 ICU Level of Service H
 Analysis Period (min) 15

Splits and Phases: 36: Elsworth St. & Cactus Av.

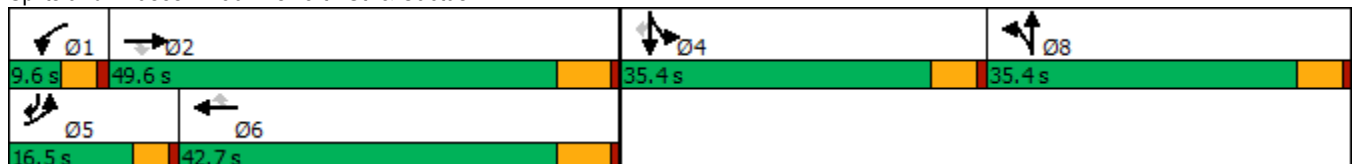

HCM 6th Signalized Intersection Summary
36: Elsworth St. & Cactus Av.

West Campus Upper Plateau (JN 14064)

09/20/2022



Movement	EBL	EBT	EBR	WBL	WBT	WBR	NBL	NBT	NBR	SBL	SBT	SBR
Lane Configurations	↶	↷↷↷	↷	↶	↷↷↷	↷	↶	↷		↶	↷	↷
Traffic Volume (veh/h)	291	2914	121	36	2144	211	556	177	130	366	73	405
Future Volume (veh/h)	291	2914	121	36	2144	211	556	177	130	366	73	405
Initial Q (Qb), veh	0	0	0	0	0	0	0	0	0	0	0	0
Ped-Bike Adj(A_pbT)	1.00		1.00	1.00		1.00	1.00		1.00	1.00		1.00
Parking Bus, Adj	1.00	1.00	1.00	1.00	1.00	1.00	1.00	1.00	1.00	1.00	1.00	1.00
Work Zone On Approach		No			No			No			No	
Adj Sat Flow, veh/h/ln	1870	1841	1870	1900	1856	1885	1900	1900	1885	1900	1900	1900
Adj Flow Rate, veh/h	303	3035	0	38	2233	184	437	383	111	435	0	315
Peak Hour Factor	0.96	0.96	0.96	0.96	0.96	0.96	0.96	0.96	0.96	0.96	0.96	0.96
Percent Heavy Veh, %	2	4	2	0	3	1	0	0	1	0	0	0
Cap, veh/h	163	1727		52	1422	449	418	327	95	835	0	519
Arrive On Green	0.09	0.34	0.00	0.03	0.28	0.28	0.23	0.23	0.23	0.23	0.00	0.23
Sat Flow, veh/h	1781	5025	1585	1810	5066	1598	1810	1416	410	3619	0	1610
Grp Volume(v), veh/h	303	3035	0	38	2233	184	437	0	494	435	0	315
Grp Sat Flow(s),veh/h/ln	1781	1675	1585	1810	1689	1598	1810	0	1826	1810	0	1610
Q Serve(g_s), s	11.9	44.7	0.0	2.7	36.5	12.2	30.0	0.0	30.0	13.7	0.0	21.4
Cycle Q Clear(g_c), s	11.9	44.7	0.0	2.7	36.5	12.2	30.0	0.0	30.0	13.7	0.0	21.4
Prop In Lane	1.00		1.00	1.00		1.00	1.00		0.22	1.00		1.00
Lane Grp Cap(c), veh/h	163	1727		52	1422	449	418	0	421	835	0	519
V/C Ratio(X)	1.86	1.76		0.73	1.57	0.41	1.05	0.00	1.17	0.52	0.00	0.61
Avail Cap(c_a), veh/h	163	1727		70	1422	449	418	0	421	835	0	519
HCM Platoon Ratio	1.00	1.00	1.00	1.00	1.00	1.00	1.00	1.00	1.00	1.00	1.00	1.00
Upstream Filter(l)	1.00	1.00	0.00	1.00	1.00	1.00	1.00	0.00	1.00	1.00	0.00	1.00
Uniform Delay (d), s/veh	59.1	42.7	0.0	62.6	46.7	38.0	50.0	0.0	50.0	43.7	0.0	37.1
Incr Delay (d2), s/veh	408.8	343.4	0.0	13.9	260.0	0.6	56.7	0.0	100.0	2.3	0.0	5.2
Initial Q Delay(d3),s/veh	0.0	0.0	0.0	0.0	0.0	0.0	0.0	0.0	0.0	0.0	0.0	0.0
%ile BackOfQ(50%),veh/ln	23.7	72.4	0.0	1.4	48.9	4.7	20.2	0.0	25.5	6.3	0.0	9.3
Unsig. Movement Delay, s/veh												
LnGrp Delay(d),s/veh	467.8	386.1	0.0	76.6	306.7	38.6	106.7	0.0	150.0	46.0	0.0	42.3
LnGrp LOS	F	F		E	F	D	F	A	F	D	A	D
Approach Vol, veh/h		3338			2455			931			750	
Approach Delay, s/veh		393.5			283.0			129.7			44.5	
Approach LOS		F			F			F			D	
Timer - Assigned Phs	1	2		4	5	6		8				
Phs Duration (G+Y+Rc), s	8.3	50.9		35.4	16.5	42.7		35.4				
Change Period (Y+Rc), s	4.6	6.2		5.4	4.6	6.2		5.4				
Max Green Setting (Gmax), s	5.0	43.4		30.0	11.9	36.5		30.0				
Max Q Clear Time (g_c+1), s	4.7	46.7		23.4	13.9	38.5		32.0				
Green Ext Time (p_c), s	0.0	0.0		1.6	0.0	0.0		0.0				

Intersection Summary

HCM 6th Ctrl Delay	289.3
HCM 6th LOS	F

Notes

- User approved pedestrian interval to be less than phase max green.
- User approved volume balancing among the lanes for turning movement.
- Unsignalized Delay for [EBR] is excluded from calculations of the approach delay and intersection delay.

Timings
37: Cactus Av. & Frederick St.

West Campus Upper Plateau (JN 14064)

09/20/2022



Lane Group	EBL	EBT	WBT	WBR	SBL	SBR
Lane Configurations	↖	↗↗↗	↖↖↖	↗	↖↖	↗
Traffic Volume (vph)	279	2951	1808	223	577	236
Future Volume (vph)	279	2951	1808	223	577	236
Turn Type	Prot	NA	NA	pm+ov	Prot	pm+ov
Protected Phases	5	2	6	4	4	5
Permitted Phases				6		4
Detector Phase	5	2	6	4	4	5
Switch Phase						
Minimum Initial (s)	5.0	10.0	10.0	10.0	10.0	5.0
Minimum Split (s)	9.2	28.2	29.2	36.4	36.4	9.2
Total Split (s)	31.0	81.0	50.0	39.0	39.0	31.0
Total Split (%)	25.8%	67.5%	41.7%	32.5%	32.5%	25.8%
Yellow Time (s)	3.2	5.2	5.2	4.4	4.4	3.2
All-Red Time (s)	1.0	1.0	1.0	1.0	1.0	1.0
Lost Time Adjust (s)	0.0	0.0	0.0	0.0	0.0	0.0
Total Lost Time (s)	4.2	6.2	6.2	5.4	5.4	4.2
Lead/Lag	Lead		Lag			Lead
Lead-Lag Optimize?	Yes		Yes			Yes
Recall Mode	None	None	None	None	None	None
Act Effct Green (s)	22.2	74.9	48.5	74.8	25.5	53.2
Actuated g/C Ratio	0.20	0.67	0.43	0.67	0.23	0.47
v/c Ratio	0.85	0.92	0.87	0.21	0.78	0.33
Control Delay	66.5	22.9	36.2	1.9	48.4	18.6
Queue Delay	0.0	0.0	0.0	0.0	0.0	0.0
Total Delay	66.5	22.9	36.2	1.9	48.4	18.6
LOS	E	C	D	A	D	B
Approach Delay		26.7	32.4		39.7	
Approach LOS		C	C		D	

Intersection Summary

Cycle Length: 120
 Actuated Cycle Length: 112.1
 Natural Cycle: 110
 Control Type: Actuated-Uncoordinated
 Maximum v/c Ratio: 0.92
 Intersection Signal Delay: 30.3
 Intersection LOS: C
 Intersection Capacity Utilization 83.1%
 ICU Level of Service E
 Analysis Period (min) 15

Splits and Phases: 37: Cactus Av. & Frederick St.

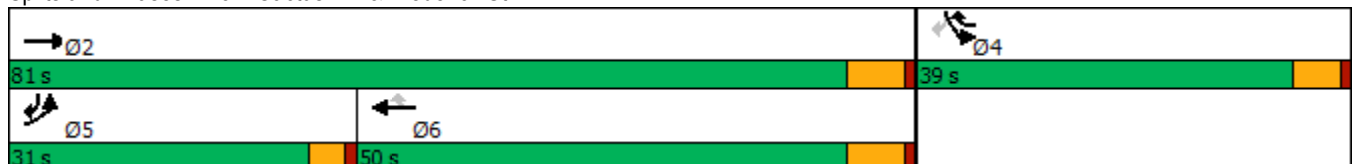

HCM 6th Signalized Intersection Summary
37: Cactus Av. & Frederick St.

West Campus Upper Plateau (JN 14064)

09/20/2022



Movement	EBL	EBT	WBT	WBR	SBL	SBR
Lane Configurations	↖	↑↑↑	↑↑↑	↗	↙	↘
Traffic Volume (veh/h)	279	2951	1808	223	577	236
Future Volume (veh/h)	279	2951	1808	223	577	236
Initial Q (Qb), veh	0	0	0	0	0	0
Ped-Bike Adj(A_pbT)	1.00			0.98	1.00	1.00
Parking Bus, Adj	1.00	1.00	1.00	1.00	1.00	1.00
Work Zone On Approach		No	No		No	
Adj Sat Flow, veh/h/ln	1841	1856	1856	1870	1856	1856
Adj Flow Rate, veh/h	294	3106	1903	173	607	151
Peak Hour Factor	0.95	0.95	0.95	0.95	0.95	0.95
Percent Heavy Veh, %	4	3	3	2	3	3
Cap, veh/h	324	3456	2321	1043	721	622
Arrive On Green	0.18	0.68	0.46	0.46	0.21	0.21
Sat Flow, veh/h	1753	5233	5233	1548	3428	1572
Grp Volume(v), veh/h	294	3106	1903	173	607	151
Grp Sat Flow(s),veh/h/ln	1753	1689	1689	1548	1714	1572
Q Serve(g_s), s	17.7	54.4	35.2	4.5	18.3	6.9
Cycle Q Clear(g_c), s	17.7	54.4	35.2	4.5	18.3	6.9
Prop In Lane	1.00			1.00	1.00	1.00
Lane Grp Cap(c), veh/h	324	3456	2321	1043	721	622
V/C Ratio(X)	0.91	0.90	0.82	0.17	0.84	0.24
Avail Cap(c_a), veh/h	435	3510	2321	1043	1067	780
HCM Platoon Ratio	1.00	1.00	1.00	1.00	1.00	1.00
Upstream Filter(I)	1.00	1.00	1.00	1.00	1.00	1.00
Uniform Delay (d), s/veh	43.1	14.1	25.4	6.7	40.9	21.8
Incr Delay (d2), s/veh	15.8	3.5	2.5	0.1	4.1	0.2
Initial Q Delay(d3),s/veh	0.0	0.0	0.0	0.0	0.0	0.0
%ile BackOfQ(50%),veh/ln	8.7	16.5	13.2	2.4	7.9	7.3
Unsig. Movement Delay, s/veh						
LnGrp Delay(d),s/veh	58.9	17.6	27.8	6.7	45.0	22.0
LnGrp LOS	E	B	C	A	D	C
Approach Vol, veh/h		3400	2076		758	
Approach Delay, s/veh		21.2	26.1		40.4	
Approach LOS		C	C		D	
Timer - Assigned Phs		2		4	5	6
Phs Duration (G+Y+Rc), s		79.8		28.1	24.2	55.7
Change Period (Y+Rc), s		6.2		5.4	* 4.2	6.2
Max Green Setting (Gmax), s		74.8		33.6	* 27	43.8
Max Q Clear Time (g_c+I1), s		56.4		20.3	19.7	37.2
Green Ext Time (p_c), s		17.3		2.4	0.2	5.4

Intersection Summary

HCM 6th Ctrl Delay	25.1
HCM 6th LOS	C

Notes

* HCM 6th computational engine requires equal clearance times for the phases crossing the barrier.

Timings
38: Riverside Dr./Graham St. & Cactus Av.

West Campus Upper Plateau (JN 14064)

09/20/2022

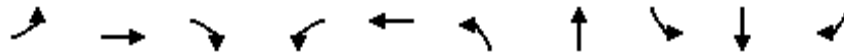

Lane Group	EBL	EBT	EBR	WBL	WBT	NBL	NBT	SBL	SBT	SBR
Lane Configurations	↘	↑↑↑	↗	↘	↑↑↑	↗	↑↑	↘	↑↑	↗
Traffic Volume (vph)	432	3308	489	27	2005	18	0	382	290	192
Future Volume (vph)	432	3308	489	27	2005	18	0	382	290	192
Turn Type	Prot	NA	Perm	Prot	NA	Prot	NA	Prot	NA	Perm
Protected Phases	7	4		3	8	5	2	1	6	
Permitted Phases			4							6
Detector Phase	7	4	4	3	8	5	2	1	6	6
Switch Phase										
Minimum Initial (s)	5.0	10.0	10.0	5.0	10.0	5.0	10.0	5.0	10.0	10.0
Minimum Split (s)	9.6	39.2	39.2	9.6	39.2	10.4	35.0	9.6	40.6	40.6
Total Split (s)	16.0	59.0	59.0	9.6	52.6	10.4	36.0	15.4	41.0	41.0
Total Split (%)	13.3%	49.2%	49.2%	8.0%	43.8%	8.7%	30.0%	12.8%	34.2%	34.2%
Yellow Time (s)	3.6	5.2	5.2	3.6	5.2	4.4	4.0	3.6	3.6	3.6
All-Red Time (s)	1.0	1.0	1.0	1.0	1.0	1.0	1.0	1.0	1.0	1.0
Lost Time Adjust (s)	0.0	0.0	0.0	0.0	0.0	0.0	0.0	0.0	0.0	0.0
Total Lost Time (s)	4.6	6.2	6.2	4.6	6.2	5.4	5.0	4.6	4.6	4.6
Lead/Lag	Lead	Lag	Lag	Lead	Lag	Lead	Lag	Lead	Lag	Lag
Lead-Lag Optimize?	Yes	Yes	Yes	Yes	Yes	Yes	Yes	Yes	Yes	Yes
Recall Mode	None	None	None	None	None	None	Max	None	Max	Max
Act Effct Green (s)	11.4	56.6	56.6	5.0	46.4	5.0	31.0	10.8	42.6	42.6
Actuated g/C Ratio	0.10	0.47	0.47	0.04	0.39	0.04	0.26	0.09	0.36	0.36
v/c Ratio	2.78	1.51	0.61	0.39	1.44	0.14	0.02	2.59	0.25	0.31
Control Delay	838.6	260.4	17.7	71.0	232.0	57.6	0.0	757.4	29.0	8.1
Queue Delay	0.0	0.0	0.0	0.0	0.0	0.0	0.0	0.0	0.0	0.0
Total Delay	838.6	260.4	17.7	71.0	232.0	57.6	0.0	757.4	29.0	8.1
LOS	F	F	B	E	F	E	A	F	C	A
Approach Delay		291.4			230.4		32.0		346.3	
Approach LOS		F			F		C		F	

Intersection Summary

Cycle Length: 120
 Actuated Cycle Length: 120
 Natural Cycle: 120
 Control Type: Actuated-Uncoordinated
 Maximum v/c Ratio: 2.78
 Intersection Signal Delay: 276.0
 Intersection LOS: F
 Intersection Capacity Utilization 115.8%
 ICU Level of Service H
 Analysis Period (min) 15

Splits and Phases: 38: Riverside Dr./Graham St. & Cactus Av.

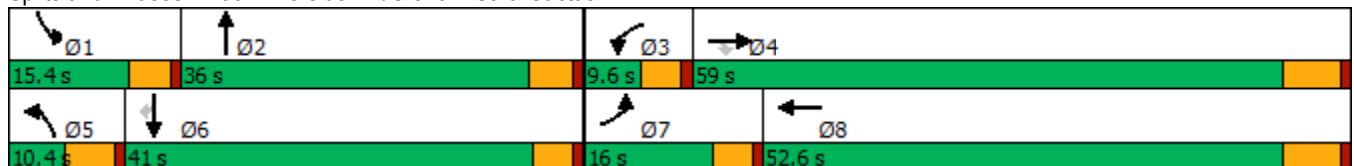

HCM 6th Signalized Intersection Summary
38: Riverside Dr./Graham St. & Cactus Av.

West Campus Upper Plateau (JN 14064)

09/20/2022



Movement	EBL	EBT	EBR	WBL	WBT	WBR	NBL	NBT	NBR	SBL	SBT	SBR
Lane Configurations	↘	↑↑↑	↗	↘	↑↑↑		↘↗	↑↗		↘	↑↑	↗
Traffic Volume (veh/h)	432	3308	489	27	2005	558	18	0	15	382	290	192
Future Volume (veh/h)	432	3308	489	27	2005	558	18	0	15	382	290	192
Initial Q (Qb), veh	0	0	0	0	0	0	0	0	0	0	0	0
Ped-Bike Adj(A_pbT)	1.00		1.00	1.00		0.99	1.00		1.00	1.00		1.00
Parking Bus, Adj	1.00	1.00	1.00	1.00	1.00	1.00	1.00	1.00	1.00	1.00	1.00	1.00
Work Zone On Approach		No			No			No			No	
Adj Sat Flow, veh/h/ln	1885	1856	1885	1900	1856	1900	1900	1900	1900	1885	1900	1856
Adj Flow Rate, veh/h	470	3596	484	29	2179	598	20	0	15	415	315	131
Peak Hour Factor	0.92	0.92	0.92	0.92	0.92	0.92	0.92	0.92	0.92	0.92	0.92	0.92
Percent Heavy Veh, %	1	3	1	0	3	0	0	0	0	1	0	3
Cap, veh/h	171	2309	728	47	1552	394	71	466	416	162	1160	505
Arrive On Green	0.09	0.46	0.46	0.03	0.39	0.39	0.02	0.00	0.26	0.09	0.32	0.32
Sat Flow, veh/h	1795	5066	1598	1810	4013	1020	3510	1805	1610	1795	3610	1572
Grp Volume(v), veh/h	470	3596	484	29	1806	971	20	0	15	415	315	131
Grp Sat Flow(s),veh/h/ln	1795	1689	1598	1810	1689	1656	1755	1805	1610	1795	1805	1572
Q Serve(g_s), s	11.4	54.7	28.4	1.9	46.4	46.4	0.7	0.0	0.8	10.8	7.8	7.4
Cycle Q Clear(g_c), s	11.4	54.7	28.4	1.9	46.4	46.4	0.7	0.0	0.8	10.8	7.8	7.4
Prop In Lane	1.00		1.00	1.00		0.62	1.00		1.00	1.00		1.00
Lane Grp Cap(c), veh/h	171	2309	728	47	1306	640	71	466	416	162	1160	505
V/C Ratio(X)	2.76	1.56	0.66	0.62	1.38	1.52	0.28	0.00	0.04	2.57	0.27	0.26
Avail Cap(c_a), veh/h	171	2309	728	75	1306	640	146	466	416	162	1160	505
HCM Platoon Ratio	1.00	1.00	1.00	1.00	1.00	1.00	1.00	1.00	1.00	1.00	1.00	1.00
Upstream Filter(I)	1.00	1.00	1.00	1.00	1.00	1.00	1.00	0.00	1.00	1.00	1.00	1.00
Uniform Delay (d), s/veh	54.3	32.6	25.5	57.9	36.8	36.8	57.9	0.0	33.3	54.6	30.3	30.1
Incr Delay (d2), s/veh	806.2	252.9	2.3	4.9	177.3	240.3	0.8	0.0	0.2	723.5	0.6	1.2
Initial Q Delay(d3),s/veh	0.0	0.0	0.0	0.0	0.0	0.0	0.0	0.0	0.0	0.0	0.0	0.0
%ile BackOfQ(50%),veh/ln	43.2	74.4	10.4	0.9	49.9	60.1	0.3	0.0	0.3	37.3	3.4	2.9
Unsig. Movement Delay, s/veh												
LnGrp Delay(d),s/veh	860.5	285.6	27.8	62.8	214.1	277.1	58.7	0.0	33.5	778.1	30.8	31.4
LnGrp LOS	F	F	C	E	F	F	E	A	C	F	C	C
Approach Vol, veh/h		4550			2806			35			861	
Approach Delay, s/veh		317.6			234.3			47.9			391.1	
Approach LOS		F			F			D			F	
Timer - Assigned Phs	1	2	3	4	5	6	7	8				
Phs Duration (G+Y+Rc), s	15.4	36.0	7.7	60.9	7.8	43.6	16.0	52.6				
Change Period (Y+Rc), s	4.6	5.0	4.6	6.2	5.4	* 5	4.6	6.2				
Max Green Setting (Gmax), s	10.8	31.0	5.0	52.8	5.0	* 36	11.4	46.4				
Max Q Clear Time (g_c+I1), s	12.8	2.8	3.9	56.7	2.7	9.8	13.4	48.4				
Green Ext Time (p_c), s	0.0	0.0	0.0	0.0	0.0	2.4	0.0	0.0				

Intersection Summary

HCM 6th Ctrl Delay	295.8
HCM 6th LOS	F

Notes

* HCM 6th computational engine requires equal clearance times for the phases crossing the barrier.

Timings
1: Washington St & Van Buren Bl.

West Campus Upper Plateau (JN 14064)

09/30/2022



Lane Group	EBL	EBT	WBL	WBT	WBR	NBL	NBT	NBR	SBL	SBT
Lane Configurations	↖	↗	↖	↗	↗	↖	↗	↗	↖	↗
Traffic Volume (vph)	147	1135	148	1103	341	170	255	168	455	222
Future Volume (vph)	147	1135	148	1103	341	170	255	168	455	222
Turn Type	Prot	NA	Prot	NA	Perm	Prot	NA	Perm	Prot	NA
Protected Phases	5	2	1	6		3	8		7	4
Permitted Phases					6			8		
Detector Phase	5	2	1	6	6	3	8	8	7	4
Switch Phase										
Minimum Initial (s)	5.0	10.0	5.0	10.0	10.0	5.0	10.0	10.0	5.0	10.0
Minimum Split (s)	9.2	34.2	9.2	33.2	33.2	9.2	38.4	38.4	9.2	30.8
Total Split (s)	14.2	49.6	14.0	49.4	49.4	11.5	38.4	38.4	18.0	44.9
Total Split (%)	11.8%	41.3%	11.7%	41.2%	41.2%	9.6%	32.0%	32.0%	15.0%	37.4%
Yellow Time (s)	3.2	5.2	3.2	5.2	5.2	3.2	4.4	4.4	3.2	4.8
All-Red Time (s)	1.0	1.0	1.0	1.0	1.0	1.0	1.0	1.0	1.0	1.0
Lost Time Adjust (s)	0.0	0.0	0.0	0.0	0.0	0.0	0.0	0.0	0.0	0.0
Total Lost Time (s)	4.2	6.2	4.2	6.2	6.2	4.2	5.4	5.4	4.2	5.8
Lead/Lag	Lead	Lag	Lead	Lag	Lag	Lead	Lag	Lag	Lead	Lag
Lead-Lag Optimize?	Yes	Yes	Yes	Yes	Yes	Yes	Yes	Yes	Yes	Yes
Recall Mode	None	None	None	None	None	None	None	None	None	None
Act Effct Green (s)	10.1	43.6	9.9	43.4	43.4	7.3	15.9	15.9	13.9	22.1
Actuated g/C Ratio	0.10	0.42	0.10	0.42	0.42	0.07	0.15	0.15	0.13	0.21
v/c Ratio	0.87	0.87	0.90	0.77	0.46	0.71	0.49	0.45	1.01	0.42
Control Delay	88.7	35.9	95.6	31.3	12.3	65.0	42.4	9.3	89.8	29.5
Queue Delay	0.0	0.0	0.0	0.0	0.0	0.0	0.0	0.0	0.0	0.0
Total Delay	88.7	35.9	95.6	31.3	12.3	65.0	42.4	9.3	89.8	29.5
LOS	F	D	F	C	B	E	D	A	F	C
Approach Delay		41.6		33.2			39.5			65.0
Approach LOS		D		C			D			E

Intersection Summary

Cycle Length: 120
 Actuated Cycle Length: 103.4
 Natural Cycle: 115
 Control Type: Actuated-Uncoordinated
 Maximum v/c Ratio: 1.01
 Intersection Signal Delay: 42.4
 Intersection LOS: D
 Intersection Capacity Utilization 81.1%
 ICU Level of Service D
 Analysis Period (min) 15



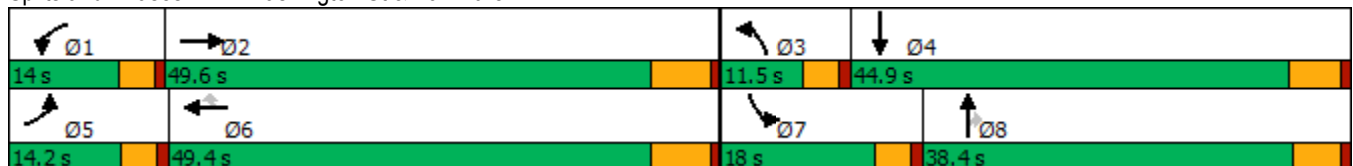



















Splits and Phases: 1: Washington St & Van Buren Bl.



HCM 6th Signalized Intersection Summary
1: Washington St & Van Buren Bl.

West Campus Upper Plateau (JN 14064)

09/30/2022

												
Movement	EBL	EBT	EBR	WBL	WBT	WBR	NBL	NBT	NBR	SBL	SBT	SBR
Lane Configurations												
Traffic Volume (veh/h)	147	1135	91	148	1103	341	170	255	168	455	222	96
Future Volume (veh/h)	147	1135	91	148	1103	341	170	255	168	455	222	96
Initial Q (Qb), veh	0	0	0	0	0	0	0	0	0	0	0	0
Ped-Bike Adj(A_pbT)	1.00		1.00	1.00		1.00	1.00		0.98	1.00		0.98
Parking Bus, Adj	1.00	1.00	1.00	1.00	1.00	1.00	1.00	1.00	1.00	1.00	1.00	1.00
Work Zone On Approach		No			No			No			No	
Adj Sat Flow, veh/h/ln	1900	1841	1856	1885	1856	1885	1885	1856	1870	1885	1885	1900
Adj Flow Rate, veh/h	152	1170	74	153	1137	257	175	263	133	469	229	52
Peak Hour Factor	0.97	0.97	0.97	0.97	0.97	0.97	0.97	0.97	0.97	0.97	0.97	0.97
Percent Heavy Veh, %	0	4	3	1	3	1	1	3	2	1	1	0
Cap, veh/h	183	1367	86	182	1443	652	242	478	211	497	606	135
Arrive On Green	0.10	0.41	0.41	0.10	0.41	0.41	0.07	0.14	0.14	0.14	0.21	0.21
Sat Flow, veh/h	1810	3340	211	1795	3526	1594	3483	3526	1555	3483	2902	645
Grp Volume(v), veh/h	152	612	632	153	1137	257	175	263	133	469	139	142
Grp Sat Flow(s),veh/h/ln	1810	1749	1803	1795	1763	1594	1742	1763	1555	1742	1791	1756
Q Serve(g_s), s	8.0	30.7	30.8	8.1	27.2	11.0	4.8	6.7	7.8	12.9	6.5	6.7
Cycle Q Clear(g_c), s	8.0	30.7	30.8	8.1	27.2	11.0	4.8	6.7	7.8	12.9	6.5	6.7
Prop In Lane	1.00		0.12	1.00		1.00	1.00		1.00	1.00		0.37
Lane Grp Cap(c), veh/h	183	716	738	182	1443	652	242	478	211	497	374	367
V/C Ratio(X)	0.83	0.86	0.86	0.84	0.79	0.39	0.72	0.55	0.63	0.94	0.37	0.39
Avail Cap(c_a), veh/h	187	785	809	182	1576	712	263	1204	531	497	724	710
HCM Platoon Ratio	1.00	1.00	1.00	1.00	1.00	1.00	1.00	1.00	1.00	1.00	1.00	1.00
Upstream Filter(I)	1.00	1.00	1.00	1.00	1.00	1.00	1.00	1.00	1.00	1.00	1.00	1.00
Uniform Delay (d), s/veh	42.6	26.0	26.0	42.7	24.9	20.1	44.1	39.0	39.5	41.0	32.8	32.9
Incr Delay (d2), s/veh	23.7	9.1	8.9	26.8	2.8	0.6	7.1	1.0	3.1	26.4	0.6	0.7
Initial Q Delay(d3),s/veh	0.0	0.0	0.0	0.0	0.0	0.0	0.0	0.0	0.0	0.0	0.0	0.0
%ile BackOfQ(50%),veh/ln	4.6	13.2	13.6	4.8	10.7	4.1	2.3	3.0	3.2	7.3	2.8	2.9
Unsig. Movement Delay, s/veh												
LnGrp Delay(d),s/veh	66.3	35.0	34.9	69.5	27.7	20.7	51.1	40.0	42.6	67.5	33.4	33.6
LnGrp LOS	E	D	C	E	C	C	D	D	D	E	C	C
Approach Vol, veh/h		1396			1547			571			750	
Approach Delay, s/veh		38.4			30.6			44.0			54.7	
Approach LOS		D			C			D			D	
Timer - Assigned Phs	1	2	3	4	5	6	7	8				
Phs Duration (G+Y+Rc), s	14.0	45.8	10.9	26.0	14.0	45.8	18.0	18.9				
Change Period (Y+Rc), s	* 4.2	6.2	* 4.2	5.8	* 4.2	6.2	* 4.2	* 5.8				
Max Green Setting (Gmax), s	* 9.8	43.4	* 7.3	39.1	* 10	43.2	* 14	* 33				
Max Q Clear Time (g_c+I1), s	10.1	32.8	6.8	8.7	10.0	29.2	14.9	9.8				
Green Ext Time (p_c), s	0.0	6.7	0.0	1.7	0.0	8.9	0.0	2.2				
Intersection Summary												
HCM 6th Ctrl Delay				39.2								
HCM 6th LOS				D								
Notes												
* HCM 6th computational engine requires equal clearance times for the phases crossing the barrier.												

Timings
2: Central Ave & Arlington Ave/Chicago Ave

West Campus Upper Plateau (JN 14064)

09/30/2022



Lane Group	EBL	EBT	EBR	WBL	WBT	WBR	NBL	NBT	NBR	SBL	SBT
Lane Configurations	↘	↑↑	↗↗	↘↘	↑↑	↗	↘↘	↑↑	↗	↘↘	↑↑↗
Traffic Volume (vph)	28	422	751	248	563	215	903	983	245	283	1113
Future Volume (vph)	28	422	751	248	563	215	903	983	245	283	1113
Turn Type	Prot	NA	pm+ov	Prot	NA	pm+ov	Prot	NA	pm+ov	Prot	NA
Protected Phases	7	4	5	3	8	1	5	2	3	1	6
Permitted Phases			4			8			2		
Detector Phase	7	4	5	3	8	1	5	2	3	1	6
Switch Phase											
Minimum Initial (s)	5.0	10.0	5.0	5.0	10.0	5.0	5.0	10.0	5.0	5.0	10.0
Minimum Split (s)	9.6	32.8	9.6	9.6	30.8	9.6	9.6	35.4	9.6	9.6	30.4
Total Split (s)	10.6	32.8	30.0	22.0	44.2	24.4	30.0	50.8	22.0	24.4	45.2
Total Split (%)	8.2%	25.2%	23.1%	16.9%	34.0%	18.8%	23.1%	39.1%	16.9%	18.8%	34.8%
Yellow Time (s)	3.6	4.8	3.6	3.6	4.8	3.6	3.6	4.4	3.6	3.6	4.4
All-Red Time (s)	1.0	1.0	1.0	1.0	1.0	1.0	1.0	1.0	1.0	1.0	1.0
Lost Time Adjust (s)	0.0	0.0	0.0	0.0	0.0	0.0	0.0	0.0	0.0	0.0	0.0
Total Lost Time (s)	4.6	5.8	4.6	4.6	5.8	4.6	4.6	5.4	4.6	4.6	5.4
Lead/Lag	Lead	Lag	Lead	Lead	Lag	Lead	Lead	Lag	Lead	Lead	Lag
Lead-Lag Optimize?	Yes	Yes	Yes	Yes	Yes	Yes	Yes	Yes	Yes	Yes	Yes
Recall Mode	None	None	None	None	None	None	None	None	None	None	None
Act Effct Green (s)	5.7	18.9	45.9	12.7	30.4	50.0	25.8	45.4	58.9	13.7	33.3
Actuated g/C Ratio	0.05	0.17	0.41	0.11	0.27	0.45	0.23	0.41	0.53	0.12	0.30
v/c Ratio	0.30	0.69	0.63	0.64	0.58	0.28	1.14	0.68	0.29	0.67	0.76
Control Delay	65.0	50.8	23.3	56.8	38.9	11.9	116.4	31.7	10.1	55.9	39.4
Queue Delay	0.0	0.0	0.0	0.0	0.0	0.0	0.0	0.0	0.0	0.0	0.0
Total Delay	65.0	50.8	23.3	56.8	38.9	11.9	116.4	31.7	10.1	55.9	39.4
LOS	E	D	C	E	D	B	F	C	B	E	D
Approach Delay		33.9			37.6			65.1			42.7
Approach LOS		C			D			E			D

Intersection Summary

Cycle Length: 130
 Actuated Cycle Length: 111.4
 Natural Cycle: 110
 Control Type: Actuated-Uncoordinated
 Maximum v/c Ratio: 1.14
 Intersection Signal Delay: 48.2
 Intersection LOS: D
 Intersection Capacity Utilization 84.8%
 ICU Level of Service E
 Analysis Period (min) 15

Splits and Phases: 2: Central Ave & Arlington Ave/Chicago Ave

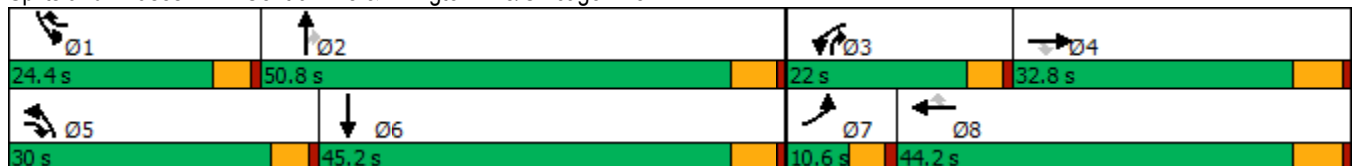

HCM 6th Signalized Intersection Summary
2: Central Ave & Arlington Ave/Chicago Ave

West Campus Upper Plateau (JN 14064)

09/30/2022



Movement	EBL	EBT	EBR	WBL	WBT	WBR	NBL	NBT	NBR	SBL	SBT	SBR
Lane Configurations												
Traffic Volume (veh/h)	28	422	751	248	563	215	903	983	245	283	1113	36
Future Volume (veh/h)	28	422	751	248	563	215	903	983	245	283	1113	36
Initial Q (Qb), veh	0	0	0	0	0	0	0	0	0	0	0	0
Ped-Bike Adj(A_pbT)	1.00		1.00	1.00		1.00	1.00		0.99	1.00		1.00
Parking Bus, Adj	1.00	1.00	1.00	1.00	1.00	1.00	1.00	1.00	1.00	1.00	1.00	1.00
Work Zone On Approach		No			No			No			No	
Adj Sat Flow, veh/h/ln	1900	1900	1885	1870	1900	1885	1885	1885	1856	1900	1885	1900
Adj Flow Rate, veh/h	28	426	374	251	569	132	912	993	181	286	1124	34
Peak Hour Factor	0.99	0.99	0.99	0.99	0.99	0.99	0.99	0.99	0.99	0.99	0.99	0.99
Percent Heavy Veh, %	0	0	1	2	0	1	1	1	3	0	1	0
Cap, veh/h	49	602	1173	323	842	537	873	1560	823	361	1478	45
Arrive On Green	0.03	0.17	0.17	0.09	0.23	0.23	0.25	0.44	0.44	0.10	0.29	0.29
Sat Flow, veh/h	1810	3610	2807	3456	3610	1598	3483	3582	1552	3510	5133	155
Grp Volume(v), veh/h	28	426	374	251	569	132	912	993	181	286	751	407
Grp Sat Flow(s),veh/h/ln	1810	1805	1403	1728	1805	1598	1742	1791	1552	1755	1716	1857
Q Serve(g_s), s	1.6	11.3	9.1	7.2	14.5	6.1	25.4	21.9	6.3	8.1	20.2	20.2
Cycle Q Clear(g_c), s	1.6	11.3	9.1	7.2	14.5	6.1	25.4	21.9	6.3	8.1	20.2	20.2
Prop In Lane	1.00		1.00	1.00		1.00	1.00		1.00	1.00		0.08
Lane Grp Cap(c), veh/h	49	602	1173	323	842	537	873	1560	823	361	988	535
V/C Ratio(X)	0.58	0.71	0.32	0.78	0.68	0.25	1.04	0.64	0.22	0.79	0.76	0.76
Avail Cap(c_a), veh/h	107	962	1452	593	1368	770	873	1604	842	686	1347	729
HCM Platoon Ratio	1.00	1.00	1.00	1.00	1.00	1.00	1.00	1.00	1.00	1.00	1.00	1.00
Upstream Filter(I)	1.00	1.00	1.00	1.00	1.00	1.00	1.00	1.00	1.00	1.00	1.00	1.00
Uniform Delay (d), s/veh	48.7	39.9	19.9	44.9	35.4	24.3	38.0	22.3	12.7	44.4	32.9	32.9
Incr Delay (d2), s/veh	3.9	1.5	0.2	1.5	1.0	0.2	42.8	0.8	0.1	1.5	1.7	3.2
Initial Q Delay(d3),s/veh	0.0	0.0	0.0	0.0	0.0	0.0	0.0	0.0	0.0	0.0	0.0	0.0
%ile BackOfQ(50%),veh/ln	0.7	4.9	2.8	3.0	6.2	2.2	15.5	8.8	2.0	3.5	8.3	9.2
Unsig. Movement Delay, s/veh												
LnGrp Delay(d),s/veh	52.7	41.4	20.0	46.4	36.3	24.6	80.8	23.1	12.9	45.9	34.6	36.1
LnGrp LOS	D	D	C	D	D	C	F	C	B	D	C	D
Approach Vol, veh/h		828			952			2086			1444	
Approach Delay, s/veh		32.1			37.4			47.5			37.3	
Approach LOS		C			D			D			D	
Timer - Assigned Phs	1	2	3	4	5	6	7	8				
Phs Duration (G+Y+Rc), s	15.0	49.6	14.1	22.7	30.0	34.6	7.3	29.4				
Change Period (Y+Rc), s	4.6	5.4	4.6	5.8	4.6	5.4	4.6	5.8				
Max Green Setting (Gmax), s	19.8	45.4	17.4	27.0	25.4	39.8	6.0	38.4				
Max Q Clear Time (g_c+I1), s	10.1	23.9	9.2	13.3	27.4	22.2	3.6	16.5				
Green Ext Time (p_c), s	0.4	7.6	0.3	3.4	0.0	6.9	0.0	3.9				
Intersection Summary												
HCM 6th Ctrl Delay			40.5									
HCM 6th LOS			D									

Timings

3: Overlook Pkwy./Canyon Crest Dr. & Alessandro Bl/Alessandro Bl.



Lane Group	EBL	EBT	WBL	WBT	WBR	NBL	NBT	NBR	SBL	SBT	SBR
Lane Configurations	↙	↕↕↕	↙	↕↕↕	↗	↙	↕↕	↗	↕↕	↙	↗
Traffic Volume (vph)	40	1677	82	1825	474	12	204	84	367	208	22
Future Volume (vph)	40	1677	82	1825	474	12	204	84	367	208	22
Turn Type	Prot	NA	Prot	NA	pm+ov	Split	NA	Perm	Split	NA	Perm
Protected Phases	5	2	1	6	4	8	8		4	4	
Permitted Phases					6			8			4
Detector Phase	5	2	1	6	4	8	8	8	4	4	4
Switch Phase											
Minimum Initial (s)	5.0	10.0	5.0	10.0	10.0	10.0	10.0	10.0	10.0	10.0	10.0
Minimum Split (s)	9.2	35.2	9.2	35.2	38.8	38.8	38.8	38.8	38.8	38.8	38.8
Total Split (s)	9.2	43.2	9.2	43.2	38.8	38.8	38.8	38.8	38.8	38.8	38.8
Total Split (%)	7.1%	33.2%	7.1%	33.2%	29.8%	29.8%	29.8%	29.8%	29.8%	29.8%	29.8%
Yellow Time (s)	3.2	5.2	3.2	5.2	4.8	4.8	4.8	4.8	4.8	4.8	4.8
All-Red Time (s)	1.0	1.0	1.0	1.0	1.0	1.0	1.0	1.0	1.0	1.0	1.0
Lost Time Adjust (s)	0.0	0.0	0.0	0.0	0.0	0.0	0.0	0.0	0.0	0.0	0.0
Total Lost Time (s)	4.2	6.2	4.2	6.2	5.8	5.8	5.8	5.8	5.8	5.8	5.8
Lead/Lag	Lead	Lag	Lead	Lag							
Lead-Lag Optimize?	Yes	Yes	Yes	Yes							
Recall Mode	None	None	None	None	None	None	None	None	None	None	None
Act Effct Green (s)	5.0	37.2	5.0	39.3	69.3	11.8	11.8	11.8	23.7	23.7	23.7
Actuated g/C Ratio	0.05	0.37	0.05	0.39	0.69	0.12	0.12	0.12	0.24	0.24	0.24
v/c Ratio	0.49	0.92	0.94	0.94	0.41	0.07	0.50	0.31	0.45	0.67	0.05
Control Delay	69.1	40.5	130.8	41.8	3.0	42.5	46.9	7.8	34.0	43.9	0.2
Queue Delay	0.0	0.0	0.0	0.0	0.0	0.0	0.0	0.0	0.0	0.0	0.0
Total Delay	69.1	40.5	130.8	41.8	3.0	42.5	46.9	7.8	34.0	43.9	0.2
LOS	E	D	F	D	A	D	D	A	C	D	A
Approach Delay		41.2		37.1			35.7			36.8	
Approach LOS		D		D			D			D	

Intersection Summary

Cycle Length: 130	
Actuated Cycle Length: 99.9	
Natural Cycle: 125	
Control Type: Actuated-Uncoordinated	
Maximum v/c Ratio: 0.94	
Intersection Signal Delay: 38.4	Intersection LOS: D
Intersection Capacity Utilization 77.0%	ICU Level of Service D
Analysis Period (min) 15	

Splits and Phases: 3: Overlook Pkwy./Canyon Crest Dr. & Alessandro Bl/Alessandro Bl.

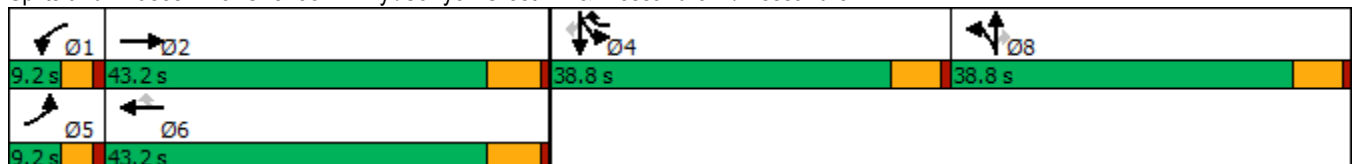

HCM 6th Signalized Intersection Summary

West Campus Upper Plateau (JN 14064)

3: Overlook Pkwy./Canyon Crest Dr. & Alessandro Bl/Alessandro Bl.

09/30/2022



Movement	EBL	EBT	EBR	WBL	WBT	WBR	NBL	NBT	NBR	SBL	SBT	SBR
Lane Configurations	↵	↑↑↑		↵	↑↑↑	↵	↵	↑↑	↵	↵↵	↵	↵
Traffic Volume (veh/h)	40	1677	16	82	1825	474	12	204	84	367	208	22
Future Volume (veh/h)	40	1677	16	82	1825	474	12	204	84	367	208	22
Initial Q (Qb), veh	0	0	0	0	0	0	0	0	0	0	0	0
Ped-Bike Adj(A_pbT)	1.00		1.00	1.00		1.00	1.00		1.00	1.00		1.00
Parking Bus, Adj	1.00	1.00	1.00	1.00	1.00	1.00	1.00	1.00	1.00	1.00	1.00	1.00
Work Zone On Approach		No			No			No			No	
Adj Sat Flow, veh/h/ln	1811	1885	1811	1900	1885	1870	1781	1900	1900	1885	1767	1841
Adj Flow Rate, veh/h	42	1747	17	85	1901	486	12	212	80	382	217	14
Peak Hour Factor	0.96	0.96	0.96	0.96	0.96	0.96	0.96	0.96	0.96	0.96	0.96	0.96
Percent Heavy Veh, %	6	1	6	0	1	2	8	0	0	1	9	4
Cap, veh/h	64	2105	20	105	2172	936	198	420	188	604	297	262
Arrive On Green	0.04	0.40	0.40	0.06	0.42	0.42	0.12	0.12	0.12	0.17	0.17	0.17
Sat Flow, veh/h	1725	5256	51	1810	5147	1585	1697	3610	1610	3591	1767	1560
Grp Volume(v), veh/h	42	1140	624	85	1901	486	12	212	80	382	217	14
Grp Sat Flow(s),veh/h/ln	1725	1716	1876	1810	1716	1585	1697	1805	1610	1795	1767	1560
Q Serve(g_s), s	2.1	25.6	25.6	4.0	29.0	15.5	0.5	4.7	4.0	8.5	10.0	0.6
Cycle Q Clear(g_c), s	2.1	25.6	25.6	4.0	29.0	15.5	0.5	4.7	4.0	8.5	10.0	0.6
Prop In Lane	1.00		0.03	1.00		1.00	1.00		1.00	1.00		1.00
Lane Grp Cap(c), veh/h	64	1374	751	105	2172	936	198	420	188	604	297	262
V/C Ratio(X)	0.66	0.83	0.83	0.81	0.88	0.52	0.06	0.50	0.43	0.63	0.73	0.05
Avail Cap(c_a), veh/h	101	1480	809	105	2220	950	653	1389	619	1381	680	600
HCM Platoon Ratio	1.00	1.00	1.00	1.00	1.00	1.00	1.00	1.00	1.00	1.00	1.00	1.00
Upstream Filter(I)	1.00	1.00	1.00	1.00	1.00	1.00	1.00	1.00	1.00	1.00	1.00	1.00
Uniform Delay (d), s/veh	40.8	23.1	23.1	39.9	22.7	10.4	33.7	35.6	35.2	33.2	33.8	29.9
Incr Delay (d2), s/veh	4.3	3.9	6.9	33.1	4.2	0.5	0.1	0.9	1.5	1.1	3.4	0.1
Initial Q Delay(d3),s/veh	0.0	0.0	0.0	0.0	0.0	0.0	0.0	0.0	0.0	0.0	0.0	0.0
%ile BackOfQ(50%),veh/ln	0.9	9.7	11.3	2.6	10.9	7.1	0.2	2.0	1.6	3.6	4.3	0.2
Unsig. Movement Delay, s/veh												
LnGrp Delay(d),s/veh	45.1	27.0	30.0	73.0	26.9	10.9	33.8	36.5	36.8	34.3	37.3	30.0
LnGrp LOS	D	C	C	E	C	B	C	D	D	C	D	C
Approach Vol, veh/h		1806			2472			304			613	
Approach Delay, s/veh		28.4			25.3			36.5			35.3	
Approach LOS		C			C			D			D	
Timer - Assigned Phs	1	2		4	5	6		8				
Phs Duration (G+Y+Rc), s	9.2	40.6		20.2	7.4	42.4		15.8				
Change Period (Y+Rc), s	* 4.2	6.2		5.8	* 4.2	6.2		5.8				
Max Green Setting (Gmax), s	* 5	37.0		33.0	* 5	37.0		33.0				
Max Q Clear Time (g_c+I1), s	6.0	27.6		12.0	4.1	31.0		6.7				
Green Ext Time (p_c), s	0.0	6.6		2.4	0.0	5.2		1.5				

Intersection Summary

HCM 6th Ctrl Delay	28.2
HCM 6th LOS	C

Notes

- User approved pedestrian interval to be less than phase max green.
- User approved volume balancing among the lanes for turning movement.
- * HCM 6th computational engine requires equal clearance times for the phases crossing the barrier.

Timings
4: Van Buren Bl. & Wood Rd.

West Campus Upper Plateau (JN 14064)

09/30/2022

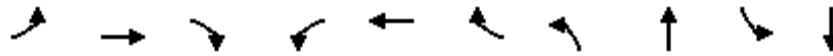

Lane Group	EBL	EBT	EBR	WBL	WBT	WBR	NBL	NBT	SBL	SBT
Lane Configurations	↘	↑↑	↗	↘↗	↑↑	↗	↘↗	↑↔	↘	↑↔
Traffic Volume (vph)	144	1719	254	257	1666	121	248	147	183	171
Future Volume (vph)	144	1719	254	257	1666	121	248	147	183	171
Turn Type	Prot	NA	pm+ov	Prot	NA	Perm	Prot	NA	Prot	NA
Protected Phases	5	2	3	1	6		3	8	7	4
Permitted Phases			2			6				
Detector Phase	5	2	3	1	6	6	3	8	7	4
Switch Phase										
Minimum Initial (s)	5.0	10.0	5.0	5.0	10.0	10.0	5.0	10.0	5.0	10.0
Minimum Split (s)	9.2	30.2	9.2	9.2	30.2	30.2	9.2	38.4	9.2	15.8
Total Split (s)	16.5	57.2	21.7	13.2	53.9	53.9	21.7	38.4	11.2	27.9
Total Split (%)	13.8%	47.7%	18.1%	11.0%	44.9%	44.9%	18.1%	32.0%	9.3%	23.3%
Yellow Time (s)	3.2	5.2	3.2	3.2	5.2	5.2	3.2	4.4	3.2	4.8
All-Red Time (s)	1.0	1.0	1.0	1.0	1.0	1.0	1.0	1.0	1.0	1.0
Lost Time Adjust (s)	0.0	0.0	0.0	0.0	0.0	0.0	0.0	0.0	0.0	0.0
Total Lost Time (s)	4.2	6.2	4.2	4.2	6.2	6.2	4.2	5.4	4.2	5.8
Lead/Lag	Lead	Lag	Lead	Lead	Lag	Lag	Lead	Lag	Lead	Lag
Lead-Lag Optimize?	Yes	Yes	Yes	Yes	Yes	Yes	Yes	Yes	Yes	Yes
Recall Mode	None	None	None	None	None	None	None	None	None	None
Act Effct Green (s)	11.8	51.2	66.1	9.0	48.4	48.4	12.8	19.8	7.0	13.6
Actuated g/C Ratio	0.11	0.48	0.62	0.08	0.45	0.45	0.12	0.18	0.07	0.13
v/c Ratio	0.80	1.13	0.27	0.97	1.15	0.17	0.67	0.49	1.72	0.66
Control Delay	76.7	94.3	3.1	95.2	102.8	3.8	54.2	23.2	390.7	31.0
Queue Delay	0.0	0.0	0.0	0.0	0.0	0.0	0.0	0.0	0.0	0.0
Total Delay	76.7	94.3	3.1	95.2	102.8	3.8	54.2	23.2	390.7	31.0
LOS	E	F	A	F	F	A	D	C	F	C
Approach Delay		82.1			96.0			36.6		158.2
Approach LOS		F			F			D		F

Intersection Summary

Cycle Length: 120
 Actuated Cycle Length: 107.2
 Natural Cycle: 120
 Control Type: Actuated-Uncoordinated
 Maximum v/c Ratio: 1.72
 Intersection Signal Delay: 90.1
 Intersection LOS: F
 Intersection Capacity Utilization 97.7%
 ICU Level of Service F
 Analysis Period (min) 15



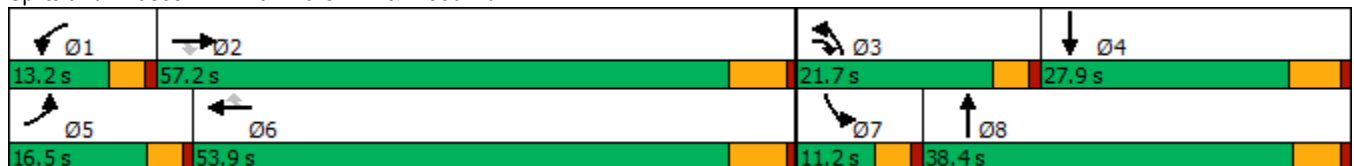





















Splits and Phases: 4: Van Buren Bl. & Wood Rd.



HCM 6th Signalized Intersection Summary
4: Van Buren Bl. & Wood Rd.

West Campus Upper Plateau (JN 14064)

09/30/2022

												
Movement	EBL	EBT	EBR	WBL	WBT	WBR	NBL	NBT	NBR	SBL	SBT	SBR
Lane Configurations												
Traffic Volume (veh/h)	144	1719	254	257	1666	121	248	147	177	183	171	163
Future Volume (veh/h)	144	1719	254	257	1666	121	248	147	177	183	171	163
Initial Q (Qb), veh	0	0	0	0	0	0	0	0	0	0	0	0
Ped-Bike Adj(A_pbT)	1.00		0.99	1.00		0.99	1.00		0.96	1.00		0.99
Parking Bus, Adj	1.00	1.00	1.00	1.00	1.00	1.00	1.00	1.00	1.00	1.00	1.00	1.00
Work Zone On Approach		No			No			No			No	
Adj Sat Flow, veh/h/ln	1885	1856	1870	1885	1870	1885	1856	1885	1870	1885	1885	1885
Adj Flow Rate, veh/h	158	1889	174	282	1831	86	273	162	114	201	188	104
Peak Hour Factor	0.91	0.91	0.91	0.91	0.91	0.91	0.91	0.91	0.91	0.91	0.91	0.91
Percent Heavy Veh, %	1	3	2	1	2	1	3	1	2	1	1	1
Cap, veh/h	188	1753	936	306	1706	756	344	302	197	123	261	137
Arrive On Green	0.10	0.50	0.50	0.09	0.48	0.48	0.10	0.15	0.15	0.07	0.12	0.12
Sat Flow, veh/h	1795	3526	1562	3483	3554	1575	3428	2042	1333	1795	2255	1187
Grp Volume(v), veh/h	158	1889	174	282	1831	86	273	141	135	201	147	145
Grp Sat Flow(s),veh/h/ln	1795	1763	1562	1742	1777	1575	1714	1791	1584	1795	1791	1652
Q Serve(g_s), s	8.9	51.0	5.2	8.2	49.2	3.1	8.0	7.4	8.2	7.0	8.1	8.7
Cycle Q Clear(g_c), s	8.9	51.0	5.2	8.2	49.2	3.1	8.0	7.4	8.2	7.0	8.1	8.7
Prop In Lane	1.00		1.00	1.00		1.00	1.00		0.84	1.00		0.72
Lane Grp Cap(c), veh/h	188	1753	936	306	1706	756	344	265	234	123	207	191
V/C Ratio(X)	0.84	1.08	0.19	0.92	1.07	0.11	0.79	0.53	0.58	1.64	0.71	0.76
Avail Cap(c_a), veh/h	215	1753	936	306	1706	756	585	576	510	123	386	356
HCM Platoon Ratio	1.00	1.00	1.00	1.00	1.00	1.00	1.00	1.00	1.00	1.00	1.00	1.00
Upstream Filter(I)	1.00	1.00	1.00	1.00	1.00	1.00	1.00	1.00	1.00	1.00	1.00	1.00
Uniform Delay (d), s/veh	45.0	25.8	9.3	46.4	26.7	14.7	45.1	40.4	40.7	47.8	43.7	43.9
Incr Delay (d2), s/veh	19.9	45.7	0.1	31.6	44.4	0.1	1.6	1.7	2.3	321.7	4.5	6.0
Initial Q Delay(d3),s/veh	0.0	0.0	0.0	0.0	0.0	0.0	0.0	0.0	0.0	0.0	0.0	0.0
%ile BackOfQ(50%),veh/ln	4.8	29.5	1.6	4.7	28.6	1.1	3.4	3.3	3.2	14.0	3.8	3.8
Unsig. Movement Delay, s/veh												
LnGrp Delay(d),s/veh	64.9	71.5	9.5	78.0	71.0	14.8	46.7	42.1	43.0	369.5	48.2	50.0
LnGrp LOS	E	F	A	E	F	B	D	D	D	F	D	D
Approach Vol, veh/h		2221			2199			549			493	
Approach Delay, s/veh		66.2			69.7			44.6			179.7	
Approach LOS		E			E			D			F	
Timer - Assigned Phs	1	2	3	4	5	6	7	8				
Phs Duration (G+Y+Rc), s	13.2	57.2	14.5	17.7	15.0	55.4	11.2	20.9				
Change Period (Y+Rc), s	* 4.2	6.2	* 4.2	5.8	* 4.2	6.2	* 4.2	* 5.8				
Max Green Setting (Gmax), s	* 9	51.0	* 18	22.1	* 12	47.7	* 7	* 33				
Max Q Clear Time (g_c+I1), s	10.2	53.0	10.0	10.7	10.9	51.2	9.0	10.2				
Green Ext Time (p_c), s	0.0	0.0	0.3	1.2	0.0	0.0	0.0	1.5				

Intersection Summary

HCM 6th Ctrl Delay	75.7
HCM 6th LOS	E

Notes

* HCM 6th computational engine requires equal clearance times for the phases crossing the barrier.

Timings

5: Trautwein Rd. & Alessandro Bl.

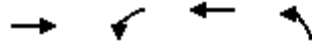

Lane Group	EBT	WBL	WBT	NBL
Lane Configurations	↑↑↑	↵↵	↑↑↑	↵↵↵
Traffic Volume (vph)	1298	227	1540	1126
Future Volume (vph)	1298	227	1540	1126
Turn Type	NA	Prot	NA	Prot
Protected Phases	2	1	6	8
Permitted Phases				
Detector Phase	2	1	6	8
Switch Phase				
Minimum Initial (s)	10.0	5.0	10.0	10.0
Minimum Split (s)	33.2	9.2	16.2	16.2
Total Split (s)	63.0	19.0	82.0	38.0
Total Split (%)	52.5%	15.8%	68.3%	31.7%
Yellow Time (s)	5.2	3.2	5.2	5.2
All-Red Time (s)	1.0	1.0	1.0	1.0
Lost Time Adjust (s)	0.0	0.0	0.0	0.0
Total Lost Time (s)	6.2	4.2	6.2	6.2
Lead/Lag	Lag	Lead		
Lead-Lag Optimize?	Yes	Yes		
Recall Mode	None	None	None	None
Act Effct Green (s)	50.9	11.7	66.9	29.9
Actuated g/C Ratio	0.47	0.11	0.61	0.27
v/c Ratio	0.72	0.64	0.51	0.87
Control Delay	25.9	56.5	12.6	46.8
Queue Delay	0.0	0.0	0.0	0.0
Total Delay	25.9	56.5	12.6	46.8
LOS	C	E	B	D
Approach Delay	25.9		18.3	46.8
Approach LOS	C		B	D

Intersection Summary

Cycle Length: 120	
Actuated Cycle Length: 109.4	
Natural Cycle: 70	
Control Type: Actuated-Uncoordinated	
Maximum v/c Ratio: 0.87	
Intersection Signal Delay: 28.2	Intersection LOS: C
Intersection Capacity Utilization 74.0%	ICU Level of Service D
Analysis Period (min) 15	

Splits and Phases: 5: Trautwein Rd. & Alessandro Bl.



HCM 6th Signalized Intersection Summary
5: Trautwein Rd. & Alessandro Bl.

West Campus Upper Plateau (JN 14064)
09/30/2022

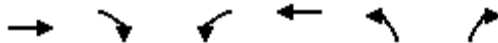

Movement	EBT	EBR	WBL	WBT	NBL	NBR
Lane Configurations	↑↑↑		↵↵	↑↑↑	↵↵↵	
Traffic Volume (veh/h)	1298	308	227	1540	1126	15
Future Volume (veh/h)	1298	308	227	1540	1126	15
Initial Q (Qb), veh	0	0	0	0	0	0
Ped-Bike Adj(A_pbT)		1.00	1.00		1.00	1.00
Parking Bus, Adj	1.00	1.00	1.00	1.00	1.00	1.00
Work Zone On Approach	No			No	No	
Adj Sat Flow, veh/h/ln	1885	1900	1885	1885	1870	1900
Adj Flow Rate, veh/h	1352	321	236	1604	1188	0
Peak Hour Factor	0.96	0.96	0.96	0.96	0.96	0.96
Percent Heavy Veh, %	1	0	1	1	2	0
Cap, veh/h	1952	463	311	3104	1427	430
Arrive On Green	0.47	0.47	0.09	0.60	0.27	0.00
Sat Flow, veh/h	4324	985	3483	5316	5344	1610
Grp Volume(v), veh/h	1116	557	236	1604	1188	0
Grp Sat Flow(s),veh/h/ln	1716	1708	1742	1716	1781	1610
Q Serve(g_s), s	24.4	24.5	6.3	17.2	20.0	0.0
Cycle Q Clear(g_c), s	24.4	24.5	6.3	17.2	20.0	0.0
Prop In Lane		0.58	1.00		1.00	1.00
Lane Grp Cap(c), veh/h	1612	802	311	3104	1427	430
V/C Ratio(X)	0.69	0.69	0.76	0.52	0.83	0.00
Avail Cap(c_a), veh/h	2040	1015	540	4083	1779	536
HCM Platoon Ratio	1.00	1.00	1.00	1.00	1.00	1.00
Upstream Filter(I)	1.00	1.00	1.00	1.00	1.00	0.00
Uniform Delay (d), s/veh	19.9	19.9	42.5	10.9	33.0	0.0
Incr Delay (d2), s/veh	0.9	1.9	1.4	0.2	2.9	0.0
Initial Q Delay(d3),s/veh	0.0	0.0	0.0	0.0	0.0	0.0
%ile BackOfQ(50%),veh/ln	8.7	8.9	2.6	5.1	8.4	0.0
Unsig. Movement Delay, s/veh						
LnGrp Delay(d),s/veh	20.8	21.8	43.9	11.1	35.9	0.0
LnGrp LOS	C	C	D	B	D	A
Approach Vol, veh/h	1673			1840	1188	
Approach Delay, s/veh	21.2			15.3	35.9	
Approach LOS	C			B	D	
Timer - Assigned Phs	1	2			6	8
Phs Duration (G+Y+Rc), s	12.7	51.1			63.8	31.7
Change Period (Y+Rc), s	* 4.2	6.2			6.2	6.2
Max Green Setting (Gmax), s	* 15	56.8			75.8	31.8
Max Q Clear Time (g_c+I1), s	8.3	26.5			19.2	22.0
Green Ext Time (p_c), s	0.2	18.4			23.8	3.5

Intersection Summary

HCM 6th Ctrl Delay			22.6			
HCM 6th LOS			C			

Notes

User approved volume balancing among the lanes for turning movement.
* HCM 6th computational engine requires equal clearance times for the phases crossing the barrier.

Timings
6: Trautwein Rd. & Grove Community Dr

West Campus Upper Plateau (JN 14064)

09/30/2022



Lane Group	WBL	WBR	NBT	NBR	SBL	SBT
Lane Configurations	↙	↗↗	↕↕	↗	↗↗	↕↕
Traffic Volume (vph)	125	447	1254	102	402	1163
Future Volume (vph)	125	447	1254	102	402	1163
Turn Type	Prot	pm+ov	NA	Perm	Prot	NA
Protected Phases	8	1	2		1	6
Permitted Phases		8		2		
Detector Phase	8	1	2	2	1	6
Switch Phase						
Minimum Initial (s)	10.0	5.0	10.0	10.0	5.0	10.0
Minimum Split (s)	34.6	9.6	46.2	46.2	9.6	28.2
Total Split (s)	35.0	29.0	56.0	56.0	29.0	85.0
Total Split (%)	29.2%	24.2%	46.7%	46.7%	24.2%	70.8%
Yellow Time (s)	3.6	3.6	5.2	5.2	3.6	5.2
All-Red Time (s)	1.0	1.0	1.0	1.0	1.0	1.0
Lost Time Adjust (s)	0.0	0.0	0.0	0.0	0.0	0.0
Total Lost Time (s)	4.6	4.6	6.2	6.2	4.6	6.2
Lead/Lag		Lead	Lag	Lag	Lead	
Lead-Lag Optimize?		Yes	Yes	Yes	Yes	
Recall Mode	None	None	None	None	None	None
Act Effct Green (s)	14.8	31.7	44.1	44.1	16.9	65.8
Actuated g/C Ratio	0.16	0.35	0.48	0.48	0.18	0.72
v/c Ratio	0.48	0.51	0.81	0.14	0.69	0.51
Control Delay	42.8	21.7	26.3	8.6	42.6	7.1
Queue Delay	0.0	0.0	0.0	0.0	0.0	0.0
Total Delay	42.8	21.7	26.3	8.6	42.6	7.1
LOS	D	C	C	A	D	A
Approach Delay	26.3		25.0			16.2
Approach LOS	C		C			B

Intersection Summary

Cycle Length: 120
 Actuated Cycle Length: 91.7
 Natural Cycle: 95
 Control Type: Actuated-Uncoordinated
 Maximum v/c Ratio: 0.81
 Intersection Signal Delay: 21.3
 Intersection LOS: C
 Intersection Capacity Utilization 68.3%
 ICU Level of Service C
 Analysis Period (min) 15

Splits and Phases: 6: Trautwein Rd. & Grove Community Dr



HCM 6th Signalized Intersection Summary
6: Trautwein Rd. & Grove Community Dr

West Campus Upper Plateau (JN 14064)

09/30/2022



Movement	WBL	WBR	NBT	NBR	SBL	SBT
Lane Configurations						
Traffic Volume (veh/h)	125	447	1254	102	402	1163
Future Volume (veh/h)	125	447	1254	102	402	1163
Initial Q (Qb), veh	0	0	0	0	0	0
Ped-Bike Adj(A_pbT)	1.00	1.00		1.00	1.00	
Parking Bus, Adj	1.00	1.00	1.00	1.00	1.00	1.00
Work Zone On Approach	No		No			No
Adj Sat Flow, veh/h/ln	1900	1900	1885	1900	1900	1870
Adj Flow Rate, veh/h	139	303	1393	107	447	1292
Peak Hour Factor	0.90	0.90	0.90	0.90	0.90	0.90
Percent Heavy Veh, %	0	0	1	0	0	2
Cap, veh/h	246	837	1774	798	559	2549
Arrive On Green	0.14	0.14	0.50	0.50	0.16	0.72
Sat Flow, veh/h	1810	2834	3676	1610	3510	3647
Grp Volume(v), veh/h	139	303	1393	107	447	1292
Grp Sat Flow(s),veh/h/ln	1810	1417	1791	1610	1755	1777
Q Serve(g_s), s	5.3	6.2	23.6	2.6	9.0	11.9
Cycle Q Clear(g_c), s	5.3	6.2	23.6	2.6	9.0	11.9
Prop In Lane	1.00	1.00		1.00	1.00	
Lane Grp Cap(c), veh/h	246	837	1774	798	559	2549
V/C Ratio(X)	0.56	0.36	0.79	0.13	0.80	0.51
Avail Cap(c_a), veh/h	748	1623	2425	1090	1165	3808
HCM Platoon Ratio	1.00	1.00	1.00	1.00	1.00	1.00
Upstream Filter(I)	1.00	1.00	1.00	1.00	1.00	1.00
Uniform Delay (d), s/veh	29.7	20.5	15.3	10.0	29.8	4.6
Incr Delay (d2), s/veh	2.0	0.3	1.2	0.1	1.0	0.2
Initial Q Delay(d3),s/veh	0.0	0.0	0.0	0.0	0.0	0.0
%ile BackOfQ(50%),veh/ln	2.3	1.9	7.7	0.8	3.5	2.1
Unsig. Movement Delay, s/veh						
LnGrp Delay(d),s/veh	31.8	20.7	16.5	10.1	30.8	4.8
LnGrp LOS	C	C	B	B	C	A
Approach Vol, veh/h	442		1500			1739
Approach Delay, s/veh	24.2		16.1			11.5
Approach LOS	C		B			B
Timer - Assigned Phs	1	2			6	8
Phs Duration (G+Y+Rc), s	16.3	42.6			58.9	14.6
Change Period (Y+Rc), s	4.6	6.2			6.2	4.6
Max Green Setting (Gmax), s	24.4	49.8			78.8	30.4
Max Q Clear Time (g_c+11), s	11.0	25.6			13.9	8.2
Green Ext Time (p_c), s	0.7	10.8			11.8	1.6

Intersection Summary

HCM 6th Ctrl Delay			14.9			
HCM 6th LOS			B			

Timings

7: Trautwein Rd. & Orange Terrace Pkwy

09/30/2022



Lane Group	EBL	EBT	WBL	WBT	WBR	NBL	NBT	NBR	SBL	SBT	SBR
Lane Configurations											
Traffic Volume (vph)	36	21	191	13	185	39	1103	178	229	1138	23
Future Volume (vph)	36	21	191	13	185	39	1103	178	229	1138	23
Turn Type	Prot	NA	Prot	NA	pm+ov	Prot	NA	Perm	Prot	NA	Perm
Protected Phases	7	4	3	8	1	5	2		1	6	
Permitted Phases					8			2			6
Detector Phase	7	4	3	8	1	5	2	2	1	6	6
Switch Phase											
Minimum Initial (s)	5.0	10.0	5.0	10.0	5.0	5.0	10.0	10.0	5.0	10.0	10.0
Minimum Split (s)	9.6	38.6	9.6	34.6	9.6	9.6	46.2	46.2	9.6	28.2	28.2
Total Split (s)	13.2	38.6	16.1	41.5	18.0	9.6	47.3	47.3	18.0	55.7	55.7
Total Split (%)	11.0%	32.2%	13.4%	34.6%	15.0%	8.0%	39.4%	39.4%	15.0%	46.4%	46.4%
Yellow Time (s)	3.6	3.6	3.6	3.6	3.6	3.6	5.2	5.2	3.6	5.2	5.2
All-Red Time (s)	1.0	1.0	1.0	1.0	1.0	1.0	1.0	1.0	1.0	1.0	1.0
Lost Time Adjust (s)	0.0	0.0	0.0	0.0	0.0	0.0	0.0	0.0	0.0	0.0	0.0
Total Lost Time (s)	4.6	4.6	4.6	4.6	4.6	4.6	6.2	6.2	4.6	6.2	6.2
Lead/Lag	Lead	Lag	Lead	Lag	Lead	Lead	Lag	Lag	Lead	Lag	Lag
Lead-Lag Optimize?	Yes	Yes	Yes	Yes	Yes	Yes	Yes	Yes	Yes	Yes	Yes
Recall Mode	None	None	None	None	None	None	None	None	None	None	None
Act Effct Green (s)	10.3	14.1	12.2	16.1	28.9	5.3	37.6	37.6	10.6	48.1	48.1
Actuated g/C Ratio	0.12	0.16	0.14	0.18	0.33	0.06	0.43	0.43	0.12	0.55	0.55
v/c Ratio	0.18	0.15	0.82	0.04	0.19	0.38	0.77	0.25	0.59	0.62	0.03
Control Delay	44.6	22.1	68.5	32.8	4.6	58.2	28.3	8.0	46.4	19.5	0.0
Queue Delay	0.0	0.0	0.0	0.0	0.0	0.0	0.0	0.0	0.0	0.0	0.0
Total Delay	44.6	22.1	68.5	32.8	4.6	58.2	28.3	8.0	46.4	19.5	0.0
LOS	D	C	E	C	A	E	C	A	D	B	A
Approach Delay		32.3		36.9			26.5			23.6	
Approach LOS		C		D			C			C	

Intersection Summary

Cycle Length: 120	
Actuated Cycle Length: 87.8	
Natural Cycle: 115	
Control Type: Actuated-Uncoordinated	
Maximum v/c Ratio: 0.82	
Intersection Signal Delay: 26.6	Intersection LOS: C
Intersection Capacity Utilization 67.1%	ICU Level of Service C
Analysis Period (min) 15	



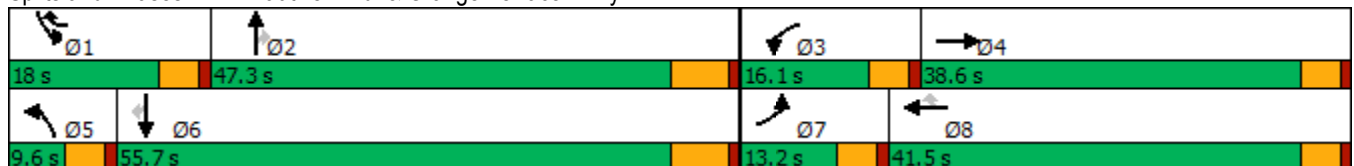



















Splits and Phases: 7: Trautwein Rd. & Orange Terrace Pkwy



HCM 6th Signalized Intersection Summary
7: Trautwein Rd. & Orange Terrace Pkwy

West Campus Upper Plateau (JN 14064)

09/30/2022

												
Movement	EBL	EBT	EBR	WBL	WBT	WBR	NBL	NBT	NBR	SBL	SBT	SBR
Lane Configurations												
Traffic Volume (veh/h)	36	21	23	191	13	185	39	1103	178	229	1138	23
Future Volume (veh/h)	36	21	23	191	13	185	39	1103	178	229	1138	23
Initial Q (Qb), veh	0	0	0	0	0	0	0	0	0	0	0	0
Ped-Bike Adj(A_pbT)	1.00		1.00	1.00		1.00	1.00		1.00	1.00		1.00
Parking Bus, Adj	1.00	1.00	1.00	1.00	1.00	1.00	1.00	1.00	1.00	1.00	1.00	1.00
Work Zone On Approach		No			No			No			No	
Adj Sat Flow, veh/h/ln	1900	1900	1900	1885	1900	1856	1900	1870	1870	1870	1870	1900
Adj Flow Rate, veh/h	38	22	22	203	14	77	41	1173	111	244	1211	14
Peak Hour Factor	0.94	0.94	0.94	0.94	0.94	0.94	0.94	0.94	0.94	0.94	0.94	0.94
Percent Heavy Veh, %	0	0	0	1	0	3	0	2	2	2	2	0
Cap, veh/h	64	105	105	240	416	870	67	1437	641	330	1644	745
Arrive On Green	0.04	0.12	0.12	0.13	0.22	0.22	0.04	0.40	0.40	0.10	0.46	0.46
Sat Flow, veh/h	1810	872	872	1795	1900	2768	1810	3554	1585	3456	3554	1610
Grp Volume(v), veh/h	38	0	44	203	14	77	41	1173	111	244	1211	14
Grp Sat Flow(s),veh/h/ln	1810	0	1743	1795	1900	1384	1810	1777	1585	1728	1777	1610
Q Serve(g_s), s	1.7	0.0	1.9	9.0	0.5	1.6	1.8	23.9	3.6	5.6	22.6	0.4
Cycle Q Clear(g_c), s	1.7	0.0	1.9	9.0	0.5	1.6	1.8	23.9	3.6	5.6	22.6	0.4
Prop In Lane	1.00		0.50	1.00		1.00	1.00		1.00	1.00		1.00
Lane Grp Cap(c), veh/h	64	0	210	240	416	870	67	1437	641	330	1644	745
V/C Ratio(X)	0.59	0.00	0.21	0.84	0.03	0.09	0.61	0.82	0.17	0.74	0.74	0.02
Avail Cap(c_a), veh/h	191	0	729	254	862	1520	111	1796	801	569	2163	980
HCM Platoon Ratio	1.00	1.00	1.00	1.00	1.00	1.00	1.00	1.00	1.00	1.00	1.00	1.00
Upstream Filter(I)	1.00	0.00	1.00	1.00	1.00	1.00	1.00	1.00	1.00	1.00	1.00	1.00
Uniform Delay (d), s/veh	38.7	0.0	32.3	34.4	25.0	19.7	38.6	21.5	15.5	35.8	17.8	11.8
Incr Delay (d2), s/veh	3.2	0.0	0.5	20.0	0.0	0.0	3.3	2.5	0.1	1.2	0.9	0.0
Initial Q Delay(d3),s/veh	0.0	0.0	0.0	0.0	0.0	0.0	0.0	0.0	0.0	0.0	0.0	0.0
%ile BackOfQ(50%),veh/ln	0.8	0.0	0.8	5.0	0.2	0.5	0.8	8.9	1.2	2.2	7.9	0.1
Unsig. Movement Delay, s/veh												
LnGrp Delay(d),s/veh	41.9	0.0	32.8	54.4	25.0	19.7	41.9	24.0	15.6	37.0	18.8	11.9
LnGrp LOS	D	A	C	D	C	B	D	C	B	D	B	B
Approach Vol, veh/h		82			294			1325			1469	
Approach Delay, s/veh		37.0			43.9			23.9			21.7	
Approach LOS		D			D			C			C	
Timer - Assigned Phs	1	2	3	4	5	6	7	8				
Phs Duration (G+Y+Rc), s	12.4	39.1	15.5	14.4	7.6	43.8	7.5	22.4				
Change Period (Y+Rc), s	4.6	6.2	4.6	4.6	4.6	6.2	4.6	4.6				
Max Green Setting (Gmax), s	13.4	41.1	11.5	34.0	5.0	49.5	8.6	36.9				
Max Q Clear Time (g_c+I1), s	7.6	25.9	11.0	3.9	3.8	24.6	3.7	3.6				
Green Ext Time (p_c), s	0.2	7.0	0.0	0.2	0.0	8.8	0.0	0.3				
Intersection Summary												
HCM 6th Ctrl Delay				25.1								
HCM 6th LOS				C								

Timings
8: Cole Av. & Van Buren Bl.

West Campus Upper Plateau (JN 14064)

09/30/2022



Lane Group	EBL	EBT	EBR	WBL	WBT	WBR	NBL	NBT	SBL	SBT	SBR
Lane Configurations	↖↗	↑↑	↖	↖	↑↑↑	↖	↖	↑↑	↖↗	↑↑	↖
Traffic Volume (vph)	566	1382	84	168	1448	412	111	276	404	247	448
Future Volume (vph)	566	1382	84	168	1448	412	111	276	404	247	448
Turn Type	Prot	NA	pm+ov	Prot	NA	pm+ov	Prot	NA	Prot	NA	pm+ov
Protected Phases	5	2	3	1	6	7	3	8	7	4	5
Permitted Phases			2			6					4
Detector Phase	5	2	3	1	6	7	3	8	7	4	5
Switch Phase											
Minimum Initial (s)	5.0	10.0	5.0	5.0	10.0	5.0	5.0	10.0	5.0	10.0	5.0
Minimum Split (s)	9.1	36.2	9.1	9.1	36.2	9.1	9.1	42.2	9.1	49.2	9.1
Total Split (s)	18.7	44.8	12.0	14.0	40.1	17.5	12.0	43.7	17.5	49.2	18.7
Total Split (%)	15.6%	37.3%	10.0%	11.7%	33.4%	14.6%	10.0%	36.4%	14.6%	41.0%	15.6%
Yellow Time (s)	3.2	5.2	3.2	3.2	5.2	3.2	3.2	5.2	3.2	5.2	3.2
All-Red Time (s)	0.5	1.0	0.5	0.5	1.0	0.5	0.5	1.0	0.5	1.0	0.5
Lost Time Adjust (s)	0.0	0.0	0.0	0.0	0.0	0.0	0.0	0.0	0.0	0.0	0.0
Total Lost Time (s)	3.7	6.2	3.7	3.7	6.2	3.7	3.7	6.2	3.7	6.2	3.7
Lead/Lag	Lead	Lag	Lead	Lead	Lag	Lead	Lead	Lag	Lead	Lag	Lead
Lead-Lag Optimize?	Yes	Yes	Yes	Yes	Yes	Yes	Yes	Yes	Yes	Yes	Yes
Recall Mode	None	None	None	None	None	None	None	None	None	None	None
Act Effct Green (s)	15.1	38.9	53.5	10.4	34.1	54.3	8.4	17.9	13.9	23.5	41.1
Actuated g/C Ratio	0.15	0.39	0.53	0.10	0.34	0.54	0.08	0.18	0.14	0.23	0.41
v/c Ratio	1.16	1.09	0.10	0.98	0.89	0.45	0.79	0.61	0.90	0.31	0.68
Control Delay	132.1	83.9	3.3	108.8	40.1	8.2	81.6	37.4	67.6	32.2	24.0
Queue Delay	0.0	0.0	0.0	0.0	0.0	0.0	0.0	0.0	0.0	0.0	0.0
Total Delay	132.1	83.9	3.3	108.8	40.1	8.2	81.6	37.4	67.6	32.2	24.0
LOS	F	F	A	F	D	A	F	D	E	C	C
Approach Delay		94.0			39.3			47.5		41.9	
Approach LOS		F			D			D		D	

Intersection Summary

Cycle Length: 120	
Actuated Cycle Length: 101	
Natural Cycle: 115	
Control Type: Actuated-Uncoordinated	
Maximum v/c Ratio: 1.16	
Intersection Signal Delay: 60.2	Intersection LOS: E
Intersection Capacity Utilization 89.3%	ICU Level of Service E
Analysis Period (min) 15	



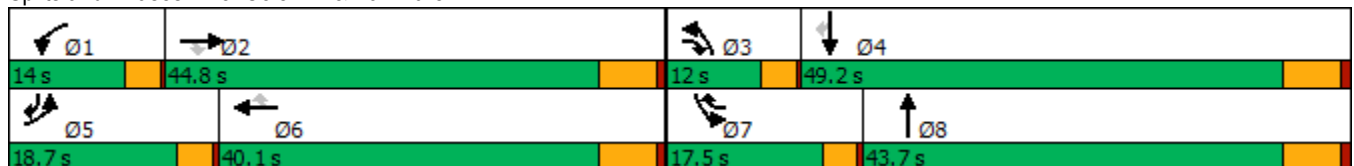



























Splits and Phases: 8: Cole Av. & Van Buren Bl.



HCM 6th Signalized Intersection Summary
8: Cole Av. & Van Buren Bl.

West Campus Upper Plateau (JN 14064)

09/30/2022

												
Movement	EBL	EBT	EBR	WBL	WBT	WBR	NBL	NBT	NBR	SBL	SBT	SBR
Lane Configurations	 	 			  			 		 	 	
Traffic Volume (veh/h)	566	1382	84	168	1448	412	111	276	98	404	247	448
Future Volume (veh/h)	566	1382	84	168	1448	412	111	276	98	404	247	448
Initial Q (Qb), veh	0	0	0	0	0	0	0	0	0	0	0	0
Ped-Bike Adj(A_pbT)	1.00		1.00	1.00		1.00	1.00		0.99	1.00		1.00
Parking Bus, Adj	1.00	1.00	1.00	1.00	1.00	1.00	1.00	1.00	1.00	1.00	1.00	1.00
Work Zone On Approach		No			No			No			No	
Adj Sat Flow, veh/h/ln	1856	1826	1856	1856	1856	1870	1885	1885	1870	1856	1885	1885
Adj Flow Rate, veh/h	590	1440	31	175	1508	340	116	288	95	421	257	369
Peak Hour Factor	0.96	0.96	0.96	0.96	0.96	0.96	0.96	0.96	0.96	0.96	0.96	0.96
Percent Heavy Veh, %	3	5	3	3	3	2	1	1	2	3	1	1
Cap, veh/h	510	1327	727	180	1702	749	144	485	157	469	856	619
Arrive On Green	0.15	0.38	0.38	0.10	0.34	0.34	0.08	0.18	0.18	0.14	0.24	0.24
Sat Flow, veh/h	3428	3469	1572	1767	5066	1585	1795	2657	858	3428	3582	1596
Grp Volume(v), veh/h	590	1440	31	175	1508	340	116	192	191	421	257	369
Grp Sat Flow(s),veh/h/ln	1714	1735	1572	1767	1689	1585	1795	1791	1724	1714	1791	1596
Q Serve(g_s), s	15.0	38.6	1.1	10.0	28.4	14.5	6.4	9.9	10.3	12.2	5.9	18.6
Cycle Q Clear(g_c), s	15.0	38.6	1.1	10.0	28.4	14.5	6.4	9.9	10.3	12.2	5.9	18.6
Prop In Lane	1.00		1.00	1.00		1.00	1.00		0.50	1.00		1.00
Lane Grp Cap(c), veh/h	510	1327	727	180	1702	749	144	327	315	469	856	619
V/C Ratio(X)	1.16	1.09	0.04	0.97	0.89	0.45	0.81	0.59	0.61	0.90	0.30	0.60
Avail Cap(c_a), veh/h	510	1327	727	180	1702	749	148	666	641	469	1526	917
HCM Platoon Ratio	1.00	1.00	1.00	1.00	1.00	1.00	1.00	1.00	1.00	1.00	1.00	1.00
Upstream Filter(I)	1.00	1.00	1.00	1.00	1.00	1.00	1.00	1.00	1.00	1.00	1.00	1.00
Uniform Delay (d), s/veh	43.0	31.2	14.9	45.2	31.7	17.9	45.6	37.8	37.9	42.9	31.5	24.6
Incr Delay (d2), s/veh	91.2	51.3	0.0	57.8	6.2	0.6	24.6	1.7	1.9	19.3	0.2	0.9
Initial Q Delay(d3),s/veh	0.0	0.0	0.0	0.0	0.0	0.0	0.0	0.0	0.0	0.0	0.0	0.0
%ile BackOfQ(50%),veh/ln	12.5	24.0	0.4	7.0	11.6	4.9	3.7	4.3	4.3	6.2	2.4	6.6
Unsig. Movement Delay, s/veh												
LnGrp Delay(d),s/veh	134.2	82.4	14.9	103.0	37.9	18.5	70.2	39.5	39.8	62.2	31.7	25.5
LnGrp LOS	F	F	B	F	D	B	E	D	D	E	C	C
Approach Vol, veh/h		2061			2023			499			1047	
Approach Delay, s/veh		96.2			40.2			46.7			41.8	
Approach LOS		F			D			D			D	
Timer - Assigned Phs	1	2	3	4	5	6	7	8				
Phs Duration (G+Y+Rc), s	14.0	44.8	11.8	30.3	18.7	40.1	17.5	24.6				
Change Period (Y+Rc), s	3.7	6.2	3.7	6.2	3.7	6.2	3.7	6.2				
Max Green Setting (Gmax), s	10.3	38.6	8.3	43.0	15.0	33.9	13.8	37.5				
Max Q Clear Time (g_c+I1), s	12.0	40.6	8.4	20.6	17.0	30.4	14.2	12.3				
Green Ext Time (p_c), s	0.0	0.0	0.0	2.7	0.0	3.1	0.0	2.0				
Intersection Summary												
HCM 6th Ctrl Delay			61.6									
HCM 6th LOS			E									

Intersection	
Intersection Delay, s/veh	11.1
Intersection LOS	B

Movement	EBT	EBR	WBL	WBT	NBL	NBR
Lane Configurations	↔		↔	↑	↔	↔
Traffic Vol, veh/h	175	19	79	258	67	60
Future Vol, veh/h	175	19	79	258	67	60
Peak Hour Factor	0.82	0.82	0.82	0.82	0.82	0.82
Heavy Vehicles, %	2	0	5	2	0	0
Mvmt Flow	213	23	96	315	82	73
Number of Lanes	1	0	1	1	1	1

Approach	EB	WB	NB
Opposing Approach	WB	EB	
Opposing Lanes	2	1	0
Conflicting Approach Left		NB	EB
Conflicting Lanes Left	0	2	1
Conflicting Approach Right	NB		WB
Conflicting Lanes Right	2	0	2
HCM Control Delay	10.9	11.7	9.7
HCM LOS	B	B	A

Lane	NBLn1	NBLn2	EBLn1	WBLn1	WBLn2
Vol Left, %	100%	0%	0%	100%	0%
Vol Thru, %	0%	0%	90%	0%	100%
Vol Right, %	0%	100%	10%	0%	0%
Sign Control	Stop	Stop	Stop	Stop	Stop
Traffic Vol by Lane	67	60	194	79	258
LT Vol	67	0	0	79	0
Through Vol	0	0	175	0	258
RT Vol	0	60	19	0	0
Lane Flow Rate	82	73	237	96	315
Geometry Grp	7	7	4	7	7
Degree of Util (X)	0.149	0.109	0.341	0.154	0.454
Departure Headway (Hd)	6.552	5.339	5.187	5.755	5.2
Convergence, Y/N	Yes	Yes	Yes	Yes	Yes
Cap	544	665	688	620	689
Service Time	4.333	3.119	3.254	3.518	2.963
HCM Lane V/C Ratio	0.151	0.11	0.344	0.155	0.457
HCM Control Delay	10.5	8.8	10.9	9.6	12.3
HCM Lane LOS	B	A	B	A	B
HCM 95th-tile Q	0.5	0.4	1.5	0.5	2.4

Intersection												
Intersection Delay, s/veh	12.2											
Intersection LOS	B											

Movement	EBL	EBT	EBR	WBL	WBT	WBR	NBL	NBT	NBR	SBL	SBT	SBR
Lane Configurations	↘	↕		↘	↕			↕			↕	
Traffic Vol, veh/h	68	323	11	11	404	67	32	5	5	63	7	68
Future Vol, veh/h	68	323	11	11	404	67	32	5	5	63	7	68
Peak Hour Factor	0.90	0.90	0.90	0.90	0.90	0.90	0.90	0.90	0.90	0.90	0.90	0.90
Heavy Vehicles, %	5	2	7	0	1	0	6	0	0	0	0	0
Mvmt Flow	76	359	12	12	449	74	36	6	6	70	8	76
Number of Lanes	1	2	0	1	2	0	0	1	0	0	1	0

Approach	EB	WB	NB	SB
Opposing Approach	WB	EB	SB	NB
Opposing Lanes	3	3	1	1
Conflicting Approach Left	SB	NB	EB	WB
Conflicting Lanes Left	1	1	3	3
Conflicting Approach Right	NB	SB	WB	EB
Conflicting Lanes Right	1	1	3	3
HCM Control Delay	11.5	12.8	11.1	12.2
HCM LOS	B	B	B	B

Lane	NBLn1	EBLn1	EBLn2	EBLn3	WBLn1	WBLn2	WBLn3	SBLn1
Vol Left, %	76%	100%	0%	0%	100%	0%	0%	46%
Vol Thru, %	12%	0%	100%	91%	0%	100%	67%	5%
Vol Right, %	12%	0%	0%	9%	0%	0%	33%	49%
Sign Control	Stop	Stop	Stop	Stop	Stop	Stop	Stop	Stop
Traffic Vol by Lane	42	68	215	119	11	269	202	138
LT Vol	32	68	0	0	11	0	0	63
Through Vol	5	0	215	108	0	269	135	7
RT Vol	5	0	0	11	0	0	67	68
Lane Flow Rate	47	76	239	132	12	299	224	153
Geometry Grp	7	7	7	7	7	7	7	7
Degree of Util (X)	0.097	0.136	0.394	0.218	0.021	0.485	0.347	0.286
Departure Headway (Hd)	7.509	6.491	5.932	5.953	6.318	5.829	5.576	6.719
Convergence, Y/N	Yes	Yes	Yes	Yes	Yes	Yes	Yes	Yes
Cap	476	552	605	603	566	616	645	534
Service Time	5.271	4.234	3.675	3.696	4.059	3.57	3.317	4.47
HCM Lane V/C Ratio	0.099	0.138	0.395	0.219	0.021	0.485	0.347	0.287
HCM Control Delay	11.1	10.3	12.5	10.4	9.2	14	11.3	12.2
HCM Lane LOS	B	B	B	B	A	B	B	B
HCM 95th-tile Q	0.3	0.5	1.9	0.8	0.1	2.6	1.5	1.2

Timings
11: Barton St & Alessandro Bl.



Lane Group	EBL	EBT	WBL	WBT	NBL	NBT	NBR	SBL	SBT	SBR
Lane Configurations	↙	↕↕↕	↙	↕↕↕		↕	↗		↕	↗
Traffic Volume (vph)	5	1558	88	1762	63	1	44	5	0	4
Future Volume (vph)	5	1558	88	1762	63	1	44	5	0	4
Turn Type	Prot	NA	Prot	NA	Perm	NA	Perm	Perm	NA	Perm
Protected Phases	5	2	1	6		8			4	
Permitted Phases					8		8	4		4
Detector Phase	5	2	1	6	8	8	8	4	4	4
Switch Phase										
Minimum Initial (s)	5.0	10.0	5.0	10.0	10.0	10.0	10.0	10.0	10.0	10.0
Minimum Split (s)	9.2	28.5	11.0	28.5	40.6	40.6	40.6	26.6	26.6	26.6
Total Split (s)	9.2	65.4	14.0	70.2	40.6	40.6	40.6	40.6	40.6	40.6
Total Split (%)	7.7%	54.5%	11.7%	58.5%	33.8%	33.8%	33.8%	33.8%	33.8%	33.8%
Yellow Time (s)	3.2	5.5	3.2	5.5	3.6	3.6	3.6	3.6	3.6	3.6
All-Red Time (s)	1.0	1.0	1.0	1.0	1.0	1.0	1.0	1.0	1.0	1.0
Lost Time Adjust (s)	0.0	0.0	0.0	0.0		0.0	0.0		0.0	0.0
Total Lost Time (s)	4.2	6.5	4.2	6.5		4.6	4.6		4.6	4.6
Lead/Lag	Lead	Lag	Lead	Lag						
Lead-Lag Optimize?	Yes	Yes	Yes	Yes						
Recall Mode	None	None	None	None	None	None	None	None	None	None
Act Effct Green (s)	5.6	52.2	8.8	60.7		15.1	15.1		15.1	15.1
Actuated g/C Ratio	0.07	0.64	0.11	0.75		0.19	0.19		0.19	0.19
v/c Ratio	0.05	0.52	0.48	0.50		0.27	0.12		0.02	0.01
Control Delay	48.6	13.6	50.8	8.8		35.9	0.6		31.4	0.0
Queue Delay	0.0	0.0	0.0	0.0		0.0	0.0		0.0	0.0
Total Delay	48.6	13.6	50.8	8.8		35.9	0.6		31.4	0.0
LOS	D	B	D	A		D	A		C	A
Approach Delay		13.7		10.8		21.6			17.4	
Approach LOS		B		B		C			B	

Intersection Summary

Cycle Length: 120
 Actuated Cycle Length: 81.3
 Natural Cycle: 85
 Control Type: Actuated-Uncoordinated
 Maximum v/c Ratio: 0.52
 Intersection Signal Delay: 12.4
 Intersection LOS: B
 Intersection Capacity Utilization 63.9%
 ICU Level of Service B
 Analysis Period (min) 15

Splits and Phases: 11: Barton St & Alessandro Bl.



HCM 6th Signalized Intersection Summary
11: Barton St & Alessandro Bl.

West Campus Upper Plateau (JN 14064)

09/30/2022



Movement	EBL	EBT	EBR	WBL	WBT	WBR	NBL	NBT	NBR	SBL	SBT	SBR
Lane Configurations	↖	↑↑↑		↖	↑↑↑			↑	↗		↑	↗
Traffic Volume (veh/h)	5	1558	39	88	1762	5	63	1	44	5	0	4
Future Volume (veh/h)	5	1558	39	88	1762	5	63	1	44	5	0	4
Initial Q (Qb), veh	0	0	0	0	0	0	0	0	0	0	0	0
Ped-Bike Adj(A_pbT)	1.00		1.00	1.00		0.98	1.00		1.00	1.00		1.00
Parking Bus, Adj	1.00	1.00	1.00	1.00	1.00	1.00	1.00	1.00	1.00	1.00	1.00	1.00
Work Zone On Approach		No			No			No			No	
Adj Sat Flow, veh/h/ln	1604	1885	1900	1900	1870	1900	1870	1900	1900	1737	1900	1900
Adj Flow Rate, veh/h	5	1675	40	95	1895	5	68	1	20	5	0	-7
Peak Hour Factor	0.93	0.93	0.93	0.93	0.93	0.93	0.93	0.93	0.93	0.93	0.93	0.93
Percent Heavy Veh, %	20	1	0	0	2	0	2	0	0	11	0	0
Cap, veh/h	10	3106	74	123	3481	9	278	3	186	215	0	186
Arrive On Green	0.01	0.60	0.60	0.07	0.66	0.66	0.12	0.12	0.12	0.12	0.00	0.00
Sat Flow, veh/h	1527	5170	123	1810	5258	14	1537	29	1610	985	0	1610
Grp Volume(v), veh/h	5	1111	604	95	1227	673	69	0	20	5	0	-7
Grp Sat Flow(s),veh/h/ln	1527	1716	1863	1810	1702	1868	1566	0	1610	985	0	1610
Q Serve(g_s), s	0.2	13.6	13.6	3.7	13.5	13.5	0.0	0.0	0.8	0.2	0.0	0.0
Cycle Q Clear(g_c), s	0.2	13.6	13.6	3.7	13.5	13.5	2.5	0.0	0.8	2.7	0.0	0.0
Prop In Lane	1.00		0.07	1.00		0.01	0.99		1.00	1.00		1.00
Lane Grp Cap(c), veh/h	10	2061	1119	123	2254	1237	282	0	186	215	0	186
V/C Ratio(X)	0.50	0.54	0.54	0.77	0.54	0.54	0.24	0.00	0.11	0.02	0.00	-0.04
Avail Cap(c_a), veh/h	108	2849	1547	250	3057	1677	848	0	817	769	0	817
HCM Platoon Ratio	1.00	1.00	1.00	1.00	1.00	1.00	1.00	1.00	1.00	1.00	1.00	1.00
Upstream Filter(I)	1.00	1.00	1.00	1.00	1.00	1.00	1.00	0.00	1.00	1.00	0.00	0.00
Uniform Delay (d), s/veh	35.1	8.4	8.4	32.5	6.3	6.3	28.8	0.0	28.1	30.1	0.0	0.0
Incr Delay (d2), s/veh	13.2	0.3	0.6	3.8	0.3	0.5	0.4	0.0	0.3	0.0	0.0	0.0
Initial Q Delay(d3),s/veh	0.0	0.0	0.0	0.0	0.0	0.0	0.0	0.0	0.0	0.0	0.0	0.0
%ile BackOfQ(50%),veh/ln	0.1	3.3	3.6	1.7	3.7	4.1	1.1	0.0	0.3	0.1	0.0	0.0
Unsig. Movement Delay, s/veh												
LnGrp Delay(d),s/veh	48.4	8.7	8.9	36.4	6.6	6.9	29.3	0.0	28.3	30.1	0.0	0.0
LnGrp LOS	D	A	A	D	A	A	C	A	C	C	A	A
Approach Vol, veh/h		1720			1995			89				-2
Approach Delay, s/veh		8.9			8.1			29.1				0.0
Approach LOS		A			A			C				A
Timer - Assigned Phs	1	2		4	5	6		8				
Phs Duration (G+Y+Rc), s	9.0	49.1		12.8	4.7	53.5		12.8				
Change Period (Y+Rc), s	* 4.2	6.5		4.6	* 4.2	6.5		4.6				
Max Green Setting (Gmax), s	* 9.8	58.9		36.0	* 5	63.7		36.0				
Max Q Clear Time (g_c+I1), s	5.7	15.6		4.7	2.2	15.5		4.5				
Green Ext Time (p_c), s	0.0	22.3		0.0	0.0	31.5		0.4				

Intersection Summary

HCM 6th Ctrl Delay	9.0
HCM 6th LOS	A

Notes

* HCM 6th computational engine requires equal clearance times for the phases crossing the barrier.

Intersection						
Int Delay, s/veh	2.4					
Movement	EBL	EBT	WBT	WBR	SBL	SBR
Lane Configurations						
Traffic Vol, veh/h	24	172	239	23	29	61
Future Vol, veh/h	24	172	239	23	29	61
Conflicting Peds, #/hr	0	0	0	7	0	0
Sign Control	Free	Free	Free	Free	Stop	Stop
RT Channelized	-	None	-	None	-	None
Storage Length	100	-	-	-	0	-
Veh in Median Storage, #	-	0	0	-	0	-
Grade, %	-	0	0	-	0	-
Peak Hour Factor	78	78	78	78	78	78
Heavy Vehicles, %	0	1	1	0	0	0
Mvmt Flow	31	221	306	29	37	78

Major/Minor	Major1	Major2	Minor2		
Conflicting Flow All	342	0	-	0	611 328
Stage 1	-	-	-	-	328 -
Stage 2	-	-	-	-	283 -
Critical Hdwy	4.1	-	-	-	6.4 6.2
Critical Hdwy Stg 1	-	-	-	-	5.4 -
Critical Hdwy Stg 2	-	-	-	-	5.4 -
Follow-up Hdwy	2.2	-	-	-	3.5 3.3
Pot Cap-1 Maneuver	1228	-	-	-	460 718
Stage 1	-	-	-	-	734 -
Stage 2	-	-	-	-	770 -
Platoon blocked, %		-	-	-	
Mov Cap-1 Maneuver	1220	-	-	-	442 713
Mov Cap-2 Maneuver	-	-	-	-	442 -
Stage 1	-	-	-	-	711 -
Stage 2	-	-	-	-	765 -

Approach	EB	WB	SB
HCM Control Delay, s	1	0	12.5
HCM LOS			B

Minor Lane/Major Mvmt	EBL	EBT	WBT	WBR	SBLn1
Capacity (veh/h)	1220	-	-	-	595
HCM Lane V/C Ratio	0.025	-	-	-	0.194
HCM Control Delay (s)	8	-	-	-	12.5
HCM Lane LOS	A	-	-	-	B
HCM 95th %tile Q(veh)	0.1	-	-	-	0.7

Intersection						
Int Delay, s/veh	99.2					
Movement	EBT	EBR	WBL	WBT	NBL	NBR
Lane Configurations	↑↑		↖	↑↑	↘	
Traffic Vol, veh/h	359	368	59	525	311	44
Future Vol, veh/h	359	368	59	525	311	44
Conflicting Peds, #/hr	0	2	0	0	0	0
Sign Control	Free	Free	Free	Free	Stop	Stop
RT Channelized	-	None	-	None	-	None
Storage Length	-	-	125	-	0	-
Veh in Median Storage, #	0	-	-	0	0	-
Grade, %	0	-	-	0	0	-
Peak Hour Factor	86	86	86	86	86	86
Heavy Vehicles, %	1	1	0	0	0	0
Mvmt Flow	417	428	69	610	362	51

Major/Minor	Major1	Major2	Minor1	Minor2	Minor3
Conflicting Flow All	0	0	847	0	1076
Stage 1	-	-	-	-	633
Stage 2	-	-	-	-	443
Critical Hdwy	-	-	4.1	-	6.8
Critical Hdwy Stg 1	-	-	-	-	5.8
Critical Hdwy Stg 2	-	-	-	-	5.8
Follow-up Hdwy	-	-	2.2	-	3.5
Pot Cap-1 Maneuver	-	-	799	-	~ 217
Stage 1	-	-	-	-	497
Stage 2	-	-	-	-	620
Platoon blocked, %	-	-	-	-	-
Mov Cap-1 Maneuver	-	-	797	-	~ 198
Mov Cap-2 Maneuver	-	-	-	-	~ 198
Stage 1	-	-	-	-	496
Stage 2	-	-	-	-	566

Approach	EB	WB	NB
HCM Control Delay, s	0	1	\$ 464
HCM LOS			F

Minor Lane/Major Mvmt	NBLn1	EBT	EBR	WBL	WBT
Capacity (veh/h)	216	-	-	797	-
HCM Lane V/C Ratio	1.911	-	-	0.086	-
HCM Control Delay (s)	\$ 464	-	-	9.9	-
HCM Lane LOS	F	-	-	A	-
HCM 95th %tile Q(veh)	29.8	-	-	0.3	-

Notes
 ~: Volume exceeds capacity \$: Delay exceeds 300s +: Computation Not Defined *: All major volume in platoon

Timings
14: Barton Rd. & Van Buren Bl.



Lane Group	EBL	EBT	WBL	WBT	NBL	NBT	NBR	SBL	SBT
Lane Configurations	↙	↕	↙	↕	↙	↕	↗	↙	↕
Traffic Volume (vph)	203	1623	236	1696	295	51	191	36	33
Future Volume (vph)	203	1623	236	1696	295	51	191	36	33
Turn Type	Prot	NA	Prot	NA	Prot	NA	Perm	Prot	NA
Protected Phases	5	2	1	6	3	8		7	4
Permitted Phases							8		
Detector Phase	5	2	1	6	3	8	8	7	4
Switch Phase									
Minimum Initial (s)	5.0	10.0	5.0	10.0	5.0	10.0	10.0	5.0	10.0
Minimum Split (s)	9.2	25.2	9.2	25.5	9.1	14.6	14.6	9.1	33.6
Total Split (s)	17.6	52.1	22.2	56.7	12.1	36.3	36.3	9.4	33.6
Total Split (%)	14.7%	43.4%	18.5%	47.3%	10.1%	30.3%	30.3%	7.8%	28.0%
Yellow Time (s)	3.2	5.2	3.2	5.5	3.6	3.6	3.6	3.6	3.6
All-Red Time (s)	1.0	1.0	1.0	1.0	0.5	1.0	1.0	0.5	1.0
Lost Time Adjust (s)	0.0	0.0	0.0	0.0	0.0	0.0	0.0	0.0	0.0
Total Lost Time (s)	4.2	6.2	4.2	6.5	4.1	4.6	4.6	4.1	4.6
Lead/Lag	Lead	Lag	Lead	Lag	Lead	Lag	Lag	Lead	Lag
Lead-Lag Optimize?	Yes	Yes	Yes	Yes	Yes	Yes	Yes	Yes	Yes
Recall Mode	None	None	None	None	None	None	None	None	None
Act Effct Green (s)	13.5	46.1	18.1	50.4	8.0	20.4	20.4	5.3	13.8
Actuated g/C Ratio	0.13	0.44	0.17	0.48	0.08	0.19	0.19	0.05	0.13
v/c Ratio	0.98	1.39	0.86	0.81	1.23	0.15	0.45	0.44	0.66
Control Delay	102.1	206.8	70.3	27.4	172.8	37.5	8.2	66.2	17.4
Queue Delay	0.0	0.0	0.0	0.0	0.0	0.0	0.0	0.0	0.0
Total Delay	102.1	206.8	70.3	27.4	172.8	37.5	8.2	66.2	17.4
LOS	F	F	E	C	F	D	A	E	B
Approach Delay		196.5		32.5		101.4			23.6
Approach LOS		F		C		F			C

Intersection Summary

Cycle Length: 120
 Actuated Cycle Length: 105.2
 Natural Cycle: 120
 Control Type: Actuated-Uncoordinated
 Maximum v/c Ratio: 1.39
 Intersection Signal Delay: 109.5
 Intersection LOS: F
 Intersection Capacity Utilization 105.2%
 ICU Level of Service G
 Analysis Period (min) 15























Splits and Phases: 14: Barton Rd. & Van Buren Bl.



HCM 6th Signalized Intersection Summary
 14: Barton Rd. & Van Buren Bl.

West Campus Upper Plateau (JN 14064)

09/30/2022

												
Movement	EBL	EBT	EBR	WBL	WBT	WBR	NBL	NBT	NBR	SBL	SBT	SBR
Lane Configurations												
Traffic Volume (veh/h)	203	1623	252	236	1696	48	295	51	191	36	33	213
Future Volume (veh/h)	203	1623	252	236	1696	48	295	51	191	36	33	213
Initial Q (Qb), veh	0	0	0	0	0	0	0	0	0	0	0	0
Ped-Bike Adj(A_pbT)	1.00		1.00	1.00		1.00	1.00		0.95	1.00		1.00
Parking Bus, Adj	1.00	1.00	1.00	1.00	1.00	1.00	1.00	1.00	1.00	1.00	1.00	1.00
Work Zone On Approach		No			No			No			No	
Adj Sat Flow, veh/h/ln	1900	1841	1870	1870	1856	1856	1900	1900	1885	1900	1841	1900
Adj Flow Rate, veh/h	226	1803	249	262	1884	42	328	57	80	40	37	175
Peak Hour Factor	0.90	0.90	0.90	0.90	0.90	0.90	0.90	0.90	0.90	0.90	0.90	0.90
Percent Heavy Veh, %	0	4	2	2	3	3	0	0	1	0	4	0
Cap, veh/h	225	1319	178	290	2369	53	261	377	303	59	44	207
Arrive On Green	0.12	0.43	0.43	0.16	0.46	0.46	0.07	0.20	0.20	0.03	0.16	0.16
Sat Flow, veh/h	1810	3096	418	1781	5098	114	3510	1900	1525	1810	280	1323
Grp Volume(v), veh/h	226	1000	1052	262	1247	679	328	57	80	40	0	212
Grp Sat Flow(s),veh/h/ln	1810	1749	1765	1781	1689	1835	1755	1900	1525	1810	0	1603
Q Serve(g_s), s	13.4	45.9	45.9	15.6	33.8	33.9	8.0	2.7	4.8	2.4	0.0	13.9
Cycle Q Clear(g_c), s	13.4	45.9	45.9	15.6	33.8	33.9	8.0	2.7	4.8	2.4	0.0	13.9
Prop In Lane	1.00		0.24	1.00		0.06	1.00		1.00	1.00		0.83
Lane Grp Cap(c), veh/h	225	745	752	290	1569	853	261	377	303	59	0	251
V/C Ratio(X)	1.00	1.34	1.40	0.90	0.80	0.80	1.26	0.15	0.26	0.68	0.00	0.84
Avail Cap(c_a), veh/h	225	745	752	298	1573	855	261	559	449	89	0	431
HCM Platoon Ratio	1.00	1.00	1.00	1.00	1.00	1.00	1.00	1.00	1.00	1.00	1.00	1.00
Upstream Filter(I)	1.00	1.00	1.00	1.00	1.00	1.00	1.00	1.00	1.00	1.00	0.00	1.00
Uniform Delay (d), s/veh	47.2	30.9	30.9	44.3	24.5	24.5	49.9	35.7	36.5	51.6	0.0	44.2
Incr Delay (d2), s/veh	61.1	163.0	188.0	27.5	2.7	4.9	143.6	0.2	0.5	13.1	0.0	7.5
Initial Q Delay(d3),s/veh	0.0	0.0	0.0	0.0	0.0	0.0	0.0	0.0	0.0	0.0	0.0	0.0
%ile BackOfQ(50%),veh/ln	9.6	51.1	56.8	8.7	12.7	14.3	8.6	1.2	1.8	1.3	0.0	6.0
Unsig. Movement Delay, s/veh												
LnGrp Delay(d),s/veh	108.3	193.9	218.9	71.7	27.2	29.4	193.5	35.9	37.0	64.7	0.0	51.7
LnGrp LOS	F	F	F	E	C	C	F	D	D	E	A	D
Approach Vol, veh/h		2278			2188			465			252	
Approach Delay, s/veh		196.9			33.2			147.3			53.7	
Approach LOS		F			C			F			D	
Timer - Assigned Phs	1	2	3	4	5	6	7	8				
Phs Duration (G+Y+Rc), s	21.8	52.4	12.1	21.5	17.6	56.6	7.6	26.0				
Change Period (Y+Rc), s	* 4.2	* 6.5	4.1	4.6	* 4.2	6.5	4.1	4.6				
Max Green Setting (Gmax), s	* 18	* 46	8.0	29.0	* 13	50.2	5.3	31.7				
Max Q Clear Time (g_c+I1), s	17.6	47.9	10.0	15.9	15.4	35.9	4.4	6.8				
Green Ext Time (p_c), s	0.0	0.0	0.0	1.0	0.0	7.2	0.0	0.5				

Intersection Summary

HCM 6th Ctrl Delay	116.4
HCM 6th LOS	F

Notes

* HCM 6th computational engine requires equal clearance times for the phases crossing the barrier.

Intersection

Intersection Delay, s/veh	9.1
Intersection LOS	A

Movement	EBT	EBR	WBL	WBT	NBL	NBR
Lane Configurations						
Traffic Vol, veh/h	100	92	47	139	88	43
Future Vol, veh/h	100	92	47	139	88	43
Peak Hour Factor	0.88	0.88	0.88	0.88	0.88	0.88
Heavy Vehicles, %	1	2	3	2	2	0
Mvmt Flow	114	105	53	158	100	49
Number of Lanes	1	0	1	1	1	0

Approach	EB	WB	NB
Opposing Approach	WB	EB	
Opposing Lanes	2	1	0
Conflicting Approach Left		NB	EB
Conflicting Lanes Left	0	1	1
Conflicting Approach Right	NB		WB
Conflicting Lanes Right	1	0	2
HCM Control Delay	9	9.2	9.1
HCM LOS	A	A	A

Lane	NBLn1	EBLn1	WBLn1	WBLn2
Vol Left, %	67%	0%	100%	0%
Vol Thru, %	0%	52%	0%	100%
Vol Right, %	33%	48%	0%	0%
Sign Control	Stop	Stop	Stop	Stop
Traffic Vol by Lane	131	192	47	139
LT Vol	88	0	47	0
Through Vol	0	100	0	139
RT Vol	43	92	0	0
Lane Flow Rate	149	218	53	158
Geometry Grp	2	5	7	7
Degree of Util (X)	0.201	0.264	0.083	0.223
Departure Headway (Hd)	4.85	4.356	5.599	5.079
Convergence, Y/N	Yes	Yes	Yes	Yes
Cap	738	823	640	706
Service Time	2.887	2.389	3.334	2.814
HCM Lane V/C Ratio	0.202	0.265	0.083	0.224
HCM Control Delay	9.1	9	8.8	9.3
HCM Lane LOS	A	A	A	A
HCM 95th-tile Q	0.7	1.1	0.3	0.9

Intersection	
Intersection Delay, s/veh	10.1
Intersection LOS	B

Movement	EBL	EBT	WBT	WBR	SBL	SBR
Lane Configurations						
Traffic Vol, veh/h	151	192	226	84	69	72
Future Vol, veh/h	151	192	226	84	69	72
Peak Hour Factor	0.90	0.90	0.90	0.90	0.90	0.90
Heavy Vehicles, %	1	0	2	0	4	3
Mvmt Flow	168	213	251	93	77	80
Number of Lanes	1	2	2	0	1	0

Approach	EB	WB	SB
Opposing Approach	WB	EB	
Opposing Lanes	2	3	0
Conflicting Approach Left			WB
Conflicting Lanes Left	1	0	2
Conflicting Approach Right		SB	EB
Conflicting Lanes Right	0	1	3
HCM Control Delay	9.3	10.5	11.1
HCM LOS	A	B	B

Lane	EBLn1	EBLn2	EBLn3	WBLn1	WBLn2	SBLn1
Vol Left, %	100%	0%	0%	0%	0%	49%
Vol Thru, %	0%	100%	100%	100%	47%	0%
Vol Right, %	0%	0%	0%	0%	53%	51%
Sign Control	Stop	Stop	Stop	Stop	Stop	Stop
Traffic Vol by Lane	151	96	96	151	159	141
LT Vol	151	0	0	0	0	69
Through Vol	0	96	96	151	75	0
RT Vol	0	0	0	0	84	72
Lane Flow Rate	168	107	107	167	177	157
Geometry Grp	7	7	7	8	8	7
Degree of Util (X)	0.273	0.158	0.107	0.274	0.269	0.267
Departure Headway (Hd)	5.964	5.442	3.627	5.882	5.475	6.13
Convergence, Y/N	Yes	Yes	Yes	Yes	Yes	Yes
Cap	606	663	969	614	660	589
Service Time	3.664	3.142	1.425	3.582	3.175	3.844
HCM Lane V/C Ratio	0.277	0.161	0.11	0.272	0.268	0.267
HCM Control Delay	10.9	9.2	6.9	10.8	10.2	11.1
HCM Lane LOS	B	A	A	B	B	B
HCM 95th-tile Q	1.1	0.6	0.4	1.1	1.1	1.1

Timings
19: Van Buren Bl. & Orange Terrace Pkwy.

West Campus Upper Plateau (JN 14064)

09/30/2022

Lane Group	EBL	EBT	EBR	WBL	WBT	WBR	NBL	NBT	NBR	SBL	SBT	SBR
Lane Configurations												
Traffic Volume (vph)	151	1491	59	39	1813	291	63	55	46	222	43	134
Future Volume (vph)	151	1491	59	39	1813	291	63	55	46	222	43	134
Turn Type	Prot	NA	Perm	Prot	NA	Perm	Prot	NA	Perm	Prot	NA	pm+ov
Protected Phases	5	2		1	6		3	8		7	4	5
Permitted Phases			2			6			8			4
Detector Phase	5	2	2	1	6	6	3	8	8	7	4	5
Switch Phase												
Minimum Initial (s)	5.0	10.0	10.0	5.0	10.0	10.0	5.0	5.0	5.0	10.0	10.0	5.0
Minimum Split (s)	9.2	25.2	25.2	9.1	25.2	25.2	9.1	26.1	26.1	15.8	24.8	9.2
Total Split (s)	16.0	63.0	63.0	11.0	58.0	58.0	12.0	27.0	27.0	19.0	34.0	16.0
Total Split (%)	13.3%	52.5%	52.5%	9.2%	48.3%	48.3%	10.0%	22.5%	22.5%	15.8%	28.3%	13.3%
Yellow Time (s)	3.2	5.2	5.2	3.6	5.2	5.2	3.6	3.6	3.6	4.8	4.8	3.2
All-Red Time (s)	1.0	1.0	1.0	0.5	1.0	1.0	0.5	0.5	0.5	1.0	1.0	1.0
Lost Time Adjust (s)	0.0	0.0	0.0	0.0	0.0	0.0	0.0	0.0	0.0	0.0	0.0	0.0
Total Lost Time (s)	4.2	6.2	6.2	4.1	6.2	6.2	4.1	4.1	4.1	5.8	5.8	4.2
Lead/Lag	Lead	Lag	Lag	Lead	Lag	Lag	Lead	Lag	Lag	Lead	Lag	Lead
Lead-Lag Optimize?	Yes	Yes	Yes	Yes	Yes	Yes	Yes	Yes	Yes	Yes	Yes	Yes
Recall Mode	None	None	None	None	None	None	None	None	None	None	None	None
Act Effct Green (s)	8.9	55.0	55.0	6.5	47.7	47.7	10.4	8.0	8.0	12.0	12.8	24.5
Actuated g/C Ratio	0.09	0.58	0.58	0.07	0.50	0.50	0.11	0.08	0.08	0.13	0.14	0.26
v/c Ratio	0.49	0.54	0.07	0.17	0.75	0.34	0.18	0.19	0.15	0.53	0.18	0.31
Control Delay	49.0	14.7	0.1	48.4	22.1	6.4	45.5	45.4	1.1	46.5	41.5	18.4
Queue Delay	0.0	0.0	0.0	0.0	0.0	0.0	0.0	0.0	0.0	0.0	0.0	0.0
Total Delay	49.0	14.7	0.1	48.4	22.1	6.4	45.5	45.4	1.1	46.5	41.5	18.4
LOS	D	B	A	D	C	A	D	D	A	D	D	B
Approach Delay		17.3			20.5			33.1			36.6	
Approach LOS		B			C			C			D	

Intersection Summary

Cycle Length: 120	
Actuated Cycle Length: 94.8	
Natural Cycle: 90	
Control Type: Actuated-Uncoordinated	
Maximum v/c Ratio: 0.75	
Intersection Signal Delay: 21.2	Intersection LOS: C
Intersection Capacity Utilization 65.8%	ICU Level of Service C
Analysis Period (min) 15	

Splits and Phases: 19: Van Buren Bl. & Orange Terrace Pkwy.

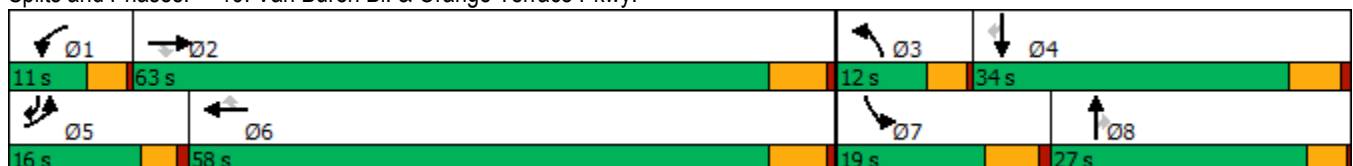

HCM 6th Signalized Intersection Summary
 19: Van Buren Bl. & Orange Terrace Pkwy.

West Campus Upper Plateau (JN 14064)

09/30/2022



Movement	EBL	EBT	EBR	WBL	WBT	WBR	NBL	NBT	NBR	SBL	SBT	SBR
Lane Configurations	↖↗	↑↑↑	↖	↖↗	↑↑↑	↖	↖↗	↑↑	↖	↖↗	↑	↖↗
Traffic Volume (veh/h)	151	1491	59	39	1813	291	63	55	46	222	43	134
Future Volume (veh/h)	151	1491	59	39	1813	291	63	55	46	222	43	134
Initial Q (Qb), veh	0	0	0	0	0	0	0	0	0	0	0	0
Ped-Bike Adj(A_pbT)	1.00		1.00	1.00		1.00	1.00		1.00	1.00		1.00
Parking Bus, Adj	1.00	1.00	1.00	1.00	1.00	1.00	1.00	1.00	1.00	1.00	1.00	1.00
Work Zone On Approach		No			No			No			No	
Adj Sat Flow, veh/h/ln	1885	1856	1811	1870	1856	1885	1796	1900	1856	1885	1900	1885
Adj Flow Rate, veh/h	159	1569	36	41	1908	246	66	58	16	234	45	67
Peak Hour Factor	0.95	0.95	0.95	0.95	0.95	0.95	0.95	0.95	0.95	0.95	0.95	0.95
Percent Heavy Veh, %	1	3	6	2	3	1	7	0	3	1	0	1
Cap, veh/h	236	2713	822	125	2549	804	153	209	91	404	280	344
Arrive On Green	0.07	0.54	0.54	0.04	0.50	0.50	0.05	0.06	0.06	0.12	0.15	0.15
Sat Flow, veh/h	3483	5066	1535	3456	5066	1598	3319	3610	1572	3483	1900	1598
Grp Volume(v), veh/h	159	1569	36	41	1908	246	66	58	16	234	45	67
Grp Sat Flow(s),veh/h/ln	1742	1689	1535	1728	1689	1598	1659	1805	1572	1742	1900	1598
Q Serve(g_s), s	3.8	18.0	1.0	1.0	25.9	7.8	1.7	1.3	0.8	5.5	1.8	3.0
Cycle Q Clear(g_c), s	3.8	18.0	1.0	1.0	25.9	7.8	1.7	1.3	0.8	5.5	1.8	3.0
Prop In Lane	1.00		1.00	1.00		1.00	1.00		1.00	1.00		1.00
Lane Grp Cap(c), veh/h	236	2713	822	125	2549	804	153	209	91	404	280	344
V/C Ratio(X)	0.67	0.58	0.04	0.33	0.75	0.31	0.43	0.28	0.18	0.58	0.16	0.19
Avail Cap(c_a), veh/h	477	3339	1012	277	3045	960	304	959	418	534	622	631
HCM Platoon Ratio	1.00	1.00	1.00	1.00	1.00	1.00	1.00	1.00	1.00	1.00	1.00	1.00
Upstream Filter(I)	1.00	1.00	1.00	1.00	1.00	1.00	1.00	1.00	1.00	1.00	1.00	1.00
Uniform Delay (d), s/veh	39.2	13.5	9.5	40.5	17.1	12.6	40.0	38.9	38.6	36.1	32.1	27.7
Incr Delay (d2), s/veh	1.3	0.2	0.0	1.5	0.9	0.2	1.9	0.7	0.9	1.3	0.3	0.3
Initial Q Delay(d3),s/veh	0.0	0.0	0.0	0.0	0.0	0.0	0.0	0.0	0.0	0.0	0.0	0.0
%ile BackOfQ(50%),veh/ln	1.6	5.6	0.3	0.4	8.5	2.7	0.7	0.6	0.3	2.3	0.8	1.1
Unsig. Movement Delay, s/veh												
LnGrp Delay(d),s/veh	40.5	13.7	9.5	42.0	17.9	12.8	41.9	39.6	39.5	37.4	32.3	28.0
LnGrp LOS	D	B	A	D	B	B	D	D	D	D	C	C
Approach Vol, veh/h		1764			2195			140			346	
Approach Delay, s/veh		16.0			17.8			40.7			34.9	
Approach LOS		B			B			D			C	
Timer - Assigned Phs	1	2	3	4	5	6	7	8				
Phs Duration (G+Y+Rc), s	7.2	52.4	8.1	18.5	10.0	49.6	15.8	10.8				
Change Period (Y+Rc), s	4.1	6.2	4.1	5.8	* 4.2	6.2	5.8	* 5.8				
Max Green Setting (Gmax), s	6.9	56.8	7.9	28.2	* 12	51.8	13.2	* 23				
Max Q Clear Time (g_c+I1), s	3.0	20.0	3.7	5.0	5.8	27.9	7.5	3.3				
Green Ext Time (p_c), s	0.0	14.0	0.0	0.3	0.1	15.5	0.4	0.3				

Intersection Summary

HCM 6th Ctrl Delay	19.1
HCM 6th LOS	B

Notes

* HCM 6th computational engine requires equal clearance times for the phases crossing the barrier.

Timings
20: Brown/San Gorgonio Dr & Alessandro Bl.

West Campus Upper Plateau (JN 14064)

09/30/2022



Lane Group	EBL	EBT	WBL	WBT	WBR	NBL	NBT	SBL	SBT	SBR
Lane Configurations	↖	↗↖↗	↖	↗↖↗	↖	↖	↗	↖	↗	↖
Traffic Volume (vph)	39	1608	4	1819	41	10	5	48	5	44
Future Volume (vph)	39	1608	4	1819	41	10	5	48	5	44
Turn Type	Prot	NA	Prot	NA	Perm	Prot	NA	Prot	NA	pm+ov
Protected Phases	5	2	1	6		3	8	7	4	5
Permitted Phases					6					4
Detector Phase	5	2	1	6	6	3	8	7	4	5
Switch Phase										
Minimum Initial (s)	5.0	10.0	5.0	10.0	10.0	5.0	5.0	5.0	10.0	5.0
Minimum Split (s)	8.7	43.5	9.1	43.5	43.5	9.1	26.1	8.7	49.8	8.7
Total Split (s)	8.7	52.0	9.1	52.4	52.4	9.1	39.3	19.6	49.8	8.7
Total Split (%)	7.3%	43.3%	7.6%	43.7%	43.7%	7.6%	32.8%	16.3%	41.5%	7.3%
Yellow Time (s)	3.2	5.5	3.6	5.5	5.5	3.6	3.6	3.2	4.8	3.2
All-Red Time (s)	0.5	1.0	0.5	1.0	1.0	0.5	0.5	0.5	1.0	0.5
Lost Time Adjust (s)	0.0	0.0	0.0	0.0	0.0	0.0	0.0	0.0	0.0	0.0
Total Lost Time (s)	3.7	6.5	4.1	6.5	6.5	4.1	4.1	3.7	5.8	3.7
Lead/Lag	Lead	Lag	Lead	Lag	Lag	Lead	Lag	Lead	Lag	Lead
Lead-Lag Optimize?	Yes	Yes	Yes	Yes	Yes	Yes	Yes	Yes	Yes	Yes
Recall Mode	None	None	None	None	None	None	None	None	None	None
Act Effct Green (s)	5.4	58.9	5.4	51.6	51.6	5.4	10.4	9.3	15.2	18.2
Actuated g/C Ratio	0.07	0.76	0.07	0.67	0.67	0.07	0.13	0.12	0.20	0.23
v/c Ratio	0.33	0.44	0.04	0.57	0.05	0.09	0.02	0.26	0.01	0.11
Control Delay	50.7	11.5	46.8	15.1	0.1	46.7	30.2	40.7	26.6	2.8
Queue Delay	0.0	0.0	0.0	0.0	0.0	0.0	0.0	0.0	0.0	0.0
Total Delay	50.7	11.5	46.8	15.1	0.1	46.7	30.2	40.7	26.6	2.8
LOS	D	B	D	B	A	D	C	D	C	A
Approach Delay		12.4		14.8			41.5		22.9	
Approach LOS		B		B			D		C	

Intersection Summary

Cycle Length: 120
 Actuated Cycle Length: 77.5
 Natural Cycle: 115
 Control Type: Actuated-Uncoordinated
 Maximum v/c Ratio: 0.57
 Intersection Signal Delay: 14.1
 Intersection LOS: B
 Intersection Capacity Utilization 55.6%
 ICU Level of Service B
 Analysis Period (min) 15

Splits and Phases: 20: Brown/San Gorgonio Dr & Alessandro Bl.

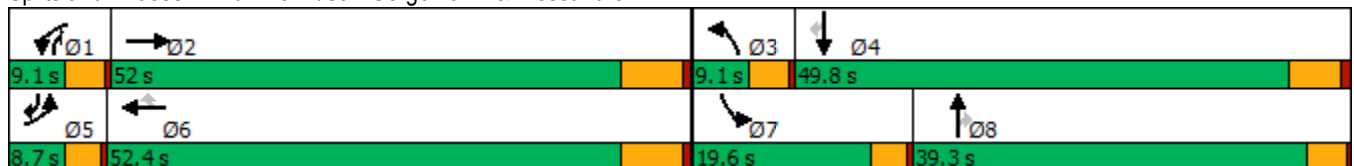

HCM 6th Signalized Intersection Summary
 20: Brown/San Gorgonio Dr & Alessandro Bl.

West Campus Upper Plateau (JN 14064)

09/30/2022



Movement	EBL	EBT	EBR	WBL	WBT	WBR	NBL	NBT	NBR	SBL	SBT	SBR
Lane Configurations	↖	↑↑↑		↖	↑↑↑	↖	↖	↑	↖	↖	↑	↖
Traffic Volume (veh/h)	39	1608	5	4	1819	41	10	5	0	48	5	44
Future Volume (veh/h)	39	1608	5	4	1819	41	10	5	0	48	5	44
Initial Q (Qb), veh	0	0	0	0	0	0	0	0	0	0	0	0
Ped-Bike Adj(A_pbT)	1.00		1.00	1.00		1.00	1.00		1.00	1.00		1.00
Parking Bus, Adj	1.00	1.00	1.00	1.00	1.00	1.00	1.00	1.00	1.00	1.00	1.00	1.00
Work Zone On Approach		No			No			No			No	
Adj Sat Flow, veh/h/ln	1900	1900	1900	1307	1885	1396	1796	1900	1322	1796	1900	1885
Adj Flow Rate, veh/h	42	1729	1	4	1956	40	11	5	-13	52	5	-2
Peak Hour Factor	0.93	0.93	0.93	0.93	0.93	0.93	0.93	0.93	0.93	0.93	0.93	0.93
Percent Heavy Veh, %	0	0	0	40	1	34	7	0	39	7	0	1
Cap, veh/h	72	3252	2	7	2978	685	23	113	72	77	162	199
Arrive On Green	0.04	0.61	0.61	0.01	0.58	0.58	0.01	0.06	0.00	0.05	0.09	0.00
Sat Flow, veh/h	1810	5354	3	1245	5147	1183	1711	1900	1120	1711	1900	1598
Grp Volume(v), veh/h	42	1117	613	4	1956	40	11	5	-13	52	5	-2
Grp Sat Flow(s),veh/h/ln	1810	1729	1899	1245	1716	1183	1711	1900	1120	1711	1900	1598
Q Serve(g_s), s	1.6	13.3	13.3	0.2	18.4	1.0	0.5	0.2	0.0	2.1	0.2	0.0
Cycle Q Clear(g_c), s	1.6	13.3	13.3	0.2	18.4	1.0	0.5	0.2	0.0	2.1	0.2	0.0
Prop In Lane	1.00		0.00	1.00		1.00	1.00		1.00	1.00		1.00
Lane Grp Cap(c), veh/h	72	2100	1154	7	2978	685	23	113	72	77	162	199
V/C Ratio(X)	0.59	0.53	0.53	0.60	0.66	0.06	0.47	0.04	-0.18	0.67	0.03	-0.01
Avail Cap(c_a), veh/h	127	2214	1216	88	3324	764	120	941	561	383	1176	1053
HCM Platoon Ratio	1.00	1.00	1.00	1.00	1.00	1.00	1.00	1.00	1.00	1.00	1.00	1.00
Upstream Filter(I)	1.00	1.00	1.00	1.00	1.00	1.00	1.00	1.00	0.00	1.00	1.00	0.00
Uniform Delay (d), s/veh	33.5	8.1	8.1	35.3	10.2	6.5	34.8	31.5	0.0	33.4	29.8	0.0
Incr Delay (d2), s/veh	2.8	0.3	0.6	64.8	0.5	0.1	13.8	0.2	0.0	3.8	0.1	0.0
Initial Q Delay(d3),s/veh	0.0	0.0	0.0	0.0	0.0	0.0	0.0	0.0	0.0	0.0	0.0	0.0
%ile BackOfQ(50%),veh/ln	0.7	3.2	3.6	0.2	5.9	0.2	0.3	0.1	0.0	0.9	0.1	0.0
Unsig. Movement Delay, s/veh												
LnGrp Delay(d),s/veh	36.3	8.4	8.6	100.1	10.7	6.6	48.6	31.7	0.0	37.2	29.9	0.0
LnGrp LOS	D	A	A	F	B	A	D	C	A	D	C	A
Approach Vol, veh/h		1772			2000			3				55
Approach Delay, s/veh		9.1			10.8			230.9				37.9
Approach LOS		A			B			F				D
Timer - Assigned Phs	1	2	3	4	5	6	7	8				
Phs Duration (G+Y+Rc), s	4.5	49.7	5.1	11.8	6.5	47.6	6.9	10.0				
Change Period (Y+Rc), s	4.1	6.5	4.1	5.8	3.7	6.5	3.7	* 5.8				
Max Green Setting (Gmax), s	5.0	45.5	5.0	44.0	5.0	45.9	15.9	* 35				
Max Q Clear Time (g_c+I1), s	2.2	15.3	2.5	2.2	3.6	20.4	4.1	2.2				
Green Ext Time (p_c), s	0.0	18.3	0.0	0.0	0.0	20.8	0.0	0.0				

Intersection Summary

HCM 6th Ctrl Delay	10.6
HCM 6th LOS	B

Notes

* HCM 6th computational engine requires equal clearance times for the phases crossing the barrier.

Timings
22: Sycamore Canyon Bl. & Eastridge Ave

West Campus Upper Plateau (JN 14064)

09/30/2022



Lane Group	EBL	EBT	EBR	WBL	WBT	WBR	NBL	NBT	NBR	SBL	SBT	SBR
Lane Configurations	↖↗	↑↑↑	↖	↖↗	↑↑	↖	↖↗	↑↑	↖	↖↗	↑↑	↖
Traffic Volume (vph)	52	88	21	248	69	397	59	387	92	154	163	40
Future Volume (vph)	52	88	21	248	69	397	59	387	92	154	163	40
Turn Type	Prot	NA	Perm	Prot	NA	pm+ov	Prot	NA	pm+ov	Prot	NA	pm+ov
Protected Phases	5	2		1	6	7	3	8	1	7	4	5
Permitted Phases			2			6			8			4
Detector Phase	5	2	2	1	6	7	3	8	1	7	4	5
Switch Phase												
Minimum Initial (s)	5.0	10.0	10.0	5.0	10.0	5.0	5.0	10.0	5.0	5.0	10.0	5.0
Minimum Split (s)	8.7	43.5	43.5	8.7	43.5	8.7	8.7	15.8	8.7	8.7	49.8	8.7
Total Split (s)	11.7	45.5	45.5	15.2	49.0	20.2	8.7	39.1	15.2	20.2	50.6	11.7
Total Split (%)	9.8%	37.9%	37.9%	12.7%	40.8%	16.8%	7.3%	32.6%	12.7%	16.8%	42.2%	9.8%
Yellow Time (s)	3.2	5.5	5.5	3.2	5.5	3.2	3.2	4.8	3.2	3.2	4.8	3.2
All-Red Time (s)	0.5	1.0	1.0	0.5	1.0	0.5	0.5	1.0	0.5	0.5	1.0	0.5
Lost Time Adjust (s)	0.0	0.0	0.0	0.0	0.0	0.0	0.0	0.0	0.0	0.0	0.0	0.0
Total Lost Time (s)	3.7	6.5	6.5	3.7	6.5	3.7	3.7	5.8	3.7	3.7	5.8	3.7
Lead/Lag	Lead	Lag	Lag	Lead	Lag	Lead	Lead	Lag	Lead	Lead	Lag	Lead
Lead-Lag Optimize?	Yes	Yes	Yes	Yes	Yes	Yes	Yes	Yes	Yes	Yes	Yes	Yes
Recall Mode	None	None	None	None	None	None	None	None	None	None	None	None
Act Effct Green (s)	10.4	13.7	13.7	11.8	16.1	25.7	5.4	14.5	28.6	9.3	22.9	35.6
Actuated g/C Ratio	0.16	0.21	0.21	0.18	0.25	0.39	0.08	0.22	0.44	0.14	0.35	0.55
v/c Ratio	0.12	0.10	0.05	0.42	0.11	0.59	0.26	0.54	0.13	0.34	0.14	0.06
Control Delay	32.3	23.1	0.2	31.3	20.5	10.7	37.3	27.5	3.9	31.9	19.1	2.2
Queue Delay	0.0	0.0	0.0	0.0	0.0	0.0	0.0	0.0	0.0	0.0	0.0	0.0
Total Delay	32.3	23.1	0.2	31.3	20.5	10.7	37.3	27.5	3.9	31.9	19.1	2.2
LOS	C	C	A	C	C	B	D	C	A	C	B	A
Approach Delay		23.1			18.8			24.5			22.7	
Approach LOS		C			B			C			C	

Intersection Summary

Cycle Length: 120
 Actuated Cycle Length: 65.3
 Natural Cycle: 115
 Control Type: Actuated-Uncoordinated
 Maximum v/c Ratio: 0.59
 Intersection Signal Delay: 21.7
 Intersection LOS: C
 Intersection Capacity Utilization 51.1%
 ICU Level of Service A
 Analysis Period (min) 15

Splits and Phases: 22: Sycamore Canyon Bl. & Eastridge Ave

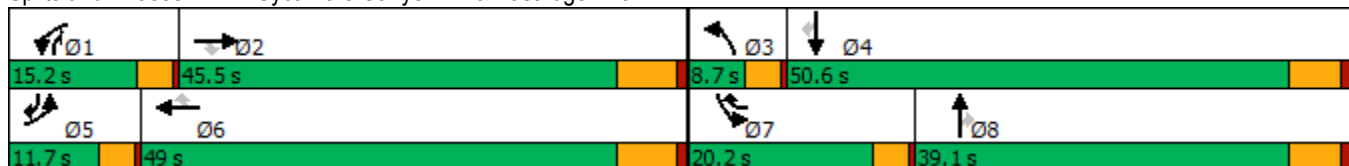

HCM 6th Signalized Intersection Summary
 22: Sycamore Canyon Bl. & Eastridge Ave

West Campus Upper Plateau (JN 14064)

09/30/2022



Movement	EBL	EBT	EBR	WBL	WBT	WBR	NBL	NBT	NBR	SBL	SBT	SBR
Lane Configurations	↔↔	↑↑↑	↔	↔↔	↑↑	↔	↔↔	↑↑	↔	↔↔	↑↑	↔
Traffic Volume (veh/h)	52	88	21	248	69	397	59	387	92	154	163	40
Future Volume (veh/h)	52	88	21	248	69	397	59	387	92	154	163	40
Initial Q (Qb), veh	0	0	0	0	0	0	0	0	0	0	0	0
Ped-Bike Adj(A_pbT)	1.00		1.00	1.00		1.00	1.00		0.99	1.00		0.99
Parking Bus, Adj	1.00	1.00	1.00	1.00	1.00	1.00	1.00	1.00	1.00	1.00	1.00	1.00
Work Zone On Approach		No			No			No			No	
Adj Sat Flow, veh/h/ln	1648	1589	1826	1856	1396	1796	1618	1796	1826	1841	1826	1530
Adj Flow Rate, veh/h	55	93	0	261	73	245	62	407	43	162	172	38
Peak Hour Factor	0.95	0.95	0.95	0.95	0.95	0.95	0.95	0.95	0.95	0.95	0.95	0.95
Percent Heavy Veh, %	17	21	5	3	34	7	19	7	5	4	5	25
Cap, veh/h	162	888		392	705	540	172	682	482	303	803	365
Arrive On Green	0.05	0.20	0.00	0.11	0.27	0.27	0.06	0.20	0.20	0.09	0.23	0.23
Sat Flow, veh/h	3045	4337	1547	3428	2653	1521	2990	3413	1527	3401	3469	1278
Grp Volume(v), veh/h	55	93	0	261	73	245	62	407	43	162	172	38
Grp Sat Flow(s),veh/h/ln	1522	1446	1547	1714	1326	1521	1495	1706	1527	1700	1735	1278
Q Serve(g_s), s	0.9	0.9	0.0	3.7	1.0	6.2	1.0	5.4	1.0	2.3	2.0	1.1
Cycle Q Clear(g_c), s	0.9	0.9	0.0	3.7	1.0	6.2	1.0	5.4	1.0	2.3	2.0	1.1
Prop In Lane	1.00		1.00	1.00		1.00	1.00		1.00	1.00		1.00
Lane Grp Cap(c), veh/h	162	888		392	705	540	172	682	482	303	803	365
V/C Ratio(X)	0.34	0.10		0.67	0.10	0.45	0.36	0.60	0.09	0.53	0.21	0.10
Avail Cap(c_a), veh/h	485	3365		784	2242	1421	297	2260	1188	1116	3091	1208
HCM Platoon Ratio	1.00	1.00	1.00	1.00	1.00	1.00	1.00	1.00	1.00	1.00	1.00	1.00
Upstream Filter(I)	1.00	1.00	0.00	1.00	1.00	1.00	1.00	1.00	1.00	1.00	1.00	1.00
Uniform Delay (d), s/veh	22.9	16.2	0.0	21.3	13.9	12.5	22.8	18.3	12.2	21.9	15.6	13.3
Incr Delay (d2), s/veh	0.5	0.1	0.0	0.7	0.1	0.8	0.5	0.8	0.1	0.5	0.1	0.1
Initial Q Delay(d3),s/veh	0.0	0.0	0.0	0.0	0.0	0.0	0.0	0.0	0.0	0.0	0.0	0.0
%ile BackOfQ(50%),veh/ln	0.3	0.2	0.0	1.3	0.3	1.7	0.3	1.8	0.3	0.8	0.7	0.3
Unsig. Movement Delay, s/veh												
LnGrp Delay(d),s/veh	23.4	16.3	0.0	22.1	14.0	13.3	23.3	19.1	12.2	22.4	15.8	13.4
LnGrp LOS	C	B		C	B	B	C	B	B	C	B	B
Approach Vol, veh/h		148			579			512			372	
Approach Delay, s/veh		18.9			17.4			19.0			18.4	
Approach LOS		B			B			B			B	
Timer - Assigned Phs	1	2	3	4	5	6	7	8				
Phs Duration (G+Y+Rc), s	9.5	16.8	6.6	17.4	6.4	19.9	8.2	15.8				
Change Period (Y+Rc), s	3.7	6.5	3.7	5.8	3.7	6.5	3.7	5.8				
Max Green Setting (Gmax), s	11.5	39.0	5.0	44.8	8.0	42.5	16.5	33.3				
Max Q Clear Time (g_c+1), s	5.7	2.9	3.0	4.0	2.9	8.2	4.3	7.4				
Green Ext Time (p_c), s	0.2	0.7	0.0	1.1	0.0	2.0	0.2	2.6				

Intersection Summary

HCM 6th Ctrl Delay	18.3
HCM 6th LOS	B

Notes

Unsignalized Delay for [EBR] is excluded from calculations of the approach delay and intersection delay.

Timings
23: Sycamore Canyon Bl. & Cottonwood Ave

West Campus Upper Plateau (JN 14064)

09/30/2022



Lane Group	WBL	WBR	NBT	SBL	SBT
Lane Configurations	↙	↗	↕↔	↙	↕↕
Traffic Volume (vph)	8	25	461	24	473
Future Volume (vph)	8	25	461	24	473
Turn Type	Prot	Perm	NA	Prot	NA
Protected Phases	8		2	1	6
Permitted Phases		8			
Detector Phase	8	8	2	1	6
Switch Phase					
Minimum Initial (s)	10.0	10.0	10.0	5.0	10.0
Minimum Split (s)	15.8	15.8	43.5	9.1	43.5
Total Split (s)	23.0	23.0	78.0	19.0	97.0
Total Split (%)	19.2%	19.2%	65.0%	15.8%	80.8%
Yellow Time (s)	4.8	4.8	5.5	3.6	5.5
All-Red Time (s)	1.0	1.0	1.0	0.5	1.0
Lost Time Adjust (s)	0.0	0.0	0.0	0.0	0.0
Total Lost Time (s)	5.8	5.8	6.5	4.1	6.5
Lead/Lag			Lag	Lead	
Lead-Lag Optimize?			Yes	Yes	
Recall Mode	None	None	None	None	None
Act Effect Green (s)	12.7	12.7	22.5	7.7	23.8
Actuated g/C Ratio	0.43	0.43	0.76	0.26	0.80
v/c Ratio	0.01	0.06	0.20	0.07	0.18
Control Delay	14.8	8.7	6.0	16.7	3.7
Queue Delay	0.0	0.0	0.0	0.0	0.0
Total Delay	14.8	8.7	6.0	16.7	3.7
LOS	B	A	A	B	A
Approach Delay	10.2		6.0		4.4
Approach LOS	B		A		A

Intersection Summary

Cycle Length: 120
 Actuated Cycle Length: 29.6
 Natural Cycle: 70
 Control Type: Actuated-Uncoordinated
 Maximum v/c Ratio: 0.20
 Intersection Signal Delay: 5.3
 Intersection LOS: A
 Intersection Capacity Utilization 38.5%
 ICU Level of Service A
 Analysis Period (min) 15

Splits and Phases: 23: Sycamore Canyon Bl. & Cottonwood Ave



HCM 6th Signalized Intersection Summary
 23: Sycamore Canyon Bl. & Cottonwood Ave

West Campus Upper Plateau (JN 14064)

09/30/2022



Movement	WBL	WBR	NBT	NBR	SBL	SBT
Lane Configurations	↶	↷	↕	↗	↘	↙
Traffic Volume (veh/h)	8	25	461	14	24	473
Future Volume (veh/h)	8	25	461	14	24	473
Initial Q (Qb), veh	0	0	0	0	0	0
Ped-Bike Adj(A_pbT)	1.00	1.00		0.98	1.00	
Parking Bus, Adj	1.00	1.00	1.00	1.00	1.00	1.00
Work Zone On Approach	No		No			No
Adj Sat Flow, veh/h/ln	1574	1070	1796	1752	1485	1870
Adj Flow Rate, veh/h	9	17	496	14	26	509
Peak Hour Factor	0.93	0.93	0.93	0.93	0.93	0.93
Percent Heavy Veh, %	22	56	7	10	28	2
Cap, veh/h	98	59	1162	33	46	1831
Arrive On Green	0.07	0.07	0.34	0.34	0.03	0.52
Sat Flow, veh/h	1499	907	3477	95	1414	3647
Grp Volume(v), veh/h	9	17	250	260	26	509
Grp Sat Flow(s),veh/h/ln	1499	907	1706	1776	1414	1777
Q Serve(g_s), s	0.2	0.5	3.3	3.3	0.5	2.4
Cycle Q Clear(g_c), s	0.2	0.5	3.3	3.3	0.5	2.4
Prop In Lane	1.00	1.00		0.05	1.00	
Lane Grp Cap(c), veh/h	98	59	585	609	46	1831
V/C Ratio(X)	0.09	0.29	0.43	0.43	0.56	0.28
Avail Cap(c_a), veh/h	880	532	4162	4333	719	10971
HCM Platoon Ratio	1.00	1.00	1.00	1.00	1.00	1.00
Upstream Filter(I)	1.00	1.00	1.00	1.00	1.00	1.00
Uniform Delay (d), s/veh	12.9	13.1	7.4	7.4	14.0	4.0
Incr Delay (d2), s/veh	0.4	2.6	0.7	0.7	10.4	0.1
Initial Q Delay(d3),s/veh	0.0	0.0	0.0	0.0	0.0	0.0
%ile BackOfQ(50%),veh/ln	0.1	0.1	0.6	0.7	0.2	0.1
Unsig. Movement Delay, s/veh						
LnGrp Delay(d),s/veh	13.3	15.7	8.1	8.1	24.4	4.1
LnGrp LOS	B	B	A	A	C	A
Approach Vol, veh/h	26		510			535
Approach Delay, s/veh	14.9		8.1			5.1
Approach LOS	B		A			A
Timer - Assigned Phs	1	2			6	8
Phs Duration (G+Y+Rc), s	5.1	16.6			21.6	7.7
Change Period (Y+Rc), s	4.1	6.5			6.5	5.8
Max Green Setting (Gmax), s	14.9	71.5			90.5	17.2
Max Q Clear Time (g_c+I1), s	2.5	5.3			4.4	2.5
Green Ext Time (p_c), s	0.0	4.6			5.1	0.0
Intersection Summary						
HCM 6th Ctrl Delay			6.8			
HCM 6th LOS			A			

Timings

West Campus Upper Plateau (JN 14064)

24: Sycamore Canyon Bl. & Alessandro Bl.

09/30/2022

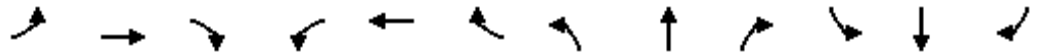

Lane Group	EBL	EBT	EBR	WBL	WBT	WBR	NBL	NBT	NBR	SBL	SBT	SBR
Lane Configurations	↖	↗↗↗	↘	↖↖↖	↗↗↗	↘	↖↖↖	↗↗	↘↘	↖↖	↗↗	↘↘
Traffic Volume (vph)	125	1364	121	72	1541	112	219	182	24	73	204	67
Future Volume (vph)	125	1364	121	72	1541	112	219	182	24	73	204	67
Turn Type	Prot	NA	Perm	Prot	NA	Perm	Prot	NA	pm+ov	Prot	NA	Perm
Protected Phases	5	2		1	6		3	8	1	7	4	
Permitted Phases			2			6			8			4
Detector Phase	5	2	2	1	6	6	3	8	1	7	4	4
Switch Phase												
Minimum Initial (s)	5.0	10.0	10.0	5.0	10.0	10.0	5.0	10.0	5.0	5.0	10.0	10.0
Minimum Split (s)	8.7	43.5	43.5	8.7	43.5	43.5	8.7	15.8	8.7	8.7	49.8	49.8
Total Split (s)	10.0	44.2	44.2	12.0	46.2	46.2	14.0	51.0	12.0	12.8	49.8	49.8
Total Split (%)	8.3%	36.8%	36.8%	10.0%	38.5%	38.5%	11.7%	42.5%	10.0%	10.7%	41.5%	41.5%
Yellow Time (s)	3.2	5.5	5.5	3.2	5.5	5.5	3.2	4.8	3.2	3.2	4.8	4.8
All-Red Time (s)	0.5	1.0	1.0	0.5	1.0	1.0	0.5	1.0	0.5	0.5	1.0	1.0
Lost Time Adjust (s)	0.0	0.0	0.0	0.0	0.0	0.0	0.0	0.0	0.0	0.0	0.0	0.0
Total Lost Time (s)	3.7	6.5	6.5	3.7	6.5	6.5	3.7	5.8	3.7	3.7	5.8	5.8
Lead/Lag	Lead	Lag	Lag	Lead	Lag	Lag	Lead	Lag	Lead	Lead	Lag	Lag
Lead-Lag Optimize?	Yes	Yes	Yes	Yes	Yes	Yes	Yes	Yes	Yes	Yes	Yes	Yes
Recall Mode	None	None	None	None	None	None	None	None	None	None	None	None
Act Effct Green (s)	6.4	41.7	41.7	6.6	39.9	39.9	9.7	21.1	33.5	6.6	15.9	15.9
Actuated g/C Ratio	0.07	0.45	0.45	0.07	0.43	0.43	0.11	0.23	0.36	0.07	0.17	0.17
v/c Ratio	1.06	0.62	0.16	0.34	0.73	0.17	0.64	0.24	0.02	0.32	0.36	0.20
Control Delay	140.0	23.5	8.4	48.2	25.9	7.7	50.2	29.8	0.0	47.4	34.1	3.5
Queue Delay	0.0	0.0	0.0	0.0	0.0	0.0	0.0	0.0	0.0	0.0	0.0	0.0
Total Delay	140.0	23.5	8.4	48.2	25.9	7.7	50.2	29.8	0.0	47.4	34.1	3.5
LOS	F	C	A	D	C	A	D	C	A	D	C	A
Approach Delay		31.5			25.7			38.7			30.9	
Approach LOS		C			C			D			C	

Intersection Summary

Cycle Length: 120	
Actuated Cycle Length: 92.1	
Natural Cycle: 115	
Control Type: Actuated-Uncoordinated	
Maximum v/c Ratio: 1.06	
Intersection Signal Delay: 29.7	Intersection LOS: C
Intersection Capacity Utilization 68.2%	ICU Level of Service C
Analysis Period (min) 15	



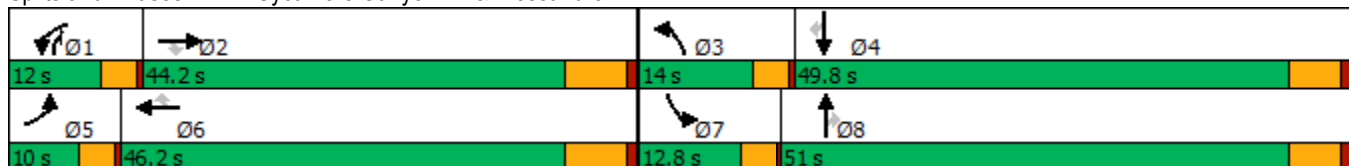































Splits and Phases: 24: Sycamore Canyon Bl. & Alessandro Bl.



HCM 6th Signalized Intersection Summary
 24: Sycamore Canyon Bl. & Alessandro Bl.

West Campus Upper Plateau (JN 14064)

09/30/2022

												
Movement	EBL	EBT	EBR	WBL	WBT	WBR	NBL	NBT	NBR	SBL	SBT	SBR
Lane Configurations		  		 	  		 	 	 	 	 	
Traffic Volume (veh/h)	125	1364	121	72	1541	112	219	182	24	73	204	67
Future Volume (veh/h)	125	1364	121	72	1541	112	219	182	24	73	204	67
Initial Q (Qb), veh	0	0	0	0	0	0	0	0	0	0	0	0
Ped-Bike Adj(A_pbT)	1.00		1.00	1.00		1.00	1.00		1.00	1.00		1.00
Parking Bus, Adj	1.00	1.00	1.00	1.00	1.00	1.00	1.00	1.00	1.00	1.00	1.00	1.00
Work Zone On Approach		No			No			No			No	
Adj Sat Flow, veh/h/ln	1900	1885	1885	1737	1885	1781	1870	1841	1841	1826	1826	1870
Adj Flow Rate, veh/h	132	1436	-70	76	1622	-17	231	192	-18	77	215	-24
Peak Hour Factor	0.95	0.95	0.95	0.95	0.95	0.95	0.95	0.95	0.95	0.95	0.95	0.95
Percent Heavy Veh, %	0	1	1	11	1	8	2	4	4	5	5	2
Cap, veh/h	147	2441	758	166	2291	672	317	589	604	176	446	204
Arrive On Green	0.08	0.47	0.00	0.05	0.45	0.00	0.09	0.17	0.00	0.05	0.13	0.00
Sat Flow, veh/h	1810	5147	1598	3209	5147	1510	3456	3497	2745	3374	3469	1585
Grp Volume(v), veh/h	132	1436	-70	76	1622	-17	231	192	-18	77	215	-24
Grp Sat Flow(s),veh/h/ln	1810	1716	1598	1605	1716	1510	1728	1749	1373	1687	1735	1585
Q Serve(g_s), s	5.6	15.8	0.0	1.8	19.9	0.0	5.1	3.8	0.0	1.7	4.5	0.0
Cycle Q Clear(g_c), s	5.6	15.8	0.0	1.8	19.9	0.0	5.1	3.8	0.0	1.7	4.5	0.0
Prop In Lane	1.00		1.00	1.00		1.00	1.00		1.00	1.00		1.00
Lane Grp Cap(c), veh/h	147	2441	758	166	2291	672	317	589	604	176	446	204
V/C Ratio(X)	0.90	0.59	-0.09	0.46	0.71	-0.03	0.73	0.33	-0.03	0.44	0.48	-0.12
Avail Cap(c_a), veh/h	147	2495	775	343	2628	771	458	2033	1738	395	1963	897
HCM Platoon Ratio	1.00	1.00	1.00	1.00	1.00	1.00	1.00	1.00	1.00	1.00	1.00	1.00
Upstream Filter(I)	1.00	1.00	0.00	1.00	1.00	0.00	1.00	1.00	0.00	1.00	1.00	0.00
Uniform Delay (d), s/veh	35.4	14.9	0.0	35.8	17.5	0.0	34.4	28.5	0.0	35.7	31.5	0.0
Incr Delay (d2), s/veh	45.1	0.4	0.0	0.7	0.9	0.0	1.3	0.3	0.0	0.6	0.8	0.0
Initial Q Delay(d3),s/veh	0.0	0.0	0.0	0.0	0.0	0.0	0.0	0.0	0.0	0.0	0.0	0.0
%ile BackOfQ(50%),veh/ln	4.2	5.3	0.0	0.7	6.8	0.0	2.0	1.5	0.0	0.7	1.8	0.0
Unsig. Movement Delay, s/veh												
LnGrp Delay(d),s/veh	80.6	15.3	0.0	36.5	18.4	0.0	35.7	28.8	0.0	36.4	32.3	0.0
LnGrp LOS	F	B	A	D	B	A	D	C	A	D	C	A
Approach Vol, veh/h		1498			1681			405			268	
Approach Delay, s/veh		21.8			19.4			34.0			36.4	
Approach LOS		C			B			C			D	
Timer - Assigned Phs	1	2	3	4	5	6	7	8				
Phs Duration (G+Y+Rc), s	7.7	43.4	10.8	15.8	10.0	41.1	7.8	18.9				
Change Period (Y+Rc), s	3.7	6.5	3.7	5.8	3.7	6.5	3.7	5.8				
Max Green Setting (Gmax), s	8.3	37.7	10.3	44.0	6.3	39.7	9.1	45.2				
Max Q Clear Time (g_c+1), s	3.8	17.8	7.1	6.5	7.6	21.9	3.7	5.8				
Green Ext Time (p_c), s	0.0	12.4	0.1	1.3	0.0	12.8	0.0	1.1				
Intersection Summary												
HCM 6th Ctrl Delay				23.0								
HCM 6th LOS				C								

Timings
25: Sycamore Canyon Bl. & Cactus Av.

West Campus Upper Plateau (JN 14064)

09/30/2022



Lane Group	EBL	EBT	EBR	WBL	WBT	WBR	NBL	NBT	NBR	SBL	SBT	SBR
Lane Configurations	↘	↑↑	↗	↘↗	↑↑	↗	↘↗	↑↑	↗	↘↗	↑↑	↗
Traffic Volume (vph)	27	83	32	232	89	285	30	200	140	139	260	14
Future Volume (vph)	27	83	32	232	89	285	30	200	140	139	260	14
Turn Type	Prot	NA	Perm	Prot	NA	Perm	Prot	NA	Perm	Prot	NA	Perm
Protected Phases	7	4		3	8		5	2		1	6	
Permitted Phases			4			8			2			6
Detector Phase	7	4	4	3	8	8	5	2	2	1	6	6
Switch Phase												
Minimum Initial (s)	5.0	10.0	10.0	5.0	10.0	10.0	5.0	10.0	10.0	5.0	10.0	10.0
Minimum Split (s)	9.6	32.8	32.8	9.6	32.8	32.8	9.6	34.8	34.8	9.6	34.8	34.8
Total Split (s)	10.3	32.8	32.8	29.0	51.5	51.5	9.6	36.2	36.2	22.0	48.6	48.6
Total Split (%)	8.6%	27.3%	27.3%	24.2%	42.9%	42.9%	8.0%	30.2%	30.2%	18.3%	40.5%	40.5%
Yellow Time (s)	3.6	4.8	4.8	3.6	4.8	4.8	3.6	4.8	4.8	3.6	4.8	4.8
All-Red Time (s)	1.0	1.0	1.0	1.0	1.0	1.0	1.0	1.0	1.0	1.0	1.0	1.0
Lost Time Adjust (s)	0.0	0.0	0.0	0.0	0.0	0.0	0.0	0.0	0.0	0.0	0.0	0.0
Total Lost Time (s)	4.6	5.8	5.8	4.6	5.8	5.8	4.6	5.8	5.8	4.6	5.8	5.8
Lead/Lag	Lead	Lag	Lag	Lead	Lag	Lag	Lead	Lag	Lag	Lead	Lag	Lag
Lead-Lag Optimize?	Yes	Yes	Yes	Yes	Yes	Yes	Yes	Yes	Yes	Yes	Yes	Yes
Recall Mode	None	None	None	None	None	None	None	None	None	None	None	None
Act Effct Green (s)	6.1	13.5	13.5	11.7	21.1	21.1	5.7	13.7	13.7	7.8	19.9	19.9
Actuated g/C Ratio	0.10	0.22	0.22	0.19	0.35	0.35	0.09	0.23	0.23	0.13	0.33	0.33
v/c Ratio	0.16	0.12	0.07	0.38	0.08	0.40	0.09	0.27	0.30	0.33	0.25	0.03
Control Delay	36.8	24.0	0.3	29.2	17.1	4.7	35.1	23.9	3.5	32.2	18.3	0.1
Queue Delay	0.0	0.0	0.0	0.0	0.0	0.0	0.0	0.0	0.0	0.0	0.0	0.0
Total Delay	36.8	24.0	0.3	29.2	17.1	4.7	35.1	23.9	3.5	32.2	18.3	0.1
LOS	D	C	A	C	B	A	D	C	A	C	B	A
Approach Delay		21.1			15.9			17.0			22.3	
Approach LOS		C			B			B			C	

Intersection Summary

Cycle Length: 120
 Actuated Cycle Length: 60.8
 Natural Cycle: 90
 Control Type: Actuated-Uncoordinated
 Maximum v/c Ratio: 0.40
 Intersection Signal Delay: 18.4
 Intersection LOS: B
 Intersection Capacity Utilization 43.6%
 ICU Level of Service A
 Analysis Period (min) 15



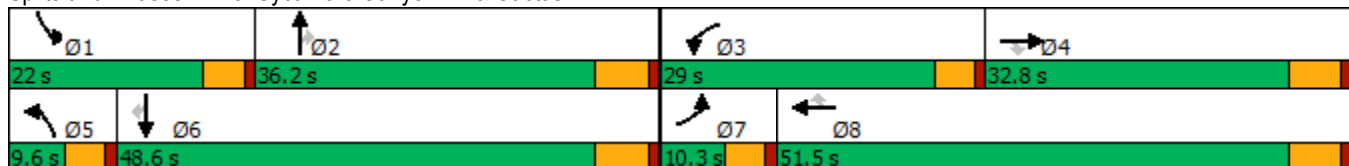





















Splits and Phases: 25: Sycamore Canyon Bl. & Cactus Av.



HCM 6th Signalized Intersection Summary
 25: Sycamore Canyon Bl. & Cactus Av.

West Campus Upper Plateau (JN 14064)

09/30/2022

												
Movement	EBL	EBT	EBR	WBL	WBT	WBR	NBL	NBT	NBR	SBL	SBT	SBR
Lane Configurations												
Traffic Volume (veh/h)	27	83	32	232	89	285	30	200	140	139	260	14
Future Volume (veh/h)	27	83	32	232	89	285	30	200	140	139	260	14
Initial Q (Qb), veh	0	0	0	0	0	0	0	0	0	0	0	0
Ped-Bike Adj(A_pbT)	1.00		1.00	1.00		1.00	1.00		1.00	1.00		1.00
Parking Bus, Adj	1.00	1.00	1.00	1.00	1.00	1.00	1.00	1.00	1.00	1.00	1.00	1.00
Work Zone On Approach		No			No			No			No	
Adj Sat Flow, veh/h/ln	1811	1678	1796	1826	1796	1870	1900	1811	1781	1885	1796	1011
Adj Flow Rate, veh/h	28	86	24	242	93	55	31	208	53	145	271	15
Peak Hour Factor	0.96	0.96	0.96	0.96	0.96	0.96	0.96	0.96	0.96	0.96	0.96	0.96
Percent Heavy Veh, %	6	15	7	5	7	2	0	6	8	1	7	60
Cap, veh/h	55	618	295	377	934	434	123	679	298	299	848	213
Arrive On Green	0.03	0.19	0.19	0.11	0.27	0.27	0.03	0.20	0.20	0.09	0.25	0.25
Sat Flow, veh/h	1725	3188	1522	3374	3413	1585	3510	3441	1510	3483	3413	857
Grp Volume(v), veh/h	28	86	24	242	93	55	31	208	53	145	271	15
Grp Sat Flow(s),veh/h/ln	1725	1594	1522	1687	1706	1585	1755	1721	1510	1742	1706	857
Q Serve(g_s), s	0.8	1.1	0.7	3.5	1.0	1.3	0.4	2.6	1.5	2.0	3.3	0.7
Cycle Q Clear(g_c), s	0.8	1.1	0.7	3.5	1.0	1.3	0.4	2.6	1.5	2.0	3.3	0.7
Prop In Lane	1.00		1.00	1.00		1.00	1.00		1.00	1.00		1.00
Lane Grp Cap(c), veh/h	55	618	295	377	934	434	123	679	298	299	848	213
V/C Ratio(X)	0.50	0.14	0.08	0.64	0.10	0.13	0.25	0.31	0.18	0.48	0.32	0.07
Avail Cap(c_a), veh/h	194	1700	812	1626	3081	1431	347	2066	906	1197	2885	724
HCM Platoon Ratio	1.00	1.00	1.00	1.00	1.00	1.00	1.00	1.00	1.00	1.00	1.00	1.00
Upstream Filter(I)	1.00	1.00	1.00	1.00	1.00	1.00	1.00	1.00	1.00	1.00	1.00	1.00
Uniform Delay (d), s/veh	24.1	16.9	16.7	21.5	13.7	13.8	23.8	17.4	16.9	22.1	15.5	14.6
Incr Delay (d2), s/veh	2.6	0.1	0.1	0.7	0.0	0.1	0.4	0.3	0.3	0.5	0.2	0.1
Initial Q Delay(d3),s/veh	0.0	0.0	0.0	0.0	0.0	0.0	0.0	0.0	0.0	0.0	0.0	0.0
%ile BackOfQ(50%),veh/ln	0.3	0.4	0.2	1.2	0.3	0.4	0.2	0.9	0.4	0.7	1.1	0.1
Unsig. Movement Delay, s/veh												
LnGrp Delay(d),s/veh	26.7	17.0	16.8	22.2	13.8	14.0	24.2	17.6	17.2	22.5	15.7	14.7
LnGrp LOS	C	B	B	C	B	B	C	B	B	C	B	B
Approach Vol, veh/h		138			390			292			431	
Approach Delay, s/veh		18.9			19.0			18.2			18.0	
Approach LOS		B			B			B			B	
Timer - Assigned Phs	1	2	3	4	5	6	7	8				
Phs Duration (G+Y+Rc), s	8.9	15.8	10.3	15.6	6.4	18.4	6.2	19.7				
Change Period (Y+Rc), s	4.6	5.8	4.6	5.8	4.6	5.8	4.6	5.8				
Max Green Setting (Gmax), s	17.4	30.4	24.4	27.0	5.0	42.8	5.7	45.7				
Max Q Clear Time (g_c+I1), s	4.0	4.6	5.5	3.1	2.4	5.3	2.8	3.3				
Green Ext Time (p_c), s	0.2	1.3	0.4	0.5	0.0	1.7	0.0	0.7				
Intersection Summary												
HCM 6th Ctrl Delay				18.5								
HCM 6th LOS				B								

Timings

26: Sycamore Canyon Bl. & Van Buren Bl.

09/30/2022



Lane Group	EBL	EBT	EBR	WBL	WBT	WBR	NBL	NBT	SBL	SBT	SBR
Lane Configurations											
Traffic Volume (vph)	214	1633	7	40	1747	42	8	7	76	11	457
Future Volume (vph)	214	1633	7	40	1747	42	8	7	76	11	457
Turn Type	Prot	NA	Perm	Prot	NA	Perm	Perm	NA	Split	NA	Perm
Protected Phases	5	2		1	6			8	4	4	
Permitted Phases			2			6	8				4
Detector Phase	5	2	2	1	6	6	8	8	4	4	4
Switch Phase											
Minimum Initial (s)	5.0	10.0	10.0	5.0	10.0	10.0	10.0	10.0	10.0	10.0	10.0
Minimum Split (s)	9.6	29.2	29.2	9.6	29.2	29.2	14.6	14.6	50.8	50.8	50.8
Total Split (s)	22.0	47.8	47.8	9.6	35.4	35.4	14.6	14.6	58.0	58.0	58.0
Total Split (%)	16.9%	36.8%	36.8%	7.4%	27.2%	27.2%	11.2%	11.2%	44.6%	44.6%	44.6%
Yellow Time (s)	3.6	5.2	5.2	3.6	5.2	5.2	3.6	3.6	4.8	4.8	4.8
All-Red Time (s)	1.0	1.0	1.0	1.0	1.0	1.0	1.0	1.0	1.0	1.0	1.0
Lost Time Adjust (s)	0.0	0.0	0.0	0.0	0.0	0.0		0.0	0.0	0.0	0.0
Total Lost Time (s)	4.6	6.2	6.2	4.6	6.2	6.2		4.6	5.8	5.8	5.8
Lead/Lag	Lead	Lag	Lag	Lead	Lag	Lag					
Lead-Lag Optimize?	Yes	Yes	Yes	Yes	Yes	Yes					
Recall Mode	None	None	None	None	None	None	None	None	None	None	None
Act Effct Green (s)	10.6	40.1	40.1	5.3	32.2	32.2		10.6	16.1	16.1	16.1
Actuated g/C Ratio	0.13	0.48	0.48	0.06	0.38	0.38		0.13	0.19	0.19	0.19
v/c Ratio	0.54	0.58	0.01	0.42	0.79	0.06		0.10	0.12	0.03	0.73
Control Delay	43.0	20.9	0.0	59.6	29.4	0.2		25.6	29.5	28.8	11.1
Queue Delay	0.0	0.0	0.0	0.0	0.0	0.0		0.0	0.0	0.0	0.0
Total Delay	43.0	20.9	0.0	59.6	29.4	0.2		25.6	29.5	28.8	11.1
LOS	D	C	A	E	C	A		C	C	C	B
Approach Delay		23.4			29.3			25.6		14.0	
Approach LOS		C			C			C		B	

Intersection Summary

Cycle Length: 130	
Actuated Cycle Length: 84.3	
Natural Cycle: 115	
Control Type: Actuated-Uncoordinated	
Maximum v/c Ratio: 0.79	
Intersection Signal Delay: 24.8	Intersection LOS: C
Intersection Capacity Utilization 75.8%	ICU Level of Service D
Analysis Period (min) 15	

Splits and Phases: 26: Sycamore Canyon Bl. & Van Buren Bl.

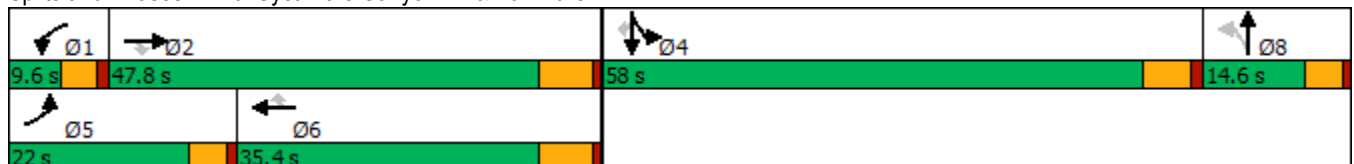

HCM 6th Signalized Intersection Summary
 26: Sycamore Canyon Bl. & Van Buren Bl.

West Campus Upper Plateau (JN 14064)

09/30/2022



Movement	EBL	EBT	EBR	WBL	WBT	WBR	NBL	NBT	NBR	SBL	SBT	SBR
Lane Configurations	↔↔	↑↑↑	↔	↔	↑↑↑	↔		↔↔		↔↔	↑	↔
Traffic Volume (veh/h)	214	1633	7	40	1747	42	8	7	22	76	11	457
Future Volume (veh/h)	214	1633	7	40	1747	42	8	7	22	76	11	457
Initial Q (Qb), veh	0	0	0	0	0	0	0	0	0	0	0	0
Ped-Bike Adj(A_pbT)	1.00		1.00	1.00		0.99	1.00		1.00	1.00		1.00
Parking Bus, Adj	1.00	1.00	1.00	1.00	1.00	1.00	1.00	1.00	1.00	1.00	1.00	1.00
Work Zone On Approach		No			No			No			No	
Adj Sat Flow, veh/h/ln	1811	1826	1900	1693	1796	1870	1900	1900	1900	1841	1900	1841
Adj Flow Rate, veh/h	225	1719	7	42	1839	22	8	7	-6	80	12	0
Peak Hour Factor	0.95	0.95	0.95	0.95	0.95	0.95	0.95	0.95	0.95	0.95	0.95	0.95
Percent Heavy Veh, %	6	5	0	14	7	2	0	0	0	4	0	4
Cap, veh/h	332	2968	761	67	2562	649	139	449	0	432	241	
Arrive On Green	0.10	0.47	0.47	0.04	0.41	0.41	0.02	0.02	0.00	0.13	0.13	0.00
Sat Flow, veh/h	3346	6281	1610	1612	6179	1565	1801	1909	0	3401	1900	1560
Grp Volume(v), veh/h	225	1719	7	42	1839	22	8	1	0	80	12	0
Grp Sat Flow(s),veh/h/ln	1673	1570	1610	1612	1545	1565	1810	1805	0	1700	1900	1560
Q Serve(g_s), s	4.1	12.5	0.1	1.6	15.6	0.5	0.0	0.0	0.0	1.3	0.4	0.0
Cycle Q Clear(g_c), s	4.1	12.5	0.1	1.6	15.6	0.5	0.0	0.0	0.0	1.3	0.4	0.0
Prop In Lane	1.00		1.00	1.00		1.00	0.99		0.00	1.00		1.00
Lane Grp Cap(c), veh/h	332	2968	761	67	2562	649	0	0	0	432	241	
V/C Ratio(X)	0.68	0.58	0.01	0.63	0.72	0.03	0.00	0.00	0.00	0.19	0.05	
Avail Cap(c_a), veh/h	923	4142	1062	128	2860	725	0	0	0	2814	1572	
HCM Platoon Ratio	1.00	1.00	1.00	1.00	1.00	1.00	1.00	1.00	1.00	1.00	1.00	1.00
Upstream Filter(I)	1.00	1.00	1.00	1.00	1.00	1.00	1.00	1.00	0.00	1.00	1.00	0.00
Uniform Delay (d), s/veh	27.4	12.1	8.8	29.8	15.4	11.0	0.0	0.0	0.0	24.6	24.2	0.0
Incr Delay (d2), s/veh	0.9	0.2	0.0	3.6	0.8	0.0	0.0	0.0	0.0	0.2	0.1	0.0
Initial Q Delay(d3),s/veh	0.0	0.0	0.0	0.0	0.0	0.0	0.0	0.0	0.0	0.0	0.0	0.0
%ile BackOfQ(50%),veh/ln	1.5	3.4	0.0	0.6	4.5	0.2	0.0	0.0	0.0	0.5	0.1	0.0
Unsig. Movement Delay, s/veh												
LnGrp Delay(d),s/veh	28.3	12.3	8.8	33.4	16.2	11.0	0.0	0.0	0.0	24.8	24.3	0.0
LnGrp LOS	C	B	A	C	B	B	A	A	A	C	C	
Approach Vol, veh/h		1951			1903			9			92	
Approach Delay, s/veh		14.1			16.5			0.0			24.8	
Approach LOS		B			B			A			C	
Timer - Assigned Phs	1	2		4	5	6		8				
Phs Duration (G+Y+Rc), s	7.2	36.0		13.8	10.9	32.4		6.1				
Change Period (Y+Rc), s	4.6	6.2		5.8	4.6	6.2		4.6				
Max Green Setting (Gmax), s	5.0	41.6		52.2	17.4	29.2		10.0				
Max Q Clear Time (g_c+1), s	3.6	14.5		3.3	6.1	17.6		2.0				
Green Ext Time (p_c), s	0.0	14.2		0.3	0.3	8.5		0.0				

Intersection Summary

HCM 6th Ctrl Delay	15.5
HCM 6th LOS	B

Notes

Unsignalized Delay for [SBR] is excluded from calculations of the approach delay and intersection delay.

Timings
27: Innovation Dr. & Cactus Av.

West Campus Upper Plateau (JN 14064)

09/30/2022

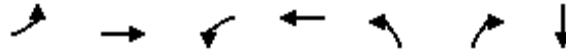

Lane Group	EBL	EBT	WBL	WBT	NBL	NBR	SBT
Lane Configurations	↖	↗↗↗	↖	↗↗↗	↖	↗	↘
Traffic Volume (vph)	1	411	27	941	1	25	0
Future Volume (vph)	1	411	27	941	1	25	0
Turn Type	Prot	NA	Prot	NA	Perm	Perm	NA
Protected Phases	5	2	1	6			4
Permitted Phases					8	8	
Detector Phase	5	2	1	6	8	8	4
Switch Phase							
Minimum Initial (s)	5.0	10.0	5.0	10.0	10.0	10.0	10.0
Minimum Split (s)	9.2	26.8	9.2	26.8	31.1	31.1	31.1
Total Split (s)	12.0	63.0	22.0	73.0	35.0	35.0	35.0
Total Split (%)	10.0%	52.5%	18.3%	60.8%	29.2%	29.2%	29.2%
Yellow Time (s)	3.2	4.8	3.2	4.8	4.1	4.1	4.1
All-Red Time (s)	1.0	1.0	1.0	1.0	1.0	1.0	1.0
Lost Time Adjust (s)	0.0	0.0	0.0	0.0	0.0	0.0	0.0
Total Lost Time (s)	4.2	5.8	4.2	5.8	5.1	5.1	5.1
Lead/Lag	Lead	Lag	Lead	Lag			
Lead-Lag Optimize?	Yes	Yes	Yes	Yes			
Recall Mode	None	None	None	None	None	None	None
Act Effct Green (s)	6.8	28.1	7.3	28.4	15.1	15.1	15.1
Actuated g/C Ratio	0.19	0.77	0.20	0.78	0.42	0.42	0.42
v/c Ratio	0.00	0.12	0.10	0.28	0.00	0.03	0.00
Control Delay	27.0	6.7	22.9	6.6	15.0	0.1	0.0
Queue Delay	0.0	0.0	0.0	0.0	0.0	0.0	0.0
Total Delay	27.0	6.7	22.9	6.6	15.0	0.1	0.0
LOS	C	A	C	A	B	A	A
Approach Delay		6.7		7.1			
Approach LOS		A		A			

Intersection Summary

Cycle Length: 120	
Actuated Cycle Length: 36.3	
Natural Cycle: 70	
Control Type: Actuated-Uncoordinated	
Maximum v/c Ratio: 0.28	
Intersection Signal Delay: 6.8	Intersection LOS: A
Intersection Capacity Utilization 39.9%	ICU Level of Service A
Analysis Period (min) 15	

Splits and Phases: 27: Innovation Dr. & Cactus Av.



HCM 6th Signalized Intersection Summary
27: Innovation Dr. & Cactus Av.

West Campus Upper Plateau (JN 14064)

09/30/2022



Movement	EBL	EBT	EBR	WBL	WBT	WBR	NBL	NBT	NBR	SBL	SBT	SBR
Lane Configurations	↗	↑↑↑		↖	↑↑↑		↖	↑	↗	↖	↑	↗
Traffic Volume (veh/h)	1	411	1	27	941	5	1	0	25	0	0	1
Future Volume (veh/h)	1	411	1	27	941	5	1	0	25	0	0	1
Initial Q (Qb), veh	0	0	0	0	0	0	0	0	0	0	0	0
Ped-Bike Adj(A_pbT)	1.00		1.00	1.00		0.98	1.00		1.00	1.00		1.00
Parking Bus, Adj	1.00	1.00	1.00	1.00	1.00	1.00	1.00	1.00	1.00	1.00	1.00	1.00
Work Zone On Approach		No			No			No			No	
Adj Sat Flow, veh/h/ln	1900	1826	1307	1663	1841	1900	1841	1900	1781	1900	1900	1781
Adj Flow Rate, veh/h	1	467	1	31	1069	6	1	0	-25	0	0	-8
Peak Hour Factor	0.88	0.88	0.88	0.88	0.88	0.88	0.88	0.88	0.88	0.88	0.88	0.88
Percent Heavy Veh, %	0	5	40	16	4	0	4	0	8	0	0	8
Cap, veh/h	6	2878	6	60	3078	17	240	6	5	240	0	401
Arrive On Green	0.00	0.56	0.56	0.04	0.60	0.60	0.00	0.00	0.00	0.00	0.00	0.00
Sat Flow, veh/h	1810	5136	11	1584	5156	29	1753	1900	1510	1810	1900	0
Grp Volume(v), veh/h	1	302	166	31	695	380	1	0	-25	0	-8	-8
Grp Sat Flow(s),veh/h/ln	1810	1662	1824	1584	1675	1835	1753	1900	1510	1810	1900	1610
Q Serve(g_s), s	0.0	1.3	1.3	0.6	3.2	3.2	0.0	0.0	0.0	0.0	0.0	0.0
Cycle Q Clear(g_c), s	0.0	1.3	1.3	0.6	3.2	3.2	0.1	0.0	0.0	0.0	0.0	0.0
Prop In Lane	1.00		0.01	1.00		0.02	1.00		1.00	1.00		0.00
Lane Grp Cap(c), veh/h	6	1862	1022	60	2000	1095	240	6	5	240	0	0
V/C Ratio(X)	0.17	0.16	0.16	0.52	0.35	0.35	0.00	0.00	-4.97	0.00	0.00	0.00
Avail Cap(c_a), veh/h	471	6338	3479	940	7507	4111	2167	1894	1505	2229	0	0
HCM Platoon Ratio	1.00	1.00	1.00	1.00	1.00	1.00	1.00	1.00	1.00	1.00	1.00	1.00
Upstream Filter(I)	1.00	1.00	1.00	1.00	1.00	1.00	1.00	0.00	0.00	0.00	0.00	0.00
Uniform Delay (d), s/veh	14.9	3.2	3.2	14.2	3.1	3.1	15.0	0.0	0.0	0.0	0.0	0.0
Incr Delay (d2), s/veh	4.7	0.1	0.1	2.5	0.1	0.3	0.0	0.0	0.0	0.0	0.0	0.0
Initial Q Delay(d3),s/veh	0.0	0.0	0.0	0.0	0.0	0.0	0.0	0.0	0.0	0.0	0.0	0.0
%ile BackOfQ(50%),veh/ln	0.0	0.0	0.0	0.2	0.0	0.1	0.0	0.0	0.0	0.0	0.0	0.0
Unsig. Movement Delay, s/veh												
LnGrp Delay(d),s/veh	19.6	3.2	3.3	16.7	3.2	3.3	15.1	0.0	0.0	0.0	0.0	0.0
LnGrp LOS	B	A	A	B	A	A	B	A	A	A	A	A
Approach Vol, veh/h		469			1106			-24				-16
Approach Delay, s/veh		3.3			3.6			0.0				0.0
Approach LOS		A			A			A				A
Timer - Assigned Phs	1	2		4	5	6		8				
Phs Duration (G+Y+Rc), s	5.3	22.6		2.0	4.2	23.7		2.0				
Change Period (Y+Rc), s	* 4.2	5.8		5.1	* 4.2	5.8		5.1				
Max Green Setting (Gmax), s	* 18	57.2		29.9	* 7.8	67.2		29.9				
Max Q Clear Time (g_c+I1), s	2.6	3.3		0.0	2.0	5.2		2.1				
Green Ext Time (p_c), s	0.0	4.3		0.0	0.0	12.7		0.0				

Intersection Summary

HCM 6th Ctrl Delay	3.6
HCM 6th LOS	A

Notes

* HCM 6th computational engine requires equal clearance times for the phases crossing the barrier.

Timings
28: I-215 SB Ramps & Alessandro Bl.

West Campus Upper Plateau (JN 14064)

09/30/2022

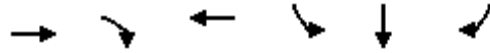

Lane Group	EBT	EBR	WBT	SBL	SBT	SBR
Lane Configurations	↑↑↑	↑	↑↑↑	↑	↔	↑
Traffic Volume (vph)	1004	411	1319	167	0	348
Future Volume (vph)	1004	411	1319	167	0	348
Turn Type	NA	Perm	NA	Split	NA	Perm
Protected Phases	2		6	4	4	
Permitted Phases		2				4
Detector Phase	2	2	6	4	4	4
Switch Phase						
Minimum Initial (s)	5.0	5.0	5.0	5.0	5.0	5.0
Minimum Split (s)	10.5	10.5	34.5	10.0	10.0	10.0
Total Split (s)	52.0	52.0	52.0	33.0	33.0	33.0
Total Split (%)	61.2%	61.2%	61.2%	38.8%	38.8%	38.8%
Yellow Time (s)	4.5	4.5	4.5	4.0	4.0	4.0
All-Red Time (s)	1.0	1.0	1.0	1.0	1.0	1.0
Lost Time Adjust (s)	0.0	0.0	0.0	0.0	0.0	0.0
Total Lost Time (s)	5.5	5.5	5.5	5.0	5.0	5.0
Lead/Lag						
Lead-Lag Optimize?						
Recall Mode	Min	Min	Min	None	None	None
Act Effct Green (s)	25.1	25.1	25.1	12.1	12.1	12.1
Actuated g/C Ratio	0.52	0.52	0.52	0.25	0.25	0.25
v/c Ratio	0.40	0.44	0.59	0.41	0.52	0.50
Control Delay	7.8	3.9	9.2	19.9	19.4	18.7
Queue Delay	0.0	0.0	0.0	0.0	0.0	0.0
Total Delay	7.8	3.9	9.2	19.9	19.4	18.7
LOS	A	A	A	B	B	B
Approach Delay	6.7		9.2		19.3	
Approach LOS	A		A		B	

Intersection Summary

Cycle Length: 85
 Actuated Cycle Length: 48.4
 Natural Cycle: 50
 Control Type: Actuated-Uncoordinated
 Maximum v/c Ratio: 0.59
 Intersection Signal Delay: 9.7
 Intersection Capacity Utilization 52.0%
 Analysis Period (min) 15

Intersection LOS: A
 ICU Level of Service A

Splits and Phases: 28: I-215 SB Ramps & Alessandro Bl.

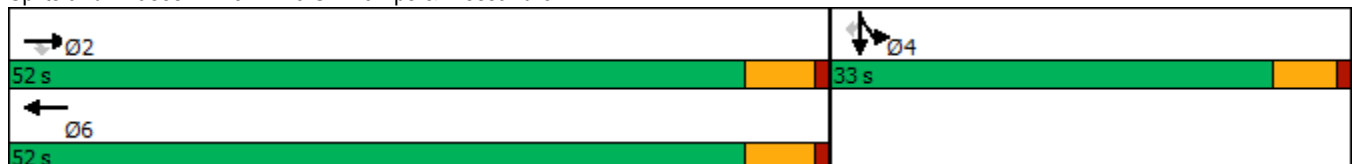

HCM 6th Signalized Intersection Summary
 28: I-215 SB Ramps & Alessandro Bl.

West Campus Upper Plateau (JN 14064)

09/30/2022



Movement	EBL	EBT	EBR	WBL	WBT	WBR	NBL	NBT	NBR	SBL	SBT	SBR
Lane Configurations		↑↑↑	↗		↑↑↑					↘	↔	↗
Traffic Volume (veh/h)	0	1004	411	0	1319	151	0	0	0	167	0	348
Future Volume (veh/h)	0	1004	411	0	1319	151	0	0	0	167	0	348
Initial Q (Qb), veh	0	0	0	0	0	0				0	0	0
Ped-Bike Adj(A_pbT)	1.00		1.00	1.00		0.98				1.00		1.00
Parking Bus, Adj	1.00	1.00	1.00	1.00	1.00	1.00				1.00	1.00	1.00
Work Zone On Approach		No			No						No	
Adj Sat Flow, veh/h/ln	0	1870	1870	0	1870	1781				1737	1900	1752
Adj Flow Rate, veh/h	0	1046	428	0	1374	149				116	0	378
Peak Hour Factor	0.96	0.96	0.96	0.96	0.96	0.96				0.96	0.96	0.96
Percent Heavy Veh, %	0	2	2	0	2	8				11	0	10
Cap, veh/h	0	2732	848	0	2496	271				343	0	615
Arrive On Green	0.00	0.54	0.54	0.00	0.54	0.54				0.21	0.00	0.21
Sat Flow, veh/h	0	5274	1585	0	4833	506				1654	0	2969
Grp Volume(v), veh/h	0	1046	428	0	1003	520				116	0	378
Grp Sat Flow(s),veh/h/ln	0	1702	1585	0	1702	1767				1654	0	1485
Q Serve(g_s), s	0.0	4.9	7.0	0.0	7.9	7.9				2.4	0.0	4.7
Cycle Q Clear(g_c), s	0.0	4.9	7.0	0.0	7.9	7.9				2.4	0.0	4.7
Prop In Lane	0.00		1.00	0.00		0.29				1.00		1.00
Lane Grp Cap(c), veh/h	0	2732	848	0	1821	945				343	0	615
V/C Ratio(X)	0.00	0.38	0.50	0.00	0.55	0.55				0.34	0.00	0.61
Avail Cap(c_a), veh/h	0	5828	1809	0	3885	2016				1137	0	2041
HCM Platoon Ratio	1.00	1.00	1.00	1.00	1.00	1.00				1.00	1.00	1.00
Upstream Filter(I)	0.00	1.00	1.00	0.00	1.00	1.00				1.00	0.00	1.00
Uniform Delay (d), s/veh	0.0	5.5	6.0	0.0	6.2	6.2				13.8	0.0	14.7
Incr Delay (d2), s/veh	0.0	0.1	0.5	0.0	0.3	0.5				0.6	0.0	1.0
Initial Q Delay(d3),s/veh	0.0	0.0	0.0	0.0	0.0	0.0				0.0	0.0	0.0
%ile BackOfQ(50%),veh/ln	0.0	0.6	0.8	0.0	1.0	1.1				0.7	0.0	1.3
Unsig. Movement Delay, s/veh												
LnGrp Delay(d),s/veh	0.0	5.6	6.5	0.0	6.5	6.7				14.3	0.0	15.7
LnGrp LOS	A	A	A	A	A	A				B	A	B
Approach Vol, veh/h		1474			1523						494	
Approach Delay, s/veh		5.9			6.6						15.4	
Approach LOS		A			A						B	
Timer - Assigned Phs		2		4		6						
Phs Duration (G+Y+Rc), s		27.3		13.4		27.3						
Change Period (Y+Rc), s		5.5		5.0		5.5						
Max Green Setting (Gmax), s		46.5		28.0		46.5						
Max Q Clear Time (g_c+I1), s		9.0		6.7		9.9						
Green Ext Time (p_c), s		9.8		1.8		11.9						

Intersection Summary

HCM 6th Ctrl Delay	7.5
HCM 6th LOS	A

Notes

User approved volume balancing among the lanes for turning movement.

Timings
29: I-215 NB Ramps & Alessandro Bl.

West Campus Upper Plateau (JN 14064)

09/30/2022



Lane Group	EBL	EBT	WBT	WBR	NBL	NBT	NBR
Lane Configurations	↘	↑↑↑	↑↑↑	↗	↘	↕	↗
Traffic Volume (vph)	239	1066	1004	183	440	12	301
Future Volume (vph)	239	1066	1004	183	440	12	301
Turn Type	Prot	NA	NA	Perm	Split	NA	Perm
Protected Phases	5	2	6		8	8	
Permitted Phases				6			8
Detector Phase	5	2	6	6	8	8	8
Switch Phase							
Minimum Initial (s)	5.0	5.0	5.0	5.0	5.0	5.0	5.0
Minimum Split (s)	9.5	10.5	33.5	33.5	10.0	10.0	10.0
Total Split (s)	13.0	48.0	35.0	35.0	37.0	37.0	37.0
Total Split (%)	15.3%	56.5%	41.2%	41.2%	43.5%	43.5%	43.5%
Yellow Time (s)	3.5	4.5	4.5	4.5	4.0	4.0	4.0
All-Red Time (s)	1.0	1.0	1.0	1.0	1.0	1.0	1.0
Lost Time Adjust (s)	0.0	0.0	0.0	0.0	0.0	0.0	0.0
Total Lost Time (s)	4.5	5.5	5.5	5.5	5.0	5.0	5.0
Lead/Lag	Lead		Lag	Lag			
Lead-Lag Optimize?	Yes		Yes	Yes			
Recall Mode	None	Min	Min	Min	Max	Max	Max
Act Effct Green (s)	8.5	36.9	23.9	23.9	32.1	32.1	32.1
Actuated g/C Ratio	0.11	0.46	0.30	0.30	0.40	0.40	0.40
v/c Ratio	1.39	0.47	0.68	0.39	0.40	0.41	0.37
Control Delay	237.2	15.1	26.7	13.2	20.1	18.8	12.8
Queue Delay	0.0	0.0	0.0	0.0	0.0	0.0	0.0
Total Delay	237.2	15.1	26.7	13.2	20.1	18.8	12.8
LOS	F	B	C	B	C	B	B
Approach Delay		55.8	24.7			17.4	
Approach LOS		E	C			B	

Intersection Summary

Cycle Length: 85
 Actuated Cycle Length: 79.5
 Natural Cycle: 70
 Control Type: Actuated-Uncoordinated
 Maximum v/c Ratio: 1.39
 Intersection Signal Delay: 35.5
 Intersection LOS: D
 Intersection Capacity Utilization 60.7%
 ICU Level of Service B
 Analysis Period (min) 15

Splits and Phases: 29: I-215 NB Ramps & Alessandro Bl.

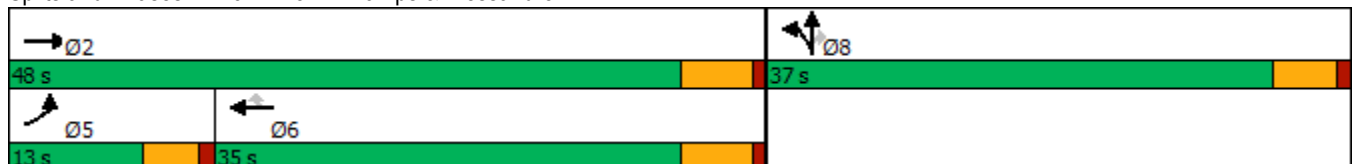

HCM 6th Signalized Intersection Summary
29: I-215 NB Ramps & Alessandro Bl.

West Campus Upper Plateau (JN 14064)
09/30/2022



Movement	EBL	EBT	EBR	WBL	WBT	WBR	NBL	NBT	NBR	SBL	SBT	SBR
Lane Configurations	↘	↑↑↑			↑↑↑	↗	↘	↕	↗			
Traffic Volume (veh/h)	239	1066	0	0	1004	183	440	12	301	0	0	0
Future Volume (veh/h)	239	1066	0	0	1004	183	440	12	301	0	0	0
Initial Q (Qb), veh	0	0	0	0	0	0	0	0	0			
Ped-Bike Adj(A_pbT)	1.00		1.00	1.00		0.98	1.00		1.00			
Parking Bus, Adj	1.00	1.00	1.00	1.00	1.00	1.00	1.00	1.00	1.00			
Work Zone On Approach		No			No			No				
Adj Sat Flow, veh/h/ln	1767	1870	0	0	1870	1707	1856	1900	1870			
Adj Flow Rate, veh/h	246	1099	0	0	1035	163	529	0	155			
Peak Hour Factor	0.97	0.97	0.97	0.97	0.97	0.97	0.97	0.97	0.97			
Percent Heavy Veh, %	9	2	0	0	2	13	3	0	2			
Cap, veh/h	185	2298	0	0	1440	399	1463	0	656			
Arrive On Green	0.11	0.45	0.00	0.00	0.28	0.28	0.41	0.00	0.41			
Sat Flow, veh/h	1682	5274	0	0	5274	1416	3534	0	1585			
Grp Volume(v), veh/h	246	1099	0	0	1035	163	529	0	155			
Grp Sat Flow(s),veh/h/ln	1682	1702	0	0	1702	1416	1767	0	1585			
Q Serve(g_s), s	8.5	11.7	0.0	0.0	14.1	7.2	8.0	0.0	4.9			
Cycle Q Clear(g_c), s	8.5	11.7	0.0	0.0	14.1	7.2	8.0	0.0	4.9			
Prop In Lane	1.00		0.00	0.00		1.00	1.00		1.00			
Lane Grp Cap(c), veh/h	185	2298	0	0	1440	399	1463	0	656			
V/C Ratio(X)	1.33	0.48	0.00	0.00	0.72	0.41	0.36	0.00	0.24			
Avail Cap(c_a), veh/h	185	2808	0	0	1949	540	1463	0	656			
HCM Platoon Ratio	1.00	1.00	1.00	1.00	1.00	1.00	1.00	1.00	1.00			
Upstream Filter(I)	1.00	1.00	0.00	0.00	1.00	1.00	1.00	0.00	1.00			
Uniform Delay (d), s/veh	34.4	14.9	0.0	0.0	25.0	22.5	15.6	0.0	14.7			
Incr Delay (d2), s/veh	180.5	0.2	0.0	0.0	0.8	0.7	0.7	0.0	0.8			
Initial Q Delay(d3),s/veh	0.0	0.0	0.0	0.0	0.0	0.0	0.0	0.0	0.0			
%ile BackOfQ(50%),veh/ln	12.4	3.7	0.0	0.0	5.1	2.2	3.0	0.0	1.7			
Unsig. Movement Delay, s/veh												
LnGrp Delay(d),s/veh	214.9	15.0	0.0	0.0	25.8	23.2	16.3	0.0	15.6			
LnGrp LOS	F	B	A	A	C	C	B	A	B			
Approach Vol, veh/h		1345			1198			684				
Approach Delay, s/veh		51.6			25.5			16.1				
Approach LOS		D			C			B				
Timer - Assigned Phs		2			5	6		8				
Phs Duration (G+Y+Rc), s		40.3			13.0	27.3		37.0				
Change Period (Y+Rc), s		5.5			4.5	5.5		5.0				
Max Green Setting (Gmax), s		42.5			8.5	29.5		32.0				
Max Q Clear Time (g_c+I1), s		13.7			10.5	16.1		10.0				
Green Ext Time (p_c), s		7.6			0.0	5.7		2.4				

Intersection Summary

HCM 6th Ctrl Delay	34.4
HCM 6th LOS	C

Notes

User approved volume balancing among the lanes for turning movement.

Timings
30: I-215 SB Ramps & Cactus Av.

West Campus Upper Plateau (JN 14064)

09/30/2022



Lane Group	EBT	EBR	WBL	WBT	NBR	SBR
Lane Configurations	↑↑	↑	↓	↑↑	↑	↑
Traffic Volume (vph)	69	24	431	476	406	112
Future Volume (vph)	69	24	431	476	406	112
Turn Type	NA	Perm	Prot	NA	Prot	Prot
Protected Phases	2		1	6	8	4
Permitted Phases		2				
Detector Phase	2	2	1	6	8	4
Switch Phase						
Minimum Initial (s)	5.0	5.0	5.0	5.0	5.0	5.0
Minimum Split (s)	11.0	11.0	9.5	23.0	9.1	9.5
Total Split (s)	35.0	35.0	43.0	78.0	27.0	27.0
Total Split (%)	33.3%	33.3%	41.0%	74.3%	25.7%	25.7%
Yellow Time (s)	5.0	5.0	3.5	5.0	3.6	3.5
All-Red Time (s)	1.0	1.0	1.0	1.0	0.5	1.0
Lost Time Adjust (s)	0.0	0.0	0.0	0.0	0.0	0.0
Total Lost Time (s)	6.0	6.0	4.5	6.0	4.1	4.5
Lead/Lag	Lag	Lag	Lead			
Lead-Lag Optimize?	Yes	Yes	Yes			
Recall Mode	Min	Min	None	Min	None	None
Act Effct Green (s)	5.8	5.8	16.1	26.5	5.6	5.1
Actuated g/C Ratio	0.14	0.14	0.38	0.63	0.13	0.12
v/c Ratio	0.16	0.11	0.73	0.25	0.46	0.25
Control Delay	18.4	3.5	18.5	3.6	1.5	1.2
Queue Delay	0.0	0.0	0.0	0.0	0.0	0.0
Total Delay	18.4	3.5	18.5	3.6	1.5	1.2
LOS	B	A	B	A	A	A
Approach Delay	14.5			10.7		
Approach LOS	B			B		

Intersection Summary

Cycle Length: 105
 Actuated Cycle Length: 42.3
 Natural Cycle: 55
 Control Type: Actuated-Uncoordinated
 Maximum v/c Ratio: 0.73
 Intersection Signal Delay: 7.8
 Intersection LOS: A
 Intersection Capacity Utilization 37.7%
 ICU Level of Service A
 Analysis Period (min) 15



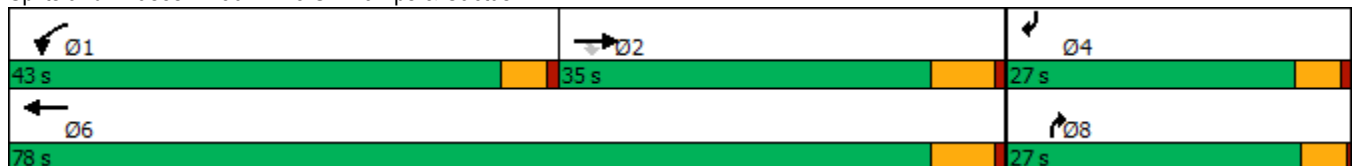









Splits and Phases: 30: I-215 SB Ramps & Cactus Av.



HCM 6th Signalized Intersection Summary
30: I-215 SB Ramps & Cactus Av.

West Campus Upper Plateau (JN 14064)

09/30/2022

												
Movement	EBL	EBT	EBR	WBL	WBT	WBR	NBL	NBT	NBR	SBL	SBT	SBR
Lane Configurations		↑↑	↗	↖	↑↑				↗			↖
Traffic Volume (veh/h)	0	69	24	431	476	0	0	0	406	0	0	112
Future Volume (veh/h)	0	69	24	431	476	0	0	0	406	0	0	112
Initial Q (Qb), veh	0	0	0	0	0	0	0	0	0	0	0	0
Ped-Bike Adj(A_pbT)	1.00		1.00	1.00		1.00	1.00		1.00	1.00		1.00
Parking Bus, Adj	1.00	1.00	1.00	1.00	1.00	1.00	1.00	1.00	1.00	1.00	1.00	1.00
Work Zone On Approach		No			No			No			No	
Adj Sat Flow, veh/h/ln	0	1841	1826	1870	1870	0	0	0	1796	0	0	1707
Adj Flow Rate, veh/h	0	79	-3	495	547	0	0	0	0	0	0	14
Peak Hour Factor	0.87	0.87	0.87	0.87	0.87	0.87	0.87	0.87	0.87	0.87	0.87	0.87
Percent Heavy Veh, %	0	4	5	2	2	0	0	0	7	0	0	13
Cap, veh/h	0	734	325	623	2659	0	0	0	0	0	0	0
Arrive On Green	0.00	0.21	0.00	0.35	0.75	0.00	0.00	0.00	0.00	0.00	0.00	0.00
Sat Flow, veh/h	0	3589	1547	1781	3647	0		0			0	
Grp Volume(v), veh/h	0	79	-3	495	547	0		0.0			0.0	
Grp Sat Flow(s),veh/h/ln	0	1749	1547	1781	1777	0						
Q Serve(g_s), s	0.0	0.4	0.0	6.0	1.1	0.0						
Cycle Q Clear(g_c), s	0.0	0.4	0.0	6.0	1.1	0.0						
Prop In Lane	0.00		1.00	1.00		0.00						
Lane Grp Cap(c), veh/h	0	734	325	623	2659	0						
V/C Ratio(X)	0.00	0.11	-0.01	0.80	0.21	0.00						
Avail Cap(c_a), veh/h	0	4256	1883	2878	10738	0						
HCM Platoon Ratio	1.00	1.00	1.00	1.00	1.00	1.00						
Upstream Filter(I)	0.00	1.00	0.00	1.00	1.00	0.00						
Uniform Delay (d), s/veh	0.0	7.6	0.0	7.0	0.9	0.0						
Incr Delay (d2), s/veh	0.0	0.0	0.0	0.9	0.0	0.0						
Initial Q Delay(d3),s/veh	0.0	0.0	0.0	0.0	0.0	0.0						
%ile BackOfQ(50%),veh/ln	0.0	0.1	0.0	0.6	0.0	0.0						
Unsig. Movement Delay, s/veh												
LnGrp Delay(d),s/veh	0.0	7.6	0.0	7.9	0.9	0.0						
LnGrp LOS	A	A	A	A	A	A						
Approach Vol, veh/h		76			1042							
Approach Delay, s/veh		7.9			4.2							
Approach LOS		A			A							
Timer - Assigned Phs	1	2				6						
Phs Duration (G+Y+Rc), s	12.8	11.0				23.8						
Change Period (Y+Rc), s	4.5	6.0				6.0						
Max Green Setting (Gmax), s	38.5	29.0				72.0						
Max Q Clear Time (g_c+I1), s	8.0	2.4				3.1						
Green Ext Time (p_c), s	0.7	0.2				2.2						

Intersection Summary

HCM 6th Ctrl Delay	4.5
HCM 6th LOS	A

Notes

Unsignalized Delay for [NBR] is excluded from calculations of the approach delay and intersection delay.

Timings

31: I-215 NB Ramps/Old 215 Frontage Rd. & Cactus Av.



Lane Group	EBL	EBT	WBT	NBL	NBT	NBR	SBL	SBT
Lane Configurations	↖	↗	↗	↖	↗	↗	↖	↗
Traffic Volume (vph)	21	753	1301	60	81	4	135	1
Future Volume (vph)	21	753	1301	60	81	4	135	1
Turn Type	Perm	NA	NA	Perm	NA	Perm	Perm	NA
Protected Phases		2	6		8			4
Permitted Phases	2			8		8	4	
Detector Phase	2	2	6	8	8	8	4	4
Switch Phase								
Minimum Initial (s)	5.0	5.0	5.0	5.0	5.0	5.0	5.0	5.0
Minimum Split (s)	11.0	11.0	44.0	10.5	10.5	10.5	10.5	10.5
Total Split (s)	57.4	57.4	57.4	27.6	27.6	27.6	27.6	27.6
Total Split (%)	67.5%	67.5%	67.5%	32.5%	32.5%	32.5%	32.5%	32.5%
Yellow Time (s)	5.0	5.0	5.0	4.5	4.5	4.5	4.5	4.5
All-Red Time (s)	1.0	1.0	1.0	1.0	1.0	1.0	1.0	1.0
Lost Time Adjust (s)	0.0	0.0	0.0	0.0	0.0	0.0	0.0	0.0
Total Lost Time (s)	6.0	6.0	6.0	5.5	5.5	5.5	5.5	5.5
Lead/Lag								
Lead-Lag Optimize?								
Recall Mode	Min	Min	Min	None	None	None	None	None
Act Effct Green (s)	35.7	35.7	35.7	11.8	11.8	11.8	11.8	11.8
Actuated g/C Ratio	0.60	0.60	0.60	0.20	0.20	0.20	0.20	0.20
v/c Ratio	0.19	0.44	0.75	0.28	0.25	0.01	0.58	0.24
Control Delay	11.1	7.5	11.9	25.1	23.4	0.0	32.5	14.0
Queue Delay	0.0	0.0	0.0	0.0	0.0	0.0	0.0	0.0
Total Delay	11.1	7.5	11.9	25.1	23.4	0.0	32.5	14.0
LOS	B	A	B	C	C	A	C	B
Approach Delay		7.5	11.9		23.5			25.6
Approach LOS		A	B		C			C

Intersection Summary

Cycle Length: 85	
Actuated Cycle Length: 59.5	
Natural Cycle: 60	
Control Type: Actuated-Uncoordinated	
Maximum v/c Ratio: 0.75	
Intersection Signal Delay: 12.2	Intersection LOS: B
Intersection Capacity Utilization 64.4%	ICU Level of Service C
Analysis Period (min) 15	

Splits and Phases: 31: I-215 NB Ramps/Old 215 Frontage Rd. & Cactus Av.

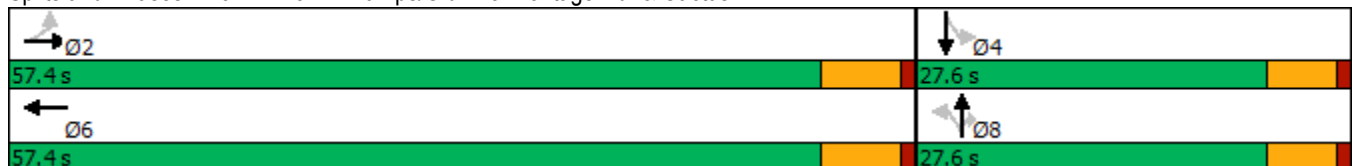

HCM 6th Signalized Intersection Summary

West Campus Upper Plateau (JN 14064)

31: I-215 NB Ramps/Old 215 Frontage Rd. & Cactus Av.

09/30/2022



Movement	EBL	EBT	EBR	WBL	WBT	WBR	NBL	NBT	NBR	SBL	SBT	SBR
Lane Configurations	↗	↗↘			↗↘		↗	↘	↗	↗	↘	↘
Traffic Volume (veh/h)	21	753	68	0	1301	146	60	81	4	135	1	79
Future Volume (veh/h)	21	753	68	0	1301	146	60	81	4	135	1	79
Initial Q (Qb), veh	0	0	0	0	0	0	0	0	0	0	0	0
Ped-Bike Adj(A_pbT)	1.00		1.00	1.00		1.00	1.00		1.00	1.00		1.00
Parking Bus, Adj	1.00	1.00	1.00	1.00	1.00	1.00	1.00	1.00	1.00	1.00	1.00	1.00
Work Zone On Approach		No			No			No			No	
Adj Sat Flow, veh/h/ln	1796	1826	1366	0	1841	1885	1722	1856	1900	1841	1900	1885
Adj Flow Rate, veh/h	23	810	69	0	1399	108	65	87	0	145	1	58
Peak Hour Factor	0.93	0.93	0.93	0.93	0.93	0.93	0.93	0.93	0.93	0.93	0.93	0.93
Percent Heavy Veh, %	7	5	36	0	4	1	12	3	0	4	0	1
Cap, veh/h	231	1773	151	0	1803	139	365	363		362	5	311
Arrive On Green	0.55	0.55	0.55	0.00	0.55	0.55	0.20	0.20	0.00	0.20	0.20	0.20
Sat Flow, veh/h	334	3235	276	0	3382	253	1237	1856	1610	1289	27	1587
Grp Volume(v), veh/h	23	434	445	0	741	766	65	87	0	145	0	59
Grp Sat Flow(s),veh/h/ln	334	1735	1776	0	1749	1795	1237	1856	1610	1289	0	1614
Q Serve(g_s), s	2.6	6.8	6.8	0.0	14.9	15.1	2.1	1.8	0.0	4.8	0.0	1.4
Cycle Q Clear(g_c), s	17.7	6.8	6.8	0.0	14.9	15.1	3.4	1.8	0.0	6.6	0.0	1.4
Prop In Lane	1.00		0.16	0.00		0.14	1.00		1.00	1.00		0.98
Lane Grp Cap(c), veh/h	231	951	973	0	958	983	365	363		362	0	316
V/C Ratio(X)	0.10	0.46	0.46	0.00	0.77	0.78	0.18	0.24		0.40	0.00	0.19
Avail Cap(c_a), veh/h	430	1987	2035	0	2003	2056	732	914		745	0	795
HCM Platoon Ratio	1.00	1.00	1.00	1.00	1.00	1.00	1.00	1.00	1.00	1.00	1.00	1.00
Upstream Filter(I)	1.00	1.00	1.00	0.00	1.00	1.00	1.00	1.00	0.00	1.00	0.00	1.00
Uniform Delay (d), s/veh	15.0	6.1	6.1	0.0	8.0	8.0	16.5	15.2	0.0	18.0	0.0	15.1
Incr Delay (d2), s/veh	0.1	0.1	0.1	0.0	0.5	0.5	0.1	0.1	0.0	0.3	0.0	0.1
Initial Q Delay(d3),s/veh	0.0	0.0	0.0	0.0	0.0	0.0	0.0	0.0	0.0	0.0	0.0	0.0
%ile BackOfQ(50%),veh/ln	0.2	1.2	1.3	0.0	2.8	2.9	0.5	0.6	0.0	1.1	0.0	0.4
Unsig. Movement Delay, s/veh												
LnGrp Delay(d),s/veh	15.1	6.2	6.2	0.0	8.5	8.5	16.6	15.4	0.0	18.3	0.0	15.2
LnGrp LOS	B	A	A	A	A	A	B	B		B	A	B
Approach Vol, veh/h		902			1507			152				204
Approach Delay, s/veh		6.5			8.5			15.9				17.4
Approach LOS		A			A			B				B
Timer - Assigned Phs		2		4		6		8				
Phs Duration (G+Y+Rc), s		30.6		14.3		30.6		14.3				
Change Period (Y+Rc), s		6.0		5.5		6.0		5.5				
Max Green Setting (Gmax), s		51.4		22.1		51.4		22.1				
Max Q Clear Time (g_c+I1), s		19.7		8.6		17.1		5.4				
Green Ext Time (p_c), s		3.7		0.3		7.3		0.3				

Intersection Summary

HCM 6th Ctrl Delay	8.9
HCM 6th LOS	A

Notes

User approved volume balancing among the lanes for turning movement.
 Unsignalized Delay for [NBR] is excluded from calculations of the approach delay and intersection delay.

Timings
32: I-215 SB Ramps & Van Buren Bl.

West Campus Upper Plateau (JN 14064)

09/30/2022



Lane Group	EBT	EBR	WBL	WBT	SBT	SBR
Lane Configurations	↑↑	↑↑	↙	↑↑	↙	↑↑
Traffic Volume (vph)	834	933	16	901	0	938
Future Volume (vph)	834	933	16	901	0	938
Turn Type	NA	Perm	Prot	NA	NA	Perm
Protected Phases	6		5	2	8	
Permitted Phases		6				8
Detector Phase	6	6	5	2	8	8
Switch Phase						
Minimum Initial (s)	5.0	5.0	5.0	5.0	5.0	5.0
Minimum Split (s)	36.0	36.0	11.0	11.0	11.0	11.0
Total Split (s)	60.0	60.0	11.0	71.0	14.0	14.0
Total Split (%)	70.6%	70.6%	12.9%	83.5%	16.5%	16.5%
Yellow Time (s)	5.0	5.0	5.0	5.0	5.0	5.0
All-Red Time (s)	1.0	1.0	1.0	1.0	1.0	1.0
Lost Time Adjust (s)	0.0	0.0	0.0	0.0	0.0	0.0
Total Lost Time (s)	6.0	6.0	6.0	6.0	6.0	6.0
Lead/Lag	Lag	Lag	Lead			
Lead-Lag Optimize?	Yes	Yes	Yes			
Recall Mode	Min	Min	None	Min	Max	Max
Act Effct Green (s)	20.3	20.3	5.3	21.8	8.4	8.4
Actuated g/C Ratio	0.47	0.47	0.12	0.51	0.20	0.20
v/c Ratio	0.57	0.54	0.10	0.55	0.10	1.28
Control Delay	9.8	1.9	23.9	7.8	20.6	151.4
Queue Delay	0.0	0.0	0.0	0.0	0.0	0.0
Total Delay	9.8	1.9	23.9	7.8	20.6	151.4
LOS	A	A	C	A	C	F
Approach Delay	5.6			8.1	147.9	
Approach LOS	A			A	F	

Intersection Summary

Cycle Length: 85
 Actuated Cycle Length: 42.9
 Natural Cycle: 80
 Control Type: Actuated-Uncoordinated
 Maximum v/c Ratio: 1.28
 Intersection Signal Delay: 43.8
 Intersection LOS: D
 Intersection Capacity Utilization 67.7%
 ICU Level of Service C
 Analysis Period (min) 15

Splits and Phases: 32: I-215 SB Ramps & Van Buren Bl.



HCM 6th Signalized Intersection Summary
 32: I-215 SB Ramps & Van Buren Bl.

West Campus Upper Plateau (JN 14064)

09/30/2022



Movement	EBL	EBT	EBR	WBL	WBT	WBR	NBL	NBT	NBR	SBL	SBT	SBR
Lane Configurations		↑↑	↑↑	↑	↑↑						↑	↑↑
Traffic Volume (veh/h)	0	834	933	16	901	0	0	0	0	25	0	938
Future Volume (veh/h)	0	834	933	16	901	0	0	0	0	25	0	938
Initial Q (Qb), veh	0	0	0	0	0	0				0	0	0
Ped-Bike Adj(A_pbT)	1.00		1.00	1.00		1.00				1.00		1.00
Parking Bus, Adj	1.00	1.00	1.00	1.00	1.00	1.00				1.00	1.00	1.00
Work Zone On Approach		No			No						No	
Adj Sat Flow, veh/h/ln	0	1767	1856	1411	1811	0				1500	1841	1663
Adj Flow Rate, veh/h	0	887	895	17	959	0				27	0	0
Peak Hour Factor	0.94	0.94	0.94	0.94	0.94	0.94				0.94	0.94	0.94
Percent Heavy Veh, %	0	9	3	33	6	0				27	4	16
Cap, veh/h	0	1440	1187	124	2173	0				258	0	
Arrive On Green	0.00	0.43	0.43	0.09	0.63	0.00				0.15	0.00	0.00
Sat Flow, veh/h	0	3445	2768	1344	3532	0				1753	0	2480
Grp Volume(v), veh/h	0	887	895	17	959	0				27	0	0
Grp Sat Flow(s),veh/h/ln	0	1678	1384	1344	1721	0				1753	0	1240
Q Serve(g_s), s	0.0	11.1	14.8	0.6	7.7	0.0				0.7	0.0	0.0
Cycle Q Clear(g_c), s	0.0	11.1	14.8	0.6	7.7	0.0				0.7	0.0	0.0
Prop In Lane	0.00		1.00	1.00		0.00				1.00		1.00
Lane Grp Cap(c), veh/h	0	1440	1187	124	2173	0				258	0	
V/C Ratio(X)	0.00	0.62	0.75	0.14	0.44	0.00				0.10	0.00	
Avail Cap(c_a), veh/h	0	3339	2753	124	4121	0				258	0	
HCM Platoon Ratio	1.00	1.00	1.00	1.00	1.00	1.00				1.00	1.00	1.00
Upstream Filter(I)	0.00	1.00	1.00	1.00	1.00	0.00				1.00	0.00	0.00
Uniform Delay (d), s/veh	0.0	12.0	13.1	22.7	5.1	0.0				20.0	0.0	0.0
Incr Delay (d2), s/veh	0.0	0.2	0.4	0.2	0.1	0.0				0.8	0.0	0.0
Initial Q Delay(d3),s/veh	0.0	0.0	0.0	0.0	0.0	0.0				0.0	0.0	0.0
%ile BackOfQ(50%),veh/ln	0.0	2.8	3.1	0.2	1.2	0.0				0.3	0.0	0.0
Unsig. Movement Delay, s/veh												
LnGrp Delay(d),s/veh	0.0	12.2	13.5	22.8	5.2	0.0				20.9	0.0	0.0
LnGrp LOS	A	B	B	C	A	A				C	A	
Approach Vol, veh/h		1782			976							27
Approach Delay, s/veh		12.8			5.5							20.9
Approach LOS		B			A							C
Timer - Assigned Phs		2			5	6		8				
Phs Duration (G+Y+Rc), s		40.3			11.0	29.3		14.0				
Change Period (Y+Rc), s		6.0			6.0	6.0		6.0				
Max Green Setting (Gmax), s		65.0			5.0	54.0		8.0				
Max Q Clear Time (g_c+I1), s		9.7			2.6	16.8		2.7				
Green Ext Time (p_c), s		4.3			0.0	6.5		0.0				

Intersection Summary

HCM 6th Ctrl Delay	10.3
HCM 6th LOS	B

Notes

Unsignalized Delay for [SBR] is excluded from calculations of the approach delay and intersection delay.

Timings
33: I-215 NB On/Off Ramp & Van Buren Bl.

Lane Group	EBR	NBL	Ø2	Ø6
Lane Configurations	↖↖	↗↗		
Traffic Volume (vph)	18	1		
Future Volume (vph)	18	1		
Turn Type	pm+ov	Prot		
Protected Phases	4	4	2	6
Permitted Phases	6			
Detector Phase	4	4		
Switch Phase				
Minimum Initial (s)	5.0	5.0	5.0	5.0
Minimum Split (s)	42.0	42.0	11.0	11.0
Total Split (s)	55.0	55.0	15.0	15.0
Total Split (%)	78.6%	78.6%	21%	21%
Yellow Time (s)	5.0	5.0	5.0	5.0
All-Red Time (s)	1.0	1.0	1.0	1.0
Lost Time Adjust (s)	0.0	0.0		
Total Lost Time (s)	6.0	6.0		
Lead/Lag				
Lead-Lag Optimize?				
Recall Mode	Min	Min	None	None
Act Effct Green (s)	32.2	32.2		
Actuated g/C Ratio	1.00	1.00		
v/c Ratio	0.01	0.00		
Control Delay	0.0	0.0		
Queue Delay	0.0	0.0		
Total Delay	0.0	0.0		
LOS	A	A		
Approach Delay				
Approach LOS				

Intersection Summary

Cycle Length: 70	
Actuated Cycle Length: 32.2	
Natural Cycle: 55	
Control Type: Actuated-Uncoordinated	
Maximum v/c Ratio: 0.01	
Intersection Signal Delay: 0.0	Intersection LOS: A
Intersection Capacity Utilization 9.2%	ICU Level of Service A
Analysis Period (min) 15	

Splits and Phases: 33: I-215 NB On/Off Ramp & Van Buren Bl.



HCM 6th Signalized Intersection Summary
 33: I-215 NB On/Off Ramp & Van Buren Bl.

West Campus Upper Plateau (JN 14064)

09/30/2022

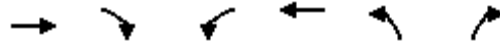

Movement	EBT	EBR	WBL	WBT	NBL	NBR
Lane Configurations	↑↑	↑↑		↑↑	↑↑	↑
Traffic Volume (veh/h)	0	18	0	0	1	0
Future Volume (veh/h)	0	18	0	0	1	0
Initial Q (Qb), veh	0	0	0	0	0	0
Ped-Bike Adj(A_pbT)		1.00	1.00		1.00	1.00
Parking Bus, Adj	1.00	1.00	1.00	1.00	1.00	1.00
Work Zone On Approach	No			No	No	
Adj Sat Flow, veh/h/ln	1900	1767	0	1752	1811	1159
Adj Flow Rate, veh/h	0	10	0	0	1	0
Peak Hour Factor	0.94	0.94	0.94	0.94	0.94	0.94
Percent Heavy Veh, %	0	9	0	10	6	50
Cap, veh/h	49	800	0	45	971	285
Arrive On Green	0.00	0.01	0.00	0.00	0.29	0.00
Sat Flow, veh/h	3705	2635	0	3504	3346	982
Grp Volume(v), veh/h	0	10	0	0	1	0
Grp Sat Flow(s),veh/h/ln	1805	1317	0	1664	1673	982
Q Serve(g_s), s	0.0	0.0	0.0	0.0	0.0	0.0
Cycle Q Clear(g_c), s	0.0	0.0	0.0	0.0	0.0	0.0
Prop In Lane		1.00	0.00		1.00	1.00
Lane Grp Cap(c), veh/h	49	800	0	45	971	285
V/C Ratio(X)	0.00	0.01	0.00	0.00	0.00	0.00
Avail Cap(c_a), veh/h	1885	2141	0	1738	9514	2793
HCM Platoon Ratio	1.00	1.00	1.00	1.00	1.00	1.00
Upstream Filter(I)	0.00	1.00	0.00	0.00	1.00	0.00
Uniform Delay (d), s/veh	0.0	4.2	0.0	0.0	4.3	0.0
Incr Delay (d2), s/veh	0.0	0.0	0.0	0.0	0.0	0.0
Initial Q Delay(d3),s/veh	0.0	0.0	0.0	0.0	0.0	0.0
%ile BackOfQ(50%),veh/ln	0.0	0.0	0.0	0.0	0.0	0.0
Unsig. Movement Delay, s/veh						
LnGrp Delay(d),s/veh	0.0	4.2	0.0	0.0	4.3	0.0
LnGrp LOS	A	A	A	A	A	A
Approach Vol, veh/h	10			0	1	
Approach Delay, s/veh	4.2			0.0	4.3	
Approach LOS	A				A	
Timer - Assigned Phs		2		4		6
Phs Duration (G+Y+Rc), s		6.2		11.0		6.2
Change Period (Y+Rc), s		6.0		6.0		6.0
Max Green Setting (Gmax), s		9.0		49.0		9.0
Max Q Clear Time (g_c+11), s		0.0		2.0		2.0
Green Ext Time (p_c), s		0.0		0.0		0.0
Intersection Summary						
HCM 6th Ctrl Delay			4.2			
HCM 6th LOS			A			

Timings

West Campus Upper Plateau (JN 14064)

34: Old 215 Frontage Rd. & Alessandro Bl.

09/30/2022

Lane Group	EBL	EBT	EBR	WBL	WBT	WBR	NBL	NBT	NBR	SBL	SBT	SBR
Lane Configurations												
Traffic Volume (vph)	385	961	15	13	880	115	28	99	16	104	124	257
Future Volume (vph)	385	961	15	13	880	115	28	99	16	104	124	257
Turn Type	Prot	NA	Perm	Prot	NA	Perm	Prot	NA	Perm	Prot	NA	Perm
Protected Phases	5	2		1	6		3	8		7	4	
Permitted Phases			2			6			8			4
Detector Phase	5	2	2	1	6	6	3	8	8	7	4	4
Switch Phase												
Minimum Initial (s)	5.0	10.0	10.0	5.0	10.0	10.0	5.0	10.0	10.0	5.0	10.0	10.0
Minimum Split (s)	8.7	43.5	43.5	8.7	15.8	15.8	8.7	16.2	16.2	8.7	40.2	40.2
Total Split (s)	22.0	62.4	62.4	8.7	49.1	49.1	8.7	29.7	29.7	19.2	40.2	40.2
Total Split (%)	18.3%	52.0%	52.0%	7.3%	40.9%	40.9%	7.3%	24.8%	24.8%	16.0%	33.5%	33.5%
Yellow Time (s)	3.2	5.5	5.5	3.2	4.8	4.8	3.2	5.2	5.2	3.2	5.2	5.2
All-Red Time (s)	0.5	1.0	1.0	0.5	1.0	1.0	0.5	1.0	1.0	0.5	1.0	1.0
Lost Time Adjust (s)	0.0	0.0	0.0	0.0	0.0	0.0	0.0	0.0	0.0	0.0	0.0	0.0
Total Lost Time (s)	3.7	6.5	6.5	3.7	5.8	5.8	3.7	6.2	6.2	3.7	6.2	6.2
Lead/Lag	Lead	Lag	Lag	Lead	Lag	Lag	Lead	Lag	Lag	Lead	Lag	Lag
Lead-Lag Optimize?	Yes	Yes	Yes	Yes	Yes	Yes	Yes	Yes	Yes	Yes	Yes	Yes
Recall Mode	None	None	None	None	None	None	None	None	None	None	None	None
Act Effct Green (s)	15.0	47.5	47.5	5.3	30.6	30.6	5.3	12.6	12.6	10.3	19.3	19.3
Actuated g/C Ratio	0.17	0.55	0.55	0.06	0.35	0.35	0.06	0.15	0.15	0.12	0.22	0.22
v/c Ratio	0.67	0.35	0.02	0.14	0.74	0.18	0.17	0.20	0.05	0.53	0.18	0.47
Control Delay	42.6	12.7	0.1	52.2	29.8	2.1	49.6	38.3	0.3	50.8	30.7	7.2
Queue Delay	0.0	0.0	0.0	0.0	0.0	0.0	0.0	0.0	0.0	0.0	0.0	0.0
Total Delay	42.6	12.7	0.1	52.2	29.8	2.1	49.6	38.3	0.3	50.8	30.7	7.2
LOS	D	B	A	D	C	A	D	D	A	D	C	A
Approach Delay		21.0			27.0			36.1			22.5	
Approach LOS		C			C			D			C	

Intersection Summary

Cycle Length: 120	
Actuated Cycle Length: 86.2	
Natural Cycle: 105	
Control Type: Actuated-Uncoordinated	
Maximum v/c Ratio: 0.74	
Intersection Signal Delay: 24.0	Intersection LOS: C
Intersection Capacity Utilization 61.1%	ICU Level of Service B
Analysis Period (min) 15	

Splits and Phases: 34: Old 215 Frontage Rd. & Alessandro Bl.

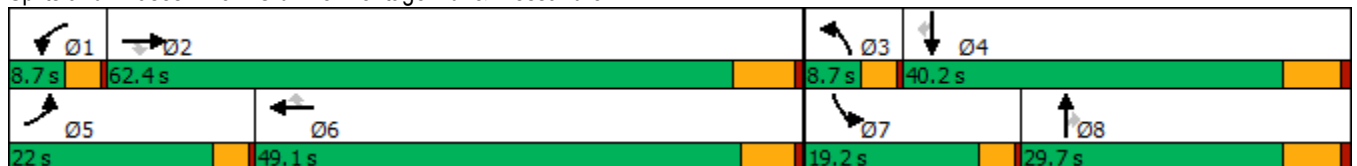

HCM 6th Signalized Intersection Summary
 34: Old 215 Frontage Rd. & Alessandro Bl.

West Campus Upper Plateau (JN 14064)

09/30/2022



Movement	EBL	EBT	EBR	WBL	WBT	WBR	NBL	NBT	NBR	SBL	SBT	SBR
Lane Configurations	↖↗	↑↑↑	↖	↖	↑↑	↖	↖↗	↑↑	↖	↖	↑↑	↖
Traffic Volume (veh/h)	385	961	15	13	880	115	28	99	16	104	124	257
Future Volume (veh/h)	385	961	15	13	880	115	28	99	16	104	124	257
Initial Q (Qb), veh	0	0	0	0	0	0	0	0	0	0	0	0
Ped-Bike Adj(A_pbT)	1.00		1.00	1.00		1.00	1.00		0.98	1.00		1.00
Parking Bus, Adj	1.00	1.00	1.00	1.00	1.00	1.00	1.00	1.00	1.00	1.00	1.00	1.00
Work Zone On Approach		No			No			No			No	
Adj Sat Flow, veh/h/ln	1870	1885	1678	1678	1856	1856	1515	1856	1559	1826	1737	1885
Adj Flow Rate, veh/h	401	1001	-11	14	917	0	29	103	7	108	129	0
Peak Hour Factor	0.96	0.96	0.96	0.96	0.96	0.96	0.96	0.96	0.96	0.96	0.96	0.96
Percent Heavy Veh, %	2	1	15	15	3	3	26	3	23	5	11	1
Cap, veh/h	509	2460	680	27	1226		86	497	183	138	626	
Arrive On Green	0.15	0.48	0.00	0.02	0.35	0.00	0.03	0.14	0.14	0.08	0.19	0.00
Sat Flow, veh/h	3456	5147	1422	1598	3526	1572	2799	3526	1301	1739	3300	1598
Grp Volume(v), veh/h	401	1001	-11	14	917	0	29	103	7	108	129	0
Grp Sat Flow(s),veh/h/ln	1728	1716	1422	1598	1763	1572	1399	1763	1301	1739	1650	1598
Q Serve(g_s), s	7.9	8.9	0.0	0.6	16.2	0.0	0.7	1.8	0.3	4.3	2.3	0.0
Cycle Q Clear(g_c), s	7.9	8.9	0.0	0.6	16.2	0.0	0.7	1.8	0.3	4.3	2.3	0.0
Prop In Lane	1.00		1.00	1.00		1.00	1.00		1.00	1.00		1.00
Lane Grp Cap(c), veh/h	509	2460	680	27	1226		86	497	183	138	626	
V/C Ratio(X)	0.79	0.41	-0.02	0.52	0.75		0.34	0.21	0.04	0.78	0.21	
Avail Cap(c_a), veh/h	896	4075	1126	113	2162		198	1174	433	382	1589	
HCM Platoon Ratio	1.00	1.00	1.00	1.00	1.00	1.00	1.00	1.00	1.00	1.00	1.00	1.00
Upstream Filter(I)	1.00	1.00	0.00	1.00	1.00	0.00	1.00	1.00	1.00	1.00	1.00	0.00
Uniform Delay (d), s/veh	29.0	11.9	0.0	34.4	20.3	0.0	33.5	26.8	26.2	31.9	24.1	0.0
Incr Delay (d2), s/veh	1.0	0.1	0.0	5.5	0.9	0.0	0.9	0.2	0.1	3.6	0.2	0.0
Initial Q Delay(d3),s/veh	0.0	0.0	0.0	0.0	0.0	0.0	0.0	0.0	0.0	0.0	0.0	0.0
%ile BackOfQ(50%),veh/ln	3.0	2.6	0.0	0.3	5.9	0.0	0.2	0.7	0.1	1.8	0.8	0.0
Unsig. Movement Delay, s/veh												
LnGrp Delay(d),s/veh	30.1	12.1	0.0	39.9	21.2	0.0	34.4	27.0	26.3	35.5	24.3	0.0
LnGrp LOS	C	B	A	D	C		C	C	C	D	C	
Approach Vol, veh/h		1391			931			139			237	
Approach Delay, s/veh		17.3			21.5			28.5			29.4	
Approach LOS		B			C			C			C	
Timer - Assigned Phs	1	2	3	4	5	6	7	8				
Phs Duration (G+Y+Rc), s	4.9	40.2	5.9	19.6	14.1	31.0	9.3	16.1				
Change Period (Y+Rc), s	3.7	6.5	3.7	6.2	3.7	* 6.5	3.7	6.2				
Max Green Setting (Gmax), s	5.0	55.9	5.0	34.0	18.3	* 43	15.5	23.5				
Max Q Clear Time (g_c+I1), s	2.6	10.9	2.7	4.3	9.9	18.2	6.3	3.8				
Green Ext Time (p_c), s	0.0	7.2	0.0	0.7	0.5	6.4	0.1	0.4				

Intersection Summary

HCM 6th Ctrl Delay	20.4
HCM 6th LOS	C

Notes

* HCM 6th computational engine requires equal clearance times for the phases crossing the barrier.
 Unsignalized Delay for [WBR, SBR] is excluded from calculations of the approach delay and intersection delay.

Timings
35: Day St. & Alessandro Bl.

West Campus Upper Plateau (JN 14064)

09/30/2022



Lane Group	EBL	EBT	EBR	WBL	WBT	WBR	NBL	NBT	NBR	SBL	SBT
Lane Configurations	↙	↑↑↑	↘	↙	↑↑	↘	↙	↑	↘	↙	↘
Traffic Volume (vph)	204	757	8	11	796	162	12	111	17	136	55
Future Volume (vph)	204	757	8	11	796	162	12	111	17	136	55
Turn Type	Prot	NA	Perm	Prot	NA	Perm	Perm	NA	Perm	Perm	NA
Protected Phases	5	2		1	6			8			4
Permitted Phases			2			6	8		8	4	
Detector Phase	5	2	2	1	6	6	8	8	8	4	4
Switch Phase											
Minimum Initial (s)	5.0	10.0	10.0	5.0	10.0	10.0	10.0	10.0	10.0	10.0	10.0
Minimum Split (s)	9.1	30.8	30.8	9.1	30.8	30.8	42.4	42.4	42.4	41.6	41.6
Total Split (s)	28.0	67.9	67.9	9.1	49.0	49.0	43.0	43.0	43.0	43.0	43.0
Total Split (%)	23.3%	56.6%	56.6%	7.6%	40.8%	40.8%	35.8%	35.8%	35.8%	35.8%	35.8%
Yellow Time (s)	3.6	4.8	4.8	3.6	4.8	4.8	4.4	4.4	4.4	3.6	3.6
All-Red Time (s)	0.5	1.0	1.0	0.5	1.0	1.0	1.0	1.0	1.0	1.0	1.0
Lost Time Adjust (s)	0.0	0.0	0.0	0.0	0.0	0.0	0.0	0.0	0.0	0.0	0.0
Total Lost Time (s)	4.1	5.8	5.8	4.1	5.8	5.8	5.4	5.4	5.4	4.6	4.6
Lead/Lag	Lead	Lag	Lag	Lead	Lag	Lag					
Lead-Lag Optimize?	Yes	Yes	Yes	Yes	Yes	Yes					
Recall Mode	None	None	None	None	None	None	None	None	None	None	None
Act Effct Green (s)	14.2	43.4	43.4	5.5	25.7	25.7	16.4	16.4	16.4	17.3	17.3
Actuated g/C Ratio	0.19	0.59	0.59	0.08	0.35	0.35	0.22	0.22	0.22	0.24	0.24
v/c Ratio	0.62	0.26	0.01	0.08	0.67	0.27	0.07	0.27	0.04	0.47	0.37
Control Delay	39.1	8.6	0.0	45.2	24.3	10.9	27.2	27.9	0.2	32.4	16.3
Queue Delay	0.0	0.0	0.0	0.0	0.0	0.0	0.0	0.0	0.0	0.0	0.0
Total Delay	39.1	8.6	0.0	45.2	24.3	10.9	27.2	27.9	0.2	32.4	16.3
LOS	D	A	A	D	C	B	C	C	A	C	B
Approach Delay		15.0			22.3			24.4			23.6
Approach LOS		B			C			C			C

Intersection Summary

Cycle Length: 120
 Actuated Cycle Length: 73.2
 Natural Cycle: 85
 Control Type: Actuated-Uncoordinated
 Maximum v/c Ratio: 0.67
 Intersection Signal Delay: 19.6
 Intersection LOS: B
 Intersection Capacity Utilization 59.6%
 ICU Level of Service B
 Analysis Period (min) 15



























Splits and Phases: 35: Day St. & Alessandro Bl.



HCM 6th Signalized Intersection Summary
35: Day St. & Alessandro Bl.

West Campus Upper Plateau (JN 14064)

09/30/2022

												
Movement	EBL	EBT	EBR	WBL	WBT	WBR	NBL	NBT	NBR	SBL	SBT	SBR
Lane Configurations		  			 							
Traffic Volume (veh/h)	204	757	8	11	796	162	12	111	17	136	55	108
Future Volume (veh/h)	204	757	8	11	796	162	12	111	17	136	55	108
Initial Q (Qb), veh	0	0	0	0	0	0	0	0	0	0	0	0
Ped-Bike Adj(A_pbT)	1.00		0.98	1.00		0.98	1.00		1.00	1.00		1.00
Parking Bus, Adj	1.00	1.00	1.00	1.00	1.00	1.00	1.00	1.00	1.00	1.00	1.00	1.00
Work Zone On Approach		No			No			No			No	
Adj Sat Flow, veh/h/ln	1885	1870	1618	1900	1870	1900	1500	1900	1767	1885	1870	1870
Adj Flow Rate, veh/h	212	789	2	11	829	101	12	116	13	142	57	81
Peak Hour Factor	0.96	0.96	0.96	0.96	0.96	0.96	0.96	0.96	0.96	0.96	0.96	0.96
Percent Heavy Veh, %	1	2	19	0	2	0	27	0	9	1	2	2
Cap, veh/h	267	2477	651	25	1245	552	282	413	326	345	152	216
Arrive On Green	0.15	0.49	0.49	0.01	0.35	0.35	0.22	0.22	0.22	0.22	0.22	0.22
Sat Flow, veh/h	1795	5106	1341	1810	3554	1575	1003	1900	1497	1271	699	993
Grp Volume(v), veh/h	212	789	2	11	829	101	12	116	13	142	0	138
Grp Sat Flow(s),veh/h/ln	1795	1702	1341	1810	1777	1575	1003	1900	1497	1271	0	1692
Q Serve(g_s), s	6.2	5.1	0.0	0.3	10.7	2.4	0.6	2.7	0.4	5.7	0.0	3.8
Cycle Q Clear(g_c), s	6.2	5.1	0.0	0.3	10.7	2.4	4.3	2.7	0.4	8.4	0.0	3.8
Prop In Lane	1.00		1.00	1.00		1.00	1.00		1.00	1.00		0.59
Lane Grp Cap(c), veh/h	267	2477	651	25	1245	552	282	413	326	345	0	368
V/C Ratio(X)	0.79	0.32	0.00	0.43	0.67	0.18	0.04	0.28	0.04	0.41	0.00	0.38
Avail Cap(c_a), veh/h	794	5869	1541	167	2842	1259	762	1322	1042	972	0	1202
HCM Platoon Ratio	1.00	1.00	1.00	1.00	1.00	1.00	1.00	1.00	1.00	1.00	1.00	1.00
Upstream Filter(I)	1.00	1.00	1.00	1.00	1.00	1.00	1.00	1.00	1.00	1.00	0.00	1.00
Uniform Delay (d), s/veh	22.2	8.5	7.2	26.4	14.9	12.2	19.8	17.6	16.7	21.1	0.0	18.0
Incr Delay (d2), s/veh	2.0	0.1	0.0	4.2	0.6	0.2	0.1	0.4	0.0	0.8	0.0	0.6
Initial Q Delay(d3),s/veh	0.0	0.0	0.0	0.0	0.0	0.0	0.0	0.0	0.0	0.0	0.0	0.0
%ile BackOfQ(50%),veh/ln	2.4	1.3	0.0	0.2	3.4	0.7	0.1	1.1	0.1	1.6	0.0	1.4
Unsig. Movement Delay, s/veh												
LnGrp Delay(d),s/veh	24.2	8.5	7.2	30.7	15.5	12.3	19.9	18.0	16.7	21.9	0.0	18.6
LnGrp LOS	C	A	A	C	B	B	B	B	B	C	A	B
Approach Vol, veh/h		1003			941			141			280	
Approach Delay, s/veh		11.9			15.3			18.0			20.3	
Approach LOS		B			B			B			C	
Timer - Assigned Phs	1	2		4	5	6		8				
Phs Duration (G+Y+Rc), s	4.9	32.0		17.2	12.1	24.7		17.2				
Change Period (Y+Rc), s	4.1	5.8		* 5.4	4.1	5.8		5.4				
Max Green Setting (Gmax), s	5.0	62.1		* 38	23.9	43.2		37.6				
Max Q Clear Time (g_c+I1), s	2.3	7.1		10.4	8.2	12.7		6.3				
Green Ext Time (p_c), s	0.0	5.8		1.4	0.2	6.3		0.7				
Intersection Summary												
HCM 6th Ctrl Delay				14.6								
HCM 6th LOS				B								
Notes												
* HCM 6th computational engine requires equal clearance times for the phases crossing the barrier.												

Timings
36: Elsworth St. & Cactus Av.

West Campus Upper Plateau (JN 14064)

09/30/2022



Lane Group	EBL	EBT	EBR	WBL	WBT	WBR	NBL	NBT	SBL	SBT	SBR
Lane Configurations	↘	↑↑↑	↗	↘	↑↑↑	↗	↘	↕	↘	↗	↗
Traffic Volume (vph)	161	1219	36	16	1215	155	25	13	186	20	132
Future Volume (vph)	161	1219	36	16	1215	155	25	13	186	20	132
Turn Type	Prot	NA	Perm	Prot	NA	Perm	Split	NA	Split	NA	pm+ov
Protected Phases	5	2		1	6		8	8	4	4	5
Permitted Phases			2			6					4
Detector Phase	5	2	2	1	6	6	8	8	4	4	5
Switch Phase											
Minimum Initial (s)	5.0	10.0	10.0	5.0	10.0	10.0	10.0	10.0	10.0	10.0	5.0
Minimum Split (s)	9.6	36.2	36.2	9.6	36.2	36.2	35.4	35.4	35.4	35.4	9.6
Total Split (s)	16.5	49.6	49.6	9.6	42.7	42.7	35.4	35.4	35.4	35.4	16.5
Total Split (%)	12.7%	38.2%	38.2%	7.4%	32.8%	32.8%	27.2%	27.2%	27.2%	27.2%	12.7%
Yellow Time (s)	3.6	5.2	5.2	3.6	5.2	5.2	4.4	4.4	4.4	4.4	3.6
All-Red Time (s)	1.0	1.0	1.0	1.0	1.0	1.0	1.0	1.0	1.0	1.0	1.0
Lost Time Adjust (s)	0.0	0.0	0.0	0.0	0.0	0.0	0.0	0.0	0.0	0.0	0.0
Total Lost Time (s)	4.6	6.2	6.2	4.6	6.2	6.2	5.4	5.4	5.4	5.4	4.6
Lead/Lag	Lead	Lag	Lag	Lead	Lag	Lag					Lead
Lead-Lag Optimize?	Yes	Yes	Yes	Yes	Yes	Yes					Yes
Recall Mode	None	None	None	None	None	None	Max	Max	Max	Max	None
Act Effct Green (s)	11.9	49.0	49.0	5.0	36.4	36.4	30.0	30.0	30.0	30.0	42.7
Actuated g/C Ratio	0.09	0.38	0.38	0.04	0.28	0.28	0.23	0.23	0.23	0.23	0.33
v/c Ratio	1.07	0.68	0.06	0.25	0.92	0.30	0.06	0.07	0.28	0.27	0.22
Control Delay	145.9	36.8	0.2	69.5	56.4	9.3	39.6	27.3	43.4	43.3	3.4
Queue Delay	0.0	0.0	0.0	0.0	0.0	0.0	0.0	0.0	0.0	0.0	0.0
Total Delay	145.9	36.8	0.2	69.5	56.4	9.3	39.6	27.3	43.4	43.3	3.4
LOS	F	D	A	E	E	A	D	C	D	D	A
Approach Delay		48.3			51.3			32.7		27.7	
Approach LOS		D			D			C		C	

Intersection Summary

Cycle Length: 130
 Actuated Cycle Length: 129.9
 Natural Cycle: 120
 Control Type: Actuated-Uncoordinated
 Maximum v/c Ratio: 1.07
 Intersection Signal Delay: 47.1
 Intersection LOS: D
 Intersection Capacity Utilization 58.2%
 ICU Level of Service B
 Analysis Period (min) 15

Splits and Phases: 36: Elsworth St. & Cactus Av.

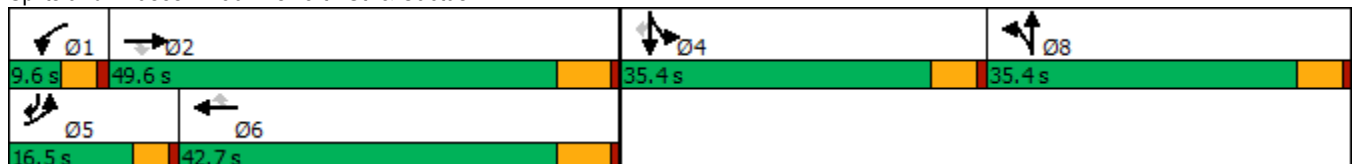

HCM 6th Signalized Intersection Summary
36: Elsworth St. & Cactus Av.

West Campus Upper Plateau (JN 14064)

09/30/2022



Movement	EBL	EBT	EBR	WBL	WBT	WBR	NBL	NBT	NBR	SBL	SBT	SBR
Lane Configurations	↖	↑↑↑	↗	↖	↑↑↑	↗	↖	↕		↖	↗	↗
Traffic Volume (veh/h)	161	1219	36	16	1215	155	25	13	11	186	20	132
Future Volume (veh/h)	161	1219	36	16	1215	155	25	13	11	186	20	132
Initial Q (Qb), veh	0	0	0	0	0	0	0	0	0	0	0	0
Ped-Bike Adj(A_pbT)	1.00		1.00	1.00		1.00	1.00		1.00	1.00		1.00
Parking Bus, Adj	1.00	1.00	1.00	1.00	1.00	1.00	1.00	1.00	1.00	1.00	1.00	1.00
Work Zone On Approach		No			No			No			No	
Adj Sat Flow, veh/h/ln	1841	1841	1781	1900	1841	1885	1885	1900	1885	1885	1900	1885
Adj Flow Rate, veh/h	169	1283	0	17	1279	126	25	0	0	211	0	31
Peak Hour Factor	0.95	0.95	0.95	0.95	0.95	0.95	0.95	0.95	0.95	0.95	0.95	0.95
Percent Heavy Veh, %	4	4	8	0	4	1	1	0	1	1	0	1
Cap, veh/h	161	1764		32	1391	442	833	441	0	833	0	518
Arrive On Green	0.09	0.35	0.00	0.02	0.28	0.28	0.23	0.00	0.00	0.23	0.00	0.23
Sat Flow, veh/h	1753	5025	1510	1810	5025	1598	3591	1900	0	3591	0	1598
Grp Volume(v), veh/h	169	1283	0	17	1279	126	25	0	0	211	0	31
Grp Sat Flow(s),veh/h/ln	1753	1675	1510	1810	1675	1598	1795	1900	0	1795	0	1598
Q Serve(g_s), s	11.9	28.8	0.0	1.2	31.9	8.0	0.7	0.0	0.0	6.2	0.0	1.7
Cycle Q Clear(g_c), s	11.9	28.8	0.0	1.2	31.9	8.0	0.7	0.0	0.0	6.2	0.0	1.7
Prop In Lane	1.00		1.00	1.00		1.00	1.00		0.00	1.00		1.00
Lane Grp Cap(c), veh/h	161	1764		32	1391	442	833	441	0	833	0	518
V/C Ratio(X)	1.05	0.73		0.53	0.92	0.29	0.03	0.00	0.00	0.25	0.00	0.06
Avail Cap(c_a), veh/h	161	1764		70	1419	451	833	441	0	833	0	518
HCM Platoon Ratio	1.00	1.00	1.00	1.00	1.00	1.00	1.00	1.00	1.00	1.00	1.00	1.00
Upstream Filter(I)	1.00	1.00	0.00	1.00	1.00	1.00	1.00	0.00	0.00	1.00	0.00	1.00
Uniform Delay (d), s/veh	58.7	36.5	0.0	63.0	45.4	36.7	38.4	0.0	0.0	40.5	0.0	30.1
Incr Delay (d2), s/veh	83.9	1.5	0.0	5.0	9.9	0.4	0.1	0.0	0.0	0.7	0.0	0.2
Initial Q Delay(d3),s/veh	0.0	0.0	0.0	0.0	0.0	0.0	0.0	0.0	0.0	0.0	0.0	0.0
%ile BackOfQ(50%),veh/ln	8.9	11.5	0.0	0.6	13.9	3.1	0.3	0.0	0.0	2.8	0.0	0.7
Unsig. Movement Delay, s/veh												
LnGrp Delay(d),s/veh	142.6	38.1	0.0	68.0	55.2	37.1	38.5	0.0	0.0	41.2	0.0	30.3
LnGrp LOS	F	D		E	E	D	D	A	A	D	A	C
Approach Vol, veh/h		1452			1422			25			242	
Approach Delay, s/veh		50.2			53.8			38.5			39.8	
Approach LOS		D			D			D			D	
Timer - Assigned Phs	1	2		4	5	6		8				
Phs Duration (G+Y+Rc), s	6.9	51.6		35.4	16.5	42.0		35.4				
Change Period (Y+Rc), s	4.6	6.2		5.4	4.6	6.2		5.4				
Max Green Setting (Gmax), s	5.0	43.4		30.0	11.9	36.5		30.0				
Max Q Clear Time (g_c+1), s	3.2	30.8		8.2	13.9	33.9		2.7				
Green Ext Time (p_c), s	0.0	6.4		0.7	0.0	1.8		0.0				

Intersection Summary

HCM 6th Ctrl Delay	50.9
HCM 6th LOS	D

Notes

- User approved pedestrian interval to be less than phase max green.
- User approved volume balancing among the lanes for turning movement.
- Unsignalized Delay for [EBR] is excluded from calculations of the approach delay and intersection delay.

Timings
37: Cactus Av. & Frederick St.

West Campus Upper Plateau (JN 14064)

09/30/2022



Lane Group	EBL	EBT	WBT	WBR	SBL	SBR
Lane Configurations	↖	↑↑↑	↑↑↑	↗	↖↗	↗
Traffic Volume (vph)	104	1343	1349	192	306	80
Future Volume (vph)	104	1343	1349	192	306	80
Turn Type	Prot	NA	NA	pm+ov	Prot	pm+ov
Protected Phases	5	2	6	4	4	5
Permitted Phases				6		4
Detector Phase	5	2	6	4	4	5
Switch Phase						
Minimum Initial (s)	5.0	10.0	10.0	10.0	10.0	5.0
Minimum Split (s)	9.2	28.2	29.2	36.4	36.4	9.2
Total Split (s)	31.0	81.0	50.0	39.0	39.0	31.0
Total Split (%)	25.8%	67.5%	41.7%	32.5%	32.5%	25.8%
Yellow Time (s)	3.2	5.2	5.2	4.4	4.4	3.2
All-Red Time (s)	1.0	1.0	1.0	1.0	1.0	1.0
Lost Time Adjust (s)	0.0	0.0	0.0	0.0	0.0	0.0
Total Lost Time (s)	4.2	6.2	6.2	5.4	5.4	4.2
Lead/Lag	Lead		Lag			Lead
Lead-Lag Optimize?	Yes		Yes			Yes
Recall Mode	None	None	None	None	None	None
Act Effect Green (s)	10.1	46.0	31.4	47.8	15.6	31.4
Actuated g/C Ratio	0.14	0.62	0.43	0.65	0.21	0.43
v/c Ratio	0.48	0.47	0.68	0.19	0.47	0.13
Control Delay	40.8	8.3	19.9	0.9	28.9	13.9
Queue Delay	0.0	0.0	0.0	0.0	0.0	0.0
Total Delay	40.8	8.3	19.9	0.9	28.9	13.9
LOS	D	A	B	A	C	B
Approach Delay		10.7	17.5		25.8	
Approach LOS		B	B		C	

Intersection Summary

Cycle Length: 120
 Actuated Cycle Length: 73.8
 Natural Cycle: 80
 Control Type: Actuated-Uncoordinated
 Maximum v/c Ratio: 0.68
 Intersection Signal Delay: 15.5
 Intersection LOS: B
 Intersection Capacity Utilization 53.7%
 ICU Level of Service A
 Analysis Period (min) 15

Splits and Phases: 37: Cactus Av. & Frederick St.

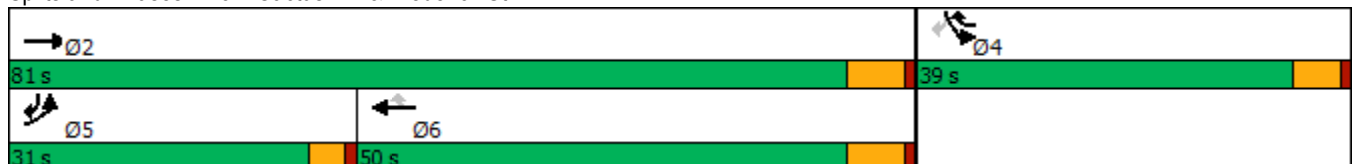

HCM 6th Signalized Intersection Summary
37: Cactus Av. & Frederick St.

West Campus Upper Plateau (JN 14064)

09/30/2022



Movement	EBL	EBT	WBT	WBR	SBL	SBR
Lane Configurations						
Traffic Volume (veh/h)	104	1343	1349	192	306	80
Future Volume (veh/h)	104	1343	1349	192	306	80
Initial Q (Qb), veh	0	0	0	0	0	0
Ped-Bike Adj(A_pbT)	1.00			0.98	1.00	1.00
Parking Bus, Adj	1.00	1.00	1.00	1.00	1.00	1.00
Work Zone On Approach		No	No		No	
Adj Sat Flow, veh/h/ln	1826	1856	1856	1870	1856	1856
Adj Flow Rate, veh/h	113	1460	1466	145	333	-13
Peak Hour Factor	0.92	0.92	0.92	0.92	0.92	0.92
Percent Heavy Veh, %	5	3	3	2	3	3
Cap, veh/h	146	3161	2364	998	595	405
Arrive On Green	0.08	0.62	0.47	0.47	0.17	0.00
Sat Flow, veh/h	1739	5233	5233	1548	3428	1572
Grp Volume(v), veh/h	113	1460	1466	145	333	-13
Grp Sat Flow(s),veh/h/ln	1739	1689	1689	1548	1714	1572
Q Serve(g_s), s	3.6	8.7	12.4	2.1	5.1	0.0
Cycle Q Clear(g_c), s	3.6	8.7	12.4	2.1	5.1	0.0
Prop In Lane	1.00			1.00	1.00	1.00
Lane Grp Cap(c), veh/h	146	3161	2364	998	595	405
V/C Ratio(X)	0.77	0.46	0.62	0.15	0.56	-0.03
Avail Cap(c_a), veh/h	814	6615	3873	1459	2011	1054
HCM Platoon Ratio	1.00	1.00	1.00	1.00	1.00	1.00
Upstream Filter(I)	1.00	1.00	1.00	1.00	1.00	0.00
Uniform Delay (d), s/veh	25.7	5.7	11.5	4.1	21.7	0.0
Incr Delay (d2), s/veh	3.3	0.1	0.3	0.1	0.8	0.0
Initial Q Delay(d3),s/veh	0.0	0.0	0.0	0.0	0.0	0.0
%ile BackOfQ(50%),veh/ln	1.4	1.5	3.3	0.8	1.9	0.0
Unsig. Movement Delay, s/veh						
LnGrp Delay(d),s/veh	29.0	5.8	11.7	4.2	22.5	0.0
LnGrp LOS	C	A	B	A	C	A
Approach Vol, veh/h		1573	1611		320	
Approach Delay, s/veh		7.5	11.0		23.4	
Approach LOS		A	B		C	
Timer - Assigned Phs		2		4	5	6
Phs Duration (G+Y+Rc), s		41.9		15.3	9.0	32.9
Change Period (Y+Rc), s		6.2		5.4	* 4.2	6.2
Max Green Setting (Gmax), s		74.8		33.6	* 27	43.8
Max Q Clear Time (g_c+I1), s		10.7		7.1	5.6	14.4
Green Ext Time (p_c), s		13.8		1.1	0.1	12.3

Intersection Summary

HCM 6th Ctrl Delay	10.6
HCM 6th LOS	B

Notes

* HCM 6th computational engine requires equal clearance times for the phases crossing the barrier.

Timings
38: Riverside Dr./Graham St. & Cactus Av.

West Campus Upper Plateau (JN 14064)

09/30/2022

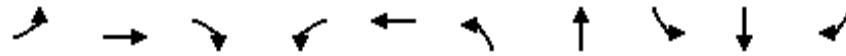

Lane Group	EBL	EBT	EBR	WBL	WBT	NBL	NBT	SBL	SBT	SBR
Lane Configurations	↘	↑↑↑	↗	↘	↑↑↑	↘↗	↑↗	↘	↑↑	↗
Traffic Volume (vph)	65	1256	202	23	1304	183	53	75	68	81
Future Volume (vph)	65	1256	202	23	1304	183	53	75	68	81
Turn Type	Prot	NA	Perm	Prot	NA	Prot	NA	Prot	NA	Perm
Protected Phases	7	4		3	8	5	2	1	6	
Permitted Phases			4							6
Detector Phase	7	4	4	3	8	5	2	1	6	6
Switch Phase										
Minimum Initial (s)	5.0	10.0	10.0	5.0	10.0	5.0	10.0	5.0	10.0	10.0
Minimum Split (s)	9.6	39.2	39.2	9.6	39.2	10.4	35.0	9.6	40.6	40.6
Total Split (s)	16.0	59.0	59.0	9.6	52.6	10.4	36.0	15.4	41.0	41.0
Total Split (%)	13.3%	49.2%	49.2%	8.0%	43.8%	8.7%	30.0%	12.8%	34.2%	34.2%
Yellow Time (s)	3.6	5.2	5.2	3.6	5.2	4.4	4.0	3.6	3.6	3.6
All-Red Time (s)	1.0	1.0	1.0	1.0	1.0	1.0	1.0	1.0	1.0	1.0
Lost Time Adjust (s)	0.0	0.0	0.0	0.0	0.0	0.0	0.0	0.0	0.0	0.0
Total Lost Time (s)	4.6	6.2	6.2	4.6	6.2	5.4	5.0	4.6	4.6	4.6
Lead/Lag	Lead	Lag	Lag	Lead	Lag	Lead	Lag	Lead	Lag	Lag
Lead-Lag Optimize?	Yes	Yes	Yes	Yes	Yes	Yes	Yes	Yes	Yes	Yes
Recall Mode	None	Min	Min	None	Min	None	None	None	None	None
Act Effct Green (s)	8.2	39.9	39.9	5.7	33.3	7.4	14.0	8.4	16.5	16.5
Actuated g/C Ratio	0.10	0.50	0.50	0.07	0.42	0.09	0.18	0.11	0.21	0.21
v/c Ratio	0.38	0.52	0.23	0.19	0.68	0.58	0.12	0.41	0.09	0.19
Control Delay	47.4	15.9	3.3	49.3	22.8	51.6	26.1	48.1	29.8	0.9
Queue Delay	0.0	0.0	0.0	0.0	0.0	0.0	0.0	0.0	0.0	0.0
Total Delay	47.4	15.9	3.3	49.3	22.8	51.6	26.1	48.1	29.8	0.9
LOS	D	B	A	D	C	D	C	D	C	A
Approach Delay		15.6			23.3		44.3		25.4	
Approach LOS		B			C		D		C	

Intersection Summary

Cycle Length: 120
 Actuated Cycle Length: 79.5
 Natural Cycle: 100
 Control Type: Actuated-Uncoordinated
 Maximum v/c Ratio: 0.68
 Intersection Signal Delay: 21.6
 Intersection LOS: C
 Intersection Capacity Utilization 56.1%
 ICU Level of Service B
 Analysis Period (min) 15

Splits and Phases: 38: Riverside Dr./Graham St. & Cactus Av.

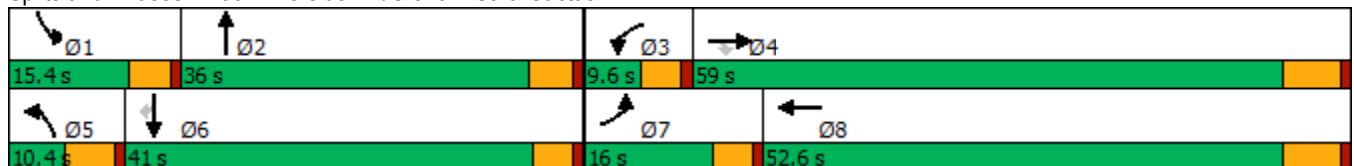

HCM 6th Signalized Intersection Summary
38: Riverside Dr./Graham St. & Cactus Av.

West Campus Upper Plateau (JN 14064)

09/30/2022



Movement	EBL	EBT	EBR	WBL	WBT	WBR	NBL	NBT	NBR	SBL	SBT	SBR
Lane Configurations	↘	↑↑↑	↗	↘	↑↑↑		↘↗	↑↗		↘	↑↑	↗
Traffic Volume (veh/h)	65	1256	202	23	1304	75	183	53	19	75	68	81
Future Volume (veh/h)	65	1256	202	23	1304	75	183	53	19	75	68	81
Initial Q (Qb), veh	0	0	0	0	0	0	0	0	0	0	0	0
Ped-Bike Adj(A_pbT)	1.00		1.00	1.00		0.99	1.00		1.00	1.00		1.00
Parking Bus, Adj	1.00	1.00	1.00	1.00	1.00	1.00	1.00	1.00	1.00	1.00	1.00	1.00
Work Zone On Approach		No			No			No			No	
Adj Sat Flow, veh/h/ln	1841	1841	1885	1900	1841	1900	1900	1900	1900	1870	1885	1826
Adj Flow Rate, veh/h	67	1295	163	24	1344	69	189	55	19	77	70	10
Peak Hour Factor	0.97	0.97	0.97	0.97	0.97	0.97	0.97	0.97	0.97	0.97	0.97	0.97
Percent Heavy Veh, %	4	4	1	0	4	0	0	0	0	2	1	5
Cap, veh/h	93	2182	694	49	1995	102	262	473	156	101	528	228
Arrive On Green	0.05	0.43	0.43	0.03	0.41	0.41	0.07	0.18	0.18	0.06	0.15	0.15
Sat Flow, veh/h	1753	5025	1598	1810	4891	251	3510	2669	878	1781	3582	1547
Grp Volume(v), veh/h	67	1295	163	24	921	492	189	36	38	77	70	10
Grp Sat Flow(s),veh/h/ln	1753	1675	1598	1810	1675	1792	1755	1805	1742	1781	1791	1547
Q Serve(g_s), s	2.5	13.1	4.3	0.9	15.0	15.0	3.5	1.1	1.2	2.9	1.1	0.4
Cycle Q Clear(g_c), s	2.5	13.1	4.3	0.9	15.0	15.0	3.5	1.1	1.2	2.9	1.1	0.4
Prop In Lane	1.00		1.00	1.00		0.14	1.00		0.50	1.00		1.00
Lane Grp Cap(c), veh/h	93	2182	694	49	1367	731	262	320	309	101	528	228
V/C Ratio(X)	0.72	0.59	0.23	0.49	0.67	0.67	0.72	0.11	0.12	0.76	0.13	0.04
Avail Cap(c_a), veh/h	299	3964	1260	135	2323	1242	262	836	807	287	1948	842
HCM Platoon Ratio	1.00	1.00	1.00	1.00	1.00	1.00	1.00	1.00	1.00	1.00	1.00	1.00
Upstream Filter(I)	1.00	1.00	1.00	1.00	1.00	1.00	1.00	1.00	1.00	1.00	1.00	1.00
Uniform Delay (d), s/veh	31.2	14.4	11.9	32.1	16.2	16.2	30.3	23.1	23.2	31.1	24.8	24.5
Incr Delay (d2), s/veh	3.8	0.3	0.2	2.9	0.6	1.1	8.1	0.2	0.2	4.3	0.1	0.1
Initial Q Delay(d3),s/veh	0.0	0.0	0.0	0.0	0.0	0.0	0.0	0.0	0.0	0.0	0.0	0.0
%ile BackOfQ(50%),veh/ln	1.1	4.0	1.3	0.4	4.7	5.1	1.7	0.5	0.5	1.3	0.5	0.1
Unsig. Movement Delay, s/veh												
LnGrp Delay(d),s/veh	35.0	14.7	12.1	35.0	16.8	17.3	38.4	23.3	23.3	35.5	24.9	24.6
LnGrp LOS	D	B	B	C	B	B	D	C	C	D	C	C
Approach Vol, veh/h		1525			1437			263			157	
Approach Delay, s/veh		15.3			17.2			34.1			30.1	
Approach LOS		B			B			C			C	
Timer - Assigned Phs	1	2	3	4	5	6	7	8				
Phs Duration (G+Y+Rc), s	8.4	16.9	6.4	35.3	10.4	14.9	8.2	33.5				
Change Period (Y+Rc), s	4.6	5.0	4.6	6.2	5.4	* 5	4.6	6.2				
Max Green Setting (Gmax), s	10.8	31.0	5.0	52.8	5.0	* 36	11.4	46.4				
Max Q Clear Time (g_c+I1), s	4.9	3.2	2.9	15.1	5.5	3.1	4.5	17.0				
Green Ext Time (p_c), s	0.0	0.3	0.0	11.4	0.0	0.4	0.0	10.3				

Intersection Summary

HCM 6th Ctrl Delay	18.3
HCM 6th LOS	B

Notes

* HCM 6th computational engine requires equal clearance times for the phases crossing the barrier.

APPENDIX 8.2:

**HORIZON YEAR (2045) WITH PROJECT CONDITIONS INTERSECTION OPERATIONS
ANALYSIS WORKSHEETS**

This Page Intentionally Left Blank

Timings
1: Washington St & Van Buren Bl.

West Campus Upper Plateau (JN 14064)

09/20/2022



Lane Group	EBL	EBT	WBL	WBT	WBR	NBL	NBT	NBR	SBL	SBT
Lane Configurations	↙	↕↗	↙	↕↗	↗	↙↗	↕↗	↗	↙↗	↕↗
Traffic Volume (vph)	175	1547	142	1992	896	328	1169	224	546	235
Future Volume (vph)	175	1547	142	1992	896	328	1169	224	546	235
Turn Type	Prot	NA	Prot	NA	Perm	Prot	NA	Perm	Prot	NA
Protected Phases	5	2	1	6		3	8		7	4
Permitted Phases					6			8		
Detector Phase	5	2	1	6	6	3	8	8	7	4
Switch Phase										
Minimum Initial (s)	5.0	10.0	5.0	10.0	10.0	5.0	10.0	10.0	5.0	10.0
Minimum Split (s)	9.2	34.2	9.2	33.2	33.2	9.2	38.4	38.4	9.2	30.8
Total Split (s)	14.0	53.1	12.3	51.4	51.4	14.2	38.4	38.4	16.2	40.4
Total Split (%)	11.7%	44.3%	10.3%	42.8%	42.8%	11.8%	32.0%	32.0%	13.5%	33.7%
Yellow Time (s)	3.2	5.2	3.2	5.2	5.2	3.2	4.4	4.4	3.2	4.8
All-Red Time (s)	1.0	1.0	1.0	1.0	1.0	1.0	1.0	1.0	1.0	1.0
Lost Time Adjust (s)	0.0	0.0	0.0	0.0	0.0	0.0	0.0	0.0	0.0	0.0
Total Lost Time (s)	4.2	6.2	4.2	6.2	6.2	4.2	5.4	5.4	4.2	5.8
Lead/Lag	Lead	Lag	Lead	Lag	Lag	Lead	Lag	Lag	Lead	Lag
Lead-Lag Optimize?	Yes	Yes	Yes	Yes	Yes	Yes	Yes	Yes	Yes	Yes
Recall Mode	None	None	None	None	None	None	None	None	None	None
Act Effct Green (s)	9.8	46.9	8.1	45.2	45.2	10.0	33.0	33.0	12.0	34.6
Actuated g/C Ratio	0.08	0.39	0.07	0.38	0.38	0.08	0.28	0.28	0.10	0.29
v/c Ratio	1.26	1.31	1.25	1.56	1.28	1.21	1.24	0.46	1.66	0.34
Control Delay	203.7	178.5	211.6	283.4	162.4	168.4	154.5	22.7	343.1	30.5
Queue Delay	0.0	0.0	0.0	0.0	0.0	0.0	0.0	0.0	0.0	0.0
Total Delay	203.7	178.5	211.6	283.4	162.4	168.4	154.5	22.7	343.1	30.5
LOS	F	F	F	F	F	F	F	C	F	C
Approach Delay		180.8		244.3			140.0			228.2
Approach LOS		F		F			F			F

Intersection Summary

Cycle Length: 120
 Actuated Cycle Length: 120
 Natural Cycle: 125
 Control Type: Actuated-Uncoordinated
 Maximum v/c Ratio: 1.66
 Intersection Signal Delay: 202.5
 Intersection LOS: F
 Intersection Capacity Utilization 129.3%
 ICU Level of Service H
 Analysis Period (min) 15



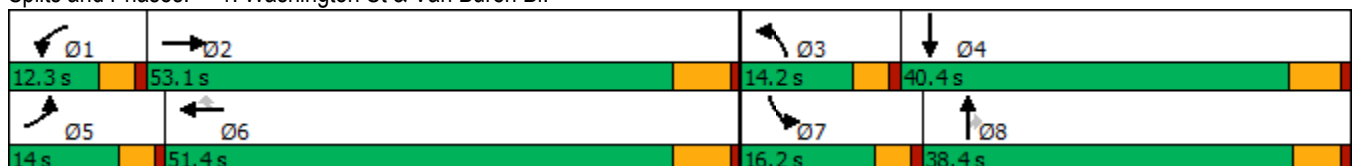



















Splits and Phases: 1: Washington St & Van Buren Bl.



HCM 6th Signalized Intersection Summary
1: Washington St & Van Buren Bl.

West Campus Upper Plateau (JN 14064)

09/20/2022

												
Movement	EBL	EBT	EBR	WBL	WBT	WBR	NBL	NBT	NBR	SBL	SBT	SBR
Lane Configurations												
Traffic Volume (veh/h)	175	1547	165	142	1992	896	328	1169	224	546	235	83
Future Volume (veh/h)	175	1547	165	142	1992	896	328	1169	224	546	235	83
Initial Q (Qb), veh	0	0	0	0	0	0	0	0	0	0	0	0
Ped-Bike Adj(A_pbT)	1.00		0.99	1.00		0.98	1.00		1.00	1.00		1.00
Parking Bus, Adj	1.00	1.00	1.00	1.00	1.00	1.00	1.00	1.00	1.00	1.00	1.00	1.00
Work Zone On Approach		No			No			No			No	
Adj Sat Flow, veh/h/ln	1885	1856	1870	1856	1870	1885	1856	1885	1870	1870	1811	1826
Adj Flow Rate, veh/h	182	1611	149	148	2075	769	342	1218	167	569	245	57
Peak Hour Factor	0.96	0.96	0.96	0.96	0.96	0.96	0.96	0.96	0.96	0.96	0.96	0.96
Percent Heavy Veh, %	1	3	2	3	2	1	3	1	2	2	6	5
Cap, veh/h	146	1271	116	119	1334	589	285	982	433	344	809	185
Arrive On Green	0.08	0.39	0.39	0.07	0.38	0.38	0.08	0.27	0.27	0.10	0.29	0.29
Sat Flow, veh/h	1795	3262	298	1767	3554	1569	3428	3582	1580	3456	2781	635
Grp Volume(v), veh/h	182	862	898	148	2075	769	342	1218	167	569	150	152
Grp Sat Flow(s),veh/h/ln	1795	1763	1797	1767	1777	1569	1714	1791	1580	1728	1721	1696
Q Serve(g_s), s	9.8	46.9	46.9	8.1	45.2	45.2	10.0	33.0	10.3	12.0	8.1	8.4
Cycle Q Clear(g_c), s	9.8	46.9	46.9	8.1	45.2	45.2	10.0	33.0	10.3	12.0	8.1	8.4
Prop In Lane	1.00		0.17	1.00		1.00	1.00		1.00	1.00		0.37
Lane Grp Cap(c), veh/h	146	687	700	119	1334	589	285	982	433	344	500	493
V/C Ratio(X)	1.25	1.26	1.28	1.24	1.56	1.31	1.20	1.24	0.39	1.65	0.30	0.31
Avail Cap(c_a), veh/h	146	687	700	119	1334	589	285	982	433	344	500	493
HCM Platoon Ratio	1.00	1.00	1.00	1.00	1.00	1.00	1.00	1.00	1.00	1.00	1.00	1.00
Upstream Filter(I)	1.00	1.00	1.00	1.00	1.00	1.00	1.00	1.00	1.00	1.00	1.00	1.00
Uniform Delay (d), s/veh	55.3	36.7	36.8	56.1	37.6	37.6	55.2	43.7	35.5	54.2	33.2	33.3
Incr Delay (d2), s/veh	155.0	126.8	137.7	162.4	253.6	149.6	119.2	117.0	0.6	306.1	0.3	0.4
Initial Q Delay(d3),s/veh	0.0	0.0	0.0	0.0	0.0	0.0	0.0	0.0	0.0	0.0	0.0	0.0
%ile BackOfQ(50%),veh/ln	10.6	42.9	45.8	8.9	65.3	41.6	9.1	30.6	4.1	19.8	3.5	3.5
Unsig. Movement Delay, s/veh												
LnGrp Delay(d),s/veh	210.3	163.6	174.5	218.6	291.2	187.2	174.4	160.7	36.0	360.3	33.5	33.6
LnGrp LOS	F	F	F	F	F	F	F	F	D	F	C	C
Approach Vol, veh/h		1942			2992			1727				871
Approach Delay, s/veh		173.0			260.9			151.4				247.0
Approach LOS		F			F			F				F
Timer - Assigned Phs	1	2	3	4	5	6	7	8				
Phs Duration (G+Y+Rc), s	12.3	53.1	14.2	40.8	14.0	51.4	16.2	38.8				
Change Period (Y+Rc), s	* 4.2	6.2	* 4.2	5.8	* 4.2	6.2	* 4.2	* 5.8				
Max Green Setting (Gmax), s	* 8.1	46.9	* 10	34.6	* 9.8	45.2	* 12	* 33				
Max Q Clear Time (g_c+I1), s	10.1	48.9	12.0	10.4	11.8	47.2	14.0	35.0				
Green Ext Time (p_c), s	0.0	0.0	0.0	1.8	0.0	0.0	0.0	0.0				
Intersection Summary												
HCM 6th Ctrl Delay				211.5								
HCM 6th LOS				F								
Notes												
* HCM 6th computational engine requires equal clearance times for the phases crossing the barrier.												

Timings
2: Central Ave & Arlington Ave/Chicago Ave

West Campus Upper Plateau (JN 14064)

09/20/2022



Lane Group	EBL	EBT	EBR	WBL	WBT	WBR	NBL	NBT	NBR	SBL	SBT
Lane Configurations											
Traffic Volume (vph)	55	656	887	317	1083	431	1733	2163	683	301	923
Future Volume (vph)	55	656	887	317	1083	431	1733	2163	683	301	923
Turn Type	Prot	NA	pm+ov	Prot	NA	pm+ov	Prot	NA	pm+ov	Prot	NA
Protected Phases	7	4	5	3	8	1	5	2	3	1	6
Permitted Phases			4			8			2		
Detector Phase	7	4	5	3	8	1	5	2	3	1	6
Switch Phase											
Minimum Initial (s)	5.0	10.0	10.0	5.0	10.0	10.0	10.0	10.0	5.0	10.0	10.0
Minimum Split (s)	9.6	35.2	15.8	9.6	38.8	15.8	15.8	38.8	9.6	15.8	38.8
Total Split (s)	9.6	35.6	42.0	12.8	38.8	15.9	42.0	65.7	12.8	15.9	39.6
Total Split (%)	7.4%	27.4%	32.3%	9.8%	29.8%	12.2%	32.3%	50.5%	9.8%	12.2%	30.5%
Yellow Time (s)	3.6	4.8	3.6	3.6	4.8	3.6	3.6	4.4	3.6	3.6	4.4
All-Red Time (s)	1.0	1.0	1.0	1.0	1.0	1.0	1.0	1.0	1.0	1.0	1.0
Lost Time Adjust (s)	0.0	0.0	0.0	0.0	0.0	0.0	0.0	0.0	0.0	0.0	0.0
Total Lost Time (s)	4.6	5.8	4.6	4.6	5.8	4.6	4.6	5.4	4.6	4.6	5.4
Lead/Lag	Lead	Lag	Lead	Lead	Lag	Lead	Lead	Lag	Lead	Lead	Lag
Lead-Lag Optimize?	Yes	Yes	Yes	Yes	Yes	Yes	Yes	Yes	Yes	Yes	Yes
Recall Mode	None	None	None	None	None	None	None	None	None	None	None
Act Effct Green (s)	5.0	29.8	73.0	8.2	33.0	50.1	37.4	60.3	69.3	11.3	34.2
Actuated g/C Ratio	0.04	0.23	0.56	0.06	0.25	0.39	0.29	0.46	0.53	0.09	0.26
v/c Ratio	0.86	0.87	0.59	1.62	1.27	0.68	1.85	1.39	0.84	1.07	0.78
Control Delay	134.5	60.8	19.1	337.5	170.3	31.8	414.6	208.8	30.3	128.2	49.1
Queue Delay	0.0	0.0	0.0	0.0	0.0	0.0	0.0	0.0	0.0	0.0	0.0
Total Delay	134.5	60.8	19.1	337.5	170.3	31.8	414.6	208.8	30.3	128.2	49.1
LOS	F	E	B	F	F	C	F	F	C	F	D
Approach Delay		40.3			166.6			260.1			67.7
Approach LOS		D			F			F			E

Intersection Summary

Cycle Length: 130
 Actuated Cycle Length: 130
 Natural Cycle: 125
 Control Type: Actuated-Uncoordinated
 Maximum v/c Ratio: 1.85
 Intersection Signal Delay: 177.3
 Intersection LOS: F
 Intersection Capacity Utilization 119.6%
 ICU Level of Service H
 Analysis Period (min) 15

Splits and Phases: 2: Central Ave & Arlington Ave/Chicago Ave



HCM 6th Signalized Intersection Summary
2: Central Ave & Arlington Ave/Chicago Ave

West Campus Upper Plateau (JN 14064)

09/20/2022



Movement	EBL	EBT	EBR	WBL	WBT	WBR	NBL	NBT	NBR	SBL	SBT	SBR
Lane Configurations	↗	↑↑	↗↗	↘↘	↑↑	↗	↘↘	↑↑	↗	↘↘	↑↑↑	
Traffic Volume (veh/h)	55	656	887	317	1083	431	1733	2163	683	301	923	56
Future Volume (veh/h)	55	656	887	317	1083	431	1733	2163	683	301	923	56
Initial Q (Qb), veh	0	0	0	0	0	0	0	0	0	0	0	0
Ped-Bike Adj(A_pbT)	1.00		1.00	1.00		1.00	1.00		0.99	1.00		1.00
Parking Bus, Adj	1.00	1.00	1.00	1.00	1.00	1.00	1.00	1.00	1.00	1.00	1.00	1.00
Work Zone On Approach		No			No			No			No	
Adj Sat Flow, veh/h/ln	1900	1856	1885	1811	1885	1885	1885	1885	1885	1870	1870	1870
Adj Flow Rate, veh/h	59	698	687	337	1152	377	1844	2301	558	320	982	50
Peak Hour Factor	0.94	0.94	0.94	0.94	0.94	0.94	0.94	0.94	0.94	0.94	0.94	0.94
Percent Heavy Veh, %	0	3	1	6	1	1	1	1	1	2	2	2
Cap, veh/h	70	808	1453	211	909	544	1002	1661	832	300	1309	67
Arrive On Green	0.04	0.23	0.23	0.06	0.25	0.25	0.29	0.46	0.46	0.09	0.26	0.26
Sat Flow, veh/h	1810	3526	2812	3346	3582	1598	3483	3582	1577	3456	4976	253
Grp Volume(v), veh/h	59	698	687	337	1152	377	1844	2301	558	320	671	361
Grp Sat Flow(s),veh/h/ln	1810	1763	1406	1673	1791	1598	1742	1791	1577	1728	1702	1825
Q Serve(g_s), s	4.2	24.7	20.3	8.2	33.0	26.5	37.4	60.3	33.7	11.3	23.5	23.6
Cycle Q Clear(g_c), s	4.2	24.7	20.3	8.2	33.0	26.5	37.4	60.3	33.7	11.3	23.5	23.6
Prop In Lane	1.00		1.00	1.00		1.00	1.00		1.00	1.00		0.14
Lane Grp Cap(c), veh/h	70	808	1453	211	909	544	1002	1661	832	300	896	480
V/C Ratio(X)	0.85	0.86	0.47	1.60	1.27	0.69	1.84	1.38	0.67	1.07	0.75	0.75
Avail Cap(c_a), veh/h	70	808	1453	211	909	544	1002	1661	832	300	896	480
HCM Platoon Ratio	1.00	1.00	1.00	1.00	1.00	1.00	1.00	1.00	1.00	1.00	1.00	1.00
Upstream Filter(I)	1.00	1.00	1.00	1.00	1.00	1.00	1.00	1.00	1.00	1.00	1.00	1.00
Uniform Delay (d), s/veh	62.1	48.1	20.1	60.9	48.5	37.0	46.3	34.8	22.5	59.4	44.0	44.0
Incr Delay (d2), s/veh	56.7	9.6	0.2	289.6	128.9	3.8	382.0	177.0	2.1	70.3	3.5	6.5
Initial Q Delay(d3),s/veh	0.0	0.0	0.0	0.0	0.0	0.0	0.0	0.0	0.0	0.0	0.0	0.0
%ile BackOfQ(50%),veh/ln	3.0	11.6	6.4	11.9	30.5	10.6	68.9	65.7	12.2	7.8	10.2	11.3
Unsig. Movement Delay, s/veh												
LnGrp Delay(d),s/veh	118.8	57.7	20.3	350.5	177.4	40.7	428.3	211.9	24.6	129.6	47.5	50.5
LnGrp LOS	F	E	C	F	F	D	F	F	C	F	D	D
Approach Vol, veh/h		1444			1866			4703			1352	
Approach Delay, s/veh		42.4			181.1			274.5			67.8	
Approach LOS		D			F			F			E	
Timer - Assigned Phs	1	2	3	4	5	6	7	8				
Phs Duration (G+Y+Rc), s	15.9	65.7	12.8	35.6	42.0	39.6	9.6	38.8				
Change Period (Y+Rc), s	4.6	5.4	4.6	5.8	4.6	5.4	4.6	5.8				
Max Green Setting (Gmax), s	11.3	60.3	8.2	29.8	37.4	34.2	5.0	33.0				
Max Q Clear Time (g_c+I1), s	13.3	62.3	10.2	26.7	39.4	25.6	6.2	35.0				
Green Ext Time (p_c), s	0.0	0.0	0.0	2.0	0.0	4.0	0.0	0.0				

Intersection Summary

HCM 6th Ctrl Delay	190.3
HCM 6th LOS	F

Timings

3: Overlook Pkwy./Canyon Crest Dr. & Alessandro Bl/Alessandro Bl.



Lane Group	EBL	EBT	WBL	WBT	WBR	NBL	NBT	NBR	SBL	SBT	SBR
Lane Configurations											
Traffic Volume (vph)	79	1891	91	4261	1302	28	202	80	584	101	80
Future Volume (vph)	79	1891	91	4261	1302	28	202	80	584	101	80
Turn Type	Prot	NA	Prot	NA	pm+ov	Split	NA	Perm	Split	NA	Perm
Protected Phases	5	2	1	6	4	8	8		4	4	
Permitted Phases					6			8			4
Detector Phase	5	2	1	6	4	8	8	8	4	4	4
Switch Phase											
Minimum Initial (s)	5.0	10.0	5.0	10.0	10.0	10.0	10.0	10.0	10.0	10.0	10.0
Minimum Split (s)	9.2	35.2	9.2	35.2	38.8	15.8	15.8	15.8	38.8	38.8	38.8
Total Split (s)	9.2	66.2	9.2	66.2	38.8	15.8	15.8	15.8	38.8	38.8	38.8
Total Split (%)	7.1%	50.9%	7.1%	50.9%	29.8%	12.2%	12.2%	12.2%	29.8%	29.8%	29.8%
Yellow Time (s)	3.2	5.2	3.2	5.2	4.8	4.8	4.8	4.8	4.8	4.8	4.8
All-Red Time (s)	1.0	1.0	1.0	1.0	1.0	1.0	1.0	1.0	1.0	1.0	1.0
Lost Time Adjust (s)	0.0	0.0	0.0	0.0	0.0	0.0	0.0	0.0	0.0	0.0	0.0
Total Lost Time (s)	4.2	6.2	4.2	6.2	5.8	5.8	5.8	5.8	5.8	5.8	5.8
Lead/Lag	Lead	Lag	Lead	Lag							
Lead-Lag Optimize?	Yes	Yes	Yes	Yes							
Recall Mode	None	None	None	None	None	None	None	None	None	None	None
Act Effct Green (s)	5.0	60.0	5.0	60.0	99.2	10.0	10.0	10.0	33.0	33.0	33.0
Actuated g/C Ratio	0.04	0.46	0.04	0.46	0.76	0.08	0.08	0.08	0.25	0.25	0.25
v/c Ratio	1.30	0.85	1.39	1.89	1.11	0.21	0.77	0.37	0.59	0.58	0.17
Control Delay	258.7	35.6	287.4	427.9	79.2	60.3	77.4	9.4	46.2	48.8	3.9
Queue Delay	0.0	0.0	0.0	0.0	0.0	0.0	0.0	0.0	0.0	0.0	0.0
Total Delay	258.7	35.6	287.4	427.9	79.2	60.3	77.4	9.4	46.2	48.8	3.9
LOS	F	D	F	F	E	E	E	A	D	D	A
Approach Delay		44.5		345.3			58.4			42.5	
Approach LOS		D		F			E			D	

Intersection Summary

Cycle Length: 130
 Actuated Cycle Length: 130
 Natural Cycle: 130
 Control Type: Actuated-Uncoordinated
 Maximum v/c Ratio: 1.89
 Intersection Signal Delay: 240.2
 Intersection LOS: F
 Intersection Capacity Utilization 118.0%
 ICU Level of Service H
 Analysis Period (min) 15

Splits and Phases: 3: Overlook Pkwy./Canyon Crest Dr. & Alessandro Bl/Alessandro Bl.



HCM 6th Signalized Intersection Summary

West Campus Upper Plateau (JN 14064)

3: Overlook Pkwy./Canyon Crest Dr. & Alessandro Bl/Alessandro Bl.

09/20/2022

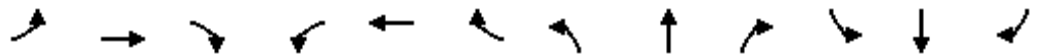

Movement	EBL	EBT	EBR	WBL	WBT	WBR	NBL	NBT	NBR	SBL	SBT	SBR
Lane Configurations	↗	↑↑↑		↖	↑↑↑	↗	↖	↑↑	↗	↖↗	↖	↗
Traffic Volume (veh/h)	79	1891	9	91	4261	1302	28	202	80	584	101	80
Future Volume (veh/h)	79	1891	9	91	4261	1302	28	202	80	584	101	80
Initial Q (Qb), veh	0	0	0	0	0	0	0	0	0	0	0	0
Ped-Bike Adj(A_pbT)	1.00		1.00	1.00		1.00	1.00		1.00	1.00		1.00
Parking Bus, Adj	1.00	1.00	1.00	1.00	1.00	1.00	1.00	1.00	1.00	1.00	1.00	1.00
Work Zone On Approach		No			No			No			No	
Adj Sat Flow, veh/h/ln	1796	1870	1900	1900	1885	1885	1900	1900	1900	1856	1885	1870
Adj Flow Rate, veh/h	83	1991	9	96	4485	1208	29	213	82	548	200	67
Peak Hour Factor	0.95	0.95	0.95	0.95	0.95	0.95	0.95	0.95	0.95	0.95	0.95	0.95
Percent Heavy Veh, %	7	2	0	0	1	1	0	0	0	3	1	2
Cap, veh/h	72	2633	12	76	2582	1103	151	302	135	667	356	299
Arrive On Green	0.04	0.50	0.50	0.04	0.50	0.50	0.08	0.08	0.08	0.19	0.19	0.19
Sat Flow, veh/h	1711	5246	24	1810	5147	1598	1810	3610	1610	3534	1885	1585
Grp Volume(v), veh/h	83	1292	708	96	4485	1208	29	213	82	548	200	67
Grp Sat Flow(s),veh/h/ln	1711	1702	1866	1810	1716	1598	1810	1805	1610	1767	1885	1585
Q Serve(g_s), s	5.0	36.4	36.4	5.0	60.0	60.0	1.8	6.9	5.9	17.8	11.5	4.3
Cycle Q Clear(g_c), s	5.0	36.4	36.4	5.0	60.0	60.0	1.8	6.9	5.9	17.8	11.5	4.3
Prop In Lane	1.00		0.01	1.00		1.00	1.00		1.00	1.00		1.00
Lane Grp Cap(c), veh/h	72	1708	936	76	2582	1103	151	302	135	667	356	299
V/C Ratio(X)	1.16	0.76	0.76	1.27	1.74	1.09	0.19	0.71	0.61	0.82	0.56	0.22
Avail Cap(c_a), veh/h	72	1708	936	76	2582	1103	151	302	135	975	520	437
HCM Platoon Ratio	1.00	1.00	1.00	1.00	1.00	1.00	1.00	1.00	1.00	1.00	1.00	1.00
Upstream Filter(I)	1.00	1.00	1.00	1.00	1.00	1.00	1.00	1.00	1.00	1.00	1.00	1.00
Uniform Delay (d), s/veh	57.3	23.9	23.9	57.3	29.8	15.0	51.0	53.4	52.9	46.6	44.0	41.1
Incr Delay (d2), s/veh	156.2	2.0	3.6	191.8	333.2	56.9	0.6	7.3	7.7	3.7	1.4	0.4
Initial Q Delay(d3),s/veh	0.0	0.0	0.0	0.0	0.0	0.0	0.0	0.0	0.0	0.0	0.0	0.0
%ile BackOfQ(50%),veh/ln	5.2	13.7	15.5	6.2	101.7	49.8	0.8	3.3	2.6	7.9	5.4	1.7
Unsig. Movement Delay, s/veh												
LnGrp Delay(d),s/veh	213.5	25.9	27.5	249.1	363.0	71.9	51.6	60.6	60.6	50.3	45.4	41.5
LnGrp LOS	F	C	C	F	F	F	D	E	E	D	D	D
Approach Vol, veh/h		2083			5789			324			815	
Approach Delay, s/veh		33.9			300.3			59.8			48.4	
Approach LOS		C			F			E			D	
Timer - Assigned Phs	1	2		4	5	6		8				
Phs Duration (G+Y+Rc), s	9.2	66.2		28.4	9.2	66.2		15.8				
Change Period (Y+Rc), s	* 4.2	6.2		5.8	* 4.2	6.2		5.8				
Max Green Setting (Gmax), s	* 5	60.0		33.0	* 5	60.0		10.0				
Max Q Clear Time (g_c+I1), s	7.0	38.4		19.8	7.0	62.0		8.9				
Green Ext Time (p_c), s	0.0	13.6		2.8	0.0	0.0		0.2				

Intersection Summary

HCM 6th Ctrl Delay	207.3
HCM 6th LOS	F

Notes

- User approved pedestrian interval to be less than phase max green.
- User approved volume balancing among the lanes for turning movement.
- * HCM 6th computational engine requires equal clearance times for the phases crossing the barrier.

Timings
4: Van Buren Bl. & Wood Rd.

West Campus Upper Plateau (JN 14064)

09/20/2022

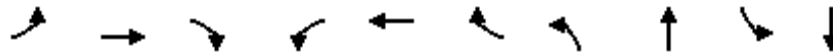

Lane Group	EBL	EBT	EBR	WBL	WBT	WBR	NBL	NBT	SBL	SBT
Lane Configurations	↘	↑↑	↗	↘↗	↑↑	↗	↘↗	↑↘	↘	↑↘
Traffic Volume (vph)	181	1560	438	609	2090	139	450	502	133	550
Future Volume (vph)	181	1560	438	609	2090	139	450	502	133	550
Turn Type	Prot	NA	pm+ov	Prot	NA	Perm	Prot	NA	Prot	NA
Protected Phases	5	2	3	1	6		3	8	7	4
Permitted Phases			2			6				
Detector Phase	5	2	3	1	6	6	3	8	7	4
Switch Phase										
Minimum Initial (s)	5.0	10.0	5.0	5.0	10.0	10.0	5.0	10.0	5.0	10.0
Minimum Split (s)	9.2	30.2	9.2	9.2	30.2	30.2	9.2	38.4	9.2	15.8
Total Split (s)	16.6	45.0	18.2	25.0	53.4	53.4	18.2	38.4	11.6	31.8
Total Split (%)	13.8%	37.5%	15.2%	20.8%	44.5%	44.5%	15.2%	32.0%	9.7%	26.5%
Yellow Time (s)	3.2	5.2	3.2	3.2	5.2	5.2	3.2	4.4	3.2	4.8
All-Red Time (s)	1.0	1.0	1.0	1.0	1.0	1.0	1.0	1.0	1.0	1.0
Lost Time Adjust (s)	0.0	0.0	0.0	0.0	0.0	0.0	0.0	0.0	0.0	0.0
Total Lost Time (s)	4.2	6.2	4.2	4.2	6.2	6.2	4.2	5.4	4.2	5.8
Lead/Lag	Lead	Lag	Lead	Lead	Lag	Lag	Lead	Lag	Lead	Lag
Lead-Lag Optimize?	Yes	Yes	Yes	Yes	Yes	Yes	Yes	Yes	Yes	Yes
Recall Mode	None	None	None	None	None	None	None	None	None	None
Act Effct Green (s)	12.4	38.8	54.8	20.8	47.2	47.2	14.0	33.0	7.4	26.0
Actuated g/C Ratio	0.10	0.32	0.46	0.17	0.39	0.39	0.12	0.28	0.06	0.22
v/c Ratio	1.09	1.50	0.63	1.10	1.63	0.22	1.21	1.02	1.33	1.12
Control Delay	142.6	259.7	21.3	114.2	315.7	5.5	160.5	69.1	241.5	111.4
Queue Delay	0.0	0.0	0.0	0.0	0.0	0.0	0.0	0.0	0.0	0.0
Total Delay	142.6	259.7	21.3	114.2	315.7	5.5	160.5	69.1	241.5	111.4
LOS	F	F	C	F	F	A	F	E	F	F
Approach Delay		202.1			257.3			98.8		129.9
Approach LOS		F			F			F		F

Intersection Summary

Cycle Length: 120
 Actuated Cycle Length: 120
 Natural Cycle: 130
 Control Type: Actuated-Uncoordinated
 Maximum v/c Ratio: 1.63
 Intersection Signal Delay: 194.7
 Intersection LOS: F
 Intersection Capacity Utilization 122.2%
 ICU Level of Service H
 Analysis Period (min) 15

Splits and Phases: 4: Van Buren Bl. & Wood Rd.

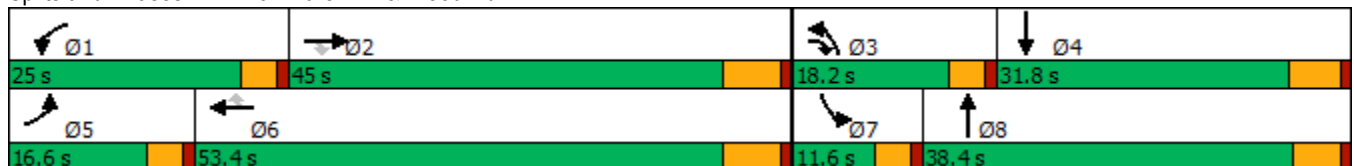

HCM 6th Signalized Intersection Summary
4: Van Buren Bl. & Wood Rd.

West Campus Upper Plateau (JN 14064)

09/20/2022

Movement	EBL	EBT	EBR	WBL	WBT	WBR	NBL	NBT	NBR	SBL	SBT	SBR
Lane Configurations												
Traffic Volume (veh/h)	181	1560	438	609	2090	139	450	502	432	133	550	257
Future Volume (veh/h)	181	1560	438	609	2090	139	450	502	432	133	550	257
Initial Q (Qb), veh	0	0	0	0	0	0	0	0	0	0	0	0
Ped-Bike Adj(A_pbT)	1.00		0.97	1.00		0.98	1.00		0.90	1.00		0.99
Parking Bus, Adj	1.00	1.00	1.00	1.00	1.00	1.00	1.00	1.00	1.00	1.00	1.00	1.00
Work Zone On Approach		No			No			No			No	
Adj Sat Flow, veh/h/ln	1856	1856	1856	1885	1870	1870	1885	1885	1885	1870	1900	1870
Adj Flow Rate, veh/h	197	1696	299	662	2272	103	489	546	333	145	598	188
Peak Hour Factor	0.92	0.92	0.92	0.92	0.92	0.92	0.92	0.92	0.92	0.92	0.92	0.92
Percent Heavy Veh, %	3	3	3	1	2	2	1	1	1	2	0	2
Cap, veh/h	182	1136	676	602	1393	612	405	560	341	109	591	185
Arrive On Green	0.10	0.32	0.32	0.17	0.39	0.39	0.12	0.27	0.27	0.06	0.22	0.22
Sat Flow, veh/h	1767	3526	1531	3483	3554	1560	3483	2044	1244	1781	2694	845
Grp Volume(v), veh/h	197	1696	299	662	2272	103	489	478	401	145	400	386
Grp Sat Flow(s),veh/h/ln	1767	1763	1531	1742	1777	1560	1742	1791	1497	1781	1805	1735
Q Serve(g_s), s	12.4	38.8	16.4	20.8	47.2	5.2	14.0	31.9	31.9	7.4	26.4	26.4
Cycle Q Clear(g_c), s	12.4	38.8	16.4	20.8	47.2	5.2	14.0	31.9	31.9	7.4	26.4	26.4
Prop In Lane	1.00		1.00	1.00		1.00	1.00		0.83	1.00		0.49
Lane Grp Cap(c), veh/h	182	1136	676	602	1393	612	405	491	410	109	396	380
V/C Ratio(X)	1.08	1.49	0.44	1.10	1.63	0.17	1.21	0.97	0.98	1.32	1.01	1.01
Avail Cap(c_a), veh/h	182	1136	676	602	1393	612	405	491	410	109	396	380
HCM Platoon Ratio	1.00	1.00	1.00	1.00	1.00	1.00	1.00	1.00	1.00	1.00	1.00	1.00
Upstream Filter(I)	1.00	1.00	1.00	1.00	1.00	1.00	1.00	1.00	1.00	1.00	1.00	1.00
Uniform Delay (d), s/veh	54.0	40.8	23.6	49.8	36.6	23.8	53.2	43.3	43.3	56.5	47.0	47.0
Incr Delay (d2), s/veh	90.4	226.5	0.6	67.1	287.2	0.2	114.4	34.0	38.1	196.0	48.1	49.8
Initial Q Delay(d3),s/veh	0.0	0.0	0.0	0.0	0.0	0.0	0.0	0.0	0.0	0.0	0.0	0.0
%ile BackOfQ(50%),veh/ln	9.9	51.6	5.9	14.3	74.5	1.9	12.4	18.3	15.8	9.2	16.8	16.4
Unsig. Movement Delay, s/veh												
LnGrp Delay(d),s/veh	144.4	267.3	24.2	116.9	323.8	24.0	167.6	77.3	81.4	252.5	95.1	96.8
LnGrp LOS	F	F	C	F	F	C	F	E	F	F	F	F
Approach Vol, veh/h		2192			3037			1368			931	
Approach Delay, s/veh		223.1			268.5			110.8			120.3	
Approach LOS		F			F			F			F	
Timer - Assigned Phs	1	2	3	4	5	6	7	8				
Phs Duration (G+Y+Rc), s	25.0	45.0	18.2	32.2	16.6	53.4	11.6	38.8				
Change Period (Y+Rc), s	* 4.2	6.2	* 4.2	5.8	* 4.2	6.2	* 4.2	* 5.8				
Max Green Setting (Gmax), s	* 21	38.8	* 14	26.0	* 12	47.2	* 7.4	* 33				
Max Q Clear Time (g_c+I1), s	22.8	40.8	16.0	28.4	14.4	49.2	9.4	33.9				
Green Ext Time (p_c), s	0.0	0.0	0.0	0.0	0.0	0.0	0.0	0.0				
Intersection Summary												
HCM 6th Ctrl Delay			208.3									
HCM 6th LOS			F									
Notes												
* HCM 6th computational engine requires equal clearance times for the phases crossing the barrier.												

Timings
5: Trautwein Rd. & Alessandro Bl.

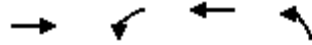

Lane Group	EBT	WBL	WBT	NBL
Lane Configurations	↑↑↑	↰↱	↑↑↑	↰↱↱
Traffic Volume (vph)	1579	303	4178	2370
Future Volume (vph)	1579	303	4178	2370
Turn Type	NA	Prot	NA	Prot
Protected Phases	2	1	6	8
Permitted Phases				
Detector Phase	2	1	6	8
Switch Phase				
Minimum Initial (s)	10.0	5.0	10.0	10.0
Minimum Split (s)	33.2	9.2	16.2	16.2
Total Split (s)	54.6	17.4	72.0	48.0
Total Split (%)	45.5%	14.5%	60.0%	40.0%
Yellow Time (s)	5.2	3.2	5.2	5.2
All-Red Time (s)	1.0	1.0	1.0	1.0
Lost Time Adjust (s)	0.0	0.0	0.0	0.0
Total Lost Time (s)	6.2	4.2	6.2	6.2
Lead/Lag	Lag	Lead		
Lead-Lag Optimize?	Yes	Yes		
Recall Mode	None	None	None	None
Act Effct Green (s)	48.6	13.0	65.8	41.8
Actuated g/C Ratio	0.40	0.11	0.55	0.35
v/c Ratio	0.99	0.88	1.61	1.55
Control Delay	54.4	77.8	301.9	280.1
Queue Delay	0.0	0.0	0.0	0.0
Total Delay	54.4	77.8	301.9	280.1
LOS	D	E	F	F
Approach Delay	54.4		286.7	280.1
Approach LOS	D		F	F

Intersection Summary

Cycle Length: 120
 Actuated Cycle Length: 120
 Natural Cycle: 130
 Control Type: Actuated-Uncoordinated
 Maximum v/c Ratio: 1.61
 Intersection Signal Delay: 236.2
 Intersection LOS: F
 Intersection Capacity Utilization 138.3%
 ICU Level of Service H
 Analysis Period (min) 15

Splits and Phases: 5: Trautwein Rd. & Alessandro Bl.

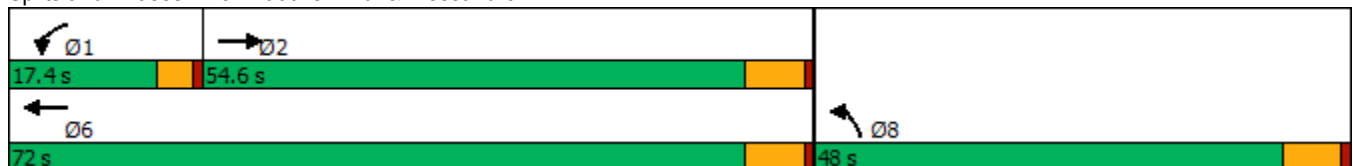

HCM 6th Signalized Intersection Summary
5: Trautwein Rd. & Alessandro Bl.

West Campus Upper Plateau (JN 14064)
09/20/2022

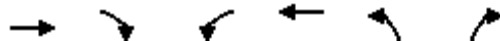

Movement	EBT	EBR	WBL	WBT	NBL	NBR
Lane Configurations	↑↑↑		↵↵	↑↑↑	↵↵↵	
Traffic Volume (veh/h)	1579	266	303	4178	2370	103
Future Volume (veh/h)	1579	266	303	4178	2370	103
Initial Q (Qb), veh	0	0	0	0	0	0
Ped-Bike Adj(A_pbT)		1.00	1.00		1.00	1.00
Parking Bus, Adj	1.00	1.00	1.00	1.00	1.00	1.00
Work Zone On Approach	No			No	No	
Adj Sat Flow, veh/h/ln	1870	1900	1870	1885	1870	1885
Adj Flow Rate, veh/h	1716	289	329	4541	2681	0
Peak Hour Factor	0.92	0.92	0.92	0.92	0.92	0.92
Percent Heavy Veh, %	2	0	2	1	2	1
Cap, veh/h	1777	297	380	2822	1861	557
Arrive On Green	0.40	0.40	0.11	0.55	0.35	0.00
Sat Flow, veh/h	4574	736	3456	5316	5344	1598
Grp Volume(v), veh/h	1323	682	329	4541	2681	0
Grp Sat Flow(s),veh/h/ln	1702	1738	1728	1716	1781	1598
Q Serve(g_s), s	45.5	46.3	11.2	65.8	41.8	0.0
Cycle Q Clear(g_c), s	45.5	46.3	11.2	65.8	41.8	0.0
Prop In Lane		0.42	1.00		1.00	1.00
Lane Grp Cap(c), veh/h	1373	701	380	2822	1861	557
V/C Ratio(X)	0.96	0.97	0.87	1.61	1.44	0.00
Avail Cap(c_a), veh/h	1373	701	380	2822	1861	557
HCM Platoon Ratio	1.00	1.00	1.00	1.00	1.00	1.00
Upstream Filter(I)	1.00	1.00	1.00	1.00	1.00	0.00
Uniform Delay (d), s/veh	34.9	35.2	52.5	27.1	39.1	0.0
Incr Delay (d2), s/veh	16.4	27.4	17.7	275.8	201.2	0.0
Initial Q Delay(d3),s/veh	0.0	0.0	0.0	0.0	0.0	0.0
%ile BackOfQ(50%),veh/ln	20.6	23.5	5.6	95.1	51.7	0.0
Unsig. Movement Delay, s/veh						
LnGrp Delay(d),s/veh	51.4	62.6	70.3	302.9	240.3	0.0
LnGrp LOS	D	E	E	F	F	A
Approach Vol, veh/h	2005			4870	2681	
Approach Delay, s/veh	55.2			287.2	240.3	
Approach LOS	E			F	F	
Timer - Assigned Phs	1	2			6	8
Phs Duration (G+Y+Rc), s	17.4	54.6			72.0	48.0
Change Period (Y+Rc), s	* 4.2	6.2			6.2	6.2
Max Green Setting (Gmax), s	* 13	48.4			65.8	41.8
Max Q Clear Time (g_c+I1), s	13.2	48.3			67.8	43.8
Green Ext Time (p_c), s	0.0	0.1			0.0	0.0

Intersection Summary

HCM 6th Ctrl Delay	225.4
HCM 6th LOS	F

Notes

User approved volume balancing among the lanes for turning movement.
* HCM 6th computational engine requires equal clearance times for the phases crossing the barrier.

Timings
6: Trautwein Rd. & Grove Community Dr

West Campus Upper Plateau (JN 14064)

09/20/2022



Lane Group	WBL	WBR	NBT	NBR	SBL	SBT
Lane Configurations	↙	↗↗	↕↕	↗	↗↗	↕↕
Traffic Volume (vph)	93	733	2235	29	253	1755
Future Volume (vph)	93	733	2235	29	253	1755
Turn Type	Prot	pm+ov	NA	Perm	Prot	NA
Protected Phases	8	1	2		1	6
Permitted Phases		8		2		
Detector Phase	8	1	2	2	1	6
Switch Phase						
Minimum Initial (s)	10.0	5.0	10.0	10.0	5.0	10.0
Minimum Split (s)	34.6	9.6	46.2	46.2	9.6	28.2
Total Split (s)	35.8	15.2	69.0	69.0	15.2	84.2
Total Split (%)	29.8%	12.7%	57.5%	57.5%	12.7%	70.2%
Yellow Time (s)	3.6	3.6	5.2	5.2	3.6	5.2
All-Red Time (s)	1.0	1.0	1.0	1.0	1.0	1.0
Lost Time Adjust (s)	0.0	0.0	0.0	0.0	0.0	0.0
Total Lost Time (s)	4.6	4.6	6.2	6.2	4.6	6.2
Lead/Lag		Lead	Lag	Lag	Lead	
Lead-Lag Optimize?		Yes	Yes	Yes	Yes	
Recall Mode	None	None	None	None	None	None
Act Effct Green (s)	13.9	24.6	63.1	63.1	10.6	78.3
Actuated g/C Ratio	0.13	0.24	0.61	0.61	0.10	0.76
v/c Ratio	0.42	1.20	1.11	0.03	0.79	0.71
Control Delay	45.4	138.5	79.0	7.1	62.6	9.5
Queue Delay	0.0	0.0	0.0	0.0	0.0	0.0
Total Delay	45.4	138.5	79.0	7.1	62.6	9.5
LOS	D	F	E	A	E	A
Approach Delay	128.0		78.1			16.2
Approach LOS	F		E			B

Intersection Summary

Cycle Length: 120	
Actuated Cycle Length: 103.1	
Natural Cycle: 125	
Control Type: Actuated-Uncoordinated	
Maximum v/c Ratio: 1.20	
Intersection Signal Delay: 61.8	Intersection LOS: E
Intersection Capacity Utilization 96.6%	ICU Level of Service F
Analysis Period (min) 15	

Splits and Phases: 6: Trautwein Rd. & Grove Community Dr



HCM 6th Signalized Intersection Summary
6: Trautwein Rd. & Grove Community Dr

West Campus Upper Plateau (JN 14064)
09/20/2022



Movement	WBL	WBR	NBT	NBR	SBL	SBT
Lane Configurations						
Traffic Volume (veh/h)	93	733	2235	29	253	1755
Future Volume (veh/h)	93	733	2235	29	253	1755
Initial Q (Qb), veh	0	0	0	0	0	0
Ped-Bike Adj(A_pbT)	1.00	1.00		0.97	1.00	
Parking Bus, Adj	1.00	1.00	1.00	1.00	1.00	1.00
Work Zone On Approach	No		No			No
Adj Sat Flow, veh/h/ln	1900	1885	1885	1900	1856	1870
Adj Flow Rate, veh/h	101	614	2429	24	275	1908
Peak Hour Factor	0.92	0.92	0.92	0.92	0.92	0.92
Percent Heavy Veh, %	0	1	1	0	3	2
Cap, veh/h	406	891	1965	861	317	2421
Arrive On Green	0.22	0.22	0.55	0.55	0.09	0.68
Sat Flow, veh/h	1810	2812	3676	1570	3428	3647
Grp Volume(v), veh/h	101	614	2429	24	275	1908
Grp Sat Flow(s),veh/h/ln	1810	1406	1791	1570	1714	1777
Q Serve(g_s), s	5.2	21.8	62.8	0.8	9.1	42.3
Cycle Q Clear(g_c), s	5.2	21.8	62.8	0.8	9.1	42.3
Prop In Lane	1.00	1.00		1.00	1.00	
Lane Grp Cap(c), veh/h	406	891	1965	861	317	2421
V/C Ratio(X)	0.25	0.69	1.24	0.03	0.87	0.79
Avail Cap(c_a), veh/h	493	1027	1965	861	317	2421
HCM Platoon Ratio	1.00	1.00	1.00	1.00	1.00	1.00
Upstream Filter(I)	1.00	1.00	1.00	1.00	1.00	1.00
Uniform Delay (d), s/veh	36.5	34.2	25.8	11.8	51.2	12.6
Incr Delay (d2), s/veh	0.3	1.6	110.9	0.0	20.6	1.8
Initial Q Delay(d3),s/veh	0.0	0.0	0.0	0.0	0.0	0.0
%ile BackOfQ(50%),veh/ln	2.3	7.5	53.3	0.3	4.7	13.7
Unsig. Movement Delay, s/veh						
LnGrp Delay(d),s/veh	36.8	35.8	136.7	11.9	71.9	14.4
LnGrp LOS	D	D	F	B	E	B
Approach Vol, veh/h	715		2453			2183
Approach Delay, s/veh	35.9		135.5			21.6
Approach LOS	D		F			C
Timer - Assigned Phs	1	2			6	8
Phs Duration (G+Y+Rc), s	15.2	69.0			84.2	30.3
Change Period (Y+Rc), s	4.6	6.2			6.2	4.6
Max Green Setting (Gmax), s	10.6	62.8			78.0	31.2
Max Q Clear Time (g_c+I1), s	11.1	64.8			44.3	23.8
Green Ext Time (p_c), s	0.0	0.0			19.0	1.8
Intersection Summary						
HCM 6th Ctrl Delay			75.7			
HCM 6th LOS			E			

Timings

7: Trautwein Rd. & Orange Terrace Pkwy

09/20/2022



Lane Group	EBL	EBT	WBL	WBT	WBR	NBL	NBT	NBR	SBL	SBT	SBR
Lane Configurations											
Traffic Volume (vph)	81	85	350	129	831	65	1613	291	469	1358	25
Future Volume (vph)	81	85	350	129	831	65	1613	291	469	1358	25
Turn Type	Prot	NA	Prot	NA	pm+ov	Prot	NA	Perm	Prot	NA	Perm
Protected Phases	7	4	3	8	1	5	2		1	6	
Permitted Phases					8			2			6
Detector Phase	7	4	3	8	1	5	2	2	1	6	6
Switch Phase											
Minimum Initial (s)	5.0	10.0	5.0	10.0	5.0	5.0	10.0	10.0	5.0	10.0	10.0
Minimum Split (s)	9.6	38.6	9.6	34.6	9.6	9.6	46.2	46.2	9.6	24.2	24.2
Total Split (s)	16.8	38.6	25.0	46.8	19.0	14.4	47.4	47.4	19.0	52.0	52.0
Total Split (%)	12.9%	29.7%	19.2%	36.0%	14.6%	11.1%	36.5%	36.5%	14.6%	40.0%	40.0%
Yellow Time (s)	3.6	3.6	3.6	3.6	3.6	3.6	5.2	5.2	3.6	5.2	5.2
All-Red Time (s)	1.0	1.0	1.0	1.0	1.0	1.0	1.0	1.0	1.0	1.0	1.0
Lost Time Adjust (s)	0.0	0.0	0.0	0.0	0.0	0.0	0.0	0.0	0.0	0.0	0.0
Total Lost Time (s)	4.6	4.6	4.6	4.6	4.6	4.6	6.2	6.2	4.6	6.2	6.2
Lead/Lag	Lead	Lag	Lead	Lag	Lead	Lead	Lag	Lag	Lead	Lag	Lag
Lead-Lag Optimize?	Yes	Yes	Yes	Yes	Yes	Yes	Yes	Yes	Yes	Yes	Yes
Recall Mode	None	None	None	None	None	None	None	None	None	None	None
Act Effct Green (s)	9.3	15.4	20.5	26.6	41.1	8.2	41.4	41.4	14.5	49.9	49.9
Actuated g/C Ratio	0.08	0.14	0.18	0.24	0.37	0.07	0.37	0.37	0.13	0.45	0.45
v/c Ratio	0.59	0.48	1.16	0.31	0.83	0.55	1.35	0.48	1.16	0.93	0.04
Control Delay	66.9	45.0	143.0	37.1	32.0	68.3	194.2	19.4	138.5	42.3	0.1
Queue Delay	0.0	0.0	0.0	0.0	0.0	0.0	0.0	0.0	0.0	0.0	0.0
Total Delay	66.9	45.0	143.0	37.1	32.0	68.3	194.2	19.4	138.5	42.3	0.1
LOS	E	D	F	D	C	E	F	B	F	D	A
Approach Delay		54.1		62.1			164.2			66.1	
Approach LOS		D		E			F			E	

Intersection Summary

Cycle Length: 130
 Actuated Cycle Length: 112
 Natural Cycle: 125
 Control Type: Actuated-Uncoordinated
 Maximum v/c Ratio: 1.35
 Intersection Signal Delay: 101.0
 Intersection LOS: F
 Intersection Capacity Utilization 105.4%
 ICU Level of Service G
 Analysis Period (min) 15



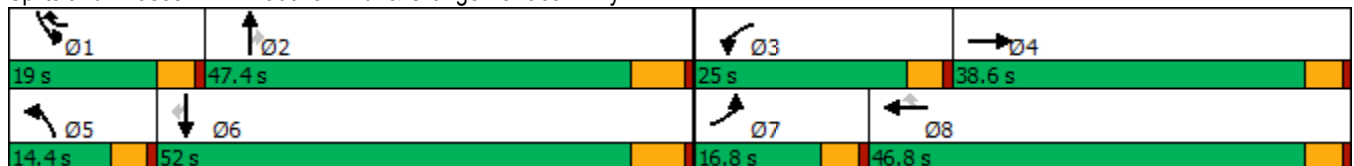



















Splits and Phases: 7: Trautwein Rd. & Orange Terrace Pkwy



HCM 6th Signalized Intersection Summary
7: Trautwein Rd. & Orange Terrace Pkwy

West Campus Upper Plateau (JN 14064)

09/20/2022

												
Movement	EBL	EBT	EBR	WBL	WBT	WBR	NBL	NBT	NBR	SBL	SBT	SBR
Lane Configurations												
Traffic Volume (veh/h)	81	85	29	350	129	831	65	1613	291	469	1358	25
Future Volume (veh/h)	81	85	29	350	129	831	65	1613	291	469	1358	25
Initial Q (Qb), veh	0	0	0	0	0	0	0	0	0	0	0	0
Ped-Bike Adj(A_pbT)	1.00		0.99	1.00		0.96	1.00		1.00	1.00		0.98
Parking Bus, Adj	1.00	1.00	1.00	1.00	1.00	1.00	1.00	1.00	1.00	1.00	1.00	1.00
Work Zone On Approach		No			No			No			No	
Adj Sat Flow, veh/h/ln	1900	1885	1900	1885	1885	1885	1870	1856	1870	1856	1885	1826
Adj Flow Rate, veh/h	88	92	28	380	140	679	71	1753	239	510	1476	19
Peak Hour Factor	0.92	0.92	0.92	0.92	0.92	0.92	0.92	0.92	0.92	0.92	0.92	0.92
Percent Heavy Veh, %	0	1	0	1	1	1	2	3	2	3	1	5
Cap, veh/h	112	186	57	330	484	1061	91	1309	588	445	1612	680
Arrive On Green	0.06	0.13	0.13	0.18	0.26	0.26	0.05	0.37	0.37	0.13	0.45	0.45
Sat Flow, veh/h	1810	1383	421	1795	1885	2711	1781	3526	1582	3428	3582	1510
Grp Volume(v), veh/h	88	0	120	380	140	679	71	1753	239	510	1476	19
Grp Sat Flow(s),veh/h/ln	1810	0	1804	1795	1885	1356	1781	1763	1582	1714	1791	1510
Q Serve(g_s), s	5.3	0.0	6.8	20.4	6.6	22.7	4.4	41.2	12.4	14.4	42.8	0.8
Cycle Q Clear(g_c), s	5.3	0.0	6.8	20.4	6.6	22.7	4.4	41.2	12.4	14.4	42.8	0.8
Prop In Lane	1.00		0.23	1.00		1.00	1.00		1.00	1.00		1.00
Lane Grp Cap(c), veh/h	112	0	243	330	484	1061	91	1309	588	445	1612	680
V/C Ratio(X)	0.79	0.00	0.49	1.15	0.29	0.64	0.78	1.34	0.41	1.15	0.92	0.03
Avail Cap(c_a), veh/h	199	0	553	330	717	1396	157	1309	588	445	1612	680
HCM Platoon Ratio	1.00	1.00	1.00	1.00	1.00	1.00	1.00	1.00	1.00	1.00	1.00	1.00
Upstream Filter(I)	1.00	0.00	1.00	1.00	1.00	1.00	1.00	1.00	1.00	1.00	1.00	1.00
Uniform Delay (d), s/veh	51.3	0.0	44.5	45.3	33.1	27.9	52.0	34.9	25.8	48.3	28.5	17.0
Incr Delay (d2), s/veh	4.5	0.0	1.6	97.1	0.3	0.6	5.3	157.8	0.5	89.2	8.6	0.0
Initial Q Delay(d3),s/veh	0.0	0.0	0.0	0.0	0.0	0.0	0.0	0.0	0.0	0.0	0.0	0.0
%ile BackOfQ(50%),veh/ln	2.5	0.0	3.2	17.6	3.0	7.0	2.0	44.9	4.5	11.4	18.4	0.3
Unsig. Movement Delay, s/veh												
LnGrp Delay(d),s/veh	55.8	0.0	46.0	142.3	33.4	28.5	57.4	192.7	26.3	137.4	37.1	17.0
LnGrp LOS	E	A	D	F	C	C	E	F	C	F	D	B
Approach Vol, veh/h		208			1199			2063			2005	
Approach Delay, s/veh		50.2			65.2			168.7			62.4	
Approach LOS		D			E			F			E	
Timer - Assigned Phs	1	2	3	4	5	6	7	8				
Phs Duration (G+Y+Rc), s	19.0	47.4	25.0	19.5	10.3	56.1	11.5	33.1				
Change Period (Y+Rc), s	4.6	6.2	4.6	4.6	4.6	6.2	4.6	4.6				
Max Green Setting (Gmax), s	14.4	41.2	20.4	34.0	9.8	45.8	12.2	42.2				
Max Q Clear Time (g_c+I1), s	16.4	43.2	22.4	8.8	6.4	44.8	7.3	24.7				
Green Ext Time (p_c), s	0.0	0.0	0.0	0.6	0.0	0.8	0.0	3.4				
Intersection Summary												
HCM 6th Ctrl Delay	102.6											
HCM 6th LOS	F											

Timings
8: Cole Av. & Van Buren Bl.

West Campus Upper Plateau (JN 14064)

09/20/2022

Lane Group	EBL	EBT	EBR	WBL	WBT	WBR	NBL	NBT	SBL	SBT	SBR	
Lane Configurations												
Traffic Volume (vph)	487	1629	130	202	2132	610	259	710	560	560	397	
Future Volume (vph)	487	1629	130	202	2132	610	259	710	560	560	397	
Turn Type	Prot	NA	pm+ov	Prot	NA	pm+ov	Prot	NA	Prot	NA	pm+ov	
Protected Phases	5	2	3	1	6	7	3	8	7	4	5	
Permitted Phases			2			6					4	
Detector Phase	5	2	3	1	6	7	3	8	7	4	5	
Switch Phase												
Minimum Initial (s)	5.0	10.0	5.0	5.0	10.0	5.0	5.0	10.0	5.0	10.0	5.0	
Minimum Split (s)	9.1	36.2	9.1	9.1	36.2	9.1	9.1	42.2	9.1	49.2	9.1	
Total Split (s)	15.0	37.8	19.0	14.0	36.8	21.6	19.0	46.6	21.6	49.2	15.0	
Total Split (%)	12.5%	31.5%	15.8%	11.7%	30.7%	18.0%	15.8%	38.8%	18.0%	41.0%	12.5%	
Yellow Time (s)	3.2	5.2	3.2	3.2	5.2	3.2	3.2	5.2	3.2	5.2	3.2	
All-Red Time (s)	0.5	1.0	0.5	0.5	1.0	0.5	0.5	1.0	0.5	1.0	0.5	
Lost Time Adjust (s)	0.0	0.0	0.0	0.0	0.0	0.0	0.0	0.0	0.0	0.0	0.0	
Total Lost Time (s)	3.7	6.2	3.7	3.7	6.2	3.7	3.7	6.2	3.7	6.2	3.7	
Lead/Lag	Lead	Lag	Lead	Lead	Lag	Lead	Lead	Lag	Lead	Lag	Lead	
Lead-Lag Optimize?	Yes	Yes	Yes	Yes	Yes	Yes	Yes	Yes	Yes	Yes	Yes	
Recall Mode	None	None	None	None	None	None	None	None	None	None	None	
Act Effct Green (s)	11.3	31.7	53.2	10.3	30.7	51.1	15.3	36.4	17.9	39.0	52.9	
Actuated g/C Ratio	0.10	0.27	0.46	0.09	0.26	0.44	0.13	0.31	0.15	0.34	0.46	
v/c Ratio	1.58	1.86	0.19	1.38	1.73	0.91	1.22	0.88	1.14	0.51	0.58	
Control Delay	311.4	416.2	11.8	243.9	359.5	45.1	175.3	46.6	127.7	32.5	21.1	
Queue Delay	0.0	0.0	0.0	0.0	0.0	0.0	0.0	0.0	0.0	0.0	0.0	
Total Delay	311.4	416.2	11.8	243.9	359.5	45.1	175.3	46.6	127.7	32.5	21.1	
LOS	F	F	B	F	F	D	F	D	F	C	C	
Approach Delay		370.1			286.4			75.9		64.6		
Approach LOS		F			F			E		E		

Intersection Summary

Cycle Length: 120
 Actuated Cycle Length: 116.2
 Natural Cycle: 125
 Control Type: Actuated-Uncoordinated
 Maximum v/c Ratio: 1.86
 Intersection Signal Delay: 236.9
 Intersection LOS: F
 Intersection Capacity Utilization 114.4%
 ICU Level of Service H
 Analysis Period (min) 15



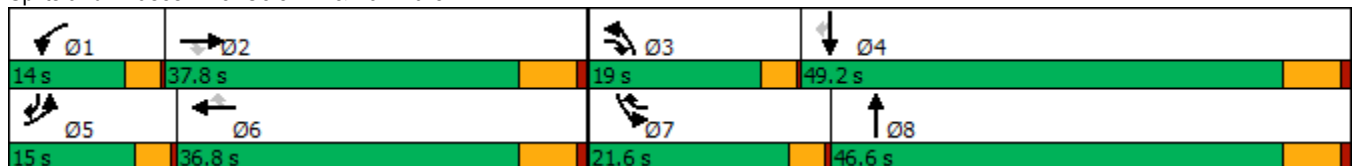



















Splits and Phases: 8: Cole Av. & Van Buren Bl.



HCM 6th Signalized Intersection Summary
8: Cole Av. & Van Buren Bl.

West Campus Upper Plateau (JN 14064)

09/20/2022

												
Movement	EBL	EBT	EBR	WBL	WBT	WBR	NBL	NBT	NBR	SBL	SBT	SBR
Lane Configurations												
Traffic Volume (veh/h)	487	1629	130	202	2132	610	259	710	169	560	560	397
Future Volume (veh/h)	487	1629	130	202	2132	610	259	710	169	560	560	397
Initial Q (Qb), veh	0	0	0	0	0	0	0	0	0	0	0	0
Ped-Bike Adj(A_pbT)	1.00		1.00	1.00		0.99	1.00		1.00	1.00		1.00
Parking Bus, Adj	1.00	1.00	1.00	1.00	1.00	1.00	1.00	1.00	1.00	1.00	1.00	1.00
Work Zone On Approach		No			No			No			No	
Adj Sat Flow, veh/h/ln	1870	1856	1841	1900	1870	1870	1856	1870	1870	1885	1870	1856
Adj Flow Rate, veh/h	529	1771	101	220	2317	575	282	772	175	609	609	361
Peak Hour Factor	0.92	0.92	0.92	0.92	0.92	0.92	0.92	0.92	0.92	0.92	0.92	0.92
Percent Heavy Veh, %	2	3	4	0	2	2	3	2	2	1	2	3
Cap, veh/h	341	973	639	163	1365	666	236	877	199	545	1164	669
Arrive On Green	0.10	0.28	0.28	0.09	0.27	0.27	0.13	0.30	0.30	0.16	0.33	0.33
Sat Flow, veh/h	3456	3526	1560	1810	5106	1565	1767	2877	652	3483	3554	1570
Grp Volume(v), veh/h	529	1771	101	220	2317	575	282	477	470	609	609	361
Grp Sat Flow(s),veh/h/ln	1728	1763	1560	1810	1702	1565	1767	1777	1752	1742	1777	1570
Q Serve(g_s), s	11.3	31.6	4.7	10.3	30.6	30.6	15.3	29.2	29.2	17.9	15.9	19.6
Cycle Q Clear(g_c), s	11.3	31.6	4.7	10.3	30.6	30.6	15.3	29.2	29.2	17.9	15.9	19.6
Prop In Lane	1.00		1.00	1.00		1.00	1.00		0.37	1.00		1.00
Lane Grp Cap(c), veh/h	341	973	639	163	1365	666	236	542	534	545	1164	669
V/C Ratio(X)	1.55	1.82	0.16	1.35	1.70	0.86	1.19	0.88	0.88	1.12	0.52	0.54
Avail Cap(c_a), veh/h	341	973	639	163	1365	666	236	627	618	545	1335	745
HCM Platoon Ratio	1.00	1.00	1.00	1.00	1.00	1.00	1.00	1.00	1.00	1.00	1.00	1.00
Upstream Filter(I)	1.00	1.00	1.00	1.00	1.00	1.00	1.00	1.00	1.00	1.00	1.00	1.00
Uniform Delay (d), s/veh	51.6	41.5	21.3	52.1	42.0	30.1	49.6	37.8	37.8	48.3	31.2	24.5
Incr Delay (d2), s/veh	262.1	373.1	0.2	193.0	317.3	11.6	121.2	12.4	12.6	75.4	0.4	0.7
Initial Q Delay(d3),s/veh	0.0	0.0	0.0	0.0	0.0	0.0	0.0	0.0	0.0	0.0	0.0	0.0
%ile BackOfQ(50%),veh/ln	17.1	63.4	1.6	13.2	52.2	15.4	14.4	13.8	13.6	13.1	6.5	6.9
Unsig. Movement Delay, s/veh												
LnGrp Delay(d),s/veh	313.7	414.6	21.5	245.1	359.2	41.7	170.8	50.2	50.4	123.7	31.6	25.2
LnGrp LOS	F	F	C	F	F	D	F	D	D	F	C	C
Approach Vol, veh/h		2401			3112			1229			1579	
Approach Delay, s/veh		375.8			292.5			78.0			65.6	
Approach LOS		F			F			E			E	
Timer - Assigned Phs	1	2	3	4	5	6	7	8				
Phs Duration (G+Y+Rc), s	14.0	37.8	19.0	43.7	15.0	36.8	21.6	41.1				
Change Period (Y+Rc), s	3.7	6.2	3.7	6.2	3.7	6.2	3.7	6.2				
Max Green Setting (Gmax), s	10.3	31.6	15.3	43.0	11.3	30.6	17.9	40.4				
Max Q Clear Time (g_c+I1), s	12.3	33.6	17.3	21.6	13.3	32.6	19.9	31.2				
Green Ext Time (p_c), s	0.0	0.0	0.0	4.9	0.0	0.0	0.0	3.7				
Intersection Summary												
HCM 6th Ctrl Delay			241.8									
HCM 6th LOS			F									

Intersection	
Intersection Delay, s/veh	22.2
Intersection LOS	C

Movement	EBT	EBR	WBL	WBT	NBL	NBR
Lane Configurations	↔		↔	↑	↔	↔
Traffic Vol, veh/h	135	105	66	438	271	41
Future Vol, veh/h	135	105	66	438	271	41
Peak Hour Factor	0.92	0.92	0.92	0.92	0.92	0.92
Heavy Vehicles, %	2	1	2	2	0	0
Mvmt Flow	147	114	72	476	295	45
Number of Lanes	1	0	1	1	1	1

Approach	EB	WB	NB
Opposing Approach	WB	EB	
Opposing Lanes	2	1	0
Conflicting Approach Left		NB	EB
Conflicting Lanes Left	0	2	1
Conflicting Approach Right	NB		WB
Conflicting Lanes Right	2	0	2
HCM Control Delay	14.2	28.1	18.8
HCM LOS	B	D	C

Lane	NBLn1	NBLn2	EBLn1	WBLn1	WBLn2
Vol Left, %	100%	0%	0%	100%	0%
Vol Thru, %	0%	0%	56%	0%	100%
Vol Right, %	0%	100%	44%	0%	0%
Sign Control	Stop	Stop	Stop	Stop	Stop
Traffic Vol by Lane	271	41	240	66	438
LT Vol	271	0	0	66	0
Through Vol	0	0	135	0	438
RT Vol	0	41	105	0	0
Lane Flow Rate	295	45	261	72	476
Geometry Grp	7	7	4	7	7
Degree of Util (X)	0.594	0.075	0.446	0.133	0.816
Departure Headway (Hd)	7.256	6.036	6.159	6.676	6.168
Convergence, Y/N	Yes	Yes	Yes	Yes	Yes
Cap	495	591	582	535	586
Service Time	5.021	3.799	4.232	4.439	3.931
HCM Lane V/C Ratio	0.596	0.076	0.448	0.135	0.812
HCM Control Delay	20.2	9.3	14.2	10.5	30.8
HCM Lane LOS	C	A	B	B	D
HCM 95th-tile Q	3.8	0.2	2.3	0.5	8.2

Intersection												
Intersection Delay, s/veh	81.6											
Intersection LOS	F											

Movement	EBL	EBT	EBR	WBL	WBT	WBR	NBL	NBT	NBR	SBL	SBT	SBR
Lane Configurations	↵	↕↗		↵	↕↗			↕↗			↕↗	
Traffic Vol, veh/h	293	583	55	5	736	67	208	52	8	110	41	49
Future Vol, veh/h	293	583	55	5	736	67	208	52	8	110	41	49
Peak Hour Factor	0.92	0.92	0.92	0.92	0.92	0.92	0.92	0.92	0.92	0.92	0.92	0.92
Heavy Vehicles, %	0	2	0	0	0	1	1	0	0	0	3	2
Mvmt Flow	318	634	60	5	800	73	226	57	9	120	45	53
Number of Lanes	1	2	0	1	2	0	0	1	0	0	1	0

Approach	EB	WB	NB	SB
Opposing Approach	WB	EB	SB	NB
Opposing Lanes	3	3	1	1
Conflicting Approach Left SB		NB	EB	WB
Conflicting Lanes Left	1	1	3	3
Conflicting Approach Right NB		SB	WB	EB
Conflicting Lanes Right	1	1	3	3
HCM Control Delay	54.1	136.9	48.9	30.1
HCM LOS	F	F	E	D

Lane	NBLn1	EBLn1	EBLn2	EBLn3	WBLn1	WBLn2	WBLn3	SBLn1
Vol Left, %	78%	100%	0%	0%	100%	0%	0%	55%
Vol Thru, %	19%	0%	100%	78%	0%	100%	79%	20%
Vol Right, %	3%	0%	0%	22%	0%	0%	21%	24%
Sign Control	Stop	Stop	Stop	Stop	Stop	Stop	Stop	Stop
Traffic Vol by Lane	268	293	389	249	5	491	312	200
LT Vol	208	293	0	0	5	0	0	110
Through Vol	52	0	389	194	0	491	245	41
RT Vol	8	0	0	55	0	0	67	49
Lane Flow Rate	291	318	422	271	5	533	339	217
Geometry Grp	7	7	7	7	7	7	7	7
Degree of Util (X)	0.826	0.81	1.019	0.639	0.014	1.343	0.842	0.622
Departure Headway (Hd)	10.812	9.594	9.102	8.902	9.809	9.281	9.141	10.958
Convergence, Y/N	Yes	Yes	Yes	Yes	Yes	Yes	Yes	Yes
Cap	338	379	401	409	367	395	401	333
Service Time	8.512	7.294	6.802	6.602	7.509	6.981	6.841	8.658
HCM Lane V/C Ratio	0.861	0.839	1.052	0.663	0.014	1.349	0.845	0.652
HCM Control Delay	48.9	42.5	80.8	26.1	12.6	196.7	45	30.1
HCM Lane LOS	E	E	F	D	B	F	E	D
HCM 95th-tile Q	7.2	7.1	12.8	4.3	0	24.6	7.9	3.9

Timings

11: Barton St & Alessandro Bl.

09/20/2022



Lane Group	EBL	EBT	WBL	WBT	NBL	NBT	NBR	SBL	SBT	SBR
Lane Configurations	↙	↕↕↕	↙	↕↕↕		↕	↗		↕	↗
Traffic Volume (vph)	8	2097	48	3516	101	2	64	12	0	10
Future Volume (vph)	8	2097	48	3516	101	2	64	12	0	10
Turn Type	Prot	NA	Prot	NA	Perm	NA	Perm	Perm	NA	Perm
Protected Phases	5	2	1	6		8			4	
Permitted Phases					8		8	4		4
Detector Phase	5	2	1	6	8	8	8	4	4	4
Switch Phase										
Minimum Initial (s)	5.0	10.0	5.0	10.0	10.0	10.0	10.0	10.0	10.0	10.0
Minimum Split (s)	9.2	28.5	11.0	28.5	40.6	40.6	40.6	26.6	26.6	26.6
Total Split (s)	9.2	68.4	11.0	70.2	40.6	40.6	40.6	40.6	40.6	40.6
Total Split (%)	7.7%	57.0%	9.2%	58.5%	33.8%	33.8%	33.8%	33.8%	33.8%	33.8%
Yellow Time (s)	3.2	5.5	3.2	5.5	3.6	3.6	3.6	3.6	3.6	3.6
All-Red Time (s)	1.0	1.0	1.0	1.0	1.0	1.0	1.0	1.0	1.0	1.0
Lost Time Adjust (s)	0.0	0.0	0.0	0.0		0.0	0.0		0.0	0.0
Total Lost Time (s)	4.2	6.5	4.2	6.5		4.6	4.6		4.6	4.6
Lead/Lag	Lead	Lag	Lead	Lag						
Lead-Lag Optimize?	Yes	Yes	Yes	Yes						
Recall Mode	None	None	None	None	Max	Max	Max	Max	Max	Max
Act Effct Green (s)	5.0	62.4	6.3	69.1		36.0	36.0		36.0	36.0
Actuated g/C Ratio	0.04	0.53	0.05	0.59		0.30	0.30		0.30	0.30
v/c Ratio	0.12	0.84	0.52	1.23		0.25	0.13		0.04	0.02
Control Delay	59.6	27.8	74.1	133.6		33.7	7.3		30.5	0.1
Queue Delay	0.0	0.0	0.0	0.0		0.0	0.0		0.0	0.0
Total Delay	59.6	27.8	74.1	133.6		33.7	7.3		30.5	0.1
LOS	E	C	E	F		C	A		C	A
Approach Delay		27.9		132.8		23.5			17.3	
Approach LOS		C		F		C			B	

Intersection Summary

Cycle Length: 120
 Actuated Cycle Length: 118.1
 Natural Cycle: 125
 Control Type: Actuated-Uncoordinated
 Maximum v/c Ratio: 1.23
 Intersection Signal Delay: 91.0
 Intersection Capacity Utilization 119.6%
 Analysis Period (min) 15
 Intersection LOS: F
 ICU Level of Service H

Splits and Phases: 11: Barton St & Alessandro Bl.



HCM 6th Signalized Intersection Summary
11: Barton St & Alessandro Bl.

West Campus Upper Plateau (JN 14064)

09/20/2022



Movement	EBL	EBT	EBR	WBL	WBT	WBR	NBL	NBT	NBR	SBL	SBT	SBR
Lane Configurations	↖	↑↑↑		↖	↑↑↑			↑	↗		↖	↗
Traffic Volume (veh/h)	8	2097	60	48	3516	9	101	2	64	12	0	10
Future Volume (veh/h)	8	2097	60	48	3516	9	101	2	64	12	0	10
Initial Q (Qb), veh	0	0	0	0	0	0	0	0	0	0	0	0
Ped-Bike Adj(A_pbT)	1.00		0.98	1.00		1.00	1.00		1.00	1.00		1.00
Parking Bus, Adj	1.00	1.00	1.00	1.00	1.00	1.00	1.00	1.00	1.00	1.00	1.00	1.00
Work Zone On Approach		No			No			No			No	
Adj Sat Flow, veh/h/ln	1663	1870	1885	1900	1870	1678	1900	1900	1885	1426	1900	1307
Adj Flow Rate, veh/h	8	2184	59	50	3662	9	105	2	37	12	0	5
Peak Hour Factor	0.96	0.96	0.96	0.96	0.96	0.96	0.96	0.96	0.96	0.96	0.96	0.96
Percent Heavy Veh, %	16	2	1	0	2	15	0	0	1	32	0	40
Cap, veh/h	16	2669	72	65	2885	7	61	1	495	62	0	343
Arrive On Green	0.01	0.52	0.52	0.04	0.55	0.55	0.31	0.31	0.31	0.31	0.00	0.31
Sat Flow, veh/h	1584	5108	138	1810	5259	13	0	2	1596	0	0	1108
Grp Volume(v), veh/h	8	1453	790	50	2369	1302	107	0	37	12	0	5
Grp Sat Flow(s),veh/h/ln	1584	1702	1842	1810	1702	1868	2	0	1596	0	0	1108
Q Serve(g_s), s	0.6	41.3	41.6	3.2	63.7	63.7	0.0	0.0	1.9	0.0	0.0	0.4
Cycle Q Clear(g_c), s	0.6	41.3	41.6	3.2	63.7	63.7	36.0	0.0	1.9	36.0	0.0	0.4
Prop In Lane	1.00		0.07	1.00		0.01	0.98		1.00	1.00		1.00
Lane Grp Cap(c), veh/h	16	1779	962	65	1867	1025	62	0	495	62	0	343
V/C Ratio(X)	0.52	0.82	0.82	0.77	1.27	1.27	1.72	0.00	0.07	0.19	0.00	0.01
Avail Cap(c_a), veh/h	68	1814	982	106	1867	1025	62	0	495	62	0	343
HCM Platoon Ratio	1.00	1.00	1.00	1.00	1.00	1.00	1.00	1.00	1.00	1.00	1.00	1.00
Upstream Filter(I)	1.00	1.00	1.00	1.00	1.00	1.00	1.00	0.00	1.00	1.00	0.00	1.00
Uniform Delay (d), s/veh	57.2	23.1	23.2	55.5	26.2	26.2	57.7	0.0	28.3	58.1	0.0	27.8
Incr Delay (d2), s/veh	9.5	3.2	5.8	7.1	125.4	129.5	384.7	0.0	0.3	6.8	0.0	0.1
Initial Q Delay(d3),s/veh	0.0	0.0	0.0	0.0	0.0	0.0	0.0	0.0	0.0	0.0	0.0	0.0
%ile BackOfQ(50%),veh/ln	0.3	15.2	17.3	1.6	56.7	63.4	8.5	0.0	0.8	0.5	0.0	0.1
Unsig. Movement Delay, s/veh												
LnGrp Delay(d),s/veh	66.7	26.3	29.0	62.6	151.6	155.7	442.4	0.0	28.6	64.9	0.0	27.9
LnGrp LOS	E	C	C	E	F	F	F	A	C	E	A	C
Approach Vol, veh/h		2251			3721			144				17
Approach Delay, s/veh		27.4			151.9			336.1				54.0
Approach LOS		C			F			F				D
Timer - Assigned Phs	1	2		4	5	6		8				
Phs Duration (G+Y+Rc), s	8.4	67.2		40.6	5.3	70.2		40.6				
Change Period (Y+Rc), s	* 4.2	6.5		4.6	* 4.2	6.5		4.6				
Max Green Setting (Gmax), s	* 6.8	61.9		36.0	* 5	63.7		36.0				
Max Q Clear Time (g_c+I1), s	5.2	43.6		38.0	2.6	65.7		38.0				
Green Ext Time (p_c), s	0.0	15.7		0.0	0.0	0.0		0.0				

Intersection Summary

HCM 6th Ctrl Delay	110.2
HCM 6th LOS	F

Notes

* HCM 6th computational engine requires equal clearance times for the phases crossing the barrier.

Intersection						
Int Delay, s/veh	0.9					
Movement	EBL	EBT	WBT	WBR	SBL	SBR
Lane Configurations						
Traffic Vol, veh/h	43	133	492	17	6	12
Future Vol, veh/h	43	133	492	17	6	12
Conflicting Peds, #/hr	0	0	0	5	0	1
Sign Control	Free	Free	Free	Free	Stop	Stop
RT Channelized	-	None	-	None	-	None
Storage Length	100	-	-	-	0	-
Veh in Median Storage, #	-	0	0	-	0	-
Grade, %	-	0	0	-	0	-
Peak Hour Factor	92	92	92	92	92	92
Heavy Vehicles, %	0	2	1	0	0	0
Mvmt Flow	47	145	535	18	7	13

Major/Minor	Major1	Major2	Minor2		
Conflicting Flow All	558	0	-	0	788 550
Stage 1	-	-	-	-	549 -
Stage 2	-	-	-	-	239 -
Critical Hdwy	4.1	-	-	-	6.4 6.2
Critical Hdwy Stg 1	-	-	-	-	5.4 -
Critical Hdwy Stg 2	-	-	-	-	5.4 -
Follow-up Hdwy	2.2	-	-	-	3.5 3.3
Pot Cap-1 Maneuver	1023	-	-	-	363 539
Stage 1	-	-	-	-	583 -
Stage 2	-	-	-	-	805 -
Platoon blocked, %		-	-	-	
Mov Cap-1 Maneuver	1018	-	-	-	343 536
Mov Cap-2 Maneuver	-	-	-	-	343 -
Stage 1	-	-	-	-	553 -
Stage 2	-	-	-	-	801 -

Approach	EB	WB	SB
HCM Control Delay, s	2.1	0	13.3
HCM LOS			B

Minor Lane/Major Mvmt	EBL	EBT	WBT	WBR	SBLn1
Capacity (veh/h)	1018	-	-	-	451
HCM Lane V/C Ratio	0.046	-	-	-	0.043
HCM Control Delay (s)	8.7	-	-	-	13.3
HCM Lane LOS	A	-	-	-	B
HCM 95th %tile Q(veh)	0.1	-	-	-	0.1

Intersection						
Int Delay, s/veh	47.5					
Movement	EBT	EBR	WBL	WBT	NBL	NBR
Lane Configurations	↑↑		↖	↑↑	↘	
Traffic Vol, veh/h	363	336	59	530	275	44
Future Vol, veh/h	363	336	59	530	275	44
Conflicting Peds, #/hr	0	0	0	0	0	0
Sign Control	Free	Free	Free	Free	Stop	Stop
RT Channelized	-	None	-	None	-	None
Storage Length	-	-	125	-	0	-
Veh in Median Storage, #	0	-	-	0	0	-
Grade, %	0	-	-	0	0	-
Peak Hour Factor	92	92	92	92	92	92
Heavy Vehicles, %	3	0	2	1	0	0
Mvmt Flow	395	365	64	576	299	48

Major/Minor	Major1	Major2	Minor1		
Conflicting Flow All	0	0	760	0	994 380
Stage 1	-	-	-	-	578 -
Stage 2	-	-	-	-	416 -
Critical Hdwy	-	-	4.14	-	6.8 6.9
Critical Hdwy Stg 1	-	-	-	-	5.8 -
Critical Hdwy Stg 2	-	-	-	-	5.8 -
Follow-up Hdwy	-	-	2.22	-	3.5 3.3
Pot Cap-1 Maneuver	-	-	848	- ~	245 624
Stage 1	-	-	-	-	530 -
Stage 2	-	-	-	-	640 -
Platoon blocked, %	-	-	-	-	-
Mov Cap-1 Maneuver	-	-	848	- ~	227 624
Mov Cap-2 Maneuver	-	-	-	- ~	227 -
Stage 1	-	-	-	-	530 -
Stage 2	-	-	-	-	592 -

Approach	EB	WB	NB
HCM Control Delay, s	0	1	237.6
HCM LOS			F

Minor Lane/Major Mvmt	NBLn1	EBT	EBR	WBL	WBT
Capacity (veh/h)	249	-	-	848	-
HCM Lane V/C Ratio	1.393	-	-	0.076	-
HCM Control Delay (s)	237.6	-	-	9.6	-
HCM Lane LOS	F	-	-	A	-
HCM 95th %tile Q(veh)	19	-	-	0.2	-

Notes
 ~: Volume exceeds capacity \$: Delay exceeds 300s +: Computation Not Defined *: All major volume in platoon

Timings
14: Barton Rd. & Van Buren Bl.

West Campus Upper Plateau (JN 14064)
09/20/2022



Lane Group	EBL	EBT	WBL	WBT	NBL	NBT	NBR	SBL	SBT
Lane Configurations	↙	↕	↙	↕	↙	↕	↗	↙	↕
Traffic Volume (vph)	203	2005	337	2325	606	97	470	76	150
Future Volume (vph)	203	2005	337	2325	606	97	470	76	150
Turn Type	Prot	NA	Prot	NA	Prot	NA	Perm	Prot	NA
Protected Phases	5	2	1	6	3	8		7	4
Permitted Phases							8		
Detector Phase	5	2	1	6	3	8	8	7	4
Switch Phase									
Minimum Initial (s)	5.0	10.0	5.0	10.0	5.0	10.0	10.0	5.0	10.0
Minimum Split (s)	9.2	25.2	9.2	25.5	9.1	14.6	14.6	9.1	33.6
Total Split (s)	18.5	47.4	22.0	50.9	17.0	37.5	37.5	13.1	33.6
Total Split (%)	15.4%	39.5%	18.3%	42.4%	14.2%	31.3%	31.3%	10.9%	28.0%
Yellow Time (s)	3.2	5.2	3.2	5.5	3.6	3.6	3.6	3.6	3.6
All-Red Time (s)	1.0	1.0	1.0	1.0	0.5	1.0	1.0	0.5	1.0
Lost Time Adjust (s)	0.0	0.0	0.0	0.0	0.0	0.0	0.0	0.0	0.0
Total Lost Time (s)	4.2	6.2	4.2	6.5	4.1	4.6	4.6	4.1	4.6
Lead/Lag	Lead	Lag	Lead	Lag	Lead	Lag	Lag	Lead	Lag
Lead-Lag Optimize?	Yes	Yes	Yes	Yes	Yes	Yes	Yes	Yes	Yes
Recall Mode	None	None	None	None	None	None	None	None	None
Act Effct Green (s)	14.3	41.2	17.8	44.4	12.9	33.3	33.3	8.6	29.0
Actuated g/C Ratio	0.12	0.34	0.15	0.37	0.11	0.28	0.28	0.07	0.24
v/c Ratio	1.03	2.05	1.40	1.37	1.79	0.20	0.79	0.64	1.25
Control Delay	120.7	499.3	238.6	202.5	396.0	34.7	28.0	77.0	159.3
Queue Delay	0.0	0.0	0.0	0.0	0.0	0.0	0.0	0.0	0.0
Total Delay	120.7	499.3	238.6	202.5	396.0	34.7	28.0	77.0	159.3
LOS	F	F	F	F	F	C	C	E	F
Approach Delay		468.1		207.0		218.7			149.4
Approach LOS		F		F		F			F

Intersection Summary

Cycle Length: 120
 Actuated Cycle Length: 120
 Natural Cycle: 130
 Control Type: Actuated-Uncoordinated
 Maximum v/c Ratio: 2.05
 Intersection Signal Delay: 296.1
 Intersection LOS: F
 Intersection Capacity Utilization 148.7%
 ICU Level of Service H
 Analysis Period (min) 15



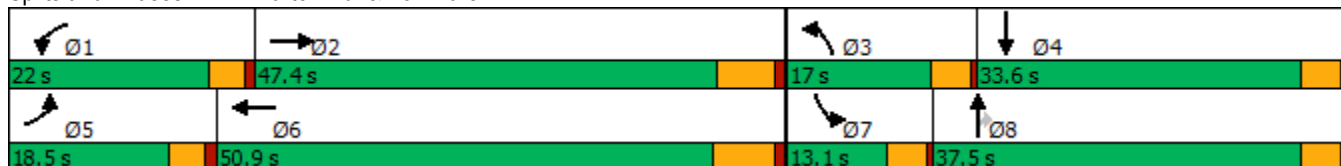

























Splits and Phases: 14: Barton Rd. & Van Buren Bl.



HCM 6th Signalized Intersection Summary
14: Barton Rd. & Van Buren Bl.

West Campus Upper Plateau (JN 14064)

09/20/2022

												
Movement	EBL	EBT	EBR	WBL	WBT	WBR	NBL	NBT	NBR	SBL	SBT	SBR
Lane Configurations		 			  		 		 		 	
Traffic Volume (veh/h)	203	2005	261	337	2325	40	606	97	470	76	150	409
Future Volume (veh/h)	203	2005	261	337	2325	40	606	97	470	76	150	409
Initial Q (Qb), veh	0	0	0	0	0	0	0	0	0	0	0	0
Ped-Bike Adj(A_pbT)	1.00		1.00	1.00		1.00	1.00		1.00	1.00		1.00
Parking Bus, Adj	1.00	1.00	1.00	1.00	1.00	1.00	1.00	1.00	1.00	1.00	1.00	1.00
Work Zone On Approach		No			No			No			No	
Adj Sat Flow, veh/h/ln	1900	1870	1870	1870	1870	1752	1870	1885	1885	1900	1870	1900
Adj Flow Rate, veh/h	221	2179	272	366	2527	38	659	105	307	83	163	330
Peak Hour Factor	0.92	0.92	0.92	0.92	0.92	0.92	0.92	0.92	0.92	0.92	0.92	0.92
Percent Heavy Veh, %	0	2	2	2	2	10	2	1	1	0	2	0
Cap, veh/h	215	1092	133	264	1926	29	371	547	463	105	133	269
Arrive On Green	0.12	0.34	0.34	0.15	0.37	0.37	0.11	0.29	0.29	0.06	0.24	0.24
Sat Flow, veh/h	1810	3188	390	1781	5183	78	3456	1885	1598	1810	552	1117
Grp Volume(v), veh/h	221	1194	1257	366	1657	908	659	105	307	83	0	493
Grp Sat Flow(s),veh/h/ln	1810	1777	1800	1781	1702	1856	1728	1885	1598	1810	0	1669
Q Serve(g_s), s	14.3	41.2	41.2	17.8	44.7	44.7	12.9	5.0	20.3	5.4	0.0	29.0
Cycle Q Clear(g_c), s	14.3	41.2	41.2	17.8	44.7	44.7	12.9	5.0	20.3	5.4	0.0	29.0
Prop In Lane	1.00		0.22	1.00		0.04	1.00		1.00	1.00		0.67
Lane Grp Cap(c), veh/h	215	609	617	264	1265	690	371	547	463	105	0	402
V/C Ratio(X)	1.03	1.96	2.04	1.39	1.31	1.32	1.78	0.19	0.66	0.79	0.00	1.23
Avail Cap(c_a), veh/h	215	609	617	264	1265	690	371	547	463	135	0	402
HCM Platoon Ratio	1.00	1.00	1.00	1.00	1.00	1.00	1.00	1.00	1.00	1.00	1.00	1.00
Upstream Filter(I)	1.00	1.00	1.00	1.00	1.00	1.00	1.00	1.00	1.00	1.00	0.00	1.00
Uniform Delay (d), s/veh	53.0	39.6	39.6	51.3	37.8	37.8	53.7	32.1	37.5	55.9	0.0	45.7
Incr Delay (d2), s/veh	68.7	439.0	473.1	196.6	145.4	152.3	361.0	0.2	3.5	20.6	0.0	121.6
Initial Q Delay(d3),s/veh	0.0	0.0	0.0	0.0	0.0	0.0	0.0	0.0	0.0	0.0	0.0	0.0
%ile BackOfQ(50%),veh/ln	10.4	91.0	98.1	22.0	42.8	48.1	24.0	2.3	8.1	3.1	0.0	25.6
Unsig. Movement Delay, s/veh												
LnGrp Delay(d),s/veh	121.7	478.5	512.6	247.8	183.2	190.1	414.7	32.3	41.0	76.5	0.0	167.3
LnGrp LOS	F	F	F	F	F	F	F	C	D	E	A	F
Approach Vol, veh/h		2672			2931			1071				576
Approach Delay, s/veh		465.0			193.4			270.1				154.2
Approach LOS		F			F			F				F
Timer - Assigned Phs	1	2	3	4	5	6	7	8				
Phs Duration (G+Y+Rc), s	22.0	47.7	17.0	33.6	18.5	51.2	11.1	39.5				
Change Period (Y+Rc), s	* 4.2	* 6.5	4.1	4.6	* 4.2	6.5	4.1	4.6				
Max Green Setting (Gmax), s	* 18	* 41	12.9	29.0	* 14	44.4	9.0	32.9				
Max Q Clear Time (g_c+I1), s	19.8	43.2	14.9	31.0	16.3	46.7	7.4	22.3				
Green Ext Time (p_c), s	0.0	0.0	0.0	0.0	0.0	0.0	0.0	1.2				

Intersection Summary

HCM 6th Ctrl Delay	301.7
HCM 6th LOS	F

Notes

* HCM 6th computational engine requires equal clearance times for the phases crossing the barrier.

Timings
15: Airman Dr & Cactus Av.



Lane Group	WBL	WBR	NBR	SBL	Ø6
Lane Configurations	↖	↗	↖	↖↗	
Traffic Volume (vph)	331	443	99	133	
Future Volume (vph)	331	443	99	133	
Turn Type	Prot	Perm	Perm	Prot	
Protected Phases	3			1	6
Permitted Phases		8	2		
Detector Phase	3	8	2	1	
Switch Phase					
Minimum Initial (s)	5.0	10.0	10.0	10.0	5.0
Minimum Split (s)	9.6	21.7	21.7	14.7	9.6
Total Split (s)	71.0	71.0	28.0	21.0	49.0
Total Split (%)	59.2%	59.2%	23.3%	17.5%	41%
Yellow Time (s)	3.6	3.7	3.7	3.7	3.6
All-Red Time (s)	1.0	1.0	1.0	1.0	1.0
Lost Time Adjust (s)	0.0	0.0	0.0	0.0	
Total Lost Time (s)	4.6	4.7	4.7	4.7	
Lead/Lag			Lag	Lead	
Lead-Lag Optimize?			Yes	Yes	
Recall Mode	None	None	Min	None	Min
Act Effect Green (s)	16.3	16.2	11.7	10.6	
Actuated g/C Ratio	0.33	0.33	0.24	0.22	
v/c Ratio	0.63	0.60	0.10	0.21	
Control Delay	20.8	5.2	0.2	20.7	
Queue Delay	0.0	0.0	0.0	0.0	
Total Delay	20.8	5.2	0.2	20.7	
LOS	C	A	A	C	
Approach Delay	11.9				
Approach LOS	B				

Intersection Summary

Cycle Length: 120	
Actuated Cycle Length: 48.8	
Natural Cycle: 60	
Control Type: Actuated-Uncoordinated	
Maximum v/c Ratio: 0.63	
Intersection Signal Delay: 11.9	Intersection LOS: B
Intersection Capacity Utilization 31.3%	ICU Level of Service A
Analysis Period (min) 15	



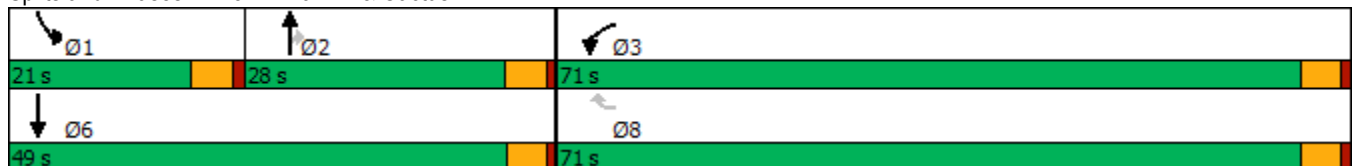









Splits and Phases: 15: Airman Dr & Cactus Av.



HCM 6th Signalized Intersection Summary
15: Airman Dr & Cactus Av.

West Campus Upper Plateau (JN 14064)

09/20/2022

						
Movement	WBL	WBR	NBT	NBR	SBL	SBT
Lane Configurations						
Traffic Volume (veh/h)	331	443	0	99	133	0
Future Volume (veh/h)	331	443	0	99	133	0
Initial Q (Qb), veh	0	0	0	0	0	0
Ped-Bike Adj(A_pbT)	1.00	1.00		1.00	1.00	
Parking Bus, Adj	1.00	1.00	1.00	1.00	1.00	1.00
Work Zone On Approach	No		No			No
Adj Sat Flow, veh/h/ln	1811	1752	1900	1811	1752	1900
Adj Flow Rate, veh/h	360	482	0	108	145	0
Peak Hour Factor	0.92	0.92	0.92	0.92	0.92	0.92
Percent Heavy Veh, %	6	10	0	6	10	0
Cap, veh/h	673	579	353	285	532	831
Arrive On Green	0.39	0.39	0.00	0.19	0.16	0.00
Sat Flow, veh/h	1725	1485	1900	1535	3237	1900
Grp Volume(v), veh/h	360	482	0	108	145	0
Grp Sat Flow(s),veh/h/ln	1725	1485	1900	1535	1618	1900
Q Serve(g_s), s	8.7	15.8	0.0	3.3	2.1	0.0
Cycle Q Clear(g_c), s	8.7	15.8	0.0	3.3	2.1	0.0
Prop In Lane	1.00	1.00		1.00	1.00	
Lane Grp Cap(c), veh/h	673	579	353	285	532	831
V/C Ratio(X)	0.53	0.83	0.00	0.38	0.27	0.00
Avail Cap(c_a), veh/h	2126	1829	822	664	979	1566
HCM Platoon Ratio	1.00	1.00	1.00	1.00	1.00	1.00
Upstream Filter(I)	1.00	1.00	0.00	1.00	1.00	0.00
Uniform Delay (d), s/veh	12.7	14.8	0.0	19.2	19.7	0.0
Incr Delay (d2), s/veh	0.7	3.2	0.0	0.8	0.1	0.0
Initial Q Delay(d3),s/veh	0.0	0.0	0.0	0.0	0.0	0.0
%ile BackOfQ(50%),veh/ln	3.0	5.0	0.0	1.1	0.7	0.0
Unsig. Movement Delay, s/veh						
LnGrp Delay(d),s/veh	13.3	18.0	0.0	20.1	19.8	0.0
LnGrp LOS	B	B	A	C	B	A
Approach Vol, veh/h	842		108			145
Approach Delay, s/veh	16.0		20.1			19.8
Approach LOS	B		C			B
Timer - Assigned Phs	1	2			6	8
Phs Duration (G+Y+Rc), s	13.6	14.7			28.3	25.6
Change Period (Y+Rc), s	* 4.7	* 4.7			* 4.7	4.6
Max Green Setting (Gmax), s	* 16	* 23			* 44	66.4
Max Q Clear Time (g_c+I1), s	4.1	5.3			0.0	17.8
Green Ext Time (p_c), s	0.2	0.3			0.0	3.2

Intersection Summary

HCM 6th Ctrl Delay	16.9
HCM 6th LOS	B

Notes

* HCM 6th computational engine requires equal clearance times for the phases crossing the barrier.

Intersection

Intersection Delay, s/veh	12.3
Intersection LOS	B

Movement	EBT	EBR	WBL	WBT	NBL	NBR
Lane Configurations						
Traffic Vol, veh/h	75	69	124	310	180	81
Future Vol, veh/h	75	69	124	310	180	81
Peak Hour Factor	0.92	0.92	0.92	0.92	0.92	0.92
Heavy Vehicles, %	4	0	0	2	2	2
Mvmt Flow	82	75	135	337	196	88
Number of Lanes	1	0	1	1	1	0

Approach	EB	WB	NB
Opposing Approach	WB	EB	
Opposing Lanes	2	1	0
Conflicting Approach Left		NB	EB
Conflicting Lanes Left	0	1	1
Conflicting Approach Right	NB		WB
Conflicting Lanes Right	1	0	2
HCM Control Delay	9.8	13.1	12.4
HCM LOS	A	B	B

Lane	NBLn1	EBLn1	WBLn1	WBLn2
Vol Left, %	69%	0%	100%	0%
Vol Thru, %	0%	52%	0%	100%
Vol Right, %	31%	48%	0%	0%
Sign Control	Stop	Stop	Stop	Stop
Traffic Vol by Lane	261	144	124	310
LT Vol	180	0	124	0
Through Vol	0	75	0	310
RT Vol	81	69	0	0
Lane Flow Rate	284	157	135	337
Geometry Grp	2	5	7	7
Degree of Util (X)	0.421	0.228	0.226	0.521
Departure Headway (Hd)	5.448	5.239	6.033	5.562
Convergence, Y/N	Yes	Yes	Yes	Yes
Cap	664	689	598	654
Service Time	3.448	3.249	3.733	3.262
HCM Lane V/C Ratio	0.428	0.228	0.226	0.515
HCM Control Delay	12.4	9.8	10.5	14.2
HCM Lane LOS	B	A	B	B
HCM 95th-tile Q	2.1	0.9	0.9	3

Intersection

Intersection Delay, s/veh	13.6
Intersection LOS	B

Movement	EBL	EBT	WBT	WBR	SBL	SBR
Lane Configurations						
Traffic Vol, veh/h	150	219	407	116	97	139
Future Vol, veh/h	150	219	407	116	97	139
Peak Hour Factor	0.92	0.92	0.92	0.92	0.92	0.92
Heavy Vehicles, %	0	2	0	2	1	1
Mvmt Flow	163	238	442	126	105	151
Number of Lanes	1	2	2	0	1	0

Approach	EB	WB	SB
Opposing Approach	WB	EB	
Opposing Lanes	2	3	0
Conflicting Approach Left SB			WB
Conflicting Lanes Left	1	0	2
Conflicting Approach Right		SB	EB
Conflicting Lanes Right	0	1	3
HCM Control Delay	10.6	15.1	15.2
HCM LOS	B	C	C

Lane	EBLn1	EBLn2	EBLn3	WBLn1	WBLn2	SBLn1
Vol Left, %	100%	0%	0%	0%	0%	41%
Vol Thru, %	0%	100%	100%	100%	54%	0%
Vol Right, %	0%	0%	0%	0%	46%	59%
Sign Control	Stop	Stop	Stop	Stop	Stop	Stop
Traffic Vol by Lane	150	110	110	271	252	236
LT Vol	150	0	0	0	0	97
Through Vol	0	110	110	271	136	0
RT Vol	0	0	0	0	116	139
Lane Flow Rate	163	119	119	295	274	257
Geometry Grp	7	7	7	8	8	7
Degree of Util (X)	0.304	0.207	0.148	0.524	0.464	0.471
Departure Headway (Hd)	6.72	6.246	4.481	6.401	6.107	6.607
Convergence, Y/N	Yes	Yes	Yes	Yes	Yes	Yes
Cap	533	572	794	560	588	544
Service Time	4.482	4.007	2.242	4.162	3.868	4.366
HCM Lane V/C Ratio	0.306	0.208	0.15	0.527	0.466	0.472
HCM Control Delay	12.4	10.6	8	16.1	14.1	15.2
HCM Lane LOS	B	B	A	C	B	C
HCM 95th-tile Q	1.3	0.8	0.5	3	2.4	2.5

Timings
18: Linebacker Dr & Cactus Av.

West Campus Upper Plateau (JN 14064)

09/20/2022

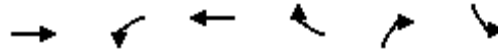

Lane Group	EBT	WBL	WBT	WBR	NBR	SBL	Ø3	Ø4	Ø5	Ø8
Lane Configurations	↑↑	↖	↑	↗	↗	↖↖				
Traffic Volume (vph)	232	277	774	277	84	84				
Future Volume (vph)	232	277	774	277	84	84				
Turn Type	NA	Prot	NA	Perm	pm+ov	Prot				
Protected Phases	2	1	6		1	7	3	4	5	8
Permitted Phases				6	8					
Detector Phase	2	1	6	6	1	7				
Switch Phase										
Minimum Initial (s)	10.0	5.0	10.0	10.0	5.0	5.0	5.0	10.0	5.0	10.0
Minimum Split (s)	27.0	9.6	27.0	27.0	9.6	9.6	9.6	27.0	9.6	27.0
Total Split (s)	27.4	16.0	33.8	33.8	16.0	9.6	9.6	27.0	9.6	27.0
Total Split (%)	34.3%	20.0%	42.3%	42.3%	20.0%	12.0%	12%	34%	12%	34%
Yellow Time (s)	4.0	3.6	4.0	4.0	3.6	3.6	3.6	4.0	3.6	4.0
All-Red Time (s)	1.0	1.0	1.0	1.0	1.0	1.0	1.0	1.0	1.0	1.0
Lost Time Adjust (s)	0.0	0.0	0.0	0.0	0.0	0.0				
Total Lost Time (s)	5.0	4.6	5.0	5.0	4.6	4.6				
Lead/Lag	Lag	Lead	Lag	Lag	Lead	Lead	Lead	Lag	Lead	Lag
Lead-Lag Optimize?	Yes	Yes	Yes	Yes	Yes	Yes	Yes	Yes	Yes	Yes
Recall Mode	None	None	None	None	None	None	None	None	None	None
Act Effct Green (s)	15.2	12.6	35.6	35.6	15.7	5.5				
Actuated g/C Ratio	0.32	0.27	0.76	0.76	0.34	0.12				
v/c Ratio	0.22	0.68	0.63	0.25	0.13	0.24				
Control Delay	15.0	31.7	12.5	2.3	0.4	26.0				
Queue Delay	0.0	0.0	0.0	0.0	0.0	0.0				
Total Delay	15.0	31.7	12.5	2.3	0.4	26.0				
LOS	B	C	B	A	A	C				
Approach Delay	15.0		14.4							
Approach LOS	B		B							

Intersection Summary

Cycle Length: 80
 Actuated Cycle Length: 46.8
 Natural Cycle: 90
 Control Type: Actuated-Uncoordinated
 Maximum v/c Ratio: 0.68
 Intersection Signal Delay: 14.3
 Intersection LOS: B
 Intersection Capacity Utilization 65.4%
 ICU Level of Service C
 Analysis Period (min) 15

Splits and Phases: 18: Linebacker Dr & Cactus Av.

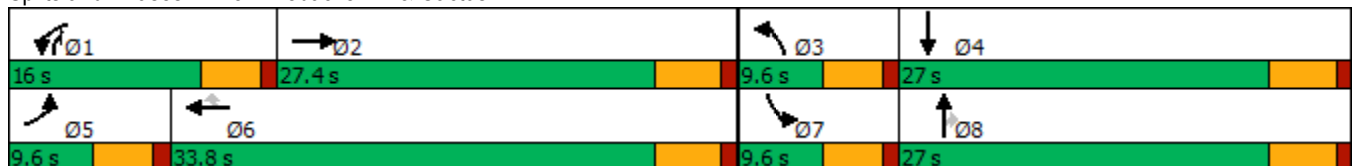

HCM 6th Signalized Intersection Summary
18: Linebacker Dr & Cactus Av.

West Campus Upper Plateau (JN 14064)

09/20/2022



Movement	EBL	EBT	EBR	WBL	WBT	WBR	NBL	NBT	NBR	SBL	SBT	SBR
Lane Configurations	↶	↷		↶	↷	↷	↶	↷	↷	↶	↷	↷
Traffic Volume (veh/h)	0	232	0	277	774	277	0	0	84	84	0	0
Future Volume (veh/h)	0	232	0	277	774	277	0	0	84	84	0	0
Initial Q (Qb), veh	0	0	0	0	0	0	0	0	0	0	0	0
Ped-Bike Adj(A_pbT)	1.00		1.00	1.00		1.00	1.00		1.00	1.00		1.00
Parking Bus, Adj	1.00	1.00	1.00	1.00	1.00	1.00	1.00	1.00	1.00	1.00	1.00	1.00
Work Zone On Approach		No			No			No			No	
Adj Sat Flow, veh/h/ln	1900	1767	1900	1752	1781	1752	1900	1900	1767	1752	1900	1900
Adj Flow Rate, veh/h	0	252	0	301	841	301	0	0	91	91	0	0
Peak Hour Factor	0.92	0.92	0.92	0.92	0.92	0.92	0.92	0.92	0.92	0.92	0.92	0.92
Percent Heavy Veh, %	0	9	0	10	8	10	0	0	9	10	0	0
Cap, veh/h	3	776	0	349	919	766	3	264	522	232	562	0
Arrive On Green	0.00	0.22	0.00	0.21	0.52	0.52	0.00	0.00	0.14	0.07	0.00	0.00
Sat Flow, veh/h	1810	3533	0	1668	1781	1485	1810	1900	1497	3337	1900	0
Grp Volume(v), veh/h	0	252	0	301	841	301	0	0	91	91	0	0
Grp Sat Flow(s),veh/h/ln	1810	1767	0	1668	1781	1485	1810	1900	1497	1668	1900	0
Q Serve(g_s), s	0.0	3.2	0.0	9.2	23.0	6.5	0.0	0.0	2.2	1.4	0.0	0.0
Cycle Q Clear(g_c), s	0.0	3.2	0.0	9.2	23.0	6.5	0.0	0.0	2.2	1.4	0.0	0.0
Prop In Lane	1.00		0.00	1.00		1.00	1.00		1.00	1.00		0.00
Lane Grp Cap(c), veh/h	3	776	0	349	919	766	3	264	522	232	562	0
V/C Ratio(X)	0.00	0.32	0.00	0.86	0.92	0.39	0.00	0.00	0.17	0.39	0.00	0.00
Avail Cap(c_a), veh/h	171	1492	0	359	967	806	171	788	935	315	788	0
HCM Platoon Ratio	1.00	1.00	1.00	1.00	1.00	1.00	1.00	1.00	1.00	1.00	1.00	1.00
Upstream Filter(I)	0.00	1.00	0.00	1.00	1.00	1.00	0.00	0.00	1.00	1.00	0.00	0.00
Uniform Delay (d), s/veh	0.0	17.4	0.0	20.2	11.8	7.8	0.0	0.0	12.0	23.6	0.0	0.0
Incr Delay (d2), s/veh	0.0	0.2	0.0	17.6	12.6	0.3	0.0	0.0	0.2	0.4	0.0	0.0
Initial Q Delay(d3),s/veh	0.0	0.0	0.0	0.0	0.0	0.0	0.0	0.0	0.0	0.0	0.0	0.0
%ile BackOfQ(50%),veh/ln	0.0	1.2	0.0	4.9	10.0	1.7	0.0	0.0	0.7	0.5	0.0	0.0
Unsig. Movement Delay, s/veh												
LnGrp Delay(d),s/veh	0.0	17.6	0.0	37.8	24.4	8.1	0.0	0.0	12.1	24.0	0.0	0.0
LnGrp LOS	A	B	A	D	C	A	A	A	B	C	A	A
Approach Vol, veh/h		252			1443			91			91	
Approach Delay, s/veh		17.6			23.8			12.1			24.0	
Approach LOS		B			C			B			C	
Timer - Assigned Phs	1	2	3	4	5	6	7	8				
Phs Duration (G+Y+Rc), s	15.7	16.7	0.0	20.7	0.0	32.4	8.3	12.4				
Change Period (Y+Rc), s	4.6	5.0	4.6	5.0	4.6	5.0	4.6	5.0				
Max Green Setting (Gmax), s	11.4	22.4	5.0	22.0	5.0	28.8	5.0	22.0				
Max Q Clear Time (g_c+I1), s	11.2	5.2	0.0	0.0	0.0	25.0	3.4	4.2				
Green Ext Time (p_c), s	0.0	1.4	0.0	0.0	0.0	2.4	0.0	0.2				

Intersection Summary

HCM 6th Ctrl Delay	22.4
HCM 6th LOS	C

Notes

User approved volume balancing among the lanes for turning movement.

Timings
19: Van Buren Bl. & Orange Terrace Pkwy.

West Campus Upper Plateau (JN 14064)

09/20/2022

Lane Group	EBL	EBT	EBR	WBL	WBT	WBR	NBL	NBT	NBR	SBL	SBT	SBR
Lane Configurations												
Traffic Volume (vph)	181	2143	225	140	2514	153	131	25	86	290	43	289
Future Volume (vph)	181	2143	225	140	2514	153	131	25	86	290	43	289
Turn Type	Prot	NA	Perm	Prot	NA	Perm	Prot	NA	Perm	Prot	NA	pm+ov
Protected Phases	5	2		1	6		3	8		7	4	5
Permitted Phases			2			6			8			4
Detector Phase	5	2	2	1	6	6	3	8	8	7	4	5
Switch Phase												
Minimum Initial (s)	5.0	10.0	10.0	5.0	10.0	10.0	5.0	5.0	5.0	10.0	10.0	5.0
Minimum Split (s)	9.2	25.2	25.2	9.1	25.2	25.2	9.1	26.1	26.1	15.8	24.8	9.2
Total Split (s)	16.0	62.8	62.8	9.1	55.9	55.9	9.1	26.1	26.1	22.0	39.0	16.0
Total Split (%)	13.3%	52.3%	52.3%	7.6%	46.6%	46.6%	7.6%	21.8%	21.8%	18.3%	32.5%	13.3%
Yellow Time (s)	3.2	5.2	5.2	3.6	5.2	5.2	3.6	3.6	3.6	4.8	4.8	3.2
All-Red Time (s)	1.0	1.0	1.0	0.5	1.0	1.0	0.5	0.5	0.5	1.0	1.0	1.0
Lost Time Adjust (s)	0.0	0.0	0.0	0.0	0.0	0.0	0.0	0.0	0.0	0.0	0.0	0.0
Total Lost Time (s)	4.2	6.2	6.2	4.1	6.2	6.2	4.1	4.1	4.1	5.8	5.8	4.2
Lead/Lag	Lead	Lag	Lag	Lead	Lag	Lag	Lead	Lag	Lag	Lead	Lag	Lead
Lead-Lag Optimize?	Yes	Yes	Yes	Yes	Yes	Yes	Yes	Yes	Yes	Yes	Yes	Yes
Recall Mode	None	None	None	None	None	None	None	None	None	None	None	None
Act Effct Green (s)	11.2	56.7	56.7	5.0	50.4	50.4	10.3	6.3	6.3	13.6	14.1	21.9
Actuated g/C Ratio	0.11	0.57	0.57	0.05	0.51	0.51	0.10	0.06	0.06	0.14	0.14	0.22
v/c Ratio	0.48	0.77	0.24	0.82	1.02	0.18	0.37	0.11	0.32	0.63	0.16	0.74
Control Delay	47.5	19.9	5.1	82.3	48.5	1.8	49.4	46.9	3.0	47.8	39.2	37.0
Queue Delay	0.0	0.0	0.0	0.0	0.0	0.0	0.0	0.0	0.0	0.0	0.0	0.0
Total Delay	47.5	19.9	5.1	82.3	48.5	1.8	49.4	46.9	3.0	47.8	39.2	37.0
LOS	D	B	A	F	D	A	D	D	A	D	D	D
Approach Delay		20.5			47.6			32.6			42.2	
Approach LOS		C			D			C			D	

Intersection Summary

Cycle Length: 120
 Actuated Cycle Length: 99.7
 Natural Cycle: 130
 Control Type: Actuated-Uncoordinated
 Maximum v/c Ratio: 1.02
 Intersection Signal Delay: 35.4
 Intersection LOS: D
 Intersection Capacity Utilization 83.0%
 ICU Level of Service E
 Analysis Period (min) 15

Splits and Phases: 19: Van Buren Bl. & Orange Terrace Pkwy.

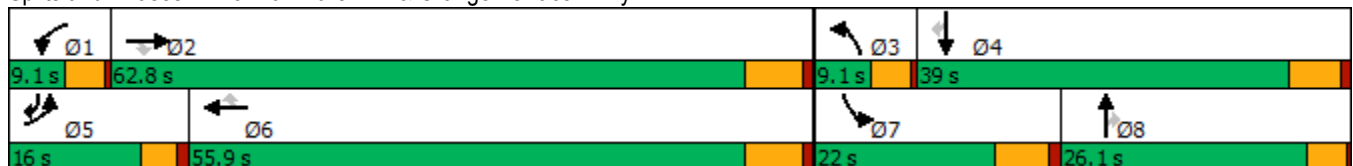

HCM 6th Signalized Intersection Summary
 19: Van Buren Bl. & Orange Terrace Pkwy.

West Campus Upper Plateau (JN 14064)

09/20/2022



Movement	EBL	EBT	EBR	WBL	WBT	WBR	NBL	NBT	NBR	SBL	SBT	SBR
Lane Configurations	↖↗	↑↑↑	↖	↖↗	↑↑↑	↖	↖↗	↑↑	↖	↖↗	↑	↖↗
Traffic Volume (veh/h)	181	2143	225	140	2514	153	131	25	86	290	43	289
Future Volume (veh/h)	181	2143	225	140	2514	153	131	25	86	290	43	289
Initial Q (Qb), veh	0	0	0	0	0	0	0	0	0	0	0	0
Ped-Bike Adj(A_pbT)	1.00		0.99	1.00		1.00	1.00		1.00	1.00		0.98
Parking Bus, Adj	1.00	1.00	1.00	1.00	1.00	1.00	1.00	1.00	1.00	1.00	1.00	1.00
Work Zone On Approach		No			No			No			No	
Adj Sat Flow, veh/h/ln	1885	1856	1870	1900	1856	1870	1900	1900	1811	1885	1900	1885
Adj Flow Rate, veh/h	187	2209	222	144	2592	117	135	26	62	299	44	185
Peak Hour Factor	0.97	0.97	0.97	0.97	0.97	0.97	0.97	0.97	0.97	0.97	0.97	0.97
Percent Heavy Veh, %	1	3	2	0	3	2	0	0	6	1	0	1
Cap, veh/h	259	2759	853	184	2643	827	184	227	97	383	263	335
Arrive On Green	0.07	0.54	0.54	0.05	0.52	0.52	0.05	0.06	0.06	0.11	0.14	0.14
Sat Flow, veh/h	3483	5066	1565	3510	5066	1585	3510	3610	1535	3483	1900	1566
Grp Volume(v), veh/h	187	2209	222	144	2592	117	135	26	62	299	44	185
Grp Sat Flow(s),veh/h/ln	1742	1689	1565	1755	1689	1585	1755	1805	1535	1742	1900	1566
Q Serve(g_s), s	5.0	33.5	7.2	3.9	47.7	3.6	3.6	0.6	3.8	8.0	1.9	10.0
Cycle Q Clear(g_c), s	5.0	33.5	7.2	3.9	47.7	3.6	3.6	0.6	3.8	8.0	1.9	10.0
Prop In Lane	1.00		1.00	1.00		1.00	1.00		1.00	1.00		1.00
Lane Grp Cap(c), veh/h	259	2759	853	184	2643	827	184	227	97	383	263	335
V/C Ratio(X)	0.72	0.80	0.26	0.78	0.98	0.14	0.73	0.11	0.64	0.78	0.17	0.55
Avail Cap(c_a), veh/h	431	3010	930	184	2643	827	184	834	354	592	662	664
HCM Platoon Ratio	1.00	1.00	1.00	1.00	1.00	1.00	1.00	1.00	1.00	1.00	1.00	1.00
Upstream Filter(I)	1.00	1.00	1.00	1.00	1.00	1.00	1.00	1.00	1.00	1.00	1.00	1.00
Uniform Delay (d), s/veh	43.1	17.5	11.5	44.6	22.3	11.8	44.5	42.1	43.6	41.3	36.2	33.5
Incr Delay (d2), s/veh	1.4	1.5	0.2	19.2	13.3	0.1	13.9	0.2	6.9	3.6	0.3	1.4
Initial Q Delay(d3),s/veh	0.0	0.0	0.0	0.0	0.0	0.0	0.0	0.0	0.0	0.0	0.0	0.0
%ile BackOfQ(50%),veh/ln	2.1	11.2	2.4	2.1	18.9	1.3	1.9	0.3	1.6	3.5	0.9	3.9
Unsig. Movement Delay, s/veh												
LnGrp Delay(d),s/veh	44.6	19.0	11.7	63.8	35.6	11.8	58.4	42.4	50.5	44.8	36.5	34.9
LnGrp LOS	D	B	B	E	D	B	E	D	D	D	D	C
Approach Vol, veh/h		2618			2853			223			528	
Approach Delay, s/veh		20.2			36.0			54.3			40.7	
Approach LOS		C			D			D			D	
Timer - Assigned Phs	1	2	3	4	5	6	7	8				
Phs Duration (G+Y+Rc), s	9.1	58.1	9.1	19.0	11.3	55.9	16.3	11.8				
Change Period (Y+Rc), s	4.1	6.2	4.1	5.8	* 4.2	6.2	5.8	* 5.8				
Max Green Setting (Gmax), s	5.0	56.6	5.0	33.2	* 12	49.7	16.2	* 22				
Max Q Clear Time (g_c+I1), s	5.9	35.5	5.6	12.0	7.0	49.7	10.0	5.8				
Green Ext Time (p_c), s	0.0	16.1	0.0	0.7	0.1	0.0	0.5	0.2				

Intersection Summary

HCM 6th Ctrl Delay	30.4
HCM 6th LOS	C

Notes

* HCM 6th computational engine requires equal clearance times for the phases crossing the barrier.

Timings
20: Brown/San Gorgonio Dr & Alessandro Bl.

West Campus Upper Plateau (JN 14064)

09/20/2022



Lane Group	EBL	EBT	WBL	WBT	WBR	NBL	NBT	NBR	SBL	SBT	SBR
Lane Configurations	↖	↖↖↖	↖	↖↖↖	↖	↖	↖	↖	↖	↖	↖
Traffic Volume (vph)	40	2100	192	3388	66	55	5	57	39	5	21
Future Volume (vph)	40	2100	192	3388	66	55	5	57	39	5	21
Turn Type	Prot	NA	Prot	NA	Perm	Prot	NA	pm+ov	Prot	NA	pm+ov
Protected Phases	5	2	1	6		3	8	1	7	4	5
Permitted Phases					6			8			4
Detector Phase	5	2	1	6	6	3	8	1	7	4	5
Switch Phase											
Minimum Initial (s)	5.0	10.0	5.0	10.0	10.0	5.0	5.0	5.0	5.0	10.0	5.0
Minimum Split (s)	8.7	43.5	9.1	43.5	43.5	9.1	26.1	9.1	8.7	49.8	8.7
Total Split (s)	8.7	51.9	9.2	52.4	52.4	9.1	48.1	9.2	10.8	49.8	8.7
Total Split (%)	7.3%	43.3%	7.7%	43.7%	43.7%	7.6%	40.1%	7.7%	9.0%	41.5%	7.3%
Yellow Time (s)	3.2	5.5	3.6	5.5	5.5	3.6	3.6	3.6	3.2	4.8	3.2
All-Red Time (s)	0.5	1.0	0.5	1.0	1.0	0.5	0.5	0.5	0.5	1.0	0.5
Lost Time Adjust (s)	0.0	0.0	0.0	0.0	0.0	0.0	0.0	0.0	0.0	0.0	0.0
Total Lost Time (s)	3.7	6.5	4.1	6.5	6.5	4.1	4.1	4.1	3.7	5.8	3.7
Lead/Lag	Lead	Lag	Lead	Lag	Lag	Lead	Lag	Lead	Lead	Lag	Lead
Lead-Lag Optimize?	Yes	Yes	Yes	Yes	Yes	Yes	Yes	Yes	Yes	Yes	Yes
Recall Mode	None	None	None	None	None	None	None	None	None	None	None
Act Effct Green (s)	5.3	47.9	5.4	52.3	52.3	5.9	11.0	13.8	6.4	15.0	11.8
Actuated g/C Ratio	0.07	0.61	0.07	0.66	0.66	0.07	0.14	0.17	0.08	0.19	0.15
v/c Ratio	0.35	0.78	1.74	1.07	0.07	0.43	0.02	0.18	0.32	0.02	0.07
Control Delay	50.3	18.1	396.7	57.3	2.3	51.2	27.2	6.3	47.6	25.6	0.5
Queue Delay	0.0	0.0	0.0	0.0	0.0	0.0	0.0	0.0	0.0	0.0	0.0
Total Delay	50.3	18.1	396.7	57.3	2.3	51.2	27.2	6.3	47.6	25.6	0.5
LOS	D	B	F	E	A	D	C	A	D	C	A
Approach Delay		18.6		74.2			28.3			30.7	
Approach LOS		B		E			C			C	

Intersection Summary

Cycle Length: 120
 Actuated Cycle Length: 78.9
 Natural Cycle: 125
 Control Type: Actuated-Uncoordinated
 Maximum v/c Ratio: 1.74
 Intersection Signal Delay: 52.0
 Intersection LOS: D
 Intersection Capacity Utilization 92.0%
 ICU Level of Service F
 Analysis Period (min) 15

Splits and Phases: 20: Brown/San Gorgonio Dr & Alessandro Bl.

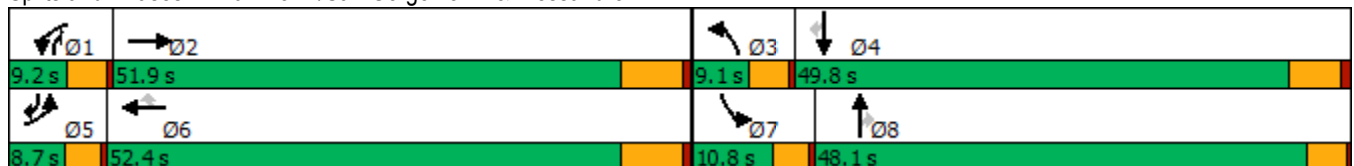

HCM 6th Signalized Intersection Summary
 20: Brown/San Gorgonio Dr & Alessandro Bl.

West Campus Upper Plateau (JN 14064)

09/20/2022

Movement	EBL	EBT	EBR	WBL	WBT	WBR	NBL	NBT	NBR	SBL	SBT	SBR
Lane Configurations												
Traffic Volume (veh/h)	40	2100	157	192	3388	66	55	5	57	39	5	21
Future Volume (veh/h)	40	2100	157	192	3388	66	55	5	57	39	5	21
Initial Q (Qb), veh	0	0	0	0	0	0	0	0	0	0	0	0
Ped-Bike Adj(A_pbT)	1.00		0.98	1.00		1.00	1.00		1.00	1.00		1.00
Parking Bus, Adj	1.00	1.00	1.00	1.00	1.00	1.00	1.00	1.00	1.00	1.00	1.00	1.00
Work Zone On Approach		No			No			No			No	
Adj Sat Flow, veh/h/ln	1900	1870	1900	1811	1856	1781	1900	1900	1826	1693	1530	1900
Adj Flow Rate, veh/h	42	2211	165	202	3566	69	58	5	57	41	5	8
Peak Hour Factor	0.95	0.95	0.95	0.95	0.95	0.95	0.95	0.95	0.95	0.95	0.95	0.95
Percent Heavy Veh, %	0	2	0	6	3	8	0	0	5	14	25	0
Cap, veh/h	68	2596	192	106	2861	853	80	236	287	59	171	240
Arrive On Green	0.04	0.54	0.54	0.06	0.56	0.56	0.04	0.12	0.12	0.04	0.11	0.11
Sat Flow, veh/h	1810	4843	357	1725	5066	1510	1810	1900	1547	1612	1530	1610
Grp Volume(v), veh/h	42	1547	829	202	3566	69	58	5	57	41	5	8
Grp Sat Flow(s),veh/h/ln	1810	1702	1797	1725	1689	1510	1810	1900	1547	1612	1530	1610
Q Serve(g_s), s	1.9	32.2	33.1	5.1	47.0	1.7	2.6	0.2	2.6	2.1	0.2	0.4
Cycle Q Clear(g_c), s	1.9	32.2	33.1	5.1	47.0	1.7	2.6	0.2	2.6	2.1	0.2	0.4
Prop In Lane	1.00		0.20	1.00		1.00	1.00		1.00	1.00		1.00
Lane Grp Cap(c), veh/h	68	1825	963	106	2861	853	80	236	287	59	171	240
V/C Ratio(X)	0.62	0.85	0.86	1.91	1.25	0.08	0.72	0.02	0.20	0.69	0.03	0.03
Avail Cap(c_a), veh/h	109	1857	980	106	2861	853	109	1005	913	138	809	911
HCM Platoon Ratio	1.00	1.00	1.00	1.00	1.00	1.00	1.00	1.00	1.00	1.00	1.00	1.00
Upstream Filter(I)	1.00	1.00	1.00	1.00	1.00	1.00	1.00	1.00	1.00	1.00	1.00	1.00
Uniform Delay (d), s/veh	39.5	16.4	16.6	39.1	18.1	8.3	39.3	32.0	28.7	39.6	32.9	30.3
Incr Delay (d2), s/veh	3.4	4.0	8.1	442.9	114.0	0.1	14.1	0.0	0.3	5.3	0.1	0.1
Initial Q Delay(d3),s/veh	0.0	0.0	0.0	0.0	0.0	0.0	0.0	0.0	0.0	0.0	0.0	0.0
%ile BackOfQ(50%),veh/ln	0.8	10.5	12.5	15.1	46.0	0.5	1.5	0.1	1.0	0.9	0.1	0.1
Unsig. Movement Delay, s/veh												
LnGrp Delay(d),s/veh	42.9	20.4	24.7	482.0	132.1	8.3	53.3	32.0	29.0	44.9	33.0	30.3
LnGrp LOS	D	C	C	F	F	A	D	C	C	D	C	C
Approach Vol, veh/h		2418			3837			120				54
Approach Delay, s/veh		22.3			148.3			40.9				41.6
Approach LOS		C			F			D				D
Timer - Assigned Phs	1	2	3	4	5	6	7	8				
Phs Duration (G+Y+Rc), s	9.2	51.1	7.8	15.1	6.8	53.5	6.8	16.1				
Change Period (Y+Rc), s	4.1	6.5	4.1	5.8	3.7	6.5	3.7	* 5.8				
Max Green Setting (Gmax), s	5.1	45.4	5.0	44.0	5.0	45.9	7.1	* 44				
Max Q Clear Time (g_c+I1), s	7.1	35.1	4.6	2.4	3.9	49.0	4.1	4.6				
Green Ext Time (p_c), s	0.0	9.5	0.0	0.0	0.0	0.0	0.0	0.2				

Intersection Summary

HCM 6th Ctrl Delay	98.0
HCM 6th LOS	F

Notes

* HCM 6th computational engine requires equal clearance times for the phases crossing the barrier.

Timings
21: Cactus Av. & Brown St



Lane Group	EBL	EBT	WBT	SBR
Lane Configurations	↘	↑↑	↑↑	↗
Traffic Volume (vph)	102	299	983	344
Future Volume (vph)	102	299	983	344
Turn Type	Prot	NA	NA	Perm
Protected Phases	7	4	8	
Permitted Phases				6
Detector Phase	7	4	8	6
Switch Phase				
Minimum Initial (s)	5.0	10.0	10.0	10.0
Minimum Split (s)	9.6	15.8	27.8	26.7
Total Split (s)	20.2	81.2	61.0	38.8
Total Split (%)	16.8%	67.7%	50.8%	32.3%
Yellow Time (s)	3.6	4.8	4.8	3.7
All-Red Time (s)	1.0	1.0	1.0	1.0
Lost Time Adjust (s)	0.0	0.0	0.0	0.0
Total Lost Time (s)	4.6	5.8	5.8	4.7
Lead/Lag	Lead		Lag	
Lead-Lag Optimize?	Yes		Yes	
Recall Mode	None	None	None	Min
Act Effct Green (s)	9.8	42.9	31.6	14.1
Actuated g/C Ratio	0.14	0.63	0.46	0.21
v/c Ratio	0.43	0.16	0.71	0.68
Control Delay	37.9	5.3	19.3	15.8
Queue Delay	0.0	0.0	0.0	0.0
Total Delay	37.9	5.3	19.3	15.8
LOS	D	A	B	B
Approach Delay		13.6	19.3	
Approach LOS		B	B	

Intersection Summary

Cycle Length: 120	
Actuated Cycle Length: 68.6	
Natural Cycle: 70	
Control Type: Actuated-Uncoordinated	
Maximum v/c Ratio: 0.71	
Intersection Signal Delay: 17.3	Intersection LOS: B
Intersection Capacity Utilization 57.2%	ICU Level of Service B
Analysis Period (min) 15	

Splits and Phases: 21: Cactus Av. & Brown St

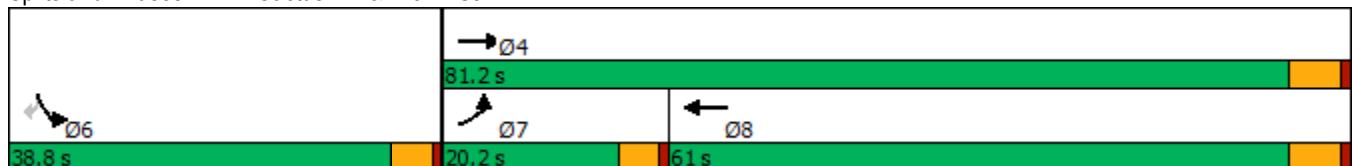

HCM 6th Signalized Intersection Summary
21: Cactus Av. & Brown St

West Campus Upper Plateau (JN 14064)
09/20/2022



Movement	EBL	EBT	WBT	WBR	SBL	SBR	
Lane Configurations	↖	↑↑	↑↗		↖	↖	
Traffic Volume (veh/h)	102	299	983	0	0	344	
Future Volume (veh/h)	102	299	983	0	0	344	
Initial Q (Qb), veh	0	0	0	0	0	0	
Ped-Bike Adj(A_pbT)	1.00			1.00	1.00	1.00	
Parking Bus, Adj	1.00	1.00	1.00	1.00	1.00	1.00	
Work Zone On Approach		No	No		No		
Adj Sat Flow, veh/h/ln	1900	1737	1737	1900	1900	1900	
Adj Flow Rate, veh/h	111	325	1068	0	0	374	
Peak Hour Factor	0.92	0.92	0.92	0.92	0.92	0.92	
Percent Heavy Veh, %	0	11	11	0	0	0	
Cap, veh/h	144	1902	1415	0	486	433	
Arrive On Green	0.08	0.58	0.43	0.00	0.00	0.27	
Sat Flow, veh/h	1810	3387	3474	0	1810	1610	
Grp Volume(v), veh/h	111	325	1068	0	0	374	
Grp Sat Flow(s),veh/h/ln	1810	1650	1650	0	1810	1610	
Q Serve(g_s), s	4.1	3.1	18.5	0.0	0.0	15.0	
Cycle Q Clear(g_c), s	4.1	3.1	18.5	0.0	0.0	15.0	
Prop In Lane	1.00			0.00	1.00	1.00	
Lane Grp Cap(c), veh/h	144	1902	1415	0	486	433	
V/C Ratio(X)	0.77	0.17	0.75	0.00	0.00	0.86	
Avail Cap(c_a), veh/h	417	3674	2690	0	911	811	
HCM Platoon Ratio	1.00	1.00	1.00	1.00	1.00	1.00	
Upstream Filter(I)	1.00	1.00	1.00	0.00	0.00	1.00	
Uniform Delay (d), s/veh	30.6	6.7	16.3	0.0	0.0	23.6	
Incr Delay (d2), s/veh	3.3	0.0	0.8	0.0	0.0	5.3	
Initial Q Delay(d3),s/veh	0.0	0.0	0.0	0.0	0.0	0.0	
%ile BackOfQ(50%),veh/ln	1.8	0.8	5.8	0.0	0.0	0.6	
Unsig. Movement Delay, s/veh							
LnGrp Delay(d),s/veh	33.8	6.8	17.2	0.0	0.0	28.9	
LnGrp LOS	C	A	B	A	A	C	
Approach Vol, veh/h		436	1068		374		
Approach Delay, s/veh		13.7	17.2		28.9		
Approach LOS		B	B		C		
Timer - Assigned Phs				4	6	7	8
Phs Duration (G+Y+Rc), s				44.8	22.9	10.0	34.8
Change Period (Y+Rc), s				5.8	4.7	4.6	5.8
Max Green Setting (Gmax), s				75.4	34.1	15.6	55.2
Max Q Clear Time (g_c+I1), s				5.1	17.0	6.1	20.5
Green Ext Time (p_c), s				2.1	1.2	0.1	8.5
Intersection Summary							
HCM 6th Ctrl Delay			18.7				
HCM 6th LOS			B				

Timings
22: Sycamore Canyon Bl. & Eastridge Ave

West Campus Upper Plateau (JN 14064)

09/20/2022

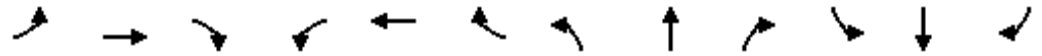

Lane Group	EBL	EBT	EBR	WBL	WBT	WBR	NBL	NBT	NBR	SBL	SBT	SBR
Lane Configurations	↖↖	↑↑↑	↗	↖↖	↑↑	↗	↖↖	↑↑	↗	↖↖	↑↑	↗
Traffic Volume (vph)	61	50	22	192	235	611	89	998	127	94	320	52
Future Volume (vph)	61	50	22	192	235	611	89	998	127	94	320	52
Turn Type	Prot	NA	Perm	Prot	NA	pm+ov	Prot	NA	pm+ov	Prot	NA	pm+ov
Protected Phases	5	2		1	6	7	3	8	1	7	4	5
Permitted Phases			2			6			8			4
Detector Phase	5	2	2	1	6	7	3	8	1	7	4	5
Switch Phase												
Minimum Initial (s)	5.0	10.0	10.0	5.0	10.0	5.0	5.0	10.0	5.0	5.0	10.0	5.0
Minimum Split (s)	8.7	43.5	43.5	8.7	43.5	8.7	8.7	15.8	8.7	8.7	49.8	8.7
Total Split (s)	10.1	47.0	47.0	11.0	47.9	21.0	10.6	41.0	11.0	21.0	51.4	10.1
Total Split (%)	8.4%	39.2%	39.2%	9.2%	39.9%	17.5%	8.8%	34.2%	9.2%	17.5%	42.8%	8.4%
Yellow Time (s)	3.2	5.5	5.5	3.2	5.5	3.2	3.2	4.8	3.2	3.2	4.8	3.2
All-Red Time (s)	0.5	1.0	1.0	0.5	1.0	0.5	0.5	1.0	0.5	0.5	1.0	0.5
Lost Time Adjust (s)	0.0	0.0	0.0	0.0	0.0	0.0	0.0	0.0	0.0	0.0	0.0	0.0
Total Lost Time (s)	3.7	6.5	6.5	3.7	6.5	3.7	3.7	5.8	3.7	3.7	5.8	3.7
Lead/Lag	Lead	Lag	Lag	Lead	Lag	Lead	Lead	Lag	Lead	Lead	Lag	Lead
Lead-Lag Optimize?	Yes	Yes	Yes	Yes	Yes	Yes	Yes	Yes	Yes	Yes	Yes	Yes
Recall Mode	None	None	None	None	None	None	None	None	None	None	None	None
Act Effct Green (s)	6.0	15.2	15.2	8.8	16.1	39.1	6.4	35.8	46.8	16.4	48.0	56.2
Actuated g/C Ratio	0.07	0.16	0.16	0.10	0.17	0.42	0.07	0.39	0.51	0.18	0.52	0.61
v/c Ratio	0.37	0.09	0.07	0.86	0.46	0.98	0.43	0.82	0.19	0.18	0.20	0.07
Control Delay	51.1	32.8	0.4	77.5	36.9	54.4	50.3	33.8	6.3	35.8	15.0	2.8
Queue Delay	0.0	0.0	0.0	0.0	0.0	0.0	0.0	0.0	0.0	0.0	0.0	0.0
Total Delay	51.1	32.8	0.4	77.5	36.9	54.4	50.3	33.8	6.3	35.8	15.0	2.8
LOS	D	C	A	E	D	D	D	C	A	D	B	A
Approach Delay		35.8			54.7			32.2			17.8	
Approach LOS		D			D			C			B	

Intersection Summary

Cycle Length: 120
 Actuated Cycle Length: 92.2
 Natural Cycle: 115
 Control Type: Actuated-Uncoordinated
 Maximum v/c Ratio: 0.98
 Intersection Signal Delay: 38.2
 Intersection LOS: D
 Intersection Capacity Utilization 81.1%
 ICU Level of Service D
 Analysis Period (min) 15

Splits and Phases: 22: Sycamore Canyon Bl. & Eastridge Ave

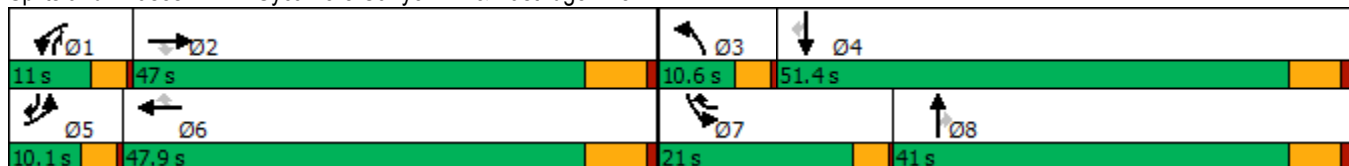

HCM 6th Signalized Intersection Summary
22: Sycamore Canyon Bl. & Eastridge Ave

West Campus Upper Plateau (JN 14064)

09/20/2022



Movement	EBL	EBT	EBR	WBL	WBT	WBR	NBL	NBT	NBR	SBL	SBT	SBR
Lane Configurations	↖↗	↑↑↑	↖	↖↗	↑↑	↖	↖↗	↑↑	↖	↖↗	↑↑	↖
Traffic Volume (veh/h)	61	50	22	192	235	611	89	998	127	94	320	52
Future Volume (veh/h)	61	50	22	192	235	611	89	998	127	94	320	52
Initial Q (Qb), veh	0	0	0	0	0	0	0	0	0	0	0	0
Ped-Bike Adj(A_pbT)	1.00		1.00	1.00		1.00	1.00		0.99	1.00		0.99
Parking Bus, Adj	1.00	1.00	1.00	1.00	1.00	1.00	1.00	1.00	1.00	1.00	1.00	1.00
Work Zone On Approach		No			No			No			No	
Adj Sat Flow, veh/h/ln	1485	1352	1722	1337	1707	1811	1796	1811	1618	1767	1811	1589
Adj Flow Rate, veh/h	66	54	0	209	255	664	97	1085	105	102	348	44
Peak Hour Factor	0.92	0.92	0.92	0.92	0.92	0.92	0.92	0.92	0.92	0.92	0.92	0.92
Percent Heavy Veh, %	28	37	12	38	13	6	7	6	19	9	6	21
Cap, veh/h	111	1343		171	1274	677	150	1142	544	157	1152	500
Arrive On Green	0.04	0.36	0.00	0.07	0.39	0.39	0.05	0.33	0.33	0.05	0.33	0.33
Sat Flow, veh/h	2744	3690	1459	2470	3244	1535	3319	3441	1354	3264	3441	1329
Grp Volume(v), veh/h	66	54	0	209	255	664	97	1085	105	102	348	44
Grp Sat Flow(s),veh/h/ln	1372	1230	1459	1235	1622	1535	1659	1721	1354	1632	1721	1329
Q Serve(g_s), s	2.5	1.0	0.0	7.3	5.5	41.4	3.0	32.4	5.3	3.2	7.9	2.3
Cycle Q Clear(g_c), s	2.5	1.0	0.0	7.3	5.5	41.4	3.0	32.4	5.3	3.2	7.9	2.3
Prop In Lane	1.00		1.00	1.00		1.00	1.00		1.00	1.00		1.00
Lane Grp Cap(c), veh/h	111	1343		171	1274	677	150	1142	544	157	1152	500
V/C Ratio(X)	0.59	0.04		1.22	0.20	0.98	0.65	0.95	0.19	0.65	0.30	0.09
Avail Cap(c_a), veh/h	167	1418		171	1274	677	217	1149	547	536	1488	630
HCM Platoon Ratio	1.00	1.00	1.00	1.00	1.00	1.00	1.00	1.00	1.00	1.00	1.00	1.00
Upstream Filter(I)	1.00	1.00	0.00	1.00	1.00	1.00	1.00	1.00	1.00	1.00	1.00	1.00
Uniform Delay (d), s/veh	49.7	21.6	0.0	49.1	21.1	29.0	49.5	34.4	20.5	49.3	26.0	21.3
Incr Delay (d2), s/veh	1.9	0.0	0.0	141.0	0.1	29.9	1.8	16.1	0.2	1.7	0.1	0.1
Initial Q Delay(d3),s/veh	0.0	0.0	0.0	0.0	0.0	0.0	0.0	0.0	0.0	0.0	0.0	0.0
%ile BackOfQ(50%),veh/ln	0.9	0.3	0.0	5.5	2.0	20.6	1.3	15.2	1.6	1.3	3.1	0.7
Unsig. Movement Delay, s/veh												
LnGrp Delay(d),s/veh	51.6	21.7	0.0	190.0	21.2	59.0	51.3	50.4	20.7	51.0	26.1	21.3
LnGrp LOS	D	C		F	C	E	D	D	C	D	C	C
Approach Vol, veh/h		120			1128			1287			494	
Approach Delay, s/veh		38.1			74.7			48.1			30.8	
Approach LOS		D			E			D			C	
Timer - Assigned Phs	1	2	3	4	5	6	7	8				
Phs Duration (G+Y+Rc), s	11.0	44.9	8.5	41.1	8.0	47.9	8.8	40.8				
Change Period (Y+Rc), s	3.7	6.5	3.7	5.8	3.7	6.5	3.7	5.8				
Max Green Setting (Gmax), s	7.3	40.5	6.9	45.6	6.4	41.4	17.3	35.2				
Max Q Clear Time (g_c+I1), s	9.3	3.0	5.0	9.9	4.5	43.4	5.2	34.4				
Green Ext Time (p_c), s	0.0	0.4	0.0	2.3	0.0	0.0	0.1	0.5				

Intersection Summary

HCM 6th Ctrl Delay	54.8
HCM 6th LOS	D

Notes

Unsignalized Delay for [EBR] is excluded from calculations of the approach delay and intersection delay.

Timings
23: Sycamore Canyon Bl. & Cottonwood Ave

West Campus Upper Plateau (JN 14064)

09/20/2022



Lane Group	WBL	WBR	NBT	SBL	SBT
Lane Configurations	↙	↗	↕↔	↙	↕↕
Traffic Volume (vph)	29	45	1191	136	400
Future Volume (vph)	29	45	1191	136	400
Turn Type	Prot	Perm	NA	Prot	NA
Protected Phases	8		2	1	6
Permitted Phases		8			
Detector Phase	8	8	2	1	6
Switch Phase					
Minimum Initial (s)	10.0	10.0	10.0	5.0	10.0
Minimum Split (s)	15.8	15.8	43.5	9.1	43.5
Total Split (s)	21.0	21.0	75.0	24.0	99.0
Total Split (%)	17.5%	17.5%	62.5%	20.0%	82.5%
Yellow Time (s)	4.8	4.8	5.5	3.6	5.5
All-Red Time (s)	1.0	1.0	1.0	0.5	1.0
Lost Time Adjust (s)	0.0	0.0	0.0	0.0	0.0
Total Lost Time (s)	5.8	5.8	6.5	4.1	6.5
Lead/Lag			Lag	Lead	
Lead-Lag Optimize?			Yes	Yes	
Recall Mode	None	None	None	None	None
Act Effect Green (s)	11.4	11.4	49.6	17.1	73.8
Actuated g/C Ratio	0.13	0.13	0.55	0.19	0.82
v/c Ratio	0.20	0.28	0.75	0.68	0.15
Control Delay	48.1	17.9	19.4	57.1	2.8
Queue Delay	0.0	0.0	0.0	0.0	0.0
Total Delay	48.1	17.9	19.4	57.1	2.8
LOS	D	B	B	E	A
Approach Delay	29.8		19.4		16.6
Approach LOS	C		B		B

Intersection Summary

Cycle Length: 120
 Actuated Cycle Length: 90.2
 Natural Cycle: 75
 Control Type: Actuated-Uncoordinated
 Maximum v/c Ratio: 0.75
 Intersection Signal Delay: 19.0
 Intersection LOS: B
 Intersection Capacity Utilization 64.9%
 ICU Level of Service C
 Analysis Period (min) 15

Splits and Phases: 23: Sycamore Canyon Bl. & Cottonwood Ave



HCM 6th Signalized Intersection Summary
23: Sycamore Canyon Bl. & Cottonwood Ave

West Campus Upper Plateau (JN 14064)

09/20/2022



Movement	WBL	WBR	NBT	NBR	SBL	SBT
Lane Configurations	↶	↷	↶↷		↶	↶↷
Traffic Volume (veh/h)	29	45	1191	77	136	400
Future Volume (veh/h)	29	45	1191	77	136	400
Initial Q (Qb), veh	0	0	0	0	0	0
Ped-Bike Adj(A_pbT)	1.00	1.00		0.98	1.00	
Parking Bus, Adj	1.00	1.00	1.00	1.00	1.00	1.00
Work Zone On Approach	No		No			No
Adj Sat Flow, veh/h/ln	1263	1115	1811	1366	1070	1826
Adj Flow Rate, veh/h	32	34	1295	83	148	435
Peak Hour Factor	0.92	0.92	0.92	0.92	0.92	0.92
Percent Heavy Veh, %	43	53	6	36	56	5
Cap, veh/h	114	89	1779	114	166	2621
Arrive On Green	0.09	0.09	0.54	0.54	0.16	0.76
Sat Flow, veh/h	1203	945	3369	210	1019	3561
Grp Volume(v), veh/h	32	34	678	700	148	435
Grp Sat Flow(s),veh/h/ln	1203	945	1721	1768	1019	1735
Q Serve(g_s), s	2.0	2.8	24.4	24.6	11.7	2.9
Cycle Q Clear(g_c), s	2.0	2.8	24.4	24.6	11.7	2.9
Prop In Lane	1.00	1.00		0.12	1.00	
Lane Grp Cap(c), veh/h	114	89	933	959	166	2621
V/C Ratio(X)	0.28	0.38	0.73	0.73	0.89	0.17
Avail Cap(c_a), veh/h	223	175	1435	1475	247	3908
HCM Platoon Ratio	1.00	1.00	1.00	1.00	1.00	1.00
Upstream Filter(I)	1.00	1.00	1.00	1.00	1.00	1.00
Uniform Delay (d), s/veh	34.6	34.9	14.2	14.2	33.6	2.8
Incr Delay (d2), s/veh	1.3	2.6	1.6	1.5	22.5	0.0
Initial Q Delay(d3),s/veh	0.0	0.0	0.0	0.0	0.0	0.0
%ile BackOfQ(50%),veh/ln	0.6	0.7	8.1	8.4	3.7	0.5
Unsig. Movement Delay, s/veh						
LnGrp Delay(d),s/veh	35.9	37.5	15.7	15.8	56.1	2.8
LnGrp LOS	D	D	B	B	E	A
Approach Vol, veh/h	66		1378			583
Approach Delay, s/veh	36.7		15.8			16.4
Approach LOS	D		B			B
Timer - Assigned Phs	1	2			6	8
Phs Duration (G+Y+Rc), s	17.5	51.0			68.5	13.6
Change Period (Y+Rc), s	4.1	6.5			6.5	5.8
Max Green Setting (Gmax), s	19.9	68.5			92.5	15.2
Max Q Clear Time (g_c+1), s	13.7	26.6			4.9	4.8
Green Ext Time (p_c), s	0.2	17.9			4.3	0.1

Intersection Summary

HCM 6th Ctrl Delay	16.6
HCM 6th LOS	B

Timings

West Campus Upper Plateau (JN 14064)

24: Sycamore Canyon Bl. & Alessandro Bl.

09/20/2022



Lane Group	EBL	EBT	EBR	WBL	WBT	WBR	NBL	NBT	NBR	SBL	SBT	SBR
Lane Configurations	↖	↑↑↑	↗	↖↗	↑↑↑	↗	↖↗	↑↑	↖↗	↖↗	↑↑	↗
Traffic Volume (vph)	201	1523	466	292	2905	741	822	837	120	123	243	172
Future Volume (vph)	201	1523	466	292	2905	741	822	837	120	123	243	172
Turn Type	Prot	NA	Perm	Prot	NA	Perm	Prot	NA	pm+ov	Prot	NA	Perm
Protected Phases	5	2		1	6		3	8	1	7	4	
Permitted Phases			2			6			8			4
Detector Phase	5	2	2	1	6	6	3	8	1	7	4	4
Switch Phase												
Minimum Initial (s)	5.0	10.0	10.0	5.0	10.0	10.0	5.0	10.0	5.0	5.0	10.0	10.0
Minimum Split (s)	8.7	43.5	43.5	8.7	43.5	43.5	8.7	15.8	8.7	8.7	49.8	49.8
Total Split (s)	10.0	47.0	47.0	9.2	46.2	46.2	14.0	52.5	9.2	11.3	49.8	49.8
Total Split (%)	8.3%	39.2%	39.2%	7.7%	38.5%	38.5%	11.7%	43.8%	7.7%	9.4%	41.5%	41.5%
Yellow Time (s)	3.2	5.5	5.5	3.2	5.5	5.5	3.2	4.8	3.2	3.2	4.8	4.8
All-Red Time (s)	0.5	1.0	1.0	0.5	1.0	1.0	0.5	1.0	0.5	0.5	1.0	1.0
Lost Time Adjust (s)	0.0	0.0	0.0	0.0	0.0	0.0	0.0	0.0	0.0	0.0	0.0	0.0
Total Lost Time (s)	3.7	6.5	6.5	3.7	6.5	6.5	3.7	5.8	3.7	3.7	5.8	5.8
Lead/Lag	Lead	Lag	Lag	Lead	Lag	Lag	Lead	Lag	Lead	Lead	Lag	Lag
Lead-Lag Optimize?	Yes	Yes	Yes	Yes	Yes	Yes	Yes	Yes	Yes	Yes	Yes	Yes
Recall Mode	None	C-Max	C-Max	None	C-Max	C-Max	None	None	None	None	None	None
Act Effct Green (s)	16.0	40.5	40.5	15.2	39.7	39.7	10.3	37.2	54.5	7.4	34.3	34.3
Actuated g/C Ratio	0.13	0.34	0.34	0.13	0.33	0.33	0.09	0.31	0.45	0.06	0.29	0.29
v/c Ratio	0.86	0.90	0.64	0.68	1.76	1.19	2.82	0.79	0.10	0.67	0.25	0.33
Control Delay	83.7	45.8	15.2	59.8	372.6	129.8	850.4	43.0	8.4	73.1	32.4	13.0
Queue Delay	0.0	0.0	0.0	0.0	0.0	0.0	0.0	0.0	0.0	0.0	0.0	0.0
Total Delay	83.7	45.8	15.2	59.8	372.6	129.8	850.4	43.0	8.4	73.1	32.4	13.0
LOS	F	D	B	E	F	F	F	D	A	E	C	B
Approach Delay		42.8			303.7			413.8			35.5	
Approach LOS		D			F			F			D	

Intersection Summary

Cycle Length: 120
 Actuated Cycle Length: 120
 Offset: 0 (0%), Referenced to phase 2:EBT and 6:WBT, Start of Yellow
 Natural Cycle: 125
 Control Type: Actuated-Coordinated
 Maximum v/c Ratio: 2.82
 Intersection Signal Delay: 242.2
 Intersection LOS: F
 Intersection Capacity Utilization 117.8%
 ICU Level of Service H
 Analysis Period (min) 15



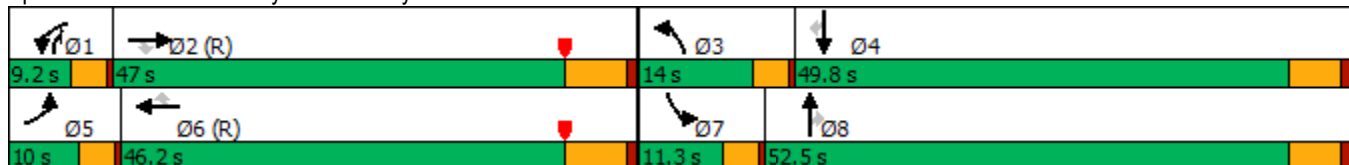





























Splits and Phases: 24: Sycamore Canyon Bl. & Alessandro Bl.



HCM 6th Signalized Intersection Summary
 24: Sycamore Canyon Bl. & Alessandro Bl.

West Campus Upper Plateau (JN 14064)

09/20/2022

												
Movement	EBL	EBT	EBR	WBL	WBT	WBR	NBL	NBT	NBR	SBL	SBT	SBR
Lane Configurations		  		 	  		 	 	 	 	 	
Traffic Volume (veh/h)	201	1523	466	292	2905	741	822	837	120	123	243	172
Future Volume (veh/h)	201	1523	466	292	2905	741	822	837	120	123	243	172
Initial Q (Qb), veh	0	0	0	0	0	0	0	0	0	0	0	0
Ped-Bike Adj(A_pbT)	1.00		1.00	1.00		1.00	1.00		1.00	1.00		1.00
Parking Bus, Adj	1.00	1.00	1.00	1.00	1.00	1.00	1.00	1.00	1.00	1.00	1.00	1.00
Work Zone On Approach		No			No			No			No	
Adj Sat Flow, veh/h/ln	1870	1870	1885	1870	1856	1796	1870	1841	1841	1663	1826	1856
Adj Flow Rate, veh/h	203	1538	389	295	2934	625	830	845	91	124	245	115
Peak Hour Factor	0.99	0.99	0.99	0.99	0.99	0.99	0.99	0.99	0.99	0.99	0.99	0.99
Percent Heavy Veh, %	2	2	1	2	3	7	2	4	4	16	5	3
Cap, veh/h	94	2277	711	158	2225	669	297	1009	917	171	896	405
Arrive On Green	0.05	0.45	0.45	0.05	0.44	0.44	0.09	0.29	0.29	0.06	0.26	0.26
Sat Flow, veh/h	1781	5106	1595	3456	5066	1522	3456	3497	2743	3072	3469	1569
Grp Volume(v), veh/h	203	1538	389	295	2934	625	830	845	91	124	245	115
Grp Sat Flow(s),veh/h/ln	1781	1702	1595	1728	1689	1522	1728	1749	1371	1536	1735	1569
Q Serve(g_s), s	6.3	28.7	21.4	5.5	52.7	46.9	10.3	27.2	2.7	4.8	6.8	7.0
Cycle Q Clear(g_c), s	6.3	28.7	21.4	5.5	52.7	46.9	10.3	27.2	2.7	4.8	6.8	7.0
Prop In Lane	1.00		1.00	1.00		1.00	1.00		1.00	1.00		1.00
Lane Grp Cap(c), veh/h	94	2277	711	158	2225	669	297	1009	917	171	896	405
V/C Ratio(X)	2.17	0.68	0.55	1.86	1.32	0.93	2.80	0.84	0.10	0.73	0.27	0.28
Avail Cap(c_a), veh/h	94	2277	711	158	2225	669	297	1361	1193	195	1272	575
HCM Platoon Ratio	1.00	1.00	1.00	1.00	1.00	1.00	1.00	1.00	1.00	1.00	1.00	1.00
Upstream Filter(I)	0.57	0.57	0.57	0.09	0.09	0.09	1.00	1.00	1.00	1.00	1.00	1.00
Uniform Delay (d), s/veh	56.8	26.4	24.4	57.2	33.6	32.0	54.8	40.0	27.5	55.8	35.5	35.6
Incr Delay (d2), s/veh	546.4	0.9	1.7	390.3	143.7	3.1	818.5	3.6	0.0	8.7	0.2	0.4
Initial Q Delay(d3),s/veh	0.0	0.0	0.0	0.0	0.0	0.0	0.0	0.0	0.0	0.0	0.0	0.0
%ile BackOfQ(50%),veh/ln	17.0	11.1	8.0	10.9	49.6	16.6	38.1	11.7	0.9	2.0	2.8	2.7
Unsig. Movement Delay, s/veh												
LnGrp Delay(d),s/veh	603.3	27.3	26.1	447.6	177.4	35.2	873.4	43.6	27.5	64.4	35.7	36.0
LnGrp LOS	F	C	C	F	F	D	F	D	C	E	D	D
Approach Vol, veh/h		2130			3854			1766			484	
Approach Delay, s/veh		82.0			175.0			432.8			43.1	
Approach LOS		F			F			F			D	
Timer - Assigned Phs	1	2	3	4	5	6	7	8				
Phs Duration (G+Y+Rc), s	9.2	60.0	14.0	36.8	10.0	59.2	10.4	40.4				
Change Period (Y+Rc), s	3.7	6.5	3.7	5.8	3.7	6.5	3.7	5.8				
Max Green Setting (Gmax), s	5.5	40.5	10.3	44.0	6.3	39.7	7.6	46.7				
Max Q Clear Time (g_c+1), s	7.5	30.7	12.3	9.0	8.3	54.7	6.8	29.2				
Green Ext Time (p_c), s	0.0	8.2	0.0	1.8	0.0	0.0	0.0	5.4				
Intersection Summary												
HCM 6th Ctrl Delay				198.5								
HCM 6th LOS				F								

Timings
25: Sycamore Canyon Bl. & Cactus Av.

West Campus Upper Plateau (JN 14064)

09/20/2022



Lane Group	EBL	EBT	EBR	WBL	WBT	WBR	NBL	NBT	NBR	SBL	SBT	SBR
Lane Configurations	↘	↑↑	↗	↘↗	↑↑	↗	↘↗	↑↑	↗	↘↗	↑↑	↗
Traffic Volume (vph)	53	223	97	898	783	1250	219	561	327	214	362	88
Future Volume (vph)	53	223	97	898	783	1250	219	561	327	214	362	88
Turn Type	Prot	NA	Perm	Prot	NA	Perm	Prot	NA	Perm	Prot	NA	Perm
Protected Phases	7	4		3	8		5	2		1	6	
Permitted Phases			4			8			2			6
Detector Phase	7	4	4	3	8	8	5	2	2	1	6	6
Switch Phase												
Minimum Initial (s)	5.0	10.0	10.0	5.0	10.0	10.0	5.0	10.0	10.0	5.0	10.0	10.0
Minimum Split (s)	9.6	32.8	32.8	9.6	32.8	32.8	9.6	34.8	34.8	9.6	34.8	34.8
Total Split (s)	9.6	45.6	45.6	27.0	63.0	63.0	9.6	36.4	36.4	11.0	37.8	37.8
Total Split (%)	8.0%	38.0%	38.0%	22.5%	52.5%	52.5%	8.0%	30.3%	30.3%	9.2%	31.5%	31.5%
Yellow Time (s)	3.6	4.8	4.8	3.6	4.8	4.8	3.6	4.8	4.8	3.6	4.8	4.8
All-Red Time (s)	1.0	1.0	1.0	1.0	1.0	1.0	1.0	1.0	1.0	1.0	1.0	1.0
Lost Time Adjust (s)	0.0	0.0	0.0	0.0	0.0	0.0	0.0	0.0	0.0	0.0	0.0	0.0
Total Lost Time (s)	4.6	5.8	5.8	4.6	5.8	5.8	4.6	5.8	5.8	4.6	5.8	5.8
Lead/Lag	Lead	Lag	Lag	Lead	Lag	Lag	Lead	Lag	Lag	Lead	Lag	Lag
Lead-Lag Optimize?	Yes	Yes	Yes	Yes	Yes	Yes	Yes	Yes	Yes	Yes	Yes	Yes
Recall Mode	None	None	None	None	None	None	None	None	None	None	None	None
Act Effct Green (s)	5.0	39.9	39.9	22.4	57.3	57.3	5.0	25.8	25.8	6.4	27.2	27.2
Actuated g/C Ratio	0.04	0.35	0.35	0.19	0.50	0.50	0.04	0.22	0.22	0.06	0.24	0.24
v/c Ratio	0.79	0.21	0.16	1.46	0.50	1.49	1.57	0.76	0.56	1.18	0.45	0.20
Control Delay	116.4	28.0	1.6	248.2	21.4	248.0	322.4	48.9	7.7	171.4	39.3	1.4
Queue Delay	0.0	0.0	0.0	0.0	0.0	0.0	0.0	0.0	0.0	0.0	0.0	0.0
Total Delay	116.4	28.0	1.6	248.2	21.4	248.1	322.4	48.9	7.7	171.4	39.3	1.4
LOS	F	C	A	F	C	F	F	D	A	F	D	A
Approach Delay		33.8			187.6			90.9			76.9	
Approach LOS		C			F			F			E	

Intersection Summary

Cycle Length: 120
 Actuated Cycle Length: 115.3
 Natural Cycle: 130
 Control Type: Actuated-Uncoordinated
 Maximum v/c Ratio: 1.57
 Intersection Signal Delay: 140.7
 Intersection LOS: F
 Intersection Capacity Utilization 110.6%
 ICU Level of Service H
 Analysis Period (min) 15



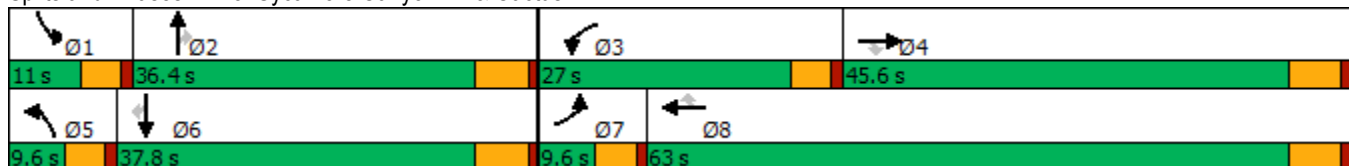





















Splits and Phases: 25: Sycamore Canyon Bl. & Cactus Av.



HCM 6th Signalized Intersection Summary
25: Sycamore Canyon Bl. & Cactus Av.

West Campus Upper Plateau (JN 14064)

09/20/2022

												
Movement	EBL	EBT	EBR	WBL	WBT	WBR	NBL	NBT	NBR	SBL	SBT	SBR
Lane Configurations												
Traffic Volume (veh/h)	53	223	97	898	783	1250	219	561	327	214	362	88
Future Volume (veh/h)	53	223	97	898	783	1250	219	561	327	214	362	88
Initial Q (Qb), veh	0	0	0	0	0	0	0	0	0	0	0	0
Ped-Bike Adj(A_pbT)	1.00		1.00	1.00		0.99	1.00		1.00	1.00		0.99
Parking Bus, Adj	1.00	1.00	1.00	1.00	1.00	1.00	1.00	1.00	1.00	1.00	1.00	1.00
Work Zone On Approach		No			No			No			No	
Adj Sat Flow, veh/h/ln	1722	1678	1826	1796	1722	1856	1826	1811	1826	1841	1856	1796
Adj Flow Rate, veh/h	55	230	99	926	807	1070	226	578	240	221	373	88
Peak Hour Factor	0.97	0.97	0.97	0.97	0.97	0.97	0.97	0.97	0.97	0.97	0.97	0.97
Percent Heavy Veh, %	12	15	5	7	12	3	5	6	5	4	3	7
Cap, veh/h	69	1121	544	662	1666	791	150	712	320	194	773	330
Arrive On Green	0.04	0.35	0.35	0.20	0.51	0.51	0.04	0.21	0.21	0.06	0.22	0.22
Sat Flow, veh/h	1640	3188	1547	3319	3272	1553	3374	3441	1547	3401	3526	1502
Grp Volume(v), veh/h	55	230	99	926	807	1070	226	578	240	221	373	88
Grp Sat Flow(s),veh/h/ln	1640	1594	1547	1659	1636	1553	1687	1721	1547	1700	1763	1502
Q Serve(g_s), s	3.7	5.7	5.0	22.4	18.1	57.2	5.0	18.0	16.4	6.4	10.4	5.5
Cycle Q Clear(g_c), s	3.7	5.7	5.0	22.4	18.1	57.2	5.0	18.0	16.4	6.4	10.4	5.5
Prop In Lane	1.00		1.00	1.00		1.00	1.00		1.00	1.00		1.00
Lane Grp Cap(c), veh/h	69	1121	544	662	1666	791	150	712	320	194	773	330
V/C Ratio(X)	0.80	0.21	0.18	1.40	0.48	1.35	1.51	0.81	0.75	1.14	0.48	0.27
Avail Cap(c_a), veh/h	73	1129	548	662	1666	791	150	937	421	194	1004	428
HCM Platoon Ratio	1.00	1.00	1.00	1.00	1.00	1.00	1.00	1.00	1.00	1.00	1.00	1.00
Upstream Filter(I)	1.00	1.00	1.00	1.00	1.00	1.00	1.00	1.00	1.00	1.00	1.00	1.00
Uniform Delay (d), s/veh	53.4	25.5	25.2	45.0	18.0	27.6	53.7	42.5	41.8	53.0	38.3	36.4
Incr Delay (d2), s/veh	39.9	0.1	0.2	188.8	0.2	167.3	258.8	4.2	5.2	107.6	0.5	0.4
Initial Q Delay(d3),s/veh	0.0	0.0	0.0	0.0	0.0	0.0	0.0	0.0	0.0	0.0	0.0	0.0
%ile BackOfQ(50%),veh/ln	2.3	2.1	1.8	26.2	6.3	55.7	7.5	7.8	6.5	5.6	4.4	2.0
Unsig. Movement Delay, s/veh												
LnGrp Delay(d),s/veh	93.2	25.5	25.4	233.8	18.2	194.9	312.4	46.6	47.1	160.6	38.8	36.8
LnGrp LOS	F	C	C	F	B	F	F	D	D	F	D	D
Approach Vol, veh/h		384			2803			1044			682	
Approach Delay, s/veh		35.2			156.8			104.3			78.0	
Approach LOS		D			F			F			E	
Timer - Assigned Phs	1	2	3	4	5	6	7	8				
Phs Duration (G+Y+Rc), s	11.0	29.0	27.0	45.3	9.6	30.4	9.3	63.0				
Change Period (Y+Rc), s	4.6	5.8	4.6	5.8	4.6	5.8	4.6	5.8				
Max Green Setting (Gmax), s	6.4	30.6	22.4	39.8	5.0	32.0	5.0	57.2				
Max Q Clear Time (g_c+I1), s	8.4	20.0	24.4	7.7	7.0	12.4	5.7	59.2				
Green Ext Time (p_c), s	0.0	3.3	0.0	1.8	0.0	2.3	0.0	0.0				
Intersection Summary												
HCM 6th Ctrl Delay				125.2								
HCM 6th LOS				F								

Timings

26: Sycamore Canyon Bl. & Van Buren Bl.

09/20/2022



Lane Group	EBL	EBT	EBR	WBL	WBT	WBR	NBL	NBT	SBL	SBT	SBR
Lane Configurations											
Traffic Volume (vph)	909	2623	31	55	3898	267	5	4	141	11	682
Future Volume (vph)	909	2623	31	55	3898	267	5	4	141	11	682
Turn Type	Prot	NA	Perm	Prot	NA	Perm	Perm	NA	Split	NA	Perm
Protected Phases	5	2		1	6			8	4	4	
Permitted Phases			2			6	8				4
Detector Phase	5	2	2	1	6	6	8	8	4	4	4
Switch Phase											
Minimum Initial (s)	5.0	10.0	10.0	5.0	10.0	10.0	10.0	10.0	10.0	10.0	10.0
Minimum Split (s)	9.6	29.2	29.2	9.6	29.2	29.2	14.6	14.6	50.8	50.8	50.8
Total Split (s)	25.0	50.9	50.9	13.7	39.6	39.6	14.6	14.6	50.8	50.8	50.8
Total Split (%)	19.2%	39.2%	39.2%	10.5%	30.5%	30.5%	11.2%	11.2%	39.1%	39.1%	39.1%
Yellow Time (s)	3.6	5.2	5.2	3.6	5.2	5.2	3.6	3.6	4.8	4.8	4.8
All-Red Time (s)	1.0	1.0	1.0	1.0	1.0	1.0	1.0	1.0	1.0	1.0	1.0
Lost Time Adjust (s)	0.0	0.0	0.0	0.0	0.0	0.0		0.0	0.0	0.0	0.0
Total Lost Time (s)	4.6	6.2	6.2	4.6	6.2	6.2		4.6	5.8	5.8	5.8
Lead/Lag	Lead	Lag	Lag	Lead	Lag	Lag					
Lead-Lag Optimize?	Yes	Yes	Yes	Yes	Yes	Yes					
Recall Mode	None	None	None	None	None	None	None	None	None	None	None
Act Effct Green (s)	21.0	50.2	50.2	7.5	34.3	34.3		10.3	32.0	32.0	32.0
Actuated g/C Ratio	0.19	0.46	0.46	0.07	0.31	0.31		0.09	0.29	0.29	0.29
v/c Ratio	1.49	1.01	0.04	0.49	2.17	0.52		0.04	0.17	0.02	0.93
Control Delay	259.6	50.9	0.1	67.7	549.8	22.3		44.7	28.7	27.5	33.5
Queue Delay	0.0	0.0	0.0	0.0	0.0	0.0		0.0	0.0	0.0	0.0
Total Delay	259.6	50.9	0.1	67.7	549.8	22.3		44.7	28.7	27.5	33.5
LOS	F	D	A	E	F	C		D	C	C	C
Approach Delay		103.7			510.2			44.7		32.6	
Approach LOS		F			F			D		C	

Intersection Summary

Cycle Length: 130
 Actuated Cycle Length: 109.3
 Natural Cycle: 125
 Control Type: Actuated-Uncoordinated
 Maximum v/c Ratio: 2.17
 Intersection Signal Delay: 295.5
 Intersection LOS: F
 Intersection Capacity Utilization 120.9%
 ICU Level of Service H
 Analysis Period (min) 15

Splits and Phases: 26: Sycamore Canyon Bl. & Van Buren Bl.

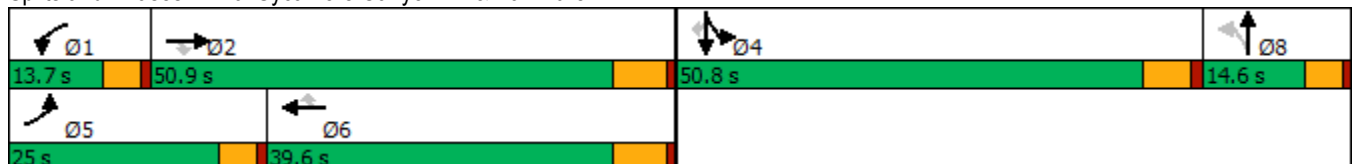

HCM 6th Signalized Intersection Summary
26: Sycamore Canyon Bl. & Van Buren Bl.

West Campus Upper Plateau (JN 14064)

09/20/2022



Movement	EBL	EBT	EBR	WBL	WBT	WBR	NBL	NBT	NBR	SBL	SBT	SBR
Lane Configurations												
Traffic Volume (veh/h)	909	2623	31	55	3898	267	5	4	4	141	11	682
Future Volume (veh/h)	909	2623	31	55	3898	267	5	4	4	141	11	682
Initial Q (Qb), veh	0	0	0	0	0	0	0	0	0	0	0	0
Ped-Bike Adj(A_pbT)	1.00		1.00	1.00		1.00	1.00		1.00	1.00		1.00
Parking Bus, Adj	1.00	1.00	1.00	1.00	1.00	1.00	1.00	1.00	1.00	1.00	1.00	1.00
Work Zone On Approach		No			No			No			No	
Adj Sat Flow, veh/h/ln	1885	1811	1900	1900	1826	1752	1900	1900	1900	1737	1900	1885
Adj Flow Rate, veh/h	988	2851	33	60	4237	265	5	4	2	153	12	0
Peak Hour Factor	0.92	0.92	0.92	0.92	0.92	0.92	0.92	0.92	0.92	0.92	0.92	0.92
Percent Heavy Veh, %	1	6	0	0	5	10	0	0	0	11	0	1
Cap, veh/h	815	3572	923	80	2407	569	42	36	18	361	214	
Arrive On Green	0.23	0.57	0.57	0.04	0.38	0.38	0.03	0.03	0.03	0.11	0.11	0.00
Sat Flow, veh/h	3483	6230	1610	1810	6281	1485	1581	1340	679	3209	1900	1598
Grp Volume(v), veh/h	988	2851	33	60	4237	265	6	0	5	153	12	0
Grp Sat Flow(s),veh/h/ln	1742	1558	1610	1810	1570	1485	1821	0	1778	1605	1900	1598
Q Serve(g_s), s	20.4	31.4	0.8	2.9	33.4	11.7	0.3	0.0	0.3	3.9	0.5	0.0
Cycle Q Clear(g_c), s	20.4	31.4	0.8	2.9	33.4	11.7	0.3	0.0	0.3	3.9	0.5	0.0
Prop In Lane	1.00		1.00	1.00		1.00	0.87		0.38	1.00		1.00
Lane Grp Cap(c), veh/h	815	3572	923	80	2407	569	49	0	48	361	214	
V/C Ratio(X)	1.21	0.80	0.04	0.75	1.76	0.47	0.12	0.00	0.11	0.42	0.06	
Avail Cap(c_a), veh/h	815	3572	923	189	2407	569	209	0	204	1657	981	
HCM Platoon Ratio	1.00	1.00	1.00	1.00	1.00	1.00	1.00	1.00	1.00	1.00	1.00	1.00
Upstream Filter(I)	1.00	1.00	1.00	1.00	1.00	1.00	1.00	0.00	1.00	1.00	1.00	0.00
Uniform Delay (d), s/veh	33.4	14.6	8.1	41.2	26.9	20.2	41.4	0.0	41.4	36.0	34.5	0.0
Incr Delay (d2), s/veh	106.6	1.3	0.0	5.3	343.8	0.6	1.1	0.0	1.0	0.8	0.1	0.0
Initial Q Delay(d3),s/veh	0.0	0.0	0.0	0.0	0.0	0.0	0.0	0.0	0.0	0.0	0.0	0.0
%ile BackOfQ(50%),veh/ln	20.0	9.2	0.2	1.3	68.6	3.8	0.1	0.0	0.1	1.5	0.2	0.0
Unsig. Movement Delay, s/veh												
LnGrp Delay(d),s/veh	140.0	16.0	8.1	46.5	370.7	20.8	42.5	0.0	42.4	36.8	34.6	0.0
LnGrp LOS	F	B	A	D	F	C	D	A	D	D	C	
Approach Vol, veh/h		3872			4562			11			165	
Approach Delay, s/veh		47.5			346.1			42.4			36.7	
Approach LOS		D			F			D			D	
Timer - Assigned Phs	1	2		4	5	6		8				
Phs Duration (G+Y+Rc), s	8.4	56.2		15.6	25.0	39.6		6.9				
Change Period (Y+Rc), s	4.6	6.2		5.8	4.6	6.2		4.6				
Max Green Setting (Gmax), s	9.1	44.7		45.0	20.4	33.4		10.0				
Max Q Clear Time (g_c+1), s	4.9	33.4		5.9	22.4	35.4		2.3				
Green Ext Time (p_c), s	0.0	10.6		0.6	0.0	0.0		0.0				

Intersection Summary

HCM 6th Ctrl Delay	205.5
HCM 6th LOS	F

Notes

Unsignalized Delay for [SBR] is excluded from calculations of the approach delay and intersection delay.

Timings
27: Innovation Dr. & Cactus Av.

West Campus Upper Plateau (JN 14064)

09/20/2022

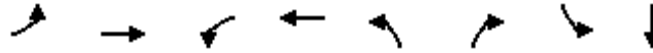

Lane Group	EBL	EBT	WBL	WBT	NBL	NBR	SBL	SBT
Lane Configurations	↶	↷	↶	↷	↶	↷	↶	↷
Traffic Volume (vph)	5	684	146	2866	13	41	5	0
Future Volume (vph)	5	684	146	2866	13	41	5	0
Turn Type	Prot	NA	Prot	NA	Perm	Perm	Perm	NA
Protected Phases	5	2	1	6				4
Permitted Phases					8	8	4	
Detector Phase	5	2	1	6	8	8	4	4
Switch Phase								
Minimum Initial (s)	5.0	10.0	5.0	10.0	10.0	10.0	10.0	10.0
Minimum Split (s)	9.2	26.8	9.2	26.8	31.1	31.1	31.1	31.1
Total Split (s)	12.0	57.0	31.0	76.0	32.0	32.0	32.0	32.0
Total Split (%)	10.0%	47.5%	25.8%	63.3%	26.7%	26.7%	26.7%	26.7%
Yellow Time (s)	3.2	4.8	3.2	4.8	4.1	4.1	4.1	4.1
All-Red Time (s)	1.0	1.0	1.0	1.0	1.0	1.0	1.0	1.0
Lost Time Adjust (s)	0.0	0.0	0.0	0.0	0.0	0.0	0.0	0.0
Total Lost Time (s)	4.2	5.8	4.2	5.8	5.1	5.1	5.1	5.1
Lead/Lag	Lead	Lag	Lead	Lag				
Lead-Lag Optimize?	Yes	Yes	Yes	Yes				
Recall Mode	None	None	None	None	None	None	None	None
Act Effct Green (s)	5.3	57.1	12.1	74.8	12.7	12.7	12.7	12.7
Actuated g/C Ratio	0.06	0.63	0.13	0.83	0.14	0.14	0.14	0.14
v/c Ratio	0.05	0.24	0.65	0.74	0.08	0.08	0.03	0.01
Control Delay	48.8	10.1	52.2	10.3	37.8	0.3	36.6	0.0
Queue Delay	0.0	0.0	0.0	0.1	0.0	0.0	0.0	0.0
Total Delay	48.8	10.1	52.2	10.5	37.8	0.3	36.6	0.0
LOS	D	B	D	B	D	A	D	A
Approach Delay		10.4		12.5				22.9
Approach LOS		B		B				C

Intersection Summary

Cycle Length: 120
 Actuated Cycle Length: 90.3
 Natural Cycle: 120
 Control Type: Actuated-Uncoordinated
 Maximum v/c Ratio: 0.74
 Intersection Signal Delay: 12.0
 Intersection LOS: B
 Intersection Capacity Utilization 81.7%
 ICU Level of Service D
 Analysis Period (min) 15

Splits and Phases: 27: Innovation Dr. & Cactus Av.



HCM 6th Signalized Intersection Summary
27: Innovation Dr. & Cactus Av.

West Campus Upper Plateau (JN 14064)

09/20/2022



Movement	EBL	EBT	EBR	WBL	WBT	WBR	NBL	NBT	NBR	SBL	SBT	SBR
Lane Configurations	↗	↑↑↑		↗	↑↑↑		↗	↑	↗	↗	↗	↗
Traffic Volume (veh/h)	5	684	19	146	2866	56	13	0	41	5	0	3
Future Volume (veh/h)	5	684	19	146	2866	56	13	0	41	5	0	3
Initial Q (Qb), veh	0	0	0	0	0	0	0	0	0	0	0	0
Ped-Bike Adj(A_pbT)	1.00		1.00	1.00		1.00	1.00		1.00	1.00		1.00
Parking Bus, Adj	1.00	1.00	1.00	1.00	1.00	1.00	1.00	1.00	1.00	1.00	1.00	1.00
Work Zone On Approach		No			No			No			No	
Adj Sat Flow, veh/h/ln	1900	1767	1900	1826	1811	1870	1455	1900	1515	1530	1900	1900
Adj Flow Rate, veh/h	5	698	17	149	2924	57	13	0	29	5	0	2
Peak Hour Factor	0.98	0.98	0.98	0.98	0.98	0.98	0.98	0.98	0.98	0.98	0.98	0.98
Percent Heavy Veh, %	0	9	0	5	6	2	30	0	26	25	0	0
Cap, veh/h	12	3153	77	183	3743	72	164	148	100	167	0	126
Arrive On Green	0.01	0.65	0.65	0.11	0.75	0.75	0.08	0.00	0.08	0.08	0.00	0.08
Sat Flow, veh/h	1810	4843	118	1739	4993	97	1101	1900	1284	1129	0	1610
Grp Volume(v), veh/h	5	463	252	149	1924	1057	13	0	29	5	0	2
Grp Sat Flow(s),veh/h/ln	1810	1608	1745	1739	1648	1794	1101	1900	1284	1129	0	1610
Q Serve(g_s), s	0.3	5.3	5.4	7.6	32.0	32.7	1.0	0.0	1.9	0.4	0.0	0.1
Cycle Q Clear(g_c), s	0.3	5.3	5.4	7.6	32.0	32.7	1.1	0.0	1.9	0.4	0.0	0.1
Prop In Lane	1.00		0.07	1.00		0.05	1.00		1.00	1.00		1.00
Lane Grp Cap(c), veh/h	12	2093	1136	183	2471	1344	164	148	100	167	0	126
V/C Ratio(X)	0.42	0.22	0.22	0.82	0.78	0.79	0.08	0.00	0.29	0.03	0.00	0.02
Avail Cap(c_a), veh/h	155	2093	1136	512	2542	1383	403	561	379	413	0	476
HCM Platoon Ratio	1.00	1.00	1.00	1.00	1.00	1.00	1.00	1.00	1.00	1.00	1.00	1.00
Upstream Filter(I)	1.00	1.00	1.00	1.00	1.00	1.00	1.00	0.00	1.00	1.00	0.00	1.00
Uniform Delay (d), s/veh	45.0	6.5	6.5	39.9	6.9	7.0	39.2	0.0	39.6	38.9	0.0	38.7
Incr Delay (d2), s/veh	8.7	0.1	0.1	3.4	1.7	3.2	0.2	0.0	1.6	0.1	0.0	0.1
Initial Q Delay(d3),s/veh	0.0	0.0	0.0	0.0	0.0	0.0	0.0	0.0	0.0	0.0	0.0	0.0
%ile BackOfQ(50%),veh/ln	0.1	1.4	1.6	3.3	7.0	8.3	0.3	0.0	0.6	0.1	0.0	0.0
Unsig. Movement Delay, s/veh												
LnGrp Delay(d),s/veh	53.7	6.6	6.6	43.2	8.5	10.2	39.5	0.0	41.2	38.9	0.0	38.8
LnGrp LOS	D	A	A	D	A	B	D	A	D	D	A	D
Approach Vol, veh/h		720			3130			42				7
Approach Delay, s/veh		6.9			10.7			40.6				38.9
Approach LOS		A			B			D				D
Timer - Assigned Phs	1	2		4	5	6		8				
Phs Duration (G+Y+Rc), s	13.8	65.1		12.2	4.8	74.0		12.2				
Change Period (Y+Rc), s	* 4.2	5.8		5.1	* 4.2	5.8		5.1				
Max Green Setting (Gmax), s	* 27	51.2		26.9	* 7.8	70.2		26.9				
Max Q Clear Time (g_c+I1), s	9.6	7.4		2.4	2.3	34.7		3.9				
Green Ext Time (p_c), s	0.2	7.1		0.0	0.0	33.5		0.1				

Intersection Summary

HCM 6th Ctrl Delay	10.4
HCM 6th LOS	B

Notes

* HCM 6th computational engine requires equal clearance times for the phases crossing the barrier.

Timings
28: I-215 SB Ramps & Alessandro Bl.

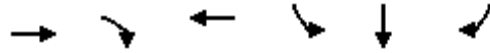

Lane Group	EBT	EBR	WBT	SBL	SBT	SBR
Lane Configurations	↑↑↑	↑	↑↑↑	↘	↔	↘
Traffic Volume (vph)	1227	513	3342	453	0	597
Future Volume (vph)	1227	513	3342	453	0	597
Turn Type	NA	Perm	NA	Split	NA	Perm
Protected Phases	2		6	4	4	
Permitted Phases		2				4
Detector Phase	2	2	6	4	4	4
Switch Phase						
Minimum Initial (s)	5.0	5.0	5.0	5.0	5.0	5.0
Minimum Split (s)	10.5	10.5	34.5	10.0	10.0	10.0
Total Split (s)	49.0	49.0	49.0	36.0	36.0	36.0
Total Split (%)	57.6%	57.6%	57.6%	42.4%	42.4%	42.4%
Yellow Time (s)	4.5	4.5	4.5	4.0	4.0	4.0
All-Red Time (s)	1.0	1.0	1.0	1.0	1.0	1.0
Lost Time Adjust (s)	0.0	0.0	0.0	0.0	0.0	0.0
Total Lost Time (s)	5.5	5.5	5.5	5.0	5.0	5.0
Lead/Lag						
Lead-Lag Optimize?						
Recall Mode	C-Min	C-Min	C-Min	None	None	None
Act Effct Green (s)	48.5	48.5	48.5	26.0	26.0	26.0
Actuated g/C Ratio	0.57	0.57	0.57	0.31	0.31	0.31
v/c Ratio	0.44	0.53	1.28	0.75	0.80	0.78
Control Delay	11.8	7.4	142.5	35.8	37.7	36.5
Queue Delay	0.0	0.0	0.0	0.0	0.0	0.0
Total Delay	11.8	7.4	142.5	35.8	37.7	36.5
LOS	B	A	F	D	D	D
Approach Delay	10.5		142.5		36.7	
Approach LOS	B		F		D	

Intersection Summary

Cycle Length: 85
 Actuated Cycle Length: 85
 Offset: 50 (59%), Referenced to phase 2:EBT and 6:WBT, Start of Yellow
 Natural Cycle: 130
 Control Type: Actuated-Coordinated
 Maximum v/c Ratio: 1.28
 Intersection Signal Delay: 89.4
 Intersection Capacity Utilization 104.2%
 Analysis Period (min) 15

Intersection LOS: F
 ICU Level of Service G

Splits and Phases: 28: I-215 SB Ramps & Alessandro Bl.

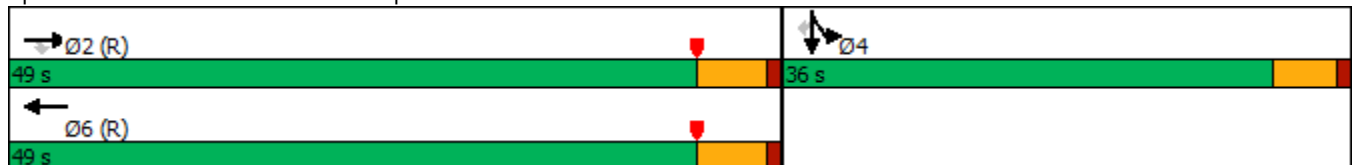

HCM 6th Signalized Intersection Summary
28: I-215 SB Ramps & Alessandro Bl.

West Campus Upper Plateau (JN 14064)
09/20/2022



Movement	EBL	EBT	EBR	WBL	WBT	WBR	NBL	NBT	NBR	SBL	SBT	SBR
Lane Configurations		↑↑↑	↗		↑↑↑					↘	↔	↗
Traffic Volume (veh/h)	0	1227	513	0	3342	280	0	0	0	453	0	597
Future Volume (veh/h)	0	1227	513	0	3342	280	0	0	0	453	0	597
Initial Q (Qb), veh	0	0	0	0	0	0				0	0	0
Ped-Bike Adj(A_pbT)	1.00		1.00	1.00		1.00				1.00		1.00
Parking Bus, Adj	1.00	1.00	1.00	1.00	1.00	1.00				1.00	1.00	1.00
Work Zone On Approach		No			No						No	
Adj Sat Flow, veh/h/ln	0	1841	1826	0	1870	1796				1796	1900	1722
Adj Flow Rate, veh/h	0	1239	518	0	3376	273				632	0	339
Peak Hour Factor	0.99	0.99	0.99	0.99	0.99	0.99				0.99	0.99	0.99
Percent Heavy Veh, %	0	4	5	0	2	7				7	0	12
Cap, veh/h	0	3020	929	0	2900	228				942	0	402
Arrive On Green	0.00	0.60	0.60	0.00	0.40	0.40				0.28	0.00	0.28
Sat Flow, veh/h	0	5191	1546	0	4994	380				3421	0	1459
Grp Volume(v), veh/h	0	1239	518	0	2355	1294				632	0	339
Grp Sat Flow(s),veh/h/ln	0	1675	1546	0	1702	1802				1711	0	1459
Q Serve(g_s), s	0.0	11.1	17.1	0.0	51.1	51.1				14.0	0.0	18.6
Cycle Q Clear(g_c), s	0.0	11.1	17.1	0.0	51.1	51.1				14.0	0.0	18.6
Prop In Lane	0.00		1.00	0.00		0.21				1.00		1.00
Lane Grp Cap(c), veh/h	0	3020	929	0	2046	1083				942	0	402
V/C Ratio(X)	0.00	0.41	0.56	0.00	1.15	1.19				0.67	0.00	0.84
Avail Cap(c_a), veh/h	0	3020	929	0	2046	1083				1248	0	532
HCM Platoon Ratio	1.00	1.00	1.00	1.00	0.67	0.67				1.00	1.00	1.00
Upstream Filter(I)	0.00	0.45	0.45	0.00	0.09	0.09				1.00	0.00	1.00
Uniform Delay (d), s/veh	0.0	9.0	10.2	0.0	25.4	25.4				27.4	0.0	29.1
Incr Delay (d2), s/veh	0.0	0.2	1.1	0.0	68.6	88.6				0.9	0.0	9.2
Initial Q Delay(d3),s/veh	0.0	0.0	0.0	0.0	0.0	0.0				0.0	0.0	0.0
%ile BackOfQ(50%),veh/ln	0.0	3.0	4.5	0.0	39.1	47.4				5.4	0.0	7.0
Unsig. Movement Delay, s/veh												
LnGrp Delay(d),s/veh	0.0	9.2	11.3	0.0	94.0	114.0				28.2	0.0	38.2
LnGrp LOS	A	A	B	A	F	F				C	A	D
Approach Vol, veh/h		1757			3649						971	
Approach Delay, s/veh		9.8			101.1						31.7	
Approach LOS		A			F						C	
Timer - Assigned Phs		2		4		6						
Phs Duration (G+Y+Rc), s		56.6		28.4		56.6						
Change Period (Y+Rc), s		5.5		5.0		5.5						
Max Green Setting (Gmax), s		43.5		31.0		43.5						
Max Q Clear Time (g_c+I1), s		19.1		20.6		53.1						
Green Ext Time (p_c), s		10.9		2.8		0.0						

Intersection Summary

HCM 6th Ctrl Delay	65.4
HCM 6th LOS	E

Notes

User approved volume balancing among the lanes for turning movement.

Timings
29: I-215 NB Ramps & Alessandro Bl.

West Campus Upper Plateau (JN 14064)

09/20/2022



Lane Group	EBL	EBT	WBT	WBR	NBL	NBT	NBR
Lane Configurations	↶	↑↑↑	↑↑↑	↷	↶	↕	↷
Traffic Volume (vph)	137	1562	2200	189	1423	0	496
Future Volume (vph)	137	1562	2200	189	1423	0	496
Turn Type	Prot	NA	NA	Perm	Split	NA	Perm
Protected Phases	5	2	6		8	8	
Permitted Phases				6			8
Detector Phase	5	2	6	6	8	8	8
Switch Phase							
Minimum Initial (s)	5.0	5.0	5.0	5.0	5.0	5.0	5.0
Minimum Split (s)	9.5	10.5	33.5	33.5	10.0	10.0	10.0
Total Split (s)	25.0	60.0	35.0	35.0	25.0	25.0	25.0
Total Split (%)	29.4%	70.6%	41.2%	41.2%	29.4%	29.4%	29.4%
Yellow Time (s)	3.5	4.5	4.5	4.5	4.0	4.0	4.0
All-Red Time (s)	1.0	1.0	1.0	1.0	1.0	1.0	1.0
Lost Time Adjust (s)	0.0	0.0	0.0	0.0	0.0	0.0	0.0
Total Lost Time (s)	4.5	5.5	5.5	5.5	5.0	5.0	5.0
Lead/Lag	Lead		Lag	Lag			
Lead-Lag Optimize?	Yes		Yes	Yes			
Recall Mode	None	C-Min	C-Min	C-Min	Max	Max	Max
Act Effct Green (s)	12.9	54.5	37.1	37.1	20.0	20.0	20.0
Actuated g/C Ratio	0.15	0.64	0.44	0.44	0.24	0.24	0.24
v/c Ratio	0.63	0.49	1.01	0.27	1.97	1.73	1.15
Control Delay	38.4	11.1	48.1	10.9	467.5	360.2	121.6
Queue Delay	0.0	0.0	0.0	0.0	0.0	0.0	0.0
Total Delay	38.4	11.1	48.1	10.9	467.5	360.2	121.6
LOS	D	B	D	B	F	F	F
Approach Delay		13.3	45.1			346.1	
Approach LOS		B	D			F	

Intersection Summary

Cycle Length: 85
 Actuated Cycle Length: 85
 Offset: 20 (24%), Referenced to phase 2:EBT and 6:WBT, Start of Yellow
 Natural Cycle: 130
 Control Type: Actuated-Coordinated
 Maximum v/c Ratio: 1.97
 Intersection Signal Delay: 132.3
 Intersection LOS: F
 Intersection Capacity Utilization 107.0%
 ICU Level of Service G
 Analysis Period (min) 15

Splits and Phases: 29: I-215 NB Ramps & Alessandro Bl.



HCM 6th Signalized Intersection Summary
 29: I-215 NB Ramps & Alessandro Bl.

West Campus Upper Plateau (JN 14064)

09/20/2022



Movement	EBL	EBT	EBR	WBL	WBT	WBR	NBL	NBT	NBR	SBL	SBT	SBR
Lane Configurations	↗	↑↑↑			↑↑↑	↗	↗	↕	↗			
Traffic Volume (veh/h)	137	1562	0	0	2200	189	1423	0	496	0	0	0
Future Volume (veh/h)	137	1562	0	0	2200	189	1423	0	496	0	0	0
Initial Q (Qb), veh	0	0	0	0	0	0	0	0	0			
Ped-Bike Adj(A_pbT)	1.00		1.00	1.00		1.00	1.00		1.00			
Parking Bus, Adj	1.00	1.00	1.00	1.00	1.00	1.00	1.00	1.00	1.00			
Work Zone On Approach		No			No			No				
Adj Sat Flow, veh/h/ln	1559	1856	0	0	1870	1796	1826	1900	1737			
Adj Flow Rate, veh/h	140	1594	0	0	2245	186	1585	0	285			
Peak Hour Factor	0.98	0.98	0.98	0.98	0.98	0.98	0.98	0.98	0.98			
Percent Heavy Veh, %	23	3	0	0	2	7	5	0	11			
Cap, veh/h	170	3248	0	0	2418	721	818	0	346			
Arrive On Green	0.04	0.21	0.00	0.00	0.47	0.47	0.24	0.00	0.24			
Sat Flow, veh/h	1485	5233	0	0	5274	1522	3478	0	1472			
Grp Volume(v), veh/h	140	1594	0	0	2245	186	1585	0	285			
Grp Sat Flow(s),veh/h/ln	1485	1689	0	0	1702	1522	1739	0	1472			
Q Serve(g_s), s	8.0	23.5	0.0	0.0	35.1	6.2	20.0	0.0	15.6			
Cycle Q Clear(g_c), s	8.0	23.5	0.0	0.0	35.1	6.2	20.0	0.0	15.6			
Prop In Lane	1.00		0.00	0.00		1.00	1.00		1.00			
Lane Grp Cap(c), veh/h	170	3248	0	0	2418	721	818	0	346			
V/C Ratio(X)	0.82	0.49	0.00	0.00	0.93	0.26	1.94	0.00	0.82			
Avail Cap(c_a), veh/h	358	3248	0	0	2418	721	818	0	346			
HCM Platoon Ratio	0.33	0.33	1.00	1.00	1.00	1.00	1.00	1.00	1.00			
Upstream Filter(I)	0.85	0.85	0.00	0.00	1.00	1.00	1.00	0.00	1.00			
Uniform Delay (d), s/veh	40.0	21.3	0.0	0.0	21.0	13.4	32.5	0.0	30.8			
Incr Delay (d2), s/veh	6.2	0.5	0.0	0.0	7.8	0.9	426.1	0.0	19.4			
Initial Q Delay(d3),s/veh	0.0	0.0	0.0	0.0	0.0	0.0	0.0	0.0	0.0			
%ile BackOfQ(50%),veh/ln	3.2	10.4	0.0	0.0	13.0	2.0	56.3	0.0	7.1			
Unsig. Movement Delay, s/veh												
LnGrp Delay(d),s/veh	46.2	21.8	0.0	0.0	28.8	14.3	458.6	0.0	50.2			
LnGrp LOS	D	C	A	A	C	B	F	A	D			
Approach Vol, veh/h		1734			2431			1870				
Approach Delay, s/veh		23.7			27.7			396.4				
Approach LOS		C			C			F				
Timer - Assigned Phs		2			5	6		8				
Phs Duration (G+Y+Rc), s		60.0			14.3	45.7		25.0				
Change Period (Y+Rc), s		5.5			4.5	5.5		5.0				
Max Green Setting (Gmax), s		54.5			20.5	29.5		20.0				
Max Q Clear Time (g_c+I1), s		25.5			10.0	37.1		22.0				
Green Ext Time (p_c), s		12.5			0.2	0.0		0.0				

Intersection Summary

HCM 6th Ctrl Delay	140.8
HCM 6th LOS	F

Notes

User approved volume balancing among the lanes for turning movement.

Timings
30: I-215 SB Ramps & Cactus Av.

West Campus Upper Plateau (JN 14064)

09/20/2022



Lane Group	EBT	EBR	WBL	WBT	NBR	SBR
Lane Configurations	↑↑	↑	↓	↑↑	↑	↑
Traffic Volume (vph)	657	61	948	2285	974	718
Future Volume (vph)	657	61	948	2285	974	718
Turn Type	NA	Perm	Prot	NA	Prot	Prot
Protected Phases	2		1	6	8	4
Permitted Phases		2				
Detector Phase	2	2	1	6	8	4
Switch Phase						
Minimum Initial (s)	5.0	5.0	5.0	5.0	5.0	5.0
Minimum Split (s)	11.0	11.0	9.5	23.0	9.5	9.5
Total Split (s)	23.0	23.0	54.0	77.0	28.0	28.0
Total Split (%)	21.9%	21.9%	51.4%	73.3%	26.7%	26.7%
Yellow Time (s)	5.0	5.0	3.5	5.0	3.5	3.5
All-Red Time (s)	1.0	1.0	1.0	1.0	1.0	1.0
Lost Time Adjust (s)	0.0	0.0	0.0	0.0	0.0	0.0
Total Lost Time (s)	6.0	6.0	4.5	6.0	4.5	4.5
Lead/Lag	Lag	Lag	Lead			
Lead-Lag Optimize?	Yes	Yes	Yes			
Recall Mode	Min	Min	None	Min	None	None
Act Effect Green (s)	17.0	17.0	49.5	71.0	23.5	23.5
Actuated g/C Ratio	0.16	0.16	0.47	0.68	0.22	0.22
v/c Ratio	1.31	0.23	1.31	1.04	1.09	2.10
Control Delay	187.8	11.9	175.0	47.5	67.5	524.9
Queue Delay	0.0	0.0	0.0	0.0	0.0	0.0
Total Delay	187.8	11.9	175.0	47.5	67.5	524.9
LOS	F	B	F	D	E	F
Approach Delay	173.0			84.9		
Approach LOS	F			F		

Intersection Summary

Cycle Length: 105	
Actuated Cycle Length: 105	
Natural Cycle: 110	
Control Type: Actuated-Uncoordinated	
Maximum v/c Ratio: 2.10	
Intersection Signal Delay: 149.0	Intersection LOS: F
Intersection Capacity Utilization 116.4%	ICU Level of Service H
Analysis Period (min) 15	



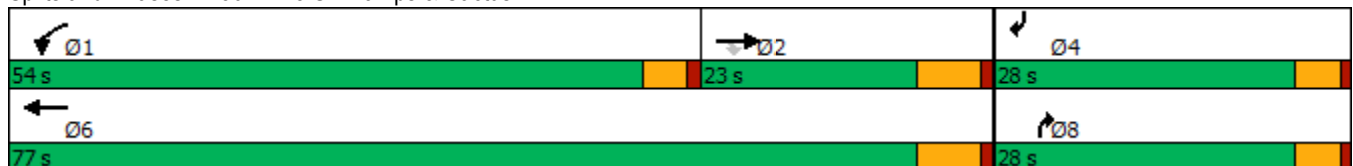









Splits and Phases: 30: I-215 SB Ramps & Cactus Av.



HCM 6th Signalized Intersection Summary
 30: I-215 SB Ramps & Cactus Av.

West Campus Upper Plateau (JN 14064)

09/20/2022

												
Movement	EBL	EBT	EBR	WBL	WBT	WBR	NBL	NBT	NBR	SBL	SBT	SBR
Lane Configurations		↑↑	↗	↖	↑↑				↗			↖
Traffic Volume (veh/h)	0	657	61	948	2285	0	0	0	974	0	0	718
Future Volume (veh/h)	0	657	61	948	2285	0	0	0	974	0	0	718
Initial Q (Qb), veh	0	0	0	0	0	0	0	0	0	0	0	0
Ped-Bike Adj(A_pbT)	1.00		1.00	1.00		1.00	1.00		1.00	1.00		1.00
Parking Bus, Adj	1.00	1.00	1.00	1.00	1.00	1.00	1.00	1.00	1.00	1.00	1.00	1.00
Work Zone On Approach		No			No			No			No	
Adj Sat Flow, veh/h/ln	0	1796	1707	1781	1870	0	0	0	1781	0	0	1633
Adj Flow Rate, veh/h	0	714	58	1030	2484	0	0	0	0	0	0	681
Peak Hour Factor	0.92	0.92	0.92	0.92	0.92	0.92	0.92	0.92	0.92	0.92	0.92	0.92
Percent Heavy Veh, %	0	7	13	8	2	0	0	0	8	0	0	18
Cap, veh/h	0	791	335	1059	3261	0	0	0	0	0	0	0
Arrive On Green	0.00	0.23	0.23	0.62	0.92	0.00	0.00	0.00	0.00	0.00	0.00	0.00
Sat Flow, veh/h	0	3503	1447	1697	3647	0		0			0	
Grp Volume(v), veh/h	0	714	58	1030	2484	0		0.0			0.0	
Grp Sat Flow(s),veh/h/ln	0	1706	1447	1697	1777	0						
Q Serve(g_s), s	0.0	14.8	2.3	42.3	13.9	0.0						
Cycle Q Clear(g_c), s	0.0	14.8	2.3	42.3	13.9	0.0						
Prop In Lane	0.00		1.00	1.00		0.00						
Lane Grp Cap(c), veh/h	0	791	335	1059	3261	0						
V/C Ratio(X)	0.00	0.90	0.17	0.97	0.76	0.00						
Avail Cap(c_a), veh/h	0	795	337	1151	3459	0						
HCM Platoon Ratio	1.00	1.00	1.00	1.00	1.00	1.00						
Upstream Filter(I)	0.00	1.00	1.00	1.00	1.00	0.00						
Uniform Delay (d), s/veh	0.0	27.2	22.4	13.1	0.8	0.0						
Incr Delay (d2), s/veh	0.0	13.2	0.1	19.0	0.8	0.0						
Initial Q Delay(d3),s/veh	0.0	0.0	0.0	0.0	0.0	0.0						
%ile BackOfQ(50%),veh/ln	0.0	6.9	0.7	16.2	0.4	0.0						
Unsig. Movement Delay, s/veh												
LnGrp Delay(d),s/veh	0.0	40.4	22.5	32.1	1.7	0.0						
LnGrp LOS	A	D	C	C	A	A						
Approach Vol, veh/h		772			3514							
Approach Delay, s/veh		39.1			10.6							
Approach LOS		D			B							
Timer - Assigned Phs	1	2			6							
Phs Duration (G+Y+Rc), s	50.0	22.9			72.9							
Change Period (Y+Rc), s	4.5	6.0			6.0							
Max Green Setting (Gmax), s	49.5	17.0			71.0							
Max Q Clear Time (g_c+I1), s	44.3	16.8			15.9							
Green Ext Time (p_c), s	1.2	0.1			25.8							

Intersection Summary

HCM 6th Ctrl Delay	15.7
HCM 6th LOS	B

Notes

Unsignalized Delay for [NBR] is excluded from calculations of the approach delay and intersection delay.

Timings

31: I-215 NB Ramps/Old 215 Frontage Rd. & Cactus Av.



Lane Group	EBL	EBT	WBT	NBL	NBT	NBR	SBL	SBT
Lane Configurations	↖	↗	↗	↖	↗	↗	↖	↗
Traffic Volume (vph)	34	2263	3688	704	393	56	67	0
Future Volume (vph)	34	2263	3688	704	393	56	67	0
Turn Type	Perm	NA	NA	Perm	NA	Perm	Perm	NA
Protected Phases		2	6		8			4
Permitted Phases	2			8		8	4	
Detector Phase	2	2	6	8	8	8	4	4
Switch Phase								
Minimum Initial (s)	5.0	5.0	5.0	5.0	5.0	5.0	5.0	5.0
Minimum Split (s)	11.0	11.0	44.0	10.5	10.5	10.5	10.5	10.5
Total Split (s)	88.0	88.0	88.0	32.0	32.0	32.0	32.0	32.0
Total Split (%)	73.3%	73.3%	73.3%	26.7%	26.7%	26.7%	26.7%	26.7%
Yellow Time (s)	5.0	5.0	5.0	4.5	4.5	4.5	4.5	4.5
All-Red Time (s)	1.0	1.0	1.0	1.0	1.0	1.0	1.0	1.0
Lost Time Adjust (s)	0.0	0.0	0.0	0.0	0.0	0.0	0.0	0.0
Total Lost Time (s)	6.0	6.0	6.0	5.5	5.5	5.5	5.5	5.5
Lead/Lag								
Lead-Lag Optimize?								
Recall Mode	Min	Min	Min	None	None	None	None	None
Act Effct Green (s)	82.0	82.0	82.0	26.5	26.5	26.5	26.5	26.5
Actuated g/C Ratio	0.68	0.68	0.68	0.22	0.22	0.22	0.22	0.22
v/c Ratio	0.65	1.12	1.73	3.82	1.19	0.16	1.18	0.66
Control Delay	68.3	82.6	352.7	1296.8	151.5	23.4	216.7	48.5
Queue Delay	0.0	0.0	0.0	0.0	0.0	0.0	0.0	0.0
Total Delay	68.3	82.6	352.7	1296.8	151.5	23.4	216.7	48.5
LOS	E	F	F	F	F	C	F	D
Approach Delay		82.4	352.7		845.0			92.7
Approach LOS		F	F		F			F

Intersection Summary

Cycle Length: 120
 Actuated Cycle Length: 120
 Natural Cycle: 90
 Control Type: Actuated-Uncoordinated
 Maximum v/c Ratio: 3.82
 Intersection Signal Delay: 330.5
 Intersection Capacity Utilization 172.7%
 Analysis Period (min) 15
 Intersection LOS: F
 ICU Level of Service H

Splits and Phases: 31: I-215 NB Ramps/Old 215 Frontage Rd. & Cactus Av.

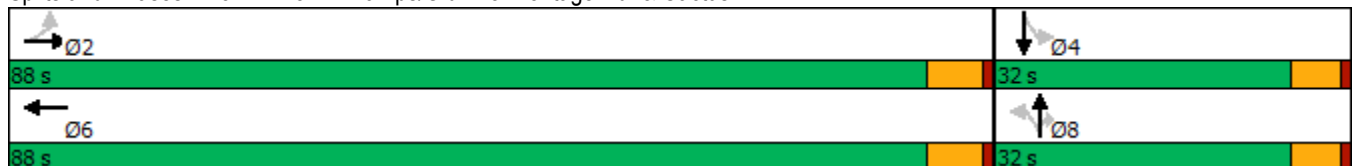

HCM 6th Signalized Intersection Summary

West Campus Upper Plateau (JN 14064)

31: I-215 NB Ramps/Old 215 Frontage Rd. & Cactus Av.

09/20/2022

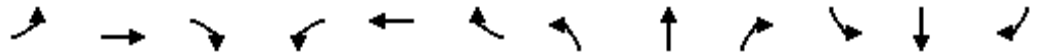

Movement	EBL	EBT	EBR	WBL	WBT	WBR	NBL	NBT	NBR	SBL	SBT	SBR
Lane Configurations	↗	↕			↕		↗	↕	↗	↗	↕	↕
Traffic Volume (veh/h)	34	2263	197	0	3688	190	704	393	56	67	0	187
Future Volume (veh/h)	34	2263	197	0	3688	190	704	393	56	67	0	187
Initial Q (Qb), veh	0	0	0	0	0	0	0	0	0	0	0	0
Ped-Bike Adj(A_pbT)	1.00		1.00	1.00		1.00	1.00		1.00	1.00		1.00
Parking Bus, Adj	1.00	1.00	1.00	1.00	1.00	1.00	1.00	1.00	1.00	1.00	1.00	1.00
Work Zone On Approach		No			No			No			No	
Adj Sat Flow, veh/h/ln	1678	1856	1515	0	1856	1841	1841	1722	1841	1841	1900	1500
Adj Flow Rate, veh/h	36	2407	205	0	3923	182	749	418	0	71	0	189
Peak Hour Factor	0.94	0.94	0.94	0.94	0.94	0.94	0.94	0.94	0.94	0.94	0.94	0.94
Percent Heavy Veh, %	15	3	26	0	3	4	4	12	4	4	0	27
Cap, veh/h	60	2250	189	0	2345	108	198	380		60	0	356
Arrive On Green	0.68	0.68	0.68	0.00	0.68	0.68	0.22	0.22	0.00	0.22	0.00	0.22
Sat Flow, veh/h	23	3292	276	0	3525	158	1175	1722	1560	953	0	1610
Grp Volume(v), veh/h	36	1273	1339	0	2000	2105	749	418	0	71	0	189
Grp Sat Flow(s),veh/h/ln	23	1763	1806	0	1763	1827	1175	1722	1560	953	0	1610
Q Serve(g_s), s	0.0	82.0	82.0	0.0	82.0	82.0	14.1	26.5	0.0	0.0	0.0	12.4
Cycle Q Clear(g_c), s	82.0	82.0	82.0	0.0	82.0	82.0	26.5	26.5	0.0	26.5	0.0	12.4
Prop In Lane	1.00		0.15	0.00		0.09	1.00		1.00	1.00		1.00
Lane Grp Cap(c), veh/h	60	1205	1234	0	1205	1249	198	380		60	0	356
V/C Ratio(X)	0.60	1.06	1.09	0.00	1.66	1.69	3.79	1.10		1.18	0.00	0.53
Avail Cap(c_a), veh/h	60	1205	1234	0	1205	1249	198	380		60	0	356
HCM Platoon Ratio	1.00	1.00	1.00	1.00	1.00	1.00	1.00	1.00	1.00	1.00	1.00	1.00
Upstream Filter(I)	1.00	1.00	1.00	0.00	1.00	1.00	1.00	1.00	0.00	1.00	0.00	1.00
Uniform Delay (d), s/veh	60.0	19.0	19.0	0.0	19.0	19.0	55.1	46.8	0.0	60.0	0.0	41.3
Incr Delay (d2), s/veh	11.2	42.2	52.1	0.0	300.8	312.2	1266.5	75.6	0.0	174.2	0.0	0.8
Initial Q Delay(d3),s/veh	0.0	0.0	0.0	0.0	0.0	0.0	0.0	0.0	0.0	0.0	0.0	0.0
%ile BackOfQ(50%),veh/ln	1.3	40.7	45.1	0.0	127.3	135.8	75.5	18.9	0.0	4.7	0.0	4.8
Unsig. Movement Delay, s/veh												
LnGrp Delay(d),s/veh	71.2	61.2	71.1	0.0	319.8	331.2	1321.6	122.3	0.0	234.2	0.0	42.1
LnGrp LOS	E	F	F	A	F	F	F	F		F	A	D
Approach Vol, veh/h		2648			4105			1167				260
Approach Delay, s/veh		66.4			325.7			892.0				94.5
Approach LOS		E			F			F				F
Timer - Assigned Phs		2		4		6		8				
Phs Duration (G+Y+Rc), s		88.0		32.0		88.0		32.0				
Change Period (Y+Rc), s		6.0		5.5		6.0		5.5				
Max Green Setting (Gmax), s		82.0		26.5		82.0		26.5				
Max Q Clear Time (g_c+I1), s		84.0		28.5		84.0		28.5				
Green Ext Time (p_c), s		0.0		0.0		0.0		0.0				

Intersection Summary

HCM 6th Ctrl Delay	315.2
HCM 6th LOS	F

Notes

User approved volume balancing among the lanes for turning movement.
 Unsignalized Delay for [NBR] is excluded from calculations of the approach delay and intersection delay.

Timings
32: I-215 SB Ramps & Van Buren Bl.

West Campus Upper Plateau (JN 14064)

09/20/2022



Lane Group	EBT	EBR	WBL	WBT	SBT	SBR
Lane Configurations	↑↑	↑↑	↙	↑↑	↙	↑↑
Traffic Volume (vph)	1181	1182	34	1844	39	1670
Future Volume (vph)	1181	1182	34	1844	39	1670
Turn Type	NA	Perm	Prot	NA	NA	Perm
Protected Phases	6		5	2	8	
Permitted Phases		6				8
Detector Phase	6	6	5	2	8	8
Switch Phase						
Minimum Initial (s)	5.0	5.0	5.0	5.0	5.0	5.0
Minimum Split (s)	36.0	36.0	11.0	11.0	11.0	11.0
Total Split (s)	37.0	37.0	11.0	48.0	37.0	37.0
Total Split (%)	43.5%	43.5%	12.9%	56.5%	43.5%	43.5%
Yellow Time (s)	5.0	5.0	5.0	5.0	5.0	5.0
All-Red Time (s)	1.0	1.0	1.0	1.0	1.0	1.0
Lost Time Adjust (s)	0.0	0.0	0.0	0.0	0.0	0.0
Total Lost Time (s)	6.0	6.0	6.0	6.0	6.0	6.0
Lead/Lag	Lag	Lag	Lead			
Lead-Lag Optimize?	Yes	Yes	Yes			
Recall Mode	Min	Min	None	Min	Max	Max
Act Effct Green (s)	35.4	35.4	5.0	42.0	31.0	31.0
Actuated g/C Ratio	0.42	0.42	0.06	0.49	0.36	0.36
v/c Ratio	0.92	0.69	0.35	1.17	0.81	1.75
Control Delay	38.0	3.6	47.9	105.6	36.2	365.8
Queue Delay	0.0	0.0	0.0	0.0	0.0	0.0
Total Delay	38.0	3.6	47.9	105.6	36.2	365.8
LOS	D	A	D	F	D	F
Approach Delay	20.8			104.5	292.4	
Approach LOS	C			F	F	

Intersection Summary

Cycle Length: 85
 Actuated Cycle Length: 85
 Natural Cycle: 130
 Control Type: Actuated-Uncoordinated
 Maximum v/c Ratio: 1.75
 Intersection Signal Delay: 136.7
 Intersection LOS: F
 Intersection Capacity Utilization 116.4%
 ICU Level of Service H
 Analysis Period (min) 15

Splits and Phases: 32: I-215 SB Ramps & Van Buren Bl.

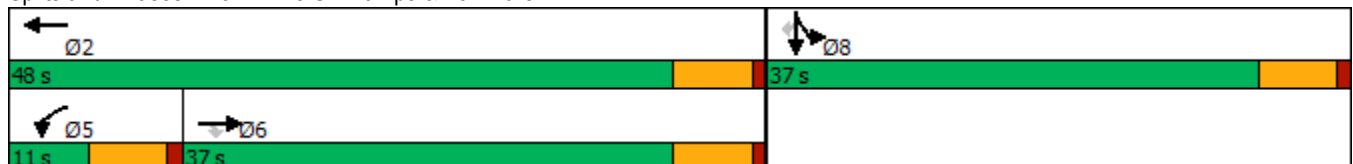

HCM 6th Signalized Intersection Summary
 32: I-215 SB Ramps & Van Buren Bl.

West Campus Upper Plateau (JN 14064)

09/20/2022



Movement	EBL	EBT	EBR	WBL	WBT	WBR	NBL	NBT	NBR	SBL	SBT	SBR
Lane Configurations		↑↑	↑↑	↑	↑↑						↑	↑↑
Traffic Volume (veh/h)	0	1181	1182	34	1844	0	0	0	0	439	39	1670
Future Volume (veh/h)	0	1181	1182	34	1844	0	0	0	0	439	39	1670
Initial Q (Qb), veh	0	0	0	0	0	0				0	0	0
Ped-Bike Adj(A_pbT)	1.00		1.00	1.00		1.00				1.00		1.00
Parking Bus, Adj	1.00	1.00	1.00	1.00	1.00	1.00				1.00	1.00	1.00
Work Zone On Approach		No			No						No	
Adj Sat Flow, veh/h/ln	0	1767	1781	1900	1826	0				1856	1663	1767
Adj Flow Rate, veh/h	0	1270	1177	37	1983	0				472	42	0
Peak Hour Factor	0.93	0.93	0.93	0.93	0.93	0.93				0.93	0.93	0.93
Percent Heavy Veh, %	0	9	8	0	5	0				3	16	9
Cap, veh/h	0	1224	969	106	1714	0				532	47	
Arrive On Green	0.00	0.36	0.36	0.06	0.49	0.00				0.36	0.36	0.00
Sat Flow, veh/h	0	3445	2657	1810	3561	0				1460	130	2635
Grp Volume(v), veh/h	0	1270	1177	37	1983	0				514	0	0
Grp Sat Flow(s),veh/h/ln	0	1678	1329	1810	1735	0				1590	0	1317
Q Serve(g_s), s	0.0	31.0	31.0	1.7	42.0	0.0				25.8	0.0	0.0
Cycle Q Clear(g_c), s	0.0	31.0	31.0	1.7	42.0	0.0				25.8	0.0	0.0
Prop In Lane	0.00		1.00	1.00		0.00				0.92		1.00
Lane Grp Cap(c), veh/h	0	1224	969	106	1714	0				580	0	
V/C Ratio(X)	0.00	1.04	1.21	0.35	1.16	0.00				0.89	0.00	
Avail Cap(c_a), veh/h	0	1224	969	106	1714	0				580	0	
HCM Platoon Ratio	1.00	1.00	1.00	1.00	1.00	1.00				1.00	1.00	1.00
Upstream Filter(I)	0.00	1.00	1.00	1.00	1.00	0.00				1.00	0.00	0.00
Uniform Delay (d), s/veh	0.0	27.0	27.0	38.4	21.5	0.0				25.3	0.0	0.0
Incr Delay (d2), s/veh	0.0	35.9	106.1	0.7	77.6	0.0				17.9	0.0	0.0
Initial Q Delay(d3),s/veh	0.0	0.0	0.0	0.0	0.0	0.0				0.0	0.0	0.0
%ile BackOfQ(50%),veh/ln	0.0	16.7	22.7	0.7	32.3	0.0				11.6	0.0	0.0
Unsig. Movement Delay, s/veh												
LnGrp Delay(d),s/veh	0.0	62.9	133.1	39.2	99.1	0.0				43.3	0.0	0.0
LnGrp LOS	A	F	F	D	F	A				D	A	
Approach Vol, veh/h		2447			2020							514
Approach Delay, s/veh		96.7			98.0							43.3
Approach LOS		F			F							D
Timer - Assigned Phs		2			5	6		8				
Phs Duration (G+Y+Rc), s		48.0			11.0	37.0		37.0				
Change Period (Y+Rc), s		6.0			6.0	6.0		6.0				
Max Green Setting (Gmax), s		42.0			5.0	31.0		31.0				
Max Q Clear Time (g_c+I1), s		44.0			3.7	33.0		27.8				
Green Ext Time (p_c), s		0.0			0.0	0.0		0.7				

Intersection Summary

HCM 6th Ctrl Delay	91.7
HCM 6th LOS	F

Notes

Unsignalized Delay for [SBR] is excluded from calculations of the approach delay and intersection delay.

Timings
33: I-215 NB On/Off Ramp & Van Buren Bl.



Lane Group	EBT	EBR	WBT	NBL	NBR
Lane Configurations	↑↑	↑↑	↑↑	↑↑	↑
Traffic Volume (vph)	600	1265	687	1712	160
Future Volume (vph)	600	1265	687	1712	160
Turn Type	NA	pm+ov	NA	Prot	Perm
Protected Phases	6	4	2	4	
Permitted Phases		6			4
Detector Phase	6	4	2	4	4
Switch Phase					
Minimum Initial (s)	5.0	5.0	5.0	5.0	5.0
Minimum Split (s)	11.0	42.0	11.0	42.0	42.0
Total Split (s)	15.0	55.0	15.0	55.0	55.0
Total Split (%)	21.4%	78.6%	21.4%	78.6%	78.6%
Yellow Time (s)	5.0	5.0	5.0	5.0	5.0
All-Red Time (s)	1.0	1.0	1.0	1.0	1.0
Lost Time Adjust (s)	0.0	0.0	0.0	0.0	0.0
Total Lost Time (s)	6.0	6.0	6.0	6.0	6.0
Lead/Lag					
Lead-Lag Optimize?					
Recall Mode	None	Min	None	Min	Min
Act Effct Green (s)	9.2	62.3	9.2	40.9	40.9
Actuated g/C Ratio	0.15	1.00	0.15	0.66	0.66
v/c Ratio	1.27	0.52	1.43	0.86	0.17
Control Delay	162.5	0.7	233.0	13.1	4.2
Queue Delay	0.0	0.0	0.0	0.0	0.0
Total Delay	162.5	0.7	233.0	13.1	4.2
LOS	F	A	F	B	A
Approach Delay	52.8		233.0	12.3	
Approach LOS	D		F	B	

Intersection Summary

Cycle Length: 70
 Actuated Cycle Length: 62.3
 Natural Cycle: 80
 Control Type: Actuated-Uncoordinated
 Maximum v/c Ratio: 1.43
 Intersection Signal Delay: 63.6
 Intersection LOS: E
 Intersection Capacity Utilization 77.8%
 ICU Level of Service D
 Analysis Period (min) 15

Splits and Phases: 33: I-215 NB On/Off Ramp & Van Buren Bl.



HCM 6th Signalized Intersection Summary
 33: I-215 NB On/Off Ramp & Van Buren Bl.

West Campus Upper Plateau (JN 14064)

09/20/2022



Movement	EBT	EBR	WBL	WBT	NBL	NBR
Lane Configurations	↑↑	↑↑		↑↑	↑↑	↑
Traffic Volume (veh/h)	600	1265	0	687	1712	160
Future Volume (veh/h)	600	1265	0	687	1712	160
Initial Q (Qb), veh	0	0	0	0	0	0
Ped-Bike Adj(A_pbT)		1.00	1.00		1.00	1.00
Parking Bus, Adj	1.00	1.00	1.00	1.00	1.00	1.00
Work Zone On Approach	No			No	No	
Adj Sat Flow, veh/h/ln	1856	1781	0	1870	1811	1870
Adj Flow Rate, veh/h	652	1360	0	747	1861	174
Peak Hour Factor	0.92	0.92	0.92	0.92	0.92	0.92
Percent Heavy Veh, %	3	8	0	2	6	2
Cap, veh/h	582	2072	0	587	2057	974
Arrive On Green	0.17	0.17	0.00	0.17	0.61	0.61
Sat Flow, veh/h	3618	2657	0	3741	3346	1585
Grp Volume(v), veh/h	652	1360	0	747	1861	174
Grp Sat Flow(s),veh/h/ln	1763	1329	0	1777	1673	1585
Q Serve(g_s), s	9.0	9.0	0.0	9.0	26.3	2.6
Cycle Q Clear(g_c), s	9.0	9.0	0.0	9.0	26.3	2.6
Prop In Lane		1.00	0.00		1.00	1.00
Lane Grp Cap(c), veh/h	582	2072	0	587	2057	974
V/C Ratio(X)	1.12	0.66	0.00	1.27	0.90	0.18
Avail Cap(c_a), veh/h	582	2072	0	587	3008	1425
HCM Platoon Ratio	1.00	1.00	1.00	1.00	1.00	1.00
Upstream Filter(I)	1.00	1.00	0.00	1.00	1.00	1.00
Uniform Delay (d), s/veh	22.8	2.3	0.0	22.8	9.1	4.5
Incr Delay (d2), s/veh	74.8	0.6	0.0	135.8	2.4	0.0
Initial Q Delay(d3),s/veh	0.0	0.0	0.0	0.0	0.0	0.0
%ile BackOfQ(50%),veh/ln	9.1	7.9	0.0	14.2	5.4	0.4
Unsig. Movement Delay, s/veh						
LnGrp Delay(d),s/veh	97.6	2.9	0.0	158.5	11.5	4.6
LnGrp LOS	F	A	A	F	B	A
Approach Vol, veh/h	2012			747	2035	
Approach Delay, s/veh	33.6			158.5	10.9	
Approach LOS	C			F	B	
Timer - Assigned Phs		2		4		6
Phs Duration (G+Y+Rc), s		15.0		39.5		15.0
Change Period (Y+Rc), s		6.0		6.0		6.0
Max Green Setting (Gmax), s		9.0		49.0		9.0
Max Q Clear Time (g_c+11), s		11.0		28.3		11.0
Green Ext Time (p_c), s		0.0		5.2		0.0
Intersection Summary						
HCM 6th Ctrl Delay			43.4			
HCM 6th LOS			D			

Timings

West Campus Upper Plateau (JN 14064)

34: Old 215 Frontage Rd. & Alessandro Bl.

09/20/2022



Lane Group	EBL	EBT	EBR	WBL	WBT	WBR	NBL	NBT	NBR	SBL	SBT	SBR
Lane Configurations	↖↗	↕↕↕	↖	↖	↕↕	↖	↖↗	↕↕	↖	↖	↕↕	↖
Traffic Volume (vph)	507	1684	60	13	1996	214	73	354	26	53	87	325
Future Volume (vph)	507	1684	60	13	1996	214	73	354	26	53	87	325
Turn Type	Prot	NA	Perm	Prot	NA	Perm	Prot	NA	Perm	Prot	NA	Perm
Protected Phases	5	2		1	6		3	8		7	4	
Permitted Phases			2			6			8			4
Detector Phase	5	2	2	1	6	6	3	8	8	7	4	4
Switch Phase												
Minimum Initial (s)	5.0	10.0	10.0	5.0	10.0	10.0	5.0	10.0	10.0	5.0	10.0	10.0
Minimum Split (s)	8.7	43.5	43.5	8.7	15.8	15.8	8.7	16.2	16.2	8.7	40.2	40.2
Total Split (s)	17.0	62.2	62.2	8.9	54.1	54.1	8.7	39.3	39.3	9.6	40.2	40.2
Total Split (%)	14.2%	51.8%	51.8%	7.4%	45.1%	45.1%	7.3%	32.8%	32.8%	8.0%	33.5%	33.5%
Yellow Time (s)	3.2	5.5	5.5	3.2	4.8	4.8	3.2	5.2	5.2	3.2	5.2	5.2
All-Red Time (s)	0.5	1.0	1.0	0.5	1.0	1.0	0.5	1.0	1.0	0.5	1.0	1.0
Lost Time Adjust (s)	0.0	0.0	0.0	0.0	0.0	0.0	0.0	0.0	0.0	0.0	0.0	0.0
Total Lost Time (s)	3.7	6.5	6.5	3.7	5.8	5.8	3.7	6.2	6.2	3.7	6.2	6.2
Lead/Lag	Lead	Lag	Lag	Lead	Lag	Lag	Lead	Lag	Lag	Lead	Lag	Lag
Lead-Lag Optimize?	Yes	Yes	Yes	Yes	Yes	Yes	Yes	Yes	Yes	Yes	Yes	Yes
Recall Mode	None	None	None	None	None	None	None	Max	Max	None	Max	Max
Act Effct Green (s)	13.3	61.2	61.2	5.1	48.4	48.4	5.0	33.3	33.3	5.7	34.0	34.0
Actuated g/C Ratio	0.11	0.52	0.52	0.04	0.41	0.41	0.04	0.28	0.28	0.05	0.29	0.29
v/c Ratio	1.43	0.65	0.09	0.27	1.40	0.29	0.56	0.38	0.05	0.64	0.09	0.58
Control Delay	247.3	23.3	1.4	69.7	212.0	4.1	73.2	36.0	0.2	87.3	31.9	21.2
Queue Delay	0.0	0.0	0.0	0.0	0.0	0.0	0.0	0.0	0.0	0.0	0.0	0.0
Total Delay	247.3	23.3	1.4	69.7	212.0	4.1	73.2	36.0	0.2	87.3	31.9	21.2
LOS	F	C	A	E	F	A	E	D	A	F	C	C
Approach Delay		73.2			191.2			39.9			30.7	
Approach LOS		E			F			D			C	

Intersection Summary

Cycle Length: 120	
Actuated Cycle Length: 118.3	
Natural Cycle: 125	
Control Type: Actuated-Uncoordinated	
Maximum v/c Ratio: 1.43	
Intersection Signal Delay: 115.4	Intersection LOS: F
Intersection Capacity Utilization 100.3%	ICU Level of Service G
Analysis Period (min) 15	































Splits and Phases: 34: Old 215 Frontage Rd. & Alessandro Bl.



HCM 6th Signalized Intersection Summary
34: Old 215 Frontage Rd. & Alessandro Bl.

West Campus Upper Plateau (JN 14064)

09/20/2022

												
Movement	EBL	EBT	EBR	WBL	WBT	WBR	NBL	NBT	NBR	SBL	SBT	SBR
Lane Configurations	 	  			 		 	 			 	
Traffic Volume (veh/h)	507	1684	60	13	1996	214	73	354	26	53	87	325
Future Volume (veh/h)	507	1684	60	13	1996	214	73	354	26	53	87	325
Initial Q (Qb), veh	0	0	0	0	0	0	0	0	0	0	0	0
Ped-Bike Adj(A_pbT)	1.00		1.00	1.00		1.00	1.00		1.00	1.00		1.00
Parking Bus, Adj	1.00	1.00	1.00	1.00	1.00	1.00	1.00	1.00	1.00	1.00	1.00	1.00
Work Zone On Approach		No			No			No			No	
Adj Sat Flow, veh/h/ln	1767	1870	1470	981	1885	1826	1707	1811	1752	1870	1811	1826
Adj Flow Rate, veh/h	517	1718	51	13	2037	0	74	361	19	54	89	0
Peak Hour Factor	0.98	0.98	0.98	0.98	0.98	0.98	0.98	0.98	0.98	0.98	0.98	0.98
Percent Heavy Veh, %	9	2	29	62	1	5	13	6	10	2	6	5
Cap, veh/h	361	2540	620	14	1438		120	969	418	69	973	
Arrive On Green	0.11	0.50	0.50	0.01	0.40	0.00	0.04	0.28	0.28	0.04	0.28	0.00
Sat Flow, veh/h	3264	5106	1246	934	3582	1547	3155	3441	1485	1781	3441	1547
Grp Volume(v), veh/h	517	1718	51	13	2037	0	74	361	19	54	89	0
Grp Sat Flow(s),veh/h/ln	1632	1702	1246	934	1791	1547	1577	1721	1485	1781	1721	1547
Q Serve(g_s), s	13.3	30.6	2.6	1.7	48.3	0.0	2.8	10.1	1.1	3.6	2.3	0.0
Cycle Q Clear(g_c), s	13.3	30.6	2.6	1.7	48.3	0.0	2.8	10.1	1.1	3.6	2.3	0.0
Prop In Lane	1.00		1.00	1.00		1.00	1.00		1.00	1.00		1.00
Lane Grp Cap(c), veh/h	361	2540	620	14	1438		120	969	418	69	973	
V/C Ratio(X)	1.43	0.68	0.08	0.95	1.42		0.62	0.37	0.05	0.78	0.09	
Avail Cap(c_a), veh/h	361	2540	620	40	1438		131	969	418	87	973	
HCM Platoon Ratio	1.00	1.00	1.00	1.00	1.00	1.00	1.00	1.00	1.00	1.00	1.00	1.00
Upstream Filter(I)	1.00	1.00	1.00	1.00	1.00	0.00	1.00	1.00	1.00	1.00	1.00	0.00
Uniform Delay (d), s/veh	53.5	22.9	15.8	59.2	36.0	0.0	57.0	34.7	31.4	57.3	31.8	0.0
Incr Delay (d2), s/veh	209.9	0.7	0.1	56.8	191.5	0.0	4.7	1.1	0.2	22.1	0.2	0.0
Initial Q Delay(d3),s/veh	0.0	0.0	0.0	0.0	0.0	0.0	0.0	0.0	0.0	0.0	0.0	0.0
%ile BackOfQ(50%),veh/ln	15.7	11.2	0.7	0.6	58.0	0.0	1.2	4.2	0.4	2.0	0.9	0.0
Unsig. Movement Delay, s/veh												
LnGrp Delay(d),s/veh	263.4	23.6	15.9	116.1	227.4	0.0	61.6	35.8	31.6	79.3	32.0	0.0
LnGrp LOS	F	C	B	F	F		E	D	C	E	C	
Approach Vol, veh/h		2286			2050			454			143	
Approach Delay, s/veh		77.7			226.7			39.8			49.8	
Approach LOS		E			F			D			D	
Timer - Assigned Phs	1	2	3	4	5	6	7	8				
Phs Duration (G+Y+Rc), s	5.5	66.3	8.3	40.2	17.0	54.8	8.4	40.1				
Change Period (Y+Rc), s	3.7	6.5	3.7	6.2	3.7	* 6.5	3.7	6.2				
Max Green Setting (Gmax), s	5.2	55.7	5.0	34.0	13.3	* 48	5.9	33.1				
Max Q Clear Time (g_c+1), s	3.7	32.6	4.8	4.3	15.3	50.3	5.6	12.1				
Green Ext Time (p_c), s	0.0	12.4	0.0	0.4	0.0	0.0	0.0	2.0				

Intersection Summary

HCM 6th Ctrl Delay	135.3
HCM 6th LOS	F

Notes

* HCM 6th computational engine requires equal clearance times for the phases crossing the barrier.
Unsignalized Delay for [WBR, SBR] is excluded from calculations of the approach delay and intersection delay.

Timings
35: Day St. & Alessandro Bl.

West Campus Upper Plateau (JN 14064)

09/20/2022

Lane Group	EBL	EBT	EBR	WBL	WBT	WBR	NBL	NBT	NBR	SBL	SBT
Lane Configurations											
Traffic Volume (vph)	293	1591	31	13	2002	182	95	214	32	122	87
Future Volume (vph)	293	1591	31	13	2002	182	95	214	32	122	87
Turn Type	Prot	NA	Perm	Prot	NA	Perm	Perm	NA	Perm	Perm	NA
Protected Phases	5	2		1	6			8			4
Permitted Phases			2			6	8		8	4	
Detector Phase	5	2	2	1	6	6	8	8	8	4	4
Switch Phase											
Minimum Initial (s)	5.0	10.0	10.0	5.0	10.0	10.0	10.0	10.0	10.0	10.0	10.0
Minimum Split (s)	9.1	30.8	30.8	9.1	30.8	30.8	42.4	42.4	42.4	41.6	41.6
Total Split (s)	21.0	68.5	68.5	9.1	56.6	56.6	42.4	42.4	42.4	42.4	42.4
Total Split (%)	17.5%	57.1%	57.1%	7.6%	47.2%	47.2%	35.3%	35.3%	35.3%	35.3%	35.3%
Yellow Time (s)	3.6	4.8	4.8	3.6	4.8	4.8	4.4	4.4	4.4	3.6	3.6
All-Red Time (s)	0.5	1.0	1.0	0.5	1.0	1.0	1.0	1.0	1.0	1.0	1.0
Lost Time Adjust (s)	0.0	0.0	0.0	0.0	0.0	0.0	0.0	0.0	0.0	0.0	0.0
Total Lost Time (s)	4.1	5.8	5.8	4.1	5.8	5.8	5.4	5.4	5.4	4.6	4.6
Lead/Lag	Lead	Lag	Lag	Lead	Lag	Lag					
Lead-Lag Optimize?	Yes	Yes	Yes	Yes	Yes	Yes					
Recall Mode	None	None	None	None	None	None	None	None	None	None	None
Act Effct Green (s)	17.0	68.7	68.7	5.0	51.1	51.1	30.7	30.7	30.7	31.5	31.5
Actuated g/C Ratio	0.15	0.60	0.60	0.04	0.45	0.45	0.27	0.27	0.27	0.28	0.28
v/c Ratio	1.20	0.56	0.04	0.19	1.35	0.26	1.27	0.45	0.07	0.54	0.72
Control Delay	162.2	16.3	1.2	61.9	189.3	11.9	224.9	37.2	0.3	43.3	30.9
Queue Delay	0.0	0.0	0.0	0.0	0.0	0.0	0.0	0.0	0.0	0.0	0.0
Total Delay	162.2	16.3	1.2	61.9	189.3	11.9	224.9	37.2	0.3	43.3	30.9
LOS	F	B	A	E	F	B	F	D	A	D	C
Approach Delay		38.4			173.9			86.0			33.9
Approach LOS		D			F			F			C

Intersection Summary

Cycle Length: 120	
Actuated Cycle Length: 114.2	
Natural Cycle: 125	
Control Type: Actuated-Uncoordinated	
Maximum v/c Ratio: 1.35	
Intersection Signal Delay: 101.3	Intersection LOS: F
Intersection Capacity Utilization 119.2%	ICU Level of Service H
Analysis Period (min) 15	



























Splits and Phases: 35: Day St. & Alessandro Bl.



HCM 6th Signalized Intersection Summary
35: Day St. & Alessandro Bl.

West Campus Upper Plateau (JN 14064)

09/20/2022

												
Movement	EBL	EBT	EBR	WBL	WBT	WBR	NBL	NBT	NBR	SBL	SBT	SBR
Lane Configurations		  			 							
Traffic Volume (veh/h)	293	1591	31	13	2002	182	95	214	32	122	87	295
Future Volume (veh/h)	293	1591	31	13	2002	182	95	214	32	122	87	295
Initial Q (Qb), veh	0	0	0	0	0	0	0	0	0	0	0	0
Ped-Bike Adj(A_pbT)	1.00		0.98	1.00		1.00	1.00		1.00	1.00		1.00
Parking Bus, Adj	1.00	1.00	1.00	1.00	1.00	1.00	1.00	1.00	1.00	1.00	1.00	1.00
Work Zone On Approach		No			No			No			No	
Adj Sat Flow, veh/h/ln	1870	1870	1544	1752	1885	1870	1767	1885	1781	1870	1900	1885
Adj Flow Rate, veh/h	315	1711	32	14	2153	161	102	230	22	131	94	290
Peak Hour Factor	0.93	0.93	0.93	0.93	0.93	0.93	0.93	0.93	0.93	0.93	0.93	0.93
Percent Heavy Veh, %	2	2	24	10	1	2	9	1	8	2	0	1
Cap, veh/h	251	2801	703	26	1516	671	156	581	465	299	126	389
Arrive On Green	0.14	0.55	0.55	0.02	0.42	0.42	0.31	0.31	0.31	0.31	0.31	0.31
Sat Flow, veh/h	1781	5106	1282	1668	3582	1585	944	1885	1508	1127	409	1263
Grp Volume(v), veh/h	315	1711	32	14	2153	161	102	230	22	131	0	384
Grp Sat Flow(s),veh/h/ln	1781	1702	1282	1668	1791	1585	944	1885	1508	1127	0	1673
Q Serve(g_s), s	16.9	27.3	1.4	1.0	50.8	7.8	12.3	11.5	1.2	12.4	0.0	24.7
Cycle Q Clear(g_c), s	16.9	27.3	1.4	1.0	50.8	7.8	37.0	11.5	1.2	24.0	0.0	24.7
Prop In Lane	1.00		1.00	1.00		1.00	1.00		1.00	1.00		0.76
Lane Grp Cap(c), veh/h	251	2801	703	26	1516	671	156	581	465	299	0	516
V/C Ratio(X)	1.26	0.61	0.05	0.54	1.42	0.24	0.65	0.40	0.05	0.44	0.00	0.74
Avail Cap(c_a), veh/h	251	2801	703	70	1516	671	156	581	465	307	0	527
HCM Platoon Ratio	1.00	1.00	1.00	1.00	1.00	1.00	1.00	1.00	1.00	1.00	1.00	1.00
Upstream Filter(I)	1.00	1.00	1.00	1.00	1.00	1.00	1.00	1.00	1.00	1.00	0.00	1.00
Uniform Delay (d), s/veh	51.5	18.4	12.5	58.6	34.6	22.2	54.2	32.7	29.1	42.1	0.0	37.3
Incr Delay (d2), s/veh	143.3	0.4	0.0	6.3	192.9	0.2	9.2	0.4	0.0	1.0	0.0	5.6
Initial Q Delay(d3),s/veh	0.0	0.0	0.0	0.0	0.0	0.0	0.0	0.0	0.0	0.0	0.0	0.0
%ile BackOfQ(50%),veh/ln	17.3	9.9	0.4	0.5	61.2	2.8	3.4	5.2	0.4	3.6	0.0	11.0
Unsig. Movement Delay, s/veh												
LnGrp Delay(d),s/veh	194.9	18.8	12.6	65.0	227.5	22.4	63.4	33.1	29.2	43.1	0.0	42.8
LnGrp LOS	F	B	B	E	F	C	E	C	C	D	A	D
Approach Vol, veh/h		2058			2328			354				515
Approach Delay, s/veh		45.6			212.3			41.6				42.9
Approach LOS		D			F			D				D
Timer - Assigned Phs	1	2		4	5	6		8				
Phs Duration (G+Y+Rc), s	6.0	71.6		42.4	21.0	56.6		42.4				
Change Period (Y+Rc), s	4.1	5.8		* 5.4	4.1	5.8		5.4				
Max Green Setting (Gmax), s	5.0	62.7		* 38	16.9	50.8		37.0				
Max Q Clear Time (g_c+I1), s	3.0	29.3		26.7	18.9	52.8		39.0				
Green Ext Time (p_c), s	0.0	15.8		2.4	0.0	0.0		0.0				

Intersection Summary

HCM 6th Ctrl Delay	118.9
HCM 6th LOS	F

Notes

* HCM 6th computational engine requires equal clearance times for the phases crossing the barrier.

Timings
36: Elsworth St. & Cactus Av.

West Campus Upper Plateau (JN 14064)

09/20/2022



Lane Group	EBL	EBT	EBR	WBL	WBT	WBR	NBL	NBT	SBL	SBT	SBR
Lane Configurations											
Traffic Volume (vph)	445	2119	683	92	2620	254	90	49	196	131	346
Future Volume (vph)	445	2119	683	92	2620	254	90	49	196	131	346
Turn Type	Prot	NA	Perm	Prot	NA	Perm	Split	NA	Split	NA	pm+ov
Protected Phases	5	2		1	6		8	8	4	4	5
Permitted Phases			2			6					4
Detector Phase	5	2	2	1	6	6	8	8	4	4	5
Switch Phase											
Minimum Initial (s)	5.0	10.0	10.0	5.0	10.0	10.0	10.0	10.0	10.0	10.0	5.0
Minimum Split (s)	9.6	36.2	36.2	9.6	36.2	36.2	35.4	35.4	35.4	35.4	9.6
Total Split (s)	15.0	48.6	48.6	10.6	44.2	44.2	35.4	35.4	35.4	35.4	15.0
Total Split (%)	11.5%	37.4%	37.4%	8.2%	34.0%	34.0%	27.2%	27.2%	27.2%	27.2%	11.5%
Yellow Time (s)	3.6	5.2	5.2	3.6	5.2	5.2	4.4	4.4	4.4	4.4	3.6
All-Red Time (s)	1.0	1.0	1.0	1.0	1.0	1.0	1.0	1.0	1.0	1.0	1.0
Lost Time Adjust (s)	0.0	0.0	0.0	0.0	0.0	0.0	0.0	0.0	0.0	0.0	0.0
Total Lost Time (s)	4.6	6.2	6.2	4.6	6.2	6.2	5.4	5.4	5.4	5.4	4.6
Lead/Lag	Lead	Lag	Lag	Lead	Lag	Lag					Lead
Lead-Lag Optimize?	Yes	Yes	Yes	Yes	Yes	Yes					Yes
Recall Mode	None	None	None	None	None	None	Max	Max	Max	Max	None
Act Effct Green (s)	10.4	42.4	42.4	6.0	38.0	38.0	30.0	30.0	30.0	30.0	41.2
Actuated g/C Ratio	0.08	0.33	0.33	0.05	0.29	0.29	0.23	0.23	0.23	0.23	0.32
v/c Ratio	3.24	1.36	0.79	1.13	1.83	0.49	0.22	0.24	0.43	0.42	0.51
Control Delay	1046.0	199.6	16.4	193.2	406.2	25.8	42.5	32.7	46.8	46.2	6.4
Queue Delay	0.0	0.0	0.0	0.0	0.0	0.0	0.0	0.0	0.0	0.0	0.0
Total Delay	1046.0	199.6	16.4	193.2	406.2	25.8	42.5	32.7	46.8	46.2	6.4
LOS	F	F	B	F	F	C	D	C	D	D	A
Approach Delay		277.0			367.1			37.2		25.9	
Approach LOS		F			F			D		C	

Intersection Summary

Cycle Length: 130
 Actuated Cycle Length: 130
 Natural Cycle: 130
 Control Type: Actuated-Uncoordinated
 Maximum v/c Ratio: 3.24
 Intersection Signal Delay: 284.9
 Intersection LOS: F
 Intersection Capacity Utilization 110.5%
 ICU Level of Service H
 Analysis Period (min) 15



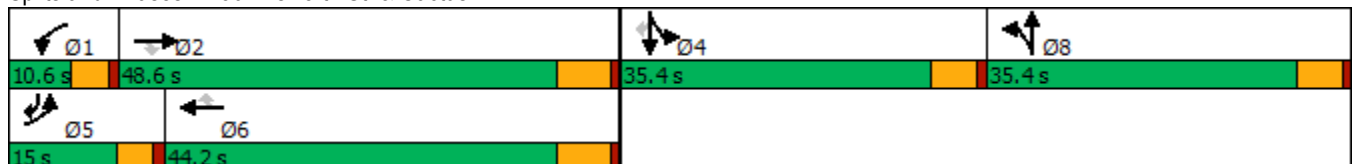

























Splits and Phases: 36: Elsworth St. & Cactus Av.



HCM 6th Signalized Intersection Summary
36: Elsworth St. & Cactus Av.

West Campus Upper Plateau (JN 14064)

09/20/2022

												
Movement	EBL	EBT	EBR	WBL	WBT	WBR	NBL	NBT	NBR	SBL	SBT	SBR
Lane Configurations		  			  			 			 	
Traffic Volume (veh/h)	445	2119	683	92	2620	254	90	49	37	196	131	346
Future Volume (veh/h)	445	2119	683	92	2620	254	90	49	37	196	131	346
Initial Q (Qb), veh	0	0	0	0	0	0	0	0	0	0	0	0
Ped-Bike Adj(A_pbT)	1.00		1.00	1.00		0.98	1.00		1.00	1.00		1.00
Parking Bus, Adj	1.00	1.00	1.00	1.00	1.00	1.00	1.00	1.00	1.00	1.00	1.00	1.00
Work Zone On Approach		No			No			No			No	
Adj Sat Flow, veh/h/ln	1856	1811	1885	1900	1841	1870	1811	1900	1900	1856	1900	1856
Adj Flow Rate, veh/h	454	2162	0	94	2673	211	86	59	30	167	180	286
Peak Hour Factor	0.98	0.98	0.98	0.98	0.98	0.98	0.98	0.98	0.98	0.98	0.98	0.98
Percent Heavy Veh, %	3	6	1	0	4	2	6	0	0	3	0	3
Cap, veh/h	141	1613		84	1469	453	398	274	139	408	438	489
Arrive On Green	0.08	0.33	0.00	0.05	0.29	0.29	0.23	0.23	0.23	0.23	0.23	0.23
Sat Flow, veh/h	1767	4944	1598	1810	5025	1551	1725	1188	604	1767	1900	1572
Grp Volume(v), veh/h	454	2162	0	94	2673	211	86	0	89	167	180	286
Grp Sat Flow(s),veh/h/ln	1767	1648	1598	1810	1675	1551	1725	0	1791	1767	1900	1572
Q Serve(g_s), s	10.4	42.4	0.0	6.0	38.0	14.5	5.2	0.0	5.2	10.4	10.5	19.9
Cycle Q Clear(g_c), s	10.4	42.4	0.0	6.0	38.0	14.5	5.2	0.0	5.2	10.4	10.5	19.9
Prop In Lane	1.00		1.00	1.00		1.00	1.00		0.34	1.00		1.00
Lane Grp Cap(c), veh/h	141	1613		84	1469	453	398	0	413	408	438	489
V/C Ratio(X)	3.21	1.34		1.13	1.82	0.47	0.22	0.00	0.22	0.41	0.41	0.59
Avail Cap(c_a), veh/h	141	1613		84	1469	453	398	0	413	408	438	489
HCM Platoon Ratio	1.00	1.00	1.00	1.00	1.00	1.00	1.00	1.00	1.00	1.00	1.00	1.00
Upstream Filter(l)	1.00	1.00	0.00	1.00	1.00	1.00	1.00	0.00	1.00	1.00	1.00	1.00
Uniform Delay (d), s/veh	59.8	43.8	0.0	62.0	46.0	37.7	40.5	0.0	40.5	42.5	42.5	37.7
Incr Delay (d2), s/veh	1013.3	157.6	0.0	136.5	371.6	0.7	1.2	0.0	1.2	3.0	2.8	5.1
Initial Q Delay(d3),s/veh	0.0	0.0	0.0	0.0	0.0	0.0	0.0	0.0	0.0	0.0	0.0	0.0
%ile BackOfQ(50%),veh/ln	44.3	39.9	0.0	5.8	65.6	5.4	2.3	0.0	2.4	4.8	5.2	8.2
Unsig. Movement Delay, s/veh												
LnGrp Delay(d),s/veh	1073.1	201.4	0.0	198.5	417.6	38.4	41.7	0.0	41.7	45.5	45.3	42.8
LnGrp LOS	F	F		F	F	D	D	A	D	D	D	D
Approach Vol, veh/h		2616			2978			175			633	
Approach Delay, s/veh		352.7			383.8			41.7			44.2	
Approach LOS		F			F			D			D	
Timer - Assigned Phs	1	2		4	5	6		8				
Phs Duration (G+Y+Rc), s	10.6	48.6		35.4	15.0	44.2		35.4				
Change Period (Y+Rc), s	4.6	6.2		5.4	4.6	6.2		5.4				
Max Green Setting (Gmax), s	6.0	42.4		30.0	10.4	38.0		30.0				
Max Q Clear Time (g_c+1), s	8.0	44.4		21.9	12.4	40.0		7.2				
Green Ext Time (p_c), s	0.0	0.0		1.6	0.0	0.0		0.6				

Intersection Summary

HCM 6th Ctrl Delay	328.2
HCM 6th LOS	F

Notes

- User approved pedestrian interval to be less than phase max green.
- User approved volume balancing among the lanes for turning movement.
- Unsignalized Delay for [EBR] is excluded from calculations of the approach delay and intersection delay.

Timings
37: Cactus Av. & Frederick St.

West Campus Upper Plateau (JN 14064)

09/20/2022



Lane Group	EBL	EBT	WBT	WBR	SBL	SBR
Lane Configurations	↗	↑↑↑	↑↑↑	↖	↗↖	↗
Traffic Volume (vph)	260	1802	2931	192	199	153
Future Volume (vph)	260	1802	2931	192	199	153
Turn Type	Prot	NA	NA	pm+ov	Prot	pm+ov
Protected Phases	5	2	6	4	4	5
Permitted Phases				6		4
Detector Phase	5	2	6	4	4	5
Switch Phase						
Minimum Initial (s)	5.0	10.0	10.0	10.0	10.0	5.0
Minimum Split (s)	9.2	28.2	29.2	36.4	36.4	9.2
Total Split (s)	23.0	83.6	60.6	36.4	36.4	23.0
Total Split (%)	19.2%	69.7%	50.5%	30.3%	30.3%	19.2%
Yellow Time (s)	3.2	5.2	5.2	4.4	4.4	3.2
All-Red Time (s)	1.0	1.0	1.0	1.0	1.0	1.0
Lost Time Adjust (s)	0.0	0.0	0.0	0.0	0.0	0.0
Total Lost Time (s)	4.2	6.2	6.2	5.4	5.4	4.2
Lead/Lag	Lead		Lag			Lead
Lead-Lag Optimize?	Yes		Yes			Yes
Recall Mode	None	None	None	Max	Max	None
Act Effct Green (s)	18.8	77.4	54.4	86.2	31.0	55.2
Actuated g/C Ratio	0.16	0.64	0.45	0.72	0.26	0.46
v/c Ratio	1.04	0.61	1.38	0.18	0.24	0.23
Control Delay	115.2	13.6	203.5	2.3	36.1	20.7
Queue Delay	0.0	0.0	0.0	0.0	0.0	0.0
Total Delay	115.2	13.6	203.5	2.3	36.1	20.7
LOS	F	B	F	A	D	C
Approach Delay		26.4	191.2		29.4	
Approach LOS		C	F		C	

Intersection Summary

Cycle Length: 120
 Actuated Cycle Length: 120
 Natural Cycle: 130
 Control Type: Actuated-Uncoordinated
 Maximum v/c Ratio: 1.38
 Intersection Signal Delay: 119.5
 Intersection LOS: F
 Intersection Capacity Utilization 92.5%
 ICU Level of Service F
 Analysis Period (min) 15

Splits and Phases: 37: Cactus Av. & Frederick St.



HCM 6th Signalized Intersection Summary
37: Cactus Av. & Frederick St.

West Campus Upper Plateau (JN 14064)

09/20/2022



Movement	EBL	EBT	WBT	WBR	SBL	SBR
Lane Configurations						
Traffic Volume (veh/h)	260	1802	2931	192	199	153
Future Volume (veh/h)	260	1802	2931	192	199	153
Initial Q (Qb), veh	0	0	0	0	0	0
Ped-Bike Adj(A_pbT)	1.00			0.98	1.00	1.00
Parking Bus, Adj	1.00	1.00	1.00	1.00	1.00	1.00
Work Zone On Approach		No	No		No	
Adj Sat Flow, veh/h/ln	1826	1811	1856	1870	1856	1826
Adj Flow Rate, veh/h	280	1938	3152	152	214	124
Peak Hour Factor	0.93	0.93	0.93	0.93	0.93	0.93
Percent Heavy Veh, %	5	6	3	2	3	5
Cap, veh/h	272	3189	2296	1112	886	642
Arrive On Green	0.16	0.65	0.45	0.45	0.26	0.26
Sat Flow, veh/h	1739	5107	5233	1550	3428	1547
Grp Volume(v), veh/h	280	1938	3152	152	214	124
Grp Sat Flow(s),veh/h/ln	1739	1648	1689	1550	1714	1547
Q Serve(g_s), s	18.8	27.5	54.4	3.8	5.9	6.1
Cycle Q Clear(g_c), s	18.8	27.5	54.4	3.8	5.9	6.1
Prop In Lane	1.00			1.00	1.00	1.00
Lane Grp Cap(c), veh/h	272	3189	2296	1112	886	642
V/C Ratio(X)	1.03	0.61	1.37	0.14	0.24	0.19
Avail Cap(c_a), veh/h	272	3189	2296	1112	886	642
HCM Platoon Ratio	1.00	1.00	1.00	1.00	1.00	1.00
Upstream Filter(I)	1.00	1.00	1.00	1.00	1.00	1.00
Uniform Delay (d), s/veh	50.6	12.4	32.8	5.5	35.2	22.3
Incr Delay (d2), s/veh	61.9	0.3	170.5	0.1	0.6	0.7
Initial Q Delay(d3),s/veh	0.0	0.0	0.0	0.0	0.0	0.0
%ile BackOfQ(50%),veh/ln	12.5	8.6	56.5	2.5	2.5	0.1
Unsig. Movement Delay, s/veh						
LnGrp Delay(d),s/veh	112.5	12.8	203.3	5.6	35.8	23.0
LnGrp LOS	F	B	F	A	D	C
Approach Vol, veh/h		2218	3304		338	
Approach Delay, s/veh		25.4	194.2		31.1	
Approach LOS		C	F		C	
Timer - Assigned Phs		2		4	5	6
Phs Duration (G+Y+Rc), s		83.6		36.4	23.0	60.6
Change Period (Y+Rc), s		6.2		5.4	* 4.2	6.2
Max Green Setting (Gmax), s		77.4		31.0	* 19	54.4
Max Q Clear Time (g_c+1), s		29.5		8.1	20.8	56.4
Green Ext Time (p_c), s		21.3		1.1	0.0	0.0

Intersection Summary

HCM 6th Ctrl Delay	120.9
HCM 6th LOS	F

Notes

* HCM 6th computational engine requires equal clearance times for the phases crossing the barrier.

Timings
38: Riverside Dr./Graham St. & Cactus Av.

West Campus Upper Plateau (JN 14064)

09/20/2022

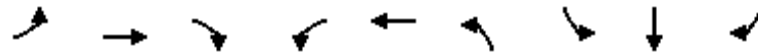

Lane Group	EBL	EBT	EBR	WBL	WBT	NBL	SBL	SBT	SBR	Ø2
Lane Configurations	↘	↑↑↑	↗	↘	↑↑↑	↗	↘	↑↑	↗	
Traffic Volume (vph)	222	1738	414	28	2989	50	355	458	338	
Future Volume (vph)	222	1738	414	28	2989	50	355	458	338	
Turn Type	Prot	NA	Perm	Prot	NA	Prot	Prot	NA	Perm	
Protected Phases	7	4		3	8	5	1	6		2
Permitted Phases			4						6	
Detector Phase	7	4	4	3	8	5	1	6	6	
Switch Phase										
Minimum Initial (s)	5.0	10.0	10.0	5.0	10.0	5.0	5.0	10.0	10.0	10.0
Minimum Split (s)	9.6	39.2	39.2	9.6	39.2	10.4	9.6	40.6	40.6	35.0
Total Split (s)	10.8	59.0	59.0	9.6	57.8	10.4	14.2	41.0	41.0	37.2
Total Split (%)	9.0%	49.2%	49.2%	8.0%	48.2%	8.7%	11.8%	34.2%	34.2%	31%
Yellow Time (s)	3.6	5.2	5.2	3.6	5.2	4.4	3.6	3.6	3.6	4.0
All-Red Time (s)	1.0	1.0	1.0	1.0	1.0	1.0	1.0	1.0	1.0	1.0
Lost Time Adjust (s)	0.0	0.0	0.0	0.0	0.0	0.0	0.0	0.0	0.0	
Total Lost Time (s)	4.6	6.2	6.2	4.6	6.2	5.4	4.6	4.6	4.6	
Lead/Lag	Lead	Lag	Lag	Lead	Lag	Lead	Lead	Lag	Lag	Lag
Lead-Lag Optimize?	Yes	Yes	Yes	Yes	Yes	Yes	Yes	Yes	Yes	Yes
Recall Mode	None	None	None	None	None	None	None	Max	Max	Max
Act Effct Green (s)	6.2	56.6	56.6	5.0	51.6	5.0	9.6	38.5	38.5	
Actuated g/C Ratio	0.05	0.47	0.47	0.04	0.43	0.04	0.08	0.32	0.32	
v/c Ratio	2.62	0.80	0.50	0.40	1.67	0.40	2.66	0.42	0.62	
Control Delay	783.4	31.0	10.0	71.8	330.8	65.3	789.5	34.0	28.5	
Queue Delay	0.0	0.0	0.0	0.0	0.0	0.0	0.0	0.0	0.0	
Total Delay	783.4	31.0	10.0	71.8	330.8	65.3	789.5	34.0	28.5	
LOS	F	C	B	E	F	E	F	C	C	
Approach Delay		97.7			328.6			265.5		
Approach LOS		F			F			F		

Intersection Summary

Cycle Length: 120
 Actuated Cycle Length: 120
 Natural Cycle: 130
 Control Type: Actuated-Uncoordinated
 Maximum v/c Ratio: 2.66
 Intersection Signal Delay: 237.7
 Intersection LOS: F
 Intersection Capacity Utilization 117.6%
 ICU Level of Service H
 Analysis Period (min) 15

Splits and Phases: 38: Riverside Dr./Graham St. & Cactus Av.

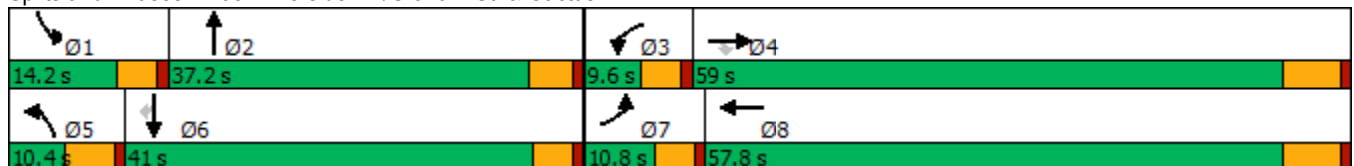

HCM 6th Signalized Intersection Summary
38: Riverside Dr./Graham St. & Cactus Av.

West Campus Upper Plateau (JN 14064)

09/20/2022



Movement	EBL	EBT	EBR	WBL	WBT	WBR	NBL	NBT	NBR	SBL	SBT	SBR
Lane Configurations	↖	↑↑↑	↗	↖	↑↑↑		↖↗	↑↗		↖	↑↑	↗
Traffic Volume (veh/h)	222	1738	414	28	2989	378	50	0	0	355	458	338
Future Volume (veh/h)	222	1738	414	28	2989	378	50	0	0	355	458	338
Initial Q (Qb), veh	0	0	0	0	0	0	0	0	0	0	0	0
Ped-Bike Adj(A_pbT)	1.00		1.00	1.00		1.00	1.00		1.00	1.00		1.00
Parking Bus, Adj	1.00	1.00	1.00	1.00	1.00	1.00	1.00	1.00	1.00	1.00	1.00	1.00
Work Zone On Approach		No			No			No			No	
Adj Sat Flow, veh/h/ln	1856	1811	1856	1900	1856	1885	1752	1900	1900	1885	1900	1856
Adj Flow Rate, veh/h	236	1849	428	30	3180	401	53	0	0	378	487	275
Peak Hour Factor	0.94	0.94	0.94	0.94	0.94	0.94	0.94	0.94	0.94	0.94	0.94	0.94
Percent Heavy Veh, %	3	6	3	0	3	1	10	0	0	1	0	3
Cap, veh/h	91	2251	716	48	1969	238	112	969	0	144	1109	483
Arrive On Green	0.05	0.46	0.46	0.03	0.43	0.43	0.03	0.00	0.00	0.08	0.31	0.31
Sat Flow, veh/h	1767	4944	1572	1810	4578	554	3237	3705	0	1795	3610	1572
Grp Volume(v), veh/h	236	1849	428	30	2311	1270	53	0	0	378	487	275
Grp Sat Flow(s),veh/h/ln	1767	1648	1572	1810	1689	1755	1618	1805	0	1795	1805	1572
Q Serve(g_s), s	6.2	39.0	24.4	2.0	51.6	51.6	1.9	0.0	0.0	9.6	13.0	17.6
Cycle Q Clear(g_c), s	6.2	39.0	24.4	2.0	51.6	51.6	1.9	0.0	0.0	9.6	13.0	17.6
Prop In Lane	1.00		1.00	1.00		0.32	1.00		0.00	1.00		1.00
Lane Grp Cap(c), veh/h	91	2251	716	48	1452	755	112	969	0	144	1109	483
V/C Ratio(X)	2.58	0.82	0.60	0.63	1.59	1.68	0.47	0.00	0.00	2.63	0.44	0.57
Avail Cap(c_a), veh/h	91	2251	716	75	1452	755	135	969	0	144	1109	483
HCM Platoon Ratio	1.00	1.00	1.00	1.00	1.00	1.00	1.00	1.00	1.00	1.00	1.00	1.00
Upstream Filter(I)	1.00	1.00	1.00	1.00	1.00	1.00	1.00	0.00	0.00	1.00	1.00	1.00
Uniform Delay (d), s/veh	56.9	28.4	24.5	57.8	34.2	34.2	56.9	0.0	0.0	55.2	33.3	34.9
Incr Delay (d2), s/veh	744.0	2.6	1.4	5.0	269.5	312.9	1.2	0.0	0.0	754.0	1.3	4.8
Initial Q Delay(d3),s/veh	0.0	0.0	0.0	0.0	0.0	0.0	0.0	0.0	0.0	0.0	0.0	0.0
%ile BackOfQ(50%),veh/ln	21.5	14.7	8.7	0.9	73.7	85.7	0.8	0.0	0.0	34.3	5.8	7.1
Unsig. Movement Delay, s/veh												
LnGrp Delay(d),s/veh	800.9	31.0	25.8	62.8	303.7	347.1	58.0	0.0	0.0	809.2	34.6	39.7
LnGrp LOS	F	C	C	E	F	F	E	A	A	F	C	D
Approach Vol, veh/h		2513			3611			53			1140	
Approach Delay, s/veh		102.4			316.9			58.0			292.6	
Approach LOS		F			F			E			F	
Timer - Assigned Phs	1	2	3	4	5	6	7	8				
Phs Duration (G+Y+Rc), s	14.2	37.2	7.8	60.8	9.5	41.9	10.8	57.8				
Change Period (Y+Rc), s	4.6	5.0	4.6	6.2	5.4	* 5	4.6	6.2				
Max Green Setting (Gmax), s	9.6	32.2	5.0	52.8	5.0	* 36	6.2	51.6				
Max Q Clear Time (g_c+I1), s	11.6	0.0	4.0	41.0	3.9	19.6	8.2	53.6				
Green Ext Time (p_c), s	0.0	0.0	0.0	9.2	0.0	3.7	0.0	0.0				

Intersection Summary

HCM 6th Ctrl Delay	237.6
HCM 6th LOS	F

Notes

* HCM 6th computational engine requires equal clearance times for the phases crossing the barrier.

Timings

1: Washington St & Van Buren Bl.

09/20/2022



Lane Group	EBL	EBT	WBL	WBT	WBR	NBL	NBT	NBR	SBL	SBT
Lane Configurations										
Traffic Volume (vph)	178	1932	284	1630	661	146	323	154	778	587
Future Volume (vph)	178	1932	284	1630	661	146	323	154	778	587
Turn Type	Prot	NA	Prot	NA	Perm	Prot	NA	Perm	Prot	NA
Protected Phases	5	2	1	6		3	8		7	4
Permitted Phases					6			8		
Detector Phase	5	2	1	6	6	3	8	8	7	4
Switch Phase										
Minimum Initial (s)	5.0	10.0	5.0	10.0	10.0	5.0	10.0	10.0	5.0	10.0
Minimum Split (s)	9.2	34.2	9.2	33.2	33.2	9.2	38.4	38.4	9.2	30.8
Total Split (s)	14.2	49.6	14.0	49.4	49.4	11.5	38.4	38.4	18.0	44.9
Total Split (%)	11.8%	41.3%	11.7%	41.2%	41.2%	9.6%	32.0%	32.0%	15.0%	37.4%
Yellow Time (s)	3.2	5.2	3.2	5.2	5.2	3.2	4.4	4.4	3.2	4.8
All-Red Time (s)	1.0	1.0	1.0	1.0	1.0	1.0	1.0	1.0	1.0	1.0
Lost Time Adjust (s)	0.0	0.0	0.0	0.0	0.0	0.0	0.0	0.0	0.0	0.0
Total Lost Time (s)	4.2	6.2	4.2	6.2	6.2	4.2	5.4	5.4	4.2	5.8
Lead/Lag	Lead	Lag	Lead	Lag	Lag	Lead	Lag	Lag	Lead	Lag
Lead-Lag Optimize?	Yes	Yes	Yes	Yes	Yes	Yes	Yes	Yes	Yes	Yes
Recall Mode	None	None	None	None	None	None	None	None	None	None
Act Effct Green (s)	10.0	43.6	9.8	43.4	43.4	7.1	22.5	22.5	13.8	28.8
Actuated g/C Ratio	0.09	0.40	0.09	0.40	0.40	0.06	0.20	0.20	0.13	0.26
v/c Ratio	1.09	1.54	1.78	1.18	0.86	0.65	0.45	0.35	1.80	0.77
Control Delay	145.1	272.2	405.5	119.8	31.7	65.7	39.8	7.7	398.0	42.2
Queue Delay	0.0	0.0	0.0	0.0	0.0	0.0	0.0	0.0	0.0	0.0
Total Delay	145.1	272.2	405.5	119.8	31.7	65.7	39.8	7.7	398.0	42.2
LOS	F	F	F	F	C	E	D	A	F	D
Approach Delay		262.2		128.7			37.9			228.4
Approach LOS		F		F			D			F

Intersection Summary

Cycle Length: 120
 Actuated Cycle Length: 109.8
 Natural Cycle: 115
 Control Type: Actuated-Uncoordinated
 Maximum v/c Ratio: 1.80
 Intersection Signal Delay: 185.5
 Intersection LOS: F
 Intersection Capacity Utilization 122.7%
 ICU Level of Service H
 Analysis Period (min) 15



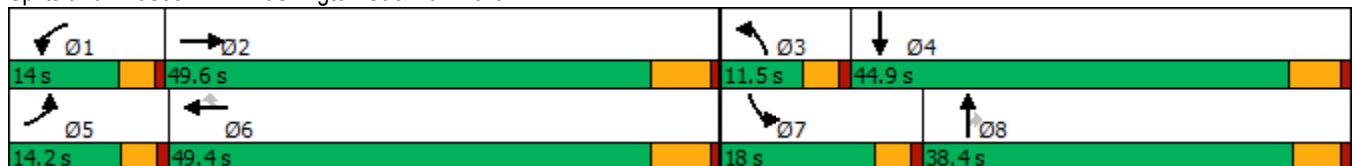



















Splits and Phases: 1: Washington St & Van Buren Bl.



HCM 6th Signalized Intersection Summary
1: Washington St & Van Buren Bl.

West Campus Upper Plateau (JN 14064)

09/20/2022

												
Movement	EBL	EBT	EBR	WBL	WBT	WBR	NBL	NBT	NBR	SBL	SBT	SBR
Lane Configurations												
Traffic Volume (veh/h)	178	1932	163	284	1630	661	146	323	154	778	587	122
Future Volume (veh/h)	178	1932	163	284	1630	661	146	323	154	778	587	122
Initial Q (Qb), veh	0	0	0	0	0	0	0	0	0	0	0	0
Ped-Bike Adj(A_pbT)	1.00		1.00	1.00		1.00	1.00		0.98	1.00		0.98
Parking Bus, Adj	1.00	1.00	1.00	1.00	1.00	1.00	1.00	1.00	1.00	1.00	1.00	1.00
Work Zone On Approach		No			No			No			No	
Adj Sat Flow, veh/h/ln	1900	1856	1870	1900	1870	1900	1885	1856	1870	1885	1885	1900
Adj Flow Rate, veh/h	180	1952	146	287	1646	575	147	326	117	786	593	77
Peak Hour Factor	0.99	0.99	0.99	0.99	0.99	0.99	0.99	0.99	0.99	0.99	0.99	0.99
Percent Heavy Veh, %	0	3	2	0	2	0	1	3	2	1	1	0
Cap, veh/h	174	1385	102	170	1472	666	209	571	252	461	745	97
Arrive On Green	0.10	0.42	0.42	0.09	0.41	0.41	0.06	0.16	0.16	0.13	0.23	0.23
Sat Flow, veh/h	1810	3328	246	1810	3554	1607	3483	3526	1557	3483	3182	412
Grp Volume(v), veh/h	180	1022	1076	287	1646	575	147	326	117	786	333	337
Grp Sat Flow(s),veh/h/ln	1810	1763	1811	1810	1777	1607	1742	1763	1557	1742	1791	1803
Q Serve(g_s), s	10.0	43.4	43.4	9.8	43.2	34.0	4.3	8.9	7.1	13.8	18.3	18.3
Cycle Q Clear(g_c), s	10.0	43.4	43.4	9.8	43.2	34.0	4.3	8.9	7.1	13.8	18.3	18.3
Prop In Lane	1.00		0.14	1.00		1.00	1.00		1.00	1.00		0.23
Lane Grp Cap(c), veh/h	174	734	754	170	1472	666	209	571	252	461	420	422
V/C Ratio(X)	1.04	1.39	1.43	1.69	1.12	0.86	0.70	0.57	0.46	1.71	0.79	0.80
Avail Cap(c_a), veh/h	174	734	754	170	1472	666	244	1116	493	461	671	676
HCM Platoon Ratio	1.00	1.00	1.00	1.00	1.00	1.00	1.00	1.00	1.00	1.00	1.00	1.00
Upstream Filter(I)	1.00	1.00	1.00	1.00	1.00	1.00	1.00	1.00	1.00	1.00	1.00	1.00
Uniform Delay (d), s/veh	47.1	30.4	30.4	47.2	30.5	27.9	48.1	40.4	39.6	45.2	37.6	37.6
Incr Delay (d2), s/veh	78.5	185.3	199.9	333.6	62.9	11.7	5.3	0.9	1.3	326.5	3.4	3.5
Initial Q Delay(d3),s/veh	0.0	0.0	0.0	0.0	0.0	0.0	0.0	0.0	0.0	0.0	0.0	0.0
%ile BackOfQ(50%),veh/ln	8.1	54.3	58.8	20.0	29.4	15.0	2.0	4.0	2.8	26.8	8.3	8.4
Unsig. Movement Delay, s/veh												
LnGrp Delay(d),s/veh	125.6	215.7	230.4	380.8	93.5	39.6	53.4	41.3	40.9	371.8	41.0	41.1
LnGrp LOS	F	F	F	F	F	D	D	D	D	F	D	D
Approach Vol, veh/h		2278			2508			590			1456	
Approach Delay, s/veh		215.5			114.0			44.2			219.6	
Approach LOS		F			F			D			F	
Timer - Assigned Phs	1	2	3	4	5	6	7	8				
Phs Duration (G+Y+Rc), s	14.0	49.6	10.5	30.2	14.2	49.4	18.0	22.7				
Change Period (Y+Rc), s	* 4.2	6.2	* 4.2	5.8	* 4.2	6.2	* 4.2	* 5.8				
Max Green Setting (Gmax), s	* 9.8	43.4	* 7.3	39.1	* 10	43.2	* 14	* 33				
Max Q Clear Time (g_c+I1), s	11.8	45.4	6.3	20.3	12.0	45.2	15.8	10.9				
Green Ext Time (p_c), s	0.0	0.0	0.0	4.0	0.0	0.0	0.0	2.6				

Intersection Summary

HCM 6th Ctrl Delay	164.3
HCM 6th LOS	F

Notes

* HCM 6th computational engine requires equal clearance times for the phases crossing the barrier.

Timings
2: Central Ave & Arlington Ave/Chicago Ave

West Campus Upper Plateau (JN 14064)

09/20/2022



Lane Group	EBL	EBT	EBR	WBL	WBT	WBR	NBL	NBT	NBR	SBL	SBT
Lane Configurations	↘	↑↑	↗↗	↘↘	↑↑	↗	↘↘	↑↑	↗	↘↘	↑↑↗
Traffic Volume (vph)	33	976	1516	832	876	281	1176	1501	388	649	2387
Future Volume (vph)	33	976	1516	832	876	281	1176	1501	388	649	2387
Turn Type	Prot	NA	pm+ov	Prot	NA	pm+ov	Prot	NA	pm+ov	Prot	NA
Protected Phases	7	4	5	3	8	1	5	2	3	1	6
Permitted Phases			4			8			2		
Detector Phase	7	4	5	3	8	1	5	2	3	1	6
Switch Phase											
Minimum Initial (s)	5.0	10.0	5.0	5.0	10.0	5.0	5.0	10.0	5.0	5.0	10.0
Minimum Split (s)	9.6	32.8	9.6	9.6	30.8	9.6	9.6	35.4	9.6	9.6	30.4
Total Split (s)	10.6	32.8	30.0	22.0	44.2	24.4	30.0	50.8	22.0	24.4	45.2
Total Split (%)	8.2%	25.2%	23.1%	16.9%	34.0%	18.8%	23.1%	39.1%	16.9%	18.8%	34.8%
Yellow Time (s)	3.6	4.8	3.6	3.6	4.8	3.6	3.6	4.4	3.6	3.6	4.4
All-Red Time (s)	1.0	1.0	1.0	1.0	1.0	1.0	1.0	1.0	1.0	1.0	1.0
Lost Time Adjust (s)	0.0	0.0	0.0	0.0	0.0	0.0	0.0	0.0	0.0	0.0	0.0
Total Lost Time (s)	4.6	5.8	4.6	4.6	5.8	4.6	4.6	5.4	4.6	4.6	5.4
Lead/Lag	Lead	Lag	Lead	Lead	Lag	Lead	Lead	Lag	Lead	Lead	Lag
Lead-Lag Optimize?	Yes	Yes	Yes	Yes	Yes	Yes	Yes	Yes	Yes	Yes	Yes
Recall Mode	None	None	None	None	None	None	None	None	None	None	None
Act Effct Green (s)	5.7	27.0	53.6	17.4	42.6	68.2	25.4	45.4	63.6	19.8	39.8
Actuated g/C Ratio	0.04	0.21	0.41	0.13	0.33	0.52	0.20	0.35	0.49	0.15	0.31
v/c Ratio	0.43	1.36	1.29	1.89	0.77	0.33	1.79	1.25	0.51	1.27	1.60
Control Delay	76.9	209.2	168.9	438.9	45.4	13.3	392.9	157.3	18.9	179.2	305.2
Queue Delay	0.0	0.0	0.0	0.0	0.0	0.0	0.0	0.0	0.0	0.0	0.0
Total Delay	76.9	209.2	168.9	438.9	45.4	13.3	392.9	157.3	18.9	179.2	305.2
LOS	E	F	F	F	D	B	F	F	B	F	F
Approach Delay		183.3			205.5			230.2			278.5
Approach LOS		F			F			F			F

Intersection Summary

Cycle Length: 130
 Actuated Cycle Length: 130
 Natural Cycle: 120
 Control Type: Actuated-Uncoordinated
 Maximum v/c Ratio: 1.89
 Intersection Signal Delay: 228.3
 Intersection LOS: F
 Intersection Capacity Utilization 148.0%
 ICU Level of Service H
 Analysis Period (min) 15

Splits and Phases: 2: Central Ave & Arlington Ave/Chicago Ave

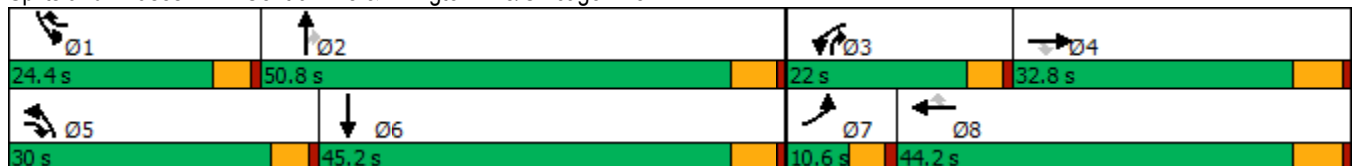

HCM 6th Signalized Intersection Summary
2: Central Ave & Arlington Ave/Chicago Ave

West Campus Upper Plateau (JN 14064)

09/20/2022



Movement	EBL	EBT	EBR	WBL	WBT	WBR	NBL	NBT	NBR	SBL	SBT	SBR
Lane Configurations	↘	↑↑	↗↘	↗↘	↑↑	↗	↗↘	↑↑	↗	↗↘	↑↑↘	
Traffic Volume (veh/h)	33	976	1516	832	876	281	1176	1501	388	649	2387	27
Future Volume (veh/h)	33	976	1516	832	876	281	1176	1501	388	649	2387	27
Initial Q (Qb), veh	0	0	0	0	0	0	0	0	0	0	0	0
Ped-Bike Adj(A_pbT)	1.00		1.00	1.00		1.00	1.00		0.99	1.00		1.00
Parking Bus, Adj	1.00	1.00	1.00	1.00	1.00	1.00	1.00	1.00	1.00	1.00	1.00	1.00
Work Zone On Approach		No			No			No			No	
Adj Sat Flow, veh/h/ln	1900	1900	1900	1870	1900	1900	1900	1885	1870	1900	1885	1900
Adj Flow Rate, veh/h	34	1017	1182	867	912	206	1225	1564	336	676	2486	26
Peak Hour Factor	0.96	0.96	0.96	0.96	0.96	0.96	0.96	0.96	0.96	0.96	0.96	0.96
Percent Heavy Veh, %	0	0	0	2	0	0	0	1	2	0	1	0
Cap, veh/h	49	750	1141	463	1135	751	686	1251	758	535	1608	17
Arrive On Green	0.03	0.21	0.21	0.13	0.31	0.31	0.20	0.35	0.35	0.15	0.31	0.31
Sat Flow, veh/h	1810	3610	2830	3456	3610	1610	3510	3582	1564	3510	5252	55
Grp Volume(v), veh/h	34	1017	1182	867	912	206	1225	1564	336	676	1623	889
Grp Sat Flow(s),veh/h/ln	1810	1805	1415	1728	1805	1610	1755	1791	1564	1755	1716	1875
Q Serve(g_s), s	2.4	27.0	27.0	17.4	30.1	10.2	25.4	45.4	18.4	19.8	39.8	39.8
Cycle Q Clear(g_c), s	2.4	27.0	27.0	17.4	30.1	10.2	25.4	45.4	18.4	19.8	39.8	39.8
Prop In Lane	1.00		1.00	1.00		1.00	1.00		1.00	1.00		0.03
Lane Grp Cap(c), veh/h	49	750	1141	463	1135	751	686	1251	758	535	1050	574
V/C Ratio(X)	0.69	1.36	1.04	1.87	0.80	0.27	1.79	1.25	0.44	1.26	1.54	1.55
Avail Cap(c_a), veh/h	84	750	1141	463	1135	751	686	1251	758	535	1050	574
HCM Platoon Ratio	1.00	1.00	1.00	1.00	1.00	1.00	1.00	1.00	1.00	1.00	1.00	1.00
Upstream Filter(I)	1.00	1.00	1.00	1.00	1.00	1.00	1.00	1.00	1.00	1.00	1.00	1.00
Uniform Delay (d), s/veh	62.7	51.5	38.8	56.3	40.9	21.2	52.3	42.3	22.1	55.1	45.1	45.1
Incr Delay (d2), s/veh	6.3	169.1	36.3	401.7	4.3	0.2	359.6	119.4	0.4	133.3	249.9	255.6
Initial Q Delay(d3),s/veh	0.0	0.0	0.0	0.0	0.0	0.0	0.0	0.0	0.0	0.0	0.0	0.0
%ile BackOfQ(50%),veh/ln	1.2	29.4	22.9	33.2	13.6	3.7	45.2	40.1	6.5	18.5	52.9	58.7
Unsig. Movement Delay, s/veh												
LnGrp Delay(d),s/veh	69.0	220.6	75.1	458.0	45.2	21.4	411.9	161.7	22.5	188.4	295.0	300.7
LnGrp LOS	E	F	F	F	D	C	F	F	C	F	F	F
Approach Vol, veh/h		2233			1985			3125			3188	
Approach Delay, s/veh		141.2			223.0			244.8			274.0	
Approach LOS		F			F			F			F	
Timer - Assigned Phs	1	2	3	4	5	6	7	8				
Phs Duration (G+Y+Rc), s	24.4	50.8	22.0	32.8	30.0	45.2	8.1	46.7				
Change Period (Y+Rc), s	4.6	5.4	4.6	5.8	4.6	5.4	4.6	5.8				
Max Green Setting (Gmax), s	19.8	45.4	17.4	27.0	25.4	39.8	6.0	38.4				
Max Q Clear Time (g_c+I1), s	21.8	47.4	19.4	29.0	27.4	41.8	4.4	32.1				
Green Ext Time (p_c), s	0.0	0.0	0.0	0.0	0.0	0.0	0.0	3.3				
Intersection Summary												
HCM 6th Ctrl Delay			227.6									
HCM 6th LOS			F									

Timings

3: Overlook Pkwy./Canyon Crest Dr. & Alessandro Bl/Alessandro Bl.



Lane Group	EBL	EBT	WBL	WBT	WBR	NBL	NBT	NBR	SBL	SBT	SBR
Lane Configurations	↙	↕↕↕	↙	↕↕↕	↙	↙	↕↕	↙	↙↙	↙	↙
Traffic Volume (vph)	89	3946	149	3001	790	87	141	240	860	235	69
Future Volume (vph)	89	3946	149	3001	790	87	141	240	860	235	69
Turn Type	Prot	NA	Prot	NA	pm+ov	Split	NA	Perm	Split	NA	Perm
Protected Phases	5	2	1	6	4	8	8		4	4	
Permitted Phases					6			8			4
Detector Phase	5	2	1	6	4	8	8	8	4	4	4
Switch Phase											
Minimum Initial (s)	5.0	10.0	5.0	10.0	10.0	10.0	10.0	10.0	10.0	10.0	10.0
Minimum Split (s)	9.2	35.2	9.2	35.2	38.8	38.8	38.8	38.8	38.8	38.8	38.8
Total Split (s)	9.2	43.2	9.2	43.2	38.8	38.8	38.8	38.8	38.8	38.8	38.8
Total Split (%)	7.1%	33.2%	7.1%	33.2%	29.8%	29.8%	29.8%	29.8%	29.8%	29.8%	29.8%
Yellow Time (s)	3.2	5.2	3.2	5.2	4.8	4.8	4.8	4.8	4.8	4.8	4.8
All-Red Time (s)	1.0	1.0	1.0	1.0	1.0	1.0	1.0	1.0	1.0	1.0	1.0
Lost Time Adjust (s)	0.0	0.0	0.0	0.0	0.0	0.0	0.0	0.0	0.0	0.0	0.0
Total Lost Time (s)	4.2	6.2	4.2	6.2	5.8	5.8	5.8	5.8	5.8	5.8	5.8
Lead/Lag	Lead	Lag	Lead	Lag							
Lead-Lag Optimize?	Yes	Yes	Yes	Yes							
Recall Mode	None	None	None	None	None	None	None	None	None	None	None
Act Effct Green (s)	5.0	37.1	5.0	37.1	75.9	16.5	16.5	16.5	32.6	32.6	32.6
Actuated g/C Ratio	0.04	0.33	0.04	0.33	0.67	0.15	0.15	0.15	0.29	0.29	0.29
v/c Ratio	1.21	2.52	1.94	1.86	0.67	0.35	0.28	0.76	0.81	0.80	0.13
Control Delay	217.8	706.5	497.9	414.3	8.1	46.7	43.8	40.3	45.9	52.4	2.4
Queue Delay	0.0	0.0	0.0	0.0	0.0	0.0	0.0	0.0	0.0	0.0	0.0
Total Delay	217.8	706.5	497.9	414.3	8.1	46.7	43.8	40.3	45.9	52.4	2.4
LOS	F	F	F	F	A	D	D	D	D	D	A
Approach Delay		696.0		336.0			42.6			45.4	
Approach LOS		F		F			D			D	

Intersection Summary

Cycle Length: 130
 Actuated Cycle Length: 113.3
 Natural Cycle: 125
 Control Type: Actuated-Uncoordinated
 Maximum v/c Ratio: 2.52
 Intersection Signal Delay: 440.6
 Intersection LOS: F
 Intersection Capacity Utilization 133.6%
 ICU Level of Service H
 Analysis Period (min) 15

Splits and Phases: 3: Overlook Pkwy./Canyon Crest Dr. & Alessandro Bl/Alessandro Bl.

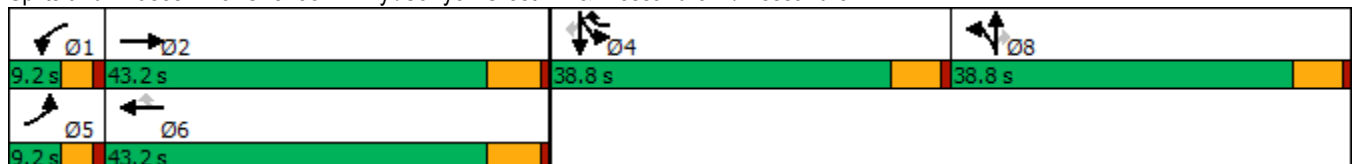

HCM 6th Signalized Intersection Summary

West Campus Upper Plateau (JN 14064)

3: Overlook Pkwy./Canyon Crest Dr. & Alessandro Bl/Alessandro Bl.

09/20/2022



Movement	EBL	EBT	EBR	WBL	WBT	WBR	NBL	NBT	NBR	SBL	SBT	SBR
Lane Configurations	↗	↑↑↑		↖	↑↑↑	↗	↖	↑↑	↗	↖↗	↖	↗
Traffic Volume (veh/h)	89	3946	111	149	3001	790	87	141	240	860	235	69
Future Volume (veh/h)	89	3946	111	149	3001	790	87	141	240	860	235	69
Initial Q (Qb), veh	0	0	0	0	0	0	0	0	0	0	0	0
Ped-Bike Adj(A_pbT)	1.00		1.00	1.00		1.00	1.00		1.00	1.00		1.00
Parking Bus, Adj	1.00	1.00	1.00	1.00	1.00	1.00	1.00	1.00	1.00	1.00	1.00	1.00
Work Zone On Approach		No			No			No			No	
Adj Sat Flow, veh/h/ln	1841	1885	1885	1900	1885	1885	1885	1900	1900	1885	1885	1870
Adj Flow Rate, veh/h	93	4110	116	155	3126	815	91	147	242	828	340	63
Peak Hour Factor	0.96	0.96	0.96	0.96	0.96	0.96	0.96	0.96	0.96	0.96	0.96	0.96
Percent Heavy Veh, %	4	1	1	0	1	1	1	0	0	1	1	2
Cap, veh/h	77	1668	47	79	1668	937	318	640	285	942	495	416
Arrive On Green	0.04	0.32	0.32	0.04	0.32	0.32	0.18	0.18	0.18	0.26	0.26	0.26
Sat Flow, veh/h	1753	5146	144	1810	5147	1598	1795	3610	1610	3591	1885	1585
Grp Volume(v), veh/h	93	2727	1499	155	3126	815	91	147	242	828	340	63
Grp Sat Flow(s),veh/h/ln	1753	1716	1859	1810	1716	1598	1795	1805	1610	1795	1885	1585
Q Serve(g_s), s	5.0	37.0	37.0	5.0	37.0	37.0	5.0	4.0	16.6	25.2	18.5	3.5
Cycle Q Clear(g_c), s	5.0	37.0	37.0	5.0	37.0	37.0	5.0	4.0	16.6	25.2	18.5	3.5
Prop In Lane	1.00		0.08	1.00		1.00	1.00		1.00	1.00		1.00
Lane Grp Cap(c), veh/h	77	1112	602	79	1668	937	318	640	285	942	495	416
V/C Ratio(X)	1.21	2.45	2.49	1.96	1.87	0.87	0.29	0.23	0.85	0.88	0.69	0.15
Avail Cap(c_a), veh/h	77	1112	602	79	1668	937	519	1043	465	1038	545	458
HCM Platoon Ratio	1.00	1.00	1.00	1.00	1.00	1.00	1.00	1.00	1.00	1.00	1.00	1.00
Upstream Filter(I)	1.00	1.00	1.00	1.00	1.00	1.00	1.00	1.00	1.00	1.00	1.00	1.00
Uniform Delay (d), s/veh	54.6	38.6	38.6	54.6	38.6	17.4	40.7	40.3	45.5	40.4	37.9	32.4
Incr Delay (d2), s/veh	170.3	656.7	674.5	472.6	395.8	8.9	0.5	0.2	7.8	8.2	3.2	0.2
Initial Q Delay(d3),s/veh	0.0	0.0	0.0	0.0	0.0	0.0	0.0	0.0	0.0	0.0	0.0	0.0
%ile BackOfQ(50%),veh/ln	5.8	115.9	128.6	12.6	75.6	25.1	2.2	1.7	7.0	11.8	8.7	1.3
Unsig. Movement Delay, s/veh												
LnGrp Delay(d),s/veh	224.9	695.3	713.1	527.2	434.4	26.3	41.2	40.5	53.3	48.6	41.1	32.5
LnGrp LOS	F	F	F	F	F	C	D	D	D	D	D	C
Approach Vol, veh/h		4319			4096			480			1231	
Approach Delay, s/veh		691.3			356.7			47.1			45.7	
Approach LOS		F			F			D			D	
Timer - Assigned Phs	1	2		4	5	6		8				
Phs Duration (G+Y+Rc), s	9.2	43.2		35.8	9.2	43.2		26.0				
Change Period (Y+Rc), s	* 4.2	6.2		5.8	* 4.2	6.2		5.8				
Max Green Setting (Gmax), s	* 5	37.0		33.0	* 5	37.0		33.0				
Max Q Clear Time (g_c+I1), s	7.0	39.0		27.2	7.0	39.0		18.6				
Green Ext Time (p_c), s	0.0	0.0		2.7	0.0	0.0		1.6				

Intersection Summary

HCM 6th Ctrl Delay	447.0
HCM 6th LOS	F

Notes

- User approved pedestrian interval to be less than phase max green.
- User approved volume balancing among the lanes for turning movement.
- * HCM 6th computational engine requires equal clearance times for the phases crossing the barrier.

Timings
4: Van Buren Bl. & Wood Rd.

West Campus Upper Plateau (JN 14064)

09/20/2022

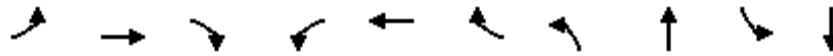

Lane Group	EBL	EBT	EBR	WBL	WBT	WBR	NBL	NBT	SBL	SBT
Lane Configurations	↘	↑↑	↗	↘↗	↑↑	↗	↘↗	↑↔	↘	↑↔
Traffic Volume (vph)	236	2238	280	387	2117	154	397	322	148	303
Future Volume (vph)	236	2238	280	387	2117	154	397	322	148	303
Turn Type	Prot	NA	pm+ov	Prot	NA	Perm	Prot	NA	Prot	NA
Protected Phases	5	2	3	1	6		3	8	7	4
Permitted Phases			2			6				
Detector Phase	5	2	3	1	6	6	3	8	7	4
Switch Phase										
Minimum Initial (s)	5.0	10.0	5.0	5.0	10.0	10.0	5.0	10.0	5.0	10.0
Minimum Split (s)	9.2	30.2	9.2	9.2	30.2	30.2	9.2	38.4	9.2	15.8
Total Split (s)	16.5	57.2	21.7	13.2	53.9	53.9	21.7	38.4	11.2	27.9
Total Split (%)	13.8%	47.7%	18.1%	11.0%	44.9%	44.9%	18.1%	32.0%	9.3%	23.3%
Yellow Time (s)	3.2	5.2	3.2	3.2	5.2	5.2	3.2	4.4	3.2	4.8
All-Red Time (s)	1.0	1.0	1.0	1.0	1.0	1.0	1.0	1.0	1.0	1.0
Lost Time Adjust (s)	0.0	0.0	0.0	0.0	0.0	0.0	0.0	0.0	0.0	0.0
Total Lost Time (s)	4.2	6.2	4.2	4.2	6.2	6.2	4.2	5.4	4.2	5.8
Lead/Lag	Lead	Lag	Lead	Lead	Lag	Lag	Lead	Lag	Lead	Lag
Lead-Lag Optimize?	Yes	Yes	Yes	Yes	Yes	Yes	Yes	Yes	Yes	Yes
Recall Mode	None	None	None	None	None	None	None	None	None	None
Act Effct Green (s)	12.3	51.1	69.9	9.0	47.8	47.8	16.8	30.3	7.0	20.1
Actuated g/C Ratio	0.10	0.44	0.60	0.08	0.41	0.41	0.14	0.26	0.06	0.17
v/c Ratio	1.37	1.58	0.32	1.58	1.58	0.23	0.88	0.73	1.52	0.86
Control Delay	237.7	291.7	8.6	315.0	293.7	6.6	69.3	35.1	312.0	49.1
Queue Delay	0.0	0.0	0.0	0.0	0.0	0.0	0.0	0.0	0.0	0.0
Total Delay	237.7	291.7	8.6	315.0	293.7	6.6	69.3	35.1	312.0	49.1
LOS	F	F	A	F	F	A	E	D	F	D
Approach Delay		258.3			280.2			48.3		105.4
Approach LOS		F			F			D		F

Intersection Summary

Cycle Length: 120
 Actuated Cycle Length: 117.4
 Natural Cycle: 120
 Control Type: Actuated-Uncoordinated
 Maximum v/c Ratio: 1.58
 Intersection Signal Delay: 221.2
 Intersection LOS: F
 Intersection Capacity Utilization 120.0%
 ICU Level of Service H
 Analysis Period (min) 15



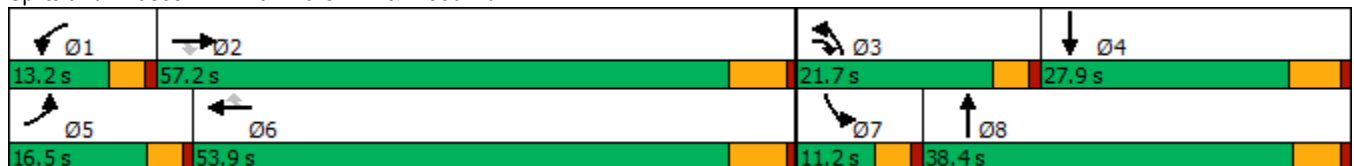





















Splits and Phases: 4: Van Buren Bl. & Wood Rd.



HCM 6th Signalized Intersection Summary
4: Van Buren Bl. & Wood Rd.

West Campus Upper Plateau (JN 14064)

09/20/2022

												
Movement	EBL	EBT	EBR	WBL	WBT	WBR	NBL	NBT	NBR	SBL	SBT	SBR
Lane Configurations												
Traffic Volume (veh/h)	236	2238	280	387	2117	154	397	322	316	148	303	240
Future Volume (veh/h)	236	2238	280	387	2117	154	397	322	316	148	303	240
Initial Q (Qb), veh	0	0	0	0	0	0	0	0	0	0	0	0
Ped-Bike Adj(A_pbT)	1.00		0.98	1.00		0.99	1.00		0.97	1.00		0.99
Parking Bus, Adj	1.00	1.00	1.00	1.00	1.00	1.00	1.00	1.00	1.00	1.00	1.00	1.00
Work Zone On Approach		No			No			No			No	
Adj Sat Flow, veh/h/ln	1885	1870	1870	1885	1885	1885	1870	1885	1870	1885	1885	1885
Adj Flow Rate, veh/h	257	2433	200	421	2301	120	432	350	263	161	329	187
Peak Hour Factor	0.92	0.92	0.92	0.92	0.92	0.92	0.92	0.92	0.92	0.92	0.92	0.92
Percent Heavy Veh, %	1	2	2	1	1	1	2	1	2	1	1	1
Cap, veh/h	189	1547	903	268	1459	641	487	493	363	107	381	212
Arrive On Green	0.11	0.44	0.44	0.08	0.41	0.41	0.14	0.25	0.25	0.06	0.17	0.17
Sat Flow, veh/h	1795	3554	1561	3483	3582	1574	3456	1942	1430	1795	2209	1227
Grp Volume(v), veh/h	257	2433	200	421	2301	120	432	322	291	161	265	251
Grp Sat Flow(s),veh/h/ln	1795	1777	1561	1742	1791	1574	1728	1791	1581	1795	1791	1645
Q Serve(g_s), s	12.3	51.0	7.3	9.0	47.7	5.7	14.4	19.2	19.7	7.0	16.9	17.4
Cycle Q Clear(g_c), s	12.3	51.0	7.3	9.0	47.7	5.7	14.4	19.2	19.7	7.0	16.9	17.4
Prop In Lane	1.00		1.00	1.00		1.00	1.00		0.90	1.00		0.75
Lane Grp Cap(c), veh/h	189	1547	903	268	1459	641	487	454	401	107	309	284
V/C Ratio(X)	1.36	1.57	0.22	1.57	1.58	0.19	0.89	0.71	0.72	1.50	0.86	0.88
Avail Cap(c_a), veh/h	189	1547	903	268	1459	641	516	505	446	107	338	310
HCM Platoon Ratio	1.00	1.00	1.00	1.00	1.00	1.00	1.00	1.00	1.00	1.00	1.00	1.00
Upstream Filter(I)	1.00	1.00	1.00	1.00	1.00	1.00	1.00	1.00	1.00	1.00	1.00	1.00
Uniform Delay (d), s/veh	52.4	33.1	12.1	54.1	34.7	22.3	49.4	39.8	40.0	55.1	47.1	47.3
Incr Delay (d2), s/veh	193.6	260.7	0.2	275.1	263.1	0.2	15.6	4.0	5.2	267.5	18.2	23.2
Initial Q Delay(d3),s/veh	0.0	0.0	0.0	0.0	0.0	0.0	0.0	0.0	0.0	0.0	0.0	0.0
%ile BackOfQ(50%),veh/ln	15.5	76.0	2.4	14.0	72.4	2.1	7.1	8.7	8.0	11.1	8.9	8.8
Unsig. Movement Delay, s/veh												
LnGrp Delay(d),s/veh	246.0	293.7	12.2	329.2	297.8	22.5	64.9	43.8	45.1	322.6	65.2	70.5
LnGrp LOS	F	F	B	F	F	C	E	D	D	F	E	E
Approach Vol, veh/h		2890			2842			1045			677	
Approach Delay, s/veh		270.0			290.9			52.9			128.4	
Approach LOS		F			F			D			F	
Timer - Assigned Phs	1	2	3	4	5	6	7	8				
Phs Duration (G+Y+Rc), s	13.2	57.2	20.7	26.0	16.5	53.9	11.2	35.5				
Change Period (Y+Rc), s	* 4.2	6.2	* 4.2	5.8	* 4.2	6.2	* 4.2	* 5.8				
Max Green Setting (Gmax), s	* 9	51.0	* 18	22.1	* 12	47.7	* 7	* 33				
Max Q Clear Time (g_c+I1), s	11.0	53.0	16.4	19.4	14.3	49.7	9.0	21.7				
Green Ext Time (p_c), s	0.0	0.0	0.1	0.8	0.0	0.0	0.0	2.8				
Intersection Summary												
HCM 6th Ctrl Delay				234.7								
HCM 6th LOS				F								
Notes												
* HCM 6th computational engine requires equal clearance times for the phases crossing the barrier.												

Timings
5: Trautwein Rd. & Alessandro Bl.

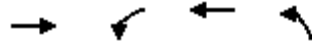

Lane Group	EBT	WBL	WBT	NBL
Lane Configurations	↑↑↑	↰↱	↑↑↑	↰↱↱
Traffic Volume (vph)	2540	427	2821	1397
Future Volume (vph)	2540	427	2821	1397
Turn Type	NA	Prot	NA	Prot
Protected Phases	2	1	6	8
Permitted Phases				
Detector Phase	2	1	6	8
Switch Phase				
Minimum Initial (s)	10.0	5.0	10.0	10.0
Minimum Split (s)	33.2	9.2	16.2	16.2
Total Split (s)	63.0	19.0	82.0	38.0
Total Split (%)	52.5%	15.8%	68.3%	31.7%
Yellow Time (s)	5.2	3.2	5.2	5.2
All-Red Time (s)	1.0	1.0	1.0	1.0
Lost Time Adjust (s)	0.0	0.0	0.0	0.0
Total Lost Time (s)	6.2	4.2	6.2	6.2
Lead/Lag	Lag	Lead		
Lead-Lag Optimize?	Yes	Yes		
Recall Mode	None	None	None	None
Act Effect Green (s)	56.8	14.8	75.8	31.8
Actuated g/C Ratio	0.47	0.12	0.63	0.26
v/c Ratio	1.26	1.05	0.92	1.21
Control Delay	149.2	108.2	25.0	139.6
Queue Delay	0.0	0.0	0.0	0.0
Total Delay	149.2	108.2	25.0	139.6
LOS	F	F	C	F
Approach Delay	149.2		35.9	139.6
Approach LOS	F		D	F

Intersection Summary

Cycle Length: 120
 Actuated Cycle Length: 120
 Natural Cycle: 120
 Control Type: Actuated-Uncoordinated
 Maximum v/c Ratio: 1.26
 Intersection Signal Delay: 99.1
 Intersection LOS: F
 Intersection Capacity Utilization 111.4%
 ICU Level of Service H
 Analysis Period (min) 15

Splits and Phases: 5: Trautwein Rd. & Alessandro Bl.



HCM 6th Signalized Intersection Summary
5: Trautwein Rd. & Alessandro Bl.

West Campus Upper Plateau (JN 14064)
09/20/2022

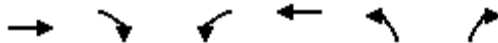

Movement	EBT	EBR	WBL	WBT	NBL	NBR
Lane Configurations	↑↑↑		↵↵	↑↑↑	↵↵↵	
Traffic Volume (veh/h)	2540	317	427	2821	1397	126
Future Volume (veh/h)	2540	317	427	2821	1397	126
Initial Q (Qb), veh	0	0	0	0	0	0
Ped-Bike Adj(A_pbT)		1.00	1.00		1.00	1.00
Parking Bus, Adj	1.00	1.00	1.00	1.00	1.00	1.00
Work Zone On Approach	No			No	No	
Adj Sat Flow, veh/h/ln	1885	1900	1885	1885	1885	1900
Adj Flow Rate, veh/h	2674	334	449	2969	1595	0
Peak Hour Factor	0.95	0.95	0.95	0.95	0.95	0.95
Percent Heavy Veh, %	1	0	1	1	1	0
Cap, veh/h	2204	264	430	3251	1427	427
Arrive On Green	0.47	0.47	0.12	0.63	0.27	0.00
Sat Flow, veh/h	4826	559	3483	5316	5386	1610
Grp Volume(v), veh/h	1941	1067	449	2969	1595	0
Grp Sat Flow(s),veh/h/ln	1716	1785	1742	1716	1795	1610
Q Serve(g_s), s	56.8	56.8	14.8	60.3	31.8	0.0
Cycle Q Clear(g_c), s	56.8	56.8	14.8	60.3	31.8	0.0
Prop In Lane		0.31	1.00		1.00	1.00
Lane Grp Cap(c), veh/h	1624	845	430	3251	1427	427
V/C Ratio(X)	1.20	1.26	1.05	0.91	1.12	0.00
Avail Cap(c_a), veh/h	1624	845	430	3251	1427	427
HCM Platoon Ratio	1.00	1.00	1.00	1.00	1.00	1.00
Upstream Filter(I)	1.00	1.00	1.00	1.00	1.00	0.00
Uniform Delay (d), s/veh	31.6	31.6	52.6	19.2	44.1	0.0
Incr Delay (d2), s/veh	94.3	127.7	55.7	4.6	62.9	0.0
Initial Q Delay(d3),s/veh	0.0	0.0	0.0	0.0	0.0	0.0
%ile BackOfQ(50%),veh/ln	42.5	52.0	9.5	20.7	21.7	0.0
Unsig. Movement Delay, s/veh						
LnGrp Delay(d),s/veh	125.9	159.3	108.3	23.8	107.0	0.0
LnGrp LOS	F	F	F	C	F	A
Approach Vol, veh/h	3008			3418	1595	
Approach Delay, s/veh	137.7			34.9	107.0	
Approach LOS	F			C	F	
Timer - Assigned Phs	1	2			6	8
Phs Duration (G+Y+Rc), s	19.0	63.0			82.0	38.0
Change Period (Y+Rc), s	* 4.2	6.2			6.2	6.2
Max Green Setting (Gmax), s	* 15	56.8			75.8	31.8
Max Q Clear Time (g_c+I1), s	16.8	58.8			62.3	33.8
Green Ext Time (p_c), s	0.0	0.0			13.2	0.0

Intersection Summary

HCM 6th Ctrl Delay	87.8
HCM 6th LOS	F

Notes

User approved volume balancing among the lanes for turning movement.
* HCM 6th computational engine requires equal clearance times for the phases crossing the barrier.

Timings
6: Trautwein Rd. & Grove Community Dr

West Campus Upper Plateau (JN 14064)

09/20/2022



Lane Group	WBL	WBR	NBT	NBR	SBL	SBT
Lane Configurations	↙	↗↗	↕↕	↗	↗↗	↕↕
Traffic Volume (vph)	61	283	1676	65	447	2413
Future Volume (vph)	61	283	1676	65	447	2413
Turn Type	Prot	pm+ov	NA	Perm	Prot	NA
Protected Phases	8	1	2		1	6
Permitted Phases		8		2		
Detector Phase	8	1	2	2	1	6
Switch Phase						
Minimum Initial (s)	10.0	5.0	10.0	10.0	5.0	10.0
Minimum Split (s)	34.6	9.6	46.2	46.2	9.6	28.2
Total Split (s)	35.0	29.0	56.0	56.0	29.0	85.0
Total Split (%)	29.2%	24.2%	46.7%	46.7%	24.2%	70.8%
Yellow Time (s)	3.6	3.6	5.2	5.2	3.6	5.2
All-Red Time (s)	1.0	1.0	1.0	1.0	1.0	1.0
Lost Time Adjust (s)	0.0	0.0	0.0	0.0	0.0	0.0
Total Lost Time (s)	4.6	4.6	6.2	6.2	4.6	6.2
Lead/Lag		Lead	Lag	Lag	Lead	
Lead-Lag Optimize?		Yes	Yes	Yes	Yes	
Recall Mode	None	None	None	None	None	None
Act Effct Green (s)	13.2	27.9	57.9	57.9	17.1	81.1
Actuated g/C Ratio	0.13	0.28	0.58	0.58	0.17	0.81
v/c Ratio	0.26	0.37	0.82	0.07	0.77	0.86
Control Delay	42.5	25.3	24.4	9.4	49.3	14.0
Queue Delay	0.0	0.0	0.0	0.0	0.0	0.0
Total Delay	42.5	25.3	24.4	9.4	49.3	14.0
LOS	D	C	C	A	D	B
Approach Delay	28.4		23.8			19.5
Approach LOS	C		C			B

Intersection Summary

Cycle Length: 120
 Actuated Cycle Length: 100.3
 Natural Cycle: 115
 Control Type: Actuated-Uncoordinated
 Maximum v/c Ratio: 0.86
 Intersection Signal Delay: 21.6
 Intersection Capacity Utilization 85.0%
 Analysis Period (min) 15
 Intersection LOS: C
 ICU Level of Service E

















Splits and Phases: 6: Trautwein Rd. & Grove Community Dr



HCM 6th Signalized Intersection Summary
6: Trautwein Rd. & Grove Community Dr

West Campus Upper Plateau (JN 14064)

09/20/2022

						
Movement	WBL	WBR	NBT	NBR	SBL	SBT
Lane Configurations		 	 		 	 
Traffic Volume (veh/h)	61	283	1676	65	447	2413
Future Volume (veh/h)	61	283	1676	65	447	2413
Initial Q (Qb), veh	0	0	0	0	0	0
Ped-Bike Adj(A_pbT)	1.00	1.00		1.00	1.00	
Parking Bus, Adj	1.00	1.00	1.00	1.00	1.00	1.00
Work Zone On Approach	No		No			No
Adj Sat Flow, veh/h/ln	1900	1900	1900	1900	1900	1870
Adj Flow Rate, veh/h	62	110	1710	61	456	2462
Peak Hour Factor	0.98	0.98	0.98	0.98	0.98	0.98
Percent Heavy Veh, %	0	0	0	0	0	2
Cap, veh/h	191	738	2075	926	543	2767
Arrive On Green	0.11	0.11	0.57	0.57	0.15	0.78
Sat Flow, veh/h	1810	2834	3705	1610	3510	3647
Grp Volume(v), veh/h	62	110	1710	61	456	2462
Grp Sat Flow(s),veh/h/ln	1810	1417	1805	1610	1755	1777
Q Serve(g_s), s	3.0	2.8	35.8	1.6	11.8	46.6
Cycle Q Clear(g_c), s	3.0	2.8	35.8	1.6	11.8	46.6
Prop In Lane	1.00	1.00		1.00	1.00	
Lane Grp Cap(c), veh/h	191	738	2075	926	543	2767
V/C Ratio(X)	0.32	0.15	0.82	0.07	0.84	0.89
Avail Cap(c_a), veh/h	589	1360	2075	926	917	2997
HCM Platoon Ratio	1.00	1.00	1.00	1.00	1.00	1.00
Upstream Filter(I)	1.00	1.00	1.00	1.00	1.00	1.00
Uniform Delay (d), s/veh	38.7	26.6	16.0	8.8	38.4	7.5
Incr Delay (d2), s/veh	1.0	0.1	2.8	0.0	1.4	3.5
Initial Q Delay(d3),s/veh	0.0	0.0	0.0	0.0	0.0	0.0
%ile BackOfQ(50%),veh/ln	1.3	0.9	12.6	0.5	4.9	9.2
Unsig. Movement Delay, s/veh						
LnGrp Delay(d),s/veh	39.7	26.7	18.9	8.8	39.7	11.0
LnGrp LOS	D	C	B	A	D	B
Approach Vol, veh/h	172		1771			2918
Approach Delay, s/veh	31.4		18.5			15.5
Approach LOS	C		B			B
Timer - Assigned Phs	1	2			6	8
Phs Duration (G+Y+Rc), s	19.0	59.9			79.0	14.5
Change Period (Y+Rc), s	4.6	6.2			6.2	4.6
Max Green Setting (Gmax), s	24.4	49.8			78.8	30.4
Max Q Clear Time (g_c+I1), s	13.8	37.8			48.6	5.0
Green Ext Time (p_c), s	0.7	8.5			24.1	0.5
Intersection Summary						
HCM 6th Ctrl Delay			17.2			
HCM 6th LOS			B			

Timings

7: Trautwein Rd. & Orange Terrace Pkwy

09/20/2022



Lane Group	EBL	EBT	WBL	WBT	WBR	NBL	NBT	NBR	SBL	SBT	SBR
Lane Configurations											
Traffic Volume (vph)	55	77	268	55	322	53	1566	397	576	1990	48
Future Volume (vph)	55	77	268	55	322	53	1566	397	576	1990	48
Turn Type	Prot	NA	Prot	NA	pm+ov	Prot	NA	Perm	Prot	NA	Perm
Protected Phases	7	4	3	8	1	5	2		1	6	
Permitted Phases					8			2			6
Detector Phase	7	4	3	8	1	5	2	2	1	6	6
Switch Phase											
Minimum Initial (s)	5.0	10.0	5.0	10.0	5.0	5.0	10.0	10.0	5.0	10.0	10.0
Minimum Split (s)	9.6	38.6	9.6	34.6	9.6	9.6	46.2	46.2	9.6	28.2	28.2
Total Split (s)	13.2	38.6	16.1	41.5	18.0	9.6	47.3	47.3	18.0	55.7	55.7
Total Split (%)	11.0%	32.2%	13.4%	34.6%	15.0%	8.0%	39.4%	39.4%	15.0%	46.4%	46.4%
Yellow Time (s)	3.6	3.6	3.6	3.6	3.6	3.6	5.2	5.2	3.6	5.2	5.2
All-Red Time (s)	1.0	1.0	1.0	1.0	1.0	1.0	1.0	1.0	1.0	1.0	1.0
Lost Time Adjust (s)	0.0	0.0	0.0	0.0	0.0	0.0	0.0	0.0	0.0	0.0	0.0
Total Lost Time (s)	4.6	4.6	4.6	4.6	4.6	4.6	6.2	6.2	4.6	6.2	6.2
Lead/Lag	Lead	Lag	Lead	Lag	Lead	Lead	Lag	Lag	Lead	Lag	Lag
Lead-Lag Optimize?	Yes	Yes	Yes	Yes	Yes	Yes	Yes	Yes	Yes	Yes	Yes
Recall Mode	None	None	None	None	None	None	None	None	None	None	None
Act Effct Green (s)	7.2	14.6	11.6	21.0	39.1	5.0	41.4	41.4	13.5	51.9	51.9
Actuated g/C Ratio	0.07	0.14	0.11	0.21	0.39	0.05	0.41	0.41	0.13	0.51	0.51
v/c Ratio	0.45	0.39	1.37	0.15	0.29	0.62	1.13	0.55	1.31	1.14	0.06
Control Delay	58.6	37.4	229.2	34.7	14.7	79.0	96.3	16.1	191.6	97.6	0.4
Queue Delay	0.0	0.0	0.0	0.0	0.0	0.0	0.0	0.0	0.0	0.0	0.0
Total Delay	58.6	37.4	229.2	34.7	14.7	79.0	96.3	16.1	191.6	97.6	0.4
LOS	E	D	F	C	B	E	F	B	F	F	A
Approach Delay		44.9		105.5			80.0			116.5	
Approach LOS		D		F			F			F	

Intersection Summary

Cycle Length: 120	
Actuated Cycle Length: 101.2	
Natural Cycle: 115	
Control Type: Actuated-Uncoordinated	
Maximum v/c Ratio: 1.37	
Intersection Signal Delay: 99.6	Intersection LOS: F
Intersection Capacity Utilization 94.1%	ICU Level of Service F
Analysis Period (min) 15	



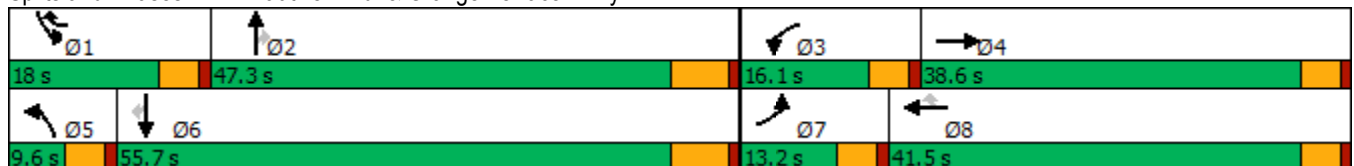



















Splits and Phases: 7: Trautwein Rd. & Orange Terrace Pkwy



HCM 6th Signalized Intersection Summary
7: Trautwein Rd. & Orange Terrace Pkwy

West Campus Upper Plateau (JN 14064)

09/20/2022

												
Movement	EBL	EBT	EBR	WBL	WBT	WBR	NBL	NBT	NBR	SBL	SBT	SBR
Lane Configurations												
Traffic Volume (veh/h)	55	77	25	268	55	322	53	1566	397	576	1990	48
Future Volume (veh/h)	55	77	25	268	55	322	53	1566	397	576	1990	48
Initial Q (Qb), veh	0	0	0	0	0	0	0	0	0	0	0	0
Ped-Bike Adj(A_pbT)	1.00		1.00	1.00		1.00	1.00		1.00	1.00		1.00
Parking Bus, Adj	1.00	1.00	1.00	1.00	1.00	1.00	1.00	1.00	1.00	1.00	1.00	1.00
Work Zone On Approach		No			No			No			No	
Adj Sat Flow, veh/h/ln	1900	1900	1900	1900	1900	1870	1900	1885	1885	1885	1885	1900
Adj Flow Rate, veh/h	58	81	24	282	58	220	56	1648	341	606	2095	42
Peak Hour Factor	0.95	0.95	0.95	0.95	0.95	0.95	0.95	0.95	0.95	0.95	0.95	0.95
Percent Heavy Veh, %	0	0	0	0	0	2	0	1	1	1	1	0
Cap, veh/h	75	147	43	217	347	898	73	1533	684	486	1889	849
Arrive On Green	0.04	0.10	0.10	0.12	0.18	0.18	0.04	0.43	0.43	0.14	0.53	0.53
Sat Flow, veh/h	1810	1408	417	1810	1900	2790	1810	3582	1598	3483	3582	1610
Grp Volume(v), veh/h	58	0	105	282	58	220	56	1648	341	606	2095	42
Grp Sat Flow(s),veh/h/ln	1810	0	1825	1810	1900	1395	1810	1791	1598	1742	1791	1610
Q Serve(g_s), s	3.0	0.0	5.3	11.5	2.5	5.6	2.9	41.1	14.9	13.4	50.6	1.2
Cycle Q Clear(g_c), s	3.0	0.0	5.3	11.5	2.5	5.6	2.9	41.1	14.9	13.4	50.6	1.2
Prop In Lane	1.00		0.23	1.00		1.00	1.00		1.00	1.00		1.00
Lane Grp Cap(c), veh/h	75	0	190	217	347	898	73	1533	684	486	1889	849
V/C Ratio(X)	0.77	0.00	0.55	1.30	0.17	0.24	0.77	1.07	0.50	1.25	1.11	0.05
Avail Cap(c_a), veh/h	162	0	646	217	730	1462	94	1533	684	486	1889	849
HCM Platoon Ratio	1.00	1.00	1.00	1.00	1.00	1.00	1.00	1.00	1.00	1.00	1.00	1.00
Upstream Filter(I)	1.00	0.00	1.00	1.00	1.00	1.00	1.00	1.00	1.00	1.00	1.00	1.00
Uniform Delay (d), s/veh	45.6	0.0	40.9	42.2	33.1	24.0	45.6	27.4	20.0	41.3	22.7	11.0
Incr Delay (d2), s/veh	6.2	0.0	2.5	164.9	0.2	0.1	17.5	46.0	0.6	127.2	57.4	0.0
Initial Q Delay(d3),s/veh	0.0	0.0	0.0	0.0	0.0	0.0	0.0	0.0	0.0	0.0	0.0	0.0
%ile BackOfQ(50%),veh/ln	1.5	0.0	2.5	14.8	1.1	1.7	1.6	25.1	5.2	14.0	32.7	0.4
Unsig. Movement Delay, s/veh												
LnGrp Delay(d),s/veh	51.7	0.0	43.4	207.2	33.3	24.1	63.2	73.4	20.5	168.5	80.1	11.0
LnGrp LOS	D	A	D	F	C	C	E	F	C	F	F	B
Approach Vol, veh/h		163			560			2045			2743	
Approach Delay, s/veh		46.3			117.2			64.3			98.6	
Approach LOS		D			F			E			F	
Timer - Assigned Phs	1	2	3	4	5	6	7	8				
Phs Duration (G+Y+Rc), s	18.0	47.3	16.1	14.6	8.5	56.8	8.6	22.1				
Change Period (Y+Rc), s	4.6	6.2	4.6	4.6	4.6	6.2	4.6	4.6				
Max Green Setting (Gmax), s	13.4	41.1	11.5	34.0	5.0	49.5	8.6	36.9				
Max Q Clear Time (g_c+I1), s	15.4	43.1	13.5	7.3	4.9	52.6	5.0	7.6				
Green Ext Time (p_c), s	0.0	0.0	0.0	0.5	0.0	0.0	0.0	1.1				
Intersection Summary												
HCM 6th Ctrl Delay				86.2								
HCM 6th LOS				F								

Timings
8: Cole Av. & Van Buren Bl.

West Campus Upper Plateau (JN 14064)

09/20/2022



Lane Group	EBL	EBT	EBR	WBL	WBT	WBR	NBL	NBT	SBL	SBT	SBR
Lane Configurations	↖↗	↑↑	↗	↖	↑↑↑	↗	↖	↑↔	↖↗	↑↑	↗
Traffic Volume (vph)	517	1807	121	223	1926	803	107	401	764	725	384
Future Volume (vph)	517	1807	121	223	1926	803	107	401	764	725	384
Turn Type	Prot	NA	pm+ov	Prot	NA	pm+ov	Prot	NA	Prot	NA	pm+ov
Protected Phases	5	2	3	1	6	7	3	8	7	4	5
Permitted Phases			2			6					4
Detector Phase	5	2	3	1	6	7	3	8	7	4	5
Switch Phase											
Minimum Initial (s)	5.0	10.0	5.0	5.0	10.0	5.0	5.0	10.0	5.0	10.0	5.0
Minimum Split (s)	9.1	36.2	9.1	9.1	36.2	9.1	9.1	42.2	9.1	49.2	9.1
Total Split (s)	18.7	44.8	12.0	14.0	40.1	17.5	12.0	43.7	17.5	49.2	18.7
Total Split (%)	15.6%	37.3%	10.0%	11.7%	33.4%	14.6%	10.0%	36.4%	14.6%	41.0%	15.6%
Yellow Time (s)	3.2	5.2	3.2	3.2	5.2	3.2	3.2	5.2	3.2	5.2	3.2
All-Red Time (s)	0.5	1.0	0.5	0.5	1.0	0.5	0.5	1.0	0.5	1.0	0.5
Lost Time Adjust (s)	0.0	0.0	0.0	0.0	0.0	0.0	0.0	0.0	0.0	0.0	0.0
Total Lost Time (s)	3.7	6.2	3.7	3.7	6.2	3.7	3.7	6.2	3.7	6.2	3.7
Lead/Lag	Lead	Lag	Lead	Lead	Lag	Lead	Lead	Lag	Lead	Lag	Lead
Lead-Lag Optimize?	Yes	Yes	Yes	Yes	Yes	Yes	Yes	Yes	Yes	Yes	Yes
Recall Mode	None	None	None	None	None	None	None	None	None	None	None
Act Effct Green (s)	15.1	38.8	53.3	10.3	34.0	54.1	8.3	24.3	13.9	29.8	47.3
Actuated g/C Ratio	0.14	0.36	0.50	0.10	0.32	0.51	0.08	0.23	0.13	0.28	0.44
v/c Ratio	1.14	1.53	0.16	1.39	1.27	0.98	0.82	0.70	1.83	0.78	0.56
Control Delay	127.8	270.9	6.2	245.8	158.3	49.0	91.2	40.1	412.1	41.2	19.2
Queue Delay	0.0	0.0	0.0	0.0	0.0	0.0	0.0	0.0	0.0	0.0	0.0
Total Delay	127.8	270.9	6.2	245.8	158.3	49.0	91.2	40.1	412.1	41.2	19.2
LOS	F	F	A	F	F	D	F	D	F	D	B
Approach Delay		227.5			135.2			48.7		188.0	
Approach LOS		F			F			D		F	

Intersection Summary

Cycle Length: 120	
Actuated Cycle Length: 107.1	
Natural Cycle: 115	
Control Type: Actuated-Uncoordinated	
Maximum v/c Ratio: 1.83	
Intersection Signal Delay: 169.2	Intersection LOS: F
Intersection Capacity Utilization 118.3%	ICU Level of Service H
Analysis Period (min) 15	



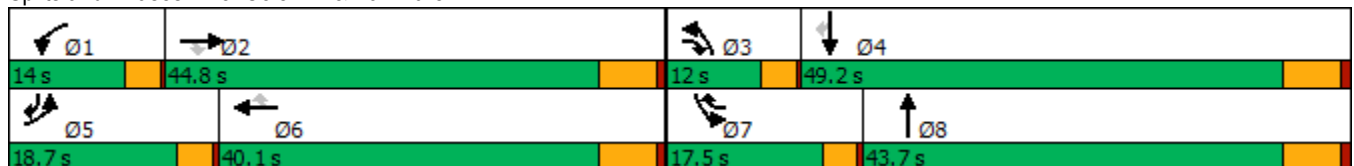



























Splits and Phases: 8: Cole Av. & Van Buren Bl.



HCM 6th Signalized Intersection Summary
8: Cole Av. & Van Buren Bl.

West Campus Upper Plateau (JN 14064)

09/20/2022

												
Movement	EBL	EBT	EBR	WBL	WBT	WBR	NBL	NBT	NBR	SBL	SBT	SBR
Lane Configurations	 	 			  			 		 	 	
Traffic Volume (veh/h)	517	1807	121	223	1926	803	107	401	131	764	725	384
Future Volume (veh/h)	517	1807	121	223	1926	803	107	401	131	764	725	384
Initial Q (Qb), veh	0	0	0	0	0	0	0	0	0	0	0	0
Ped-Bike Adj(A_pbT)	1.00		1.00	1.00		1.00	1.00		0.99	1.00		1.00
Parking Bus, Adj	1.00	1.00	1.00	1.00	1.00	1.00	1.00	1.00	1.00	1.00	1.00	1.00
Work Zone On Approach		No			No			No			No	
Adj Sat Flow, veh/h/ln	1870	1841	1856	1870	1870	1885	1885	1885	1885	1870	1885	1885
Adj Flow Rate, veh/h	550	1922	70	237	2049	764	114	427	132	813	771	309
Peak Hour Factor	0.94	0.94	0.94	0.94	0.94	0.94	0.94	0.94	0.94	0.94	0.94	0.94
Percent Heavy Veh, %	2	4	3	2	2	1	1	1	1	2	1	1
Cap, veh/h	487	1269	693	172	1627	716	140	605	185	448	989	666
Arrive On Green	0.14	0.36	0.36	0.10	0.32	0.32	0.08	0.22	0.22	0.13	0.28	0.28
Sat Flow, veh/h	3456	3497	1572	1781	5106	1598	1795	2697	825	3456	3582	1596
Grp Volume(v), veh/h	550	1922	70	237	2049	764	114	282	277	813	771	309
Grp Sat Flow(s),veh/h/ln	1728	1749	1572	1781	1702	1598	1795	1791	1731	1728	1791	1596
Q Serve(g_s), s	15.0	38.6	2.8	10.3	33.9	33.9	6.6	15.4	15.7	13.8	21.1	14.9
Cycle Q Clear(g_c), s	15.0	38.6	2.8	10.3	33.9	33.9	6.6	15.4	15.7	13.8	21.1	14.9
Prop In Lane	1.00		1.00	1.00		1.00	1.00		0.48	1.00		1.00
Lane Grp Cap(c), veh/h	487	1269	693	172	1627	716	140	402	389	448	989	666
V/C Ratio(X)	1.13	1.51	0.10	1.37	1.26	1.07	0.81	0.70	0.71	1.81	0.78	0.46
Avail Cap(c_a), veh/h	487	1269	693	172	1627	716	140	631	610	448	1448	870
HCM Platoon Ratio	1.00	1.00	1.00	1.00	1.00	1.00	1.00	1.00	1.00	1.00	1.00	1.00
Upstream Filter(I)	1.00	1.00	1.00	1.00	1.00	1.00	1.00	1.00	1.00	1.00	1.00	1.00
Uniform Delay (d), s/veh	45.7	33.9	17.4	48.0	36.2	29.3	48.3	38.0	38.1	46.3	35.5	22.4
Incr Delay (d2), s/veh	81.0	235.6	0.1	200.5	121.8	52.7	27.7	2.2	2.4	374.8	1.7	0.5
Initial Q Delay(d3),s/veh	0.0	0.0	0.0	0.0	0.0	0.0	0.0	0.0	0.0	0.0	0.0	0.0
%ile BackOfQ(50%),veh/ln	11.6	56.5	0.9	14.0	31.4	26.8	3.9	6.6	6.6	29.0	8.9	5.2
Unsig. Movement Delay, s/veh												
LnGrp Delay(d),s/veh	126.7	269.5	17.5	248.5	158.0	82.1	76.0	40.2	40.5	421.1	37.2	22.9
LnGrp LOS	F	F	B	F	F	F	E	D	D	F	D	C
Approach Vol, veh/h		2542			3050			673			1893	
Approach Delay, s/veh		231.7			146.0			46.4			199.7	
Approach LOS		F			F			D			F	
Timer - Assigned Phs	1	2	3	4	5	6	7	8				
Phs Duration (G+Y+Rc), s	14.0	44.8	12.0	35.6	18.7	40.1	17.5	30.1				
Change Period (Y+Rc), s	3.7	6.2	3.7	6.2	3.7	6.2	3.7	6.2				
Max Green Setting (Gmax), s	10.3	38.6	8.3	43.0	15.0	33.9	13.8	37.5				
Max Q Clear Time (g_c+I1), s	12.3	40.6	8.6	23.1	17.0	35.9	15.8	17.7				
Green Ext Time (p_c), s	0.0	0.0	0.0	5.7	0.0	0.0	0.0	2.9				
Intersection Summary												
HCM 6th Ctrl Delay	177.0											
HCM 6th LOS	F											

Intersection	
Intersection Delay, s/veh	10.6
Intersection LOS	B

Movement	EBT	EBR	WBL	WBT	NBL	NBR
Lane Configurations						
Traffic Vol, veh/h	281	24	28	201	36	47
Future Vol, veh/h	281	24	28	201	36	47
Peak Hour Factor	0.92	0.92	0.92	0.92	0.92	0.92
Heavy Vehicles, %	1	0	1	2	0	0
Mvmt Flow	305	26	30	218	39	51
Number of Lanes	1	0	1	1	1	1

Approach	EB	WB	NB
Opposing Approach	WB	EB	
Opposing Lanes	2	1	0
Conflicting Approach Left		NB	EB
Conflicting Lanes Left	0	2	1
Conflicting Approach Right	NB		WB
Conflicting Lanes Right	2	0	2
HCM Control Delay	11.6	9.8	8.9
HCM LOS	B	A	A

Lane	NBLn1	NBLn2	EBLn1	WBLn1	WBLn2
Vol Left, %	100%	0%	0%	100%	0%
Vol Thru, %	0%	0%	92%	0%	100%
Vol Right, %	0%	100%	8%	0%	0%
Sign Control	Stop	Stop	Stop	Stop	Stop
Traffic Vol by Lane	36	47	305	28	201
LT Vol	36	0	0	28	0
Through Vol	0	0	281	0	201
RT Vol	0	47	24	0	0
Lane Flow Rate	39	51	332	30	218
Geometry Grp	7	7	4	7	7
Degree of Util (X)	0.069	0.073	0.443	0.047	0.307
Departure Headway (Hd)	6.377	5.166	4.809	5.541	5.055
Convergence, Y/N	Yes	Yes	Yes	Yes	Yes
Cap	560	690	749	646	710
Service Time	4.132	2.92	2.84	3.275	2.789
HCM Lane V/C Ratio	0.07	0.074	0.443	0.046	0.307
HCM Control Delay	9.6	8.3	11.6	8.5	10
HCM Lane LOS	A	A	B	A	A
HCM 95th-tile Q	0.2	0.2	2.3	0.1	1.3

Intersection												
Intersection Delay, s/veh	13.4											
Intersection LOS	B											

Movement	EBL	EBT	EBR	WBL	WBT	WBR	NBL	NBT	NBR	SBL	SBT	SBR
Lane Configurations	↵	↕		↵	↕			↕			↕	
Traffic Vol, veh/h	57	618	20	4	365	61	24	6	3	36	10	26
Future Vol, veh/h	57	618	20	4	365	61	24	6	3	36	10	26
Peak Hour Factor	0.96	0.96	0.96	0.96	0.96	0.96	0.96	0.96	0.96	0.96	0.96	0.96
Heavy Vehicles, %	3	2	7	0	1	0	6	0	0	0	0	0
Mvmt Flow	59	644	21	4	380	64	25	6	3	38	10	27
Number of Lanes	1	2	0	1	2	0	0	1	0	0	1	0

Approach	EB	WB	NB	SB
Opposing Approach	WB	EB	SB	NB
Opposing Lanes	3	3	1	1
Conflicting Approach Left	SB	NB	EB	WB
Conflicting Lanes Left	1	1	3	3
Conflicting Approach Right	NB	SB	WB	EB
Conflicting Lanes Right	1	1	3	3
HCM Control Delay	15	11.5	10.9	11
HCM LOS	B	B	B	B

Lane	NBLn1	EBLn1	EBLn2	EBLn3	WBLn1	WBLn2	WBLn3	SBLn1
Vol Left, %	73%	100%	0%	0%	100%	0%	0%	50%
Vol Thru, %	18%	0%	100%	91%	0%	100%	67%	14%
Vol Right, %	9%	0%	0%	9%	0%	0%	33%	36%
Sign Control	Stop	Stop	Stop	Stop	Stop	Stop	Stop	Stop
Traffic Vol by Lane	33	57	412	226	4	243	183	72
LT Vol	24	57	0	0	4	0	0	36
Through Vol	6	0	412	206	0	243	122	10
RT Vol	3	0	0	20	0	0	61	26
Lane Flow Rate	34	59	429	235	4	253	190	75
Geometry Grp	7	7	7	7	7	7	7	7
Degree of Util (X)	0.072	0.099	0.653	0.359	0.007	0.404	0.29	0.147
Departure Headway (Hd)	7.554	5.995	5.474	5.497	6.228	5.741	5.488	7.034
Convergence, Y/N	Yes	Yes	Yes	Yes	Yes	Yes	Yes	Yes
Cap	474	601	665	659	575	626	655	510
Service Time	5.302	3.695	3.174	3.197	3.962	3.475	3.222	4.777
HCM Lane V/C Ratio	0.072	0.098	0.645	0.357	0.007	0.404	0.29	0.147
HCM Control Delay	10.9	9.4	17.9	11.2	9	12.3	10.5	11
HCM Lane LOS	B	A	C	B	A	B	B	B
HCM 95th-tile Q	0.2	0.3	4.8	1.6	0	2	1.2	0.5

Timings

11: Barton St & Alessandro Bl.



Lane Group	EBL	EBT	WBL	WBT	NBL	NBT	NBR	SBL	SBT	SBR
Lane Configurations	↙	↕↕↕	↙	↕↕↕		↕	↗		↕	↗
Traffic Volume (vph)	7	2725	90	3102	91	1	44	18	0	16
Future Volume (vph)	7	2725	90	3102	91	1	44	18	0	16
Turn Type	Prot	NA	Prot	NA	Perm	NA	Perm	Perm	NA	Perm
Protected Phases	5	2	1	6		8			4	
Permitted Phases					8		8	4		4
Detector Phase	5	2	1	6	8	8	8	4	4	4
Switch Phase										
Minimum Initial (s)	5.0	10.0	5.0	10.0	10.0	10.0	10.0	10.0	10.0	10.0
Minimum Split (s)	9.2	28.5	11.0	28.5	40.6	40.6	40.6	26.6	26.6	26.6
Total Split (s)	9.2	65.4	14.0	70.2	40.6	40.6	40.6	40.6	40.6	40.6
Total Split (%)	7.7%	54.5%	11.7%	58.5%	33.8%	33.8%	33.8%	33.8%	33.8%	33.8%
Yellow Time (s)	3.2	5.5	3.2	5.5	3.6	3.6	3.6	3.6	3.6	3.6
All-Red Time (s)	1.0	1.0	1.0	1.0	1.0	1.0	1.0	1.0	1.0	1.0
Lost Time Adjust (s)	0.0	0.0	0.0	0.0		0.0	0.0		0.0	0.0
Total Lost Time (s)	4.2	6.5	4.2	6.5		4.6	4.6		4.6	4.6
Lead/Lag	Lead	Lag	Lead	Lag						
Lead-Lag Optimize?	Yes	Yes	Yes	Yes						
Recall Mode	None	None	None	None	None	None	None	None	None	None
Act Effct Green (s)	5.1	63.7	8.6	72.5		15.6	15.6		15.6	15.6
Actuated g/C Ratio	0.05	0.67	0.09	0.76		0.16	0.16		0.16	0.16
v/c Ratio	0.09	0.85	0.58	0.84		0.43	0.13		0.10	0.05
Control Delay	52.7	21.2	60.5	15.4		43.1	0.8		35.1	0.2
Queue Delay	0.0	0.0	0.0	0.0		0.0	0.0		0.0	0.0
Total Delay	52.7	21.2	60.5	15.4		43.1	0.8		35.1	0.2
LOS	D	C	E	B		D	A		D	A
Approach Delay		21.3		16.7		29.4			18.6	
Approach LOS		C		B		C			B	

Intersection Summary

Cycle Length: 120
 Actuated Cycle Length: 95.2
 Natural Cycle: 115
 Control Type: Actuated-Uncoordinated
 Maximum v/c Ratio: 0.85
 Intersection Signal Delay: 19.1
 Intersection LOS: B
 Intersection Capacity Utilization 90.1%
 ICU Level of Service E
 Analysis Period (min) 15

Splits and Phases: 11: Barton St & Alessandro Bl.



HCM 6th Signalized Intersection Summary
11: Barton St & Alessandro Bl.

West Campus Upper Plateau (JN 14064)

09/20/2022



Movement	EBL	EBT	EBR	WBL	WBT	WBR	NBL	NBT	NBR	SBL	SBT	SBR
Lane Configurations	↖	↑↑↑		↖	↑↑↑			↑	↗		↑	↗
Traffic Volume (veh/h)	7	2725	64	90	3102	20	91	1	44	18	0	16
Future Volume (veh/h)	7	2725	64	90	3102	20	91	1	44	18	0	16
Initial Q (Qb), veh	0	0	0	0	0	0	0	0	0	0	0	0
Ped-Bike Adj(A_pbT)	1.00		1.00	1.00		0.98	1.00		1.00	1.00		1.00
Parking Bus, Adj	1.00	1.00	1.00	1.00	1.00	1.00	1.00	1.00	1.00	1.00	1.00	1.00
Work Zone On Approach		No			No			No			No	
Adj Sat Flow, veh/h/ln	1604	1885	1900	1900	1870	1900	1900	1900	1900	1796	1900	1900
Adj Flow Rate, veh/h	7	2839	65	94	3231	21	95	1	20	19	0	7
Peak Hour Factor	0.96	0.96	0.96	0.96	0.96	0.96	0.96	0.96	0.96	0.96	0.96	0.96
Percent Heavy Veh, %	20	1	0	0	2	0	0	0	0	7	0	0
Cap, veh/h	13	2599	59	117	2920	19	69	0	488	69	0	488
Arrive On Green	0.01	0.50	0.50	0.06	0.56	0.56	0.30	0.30	0.30	0.30	0.00	0.30
Sat Flow, veh/h	1527	5177	118	1810	5234	34	25	1	1610	25	0	1610
Grp Volume(v), veh/h	7	1874	1030	94	2099	1153	96	0	20	19	0	7
Grp Sat Flow(s),veh/h/ln	1527	1716	1864	1810	1702	1863	26	0	1610	25	0	1610
Q Serve(g_s), s	0.5	58.9	58.9	6.0	65.5	65.5	0.6	0.0	1.0	0.6	0.0	0.4
Cycle Q Clear(g_c), s	0.5	58.9	58.9	6.0	65.5	65.5	35.6	0.0	1.0	35.6	0.0	0.4
Prop In Lane	1.00		0.06	1.00		0.02	0.99		1.00	1.00		1.00
Lane Grp Cap(c), veh/h	13	1722	936	117	1899	1040	69	0	488	69	0	488
V/C Ratio(X)	0.53	1.09	1.10	0.80	1.11	1.11	1.39	0.00	0.04	0.28	0.00	0.01
Avail Cap(c_a), veh/h	65	1722	936	151	1899	1040	74	0	494	74	0	494
HCM Platoon Ratio	1.00	1.00	1.00	1.00	1.00	1.00	1.00	1.00	1.00	1.00	1.00	1.00
Upstream Filter(I)	1.00	1.00	1.00	1.00	1.00	1.00	1.00	0.00	1.00	1.00	0.00	1.00
Uniform Delay (d), s/veh	57.9	29.2	29.2	54.2	25.9	25.9	58.5	0.0	28.9	58.5	0.0	28.6
Incr Delay (d2), s/veh	11.9	50.0	60.9	16.3	55.8	62.9	242.6	0.0	0.0	2.1	0.0	0.0
Initial Q Delay(d3),s/veh	0.0	0.0	0.0	0.0	0.0	0.0	0.0	0.0	0.0	0.0	0.0	0.0
%ile BackOfQ(50%),veh/ln	0.2	33.1	38.8	3.3	39.4	45.3	6.7	0.0	0.4	0.6	0.0	0.1
Unsig. Movement Delay, s/veh												
LnGrp Delay(d),s/veh	69.8	79.2	90.1	70.4	81.7	88.8	301.1	0.0	28.9	60.7	0.0	28.6
LnGrp LOS	E	F	F	E	F	F	F	A	C	E	A	C
Approach Vol, veh/h		2911			3346			116				26
Approach Delay, s/veh		83.1			83.8			254.2				52.1
Approach LOS		F			F			F				D
Timer - Assigned Phs	1	2		4	5	6		8				
Phs Duration (G+Y+Rc), s	11.8	65.4		40.4	5.2	72.0		40.4				
Change Period (Y+Rc), s	* 4.2	6.5		4.6	* 4.2	6.5		4.6				
Max Green Setting (Gmax), s	* 9.8	58.9		36.0	* 5	63.7		36.0				
Max Q Clear Time (g_c+I1), s	8.0	60.9		37.6	2.5	67.5		37.6				
Green Ext Time (p_c), s	0.0	0.0		0.0	0.0	0.0		0.0				

Intersection Summary

HCM 6th Ctrl Delay	86.4
HCM 6th LOS	F

Notes

* HCM 6th computational engine requires equal clearance times for the phases crossing the barrier.

Intersection						
Int Delay, s/veh	1.7					
Movement	EBL	EBT	WBT	WBR	SBL	SBR
Lane Configurations						
Traffic Vol, veh/h	50	278	169	27	3	59
Future Vol, veh/h	50	278	169	27	3	59
Conflicting Peds, #/hr	0	0	0	7	0	0
Sign Control	Free	Free	Free	Free	Stop	Stop
RT Channelized	-	None	-	None	-	None
Storage Length	100	-	-	-	0	-
Veh in Median Storage, #	-	0	0	-	0	-
Grade, %	-	0	0	-	0	-
Peak Hour Factor	94	94	94	94	94	94
Heavy Vehicles, %	0	0	1	0	0	0
Mvmt Flow	53	296	180	29	3	63

Major/Minor	Major1	Major2	Minor2		
Conflicting Flow All	216	0	-	0	604 202
Stage 1	-	-	-	-	202 -
Stage 2	-	-	-	-	402 -
Critical Hdwy	4.1	-	-	-	6.4 6.2
Critical Hdwy Stg 1	-	-	-	-	5.4 -
Critical Hdwy Stg 2	-	-	-	-	5.4 -
Follow-up Hdwy	2.2	-	-	-	3.5 3.3
Pot Cap-1 Maneuver	1366	-	-	-	465 844
Stage 1	-	-	-	-	837 -
Stage 2	-	-	-	-	680 -
Platoon blocked, %		-	-	-	
Mov Cap-1 Maneuver	1357	-	-	-	441 838
Mov Cap-2 Maneuver	-	-	-	-	441 -
Stage 1	-	-	-	-	798 -
Stage 2	-	-	-	-	675 -

Approach	EB	WB	SB
HCM Control Delay, s	1.2	0	9.9
HCM LOS			A

Minor Lane/Major Mvmt	EBL	EBT	WBT	WBR	SBLn1
Capacity (veh/h)	1357	-	-	-	803
HCM Lane V/C Ratio	0.039	-	-	-	0.082
HCM Control Delay (s)	7.8	-	-	-	9.9
HCM Lane LOS	A	-	-	-	A
HCM 95th %tile Q(veh)	0.1	-	-	-	0.3

Intersection						
Int Delay, s/veh	4.9					
Movement	EBT	EBR	WBL	WBT	NBL	NBR
Lane Configurations	↑↑		↘	↑↑	↘	
Traffic Vol, veh/h	499	150	54	297	131	53
Future Vol, veh/h	499	150	54	297	131	53
Conflicting Peds, #/hr	0	2	0	0	0	0
Sign Control	Free	Free	Free	Free	Stop	Stop
RT Channelized	-	None	-	None	-	None
Storage Length	-	-	125	-	0	-
Veh in Median Storage, #	0	-	-	0	0	-
Grade, %	0	-	-	0	0	-
Peak Hour Factor	97	97	97	97	97	97
Heavy Vehicles, %	1	1	0	0	0	0
Mvmt Flow	514	155	56	306	135	55

Major/Minor	Major1	Major2	Minor1	Minor2	Minor3
Conflicting Flow All	0	0	671	0	859
Stage 1	-	-	-	-	594
Stage 2	-	-	-	-	265
Critical Hdwy	-	-	4.1	-	6.8
Critical Hdwy Stg 1	-	-	-	-	5.8
Critical Hdwy Stg 2	-	-	-	-	5.8
Follow-up Hdwy	-	-	2.2	-	3.5
Pot Cap-1 Maneuver	-	-	929	-	299
Stage 1	-	-	-	-	520
Stage 2	-	-	-	-	761
Platoon blocked, %	-	-	-	-	-
Mov Cap-1 Maneuver	-	-	927	-	280
Mov Cap-2 Maneuver	-	-	-	-	280
Stage 1	-	-	-	-	519
Stage 2	-	-	-	-	715

Approach	EB	WB	NB
HCM Control Delay, s	0	1.4	28.7
HCM LOS			D

Minor Lane/Major Mvmt	NBLn1	EBT	EBR	WBL	WBT
Capacity (veh/h)	336	-	-	927	-
HCM Lane V/C Ratio	0.565	-	-	0.06	-
HCM Control Delay (s)	28.7	-	-	9.1	-
HCM Lane LOS	D	-	-	A	-
HCM 95th %tile Q(veh)	3.3	-	-	0.2	-

Timings

14: Barton Rd. & Van Buren Bl.



Lane Group	EBL	EBT	WBL	WBT	NBL	NBT	NBR	SBL	SBT
Lane Configurations	↘	↗	↘	↗	↘	↗	↗	↘	↗
Traffic Volume (vph)	223	2361	371	2580	405	108	298	33	36
Future Volume (vph)	223	2361	371	2580	405	108	298	33	36
Turn Type	Prot	NA	Prot	NA	Prot	NA	Perm	Prot	NA
Protected Phases	5	2	1	6	3	8		7	4
Permitted Phases							8		
Detector Phase	5	2	1	6	3	8	8	7	4
Switch Phase									
Minimum Initial (s)	5.0	10.0	5.0	10.0	5.0	10.0	10.0	5.0	10.0
Minimum Split (s)	9.2	25.2	9.2	25.5	9.1	14.6	14.6	9.1	33.6
Total Split (s)	17.6	52.1	22.2	56.7	12.1	36.3	36.3	9.4	33.6
Total Split (%)	14.7%	43.4%	18.5%	47.3%	10.1%	30.3%	30.3%	7.8%	28.0%
Yellow Time (s)	3.2	5.2	3.2	5.5	3.6	3.6	3.6	3.6	3.6
All-Red Time (s)	1.0	1.0	1.0	1.0	0.5	1.0	1.0	0.5	1.0
Lost Time Adjust (s)	0.0	0.0	0.0	0.0	0.0	0.0	0.0	0.0	0.0
Total Lost Time (s)	4.2	6.2	4.2	6.5	4.1	4.6	4.6	4.1	4.6
Lead/Lag	Lead	Lag	Lead	Lag	Lead	Lag	Lag	Lead	Lag
Lead-Lag Optimize?	Yes	Yes	Yes	Yes	Yes	Yes	Yes	Yes	Yes
Recall Mode	None	None	None	None	None	None	None	None	None
Act Effct Green (s)	13.5	46.1	18.1	50.4	8.0	20.2	20.2	5.3	13.6
Actuated g/C Ratio	0.13	0.44	0.17	0.48	0.08	0.19	0.19	0.05	0.13
v/c Ratio	1.00	1.87	1.26	1.12	1.57	0.31	0.61	0.37	0.62
Control Delay	107.8	418.8	176.4	88.0	310.2	39.8	13.2	62.5	16.3
Queue Delay	0.0	0.0	0.0	0.0	0.0	0.0	0.0	0.0	0.0
Total Delay	107.8	418.8	176.4	88.0	310.2	39.8	13.2	62.5	16.3
LOS	F	F	F	F	F	D	B	E	B
Approach Delay		395.5		98.8		165.1			22.0
Approach LOS		F		F		F			C

Intersection Summary

Cycle Length: 120
 Actuated Cycle Length: 105
 Natural Cycle: 120
 Control Type: Actuated-Uncoordinated
 Maximum v/c Ratio: 1.87
 Intersection Signal Delay: 228.4
 Intersection LOS: F
 Intersection Capacity Utilization 139.6%
 ICU Level of Service H
 Analysis Period (min) 15























Splits and Phases: 14: Barton Rd. & Van Buren Bl.



HCM 6th Signalized Intersection Summary
14: Barton Rd. & Van Buren Bl.

West Campus Upper Plateau (JN 14064)

09/20/2022

												
Movement	EBL	EBT	EBR	WBL	WBT	WBR	NBL	NBT	NBR	SBL	SBT	SBR
Lane Configurations												
Traffic Volume (veh/h)	223	2361	388	371	2580	62	405	108	298	33	36	195
Future Volume (veh/h)	223	2361	388	371	2580	62	405	108	298	33	36	195
Initial Q (Qb), veh	0	0	0	0	0	0	0	0	0	0	0	0
Ped-Bike Adj(A_pbT)	1.00		1.00	1.00		1.00	1.00		0.95	1.00		1.00
Parking Bus, Adj	1.00	1.00	1.00	1.00	1.00	1.00	1.00	1.00	1.00	1.00	1.00	1.00
Work Zone On Approach		No			No			No			No	
Adj Sat Flow, veh/h/ln	1900	1870	1885	1885	1885	1870	1900	1900	1885	1900	1885	1900
Adj Flow Rate, veh/h	232	2459	375	386	2688	55	422	112	186	34	38	145
Peak Hour Factor	0.96	0.96	0.96	0.96	0.96	0.96	0.96	0.96	0.96	0.96	0.96	0.96
Percent Heavy Veh, %	0	2	1	1	1	2	0	0	1	0	1	0
Cap, veh/h	230	1348	200	306	2482	51	266	345	276	54	46	177
Arrive On Green	0.13	0.43	0.43	0.17	0.48	0.48	0.08	0.18	0.18	0.03	0.14	0.14
Sat Flow, veh/h	1810	3103	461	1795	5191	106	3510	1900	1520	1810	343	1307
Grp Volume(v), veh/h	232	1381	1453	386	1772	971	422	112	186	34	0	183
Grp Sat Flow(s),veh/h/ln	1810	1777	1787	1795	1716	1866	1755	1900	1520	1810	0	1650
Q Serve(g_s), s	13.4	45.9	45.9	18.0	50.5	50.5	8.0	5.4	12.1	2.0	0.0	11.4
Cycle Q Clear(g_c), s	13.4	45.9	45.9	18.0	50.5	50.5	8.0	5.4	12.1	2.0	0.0	11.4
Prop In Lane	1.00		0.26	1.00		0.06	1.00		1.00	1.00		0.79
Lane Grp Cap(c), veh/h	230	772	776	306	1640	892	266	345	276	54	0	224
V/C Ratio(X)	1.01	1.79	1.87	1.26	1.08	1.09	1.59	0.32	0.67	0.63	0.00	0.82
Avail Cap(c_a), veh/h	230	772	776	306	1640	892	266	570	456	91	0	453
HCM Platoon Ratio	1.00	1.00	1.00	1.00	1.00	1.00	1.00	1.00	1.00	1.00	1.00	1.00
Upstream Filter(I)	1.00	1.00	1.00	1.00	1.00	1.00	1.00	1.00	1.00	1.00	0.00	1.00
Uniform Delay (d), s/veh	46.1	29.9	29.9	43.8	27.6	27.6	48.8	37.6	40.3	50.7	0.0	44.4
Incr Delay (d2), s/veh	62.2	359.9	397.3	141.4	47.3	57.2	281.5	0.5	2.9	11.4	0.0	7.2
Initial Q Delay(d3),s/veh	0.0	0.0	0.0	0.0	0.0	0.0	0.0	0.0	0.0	0.0	0.0	0.0
%ile BackOfQ(50%),veh/ln	9.7	94.7	103.3	19.6	28.9	33.9	13.8	2.5	4.5	1.1	0.0	5.1
Unsig. Movement Delay, s/veh												
LnGrp Delay(d),s/veh	108.3	389.8	427.2	185.2	74.9	84.8	330.3	38.1	43.2	62.1	0.0	51.5
LnGrp LOS	F	F	F	F	F	F	F	D	D	E	A	D
Approach Vol, veh/h		3066			3129			720				217
Approach Delay, s/veh		386.2			91.6			210.7				53.2
Approach LOS		F			F			F				D
Timer - Assigned Phs	1	2	3	4	5	6	7	8				
Phs Duration (G+Y+Rc), s	22.2	52.4	12.1	18.9	17.6	57.0	7.3	23.8				
Change Period (Y+Rc), s	* 4.2	* 6.5	4.1	4.6	* 4.2	6.5	4.1	4.6				
Max Green Setting (Gmax), s	* 18	* 46	8.0	29.0	* 13	50.2	5.3	31.7				
Max Q Clear Time (g_c+I1), s	20.0	47.9	10.0	13.4	15.4	52.5	4.0	14.1				
Green Ext Time (p_c), s	0.0	0.0	0.0	0.9	0.0	0.0	0.0	1.1				

Intersection Summary

HCM 6th Ctrl Delay	229.1
HCM 6th LOS	F

Notes

* HCM 6th computational engine requires equal clearance times for the phases crossing the barrier.

Timings
15: Airman Dr & Cactus Av.



Lane Group	WBL	WBR	NBR	SBL	Ø6
Lane Configurations	↖	↗	↖	↖↗	
Traffic Volume (vph)	305	379	696	902	
Future Volume (vph)	305	379	696	902	
Turn Type	Prot	Perm	Perm	Prot	
Protected Phases	3			1	6
Permitted Phases		8	2		
Detector Phase	3	8	2	1	
Switch Phase					
Minimum Initial (s)	5.0	10.0	10.0	5.0	10.0
Minimum Split (s)	9.6	21.7	21.7	9.6	14.7
Total Split (s)	30.0	30.0	48.0	42.0	90.0
Total Split (%)	25.0%	25.0%	40.0%	35.0%	75%
Yellow Time (s)	3.6	3.7	3.7	3.6	3.7
All-Red Time (s)	1.0	1.0	1.0	1.0	1.0
Lost Time Adjust (s)	0.0	0.0	0.0	0.0	
Total Lost Time (s)	4.6	4.7	4.7	4.6	
Lead/Lag			Lag	Lead	
Lead-Lag Optimize?			Yes	Yes	
Recall Mode	None	None	Min	None	Min
Act Effct Green (s)	23.1	23.0	32.3	33.2	
Actuated g/C Ratio	0.22	0.22	0.31	0.32	
v/c Ratio	0.83	0.62	0.93	0.90	
Control Delay	59.9	8.7	33.5	47.1	
Queue Delay	0.0	0.0	0.0	0.0	
Total Delay	59.9	8.7	33.5	47.1	
LOS	E	A	C	D	
Approach Delay	31.5				
Approach LOS	C				

Intersection Summary

Cycle Length: 120	
Actuated Cycle Length: 103.3	
Natural Cycle: 75	
Control Type: Actuated-Uncoordinated	
Maximum v/c Ratio: 0.93	
Intersection Signal Delay: 38.3	Intersection LOS: D
Intersection Capacity Utilization 76.6%	ICU Level of Service D
Analysis Period (min) 15	













Splits and Phases: 15: Airman Dr & Cactus Av.



HCM 6th Signalized Intersection Summary
15: Airman Dr & Cactus Av.

West Campus Upper Plateau (JN 14064)

09/20/2022

						
Movement	WBL	WBR	NBT	NBR	SBL	SBT
Lane Configurations						
Traffic Volume (veh/h)	305	379	0	696	902	0
Future Volume (veh/h)	305	379	0	696	902	0
Initial Q (Qb), veh	0	0	0	0	0	0
Ped-Bike Adj(A_pbT)	1.00	1.00		0.97	1.00	
Parking Bus, Adj	1.00	1.00	1.00	1.00	1.00	1.00
Work Zone On Approach	No		No			No
Adj Sat Flow, veh/h/ln	1856	1826	1900	1856	1826	1900
Adj Flow Rate, veh/h	324	323	0	490	960	0
Peak Hour Factor	0.94	0.94	0.94	0.94	0.94	0.94
Percent Heavy Veh, %	3	5	0	3	5	0
Cap, veh/h	399	349	646	521	1033	1309
Arrive On Green	0.23	0.23	0.00	0.34	0.31	0.00
Sat Flow, veh/h	1767	1547	1900	1531	3374	1900
Grp Volume(v), veh/h	324	323	0	490	960	0
Grp Sat Flow(s),veh/h/ln	1767	1547	1900	1531	1687	1900
Q Serve(g_s), s	18.9	22.2	0.0	33.8	30.0	0.0
Cycle Q Clear(g_c), s	18.9	22.2	0.0	33.8	30.0	0.0
Prop In Lane	1.00	1.00		1.00	1.00	
Lane Grp Cap(c), veh/h	399	349	646	521	1033	1309
V/C Ratio(X)	0.81	0.92	0.00	0.94	0.93	0.00
Avail Cap(c_a), veh/h	413	361	756	609	1160	1490
HCM Platoon Ratio	1.00	1.00	1.00	1.00	1.00	1.00
Upstream Filter(I)	1.00	1.00	0.00	1.00	1.00	0.00
Uniform Delay (d), s/veh	39.9	41.2	0.0	34.8	36.6	0.0
Incr Delay (d2), s/veh	11.4	28.6	0.0	21.2	11.5	0.0
Initial Q Delay(d3),s/veh	0.0	0.0	0.0	0.0	0.0	0.0
%ile BackOfQ(50%),veh/ln	9.4	11.1	0.0	15.3	13.8	0.0
Unsig. Movement Delay, s/veh						
LnGrp Delay(d),s/veh	51.3	69.8	0.0	56.0	48.1	0.0
LnGrp LOS	D	E	A	E	D	A
Approach Vol, veh/h	647		490			960
Approach Delay, s/veh	60.5		56.0			48.1
Approach LOS	E		E			D
Timer - Assigned Phs	1	2			6	8
Phs Duration (G+Y+Rc), s	37.9	41.7			79.6	29.2
Change Period (Y+Rc), s	4.6	* 4.7			* 4.7	4.6
Max Green Setting (Gmax), s	37.4	* 43			* 85	25.4
Max Q Clear Time (g_c+I1), s	32.0	35.8			0.0	24.2
Green Ext Time (p_c), s	1.3	1.2			0.0	0.3

Intersection Summary

HCM 6th Ctrl Delay	53.8
HCM 6th LOS	D

Notes

* HCM 6th computational engine requires equal clearance times for the phases crossing the barrier.

Intersection	
Intersection Delay, s/veh	9.9
Intersection LOS	A

Movement	EBT	EBR	WBL	WBT	NBL	NBR
Lane Configurations						
Traffic Vol, veh/h	239	81	47	110	66	77
Future Vol, veh/h	239	81	47	110	66	77
Peak Hour Factor	0.94	0.94	0.94	0.94	0.94	0.94
Heavy Vehicles, %	1	2	3	1	2	0
Mvmt Flow	254	86	50	117	70	82
Number of Lanes	1	0	1	1	1	0

Approach	EB	WB	NB
Opposing Approach	WB	EB	
Opposing Lanes	2	1	0
Conflicting Approach Left		NB	EB
Conflicting Lanes Left	0	1	1
Conflicting Approach Right	NB		WB
Conflicting Lanes Right	1	0	2
HCM Control Delay	10.7	9	9.2
HCM LOS	B	A	A

Lane	NBLn1	EBLn1	WBLn1	WBLn2
Vol Left, %	46%	0%	100%	0%
Vol Thru, %	0%	75%	0%	100%
Vol Right, %	54%	25%	0%	0%
Sign Control	Stop	Stop	Stop	Stop
Traffic Vol by Lane	143	320	47	110
LT Vol	66	0	47	0
Through Vol	0	239	0	110
RT Vol	77	81	0	0
Lane Flow Rate	152	340	50	117
Geometry Grp	2	5	7	7
Degree of Util (X)	0.205	0.421	0.079	0.168
Departure Headway (Hd)	4.858	4.451	5.709	5.171
Convergence, Y/N	Yes	Yes	Yes	Yes
Cap	736	807	627	693
Service Time	2.902	2.485	3.451	2.913
HCM Lane V/C Ratio	0.207	0.421	0.08	0.169
HCM Control Delay	9.2	10.7	8.9	9
HCM Lane LOS	A	B	A	A
HCM 95th-tile Q	0.8	2.1	0.3	0.6

Intersection	
Intersection Delay, s/veh	9.4
Intersection LOS	A

Movement	EBL	EBT	WBT	WBR	SBL	SBR
Lane Configurations						
Traffic Vol, veh/h	151	376	271	43	33	48
Future Vol, veh/h	151	376	271	43	33	48
Peak Hour Factor	0.97	0.97	0.97	0.97	0.97	0.97
Heavy Vehicles, %	1	0	2	0	4	3
Mvmt Flow	156	388	279	44	34	49
Number of Lanes	1	2	2	0	1	0

Approach	EB	WB	SB
Opposing Approach	WB	EB	
Opposing Lanes	2	3	0
Conflicting Approach Left	SB		WB
Conflicting Lanes Left	1	0	2
Conflicting Approach Right		SB	EB
Conflicting Lanes Right	0	1	3
HCM Control Delay	8.8	10.4	9.9
HCM LOS	A	B	A

Lane	EBLn1	EBLn2	EBLn3	WBLn1	WBLn2	SBLn1
Vol Left, %	100%	0%	0%	0%	0%	41%
Vol Thru, %	0%	100%	100%	100%	68%	0%
Vol Right, %	0%	0%	0%	0%	32%	59%
Sign Control	Stop	Stop	Stop	Stop	Stop	Stop
Traffic Vol by Lane	151	188	188	181	133	81
LT Vol	151	0	0	0	0	33
Through Vol	0	188	188	181	90	0
RT Vol	0	0	0	0	43	48
Lane Flow Rate	156	194	194	186	137	84
Geometry Grp	7	7	7	8	8	7
Degree of Util (X)	0.242	0.273	0.181	0.296	0.208	0.142
Departure Headway (Hd)	5.598	5.078	3.368	5.719	5.458	6.104
Convergence, Y/N	Yes	Yes	Yes	Yes	Yes	Yes
Cap	640	705	1056	626	654	584
Service Time	3.348	2.827	1.117	3.486	3.225	3.884
HCM Lane V/C Ratio	0.244	0.275	0.184	0.297	0.209	0.144
HCM Control Delay	10.1	9.7	6.9	10.9	9.7	9.9
HCM Lane LOS	B	A	A	B	A	A
HCM 95th-tile Q	0.9	1.1	0.7	1.2	0.8	0.5

Timings
18: Linebacker Dr & Cactus Av.

West Campus Upper Plateau (JN 14064)

09/20/2022

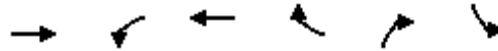

Lane Group	EBT	WBL	WBT	WBR	NBR	SBL	Ø3	Ø4	Ø5	Ø8
Lane Configurations	↑↑	↑	↑	↑	↑	↑↑				
Traffic Volume (vph)	1598	183	684	182	503	502				
Future Volume (vph)	1598	183	684	182	503	502				
Turn Type	NA	Prot	NA	Perm	pm+ov	Prot				
Protected Phases	2	1	6		1	7	3	4	5	8
Permitted Phases				6	8					
Detector Phase	2	1	6	6	1	7				
Switch Phase										
Minimum Initial (s)	10.0	5.0	10.0	10.0	5.0	5.0	5.0	10.0	5.0	10.0
Minimum Split (s)	27.0	9.6	27.0	27.0	9.6	9.1	9.1	27.0	9.6	27.0
Total Split (s)	56.0	17.0	63.4	63.4	17.0	20.0	9.1	37.9	9.6	27.0
Total Split (%)	46.7%	14.2%	52.8%	52.8%	14.2%	16.7%	8%	32%	8%	23%
Yellow Time (s)	4.0	3.6	4.0	4.0	3.6	3.6	3.6	4.0	3.6	4.0
All-Red Time (s)	1.0	1.0	1.0	1.0	1.0	0.5	0.5	1.0	1.0	1.0
Lost Time Adjust (s)	0.0	0.0	0.0	0.0	0.0	0.0				
Total Lost Time (s)	5.0	4.6	5.0	5.0	4.6	4.1				
Lead/Lag	Lead	Lag	Lag	Lag	Lag	Lag	Lag	Lead	Lead	Lead
Lead-Lag Optimize?	Yes	Yes	Yes	Yes	Yes	Yes	Yes	Yes	Yes	Yes
Recall Mode	None	None	None	None	None	None	None	None	None	None
Act Effct Green (s)	51.5	12.5	68.7	68.7	17.0	16.1				
Actuated g/C Ratio	0.52	0.13	0.70	0.70	0.17	0.16				
v/c Ratio	0.91	0.91	0.58	0.18	1.43	0.97				
Control Delay	30.8	86.0	11.9	2.3	231.5	74.4				
Queue Delay	0.0	0.0	0.0	0.0	0.0	0.0				
Total Delay	30.8	86.0	11.9	2.3	231.5	74.4				
LOS	C	F	B	A	F	E				
Approach Delay	30.8		23.2							
Approach LOS	C		C							

Intersection Summary

Cycle Length: 120	
Actuated Cycle Length: 98.4	
Natural Cycle: 120	
Control Type: Actuated-Uncoordinated	
Maximum v/c Ratio: 1.43	
Intersection Signal Delay: 62.3	Intersection LOS: E
Intersection Capacity Utilization 101.1%	ICU Level of Service G
Analysis Period (min) 15	

Splits and Phases: 18: Linebacker Dr & Cactus Av.

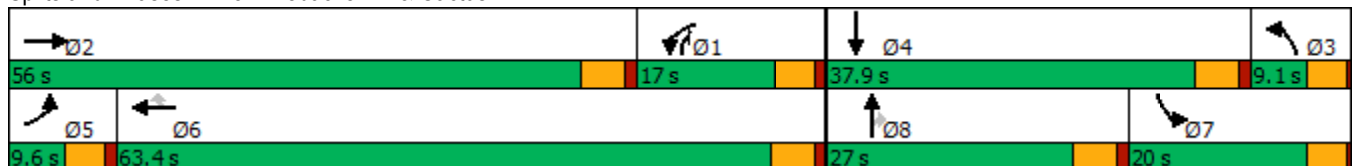

HCM 6th Signalized Intersection Summary
18: Linebacker Dr & Cactus Av.

West Campus Upper Plateau (JN 14064)

09/20/2022



Movement	EBL	EBT	EBR	WBL	WBT	WBR	NBL	NBT	NBR	SBL	SBT	SBR
Lane Configurations	↖	↖↗		↖	↖	↖	↖	↖	↖	↖↗	↖	↖
Traffic Volume (veh/h)	0	1598	0	183	684	182	0	0	503	502	0	0
Future Volume (veh/h)	0	1598	0	183	684	182	0	0	503	502	0	0
Initial Q (Qb), veh	0	0	0	0	0	0	0	0	0	0	0	0
Ped-Bike Adj(A_pbT)	1.00		1.00	1.00		1.00	1.00		1.00	1.00		1.00
Parking Bus, Adj	1.00	1.00	1.00	1.00	1.00	1.00	1.00	1.00	1.00	1.00	1.00	1.00
Work Zone On Approach		No			No			No			No	
Adj Sat Flow, veh/h/ln	1900	1841	1900	1826	1841	1826	1900	1900	1826	1826	1900	1900
Adj Flow Rate, veh/h	0	1737	0	199	743	198	0	0	297	546	0	0
Peak Hour Factor	0.92	0.92	0.92	0.92	0.92	0.92	0.92	0.92	0.92	0.92	0.92	0.92
Percent Heavy Veh, %	0	4	0	5	4	5	0	0	5	5	0	0
Cap, veh/h	2	1719	0	197	1153	969	526	188	329	506	2	0
Arrive On Green	0.00	0.47	0.00	0.11	0.63	0.63	0.00	0.00	0.10	0.15	0.00	0.00
Sat Flow, veh/h	1810	3681	0	1739	1841	1547	1810	1900	1547	3478	1900	0
Grp Volume(v), veh/h	0	1737	0	199	743	198	0	0	297	546	0	0
Grp Sat Flow(s),veh/h/ln	1810	1841	0	1739	1841	1547	1810	1900	1547	1739	1900	0
Q Serve(g_s), s	0.0	51.0	0.0	12.4	27.6	2.3	0.0	0.0	8.0	15.9	0.0	0.0
Cycle Q Clear(g_c), s	0.0	51.0	0.0	12.4	27.6	2.3	0.0	0.0	8.0	15.9	0.0	0.0
Prop In Lane	1.00		0.00	1.00		1.00	1.00		1.00	1.00		0.00
Lane Grp Cap(c), veh/h	2	1719	0	197	1153	969	526	188	329	506	2	0
V/C Ratio(X)	0.00	1.01	0.00	1.01	0.64	0.20	0.00	0.00	0.90	1.08	0.00	0.00
Avail Cap(c_a), veh/h	83	1719	0	197	1153	969	526	383	487	506	572	0
HCM Platoon Ratio	1.00	1.00	1.00	1.00	1.00	1.00	1.00	1.00	1.00	1.00	1.00	1.00
Upstream Filter(I)	0.00	1.00	0.00	1.00	1.00	1.00	0.00	0.00	1.00	1.00	0.00	0.00
Uniform Delay (d), s/veh	0.0	29.1	0.0	48.4	12.8	1.3	0.0	0.0	41.9	46.7	0.0	0.0
Incr Delay (d2), s/veh	0.0	24.3	0.0	66.1	1.2	0.1	0.0	0.0	14.7	62.8	0.0	0.0
Initial Q Delay(d3),s/veh	0.0	0.0	0.0	0.0	0.0	0.0	0.0	0.0	0.0	0.0	0.0	0.0
%ile BackOfQ(50%),veh/ln	0.0	27.2	0.0	9.0	10.9	1.7	0.0	0.0	3.7	11.2	0.0	0.0
Unsig. Movement Delay, s/veh												
LnGrp Delay(d),s/veh	0.0	53.4	0.0	114.6	14.0	1.4	0.0	0.0	56.6	109.5	0.0	0.0
LnGrp LOS	A	F	A	F	B	A	A	A	E	F	A	A
Approach Vol, veh/h		1737			1140			297			546	
Approach Delay, s/veh		53.4			29.4			56.6			109.5	
Approach LOS		D			C			E			F	
Timer - Assigned Phs	1	2	3	4	5	6	7	8				
Phs Duration (G+Y+Rc), s	17.4	56.0	35.8	0.0	0.0	73.4	20.0	15.8				
Change Period (Y+Rc), s	5.0	* 5	4.1	5.0	4.6	5.0	4.1	5.0				
Max Green Setting (Gmax), s	12.4	* 51	5.0	32.9	5.0	58.4	15.9	22.0				
Max Q Clear Time (g_c+I1), s	14.4	53.0	0.0	0.0	0.0	29.6	17.9	10.0				
Green Ext Time (p_c), s	0.0	0.0	0.0	0.0	0.0	6.9	0.0	0.8				

Intersection Summary

HCM 6th Ctrl Delay	54.5
HCM 6th LOS	D

Notes

- User approved pedestrian interval to be less than phase max green.
- * HCM 6th computational engine requires equal clearance times for the phases crossing the barrier.

Timings
19: Van Buren Bl. & Orange Terrace Pkwy.

West Campus Upper Plateau (JN 14064)

09/20/2022

Lane Group	EBL	EBT	EBR	WBL	WBT	WBR	NBL	NBT	NBR	SBL	SBT	SBR
Lane Configurations												
Traffic Volume (vph)	206	2586	310	186	2579	254	328	51	239	143	47	167
Future Volume (vph)	206	2586	310	186	2579	254	328	51	239	143	47	167
Turn Type	Prot	NA	Perm	Prot	NA	Perm	Prot	NA	Perm	Prot	NA	pm+ov
Protected Phases	5	2		1	6		3	8		7	4	5
Permitted Phases			2			6			8			4
Detector Phase	5	2	2	1	6	6	3	8	8	7	4	5
Switch Phase												
Minimum Initial (s)	5.0	10.0	10.0	5.0	10.0	10.0	5.0	5.0	5.0	10.0	10.0	5.0
Minimum Split (s)	9.2	25.2	25.2	9.1	25.2	25.2	9.1	26.1	26.1	15.8	24.8	9.2
Total Split (s)	16.0	63.0	63.0	11.0	58.0	58.0	12.0	27.0	27.0	19.0	34.0	16.0
Total Split (%)	13.3%	52.5%	52.5%	9.2%	48.3%	48.3%	10.0%	22.5%	22.5%	15.8%	28.3%	13.3%
Yellow Time (s)	3.2	5.2	5.2	3.6	5.2	5.2	3.6	3.6	3.6	4.8	4.8	3.2
All-Red Time (s)	1.0	1.0	1.0	0.5	1.0	1.0	0.5	0.5	0.5	1.0	1.0	1.0
Lost Time Adjust (s)	0.0	0.0	0.0	0.0	0.0	0.0	0.0	0.0	0.0	0.0	0.0	0.0
Total Lost Time (s)	4.2	6.2	6.2	4.1	6.2	6.2	4.1	4.1	4.1	5.8	5.8	4.2
Lead/Lag	Lead	Lag	Lag	Lead	Lag	Lag	Lead	Lag	Lag	Lead	Lag	Lead
Lead-Lag Optimize?	Yes	Yes	Yes	Yes	Yes	Yes	Yes	Yes	Yes	Yes	Yes	Yes
Recall Mode	None	None	None	None	None	None	None	None	None	None	None	None
Act Effct Green (s)	10.2	57.0	57.0	6.9	53.6	53.6	10.8	10.7	10.7	10.8	14.0	26.7
Actuated g/C Ratio	0.10	0.54	0.54	0.07	0.51	0.51	0.10	0.10	0.10	0.10	0.13	0.25
v/c Ratio	0.64	0.98	0.35	0.86	1.05	0.29	0.98	0.15	0.74	0.42	0.19	0.38
Control Delay	55.8	38.3	8.8	82.3	60.2	6.2	93.4	43.4	25.8	49.2	41.8	20.1
Queue Delay	0.0	0.0	0.0	0.0	0.0	0.0	0.0	0.0	0.0	0.0	0.0	0.0
Total Delay	55.8	38.3	8.8	82.3	60.2	6.2	93.4	43.4	25.8	49.2	41.8	20.1
LOS	E	D	A	F	E	A	F	D	C	D	D	C
Approach Delay		36.6			57.0			63.2			34.6	
Approach LOS		D			E			E			C	

Intersection Summary

Cycle Length: 120
 Actuated Cycle Length: 105.6
 Natural Cycle: 120
 Control Type: Actuated-Uncoordinated
 Maximum v/c Ratio: 1.05
 Intersection Signal Delay: 47.5
 Intersection LOS: D
 Intersection Capacity Utilization 86.5%
 ICU Level of Service E
 Analysis Period (min) 15



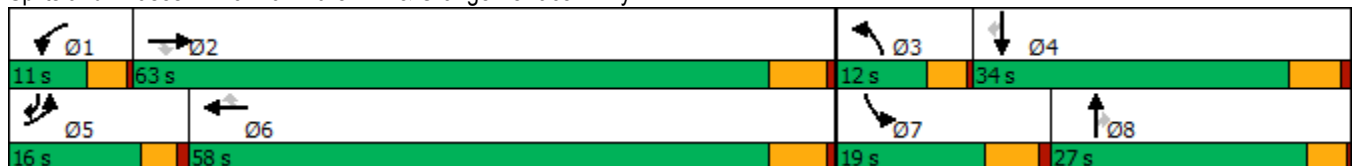































Splits and Phases: 19: Van Buren Bl. & Orange Terrace Pkwy.



HCM 6th Signalized Intersection Summary
 19: Van Buren Bl. & Orange Terrace Pkwy.

West Campus Upper Plateau (JN 14064)

09/20/2022

												
Movement	EBL	EBT	EBR	WBL	WBT	WBR	NBL	NBT	NBR	SBL	SBT	SBR
Lane Configurations	 	  		 	  		 	 		 	 	
Traffic Volume (veh/h)	206	2586	310	186	2579	254	328	51	239	143	47	167
Future Volume (veh/h)	206	2586	310	186	2579	254	328	51	239	143	47	167
Initial Q (Qb), veh	0	0	0	0	0	0	0	0	0	0	0	0
Ped-Bike Adj(A_pbT)	1.00		1.00	1.00		1.00	1.00		1.00	1.00		1.00
Parking Bus, Adj	1.00	1.00	1.00	1.00	1.00	1.00	1.00	1.00	1.00	1.00	1.00	1.00
Work Zone On Approach		No			No			No			No	
Adj Sat Flow, veh/h/ln	1885	1870	1870	1885	1856	1885	1870	1900	1885	1885	1900	1885
Adj Flow Rate, veh/h	215	2694	297	194	2686	206	342	53	218	149	49	101
Peak Hour Factor	0.96	0.96	0.96	0.96	0.96	0.96	0.96	0.96	0.96	0.96	0.96	0.96
Percent Heavy Veh, %	1	2	2	1	3	1	2	0	1	1	0	1
Cap, veh/h	276	2562	795	212	2445	771	241	562	249	308	359	429
Arrive On Green	0.08	0.50	0.50	0.06	0.48	0.48	0.07	0.16	0.16	0.09	0.19	0.19
Sat Flow, veh/h	3483	5106	1585	3483	5066	1598	3456	3610	1598	3483	1900	1598
Grp Volume(v), veh/h	215	2694	297	194	2686	206	342	53	218	149	49	101
Grp Sat Flow(s),veh/h/ln	1742	1702	1585	1742	1689	1598	1728	1805	1598	1742	1900	1598
Q Serve(g_s), s	6.9	56.8	13.0	6.3	54.6	8.7	7.9	1.4	15.1	4.6	2.4	5.6
Cycle Q Clear(g_c), s	6.9	56.8	13.0	6.3	54.6	8.7	7.9	1.4	15.1	4.6	2.4	5.6
Prop In Lane	1.00		1.00	1.00		1.00	1.00		1.00	1.00		1.00
Lane Grp Cap(c), veh/h	276	2562	795	212	2445	771	241	562	249	308	359	429
V/C Ratio(X)	0.78	1.05	0.37	0.91	1.10	0.27	1.42	0.09	0.88	0.48	0.14	0.24
Avail Cap(c_a), veh/h	363	2562	795	212	2445	771	241	730	323	406	473	524
HCM Platoon Ratio	1.00	1.00	1.00	1.00	1.00	1.00	1.00	1.00	1.00	1.00	1.00	1.00
Upstream Filter(I)	1.00	1.00	1.00	1.00	1.00	1.00	1.00	1.00	1.00	1.00	1.00	1.00
Uniform Delay (d), s/veh	51.2	28.2	17.3	52.9	29.3	17.4	52.7	41.0	46.7	49.2	38.2	32.4
Incr Delay (d2), s/veh	5.5	33.2	0.3	38.9	51.4	0.2	210.8	0.1	18.9	1.2	0.2	0.3
Initial Q Delay(d3),s/veh	0.0	0.0	0.0	0.0	0.0	0.0	0.0	0.0	0.0	0.0	0.0	0.0
%ile BackOfQ(50%),veh/ln	3.1	28.3	4.7	3.8	31.3	3.2	10.5	0.6	7.3	2.0	1.1	2.2
Unsig. Movement Delay, s/veh												
LnGrp Delay(d),s/veh	56.7	61.4	17.6	91.7	80.7	17.6	263.5	41.0	65.6	50.3	38.4	32.6
LnGrp LOS	E	F	B	F	F	B	F	D	E	D	D	C
Approach Vol, veh/h		3206			3086			613			299	
Approach Delay, s/veh		57.1			77.2			173.9			42.4	
Approach LOS		E			E			F			D	
Timer - Assigned Phs	1	2	3	4	5	6	7	8				
Phs Duration (G+Y+Rc), s	11.0	63.0	12.0	27.2	13.2	60.8	15.8	23.4				
Change Period (Y+Rc), s	4.1	6.2	4.1	5.8	* 4.2	6.2	5.8	* 5.8				
Max Green Setting (Gmax), s	6.9	56.8	7.9	28.2	* 12	51.8	13.2	* 23				
Max Q Clear Time (g_c+I1), s	8.3	58.8	9.9	7.6	8.9	56.6	6.6	17.1				
Green Ext Time (p_c), s	0.0	0.0	0.0	0.5	0.1	0.0	0.2	0.5				

Intersection Summary

HCM 6th Ctrl Delay	75.0
HCM 6th LOS	E

Notes

* HCM 6th computational engine requires equal clearance times for the phases crossing the barrier.

Timings
20: Brown/San Gorgonio Dr & Alessandro Bl.

West Campus Upper Plateau (JN 14064)

09/20/2022



Lane Group	EBL	EBT	WBL	WBT	WBR	NBL	NBT	NBR	SBL	SBT	SBR
Lane Configurations	↖	↖↖↖	↖	↖↖↖	↖	↖	↖	↖	↖	↖	↖
Traffic Volume (vph)	35	2749	213	2909	39	389	5	477	150	5	91
Future Volume (vph)	35	2749	213	2909	39	389	5	477	150	5	91
Turn Type	Prot	NA	Prot	NA	Perm	Prot	NA	pm+ov	Prot	NA	pm+ov
Protected Phases	5	2	1	6		3	8	1	7	4	5
Permitted Phases					6			8			4
Detector Phase	5	2	1	6	6	3	8	1	7	4	5
Switch Phase											
Minimum Initial (s)	5.0	10.0	5.0	10.0	10.0	5.0	5.0	5.0	5.0	10.0	5.0
Minimum Split (s)	8.7	43.5	9.1	43.5	43.5	9.1	26.1	9.1	8.7	49.8	8.7
Total Split (s)	8.7	52.0	9.1	52.4	52.4	9.1	39.3	9.1	19.6	49.8	8.7
Total Split (%)	7.3%	43.3%	7.6%	43.7%	43.7%	7.6%	32.8%	7.6%	16.3%	41.5%	7.3%
Yellow Time (s)	3.2	5.5	3.6	5.5	5.5	3.6	3.6	3.6	3.2	4.8	3.2
All-Red Time (s)	0.5	1.0	0.5	1.0	1.0	0.5	0.5	0.5	0.5	1.0	0.5
Lost Time Adjust (s)	0.0	0.0	0.0	0.0	0.0	0.0	0.0	0.0	0.0	0.0	0.0
Total Lost Time (s)	3.7	6.5	4.1	6.5	6.5	4.1	4.1	4.1	3.7	5.8	3.7
Lead/Lag	Lead	Lag	Lead	Lag	Lag	Lead	Lag	Lead	Lead	Lag	Lead
Lead-Lag Optimize?	Yes	Yes	Yes	Yes	Yes	Yes	Yes	Yes	Yes	Yes	Yes
Recall Mode	None	None	None	None	None	None	None	None	None	None	None
Act Effct Green (s)	5.2	47.1	5.2	49.6	49.6	9.9	10.0	10.7	11.8	15.1	12.2
Actuated g/C Ratio	0.06	0.56	0.06	0.59	0.59	0.12	0.12	0.13	0.14	0.18	0.14
v/c Ratio	0.34	1.10	2.15	1.02	0.05	1.96	0.02	1.79	0.67	0.01	0.33
Control Delay	52.3	71.4	574.9	41.1	0.1	473.0	32.0	390.9	51.4	26.8	13.8
Queue Delay	0.0	0.0	0.0	0.0	0.0	0.0	0.0	0.0	0.0	0.0	0.0
Total Delay	52.3	71.4	574.9	41.1	0.1	473.0	32.0	390.9	51.4	26.8	13.8
LOS	D	E	F	D	A	F	C	F	D	C	B
Approach Delay		71.1		76.6			425.6			37.0	
Approach LOS		E		E			F			D	

Intersection Summary

Cycle Length: 120	
Actuated Cycle Length: 84.4	
Natural Cycle: 115	
Control Type: Actuated-Uncoordinated	
Maximum v/c Ratio: 2.15	
Intersection Signal Delay: 114.9	Intersection LOS: F
Intersection Capacity Utilization 109.6%	ICU Level of Service H
Analysis Period (min) 15	

Splits and Phases: 20: Brown/San Gorgonio Dr & Alessandro Bl.

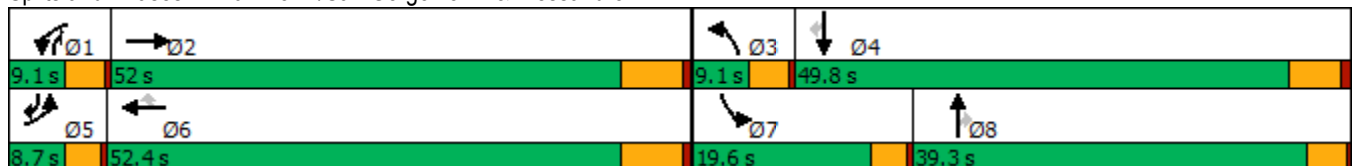

HCM 6th Signalized Intersection Summary
 20: Brown/San Gorgonio Dr & Alessandro Bl.

West Campus Upper Plateau (JN 14064)

09/20/2022



Movement	EBL	EBT	EBR	WBL	WBT	WBR	NBL	NBT	NBR	SBL	SBT	SBR
Lane Configurations	↖	↕↕↕		↖	↕↕↕	↖	↖	↕	↖	↖	↕	↖
Traffic Volume (veh/h)	35	2749	191	213	2909	39	389	5	477	150	5	91
Future Volume (veh/h)	35	2749	191	213	2909	39	389	5	477	150	5	91
Initial Q (Qb), veh	0	0	0	0	0	0	0	0	0	0	0	0
Ped-Bike Adj(A_pbT)	1.00		1.00	1.00		1.00	1.00		1.00	1.00		1.00
Parking Bus, Adj	1.00	1.00	1.00	1.00	1.00	1.00	1.00	1.00	1.00	1.00	1.00	1.00
Work Zone On Approach		No			No			No			No	
Adj Sat Flow, veh/h/ln	1900	1870	1900	1811	1885	1396	1885	1900	1796	1811	1900	1885
Adj Flow Rate, veh/h	37	2894	197	224	3062	37	409	5	489	158	5	48
Peak Hour Factor	0.95	0.95	0.95	0.95	0.95	0.95	0.95	0.95	0.95	0.95	0.95	0.95
Percent Heavy Veh, %	0	2	0	6	1	34	1	0	7	6	0	1
Cap, veh/h	54	1878	125	73	2058	473	76	565	517	184	681	620
Arrive On Green	0.03	0.38	0.38	0.04	0.40	0.40	0.04	0.30	0.30	0.11	0.36	0.36
Sat Flow, veh/h	1810	4890	326	1725	5147	1183	1795	1900	1522	1725	1900	1598
Grp Volume(v), veh/h	37	1995	1096	224	3062	37	409	5	489	158	5	48
Grp Sat Flow(s),veh/h/ln	1810	1702	1812	1725	1716	1183	1795	1900	1522	1725	1900	1598
Q Serve(g_s), s	2.4	45.5	45.5	5.0	47.4	2.3	5.0	0.2	35.2	10.7	0.2	2.2
Cycle Q Clear(g_c), s	2.4	45.5	45.5	5.0	47.4	2.3	5.0	0.2	35.2	10.7	0.2	2.2
Prop In Lane	1.00		0.18	1.00		1.00	1.00		1.00	1.00		1.00
Lane Grp Cap(c), veh/h	54	1307	696	73	2058	473	76	565	517	184	681	620
V/C Ratio(X)	0.69	1.53	1.58	3.08	1.49	0.08	5.40	0.01	0.95	0.86	0.01	0.08
Avail Cap(c_a), veh/h	76	1307	696	73	2058	473	76	565	517	232	706	641
HCM Platoon Ratio	1.00	1.00	1.00	1.00	1.00	1.00	1.00	1.00	1.00	1.00	1.00	1.00
Upstream Filter(I)	1.00	1.00	1.00	1.00	1.00	1.00	1.00	1.00	1.00	1.00	1.00	1.00
Uniform Delay (d), s/veh	56.9	36.5	36.5	56.7	35.5	22.0	56.7	29.3	38.1	52.0	24.4	22.9
Incr Delay (d2), s/veh	5.7	240.5	265.7	969.9	222.0	0.1	2007.5	0.0	26.8	18.8	0.0	0.1
Initial Q Delay(d3),s/veh	0.0	0.0	0.0	0.0	0.0	0.0	0.0	0.0	0.0	0.0	0.0	0.0
%ile BackOfQ(50%),veh/ln	1.1	60.9	69.7	21.8	61.6	0.7	44.5	0.1	17.4	5.6	0.1	0.9
Unsig. Movement Delay, s/veh												
LnGrp Delay(d),s/veh	62.6	277.0	302.2	1026.6	257.6	22.1	2064.2	29.3	64.9	70.8	24.4	22.9
LnGrp LOS	E	F	F	F	F	C	F	C	E	E	C	C
Approach Vol, veh/h		3128			3323			903			211	
Approach Delay, s/veh		283.3			306.8			970.2			58.8	
Approach LOS		F			F			F			E	
Timer - Assigned Phs	1	2	3	4	5	6	7	8				
Phs Duration (G+Y+Rc), s	9.1	52.0	9.1	48.3	7.2	53.9	16.4	41.0				
Change Period (Y+Rc), s	4.1	6.5	4.1	5.8	3.7	6.5	3.7	* 5.8				
Max Green Setting (Gmax), s	5.0	45.5	5.0	44.0	5.0	45.9	15.9	* 35				
Max Q Clear Time (g_c+I1), s	7.0	47.5	7.0	4.2	4.4	49.4	12.7	37.2				
Green Ext Time (p_c), s	0.0	0.0	0.0	0.2	0.0	0.0	0.1	0.0				

Intersection Summary

HCM 6th Ctrl Delay	369.4
HCM 6th LOS	F

Notes

* HCM 6th computational engine requires equal clearance times for the phases crossing the barrier.

Timings
21: Cactus Av. & Brown St

West Campus Upper Plateau (JN 14064)

09/20/2022



Lane Group	EBL	EBT	WBT	SBR
Lane Configurations	↘	↑↑	↑↑	↗
Traffic Volume (vph)	815	1787	649	400
Future Volume (vph)	815	1787	649	400
Turn Type	Prot	NA	NA	Perm
Protected Phases	7	4	8	
Permitted Phases				6
Detector Phase	7	4	8	6
Switch Phase				
Minimum Initial (s)	5.0	10.0	10.0	10.0
Minimum Split (s)	9.6	15.8	27.8	26.7
Total Split (s)	62.0	92.4	30.4	27.6
Total Split (%)	51.7%	77.0%	25.3%	23.0%
Yellow Time (s)	3.6	4.8	4.8	3.7
All-Red Time (s)	1.0	1.0	1.0	1.0
Lost Time Adjust (s)	0.0	0.0	0.0	0.0
Total Lost Time (s)	4.6	5.8	5.8	4.7
Lead/Lag	Lead		Lag	
Lead-Lag Optimize?	Yes		Yes	
Recall Mode	None	None	None	Min
Act Effct Green (s)	57.5	86.8	24.6	12.2
Actuated g/C Ratio	0.53	0.79	0.22	0.11
v/c Ratio	0.94	0.72	0.92	0.51
Control Delay	42.9	8.1	60.3	2.1
Queue Delay	0.0	0.0	0.0	0.0
Total Delay	42.9	8.1	60.3	2.1
LOS	D	A	E	A
Approach Delay		19.0	60.3	
Approach LOS		B	E	

Intersection Summary

Cycle Length: 120
 Actuated Cycle Length: 109.5
 Natural Cycle: 120
 Control Type: Actuated-Uncoordinated
 Maximum v/c Ratio: 0.94
 Intersection Signal Delay: 24.5
 Intersection LOS: C
 Intersection Capacity Utilization 71.8%
 ICU Level of Service C
 Analysis Period (min) 15

Splits and Phases: 21: Cactus Av. & Brown St



HCM 6th Signalized Intersection Summary
 21: Cactus Av. & Brown St

West Campus Upper Plateau (JN 14064)

09/20/2022



Movement	EBL	EBT	WBT	WBR	SBL	SBR	
Lane Configurations	↖	↑↑	↗		↖	↗	
Traffic Volume (veh/h)	815	1787	649	0	0	400	
Future Volume (veh/h)	815	1787	649	0	0	400	
Initial Q (Qb), veh	0	0	0	0	0	0	
Ped-Bike Adj(A_pbT)	1.00			1.00	1.00	1.00	
Parking Bus, Adj	1.00	1.00	1.00	1.00	1.00	1.00	
Work Zone On Approach		No	No		No		
Adj Sat Flow, veh/h/ln	1900	1811	1811	1900	1900	1900	
Adj Flow Rate, veh/h	886	1942	705	0	0	239	
Peak Hour Factor	0.92	0.92	0.92	0.92	0.92	0.92	
Percent Heavy Veh, %	0	6	6	0	0	0	
Cap, veh/h	893	2562	728	0	299	266	
Arrive On Green	0.49	0.74	0.21	0.00	0.00	0.17	
Sat Flow, veh/h	1810	3532	3622	0	1810	1610	
Grp Volume(v), veh/h	886	1942	705	0	0	239	
Grp Sat Flow(s),veh/h/ln	1810	1721	1721	0	1810	1610	
Q Serve(g_s), s	56.5	38.5	23.6	0.0	0.0	16.9	
Cycle Q Clear(g_c), s	56.5	38.5	23.6	0.0	0.0	16.9	
Prop In Lane	1.00			0.00	1.00	1.00	
Lane Grp Cap(c), veh/h	893	2562	728	0	299	266	
V/C Ratio(X)	0.99	0.76	0.97	0.00	0.00	0.90	
Avail Cap(c_a), veh/h	893	2562	728	0	356	317	
HCM Platoon Ratio	1.00	1.00	1.00	1.00	1.00	1.00	
Upstream Filter(I)	1.00	1.00	1.00	0.00	0.00	1.00	
Uniform Delay (d), s/veh	29.2	8.7	45.5	0.0	0.0	47.6	
Incr Delay (d2), s/veh	28.1	1.3	25.7	0.0	0.0	24.1	
Initial Q Delay(d3),s/veh	0.0	0.0	0.0	0.0	0.0	0.0	
%ile BackOfQ(50%),veh/ln	29.2	11.0	12.3	0.0	0.0	1.8	
Unsig. Movement Delay, s/veh							
LnGrp Delay(d),s/veh	57.3	10.1	71.2	0.0	0.0	71.7	
LnGrp LOS	E	B	E	A	A	E	
Approach Vol, veh/h		2828	705		239		
Approach Delay, s/veh		24.9	71.2		71.7		
Approach LOS		C	E		E		
Timer - Assigned Phs				4	6	7	8
Phs Duration (G+Y+Rc), s				92.4	23.9	62.0	30.4
Change Period (Y+Rc), s				5.8	4.7	4.6	5.8
Max Green Setting (Gmax), s				86.6	22.9	57.4	24.6
Max Q Clear Time (g_c+11), s				40.5	18.9	58.5	25.6
Green Ext Time (p_c), s				24.0	0.3	0.0	0.0
Intersection Summary							
HCM 6th Ctrl Delay			36.5				
HCM 6th LOS			D				

Timings
22: Sycamore Canyon Bl. & Eastridge Ave

West Campus Upper Plateau (JN 14064)

09/20/2022



Lane Group	EBL	EBT	EBR	WBL	WBT	WBR	NBL	NBT	NBR	SBL	SBT	SBR
Lane Configurations	↖↗	↑↑↑	↖	↖↗	↑↑	↖	↖↗	↑↑	↖	↖↗	↑↑	↖
Traffic Volume (vph)	110	125	61	238	80	426	38	919	235	335	505	23
Future Volume (vph)	110	125	61	238	80	426	38	919	235	335	505	23
Turn Type	Prot	NA	Perm	Prot	NA	pm+ov	Prot	NA	pm+ov	Prot	NA	pm+ov
Protected Phases	5	2		1	6	7	3	8	1	7	4	5
Permitted Phases			2			6			8			4
Detector Phase	5	2	2	1	6	7	3	8	1	7	4	5
Switch Phase												
Minimum Initial (s)	5.0	10.0	10.0	5.0	10.0	5.0	5.0	10.0	5.0	5.0	10.0	5.0
Minimum Split (s)	8.7	43.5	43.5	8.7	43.5	8.7	8.7	15.8	8.7	8.7	49.8	8.7
Total Split (s)	11.7	45.5	45.5	15.2	49.0	20.2	8.7	39.1	15.2	20.2	50.6	11.7
Total Split (%)	9.8%	37.9%	37.9%	12.7%	40.8%	16.8%	7.3%	32.6%	12.7%	16.8%	42.2%	9.8%
Yellow Time (s)	3.2	5.5	5.5	3.2	5.5	3.2	3.2	4.8	3.2	3.2	4.8	3.2
All-Red Time (s)	0.5	1.0	1.0	0.5	1.0	0.5	0.5	1.0	0.5	0.5	1.0	0.5
Lost Time Adjust (s)	0.0	0.0	0.0	0.0	0.0	0.0	0.0	0.0	0.0	0.0	0.0	0.0
Total Lost Time (s)	3.7	6.5	6.5	3.7	6.5	3.7	3.7	5.8	3.7	3.7	5.8	3.7
Lead/Lag	Lead	Lag	Lag	Lead	Lag	Lead	Lead	Lag	Lead	Lead	Lag	Lead
Lead-Lag Optimize?	Yes	Yes	Yes	Yes	Yes	Yes	Yes	Yes	Yes	Yes	Yes	Yes
Recall Mode	None	None	None	None	None	None	None	None	None	None	None	None
Act Effct Green (s)	11.6	13.7	13.7	11.0	16.7	32.1	5.0	33.6	46.8	15.3	47.6	61.3
Actuated g/C Ratio	0.12	0.15	0.15	0.12	0.18	0.34	0.05	0.36	0.50	0.16	0.51	0.65
v/c Ratio	0.32	0.21	0.20	0.69	0.18	0.84	0.25	0.82	0.35	0.66	0.31	0.03
Control Delay	44.8	35.1	1.3	51.4	32.2	35.6	49.6	35.1	6.7	44.4	16.1	0.0
Queue Delay	0.0	0.0	0.0	0.0	0.0	0.0	0.0	0.0	0.0	0.0	0.0	0.0
Total Delay	44.8	35.1	1.3	51.4	32.2	35.6	49.6	35.1	6.7	44.4	16.1	0.0
LOS	D	D	A	D	C	D	D	D	A	D	B	A
Approach Delay		31.8			40.3			30.0			26.7	
Approach LOS		C			D			C			C	

Intersection Summary

Cycle Length: 120
 Actuated Cycle Length: 93.6
 Natural Cycle: 115
 Control Type: Actuated-Uncoordinated
 Maximum v/c Ratio: 0.84
 Intersection Signal Delay: 31.7
 Intersection LOS: C
 Intersection Capacity Utilization 67.6%
 ICU Level of Service C
 Analysis Period (min) 15

Splits and Phases: 22: Sycamore Canyon Bl. & Eastridge Ave

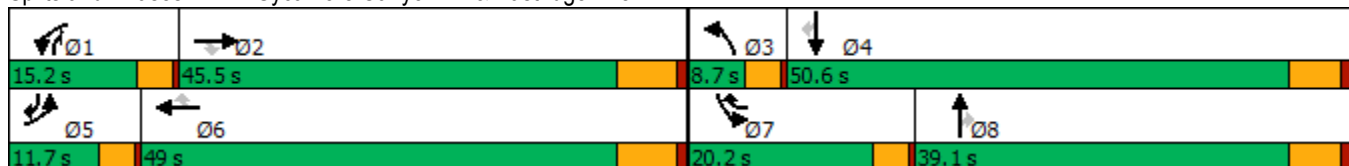

HCM 6th Signalized Intersection Summary
22: Sycamore Canyon Bl. & Eastridge Ave

West Campus Upper Plateau (JN 14064)

09/20/2022



Movement	EBL	EBT	EBR	WBL	WBT	WBR	NBL	NBT	NBR	SBL	SBT	SBR
Lane Configurations	↖↗	↑↑↑	↖	↖↗	↑↑	↖	↖↗	↑↑	↖	↖↗	↑↑	↖
Traffic Volume (veh/h)	110	125	61	238	80	426	38	919	235	335	505	23
Future Volume (veh/h)	110	125	61	238	80	426	38	919	235	335	505	23
Initial Q (Qb), veh	0	0	0	0	0	0	0	0	0	0	0	0
Ped-Bike Adj(A_pbT)	1.00		1.00	1.00		1.00	1.00		0.99	1.00		0.99
Parking Bus, Adj	1.00	1.00	1.00	1.00	1.00	1.00	1.00	1.00	1.00	1.00	1.00	1.00
Work Zone On Approach		No			No			No			No	
Adj Sat Flow, veh/h/ln	1663	1648	1841	1752	1426	1796	1648	1811	1544	1841	1841	1559
Adj Flow Rate, veh/h	120	136	0	259	87	285	41	999	200	364	549	21
Peak Hour Factor	0.92	0.92	0.92	0.92	0.92	0.92	0.92	0.92	0.92	0.92	0.92	0.92
Percent Heavy Veh, %	16	17	4	10	32	7	17	6	24	4	4	23
Cap, veh/h	182	739		338	567	522	114	1212	592	454	1568	663
Arrive On Green	0.06	0.16	0.00	0.10	0.21	0.21	0.04	0.35	0.35	0.13	0.45	0.45
Sat Flow, veh/h	3072	4499	1560	3237	2709	1520	3045	3441	1292	3401	3497	1304
Grp Volume(v), veh/h	120	136	0	259	87	285	41	999	200	364	549	21
Grp Sat Flow(s),veh/h/ln	1536	1500	1560	1618	1354	1520	1522	1721	1292	1700	1749	1304
Q Serve(g_s), s	3.1	2.1	0.0	6.2	2.1	12.2	1.1	21.3	8.0	8.3	8.2	0.6
Cycle Q Clear(g_c), s	3.1	2.1	0.0	6.2	2.1	12.2	1.1	21.3	8.0	8.3	8.2	0.6
Prop In Lane	1.00		1.00	1.00		1.00	1.00		1.00	1.00		1.00
Lane Grp Cap(c), veh/h	182	739		338	567	522	114	1212	592	454	1568	663
V/C Ratio(X)	0.66	0.18		0.77	0.15	0.55	0.36	0.82	0.34	0.80	0.35	0.03
Avail Cap(c_a), veh/h	306	2187		464	1435	1009	190	1428	673	700	1953	807
HCM Platoon Ratio	1.00	1.00	1.00	1.00	1.00	1.00	1.00	1.00	1.00	1.00	1.00	1.00
Upstream Filter(I)	1.00	1.00	0.00	1.00	1.00	1.00	1.00	1.00	1.00	1.00	1.00	1.00
Uniform Delay (d), s/veh	36.9	28.9	0.0	35.0	25.9	21.3	37.7	23.7	14.0	33.7	14.5	9.9
Incr Delay (d2), s/veh	1.5	0.2	0.0	3.2	0.2	1.3	0.7	3.5	0.3	1.8	0.1	0.0
Initial Q Delay(d3),s/veh	0.0	0.0	0.0	0.0	0.0	0.0	0.0	0.0	0.0	0.0	0.0	0.0
%ile BackOfQ(50%),veh/ln	1.1	0.7	0.0	2.4	0.6	4.1	0.4	8.2	2.1	3.3	2.9	0.2
Unsig. Movement Delay, s/veh												
LnGrp Delay(d),s/veh	38.4	29.1	0.0	38.1	26.1	22.6	38.4	27.2	14.3	35.6	14.6	9.9
LnGrp LOS	D	C		D	C	C	D	C	B	D	B	A
Approach Vol, veh/h		256			631			1240			934	
Approach Delay, s/veh		33.5			29.5			25.5			22.7	
Approach LOS		C			C			C			C	
Timer - Assigned Phs	1	2	3	4	5	6	7	8				
Phs Duration (G+Y+Rc), s	12.1	19.7	6.7	41.8	8.5	23.3	14.4	34.1				
Change Period (Y+Rc), s	3.7	6.5	3.7	5.8	3.7	6.5	3.7	5.8				
Max Green Setting (Gmax), s	11.5	39.0	5.0	44.8	8.0	42.5	16.5	33.3				
Max Q Clear Time (g_c+I1), s	8.2	4.1	3.1	10.2	5.1	14.2	10.3	23.3				
Green Ext Time (p_c), s	0.2	1.1	0.0	3.7	0.0	2.3	0.4	5.0				

Intersection Summary

HCM 6th Ctrl Delay	26.1
HCM 6th LOS	C

Notes

Unsignalized Delay for [EBR] is excluded from calculations of the approach delay and intersection delay.

Timings
23: Sycamore Canyon Bl. & Cottonwood Ave

West Campus Upper Plateau (JN 14064)

09/20/2022



Lane Group	WBL	WBR	NBT	SBL	SBT
Lane Configurations	↙	↗	↕	↙	↕
Traffic Volume (vph)	83	73	1057	61	824
Future Volume (vph)	83	73	1057	61	824
Turn Type	Prot	Perm	NA	Prot	NA
Protected Phases	8		2	1	6
Permitted Phases		8			
Detector Phase	8	8	2	1	6
Switch Phase					
Minimum Initial (s)	10.0	10.0	10.0	5.0	10.0
Minimum Split (s)	15.8	15.8	43.5	9.1	43.5
Total Split (s)	23.0	23.0	78.0	19.0	97.0
Total Split (%)	19.2%	19.2%	65.0%	15.8%	80.8%
Yellow Time (s)	4.8	4.8	5.5	3.6	5.5
All-Red Time (s)	1.0	1.0	1.0	0.5	1.0
Lost Time Adjust (s)	0.0	0.0	0.0	0.0	0.0
Total Lost Time (s)	5.8	5.8	6.5	4.1	6.5
Lead/Lag			Lag	Lead	
Lead-Lag Optimize?			Yes	Yes	
Recall Mode	None	None	None	None	None
Act Effect Green (s)	14.2	14.2	44.0	10.6	54.4
Actuated g/C Ratio	0.20	0.20	0.61	0.15	0.76
v/c Ratio	0.35	0.32	0.58	0.35	0.34
Control Delay	38.8	13.0	15.0	41.6	5.0
Queue Delay	0.0	0.0	0.0	0.0	0.0
Total Delay	38.8	13.0	15.0	41.6	5.0
LOS	D	B	B	D	A
Approach Delay	26.7		15.0		7.5
Approach LOS	C		B		A

Intersection Summary

Cycle Length: 120
 Actuated Cycle Length: 72
 Natural Cycle: 70
 Control Type: Actuated-Uncoordinated
 Maximum v/c Ratio: 0.58
 Intersection Signal Delay: 12.8
 Intersection LOS: B
 Intersection Capacity Utilization 56.9%
 ICU Level of Service B
 Analysis Period (min) 15

Splits and Phases: 23: Sycamore Canyon Bl. & Cottonwood Ave



HCM 6th Signalized Intersection Summary
23: Sycamore Canyon Bl. & Cottonwood Ave

West Campus Upper Plateau (JN 14064)

09/20/2022



Movement	WBL	WBR	NBT	NBR	SBL	SBT
Lane Configurations						
Traffic Volume (veh/h)	83	73	1057	46	61	824
Future Volume (veh/h)	83	73	1057	46	61	824
Initial Q (Qb), veh	0	0	0	0	0	0
Ped-Bike Adj(A_pbT)	1.00	1.00		0.98	1.00	
Parking Bus, Adj	1.00	1.00	1.00	1.00	1.00	1.00
Work Zone On Approach	No		No			No
Adj Sat Flow, veh/h/ln	1337	818	1811	1544	1263	1870
Adj Flow Rate, veh/h	90	69	1149	49	66	896
Peak Hour Factor	0.92	0.92	0.92	0.92	0.92	0.92
Percent Heavy Veh, %	38	73	6	24	43	2
Cap, veh/h	192	105	1764	75	72	2313
Arrive On Green	0.15	0.15	0.53	0.53	0.06	0.65
Sat Flow, veh/h	1273	693	3449	143	1203	3647
Grp Volume(v), veh/h	90	69	588	610	66	896
Grp Sat Flow(s),veh/h/ln	1273	693	1721	1782	1203	1777
Q Serve(g_s), s	4.0	5.8	15.3	15.3	3.4	7.3
Cycle Q Clear(g_c), s	4.0	5.8	15.3	15.3	3.4	7.3
Prop In Lane	1.00	1.00		0.08	1.00	
Lane Grp Cap(c), veh/h	192	105	903	936	72	2313
V/C Ratio(X)	0.47	0.66	0.65	0.65	0.92	0.39
Avail Cap(c_a), veh/h	353	192	1983	2053	289	5183
HCM Platoon Ratio	1.00	1.00	1.00	1.00	1.00	1.00
Upstream Filter(I)	1.00	1.00	1.00	1.00	1.00	1.00
Uniform Delay (d), s/veh	24.1	24.8	10.6	10.6	29.0	5.1
Incr Delay (d2), s/veh	1.8	6.9	1.1	1.1	32.2	0.2
Initial Q Delay(d3),s/veh	0.0	0.0	0.0	0.0	0.0	0.0
%ile BackOfQ(50%),veh/ln	1.2	1.1	4.4	4.6	1.5	1.5
Unsig. Movement Delay, s/veh						
LnGrp Delay(d),s/veh	25.9	31.8	11.8	11.7	61.2	5.2
LnGrp LOS	C	C	B	B	E	A
Approach Vol, veh/h	159		1198			962
Approach Delay, s/veh	28.4		11.8			9.0
Approach LOS	C		B			A
Timer - Assigned Phs	1	2			6	8
Phs Duration (G+Y+Rc), s	7.8	39.1			46.9	15.2
Change Period (Y+Rc), s	4.1	6.5			6.5	5.8
Max Green Setting (Gmax), s	14.9	71.5			90.5	17.2
Max Q Clear Time (g_c+I1), s	5.4	17.3			9.3	7.8
Green Ext Time (p_c), s	0.1	15.3			10.9	0.3

Intersection Summary

HCM 6th Ctrl Delay			11.8			
HCM 6th LOS			B			

Timings

West Campus Upper Plateau (JN 14064)

24: Sycamore Canyon Bl. & Alessandro Bl.

09/20/2022



Lane Group	EBL	EBT	EBR	WBL	WBT	WBR	NBL	NBT	NBR	SBL	SBT	SBR
Lane Configurations	↘	↑↑↑	↗	↘↗	↑↑↑	↗	↘↗	↑↑	↗↘	↘↗	↑↑	↗
Traffic Volume (vph)	183	2404	790	460	2341	531	743	633	220	194	736	354
Future Volume (vph)	183	2404	790	460	2341	531	743	633	220	194	736	354
Turn Type	Prot	NA	Perm	Prot	NA	Perm	Prot	NA	pm+ov	Prot	NA	Perm
Protected Phases	5	2		1	6		3	8	1	7	4	
Permitted Phases			2			6			8			4
Detector Phase	5	2	2	1	6	6	3	8	1	7	4	4
Switch Phase												
Minimum Initial (s)	5.0	10.0	10.0	5.0	10.0	10.0	5.0	10.0	5.0	5.0	10.0	10.0
Minimum Split (s)	8.7	43.5	43.5	8.7	43.5	43.5	8.7	15.8	8.7	8.7	49.8	49.8
Total Split (s)	10.0	44.2	44.2	12.0	46.2	46.2	14.0	51.0	12.0	12.8	49.8	49.8
Total Split (%)	8.3%	36.8%	36.8%	10.0%	38.5%	38.5%	11.7%	42.5%	10.0%	10.7%	41.5%	41.5%
Yellow Time (s)	3.2	5.5	5.5	3.2	5.5	5.5	3.2	4.8	3.2	3.2	4.8	4.8
All-Red Time (s)	0.5	1.0	1.0	0.5	1.0	1.0	0.5	1.0	0.5	0.5	1.0	1.0
Lost Time Adjust (s)	0.0	0.0	0.0	0.0	0.0	0.0	0.0	0.0	0.0	0.0	0.0	0.0
Total Lost Time (s)	3.7	6.5	6.5	3.7	6.5	6.5	3.7	5.8	3.7	3.7	5.8	5.8
Lead/Lag	Lead	Lag	Lag	Lead	Lag	Lag	Lead	Lag	Lead	Lead	Lag	Lag
Lead-Lag Optimize?	Yes	Yes	Yes	Yes	Yes	Yes	Yes	Yes	Yes	Yes	Yes	Yes
Recall Mode	None	None	None	None	None	None	None	None	None	None	None	None
Act Effct Green (s)	6.3	37.9	37.9	8.3	39.9	39.9	10.3	33.0	47.1	9.1	31.7	31.7
Actuated g/C Ratio	0.06	0.35	0.35	0.08	0.37	0.37	0.10	0.31	0.44	0.08	0.29	0.29
v/c Ratio	1.78	1.39	1.15	1.89	1.27	0.84	2.28	0.61	0.18	0.79	0.74	0.65
Control Delay	414.9	209.0	107.4	445.3	158.0	35.0	612.2	34.3	12.9	72.3	38.9	26.3
Queue Delay	0.0	0.0	0.0	0.0	0.0	0.0	0.0	0.0	0.0	0.0	0.0	0.0
Total Delay	414.9	209.0	107.4	445.3	158.0	35.0	612.2	34.3	12.9	72.3	38.9	26.3
LOS	F	F	F	F	F	D	F	C	B	E	D	C
Approach Delay		196.4			178.0			300.4			40.5	
Approach LOS		F			F			F			D	

Intersection Summary

Cycle Length: 120	
Actuated Cycle Length: 108	
Natural Cycle: 115	
Control Type: Actuated-Uncoordinated	
Maximum v/c Ratio: 2.28	
Intersection Signal Delay: 186.5	Intersection LOS: F
Intersection Capacity Utilization 118.0%	ICU Level of Service H
Analysis Period (min) 15	



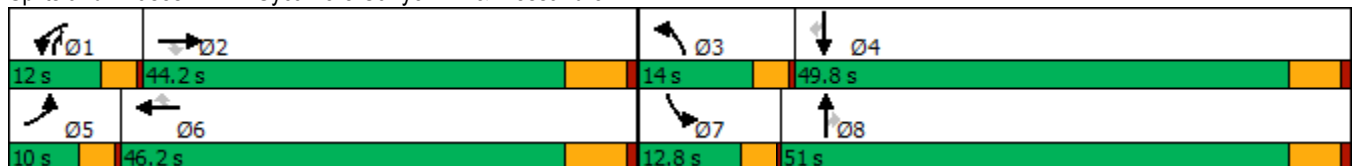































Splits and Phases: 24: Sycamore Canyon Bl. & Alessandro Bl.



HCM 6th Signalized Intersection Summary
 24: Sycamore Canyon Bl. & Alessandro Bl.

West Campus Upper Plateau (JN 14064)

09/20/2022

												
Movement	EBL	EBT	EBR	WBL	WBT	WBR	NBL	NBT	NBR	SBL	SBT	SBR
Lane Configurations		  		  	  		 	 	 	 	 	
Traffic Volume (veh/h)	183	2404	790	460	2341	531	743	633	220	194	736	354
Future Volume (veh/h)	183	2404	790	460	2341	531	743	633	220	194	736	354
Initial Q (Qb), veh	0	0	0	0	0	0	0	0	0	0	0	0
Ped-Bike Adj(A_pbT)	1.00		1.00	1.00		0.99	1.00		1.00	1.00		1.00
Parking Bus, Adj	1.00	1.00	1.00	1.00	1.00	1.00	1.00	1.00	1.00	1.00	1.00	1.00
Work Zone On Approach		No			No			No			No	
Adj Sat Flow, veh/h/ln	1900	1856	1885	1767	1870	1767	1885	1841	1870	1648	1841	1870
Adj Flow Rate, veh/h	187	2453	615	469	2389	411	758	646	182	198	751	269
Peak Hour Factor	0.98	0.98	0.98	0.98	0.98	0.98	0.98	0.98	0.98	0.98	0.98	0.98
Percent Heavy Veh, %	0	3	1	9	2	9	1	4	2	17	4	2
Cap, veh/h	109	1827	576	259	1939	561	343	1009	1027	252	954	432
Arrive On Green	0.06	0.36	0.36	0.08	0.38	0.38	0.10	0.29	0.29	0.08	0.27	0.27
Sat Flow, veh/h	1810	5066	1598	3264	5106	1477	3483	3497	2790	3045	3497	1585
Grp Volume(v), veh/h	187	2453	615	469	2389	411	758	646	182	198	751	269
Grp Sat Flow(s),veh/h/ln	1810	1689	1598	1632	1702	1477	1742	1749	1395	1522	1749	1585
Q Serve(g_s), s	6.3	37.7	37.7	8.3	39.7	25.0	10.3	16.8	4.6	6.7	20.8	15.5
Cycle Q Clear(g_c), s	6.3	37.7	37.7	8.3	39.7	25.0	10.3	16.8	4.6	6.7	20.8	15.5
Prop In Lane	1.00		1.00	1.00		1.00	1.00		1.00	1.00		1.00
Lane Grp Cap(c), veh/h	109	1827	576	259	1939	561	343	1009	1027	252	954	432
V/C Ratio(X)	1.71	1.34	1.07	1.81	1.23	0.73	2.21	0.64	0.18	0.79	0.79	0.62
Avail Cap(c_a), veh/h	109	1827	576	259	1939	561	343	1512	1428	265	1472	667
HCM Platoon Ratio	1.00	1.00	1.00	1.00	1.00	1.00	1.00	1.00	1.00	1.00	1.00	1.00
Upstream Filter(I)	1.00	1.00	1.00	1.00	1.00	1.00	1.00	1.00	1.00	1.00	1.00	1.00
Uniform Delay (d), s/veh	49.1	33.4	33.4	48.1	32.4	27.9	47.1	32.4	22.3	47.0	35.2	33.3
Incr Delay (d2), s/veh	357.2	157.9	56.7	379.1	109.0	5.3	553.2	0.7	0.1	12.4	1.6	1.5
Initial Q Delay(d3),s/veh	0.0	0.0	0.0	0.0	0.0	0.0	0.0	0.0	0.0	0.0	0.0	0.0
%ile BackOfQ(50%),veh/ln	13.6	41.0	22.6	16.9	34.6	9.0	30.7	6.9	1.4	2.9	8.6	5.9
Unsig. Movement Delay, s/veh												
LnGrp Delay(d),s/veh	406.3	191.3	90.1	427.2	141.4	33.2	600.3	33.1	22.4	59.4	36.8	34.7
LnGrp LOS	F	F	F	F	F	C	F	C	C	E	D	C
Approach Vol, veh/h		3255			3269			1586			1218	
Approach Delay, s/veh		184.5			168.8			302.9			40.0	
Approach LOS		F			F			F			D	
Timer - Assigned Phs	1	2	3	4	5	6	7	8				
Phs Duration (G+Y+Rc), s	12.0	44.2	14.0	34.3	10.0	46.2	12.4	36.0				
Change Period (Y+Rc), s	3.7	6.5	3.7	5.8	3.7	6.5	3.7	5.8				
Max Green Setting (Gmax), s	8.3	37.7	10.3	44.0	6.3	39.7	9.1	45.2				
Max Q Clear Time (g_c+I1), s	10.3	39.7	12.3	22.8	8.3	41.7	8.7	18.8				
Green Ext Time (p_c), s	0.0	0.0	0.0	5.7	0.0	0.0	0.0	5.0				
Intersection Summary												
HCM 6th Ctrl Delay			180.3									
HCM 6th LOS			F									

Timings
25: Sycamore Canyon Bl. & Cactus Av.

West Campus Upper Plateau (JN 14064)

09/20/2022



Lane Group	EBL	EBT	EBR	WBL	WBT	WBR	NBL	NBT	NBR	SBL	SBT	SBR
Lane Configurations	↘	↑↑	↗	↘↗	↑↑	↗	↘↗	↑↑	↗	↘↗	↑↑	↗
Traffic Volume (vph)	202	1179	616	1070	482	684	216	626	376	757	1303	60
Future Volume (vph)	202	1179	616	1070	482	684	216	626	376	757	1303	60
Turn Type	Prot	NA	Perm	Prot	NA	Perm	Prot	NA	Perm	Prot	NA	Perm
Protected Phases	7	4		3	8		5	2		1	6	
Permitted Phases			4			8			2			6
Detector Phase	7	4	4	3	8	8	5	2	2	1	6	6
Switch Phase												
Minimum Initial (s)	5.0	10.0	10.0	5.0	10.0	10.0	5.0	10.0	10.0	5.0	10.0	10.0
Minimum Split (s)	9.6	32.8	32.8	9.6	32.8	32.8	9.6	34.8	34.8	9.6	34.8	34.8
Total Split (s)	10.3	32.8	32.8	29.0	51.5	51.5	9.6	36.2	36.2	22.0	48.6	48.6
Total Split (%)	8.6%	27.3%	27.3%	24.2%	42.9%	42.9%	8.0%	30.2%	30.2%	18.3%	40.5%	40.5%
Yellow Time (s)	3.6	4.8	4.8	3.6	4.8	4.8	3.6	4.8	4.8	3.6	4.8	4.8
All-Red Time (s)	1.0	1.0	1.0	1.0	1.0	1.0	1.0	1.0	1.0	1.0	1.0	1.0
Lost Time Adjust (s)	0.0	0.0	0.0	0.0	0.0	0.0	0.0	0.0	0.0	0.0	0.0	0.0
Total Lost Time (s)	4.6	5.8	5.8	4.6	5.8	5.8	4.6	5.8	5.8	4.6	5.8	5.8
Lead/Lag	Lead	Lag	Lag	Lead	Lag	Lag	Lead	Lag	Lag	Lead	Lag	Lag
Lead-Lag Optimize?	Yes	Yes	Yes	Yes	Yes	Yes	Yes	Yes	Yes	Yes	Yes	Yes
Recall Mode	None	None	None	None	None	None	None	None	None	None	None	None
Act Effct Green (s)	5.7	27.0	27.0	24.4	45.7	45.7	5.0	30.4	30.4	17.4	42.8	42.8
Actuated g/C Ratio	0.05	0.22	0.22	0.20	0.38	0.38	0.04	0.25	0.25	0.14	0.36	0.36
v/c Ratio	2.65	1.70	1.33	1.70	0.41	0.94	1.67	0.77	0.62	1.64	1.17	0.10
Control Delay	798.3	353.4	191.1	352.5	28.4	41.9	364.2	48.6	10.7	330.0	119.8	0.3
Queue Delay	0.0	0.0	0.0	0.0	0.0	0.0	0.0	0.0	0.0	0.0	0.0	0.0
Total Delay	798.3	353.4	191.1	352.5	28.4	41.9	364.2	48.6	10.7	330.0	119.8	0.3
LOS	F	F	F	F	C	D	F	D	B	F	F	A
Approach Delay		348.4			187.6			92.9			191.5	
Approach LOS		F			F			F			F	

Intersection Summary

Cycle Length: 120
 Actuated Cycle Length: 120
 Natural Cycle: 120
 Control Type: Actuated-Uncoordinated
 Maximum v/c Ratio: 2.65
 Intersection Signal Delay: 215.9
 Intersection LOS: F
 Intersection Capacity Utilization 122.6%
 ICU Level of Service H
 Analysis Period (min) 15



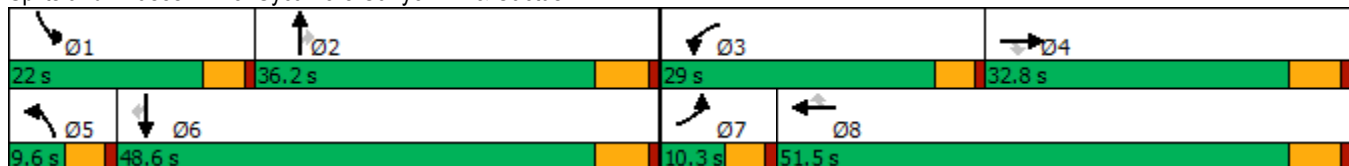





















Splits and Phases: 25: Sycamore Canyon Bl. & Cactus Av.



HCM 6th Signalized Intersection Summary
25: Sycamore Canyon Bl. & Cactus Av.

West Campus Upper Plateau (JN 14064)

09/20/2022

												
Movement	EBL	EBT	EBR	WBL	WBT	WBR	NBL	NBT	NBR	SBL	SBT	SBR
Lane Configurations												
Traffic Volume (veh/h)	202	1179	616	1070	482	684	216	626	376	757	1303	60
Future Volume (veh/h)	202	1179	616	1070	482	684	216	626	376	757	1303	60
Initial Q (Qb), veh	0	0	0	0	0	0	0	0	0	0	0	0
Ped-Bike Adj(A_pbT)	1.00		1.00	1.00		1.00	1.00		1.00	1.00		1.00
Parking Bus, Adj	1.00	1.00	1.00	1.00	1.00	1.00	1.00	1.00	1.00	1.00	1.00	1.00
Work Zone On Approach		No			No			No			No	
Adj Sat Flow, veh/h/ln	1856	1781	1856	1841	1796	1870	1856	1841	1811	1885	1811	1767
Adj Flow Rate, veh/h	220	1282	660	1163	524	491	235	680	312	823	1416	65
Peak Hour Factor	0.92	0.92	0.92	0.92	0.92	0.92	0.92	0.92	0.92	0.92	0.92	0.92
Percent Heavy Veh, %	3	8	3	4	7	2	3	4	6	1	6	9
Cap, veh/h	84	762	354	692	1300	604	143	886	389	505	1227	534
Arrive On Green	0.05	0.22	0.22	0.20	0.38	0.38	0.04	0.25	0.25	0.14	0.36	0.36
Sat Flow, veh/h	1767	3385	1572	3401	3413	1585	3428	3497	1535	3483	3441	1497
Grp Volume(v), veh/h	220	1282	660	1163	524	491	235	680	312	823	1416	65
Grp Sat Flow(s),veh/h/ln	1767	1692	1572	1700	1706	1585	1714	1749	1535	1742	1721	1497
Q Serve(g_s), s	5.7	27.0	27.0	24.4	13.5	33.3	5.0	21.6	22.9	17.4	42.8	3.5
Cycle Q Clear(g_c), s	5.7	27.0	27.0	24.4	13.5	33.3	5.0	21.6	22.9	17.4	42.8	3.5
Prop In Lane	1.00		1.00	1.00		1.00	1.00		1.00	1.00		1.00
Lane Grp Cap(c), veh/h	84	762	354	692	1300	604	143	886	389	505	1227	534
V/C Ratio(X)	2.62	1.68	1.87	1.68	0.40	0.81	1.65	0.77	0.80	1.63	1.15	0.12
Avail Cap(c_a), veh/h	84	762	354	692	1300	604	143	886	389	505	1227	534
HCM Platoon Ratio	1.00	1.00	1.00	1.00	1.00	1.00	1.00	1.00	1.00	1.00	1.00	1.00
Upstream Filter(I)	1.00	1.00	1.00	1.00	1.00	1.00	1.00	1.00	1.00	1.00	1.00	1.00
Uniform Delay (d), s/veh	57.2	46.5	46.5	47.8	27.2	33.3	57.5	41.5	42.0	51.3	38.6	26.0
Incr Delay (d2), s/veh	762.6	313.2	400.1	313.1	0.2	8.4	319.5	4.1	11.5	292.2	78.8	0.1
Initial Q Delay(d3),s/veh	0.0	0.0	0.0	0.0	0.0	0.0	0.0	0.0	0.0	0.0	0.0	0.0
%ile BackOfQ(50%),veh/ln	20.3	44.2	49.5	40.0	5.3	13.6	8.5	9.5	9.6	27.9	30.5	1.2
Unsig. Movement Delay, s/veh												
LnGrp Delay(d),s/veh	819.7	359.7	446.6	360.9	27.4	41.7	377.0	45.6	53.5	343.5	117.4	26.1
LnGrp LOS	F	F	F	F	C	D	F	D	D	F	F	C
Approach Vol, veh/h		2162			2178			1227			2304	
Approach Delay, s/veh		433.1			208.7			111.1			195.6	
Approach LOS		F			F			F			F	
Timer - Assigned Phs	1	2	3	4	5	6	7	8				
Phs Duration (G+Y+Rc), s	22.0	36.2	29.0	32.8	9.6	48.6	10.3	51.5				
Change Period (Y+Rc), s	4.6	5.8	4.6	5.8	4.6	5.8	4.6	5.8				
Max Green Setting (Gmax), s	17.4	30.4	24.4	27.0	5.0	42.8	5.7	45.7				
Max Q Clear Time (g_c+1), s	19.4	24.9	26.4	29.0	7.0	44.8	7.7	35.3				
Green Ext Time (p_c), s	0.0	2.5	0.0	0.0	0.0	0.0	0.0	3.7				
Intersection Summary												
HCM 6th Ctrl Delay			251.3									
HCM 6th LOS			F									

Timings

26: Sycamore Canyon Bl. & Van Buren Bl.

09/20/2022



Lane Group	EBL	EBT	EBR	WBL	WBT	WBR	NBL	NBT	SBL	SBT	SBR
Lane Configurations											
Traffic Volume (vph)	681	4541	6	8	3192	153	27	18	1341	16	1250
Future Volume (vph)	681	4541	6	8	3192	153	27	18	1341	16	1250
Turn Type	Prot	NA	Perm	Prot	NA	Perm	Perm	NA	Split	NA	Perm
Protected Phases	5	2		1	6			8	4	4	
Permitted Phases			2			6	8				4
Detector Phase	5	2	2	1	6	6	8	8	4	4	4
Switch Phase											
Minimum Initial (s)	5.0	10.0	10.0	5.0	10.0	10.0	10.0	10.0	10.0	10.0	10.0
Minimum Split (s)	9.6	29.2	29.2	9.6	29.2	29.2	14.6	14.6	50.8	50.8	50.8
Total Split (s)	22.0	47.8	47.8	9.6	35.4	35.4	14.6	14.6	58.0	58.0	58.0
Total Split (%)	16.9%	36.8%	36.8%	7.4%	27.2%	27.2%	11.2%	11.2%	44.6%	44.6%	44.6%
Yellow Time (s)	3.6	5.2	5.2	3.6	5.2	5.2	3.6	3.6	4.8	4.8	4.8
All-Red Time (s)	1.0	1.0	1.0	1.0	1.0	1.0	1.0	1.0	1.0	1.0	1.0
Lost Time Adjust (s)	0.0	0.0	0.0	0.0	0.0	0.0		0.0	0.0	0.0	0.0
Total Lost Time (s)	4.6	6.2	6.2	4.6	6.2	6.2		4.6	5.8	5.8	5.8
Lead/Lag	Lead	Lag	Lag	Lead	Lag	Lag					
Lead-Lag Optimize?	Yes	Yes	Yes	Yes	Yes	Yes					
Recall Mode	None	None	None	None	None	None	None	None	None	None	None
Act Effct Green (s)	17.4	49.3	49.3	5.0	29.2	29.2		10.0	52.2	52.2	52.2
Actuated g/C Ratio	0.13	0.38	0.38	0.04	0.22	0.22		0.08	0.40	0.40	0.40
v/c Ratio	1.63	2.07	0.01	0.15	2.48	0.36		0.35	1.08	0.02	1.57
Control Delay	327.3	508.2	0.0	66.4	691.7	12.5		36.1	86.3	23.8	283.4
Queue Delay	0.0	0.0	0.0	0.0	0.0	0.0		0.0	0.0	0.0	0.0
Total Delay	327.3	508.2	0.0	66.4	691.7	12.5		36.1	86.3	23.8	283.4
LOS	F	F	A	E	F	B		D	F	C	F
Approach Delay		484.0			659.2			36.1		180.4	
Approach LOS		F			F			D		F	

Intersection Summary

Cycle Length: 130
 Actuated Cycle Length: 130
 Natural Cycle: 115
 Control Type: Actuated-Uncoordinated
 Maximum v/c Ratio: 2.48
 Intersection Signal Delay: 462.6
 Intersection LOS: F
 Intersection Capacity Utilization 145.8%
 ICU Level of Service H
 Analysis Period (min) 15

Splits and Phases: 26: Sycamore Canyon Bl. & Van Buren Bl.

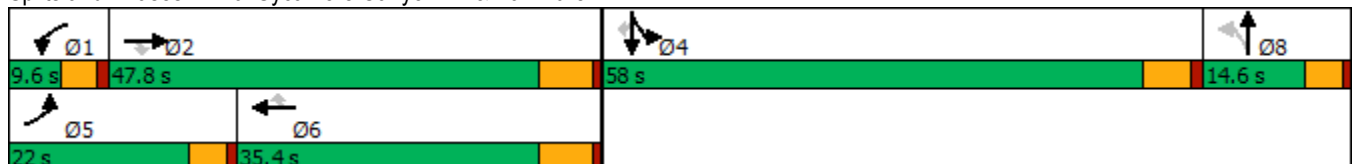

HCM 6th Signalized Intersection Summary
26: Sycamore Canyon Bl. & Van Buren Bl.

West Campus Upper Plateau (JN 14064)

09/20/2022



Movement	EBL	EBT	EBR	WBL	WBT	WBR	NBL	NBT	NBR	SBL	SBT	SBR
Lane Configurations												
Traffic Volume (veh/h)	681	4541	6	8	3192	153	27	18	40	1341	16	1250
Future Volume (veh/h)	681	4541	6	8	3192	153	27	18	40	1341	16	1250
Initial Q (Qb), veh	0	0	0	0	0	0	0	0	0	0	0	0
Ped-Bike Adj(A_pbT)	1.00		1.00	1.00		0.99	1.00		0.99	1.00		1.00
Parking Bus, Adj	1.00	1.00	1.00	1.00	1.00	1.00	1.00	1.00	1.00	1.00	1.00	1.00
Work Zone On Approach		No			No			No			No	
Adj Sat Flow, veh/h/ln	1856	1841	1900	1663	1826	1856	1900	1900	1900	1841	1900	1856
Adj Flow Rate, veh/h	740	4936	7	9	3470	143	29	20	13	1458	17	0
Peak Hour Factor	0.92	0.92	0.92	0.92	0.92	0.92	0.92	0.92	0.92	0.92	0.92	0.92
Percent Heavy Veh, %	3	4	0	16	5	3	0	0	0	4	0	3
Cap, veh/h	463	2221	565	17	1423	352	112	81	53	1377	769	
Arrive On Green	0.13	0.35	0.35	0.01	0.23	0.23	0.07	0.07	0.07	0.40	0.40	0.00
Sat Flow, veh/h	3428	6332	1610	1584	6281	1552	1621	1174	771	3401	1900	1572
Grp Volume(v), veh/h	740	4936	7	9	3470	143	33	0	29	1458	17	0
Grp Sat Flow(s),veh/h/ln	1714	1583	1610	1584	1570	1552	1819	0	1747	1700	1900	1572
Q Serve(g_s), s	17.4	45.2	0.4	0.7	29.2	10.1	2.2	0.0	2.1	52.2	0.7	0.0
Cycle Q Clear(g_c), s	17.4	45.2	0.4	0.7	29.2	10.1	2.2	0.0	2.1	52.2	0.7	0.0
Prop In Lane	1.00		1.00	1.00		1.00	0.89		0.44	1.00		1.00
Lane Grp Cap(c), veh/h	463	2221	565	17	1423	352	126	0	121	1377	769	
V/C Ratio(X)	1.60	2.22	0.01	0.53	2.44	0.41	0.26	0.00	0.24	1.06	0.02	
Avail Cap(c_a), veh/h	463	2221	565	61	1423	352	141	0	136	1377	769	
HCM Platoon Ratio	1.00	1.00	1.00	1.00	1.00	1.00	1.00	1.00	1.00	1.00	1.00	1.00
Upstream Filter(I)	1.00	1.00	1.00	1.00	1.00	1.00	1.00	0.00	1.00	1.00	1.00	0.00
Uniform Delay (d), s/veh	55.8	41.8	27.3	63.4	49.9	42.5	56.9	0.0	56.8	38.4	23.0	0.0
Incr Delay (d2), s/veh	279.6	551.4	0.0	9.3	649.7	0.8	1.1	0.0	1.0	41.5	0.0	0.0
Initial Q Delay(d3),s/veh	0.0	0.0	0.0	0.0	0.0	0.0	0.0	0.0	0.0	0.0	0.0	0.0
%ile BackOfQ(50%),veh/ln	25.3	101.9	0.1	0.3	75.3	3.9	1.0	0.0	0.9	28.5	0.3	0.0
Unsig. Movement Delay, s/veh												
LnGrp Delay(d),s/veh	335.4	593.3	27.3	72.7	699.5	43.2	57.9	0.0	57.8	79.8	23.0	0.0
LnGrp LOS	F	F	C	E	F	D	E	A	E	F	C	
Approach Vol, veh/h		5683			3622			62			1475	
Approach Delay, s/veh		559.0			672.1			57.9			79.2	
Approach LOS		F			F			E			E	
Timer - Assigned Phs	1	2		4	5	6		8				
Phs Duration (G+Y+Rc), s	6.0	51.4		58.0	22.0	35.4		13.5				
Change Period (Y+Rc), s	4.6	6.2		5.8	4.6	6.2		4.6				
Max Green Setting (Gmax), s	5.0	41.6		52.2	17.4	29.2		10.0				
Max Q Clear Time (g_c+I1), s	2.7	47.2		54.2	19.4	31.2		4.2				
Green Ext Time (p_c), s	0.0	0.0		0.0	0.0	0.0		0.1				

Intersection Summary

HCM 6th Ctrl Delay	528.6
HCM 6th LOS	F

Notes

Unsignalized Delay for [SBR] is excluded from calculations of the approach delay and intersection delay.

Timings
27: Innovation Dr. & Cactus Av.

West Campus Upper Plateau (JN 14064)

09/20/2022

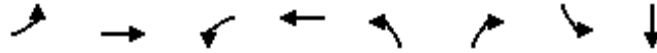

Lane Group	EBL	EBT	WBL	WBT	NBL	NBR	SBL	SBT
Lane Configurations	↖	↕↕↕	↖	↕↕↕	↖	↗	↖	↗
Traffic Volume (vph)	4	2302	69	2166	54	152	42	0
Future Volume (vph)	4	2302	69	2166	54	152	42	0
Turn Type	Prot	NA	Prot	NA	Perm	Perm	Perm	NA
Protected Phases	5	2	1	6				4
Permitted Phases					8	8	4	
Detector Phase	5	2	1	6	8	8	4	4
Switch Phase								
Minimum Initial (s)	5.0	10.0	5.0	10.0	10.0	10.0	10.0	10.0
Minimum Split (s)	9.2	26.8	9.2	26.8	31.1	31.1	31.1	31.1
Total Split (s)	12.0	63.0	22.0	73.0	35.0	35.0	35.0	35.0
Total Split (%)	10.0%	52.5%	18.3%	60.8%	29.2%	29.2%	29.2%	29.2%
Yellow Time (s)	3.2	4.8	3.2	4.8	4.1	4.1	4.1	4.1
All-Red Time (s)	1.0	1.0	1.0	1.0	1.0	1.0	1.0	1.0
Lost Time Adjust (s)	0.0	0.0	0.0	0.0	0.0	0.0	0.0	0.0
Total Lost Time (s)	4.2	5.8	4.2	5.8	5.1	5.1	5.1	5.1
Lead/Lag	Lead	Lag	Lead	Lag				
Lead-Lag Optimize?	Yes	Yes	Yes	Yes				
Recall Mode	None	None	None	None	None	None	None	None
Act Effct Green (s)	5.2	58.3	8.9	67.6	12.9	12.9	12.9	12.9
Actuated g/C Ratio	0.06	0.63	0.10	0.73	0.14	0.14	0.14	0.14
v/c Ratio	0.04	0.82	0.50	0.66	0.31	0.42	0.23	0.05
Control Delay	48.0	18.7	54.1	9.4	41.6	5.3	39.7	0.3
Queue Delay	0.0	0.4	0.0	0.1	0.0	0.0	0.0	0.0
Total Delay	48.0	19.1	54.1	9.5	41.6	5.3	39.7	0.3
LOS	D	B	D	A	D	A	D	A
Approach Delay		19.1		10.9				29.1
Approach LOS		B		B				C

Intersection Summary

Cycle Length: 120
 Actuated Cycle Length: 93.2
 Natural Cycle: 90
 Control Type: Actuated-Uncoordinated
 Maximum v/c Ratio: 0.82
 Intersection Signal Delay: 15.2
 Intersection LOS: B
 Intersection Capacity Utilization 75.7%
 ICU Level of Service D
 Analysis Period (min) 15

Splits and Phases: 27: Innovation Dr. & Cactus Av.



HCM 6th Signalized Intersection Summary
27: Innovation Dr. & Cactus Av.

West Campus Upper Plateau (JN 14064)

09/20/2022



Movement	EBL	EBT	EBR	WBL	WBT	WBR	NBL	NBT	NBR	SBL	SBT	SBR
Lane Configurations	↗	↑↑↑		↖	↑↑↑		↖	↑	↗	↖	↑	↗
Traffic Volume (veh/h)	4	2302	6	69	2166	16	54	0	152	42	0	16
Future Volume (veh/h)	4	2302	6	69	2166	16	54	0	152	42	0	16
Initial Q (Qb), veh	0	0	0	0	0	0	0	0	0	0	0	0
Ped-Bike Adj(A_pbT)	1.00		1.00	1.00		0.98	1.00		1.00	1.00		1.00
Parking Bus, Adj	1.00	1.00	1.00	1.00	1.00	1.00	1.00	1.00	1.00	1.00	1.00	1.00
Work Zone On Approach		No			No			No			No	
Adj Sat Flow, veh/h/ln	1900	1811	1248	1678	1841	1900	1870	1900	1841	1900	1900	1767
Adj Flow Rate, veh/h	4	2502	7	75	2354	17	59	0	114	46	0	8
Peak Hour Factor	0.92	0.92	0.92	0.92	0.92	0.92	0.92	0.92	0.92	0.92	0.92	0.92
Percent Heavy Veh, %	0	6	44	15	4	0	2	0	4	0	0	9
Cap, veh/h	10	3281	9	93	3591	26	245	224	184	238	0	190
Arrive On Green	0.01	0.64	0.64	0.06	0.70	0.70	0.12	0.00	0.12	0.12	0.00	0.12
Sat Flow, veh/h	1810	5090	14	1598	5146	37	1407	1900	1560	1299	0	1610
Grp Volume(v), veh/h	4	1620	889	75	1532	839	59	0	114	46	0	8
Grp Sat Flow(s),veh/h/ln	1810	1648	1809	1598	1675	1833	1407	1900	1560	1299	0	1610
Q Serve(g_s), s	0.2	29.0	29.0	3.9	21.5	21.5	3.3	0.0	5.9	2.7	0.0	0.4
Cycle Q Clear(g_c), s	0.2	29.0	29.0	3.9	21.5	21.5	3.6	0.0	5.9	2.7	0.0	0.4
Prop In Lane	1.00		0.01	1.00		0.02	1.00		1.00	1.00		1.00
Lane Grp Cap(c), veh/h	10	2125	1166	93	2338	1279	245	224	184	238	0	190
V/C Ratio(X)	0.42	0.76	0.76	0.80	0.66	0.66	0.24	0.00	0.62	0.19	0.00	0.04
Avail Cap(c_a), veh/h	167	2234	1226	337	2668	1460	578	673	553	546	0	571
HCM Platoon Ratio	1.00	1.00	1.00	1.00	1.00	1.00	1.00	1.00	1.00	1.00	1.00	1.00
Upstream Filter(I)	1.00	1.00	1.00	1.00	1.00	1.00	1.00	0.00	1.00	1.00	0.00	1.00
Uniform Delay (d), s/veh	41.8	10.5	10.5	39.2	7.1	7.1	34.6	0.0	35.4	34.0	0.0	33.0
Incr Delay (d2), s/veh	10.4	1.7	3.0	5.9	0.6	1.1	0.5	0.0	3.4	0.4	0.0	0.1
Initial Q Delay(d3),s/veh	0.0	0.0	0.0	0.0	0.0	0.0	0.0	0.0	0.0	0.0	0.0	0.0
%ile BackOfQ(50%),veh/ln	0.1	8.1	9.3	1.6	5.1	5.8	1.1	0.0	2.3	0.9	0.0	0.1
Unsig. Movement Delay, s/veh												
LnGrp Delay(d),s/veh	52.2	12.1	13.5	45.1	7.7	8.2	35.1	0.0	38.8	34.4	0.0	33.1
LnGrp LOS	D	B	B	D	A	A	D	A	D	C	A	C
Approach Vol, veh/h		2513			2446			173				54
Approach Delay, s/veh		12.7			9.0			37.5				34.2
Approach LOS		B			A			D				C
Timer - Assigned Phs	1	2		4	5	6		8				
Phs Duration (G+Y+Rc), s	9.1	60.2		15.1	4.6	64.7		15.1				
Change Period (Y+Rc), s	* 4.2	5.8		5.1	* 4.2	5.8		5.1				
Max Green Setting (Gmax), s	* 18	57.2		29.9	* 7.8	67.2		29.9				
Max Q Clear Time (g_c+I1), s	5.9	31.0		4.7	2.2	23.5		7.9				
Green Ext Time (p_c), s	0.1	23.4		0.1	0.0	34.8		0.5				

Intersection Summary

HCM 6th Ctrl Delay	12.0
HCM 6th LOS	B

Notes

* HCM 6th computational engine requires equal clearance times for the phases crossing the barrier.

Timings
28: I-215 SB Ramps & Alessandro Bl.

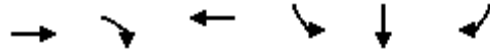

Lane Group	EBT	EBR	WBT	SBL	SBT	SBR
Lane Configurations	↑↑↑	↑	↑↑↑	↘	↔	↘
Traffic Volume (vph)	1227	513	3342	453	0	597
Future Volume (vph)	1227	513	3342	453	0	597
Turn Type	NA	Perm	NA	Split	NA	Perm
Protected Phases	2		6	4	4	
Permitted Phases		2				4
Detector Phase	2	2	6	4	4	4
Switch Phase						
Minimum Initial (s)	5.0	5.0	5.0	5.0	5.0	5.0
Minimum Split (s)	10.5	10.5	34.5	10.0	10.0	10.0
Total Split (s)	49.0	49.0	49.0	36.0	36.0	36.0
Total Split (%)	57.6%	57.6%	57.6%	42.4%	42.4%	42.4%
Yellow Time (s)	4.5	4.5	4.5	4.0	4.0	4.0
All-Red Time (s)	1.0	1.0	1.0	1.0	1.0	1.0
Lost Time Adjust (s)	0.0	0.0	0.0	0.0	0.0	0.0
Total Lost Time (s)	5.5	5.5	5.5	5.0	5.0	5.0
Lead/Lag						
Lead-Lag Optimize?						
Recall Mode	C-Min	C-Min	C-Min	None	None	None
Act Effct Green (s)	48.5	48.5	48.5	26.0	26.0	26.0
Actuated g/C Ratio	0.57	0.57	0.57	0.31	0.31	0.31
v/c Ratio	0.44	0.53	1.28	0.75	0.80	0.78
Control Delay	11.8	7.4	142.5	35.8	37.7	36.5
Queue Delay	0.0	0.0	0.0	0.0	0.0	0.0
Total Delay	11.8	7.4	142.5	35.8	37.7	36.5
LOS	B	A	F	D	D	D
Approach Delay	10.5		142.5		36.7	
Approach LOS	B		F		D	

Intersection Summary

Cycle Length: 85
 Actuated Cycle Length: 85
 Offset: 50 (59%), Referenced to phase 2:EBT and 6:WBT, Start of Yellow
 Natural Cycle: 130
 Control Type: Actuated-Coordinated
 Maximum v/c Ratio: 1.28
 Intersection Signal Delay: 89.4
 Intersection Capacity Utilization 104.2%
 Analysis Period (min) 15

Intersection LOS: F
 ICU Level of Service G

Splits and Phases: 28: I-215 SB Ramps & Alessandro Bl.

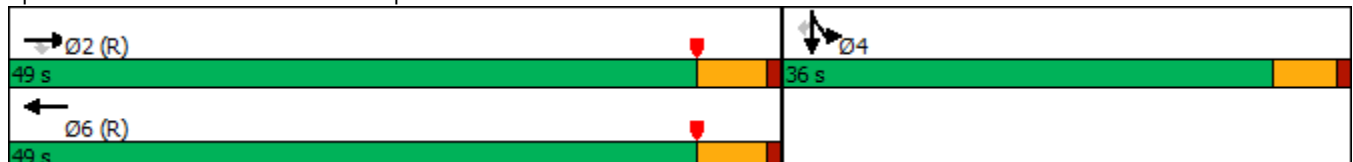

HCM 6th Signalized Intersection Summary
28: I-215 SB Ramps & Alessandro Bl.

West Campus Upper Plateau (JN 14064)
09/20/2022



Movement	EBL	EBT	EBR	WBL	WBT	WBR	NBL	NBT	NBR	SBL	SBT	SBR
Lane Configurations		↑↑↑	↗		↑↑↑					↘	↕	↗
Traffic Volume (veh/h)	0	1227	513	0	3342	280	0	0	0	453	0	597
Future Volume (veh/h)	0	1227	513	0	3342	280	0	0	0	453	0	597
Initial Q (Qb), veh	0	0	0	0	0	0				0	0	0
Ped-Bike Adj(A_pbT)	1.00		1.00	1.00		1.00				1.00		1.00
Parking Bus, Adj	1.00	1.00	1.00	1.00	1.00	1.00				1.00	1.00	1.00
Work Zone On Approach		No			No						No	
Adj Sat Flow, veh/h/ln	0	1841	1826	0	1870	1796				1796	1900	1722
Adj Flow Rate, veh/h	0	1239	518	0	3376	157				632	0	339
Peak Hour Factor	0.99	0.99	0.99	0.99	0.99	0.99				0.99	0.99	0.99
Percent Heavy Veh, %	0	4	5	0	2	7				7	0	12
Cap, veh/h	0	3020	929	0	3007	138				942	0	402
Arrive On Green	0.00	0.60	0.60	0.00	0.40	0.40				0.28	0.00	0.28
Sat Flow, veh/h	0	5191	1546	0	5172	229				3421	0	1459
Grp Volume(v), veh/h	0	1239	518	0	2280	1253				632	0	339
Grp Sat Flow(s),veh/h/ln	0	1675	1546	0	1702	1829				1711	0	1459
Q Serve(g_s), s	0.0	11.1	17.1	0.0	51.1	51.1				14.0	0.0	18.6
Cycle Q Clear(g_c), s	0.0	11.1	17.1	0.0	51.1	51.1				14.0	0.0	18.6
Prop In Lane	0.00		1.00	0.00		0.13				1.00		1.00
Lane Grp Cap(c), veh/h	0	3020	929	0	2046	1099				942	0	402
V/C Ratio(X)	0.00	0.41	0.56	0.00	1.11	1.14				0.67	0.00	0.84
Avail Cap(c_a), veh/h	0	3020	929	0	2046	1099				1248	0	532
HCM Platoon Ratio	1.00	1.00	1.00	1.00	0.67	0.67				1.00	1.00	1.00
Upstream Filter(I)	0.00	0.45	0.45	0.00	0.09	0.09				1.00	0.00	1.00
Uniform Delay (d), s/veh	0.0	9.0	10.2	0.0	25.4	25.4				27.4	0.0	29.1
Incr Delay (d2), s/veh	0.0	0.2	1.1	0.0	52.3	64.0				0.9	0.0	9.2
Initial Q Delay(d3),s/veh	0.0	0.0	0.0	0.0	0.0	0.0				0.0	0.0	0.0
%ile BackOfQ(50%),veh/ln	0.0	3.0	4.5	0.0	34.5	40.6				5.4	0.0	7.0
Unsig. Movement Delay, s/veh												
LnGrp Delay(d),s/veh	0.0	9.2	11.3	0.0	77.7	89.4				28.2	0.0	38.2
LnGrp LOS	A	A	B	A	F	F				C	A	D
Approach Vol, veh/h		1757			3533						971	
Approach Delay, s/veh		9.8			81.8						31.7	
Approach LOS		A			F						C	
Timer - Assigned Phs		2		4		6						
Phs Duration (G+Y+Rc), s		56.6		28.4		56.6						
Change Period (Y+Rc), s		5.5		5.0		5.5						
Max Green Setting (Gmax), s		43.5		31.0		43.5						
Max Q Clear Time (g_c+I1), s		19.1		20.6		53.1						
Green Ext Time (p_c), s		10.9		2.8		0.0						
Intersection Summary												
HCM 6th Ctrl Delay			53.8									
HCM 6th LOS			D									
Notes												
User approved volume balancing among the lanes for turning movement.												

Timings
29: I-215 NB Ramps & Alessandro Bl.

West Campus Upper Plateau (JN 14064)

09/20/2022



Lane Group	EBL	EBT	WBT	WBR	NBL	NBT	NBR
Lane Configurations	↘	↑↑↑	↑↑↑	↗	↘	↕	↗
Traffic Volume (vph)	273	2352	1765	218	1101	15	462
Future Volume (vph)	273	2352	1765	218	1101	15	462
Turn Type	Prot	NA	NA	Perm	Split	NA	Perm
Protected Phases	5	2	6		8	8	
Permitted Phases				6			8
Detector Phase	5	2	6	6	8	8	8
Switch Phase							
Minimum Initial (s)	5.0	5.0	5.0	5.0	5.0	5.0	5.0
Minimum Split (s)	9.5	10.5	33.5	33.5	10.0	10.0	10.0
Total Split (s)	13.0	48.0	35.0	35.0	37.0	37.0	37.0
Total Split (%)	15.3%	56.5%	41.2%	41.2%	43.5%	43.5%	43.5%
Yellow Time (s)	3.5	4.5	4.5	4.5	4.0	4.0	4.0
All-Red Time (s)	1.0	1.0	1.0	1.0	1.0	1.0	1.0
Lost Time Adjust (s)	0.0	0.0	0.0	0.0	0.0	0.0	0.0
Total Lost Time (s)	4.5	5.5	5.5	5.5	5.0	5.0	5.0
Lead/Lag	Lead		Lag	Lag			
Lead-Lag Optimize?	Yes		Yes	Yes			
Recall Mode	None	Min	Min	Min	Max	Max	Max
Act Effct Green (s)	8.5	42.5	29.5	29.5	32.0	32.0	32.0
Actuated g/C Ratio	0.10	0.50	0.35	0.35	0.38	0.38	0.38
v/c Ratio	1.87	0.98	1.08	0.41	1.00	1.04	0.73
Control Delay	441.4	36.4	77.0	15.9	65.2	75.9	26.3
Queue Delay	0.0	0.0	0.0	0.0	0.0	0.0	0.0
Total Delay	441.4	36.4	77.0	15.9	65.2	75.9	26.3
LOS	F	D	E	B	E	E	C
Approach Delay		78.5	70.2			58.9	
Approach LOS		E	E			E	

Intersection Summary

Cycle Length: 85
 Actuated Cycle Length: 85
 Natural Cycle: 120
 Control Type: Actuated-Uncoordinated
 Maximum v/c Ratio: 1.87
 Intersection Signal Delay: 70.8
 Intersection Capacity Utilization 97.3%
 Analysis Period (min) 15
 Intersection LOS: E
 ICU Level of Service F

Splits and Phases: 29: I-215 NB Ramps & Alessandro Bl.

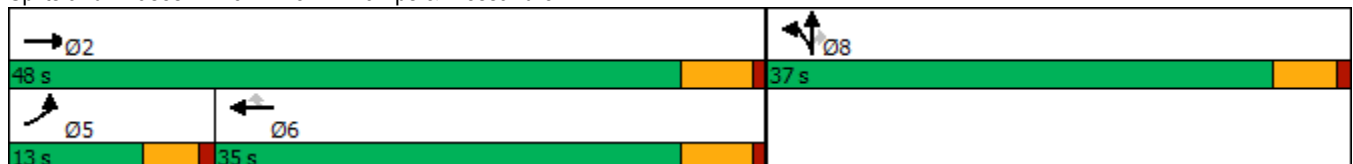

HCM 6th Signalized Intersection Summary
 29: I-215 NB Ramps & Alessandro Bl.

West Campus Upper Plateau (JN 14064)

09/20/2022



Movement	EBL	EBT	EBR	WBL	WBT	WBR	NBL	NBT	NBR	SBL	SBT	SBR
Lane Configurations	↘	↑↑↑			↑↑↑	↗	↘	↕	↗			
Traffic Volume (veh/h)	273	2352	0	0	1765	218	1101	15	462	0	0	0
Future Volume (veh/h)	273	2352	0	0	1765	218	1101	15	462	0	0	0
Initial Q (Qb), veh	0	0	0	0	0	0	0	0	0			
Ped-Bike Adj(A_pbT)	1.00		1.00	1.00		0.98	1.00		1.00			
Parking Bus, Adj	1.00	1.00	1.00	1.00	1.00	1.00	1.00	1.00	1.00			
Work Zone On Approach		No			No			No				
Adj Sat Flow, veh/h/ln	1663	1870	0	0	1841	1781	1841	1900	1826			
Adj Flow Rate, veh/h	290	2502	0	0	1878	205	1303	0	275			
Peak Hour Factor	0.94	0.94	0.94	0.94	0.94	0.94	0.94	0.94	0.94			
Percent Heavy Veh, %	16	2	0	0	4	8	4	0	5			
Cap, veh/h	158	2553	0	0	1744	513	1320	0	583			
Arrive On Green	0.10	0.50	0.00	0.00	0.35	0.35	0.38	0.00	0.38			
Sat Flow, veh/h	1584	5274	0	0	5191	1478	3506	0	1547			
Grp Volume(v), veh/h	290	2502	0	0	1878	205	1303	0	275			
Grp Sat Flow(s),veh/h/ln	1584	1702	0	0	1675	1478	1753	0	1547			
Q Serve(g_s), s	8.5	40.8	0.0	0.0	29.5	8.9	31.3	0.0	11.5			
Cycle Q Clear(g_c), s	8.5	40.8	0.0	0.0	29.5	8.9	31.3	0.0	11.5			
Prop In Lane	1.00		0.00	0.00		1.00	1.00		1.00			
Lane Grp Cap(c), veh/h	158	2553	0	0	1744	513	1320	0	583			
V/C Ratio(X)	1.83	0.98	0.00	0.00	1.08	0.40	0.99	0.00	0.47			
Avail Cap(c_a), veh/h	158	2553	0	0	1744	513	1320	0	583			
HCM Platoon Ratio	1.00	1.00	1.00	1.00	1.00	1.00	1.00	1.00	1.00			
Upstream Filter(I)	1.00	1.00	0.00	0.00	1.00	1.00	1.00	0.00	1.00			
Uniform Delay (d), s/veh	38.3	20.8	0.0	0.0	27.7	21.0	26.3	0.0	20.1			
Incr Delay (d2), s/veh	397.6	13.4	0.0	0.0	45.5	0.5	21.9	0.0	2.7			
Initial Q Delay(d3),s/veh	0.0	0.0	0.0	0.0	0.0	0.0	0.0	0.0	0.0			
%ile BackOfQ(50%),veh/ln	20.5	15.9	0.0	0.0	17.5	2.8	15.8	0.0	4.2			
Unsig. Movement Delay, s/veh												
LnGrp Delay(d),s/veh	435.8	34.3	0.0	0.0	73.3	21.5	48.2	0.0	22.8			
LnGrp LOS	F	C	A	A	F	C	D	A	C			
Approach Vol, veh/h		2792			2083			1578				
Approach Delay, s/veh		76.0			68.2			43.8				
Approach LOS		E			E			D				
Timer - Assigned Phs		2			5	6		8				
Phs Duration (G+Y+Rc), s		48.0			13.0	35.0		37.0				
Change Period (Y+Rc), s		5.5			4.5	5.5		5.0				
Max Green Setting (Gmax), s		42.5			8.5	29.5		32.0				
Max Q Clear Time (g_c+I1), s		42.8			10.5	31.5		33.3				
Green Ext Time (p_c), s		0.0			0.0	0.0		0.0				

Intersection Summary

HCM 6th Ctrl Delay	65.6
HCM 6th LOS	E

Notes

User approved volume balancing among the lanes for turning movement.

Timings
30: I-215 SB Ramps & Cactus Av.

West Campus Upper Plateau (JN 14064)

09/20/2022



Lane Group	EBT	EBR	WBL	WBT	NBR	SBR
Lane Configurations	↑↑	↑	↓	↑↑	↑	↑
Traffic Volume (vph)	2017	480	936	1522	877	632
Future Volume (vph)	2017	480	936	1522	877	632
Turn Type	NA	Perm	Prot	NA	Prot	Prot
Protected Phases	2		1	6	8	4
Permitted Phases		2				
Detector Phase	2	2	1	6	8	4
Switch Phase						
Minimum Initial (s)	5.0	5.0	5.0	5.0	5.0	5.0
Minimum Split (s)	11.0	11.0	9.5	23.0	9.1	9.5
Total Split (s)	35.0	35.0	43.0	78.0	27.0	27.0
Total Split (%)	33.3%	33.3%	41.0%	74.3%	25.7%	25.7%
Yellow Time (s)	5.0	5.0	3.5	5.0	3.6	3.5
All-Red Time (s)	1.0	1.0	1.0	1.0	0.5	1.0
Lost Time Adjust (s)	0.0	0.0	0.0	0.0	0.0	0.0
Total Lost Time (s)	6.0	6.0	4.5	6.0	4.1	4.5
Lead/Lag	Lag	Lag	Lead			
Lead-Lag Optimize?	Yes	Yes	Yes			
Recall Mode	Min	Min	None	Min	None	None
Act Effct Green (s)	29.0	29.0	38.5	72.0	22.9	22.5
Actuated g/C Ratio	0.28	0.28	0.37	0.69	0.22	0.21
v/c Ratio	2.24	0.85	1.50	0.66	1.12	1.76
Control Delay	582.5	34.4	262.7	11.1	84.0	377.7
Queue Delay	0.0	0.0	0.0	0.0	0.0	0.0
Total Delay	582.5	34.4	262.7	11.1	84.0	377.7
LOS	F	C	F	B	F	F
Approach Delay	477.2			106.9		
Approach LOS	F			F		

Intersection Summary

Cycle Length: 105	
Actuated Cycle Length: 105	
Natural Cycle: 120	
Control Type: Actuated-Uncoordinated	
Maximum v/c Ratio: 2.24	
Intersection Signal Delay: 273.3	Intersection LOS: F
Intersection Capacity Utilization 118.5%	ICU Level of Service H
Analysis Period (min) 15	



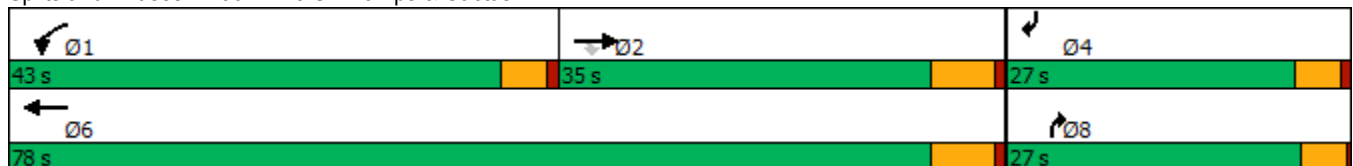









Splits and Phases: 30: I-215 SB Ramps & Cactus Av.



HCM 6th Signalized Intersection Summary
 30: I-215 SB Ramps & Cactus Av.

West Campus Upper Plateau (JN 14064)

09/20/2022

												
Movement	EBL	EBT	EBR	WBL	WBT	WBR	NBL	NBT	NBR	SBL	SBT	SBR
Lane Configurations		↑↑	↗	↖	↑↑				↗			↖
Traffic Volume (veh/h)	0	2017	480	936	1522	0	0	0	877	0	0	632
Future Volume (veh/h)	0	2017	480	936	1522	0	0	0	877	0	0	632
Initial Q (Qb), veh	0	0	0	0	0	0	0	0	0	0	0	0
Ped-Bike Adj(A_pbT)	1.00		1.00	1.00		1.00	1.00		1.00	1.00		1.00
Parking Bus, Adj	1.00	1.00	1.00	1.00	1.00	1.00	1.00	1.00	1.00	1.00	1.00	1.00
Work Zone On Approach		No			No			No			No	
Adj Sat Flow, veh/h/ln	0	1826	1811	1885	1870	0	0	0	1811	0	0	1737
Adj Flow Rate, veh/h	0	2123	477	985	1602	0	0	0	0	0	0	560
Peak Hour Factor	0.95	0.95	0.95	0.95	0.95	0.95	0.95	0.95	0.95	0.95	0.95	0.95
Percent Heavy Veh, %	0	5	6	1	2	0	0	0	6	0	0	11
Cap, veh/h	0	1290	571	886	3280	0	0	0	0	0	0	0
Arrive On Green	0.00	0.37	0.37	0.49	0.92	0.00	0.00	0.00	0.00	0.00	0.00	0.00
Sat Flow, veh/h	0	3561	1535	1795	3647	0		0			0	
Grp Volume(v), veh/h	0	2123	477	985	1602	0		0.0			0.0	
Grp Sat Flow(s),veh/h/ln	0	1735	1535	1795	1777	0						
Q Serve(g_s), s	0.0	29.0	22.1	38.5	4.9	0.0						
Cycle Q Clear(g_c), s	0.0	29.0	22.1	38.5	4.9	0.0						
Prop In Lane	0.00		1.00	1.00		0.00						
Lane Grp Cap(c), veh/h	0	1290	571	886	3280	0						
V/C Ratio(X)	0.00	1.65	0.84	1.11	0.49	0.00						
Avail Cap(c_a), veh/h	0	1290	571	886	3280	0						
HCM Platoon Ratio	1.00	1.00	1.00	1.00	1.00	1.00						
Upstream Filter(I)	0.00	1.00	1.00	1.00	1.00	0.00						
Uniform Delay (d), s/veh	0.0	24.5	22.3	19.8	0.4	0.0						
Incr Delay (d2), s/veh	0.0	294.2	9.9	65.6	0.0	0.0						
Initial Q Delay(d3),s/veh	0.0	0.0	0.0	0.0	0.0	0.0						
%ile BackOfQ(50%),veh/ln	0.0	63.0	8.5	29.1	0.0	0.0						
Unsig. Movement Delay, s/veh												
LnGrp Delay(d),s/veh	0.0	318.7	32.2	85.4	0.5	0.0						
LnGrp LOS	A	F	C	F	A	A						
Approach Vol, veh/h		2600			2587							
Approach Delay, s/veh		266.1			32.8							
Approach LOS		F			C							
Timer - Assigned Phs	1	2				6						
Phs Duration (G+Y+Rc), s	43.0	35.0				78.0						
Change Period (Y+Rc), s	4.5	6.0				6.0						
Max Green Setting (Gmax), s	38.5	29.0				72.0						
Max Q Clear Time (g_c+I1), s	40.5	31.0				6.9						
Green Ext Time (p_c), s	0.0	0.0				10.1						

Intersection Summary

HCM 6th Ctrl Delay	149.8
HCM 6th LOS	F

Notes

Unsignalized Delay for [NBR] is excluded from calculations of the approach delay and intersection delay.

Timings

31: I-215 NB Ramps/Old 215 Frontage Rd. & Cactus Av.



Lane Group	EBL	EBT	WBT	NBL	NBT	NBR	SBL	SBT
Lane Configurations	↘	↕	↕	↙	↕	↗	↘	↕
Traffic Volume (vph)	122	2270	2926	438	298	100	227	3
Future Volume (vph)	122	2270	2926	438	298	100	227	3
Turn Type	Perm	NA	NA	Perm	NA	Perm	Perm	NA
Protected Phases		2	6		8			4
Permitted Phases	2			8		8	4	
Detector Phase	2	2	6	8	8	8	4	4
Switch Phase								
Minimum Initial (s)	5.0	5.0	5.0	5.0	5.0	5.0	5.0	5.0
Minimum Split (s)	11.0	11.0	44.0	10.5	10.5	10.5	10.5	10.5
Total Split (s)	57.4	57.4	57.4	27.6	27.6	27.6	27.6	27.6
Total Split (%)	67.5%	67.5%	67.5%	32.5%	32.5%	32.5%	32.5%	32.5%
Yellow Time (s)	5.0	5.0	5.0	4.5	4.5	4.5	4.5	4.5
All-Red Time (s)	1.0	1.0	1.0	1.0	1.0	1.0	1.0	1.0
Lost Time Adjust (s)	0.0	0.0	0.0	0.0	0.0	0.0	0.0	0.0
Total Lost Time (s)	6.0	6.0	6.0	5.5	5.5	5.5	5.5	5.5
Lead/Lag								
Lead-Lag Optimize?								
Recall Mode	Min	Min	Min	None	None	None	None	None
Act Effct Green (s)	51.4	51.4	51.4	22.1	22.1	22.1	22.1	22.1
Actuated g/C Ratio	0.60	0.60	0.60	0.26	0.26	0.26	0.26	0.26
v/c Ratio	1.46	1.61	1.56	1.99	0.70	0.22	1.50	0.59
Control Delay	282.3	297.3	273.5	484.3	38.1	17.2	284.5	34.0
Queue Delay	0.0	0.0	0.0	0.0	0.0	0.0	0.0	0.0
Total Delay	282.3	297.3	273.5	484.3	38.1	17.2	284.5	34.0
LOS	F	F	F	F	D	B	F	C
Approach Delay		296.7	273.5		269.7			157.2
Approach LOS		F	F		F			F

Intersection Summary

Cycle Length: 85
 Actuated Cycle Length: 85
 Natural Cycle: 55
 Control Type: Actuated-Uncoordinated
 Maximum v/c Ratio: 1.99
 Intersection Signal Delay: 275.9
 Intersection LOS: F
 Intersection Capacity Utilization 152.5%
 ICU Level of Service H
 Analysis Period (min) 15

Splits and Phases: 31: I-215 NB Ramps/Old 215 Frontage Rd. & Cactus Av.

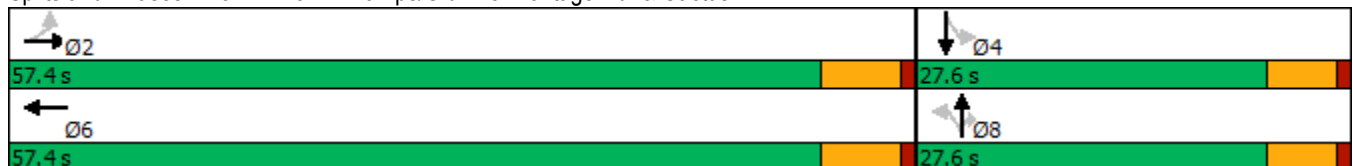

HCM 6th Signalized Intersection Summary

West Campus Upper Plateau (JN 14064)

31: I-215 NB Ramps/Old 215 Frontage Rd. & Cactus Av.

09/20/2022



Movement	EBL	EBT	EBR	WBL	WBT	WBR	NBL	NBT	NBR	SBL	SBT	SBR
Lane Configurations	↵	↕			↕		↵	↕	↗	↵	↕	↗
Traffic Volume (veh/h)	122	2270	870	0	2926	218	438	298	100	227	3	231
Future Volume (veh/h)	122	2270	870	0	2926	218	438	298	100	227	3	231
Initial Q (Qb), veh	0	0	0	0	0	0	0	0	0	0	0	0
Ped-Bike Adj(A_pbT)	1.00		1.00	1.00		1.00	1.00		1.00	1.00		1.00
Parking Bus, Adj	1.00	1.00	1.00	1.00	1.00	1.00	1.00	1.00	1.00	1.00	1.00	1.00
Work Zone On Approach		No			No			No			No	
Adj Sat Flow, veh/h/ln	1856	1841	1767	0	1856	1885	1826	1856	1870	1841	1900	1885
Adj Flow Rate, veh/h	127	2365	902	0	3048	179	456	310	0	236	3	215
Peak Hour Factor	0.96	0.96	0.96	0.96	0.96	0.96	0.96	0.96	0.96	0.96	0.96	0.96
Percent Heavy Veh, %	3	4	9	0	3	1	5	3	2	4	0	1
Cap, veh/h	85	1526	546	0	2047	119	249	482		202	6	414
Arrive On Green	0.60	0.60	0.60	0.00	0.60	0.60	0.26	0.26	0.00	0.26	0.26	0.26
Sat Flow, veh/h	62	2523	903	0	3478	197	1136	1856	1585	1052	22	1591
Grp Volume(v), veh/h	127	1592	1675	0	1572	1655	456	310	0	236	0	218
Grp Sat Flow(s),veh/h/ln	62	1749	1678	0	1763	1820	1136	1856	1585	1052	0	1614
Q Serve(g_s), s	0.0	51.4	51.4	0.0	51.4	51.4	12.3	12.6	0.0	9.5	0.0	9.8
Cycle Q Clear(g_c), s	51.4	51.4	51.4	0.0	51.4	51.4	22.1	12.6	0.0	22.1	0.0	9.8
Prop In Lane	1.00		0.54	0.00		0.11	1.00		1.00	1.00		0.99
Lane Grp Cap(c), veh/h	85	1057	1015	0	1066	1100	249	482		202	0	420
V/C Ratio(X)	1.50	1.51	1.65	0.00	1.47	1.50	1.83	0.64		1.17	0.00	0.52
Avail Cap(c_a), veh/h	85	1057	1015	0	1066	1100	249	482		202	0	420
HCM Platoon Ratio	1.00	1.00	1.00	1.00	1.00	1.00	1.00	1.00	1.00	1.00	1.00	1.00
Upstream Filter(I)	1.00	1.00	1.00	0.00	1.00	1.00	1.00	1.00	0.00	1.00	0.00	1.00
Uniform Delay (d), s/veh	42.5	16.8	16.8	0.0	16.8	16.8	38.5	27.9	0.0	39.7	0.0	26.9
Incr Delay (d2), s/veh	276.5	232.3	297.4	0.0	218.8	231.5	390.4	2.3	0.0	115.8	0.0	0.5
Initial Q Delay(d3),s/veh	0.0	0.0	0.0	0.0	0.0	0.0	0.0	0.0	0.0	0.0	0.0	0.0
%ile BackOfQ(50%),veh/ln	8.2	83.7	98.6	0.0	80.3	86.8	32.0	5.5	0.0	10.5	0.0	3.5
Unsig. Movement Delay, s/veh												
LnGrp Delay(d),s/veh	319.0	249.1	314.2	0.0	235.6	248.3	428.9	30.2	0.0	155.5	0.0	27.4
LnGrp LOS	F	F	F	A	F	F	F	C		F	A	C
Approach Vol, veh/h		3394			3227			766				454
Approach Delay, s/veh		283.8			242.1			267.5				94.0
Approach LOS		F			F			F				F
Timer - Assigned Phs		2		4		6		8				
Phs Duration (G+Y+Rc), s		57.4		27.6		57.4		27.6				
Change Period (Y+Rc), s		6.0		5.5		6.0		5.5				
Max Green Setting (Gmax), s		51.4		22.1		51.4		22.1				
Max Q Clear Time (g_c+I1), s		53.4		24.1		53.4		24.1				
Green Ext Time (p_c), s		0.0		0.0		0.0		0.0				

Intersection Summary

HCM 6th Ctrl Delay	254.1
HCM 6th LOS	F

Notes

User approved volume balancing among the lanes for turning movement.
 Unsignalized Delay for [NBR] is excluded from calculations of the approach delay and intersection delay.

Timings
32: I-215 SB Ramps & Van Buren Bl.

West Campus Upper Plateau (JN 14064)

09/20/2022



Lane Group	EBT	EBR	WBL	WBT	SBT	SBR
Lane Configurations	↑↑	↑↑	↙	↑↑	↙	↑↑
Traffic Volume (vph)	1655	2856	214	1789	136	869
Future Volume (vph)	1655	2856	214	1789	136	869
Turn Type	NA	Perm	Prot	NA	NA	Perm
Protected Phases	6		5	2	8	
Permitted Phases		6				8
Detector Phase	6	6	5	2	8	8
Switch Phase						
Minimum Initial (s)	5.0	5.0	5.0	5.0	5.0	5.0
Minimum Split (s)	36.0	36.0	11.0	11.0	11.0	11.0
Total Split (s)	60.0	60.0	11.0	71.0	14.0	14.0
Total Split (%)	70.6%	70.6%	12.9%	83.5%	16.5%	16.5%
Yellow Time (s)	5.0	5.0	5.0	5.0	5.0	5.0
All-Red Time (s)	1.0	1.0	1.0	1.0	1.0	1.0
Lost Time Adjust (s)	0.0	0.0	0.0	0.0	0.0	0.0
Total Lost Time (s)	6.0	6.0	6.0	6.0	6.0	6.0
Lead/Lag	Lag	Lag	Lead			
Lead-Lag Optimize?	Yes	Yes	Yes			
Recall Mode	Min	Min	None	Min	Max	Max
Act Effect Green (s)	54.0	54.0	5.0	65.0	8.0	8.0
Actuated g/C Ratio	0.64	0.64	0.06	0.76	0.09	0.09
v/c Ratio	0.83	1.70	2.19	0.73	4.80	2.72
Control Delay	16.4	335.8	588.8	7.5	1734.4	800.9
Queue Delay	0.0	0.0	0.0	0.0	0.0	0.0
Total Delay	16.4	335.8	588.8	7.5	1734.4	800.9
LOS	B	F	F	A	F	F
Approach Delay	218.6			69.5	1234.8	
Approach LOS	F			E	F	

Intersection Summary

Cycle Length: 85
 Actuated Cycle Length: 85
 Natural Cycle: 120
 Control Type: Actuated-Uncoordinated
 Maximum v/c Ratio: 4.80
 Intersection Signal Delay: 384.5
 Intersection LOS: F
 Intersection Capacity Utilization 158.0%
 ICU Level of Service H
 Analysis Period (min) 15













Splits and Phases: 32: I-215 SB Ramps & Van Buren Bl.



HCM 6th Signalized Intersection Summary
32: I-215 SB Ramps & Van Buren Bl.

West Campus Upper Plateau (JN 14064)

09/20/2022

												
Movement	EBL	EBT	EBR	WBL	WBT	WBR	NBL	NBT	NBR	SBL	SBT	SBR
Lane Configurations		↑↑	↑↑	↑	↑↑						↑	↑↑
Traffic Volume (veh/h)	0	1655	2856	214	1789	0	0	0	0	618	136	869
Future Volume (veh/h)	0	1655	2856	214	1789	0	0	0	0	618	136	869
Initial Q (Qb), veh	0	0	0	0	0	0				0	0	0
Ped-Bike Adj(A_pbT)	1.00		1.00	1.00		1.00				1.00		1.00
Parking Bus, Adj	1.00	1.00	1.00	1.00	1.00	1.00				1.00	1.00	1.00
Work Zone On Approach		No			No						No	
Adj Sat Flow, veh/h/ln	0	1796	1856	1885	1826	0				1885	1856	1722
Adj Flow Rate, veh/h	0	1780	2972	230	1924	0				665	146	0
Peak Hour Factor	0.93	0.93	0.93	0.93	0.93	0.93				0.93	0.93	0.93
Percent Heavy Veh, %	0	7	3	1	5	0				1	3	12
Cap, veh/h	0	2168	1758	106	2653	0				138	30	
Arrive On Green	0.00	0.64	0.64	0.06	0.76	0.00				0.09	0.09	0.00
Sat Flow, veh/h	0	3503	2768	1795	3561	0				1462	321	2569
Grp Volume(v), veh/h	0	1780	2972	230	1924	0				811	0	0
Grp Sat Flow(s),veh/h/ln	0	1706	1384	1795	1735	0				1782	0	1284
Q Serve(g_s), s	0.0	33.8	54.0	5.0	24.9	0.0				8.0	0.0	0.0
Cycle Q Clear(g_c), s	0.0	33.8	54.0	5.0	24.9	0.0				8.0	0.0	0.0
Prop In Lane	0.00		1.00	1.00		0.00				0.82		1.00
Lane Grp Cap(c), veh/h	0	2168	1758	106	2653	0				168	0	
V/C Ratio(X)	0.00	0.82	1.69	2.18	0.73	0.00				4.83	0.00	
Avail Cap(c_a), veh/h	0	2168	1758	106	2653	0				168	0	
HCM Platoon Ratio	1.00	1.00	1.00	1.00	1.00	1.00				1.00	1.00	1.00
Upstream Filter(l)	0.00	1.00	1.00	1.00	1.00	0.00				1.00	0.00	0.00
Uniform Delay (d), s/veh	0.0	11.8	15.5	40.0	5.3	0.0				38.5	0.0	0.0
Incr Delay (d2), s/veh	0.0	2.5	313.1	559.8	0.9	0.0				1738.8	0.0	0.0
Initial Q Delay(d3),s/veh	0.0	0.0	0.0	0.0	0.0	0.0				0.0	0.0	0.0
%ile BackOfQ(50%),veh/ln	0.0	9.3	87.6	18.5	4.1	0.0				84.3	0.0	0.0
Unsig. Movement Delay, s/veh												
LnGrp Delay(d),s/veh	0.0	14.3	328.6	599.8	6.2	0.0				1777.3	0.0	0.0
LnGrp LOS	A	B	F	F	A	A				F	A	
Approach Vol, veh/h		4752			2154							811
Approach Delay, s/veh		210.9			69.6						1777.3	
Approach LOS		F			E						F	
Timer - Assigned Phs		2			5	6			8			
Phs Duration (G+Y+Rc), s		71.0			11.0	60.0			14.0			
Change Period (Y+Rc), s		6.0			6.0	6.0			6.0			
Max Green Setting (Gmax), s		65.0			5.0	54.0			8.0			
Max Q Clear Time (g_c+1), s		26.9			7.0	56.0			10.0			
Green Ext Time (p_c), s		12.8			0.0	0.0			0.0			
Intersection Summary												
HCM 6th Ctrl Delay			336.1									
HCM 6th LOS			F									
Notes												
Unsignalized Delay for [SBR] is excluded from calculations of the approach delay and intersection delay.												

Timings
33: I-215 NB On/Off Ramp & Van Buren Bl.



Lane Group	EBT	EBR	WBT	NBL	NBR
Lane Configurations	↑↑	↑↑	↑↑	↑↑	↑
Traffic Volume (vph)	831	1359	1032	1378	232
Future Volume (vph)	831	1359	1032	1378	232
Turn Type	NA	pm+ov	NA	Prot	Perm
Protected Phases	6	4	2	4	
Permitted Phases		6			4
Detector Phase	6	4	2	4	4
Switch Phase					
Minimum Initial (s)	5.0	5.0	5.0	5.0	5.0
Minimum Split (s)	11.0	42.0	11.0	42.0	42.0
Total Split (s)	17.0	53.0	17.0	53.0	53.0
Total Split (%)	24.3%	75.7%	24.3%	75.7%	75.7%
Yellow Time (s)	5.0	5.0	5.0	5.0	5.0
All-Red Time (s)	1.0	1.0	1.0	1.0	1.0
Lost Time Adjust (s)	0.0	0.0	0.0	0.0	0.0
Total Lost Time (s)	6.0	6.0	6.0	6.0	6.0
Lead/Lag					
Lead-Lag Optimize?					
Recall Mode	None	Min	None	Min	Min
Act Effct Green (s)	11.3	56.3	11.3	32.7	32.7
Actuated g/C Ratio	0.20	1.00	0.20	0.58	0.58
v/c Ratio	1.21	0.54	1.50	0.76	0.26
Control Delay	133.4	0.8	256.8	11.5	6.1
Queue Delay	0.0	0.0	0.0	0.0	0.0
Total Delay	133.4	0.8	256.8	11.5	6.1
LOS	F	A	F	B	A
Approach Delay	51.1		256.8	10.7	
Approach LOS	D		F	B	

Intersection Summary

Cycle Length: 70
 Actuated Cycle Length: 56.3
 Natural Cycle: 70
 Control Type: Actuated-Uncoordinated
 Maximum v/c Ratio: 1.50
 Intersection Signal Delay: 81.6
 Intersection Capacity Utilization 77.8%
 Analysis Period (min) 15
 Intersection LOS: F
 ICU Level of Service D

Splits and Phases: 33: I-215 NB On/Off Ramp & Van Buren Bl.



HCM 6th Signalized Intersection Summary
 33: I-215 NB On/Off Ramp & Van Buren Bl.

West Campus Upper Plateau (JN 14064)

09/20/2022

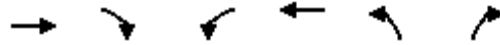

Movement	EBT	EBR	WBL	WBT	NBL	NBR
Lane Configurations	↑↑	↑↑		↑↑	↑↑	↑
Traffic Volume (veh/h)	831	1359	0	1032	1378	232
Future Volume (veh/h)	831	1359	0	1032	1378	232
Initial Q (Qb), veh	0	0	0	0	0	0
Ped-Bike Adj(A_pbT)		1.00	1.00		1.00	1.00
Parking Bus, Adj	1.00	1.00	1.00	1.00	1.00	1.00
Work Zone On Approach	No			No	No	
Adj Sat Flow, veh/h/ln	1900	1781	0	1900	1796	1885
Adj Flow Rate, veh/h	875	1423	0	1086	1451	244
Peak Hour Factor	0.95	0.95	0.95	0.95	0.95	0.95
Percent Heavy Veh, %	0	8	0	0	7	1
Cap, veh/h	849	1975	0	849	1686	812
Arrive On Green	0.24	0.24	0.00	0.24	0.51	0.51
Sat Flow, veh/h	3705	2657	0	3800	3319	1598
Grp Volume(v), veh/h	875	1423	0	1086	1451	244
Grp Sat Flow(s),veh/h/ln	1805	1329	0	1805	1659	1598
Q Serve(g_s), s	11.0	11.0	0.0	11.0	17.9	4.1
Cycle Q Clear(g_c), s	11.0	11.0	0.0	11.0	17.9	4.1
Prop In Lane		1.00	0.00		1.00	1.00
Lane Grp Cap(c), veh/h	849	1975	0	849	1686	812
V/C Ratio(X)	1.03	0.72	0.00	1.28	0.86	0.30
Avail Cap(c_a), veh/h	849	1975	0	849	3336	1606
HCM Platoon Ratio	1.00	1.00	1.00	1.00	1.00	1.00
Upstream Filter(I)	1.00	1.00	0.00	1.00	1.00	1.00
Uniform Delay (d), s/veh	17.9	3.0	0.0	17.9	10.1	6.7
Incr Delay (d2), s/veh	38.9	1.1	0.0	134.5	0.5	0.1
Initial Q Delay(d3),s/veh	0.0	0.0	0.0	0.0	0.0	0.0
%ile BackOfQ(50%),veh/ln	8.0	6.8	0.0	19.3	3.8	0.8
Unsig. Movement Delay, s/veh						
LnGrp Delay(d),s/veh	56.8	4.1	0.0	152.4	10.6	6.8
LnGrp LOS	F	A	A	F	B	A
Approach Vol, veh/h	2298			1086	1695	
Approach Delay, s/veh	24.2			152.4	10.0	
Approach LOS	C			F	B	
Timer - Assigned Phs		2		4		6
Phs Duration (G+Y+Rc), s		17.0		29.8		17.0
Change Period (Y+Rc), s		6.0		6.0		6.0
Max Green Setting (Gmax), s		11.0		47.0		11.0
Max Q Clear Time (g_c+11), s		13.0		19.9		13.0
Green Ext Time (p_c), s		0.0		3.9		0.0
Intersection Summary						
HCM 6th Ctrl Delay			46.9			
HCM 6th LOS			D			

Timings

West Campus Upper Plateau (JN 14064)

34: Old 215 Frontage Rd. & Alessandro Bl.

09/20/2022

Lane Group	EBL	EBT	EBR	WBL	WBT	WBR	NBL	NBT	NBR	SBL	SBT	SBR
Lane Configurations												
Traffic Volume (vph)	463	2199	134	17	1573	299	48	247	19	322	283	313
Future Volume (vph)	463	2199	134	17	1573	299	48	247	19	322	283	313
Turn Type	Prot	NA	Perm	Prot	NA	Perm	Prot	NA	Perm	Prot	NA	Perm
Protected Phases	5	2		1	6		3	8		7	4	
Permitted Phases			2			6			8			4
Detector Phase	5	2	2	1	6	6	3	8	8	7	4	4
Switch Phase												
Minimum Initial (s)	5.0	10.0	10.0	5.0	10.0	10.0	5.0	10.0	10.0	5.0	10.0	10.0
Minimum Split (s)	8.7	43.5	43.5	8.7	15.8	15.8	8.7	16.2	16.2	8.7	40.2	40.2
Total Split (s)	22.0	62.4	62.4	8.7	49.1	49.1	8.7	29.7	29.7	19.2	40.2	40.2
Total Split (%)	18.3%	52.0%	52.0%	7.3%	40.9%	40.9%	7.3%	24.8%	24.8%	16.0%	33.5%	33.5%
Yellow Time (s)	3.2	5.5	5.5	3.2	4.8	4.8	3.2	5.2	5.2	3.2	5.2	5.2
All-Red Time (s)	0.5	1.0	1.0	0.5	1.0	1.0	0.5	1.0	1.0	0.5	1.0	1.0
Lost Time Adjust (s)	0.0	0.0	0.0	0.0	0.0	0.0	0.0	0.0	0.0	0.0	0.0	0.0
Total Lost Time (s)	3.7	6.5	6.5	3.7	5.8	5.8	3.7	6.2	6.2	3.7	6.2	6.2
Lead/Lag	Lead	Lag	Lag	Lead	Lag	Lag	Lead	Lag	Lag	Lead	Lag	Lag
Lead-Lag Optimize?	Yes	Yes	Yes	Yes	Yes	Yes	Yes	Yes	Yes	Yes	Yes	Yes
Recall Mode	None	None	None	None	None	None	None	None	None	None	None	None
Act Effct Green (s)	17.9	60.9	60.9	5.0	43.4	43.4	5.0	14.4	14.4	15.5	26.7	26.7
Actuated g/C Ratio	0.16	0.55	0.55	0.05	0.39	0.39	0.05	0.13	0.13	0.14	0.24	0.24
v/c Ratio	0.88	0.79	0.17	0.24	1.16	0.38	0.38	0.55	0.06	1.33	0.36	0.58
Control Delay	64.0	24.0	3.8	61.6	111.4	4.3	61.7	49.7	0.4	210.9	36.8	11.4
Queue Delay	0.0	0.0	0.0	0.0	0.0	0.0	0.0	0.0	0.0	0.0	0.0	0.0
Total Delay	64.0	24.0	3.8	61.6	111.4	4.3	61.7	49.7	0.4	210.9	36.8	11.4
LOS	E	C	A	E	F	A	E	D	A	F	D	B
Approach Delay		29.6			94.0			48.6			89.3	
Approach LOS		C			F			D			F	

Intersection Summary

Cycle Length: 120	
Actuated Cycle Length: 110.6	
Natural Cycle: 115	
Control Type: Actuated-Uncoordinated	
Maximum v/c Ratio: 1.33	
Intersection Signal Delay: 60.4	Intersection LOS: E
Intersection Capacity Utilization 99.5%	ICU Level of Service F
Analysis Period (min) 15	

Splits and Phases: 34: Old 215 Frontage Rd. & Alessandro Bl.

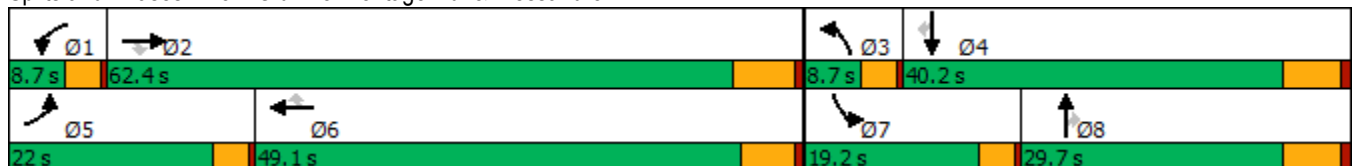

HCM 6th Signalized Intersection Summary
34: Old 215 Frontage Rd. & Alessandro Bl.

West Campus Upper Plateau (JN 14064)

09/20/2022



Movement	EBL	EBT	EBR	WBL	WBT	WBR	NBL	NBT	NBR	SBL	SBT	SBR
Lane Configurations	↖↗	↑↑↑	↖	↖	↑↑	↖	↖↗	↑↑	↖	↖	↑↑	↖
Traffic Volume (veh/h)	463	2199	134	17	1573	299	48	247	19	322	283	313
Future Volume (veh/h)	463	2199	134	17	1573	299	48	247	19	322	283	313
Initial Q (Qb), veh	0	0	0	0	0	0	0	0	0	0	0	0
Ped-Bike Adj(A_pbT)	1.00		0.99	1.00		1.00	1.00		0.98	1.00		1.00
Parking Bus, Adj	1.00	1.00	1.00	1.00	1.00	1.00	1.00	1.00	1.00	1.00	1.00	1.00
Work Zone On Approach		No			No			No			No	
Adj Sat Flow, veh/h/ln	1826	1885	1678	1678	1870	1885	1574	1856	1574	1870	1752	1693
Adj Flow Rate, veh/h	472	2244	110	17	1605	0	49	252	9	329	289	0
Peak Hour Factor	0.98	0.98	0.98	0.98	0.98	0.98	0.98	0.98	0.98	0.98	0.98	0.98
Percent Heavy Veh, %	5	1	15	15	2	1	22	3	22	2	10	14
Cap, veh/h	532	2816	768	30	1450		105	348	130	260	695	
Arrive On Green	0.16	0.55	0.55	0.02	0.41	0.00	0.04	0.10	0.10	0.15	0.21	0.00
Sat Flow, veh/h	3374	5147	1404	1598	3554	1598	2908	3526	1312	1781	3328	1434
Grp Volume(v), veh/h	472	2244	110	17	1605	0	49	252	9	329	289	0
Grp Sat Flow(s),veh/h/ln	1687	1716	1404	1598	1777	1598	1454	1763	1312	1781	1664	1434
Q Serve(g_s), s	14.5	37.2	4.1	1.1	43.3	0.0	1.8	7.4	0.7	15.5	8.0	0.0
Cycle Q Clear(g_c), s	14.5	37.2	4.1	1.1	43.3	0.0	1.8	7.4	0.7	15.5	8.0	0.0
Prop In Lane	1.00		1.00	1.00		1.00	1.00		1.00	1.00		1.00
Lane Grp Cap(c), veh/h	532	2816	768	30	1450		105	348	130	260	695	
V/C Ratio(X)	0.89	0.80	0.14	0.57	1.11		0.47	0.72	0.07	1.26	0.42	
Avail Cap(c_a), veh/h	582	2816	768	75	1450		137	781	290	260	1066	
HCM Platoon Ratio	1.00	1.00	1.00	1.00	1.00	1.00	1.00	1.00	1.00	1.00	1.00	1.00
Upstream Filter(I)	1.00	1.00	1.00	1.00	1.00	0.00	1.00	1.00	1.00	1.00	1.00	0.00
Uniform Delay (d), s/veh	43.8	19.3	11.8	51.7	31.4	0.0	50.2	46.4	43.4	45.3	36.4	0.0
Incr Delay (d2), s/veh	13.6	1.7	0.1	6.3	58.7	0.0	1.2	2.9	0.2	146.1	0.4	0.0
Initial Q Delay(d3),s/veh	0.0	0.0	0.0	0.0	0.0	0.0	0.0	0.0	0.0	0.0	0.0	0.0
%ile BackOfQ(50%),veh/ln	6.7	12.8	1.2	0.5	28.8	0.0	0.6	3.2	0.2	17.1	3.1	0.0
Unsig. Movement Delay, s/veh												
LnGrp Delay(d),s/veh	57.4	21.0	11.9	58.0	90.1	0.0	51.4	49.3	43.6	191.4	36.8	0.0
LnGrp LOS	E	C	B	E	F		D	D	D	F	D	
Approach Vol, veh/h		2826			1622			310			618	
Approach Delay, s/veh		26.7			89.8			49.4			119.1	
Approach LOS		C			F			D			F	
Timer - Assigned Phs	1	2	3	4	5	6	7	8				
Phs Duration (G+Y+Rc), s	5.7	64.6	7.5	28.4	20.4	49.8	19.2	16.7				
Change Period (Y+Rc), s	3.7	6.5	3.7	6.2	3.7	* 6.5	3.7	6.2				
Max Green Setting (Gmax), s	5.0	55.9	5.0	34.0	18.3	* 43	15.5	23.5				
Max Q Clear Time (g_c+I1), s	3.1	39.2	3.8	10.0	16.5	45.3	17.5	9.4				
Green Ext Time (p_c), s	0.0	13.1	0.0	1.6	0.2	0.0	0.0	1.1				

Intersection Summary

HCM 6th Ctrl Delay	57.7
HCM 6th LOS	E

Notes

* HCM 6th computational engine requires equal clearance times for the phases crossing the barrier.
Unsignalized Delay for [WBR, SBR] is excluded from calculations of the approach delay and intersection delay.

Timings
35: Day St. & Alessandro Bl.

West Campus Upper Plateau (JN 14064)

09/20/2022



Lane Group	EBL	EBT	EBR	WBL	WBT	WBR	NBL	NBT	NBR	SBL	SBT
Lane Configurations	↘	↑↑↑	↗	↘	↑↑	↗	↘	↑	↗	↘	↗
Traffic Volume (vph)	328	2121	79	36	1653	251	76	214	32	288	186
Future Volume (vph)	328	2121	79	36	1653	251	76	214	32	288	186
Turn Type	Prot	NA	Perm	Prot	NA	Perm	Perm	NA	Perm	Perm	NA
Protected Phases	5	2		1	6			8			4
Permitted Phases			2			6	8		8	4	
Detector Phase	5	2	2	1	6	6	8	8	8	4	4
Switch Phase											
Minimum Initial (s)	5.0	10.0	10.0	5.0	10.0	10.0	10.0	10.0	10.0	10.0	10.0
Minimum Split (s)	9.1	30.8	30.8	9.1	30.8	30.8	42.4	42.4	42.4	41.6	41.6
Total Split (s)	28.0	67.9	67.9	9.1	49.0	49.0	43.0	43.0	43.0	43.0	43.0
Total Split (%)	23.3%	56.6%	56.6%	7.6%	40.8%	40.8%	35.8%	35.8%	35.8%	35.8%	35.8%
Yellow Time (s)	3.6	4.8	4.8	3.6	4.8	4.8	4.4	4.4	4.4	3.6	3.6
All-Red Time (s)	0.5	1.0	1.0	0.5	1.0	1.0	1.0	1.0	1.0	1.0	1.0
Lost Time Adjust (s)	0.0	0.0	0.0	0.0	0.0	0.0	0.0	0.0	0.0	0.0	0.0
Total Lost Time (s)	4.1	5.8	5.8	4.1	5.8	5.8	5.4	5.4	5.4	4.6	4.6
Lead/Lag	Lead	Lag	Lag	Lead	Lag	Lag					
Lead-Lag Optimize?	Yes	Yes	Yes	Yes	Yes	Yes					
Recall Mode	None	None	None	None	None	None	None	None	None	None	None
Act Effct Green (s)	23.6	63.7	63.7	5.0	43.2	43.2	37.3	37.3	37.3	38.1	38.1
Actuated g/C Ratio	0.20	0.53	0.53	0.04	0.36	0.36	0.31	0.31	0.31	0.32	0.32
v/c Ratio	0.96	0.81	0.10	0.51	1.33	0.41	0.95	0.38	0.06	0.97	0.82
Control Delay	86.5	26.7	5.9	79.0	187.4	19.9	131.1	34.3	0.2	85.5	45.3
Queue Delay	0.0	0.0	0.0	0.0	0.0	0.0	0.0	0.0	0.0	0.0	0.0
Total Delay	86.5	26.7	5.9	79.0	187.4	19.9	131.1	34.3	0.2	85.5	45.3
LOS	F	C	A	E	F	B	F	C	A	F	D
Approach Delay		33.8			163.7			53.8			60.6
Approach LOS		C			F			D			E

Intersection Summary

Cycle Length: 120	
Actuated Cycle Length: 119.4	
Natural Cycle: 115	
Control Type: Actuated-Uncoordinated	
Maximum v/c Ratio: 1.33	
Intersection Signal Delay: 84.1	Intersection LOS: F
Intersection Capacity Utilization 115.8%	ICU Level of Service H
Analysis Period (min) 15	





























Splits and Phases: 35: Day St. & Alessandro Bl.



HCM 6th Signalized Intersection Summary
35: Day St. & Alessandro Bl.

West Campus Upper Plateau (JN 14064)

09/20/2022

												
Movement	EBL	EBT	EBR	WBL	WBT	WBR	NBL	NBT	NBR	SBL	SBT	SBR
Lane Configurations		  			 						 	
Traffic Volume (veh/h)	328	2121	79	36	1653	251	76	214	32	288	186	281
Future Volume (veh/h)	328	2121	79	36	1653	251	76	214	32	288	186	281
Initial Q (Qb), veh	0	0	0	0	0	0	0	0	0	0	0	0
Ped-Bike Adj(A_pbT)	1.00		0.98	1.00		0.98	1.00		1.00	1.00		1.00
Parking Bus, Adj	1.00	1.00	1.00	1.00	1.00	1.00	1.00	1.00	1.00	1.00	1.00	1.00
Work Zone On Approach		No			No			No			No	
Adj Sat Flow, veh/h/ln	1900	1870	1811	1900	1885	1900	1796	1900	1841	1885	1885	1885
Adj Flow Rate, veh/h	342	2209	76	38	1722	193	79	223	28	300	194	262
Peak Hour Factor	0.96	0.96	0.96	0.96	0.96	0.96	0.96	0.96	0.96	0.96	0.96	0.96
Percent Heavy Veh, %	0	2	6	0	1	0	7	0	4	1	1	1
Cap, veh/h	358	2684	789	54	1281	563	122	604	496	318	231	312
Arrive On Green	0.20	0.53	0.53	0.03	0.36	0.36	0.32	0.32	0.32	0.32	0.32	0.32
Sat Flow, veh/h	1810	5106	1501	1810	3582	1575	898	1900	1560	1138	727	982
Grp Volume(v), veh/h	342	2209	76	38	1722	193	79	223	28	300	0	456
Grp Sat Flow(s),veh/h/ln	1810	1702	1501	1810	1791	1575	898	1900	1560	1138	0	1708
Q Serve(g_s), s	22.6	43.7	3.1	2.5	43.2	10.8	8.4	11.0	1.5	27.4	0.0	30.0
Cycle Q Clear(g_c), s	22.6	43.7	3.1	2.5	43.2	10.8	38.4	11.0	1.5	38.4	0.0	30.0
Prop In Lane	1.00		1.00	1.00		1.00	1.00		1.00	1.00		0.57
Lane Grp Cap(c), veh/h	358	2684	789	54	1281	563	122	604	496	318	0	543
V/C Ratio(X)	0.96	0.82	0.10	0.70	1.34	0.34	0.65	0.37	0.06	0.94	0.00	0.84
Avail Cap(c_a), veh/h	358	2684	789	75	1281	563	122	604	496	318	0	543
HCM Platoon Ratio	1.00	1.00	1.00	1.00	1.00	1.00	1.00	1.00	1.00	1.00	1.00	1.00
Upstream Filter(I)	1.00	1.00	1.00	1.00	1.00	1.00	1.00	1.00	1.00	1.00	0.00	1.00
Uniform Delay (d), s/veh	47.9	24.0	14.3	58.1	38.8	28.4	57.1	31.8	28.6	48.6	0.0	38.3
Incr Delay (d2), s/veh	35.6	2.2	0.1	7.1	160.3	0.4	11.3	0.4	0.0	35.7	0.0	11.2
Initial Q Delay(d3),s/veh	0.0	0.0	0.0	0.0	0.0	0.0	0.0	0.0	0.0	0.0	0.0	0.0
%ile BackOfQ(50%),veh/ln	13.4	16.6	1.0	1.2	46.5	4.0	2.8	5.0	0.6	12.4	0.0	14.3
Unsig. Movement Delay, s/veh												
LnGrp Delay(d),s/veh	83.5	26.1	14.4	65.1	199.1	28.8	68.4	32.2	28.7	84.3	0.0	49.6
LnGrp LOS	F	C	B	E	F	C	E	C	C	F	A	D
Approach Vol, veh/h		2627			1953			330				756
Approach Delay, s/veh		33.3			179.6			40.6				63.4
Approach LOS		C			F			D				E
Timer - Assigned Phs	1	2		4	5	6		8				
Phs Duration (G+Y+Rc), s	7.7	69.3		43.8	28.0	49.0		43.8				
Change Period (Y+Rc), s	4.1	5.8		* 5.4	4.1	5.8		5.4				
Max Green Setting (Gmax), s	5.0	62.1		* 38	23.9	43.2		37.6				
Max Q Clear Time (g_c+I1), s	4.5	45.7		40.4	24.6	45.2		40.4				
Green Ext Time (p_c), s	0.0	13.0		0.0	0.0	0.0		0.0				

Intersection Summary

HCM 6th Ctrl Delay	88.2
HCM 6th LOS	F

Notes

* HCM 6th computational engine requires equal clearance times for the phases crossing the barrier.

Timings
36: Elsworth St. & Cactus Av.

West Campus Upper Plateau (JN 14064)

09/20/2022



Lane Group	EBL	EBT	EBR	WBL	WBT	WBR	NBL	NBT	SBL	SBT	SBR
Lane Configurations	↘	↑↑↑	↗	↘	↑↑↑	↗	↘	↕	↘	↗	↗
Traffic Volume (vph)	339	3013	121	36	2180	211	556	177	366	73	422
Future Volume (vph)	339	3013	121	36	2180	211	556	177	366	73	422
Turn Type	Prot	NA	Perm	Prot	NA	Perm	Split	NA	Split	NA	pm+ov
Protected Phases	5	2		1	6		8	8	4	4	5
Permitted Phases			2			6					4
Detector Phase	5	2	2	1	6	6	8	8	4	4	5
Switch Phase											
Minimum Initial (s)	5.0	10.0	10.0	5.0	10.0	10.0	10.0	10.0	10.0	10.0	5.0
Minimum Split (s)	9.6	36.2	36.2	9.6	36.2	36.2	35.4	35.4	35.4	35.4	9.6
Total Split (s)	16.5	49.6	49.6	9.6	42.7	42.7	35.4	35.4	35.4	35.4	16.5
Total Split (%)	12.7%	38.2%	38.2%	7.4%	32.8%	32.8%	27.2%	27.2%	27.2%	27.2%	12.7%
Yellow Time (s)	3.6	5.2	5.2	3.6	5.2	5.2	4.4	4.4	4.4	4.4	3.6
All-Red Time (s)	1.0	1.0	1.0	1.0	1.0	1.0	1.0	1.0	1.0	1.0	1.0
Lost Time Adjust (s)	0.0	0.0	0.0	0.0	0.0	0.0	0.0	0.0	0.0	0.0	0.0
Total Lost Time (s)	4.6	6.2	6.2	4.6	6.2	6.2	5.4	5.4	5.4	5.4	4.6
Lead/Lag	Lead	Lag	Lag	Lead	Lag	Lag					Lead
Lead-Lag Optimize?	Yes	Yes	Yes	Yes	Yes	Yes					Yes
Recall Mode	None	None	None	None	None	None	Max	Max	Max	Max	None
Act Effct Green (s)	11.9	45.3	45.3	5.0	36.5	36.5	30.0	30.0	30.0	30.0	42.7
Actuated g/C Ratio	0.09	0.35	0.35	0.04	0.28	0.28	0.23	0.23	0.23	0.23	0.33
v/c Ratio	2.18	1.81	0.20	0.55	1.61	0.40	1.14	1.11	0.57	0.58	0.76
Control Delay	577.7	392.5	9.1	89.9	308.8	15.8	135.5	121.3	50.8	51.0	28.8
Queue Delay	0.0	0.0	0.0	0.0	0.0	0.0	0.0	0.0	0.0	0.0	0.0
Total Delay	577.7	392.5	9.1	89.9	308.8	15.8	135.5	121.3	50.8	51.0	28.8
LOS	F	F	A	F	F	B	F	F	D	D	C
Approach Delay		397.2			280.0			128.5		40.1	
Approach LOS		F			F			F		D	

Intersection Summary

Cycle Length: 130
 Actuated Cycle Length: 130
 Natural Cycle: 120
 Control Type: Actuated-Uncoordinated
 Maximum v/c Ratio: 2.18
 Intersection Signal Delay: 289.2
 Intersection LOS: F
 Intersection Capacity Utilization 116.4%
 ICU Level of Service H
 Analysis Period (min) 15

Splits and Phases: 36: Elsworth St. & Cactus Av.

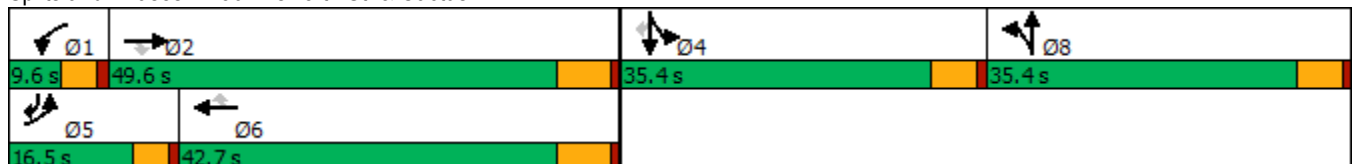

HCM 6th Signalized Intersection Summary
36: Elsworth St. & Cactus Av.

West Campus Upper Plateau (JN 14064)

09/20/2022



Movement	EBL	EBT	EBR	WBL	WBT	WBR	NBL	NBT	NBR	SBL	SBT	SBR
Lane Configurations												
Traffic Volume (veh/h)	339	3013	121	36	2180	211	556	177	130	366	73	422
Future Volume (veh/h)	339	3013	121	36	2180	211	556	177	130	366	73	422
Initial Q (Qb), veh	0	0	0	0	0	0	0	0	0	0	0	0
Ped-Bike Adj(A_pbT)	1.00		1.00	1.00		1.00	1.00		1.00	1.00		1.00
Parking Bus, Adj	1.00	1.00	1.00	1.00	1.00	1.00	1.00	1.00	1.00	1.00	1.00	1.00
Work Zone On Approach		No			No			No			No	
Adj Sat Flow, veh/h/ln	1870	1841	1870	1900	1856	1885	1900	1900	1885	1900	1900	1900
Adj Flow Rate, veh/h	353	3139	0	38	2271	184	437	383	111	435	0	333
Peak Hour Factor	0.96	0.96	0.96	0.96	0.96	0.96	0.96	0.96	0.96	0.96	0.96	0.96
Percent Heavy Veh, %	2	4	2	0	3	1	0	0	1	0	0	0
Cap, veh/h	163	1727		52	1422	449	418	327	95	835	0	519
Arrive On Green	0.09	0.34	0.00	0.03	0.28	0.28	0.23	0.23	0.23	0.23	0.00	0.23
Sat Flow, veh/h	1781	5025	1585	1810	5066	1598	1810	1416	410	3619	0	1610
Grp Volume(v), veh/h	353	3139	0	38	2271	184	437	0	494	435	0	333
Grp Sat Flow(s),veh/h/ln	1781	1675	1585	1810	1689	1598	1810	0	1826	1810	0	1610
Q Serve(g_s), s	11.9	44.7	0.0	2.7	36.5	12.2	30.0	0.0	30.0	13.7	0.0	23.0
Cycle Q Clear(g_c), s	11.9	44.7	0.0	2.7	36.5	12.2	30.0	0.0	30.0	13.7	0.0	23.0
Prop In Lane	1.00		1.00	1.00		1.00	1.00		0.22	1.00		1.00
Lane Grp Cap(c), veh/h	163	1727		52	1422	449	418	0	421	835	0	519
V/C Ratio(X)	2.16	1.82		0.73	1.60	0.41	1.05	0.00	1.17	0.52	0.00	0.64
Avail Cap(c_a), veh/h	163	1727		70	1422	449	418	0	421	835	0	519
HCM Platoon Ratio	1.00	1.00	1.00	1.00	1.00	1.00	1.00	1.00	1.00	1.00	1.00	1.00
Upstream Filter(I)	1.00	1.00	0.00	1.00	1.00	1.00	1.00	0.00	1.00	1.00	0.00	1.00
Uniform Delay (d), s/veh	59.1	42.7	0.0	62.6	46.7	38.0	50.0	0.0	50.0	43.7	0.0	37.6
Incr Delay (d2), s/veh	544.0	370.4	0.0	13.9	271.9	0.6	56.7	0.0	100.0	2.3	0.0	6.0
Initial Q Delay(d3),s/veh	0.0	0.0	0.0	0.0	0.0	0.0	0.0	0.0	0.0	0.0	0.0	0.0
%ile BackOfQ(50%),veh/ln	29.8	76.7	0.0	1.4	50.4	4.7	20.2	0.0	25.5	6.3	0.0	10.0
Unsig. Movement Delay, s/veh												
LnGrp Delay(d),s/veh	603.0	413.1	0.0	76.6	318.6	38.6	106.7	0.0	150.0	46.0	0.0	43.6
LnGrp LOS	F	F		E	F	D	F	A	F	D	A	D
Approach Vol, veh/h		3492			2493			931			768	
Approach Delay, s/veh		432.3			294.3			129.7			45.0	
Approach LOS		F			F			F			D	
Timer - Assigned Phs	1	2		4	5	6		8				
Phs Duration (G+Y+Rc), s	8.3	50.9		35.4	16.5	42.7		35.4				
Change Period (Y+Rc), s	4.6	6.2		5.4	4.6	6.2		5.4				
Max Green Setting (Gmax), s	5.0	43.4		30.0	11.9	36.5		30.0				
Max Q Clear Time (g_c+I1), s	4.7	46.7		25.0	13.9	38.5		32.0				
Green Ext Time (p_c), s	0.0	0.0		1.4	0.0	0.0		0.0				

Intersection Summary

HCM 6th Ctrl Delay	312.1
HCM 6th LOS	F

Notes

- User approved pedestrian interval to be less than phase max green.
- User approved volume balancing among the lanes for turning movement.
- Unsignalized Delay for [EBR] is excluded from calculations of the approach delay and intersection delay.

Timings
37: Cactus Av. & Frederick St.

West Campus Upper Plateau (JN 14064)

09/20/2022



Lane Group	EBL	EBT	WBT	WBR	SBL	SBR
Lane Configurations	↖	↑↑↑	↑↑↑	↗	↖↗	↗
Traffic Volume (vph)	327	3002	1826	223	577	253
Future Volume (vph)	327	3002	1826	223	577	253
Turn Type	Prot	NA	NA	pm+ov	Prot	pm+ov
Protected Phases	5	2	6	4	4	5
Permitted Phases				6		4
Detector Phase	5	2	6	4	4	5
Switch Phase						
Minimum Initial (s)	5.0	10.0	10.0	10.0	10.0	5.0
Minimum Split (s)	9.2	28.2	29.2	36.4	36.4	9.2
Total Split (s)	31.0	81.0	50.0	39.0	39.0	31.0
Total Split (%)	25.8%	67.5%	41.7%	32.5%	32.5%	25.8%
Yellow Time (s)	3.2	5.2	5.2	4.4	4.4	3.2
All-Red Time (s)	1.0	1.0	1.0	1.0	1.0	1.0
Lost Time Adjust (s)	0.0	0.0	0.0	0.0	0.0	0.0
Total Lost Time (s)	4.2	6.2	6.2	5.4	5.4	4.2
Lead/Lag	Lead		Lag			Lead
Lead-Lag Optimize?	Yes		Yes			Yes
Recall Mode	None	None	None	None	None	None
Act Effct Green (s)	24.7	74.9	46.0	72.4	25.5	55.6
Actuated g/C Ratio	0.22	0.67	0.41	0.65	0.23	0.50
v/c Ratio	0.90	0.94	0.93	0.22	0.78	0.34
Control Delay	70.1	24.5	41.9	3.1	48.4	17.8
Queue Delay	0.0	0.0	0.0	0.0	0.0	0.0
Total Delay	70.1	24.5	41.9	3.1	48.4	17.8
LOS	E	C	D	A	D	B
Approach Delay		29.0	37.6		39.0	
Approach LOS		C	D		D	

Intersection Summary

Cycle Length: 120
 Actuated Cycle Length: 112.1
 Natural Cycle: 110
 Control Type: Actuated-Uncoordinated
 Maximum v/c Ratio: 0.94
 Intersection Signal Delay: 33.2
 Intersection LOS: C
 Intersection Capacity Utilization 84.1%
 ICU Level of Service E
 Analysis Period (min) 15

Splits and Phases: 37: Cactus Av. & Frederick St.



HCM 6th Signalized Intersection Summary
37: Cactus Av. & Frederick St.

West Campus Upper Plateau (JN 14064)
09/20/2022

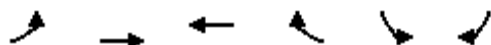

Movement	EBL	EBT	WBT	WBR	SBL	SBR
Lane Configurations	↗	↑↑↑	↑↑↑	↖	↗↖	↖
Traffic Volume (veh/h)	327	3002	1826	223	577	253
Future Volume (veh/h)	327	3002	1826	223	577	253
Initial Q (Qb), veh	0	0	0	0	0	0
Ped-Bike Adj(A_pbT)	1.00			0.98	1.00	1.00
Parking Bus, Adj	1.00	1.00	1.00	1.00	1.00	1.00
Work Zone On Approach		No	No		No	
Adj Sat Flow, veh/h/ln	1841	1856	1856	1870	1856	1856
Adj Flow Rate, veh/h	344	3160	1922	173	607	169
Peak Hour Factor	0.95	0.95	0.95	0.95	0.95	0.95
Percent Heavy Veh, %	4	3	3	2	3	3
Cap, veh/h	373	3457	2184	1001	722	666
Arrive On Green	0.21	0.68	0.43	0.43	0.21	0.21
Sat Flow, veh/h	1753	5233	5233	1548	3428	1572
Grp Volume(v), veh/h	344	3160	1922	173	607	169
Grp Sat Flow(s),veh/h/ln	1753	1689	1689	1548	1714	1572
Q Serve(g_s), s	20.9	57.1	37.7	4.9	18.4	7.5
Cycle Q Clear(g_c), s	20.9	57.1	37.7	4.9	18.4	7.5
Prop In Lane	1.00			1.00	1.00	1.00
Lane Grp Cap(c), veh/h	373	3457	2184	1001	722	666
V/C Ratio(X)	0.92	0.91	0.88	0.17	0.84	0.25
Avail Cap(c_a), veh/h	433	3493	2184	1001	1062	821
HCM Platoon Ratio	1.00	1.00	1.00	1.00	1.00	1.00
Upstream Filter(I)	1.00	1.00	1.00	1.00	1.00	1.00
Uniform Delay (d), s/veh	41.8	14.5	28.3	7.8	41.1	20.2
Incr Delay (d2), s/veh	22.0	4.2	4.5	0.1	4.1	0.2
Initial Q Delay(d3),s/veh	0.0	0.0	0.0	0.0	0.0	0.0
%ile BackOfQ(50%),veh/ln	10.8	17.6	14.7	2.6	8.0	8.1
Unsig. Movement Delay, s/veh						
LnGrp Delay(d),s/veh	63.8	18.8	32.8	7.9	45.1	20.4
LnGrp LOS	E	B	C	A	D	C
Approach Vol, veh/h		3504	2095		776	
Approach Delay, s/veh		23.2	30.8		39.8	
Approach LOS		C	C		D	
Timer - Assigned Phs		2		4	5	6
Phs Duration (G+Y+Rc), s		80.2		28.2	27.3	53.0
Change Period (Y+Rc), s		6.2		5.4	* 4.2	6.2
Max Green Setting (Gmax), s		74.8		33.6	* 27	43.8
Max Q Clear Time (g_c+I1), s		59.1		20.4	22.9	39.7
Green Ext Time (p_c), s		14.9		2.4	0.2	3.5

Intersection Summary

HCM 6th Ctrl Delay	27.7
HCM 6th LOS	C

Notes

* HCM 6th computational engine requires equal clearance times for the phases crossing the barrier.

Timings
38: Riverside Dr./Graham St. & Cactus Av.

West Campus Upper Plateau (JN 14064)

09/20/2022

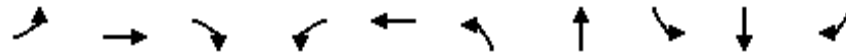

Lane Group	EBL	EBT	EBR	WBL	WBT	NBL	NBT	SBL	SBT	SBR
Lane Configurations	↘	↑↑↑	↗	↘	↑↑↑	↘	↑	↘	↑↑	↗
Traffic Volume (vph)	432	3359	489	27	2023	18	0	382	290	192
Future Volume (vph)	432	3359	489	27	2023	18	0	382	290	192
Turn Type	Prot	NA	Perm	Prot	NA	Prot	NA	Prot	NA	Perm
Protected Phases	7	4		3	8	5	2	1	6	
Permitted Phases			4							6
Detector Phase	7	4	4	3	8	5	2	1	6	6
Switch Phase										
Minimum Initial (s)	5.0	10.0	10.0	5.0	10.0	5.0	10.0	5.0	10.0	10.0
Minimum Split (s)	9.6	39.2	39.2	9.6	39.2	10.4	35.0	9.6	40.6	40.6
Total Split (s)	16.0	59.0	59.0	9.6	52.6	10.4	36.0	15.4	41.0	41.0
Total Split (%)	13.3%	49.2%	49.2%	8.0%	43.8%	8.7%	30.0%	12.8%	34.2%	34.2%
Yellow Time (s)	3.6	5.2	5.2	3.6	5.2	4.4	4.0	3.6	3.6	3.6
All-Red Time (s)	1.0	1.0	1.0	1.0	1.0	1.0	1.0	1.0	1.0	1.0
Lost Time Adjust (s)	0.0	0.0	0.0	0.0	0.0	0.0	0.0	0.0	0.0	0.0
Total Lost Time (s)	4.6	6.2	6.2	4.6	6.2	5.4	5.0	4.6	4.6	4.6
Lead/Lag	Lead	Lag	Lag	Lead	Lag	Lead	Lag	Lead	Lag	Lag
Lead-Lag Optimize?	Yes	Yes	Yes	Yes	Yes	Yes	Yes	Yes	Yes	Yes
Recall Mode	None	None	None	None	None	None	Max	None	Max	Max
Act Effct Green (s)	11.4	56.6	56.6	5.0	46.4	5.0	31.0	10.8	42.6	42.6
Actuated g/C Ratio	0.10	0.47	0.47	0.04	0.39	0.04	0.26	0.09	0.36	0.36
v/c Ratio	2.78	1.54	0.62	0.39	1.45	0.14	0.02	2.59	0.25	0.31
Control Delay	838.6	270.5	17.9	71.0	235.9	57.6	0.0	757.4	29.0	8.1
Queue Delay	0.0	0.0	0.0	0.0	0.0	0.0	0.0	0.0	0.0	0.0
Total Delay	838.6	270.5	17.9	71.0	235.9	57.6	0.0	757.4	29.0	8.1
LOS	F	F	B	E	F	E	A	F	C	A
Approach Delay		299.0			234.2		32.0		346.3	
Approach LOS		F			F		C		F	

Intersection Summary

Cycle Length: 120
 Actuated Cycle Length: 120
 Natural Cycle: 120
 Control Type: Actuated-Uncoordinated
 Maximum v/c Ratio: 2.78
 Intersection Signal Delay: 281.4
 Intersection LOS: F
 Intersection Capacity Utilization 116.1%
 ICU Level of Service H
 Analysis Period (min) 15

Splits and Phases: 38: Riverside Dr./Graham St. & Cactus Av.

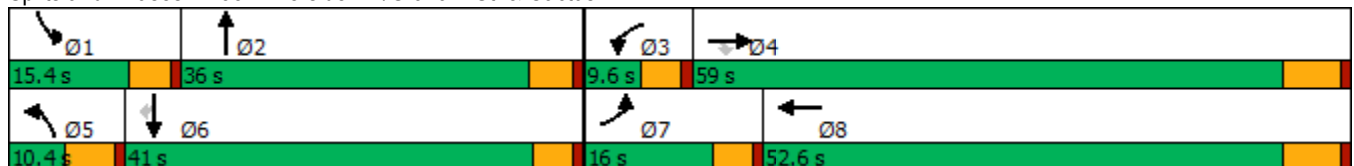

HCM 6th Signalized Intersection Summary
38: Riverside Dr./Graham St. & Cactus Av.

West Campus Upper Plateau (JN 14064)

09/20/2022



Movement	EBL	EBT	EBR	WBL	WBT	WBR	NBL	NBT	NBR	SBL	SBT	SBR
Lane Configurations	↘	↑↑↑	↗	↘	↑↑↑		↘↗	↑↗		↘	↑↑	↗
Traffic Volume (veh/h)	432	3359	489	27	2023	558	18	0	15	382	290	192
Future Volume (veh/h)	432	3359	489	27	2023	558	18	0	15	382	290	192
Initial Q (Qb), veh	0	0	0	0	0	0	0	0	0	0	0	0
Ped-Bike Adj(A_pbT)	1.00		1.00	1.00		0.99	1.00		1.00	1.00		1.00
Parking Bus, Adj	1.00	1.00	1.00	1.00	1.00	1.00	1.00	1.00	1.00	1.00	1.00	1.00
Work Zone On Approach		No			No			No			No	
Adj Sat Flow, veh/h/ln	1885	1856	1885	1900	1856	1900	1900	1900	1900	1885	1900	1856
Adj Flow Rate, veh/h	470	3651	484	29	2199	598	20	0	15	415	315	131
Peak Hour Factor	0.92	0.92	0.92	0.92	0.92	0.92	0.92	0.92	0.92	0.92	0.92	0.92
Percent Heavy Veh, %	1	3	1	0	3	0	0	0	0	1	0	3
Cap, veh/h	171	2309	728	47	1556	391	71	466	416	162	1160	505
Arrive On Green	0.09	0.46	0.46	0.03	0.39	0.39	0.02	0.00	0.26	0.09	0.32	0.32
Sat Flow, veh/h	1795	5066	1598	1810	4023	1012	3510	1805	1610	1795	3610	1572
Grp Volume(v), veh/h	470	3651	484	29	1817	980	20	0	15	415	315	131
Grp Sat Flow(s),veh/h/ln	1795	1689	1598	1810	1689	1658	1755	1805	1610	1795	1805	1572
Q Serve(g_s), s	11.4	54.7	28.4	1.9	46.4	46.4	0.7	0.0	0.8	10.8	7.8	7.4
Cycle Q Clear(g_c), s	11.4	54.7	28.4	1.9	46.4	46.4	0.7	0.0	0.8	10.8	7.8	7.4
Prop In Lane	1.00		1.00	1.00		0.61	1.00		1.00	1.00		1.00
Lane Grp Cap(c), veh/h	171	2309	728	47	1306	641	71	466	416	162	1160	505
V/C Ratio(X)	2.76	1.58	0.66	0.62	1.39	1.53	0.28	0.00	0.04	2.57	0.27	0.26
Avail Cap(c_a), veh/h	171	2309	728	75	1306	641	146	466	416	162	1160	505
HCM Platoon Ratio	1.00	1.00	1.00	1.00	1.00	1.00	1.00	1.00	1.00	1.00	1.00	1.00
Upstream Filter(I)	1.00	1.00	1.00	1.00	1.00	1.00	1.00	0.00	1.00	1.00	1.00	1.00
Uniform Delay (d), s/veh	54.3	32.6	25.5	57.9	36.8	36.8	57.9	0.0	33.3	54.6	30.3	30.1
Incr Delay (d2), s/veh	806.2	263.6	2.3	4.9	181.0	245.8	0.8	0.0	0.2	723.5	0.6	1.2
Initial Q Delay(d3),s/veh	0.0	0.0	0.0	0.0	0.0	0.0	0.0	0.0	0.0	0.0	0.0	0.0
%ile BackOfQ(50%),veh/ln	43.2	76.7	10.4	0.9	50.6	61.2	0.3	0.0	0.3	37.3	3.4	2.9
Unsig. Movement Delay, s/veh												
LnGrp Delay(d),s/veh	860.5	296.2	27.8	62.8	217.8	282.6	58.7	0.0	33.5	778.1	30.8	31.4
LnGrp LOS	F	F	C	E	F	F	E	A	C	F	C	C
Approach Vol, veh/h		4605			2826			35			861	
Approach Delay, s/veh		325.6			238.7			47.9			391.1	
Approach LOS		F			F			D			F	
Timer - Assigned Phs	1	2	3	4	5	6	7	8				
Phs Duration (G+Y+Rc), s	15.4	36.0	7.7	60.9	7.8	43.6	16.0	52.6				
Change Period (Y+Rc), s	4.6	5.0	4.6	6.2	5.4	* 5	4.6	6.2				
Max Green Setting (Gmax), s	10.8	31.0	5.0	52.8	5.0	* 36	11.4	46.4				
Max Q Clear Time (g_c+I1), s	12.8	2.8	3.9	56.7	2.7	9.8	13.4	48.4				
Green Ext Time (p_c), s	0.0	0.0	0.0	0.0	0.0	2.4	0.0	0.0				

Intersection Summary

HCM 6th Ctrl Delay	301.7
HCM 6th LOS	F

Notes

* HCM 6th computational engine requires equal clearance times for the phases crossing the barrier.

Timings
1: Washington St & Van Buren Bl.

West Campus Upper Plateau (JN 14064)

09/30/2022



Lane Group	EBL	EBT	WBL	WBT	WBR	NBL	NBT	NBR	SBL	SBT
Lane Configurations	↙	↕	↙	↕	↗	↙	↕	↗	↙	↕
Traffic Volume (vph)	147	1152	164	1119	357	170	255	185	472	222
Future Volume (vph)	147	1152	164	1119	357	170	255	185	472	222
Turn Type	Prot	NA	Prot	NA	Perm	Prot	NA	Perm	Prot	NA
Protected Phases	5	2	1	6		3	8		7	4
Permitted Phases					6			8		
Detector Phase	5	2	1	6	6	3	8	8	7	4
Switch Phase										
Minimum Initial (s)	5.0	10.0	5.0	10.0	10.0	5.0	10.0	10.0	5.0	10.0
Minimum Split (s)	9.2	34.2	9.2	33.2	33.2	9.2	38.4	38.4	9.2	30.8
Total Split (s)	14.2	49.6	14.0	49.4	49.4	11.5	38.4	38.4	18.0	44.9
Total Split (%)	11.8%	41.3%	11.7%	41.2%	41.2%	9.6%	32.0%	32.0%	15.0%	37.4%
Yellow Time (s)	3.2	5.2	3.2	5.2	5.2	3.2	4.4	4.4	3.2	4.8
All-Red Time (s)	1.0	1.0	1.0	1.0	1.0	1.0	1.0	1.0	1.0	1.0
Lost Time Adjust (s)	0.0	0.0	0.0	0.0	0.0	0.0	0.0	0.0	0.0	0.0
Total Lost Time (s)	4.2	6.2	4.2	6.2	6.2	4.2	5.4	5.4	4.2	5.8
Lead/Lag	Lead	Lag	Lead	Lag	Lag	Lead	Lag	Lag	Lead	Lag
Lead-Lag Optimize?	Yes	Yes	Yes	Yes	Yes	Yes	Yes	Yes	Yes	Yes
Recall Mode	None	None	None	None	None	None	None	None	None	None
Act Effct Green (s)	10.1	43.6	9.9	43.4	43.4	7.3	15.9	15.9	13.9	22.1
Actuated g/C Ratio	0.10	0.42	0.10	0.42	0.42	0.07	0.15	0.15	0.13	0.21
v/c Ratio	0.87	0.88	0.99	0.78	0.47	0.71	0.49	0.49	1.05	0.42
Control Delay	88.7	36.8	116.9	31.7	12.7	65.0	42.4	10.9	99.2	29.5
Queue Delay	0.0	0.0	0.0	0.0	0.0	0.0	0.0	0.0	0.0	0.0
Total Delay	88.7	36.8	116.9	31.7	12.7	65.0	42.4	10.9	99.2	29.5
LOS	F	D	F	C	B	E	D	B	F	C
Approach Delay		42.3		36.1			39.1			71.1
Approach LOS		D		D			D			E

Intersection Summary

Cycle Length: 120
 Actuated Cycle Length: 103.4
 Natural Cycle: 115
 Control Type: Actuated-Uncoordinated
 Maximum v/c Ratio: 1.05
 Intersection Signal Delay: 44.7
 Intersection LOS: D
 Intersection Capacity Utilization 82.9%
 ICU Level of Service E
 Analysis Period (min) 15



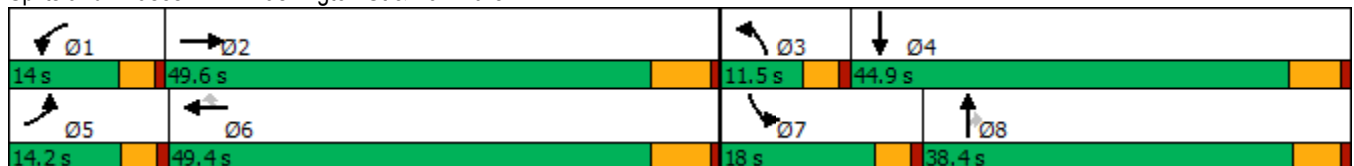



















Splits and Phases: 1: Washington St & Van Buren Bl.



HCM 6th Signalized Intersection Summary
1: Washington St & Van Buren Bl.

West Campus Upper Plateau (JN 14064)

09/30/2022

												
Movement	EBL	EBT	EBR	WBL	WBT	WBR	NBL	NBT	NBR	SBL	SBT	SBR
Lane Configurations												
Traffic Volume (veh/h)	147	1152	91	164	1119	357	170	255	185	472	222	96
Future Volume (veh/h)	147	1152	91	164	1119	357	170	255	185	472	222	96
Initial Q (Qb), veh	0	0	0	0	0	0	0	0	0	0	0	0
Ped-Bike Adj(A_pbT)	1.00		1.00	1.00		1.00	1.00		0.98	1.00		0.98
Parking Bus, Adj	1.00	1.00	1.00	1.00	1.00	1.00	1.00	1.00	1.00	1.00	1.00	1.00
Work Zone On Approach		No			No			No			No	
Adj Sat Flow, veh/h/ln	1900	1841	1856	1885	1856	1885	1885	1856	1870	1885	1885	1900
Adj Flow Rate, veh/h	152	1188	74	169	1154	273	175	263	151	487	229	52
Peak Hour Factor	0.97	0.97	0.97	0.97	0.97	0.97	0.97	0.97	0.97	0.97	0.97	0.97
Percent Heavy Veh, %	0	4	3	1	3	1	1	3	2	1	1	0
Cap, veh/h	183	1366	85	178	1434	649	241	513	226	487	627	139
Arrive On Green	0.10	0.41	0.41	0.10	0.41	0.41	0.07	0.15	0.15	0.14	0.22	0.22
Sat Flow, veh/h	1810	3344	208	1795	3526	1594	3483	3526	1556	3483	2902	645
Grp Volume(v), veh/h	152	621	641	169	1154	273	175	263	151	487	139	142
Grp Sat Flow(s),veh/h/ln	1810	1749	1803	1795	1763	1594	1742	1763	1556	1742	1791	1756
Q Serve(g_s), s	8.1	32.1	32.2	9.2	28.5	12.1	4.9	6.8	9.1	13.8	6.5	6.8
Cycle Q Clear(g_c), s	8.1	32.1	32.2	9.2	28.5	12.1	4.9	6.8	9.1	13.8	6.5	6.8
Prop In Lane	1.00		0.12	1.00		1.00	1.00		1.00	1.00		0.37
Lane Grp Cap(c), veh/h	183	715	737	178	1434	649	241	513	226	487	387	380
V/C Ratio(X)	0.83	0.87	0.87	0.95	0.80	0.42	0.73	0.51	0.67	1.00	0.36	0.37
Avail Cap(c_a), veh/h	183	769	793	178	1544	698	258	1179	520	487	710	696
HCM Platoon Ratio	1.00	1.00	1.00	1.00	1.00	1.00	1.00	1.00	1.00	1.00	1.00	1.00
Upstream Filter(I)	1.00	1.00	1.00	1.00	1.00	1.00	1.00	1.00	1.00	1.00	1.00	1.00
Uniform Delay (d), s/veh	43.5	26.7	26.8	44.2	25.8	20.9	45.0	38.9	39.9	42.4	32.9	33.0
Incr Delay (d2), s/veh	24.9	10.4	10.2	51.6	3.2	0.6	7.7	0.8	3.4	40.6	0.6	0.6
Initial Q Delay(d3),s/veh	0.0	0.0	0.0	0.0	0.0	0.0	0.0	0.0	0.0	0.0	0.0	0.0
%ile BackOfQ(50%),veh/ln	4.7	14.0	14.5	6.5	11.3	4.6	2.4	3.0	3.7	8.6	2.9	2.9
Unsig. Movement Delay, s/veh												
LnGrp Delay(d),s/veh	68.4	37.1	37.0	95.8	29.0	21.6	52.7	39.7	43.3	83.0	33.4	33.6
LnGrp LOS	E	D	D	F	C	C	D	D	D	F	C	C
Approach Vol, veh/h		1414			1596			589			768	
Approach Delay, s/veh		40.4			34.8			44.5			64.9	
Approach LOS		D			C			D			E	
Timer - Assigned Phs	1	2	3	4	5	6	7	8				
Phs Duration (G+Y+Rc), s	14.0	46.5	11.0	27.1	14.2	46.3	18.0	20.1				
Change Period (Y+Rc), s	* 4.2	6.2	* 4.2	5.8	* 4.2	6.2	* 4.2	* 5.8				
Max Green Setting (Gmax), s	* 9.8	43.4	* 7.3	39.1	* 10	43.2	* 14	* 33				
Max Q Clear Time (g_c+I1), s	11.2	34.2	6.9	8.8	10.1	30.5	15.8	11.1				
Green Ext Time (p_c), s	0.0	6.1	0.0	1.7	0.0	8.4	0.0	2.3				
Intersection Summary												
HCM 6th Ctrl Delay				43.2								
HCM 6th LOS				D								
Notes												
* HCM 6th computational engine requires equal clearance times for the phases crossing the barrier.												

Timings
2: Central Ave & Arlington Ave/Chicago Ave

West Campus Upper Plateau (JN 14064)

09/30/2022



Lane Group	EBL	EBT	EBR	WBL	WBT	WBR	NBL	NBT	NBR	SBL	SBT
Lane Configurations	↖	↗	↘	↙	↕	↗	↖	↕	↗	↖	↕
Traffic Volume (vph)	28	422	768	265	563	215	919	999	261	283	1130
Future Volume (vph)	28	422	768	265	563	215	919	999	261	283	1130
Turn Type	Prot	NA	pm+ov	Prot	NA	pm+ov	Prot	NA	pm+ov	Prot	NA
Protected Phases	7	4	5	3	8	1	5	2	3	1	6
Permitted Phases			4			8			2		
Detector Phase	7	4	5	3	8	1	5	2	3	1	6
Switch Phase											
Minimum Initial (s)	5.0	10.0	5.0	5.0	10.0	5.0	5.0	10.0	5.0	5.0	10.0
Minimum Split (s)	9.6	32.8	9.6	9.6	30.8	9.6	9.6	35.4	9.6	9.6	30.4
Total Split (s)	10.6	32.8	30.0	22.0	44.2	24.4	30.0	50.8	22.0	24.4	45.2
Total Split (%)	8.2%	25.2%	23.1%	16.9%	34.0%	18.8%	23.1%	39.1%	16.9%	18.8%	34.8%
Yellow Time (s)	3.6	4.8	3.6	3.6	4.8	3.6	3.6	4.4	3.6	3.6	4.4
All-Red Time (s)	1.0	1.0	1.0	1.0	1.0	1.0	1.0	1.0	1.0	1.0	1.0
Lost Time Adjust (s)	0.0	0.0	0.0	0.0	0.0	0.0	0.0	0.0	0.0	0.0	0.0
Total Lost Time (s)	4.6	5.8	4.6	4.6	5.8	4.6	4.6	5.4	4.6	4.6	5.4
Lead/Lag	Lead	Lag	Lead	Lead	Lag	Lead	Lead	Lag	Lead	Lead	Lag
Lead-Lag Optimize?	Yes	Yes	Yes	Yes	Yes	Yes	Yes	Yes	Yes	Yes	Yes
Recall Mode	None	None	None	None	None	None	None	None	None	None	None
Act Effct Green (s)	5.7	19.1	46.0	13.1	31.0	50.6	25.8	45.7	59.7	13.8	33.7
Actuated g/C Ratio	0.05	0.17	0.41	0.12	0.28	0.45	0.23	0.41	0.53	0.12	0.30
v/c Ratio	0.31	0.70	0.65	0.67	0.57	0.28	1.17	0.69	0.31	0.67	0.77
Control Delay	65.6	51.3	24.2	57.7	38.9	11.9	128.6	32.3	10.5	56.5	39.9
Queue Delay	0.0	0.0	0.0	0.0	0.0	0.0	0.0	0.0	0.0	0.0	0.0
Total Delay	65.6	51.3	24.2	57.7	38.9	11.9	128.6	32.3	10.5	56.5	39.9
LOS	E	D	C	E	D	B	F	C	B	E	D
Approach Delay		34.5			38.1			70.3			43.1
Approach LOS		C			D			E			D

Intersection Summary

Cycle Length: 130
 Actuated Cycle Length: 112.4
 Natural Cycle: 110
 Control Type: Actuated-Uncoordinated
 Maximum v/c Ratio: 1.17
 Intersection Signal Delay: 50.5
 Intersection LOS: D
 Intersection Capacity Utilization 85.6%
 ICU Level of Service E
 Analysis Period (min) 15

Splits and Phases: 2: Central Ave & Arlington Ave/Chicago Ave

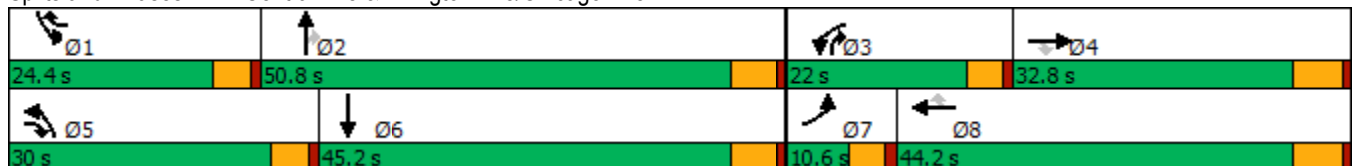

HCM 6th Signalized Intersection Summary
2: Central Ave & Arlington Ave/Chicago Ave

West Campus Upper Plateau (JN 14064)

09/30/2022



Movement	EBL	EBT	EBR	WBL	WBT	WBR	NBL	NBT	NBR	SBL	SBT	SBR
Lane Configurations												
Traffic Volume (veh/h)	28	422	768	265	563	215	919	999	261	283	1130	36
Future Volume (veh/h)	28	422	768	265	563	215	919	999	261	283	1130	36
Initial Q (Qb), veh	0	0	0	0	0	0	0	0	0	0	0	0
Ped-Bike Adj(A_pbT)	1.00		1.00	1.00		1.00	1.00		0.99	1.00		1.00
Parking Bus, Adj	1.00	1.00	1.00	1.00	1.00	1.00	1.00	1.00	1.00	1.00	1.00	1.00
Work Zone On Approach		No			No			No			No	
Adj Sat Flow, veh/h/ln	1900	1900	1885	1870	1900	1885	1885	1885	1856	1900	1885	1900
Adj Flow Rate, veh/h	28	426	391	268	569	132	928	1009	198	286	1141	34
Peak Hour Factor	0.99	0.99	0.99	0.99	0.99	0.99	0.99	0.99	0.99	0.99	0.99	0.99
Percent Heavy Veh, %	0	0	1	2	0	1	1	1	3	0	1	0
Cap, veh/h	48	601	1162	339	858	544	861	1556	828	360	1489	44
Arrive On Green	0.03	0.17	0.17	0.10	0.24	0.24	0.25	0.43	0.43	0.10	0.29	0.29
Sat Flow, veh/h	1810	3610	2807	3456	3610	1598	3483	3582	1552	3510	5136	153
Grp Volume(v), veh/h	28	426	391	268	569	132	928	1009	198	286	762	413
Grp Sat Flow(s),veh/h/ln	1810	1805	1403	1728	1805	1598	1742	1791	1552	1755	1716	1858
Q Serve(g_s), s	1.6	11.5	9.8	7.8	14.7	6.1	25.4	22.8	7.0	8.2	20.8	20.9
Cycle Q Clear(g_c), s	1.6	11.5	9.8	7.8	14.7	6.1	25.4	22.8	7.0	8.2	20.8	20.9
Prop In Lane	1.00		1.00	1.00		1.00	1.00		1.00	1.00		0.08
Lane Grp Cap(c), veh/h	48	601	1162	339	858	544	861	1556	828	360	995	538
V/C Ratio(X)	0.58	0.71	0.34	0.79	0.66	0.24	1.08	0.65	0.24	0.79	0.77	0.77
Avail Cap(c_a), veh/h	106	948	1432	585	1349	761	861	1582	840	676	1329	719
HCM Platoon Ratio	1.00	1.00	1.00	1.00	1.00	1.00	1.00	1.00	1.00	1.00	1.00	1.00
Upstream Filter(I)	1.00	1.00	1.00	1.00	1.00	1.00	1.00	1.00	1.00	1.00	1.00	1.00
Uniform Delay (d), s/veh	49.4	40.5	20.5	45.3	35.4	24.4	38.7	22.9	12.9	45.1	33.3	33.3
Incr Delay (d2), s/veh	4.0	1.6	0.2	1.6	0.9	0.2	53.9	0.9	0.1	1.5	1.9	3.5
Initial Q Delay(d3),s/veh	0.0	0.0	0.0	0.0	0.0	0.0	0.0	0.0	0.0	0.0	0.0	0.0
%ile BackOfQ(50%),veh/ln	0.7	5.0	3.0	3.3	6.3	2.2	16.8	9.2	2.3	3.5	8.6	9.5
Unsig. Movement Delay, s/veh												
LnGrp Delay(d),s/veh	53.4	42.0	20.7	46.9	36.3	24.6	92.6	23.8	13.0	46.6	35.2	36.8
LnGrp LOS	D	D	C	D	D	C	F	C	B	D	D	D
Approach Vol, veh/h		845			969			2135			1461	
Approach Delay, s/veh		32.5			37.7			52.7			37.9	
Approach LOS		C			D			D			D	
Timer - Assigned Phs	1	2	3	4	5	6	7	8				
Phs Duration (G+Y+Rc), s	15.1	50.0	14.7	22.9	30.0	35.2	7.4	30.2				
Change Period (Y+Rc), s	4.6	5.4	4.6	5.8	4.6	5.4	4.6	5.8				
Max Green Setting (Gmax), s	19.8	45.4	17.4	27.0	25.4	39.8	6.0	38.4				
Max Q Clear Time (g_c+I1), s	10.2	24.8	9.8	13.5	27.4	22.9	3.6	16.7				
Green Ext Time (p_c), s	0.4	7.7	0.3	3.5	0.0	6.9	0.0	3.9				

Intersection Summary

HCM 6th Ctrl Delay	42.9
HCM 6th LOS	D

Timings

3: Overlook Pkwy./Canyon Crest Dr. & Alessandro Bl/Alessandro Bl.



Lane Group	EBL	EBT	WBL	WBT	WBR	NBL	NBT	NBR	SBL	SBT	SBR
Lane Configurations	↙	↕↕↕	↙	↕↕↕	↗	↙	↕↕	↗	↕↕	↙↕	↙
Traffic Volume (vph)	40	1677	99	1825	474	20	252	100	367	258	22
Future Volume (vph)	40	1677	99	1825	474	20	252	100	367	258	22
Turn Type	Prot	NA	Prot	NA	pm+ov	Split	NA	Perm	Split	NA	Perm
Protected Phases	5	2	1	6	4	8	8		4	4	
Permitted Phases					6			8			4
Detector Phase	5	2	1	6	4	8	8	8	4	4	4
Switch Phase											
Minimum Initial (s)	5.0	10.0	5.0	10.0	10.0	10.0	10.0	10.0	10.0	10.0	10.0
Minimum Split (s)	9.2	35.2	9.2	35.2	38.8	38.8	38.8	38.8	38.8	38.8	38.8
Total Split (s)	9.2	43.2	9.2	43.2	38.8	38.8	38.8	38.8	38.8	38.8	38.8
Total Split (%)	7.1%	33.2%	7.1%	33.2%	29.8%	29.8%	29.8%	29.8%	29.8%	29.8%	29.8%
Yellow Time (s)	3.2	5.2	3.2	5.2	4.8	4.8	4.8	4.8	4.8	4.8	4.8
All-Red Time (s)	1.0	1.0	1.0	1.0	1.0	1.0	1.0	1.0	1.0	1.0	1.0
Lost Time Adjust (s)	0.0	0.0	0.0	0.0	0.0	0.0	0.0	0.0	0.0	0.0	0.0
Total Lost Time (s)	4.2	6.2	4.2	6.2	5.8	5.8	5.8	5.8	5.8	5.8	5.8
Lead/Lag	Lead	Lag	Lead	Lag							
Lead-Lag Optimize?	Yes	Yes	Yes	Yes							
Recall Mode	None	None	None	None	None	None	None	None	None	None	None
Act Effct Green (s)	5.0	37.2	5.0	39.3	72.8	13.4	13.4	13.4	27.2	27.2	27.2
Actuated g/C Ratio	0.05	0.35	0.05	0.37	0.69	0.13	0.13	0.13	0.26	0.26	0.26
v/c Ratio	0.52	0.98	1.20	0.99	0.42	0.10	0.57	0.34	0.41	0.75	0.05
Control Delay	74.1	50.8	205.7	52.7	4.2	43.0	49.1	10.6	33.7	47.8	0.2
Queue Delay	0.0	0.0	0.0	0.0	0.0	0.0	0.0	0.0	0.0	0.0	0.0
Total Delay	74.1	50.8	205.7	52.7	4.2	43.0	49.1	10.6	33.7	47.8	0.2
LOS	E	D	F	D	A	D	D	B	C	D	A
Approach Delay		51.4		49.4			38.4			39.0	
Approach LOS		D		D			D			D	

Intersection Summary

Cycle Length: 130
 Actuated Cycle Length: 105
 Natural Cycle: 125
 Control Type: Actuated-Uncoordinated
 Maximum v/c Ratio: 1.20
 Intersection Signal Delay: 48.0
 Intersection LOS: D
 Intersection Capacity Utilization 79.7%
 ICU Level of Service D
 Analysis Period (min) 15

Splits and Phases: 3: Overlook Pkwy./Canyon Crest Dr. & Alessandro Bl/Alessandro Bl.

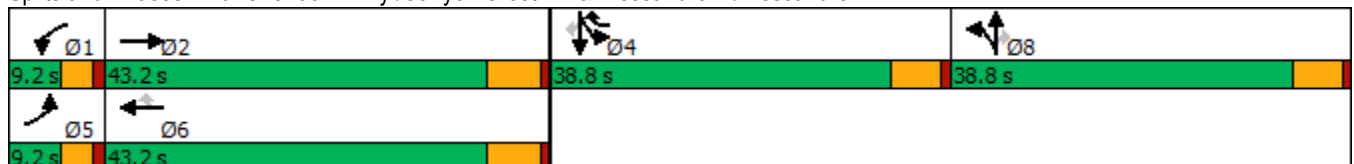

HCM 6th Signalized Intersection Summary

West Campus Upper Plateau (JN 14064)

3: Overlook Pkwy./Canyon Crest Dr. & Alessandro Bl/Alessandro Bl.

09/30/2022



Movement	EBL	EBT	EBR	WBL	WBT	WBR	NBL	NBT	NBR	SBL	SBT	SBR
Lane Configurations	↵	↑↑↑		↵	↑↑↑	↵	↵	↑↑	↵	↵↵	↵	↵
Traffic Volume (veh/h)	40	1677	24	99	1825	474	20	252	100	367	258	22
Future Volume (veh/h)	40	1677	24	99	1825	474	20	252	100	367	258	22
Initial Q (Qb), veh	0	0	0	0	0	0	0	0	0	0	0	0
Ped-Bike Adj(A_pbT)	1.00		1.00	1.00		1.00	1.00		1.00	1.00		1.00
Parking Bus, Adj	1.00	1.00	1.00	1.00	1.00	1.00	1.00	1.00	1.00	1.00	1.00	1.00
Work Zone On Approach		No			No			No			No	
Adj Sat Flow, veh/h/ln	1811	1885	1811	1900	1885	1870	1781	1900	1900	1885	1767	1841
Adj Flow Rate, veh/h	42	1747	25	103	1901	486	21	262	96	382	269	14
Peak Hour Factor	0.96	0.96	0.96	0.96	0.96	0.96	0.96	0.96	0.96	0.96	0.96	0.96
Percent Heavy Veh, %	6	1	6	0	1	2	8	0	0	1	9	4
Cap, veh/h	62	2040	29	101	2109	961	190	405	181	705	347	306
Arrive On Green	0.04	0.39	0.39	0.06	0.41	0.41	0.11	0.11	0.11	0.20	0.20	0.20
Sat Flow, veh/h	1725	5228	75	1810	5147	1585	1697	3610	1610	3591	1767	1560
Grp Volume(v), veh/h	42	1146	626	103	1901	486	21	262	96	382	269	14
Grp Sat Flow(s),veh/h/ln	1725	1716	1872	1810	1716	1585	1697	1805	1610	1795	1767	1560
Q Serve(g_s), s	2.2	27.4	27.4	5.0	31.0	15.6	1.0	6.2	5.0	8.6	12.9	0.7
Cycle Q Clear(g_c), s	2.2	27.4	27.4	5.0	31.0	15.6	1.0	6.2	5.0	8.6	12.9	0.7
Prop In Lane	1.00		0.04	1.00		1.00	1.00		1.00	1.00		1.00
Lane Grp Cap(c), veh/h	62	1339	730	101	2109	961	190	405	181	705	347	306
V/C Ratio(X)	0.67	0.86	0.86	1.02	0.90	0.51	0.11	0.65	0.53	0.54	0.78	0.05
Avail Cap(c_a), veh/h	96	1416	773	101	2125	965	625	1329	593	1322	650	574
HCM Platoon Ratio	1.00	1.00	1.00	1.00	1.00	1.00	1.00	1.00	1.00	1.00	1.00	1.00
Upstream Filter(I)	1.00	1.00	1.00	1.00	1.00	1.00	1.00	1.00	1.00	1.00	1.00	1.00
Uniform Delay (d), s/veh	42.7	25.0	25.0	42.3	24.7	10.0	35.8	38.1	37.6	32.4	34.2	29.2
Incr Delay (d2), s/veh	4.6	5.2	9.1	95.2	5.8	0.4	0.3	1.7	2.4	0.7	3.7	0.1
Initial Q Delay(d3),s/veh	0.0	0.0	0.0	0.0	0.0	0.0	0.0	0.0	0.0	0.0	0.0	0.0
%ile BackOfQ(50%),veh/ln	0.9	10.8	12.5	4.8	12.1	7.7	0.4	2.7	2.0	3.6	5.6	0.2
Unsig. Movement Delay, s/veh												
LnGrp Delay(d),s/veh	47.3	30.2	34.1	137.5	30.5	10.5	36.0	39.8	40.0	33.0	37.9	29.3
LnGrp LOS	D	C	C	F	C	B	D	D	D	C	D	C
Approach Vol, veh/h		1814			2490			379			665	
Approach Delay, s/veh		31.9			31.0			39.6			34.9	
Approach LOS		C			C			D			C	
Timer - Assigned Phs	1	2		4	5	6		8				
Phs Duration (G+Y+Rc), s	9.2	41.2		23.4	7.4	42.9		15.9				
Change Period (Y+Rc), s	* 4.2	6.2		5.8	* 4.2	6.2		5.8				
Max Green Setting (Gmax), s	* 5	37.0		33.0	* 5	37.0		33.0				
Max Q Clear Time (g_c+1), s	7.0	29.4		14.9	4.2	33.0		8.2				
Green Ext Time (p_c), s	0.0	5.5		2.6	0.0	3.6		1.8				

Intersection Summary

HCM 6th Ctrl Delay	32.4
HCM 6th LOS	C

Notes

- User approved pedestrian interval to be less than phase max green.
- User approved volume balancing among the lanes for turning movement.
- * HCM 6th computational engine requires equal clearance times for the phases crossing the barrier.

Timings
4: Van Buren Bl. & Wood Rd.

West Campus Upper Plateau (JN 14064)

09/30/2022

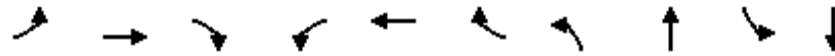

Lane Group	EBL	EBT	EBR	WBL	WBT	WBR	NBL	NBT	SBL	SBT
Lane Configurations	↘	↑↑	↗	↘↗	↑↑	↗	↘↗	↑↑	↘	↑↑
Traffic Volume (vph)	144	1769	254	273	1714	121	248	147	183	171
Future Volume (vph)	144	1769	254	273	1714	121	248	147	183	171
Turn Type	Prot	NA	pm+ov	Prot	NA	Perm	Prot	NA	Prot	NA
Protected Phases	5	2	3	1	6		3	8	7	4
Permitted Phases			2			6				
Detector Phase	5	2	3	1	6	6	3	8	7	4
Switch Phase										
Minimum Initial (s)	5.0	10.0	5.0	5.0	10.0	10.0	5.0	10.0	5.0	10.0
Minimum Split (s)	9.2	30.2	9.2	9.2	30.2	30.2	9.2	38.4	9.2	15.8
Total Split (s)	16.5	57.2	21.7	13.2	53.9	53.9	21.7	38.4	11.2	27.9
Total Split (%)	13.8%	47.7%	18.1%	11.0%	44.9%	44.9%	18.1%	32.0%	9.3%	23.3%
Yellow Time (s)	3.2	5.2	3.2	3.2	5.2	5.2	3.2	4.4	3.2	4.8
All-Red Time (s)	1.0	1.0	1.0	1.0	1.0	1.0	1.0	1.0	1.0	1.0
Lost Time Adjust (s)	0.0	0.0	0.0	0.0	0.0	0.0	0.0	0.0	0.0	0.0
Total Lost Time (s)	4.2	6.2	4.2	4.2	6.2	6.2	4.2	5.4	4.2	5.8
Lead/Lag	Lead	Lag	Lead	Lead	Lag	Lag	Lead	Lag	Lead	Lag
Lead-Lag Optimize?	Yes	Yes	Yes	Yes	Yes	Yes	Yes	Yes	Yes	Yes
Recall Mode	None	None	None	None	None	None	None	None	None	None
Act Effct Green (s)	11.8	51.2	66.1	9.0	48.4	48.4	12.8	19.8	7.0	13.6
Actuated g/C Ratio	0.11	0.48	0.62	0.08	0.45	0.45	0.12	0.18	0.07	0.13
v/c Ratio	0.80	1.16	0.27	1.03	1.18	0.17	0.67	0.52	1.72	0.66
Control Delay	76.7	107.6	3.1	109.4	116.4	3.8	54.2	24.5	390.7	31.1
Queue Delay	0.0	0.0	0.0	0.0	0.0	0.0	0.0	0.0	0.0	0.0
Total Delay	76.7	107.6	3.1	109.4	116.4	3.8	54.2	24.5	390.7	31.1
LOS	E	F	A	F	F	A	D	C	F	C
Approach Delay		93.3			109.0			37.0		158.3
Approach LOS		F			F			D		F

Intersection Summary





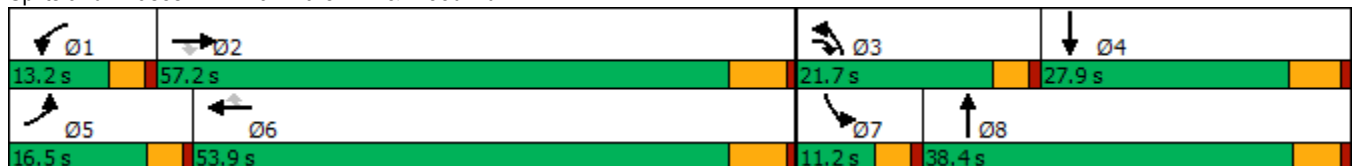



















Cycle Length: 120
 Actuated Cycle Length: 107.2
 Natural Cycle: 120
 Control Type: Actuated-Uncoordinated
 Maximum v/c Ratio: 1.72
 Intersection Signal Delay: 99.6
 Intersection LOS: F
 Intersection Capacity Utilization 99.9%
 ICU Level of Service F
 Analysis Period (min) 15

Splits and Phases: 4: Van Buren Bl. & Wood Rd.



HCM 6th Signalized Intersection Summary
4: Van Buren Bl. & Wood Rd.

West Campus Upper Plateau (JN 14064)
09/30/2022

												
Movement	EBL	EBT	EBR	WBL	WBT	WBR	NBL	NBT	NBR	SBL	SBT	SBR
Lane Configurations												
Traffic Volume (veh/h)	144	1769	254	273	1714	121	248	147	194	183	171	163
Future Volume (veh/h)	144	1769	254	273	1714	121	248	147	194	183	171	163
Initial Q (Qb), veh	0	0	0	0	0	0	0	0	0	0	0	0
Ped-Bike Adj(A_pbT)	1.00		0.99	1.00		0.99	1.00		0.96	1.00		0.99
Parking Bus, Adj	1.00	1.00	1.00	1.00	1.00	1.00	1.00	1.00	1.00	1.00	1.00	1.00
Work Zone On Approach		No			No			No			No	
Adj Sat Flow, veh/h/ln	1885	1856	1870	1885	1870	1885	1856	1885	1870	1885	1885	1885
Adj Flow Rate, veh/h	158	1944	174	300	1884	86	273	162	132	201	188	104
Peak Hour Factor	0.91	0.91	0.91	0.91	0.91	0.91	0.91	0.91	0.91	0.91	0.91	0.91
Percent Heavy Veh, %	1	3	2	1	2	1	3	1	2	1	1	1
Cap, veh/h	188	1743	931	304	1695	751	343	292	219	122	271	143
Arrive On Green	0.10	0.49	0.49	0.09	0.48	0.48	0.10	0.15	0.15	0.07	0.12	0.12
Sat Flow, veh/h	1795	3526	1562	3483	3554	1575	3428	1915	1438	1795	2255	1187
Grp Volume(v), veh/h	158	1944	174	300	1884	86	273	151	143	201	147	145
Grp Sat Flow(s),veh/h/ln	1795	1763	1562	1742	1777	1575	1714	1791	1562	1795	1791	1652
Q Serve(g_s), s	8.9	51.0	5.2	8.9	49.2	3.1	8.0	8.0	8.8	7.0	8.1	8.7
Cycle Q Clear(g_c), s	8.9	51.0	5.2	8.9	49.2	3.1	8.0	8.0	8.8	7.0	8.1	8.7
Prop In Lane	1.00		1.00	1.00		1.00	1.00		0.92	1.00		0.72
Lane Grp Cap(c), veh/h	188	1743	931	304	1695	751	343	273	238	122	215	199
V/C Ratio(X)	0.84	1.12	0.19	0.99	1.11	0.11	0.79	0.55	0.60	1.65	0.68	0.73
Avail Cap(c_a), veh/h	214	1743	931	304	1695	751	582	573	500	122	384	354
HCM Platoon Ratio	1.00	1.00	1.00	1.00	1.00	1.00	1.00	1.00	1.00	1.00	1.00	1.00
Upstream Filter(I)	1.00	1.00	1.00	1.00	1.00	1.00	1.00	1.00	1.00	1.00	1.00	1.00
Uniform Delay (d), s/veh	45.3	26.1	9.5	47.0	27.0	14.9	45.4	40.4	40.8	48.1	43.5	43.7
Incr Delay (d2), s/veh	20.2	60.4	0.1	47.8	59.2	0.1	1.6	1.7	2.4	325.9	3.8	5.0
Initial Q Delay(d3),s/veh	0.0	0.0	0.0	0.0	0.0	0.0	0.0	0.0	0.0	0.0	0.0	0.0
%ile BackOfQ(50%),veh/ln	4.8	33.1	1.6	5.7	32.1	1.1	3.4	3.6	3.5	14.1	3.7	3.7
Unsig. Movement Delay, s/veh												
LnGrp Delay(d),s/veh	65.5	86.4	9.7	94.8	86.2	15.0	47.0	42.2	43.2	373.9	47.3	48.8
LnGrp LOS	E	F	A	F	F	B	D	D	D	F	D	D
Approach Vol, veh/h		2276			2270			567			493	
Approach Delay, s/veh		79.1			84.6			44.7			180.9	
Approach LOS		E			F			D			F	
Timer - Assigned Phs	1	2	3	4	5	6	7	8				
Phs Duration (G+Y+Rc), s	13.2	57.2	14.5	18.2	15.0	55.4	11.2	21.5				
Change Period (Y+Rc), s	* 4.2	6.2	* 4.2	5.8	* 4.2	6.2	* 4.2	* 5.8				
Max Green Setting (Gmax), s	* 9	51.0	* 18	22.1	* 12	47.7	* 7	* 33				
Max Q Clear Time (g_c+I1), s	10.9	53.0	10.0	10.7	10.9	51.2	9.0	10.8				
Green Ext Time (p_c), s	0.0	0.0	0.3	1.2	0.0	0.0	0.0	1.6				

Intersection Summary

HCM 6th Ctrl Delay	86.8
HCM 6th LOS	F

Notes

* HCM 6th computational engine requires equal clearance times for the phases crossing the barrier.

Timings

5: Trautwein Rd. & Alessandro Bl.

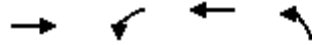

Lane Group	EBT	WBL	WBT	NBL
Lane Configurations	↑↑↑	↘↘	↑↑↑	↘↘↘
Traffic Volume (vph)	1373	227	1611	1126
Future Volume (vph)	1373	227	1611	1126
Turn Type	NA	Prot	NA	Prot
Protected Phases	2	1	6	8
Permitted Phases				
Detector Phase	2	1	6	8
Switch Phase				
Minimum Initial (s)	10.0	5.0	10.0	10.0
Minimum Split (s)	33.2	9.2	16.2	16.2
Total Split (s)	63.0	19.0	82.0	38.0
Total Split (%)	52.5%	15.8%	68.3%	31.7%
Yellow Time (s)	5.2	3.2	5.2	5.2
All-Red Time (s)	1.0	1.0	1.0	1.0
Lost Time Adjust (s)	0.0	0.0	0.0	0.0
Total Lost Time (s)	6.2	4.2	6.2	6.2
Lead/Lag	Lag	Lead		
Lead-Lag Optimize?	Yes	Yes		
Recall Mode	None	None	None	None
Act Effct Green (s)	52.7	11.8	68.8	30.3
Actuated g/C Ratio	0.47	0.11	0.62	0.27
v/c Ratio	0.74	0.64	0.53	0.88
Control Delay	26.5	57.7	12.9	48.1
Queue Delay	0.0	0.0	0.0	0.0
Total Delay	26.5	57.7	12.9	48.1
LOS	C	E	B	D
Approach Delay	26.5		18.4	48.1
Approach LOS	C		B	D

Intersection Summary

Cycle Length: 120
 Actuated Cycle Length: 111.6
 Natural Cycle: 70
 Control Type: Actuated-Uncoordinated
 Maximum v/c Ratio: 0.88
 Intersection Signal Delay: 28.6
 Intersection LOS: C
 Intersection Capacity Utilization 75.4%
 ICU Level of Service D
 Analysis Period (min) 15







Splits and Phases: 5: Trautwein Rd. & Alessandro Bl.



HCM 6th Signalized Intersection Summary
5: Trautwein Rd. & Alessandro Bl.

West Campus Upper Plateau (JN 14064)

09/30/2022

						
Movement	EBT	EBR	WBL	WBT	NBL	NBR
Lane Configurations	↑↑↑		↵↵	↑↑↑	↵↵↵	
Traffic Volume (veh/h)	1373	308	227	1611	1126	15
Future Volume (veh/h)	1373	308	227	1611	1126	15
Initial Q (Qb), veh	0	0	0	0	0	0
Ped-Bike Adj(A_pbT)		1.00	1.00		1.00	1.00
Parking Bus, Adj	1.00	1.00	1.00	1.00	1.00	1.00
Work Zone On Approach	No			No	No	
Adj Sat Flow, veh/h/ln	1885	1900	1885	1885	1870	1900
Adj Flow Rate, veh/h	1430	321	236	1678	1188	0
Peak Hour Factor	0.96	0.96	0.96	0.96	0.96	0.96
Percent Heavy Veh, %	1	0	1	1	2	0
Cap, veh/h	2010	450	309	3136	1414	426
Arrive On Green	0.48	0.48	0.09	0.61	0.26	0.00
Sat Flow, veh/h	4375	941	3483	5316	5344	1610
Grp Volume(v), veh/h	1166	585	236	1678	1188	0
Grp Sat Flow(s),veh/h/ln	1716	1716	1742	1716	1781	1610
Q Serve(g_s), s	26.4	26.6	6.5	18.6	20.7	0.0
Cycle Q Clear(g_c), s	26.4	26.6	6.5	18.6	20.7	0.0
Prop In Lane		0.55	1.00		1.00	1.00
Lane Grp Cap(c), veh/h	1640	820	309	3136	1414	426
V/C Ratio(X)	0.71	0.71	0.76	0.54	0.84	0.00
Avail Cap(c_a), veh/h	1981	990	524	3965	1727	520
HCM Platoon Ratio	1.00	1.00	1.00	1.00	1.00	1.00
Upstream Filter(I)	1.00	1.00	1.00	1.00	1.00	0.00
Uniform Delay (d), s/veh	20.3	20.3	43.8	11.1	34.2	0.0
Incr Delay (d2), s/veh	1.2	2.3	1.5	0.2	3.3	0.0
Initial Q Delay(d3),s/veh	0.0	0.0	0.0	0.0	0.0	0.0
%ile BackOfQ(50%),veh/ln	9.5	9.8	2.7	5.6	8.7	0.0
Unsig. Movement Delay, s/veh						
LnGrp Delay(d),s/veh	21.5	22.7	45.3	11.3	37.5	0.0
LnGrp LOS	C	C	D	B	D	A
Approach Vol, veh/h	1751			1914	1188	
Approach Delay, s/veh	21.9			15.5	37.5	
Approach LOS	C			B	D	
Timer - Assigned Phs	1	2			6	8
Phs Duration (G+Y+Rc), s	12.9	53.2			66.1	32.2
Change Period (Y+Rc), s	* 4.2	6.2			6.2	6.2
Max Green Setting (Gmax), s	* 15	56.8			75.8	31.8
Max Q Clear Time (g_c+I1), s	8.5	28.6			20.6	22.7
Green Ext Time (p_c), s	0.2	18.4			25.3	3.4

Intersection Summary

HCM 6th Ctrl Delay	23.2
HCM 6th LOS	C

Notes

User approved volume balancing among the lanes for turning movement.

* HCM 6th computational engine requires equal clearance times for the phases crossing the barrier.

Timings
6: Trautwein Rd. & Grove Community Dr

West Campus Upper Plateau (JN 14064)

09/30/2022



Lane Group	WBL	WBR	NBT	NBR	SBL	SBT
Lane Configurations	↙	↗↗	↕↕	↗	↗↗	↕↕
Traffic Volume (vph)	125	447	1254	102	402	1163
Future Volume (vph)	125	447	1254	102	402	1163
Turn Type	Prot	pm+ov	NA	Perm	Prot	NA
Protected Phases	8	1	2		1	6
Permitted Phases		8		2		
Detector Phase	8	1	2	2	1	6
Switch Phase						
Minimum Initial (s)	10.0	5.0	10.0	10.0	5.0	10.0
Minimum Split (s)	34.6	9.6	46.2	46.2	9.6	28.2
Total Split (s)	35.0	29.0	56.0	56.0	29.0	85.0
Total Split (%)	29.2%	24.2%	46.7%	46.7%	24.2%	70.8%
Yellow Time (s)	3.6	3.6	5.2	5.2	3.6	5.2
All-Red Time (s)	1.0	1.0	1.0	1.0	1.0	1.0
Lost Time Adjust (s)	0.0	0.0	0.0	0.0	0.0	0.0
Total Lost Time (s)	4.6	4.6	6.2	6.2	4.6	6.2
Lead/Lag		Lead	Lag	Lag	Lead	
Lead-Lag Optimize?		Yes	Yes	Yes	Yes	
Recall Mode	None	None	None	None	None	None
Act Effct Green (s)	14.8	31.7	44.1	44.1	16.9	65.8
Actuated g/C Ratio	0.16	0.35	0.48	0.48	0.18	0.72
v/c Ratio	0.48	0.51	0.81	0.14	0.69	0.51
Control Delay	42.8	21.7	26.3	8.6	42.6	7.1
Queue Delay	0.0	0.0	0.0	0.0	0.0	0.0
Total Delay	42.8	21.7	26.3	8.6	42.6	7.1
LOS	D	C	C	A	D	A
Approach Delay	26.3		25.0			16.2
Approach LOS	C		C			B

Intersection Summary

Cycle Length: 120	
Actuated Cycle Length: 91.7	
Natural Cycle: 95	
Control Type: Actuated-Uncoordinated	
Maximum v/c Ratio: 0.81	
Intersection Signal Delay: 21.3	Intersection LOS: C
Intersection Capacity Utilization 68.3%	ICU Level of Service C
Analysis Period (min) 15	

Splits and Phases: 6: Trautwein Rd. & Grove Community Dr



HCM 6th Signalized Intersection Summary
6: Trautwein Rd. & Grove Community Dr

West Campus Upper Plateau (JN 14064)

09/30/2022



Movement	WBL	WBR	NBT	NBR	SBL	SBT
Lane Configurations						
Traffic Volume (veh/h)	125	447	1254	102	402	1163
Future Volume (veh/h)	125	447	1254	102	402	1163
Initial Q (Qb), veh	0	0	0	0	0	0
Ped-Bike Adj(A_pbT)	1.00	1.00		1.00	1.00	
Parking Bus, Adj	1.00	1.00	1.00	1.00	1.00	1.00
Work Zone On Approach	No		No			No
Adj Sat Flow, veh/h/ln	1900	1900	1885	1900	1900	1870
Adj Flow Rate, veh/h	139	303	1393	107	447	1292
Peak Hour Factor	0.90	0.90	0.90	0.90	0.90	0.90
Percent Heavy Veh, %	0	0	1	0	0	2
Cap, veh/h	246	837	1774	798	559	2549
Arrive On Green	0.14	0.14	0.50	0.50	0.16	0.72
Sat Flow, veh/h	1810	2834	3676	1610	3510	3647
Grp Volume(v), veh/h	139	303	1393	107	447	1292
Grp Sat Flow(s),veh/h/ln	1810	1417	1791	1610	1755	1777
Q Serve(g_s), s	5.3	6.2	23.6	2.6	9.0	11.9
Cycle Q Clear(g_c), s	5.3	6.2	23.6	2.6	9.0	11.9
Prop In Lane	1.00	1.00		1.00	1.00	
Lane Grp Cap(c), veh/h	246	837	1774	798	559	2549
V/C Ratio(X)	0.56	0.36	0.79	0.13	0.80	0.51
Avail Cap(c_a), veh/h	748	1623	2425	1090	1165	3808
HCM Platoon Ratio	1.00	1.00	1.00	1.00	1.00	1.00
Upstream Filter(I)	1.00	1.00	1.00	1.00	1.00	1.00
Uniform Delay (d), s/veh	29.7	20.5	15.3	10.0	29.8	4.6
Incr Delay (d2), s/veh	2.0	0.3	1.2	0.1	1.0	0.2
Initial Q Delay(d3),s/veh	0.0	0.0	0.0	0.0	0.0	0.0
%ile BackOfQ(50%),veh/ln	2.3	1.9	7.7	0.8	3.5	2.1
Unsig. Movement Delay, s/veh						
LnGrp Delay(d),s/veh	31.8	20.7	16.5	10.1	30.8	4.8
LnGrp LOS	C	C	B	B	C	A
Approach Vol, veh/h	442		1500			1739
Approach Delay, s/veh	24.2		16.1			11.5
Approach LOS	C		B			B
Timer - Assigned Phs	1	2			6	8
Phs Duration (G+Y+Rc), s	16.3	42.6			58.9	14.6
Change Period (Y+Rc), s	4.6	6.2			6.2	4.6
Max Green Setting (Gmax), s	24.4	49.8			78.8	30.4
Max Q Clear Time (g_c+I1), s	11.0	25.6			13.9	8.2
Green Ext Time (p_c), s	0.7	10.8			11.8	1.6

Intersection Summary

HCM 6th Ctrl Delay			14.9			
HCM 6th LOS			B			

Timings

7: Trautwein Rd. & Orange Terrace Pkwy

09/30/2022



Lane Group	EBL	EBT	WBL	WBT	WBR	NBL	NBT	NBR	SBL	SBT	SBR
Lane Configurations											
Traffic Volume (vph)	36	21	191	13	185	39	1103	178	229	1138	23
Future Volume (vph)	36	21	191	13	185	39	1103	178	229	1138	23
Turn Type	Prot	NA	Prot	NA	pm+ov	Prot	NA	Perm	Prot	NA	Perm
Protected Phases	7	4	3	8	1	5	2		1	6	
Permitted Phases					8			2			6
Detector Phase	7	4	3	8	1	5	2	2	1	6	6
Switch Phase											
Minimum Initial (s)	5.0	10.0	5.0	10.0	5.0	5.0	10.0	10.0	5.0	10.0	10.0
Minimum Split (s)	9.6	38.6	9.6	34.6	9.6	9.6	46.2	46.2	9.6	28.2	28.2
Total Split (s)	13.2	38.6	16.1	41.5	18.0	9.6	47.3	47.3	18.0	55.7	55.7
Total Split (%)	11.0%	32.2%	13.4%	34.6%	15.0%	8.0%	39.4%	39.4%	15.0%	46.4%	46.4%
Yellow Time (s)	3.6	3.6	3.6	3.6	3.6	3.6	5.2	5.2	3.6	5.2	5.2
All-Red Time (s)	1.0	1.0	1.0	1.0	1.0	1.0	1.0	1.0	1.0	1.0	1.0
Lost Time Adjust (s)	0.0	0.0	0.0	0.0	0.0	0.0	0.0	0.0	0.0	0.0	0.0
Total Lost Time (s)	4.6	4.6	4.6	4.6	4.6	4.6	6.2	6.2	4.6	6.2	6.2
Lead/Lag	Lead	Lag	Lead	Lag	Lead	Lead	Lag	Lag	Lead	Lag	Lag
Lead-Lag Optimize?	Yes	Yes	Yes	Yes	Yes	Yes	Yes	Yes	Yes	Yes	Yes
Recall Mode	None	None	None	None	None	None	None	None	None	None	None
Act Effct Green (s)	10.3	14.1	12.2	16.1	28.9	5.3	37.6	37.6	10.6	48.1	48.1
Actuated g/C Ratio	0.12	0.16	0.14	0.18	0.33	0.06	0.43	0.43	0.12	0.55	0.55
v/c Ratio	0.18	0.15	0.82	0.04	0.19	0.38	0.77	0.25	0.59	0.62	0.03
Control Delay	44.6	22.1	68.5	32.8	4.6	58.2	28.3	8.0	46.4	19.5	0.0
Queue Delay	0.0	0.0	0.0	0.0	0.0	0.0	0.0	0.0	0.0	0.0	0.0
Total Delay	44.6	22.1	68.5	32.8	4.6	58.2	28.3	8.0	46.4	19.5	0.0
LOS	D	C	E	C	A	E	C	A	D	B	A
Approach Delay		32.3		36.9			26.5			23.6	
Approach LOS		C		D			C			C	

Intersection Summary

Cycle Length: 120	
Actuated Cycle Length: 87.8	
Natural Cycle: 115	
Control Type: Actuated-Uncoordinated	
Maximum v/c Ratio: 0.82	
Intersection Signal Delay: 26.6	Intersection LOS: C
Intersection Capacity Utilization 67.1%	ICU Level of Service C
Analysis Period (min) 15	



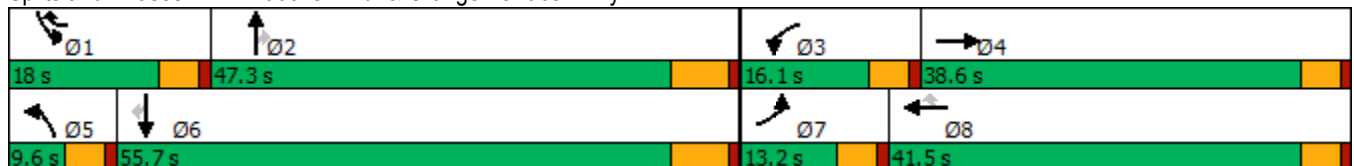



















Splits and Phases: 7: Trautwein Rd. & Orange Terrace Pkwy



HCM 6th Signalized Intersection Summary
7: Trautwein Rd. & Orange Terrace Pkwy

West Campus Upper Plateau (JN 14064)

09/30/2022

												
Movement	EBL	EBT	EBR	WBL	WBT	WBR	NBL	NBT	NBR	SBL	SBT	SBR
Lane Configurations												
Traffic Volume (veh/h)	36	21	23	191	13	185	39	1103	178	229	1138	23
Future Volume (veh/h)	36	21	23	191	13	185	39	1103	178	229	1138	23
Initial Q (Qb), veh	0	0	0	0	0	0	0	0	0	0	0	0
Ped-Bike Adj(A_pbT)	1.00		1.00	1.00		1.00	1.00		1.00	1.00		1.00
Parking Bus, Adj	1.00	1.00	1.00	1.00	1.00	1.00	1.00	1.00	1.00	1.00	1.00	1.00
Work Zone On Approach		No			No			No			No	
Adj Sat Flow, veh/h/ln	1900	1900	1900	1885	1900	1856	1900	1870	1870	1870	1870	1900
Adj Flow Rate, veh/h	38	22	22	203	14	77	41	1173	111	244	1211	14
Peak Hour Factor	0.94	0.94	0.94	0.94	0.94	0.94	0.94	0.94	0.94	0.94	0.94	0.94
Percent Heavy Veh, %	0	0	0	1	0	3	0	2	2	2	2	0
Cap, veh/h	64	105	105	240	416	870	67	1437	641	330	1644	745
Arrive On Green	0.04	0.12	0.12	0.13	0.22	0.22	0.04	0.40	0.40	0.10	0.46	0.46
Sat Flow, veh/h	1810	872	872	1795	1900	2768	1810	3554	1585	3456	3554	1610
Grp Volume(v), veh/h	38	0	44	203	14	77	41	1173	111	244	1211	14
Grp Sat Flow(s),veh/h/ln	1810	0	1743	1795	1900	1384	1810	1777	1585	1728	1777	1610
Q Serve(g_s), s	1.7	0.0	1.9	9.0	0.5	1.6	1.8	23.9	3.6	5.6	22.6	0.4
Cycle Q Clear(g_c), s	1.7	0.0	1.9	9.0	0.5	1.6	1.8	23.9	3.6	5.6	22.6	0.4
Prop In Lane	1.00		0.50	1.00		1.00	1.00		1.00	1.00		1.00
Lane Grp Cap(c), veh/h	64	0	210	240	416	870	67	1437	641	330	1644	745
V/C Ratio(X)	0.59	0.00	0.21	0.84	0.03	0.09	0.61	0.82	0.17	0.74	0.74	0.02
Avail Cap(c_a), veh/h	191	0	729	254	862	1520	111	1796	801	569	2163	980
HCM Platoon Ratio	1.00	1.00	1.00	1.00	1.00	1.00	1.00	1.00	1.00	1.00	1.00	1.00
Upstream Filter(I)	1.00	0.00	1.00	1.00	1.00	1.00	1.00	1.00	1.00	1.00	1.00	1.00
Uniform Delay (d), s/veh	38.7	0.0	32.3	34.4	25.0	19.7	38.6	21.5	15.5	35.8	17.8	11.8
Incr Delay (d2), s/veh	3.2	0.0	0.5	20.0	0.0	0.0	3.3	2.5	0.1	1.2	0.9	0.0
Initial Q Delay(d3),s/veh	0.0	0.0	0.0	0.0	0.0	0.0	0.0	0.0	0.0	0.0	0.0	0.0
%ile BackOfQ(50%),veh/ln	0.8	0.0	0.8	5.0	0.2	0.5	0.8	8.9	1.2	2.2	7.9	0.1
Unsig. Movement Delay, s/veh												
LnGrp Delay(d),s/veh	41.9	0.0	32.8	54.4	25.0	19.7	41.9	24.0	15.6	37.0	18.8	11.9
LnGrp LOS	D	A	C	D	C	B	D	C	B	D	B	B
Approach Vol, veh/h		82			294			1325			1469	
Approach Delay, s/veh		37.0			43.9			23.9			21.7	
Approach LOS		D			D			C			C	
Timer - Assigned Phs	1	2	3	4	5	6	7	8				
Phs Duration (G+Y+Rc), s	12.4	39.1	15.5	14.4	7.6	43.8	7.5	22.4				
Change Period (Y+Rc), s	4.6	6.2	4.6	4.6	4.6	6.2	4.6	4.6				
Max Green Setting (Gmax), s	13.4	41.1	11.5	34.0	5.0	49.5	8.6	36.9				
Max Q Clear Time (g_c+I1), s	7.6	25.9	11.0	3.9	3.8	24.6	3.7	3.6				
Green Ext Time (p_c), s	0.2	7.0	0.0	0.2	0.0	8.8	0.0	0.3				
Intersection Summary												
HCM 6th Ctrl Delay				25.1								
HCM 6th LOS				C								

Timings
8: Cole Av. & Van Buren Bl.

West Campus Upper Plateau (JN 14064)

09/30/2022



Lane Group	EBL	EBT	EBR	WBL	WBT	WBR	NBL	NBT	SBL	SBT	SBR
Lane Configurations	↖↗	↑↑	↖	↖	↑↑↑	↖	↖	↑↑	↖↗	↑↑	↖
Traffic Volume (vph)	566	1449	84	184	1512	412	111	276	404	247	448
Future Volume (vph)	566	1449	84	184	1512	412	111	276	404	247	448
Turn Type	Prot	NA	pm+ov	Prot	NA	pm+ov	Prot	NA	Prot	NA	pm+ov
Protected Phases	5	2	3	1	6	7	3	8	7	4	5
Permitted Phases			2			6					4
Detector Phase	5	2	3	1	6	7	3	8	7	4	5
Switch Phase											
Minimum Initial (s)	5.0	10.0	5.0	5.0	10.0	5.0	5.0	10.0	5.0	10.0	5.0
Minimum Split (s)	9.1	36.2	9.1	9.1	36.2	9.1	9.1	42.2	9.1	49.2	9.1
Total Split (s)	18.7	44.8	12.0	14.0	40.1	17.5	12.0	43.7	17.5	49.2	18.7
Total Split (%)	15.6%	37.3%	10.0%	11.7%	33.4%	14.6%	10.0%	36.4%	14.6%	41.0%	15.6%
Yellow Time (s)	3.2	5.2	3.2	3.2	5.2	3.2	3.2	5.2	3.2	5.2	3.2
All-Red Time (s)	0.5	1.0	0.5	0.5	1.0	0.5	0.5	1.0	0.5	1.0	0.5
Lost Time Adjust (s)	0.0	0.0	0.0	0.0	0.0	0.0	0.0	0.0	0.0	0.0	0.0
Total Lost Time (s)	3.7	6.2	3.7	3.7	6.2	3.7	3.7	6.2	3.7	6.2	3.7
Lead/Lag	Lead	Lag	Lead	Lead	Lag	Lead	Lead	Lag	Lead	Lag	Lead
Lead-Lag Optimize?	Yes	Yes	Yes	Yes	Yes	Yes	Yes	Yes	Yes	Yes	Yes
Recall Mode	None	None	None	None	None	None	None	None	None	None	None
Act Effct Green (s)	15.1	38.9	53.5	10.4	34.1	54.3	8.4	18.2	13.9	23.7	41.4
Actuated g/C Ratio	0.15	0.38	0.53	0.10	0.34	0.54	0.08	0.18	0.14	0.23	0.41
v/c Ratio	1.16	1.14	0.10	1.07	0.93	0.45	0.79	0.62	0.90	0.31	0.68
Control Delay	133.2	104.8	3.3	133.0	43.9	8.3	81.9	36.7	68.1	32.2	23.9
Queue Delay	0.0	0.0	0.0	0.0	0.0	0.0	0.0	0.0	0.0	0.0	0.0
Total Delay	133.2	104.8	3.3	133.0	43.9	8.3	81.9	36.7	68.1	32.2	23.9
LOS	F	F	A	F	D	A	F	D	E	C	C
Approach Delay		108.4			44.7			46.7		42.0	
Approach LOS		F			D			D		D	

Intersection Summary

Cycle Length: 120	
Actuated Cycle Length: 101.3	
Natural Cycle: 115	
Control Type: Actuated-Uncoordinated	
Maximum v/c Ratio: 1.16	
Intersection Signal Delay: 67.4	Intersection LOS: E
Intersection Capacity Utilization 92.5%	ICU Level of Service F
Analysis Period (min) 15	



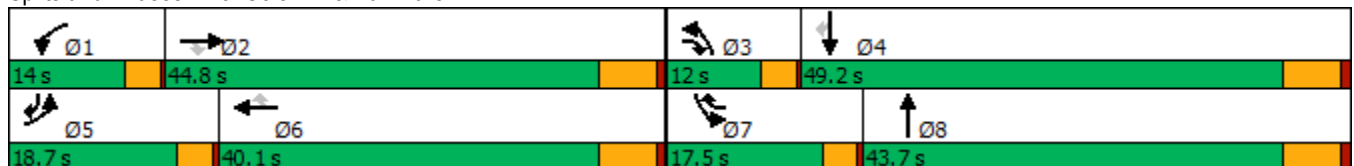



























Splits and Phases: 8: Cole Av. & Van Buren Bl.



HCM 6th Signalized Intersection Summary
8: Cole Av. & Van Buren Bl.

West Campus Upper Plateau (JN 14064)

09/30/2022

												
Movement	EBL	EBT	EBR	WBL	WBT	WBR	NBL	NBT	NBR	SBL	SBT	SBR
Lane Configurations	 	 			  			 		 	 	
Traffic Volume (veh/h)	566	1449	84	184	1512	412	111	276	115	404	247	448
Future Volume (veh/h)	566	1449	84	184	1512	412	111	276	115	404	247	448
Initial Q (Qb), veh	0	0	0	0	0	0	0	0	0	0	0	0
Ped-Bike Adj(A_pbT)	1.00		1.00	1.00		1.00	1.00		0.99	1.00		1.00
Parking Bus, Adj	1.00	1.00	1.00	1.00	1.00	1.00	1.00	1.00	1.00	1.00	1.00	1.00
Work Zone On Approach		No			No			No			No	
Adj Sat Flow, veh/h/ln	1856	1826	1856	1856	1856	1870	1885	1885	1870	1856	1885	1885
Adj Flow Rate, veh/h	590	1509	31	192	1575	340	116	288	113	421	257	369
Peak Hour Factor	0.96	0.96	0.96	0.96	0.96	0.96	0.96	0.96	0.96	0.96	0.96	0.96
Percent Heavy Veh, %	3	5	3	3	3	2	1	1	2	3	1	1
Cap, veh/h	510	1327	727	180	1702	749	144	461	177	469	856	619
Arrive On Green	0.15	0.38	0.38	0.10	0.34	0.34	0.08	0.18	0.18	0.14	0.24	0.24
Sat Flow, veh/h	3428	3469	1572	1767	5066	1585	1795	2526	968	3428	3582	1596
Grp Volume(v), veh/h	590	1509	31	192	1575	340	116	202	199	421	257	369
Grp Sat Flow(s),veh/h/ln	1714	1735	1572	1767	1689	1585	1795	1791	1703	1714	1791	1596
Q Serve(g_s), s	15.0	38.6	1.1	10.3	30.2	14.5	6.4	10.5	10.9	12.2	5.9	18.6
Cycle Q Clear(g_c), s	15.0	38.6	1.1	10.3	30.2	14.5	6.4	10.5	10.9	12.2	5.9	18.6
Prop In Lane	1.00		1.00	1.00		1.00	1.00		0.57	1.00		1.00
Lane Grp Cap(c), veh/h	510	1327	727	180	1702	749	144	327	311	469	856	619
V/C Ratio(X)	1.16	1.14	0.04	1.06	0.93	0.45	0.81	0.62	0.64	0.90	0.30	0.60
Avail Cap(c_a), veh/h	510	1327	727	180	1702	749	148	666	633	469	1526	917
HCM Platoon Ratio	1.00	1.00	1.00	1.00	1.00	1.00	1.00	1.00	1.00	1.00	1.00	1.00
Upstream Filter(I)	1.00	1.00	1.00	1.00	1.00	1.00	1.00	1.00	1.00	1.00	1.00	1.00
Uniform Delay (d), s/veh	43.0	31.2	14.9	45.3	32.3	17.9	45.6	38.0	38.2	42.9	31.5	24.6
Incr Delay (d2), s/veh	91.2	71.4	0.0	85.2	9.2	0.6	24.6	1.9	2.2	19.3	0.2	0.9
Initial Q Delay(d3),s/veh	0.0	0.0	0.0	0.0	0.0	0.0	0.0	0.0	0.0	0.0	0.0	0.0
%ile BackOfQ(50%),veh/ln	12.5	27.7	0.4	8.6	12.8	4.9	3.7	4.5	4.5	6.2	2.4	6.6
Unsig. Movement Delay, s/veh												
LnGrp Delay(d),s/veh	134.2	102.6	14.9	130.5	41.5	18.5	70.2	39.9	40.4	62.2	31.7	25.5
LnGrp LOS	F	F	B	F	D	B	E	D	D	E	C	C
Approach Vol, veh/h		2130			2107			517			1047	
Approach Delay, s/veh		110.1			45.9			46.9			41.8	
Approach LOS		F			D			D			D	
Timer - Assigned Phs	1	2	3	4	5	6	7	8				
Phs Duration (G+Y+Rc), s	14.0	44.8	11.8	30.3	18.7	40.1	17.5	24.6				
Change Period (Y+Rc), s	3.7	6.2	3.7	6.2	3.7	6.2	3.7	6.2				
Max Green Setting (Gmax), s	10.3	38.6	8.3	43.0	15.0	33.9	13.8	37.5				
Max Q Clear Time (g_c+I1), s	12.3	40.6	8.4	20.6	17.0	32.2	14.2	12.9				
Green Ext Time (p_c), s	0.0	0.0	0.0	2.7	0.0	1.5	0.0	2.1				
Intersection Summary												
HCM 6th Ctrl Delay			68.8									
HCM 6th LOS			E									

Intersection	
Intersection Delay, s/veh	11.3
Intersection LOS	B

Movement	EBT	EBR	WBL	WBT	NBL	NBR
Lane Configurations						
Traffic Vol, veh/h	183	19	79	266	67	60
Future Vol, veh/h	183	19	79	266	67	60
Peak Hour Factor	0.82	0.82	0.82	0.82	0.82	0.82
Heavy Vehicles, %	2	0	5	2	0	0
Mvmt Flow	223	23	96	324	82	73
Number of Lanes	1	0	1	1	1	1

Approach	EB	WB	NB
Opposing Approach	WB	EB	
Opposing Lanes	2	1	0
Conflicting Approach Left		NB	EB
Conflicting Lanes Left	0	2	1
Conflicting Approach Right	NB		WB
Conflicting Lanes Right	2	0	2
HCM Control Delay	11.2	11.9	9.7
HCM LOS	B	B	A

Lane	NBLn1	NBLn2	EBLn1	WBLn1	WBLn2
Vol Left, %	100%	0%	0%	100%	0%
Vol Thru, %	0%	0%	91%	0%	100%
Vol Right, %	0%	100%	9%	0%	0%
Sign Control	Stop	Stop	Stop	Stop	Stop
Traffic Vol by Lane	67	60	202	79	266
LT Vol	67	0	0	79	0
Through Vol	0	0	183	0	266
RT Vol	0	60	19	0	0
Lane Flow Rate	82	73	246	96	324
Geometry Grp	7	7	4	7	7
Degree of Util (X)	0.15	0.109	0.356	0.154	0.47
Departure Headway (Hd)	6.596	5.383	5.205	5.769	5.214
Convergence, Y/N	Yes	Yes	Yes	Yes	Yes
Cap	540	659	687	619	688
Service Time	4.381	3.167	3.271	3.531	2.975
HCM Lane V/C Ratio	0.152	0.111	0.358	0.155	0.471
HCM Control Delay	10.6	8.8	11.2	9.6	12.6
HCM Lane LOS	B	A	B	A	B
HCM 95th-tile Q	0.5	0.4	1.6	0.5	2.5

Intersection												
Intersection Delay, s/veh	12.2											
Intersection LOS	B											

Movement	EBL	EBT	EBR	WBL	WBT	WBR	NBL	NBT	NBR	SBL	SBT	SBR
Lane Configurations	↖	↕		↖	↕			↕			↕	
Traffic Vol, veh/h	68	323	11	11	404	67	32	5	5	63	7	68
Future Vol, veh/h	68	323	11	11	404	67	32	5	5	63	7	68
Peak Hour Factor	0.90	0.90	0.90	0.90	0.90	0.90	0.90	0.90	0.90	0.90	0.90	0.90
Heavy Vehicles, %	5	2	7	0	1	0	6	0	0	0	0	0
Mvmt Flow	76	359	12	12	449	74	36	6	6	70	8	76
Number of Lanes	1	2	0	1	2	0	0	1	0	0	1	0

Approach	EB	WB	NB	SB
Opposing Approach	WB	EB	SB	NB
Opposing Lanes	3	3	1	1
Conflicting Approach Left	SB	NB	EB	WB
Conflicting Lanes Left	1	1	3	3
Conflicting Approach Right	NB	SB	WB	EB
Conflicting Lanes Right	1	1	3	3
HCM Control Delay	11.5	12.8	11.1	12.2
HCM LOS	B	B	B	B

Lane	NBLn1	EBLn1	EBLn2	EBLn3	WBLn1	WBLn2	WBLn3	SBLn1
Vol Left, %	76%	100%	0%	0%	100%	0%	0%	46%
Vol Thru, %	12%	0%	100%	91%	0%	100%	67%	5%
Vol Right, %	12%	0%	0%	9%	0%	0%	33%	49%
Sign Control	Stop	Stop	Stop	Stop	Stop	Stop	Stop	Stop
Traffic Vol by Lane	42	68	215	119	11	269	202	138
LT Vol	32	68	0	0	11	0	0	63
Through Vol	5	0	215	108	0	269	135	7
RT Vol	5	0	0	11	0	0	67	68
Lane Flow Rate	47	76	239	132	12	299	224	153
Geometry Grp	7	7	7	7	7	7	7	7
Degree of Util (X)	0.097	0.136	0.394	0.218	0.021	0.485	0.347	0.286
Departure Headway (Hd)	7.509	6.491	5.932	5.953	6.318	5.829	5.576	6.719
Convergence, Y/N	Yes	Yes	Yes	Yes	Yes	Yes	Yes	Yes
Cap	476	552	605	603	566	616	645	534
Service Time	5.271	4.234	3.675	3.696	4.059	3.57	3.317	4.47
HCM Lane V/C Ratio	0.099	0.138	0.395	0.219	0.021	0.485	0.347	0.287
HCM Control Delay	11.1	10.3	12.5	10.4	9.2	14	11.3	12.2
HCM Lane LOS	B	B	B	B	A	B	B	B
HCM 95th-tile Q	0.3	0.5	1.9	0.8	0.1	2.6	1.5	1.2

Timings
11: Barton St & Alessandro Bl.

West Campus Upper Plateau (JN 14064)

09/30/2022



Lane Group	EBL	EBT	WBL	WBT	NBL	NBT	NBR	SBL	SBT	SBR
Lane Configurations	↙	↕↕↕	↙	↕↕↕		↕	↗		↕	↗
Traffic Volume (vph)	5	1658	88	1857	71	1	44	5	0	4
Future Volume (vph)	5	1658	88	1857	71	1	44	5	0	4
Turn Type	Prot	NA	Prot	NA	Perm	NA	Perm	Perm	NA	Perm
Protected Phases	5	2	1	6		8			4	
Permitted Phases					8		8	4		4
Detector Phase	5	2	1	6	8	8	8	4	4	4
Switch Phase										
Minimum Initial (s)	5.0	10.0	5.0	10.0	10.0	10.0	10.0	10.0	10.0	10.0
Minimum Split (s)	9.2	28.5	11.0	28.5	40.6	40.6	40.6	26.6	26.6	26.6
Total Split (s)	9.2	65.4	14.0	70.2	40.6	40.6	40.6	40.6	40.6	40.6
Total Split (%)	7.7%	54.5%	11.7%	58.5%	33.8%	33.8%	33.8%	33.8%	33.8%	33.8%
Yellow Time (s)	3.2	5.5	3.2	5.5	3.6	3.6	3.6	3.6	3.6	3.6
All-Red Time (s)	1.0	1.0	1.0	1.0	1.0	1.0	1.0	1.0	1.0	1.0
Lost Time Adjust (s)	0.0	0.0	0.0	0.0		0.0	0.0		0.0	0.0
Total Lost Time (s)	4.2	6.5	4.2	6.5		4.6	4.6		4.6	4.6
Lead/Lag	Lead	Lag	Lead	Lag						
Lead-Lag Optimize?	Yes	Yes	Yes	Yes						
Recall Mode	None	None	None	None	None	None	None	None	None	None
Act Effct Green (s)	5.5	55.6	8.8	64.2		15.2	15.2		15.2	15.2
Actuated g/C Ratio	0.06	0.65	0.10	0.75		0.18	0.18		0.18	0.18
v/c Ratio	0.05	0.55	0.51	0.52		0.32	0.12		0.02	0.01
Control Delay	50.0	13.9	53.4	9.1		38.0	0.7		32.2	0.0
Queue Delay	0.0	0.0	0.0	0.0		0.0	0.0		0.0	0.0
Total Delay	50.0	13.9	53.4	9.1		38.0	0.7		32.2	0.0
LOS	D	B	D	A		D	A		C	A
Approach Delay		14.0		11.1		23.9			17.9	
Approach LOS		B		B		C			B	

Intersection Summary

Cycle Length: 120
 Actuated Cycle Length: 85.2
 Natural Cycle: 85
 Control Type: Actuated-Uncoordinated
 Maximum v/c Ratio: 0.55
 Intersection Signal Delay: 12.8
 Intersection LOS: B
 Intersection Capacity Utilization 65.7%
 ICU Level of Service C
 Analysis Period (min) 15

Splits and Phases: 11: Barton St & Alessandro Bl.



HCM 6th Signalized Intersection Summary
11: Barton St & Alessandro Bl.

West Campus Upper Plateau (JN 14064)

09/30/2022



Movement	EBL	EBT	EBR	WBL	WBT	WBR	NBL	NBT	NBR	SBL	SBT	SBR
Lane Configurations	↖	↑↑↑		↖	↑↑↑			↑	↗		↑	↗
Traffic Volume (veh/h)	5	1658	47	88	1857	5	71	1	44	5	0	4
Future Volume (veh/h)	5	1658	47	88	1857	5	71	1	44	5	0	4
Initial Q (Qb), veh	0	0	0	0	0	0	0	0	0	0	0	0
Ped-Bike Adj(A_pbT)	1.00		1.00	1.00		0.98	1.00		1.00	1.00		1.00
Parking Bus, Adj	1.00	1.00	1.00	1.00	1.00	1.00	1.00	1.00	1.00	1.00	1.00	1.00
Work Zone On Approach		No			No			No			No	
Adj Sat Flow, veh/h/ln	1604	1885	1900	1900	1870	1900	1870	1900	1900	1737	1900	1900
Adj Flow Rate, veh/h	5	1783	49	95	1997	5	76	1	20	5	0	-7
Peak Hour Factor	0.93	0.93	0.93	0.93	0.93	0.93	0.93	0.93	0.93	0.93	0.93	0.93
Percent Heavy Veh, %	20	1	0	0	2	0	2	0	0	11	0	0
Cap, veh/h	10	3140	86	123	3529	9	276	3	186	205	0	186
Arrive On Green	0.01	0.61	0.61	0.07	0.67	0.67	0.12	0.12	0.12	0.12	0.00	0.00
Sat Flow, veh/h	1527	5149	141	1810	5259	13	1553	26	1610	934	0	1610
Grp Volume(v), veh/h	5	1188	644	95	1293	709	77	0	20	5	0	-7
Grp Sat Flow(s),veh/h/ln	1527	1716	1860	1810	1702	1868	1579	0	1610	934	0	1610
Q Serve(g_s), s	0.2	15.3	15.3	3.8	14.9	14.9	0.0	0.0	0.8	0.2	0.0	0.0
Cycle Q Clear(g_c), s	0.2	15.3	15.3	3.8	14.9	14.9	2.9	0.0	0.8	3.2	0.0	0.0
Prop In Lane	1.00		0.08	1.00		0.01	0.99		1.00	1.00		1.00
Lane Grp Cap(c), veh/h	10	2093	1134	123	2285	1254	279	0	186	205	0	186
V/C Ratio(X)	0.50	0.57	0.57	0.77	0.57	0.57	0.28	0.00	0.11	0.02	0.00	-0.04
Avail Cap(c_a), veh/h	103	2726	1478	239	2925	1605	814	0	782	728	0	782
HCM Platoon Ratio	1.00	1.00	1.00	1.00	1.00	1.00	1.00	1.00	1.00	1.00	1.00	1.00
Upstream Filter(I)	1.00	1.00	1.00	1.00	1.00	1.00	1.00	0.00	1.00	1.00	0.00	0.00
Uniform Delay (d), s/veh	36.7	8.6	8.6	34.0	6.5	6.5	30.3	0.0	29.3	31.7	0.0	0.0
Incr Delay (d2), s/veh	13.3	0.3	0.6	3.9	0.3	0.6	0.5	0.0	0.3	0.0	0.0	0.0
Initial Q Delay(d3),s/veh	0.0	0.0	0.0	0.0	0.0	0.0	0.0	0.0	0.0	0.0	0.0	0.0
%ile BackOfQ(50%),veh/ln	0.1	3.8	4.2	1.8	4.1	4.6	1.3	0.0	0.3	0.1	0.0	0.0
Unsig. Movement Delay, s/veh												
LnGrp Delay(d),s/veh	50.0	9.0	9.3	37.8	6.8	7.0	30.8	0.0	29.6	31.8	0.0	0.0
LnGrp LOS	D	A	A	D	A	A	C	A	C	C	A	A
Approach Vol, veh/h		1837			2097			97				-2
Approach Delay, s/veh		9.2			8.3			30.5				0.0
Approach LOS		A			A			C				A
Timer - Assigned Phs	1	2		4	5	6		8				
Phs Duration (G+Y+Rc), s	9.2	51.7		13.2	4.7	56.3		13.2				
Change Period (Y+Rc), s	* 4.2	6.5		4.6	* 4.2	6.5		4.6				
Max Green Setting (Gmax), s	* 9.8	58.9		36.0	* 5	63.7		36.0				
Max Q Clear Time (g_c+I1), s	5.8	17.3		5.2	2.2	16.9		4.9				
Green Ext Time (p_c), s	0.0	23.9		0.0	0.0	32.8		0.4				

Intersection Summary

HCM 6th Ctrl Delay	9.2
HCM 6th LOS	A

Notes

* HCM 6th computational engine requires equal clearance times for the phases crossing the barrier.

Intersection						
Int Delay, s/veh	2.7					
Movement	EBL	EBT	WBT	WBR	SBL	SBR
Lane Configurations						
Traffic Vol, veh/h	32	172	239	23	29	69
Future Vol, veh/h	32	172	239	23	29	69
Conflicting Peds, #/hr	0	0	0	7	0	0
Sign Control	Free	Free	Free	Free	Stop	Stop
RT Channelized	-	None	-	None	-	None
Storage Length	100	-	-	-	0	-
Veh in Median Storage, #	-	0	0	-	0	-
Grade, %	-	0	0	-	0	-
Peak Hour Factor	78	78	78	78	78	78
Heavy Vehicles, %	0	1	1	0	0	0
Mvmt Flow	41	221	306	29	37	88

Major/Minor	Major1	Major2	Minor2		
Conflicting Flow All	342	0	-	0	631 328
Stage 1	-	-	-	-	328 -
Stage 2	-	-	-	-	303 -
Critical Hdwy	4.1	-	-	-	6.4 6.2
Critical Hdwy Stg 1	-	-	-	-	5.4 -
Critical Hdwy Stg 2	-	-	-	-	5.4 -
Follow-up Hdwy	2.2	-	-	-	3.5 3.3
Pot Cap-1 Maneuver	1228	-	-	-	448 718
Stage 1	-	-	-	-	734 -
Stage 2	-	-	-	-	754 -
Platoon blocked, %		-	-	-	
Mov Cap-1 Maneuver	1220	-	-	-	427 713
Mov Cap-2 Maneuver	-	-	-	-	427 -
Stage 1	-	-	-	-	704 -
Stage 2	-	-	-	-	749 -

Approach	EB	WB	SB
HCM Control Delay, s	1.3	0	12.7
HCM LOS			B

Minor Lane/Major Mvmt	EBL	EBT	WBT	WBR	SBLn1
Capacity (veh/h)	1220	-	-	-	595
HCM Lane V/C Ratio	0.034	-	-	-	0.211
HCM Control Delay (s)	8.1	-	-	-	12.7
HCM Lane LOS	A	-	-	-	B
HCM 95th %tile Q(veh)	0.1	-	-	-	0.8

Intersection						
Int Delay, s/veh	99.2					
Movement	EBT	EBR	WBL	WBT	NBL	NBR
Lane Configurations	↑↑		↖	↑↑	↘	
Traffic Vol, veh/h	359	368	59	525	311	44
Future Vol, veh/h	359	368	59	525	311	44
Conflicting Peds, #/hr	0	2	0	0	0	0
Sign Control	Free	Free	Free	Free	Stop	Stop
RT Channelized	-	None	-	None	-	None
Storage Length	-	-	125	-	0	-
Veh in Median Storage, #	0	-	-	0	0	-
Grade, %	0	-	-	0	0	-
Peak Hour Factor	86	86	86	86	86	86
Heavy Vehicles, %	1	1	0	0	0	0
Mvmt Flow	417	428	69	610	362	51

Major/Minor	Major1	Major2	Minor1	Minor2	Minor3
Conflicting Flow All	0	0	847	0	1076
Stage 1	-	-	-	-	633
Stage 2	-	-	-	-	443
Critical Hdwy	-	-	4.1	-	6.8
Critical Hdwy Stg 1	-	-	-	-	5.8
Critical Hdwy Stg 2	-	-	-	-	5.8
Follow-up Hdwy	-	-	2.2	-	3.5
Pot Cap-1 Maneuver	-	-	799	-	~ 217
Stage 1	-	-	-	-	497
Stage 2	-	-	-	-	620
Platoon blocked, %	-	-	-	-	-
Mov Cap-1 Maneuver	-	-	797	-	~ 198
Mov Cap-2 Maneuver	-	-	-	-	~ 198
Stage 1	-	-	-	-	496
Stage 2	-	-	-	-	566

Approach	EB	WB	NB
HCM Control Delay, s	0	1	\$ 464
HCM LOS			F

Minor Lane/Major Mvmt	NBLn1	EBT	EBR	WBL	WBT
Capacity (veh/h)	216	-	-	797	-
HCM Lane V/C Ratio	1.911	-	-	0.086	-
HCM Control Delay (s)	\$ 464	-	-	9.9	-
HCM Lane LOS	F	-	-	A	-
HCM 95th %tile Q(veh)	29.8	-	-	0.3	-

Notes
 ~: Volume exceeds capacity \$: Delay exceeds 300s +: Computation Not Defined *: All major volume in platoon

Timings

14: Barton Rd. & Van Buren Bl.

09/30/2022



Lane Group	EBL	EBT	WBL	WBT	NBL	NBT	NBR	SBL	SBT
Lane Configurations	↘	↗	↘	↗	↘	↗	↗	↘	↗
Traffic Volume (vph)	203	1707	252	1775	295	51	208	53	33
Future Volume (vph)	203	1707	252	1775	295	51	208	53	33
Turn Type	Prot	NA	Prot	NA	Prot	NA	Perm	Prot	NA
Protected Phases	5	2	1	6	3	8		7	4
Permitted Phases							8		
Detector Phase	5	2	1	6	3	8	8	7	4
Switch Phase									
Minimum Initial (s)	5.0	10.0	5.0	10.0	5.0	10.0	10.0	5.0	10.0
Minimum Split (s)	9.2	25.2	9.2	25.5	9.1	14.6	14.6	9.1	33.6
Total Split (s)	17.6	52.1	22.2	56.7	12.1	36.3	36.3	9.4	33.6
Total Split (%)	14.7%	43.4%	18.5%	47.3%	10.1%	30.3%	30.3%	7.8%	28.0%
Yellow Time (s)	3.2	5.2	3.2	5.5	3.6	3.6	3.6	3.6	3.6
All-Red Time (s)	1.0	1.0	1.0	1.0	0.5	1.0	1.0	0.5	1.0
Lost Time Adjust (s)	0.0	0.0	0.0	0.0	0.0	0.0	0.0	0.0	0.0
Total Lost Time (s)	4.2	6.2	4.2	6.5	4.1	4.6	4.6	4.1	4.6
Lead/Lag	Lead	Lag	Lead	Lag	Lead	Lag	Lag	Lead	Lag
Lead-Lag Optimize?	Yes	Yes	Yes	Yes	Yes	Yes	Yes	Yes	Yes
Recall Mode	None	None	None	None	None	None	None	None	None
Act Effct Green (s)	13.5	46.1	18.1	50.4	8.0	18.5	18.5	5.3	13.8
Actuated g/C Ratio	0.13	0.44	0.17	0.48	0.08	0.18	0.18	0.05	0.13
v/c Ratio	0.98	1.45	0.92	0.85	1.23	0.17	0.50	0.65	0.66
Control Delay	102.1	233.7	79.7	29.2	172.8	38.6	8.8	82.7	17.4
Queue Delay	0.0	0.0	0.0	0.0	0.0	0.0	0.0	0.0	0.0
Total Delay	102.1	233.7	79.7	29.2	172.8	38.6	8.8	82.7	17.4
LOS	F	F	E	C	F	D	A	F	B
Approach Delay		221.3		35.3		98.9			29.0
Approach LOS		F		D		F			C

Intersection Summary

Cycle Length: 120
 Actuated Cycle Length: 105.2
 Natural Cycle: 120
 Control Type: Actuated-Uncoordinated
 Maximum v/c Ratio: 1.45
 Intersection Signal Delay: 120.6
 Intersection LOS: F
 Intersection Capacity Utilization 108.4%
 ICU Level of Service G
 Analysis Period (min) 15



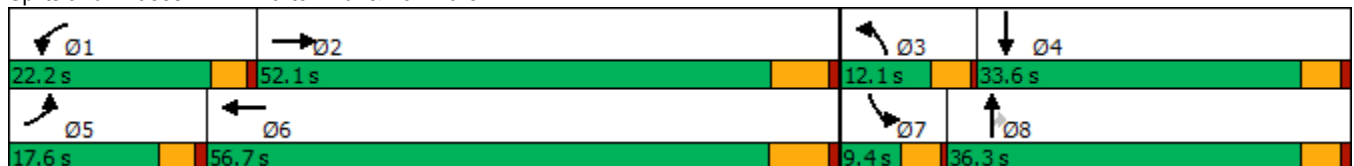





















Splits and Phases: 14: Barton Rd. & Van Buren Bl.



HCM 6th Signalized Intersection Summary
 14: Barton Rd. & Van Buren Bl.

West Campus Upper Plateau (JN 14064)

09/30/2022

												
Movement	EBL	EBT	EBR	WBL	WBT	WBR	NBL	NBT	NBR	SBL	SBT	SBR
Lane Configurations		 			 						 	
Traffic Volume (veh/h)	203	1707	252	252	1775	64	295	51	208	53	33	213
Future Volume (veh/h)	203	1707	252	252	1775	64	295	51	208	53	33	213
Initial Q (Qb), veh	0	0	0	0	0	0	0	0	0	0	0	0
Ped-Bike Adj(A_pbT)	1.00		1.00	1.00		1.00	1.00		0.95	1.00		1.00
Parking Bus, Adj	1.00	1.00	1.00	1.00	1.00	1.00	1.00	1.00	1.00	1.00	1.00	1.00
Work Zone On Approach		No			No			No			No	
Adj Sat Flow, veh/h/ln	1900	1841	1870	1870	1856	1856	1900	1900	1885	1900	1841	1900
Adj Flow Rate, veh/h	226	1897	249	280	1972	60	328	57	99	59	37	175
Peak Hour Factor	0.90	0.90	0.90	0.90	0.90	0.90	0.90	0.90	0.90	0.90	0.90	0.90
Percent Heavy Veh, %	0	4	2	2	3	3	0	0	1	0	4	0
Cap, veh/h	224	1321	170	296	2356	72	259	358	287	76	44	207
Arrive On Green	0.12	0.42	0.42	0.17	0.47	0.47	0.07	0.19	0.19	0.04	0.16	0.16
Sat Flow, veh/h	1810	3117	400	1781	5051	153	3510	1900	1522	1810	280	1323
Grp Volume(v), veh/h	226	1045	1101	280	1317	715	328	57	99	59	0	212
Grp Sat Flow(s),veh/h/ln	1810	1749	1768	1781	1689	1828	1755	1900	1522	1810	0	1603
Q Serve(g_s), s	13.4	45.9	45.9	16.8	36.9	37.1	8.0	2.7	6.1	3.5	0.0	13.9
Cycle Q Clear(g_c), s	13.4	45.9	45.9	16.8	36.9	37.1	8.0	2.7	6.1	3.5	0.0	13.9
Prop In Lane	1.00		0.23	1.00		0.08	1.00		1.00	1.00		0.83
Lane Grp Cap(c), veh/h	224	741	750	296	1575	853	259	358	287	76	0	251
V/C Ratio(X)	1.01	1.41	1.47	0.95	0.84	0.84	1.26	0.16	0.35	0.77	0.00	0.84
Avail Cap(c_a), veh/h	224	741	750	296	1575	853	259	556	446	89	0	429
HCM Platoon Ratio	1.00	1.00	1.00	1.00	1.00	1.00	1.00	1.00	1.00	1.00	1.00	1.00
Upstream Filter(I)	1.00	1.00	1.00	1.00	1.00	1.00	1.00	1.00	1.00	1.00	0.00	1.00
Uniform Delay (d), s/veh	47.4	31.2	31.2	44.6	25.3	25.3	50.1	36.8	38.1	51.3	0.0	44.4
Incr Delay (d2), s/veh	62.5	192.6	217.9	37.5	3.9	7.0	146.0	0.2	0.7	29.7	0.0	7.6
Initial Q Delay(d3),s/veh	0.0	0.0	0.0	0.0	0.0	0.0	0.0	0.0	0.0	0.0	0.0	0.0
%ile BackOfQ(50%),veh/ln	9.6	57.1	63.0	10.2	14.1	16.0	8.7	1.2	2.3	2.2	0.0	6.1
Unsig. Movement Delay, s/veh												
LnGrp Delay(d),s/veh	109.9	223.8	249.1	82.1	29.1	32.3	196.2	37.0	38.8	81.1	0.0	51.9
LnGrp LOS	F	F	F	F	C	C	F	D	D	F	A	D
Approach Vol, veh/h		2372			2312			484				271
Approach Delay, s/veh		224.7			36.5			145.2				58.3
Approach LOS		F			D			F				E
Timer - Assigned Phs	1	2	3	4	5	6	7	8				
Phs Duration (G+Y+Rc), s	22.2	52.4	12.1	21.6	17.6	57.0	8.7	25.0				
Change Period (Y+Rc), s	* 4.2	* 6.5	4.1	4.6	* 4.2	6.5	4.1	4.6				
Max Green Setting (Gmax), s	* 18	* 46	8.0	29.0	* 13	50.2	5.3	31.7				
Max Q Clear Time (g_c+I1), s	18.8	47.9	10.0	15.9	15.4	39.1	5.5	8.1				
Green Ext Time (p_c), s	0.0	0.0	0.0	1.0	0.0	6.5	0.0	0.5				

Intersection Summary

HCM 6th Ctrl Delay	129.3
HCM 6th LOS	F

Notes

* HCM 6th computational engine requires equal clearance times for the phases crossing the barrier.

Timings
15: Airman Dr & Cactus Av.



Lane Group	WBL	WBR	NBR	SBL	Ø6
Lane Configurations	↖	↗	↖	↖↗	
Traffic Volume (vph)	356	426	345	411	
Future Volume (vph)	356	426	345	411	
Turn Type	Prot	Perm	Perm	Prot	
Protected Phases	3			1	6
Permitted Phases		8	2		
Detector Phase	3	8	2	1	
Switch Phase					
Minimum Initial (s)	5.0	10.0	10.0	5.0	10.0
Minimum Split (s)	9.6	21.7	21.7	9.6	14.7
Total Split (s)	72.0	72.0	27.0	21.0	48.0
Total Split (%)	60.0%	60.0%	22.5%	17.5%	40%
Yellow Time (s)	3.6	3.7	3.7	3.6	3.7
All-Red Time (s)	1.0	1.0	1.0	1.0	1.0
Lost Time Adjust (s)	0.0	0.0	0.0	0.0	
Total Lost Time (s)	4.6	4.7	4.7	4.6	
Lead/Lag			Lag	Lead	
Lead-Lag Optimize?			Yes	Yes	
Recall Mode	None	None	Min	None	Min
Act Effect Green (s)	17.6	17.5	11.3	16.2	
Actuated g/C Ratio	0.30	0.30	0.19	0.27	
v/c Ratio	0.76	0.61	0.37	0.51	
Control Delay	29.8	5.8	1.1	22.2	
Queue Delay	0.0	0.0	0.0	0.0	
Total Delay	29.8	5.8	1.1	22.2	
LOS	C	A	A	C	
Approach Delay	16.7				
Approach LOS	B				

Intersection Summary

Cycle Length: 120	
Actuated Cycle Length: 59.2	
Natural Cycle: 60	
Control Type: Actuated-Uncoordinated	
Maximum v/c Ratio: 0.76	
Intersection Signal Delay: 14.7	Intersection LOS: B
Intersection Capacity Utilization 40.8%	ICU Level of Service A
Analysis Period (min) 15	

Splits and Phases: 15: Airman Dr & Cactus Av.

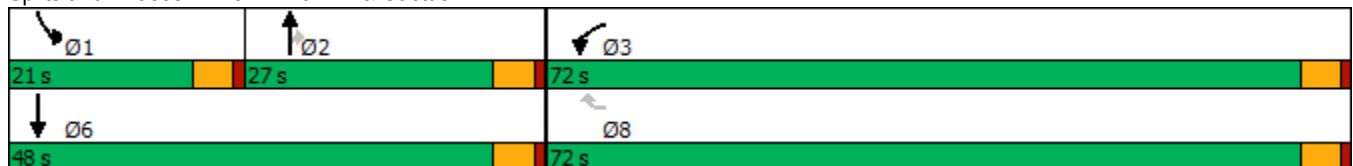

HCM 6th Signalized Intersection Summary
15: Airman Dr & Cactus Av.

West Campus Upper Plateau (JN 14064)

09/30/2022



Movement	WBL	WBR	NBT	NBR	SBL	SBT
Lane Configurations						
Traffic Volume (veh/h)	356	426	0	345	411	0
Future Volume (veh/h)	356	426	0	345	411	0
Initial Q (Qb), veh	0	0	0	0	0	0
Ped-Bike Adj(A_pbT)	1.00	1.00		1.00	1.00	
Parking Bus, Adj	1.00	1.00	1.00	1.00	1.00	1.00
Work Zone On Approach	No		No			No
Adj Sat Flow, veh/h/ln	1811	1752	1900	1811	1752	1900
Adj Flow Rate, veh/h	387	327	0	375	447	0
Peak Hour Factor	0.92	0.92	0.92	0.92	0.92	0.92
Percent Heavy Veh, %	6	10	0	6	10	0
Cap, veh/h	468	403	542	438	584	1050
Arrive On Green	0.27	0.27	0.00	0.29	0.18	0.00
Sat Flow, veh/h	1725	1485	1900	1535	3237	1900
Grp Volume(v), veh/h	387	327	0	375	447	0
Grp Sat Flow(s),veh/h/ln	1725	1485	1900	1535	1618	1900
Q Serve(g_s), s	11.2	10.9	0.0	12.2	7.0	0.0
Cycle Q Clear(g_c), s	11.2	10.9	0.0	12.2	7.0	0.0
Prop In Lane	1.00	1.00		1.00	1.00	
Lane Grp Cap(c), veh/h	468	403	542	438	584	1050
V/C Ratio(X)	0.83	0.81	0.00	0.86	0.77	0.00
Avail Cap(c_a), veh/h	2196	1890	800	647	1003	1554
HCM Platoon Ratio	1.00	1.00	1.00	1.00	1.00	1.00
Upstream Filter(I)	1.00	1.00	0.00	1.00	1.00	0.00
Uniform Delay (d), s/veh	18.1	18.0	0.0	17.9	20.6	0.0
Incr Delay (d2), s/veh	1.4	1.5	0.0	7.5	0.8	0.0
Initial Q Delay(d3),s/veh	0.0	0.0	0.0	0.0	0.0	0.0
%ile BackOfQ(50%),veh/ln	4.1	3.4	0.0	4.7	2.4	0.0
Unsig. Movement Delay, s/veh						
LnGrp Delay(d),s/veh	19.6	19.5	0.0	25.4	21.4	0.0
LnGrp LOS	B	B	A	C	C	A
Approach Vol, veh/h	714		375			447
Approach Delay, s/veh	19.5		25.4			21.4
Approach LOS	B		C			C
Timer - Assigned Phs	1	2			6	8
Phs Duration (G+Y+Rc), s	14.2	19.8			34.0	19.0
Change Period (Y+Rc), s	4.6	* 4.7			* 4.7	4.6
Max Green Setting (Gmax), s	16.4	* 22			* 43	67.4
Max Q Clear Time (g_c+11), s	9.0	14.2			0.0	13.2
Green Ext Time (p_c), s	0.6	0.9			0.0	1.2

Intersection Summary

HCM 6th Ctrl Delay	21.5
HCM 6th LOS	C

Notes

* HCM 6th computational engine requires equal clearance times for the phases crossing the barrier.

Intersection

Intersection Delay, s/veh 9.3

Intersection LOS A

Movement	EBT	EBR	WBL	WBT	NBL	NBR
Lane Configurations						
Traffic Vol, veh/h	116	92	47	156	88	43
Future Vol, veh/h	116	92	47	156	88	43
Peak Hour Factor	0.88	0.88	0.88	0.88	0.88	0.88
Heavy Vehicles, %	1	2	3	2	2	0
Mvmt Flow	132	105	53	177	100	49
Number of Lanes	1	0	1	1	1	0

Approach	EB	WB	NB
Opposing Approach	WB	EB	
Opposing Lanes	2	1	0
Conflicting Approach Left		NB	EB
Conflicting Lanes Left	0	1	1
Conflicting Approach Right	NB		WB
Conflicting Lanes Right	1	0	2
HCM Control Delay	9.2	9.4	9.2
HCM LOS	A	A	A

Lane	NBLn1	EBLn1	WBLn1	WBLn2
Vol Left, %	67%	0%	100%	0%
Vol Thru, %	0%	56%	0%	100%
Vol Right, %	33%	44%	0%	0%
Sign Control	Stop	Stop	Stop	Stop
Traffic Vol by Lane	131	208	47	156
LT Vol	88	0	47	0
Through Vol	0	116	0	156
RT Vol	43	92	0	0
Lane Flow Rate	149	236	53	177
Geometry Grp	2	5	7	7
Degree of Util (X)	0.204	0.289	0.083	0.251
Departure Headway (Hd)	4.935	4.405	5.62	5.099
Convergence, Y/N	Yes	Yes	Yes	Yes
Cap	726	813	637	704
Service Time	2.975	2.441	3.358	2.837
HCM Lane V/C Ratio	0.205	0.29	0.083	0.251
HCM Control Delay	9.2	9.2	8.9	9.5
HCM Lane LOS	A	A	A	A
HCM 95th-tile Q	0.8	1.2	0.3	1

Intersection	
Intersection Delay, s/veh	10.1
Intersection LOS	B

Movement	EBL	EBT	WBT	WBR	SBL	SBR
Lane Configurations						
Traffic Vol, veh/h	151	192	226	84	69	72
Future Vol, veh/h	151	192	226	84	69	72
Peak Hour Factor	0.90	0.90	0.90	0.90	0.90	0.90
Heavy Vehicles, %	1	0	2	0	4	3
Mvmt Flow	168	213	251	93	77	80
Number of Lanes	1	2	2	0	1	0

Approach	EB	WB	SB
Opposing Approach	WB	EB	
Opposing Lanes	2	3	0
Conflicting Approach Left			WB
Conflicting Lanes Left	1	0	2
Conflicting Approach Right		SB	EB
Conflicting Lanes Right	0	1	3
HCM Control Delay	9.3	10.5	11.1
HCM LOS	A	B	B

Lane	EBLn1	EBLn2	EBLn3	WBLn1	WBLn2	SBLn1
Vol Left, %	100%	0%	0%	0%	0%	49%
Vol Thru, %	0%	100%	100%	100%	47%	0%
Vol Right, %	0%	0%	0%	0%	53%	51%
Sign Control	Stop	Stop	Stop	Stop	Stop	Stop
Traffic Vol by Lane	151	96	96	151	159	141
LT Vol	151	0	0	0	0	69
Through Vol	0	96	96	151	75	0
RT Vol	0	0	0	0	84	72
Lane Flow Rate	168	107	107	167	177	157
Geometry Grp	7	7	7	8	8	7
Degree of Util (X)	0.273	0.158	0.107	0.274	0.269	0.267
Departure Headway (Hd)	5.964	5.442	3.627	5.882	5.475	6.13
Convergence, Y/N	Yes	Yes	Yes	Yes	Yes	Yes
Cap	606	663	969	614	660	589
Service Time	3.664	3.142	1.425	3.582	3.175	3.844
HCM Lane V/C Ratio	0.277	0.161	0.11	0.272	0.268	0.267
HCM Control Delay	10.9	9.2	6.9	10.8	10.2	11.1
HCM Lane LOS	B	A	A	B	B	B
HCM 95th-tile Q	1.1	0.6	0.4	1.1	1.1	1.1

Timings
18: Linebacker Dr & Cactus Av.

West Campus Upper Plateau (JN 14064)

09/30/2022

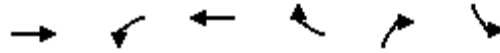

Lane Group	EBT	WBL	WBT	WBR	NBR	SBL	Ø3	Ø4	Ø5	Ø8
Lane Configurations	↑↑	↖	↑	↗	↗	↖↖				
Traffic Volume (vph)	756	169	782	168	159	159				
Future Volume (vph)	756	169	782	168	159	159				
Turn Type	NA	Prot	NA	Perm	pm+ov	Prot				
Protected Phases	2	1	6		1	7	3	4	5	8
Permitted Phases				6	8					
Detector Phase	2	1	6	6	1	7				
Switch Phase										
Minimum Initial (s)	10.0	5.0	10.0	10.0	5.0	5.0	5.0	10.0	5.0	10.0
Minimum Split (s)	27.0	9.6	27.0	27.0	9.6	9.6	9.6	27.0	9.6	27.0
Total Split (s)	27.4	16.0	33.8	33.8	16.0	9.6	9.6	27.0	9.6	27.0
Total Split (%)	34.3%	20.0%	42.3%	42.3%	20.0%	12.0%	12%	34%	12%	34%
Yellow Time (s)	4.0	3.6	4.0	4.0	3.6	3.6	3.6	4.0	3.6	4.0
All-Red Time (s)	1.0	1.0	1.0	1.0	1.0	1.0	1.0	1.0	1.0	1.0
Lost Time Adjust (s)	0.0	0.0	0.0	0.0	0.0	0.0				
Total Lost Time (s)	5.0	4.6	5.0	5.0	4.6	4.6				
Lead/Lag	Lag	Lead	Lag	Lag	Lead	Lead	Lead	Lag	Lead	Lag
Lead-Lag Optimize?	Yes	Yes	Yes	Yes	Yes	Yes	Yes	Yes	Yes	Yes
Recall Mode	None	None	None	None	None	None	None	None	None	None
Act Effct Green (s)	20.1	10.5	35.3	35.3	14.1	5.2				
Actuated g/C Ratio	0.37	0.19	0.65	0.65	0.26	0.10				
v/c Ratio	0.64	0.58	0.74	0.18	0.38	0.55				
Control Delay	19.3	32.8	15.3	2.4	10.5	35.9				
Queue Delay	0.0	0.0	0.0	0.0	0.0	0.0				
Total Delay	19.3	32.8	15.3	2.4	10.5	35.9				
LOS	B	C	B	A	B	D				
Approach Delay	19.3		16.0							
Approach LOS	B		B							

Intersection Summary

Cycle Length: 80
 Actuated Cycle Length: 54.3
 Natural Cycle: 100
 Control Type: Actuated-Uncoordinated
 Maximum v/c Ratio: 0.74
 Intersection Signal Delay: 18.2
 Intersection LOS: B
 Intersection Capacity Utilization 65.8%
 ICU Level of Service C
 Analysis Period (min) 15

Splits and Phases: 18: Linebacker Dr & Cactus Av.

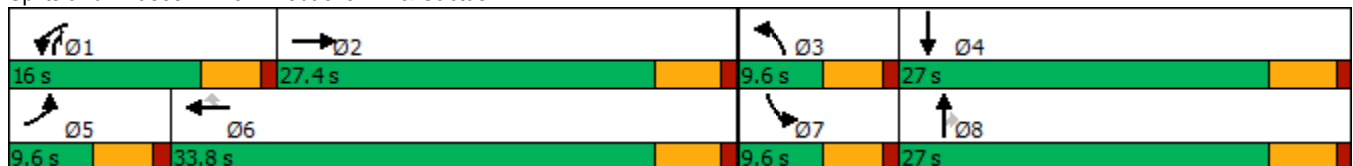

HCM 6th Signalized Intersection Summary
18: Linebacker Dr & Cactus Av.

West Campus Upper Plateau (JN 14064)

09/30/2022



Movement	EBL	EBT	EBR	WBL	WBT	WBR	NBL	NBT	NBR	SBL	SBT	SBR
Lane Configurations	↖	↗		↖	↗	↗	↖	↗	↗	↗	↗	↗
Traffic Volume (veh/h)	0	756	0	169	782	168	0	0	159	159	0	0
Future Volume (veh/h)	0	756	0	169	782	168	0	0	159	159	0	0
Initial Q (Qb), veh	0	0	0	0	0	0	0	0	0	0	0	0
Ped-Bike Adj(A_pbT)	1.00		1.00	1.00		1.00	1.00		1.00	1.00		1.00
Parking Bus, Adj	1.00	1.00	1.00	1.00	1.00	1.00	1.00	1.00	1.00	1.00	1.00	1.00
Work Zone On Approach		No			No			No			No	
Adj Sat Flow, veh/h/ln	1900	1767	1900	1752	1781	1752	1900	1900	1767	1752	1900	1900
Adj Flow Rate, veh/h	0	822	0	184	850	183	0	0	173	173	0	0
Peak Hour Factor	0.92	0.92	0.92	0.92	0.92	0.92	0.92	0.92	0.92	0.92	0.92	0.92
Percent Heavy Veh, %	0	9	0	10	8	10	0	0	9	10	0	0
Cap, veh/h	3	1070	0	226	919	766	3	302	440	265	600	0
Arrive On Green	0.00	0.30	0.00	0.14	0.52	0.52	0.00	0.00	0.16	0.08	0.00	0.00
Sat Flow, veh/h	1810	3533	0	1668	1781	1485	1810	1900	1497	3337	1900	0
Grp Volume(v), veh/h	0	822	0	184	850	183	0	0	173	173	0	0
Grp Sat Flow(s),veh/h/ln	1810	1767	0	1668	1781	1485	1810	1900	1497	1668	1900	0
Q Serve(g_s), s	0.0	12.5	0.0	6.4	26.2	4.0	0.0	0.0	5.5	3.0	0.0	0.0
Cycle Q Clear(g_c), s	0.0	12.5	0.0	6.4	26.2	4.0	0.0	0.0	5.5	3.0	0.0	0.0
Prop In Lane	1.00		0.00	1.00		1.00	1.00		1.00	1.00		0.00
Lane Grp Cap(c), veh/h	3	1070	0	226	919	766	3	302	440	265	600	0
V/C Ratio(X)	0.00	0.77	0.00	0.81	0.93	0.24	0.00	0.00	0.39	0.65	0.00	0.00
Avail Cap(c_a), veh/h	152	1334	0	321	919	766	152	705	758	281	705	0
HCM Platoon Ratio	1.00	1.00	1.00	1.00	1.00	1.00	1.00	1.00	1.00	1.00	1.00	1.00
Upstream Filter(I)	0.00	1.00	0.00	1.00	1.00	1.00	0.00	0.00	1.00	1.00	0.00	0.00
Uniform Delay (d), s/veh	0.0	18.8	0.0	24.9	13.3	7.9	0.0	0.0	16.7	26.5	0.0	0.0
Incr Delay (d2), s/veh	0.0	2.2	0.0	7.0	14.8	0.2	0.0	0.0	0.6	3.6	0.0	0.0
Initial Q Delay(d3),s/veh	0.0	0.0	0.0	0.0	0.0	0.0	0.0	0.0	0.0	0.0	0.0	0.0
%ile BackOfQ(50%),veh/ln	0.0	4.9	0.0	2.8	12.1	1.1	0.0	0.0	1.8	1.3	0.0	0.0
Unsig. Movement Delay, s/veh												
LnGrp Delay(d),s/veh	0.0	21.0	0.0	31.9	28.2	8.1	0.0	0.0	17.3	30.2	0.0	0.0
LnGrp LOS	A	C	A	C	C	A	A	A	B	C	A	A
Approach Vol, veh/h		822			1217			173				173
Approach Delay, s/veh		21.0			25.7			17.3				30.2
Approach LOS		C			C			B				C
Timer - Assigned Phs	1	2	3	4	5	6	7	8				
Phs Duration (G+Y+Rc), s	12.6	23.0	0.0	23.7	0.0	35.6	9.3	14.4				
Change Period (Y+Rc), s	4.6	5.0	4.6	5.0	4.6	5.0	4.6	5.0				
Max Green Setting (Gmax), s	11.4	22.4	5.0	22.0	5.0	28.8	5.0	22.0				
Max Q Clear Time (g_c+I1), s	8.4	14.5	0.0	0.0	0.0	28.2	5.0	7.5				
Green Ext Time (p_c), s	0.1	3.4	0.0	0.0	0.0	0.4	0.0	0.4				

Intersection Summary

HCM 6th Ctrl Delay	23.8
HCM 6th LOS	C

Timings
19: Van Buren Bl. & Orange Terrace Pkwy.

West Campus Upper Plateau (JN 14064)

09/30/2022

Lane Group	EBL	EBT	EBR	WBL	WBT	WBR	NBL	NBT	NBR	SBL	SBT	SBR
Lane Configurations												
Traffic Volume (vph)	151	1608	59	39	1924	291	63	55	46	222	43	134
Future Volume (vph)	151	1608	59	39	1924	291	63	55	46	222	43	134
Turn Type	Prot	NA	Perm	Prot	NA	Perm	Prot	NA	Perm	Prot	NA	pm+ov
Protected Phases	5	2		1	6		3	8		7	4	5
Permitted Phases			2			6			8			4
Detector Phase	5	2	2	1	6	6	3	8	8	7	4	5
Switch Phase												
Minimum Initial (s)	5.0	10.0	10.0	5.0	10.0	10.0	5.0	5.0	5.0	10.0	10.0	5.0
Minimum Split (s)	9.2	25.2	25.2	9.1	25.2	25.2	9.1	26.1	26.1	15.8	24.8	9.2
Total Split (s)	16.0	63.0	63.0	11.0	58.0	58.0	12.0	27.0	27.0	19.0	34.0	16.0
Total Split (%)	13.3%	52.5%	52.5%	9.2%	48.3%	48.3%	10.0%	22.5%	22.5%	15.8%	28.3%	13.3%
Yellow Time (s)	3.2	5.2	5.2	3.6	5.2	5.2	3.6	3.6	3.6	4.8	4.8	3.2
All-Red Time (s)	1.0	1.0	1.0	0.5	1.0	1.0	0.5	0.5	0.5	1.0	1.0	1.0
Lost Time Adjust (s)	0.0	0.0	0.0	0.0	0.0	0.0	0.0	0.0	0.0	0.0	0.0	0.0
Total Lost Time (s)	4.2	6.2	6.2	4.1	6.2	6.2	4.1	4.1	4.1	5.8	5.8	4.2
Lead/Lag	Lead	Lag	Lag	Lead	Lag	Lag	Lead	Lag	Lag	Lead	Lag	Lead
Lead-Lag Optimize?	Yes	Yes	Yes	Yes	Yes	Yes	Yes	Yes	Yes	Yes	Yes	Yes
Recall Mode	None	None	None	None	None	None	None	None	None	None	None	None
Act Effct Green (s)	8.9	56.6	56.6	6.5	49.4	49.4	10.4	8.0	8.0	11.9	12.7	24.4
Actuated g/C Ratio	0.09	0.59	0.59	0.07	0.51	0.51	0.11	0.08	0.08	0.12	0.13	0.25
v/c Ratio	0.50	0.57	0.06	0.18	0.78	0.33	0.19	0.19	0.16	0.55	0.18	0.31
Control Delay	49.6	15.2	0.1	48.6	23.0	6.9	45.8	45.6	1.1	47.3	41.7	18.5
Queue Delay	0.0	0.0	0.0	0.0	0.0	0.0	0.0	0.0	0.0	0.0	0.0	0.0
Total Delay	49.6	15.2	0.1	48.6	23.0	6.9	45.8	45.6	1.1	47.3	41.7	18.5
LOS	D	B	A	D	C	A	D	D	A	D	D	B
Approach Delay		17.6			21.4			33.2			37.0	
Approach LOS		B			C			C			D	

Intersection Summary

Cycle Length: 120	
Actuated Cycle Length: 96.4	
Natural Cycle: 90	
Control Type: Actuated-Uncoordinated	
Maximum v/c Ratio: 0.78	
Intersection Signal Delay: 21.7	Intersection LOS: C
Intersection Capacity Utilization 68.0%	ICU Level of Service C
Analysis Period (min) 15	

Splits and Phases: 19: Van Buren Bl. & Orange Terrace Pkwy.

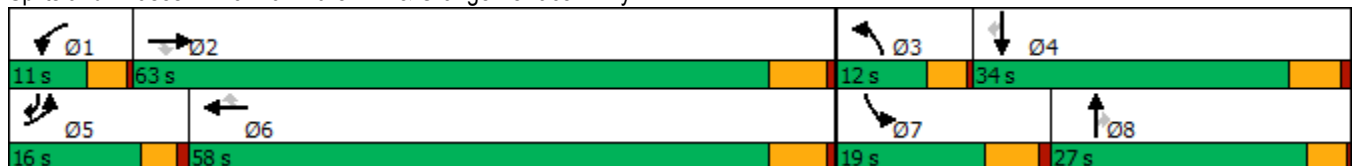

HCM 6th Signalized Intersection Summary
 19: Van Buren Bl. & Orange Terrace Pkwy.

West Campus Upper Plateau (JN 14064)

09/30/2022



Movement	EBL	EBT	EBR	WBL	WBT	WBR	NBL	NBT	NBR	SBL	SBT	SBR
Lane Configurations	↔↔	↑↑↑	↗	↔↔	↑↑↑	↗	↔↔	↑↑	↗	↔↔	↑	↗
Traffic Volume (veh/h)	151	1608	59	39	1924	291	63	55	46	222	43	134
Future Volume (veh/h)	151	1608	59	39	1924	291	63	55	46	222	43	134
Initial Q (Qb), veh	0	0	0	0	0	0	0	0	0	0	0	0
Ped-Bike Adj(A_pbT)	1.00		1.00	1.00		1.00	1.00		1.00	1.00		1.00
Parking Bus, Adj	1.00	1.00	1.00	1.00	1.00	1.00	1.00	1.00	1.00	1.00	1.00	1.00
Work Zone On Approach		No			No			No			No	
Adj Sat Flow, veh/h/ln	1885	1856	1811	1870	1856	1885	1796	1900	1856	1885	1900	1885
Adj Flow Rate, veh/h	159	1693	36	41	2025	246	66	58	16	234	45	67
Peak Hour Factor	0.95	0.95	0.95	0.95	0.95	0.95	0.95	0.95	0.95	0.95	0.95	0.95
Percent Heavy Veh, %	1	3	6	2	3	1	7	0	3	1	0	1
Cap, veh/h	234	2775	841	124	2610	823	150	203	89	393	272	336
Arrive On Green	0.07	0.55	0.55	0.04	0.52	0.52	0.05	0.06	0.06	0.11	0.14	0.14
Sat Flow, veh/h	3483	5066	1535	3456	5066	1598	3319	3610	1572	3483	1900	1598
Grp Volume(v), veh/h	159	1693	36	41	2025	246	66	58	16	234	45	67
Grp Sat Flow(s),veh/h/ln	1742	1689	1535	1728	1689	1598	1659	1805	1572	1742	1900	1598
Q Serve(g_s), s	4.0	20.1	1.0	1.0	28.6	7.8	1.7	1.4	0.9	5.7	1.8	3.1
Cycle Q Clear(g_c), s	4.0	20.1	1.0	1.0	28.6	7.8	1.7	1.4	0.9	5.7	1.8	3.1
Prop In Lane	1.00		1.00	1.00		1.00	1.00		1.00	1.00		1.00
Lane Grp Cap(c), veh/h	234	2775	841	124	2610	823	150	203	89	393	272	336
V/C Ratio(X)	0.68	0.61	0.04	0.33	0.78	0.30	0.44	0.29	0.18	0.60	0.17	0.20
Avail Cap(c_a), veh/h	464	3248	984	269	2962	934	296	933	406	519	605	616
HCM Platoon Ratio	1.00	1.00	1.00	1.00	1.00	1.00	1.00	1.00	1.00	1.00	1.00	1.00
Upstream Filter(I)	1.00	1.00	1.00	1.00	1.00	1.00	1.00	1.00	1.00	1.00	1.00	1.00
Uniform Delay (d), s/veh	40.4	13.6	9.3	41.7	17.3	12.3	41.2	40.1	39.9	37.4	33.3	28.8
Incr Delay (d2), s/veh	1.3	0.3	0.0	1.5	1.2	0.2	2.0	0.8	1.0	1.4	0.3	0.3
Initial Q Delay(d3),s/veh	0.0	0.0	0.0	0.0	0.0	0.0	0.0	0.0	0.0	0.0	0.0	0.0
%ile BackOfQ(50%),veh/ln	1.6	6.3	0.3	0.4	9.5	2.7	0.7	0.6	0.4	2.4	0.8	1.2
Unsig. Movement Delay, s/veh												
LnGrp Delay(d),s/veh	41.7	13.9	9.3	43.2	18.5	12.5	43.2	40.9	40.8	38.8	33.6	29.1
LnGrp LOS	D	B	A	D	B	B	D	D	D	D	C	C
Approach Vol, veh/h		1888			2312			140			346	
Approach Delay, s/veh		16.1			18.3			42.0			36.3	
Approach LOS		B			B			D			D	
Timer - Assigned Phs	1	2	3	4	5	6	7	8				
Phs Duration (G+Y+Rc), s	7.3	54.7	8.1	18.5	10.1	51.9	15.8	10.8				
Change Period (Y+Rc), s	4.1	6.2	4.1	5.8	* 4.2	6.2	5.8	* 5.8				
Max Green Setting (Gmax), s	6.9	56.8	7.9	28.2	* 12	51.8	13.2	* 23				
Max Q Clear Time (g_c+I1), s	3.0	22.1	3.7	5.1	6.0	30.6	7.7	3.4				
Green Ext Time (p_c), s	0.0	15.3	0.0	0.3	0.1	15.1	0.3	0.3				

Intersection Summary

HCM 6th Ctrl Delay	19.5
HCM 6th LOS	B

Notes

* HCM 6th computational engine requires equal clearance times for the phases crossing the barrier.

Timings
20: Brown/San Gorgonio Dr & Alessandro Bl.

West Campus Upper Plateau (JN 14064)

09/30/2022



Lane Group	EBL	EBT	WBL	WBT	WBR	NBL	NBT	NBR	SBL	SBT	SBR
Lane Configurations	↖	↖↖↖	↖	↖↖↖	↖	↖	↖	↖	↖	↖	↖
Traffic Volume (vph)	39	1462	276	1673	41	251	5	266	48	5	44
Future Volume (vph)	39	1462	276	1673	41	251	5	266	48	5	44
Turn Type	Prot	NA	Prot	NA	Perm	Prot	NA	pm+ov	Prot	NA	pm+ov
Protected Phases	5	2	1	6		3	8	1	7	4	5
Permitted Phases					6			8			4
Detector Phase	5	2	1	6	6	3	8	1	7	4	5
Switch Phase											
Minimum Initial (s)	5.0	10.0	5.0	10.0	10.0	5.0	5.0	5.0	5.0	10.0	5.0
Minimum Split (s)	8.7	43.5	9.1	43.5	43.5	9.1	26.1	9.1	8.7	49.8	8.7
Total Split (s)	8.7	52.0	9.1	52.4	52.4	9.1	39.3	9.1	19.6	49.8	8.7
Total Split (%)	7.3%	43.3%	7.6%	43.7%	43.7%	7.6%	32.8%	7.6%	16.3%	41.5%	7.3%
Yellow Time (s)	3.2	5.5	3.6	5.5	5.5	3.6	3.6	3.6	3.2	4.8	3.2
All-Red Time (s)	0.5	1.0	0.5	1.0	1.0	0.5	0.5	0.5	0.5	1.0	0.5
Lost Time Adjust (s)	0.0	0.0	0.0	0.0	0.0	0.0	0.0	0.0	0.0	0.0	0.0
Total Lost Time (s)	3.7	6.5	4.1	6.5	6.5	4.1	4.1	4.1	3.7	5.8	3.7
Lead/Lag	Lead	Lag	Lead	Lag	Lag	Lead	Lag	Lead	Lead	Lag	Lead
Lead-Lag Optimize?	Yes	Yes	Yes	Yes	Yes	Yes	Yes	Yes	Yes	Yes	Yes
Recall Mode	None	None	None	None	None	None	None	None	None	None	None
Act Effct Green (s)	5.3	44.8	5.3	47.6	47.6	6.3	10.4	15.7	7.2	15.1	11.8
Actuated g/C Ratio	0.07	0.57	0.07	0.61	0.61	0.08	0.13	0.20	0.09	0.19	0.15
v/c Ratio	0.35	0.63	3.41	0.58	0.06	2.01	0.02	0.83	0.34	0.01	0.16
Control Delay	50.2	15.8	1133.6	14.7	0.1	504.4	29.0	40.4	44.7	25.6	3.5
Queue Delay	0.0	0.0	0.0	0.0	0.0	0.0	0.0	0.0	0.0	0.0	0.0
Total Delay	50.2	15.8	1133.6	14.7	0.1	504.4	29.0	40.4	44.7	25.6	3.5
LOS	D	B	F	B	A	F	C	D	D	C	A
Approach Delay		16.6		169.7			263.6			25.2	
Approach LOS		B		F			F			C	

Intersection Summary

Cycle Length: 120
 Actuated Cycle Length: 78.5
 Natural Cycle: 115
 Control Type: Actuated-Uncoordinated
 Maximum v/c Ratio: 3.41
 Intersection Signal Delay: 116.2
 Intersection Capacity Utilization 82.0%
 Analysis Period (min) 15
 Intersection LOS: F
 ICU Level of Service D

Splits and Phases: 20: Brown/San Gorgonio Dr & Alessandro Bl.

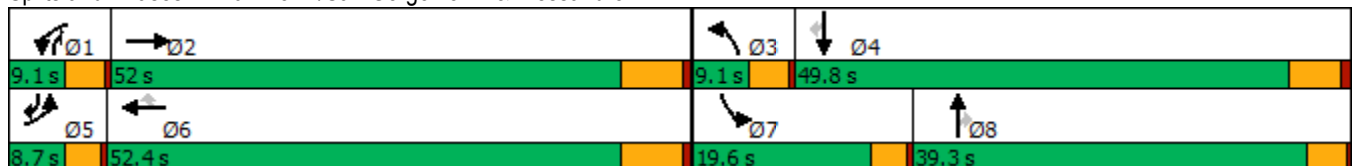

HCM 6th Signalized Intersection Summary
 20: Brown/San Gorgonio Dr & Alessandro Bl.

West Campus Upper Plateau (JN 14064)

09/30/2022



Movement	EBL	EBT	EBR	WBL	WBT	WBR	NBL	NBT	NBR	SBL	SBT	SBR
Lane Configurations	↖	↑↑↑		↖	↑↑↑	↖	↖	↑	↖	↖	↑	↖
Traffic Volume (veh/h)	39	1462	251	276	1673	41	251	5	266	48	5	44
Future Volume (veh/h)	39	1462	251	276	1673	41	251	5	266	48	5	44
Initial Q (Qb), veh	0	0	0	0	0	0	0	0	0	0	0	0
Ped-Bike Adj(A_pbT)	1.00		1.00	1.00		1.00	1.00		1.00	1.00		1.00
Parking Bus, Adj	1.00	1.00	1.00	1.00	1.00	1.00	1.00	1.00	1.00	1.00	1.00	1.00
Work Zone On Approach		No			No			No			No	
Adj Sat Flow, veh/h/ln	1900	1900	1900	1307	1885	1396	1796	1900	1322	1796	1900	1885
Adj Flow Rate, veh/h	42	1572	266	297	1799	40	270	5	273	52	5	-2
Peak Hour Factor	0.93	0.93	0.93	0.93	0.93	0.93	0.93	0.93	0.93	0.93	0.93	0.93
Percent Heavy Veh, %	0	0	0	40	1	34	7	0	39	7	0	1
Cap, veh/h	64	1985	335	65	2397	551	90	481	342	67	448	433
Arrive On Green	0.04	0.44	0.44	0.05	0.47	0.47	0.05	0.25	0.25	0.04	0.24	0.00
Sat Flow, veh/h	1810	4469	753	1245	5147	1183	1711	1900	1120	1711	1900	1598
Grp Volume(v), veh/h	42	1215	623	297	1799	40	270	5	273	52	5	-2
Grp Sat Flow(s),veh/h/ln	1810	1729	1764	1245	1716	1183	1711	1900	1120	1711	1900	1598
Q Serve(g_s), s	2.2	28.7	28.9	5.0	27.4	1.8	5.0	0.2	21.3	2.9	0.2	0.0
Cycle Q Clear(g_c), s	2.2	28.7	28.9	5.0	27.4	1.8	5.0	0.2	21.3	2.9	0.2	0.0
Prop In Lane	1.00		0.43	1.00		1.00	1.00		1.00	1.00		1.00
Lane Grp Cap(c), veh/h	64	1536	784	65	2397	551	90	481	342	67	448	433
V/C Ratio(X)	0.66	0.79	0.79	4.55	0.75	0.07	3.01	0.01	0.80	0.77	0.01	0.00
Avail Cap(c_a), veh/h	95	1652	843	65	2480	570	90	702	473	286	878	794
HCM Platoon Ratio	1.00	1.00	1.00	1.00	1.00	1.00	1.00	1.00	1.00	1.00	1.00	1.00
Upstream Filter(I)	1.00	1.00	1.00	1.00	1.00	1.00	1.00	1.00	1.00	1.00	1.00	0.00
Uniform Delay (d), s/veh	45.4	22.7	22.7	45.1	20.9	14.1	45.1	26.6	30.4	45.3	27.9	0.0
Incr Delay (d2), s/veh	4.3	2.7	5.4	1630.0	1.4	0.1	932.3	0.0	6.5	6.9	0.0	0.0
Initial Q Delay(d3),s/veh	0.0	0.0	0.0	0.0	0.0	0.0	0.0	0.0	0.0	0.0	0.0	0.0
%ile BackOfQ(50%),veh/ln	1.0	10.6	11.5	31.1	10.7	0.5	25.4	0.1	6.2	1.3	0.1	0.0
Unsig. Movement Delay, s/veh												
LnGrp Delay(d),s/veh	49.7	25.4	28.1	1675.1	22.3	14.1	977.4	26.7	36.9	52.3	27.9	0.0
LnGrp LOS	D	C	C	F	C	B	F	C	D	D	C	A
Approach Vol, veh/h		1880			2136			548			55	
Approach Delay, s/veh		26.8			251.9			500.2			52.0	
Approach LOS		C			F			F			D	
Timer - Assigned Phs	1	2	3	4	5	6	7	8				
Phs Duration (G+Y+Rc), s	9.1	48.8	9.1	28.2	7.1	50.9	7.4	29.9				
Change Period (Y+Rc), s	4.1	6.5	4.1	5.8	3.7	6.5	3.7	* 5.8				
Max Green Setting (Gmax), s	5.0	45.5	5.0	44.0	5.0	45.9	15.9	* 35				
Max Q Clear Time (g_c+I1), s	7.0	30.9	7.0	2.2	4.2	29.4	4.9	23.3				
Green Ext Time (p_c), s	0.0	11.4	0.0	0.0	0.0	13.6	0.0	0.8				

Intersection Summary

HCM 6th Ctrl Delay	187.4
HCM 6th LOS	F

Notes

* HCM 6th computational engine requires equal clearance times for the phases crossing the barrier.

Timings
21: Cactus Av. & Brown St



Lane Group	EBL	EBT	WBT	SBR
Lane Configurations	↖	↑↑	↑↑	↗
Traffic Volume (vph)	507	567	601	518
Future Volume (vph)	507	567	601	518
Turn Type	Prot	NA	NA	Perm
Protected Phases	7	4	8	
Permitted Phases				6
Detector Phase	7	4	8	6
Switch Phase				
Minimum Initial (s)	5.0	10.0	10.0	10.0
Minimum Split (s)	9.6	15.8	27.8	26.7
Total Split (s)	50.0	86.0	36.0	34.0
Total Split (%)	41.7%	71.7%	30.0%	28.3%
Yellow Time (s)	3.6	4.8	4.8	3.7
All-Red Time (s)	1.0	1.0	1.0	1.0
Lost Time Adjust (s)	0.0	0.0	0.0	0.0
Total Lost Time (s)	4.6	5.8	5.8	4.7
Lead/Lag	Lead		Lag	
Lead-Lag Optimize?	Yes		Yes	
Recall Mode	None	None	None	Min
Act Effct Green (s)	30.5	58.4	23.1	12.2
Actuated g/C Ratio	0.37	0.71	0.28	0.15
v/c Ratio	0.82	0.26	0.71	0.70
Control Delay	35.1	4.4	32.7	5.9
Queue Delay	0.0	0.0	0.0	0.0
Total Delay	35.1	4.4	32.7	5.9
LOS	D	A	C	A
Approach Delay		18.9	32.7	
Approach LOS		B	C	

Intersection Summary

Cycle Length: 120	
Actuated Cycle Length: 81.7	
Natural Cycle: 90	
Control Type: Actuated-Uncoordinated	
Maximum v/c Ratio: 0.82	
Intersection Signal Delay: 19.6	Intersection LOS: B
Intersection Capacity Utilization 57.4%	ICU Level of Service B
Analysis Period (min) 15	

Splits and Phases: 21: Cactus Av. & Brown St



HCM 6th Signalized Intersection Summary
21: Cactus Av. & Brown St

West Campus Upper Plateau (JN 14064)
09/30/2022



Movement	EBL	EBT	WBT	WBR	SBL	SBR	
Lane Configurations	↖	↑↑	↑↗		↙	↘	
Traffic Volume (veh/h)	507	567	601	0	0	518	
Future Volume (veh/h)	507	567	601	0	0	518	
Initial Q (Qb), veh	0	0	0	0	0	0	
Ped-Bike Adj(A_pbT)	1.00			1.00	1.00	1.00	
Parking Bus, Adj	1.00	1.00	1.00	1.00	1.00	1.00	
Work Zone On Approach		No	No		No		
Adj Sat Flow, veh/h/ln	1900	1737	1737	1900	1900	1900	
Adj Flow Rate, veh/h	551	616	653	0	0	405	
Peak Hour Factor	0.92	0.92	0.92	0.92	0.92	0.92	
Percent Heavy Veh, %	0	11	11	0	0	0	
Cap, veh/h	588	2029	794	0	494	439	
Arrive On Green	0.32	0.61	0.24	0.00	0.00	0.27	
Sat Flow, veh/h	1810	3387	3474	0	1810	1610	
Grp Volume(v), veh/h	551	616	653	0	0	405	
Grp Sat Flow(s),veh/h/ln	1810	1650	1650	0	1810	1610	
Q Serve(g_s), s	27.6	8.3	17.5	0.0	0.0	22.8	
Cycle Q Clear(g_c), s	27.6	8.3	17.5	0.0	0.0	22.8	
Prop In Lane	1.00			0.00	1.00	1.00	
Lane Grp Cap(c), veh/h	588	2029	794	0	494	439	
V/C Ratio(X)	0.94	0.30	0.82	0.00	0.00	0.92	
Avail Cap(c_a), veh/h	879	2833	1067	0	567	505	
HCM Platoon Ratio	1.00	1.00	1.00	1.00	1.00	1.00	
Upstream Filter(I)	1.00	1.00	1.00	0.00	0.00	1.00	
Uniform Delay (d), s/veh	30.6	8.5	33.6	0.0	0.0	33.0	
Incr Delay (d2), s/veh	10.4	0.1	3.9	0.0	0.0	21.0	
Initial Q Delay(d3),s/veh	0.0	0.0	0.0	0.0	0.0	0.0	
%ile BackOfQ(50%),veh/ln	12.8	2.5	7.0	0.0	0.0	2.6	
Unsig. Movement Delay, s/veh							
LnGrp Delay(d),s/veh	41.1	8.6	37.5	0.0	0.0	54.0	
LnGrp LOS	D	A	D	A	A	D	
Approach Vol, veh/h		1167	653		405		
Approach Delay, s/veh		23.9	37.5		54.0		
Approach LOS		C	D		D		
Timer - Assigned Phs				4	6	7	8
Phs Duration (G+Y+Rc), s				63.3	30.2	35.0	28.3
Change Period (Y+Rc), s				5.8	4.7	4.6	5.8
Max Green Setting (Gmax), s				80.2	29.3	45.4	30.2
Max Q Clear Time (g_c+11), s				10.3	24.8	29.6	19.5
Green Ext Time (p_c), s				4.3	0.6	0.7	3.0
Intersection Summary							
HCM 6th Ctrl Delay			33.4				
HCM 6th LOS			C				

Timings
22: Sycamore Canyon Bl. & Eastridge Ave

West Campus Upper Plateau (JN 14064)

09/30/2022



Lane Group	EBL	EBT	EBR	WBL	WBT	WBR	NBL	NBT	NBR	SBL	SBT	SBR
Lane Configurations	↖↖	↑↑↑	↗	↖↖	↑↑	↗	↖↖	↑↑	↗	↖↖	↑↑	↗
Traffic Volume (vph)	52	88	21	248	69	397	59	403	92	154	180	40
Future Volume (vph)	52	88	21	248	69	397	59	403	92	154	180	40
Turn Type	Prot	NA	Perm	Prot	NA	pm+ov	Prot	NA	pm+ov	Prot	NA	pm+ov
Protected Phases	5	2		1	6	7	3	8	1	7	4	5
Permitted Phases			2			6			8			4
Detector Phase	5	2	2	1	6	7	3	8	1	7	4	5
Switch Phase												
Minimum Initial (s)	5.0	10.0	10.0	5.0	10.0	5.0	5.0	10.0	5.0	5.0	10.0	5.0
Minimum Split (s)	8.7	43.5	43.5	8.7	43.5	8.7	8.7	15.8	8.7	8.7	49.8	8.7
Total Split (s)	11.7	45.5	45.5	15.2	49.0	20.2	8.7	39.1	15.2	20.2	50.6	11.7
Total Split (%)	9.8%	37.9%	37.9%	12.7%	40.8%	16.8%	7.3%	32.6%	12.7%	16.8%	42.2%	9.8%
Yellow Time (s)	3.2	5.5	5.5	3.2	5.5	3.2	3.2	4.8	3.2	3.2	4.8	3.2
All-Red Time (s)	0.5	1.0	1.0	0.5	1.0	0.5	0.5	1.0	0.5	0.5	1.0	0.5
Lost Time Adjust (s)	0.0	0.0	0.0	0.0	0.0	0.0	0.0	0.0	0.0	0.0	0.0	0.0
Total Lost Time (s)	3.7	6.5	6.5	3.7	6.5	3.7	3.7	5.8	3.7	3.7	5.8	3.7
Lead/Lag	Lead	Lag	Lag	Lead	Lag	Lead	Lead	Lag	Lead	Lead	Lag	Lead
Lead-Lag Optimize?	Yes	Yes	Yes	Yes	Yes	Yes	Yes	Yes	Yes	Yes	Yes	Yes
Recall Mode	None	None	None	None	None	None	None	None	None	None	None	None
Act Effct Green (s)	10.4	13.7	13.7	11.9	16.1	25.9	5.4	14.7	28.8	9.4	23.3	35.9
Actuated g/C Ratio	0.16	0.21	0.21	0.18	0.25	0.39	0.08	0.22	0.44	0.14	0.35	0.55
v/c Ratio	0.12	0.10	0.05	0.43	0.11	0.59	0.26	0.56	0.13	0.34	0.16	0.06
Control Delay	32.3	23.3	0.2	31.5	20.7	11.2	37.5	27.8	3.9	31.9	19.0	2.2
Queue Delay	0.0	0.0	0.0	0.0	0.0	0.0	0.0	0.0	0.0	0.0	0.0	0.0
Total Delay	32.3	23.3	0.2	31.5	20.7	11.2	37.5	27.8	3.9	31.9	19.0	2.2
LOS	C	C	A	C	C	B	D	C	A	C	B	A
Approach Delay		23.2			19.2			24.9			22.5	
Approach LOS		C			B			C			C	

Intersection Summary

Cycle Length: 120	
Actuated Cycle Length: 65.7	
Natural Cycle: 115	
Control Type: Actuated-Uncoordinated	
Maximum v/c Ratio: 0.59	
Intersection Signal Delay: 22.0	Intersection LOS: C
Intersection Capacity Utilization 51.5%	ICU Level of Service A
Analysis Period (min) 15	

Splits and Phases: 22: Sycamore Canyon Bl. & Eastridge Ave

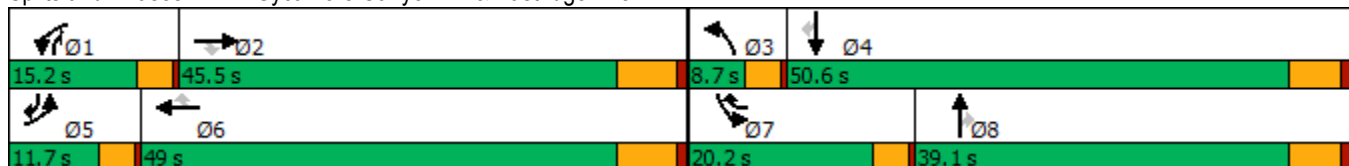

HCM 6th Signalized Intersection Summary
22: Sycamore Canyon Bl. & Eastridge Ave

West Campus Upper Plateau (JN 14064)

09/30/2022



Movement	EBL	EBT	EBR	WBL	WBT	WBR	NBL	NBT	NBR	SBL	SBT	SBR
Lane Configurations	↖↗	↑↑↑	↖	↖↗	↑↑	↖	↖↗	↑↑	↖	↖↗	↑↑	↖
Traffic Volume (veh/h)	52	88	21	248	69	397	59	403	92	154	180	40
Future Volume (veh/h)	52	88	21	248	69	397	59	403	92	154	180	40
Initial Q (Qb), veh	0	0	0	0	0	0	0	0	0	0	0	0
Ped-Bike Adj(A_pbT)	1.00		1.00	1.00		1.00	1.00		0.99	1.00		0.99
Parking Bus, Adj	1.00	1.00	1.00	1.00	1.00	1.00	1.00	1.00	1.00	1.00	1.00	1.00
Work Zone On Approach		No			No			No			No	
Adj Sat Flow, veh/h/ln	1648	1589	1826	1856	1396	1796	1618	1796	1826	1841	1826	1530
Adj Flow Rate, veh/h	55	93	0	261	73	245	62	424	43	162	189	38
Peak Hour Factor	0.95	0.95	0.95	0.95	0.95	0.95	0.95	0.95	0.95	0.95	0.95	0.95
Percent Heavy Veh, %	17	21	5	3	34	7	19	7	5	4	5	25
Cap, veh/h	162	881		391	701	536	172	702	491	301	821	371
Arrive On Green	0.05	0.20	0.00	0.11	0.26	0.26	0.06	0.21	0.21	0.09	0.24	0.24
Sat Flow, veh/h	3045	4337	1547	3428	2653	1521	2990	3413	1527	3401	3469	1278
Grp Volume(v), veh/h	55	93	0	261	73	245	62	424	43	162	189	38
Grp Sat Flow(s),veh/h/ln	1522	1446	1547	1714	1326	1521	1495	1706	1527	1700	1735	1278
Q Serve(g_s), s	0.9	0.9	0.0	3.7	1.1	6.3	1.0	5.7	1.0	2.3	2.2	1.1
Cycle Q Clear(g_c), s	0.9	0.9	0.0	3.7	1.1	6.3	1.0	5.7	1.0	2.3	2.2	1.1
Prop In Lane	1.00		1.00	1.00		1.00	1.00		1.00	1.00		1.00
Lane Grp Cap(c), veh/h	162	881		391	701	536	172	702	491	301	821	371
V/C Ratio(X)	0.34	0.11		0.67	0.10	0.46	0.36	0.60	0.09	0.54	0.23	0.10
Avail Cap(c_a), veh/h	480	3336		778	2223	1409	295	2241	1180	1107	3065	1198
HCM Platoon Ratio	1.00	1.00	1.00	1.00	1.00	1.00	1.00	1.00	1.00	1.00	1.00	1.00
Upstream Filter(I)	1.00	1.00	0.00	1.00	1.00	1.00	1.00	1.00	1.00	1.00	1.00	1.00
Uniform Delay (d), s/veh	23.1	16.5	0.0	21.5	14.1	12.7	23.0	18.3	12.1	22.1	15.6	13.2
Incr Delay (d2), s/veh	0.5	0.1	0.0	0.7	0.1	0.9	0.5	0.8	0.1	0.6	0.1	0.1
Initial Q Delay(d3),s/veh	0.0	0.0	0.0	0.0	0.0	0.0	0.0	0.0	0.0	0.0	0.0	0.0
%ile BackOfQ(50%),veh/ln	0.3	0.2	0.0	1.3	0.3	1.7	0.3	1.9	0.3	0.8	0.7	0.3
Unsig. Movement Delay, s/veh												
LnGrp Delay(d),s/veh	23.6	16.5	0.0	22.3	14.2	13.5	23.5	19.1	12.1	22.7	15.8	13.3
LnGrp LOS	C	B		C	B	B	C	B	B	C	B	B
Approach Vol, veh/h		148			579			529			389	
Approach Delay, s/veh		19.2			17.6			19.1			18.4	
Approach LOS		B			B			B			B	
Timer - Assigned Phs	1	2	3	4	5	6	7	8				
Phs Duration (G+Y+Rc), s	9.5	16.8	6.6	17.8	6.4	19.9	8.2	16.2				
Change Period (Y+Rc), s	3.7	6.5	3.7	5.8	3.7	6.5	3.7	5.8				
Max Green Setting (Gmax), s	11.5	39.0	5.0	44.8	8.0	42.5	16.5	33.3				
Max Q Clear Time (g_c+I1), s	5.7	2.9	3.0	4.2	2.9	8.3	4.3	7.7				
Green Ext Time (p_c), s	0.2	0.7	0.0	1.3	0.0	2.0	0.2	2.7				

Intersection Summary

HCM 6th Ctrl Delay	18.4
HCM 6th LOS	B

Notes

Unsignalized Delay for [EBR] is excluded from calculations of the approach delay and intersection delay.

Timings
23: Sycamore Canyon Bl. & Cottonwood Ave

West Campus Upper Plateau (JN 14064)

09/30/2022



Lane Group	WBL	WBR	NBT	SBL	SBT
Lane Configurations	↙	↗	↕	↙	↕
Traffic Volume (vph)	8	25	477	24	490
Future Volume (vph)	8	25	477	24	490
Turn Type	Prot	Perm	NA	Prot	NA
Protected Phases	8		2	1	6
Permitted Phases		8			
Detector Phase	8	8	2	1	6
Switch Phase					
Minimum Initial (s)	10.0	10.0	10.0	5.0	10.0
Minimum Split (s)	15.8	15.8	43.5	9.1	43.5
Total Split (s)	23.0	23.0	78.0	19.0	97.0
Total Split (%)	19.2%	19.2%	65.0%	15.8%	80.8%
Yellow Time (s)	4.8	4.8	5.5	3.6	5.5
All-Red Time (s)	1.0	1.0	1.0	0.5	1.0
Lost Time Adjust (s)	0.0	0.0	0.0	0.0	0.0
Total Lost Time (s)	5.8	5.8	6.5	4.1	6.5
Lead/Lag			Lag	Lead	
Lead-Lag Optimize?			Yes	Yes	
Recall Mode	None	None	None	None	None
Act Effct Green (s)	12.7	12.7	22.6	7.7	23.9
Actuated g/C Ratio	0.43	0.43	0.76	0.26	0.80
v/c Ratio	0.01	0.06	0.21	0.07	0.19
Control Delay	14.8	8.7	6.0	16.8	3.7
Queue Delay	0.0	0.0	0.0	0.0	0.0
Total Delay	14.8	8.7	6.0	16.8	3.7
LOS	B	A	A	B	A
Approach Delay	10.2		6.0		4.4
Approach LOS	B		A		A

Intersection Summary

Cycle Length: 120
 Actuated Cycle Length: 29.7
 Natural Cycle: 70
 Control Type: Actuated-Uncoordinated
 Maximum v/c Ratio: 0.21
 Intersection Signal Delay: 5.3
 Intersection LOS: A
 Intersection Capacity Utilization 38.5%
 ICU Level of Service A
 Analysis Period (min) 15

Splits and Phases: 23: Sycamore Canyon Bl. & Cottonwood Ave



HCM 6th Signalized Intersection Summary
 23: Sycamore Canyon Bl. & Cottonwood Ave

West Campus Upper Plateau (JN 14064)
 09/30/2022



Movement	WBL	WBR	NBT	NBR	SBL	SBT
Lane Configurations						
Traffic Volume (veh/h)	8	25	477	14	24	490
Future Volume (veh/h)	8	25	477	14	24	490
Initial Q (Qb), veh	0	0	0	0	0	0
Ped-Bike Adj(A_pbT)	1.00	1.00		0.98	1.00	
Parking Bus, Adj	1.00	1.00	1.00	1.00	1.00	1.00
Work Zone On Approach	No		No			No
Adj Sat Flow, veh/h/ln	1574	1070	1796	1752	1485	1870
Adj Flow Rate, veh/h	9	17	513	14	26	527
Peak Hour Factor	0.93	0.93	0.93	0.93	0.93	0.93
Percent Heavy Veh, %	22	56	7	10	28	2
Cap, veh/h	97	59	1177	32	46	1843
Arrive On Green	0.07	0.07	0.35	0.35	0.03	0.52
Sat Flow, veh/h	1499	907	3481	92	1414	3647
Grp Volume(v), veh/h	9	17	258	269	26	527
Grp Sat Flow(s),veh/h/ln	1499	907	1706	1777	1414	1777
Q Serve(g_s), s	0.2	0.5	3.4	3.4	0.5	2.5
Cycle Q Clear(g_c), s	0.2	0.5	3.4	3.4	0.5	2.5
Prop In Lane	1.00	1.00		0.05	1.00	
Lane Grp Cap(c), veh/h	97	59	592	617	46	1843
V/C Ratio(X)	0.09	0.29	0.44	0.44	0.57	0.29
Avail Cap(c_a), veh/h	873	528	4131	4302	713	10889
HCM Platoon Ratio	1.00	1.00	1.00	1.00	1.00	1.00
Upstream Filter(I)	1.00	1.00	1.00	1.00	1.00	1.00
Uniform Delay (d), s/veh	13.0	13.2	7.4	7.4	14.1	4.0
Incr Delay (d2), s/veh	0.4	2.6	0.7	0.7	10.4	0.1
Initial Q Delay(d3),s/veh	0.0	0.0	0.0	0.0	0.0	0.0
%ile BackOfQ(50%),veh/ln	0.1	0.1	0.7	0.7	0.2	0.1
Unsig. Movement Delay, s/veh						
LnGrp Delay(d),s/veh	13.4	15.8	8.1	8.1	24.5	4.1
LnGrp LOS	B	B	A	A	C	A
Approach Vol, veh/h	26		527			553
Approach Delay, s/veh	15.0		8.1			5.1
Approach LOS	B		A			A
Timer - Assigned Phs	1	2			6	8
Phs Duration (G+Y+Rc), s	5.1	16.8			21.8	7.7
Change Period (Y+Rc), s	4.1	6.5			6.5	5.8
Max Green Setting (Gmax), s	14.9	71.5			90.5	17.2
Max Q Clear Time (g_c+I1), s	2.5	5.4			4.5	2.5
Green Ext Time (p_c), s	0.0	4.8			5.4	0.0
Intersection Summary						
HCM 6th Ctrl Delay			6.8			
HCM 6th LOS			A			

Timings

West Campus Upper Plateau (JN 14064)

24: Sycamore Canyon Bl. & Alessandro Bl.

09/30/2022

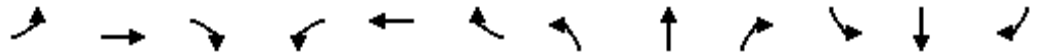

Lane Group	EBL	EBT	EBR	WBL	WBT	WBR	NBL	NBT	NBR	SBL	SBT	SBR
Lane Configurations	↖	↑↑↑	↗	↖↗	↑↑↑	↗	↖↗	↑↑	↖↗	↖↗	↑↑	↗
Traffic Volume (vph)	125	1484	121	98	1667	112	219	198	49	73	221	67
Future Volume (vph)	125	1484	121	98	1667	112	219	198	49	73	221	67
Turn Type	Prot	NA	Perm	Prot	NA	Perm	Prot	NA	pm+ov	Prot	NA	Perm
Protected Phases	5	2		1	6		3	8	1	7	4	
Permitted Phases			2			6			8			4
Detector Phase	5	2	2	1	6	6	3	8	1	7	4	4
Switch Phase												
Minimum Initial (s)	5.0	10.0	10.0	5.0	10.0	10.0	5.0	10.0	5.0	5.0	10.0	10.0
Minimum Split (s)	8.7	43.5	43.5	8.7	43.5	43.5	8.7	15.8	8.7	8.7	49.8	49.8
Total Split (s)	10.0	44.2	44.2	12.0	46.2	46.2	14.0	51.0	12.0	12.8	49.8	49.8
Total Split (%)	8.3%	36.8%	36.8%	10.0%	38.5%	38.5%	11.7%	42.5%	10.0%	10.7%	41.5%	41.5%
Yellow Time (s)	3.2	5.5	5.5	3.2	5.5	5.5	3.2	4.8	3.2	3.2	4.8	4.8
All-Red Time (s)	0.5	1.0	1.0	0.5	1.0	1.0	0.5	1.0	0.5	0.5	1.0	1.0
Lost Time Adjust (s)	0.0	0.0	0.0	0.0	0.0	0.0	0.0	0.0	0.0	0.0	0.0	0.0
Total Lost Time (s)	3.7	6.5	6.5	3.7	6.5	6.5	3.7	5.8	3.7	3.7	5.8	5.8
Lead/Lag	Lead	Lag	Lag	Lead	Lag	Lag	Lead	Lag	Lead	Lead	Lag	Lag
Lead-Lag Optimize?	Yes	Yes	Yes	Yes	Yes	Yes	Yes	Yes	Yes	Yes	Yes	Yes
Recall Mode	None	None	None	None	None	None	None	None	None	None	None	None
Act Effct Green (s)	6.4	39.7	39.7	7.1	40.4	40.4	9.7	21.2	34.2	6.6	16.2	16.2
Actuated g/C Ratio	0.07	0.43	0.43	0.08	0.44	0.44	0.10	0.23	0.37	0.07	0.17	0.17
v/c Ratio	1.06	0.71	0.17	0.43	0.78	0.17	0.64	0.26	0.05	0.32	0.39	0.20
Control Delay	143.2	26.2	8.6	49.2	27.4	7.7	50.7	30.1	3.2	47.5	34.5	3.5
Queue Delay	0.0	0.0	0.0	0.0	0.0	0.0	0.0	0.0	0.0	0.0	0.0	0.0
Total Delay	143.2	26.2	8.6	49.2	27.4	7.7	50.7	30.1	3.2	47.5	34.5	3.5
LOS	F	C	A	D	C	A	D	C	A	D	C	A
Approach Delay		33.5			27.4			36.9			31.4	
Approach LOS		C			C			D			C	

Intersection Summary

Cycle Length: 120
 Actuated Cycle Length: 92.8
 Natural Cycle: 115
 Control Type: Actuated-Uncoordinated
 Maximum v/c Ratio: 1.06
 Intersection Signal Delay: 31.1
 Intersection LOS: C
 Intersection Capacity Utilization 70.6%
 ICU Level of Service C
 Analysis Period (min) 15



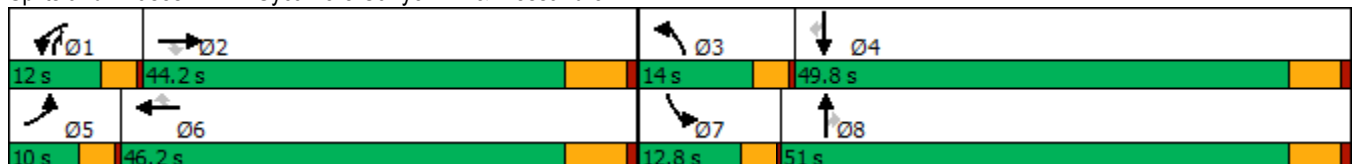































Splits and Phases: 24: Sycamore Canyon Bl. & Alessandro Bl.



HCM 6th Signalized Intersection Summary
 24: Sycamore Canyon Bl. & Alessandro Bl.

West Campus Upper Plateau (JN 14064)

09/30/2022

												
Movement	EBL	EBT	EBR	WBL	WBT	WBR	NBL	NBT	NBR	SBL	SBT	SBR
Lane Configurations		  		 	  		 	 	 	 	 	
Traffic Volume (veh/h)	125	1484	121	98	1667	112	219	198	49	73	221	67
Future Volume (veh/h)	125	1484	121	98	1667	112	219	198	49	73	221	67
Initial Q (Qb), veh	0	0	0	0	0	0	0	0	0	0	0	0
Ped-Bike Adj(A_pbT)	1.00		1.00	1.00		1.00	1.00		1.00	1.00		1.00
Parking Bus, Adj	1.00	1.00	1.00	1.00	1.00	1.00	1.00	1.00	1.00	1.00	1.00	1.00
Work Zone On Approach		No			No			No			No	
Adj Sat Flow, veh/h/ln	1900	1885	1885	1737	1885	1781	1870	1841	1841	1826	1826	1870
Adj Flow Rate, veh/h	132	1562	-70	103	1755	-17	231	208	9	77	233	-24
Peak Hour Factor	0.95	0.95	0.95	0.95	0.95	0.95	0.95	0.95	0.95	0.95	0.95	0.95
Percent Heavy Veh, %	0	1	1	11	1	8	2	4	4	5	5	2
Cap, veh/h	143	2467	766	181	2350	689	315	579	609	173	436	199
Arrive On Green	0.08	0.48	0.00	0.06	0.46	0.00	0.09	0.17	0.17	0.05	0.13	0.00
Sat Flow, veh/h	1810	5147	1598	3209	5147	1510	3456	3497	2745	3374	3469	1585
Grp Volume(v), veh/h	132	1562	-70	103	1755	-17	231	208	9	77	233	-24
Grp Sat Flow(s),veh/h/ln	1810	1716	1598	1605	1716	1510	1728	1749	1373	1687	1735	1585
Q Serve(g_s), s	5.8	18.1	0.0	2.5	22.4	0.0	5.2	4.2	0.2	1.8	5.0	0.0
Cycle Q Clear(g_c), s	5.8	18.1	0.0	2.5	22.4	0.0	5.2	4.2	0.2	1.8	5.0	0.0
Prop In Lane	1.00		1.00	1.00		1.00	1.00		1.00	1.00		1.00
Lane Grp Cap(c), veh/h	143	2467	766	181	2350	689	315	579	609	173	436	199
V/C Ratio(X)	0.92	0.63	-0.09	0.57	0.75	-0.02	0.73	0.36	0.01	0.44	0.53	-0.12
Avail Cap(c_a), veh/h	143	2467	766	335	2566	753	447	1985	1713	386	1917	876
HCM Platoon Ratio	1.00	1.00	1.00	1.00	1.00	1.00	1.00	1.00	1.00	1.00	1.00	1.00
Upstream Filter(I)	1.00	1.00	0.00	1.00	1.00	0.00	1.00	1.00	1.00	1.00	1.00	0.00
Uniform Delay (d), s/veh	36.4	15.5	0.0	36.6	17.8	0.0	35.2	29.5	24.2	36.7	32.6	0.0
Incr Delay (d2), s/veh	51.5	0.6	0.0	1.1	1.3	0.0	1.7	0.4	0.0	0.7	1.0	0.0
Initial Q Delay(d3),s/veh	0.0	0.0	0.0	0.0	0.0	0.0	0.0	0.0	0.0	0.0	0.0	0.0
%ile BackOfQ(50%),veh/ln	4.4	6.1	0.0	0.9	7.8	0.0	2.1	1.7	0.1	0.7	2.0	0.0
Unsig. Movement Delay, s/veh												
LnGrp Delay(d),s/veh	88.0	16.1	0.0	37.7	19.1	0.0	36.9	29.9	24.2	37.3	33.7	0.0
LnGrp LOS	F	B	A	D	B	A	D	C	C	D	C	A
Approach Vol, veh/h		1624			1841			448			286	
Approach Delay, s/veh		22.6			20.3			33.4			37.5	
Approach LOS		C			C			C			D	
Timer - Assigned Phs	1	2	3	4	5	6	7	8				
Phs Duration (G+Y+Rc), s	8.2	44.7	11.0	15.8	10.0	42.9	7.8	19.0				
Change Period (Y+Rc), s	3.7	6.5	3.7	5.8	3.7	6.5	3.7	5.8				
Max Green Setting (Gmax), s	8.3	37.7	10.3	44.0	6.3	39.7	9.1	45.2				
Max Q Clear Time (g_c+1), s	4.5	20.1	7.2	7.0	7.8	24.4	3.8	6.2				
Green Ext Time (p_c), s	0.0	12.3	0.1	1.4	0.0	12.0	0.0	1.3				
Intersection Summary												
HCM 6th Ctrl Delay				23.8								
HCM 6th LOS				C								

Timings
25: Sycamore Canyon Bl. & Cactus Av.

West Campus Upper Plateau (JN 14064)

09/30/2022



Lane Group	EBL	EBT	EBR	WBL	WBT	WBR	NBL	NBT	NBR	SBL	SBT	SBR
Lane Configurations	↘	↑↑	↗	↘↗	↑↑	↗	↘↗	↑↑	↗	↘↗	↑↑	↗
Traffic Volume (vph)	68	441	199	232	470	285	207	200	140	139	260	57
Future Volume (vph)	68	441	199	232	470	285	207	200	140	139	260	57
Turn Type	Prot	NA	Perm	Prot	NA	Perm	Prot	NA	Perm	Prot	NA	Perm
Protected Phases	7	4		3	8		5	2		1	6	
Permitted Phases			4			8			2			6
Detector Phase	7	4	4	3	8	8	5	2	2	1	6	6
Switch Phase												
Minimum Initial (s)	5.0	10.0	10.0	5.0	10.0	10.0	5.0	10.0	10.0	5.0	10.0	10.0
Minimum Split (s)	9.6	32.8	32.8	9.6	32.8	32.8	9.6	34.8	34.8	9.6	34.8	34.8
Total Split (s)	10.3	32.8	32.8	29.0	51.5	51.5	9.6	36.2	36.2	22.0	48.6	48.6
Total Split (%)	8.6%	27.3%	27.3%	24.2%	42.9%	42.9%	8.0%	30.2%	30.2%	18.3%	40.5%	40.5%
Yellow Time (s)	3.6	4.8	4.8	3.6	4.8	4.8	3.6	4.8	4.8	3.6	4.8	4.8
All-Red Time (s)	1.0	1.0	1.0	1.0	1.0	1.0	1.0	1.0	1.0	1.0	1.0	1.0
Lost Time Adjust (s)	0.0	0.0	0.0	0.0	0.0	0.0	0.0	0.0	0.0	0.0	0.0	0.0
Total Lost Time (s)	4.6	5.8	5.8	4.6	5.8	5.8	4.6	5.8	5.8	4.6	5.8	5.8
Lead/Lag	Lead	Lag	Lag	Lead	Lag	Lag	Lead	Lag	Lag	Lead	Lag	Lag
Lead-Lag Optimize?	Yes	Yes	Yes	Yes	Yes	Yes	Yes	Yes	Yes	Yes	Yes	Yes
Recall Mode	None	None	None	None	None	None	None	None	None	None	None	None
Act Effct Green (s)	6.0	17.1	17.1	10.2	21.3	21.3	5.3	13.4	13.4	7.9	16.0	16.0
Actuated g/C Ratio	0.09	0.24	0.24	0.14	0.30	0.30	0.08	0.19	0.19	0.11	0.23	0.23
v/c Ratio	0.49	0.60	0.40	0.50	0.48	0.43	0.83	0.32	0.33	0.37	0.35	0.17
Control Delay	49.8	28.4	6.7	34.2	21.9	4.9	63.0	27.3	3.8	35.5	24.6	1.1
Queue Delay	0.0	0.0	0.0	0.0	0.0	0.0	0.0	0.0	0.0	0.0	0.0	0.0
Total Delay	49.8	28.4	6.7	34.2	21.9	4.9	63.0	27.3	3.8	35.5	24.6	1.1
LOS	D	C	A	C	C	A	E	C	A	D	C	A
Approach Delay		24.4			19.9			34.8			25.0	
Approach LOS		C			B			C			C	

Intersection Summary

Cycle Length: 120
 Actuated Cycle Length: 70.4
 Natural Cycle: 90
 Control Type: Actuated-Uncoordinated
 Maximum v/c Ratio: 0.83
 Intersection Signal Delay: 24.9
 Intersection LOS: C
 Intersection Capacity Utilization 50.4%
 ICU Level of Service A
 Analysis Period (min) 15



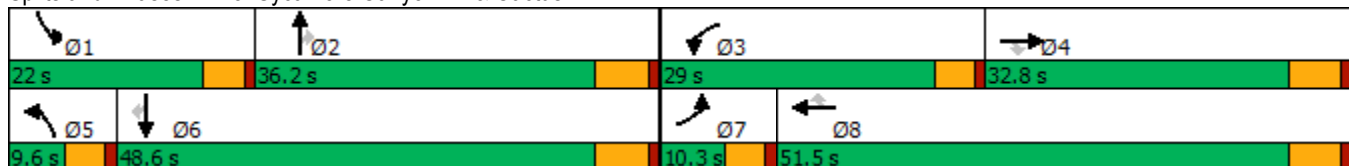





















Splits and Phases: 25: Sycamore Canyon Bl. & Cactus Av.



HCM 6th Signalized Intersection Summary
25: Sycamore Canyon Bl. & Cactus Av.

West Campus Upper Plateau (JN 14064)

09/30/2022

												
Movement	EBL	EBT	EBR	WBL	WBT	WBR	NBL	NBT	NBR	SBL	SBT	SBR
Lane Configurations												
Traffic Volume (veh/h)	68	441	199	232	470	285	207	200	140	139	260	57
Future Volume (veh/h)	68	441	199	232	470	285	207	200	140	139	260	57
Initial Q (Qb), veh	0	0	0	0	0	0	0	0	0	0	0	0
Ped-Bike Adj(A_pbT)	1.00		1.00	1.00		1.00	1.00		1.00	1.00		1.00
Parking Bus, Adj	1.00	1.00	1.00	1.00	1.00	1.00	1.00	1.00	1.00	1.00	1.00	1.00
Work Zone On Approach		No			No			No			No	
Adj Sat Flow, veh/h/ln	1811	1678	1796	1826	1796	1870	1900	1811	1781	1885	1796	1011
Adj Flow Rate, veh/h	71	459	198	242	490	55	216	208	53	145	271	59
Peak Hour Factor	0.96	0.96	0.96	0.96	0.96	0.96	0.96	0.96	0.96	0.96	0.96	0.96
Percent Heavy Veh, %	6	15	7	5	7	2	0	6	8	1	7	60
Cap, veh/h	105	728	348	370	948	440	324	672	295	285	631	158
Arrive On Green	0.06	0.23	0.23	0.11	0.28	0.28	0.09	0.20	0.20	0.08	0.18	0.18
Sat Flow, veh/h	1725	3188	1522	3374	3413	1585	3510	3441	1510	3483	3413	857
Grp Volume(v), veh/h	71	459	198	242	490	55	216	208	53	145	271	59
Grp Sat Flow(s),veh/h/ln	1725	1594	1522	1687	1706	1585	1755	1721	1510	1742	1706	857
Q Serve(g_s), s	2.2	7.0	6.2	3.7	6.6	1.4	3.2	2.8	1.6	2.2	3.8	3.3
Cycle Q Clear(g_c), s	2.2	7.0	6.2	3.7	6.6	1.4	3.2	2.8	1.6	2.2	3.8	3.3
Prop In Lane	1.00		1.00	1.00		1.00	1.00		1.00	1.00		1.00
Lane Grp Cap(c), veh/h	105	728	348	370	948	440	324	672	295	285	631	158
V/C Ratio(X)	0.68	0.63	0.57	0.65	0.52	0.12	0.67	0.31	0.18	0.51	0.43	0.37
Avail Cap(c_a), veh/h	182	1591	760	1521	2883	1339	324	1933	848	1120	2700	678
HCM Platoon Ratio	1.00	1.00	1.00	1.00	1.00	1.00	1.00	1.00	1.00	1.00	1.00	1.00
Upstream Filter(I)	1.00	1.00	1.00	1.00	1.00	1.00	1.00	1.00	1.00	1.00	1.00	1.00
Uniform Delay (d), s/veh	24.9	18.8	18.5	23.1	16.5	14.6	23.7	18.6	18.2	23.8	19.5	19.3
Incr Delay (d2), s/veh	2.9	0.9	1.5	0.7	0.4	0.1	4.1	0.3	0.3	0.5	0.5	1.5
Initial Q Delay(d3),s/veh	0.0	0.0	0.0	0.0	0.0	0.0	0.0	0.0	0.0	0.0	0.0	0.0
%ile BackOfQ(50%),veh/ln	0.9	2.3	2.0	1.3	2.1	0.4	1.3	1.0	0.5	0.8	1.3	0.6
Unsig. Movement Delay, s/veh												
LnGrp Delay(d),s/veh	27.8	19.7	20.0	23.8	16.9	14.7	27.9	18.9	18.4	24.3	20.0	20.8
LnGrp LOS	C	B	B	C	B	B	C	B	B	C	B	C
Approach Vol, veh/h		728			787			477			475	
Approach Delay, s/veh		20.6			18.9			22.9			21.4	
Approach LOS		C			B			C			C	
Timer - Assigned Phs	1	2	3	4	5	6	7	8				
Phs Duration (G+Y+Rc), s	9.0	16.4	10.5	18.2	9.6	15.8	7.9	20.8				
Change Period (Y+Rc), s	4.6	5.8	4.6	5.8	4.6	5.8	4.6	5.8				
Max Green Setting (Gmax), s	17.4	30.4	24.4	27.0	5.0	42.8	5.7	45.7				
Max Q Clear Time (g_c+I1), s	4.2	4.8	5.7	9.0	5.2	5.8	4.2	8.6				
Green Ext Time (p_c), s	0.2	1.3	0.4	3.3	0.0	1.9	0.0	3.4				
Intersection Summary												
HCM 6th Ctrl Delay				20.6								
HCM 6th LOS				C								

Timings

West Campus Upper Plateau (JN 14064)

26: Sycamore Canyon Bl. & Van Buren Bl.

09/30/2022



Lane Group	EBL	EBT	EBR	WBL	WBT	WBR	NBL	NBT	SBL	SBT	SBR
Lane Configurations											
Traffic Volume (vph)	348	1633	7	40	1747	85	8	7	116	11	584
Future Volume (vph)	348	1633	7	40	1747	85	8	7	116	11	584
Turn Type	Prot	NA	Perm	Prot	NA	Perm	Perm	NA	Split	NA	Perm
Protected Phases	5	2		1	6			8	4	4	
Permitted Phases			2			6	8				4
Detector Phase	5	2	2	1	6	6	8	8	4	4	4
Switch Phase											
Minimum Initial (s)	5.0	10.0	10.0	5.0	10.0	10.0	10.0	10.0	10.0	10.0	10.0
Minimum Split (s)	9.6	29.2	29.2	9.6	29.2	29.2	14.6	14.6	50.8	50.8	50.8
Total Split (s)	22.0	47.8	47.8	9.6	35.4	35.4	14.6	14.6	58.0	58.0	58.0
Total Split (%)	16.9%	36.8%	36.8%	7.4%	27.2%	27.2%	11.2%	11.2%	44.6%	44.6%	44.6%
Yellow Time (s)	3.6	5.2	5.2	3.6	5.2	5.2	3.6	3.6	4.8	4.8	4.8
All-Red Time (s)	1.0	1.0	1.0	1.0	1.0	1.0	1.0	1.0	1.0	1.0	1.0
Lost Time Adjust (s)	0.0	0.0	0.0	0.0	0.0	0.0		0.0	0.0	0.0	0.0
Total Lost Time (s)	4.6	6.2	6.2	4.6	6.2	6.2		4.6	5.8	5.8	5.8
Lead/Lag	Lead	Lag	Lag	Lead	Lag	Lag					
Lead-Lag Optimize?	Yes	Yes	Yes	Yes	Yes	Yes					
Recall Mode	None	None	None	None	None	None	None	None	None	None	None
Act Effct Green (s)	14.7	43.0	43.0	5.3	30.9	30.9		10.6	22.2	22.2	22.2
Actuated g/C Ratio	0.16	0.46	0.46	0.06	0.33	0.33		0.11	0.24	0.24	0.24
v/c Ratio	0.70	0.60	0.01	0.47	0.91	0.15		0.11	0.15	0.03	0.86
Control Delay	47.9	24.0	0.0	67.7	40.6	1.8		27.6	28.2	27.2	22.3
Queue Delay	0.0	0.0	0.0	0.0	0.0	0.0		0.0	0.0	0.0	0.0
Total Delay	47.9	24.0	0.0	67.7	40.6	1.8		27.6	28.2	27.2	22.3
LOS	D	C	A	E	D	A		C	C	C	C
Approach Delay		28.1			39.4			27.6		23.3	
Approach LOS		C			D			C		C	

Intersection Summary

Cycle Length: 130	
Actuated Cycle Length: 92.8	
Natural Cycle: 115	
Control Type: Actuated-Uncoordinated	
Maximum v/c Ratio: 0.91	
Intersection Signal Delay: 32.0	Intersection LOS: C
Intersection Capacity Utilization 83.6%	ICU Level of Service E
Analysis Period (min) 15	

Splits and Phases: 26: Sycamore Canyon Bl. & Van Buren Bl.

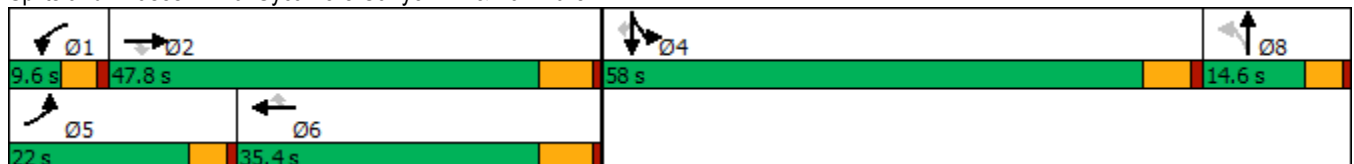

HCM 6th Signalized Intersection Summary
26: Sycamore Canyon Bl. & Van Buren Bl.

West Campus Upper Plateau (JN 14064)

09/30/2022



Movement	EBL	EBT	EBR	WBL	WBT	WBR	NBL	NBT	NBR	SBL	SBT	SBR
Lane Configurations												
Traffic Volume (veh/h)	348	1633	7	40	1747	85	8	7	22	116	11	584
Future Volume (veh/h)	348	1633	7	40	1747	85	8	7	22	116	11	584
Initial Q (Qb), veh	0	0	0	0	0	0	0	0	0	0	0	0
Ped-Bike Adj(A_pbT)	1.00		1.00	1.00		0.99	1.00		1.00	1.00		1.00
Parking Bus, Adj	1.00	1.00	1.00	1.00	1.00	1.00	1.00	1.00	1.00	1.00	1.00	1.00
Work Zone On Approach		No			No			No			No	
Adj Sat Flow, veh/h/ln	1811	1826	1900	1693	1796	1870	1900	1900	1900	1841	1900	1841
Adj Flow Rate, veh/h	366	1719	7	42	1839	67	8	7	-6	122	12	0
Peak Hour Factor	0.95	0.95	0.95	0.95	0.95	0.95	0.95	0.95	0.95	0.95	0.95	0.95
Percent Heavy Veh, %	6	5	0	14	7	2	0	0	0	4	0	4
Cap, veh/h	472	3103	795	65	2428	615	139	449	0	457	255	
Arrive On Green	0.14	0.49	0.49	0.04	0.39	0.39	0.02	0.02	0.00	0.13	0.13	0.00
Sat Flow, veh/h	3346	6281	1610	1612	6179	1565	1801	1909	0	3401	1900	1560
Grp Volume(v), veh/h	366	1719	7	42	1839	67	8	1	0	122	12	0
Grp Sat Flow(s),veh/h/ln	1673	1570	1610	1612	1545	1565	1810	1805	0	1700	1900	1560
Q Serve(g_s), s	7.2	13.1	0.2	1.8	17.7	1.9	0.0	0.0	0.0	2.2	0.4	0.0
Cycle Q Clear(g_c), s	7.2	13.1	0.2	1.8	17.7	1.9	0.0	0.0	0.0	2.2	0.4	0.0
Prop In Lane	1.00		1.00	1.00		1.00	0.99		0.00	1.00		1.00
Lane Grp Cap(c), veh/h	472	3103	795	65	2428	615	0	0	0	457	255	
V/C Ratio(X)	0.77	0.55	0.01	0.65	0.76	0.11	0.00	0.00	0.00	0.27	0.05	
Avail Cap(c_a), veh/h	848	3804	975	117	2627	665	0	0	0	2585	1444	
HCM Platoon Ratio	1.00	1.00	1.00	1.00	1.00	1.00	1.00	1.00	1.00	1.00	1.00	1.00
Upstream Filter(I)	1.00	1.00	1.00	1.00	1.00	1.00	1.00	1.00	0.00	1.00	1.00	0.00
Uniform Delay (d), s/veh	28.4	12.1	8.8	32.5	18.0	13.2	0.0	0.0	0.0	26.7	25.9	0.0
Incr Delay (d2), s/veh	1.0	0.2	0.0	4.0	1.2	0.1	0.0	0.0	0.0	0.3	0.1	0.0
Initial Q Delay(d3),s/veh	0.0	0.0	0.0	0.0	0.0	0.0	0.0	0.0	0.0	0.0	0.0	0.0
%ile BackOfQ(50%),veh/ln	2.7	3.6	0.0	0.7	5.5	0.6	0.0	0.0	0.0	0.8	0.2	0.0
Unsig. Movement Delay, s/veh												
LnGrp Delay(d),s/veh	29.5	12.3	8.8	36.5	19.2	13.3	0.0	0.0	0.0	27.0	26.0	0.0
LnGrp LOS	C	B	A	D	B	B	A	A	A	C	C	
Approach Vol, veh/h		2092			1948			9			134	
Approach Delay, s/veh		15.3			19.4			0.0			26.9	
Approach LOS		B			B			A			C	
Timer - Assigned Phs	1	2		4	5	6		8				
Phs Duration (G+Y+Rc), s	7.4	40.1		15.0	14.3	33.2		6.2				
Change Period (Y+Rc), s	4.6	6.2		5.8	4.6	6.2		4.6				
Max Green Setting (Gmax), s	5.0	41.6		52.2	17.4	29.2		10.0				
Max Q Clear Time (g_c+1), s	3.8	15.1		4.2	9.2	19.7		2.0				
Green Ext Time (p_c), s	0.0	14.1		0.5	0.5	7.3		0.0				

Intersection Summary

HCM 6th Ctrl Delay	17.5
HCM 6th LOS	B

Notes

Unsignalized Delay for [SBR] is excluded from calculations of the approach delay and intersection delay.

Timings
27: Innovation Dr. & Cactus Av.

West Campus Upper Plateau (JN 14064)

09/30/2022

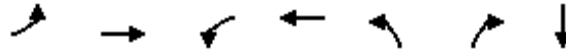

Lane Group	EBL	EBT	WBL	WBT	NBL	NBR	SBT
Lane Configurations	↖	↖↖↖	↖	↖↖↖	↖	↖	↖
Traffic Volume (vph)	1	769	27	1322	1	25	0
Future Volume (vph)	1	769	27	1322	1	25	0
Turn Type	Prot	NA	Prot	NA	Perm	Perm	NA
Protected Phases	5	2	1	6			4
Permitted Phases					8	8	
Detector Phase	5	2	1	6	8	8	4
Switch Phase							
Minimum Initial (s)	5.0	10.0	5.0	10.0	10.0	10.0	10.0
Minimum Split (s)	9.2	26.8	9.2	26.8	31.1	31.1	31.1
Total Split (s)	12.0	63.0	22.0	73.0	35.0	35.0	35.0
Total Split (%)	10.0%	52.5%	18.3%	60.8%	29.2%	29.2%	29.2%
Yellow Time (s)	3.2	4.8	3.2	4.8	4.1	4.1	4.1
All-Red Time (s)	1.0	1.0	1.0	1.0	1.0	1.0	1.0
Lost Time Adjust (s)	0.0	0.0	0.0	0.0	0.0	0.0	0.0
Total Lost Time (s)	4.2	5.8	4.2	5.8	5.1	5.1	5.1
Lead/Lag	Lead	Lag	Lead	Lag			
Lead-Lag Optimize?	Yes	Yes	Yes	Yes			
Recall Mode	None	None	None	None	None	None	None
Act Effect Green (s)	6.6	38.2	7.4	40.5	14.7	14.7	14.7
Actuated g/C Ratio	0.14	0.79	0.15	0.83	0.30	0.30	0.30
v/c Ratio	0.00	0.23	0.13	0.36	0.00	0.04	0.00
Control Delay	36.0	7.0	31.1	5.6	24.0	0.1	0.0
Queue Delay	0.0	0.0	0.0	0.0	0.0	0.0	0.0
Total Delay	36.0	7.0	31.1	5.6	24.0	0.1	0.0
LOS	D	A	C	A	C	A	A
Approach Delay		7.0		6.2			
Approach LOS		A		A			

Intersection Summary

Cycle Length: 120
 Actuated Cycle Length: 48.6
 Natural Cycle: 70
 Control Type: Actuated-Uncoordinated
 Maximum v/c Ratio: 0.36
 Intersection Signal Delay: 6.4
 Intersection Capacity Utilization 43.1%
 Analysis Period (min) 15
 Intersection LOS: A
 ICU Level of Service A

Splits and Phases: 27: Innovation Dr. & Cactus Av.



HCM 6th Signalized Intersection Summary
27: Innovation Dr. & Cactus Av.

West Campus Upper Plateau (JN 14064)

09/30/2022



Movement	EBL	EBT	EBR	WBL	WBT	WBR	NBL	NBT	NBR	SBL	SBT	SBR
Lane Configurations	↗	↑↑↑		↖	↑↑↑		↖	↑	↗	↖	↑	↗
Traffic Volume (veh/h)	1	769	1	27	1322	5	1	0	25	0	0	1
Future Volume (veh/h)	1	769	1	27	1322	5	1	0	25	0	0	1
Initial Q (Qb), veh	0	0	0	0	0	0	0	0	0	0	0	0
Ped-Bike Adj(A_pbT)	1.00		1.00	1.00		0.98	1.00		1.00	1.00		1.00
Parking Bus, Adj	1.00	1.00	1.00	1.00	1.00	1.00	1.00	1.00	1.00	1.00	1.00	1.00
Work Zone On Approach		No			No			No			No	
Adj Sat Flow, veh/h/ln	1900	1826	1307	1663	1841	1900	1841	1900	1781	1900	1900	1781
Adj Flow Rate, veh/h	1	874	1	31	1502	6	1	0	-25	0	0	-8
Peak Hour Factor	0.88	0.88	0.88	0.88	0.88	0.88	0.88	0.88	0.88	0.88	0.88	0.88
Percent Heavy Veh, %	0	5	40	16	4	0	4	0	8	0	0	8
Cap, veh/h	5	3538	4	58	3736	15	182	5	4	182	0	401
Arrive On Green	0.00	0.69	0.69	0.04	0.72	0.72	0.00	0.00	0.00	0.00	0.00	0.00
Sat Flow, veh/h	1810	5142	6	1584	5166	21	1753	1900	1510	1810	1900	0
Grp Volume(v), veh/h	1	565	310	31	974	534	1	0	-25	0	-8	-8
Grp Sat Flow(s),veh/h/ln	1810	1662	1825	1584	1675	1836	1753	1900	1510	1810	1900	1610
Q Serve(g_s), s	0.0	2.5	2.5	0.8	4.5	4.5	0.0	0.0	0.0	0.0	0.0	0.0
Cycle Q Clear(g_c), s	0.0	2.5	2.5	0.8	4.5	4.5	0.1	0.0	0.0	0.0	0.0	0.0
Prop In Lane	1.00		0.00	1.00		0.01	1.00		1.00	1.00		0.00
Lane Grp Cap(c), veh/h	5	2287	1256	58	2423	1328	182	5	4	182	0	0
V/C Ratio(X)	0.22	0.25	0.25	0.54	0.40	0.40	0.01	0.00	-6.55	0.00	0.00	0.00
Avail Cap(c_a), veh/h	357	4808	2640	713	5694	3121	1695	1437	1142	1743	0	0
HCM Platoon Ratio	1.00	1.00	1.00	1.00	1.00	1.00	1.00	1.00	1.00	1.00	1.00	1.00
Upstream Filter(I)	1.00	1.00	1.00	1.00	1.00	1.00	1.00	0.00	0.00	0.00	0.00	0.00
Uniform Delay (d), s/veh	19.7	2.3	2.3	18.7	2.1	2.1	19.8	0.0	0.0	0.0	0.0	0.0
Incr Delay (d2), s/veh	8.6	0.1	0.1	2.9	0.2	0.3	0.0	0.0	0.0	0.0	0.0	0.0
Initial Q Delay(d3),s/veh	0.0	0.0	0.0	0.0	0.0	0.0	0.0	0.0	0.0	0.0	0.0	0.0
%ile BackOfQ(50%),veh/ln	0.0	0.0	0.1	0.3	0.1	0.1	0.0	0.0	0.0	0.0	0.0	0.0
Unsig. Movement Delay, s/veh												
LnGrp Delay(d),s/veh	28.3	2.4	2.5	21.6	2.3	2.4	19.8	0.0	0.0	0.0	0.0	0.0
LnGrp LOS	C	A	A	C	A	A	B	A	A	A	A	A
Approach Vol, veh/h		876			1539			-24				-16
Approach Delay, s/veh		2.4			2.7			0.0				0.0
Approach LOS		A			A			A				A
Timer - Assigned Phs	1	2		4	5	6		8				
Phs Duration (G+Y+Rc), s	5.6	33.0		0.9	4.3	34.4		0.9				
Change Period (Y+Rc), s	* 4.2	5.8		5.1	* 4.2	5.8		5.1				
Max Green Setting (Gmax), s	* 18	57.2		29.9	* 7.8	67.2		29.9				
Max Q Clear Time (g_c+I1), s	2.8	4.5		0.0	2.0	6.5		2.1				
Green Ext Time (p_c), s	0.0	9.3		0.0	0.0	22.1		0.0				

Intersection Summary

HCM 6th Ctrl Delay	2.7
HCM 6th LOS	A

Notes

* HCM 6th computational engine requires equal clearance times for the phases crossing the barrier.

Timings
28: I-215 SB Ramps & Alessandro Bl.

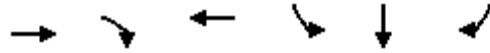

Lane Group	EBT	EBR	WBT	SBL	SBT	SBR
Lane Configurations	↑↑↑	↑	↑↑↑	↑	↔	↑
Traffic Volume (vph)	1076	483	1429	167	0	391
Future Volume (vph)	1076	483	1429	167	0	391
Turn Type	NA	Perm	NA	Split	NA	Perm
Protected Phases	2		6	4	4	
Permitted Phases		2				4
Detector Phase	2	2	6	4	4	4
Switch Phase						
Minimum Initial (s)	5.0	5.0	5.0	5.0	5.0	5.0
Minimum Split (s)	10.5	10.5	34.5	10.0	10.0	10.0
Total Split (s)	52.0	52.0	52.0	33.0	33.0	33.0
Total Split (%)	61.2%	61.2%	61.2%	38.8%	38.8%	38.8%
Yellow Time (s)	4.5	4.5	4.5	4.0	4.0	4.0
All-Red Time (s)	1.0	1.0	1.0	1.0	1.0	1.0
Lost Time Adjust (s)	0.0	0.0	0.0	0.0	0.0	0.0
Total Lost Time (s)	5.5	5.5	5.5	5.0	5.0	5.0
Lead/Lag						
Lead-Lag Optimize?						
Recall Mode	Min	Min	Min	None	None	None
Act Effct Green (s)	28.8	28.8	28.8	14.2	14.2	14.2
Actuated g/C Ratio	0.53	0.53	0.53	0.26	0.26	0.26
v/c Ratio	0.42	0.50	0.62	0.39	0.57	0.55
Control Delay	8.5	4.8	10.3	21.2	22.4	21.7
Queue Delay	0.0	0.0	0.0	0.0	0.0	0.0
Total Delay	8.5	4.8	10.3	21.2	22.4	21.7
LOS	A	A	B	C	C	C
Approach Delay	7.4		10.3		21.8	
Approach LOS	A		B		C	

Intersection Summary

Cycle Length: 85	
Actuated Cycle Length: 54.3	
Natural Cycle: 50	
Control Type: Actuated-Uncoordinated	
Maximum v/c Ratio: 0.62	
Intersection Signal Delay: 10.8	Intersection LOS: B
Intersection Capacity Utilization 55.9%	ICU Level of Service B
Analysis Period (min) 15	

Splits and Phases: 28: I-215 SB Ramps & Alessandro Bl.

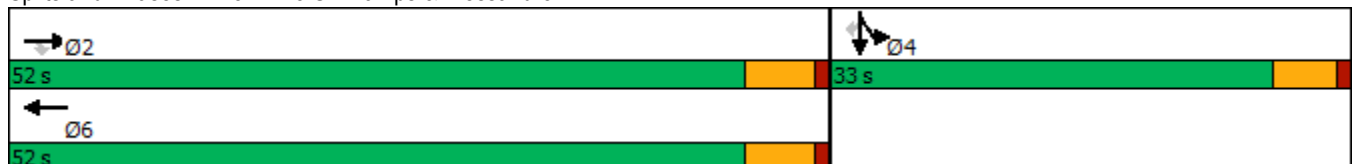

HCM 6th Signalized Intersection Summary
 28: I-215 SB Ramps & Alessandro Bl.

West Campus Upper Plateau (JN 14064)

09/30/2022



Movement	EBL	EBT	EBR	WBL	WBT	WBR	NBL	NBT	NBR	SBL	SBT	SBR
Lane Configurations		↑↑↑	↗		↑↑↑					↘	↔	↗
Traffic Volume (veh/h)	0	1076	483	0	1429	151	0	0	0	167	0	391
Future Volume (veh/h)	0	1076	483	0	1429	151	0	0	0	167	0	391
Initial Q (Qb), veh	0	0	0	0	0	0				0	0	0
Ped-Bike Adj(A_pbT)	1.00		1.00	1.00		0.98				1.00		1.00
Parking Bus, Adj	1.00	1.00	1.00	1.00	1.00	1.00				1.00	1.00	1.00
Work Zone On Approach		No			No						No	
Adj Sat Flow, veh/h/ln	0	1870	1870	0	1870	1781				1737	1900	1752
Adj Flow Rate, veh/h	0	1121	503	0	1489	149				116	0	423
Peak Hour Factor	0.96	0.96	0.96	0.96	0.96	0.96				0.96	0.96	0.96
Percent Heavy Veh, %	0	2	2	0	2	8				11	0	10
Cap, veh/h	0	2795	868	0	2577	258				360	0	646
Arrive On Green	0.00	0.55	0.55	0.00	0.55	0.55				0.22	0.00	0.22
Sat Flow, veh/h	0	5274	1585	0	4876	471				1654	0	2969
Grp Volume(v), veh/h	0	1121	503	0	1077	561				116	0	423
Grp Sat Flow(s),veh/h/ln	0	1702	1585	0	1702	1774				1654	0	1485
Q Serve(g_s), s	0.0	5.7	9.4	0.0	9.4	9.4				2.6	0.0	5.8
Cycle Q Clear(g_c), s	0.0	5.7	9.4	0.0	9.4	9.4				2.6	0.0	5.8
Prop In Lane	0.00		1.00	0.00		0.27				1.00		1.00
Lane Grp Cap(c), veh/h	0	2795	868	0	1863	971				360	0	646
V/C Ratio(X)	0.00	0.40	0.58	0.00	0.58	0.58				0.32	0.00	0.65
Avail Cap(c_a), veh/h	0	5312	1649	0	3541	1845				1036	0	1860
HCM Platoon Ratio	1.00	1.00	1.00	1.00	1.00	1.00				1.00	1.00	1.00
Upstream Filter(I)	0.00	1.00	1.00	0.00	1.00	1.00				1.00	0.00	1.00
Uniform Delay (d), s/veh	0.0	5.9	6.7	0.0	6.7	6.7				14.7	0.0	15.9
Incr Delay (d2), s/veh	0.0	0.1	0.6	0.0	0.3	0.5				0.5	0.0	1.1
Initial Q Delay(d3),s/veh	0.0	0.0	0.0	0.0	0.0	0.0				0.0	0.0	0.0
%ile BackOfQ(50%),veh/ln	0.0	0.8	1.3	0.0	1.3	1.5				0.8	0.0	1.6
Unsig. Movement Delay, s/veh												
LnGrp Delay(d),s/veh	0.0	6.0	7.3	0.0	7.0	7.2				15.2	0.0	17.1
LnGrp LOS	A	A	A	A	A	A				B	A	B
Approach Vol, veh/h		1624			1638						539	
Approach Delay, s/veh		6.4			7.1						16.7	
Approach LOS		A			A						B	
Timer - Assigned Phs		2		4		6						
Phs Duration (G+Y+Rc), s		30.0		14.7		30.0						
Change Period (Y+Rc), s		5.5		5.0		5.5						
Max Green Setting (Gmax), s		46.5		28.0		46.5						
Max Q Clear Time (g_c+I1), s		11.4		7.8		11.4						
Green Ext Time (p_c), s		11.0		1.9		13.1						

Intersection Summary

HCM 6th Ctrl Delay	8.1
HCM 6th LOS	A

Notes

User approved volume balancing among the lanes for turning movement.

Timings
29: I-215 NB Ramps & Alessandro Bl.

West Campus Upper Plateau (JN 14064)

09/30/2022



Lane Group	EBL	EBT	WBT	WBR	NBL	NBT	NBR
Lane Configurations	↶	↑↑↑	↑↑↑	↷	↶	↕	↷
Traffic Volume (vph)	280	1098	1037	183	516	12	301
Future Volume (vph)	280	1098	1037	183	516	12	301
Turn Type	Prot	NA	NA	Perm	Split	NA	Perm
Protected Phases	5	2	6		8	8	
Permitted Phases				6			8
Detector Phase	5	2	6	6	8	8	8
Switch Phase							
Minimum Initial (s)	5.0	5.0	5.0	5.0	5.0	5.0	5.0
Minimum Split (s)	9.5	10.5	33.5	33.5	10.0	10.0	10.0
Total Split (s)	13.0	48.0	35.0	35.0	37.0	37.0	37.0
Total Split (%)	15.3%	56.5%	41.2%	41.2%	43.5%	43.5%	43.5%
Yellow Time (s)	3.5	4.5	4.5	4.5	4.0	4.0	4.0
All-Red Time (s)	1.0	1.0	1.0	1.0	1.0	1.0	1.0
Lost Time Adjust (s)	0.0	0.0	0.0	0.0	0.0	0.0	0.0
Total Lost Time (s)	4.5	5.5	5.5	5.5	5.0	5.0	5.0
Lead/Lag	Lead		Lag	Lag			
Lead-Lag Optimize?	Yes		Yes	Yes			
Recall Mode	None	Min	Min	Min	Max	Max	Max
Act Effct Green (s)	8.5	37.6	24.5	24.5	32.1	32.1	32.1
Actuated g/C Ratio	0.11	0.47	0.31	0.31	0.40	0.40	0.40
v/c Ratio	1.65	0.48	0.69	0.38	0.45	0.46	0.40
Control Delay	343.5	15.2	26.8	13.3	21.2	20.7	14.0
Queue Delay	0.0	0.0	0.0	0.0	0.0	0.0	0.0
Total Delay	343.5	15.2	26.8	13.3	21.2	20.7	14.0
LOS	F	B	C	B	C	C	B
Approach Delay		81.9	24.8			18.8	
Approach LOS		F	C			B	

Intersection Summary

Cycle Length: 85
 Actuated Cycle Length: 80.2
 Natural Cycle: 75
 Control Type: Actuated-Uncoordinated
 Maximum v/c Ratio: 1.65
 Intersection Signal Delay: 46.3
 Intersection LOS: D
 Intersection Capacity Utilization 65.7%
 ICU Level of Service C
 Analysis Period (min) 15

Splits and Phases: 29: I-215 NB Ramps & Alessandro Bl.

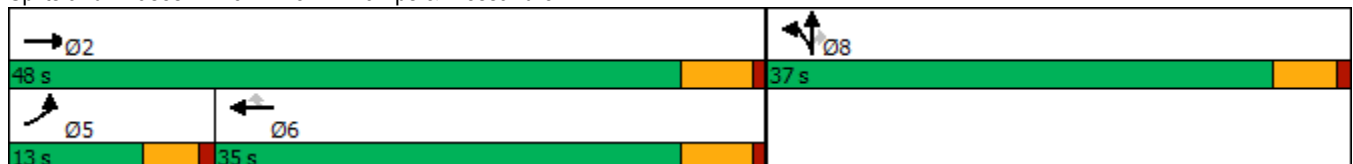

HCM 6th Signalized Intersection Summary
29: I-215 NB Ramps & Alessandro Bl.

West Campus Upper Plateau (JN 14064)
09/30/2022



Movement	EBL	EBT	EBR	WBL	WBT	WBR	NBL	NBT	NBR	SBL	SBT	SBR
Lane Configurations	↘	↑↑↑			↑↑↑	↗	↘	↕	↗			
Traffic Volume (veh/h)	280	1098	0	0	1037	183	516	12	301	0	0	0
Future Volume (veh/h)	280	1098	0	0	1037	183	516	12	301	0	0	0
Initial Q (Qb), veh	0	0	0	0	0	0	0	0	0			
Ped-Bike Adj(A_pbT)	1.00		1.00	1.00		0.98	1.00		1.00			
Parking Bus, Adj	1.00	1.00	1.00	1.00	1.00	1.00	1.00	1.00	1.00			
Work Zone On Approach		No			No			No				
Adj Sat Flow, veh/h/ln	1767	1870	0	0	1870	1707	1856	1900	1870			
Adj Flow Rate, veh/h	289	1132	0	0	1069	163	607	0	155			
Peak Hour Factor	0.97	0.97	0.97	0.97	0.97	0.97	0.97	0.97	0.97			
Percent Heavy Veh, %	9	2	0	0	2	13	3	0	2			
Cap, veh/h	184	2321	0	0	1469	407	1452	0	651			
Arrive On Green	0.11	0.45	0.00	0.00	0.29	0.29	0.41	0.00	0.41			
Sat Flow, veh/h	1682	5274	0	0	5274	1416	3534	0	1585			
Grp Volume(v), veh/h	289	1132	0	0	1069	163	607	0	155			
Grp Sat Flow(s),veh/h/ln	1682	1702	0	0	1702	1416	1767	0	1585			
Q Serve(g_s), s	8.5	12.1	0.0	0.0	14.7	7.2	9.5	0.0	5.0			
Cycle Q Clear(g_c), s	8.5	12.1	0.0	0.0	14.7	7.2	9.5	0.0	5.0			
Prop In Lane	1.00		0.00	0.00		1.00	1.00		1.00			
Lane Grp Cap(c), veh/h	184	2321	0	0	1469	407	1452	0	651			
V/C Ratio(X)	1.57	0.49	0.00	0.00	0.73	0.40	0.42	0.00	0.24			
Avail Cap(c_a), veh/h	184	2786	0	0	1933	536	1452	0	651			
HCM Platoon Ratio	1.00	1.00	1.00	1.00	1.00	1.00	1.00	1.00	1.00			
Upstream Filter(I)	1.00	1.00	0.00	0.00	1.00	1.00	1.00	0.00	1.00			
Uniform Delay (d), s/veh	34.7	14.9	0.0	0.0	25.0	22.3	16.3	0.0	15.0			
Incr Delay (d2), s/veh	283.0	0.2	0.0	0.0	1.0	0.6	0.9	0.0	0.9			
Initial Q Delay(d3),s/veh	0.0	0.0	0.0	0.0	0.0	0.0	0.0	0.0	0.0			
%ile BackOfQ(50%),veh/ln	17.6	3.8	0.0	0.0	5.3	2.2	3.6	0.0	1.8			
Unsig. Movement Delay, s/veh												
LnGrp Delay(d),s/veh	317.7	15.1	0.0	0.0	26.0	23.0	17.2	0.0	15.9			
LnGrp LOS	F	B	A	A	C	C	B	A	B			
Approach Vol, veh/h		1421			1232			762				
Approach Delay, s/veh		76.6			25.6			16.9				
Approach LOS		E			C			B				
Timer - Assigned Phs		2			5	6		8				
Phs Duration (G+Y+Rc), s		40.9			13.0	27.9		37.0				
Change Period (Y+Rc), s		5.5			4.5	5.5		5.0				
Max Green Setting (Gmax), s		42.5			8.5	29.5		32.0				
Max Q Clear Time (g_c+I1), s		14.1			10.5	16.7		11.5				
Green Ext Time (p_c), s		7.9			0.0	5.7		2.7				

Intersection Summary

HCM 6th Ctrl Delay	44.9
HCM 6th LOS	D

Notes

User approved volume balancing among the lanes for turning movement.

Timings
30: I-215 SB Ramps & Cactus Av.

West Campus Upper Plateau (JN 14064)

09/30/2022



Lane Group	EBT	EBR	WBL	WBT	NBR	SBR
Lane Configurations	↑↑	↑	↓	↑↑	↑	↑
Traffic Volume (vph)	349	103	431	627	406	342
Future Volume (vph)	349	103	431	627	406	342
Turn Type	NA	Perm	Prot	NA	Prot	Prot
Protected Phases	2		1	6	8	4
Permitted Phases		2				
Detector Phase	2	2	1	6	8	4
Switch Phase						
Minimum Initial (s)	5.0	5.0	5.0	5.0	5.0	5.0
Minimum Split (s)	11.0	11.0	9.5	23.0	9.1	9.5
Total Split (s)	35.0	35.0	43.0	78.0	27.0	27.0
Total Split (%)	33.3%	33.3%	41.0%	74.3%	25.7%	25.7%
Yellow Time (s)	5.0	5.0	3.5	5.0	3.6	3.5
All-Red Time (s)	1.0	1.0	1.0	1.0	0.5	1.0
Lost Time Adjust (s)	0.0	0.0	0.0	0.0	0.0	0.0
Total Lost Time (s)	6.0	6.0	4.5	6.0	4.1	4.5
Lead/Lag	Lag	Lag	Lead			
Lead-Lag Optimize?	Yes	Yes	Yes			
Recall Mode	Min	Min	None	Min	None	None
Act Effct Green (s)	13.3	13.3	23.5	41.7	12.5	12.0
Actuated g/C Ratio	0.20	0.20	0.36	0.64	0.19	0.18
v/c Ratio	0.57	0.29	0.78	0.32	0.55	0.80
Control Delay	29.5	8.5	29.4	6.0	2.5	22.3
Queue Delay	0.0	0.0	0.0	0.0	0.0	0.0
Total Delay	29.5	8.5	29.4	6.0	2.5	22.3
LOS	C	A	C	A	A	C
Approach Delay	24.7			15.5		
Approach LOS	C			B		

Intersection Summary

Cycle Length: 105
 Actuated Cycle Length: 65.3
 Natural Cycle: 50
 Control Type: Actuated-Uncoordinated
 Maximum v/c Ratio: 0.80
 Intersection Signal Delay: 16.1
 Intersection LOS: B
 Intersection Capacity Utilization 47.3%
 ICU Level of Service A
 Analysis Period (min) 15

Splits and Phases: 30: I-215 SB Ramps & Cactus Av.

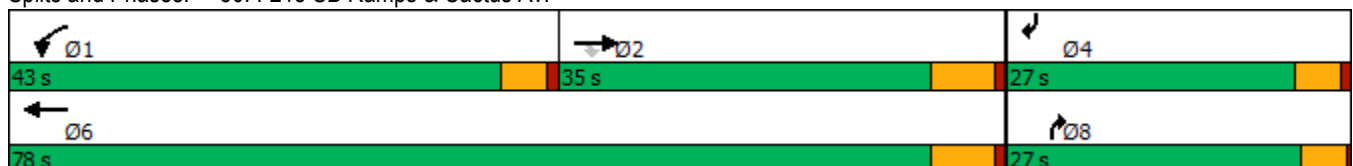

HCM 6th Signalized Intersection Summary
 30: I-215 SB Ramps & Cactus Av.

West Campus Upper Plateau (JN 14064)

09/30/2022



Movement	EBL	EBT	EBR	WBL	WBT	WBR	NBL	NBT	NBR	SBL	SBT	SBR
Lane Configurations		↑↑	↑	↑	↑↑				↑			↑
Traffic Volume (veh/h)	0	349	103	431	627	0	0	0	406	0	0	342
Future Volume (veh/h)	0	349	103	431	627	0	0	0	406	0	0	342
Initial Q (Qb), veh	0	0	0	0	0	0	0	0	0	0	0	0
Ped-Bike Adj(A_pbT)	1.00		1.00	1.00		1.00	1.00		1.00	1.00		1.00
Parking Bus, Adj	1.00	1.00	1.00	1.00	1.00	1.00	1.00	1.00	1.00	1.00	1.00	1.00
Work Zone On Approach		No			No			No			No	
Adj Sat Flow, veh/h/ln	0	1841	1826	1870	1870	0	0	0	1796	0	0	1707
Adj Flow Rate, veh/h	0	401	87	495	721	0	0	0	0	0	0	278
Peak Hour Factor	0.87	0.87	0.87	0.87	0.87	0.87	0.87	0.87	0.87	0.87	0.87	0.87
Percent Heavy Veh, %	0	4	5	2	2	0	0	0	7	0	0	13
Cap, veh/h	0	843	373	617	2716	0	0	0	0	0	0	0
Arrive On Green	0.00	0.24	0.24	0.35	0.76	0.00	0.00	0.00	0.00	0.00	0.00	0.00
Sat Flow, veh/h	0	3589	1547	1781	3647	0		0			0	
Grp Volume(v), veh/h	0	401	87	495	721	0		0.0			0.0	
Grp Sat Flow(s),veh/h/ln	0	1749	1547	1781	1777	0						
Q Serve(g_s), s	0.0	2.5	1.2	6.4	1.5	0.0						
Cycle Q Clear(g_c), s	0.0	2.5	1.2	6.4	1.5	0.0						
Prop In Lane	0.00		1.00	1.00		0.00						
Lane Grp Cap(c), veh/h	0	843	373	617	2716	0						
V/C Ratio(X)	0.00	0.48	0.23	0.80	0.27	0.00						
Avail Cap(c_a), veh/h	0	3984	1763	2694	10050	0						
HCM Platoon Ratio	1.00	1.00	1.00	1.00	1.00	1.00						
Upstream Filter(I)	0.00	1.00	1.00	1.00	1.00	0.00						
Uniform Delay (d), s/veh	0.0	8.3	7.8	7.5	0.9	0.0						
Incr Delay (d2), s/veh	0.0	0.2	0.1	0.9	0.0	0.0						
Initial Q Delay(d3),s/veh	0.0	0.0	0.0	0.0	0.0	0.0						
%ile BackOfQ(50%),veh/ln	0.0	0.4	0.2	0.9	0.0	0.0						
Unsig. Movement Delay, s/veh												
LnGrp Delay(d),s/veh	0.0	8.4	7.9	8.5	0.9	0.0						
LnGrp LOS	A	A	A	A	A	A						
Approach Vol, veh/h		488			1216							
Approach Delay, s/veh		8.3			4.0							
Approach LOS		A			A							
Timer - Assigned Phs	1	2				6						
Phs Duration (G+Y+Rc), s	13.3	12.1				25.5						
Change Period (Y+Rc), s	4.5	6.0				6.0						
Max Green Setting (Gmax), s	38.5	29.0				72.0						
Max Q Clear Time (g_c+I1), s	8.4	4.5				3.5						
Green Ext Time (p_c), s	0.7	1.6				3.1						

Intersection Summary

HCM 6th Ctrl Delay			5.2									
HCM 6th LOS			A									

Notes

Unsignalized Delay for [NBR] is excluded from calculations of the approach delay and intersection delay.

Timings

31: I-215 NB Ramps/Old 215 Frontage Rd. & Cactus Av.



Lane Group	EBL	EBT	WBT	NBL	NBT	NBR	SBL	SBT
Lane Configurations	↖	↗	↗	↖	↗	↗	↖	↗
Traffic Volume (vph)	37	801	1351	144	81	4	135	1
Future Volume (vph)	37	801	1351	144	81	4	135	1
Turn Type	Perm	NA	NA	Perm	NA	Perm	Perm	NA
Protected Phases		2	6		8			4
Permitted Phases	2			8		8	4	
Detector Phase	2	2	6	8	8	8	4	4
Switch Phase								
Minimum Initial (s)	5.0	5.0	5.0	5.0	5.0	5.0	5.0	5.0
Minimum Split (s)	11.0	11.0	44.0	10.5	10.5	10.5	10.5	10.5
Total Split (s)	57.4	57.4	57.4	27.6	27.6	27.6	27.6	27.6
Total Split (%)	67.5%	67.5%	67.5%	32.5%	32.5%	32.5%	32.5%	32.5%
Yellow Time (s)	5.0	5.0	5.0	4.5	4.5	4.5	4.5	4.5
All-Red Time (s)	1.0	1.0	1.0	1.0	1.0	1.0	1.0	1.0
Lost Time Adjust (s)	0.0	0.0	0.0	0.0	0.0	0.0	0.0	0.0
Total Lost Time (s)	6.0	6.0	6.0	5.5	5.5	5.5	5.5	5.5
Lead/Lag								
Lead-Lag Optimize?								
Recall Mode	Min	Min	Min	None	None	None	None	None
Act Effct Green (s)	36.9	36.9	36.9	13.2	13.2	13.2	13.2	13.2
Actuated g/C Ratio	0.59	0.59	0.59	0.21	0.21	0.21	0.21	0.21
v/c Ratio	0.35	0.63	0.79	0.62	0.23	0.01	0.54	0.28
Control Delay	18.2	9.5	13.5	35.9	23.7	0.0	31.4	16.7
Queue Delay	0.0	0.0	0.0	0.0	0.0	0.0	0.0	0.0
Total Delay	18.2	9.5	13.5	35.9	23.7	0.0	31.4	16.7
LOS	B	A	B	D	C	A	C	B
Approach Delay		9.8	13.5		31.0			25.3
Approach LOS		A	B		C			C

Intersection Summary

Cycle Length: 85
 Actuated Cycle Length: 62.2
 Natural Cycle: 60
 Control Type: Actuated-Uncoordinated
 Maximum v/c Ratio: 0.79
 Intersection Signal Delay: 14.4
 Intersection Capacity Utilization 66.2%
 Analysis Period (min) 15

Intersection LOS: B
 ICU Level of Service C

Splits and Phases: 31: I-215 NB Ramps/Old 215 Frontage Rd. & Cactus Av.

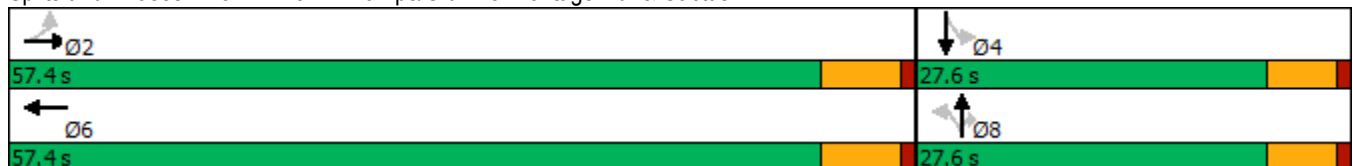

HCM 6th Signalized Intersection Summary

West Campus Upper Plateau (JN 14064)

31: I-215 NB Ramps/Old 215 Frontage Rd. & Cactus Av.

09/30/2022



Movement	EBL	EBT	EBR	WBL	WBT	WBR	NBL	NBT	NBR	SBL	SBT	SBR
Lane Configurations	↗	↕			↕		↗	↕	↗	↗	↕	↕
Traffic Volume (veh/h)	37	801	284	0	1351	146	144	81	4	135	1	96
Future Volume (veh/h)	37	801	284	0	1351	146	144	81	4	135	1	96
Initial Q (Qb), veh	0	0	0	0	0	0	0	0	0	0	0	0
Ped-Bike Adj(A_pbT)	1.00		1.00	1.00		1.00	1.00		1.00	1.00		1.00
Parking Bus, Adj	1.00	1.00	1.00	1.00	1.00	1.00	1.00	1.00	1.00	1.00	1.00	1.00
Work Zone On Approach		No			No			No			No	
Adj Sat Flow, veh/h/ln	1796	1826	1366	0	1841	1885	1722	1856	1900	1841	1900	1885
Adj Flow Rate, veh/h	40	861	301	0	1453	108	155	87	0	145	1	76
Peak Hour Factor	0.93	0.93	0.93	0.93	0.93	0.93	0.93	0.93	0.93	0.93	0.93	0.93
Percent Heavy Veh, %	7	5	36	0	4	1	12	3	0	4	0	1
Cap, veh/h	212	1468	512	0	1921	142	335	382		348	4	327
Arrive On Green	0.58	0.58	0.58	0.00	0.58	0.58	0.21	0.21	0.00	0.21	0.21	0.21
Sat Flow, veh/h	317	2522	880	0	3393	244	1217	1856	1610	1289	21	1592
Grp Volume(v), veh/h	40	592	570	0	767	794	155	87	0	145	0	77
Grp Sat Flow(s),veh/h/ln	317	1735	1668	0	1749	1796	1217	1856	1610	1289	0	1613
Q Serve(g_s), s	5.9	11.7	11.8	0.0	17.7	17.9	6.6	2.1	0.0	5.7	0.0	2.2
Cycle Q Clear(g_c), s	23.8	11.7	11.8	0.0	17.7	17.9	8.7	2.1	0.0	7.8	0.0	2.2
Prop In Lane	1.00		0.53	0.00		0.14	1.00		1.00	1.00		0.99
Lane Grp Cap(c), veh/h	212	1010	971	0	1018	1046	335	382		348	0	332
V/C Ratio(X)	0.19	0.59	0.59	0.00	0.75	0.76	0.46	0.23		0.42	0.00	0.23
Avail Cap(c_a), veh/h	329	1646	1583	0	1660	1705	581	757		609	0	658
HCM Platoon Ratio	1.00	1.00	1.00	1.00	1.00	1.00	1.00	1.00	1.00	1.00	1.00	1.00
Upstream Filter(I)	1.00	1.00	1.00	0.00	1.00	1.00	1.00	1.00	0.00	1.00	0.00	1.00
Uniform Delay (d), s/veh	17.4	7.2	7.2	0.0	8.4	8.5	21.6	17.9	0.0	21.2	0.0	17.9
Incr Delay (d2), s/veh	0.2	0.2	0.2	0.0	0.4	0.4	0.4	0.1	0.0	0.3	0.0	0.1
Initial Q Delay(d3),s/veh	0.0	0.0	0.0	0.0	0.0	0.0	0.0	0.0	0.0	0.0	0.0	0.0
%ile BackOfQ(50%),veh/ln	0.4	2.5	2.4	0.0	3.8	4.0	1.6	0.8	0.0	1.5	0.0	0.7
Unsig. Movement Delay, s/veh												
LnGrp Delay(d),s/veh	17.6	7.4	7.4	0.0	8.9	8.9	22.0	18.0	0.0	21.5	0.0	18.1
LnGrp LOS	B	A	A	A	A	A	C	B		C	A	B
Approach Vol, veh/h		1202			1561			242				222
Approach Delay, s/veh		7.7			8.9			20.6				20.3
Approach LOS		A			A			C				C
Timer - Assigned Phs		2		4		6		8				
Phs Duration (G+Y+Rc), s		37.5		16.6		37.5		16.6				
Change Period (Y+Rc), s		6.0		5.5		6.0		5.5				
Max Green Setting (Gmax), s		51.4		22.1		51.4		22.1				
Max Q Clear Time (g_c+I1), s		25.8		9.8		19.9		10.7				
Green Ext Time (p_c), s		5.7		0.4		7.7		0.4				

Intersection Summary

HCM 6th Ctrl Delay	10.1
HCM 6th LOS	B

Notes

User approved volume balancing among the lanes for turning movement.
 Unsignalized Delay for [NBR] is excluded from calculations of the approach delay and intersection delay.

Timings
32: I-215 SB Ramps & Van Buren Bl.

West Campus Upper Plateau (JN 14064)

09/30/2022



Lane Group	EBT	EBR	WBL	WBT	SBT	SBR
Lane Configurations	↑↑	↑↑	↵	↑↑	↵	↑↑
Traffic Volume (vph)	834	973	16	944	0	938
Future Volume (vph)	834	973	16	944	0	938
Turn Type	NA	Perm	Prot	NA	NA	Perm
Protected Phases	6		5	2	8	
Permitted Phases		6				8
Detector Phase	6	6	5	2	8	8
Switch Phase						
Minimum Initial (s)	5.0	5.0	5.0	5.0	5.0	5.0
Minimum Split (s)	36.0	36.0	11.0	11.0	11.0	11.0
Total Split (s)	60.0	60.0	11.0	71.0	14.0	14.0
Total Split (%)	70.6%	70.6%	12.9%	83.5%	16.5%	16.5%
Yellow Time (s)	5.0	5.0	5.0	5.0	5.0	5.0
All-Red Time (s)	1.0	1.0	1.0	1.0	1.0	1.0
Lost Time Adjust (s)	0.0	0.0	0.0	0.0	0.0	0.0
Total Lost Time (s)	6.0	6.0	6.0	6.0	6.0	6.0
Lead/Lag	Lag	Lag	Lead			
Lead-Lag Optimize?	Yes	Yes	Yes			
Recall Mode	Min	Min	None	Min	Max	Max
Act Effct Green (s)	20.5	20.5	5.3	22.0	8.4	8.4
Actuated g/C Ratio	0.48	0.48	0.12	0.51	0.19	0.19
v/c Ratio	0.56	0.56	0.10	0.58	0.10	1.32
Control Delay	9.7	1.9	24.1	8.0	20.7	170.9
Queue Delay	0.0	0.0	0.0	0.0	0.0	0.0
Total Delay	9.7	1.9	24.1	8.0	20.7	170.9
LOS	A	A	C	A	C	F
Approach Delay	5.5			8.3	167.0	
Approach LOS	A			A	F	

Intersection Summary

Cycle Length: 85
 Actuated Cycle Length: 43.1
 Natural Cycle: 80
 Control Type: Actuated-Uncoordinated
 Maximum v/c Ratio: 1.32
 Intersection Signal Delay: 47.9
 Intersection LOS: D
 Intersection Capacity Utilization 68.9%
 ICU Level of Service C
 Analysis Period (min) 15

Splits and Phases: 32: I-215 SB Ramps & Van Buren Bl.



HCM 6th Signalized Intersection Summary
 32: I-215 SB Ramps & Van Buren Bl.

West Campus Upper Plateau (JN 14064)

09/30/2022



Movement	EBL	EBT	EBR	WBL	WBT	WBR	NBL	NBT	NBR	SBL	SBT	SBR
Lane Configurations		↑↑	↑↑	↑	↑↑						↑	↑↑
Traffic Volume (veh/h)	0	834	973	16	944	0	0	0	0	25	0	938
Future Volume (veh/h)	0	834	973	16	944	0	0	0	0	25	0	938
Initial Q (Qb), veh	0	0	0	0	0	0				0	0	0
Ped-Bike Adj(A_pbT)	1.00		1.00	1.00		1.00				1.00		1.00
Parking Bus, Adj	1.00	1.00	1.00	1.00	1.00	1.00				1.00	1.00	1.00
Work Zone On Approach		No			No						No	
Adj Sat Flow, veh/h/ln	0	1767	1856	1411	1811	0				1500	1841	1663
Adj Flow Rate, veh/h	0	887	937	17	1004	0				27	0	0
Peak Hour Factor	0.94	0.94	0.94	0.94	0.94	0.94				0.94	0.94	0.94
Percent Heavy Veh, %	0	9	3	33	6	0				27	4	16
Cap, veh/h	0	1482	1222	121	2201	0				253	0	
Arrive On Green	0.00	0.44	0.44	0.09	0.64	0.00				0.14	0.00	0.00
Sat Flow, veh/h	0	3445	2768	1344	3532	0				1753	0	2480
Grp Volume(v), veh/h	0	887	937	17	1004	0				27	0	0
Grp Sat Flow(s),veh/h/ln	0	1678	1384	1344	1721	0				1753	0	1240
Q Serve(g_s), s	0.0	11.1	15.9	0.6	8.2	0.0				0.7	0.0	0.0
Cycle Q Clear(g_c), s	0.0	11.1	15.9	0.6	8.2	0.0				0.7	0.0	0.0
Prop In Lane	0.00		1.00	1.00		0.00				1.00		1.00
Lane Grp Cap(c), veh/h	0	1482	1222	121	2201	0				253	0	
V/C Ratio(X)	0.00	0.60	0.77	0.14	0.46	0.00				0.11	0.00	
Avail Cap(c_a), veh/h	0	3266	2693	121	4030	0				253	0	
HCM Platoon Ratio	1.00	1.00	1.00	1.00	1.00	1.00				1.00	1.00	1.00
Upstream Filter(I)	0.00	1.00	1.00	1.00	1.00	0.00				1.00	0.00	0.00
Uniform Delay (d), s/veh	0.0	11.8	13.1	23.3	5.1	0.0				20.6	0.0	0.0
Incr Delay (d2), s/veh	0.0	0.1	0.4	0.2	0.1	0.0				0.9	0.0	0.0
Initial Q Delay(d3),s/veh	0.0	0.0	0.0	0.0	0.0	0.0				0.0	0.0	0.0
%ile BackOfQ(50%),veh/ln	0.0	2.8	3.3	0.2	1.3	0.0				0.3	0.0	0.0
Unsig. Movement Delay, s/veh												
LnGrp Delay(d),s/veh	0.0	11.9	13.5	23.5	5.1	0.0				21.5	0.0	0.0
LnGrp LOS	A	B	B	C	A	A				C	A	
Approach Vol, veh/h		1824			1021							27
Approach Delay, s/veh		12.7			5.4							21.5
Approach LOS		B			A							C
Timer - Assigned Phs		2			5	6		8				
Phs Duration (G+Y+Rc), s		41.5			11.0	30.5		14.0				
Change Period (Y+Rc), s		6.0			6.0	6.0		6.0				
Max Green Setting (Gmax), s		65.0			5.0	54.0		8.0				
Max Q Clear Time (g_c+1), s		10.2			2.6	17.9		2.7				
Green Ext Time (p_c), s		4.5			0.0	6.6		0.0				

Intersection Summary

HCM 6th Ctrl Delay	10.2
HCM 6th LOS	B

Notes

Unsignalized Delay for [SBR] is excluded from calculations of the approach delay and intersection delay.

Timings
33: I-215 NB On/Off Ramp & Van Buren Bl.

Lane Group	EBR	NBL	Ø2	Ø6
Lane Configurations	↔↔	↔↔		
Traffic Volume (vph)	18	1		
Future Volume (vph)	18	1		
Turn Type	pm+ov	Prot		
Protected Phases	4	4	2	6
Permitted Phases	6			
Detector Phase	4	4		
Switch Phase				
Minimum Initial (s)	5.0	5.0	5.0	5.0
Minimum Split (s)	42.0	42.0	11.0	11.0
Total Split (s)	55.0	55.0	15.0	15.0
Total Split (%)	78.6%	78.6%	21%	21%
Yellow Time (s)	5.0	5.0	5.0	5.0
All-Red Time (s)	1.0	1.0	1.0	1.0
Lost Time Adjust (s)	0.0	0.0		
Total Lost Time (s)	6.0	6.0		
Lead/Lag				
Lead-Lag Optimize?				
Recall Mode	Min	Min	None	None
Act Effct Green (s)	32.2	32.2		
Actuated g/C Ratio	1.00	1.00		
v/c Ratio	0.01	0.00		
Control Delay	0.0	0.0		
Queue Delay	0.0	0.0		
Total Delay	0.0	0.0		
LOS	A	A		
Approach Delay				
Approach LOS				

Intersection Summary

Cycle Length: 70	
Actuated Cycle Length: 32.2	
Natural Cycle: 55	
Control Type: Actuated-Uncoordinated	
Maximum v/c Ratio: 0.01	
Intersection Signal Delay: 0.0	Intersection LOS: A
Intersection Capacity Utilization 9.2%	ICU Level of Service A
Analysis Period (min) 15	

Splits and Phases: 33: I-215 NB On/Off Ramp & Van Buren Bl.



HCM 6th Signalized Intersection Summary
 33: I-215 NB On/Off Ramp & Van Buren Bl.

West Campus Upper Plateau (JN 14064)

09/30/2022

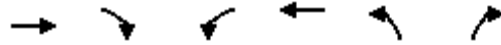

Movement	EBT	EBR	WBL	WBT	NBL	NBR
Lane Configurations	↑↑	↑↑		↑↑	↑↑	↑
Traffic Volume (veh/h)	0	18	0	0	1	0
Future Volume (veh/h)	0	18	0	0	1	0
Initial Q (Qb), veh	0	0	0	0	0	0
Ped-Bike Adj(A_pbT)		1.00	1.00		1.00	1.00
Parking Bus, Adj	1.00	1.00	1.00	1.00	1.00	1.00
Work Zone On Approach	No			No	No	
Adj Sat Flow, veh/h/ln	1900	1767	0	1752	1811	1159
Adj Flow Rate, veh/h	0	10	0	0	1	0
Peak Hour Factor	0.94	0.94	0.94	0.94	0.94	0.94
Percent Heavy Veh, %	0	9	0	10	6	50
Cap, veh/h	49	800	0	45	971	285
Arrive On Green	0.00	0.01	0.00	0.00	0.29	0.00
Sat Flow, veh/h	3705	2635	0	3504	3346	982
Grp Volume(v), veh/h	0	10	0	0	1	0
Grp Sat Flow(s),veh/h/ln	1805	1317	0	1664	1673	982
Q Serve(g_s), s	0.0	0.0	0.0	0.0	0.0	0.0
Cycle Q Clear(g_c), s	0.0	0.0	0.0	0.0	0.0	0.0
Prop In Lane		1.00	0.00		1.00	1.00
Lane Grp Cap(c), veh/h	49	800	0	45	971	285
V/C Ratio(X)	0.00	0.01	0.00	0.00	0.00	0.00
Avail Cap(c_a), veh/h	1885	2141	0	1738	9514	2793
HCM Platoon Ratio	1.00	1.00	1.00	1.00	1.00	1.00
Upstream Filter(I)	0.00	1.00	0.00	0.00	1.00	0.00
Uniform Delay (d), s/veh	0.0	4.2	0.0	0.0	4.3	0.0
Incr Delay (d2), s/veh	0.0	0.0	0.0	0.0	0.0	0.0
Initial Q Delay(d3),s/veh	0.0	0.0	0.0	0.0	0.0	0.0
%ile BackOfQ(50%),veh/ln	0.0	0.0	0.0	0.0	0.0	0.0
Unsig. Movement Delay, s/veh						
LnGrp Delay(d),s/veh	0.0	4.2	0.0	0.0	4.3	0.0
LnGrp LOS	A	A	A	A	A	A
Approach Vol, veh/h	10			0	1	
Approach Delay, s/veh	4.2			0.0	4.3	
Approach LOS	A				A	
Timer - Assigned Phs		2		4		6
Phs Duration (G+Y+Rc), s		6.2		11.0		6.2
Change Period (Y+Rc), s		6.0		6.0		6.0
Max Green Setting (Gmax), s		9.0		49.0		9.0
Max Q Clear Time (g_c+I1), s		0.0		2.0		2.0
Green Ext Time (p_c), s		0.0		0.0		0.0
Intersection Summary						
HCM 6th Ctrl Delay			4.2			
HCM 6th LOS			A			

Timings

West Campus Upper Plateau (JN 14064)

34: Old 215 Frontage Rd. & Alessandro Bl.

09/30/2022

Lane Group	EBL	EBT	EBR	WBL	WBT	WBR	NBL	NBT	NBR	SBL	SBT	SBR
Lane Configurations												
Traffic Volume (vph)	385	993	15	13	913	115	28	115	16	104	141	257
Future Volume (vph)	385	993	15	13	913	115	28	115	16	104	141	257
Turn Type	Prot	NA	Perm	Prot	NA	Perm	Prot	NA	Perm	Prot	NA	Perm
Protected Phases	5	2		1	6		3	8		7	4	
Permitted Phases			2			6			8			4
Detector Phase	5	2	2	1	6	6	3	8	8	7	4	4
Switch Phase												
Minimum Initial (s)	5.0	10.0	10.0	5.0	10.0	10.0	5.0	10.0	10.0	5.0	10.0	10.0
Minimum Split (s)	8.7	43.5	43.5	8.7	15.8	15.8	8.7	16.2	16.2	8.7	40.2	40.2
Total Split (s)	22.0	62.4	62.4	8.7	49.1	49.1	8.7	29.7	29.7	19.2	40.2	40.2
Total Split (%)	18.3%	52.0%	52.0%	7.3%	40.9%	40.9%	7.3%	24.8%	24.8%	16.0%	33.5%	33.5%
Yellow Time (s)	3.2	5.5	5.5	3.2	4.8	4.8	3.2	5.2	5.2	3.2	5.2	5.2
All-Red Time (s)	0.5	1.0	1.0	0.5	1.0	1.0	0.5	1.0	1.0	0.5	1.0	1.0
Lost Time Adjust (s)	0.0	0.0	0.0	0.0	0.0	0.0	0.0	0.0	0.0	0.0	0.0	0.0
Total Lost Time (s)	3.7	6.5	6.5	3.7	5.8	5.8	3.7	6.2	6.2	3.7	6.2	6.2
Lead/Lag	Lead	Lag	Lag	Lead	Lag	Lag	Lead	Lag	Lag	Lead	Lag	Lag
Lead-Lag Optimize?	Yes	Yes	Yes	Yes	Yes	Yes	Yes	Yes	Yes	Yes	Yes	Yes
Recall Mode	None	None	None	None	None	None	None	None	None	None	None	None
Act Effct Green (s)	15.0	47.1	47.1	5.2	31.9	31.9	5.2	12.4	12.4	10.3	21.9	21.9
Actuated g/C Ratio	0.17	0.52	0.52	0.06	0.35	0.35	0.06	0.14	0.14	0.11	0.24	0.24
v/c Ratio	0.70	0.38	0.02	0.16	0.76	0.18	0.18	0.25	0.05	0.55	0.19	0.45
Control Delay	44.7	14.4	0.1	52.9	31.2	2.1	50.5	39.0	0.3	52.2	31.0	6.8
Queue Delay	0.0	0.0	0.0	0.0	0.0	0.0	0.0	0.0	0.0	0.0	0.0	0.0
Total Delay	44.7	14.4	0.1	52.9	31.2	2.1	50.5	39.0	0.3	52.2	31.0	6.8
LOS	D	B	A	D	C	A	D	D	A	D	C	A
Approach Delay		22.6			28.3			37.1			23.0	
Approach LOS		C			C			D			C	

Intersection Summary

Cycle Length: 120
 Actuated Cycle Length: 89.9
 Natural Cycle: 105
 Control Type: Actuated-Uncoordinated
 Maximum v/c Ratio: 0.76
 Intersection Signal Delay: 25.3
 Intersection LOS: C
 Intersection Capacity Utilization 62.0%
 ICU Level of Service B
 Analysis Period (min) 15

Splits and Phases: 34: Old 215 Frontage Rd. & Alessandro Bl.



HCM 6th Signalized Intersection Summary
 34: Old 215 Frontage Rd. & Alessandro Bl.

West Campus Upper Plateau (JN 14064)

09/30/2022



Movement	EBL	EBT	EBR	WBL	WBT	WBR	NBL	NBT	NBR	SBL	SBT	SBR
Lane Configurations	↖↗	↑↑↑	↖	↖	↑↑	↖	↖↗	↑↑	↖	↖	↑↑	↖
Traffic Volume (veh/h)	385	993	15	13	913	115	28	115	16	104	141	257
Future Volume (veh/h)	385	993	15	13	913	115	28	115	16	104	141	257
Initial Q (Qb), veh	0	0	0	0	0	0	0	0	0	0	0	0
Ped-Bike Adj(A_pbT)	1.00		1.00	1.00		1.00	1.00		0.98	1.00		1.00
Parking Bus, Adj	1.00	1.00	1.00	1.00	1.00	1.00	1.00	1.00	1.00	1.00	1.00	1.00
Work Zone On Approach		No			No			No			No	
Adj Sat Flow, veh/h/ln	1870	1885	1678	1678	1856	1856	1515	1856	1559	1826	1737	1885
Adj Flow Rate, veh/h	401	1034	-11	14	951	0	29	120	7	108	147	0
Peak Hour Factor	0.96	0.96	0.96	0.96	0.96	0.96	0.96	0.96	0.96	0.96	0.96	0.96
Percent Heavy Veh, %	2	1	15	15	3	3	26	3	23	5	11	1
Cap, veh/h	507	2503	691	27	1257		86	488	180	138	618	
Arrive On Green	0.15	0.49	0.00	0.02	0.36	0.00	0.03	0.14	0.14	0.08	0.19	0.00
Sat Flow, veh/h	3456	5147	1422	1598	3526	1572	2799	3526	1301	1739	3300	1598
Grp Volume(v), veh/h	401	1034	-11	14	951	0	29	120	7	108	147	0
Grp Sat Flow(s),veh/h/ln	1728	1716	1422	1598	1763	1572	1399	1763	1301	1739	1650	1598
Q Serve(g_s), s	8.1	9.3	0.0	0.6	17.1	0.0	0.7	2.2	0.3	4.4	2.7	0.0
Cycle Q Clear(g_c), s	8.1	9.3	0.0	0.6	17.1	0.0	0.7	2.2	0.3	4.4	2.7	0.0
Prop In Lane	1.00		1.00	1.00		1.00	1.00		1.00	1.00		1.00
Lane Grp Cap(c), veh/h	507	2503	691	27	1257		86	488	180	138	618	
V/C Ratio(X)	0.79	0.41	-0.02	0.52	0.76		0.34	0.25	0.04	0.78	0.24	
Avail Cap(c_a), veh/h	878	3992	1103	111	2118		194	1150	424	374	1557	
HCM Platoon Ratio	1.00	1.00	1.00	1.00	1.00	1.00	1.00	1.00	1.00	1.00	1.00	1.00
Upstream Filter(I)	1.00	1.00	0.00	1.00	1.00	0.00	1.00	1.00	1.00	1.00	1.00	0.00
Uniform Delay (d), s/veh	29.7	11.9	0.0	35.1	20.4	0.0	34.2	27.7	26.9	32.6	24.9	0.0
Incr Delay (d2), s/veh	1.1	0.1	0.0	5.6	1.0	0.0	0.9	0.3	0.1	3.6	0.2	0.0
Initial Q Delay(d3),s/veh	0.0	0.0	0.0	0.0	0.0	0.0	0.0	0.0	0.0	0.0	0.0	0.0
%ile BackOfQ(50%),veh/ln	3.0	2.7	0.0	0.3	6.2	0.0	0.2	0.9	0.1	1.8	1.0	0.0
Unsig. Movement Delay, s/veh												
LnGrp Delay(d),s/veh	30.8	12.0	0.0	40.7	21.4	0.0	35.1	27.9	27.0	36.2	25.1	0.0
LnGrp LOS	C	B	A	D	C		D	C	C	D	C	
Approach Vol, veh/h		1424			965			156			255	
Approach Delay, s/veh		17.4			21.7			29.2			29.8	
Approach LOS		B			C			C			C	
Timer - Assigned Phs	1	2	3	4	5	6	7	8				
Phs Duration (G+Y+Rc), s	4.9	41.5	5.9	19.7	14.3	32.2	9.4	16.2				
Change Period (Y+Rc), s	3.7	6.5	3.7	6.2	3.7	* 6.5	3.7	6.2				
Max Green Setting (Gmax), s	5.0	55.9	5.0	34.0	18.3	* 43	15.5	23.5				
Max Q Clear Time (g_c+I1), s	2.6	11.3	2.7	4.7	10.1	19.1	6.4	4.2				
Green Ext Time (p_c), s	0.0	7.5	0.0	0.8	0.5	6.6	0.1	0.5				

Intersection Summary

HCM 6th Ctrl Delay	20.6
HCM 6th LOS	C

Notes

* HCM 6th computational engine requires equal clearance times for the phases crossing the barrier.
 Unsignalized Delay for [WBR, SBR] is excluded from calculations of the approach delay and intersection delay.

Timings
35: Day St. & Alessandro Bl.

West Campus Upper Plateau (JN 14064)

09/30/2022



Lane Group	EBL	EBT	EBR	WBL	WBT	WBR	NBL	NBT	NBR	SBL	SBT
Lane Configurations	↖	↗↗↗	↖	↖	↗↗	↖	↖	↗	↖	↖	↗
Traffic Volume (vph)	220	773	8	11	813	162	12	111	17	136	55
Future Volume (vph)	220	773	8	11	813	162	12	111	17	136	55
Turn Type	Prot	NA	Perm	Prot	NA	Perm	Perm	NA	Perm	Perm	NA
Protected Phases	5	2		1	6			8			4
Permitted Phases			2			6	8		8	4	
Detector Phase	5	2	2	1	6	6	8	8	8	4	4
Switch Phase											
Minimum Initial (s)	5.0	10.0	10.0	5.0	10.0	10.0	10.0	10.0	10.0	10.0	10.0
Minimum Split (s)	9.1	30.8	30.8	9.1	30.8	30.8	42.4	42.4	42.4	41.6	41.6
Total Split (s)	28.0	67.9	67.9	9.1	49.0	49.0	43.0	43.0	43.0	43.0	43.0
Total Split (%)	23.3%	56.6%	56.6%	7.6%	40.8%	40.8%	35.8%	35.8%	35.8%	35.8%	35.8%
Yellow Time (s)	3.6	4.8	4.8	3.6	4.8	4.8	4.4	4.4	4.4	3.6	3.6
All-Red Time (s)	0.5	1.0	1.0	0.5	1.0	1.0	1.0	1.0	1.0	1.0	1.0
Lost Time Adjust (s)	0.0	0.0	0.0	0.0	0.0	0.0	0.0	0.0	0.0	0.0	0.0
Total Lost Time (s)	4.1	5.8	5.8	4.1	5.8	5.8	5.4	5.4	5.4	4.6	4.6
Lead/Lag	Lead	Lag	Lag	Lead	Lag	Lag					
Lead-Lag Optimize?	Yes	Yes	Yes	Yes	Yes	Yes					
Recall Mode	None	None	None	None	None	None	None	None	None	None	None
Act Effct Green (s)	14.9	44.7	44.7	5.5	26.4	26.4	16.5	16.5	16.5	17.4	17.4
Actuated g/C Ratio	0.20	0.60	0.60	0.07	0.35	0.35	0.22	0.22	0.22	0.23	0.23
v/c Ratio	0.64	0.26	0.01	0.08	0.68	0.27	0.07	0.28	0.04	0.48	0.40
Control Delay	40.2	8.6	0.0	45.9	24.8	11.0	27.9	28.5	0.2	33.2	16.1
Queue Delay	0.0	0.0	0.0	0.0	0.0	0.0	0.0	0.0	0.0	0.0	0.0
Total Delay	40.2	8.6	0.0	45.9	24.8	11.0	27.9	28.5	0.2	33.2	16.1
LOS	D	A	A	D	C	B	C	C	A	C	B
Approach Delay		15.5			22.8			25.0			23.5
Approach LOS		B			C			C			C

Intersection Summary

Cycle Length: 120
 Actuated Cycle Length: 74.6
 Natural Cycle: 85
 Control Type: Actuated-Uncoordinated
 Maximum v/c Ratio: 0.68
 Intersection Signal Delay: 20.0
 Intersection LOS: C
 Intersection Capacity Utilization 60.9%
 ICU Level of Service B
 Analysis Period (min) 15



























Splits and Phases: 35: Day St. & Alessandro Bl.



HCM 6th Signalized Intersection Summary
35: Day St. & Alessandro Bl.

West Campus Upper Plateau (JN 14064)

09/30/2022

												
Movement	EBL	EBT	EBR	WBL	WBT	WBR	NBL	NBT	NBR	SBL	SBT	SBR
Lane Configurations		  			 							
Traffic Volume (veh/h)	220	773	8	11	813	162	12	111	17	136	55	125
Future Volume (veh/h)	220	773	8	11	813	162	12	111	17	136	55	125
Initial Q (Qb), veh	0	0	0	0	0	0	0	0	0	0	0	0
Ped-Bike Adj(A_pbT)	1.00		0.98	1.00		0.98	1.00		1.00	1.00		1.00
Parking Bus, Adj	1.00	1.00	1.00	1.00	1.00	1.00	1.00	1.00	1.00	1.00	1.00	1.00
Work Zone On Approach		No			No			No			No	
Adj Sat Flow, veh/h/ln	1885	1870	1618	1900	1870	1900	1500	1900	1767	1885	1870	1870
Adj Flow Rate, veh/h	229	805	2	11	847	101	12	116	13	142	57	99
Peak Hour Factor	0.96	0.96	0.96	0.96	0.96	0.96	0.96	0.96	0.96	0.96	0.96	0.96
Percent Heavy Veh, %	1	2	19	0	2	0	27	0	9	1	2	2
Cap, veh/h	285	2535	666	25	1251	554	264	413	326	340	133	232
Arrive On Green	0.16	0.50	0.50	0.01	0.35	0.35	0.22	0.22	0.22	0.22	0.22	0.22
Sat Flow, veh/h	1795	5106	1341	1810	3554	1575	987	1900	1497	1271	613	1065
Grp Volume(v), veh/h	229	805	2	11	847	101	12	116	13	142	0	156
Grp Sat Flow(s),veh/h/ln	1795	1702	1341	1810	1777	1575	987	1900	1497	1271	0	1679
Q Serve(g_s), s	6.9	5.3	0.0	0.3	11.4	2.5	0.6	2.9	0.4	5.9	0.0	4.5
Cycle Q Clear(g_c), s	6.9	5.3	0.0	0.3	11.4	2.5	5.1	2.9	0.4	8.8	0.0	4.5
Prop In Lane	1.00		1.00	1.00		1.00	1.00		1.00	1.00		0.63
Lane Grp Cap(c), veh/h	285	2535	666	25	1251	554	264	413	326	340	0	365
V/C Ratio(X)	0.80	0.32	0.00	0.43	0.68	0.18	0.05	0.28	0.04	0.42	0.00	0.43
Avail Cap(c_a), veh/h	763	5637	1481	161	2729	1209	709	1270	1001	931	0	1146
HCM Platoon Ratio	1.00	1.00	1.00	1.00	1.00	1.00	1.00	1.00	1.00	1.00	1.00	1.00
Upstream Filter(I)	1.00	1.00	1.00	1.00	1.00	1.00	1.00	1.00	1.00	1.00	0.00	1.00
Uniform Delay (d), s/veh	22.8	8.5	7.1	27.5	15.5	12.6	21.2	18.3	17.4	22.0	0.0	19.0
Incr Delay (d2), s/veh	2.0	0.1	0.0	4.3	0.6	0.2	0.1	0.4	0.0	0.8	0.0	0.8
Initial Q Delay(d3),s/veh	0.0	0.0	0.0	0.0	0.0	0.0	0.0	0.0	0.0	0.0	0.0	0.0
%ile BackOfQ(50%),veh/ln	2.7	1.4	0.0	0.2	3.8	0.7	0.1	1.1	0.1	1.7	0.0	1.7
Unsig. Movement Delay, s/veh												
LnGrp Delay(d),s/veh	24.9	8.5	7.1	31.8	16.2	12.8	21.3	18.7	17.4	22.8	0.0	19.8
LnGrp LOS	C	A	A	C	B	B	C	B	B	C	A	B
Approach Vol, veh/h		1036			959			141			298	
Approach Delay, s/veh		12.1			16.0			18.8			21.2	
Approach LOS		B			B			B			C	
Timer - Assigned Phs	1	2		4	5	6		8				
Phs Duration (G+Y+Rc), s	4.9	33.7		17.6	13.0	25.6		17.6				
Change Period (Y+Rc), s	4.1	5.8		* 5.4	4.1	5.8		5.4				
Max Green Setting (Gmax), s	5.0	62.1		* 38	23.9	43.2		37.6				
Max Q Clear Time (g_c+I1), s	2.3	7.3		10.8	8.9	13.4		7.1				
Green Ext Time (p_c), s	0.0	6.0		1.5	0.3	6.4		0.7				

Intersection Summary

HCM 6th Ctrl Delay	15.2
HCM 6th LOS	B

Notes

* HCM 6th computational engine requires equal clearance times for the phases crossing the barrier.

Timings
36: Elsworth St. & Cactus Av.

West Campus Upper Plateau (JN 14064)

09/30/2022



Lane Group	EBL	EBT	EBR	WBL	WBT	WBR	NBL	NBT	SBL	SBT	SBR
Lane Configurations	↘	↑↑↑	↗	↘	↑↑↑	↗	↘	↕	↘	↗	↗
Traffic Volume (vph)	177	1251	36	16	1249	155	25	13	186	20	149
Future Volume (vph)	177	1251	36	16	1249	155	25	13	186	20	149
Turn Type	Prot	NA	Perm	Prot	NA	Perm	Split	NA	Split	NA	pm+ov
Protected Phases	5	2		1	6		8	8	4	4	5
Permitted Phases			2			6					4
Detector Phase	5	2	2	1	6	6	8	8	4	4	5
Switch Phase											
Minimum Initial (s)	5.0	10.0	10.0	5.0	10.0	10.0	10.0	10.0	10.0	10.0	5.0
Minimum Split (s)	9.6	36.2	36.2	9.6	36.2	36.2	35.4	35.4	35.4	35.4	9.6
Total Split (s)	16.5	49.6	49.6	9.6	42.7	42.7	35.4	35.4	35.4	35.4	16.5
Total Split (%)	12.7%	38.2%	38.2%	7.4%	32.8%	32.8%	27.2%	27.2%	27.2%	27.2%	12.7%
Yellow Time (s)	3.6	5.2	5.2	3.6	5.2	5.2	4.4	4.4	4.4	4.4	3.6
All-Red Time (s)	1.0	1.0	1.0	1.0	1.0	1.0	1.0	1.0	1.0	1.0	1.0
Lost Time Adjust (s)	0.0	0.0	0.0	0.0	0.0	0.0	0.0	0.0	0.0	0.0	0.0
Total Lost Time (s)	4.6	6.2	6.2	4.6	6.2	6.2	5.4	5.4	5.4	5.4	4.6
Lead/Lag	Lead	Lag	Lag	Lead	Lag	Lag					Lead
Lead-Lag Optimize?	Yes	Yes	Yes	Yes	Yes	Yes					Yes
Recall Mode	None	None	None	None	None	None	Max	Max	Max	Max	None
Act Effct Green (s)	11.9	49.2	49.2	5.0	36.5	36.5	30.0	30.0	30.0	30.0	42.7
Actuated g/C Ratio	0.09	0.38	0.38	0.04	0.28	0.28	0.23	0.23	0.23	0.23	0.33
v/c Ratio	1.18	0.70	0.06	0.25	0.94	0.30	0.06	0.07	0.28	0.27	0.25
Control Delay	177.3	37.3	0.2	69.5	59.2	9.3	39.6	27.3	43.4	43.3	3.3
Queue Delay	0.0	0.0	0.0	0.0	0.0	0.0	0.0	0.0	0.0	0.0	0.0
Total Delay	177.3	37.3	0.2	69.5	59.2	9.3	39.6	27.3	43.4	43.3	3.3
LOS	F	D	A	E	E	A	D	C	D	D	A
Approach Delay		53.3			53.8			32.7		26.5	
Approach LOS		D			D			C		C	

Intersection Summary

Cycle Length: 130
 Actuated Cycle Length: 130
 Natural Cycle: 120
 Control Type: Actuated-Uncoordinated
 Maximum v/c Ratio: 1.18
 Intersection Signal Delay: 50.3
 Intersection LOS: D
 Intersection Capacity Utilization 59.8%
 ICU Level of Service B
 Analysis Period (min) 15

Splits and Phases: 36: Elsworth St. & Cactus Av.

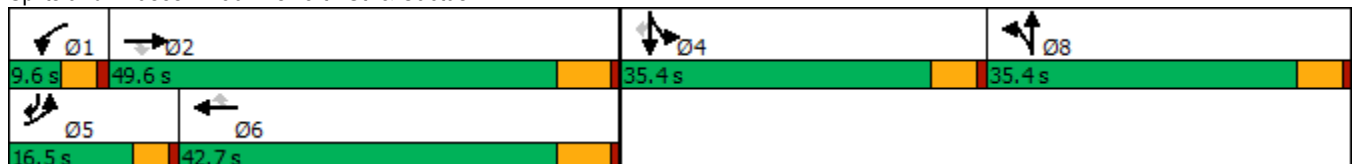

HCM 6th Signalized Intersection Summary
36: Elsworth St. & Cactus Av.

West Campus Upper Plateau (JN 14064)

09/30/2022



Movement	EBL	EBT	EBR	WBL	WBT	WBR	NBL	NBT	NBR	SBL	SBT	SBR
Lane Configurations	↖	↑↑↑	↗	↖	↑↑↑	↗	↖	↕		↖	↗	↖
Traffic Volume (veh/h)	177	1251	36	16	1249	155	25	13	11	186	20	149
Future Volume (veh/h)	177	1251	36	16	1249	155	25	13	11	186	20	149
Initial Q (Qb), veh	0	0	0	0	0	0	0	0	0	0	0	0
Ped-Bike Adj(A_pbT)	1.00		1.00	1.00		1.00	1.00		1.00	1.00		1.00
Parking Bus, Adj	1.00	1.00	1.00	1.00	1.00	1.00	1.00	1.00	1.00	1.00	1.00	1.00
Work Zone On Approach		No			No			No			No	
Adj Sat Flow, veh/h/ln	1841	1841	1781	1900	1841	1885	1885	1900	1885	1885	1900	1885
Adj Flow Rate, veh/h	186	1317	0	17	1315	126	25	0	0	211	0	49
Peak Hour Factor	0.95	0.95	0.95	0.95	0.95	0.95	0.95	0.95	0.95	0.95	0.95	0.95
Percent Heavy Veh, %	4	4	8	0	4	1	1	0	1	1	0	1
Cap, veh/h	161	1774		32	1402	446	831	440	0	831	0	516
Arrive On Green	0.09	0.35	0.00	0.02	0.28	0.28	0.23	0.00	0.00	0.23	0.00	0.23
Sat Flow, veh/h	1753	5025	1510	1810	5025	1598	3591	1900	0	3591	0	1598
Grp Volume(v), veh/h	186	1317	0	17	1315	126	25	0	0	211	0	49
Grp Sat Flow(s),veh/h/ln	1753	1675	1510	1810	1675	1598	1795	1900	0	1795	0	1598
Q Serve(g_s), s	11.9	29.8	0.0	1.2	33.1	8.0	0.7	0.0	0.0	6.2	0.0	2.8
Cycle Q Clear(g_c), s	11.9	29.8	0.0	1.2	33.1	8.0	0.7	0.0	0.0	6.2	0.0	2.8
Prop In Lane	1.00		1.00	1.00		1.00	1.00		0.00	1.00		1.00
Lane Grp Cap(c), veh/h	161	1774		32	1402	446	831	440	0	831	0	516
V/C Ratio(X)	1.16	0.74		0.53	0.94	0.28	0.03	0.00	0.00	0.25	0.00	0.09
Avail Cap(c_a), veh/h	161	1774		70	1415	450	831	440	0	831	0	516
HCM Platoon Ratio	1.00	1.00	1.00	1.00	1.00	1.00	1.00	1.00	1.00	1.00	1.00	1.00
Upstream Filter(I)	1.00	1.00	0.00	1.00	1.00	1.00	1.00	0.00	0.00	1.00	0.00	1.00
Uniform Delay (d), s/veh	58.9	36.8	0.0	63.2	45.7	36.6	38.6	0.0	0.0	40.7	0.0	30.6
Incr Delay (d2), s/veh	119.1	1.7	0.0	5.0	12.1	0.3	0.1	0.0	0.0	0.7	0.0	0.4
Initial Q Delay(d3),s/veh	0.0	0.0	0.0	0.0	0.0	0.0	0.0	0.0	0.0	0.0	0.0	0.0
%ile BackOfQ(50%),veh/ln	10.4	11.9	0.0	0.6	14.7	3.1	0.3	0.0	0.0	2.8	0.0	1.1
Unsig. Movement Delay, s/veh												
LnGrp Delay(d),s/veh	178.0	38.5	0.0	68.2	57.7	36.9	38.6	0.0	0.0	41.4	0.0	31.0
LnGrp LOS	F	D		E	E	D	D	A	A	D	A	C
Approach Vol, veh/h		1503			1458			25				260
Approach Delay, s/veh		55.8			56.1			38.6				39.5
Approach LOS		E			E			D				D
Timer - Assigned Phs	1	2		4	5	6		8				
Phs Duration (G+Y+Rc), s	6.9	52.0		35.4	16.5	42.4		35.4				
Change Period (Y+Rc), s	4.6	6.2		5.4	4.6	6.2		5.4				
Max Green Setting (Gmax), s	5.0	43.4		30.0	11.9	36.5		30.0				
Max Q Clear Time (g_c+1), s	3.2	31.8		8.2	13.9	35.1		2.7				
Green Ext Time (p_c), s	0.0	6.2		0.8	0.0	1.0		0.0				

Intersection Summary

HCM 6th Ctrl Delay	54.5
HCM 6th LOS	D

Notes

- User approved pedestrian interval to be less than phase max green.
- User approved volume balancing among the lanes for turning movement.
- Unsignalized Delay for [EBR] is excluded from calculations of the approach delay and intersection delay.

Timings
37: Cactus Av. & Frederick St.

West Campus Upper Plateau (JN 14064)

09/30/2022

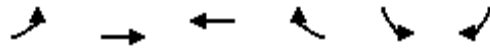

Lane Group	EBL	EBT	WBT	WBR	SBL	SBR
Lane Configurations	↖	↑↑↑	↑↑↑	↗	↙↘	↘
Traffic Volume (vph)	120	1359	1366	192	306	97
Future Volume (vph)	120	1359	1366	192	306	97
Turn Type	Prot	NA	NA	pm+ov	Prot	pm+ov
Protected Phases	5	2	6	4	4	5
Permitted Phases				6		4
Detector Phase	5	2	6	4	4	5
Switch Phase						
Minimum Initial (s)	5.0	10.0	10.0	10.0	10.0	5.0
Minimum Split (s)	9.2	28.2	29.2	36.4	36.4	9.2
Total Split (s)	31.0	81.0	50.0	39.0	39.0	31.0
Total Split (%)	25.8%	67.5%	41.7%	32.5%	32.5%	25.8%
Yellow Time (s)	3.2	5.2	5.2	4.4	4.4	3.2
All-Red Time (s)	1.0	1.0	1.0	1.0	1.0	1.0
Lost Time Adjust (s)	0.0	0.0	0.0	0.0	0.0	0.0
Total Lost Time (s)	4.2	6.2	6.2	5.4	5.4	4.2
Lead/Lag	Lead		Lag			Lead
Lead-Lag Optimize?	Yes		Yes			Yes
Recall Mode	None	None	None	None	None	None
Act Effct Green (s)	11.0	47.4	32.0	48.5	15.6	32.3
Actuated g/C Ratio	0.15	0.63	0.42	0.64	0.21	0.43
v/c Ratio	0.52	0.47	0.69	0.19	0.47	0.16
Control Delay	41.3	8.2	20.6	1.0	29.8	14.3
Queue Delay	0.0	0.0	0.0	0.0	0.0	0.0
Total Delay	41.3	8.2	20.6	1.0	29.8	14.3
LOS	D	A	C	A	C	B
Approach Delay		10.9	18.1		26.1	
Approach LOS		B	B		C	

Intersection Summary

Cycle Length: 120
 Actuated Cycle Length: 75.3
 Natural Cycle: 80
 Control Type: Actuated-Uncoordinated
 Maximum v/c Ratio: 0.69
 Intersection Signal Delay: 16.0
 Intersection LOS: B
 Intersection Capacity Utilization 54.9%
 ICU Level of Service A
 Analysis Period (min) 15

Splits and Phases: 37: Cactus Av. & Frederick St.



HCM 6th Signalized Intersection Summary
37: Cactus Av. & Frederick St.

West Campus Upper Plateau (JN 14064)
09/30/2022



Movement	EBL	EBT	WBT	WBR	SBL	SBR
Lane Configurations						
Traffic Volume (veh/h)	120	1359	1366	192	306	97
Future Volume (veh/h)	120	1359	1366	192	306	97
Initial Q (Qb), veh	0	0	0	0	0	0
Ped-Bike Adj(A_pbT)	1.00			0.98	1.00	1.00
Parking Bus, Adj	1.00	1.00	1.00	1.00	1.00	1.00
Work Zone On Approach		No	No		No	
Adj Sat Flow, veh/h/ln	1826	1856	1856	1870	1856	1856
Adj Flow Rate, veh/h	130	1477	1485	145	333	5
Peak Hour Factor	0.92	0.92	0.92	0.92	0.92	0.92
Percent Heavy Veh, %	5	3	3	2	3	3
Cap, veh/h	167	3210	2361	990	580	418
Arrive On Green	0.10	0.63	0.47	0.47	0.17	0.17
Sat Flow, veh/h	1739	5233	5233	1548	3428	1572
Grp Volume(v), veh/h	130	1477	1485	145	333	5
Grp Sat Flow(s),veh/h/ln	1739	1689	1689	1548	1714	1572
Q Serve(g_s), s	4.3	8.9	13.0	2.2	5.3	0.1
Cycle Q Clear(g_c), s	4.3	8.9	13.0	2.2	5.3	0.1
Prop In Lane	1.00			1.00	1.00	1.00
Lane Grp Cap(c), veh/h	167	3210	2361	990	580	418
V/C Ratio(X)	0.78	0.46	0.63	0.15	0.57	0.01
Avail Cap(c_a), veh/h	792	6438	3770	1421	1957	1049
HCM Platoon Ratio	1.00	1.00	1.00	1.00	1.00	1.00
Upstream Filter(I)	1.00	1.00	1.00	1.00	1.00	1.00
Uniform Delay (d), s/veh	26.0	5.6	11.9	4.3	22.5	15.9
Incr Delay (d2), s/veh	2.9	0.1	0.3	0.1	0.9	0.0
Initial Q Delay(d3),s/veh	0.0	0.0	0.0	0.0	0.0	0.0
%ile BackOfQ(50%),veh/ln	1.7	1.5	3.5	0.8	2.0	0.1
Unsig. Movement Delay, s/veh						
LnGrp Delay(d),s/veh	28.9	5.7	12.1	4.4	23.4	15.9
LnGrp LOS	C	A	B	A	C	B
Approach Vol, veh/h		1607	1630		338	
Approach Delay, s/veh		7.6	11.5		23.3	
Approach LOS		A	B		C	
Timer - Assigned Phs		2		4	5	6
Phs Duration (G+Y+Rc), s		43.5		15.4	9.9	33.6
Change Period (Y+Rc), s		6.2		5.4	* 4.2	6.2
Max Green Setting (Gmax), s		74.8		33.6	* 27	43.8
Max Q Clear Time (g_c+I1), s		10.9		7.3	6.3	15.0
Green Ext Time (p_c), s		14.1		1.1	0.1	12.4

Intersection Summary

HCM 6th Ctrl Delay	10.8
HCM 6th LOS	B

Notes

* HCM 6th computational engine requires equal clearance times for the phases crossing the barrier.

Timings
38: Riverside Dr./Graham St. & Cactus Av.

West Campus Upper Plateau (JN 14064)

09/30/2022

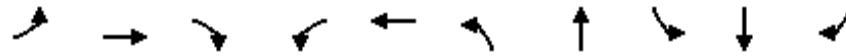

Lane Group	EBL	EBT	EBR	WBL	WBT	NBL	NBT	SBL	SBT	SBR
Lane Configurations	↘	↑↑↑	↗	↘	↑↑↑	↘↗	↑↗	↘	↑↑	↗
Traffic Volume (vph)	65	1272	202	23	1321	183	53	75	68	81
Future Volume (vph)	65	1272	202	23	1321	183	53	75	68	81
Turn Type	Prot	NA	Perm	Prot	NA	Prot	NA	Prot	NA	Perm
Protected Phases	7	4		3	8	5	2	1	6	
Permitted Phases			4							6
Detector Phase	7	4	4	3	8	5	2	1	6	6
Switch Phase										
Minimum Initial (s)	5.0	10.0	10.0	5.0	10.0	5.0	10.0	5.0	10.0	10.0
Minimum Split (s)	9.6	39.2	39.2	9.6	39.2	10.4	35.0	9.6	40.6	40.6
Total Split (s)	16.0	59.0	59.0	9.6	52.6	10.4	36.0	15.4	41.0	41.0
Total Split (%)	13.3%	49.2%	49.2%	8.0%	43.8%	8.7%	30.0%	12.8%	34.2%	34.2%
Yellow Time (s)	3.6	5.2	5.2	3.6	5.2	4.4	4.0	3.6	3.6	3.6
All-Red Time (s)	1.0	1.0	1.0	1.0	1.0	1.0	1.0	1.0	1.0	1.0
Lost Time Adjust (s)	0.0	0.0	0.0	0.0	0.0	0.0	0.0	0.0	0.0	0.0
Total Lost Time (s)	4.6	6.2	6.2	4.6	6.2	5.4	5.0	4.6	4.6	4.6
Lead/Lag	Lead	Lag	Lag	Lead	Lag	Lead	Lag	Lead	Lag	Lag
Lead-Lag Optimize?	Yes	Yes	Yes	Yes	Yes	Yes	Yes	Yes	Yes	Yes
Recall Mode	None	Min	Min	None	Min	None	None	None	None	None
Act Effct Green (s)	8.2	40.4	40.4	5.6	33.8	7.4	14.1	8.4	16.5	16.5
Actuated g/C Ratio	0.10	0.50	0.50	0.07	0.42	0.09	0.18	0.10	0.21	0.21
v/c Ratio	0.38	0.52	0.23	0.19	0.69	0.58	0.12	0.42	0.10	0.19
Control Delay	47.6	15.9	3.3	49.6	22.9	52.0	26.3	48.5	30.0	0.9
Queue Delay	0.0	0.0	0.0	0.0	0.0	0.0	0.0	0.0	0.0	0.0
Total Delay	47.6	15.9	3.3	49.6	22.9	52.0	26.3	48.5	30.0	0.9
LOS	D	B	A	D	C	D	C	D	C	A
Approach Delay		15.6			23.3		44.7		25.6	
Approach LOS		B			C		D		C	

Intersection Summary

Cycle Length: 120
 Actuated Cycle Length: 80
 Natural Cycle: 100
 Control Type: Actuated-Uncoordinated
 Maximum v/c Ratio: 0.69
 Intersection Signal Delay: 21.6
 Intersection LOS: C
 Intersection Capacity Utilization 56.4%
 ICU Level of Service B
 Analysis Period (min) 15

Splits and Phases: 38: Riverside Dr./Graham St. & Cactus Av.

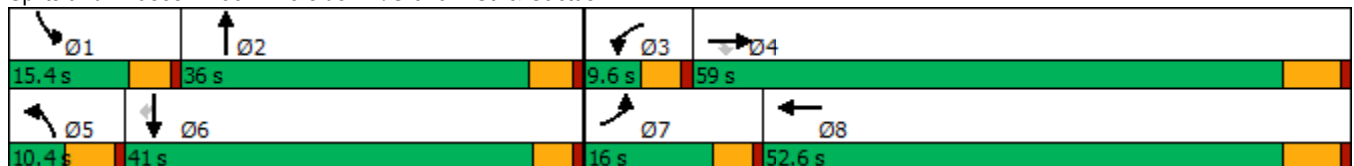

HCM 6th Signalized Intersection Summary
38: Riverside Dr./Graham St. & Cactus Av.

West Campus Upper Plateau (JN 14064)

09/30/2022



Movement	EBL	EBT	EBR	WBL	WBT	WBR	NBL	NBT	NBR	SBL	SBT	SBR
Lane Configurations	↗	↑↑↑	↘	↖	↑↑↑		↖	↑		↘	↑↑	↗
Traffic Volume (veh/h)	65	1272	202	23	1321	75	183	53	19	75	68	81
Future Volume (veh/h)	65	1272	202	23	1321	75	183	53	19	75	68	81
Initial Q (Qb), veh	0	0	0	0	0	0	0	0	0	0	0	0
Ped-Bike Adj(A_pbT)	1.00		1.00	1.00		0.99	1.00		1.00	1.00		1.00
Parking Bus, Adj	1.00	1.00	1.00	1.00	1.00	1.00	1.00	1.00	1.00	1.00	1.00	1.00
Work Zone On Approach		No			No			No			No	
Adj Sat Flow, veh/h/ln	1841	1841	1885	1900	1841	1900	1900	1900	1900	1870	1885	1826
Adj Flow Rate, veh/h	67	1311	163	24	1362	69	189	55	19	77	70	10
Peak Hour Factor	0.97	0.97	0.97	0.97	0.97	0.97	0.97	0.97	0.97	0.97	0.97	0.97
Percent Heavy Veh, %	4	4	1	0	4	0	0	0	0	2	1	5
Cap, veh/h	93	2200	699	49	2014	102	261	470	154	101	525	227
Arrive On Green	0.05	0.44	0.44	0.03	0.41	0.41	0.07	0.18	0.18	0.06	0.15	0.15
Sat Flow, veh/h	1753	5025	1598	1810	4894	248	3510	2669	878	1781	3582	1547
Grp Volume(v), veh/h	67	1311	163	24	932	499	189	36	38	77	70	10
Grp Sat Flow(s),veh/h/ln	1753	1675	1598	1810	1675	1792	1755	1805	1742	1781	1791	1547
Q Serve(g_s), s	2.5	13.4	4.3	0.9	15.3	15.3	3.5	1.1	1.2	2.9	1.1	0.4
Cycle Q Clear(g_c), s	2.5	13.4	4.3	0.9	15.3	15.3	3.5	1.1	1.2	2.9	1.1	0.4
Prop In Lane	1.00		1.00	1.00		0.14	1.00		0.50	1.00		1.00
Lane Grp Cap(c), veh/h	93	2200	699	49	1379	738	261	318	306	101	525	227
V/C Ratio(X)	0.72	0.60	0.23	0.49	0.68	0.68	0.73	0.11	0.12	0.76	0.13	0.04
Avail Cap(c_a), veh/h	297	3939	1252	134	2308	1235	261	831	802	286	1936	836
HCM Platoon Ratio	1.00	1.00	1.00	1.00	1.00	1.00	1.00	1.00	1.00	1.00	1.00	1.00
Upstream Filter(I)	1.00	1.00	1.00	1.00	1.00	1.00	1.00	1.00	1.00	1.00	1.00	1.00
Uniform Delay (d), s/veh	31.4	14.4	11.9	32.3	16.2	16.2	30.5	23.3	23.4	31.3	25.0	24.7
Incr Delay (d2), s/veh	3.9	0.3	0.2	2.9	0.6	1.1	8.4	0.2	0.2	4.4	0.1	0.1
Initial Q Delay(d3),s/veh	0.0	0.0	0.0	0.0	0.0	0.0	0.0	0.0	0.0	0.0	0.0	0.0
%ile BackOfQ(50%),veh/ln	1.1	4.0	1.3	0.4	4.8	5.2	1.7	0.5	0.5	1.3	0.5	0.1
Unsig. Movement Delay, s/veh												
LnGrp Delay(d),s/veh	35.3	14.7	12.0	35.2	16.7	17.3	39.0	23.5	23.6	35.7	25.1	24.8
LnGrp LOS	D	B	B	D	B	B	D	C	C	D	C	C
Approach Vol, veh/h		1541			1455			263			157	
Approach Delay, s/veh		15.3			17.2			34.6			30.3	
Approach LOS		B			B			C			C	
Timer - Assigned Phs	1	2	3	4	5	6	7	8				
Phs Duration (G+Y+Rc), s	8.4	16.9	6.4	35.7	10.4	14.9	8.2	33.9				
Change Period (Y+Rc), s	4.6	5.0	4.6	6.2	5.4	* 5	4.6	6.2				
Max Green Setting (Gmax), s	10.8	31.0	5.0	52.8	5.0	* 36	11.4	46.4				
Max Q Clear Time (g_c+I1), s	4.9	3.2	2.9	15.4	5.5	3.1	4.5	17.3				
Green Ext Time (p_c), s	0.0	0.3	0.0	11.6	0.0	0.4	0.0	10.4				

Intersection Summary

HCM 6th Ctrl Delay	18.3
HCM 6th LOS	B

Notes

* HCM 6th computational engine requires equal clearance times for the phases crossing the barrier.

APPENDIX 8.3:

**HORIZON YEAR (2045) WITHOUT PROJECT CONDITIONS TRAFFIC SIGNAL WARRANT
ANALYSIS WORKSHEETS**

This Page Intentionally Left Blank

Figure 4C-3. Warrant 3, Peak Hour

Traffic Conditions = **2045 Without Project Conditions - Weekday AM Peak Hour**

Major Street Name = **Grove Community Dr.** Total of Both Approaches (VPH) = **726**
 Number of Approach Lanes on Major Street = **1**

Minor Street Name = **Deercreek Dr.** High Volume Approach (VPH) = **312**
 Number of Approach Lanes On Minor Street = **1**

SIGNAL WARRANT NOT SATISFIED

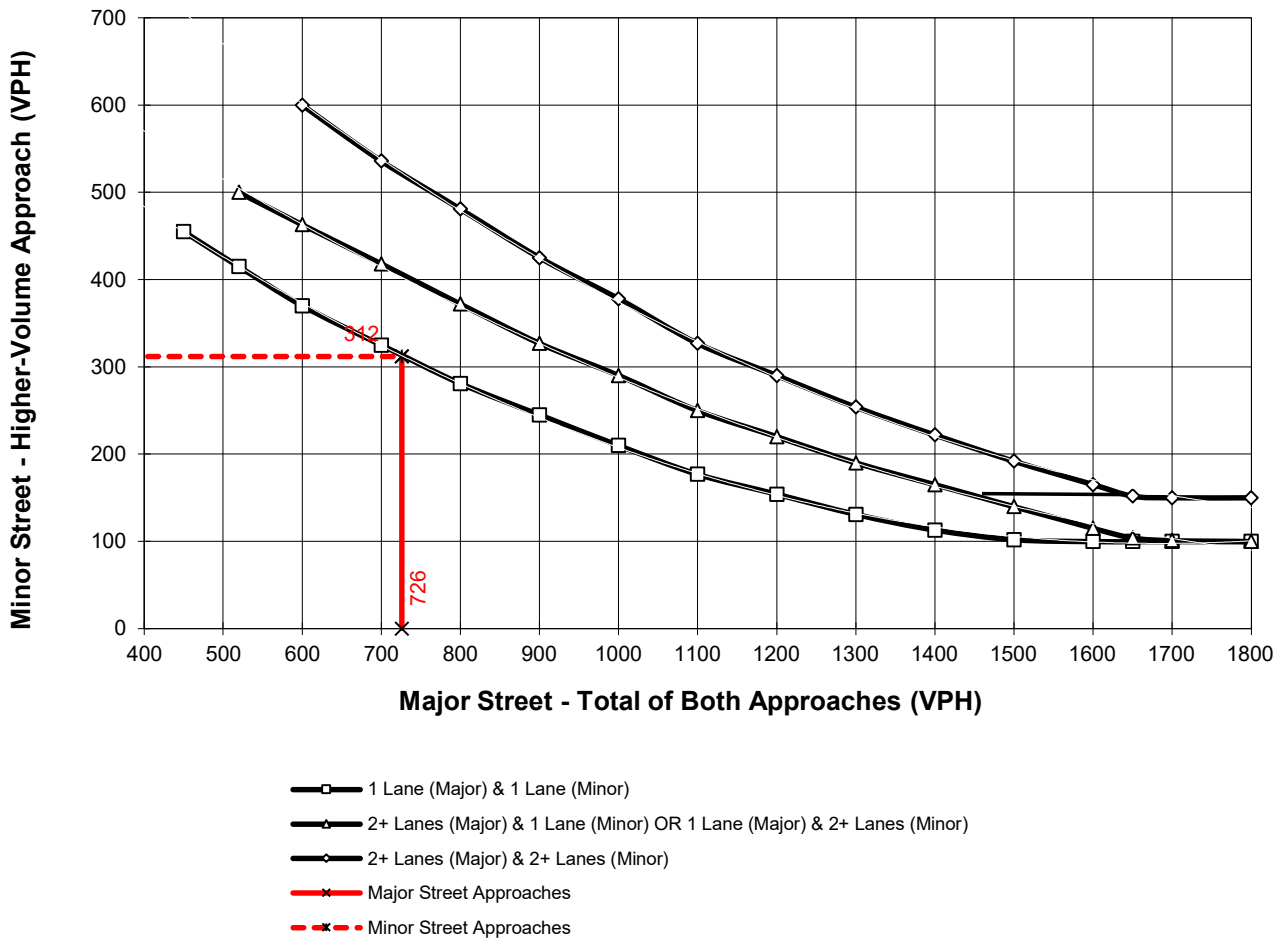

*Note: 150 vph applies as the lower threshold for a minor-street approach with two or more lanes and 100 vph applies as the lower threshold for a minor-street approach with one lane

Figure 4C-3. Warrant 3, Peak Hour

Traffic Conditions = **2045 Without Project Conditions - Weekday PM Peak Hour**

Major Street Name = **Grove Community Dr.** Total of Both Approaches (VPH) = **515**
 Number of Approach Lanes on Major Street = **1**

Minor Street Name = **Barton Rd.** High Volume Approach (VPH) = **38**
 Number of Approach Lanes On Minor Street = **1**

SIGNAL WARRANT NOT SATISFIED

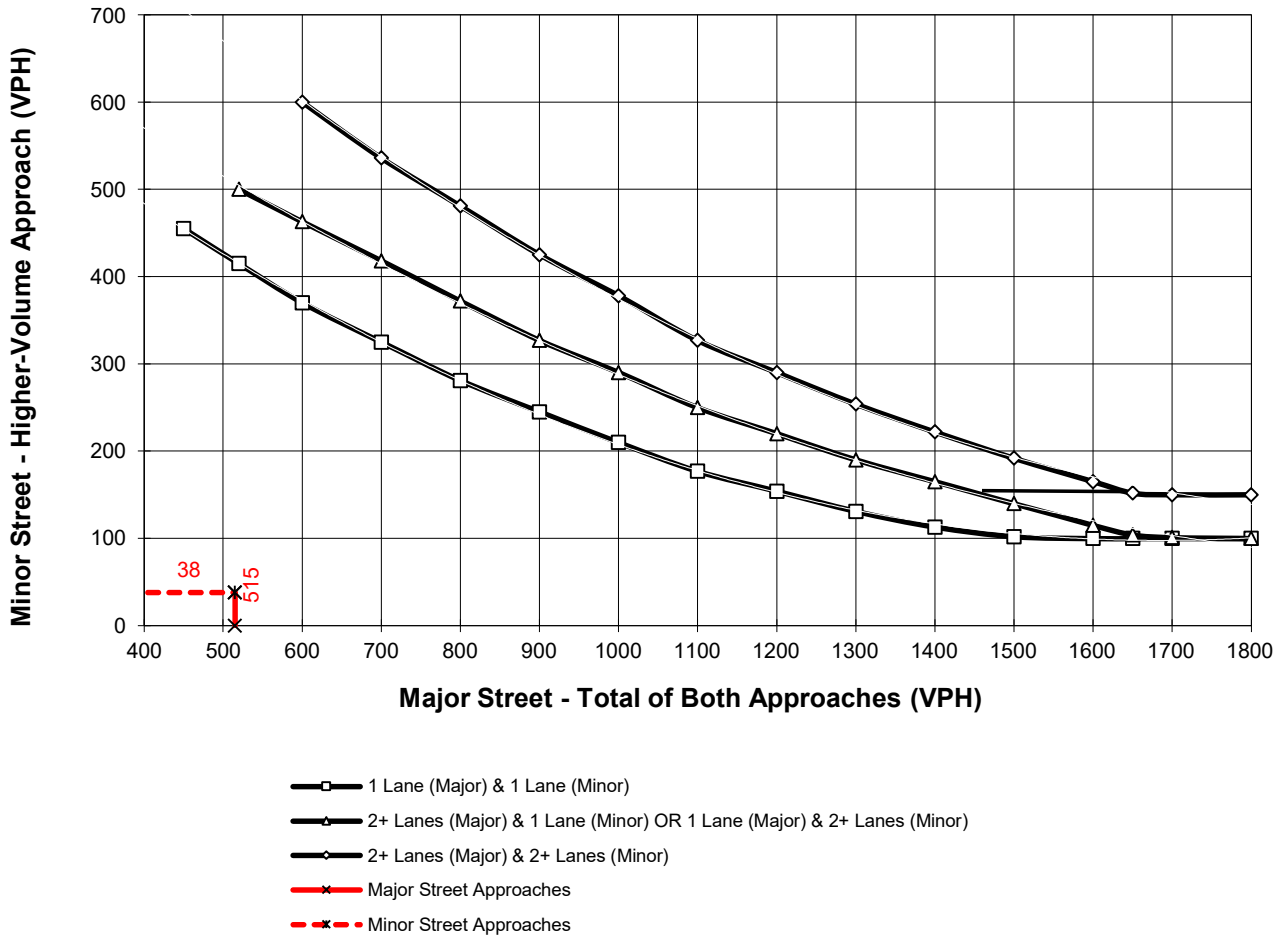

*Note: 150 vph applies as the lower threshold for a minor-street approach with two or more lanes and 100 vph applies as the lower threshold for a minor-street approach with one lane

Figure 4C-3. Warrant 3, Peak Hour

Traffic Conditions = **2045 Without Project Conditions - Weekday AM Peak Hour**

Major Street Name = **Grove Community Dr.** Total of Both Approaches (VPH) = **545**
 Number of Approach Lanes on Major Street = **1**

Minor Street Name = **Abrams Dr** High Volume Approach (VPH) = **261**
 Number of Approach Lanes On Minor Street = **1**

SIGNAL WARRANT NOT SATISFIED

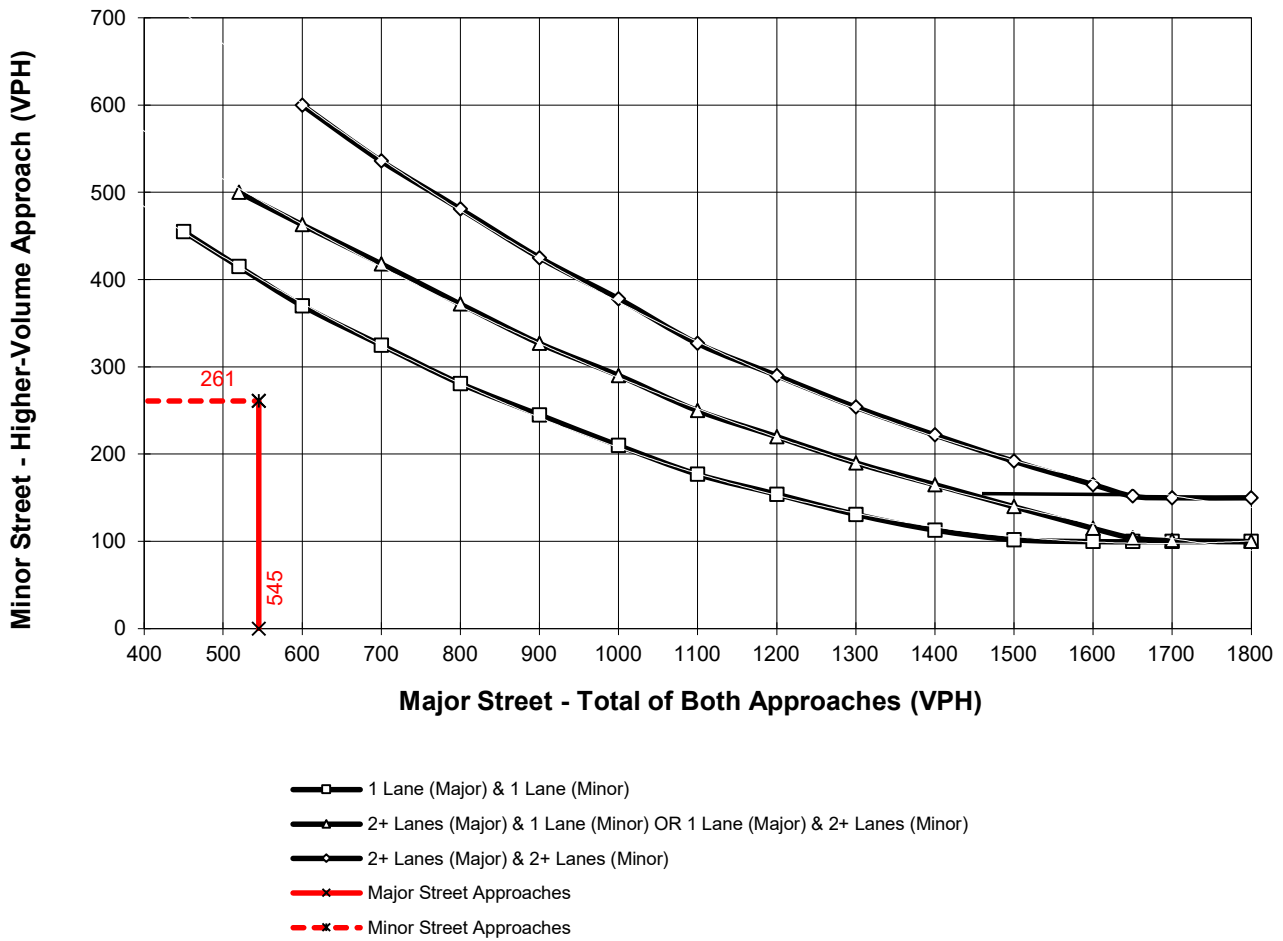

*Note: 150 vph applies as the lower threshold for a minor-street approach with two or more lanes and 100 vph applies as the lower threshold for a minor-street approach with one lane

Figure 4C-3. Warrant 3, Peak Hour

Traffic Conditions = **2045 Without Project Conditions - Weekday AM Peak Hour**

Major Street Name = **Orange Terrace Pkwy**

Total of Both Approaches (VPH) = **892**

Number of Approach Lanes on Major Street = **1**

Minor Street Name = **Abrams Dr.**

High Volume Approach (VPH) = **236**

Number of Approach Lanes On Minor Street = **1**

SIGNAL WARRANT NOT SATISFIED

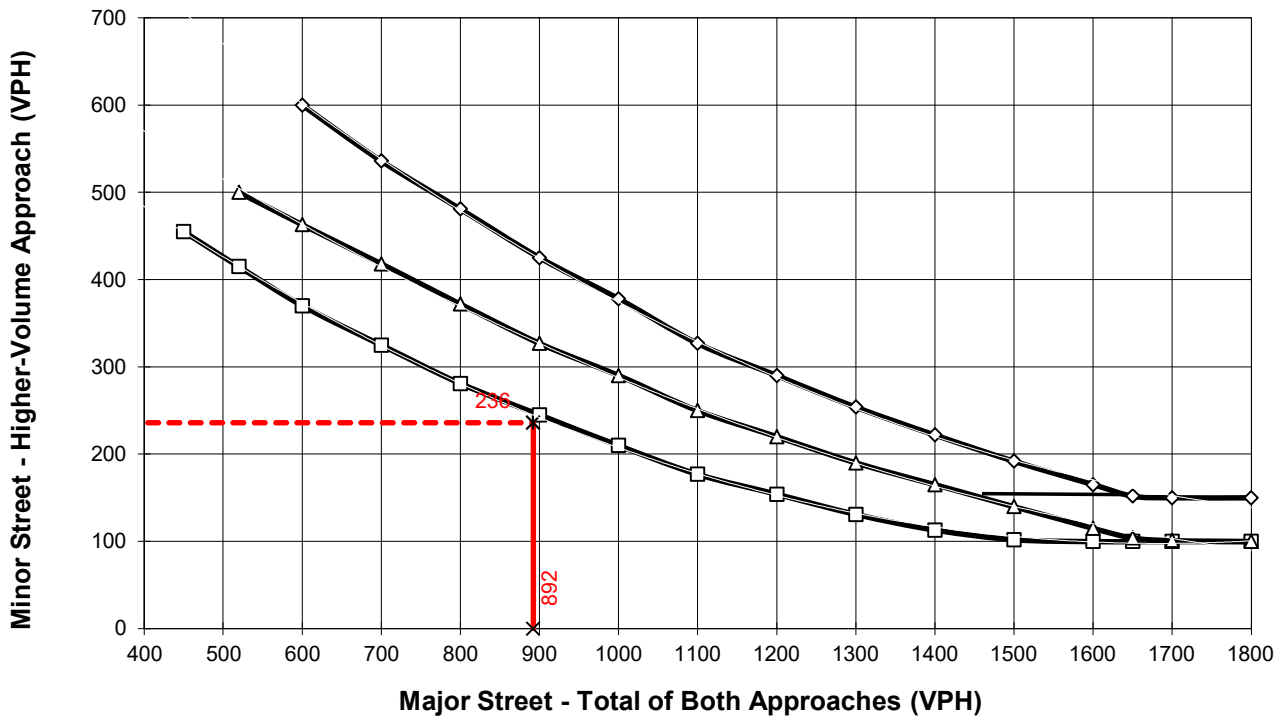

- 1 Lane (Major) & 1 Lane (Minor)
- △— 2+ Lanes (Major) & 1 Lane (Minor) OR 1 Lane (Major) & 2+ Lanes (Minor)
- ◇— 2+ Lanes (Major) & 2+ Lanes (Minor)
- x— Major Street Approaches
- x- Minor Street Approaches

*Note: 150 vph applies as the lower threshold for a minor-street approach with two or more lanes and 100 vph applies as the lower threshold for a minor-street approach with one lane

APPENDIX 8.4:

**HORIZON YEAR (2045) WITH PROJECT CONDITIONS TRAFFIC SIGNAL WARRANT
ANALYSIS WORKSHEETS**

This Page Intentionally Left Blank

Figure 4C-3. Warrant 3, Peak Hour

Traffic Conditions = **2045 With Project Conditions - Weekday AM Peak Hour**

Major Street Name = **Grove Community Dr.** Total of Both Approaches (VPH) = **743**
 Number of Approach Lanes on Major Street = **1**

Minor Street Name = **Deercreek Dr.** High Volume Approach (VPH) = **312**
 Number of Approach Lanes On Minor Street = **1**

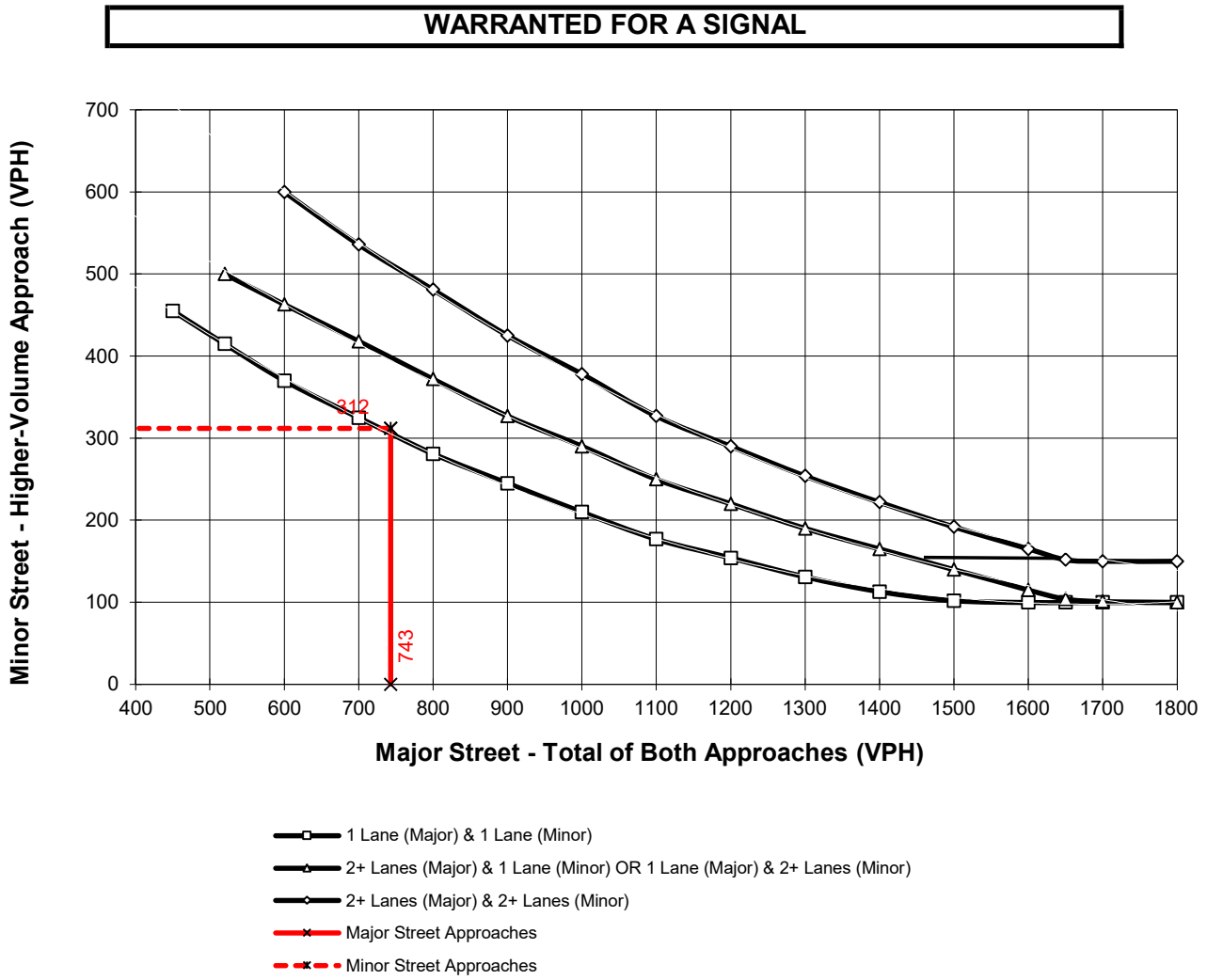

*Note: 150 vph applies as the lower threshold for a minor-street approach with two or more lanes and 100 vph applies as the lower threshold for a minor-street approach with one lane



Figure 4C-3. Warrant 3, Peak Hour

Traffic Conditions = **2045 With Project Conditions - Weekday PM Peak Hour**

Major Street Name = **Grove Community Dr.** Total of Both Approaches (VPH) = **541**
 Number of Approach Lanes on Major Street = **1**

Minor Street Name = **Barton Rd.** High Volume Approach (VPH) = **62**
 Number of Approach Lanes On Minor Street = **1**

SIGNAL WARRANT NOT SATISFIED

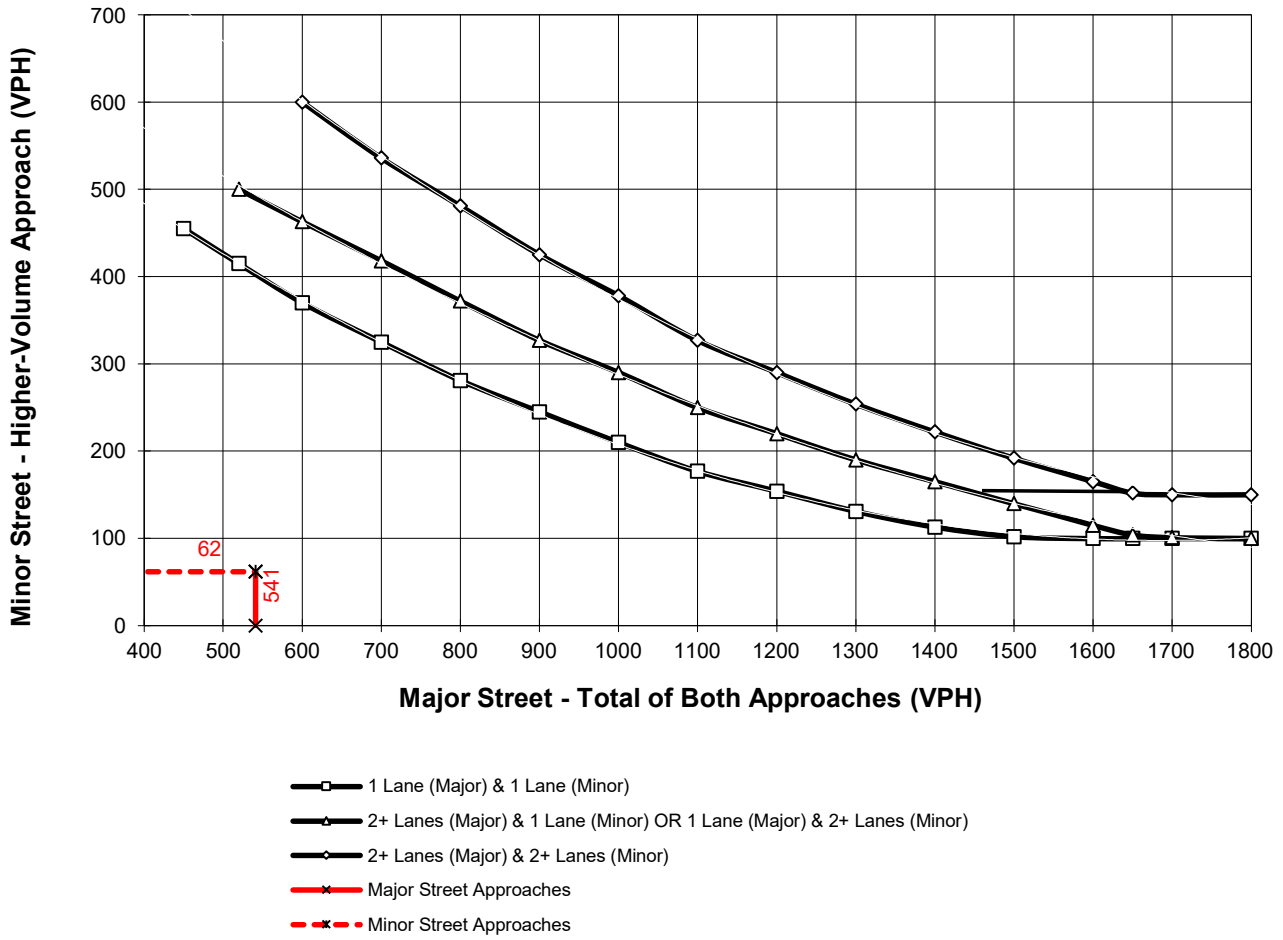

*Note: 150 vph applies as the lower threshold for a minor-street approach with two or more lanes and 100 vph applies as the lower threshold for a minor-street approach with one lane



Figure 4C-3. Warrant 3, Peak Hour

Traffic Conditions = **2045 With Project Conditions - Weekday AM Peak Hour**

Major Street Name = **Grove Community Dr.** Total of Both Approaches (VPH) = **578**
 Number of Approach Lanes on Major Street = **1**

Minor Street Name = **Abrams Dr** High Volume Approach (VPH) = **261**
 Number of Approach Lanes On Minor Street = **1**

SIGNAL WARRANT NOT SATISFIED

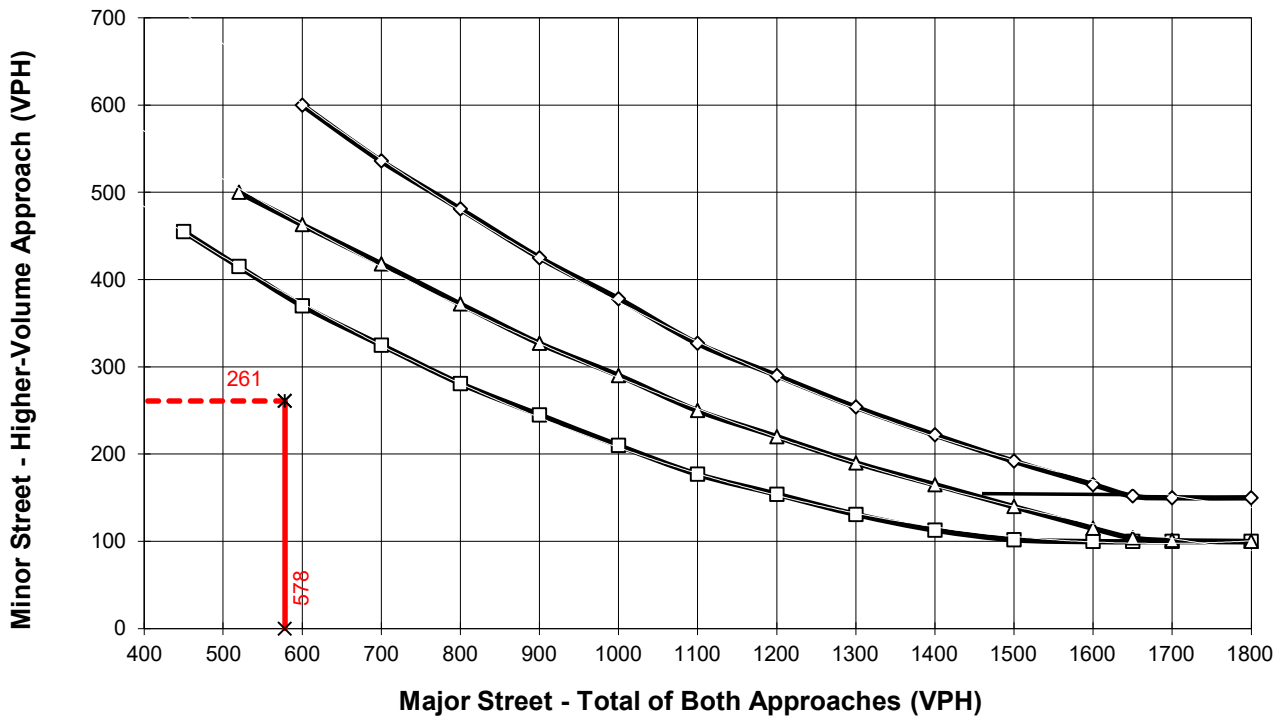

- 1 Lane (Major) & 1 Lane (Minor)
- △— 2+ Lanes (Major) & 1 Lane (Minor) OR 1 Lane (Major) & 2+ Lanes (Minor)
- ◇— 2+ Lanes (Major) & 2+ Lanes (Minor)
- x— Major Street Approaches
- x— Minor Street Approaches

*Note: 150 vph applies as the lower threshold for a minor-street approach with two or more lanes and 100 vph applies as the lower threshold for a minor-street approach with one lane

Figure 4C-3. Warrant 3, Peak Hour

Traffic Conditions = **2045 With Project Conditions - Weekday AM Peak Hour**

Major Street Name = **Orange Terrace Pkwy** Total of Both Approaches (VPH) = **892**
 Number of Approach Lanes on Major Street = **1**

Minor Street Name = **Abrams Dr.** High Volume Approach (VPH) = **236**
 Number of Approach Lanes On Minor Street = **1**

SIGNAL WARRANT NOT SATISFIED

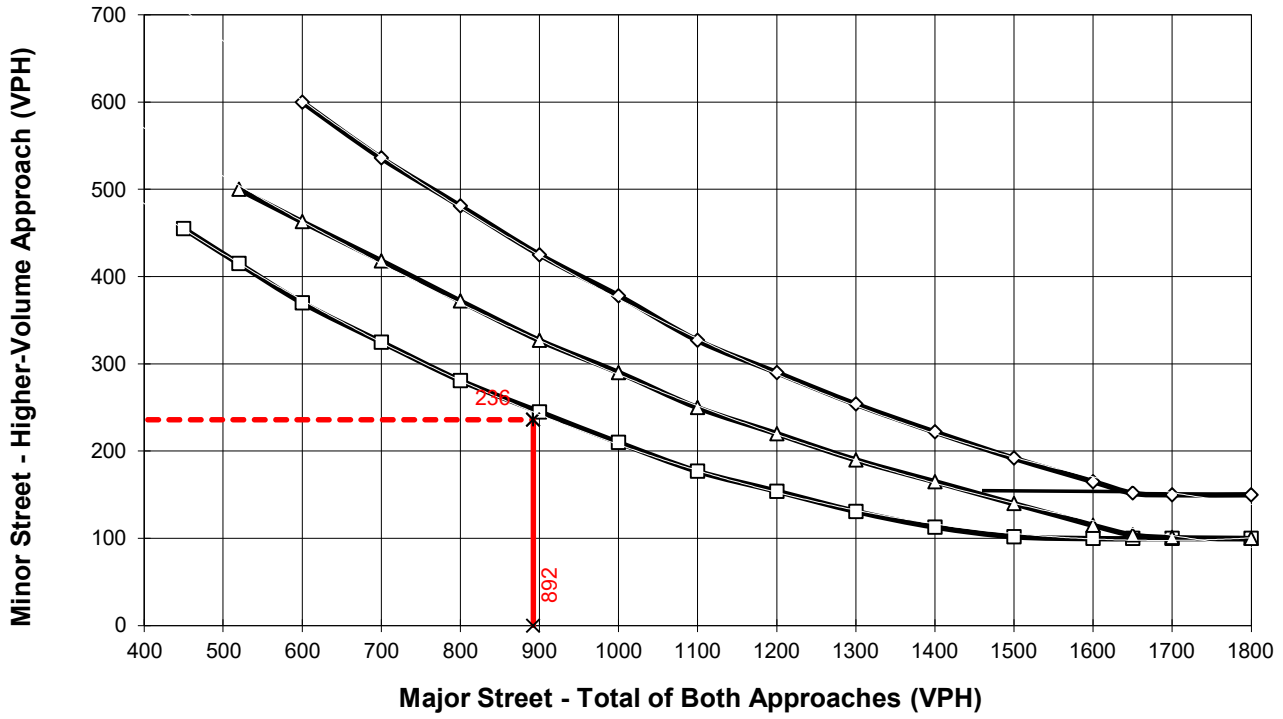

- 1 Lane (Major) & 1 Lane (Minor)
- △— 2+ Lanes (Major) & 1 Lane (Minor) OR 1 Lane (Major) & 2+ Lanes (Minor)
- ◇— 2+ Lanes (Major) & 2+ Lanes (Minor)
- x— Major Street Approaches
- x- Minor Street Approaches

*Note: 150 vph applies as the lower threshold for a minor-street approach with two or more lanes and 100 vph applies as the lower threshold for a minor-street approach with one lane



APPENDIX 8.5:

**HORIZON YEAR (2045) WITHOUT PROJECT OFF-RAMP QUEUING ANALYSIS
WORKSHEETS**

This Page Intentionally Left Blank

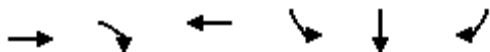

Lane Group	EBT	EBR	WBT	SBL	SBT	SBR
Lane Group Flow (vph)	1205	484	3490	348	330	317
v/c Ratio	0.42	0.49	1.21	0.74	0.77	0.75
Control Delay	11.2	6.6	110.4	36.0	36.3	35.0
Queue Delay	0.0	0.0	0.0	0.0	0.0	0.0
Total Delay	11.2	6.6	110.4	36.0	36.3	35.0
Queue Length 50th (ft)	124	49	~841	171	156	141
Queue Length 95th (ft)	178	136	m#705	249	242	223
Internal Link Dist (ft)	750		688		1585	
Turn Bay Length (ft)		50		525		525
Base Capacity (vph)	2899	995	2894	584	523	515
Starvation Cap Reductn	0	0	0	0	0	0
Spillback Cap Reductn	0	0	0	0	0	0
Storage Cap Reductn	0	0	0	0	0	0
Reduced v/c Ratio	0.42	0.49	1.21	0.60	0.63	0.62

Intersection Summary

- ~ Volume exceeds capacity, queue is theoretically infinite.
Queue shown is maximum after two cycles.
- # 95th percentile volume exceeds capacity, queue may be longer.
Queue shown is maximum after two cycles.
- m Volume for 95th percentile queue is metered by upstream signal.



Lane Group	EBL	EBT	WBT	WBR	NBL	NBT	NBR
Lane Group Flow (vph)	120	1579	2193	193	694	691	455
v/c Ratio	0.60	0.49	0.91	0.25	1.83	1.61	1.15
Control Delay	38.3	10.5	30.2	10.3	406.6	307.8	121.6
Queue Delay	0.0	0.0	0.0	0.0	0.0	0.0	0.0
Total Delay	38.3	10.5	30.2	10.3	406.6	307.8	121.6
Queue Length 50th (ft)	61	121	402	34	~596	~551	~265
Queue Length 95th (ft)	113	222	#596	87	#814	#784	#458
Internal Link Dist (ft)		688	447			1005	
Turn Bay Length (ft)	200			50	400		400
Base Capacity (vph)	342	3228	2407	758	380	430	394
Starvation Cap Reductn	0	0	0	0	0	0	0
Spillback Cap Reductn	0	0	0	0	0	0	0
Storage Cap Reductn	0	0	0	0	0	0	0
Reduced v/c Ratio	0.35	0.49	0.91	0.25	1.83	1.61	1.15

Intersection Summary

- ~ Volume exceeds capacity, queue is theoretically infinite.
Queue shown is maximum after two cycles.
- # 95th percentile volume exceeds capacity, queue may be longer.
Queue shown is maximum after two cycles.



Lane Group	EBT	EBR	WBL	WBT	NBR	SBR
Lane Group Flow (vph)	549	20	1030	2217	1059	353
v/c Ratio	1.00	0.07	1.31	0.92	1.09	0.98
Control Delay	82.3	0.5	175.0	22.3	66.6	76.5
Queue Delay	0.0	0.0	0.0	0.0	0.0	0.0
Total Delay	82.3	0.5	175.0	22.3	66.6	76.5
Queue Length 50th (ft)	196	0	~893	598	~344	192
Queue Length 95th (ft)	#312	0	#1138	753	#596	#382
Internal Link Dist (ft)	658			918		
Turn Bay Length (ft)						
Base Capacity (vph)	551	281	787	2416	973	359
Starvation Cap Reductn	0	0	0	0	0	0
Spillback Cap Reductn	0	0	0	0	0	0
Storage Cap Reductn	0	0	0	0	0	0
Reduced v/c Ratio	1.00	0.07	1.31	0.92	1.09	0.98

Intersection Summary

~ Volume exceeds capacity, queue is theoretically infinite.

Queue shown is maximum after two cycles.

95th percentile volume exceeds capacity, queue may be longer.

Queue shown is maximum after two cycles.



Lane Group	EBL	EBT	WBT	NBL	NBT	NBR	SBL	SBT
Lane Group Flow (vph)	28	2463	4041	599	424	54	71	172
v/c Ratio	0.53	1.05	1.70	2.70	1.19	0.16	1.18	0.59
Control Delay	50.7	51.9	337.0	797.3	151.5	23.4	216.7	44.3
Queue Delay	0.0	0.0	0.0	0.0	0.0	0.0	0.0	0.0
Total Delay	50.7	51.9	337.0	797.3	151.5	23.4	216.7	44.3
Queue Length 50th (ft)	10	~1091	~2441	~786	~417	17	~65	101
Queue Length 95th (ft)	#67	#1225	#2537	#1010	#633	54	#164	179
Internal Link Dist (ft)		310	1149		1221			746
Turn Bay Length (ft)	175			145			100	
Base Capacity (vph)	53	2355	2380	222	356	346	60	293
Starvation Cap Reductn	0	0	0	0	0	0	0	0
Spillback Cap Reductn	0	0	0	0	0	0	0	0
Storage Cap Reductn	0	0	0	0	0	0	0	0
Reduced v/c Ratio	0.53	1.05	1.70	2.70	1.19	0.16	1.18	0.59

Intersection Summary

~ Volume exceeds capacity, queue is theoretically infinite.

Queue shown is maximum after two cycles.

95th percentile volume exceeds capacity, queue may be longer.

Queue shown is maximum after two cycles.

Queues

West Campus Upper Plateau (JN 14064)

32: I-215 SB Ramps & Van Buren Bl.

09/20/2022



Lane Group	EBT	EBR	WBL	WBT	SBT	SBR
Lane Group Flow (vph)	1270	1247	37	1905	514	1796
v/c Ratio	0.92	0.68	0.35	1.11	0.81	1.75
Control Delay	38.0	3.5	47.9	81.9	36.2	365.8
Queue Delay	0.0	0.0	0.0	0.0	0.0	0.0
Total Delay	38.0	3.5	47.9	81.9	36.2	365.8
Queue Length 50th (ft)	~394	0	19	~620	243	~808
Queue Length 95th (ft)	#523	44	50	#756	#408	#958
Internal Link Dist (ft)	2745			429	1115	
Turn Bay Length (ft)			200			
Base Capacity (vph)	1379	1824	106	1715	636	1024
Starvation Cap Reductn	0	0	0	0	0	0
Spillback Cap Reductn	0	0	0	0	0	0
Storage Cap Reductn	0	0	0	0	0	0
Reduced v/c Ratio	0.92	0.68	0.35	1.11	0.81	1.75

Intersection Summary

~ Volume exceeds capacity, queue is theoretically infinite.

Queue shown is maximum after two cycles.

95th percentile volume exceeds capacity, queue may be longer.

Queue shown is maximum after two cycles.



Lane Group	EBT	EBR	WBT	NBL	NBR
Lane Group Flow (vph)	652	1375	747	1861	174
v/c Ratio	1.27	0.52	1.43	0.86	0.17
Control Delay	162.5	0.7	233.0	13.1	4.2
Queue Delay	0.0	0.0	0.0	0.0	0.0
Total Delay	162.5	0.7	233.0	13.1	4.2
Queue Length 50th (ft)	~181	0	~223	229	20
Queue Length 95th (ft)	#305	0	#354	324	38
Internal Link Dist (ft)	669		611	856	
Turn Bay Length (ft)		300			585
Base Capacity (vph)	515	2623	521	2647	1268
Starvation Cap Reductn	0	0	0	0	0
Spillback Cap Reductn	0	0	0	0	0
Storage Cap Reductn	0	0	0	0	0
Reduced v/c Ratio	1.27	0.52	1.43	0.70	0.14

Intersection Summary

~ Volume exceeds capacity, queue is theoretically infinite.

Queue shown is maximum after two cycles.

95th percentile volume exceeds capacity, queue may be longer.

Queue shown is maximum after two cycles.

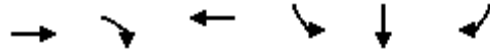

Lane Group	EBT	EBR	WBT	SBL	SBT	SBR
Lane Group Flow (vph)	1941	459	2777	379	362	355
v/c Ratio	0.67	0.51	0.98	0.80	0.84	0.81
Control Delay	14.3	8.9	31.5	40.5	42.2	40.0
Queue Delay	0.0	0.0	0.0	0.0	0.0	0.0
Total Delay	14.3	8.9	31.5	40.5	42.2	40.0
Queue Length 50th (ft)	261	81	~546	186	172	160
Queue Length 95th (ft)	315	159	#679	#305	#324	#298
Internal Link Dist (ft)	750		688		1585	
Turn Bay Length (ft)		50		525		525
Base Capacity (vph)	2876	908	2838	541	493	496
Starvation Cap Reductn	0	0	0	0	0	0
Spillback Cap Reductn	0	0	0	0	0	0
Storage Cap Reductn	0	0	0	0	0	0
Reduced v/c Ratio	0.67	0.51	0.98	0.70	0.73	0.72

Intersection Summary

- ~ Volume exceeds capacity, queue is theoretically infinite.
Queue shown is maximum after two cycles.
- # 95th percentile volume exceeds capacity, queue may be longer.
Queue shown is maximum after two cycles.

Queues
29: I-215 NB Ramps & Alessandro Bl.

West Campus Upper Plateau (JN 14064)

09/20/2022



Lane Group	EBL	EBT	WBT	WBR	NBL	NBT	NBR
Lane Group Flow (vph)	160	2400	1840	232	576	576	442
v/c Ratio	1.15	0.94	1.06	0.41	0.93	0.97	0.73
Control Delay	160.6	29.7	69.1	15.9	49.7	59.1	26.3
Queue Delay	0.0	0.0	0.0	0.0	0.0	0.0	0.0
Total Delay	160.6	29.7	69.1	15.9	49.7	59.1	26.3
Queue Length 50th (ft)	~101	421	~401	57	304	325	168
Queue Length 95th (ft)	#221	#561	#496	119	#521	#565	290
Internal Link Dist (ft)		688	447			1005	
Turn Bay Length (ft)	200			50	400		400
Base Capacity (vph)	139	2542	1731	562	620	592	606
Starvation Cap Reductn	0	0	0	0	0	0	0
Spillback Cap Reductn	0	0	0	0	0	0	0
Storage Cap Reductn	0	0	0	0	0	0	0
Reduced v/c Ratio	1.15	0.94	1.06	0.41	0.93	0.97	0.73

Intersection Summary

- ~ Volume exceeds capacity, queue is theoretically infinite.
Queue shown is maximum after two cycles.
- # 95th percentile volume exceeds capacity, queue may be longer.
Queue shown is maximum after two cycles.



Lane Group	EBT	EBR	WBL	WBT	NBR	SBR
Lane Group Flow (vph)	1183	239	985	1431	923	398
v/c Ratio	1.23	0.42	1.50	0.59	1.12	1.07
Control Delay	149.0	9.4	262.7	9.9	83.4	99.5
Queue Delay	0.0	0.0	0.0	0.0	0.0	0.0
Total Delay	149.0	9.4	262.7	9.9	83.4	99.5
Queue Length 50th (ft)	~520	20	~923	237	~364	~253
Queue Length 95th (ft)	#652	83	#1165	293	#609	#443
Internal Link Dist (ft)	658			918		
Turn Bay Length (ft)						
Base Capacity (vph)	958	569	655	2426	825	372
Starvation Cap Reductn	0	0	0	0	0	0
Spillback Cap Reductn	0	0	0	0	0	0
Storage Cap Reductn	0	0	0	0	0	0
Reduced v/c Ratio	1.23	0.42	1.50	0.59	1.12	1.07

Intersection Summary

- ~ Volume exceeds capacity, queue is theoretically infinite.
Queue shown is maximum after two cycles.
- # 95th percentile volume exceeds capacity, queue may be longer.
Queue shown is maximum after two cycles.



Lane Group	EBL	EBT	WBT	NBL	NBT	NBR	SBL	SBT
Lane Group Flow (vph)	77	2390	3220	360	320	94	236	226
v/c Ratio	0.91	1.16	1.53	1.48	0.70	0.22	1.50	0.54
Control Delay	99.3	96.3	262.5	262.6	38.1	17.2	284.5	32.7
Queue Delay	0.0	0.0	0.0	0.0	0.0	0.0	0.0	0.0
Total Delay	99.3	96.3	262.5	262.6	38.1	17.2	284.5	32.7
Queue Length 50th (ft)	33	~806	~1298	~268	162	24	~177	103
Queue Length 95th (ft)	#81	#947	#1434	#433	#265	63	#317	175
Internal Link Dist (ft)		310	1149		1221			746
Turn Bay Length (ft)	175			145			100	
Base Capacity (vph)	85	2065	2102	244	454	419	157	417
Starvation Cap Reductn	0	0	0	0	0	0	0	0
Spillback Cap Reductn	0	0	0	0	0	0	0	0
Storage Cap Reductn	0	0	0	0	0	0	0	0
Reduced v/c Ratio	0.91	1.16	1.53	1.48	0.70	0.22	1.50	0.54

Intersection Summary

~ Volume exceeds capacity, queue is theoretically infinite.

Queue shown is maximum after two cycles.

95th percentile volume exceeds capacity, queue may be longer.

Queue shown is maximum after two cycles.



Lane Group	EBT	EBR	WBL	WBT	SBT	SBR
Lane Group Flow (vph)	1780	2931	230	1873	811	934
v/c Ratio	0.83	1.62	2.19	0.71	4.80	2.72
Control Delay	16.4	301.2	588.8	7.1	1734.4	800.9
Queue Delay	0.0	0.0	0.0	0.0	0.0	0.0
Total Delay	16.4	301.2	588.8	7.1	1734.4	800.9
Queue Length 50th (ft)	345	~1294	~200	210	~818	~461
Queue Length 95th (ft)	454	#1444	#338	276	#1035	#593
Internal Link Dist (ft)	2745			429	1115	
Turn Bay Length (ft)			200			
Base Capacity (vph)	2143	1809	105	2629	169	343
Starvation Cap Reductn	0	0	0	0	0	0
Spillback Cap Reductn	0	0	0	0	0	0
Storage Cap Reductn	0	0	0	0	0	0
Reduced v/c Ratio	0.83	1.62	2.19	0.71	4.80	2.72

Intersection Summary

~ Volume exceeds capacity, queue is theoretically infinite.

Queue shown is maximum after two cycles.

95th percentile volume exceeds capacity, queue may be longer.

Queue shown is maximum after two cycles.



Lane Group	EBT	EBR	WBT	NBL	NBR
Lane Group Flow (vph)	875	1431	1086	1451	244
v/c Ratio	1.14	0.54	1.41	0.77	0.27
Control Delay	105.2	0.8	218.7	12.2	6.4
Queue Delay	0.0	0.0	0.0	0.0	0.0
Total Delay	105.2	0.8	218.7	12.2	6.4
Queue Length 50th (ft)	~189	0	~270	168	36
Queue Length 95th (ft)	#382	0	#491	230	63
Internal Link Dist (ft)	669		611	856	
Turn Bay Length (ft)		300			585
Base Capacity (vph)	768	2632	768	2668	1303
Starvation Cap Reductn	0	0	0	0	0
Spillback Cap Reductn	0	0	0	0	0
Storage Cap Reductn	0	0	0	0	0
Reduced v/c Ratio	1.14	0.54	1.41	0.54	0.19

Intersection Summary

~ Volume exceeds capacity, queue is theoretically infinite.

Queue shown is maximum after two cycles.

95th percentile volume exceeds capacity, queue may be longer.

Queue shown is maximum after two cycles.

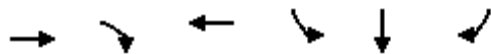

Lane Group	EBT	EBR	WBT	SBL	SBT	SBR
Lane Group Flow (vph)	1046	428	1531	157	191	189
v/c Ratio	0.40	0.44	0.59	0.41	0.52	0.50
Control Delay	7.8	3.9	9.2	19.9	19.4	18.7
Queue Delay	0.0	0.0	0.0	0.0	0.0	0.0
Total Delay	7.8	3.9	9.2	19.9	19.4	18.7
Queue Length 50th (ft)	52	14	85	35	37	35
Queue Length 95th (ft)	112	64	179	102	116	108
Internal Link Dist (ft)	750		688		1585	
Turn Bay Length (ft)		50		525		525
Base Capacity (vph)	4616	1466	4513	949	843	871
Starvation Cap Reductn	0	0	0	0	0	0
Spillback Cap Reductn	0	0	0	0	0	0
Storage Cap Reductn	0	0	0	0	0	0
Reduced v/c Ratio	0.23	0.29	0.34	0.17	0.23	0.22
Intersection Summary						

Queues
29: I-215 NB Ramps & Alessandro Bl.

West Campus Upper Plateau (JN 14064)

09/30/2022



Lane Group	EBL	EBT	WBT	WBR	NBL	NBT	NBR
Lane Group Flow (vph)	246	1099	1035	189	268	266	242
v/c Ratio	1.39	0.47	0.68	0.39	0.40	0.41	0.37
Control Delay	237.2	15.1	26.7	13.2	20.1	18.8	12.8
Queue Delay	0.0	0.0	0.0	0.0	0.0	0.0	0.0
Total Delay	237.2	15.1	26.7	13.2	20.1	18.8	12.8
Queue Length 50th (ft)	~166	130	163	34	97	92	51
Queue Length 95th (ft)	#327	163	206	85	180	178	121
Internal Link Dist (ft)		688	447			1005	
Turn Bay Length (ft)	200			50	400		400
Base Capacity (vph)	177	2724	1891	581	671	645	660
Starvation Cap Reductn	0	0	0	0	0	0	0
Spillback Cap Reductn	0	0	0	0	0	0	0
Storage Cap Reductn	0	0	0	0	0	0	0
Reduced v/c Ratio	1.39	0.40	0.55	0.33	0.40	0.41	0.37

Intersection Summary

~ Volume exceeds capacity, queue is theoretically infinite.

Queue shown is maximum after two cycles.

95th percentile volume exceeds capacity, queue may be longer.

Queue shown is maximum after two cycles.

Queues
30: I-215 SB Ramps & Cactus Av.

West Campus Upper Plateau (JN 14064)

09/30/2022



Lane Group	EBT	EBR	WBL	WBT	NBR	SBR
Lane Group Flow (vph)	79	28	495	547	467	129
v/c Ratio	0.16	0.11	0.73	0.25	0.46	0.25
Control Delay	18.4	3.5	18.5	3.6	1.5	1.2
Queue Delay	0.0	0.0	0.0	0.0	0.0	0.0
Total Delay	18.4	3.5	18.5	3.6	1.5	1.2
Queue Length 50th (ft)	8	0	95	22	0	0
Queue Length 95th (ft)	25	7	171	34	0	0
Internal Link Dist (ft)	658		918			
Turn Bay Length (ft)						
Base Capacity (vph)	2408	1086	1607	3539	1269	962
Starvation Cap Reductn	0	0	0	0	0	0
Spillback Cap Reductn	0	0	0	0	0	0
Storage Cap Reductn	0	0	0	0	0	0
Reduced v/c Ratio	0.03	0.03	0.31	0.15	0.37	0.13
Intersection Summary						

Queues

West Campus Upper Plateau (JN 14064)

31: I-215 NB Ramps/Old 215 Frontage Rd. & Cactus Av.

09/30/2022



Lane Group	EBL	EBT	WBT	NBL	NBT	NBR	SBL	SBT
Lane Group Flow (vph)	23	883	1556	65	87	4	145	86
v/c Ratio	0.19	0.44	0.75	0.28	0.25	0.01	0.58	0.24
Control Delay	11.1	7.5	11.9	25.1	23.4	0.0	32.5	14.0
Queue Delay	0.0	0.0	0.0	0.0	0.0	0.0	0.0	0.0
Total Delay	11.1	7.5	11.9	25.1	23.4	0.0	32.5	14.0
Queue Length 50th (ft)	3	71	169	17	24	0	41	10
Queue Length 95th (ft)	18	146	342	61	77	0	122	51
Internal Link Dist (ft)		310	1149		1221			746
Turn Bay Length (ft)	175			145			100	
Base Capacity (vph)	174	2910	3003	461	679	619	494	651
Starvation Cap Reductn	0	0	0	0	0	0	0	0
Spillback Cap Reductn	0	0	0	0	0	0	0	0
Storage Cap Reductn	0	0	0	0	0	0	0	0
Reduced v/c Ratio	0.13	0.30	0.52	0.14	0.13	0.01	0.29	0.13

Intersection Summary

Queues

32: I-215 SB Ramps & Van Buren Bl.



Lane Group	EBT	EBR	WBL	WBT	SBT	SBR
Lane Group Flow (vph)	887	993	17	959	27	998
v/c Ratio	0.57	0.54	0.10	0.55	0.10	1.28
Control Delay	9.8	1.9	23.9	7.8	20.6	151.4
Queue Delay	0.0	0.0	0.0	0.0	0.0	0.0
Total Delay	9.8	1.9	23.9	7.8	20.6	151.4
Queue Length 50th (ft)	62	0	3	68	5	~116
Queue Length 95th (ft)	156	27	23	96	30	#363
Internal Link Dist (ft)	2745		429		1115	
Turn Bay Length (ft)	200					
Base Capacity (vph)	3218	2710	166	3406	279	781
Starvation Cap Reductn	0	0	0	0	0	0
Spillback Cap Reductn	0	0	0	0	0	0
Storage Cap Reductn	0	0	0	0	0	0
Reduced v/c Ratio	0.28	0.37	0.10	0.28	0.10	1.28

Intersection Summary

~ Volume exceeds capacity, queue is theoretically infinite.

Queue shown is maximum after two cycles.

95th percentile volume exceeds capacity, queue may be longer.

Queue shown is maximum after two cycles.



Lane Group	EBR	NBL
Lane Group Flow (vph)	19	1
v/c Ratio	0.01	0.00
Control Delay	0.0	0.0
Queue Delay	0.0	0.0
Total Delay	0.0	0.0
Queue Length 50th (ft)	0	0
Queue Length 95th (ft)	0	0
Internal Link Dist (ft)		856
Turn Bay Length (ft)	300	
Base Capacity (vph)	2608	3303
Starvation Cap Reductn	0	0
Spillback Cap Reductn	0	0
Storage Cap Reductn	0	0
Reduced v/c Ratio	0.01	0.00
Intersection Summary		

APPENDIX 8.6:

**HORIZON YEAR (2045) WITH PROJECT CONDITIONS OFF-RAMP QUEUING ANALYSIS
WORKSHEETS**

This Page Intentionally Left Blank

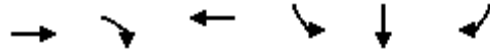

Lane Group	EBT	EBR	WBT	SBL	SBT	SBR
Lane Group Flow (vph)	1239	518	3659	366	351	344
v/c Ratio	0.44	0.53	1.28	0.75	0.80	0.78
Control Delay	11.8	7.4	142.5	35.8	37.7	36.5
Queue Delay	0.0	0.0	0.0	0.0	0.0	0.0
Total Delay	11.8	7.4	142.5	35.8	37.7	36.5
Queue Length 50th (ft)	135	58	~921	177	165	154
Queue Length 95th (ft)	185	154	m#658	265	264	247
Internal Link Dist (ft)	750		688		1585	
Turn Bay Length (ft)		50		525		525
Base Capacity (vph)	2844	986	2864	584	520	519
Starvation Cap Reductn	0	0	0	0	0	0
Spillback Cap Reductn	0	0	0	0	0	0
Storage Cap Reductn	0	0	0	0	0	0
Reduced v/c Ratio	0.44	0.53	1.28	0.63	0.68	0.66

Intersection Summary

~ Volume exceeds capacity, queue is theoretically infinite.

Queue shown is maximum after two cycles.

95th percentile volume exceeds capacity, queue may be longer.

Queue shown is maximum after two cycles.

m Volume for 95th percentile queue is metered by upstream signal.

Queues
29: I-215 NB Ramps & Alessandro Bl.

West Campus Upper Plateau (JN 14064)

09/20/2022



Lane Group	EBL	EBT	WBT	WBR	NBL	NBT	NBR
Lane Group Flow (vph)	140	1594	2245	193	755	748	455
v/c Ratio	0.63	0.49	1.01	0.27	1.97	1.73	1.15
Control Delay	38.4	11.1	48.1	10.9	467.5	360.2	121.6
Queue Delay	0.0	0.0	0.0	0.0	0.0	0.0	0.0
Total Delay	38.4	11.1	48.1	10.9	467.5	360.2	121.6
Queue Length 50th (ft)	73	146	~438	35	~667	~621	~265
Queue Length 95th (ft)	130	226	#632	89	#890	#861	#458
Internal Link Dist (ft)		688	447			1005	
Turn Bay Length (ft)	200			50	400		400
Base Capacity (vph)	353	3228	2219	705	384	433	394
Starvation Cap Reductn	0	0	0	0	0	0	0
Spillback Cap Reductn	0	0	0	0	0	0	0
Storage Cap Reductn	0	0	0	0	0	0	0
Reduced v/c Ratio	0.40	0.49	1.01	0.27	1.97	1.73	1.15

Intersection Summary

~ Volume exceeds capacity, queue is theoretically infinite.

Queue shown is maximum after two cycles.

95th percentile volume exceeds capacity, queue may be longer.

Queue shown is maximum after two cycles.

Queues
30: I-215 SB Ramps & Cactus Av.



Lane Group	EBT	EBR	WBL	WBT	NBR	SBR
Lane Group Flow (vph)	714	66	1030	2484	1059	780
v/c Ratio	1.31	0.23	1.31	1.04	1.09	2.10
Control Delay	187.8	11.9	175.0	47.5	67.5	524.9
Queue Delay	0.0	0.0	0.0	0.0	0.0	0.0
Total Delay	187.8	11.9	175.0	47.5	67.5	524.9
Queue Length 50th (ft)	~325	0	~893	~951	~347	~800
Queue Length 95th (ft)	#443	38	#1138	#1086	#599	#1035
Internal Link Dist (ft)	658			918		
Turn Bay Length (ft)						
Base Capacity (vph)	546	286	787	2393	971	372
Starvation Cap Reductn	0	0	0	0	0	0
Spillback Cap Reductn	0	0	0	0	0	0
Storage Cap Reductn	0	0	0	0	0	0
Reduced v/c Ratio	1.31	0.23	1.31	1.04	1.09	2.10

Intersection Summary

~ Volume exceeds capacity, queue is theoretically infinite.

Queue shown is maximum after two cycles.

95th percentile volume exceeds capacity, queue may be longer.

Queue shown is maximum after two cycles.

Queues

31: I-215 NB Ramps/Old 215 Frontage Rd. & Cactus Av.



Lane Group	EBL	EBT	WBT	NBL	NBT	NBR	SBL	SBT
Lane Group Flow (vph)	36	2617	4125	749	424	54	71	199
v/c Ratio	0.65	1.12	1.73	3.82	1.19	0.16	1.18	0.66
Control Delay	68.3	82.6	352.7	1296.8	151.5	23.4	216.7	48.5
Queue Delay	0.0	0.0	0.0	0.0	0.0	0.0	0.0	0.0
Total Delay	68.3	82.6	352.7	1296.8	151.5	23.4	216.7	48.5
Queue Length 50th (ft)	14	~1233	~2513	~1049	~417	17	~65	123
Queue Length 95th (ft)	#43	#1365	#2607	#1166	#633	54	#164	209
Internal Link Dist (ft)		310	1149		1221			746
Turn Bay Length (ft)	175			145			100	
Base Capacity (vph)	55	2330	2380	196	356	346	60	301
Starvation Cap Reductn	0	0	0	0	0	0	0	0
Spillback Cap Reductn	0	0	0	0	0	0	0	0
Storage Cap Reductn	0	0	0	0	0	0	0	0
Reduced v/c Ratio	0.65	1.12	1.73	3.82	1.19	0.16	1.18	0.66

Intersection Summary

~ Volume exceeds capacity, queue is theoretically infinite.

Queue shown is maximum after two cycles.

95th percentile volume exceeds capacity, queue may be longer.

Queue shown is maximum after two cycles.

Queues

32: I-215 SB Ramps & Van Buren Bl.



Lane Group	EBT	EBR	WBL	WBT	SBT	SBR
Lane Group Flow (vph)	1270	1271	37	1983	514	1796
v/c Ratio	0.92	0.69	0.35	1.17	0.81	1.75
Control Delay	38.0	3.6	47.9	105.6	36.2	365.8
Queue Delay	0.0	0.0	0.0	0.0	0.0	0.0
Total Delay	38.0	3.6	47.9	105.6	36.2	365.8
Queue Length 50th (ft)	~394	0	19	~671	243	~808
Queue Length 95th (ft)	#523	44	50	#808	#408	#958
Internal Link Dist (ft)	2745			429	1115	
Turn Bay Length (ft)			200			
Base Capacity (vph)	1379	1837	106	1698	636	1024
Starvation Cap Reductn	0	0	0	0	0	0
Spillback Cap Reductn	0	0	0	0	0	0
Storage Cap Reductn	0	0	0	0	0	0
Reduced v/c Ratio	0.92	0.69	0.35	1.17	0.81	1.75

Intersection Summary

~ Volume exceeds capacity, queue is theoretically infinite.

Queue shown is maximum after two cycles.

95th percentile volume exceeds capacity, queue may be longer.

Queue shown is maximum after two cycles.



Lane Group	EBT	EBR	WBT	NBL	NBR
Lane Group Flow (vph)	652	1375	747	1861	174
v/c Ratio	1.27	0.52	1.43	0.86	0.17
Control Delay	162.5	0.7	233.0	13.1	4.2
Queue Delay	0.0	0.0	0.0	0.0	0.0
Total Delay	162.5	0.7	233.0	13.1	4.2
Queue Length 50th (ft)	~181	0	~223	229	20
Queue Length 95th (ft)	#305	0	#354	324	38
Internal Link Dist (ft)	669		611	856	
Turn Bay Length (ft)		300			585
Base Capacity (vph)	515	2623	521	2647	1268
Starvation Cap Reductn	0	0	0	0	0
Spillback Cap Reductn	0	0	0	0	0
Storage Cap Reductn	0	0	0	0	0
Reduced v/c Ratio	1.27	0.52	1.43	0.70	0.14

Intersection Summary

~ Volume exceeds capacity, queue is theoretically infinite.

Queue shown is maximum after two cycles.

95th percentile volume exceeds capacity, queue may be longer.

Queue shown is maximum after two cycles.

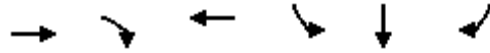

Lane Group	EBT	EBR	WBT	SBL	SBT	SBR
Lane Group Flow (vph)	2163	680	2892	398	376	367
v/c Ratio	0.76	0.72	1.03	0.83	0.85	0.82
Control Delay	16.4	13.7	44.4	42.4	43.9	40.2
Queue Delay	0.0	0.0	0.0	0.0	0.0	0.0
Total Delay	16.4	13.7	44.4	42.4	43.9	40.2
Queue Length 50th (ft)	313	164	~631	198	182	167
Queue Length 95th (ft)	378	308	#727	#346	#345	#312
Internal Link Dist (ft)	750		688		1585	
Turn Bay Length (ft)		50		525		525
Base Capacity (vph)	2850	951	2814	536	488	496
Starvation Cap Reductn	0	0	0	0	0	0
Spillback Cap Reductn	0	0	0	0	0	0
Storage Cap Reductn	0	0	0	0	0	0
Reduced v/c Ratio	0.76	0.72	1.03	0.74	0.77	0.74

Intersection Summary

~ Volume exceeds capacity, queue is theoretically infinite.

Queue shown is maximum after two cycles.

95th percentile volume exceeds capacity, queue may be longer.

Queue shown is maximum after two cycles.

Queues
29: I-215 NB Ramps & Alessandro Bl.

West Campus Upper Plateau (JN 14064)

09/20/2022



Lane Group	EBL	EBT	WBT	WBR	NBL	NBT	NBR
Lane Group Flow (vph)	290	2502	1878	232	621	615	442
v/c Ratio	1.87	0.98	1.08	0.41	1.00	1.04	0.73
Control Delay	441.4	36.4	77.0	15.9	65.2	75.9	26.3
Queue Delay	0.0	0.0	0.0	0.0	0.0	0.0	0.0
Total Delay	441.4	36.4	77.0	15.9	65.2	75.9	26.3
Queue Length 50th (ft)	~239	457	~417	57	~343	~394	168
Queue Length 95th (ft)	#391	#602	#512	119	#578	#618	290
Internal Link Dist (ft)		688	447			1005	
Turn Bay Length (ft)	200			50	400		400
Base Capacity (vph)	155	2542	1731	562	620	592	606
Starvation Cap Reductn	0	0	0	0	0	0	0
Spillback Cap Reductn	0	0	0	0	0	0	0
Storage Cap Reductn	0	0	0	0	0	0	0
Reduced v/c Ratio	1.87	0.98	1.08	0.41	1.00	1.04	0.73

Intersection Summary

~ Volume exceeds capacity, queue is theoretically infinite.

Queue shown is maximum after two cycles.

95th percentile volume exceeds capacity, queue may be longer.

Queue shown is maximum after two cycles.

Queues
30: I-215 SB Ramps & Cactus Av.



Lane Group	EBT	EBR	WBL	WBT	NBR	SBR
Lane Group Flow (vph)	2123	505	985	1602	923	665
v/c Ratio	2.24	0.85	1.50	0.66	1.12	1.76
Control Delay	582.5	34.4	262.7	11.1	84.0	377.7
Queue Delay	0.0	0.0	0.0	0.0	0.0	0.0
Total Delay	582.5	34.4	262.7	11.1	84.0	377.7
Queue Length 50th (ft)	~1217	181	~923	288	~365	~631
Queue Length 95th (ft)	#1355	#373	#1165	357	#610	#855
Internal Link Dist (ft)	658			918		
Turn Bay Length (ft)						
Base Capacity (vph)	949	591	655	2426	824	378
Starvation Cap Reductn	0	0	0	0	0	0
Spillback Cap Reductn	0	0	0	0	0	0
Storage Cap Reductn	0	0	0	0	0	0
Reduced v/c Ratio	2.24	0.85	1.50	0.66	1.12	1.76

Intersection Summary

~ Volume exceeds capacity, queue is theoretically infinite.

Queue shown is maximum after two cycles.

95th percentile volume exceeds capacity, queue may be longer.

Queue shown is maximum after two cycles.

Queues

West Campus Upper Plateau (JN 14064)

31: I-215 NB Ramps/Old 215 Frontage Rd. & Cactus Av.

09/20/2022



Lane Group	EBL	EBT	WBT	NBL	NBT	NBR	SBL	SBT
Lane Group Flow (vph)	127	3271	3275	456	320	94	236	244
v/c Ratio	1.46	1.61	1.56	1.99	0.70	0.22	1.50	0.59
Control Delay	282.3	297.3	273.5	484.3	38.1	17.2	284.5	34.0
Queue Delay	0.0	0.0	0.0	0.0	0.0	0.0	0.0	0.0
Total Delay	282.3	297.3	273.5	484.3	38.1	17.2	284.5	34.0
Queue Length 50th (ft)	~94	~1339	~1332	~384	162	24	~177	113
Queue Length 95th (ft)	#158	#1475	#1467	#566	#265	63	#317	190
Internal Link Dist (ft)		310	1149		1221			746
Turn Bay Length (ft)	175			145			100	
Base Capacity (vph)	87	2031	2104	229	454	419	157	417
Starvation Cap Reductn	0	0	0	0	0	0	0	0
Spillback Cap Reductn	0	0	0	0	0	0	0	0
Storage Cap Reductn	0	0	0	0	0	0	0	0
Reduced v/c Ratio	1.46	1.61	1.56	1.99	0.70	0.22	1.50	0.59

Intersection Summary

~ Volume exceeds capacity, queue is theoretically infinite.

Queue shown is maximum after two cycles.

95th percentile volume exceeds capacity, queue may be longer.

Queue shown is maximum after two cycles.



Lane Group	EBT	EBR	WBL	WBT	SBT	SBR
Lane Group Flow (vph)	1780	3071	230	1924	811	934
v/c Ratio	0.83	1.70	2.19	0.73	4.80	2.72
Control Delay	16.4	335.8	588.8	7.5	1734.4	800.9
Queue Delay	0.0	0.0	0.0	0.0	0.0	0.0
Total Delay	16.4	335.8	588.8	7.5	1734.4	800.9
Queue Length 50th (ft)	345	~1386	~200	224	~818	~461
Queue Length 95th (ft)	454	#1534	#338	296	#1035	#593
Internal Link Dist (ft)	2745			429	1115	
Turn Bay Length (ft)			200			
Base Capacity (vph)	2143	1809	105	2629	169	343
Starvation Cap Reductn	0	0	0	0	0	0
Spillback Cap Reductn	0	0	0	0	0	0
Storage Cap Reductn	0	0	0	0	0	0
Reduced v/c Ratio	0.83	1.70	2.19	0.73	4.80	2.72

Intersection Summary

~ Volume exceeds capacity, queue is theoretically infinite.

Queue shown is maximum after two cycles.

95th percentile volume exceeds capacity, queue may be longer.

Queue shown is maximum after two cycles.



Lane Group	EBT	EBR	WBT	NBL	NBR
Lane Group Flow (vph)	875	1431	1086	1451	244
v/c Ratio	1.21	0.54	1.50	0.76	0.26
Control Delay	133.4	0.8	256.8	11.5	6.1
Queue Delay	0.0	0.0	0.0	0.0	0.0
Total Delay	133.4	0.8	256.8	11.5	6.1
Queue Length 50th (ft)	~190	0	~268	159	34
Queue Length 95th (ft)	#395	0	#504	218	60
Internal Link Dist (ft)	669		611	856	
Turn Bay Length (ft)		300			585
Base Capacity (vph)	723	2596	723	2764	1350
Starvation Cap Reductn	0	0	0	0	0
Spillback Cap Reductn	0	0	0	0	0
Storage Cap Reductn	0	0	0	0	0
Reduced v/c Ratio	1.21	0.55	1.50	0.52	0.18

Intersection Summary

~ Volume exceeds capacity, queue is theoretically infinite.

Queue shown is maximum after two cycles.

95th percentile volume exceeds capacity, queue may be longer.

Queue shown is maximum after two cycles.

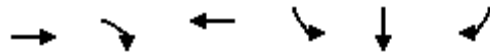

Lane Group	EBT	EBR	WBT	SBL	SBT	SBR
Lane Group Flow (vph)	1121	503	1646	157	212	212
v/c Ratio	0.42	0.50	0.62	0.39	0.57	0.55
Control Delay	8.5	4.8	10.3	21.2	22.4	21.7
Queue Delay	0.0	0.0	0.0	0.0	0.0	0.0
Total Delay	8.5	4.8	10.3	21.2	22.4	21.7
Queue Length 50th (ft)	67	23	111	41	50	48
Queue Length 95th (ft)	139	97	228	113	147	140
Internal Link Dist (ft)	750		688		1585	
Turn Bay Length (ft)		50		525		525
Base Capacity (vph)	4318	1396	4230	859	764	790
Starvation Cap Reductn	0	0	0	0	0	0
Spillback Cap Reductn	0	0	0	0	0	0
Storage Cap Reductn	0	0	0	0	0	0
Reduced v/c Ratio	0.26	0.36	0.39	0.18	0.28	0.27

Intersection Summary

Queues
29: I-215 NB Ramps & Alessandro Bl.

West Campus Upper Plateau (JN 14064)

09/30/2022



Lane Group	EBL	EBT	WBT	WBR	NBL	NBT	NBR
Lane Group Flow (vph)	289	1132	1069	189	298	293	263
v/c Ratio	1.65	0.48	0.69	0.38	0.45	0.46	0.40
Control Delay	343.5	15.2	26.8	13.3	21.2	20.7	14.0
Queue Delay	0.0	0.0	0.0	0.0	0.0	0.0	0.0
Total Delay	343.5	15.2	26.8	13.3	21.2	20.7	14.0
Queue Length 50th (ft)	~214	135	170	35	112	110	61
Queue Length 95th (ft)	#384	169	215	86	202	203	135
Internal Link Dist (ft)		688	447			1005	
Turn Bay Length (ft)	200			50	400		400
Base Capacity (vph)	175	2702	1875	575	666	639	655
Starvation Cap Reductn	0	0	0	0	0	0	0
Spillback Cap Reductn	0	0	0	0	0	0	0
Storage Cap Reductn	0	0	0	0	0	0	0
Reduced v/c Ratio	1.65	0.42	0.57	0.33	0.45	0.46	0.40

Intersection Summary

~ Volume exceeds capacity, queue is theoretically infinite.

Queue shown is maximum after two cycles.

95th percentile volume exceeds capacity, queue may be longer.

Queue shown is maximum after two cycles.

Queues
30: I-215 SB Ramps & Cactus Av.

West Campus Upper Plateau (JN 14064)
09/30/2022



Lane Group	EBT	EBR	WBL	WBT	NBR	SBR
Lane Group Flow (vph)	401	118	495	721	467	393
v/c Ratio	0.57	0.29	0.78	0.32	0.55	0.80
Control Delay	29.5	8.5	29.4	6.0	2.5	22.3
Queue Delay	0.0	0.0	0.0	0.0	0.0	0.0
Total Delay	29.5	8.5	29.4	6.0	2.5	22.3
Queue Length 50th (ft)	72	0	159	53	0	39
Queue Length 95th (ft)	157	40	349	112	0	155
Internal Link Dist (ft)	658			918		
Turn Bay Length (ft)						
Base Capacity (vph)	1697	812	1148	3306	1017	724
Starvation Cap Reductn	0	0	0	0	0	0
Spillback Cap Reductn	0	0	0	0	0	0
Storage Cap Reductn	0	0	0	0	0	0
Reduced v/c Ratio	0.24	0.15	0.43	0.22	0.46	0.54
Intersection Summary						

Queues

31: I-215 NB Ramps/Old 215 Frontage Rd. & Cactus Av.



Lane Group	EBL	EBT	WBT	NBL	NBT	NBR	SBL	SBT
Lane Group Flow (vph)	40	1166	1610	155	87	4	145	104
v/c Ratio	0.35	0.63	0.79	0.62	0.23	0.01	0.54	0.28
Control Delay	18.2	9.5	13.5	35.9	23.7	0.0	31.4	16.7
Queue Delay	0.0	0.0	0.0	0.0	0.0	0.0	0.0	0.0
Total Delay	18.2	9.5	13.5	35.9	23.7	0.0	31.4	16.7
Queue Length 50th (ft)	6	111	200	49	26	0	45	18
Queue Length 95th (ft)	38	229	394	131	76	0	121	65
Internal Link Dist (ft)		310	1149		1221			746
Turn Bay Length (ft)	175			145			100	
Base Capacity (vph)	161	2591	2875	437	655	597	476	625
Starvation Cap Reductn	0	0	0	0	0	0	0	0
Spillback Cap Reductn	0	0	0	0	0	0	0	0
Storage Cap Reductn	0	0	0	0	0	0	0	0
Reduced v/c Ratio	0.25	0.45	0.56	0.35	0.13	0.01	0.30	0.17

Intersection Summary



Lane Group	EBT	EBR	WBL	WBT	SBT	SBR
Lane Group Flow (vph)	887	1035	17	1004	27	998
v/c Ratio	0.56	0.56	0.10	0.58	0.10	1.32
Control Delay	9.7	1.9	24.1	8.0	20.7	170.9
Queue Delay	0.0	0.0	0.0	0.0	0.0	0.0
Total Delay	9.7	1.9	24.1	8.0	20.7	170.9
Queue Length 50th (ft)	62	0	3	72	5	~128
Queue Length 95th (ft)	156	27	23	102	30	#375
Internal Link Dist (ft)	2745		429		1115	
Turn Bay Length (ft)	200					
Base Capacity (vph)	3218	2711	165	3406	278	756
Starvation Cap Reductn	0	0	0	0	0	0
Spillback Cap Reductn	0	0	0	0	0	0
Storage Cap Reductn	0	0	0	0	0	0
Reduced v/c Ratio	0.28	0.38	0.10	0.29	0.10	1.32

Intersection Summary

~ Volume exceeds capacity, queue is theoretically infinite.

Queue shown is maximum after two cycles.

95th percentile volume exceeds capacity, queue may be longer.

Queue shown is maximum after two cycles.



Lane Group	EBR	NBL
Lane Group Flow (vph)	19	1
v/c Ratio	0.01	0.00
Control Delay	0.0	0.0
Queue Delay	0.0	0.0
Total Delay	0.0	0.0
Queue Length 50th (ft)	0	0
Queue Length 95th (ft)	0	0
Internal Link Dist (ft)		856
Turn Bay Length (ft)	300	
Base Capacity (vph)	2608	3303
Starvation Cap Reductn	0	0
Spillback Cap Reductn	0	0
Storage Cap Reductn	0	0
Reduced v/c Ratio	0.01	0.00
Intersection Summary		

APPENDIX 8.7:

**HORIZON YEAR (2045) WITH PROJECT CONDITIONS INTERSECTION OPERATIONS
ANALYSIS WORKSHEETS WITH IMPROVEMENTS**

This Page Intentionally Left Blank

Timings
1: Washington St & Van Buren Bl.

West Campus Upper Plateau (JN 14064)

09/20/2022

Lane Group	EBL	EBT	EBR	WBL	WBT	WBR	NBL	NBT	NBR	SBL	SBT
Lane Configurations											
Traffic Volume (vph)	175	1547	165	142	1992	896	328	1169	224	546	235
Future Volume (vph)	175	1547	165	142	1992	896	328	1169	224	546	235
Turn Type	Prot	NA	Perm	Prot	NA	Perm	Prot	NA	Perm	Prot	NA
Protected Phases	5	2		1	6		3	8		7	4
Permitted Phases			2			6			8		
Detector Phase	5	2	2	1	6	6	3	8	8	7	4
Switch Phase											
Minimum Initial (s)	5.0	10.0	10.0	5.0	10.0	10.0	5.0	10.0	10.0	5.0	10.0
Minimum Split (s)	9.2	34.2	34.2	9.2	33.2	33.2	9.2	38.4	38.4	9.2	30.8
Total Split (s)	14.0	53.1	53.1	12.3	51.4	51.4	14.2	38.4	38.4	16.2	40.4
Total Split (%)	11.7%	44.3%	44.3%	10.3%	42.8%	42.8%	11.8%	32.0%	32.0%	13.5%	33.7%
Yellow Time (s)	3.2	5.2	5.2	3.2	5.2	5.2	3.2	4.4	4.4	3.2	4.8
All-Red Time (s)	1.0	1.0	1.0	1.0	1.0	1.0	1.0	1.0	1.0	1.0	1.0
Lost Time Adjust (s)	0.0	0.0	0.0	0.0	0.0	0.0	0.0	0.0	0.0	0.0	0.0
Total Lost Time (s)	4.2	6.2	6.2	4.2	6.2	6.2	4.2	5.4	5.4	4.2	5.8
Lead/Lag	Lead	Lag	Lag	Lead	Lag	Lag	Lead	Lag	Lag	Lead	Lag
Lead-Lag Optimize?	Yes	Yes	Yes	Yes	Yes	Yes	Yes	Yes	Yes	Yes	Yes
Recall Mode	None	None	None	None	None	None	None	None	None	None	None
Act Effct Green (s)	9.8	46.9	46.9	8.1	45.2	45.2	10.0	33.0	33.0	12.0	34.6
Actuated g/C Ratio	0.08	0.39	0.39	0.07	0.38	0.38	0.08	0.28	0.28	0.10	0.29
v/c Ratio	1.26	0.82	0.24	1.25	1.08	1.28	1.21	1.24	0.46	1.66	0.34
Control Delay	203.7	37.0	5.5	211.6	83.4	162.4	168.4	154.5	22.7	343.1	30.5
Queue Delay	0.0	0.0	0.0	0.0	0.0	0.0	0.0	0.0	0.0	0.0	0.0
Total Delay	203.7	37.0	5.5	211.6	83.4	162.4	168.4	154.5	22.7	343.1	30.5
LOS	F	D	A	F	F	F	F	F	C	F	C
Approach Delay		49.7			112.8			140.0			228.2
Approach LOS		D			F			F			F

Intersection Summary

Cycle Length: 120
 Actuated Cycle Length: 120
 Natural Cycle: 125
 Control Type: Actuated-Uncoordinated
 Maximum v/c Ratio: 1.66
 Intersection Signal Delay: 116.5
 Intersection LOS: F
 Intersection Capacity Utilization 112.7%
 ICU Level of Service H
 Analysis Period (min) 15



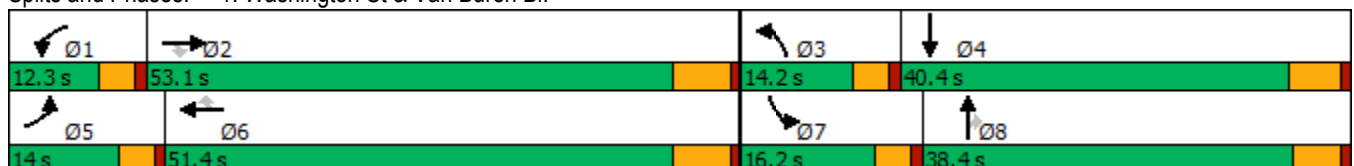





























Splits and Phases: 1: Washington St & Van Buren Bl.



HCM 6th Signalized Intersection Summary
1: Washington St & Van Buren Bl.

West Campus Upper Plateau (JN 14064)

09/20/2022

												
Movement	EBL	EBT	EBR	WBL	WBT	WBR	NBL	NBT	NBR	SBL	SBT	SBR
Lane Configurations		  			  		 	 		 	 	
Traffic Volume (veh/h)	175	1547	165	142	1992	896	328	1169	224	546	235	83
Future Volume (veh/h)	175	1547	165	142	1992	896	328	1169	224	546	235	83
Initial Q (Qb), veh	0	0	0	0	0	0	0	0	0	0	0	0
Ped-Bike Adj(A_pbT)	1.00		0.99	1.00		0.98	1.00		1.00	1.00		1.00
Parking Bus, Adj	1.00	1.00	1.00	1.00	1.00	1.00	1.00	1.00	1.00	1.00	1.00	1.00
Work Zone On Approach		No			No			No			No	
Adj Sat Flow, veh/h/ln	1885	1856	1870	1856	1870	1885	1856	1885	1870	1870	1811	1826
Adj Flow Rate, veh/h	182	1611	149	148	2075	769	342	1218	167	569	245	57
Peak Hour Factor	0.96	0.96	0.96	0.96	0.96	0.96	0.96	0.96	0.96	0.96	0.96	0.96
Percent Heavy Veh, %	1	3	2	3	2	1	3	1	2	2	6	5
Cap, veh/h	146	1973	610	119	1917	589	285	982	433	344	809	185
Arrive On Green	0.08	0.39	0.39	0.07	0.38	0.38	0.08	0.27	0.27	0.10	0.29	0.29
Sat Flow, veh/h	1795	5066	1565	1767	5106	1569	3428	3582	1580	3456	2781	635
Grp Volume(v), veh/h	182	1611	149	148	2075	769	342	1218	167	569	150	152
Grp Sat Flow(s),veh/h/ln	1795	1689	1565	1767	1702	1569	1714	1791	1580	1728	1721	1696
Q Serve(g_s), s	9.8	34.3	7.7	8.1	45.2	45.2	10.0	33.0	10.3	12.0	8.1	8.4
Cycle Q Clear(g_c), s	9.8	34.3	7.7	8.1	45.2	45.2	10.0	33.0	10.3	12.0	8.1	8.4
Prop In Lane	1.00		1.00	1.00		1.00	1.00		1.00	1.00		0.37
Lane Grp Cap(c), veh/h	146	1973	610	119	1917	589	285	982	433	344	500	493
V/C Ratio(X)	1.25	0.82	0.24	1.24	1.08	1.31	1.20	1.24	0.39	1.65	0.30	0.31
Avail Cap(c_a), veh/h	146	1973	610	119	1917	589	285	982	433	344	500	493
HCM Platoon Ratio	1.00	1.00	1.00	1.00	1.00	1.00	1.00	1.00	1.00	1.00	1.00	1.00
Upstream Filter(I)	1.00	1.00	1.00	1.00	1.00	1.00	1.00	1.00	1.00	1.00	1.00	1.00
Uniform Delay (d), s/veh	55.3	32.9	24.8	56.1	37.6	37.6	55.2	43.7	35.5	54.2	33.2	33.3
Incr Delay (d2), s/veh	155.0	2.9	0.3	162.4	46.9	149.6	119.2	117.0	0.6	306.1	0.3	0.4
Initial Q Delay(d3),s/veh	0.0	0.0	0.0	0.0	0.0	0.0	0.0	0.0	0.0	0.0	0.0	0.0
%ile BackOfQ(50%),veh/ln	10.6	13.6	3.0	8.9	25.8	41.6	9.1	30.6	4.1	19.8	3.5	3.5
Unsig. Movement Delay, s/veh												
LnGrp Delay(d),s/veh	210.3	35.8	25.1	218.6	84.5	187.2	174.4	160.7	36.0	360.3	33.5	33.6
LnGrp LOS	F	D	C	F	F	F	F	F	D	F	C	C
Approach Vol, veh/h		1942			2992			1727				871
Approach Delay, s/veh		51.3			117.5			151.4				247.0
Approach LOS		D			F			F				F
Timer - Assigned Phs	1	2	3	4	5	6	7	8				
Phs Duration (G+Y+Rc), s	12.3	53.1	14.2	40.8	14.0	51.4	16.2	38.8				
Change Period (Y+Rc), s	* 4.2	6.2	* 4.2	5.8	* 4.2	6.2	* 4.2	* 5.8				
Max Green Setting (Gmax), s	* 8.1	46.9	* 10	34.6	* 9.8	45.2	* 12	* 33				
Max Q Clear Time (g_c+1), s	10.1	36.3	12.0	10.4	11.8	47.2	14.0	35.0				
Green Ext Time (p_c), s	0.0	8.5	0.0	1.8	0.0	0.0	0.0	0.0				
Intersection Summary												
HCM 6th Ctrl Delay				123.2								
HCM 6th LOS				F								
Notes												
* HCM 6th computational engine requires equal clearance times for the phases crossing the barrier.												

Timings

3: Overlook Pkwy./Canyon Crest Dr. & Alessandro Bl/Alessandro Bl.



Lane Group	EBL	EBT	WBL	WBT	WBR	NBL	NBT	NBR	SBL	SBT
Lane Configurations	↙	↕↕↕↕	↙	↕↕↕↕	↗	↙	↕↕	↗	↙↙↙↙	↘
Traffic Volume (vph)	79	1891	91	4261	1302	28	202	80	584	101
Future Volume (vph)	79	1891	91	4261	1302	28	202	80	584	101
Turn Type	Prot	NA	Prot	NA	pm+ov	Split	NA	Perm	Split	NA
Protected Phases	5	2	1	6	4	8	8		4	4
Permitted Phases					6			8		
Detector Phase	5	2	1	6	4	8	8	8	4	4
Switch Phase										
Minimum Initial (s)	5.0	10.0	5.0	10.0	10.0	10.0	10.0	10.0	10.0	10.0
Minimum Split (s)	9.2	35.2	9.2	35.2	38.8	15.8	15.8	15.8	38.8	38.8
Total Split (s)	9.2	63.0	12.4	66.2	38.8	15.8	15.8	15.8	38.8	38.8
Total Split (%)	7.1%	48.5%	9.5%	50.9%	29.8%	12.2%	12.2%	12.2%	29.8%	29.8%
Yellow Time (s)	3.2	5.2	3.2	5.2	4.8	4.8	4.8	4.8	4.8	4.8
All-Red Time (s)	1.0	1.0	1.0	1.0	1.0	1.0	1.0	1.0	1.0	1.0
Lost Time Adjust (s)	0.0	0.0	0.0	0.0	0.0	0.0	0.0	0.0	0.0	0.0
Total Lost Time (s)	4.2	6.2	4.2	6.2	5.8	5.8	5.8	5.8	5.8	5.8
Lead/Lag	Lead	Lag	Lead	Lag						
Lead-Lag Optimize?	Yes	Yes	Yes	Yes						
Recall Mode	None	None	None	None	None	None	None	None	None	None
Act Effct Green (s)	5.0	56.8	8.2	60.0	99.2	10.0	10.0	10.0	33.0	33.0
Actuated g/C Ratio	0.04	0.44	0.06	0.46	0.76	0.08	0.08	0.08	0.25	0.25
v/c Ratio	1.30	0.90	0.85	1.89	1.11	0.21	0.77	0.37	0.49	0.41
Control Delay	258.7	40.7	111.8	427.9	79.2	60.3	77.4	9.4	42.9	37.1
Queue Delay	0.0	0.0	0.0	0.0	0.0	0.0	0.0	0.0	0.0	0.0
Total Delay	258.7	40.7	111.8	427.9	79.2	60.3	77.4	9.4	42.9	37.1
LOS	F	D	F	F	E	E	E	A	D	D
Approach Delay		49.4		342.5			58.4			41.5
Approach LOS		D		F			E			D

Intersection Summary

Cycle Length: 130
 Actuated Cycle Length: 130
 Natural Cycle: 130
 Control Type: Actuated-Uncoordinated
 Maximum v/c Ratio: 1.89
 Intersection Signal Delay: 239.3
 Intersection LOS: F
 Intersection Capacity Utilization 116.6%
 ICU Level of Service H
 Analysis Period (min) 15

Splits and Phases: 3: Overlook Pkwy./Canyon Crest Dr. & Alessandro Bl/Alessandro Bl.



HCM 6th Signalized Intersection Summary

West Campus Upper Plateau (JN 14064)

3: Overlook Pkwy./Canyon Crest Dr. & Alessandro Bl/Alessandro Bl.

09/20/2022



Movement	EBL	EBT	EBR	WBL	WBT	WBR	NBL	NBT	NBR	SBL	SBT	SBR
Lane Configurations	↘	↑↑↑		↘	↑↑↑	↗	↘	↑↑	↗	↗↗↗	↘	↘
Traffic Volume (veh/h)	79	1891	9	91	4261	1302	28	202	80	584	101	80
Future Volume (veh/h)	79	1891	9	91	4261	1302	28	202	80	584	101	80
Initial Q (Qb), veh	0	0	0	0	0	0	0	0	0	0	0	0
Ped-Bike Adj(A_pbT)	1.00		1.00	1.00		1.00	1.00		1.00	1.00		1.00
Parking Bus, Adj	1.00	1.00	1.00	1.00	1.00	1.00	1.00	1.00	1.00	1.00	1.00	1.00
Work Zone On Approach		No			No			No				No
Adj Sat Flow, veh/h/ln	1796	1870	1900	1900	1885	1885	1900	1900	1900	1856	1885	1870
Adj Flow Rate, veh/h	83	1991	9	96	4485	1208	29	213	82	615	106	67
Peak Hour Factor	0.95	0.95	0.95	0.95	0.95	0.95	0.95	0.95	0.95	0.95	0.95	0.95
Percent Heavy Veh, %	7	2	0	0	1	1	0	0	0	3	1	2
Cap, veh/h	74	2599	12	120	2669	1087	156	312	139	806	175	110
Arrive On Green	0.04	0.50	0.50	0.07	0.52	0.52	0.09	0.09	0.09	0.16	0.16	0.16
Sat Flow, veh/h	1711	5246	24	1810	5147	1598	1810	3610	1610	4983	1080	683
Grp Volume(v), veh/h	83	1292	708	96	4485	1208	29	213	82	615	0	173
Grp Sat Flow(s),veh/h/ln	1711	1702	1866	1810	1716	1598	1810	1805	1610	1661	0	1762
Q Serve(g_s), s	5.0	35.7	35.7	6.1	60.0	60.0	1.7	6.6	5.7	13.7	0.0	10.6
Cycle Q Clear(g_c), s	5.0	35.7	35.7	6.1	60.0	60.0	1.7	6.6	5.7	13.7	0.0	10.6
Prop In Lane	1.00		0.01	1.00		1.00	1.00		1.00	1.00		0.39
Lane Grp Cap(c), veh/h	74	1686	924	120	2669	1087	156	312	139	806	0	285
V/C Ratio(X)	1.12	0.77	0.77	0.80	1.68	1.11	0.19	0.68	0.59	0.76	0.00	0.61
Avail Cap(c_a), veh/h	74	1686	924	128	2669	1087	156	312	139	1421	0	503
HCM Platoon Ratio	1.00	1.00	1.00	1.00	1.00	1.00	1.00	1.00	1.00	1.00	1.00	1.00
Upstream Filter(I)	1.00	1.00	1.00	1.00	1.00	1.00	1.00	1.00	1.00	1.00	0.00	1.00
Uniform Delay (d), s/veh	55.4	23.7	23.8	53.2	27.9	15.5	49.1	51.3	50.9	46.4	0.0	45.1
Incr Delay (d2), s/veh	141.9	2.2	3.9	25.0	307.9	63.3	0.6	6.0	6.4	1.5	0.0	2.1
Initial Q Delay(d3),s/veh	0.0	0.0	0.0	0.0	0.0	0.0	0.0	0.0	0.0	0.0	0.0	0.0
%ile BackOfQ(50%),veh/ln	5.0	13.4	15.2	3.5	97.7	49.9	0.8	3.2	2.5	5.6	0.0	4.6
Unsig. Movement Delay, s/veh												
LnGrp Delay(d),s/veh	197.3	25.9	27.7	78.3	335.8	78.8	49.6	57.3	57.3	47.9	0.0	47.2
LnGrp LOS	F	C	C	E	F	F	D	E	E	D	A	D
Approach Vol, veh/h		2083			5789			324			788	
Approach Delay, s/veh		33.3			277.9			56.6			47.8	
Approach LOS		C			F			E			D	
Timer - Assigned Phs	1	2		4	5	6		8				
Phs Duration (G+Y+Rc), s	11.9	63.5		24.5	9.2	66.2		15.8				
Change Period (Y+Rc), s	* 4.2	6.2		5.8	* 4.2	6.2		5.8				
Max Green Setting (Gmax), s	* 8.2	56.8		33.0	* 5	60.0		10.0				
Max Q Clear Time (g_c+I1), s	8.1	37.7		15.7	7.0	62.0		8.6				
Green Ext Time (p_c), s	0.0	12.5		3.1	0.0	0.0		0.2				

Intersection Summary

HCM 6th Ctrl Delay	193.0
HCM 6th LOS	F

Notes

- User approved pedestrian interval to be less than phase max green.
- * HCM 6th computational engine requires equal clearance times for the phases crossing the barrier.

Timings
4: Van Buren Bl. & Wood Rd.

West Campus Upper Plateau (JN 14064)

09/20/2022

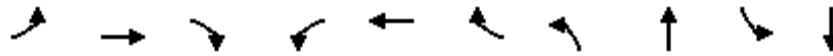

Lane Group	EBL	EBT	EBR	WBL	WBT	WBR	NBL	NBT	SBL	SBT
Lane Configurations	↘	↑↑↑	↗	↘↗	↑↑↑	↗	↘↗	↑↘	↘	↑↘
Traffic Volume (vph)	181	1560	438	609	2090	139	450	502	133	550
Future Volume (vph)	181	1560	438	609	2090	139	450	502	133	550
Turn Type	Prot	NA	pm+ov	Prot	NA	Perm	Prot	NA	Prot	NA
Protected Phases	5	2	3	1	6		3	8	7	4
Permitted Phases			2			6				
Detector Phase	5	2	3	1	6	6	3	8	7	4
Switch Phase										
Minimum Initial (s)	5.0	10.0	5.0	5.0	10.0	10.0	5.0	10.0	5.0	10.0
Minimum Split (s)	9.2	30.2	9.2	9.2	30.2	30.2	9.2	38.4	9.2	15.8
Total Split (s)	16.0	45.6	18.0	23.0	52.6	52.6	18.0	38.4	13.0	33.4
Total Split (%)	13.3%	38.0%	15.0%	19.2%	43.8%	43.8%	15.0%	32.0%	10.8%	27.8%
Yellow Time (s)	3.2	5.2	3.2	3.2	5.2	5.2	3.2	4.4	3.2	4.8
All-Red Time (s)	1.0	1.0	1.0	1.0	1.0	1.0	1.0	1.0	1.0	1.0
Lost Time Adjust (s)	0.0	0.0	0.0	0.0	0.0	0.0	0.0	0.0	0.0	0.0
Total Lost Time (s)	4.2	6.2	4.2	4.2	6.2	6.2	4.2	5.4	4.2	5.8
Lead/Lag	Lead	Lag	Lead	Lead	Lag	Lag	Lead	Lag	Lead	Lag
Lead-Lag Optimize?	Yes	Yes	Yes	Yes	Yes	Yes	Yes	Yes	Yes	Yes
Recall Mode	None	None	None	None	None	None	None	None	None	None
Act Effct Green (s)	11.8	39.4	55.2	18.8	46.4	46.4	13.8	33.0	8.8	27.6
Actuated g/C Ratio	0.10	0.33	0.46	0.16	0.39	0.39	0.12	0.28	0.07	0.23
v/c Ratio	1.15	1.03	0.63	1.22	1.16	0.22	1.23	1.02	1.12	1.06
Control Delay	161.1	68.9	21.0	157.4	110.8	5.6	167.5	69.1	166.5	90.1
Queue Delay	0.0	0.0	0.0	0.0	0.0	0.0	0.0	0.0	0.0	0.0
Total Delay	161.1	68.9	21.0	157.4	110.8	5.6	167.5	69.1	166.5	90.1
LOS	F	E	C	F	F	A	F	E	F	F
Approach Delay		66.9			115.7			101.1		100.9
Approach LOS		E			F			F		F

Intersection Summary

Cycle Length: 120
 Actuated Cycle Length: 120
 Natural Cycle: 130
 Control Type: Actuated-Uncoordinated
 Maximum v/c Ratio: 1.23
 Intersection Signal Delay: 96.6
 Intersection LOS: F
 Intersection Capacity Utilization 104.8%
 ICU Level of Service G
 Analysis Period (min) 15

Splits and Phases: 4: Van Buren Bl. & Wood Rd.

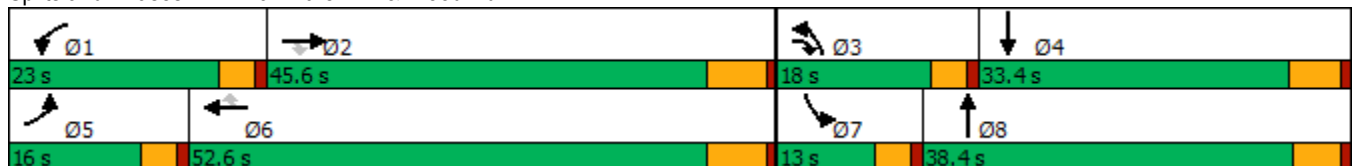

HCM 6th Signalized Intersection Summary
4: Van Buren Bl. & Wood Rd.

West Campus Upper Plateau (JN 14064)
09/20/2022

Movement	EBL	EBT	EBR	WBL	WBT	WBR	NBL	NBT	NBR	SBL	SBT	SBR
Lane Configurations												
Traffic Volume (veh/h)	181	1560	438	609	2090	139	450	502	432	133	550	257
Future Volume (veh/h)	181	1560	438	609	2090	139	450	502	432	133	550	257
Initial Q (Qb), veh	0	0	0	0	0	0	0	0	0	0	0	0
Ped-Bike Adj(A_pbT)	1.00		0.97	1.00		0.98	1.00		0.90	1.00		0.99
Parking Bus, Adj	1.00	1.00	1.00	1.00	1.00	1.00	1.00	1.00	1.00	1.00	1.00	1.00
Work Zone On Approach		No			No			No			No	
Adj Sat Flow, veh/h/ln	1856	1856	1856	1885	1870	1870	1885	1885	1885	1870	1900	1870
Adj Flow Rate, veh/h	197	1696	299	662	2272	103	489	546	333	145	598	188
Peak Hour Factor	0.92	0.92	0.92	0.92	0.92	0.92	0.92	0.92	0.92	0.92	0.92	0.92
Percent Heavy Veh, %	3	3	3	1	2	2	1	1	1	2	0	2
Cap, veh/h	173	1658	681	544	1968	601	399	560	341	130	627	197
Arrive On Green	0.10	0.33	0.33	0.16	0.39	0.39	0.11	0.27	0.27	0.07	0.23	0.23
Sat Flow, veh/h	1767	5066	1531	3483	5106	1560	3483	2044	1244	1781	2694	845
Grp Volume(v), veh/h	197	1696	299	662	2272	103	489	478	401	145	400	386
Grp Sat Flow(s),veh/h/ln	1767	1689	1531	1742	1702	1560	1742	1791	1497	1781	1805	1735
Q Serve(g_s), s	11.8	39.4	16.3	18.8	46.4	5.2	13.8	31.9	31.9	8.8	26.3	26.4
Cycle Q Clear(g_c), s	11.8	39.4	16.3	18.8	46.4	5.2	13.8	31.9	31.9	8.8	26.3	26.4
Prop In Lane	1.00		1.00	1.00		1.00	1.00		0.83	1.00		0.49
Lane Grp Cap(c), veh/h	173	1658	681	544	1968	601	399	491	410	130	420	403
V/C Ratio(X)	1.14	1.02	0.44	1.22	1.15	0.17	1.22	0.97	0.98	1.11	0.95	0.96
Avail Cap(c_a), veh/h	173	1658	681	544	1968	601	399	491	410	130	420	403
HCM Platoon Ratio	1.00	1.00	1.00	1.00	1.00	1.00	1.00	1.00	1.00	1.00	1.00	1.00
Upstream Filter(I)	1.00	1.00	1.00	1.00	1.00	1.00	1.00	1.00	1.00	1.00	1.00	1.00
Uniform Delay (d), s/veh	54.3	40.5	23.3	50.8	37.0	24.3	53.3	43.3	43.3	55.8	45.6	45.6
Incr Delay (d2), s/veh	110.1	28.2	0.6	113.7	75.8	0.2	121.6	34.0	38.1	112.7	32.1	33.6
Initial Q Delay(d3),s/veh	0.0	0.0	0.0	0.0	0.0	0.0	0.0	0.0	0.0	0.0	0.0	0.0
%ile BackOfQ(50%),veh/ln	10.4	19.7	5.8	16.5	31.7	1.9	12.7	18.3	15.8	8.0	15.2	14.8
Unsig. Movement Delay, s/veh												
LnGrp Delay(d),s/veh	164.4	68.7	23.9	164.5	112.8	24.5	174.9	77.3	81.4	168.5	77.7	79.2
LnGrp LOS	F	F	C	F	F	C	F	E	F	F	E	E
Approach Vol, veh/h		2192			3037			1368			931	
Approach Delay, s/veh		71.2			121.1			113.4			92.4	
Approach LOS		E			F			F			F	
Timer - Assigned Phs	1	2	3	4	5	6	7	8				
Phs Duration (G+Y+Rc), s	23.0	45.6	18.0	33.8	16.0	52.6	13.0	38.8				
Change Period (Y+Rc), s	* 4.2	6.2	* 4.2	5.8	* 4.2	6.2	* 4.2	* 5.8				
Max Green Setting (Gmax), s	* 19	39.4	* 14	27.6	* 12	46.4	* 8.8	* 33				
Max Q Clear Time (g_c+I1), s	20.8	41.4	15.8	28.4	13.8	48.4	10.8	33.9				
Green Ext Time (p_c), s	0.0	0.0	0.0	0.0	0.0	0.0	0.0	0.0				
Intersection Summary												
HCM 6th Ctrl Delay				101.6								
HCM 6th LOS				F								
Notes												
* HCM 6th computational engine requires equal clearance times for the phases crossing the barrier.												

Timings
8: Cole Av. & Van Buren Bl.

West Campus Upper Plateau (JN 14064)

09/20/2022



Lane Group	EBL	EBT	EBR	WBL	WBT	WBR	NBL	NBT	SBL	SBT	SBR
Lane Configurations	↖↗	↑↑↑	↖	↖	↑↑↑	↖	↖	↑↑	↖↗	↑↑	↖
Traffic Volume (vph)	487	1629	130	202	2132	610	259	710	560	560	397
Future Volume (vph)	487	1629	130	202	2132	610	259	710	560	560	397
Turn Type	Prot	NA	pm+ov	Prot	NA	pm+ov	Prot	NA	Prot	NA	pm+ov
Protected Phases	5	2	3	1	6	7	3	8	7	4	5
Permitted Phases			2			6					4
Detector Phase	5	2	3	1	6	7	3	8	7	4	5
Switch Phase											
Minimum Initial (s)	5.0	10.0	5.0	5.0	10.0	5.0	5.0	10.0	5.0	10.0	5.0
Minimum Split (s)	9.1	36.2	9.1	9.1	36.2	9.1	9.1	42.2	9.1	49.2	9.1
Total Split (s)	14.0	45.8	13.0	12.0	43.8	14.0	13.0	48.2	14.0	49.2	14.0
Total Split (%)	11.7%	38.2%	10.8%	10.0%	36.5%	11.7%	10.8%	40.2%	11.7%	41.0%	11.7%
Yellow Time (s)	3.2	5.2	3.2	3.2	5.2	3.2	3.2	5.2	3.2	5.2	3.2
All-Red Time (s)	0.5	1.0	0.5	0.5	1.0	0.5	0.5	1.0	0.5	1.0	0.5
Lost Time Adjust (s)	0.0	0.0	0.0	0.0	0.0	0.0	0.0	0.0	0.0	0.0	0.0
Total Lost Time (s)	3.7	6.2	3.7	3.7	6.2	3.7	3.7	6.2	3.7	6.2	3.7
Lead/Lag	Lead	Lag	Lead	Lead	Lag	Lead	Lead	Lag	Lead	Lag	Lead
Lead-Lag Optimize?	Yes	Yes	Yes	Yes	Yes	Yes	Yes	Yes	Yes	Yes	Yes
Recall Mode	None	None	None	None	None	None	None	None	None	None	None
Act Effct Green (s)	10.3	39.7	55.2	8.3	37.7	50.5	9.3	36.7	10.3	37.7	50.5
Actuated g/C Ratio	0.09	0.35	0.48	0.07	0.33	0.44	0.08	0.32	0.09	0.33	0.44
v/c Ratio	1.72	1.02	0.18	1.69	1.39	0.92	1.99	0.86	1.96	0.52	0.60
Control Delay	369.0	64.2	7.8	375.5	210.9	44.9	498.7	44.2	471.3	32.9	22.2
Queue Delay	0.0	0.0	0.0	0.0	0.0	0.0	0.0	0.0	0.0	0.0	0.0
Total Delay	369.0	64.2	7.8	375.5	210.9	44.9	498.7	44.2	471.3	32.9	22.2
LOS	F	E	A	F	F	D	F	D	F	C	C
Approach Delay		127.0			187.9			147.7		191.9	
Approach LOS		F			F			F		F	

Intersection Summary

Cycle Length: 120
 Actuated Cycle Length: 114.9
 Natural Cycle: 125
 Control Type: Actuated-Uncoordinated
 Maximum v/c Ratio: 1.99
 Intersection Signal Delay: 165.4
 Intersection LOS: F
 Intersection Capacity Utilization 113.3%
 ICU Level of Service H
 Analysis Period (min) 15



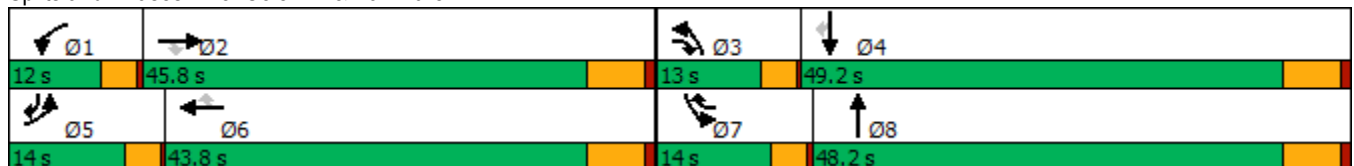



























Splits and Phases: 8: Cole Av. & Van Buren Bl.



HCM 6th Signalized Intersection Summary
8: Cole Av. & Van Buren Bl.

West Campus Upper Plateau (JN 14064)

09/20/2022

												
Movement	EBL	EBT	EBR	WBL	WBT	WBR	NBL	NBT	NBR	SBL	SBT	SBR
Lane Configurations	 	  			  			 		 	 	
Traffic Volume (veh/h)	487	1629	130	202	2132	610	259	710	169	560	560	397
Future Volume (veh/h)	487	1629	130	202	2132	610	259	710	169	560	560	397
Initial Q (Qb), veh	0	0	0	0	0	0	0	0	0	0	0	0
Ped-Bike Adj(A_pbT)	1.00		1.00	1.00		0.99	1.00		1.00	1.00		1.00
Parking Bus, Adj	1.00	1.00	1.00	1.00	1.00	1.00	1.00	1.00	1.00	1.00	1.00	1.00
Work Zone On Approach		No			No			No			No	
Adj Sat Flow, veh/h/ln	1870	1856	1841	1900	1870	1870	1856	1870	1870	1885	1870	1856
Adj Flow Rate, veh/h	529	1771	101	220	2317	575	282	772	175	609	609	361
Peak Hour Factor	0.92	0.92	0.92	0.92	0.92	0.92	0.92	0.92	0.92	0.92	0.92	0.92
Percent Heavy Veh, %	2	3	4	0	2	2	3	2	2	1	2	3
Cap, veh/h	316	1778	676	133	1702	666	146	888	201	318	1128	642
Arrive On Green	0.09	0.35	0.35	0.07	0.33	0.33	0.08	0.31	0.31	0.09	0.32	0.32
Sat Flow, veh/h	3456	5066	1560	1810	5106	1565	1767	2877	652	3483	3554	1570
Grp Volume(v), veh/h	529	1771	101	220	2317	575	282	477	470	609	609	361
Grp Sat Flow(s),veh/h/ln	1728	1689	1560	1810	1702	1565	1767	1777	1752	1742	1777	1570
Q Serve(g_s), s	10.3	39.4	4.4	8.3	37.6	37.6	9.3	28.6	28.6	10.3	15.9	19.9
Cycle Q Clear(g_c), s	10.3	39.4	4.4	8.3	37.6	37.6	9.3	28.6	28.6	10.3	15.9	19.9
Prop In Lane	1.00		1.00	1.00		1.00	1.00		0.37	1.00		1.00
Lane Grp Cap(c), veh/h	316	1778	676	133	1702	666	146	548	541	318	1128	642
V/C Ratio(X)	1.68	1.00	0.15	1.65	1.36	0.86	1.94	0.87	0.87	1.92	0.54	0.56
Avail Cap(c_a), veh/h	316	1778	676	133	1702	666	146	661	652	318	1354	742
HCM Platoon Ratio	1.00	1.00	1.00	1.00	1.00	1.00	1.00	1.00	1.00	1.00	1.00	1.00
Upstream Filter(I)	1.00	1.00	1.00	1.00	1.00	1.00	1.00	1.00	1.00	1.00	1.00	1.00
Uniform Delay (d), s/veh	51.3	36.5	19.4	52.3	37.6	29.5	51.8	36.9	36.9	51.3	31.7	25.6
Incr Delay (d2), s/veh	318.0	20.4	0.1	324.6	166.6	11.6	445.3	10.4	10.6	423.3	0.4	0.8
Initial Q Delay(d3),s/veh	0.0	0.0	0.0	0.0	0.0	0.0	0.0	0.0	0.0	0.0	0.0	0.0
%ile BackOfQ(50%),veh/ln	18.2	18.4	1.5	15.6	40.8	15.1	22.0	13.2	13.1	23.0	6.5	7.0
Unsig. Movement Delay, s/veh												
LnGrp Delay(d),s/veh	369.3	56.9	19.5	376.9	204.2	41.1	497.0	47.3	47.4	474.6	32.1	26.4
LnGrp LOS	F	E	B	F	F	D	F	D	D	F	C	C
Approach Vol, veh/h		2401			3112			1229			1579	
Approach Delay, s/veh		124.2			186.3			150.5			201.5	
Approach LOS		F			F			F			F	
Timer - Assigned Phs	1	2	3	4	5	6	7	8				
Phs Duration (G+Y+Rc), s	12.0	45.8	13.0	42.0	14.0	43.8	14.0	41.0				
Change Period (Y+Rc), s	3.7	6.2	3.7	6.2	3.7	6.2	3.7	6.2				
Max Green Setting (Gmax), s	8.3	39.6	9.3	43.0	10.3	37.6	10.3	42.0				
Max Q Clear Time (g_c+1), s	10.3	41.4	11.3	21.9	12.3	39.6	12.3	30.6				
Green Ext Time (p_c), s	0.0	0.0	0.0	4.9	0.0	0.0	0.0	4.2				
Intersection Summary												
HCM 6th Ctrl Delay	165.9											
HCM 6th LOS	F											

Timings
11: Barton St & Alessandro Bl.



Lane Group	EBL	EBT	WBL	WBT	NBL	NBT	SBL	SBT
Lane Configurations	↘	↗↗↗	↘	↗↗↗	↘	↗	↘	↗
Traffic Volume (vph)	8	2097	48	3516	101	2	12	0
Future Volume (vph)	8	2097	48	3516	101	2	12	0
Turn Type	Prot	NA	Prot	NA	Perm	NA	Perm	NA
Protected Phases	5	2	1	6		8		4
Permitted Phases					8		4	
Detector Phase	5	2	1	6	8	8	4	4
Switch Phase								
Minimum Initial (s)	5.0	10.0	5.0	10.0	10.0	10.0	10.0	10.0
Minimum Split (s)	9.2	28.5	11.0	28.5	40.6	40.6	26.6	26.6
Total Split (s)	9.2	63.4	16.0	70.2	40.6	40.6	40.6	40.6
Total Split (%)	7.7%	52.8%	13.3%	58.5%	33.8%	33.8%	33.8%	33.8%
Yellow Time (s)	3.2	5.5	3.2	5.5	3.6	3.6	3.6	3.6
All-Red Time (s)	1.0	1.0	1.0	1.0	1.0	1.0	1.0	1.0
Lost Time Adjust (s)	0.0	0.0	0.0	0.0	0.0	0.0	0.0	0.0
Total Lost Time (s)	4.2	6.5	4.2	6.5	4.6	4.6	4.6	4.6
Lead/Lag	Lead	Lag	Lead	Lag				
Lead-Lag Optimize?	Yes	Yes	Yes	Yes				
Recall Mode	None	None	None	None	Max	Max	Max	Max
Act Effct Green (s)	5.0	58.5	7.7	66.7	36.0	36.0	36.0	36.0
Actuated g/C Ratio	0.04	0.51	0.07	0.58	0.31	0.31	0.31	0.31
v/c Ratio	0.12	0.88	0.42	1.25	0.24	0.13	0.04	0.02
Control Delay	58.8	31.0	62.4	141.5	32.2	8.2	29.7	0.1
Queue Delay	0.0	0.0	0.0	0.0	0.0	0.0	0.0	0.0
Total Delay	58.8	31.0	62.4	141.5	32.2	8.2	29.7	0.1
LOS	E	C	E	F	C	A	C	A
Approach Delay		31.1		140.4		22.7		16.8
Approach LOS		C		F		C		B

Intersection Summary

Cycle Length: 120
 Actuated Cycle Length: 115.6
 Natural Cycle: 125
 Control Type: Actuated-Uncoordinated
 Maximum v/c Ratio: 1.25
 Intersection Signal Delay: 96.7
 Intersection LOS: F
 Intersection Capacity Utilization 107.4%
 ICU Level of Service G
 Analysis Period (min) 15

Splits and Phases: 11: Barton St & Alessandro Bl.



HCM 6th Signalized Intersection Summary
11: Barton St & Alessandro Bl.

West Campus Upper Plateau (JN 14064)

09/20/2022

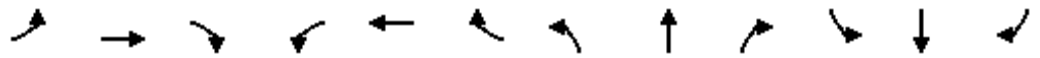

Movement	EBL	EBT	EBR	WBL	WBT	WBR	NBL	NBT	NBR	SBL	SBT	SBR
Lane Configurations	↗	↑↑↑		↖	↑↑↑		↖	↑		↗	↑	
Traffic Volume (veh/h)	8	2097	60	48	3516	9	101	2	64	12	0	10
Future Volume (veh/h)	8	2097	60	48	3516	9	101	2	64	12	0	10
Initial Q (Qb), veh	0	0	0	0	0	0	0	0	0	0	0	0
Ped-Bike Adj(A_pbT)	1.00		0.98	1.00		1.00	1.00		1.00	1.00		1.00
Parking Bus, Adj	1.00	1.00	1.00	1.00	1.00	1.00	1.00	1.00	1.00	1.00	1.00	1.00
Work Zone On Approach		No		No		No		No		No		No
Adj Sat Flow, veh/h/ln	1663	1870	1885	1900	1870	1678	1900	1900	1885	1426	1900	1307
Adj Flow Rate, veh/h	8	2184	59	50	3662	9	105	2	37	12	0	5
Peak Hour Factor	0.96	0.96	0.96	0.96	0.96	0.96	0.96	0.96	0.96	0.96	0.96	0.96
Percent Heavy Veh, %	16	2	1	0	2	15	0	0	1	32	0	40
Cap, veh/h	16	2669	72	65	2885	7	503	26	477	367	0	499
Arrive On Green	0.01	0.52	0.52	0.04	0.55	0.55	0.31	0.31	0.31	0.31	0.00	0.31
Sat Flow, veh/h	1584	5108	138	1810	5259	13	1434	83	1538	1042	0	1610
Grp Volume(v), veh/h	8	1453	790	50	2369	1302	105	0	39	12	0	5
Grp Sat Flow(s),veh/h/ln	1584	1702	1842	1810	1702	1868	1434	0	1621	1042	0	1610
Q Serve(g_s), s	0.6	41.3	41.6	3.2	63.7	63.7	6.4	0.0	2.0	1.0	0.0	0.2
Cycle Q Clear(g_c), s	0.6	41.3	41.6	3.2	63.7	63.7	6.6	0.0	2.0	2.9	0.0	0.2
Prop In Lane	1.00		0.07	1.00		0.01	1.00		0.95	1.00		1.00
Lane Grp Cap(c), veh/h	16	1778	962	65	1867	1025	503	0	503	367	0	499
V/C Ratio(X)	0.52	0.82	0.82	0.77	1.27	1.27	0.21	0.00	0.08	0.03	0.00	0.01
Avail Cap(c_a), veh/h	68	1778	962	184	1867	1025	503	0	503	367	0	499
HCM Platoon Ratio	1.00	1.00	1.00	1.00	1.00	1.00	1.00	1.00	1.00	1.00	1.00	1.00
Upstream Filter(I)	1.00	1.00	1.00	1.00	1.00	1.00	1.00	0.00	1.00	1.00	0.00	1.00
Uniform Delay (d), s/veh	57.2	23.1	23.2	55.5	26.2	26.2	30.0	0.0	28.3	29.4	0.0	27.7
Incr Delay (d2), s/veh	9.5	3.3	6.0	7.0	125.4	129.5	0.9	0.0	0.3	0.2	0.0	0.0
Initial Q Delay(d3),s/veh	0.0	0.0	0.0	0.0	0.0	0.0	0.0	0.0	0.0	0.0	0.0	0.0
%ile BackOfQ(50%),veh/ln	0.3	15.3	17.4	1.6	56.7	63.4	2.3	0.0	0.8	0.3	0.0	0.1
Unsig. Movement Delay, s/veh												
LnGrp Delay(d),s/veh	66.7	26.4	29.2	62.5	151.6	155.7	31.0	0.0	28.6	29.5	0.0	27.8
LnGrp LOS	E	C	C	E	F	F	C	A	C	C	A	C
Approach Vol, veh/h		2251			3721			144				17
Approach Delay, s/veh		27.5			151.9			30.3				29.0
Approach LOS		C			F			C				C
Timer - Assigned Phs	1	2		4	5	6		8				
Phs Duration (G+Y+Rc), s	8.4	67.2		40.6	5.3	70.2		40.6				
Change Period (Y+Rc), s	* 4.2	6.5		4.6	* 4.2	6.5		4.6				
Max Green Setting (Gmax), s	* 12	56.9		36.0	* 5	63.7		36.0				
Max Q Clear Time (g_c+I1), s	5.2	43.6		4.9	2.6	65.7		8.6				
Green Ext Time (p_c), s	0.0	11.7		0.0	0.0	0.0		0.5				

Intersection Summary

HCM 6th Ctrl Delay	103.0
HCM 6th LOS	F

Notes

* HCM 6th computational engine requires equal clearance times for the phases crossing the barrier.

Timings
13: Barton Rd. & Orange Terrace Pkwy

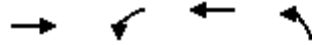

Lane Group	EBT	WBL	WBT	NBL
Lane Configurations	↑↑	↑	↑↑	↑
Traffic Volume (vph)	363	59	530	275
Future Volume (vph)	363	59	530	275
Turn Type	NA	Perm	NA	Prot
Protected Phases	4		8	2
Permitted Phases		8		
Detector Phase	4	8	8	2
Switch Phase				
Minimum Initial (s)	5.0	5.0	5.0	5.0
Minimum Split (s)	26.1	26.1	26.1	26.1
Total Split (s)	27.0	27.0	27.0	28.0
Total Split (%)	49.1%	49.1%	49.1%	50.9%
Yellow Time (s)	3.6	3.6	3.6	3.6
All-Red Time (s)	0.5	0.5	0.5	0.5
Lost Time Adjust (s)	0.0	0.0	0.0	0.0
Total Lost Time (s)	4.1	4.1	4.1	4.1
Lead/Lag				
Lead-Lag Optimize?				
Recall Mode	Max	Max	Max	Max
Act Effct Green (s)	22.9	22.9	22.9	23.9
Actuated g/C Ratio	0.42	0.42	0.42	0.43
v/c Ratio	0.48	0.29	0.39	0.44
Control Delay	6.9	15.2	12.1	12.4
Queue Delay	0.0	0.0	0.0	0.0
Total Delay	6.9	15.2	12.1	12.4
LOS	A	B	B	B
Approach Delay	6.9		12.4	12.4
Approach LOS	A		B	B

Intersection Summary

Cycle Length: 55
 Actuated Cycle Length: 55
 Offset: 0 (0%), Referenced to phase 2:NBL and 6:, Start of Yellow
 Natural Cycle: 55
 Control Type: Pretimed
 Maximum v/c Ratio: 0.48
 Intersection Signal Delay: 10.1
 Intersection LOS: B
 Intersection Capacity Utilization 53.2%
 ICU Level of Service A
 Analysis Period (min) 15

Splits and Phases: 13: Barton Rd. & Orange Terrace Pkwy

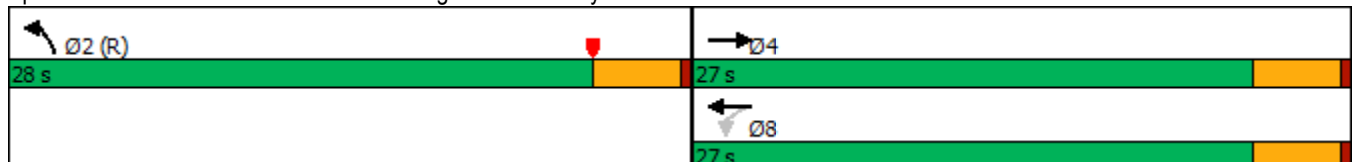

HCM 6th Signalized Intersection Summary
 13: Barton Rd. & Orange Terrace Pkwy

West Campus Upper Plateau (JN 14064)

09/20/2022

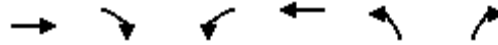

Movement	EBT	EBR	WBL	WBT	NBL	NBR
Lane Configurations	↑↑		↵	↑↑	↵	
Traffic Volume (veh/h)	363	336	59	530	275	44
Future Volume (veh/h)	363	336	59	530	275	44
Initial Q (Qb), veh	0	0	0	0	0	0
Ped-Bike Adj(A_pbT)		0.98	1.00		1.00	1.00
Parking Bus, Adj	1.00	1.00	1.00	1.00	1.00	1.00
Work Zone On Approach	No			No	No	
Adj Sat Flow, veh/h/ln	1856	1900	1870	1885	1900	1900
Adj Flow Rate, veh/h	395	365	64	576	299	48
Peak Hour Factor	0.92	0.92	0.92	0.92	0.92	0.92
Percent Heavy Veh, %	3	0	2	1	0	0
Cap, veh/h	734	640	297	1491	664	107
Arrive On Green	0.42	0.42	0.42	0.42	0.43	0.43
Sat Flow, veh/h	1856	1538	706	3676	1529	245
Grp Volume(v), veh/h	395	365	64	576	348	0
Grp Sat Flow(s),veh/h/ln	1763	1538	706	1791	1779	0
Q Serve(g_s), s	9.3	10.0	4.2	6.2	7.6	0.0
Cycle Q Clear(g_c), s	9.3	10.0	14.2	6.2	7.6	0.0
Prop In Lane		1.00	1.00		0.86	0.14
Lane Grp Cap(c), veh/h	734	640	297	1491	773	0
V/C Ratio(X)	0.54	0.57	0.22	0.39	0.45	0.00
Avail Cap(c_a), veh/h	734	640	297	1491	773	0
HCM Platoon Ratio	1.00	1.00	1.00	1.00	1.00	1.00
Upstream Filter(I)	1.00	1.00	1.00	1.00	1.00	0.00
Uniform Delay (d), s/veh	12.1	12.3	17.7	11.2	10.9	0.0
Incr Delay (d2), s/veh	2.8	3.7	1.7	0.8	1.9	0.0
Initial Q Delay(d3),s/veh	0.0	0.0	0.0	0.0	0.0	0.0
%ile BackOfQ(50%),veh/ln	3.6	3.5	0.8	2.2	3.0	0.0
Unsig. Movement Delay, s/veh						
LnGrp Delay(d),s/veh	14.9	15.9	19.4	11.9	12.8	0.0
LnGrp LOS	B	B	B	B	B	A
Approach Vol, veh/h	760			640	348	
Approach Delay, s/veh	15.4			12.7	12.8	
Approach LOS	B			B	B	
Timer - Assigned Phs		2		4		8
Phs Duration (G+Y+Rc), s		28.0		27.0		27.0
Change Period (Y+Rc), s		4.1		4.1		4.1
Max Green Setting (Gmax), s		23.9		22.9		22.9
Max Q Clear Time (g_c+I1), s		9.6		12.0		16.2
Green Ext Time (p_c), s		1.0		3.8		2.4

Intersection Summary

HCM 6th Ctrl Delay	13.9
HCM 6th LOS	B

Notes

User approved volume balancing among the lanes for turning movement.

Timings

West Campus Upper Plateau (JN 14064)

14: Barton Rd. & Van Buren Bl.

09/20/2022

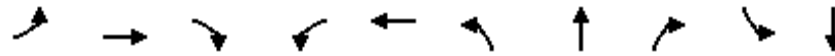

Lane Group	EBL	EBT	EBR	WBL	WBT	NBL	NBT	NBR	SBL	SBT
Lane Configurations	↘	↑↑↑	↗	↘↗	↑↑↑	↘↗	↑	↗	↘	↗
Traffic Volume (vph)	203	2005	261	337	2325	606	97	470	76	150
Future Volume (vph)	203	2005	261	337	2325	606	97	470	76	150
Turn Type	Prot	NA	pm+ov	Prot	NA	Prot	NA	Perm	Prot	NA
Protected Phases	5	2	3	1	6	3	8		7	4
Permitted Phases			2					8		
Detector Phase	5	2	3	1	6	3	8	8	7	4
Switch Phase										
Minimum Initial (s)	5.0	10.0	5.0	5.0	10.0	5.0	10.0	10.0	5.0	10.0
Minimum Split (s)	9.2	25.2	9.1	9.2	25.5	9.1	14.6	14.6	9.1	33.6
Total Split (s)	15.0	51.0	21.0	14.0	50.0	21.0	42.4	42.4	12.6	34.0
Total Split (%)	12.5%	42.5%	17.5%	11.7%	41.7%	17.5%	35.3%	35.3%	10.5%	28.3%
Yellow Time (s)	3.2	5.2	3.6	3.2	5.5	3.6	3.6	3.6	3.6	3.6
All-Red Time (s)	1.0	1.0	0.5	1.0	1.0	0.5	1.0	1.0	0.5	1.0
Lost Time Adjust (s)	0.0	0.0	0.0	0.0	0.0	0.0	0.0	0.0	0.0	0.0
Total Lost Time (s)	4.2	6.2	4.1	4.2	6.5	4.1	4.6	4.6	4.1	4.6
Lead/Lag	Lead	Lag	Lead	Lead	Lag	Lead	Lag	Lag	Lead	Lag
Lead-Lag Optimize?	Yes	Yes	Yes	Yes	Yes	Yes	Yes	Yes	Yes	Yes
Recall Mode	None	None	None	None	None	None	None	None	None	None
Act Effct Green (s)	10.8	44.8	67.9	9.8	43.5	16.9	38.1	38.1	8.2	29.4
Actuated g/C Ratio	0.09	0.37	0.57	0.08	0.36	0.14	0.32	0.32	0.07	0.24
v/c Ratio	1.36	1.04	0.31	1.31	1.27	1.36	0.18	0.79	0.67	1.23
Control Delay	239.4	69.5	10.5	204.6	160.8	216.3	30.8	32.0	81.2	154.1
Queue Delay	0.0	0.0	0.0	0.0	0.0	0.0	0.0	0.0	0.0	0.0
Total Delay	239.4	69.5	10.5	204.6	160.8	216.3	30.8	32.0	81.2	154.1
LOS	F	E	B	F	F	F	C	C	F	F
Approach Delay		77.2			166.2		127.2			145.4
Approach LOS		E			F		F			F

Intersection Summary

Cycle Length: 120
 Actuated Cycle Length: 120
 Natural Cycle: 130
 Control Type: Actuated-Uncoordinated
 Maximum v/c Ratio: 1.36
 Intersection Signal Delay: 126.3
 Intersection LOS: F
 Intersection Capacity Utilization 123.6%
 ICU Level of Service H
 Analysis Period (min) 15



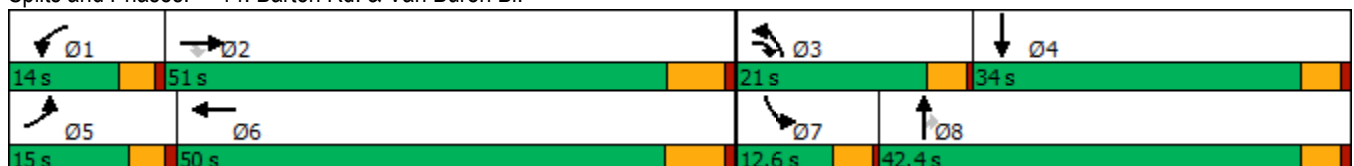

























Splits and Phases: 14: Barton Rd. & Van Buren Bl.



HCM 6th Signalized Intersection Summary
 14: Barton Rd. & Van Buren Bl.

West Campus Upper Plateau (JN 14064)

09/20/2022

												
Movement	EBL	EBT	EBR	WBL	WBT	WBR	NBL	NBT	NBR	SBL	SBT	SBR
Lane Configurations		  		 	  		 					
Traffic Volume (veh/h)	203	2005	261	337	2325	40	606	97	470	76	150	409
Future Volume (veh/h)	203	2005	261	337	2325	40	606	97	470	76	150	409
Initial Q (Qb), veh	0	0	0	0	0	0	0	0	0	0	0	0
Ped-Bike Adj(A_pbT)	1.00		1.00	1.00		1.00	1.00		1.00	1.00		1.00
Parking Bus, Adj	1.00	1.00	1.00	1.00	1.00	1.00	1.00	1.00	1.00	1.00	1.00	1.00
Work Zone On Approach		No			No			No			No	
Adj Sat Flow, veh/h/ln	1900	1870	1870	1870	1870	1752	1870	1885	1885	1900	1870	1900
Adj Flow Rate, veh/h	221	2179	272	366	2527	38	659	105	307	83	163	266
Peak Hour Factor	0.92	0.92	0.92	0.92	0.92	0.92	0.92	0.92	0.92	0.92	0.92	0.92
Percent Heavy Veh, %	0	2	2	2	2	10	2	1	1	0	2	0
Cap, veh/h	162	2090	813	282	2007	30	485	616	522	105	156	255
Arrive On Green	0.09	0.37	0.37	0.08	0.36	0.36	0.14	0.33	0.33	0.06	0.24	0.24
Sat Flow, veh/h	1810	5611	1585	3456	5514	83	3456	1885	1598	1810	639	1043
Grp Volume(v), veh/h	221	2179	272	366	1712	853	659	105	307	83	0	429
Grp Sat Flow(s),veh/h/ln	1810	1870	1585	1728	1870	1855	1728	1885	1598	1810	0	1683
Q Serve(g_s), s	10.8	44.8	12.1	9.8	43.8	43.8	16.9	4.8	19.3	5.4	0.0	29.4
Cycle Q Clear(g_c), s	10.8	44.8	12.1	9.8	43.8	43.8	16.9	4.8	19.3	5.4	0.0	29.4
Prop In Lane	1.00		1.00	1.00		0.04	1.00		1.00	1.00		0.62
Lane Grp Cap(c), veh/h	162	2090	813	282	1362	676	485	616	522	105	0	411
V/C Ratio(X)	1.36	1.04	0.33	1.30	1.26	1.26	1.36	0.17	0.59	0.79	0.00	1.04
Avail Cap(c_a), veh/h	162	2090	813	282	1362	676	485	616	522	128	0	411
HCM Platoon Ratio	1.00	1.00	1.00	1.00	1.00	1.00	1.00	1.00	1.00	1.00	1.00	1.00
Upstream Filter(I)	1.00	1.00	1.00	1.00	1.00	1.00	1.00	1.00	1.00	1.00	0.00	1.00
Uniform Delay (d), s/veh	54.8	37.7	17.2	55.3	38.3	38.3	51.7	28.9	33.8	55.9	0.0	45.5
Incr Delay (d2), s/veh	196.7	31.9	0.1	158.6	121.8	129.9	173.9	0.1	1.7	23.1	0.0	56.1
Initial Q Delay(d3),s/veh	0.0	0.0	0.0	0.0	0.0	0.0	0.0	0.0	0.0	0.0	0.0	0.0
%ile BackOfQ(50%),veh/ln	13.6	25.3	4.2	10.3	41.7	42.9	18.8	2.1	7.4	3.2	0.0	18.7
Unsig. Movement Delay, s/veh												
LnGrp Delay(d),s/veh	251.4	69.7	17.3	213.9	160.0	168.1	225.6	29.0	35.5	79.0	0.0	101.6
LnGrp LOS	F	F	B	F	F	F	F	C	D	E	A	F
Approach Vol, veh/h		2672			2931			1071				512
Approach Delay, s/veh		79.4			169.1			151.8				97.9
Approach LOS		E			F			F				F
Timer - Assigned Phs	1	2	3	4	5	6	7	8				
Phs Duration (G+Y+Rc), s	14.0	51.3	21.0	34.0	15.0	50.3	11.1	43.9				
Change Period (Y+Rc), s	* 4.2	* 6.5	4.1	4.6	* 4.2	6.5	4.1	4.6				
Max Green Setting (Gmax), s	* 9.8	* 45	16.9	29.4	* 11	43.5	8.5	37.8				
Max Q Clear Time (g_c+I1), s	11.8	46.8	18.9	31.4	12.8	45.8	7.4	21.3				
Green Ext Time (p_c), s	0.0	0.0	0.0	0.0	0.0	0.0	0.0	1.4				
Intersection Summary												
HCM 6th Ctrl Delay				128.1								
HCM 6th LOS				F								
Notes												
* HCM 6th computational engine requires equal clearance times for the phases crossing the barrier.												

Timings
19: Van Buren Bl. & Orange Terrace Pkwy.

West Campus Upper Plateau (JN 14064)

09/20/2022

Lane Group	EBL	EBT	EBR	WBL	WBT	WBR	NBL	NBT	NBR	SBL	SBT	SBR
Lane Configurations												
Traffic Volume (vph)	181	2143	225	140	2514	153	131	25	86	290	43	289
Future Volume (vph)	181	2143	225	140	2514	153	131	25	86	290	43	289
Turn Type	Prot	NA	Perm	Prot	NA	Perm	Prot	NA	Perm	Prot	NA	pm+ov
Protected Phases	5	2		1	6		3	8		7	4	5
Permitted Phases			2			6			8			4
Detector Phase	5	2	2	1	6	6	3	8	8	7	4	5
Switch Phase												
Minimum Initial (s)	5.0	10.0	10.0	5.0	10.0	10.0	5.0	5.0	5.0	10.0	10.0	5.0
Minimum Split (s)	9.2	25.2	25.2	9.1	25.2	25.2	9.1	26.1	26.1	15.8	24.8	9.2
Total Split (s)	11.2	66.6	66.6	11.3	66.7	66.7	12.9	26.1	26.1	16.0	29.2	11.2
Total Split (%)	9.3%	55.5%	55.5%	9.4%	55.6%	55.6%	10.8%	21.8%	21.8%	13.3%	24.3%	9.3%
Yellow Time (s)	3.2	5.2	5.2	3.6	5.2	5.2	3.6	3.6	3.6	4.8	4.8	3.2
All-Red Time (s)	1.0	1.0	1.0	0.5	1.0	1.0	0.5	0.5	0.5	1.0	1.0	1.0
Lost Time Adjust (s)	0.0	0.0	0.0	0.0	0.0	0.0	0.0	0.0	0.0	0.0	0.0	0.0
Total Lost Time (s)	4.2	6.2	6.2	4.1	6.2	6.2	4.1	4.1	4.1	5.8	5.8	4.2
Lead/Lag	Lead	Lag	Lag	Lead	Lag	Lag	Lead	Lag	Lag	Lead	Lag	Lead
Lead-Lag Optimize?	Yes	Yes	Yes	Yes	Yes	Yes	Yes	Yes	Yes	Yes	Yes	Yes
Recall Mode	None	None	None	None	None	None	None	None	None	None	None	None
Act Effct Green (s)	7.0	60.7	60.7	7.2	60.8	60.8	12.2	9.0	9.0	10.2	11.7	15.4
Actuated g/C Ratio	0.07	0.58	0.58	0.07	0.58	0.58	0.12	0.09	0.09	0.10	0.11	0.15
v/c Ratio	0.81	0.76	0.25	0.60	0.89	0.17	0.33	0.08	0.39	0.89	0.21	1.04
Control Delay	76.0	20.1	7.7	60.2	25.6	5.4	48.3	44.6	11.4	76.1	46.0	95.8
Queue Delay	0.0	0.0	0.0	0.0	0.0	0.0	0.0	0.0	0.0	0.0	0.0	0.0
Total Delay	76.0	20.1	7.7	60.2	25.6	5.4	48.3	44.6	11.4	76.1	46.0	95.8
LOS	E	C	A	E	C	A	D	D	B	E	D	F
Approach Delay		23.0			26.2			34.8			83.2	
Approach LOS		C			C			C			F	

Intersection Summary

Cycle Length: 120
 Actuated Cycle Length: 105.3
 Natural Cycle: 130
 Control Type: Actuated-Uncoordinated
 Maximum v/c Ratio: 1.04
 Intersection Signal Delay: 30.9
 Intersection LOS: C
 Intersection Capacity Utilization 83.0%
 ICU Level of Service E
 Analysis Period (min) 15



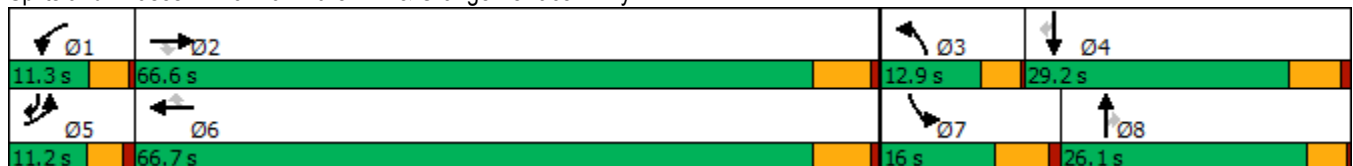





























Splits and Phases: 19: Van Buren Bl. & Orange Terrace Pkwy.



HCM 6th Signalized Intersection Summary
 19: Van Buren Bl. & Orange Terrace Pkwy.

West Campus Upper Plateau (JN 14064)

09/20/2022

												
Movement	EBL	EBT	EBR	WBL	WBT	WBR	NBL	NBT	NBR	SBL	SBT	SBR
Lane Configurations	 	  		 	  		 	 		 		
Traffic Volume (veh/h)	181	2143	225	140	2514	153	131	25	86	290	43	289
Future Volume (veh/h)	181	2143	225	140	2514	153	131	25	86	290	43	289
Initial Q (Qb), veh	0	0	0	0	0	0	0	0	0	0	0	0
Ped-Bike Adj(A_pbT)	1.00		0.99	1.00		1.00	1.00		1.00	1.00		0.98
Parking Bus, Adj	1.00	1.00	1.00	1.00	1.00	1.00	1.00	1.00	1.00	1.00	1.00	1.00
Work Zone On Approach		No			No			No			No	
Adj Sat Flow, veh/h/ln	1885	1856	1870	1900	1856	1870	1900	1900	1811	1885	1900	1885
Adj Flow Rate, veh/h	187	2209	222	144	2592	117	135	26	62	299	44	185
Peak Hour Factor	0.97	0.97	0.97	0.97	0.97	0.97	0.97	0.97	0.97	0.97	0.97	0.97
Percent Heavy Veh, %	1	3	2	0	3	2	0	0	6	1	0	1
Cap, veh/h	227	2859	883	205	2820	882	197	283	121	331	253	312
Arrive On Green	0.07	0.56	0.56	0.06	0.56	0.56	0.06	0.08	0.08	0.09	0.13	0.13
Sat Flow, veh/h	3483	5066	1565	3510	5066	1585	3510	3610	1535	3483	1900	1565
Grp Volume(v), veh/h	187	2209	222	144	2592	117	135	26	62	299	44	185
Grp Sat Flow(s),veh/h/ln	1742	1689	1565	1755	1689	1585	1755	1805	1535	1742	1900	1565
Q Serve(g_s), s	5.7	36.2	7.7	4.3	49.9	3.8	4.1	0.7	4.2	9.1	2.2	11.5
Cycle Q Clear(g_c), s	5.7	36.2	7.7	4.3	49.9	3.8	4.1	0.7	4.2	9.1	2.2	11.5
Prop In Lane	1.00		1.00	1.00		1.00	1.00		1.00	1.00		1.00
Lane Grp Cap(c), veh/h	227	2859	883	205	2820	882	197	283	121	331	253	312
V/C Ratio(X)	0.82	0.77	0.25	0.70	0.92	0.13	0.68	0.09	0.51	0.90	0.17	0.59
Avail Cap(c_a), veh/h	227	2859	883	235	2852	892	288	739	314	331	414	445
HCM Platoon Ratio	1.00	1.00	1.00	1.00	1.00	1.00	1.00	1.00	1.00	1.00	1.00	1.00
Upstream Filter(I)	1.00	1.00	1.00	1.00	1.00	1.00	1.00	1.00	1.00	1.00	1.00	1.00
Uniform Delay (d), s/veh	49.6	18.1	11.9	49.7	21.6	11.4	49.8	45.9	47.5	48.1	41.3	39.2
Incr Delay (d2), s/veh	20.1	1.4	0.1	7.7	5.4	0.1	4.1	0.1	3.4	26.9	0.3	1.8
Initial Q Delay(d3),s/veh	0.0	0.0	0.0	0.0	0.0	0.0	0.0	0.0	0.0	0.0	0.0	0.0
%ile BackOfQ(50%),veh/ln	3.0	12.4	2.7	2.0	18.1	1.3	1.9	0.3	1.7	5.1	1.0	4.6
Unsig. Movement Delay, s/veh												
LnGrp Delay(d),s/veh	69.7	19.4	12.0	57.4	27.0	11.5	53.9	46.1	50.9	75.0	41.7	41.0
LnGrp LOS	E	B	B	E	C	B	D	D	D	E	D	D
Approach Vol, veh/h		2618			2853			223			528	
Approach Delay, s/veh		22.4			27.9			52.2			60.3	
Approach LOS		C			C			D			E	
Timer - Assigned Phs	1	2	3	4	5	6	7	8				
Phs Duration (G+Y+Rc), s	10.4	66.8	10.1	20.1	11.2	66.0	16.0	14.2				
Change Period (Y+Rc), s	4.1	6.2	4.1	5.8	* 4.2	6.2	5.8	* 5.8				
Max Green Setting (Gmax), s	7.2	60.4	8.8	23.4	* 7	60.5	10.2	* 22				
Max Q Clear Time (g_c+I1), s	6.3	38.2	6.1	13.5	7.7	51.9	11.1	6.2				
Green Ext Time (p_c), s	0.0	16.8	0.1	0.5	0.0	7.9	0.0	0.2				
Intersection Summary												
HCM 6th Ctrl Delay				29.2								
HCM 6th LOS				C								
Notes												
* HCM 6th computational engine requires equal clearance times for the phases crossing the barrier.												

Timings
25: Sycamore Canyon Bl. & Cactus Av.

West Campus Upper Plateau (JN 14064)

09/20/2022



Lane Group	EBL	EBT	WBL	WBT	WBR	NBL	NBT	NBR	SBL	SBT
Lane Configurations	↘	↗↗↗	↘↘	↗↗	↗	↘↘	↗↗	↗	↘↘	↗↗↗
Traffic Volume (vph)	53	223	898	783	1250	219	561	327	214	362
Future Volume (vph)	53	223	898	783	1250	219	561	327	214	362
Turn Type	Prot	NA	Prot	NA	Perm	Prot	NA	Perm	Prot	NA
Protected Phases	7	4	3	8		5	2		1	6
Permitted Phases					8			2		
Detector Phase	7	4	3	8	8	5	2	2	1	6
Switch Phase										
Minimum Initial (s)	5.0	10.0	5.0	10.0	10.0	5.0	10.0	10.0	5.0	10.0
Minimum Split (s)	9.6	32.8	9.6	32.8	32.8	9.6	34.8	34.8	9.6	34.8
Total Split (s)	9.6	36.6	54.0	81.0	81.0	13.0	37.4	37.4	12.0	36.4
Total Split (%)	6.9%	26.1%	38.6%	57.9%	57.9%	9.3%	26.7%	26.7%	8.6%	26.0%
Yellow Time (s)	3.6	4.8	3.6	4.8	4.8	3.6	4.8	4.8	3.6	4.8
All-Red Time (s)	1.0	1.0	1.0	1.0	1.0	1.0	1.0	1.0	1.0	1.0
Lost Time Adjust (s)	0.0	0.0	0.0	0.0	0.0	0.0	0.0	0.0	0.0	0.0
Total Lost Time (s)	4.6	5.8	4.6	5.8	5.8	4.6	5.8	5.8	4.6	5.8
Lead/Lag	Lead	Lag	Lead	Lag	Lag	Lead	Lag	Lag	Lead	Lag
Lead-Lag Optimize?	Yes	Yes	Yes	Yes	Yes	Yes	Yes	Yes	Yes	Yes
Recall Mode	None	None	None	None	None	None	None	None	None	None
Act Effct Green (s)	5.0	37.6	42.7	75.2	75.2	8.4	28.4	28.4	7.4	27.4
Actuated g/C Ratio	0.04	0.27	0.31	0.55	0.55	0.06	0.21	0.21	0.05	0.20
v/c Ratio	0.95	0.26	0.91	0.46	1.35	1.11	0.82	0.58	1.22	0.46
Control Delay	166.9	32.4	58.3	19.9	189.8	151.4	62.0	8.6	190.4	45.5
Queue Delay	0.0	0.0	0.0	0.0	0.2	0.0	0.0	0.0	0.0	0.0
Total Delay	166.9	32.4	58.3	19.9	190.0	151.4	62.0	8.6	190.4	45.5
LOS	F	C	E	B	F	F	E	A	F	D
Approach Delay		51.6		104.2			63.9			92.3
Approach LOS		D		F			E			F

Intersection Summary

Cycle Length: 140
 Actuated Cycle Length: 136.9
 Natural Cycle: 130
 Control Type: Actuated-Uncoordinated
 Maximum v/c Ratio: 1.35
 Intersection Signal Delay: 90.0
 Intersection LOS: F
 Intersection Capacity Utilization 110.6%
 ICU Level of Service H
 Analysis Period (min) 15

Splits and Phases: 25: Sycamore Canyon Bl. & Cactus Av.

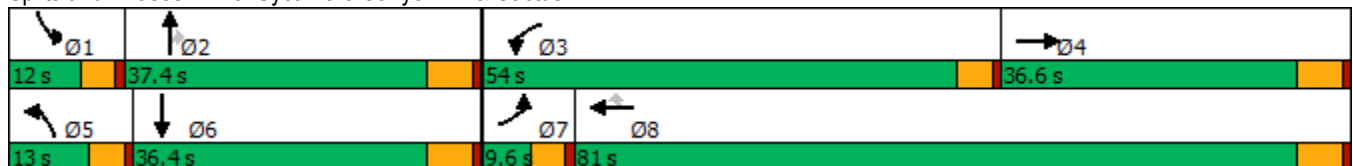

HCM 6th Signalized Intersection Summary
25: Sycamore Canyon Bl. & Cactus Av.

West Campus Upper Plateau (JN 14064)

09/20/2022

Movement	EBL	EBT	EBR	WBL	WBT	WBR	NBL	NBT	NBR	SBL	SBT	SBR
Lane Configurations												
Traffic Volume (veh/h)	53	223	97	898	783	1250	219	561	327	214	362	88
Future Volume (veh/h)	53	223	97	898	783	1250	219	561	327	214	362	88
Initial Q (Qb), veh	0	0	0	0	0	0	0	0	0	0	0	0
Ped-Bike Adj(A_pbT)	1.00		1.00	1.00		0.99	1.00		1.00	1.00		0.99
Parking Bus, Adj	1.00	1.00	1.00	1.00	1.00	1.00	1.00	1.00	1.00	1.00	1.00	1.00
Work Zone On Approach		No			No			No			No	
Adj Sat Flow, veh/h/ln	1722	1678	1826	1796	1722	1856	1826	1811	1826	1841	1856	1796
Adj Flow Rate, veh/h	55	230	99	926	807	1070	226	578	240	221	373	88
Peak Hour Factor	0.97	0.97	0.97	0.97	0.97	0.97	0.97	0.97	0.97	0.97	0.97	0.97
Percent Heavy Veh, %	12	15	5	7	12	3	5	6	5	4	3	7
Cap, veh/h	61	954	379	990	1823	865	210	677	305	186	780	177
Arrive On Green	0.04	0.30	0.30	0.30	0.56	0.56	0.06	0.20	0.20	0.05	0.19	0.19
Sat Flow, veh/h	1640	3222	1279	3319	3272	1553	3374	3441	1547	3401	4116	934
Grp Volume(v), veh/h	55	217	112	926	807	1070	226	578	240	221	303	158
Grp Sat Flow(s),veh/h/ln	1640	1527	1448	1659	1636	1553	1687	1721	1547	1700	1689	1673
Q Serve(g_s), s	4.5	7.3	8.0	36.7	19.6	75.2	8.4	21.9	19.9	7.4	10.8	11.4
Cycle Q Clear(g_c), s	4.5	7.3	8.0	36.7	19.6	75.2	8.4	21.9	19.9	7.4	10.8	11.4
Prop In Lane	1.00		0.88	1.00		1.00	1.00		1.00	1.00		0.56
Lane Grp Cap(c), veh/h	61	904	428	990	1823	865	210	677	305	186	640	317
V/C Ratio(X)	0.91	0.24	0.26	0.94	0.44	1.24	1.08	0.85	0.79	1.19	0.47	0.50
Avail Cap(c_a), veh/h	61	904	428	1215	1823	865	210	806	362	186	766	379
HCM Platoon Ratio	1.00	1.00	1.00	1.00	1.00	1.00	1.00	1.00	1.00	1.00	1.00	1.00
Upstream Filter(I)	1.00	1.00	1.00	1.00	1.00	1.00	1.00	1.00	1.00	1.00	1.00	1.00
Uniform Delay (d), s/veh	64.7	36.0	36.3	46.1	17.6	29.9	63.3	52.3	51.5	63.8	48.7	48.9
Incr Delay (d2), s/veh	80.7	0.1	0.3	10.8	0.2	116.4	83.9	7.7	9.4	124.6	0.5	1.2
Initial Q Delay(d3),s/veh	0.0	0.0	0.0	0.0	0.0	0.0	0.0	0.0	0.0	0.0	0.0	0.0
%ile BackOfQ(50%),veh/ln	3.2	2.7	2.8	16.1	7.0	53.5	6.0	9.9	8.3	6.4	4.5	4.8
Unsig. Movement Delay, s/veh												
LnGrp Delay(d),s/veh	145.5	36.1	36.6	56.9	17.7	146.3	147.2	60.0	60.9	188.4	49.3	50.2
LnGrp LOS	F	D	D	E	B	F	F	E	E	F	D	D
Approach Vol, veh/h		384			2803			1044			682	
Approach Delay, s/veh		51.9			79.8			79.1			94.6	
Approach LOS		D			E			E			F	
Timer - Assigned Phs	1	2	3	4	5	6	7	8				
Phs Duration (G+Y+Rc), s	12.0	32.4	44.8	45.8	13.0	31.4	9.6	81.0				
Change Period (Y+Rc), s	4.6	5.8	4.6	5.8	4.6	5.8	4.6	5.8				
Max Green Setting (Gmax), s	7.4	31.6	49.4	30.8	8.4	30.6	5.0	75.2				
Max Q Clear Time (g_c+I1), s	9.4	23.9	38.7	10.0	10.4	13.4	6.5	77.2				
Green Ext Time (p_c), s	0.0	2.7	1.6	1.9	0.0	2.4	0.0	0.0				
Intersection Summary												
HCM 6th Ctrl Delay				79.5								
HCM 6th LOS				E								

Timings

West Campus Upper Plateau (JN 14064)

26: Sycamore Canyon Bl. & Van Buren Bl.

09/20/2022



Lane Group	EBL	EBT	EBR	WBL	WBT	WBR	NBL	NBT	SBL	SBT	SBR
Lane Configurations											
Traffic Volume (vph)	909	2623	31	55	3898	267	5	4	141	11	682
Future Volume (vph)	909	2623	31	55	3898	267	5	4	141	11	682
Turn Type	Prot	NA	Perm	Prot	NA	Perm	Perm	NA	Split	NA	pm+ov
Protected Phases	5	2		1	6			8	4	4	5
Permitted Phases			2			6	8				4
Detector Phase	5	2	2	1	6	6	8	8	4	4	5
Switch Phase											
Minimum Initial (s)	5.0	10.0	10.0	5.0	10.0	10.0	10.0	10.0	10.0	10.0	5.0
Minimum Split (s)	9.6	29.2	29.2	9.6	29.2	29.2	14.6	14.6	50.8	50.8	9.6
Total Split (s)	15.0	45.0	45.0	9.6	39.6	39.6	14.6	14.6	50.8	50.8	15.0
Total Split (%)	12.5%	37.5%	37.5%	8.0%	33.0%	33.0%	12.2%	12.2%	42.3%	42.3%	12.5%
Yellow Time (s)	3.6	5.2	5.2	3.6	5.2	5.2	3.6	3.6	4.8	4.8	3.6
All-Red Time (s)	1.0	1.0	1.0	1.0	1.0	1.0	1.0	1.0	1.0	1.0	1.0
Lost Time Adjust (s)	0.0	0.0	0.0	0.0	0.0	0.0		0.0	0.0	0.0	0.0
Total Lost Time (s)	4.6	6.2	6.2	4.6	6.2	6.2		4.6	5.8	5.8	4.6
Lead/Lag	Lead	Lag	Lag	Lead	Lag	Lag					Lead
Lead-Lag Optimize?	Yes	Yes	Yes	Yes	Yes	Yes					Yes
Recall Mode	None	None	None	None	None	None	None	None	None	None	None
Act Effct Green (s)	10.9	42.7	42.7	5.2	34.9	34.9		10.4	16.3	16.3	32.6
Actuated g/C Ratio	0.13	0.53	0.53	0.06	0.43	0.43		0.13	0.20	0.20	0.40
v/c Ratio	2.08	0.76	0.04	0.52	1.37	0.41		0.03	0.23	0.70	0.51
Control Delay	513.2	20.6	0.1	58.5	190.2	12.4		33.8	27.0	12.7	8.2
Queue Delay	0.0	0.0	0.0	0.0	0.0	0.0		0.0	0.0	0.0	0.0
Total Delay	513.2	20.6	0.1	58.5	190.2	12.4		33.8	27.0	12.7	8.2
LOS	F	C	A	E	F	B		C	C	B	A
Approach Delay		146.1			177.2			33.8		13.0	
Approach LOS		F			F			C		B	

Intersection Summary

Cycle Length: 120	
Actuated Cycle Length: 81.3	
Natural Cycle: 125	
Control Type: Actuated-Uncoordinated	
Maximum v/c Ratio: 2.08	
Intersection Signal Delay: 148.3	Intersection LOS: F
Intersection Capacity Utilization 110.4%	ICU Level of Service H
Analysis Period (min) 15	

Splits and Phases: 26: Sycamore Canyon Bl. & Van Buren Bl.

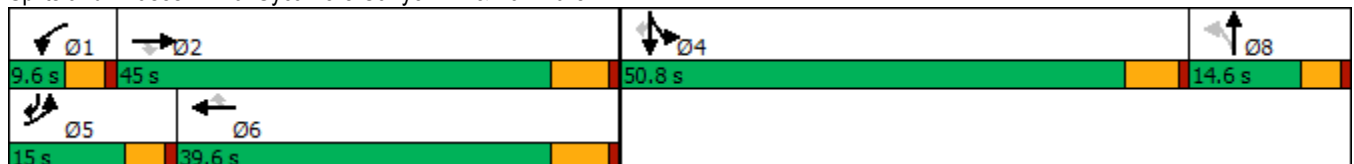

HCM 6th Signalized Intersection Summary
 26: Sycamore Canyon Bl. & Van Buren Bl.

West Campus Upper Plateau (JN 14064)

09/20/2022



Movement	EBL	EBT	EBR	WBL	WBT	WBR	NBL	NBT	NBR	SBL	SBT	SBR
Lane Configurations												
Traffic Volume (veh/h)	909	2623	31	55	3898	267	5	4	4	141	11	682
Future Volume (veh/h)	909	2623	31	55	3898	267	5	4	4	141	11	682
Initial Q (Qb), veh	0	0	0	0	0	0	0	0	0	0	0	0
Ped-Bike Adj(A_pbT)	1.00		1.00	1.00		1.00	1.00		1.00	1.00		1.00
Parking Bus, Adj	1.00	1.00	1.00	1.00	1.00	1.00	1.00	1.00	1.00	1.00	1.00	1.00
Work Zone On Approach		No			No			No			No	
Adj Sat Flow, veh/h/ln	1885	1811	1900	1900	1826	1752	1900	1900	1900	1737	1900	1885
Adj Flow Rate, veh/h	988	2851	33	60	4237	265	5	4	2	127	0	0
Peak Hour Factor	0.92	0.92	0.92	0.92	0.92	0.92	0.92	0.92	0.92	0.92	0.92	0.92
Percent Heavy Veh, %	1	6	0	0	5	10	0	0	0	11	0	1
Cap, veh/h	489	3811	847	85	3193	649	43	37	18	404	0	
Arrive On Green	0.14	0.53	0.53	0.05	0.44	0.44	0.03	0.03	0.03	0.12	0.00	0.00
Sat Flow, veh/h	3591	7244	1610	1810	7304	1485	1581	1340	679	3309	0	3195
Grp Volume(v), veh/h	988	2851	33	60	4237	265	6	0	5	127	0	0
Grp Sat Flow(s),veh/h/ln	1795	1811	1610	1810	1826	1485	1821	0	1778	1654	0	1598
Q Serve(g_s), s	10.4	23.5	0.8	2.5	33.4	9.3	0.2	0.0	0.2	2.7	0.0	0.0
Cycle Q Clear(g_c), s	10.4	23.5	0.8	2.5	33.4	9.3	0.2	0.0	0.2	2.7	0.0	0.0
Prop In Lane	1.00		1.00	1.00		1.00	0.87		0.38	1.00		1.00
Lane Grp Cap(c), veh/h	489	3811	847	85	3193	649	50	0	48	404	0	
V/C Ratio(X)	2.02	0.75	0.04	0.70	1.33	0.41	0.12	0.00	0.11	0.31	0.00	
Avail Cap(c_a), veh/h	489	3811	847	118	3193	649	238	0	233	1949	0	
HCM Platoon Ratio	1.00	1.00	1.00	1.00	1.00	1.00	1.00	1.00	1.00	1.00	1.00	1.00
Upstream Filter(I)	1.00	1.00	1.00	1.00	1.00	1.00	1.00	0.00	1.00	1.00	0.00	0.00
Uniform Delay (d), s/veh	33.0	14.1	8.8	35.9	21.5	14.7	36.3	0.0	36.3	30.6	0.0	0.0
Incr Delay (d2), s/veh	466.8	0.8	0.0	4.5	149.5	0.4	1.0	0.0	1.0	0.4	0.0	0.0
Initial Q Delay(d3),s/veh	0.0	0.0	0.0	0.0	0.0	0.0	0.0	0.0	0.0	0.0	0.0	0.0
%ile BackOfQ(50%),veh/ln	35.9	7.9	0.2	1.1	45.0	2.8	0.1	0.0	0.1	1.0	0.0	0.0
Unsig. Movement Delay, s/veh												
LnGrp Delay(d),s/veh	499.8	15.0	8.8	40.4	171.0	15.1	37.3	0.0	37.2	31.1	0.0	0.0
LnGrp LOS	F	B	A	D	F	B	D	A	D	C	A	
Approach Vol, veh/h		3872			4562			11			127	
Approach Delay, s/veh		138.7			160.2			37.3			31.1	
Approach LOS		F			F			D			C	
Timer - Assigned Phs	1	2		4	5	6		8				
Phs Duration (G+Y+Rc), s	8.2	46.4		15.1	15.0	39.6		6.7				
Change Period (Y+Rc), s	4.6	6.2		5.8	4.6	6.2		4.6				
Max Green Setting (Gmax), s	5.0	38.8		45.0	10.4	33.4		10.0				
Max Q Clear Time (g_c+1), s	4.5	25.5		4.7	12.4	35.4		2.2				
Green Ext Time (p_c), s	0.0	12.4		0.4	0.0	0.0		0.0				

Intersection Summary

HCM 6th Ctrl Delay	148.4
HCM 6th LOS	F

Notes

User approved volume balancing among the lanes for turning movement.
 Unsignalized Delay for [SBR] is excluded from calculations of the approach delay and intersection delay.

Timings
29: I-215 NB Ramps & Alessandro Bl.

West Campus Upper Plateau (JN 14064)

09/20/2022

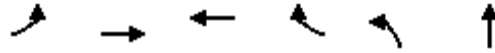

Lane Group	EBL	EBT	WBT	WBR	NBL	NBT
Lane Configurations	↶	↑↑↑	↑↑↑	↷	↶↷	↕
Traffic Volume (vph)	137	1562	2200	189	1423	0
Future Volume (vph)	137	1562	2200	189	1423	0
Turn Type	Prot	NA	NA	Perm	Split	NA
Protected Phases	5	2	6		8	8
Permitted Phases				6		
Detector Phase	5	2	6	6	8	8
Switch Phase						
Minimum Initial (s)	5.0	5.0	5.0	5.0	5.0	5.0
Minimum Split (s)	9.5	10.5	33.5	33.5	10.0	10.0
Total Split (s)	14.0	64.0	50.0	50.0	46.0	46.0
Total Split (%)	12.7%	58.2%	45.5%	45.5%	41.8%	41.8%
Yellow Time (s)	3.5	4.5	4.5	4.5	4.0	4.0
All-Red Time (s)	1.0	1.0	1.0	1.0	1.0	1.0
Lost Time Adjust (s)	0.0	0.0	0.0	0.0	0.0	0.0
Total Lost Time (s)	4.5	5.5	5.5	5.5	5.0	5.0
Lead/Lag	Lead		Lag	Lag		
Lead-Lag Optimize?	Yes		Yes	Yes		
Recall Mode	None	C-Min	C-Min	C-Min	None	None
Act Effct Green (s)	9.5	58.5	44.5	44.5	41.0	41.0
Actuated g/C Ratio	0.09	0.53	0.40	0.40	0.37	0.37
v/c Ratio	1.11	0.60	1.09	0.30	1.12	1.17
Control Delay	152.9	19.5	81.9	15.9	99.5	124.6
Queue Delay	0.0	0.0	0.0	0.0	0.0	0.0
Total Delay	152.9	19.5	81.9	15.9	99.5	124.6
LOS	F	B	F	B	F	F
Approach Delay		30.2	76.7			107.9
Approach LOS		C	E			F

Intersection Summary

Cycle Length: 110
 Actuated Cycle Length: 110
 Offset: 0 (0%), Referenced to phase 2:EBT and 6:WBT, Start of Yellow
 Natural Cycle: 130
 Control Type: Actuated-Coordinated
 Maximum v/c Ratio: 1.17
 Intersection Signal Delay: 73.5
 Intersection LOS: E
 Intersection Capacity Utilization 99.0%
 ICU Level of Service F
 Analysis Period (min) 15

Splits and Phases: 29: I-215 NB Ramps & Alessandro Bl.

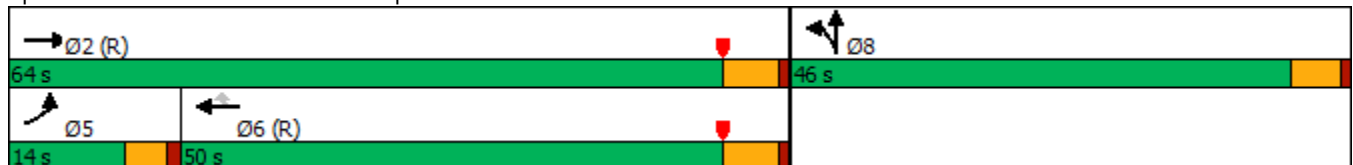

HCM 6th Signalized Intersection Summary
 29: I-215 NB Ramps & Alessandro Bl.

West Campus Upper Plateau (JN 14064)

09/20/2022

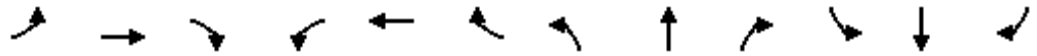

Movement	EBL	EBT	EBR	WBL	WBT	WBR	NBL	NBT	NBR	SBL	SBT	SBR
Lane Configurations	↗	↑↑↑			↑↑↑	↗	↗↗	↕				
Traffic Volume (veh/h)	137	1562	0	0	2200	189	1423	0	496	0	0	0
Future Volume (veh/h)	137	1562	0	0	2200	189	1423	0	496	0	0	0
Initial Q (Qb), veh	0	0	0	0	0	0	0	0	0			
Ped-Bike Adj(A_pbT)	1.00		1.00	1.00		1.00	1.00		1.00			
Parking Bus, Adj	1.00	1.00	1.00	1.00	1.00	1.00	1.00	1.00	1.00			
Work Zone On Approach		No			No			No				
Adj Sat Flow, veh/h/ln	1559	1856	0	0	1870	1796	1826	1900	1737			
Adj Flow Rate, veh/h	140	1594	0	0	2245	186	1352	139	427			
Peak Hour Factor	0.98	0.98	0.98	0.98	0.98	0.98	0.98	0.98	0.98			
Percent Heavy Veh, %	23	3	0	0	2	7	5	0	11			
Cap, veh/h	128	2694	0	0	2066	616	1296	153	470			
Arrive On Green	0.17	1.00	0.00	0.00	0.40	0.40	0.37	0.37	0.37			
Sat Flow, veh/h	1485	5233	0	0	5274	1522	3478	411	1262			
Grp Volume(v), veh/h	140	1594	0	0	2245	186	1352	0	566			
Grp Sat Flow(s),veh/h/ln	1485	1689	0	0	1702	1522	1739	0	1673			
Q Serve(g_s), s	9.5	0.0	0.0	0.0	44.5	9.1	41.0	0.0	35.3			
Cycle Q Clear(g_c), s	9.5	0.0	0.0	0.0	44.5	9.1	41.0	0.0	35.3			
Prop In Lane	1.00		0.00	0.00		1.00	1.00		0.75			
Lane Grp Cap(c), veh/h	128	2694	0	0	2066	616	1296	0	624			
V/C Ratio(X)	1.09	0.59	0.00	0.00	1.09	0.30	1.04	0.00	0.91			
Avail Cap(c_a), veh/h	128	2694	0	0	2066	616	1296	0	624			
HCM Platoon Ratio	2.00	2.00	1.00	1.00	1.00	1.00	1.00	1.00	1.00			
Upstream Filter(I)	0.85	0.85	0.00	0.00	1.00	1.00	1.00	0.00	1.00			
Uniform Delay (d), s/veh	45.5	0.0	0.0	0.0	32.8	22.2	34.5	0.0	32.7			
Incr Delay (d2), s/veh	99.9	0.8	0.0	0.0	48.0	1.3	37.0	0.0	17.2			
Initial Q Delay(d3),s/veh	0.0	0.0	0.0	0.0	0.0	0.0	0.0	0.0	0.0			
%ile BackOfQ(50%),veh/ln	6.6	0.2	0.0	0.0	25.6	3.2	23.0	0.0	16.5			
Unsig. Movement Delay, s/veh												
LnGrp Delay(d),s/veh	145.4	0.8	0.0	0.0	80.7	23.5	71.5	0.0	49.9			
LnGrp LOS	F	A	A	A	F	C	F	A	D			
Approach Vol, veh/h		1734			2431			1918				
Approach Delay, s/veh		12.5			76.3			65.1				
Approach LOS		B			E			E				
Timer - Assigned Phs		2			5	6		8				
Phs Duration (G+Y+Rc), s		64.0			14.0	50.0		46.0				
Change Period (Y+Rc), s		5.5			4.5	5.5		5.0				
Max Green Setting (Gmax), s		58.5			9.5	44.5		41.0				
Max Q Clear Time (g_c+I1), s		2.0			11.5	46.5		43.0				
Green Ext Time (p_c), s		15.1			0.0	0.0		0.0				

Intersection Summary

HCM 6th Ctrl Delay	54.6
HCM 6th LOS	D

Notes

User approved volume balancing among the lanes for turning movement.

Timings
30: I-215 SB Ramps & Cactus Av.

West Campus Upper Plateau (JN 14064)

09/20/2022



Lane Group	EBT	EBR	WBL	WBT	NBR	SBR
Lane Configurations	↑↑↑	↑	↓	↑↑↑	↑	↑
Traffic Volume (vph)	657	61	948	2285	974	718
Future Volume (vph)	657	61	948	2285	974	718
Turn Type	NA	Perm	Prot	NA	Prot	Prot
Protected Phases	2		1	6	8	4
Permitted Phases		2				
Detector Phase	2	2	1	6	8	4
Switch Phase						
Minimum Initial (s)	5.0	5.0	5.0	5.0	5.0	5.0
Minimum Split (s)	11.0	11.0	9.5	23.0	9.5	9.5
Total Split (s)	24.0	24.0	58.0	82.0	48.0	48.0
Total Split (%)	18.5%	18.5%	44.6%	63.1%	36.9%	36.9%
Yellow Time (s)	5.0	5.0	3.5	5.0	3.5	3.5
All-Red Time (s)	1.0	1.0	1.0	1.0	1.0	1.0
Lost Time Adjust (s)	0.0	0.0	0.0	0.0	0.0	0.0
Total Lost Time (s)	6.0	6.0	4.5	6.0	4.5	4.5
Lead/Lag	Lag	Lag	Lead			
Lead-Lag Optimize?	Yes	Yes	Yes			
Recall Mode	Min	Min	None	Min	None	None
Act Effct Green (s)	18.0	18.0	53.5	76.0	43.5	43.5
Actuated g/C Ratio	0.14	0.14	0.41	0.58	0.33	0.33
v/c Ratio	1.06	0.26	1.50	0.84	1.01	1.54
Control Delay	105.7	14.1	262.6	25.2	40.0	280.4
Queue Delay	0.0	0.0	0.0	0.0	0.0	0.0
Total Delay	105.7	14.1	262.6	25.2	40.0	280.4
LOS	F	B	F	C	D	F
Approach Delay	98.0			94.8		
Approach LOS	F			F		

Intersection Summary

Cycle Length: 130	
Actuated Cycle Length: 130	
Natural Cycle: 130	
Control Type: Actuated-Uncoordinated	
Maximum v/c Ratio: 1.54	
Intersection Signal Delay: 109.4	Intersection LOS: F
Intersection Capacity Utilization 97.4%	ICU Level of Service F
Analysis Period (min) 15	

Splits and Phases: 30: I-215 SB Ramps & Cactus Av.

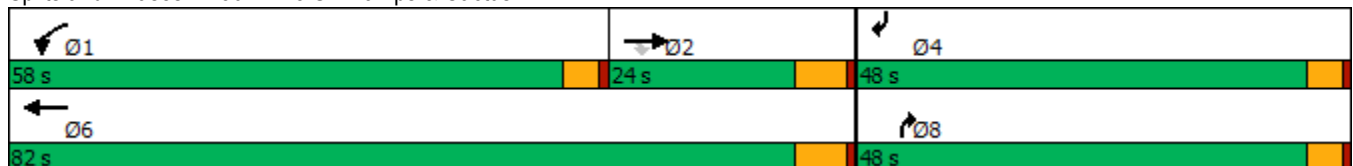

HCM 6th Signalized Intersection Summary
 30: I-215 SB Ramps & Cactus Av.

West Campus Upper Plateau (JN 14064)

09/20/2022



Movement	EBL	EBT	EBR	WBL	WBT	WBR	NBL	NBT	NBR	SBL	SBT	SBR
Lane Configurations		↑↑↑	↑	↑	↑↑↑				↑			↑
Traffic Volume (veh/h)	0	657	61	948	2285	0	0	0	974	0	0	718
Future Volume (veh/h)	0	657	61	948	2285	0	0	0	974	0	0	718
Initial Q (Qb), veh	0	0	0	0	0	0	0	0	0	0	0	0
Ped-Bike Adj(A_pbT)	1.00		1.00	1.00		1.00	1.00		1.00	1.00		1.00
Parking Bus, Adj	1.00	1.00	1.00	1.00	1.00	1.00	1.00	1.00	1.00	1.00	1.00	1.00
Work Zone On Approach		No			No			No			No	
Adj Sat Flow, veh/h/ln	0	1796	1707	1781	1870	0	0	0	1781	0	0	1633
Adj Flow Rate, veh/h	0	714	58	1030	2484	0	0	0	0	0	0	681
Peak Hour Factor	0.92	0.92	0.92	0.92	0.92	0.92	0.92	0.92	0.92	0.92	0.92	0.92
Percent Heavy Veh, %	0	7	13	8	2	0	0	0	8	0	0	18
Cap, veh/h	0	982	290	1071	4615	0	0	0	0	0	0	0
Arrive On Green	0.00	0.20	0.20	0.63	0.90	0.00	0.00	0.00	0.00	0.00	0.00	0.00
Sat Flow, veh/h	0	5065	1447	1697	5274	0		0			0	
Grp Volume(v), veh/h	0	714	58	1030	2484	0		0.0			0.0	
Grp Sat Flow(s),veh/h/ln	0	1635	1447	1697	1702	0						
Q Serve(g_s), s	0.0	8.5	2.1	35.5	5.7	0.0						
Cycle Q Clear(g_c), s	0.0	8.5	2.1	35.5	5.7	0.0						
Prop In Lane	0.00		1.00	1.00		0.00						
Lane Grp Cap(c), veh/h	0	982	290	1071	4615	0						
V/C Ratio(X)	0.00	0.73	0.20	0.96	0.54	0.00						
Avail Cap(c_a), veh/h	0	1416	418	1456	6223	0						
HCM Platoon Ratio	1.00	1.00	1.00	1.00	1.00	1.00						
Upstream Filter(I)	0.00	1.00	1.00	1.00	1.00	0.00						
Uniform Delay (d), s/veh	0.0	23.3	20.8	10.8	0.6	0.0						
Incr Delay (d2), s/veh	0.0	0.4	0.1	11.6	0.0	0.0						
Initial Q Delay(d3),s/veh	0.0	0.0	0.0	0.0	0.0	0.0						
%ile BackOfQ(50%),veh/ln	0.0	2.9	0.6	10.8	0.0	0.0						
Unsig. Movement Delay, s/veh												
LnGrp Delay(d),s/veh	0.0	23.8	20.9	22.4	0.6	0.0						
LnGrp LOS	A	C	C	C	A	A						
Approach Vol, veh/h		772			3514							
Approach Delay, s/veh		23.6			7.0							
Approach LOS		C			A							
Timer - Assigned Phs	1	2				6						
Phs Duration (G+Y+Rc), s	43.9	18.5				62.4						
Change Period (Y+Rc), s	4.5	6.0				6.0						
Max Green Setting (Gmax), s	53.5	18.0				76.0						
Max Q Clear Time (g_c+I1), s	37.5	10.5				7.7						
Green Ext Time (p_c), s	1.9	2.0				23.8						

Intersection Summary

HCM 6th Ctrl Delay	10.0
HCM 6th LOS	A

Notes

Unsignalized Delay for [NBR] is excluded from calculations of the approach delay and intersection delay.

Timings

31: I-215 NB Ramps/Old 215 Frontage Rd. & Cactus Av.



Lane Group	EBL	EBT	EBR	WBT	NBL	NBT	NBR	SBL	SBT
Lane Configurations	↖	↑↑↑	↗	↑↑↑	↖	↗	↖	↖	↗
Traffic Volume (vph)	34	2263	197	3688	704	393	56	67	0
Future Volume (vph)	34	2263	197	3688	704	393	56	67	0
Turn Type	Perm	NA	Perm	NA	Prot	NA	Free	Perm	NA
Protected Phases		2		6	3	8			4
Permitted Phases	2		2				Free	4	
Detector Phase	2	2	2	6	3	8		4	4
Switch Phase									
Minimum Initial (s)	5.0	5.0	5.0	5.0	5.0	5.0		5.0	5.0
Minimum Split (s)	11.0	11.0	11.0	44.0	9.1	10.5		10.5	10.5
Total Split (s)	79.0	79.0	79.0	79.0	24.0	41.0		17.0	17.0
Total Split (%)	65.8%	65.8%	65.8%	65.8%	20.0%	34.2%		14.2%	14.2%
Yellow Time (s)	5.0	5.0	5.0	5.0	3.6	4.5		4.5	4.5
All-Red Time (s)	1.0	1.0	1.0	1.0	0.5	1.0		1.0	1.0
Lost Time Adjust (s)	0.0	0.0	0.0	0.0	0.0	0.0		0.0	0.0
Total Lost Time (s)	6.0	6.0	6.0	6.0	4.1	5.5		5.5	5.5
Lead/Lag					Lead			Lag	Lag
Lead-Lag Optimize?					Yes			Yes	Yes
Recall Mode	Min	Min	Min	Min	None	None		None	None
Act Effct Green (s)	73.0	73.0	73.0	73.0	19.9	35.5	120.0	11.5	11.5
Actuated g/C Ratio	0.61	0.61	0.61	0.61	0.17	0.30	1.00	0.10	0.10
v/c Ratio	0.65	0.79	0.24	1.08	1.34	0.89	0.04	0.81	1.11
Control Delay	72.2	20.0	2.3	63.7	204.9	62.6	0.0	107.4	132.0
Queue Delay	0.0	0.0	0.0	0.0	0.0	0.0	0.0	0.0	0.0
Total Delay	72.2	20.0	2.3	63.7	204.9	62.6	0.0	107.4	132.0
LOS	E	C	A	E	F	E	A	F	F
Approach Delay		19.3		63.7		146.7			125.5
Approach LOS		B		E		F			F

Intersection Summary

Cycle Length: 120
 Actuated Cycle Length: 120
 Natural Cycle: 130
 Control Type: Actuated-Uncoordinated
 Maximum v/c Ratio: 1.34
 Intersection Signal Delay: 63.8
 Intersection LOS: E
 Intersection Capacity Utilization 101.3%
 ICU Level of Service G
 Analysis Period (min) 15

Splits and Phases: 31: I-215 NB Ramps/Old 215 Frontage Rd. & Cactus Av.



HCM 6th Signalized Intersection Summary

West Campus Upper Plateau (JN 14064)

31: I-215 NB Ramps/Old 215 Frontage Rd. & Cactus Av.

09/20/2022

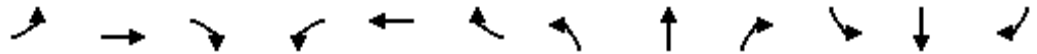

Movement	EBL	EBT	EBR	WBL	WBT	WBR	NBL	NBT	NBR	SBL	SBT	SBR
Lane Configurations	↖	↑↑↑	↗		↑↑↑		↖↗	↖	↗	↖	↗	
Traffic Volume (veh/h)	34	2263	197	0	3688	190	704	393	56	67	0	187
Future Volume (veh/h)	34	2263	197	0	3688	190	704	393	56	67	0	187
Initial Q (Qb), veh	0	0	0	0	0	0	0	0	0	0	0	0
Ped-Bike Adj(A_pbT)	1.00		1.00	1.00		1.00	1.00		1.00	1.00		1.00
Parking Bus, Adj	1.00	1.00	1.00	1.00	1.00	1.00	1.00	1.00	1.00	1.00	1.00	1.00
Work Zone On Approach		No			No			No			No	
Adj Sat Flow, veh/h/ln	1678	1856	1515	0	1856	1841	1841	1722	1841	1841	1900	1500
Adj Flow Rate, veh/h	36	2407	205	0	3923	154	749	418	0	71	0	151
Peak Hour Factor	0.94	0.94	0.94	0.94	0.94	0.94	0.94	0.94	0.94	0.94	0.94	0.94
Percent Heavy Veh, %	15	3	26	0	3	4	4	12	4	4	0	27
Cap, veh/h	60	3082	781	0	3865	149	581	509		127	0	154
Arrive On Green	0.61	0.61	0.61	0.00	0.61	0.61	0.17	0.30	0.00	0.10	0.00	0.10
Sat Flow, veh/h	23	5066	1284	0	6614	245	3506	1722	1560	953	0	1610
Grp Volume(v), veh/h	36	2407	205	0	2938	1139	749	418	0	71	0	151
Grp Sat Flow(s),veh/h/ln	23	1689	1284	0	1596	1811	1753	1722	1560	953	0	1610
Q Serve(g_s), s	0.0	42.6	8.9	0.0	73.0	73.0	19.9	27.1	0.0	8.4	0.0	11.2
Cycle Q Clear(g_c), s	73.0	42.6	8.9	0.0	73.0	73.0	19.9	27.1	0.0	11.5	0.0	11.2
Prop In Lane	1.00		1.00	0.00		0.14	1.00		1.00	1.00		1.00
Lane Grp Cap(c), veh/h	60	3082	781	0	2912	1102	581	509		127	0	154
V/C Ratio(X)	0.60	0.78	0.26	0.00	1.01	1.03	1.29	0.82		0.56	0.00	0.98
Avail Cap(c_a), veh/h	60	3082	781	0	2912	1102	581	509		127	0	154
HCM Platoon Ratio	1.00	1.00	1.00	1.00	1.00	1.00	1.00	1.00	1.00	1.00	1.00	1.00
Upstream Filter(I)	1.00	1.00	1.00	0.00	1.00	1.00	1.00	1.00	0.00	1.00	0.00	1.00
Uniform Delay (d), s/veh	60.0	17.5	11.0	0.0	23.5	23.5	50.0	39.3	0.0	56.0	0.0	54.1
Incr Delay (d2), s/veh	11.2	1.2	0.1	0.0	18.9	36.1	142.3	9.7	0.0	3.4	0.0	65.6
Initial Q Delay(d3),s/veh	0.0	0.0	0.0	0.0	0.0	0.0	0.0	0.0	0.0	0.0	0.0	0.0
%ile BackOfQ(50%),veh/ln	1.3	14.9	2.3	0.0	28.6	37.8	19.9	12.3	0.0	2.2	0.0	7.2
Unsig. Movement Delay, s/veh												
LnGrp Delay(d),s/veh	71.2	18.8	11.0	0.0	42.4	59.6	192.3	48.9	0.0	59.4	0.0	119.7
LnGrp LOS	E	B	B	A	F	F	F	D		E	A	F
Approach Vol, veh/h		2648			4077			1167				222
Approach Delay, s/veh		18.9			47.2			141.0				100.4
Approach LOS		B			D			F				F
Timer - Assigned Phs		2	3	4		6		8				
Phs Duration (G+Y+Rc), s		79.0	24.0	17.0		79.0		41.0				
Change Period (Y+Rc), s		6.0	4.1	5.5		6.0		5.5				
Max Green Setting (Gmax), s		73.0	19.9	11.5		73.0		35.5				
Max Q Clear Time (g_c+I1), s		75.0	21.9	13.5		75.0		29.1				
Green Ext Time (p_c), s		0.0	0.0	0.0		0.0		0.8				

Intersection Summary

HCM 6th Ctrl Delay	52.9
HCM 6th LOS	D

Notes

User approved volume balancing among the lanes for turning movement.
 Unsignalized Delay for [NBR] is excluded from calculations of the approach delay and intersection delay.

Timings
32: I-215 SB Ramps & Van Buren Bl.

West Campus Upper Plateau (JN 14064)

09/20/2022

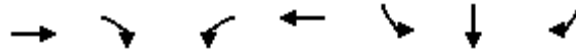

Lane Group	EBT	EBR	WBL	WBT	SBL	SBT	SBR
Lane Configurations	↑↑↑	↑	↘	↑↑↑	↘	↕	↘
Traffic Volume (vph)	1181	1182	34	1844	439	39	1670
Future Volume (vph)	1181	1182	34	1844	439	39	1670
Turn Type	NA	Perm	Prot	NA	Split	NA	Perm
Protected Phases	6		5	2	8	8	
Permitted Phases		6					8
Detector Phase	6	6	5	2	8	8	8
Switch Phase							
Minimum Initial (s)	5.0	5.0	5.0	5.0	5.0	5.0	5.0
Minimum Split (s)	36.0	36.0	11.0	11.0	11.0	11.0	11.0
Total Split (s)	48.0	48.0	11.0	59.0	71.0	71.0	71.0
Total Split (%)	36.9%	36.9%	8.5%	45.4%	54.6%	54.6%	54.6%
Yellow Time (s)	5.0	5.0	5.0	5.0	5.0	5.0	5.0
All-Red Time (s)	1.0	1.0	1.0	1.0	1.0	1.0	1.0
Lost Time Adjust (s)	0.0	0.0	0.0	0.0	0.0	0.0	0.0
Total Lost Time (s)	6.0	6.0	6.0	6.0	6.0	6.0	6.0
Lead/Lag	Lag	Lag	Lead				
Lead-Lag Optimize?	Yes	Yes	Yes				
Recall Mode	None	None	None	None	None	None	None
Act Effct Green (s)	44.2	44.2	5.0	53.0	65.0	65.0	65.0
Actuated g/C Ratio	0.34	0.34	0.04	0.41	0.50	0.50	0.50
v/c Ratio	0.78	1.13	0.54	0.98	0.51	1.39	1.26
Control Delay	43.4	82.6	88.5	54.9	24.5	213.5	155.4
Queue Delay	0.0	0.0	0.0	0.0	0.0	0.0	0.0
Total Delay	43.4	82.6	88.5	54.9	24.5	213.5	155.4
LOS	D	F	F	D	C	F	F
Approach Delay	63.0			55.5		155.2	
Approach LOS	E			E		F	

Intersection Summary

Cycle Length: 130
 Actuated Cycle Length: 130
 Natural Cycle: 130
 Control Type: Actuated-Uncoordinated
 Maximum v/c Ratio: 1.39
 Intersection Signal Delay: 91.8
 Intersection LOS: F
 Intersection Capacity Utilization 122.6%
 ICU Level of Service H
 Analysis Period (min) 15

Splits and Phases: 32: I-215 SB Ramps & Van Buren Bl.

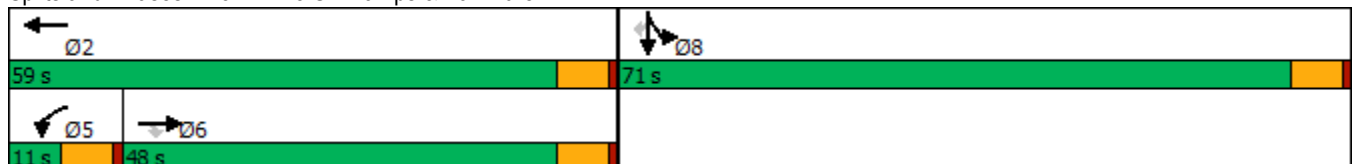

HCM 6th Signalized Intersection Summary
32: I-215 SB Ramps & Van Buren Bl.

West Campus Upper Plateau (JN 14064)

09/20/2022



Movement	EBL	EBT	EBR	WBL	WBT	WBR	NBL	NBT	NBR	SBL	SBT	SBR
Lane Configurations		↑↑↑	↗	↘	↑↑↑					↘	↕	↗
Traffic Volume (veh/h)	0	1181	1182	34	1844	0	0	0	0	439	39	1670
Future Volume (veh/h)	0	1181	1182	34	1844	0	0	0	0	439	39	1670
Initial Q (Qb), veh	0	0	0	0	0	0				0	0	0
Ped-Bike Adj(A_pbT)	1.00		1.00	1.00		1.00				1.00		1.00
Parking Bus, Adj	1.00	1.00	1.00	1.00	1.00	1.00				1.00	1.00	1.00
Work Zone On Approach		No			No						No	
Adj Sat Flow, veh/h/ln	0	1767	1781	1900	1826	0				1856	1663	1767
Adj Flow Rate, veh/h	0	1270	0	37	1983	0				329	0	0
Peak Hour Factor	0.93	0.93	0.93	0.93	0.93	0.93				0.93	0.93	0.93
Percent Heavy Veh, %	0	9	8	0	5	0				3	16	9
Cap, veh/h	0	1761		163	2807	0				390	0	
Arrive On Green	0.00	0.37	0.00	0.09	0.56	0.00				0.22	0.00	0.00
Sat Flow, veh/h	0	4982	1510	1810	5149	0				1767	0	2994
Grp Volume(v), veh/h	0	1270	0	37	1983	0				329	0	0
Grp Sat Flow(s),veh/h/ln	0	1608	1510	1810	1662	0				1767	0	1497
Q Serve(g_s), s	0.0	12.6	0.0	1.1	16.0	0.0				9.9	0.0	0.0
Cycle Q Clear(g_c), s	0.0	12.6	0.0	1.1	16.0	0.0				9.9	0.0	0.0
Prop In Lane	0.00		1.00	1.00		0.00				1.00		1.00
Lane Grp Cap(c), veh/h	0	1761		163	2807	0				390	0	
V/C Ratio(X)	0.00	0.72		0.23	0.71	0.00				0.84	0.00	
Avail Cap(c_a), veh/h	0	3648		163	4758	0				2069	0	
HCM Platoon Ratio	1.00	1.00	1.00	1.00	1.00	1.00				1.00	1.00	1.00
Upstream Filter(I)	0.00	1.00	0.00	1.00	1.00	0.00				1.00	0.00	0.00
Uniform Delay (d), s/veh	0.0	15.2	0.0	23.5	8.8	0.0				20.7	0.0	0.0
Incr Delay (d2), s/veh	0.0	0.2	0.0	0.3	0.1	0.0				1.9	0.0	0.0
Initial Q Delay(d3),s/veh	0.0	0.0	0.0	0.0	0.0	0.0				0.0	0.0	0.0
%ile BackOfQ(50%),veh/ln	0.0	3.4	0.0	0.4	3.3	0.0				3.6	0.0	0.0
Unsig. Movement Delay, s/veh												
LnGrp Delay(d),s/veh	0.0	15.4	0.0	23.7	8.9	0.0				22.7	0.0	0.0
LnGrp LOS	A	B		C	A	A				C	A	
Approach Vol, veh/h		1270			2020							329
Approach Delay, s/veh		15.4			9.2							22.7
Approach LOS		B			A							C
Timer - Assigned Phs		2			5	6		8				
Phs Duration (G+Y+Rc), s		37.3			11.0	26.3		18.3				
Change Period (Y+Rc), s		6.0			6.0	6.0		6.0				
Max Green Setting (Gmax), s		53.0			5.0	42.0		65.0				
Max Q Clear Time (g_c+I1), s		18.0			3.1	14.6		11.9				
Green Ext Time (p_c), s		12.1			0.0	5.7		0.4				

Intersection Summary

HCM 6th Ctrl Delay	12.6
HCM 6th LOS	B

Notes

User approved volume balancing among the lanes for turning movement.
Unsignalized Delay for [EBR, SBR] is excluded from calculations of the approach delay and intersection delay.

Timings

West Campus Upper Plateau (JN 14064)

34: Old 215 Frontage Rd. & Alessandro Bl.

09/20/2022



Lane Group	EBL	EBT	EBR	WBL	WBT	WBR	NBL	NBT	NBR	SBL	SBT	SBR
Lane Configurations	↔↔	↑↑↑	↗	↖	↑↑↑	↗	↔↔	↑↑	↗	↖	↑↑	↗
Traffic Volume (vph)	507	1684	60	13	1996	214	73	354	26	53	87	325
Future Volume (vph)	507	1684	60	13	1996	214	73	354	26	53	87	325
Turn Type	Prot	NA	Perm	Prot	NA	Perm	Prot	NA	Perm	Prot	NA	Perm
Protected Phases	5	2		1	6		3	8		7	4	
Permitted Phases			2			6			8			4
Detector Phase	5	2	2	1	6	6	3	8	8	7	4	4
Switch Phase												
Minimum Initial (s)	5.0	10.0	10.0	5.0	10.0	10.0	5.0	10.0	10.0	5.0	10.0	10.0
Minimum Split (s)	8.7	43.5	43.5	8.7	15.8	15.8	8.7	16.2	16.2	8.7	40.2	40.2
Total Split (s)	21.2	62.4	62.4	8.7	49.9	49.9	8.7	36.0	36.0	12.9	40.2	40.2
Total Split (%)	17.7%	52.0%	52.0%	7.3%	41.6%	41.6%	7.3%	30.0%	30.0%	10.8%	33.5%	33.5%
Yellow Time (s)	3.2	5.5	5.5	3.2	4.8	4.8	3.2	5.2	5.2	3.2	5.2	5.2
All-Red Time (s)	0.5	1.0	1.0	0.5	1.0	1.0	0.5	1.0	1.0	0.5	1.0	1.0
Lost Time Adjust (s)	0.0	0.0	0.0	0.0	0.0	0.0	0.0	0.0	0.0	0.0	0.0	0.0
Total Lost Time (s)	3.7	6.5	6.5	3.7	5.8	5.8	3.7	6.2	6.2	3.7	6.2	6.2
Lead/Lag	Lead	Lag	Lag	Lead	Lag	Lag	Lead	Lag	Lag	Lead	Lag	Lag
Lead-Lag Optimize?	Yes	Yes	Yes	Yes	Yes	Yes	Yes	Yes	Yes	Yes	Yes	Yes
Recall Mode	None	None	None	None	None	None	None	None	None	None	None	None
Act Effct Green (s)	17.7	63.7	63.7	5.1	44.5	44.5	5.1	17.6	17.6	7.3	19.9	19.9
Actuated g/C Ratio	0.17	0.61	0.61	0.05	0.43	0.43	0.05	0.17	0.17	0.07	0.19	0.19
v/c Ratio	0.95	0.56	0.08	0.25	0.93	0.28	0.50	0.63	0.07	0.44	0.14	0.67
Control Delay	73.7	15.2	0.2	63.8	39.1	4.3	63.5	45.8	0.3	60.6	35.1	17.3
Queue Delay	0.0	0.0	0.0	0.0	0.0	0.0	0.0	0.0	0.0	0.0	0.0	0.0
Total Delay	73.7	15.2	0.2	63.8	39.1	4.3	63.5	45.8	0.3	60.6	35.1	17.3
LOS	E	B	A	E	D	A	E	D	A	E	D	B
Approach Delay		28.0			35.9			46.0			25.6	
Approach LOS		C			D			D			C	

Intersection Summary

Cycle Length: 120
 Actuated Cycle Length: 104.7
 Natural Cycle: 125
 Control Type: Actuated-Uncoordinated
 Maximum v/c Ratio: 0.95
 Intersection Signal Delay: 32.6
 Intersection LOS: C
 Intersection Capacity Utilization 83.6%
 ICU Level of Service E
 Analysis Period (min) 15

































Splits and Phases: 34: Old 215 Frontage Rd. & Alessandro Bl.



HCM 6th Signalized Intersection Summary
34: Old 215 Frontage Rd. & Alessandro Bl.

West Campus Upper Plateau (JN 14064)

09/20/2022

												
Movement	EBL	EBT	EBR	WBL	WBT	WBR	NBL	NBT	NBR	SBL	SBT	SBR
Lane Configurations	 	  			  		 	 			 	
Traffic Volume (veh/h)	507	1684	60	13	1996	214	73	354	26	53	87	325
Future Volume (veh/h)	507	1684	60	13	1996	214	73	354	26	53	87	325
Initial Q (Qb), veh	0	0	0	0	0	0	0	0	0	0	0	0
Ped-Bike Adj(A_pbT)	1.00		1.00	1.00		1.00	1.00		1.00	1.00		1.00
Parking Bus, Adj	1.00	1.00	1.00	1.00	1.00	1.00	1.00	1.00	1.00	1.00	1.00	1.00
Work Zone On Approach		No			No			No			No	
Adj Sat Flow, veh/h/ln	1767	1870	1470	981	1885	1826	1707	1811	1752	1870	1811	1826
Adj Flow Rate, veh/h	517	1718	51	13	2037	0	74	361	19	54	89	0
Peak Hour Factor	0.98	0.98	0.98	0.98	0.98	0.98	0.98	0.98	0.98	0.98	0.98	0.98
Percent Heavy Veh, %	9	2	29	62	1	5	13	6	10	2	6	5
Cap, veh/h	574	3065	748	14	2263		139	484	209	70	467	
Arrive On Green	0.18	0.60	0.60	0.02	0.44	0.00	0.04	0.14	0.14	0.04	0.14	0.00
Sat Flow, veh/h	3264	5106	1246	934	5147	1547	3155	3441	1485	1781	3441	1547
Grp Volume(v), veh/h	517	1718	51	13	2037	0	74	361	19	54	89	0
Grp Sat Flow(s),veh/h/ln	1632	1702	1246	934	1716	1547	1577	1721	1485	1781	1721	1547
Q Serve(g_s), s	15.2	19.9	1.7	1.4	36.1	0.0	2.3	9.9	1.1	3.0	2.3	0.0
Cycle Q Clear(g_c), s	15.2	19.9	1.7	1.4	36.1	0.0	2.3	9.9	1.1	3.0	2.3	0.0
Prop In Lane	1.00		1.00	1.00		1.00	1.00		1.00	1.00		1.00
Lane Grp Cap(c), veh/h	574	3065	748	14	2263		139	484	209	70	467	
V/C Ratio(X)	0.90	0.56	0.07	0.92	0.90		0.53	0.75	0.09	0.77	0.19	
Avail Cap(c_a), veh/h	581	3065	748	48	2310		161	1044	450	167	1191	
HCM Platoon Ratio	1.00	1.00	1.00	1.00	1.00	1.00	1.00	1.00	1.00	1.00	1.00	1.00
Upstream Filter(I)	1.00	1.00	1.00	1.00	1.00	0.00	1.00	1.00	1.00	1.00	1.00	0.00
Uniform Delay (d), s/veh	39.6	11.8	8.2	48.3	25.5	0.0	46.0	40.5	36.7	46.8	37.7	0.0
Incr Delay (d2), s/veh	16.5	0.2	0.0	48.4	5.2	0.0	1.2	2.3	0.2	6.6	0.2	0.0
Initial Q Delay(d3),s/veh	0.0	0.0	0.0	0.0	0.0	0.0	0.0	0.0	0.0	0.0	0.0	0.0
%ile BackOfQ(50%),veh/ln	7.0	6.0	0.4	0.5	14.3	0.0	0.9	4.1	0.4	1.4	0.9	0.0
Unsig. Movement Delay, s/veh												
LnGrp Delay(d),s/veh	56.2	12.1	8.2	96.7	30.8	0.0	47.1	42.8	36.9	53.4	37.9	0.0
LnGrp LOS	E	B	A	F	C		D	D	D	D	D	
Approach Vol, veh/h		2286			2050			454			143	
Approach Delay, s/veh		21.9			31.2			43.3			43.7	
Approach LOS		C			C			D			D	
Timer - Assigned Phs	1	2	3	4	5	6	7	8				
Phs Duration (G+Y+Rc), s	5.2	65.5	8.0	19.5	21.0	49.7	7.6	20.0				
Change Period (Y+Rc), s	3.7	6.5	3.7	6.2	3.7	* 6.5	3.7	6.2				
Max Green Setting (Gmax), s	5.0	55.9	5.0	34.0	17.5	* 44	9.2	29.8				
Max Q Clear Time (g_c+I1), s	3.4	21.9	4.3	4.3	17.2	38.1	5.0	11.9				
Green Ext Time (p_c), s	0.0	15.1	0.0	0.4	0.0	5.1	0.0	1.9				

Intersection Summary

HCM 6th Ctrl Delay	28.4
HCM 6th LOS	C

Notes

* HCM 6th computational engine requires equal clearance times for the phases crossing the barrier.
Unsignalized Delay for [WBR, SBR] is excluded from calculations of the approach delay and intersection delay.

Timings
35: Day St. & Alessandro Bl.

West Campus Upper Plateau (JN 14064)

09/20/2022



Lane Group	EBL	EBT	EBR	WBL	WBT	WBR	NBL	NBT	NBR	SBL	SBT
Lane Configurations	↘	↑↑↑	↗	↘	↑↑↑	↗	↘	↑	↗	↘	↗
Traffic Volume (vph)	293	1591	31	13	2002	182	95	214	32	122	87
Future Volume (vph)	293	1591	31	13	2002	182	95	214	32	122	87
Turn Type	Prot	NA	Perm	Prot	NA	Perm	Perm	NA	Perm	Perm	NA
Protected Phases	5	2		1	6			8			4
Permitted Phases			2			6	8		8	4	
Detector Phase	5	2	2	1	6	6	8	8	8	4	4
Switch Phase											
Minimum Initial (s)	5.0	10.0	10.0	5.0	10.0	10.0	10.0	10.0	10.0	10.0	10.0
Minimum Split (s)	9.1	30.8	30.8	9.1	30.8	30.8	42.4	42.4	42.4	41.6	41.6
Total Split (s)	24.3	68.5	68.5	9.1	53.3	53.3	42.4	42.4	42.4	42.4	42.4
Total Split (%)	20.3%	57.1%	57.1%	7.6%	44.4%	44.4%	35.3%	35.3%	35.3%	35.3%	35.3%
Yellow Time (s)	3.6	4.8	4.8	3.6	4.8	4.8	4.4	4.4	4.4	3.6	3.6
All-Red Time (s)	0.5	1.0	1.0	0.5	1.0	1.0	1.0	1.0	1.0	1.0	1.0
Lost Time Adjust (s)	0.0	0.0	0.0	0.0	0.0	0.0	0.0	0.0	0.0	0.0	0.0
Total Lost Time (s)	4.1	5.8	5.8	4.1	5.8	5.8	5.4	5.4	5.4	4.6	4.6
Lead/Lag	Lead	Lag	Lag	Lead	Lag	Lag					
Lead-Lag Optimize?	Yes	Yes	Yes	Yes	Yes	Yes					
Recall Mode	None	None	None	None	None	None	None	None	None	None	None
Act Effct Green (s)	20.3	68.7	68.7	5.0	47.8	47.8	30.7	30.7	30.7	31.5	31.5
Actuated g/C Ratio	0.18	0.60	0.60	0.04	0.42	0.42	0.27	0.27	0.27	0.28	0.28
v/c Ratio	1.00	0.56	0.04	0.19	1.00	0.27	1.27	0.45	0.07	0.54	0.72
Control Delay	100.1	16.3	1.2	61.9	54.3	13.2	224.9	37.2	0.3	43.3	30.9
Queue Delay	0.0	0.0	0.0	0.0	0.0	0.0	0.0	0.0	0.0	0.0	0.0
Total Delay	100.1	16.3	1.2	61.9	54.3	13.2	224.9	37.2	0.3	43.3	30.9
LOS	F	B	A	E	D	B	F	D	A	D	C
Approach Delay		28.9			50.9			86.0			33.9
Approach LOS		C			D			F			C

Intersection Summary

Cycle Length: 120
 Actuated Cycle Length: 114.2
 Natural Cycle: 125
 Control Type: Actuated-Uncoordinated
 Maximum v/c Ratio: 1.27
 Intersection Signal Delay: 43.1
 Intersection LOS: D
 Intersection Capacity Utilization 102.6%
 ICU Level of Service G
 Analysis Period (min) 15





























Splits and Phases: 35: Day St. & Alessandro Bl.



HCM 6th Signalized Intersection Summary
35: Day St. & Alessandro Bl.

West Campus Upper Plateau (JN 14064)

09/20/2022

												
Movement	EBL	EBT	EBR	WBL	WBT	WBR	NBL	NBT	NBR	SBL	SBT	SBR
Lane Configurations		  			  						 	
Traffic Volume (veh/h)	293	1591	31	13	2002	182	95	214	32	122	87	295
Future Volume (veh/h)	293	1591	31	13	2002	182	95	214	32	122	87	295
Initial Q (Qb), veh	0	0	0	0	0	0	0	0	0	0	0	0
Ped-Bike Adj(A_pbT)	1.00		0.98	1.00		1.00	1.00		1.00	1.00		1.00
Parking Bus, Adj	1.00	1.00	1.00	1.00	1.00	1.00	1.00	1.00	1.00	1.00	1.00	1.00
Work Zone On Approach		No			No			No			No	
Adj Sat Flow, veh/h/ln	1870	1870	1544	1752	1885	1870	1767	1885	1781	1870	1900	1885
Adj Flow Rate, veh/h	315	1711	32	14	2153	161	102	230	22	131	94	290
Peak Hour Factor	0.93	0.93	0.93	0.93	0.93	0.93	0.93	0.93	0.93	0.93	0.93	0.93
Percent Heavy Veh, %	2	2	24	10	1	2	9	1	8	2	0	1
Cap, veh/h	300	2801	703	26	2037	627	156	581	465	299	126	389
Arrive On Green	0.17	0.55	0.55	0.02	0.40	0.40	0.31	0.31	0.31	0.31	0.31	0.31
Sat Flow, veh/h	1781	5106	1282	1668	5147	1585	944	1885	1508	1127	409	1263
Grp Volume(v), veh/h	315	1711	32	14	2153	161	102	230	22	131	0	384
Grp Sat Flow(s),veh/h/ln	1781	1702	1282	1668	1716	1585	944	1885	1508	1127	0	1673
Q Serve(g_s), s	20.2	27.3	1.4	1.0	47.5	8.2	12.3	11.5	1.2	12.4	0.0	24.7
Cycle Q Clear(g_c), s	20.2	27.3	1.4	1.0	47.5	8.2	37.0	11.5	1.2	24.0	0.0	24.7
Prop In Lane	1.00		1.00	1.00		1.00	1.00		1.00	1.00		0.76
Lane Grp Cap(c), veh/h	300	2801	703	26	2037	627	156	581	465	299	0	516
V/C Ratio(X)	1.05	0.61	0.05	0.54	1.06	0.26	0.65	0.40	0.05	0.44	0.00	0.74
Avail Cap(c_a), veh/h	300	2801	703	70	2037	627	156	581	465	307	0	527
HCM Platoon Ratio	1.00	1.00	1.00	1.00	1.00	1.00	1.00	1.00	1.00	1.00	1.00	1.00
Upstream Filter(I)	1.00	1.00	1.00	1.00	1.00	1.00	1.00	1.00	1.00	1.00	0.00	1.00
Uniform Delay (d), s/veh	49.9	18.4	12.5	58.6	36.3	24.4	54.2	32.7	29.1	42.1	0.0	37.3
Incr Delay (d2), s/veh	65.8	0.4	0.0	6.3	37.0	0.2	9.2	0.4	0.0	1.0	0.0	5.6
Initial Q Delay(d3),s/veh	0.0	0.0	0.0	0.0	0.0	0.0	0.0	0.0	0.0	0.0	0.0	0.0
%ile BackOfQ(50%),veh/ln	14.2	9.9	0.4	0.5	25.6	3.0	3.4	5.2	0.4	3.6	0.0	11.0
Unsig. Movement Delay, s/veh												
LnGrp Delay(d),s/veh	115.7	18.8	12.6	65.0	73.2	24.6	63.4	33.1	29.2	43.1	0.0	42.8
LnGrp LOS	F	B	B	E	F	C	E	C	C	D	A	D
Approach Vol, veh/h		2058			2328			354			515	
Approach Delay, s/veh		33.5			69.8			41.6			42.9	
Approach LOS		C			E			D			D	
Timer - Assigned Phs	1	2		4	5	6		8				
Phs Duration (G+Y+Rc), s	6.0	71.6		42.4	24.3	53.3		42.4				
Change Period (Y+Rc), s	4.1	5.8		* 5.4	4.1	5.8		5.4				
Max Green Setting (Gmax), s	5.0	62.7		* 38	20.2	47.5		37.0				
Max Q Clear Time (g_c+I1), s	3.0	29.3		26.7	22.2	49.5		39.0				
Green Ext Time (p_c), s	0.0	15.8		2.4	0.0	0.0		0.0				

Intersection Summary

HCM 6th Ctrl Delay	51.1
HCM 6th LOS	D

Notes

* HCM 6th computational engine requires equal clearance times for the phases crossing the barrier.

Timings
36: Elsworth St. & Cactus Av.

West Campus Upper Plateau (JN 14064)

09/20/2022



Lane Group	EBL	EBT	EBR	WBL	WBT	WBR	NBL	NBT	SBL	SBT	SBR
Lane Configurations											
Traffic Volume (vph)	445	2119	683	92	2620	254	90	49	196	131	346
Future Volume (vph)	445	2119	683	92	2620	254	90	49	196	131	346
Turn Type	Prot	NA	Perm	Prot	NA	Perm	Prot	NA	Prot	NA	pm+ov
Protected Phases	5	2		1	6		3	8	7	4	5
Permitted Phases			2			6					4
Detector Phase	5	2	2	1	6	6	3	8	7	4	5
Switch Phase											
Minimum Initial (s)	5.0	10.0	10.0	5.0	10.0	10.0	10.0	10.0	10.0	10.0	5.0
Minimum Split (s)	9.6	36.2	36.2	9.6	36.2	36.2	15.4	35.4	15.4	35.4	9.6
Total Split (s)	28.0	60.2	60.2	17.4	49.6	49.6	15.4	35.4	17.0	37.0	28.0
Total Split (%)	21.5%	46.3%	46.3%	13.4%	38.2%	38.2%	11.8%	27.2%	13.1%	28.5%	21.5%
Yellow Time (s)	3.6	5.2	5.2	3.6	5.2	5.2	4.4	4.4	4.4	4.4	3.6
All-Red Time (s)	1.0	1.0	1.0	1.0	1.0	1.0	1.0	1.0	1.0	1.0	1.0
Lost Time Adjust (s)	0.0	0.0	0.0	0.0	0.0	0.0	0.0	0.0	0.0	0.0	0.0
Total Lost Time (s)	4.6	6.2	6.2	4.6	6.2	6.2	5.4	5.4	5.4	5.4	4.6
Lead/Lag	Lead	Lag	Lag	Lead	Lag	Lag	Lead	Lag	Lead	Lag	Lead
Lead-Lag Optimize?	Yes	Yes	Yes	Yes	Yes	Yes	Yes	Yes	Yes	Yes	Yes
Recall Mode	None	None	None	None	None	None	None	None	None	None	None
Act Effct Green (s)	23.4	56.3	56.3	10.5	43.4	43.4	10.0	30.0	11.6	11.6	60.4
Actuated g/C Ratio	0.18	0.43	0.43	0.08	0.33	0.33	0.08	0.23	0.09	0.09	0.46
v/c Ratio	1.44	0.70	0.64	0.65	1.10	0.42	0.35	0.20	1.05	1.08	0.46
Control Delay	254.1	31.7	4.8	77.9	91.2	14.6	60.9	29.4	142.3	148.1	20.7
Queue Delay	0.0	0.0	0.0	0.0	0.0	0.0	0.0	0.0	0.0	0.0	0.0
Total Delay	254.1	31.7	4.8	77.9	91.2	14.6	60.9	29.4	142.3	148.1	20.7
LOS	F	C	A	E	F	B	E	C	F	F	C
Approach Delay		56.5			84.2			45.5		81.3	
Approach LOS		E			F			D		F	

Intersection Summary

Cycle Length: 130
 Actuated Cycle Length: 130
 Natural Cycle: 130
 Control Type: Actuated-Uncoordinated
 Maximum v/c Ratio: 1.44
 Intersection Signal Delay: 70.2
 Intersection LOS: E
 Intersection Capacity Utilization 97.8%
 ICU Level of Service F
 Analysis Period (min) 15

Splits and Phases: 36: Elsworth St. & Cactus Av.

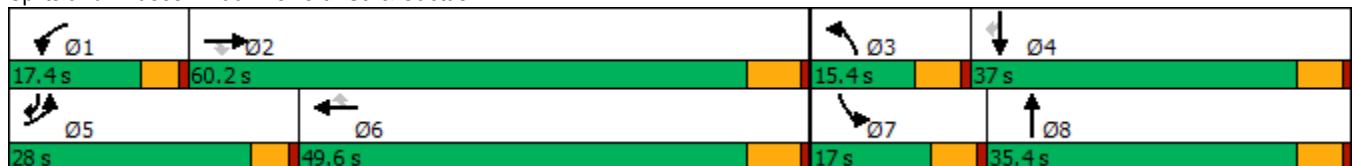

HCM 6th Signalized Intersection Summary
36: Elsworth St. & Cactus Av.

West Campus Upper Plateau (JN 14064)

09/20/2022



Movement	EBL	EBT	EBR	WBL	WBT	WBR	NBL	NBT	NBR	SBL	SBT	SBR
Lane Configurations												
Traffic Volume (veh/h)	445	2119	683	92	2620	254	90	49	37	196	131	346
Future Volume (veh/h)	445	2119	683	92	2620	254	90	49	37	196	131	346
Initial Q (Qb), veh	0	0	0	0	0	0	0	0	0	0	0	0
Ped-Bike Adj(A_pbT)	1.00		1.00	1.00		0.98	1.00		1.00	1.00		1.00
Parking Bus, Adj	1.00	1.00	1.00	1.00	1.00	1.00	1.00	1.00	1.00	1.00	1.00	1.00
Work Zone On Approach		No			No			No			No	
Adj Sat Flow, veh/h/ln	1856	1811	1885	1900	1841	1870	1811	1900	1900	1856	1900	1856
Adj Flow Rate, veh/h	454	2162	0	94	2673	211	92	50	30	167	180	286
Peak Hour Factor	0.98	0.98	0.98	0.98	0.98	0.98	0.98	0.98	0.98	0.98	0.98	0.98
Percent Heavy Veh, %	3	6	1	0	4	2	6	0	0	3	0	3
Cap, veh/h	348	3605		118	2693	568	291	175	105	173	324	579
Arrive On Green	0.20	0.50	0.00	0.07	0.37	0.37	0.08	0.16	0.16	0.10	0.17	0.17
Sat Flow, veh/h	1767	7244	1598	1810	7363	1552	3450	1112	667	1767	1900	1572
Grp Volume(v), veh/h	454	2162	0	94	2673	211	92	0	80	167	180	286
Grp Sat Flow(s),veh/h/ln	1767	1811	1598	1810	1841	1552	1725	0	1780	1767	1900	1572
Q Serve(g_s), s	23.4	25.4	0.0	6.1	42.9	11.8	3.0	0.0	4.7	11.2	10.3	16.7
Cycle Q Clear(g_c), s	23.4	25.4	0.0	6.1	42.9	11.8	3.0	0.0	4.7	11.2	10.3	16.7
Prop In Lane	1.00		1.00	1.00		1.00	1.00		0.38	1.00		1.00
Lane Grp Cap(c), veh/h	348	3605		118	2693	568	291	0	280	173	324	579
V/C Ratio(X)	1.30	0.60		0.80	0.99	0.37	0.32	0.00	0.29	0.97	0.55	0.49
Avail Cap(c_a), veh/h	348	3605		195	2693	568	291	0	450	173	506	729
HCM Platoon Ratio	1.00	1.00	1.00	1.00	1.00	1.00	1.00	1.00	1.00	1.00	1.00	1.00
Upstream Filter(I)	1.00	1.00	0.00	1.00	1.00	1.00	1.00	0.00	1.00	1.00	1.00	1.00
Uniform Delay (d), s/veh	47.6	21.3	0.0	54.7	37.5	27.6	51.1	0.0	44.1	53.3	45.1	29.0
Incr Delay (d2), s/veh	155.7	0.3	0.0	4.5	15.6	0.4	0.6	0.0	0.6	58.5	1.5	0.7
Initial Q Delay(d3),s/veh	0.0	0.0	0.0	0.0	0.0	0.0	0.0	0.0	0.0	0.0	0.0	0.0
%ile BackOfQ(50%),veh/ln	24.9	9.9	0.0	2.8	20.9	4.4	1.3	0.0	2.1	7.7	4.9	6.2
Unsig. Movement Delay, s/veh												
LnGrp Delay(d),s/veh	203.3	21.6	0.0	59.2	53.1	28.0	51.7	0.0	44.7	111.8	46.6	29.6
LnGrp LOS	F	C		E	D	C	D	A	D	F	D	C
Approach Vol, veh/h		2616			2978			172				633
Approach Delay, s/veh		53.2			51.5			48.5				56.1
Approach LOS		D			D			D				E
Timer - Assigned Phs	1	2	3	4	5	6	7	8				
Phs Duration (G+Y+Rc), s	12.3	65.3	15.4	25.7	28.0	49.6	17.0	24.1				
Change Period (Y+Rc), s	4.6	6.2	5.4	5.4	4.6	6.2	5.4	5.4				
Max Green Setting (Gmax), s	12.8	54.0	10.0	31.6	23.4	43.4	11.6	30.0				
Max Q Clear Time (g_c+I1), s	8.1	27.4	5.0	18.7	25.4	44.9	13.2	6.7				
Green Ext Time (p_c), s	0.0	18.0	0.1	1.6	0.0	0.0	0.0	0.3				

Intersection Summary

HCM 6th Ctrl Delay	52.5
HCM 6th LOS	D

Notes

- User approved pedestrian interval to be less than phase max green.
- User approved volume balancing among the lanes for turning movement.
- Unsignalized Delay for [EBR] is excluded from calculations of the approach delay and intersection delay.

Timings
38: Riverside Dr./Graham St. & Cactus Av.

West Campus Upper Plateau (JN 14064)

09/20/2022

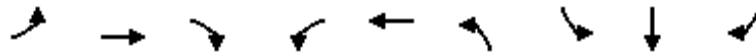

Lane Group	EBL	EBT	EBR	WBL	WBT	NBL	SBL	SBT	SBR	Ø2
Lane Configurations	↖	↑↑↑	↗	↖	↑↑↑	↖	↖	↑↑	↗	
Traffic Volume (vph)	222	1738	414	28	2989	50	355	458	338	
Future Volume (vph)	222	1738	414	28	2989	50	355	458	338	
Turn Type	Prot	NA	Perm	Prot	NA	Prot	Prot	NA	pm+ov	
Protected Phases	7	4		3	8	5	1	6	7	2
Permitted Phases			4							6
Detector Phase	7	4	4	3	8	5	1	6	7	
Switch Phase										
Minimum Initial (s)	5.0	10.0	10.0	5.0	10.0	10.0	10.0	10.0	5.0	10.0
Minimum Split (s)	9.6	39.2	39.2	9.6	39.2	15.0	14.6	40.6	9.6	35.0
Total Split (s)	13.0	58.4	58.4	9.6	55.0	15.0	19.2	42.0	13.0	37.8
Total Split (%)	10.4%	46.7%	46.7%	7.7%	44.0%	12.0%	15.4%	33.6%	10.4%	30%
Yellow Time (s)	3.6	5.2	5.2	3.6	5.2	4.0	3.6	3.6	3.6	4.0
All-Red Time (s)	1.0	1.0	1.0	1.0	1.0	1.0	1.0	1.0	1.0	1.0
Lost Time Adjust (s)	0.0	0.0	0.0	0.0	0.0	0.0	0.0	0.0	0.0	
Total Lost Time (s)	4.6	6.2	6.2	4.6	6.2	5.0	4.6	4.6	4.6	
Lead/Lag	Lead	Lag	Lag	Lead	Lag	Lead	Lead	Lag	Lead	Lag
Lead-Lag Optimize?	Yes	Yes	Yes	Yes	Yes	Yes	Yes	Yes	Yes	Yes
Recall Mode	None	None	None	None	None	None	None	None	None	None
Act Effct Green (s)	8.5	57.3	57.3	5.1	49.5	10.1	26.5	21.3	34.5	
Actuated g/C Ratio	0.08	0.54	0.54	0.05	0.47	0.09	0.25	0.20	0.32	
v/c Ratio	1.69	0.70	0.44	0.35	1.55	0.17	0.44	0.68	0.64	
Control Delay	369.4	23.6	7.4	65.0	273.7	50.0	37.5	44.3	29.6	
Queue Delay	0.0	0.0	0.0	0.0	0.0	0.0	0.0	0.0	0.0	
Total Delay	369.4	23.6	7.4	65.0	273.7	50.0	37.5	44.3	29.6	
LOS	F	C	A	E	F	D	D	D	C	
Approach Delay		53.1			272.0			37.9		
Approach LOS		D			F			D		

Intersection Summary

Cycle Length: 125
 Actuated Cycle Length: 106.4
 Natural Cycle: 125
 Control Type: Actuated-Uncoordinated
 Maximum v/c Ratio: 1.69
 Intersection Signal Delay: 157.2
 Intersection LOS: F
 Intersection Capacity Utilization 113.0%
 ICU Level of Service H
 Analysis Period (min) 15

Splits and Phases: 38: Riverside Dr./Graham St. & Cactus Av.

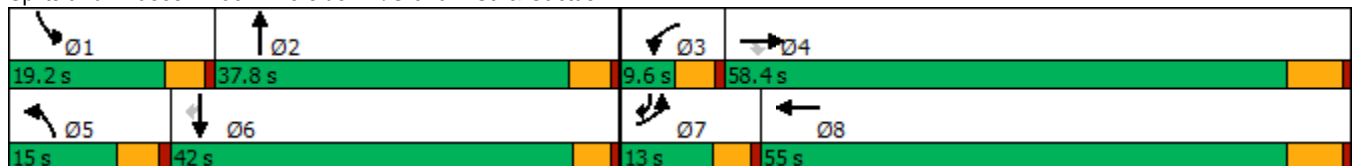

HCM 6th Signalized Intersection Summary
38: Riverside Dr./Graham St. & Cactus Av.

West Campus Upper Plateau (JN 14064)

09/20/2022



Movement	EBL	EBT	EBR	WBL	WBT	WBR	NBL	NBT	NBR	SBL	SBT	SBR
Lane Configurations	↘	↑↑↑	↗	↘	↑↑↑		↘↗	↑↗		↘↗	↑↑	↗
Traffic Volume (veh/h)	222	1738	414	28	2989	378	50	0	0	355	458	338
Future Volume (veh/h)	222	1738	414	28	2989	378	50	0	0	355	458	338
Initial Q (Qb), veh	0	0	0	0	0	0	0	0	0	0	0	0
Ped-Bike Adj(A_pbT)	1.00		1.00	1.00		1.00	1.00		1.00	1.00		1.00
Parking Bus, Adj	1.00	1.00	1.00	1.00	1.00	1.00	1.00	1.00	1.00	1.00	1.00	1.00
Work Zone On Approach		No			No			No			No	
Adj Sat Flow, veh/h/ln	1856	1811	1856	1900	1856	1885	1752	1900	1900	1885	1900	1856
Adj Flow Rate, veh/h	236	1849	428	30	3180	401	53	0	0	378	487	275
Peak Hour Factor	0.94	0.94	0.94	0.94	0.94	0.94	0.94	0.94	0.94	0.94	0.94	0.94
Percent Heavy Veh, %	3	6	3	0	3	1	10	0	0	1	0	3
Cap, veh/h	134	2421	770	49	2019	244	292	625	0	438	739	441
Arrive On Green	0.08	0.49	0.49	0.03	0.44	0.44	0.09	0.00	0.00	0.13	0.20	0.20
Sat Flow, veh/h	1767	4944	1572	1810	4578	554	3237	3705	0	3483	3610	1572
Grp Volume(v), veh/h	236	1849	428	30	2311	1270	53	0	0	378	487	275
Grp Sat Flow(s),veh/h/ln	1767	1648	1572	1810	1689	1755	1618	1805	0	1742	1805	1572
Q Serve(g_s), s	8.4	33.7	21.1	1.8	48.8	48.8	1.7	0.0	0.0	11.8	13.7	16.9
Cycle Q Clear(g_c), s	8.4	33.7	21.1	1.8	48.8	48.8	1.7	0.0	0.0	11.8	13.7	16.9
Prop In Lane	1.00		1.00	1.00		0.32	1.00		0.00	1.00		1.00
Lane Grp Cap(c), veh/h	134	2421	770	49	1489	774	292	625	0	438	739	441
V/C Ratio(X)	1.76	0.76	0.56	0.61	1.55	1.64	0.18	0.00	0.00	0.86	0.66	0.62
Avail Cap(c_a), veh/h	134	2421	770	82	1489	774	292	1070	0	460	1220	651
HCM Platoon Ratio	1.00	1.00	1.00	1.00	1.00	1.00	1.00	1.00	1.00	1.00	1.00	1.00
Upstream Filter(I)	1.00	1.00	1.00	1.00	1.00	1.00	1.00	0.00	0.00	1.00	1.00	1.00
Uniform Delay (d), s/veh	51.1	23.0	19.8	53.2	30.9	30.9	46.5	0.0	0.0	47.4	40.4	34.7
Incr Delay (d2), s/veh	370.4	1.5	0.9	4.5	251.8	294.1	0.3	0.0	0.0	15.1	1.0	1.4
Initial Q Delay(d3),s/veh	0.0	0.0	0.0	0.0	0.0	0.0	0.0	0.0	0.0	0.0	0.0	0.0
%ile BackOfQ(50%),veh/ln	17.4	12.0	7.2	0.9	69.9	81.8	0.7	0.0	0.0	5.9	6.0	6.3
Unsig. Movement Delay, s/veh												
LnGrp Delay(d),s/veh	421.6	24.5	20.7	57.7	282.7	325.1	46.8	0.0	0.0	62.5	41.5	36.1
LnGrp LOS	F	C	C	E	F	F	D	A	A	E	D	D
Approach Vol, veh/h		2513			3611			53			1140	
Approach Delay, s/veh		61.2			295.7			46.8			47.2	
Approach LOS		E			F			D			D	
Timer - Assigned Phs	1	2	3	4	5	6	7	8				
Phs Duration (G+Y+Rc), s	18.5	24.2	7.6	60.4	15.0	27.7	13.0	55.0				
Change Period (Y+Rc), s	4.6	5.0	4.6	6.2	5.0	* 5	4.6	6.2				
Max Green Setting (Gmax), s	14.6	32.8	5.0	52.2	10.0	* 37	8.4	48.8				
Max Q Clear Time (g_c+I1), s	13.8	0.0	3.8	35.7	3.7	18.9	10.4	50.8				
Green Ext Time (p_c), s	0.1	0.0	0.0	12.1	0.0	3.8	0.0	0.0				

Intersection Summary

HCM 6th Ctrl Delay	174.6
HCM 6th LOS	F

Notes

* HCM 6th computational engine requires equal clearance times for the phases crossing the barrier.

Timings

1: Washington St & Van Buren Bl.

09/20/2022



Lane Group	EBL	EBT	EBR	WBL	WBT	WBR	NBL	NBT	NBR	SBL	SBT
Lane Configurations	↘	↑↑↑	↗	↘	↑↑↑	↗	↘↗	↑↑	↗	↘↗	↑↗
Traffic Volume (vph)	178	1932	163	284	1630	661	146	323	154	778	587
Future Volume (vph)	178	1932	163	284	1630	661	146	323	154	778	587
Turn Type	Prot	NA	Perm	Prot	NA	pm+ov	Prot	NA	Perm	Prot	NA
Protected Phases	5	2		1	6	7	3	8		7	4
Permitted Phases			2			6			8		
Detector Phase	5	2	2	1	6	7	3	8	8	7	4
Switch Phase											
Minimum Initial (s)	5.0	10.0	10.0	5.0	10.0	10.0	10.0	10.0	10.0	10.0	10.0
Minimum Split (s)	9.2	34.2	34.2	9.2	33.2	30.8	37.4	37.4	37.4	30.8	30.8
Total Split (s)	16.4	44.6	44.6	17.0	45.2	31.0	37.4	37.4	37.4	31.0	31.0
Total Split (%)	12.6%	34.3%	34.3%	13.1%	34.8%	23.8%	28.8%	28.8%	28.8%	23.8%	23.8%
Yellow Time (s)	3.2	5.2	5.2	3.2	5.2	4.8	4.4	4.4	4.4	4.8	4.8
All-Red Time (s)	1.0	1.0	1.0	1.0	1.0	1.0	1.0	1.0	1.0	1.0	1.0
Lost Time Adjust (s)	0.0	0.0	0.0	0.0	0.0	0.0	0.0	0.0	0.0	0.0	0.0
Total Lost Time (s)	4.2	6.2	6.2	4.2	6.2	5.8	5.4	5.4	5.4	5.8	5.8
Lead/Lag	Lead	Lag	Lag	Lead	Lag	Lead	Lead	Lag	Lag	Lead	Lag
Lead-Lag Optimize?	Yes	Yes	Yes	Yes	Yes	Yes	Yes	Yes	Yes	Yes	Yes
Recall Mode	None	None	None	None	None	None	None	None	None	None	None
Act Effct Green (s)	12.2	38.5	38.5	12.8	39.1	64.8	14.3	18.3	18.3	25.3	29.2
Actuated g/C Ratio	0.10	0.33	0.33	0.11	0.34	0.56	0.12	0.16	0.16	0.22	0.25
v/c Ratio	0.95	1.17	0.26	1.45	0.96	0.70	0.35	0.59	0.42	1.05	0.81
Control Delay	107.1	120.6	7.2	264.6	53.5	17.2	48.3	49.9	9.6	90.0	48.9
Queue Delay	0.0	0.0	0.0	0.0	0.0	0.0	0.0	0.0	0.0	0.0	0.0
Total Delay	107.1	120.6	7.2	264.6	53.5	17.2	48.3	49.9	9.6	90.0	48.9
LOS	F	F	A	F	D	B	D	D	A	F	D
Approach Delay		111.4			67.5			39.5			70.4
Approach LOS		F			E			D			E

Intersection Summary

Cycle Length: 130
 Actuated Cycle Length: 116.6
 Natural Cycle: 115
 Control Type: Actuated-Uncoordinated
 Maximum v/c Ratio: 1.45
 Intersection Signal Delay: 79.9
 Intersection LOS: E
 Intersection Capacity Utilization 102.8%
 ICU Level of Service G
 Analysis Period (min) 15

Splits and Phases: 1: Washington St & Van Buren Bl.

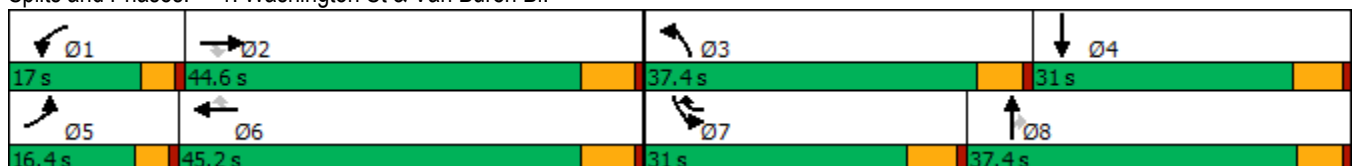

HCM 6th Signalized Intersection Summary
1: Washington St & Van Buren Bl.

West Campus Upper Plateau (JN 14064)

09/20/2022

Movement	EBL	EBT	EBR	WBL	WBT	WBR	NBL	NBT	NBR	SBL	SBT	SBR
Lane Configurations												
Traffic Volume (veh/h)	178	1932	163	284	1630	661	146	323	154	778	587	122
Future Volume (veh/h)	178	1932	163	284	1630	661	146	323	154	778	587	122
Initial Q (Qb), veh	0	0	0	0	0	0	0	0	0	0	0	0
Ped-Bike Adj(A_pbT)	1.00		1.00	1.00		1.00	1.00		0.98	1.00		0.98
Parking Bus, Adj	1.00	1.00	1.00	1.00	1.00	1.00	1.00	1.00	1.00	1.00	1.00	1.00
Work Zone On Approach		No			No			No			No	
Adj Sat Flow, veh/h/ln	1900	1856	1870	1900	1870	1900	1885	1856	1870	1885	1885	1900
Adj Flow Rate, veh/h	180	1952	146	287	1646	575	147	326	117	786	593	77
Peak Hour Factor	0.99	0.99	0.99	0.99	0.99	0.99	0.99	0.99	0.99	0.99	0.99	0.99
Percent Heavy Veh, %	0	3	2	0	2	0	1	3	2	1	1	0
Cap, veh/h	194	1706	534	203	1746	905	305	484	213	770	872	113
Arrive On Green	0.11	0.34	0.34	0.11	0.34	0.34	0.09	0.14	0.14	0.22	0.27	0.27
Sat Flow, veh/h	1810	5066	1585	1810	5106	1606	3483	3526	1555	3483	3182	412
Grp Volume(v), veh/h	180	1952	146	287	1646	575	147	326	117	786	333	337
Grp Sat Flow(s),veh/h/ln	1810	1689	1585	1810	1702	1606	1742	1763	1555	1742	1791	1803
Q Serve(g_s), s	11.3	38.4	7.7	12.8	35.7	27.8	4.6	10.0	8.0	25.2	18.9	19.0
Cycle Q Clear(g_c), s	11.3	38.4	7.7	12.8	35.7	27.8	4.6	10.0	8.0	25.2	18.9	19.0
Prop In Lane	1.00		1.00	1.00		1.00	1.00		1.00	1.00		0.23
Lane Grp Cap(c), veh/h	194	1706	534	203	1746	905	305	484	213	770	491	494
V/C Ratio(X)	0.93	1.14	0.27	1.41	0.94	0.64	0.48	0.67	0.55	1.02	0.68	0.68
Avail Cap(c_a), veh/h	194	1706	534	203	1746	905	977	989	436	770	491	494
HCM Platoon Ratio	1.00	1.00	1.00	1.00	1.00	1.00	1.00	1.00	1.00	1.00	1.00	1.00
Upstream Filter(I)	1.00	1.00	1.00	1.00	1.00	1.00	1.00	1.00	1.00	1.00	1.00	1.00
Uniform Delay (d), s/veh	50.5	37.8	27.6	50.6	36.4	17.0	49.6	46.8	45.9	44.4	36.9	37.0
Incr Delay (d2), s/veh	44.5	72.5	0.4	212.5	11.0	1.7	1.2	1.6	2.2	37.9	3.8	3.8
Initial Q Delay(d3),s/veh	0.0	0.0	0.0	0.0	0.0	0.0	0.0	0.0	0.0	0.0	0.0	0.0
%ile BackOfQ(50%),veh/ln	7.3	26.2	3.0	17.5	15.6	10.4	2.1	4.5	3.3	14.8	8.7	8.9
Unsig. Movement Delay, s/veh												
LnGrp Delay(d),s/veh	95.0	110.3	28.0	263.1	47.4	18.7	50.7	48.4	48.1	82.3	40.7	40.8
LnGrp LOS	F	F	C	F	D	B	D	D	D	F	D	D
Approach Vol, veh/h		2278			2508			590			1456	
Approach Delay, s/veh		103.9			65.5			48.9			63.2	
Approach LOS		F			E			D			E	
Timer - Assigned Phs	1	2	3	4	5	6	7	8				
Phs Duration (G+Y+Rc), s	17.0	44.6	15.4	37.0	16.4	45.2	31.0	21.4				
Change Period (Y+Rc), s	* 4.2	6.2	5.4	5.8	* 4.2	6.2	5.8	* 5.8				
Max Green Setting (Gmax), s	* 13	38.4	32.0	25.2	* 12	39.0	25.2	* 32				
Max Q Clear Time (g_c+I1), s	14.8	40.4	6.6	21.0	13.3	37.7	27.2	12.0				
Green Ext Time (p_c), s	0.0	0.0	0.5	1.6	0.0	1.2	0.0	2.5				

Intersection Summary

HCM 6th Ctrl Delay	76.4
HCM 6th LOS	E

Notes

- User approved pedestrian interval to be less than phase max green.
- * HCM 6th computational engine requires equal clearance times for the phases crossing the barrier.

Timings

3: Overlook Pkwy./Canyon Crest Dr. & Alessandro Bl/Alessandro Bl.



Lane Group	EBL	EBT	WBL	WBT	WBR	NBL	NBT	NBR	SBL	SBT
Lane Configurations	↘	↗↗↗	↘	↗↗↗	↗	↘	↗↗	↗	↗↗↗	↘
Traffic Volume (vph)	89	3946	149	3001	790	87	141	240	860	235
Future Volume (vph)	89	3946	149	3001	790	87	141	240	860	235
Turn Type	Prot	NA	Prot	NA	pm+ov	Split	NA	Perm	Split	NA
Protected Phases	5	2	1	6	4	8	8		4	4
Permitted Phases					6			8		
Detector Phase	5	2	1	6	4	8	8	8	4	4
Switch Phase										
Minimum Initial (s)	5.0	10.0	5.0	10.0	10.0	10.0	10.0	10.0	10.0	10.0
Minimum Split (s)	9.2	35.2	9.2	35.2	38.8	38.8	38.8	38.8	38.8	38.8
Total Split (s)	9.2	43.2	9.2	43.2	38.8	38.8	38.8	38.8	38.8	38.8
Total Split (%)	7.1%	33.2%	7.1%	33.2%	29.8%	29.8%	29.8%	29.8%	29.8%	29.8%
Yellow Time (s)	3.2	5.2	3.2	5.2	4.8	4.8	4.8	4.8	4.8	4.8
All-Red Time (s)	1.0	1.0	1.0	1.0	1.0	1.0	1.0	1.0	1.0	1.0
Lost Time Adjust (s)	0.0	0.0	0.0	0.0	0.0	0.0	0.0	0.0	0.0	0.0
Total Lost Time (s)	4.2	6.2	4.2	6.2	5.8	5.8	5.8	5.8	5.8	5.8
Lead/Lag	Lead	Lag	Lead	Lag						
Lead-Lag Optimize?	Yes	Yes	Yes	Yes						
Recall Mode	None	None	None	None	None	None	None	None	None	None
Act Effct Green (s)	5.0	37.2	5.0	37.2	74.9	16.5	16.5	16.5	31.5	31.5
Actuated g/C Ratio	0.04	0.33	0.04	0.33	0.67	0.15	0.15	0.15	0.28	0.28
v/c Ratio	1.21	2.49	1.94	1.84	0.68	0.35	0.28	0.76	0.63	0.61
Control Delay	213.2	694.8	489.3	405.7	8.2	46.6	43.6	40.0	38.2	40.6
Queue Delay	0.0	0.0	0.0	0.0	0.0	0.0	0.0	0.0	0.0	0.0
Total Delay	213.2	694.8	489.3	405.7	8.2	46.6	43.6	40.0	38.2	40.6
LOS	F	F	F	F	A	D	D	D	D	D
Approach Delay		684.4		329.1			42.3			38.9
Approach LOS		F		F			D			D

Intersection Summary

Cycle Length: 130
 Actuated Cycle Length: 112.3
 Natural Cycle: 125
 Control Type: Actuated-Uncoordinated
 Maximum v/c Ratio: 2.49
 Intersection Signal Delay: 432.1
 Intersection Capacity Utilization 130.2%
 Analysis Period (min) 15
 Intersection LOS: F
 ICU Level of Service H

Splits and Phases: 3: Overlook Pkwy./Canyon Crest Dr. & Alessandro Bl/Alessandro Bl.

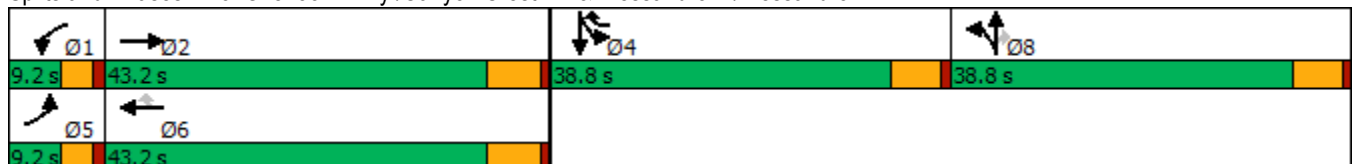

HCM 6th Signalized Intersection Summary

West Campus Upper Plateau (JN 14064)

3: Overlook Pkwy./Canyon Crest Dr. & Alessandro Bl/Alessandro Bl.

09/20/2022



Movement	EBL	EBT	EBR	WBL	WBT	WBR	NBL	NBT	NBR	SBL	SBT	SBR
Lane Configurations	↗	↑↑↑		↖	↑↑↑	↗	↖	↑↑	↗	↖↖↖	↖	
Traffic Volume (veh/h)	89	3946	111	149	3001	790	87	141	240	860	235	69
Future Volume (veh/h)	89	3946	111	149	3001	790	87	141	240	860	235	69
Initial Q (Qb), veh	0	0	0	0	0	0	0	0	0	0	0	0
Ped-Bike Adj(A_pbT)	1.00		1.00	1.00		1.00	1.00		1.00	1.00		1.00
Parking Bus, Adj	1.00	1.00	1.00	1.00	1.00	1.00	1.00	1.00	1.00	1.00	1.00	1.00
Work Zone On Approach		No			No			No			No	
Adj Sat Flow, veh/h/ln	1841	1885	1885	1900	1885	1885	1885	1900	1900	1885	1885	1870
Adj Flow Rate, veh/h	93	4110	116	155	3126	815	91	147	242	896	245	63
Peak Hour Factor	0.96	0.96	0.96	0.96	0.96	0.96	0.96	0.96	0.96	0.96	0.96	0.96
Percent Heavy Veh, %	4	1	1	0	1	1	1	0	0	1	1	2
Cap, veh/h	81	1769	49	84	1769	911	322	647	288	1145	327	84
Arrive On Green	0.05	0.34	0.34	0.05	0.34	0.34	0.18	0.18	0.18	0.23	0.23	0.23
Sat Flow, veh/h	1753	5146	144	1810	5147	1598	1795	3610	1610	5063	1446	372
Grp Volume(v), veh/h	93	2727	1499	155	3126	815	91	147	242	896	0	308
Grp Sat Flow(s),veh/h/ln	1753	1716	1859	1810	1716	1598	1795	1805	1610	1688	0	1818
Q Serve(g_s), s	5.0	37.0	37.0	5.0	37.0	37.0	4.7	3.8	15.6	17.9	0.0	17.0
Cycle Q Clear(g_c), s	5.0	37.0	37.0	5.0	37.0	37.0	4.7	3.8	15.6	17.9	0.0	17.0
Prop In Lane	1.00		0.08	1.00		1.00	1.00		1.00	1.00		0.20
Lane Grp Cap(c), veh/h	81	1180	639	84	1769	911	322	647	288	1145	0	411
V/C Ratio(X)	1.14	2.31	2.34	1.84	1.77	0.89	0.28	0.23	0.84	0.78	0.00	0.75
Avail Cap(c_a), veh/h	81	1180	639	84	1769	911	551	1107	494	1552	0	558
HCM Platoon Ratio	1.00	1.00	1.00	1.00	1.00	1.00	1.00	1.00	1.00	1.00	1.00	1.00
Upstream Filter(I)	1.00	1.00	1.00	1.00	1.00	1.00	1.00	1.00	1.00	1.00	0.00	1.00
Uniform Delay (d), s/veh	51.3	35.3	35.3	51.3	35.3	17.9	38.2	37.8	42.7	39.1	0.0	38.8
Incr Delay (d2), s/veh	143.2	593.2	610.0	421.8	347.4	11.3	0.5	0.2	6.5	1.9	0.0	3.8
Initial Q Delay(d3),s/veh	0.0	0.0	0.0	0.0	0.0	0.0	0.0	0.0	0.0	0.0	0.0	0.0
%ile BackOfQ(50%),veh/ln	5.3	111.4	123.7	12.0	71.1	24.1	2.1	1.6	6.5	7.3	0.0	7.7
Unsig. Movement Delay, s/veh												
LnGrp Delay(d),s/veh	194.5	628.5	645.3	473.1	382.7	29.2	38.7	38.0	49.1	41.0	0.0	42.6
LnGrp LOS	F	F	F	F	F	C	D	D	D	D	A	D
Approach Vol, veh/h		4319			4096			480			1204	
Approach Delay, s/veh		625.0			315.8			43.7			41.4	
Approach LOS		F			F			D			D	
Timer - Assigned Phs	1	2		4	5	6		8				
Phs Duration (G+Y+Rc), s	9.2	43.2		30.1	9.2	43.2		25.1				
Change Period (Y+Rc), s	* 4.2	6.2		5.8	* 4.2	6.2		5.8				
Max Green Setting (Gmax), s	* 5	37.0		33.0	* 5	37.0		33.0				
Max Q Clear Time (g_c+I1), s	7.0	39.0		19.9	7.0	39.0		17.6				
Green Ext Time (p_c), s	0.0	0.0		4.4	0.0	0.0		1.6				

Intersection Summary

HCM 6th Ctrl Delay	402.4
HCM 6th LOS	F

Notes

- User approved pedestrian interval to be less than phase max green.
- User approved volume balancing among the lanes for turning movement.
- * HCM 6th computational engine requires equal clearance times for the phases crossing the barrier.

Timings
4: Van Buren Bl. & Wood Rd.

West Campus Upper Plateau (JN 14064)

09/20/2022

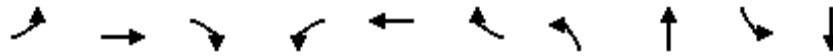

Lane Group	EBL	EBT	EBR	WBL	WBT	WBR	NBL	NBT	SBL	SBT
Lane Configurations	↘	↑↑↑	↗	↘↗	↑↑↑	↗	↘↗	↑↘	↘	↑↘
Traffic Volume (vph)	236	2238	280	387	2117	154	397	322	148	303
Future Volume (vph)	236	2238	280	387	2117	154	397	322	148	303
Turn Type	Prot	NA	pm+ov	Prot	NA	Perm	Prot	NA	Prot	NA
Protected Phases	5	2	3	1	6		3	8	7	4
Permitted Phases			2			6				
Detector Phase	5	2	3	1	6	6	3	8	7	4
Switch Phase										
Minimum Initial (s)	5.0	10.0	5.0	5.0	10.0	10.0	5.0	10.0	5.0	10.0
Minimum Split (s)	9.2	30.2	9.2	9.2	30.2	30.2	9.2	38.4	9.2	15.8
Total Split (s)	18.0	52.6	22.0	16.0	50.6	50.6	22.0	38.4	13.0	29.4
Total Split (%)	15.0%	43.8%	18.3%	13.3%	42.2%	42.2%	18.3%	32.0%	10.8%	24.5%
Yellow Time (s)	3.2	5.2	3.2	3.2	5.2	5.2	3.2	4.4	3.2	4.8
All-Red Time (s)	1.0	1.0	1.0	1.0	1.0	1.0	1.0	1.0	1.0	1.0
Lost Time Adjust (s)	0.0	0.0	0.0	0.0	0.0	0.0	0.0	0.0	0.0	0.0
Total Lost Time (s)	4.2	6.2	4.2	4.2	6.2	6.2	4.2	5.4	4.2	5.8
Lead/Lag	Lead	Lag	Lead	Lead	Lag	Lag	Lead	Lag	Lead	Lag
Lead-Lag Optimize?	Yes	Yes	Yes	Yes	Yes	Yes	Yes	Yes	Yes	Yes
Recall Mode	None	None	None	None	None	None	None	None	None	None
Act Effct Green (s)	13.8	46.5	65.4	11.8	44.5	44.5	16.9	28.8	8.8	20.4
Actuated g/C Ratio	0.12	0.40	0.56	0.10	0.38	0.38	0.15	0.25	0.08	0.18
v/c Ratio	1.21	1.19	0.33	1.19	1.17	0.24	0.87	0.72	1.18	0.84
Control Delay	173.5	124.7	9.7	156.5	115.1	7.2	67.2	32.3	183.0	45.6
Queue Delay	0.0	0.0	0.0	0.0	0.0	0.0	0.0	0.0	0.0	0.0
Total Delay	173.5	124.7	9.7	156.5	115.1	7.2	67.2	32.3	183.0	45.6
LOS	F	F	A	F	F	A	E	C	F	D
Approach Delay		117.2			114.9			45.7		75.0
Approach LOS		F			F			D		E

Intersection Summary

Cycle Length: 120
 Actuated Cycle Length: 116
 Natural Cycle: 120
 Control Type: Actuated-Uncoordinated
 Maximum v/c Ratio: 1.21
 Intersection Signal Delay: 101.9
 Intersection LOS: F
 Intersection Capacity Utilization 101.4%
 ICU Level of Service G
 Analysis Period (min) 15

Splits and Phases: 4: Van Buren Bl. & Wood Rd.

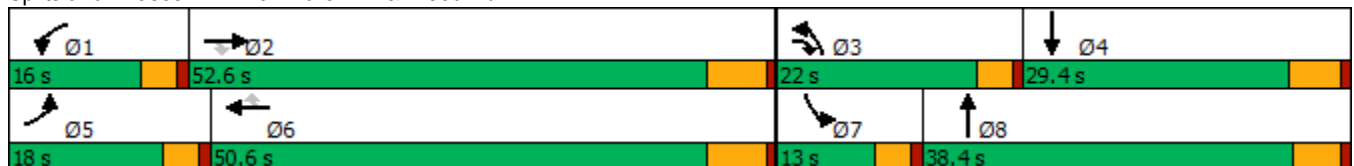

HCM 6th Signalized Intersection Summary
4: Van Buren Bl. & Wood Rd.

West Campus Upper Plateau (JN 14064)
09/20/2022

Movement	EBL	EBT	EBR	WBL	WBT	WBR	NBL	NBT	NBR	SBL	SBT	SBR	
Lane Configurations													
Traffic Volume (veh/h)	236	2238	280	387	2117	154	397	322	316	148	303	240	
Future Volume (veh/h)	236	2238	280	387	2117	154	397	322	316	148	303	240	
Initial Q (Qb), veh	0	0	0	0	0	0	0	0	0	0	0	0	
Ped-Bike Adj(A_pbT)	1.00		0.98	1.00		0.99	1.00		0.97	1.00		0.99	
Parking Bus, Adj	1.00	1.00	1.00	1.00	1.00	1.00	1.00	1.00	1.00	1.00	1.00	1.00	
Work Zone On Approach		No			No			No			No		
Adj Sat Flow, veh/h/ln	1885	1870	1870	1885	1885	1885	1870	1885	1870	1885	1885	1885	
Adj Flow Rate, veh/h	257	2433	200	421	2301	120	432	350	263	161	329	187	
Peak Hour Factor	0.92	0.92	0.92	0.92	0.92	0.92	0.92	0.92	0.92	0.92	0.92	0.92	
Percent Heavy Veh, %	1	2	2	1	1	1	2	1	2	1	1	1	
Cap, veh/h	215	2056	853	357	1983	607	489	469	345	137	389	216	
Arrive On Green	0.12	0.40	0.40	0.10	0.39	0.39	0.14	0.24	0.24	0.08	0.18	0.18	
Sat Flow, veh/h	1795	5106	1561	3483	5147	1574	3456	1942	1429	1795	2209	1227	
Grp Volume(v), veh/h	257	2433	200	421	2301	120	432	322	291	161	265	251	
Grp Sat Flow(s),veh/h/ln	1795	1702	1561	1742	1716	1574	1728	1791	1580	1795	1791	1645	
Q Serve(g_s), s	13.8	46.4	7.7	11.8	44.4	5.8	14.1	19.2	19.7	8.8	16.5	17.1	
Cycle Q Clear(g_c), s	13.8	46.4	7.7	11.8	44.4	5.8	14.1	19.2	19.7	8.8	16.5	17.1	
Prop In Lane	1.00		1.00	1.00		1.00	1.00		0.90	1.00		0.75	
Lane Grp Cap(c), veh/h	215	2056	853	357	1983	607	489	432	381	137	315	290	
V/C Ratio(X)	1.19	1.18	0.23	1.18	1.16	0.20	0.88	0.75	0.76	1.17	0.84	0.87	
Avail Cap(c_a), veh/h	215	2056	853	357	1983	607	534	513	453	137	367	337	
HCM Platoon Ratio	1.00	1.00	1.00	1.00	1.00	1.00	1.00	1.00	1.00	1.00	1.00	1.00	
Upstream Filter(I)	1.00	1.00	1.00	1.00	1.00	1.00	1.00	1.00	1.00	1.00	1.00	1.00	
Uniform Delay (d), s/veh	50.7	34.4	13.7	51.7	35.4	23.6	48.5	40.4	40.6	53.2	45.9	46.1	
Incr Delay (d2), s/veh	124.0	87.7	0.2	106.3	78.1	0.2	14.2	4.9	6.3	131.2	14.2	18.3	
Initial Q Delay(d3),s/veh	0.0	0.0	0.0	0.0	0.0	0.0	0.0	0.0	0.0	0.0	0.0	0.0	
%ile BackOfQ(50%),veh/ln	13.4	34.3	2.6	10.2	31.4	2.2	6.9	8.8	8.1	8.9	8.4	8.3	
Unsig. Movement Delay, s/veh													
LnGrp Delay(d),s/veh	174.7	122.1	13.9	158.0	113.5	23.8	62.7	45.3	46.9	184.4	60.1	64.5	
LnGrp LOS	F	F	B	F	F	C	E	D	D	F	E	E	
Approach Vol, veh/h		2890			2842			1045			677		
Approach Delay, s/veh		119.3			116.3			52.9			91.3		
Approach LOS		F			F			D			F		
Timer - Assigned Phs	1	2	3	4	5	6	7	8					
Phs Duration (G+Y+Rc), s	16.0	52.6	20.5	26.1	18.0	50.6	13.0	33.6					
Change Period (Y+Rc), s	* 4.2	6.2	* 4.2	5.8	* 4.2	6.2	* 4.2	* 5.8					
Max Green Setting (Gmax), s	* 12	46.4	* 18	23.6	* 14	44.4	* 8.8	* 33					
Max Q Clear Time (g_c+I1), s	13.8	48.4	16.1	19.1	15.8	46.4	10.8	21.7					
Green Ext Time (p_c), s	0.0	0.0	0.2	1.2	0.0	0.0	0.0	2.8					
Intersection Summary													
HCM 6th Ctrl Delay			106.3										
HCM 6th LOS			F										
Notes													
* HCM 6th computational engine requires equal clearance times for the phases crossing the barrier.													

Timings
8: Cole Av. & Van Buren Bl.

West Campus Upper Plateau (JN 14064)

09/20/2022



Lane Group	EBL	EBT	EBR	WBL	WBT	WBR	NBL	NBT	SBL	SBT	SBR
Lane Configurations	↖↗	↑↑↑	↗	↖	↑↑↑	↗	↖	↑↔	↖↗	↑↑	↗
Traffic Volume (vph)	517	1807	121	223	1926	803	107	401	764	725	384
Future Volume (vph)	517	1807	121	223	1926	803	107	401	764	725	384
Turn Type	Prot	NA	pm+ov	Prot	NA	pm+ov	Prot	NA	Prot	NA	pm+ov
Protected Phases	5	2	3	1	6	7	3	8	7	4	5
Permitted Phases			2			6					4
Detector Phase	5	2	3	1	6	7	3	8	7	4	5
Switch Phase											
Minimum Initial (s)	5.0	10.0	5.0	5.0	10.0	5.0	5.0	10.0	5.0	10.0	5.0
Minimum Split (s)	9.1	36.2	9.1	9.1	36.2	9.1	9.1	42.2	9.1	49.2	9.1
Total Split (s)	15.0	43.8	11.0	14.0	42.8	19.0	11.0	43.2	19.0	51.2	15.0
Total Split (%)	12.5%	36.5%	9.2%	11.7%	35.7%	15.8%	9.2%	36.0%	15.8%	42.7%	12.5%
Yellow Time (s)	3.2	5.2	3.2	3.2	5.2	3.2	3.2	5.2	3.2	5.2	3.2
All-Red Time (s)	0.5	1.0	0.5	0.5	1.0	0.5	0.5	1.0	0.5	1.0	0.5
Lost Time Adjust (s)	0.0	0.0	0.0	0.0	0.0	0.0	0.0	0.0	0.0	0.0	0.0
Total Lost Time (s)	3.7	6.2	3.7	3.7	6.2	3.7	3.7	6.2	3.7	6.2	3.7
Lead/Lag	Lead	Lag	Lead	Lead	Lag	Lead	Lead	Lag	Lead	Lag	Lead
Lead-Lag Optimize?	Yes	Yes	Yes	Yes	Yes	Yes	Yes	Yes	Yes	Yes	Yes
Recall Mode	None	None	None	None	None	None	None	None	None	None	None
Act Effct Green (s)	11.3	37.8	51.3	10.3	36.8	58.3	7.3	23.1	15.4	31.2	45.0
Actuated g/C Ratio	0.11	0.35	0.48	0.10	0.35	0.55	0.07	0.22	0.14	0.29	0.42
v/c Ratio	1.51	1.09	0.16	1.39	1.17	0.91	0.93	0.73	1.64	0.74	0.58
Control Delay	275.8	83.1	6.5	241.7	115.0	35.0	115.6	41.7	329.5	38.3	20.7
Queue Delay	0.0	0.0	0.0	0.0	0.0	0.0	0.0	0.0	0.0	0.0	0.0
Total Delay	275.8	83.1	6.5	241.7	115.0	35.0	115.6	41.7	329.5	38.3	20.7
LOS	F	F	A	F	F	C	F	D	F	D	C
Approach Delay		120.0			102.8			54.0		153.5	
Approach LOS		F			F			D		F	

Intersection Summary

Cycle Length: 120
 Actuated Cycle Length: 106.5
 Natural Cycle: 115
 Control Type: Actuated-Uncoordinated
 Maximum v/c Ratio: 1.64
 Intersection Signal Delay: 116.2
 Intersection LOS: F
 Intersection Capacity Utilization 108.0%
 ICU Level of Service G
 Analysis Period (min) 15



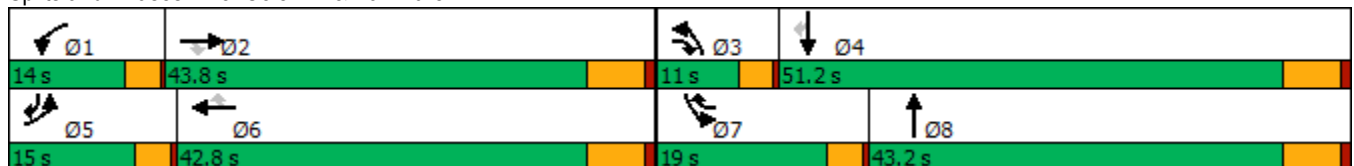



























Splits and Phases: 8: Cole Av. & Van Buren Bl.



HCM 6th Signalized Intersection Summary
8: Cole Av. & Van Buren Bl.

West Campus Upper Plateau (JN 14064)

09/20/2022

												
Movement	EBL	EBT	EBR	WBL	WBT	WBR	NBL	NBT	NBR	SBL	SBT	SBR
Lane Configurations	 	  			  			 		 	 	
Traffic Volume (veh/h)	517	1807	121	223	1926	803	107	401	131	764	725	384
Future Volume (veh/h)	517	1807	121	223	1926	803	107	401	131	764	725	384
Initial Q (Qb), veh	0	0	0	0	0	0	0	0	0	0	0	0
Ped-Bike Adj(A_pbT)	1.00		1.00	1.00		1.00	1.00		0.99	1.00		1.00
Parking Bus, Adj	1.00	1.00	1.00	1.00	1.00	1.00	1.00	1.00	1.00	1.00	1.00	1.00
Work Zone On Approach		No			No			No			No	
Adj Sat Flow, veh/h/ln	1870	1841	1856	1870	1870	1885	1885	1885	1885	1870	1885	1885
Adj Flow Rate, veh/h	550	1922	70	237	2049	764	114	427	132	813	771	309
Peak Hour Factor	0.94	0.94	0.94	0.94	0.94	0.94	0.94	0.94	0.94	0.94	0.94	0.94
Percent Heavy Veh, %	2	4	3	2	2	1	1	1	1	2	1	1
Cap, veh/h	373	1804	674	175	1784	792	125	559	171	505	1017	625
Arrive On Green	0.11	0.36	0.36	0.10	0.35	0.35	0.07	0.21	0.21	0.15	0.28	0.28
Sat Flow, veh/h	3456	5025	1572	1781	5106	1598	1795	2696	825	3456	3582	1596
Grp Volume(v), veh/h	550	1922	70	237	2049	764	114	282	277	813	771	309
Grp Sat Flow(s),veh/h/ln	1728	1675	1572	1781	1702	1598	1795	1791	1731	1728	1791	1596
Q Serve(g_s), s	11.3	37.6	2.8	10.3	36.6	36.6	6.6	15.5	15.8	15.3	20.6	15.3
Cycle Q Clear(g_c), s	11.3	37.6	2.8	10.3	36.6	36.6	6.6	15.5	15.8	15.3	20.6	15.3
Prop In Lane	1.00		1.00	1.00		1.00	1.00		0.48	1.00		1.00
Lane Grp Cap(c), veh/h	373	1804	674	175	1784	792	125	372	359	505	1017	625
V/C Ratio(X)	1.48	1.07	0.10	1.35	1.15	0.96	0.91	0.76	0.77	1.61	0.76	0.49
Avail Cap(c_a), veh/h	373	1804	674	175	1784	792	125	633	612	505	1539	858
HCM Platoon Ratio	1.00	1.00	1.00	1.00	1.00	1.00	1.00	1.00	1.00	1.00	1.00	1.00
Upstream Filter(I)	1.00	1.00	1.00	1.00	1.00	1.00	1.00	1.00	1.00	1.00	1.00	1.00
Uniform Delay (d), s/veh	46.7	33.6	17.9	47.2	34.1	25.5	48.4	39.0	39.2	44.7	34.2	24.0
Incr Delay (d2), s/veh	227.9	41.1	0.1	191.4	73.8	23.8	53.0	3.2	3.5	283.8	1.2	0.6
Initial Q Delay(d3),s/veh	0.0	0.0	0.0	0.0	0.0	0.0	0.0	0.0	0.0	0.0	0.0	0.0
%ile BackOfQ(50%),veh/ln	16.4	20.8	1.0	13.7	26.0	21.2	4.7	6.8	6.7	26.1	8.5	5.4
Unsig. Movement Delay, s/veh												
LnGrp Delay(d),s/veh	274.6	74.6	18.0	238.7	107.9	49.3	101.4	42.2	42.7	328.5	35.4	24.6
LnGrp LOS	F	F	B	F	F	D	F	D	D	F	D	C
Approach Vol, veh/h		2542			3050			673			1893	
Approach Delay, s/veh		116.3			103.4			52.4			159.5	
Approach LOS		F			F			D			F	
Timer - Assigned Phs	1	2	3	4	5	6	7	8				
Phs Duration (G+Y+Rc), s	14.0	43.8	11.0	35.9	15.0	42.8	19.0	27.9				
Change Period (Y+Rc), s	3.7	6.2	3.7	6.2	3.7	6.2	3.7	6.2				
Max Green Setting (Gmax), s	10.3	37.6	7.3	45.0	11.3	36.6	15.3	37.0				
Max Q Clear Time (g_c+I1), s	12.3	39.6	8.6	22.6	13.3	38.6	17.3	17.8				
Green Ext Time (p_c), s	0.0	0.0	0.0	6.0	0.0	0.0	0.0	2.8				
Intersection Summary												
HCM 6th Ctrl Delay				116.2								
HCM 6th LOS				F								

Timings
11: Barton St & Alessandro Bl.

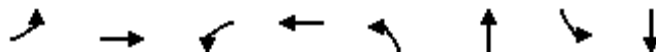

Lane Group	EBL	EBT	WBL	WBT	NBL	NBT	SBL	SBT
Lane Configurations	↵	↑↑↑	↵	↑↑↑	↵	↑	↵	↑
Traffic Volume (vph)	7	2725	90	3102	91	1	18	0
Future Volume (vph)	7	2725	90	3102	91	1	18	0
Turn Type	Prot	NA	Prot	NA	Perm	NA	Perm	NA
Protected Phases	5	2	1	6		8		4
Permitted Phases					8		4	
Detector Phase	5	2	1	6	8	8	4	4
Switch Phase								
Minimum Initial (s)	5.0	10.0	5.0	10.0	10.0	10.0	10.0	10.0
Minimum Split (s)	9.2	28.5	11.0	28.5	40.6	40.6	26.6	26.6
Total Split (s)	9.2	61.4	13.0	65.2	40.6	40.6	40.6	40.6
Total Split (%)	8.0%	53.4%	11.3%	56.7%	35.3%	35.3%	35.3%	35.3%
Yellow Time (s)	3.2	5.5	3.2	5.5	3.6	3.6	3.6	3.6
All-Red Time (s)	1.0	1.0	1.0	1.0	1.0	1.0	1.0	1.0
Lost Time Adjust (s)	0.0	0.0	0.0	0.0	0.0	0.0	0.0	0.0
Total Lost Time (s)	4.2	6.5	4.2	6.5	4.6	4.6	4.6	4.6
Lead/Lag	Lead	Lag	Lead	Lag				
Lead-Lag Optimize?	Yes	Yes	Yes	Yes				
Recall Mode	None	None	None	None	None	None	None	None
Act Effct Green (s)	5.2	59.6	8.1	67.8	15.3	15.3	15.3	15.3
Actuated g/C Ratio	0.06	0.66	0.09	0.75	0.17	0.17	0.17	0.17
v/c Ratio	0.08	0.86	0.58	0.85	0.40	0.15	0.09	0.05
Control Delay	49.6	21.6	59.1	16.0	39.4	10.4	32.5	0.2
Queue Delay	0.0	0.0	0.0	0.0	0.0	0.0	0.0	0.0
Total Delay	49.6	21.6	59.1	16.0	39.4	10.4	32.5	0.2
LOS	D	C	E	B	D	B	C	A
Approach Delay		21.7		17.2		29.8		17.3
Approach LOS		C		B		C		B

Intersection Summary

Cycle Length: 115
 Actuated Cycle Length: 90.2
 Natural Cycle: 115
 Control Type: Actuated-Uncoordinated
 Maximum v/c Ratio: 0.86
 Intersection Signal Delay: 19.5
 Intersection LOS: B
 Intersection Capacity Utilization 89.0%
 ICU Level of Service E
 Analysis Period (min) 15

Splits and Phases: 11: Barton St & Alessandro Bl.



HCM 6th Signalized Intersection Summary
11: Barton St & Alessandro Bl.

West Campus Upper Plateau (JN 14064)

09/20/2022



Movement	EBL	EBT	EBR	WBL	WBT	WBR	NBL	NBT	NBR	SBL	SBT	SBR
Lane Configurations	↖	↑↑↑		↖	↑↑↑		↖	↑		↖	↑	
Traffic Volume (veh/h)	7	2725	64	90	3102	20	91	1	44	18	0	16
Future Volume (veh/h)	7	2725	64	90	3102	20	91	1	44	18	0	16
Initial Q (Qb), veh	0	0	0	0	0	0	0	0	0	0	0	0
Ped-Bike Adj(A_pbT)	1.00		1.00	1.00		0.98	1.00		1.00	1.00		1.00
Parking Bus, Adj	1.00	1.00	1.00	1.00	1.00	1.00	1.00	1.00	1.00	1.00	1.00	1.00
Work Zone On Approach		No			No			No			No	
Adj Sat Flow, veh/h/ln	1604	1885	1900	1900	1870	1900	1900	1900	1900	1796	1900	1900
Adj Flow Rate, veh/h	7	2839	65	94	3231	21	95	1	20	19	0	7
Peak Hour Factor	0.96	0.96	0.96	0.96	0.96	0.96	0.96	0.96	0.96	0.96	0.96	0.96
Percent Heavy Veh, %	20	1	0	0	2	0	0	0	0	7	0	0
Cap, veh/h	14	3311	75	121	3649	24	242	9	175	221	0	183
Arrive On Green	0.01	0.64	0.64	0.07	0.70	0.70	0.11	0.11	0.11	0.11	0.00	0.11
Sat Flow, veh/h	1527	5177	118	1810	5234	34	1431	77	1545	1336	0	1610
Grp Volume(v), veh/h	7	1874	1030	94	2099	1153	95	0	21	19	0	7
Grp Sat Flow(s),veh/h/ln	1527	1716	1864	1810	1702	1863	1431	0	1622	1336	0	1610
Q Serve(g_s), s	0.4	36.9	37.8	4.3	41.3	41.7	5.4	0.0	1.0	1.1	0.0	0.3
Cycle Q Clear(g_c), s	0.4	36.9	37.8	4.3	41.3	41.7	5.7	0.0	1.0	2.1	0.0	0.3
Prop In Lane	1.00		0.06	1.00		0.02	1.00		0.95	1.00		1.00
Lane Grp Cap(c), veh/h	14	2194	1192	121	2374	1299	242	0	184	221	0	183
V/C Ratio(X)	0.51	0.85	0.86	0.78	0.88	0.89	0.39	0.00	0.11	0.09	0.00	0.04
Avail Cap(c_a), veh/h	90	2218	1205	187	2374	1299	686	0	687	635	0	682
HCM Platoon Ratio	1.00	1.00	1.00	1.00	1.00	1.00	1.00	1.00	1.00	1.00	1.00	1.00
Upstream Filter(I)	1.00	1.00	1.00	1.00	1.00	1.00	1.00	0.00	1.00	1.00	0.00	1.00
Uniform Delay (d), s/veh	41.9	12.2	12.3	39.0	10.1	10.2	36.1	0.0	33.8	34.7	0.0	33.5
Incr Delay (d2), s/veh	10.5	3.6	6.9	4.1	4.5	8.0	1.0	0.0	0.3	0.2	0.0	0.1
Initial Q Delay(d3),s/veh	0.0	0.0	0.0	0.0	0.0	0.0	0.0	0.0	0.0	0.0	0.0	0.0
%ile BackOfQ(50%),veh/ln	0.2	10.4	12.7	2.0	13.2	15.8	1.9	0.0	0.4	0.4	0.0	0.1
Unsig. Movement Delay, s/veh												
LnGrp Delay(d),s/veh	52.4	15.7	19.2	43.2	14.6	18.2	37.1	0.0	34.1	34.9	0.0	33.6
LnGrp LOS	D	B	B	D	B	B	D	A	C	C	A	C
Approach Vol, veh/h		2911			3346			116				26
Approach Delay, s/veh		17.1			16.7			36.5				34.6
Approach LOS		B			B			D				C
Timer - Assigned Phs	1	2		4	5	6		8				
Phs Duration (G+Y+Rc), s	9.9	60.8		14.2	5.0	65.7		14.2				
Change Period (Y+Rc), s	* 4.2	6.5		4.6	* 4.2	6.5		4.6				
Max Green Setting (Gmax), s	* 8.8	54.9		36.0	* 5	58.7		36.0				
Max Q Clear Time (g_c+I1), s	6.3	39.8		4.1	2.4	43.7		7.7				
Green Ext Time (p_c), s	0.0	14.5		0.1	0.0	14.8		0.3				

Intersection Summary

HCM 6th Ctrl Delay	17.3
HCM 6th LOS	B

Notes

* HCM 6th computational engine requires equal clearance times for the phases crossing the barrier.

Timings
13: Barton Rd. & Orange Terrace Pkwy

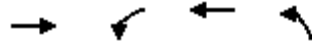

Lane Group	EBT	WBL	WBT	NBL
Lane Configurations	↑↑	↑	↑↑	↑
Traffic Volume (vph)	499	54	297	131
Future Volume (vph)	499	54	297	131
Turn Type	NA	Perm	NA	Prot
Protected Phases	4		8	2
Permitted Phases		8		
Detector Phase	4	8	8	2
Switch Phase				
Minimum Initial (s)	5.0	5.0	5.0	5.0
Minimum Split (s)	26.1	26.1	26.1	26.1
Total Split (s)	27.0	27.0	27.0	28.0
Total Split (%)	49.1%	49.1%	49.1%	50.9%
Yellow Time (s)	3.6	3.6	3.6	3.6
All-Red Time (s)	0.5	0.5	0.5	0.5
Lost Time Adjust (s)	0.0	0.0	0.0	0.0
Total Lost Time (s)	4.1	4.1	4.1	4.1
Lead/Lag				
Lead-Lag Optimize?				
Recall Mode	Max	Max	Max	Max
Act Effct Green (s)	22.9	22.9	22.9	23.9
Actuated g/C Ratio	0.42	0.42	0.42	0.43
v/c Ratio	0.45	0.21	0.20	0.24
Control Delay	11.1	12.9	10.7	8.3
Queue Delay	0.0	0.0	0.0	0.0
Total Delay	11.1	12.9	10.7	8.3
LOS	B	B	B	A
Approach Delay	11.1		11.0	8.3
Approach LOS	B		B	A

Intersection Summary

Cycle Length: 55
 Actuated Cycle Length: 55
 Offset: 0 (0%), Referenced to phase 2:NBL and 6:, Start of Yellow
 Natural Cycle: 55
 Control Type: Pretimed
 Maximum v/c Ratio: 0.45
 Intersection Signal Delay: 10.6
 Intersection LOS: B
 Intersection Capacity Utilization 43.5%
 ICU Level of Service A
 Analysis Period (min) 15

Splits and Phases: 13: Barton Rd. & Orange Terrace Pkwy

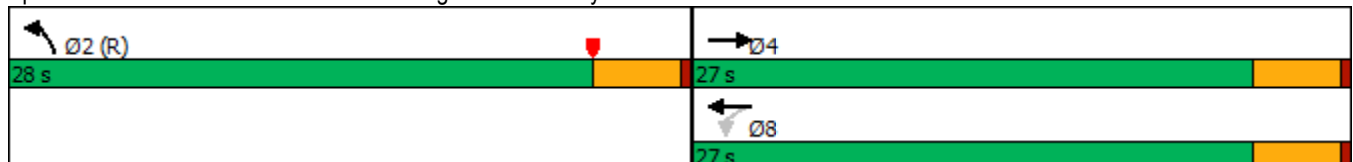

HCM 6th Signalized Intersection Summary
 13: Barton Rd. & Orange Terrace Pkwy

West Campus Upper Plateau (JN 14064)

09/20/2022

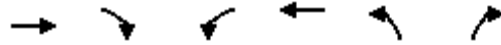

Movement	EBT	EBR	WBL	WBT	NBL	NBR
Lane Configurations	↑↑		↵	↑↑	↵	
Traffic Volume (veh/h)	499	150	54	297	131	53
Future Volume (veh/h)	499	150	54	297	131	53
Initial Q (Qb), veh	0	0	0	0	0	0
Ped-Bike Adj(A_pbT)		0.98	1.00		1.00	1.00
Parking Bus, Adj	1.00	1.00	1.00	1.00	1.00	1.00
Work Zone On Approach	No			No	No	
Adj Sat Flow, veh/h/ln	1885	1885	1900	1900	1900	1900
Adj Flow Rate, veh/h	514	155	56	306	135	55
Peak Hour Factor	0.97	0.97	0.97	0.97	0.97	0.97
Percent Heavy Veh, %	1	1	0	0	0	0
Cap, veh/h	1123	337	348	1503	537	219
Arrive On Green	0.42	0.42	0.42	0.42	0.43	0.43
Sat Flow, veh/h	2792	809	780	3705	1235	503
Grp Volume(v), veh/h	340	329	56	306	191	0
Grp Sat Flow(s),veh/h/ln	1791	1716	780	1805	1748	0
Q Serve(g_s), s	7.5	7.6	3.1	3.0	3.8	0.0
Cycle Q Clear(g_c), s	7.5	7.6	10.7	3.0	3.8	0.0
Prop In Lane		0.47	1.00		0.71	0.29
Lane Grp Cap(c), veh/h	746	714	348	1503	759	0
V/C Ratio(X)	0.46	0.46	0.16	0.20	0.25	0.00
Avail Cap(c_a), veh/h	746	714	348	1503	759	0
HCM Platoon Ratio	1.00	1.00	1.00	1.00	1.00	1.00
Upstream Filter(I)	1.00	1.00	1.00	1.00	1.00	0.00
Uniform Delay (d), s/veh	11.6	11.6	15.4	10.2	9.9	0.0
Incr Delay (d2), s/veh	2.0	2.1	1.0	0.3	0.8	0.0
Initial Q Delay(d3),s/veh	0.0	0.0	0.0	0.0	0.0	0.0
%ile BackOfQ(50%),veh/ln	2.9	2.9	0.6	1.1	1.4	0.0
Unsig. Movement Delay, s/veh						
LnGrp Delay(d),s/veh	13.6	13.7	16.4	10.5	10.7	0.0
LnGrp LOS	B	B	B	B	B	A
Approach Vol, veh/h	669			362	191	
Approach Delay, s/veh	13.6			11.5	10.7	
Approach LOS	B			B	B	
Timer - Assigned Phs		2		4		8
Phs Duration (G+Y+Rc), s		28.0		27.0		27.0
Change Period (Y+Rc), s		4.1		4.1		4.1
Max Green Setting (Gmax), s		23.9		22.9		22.9
Max Q Clear Time (g_c+I1), s		5.8		9.6		12.7
Green Ext Time (p_c), s		0.5		3.5		1.6

Intersection Summary

HCM 6th Ctrl Delay	12.5
HCM 6th LOS	B

Notes

User approved volume balancing among the lanes for turning movement.

Timings

14: Barton Rd. & Van Buren Bl.

09/20/2022

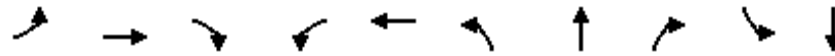

Lane Group	EBL	EBT	EBR	WBL	WBT	NBL	NBT	NBR	SBL	SBT
Lane Configurations	↘	↑↑↑	↗	↘↗	↑↑↑	↘↗	↑	↗	↘	↗
Traffic Volume (vph)	223	2361	388	371	2580	405	108	298	33	36
Future Volume (vph)	223	2361	388	371	2580	405	108	298	33	36
Turn Type	Prot	NA	pm+ov	Prot	NA	Prot	NA	Perm	Prot	NA
Protected Phases	5	2	3	1	6	3	8		7	4
Permitted Phases			2					8		
Detector Phase	5	2	3	1	6	3	8	8	7	4
Switch Phase										
Minimum Initial (s)	5.0	10.0	5.0	5.0	10.0	5.0	10.0	10.0	5.0	10.0
Minimum Split (s)	9.2	25.2	9.1	9.2	25.5	9.1	14.6	14.6	9.1	33.6
Total Split (s)	17.0	54.2	16.0	16.2	53.4	16.0	39.1	39.1	10.5	33.6
Total Split (%)	14.2%	45.2%	13.3%	13.5%	44.5%	13.3%	32.6%	32.6%	8.8%	28.0%
Yellow Time (s)	3.2	5.2	3.6	3.2	5.5	3.6	3.6	3.6	3.6	3.6
All-Red Time (s)	1.0	1.0	0.5	1.0	1.0	0.5	1.0	1.0	0.5	1.0
Lost Time Adjust (s)	0.0	0.0	0.0	0.0	0.0	0.0	0.0	0.0	0.0	0.0
Total Lost Time (s)	4.2	6.2	4.1	4.2	6.5	4.1	4.6	4.6	4.1	4.6
Lead/Lag	Lead	Lag	Lead	Lead	Lag	Lead	Lag	Lag	Lead	Lag
Lead-Lag Optimize?	Yes	Yes	Yes	Yes	Yes	Yes	Yes	Yes	Yes	Yes
Recall Mode	None	None	None	None	None	None	None	None	None	None
Act Effct Green (s)	12.9	48.2	62.3	12.1	47.1	12.0	23.6	23.6	6.2	13.7
Actuated g/C Ratio	0.12	0.46	0.59	0.12	0.45	0.11	0.22	0.22	0.06	0.13
v/c Ratio	1.05	0.96	0.41	0.97	1.09	1.06	0.27	0.58	0.32	0.62
Control Delay	121.2	38.8	9.5	86.4	77.8	107.5	36.5	13.4	57.8	17.2
Queue Delay	0.0	0.0	0.0	0.0	0.0	0.0	0.0	0.0	0.0	0.0
Total Delay	121.2	38.8	9.5	86.4	77.8	107.5	36.5	13.4	57.8	17.2
LOS	F	D	A	F	E	F	D	B	E	B
Approach Delay		41.2			78.8		63.5			22.2
Approach LOS		D			E		E			C

Intersection Summary

Cycle Length: 120
 Actuated Cycle Length: 105.1
 Natural Cycle: 120
 Control Type: Actuated-Uncoordinated
 Maximum v/c Ratio: 1.09
 Intersection Signal Delay: 59.1
 Intersection LOS: E
 Intersection Capacity Utilization 105.2%
 ICU Level of Service G
 Analysis Period (min) 15



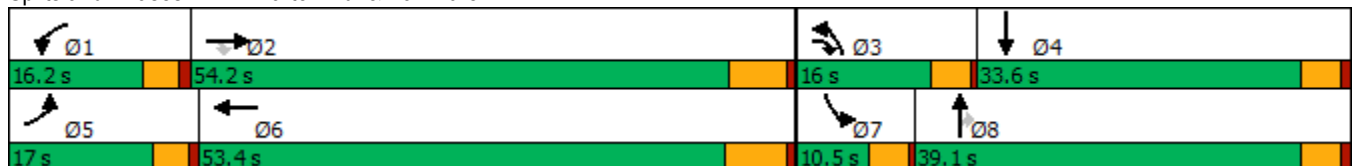

























Splits and Phases: 14: Barton Rd. & Van Buren Bl.



HCM 6th Signalized Intersection Summary
14: Barton Rd. & Van Buren Bl.

West Campus Upper Plateau (JN 14064)

09/20/2022

												
Movement	EBL	EBT	EBR	WBL	WBT	WBR	NBL	NBT	NBR	SBL	SBT	SBR
Lane Configurations		  		  	  			 				
Traffic Volume (veh/h)	223	2361	388	371	2580	62	405	108	298	33	36	195
Future Volume (veh/h)	223	2361	388	371	2580	62	405	108	298	33	36	195
Initial Q (Qb), veh	0	0	0	0	0	0	0	0	0	0	0	0
Ped-Bike Adj(A_pbT)	1.00		1.00	1.00		1.00	1.00		0.96	1.00		1.00
Parking Bus, Adj	1.00	1.00	1.00	1.00	1.00	1.00	1.00	1.00	1.00	1.00	1.00	1.00
Work Zone On Approach		No			No			No			No	
Adj Sat Flow, veh/h/ln	1900	1870	1885	1885	1885	1870	1900	1900	1885	1900	1885	1900
Adj Flow Rate, veh/h	232	2459	375	386	2688	55	422	112	186	34	38	145
Peak Hour Factor	0.96	0.96	0.96	0.96	0.96	0.96	0.96	0.96	0.96	0.96	0.96	0.96
Percent Heavy Veh, %	0	2	1	1	1	2	0	0	1	0	1	0
Cap, veh/h	219	2547	905	396	2465	50	396	415	334	54	47	177
Arrive On Green	0.12	0.45	0.45	0.11	0.45	0.45	0.11	0.22	0.22	0.03	0.14	0.14
Sat Flow, veh/h	1810	5611	1597	3483	5523	112	3510	1900	1530	1810	343	1307
Grp Volume(v), veh/h	232	2459	375	386	1830	913	422	112	186	34	0	183
Grp Sat Flow(s),veh/h/ln	1810	1870	1597	1742	1885	1865	1755	1900	1530	1810	0	1650
Q Serve(g_s), s	12.8	45.0	14.0	11.7	47.1	47.1	11.9	5.2	11.4	2.0	0.0	11.4
Cycle Q Clear(g_c), s	12.8	45.0	14.0	11.7	47.1	47.1	11.9	5.2	11.4	2.0	0.0	11.4
Prop In Lane	1.00		1.00	1.00		0.06	1.00		1.00	1.00		0.79
Lane Grp Cap(c), veh/h	219	2547	905	396	1683	832	396	415	334	54	0	224
V/C Ratio(X)	1.06	0.97	0.41	0.97	1.09	1.10	1.07	0.27	0.56	0.63	0.00	0.82
Avail Cap(c_a), veh/h	219	2552	906	396	1683	832	396	621	500	110	0	453
HCM Platoon Ratio	1.00	1.00	1.00	1.00	1.00	1.00	1.00	1.00	1.00	1.00	1.00	1.00
Upstream Filter(I)	1.00	1.00	1.00	1.00	1.00	1.00	1.00	1.00	1.00	1.00	0.00	1.00
Uniform Delay (d), s/veh	46.4	28.0	12.9	46.6	29.2	29.2	46.8	34.2	36.7	50.6	0.0	44.3
Incr Delay (d2), s/veh	76.6	10.8	0.1	38.3	49.8	60.9	63.9	0.3	1.4	11.4	0.0	7.1
Initial Q Delay(d3),s/veh	0.0	0.0	0.0	0.0	0.0	0.0	0.0	0.0	0.0	0.0	0.0	0.0
%ile BackOfQ(50%),veh/ln	10.2	20.4	4.5	6.9	30.6	32.8	8.5	2.3	4.2	1.1	0.0	5.1
Unsig. Movement Delay, s/veh												
LnGrp Delay(d),s/veh	123.0	38.8	13.1	84.9	79.0	90.1	110.7	34.6	38.1	62.0	0.0	51.5
LnGrp LOS	F	D	B	F	F	F	F	C	D	E	A	D
Approach Vol, veh/h		3066			3129			720				217
Approach Delay, s/veh		42.0			83.0			80.1				53.1
Approach LOS		D			F			F				D
Timer - Assigned Phs	1	2	3	4	5	6	7	8				
Phs Duration (G+Y+Rc), s	16.2	54.4	16.0	18.9	17.0	53.6	7.3	27.7				
Change Period (Y+Rc), s	* 4.2	* 6.5	4.1	4.6	* 4.2	6.5	4.1	4.6				
Max Green Setting (Gmax), s	* 12	* 48	11.9	29.0	* 13	46.9	6.4	34.5				
Max Q Clear Time (g_c+I1), s	13.7	47.0	13.9	13.4	14.8	49.1	4.0	13.4				
Green Ext Time (p_c), s	0.0	1.0	0.0	0.9	0.0	0.0	0.0	1.1				

Intersection Summary

HCM 6th Ctrl Delay	64.2
HCM 6th LOS	E

Notes

* HCM 6th computational engine requires equal clearance times for the phases crossing the barrier.

Timings
19: Van Buren Bl. & Orange Terrace Pkwy.

West Campus Upper Plateau (JN 14064)

09/20/2022

Lane Group	EBL	EBT	EBR	WBL	WBT	WBR	NBL	NBT	NBR	SBL	SBT	SBR
Lane Configurations												
Traffic Volume (vph)	206	2586	310	186	2579	254	328	51	239	143	47	167
Future Volume (vph)	206	2586	310	186	2579	254	328	51	239	143	47	167
Turn Type	Prot	NA	pm+ov	Prot	NA	pm+ov	Prot	NA	pm+ov	Prot	NA	pm+ov
Protected Phases	5	2	3	1	6	7	3	8	1	7	4	5
Permitted Phases			2			6			8			4
Detector Phase	5	2	3	1	6	7	3	8	1	7	4	5
Switch Phase												
Minimum Initial (s)	5.0	10.0	5.0	5.0	10.0	10.0	5.0	5.0	5.0	10.0	10.0	5.0
Minimum Split (s)	9.2	25.2	9.1	9.1	25.2	15.8	9.1	26.1	9.1	15.8	24.8	9.2
Total Split (s)	12.0	66.6	16.8	11.5	66.1	15.8	16.8	26.1	11.5	15.8	25.1	12.0
Total Split (%)	10.0%	55.5%	14.0%	9.6%	55.1%	13.2%	14.0%	21.8%	9.6%	13.2%	20.9%	10.0%
Yellow Time (s)	3.2	5.2	3.6	3.6	5.2	4.8	3.6	3.6	3.6	4.8	4.8	3.2
All-Red Time (s)	1.0	1.0	0.5	0.5	1.0	1.0	0.5	0.5	0.5	1.0	1.0	1.0
Lost Time Adjust (s)	0.0	0.0	0.0	0.0	0.0	0.0	0.0	0.0	0.0	0.0	0.0	0.0
Total Lost Time (s)	4.2	6.2	4.1	4.1	6.2	5.8	4.1	4.1	4.1	5.8	5.8	4.2
Lead/Lag	Lead	Lag	Lead	Lead	Lag	Lead	Lead	Lag	Lead	Lead	Lag	Lead
Lead-Lag Optimize?	Yes	Yes	Yes	Yes	Yes	Yes	Yes	Yes	Yes	Yes	Yes	Yes
Recall Mode	None	None	None	None	None	None	None	None	None	None	None	None
Act Effct Green (s)	7.8	60.7	79.7	7.4	60.2	76.7	12.8	12.8	22.1	10.3	11.7	21.7
Actuated g/C Ratio	0.07	0.56	0.73	0.07	0.55	0.70	0.12	0.12	0.20	0.09	0.11	0.20
v/c Ratio	0.87	0.95	0.27	0.83	0.97	0.22	0.85	0.13	0.64	0.46	0.24	0.45
Control Delay	83.0	33.7	3.9	78.9	36.3	2.6	69.1	43.6	33.5	53.7	49.0	23.4
Queue Delay	0.0	0.0	0.0	0.0	0.0	0.0	0.0	0.0	0.0	0.0	0.0	0.0
Total Delay	83.0	33.7	3.9	78.9	36.3	2.6	69.1	43.6	33.5	53.7	49.0	23.4
LOS	F	C	A	E	D	A	E	D	C	D	D	C
Approach Delay		34.0			36.1			53.2			38.9	
Approach LOS		C			D			D			D	

Intersection Summary

Cycle Length: 120
 Actuated Cycle Length: 109.3
 Natural Cycle: 120
 Control Type: Actuated-Uncoordinated
 Maximum v/c Ratio: 0.97
 Intersection Signal Delay: 36.8
 Intersection LOS: D
 Intersection Capacity Utilization 86.5%
 ICU Level of Service E
 Analysis Period (min) 15

Splits and Phases: 19: Van Buren Bl. & Orange Terrace Pkwy.

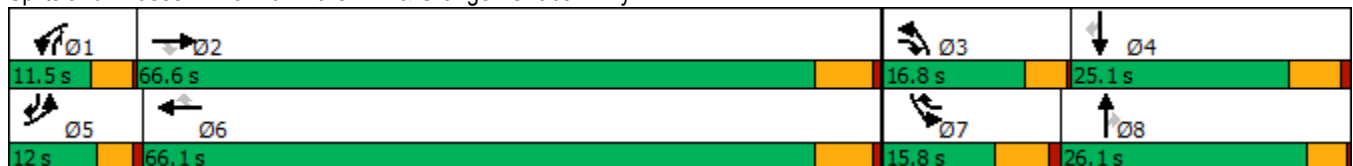

HCM 6th Signalized Intersection Summary
 19: Van Buren Bl. & Orange Terrace Pkwy.

West Campus Upper Plateau (JN 14064)

09/20/2022



Movement	EBL	EBT	EBR	WBL	WBT	WBR	NBL	NBT	NBR	SBL	SBT	SBR
Lane Configurations	↖↗	↑↑↑	↖	↖↗	↑↑↑	↖	↖↗	↑↑	↖	↖↗	↑	↖↗
Traffic Volume (veh/h)	206	2586	310	186	2579	254	328	51	239	143	47	167
Future Volume (veh/h)	206	2586	310	186	2579	254	328	51	239	143	47	167
Initial Q (Qb), veh	0	0	0	0	0	0	0	0	0	0	0	0
Ped-Bike Adj(A_pbT)	1.00		1.00	1.00		1.00	1.00		1.00	1.00		1.00
Parking Bus, Adj	1.00	1.00	1.00	1.00	1.00	1.00	1.00	1.00	1.00	1.00	1.00	1.00
Work Zone On Approach		No			No			No			No	
Adj Sat Flow, veh/h/ln	1885	1870	1870	1885	1856	1885	1870	1900	1885	1885	1900	1885
Adj Flow Rate, veh/h	215	2694	297	194	2686	206	342	53	218	149	49	101
Peak Hour Factor	0.96	0.96	0.96	0.96	0.96	0.96	0.96	0.96	0.96	0.96	0.96	0.96
Percent Heavy Veh, %	1	2	2	1	3	1	2	0	1	1	0	1
Cap, veh/h	233	2641	992	221	2599	956	376	528	335	298	261	327
Arrive On Green	0.07	0.52	0.52	0.06	0.51	0.51	0.11	0.15	0.15	0.09	0.14	0.14
Sat Flow, veh/h	3483	5106	1585	3483	5066	1598	3456	3610	1598	3483	1900	1598
Grp Volume(v), veh/h	215	2694	297	194	2686	206	342	53	218	149	49	101
Grp Sat Flow(s),veh/h/ln	1742	1702	1585	1742	1689	1598	1728	1805	1598	1742	1900	1598
Q Serve(g_s), s	7.2	60.4	10.1	6.5	59.9	6.9	11.4	1.5	14.6	4.8	2.7	6.3
Cycle Q Clear(g_c), s	7.2	60.4	10.1	6.5	59.9	6.9	11.4	1.5	14.6	4.8	2.7	6.3
Prop In Lane	1.00		1.00	1.00		1.00	1.00		1.00	1.00		1.00
Lane Grp Cap(c), veh/h	233	2641	992	221	2599	956	376	528	335	298	261	327
V/C Ratio(X)	0.92	1.02	0.30	0.88	1.03	0.22	0.91	0.10	0.65	0.50	0.19	0.31
Avail Cap(c_a), veh/h	233	2641	992	221	2599	956	376	680	402	298	314	371
HCM Platoon Ratio	1.00	1.00	1.00	1.00	1.00	1.00	1.00	1.00	1.00	1.00	1.00	1.00
Upstream Filter(I)	1.00	1.00	1.00	1.00	1.00	1.00	1.00	1.00	1.00	1.00	1.00	1.00
Uniform Delay (d), s/veh	54.2	28.2	10.0	54.2	28.4	10.8	51.5	43.2	42.2	51.0	44.6	39.4
Incr Delay (d2), s/veh	38.2	22.7	0.2	30.7	27.0	0.1	25.5	0.1	2.8	1.3	0.3	0.5
Initial Q Delay(d3),s/veh	0.0	0.0	0.0	0.0	0.0	0.0	0.0	0.0	0.0	0.0	0.0	0.0
%ile BackOfQ(50%),veh/ln	4.3	27.2	3.4	3.7	27.9	2.4	6.3	0.7	6.0	2.1	1.3	2.5
Unsig. Movement Delay, s/veh												
LnGrp Delay(d),s/veh	92.4	50.9	10.2	84.9	55.5	10.9	77.0	43.3	45.0	52.3	44.9	40.0
LnGrp LOS	F	F	B	F	F	B	E	D	D	D	D	D
Approach Vol, veh/h		3206			3086			613			299	
Approach Delay, s/veh		49.9			54.4			62.7			46.9	
Approach LOS		D			D			E			D	
Timer - Assigned Phs	1	2	3	4	5	6	7	8				
Phs Duration (G+Y+Rc), s	11.5	66.6	16.8	21.9	12.0	66.1	15.8	22.9				
Change Period (Y+Rc), s	4.1	6.2	4.1	5.8	* 4.2	6.2	5.8	* 5.8				
Max Green Setting (Gmax), s	7.4	60.4	12.7	19.3	* 7.8	59.9	10.0	* 22				
Max Q Clear Time (g_c+I1), s	8.5	62.4	13.4	8.3	9.2	61.9	6.8	16.6				
Green Ext Time (p_c), s	0.0	0.0	0.0	0.3	0.0	0.0	0.1	0.5				

Intersection Summary

HCM 6th Ctrl Delay	52.8
HCM 6th LOS	D

Notes

* HCM 6th computational engine requires equal clearance times for the phases crossing the barrier.

Timings
25: Sycamore Canyon Bl. & Cactus Av.

West Campus Upper Plateau (JN 14064)

09/20/2022



Lane Group	EBL	EBT	WBL	WBT	WBR	NBL	NBT	NBR	SBL	SBT
Lane Configurations	↖	↕↕↕	↖↖	↕↕	↖	↖↖	↕↕	↖	↖↖	↕↕↕
Traffic Volume (vph)	202	1179	1070	482	684	216	626	376	757	1303
Future Volume (vph)	202	1179	1070	482	684	216	626	376	757	1303
Turn Type	Prot	NA	Prot	NA	pm+ov	Prot	NA	pm+ov	Prot	NA
Protected Phases	7	4	3	8	1	5	2	3	1	6
Permitted Phases					8			2		
Detector Phase	7	4	3	8	1	5	2	3	1	6
Switch Phase										
Minimum Initial (s)	5.0	10.0	5.0	10.0	10.0	10.0	10.0	5.0	10.0	10.0
Minimum Split (s)	9.6	32.8	9.6	32.8	15.8	15.8	15.8	9.6	15.8	34.8
Total Split (s)	35.9	48.0	40.0	52.1	32.0	17.0	30.0	40.0	32.0	45.0
Total Split (%)	23.9%	32.0%	26.7%	34.7%	21.3%	11.3%	20.0%	26.7%	21.3%	30.0%
Yellow Time (s)	3.6	4.8	3.6	4.8	4.8	4.8	4.8	3.6	4.8	4.8
All-Red Time (s)	1.0	1.0	1.0	1.0	1.0	1.0	1.0	1.0	1.0	1.0
Lost Time Adjust (s)	0.0	0.0	0.0	0.0	0.0	0.0	0.0	0.0	0.0	0.0
Total Lost Time (s)	4.6	5.8	4.6	5.8	5.8	5.8	5.8	4.6	5.8	5.8
Lead/Lag	Lead	Lag	Lead	Lag	Lead	Lead	Lag	Lead	Lead	Lag
Lead-Lag Optimize?	Yes	Yes	Yes	Yes	Yes	Yes	Yes	Yes	Yes	Yes
Recall Mode	None	None	None	None	None	None	None	None	None	None
Act Effct Green (s)	23.2	42.2	35.4	54.4	86.4	11.2	24.2	65.4	26.2	39.2
Actuated g/C Ratio	0.15	0.28	0.24	0.36	0.58	0.07	0.16	0.44	0.17	0.26
v/c Ratio	0.81	1.43	1.46	0.43	0.76	0.93	1.22	0.57	1.36	1.17
Control Delay	83.6	235.1	255.7	38.4	25.6	108.8	164.1	26.4	217.8	131.2
Queue Delay	0.0	0.0	0.0	0.0	4.4	0.0	0.0	0.0	0.0	0.0
Total Delay	83.6	235.1	255.7	38.4	30.0	108.8	164.1	26.4	217.8	131.2
LOS	F	F	F	D	C	F	F	C	F	F
Approach Delay		219.7		139.9			111.8			162.1
Approach LOS		F		F			F			F

Intersection Summary

Cycle Length: 150
 Actuated Cycle Length: 150
 Natural Cycle: 115
 Control Type: Actuated-Uncoordinated
 Maximum v/c Ratio: 1.46
 Intersection Signal Delay: 162.7
 Intersection LOS: F
 Intersection Capacity Utilization 124.3%
 ICU Level of Service H
 Analysis Period (min) 15

Splits and Phases: 25: Sycamore Canyon Bl. & Cactus Av.

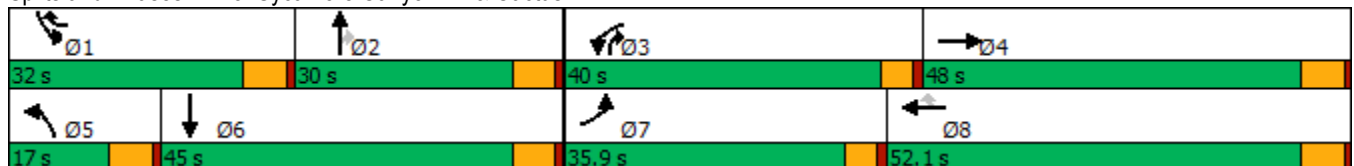

HCM 6th Signalized Intersection Summary
 25: Sycamore Canyon Bl. & Cactus Av.

West Campus Upper Plateau (JN 14064)

09/20/2022



Movement	EBL	EBT	EBR	WBL	WBT	WBR	NBL	NBT	NBR	SBL	SBT	SBR
Lane Configurations	↖	↕↕↗		↖↖	↕↕	↖	↖↖	↕↕	↖	↖↖	↕↕↗	
Traffic Volume (veh/h)	202	1179	616	1070	482	684	216	626	376	757	1303	60
Future Volume (veh/h)	202	1179	616	1070	482	684	216	626	376	757	1303	60
Initial Q (Qb), veh	0	0	0	0	0	0	0	0	0	0	0	0
Ped-Bike Adj(A_pbT)	1.00		1.00	1.00		1.00	1.00		1.00	1.00		1.00
Parking Bus, Adj	1.00	1.00	1.00	1.00	1.00	1.00	1.00	1.00	1.00	1.00	1.00	1.00
Work Zone On Approach		No			No			No			No	
Adj Sat Flow, veh/h/ln	1856	1781	1856	1841	1796	1870	1856	1841	1811	1885	1811	1767
Adj Flow Rate, veh/h	220	1282	660	1163	524	491	235	680	312	823	1416	65
Peak Hour Factor	0.92	0.92	0.92	0.92	0.92	0.92	0.92	0.92	0.92	0.92	0.92	0.92
Percent Heavy Veh, %	3	8	3	4	7	2	3	4	6	1	6	9
Cap, veh/h	243	912	425	803	1297	879	256	564	610	608	1266	58
Arrive On Green	0.14	0.28	0.28	0.24	0.38	0.38	0.07	0.16	0.16	0.17	0.26	0.26
Sat Flow, veh/h	1767	3242	1510	3401	3413	1585	3428	3497	1535	3483	4845	222
Grp Volume(v), veh/h	220	1282	660	1163	524	491	235	680	312	823	963	518
Grp Sat Flow(s),veh/h/ln	1767	1621	1510	1700	1706	1585	1714	1749	1535	1742	1648	1771
Q Serve(g_s), s	18.4	42.2	42.2	35.4	16.9	30.0	10.2	24.2	23.1	26.2	39.2	39.2
Cycle Q Clear(g_c), s	18.4	42.2	42.2	35.4	16.9	30.0	10.2	24.2	23.1	26.2	39.2	39.2
Prop In Lane	1.00		1.00	1.00		1.00	1.00		1.00	1.00		0.13
Lane Grp Cap(c), veh/h	243	912	425	803	1297	879	256	564	610	608	861	463
V/C Ratio(X)	0.91	1.41	1.55	1.45	0.40	0.56	0.92	1.21	0.51	1.35	1.12	1.12
Avail Cap(c_a), veh/h	369	912	425	803	1297	879	256	564	610	608	861	463
HCM Platoon Ratio	1.00	1.00	1.00	1.00	1.00	1.00	1.00	1.00	1.00	1.00	1.00	1.00
Upstream Filter(I)	1.00	1.00	1.00	1.00	1.00	1.00	1.00	1.00	1.00	1.00	1.00	1.00
Uniform Delay (d), s/veh	63.7	53.9	53.9	57.3	34.1	21.6	68.9	62.9	34.2	61.9	55.4	55.4
Incr Delay (d2), s/veh	13.9	189.1	260.6	209.0	0.2	0.8	35.1	108.3	0.7	169.4	68.6	78.3
Initial Q Delay(d3),s/veh	0.0	0.0	0.0	0.0	0.0	0.0	0.0	0.0	0.0	0.0	0.0	0.0
%ile BackOfQ(50%),veh/ln	9.1	40.8	46.5	38.1	6.9	10.9	5.7	19.0	8.6	25.7	24.1	27.1
Unsig. Movement Delay, s/veh												
LnGrp Delay(d),s/veh	77.6	243.0	314.5	266.3	34.3	22.4	104.1	171.2	34.9	231.3	124.0	133.7
LnGrp LOS	E	F	F	F	C	C	F	F	C	F	F	F
Approach Vol, veh/h		2162			2178			1227			2304	
Approach Delay, s/veh		248.0			155.5			123.7			164.5	
Approach LOS		F			F			F			F	
Timer - Assigned Phs	1	2	3	4	5	6	7	8				
Phs Duration (G+Y+Rc), s	32.0	30.0	40.0	48.0	17.0	45.0	25.2	62.8				
Change Period (Y+Rc), s	5.8	5.8	4.6	5.8	5.8	5.8	4.6	5.8				
Max Green Setting (Gmax), s	26.2	24.2	35.4	42.2	11.2	39.2	31.3	46.3				
Max Q Clear Time (g_c+I1), s	28.2	26.2	37.4	44.2	12.2	41.2	20.4	32.0				
Green Ext Time (p_c), s	0.0	0.0	0.0	0.0	0.0	0.0	0.2	4.4				

Intersection Summary

HCM 6th Ctrl Delay	178.6
HCM 6th LOS	F

Notes

User approved pedestrian interval to be less than phase max green.

Timings
26: Sycamore Canyon Bl. & Van Buren Bl.

West Campus Upper Plateau (JN 14064)

09/20/2022

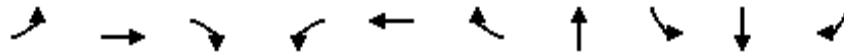

Lane Group	EBL	EBT	EBR	WBL	WBT	WBR	NBT	SBL	SBT	SBR
Lane Configurations										
Traffic Volume (vph)	681	4541	6	8	3192	153	18	1341	16	1250
Future Volume (vph)	681	4541	6	8	3192	153	18	1341	16	1250
Turn Type	Prot	NA	Perm	Prot	NA	Perm	NA	Split	NA	Perm
Protected Phases	5	2		1	6		8	4	4	
Permitted Phases			2			6				4
Detector Phase	5	2	2	1	6	6	8	4	4	4
Switch Phase										
Minimum Initial (s)	5.0	10.0	10.0	5.0	10.0	10.0	10.0	10.0	10.0	10.0
Minimum Split (s)	9.6	29.2	29.2	9.6	29.2	29.2	14.6	50.8	50.8	50.8
Total Split (s)	14.0	44.8	44.8	9.6	40.4	40.4	14.6	51.0	51.0	51.0
Total Split (%)	11.7%	37.3%	37.3%	8.0%	33.7%	33.7%	12.2%	42.5%	42.5%	42.5%
Yellow Time (s)	3.6	5.2	5.2	3.6	5.2	5.2	3.6	4.8	4.8	4.8
All-Red Time (s)	1.0	1.0	1.0	1.0	1.0	1.0	1.0	1.0	1.0	1.0
Lost Time Adjust (s)	0.0	0.0	0.0	0.0	0.0	0.0	0.0	0.0	0.0	0.0
Total Lost Time (s)	4.6	6.2	6.2	4.6	6.2	6.2	4.6	5.8	5.8	5.8
Lead/Lag	Lead	Lag	Lag	Lead	Lag	Lag				
Lead-Lag Optimize?	Yes	Yes	Yes	Yes	Yes	Yes				
Recall Mode	None	None	None	None	None	None	None	None	None	None
Act Effct Green (s)	9.4	46.3	46.3	5.0	34.2	34.2	10.0	45.2	45.2	45.2
Actuated g/C Ratio	0.08	0.39	0.39	0.04	0.28	0.28	0.08	0.38	0.38	0.38
v/c Ratio	2.70	1.75	0.01	0.14	1.68	0.32	0.29	1.10	1.22	1.04
Control Delay	797.2	366.4	0.0	60.5	339.0	14.3	32.0	95.1	140.6	69.6
Queue Delay	0.0	0.0	0.0	0.0	0.0	0.0	0.0	0.0	0.0	0.0
Total Delay	797.2	366.4	0.0	60.5	339.0	14.3	32.0	95.1	140.6	69.6
LOS	F	F	A	E	F	B	C	F	F	E
Approach Delay		422.0			323.5		32.0		100.8	
Approach LOS		F			F		C		F	

Intersection Summary

Cycle Length: 120
 Actuated Cycle Length: 120
 Natural Cycle: 115
 Control Type: Actuated-Uncoordinated
 Maximum v/c Ratio: 2.70
 Intersection Signal Delay: 315.5
 Intersection LOS: F
 Intersection Capacity Utilization 124.0%
 ICU Level of Service H
 Analysis Period (min) 15

Splits and Phases: 26: Sycamore Canyon Bl. & Van Buren Bl.

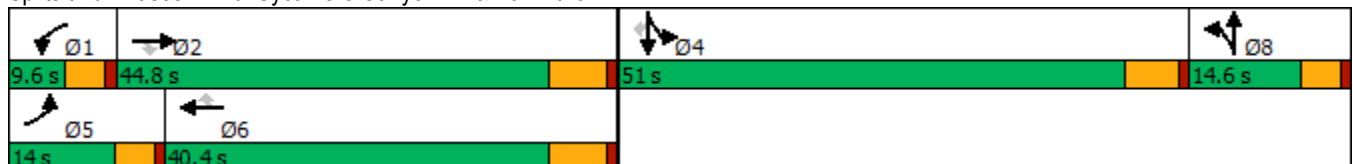

HCM 6th Signalized Intersection Summary
 26: Sycamore Canyon Bl. & Van Buren Bl.

West Campus Upper Plateau (JN 14064)

09/20/2022



Movement	EBL	EBT	EBR	WBL	WBT	WBR	NBL	NBT	NBR	SBL	SBT	SBR
Lane Configurations												
Traffic Volume (veh/h)	681	4541	6	8	3192	153	27	18	40	1341	16	1250
Future Volume (veh/h)	681	4541	6	8	3192	153	27	18	40	1341	16	1250
Initial Q (Qb), veh	0	0	0	0	0	0	0	0	0	0	0	0
Ped-Bike Adj(A_pbT)	1.00		1.00	1.00		0.99	1.00		0.99	1.00		1.00
Parking Bus, Adj	1.00	1.00	1.00	1.00	1.00	1.00	1.00	1.00	1.00	1.00	1.00	1.00
Work Zone On Approach		No			No			No			No	
Adj Sat Flow, veh/h/ln	1856	1841	1900	1663	1826	1856	1900	1900	1900	1841	1900	1856
Adj Flow Rate, veh/h	740	4936	7	9	3470	143	29	20	13	1173	0	0
Peak Hour Factor	0.92	0.92	0.92	0.92	0.92	0.92	0.92	0.92	0.92	0.92	0.92	0.92
Percent Heavy Veh, %	3	4	0	16	5	3	0	0	0	4	0	3
Cap, veh/h	289	2711	593	17	2172	462	122	88	58	1268	0	
Arrive On Green	0.08	0.37	0.37	0.01	0.30	0.30	0.07	0.07	0.07	0.36	0.00	0.00
Sat Flow, veh/h	3534	7363	1610	1584	7304	1552	1621	1174	771	3506	0	3145
Grp Volume(v), veh/h	740	4936	7	9	3470	143	33	0	29	1173	0	0
Grp Sat Flow(s),veh/h/ln	1767	1841	1610	1584	1826	1552	1819	0	1748	1753	0	1572
Q Serve(g_s), s	9.4	42.4	0.3	0.7	34.2	8.2	1.9	0.0	1.8	36.9	0.0	0.0
Cycle Q Clear(g_c), s	9.4	42.4	0.3	0.7	34.2	8.2	1.9	0.0	1.8	36.9	0.0	0.0
Prop In Lane	1.00		1.00	1.00		1.00	0.89		0.44	1.00		1.00
Lane Grp Cap(c), veh/h	289	2711	593	17	2172	462	136	0	131	1268	0	
V/C Ratio(X)	2.56	1.82	0.01	0.52	1.60	0.31	0.24	0.00	0.22	0.93	0.00	
Avail Cap(c_a), veh/h	289	2711	593	69	2172	462	158	0	152	1378	0	
HCM Platoon Ratio	1.00	1.00	1.00	1.00	1.00	1.00	1.00	1.00	1.00	1.00	1.00	1.00
Upstream Filter(I)	1.00	1.00	1.00	1.00	1.00	1.00	1.00	0.00	1.00	1.00	0.00	0.00
Uniform Delay (d), s/veh	52.8	36.3	23.1	56.6	40.4	31.3	50.1	0.0	50.1	35.2	0.0	0.0
Incr Delay (d2), s/veh	712.8	370.7	0.0	8.8	271.2	0.4	0.9	0.0	0.9	10.3	0.0	0.0
Initial Q Delay(d3),s/veh	0.0	0.0	0.0	0.0	0.0	0.0	0.0	0.0	0.0	0.0	0.0	0.0
%ile BackOfQ(50%),veh/ln	32.7	87.6	0.1	0.3	55.5	3.0	0.9	0.0	0.8	16.7	0.0	0.0
Unsig. Movement Delay, s/veh												
LnGrp Delay(d),s/veh	765.6	407.0	23.1	65.4	311.6	31.6	51.0	0.0	50.9	45.5	0.0	0.0
LnGrp LOS	F	F	C	E	F	C	D	A	D	D	A	
Approach Vol, veh/h		5683			3622			62			1173	
Approach Delay, s/veh		453.2			299.9			51.0			45.5	
Approach LOS		F			F			D			D	
Timer - Assigned Phs	1	2		4	5	6		8				
Phs Duration (G+Y+Rc), s	5.8	48.6		47.4	14.0	40.4		13.2				
Change Period (Y+Rc), s	4.6	6.2		5.8	4.6	6.2		4.6				
Max Green Setting (Gmax), s	5.0	38.6		45.2	9.4	34.2		10.0				
Max Q Clear Time (g_c+I1), s	2.7	44.4		38.9	11.4	36.2		3.9				
Green Ext Time (p_c), s	0.0	0.0		2.7	0.0	0.0		0.1				

Intersection Summary

HCM 6th Ctrl Delay	352.8
HCM 6th LOS	F

Notes

User approved volume balancing among the lanes for turning movement.
 Unsignalized Delay for [SBR] is excluded from calculations of the approach delay and intersection delay.

Timings
29: I-215 NB Ramps & Alessandro Bl.

West Campus Upper Plateau (JN 14064)

09/20/2022

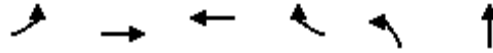

Lane Group	EBL	EBT	WBT	WBR	NBL	NBT
Lane Configurations	↶	↑↑↑	↑↑↑	↷	↶↷	↕
Traffic Volume (vph)	273	2352	1765	218	1101	15
Future Volume (vph)	273	2352	1765	218	1101	15
Turn Type	Prot	NA	NA	Perm	Split	NA
Protected Phases	5	2	6		8	8
Permitted Phases				6		
Detector Phase	5	2	6	6	8	8
Switch Phase						
Minimum Initial (s)	5.0	5.0	5.0	5.0	5.0	5.0
Minimum Split (s)	9.5	10.5	33.5	33.5	10.0	10.0
Total Split (s)	23.0	67.0	44.0	44.0	43.0	43.0
Total Split (%)	20.9%	60.9%	40.0%	40.0%	39.1%	39.1%
Yellow Time (s)	3.5	4.5	4.5	4.5	4.0	4.0
All-Red Time (s)	1.0	1.0	1.0	1.0	1.0	1.0
Lost Time Adjust (s)	0.0	0.0	0.0	0.0	0.0	0.0
Total Lost Time (s)	4.5	5.5	5.5	5.5	5.0	5.0
Lead/Lag	Lead		Lag	Lag		
Lead-Lag Optimize?	Yes		Yes	Yes		
Recall Mode	None	Min	Min	Min	Max	Max
Act Effct Green (s)	18.5	61.5	38.5	38.5	38.0	38.0
Actuated g/C Ratio	0.17	0.56	0.35	0.35	0.35	0.35
v/c Ratio	1.11	0.88	1.08	0.42	0.97	1.25
Control Delay	131.9	25.8	80.3	22.1	56.2	160.1
Queue Delay	0.0	0.5	0.0	0.0	0.0	0.0
Total Delay	131.9	26.3	80.3	22.1	56.2	160.1
LOS	F	C	F	C	E	F
Approach Delay		37.3	73.9			94.9
Approach LOS		D	E			F

Intersection Summary

Cycle Length: 110	
Actuated Cycle Length: 110	
Natural Cycle: 120	
Control Type: Actuated-Uncoordinated	
Maximum v/c Ratio: 1.25	
Intersection Signal Delay: 63.7	Intersection LOS: E
Intersection Capacity Utilization 91.7%	ICU Level of Service F
Analysis Period (min) 15	

Splits and Phases: 29: I-215 NB Ramps & Alessandro Bl.



HCM 6th Signalized Intersection Summary
 29: I-215 NB Ramps & Alessandro Bl.

West Campus Upper Plateau (JN 14064)

09/20/2022



Movement	EBL	EBT	EBR	WBL	WBT	WBR	NBL	NBT	NBR	SBL	SBT	SBR
Lane Configurations	↘	↑↑↑			↑↑↑	↗	↘↗	↕				
Traffic Volume (veh/h)	273	2352	0	0	1765	218	1101	15	462	0	0	0
Future Volume (veh/h)	273	2352	0	0	1765	218	1101	15	462	0	0	0
Initial Q (Qb), veh	0	0	0	0	0	0	0	0	0			
Ped-Bike Adj(A_pbT)	1.00		1.00	1.00		0.98	1.00		1.00			
Parking Bus, Adj	1.00	1.00	1.00	1.00	1.00	1.00	1.00	1.00	1.00			
Work Zone On Approach		No			No			No				
Adj Sat Flow, veh/h/ln	1663	1870	0	0	1841	1781	1841	1900	1826			
Adj Flow Rate, veh/h	290	2502	0	0	1878	205	1116	93	405			
Peak Hour Factor	0.94	0.94	0.94	0.94	0.94	0.94	0.94	0.94	0.94			
Percent Heavy Veh, %	16	2	0	0	4	8	4	0	5			
Cap, veh/h	266	2855	0	0	1759	517	1211	107	466			
Arrive On Green	0.17	0.56	0.00	0.00	0.35	0.35	0.35	0.35	0.35			
Sat Flow, veh/h	1584	5274	0	0	5191	1478	3506	310	1348			
Grp Volume(v), veh/h	290	2502	0	0	1878	205	1116	0	498			
Grp Sat Flow(s),veh/h/ln	1584	1702	0	0	1675	1478	1753	0	1657			
Q Serve(g_s), s	18.5	46.6	0.0	0.0	38.5	11.5	33.6	0.0	30.9			
Cycle Q Clear(g_c), s	18.5	46.6	0.0	0.0	38.5	11.5	33.6	0.0	30.9			
Prop In Lane	1.00		0.00	0.00		1.00	1.00		0.81			
Lane Grp Cap(c), veh/h	266	2855	0	0	1759	517	1211	0	573			
V/C Ratio(X)	1.09	0.88	0.00	0.00	1.07	0.40	0.92	0.00	0.87			
Avail Cap(c_a), veh/h	266	2855	0	0	1759	517	1211	0	573			
HCM Platoon Ratio	1.00	1.00	1.00	1.00	1.00	1.00	1.00	1.00	1.00			
Upstream Filter(I)	1.00	1.00	0.00	0.00	1.00	1.00	1.00	0.00	1.00			
Uniform Delay (d), s/veh	45.7	21.0	0.0	0.0	35.8	27.0	34.6	0.0	33.7			
Incr Delay (d2), s/veh	80.9	3.4	0.0	0.0	42.2	0.5	12.8	0.0	16.4			
Initial Q Delay(d3),s/veh	0.0	0.0	0.0	0.0	0.0	0.0	0.0	0.0	0.0			
%ile BackOfQ(50%),veh/ln	12.8	16.4	0.0	0.0	21.1	3.8	15.8	0.0	14.5			
Unsig. Movement Delay, s/veh												
LnGrp Delay(d),s/veh	126.6	24.4	0.0	0.0	77.9	27.5	47.4	0.0	50.1			
LnGrp LOS	F	C	A	A	F	C	D	A	D			
Approach Vol, veh/h		2792			2083			1614				
Approach Delay, s/veh		35.0			72.9			48.2				
Approach LOS		C			E			D				
Timer - Assigned Phs		2			5	6		8				
Phs Duration (G+Y+Rc), s		67.0			23.0	44.0		43.0				
Change Period (Y+Rc), s		5.5			4.5	5.5		5.0				
Max Green Setting (Gmax), s		61.5			18.5	38.5		38.0				
Max Q Clear Time (g_c+I1), s		48.6			20.5	40.5		35.6				
Green Ext Time (p_c), s		11.1			0.0	0.0		1.7				

Intersection Summary

HCM 6th Ctrl Delay	50.5
HCM 6th LOS	D

Notes

User approved volume balancing among the lanes for turning movement.

Timings
30: I-215 SB Ramps & Cactus Av.

West Campus Upper Plateau (JN 14064)

09/20/2022



Lane Group	EBT	EBR	WBL	WBT	NBR	SBR
Lane Configurations	↑↑↑	↑	↓	↑↑↑	↑	↑
Traffic Volume (vph)	2017	480	936	1522	877	632
Future Volume (vph)	2017	480	936	1522	877	632
Turn Type	NA	Perm	Prot	NA	Prot	Prot
Protected Phases	2		1	6	8	4
Permitted Phases		2				
Detector Phase	2	2	1	6	8	4
Switch Phase						
Minimum Initial (s)	5.0	5.0	5.0	5.0	5.0	5.0
Minimum Split (s)	11.0	11.0	9.5	23.0	9.1	9.5
Total Split (s)	39.0	39.0	42.0	81.0	29.0	29.0
Total Split (%)	35.5%	35.5%	38.2%	73.6%	26.4%	26.4%
Yellow Time (s)	5.0	5.0	3.5	5.0	3.6	3.5
All-Red Time (s)	1.0	1.0	1.0	1.0	0.5	1.0
Lost Time Adjust (s)	0.0	0.0	0.0	0.0	0.0	0.0
Total Lost Time (s)	6.0	6.0	4.5	6.0	4.1	4.5
Lead/Lag	Lag	Lag	Lead			
Lead-Lag Optimize?	Yes	Yes	Yes			
Recall Mode	Min	Min	None	Min	None	None
Act Effct Green (s)	33.0	33.0	37.5	75.0	24.9	24.5
Actuated g/C Ratio	0.30	0.30	0.34	0.68	0.23	0.22
v/c Ratio	1.43	0.73	1.62	0.46	1.16	1.72
Control Delay	230.0	18.3	313.4	8.7	99.7	360.3
Queue Delay	0.0	0.0	0.0	0.0	0.0	0.0
Total Delay	230.0	18.3	313.4	8.7	99.7	360.3
LOS	F	B	F	A	F	F
Approach Delay	189.3			124.7		
Approach LOS	F			F		

Intersection Summary

Cycle Length: 110
 Actuated Cycle Length: 110
 Natural Cycle: 120
 Control Type: Actuated-Uncoordinated
 Maximum v/c Ratio: 1.72
 Intersection Signal Delay: 169.3
 Intersection LOS: F
 Intersection Capacity Utilization 101.7%
 ICU Level of Service G
 Analysis Period (min) 15

Splits and Phases: 30: I-215 SB Ramps & Cactus Av.

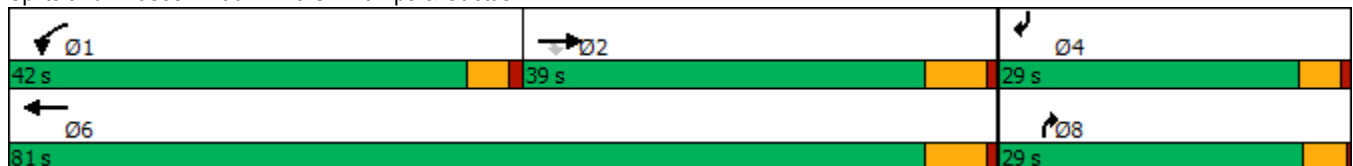

HCM 6th Signalized Intersection Summary
 30: I-215 SB Ramps & Cactus Av.

West Campus Upper Plateau (JN 14064)

09/20/2022



Movement	EBL	EBT	EBR	WBL	WBT	WBR	NBL	NBT	NBR	SBL	SBT	SBR
Lane Configurations		↑↑↑	↗	↘	↑↑↑				↗			↗
Traffic Volume (veh/h)	0	2017	480	936	1522	0	0	0	877	0	0	632
Future Volume (veh/h)	0	2017	480	936	1522	0	0	0	877	0	0	632
Initial Q (Qb), veh	0	0	0	0	0	0	0	0	0	0	0	0
Ped-Bike Adj(A_pbT)	1.00		1.00	1.00		1.00	1.00		1.00	1.00		1.00
Parking Bus, Adj	1.00	1.00	1.00	1.00	1.00	1.00	1.00	1.00	1.00	1.00	1.00	1.00
Work Zone On Approach		No			No			No			No	
Adj Sat Flow, veh/h/ln	0	1826	1811	1885	1870	0	0	0	1811	0	0	1737
Adj Flow Rate, veh/h	0	2123	477	985	1602	0	0	0	0	0	0	560
Peak Hour Factor	0.95	0.95	0.95	0.95	0.95	0.95	0.95	0.95	0.95	0.95	0.95	0.95
Percent Heavy Veh, %	0	5	6	1	2	0	0	0	6	0	0	11
Cap, veh/h	0	2031	625	831	4728	0	0	0	0	0	0	0
Arrive On Green	0.00	0.41	0.41	0.46	0.93	0.00	0.00	0.00	0.00	0.00	0.00	0.00
Sat Flow, veh/h	0	5149	1535	1795	5274	0		0			0	
Grp Volume(v), veh/h	0	2123	477	985	1602	0		0.0			0.0	
Grp Sat Flow(s),veh/h/ln	0	1662	1535	1795	1702	0						
Q Serve(g_s), s	0.0	33.0	21.6	37.5	2.7	0.0						
Cycle Q Clear(g_c), s	0.0	33.0	21.6	37.5	2.7	0.0						
Prop In Lane	0.00		1.00	1.00		0.00						
Lane Grp Cap(c), veh/h	0	2031	625	831	4728	0						
V/C Ratio(X)	0.00	1.05	0.76	1.19	0.34	0.00						
Avail Cap(c_a), veh/h	0	2031	625	831	4728	0						
HCM Platoon Ratio	1.00	1.00	1.00	1.00	1.00	1.00						
Upstream Filter(I)	0.00	1.00	1.00	1.00	1.00	0.00						
Uniform Delay (d), s/veh	0.0	24.0	20.6	21.8	0.3	0.0						
Incr Delay (d2), s/veh	0.0	33.0	5.0	95.4	0.0	0.0						
Initial Q Delay(d3),s/veh	0.0	0.0	0.0	0.0	0.0	0.0						
%ile BackOfQ(50%),veh/ln	0.0	17.4	7.6	35.2	0.0	0.0						
Unsig. Movement Delay, s/veh												
LnGrp Delay(d),s/veh	0.0	57.0	25.6	117.1	0.3	0.0						
LnGrp LOS	A	F	C	F	A	A						
Approach Vol, veh/h		2600			2587							
Approach Delay, s/veh		51.3			44.8							
Approach LOS		D			D							
Timer - Assigned Phs	1	2			6							
Phs Duration (G+Y+Rc), s	42.0	39.0			81.0							
Change Period (Y+Rc), s	4.5	6.0			6.0							
Max Green Setting (Gmax), s	37.5	33.0			75.0							
Max Q Clear Time (g_c+1), s	39.5	35.0			4.7							
Green Ext Time (p_c), s	0.0	0.0			9.5							

Intersection Summary

HCM 6th Ctrl Delay	48.1
HCM 6th LOS	D

Notes

Unsignalized Delay for [NBR] is excluded from calculations of the approach delay and intersection delay.

Timings

31: I-215 NB Ramps/Old 215 Frontage Rd. & Cactus Av.



Lane Group	EBL	EBT	EBR	WBT	NBL	NBT	NBR	SBL	SBT
Lane Configurations	↘	↑↑↑	↗	↑↑↑	↘↗	↗	↗	↘	↗
Traffic Volume (vph)	122	2270	870	2926	438	298	100	227	3
Future Volume (vph)	122	2270	870	2926	438	298	100	227	3
Turn Type	Perm	NA	Perm	NA	Prot	NA	Free	Perm	NA
Protected Phases		2		6	3	8			4
Permitted Phases	2		2				Free	4	
Detector Phase	2	2	2	6	3	8		4	4
Switch Phase									
Minimum Initial (s)	5.0	5.0	5.0	5.0	5.0	5.0		5.0	5.0
Minimum Split (s)	11.0	11.0	11.0	44.0	9.1	10.5		10.5	10.5
Total Split (s)	73.0	73.0	73.0	73.0	20.0	47.0		27.0	27.0
Total Split (%)	60.8%	60.8%	60.8%	60.8%	16.7%	39.2%		22.5%	22.5%
Yellow Time (s)	5.0	5.0	5.0	5.0	3.6	4.5		4.5	4.5
All-Red Time (s)	1.0	1.0	1.0	1.0	0.5	1.0		1.0	1.0
Lost Time Adjust (s)	0.0	0.0	0.0	0.0	0.0	0.0		0.0	0.0
Total Lost Time (s)	6.0	6.0	6.0	6.0	4.1	5.5		5.5	5.5
Lead/Lag					Lead			Lag	Lag
Lead-Lag Optimize?					Yes			Yes	Yes
Recall Mode	Min	Min	Min	Min	None	None		None	None
Act Effct Green (s)	67.0	67.0	67.0	67.0	15.9	41.5	120.0	21.5	21.5
Actuated g/C Ratio	0.56	0.56	0.56	0.56	0.13	0.35	1.00	0.18	0.18
v/c Ratio	2.08	0.85	0.77	0.93	1.03	0.53	0.06	1.30	0.85
Control Delay	559.4	26.1	7.9	30.4	102.6	35.3	0.1	207.9	73.3
Queue Delay	0.0	0.0	0.0	0.0	0.0	0.0	0.0	0.0	0.0
Total Delay	559.4	26.1	7.9	30.4	102.6	35.3	0.1	207.9	73.3
LOS	F	C	A	C	F	D	A	F	E
Approach Delay		41.2		30.4		66.8			139.5
Approach LOS		D		C		E			F

Intersection Summary

Cycle Length: 120
 Actuated Cycle Length: 120
 Natural Cycle: 75
 Control Type: Actuated-Uncoordinated
 Maximum v/c Ratio: 2.08
 Intersection Signal Delay: 45.4
 Intersection LOS: D
 Intersection Capacity Utilization 102.3%
 ICU Level of Service G
 Analysis Period (min) 15

Splits and Phases: 31: I-215 NB Ramps/Old 215 Frontage Rd. & Cactus Av.

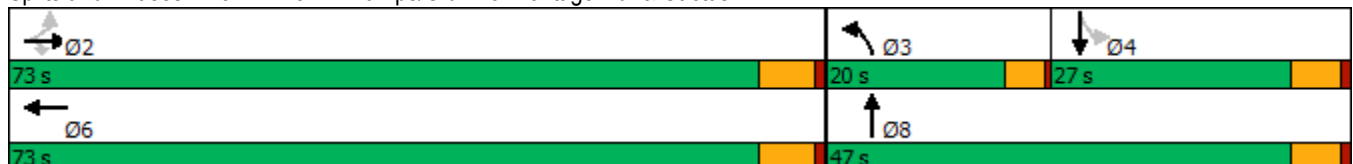

HCM 6th Signalized Intersection Summary

West Campus Upper Plateau (JN 14064)

31: I-215 NB Ramps/Old 215 Frontage Rd. & Cactus Av.

09/20/2022



Movement	EBL	EBT	EBR	WBL	WBT	WBR	NBL	NBT	NBR	SBL	SBT	SBR
Lane Configurations												
Traffic Volume (veh/h)	122	2270	870	0	2926	218	438	298	100	227	3	231
Future Volume (veh/h)	122	2270	870	0	2926	218	438	298	100	227	3	231
Initial Q (Qb), veh	0	0	0	0	0	0	0	0	0	0	0	0
Ped-Bike Adj(A_pbT)	1.00		1.00	1.00		1.00	1.00		1.00	1.00		1.00
Parking Bus, Adj	1.00	1.00	1.00	1.00	1.00	1.00	1.00	1.00	1.00	1.00	1.00	1.00
Work Zone On Approach		No			No			No			No	
Adj Sat Flow, veh/h/ln	1856	1841	1767	0	1856	1885	1826	1856	1870	1841	1900	1885
Adj Flow Rate, veh/h	127	2365	902	0	3048	179	456	310	0	236	3	215
Peak Hour Factor	0.96	0.96	0.96	0.96	0.96	0.96	0.96	0.96	0.96	0.96	0.96	0.96
Percent Heavy Veh, %	3	4	9	0	3	1	5	3	2	4	0	1
Cap, veh/h	68	2806	836	0	3471	201	461	642		249	4	285
Arrive On Green	0.56	0.56	0.56	0.00	0.56	0.56	0.13	0.35	0.00	0.18	0.18	0.18
Sat Flow, veh/h	62	5025	1497	0	6476	361	3478	1856	1585	1052	22	1591
Grp Volume(v), veh/h	127	2365	902	0	2339	888	456	310	0	236	0	218
Grp Sat Flow(s),veh/h/ln	62	1675	1497	0	1596	1790	1739	1856	1585	1052	0	1614
Q Serve(g_s), s	14.8	47.1	67.0	0.0	50.6	52.2	15.7	15.7	0.0	21.5	0.0	15.4
Cycle Q Clear(g_c), s	67.0	47.1	67.0	0.0	50.6	52.2	15.7	15.7	0.0	21.5	0.0	15.4
Prop In Lane	1.00		1.00	0.00		0.20	1.00		1.00	1.00		0.99
Lane Grp Cap(c), veh/h	68	2806	836	0	2673	999	461	642		249	0	289
V/C Ratio(X)	1.88	0.84	1.08	0.00	0.88	0.89	0.99	0.48		0.95	0.00	0.75
Avail Cap(c_a), veh/h	68	2806	836	0	2673	999	461	642		249	0	289
HCM Platoon Ratio	1.00	1.00	1.00	1.00	1.00	1.00	1.00	1.00	1.00	1.00	1.00	1.00
Upstream Filter(I)	1.00	1.00	1.00	0.00	1.00	1.00	1.00	1.00	0.00	1.00	0.00	1.00
Uniform Delay (d), s/veh	59.2	22.1	26.5	0.0	22.9	23.2	52.0	30.8	0.0	51.4	0.0	46.7
Incr Delay (d2), s/veh	444.6	2.4	54.7	0.0	3.4	9.6	39.1	0.2	0.0	42.8	0.0	9.6
Initial Q Delay(d3),s/veh	0.0	0.0	0.0	0.0	0.0	0.0	0.0	0.0	0.0	0.0	0.0	0.0
%ile BackOfQ(50%),veh/ln	10.4	17.2	33.8	0.0	17.8	22.3	9.2	6.8	0.0	9.9	0.0	6.7
Unsig. Movement Delay, s/veh												
LnGrp Delay(d),s/veh	503.8	24.5	81.2	0.0	26.3	32.8	91.0	31.0	0.0	94.2	0.0	56.4
LnGrp LOS	F	C	F	A	C	C	F	C		F	A	E
Approach Vol, veh/h		3394			3227			766				454
Approach Delay, s/veh		57.5			28.1			66.8				76.0
Approach LOS		E			C			E				E
Timer - Assigned Phs		2	3	4		6		8				
Phs Duration (G+Y+Rc), s		73.0	20.0	27.0		73.0		47.0				
Change Period (Y+Rc), s		6.0	4.1	5.5		6.0		5.5				
Max Green Setting (Gmax), s		67.0	15.9	21.5		67.0		41.5				
Max Q Clear Time (g_c+I1), s		69.0	17.7	23.5		54.2		17.7				
Green Ext Time (p_c), s		0.0	0.0	0.0		10.9		1.0				

Intersection Summary

HCM 6th Ctrl Delay	47.4
HCM 6th LOS	D

Notes

User approved volume balancing among the lanes for turning movement.
 Unsignalized Delay for [NBR] is excluded from calculations of the approach delay and intersection delay.

Timings
32: I-215 SB Ramps & Van Buren Bl.

West Campus Upper Plateau (JN 14064)

09/20/2022

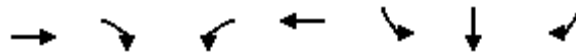

Lane Group	EBT	EBR	WBL	WBT	SBL	SBT	SBR
Lane Configurations	↑↑↑	↑	↵	↑↑↑	↵	↕	↵
Traffic Volume (vph)	1655	2856	214	1789	618	136	869
Future Volume (vph)	1655	2856	214	1789	618	136	869
Turn Type	NA	Perm	Prot	NA	Split	NA	Perm
Protected Phases	6		5	2	8	8	
Permitted Phases		6					8
Detector Phase	6	6	5	2	8	8	8
Switch Phase							
Minimum Initial (s)	5.0	5.0	5.0	5.0	5.0	5.0	5.0
Minimum Split (s)	36.0	36.0	11.0	11.0	11.0	11.0	11.0
Total Split (s)	78.0	78.0	15.0	93.0	27.0	27.0	27.0
Total Split (%)	65.0%	65.0%	12.5%	77.5%	22.5%	22.5%	22.5%
Yellow Time (s)	5.0	5.0	5.0	5.0	5.0	5.0	5.0
All-Red Time (s)	1.0	1.0	1.0	1.0	1.0	1.0	1.0
Lost Time Adjust (s)	0.0	0.0	0.0	0.0	0.0	0.0	0.0
Total Lost Time (s)	6.0	6.0	6.0	6.0	6.0	6.0	6.0
Lead/Lag	Lag	Lag	Lead				
Lead-Lag Optimize?	Yes	Yes	Yes				
Recall Mode	None	None	None	None	None	None	None
Act Effct Green (s)	72.0	72.0	9.0	87.0	21.0	21.0	21.0
Actuated g/C Ratio	0.60	0.60	0.08	0.72	0.18	0.18	0.18
v/c Ratio	0.61	2.94	1.72	0.54	2.01	2.13	1.82
Control Delay	16.3	889.3	385.3	8.1	495.0	547.2	409.2
Queue Delay	0.0	0.0	0.0	0.0	0.0	0.0	0.0
Total Delay	16.3	889.3	385.3	8.1	495.0	547.2	409.2
LOS	B	F	F	A	F	F	F
Approach Delay	569.0			48.4		485.0	
Approach LOS	F			D		F	

Intersection Summary

Cycle Length: 120
 Actuated Cycle Length: 120
 Natural Cycle: 120
 Control Type: Actuated-Uncoordinated
 Maximum v/c Ratio: 2.94
 Intersection Signal Delay: 424.1
 Intersection LOS: F
 Intersection Capacity Utilization 229.4%
 ICU Level of Service H
 Analysis Period (min) 15













Splits and Phases: 32: I-215 SB Ramps & Van Buren Bl.



HCM 6th Signalized Intersection Summary
32: I-215 SB Ramps & Van Buren Bl.

West Campus Upper Plateau (JN 14064)

09/20/2022

												
Movement	EBL	EBT	EBR	WBL	WBT	WBR	NBL	NBT	NBR	SBL	SBT	SBR
Lane Configurations		↑↑↑	↗	↖	↑↑↑					↖	↕	↗
Traffic Volume (veh/h)	0	1655	2856	214	1789	0	0	0	0	618	136	869
Future Volume (veh/h)	0	1655	2856	214	1789	0	0	0	0	618	136	869
Initial Q (Qb), veh	0	0	0	0	0	0				0	0	0
Ped-Bike Adj(A_pbT)	1.00		1.00	1.00		1.00				1.00		1.00
Parking Bus, Adj	1.00	1.00	1.00	1.00	1.00	1.00				1.00	1.00	1.00
Work Zone On Approach		No			No						No	
Adj Sat Flow, veh/h/ln	0	1796	1856	1885	1826	0				1885	1856	1722
Adj Flow Rate, veh/h	0	1780	0	230	1924	0				492	0	0
Peak Hour Factor	0.93	0.93	0.93	0.93	0.93	0.93				0.93	0.93	0.93
Percent Heavy Veh, %	0	7	3	1	5	0				1	3	12
Cap, veh/h	0	2209		185	3102	0				432	0	
Arrive On Green	0.00	0.45	0.00	0.10	0.62	0.00				0.24	0.00	0.00
Sat Flow, veh/h	0	5065	1572	1795	5149	0				1795	0	2919
Grp Volume(v), veh/h	0	1780	0	230	1924	0				492	0	0
Grp Sat Flow(s),veh/h/ln	0	1635	1572	1795	1662	0				1795	0	1459
Q Serve(g_s), s	0.0	27.4	0.0	9.0	20.7	0.0				21.0	0.0	0.0
Cycle Q Clear(g_c), s	0.0	27.4	0.0	9.0	20.7	0.0				21.0	0.0	0.0
Prop In Lane	0.00		1.00	1.00		0.00				1.00		1.00
Lane Grp Cap(c), veh/h	0	2209		185	3102	0				432	0	
V/C Ratio(X)	0.00	0.81		1.24	0.62	0.00				1.14	0.00	
Avail Cap(c_a), veh/h	0	4042		185	4965	0				432	0	
HCM Platoon Ratio	1.00	1.00	1.00	1.00	1.00	1.00				1.00	1.00	1.00
Upstream Filter(I)	0.00	1.00	0.00	1.00	1.00	0.00				1.00	0.00	0.00
Uniform Delay (d), s/veh	0.0	20.7	0.0	39.2	10.2	0.0				33.2	0.0	0.0
Incr Delay (d2), s/veh	0.0	0.3	0.0	146.6	0.1	0.0				87.4	0.0	0.0
Initial Q Delay(d3),s/veh	0.0	0.0	0.0	0.0	0.0	0.0				0.0	0.0	0.0
%ile BackOfQ(50%),veh/ln	0.0	8.7	0.0	11.2	5.6	0.0				18.9	0.0	0.0
Unsig. Movement Delay, s/veh												
LnGrp Delay(d),s/veh	0.0	21.0	0.0	185.8	10.2	0.0				120.6	0.0	0.0
LnGrp LOS	A	C		F	B	A				F	A	
Approach Vol, veh/h		1780			2154						492	
Approach Delay, s/veh		21.0			29.0						120.6	
Approach LOS		C			C						F	
Timer - Assigned Phs		2			5	6			8			
Phs Duration (G+Y+Rc), s		60.3			15.0	45.3			27.0			
Change Period (Y+Rc), s		6.0			6.0	6.0			6.0			
Max Green Setting (Gmax), s		87.0			9.0	72.0			21.0			
Max Q Clear Time (g_c+I1), s		22.7			11.0	29.4			23.0			
Green Ext Time (p_c), s		12.7			0.0	10.0			0.0			

Intersection Summary

HCM 6th Ctrl Delay	35.9
HCM 6th LOS	D

Notes

User approved volume balancing among the lanes for turning movement.
Unsignalized Delay for [EBR, SBR] is excluded from calculations of the approach delay and intersection delay.

Timings

West Campus Upper Plateau (JN 14064)

34: Old 215 Frontage Rd. & Alessandro Bl.

09/20/2022

Lane Group	EBL	EBT	EBR	WBL	WBT	WBR	NBL	NBT	NBR	SBL	SBT	SBR
Lane Configurations												
Traffic Volume (vph)	463	2199	134	17	1573	299	48	247	19	322	283	313
Future Volume (vph)	463	2199	134	17	1573	299	48	247	19	322	283	313
Turn Type	Prot	NA	Perm	Prot	NA	Perm	Prot	NA	Perm	Prot	NA	Perm
Protected Phases	5	2		1	6		3	8		7	4	
Permitted Phases			2			6			8			4
Detector Phase	5	2	2	1	6	6	3	8	8	7	4	4
Switch Phase												
Minimum Initial (s)	5.0	10.0	10.0	5.0	10.0	10.0	5.0	10.0	10.0	5.0	10.0	10.0
Minimum Split (s)	8.7	43.5	43.5	8.7	15.8	15.8	8.7	16.2	16.2	8.7	40.2	40.2
Total Split (s)	23.0	62.4	62.4	8.7	48.1	48.1	8.7	17.9	17.9	31.0	40.2	40.2
Total Split (%)	19.2%	52.0%	52.0%	7.3%	40.1%	40.1%	7.3%	14.9%	14.9%	25.8%	33.5%	33.5%
Yellow Time (s)	3.2	5.5	5.5	3.2	4.8	4.8	3.2	5.2	5.2	3.2	5.2	5.2
All-Red Time (s)	0.5	1.0	1.0	0.5	1.0	1.0	0.5	1.0	1.0	0.5	1.0	1.0
Lost Time Adjust (s)	0.0	0.0	0.0	0.0	0.0	0.0	0.0	0.0	0.0	0.0	0.0	0.0
Total Lost Time (s)	3.7	6.5	6.5	3.7	5.8	5.8	3.7	6.2	6.2	3.7	6.2	6.2
Lead/Lag	Lead	Lag	Lag	Lead	Lag	Lag	Lead	Lag	Lag	Lead	Lag	Lag
Lead-Lag Optimize?	Yes	Yes	Yes	Yes	Yes	Yes	Yes	Yes	Yes	Yes	Yes	Yes
Recall Mode	None	None	None	None	None	None	None	None	None	None	None	None
Act Effct Green (s)	18.5	59.6	59.6	5.0	41.4	41.4	5.0	11.4	11.4	24.3	32.6	32.6
Actuated g/C Ratio	0.16	0.52	0.52	0.04	0.36	0.36	0.04	0.10	0.10	0.21	0.28	0.28
v/c Ratio	0.88	0.84	0.18	0.25	0.88	0.40	0.39	0.73	0.07	0.88	0.31	0.52
Control Delay	66.7	28.8	4.1	64.8	41.6	4.6	65.3	64.5	0.5	69.4	34.3	8.6
Queue Delay	0.0	0.0	0.0	0.0	0.0	0.0	0.0	0.0	0.0	0.0	0.0	0.0
Total Delay	66.7	28.8	4.1	64.8	41.6	4.6	65.3	64.5	0.5	69.4	34.3	8.6
LOS	E	C	A	E	D	A	E	E	A	E	C	A
Approach Delay		33.9			36.0			60.8			37.9	
Approach LOS		C			D			E			D	

Intersection Summary

Cycle Length: 120
 Actuated Cycle Length: 115.1
 Natural Cycle: 115
 Control Type: Actuated-Uncoordinated
 Maximum v/c Ratio: 0.88
 Intersection Signal Delay: 36.6
 Intersection LOS: D
 Intersection Capacity Utilization 90.1%
 ICU Level of Service E
 Analysis Period (min) 15

Splits and Phases: 34: Old 215 Frontage Rd. & Alessandro Bl.



HCM 6th Signalized Intersection Summary
 34: Old 215 Frontage Rd. & Alessandro Bl.

West Campus Upper Plateau (JN 14064)

09/20/2022



Movement	EBL	EBT	EBR	WBL	WBT	WBR	NBL	NBT	NBR	SBL	SBT	SBR
Lane Configurations	↔↔	↑↑↑	↔	↔	↑↑↑	↔	↔↔	↑↑	↔	↔	↑↑	↔
Traffic Volume (veh/h)	463	2199	134	17	1573	299	48	247	19	322	283	313
Future Volume (veh/h)	463	2199	134	17	1573	299	48	247	19	322	283	313
Initial Q (Qb), veh	0	0	0	0	0	0	0	0	0	0	0	0
Ped-Bike Adj(A_pbT)	1.00		0.99	1.00		1.00	1.00		0.98	1.00		1.00
Parking Bus, Adj	1.00	1.00	1.00	1.00	1.00	1.00	1.00	1.00	1.00	1.00	1.00	1.00
Work Zone On Approach		No			No			No			No	
Adj Sat Flow, veh/h/ln	1826	1885	1678	1678	1870	1885	1574	1856	1574	1870	1752	1693
Adj Flow Rate, veh/h	472	2244	110	17	1605	0	49	252	9	329	289	0
Peak Hour Factor	0.98	0.98	0.98	0.98	0.98	0.98	0.98	0.98	0.98	0.98	0.98	0.98
Percent Heavy Veh, %	5	1	15	15	2	1	22	3	22	2	10	14
Cap, veh/h	532	2593	708	29	1861		103	323	120	359	858	
Arrive On Green	0.16	0.50	0.50	0.02	0.36	0.00	0.04	0.09	0.09	0.20	0.26	0.00
Sat Flow, veh/h	3374	5147	1404	1598	5106	1598	2908	3526	1311	1781	3328	1434
Grp Volume(v), veh/h	472	2244	110	17	1605	0	49	252	9	329	289	0
Grp Sat Flow(s),veh/h/ln	1687	1716	1404	1598	1702	1598	1454	1763	1311	1781	1664	1434
Q Serve(g_s), s	14.9	41.8	4.6	1.2	31.8	0.0	1.8	7.6	0.7	19.7	7.7	0.0
Cycle Q Clear(g_c), s	14.9	41.8	4.6	1.2	31.8	0.0	1.8	7.6	0.7	19.7	7.7	0.0
Prop In Lane	1.00		1.00	1.00		1.00	1.00		1.00	1.00		1.00
Lane Grp Cap(c), veh/h	532	2593	708	29	1861		103	323	120	359	858	
V/C Ratio(X)	0.89	0.87	0.16	0.58	0.86		0.48	0.78	0.07	0.92	0.34	
Avail Cap(c_a), veh/h	597	2639	720	73	1982		133	378	141	446	1038	
HCM Platoon Ratio	1.00	1.00	1.00	1.00	1.00	1.00	1.00	1.00	1.00	1.00	1.00	1.00
Upstream Filter(I)	1.00	1.00	1.00	1.00	1.00	0.00	1.00	1.00	1.00	1.00	1.00	0.00
Uniform Delay (d), s/veh	44.9	23.8	14.6	53.1	32.1	0.0	51.6	48.4	45.3	42.6	32.9	0.0
Incr Delay (d2), s/veh	13.0	3.2	0.1	6.4	4.0	0.0	1.3	8.6	0.3	18.9	0.2	0.0
Initial Q Delay(d3),s/veh	0.0	0.0	0.0	0.0	0.0	0.0	0.0	0.0	0.0	0.0	0.0	0.0
%ile BackOfQ(50%),veh/ln	6.9	15.4	1.4	0.5	12.9	0.0	0.7	3.6	0.2	10.1	3.0	0.0
Unsig. Movement Delay, s/veh												
LnGrp Delay(d),s/veh	57.9	27.0	14.7	59.5	36.1	0.0	52.8	57.0	45.5	61.6	33.1	0.0
LnGrp LOS	E	C	B	E	D		D	E	D	E	C	
Approach Vol, veh/h		2826			1622			310			618	
Approach Delay, s/veh		31.7			36.3			56.0			48.3	
Approach LOS		C			D			E			D	
Timer - Assigned Phs	1	2	3	4	5	6	7	8				
Phs Duration (G+Y+Rc), s	5.7	61.4	7.6	34.3	20.9	46.2	25.7	16.2				
Change Period (Y+Rc), s	3.7	6.5	3.7	6.2	3.7	* 6.5	3.7	6.2				
Max Green Setting (Gmax), s	5.0	55.9	5.0	34.0	19.3	* 42	27.3	11.7				
Max Q Clear Time (g_c+I1), s	3.2	43.8	3.8	9.7	16.9	33.8	21.7	9.6				
Green Ext Time (p_c), s	0.0	10.0	0.0	1.6	0.3	6.0	0.2	0.3				

Intersection Summary

HCM 6th Ctrl Delay	36.4
HCM 6th LOS	D

Notes

* HCM 6th computational engine requires equal clearance times for the phases crossing the barrier.
 Unsignalized Delay for [WBR, SBR] is excluded from calculations of the approach delay and intersection delay.

Timings
35: Day St. & Alessandro Bl.

West Campus Upper Plateau (JN 14064)

09/20/2022



Lane Group	EBL	EBT	EBR	WBL	WBT	WBR	NBL	NBT	NBR	SBL	SBT
Lane Configurations	↘	↑↑↑	↗	↘	↑↑↑	↗	↘	↑	↗	↘	↗
Traffic Volume (vph)	328	2121	79	36	1653	251	76	214	32	288	186
Future Volume (vph)	328	2121	79	36	1653	251	76	214	32	288	186
Turn Type	Prot	NA	Perm	Prot	NA	Perm	Perm	NA	Perm	Perm	NA
Protected Phases	5	2		1	6			8			4
Permitted Phases			2			6	8		8	4	
Detector Phase	5	2	2	1	6	6	8	8	8	4	4
Switch Phase											
Minimum Initial (s)	5.0	10.0	10.0	5.0	10.0	10.0	10.0	10.0	10.0	10.0	10.0
Minimum Split (s)	9.1	30.8	30.8	9.1	30.8	30.8	42.4	42.4	42.4	41.6	41.6
Total Split (s)	27.0	67.9	67.9	9.1	50.0	50.0	43.0	43.0	43.0	43.0	43.0
Total Split (%)	22.5%	56.6%	56.6%	7.6%	41.7%	41.7%	35.8%	35.8%	35.8%	35.8%	35.8%
Yellow Time (s)	3.6	4.8	4.8	3.6	4.8	4.8	4.4	4.4	4.4	3.6	3.6
All-Red Time (s)	0.5	1.0	1.0	0.5	1.0	1.0	1.0	1.0	1.0	1.0	1.0
Lost Time Adjust (s)	0.0	0.0	0.0	0.0	0.0	0.0	0.0	0.0	0.0	0.0	0.0
Total Lost Time (s)	4.1	5.8	5.8	4.1	5.8	5.8	5.4	5.4	5.4	4.6	4.6
Lead/Lag	Lead	Lag	Lag	Lead	Lag	Lag					
Lead-Lag Optimize?	Yes	Yes	Yes	Yes	Yes	Yes					
Recall Mode	None	None	None	None	None	None	None	None	None	None	None
Act Effct Green (s)	22.9	63.9	63.9	5.0	44.2	44.2	37.3	37.3	37.3	38.1	38.1
Actuated g/C Ratio	0.19	0.53	0.53	0.04	0.37	0.37	0.31	0.31	0.31	0.32	0.32
v/c Ratio	0.99	0.81	0.10	0.51	0.91	0.41	0.96	0.38	0.06	0.97	0.83
Control Delay	95.3	26.6	5.9	79.2	44.1	19.4	134.8	34.4	0.2	86.0	45.5
Queue Delay	0.0	0.0	0.0	0.0	0.0	0.0	0.0	0.0	0.0	0.0	0.0
Total Delay	95.3	26.6	5.9	79.2	44.1	19.4	134.8	34.4	0.2	86.0	45.5
LOS	F	C	A	E	D	B	F	C	A	F	D
Approach Delay		34.9			41.6			54.7			60.9
Approach LOS		C			D			D			E

Intersection Summary

Cycle Length: 120
 Actuated Cycle Length: 119.7
 Natural Cycle: 105
 Control Type: Actuated-Uncoordinated
 Maximum v/c Ratio: 0.99
 Intersection Signal Delay: 41.9
 Intersection LOS: D
 Intersection Capacity Utilization 102.0%
 ICU Level of Service G
 Analysis Period (min) 15





























Splits and Phases: 35: Day St. & Alessandro Bl.



HCM 6th Signalized Intersection Summary
35: Day St. & Alessandro Bl.

West Campus Upper Plateau (JN 14064)

09/20/2022

												
Movement	EBL	EBT	EBR	WBL	WBT	WBR	NBL	NBT	NBR	SBL	SBT	SBR
Lane Configurations		  			  							
Traffic Volume (veh/h)	328	2121	79	36	1653	251	76	214	32	288	186	281
Future Volume (veh/h)	328	2121	79	36	1653	251	76	214	32	288	186	281
Initial Q (Qb), veh	0	0	0	0	0	0	0	0	0	0	0	0
Ped-Bike Adj(A_pbT)	1.00		0.98	1.00		0.98	1.00		1.00	1.00		1.00
Parking Bus, Adj	1.00	1.00	1.00	1.00	1.00	1.00	1.00	1.00	1.00	1.00	1.00	1.00
Work Zone On Approach		No			No			No			No	
Adj Sat Flow, veh/h/ln	1900	1870	1811	1900	1885	1900	1796	1900	1841	1885	1885	1885
Adj Flow Rate, veh/h	342	2209	76	38	1722	193	79	223	28	300	194	262
Peak Hour Factor	0.96	0.96	0.96	0.96	0.96	0.96	0.96	0.96	0.96	0.96	0.96	0.96
Percent Heavy Veh, %	0	2	6	0	1	0	7	0	4	1	1	1
Cap, veh/h	345	2672	785	54	1867	571	124	607	498	320	232	314
Arrive On Green	0.19	0.52	0.52	0.03	0.36	0.36	0.32	0.32	0.32	0.32	0.32	0.32
Sat Flow, veh/h	1810	5106	1501	1810	5147	1575	898	1900	1560	1138	727	982
Grp Volume(v), veh/h	342	2209	76	38	1722	193	79	223	28	300	0	456
Grp Sat Flow(s),veh/h/ln	1810	1702	1501	1810	1716	1575	898	1900	1560	1138	0	1708
Q Serve(g_s), s	22.7	43.7	3.1	2.5	38.5	10.7	8.6	10.9	1.5	27.5	0.0	29.8
Cycle Q Clear(g_c), s	22.7	43.7	3.1	2.5	38.5	10.7	38.4	10.9	1.5	38.4	0.0	29.8
Prop In Lane	1.00		1.00	1.00		1.00	1.00		1.00	1.00		0.57
Lane Grp Cap(c), veh/h	345	2672	785	54	1867	571	124	607	498	320	0	546
V/C Ratio(X)	0.99	0.83	0.10	0.70	0.92	0.34	0.64	0.37	0.06	0.94	0.00	0.84
Avail Cap(c_a), veh/h	345	2672	785	75	1893	579	124	607	498	320	0	546
HCM Platoon Ratio	1.00	1.00	1.00	1.00	1.00	1.00	1.00	1.00	1.00	1.00	1.00	1.00
Upstream Filter(I)	1.00	1.00	1.00	1.00	1.00	1.00	1.00	1.00	1.00	1.00	0.00	1.00
Uniform Delay (d), s/veh	48.6	24.1	14.4	57.8	36.7	27.8	56.6	31.5	28.3	48.1	0.0	38.0
Incr Delay (d2), s/veh	46.2	2.3	0.1	6.7	8.0	0.3	10.2	0.4	0.0	34.0	0.0	10.8
Initial Q Delay(d3),s/veh	0.0	0.0	0.0	0.0	0.0	0.0	0.0	0.0	0.0	0.0	0.0	0.0
%ile BackOfQ(50%),veh/ln	14.3	16.6	1.0	1.2	16.7	4.0	2.7	5.0	0.6	12.2	0.0	14.1
Unsig. Movement Delay, s/veh												
LnGrp Delay(d),s/veh	94.7	26.3	14.4	64.4	44.7	28.2	66.8	31.9	28.4	82.2	0.0	48.8
LnGrp LOS	F	C	B	E	D	C	E	C	C	F	A	D
Approach Vol, veh/h		2627			1953			330				756
Approach Delay, s/veh		34.9			43.4			40.0				62.0
Approach LOS		C			D			D				E
Timer - Assigned Phs	1	2		4	5	6		8				
Phs Duration (G+Y+Rc), s	7.7	68.7		43.8	27.0	49.4		43.8				
Change Period (Y+Rc), s	4.1	5.8		* 5.4	4.1	5.8		5.4				
Max Green Setting (Gmax), s	5.0	62.1		* 38	22.9	44.2		37.6				
Max Q Clear Time (g_c+I1), s	4.5	45.7		40.4	24.7	40.5		40.4				
Green Ext Time (p_c), s	0.0	13.0		0.0	0.0	3.1		0.0				
Intersection Summary												
HCM 6th Ctrl Delay				41.8								
HCM 6th LOS				D								
Notes												
* HCM 6th computational engine requires equal clearance times for the phases crossing the barrier.												

Timings
36: Elsworth St. & Cactus Av.

West Campus Upper Plateau (JN 14064)

09/20/2022



Lane Group	EBL	EBT	EBR	WBL	WBT	WBR	NBL	NBT	SBL	SBT	SBR
Lane Configurations	↘	↑↑↑	↗	↘	↑↑↑	↗	↘↗	↗	↘	↗	↗
Traffic Volume (vph)	339	3013	121	36	2180	211	556	177	366	73	422
Future Volume (vph)	339	3013	121	36	2180	211	556	177	366	73	422
Turn Type	Prot	NA	Perm	Prot	NA	Perm	Prot	NA	Prot	NA	pm+ov
Protected Phases	5	2		1	6		3	8	7	4	5
Permitted Phases			2			6					4
Detector Phase	5	2	2	1	6	6	3	8	7	4	5
Switch Phase											
Minimum Initial (s)	5.0	10.0	10.0	5.0	10.0	10.0	5.0	10.0	5.0	10.0	5.0
Minimum Split (s)	9.6	36.2	36.2	9.6	36.2	36.2	15.4	35.4	15.4	35.4	9.6
Total Split (s)	20.0	54.0	54.0	9.6	43.6	43.6	21.0	35.8	20.6	35.4	20.0
Total Split (%)	16.7%	45.0%	45.0%	8.0%	36.3%	36.3%	17.5%	29.8%	17.2%	29.5%	16.7%
Yellow Time (s)	3.6	5.2	5.2	3.6	5.2	5.2	4.4	4.4	4.4	4.4	3.6
All-Red Time (s)	1.0	1.0	1.0	1.0	1.0	1.0	1.0	1.0	1.0	1.0	1.0
Lost Time Adjust (s)	0.0	0.0	0.0	0.0	0.0	0.0	0.0	0.0	0.0	0.0	0.0
Total Lost Time (s)	4.6	6.2	6.2	4.6	6.2	6.2	5.4	5.4	5.4	5.4	4.6
Lead/Lag	Lead	Lead	Lead	Lag	Lag	Lag	Lag	Lead	Lag	Lead	Lead
Lead-Lag Optimize?	Yes	Yes	Yes	Yes	Yes	Yes	Yes	Yes	Yes	Yes	Yes
Recall Mode	None	None	None	None	None	None	None	None	None	None	None
Act Effct Green (s)	15.4	49.7	49.7	5.0	37.4	37.4	15.6	24.5	21.1	21.1	46.2
Actuated g/C Ratio	0.13	0.41	0.41	0.04	0.31	0.31	0.13	0.20	0.18	0.18	0.38
v/c Ratio	1.56	1.04	0.17	0.51	0.99	0.36	1.23	0.83	0.71	0.76	0.62
Control Delay	305.7	61.9	4.4	79.3	57.3	10.3	166.4	59.4	61.3	64.9	15.4
Queue Delay	0.0	0.0	0.0	0.0	0.0	0.0	0.0	0.0	0.0	0.0	0.0
Total Delay	305.7	61.9	4.4	79.3	57.3	10.3	166.4	59.4	61.3	64.9	15.4
LOS	F	E	A	E	E	B	F	E	E	E	B
Approach Delay		83.7			53.6			128.4		39.7	
Approach LOS		F			D			F		D	

Intersection Summary

Cycle Length: 120
 Actuated Cycle Length: 120
 Natural Cycle: 120
 Control Type: Actuated-Uncoordinated
 Maximum v/c Ratio: 1.56
 Intersection Signal Delay: 74.2
 Intersection LOS: E
 Intersection Capacity Utilization 97.7%
 ICU Level of Service F
 Analysis Period (min) 15

Splits and Phases: 36: Elsworth St. & Cactus Av.

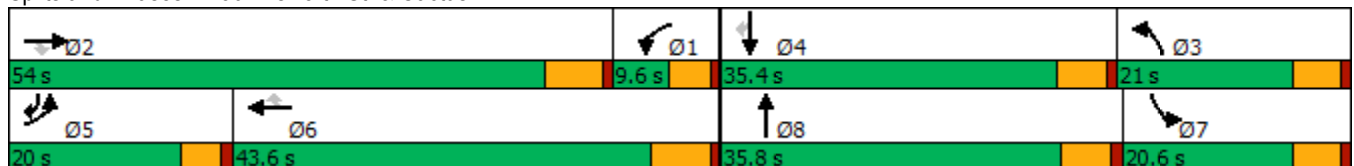

HCM 6th Signalized Intersection Summary
36: Elsworth St. & Cactus Av.

West Campus Upper Plateau (JN 14064)

09/20/2022



Movement	EBL	EBT	EBR	WBL	WBT	WBR	NBL	NBT	NBR	SBL	SBT	SBR
Lane Configurations												
Traffic Volume (veh/h)	339	3013	121	36	2180	211	556	177	130	366	73	422
Future Volume (veh/h)	339	3013	121	36	2180	211	556	177	130	366	73	422
Initial Q (Qb), veh	0	0	0	0	0	0	0	0	0	0	0	0
Ped-Bike Adj(A_pbT)	1.00		1.00	1.00		1.00	1.00		1.00	1.00		1.00
Parking Bus, Adj	1.00	1.00	1.00	1.00	1.00	1.00	1.00	1.00	1.00	1.00	1.00	1.00
Work Zone On Approach		No			No			No			No	
Adj Sat Flow, veh/h/ln	1870	1841	1870	1900	1856	1885	1900	1900	1885	1900	1900	1900
Adj Flow Rate, veh/h	353	3139	0	38	2271	184	579	184	88	435	0	333
Peak Hour Factor	0.96	0.96	0.96	0.96	0.96	0.96	0.96	0.96	0.96	0.96	0.96	0.96
Percent Heavy Veh, %	2	4	2	0	3	1	0	0	1	0	0	0
Cap, veh/h	253	3243		57	2558	551	659	215	103	496	0	442
Arrive On Green	0.14	0.44	0.00	0.03	0.34	0.34	0.18	0.18	0.18	0.14	0.00	0.13
Sat Flow, veh/h	1781	7363	1585	1810	7422	1598	3619	1215	581	3619	0	1610
Grp Volume(v), veh/h	353	3139	0	38	2271	184	579	0	272	435	0	333
Grp Sat Flow(s),veh/h/ln	1781	1841	1585	1810	1856	1598	1810	0	1795	1810	0	1610
Q Serve(g_s), s	15.4	45.1	0.0	2.3	31.4	5.8	16.9	0.0	15.9	12.8	0.0	11.4
Cycle Q Clear(g_c), s	15.4	45.1	0.0	2.3	31.4	5.8	16.9	0.0	15.9	12.8	0.0	11.4
Prop In Lane	1.00		1.00	1.00		1.00	1.00		0.32	1.00		1.00
Lane Grp Cap(c), veh/h	253	3243		57	2558	551	659	0	318	496	0	442
V/C Ratio(X)	1.40	0.97		0.67	0.89	0.33	0.88	0.00	0.85	0.88	0.00	0.75
Avail Cap(c_a), veh/h	253	3243		83	2558	551	659	0	503	507	0	674
HCM Platoon Ratio	1.00	1.00	1.00	1.00	1.00	1.00	1.00	1.00	1.00	1.00	1.00	1.00
Upstream Filter(I)	1.00	1.00	0.00	1.00	1.00	1.00	1.00	0.00	1.00	1.00	0.00	1.00
Uniform Delay (d), s/veh	46.6	29.6	0.0	52.0	33.6	10.4	43.2	0.0	43.3	45.9	0.0	14.7
Incr Delay (d2), s/veh	200.7	9.6	0.0	5.0	4.2	0.4	13.0	0.0	8.2	15.7	0.0	2.6
Initial Q Delay(d3),s/veh	0.0	0.0	0.0	0.0	0.0	0.0	0.0	0.0	0.0	0.0	0.0	0.0
%ile BackOfQ(50%),veh/ln	20.6	20.1	0.0	1.1	13.8	3.4	8.8	0.0	7.8	6.7	0.0	4.3
Unsig. Movement Delay, s/veh												
LnGrp Delay(d),s/veh	247.3	39.2	0.0	57.0	37.8	10.7	56.2	0.0	51.5	61.6	0.0	17.3
LnGrp LOS	F	D		E	D	B	E	A	D	E	A	B
Approach Vol, veh/h		3492			2493			851			768	
Approach Delay, s/veh		60.2			36.1			54.7			42.4	
Approach LOS		E			D			D			D	
Timer - Assigned Phs	1	2	3	4	5	6	7	8				
Phs Duration (G+Y+Rc), s	9.6	54.0	25.1	19.8	20.0	43.6	20.3	24.6				
Change Period (Y+Rc), s	6.2	* 6.2	5.4	5.4	4.6	6.2	5.4	5.4				
Max Green Setting (Gmax), s	5.0	* 48	15.6	30.0	15.4	37.4	15.2	30.4				
Max Q Clear Time (g_c+I1), s	4.3	47.1	18.9	13.4	17.4	33.4	14.8	17.9				
Green Ext Time (p_c), s	0.0	0.7	0.0	1.0	0.0	3.7	0.1	1.3				

Intersection Summary

HCM 6th Ctrl Delay	49.9
HCM 6th LOS	D

Notes

- User approved pedestrian interval to be less than phase max green.
- User approved volume balancing among the lanes for turning movement.
- * HCM 6th computational engine requires equal clearance times for the phases crossing the barrier.

Timings
38: Riverside Dr./Graham St. & Cactus Av.

West Campus Upper Plateau (JN 14064)

09/20/2022

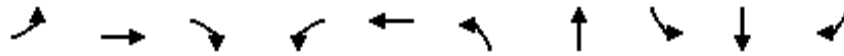

Lane Group	EBL	EBT	EBR	WBL	WBT	NBL	NBT	SBL	SBT	SBR
Lane Configurations	↘	↑↑↑	↗	↘	↑↑↑	↘	↑	↘	↑↑	↗
Traffic Volume (vph)	432	3359	489	27	2023	18	0	382	290	192
Future Volume (vph)	432	3359	489	27	2023	18	0	382	290	192
Turn Type	Prot	NA	Perm	Prot	NA	Prot	NA	Prot	NA	Perm
Protected Phases	7	4		3	8	5	2	1	6	
Permitted Phases			4							6
Detector Phase	7	4	4	3	8	5	2	1	6	6
Switch Phase										
Minimum Initial (s)	5.0	10.0	10.0	5.0	10.0	5.0	10.0	5.0	10.0	10.0
Minimum Split (s)	9.6	39.2	39.2	9.6	39.2	10.4	35.0	9.6	40.6	40.6
Total Split (s)	18.0	57.4	57.4	9.6	49.0	10.4	41.0	12.0	42.6	42.6
Total Split (%)	15.0%	47.8%	47.8%	8.0%	40.8%	8.7%	34.2%	10.0%	35.5%	35.5%
Yellow Time (s)	3.6	5.2	5.2	3.6	5.2	4.4	4.0	3.6	3.6	3.6
All-Red Time (s)	1.0	1.0	1.0	1.0	1.0	1.0	1.0	1.0	1.0	1.0
Lost Time Adjust (s)	0.0	0.0	0.0	0.0	0.0	0.0	0.0	0.0	0.0	0.0
Total Lost Time (s)	4.6	6.2	6.2	4.6	6.2	5.4	5.0	4.6	4.6	4.6
Lead/Lag	Lead	Lag	Lag	Lead	Lag	Lead	Lag	Lead	Lag	Lag
Lead-Lag Optimize?	Yes	Yes	Yes	Yes	Yes	Yes	Yes	Yes	Yes	Yes
Recall Mode	None	None	None	None	None	None	None	None	None	None
Act Effct Green (s)	13.7	58.7	58.7	5.1	43.6	5.1	14.7	10.1	16.3	16.3
Actuated g/C Ratio	0.15	0.63	0.63	0.05	0.47	0.05	0.16	0.11	0.18	0.18
v/c Ratio	1.79	1.15	0.49	0.29	1.20	0.10	0.03	1.10	0.50	0.47
Control Delay	398.3	90.8	10.5	55.5	120.6	48.8	0.1	116.5	37.0	8.2
Queue Delay	0.0	0.0	0.0	0.0	0.0	0.0	0.0	0.0	0.0	0.0
Total Delay	398.3	90.8	10.5	55.5	120.6	48.8	0.1	116.5	37.0	8.2
LOS	F	F	B	E	F	D	A	F	D	A
Approach Delay		112.7			120.0		27.2		65.7	
Approach LOS		F			F		C		E	

Intersection Summary

Cycle Length: 120
 Actuated Cycle Length: 92.9
 Natural Cycle: 120
 Control Type: Actuated-Uncoordinated
 Maximum v/c Ratio: 1.79
 Intersection Signal Delay: 109.5
 Intersection LOS: F
 Intersection Capacity Utilization 105.9%
 ICU Level of Service G
 Analysis Period (min) 15

Splits and Phases: 38: Riverside Dr./Graham St. & Cactus Av.

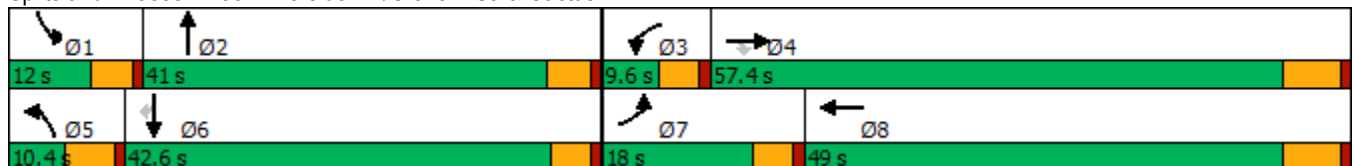

HCM 6th Signalized Intersection Summary
38: Riverside Dr./Graham St. & Cactus Av.

West Campus Upper Plateau (JN 14064)

09/20/2022



Movement	EBL	EBT	EBR	WBL	WBT	WBR	NBL	NBT	NBR	SBL	SBT	SBR
Lane Configurations	↘	↑↑↑	↗	↘	↑↑↑		↘↗	↑↗		↘↗	↑↑	↗
Traffic Volume (veh/h)	432	3359	489	27	2023	558	18	0	15	382	290	192
Future Volume (veh/h)	432	3359	489	27	2023	558	18	0	15	382	290	192
Initial Q (Qb), veh	0	0	0	0	0	0	0	0	0	0	0	0
Ped-Bike Adj(A_pbT)	1.00		1.00	1.00		0.99	1.00		1.00	1.00		1.00
Parking Bus, Adj	1.00	1.00	1.00	1.00	1.00	1.00	1.00	1.00	1.00	1.00	1.00	1.00
Work Zone On Approach		No			No			No			No	
Adj Sat Flow, veh/h/ln	1885	1856	1885	1900	1856	1900	1900	1900	1900	1885	1900	1856
Adj Flow Rate, veh/h	470	3651	484	29	2199	598	20	0	15	415	315	131
Peak Hour Factor	0.92	0.92	0.92	0.92	0.92	0.92	0.92	0.92	0.92	0.92	0.92	0.92
Percent Heavy Veh, %	1	3	1	0	3	0	0	0	0	1	0	3
Cap, veh/h	256	2886	910	51	1832	461	76	192	171	274	559	244
Arrive On Green	0.14	0.57	0.57	0.03	0.46	0.46	0.02	0.00	0.11	0.08	0.15	0.15
Sat Flow, veh/h	1795	5066	1598	1810	4023	1012	3510	1805	1610	3483	3610	1572
Grp Volume(v), veh/h	470	3651	484	29	1817	980	20	0	15	415	315	131
Grp Sat Flow(s),veh/h/ln	1795	1689	1598	1810	1689	1658	1755	1805	1610	1742	1805	1572
Q Serve(g_s), s	13.4	53.5	17.6	1.5	42.8	42.8	0.5	0.0	0.8	7.4	7.6	7.2
Cycle Q Clear(g_c), s	13.4	53.5	17.6	1.5	42.8	42.8	0.5	0.0	0.8	7.4	7.6	7.2
Prop In Lane	1.00		1.00	1.00		0.61	1.00		1.00	1.00		1.00
Lane Grp Cap(c), veh/h	256	2886	910	51	1538	755	76	192	171	274	559	244
V/C Ratio(X)	1.84	1.27	0.53	0.57	1.18	1.30	0.26	0.00	0.09	1.51	0.56	0.54
Avail Cap(c_a), veh/h	256	2886	910	96	1538	755	187	691	617	274	1459	636
HCM Platoon Ratio	1.00	1.00	1.00	1.00	1.00	1.00	1.00	1.00	1.00	1.00	1.00	1.00
Upstream Filter(I)	1.00	1.00	1.00	1.00	1.00	1.00	1.00	0.00	1.00	1.00	1.00	1.00
Uniform Delay (d), s/veh	40.3	20.2	12.5	45.1	25.6	25.6	45.2	0.0	37.9	43.3	36.8	36.6
Incr Delay (d2), s/veh	391.2	122.3	0.6	3.6	88.8	143.8	0.7	0.0	0.2	249.0	0.9	1.8
Initial Q Delay(d3),s/veh	0.0	0.0	0.0	0.0	0.0	0.0	0.0	0.0	0.0	0.0	0.0	0.0
%ile BackOfQ(50%),veh/ln	33.4	49.4	5.3	0.7	33.7	44.6	0.2	0.0	0.3	12.6	3.3	2.7
Unsig. Movement Delay, s/veh												
LnGrp Delay(d),s/veh	431.5	142.5	13.1	48.7	114.4	169.4	45.9	0.0	38.1	292.3	37.7	38.5
LnGrp LOS	F	F	B	D	F	F	D	A	D	F	D	D
Approach Vol, veh/h		4605			2826			35				861
Approach Delay, s/veh		158.4			132.8			42.6				160.5
Approach LOS		F			F			D				F
Timer - Assigned Phs	1	2	3	4	5	6	7	8				
Phs Duration (G+Y+Rc), s	12.0	15.0	7.3	59.7	7.4	19.6	18.0	49.0				
Change Period (Y+Rc), s	4.6	5.0	4.6	6.2	5.4	* 5	4.6	6.2				
Max Green Setting (Gmax), s	7.4	36.0	5.0	51.2	5.0	* 38	13.4	42.8				
Max Q Clear Time (g_c+I1), s	9.4	2.8	3.5	55.5	2.5	9.6	15.4	44.8				
Green Ext Time (p_c), s	0.0	0.0	0.0	0.0	0.0	2.4	0.0	0.0				

Intersection Summary

HCM 6th Ctrl Delay	149.5
HCM 6th LOS	F

Notes

* HCM 6th computational engine requires equal clearance times for the phases crossing the barrier.

Timings

West Campus Upper Plateau (JN 14064)

1: Washington St & Van Buren Bl.

09/30/2022



Lane Group	EBL	EBT	EBR	WBL	WBT	WBR	NBL	NBT	NBR	SBL	SBT
Lane Configurations	↙	↑↑↑	↗	↙	↑↑↑	↗	↙↗	↑↑	↗	↙↗	↑↗
Traffic Volume (vph)	147	1152	91	164	1119	357	170	255	185	472	222
Future Volume (vph)	147	1152	91	164	1119	357	170	255	185	472	222
Turn Type	Prot	NA	Perm	Prot	NA	pm+ov	Prot	NA	Perm	Prot	NA
Protected Phases	5	2		1	6	7	3	8		7	4
Permitted Phases			2			6			8		
Detector Phase	5	2	2	1	6	7	3	8	8	7	4
Switch Phase											
Minimum Initial (s)	5.0	10.0	10.0	5.0	10.0	10.0	10.0	10.0	10.0	10.0	10.0
Minimum Split (s)	9.2	34.2	34.2	9.2	33.2	30.8	37.4	37.4	37.4	30.8	30.8
Total Split (s)	16.4	44.6	44.6	17.0	45.2	31.0	37.4	37.4	37.4	31.0	31.0
Total Split (%)	12.6%	34.3%	34.3%	13.1%	34.8%	23.8%	28.8%	28.8%	28.8%	23.8%	23.8%
Yellow Time (s)	3.2	5.2	5.2	3.2	5.2	4.8	4.4	4.4	4.4	4.8	4.8
All-Red Time (s)	1.0	1.0	1.0	1.0	1.0	1.0	1.0	1.0	1.0	1.0	1.0
Lost Time Adjust (s)	0.0	0.0	0.0	0.0	0.0	0.0	0.0	0.0	0.0	0.0	0.0
Total Lost Time (s)	4.2	6.2	6.2	4.2	6.2	5.8	5.4	5.4	5.4	5.8	5.8
Lead/Lag	Lead	Lag	Lag	Lead	Lag	Lead	Lead	Lag	Lag	Lead	Lag
Lead-Lag Optimize?	Yes	Yes	Yes	Yes	Yes	Yes	Yes	Yes	Yes	Yes	Yes
Recall Mode	None	None	None	None	None	None	None	None	None	None	None
Act Effct Green (s)	12.0	34.9	34.9	13.0	35.9	56.7	14.4	16.3	16.3	20.4	22.2
Actuated g/C Ratio	0.11	0.33	0.33	0.12	0.34	0.53	0.14	0.15	0.15	0.19	0.21
v/c Ratio	0.75	0.72	0.15	0.77	0.67	0.39	0.37	0.49	0.48	0.73	0.44
Control Delay	72.0	35.6	0.9	71.3	33.8	6.1	45.0	45.1	10.1	49.1	34.6
Queue Delay	0.0	0.0	0.0	0.0	0.0	0.0	0.0	0.0	0.0	0.0	0.0
Total Delay	72.0	35.6	0.9	71.3	33.8	6.1	45.0	45.1	10.1	49.1	34.6
LOS	E	D	A	E	C	A	D	D	B	D	C
Approach Delay		37.2			31.5			34.4			43.3
Approach LOS		D			C			C			D

Intersection Summary

Cycle Length: 130
 Actuated Cycle Length: 106.6
 Natural Cycle: 115
 Control Type: Actuated-Uncoordinated
 Maximum v/c Ratio: 0.77
 Intersection Signal Delay: 35.8
 Intersection LOS: D
 Intersection Capacity Utilization 71.7%
 ICU Level of Service C
 Analysis Period (min) 15



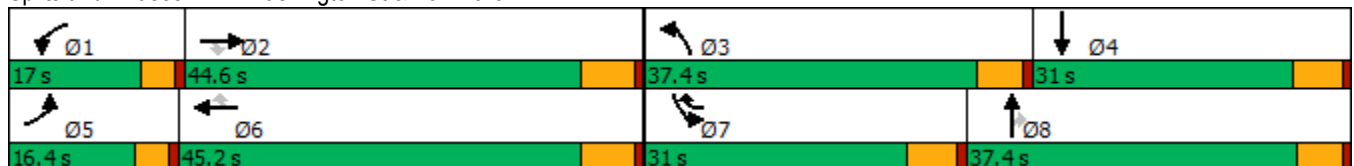





























Splits and Phases: 1: Washington St & Van Buren Bl.



HCM 6th Signalized Intersection Summary
1: Washington St & Van Buren Bl.

West Campus Upper Plateau (JN 14064)

09/30/2022

												
Movement	EBL	EBT	EBR	WBL	WBT	WBR	NBL	NBT	NBR	SBL	SBT	SBR
Lane Configurations		  			  		 	 		 	 	
Traffic Volume (veh/h)	147	1152	91	164	1119	357	170	255	185	472	222	96
Future Volume (veh/h)	147	1152	91	164	1119	357	170	255	185	472	222	96
Initial Q (Qb), veh	0	0	0	0	0	0	0	0	0	0	0	0
Ped-Bike Adj(A_pbT)	1.00		1.00	1.00		1.00	1.00		0.98	1.00		0.98
Parking Bus, Adj	1.00	1.00	1.00	1.00	1.00	1.00	1.00	1.00	1.00	1.00	1.00	1.00
Work Zone On Approach		No			No			No			No	
Adj Sat Flow, veh/h/ln	1900	1856	1870	1900	1870	1900	1885	1856	1870	1885	1885	1900
Adj Flow Rate, veh/h	152	1188	74	169	1154	273	175	263	151	487	229	52
Peak Hour Factor	0.97	0.97	0.97	0.97	0.97	0.97	0.97	0.97	0.97	0.97	0.97	0.97
Percent Heavy Veh, %	0	3	2	0	2	0	1	3	2	1	1	0
Cap, veh/h	185	1676	524	203	1739	823	376	522	230	597	626	139
Arrive On Green	0.10	0.33	0.33	0.11	0.34	0.34	0.11	0.15	0.15	0.17	0.22	0.22
Sat Flow, veh/h	1810	5066	1585	1810	5106	1606	3483	3526	1556	3483	2902	645
Grp Volume(v), veh/h	152	1188	74	169	1154	273	175	263	151	487	139	142
Grp Sat Flow(s),veh/h/ln	1810	1689	1585	1810	1702	1606	1742	1763	1556	1742	1791	1756
Q Serve(g_s), s	7.6	19.0	3.0	8.5	17.8	9.3	4.4	6.4	8.5	12.5	6.1	6.4
Cycle Q Clear(g_c), s	7.6	19.0	3.0	8.5	17.8	9.3	4.4	6.4	8.5	12.5	6.1	6.4
Prop In Lane	1.00		1.00	1.00		1.00	1.00		1.00	1.00		0.37
Lane Grp Cap(c), veh/h	185	1676	524	203	1739	823	376	522	230	597	386	379
V/C Ratio(X)	0.82	0.71	0.14	0.83	0.66	0.33	0.47	0.50	0.66	0.82	0.36	0.37
Avail Cap(c_a), veh/h	238	2101	658	250	2151	952	1204	1219	538	948	488	478
HCM Platoon Ratio	1.00	1.00	1.00	1.00	1.00	1.00	1.00	1.00	1.00	1.00	1.00	1.00
Upstream Filter(I)	1.00	1.00	1.00	1.00	1.00	1.00	1.00	1.00	1.00	1.00	1.00	1.00
Uniform Delay (d), s/veh	40.7	27.1	21.7	40.2	26.0	13.3	38.8	36.3	37.2	37.0	30.9	31.0
Incr Delay (d2), s/veh	12.8	1.0	0.2	14.9	0.7	0.3	0.9	0.8	3.1	3.1	0.6	0.6
Initial Q Delay(d3),s/veh	0.0	0.0	0.0	0.0	0.0	0.0	0.0	0.0	0.0	0.0	0.0	0.0
%ile BackOfQ(50%),veh/ln	3.9	7.1	1.2	4.4	6.7	3.3	1.9	2.8	3.4	5.5	2.7	2.7
Unsig. Movement Delay, s/veh												
LnGrp Delay(d),s/veh	53.5	28.1	21.9	55.1	26.7	13.6	39.7	37.0	40.3	40.0	31.4	31.6
LnGrp LOS	D	C	C	E	C	B	D	D	D	D	C	C
Approach Vol, veh/h		1414			1596			589			768	
Approach Delay, s/veh		30.5			27.5			38.7			36.9	
Approach LOS		C			C			D			D	
Timer - Assigned Phs	1	2	3	4	5	6	7	8				
Phs Duration (G+Y+Rc), s	14.6	36.8	15.4	25.8	13.7	37.7	21.7	19.5				
Change Period (Y+Rc), s	* 4.2	6.2	5.4	5.8	* 4.2	6.2	5.8	* 5.8				
Max Green Setting (Gmax), s	* 13	38.4	32.0	25.2	* 12	39.0	25.2	* 32				
Max Q Clear Time (g_c+I1), s	10.5	21.0	6.4	8.4	9.6	19.8	14.5	10.5				
Green Ext Time (p_c), s	0.0	9.6	0.6	1.4	0.0	11.0	1.4	2.3				
Intersection Summary												
HCM 6th Ctrl Delay				31.6								
HCM 6th LOS				C								
Notes												
User approved pedestrian interval to be less than phase max green.												
* HCM 6th computational engine requires equal clearance times for the phases crossing the barrier.												

Timings

3: Overlook Pkwy./Canyon Crest Dr. & Alessandro Bl/Alessandro Bl.



Lane Group	EBL	EBT	WBL	WBT	WBR	NBL	NBT	NBR	SBL	SBT
Lane Configurations	↖	↖↖↖	↖	↖↖↖	↖	↖	↖↖	↖	↖↖↖	↖
Traffic Volume (vph)	40	1677	99	1825	474	20	252	100	367	258
Future Volume (vph)	40	1677	99	1825	474	20	252	100	367	258
Turn Type	Prot	NA	Prot	NA	pm+ov	Split	NA	Perm	Split	NA
Protected Phases	5	2	1	6	4	8	8		4	4
Permitted Phases					6			8		
Detector Phase	5	2	1	6	4	8	8	8	4	4
Switch Phase										
Minimum Initial (s)	5.0	10.0	5.0	10.0	10.0	10.0	10.0	10.0	10.0	10.0
Minimum Split (s)	9.2	35.2	9.2	35.2	38.8	38.8	38.8	38.8	38.8	38.8
Total Split (s)	9.2	43.2	9.2	43.2	38.8	38.8	38.8	38.8	38.8	38.8
Total Split (%)	7.1%	33.2%	7.1%	33.2%	29.8%	29.8%	29.8%	29.8%	29.8%	29.8%
Yellow Time (s)	3.2	5.2	3.2	5.2	4.8	4.8	4.8	4.8	4.8	4.8
All-Red Time (s)	1.0	1.0	1.0	1.0	1.0	1.0	1.0	1.0	1.0	1.0
Lost Time Adjust (s)	0.0	0.0	0.0	0.0	0.0	0.0	0.0	0.0	0.0	0.0
Total Lost Time (s)	4.2	6.2	4.2	6.2	5.8	5.8	5.8	5.8	5.8	5.8
Lead/Lag	Lead	Lag	Lead	Lag						
Lead-Lag Optimize?	Yes	Yes	Yes	Yes						
Recall Mode	None	None	None	None	None	None	None	None	None	None
Act Effct Green (s)	5.0	37.3	5.0	39.4	69.2	13.0	13.0	13.0	23.5	23.5
Actuated g/C Ratio	0.05	0.37	0.05	0.39	0.68	0.13	0.13	0.13	0.23	0.23
v/c Ratio	0.48	0.92	1.12	0.93	0.41	0.09	0.55	0.34	0.32	0.66
Control Delay	68.8	40.6	180.1	41.2	4.0	41.7	47.0	10.3	32.6	42.4
Queue Delay	0.0	0.0	0.0	0.0	0.0	0.0	0.0	0.0	0.0	0.0
Total Delay	68.8	40.6	180.1	41.2	4.0	41.7	47.0	10.3	32.6	42.4
LOS	E	D	F	D	A	D	D	B	C	D
Approach Delay		41.2		39.6			36.8			36.8
Approach LOS		D		D			D			D

Intersection Summary

Cycle Length: 130
 Actuated Cycle Length: 101.1
 Natural Cycle: 125
 Control Type: Actuated-Uncoordinated
 Maximum v/c Ratio: 1.12
 Intersection Signal Delay: 39.6
 Intersection LOS: D
 Intersection Capacity Utilization 81.0%
 ICU Level of Service D
 Analysis Period (min) 15

Splits and Phases: 3: Overlook Pkwy./Canyon Crest Dr. & Alessandro Bl/Alessandro Bl.

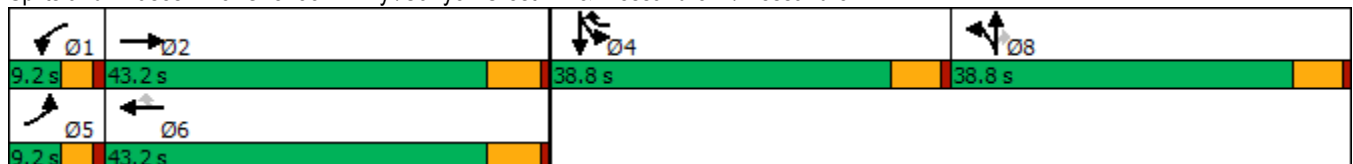

HCM 6th Signalized Intersection Summary

West Campus Upper Plateau (JN 14064)

3: Overlook Pkwy./Canyon Crest Dr. & Alessandro Bl/Alessandro Bl.

09/30/2022

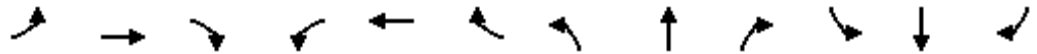

Movement	EBL	EBT	EBR	WBL	WBT	WBR	NBL	NBT	NBR	SBL	SBT	SBR
Lane Configurations	↖	↑↑↑		↖	↑↑↑	↖	↖	↑↑	↖	↖↖↖	↖	↖
Traffic Volume (veh/h)	40	1677	24	99	1825	474	20	252	100	367	258	22
Future Volume (veh/h)	40	1677	24	99	1825	474	20	252	100	367	258	22
Initial Q (Qb), veh	0	0	0	0	0	0	0	0	0	0	0	0
Ped-Bike Adj(A_pbT)	1.00		1.00	1.00		1.00	1.00		1.00	1.00		1.00
Parking Bus, Adj	1.00	1.00	1.00	1.00	1.00	1.00	1.00	1.00	1.00	1.00	1.00	1.00
Work Zone On Approach		No			No			No			No	
Adj Sat Flow, veh/h/ln	1841	1885	1885	1900	1885	1885	1885	1900	1900	1885	1885	1870
Adj Flow Rate, veh/h	41	1711	24	101	1862	476	20	257	94	374	263	13
Peak Hour Factor	0.98	0.98	0.98	0.98	0.98	0.98	0.98	0.98	0.98	0.98	0.98	0.98
Percent Heavy Veh, %	4	1	1	0	1	1	1	0	0	1	1	2
Cap, veh/h	63	2035	29	102	2109	963	203	408	182	977	344	17
Arrive On Green	0.04	0.39	0.39	0.06	0.41	0.41	0.11	0.11	0.11	0.19	0.19	0.19
Sat Flow, veh/h	1753	5230	73	1810	5147	1598	1795	3610	1610	5063	1781	88
Grp Volume(v), veh/h	41	1122	613	101	1862	476	20	257	94	374	0	276
Grp Sat Flow(s),veh/h/ln	1753	1716	1872	1810	1716	1598	1795	1805	1610	1688	0	1869
Q Serve(g_s), s	2.0	26.3	26.3	4.9	29.6	14.9	0.9	6.0	4.9	5.7	0.0	12.4
Cycle Q Clear(g_c), s	2.0	26.3	26.3	4.9	29.6	14.9	0.9	6.0	4.9	5.7	0.0	12.4
Prop In Lane	1.00		0.04	1.00		1.00	1.00		1.00	1.00		0.05
Lane Grp Cap(c), veh/h	63	1335	728	102	2109	963	203	408	182	977	0	361
V/C Ratio(X)	0.65	0.84	0.84	0.99	0.88	0.49	0.10	0.63	0.52	0.38	0.00	0.77
Avail Cap(c_a), veh/h	99	1434	782	102	2151	976	669	1346	600	1887	0	697
HCM Platoon Ratio	1.00	1.00	1.00	1.00	1.00	1.00	1.00	1.00	1.00	1.00	1.00	1.00
Upstream Filter(I)	1.00	1.00	1.00	1.00	1.00	1.00	1.00	1.00	1.00	1.00	0.00	1.00
Uniform Delay (d), s/veh	42.1	24.5	24.5	41.7	24.2	10.0	35.2	37.5	37.0	31.1	0.0	33.8
Incr Delay (d2), s/veh	4.2	4.4	7.8	84.9	4.7	0.4	0.2	1.6	2.3	0.2	0.0	3.4
Initial Q Delay(d3),s/veh	0.0	0.0	0.0	0.0	0.0	0.0	0.0	0.0	0.0	0.0	0.0	0.0
%ile BackOfQ(50%),veh/ln	0.9	10.2	11.8	4.5	11.3	7.4	0.4	2.6	1.9	2.2	0.0	5.6
Unsig. Movement Delay, s/veh												
LnGrp Delay(d),s/veh	46.3	29.0	32.3	126.6	28.8	10.3	35.4	39.1	39.2	31.4	0.0	37.2
LnGrp LOS	D	C	C	F	C	B	D	D	D	C	A	D
Approach Vol, veh/h		1776			2439			371			650	
Approach Delay, s/veh		30.5			29.3			38.9			33.9	
Approach LOS		C			C			D			C	
Timer - Assigned Phs	1	2		4	5	6		8				
Phs Duration (G+Y+Rc), s	9.2	40.6		22.9	7.4	42.5		15.8				
Change Period (Y+Rc), s	* 4.2	6.2		5.8	* 4.2	6.2		5.8				
Max Green Setting (Gmax), s	* 5	37.0		33.0	* 5	37.0		33.0				
Max Q Clear Time (g_c+1), s	6.9	28.3		14.4	4.0	31.6		8.0				
Green Ext Time (p_c), s	0.0	6.1		2.7	0.0	4.7		1.8				

Intersection Summary

HCM 6th Ctrl Delay	31.0
HCM 6th LOS	C

Notes

- User approved pedestrian interval to be less than phase max green.
- User approved volume balancing among the lanes for turning movement.
- * HCM 6th computational engine requires equal clearance times for the phases crossing the barrier.

Timings
4: Van Buren Bl. & Wood Rd.

West Campus Upper Plateau (JN 14064)

09/30/2022

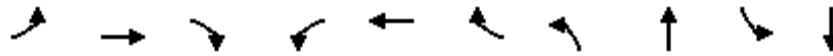

Lane Group	EBL	EBT	EBR	WBL	WBT	WBR	NBL	NBT	SBL	SBT
Lane Configurations	↘	↑↑↑	↗	↘↗	↑↑↑	↗	↘↗	↑↘	↘	↑↘
Traffic Volume (vph)	144	1769	254	273	1714	121	248	147	183	171
Future Volume (vph)	144	1769	254	273	1714	121	248	147	183	171
Turn Type	Prot	NA	pm+ov	Prot	NA	Perm	Prot	NA	Prot	NA
Protected Phases	5	2	3	1	6		3	8	7	4
Permitted Phases			2			6				
Detector Phase	5	2	3	1	6	6	3	8	7	4
Switch Phase										
Minimum Initial (s)	5.0	10.0	5.0	5.0	10.0	10.0	5.0	10.0	5.0	10.0
Minimum Split (s)	9.2	30.2	9.2	9.2	30.2	30.2	9.2	38.4	9.2	15.8
Total Split (s)	18.0	52.6	22.0	16.0	50.6	50.6	22.0	38.4	13.0	29.4
Total Split (%)	15.0%	43.8%	18.3%	13.3%	42.2%	42.2%	18.3%	32.0%	10.8%	24.5%
Yellow Time (s)	3.2	5.2	3.2	3.2	5.2	5.2	3.2	4.4	3.2	4.8
All-Red Time (s)	1.0	1.0	1.0	1.0	1.0	1.0	1.0	1.0	1.0	1.0
Lost Time Adjust (s)	0.0	0.0	0.0	0.0	0.0	0.0	0.0	0.0	0.0	0.0
Total Lost Time (s)	4.2	6.2	4.2	4.2	6.2	6.2	4.2	5.4	4.2	5.8
Lead/Lag	Lead	Lag	Lead	Lead	Lag	Lag	Lead	Lag	Lead	Lag
Lead-Lag Optimize?	Yes	Yes	Yes	Yes	Yes	Yes	Yes	Yes	Yes	Yes
Recall Mode	None	None	None	None	None	None	None	None	None	None
Act Effct Green (s)	12.0	46.5	60.7	11.3	45.8	45.8	12.2	17.1	8.9	13.4
Actuated g/C Ratio	0.12	0.45	0.58	0.11	0.44	0.44	0.12	0.16	0.09	0.13
v/c Ratio	0.72	0.81	0.26	0.75	0.79	0.16	0.64	0.51	1.26	0.61
Control Delay	66.0	29.6	2.6	59.4	29.6	3.7	52.3	18.5	198.6	26.3
Queue Delay	0.0	0.0	0.0	0.0	0.0	0.0	0.0	0.0	0.0	0.0
Total Delay	66.0	29.6	2.6	59.4	29.6	3.7	52.3	18.5	198.6	26.3
LOS	E	C	A	E	C	A	D	B	F	C
Approach Delay		28.9			31.9			32.7		87.4
Approach LOS		C			C			C		F

Intersection Summary

Cycle Length: 120
 Actuated Cycle Length: 103.9
 Natural Cycle: 120
 Control Type: Actuated-Uncoordinated
 Maximum v/c Ratio: 1.26
 Intersection Signal Delay: 36.1
 Intersection LOS: D
 Intersection Capacity Utilization 85.2%
 ICU Level of Service E
 Analysis Period (min) 15



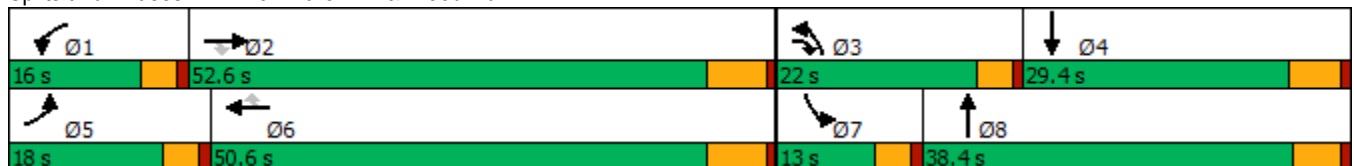



























Splits and Phases: 4: Van Buren Bl. & Wood Rd.



HCM 6th Signalized Intersection Summary
4: Van Buren Bl. & Wood Rd.

West Campus Upper Plateau (JN 14064)

09/30/2022

												
Movement	EBL	EBT	EBR	WBL	WBT	WBR	NBL	NBT	NBR	SBL	SBT	SBR
Lane Configurations		  		 	  		 	 			 	
Traffic Volume (veh/h)	144	1769	254	273	1714	121	248	147	194	183	171	163
Future Volume (veh/h)	144	1769	254	273	1714	121	248	147	194	183	171	163
Initial Q (Qb), veh	0	0	0	0	0	0	0	0	0	0	0	0
Ped-Bike Adj(A_pbT)	1.00		0.98	1.00		0.99	1.00		0.96	1.00		0.99
Parking Bus, Adj	1.00	1.00	1.00	1.00	1.00	1.00	1.00	1.00	1.00	1.00	1.00	1.00
Work Zone On Approach		No			No			No			No	
Adj Sat Flow, veh/h/ln	1885	1870	1870	1885	1885	1885	1870	1885	1870	1885	1885	1885
Adj Flow Rate, veh/h	150	1843	165	284	1785	81	258	153	125	191	178	99
Peak Hour Factor	0.96	0.96	0.96	0.96	0.96	0.96	0.96	0.96	0.96	0.96	0.96	0.96
Percent Heavy Veh, %	1	2	2	1	1	1	2	1	2	1	1	1
Cap, veh/h	182	2298	855	353	2316	709	333	288	216	161	324	171
Arrive On Green	0.10	0.45	0.45	0.10	0.45	0.45	0.10	0.15	0.15	0.09	0.14	0.14
Sat Flow, veh/h	1795	5106	1561	3483	5147	1575	3456	1916	1437	1795	2253	1190
Grp Volume(v), veh/h	150	1843	165	284	1785	81	258	142	136	191	140	137
Grp Sat Flow(s),veh/h/ln	1795	1702	1561	1742	1716	1575	1728	1791	1562	1795	1791	1652
Q Serve(g_s), s	8.0	30.4	5.3	7.8	28.6	2.9	7.1	7.2	7.9	8.8	7.1	7.6
Cycle Q Clear(g_c), s	8.0	30.4	5.3	7.8	28.6	2.9	7.1	7.2	7.9	8.8	7.1	7.6
Prop In Lane	1.00		1.00	1.00		1.00	1.00		0.92	1.00		0.72
Lane Grp Cap(c), veh/h	182	2298	855	353	2316	709	333	270	235	161	258	238
V/C Ratio(X)	0.83	0.80	0.19	0.80	0.77	0.11	0.77	0.53	0.58	1.18	0.54	0.58
Avail Cap(c_a), veh/h	253	2419	892	420	2333	714	628	603	526	161	432	398
HCM Platoon Ratio	1.00	1.00	1.00	1.00	1.00	1.00	1.00	1.00	1.00	1.00	1.00	1.00
Upstream Filter(I)	1.00	1.00	1.00	1.00	1.00	1.00	1.00	1.00	1.00	1.00	1.00	1.00
Uniform Delay (d), s/veh	43.2	23.2	11.3	43.1	22.7	15.6	43.2	38.4	38.7	44.6	38.9	39.1
Incr Delay (d2), s/veh	10.4	2.1	0.2	7.8	1.7	0.1	1.5	1.6	2.2	128.9	1.8	2.2
Initial Q Delay(d3),s/veh	0.0	0.0	0.0	0.0	0.0	0.0	0.0	0.0	0.0	0.0	0.0	0.0
%ile BackOfQ(50%),veh/ln	3.9	11.2	1.7	3.6	10.5	1.0	3.0	3.2	3.1	9.6	3.1	3.1
Unsig. Movement Delay, s/veh												
LnGrp Delay(d),s/veh	53.5	25.3	11.4	50.9	24.4	15.7	44.7	40.0	40.9	173.4	40.7	41.3
LnGrp LOS	D	C	B	D	C	B	D	D	D	F	D	D
Approach Vol, veh/h		2158			2150			536			468	
Approach Delay, s/veh		26.2			27.6			42.5			95.1	
Approach LOS		C			C			D			F	
Timer - Assigned Phs	1	2	3	4	5	6	7	8				
Phs Duration (G+Y+Rc), s	14.1	50.3	13.6	19.9	14.1	50.3	13.0	20.5				
Change Period (Y+Rc), s	* 4.2	6.2	* 4.2	5.8	* 4.2	6.2	* 4.2	* 5.8				
Max Green Setting (Gmax), s	* 12	46.4	* 18	23.6	* 14	44.4	* 8.8	* 33				
Max Q Clear Time (g_c+I1), s	9.8	32.4	9.1	9.6	10.0	30.6	10.8	9.9				
Green Ext Time (p_c), s	0.1	11.6	0.3	1.2	0.1	11.1	0.0	1.5				

Intersection Summary

HCM 6th Ctrl Delay	34.5
HCM 6th LOS	C

Notes

* HCM 6th computational engine requires equal clearance times for the phases crossing the barrier.

Timings
8: Cole Av. & Van Buren Bl.

West Campus Upper Plateau (JN 14064)

09/30/2022



Lane Group	EBL	EBT	EBR	WBL	WBT	WBR	NBL	NBT	SBL	SBT	SBR
Lane Configurations	↖↗	↑↑↑	↖	↖	↑↑↑	↖	↖	↑↑	↖↗	↑↑	↖
Traffic Volume (vph)	566	1449	84	184	1512	412	111	276	404	247	448
Future Volume (vph)	566	1449	84	184	1512	412	111	276	404	247	448
Turn Type	Prot	NA	pm+ov	Prot	NA	pm+ov	Prot	NA	Prot	NA	pm+ov
Protected Phases	5	2	3	1	6	7	3	8	7	4	5
Permitted Phases			2			6					4
Detector Phase	5	2	3	1	6	7	3	8	7	4	5
Switch Phase											
Minimum Initial (s)	5.0	10.0	5.0	5.0	10.0	5.0	5.0	10.0	5.0	10.0	5.0
Minimum Split (s)	9.1	36.2	9.1	9.1	36.2	9.1	9.1	42.2	9.1	49.2	9.1
Total Split (s)	15.0	43.8	11.0	14.0	42.8	19.0	11.0	43.2	19.0	51.2	15.0
Total Split (%)	12.5%	36.5%	9.2%	11.7%	35.7%	15.8%	9.2%	36.0%	15.8%	42.7%	12.5%
Yellow Time (s)	3.2	5.2	3.2	3.2	5.2	3.2	3.2	5.2	3.2	5.2	3.2
All-Red Time (s)	0.5	1.0	0.5	0.5	1.0	0.5	0.5	1.0	0.5	1.0	0.5
Lost Time Adjust (s)	0.0	0.0	0.0	0.0	0.0	0.0	0.0	0.0	0.0	0.0	0.0
Total Lost Time (s)	3.7	6.2	3.7	3.7	6.2	3.7	3.7	6.2	3.7	6.2	3.7
Lead/Lag	Lead	Lag	Lead	Lead	Lag	Lead	Lead	Lag	Lead	Lag	Lead
Lead-Lag Optimize?	Yes	Yes	Yes	Yes	Yes	Yes	Yes	Yes	Yes	Yes	Yes
Recall Mode	None	None	None	None	None	None	None	None	None	None	None
Act Effct Green (s)	11.4	37.9	51.5	10.4	36.9	58.3	7.4	18.2	15.3	26.1	40.0
Actuated g/C Ratio	0.11	0.37	0.51	0.10	0.36	0.57	0.07	0.18	0.15	0.26	0.39
v/c Ratio	1.54	0.81	0.10	1.07	0.85	0.42	0.90	0.62	0.82	0.28	0.71
Control Delay	287.1	34.1	3.6	131.0	36.5	7.1	106.2	36.9	56.8	30.3	25.8
Queue Delay	0.0	0.0	0.0	0.0	0.0	0.0	0.0	0.0	0.0	0.0	0.0
Total Delay	287.1	34.1	3.6	131.0	36.5	7.1	106.2	36.9	56.8	30.3	25.8
LOS	F	C	A	F	D	A	F	D	E	C	C
Approach Delay		101.1			39.0			52.2		38.2	
Approach LOS		F			D			D		D	

Intersection Summary

Cycle Length: 120	
Actuated Cycle Length: 101.6	
Natural Cycle: 115	
Control Type: Actuated-Uncoordinated	
Maximum v/c Ratio: 1.54	
Intersection Signal Delay: 62.4	Intersection LOS: E
Intersection Capacity Utilization 87.6%	ICU Level of Service E
Analysis Period (min) 15	



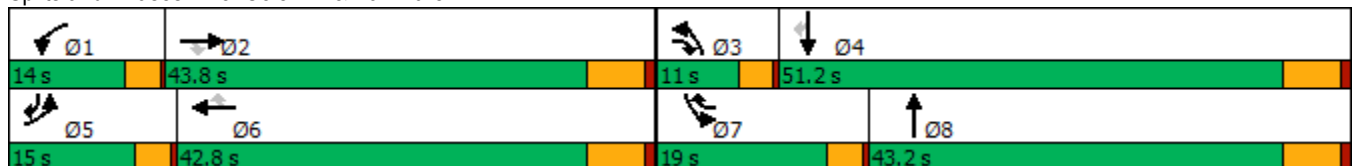



























Splits and Phases: 8: Cole Av. & Van Buren Bl.



HCM 6th Signalized Intersection Summary
8: Cole Av. & Van Buren Bl.

West Campus Upper Plateau (JN 14064)

09/30/2022

												
Movement	EBL	EBT	EBR	WBL	WBT	WBR	NBL	NBT	NBR	SBL	SBT	SBR
Lane Configurations	 	  			  			 		 	 	
Traffic Volume (veh/h)	566	1449	84	184	1512	412	111	276	115	404	247	448
Future Volume (veh/h)	566	1449	84	184	1512	412	111	276	115	404	247	448
Initial Q (Qb), veh	0	0	0	0	0	0	0	0	0	0	0	0
Ped-Bike Adj(A_pbT)	1.00		1.00	1.00		1.00	1.00		0.99	1.00		1.00
Parking Bus, Adj	1.00	1.00	1.00	1.00	1.00	1.00	1.00	1.00	1.00	1.00	1.00	1.00
Work Zone On Approach		No			No			No			No	
Adj Sat Flow, veh/h/ln	1870	1841	1856	1870	1870	1885	1885	1885	1885	1870	1885	1885
Adj Flow Rate, veh/h	590	1509	31	192	1575	340	116	288	113	421	257	369
Peak Hour Factor	0.96	0.96	0.96	0.96	0.96	0.96	0.96	0.96	0.96	0.96	0.96	0.96
Percent Heavy Veh, %	2	4	3	2	2	1	1	1	1	2	1	1
Cap, veh/h	396	1872	702	186	1850	804	133	457	175	488	888	579
Arrive On Green	0.11	0.37	0.37	0.10	0.36	0.36	0.07	0.18	0.18	0.14	0.25	0.25
Sat Flow, veh/h	3456	5025	1572	1781	5106	1598	1795	2526	968	3456	3582	1596
Grp Volume(v), veh/h	590	1509	31	192	1575	340	116	202	199	421	257	369
Grp Sat Flow(s),veh/h/ln	1728	1675	1572	1781	1702	1598	1795	1791	1703	1728	1791	1596
Q Serve(g_s), s	11.3	26.5	1.1	10.3	28.0	13.2	6.3	10.3	10.7	11.7	5.7	18.9
Cycle Q Clear(g_c), s	11.3	26.5	1.1	10.3	28.0	13.2	6.3	10.3	10.7	11.7	5.7	18.9
Prop In Lane	1.00		1.00	1.00		1.00	1.00		0.57	1.00		1.00
Lane Grp Cap(c), veh/h	396	1872	702	186	1850	804	133	324	308	488	888	579
V/C Ratio(X)	1.49	0.81	0.04	1.03	0.85	0.42	0.87	0.62	0.65	0.86	0.29	0.64
Avail Cap(c_a), veh/h	396	1918	717	186	1897	819	133	673	640	537	1636	912
HCM Platoon Ratio	1.00	1.00	1.00	1.00	1.00	1.00	1.00	1.00	1.00	1.00	1.00	1.00
Upstream Filter(I)	1.00	1.00	1.00	1.00	1.00	1.00	1.00	1.00	1.00	1.00	1.00	1.00
Uniform Delay (d), s/veh	43.6	27.7	15.4	44.1	29.0	15.4	45.1	37.3	37.4	41.4	30.0	26.0
Incr Delay (d2), s/veh	232.9	2.7	0.0	74.3	4.0	0.5	41.1	2.0	2.3	11.8	0.2	1.2
Initial Q Delay(d3),s/veh	0.0	0.0	0.0	0.0	0.0	0.0	0.0	0.0	0.0	0.0	0.0	0.0
%ile BackOfQ(50%),veh/ln	17.4	10.1	0.4	8.2	11.1	4.3	4.2	4.4	4.4	5.5	2.3	6.7
Unsig. Movement Delay, s/veh												
LnGrp Delay(d),s/veh	276.5	30.5	15.4	118.4	33.0	15.9	86.2	39.2	39.7	53.2	30.2	27.2
LnGrp LOS	F	C	B	F	C	B	F	D	D	D	C	C
Approach Vol, veh/h		2130			2107			517			1047	
Approach Delay, s/veh		98.4			38.0			49.9			38.4	
Approach LOS		F			D			D			D	
Timer - Assigned Phs	1	2	3	4	5	6	7	8				
Phs Duration (G+Y+Rc), s	14.0	42.9	11.0	30.6	15.0	41.9	17.6	24.0				
Change Period (Y+Rc), s	3.7	6.2	3.7	6.2	3.7	6.2	3.7	6.2				
Max Green Setting (Gmax), s	10.3	37.6	7.3	45.0	11.3	36.6	15.3	37.0				
Max Q Clear Time (g_c+I1), s	12.3	28.5	8.3	20.9	13.3	30.0	13.7	12.7				
Green Ext Time (p_c), s	0.0	7.0	0.0	2.7	0.0	5.7	0.2	2.1				
Intersection Summary												
HCM 6th Ctrl Delay			61.3									
HCM 6th LOS			E									

Timings
11: Barton St & Alessandro Bl.

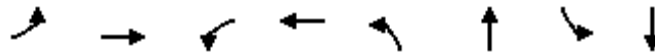

Lane Group	EBL	EBT	WBL	WBT	NBL	NBT	SBL	SBT
Lane Configurations	↵	↑↑↑	↵	↑↑↑	↵	↑	↵	↑
Traffic Volume (vph)	5	1658	88	1857	71	1	5	0
Future Volume (vph)	5	1658	88	1857	71	1	5	0
Turn Type	Prot	NA	Prot	NA	Perm	NA	Perm	NA
Protected Phases	5	2	1	6		8		4
Permitted Phases					8		4	
Detector Phase	5	2	1	6	8	8	4	4
Switch Phase								
Minimum Initial (s)	5.0	10.0	5.0	10.0	10.0	10.0	10.0	10.0
Minimum Split (s)	9.2	28.5	11.0	28.5	40.6	40.6	26.6	26.6
Total Split (s)	9.2	61.4	13.0	65.2	40.6	40.6	40.6	40.6
Total Split (%)	8.0%	53.4%	11.3%	56.7%	35.3%	35.3%	35.3%	35.3%
Yellow Time (s)	3.2	5.5	3.2	5.5	3.6	3.6	3.6	3.6
All-Red Time (s)	1.0	1.0	1.0	1.0	1.0	1.0	1.0	1.0
Lost Time Adjust (s)	0.0	0.0	0.0	0.0	0.0	0.0	0.0	0.0
Total Lost Time (s)	4.2	6.5	4.2	6.5	4.6	4.6	4.6	4.6
Lead/Lag	Lead	Lag	Lead	Lag				
Lead-Lag Optimize?	Yes	Yes	Yes	Yes				
Recall Mode	None	None	None	None	None	None	None	None
Act Effct Green (s)	5.5	53.4	8.4	61.4	15.0	15.0	15.0	15.0
Actuated g/C Ratio	0.07	0.65	0.10	0.75	0.18	0.18	0.18	0.18
v/c Ratio	0.05	0.55	0.52	0.53	0.29	0.14	0.02	0.01
Control Delay	48.0	13.8	53.0	9.4	35.5	10.4	30.4	0.0
Queue Delay	0.0	0.0	0.0	0.0	0.0	0.0	0.0	0.0
Total Delay	48.0	13.8	53.0	9.4	35.5	10.4	30.4	0.0
LOS	D	B	D	A	D	B	C	A
Approach Delay		13.9		11.4		25.8		16.9
Approach LOS		B		B		C		B

Intersection Summary

Cycle Length: 115	
Actuated Cycle Length: 82.3	
Natural Cycle: 85	
Control Type: Actuated-Uncoordinated	
Maximum v/c Ratio: 0.55	
Intersection Signal Delay: 13.0	Intersection LOS: B
Intersection Capacity Utilization 63.5%	ICU Level of Service B
Analysis Period (min) 15	

Splits and Phases: 11: Barton St & Alessandro Bl.



HCM 6th Signalized Intersection Summary
11: Barton St & Alessandro Bl.

West Campus Upper Plateau (JN 14064)

09/30/2022



Movement	EBL	EBT	EBR	WBL	WBT	WBR	NBL	NBT	NBR	SBL	SBT	SBR
Lane Configurations	↖	↑↑↑		↖	↑↑↑		↖	↑		↖	↑	
Traffic Volume (veh/h)	5	1658	47	88	1857	5	71	1	44	5	0	4
Future Volume (veh/h)	5	1658	47	88	1857	5	71	1	44	5	0	4
Initial Q (Qb), veh	0	0	0	0	0	0	0	0	0	0	0	0
Ped-Bike Adj(A_pbT)	1.00		1.00	1.00		0.98	1.00		1.00	1.00		1.00
Parking Bus, Adj	1.00	1.00	1.00	1.00	1.00	1.00	1.00	1.00	1.00	1.00	1.00	1.00
Work Zone On Approach		No			No			No			No	
Adj Sat Flow, veh/h/ln	1604	1885	1900	1900	1870	1900	1900	1900	1900	1796	1900	1900
Adj Flow Rate, veh/h	5	1783	49	95	1997	5	76	1	20	5	0	-7
Peak Hour Factor	0.93	0.93	0.93	0.93	0.93	0.93	0.93	0.93	0.93	0.93	0.93	0.93
Percent Heavy Veh, %	20	1	0	0	2	0	0	0	0	7	0	0
Cap, veh/h	10	3085	85	123	3473	9	316	9	183	244	0	504
Arrive On Green	0.01	0.60	0.60	0.07	0.66	0.66	0.12	0.12	0.12	0.12	0.00	0.00
Sat Flow, veh/h	1527	5149	141	1810	5259	13	1810	77	1545	1336	1900	0
Grp Volume(v), veh/h	5	1188	644	95	1293	709	76	0	21	5	-7	-7
Grp Sat Flow(s),veh/h/ln	1527	1716	1860	1810	1702	1868	1810	0	1622	1336	1900	1610
Q Serve(g_s), s	0.2	15.2	15.2	3.7	14.8	14.9	2.8	0.0	0.8	0.2	0.0	0.0
Cycle Q Clear(g_c), s	0.2	15.2	15.2	3.7	14.8	14.9	2.8	0.0	0.8	1.1	0.0	0.0
Prop In Lane	1.00		0.08	1.00		0.01	1.00		0.95	1.00		0.00
Lane Grp Cap(c), veh/h	10	2056	1114	123	2248	1233	316	0	193	244	0	0
V/C Ratio(X)	0.50	0.58	0.58	0.77	0.58	0.58	0.24	0.00	0.11	0.02	0.00	0.00
Avail Cap(c_a), veh/h	107	2638	1430	223	2798	1535	1013	0	818	759	0	0
HCM Platoon Ratio	1.00	1.00	1.00	1.00	1.00	1.00	1.00	1.00	1.00	1.00	1.00	1.00
Upstream Filter(I)	1.00	1.00	1.00	1.00	1.00	1.00	1.00	0.00	1.00	1.00	0.00	0.00
Uniform Delay (d), s/veh	35.4	8.8	8.8	32.7	6.6	6.6	28.9	0.0	28.1	28.6	0.0	0.0
Incr Delay (d2), s/veh	13.3	0.4	0.7	3.9	0.3	0.6	0.4	0.0	0.2	0.0	0.0	0.0
Initial Q Delay(d3),s/veh	0.0	0.0	0.0	0.0	0.0	0.0	0.0	0.0	0.0	0.0	0.0	0.0
%ile BackOfQ(50%),veh/ln	0.1	3.7	4.1	1.7	4.1	4.6	1.2	0.0	0.3	0.1	0.0	0.0
Unsig. Movement Delay, s/veh												
LnGrp Delay(d),s/veh	48.6	9.1	9.5	36.6	7.0	7.2	29.3	0.0	28.3	28.6	0.0	0.0
LnGrp LOS	D	A	A	D	A	A	C	A	C	C	A	A
Approach Vol, veh/h		1837			2097			97				-9
Approach Delay, s/veh		9.4			8.4			29.1				0.0
Approach LOS		A			A			C				A
Timer - Assigned Phs	1	2		4	5	6		8				
Phs Duration (G+Y+Rc), s	9.0	49.3		13.1	4.7	53.7		13.1				
Change Period (Y+Rc), s	* 4.2	6.5		4.6	* 4.2	6.5		4.6				
Max Green Setting (Gmax), s	* 8.8	54.9		36.0	* 5	58.7		36.0				
Max Q Clear Time (g_c+I1), s	5.7	17.2		3.1	2.2	16.9		4.8				
Green Ext Time (p_c), s	0.0	22.6		0.0	0.0	30.3		0.3				

Intersection Summary

HCM 6th Ctrl Delay	9.4
HCM 6th LOS	A

Notes

* HCM 6th computational engine requires equal clearance times for the phases crossing the barrier.

Timings
13: Barton Rd. & Orange Terrace Pkwy

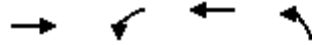

Lane Group	EBT	WBL	WBT	NBL
Lane Configurations	↑↑	↑	↑↑	↑
Traffic Volume (vph)	359	59	525	311
Future Volume (vph)	359	59	525	311
Turn Type	NA	Perm	NA	Prot
Protected Phases	4		8	2
Permitted Phases		8		
Detector Phase	4	8	8	2
Switch Phase				
Minimum Initial (s)	5.0	5.0	5.0	5.0
Minimum Split (s)	26.1	26.1	26.1	26.1
Total Split (s)	27.0	27.0	27.0	28.0
Total Split (%)	49.1%	49.1%	49.1%	50.9%
Yellow Time (s)	3.6	3.6	3.6	3.6
All-Red Time (s)	0.5	0.5	0.5	0.5
Lost Time Adjust (s)	0.0	0.0	0.0	0.0
Total Lost Time (s)	4.1	4.1	4.1	4.1
Lead/Lag				
Lead-Lag Optimize?				
Recall Mode	Max	Max	Max	Max
Act Effct Green (s)	22.9	22.9	22.9	23.9
Actuated g/C Ratio	0.42	0.42	0.42	0.43
v/c Ratio	0.50	0.30	0.38	0.49
Control Delay	6.7	15.6	12.1	13.3
Queue Delay	0.0	0.0	0.0	0.0
Total Delay	6.7	15.6	12.1	13.3
LOS	A	B	B	B
Approach Delay	6.7		12.4	13.3
Approach LOS	A		B	B

Intersection Summary

Cycle Length: 55
 Actuated Cycle Length: 55
 Offset: 0 (0%), Referenced to phase 2:NBL and 6:, Start of Yellow
 Natural Cycle: 55
 Control Type: Pretimed
 Maximum v/c Ratio: 0.50
 Intersection Signal Delay: 10.1
 Intersection Capacity Utilization 56.2%
 Analysis Period (min) 15

Intersection LOS: B
 ICU Level of Service B

Splits and Phases: 13: Barton Rd. & Orange Terrace Pkwy

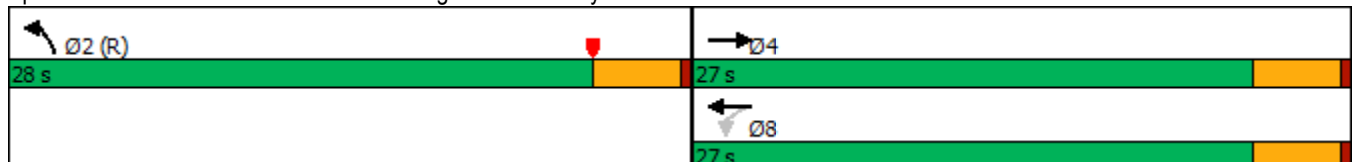

HCM 6th Signalized Intersection Summary
 13: Barton Rd. & Orange Terrace Pkwy

West Campus Upper Plateau (JN 14064)

09/30/2022



Movement	EBT	EBR	WBL	WBT	NBL	NBR
Lane Configurations	↑↑		↵	↑↑	↵	
Traffic Volume (veh/h)	359	368	59	525	311	44
Future Volume (veh/h)	359	368	59	525	311	44
Initial Q (Qb), veh	0	0	0	0	0	0
Ped-Bike Adj(A_pbT)		0.98	1.00		1.00	1.00
Parking Bus, Adj	1.00	1.00	1.00	1.00	1.00	1.00
Work Zone On Approach	No			No	No	
Adj Sat Flow, veh/h/ln	1885	1885	1900	1900	1900	1900
Adj Flow Rate, veh/h	390	400	64	571	338	48
Peak Hour Factor	0.92	0.92	0.92	0.92	0.92	0.92
Percent Heavy Veh, %	1	1	0	0	0	0
Cap, veh/h	746	649	281	1503	676	96
Arrive On Green	0.42	0.42	0.42	0.42	0.43	0.43
Sat Flow, veh/h	1885	1559	697	3705	1557	221
Grp Volume(v), veh/h	390	400	64	571	387	0
Grp Sat Flow(s),veh/h/ln	1791	1559	697	1805	1782	0
Q Serve(g_s), s	8.9	11.1	4.4	6.0	8.6	0.0
Cycle Q Clear(g_c), s	8.9	11.1	15.4	6.0	8.6	0.0
Prop In Lane		1.00	1.00		0.87	0.12
Lane Grp Cap(c), veh/h	746	649	281	1503	775	0
V/C Ratio(X)	0.52	0.62	0.23	0.38	0.50	0.00
Avail Cap(c_a), veh/h	746	649	281	1503	775	0
HCM Platoon Ratio	1.00	1.00	1.00	1.00	1.00	1.00
Upstream Filter(I)	1.00	1.00	1.00	1.00	1.00	0.00
Uniform Delay (d), s/veh	12.0	12.6	18.7	11.1	11.2	0.0
Incr Delay (d2), s/veh	2.6	4.3	1.9	0.7	2.3	0.0
Initial Q Delay(d3),s/veh	0.0	0.0	0.0	0.0	0.0	0.0
%ile BackOfQ(50%),veh/ln	3.5	4.0	0.8	2.2	3.4	0.0
Unsig. Movement Delay, s/veh						
LnGrp Delay(d),s/veh	14.6	16.9	20.5	11.9	13.5	0.0
LnGrp LOS	B	B	C	B	B	A
Approach Vol, veh/h	790			635	387	
Approach Delay, s/veh	15.8			12.7	13.5	
Approach LOS	B			B	B	
Timer - Assigned Phs		2		4		8
Phs Duration (G+Y+Rc), s		28.0		27.0		27.0
Change Period (Y+Rc), s		4.1		4.1		4.1
Max Green Setting (Gmax), s		23.9		22.9		22.9
Max Q Clear Time (g_c+I1), s		10.6		13.1		17.4
Green Ext Time (p_c), s		1.1		3.7		2.0

Intersection Summary

HCM 6th Ctrl Delay	14.2
HCM 6th LOS	B

Notes

User approved volume balancing among the lanes for turning movement.

Timings

14: Barton Rd. & Van Buren Bl.

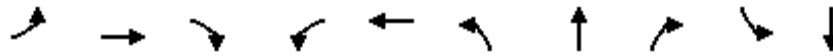

Lane Group	EBL	EBT	EBR	WBL	WBT	NBL	NBT	NBR	SBL	SBT
Lane Configurations	↘	↑↑↑	↗	↘↗	↑↑↑	↘↗	↑	↗	↘	↘
Traffic Volume (vph)	203	1707	252	252	1775	295	51	208	53	33
Future Volume (vph)	203	1707	252	252	1775	295	51	208	53	33
Turn Type	Prot	NA	pm+ov	Prot	NA	Prot	NA	Perm	Prot	NA
Protected Phases	5	2	3	1	6	3	8		7	4
Permitted Phases			2					8		
Detector Phase	5	2	3	1	6	3	8	8	7	4
Switch Phase										
Minimum Initial (s)	5.0	10.0	5.0	5.0	10.0	5.0	10.0	10.0	5.0	10.0
Minimum Split (s)	9.2	25.2	9.1	9.2	25.5	9.1	14.6	14.6	9.1	33.6
Total Split (s)	17.0	54.2	16.0	16.2	53.4	16.0	39.1	39.1	10.5	33.6
Total Split (%)	14.2%	45.2%	13.3%	13.5%	44.5%	13.3%	32.6%	32.6%	8.8%	28.0%
Yellow Time (s)	3.2	5.2	3.6	3.2	5.5	3.6	3.6	3.6	3.6	3.6
All-Red Time (s)	1.0	1.0	0.5	1.0	1.0	0.5	1.0	1.0	0.5	1.0
Lost Time Adjust (s)	0.0	0.0	0.0	0.0	0.0	0.0	0.0	0.0	0.0	0.0
Total Lost Time (s)	4.2	6.2	4.1	4.2	6.5	4.1	4.6	4.6	4.1	4.6
Lead/Lag	Lead	Lag	Lead	Lead	Lag	Lead	Lag	Lag	Lead	Lag
Lead-Lag Optimize?	Yes	Yes	Yes	Yes	Yes	Yes	Yes	Yes	Yes	Yes
Recall Mode	None	None	None	None	None	None	None	None	None	None
Act Effct Green (s)	12.9	44.3	58.5	11.3	42.4	12.0	22.0	22.0	6.4	14.0
Actuated g/C Ratio	0.13	0.44	0.58	0.11	0.42	0.12	0.22	0.22	0.06	0.14
v/c Ratio	0.96	0.76	0.29	0.71	0.85	0.77	0.13	0.44	0.51	0.67
Control Delay	96.0	27.0	7.8	55.6	31.1	58.2	34.9	7.4	65.6	20.8
Queue Delay	0.0	0.0	0.0	0.0	0.0	0.0	0.0	0.0	0.0	0.0
Total Delay	96.0	27.0	7.8	55.6	31.1	58.2	34.9	7.4	65.6	20.8
LOS	F	C	A	E	C	E	C	A	E	C
Approach Delay		31.2			34.1		37.0			28.8
Approach LOS		C			C		D			C

Intersection Summary

Cycle Length: 120	
Actuated Cycle Length: 101	
Natural Cycle: 110	
Control Type: Actuated-Uncoordinated	
Maximum v/c Ratio: 0.96	
Intersection Signal Delay: 32.9	Intersection LOS: C
Intersection Capacity Utilization 86.4%	ICU Level of Service E
Analysis Period (min) 15	



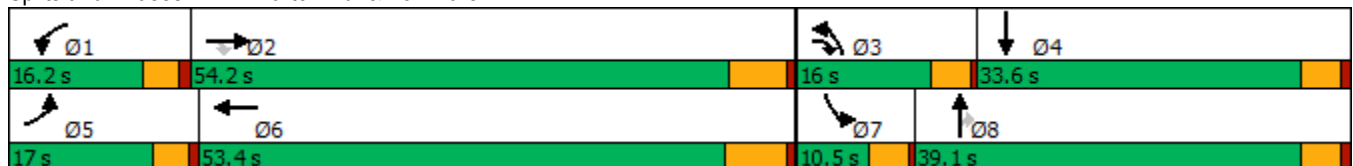

























Splits and Phases: 14: Barton Rd. & Van Buren Bl.



HCM 6th Signalized Intersection Summary
14: Barton Rd. & Van Buren Bl.

West Campus Upper Plateau (JN 14064)

09/30/2022

												
Movement	EBL	EBT	EBR	WBL	WBT	WBR	NBL	NBT	NBR	SBL	SBT	SBR
Lane Configurations		  		 	  		 					
Traffic Volume (veh/h)	203	1707	252	252	1775	64	295	51	208	53	33	213
Future Volume (veh/h)	203	1707	252	252	1775	64	295	51	208	53	33	213
Initial Q (Qb), veh	0	0	0	0	0	0	0	0	0	0	0	0
Ped-Bike Adj(A_pbT)	1.00		1.00	1.00		1.00	1.00		0.96	1.00		1.00
Parking Bus, Adj	1.00	1.00	1.00	1.00	1.00	1.00	1.00	1.00	1.00	1.00	1.00	1.00
Work Zone On Approach		No			No			No			No	
Adj Sat Flow, veh/h/ln	1900	1870	1885	1885	1885	1870	1900	1900	1885	1900	1885	1900
Adj Flow Rate, veh/h	221	1855	244	274	1929	59	321	55	97	58	36	171
Peak Hour Factor	0.92	0.92	0.92	0.92	0.92	0.92	0.92	0.92	0.92	0.92	0.92	0.92
Percent Heavy Veh, %	0	2	1	1	1	2	0	0	1	0	1	0
Cap, veh/h	233	2484	884	342	2251	69	389	423	341	75	44	208
Arrive On Green	0.13	0.44	0.44	0.10	0.41	0.41	0.11	0.22	0.22	0.04	0.15	0.15
Sat Flow, veh/h	1810	5611	1597	3483	5459	167	3510	1900	1531	1810	285	1356
Grp Volume(v), veh/h	221	1855	244	274	1332	656	321	55	97	58	0	207
Grp Sat Flow(s),veh/h/ln	1810	1870	1597	1742	1885	1855	1755	1900	1531	1810	0	1641
Q Serve(g_s), s	12.1	27.4	8.0	7.7	31.9	32.0	8.9	2.3	5.2	3.2	0.0	12.2
Cycle Q Clear(g_c), s	12.1	27.4	8.0	7.7	31.9	32.0	8.9	2.3	5.2	3.2	0.0	12.2
Prop In Lane	1.00		1.00	1.00		0.09	1.00		1.00	1.00		0.83
Lane Grp Cap(c), veh/h	233	2484	884	342	1555	765	389	423	341	75	0	251
V/C Ratio(X)	0.95	0.75	0.28	0.80	0.86	0.86	0.83	0.13	0.28	0.77	0.00	0.82
Avail Cap(c_a), veh/h	233	2707	947	420	1778	875	420	659	531	116	0	478
HCM Platoon Ratio	1.00	1.00	1.00	1.00	1.00	1.00	1.00	1.00	1.00	1.00	1.00	1.00
Upstream Filter(I)	1.00	1.00	1.00	1.00	1.00	1.00	1.00	1.00	1.00	1.00	0.00	1.00
Uniform Delay (d), s/veh	43.0	23.1	11.7	43.9	26.6	26.6	43.3	31.0	32.1	47.2	0.0	40.8
Incr Delay (d2), s/veh	44.5	0.9	0.1	7.0	3.5	7.0	12.0	0.1	0.5	15.3	0.0	6.7
Initial Q Delay(d3),s/veh	0.0	0.0	0.0	0.0	0.0	0.0	0.0	0.0	0.0	0.0	0.0	0.0
%ile BackOfQ(50%),veh/ln	8.0	10.9	2.5	3.5	13.6	14.1	4.4	1.0	1.9	1.7	0.0	5.4
Unsig. Movement Delay, s/veh												
LnGrp Delay(d),s/veh	87.5	24.0	11.8	50.9	30.1	33.5	55.2	31.1	32.6	62.5	0.0	47.5
LnGrp LOS	F	C	B	D	C	C	E	C	C	E	A	D
Approach Vol, veh/h		2320			2262			473				265
Approach Delay, s/veh		28.7			33.6			47.8				50.8
Approach LOS		C			C			D				D
Timer - Assigned Phs	1	2	3	4	5	6	7	8				
Phs Duration (G+Y+Rc), s	14.0	50.5	15.1	19.8	17.0	47.5	8.2	26.7				
Change Period (Y+Rc), s	* 4.2	* 6.5	4.1	4.6	* 4.2	6.5	4.1	4.6				
Max Green Setting (Gmax), s	* 12	* 48	11.9	29.0	* 13	46.9	6.4	34.5				
Max Q Clear Time (g_c+I1), s	9.7	29.4	10.9	14.2	14.1	34.0	5.2	7.2				
Green Ext Time (p_c), s	0.1	9.1	0.1	1.1	0.0	7.0	0.0	0.5				

Intersection Summary

HCM 6th Ctrl Delay	33.6
HCM 6th LOS	C

Notes

* HCM 6th computational engine requires equal clearance times for the phases crossing the barrier.

Timings
19: Van Buren Bl. & Orange Terrace Pkwy.

West Campus Upper Plateau (JN 14064)

09/30/2022



Lane Group	EBL	EBT	EBR	WBL	WBT	WBR	NBL	NBT	NBR	SBL	SBT	SBR
Lane Configurations	↖↖	↑↑↑	↗	↖↖	↑↑↑	↗	↖↖	↑↑	↗	↖↖	↑	↗
Traffic Volume (vph)	151	1608	59	39	1924	291	63	55	46	222	43	134
Future Volume (vph)	151	1608	59	39	1924	291	63	55	46	222	43	134
Turn Type	Prot	NA	pm+ov	Prot	NA	pm+ov	Prot	NA	pm+ov	Prot	NA	pm+ov
Protected Phases	5	2	3	1	6	7	3	8	1	7	4	5
Permitted Phases			2			6			8			4
Detector Phase	5	2	3	1	6	7	3	8	1	7	4	5
Switch Phase												
Minimum Initial (s)	5.0	10.0	5.0	5.0	10.0	10.0	5.0	5.0	5.0	10.0	10.0	5.0
Minimum Split (s)	9.2	25.2	9.1	9.1	25.2	15.8	9.1	26.1	9.1	15.8	24.8	9.2
Total Split (s)	12.0	66.6	16.8	11.5	66.1	15.8	16.8	26.1	11.5	15.8	25.1	12.0
Total Split (%)	10.0%	55.5%	14.0%	9.6%	55.1%	13.2%	14.0%	21.8%	9.6%	13.2%	20.9%	10.0%
Yellow Time (s)	3.2	5.2	3.6	3.6	5.2	4.8	3.6	3.6	3.6	4.8	4.8	3.2
All-Red Time (s)	1.0	1.0	0.5	0.5	1.0	1.0	0.5	0.5	0.5	1.0	1.0	1.0
Lost Time Adjust (s)	0.0	0.0	0.0	0.0	0.0	0.0	0.0	0.0	0.0	0.0	0.0	0.0
Total Lost Time (s)	4.2	6.2	4.1	4.1	6.2	5.8	4.1	4.1	4.1	5.8	5.8	4.2
Lead/Lag	Lead	Lag	Lead	Lead	Lag	Lead	Lead	Lag	Lead	Lead	Lag	Lead
Lead-Lag Optimize?	Yes	Yes	Yes	Yes	Yes	Yes	Yes	Yes	Yes	Yes	Yes	Yes
Recall Mode	None	None	None	None	None	None	None	None	None	None	None	None
Act Effct Green (s)	7.6	54.6	71.8	6.7	50.8	67.6	10.8	8.9	17.0	10.4	11.9	22.2
Actuated g/C Ratio	0.08	0.57	0.75	0.07	0.53	0.70	0.11	0.09	0.18	0.11	0.12	0.23
v/c Ratio	0.58	0.59	0.05	0.17	0.76	0.25	0.17	0.17	0.14	0.63	0.19	0.33
Control Delay	55.7	15.9	1.8	49.4	20.5	1.3	46.1	44.6	2.8	52.9	44.4	17.7
Queue Delay	0.0	0.0	0.0	0.0	0.0	0.0	0.0	0.0	0.0	0.0	0.0	0.0
Total Delay	55.7	15.9	1.8	49.4	20.5	1.3	46.1	44.6	2.8	52.9	44.4	17.7
LOS	E	B	A	D	C	A	D	D	A	D	D	B
Approach Delay		18.7			18.6			33.5			40.2	
Approach LOS		B			B			C			D	

Intersection Summary

Cycle Length: 120
 Actuated Cycle Length: 96
 Natural Cycle: 90
 Control Type: Actuated-Uncoordinated
 Maximum v/c Ratio: 0.76
 Intersection Signal Delay: 21.0
 Intersection LOS: C
 Intersection Capacity Utilization 68.0%
 ICU Level of Service C
 Analysis Period (min) 15

Splits and Phases: 19: Van Buren Bl. & Orange Terrace Pkwy.

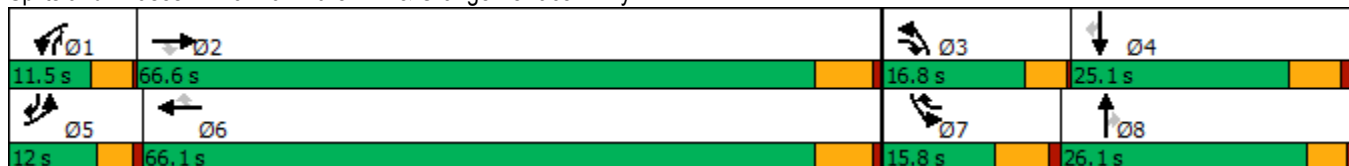

HCM 6th Signalized Intersection Summary
 19: Van Buren Bl. & Orange Terrace Pkwy.

West Campus Upper Plateau (JN 14064)

09/30/2022



Movement	EBL	EBT	EBR	WBL	WBT	WBR	NBL	NBT	NBR	SBL	SBT	SBR
Lane Configurations	↖↗	↑↑↑	↖	↖↗	↑↑↑	↖	↖↗	↑↑	↖	↖↗	↑	↖↗
Traffic Volume (veh/h)	151	1608	59	39	1924	291	63	55	46	222	43	134
Future Volume (veh/h)	151	1608	59	39	1924	291	63	55	46	222	43	134
Initial Q (Qb), veh	0	0	0	0	0	0	0	0	0	0	0	0
Ped-Bike Adj(A_pbT)	1.00		1.00	1.00		1.00	1.00		1.00	1.00		1.00
Parking Bus, Adj	1.00	1.00	1.00	1.00	1.00	1.00	1.00	1.00	1.00	1.00	1.00	1.00
Work Zone On Approach		No			No			No			No	
Adj Sat Flow, veh/h/ln	1885	1870	1870	1885	1856	1885	1870	1900	1885	1885	1900	1885
Adj Flow Rate, veh/h	159	1693	36	41	2025	246	66	58	16	234	45	67
Peak Hour Factor	0.95	0.95	0.95	0.95	0.95	0.95	0.95	0.95	0.95	0.95	0.95	0.95
Percent Heavy Veh, %	1	2	2	1	3	1	2	0	1	1	0	1
Cap, veh/h	229	2891	967	123	2709	1027	152	195	142	376	259	322
Arrive On Green	0.07	0.57	0.57	0.04	0.53	0.53	0.04	0.05	0.05	0.11	0.14	0.14
Sat Flow, veh/h	3483	5106	1585	3483	5066	1598	3456	3610	1598	3483	1900	1598
Grp Volume(v), veh/h	159	1693	36	41	2025	246	66	58	16	234	45	67
Grp Sat Flow(s),veh/h/ln	1742	1702	1585	1742	1689	1598	1728	1805	1598	1742	1900	1598
Q Serve(g_s), s	4.1	19.9	0.8	1.1	28.7	6.0	1.7	1.4	0.9	5.9	1.9	3.2
Cycle Q Clear(g_c), s	4.1	19.9	0.8	1.1	28.7	6.0	1.7	1.4	0.9	5.9	1.9	3.2
Prop In Lane	1.00		1.00	1.00		1.00	1.00		1.00	1.00		1.00
Lane Grp Cap(c), veh/h	229	2891	967	123	2709	1027	152	195	142	376	259	322
V/C Ratio(X)	0.70	0.59	0.04	0.33	0.75	0.24	0.43	0.30	0.11	0.62	0.17	0.21
Avail Cap(c_a), veh/h	294	3332	1104	278	3278	1206	474	858	436	376	396	438
HCM Platoon Ratio	1.00	1.00	1.00	1.00	1.00	1.00	1.00	1.00	1.00	1.00	1.00	1.00
Upstream Filter(I)	1.00	1.00	1.00	1.00	1.00	1.00	1.00	1.00	1.00	1.00	1.00	1.00
Uniform Delay (d), s/veh	42.3	13.0	7.2	43.6	16.7	7.0	43.1	42.1	38.8	39.5	35.4	30.8
Incr Delay (d2), s/veh	2.8	0.2	0.0	1.6	0.8	0.1	1.9	0.8	0.3	3.1	0.3	0.3
Initial Q Delay(d3),s/veh	0.0	0.0	0.0	0.0	0.0	0.0	0.0	0.0	0.0	0.0	0.0	0.0
%ile BackOfQ(50%),veh/ln	1.8	6.3	0.3	0.5	9.4	1.9	0.8	0.7	0.3	2.6	0.9	1.3
Unsig. Movement Delay, s/veh												
LnGrp Delay(d),s/veh	45.1	13.2	7.2	45.2	17.5	7.1	45.0	42.9	39.1	42.6	35.7	31.1
LnGrp LOS	D	B	A	D	B	A	D	D	D	D	D	C
Approach Vol, veh/h		1888			2312			140			346	
Approach Delay, s/veh		15.8			16.9			43.5			39.5	
Approach LOS		B			B			D			D	
Timer - Assigned Phs	1	2	3	4	5	6	7	8				
Phs Duration (G+Y+Rc), s	7.4	58.6	8.2	18.4	10.3	55.7	15.8	10.8				
Change Period (Y+Rc), s	4.1	6.2	4.1	5.8	* 4.2	6.2	5.8	* 5.8				
Max Green Setting (Gmax), s	7.4	60.4	12.7	19.3	* 7.8	59.9	10.0	* 22				
Max Q Clear Time (g_c+I1), s	3.1	21.9	3.7	5.2	6.1	30.7	7.9	3.4				
Green Ext Time (p_c), s	0.0	15.9	0.1	0.3	0.0	18.8	0.2	0.3				

Intersection Summary

HCM 6th Ctrl Delay	18.9
HCM 6th LOS	B

Notes

* HCM 6th computational engine requires equal clearance times for the phases crossing the barrier.

Timings
25: Sycamore Canyon Bl. & Cactus Av.

West Campus Upper Plateau (JN 14064)

09/30/2022



Lane Group	EBL	EBT	WBL	WBT	WBR	NBL	NBT	NBR	SBL	SBT
Lane Configurations	↖	↕↕↕	↖↖	↕↕	↖	↖↖	↕↕	↖	↖↖	↕↕↕
Traffic Volume (vph)	68	441	232	470	285	207	200	140	139	260
Future Volume (vph)	68	441	232	470	285	207	200	140	139	260
Turn Type	Prot	NA	Prot	NA	pm+ov	Prot	NA	pm+ov	Prot	NA
Protected Phases	7	4	3	8	1	5	2	3	1	6
Permitted Phases					8			2		
Detector Phase	7	4	3	8	1	5	2	3	1	6
Switch Phase										
Minimum Initial (s)	5.0	10.0	5.0	10.0	10.0	10.0	10.0	5.0	10.0	10.0
Minimum Split (s)	9.6	32.8	9.6	32.8	15.8	15.8	15.8	9.6	15.8	34.8
Total Split (s)	35.9	48.0	40.0	52.1	32.0	17.0	30.0	40.0	32.0	45.0
Total Split (%)	23.9%	32.0%	26.7%	34.7%	21.3%	11.3%	20.0%	26.7%	21.3%	30.0%
Yellow Time (s)	3.6	4.8	3.6	4.8	4.8	4.8	4.8	3.6	4.8	4.8
All-Red Time (s)	1.0	1.0	1.0	1.0	1.0	1.0	1.0	1.0	1.0	1.0
Lost Time Adjust (s)	0.0	0.0	0.0	0.0	0.0	0.0	0.0	0.0	0.0	0.0
Total Lost Time (s)	4.6	5.8	4.6	5.8	5.8	5.8	5.8	4.6	5.8	5.8
Lead/Lag	Lead	Lag	Lead	Lag	Lead	Lead	Lag	Lead	Lead	Lag
Lead-Lag Optimize?	Yes	Yes	Yes	Yes	Yes	Yes	Yes	Yes	Yes	Yes
Recall Mode	None	None	None	None	None	None	None	None	None	None
Act Effct Green (s)	7.9	17.0	10.5	22.0	38.6	11.1	13.8	30.3	10.7	13.5
Actuated g/C Ratio	0.11	0.23	0.14	0.29	0.52	0.15	0.18	0.41	0.14	0.18
v/c Ratio	0.38	0.60	0.51	0.49	0.31	0.43	0.32	0.21	0.29	0.38
Control Delay	41.0	25.7	36.0	25.7	2.8	35.2	28.6	3.6	34.2	26.1
Queue Delay	0.0	0.0	0.0	0.0	0.0	0.0	0.0	0.0	0.0	0.0
Total Delay	41.0	25.7	36.0	25.7	2.8	35.2	28.6	3.6	34.2	26.1
LOS	D	C	D	C	A	D	C	A	C	C
Approach Delay		27.2		21.5			24.7			28.5
Approach LOS		C		C			C			C

Intersection Summary

Cycle Length: 150
 Actuated Cycle Length: 74.8
 Natural Cycle: 95
 Control Type: Actuated-Uncoordinated
 Maximum v/c Ratio: 0.60
 Intersection Signal Delay: 24.8
 Intersection LOS: C
 Intersection Capacity Utilization 54.6%
 ICU Level of Service A
 Analysis Period (min) 15

Splits and Phases: 25: Sycamore Canyon Bl. & Cactus Av.

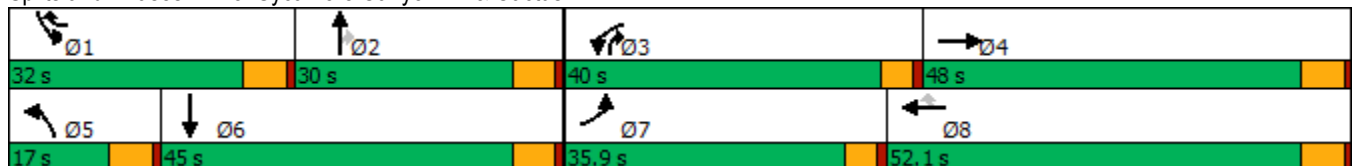

HCM 6th Signalized Intersection Summary
 25: Sycamore Canyon Bl. & Cactus Av.

West Campus Upper Plateau (JN 14064)

09/30/2022



Movement	EBL	EBT	EBR	WBL	WBT	WBR	NBL	NBT	NBR	SBL	SBT	SBR
Lane Configurations	↘	↑↑↑		↘↘	↑↑	↗	↘↘	↑↑	↗	↘↘	↑↑↑	
Traffic Volume (veh/h)	68	441	199	232	470	285	207	200	140	139	260	57
Future Volume (veh/h)	68	441	199	232	470	285	207	200	140	139	260	57
Initial Q (Qb), veh	0	0	0	0	0	0	0	0	0	0	0	0
Ped-Bike Adj(A_pbT)	1.00		1.00	1.00		1.00	1.00		1.00	1.00		1.00
Parking Bus, Adj	1.00	1.00	1.00	1.00	1.00	1.00	1.00	1.00	1.00	1.00	1.00	1.00
Work Zone On Approach		No			No			No			No	
Adj Sat Flow, veh/h/ln	1856	1781	1856	1841	1796	1870	1856	1841	1811	1885	1811	1767
Adj Flow Rate, veh/h	71	459	198	242	490	55	216	208	53	145	271	59
Peak Hour Factor	0.96	0.96	0.96	0.96	0.96	0.96	0.96	0.96	0.96	0.96	0.96	0.96
Percent Heavy Veh, %	3	8	3	4	7	2	3	4	6	1	6	9
Cap, veh/h	100	776	321	358	951	693	543	554	404	551	649	135
Arrive On Green	0.06	0.23	0.23	0.11	0.28	0.28	0.16	0.16	0.16	0.16	0.16	0.16
Sat Flow, veh/h	1767	3376	1397	3401	3413	1585	3428	3497	1535	3483	4098	856
Grp Volume(v), veh/h	71	440	217	242	490	55	216	208	53	145	216	114
Grp Sat Flow(s),veh/h/ln	1767	1621	1530	1700	1706	1585	1714	1749	1535	1742	1648	1657
Q Serve(g_s), s	2.5	7.6	8.0	4.3	7.6	1.3	3.6	3.4	1.7	2.3	3.7	3.9
Cycle Q Clear(g_c), s	2.5	7.6	8.0	4.3	7.6	1.3	3.6	3.4	1.7	2.3	3.7	3.9
Prop In Lane	1.00		0.91	1.00		1.00	1.00		1.00	1.00		0.52
Lane Grp Cap(c), veh/h	100	746	352	358	951	693	543	554	404	551	522	262
V/C Ratio(X)	0.71	0.59	0.62	0.68	0.52	0.08	0.40	0.38	0.13	0.26	0.41	0.44
Avail Cap(c_a), veh/h	876	2166	1022	1906	2501	1413	608	1340	749	1445	2045	1028
HCM Platoon Ratio	1.00	1.00	1.00	1.00	1.00	1.00	1.00	1.00	1.00	1.00	1.00	1.00
Upstream Filter(I)	1.00	1.00	1.00	1.00	1.00	1.00	1.00	1.00	1.00	1.00	1.00	1.00
Uniform Delay (d), s/veh	29.3	21.7	21.8	27.2	19.2	10.4	23.9	23.8	17.7	23.3	23.9	24.0
Incr Delay (d2), s/veh	3.5	0.7	1.8	0.8	0.4	0.0	0.5	0.4	0.1	0.3	0.5	1.1
Initial Q Delay(d3),s/veh	0.0	0.0	0.0	0.0	0.0	0.0	0.0	0.0	0.0	0.0	0.0	0.0
%ile BackOfQ(50%),veh/ln	1.1	2.7	2.7	1.6	2.7	0.4	1.3	1.3	0.5	0.9	1.3	1.5
Unsig. Movement Delay, s/veh												
LnGrp Delay(d),s/veh	32.8	22.4	23.6	28.1	19.6	10.4	24.4	24.2	17.9	23.6	24.5	25.2
LnGrp LOS	C	C	C	C	B	B	C	C	B	C	C	C
Approach Vol, veh/h		728			787			477			475	
Approach Delay, s/veh		23.8			21.6			23.6			24.4	
Approach LOS		C			C			C			C	
Timer - Assigned Phs	1	2	3	4	5	6	7	8				
Phs Duration (G+Y+Rc), s	15.8	15.8	11.2	20.3	15.8	15.8	8.2	23.4				
Change Period (Y+Rc), s	5.8	5.8	4.6	5.8	5.8	5.8	4.6	5.8				
Max Green Setting (Gmax), s	26.2	24.2	35.4	42.2	11.2	39.2	31.3	46.3				
Max Q Clear Time (g_c+I1), s	4.3	5.4	6.3	10.0	5.6	5.9	4.5	9.6				
Green Ext Time (p_c), s	0.4	1.2	0.4	4.5	0.3	2.0	0.1	3.4				

Intersection Summary

HCM 6th Ctrl Delay	23.1
HCM 6th LOS	C

Notes

User approved pedestrian interval to be less than phase max green.

Timings

West Campus Upper Plateau (JN 14064)

26: Sycamore Canyon Bl. & Van Buren Bl.

09/30/2022

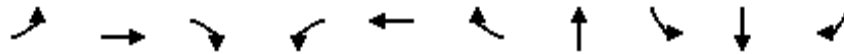

Lane Group	EBL	EBT	EBR	WBL	WBT	WBR	NBT	SBL	SBT	SBR
Lane Configurations										
Traffic Volume (vph)	348	1633	7	40	1747	85	7	116	11	584
Future Volume (vph)	348	1633	7	40	1747	85	7	116	11	584
Turn Type	Prot	NA	Perm	Prot	NA	Perm	NA	Split	NA	Perm
Protected Phases	5	2		1	6		8	4	4	
Permitted Phases			2			6				4
Detector Phase	5	2	2	1	6	6	8	4	4	4
Switch Phase										
Minimum Initial (s)	5.0	10.0	10.0	5.0	10.0	10.0	10.0	10.0	10.0	10.0
Minimum Split (s)	9.6	29.2	29.2	9.6	29.2	29.2	14.6	50.8	50.8	50.8
Total Split (s)	14.0	44.8	44.8	9.6	40.4	40.4	14.6	51.0	51.0	51.0
Total Split (%)	11.7%	37.3%	37.3%	8.0%	33.7%	33.7%	12.2%	42.5%	42.5%	42.5%
Yellow Time (s)	3.6	5.2	5.2	3.6	5.2	5.2	3.6	4.8	4.8	4.8
All-Red Time (s)	1.0	1.0	1.0	1.0	1.0	1.0	1.0	1.0	1.0	1.0
Lost Time Adjust (s)	0.0	0.0	0.0	0.0	0.0	0.0	0.0	0.0	0.0	0.0
Total Lost Time (s)	4.6	6.2	6.2	4.6	6.2	6.2	4.6	5.8	5.8	5.8
Lead/Lag	Lead	Lag	Lag	Lead	Lag	Lag				
Lead-Lag Optimize?	Yes	Yes	Yes	Yes	Yes	Yes				
Recall Mode	None	None	None	None	None	None	None	None	None	None
Act Effct Green (s)	10.0	42.1	42.1	5.3	32.3	32.3	10.6	16.1	16.1	16.1
Actuated g/C Ratio	0.12	0.50	0.50	0.06	0.39	0.39	0.13	0.19	0.19	0.19
v/c Ratio	0.88	0.47	0.01	0.43	0.66	0.13	0.09	0.18	0.64	0.60
Control Delay	63.1	18.5	0.0	59.7	25.0	4.4	25.0	29.7	11.2	9.2
Queue Delay	0.0	0.0	0.0	0.0	0.0	0.0	0.0	0.0	0.0	0.0
Total Delay	63.1	18.5	0.0	59.7	25.0	4.4	25.0	29.7	11.2	9.2
LOS	E	B	A	E	C	A	C	C	B	A
Approach Delay		26.2			24.8		25.0		13.0	
Approach LOS		C			C		C		B	

Intersection Summary

Cycle Length: 120	
Actuated Cycle Length: 83.7	
Natural Cycle: 115	
Control Type: Actuated-Uncoordinated	
Maximum v/c Ratio: 0.88	
Intersection Signal Delay: 23.6	Intersection LOS: C
Intersection Capacity Utilization 71.6%	ICU Level of Service C
Analysis Period (min) 15	

Splits and Phases: 26: Sycamore Canyon Bl. & Van Buren Bl.

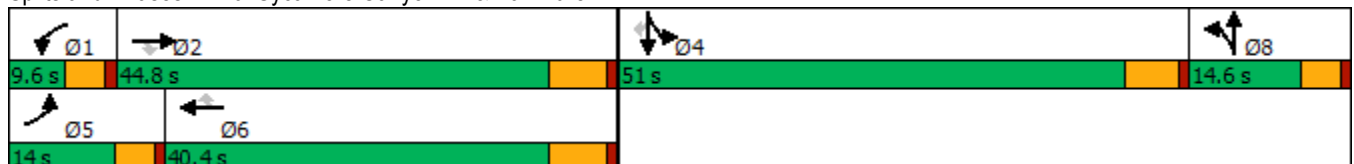

HCM 6th Signalized Intersection Summary
 26: Sycamore Canyon Bl. & Van Buren Bl.

West Campus Upper Plateau (JN 14064)

09/30/2022



Movement	EBL	EBT	EBR	WBL	WBT	WBR	NBL	NBT	NBR	SBL	SBT	SBR
Lane Configurations												
Traffic Volume (veh/h)	348	1633	7	40	1747	85	8	7	22	116	11	584
Future Volume (veh/h)	348	1633	7	40	1747	85	8	7	22	116	11	584
Initial Q (Qb), veh	0	0	0	0	0	0	0	0	0	0	0	0
Ped-Bike Adj(A_pbT)	1.00		1.00	1.00		0.99	1.00		1.00	1.00		1.00
Parking Bus, Adj	1.00	1.00	1.00	1.00	1.00	1.00	1.00	1.00	1.00	1.00	1.00	1.00
Work Zone On Approach		No			No			No			No	
Adj Sat Flow, veh/h/ln	1856	1841	1900	1663	1826	1856	1900	1900	1900	1841	1900	1856
Adj Flow Rate, veh/h	366	1719	7	42	1839	67	8	7	-6	102	0	0
Peak Hour Factor	0.95	0.95	0.95	0.95	0.95	0.95	0.95	0.95	0.95	0.95	0.95	0.95
Percent Heavy Veh, %	3	4	0	16	5	3	0	0	0	4	0	3
Cap, veh/h	461	3679	805	64	2991	636	151	486	0	440	0	
Arrive On Green	0.13	0.50	0.50	0.04	0.41	0.41	0.02	0.02	0.00	0.13	0.00	0.00
Sat Flow, veh/h	3534	7363	1610	1584	7304	1553	1801	1909	0	3506	0	3145
Grp Volume(v), veh/h	366	1719	7	42	1839	67	8	1	0	102	0	0
Grp Sat Flow(s),veh/h/ln	1767	1841	1610	1584	1826	1553	1810	1805	0	1753	0	1572
Q Serve(g_s), s	6.8	10.4	0.1	1.8	13.5	1.8	0.0	0.0	0.0	1.8	0.0	0.0
Cycle Q Clear(g_c), s	6.8	10.4	0.1	1.8	13.5	1.8	0.0	0.0	0.0	1.8	0.0	0.0
Prop In Lane	1.00		1.00	1.00		1.00	0.99		0.00	1.00		1.00
Lane Grp Cap(c), veh/h	461	3679	805	64	2991	636	0	0	0	440	0	
V/C Ratio(X)	0.79	0.47	0.01	0.66	0.61	0.11	0.00	0.00	0.00	0.23	0.00	
Avail Cap(c_a), veh/h	488	4176	913	116	3670	780	0	0	0	2329	0	
HCM Platoon Ratio	1.00	1.00	1.00	1.00	1.00	1.00	1.00	1.00	1.00	1.00	1.00	1.00
Upstream Filter(I)	1.00	1.00	1.00	1.00	1.00	1.00	1.00	1.00	0.00	1.00	0.00	0.00
Uniform Delay (d), s/veh	28.7	11.1	8.6	32.2	15.9	12.4	0.0	0.0	0.0	26.8	0.0	0.0
Incr Delay (d2), s/veh	7.5	0.1	0.0	4.3	0.2	0.1	0.0	0.0	0.0	0.3	0.0	0.0
Initial Q Delay(d3),s/veh	0.0	0.0	0.0	0.0	0.0	0.0	0.0	0.0	0.0	0.0	0.0	0.0
%ile BackOfQ(50%),veh/ln	3.1	3.3	0.0	0.7	4.7	0.5	0.0	0.0	0.0	0.7	0.0	0.0
Unsig. Movement Delay, s/veh												
LnGrp Delay(d),s/veh	36.2	11.2	8.6	36.5	16.1	12.5	0.0	0.0	0.0	27.1	0.0	0.0
LnGrp LOS	D	B	A	D	B	B	A	A	A	C	A	
Approach Vol, veh/h		2092			1948			9			102	
Approach Delay, s/veh		15.6			16.4			0.0			27.1	
Approach LOS		B			B			A			C	
Timer - Assigned Phs	1	2		4	5	6		8				
Phs Duration (G+Y+Rc), s	7.3	40.2		14.3	13.5	34.1		6.2				
Change Period (Y+Rc), s	4.6	6.2		5.8	4.6	6.2		4.6				
Max Green Setting (Gmax), s	5.0	38.6		45.2	9.4	34.2		10.0				
Max Q Clear Time (g_c+1), s	3.8	12.4		3.8	8.8	15.5		2.0				
Green Ext Time (p_c), s	0.0	14.0		0.3	0.1	12.3		0.0				

Intersection Summary

HCM 6th Ctrl Delay	16.2
HCM 6th LOS	B

Notes

User approved volume balancing among the lanes for turning movement.
 Unsignalized Delay for [SBR] is excluded from calculations of the approach delay and intersection delay.

Timings
29: I-215 NB Ramps & Alessandro Bl.

West Campus Upper Plateau (JN 14064)

09/30/2022

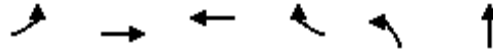

Lane Group	EBL	EBT	WBT	WBR	NBL	NBT
Lane Configurations	↶	↑↑↑	↑↑↑	↷	↶↷	↕
Traffic Volume (vph)	280	1098	1037	183	516	12
Future Volume (vph)	280	1098	1037	183	516	12
Turn Type	Prot	NA	NA	Perm	Split	NA
Protected Phases	5	2	6		8	8
Permitted Phases				6		
Detector Phase	5	2	6	6	8	8
Switch Phase						
Minimum Initial (s)	5.0	5.0	5.0	5.0	5.0	5.0
Minimum Split (s)	9.5	10.5	33.5	33.5	10.0	10.0
Total Split (s)	23.0	67.0	44.0	44.0	43.0	43.0
Total Split (%)	20.9%	60.9%	40.0%	40.0%	39.1%	39.1%
Yellow Time (s)	3.5	4.5	4.5	4.5	4.0	4.0
All-Red Time (s)	1.0	1.0	1.0	1.0	1.0	1.0
Lost Time Adjust (s)	0.0	0.0	0.0	0.0	0.0	0.0
Total Lost Time (s)	4.5	5.5	5.5	5.5	5.0	5.0
Lead/Lag	Lead		Lag	Lag		
Lead-Lag Optimize?	Yes		Yes	Yes		
Recall Mode	None	Min	Min	Min	Max	Max
Act Effct Green (s)	18.5	52.8	29.7	29.7	38.1	38.1
Actuated g/C Ratio	0.18	0.52	0.29	0.29	0.38	0.38
v/c Ratio	1.02	0.43	0.73	0.39	0.40	0.64
Control Delay	101.0	15.4	35.3	19.2	25.5	27.7
Queue Delay	0.0	0.0	0.0	0.0	0.0	0.0
Total Delay	101.0	15.4	35.3	19.2	25.5	27.7
LOS	F	B	D	B	C	C
Approach Delay		32.8	32.9			26.4
Approach LOS		C	C			C

Intersection Summary

Cycle Length: 110
 Actuated Cycle Length: 101.4
 Natural Cycle: 80
 Control Type: Actuated-Uncoordinated
 Maximum v/c Ratio: 1.02
 Intersection Signal Delay: 31.3
 Intersection LOS: C
 Intersection Capacity Utilization 63.9%
 ICU Level of Service B
 Analysis Period (min) 15

Splits and Phases: 29: I-215 NB Ramps & Alessandro Bl.



HCM 6th Signalized Intersection Summary
 29: I-215 NB Ramps & Alessandro Bl.

West Campus Upper Plateau (JN 14064)

09/30/2022



Movement	EBL	EBT	EBR	WBL	WBT	WBR	NBL	NBT	NBR	SBL	SBT	SBR
Lane Configurations	↘	↑↑↑			↑↑↑	↗	↘↗	↕				
Traffic Volume (veh/h)	280	1098	0	0	1037	183	516	12	301	0	0	0
Future Volume (veh/h)	280	1098	0	0	1037	183	516	12	301	0	0	0
Initial Q (Qb), veh	0	0	0	0	0	0	0	0	0			
Ped-Bike Adj(A_pbT)	1.00		1.00	1.00		0.98	1.00		1.00			
Parking Bus, Adj	1.00	1.00	1.00	1.00	1.00	1.00	1.00	1.00	1.00			
Work Zone On Approach		No			No			No				
Adj Sat Flow, veh/h/ln	1663	1870	0	0	1841	1781	1841	1900	1826			
Adj Flow Rate, veh/h	289	1132	0	0	1069	163	523	25	226			
Peak Hour Factor	0.97	0.97	0.97	0.97	0.97	0.97	0.97	0.97	0.97			
Percent Heavy Veh, %	16	2	0	0	4	8	4	0	5			
Cap, veh/h	294	2617	0	0	1414	416	1339	62	562			
Arrive On Green	0.19	0.51	0.00	0.00	0.28	0.28	0.38	0.38	0.38			
Sat Flow, veh/h	1584	5274	0	0	5191	1478	3506	163	1472			
Grp Volume(v), veh/h	289	1132	0	0	1069	163	523	0	251			
Grp Sat Flow(s),veh/h/ln	1584	1702	0	0	1675	1478	1753	0	1635			
Q Serve(g_s), s	18.1	13.8	0.0	0.0	19.3	8.9	10.8	0.0	11.2			
Cycle Q Clear(g_c), s	18.1	13.8	0.0	0.0	19.3	8.9	10.8	0.0	11.2			
Prop In Lane	1.00		0.00	0.00		1.00	1.00		0.90			
Lane Grp Cap(c), veh/h	294	2617	0	0	1414	416	1339	0	624			
V/C Ratio(X)	0.98	0.43	0.00	0.00	0.76	0.39	0.39	0.00	0.40			
Avail Cap(c_a), veh/h	294	3156	0	0	1945	572	1339	0	624			
HCM Platoon Ratio	1.00	1.00	1.00	1.00	1.00	1.00	1.00	1.00	1.00			
Upstream Filter(I)	1.00	1.00	0.00	0.00	1.00	1.00	1.00	0.00	1.00			
Uniform Delay (d), s/veh	40.3	15.2	0.0	0.0	32.6	28.9	22.3	0.0	22.5			
Incr Delay (d2), s/veh	47.1	0.1	0.0	0.0	1.1	0.6	0.9	0.0	1.9			
Initial Q Delay(d3),s/veh	0.0	0.0	0.0	0.0	0.0	0.0	0.0	0.0	0.0			
%ile BackOfQ(50%),veh/ln	10.4	4.6	0.0	0.0	7.3	3.0	4.4	0.0	4.4			
Unsig. Movement Delay, s/veh												
LnGrp Delay(d),s/veh	87.5	15.3	0.0	0.0	33.8	29.5	23.2	0.0	24.4			
LnGrp LOS	F	B	A	A	C	C	C	A	C			
Approach Vol, veh/h		1421			1232			774				
Approach Delay, s/veh		30.0			33.2			23.6				
Approach LOS		C			C			C				
Timer - Assigned Phs		2			5	6		8				
Phs Duration (G+Y+Rc), s		56.5			23.0	33.5		43.0				
Change Period (Y+Rc), s		5.5			4.5	5.5		5.0				
Max Green Setting (Gmax), s		61.5			18.5	38.5		38.0				
Max Q Clear Time (g_c+I1), s		15.8			20.1	21.3		13.2				
Green Ext Time (p_c), s		8.6			0.0	6.7		3.5				

Intersection Summary

HCM 6th Ctrl Delay	29.7
HCM 6th LOS	C

Notes

User approved volume balancing among the lanes for turning movement.

Timings
30: I-215 SB Ramps & Cactus Av.

West Campus Upper Plateau (JN 14064)

09/30/2022



Lane Group	EBT	EBR	WBL	WBT	NBR	SBR
Lane Configurations	↑↑↑	↑	↓	↑↑↑	↑	↓
Traffic Volume (vph)	349	103	431	627	406	342
Future Volume (vph)	349	103	431	627	406	342
Turn Type	NA	Perm	Prot	NA	Prot	Prot
Protected Phases	2		1	6	8	4
Permitted Phases		2				
Detector Phase	2	2	1	6	8	4
Switch Phase						
Minimum Initial (s)	5.0	5.0	5.0	5.0	5.0	5.0
Minimum Split (s)	11.0	11.0	9.5	23.0	9.1	9.5
Total Split (s)	39.0	39.0	42.0	81.0	29.0	29.0
Total Split (%)	35.5%	35.5%	38.2%	73.6%	26.4%	26.4%
Yellow Time (s)	5.0	5.0	3.5	5.0	3.6	3.5
All-Red Time (s)	1.0	1.0	1.0	1.0	0.5	1.0
Lost Time Adjust (s)	0.0	0.0	0.0	0.0	0.0	0.0
Total Lost Time (s)	6.0	6.0	4.5	6.0	4.1	4.5
Lead/Lag	Lag	Lag	Lead			
Lead-Lag Optimize?	Yes	Yes	Yes			
Recall Mode	Min	Min	None	Min	None	None
Act Effct Green (s)	10.0	10.0	20.1	35.0	10.1	9.6
Actuated g/C Ratio	0.18	0.18	0.36	0.62	0.18	0.17
v/c Ratio	0.43	0.31	0.73	0.21	0.53	0.74
Control Delay	24.5	9.1	24.0	5.0	2.4	16.4
Queue Delay	0.0	0.0	0.0	0.0	0.0	0.0
Total Delay	24.5	9.1	24.0	5.0	2.4	16.4
LOS	C	A	C	A	A	B
Approach Delay	21.0			12.7		
Approach LOS	C			B		

Intersection Summary

Cycle Length: 110
 Actuated Cycle Length: 56
 Natural Cycle: 55
 Control Type: Actuated-Uncoordinated
 Maximum v/c Ratio: 0.74
 Intersection Signal Delay: 13.1
 Intersection LOS: B
 Intersection Capacity Utilization 42.0%
 ICU Level of Service A
 Analysis Period (min) 15



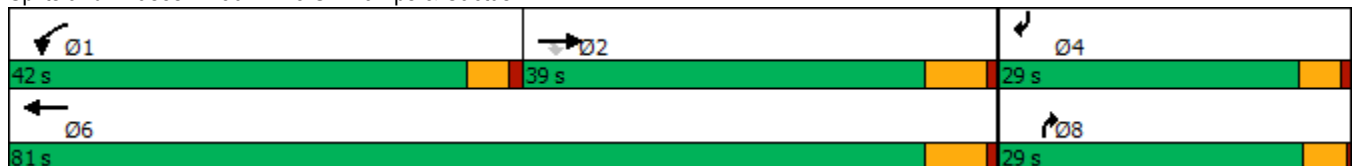









Splits and Phases: 30: I-215 SB Ramps & Cactus Av.



HCM 6th Signalized Intersection Summary
30: I-215 SB Ramps & Cactus Av.

West Campus Upper Plateau (JN 14064)

09/30/2022

												
Movement	EBL	EBT	EBR	WBL	WBT	WBR	NBL	NBT	NBR	SBL	SBT	SBR
Lane Configurations		↑↑↑	↗	↖	↑↑↑				↗			↗
Traffic Volume (veh/h)	0	349	103	431	627	0	0	0	406	0	0	342
Future Volume (veh/h)	0	349	103	431	627	0	0	0	406	0	0	342
Initial Q (Qb), veh	0	0	0	0	0	0	0	0	0	0	0	0
Ped-Bike Adj(A_pbT)	1.00		1.00	1.00		1.00	1.00		1.00	1.00		1.00
Parking Bus, Adj	1.00	1.00	1.00	1.00	1.00	1.00	1.00	1.00	1.00	1.00	1.00	1.00
Work Zone On Approach		No			No			No			No	
Adj Sat Flow, veh/h/ln	0	1826	1811	1885	1870	0	0	0	1811	0	0	1737
Adj Flow Rate, veh/h	0	379	83	468	682	0	0	0	0	0	0	263
Peak Hour Factor	0.92	0.92	0.92	0.92	0.92	0.92	0.92	0.92	0.92	0.92	0.92	0.92
Percent Heavy Veh, %	0	5	6	1	2	0	0	0	6	0	0	11
Cap, veh/h	0	1096	337	596	3798	0	0	0	0	0	0	0
Arrive On Green	0.00	0.22	0.22	0.33	0.74	0.00	0.00	0.00	0.00	0.00	0.00	0.00
Sat Flow, veh/h	0	5149	1535	1795	5274	0		0			0	
Grp Volume(v), veh/h	0	379	83	468	682	0		0.0			0.0	
Grp Sat Flow(s),veh/h/ln	0	1662	1535	1795	1702	0						
Q Serve(g_s), s	0.0	1.5	1.0	5.5	0.9	0.0						
Cycle Q Clear(g_c), s	0.0	1.5	1.0	5.5	0.9	0.0						
Prop In Lane	0.00		1.00	1.00		0.00						
Lane Grp Cap(c), veh/h	0	1096	337	596	3798	0						
V/C Ratio(X)	0.00	0.35	0.25	0.79	0.18	0.00						
Avail Cap(c_a), veh/h	0	7024	2163	2875	16352	0						
HCM Platoon Ratio	1.00	1.00	1.00	1.00	1.00	1.00						
Upstream Filter(I)	0.00	1.00	1.00	1.00	1.00	0.00						
Uniform Delay (d), s/veh	0.0	7.7	7.5	7.1	0.9	0.0						
Incr Delay (d2), s/veh	0.0	0.1	0.1	0.9	0.0	0.0						
Initial Q Delay(d3),s/veh	0.0	0.0	0.0	0.0	0.0	0.0						
%ile BackOfQ(50%),veh/ln	0.0	0.2	0.1	0.6	0.0	0.0						
Unsig. Movement Delay, s/veh												
LnGrp Delay(d),s/veh	0.0	7.8	7.7	7.9	0.9	0.0						
LnGrp LOS	A	A	A	A	A	A						
Approach Vol, veh/h		462			1150							
Approach Delay, s/veh		7.8			3.8							
Approach LOS		A			A							
Timer - Assigned Phs	1	2				6						
Phs Duration (G+Y+Rc), s	12.3	11.1				23.4						
Change Period (Y+Rc), s	4.5	6.0				6.0						
Max Green Setting (Gmax), s	37.5	33.0				75.0						
Max Q Clear Time (g_c+I1), s	7.5	3.5				2.9						
Green Ext Time (p_c), s	0.6	1.6				3.0						

Intersection Summary

HCM 6th Ctrl Delay	4.9
HCM 6th LOS	A

Notes

Unsignalized Delay for [NBR] is excluded from calculations of the approach delay and intersection delay.

Timings

31: I-215 NB Ramps/Old 215 Frontage Rd. & Cactus Av.



Lane Group	EBL	EBT	EBR	WBT	NBL	NBT	NBR	SBL	SBT
Lane Configurations	↔	↑↑↑	↔	↑↑↑	↔	↔	↔	↔	↔
Traffic Volume (vph)	37	801	284	1351	144	81	4	135	1
Future Volume (vph)	37	801	284	1351	144	81	4	135	1
Turn Type	Perm	NA	Perm	NA	Prot	NA	Free	Perm	NA
Protected Phases		2		6	3	8			4
Permitted Phases	2		2				Free	4	
Detector Phase	2	2	2	6	3	8		4	4
Switch Phase									
Minimum Initial (s)	5.0	5.0	5.0	5.0	5.0	5.0		5.0	5.0
Minimum Split (s)	11.0	11.0	11.0	44.0	9.1	10.5		10.5	10.5
Total Split (s)	73.0	73.0	73.0	73.0	20.0	47.0		27.0	27.0
Total Split (%)	60.8%	60.8%	60.8%	60.8%	16.7%	39.2%		22.5%	22.5%
Yellow Time (s)	5.0	5.0	5.0	5.0	3.6	4.5		4.5	4.5
All-Red Time (s)	1.0	1.0	1.0	1.0	0.5	1.0		1.0	1.0
Lost Time Adjust (s)	0.0	0.0	0.0	0.0	0.0	0.0		0.0	0.0
Total Lost Time (s)	6.0	6.0	6.0	6.0	4.1	5.5		5.5	5.5
Lead/Lag					Lead			Lag	Lag
Lead-Lag Optimize?					Yes			Yes	Yes
Recall Mode	Min	Min	Min	Min	None	None		None	None
Act Effct Green (s)	27.6	27.6	27.6	27.6	9.1	26.0	65.9	12.5	12.5
Actuated g/C Ratio	0.42	0.42	0.42	0.42	0.14	0.39	1.00	0.19	0.19
v/c Ratio	0.36	0.41	0.38	0.61	0.34	0.13	0.00	0.60	0.29
Control Delay	24.6	14.0	3.2	15.5	32.1	15.7	0.0	38.8	14.2
Queue Delay	0.0	0.0	0.0	0.0	0.0	0.0	0.0	0.0	0.0
Total Delay	24.6	14.0	3.2	15.5	32.1	15.7	0.0	38.8	14.2
LOS	C	B	A	B	C	B	A	D	B
Approach Delay		11.6		15.5		25.8			28.5
Approach LOS		B		B		C			C

Intersection Summary

Cycle Length: 120
 Actuated Cycle Length: 65.9
 Natural Cycle: 70
 Control Type: Actuated-Uncoordinated
 Maximum v/c Ratio: 0.61
 Intersection Signal Delay: 15.8
 Intersection Capacity Utilization 54.5%
 Analysis Period (min) 15
 Intersection LOS: B
 ICU Level of Service A

Splits and Phases: 31: I-215 NB Ramps/Old 215 Frontage Rd. & Cactus Av.

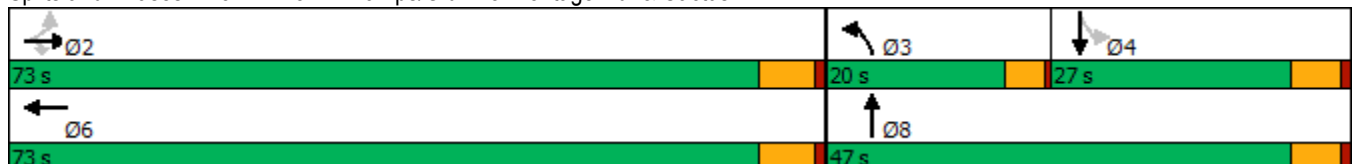

HCM 6th Signalized Intersection Summary

West Campus Upper Plateau (JN 14064)

31: I-215 NB Ramps/Old 215 Frontage Rd. & Cactus Av.

09/30/2022

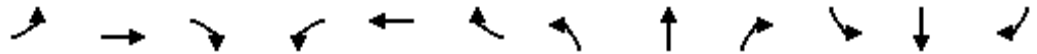

Movement	EBL	EBT	EBR	WBL	WBT	WBR	NBL	NBT	NBR	SBL	SBT	SBR
Lane Configurations												
Traffic Volume (veh/h)	37	801	284	0	1351	146	144	81	4	135	1	96
Future Volume (veh/h)	37	801	284	0	1351	146	144	81	4	135	1	96
Initial Q (Qb), veh	0	0	0	0	0	0	0	0	0	0	0	0
Ped-Bike Adj(A_pbT)	1.00		1.00	1.00		1.00	1.00		1.00	1.00		1.00
Parking Bus, Adj	1.00	1.00	1.00	1.00	1.00	1.00	1.00	1.00	1.00	1.00	1.00	1.00
Work Zone On Approach		No			No			No			No	
Adj Sat Flow, veh/h/ln	1856	1841	1767	0	1856	1885	1826	1856	1870	1841	1900	1885
Adj Flow Rate, veh/h	40	861	301	0	1453	108	155	87	0	145	1	76
Peak Hour Factor	0.93	0.93	0.93	0.93	0.93	0.93	0.93	0.93	0.93	0.93	0.93	0.93
Percent Heavy Veh, %	3	4	9	0	3	1	5	3	2	4	0	1
Cap, veh/h	233	2179	649	0	2648	197	314	610		347	3	245
Arrive On Green	0.43	0.43	0.43	0.00	0.43	0.43	0.09	0.33	0.00	0.15	0.15	0.15
Sat Flow, veh/h	327	5025	1497	0	6366	453	3478	1856	1585	1289	21	1592
Grp Volume(v), veh/h	40	861	301	0	1139	422	155	87	0	145	0	77
Grp Sat Flow(s),veh/h/ln	327	1675	1497	0	1596	1773	1739	1856	1585	1289	0	1613
Q Serve(g_s), s	5.0	5.7	6.9	0.0	8.6	8.6	2.1	1.6	0.0	5.2	0.0	2.1
Cycle Q Clear(g_c), s	13.6	5.7	6.9	0.0	8.6	8.6	2.1	1.6	0.0	5.2	0.0	2.1
Prop In Lane	1.00		1.00	0.00		0.26	1.00		1.00	1.00		0.99
Lane Grp Cap(c), veh/h	233	2179	649	0	2076	769	314	610		347	0	248
V/C Ratio(X)	0.17	0.40	0.46	0.00	0.55	0.55	0.49	0.14		0.42	0.00	0.31
Avail Cap(c_a), veh/h	544	6953	2071	0	6624	2453	1142	1590		721	0	716
HCM Platoon Ratio	1.00	1.00	1.00	1.00	1.00	1.00	1.00	1.00	1.00	1.00	1.00	1.00
Upstream Filter(I)	1.00	1.00	1.00	0.00	1.00	1.00	1.00	1.00	0.00	1.00	0.00	1.00
Uniform Delay (d), s/veh	15.3	9.4	9.7	0.0	10.2	10.2	21.0	11.4	0.0	19.5	0.0	18.2
Incr Delay (d2), s/veh	0.1	0.0	0.2	0.0	0.1	0.2	1.2	0.0	0.0	0.3	0.0	0.3
Initial Q Delay(d3),s/veh	0.0	0.0	0.0	0.0	0.0	0.0	0.0	0.0	0.0	0.0	0.0	0.0
%ile BackOfQ(50%),veh/ln	0.3	1.4	1.6	0.0	2.0	2.3	0.8	0.5	0.0	1.3	0.0	0.6
Unsig. Movement Delay, s/veh												
LnGrp Delay(d),s/veh	15.4	9.4	9.9	0.0	10.3	10.4	22.2	11.5	0.0	19.8	0.0	18.5
LnGrp LOS	B	A	A	A	B	B	C	B		B	A	B
Approach Vol, veh/h		1202			1561			242				222
Approach Delay, s/veh		9.7			10.3			18.3				19.4
Approach LOS		A			B			B				B
Timer - Assigned Phs		2	3	4		6		8				
Phs Duration (G+Y+Rc), s		27.0	8.5	12.9		27.0		21.4				
Change Period (Y+Rc), s		6.0	4.1	5.5		6.0		5.5				
Max Green Setting (Gmax), s		67.0	15.9	21.5		67.0		41.5				
Max Q Clear Time (g_c+I1), s		15.6	4.1	7.2		10.6		3.6				
Green Ext Time (p_c), s		5.4	0.3	0.4		8.1		0.2				

Intersection Summary

HCM 6th Ctrl Delay	11.3
HCM 6th LOS	B

Notes

User approved volume balancing among the lanes for turning movement.
 Unsignalized Delay for [NBR] is excluded from calculations of the approach delay and intersection delay.

Timings
32: I-215 SB Ramps & Van Buren Bl.

West Campus Upper Plateau (JN 14064)

09/30/2022

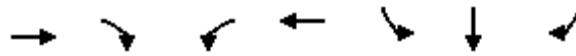

Lane Group	EBT	EBR	WBL	WBT	SBL	SBT	SBR
Lane Configurations	↑↑↑	↑	↵	↑↑↑	↵	↕	↑
Traffic Volume (vph)	834	973	16	944	25	0	938
Future Volume (vph)	834	973	16	944	25	0	938
Turn Type	NA	Perm	Prot	NA	Split	NA	Perm
Protected Phases	6		5	2	8	8	
Permitted Phases		6					8
Detector Phase	6	6	5	2	8	8	8
Switch Phase							
Minimum Initial (s)	5.0	5.0	5.0	5.0	5.0	5.0	5.0
Minimum Split (s)	36.0	36.0	11.0	11.0	11.0	11.0	11.0
Total Split (s)	78.0	78.0	15.0	93.0	27.0	27.0	27.0
Total Split (%)	65.0%	65.0%	12.5%	77.5%	22.5%	22.5%	22.5%
Yellow Time (s)	5.0	5.0	5.0	5.0	5.0	5.0	5.0
All-Red Time (s)	1.0	1.0	1.0	1.0	1.0	1.0	1.0
Lost Time Adjust (s)	0.0	0.0	0.0	0.0	0.0	0.0	0.0
Total Lost Time (s)	6.0	6.0	6.0	6.0	6.0	6.0	6.0
Lead/Lag	Lag	Lag	Lead				
Lead-Lag Optimize?	Yes	Yes	Yes				
Recall Mode	None	None	None	None	None	None	None
Act Effct Green (s)	23.6	23.6	5.7	25.2	22.7	22.7	22.7
Actuated g/C Ratio	0.39	0.39	0.09	0.41	0.37	0.37	0.37
v/c Ratio	0.47	0.84	0.10	0.49	0.04	0.84	0.80
Control Delay	13.8	8.8	34.6	12.4	21.0	29.3	26.5
Queue Delay	0.0	0.0	0.0	0.0	0.0	0.0	0.0
Total Delay	13.8	8.8	34.6	12.4	21.0	29.3	26.5
LOS	B	A	C	B	C	C	C
Approach Delay	11.1			12.8		27.8	
Approach LOS	B			B		C	

Intersection Summary

Cycle Length: 120
 Actuated Cycle Length: 60.8
 Natural Cycle: 90
 Control Type: Actuated-Uncoordinated
 Maximum v/c Ratio: 0.84
 Intersection Signal Delay: 15.9
 Intersection LOS: B
 Intersection Capacity Utilization 89.8%
 ICU Level of Service E
 Analysis Period (min) 15













Splits and Phases: 32: I-215 SB Ramps & Van Buren Bl.



HCM 6th Signalized Intersection Summary
32: I-215 SB Ramps & Van Buren Bl.

West Campus Upper Plateau (JN 14064)

09/30/2022

												
Movement	EBL	EBT	EBR	WBL	WBT	WBR	NBL	NBT	NBR	SBL	SBT	SBR
Lane Configurations		↑↑↑	↗	↖	↑↑↑					↖	↔	↗
Traffic Volume (veh/h)	0	834	973	16	944	0	0	0	0	25	0	938
Future Volume (veh/h)	0	834	973	16	944	0	0	0	0	25	0	938
Initial Q (Qb), veh	0	0	0	0	0	0				0	0	0
Ped-Bike Adj(A_pbT)	1.00		1.00	1.00		1.00				1.00		1.00
Parking Bus, Adj	1.00	1.00	1.00	1.00	1.00	1.00				1.00	1.00	1.00
Work Zone On Approach		No			No						No	
Adj Sat Flow, veh/h/ln	0	1796	1856	1885	1826	0				1885	1856	1722
Adj Flow Rate, veh/h	0	887	0	17	1004	0				18	0	0
Peak Hour Factor	0.94	0.94	0.94	0.94	0.94	0.94				0.94	0.94	0.94
Percent Heavy Veh, %	0	7	3	1	5	0				1	3	12
Cap, veh/h	0	1548		258	3150	0				41	0	
Arrive On Green	0.00	0.32	0.00	0.14	0.63	0.00				0.02	0.00	0.00
Sat Flow, veh/h	0	5065	1572	1795	5149	0				1795	0	2919
Grp Volume(v), veh/h	0	887	0	17	1004	0				18	0	0
Grp Sat Flow(s),veh/h/ln	0	1635	1572	1795	1662	0				1795	0	1459
Q Serve(g_s), s	0.0	5.3	0.0	0.3	3.2	0.0				0.3	0.0	0.0
Cycle Q Clear(g_c), s	0.0	5.3	0.0	0.3	3.2	0.0				0.3	0.0	0.0
Prop In Lane	0.00		1.00	1.00		0.00				1.00		1.00
Lane Grp Cap(c), veh/h	0	1548		258	3150	0				41	0	
V/C Ratio(X)	0.00	0.57		0.07	0.32	0.00				0.44	0.00	
Avail Cap(c_a), veh/h	0	10153		465	12471	0				1084	0	
HCM Platoon Ratio	1.00	1.00	1.00	1.00	1.00	1.00				1.00	1.00	1.00
Upstream Filter(I)	0.00	1.00	0.00	1.00	1.00	0.00				1.00	0.00	0.00
Uniform Delay (d), s/veh	0.0	9.9	0.0	12.9	2.9	0.0				16.8	0.0	0.0
Incr Delay (d2), s/veh	0.0	0.1	0.0	0.0	0.0	0.0				2.7	0.0	0.0
Initial Q Delay(d3),s/veh	0.0	0.0	0.0	0.0	0.0	0.0				0.0	0.0	0.0
%ile BackOfQ(50%),veh/ln	0.0	0.9	0.0	0.1	0.0	0.0				0.1	0.0	0.0
Unsig. Movement Delay, s/veh												
LnGrp Delay(d),s/veh	0.0	10.1	0.0	12.9	3.0	0.0				19.5	0.0	0.0
LnGrp LOS	A	B		B	A	A				B	A	
Approach Vol, veh/h		887			1021							18
Approach Delay, s/veh		10.1			3.1							19.5
Approach LOS		B			A							B
Timer - Assigned Phs		2			5	6				8		
Phs Duration (G+Y+Rc), s		28.0			11.0	17.0				6.8		
Change Period (Y+Rc), s		6.0			6.0	6.0				6.0		
Max Green Setting (Gmax), s		87.0			9.0	72.0				21.0		
Max Q Clear Time (g_c+I1), s		5.2			2.3	7.3				2.3		
Green Ext Time (p_c), s		4.5			0.0	3.7				0.0		

Intersection Summary

HCM 6th Ctrl Delay	6.5
HCM 6th LOS	A

Notes

User approved volume balancing among the lanes for turning movement.
Unsignalized Delay for [EBR, SBR] is excluded from calculations of the approach delay and intersection delay.

Timings

West Campus Upper Plateau (JN 14064)

34: Old 215 Frontage Rd. & Alessandro Bl.

09/30/2022

Lane Group	EBL	EBT	EBR	WBL	WBT	WBR	NBL	NBT	NBR	SBL	SBT	SBR
Lane Configurations												
Traffic Volume (vph)	385	993	15	13	913	115	28	115	16	104	141	257
Future Volume (vph)	385	993	15	13	913	115	28	115	16	104	141	257
Turn Type	Prot	NA	Perm	Prot	NA	Perm	Prot	NA	Perm	Prot	NA	Perm
Protected Phases	5	2		1	6		3	8		7	4	
Permitted Phases			2			6			8			4
Detector Phase	5	2	2	1	6	6	3	8	8	7	4	4
Switch Phase												
Minimum Initial (s)	5.0	10.0	10.0	5.0	10.0	10.0	5.0	10.0	10.0	5.0	10.0	10.0
Minimum Split (s)	8.7	43.5	43.5	8.7	15.8	15.8	8.7	16.2	16.2	8.7	40.2	40.2
Total Split (s)	23.0	62.4	62.4	8.7	48.1	48.1	8.7	17.9	17.9	31.0	40.2	40.2
Total Split (%)	19.2%	52.0%	52.0%	7.3%	40.1%	40.1%	7.3%	14.9%	14.9%	25.8%	33.5%	33.5%
Yellow Time (s)	3.2	5.5	5.5	3.2	4.8	4.8	3.2	5.2	5.2	3.2	5.2	5.2
All-Red Time (s)	0.5	1.0	1.0	0.5	1.0	1.0	0.5	1.0	1.0	0.5	1.0	1.0
Lost Time Adjust (s)	0.0	0.0	0.0	0.0	0.0	0.0	0.0	0.0	0.0	0.0	0.0	0.0
Total Lost Time (s)	3.7	6.5	6.5	3.7	5.8	5.8	3.7	6.2	6.2	3.7	6.2	6.2
Lead/Lag	Lead	Lag	Lag	Lead	Lag	Lag	Lead	Lag	Lag	Lead	Lag	Lag
Lead-Lag Optimize?	Yes	Yes	Yes	Yes	Yes	Yes	Yes	Yes	Yes	Yes	Yes	Yes
Recall Mode	None	None	None	None	None	None	None	None	None	None	None	None
Act Effct Green (s)	14.3	40.5	40.5	5.3	24.2	24.2	5.3	12.5	12.5	9.9	20.6	20.6
Actuated g/C Ratio	0.18	0.51	0.51	0.07	0.31	0.31	0.07	0.16	0.16	0.13	0.26	0.26
v/c Ratio	0.66	0.39	0.02	0.13	0.61	0.20	0.15	0.22	0.05	0.49	0.17	0.47
Control Delay	38.5	13.8	0.1	47.2	26.5	2.5	44.7	34.1	0.2	44.6	25.4	6.9
Queue Delay	0.0	0.0	0.0	0.0	0.0	0.0	0.0	0.0	0.0	0.0	0.0	0.0
Total Delay	38.5	13.8	0.1	47.2	26.5	2.5	44.7	34.1	0.2	44.6	25.4	6.9
LOS	D	B	A	D	C	A	D	C	A	D	C	A
Approach Delay		20.5			24.1			32.5			19.9	
Approach LOS		C			C			C			B	

Intersection Summary

Cycle Length: 120
 Actuated Cycle Length: 78.7
 Natural Cycle: 105
 Control Type: Actuated-Uncoordinated
 Maximum v/c Ratio: 0.66
 Intersection Signal Delay: 22.2
 Intersection LOS: C
 Intersection Capacity Utilization 54.4%
 ICU Level of Service A
 Analysis Period (min) 15

Splits and Phases: 34: Old 215 Frontage Rd. & Alessandro Bl.

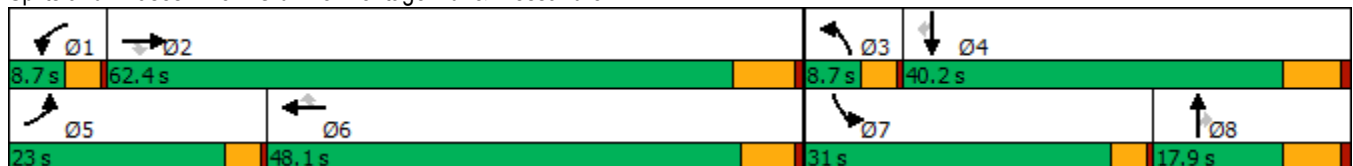

HCM 6th Signalized Intersection Summary
34: Old 215 Frontage Rd. & Alessandro Bl.

West Campus Upper Plateau (JN 14064)

09/30/2022



Movement	EBL	EBT	EBR	WBL	WBT	WBR	NBL	NBT	NBR	SBL	SBT	SBR
Lane Configurations	↖↗	↑↑↑	↖	↖	↑↑↑	↖	↖↗	↑↑	↖	↖	↑↑	↖
Traffic Volume (veh/h)	385	993	15	13	913	115	28	115	16	104	141	257
Future Volume (veh/h)	385	993	15	13	913	115	28	115	16	104	141	257
Initial Q (Qb), veh	0	0	0	0	0	0	0	0	0	0	0	0
Ped-Bike Adj(A_pbT)	1.00		1.00	1.00		1.00	1.00		0.99	1.00		1.00
Parking Bus, Adj	1.00	1.00	1.00	1.00	1.00	1.00	1.00	1.00	1.00	1.00	1.00	1.00
Work Zone On Approach		No			No			No			No	
Adj Sat Flow, veh/h/ln	1826	1885	1678	1678	1870	1885	1574	1856	1574	1870	1752	1693
Adj Flow Rate, veh/h	401	1034	-11	14	951	0	29	120	7	108	147	0
Peak Hour Factor	0.96	0.96	0.96	0.96	0.96	0.96	0.96	0.96	0.96	0.96	0.96	0.96
Percent Heavy Veh, %	5	1	15	15	2	1	22	3	22	2	10	14
Cap, veh/h	518	2240	619	27	1526		91	547	204	140	674	
Arrive On Green	0.15	0.44	0.00	0.02	0.30	0.00	0.03	0.16	0.16	0.08	0.20	0.00
Sat Flow, veh/h	3374	5147	1422	1598	5106	1598	2908	3526	1314	1781	3328	1434
Grp Volume(v), veh/h	401	1034	-11	14	951	0	29	120	7	108	147	0
Grp Sat Flow(s),veh/h/ln	1687	1716	1422	1598	1702	1598	1454	1763	1314	1781	1664	1434
Q Serve(g_s), s	7.3	9.1	0.0	0.6	10.3	0.0	0.6	1.9	0.3	3.8	2.4	0.0
Cycle Q Clear(g_c), s	7.3	9.1	0.0	0.6	10.3	0.0	0.6	1.9	0.3	3.8	2.4	0.0
Prop In Lane	1.00		1.00	1.00		1.00	1.00		1.00	1.00		1.00
Lane Grp Cap(c), veh/h	518	2240	619	27	1526		91	547	204	140	674	
V/C Ratio(X)	0.77	0.46	-0.02	0.51	0.62		0.32	0.22	0.03	0.77	0.22	
Avail Cap(c_a), veh/h	1015	4486	1239	125	3368		227	643	240	758	1764	
HCM Platoon Ratio	1.00	1.00	1.00	1.00	1.00	1.00	1.00	1.00	1.00	1.00	1.00	1.00
Upstream Filter(I)	1.00	1.00	0.00	1.00	1.00	0.00	1.00	1.00	1.00	1.00	1.00	0.00
Uniform Delay (d), s/veh	26.1	12.8	0.0	31.2	19.4	0.0	30.4	23.7	23.0	29.0	21.3	0.0
Incr Delay (d2), s/veh	0.9	0.1	0.0	5.3	0.4	0.0	0.7	0.2	0.1	3.3	0.2	0.0
Initial Q Delay(d3),s/veh	0.0	0.0	0.0	0.0	0.0	0.0	0.0	0.0	0.0	0.0	0.0	0.0
%ile BackOfQ(50%),veh/ln	2.6	2.6	0.0	0.2	3.5	0.0	0.2	0.7	0.1	1.6	0.8	0.0
Unsig. Movement Delay, s/veh												
LnGrp Delay(d),s/veh	27.0	12.9	0.0	36.6	19.8	0.0	31.1	23.9	23.1	32.3	21.5	0.0
LnGrp LOS	C	B	A	D	B		C	C	C	C	C	
Approach Vol, veh/h		1424			965			156			255	
Approach Delay, s/veh		17.0			20.0			25.2			26.1	
Approach LOS		B			C			C			C	
Timer - Assigned Phs	1	2	3	4	5	6	7	8				
Phs Duration (G+Y+Rc), s	4.8	34.4	5.7	19.2	13.6	25.7	8.8	16.2				
Change Period (Y+Rc), s	3.7	6.5	3.7	6.2	3.7	* 6.5	3.7	6.2				
Max Green Setting (Gmax), s	5.0	55.9	5.0	34.0	19.3	* 42	27.3	11.7				
Max Q Clear Time (g_c+I1), s	2.6	11.1	2.6	4.4	9.3	12.3	5.8	3.9				
Green Ext Time (p_c), s	0.0	7.5	0.0	0.8	0.5	6.9	0.1	0.3				

Intersection Summary

HCM 6th Ctrl Delay	19.3
HCM 6th LOS	B

Notes

* HCM 6th computational engine requires equal clearance times for the phases crossing the barrier.
Unsignalized Delay for [WBR, SBR] is excluded from calculations of the approach delay and intersection delay.

Timings
35: Day St. & Alessandro Bl.

West Campus Upper Plateau (JN 14064)

09/30/2022



Lane Group	EBL	EBT	EBR	WBL	WBT	WBR	NBL	NBT	NBR	SBL	SBT
Lane Configurations	↖	↗↗↗	↖	↖	↗↗↗	↖	↖	↗	↖	↖	↗
Traffic Volume (vph)	220	773	8	11	813	162	12	111	17	136	55
Future Volume (vph)	220	773	8	11	813	162	12	111	17	136	55
Turn Type	Prot	NA	Perm	Prot	NA	Perm	Perm	NA	Perm	Perm	NA
Protected Phases	5	2		1	6			8			4
Permitted Phases			2			6	8		8	4	
Detector Phase	5	2	2	1	6	6	8	8	8	4	4
Switch Phase											
Minimum Initial (s)	5.0	10.0	10.0	5.0	10.0	10.0	10.0	10.0	10.0	10.0	10.0
Minimum Split (s)	9.1	30.8	30.8	9.1	30.8	30.8	42.4	42.4	42.4	41.6	41.6
Total Split (s)	27.0	67.9	67.9	9.1	50.0	50.0	43.0	43.0	43.0	43.0	43.0
Total Split (%)	22.5%	56.6%	56.6%	7.6%	41.7%	41.7%	35.8%	35.8%	35.8%	35.8%	35.8%
Yellow Time (s)	3.6	4.8	4.8	3.6	4.8	4.8	4.4	4.4	4.4	3.6	3.6
All-Red Time (s)	0.5	1.0	1.0	0.5	1.0	1.0	1.0	1.0	1.0	1.0	1.0
Lost Time Adjust (s)	0.0	0.0	0.0	0.0	0.0	0.0	0.0	0.0	0.0	0.0	0.0
Total Lost Time (s)	4.1	5.8	5.8	4.1	5.8	5.8	5.4	5.4	5.4	4.6	4.6
Lead/Lag	Lead	Lag	Lag	Lead	Lag	Lag					
Lead-Lag Optimize?	Yes	Yes	Yes	Yes	Yes	Yes					
Recall Mode	None	None	None	None	None	None	None	None	None	None	None
Act Effct Green (s)	13.6	36.9	36.9	5.5	19.9	19.9	15.8	15.8	15.8	16.6	16.6
Actuated g/C Ratio	0.21	0.56	0.56	0.08	0.30	0.30	0.24	0.24	0.24	0.25	0.25
v/c Ratio	0.62	0.28	0.01	0.07	0.55	0.31	0.05	0.26	0.04	0.44	0.37
Control Delay	34.7	9.4	0.0	39.9	22.1	12.2	22.4	23.6	0.2	27.4	13.4
Queue Delay	0.0	0.0	0.0	0.0	0.0	0.0	0.0	0.0	0.0	0.0	0.0
Total Delay	34.7	9.4	0.0	39.9	22.1	12.2	22.4	23.6	0.2	27.4	13.4
LOS	C	A	A	D	C	B	C	C	A	C	B
Approach Delay		14.9			20.7			20.6			19.4
Approach LOS		B			C			C			B

Intersection Summary

Cycle Length: 120
 Actuated Cycle Length: 66
 Natural Cycle: 85
 Control Type: Actuated-Uncoordinated
 Maximum v/c Ratio: 0.62
 Intersection Signal Delay: 18.1
 Intersection LOS: B
 Intersection Capacity Utilization 54.2%
 ICU Level of Service A
 Analysis Period (min) 15





























Splits and Phases: 35: Day St. & Alessandro Bl.



HCM 6th Signalized Intersection Summary
35: Day St. & Alessandro Bl.

West Campus Upper Plateau (JN 14064)

09/30/2022

												
Movement	EBL	EBT	EBR	WBL	WBT	WBR	NBL	NBT	NBR	SBL	SBT	SBR
Lane Configurations		  			  							
Traffic Volume (veh/h)	220	773	8	11	813	162	12	111	17	136	55	125
Future Volume (veh/h)	220	773	8	11	813	162	12	111	17	136	55	125
Initial Q (Qb), veh	0	0	0	0	0	0	0	0	0	0	0	0
Ped-Bike Adj(A_pbT)	1.00		0.98	1.00		0.98	1.00		1.00	1.00		1.00
Parking Bus, Adj	1.00	1.00	1.00	1.00	1.00	1.00	1.00	1.00	1.00	1.00	1.00	1.00
Work Zone On Approach		No			No			No			No	
Adj Sat Flow, veh/h/ln	1900	1870	1811	1900	1885	1900	1796	1900	1841	1885	1885	1885
Adj Flow Rate, veh/h	229	805	2	11	847	101	12	116	13	142	57	99
Peak Hour Factor	0.96	0.96	0.96	0.96	0.96	0.96	0.96	0.96	0.96	0.96	0.96	0.96
Percent Heavy Veh, %	0	2	6	0	1	0	7	0	4	1	1	1
Cap, veh/h	289	2318	681	26	1586	485	317	426	350	366	139	241
Arrive On Green	0.16	0.45	0.45	0.01	0.31	0.31	0.22	0.22	0.22	0.22	0.22	0.22
Sat Flow, veh/h	1810	5106	1500	1810	5147	1574	1182	1900	1560	1271	618	1074
Grp Volume(v), veh/h	229	805	2	11	847	101	12	116	13	142	0	156
Grp Sat Flow(s),veh/h/ln	1810	1702	1500	1810	1716	1574	1182	1900	1560	1271	0	1692
Q Serve(g_s), s	6.1	5.1	0.0	0.3	6.8	2.4	0.4	2.5	0.3	5.2	0.0	3.9
Cycle Q Clear(g_c), s	6.1	5.1	0.0	0.3	6.8	2.4	4.4	2.5	0.3	7.7	0.0	3.9
Prop In Lane	1.00		1.00	1.00		1.00	1.00		1.00	1.00		0.63
Lane Grp Cap(c), veh/h	289	2318	681	26	1586	485	317	426	350	366	0	379
V/C Ratio(X)	0.79	0.35	0.00	0.43	0.53	0.21	0.04	0.27	0.04	0.39	0.00	0.41
Avail Cap(c_a), veh/h	833	6377	1874	182	4575	1399	945	1437	1180	1062	0	1307
HCM Platoon Ratio	1.00	1.00	1.00	1.00	1.00	1.00	1.00	1.00	1.00	1.00	1.00	1.00
Upstream Filter(I)	1.00	1.00	1.00	1.00	1.00	1.00	1.00	1.00	1.00	1.00	0.00	1.00
Uniform Delay (d), s/veh	20.1	8.8	7.4	24.3	14.2	12.7	18.3	15.9	15.1	19.1	0.0	16.5
Incr Delay (d2), s/veh	1.9	0.1	0.0	4.2	0.3	0.2	0.0	0.3	0.0	0.7	0.0	0.7
Initial Q Delay(d3),s/veh	0.0	0.0	0.0	0.0	0.0	0.0	0.0	0.0	0.0	0.0	0.0	0.0
%ile BackOfQ(50%),veh/ln	2.3	1.3	0.0	0.1	2.1	0.7	0.1	0.9	0.1	1.5	0.0	1.5
Unsig. Movement Delay, s/veh												
LnGrp Delay(d),s/veh	21.9	8.9	7.4	28.5	14.5	12.9	18.4	16.3	15.1	19.8	0.0	17.2
LnGrp LOS	C	A	A	C	B	B	B	B	B	B	A	B
Approach Vol, veh/h		1036			959			141			298	
Approach Delay, s/veh		11.8			14.5			16.4			18.4	
Approach LOS		B			B			B			B	
Timer - Assigned Phs	1	2		4	5	6		8				
Phs Duration (G+Y+Rc), s	4.8	28.4		16.6	12.1	21.1		16.6				
Change Period (Y+Rc), s	4.1	5.8		* 5.4	4.1	5.8		5.4				
Max Green Setting (Gmax), s	5.0	62.1		* 38	22.9	44.2		37.6				
Max Q Clear Time (g_c+I1), s	2.3	7.1		9.7	8.1	8.8		6.4				
Green Ext Time (p_c), s	0.0	6.0		1.5	0.3	6.5		0.7				

Intersection Summary

HCM 6th Ctrl Delay	13.9
HCM 6th LOS	B

Notes

* HCM 6th computational engine requires equal clearance times for the phases crossing the barrier.

Timings
36: Elsworth St. & Cactus Av.

West Campus Upper Plateau (JN 14064)

09/30/2022



Lane Group	EBL	EBT	EBR	WBL	WBT	WBR	NBL	NBT	SBL	SBT	SBR
Lane Configurations	↘	↑↑↑	↗	↘	↑↑↑	↗	↘↗	↗	↘	↗	↗
Traffic Volume (vph)	177	1251	36	16	1249	155	25	13	186	20	149
Future Volume (vph)	177	1251	36	16	1249	155	25	13	186	20	149
Turn Type	Prot	NA	Perm	Prot	NA	Perm	Prot	NA	Prot	NA	pm+ov
Protected Phases	5	2		1	6		3	8	7	4	5
Permitted Phases			2			6					4
Detector Phase	5	2	2	1	6	6	3	8	7	4	5
Switch Phase											
Minimum Initial (s)	5.0	10.0	10.0	5.0	10.0	10.0	5.0	10.0	5.0	10.0	5.0
Minimum Split (s)	9.6	36.2	36.2	9.6	36.2	36.2	15.4	35.4	15.4	35.4	9.6
Total Split (s)	20.0	54.0	54.0	9.6	43.6	43.6	21.0	35.8	20.6	35.4	20.0
Total Split (%)	16.7%	45.0%	45.0%	8.0%	36.3%	36.3%	17.5%	29.8%	17.2%	29.5%	16.7%
Yellow Time (s)	3.6	5.2	5.2	3.6	5.2	5.2	4.4	4.4	4.4	4.4	3.6
All-Red Time (s)	1.0	1.0	1.0	1.0	1.0	1.0	1.0	1.0	1.0	1.0	1.0
Lost Time Adjust (s)	0.0	0.0	0.0	0.0	0.0	0.0	0.0	0.0	0.0	0.0	0.0
Total Lost Time (s)	4.6	6.2	6.2	4.6	6.2	6.2	5.4	5.4	5.4	5.4	4.6
Lead/Lag	Lead	Lead	Lead	Lag	Lag	Lag	Lag	Lead	Lag	Lead	Lead
Lead-Lag Optimize?	Yes	Yes	Yes	Yes	Yes	Yes	Yes	Yes	Yes	Yes	Yes
Recall Mode	None	None	None	None	None	None	None	None	None	None	None
Act Effct Green (s)	14.7	46.8	46.8	9.1	30.3	30.3	8.2	14.7	20.9	17.9	37.7
Actuated g/C Ratio	0.16	0.52	0.52	0.10	0.34	0.34	0.09	0.16	0.23	0.20	0.42
v/c Ratio	0.64	0.35	0.04	0.09	0.53	0.25	0.08	0.09	0.26	0.32	0.20
Control Delay	54.6	21.9	0.1	45.2	28.8	5.9	46.3	27.0	37.8	38.8	2.8
Queue Delay	0.0	0.0	0.0	0.0	0.0	0.0	0.0	0.0	0.0	0.0	0.0
Total Delay	54.6	21.9	0.1	45.2	28.8	5.9	46.3	27.0	37.8	38.8	2.8
LOS	D	C	A	D	C	A	D	C	D	D	A
Approach Delay		25.3			26.5			36.6		23.4	
Approach LOS		C			C			D		C	

Intersection Summary

Cycle Length: 120
 Actuated Cycle Length: 90.1
 Natural Cycle: 100
 Control Type: Actuated-Uncoordinated
 Maximum v/c Ratio: 0.64
 Intersection Signal Delay: 25.8
 Intersection LOS: C
 Intersection Capacity Utilization 53.7%
 ICU Level of Service A
 Analysis Period (min) 15

Splits and Phases: 36: Elsworth St. & Cactus Av.

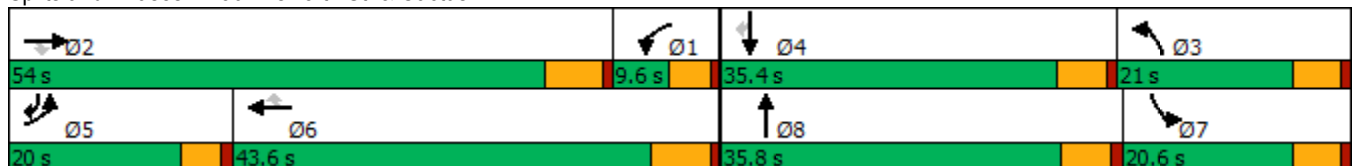

HCM 6th Signalized Intersection Summary
36: Elsworth St. & Cactus Av.

West Campus Upper Plateau (JN 14064)

09/30/2022



Movement	EBL	EBT	EBR	WBL	WBT	WBR	NBL	NBT	NBR	SBL	SBT	SBR
Lane Configurations												
Traffic Volume (veh/h)	177	1251	36	16	1249	155	25	13	11	186	20	149
Future Volume (veh/h)	177	1251	36	16	1249	155	25	13	11	186	20	149
Initial Q (Qb), veh	0	0	0	0	0	0	0	0	0	0	0	0
Ped-Bike Adj(A_pbT)	1.00		1.00	1.00		1.00	1.00		1.00	1.00		1.00
Parking Bus, Adj	1.00	1.00	1.00	1.00	1.00	1.00	1.00	1.00	1.00	1.00	1.00	1.00
Work Zone On Approach		No			No			No			No	
Adj Sat Flow, veh/h/ln	1870	1841	1870	1900	1856	1885	1900	1900	1885	1900	1900	1900
Adj Flow Rate, veh/h	186	1317	0	17	1315	126	26	14	-35	211	0	49
Peak Hour Factor	0.95	0.95	0.95	0.95	0.95	0.95	0.95	0.95	0.95	0.95	0.95	0.95
Percent Heavy Veh, %	2	4	2	0	3	1	0	0	1	0	0	0
Cap, veh/h	230	2463		175	2419	521	266	0	408	1094	0	446
Arrive On Green	0.13	0.33	0.00	0.10	0.33	0.33	0.07	0.00	0.00	0.30	0.00	0.15
Sat Flow, veh/h	1781	7363	1585	1810	7422	1598	3619	1900	0	3619	0	1610
Grp Volume(v), veh/h	186	1317	0	17	1315	126	26	-21	-21	211	0	49
Grp Sat Flow(s),veh/h/ln	1781	1841	1585	1810	1856	1598	1810	1900	1610	1810	0	1610
Q Serve(g_s), s	6.8	9.7	0.0	0.6	9.7	1.1	0.4	0.0	0.0	2.9	0.0	0.9
Cycle Q Clear(g_c), s	6.8	9.7	0.0	0.6	9.7	1.1	0.4	0.0	0.0	2.9	0.0	0.9
Prop In Lane	1.00		1.00	1.00		1.00	1.00		0.00	1.00		1.00
Lane Grp Cap(c), veh/h	230	2463		175	2419	521	266	0	0	1094	0	446
V/C Ratio(X)	0.81	0.53		0.10	0.54	0.24	0.10	0.00	0.00	0.19	0.00	0.11
Avail Cap(c_a), veh/h	411	5270		175	4157	895	845	0	0	1094	0	931
HCM Platoon Ratio	1.00	1.00	1.00	1.00	1.00	1.00	1.00	1.00	1.00	1.00	1.00	1.00
Upstream Filter(I)	1.00	1.00	0.00	1.00	1.00	1.00	1.00	0.00	0.00	1.00	0.00	1.00
Uniform Delay (d), s/veh	28.3	18.0	0.0	27.5	18.4	1.4	28.9	0.0	0.0	17.3	0.0	6.9
Incr Delay (d2), s/veh	2.6	0.2	0.0	0.1	0.2	0.2	0.2	0.0	0.0	0.1	0.0	0.1
Initial Q Delay(d3),s/veh	0.0	0.0	0.0	0.0	0.0	0.0	0.0	0.0	0.0	0.0	0.0	0.0
%ile BackOfQ(50%),veh/ln	2.7	3.5	0.0	0.2	3.5	1.3	0.2	0.0	0.0	1.1	0.0	0.4
Unsig. Movement Delay, s/veh												
LnGrp Delay(d),s/veh	30.9	18.2	0.0	27.6	18.6	1.7	29.0	0.0	0.0	17.3	0.0	7.0
LnGrp LOS	C	B		C	B	A	C	A	A	B	A	A
Approach Vol, veh/h		1503			1458			-16				260
Approach Delay, s/veh		19.8			17.3			0.0				15.4
Approach LOS		B			B			A				B
Timer - Assigned Phs	1	2	3	4	5	6	7	8				
Phs Duration (G+Y+Rc), s	12.7	28.5	10.3	15.3	13.2	28.0	25.6	0.0				
Change Period (Y+Rc), s	6.2	* 6.2	5.4	5.4	4.6	6.2	5.4	5.4				
Max Green Setting (Gmax), s	5.0	* 48	15.6	30.0	15.4	37.4	15.2	30.4				
Max Q Clear Time (g_c+I1), s	2.6	11.7	2.4	2.9	8.8	11.7	4.9	0.0				
Green Ext Time (p_c), s	0.0	10.7	0.0	0.1	0.1	10.1	0.5	0.0				

Intersection Summary

HCM 6th Ctrl Delay	18.4
HCM 6th LOS	B

Notes

- User approved pedestrian interval to be less than phase max green.
- User approved volume balancing among the lanes for turning movement.
- * HCM 6th computational engine requires equal clearance times for the phases crossing the barrier.

Timings
38: Riverside Dr./Graham St. & Cactus Av.

West Campus Upper Plateau (JN 14064)

09/30/2022

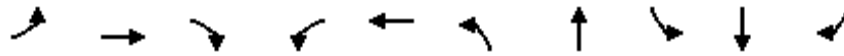

Lane Group	EBL	EBT	EBR	WBL	WBT	NBL	NBT	SBL	SBT	SBR
Lane Configurations	↘	↑↑↑	↗	↘	↑↑↑	↘	↑↑	↘	↑↑	↗
Traffic Volume (vph)	65	1272	202	23	1321	183	53	75	68	81
Future Volume (vph)	65	1272	202	23	1321	183	53	75	68	81
Turn Type	Prot	NA	Perm	Prot	NA	Prot	NA	Prot	NA	Perm
Protected Phases	7	4		3	8	5	2	1	6	
Permitted Phases			4							6
Detector Phase	7	4	4	3	8	5	2	1	6	6
Switch Phase										
Minimum Initial (s)	5.0	10.0	10.0	5.0	10.0	5.0	10.0	5.0	10.0	10.0
Minimum Split (s)	9.6	39.2	39.2	9.6	39.2	10.4	35.0	9.6	40.6	40.6
Total Split (s)	18.0	57.4	57.4	9.6	49.0	10.4	41.0	12.0	42.6	42.6
Total Split (%)	15.0%	47.8%	47.8%	8.0%	40.8%	8.7%	34.2%	10.0%	35.5%	35.5%
Yellow Time (s)	3.6	5.2	5.2	3.6	5.2	4.4	4.0	3.6	3.6	3.6
All-Red Time (s)	1.0	1.0	1.0	1.0	1.0	1.0	1.0	1.0	1.0	1.0
Lost Time Adjust (s)	0.0	0.0	0.0	0.0	0.0	0.0	0.0	0.0	0.0	0.0
Total Lost Time (s)	4.6	6.2	6.2	4.6	6.2	5.4	5.0	4.6	4.6	4.6
Lead/Lag	Lead	Lag	Lag	Lead	Lag	Lead	Lag	Lead	Lag	Lag
Lead-Lag Optimize?	Yes	Yes	Yes	Yes	Yes	Yes	Yes	Yes	Yes	Yes
Recall Mode	None	None	None	None	None	None	None	None	None	None
Act Effct Green (s)	8.2	39.0	39.0	5.6	32.3	7.3	14.4	6.8	15.2	15.2
Actuated g/C Ratio	0.11	0.50	0.50	0.07	0.42	0.09	0.19	0.09	0.20	0.20
v/c Ratio	0.35	0.52	0.23	0.18	0.69	0.57	0.11	0.25	0.10	0.19
Control Delay	44.7	15.5	3.4	47.6	22.7	49.9	24.1	43.1	29.5	1.0
Queue Delay	0.0	0.0	0.0	0.0	0.0	0.0	0.0	0.0	0.0	0.0
Total Delay	44.7	15.5	3.4	47.6	22.7	49.9	24.1	43.1	29.5	1.0
LOS	D	B	A	D	C	D	C	D	C	A
Approach Delay		15.2			23.1		42.5		23.6	
Approach LOS		B			C		D		C	

Intersection Summary

Cycle Length: 120
 Actuated Cycle Length: 77.3
 Natural Cycle: 100
 Control Type: Actuated-Uncoordinated
 Maximum v/c Ratio: 0.69
 Intersection Signal Delay: 21.0
 Intersection LOS: C
 Intersection Capacity Utilization 56.4%
 ICU Level of Service B
 Analysis Period (min) 15

Splits and Phases: 38: Riverside Dr./Graham St. & Cactus Av.

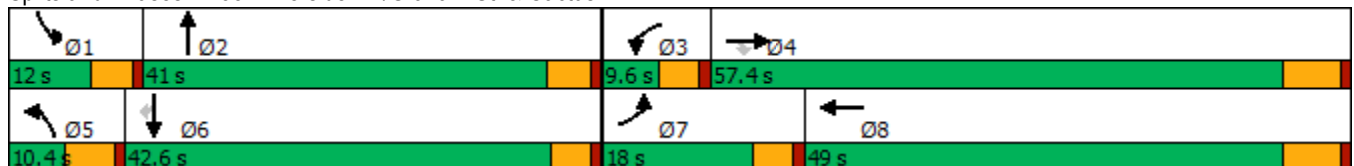

HCM 6th Signalized Intersection Summary
38: Riverside Dr./Graham St. & Cactus Av.

West Campus Upper Plateau (JN 14064)

09/30/2022



Movement	EBL	EBT	EBR	WBL	WBT	WBR	NBL	NBT	NBR	SBL	SBT	SBR
Lane Configurations	↘	↑↑↑	↗	↘	↑↑↑		↘↗	↑↗		↘↗	↑↑	↗
Traffic Volume (veh/h)	65	1272	202	23	1321	75	183	53	19	75	68	81
Future Volume (veh/h)	65	1272	202	23	1321	75	183	53	19	75	68	81
Initial Q (Qb), veh	0	0	0	0	0	0	0	0	0	0	0	0
Ped-Bike Adj(A_pbT)	1.00		1.00	1.00		0.99	1.00		1.00	1.00		1.00
Parking Bus, Adj	1.00	1.00	1.00	1.00	1.00	1.00	1.00	1.00	1.00	1.00	1.00	1.00
Work Zone On Approach		No			No			No			No	
Adj Sat Flow, veh/h/ln	1885	1856	1885	1900	1856	1900	1900	1900	1900	1885	1900	1856
Adj Flow Rate, veh/h	67	1311	163	24	1362	69	189	55	19	77	70	10
Peak Hour Factor	0.97	0.97	0.97	0.97	0.97	0.97	0.97	0.97	0.97	0.97	0.97	0.97
Percent Heavy Veh, %	1	3	1	0	3	0	0	0	0	1	0	3
Cap, veh/h	96	2189	690	49	2002	101	263	475	156	198	534	233
Arrive On Green	0.05	0.43	0.43	0.03	0.41	0.41	0.07	0.18	0.18	0.06	0.15	0.15
Sat Flow, veh/h	1795	5066	1598	1810	4934	250	3510	2669	878	3483	3610	1572
Grp Volume(v), veh/h	67	1311	163	24	932	499	189	36	38	77	70	10
Grp Sat Flow(s),veh/h/ln	1795	1689	1598	1810	1689	1807	1755	1805	1742	1742	1805	1572
Q Serve(g_s), s	2.4	13.2	4.3	0.9	15.1	15.1	3.5	1.1	1.2	1.4	1.1	0.4
Cycle Q Clear(g_c), s	2.4	13.2	4.3	0.9	15.1	15.1	3.5	1.1	1.2	1.4	1.1	0.4
Prop In Lane	1.00		1.00	1.00		0.14	1.00		0.50	1.00		1.00
Lane Grp Cap(c), veh/h	96	2189	690	49	1370	733	263	321	310	198	534	233
V/C Ratio(X)	0.70	0.60	0.24	0.49	0.68	0.68	0.72	0.11	0.12	0.39	0.13	0.04
Avail Cap(c_a), veh/h	361	3890	1227	136	2168	1160	263	975	941	387	2058	896
HCM Platoon Ratio	1.00	1.00	1.00	1.00	1.00	1.00	1.00	1.00	1.00	1.00	1.00	1.00
Upstream Filter(I)	1.00	1.00	1.00	1.00	1.00	1.00	1.00	1.00	1.00	1.00	1.00	1.00
Uniform Delay (d), s/veh	31.0	14.5	12.0	32.0	16.3	16.3	30.1	23.0	23.0	30.3	24.7	24.4
Incr Delay (d2), s/veh	3.4	0.3	0.2	2.8	0.6	1.1	7.9	0.2	0.2	0.5	0.1	0.1
Initial Q Delay(d3),s/veh	0.0	0.0	0.0	0.0	0.0	0.0	0.0	0.0	0.0	0.0	0.0	0.0
%ile BackOfQ(50%),veh/ln	1.0	4.0	1.2	0.4	4.8	5.2	1.7	0.5	0.5	0.6	0.5	0.1
Unsig. Movement Delay, s/veh												
LnGrp Delay(d),s/veh	34.5	14.8	12.1	34.8	16.9	17.4	38.0	23.1	23.2	30.8	24.8	24.4
LnGrp LOS	C	B	B	C	B	B	D	C	C	C	C	C
Approach Vol, veh/h		1541			1455			263			157	
Approach Delay, s/veh		15.3			17.3			33.8			27.7	
Approach LOS		B			B			C			C	
Timer - Assigned Phs	1	2	3	4	5	6	7	8				
Phs Duration (G+Y+Rc), s	8.4	16.9	6.4	35.0	10.4	14.9	8.2	33.3				
Change Period (Y+Rc), s	4.6	5.0	4.6	6.2	5.4	* 5	4.6	6.2				
Max Green Setting (Gmax), s	7.4	36.0	5.0	51.2	5.0	* 38	13.4	42.8				
Max Q Clear Time (g_c+I1), s	3.4	3.2	2.9	15.2	5.5	3.1	4.4	17.1				
Green Ext Time (p_c), s	0.0	0.4	0.0	11.4	0.0	0.4	0.0	9.9				

Intersection Summary

HCM 6th Ctrl Delay	18.2
HCM 6th LOS	B

Notes

* HCM 6th computational engine requires equal clearance times for the phases crossing the barrier.