

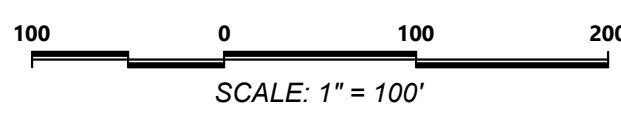

**PROJECT STATISTICS**  
 EARTHWORK:  
 CUT 3500 CY ±  
 FILL 1800 CY ±  
 AREA OF DISTURBANCE = 104,000 SF



|  |                     |   |
|--|---------------------|---|
| Roberts Engineering, Inc.              |                     |   |
| Bigfoot Valley - Highway 58            |                     |   |
| <b>Site Map</b>                        |                     |   |
| Design/Drawn<br><i>TRJM</i>            | County Plan Checker | Approved for County Requirements                          |
| Job #<br><i>20170</i>                  | County W.O. No.     | Development Services Engineer<br>Date<br><i>9/29/2021</i> |
| California Coordinates (CCS83, Zone 5) |                     | County Road #<br>Sheet<br><b>C-1</b>                      |



**Roberts Engineering**  
 Timothy P. Roberts  
 Civil Engineer - RCE 35366  
 2015 Vista de la Vina  
 Templeton, CA 93465  
 Phone (805) 239-0664  
 Fax (805) 238-6148  
 Email tim@robertsenginc.com  
 Website robertsenginc.com

| Record Drawings                            |      |
|--|------|
| Timothy P. Roberts, RCE 35366 exp 09/30/23 | Date |
| Revisions:                                 |      |
|  |      |
|  |      |
|  |      |

9/29/2021 8:09 AM



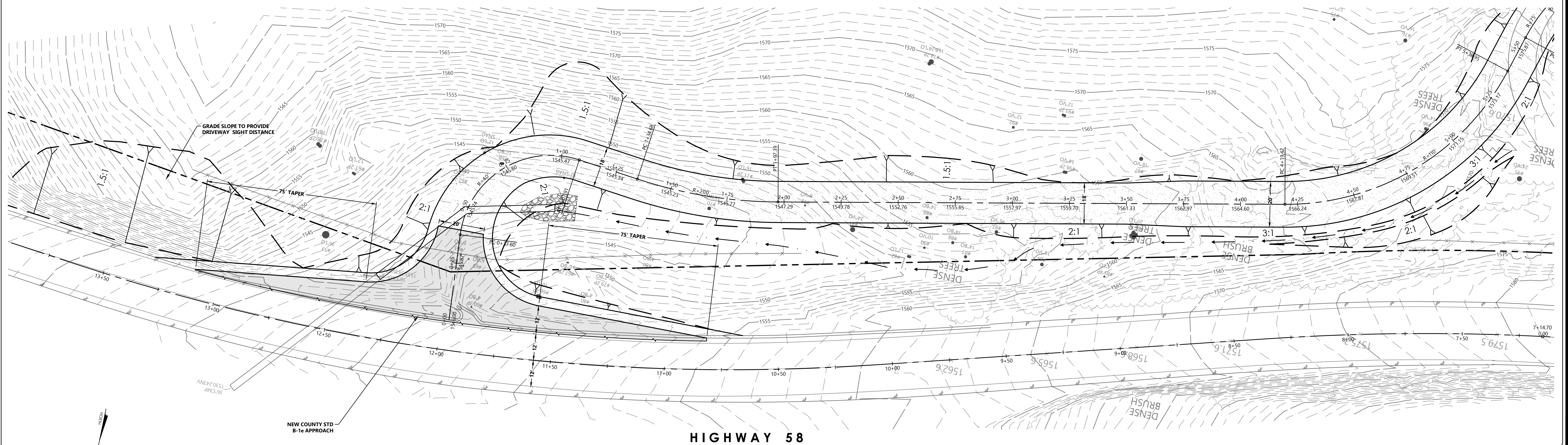
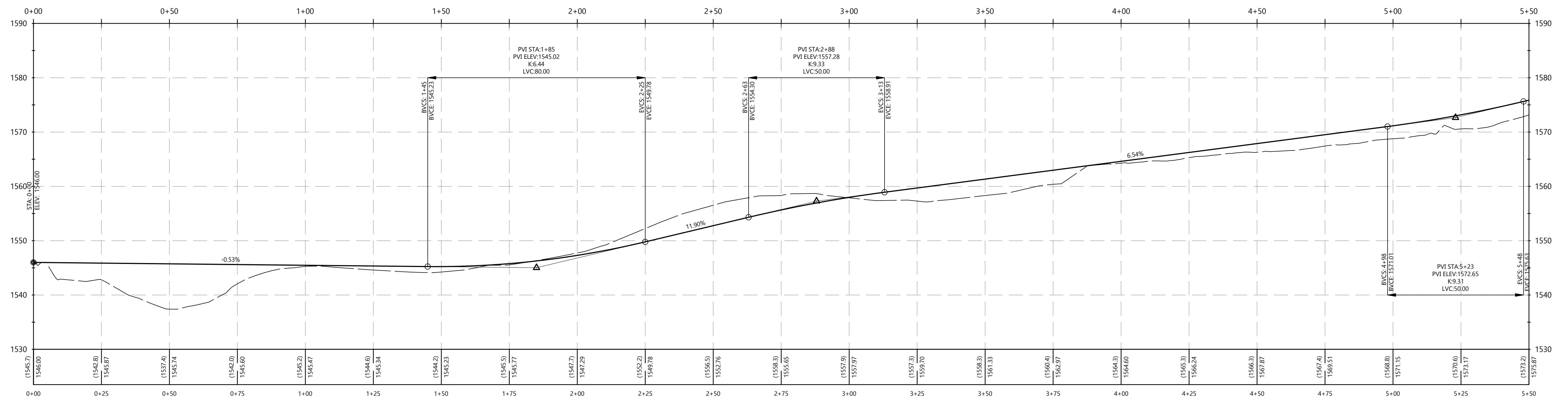

**HIGHWAY 58**

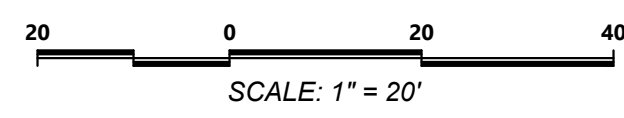
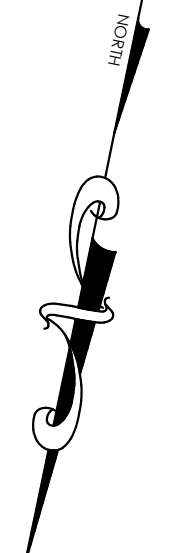

|  |                     |                                  |
|--|---------------------|----------------------------------|
| Roberts Engineering, Inc.              |                     |                                  |
| Bigfoot Valley - Highway 58            |                     |                                  |
| Preliminary Road Plan                  |                     |                                  |
| Design/Drawn                           | County Plan Checker | Approved for County Requirements |
| TR/JM                                  |                     | Development Services Engineer    |
| Job #                                  | County W.O. No.     | Date                             |
| 20170                                  |                     | 9/29/2021                        |
| California Coordinates (CCS38, Zone 5) |                     | County Road # Sheet              |
|  |                     | 5 of <b>C-2</b>                  |



**Roberts Engineering**  
 Timothy P. Roberts  
 Civil Engineer - RCE 35366  
 2015 Vista de la Vina  
 Tempton, CA 93465  
 Phone (805) 239-0664  
 Fax (805) 238-6148  
 Email tim@robtsenginc.com  
 Website robtsenginc.com

| Record Drawings                            |      |
|--|------|
| Timothy P. Roberts, RCE 35366 exp 09/30/23 | Date |
| Revisions:                                 |      |
|  |      |
|  |      |

9/29/2021 8:07 AM



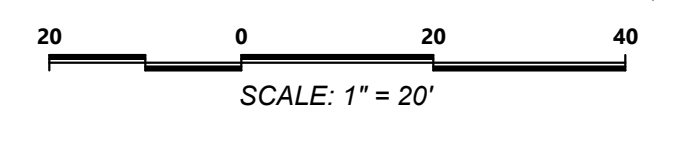
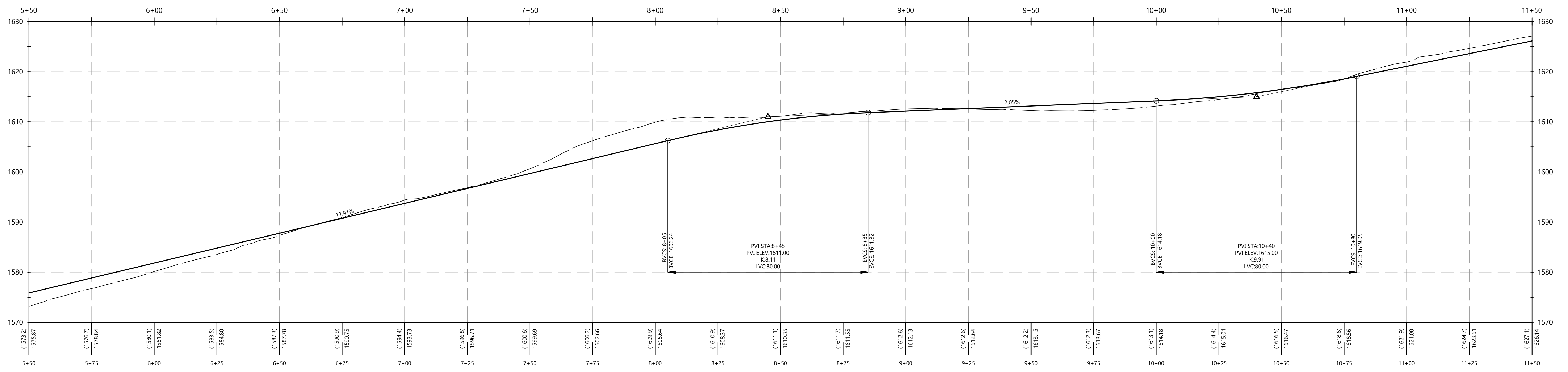

|  |                     |                                  |
|--|---------------------|----------------------------------|
| Roberts Engineering, Inc.              |                     |                                  |
| Bigfoot Valley - Highway 58            |                     |                                  |
| Preliminary Road Plan                  |                     |                                  |
| Design/Drawn                           | County Plan Checker | Approved for County Requirements |
| TR/JM                                  |                     | Development Services Engineer    |
| Job #                                  | County W.O. No.     | Date                             |
| 20170                                  |                     | 9/29/2021                        |
| California Coordinates (CCS83, Zone 5) | County Road #       | Sheet                            |
|  |                     | 5 of 5                           |



**Roberts Engineering**  
 Timothy P. Roberts  
 Civil Engineer - RCE 35366  
 2015 Vista de la Vina  
 Tempton, CA 93465  
 Phone (805) 239-0664  
 Fax (805) 238-6148  
 Email tim@robtsenginc.com  
 Website robtsenginc.com

| Record Drawings                            |      |
|--|------|
| Timothy P. Roberts, RCE 35366 exp 09/30/23 | Date |
| Revisions:                                 |      |
|  |      |
|  |      |
|  |      |

9/29/2021 8:10 AM



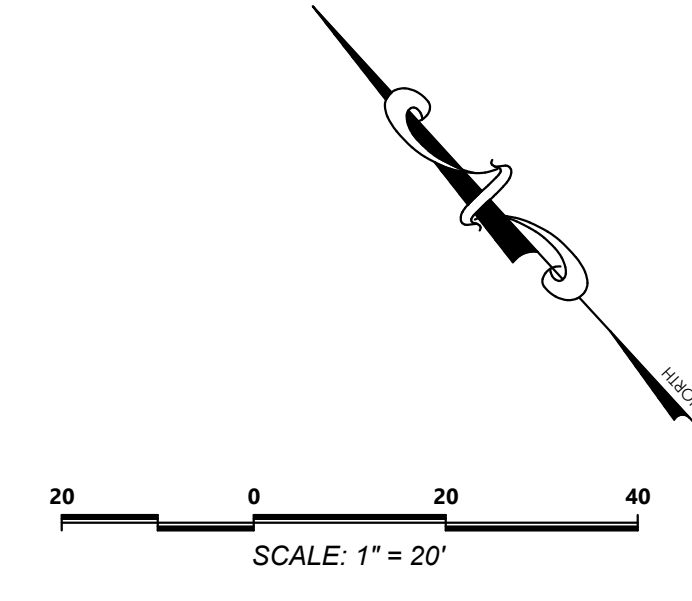
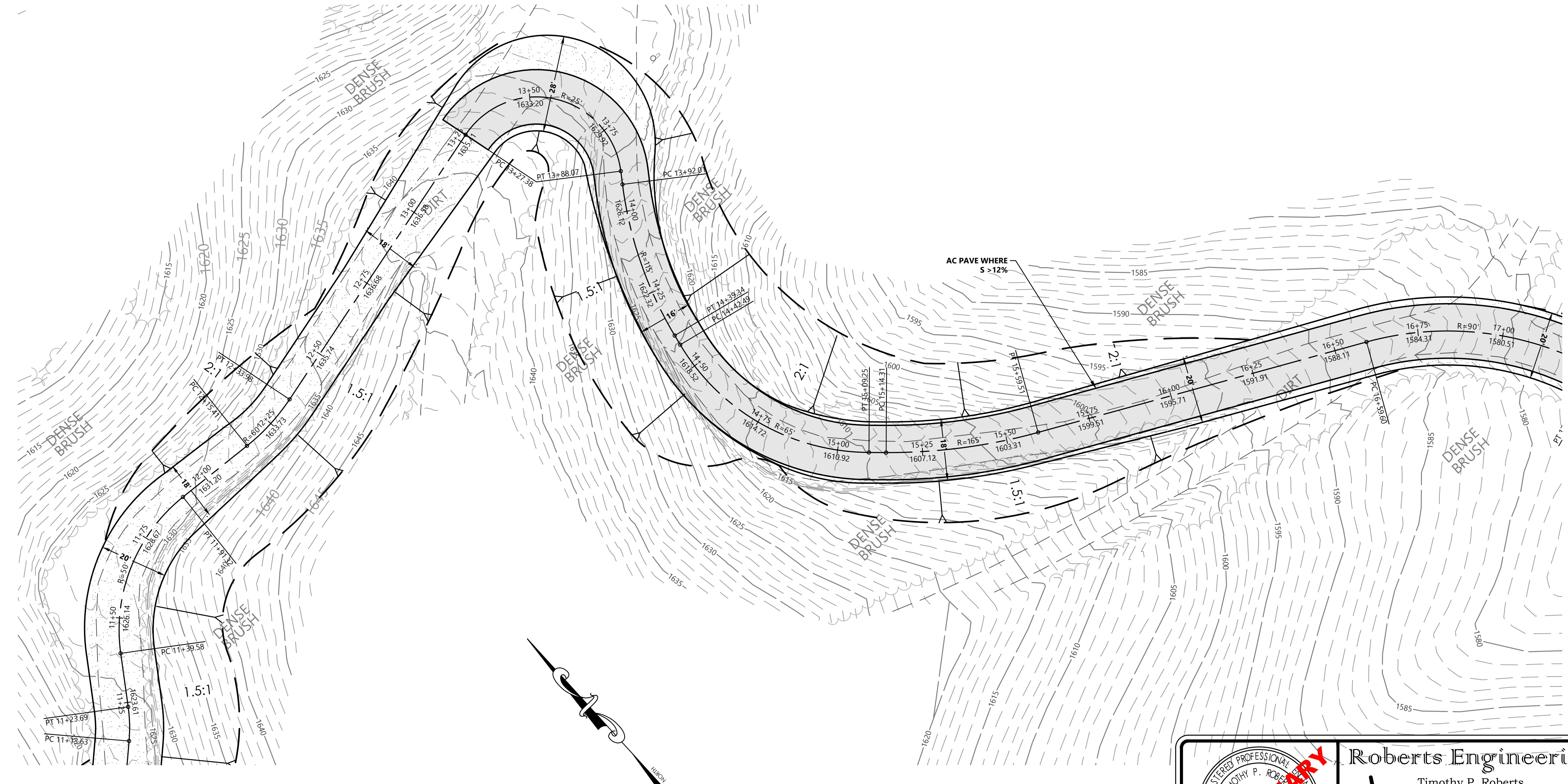
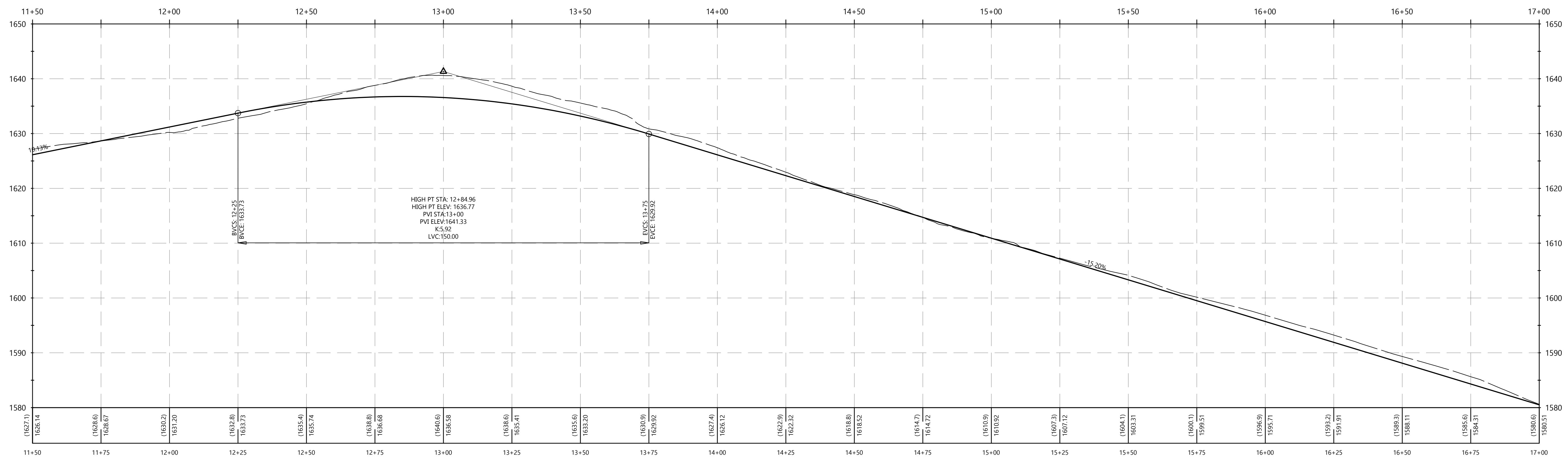

|  |                     |  |
|--|---------------------|--|
| Roberts Engineering, Inc.              |                     |  |
| Bigfoot Valley - Highway 58            |                     |  |
| Preliminary Road Plan                  |                     |  |
| Design/Drawn                           | County Plan Checker | Approved for County Requirements           |
| TR/JM                                  |                     | Development Services Engineer Date         |
| Job #                                  | County W.O. No.     | 9/29/2021 Date                             |
| 20170                                  |                     | Timothy P. Roberts, RCE 35366 exp 09/30/23 |
| California Coordinates (CCS83, Zone 5) | County Road #       | Sheet                                      |
|  |                     | 5 of 5 <b>C-4</b>                          |



**Roberts Engineering**  
 Timothy P. Roberts  
 Civil Engineer - RCE 35366  
 2015 Vista de la Vina  
 Tempton, CA 93465  
 Phone (805) 239-0664  
 Fax (805) 238-6148  
 Email tim@robtsenginc.com  
 Website robtsenginc.com

| Record Drawings                            |      |
|--|------|
| Timothy P. Roberts, RCE 35366 exp 09/30/23 | Date |
| Revisions:                                 |      |
|  |      |
|  |      |
|  |      |

9/29/2021 8:10 AM



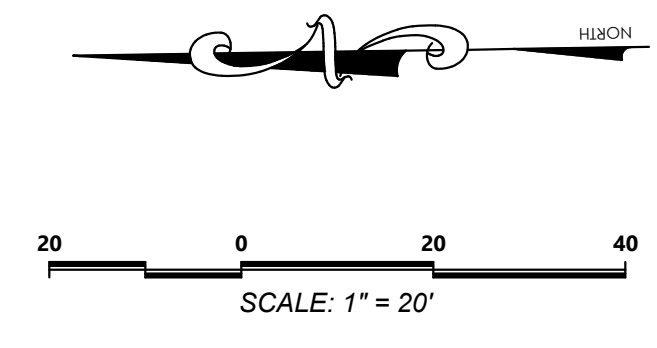
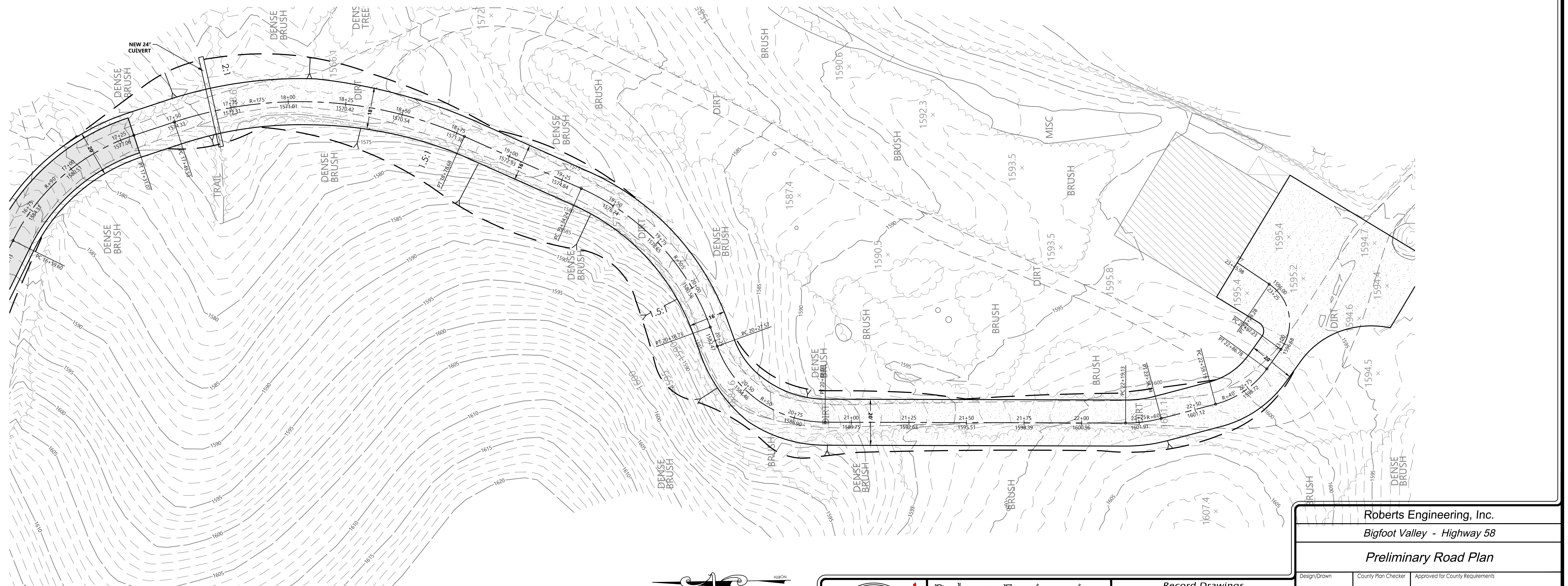
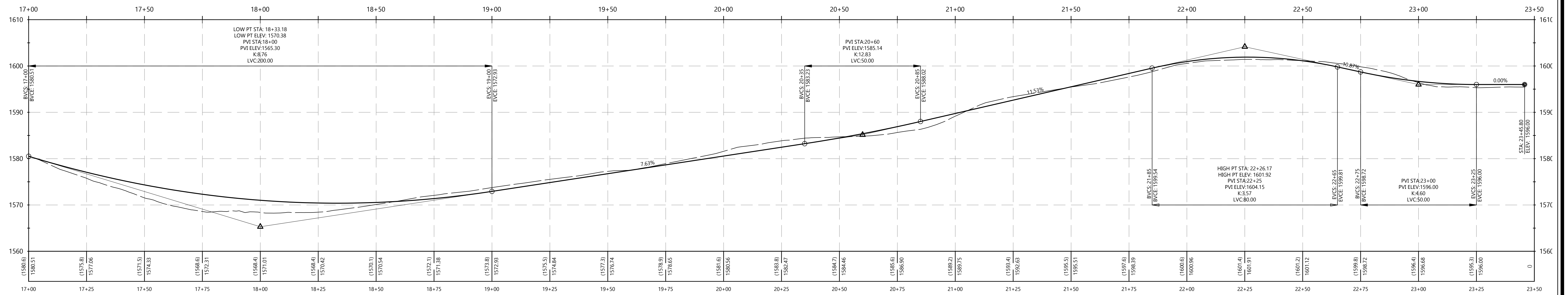

|  |                     |                                  |
|--|---------------------|----------------------------------|
| Roberts Engineering, Inc.              |                     |                                  |
| Bigfoot Valley - Highway 58            |                     |                                  |
| Preliminary Road Plan                  |                     |                                  |
| Design/Drawn                           | County Plan Checker | Approved for County Requirements |
| TR/JM                                  |                     | Development Services Engineer    |
| Job #                                  | County W.O. No.     | Date                             |
| 20170                                  |                     | 9/29/2021                        |
| California Coordinates (CCS83, Zone 5) | County Road #       | Sheet                            |
|  |                     | C-5                              |



**Roberts Engineering**  
 Timothy P. Roberts  
 Civil Engineer - RCE 35366  
 2015 Vista de la Vina  
 Tempton, CA 93465  
 Phone (805) 239-0664  
 Fax (805) 238-6148  
 Email tim@robtsenginc.com  
 Website robtsenginc.com

|  |      |
|--|------|
| Record Drawings                            |      |
| Timothy P. Roberts, RCE 35366 exp 09/30/23 | Date |
| Revision:                                  |      |

9/29/2021 8:10 AM