



Referral Early Consultation

Date: December 2, 2021
To: Distribution List (See Attachment A)
From: Emily Basnight, Assistant Planner
Planning and Community Development
Subject: USE PERMIT APPLICATION NO. PLN2021-0104 – KOOISTRA DAIRY,
HULTBERG ROAD
Respond By: December 17, 2021

******PLEASE REVIEW REFERRAL PROCESS POLICY******

The Stanislaus County Department of Planning and Community Development is soliciting comments from responsible agencies under the Early Consultation process to determine: a) whether or not the project is subject to CEQA and b) if specific conditions should be placed upon project approval.

Therefore, please contact this office by the response date if you have any comments pertaining to the proposal. Comments made identifying potential impacts should be as specific as possible and should be based on supporting data (e.g., traffic counts, expected pollutant levels, etc.). Your comments should emphasize potential impacts in areas which your agency has expertise and/or jurisdictional responsibilities.

These comments will assist our Department in preparing a staff report to present to the Planning Commission. Those reports will contain our recommendations for approval or denial. They will also contain recommended conditions to be required should the project be approved. Therefore, please list any conditions that you wish to have included for presentation to the Commission as well as any other comments you may have. Please return all comments and/or conditions as soon as possible or no later than the response date referenced above.

Thank you for your cooperation. Please call (209) 525-6330 if you have any questions.

Applicant: Sam and Cynthia Kooistra, Kooistra Dairy
Project Location: 5831 and 5837 Hultberg Road, between Ehrlich and Bradbury Roads, northwest of the Merced County border, in the Turlock area.
APN: 057-017-005
Williamson Act Contract: N/A
General Plan: Agriculture
Current Zoning: General Agriculture (A-2-40)

Project Description: Request to expand the herd of an existing dairy facility on a 19.11± acre parcel in the General Agricultural (A-2-40) zoning district. The applicant proposes to expand the herd from 436 to 1,000 mature cows, which includes an increase of 425 milk and 139 dry cows. Currently, no support stock is located on site which will remain unchanged. The existing facility is currently improved with 85,153 square-feet of free stall barns and other accessory structures associated with the dairy, two single family residences, a dry manure storage area, feed storage area, and three wastewater ponds. The applicant proposes to demolish three existing structures totaling approximately 3,700 square-feet in order to construct a 14,352 square-foot free stall barn for animal housing as well as install a mechanical manure separator adjacent to an existing storage pond to process wastewater before it reaches the pond.

The applicant anticipates an increase of 1,156 cubic feet of additional manure per day generated from the proposed herd expansion, for a total of 2,056 cubic feet of manure per day. Nutrients produced from the herd will be used to fertilize irrigated cropland on parcels located in both Stanislaus and Merced Counties to the southeast of the existing dairy operation owned by the property owner, as well as one parcel located to the southeast of the dairy that is under different ownership. Hours of operation are up to 24 hours per day, seven days a week.

There are currently two single-family dwellings onsite; one of which is used for one employee. There are currently five employees on a maximum shift. The proposed request is expected to decrease the number of employees by one for a total of four employees on a maximum shift. No additional employees are proposed to live onsite. The applicant does not anticipate any customers onsite. The dairy currently receives five truck trips for tallow, feed and veterinary services every two weeks, and a total of two milk truck trips per day. The proposed request is expected to increase the number of feed truck trips from one to three per week, and decrease milk truck trips from two to one per day for a new combined total of nine truck trips for tallow, feed, and veterinary services every two weeks, and one milk truck trip per day.

The project site is served by private well and septic system, and has access to a County maintained road by way of Hultberg Road. Confined Animal Facilities (CAF), which include dairies, are considered to be permitted agricultural uses; however, a use permit is required for new or expanding CAFs requiring a new or modified permit waiver, order, or Waste Discharge Requirements (WDRs) from the Regional Water Quality Control Board (RWQCB), where the issuance of such permit, waiver, order, or WDR requires compliance with the California Environmental Quality Act (CEQA) (Section 21.20.030 (F) of the Stanislaus County Zoning Code). The County adopted the use permit requirement in 2003 in order to allow the County to facilitate the environmental review (in accordance with CEQA) required for issuance of any permit, waiver, order, or WDR by the RWQCB.

Full document with attachments available for viewing at:
<http://www.stancounty.com/planning/pl/act-projects.shtm>



DEPARTMENT OF PLANNING AND COMMUNITY DEVELOPMENT

1010 10TH Street, Suite 3400, Modesto, CA 95354
 Planning Phone: (209) 525-6330 Fax: (209) 525-5911
 Building Phone: (209) 525-6557 Fax: (209) 525-7759

USE PERMIT APPLICATION NO. PLN2021-0104 – KOOISTRA DAIRY, HULTBERG ROAD

Attachment A

Distribution List

	CA DEPT OF CONSERVATION Land Resources / Mine Reclamation		STAN CO ALUC
X	CA DEPT OF FISH & WILDLIFE		STAN CO ANIMAL SERVICES
	CA DEPT OF FORESTRY (CAL FIRE)	X	STAN CO BUILDING PERMITS DIVISION
	CA DEPT OF TRANSPORTATION DIST 10	X	STAN CO CEO
X	CA OPR STATE CLEARINGHOUSE		STAN CO CSA
X	CA RWQCB CENTRAL VALLEY REGION	X	STAN CO DER
	CA STATE LANDS COMMISSION	X	STAN CO ERC
	CEMETERY DISTRICT	X	STAN CO FARM BUREAU
	CENTRAL VALLEY FLOOD PROTECTION	X	STAN CO HAZARDOUS MATERIALS
	CITY OF:	X	STAN CO MILK AND DAIRY
	COMMUNITY SERVICES DIST:	X	STAN CO PUBLIC WORKS
X	COOPERATIVE EXTENSION		STAN CO RISK MANAGEMENT
X	COUNTY OF: MERCED	X	STAN CO SHERIFF
X	DER GROUNDWATER RESOURCES DIVISION	X	STAN CO SUPERVISOR DIST 2: CHIESA
X	FIRE PROTECTION DIST: MOUNTAIN VIEW	X	STAN COUNTY COUNSEL
X	GSA: WEST TURLOCK SUBBASIN		StanCOG
	HOSPITAL DIST:	X	STANISLAUS FIRE PREVENTION BUREAU
X	IRRIGATION DIST: TURLOCK	X	STANISLAUS LAFCO
X	MOSQUITO DIST: TURLOCK	X	STATE OF CA SWRCB DIVISION OF DRINKING WATER DIST. 10
	MOUNTAIN VALLEY EMERGENCY MEDICAL SERVICES		SURROUNDING LAND OWNERS
	MUNICIPAL ADVISORY COUNCIL:	X	TELEPHONE COMPANY: AT&T
X	PACIFIC GAS & ELECTRIC		TRIBAL CONTACTS (CA Government Code §65352.3)
	POSTMASTER:		US ARMY CORPS OF ENGINEERS
	RAILROAD:		US FISH & WILDLIFE
X	SAN JOAQUIN VALLEY APCD		US MILITARY (SB 1462) (7 agencies)
X	SCHOOL DIST 1: CHATOM UNION		USDA NRCS
X	SCHOOL DIST 2: TURLOCK UNIFIED		WATER DIST:
	WORKFORCE DEVELOPMENT		
X	STAN CO AG COMMISSIONER		
	TUOLUMNE RIVER TRUST		

**STANISLAUS COUNTY
CEQA REFERRAL RESPONSE FORM**

TO: Stanislaus County Planning & Community Development
1010 10th Street, Suite 3400
Modesto, CA 95354

FROM: _____

SUBJECT: USE PERMIT APPLICATION NO. PLN2021-0104 – KOOISTRA DAIRY,
HULTBERG ROAD

Based on this agency's particular field(s) of expertise, it is our position the above described project:

- _____ Will not have a significant effect on the environment.
- _____ May have a significant effect on the environment.
- _____ No Comments.

Listed below are specific impacts which support our determination (e.g., traffic general, carrying capacity, soil types, air quality, etc.) – (attach additional sheet if necessary)

- 1.
- 2.
- 3.
- 4.

Listed below are possible mitigation measures for the above-listed impacts: *PLEASE BE SURE TO INCLUDE WHEN THE MITIGATION OR CONDITION NEEDS TO BE IMPLEMENTED (PRIOR TO RECORDING A MAP, PRIOR TO ISSUANCE OF A BUILDING PERMIT, ETC.):*

- 1.
- 2.
- 3.
- 4.

In addition, our agency has the following comments (attach additional sheets if necessary).





Response prepared by:

Name Title Date

KOOISTRA DAIRY UP PLN2021-0104

AREA MAP

LEGEND

-  Project Site
-  Sphere of Influence
-  City
-  Road
-  River

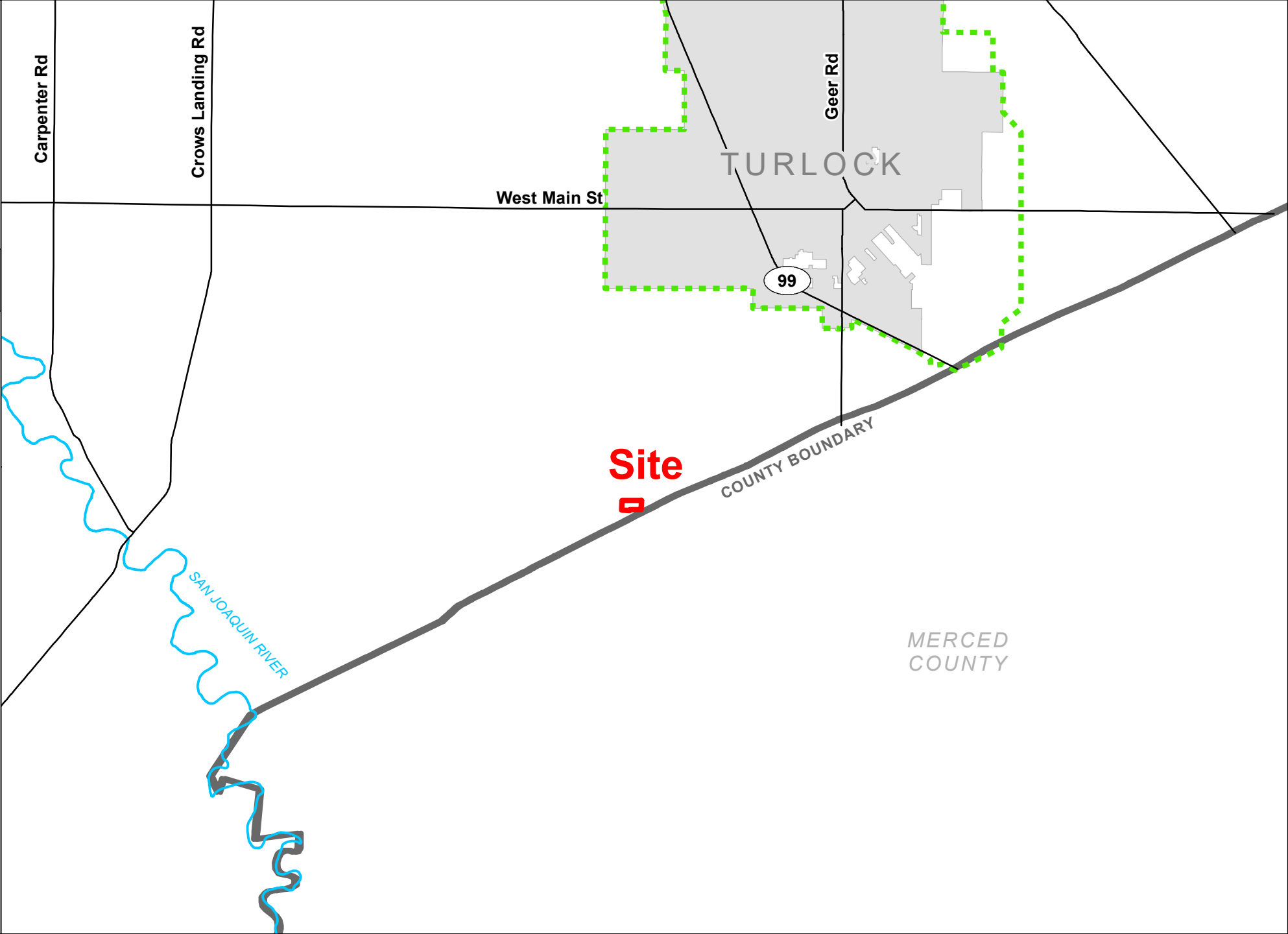
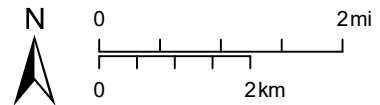





KOOISTRA DAIRY

UP PLN2021-0104

GENERAL PLAN MAP

LEGEND

-  Project Site
-  Parcel
-  Road
-  Canal

- General Plan**
-  Agriculture

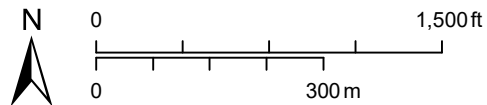





KOOISTRA DAIRY

UP
PLN2021-0104

ZONING MAP

LEGEND

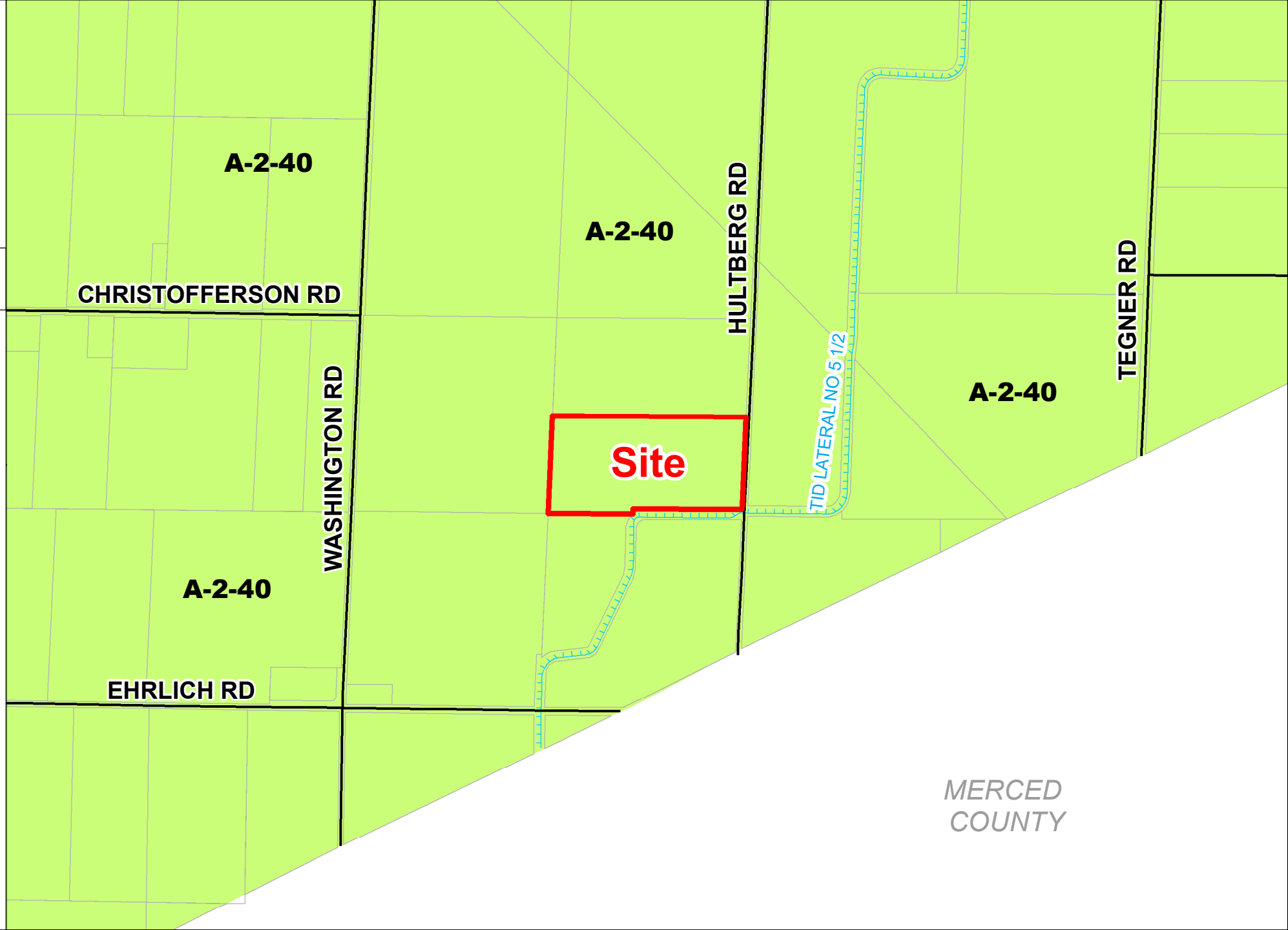
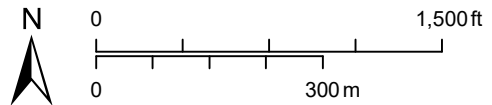

-  Project Site
 -  Parcel
 -  Road
 -  Canal
- Zoning Designation**
-  General Agriculture 40 Acre



KOOISTRA DAIRY UP PLN2021-0104

2021 AERIAL AREA MAP

LEGEND

-  Project Site
-  Road
-  Canal

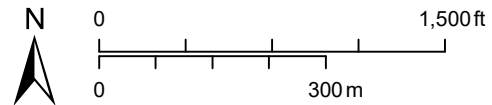

Source: Planning Department GIS

Date: 11/17/2021





KOOISTRA DAIRY

UP
PLN2021-0104

2021 AERIAL SITE MAP

LEGEND



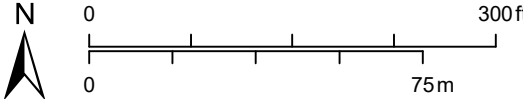

-  Project Site
-  Road
-  Canal



KOOISTRA DAIRY UP PLN2021-0104

ACREAGE MAP

LEGEND

-  Project Site
-  Parcel/Acres
-  Road
-  Canal

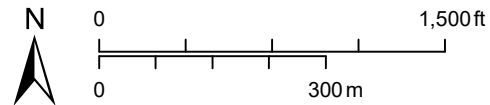

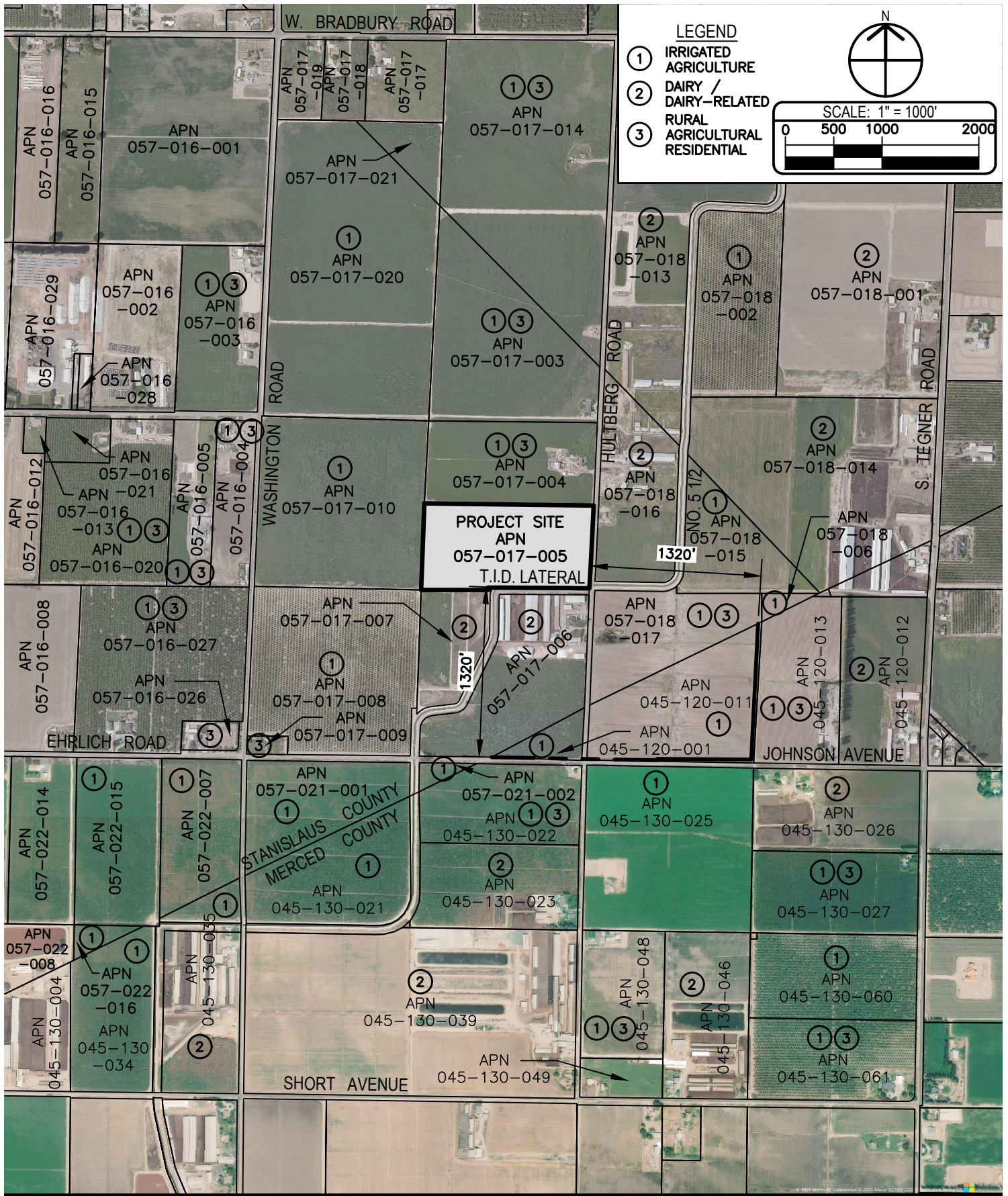

SOUSA
 ENGINEERING
 INFRASTRUCTURE - DEVELOPMENT -
 AGRICULTURE

PO BOX 1613
 OAKDALE, CA 95361

PH: (209)238-3151
 WWW.SOUSAENG.COM

AREA LAND USE MAP
 KOOISTRA DAIRY

STANISLAUS COUNTY, CA

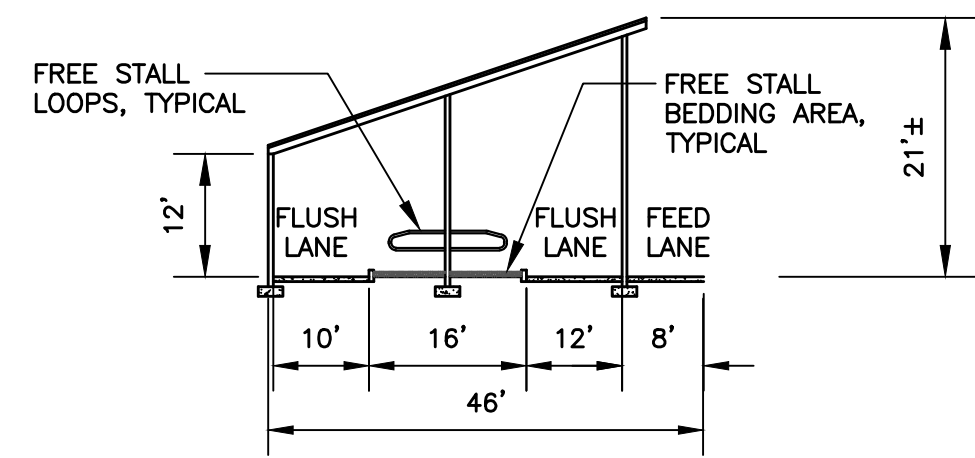

FREE STALL BARN END ELEVATION
SCALE: 1" = 20'

NOTE: FEATURES AND DIMENSIONS SHOWN ARE CONCEPTUAL ONLY. DETAILS MAY DIFFER AT THE TIME OF BUILDING DEPARTMENT SUBMITTAL.

APN 057-017-010

PROJECT SITE
APN 057-017-005

APN 057-017-004

APN 057-017-008

APN 058-017-007

PROJECT SITE
APN 058-017-006

APN 057-018-017

APN 057-018-016

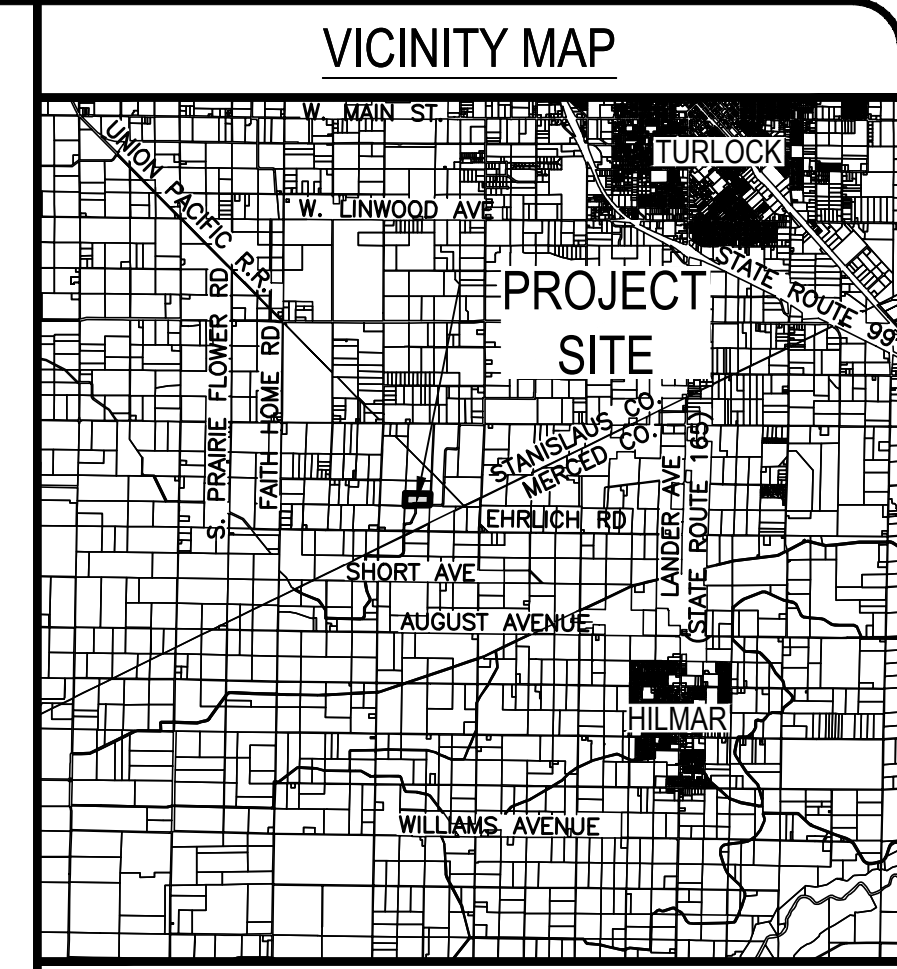
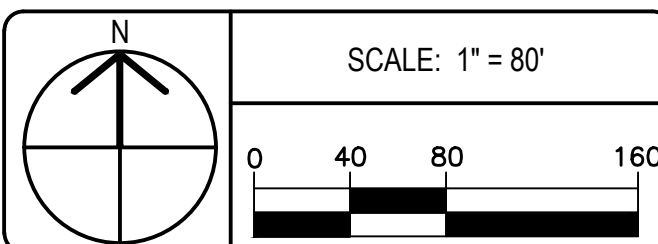

PROJECT SITE INFORMATION

APPLICANT: KOOISTRA DAIRY
ATTN: SAM AND CYNTHIA KOOISTRA
5837 HULTBERG ROAD
TURLOCK, CA 95380

PROPERTY OWNER: SAM AND CYNTHIA KOOISTRA
5837 HULTBERG ROAD
TURLOCK, CA 95380

PROPERTY ADDRESS: 5837 HULTBERG ROAD
TURLOCK, CA 95380

PROPERTY ASSESSOR'S PARCEL NUMBER: 057-017-005

PROPOSED BUILDING SQUARE FOOTAGE: 14,352 S.F.

THE PROJECT SITE IS LOCATED IN ZONE X PER FEMA FLOOD INSURANCE RATE MAP 06099C0800F. ZONE X IS DEFINED AS AN AREA DETERMINED TO BE OUTSIDE THE 0.2% ANNUAL CHANCE FLOODPLAIN.

THE PROJECT SITE IS LOCATED NEAR THE 80' CONTOUR ACCORDING TO USGS TOPOGRAPHIC MAPS (NAVD83 DATUM).

ALL STRUCTURES LABELED "LOAFING BARN" OR "FREE STALL BARN" ARE ANIMAL HOUSING STRUCTURES.

LEGEND

- FREE STALL BARN (E) EXISTING FACILITY IMPROVEMENT
- EXISTING FENCE
- DW EXISTING DOMESTIC WELL
- IW EXISTING IRRIGATION WELL
- SS APPROXIMATE LOCATION OF EXISTING SEPTIC TANK AND LEACH FIELD
- WT EXISTING WATER TANK
- EXISTING IRRIGATION BOX OR VALVE
- EXISTING STRUCTURE TO BE REMOVED
- FREE STALL BARN (P) PROPOSED STRUCTURE OR IMPROVEMENT
- S MECHANICAL MANURE SEPARATOR - PROPOSED

ANIMAL HOUSING IDENTIFICATION LEGEND

- EXISTING LOAFING BARN NUMBER
- EXISTING FREE STALL BARN NUMBER
- PROPOSED FREE STALL BARN NUMBER

FACILITY BUILDING DIMENSIONS

BUILDING NO.	LENGTH (FT.)	WIDTH (FT.)	AREA (SQ. FT.)
FREE STALL 1	187.5	96	18,000
FREE STALL 2	182	40	7,280
FREE STALL 3	208	40	8,320
FREE STALL 4	162	35	5,670
FREE STALL 5	198	35	6,930
FREE STALL 6	345	VARIES	14,355
FREE STALL 7	312	46	14,352
LOAFING BARN 1	245	40	9,800
MATERNITY BARN	32	15	480
OLD MILKING	44	32	1,408
OFFICE	12	10	120
MILK HOUSE	24	20	480
STORAGE BARN	IRREGULAR	IRREGULAR	2,030
HOLDING PEN	20	16	320
NEW MILKING	IRREGULAR	IRREGULAR	5,040
COMMODITY 1	40	37	1,480
COMMODITY 2	35	28	980
HAY BARN	45	42	1,890

SOSA
ENGINEERING
INFRASTRUCTURE - DEVELOPMENT - AGRICULTURE

PH: (209)238-3151
WWW.SOSAENG.COM

PO BOX 1613
OAKDALE, CA 95361

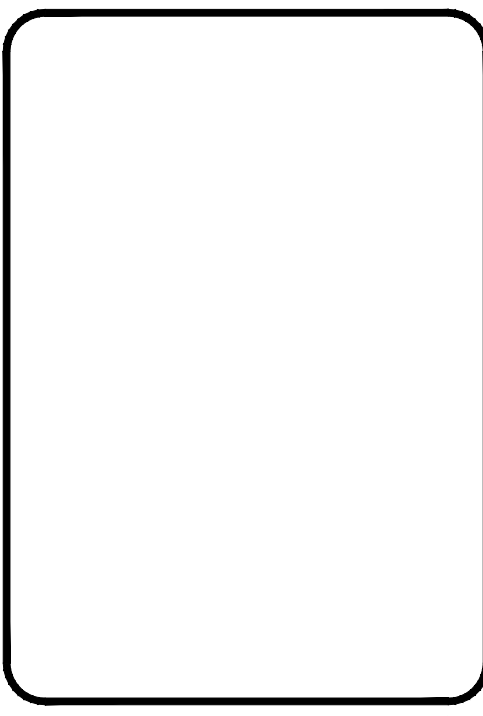

SITE PLAN
TO ACCOMPANY USE PERMIT
APPLICATION
KOOISTRA DAIRY
STANISLAUS COUNTY, CA

SYMBOL	REVISIONS	DESCRIPTION	APPD.

DRAWN BY: MS
DATE: 11/16/2021
FILE: 01_site.dwg
JOB NO.: 2021-014

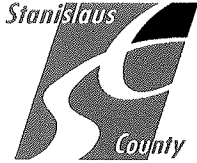

APPLICATION QUESTIONNAIRE

<p>Please Check all applicable boxes APPLICATION FOR: <i>Staff is available to assist you with determining which applications are necessary</i></p> <table style="width: 100%; border: none;"> <tr> <td style="width: 50%; vertical-align: top;"> <input type="checkbox"/> General Plan Amendment <input type="checkbox"/> Rezone <input checked="" type="checkbox"/> Use Permit <input type="checkbox"/> Variance <input type="checkbox"/> Historic Site Permit </td> <td style="width: 50%; vertical-align: top;"> <input type="checkbox"/> Subdivision Map <input type="checkbox"/> Parcel Map <input type="checkbox"/> Exception <input type="checkbox"/> Williamson Act Cancellation <input type="checkbox"/> Other _____ </td> </tr> </table>	<input type="checkbox"/> General Plan Amendment <input type="checkbox"/> Rezone <input checked="" type="checkbox"/> Use Permit <input type="checkbox"/> Variance <input type="checkbox"/> Historic Site Permit	<input type="checkbox"/> Subdivision Map <input type="checkbox"/> Parcel Map <input type="checkbox"/> Exception <input type="checkbox"/> Williamson Act Cancellation <input type="checkbox"/> Other _____	<p>PLANNING STAFF USE ONLY: Application No(s): <u>PLN 2021-0104</u> Date: <u>11/3/2021</u> S <u>05</u> T <u>6S</u> R <u>10E</u> GP Designation: <u>Agriculture</u> Zoning: <u>6. Agriculture - A-2-40</u> Fee: <u>\$ 4999/-</u> Receipt No. <u>56149</u> Received By: <u>Ashleen K. Anjla</u> Notes: _____</p>
<input type="checkbox"/> General Plan Amendment <input type="checkbox"/> Rezone <input checked="" type="checkbox"/> Use Permit <input type="checkbox"/> Variance <input type="checkbox"/> Historic Site Permit	<input type="checkbox"/> Subdivision Map <input type="checkbox"/> Parcel Map <input type="checkbox"/> Exception <input type="checkbox"/> Williamson Act Cancellation <input type="checkbox"/> Other _____		

In order for your application to be considered COMPLETE, please answer all applicable questions on the following pages, and provide all applicable information listed on the checklist on pages i – v. Under State law, upon receipt of this application, staff has 30 days to determine if the application is complete. We typically do not take the full 30 days. It may be necessary for you to provide additional information and/or meet with staff to discuss the application. Pre-application meetings are not required, but are highly recommended. An incomplete application will be placed on hold until all the necessary information is provided to the satisfaction of the requesting agency. An application will not be accepted without all the information identified on the checklist.

Please contact staff at (209) 525-6330 to discuss any questions you may have. Staff will attempt to help you in any way we can.

PROJECT INFORMATION

PROJECT DESCRIPTION: (Describe the project in detail, including physical features of the site, proposed improvements, proposed uses or business, operating hours, number of employees, anticipated customers, etc. – Attach additional sheets as necessary)

***Please note:** A detailed project description is essential to the reviewing process of this request. In order to approve a project, the Planning Commission or the Board of Supervisors must decide whether there is enough information available to be able to make very specific statements about the project. These statements are called "Findings". It is your responsibility as an applicant to provide enough information about the proposed project, so that staff can recommend that the Commission or the Board make the required Findings. Specific project Findings are shown on pages 17 – 19 and can be used as a guide for preparing your project description. (If you are applying for a Variance or Exception, please contact staff to discuss special requirements).

The proposed project will expand the existing dairy facility herd size from 431 combined milk and dry cows to

 1,000 combined milk and dry cows (approximately 800 milk and 200dry). The project will also involve the

 removal of three (3) existing structures totalling approximately 3,700 square feet; construction of one (1)

 additional free stall barn of approximately 14,352 square feet for animal housing; and installation of a mechanical

 manure separator.

PROJECT SITE INFORMATION

Complete and accurate information saves time and is vital to project review and assessment. Please complete each section entirely. If a question is not applicable to your project, please indicated this to show that each question has been carefully considered. Contact the Planning & Community Development Department Staff, 1010 10th Street – 3rd Floor, (209) 525-6330, if you have any questions. Pre-application meetings are highly recommended.

ASSESSOR'S PARCEL NUMBER(S): Book _____ Page _____ Parcel _____

Additional parcel numbers: _____
Project Site Address
or Physical Location: _____

Property Area: Acres: _____ or Square feet: _____

Current and Previous Land Use: (Explain existing and previous land use(s) of site for the last ten years)

List any known previous projects approved for this site, such as a Use Permit, Parcel Map, etc.: (Please identify project name, type of project, and date of approval)

Existing General Plan & Zoning: _____

Proposed General Plan & Zoning: _____
(if applicable)

ADJACENT LAND USE: (Describe adjacent land uses within 1,320 feet (1/4 mile) and/or two parcels in each direction of the project site)

East: _____

West: _____

North: _____

South: _____

WILLIAMSON ACT CONTRACT:

Yes No

Is the property currently under a Williamson Act Contract?

Contract Number: _____

If yes, has a Notice of Non-Renewal been filed?

Date Filed: _____

Yes No

Do you propose to cancel any portion of the Contract?

Yes No

Are there any agriculture, conservation, open space or similar easements affecting the use of the project site. (Such easements do not include Williamson Act Contracts)

If yes, please list and provide a recorded copy: _____

SITE CHARACTERISTICS: (Check one or more) Flat Rolling Steep

VEGETATION: What kind of plants are growing on your property? (Check one or more)

Field crops Orchard Pasture/Grassland Scattered trees

Shrubs Woodland River/Riparian Other

Explain Other: _____

Yes No

Do you plan to remove any trees? (If yes, please show location of trees planned for removal on plot plan and provide information regarding transplanting or replanting.)

GRADING:

Yes No

Do you plan to do any grading? (If yes, please indicate how many cubic yards and acres to be disturbed. Please show areas to be graded on plot plan.) _____

STREAMS, LAKES, & PONDS:

Yes No

Are there any streams, lakes, ponds or other watercourses on the property? (If yes, please show on plot plan)

Yes No

Will the project change any drainage patterns? (If yes, please explain – provide additional sheet if needed) _____

Yes No

Are there any gullies or areas of soil erosion? (If yes, please show on plot plan)

Yes No

Do you plan to grade, disturb, or in any way change swales, drainages, ditches, gullies, ponds, low lying areas, seeps, springs, streams, creeks, river banks, or other area on the site that carries or holds water for any amount of time during the year? (If yes, please show areas to be graded on plot plan)

Please note: If the answer above is yes, you may be required to obtain authorization from other agencies such as the Corps of Engineers or California Department of Fish and Game.

STRUCTURES:

Yes No Are there structures on the site? (If yes, please show on plot plan. Show a relationship to property lines and other features of the site.)

Yes No Will structures be moved or demolished? (If yes, indicate on plot plan.)

Yes No Do you plan to build new structures? (If yes, show location and size on plot plan.)

Yes No Are there buildings of possible Historical significance? (If yes, please explain and show location and size on plot plan.) _____

PROJECT SITE COVERAGE:

Existing Building Coverage: _____ Sq. Ft. Landscaped Area: _____ Sq. Ft.

Proposed Building Coverage: _____ Sq. Ft. Paved Surface Area: _____ Sq. Ft.

BUILDING CHARACTERISTICS:

Size of new structure(s) or building addition(s) in gross sq. ft.: (Provide additional sheets if necessary) _____

Number of floors for each building: _____

Building height in feet (measured from ground to highest point): (Provide additional sheets if necessary) _____

Height of other appurtenances, excluding buildings, measured from ground to highest point (i.e., antennas, mechanical equipment, light poles, etc.): (Provide additional sheets if necessary) _____

Proposed surface material for parking area: (Provide information addressing dust control measures if non-asphalt/concrete material to be used) _____

UTILITIES AND IRRIGATION FACILITIES:

Yes No Are there existing public or private utilities on the site? Includes telephone, power, water, etc. (If yes, show location and size on plot plan)

Who provides, or will provide the following services to the property?

Electrical: _____ Sewer*: _____

Telephone: _____ Gas/Propane: _____

Water**: _____ Irrigation: _____

***Please Note:** A “will serve” letter is required if the sewer service will be provided by City, Sanitary District, Community Services District, etc.

****Please Note:** A “will serve” letter is required if the water source is a City, Irrigation District, Water District, etc., and the water purveyor may be required to provide verification through an Urban Water Management Plan that an adequate water supply exists to service your proposed development.

Will any special or unique sewage wastes be generated by this development other than that normally associated with resident or employee restrooms? Industrial, chemical, manufacturing, animal wastes? (Please describe:)

with this application.

Please Note: Should any waste be generated by the proposed project other than that normally associated with a single family residence, it is likely that Waste Discharge Requirements will be required by the Regional Water Quality Control Board. Detailed descriptions of quantities, quality, treatment, and disposal may be required.

Yes No Are there existing irrigation, telephone, or power company easements on the property? (If yes, show location and size on plot plan.)

Yes No Do the existing utilities, including irrigation facilities, need to be moved? (If yes, show location and size on plot plan.)

Yes No Does the project require extension of utilities? (If yes, show location and size on plot plan.)

AFFORDABLE HOUSING/SENIOR:

Yes No Will the project include affordable or senior housing provisions? (If yes, please explain)

RESIDENTIAL PROJECTS: (Please complete if applicable – Attach additional sheets if necessary)

Total No. Lots: _____ Total Dwelling Units: _____ Total Acreage: _____

Net Density per Acre: _____ Gross Density per Acre: _____

<i>(complete if applicable)</i>	Single Family	Two Family Duplex	Multi-Family Apartments	Multi-Family Condominium/Townhouse
Number of Units:	_____	_____	_____	_____
Acreage:	_____	_____	_____	_____

COMMERCIAL, INDUSTRIAL, MANUFACTURING, RETAIL, USE PERMIT, OR OTHER PROJECTS: (Please complete if applicable – Attach additional sheets if necessary)

Square footage of each existing or proposed building(s): _____

Type of use(s): _____

Days and hours of operation: _____

Seasonal operation (i.e., packing shed, huller, etc.) months and hours of operation: _____

Occupancy/capacity of building: _____

Number of employees: (Maximum Shift): _____ (Minimum Shift): _____

Estimated number of daily customers/visitors on site at peak time: _____

Other occupants: _____

Estimated number of truck deliveries/loadings per day: _____

Estimated hours of truck deliveries/loadings per day: _____

Estimated percentage of traffic to be generated by trucks: _____

Estimated number of railroad deliveries/loadings per day: _____

Square footage of:

Office area: _____

Warehouse area: _____

Sales area: _____

Storage area: _____

Loading area: _____

Manufacturing area: _____

Other: (explain type of area) _____

Yes No Will the proposed use involve toxic or hazardous materials or waste? (Please explain)

a copy of which is included with this application.

ROAD AND ACCESS INFORMATION:

What County road(s) will provide the project's main access? (Please show all existing and proposed driveways on the plot plan)

Yes No Are there private or public road or access easements on the property now? (If yes, show location and size on plot plan)

Yes No Do you require a private road or easement to access the property? (If yes, show location and size on plot plan)

Yes No Do you require security gates and fencing on the access? (If yes, show location and size on plot plan)

Please Note: Parcels that do not front on a County-maintained road or require special access may require approval of an Exception to the Subdivision Ordinance. Please contact staff to determine if an exception is needed and to discuss the necessary Findings.

STORM DRAINAGE:

How will your project handle storm water runoff? (Check one) Drainage Basin Direct Discharge Overland

Other: (please explain) _____

If direct discharge is proposed, what specific waterway are you proposing to discharge to? _____

Please Note: If direct discharge is proposed, you will be required to obtain a NPDES permit from the Regional Water Quality Control Board, and must provide evidence that you have contacted them regarding this proposal with your application.

EROSION CONTROL:

If you plan on grading any portion of the site, please provide a description of erosion control measures you propose to implement.

Please note: You may be required to obtain an NPDES Storm Water Permit from the Regional Water Quality Control Board and prepare a Storm Water Pollution Prevention Plan.

ADDITIONAL INFORMATION:

Please use this space to provide any other information you feel is appropriate for the County to consider during review of your application. (Attach extra sheets if necessary)

Waste Management Plan For Kooistra Dairy Stanislaus County, CA

Prepared For:
Kooistra Dairy
5837 Hultberg Road
Turlock, CA 95380



SOUSA
ENGINEERING
INFRASTRUCTURE-DEVELOPMENT-
AGRICULTURE



Sousa
ENGINEERING
INFRASTRUCTURE-DEVELOPMENT-
AGRICULTURE

PO BOX 1613
OAKDALE, CA 95361
PHONE: (209)238-3151
www.sousaeng.com

**WASTE MANAGEMENT PLAN
FOR
KOOISTRA DAIRY
STANISLAUS COUNTY, CA**

TABLE OF CONTENTS

1. NARRATIVE

- a. Introduction
- b. Compliance Criteria
- c. Results and Conclusions

2. EXHIBITS

- a. Sheet 1 – Vicinity Map
- b. Sheet 2 – Site Map – Land Application Areas
- c. Sheet 3 – Site Map – Production Area
- d. Sheet 4 – Production Area Hydrologic Map
- e. Sheet 5 – FEMA Panel No. 06099C0800F

3. DESIGN, CONSTRUCTION, OPERATION, AND MAINTENANCE DOCUMENTATION

- a. Waste Management Plan Report / Process Wastewater Calculations
- b. Vector Control Plan

1. NARRATIVE

INTRODUCTION

This Waste Management Plan (WMP) has been prepared at the request of the subject dairy's owner and/or operator to comply with Section H.1.b., *Waste Management Plan*, of Order No. R5-2013-0122, *Reissued Waste Discharge Requirements General Order for Existing Milk Cow Dairies*, (Order) adopted by the California Regional Water Quality Control Board (CRWQCB) Central Valley Region. Per the requirements set forth by the aforementioned Order it is the intent of this plan to provide an evaluation of the existing milk cow facility's design, construction, operation, and maintenance for flood protection and waste containment and to determine whether the facility complies with Prohibition A.14, General Specifications B.1 through B.3, Pond Specifications C.1 through C.3, and Production Area Specifications D.1, D.4, and D.5. Should the evaluation provided by this plan determine that the existing facility does not comply with the requirements of the Order, then modifications will be proposed for the facility that will bring it into compliance and those modifications shall be made a part of this plan.

COMPLIANCE CRITERIA

As required by the Order this plan must evaluate the existing facility's compliance with Prohibition A.14, General Specifications B.1 through B.3, Pond Specifications C.1 through C.3, and Production Area Specifications D.1, D.4, and D.5. The criteria set forth by this Prohibition and General Specifications are as follows:

Prohibition A.14: *"The direct discharge of wastewater into groundwater via backflow through water supply or irrigation supply wells is prohibited."*

The water, irrigation, and wastewater systems of this facility have been examined by a Registered Civil Engineer licensed in the State of California. It has been determined and hereby documented that there are no existing conditions on the project site that would allow for direct discharge of wastewater into groundwater via backflow through water supply or irrigation supply wells.

General Specification B.1: *"The existing milk cow dairy shall have facilities that are designed, constructed, operated, and maintained to retain all facility process wastewater generated during the storage period (maximum period of time anticipated between land application of process wastewater), together with all precipitation on and drainage through manured areas, up to and including during a 25-year, 24-hour storm (see item II of Attachment B, which is attached to and made part of this Order)."*

Section 3.a. of this plan contains calculations that demonstrate the facility's ability to retain all process wastewater and precipitation generated by the 25-year, 24-hour storm. The tributary areas for storm drain runoff were determined by utilizing field measurements and aerial photography. The existing Wastewater Basins (Ponds 1, 2, and 3) were field measured.

General Specification B.2: *"In the Sacramento and San Joaquin River Basins, ponds and manured areas at existing milk cow dairies in operation on or before 27 November 1984 shall be protected from inundation or washout by overflow from any stream channel during 20-year peak stream flows. Existing milk cow dairies that were in operation on or before 27 November 1984 and that are protected against 100-year peak stream flows must continue to provide such protection. Existing milk cow dairies built or expanded after 27 November 1984 shall be protected against 100-year peak stream flows (Title 27 Section 22562(c))."*

The relevant Flood Zone Map published by the Federal Emergency Management Agency (FEMA) is Panel No. 06099C0800F. This map indicates that the existing dairy facility is in Zone X and is thus outside of the 1% annual chance, or 100-year, floodplain.

General Specification B.3: *"In the Tulare Lake Basin, existing milk cow dairies that existed as of 25 July 1975 shall be protected from inundation or washout from overflow from any stream channel during 20-year peak stream flows and existing milk cow dairies constructed after 25 July 1975 shall be protected*

from 100-year peak stream flows. Existing milk cow dairies expanded after 8 December 1984 shall be protected from 100-year peak stream flows.”

As the facility is in the San Joaquin River Basin this specification is not applicable.

Pond Specification C.1: *“The level of waste in the process wastewater retention ponds shall be kept a minimum of two (2) feet from the top of each aboveground embankment and a minimum of one (1) foot from the ground surface of each belowground pond. Less freeboard may be approved by the Executive Officer when a Civil Engineer who is registered pursuant to California law, or other person as may be permitted under the provisions of the California Business and Professions Code to assume responsible charge of such work, demonstrates that the structural integrity of the pond will be maintained with the proposed freeboard.*

2' of freeboard has been assigned to the wastewater retention Pond 2 as it has been constructed above grade. 1' of freeboard has been assigned to Ponds 1 and 3 as they have been constructed in ground or below grade.

Pond Specification C.2: *“Ponds shall be managed and maintained to prevent breeding of mosquitoes and other vectors. In particular,*

- a. Small coves and irregularities shall not be allowed around the perimeter of the water surface;*
- b. Weeds shall be minimized through control of water depth, harvesting, or other appropriate method;*
- c. Dead algae, vegetation, and debris shall not accumulate on the water surface; and*
- d. Management shall be in accordance with the requirements of the Mosquito Abatement District.”*

An Operations and Maintenance Plan addressing these items has been included in Section 3.a. and is hereby made a part of this plan.

Pond Specification C.3: *“Ponds designated to contain the 25-year, 24-hour storm event runoff must have a depth marker that clearly indicates the minimum capacity necessary to contain the runoff and direct precipitation from a 25-year, 24-hour storm event.”*

A marker meeting this specification will be installed in all the facility's ponds by the compliance date.

Production Area Specification D.1: *“All dirt or unpaved corrals shall be graded to promote drainage. Cow washing areas shall be paved (concrete or equivalent) and sloped to a drain. Water troughs, permanent feed racks, and mangers shall have paved access, and water troughs shall have a drain to carry water away from the corrals. (Cal Code Regs., title 3, § 646.1.)”*

Dirt or unpaved areas are graded to promote drainage.

All cow washing areas are paved with Portland Cement Concrete (PCC) and sloped to a drain which conveys wastewater to the retention ponds.

Water troughs, feed racks, and mangers have access paved with PCC. Water troughs have drains which convey wastewater to the retention ponds.

Production Area Specification D.4: *“All roofs, buildings, and non-manured areas located in the production area of the existing milk cow dairy shall be constructed or otherwise designed so that clean rainwater is diverted away from manured areas and waste containment facilities, unless such drainage is fully contained in the wastewater retention ponds. (Title 27, § 22562(b).)”*

The production area is designed such that rainwater that is not diverted away from manured areas and waste containment facilities is collected and conveyed to the wastewater retention ponds.

Production Area Specification D.5: *“Roof drainage from barns, milk houses, or shelters shall not drain into the corrals unless the corrals are properly graded and drained. (Cal Code Regs., title 3, § 661).”*

Roof drainage is collected by gutters, downspouts, and drains and is conveyed to the wastewater retention ponds.

RESULTS AND CONCLUSIONS

After conducting a visual inspection of the site, obtaining herd and facility information from the operator, performing the required measurements of facility improvements, and performing the calculations included in Section 3.a. it has been determined that the design, construction, operation, and waste containment of this facility are in compliance with Prohibition A.14 and General Specifications B.1 through B.3 and B.10 through B.16 of Order No. R5-2013-0122, *Reissued Waste Discharge Requirements General Order for Existing Milk Cow Dairies*.

2. EXHIBITS

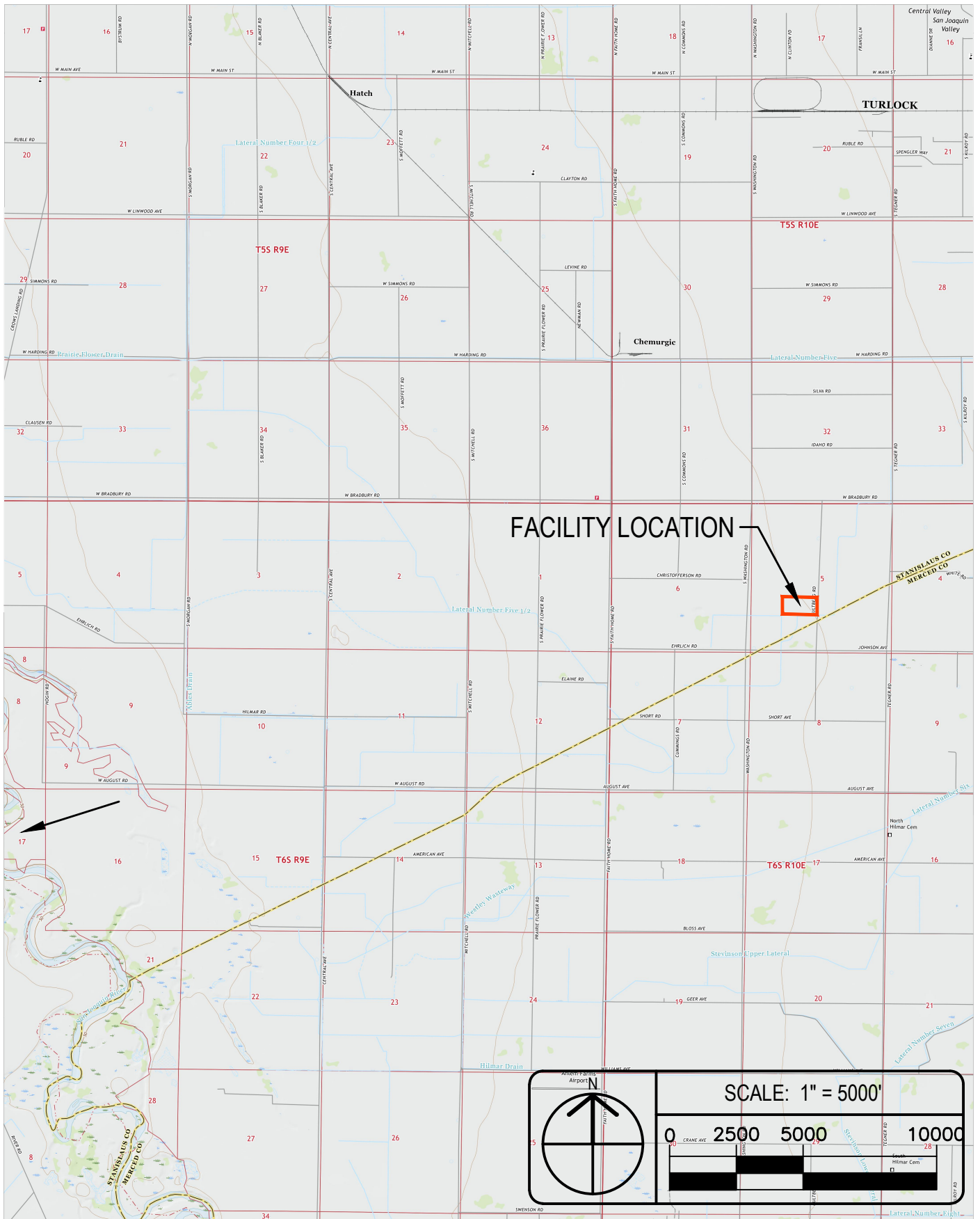

SOUSA
 ENGINEERING
 INFRASTRUCTURE - DEVELOPMENT -
 AGRICULTURE

PO BOX 1613
 OAKDALE, CA 95361

PH: (209)238-3151
 WWW.SOUSAENG.COM

VICINITY MAP
 KOOISTRA DAIRY

STANISLAUS COUNTY, CA

DRAWN BY: MS	REVISIONS	APPD.
DATE: 10/17/2021	DESCRIPTION	
FILE: 02_site.dwg		
JOB NO.: 2021-014		

DISCHARGE POINTS		
LAND APP. AREA	LATITUDE	LONGITUDE
1-KOOISTRA DAIRY	N37° 26' 19.02"	W120° 53' 54.98"
2-KOOISTRA	N37° 26' 07.28"	W120° 53' 34.17"
3-KOOISTRA HEIFER	N37° 25' 57.58"	W120° 53' 15.98"
4-FERNANDES	N37° 26' 08.16"	W120° 53' 22.74"

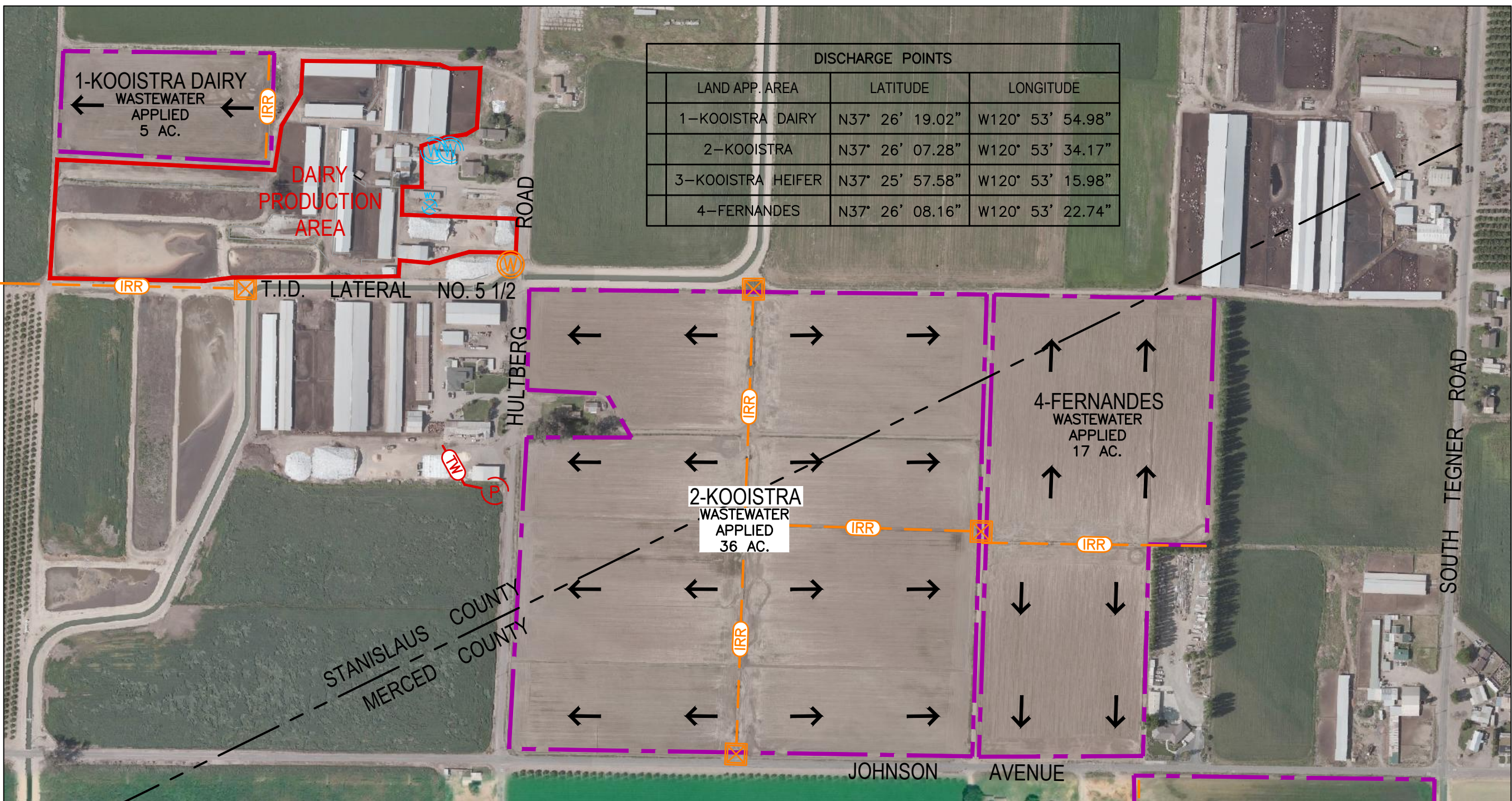

LEGEND

- LAND APPLICATION AREA
- IRRIGATION LINE
- IRRIGATION CONTROL BOX OR VALVE
- IRRIGATION WELL
- DOMESTIC WELL
- GENERAL SLOPE AND DIRECTION OF FLOW

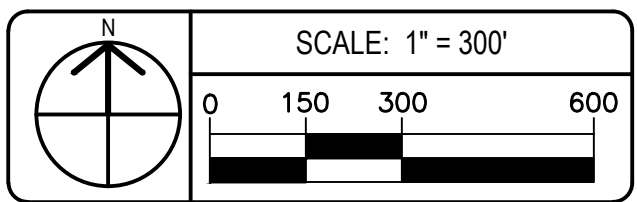



SITE MAP - PRODUCTION AREA
KOOISTRA DAIRY
MERCED COUNTY, CA

SYMBOL	REVISIONS DESCRIPTION	APPD.

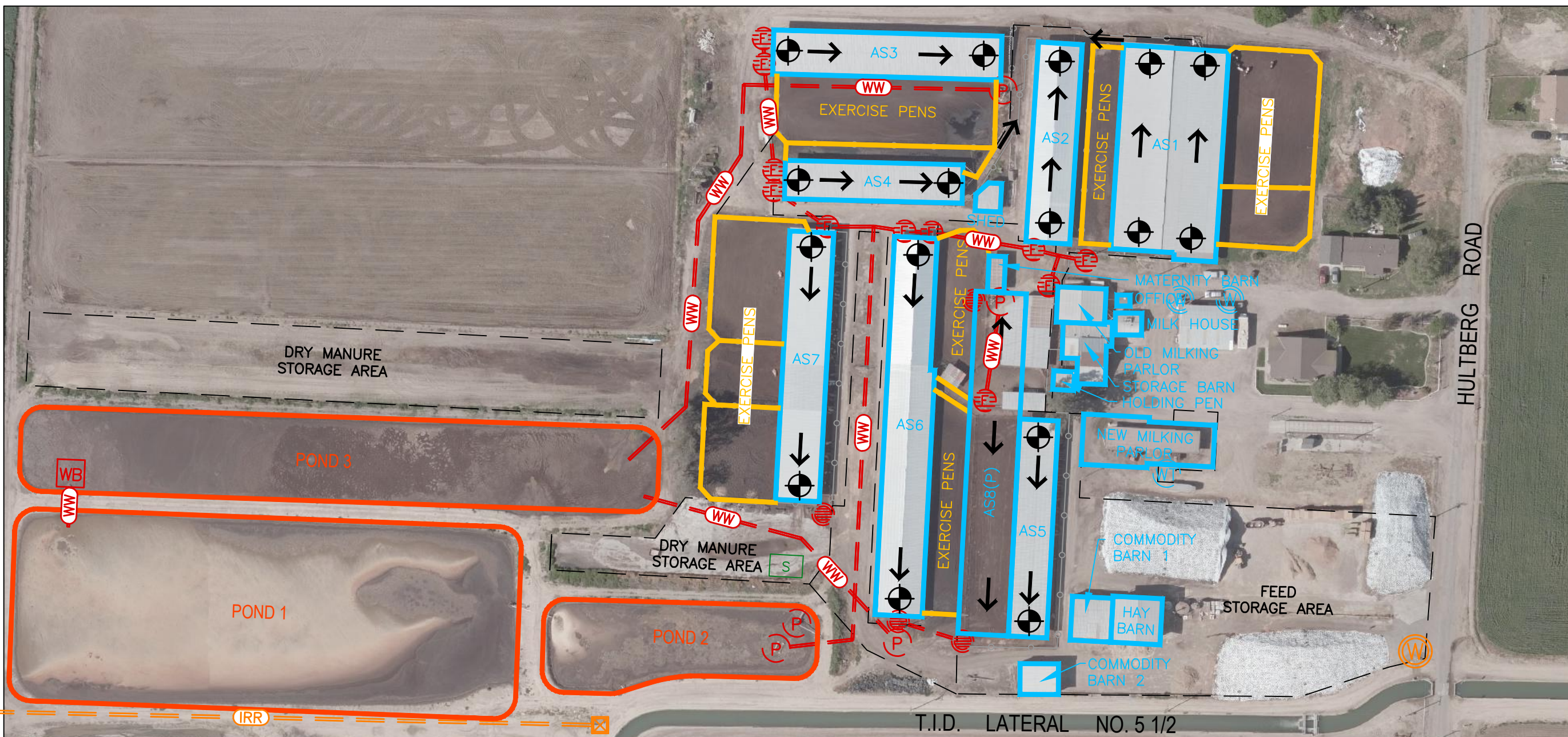

LEGEND

- ROOF AREA
- (P) ROOF AREA (PROPOSED)
- EXERCISE PEN AREA
- IRRIGATION LINE
- WASTEWATER LINE
- P WASTEWATER SUMP WITH PUMP
- S MECHANICAL SEPARATOR (PROPOSED)
- W DOMESTIC WELL
- W IRRIGATION WELL
- GENERAL SLOPE AND DIRECTION OF FLOW
- N INSPECTION POINT FOR MONITORING ANIMAL HOUSING AND FLUSH WATER CONVEYANCE SYSTEM
- E FLUSH SYSTEM DRAIN INLET
- E FLUSH SYSTEM DISCHARGE VALVE

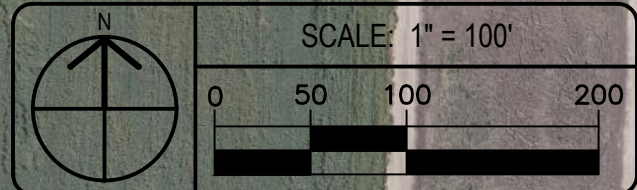

DRAWN BY: MS
DATE: 10/17/2021
FILE: 03_dpa.dwg.dwg
JOB NO.: 2021-014

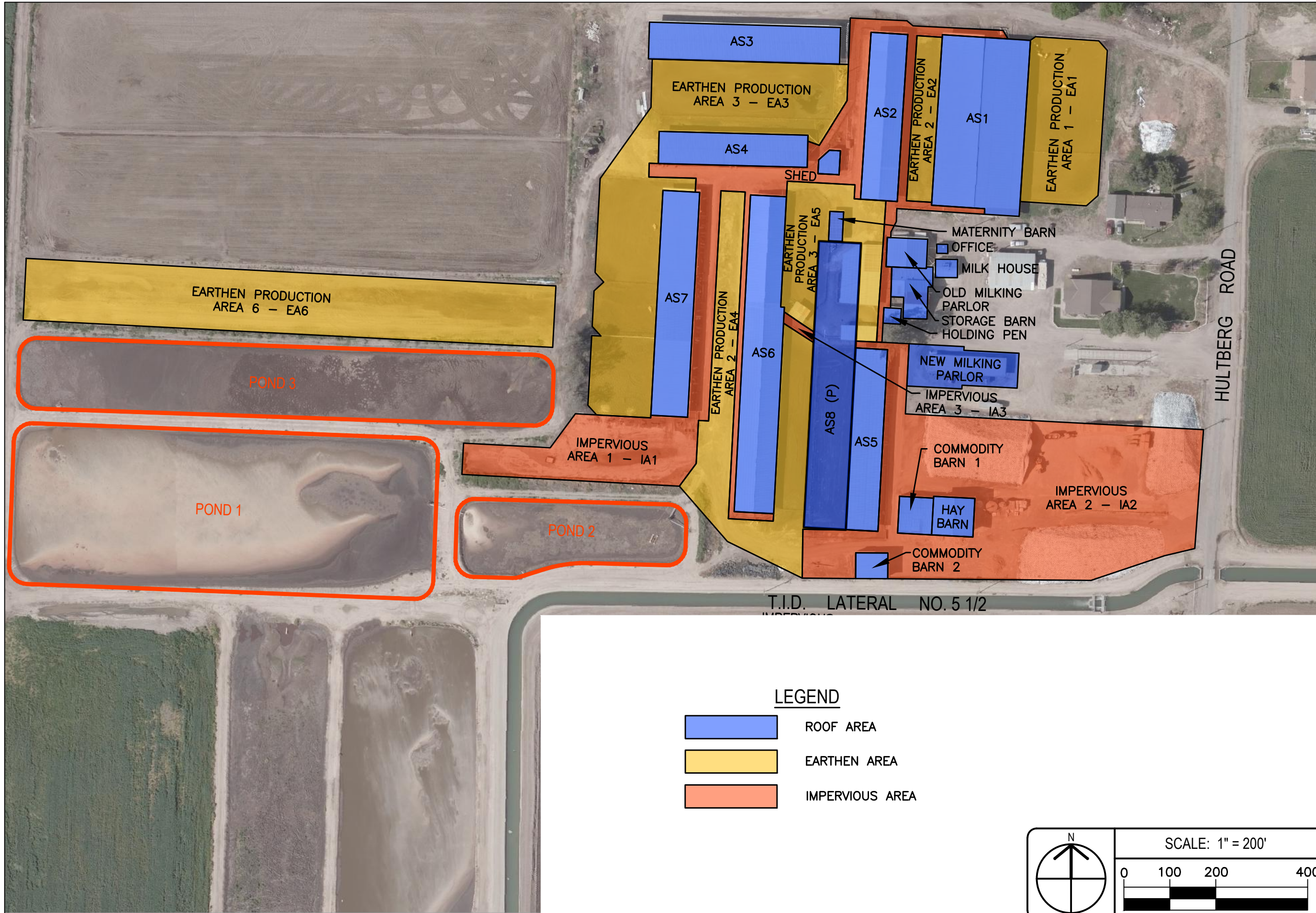

LEGEND

- ROOF AREA
- EARTHEN AREA
- IMPERVIOUS AREA

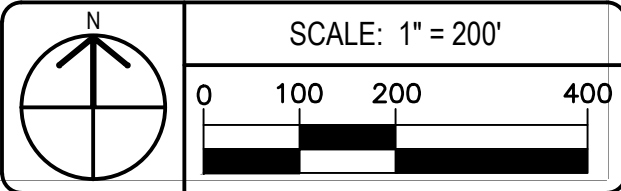

PRODUCTION AREA
HYDROLOGIC MAP
KOOISTRA DAIRY
MERCED COUNTY, CA

SYMBOL	REVISIONS DESCRIPTION	APPD.

DRAWN BY: MS
DATE: 10/11/2021
FILE: 04_hydro.dwg
JOB NO.: 2021-014

National Flood Hazard Layer FIRMette



120°54'9"W 37°26'32"N



Legend

SEE FIS REPORT FOR DETAILED LEGEND AND INDEX MAP FOR FIRM PANEL LAYOUT

- | | | |
|------------------------------------|--|--|
| SPECIAL FLOOD HAZARD AREAS | | Without Base Flood Elevation (BFE)
<i>Zone A, V, A99</i> |
| | | With BFE or Depth <i>Zone AE, AO, AH, VE, AR</i> |
| | | Regulatory Floodway |
| OTHER AREAS OF FLOOD HAZARD | | 0.2% Annual Chance Flood Hazard, Areas of 1% annual chance flood with average depth less than one foot or with drainage areas of less than one square mile <i>Zone X</i> |
| | | Future Conditions 1% Annual Chance Flood Hazard <i>Zone X</i> |
| | | Area with Reduced Flood Risk due to Levee. See Notes. <i>Zone X</i> |
| | | Area with Flood Risk due to Levee <i>Zone D</i> |
| OTHER AREAS | | NO SCREEN Area of Minimal Flood Hazard <i>Zone X</i> |
| | | Effective LOMRs |
| | | Area of Undetermined Flood Hazard <i>Zone D</i> |
| GENERAL STRUCTURES | | Channel, Culvert, or Storm Sewer |
| | | Levee, Dike, or Floodwall |
| OTHER FEATURES | | 20.2 Cross Sections with 1% Annual Chance Water Surface Elevation
17.5 |
| | | Coastal Transect |
| | | Base Flood Elevation Line (BFE) |
| | | Limit of Study |
| | | Jurisdiction Boundary |
| | | Coastal Transect Baseline |
| | | Profile Baseline |
| | | Hydrographic Feature |
| MAP PANELS | | Digital Data Available |
| | | No Digital Data Available |
| | | Unmapped |
| | | The pin displayed on the map is an approximate point selected by the user and does not represent an authoritative property location. |



This map complies with FEMA's standards for the use of digital flood maps if it is not void as described below. The basemap shown complies with FEMA's basemap accuracy standards

The flood hazard information is derived directly from the authoritative NFHL web services provided by FEMA. This map was exported on 9/13/2021 at 5:33 PM and does not reflect changes or amendments subsequent to this date and time. The NFHL and effective information may change or become superseded by new data over time.

This map image is void if the one or more of the following map elements do not appear: basemap imagery, flood zone labels, legend, scale bar, map creation date, community identifiers, FIRM panel number, and FIRM effective date. Map images for unmapped and unmodernized areas cannot be used for regulatory purposes.

3. DESIGN, CONSTRUCTION, OPERATION, AND MAINTENANCE DOCUMENTATION

Waste Management Plan Report
General Order No. R5-2007-0035, Attachment B
July 1, 2010 deadline

DAIRY FACILITY INFORMATION

A. NAME OF DAIRY OR BUSINESS OPERATING THE DAIRY: Kooistra Dairy

Physical address of dairy:

<u>5837 Hultberg RD</u>	<u>Turlock</u>	<u>Stanislaus</u>	<u>95380</u>
Number and Street	City	County	Zip Code

Street and nearest cross street (if no address): _____

TRS Data and Coordinates:

<u>6S</u>	<u>10E</u>	<u>5</u>	<u>Mt. Diablo</u>	<u>37° 26' 16.46" N</u>	<u>120° 53' 45.58" W</u>
Township (T_)	Range (R_)	Section (S_)	Baseline meridian	Latitude (N)	Longitude (W)

Date facility was originally placed in operation: 05/01/1980

Regional Water Quality Control Board Basin Plan designation: San Joaquin River Basin

County Assessor Parcel Number(s) for dairy facility:

0057-0017-0005-0000

B. OPERATOR NAME: Kooistra, Cynthia Lea

Telephone no.: (209) 634-2311

Landline Cellular

<u>5837 Kooistra RD</u>	<u>Turlock</u>	<u>CA</u>	<u>95380</u>
Mailing Address Number and Street	City	State	Zip Code

Operator should receive Regional Board correspondence (check): Yes No

OPERATOR NAME: Kooistra, Sam Sikke

Telephone no.: (209) 634-2311

Landline Cellular

<u>5837 Hultberg RD</u>	<u>Turlock</u>	<u>CA</u>	<u>95380</u>
Mailing Address Number and Street	City	State	Zip Code

Operator should receive Regional Board correspondence (check): Yes No

C. LEGAL OWNER NAME: Kooistra, Cynthia Lea

Telephone no.: (209) 634-2311

Landline Cellular

<u>5837 Kooistra RD</u>	<u>Turlock</u>	<u>CA</u>	<u>95380</u>
Mailing Address Number and Street	City	State	Zip Code

Owner should receive Regional Board correspondence (check): Yes No

LEGAL OWNER NAME: Kooistra, Sam Sikke

Telephone no.: (209) 634-2311

Landline Cellular

<u>5837 Hultberg RD</u>	<u>Turlock</u>	<u>CA</u>	<u>95380</u>
Mailing Address Number and Street	City	State	Zip Code

Owner should receive Regional Board correspondence (check): Yes No

D. CONTACT NAME: Sousa, Manny

Telephone no.: (209) 238-3151

Landline Cellular

Title: Civil Engineer

<u>P.O. Box 1613</u>	<u>Oakdale</u>	<u>CA</u>	<u>95361</u>
Mailing Address Number and Street	City	State	Zip Code

Waste Management Plan Report
 General Order No. R5-2007-0035, Attachment B
 July 1, 2010 deadline

HERD AND MILKING EQUIPMENT

A. HERD AND MILKING

The milk cow dairy is currently regulated under individual Waste Discharge Requirements.

Total number of milk and dry cows combined as a baseline value in response to the Report of Waste Discharge (ROWD) request of October, 2005:

1,000 milk and dry cows combined (regulatory review is required for any expansion)

Type of Animal	Present Count	Maximum Count	Daily Flush Hours	Avg Live Weight (lbs)
Milk Cows	800	800	20	1,250
Dry Cows	200	200	18	1,300
Bred Heifers (15-24 mo.)	0	0	0	0
Heifers (7-14 mo.)	0	0	0	0
Calves (4-6 mo.)	0	0	0	
Calves (0-3 mo.)	0	0	0	

Predominant milk cow breed: Jersey

Average milk production: 72 pounds per cow per day

Average number of milk cows per string sent to the milkbarn: 115 milk cows per string

Number of milkings per day: 2.0 milkings per day

Number of times milk tank is emptied/filled each day: 2.0 per day

Number of hours spent milking each day: 14.0 hours per day

B. MILKBARN EQUIPMENT AND FLOOR WASH

Bulk tank wash and sanitizing: 3.0 run cycles/wash

Bulk tank wash vat volume: 30 gallons/cycle

Bulk tank wash wastewater: 180.0 gallons/day

Pipeline wash and sanitizing: 3.0 run cycles/wash

Pipeline wash vat volume: 40 gallons/cycle

Pipeline wash wastewater: 240.0 gallons/day

Reused / recycled water is the source of parlor floor wash water: Yes No

Milkbarn / parlor floor wash volume: 2,000 gallons/day

Plate coolers type: Well Water Cooled (Water Reused/Recycled)

Plate coolers volume: 13,395 gallons/day

Vacuum pumps / air compressors / chillers type: Mechanically/Air Cooled

Vacuum pumps / air compressors / chillers volume: 0 gallons/day

Milkbarn and equipment wastewater volume generated daily: 2,420 gallons/day

Waste Management Plan Report
 General Order No. R5-2007-0035, Attachment B
 July 1, 2010 deadline

C. OTHER WATER USES

Reused/recycled water is the source of herd drinking water: Yes No

	Milk Cows	Dry Cows	Bred Heifers (15-24 mo.)	Bred Heifers (7-14 mo.)	Calves (4-6 mo.)	Calves (0-3 mo.)
<i>Number of cows drinking from reusable water:</i>	800	200	0	0	0	0
	<i>of 800</i>	<i>of 200</i>	<i>of 0</i>	<i>of 0</i>	<i>of 0</i>	<i>of 0</i>
<i>Gallons per head per day:</i>	28	12	0	0	0	0

Total reusable water consumed by herd: 24,800 gallons/day

Reused/recycled water is the source of sprinkler pen water: Yes No

Number of sprinklers in the holding pen: 0 sprinklers

Duration of each sprinkler cycle: 1.0 minutes

Number of sprinkler pen runs/milking: 0 cycles/milking

Flow rate for each sprinkler head: 1.0 gallons/minute

Total sprinkler pen wastewater volume: 0 gallons/day

Total fresh water used in manure flush lane system(s): 0 gallons/day

D. MISCELLANEOUS EQUIPMENT

No miscellaneous equipment entered.

E. MILKBARN AND EQUIPMENT SUMMARY

Number of days in storage period: 120 days

Water available for reuse/recycle: 13,395 gallons/day

Recycled water reused: 26,800 gallons/day

Recycled water leaving system: 24,800 gallons/day

Reusable water balance: 0 gallons/day

Volume of milkbarn and equipment wastewater generated for storage period: 290,400 gallons/storage period

MANURE AND BEDDING SOLIDS

A. IMPORTED AND FACILITY GENERATED BEDDING

Bedding Type	Imported or Generated (tons)	Density (lbs/cu. ft.)	Applied Separation Efficiency (default)	Solids to Pond (cu. ft./period)
Facility generated bedding	100	40.0	50%	2,500
			Total:	2,500

B. SOLIDS SEPARATION PROCESS

Combined manure solids separation efficiency (weight basis): 35 %

Description of all solids separation equipment used in flushed lane manure management systems:

Solid manure separator (proposed).

Waste Management Plan Report
 General Order No. R5-2007-0035, Attachment B
 July 1, 2010 deadline

C. MANURE AND BEDDING SOLIDS SUMMARY

	cubic feet		gallons	
	day	storage period	day	storage period
Manure generated by the herd (pre-separation):	2,056.30	246,756	15,382.21	1,845,865
Manure generated by the herd sent to pond(s):	1,498.90	179,868	11,212.56	1,345,507
Manure generated by the herd sent to dry lot(s):	362.77	43,532	2,713.70	325,644
Manure solids (herd) removed by separation:	94.22	11,306	704.82	84,578
Liquid component in separated solids not send to pond(s):	100.41	12,049	751.13	90,136
Imported and facility generated bedding sent to pond(s):	20.83	2,500	155.84	18,701
Total manure and bedding sent to pond(s):	1,519.73	182,368	11,368.40	1,364,208
Residual manure solids and bedding sent to pond(s) w/factor:	97.91	11,749	732.40	87,888
	cubic feet per year		gallons per year	
Residual manure solids and bedding sent to pond(s) w/factor:		35,736		267,325

RAINFALL AND RUNOFF

A. RAINFALL ESTIMATES

Rainfall station nearest the facility: Turlock

25 year/24 hour storm event (default NOAA Atlas 2, 1973): 2.50 inches/storage period

25 year/24 hour storm event (user-override): _____ inches/storage period

Storage period rainfall (default DWR climate data): 8.56 inches/storage period

Storage period rainfall (user-override): _____ inches/storage period

Flood zone: Zone X

B. IMPERVIOUS AREAS

Name	Surface Area (sq. ft.)	Quantity	25yr/24hr Storm Runoff Coefficient	Storage Period Runoff Coefficient	Runoff Destination
Impervious Area 1 - IA1	37,800	1	0.95	0.50	Drains into pond(s).
Impervious Area 2 - IA2	59,800	1	0.95	0.50	Drains into pond(s).
Impervious Area 3 - IA3	400	1	0.95	0.50	Drains into pond(s).

Surface area that does not run off into pond(s): 0 sq. ft.

Surface area that runs off into pond(s): 98,000 sq. ft.

Total surface area: 98,000 sq. ft.

Runoff from normal storage period rainfall: 261,469 gallons/storage period

Runoff from normal storage period rainfall with 1.5 factor: 392,204 gallons/storage period

25 year/24 hour storm event runoff: 145,091 gallons/storage period

Total surface area runoff: 406,560 gallons/storage period

Total surface area runoff with 1.5 factor: 537,295 gallons/storage period

Waste Management Plan Report
 General Order No. R5-2007-0035, Attachment B
 July 1, 2010 deadline

C. ROOF AREAS

Name	Surface Area (sq. ft.)	Quantity	Runoff Destination
Animal Shelter 1 - AS1	18,000	1	Adjacent field
Animal Shelter 2 - AS2	7,280	1	Adjacent field
Animal Shelter 3 - AS3	8,320	1	Adjacent field
Animal Shelter 4 - AS4	5,670	1	Field to west
Animal Shelter 5 - AS5	6,930	1	Wastewater pond
Animal Shelter 6 - AS6	14,355	1	Wastewater pond
Animal Shelter 7 - AS7	9,800	1	Field to west
Animal Shelter 8 - AS8	14,352	1	Wastewater pond
Commodity Barn 1	1,480	1	Wastewater pond
Commodity Barn 2	980	1	Wastewater pond
Hay Barn	1,890	1	Wastewater pond
Holding Pen	320	1	Wastewater pond
Maternity Barn	480	1	Wastewater pond
Milk House	480	1	Wastewater pond
New Milking Parlor	5,040	1	Wastewater pond
Office	120	1	Wastewater pond
Old Milking Parlor	1,408	1	Wastewater pond
Storage Barn	2,030	1	Wastewater pond

Surface area that does not run off into pond(s): 49,070 sq. ft.
 Surface area that runs off into pond(s): 49,865 sq. ft.
 Total surface area: 98,935 sq. ft.
 Runoff from normal storage period rainfall: 266,085 gallons/storage period
 Runoff from normal storage period rainfall with 1.5 factor: 399,127 gallons/storage period
 25 year/24 hour storm event runoff: 77,712 gallons/storage period
 Total surface area runoff: 343,797 gallons/storage period
 Total surface area runoff with 1.5 factor: 476,839 gallons/storage period

D. EARTHEN AREAS

Name	Surface Area (sq. ft.)	Quantity	25yr/24 Storm Coefficient	Storage Period Coefficient	Runoff Destination
Earthen Area 1 - EA1	15,000	1	0.35	0.20	Drains into pond(s).
Earthen Area 2 - EA2	4,960	14	0.35	0.20	Drains into pond(s).
Earthen Area 3 - EA3	37,000	1	0.35	0.20	Drains into pond(s).
Earthen Area 4 - EA4	21,700	1	0.35	0.20	Drains into pond(s).

Waste Management Plan Report
 General Order No. R5-2007-0035, Attachment B
 July 1, 2010 deadline

Earthen Area 5 - EA5	11,600	1	0.35	0.20	Drains into pond(s).
Earthen Area 6 - EA6	38,700	1	0.35	0.20	Drains into pond(s).

Surface area that does not run off into pond(s): 0 sq. ft.
 Surface area that runs off into pond(s): 193,440 sq. ft.
 Total surface area: 193,440 sq. ft.
 Runoff from normal storage period rainfall: 206,443 gallons/storage period
 Runoff from normal storage period rainfall with 1.5 factor: 309,665 gallons/storage period
 25 year/24 hour storm event runoff: 105,513 gallons/storage period
 Total surface area runoff: 311,956 gallons/storage period
 Total surface area runoff with 1.5 factor: 415,178 gallons/storage period

E. TAILWATER MANAGEMENT

No fields with tailwater entered.

Waste Management Plan Report
 General Order No. R5-2007-0035, Attachment B
 July 1, 2010 deadline

LIQUID STORAGE

A. POND OR BASIN DESCRIPTION: Pond 1

Pond is rectangular in shape: Yes No

Dimensions			
Earthen Length (EL):	462 ft.	Earthen Depth (ED):	5 ft.
Earthen Width (EW):	175 ft.	Side Slope (S):	1.0 ft. (h:1v)
Free Board (FB):	1 ft.	Dead Storage Loss (DS):	0.0 ft.
Calculations			
Liquid Length (LL):	460 ft.	Storage Volume Adjusted for Dead Storage Loss:	308,277 cu. ft.
Liquid Width (LW):	173 ft.		
Pond Surface Area:	80,850 sq. ft.	Pond Marker Elevation:	3.5 ft.
Storage Volume:	308,277 cu. ft.	Evaporation Volume:	426,106 gals/period
		Adjusted Surface Area:	79,252 sq. ft.

POND OR BASIN DESCRIPTION: Pond 2

Pond is rectangular in shape: Yes No

Dimensions			
Earthen Length (EL):	250 ft.	Earthen Depth (ED):	10 ft.
Earthen Width (EW):	77 ft.	Side Slope (S):	1.0 ft. (h:1v)
Free Board (FB):	2 ft.	Dead Storage Loss (DS):	1.0 ft.
Calculations			
Liquid Length (LL):	246 ft.	Storage Volume Adjusted for Dead Storage Loss:	110,532 cu. ft.
Liquid Width (LW):	73 ft.		
Pond Surface Area:	19,250 sq. ft.	Pond Marker Elevation:	7.4 ft.
Storage Volume:	123,931 cu. ft.	Evaporation Volume:	95,615 gals/period
		Adjusted Surface Area:	17,783 sq. ft.

Waste Management Plan Report
 General Order No. R5-2007-0035, Attachment B
 July 1, 2010 deadline

POND OR BASIN DESCRIPTION: Pond 3

Pond is rectangular in shape: Yes No

Dimensions			
Earthen Length (EL):	<u>582</u> ft.	Earthen Depth (ED):	<u>3</u> ft.
Earthen Width (EW):	<u>77</u> ft.	Side Slope (S):	<u>1.0</u> ft. (h:1v)
Free Board (FB):	<u>1</u> ft.	Dead Storage Loss (DS):	<u>0.0</u> ft.
Calculations			
Liquid Length (LL):	<u>580</u> ft.	Storage Volume Adjusted for Dead Storage Loss:	<u>84,391</u> cu. ft.
Liquid Width (LW):	<u>75</u> ft.		
Pond Surface Area:	<u>44,814</u> sq. ft.	Pond Marker Elevation:	<u>1.5</u> ft.
Storage Volume:	<u>84,391</u> cu. ft.	Evaporation Volume:	<u>232,030</u> gals/period
		Adjusted Surface Area:	<u>43,155</u> sq. ft.

Potential storage losses (due to dead storage): 13,399.0 cubic feet - or - 100,231.5 gallons

Liquid storage surface area: 141,038 sq. ft.

Rainfall onto retention pond(s): 773,276 gallons/storage period

Rainfall runoff into retention pond(s): 733,997 gallons/storage period

Normal rainfall onto retention pond(s) with 1.5 factor: 1,159,914 gallons/storage period

Normal rainfall runoff into retention pond(s) with 1.5 factor: 1,100,996 gallons/storage period

Storage period evaporation (default): 11.50 inches/storage period

Storage period evaporation (user-override): _____ inches/storage period

Storage period evaporation volume: 753,751 gallons/storage period

Manure and bedding sent to pond(s): 1,364,208 gallons/storage period

Milkbarn water sent to pond(s): 290,400 gallons/storage period

Fresh flush water for storage period: 0 gallons/storage period

Waste Management Plan Report
 General Order No. R5-2007-0035, Attachment B
 July 1, 2010 deadline

CHARTS

A. MILKBARN WASTEWATER SENT TO POND(S)

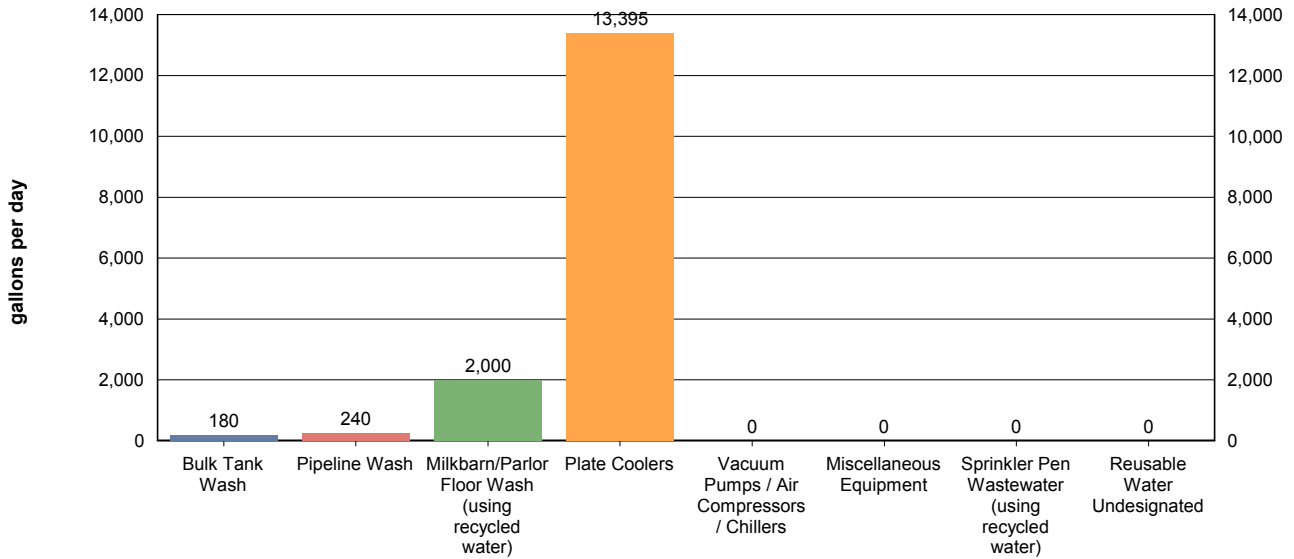

Values shown in chart are approximate values per day.

Total milkbarn wastewater generated daily: 2,420 gallons/day
 Total milkbarn wastewater generated per period: 290,400 gallons/storage period

Waste Management Plan Report
 General Order No. R5-2007-0035, Attachment B
 July 1, 2010 deadline

B. PROCESS WASTEWATER (NORMAL PRECIPITATION)

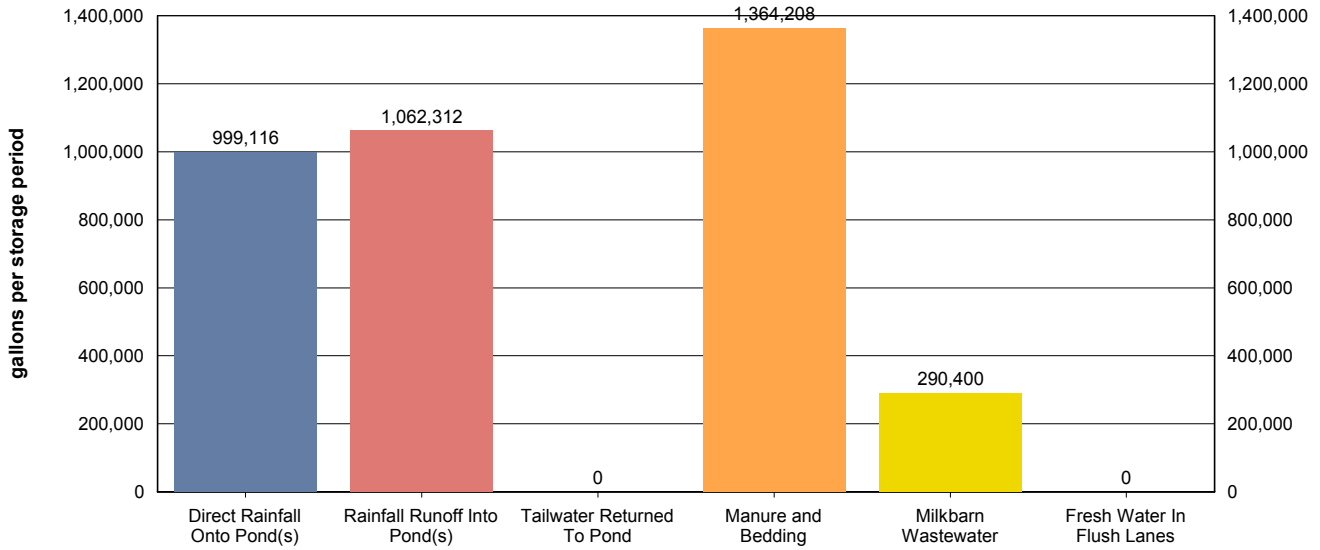

Values shown in chart are approximate values for storage period.

Storage period:	<u>120</u> days
Total process wastewater generated daily:	<u>30,967</u> gallons/day
Total process wastewater generated per period:	<u>3,716,037</u> gallons/storage period
Total process wastewater removed due to evaporation:	<u>753,751</u> gallons/storage period
Total storage capacity required:	<u>2,962,286</u> gallons
	<u>396,000</u> cu. ft.
Existing storage capacity (adjusted for dead storage loss):	<u>3,764,197</u> gallons
	<u>503,200</u> cu. ft.

Considering normal precipitation, existing capacity meets estimated storage needs: Yes No

Waste Management Plan Report
 General Order No. R5-2007-0035, Attachment B
 July 1, 2010 deadline

C. PROCESS WASTEWATER (NORMAL PRECIPITATION WITH 1.5 FACTOR)

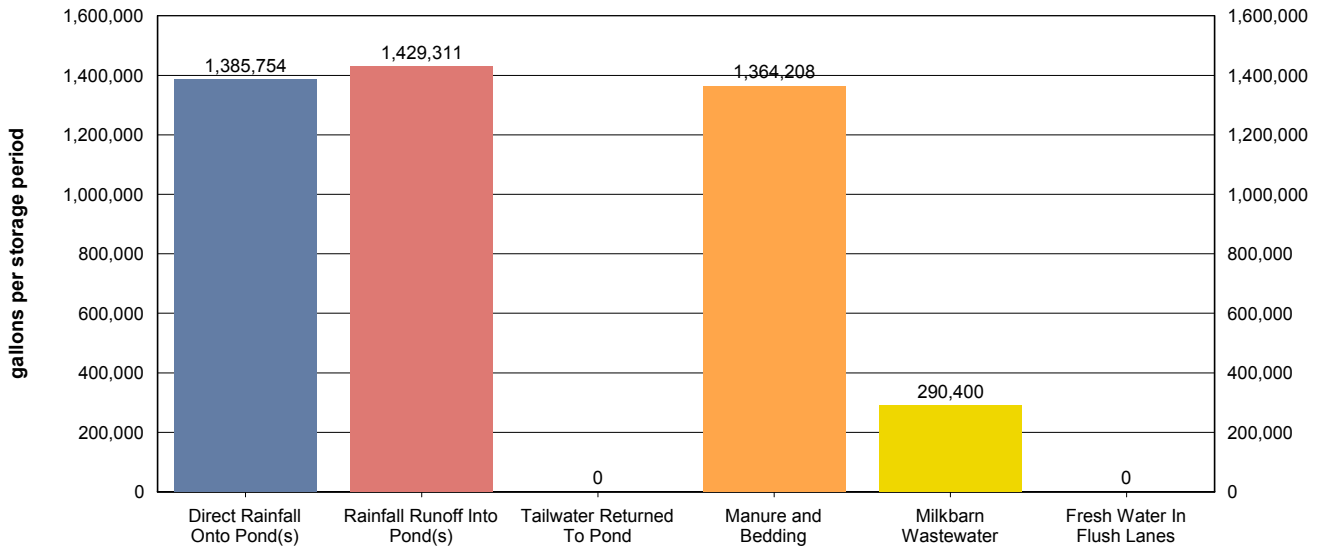

Values shown in chart are approximate values for storage period.

Storage period:	<u>120</u> days
Total process wastewater generated daily:	<u>37,247</u> gallons/day
Total process wastewater generated per period:	<u>4,469,673</u> gallons/storage period
Total process wastewater removed due to evaporation:	<u>753,751</u> gallons/storage period
Total storage capacity required:	<u>3,715,922</u> gallons
	<u>496,747</u> cu. ft.
Existing storage capacity (adjusted for dead storage loss):	<u>3,764,197</u> gallons
	<u>503,200</u> cu. ft.

Considering factored precipitation, existing capacity meets estimated storage needs: Yes No

Waste Management Plan Report
 General Order No. R5-2007-0035, Attachment B
 July 1, 2010 deadline

D. STORAGE VOLUME ASSESSMENT (NORMAL PRECIPITATION WITH 1.5 FACTOR)

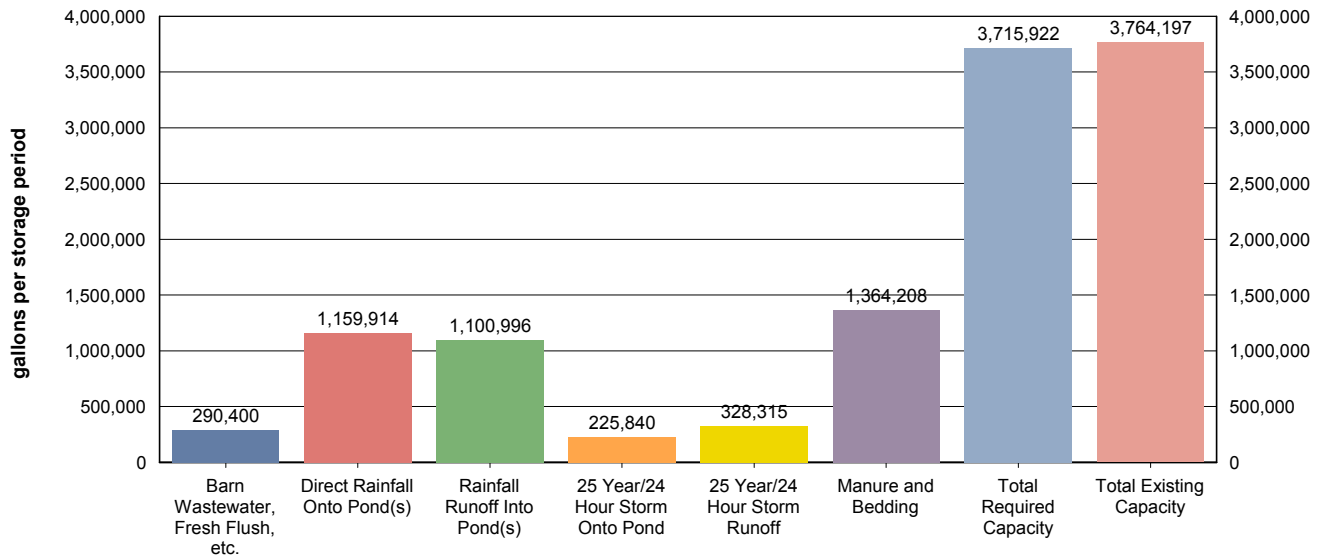

Values shown in chart are approximate values for storage period.

Storage period:	<u>120</u> days
Barn wastewater, fresh flush water, and tailwater:	<u>290,400</u> gallons/storage period
Manure and bedding sent to pond:	<u>1,364,208</u> gallons/storage period
Precipitation onto pond:	<u>1,159,914</u> gallons/storage period
Precipitation runoff:	<u>1,100,996</u> gallons/storage period
25 year/24 hour storm onto pond:	<u>225,840</u> gallons/storage period
25 year/24 hour storm runoff:	<u>328,315</u> gallons/storage period
Residual solids after liquids have been removed (liquid equivalent):	<u>87,888</u> gallons/storage period
Total process wastewater removed due to evaporation:	<u>753,751</u> gallons/storage period
Total required capacity:	<u>3,715,922</u> gallons/storage period
Total existing capacity:	<u>3,764,197</u> gallons/storage period
Existing capacity meets estimated storage needs:	<input checked="" type="checkbox"/> Yes [] No

Waste Management Plan Report
General Order No. R5-2007-0035, Attachment B
July 1, 2010 deadline

OPERATION AND MAINTENANCE PLAN

The goal of the Operation and Maintenance Plan is to eliminate discharges of waste or storm water to surface waters from the production area and the protection of underlying soils and ground water.

A. POND MAINTENANCE

i. FREEBOARD MONITORING

1. Freeboard will be monitored monthly from June 1 through September 1 (dry season) and weekly from October 1 through May 31 (wet season). The results will be recorded on a Dairy Production Area Visual Inspection Form.
2. Freeboard will be monitored during and after each significant storm event and the results recorded on a Production Area Significant Storm Event Inspection Form.
3. Ponds will be photographed on the first day of each month. Pond photos will be labeled and maintained with the dairy's monitoring records.

ii. PREPARATION FOR MAINTAINING WINTER STORAGE CAPACITY

1. The retention pond(s) will begin to be lowered to the minimum operating level on or before a designated date each year.
2. The minimum operating level will include the necessary storage volume as identified in Section II.A in Attachment B of the General Order.

iii. OTHER POND MONITORING

1. At the time of each monitoring for freeboard, the pond(s) will be inspected for evidence of excessive odors, mosquito breeding, algae, or equipment damage; and issues with berm integrity, including cracking, slumping, erosion, excess vegetation, animal burrows, and seepage. Any issues identified and corrective actions performed will be recorded on a Dairy Production Area Visual Inspection Form - Other Pond Monitoring.
2. At the time of each monitoring during and after each significant storm event, the ponds will be inspected for evidence of any discharge and issues with berm integrity, including cracking, slumping, erosion, excess vegetation, animal burrows, and seepage. Any issues identified and corrective actions performed will be recorded on a Production Area Significant Storm Event Inspection Form.

iv. SOLIDS REMOVAL PROCEDURES

1. The average thickness of the solids accumulated on the bottom of the pond (s) will be measured on the designated interval using the owner, operator, and/or designer specified procedure.
2. Once solids/sludge on the bottom of the pond(s) reach the owner, operator, and/or designer specified critical thickness, solids/sludge will be removed so that adequate capacity is maintained.
3. When necessary, solids/sludge will be removed using the owner, operator, and/or designer specified methods for protecting any pond liner.

OPERATIONS AND MAINTENANCE PLAN FOR POND: Pond 1

Dry season freeboard monitoring will occur on the 1st of each month.

Wet season freeboard monitoring will occur every Monday of each week.

Process wastewater pond contents will be lowered to the minimum operating level (elevation) of 0.0 feet above the pond invert beginning in March of each year.

Sludge accumulation will be measured annually.

The following method will be used to measure solids/sludge accumulation:

Solids will be measured manually after lowering of the liquid pond level.

Waste Management Plan Report
 General Order No. R5-2007-0035, Attachment B
 July 1, 2010 deadline

When solids/sludge accumulate to a thickness of 1.0 feet, the following method will be used to maintain adequate storage capacity while protecting any pond liner:

Solids will be removed with an excavator.

OPERATIONS AND MAINTENANCE PLAN FOR POND: Pond 3

Dry season freeboard monitoring will occur on the 1st of each month.

Wet season freeboard monitoring will occur every Monday of each week.

Process wastewater pond contents will be lowered to the minimum operating level (elevation) of 0.0 feet above the pond invert beginning in March of each year.

Sludge accumulation will be measured annually.

The following method will be used to measure solids/sludge accumulation:

Solids will be measured manually after lowering of the liquid pond level.

When solids/sludge accumulate to a thickness of 1.0 feet, the following method will be used to maintain adequate storage capacity while protecting any pond liner:

Solids will be removed with an excavator.

OPERATIONS AND MAINTENANCE PLAN FOR POND: Pond 2

Dry season freeboard monitoring will occur on the 1st of each month.

Wet season freeboard monitoring will occur every Monday of each week.

Process wastewater pond contents will be lowered to the minimum operating level (elevation) of 1.0 feet above the pond invert beginning in March of each year.

Sludge accumulation will be measured annually.

The following method will be used to measure solids/sludge accumulation:

Solids will be measured manually after lowering of the liquid pond level.

When solids/sludge accumulate to a thickness of 1.0 feet, the following method will be used to maintain adequate storage capacity while protecting any pond liner:

Solids will be removed with an excavator.

B. RAINFALL COLLECTION SYSTEM MAINTENANCE

- i. Annually, rainfall collection systems will be assessed to ensure:
 1. Conveyances are free of debris and operating within designer/manufacturer specifications.
 2. Components are properly fastened according to designer/manufacturer specifications.
 3. All downspouts and related infrastructure are connected to conveyances that divert water away from manured areas.
 4. Water from the rainfall collection system(s) is diverted to an appropriate destination.

<i>Buildings with rooftop rainfall collection systems</i>	Quantity	Surface Area (sq. ft.)
Animal Shelter 1 - AS1	1	18,000
Animal Shelter 2 - AS2	1	7,280
Animal Shelter 3 - AS3	1	8,320
Animal Shelter 4 - AS4	1	5,670

Waste Management Plan Report
 General Order No. R5-2007-0035, Attachment B
 July 1, 2010 deadline

Animal Shelter 5 - AS5	1	6,930
Animal Shelter 6 - AS6	1	14,355
Animal Shelter 7 - AS7	1	9,800
Animal Shelter 8 - AS8	1	14,352
Commodity Barn 1	1	1,480
Commodity Barn 2	1	980
Hay Barn	1	1,890
Holding Pen	1	320
Maternity Barn	1	480
Milk House	1	480
New Milking Parlor	1	5,040
Office	1	120
Old Milking Parlor	1	1,408
Storage Barn	1	2,030

Assessment for buildings with rooftop rainfall collection systems will occur on or before: 1st of October

Assessment for other rainfall collections systems will occur on or before: 1st of October

Description of how rainfall collection systems will be assessed:

Gutters, downspouts, and all other collection and conveyance systems are to be inspected, cleaned, and/or repaired as required.

C. CORRAL MAINTENANCE

- i. Monthly from June 1st through September 30th (dry season) and weekly from October 1st through May 31st (wet season), the perimeter of the corrals and pens will be assessed to ensure that runoff and runoff controls such as berms are functioning correctly, and that all water that contacts waste is collected and diverted into the wastewater retention pond(s). Any issues identified and corrective actions performed will be recorded on a Dairy Production Area Visual Inspection Form - Corrals.
- ii. The corrals will be assessed by the designated date to determine:
 - 1. Whether manure needs to be removed from the corrals based on the owner, operator, and/or designer specified conditions.
 - 2. Whether there are depressions within the corrals that should be filled/groomed to prevent ponding.
- iii. Removal of manure and/or regrading, when necessary, will be completed on or before the designated month/day of each year.

Day of the month dry season assessment will occur: 1st of each month

Day of the week wet season assessment will occur: Monday

Solid manure removal and regrading assessment will occur on or before: 1st of September

Conditions requiring manure removal and/or regrading:

Solids will be removed with scrapers and/or loaders. Regrading will be performed as necessary after solids removal to ensure proper drainage.

Solid manure removal and/or regrading will occur on or before: 1st of November

Waste Management Plan Report
General Order No. R5-2007-0035, Attachment B
July 1, 2010 deadline

D. FEED STORAGE AREA MAINTENANCE

- i. During the dry season and prior to the wet season, the perimeter of storage areas will be assessed to ensure all runoff and runoff controls such as berms are functioning correctly and runoff and leachate from the areas are collected and diverted into the wastewater pond(s). Any issues identified and corrective actions performed will be recorded on a Dairy Production Area Visual Inspection Form - Manure and Feed Storage Areas.
- ii. During the wet season, feed storage area(s) will be assessed to determine if there are depressions within any feed storage area that should be filled or repaired to prevent ponding.
- iii. Any necessary regrading/resurfacing and berm/conveyance maintenance will be completed on an annual basis.

Day of the month dry season assessment will occur: 1st of each month

Day of the week wet season assessment will occur: Monday

Regrading/resurfacing and berm maintenance assessment will occur on or before: 1st of October

Regrading/resurfacing and berm maintenance completion will occur on or before: 1st of November

E. SOLID MANURE STORAGE AREA MAINTENANCE

- i. During the dry season and prior to the wet season, the perimeter of manure storage areas will be assessed to ensure all runoff and runoff controls such as berms are functioning correctly and runoff and leachate from the areas are collected and diverted into the wastewater pond(s). Any issues identified and corrective actions performed will be recorded on a Dairy Production Area Visual Inspection Form - Manure and Feed Storage Areas.
- ii. During the wet season, manure storage area(s) will be assessed to determine if there are depressions within any manure storage area that should be filled to prevent ponding.
- iii. Any necessary regrading/resurfacing and berm/conveyance maintenance will be completed on an annual basis.

Day of the month dry season assessment will occur: 1st of each month

Day of the month wet season assessment will occur: Monday

Regrading/resurfacing and berm maintenance assessment will occur on or before: 1st of October

Regrading/resurfacing and berm maintenance completion will occur on or before: 1st of November

F. ANIMAL HOUSING AND FLUSH WATER CONVEYANCE SYSTEM MAINTENANCE

- i. A map will be attached that identifies critical points for monitoring the animal housing and flush water conveyance system to verify that water is being managed as identified in this Waste Management Plan. These points will be maintained at owner, operator, and/or designer specified intervals.

Animal housing area assessment will occur on or before: 1st of October

Animal housing drainage system maintenance will occur on or before: 1st of October

Animal housing area drainage system assessment and maintenance methods:

Flush and/or wastewater conveyance lanes are to be inspected and cleared of debris and/or other obstructions as required. Defects in said conveyance systems, such as failed concrete and/or pipes, shall be repaired as needed.

G. MORTALITY MANAGEMENT

- i. Dead animals will be stored, removed, and disposed of properly.

Rendering company or landfill name: Sisk Tallow

Rendering company or landfill telephone number: (209) 667-1451

Waste Management Plan Report
 General Order No. R5-2007-0035, Attachment B
 July 1, 2010 deadline

H. ANIMALS AND SURFACE WATER MANAGEMENT

- i. A system will be in place, monitored, and maintained to prevent animals from entering any surface waters when a stream or other surface water crosses or adjoins the corral(s).

Does a stream or any other surface water cross or adjoin the corrals? [] Yes [X] No

I. MONITORING SALT IN ANIMAL RATIONS

- i. The combined quantity of minerals as salt in animal drinking water and feed rations will be reviewed by a qualified nutritionist on a routine basis to verify that minerals are limited to the amount required to maintain animal health and optimum production . As feed rations change, mineral content may change.

Assessment interval: Annually

J. CHEMICAL MANAGEMENT

- i. Chemicals and other contaminants handled at the facility will not be disposed of in any manure or process wastewater, storm water storage or treatment system unless specifically designed to treat such chemicals and other contaminants.

Chemical Name	Quantity	Units	Frequency	Usage Area	Destination (Used Chemical / Container)	Disposal Company		Collection Frequency
						Name	Phone	
Iodine / Teat Dip	200	gallons	year	Milking Parlor	Picked up by distributor			
Acid	60	gallons	year	Milking Parlor	Picked up by distributor			
CIP Detergent	100	gallons	year	Milking Parlor	Picked up by distributor			

Waste Management Plan Report
General Order No. R5-2007-0035, Attachment B
July 1, 2010 deadline

REQUIRED ATTACHMENTS

The following list, based upon user selections and data entries, describes the minimum required attachments that must be submitted with the Waste Management Plan for the reporting schedule of 'July 1, 2010'.

A. SITE MAP(S)

Provide a site map (or maps) of appropriate scale to show property boundaries and the location of the features of the production area including the following in sufficient detail: structures used for animal housing, milk parlor, and other buildings; corrals and ponds; solids separation facilities (settling basins or mechanical separators); other areas where animal wastes are deposited or stored; feed storage areas; drainage flow directions and nearby surface waters; all water supply wells (domestic, irrigation, and barn wells) and groundwater monitoring wells.

Production area map reference number: Exhibit Sheet 3

Provide a site map (or maps) of appropriate scale to show property boundaries and the location of the features of all land application areas (land under the Discharger's control, whether it is owned, rented, or leased, to which manure or process wastewater from the production area is or may be applied for nutrient recycling) including the following in sufficient detail: a field identification system (Assessor's Parcel Number; field by name or number; total acreage of each field; crops grown; indication if each field is owned, leased, or used pursuant to a formal agreement); indication of what type of waste is applied (solid manure only, wastewater only, or both solid manure and wastewater); drainage flow direction in each field, nearby surface waters, and storm water discharge points; tailwater and storm water drainage controls; subsurface (tile) drainage systems (including discharge points and lateral extent); irrigation supply wells and groundwater monitoring wells; sampling locations for discharges of storm water and tailwater to surface water from the field.

Application area map reference number: Exhibit Sheet 2

Provide a site map (or maps) of appropriate scale to show property boundaries and the location of all cropland (land that is part of the dairy but not used for dairy waste application) including the following in sufficient detail: Assessor's Parcel Number, total acreage, crops grown, and information on who owns or leases the field. The Waste Management Plan shall indicate if such cropland is covered under the Conditional Waiver of Waste Discharge Requirements for Discharges from Irrigated Lands (Order No. R5-2006-0053 for Coalition Group or Order No. R5-2006-0054 for Individual Discharger, or updates thereto).

Non-application area map reference number: n/a

Provide a site map (or maps) of appropriate scale to show property boundaries and the location of all off-property domestic wells within 600 feet of the production area or land application area(s) associated with the dairy and the location of all municipal supply wells within 1,500 feet of the production area or land application area(s) associated with the dairy.

Well area map reference number: Exhibit Sheets 2 & 3

Provide a site map (or maps) of appropriate scale to show property boundaries and a vicinity map, north arrow and the date the map was prepared. The map shall be drawn on a published base map (e.g., a topographic map or aerial photo) using an appropriate scale that shows sufficient details of all facilities.

Vicinity map reference number: Exhibit Sheet 1

B. PROCESS WASTEWATER MAP(S)

Provide a site map (or maps) of appropriate scale to show property boundaries and the location of the features of the production area including the following in sufficient detail: process wastewater conveyance structures, discharge points, and discharge /mixing points with irrigation water supplies; pumping facilities and flow meter locations; upstream diversion structures, drainage ditches and canals, culverts, drainage controls (berms/levees, etc.), and drainage easements; and any additional components of the waste handling and storage system.

Production infrastructure system area map reference number: Exhibit Sheet 3

Waste Management Plan Report
General Order No. R5-2007-0035, Attachment B
July 1, 2010 deadline

Provide a site map (or maps) of appropriate scale to show property boundaries and the location of the features of all land application areas (land under the Discharger's control, whether it is owned, rented, or leased, to which manure or process wastewater from the production area is or may be applied for nutrient recycling) including the following in sufficient detail: process wastewater conveyance structures, discharge points and discharge mixing points with irrigation water supplies; pumping facilities; flow meter locations; drainage ditches and canals, culverts, drainage controls (berms, levees, etc.), and drainage easements.

Land application infrastructure system area map reference number: Exhibit Sheet 2

C. EXCESS PRECIPITATION CONTINGENCY REPORT

There were no attachment references entered or required for this attachment section.

D. OPERATION AND MAINTENANCE PLAN

Attach a map that identifies critical points for monitoring the system to verify that water is being managed as identified in this Waste Management Plan (see Attachment B, Pg B-7 V.F, V.G, and V.H for additional requirements).

Animal housing assessment map reference number: Exhibit Sheet 3

E. FLOOD PROTECTION / INUNDATION REPORT

Provide a published flood zone map that shows the facility is outside the relevant flood zones.

Flood zone map and/or document reference number: Exhibit Sheet 5

F. BACKFLOW PROTECTION

Attach documentation from a trained professional (i.e. a person certified by the American Backflow Prevention Association, an inspector from a state or local governmental agency who has experience and/or training in backflow prevention, or a consultant with such experience and/or training), as specified in Required Reports and Notices H.1 of Waste Discharge Requirements General Order No. R5-2007-0035, that there are no cross-connections that would allow the backflow of wastewater into a water supply well, irrigation well, or surface water as identified on the Site Map.

Backflow documentation reference number: WMP Section 1.b.

Waste Management Plan Report
General Order No. R5-2007-0035, Attachment B
July 1, 2010 deadline

CERTIFICATION

A. DAIRY FACILITY INFORMATION

Name of dairy or business operating the dairy: Kooistra Dairy

Physical address of dairy:

5837 Hultberg RD
Number and Street

Turlock
City

Stanislaus
County

95380
Zip Code

Street and nearest cross street (if no address): _____

B. DOCUMENTATION OF QUALIFICATIONS AND PLAN DEVELOPMENT

I have reviewed the portion of the waste management plan that is related to storage capacity facility and design specifications in accordance with Item II, Attachment B of the Waste Discharge Requirements General Order for Existing Milk Cow Dairies - Order No. R5-2007-0035 and certify that this plan was prepared by, or under the responsible charge of, and certified by a civil engineer who is registered pursuant to California law or other person as may be permitted under the provisions of the California Business and Professions Code to assume responsible charge of such work.

Storage capacity is:

Insufficient

- Retrofitting Plan/Schedule/Design Criteria attached in accordance with Attachment B, II.B. 1-5 and Attachment B, II. C.

Sufficient

- Certification 1 - Certified in accordance with Attachment B, II. A. 1-8. (no contingency plan)
- Certification 2 - Certified in accordance with Attachment B, II. A. 1-8, II. C. (with contingency plan attached)

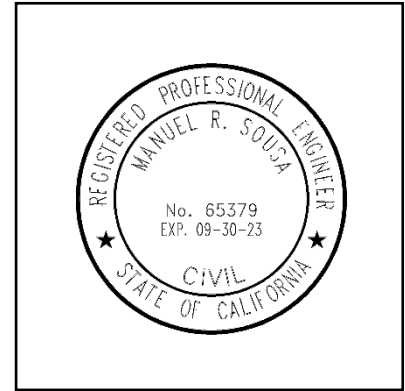

CIVIL ENGINEER'S WET STAMP

10/20/2021

SIGNATURE OF CIVIL ENGINEER

DATE

Manny Sousa

PRINT OR TYPE NAME

P.O. Box 1613; Oakdale, CA 95361

MAILING ADDRESS

(209) 238-3151

PHONE NUMBER

Waste Management Plan Report
General Order No. R5-2007-0035, Attachment B
July 1, 2010 deadline

C. OWNER AND/OR OPERATOR CERTIFICATION

I certify under penalty of law that I have personally examined and am familiar with the information submitted in this document and all attachments and that, based on my inquiry of those individuals immediately responsible for obtaining the information, I believe that the information is true, accurate, and complete. I am aware that there are significant penalties for submitting false information, including the possibility of fine and imprisonment.

	
_____ SIGNATURE OF OWNER	_____ SIGNATURE OF OPERATOR
Sam Sikke Kooistra _____ PRINT OR TYPE NAME	_____ PRINT OR TYPE NAME
10-19-21 _____ DATE	_____ DATE



Sousa
ENGINEERING
INFRASTRUCTURE-DEVELOPMENT-
AGRICULTURE

PO BOX 1613
OAKDALE, CA 95361
PHONE: (209)238-3151
www.sousaeng.com

**VECTOR CONTROL PLAN
FOR
KOOISTRA DAIRY
STANISLAUS COUNTY, CA**

TABLE OF CONTENTS

- 1. INTRODUCTION**
- 2. BEST MANAGEMENT PRACTICES**
 - a. Land Application Areas
 - b. Dairy Production Area (DPA)
- 3. CONTACT INFORMATION**

1. INTRODUCTION

Vector control is an important aspect of disease prevention and public health. Without proper management, agricultural production facilities can create or enhance opportunities for vectors to develop and proliferate. Certain land management practices can reduce vector populations thereby reducing long-term vector treatment costs, reducing the amount of pesticides used in vector control operations, helping to protect public health, and contributing to an integrated pest management (IPM) approach to vector control.

Integrated Pest Management is an approach that focuses on site-specific, scientifically sound decisions to manage pest populations by matching a wide variety of techniques with the conditions found on site. These techniques are commonly grouped into four categories:

1. Source reduction or physical control—environmental manipulation that results in a reduction of vector development sites.
2. Biological Control—use of biological agents to limit vector populations
3. Chemical Control—larvicides (materials that kill immature larval vectors and mosquitoes) and adulticides (materials that kill adult vectors and mosquitoes)
4. Cultural Control—change the behavior of people so that their actions prevent the development of vectors or the transmission of vector-borne disease.

Through the adoption of these policies and procedures, this Plan will provide an outline to effectively control vectors by physical, cultural, and biological means.

The Vector Reduction Best Management Practices (BMPs) referred to in this document are the recommended land management practices that can provide a reduction in vector populations by various means including: reducing or eliminating breeding areas, increasing the efficacy of biological controls, increasing the efficacy of chemical controls, and improving access for control operations.

While it is generally accepted that vector production from all sources may be reduced through the widespread implementation of vector Reduction BMPs, these policies specifically target the most severe vector problems with the greatest likelihood of responding through the use of BMPs.

2. BEST MANAGEMENT PRACTICES (BMPs)

- a. **Land Application Areas:** for Land Application Areas, the following are areas of concern and recommended BMPs for vector control:

Common Vector Development Areas

- Vegetated ditches
- Seepage or flooding of fallow fields
- Irrigation tail water return sumps
- Blocked ditches or culverts
- Leaky water control structures
- Irrigated pastures
- Low areas caused by improper grading
- Broken or leaky irrigation pipes or valves

Special Concerns

Agricultural practices vary among growers, locations, and conventional or organic production methods. Pesticide regulations can affect the ability to use chemical control. The Best Management Practices below are offered as tools to balance the economic and agronomic requirements of the growers and land owners with the need for effective vector control.

General Vector Reduction Principles

1. Prevent or eliminate unnecessary standing water that stands for more than 72 –96 hours during mosquito season which can start as early as March and extend through October depending on weather.
2. Maintain access for Abatement District staff to monitor and treat mosquito breeding sources.
3. Minimize emergent vegetation and surface debris on the water.
4. Contact the County Department of Environmental Health or Mosquito Abatement District for technical guidance or assistance in implementing vector reduction BMPs.

Vector Reduction BMPs for Land Application Areas

Ditches and Drains

- DD-1** Construct or improve ditches with at least 2:1 slopes and a minimum 4-foot bottom. Consider a 3:1 slope or greater to discourage burrowing animal damage, potential seepage problems, and prevent unwanted vegetation growth. Other designs may be approved by the MVCD based on special circumstances.
- DD-2** Keep ditches clean and well-maintained. Periodically remove accumulated sediment and vegetation. Maintain ditch grade to prevent areas of standing water.

DD-3 Design irrigation systems to use water efficiently and drain completely to avoid standing water.

Irrigated Pastures

IP-1 Grade field to achieve efficient use of irrigation water. Use NRCS guidelines for irrigated pastures. Initial laser leveling and periodic maintenance to repair damaged areas are needed to maintain efficient water flow.

IP-2 Irrigate only as frequently as is needed to maintain proper soil moisture. Check soil moisture regularly until you know how your pasture behaves

IP-3 Do not over fertilize. Excess fertilizers can leach into irrigation tail water, making mosquito production more likely in ditches or further downstream

IP-4 Apply only enough water to wet the soil to the depth of rooting.

IP-5 Drain excess water from the pasture within 24 hours following each irrigation. This prevents scalding and reduces the number of weeds in the pasture. good check slopes are needed to achieve drainage. A drainage ditch may be used to remove water from the lower end of the field.

IP-6 Inspect fields for drainage and broken checks to see whether re-leveling or reconstruction of levees is needed. Small low areas that hold water can be filled and replanted by hand. Broken checks create cross-leakage that provide habitat for vectors.

IP-7 Keep animals off the pasture while the soil is soft. An ideal mosquito habitat is created in irrigated pastures when water collects in hoof prints of livestock that were run on wet fields or left in the field during irrigation. Keeping animals off wet fields until soils stiffen also protects the roots of the forage crop and prevents soil compaction that interferes with plant growth.

IP-8 Break up pastures into smaller fields so that the animals can be rotated from one field to another. This allows fields to dry between irrigations and provides a sufficient growth period between grazings. It also prevents hoof damage (pugging), increases production from irrigated pastures, and helps improve water penetration into the soil by promoting a better root system.

b. Dairy Production Area (DPA): for the Dairy Production Area, the following are areas of concern and recommended BMPs for vector control:

Common Vector Development Areas

- Wastewater lagoons
- Animal washing areas

- Drain ditches
- Sumps/ponds
- Watering troughs

Special Concerns

Dairy and associated agricultural practices vary; however, these practices need to consider mosquito and vector control issues. The Best Management Practices for Vector Reduction below offer options to balance the requirements of the dairy operators with the need for effective vector control.

General Vector Control Principles

1. Prevent or eliminate unnecessary standing water that remains for more than 72 –96 hours during mosquito season which can start as early as March and extend through October depending on weather.
2. Maintain access for Abatement District staff to monitor and treat mosquito breeding sources.
3. Minimize emergent vegetation and surface debris on the water.
4. Contact the County Department of Environmental Health or Mosquito Abatement District for technical guidance or assistance in implementing vector reduction BMPs.

Vector Reduction BMPs for Dairy Production Area

- DA-1 All holding ponds should be surrounded by lanes of adequate width to allow safe passage of vector control equipment. This includes keeping the lanes clear of any materials or equipment (e.g. trees, calf pens, hay stacks, silage, tires, equipment, etc.).
- DA-2 If fencing is used around the holding ponds, it should be placed on the outside of the lanes with gates provided for vehicle access.
- DA-3 It is recommended that all interior banks of the holding ponds should have a grade of at least 2:1.
- DA-4 An effective solids separation system should be utilized such as a mechanical separator or two or more solids separator ponds. If ponds are used, they should not exceed sixty feet in surface width.
- DA-5 Drainage lines should not by-pass the separator ponds whenever possible, except those that provide for normal corral run-off and do not contain solids. All drain inlets must be sufficiently graded to prevent solids accumulation.
- DA-6 Floating debris should be minimized in all ponds; mechanical agitators may be used to break up crusts.

- DA-7 Vegetation should be controlled regularly to prevent emergent vegetation and barriers to access. This includes access lanes, interior pond embankments and any weed growth that might become established within the pond surface.
- DA-8 Dairy wastewater discharged for irrigation purposes should be managed so that it does not stand for more than three days.
- DA-9 All structures and water management practices should meet current California Regional Water Quality Control Board requirements.
- DA-10 Tire sidewalls or other objects that will not hold water should be used to hold down tarps (e.g. on silage piles). Whole tires or other water-holding objects should be replaced.

3. **CONTACT INFORMATION**

- a. Stanislaus County Department of Environmental Health
3800 Cornucopia Way, Suite C
Modesto, CA 95358
Phone: (209)525-6700

- b. Turlock Mosquito Abatement District
4412 N. Washington Road
Turlock, CA 95380
Phone: (209) 634-1234

Nutrient Management Plan Report
General Order No. R5-2007-0035, Attachment C
July 1, 2009 deadline

DAIRY FACILITY INFORMATION

A. NAME OF DAIRY OR BUSINESS OPERATING THE DAIRY: Kooistra Dairy

Physical address of dairy:

<u>5837 Hultberg RD</u>	<u>Turlock</u>	<u>Stanislaus</u>	<u>95380</u>
Number and Street	City	County	Zip Code

Street and nearest cross street (if no address): _____

Date facility was originally placed in operation: 05/01/1980

Regional Water Quality Control Board Basin Plan designation: San Joaquin River Basin

County Assessor Parcel Number(s) for dairy facility:

0045-0001-0003-0026 0057-0017-0005-0000

B. OPERATOR NAME: Kooistra, Cynthia Lea Telephone no.: (209) 634-2311 (209) 678-3112
Landline Cellular

<u>5837 Hultberg RD</u>	<u>Turlock</u>	<u>CA</u>	<u>95380</u>
Mailing Address Number and Street	City	State	Zip Code

Operator should receive Regional Board correspondence (check): Yes No

OPERATOR NAME: Kooistra, Sam Sikke Telephone no.: (209) 634-2311 (209) 678-3114
Landline Cellular

<u>5837 Hultberg RD</u>	<u>Turlock</u>	<u>CA</u>	<u>95380</u>
Mailing Address Number and Street	City	State	Zip Code

Operator should receive Regional Board correspondence (check): Yes No

C. LEGAL OWNER NAME: Kooistra, Cynthia Lea Telephone no.: (209) 634-2311 (209) 678-3112
Landline Cellular

<u>5837 Hultberg RD</u>	<u>Turlock</u>	<u>CA</u>	<u>95380</u>
Mailing Address Number and Street	City	State	Zip Code

Owner should receive Regional Board correspondence (check): Yes No

LEGAL OWNER NAME: Kooistra, Sam Sikke Telephone no.: (209) 634-2311 (209) 678-3114
Landline Cellular

<u>5837 Hultberg RD</u>	<u>Turlock</u>	<u>CA</u>	<u>95380</u>
Mailing Address Number and Street	City	State	Zip Code

Owner should receive Regional Board correspondence (check): Yes No

D. CONTACT NAME: Machado, Patrick Telephone no.: _____ (209) 678-6720
Landline Cellular

Title: CCA # 385124

<u>7112 Metcalf WAY</u>	<u>Hughson</u>	<u>CA</u>	<u>95326</u>
Mailing Address Number and Street	City	State	Zip Code

Nutrient Management Plan Report
General Order No. R5-2007-0035, Attachment C
July 1, 2009 deadline

CONTACT NAME: Kashefi, Kion	Telephone no.:	(209) 988-1724	
Title: CCA/Dairy Specialist	Landline	Cellular	
624 E Service RD	Modesto	CA	95358
Mailing Address Number and Street	City	State	Zip Code

Nutrient Management Plan Report
 General Order No. R5-2007-0035, Attachment C
 July 1, 2009 deadline

AVAILABLE NUTRIENTS

A. HERD INFORMATION

The milk cow dairy is currently regulated under individual Waste Discharge Requirements.

Total number of milk and dry cows combined as a baseline value in response to the Report of Waste Discharge (ROWD) request of October, 2005:

1,000 milk and dry cows combined (regulatory review is required for any expansion)

	Milk Cows	Dry Cows	Bred Heifers (15-24 mo.)	Heifers (7-14 mo. to breeding)	Calves (4-6 mo.)	Calves (0-3 mo.)
Present count	800	200	0	0	0	0
Maximum count	800	200	0	0	0	0
Avg live weight (lbs)	1,250	1,300	0	0		
Daily hours on flush	20	18	0	0	0	0

Predominant milk cow breed: Jersey

Average milk production: 72 pounds per cow per day

B. IRRIGATION SOURCES

Irrigation Source Name	Type	Nitrogen (mg/L)	Phosphorus (mg/L)	Potassium (mg/L)	Discharge Rate
Canal Water	Surface water (canal, river)	0.05	0.00	0.00	15 cfs

C. NUTRIENT IMPORTS

No nutrient imports entered.

D. NUTRIENT EXPORTS

Nutrient Type/Name	Quantity	Moisture	Nitrogen	Phosphorus (as P2O5)	Potassium (as K2O)
Wastewater	3,200,000.00 gal	0.0%	0.100%	0.030%	0.170%
Corral Solids	3,700.00 ton	10.5%	2.020%	1.240%	4.540%

Total nitrogen exported: 160,488.60 lbs

Total phosphorus exported: 39,389.61 lbs

Total potassium exported: 287,247.23 lbs

Nutrient Management Plan Report
General Order No. R5-2007-0035, Attachment C
July 1, 2009 deadline

E. STORAGE PERIOD

Storage period is the maximum period of time anticipated between land application of process wastewater (from storage ponds/lagoons) to croplands. A qualified agronomist and civil engineer should collaborate and collectively consider predominant soil types, soil infiltration rates, maximum depth, available water, field capacity, permanent wilting point, allowable depletion, crop water use, evapotranspiration, precipitation, irrigation system capacity, water delivery constraints, crop nutrient requirements, soil nutrient adsorption/desorption, rooting depth, nutrient accumulation/availability for current and future crop needs, facility wide process wastewater storage capacity and other factors as deemed necessary across all croplands where process wastewater is applied in selecting a storage period. In many cases conflicts will arise between crop water demands, crop nutrient demands and insufficient process wastewater storage capacity. Process wastewater may not be the best choice as a source of either water and/or nutrients to meet crop demands throughout the year. Groundwater and surface water vulnerability has been considered.

The storage period selected in this Nutrient Management Plan is consistent with the storage period selected in the Waste Management Plan.

Storage period: 120 days

Nutrient Management Plan Report
General Order No. R5-2007-0035, Attachment C
July 1, 2009 deadline

APPLICATION AREA

A. ASSESSOR PARCEL NUMBER: 0045-0120-0011-0000

Legal owner of parcel: Owned by Dairy

ASSESSOR PARCEL NUMBER: 0045-0120-0013-0000

Legal owner of parcel: <u>Fernandes, Robert</u>	Telephone no.:	<u>(209) 495-0708</u>
	Landline	Cellular
<u>22132 W Johnson AVE</u>	<u>Turlock</u>	<u>CA</u>
Mailing Address Number and Street	City	State
		<u>95380</u>
		Zip Code

ASSESSOR PARCEL NUMBER: 0045-0130-0026-0000

Legal owner of parcel: Owned by Dairy

ASSESSOR PARCEL NUMBER: 0057-0017-0005-0000

Legal owner of parcel: Owned by Dairy

Nutrient Management Plan Report
 General Order No. R5-2007-0035, Attachment C
 July 1, 2009 deadline

B. FIELD NAME: 1-Kooistra Dairy

Cropable acres: 5

Predominant soil type: Loamy sand

Do irrigation system head-to-head flow conditions exist on the field? [] Yes [X] No

Can fresh water for irrigation purposes be delivered to the field year round? [] Yes [X] No

Can process wastewater be delivered to the field at agronomic rates and times? [X] Yes [] No

Tailwater management method: Berm

Crops grown and rotation:

Crop Type	Plant Date	Harvest Date	Acres Planted
Oats, silage-soft dough	Early October	Early April	5
Corn, silage	Middle April	Middle August	5
Sudangrass, silage	Late August	Late September	5

FIELD NAME: 2-Kooistra

Cropable acres: 36

Predominant soil type: Loamy sand

Do irrigation system head-to-head flow conditions exist on the field? [] Yes [X] No

Can fresh water for irrigation purposes be delivered to the field year round? [] Yes [X] No

Can process wastewater be delivered to the field at agronomic rates and times? [X] Yes [] No

Tailwater management method: Berm

Crops grown and rotation:

Crop Type	Plant Date	Harvest Date	Acres Planted
Oats, silage-soft dough	Early October	Early April	36
Corn, silage	Middle April	Middle August	36
Sudangrass, silage	Late August	Late September	36

FIELD NAME: 3-Kooistra heifer

Cropable acres: 10

Predominant soil type: Loamy sand

Do irrigation system head-to-head flow conditions exist on the field? [] Yes [X] No

Can fresh water for irrigation purposes be delivered to the field year round? [] Yes [X] No

Can process wastewater be delivered to the field at agronomic rates and times? [X] Yes [] No

Tailwater management method: Berm

Crops grown and rotation:

Crop Type	Plant Date	Harvest Date	Acres Planted
Oats, silage-soft dough	Early October	Early April	10
Corn, silage	Middle April	Middle August	10

Nutrient Management Plan Report
 General Order No. R5-2007-0035, Attachment C
 July 1, 2009 deadline

Sudangrass, silage	Late August	Late September	10
--------------------	-------------	----------------	----

FIELD NAME: 4-Fernandes

Cropable acres: 17

Predominant soil type: Loamy sand

Do irrigation system head-to-head flow conditions exist on the field? [] Yes [X] No

Can fresh water for irrigation purposes be delivered to the field year round? [] Yes [X] No

Can process wastewater be delivered to the field at agronomic rates and times? [X] Yes [] No

Tailwater management method: Berm

Crops grown and rotation:

Crop Type	Plant Date	Harvest Date	Acres Planted
Oats, silage-soft dough	Early October	Early April	17
Corn, silage	Middle April	Middle August	17
Sudangrass, silage	Late August	Late September	17

C. LAND APPLICATION AREA FIELDS AND PARCELS

Field name	Cropable acres	Total harvests	Parcel number
1-Kooistra Dairy	5	3	0057-0017-00050000
2-Kooistra	36	3	0045-0120-00110000
3-Kooistra heifer	10	3	0045-0130-00260000
4-Fernandes	17	3	0045-0120-00130000
Land application area totals	68	12	

Nutrient Management Plan Report
 General Order No. R5-2007-0035, Attachment C
 July 1, 2009 deadline

NUTRIENT BUDGET

A. NUTRIENT BUDGET FOR CROP: 1-Kooistra Dairy / Oats, silage-soft dough

Activity / Event	# of Events	N (lbs/acre) % avail.	P (lbs/acre) % avail.	K (lbs/acre) % avail.	Total N (lbs/acre)
Existing soil nutrient content <i>Nutrient source:</i> Soil <i>Application method:</i> Lab results	1	0.0 50%	0.1 50%	0.0 50%	0.0
Dry manure <i>Nutrient source:</i> From dairy <i>Application method:</i> Broadcast/incorporate	1	95.0 25%	61.4 50%	224.8 85%	95.0
Pre-irrigation prior to planting (with fertilizer) <i>Nutrient source:</i> Retention pond (lagoon) <i>Application method:</i> Pipeline	1	90.0 35%	60.0 50%	205.0 85%	90.1
Irrigation Source		N (lbs/acre)	P (lbs/acre)	K (lbs/acre)	Runtime (hrs)
Canal Water	0.1	0.0	0.0	0.0	2.0
	0.1	0.0	0.0		
In season irrigation (no fertilizer) <i>Nutrient source:</i> Water only <i>Application method:</i> Surface	2	0.0 0%	0.0 0%	0.0 0%	0.1
Irrigation Source		N (lbs/acre)	P (lbs/acre)	K (lbs/acre)	Runtime (hrs)
Canal Water	0.1	0.0	0.0	0.0	2.0
	0.1	0.0	0.0		

	Total N (lbs/acre)	Total P (lbs/acre)	Total K (lbs/acre)
Irrigation sources	0.2	0.0	0.0
Existing soil nutrient content	0.0	0.1	0.0
Plowdown credit	0.0	0.0	0.0
Commercial fertilizer	0.0	0.0	0.0
Dry manure	95.0	61.4	224.8
Liquid manure	90.0	60.0	205.0
Other	0.0	0.0	0.0
Atmospheric deposition	4.7		
Nutrients applied	189.9	121.5	429.8
Potential crop nutrient removal	160.0	25.6	132.8
Nutrient balance	29.9	95.9	297.0
Applied to removal ratio	1.19	4.75	3.24

Fresh water applied: 1.49 feet Total harvests: 1

NUTRIENT BUDGET FOR CROP: 1-Kooistra Dairy / Corn, silage

Activity / Event	# of Events	N (lbs/acre) % avail.	P (lbs/acre) % avail.	K (lbs/acre) % avail.	Total N (lbs/acre)
------------------	-------------	--------------------------	--------------------------	--------------------------	-----------------------

Nutrient Management Plan Report
 General Order No. R5-2007-0035, Attachment C
 July 1, 2009 deadline

NUTRIENT BUDGET FOR CROP (CONTINUED): 1-Kooistra Dairy / Corn, silage

Activity / Event	# of Events	N (lbs/acre) % avail.	P (lbs/acre) % avail.	K (lbs/acre) % avail.	Total N (lbs/acre)															
Existing soil nutrient content <i>Nutrient source:</i> Soil <i>Application method:</i> Lab results	1	0.0 50%	0.1 50%	0.0 50%	0.0															
Pre-irrigation prior to planting (no fertilizer) <i>Nutrient source:</i> Water only <i>Application method:</i> Surface	1	0.0 0%	0.0 0%	0.0 0%	0.1															
<table border="1" style="width: 100%;"> <thead> <tr> <th>Irrigation Source</th> <th>N (lbs/acre)</th> <th>P (lbs/acre)</th> <th>K (lbs/acre)</th> <th>Runtime (hrs)</th> </tr> </thead> <tbody> <tr> <td>Canal Water</td> <td>0.1</td> <td>0.0</td> <td>0.0</td> <td>2.0</td> </tr> <tr> <td></td> <td>0.1</td> <td>0.0</td> <td>0.0</td> <td></td> </tr> </tbody> </table>						Irrigation Source	N (lbs/acre)	P (lbs/acre)	K (lbs/acre)	Runtime (hrs)	Canal Water	0.1	0.0	0.0	2.0		0.1	0.0	0.0	
Irrigation Source	N (lbs/acre)	P (lbs/acre)	K (lbs/acre)	Runtime (hrs)																
Canal Water	0.1	0.0	0.0	2.0																
	0.1	0.0	0.0																	
In season irrigation (no fertilizer) <i>Nutrient source:</i> Water only <i>Application method:</i> Surface	4	0.0 0%	0.0 0%	0.0 0%	0.3															
<table border="1" style="width: 100%;"> <thead> <tr> <th>Irrigation Source</th> <th>N (lbs/acre)</th> <th>P (lbs/acre)</th> <th>K (lbs/acre)</th> <th>Runtime (hrs)</th> </tr> </thead> <tbody> <tr> <td>Canal Water</td> <td>0.1</td> <td>0.0</td> <td>0.0</td> <td>2.0</td> </tr> <tr> <td></td> <td>0.1</td> <td>0.0</td> <td>0.0</td> <td></td> </tr> </tbody> </table>						Irrigation Source	N (lbs/acre)	P (lbs/acre)	K (lbs/acre)	Runtime (hrs)	Canal Water	0.1	0.0	0.0	2.0		0.1	0.0	0.0	
Irrigation Source	N (lbs/acre)	P (lbs/acre)	K (lbs/acre)	Runtime (hrs)																
Canal Water	0.1	0.0	0.0	2.0																
	0.1	0.0	0.0																	
In season irrigation (with fertilizer) <i>Nutrient source:</i> Retention pond (lagoon) <i>Application method:</i> Pipeline	3	100.0 35%	50.0 50%	270.0 85%	300.1															
<table border="1" style="width: 100%;"> <thead> <tr> <th>Irrigation Source</th> <th>N (lbs/acre)</th> <th>P (lbs/acre)</th> <th>K (lbs/acre)</th> <th>Runtime (hrs)</th> </tr> </thead> <tbody> <tr> <td>Canal Water</td> <td>0.0</td> <td>0.0</td> <td>0.0</td> <td>1.0</td> </tr> <tr> <td></td> <td>0.0</td> <td>0.0</td> <td>0.0</td> <td></td> </tr> </tbody> </table>						Irrigation Source	N (lbs/acre)	P (lbs/acre)	K (lbs/acre)	Runtime (hrs)	Canal Water	0.0	0.0	0.0	1.0		0.0	0.0	0.0	
Irrigation Source	N (lbs/acre)	P (lbs/acre)	K (lbs/acre)	Runtime (hrs)																
Canal Water	0.0	0.0	0.0	1.0																
	0.0	0.0	0.0																	

	Total N (lbs/acre)	Total P (lbs/acre)	Total K (lbs/acre)
Irrigation sources	0.4	0.0	0.0
Existing soil nutrient content	0.0	0.1	0.0
Plowdown credit	0.0	0.0	0.0
Commercial fertilizer	0.0	0.0	0.0
Dry manure	0.0	0.0	0.0
Liquid manure	300.0	150.0	810.0
Other	0.0	0.0	0.0
Atmospheric deposition	4.7		
Nutrients applied	305.1	150.1	810.0
Potential crop nutrient removal	256.0	48.0	211.2
Nutrient balance	49.1	102.1	598.8
Applied to removal ratio	1.19	3.13	3.84

Fresh water applied: 3.22 feet Total harvests: 1

Nutrient Management Plan Report
 General Order No. R5-2007-0035, Attachment C
 July 1, 2009 deadline

NUTRIENT BUDGET FOR CROP: 1-Kooistra Dairy / Sudangrass, silage

Activity / Event	# of Events	N (lbs/acre) % avail.	P (lbs/acre) % avail.	K (lbs/acre) % avail.	Total N (lbs/acre)
Existing soil nutrient content <i>Nutrient source:</i> Soil <i>Application method:</i> Lab results	1	0.0 50%	0.1 50%	0.0 50%	0.0
In season irrigation (with fertilizer) <i>Nutrient source:</i> Retention pond (lagoon) <i>Application method:</i> Pipeline	1	100.0 35%	50.0 50%	270.0 85%	100.1
Irrigation Source		N (lbs/acre)	P (lbs/acre)	K (lbs/acre)	Runtime (hrs)
Canal Water		0.1	0.0	0.0	1.5
		0.1	0.0	0.0	

	Total N (lbs/acre)	Total P (lbs/acre)	Total K (lbs/acre)
Irrigation sources	0.1	0.0	0.0
Existing soil nutrient content	0.0	0.1	0.0
Plowdown credit	0.0	0.0	0.0
Commercial fertilizer	0.0	0.0	0.0
Dry manure	0.0	0.0	0.0
Liquid manure	100.0	50.0	270.0
Other	0.0	0.0	0.0
Atmospheric deposition	4.7		
Nutrients applied	104.7	50.1	270.0
Potential crop nutrient removal	110.0	17.0	120.0
Nutrient balance	-5.3	33.1	150.0
Applied to removal ratio	0.95	2.95	2.25

Fresh water applied: 0.37 feet Total harvests: 1

NUTRIENT BUDGET FOR CROP: 2-Kooistra / Oats, silage-soft dough

Activity / Event	# of Events	N (lbs/acre) % avail.	P (lbs/acre) % avail.	K (lbs/acre) % avail.	Total N (lbs/acre)
Existing soil nutrient content <i>Nutrient source:</i> Soil <i>Application method:</i> Lab results	1	0.0 50%	0.1 50%	0.0 50%	0.0
Dry manure <i>Nutrient source:</i> From dairy <i>Application method:</i> Broadcast/incorporate	1	100.0 25%	61.4 50%	224.8 85%	100.0

Nutrient Management Plan Report
 General Order No. R5-2007-0035, Attachment C
 July 1, 2009 deadline

NUTRIENT BUDGET FOR CROP (CONTINUED): 2-Kooistra / Oats, silage-soft dough

Activity / Event	# of Events	N (lbs/acre) % avail.	P (lbs/acre) % avail.	K (lbs/acre) % avail.	Total N (lbs/acre)															
Pre-irrigation prior to planting (with fertilizer) <i>Nutrient source:</i> Retention pond (lagoon) <i>Application method:</i> Pipeline	1	80.0 35%	40.0 50%	200.0 85%	80.0															
<table border="1" style="width: 100%;"> <thead> <tr> <th>Irrigation Source</th> <th>N (lbs/acre)</th> <th>P (lbs/acre)</th> <th>K (lbs/acre)</th> <th>Runtime (hrs)</th> </tr> </thead> <tbody> <tr> <td>Canal Water</td> <td>0.0</td> <td>0.0</td> <td>0.0</td> <td>10.0</td> </tr> <tr> <td></td> <td>0.0</td> <td>0.0</td> <td>0.0</td> <td></td> </tr> </tbody> </table>						Irrigation Source	N (lbs/acre)	P (lbs/acre)	K (lbs/acre)	Runtime (hrs)	Canal Water	0.0	0.0	0.0	10.0		0.0	0.0	0.0	
Irrigation Source	N (lbs/acre)	P (lbs/acre)	K (lbs/acre)	Runtime (hrs)																
Canal Water	0.0	0.0	0.0	10.0																
	0.0	0.0	0.0																	
In season irrigation (no fertilizer) <i>Nutrient source:</i> Water only <i>Application method:</i> Surface	2	0.0 0%	0.0 0%	0.0 0%	0.1															
<table border="1" style="width: 100%;"> <thead> <tr> <th>Irrigation Source</th> <th>N (lbs/acre)</th> <th>P (lbs/acre)</th> <th>K (lbs/acre)</th> <th>Runtime (hrs)</th> </tr> </thead> <tbody> <tr> <td>Canal Water</td> <td>0.0</td> <td>0.0</td> <td>0.0</td> <td>10.0</td> </tr> <tr> <td></td> <td>0.0</td> <td>0.0</td> <td>0.0</td> <td></td> </tr> </tbody> </table>						Irrigation Source	N (lbs/acre)	P (lbs/acre)	K (lbs/acre)	Runtime (hrs)	Canal Water	0.0	0.0	0.0	10.0		0.0	0.0	0.0	
Irrigation Source	N (lbs/acre)	P (lbs/acre)	K (lbs/acre)	Runtime (hrs)																
Canal Water	0.0	0.0	0.0	10.0																
	0.0	0.0	0.0																	

	Total N (lbs/acre)	Total P (lbs/acre)	Total K (lbs/acre)
Irrigation sources	0.1	0.0	0.0
Existing soil nutrient content	0.0	0.1	0.0
Plowdown credit	0.0	0.0	0.0
Commercial fertilizer	0.0	0.0	0.0
Dry manure	100.0	61.4	224.8
Liquid manure	80.0	40.0	200.0
Other	0.0	0.0	0.0
Atmospheric deposition	4.7		
Nutrients applied	184.8	101.5	424.8
Potential crop nutrient removal	160.0	25.6	132.8
Nutrient balance	24.8	75.9	292.0
Applied to removal ratio	1.16	3.96	3.20

Fresh water applied: 1.03 feet Total harvests: 1

NUTRIENT BUDGET FOR CROP: 2-Kooistra / Corn, silage

Activity / Event	# of Events	N (lbs/acre) % avail.	P (lbs/acre) % avail.	K (lbs/acre) % avail.	Total N (lbs/acre)
Existing soil nutrient content <i>Nutrient source:</i> Soil <i>Application method:</i> Lab results	1	0.0 50%	0.1 50%	0.0 50%	0.0

Nutrient Management Plan Report
 General Order No. R5-2007-0035, Attachment C
 July 1, 2009 deadline

NUTRIENT BUDGET FOR CROP (CONTINUED): 2-Kooistra / Corn, silage

Activity / Event	# of Events	N (lbs/acre) % avail.	P (lbs/acre) % avail.	K (lbs/acre) % avail.	Total N (lbs/acre)															
Pre-irrigation prior to planting (no fertilizer) <i>Nutrient source:</i> Water only <i>Application method:</i> Surface	1	0.0 0%	0.0 0%	0.0 0%	0.1															
<table border="1" style="width: 100%; border-collapse: collapse;"> <thead> <tr> <th style="width: 50%;">Irrigation Source</th> <th>N (lbs/acre)</th> <th>P (lbs/acre)</th> <th>K (lbs/acre)</th> <th>Runtime (hrs)</th> </tr> </thead> <tbody> <tr> <td>Canal Water</td> <td>0.1</td> <td>0.0</td> <td>0.0</td> <td>11.0</td> </tr> <tr> <td></td> <td>0.1</td> <td>0.0</td> <td>0.0</td> <td></td> </tr> </tbody> </table>						Irrigation Source	N (lbs/acre)	P (lbs/acre)	K (lbs/acre)	Runtime (hrs)	Canal Water	0.1	0.0	0.0	11.0		0.1	0.0	0.0	
Irrigation Source	N (lbs/acre)	P (lbs/acre)	K (lbs/acre)	Runtime (hrs)																
Canal Water	0.1	0.0	0.0	11.0																
	0.1	0.0	0.0																	
In season irrigation (no fertilizer) <i>Nutrient source:</i> Water only <i>Application method:</i> Surface	4	0.0 0%	0.0 0%	0.0 0%	0.2															
<table border="1" style="width: 100%; border-collapse: collapse;"> <thead> <tr> <th style="width: 50%;">Irrigation Source</th> <th>N (lbs/acre)</th> <th>P (lbs/acre)</th> <th>K (lbs/acre)</th> <th>Runtime (hrs)</th> </tr> </thead> <tbody> <tr> <td>Canal Water</td> <td>0.1</td> <td>0.0</td> <td>0.0</td> <td>11.0</td> </tr> <tr> <td></td> <td>0.1</td> <td>0.0</td> <td>0.0</td> <td></td> </tr> </tbody> </table>						Irrigation Source	N (lbs/acre)	P (lbs/acre)	K (lbs/acre)	Runtime (hrs)	Canal Water	0.1	0.0	0.0	11.0		0.1	0.0	0.0	
Irrigation Source	N (lbs/acre)	P (lbs/acre)	K (lbs/acre)	Runtime (hrs)																
Canal Water	0.1	0.0	0.0	11.0																
	0.1	0.0	0.0																	
In season irrigation (with fertilizer) <i>Nutrient source:</i> Retention pond (lagoon) <i>Application method:</i> Pipeline	3	100.0 35%	50.0 50%	250.0 85%	300.2															
<table border="1" style="width: 100%; border-collapse: collapse;"> <thead> <tr> <th style="width: 50%;">Irrigation Source</th> <th>N (lbs/acre)</th> <th>P (lbs/acre)</th> <th>K (lbs/acre)</th> <th>Runtime (hrs)</th> </tr> </thead> <tbody> <tr> <td>Canal Water</td> <td>0.1</td> <td>0.0</td> <td>0.0</td> <td>11.0</td> </tr> <tr> <td></td> <td>0.1</td> <td>0.0</td> <td>0.0</td> <td></td> </tr> </tbody> </table>						Irrigation Source	N (lbs/acre)	P (lbs/acre)	K (lbs/acre)	Runtime (hrs)	Canal Water	0.1	0.0	0.0	11.0		0.1	0.0	0.0	
Irrigation Source	N (lbs/acre)	P (lbs/acre)	K (lbs/acre)	Runtime (hrs)																
Canal Water	0.1	0.0	0.0	11.0																
	0.1	0.0	0.0																	

	Total N (lbs/acre)	Total P (lbs/acre)	Total K (lbs/acre)
Irrigation sources	0.4	0.0	0.0
Existing soil nutrient content	0.0	0.1	0.0
Plowdown credit	0.0	0.0	0.0
Commercial fertilizer	0.0	0.0	0.0
Dry manure	0.0	0.0	0.0
Liquid manure	300.0	150.0	750.0
Other	0.0	0.0	0.0
Atmospheric deposition	4.7		
Nutrients applied	305.1	150.1	750.0
Potential crop nutrient removal	256.0	48.0	211.2
Nutrient balance	49.1	102.1	538.8
Applied to removal ratio	1.19	3.13	3.55

Fresh water applied: 3.03 feet Total harvests: 1

NUTRIENT BUDGET FOR CROP: 2-Kooistra / Sudangrass, silage

Activity / Event	# of Events	N (lbs/acre) % avail.	P (lbs/acre) % avail.	K (lbs/acre) % avail.	Total N (lbs/acre)
------------------	-------------	--------------------------	--------------------------	--------------------------	-----------------------

Nutrient Management Plan Report
 General Order No. R5-2007-0035, Attachment C
 July 1, 2009 deadline

NUTRIENT BUDGET FOR CROP (CONTINUED): 2-Kooistra / Sudangrass, silage

Activity / Event	# of Events	N (lbs/acre) % avail.	P (lbs/acre) % avail.	K (lbs/acre) % avail.	Total N (lbs/acre)
Existing soil nutrient content <i>Nutrient source:</i> Soil <i>Application method:</i> Lab results	1	0.0 50%	0.1 50%	0.0 50%	0.0
In season irrigation (with fertilizer) <i>Nutrient source:</i> Retention pond (lagoon) <i>Application method:</i> Pipeline	1	100.0 50%	50.0 50%	270.0 50%	100.0
Irrigation Source		N (lbs/acre)	P (lbs/acre)	K (lbs/acre)	Runtime (hrs)
Canal Water		0.0	0.0	0.0	6.0
		0.0	0.0	0.0	

	Total N (lbs/acre)	Total P (lbs/acre)	Total K (lbs/acre)
Irrigation sources	0.0	0.0	0.0
Existing soil nutrient content	0.0	0.1	0.0
Plowdown credit	0.0	0.0	0.0
Commercial fertilizer	0.0	0.0	0.0
Dry manure	0.0	0.0	0.0
Liquid manure	100.0	50.0	270.0
Other	0.0	0.0	0.0
Atmospheric deposition	4.7		
Nutrients applied	104.7	50.1	270.0
Potential crop nutrient removal	110.0	17.0	120.0
Nutrient balance	-5.3	33.1	150.0
Applied to removal ratio	0.95	2.95	2.25

Fresh water applied: 0.21 feet Total harvests: 1

NUTRIENT BUDGET FOR CROP: 3-Kooistra heifer / Oats, silage-soft dough

Activity / Event	# of Events	N (lbs/acre) % avail.	P (lbs/acre) % avail.	K (lbs/acre) % avail.	Total N (lbs/acre)
Existing soil nutrient content <i>Nutrient source:</i> Soil <i>Application method:</i> Lab results	1	0.0 50%	0.1 50%	0.0 50%	0.0
Dry manure <i>Nutrient source:</i> From dairy <i>Application method:</i> Broadcast/incorporate	1	100.0 25%	61.4 50%	224.8 85%	100.0

Nutrient Management Plan Report
 General Order No. R5-2007-0035, Attachment C
 July 1, 2009 deadline

NUTRIENT BUDGET FOR CROP (CONTINUED): 3-Kooistra heifer / Oats, silage-soft dough

Activity / Event	# of Events	N (lbs/acre) % avail.	P (lbs/acre) % avail.	K (lbs/acre) % avail.	Total N (lbs/acre)															
Pre-irrigation prior to planting (with fertilizer) <i>Nutrient source:</i> Retention pond (lagoon) <i>Application method:</i> Pipeline	1	80.0 35%	40.0 50%	200.0 85%	80.0															
<table border="1" style="width: 100%;"> <thead> <tr> <th>Irrigation Source</th> <th>N (lbs/acre)</th> <th>P (lbs/acre)</th> <th>K (lbs/acre)</th> <th>Runtime (hrs)</th> </tr> </thead> <tbody> <tr> <td>Canal Water</td> <td>0.0</td> <td>0.0</td> <td>0.0</td> <td>2.5</td> </tr> <tr> <td></td> <td>0.0</td> <td>0.0</td> <td>0.0</td> <td></td> </tr> </tbody> </table>						Irrigation Source	N (lbs/acre)	P (lbs/acre)	K (lbs/acre)	Runtime (hrs)	Canal Water	0.0	0.0	0.0	2.5		0.0	0.0	0.0	
Irrigation Source	N (lbs/acre)	P (lbs/acre)	K (lbs/acre)	Runtime (hrs)																
Canal Water	0.0	0.0	0.0	2.5																
	0.0	0.0	0.0																	
In season irrigation (no fertilizer) <i>Nutrient source:</i> Water only <i>Application method:</i> Surface	2	0.0 0%	0.0 0%	0.0 0%	0.1															
<table border="1" style="width: 100%;"> <thead> <tr> <th>Irrigation Source</th> <th>N (lbs/acre)</th> <th>P (lbs/acre)</th> <th>K (lbs/acre)</th> <th>Runtime (hrs)</th> </tr> </thead> <tbody> <tr> <td>Canal Water</td> <td>0.0</td> <td>0.0</td> <td>0.0</td> <td>2.5</td> </tr> <tr> <td></td> <td>0.0</td> <td>0.0</td> <td>0.0</td> <td></td> </tr> </tbody> </table>						Irrigation Source	N (lbs/acre)	P (lbs/acre)	K (lbs/acre)	Runtime (hrs)	Canal Water	0.0	0.0	0.0	2.5		0.0	0.0	0.0	
Irrigation Source	N (lbs/acre)	P (lbs/acre)	K (lbs/acre)	Runtime (hrs)																
Canal Water	0.0	0.0	0.0	2.5																
	0.0	0.0	0.0																	

	Total N (lbs/acre)	Total P (lbs/acre)	Total K (lbs/acre)
Irrigation sources	0.1	0.0	0.0
Existing soil nutrient content	0.0	0.1	0.0
Plowdown credit	0.0	0.0	0.0
Commercial fertilizer	0.0	0.0	0.0
Dry manure	100.0	61.4	224.8
Liquid manure	80.0	40.0	200.0
Other	0.0	0.0	0.0
Atmospheric deposition	4.7		
Nutrients applied	184.8	101.5	424.8
Potential crop nutrient removal	160.0	25.6	132.8
Nutrient balance	24.8	75.9	292.0
Applied to removal ratio	1.15	3.96	3.20

Fresh water applied: 0.93 feet Total harvests: 1

NUTRIENT BUDGET FOR CROP: 3-Kooistra heifer / Corn, silage

Activity / Event	# of Events	N (lbs/acre) % avail.	P (lbs/acre) % avail.	K (lbs/acre) % avail.	Total N (lbs/acre)
Existing soil nutrient content <i>Nutrient source:</i> Soil <i>Application method:</i> Lab results	1	0.0 50%	0.1 50%	0.0 50%	0.0

Nutrient Management Plan Report
 General Order No. R5-2007-0035, Attachment C
 July 1, 2009 deadline

NUTRIENT BUDGET FOR CROP (CONTINUED): 3-Kooistra heifer / Corn, silage

Activity / Event	# of Events	N (lbs/acre) % avail.	P (lbs/acre) % avail.	K (lbs/acre) % avail.	Total N (lbs/acre)															
Pre-irrigation prior to planting (no fertilizer) <i>Nutrient source:</i> Water only <i>Application method:</i> Surface	1	0.0 0%	0.0 0%	0.0 0%	0.1															
<table border="1" style="width: 100%;"> <thead> <tr> <th>Irrigation Source</th> <th>N (lbs/acre)</th> <th>P (lbs/acre)</th> <th>K (lbs/acre)</th> <th>Runtime (hrs)</th> </tr> </thead> <tbody> <tr> <td>Canal Water</td> <td>0.1</td> <td>0.0</td> <td>0.0</td> <td>4.0</td> </tr> <tr> <td></td> <td>0.1</td> <td>0.0</td> <td>0.0</td> <td></td> </tr> </tbody> </table>						Irrigation Source	N (lbs/acre)	P (lbs/acre)	K (lbs/acre)	Runtime (hrs)	Canal Water	0.1	0.0	0.0	4.0		0.1	0.0	0.0	
Irrigation Source	N (lbs/acre)	P (lbs/acre)	K (lbs/acre)	Runtime (hrs)																
Canal Water	0.1	0.0	0.0	4.0																
	0.1	0.0	0.0																	
In season irrigation (no fertilizer) <i>Nutrient source:</i> Water only <i>Application method:</i> Surface	4	0.0 0%	0.0 0%	0.0 0%	0.3															
<table border="1" style="width: 100%;"> <thead> <tr> <th>Irrigation Source</th> <th>N (lbs/acre)</th> <th>P (lbs/acre)</th> <th>K (lbs/acre)</th> <th>Runtime (hrs)</th> </tr> </thead> <tbody> <tr> <td>Canal Water</td> <td>0.1</td> <td>0.0</td> <td>0.0</td> <td>4.0</td> </tr> <tr> <td></td> <td>0.1</td> <td>0.0</td> <td>0.0</td> <td></td> </tr> </tbody> </table>						Irrigation Source	N (lbs/acre)	P (lbs/acre)	K (lbs/acre)	Runtime (hrs)	Canal Water	0.1	0.0	0.0	4.0		0.1	0.0	0.0	
Irrigation Source	N (lbs/acre)	P (lbs/acre)	K (lbs/acre)	Runtime (hrs)																
Canal Water	0.1	0.0	0.0	4.0																
	0.1	0.0	0.0																	
In season irrigation (with fertilizer) <i>Nutrient source:</i> Retention pond (lagoon) <i>Application method:</i> Pipeline	3	100.0 35%	50.0 50%	270.0 85%	300.1															
<table border="1" style="width: 100%;"> <thead> <tr> <th>Irrigation Source</th> <th>N (lbs/acre)</th> <th>P (lbs/acre)</th> <th>K (lbs/acre)</th> <th>Runtime (hrs)</th> </tr> </thead> <tbody> <tr> <td>Canal Water</td> <td>0.0</td> <td>0.0</td> <td>0.0</td> <td>2.0</td> </tr> <tr> <td></td> <td>0.0</td> <td>0.0</td> <td>0.0</td> <td></td> </tr> </tbody> </table>						Irrigation Source	N (lbs/acre)	P (lbs/acre)	K (lbs/acre)	Runtime (hrs)	Canal Water	0.0	0.0	0.0	2.0		0.0	0.0	0.0	
Irrigation Source	N (lbs/acre)	P (lbs/acre)	K (lbs/acre)	Runtime (hrs)																
Canal Water	0.0	0.0	0.0	2.0																
	0.0	0.0	0.0																	

	Total N (lbs/acre)	Total P (lbs/acre)	Total K (lbs/acre)
Irrigation sources	0.4	0.0	0.0
Existing soil nutrient content	0.0	0.1	0.0
Plowdown credit	0.0	0.0	0.0
Commercial fertilizer	0.0	0.0	0.0
Dry manure	0.0	0.0	0.0
Liquid manure	300.0	150.0	810.0
Other	0.0	0.0	0.0
Atmospheric deposition	4.7		
Nutrients applied	305.1	150.1	810.0
Potential crop nutrient removal	256.0	48.0	211.2
Nutrient balance	49.1	102.1	598.8
Applied to removal ratio	1.19	3.13	3.84

Fresh water applied: 3.22 feet Total harvests: 1

NUTRIENT BUDGET FOR CROP: 3-Kooistra heifer / Sudangrass, silage

Activity / Event	# of Events	N (lbs/acre) % avail.	P (lbs/acre) % avail.	K (lbs/acre) % avail.	Total N (lbs/acre)
------------------	-------------	--------------------------	--------------------------	--------------------------	-----------------------

Nutrient Management Plan Report
 General Order No. R5-2007-0035, Attachment C
 July 1, 2009 deadline

NUTRIENT BUDGET FOR CROP (CONTINUED): 3-Kooistra heifer / Sudangrass, silage

Activity / Event	# of Events	N (lbs/acre) % avail.	P (lbs/acre) % avail.	K (lbs/acre) % avail.	Total N (lbs/acre)
Existing soil nutrient content <i>Nutrient source:</i> Soil <i>Application method:</i> Lab results	1	0.0 50%	0.1 50%	0.0 50%	0.0
In season irrigation (with fertilizer) <i>Nutrient source:</i> Retention pond (lagoon) <i>Application method:</i> Pipeline	1	100.0 35%	50.0 50%	270.0 85%	100.0
Irrigation Source		N (lbs/acre)	P (lbs/acre)	K (lbs/acre)	Runtime (hrs)
Canal Water		0.0	0.0	0.0	2.5
		0.0	0.0	0.0	

	Total N (lbs/acre)	Total P (lbs/acre)	Total K (lbs/acre)
Irrigation sources	0.0	0.0	0.0
Existing soil nutrient content	0.0	0.1	0.0
Plowdown credit	0.0	0.0	0.0
Commercial fertilizer	0.0	0.0	0.0
Dry manure	0.0	0.0	0.0
Liquid manure	100.0	50.0	270.0
Other	0.0	0.0	0.0
Atmospheric deposition	4.7		
Nutrients applied	104.7	50.1	270.0
Potential crop nutrient removal	110.0	17.0	120.0
Nutrient balance	-5.3	33.1	150.0
Applied to removal ratio	0.95	2.95	2.25

Fresh water applied: 0.31 feet Total harvests: 1

NUTRIENT BUDGET FOR CROP: 4-Fernandes / Oats, silage-soft dough

Activity / Event	# of Events	N (lbs/acre) % avail.	P (lbs/acre) % avail.	K (lbs/acre) % avail.	Total N (lbs/acre)
Existing soil nutrient content <i>Nutrient source:</i> Soil <i>Application method:</i> Lab results	1	0.0 50%	0.1 50%	0.0 50%	0.0
Dry manure <i>Nutrient source:</i> From dairy <i>Application method:</i> Broadcast/incorporate	1	100.0 25%	61.4 50%	224.8 85%	100.0

Nutrient Management Plan Report
 General Order No. R5-2007-0035, Attachment C
 July 1, 2009 deadline

NUTRIENT BUDGET FOR CROP (CONTINUED): 4-Fernandes / Oats, silage-soft dough

Activity / Event	# of Events	N (lbs/acre) % avail.	P (lbs/acre) % avail.	K (lbs/acre) % avail.	Total N (lbs/acre)															
Pre-irrigation prior to planting (with fertilizer) <i>Nutrient source:</i> Retention pond (lagoon) <i>Application method:</i> Pipeline	1	80.0 35%	40.0 50%	200.0 85%	80.0															
<table border="1" style="width: 100%; border-collapse: collapse;"> <thead> <tr> <th style="width: 50%;">Irrigation Source</th> <th>N (lbs/acre)</th> <th>P (lbs/acre)</th> <th>K (lbs/acre)</th> <th>Runtime (hrs)</th> </tr> </thead> <tbody> <tr> <td>Canal Water</td> <td>0.0</td> <td>0.0</td> <td>0.0</td> <td>3.8</td> </tr> <tr> <td></td> <td>0.0</td> <td>0.0</td> <td>0.0</td> <td></td> </tr> </tbody> </table>						Irrigation Source	N (lbs/acre)	P (lbs/acre)	K (lbs/acre)	Runtime (hrs)	Canal Water	0.0	0.0	0.0	3.8		0.0	0.0	0.0	
Irrigation Source	N (lbs/acre)	P (lbs/acre)	K (lbs/acre)	Runtime (hrs)																
Canal Water	0.0	0.0	0.0	3.8																
	0.0	0.0	0.0																	
In season irrigation (no fertilizer) <i>Nutrient source:</i> Water only <i>Application method:</i> Surface	2	0.0 0%	0.0 0%	0.0 0%	0.1															
<table border="1" style="width: 100%; border-collapse: collapse;"> <thead> <tr> <th style="width: 50%;">Irrigation Source</th> <th>N (lbs/acre)</th> <th>P (lbs/acre)</th> <th>K (lbs/acre)</th> <th>Runtime (hrs)</th> </tr> </thead> <tbody> <tr> <td>Canal Water</td> <td>0.0</td> <td>0.0</td> <td>0.0</td> <td>3.8</td> </tr> <tr> <td></td> <td>0.0</td> <td>0.0</td> <td>0.0</td> <td></td> </tr> </tbody> </table>						Irrigation Source	N (lbs/acre)	P (lbs/acre)	K (lbs/acre)	Runtime (hrs)	Canal Water	0.0	0.0	0.0	3.8		0.0	0.0	0.0	
Irrigation Source	N (lbs/acre)	P (lbs/acre)	K (lbs/acre)	Runtime (hrs)																
Canal Water	0.0	0.0	0.0	3.8																
	0.0	0.0	0.0																	

	Total N (lbs/acre)	Total P (lbs/acre)	Total K (lbs/acre)
Irrigation sources	0.1	0.0	0.0
Existing soil nutrient content	0.0	0.1	0.0
Plowdown credit	0.0	0.0	0.0
Commercial fertilizer	0.0	0.0	0.0
Dry manure	100.0	61.4	224.8
Liquid manure	80.0	40.0	200.0
Other	0.0	0.0	0.0
Atmospheric deposition	4.7		
Nutrients applied	184.8	101.5	424.8
Potential crop nutrient removal	160.0	25.6	132.8
Nutrient balance	24.8	75.9	292.0
Applied to removal ratio	1.15	3.96	3.20

Fresh water applied: 0.83 feet Total harvests: 1

NUTRIENT BUDGET FOR CROP: 4-Fernandes / Corn, silage

Activity / Event	# of Events	N (lbs/acre) % avail.	P (lbs/acre) % avail.	K (lbs/acre) % avail.	Total N (lbs/acre)
Existing soil nutrient content <i>Nutrient source:</i> Soil <i>Application method:</i> Lab results	1	0.0 50%	0.1 50%	0.0 50%	0.0

Nutrient Management Plan Report
 General Order No. R5-2007-0035, Attachment C
 July 1, 2009 deadline

NUTRIENT BUDGET FOR CROP (CONTINUED): 4-Fernandes / Corn, silage

Activity / Event	# of Events	N (lbs/acre) % avail.	P (lbs/acre) % avail.	K (lbs/acre) % avail.	Total N (lbs/acre)															
Pre-irrigation prior to planting (no fertilizer) <i>Nutrient source:</i> Water only <i>Application method:</i> Surface	1	0.0 0%	0.0 0%	0.0 0%	0.1															
<table border="1" style="width: 100%;"> <thead> <tr> <th>Irrigation Source</th> <th>N (lbs/acre)</th> <th>P (lbs/acre)</th> <th>K (lbs/acre)</th> <th>Runtime (hrs)</th> </tr> </thead> <tbody> <tr> <td>Canal Water</td> <td>0.1</td> <td>0.0</td> <td>0.0</td> <td>7.0</td> </tr> <tr> <td></td> <td>0.1</td> <td>0.0</td> <td>0.0</td> <td></td> </tr> </tbody> </table>						Irrigation Source	N (lbs/acre)	P (lbs/acre)	K (lbs/acre)	Runtime (hrs)	Canal Water	0.1	0.0	0.0	7.0		0.1	0.0	0.0	
Irrigation Source	N (lbs/acre)	P (lbs/acre)	K (lbs/acre)	Runtime (hrs)																
Canal Water	0.1	0.0	0.0	7.0																
	0.1	0.0	0.0																	
In season irrigation (no fertilizer) <i>Nutrient source:</i> Water only <i>Application method:</i> Surface	4	0.0 0%	0.0 0%	0.0 0%	0.3															
<table border="1" style="width: 100%;"> <thead> <tr> <th>Irrigation Source</th> <th>N (lbs/acre)</th> <th>P (lbs/acre)</th> <th>K (lbs/acre)</th> <th>Runtime (hrs)</th> </tr> </thead> <tbody> <tr> <td>Canal Water</td> <td>0.1</td> <td>0.0</td> <td>0.0</td> <td>7.0</td> </tr> <tr> <td></td> <td>0.1</td> <td>0.0</td> <td>0.0</td> <td></td> </tr> </tbody> </table>						Irrigation Source	N (lbs/acre)	P (lbs/acre)	K (lbs/acre)	Runtime (hrs)	Canal Water	0.1	0.0	0.0	7.0		0.1	0.0	0.0	
Irrigation Source	N (lbs/acre)	P (lbs/acre)	K (lbs/acre)	Runtime (hrs)																
Canal Water	0.1	0.0	0.0	7.0																
	0.1	0.0	0.0																	
In season irrigation (with fertilizer) <i>Nutrient source:</i> Retention pond (lagoon) <i>Application method:</i> Pipeline	3	100.0 35%	50.0 50%	270.0 85%	300.1															
<table border="1" style="width: 100%;"> <thead> <tr> <th>Irrigation Source</th> <th>N (lbs/acre)</th> <th>P (lbs/acre)</th> <th>K (lbs/acre)</th> <th>Runtime (hrs)</th> </tr> </thead> <tbody> <tr> <td>Canal Water</td> <td>0.0</td> <td>0.0</td> <td>0.0</td> <td>3.0</td> </tr> <tr> <td></td> <td>0.0</td> <td>0.0</td> <td>0.0</td> <td></td> </tr> </tbody> </table>						Irrigation Source	N (lbs/acre)	P (lbs/acre)	K (lbs/acre)	Runtime (hrs)	Canal Water	0.0	0.0	0.0	3.0		0.0	0.0	0.0	
Irrigation Source	N (lbs/acre)	P (lbs/acre)	K (lbs/acre)	Runtime (hrs)																
Canal Water	0.0	0.0	0.0	3.0																
	0.0	0.0	0.0																	

	Total N (lbs/acre)	Total P (lbs/acre)	Total K (lbs/acre)
Irrigation sources	0.4	0.0	0.0
Existing soil nutrient content	0.0	0.1	0.0
Plowdown credit	0.0	0.0	0.0
Commercial fertilizer	0.0	0.0	0.0
Dry manure	0.0	0.0	0.0
Liquid manure	300.0	150.0	810.0
Other	0.0	0.0	0.0
Atmospheric deposition	4.7		
Nutrients applied	305.1	150.1	810.0
Potential crop nutrient removal	256.0	48.0	211.2
Nutrient balance	49.1	102.1	598.8
Applied to removal ratio	1.19	3.13	3.84

Fresh water applied: 3.21 feet Total harvests: 1

NUTRIENT BUDGET FOR CROP: 4-Fernandes / Sudangrass, silage

Activity / Event	# of Events	N (lbs/acre) % avail.	P (lbs/acre) % avail.	K (lbs/acre) % avail.	Total N (lbs/acre)
------------------	-------------	--------------------------	--------------------------	--------------------------	-----------------------

Nutrient Management Plan Report
 General Order No. R5-2007-0035, Attachment C
 July 1, 2009 deadline

NUTRIENT BUDGET FOR CROP (CONTINUED): 4-Fernandes / Sudangrass, silage

Activity / Event	# of Events	N (lbs/acre) % avail.	P (lbs/acre) % avail.	K (lbs/acre) % avail.	Total N (lbs/acre)
Existing soil nutrient content <i>Nutrient source:</i> Soil <i>Application method:</i> Lab results	1	0.0 50%	0.1 50%	0.0 50%	0.0
In season irrigation (with fertilizer) <i>Nutrient source:</i> Retention pond (lagoon) <i>Application method:</i> Pipeline	1	100.0 35%	50.0 50%	270.0 85%	100.1
Irrigation Source		N (lbs/acre)	P (lbs/acre)	K (lbs/acre)	Runtime (hrs)
Canal Water		0.1	0.0	0.0	6.0
		0.1	0.0	0.0	

	Total N (lbs/acre)	Total P (lbs/acre)	Total K (lbs/acre)
Irrigation sources	0.1	0.0	0.0
Existing soil nutrient content	0.0	0.1	0.0
Plowdown credit	0.0	0.0	0.0
Commercial fertilizer	0.0	0.0	0.0
Dry manure	0.0	0.0	0.0
Liquid manure	100.0	50.0	270.0
Other	0.0	0.0	0.0
Atmospheric deposition	4.7		
Nutrients applied	104.7	50.1	270.0
Potential crop nutrient removal	110.0	17.0	120.0
Nutrient balance	-5.3	33.1	150.0
Applied to removal ratio	0.95	2.95	2.25

Fresh water applied: 0.44 feet Total harvests: 1

Nutrient Management Plan Report
 General Order No. R5-2007-0035, Attachment C
 July 1, 2009 deadline

NUTRIENT APPLICATIONS, POTENTIAL REMOVAL, AND BALANCE

A. POUNDS OF NUTRIENT APPLIED VS. CROP REMOVAL POTENTIAL

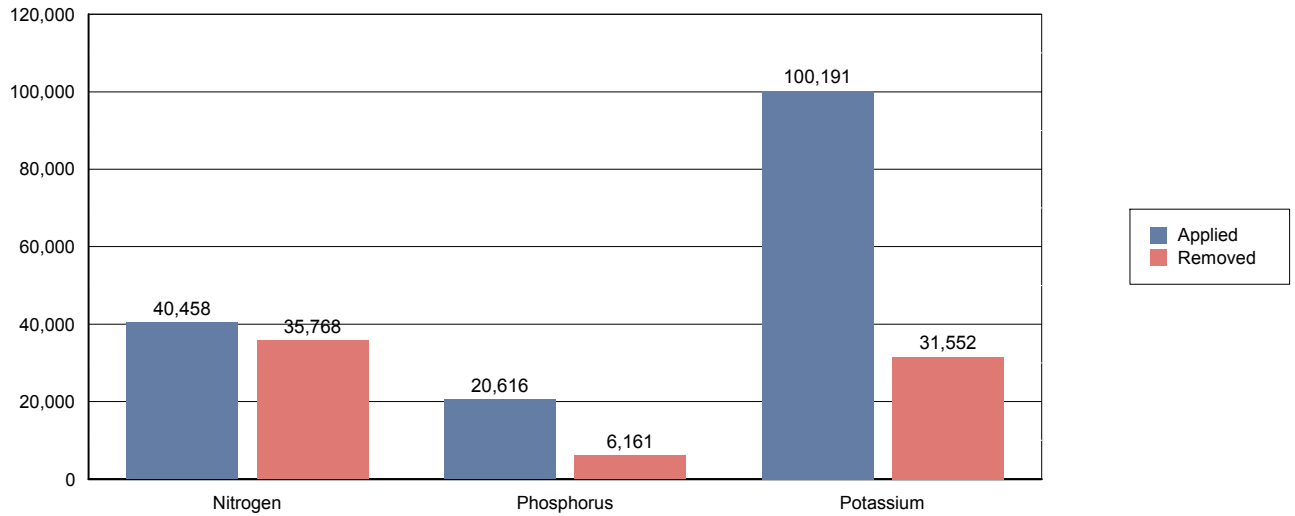

	Total N (lbs)	Total P (lbs)	Total K (lbs)
Irrigation sources	40.8	0.0	0.0
Existing soil nutrient content	0.0	20.4	0.0
Plowdown credit	0.0	0.0	0.0
Commercial fertilizer	0.0	0.0	0.0
Dry manure	6,775.0	4,175.2	15,286.4
Liquid manure	32,690.0	16,420.0	84,905.0
Other	0.0	0.0	0.0
Atmospheric deposition	952.0		
Nutrients applied to all crops	40,457.8	20,615.6	100,191.4
Potential crop nutrient removal	35,768.0	6,160.8	31,552.0
Nutrient balance	4,689.8	14,454.8	68,639.4
Applied to removal ratio	1.13	3.35	3.18

Nutrient Management Plan Report
 General Order No. R5-2007-0035, Attachment C
 July 1, 2009 deadline

B. POUNDS OF NITROGEN APPLIED BY NUTRIENT SOURCE

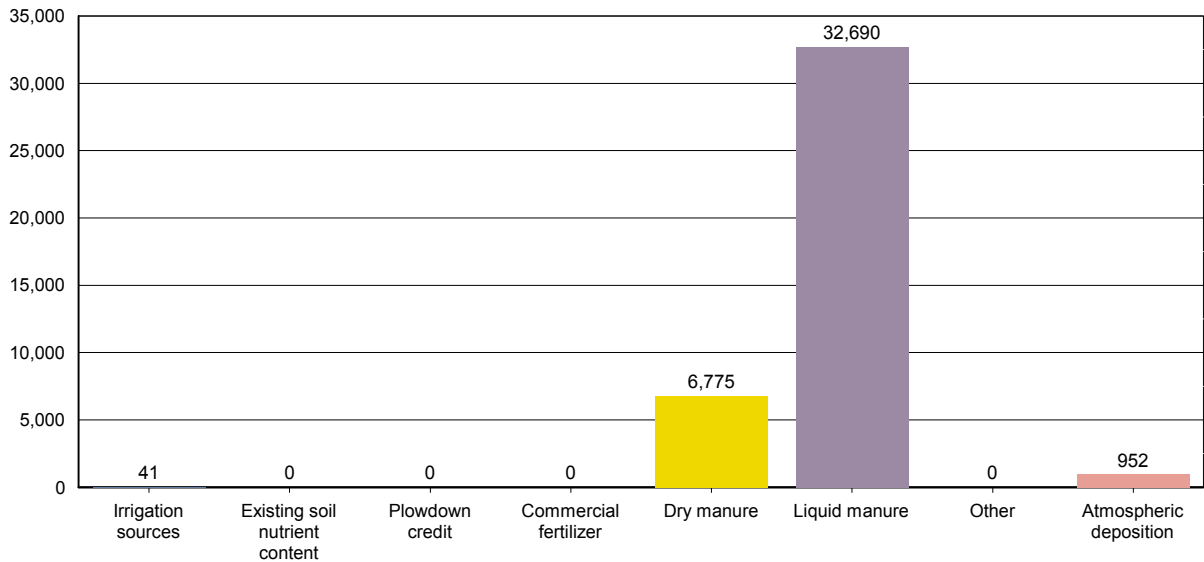

	Total N (lbs)	Total P (lbs)	Total K (lbs)
Irrigation sources	40.8	0.0	0.0
Existing soil nutrient content	0.0	20.4	0.0
Plowdown credit	0.0	0.0	0.0
Commercial fertilizer	0.0	0.0	0.0
Dry manure	6,775.0	4,175.2	15,286.4
Liquid manure	32,690.0	16,420.0	84,905.0
Other	0.0	0.0	0.0
Atmospheric deposition	952.0		
Nutrients applied to all crops	40,457.8	20,615.6	100,191.4
Potential crop nutrient removal	35,768.0	6,160.8	31,552.0
Nutrient balance	4,689.8	14,454.8	68,639.4
Applied to removal ratio	1.13	3.35	3.18

Nutrient Management Plan Report
 General Order No. R5-2007-0035, Attachment C
 July 1, 2009 deadline

NUTRIENT BALANCE

A. WHOLE FARM BALANCE

	Total N (lbs)	Total P (lbs)	Total K (lbs)
Nutrients in storage from herd*			
Daily gross	841.8	138.9	422.6
Annual gross	307,259.2	50,691.7	154,258.6
Net to pond storage after ammonia losses (30% loss applied)	177,105.4	41,841.6	128,548.8
Net to drylot storage after ammonia losses (30% loss applied)	37,976.1	8,850.1	33,739.8
Net in storage (30% loss applied)	215,081.5	50,691.7	162,288.6
Irrigation sources	40.8	0.0	0.0
Atmospheric deposition	952.0		
Imports	0.0	0.0	0.0
Exports	160,488.6	39,389.6	287,247.2
Potential crop nutrient removal	35,768.0	6,160.8	31,552.0
Nutrient balance	19,817.6	5,141.3	-156,510.6
Nutrient balance ratio	1.55	1.83	-3.96

* Potassium excretion from milk cows and dry cows only.

Nutrient Management Plan Report
 General Order No. R5-2007-0035, Attachment C
 July 1, 2009 deadline

SAMPLING AND ANALYSIS PLAN

A. MANURE SAMPLING AND ANALYSIS PLAN

Frequency	Sampling Methods	Source	Minimum data collection requirements	
			Field Analytes	Lab Analytes
Annually	<p>Annual estimation for total manure dry weight applied to each field will be quantified using the following:</p> <p>Dry weight applied from a source to a crop per application event = weight applied * (1 - (percent moisture / 100))</p> <p>Dry weight applied to crop per application event = sum of dry weights applied from each source</p> <p>Dry weight applied to a crop = sum of dry weights applied during each application</p> <p>Dry weight applied to a field = sum of dry weights applied to each crop</p> <p>Annual estimation for total manure dry weight exported will be quantified using the following:</p> <p>Dry weight exported from a source per event = weight exported * (1 - (percent moisture / 100))</p> <p>Dry weight exported per event = sum of dry weights exported from each source</p> <p>Dry weight exported to any offsite destination = sum of dry weights exported per event</p>	<p>Corral solids Settling basin solids Freestall scrapings</p>	<p>Total dry weight (tons) manure applied annually to each land application area, and total dry weight (tons) manure exported offsite annually</p>	<p>None required</p>

Nutrient Management Plan Report
 General Order No. R5-2007-0035, Attachment C
 July 1, 2009 deadline

A. MANURE SAMPLING AND ANALYSIS PLAN (CONTINUED)

Frequency	Sampling Methods	Source	Minimum data collection requirements	
			Field Analytes	Lab Analytes
Twice per year	For each manure source, a composite sample per the "Approved Sampling Procedures for Nutrient and Groundwater Monitoring at Existing Milk Cow Dairies" will be collected.	Corral solids Settling basin solids Freestall scrapings	None required	Total nitrogen, total phosphorus, total potassium, and percent moisture
Once every two years (biennially)	For each manure source, a composite sample per the "Approved Sampling Procedures for Nutrient and Groundwater Monitoring at Existing Milk Cow Dairies" will be collected.	Corral solids Settling basin solids Freestall scrapings	None required	General minerals, including: calcium, magnesium, sodium, sulfate, chloride Fixed solids (ash)
Each application to each land application area	For each applied manure source, a composite sample per the "Approved Sampling Procedures for Nutrient and Groundwater Monitoring at Existing Milk Cow Dairies" will be collected. For each applied manure source, a scaled weight by truckload will be recorded.	Corral solids Settling basin solids Freestall scrapings	Date applied and total weight (tons) applied	Percent moisture

Nutrient Management Plan Report
 General Order No. R5-2007-0035, Attachment C
 July 1, 2009 deadline

A. MANURE SAMPLING AND ANALYSIS PLAN (CONTINUED)

Frequency	Sampling Methods	Source	Minimum data collection requirements	
			Field Analytes	Lab Analytes
Each offsite export of manure	<p>For each manure source exported, a composite sample "Approved Sampling Procedures for Nutrient and Groundwater Monitoring at Existing Milk Cow Dairies" will be collected.</p> <p>For each manure source exported, a scaled weight by truckload will be recorded.</p>	<p>Corral solids Settling basin solids Freestall scrapings</p>	Date exported and total weight (tons) exported	Percent moisture

B. PROCESS WASTEWATER SAMPLING AND ANALYSIS PLAN

Frequency	Sampling Methods	Source	Minimum data collection requirements	
			Field Analytes	Lab Analytes
Annually	A composite or grab sample prior to blending with irrigation water per the "Approved Sampling Procedures for Nutrient and Groundwater Monitoring at Existing Milk Cow Dairies" will be collected.	Lagoon	None required	pH, total dissolved solids, electrical conductivity, nitrate-nitrogen, ammonium-nitrogen, total Kjeldahl nitrogen, total phosphorus, and total potassium
Once every two years (biennially)	For each pond, a composite or grab sample per the "Approved Sampling Procedures for Nutrient and Groundwater Monitoring at Existing Milk Cow Dairies" will be collected.	Lagoon	None required	General minerals, including: calcium, magnesium, sodium, bicarbonate, carbonate, sulfate, and chloride

Nutrient Management Plan Report
 General Order No. R5-2007-0035, Attachment C
 July 1, 2009 deadline

B. PROCESS WASTEWATER SAMPLING AND ANALYSIS PLAN (CONTINUED)

Frequency	Sampling Methods	Source	Minimum data collection requirements	
			Field Analytes	Lab Analytes
Each application	For each pond, a composite or grab sample per the "Approved Sampling Procedures for Nutrient and Groundwater Monitoring at Existing Milk Cow Dairies" will be collected.	Lagoon	Date applied and volume (gallons or acre-inches) applied	None required
Quarterly during one application event	For field measurement: For each pond, a composite or grab sample per the "Approved Sampling Procedures for Nutrient and Groundwater Monitoring at Existing Milk Cow Dairies" will be collected. For laboratory analyses: For each pond, a composite or grab sample per the "Approved Sampling Procedures for Nutrient and Groundwater Monitoring at Existing Milk Cow Dairies" will be collected.	Lagoon	Date applied and electrical conductivity	Nitrate-nitrogen (only when pond is aerated), un-ionized ammonia-nitrogen, total Kjeldahl nitrogen, total phosphorus, total potassium, and total dissolved solids

C. SOIL SAMPLING AND ANALYSIS PLAN

Frequency	Sampling Methods	Source	Minimum data collection requirements	
			Field Analytes	Lab Analytes

Nutrient Management Plan Report
 General Order No. R5-2007-0035, Attachment C
 July 1, 2009 deadline

C. SOIL SAMPLING AND ANALYSIS PLAN (CONTINUED)

Frequency	Sampling Methods	Source	Minimum data collection requirements	
			Field Analytes	Lab Analytes
Once every five years for each land application area (may be distributed over a 5-year period by sampling 20% of the land application areas annually)	For each field, a composite sample per the "Approved Sampling Procedures for Nutrient and Groundwater Monitoring at Existing Milk Cow Dairies" will be collected.	See LAA Table	None required	Soluble phosphorus
Fall pre-plant for each crop	For each field, a composite sample per the "Approved Sampling Procedures for Nutrient and Groundwater Monitoring at Existing Milk Cow Dairies" will be collected.	See LAA Table	None required	0 to 1 foot: Electrical conductivity, nitrate-nitrogen, soluble phosphorus, potassium, and organic matter 1 to 2 feet: Nitrate-nitrogen
Spring pre-plant for each crop	For each field, a composite sample per the "Approved Sampling Procedures for Nutrient and Groundwater Monitoring at Existing Milk Cow Dairies" will be collected.	See LAA Table	None required	0 to 1 foot: Nitrate-nitrogen and organic matter 1 to 2 foot: Nitrate-nitrogen

D. PLANT TISSUE SAMPLING AND ANALYSIS PLAN

Frequency	Sampling Methods	Source	Minimum data collection requirements	
			Field Analytes	Lab Analytes
Each crop harvest from each land application area	For each field and crop, a composite sample per the "Approved Sampling Procedures for Nutrient and Groundwater Monitoring at Existing Milk Cow Dairies" will be collected. For each field and crop, a scaled weight by truckload will be recorded.	See LAA Table	Date harvested and total weight (tons) of harvested material removed from each land application area	Percent wet weight of harvested plant removed Laboratory analyses for total nitrogen, total phosphorus, total potassium (expressed on a dry weight basis), fixed solids (ash), and percent moisture

Nutrient Management Plan Report
 General Order No. R5-2007-0035, Attachment C
 July 1, 2009 deadline

D. PLANT TISSUE SAMPLING AND ANALYSIS PLAN (CONTINUED)

Frequency	Sampling Methods	Source	Minimum data collection requirements	
			Field Analytes	Lab Analytes
Mid-season, as necessary to assess need for additional nitrogen fertilizer during the growing season (only required if Discharger wants to add fertilizer in excess of 1.4 times the nitrogen expected to be removed by the harvested portion of the crop)	For each field and crop, a composite sample per the "Approved Sampling Procedures for Nutrient and Groundwater Monitoring at Existing Milk Cow Dairies" will be collected.	See LAA Table	None required	Total nitrogen, expressed on a dry weight basis

E. IRRIGATION WATER SAMPLING AND ANALYSIS PLAN

Frequency	Sampling Methods	Source	Minimum data collection requirements	
			Field Analytes	Lab Analytes
Each fresh water irrigation event for each land application area	List individual irrigation sources and the measurement method, e.g.: Irrigation Well 1 - inline totalizing flow meter Irrigation Well 2 - flow rate multiplied by runtime Canal 1 - flow rate multiplied by runtime	Canal Water	Date applied and volume (gallons or acre-inches) applied	None required
One irrigation event during each irrigation season during actual irrigation events – for each irrigation water source (well and canal)	For each irrigation source, a grab sample per the "Approved Sampling Procedures for Nutrient and Groundwater Monitoring at Existing Milk Cow Dairies" will be collected. In lieu of sampling the irrigation water, the Discharger may provide equivalent data from the local irrigation district.	Canal Water	None required	Electrical conductivity, total dissolved solids, and total nitrogen

Nutrient Management Plan Report
General Order No. R5-2007-0035, Attachment C
July 1, 2009 deadline

NUTRIENT MANAGEMENT PLAN REVIEW

A. NUTRIENT MANAGEMENT PLAN REVIEW

Person who created the NMP:	<u>Machado, Patrick</u>	<i>See above for contact information.</i>
Date the NMP was drafted:	<u>10/08/2021</u>	
Person who approved the final NMP:	<u>Machado, Patrick</u>	<i>See above for contact information.</i>
Date of NMP implementation:	<u>10/08/2021</u>	

Nutrient Management Plan Report
General Order No. R5-2007-0035, Attachment C
July 1, 2009 deadline

ATTACHED MAP AND DOCUMENTATION REFERENCES

The following list, based upon user selections and data entries, describes the minimum required attachments that must be submitted with the Nutrient Management Plan for the reporting schedule of 'July 1, 2009'.

A. PRELIMINARY DAIRY FACILITY ASSESSMENT

The NMP will include the initial Preliminary Dairy Facility Assessment (Attachment A) and the annual updates as required by Monitoring and Reporting Program No. R5-2007-0035. Copies of these assessments shall be maintained for 10 years.

B. LAND AREA MAP(S)

Identify each land application area (under the Discharger's control, whether it is owned, rented, or leased, to which manure or process wastewater from the production area is or may be applied for nutrient recycling) on a single published base map

1. A field identification system (Assessor's Parcel Number; land application area; crops grown); indication if each land application is owned, rented, or leased by the Discharger; indication of what type of waste is applied (solid manure only, wastewater only, or both solid manure and wastewater); drainage flow direction in each field, nearby surface waters, and storm water discharge points; tailwater and storm water drainage controls; subsurface (tile) drainage systems (including discharge points and lateral extent); irrigation supply wells and groundwater monitoring wells; sampling locations for discharges of storm water and tailwater to surface water from the field.
2. Process wastewater conveyance structures, discharge points and discharge mixing points with irrigation water supplies; pumping facilities; flow meter locations; drainage ditches and canals, culverts, draining controls (berms, levees, etc.), and drainage easements.

Application area map reference number: Maps #1

Identify each field under control of the Discharger and within five miles of the dairy where neither process wastewater nor manure is applied. Each field shall be identified on a single published base map at an appropriate scale by the following:

1. Assessor's Parcel Number.
2. Total acreage.
3. Information on who owns or leases the field

Non-application area map reference number: N/A

Setbacks, Buffers, and Other Alternatives to Protect Surface Water (see Technical Standard VII):

1. Identify all potential surface waters or conduits to surface water that are within 100 feet of any land application area.
2. For each land application area that is within 100 feet of a surface water or a conduit to surface water, identify the setback, vegetated buffer, or other alternative practice that will be implemented to protect surface water (Technical Standard VII).

Setbacks and buffers map reference number: Setback form

C. PROCESS WASTEWATER WRITTEN AGREEMENTS

Provide copies of written agreements with third parties that receive process wastewater for their own use from the Discharger's dairy (Technical Standards V.A.1 and V.A.3).

Nutrient Management Plan Report
General Order No. R5-2007-0035, Attachment C
July 1, 2009 deadline

SAMPLING AND ANALYSIS PLAN CERTIFICATION

A. DAIRY FACILITY INFORMATION

Name of dairy or business operating the dairy: Kooistra Dairy

Physical address of dairy:

<u>5837 Hultberg RD</u>	<u>Turlock</u>	<u>Stanislaus</u>	<u>95380</u>
Physical Address Number and Street	City	County	Zip Code

Street and nearest cross street (if no address): _____

B. DOCUMENTATION OF QUALIFICATIONS AND PLAN DEVELOPMENT

I certify that I meet the requirements as a certified specialist in developing nutrient management plans as described in Attachment C of Waste Discharge Requirements General Order No. R5-2007-0035 and that I prepared the Sampling and Analysis plan.

CCA # 385124

TITLE/QUALIFICATIONS OF CERTIFIED NUTRIENT MANAGEMENT SPECIALIST



10/8/2021

SIGNATURE OF TRAINED PROFESSIONAL

DATE

Patrick Machado

PRINT OR TYPE NAME

7112 Metcalf WAY; Hughson, CA 95326

MAILING ADDRESS

(209) 678-6720

PHONE NUMBER

C. OWNER AND/OR OPERATOR CERTIFICATION

I certify under penalty of law that I have personally examined and am familiar with the information submitted in this document and all attachments and that, based on my inquiry of those individuals immediately responsible for obtaining the information, I believe that the information is true, accurate, and complete. I am aware that there are significant penalties for submitting false information, including the possibility of fine and imprisonment.



SIGNATURE OF OWNER OF FACILITY

SIGNATURE OF OPERATOR OF FACILITY

Sam Sikke Kooistra

PRINT OR TYPE NAME

PRINT OR TYPE NAME

10/8/2021

DATE

DATE

Nutrient Management Plan Report
General Order No. R5-2007-0035, Attachment C
July 1, 2009 deadline

NUTRIENT BUDGET CERTIFICATION

A. DAIRY FACILITY INFORMATION

Name of dairy or business operating the dairy: Kooistra Dairy

Physical address of dairy:

5837 Hultberg RD
Number and Street

Turlock
City

Stanislaus
County

95380
Zip Code

Street and nearest cross street (if no address): _____

B. DOCUMENTATION OF QUALIFICATIONS AND PLAN DEVELOPMENT

I certify that I meet the requirements as a certified specialist in developing nutrient management plans as described in Attachment C of Waste Discharge Requirements General Order No. R5-2007-0035 and that I prepared the Nutrient Budget plan.

CCA # 385124

TITLE/QUALIFICATIONS OF CERTIFIED NUTRIENT MANAGEMENT SPECIALIST

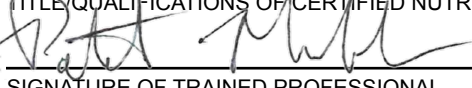

10/8/2021

SIGNATURE OF TRAINED PROFESSIONAL

DATE

Patrick Machado

PRINT OR TYPE NAME

7112 Metcalf WAY; Hughson, CA 95326

MAILING ADDRESS

(209) 678-6720

PHONE NUMBER

C. OWNER AND/OR OPERATOR CERTIFICATION

I certify under penalty of law that I have personally examined and am familiar with the information submitted in this document and all attachments and that, based on my inquiry of those individuals immediately responsible for obtaining the information, I believe that the information is true, accurate, and complete. I am aware that there are significant penalties for submitting false information, including the possibility of fine and imprisonment.



SIGNATURE OF OWNER OF FACILITY

SIGNATURE OF OPERATOR OF FACILITY

Sam Sikke Kooistra

PRINT OR TYPE NAME

PRINT OR TYPE NAME

10/8/2021

DATE

DATE

Nutrient Management Plan Report
 General Order No. R5-2007-0035, Attachment C
 July 1, 2009 deadline

STATEMENTS OF COMPLETION

Waste Discharge Requirements General Order No. R5-2007-0035 for Existing Milk Cow Dairies (General Order) requires owners and operators of existing milk cow dairies (Dischargers) to develop and implement a Nutrient Management Plan for their land application areas (land under control of the Discharger, whether it is owned, rented, or leased, to which manure or process wastewater from the production area is or may be applied for nutrient cycling). The Discharger is required to maintain the NMP at the dairy, make the NMP available to Central Valley Water Board staff during their inspections, and submit the NMP to the Executive Officer upon request.

The General Order requires the Discharger to submit two Statements of Completion during development of the NMP. The Discharger may use this form to comply with the General Order requirement to submit one or both of these Statements of Completion. Parts A and E must be completed for each Statement of Completion. Parts B, C and D are to be completed for the Statements of Completion due by 1 July 2008, 31 December 2008 and 1 July 2009, respectively. Both the owner and the operator of the dairy must sign this form in Part E below.

A. DAIRY FACILITY INFORMATION

Name of dairy or business operating the dairy: Kooistra Dairy

5837 Hultberg RD	Turlock	Stanislaus	95380
Number and Street	City	County	Zip Code

Street and nearest cross street (if no address): _____

Operator name: _____	Telephone no.:	_____	_____
		Landline	Cellular

Mailing Address Number and Street	City	State	Zip Code
-----------------------------------	------	-------	----------

Legal owner name: <u>Kooistra, Sam Sikke</u>	Telephone no.:	(209) 634-2311	(209) 678-3114
		Landline	Cellular

5837 Hultberg RD	Turlock	CA	95380
Mailing Address Number and Street	City	State	Zip Code

Nutrient Management Plan Report
General Order No. R5-2007-0035, Attachment C
July 1, 2009 deadline

B. STATEMENT OF COMPLETION DUE 1 JULY 2008

I have completed the following items of the Nutrient Management Plan (check the boxes of completed sections), which are due 1 July 2008:

- Item I.A.1 Land Application Information**
Identification of land used for manure application and needed information on a facility map.
- Item I.B Land Application Information**
Information list for information provided on map above.
- Item I.C Land Application Information**
Copies of written third-party process wastewater agreements.
- Item I.D Land Application Information**
Identification of fields under control of the discharger within five miles of the dairy where neither process wastewater nor manure is applied.
- Item II Sampling and Analysis Plan**
- Item IV Setbacks, Buffers, and Other Alternatives to Protect Surface Water**
Identification of all potential surface waters or conduits to surface waters within 100 feet of land application areas and appropriate protection.
- Item VI Record-Keeping Requirements**
Identification of monitoring records that will be maintained as required in the production and land application areas.

Has Item II (Sampling and Analysis Plan) of the Nutrient Management Plan been certified by a Certified Nutrient Management Specialist as required in the General Order?

Yes No

C. STATEMENT OF COMPLETION DUE 31 DECEMBER 2008

I have completed the following items of the Nutrient Management Plan (check the boxes of completed sections), which are due 31 December 2008:

- Item V Field Risk Assessment**
Evaluation of the effectiveness of management practices used to control the discharge of waste constituents from land application areas by assessing the water quality monitoring results of discharges of manure, process wastewater, tailwater, subsurface (tile) drainage, or storm water from the land application areas.

D. STATEMENT OF COMPLETION DUE 1 JULY 2009

I have completed the following items of the Nutrient Management Plan (check the boxes of completed sections), which are due 1 July 2009:

- Item I.A.2 Land Application Area Information**
Identification of process wastewater conveyance, mixing and drainage information for each land application area on a facility map.
- Item III Nutrient Budget**
Established planned rates of nutrient applications by crop based on nutrient monitoring results for each land application area.

Has Item III (Nutrient Budget) of the Nutrient Management Plan been certified by a Certified Nutrient Management Specialist as required in the General Order?

Yes No

Nutrient Management Plan Report
General Order No. R5-2007-0035, Attachment C
July 1, 2009 deadline

E. CERTIFICATION STATEMENT

I certify under penalty of law that I have completed the items of the Nutrient Management Plan that are checked in Parts B, C and/or D above for the dairy identified in Part A above and that the appropriate certified nutrient management specialist has certified the items requiring such certification as noted in part B and/or D above and that I have personally examined and am familiar with the information submitted in Parts A, B, C and D of this document and all attachments and that, based on my inquiry of those individuals immediately responsible for obtaining the information, I believe that the information is true, accurate, and complete. I am aware that there are significant penalties for submitting false information, including the possibility of fine and imprisonment.

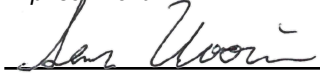

SIGNATURE OF OWNER OF FACILITY

SIGNATURE OF OPERATOR OF FACILITY

Sam Sikke Kooistra

PRINT OR TYPE NAME

PRINT OR TYPE NAME

10/8/2021

DATE

DATE