

# FOCUSED TRAFFIC IMPACT ANALYSIS REPORT

## LOS ANGELES

201 S. Figueroa St,  
Suite 240  
Los Angeles, CA 90012  
213.337.3680  
Fax :213.337.3679

## ONTARIO

4141 E. Inland Empire Blvd,  
Suite 250  
Ontario, CA 91764  
909.481.5750  
Fax:909.481.5757

## SAN DIEGO

3530 Camino Del Rio North,  
Suite 105  
San Diego, CA 92108  
619.400.0600  
Fax: 619.400.0599

## SANTA CLARITA

25152 Springfield Ct,  
Suite 350  
Santa Clarita, CA 91355  
661.284.7400  
Fax 661.284.7401

## TEMECULA

41951 Remington Ave,  
Suite 220  
Temecula, CA 92590  
951.294.9300  
Fax: 951.294-9301

## TUSTIN

17782 17th St,  
Suite 200  
Tustin, CA 92780  
714.665.4500  
Fax: 714.665.4501

## VICTORVILLE

18484 Outer Highway 18 North,  
Suite 225  
Apple Valley, CA 92307  
760.524.9100  
Fax 760.524.9101

[www.deainc](http://www.deainc)

## AMETHYST CROSSING DEVELOPMENT

## VICTORVILLE, CALIFORNIA

*Prepared by:*



DAVID EVANS  
AND ASSOCIATES INC.

**REPORT**  
**September 9, 2021**



September 9, 2021

Job No. PTCO0000-0001

Bobby Younessi  
**Highland Park Developments**  
5567 Reseda Boulevard Suite 318  
Tarzana, CA 91356

**RE: FOCUSED TRAFFIC IMPACT ANALYSIS – AMETHYST CROSSING DEVELOPMENT –  
VICTORVILLE, CALIFORNIA**

Dear Mr. Younessi,

**David Evans and Associates, Inc.** is pleased to submit this Focused Traffic Impact Analysis Report (TIA) for your proposed Amethyst Crossing Development Project in the City of Victorville, California. The proposed project consists of a Shopping Center, Coffee/Donut Shop with Drive-Through Window, Drive-In Bank, and three Fast-Food Restaurants with Drive-Through Windows. The project is proposed at the southeast corner of Bear Valley Road and Amethyst Road in the City of Victorville, California.

The report examines the traffic impacts specifically for the project and presents recommended traffic improvements. The report also evaluates the impacts of overall growth within the area to assure that cumulative traffic mitigations can be addressed. The report has been prepared in coordination with the City of Victorville Engineering Department requirements and scope of work approved prior to this report.

We are pleased to have been of assistance to you in processing and obtaining approval for the project. If you have any questions or comments, please feel free to contact me at 909-912-7304.

Respectfully submitted,

**David Evans and Associates, Inc.**

A handwritten signature in blue ink, appearing to read 'Jim Daisa', is written over a faint circular stamp.

James M. Daisa, P.E.  
Senior Project Manager



TABLE OF CONTENTS

1 EXECUTIVE SUMMARY..... 5

    1.1 City of Victorville Level of Service Standard ..... 5

    1.2 Proposed Project-Specific Access, Roadway, and Off-Site Intersection Improvements..... 5

    The proposed project-specific access, roadway, and off-site intersection improvements are described in detail in Chapter 4, Section 4.1..... 5

    1.3 Level of Service Comparison With and Without the Proposed Project..... 5

        1.3.1 Determination of Project-Specific Impacts..... 5

        1.3.2 Determination of Cumulative Impacts..... 5

        1.3.3 Recommendations for Mitigating Level of Service Impacts ..... 6

2 INTRODUCTION ..... 7

    2.1 Scenario Definitions..... 7

3 EXISTING CONDITIONS ..... 10

    3.1 Existing Street System..... 10

    3.2 Site Access and Study Intersections..... 10

    3.3 Existing Traffic Volumes..... 11

        3.1 Capacity Analysis Methodology ..... 11

        3.1 Existing Traffic Analysis..... 12

        3.2 Existing Traffic Signal Warrant Analysis..... 14

4 EXISTING PLUS PROJECT CONDITIONS ..... 16

    4.1 Site Access and Project-Specific Roadway Improvements ..... 16

    4.2 Project Trip Generation ..... 18

    4.3 Project Trip Distribution and Assignment..... 19

    4.4 Existing Plus Project Traffic Analysis..... 19

    4.5 Existing Plus Project Traffic Signal Warrant Analysis ..... 20

5 BACKGROUND CONDITIONS (YEAR 2023) ..... 27

    5.1 Ambient Growth Projections ..... 27

    5.2 Background Conditions (Year 2023) Traffic Analysis ..... 27

    5.3 Background Conditions Traffic Signal Warrant Analysis..... 27

6 PROJECT TRAFFIC CONDITIONS ..... 29

    6.1 Project Traffic Analysis..... 29

    6.2 Project Conditions Traffic Signal Warrant Analysis..... 29

7 FUTURE CONDITIONS (YEAR 2033)..... 31

    7.1 Future Traffic Analysis ..... 31

    7.2 Future Conditions Traffic Signal Warrant Analysis ..... 31

8 FUTURE PLUS PROJECT CONDITIONS (YEAR 2033)..... 33

    8.1 Future Plus Project Traffic Analysis..... 33

    8.2 Future Plus Project Conditions Traffic Signal Warrant Analysis ..... 33

9 APPENDICES..... 36



**TABLE OF FIGURES**

Figure 1: Vicinity Map .....8

Figure 2: Site Plan .....9

Figure 3: Existing Condition Traffic Volumes .....13

Figure 4: Existing Condition Intersection Geometrics .....15

Figure 5: Project Trip Distribution.....21

Figure 6: Primary Project Trips.....22

Figure 7: Pass-by Project Trips .....23

Figure 8: Total Project Trips .....24

Figure 9: Existing plus Project Traffic Volumes .....25

Figure 10: Existing plus Project Intersection Geometrics .....26

Figure 11: Background Traffic Volumes .....28

Figure 12: Project Traffic Volumes.....30

Figure 13: Future Traffic Volumes .....32

Figure 14: Future Plus Project Traffic Volumes.....34

Figure 15: Future Plus Project Intersection Geometrics.....35

**TABLE OF TABLES**

Table 3-1: HCM 6 – LOS Criteria for Signalized Intersections .....12

Table 3-2: HCM 6 – LOS Criteria for TWSC.....12

Table 3-3: Intersection Capacity Analysis – Existing Conditions .....14

Table 4-1: Proposed Project-Specific Off-Site Intersection Improvements .....18

Table 4-2: Project Trip Generation .....19

Table 4-3: Intersection Capacity Analysis – Existing Plus Project Conditions .....20

Table 5-1: Intersection Capacity Analysis – Background Condition.....27

Table 6-1: Intersection Capacity Analysis – Project Conditions.....29

Table 7-1: Intersection Capacity Analysis – Future Conditions (Year 2033) .....31

Table 8-1: Intersection Capacity Analysis – Future Plus Project Conditions (Year 2033) .....33

**APPENDICES**

- Appendix A: Turn Movement Count Volumes
- Appendix B: Intersection Capacity Analysis Calculations
- Appendix C: Traffic Signal Warrant Worksheet

## 1 EXECUTIVE SUMMARY

This executive summary presents the findings and recommendations of this study.

### 1.1 City of Victorville Level of Service Standard

The City's peak hour level of service standard is LOS D. An intersection found to operate at a LOS E with an Intersection Capacity Utilization (ICU) value greater than 0.95 or Highway Capacity Manual (HCM) delay worse than LOS D (i.e., LOS E or F) is considered deficient.

If a development project would worsen the peak hour level of service to a LOS E or LOS F, it is considered an impact that requires improvement to return the level of service to pre-project conditions. If a development project would worsen the level of service at an already deficient intersection by two percent or more, it is considered a significant impact that requires improvement to return the level of service to pre-project conditions.

### 1.2 Proposed Project-Specific Access, Roadway, and Off-Site Intersection Improvements

The project proposes to construct several roadway and intersection improvements on Bear Valley Road and Amethyst Road concurrent with the construction of the project site. These improvements include right-of-way dedication and widening of Bear Valley Road and Amethyst Road frontages to meet City cross-section standards for each road's functional classification and access driveways including turning lanes as needed to safely accommodate entering traffic.

The dedication of right-of-way and widening of Bear Valley Road and Amethyst Road along the project's frontages allows for additional lane addition improvements at the off-site intersection of these two roads and at the intersection of Bear Valley Road and Pluto Drive. Because the project would not be constructed without these proposed improvements, the analysis of project conditions includes the proposed improvements at off-site intersections and site access driveways.

The proposed project-specific access, roadway, and off-site intersection improvements are described in detail in Chapter 4, Section 4.1.

### 1.3 Level of Service Comparison With and Without the Proposed Project

#### 1.3.1 *Determination of Project-Specific Impacts*

A comparison of level of service between existing and existing plus project conditions is used to identify impacts that are solely caused by the project and for which the project is responsible for mitigating. These two scenarios exclude any estimated traffic from planned and approved, but not yet built, developments allowing for an unadulterated assessment of project impacts.

The comparison of existing and existing plus project conditions (see Chapters 3 and 4) identifies one intersection where the addition of the project causes the intersection level of service to change from a LOS B to a LOS F. Currently the intersection of Bear Valley Road and Pluto Drive is a "T" intersection with Pluto Drive controlled by a stop sign and no control on Bear Valley Road. This intersection allows all movements into and out of Pluto Drive.

#### 1.3.2 *Determination of Cumulative Impacts*

A comparison of level of service between background or future conditions and future plus project conditions is used to identify impacts that cumulative in nature due to the contribution of traffic from planned and approved, but not yet built, developments (see Chapters 5 through 8). A cumulative impact is typically

mitigated by developments sharing in the cost of the mitigation measure.

The comparison of background (2023) and background plus project conditions resulted in identifying the same impacted intersection of Bear Valley Road and Pluto Drive. Since this intersection is already considered a project-specific impact it is not a cumulative impact under future conditions. Similarly, the comparison of future (2033) and future plus project conditions resulted in the same impact.

### *1.3.3 Recommendations for Mitigating Level of Service Impacts*

The project proposes to modify the intersection of Bear Valley Road and Pluto Drive by adding a south leg (project driveway) and forming a four-leg intersection with both minor streets (Pluto Drive and project driveway) controlled by a stop sign. The level of service for this type of intersection (side-street stop controlled) is measured by the level of service for the worst side street movement. In this case (and all subsequent project scenarios), the movements experiencing the highest delay and worse level of service are the project's northbound through and left movement.

It is common for a minor stop-controlled street intersecting a multi-lane arterial to operate at a poor level of service during peak hours. Drivers exiting the minor street must identify adequate gaps in the traffic flow in both directions of the uncontrolled major street to complete their maneuver. Depending on the volume of traffic exiting the minor street and the existence of alternative exits, it may not be desirable to mitigate the level of service impact for the minor street. A common mitigation is to install a traffic signal but only if the intersection meets specific criteria or warrants. If warrants are not met, installation of a traffic signal causes more delays (and crashes) than if the intersection was left unmitigated.

The south leg of the Bear Valley Road and Pluto Drive intersection is a case where the exiting volumes are relatively low compared to the major street through traffic and the intersection does meet the planning warrant (Warrant 3 Peak Hour) as published in the California Manual on Uniform Traffic Control Devices (MUTCD). Although the intersection may meet other MUTCD warrants under existing plus project or future plus project conditions, the intersection would need to be monitored for signal warrants other than Warrant 3 over time to determine if a signal should be considered in the future.

**This study recommends maintaining the Bear Valley Road / Pluto Drive intersection as proposed by the project without mitigation. Feasible mitigation such as a traffic signal would cause substantial secondary impacts on the majority of vehicles using the intersection. Further, the project proposes multiple site access points giving drivers a choice of using an access driveway experience less delay.**

## 2 INTRODUCTION

This report identifies traffic impacts and recommends traffic mitigation for the proposed development project located at the southeast corner of Bear Valley Road and Amethyst Road in the City of Victorville, California. The project consists of a Shopping Center, Coffee/Donut Shop with Drive-Through Window, Drive-In Bank, and three Fast-Food Restaurants with Drive-Through Windows, located in the City of Victorville. **Figure 1** illustrates the vicinity map, and **Figure 2** illustrates the proposed project site plan.

The intent of this report is to evaluate potentially significant traffic impacts caused by the proposed development in accordance with the City of Victorville’s traffic impact study requirements and under the following scenarios as outlined in the traffic scope approved by the City’s Department of Public Works:

- Existing Conditions - **Chapter 3**
- Existing plus Project Conditions - **Chapter 4**
- Background Conditions (Year 2023) - **Chapter 5**
- Background plus Project Conditions- **Chapter 6**
- Future Conditions (Year 2033) - **Chapter 7**
- Future plus Project Conditions (Year 2033) - **Chapter 8**

### 2.1 Scenario Definitions

**Existing Conditions.** This scenario represents existing transportation conditions at the time this report was prepared. Data includes traffic counts collected in July 2021. This scenario is used as the baseline condition from which to measure project-specific impacts.

**Existing Plus Project Conditions.** This scenario represents transportation conditions as if the project were built and occupied today. This scenario is intended to identify potentially significant impact (requiring mitigation) when compared to existing conditions without any unrelated transportation system improvements or other development. Impacts identified in this scenario are considered “project-specific”—impacts that are the sole responsibility of the project to mitigate.

**Background Conditions (Year 2023).** This scenario represents conditions at the time the project is anticipated to be fully constructed and occupied (known as buildout year 2023) but without traffic generated by the project. This scenario is comprised of an ambient growth, a general rate of growth in traffic from overall regional growth but not specific to any nearby development (assumed to be 3.5% annually for this study).

**Project Conditions (Year 2023).** This scenario adds the project’s estimated traffic generation at buildout (2023) to the Background Conditions scenario described above. Impacts identified in this near-term scenario are considered “cumulative” impacts—impacts that the project contributes to, but does not solely cause, and may be responsible for a fair-share of the cost to implement any mitigation measures.

**Future Conditions (Year 2033).** This scenario represents conditions at the horizon year 2033 but without traffic generated by the project. This scenario is comprised of an ambient growth, a general rate of growth in traffic from overall regional growth but not specific to any nearby development (assumed to be 3.5% annually for this study).

**Future with Project Conditions (Year 2033).** This scenario adds the project’s estimated traffic generation to the Future Conditions scenario described above. Impacts identified in this scenario are considered “cumulative” impacts—impacts that the project contributes to, but does not solely cause, and may be responsible for a fair-share of the cost to implement any mitigation measures.

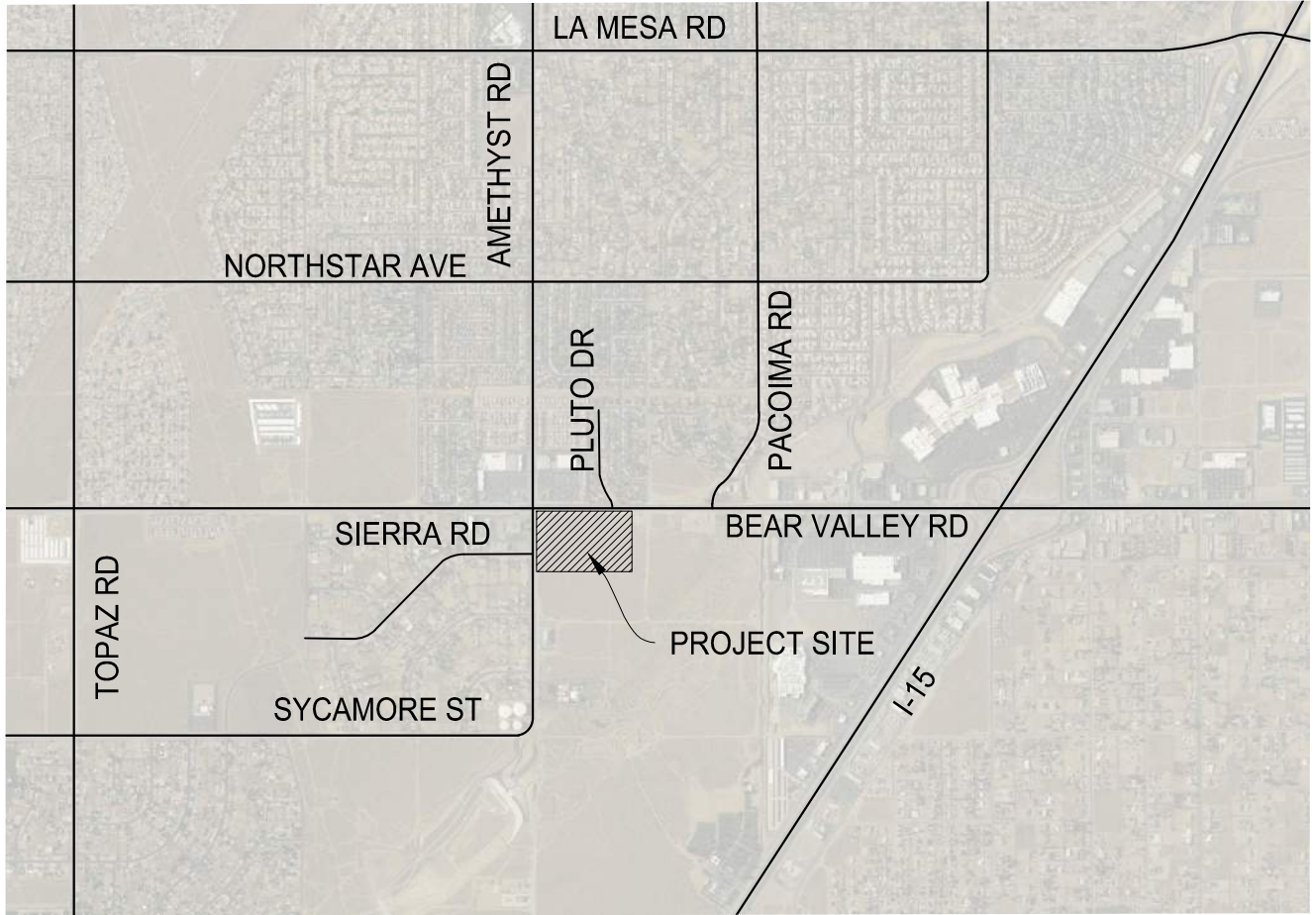
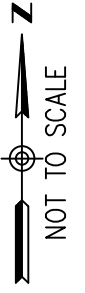

FIGURE 1: VICINITY MAP  
AMETHYST CROSSING  
VICTORVILLE, CALIFORNIA





### 3 EXISTING CONDITIONS

The project site is currently vacant and undeveloped property. It is bounded to the north by Bear Valley Road and commercial properties, to the south by vacant/undeveloped properties, to the west by Amethyst Road and commercial properties, and to the east by vacant/undeveloped properties

#### 3.1 Existing Street System

The following roadways provide local and regional access to the project within the study area:

**Bear Valley Road** is identified as a super arterial street on the City of Victorville circulation map. It is an east-west five-lane road (two in each direction, a continuous two-way-left-turn-lane (CTWLTL) and turn pockets at key intersections) in the project area study area. Posted speed limit of 50 mph in the project area study area.

**Amethyst Road** is identified as a super arterial street on the City of Victorville circulation map. It is a north-south four-lane road (two in each direction and turn pockets at key intersections) in the project area study area. Posted speed limit of 50 mph in the project area study area.

**Pacoima Road** is identified as a collector street on the City of Victorville circulation map. It is a north-south two-lane (one in each direction) street in the project area study area. Posted speed limit of 40 mph in the project area study area.

**Pluto Drive** is a local north-south two-lane (one in each direction) street. Pluto Drive will provide direct access to the project site. Posted speed limit of 25 mph in the project area study area.

**Sierra Road** is a local east-west two-lane (one in each direction) street. Sierra Road will provide direct access to the project site.

#### 3.2 Site Access and Study Intersections

Access to the site is proposed to at driveways along Amethyst Road, Bear Valley Road, and on an extension of Pluto Drive south of Bear Valley Road. The proposed Amethyst Road driveways include:

- A full access driveway is proposed at Project Driveway “A” on Amethyst Road. Project Driveway “A” is directly aligned with Sierra Road on the west side of Amethyst Road forming a four-leg intersection. The driveway centerline is located approximately 488 feet south of Bear Valley Road.

Proposed improvements to Amethyst Road include widening the east side of the road and restriping the lanes to provide a northbound left turn lane into Sierra Road and a continuous two-way center turn lane north of Sierra Road to accommodate southbound left turns into Project Driveways “A” and “B”.

- A full access driveway is proposed at Project Driveway “B” on Amethyst Road located about 320 feet south of Bear Valley Road at the midpoint between Sierra Road and a private driveway to the Shops at Bear Valley shopping center, about 100 feet north of Sierra Road and 100 feet south of the shopping center driveway.

Proposed improvements to Amethyst Road include widening the east side of the road to accommodate a northbound left turn lane into Sierra Road and continuous two-way center turn lane north of Sierra Road.

The proposed Bear Valley Road driveways include:

- Project Driveway “C” is proposed about 220 east of Amethyst Road. This driveway is proposed to restrict movements to right turn in / right turn out. enforced by a raised curb median on Bear Valley Road.

- Project Driveway “D” is proposed about 620 feet east of Amethyst Road. This driveway is also proposed to restrict movements to right turn in / right turn out enforced by a raised curb median on Bear Valley Road.
- The project proposes to extend Pluto Drive south of Bear Valley Road along the project’s eastern frontage and construct three driveway curb cuts accessing the site. Until the vacant property to the east develops, or Pluto Drive is extended further south to connect with other streets, the extension of Pluto Drive serves as an access driveway for the project where it intersects Bear Valley Road. The four-leg intersection created by the extension of Pluto Drive is proposed to provide full access to the project and the north side of Pluto Road.

Improvements to Bear Valley Road include widening the south side of the road to provide an eastbound right turn lane and a westbound left turn lane into Pluto Drive. The widening of Bear Valley Road along the project’s frontage provides width for eastbound right turn lanes at Project Driveways “C” and “D”

The study area for determining level of service impacts includes three existing intersections and four future project driveway intersections:

1. Bear Valley Road / Amethyst Road
2. Bear Valley Road / Pluto Drive
3. Bear Valley Rd / Pacoima Rd
4. Amethyst Road / Sierra Road/ Project Driveway “A”
5. Amethyst Road / Project Driveway “B”
6. Bear Valley Road / Project Driveway “C”
7. Bear Valley Road / Project Driveway “D”

The intersection of Amethyst Road at Bear Valley Road is signalized. The existing and future intersections of Amethyst Road at Pluto Drive, Bear Valley Rd at Pacoima Rd, and Amethyst Road at Sierra Road are side-street stop controlled.

### 3.3 Existing Traffic Volumes

Turn movement counts were conducted in July 2021 by Newport Traffic Studies, an independent traffic data collection company. These counts were collected during the AM (7:00-9:00 AM) and PM (4:00-6:00 PM) peak periods. The raw turning movement counts are included in **Appendix A** of this study. **Figure 3** illustrates the calibrated existing peak hour traffic volumes in the study area.

### 3.1 Capacity Analysis Methodology

Intersection capacity analyses were conducted using Synchro software<sup>1</sup>, which implements the methods of the Highway Capacity Manual, 6<sup>th</sup> Edition (HCM 6)<sup>2</sup> used in this report. The intersection capacity analyses utilize existing intersection geometrics and existing and forecasted traffic volumes in analyzing AM and PM peak hour intersection operating conditions. The traffic analysis methodology concepts presented in Chapters

---

1 Trafficware Ltd, Version 10.

2 Transportation Research Board, Washington D.C., 2010.

19 and 20 of the Highway Capacity Manual (HCM 6) were utilized to calculate intersection Level of Service (LOS) based on the average control delay (in seconds per vehicle) of vehicles utilizing the intersections.

The analysis determines a LOS that quantitatively describes the operating characteristics of signalized intersections. **Table 3-1** provides LOS thresholds for signalized intersections as provided in the HCM 6 Chapter 19.

Table 3-1: HCM 6 – LOS Criteria for Signalized Intersections

Control Delay (seconds /veh)	LOS by Volume-to-Capacity Ratio <sup>a</sup>	
	≤1.0	>1.0
≤ 10	A	F
> 10 - 20	B	F
> 20 - 35	C	F
> 35 - 55	D	F
> 55 - 80	E	F
> 80	F	F

Note: <sup>a</sup> For approach-based and intersection-wide assessments, LOS is defined solely by control delay.  
Source: Highway Capacity Manual 6<sup>th</sup> Edition, Exhibit 19-8.

The LOS for a Two-Way Stop Controlled (TWSC) intersection is determined by the computed or measured control delay. The LOS is determined for each minor street movement (or shared movement) by using the criteria provided in **Table 3-2** referenced from HCM 6 Chapter 20.

Table 3-2: HCM 6 – LOS Criteria for TWSC

Control Delay (seconds/vehicle)	LOS by Volume-to-Capacity Ratio	
	Volume / Capacity Ratio ≤ 0.99	Volume / Capacity Ratio < 1.0
0 - 10	A	F
> 10 - 15	B	F
> 15 - 25	C	F
> 25 - 35	D	F
> 35 - 50	E	F
> 50	F	F

Note: The LOS criteria apply to each lane on each approach of the stop-controlled minor street. LOS is not calculated for major-street approaches or for the intersection as a whole.  
Source: Highway Capacity Manual 6<sup>th</sup> Edition, Exhibit 20-2.

### Current City Policy on Intersection Performance

The City’s peak hour level of service standard is LOS D. An intersection found to operate at a LOS E with an Intersection Capacity Utilization (ICU) value greater than 0.95 or Highway Capacity Manual (HCM) delay worse than LOS D (i.e., LOS E or F) is considered deficient.

If a development project would worsen an intersection peak hour LOS to E or worse, it is considered a significant impact that must be mitigated. If a development project would worsen an already deficient intersection by two percent or more, it is considered a significant impact that must be mitigated.

#### 3.1 Existing Traffic Analysis

Existing intersection capacity and LOS analyses are based on the existing intersection geometrics and the AM and PM peak hour traffic volumes discussed earlier. The results of the analysis are shown in **Table 3-3** and provided in **Appendix B**.



Table 3-3: Intersection Capacity Analysis – Existing Conditions

Intersection	Intersection Control Type	AM Peak		PM Peak	
		Delay	LOS	Delay	LOS
1. Bear Valley Rd / Amethyst Rd	TS	42.7	D	40.2	D
2. Bear Valley Rd / Pluto Dr	SSSC	12.3	B	12.6	B
3. Bear Valley Rd / Pacoima Rd	SSSC	13.7	B	15.3	B
4. Amethyst Rd / Sierra Rd	SSSC/Dwy	10.3	B	12.0	B
5. Amethyst Rd / Project Dwy "B"	SSSC/Dwy	N/A			
6. Bear Valley Rd / Project Dwy "C"	SSSC/Dwy	N/A			
7. Bear Valley Rd / Project Dwy "D"	SSSC/Dwy	N/A			
Dwy – Driveway TS – Traffic Signal Controlled Intersection SSSC – Side Street Stop Controlled Intersection N/A – Not Applicable - Future Intersection. Delay – seconds per vehicle LOS – Level of Service 99.9* - Delay exceeds LOS F					



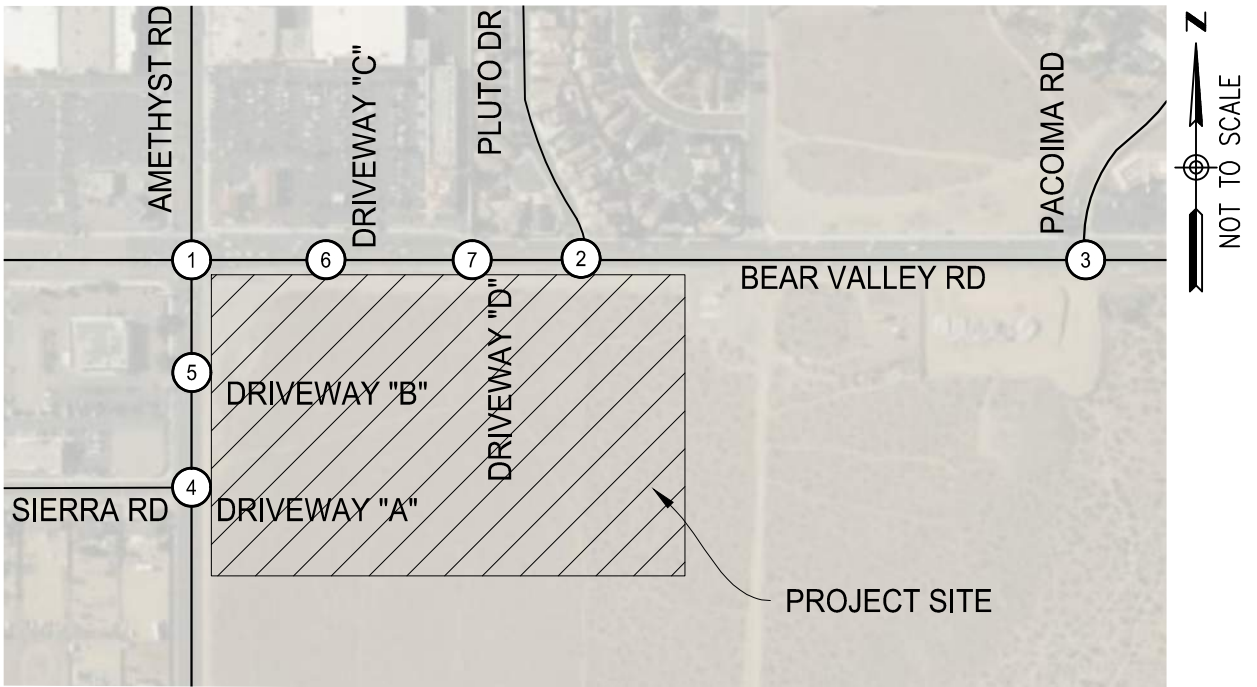
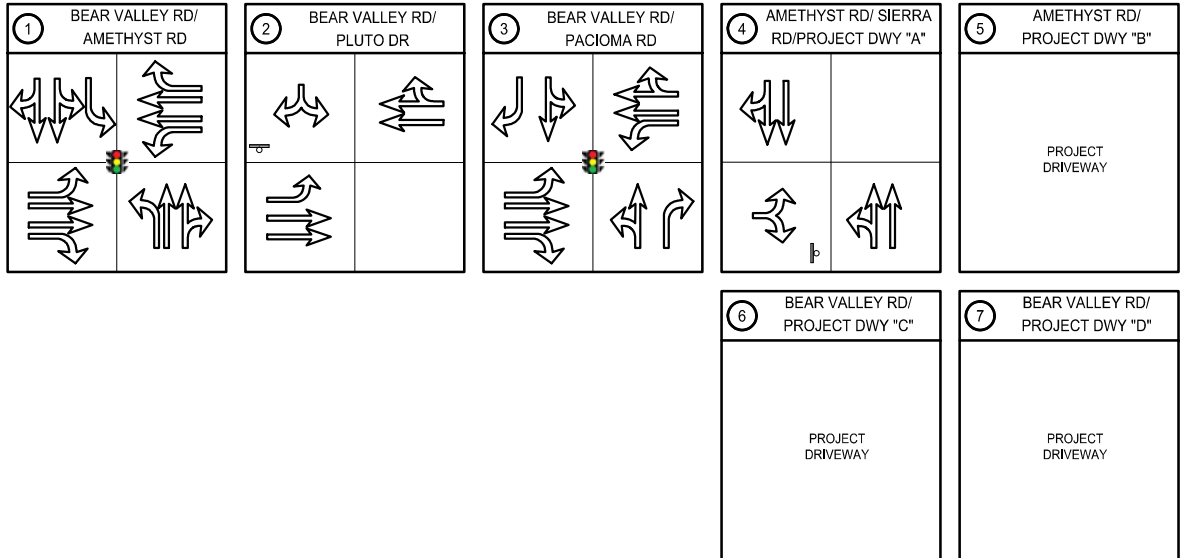

As shown in **Table 3-3** under existing conditions, the study intersections operate at LOS D or better with the existing geometrics illustrated in **Figure 4**.

### 3.2 Existing Traffic Signal Warrant Analysis

A traffic signal warrant analysis was completed for the side street stop-controlled intersection of Bear Valley Rd and Pluto Dr. This study reviewed Warrant 3 (Peak Hour) included in the most recent California Manual on Uniform Traffic Control Manual (CA MUTCD, 2014). The intersection of Bear Valley Rd and Pluto Dr does not meet the peak hour warrant for the installation of a traffic signal. The traffic signal warrant analysis is provided in **Appendix C**.



### LEGEND

-  - EXISTING GEOMETRICS
-  - STUDY INTERSECTIONS
-  - SIGNALIZED INTERSECTION
-  - STOP CONTROLLED APPROACH

**FIGURE 4: EXISTING INTERSECTION GEOMETRICS  
AMETHYST CROSSING  
VICTORVILLE, CALIFORNIA**

#### 4 EXISTING PLUS PROJECT CONDITIONS

Existing plus project conditions identifies impacts to the City’s level of service standards when compared to existing conditions without any unrelated transportation system improvements or other development. Impacts identified in this scenario are considered “project-specific”—impacts that are the sole responsibility of the project to mitigate.

##### 4.1 Site Access and Project-Specific Roadway Improvements

The analysis of intersection level of service in the future project scenarios includes site access and roadway and off-site intersection improvements as part of the project. These improvements are described in the following sections.

###### *Project Access*

Access to the site is proposed to at driveways along Amethyst Road, Bear Valley Road, and on an extension of Pluto Drive south of Bear Valley Road. The proposed Amethyst Road driveways include:

- A full access driveway is proposed at Project Driveway “A” on Amethyst Road. Project Driveway “A” is directly aligned with Sierra Road on the west side of Amethyst Road forming a four-leg intersection. The driveway centerline is located approximately 488 feet south of Bear Valley Road.

Proposed improvements to Amethyst Road include widening the east side of the road and restriping the lanes to provide a northbound left turn lane into Sierra Road and a continuous two-way center turn lane north of Sierra Road to accommodate southbound left turns into Project Driveways “A” and “B”.

- A full access driveway is proposed at Project Driveway “B” on Amethyst Road located about 320 feet south of Bear Valley Road at the midpoint between Sierra Road and a private driveway to the Shops at Bear Valley shopping center, about 100 feet north of Sierra Road and 100 feet south of the shopping center driveway.

Proposed improvements to Amethyst Road include widening the east side of the road to accommodate a northbound left turn lane into Sierra Road and continuous two-way center turn lane north of Sierra Road.

The proposed Bear Valley Road driveways include:

- Project Driveway “C” is proposed about 220 east of Amethyst Road. This driveway is proposed to restrict movements to right turn in / right turn out. enforced by a raised curb median on Bear Valley Road.
- Project Driveway “D” is proposed about 620 feet east of Amethyst Road. This driveway is also proposed to restrict movements to right turn in / right turn out enforced by a raised curb median on Bear Valley Road.
- The project proposes to extend Pluto Drive south of Bear Valley Road along the project’s eastern frontage and construct three driveway curb cuts accessing the site. Until the vacant property to the east develops, or Pluto Drive is extended further south to connect with other streets, the extension of Pluto Drive serves as an access driveway for the project where it intersects Bear Valley Road. The four-leg intersection created by the extension of Pluto Drive is proposed to provide full access to the project and the north side of Pluto Road.



Improvements to Bear Valley Road include widening the south side of the road to provide an eastbound right turn lane and a westbound left turn lane into Pluto Drive. The widening of Bear Valley Road along the project's frontage provides width for eastbound right turn lanes at Project Driveways "C" and "D".

#### *Project-Specific Roadway Improvements*

1. Frontage Improvements on Bear Valley Road. The project will be conditioned to improve its frontage along Bear Valley Road. The project proposes to dedicate the necessary right-of-way and construct the following improvements:
  - a. Dedicate the right-of-way to accommodate the half-width of the 124-foot right-of-way for a super arterial (62-feet) per the City's Circulation Map (February 2018).
  - b. Construct curb/gutter, sidewalk, and pavement along the project's frontage per City standards.
  - c. Construct a raised curbed median along Bear Valley Road from Amethyst Road east to Pluto Drive.
  - d. Stripe a 5-foot bike lane in the eastbound direction of Bear Valley Road.
2. Frontage Improvements on Amethyst Road. The project will be conditioned to improve its frontage along Amethyst Road. The project proposes to dedicate the necessary right-of-way and construct the following improvements:
  - a. Dedicate the right-of-way to accommodate the half-width of the 124-foot right-of-way for a super arterial (62-feet) per the City's Circulation Map (February 2018).
  - b. Construct curb/gutter, sidewalk, and pavement along the project's frontage per City standards.
  - c. Stripe a 5-foot bike lane in the northbound direction of Amethyst Road.
3. Extension of Pluto Drive South of Bear Valley Road. The project proposes to construct an extension of Pluto Drive from Bear Valley Road south to the southern edge of the project's property line where it will terminate as a stub for potential future extension by others. Within a 60-foot right-of-way, the project will construct curb, gutter and sidewalk per City standards on the west side and construct curb and gutter on the east side of Pluto Drive, and provide 40 feet of pavement for two-way traffic. Curb cuts on the extension of Pluto Drive provide access to the site.

#### *Project Access Intersection Improvements*

The project proposes to construct the following access intersections on the improved frontages of Bear Valley Road and Amethyst Road.

1. Project Driveway "A" on Amethyst Road at Sierra Road. The project proposes to construct the east leg of the Amethyst Road / Sierra Road intersection as a full access project driveway as described under Project Access.
  - a. Construct a dedicated northbound left turn lane into Sierra Rd.
  - b. Stripe a two way left turn lane on Amethyst Road north of Sierra Road.
2. Project Driveway "B" on Amethyst Road. The project proposes to construct a full access driveway on Amethyst Road as described under Project Access.

- a. Construct a northbound right turn lane into Project Driveway “B” which extends to Bear Valley Road.
- b. Stripe a two way left turn lane along Amethyst Rd between Bear Valley Road and Sierra Road.
3. Project Driveway “C” on Bear Valley Road. The project proposes to construct a right in/right out only driveway Bear Valley Road as described under Project Access.
  - a. Construct a dedicated eastbound right turn lane into Project Driveway “C”.
4. Project Driveway “D” on Bear Valley Road. The project proposes to construct a right in/right out only driveway on Bear Valley Road as described under Project Access.
  - a. Construct a dedicated eastbound right turn lane into Project Driveway “D”.

*Project-Specific Off-Site Intersection Improvements*

The dedication of right-of-way and widening of Bear Valley Road and Amethyst Road along the project’s frontage allows for improvements at the off-site intersection of these two roads and at the intersection of Bear Valley Road and Pluto Drive. Table 4-1 describes the lane geometry and traffic control improvements as used in the capacity analyses of project conditions.

Table 4-1: Proposed Project-Specific Off-Site Intersection Improvements

Intersection	Lane Geometry Improvements
Bear Valley Road / Amethyst Road	<p>The following lane additions can be implemented by revising the intersection’s pavement markings without land acquisition or widening of the roads outside of the project’s frontages:</p> <ul style="list-style-type: none"> <li>• Add a second eastbound left turn lane onto Amethyst Rd</li> <li>• Add a second westbound left turn lane onto Amethyst Rd</li> <li>• Add a second northbound left turn lane onto Bear Valley Rd</li> <li>• Add a northbound right turn lane onto Bear Valley Rd</li> <li>• Add a second southbound left turn lane onto Bear Valley Rd</li> <li>• Convert the existing north-south split phasing to provide protected left turn movements in the north-south direction</li> </ul>
Bear Valley Road / Pluto Drive	<ul style="list-style-type: none"> <li>• Construct a dedicated eastbound right turn lane into Pluto Drive from Bear Valley Road</li> <li>• Provide a westbound left turn lane into Pluto Drive from Bear Valley Road</li> <li>• Extend the existing eastbound left turn lane to a length of about 200 feet</li> </ul>

**4.2 Project Trip Generation**

The trip generation rates for the site were obtained from the Institute of Transportation Engineers (ITE) Trip Generation Manual, 10th Edition. Land use categories for estimating trips include Shopping Center (ITE Land Use 820), Fast-Food Restaurant with Drive-Through Window (ITE Land Use 934), Coffee/Donut Shop with Drive-Through Window (ITE Land Use 937), and Drive-In Bank (ITE Land Use 912).

Pass-by factors for Shopping Center (ITE Land Use 820) and Fast-Food Restaurant with Drive-Through Window (ITE Land Use 934) were provided by the City of Victorville. Pass-by factors for Drive-In Bank (ITE Land Use 912) were obtained from the ITE Trip Generation Handbook 3<sup>rd</sup> Edition. **Table 4-2** summarizes the estimated trip generation for the project on an average weekday, and during the AM (7-9 AM) and PM (4-6 PM) peak hours.

Table 4-2: Project Trip Generation

Use	Size/ Quantity	Daily	AM			PM		
			In	Out	Total	In	Out	Total
<b>1 Shopping Center - Land Use Category (ITE 820) - 4 Buildings</b>								
Per 1,000 Sq. Ft. GLA	82,600	37.75	0.58	0.36	0.94	1.83	1.98	3.81
Trips		3,119	48	30	78	151	164	315
Pass-By Trips (0%, 25%)		390	0	0	0	38	41	79
Primary Trips (100%, 75%)		2,729	48	30	78	113	123	236
<b>2 Fast-Food Restaurant with Drive-Through Window - Land Use Category (ITE 934) - Pad 1</b>								
Per 1,000 Sq. Ft. GLA	2,400	470.95	20	20	40	16.99	15.68	32.67
Trips		1,131	49	48	97	41	38	79
Pass-By Trips (35%, 35%)		396	17	17	34	14	14	28
Primary Trips (65%, 65%)		735	32	31	63	27	24	51
<b>3 Coffee/Donut Shop with Drive-Through Window - Land Use Category (ITE 937) - Pad 2</b>								
Per 1,000 Sq. Ft. GLA	2,200	820.38	45	44	89	21.69	21.69	43.38
Trips		1,805	100	96	196	48	48	96
<b>4 Fast-Food Restaurant with Drive-Through Window - Land Use Category (ITE 934) - Pad 2</b>								
Per 1,000 Sq. Ft. GLA	1,800	470.95	20	20	40	16.99	15.68	32.67
Trips		1,037	45	44	89	37	35	72
Pass-By Trips (35%, 35%)		363	16	15	31	13	12	25
Primary Trips (65%, 65%)		674	29	29	58	24	23	47
<b>5 Fast-Food Restaurant with Drive-Through Window - Land Use Category (ITE 934) - Pad 3</b>								
Per 1,000 Sq. Ft. GLA	4,500	470.95	20	20	40	16.99	15.68	32.67
Trips		2,120	92	89	181	76	71	147
Pass-By Trips (35%, 35%)		742	32	31	63	27	25	52
Primary Trips (65%, 65%)		1,378	60	58	118	49	46	95
<b>6 Drive-In Bank - Land Use Category (ITE 912) - Pad 4</b>								
Per 1,000 Sq. Ft. GLA	4,500	100.03	6	4	10	10.23	10.23	20.45
Trips		451	25	18	43	46	46	92
Pass-By Trips (29%, 35%)		145	7	5	12	16	16	32
Primary Trips (71%, 65%)		306	18	13	31	30	30	60
<b>Total Project Trips</b>		<b>8,626</b>	<b>314</b>	<b>281</b>	<b>595</b>	<b>362</b>	<b>367</b>	<b>729</b>
<b>Total Pass-By Trips</b>		<b>2,036</b>	<b>72</b>	<b>68</b>	<b>140</b>	<b>108</b>	<b>108</b>	<b>216</b>
<b>Total Primary Trips</b>		<b>6,590</b>	<b>242</b>	<b>213</b>	<b>455</b>	<b>254</b>	<b>259</b>	<b>513</b>

Source: "Trip Generation Manual, Institute of Transportation Engineers", 10<sup>th</sup> Edition

As presented in **Table 4-2** the project is estimated to generate 6,590 primary daily trips, 455 primary AM peak hour and 513 primary PM peak hour trips.

### 4.3 Project Trip Distribution and Assignment

The estimated project trips are distributed by direction and assigned to the local network of streets. **Figure 5** distribution of the project trips. **Figure 6** illustrates the assignment of primary project trips to study intersections. **Figure 7** illustrates the assignment of pass-by project trips to study intersections. **Figure 8** illustrates the assignment of total project trips to study intersections.

### 4.4 Existing Plus Project Traffic Analysis

The project trip generation, traffic distribution and assignment patterns were used in the intersection capacity analyses to assess potential project impacts to level of service. The project trips were added to existing traffic volumes to derive existing plus project conditions. This scenario's traffic volumes are illustrated in **Figure 9**. Intersection capacity analysis for the study intersections uses the existing lanes geometries and project access

driveway improvements. The results of the analysis are shown in **Table 4-3** and provided in **Appendix B**.

Table 4-3: Intersection Capacity Analysis – Existing Plus Project Conditions

Intersection	Intersection Control Type	Existing Condition				Existing + Project Condition			
		AM Peak		PM Peak		AM Peak		PM Peak	
		Delay	LOS	Delay	LOS	Delay	LOS	Delay	LOS
1. Bear Valley Rd / Amethyst Rd	TS	42.7	D	40.2	D	41.9	D	40.8	D
2. Bear Valley Rd / Pluto Dr	SSSC	12.3	B	12.6	B	32.5	D	99.9*	F
3. Bear Valley Rd / Pacoima Rd	SSSC	13.7	B	15.3	B	19.3	B	23.2	C
4. Amethyst Rd / Sierra Rd/ Project Dwy "A"	SSSC/Dwy	10.3	B	12.0	B	12.9	B	15.1	C
5. Amethyst Rd / Project Dwy "B"	SSSC/Dwy	N/A				12.2	B	13.0	B
6. Bear Valley Rd / Project Dwy "C"	SSSC/Dwy	N/A				12.0	B	12.8	B
7. Bear Valley Rd / Project Dwy "D"	SSSC/Dwy	N/A				11.1	B	12.9	B
Dwy – Driveway RI/RO – Right in / Right out only access TS – Traffic Signal Controlled Intersection SSSC – Side Street Stop Controlled Intersection Delay – seconds per vehicle LOS – Level of Service 99.9* - Delay exceeds LOS F									

As presented in **Table 4-3**, under existing plus project conditions, the study intersections would operate at LOS D or better except at Bear Valley Road and Pluto Drive. The construction of the south leg of the intersection and the addition of project traffic causes the PM peak hour to operate at LOS F for the worst movement from the stop-controlled side street. The existing and project geometrics are illustrated in **Figure 10**.

#### 4.5 Existing Plus Project Traffic Signal Warrant Analysis

A traffic signal warrant analysis (Warrant 3 - Peak Hour) was completed for the side street stop-controlled intersection of Bear Valley Road and Pluto Drive. The intersection does not meet the peak hour warrant under the existing plus project conditions scenario. The traffic signal warrant analyses are provided in **Appendix C**.













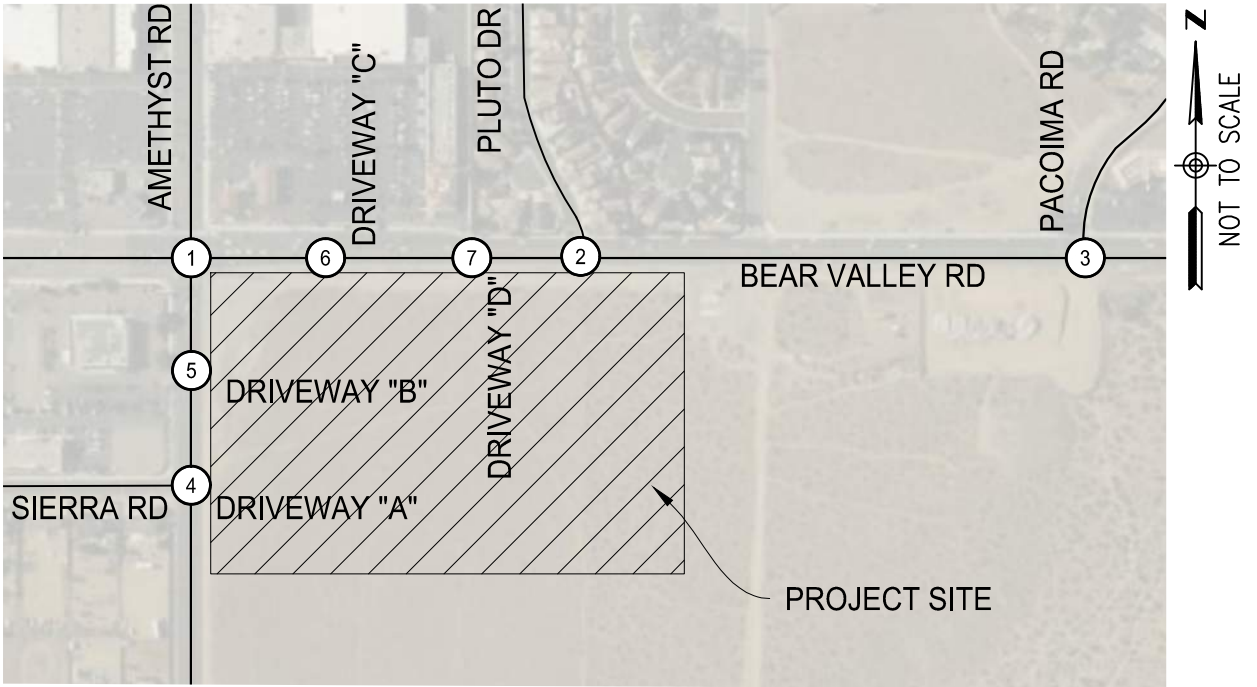
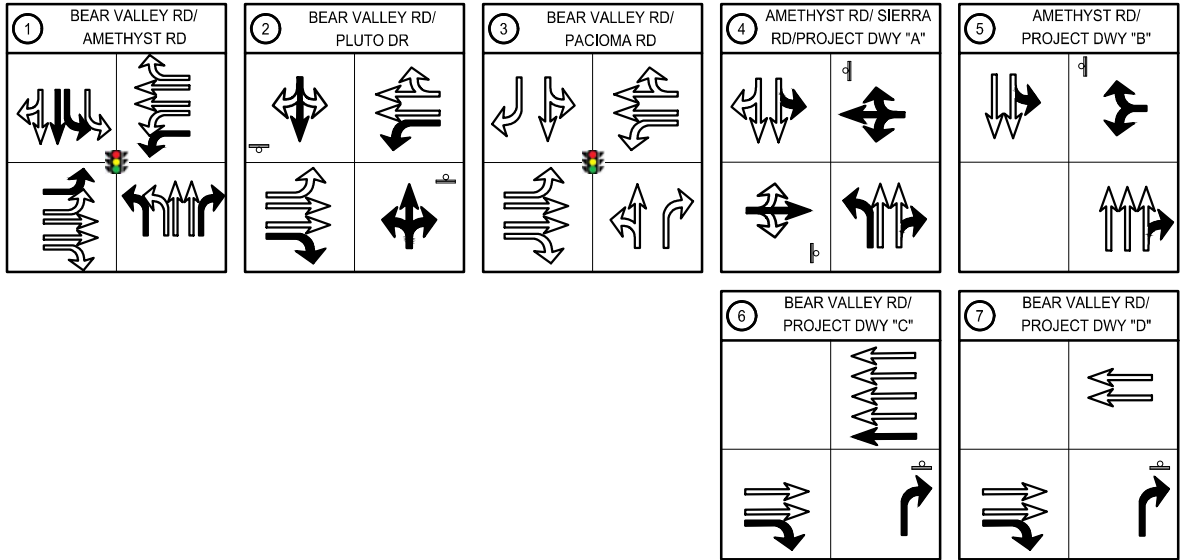

**LEGEND**

- EXISTING GEOMETRICS
- PROPOSED GEOMETRICS
- STUDY INTERSECTIONS
- SIGNALIZED INTERSECTION
- STOP CONTROLLED APPROACH

**FIGURE 10: EXISTING PLUS PROJECT INTERSECTION GEOMETRICS AMETHYST CROSSING VICTORVILLE, CALIFORNIA**

## 5 BACKGROUND CONDITIONS (YEAR 2023)

This scenario represents conditions at the time the project is anticipated to be fully constructed and occupied (known as buildout which is the year 2023 for this project) but without traffic generated by the project. This scenario is comprised of Ambient growth—a general rate of growth in traffic from overall regional growth but not specific to any nearby development.

### 5.1 Ambient Growth Projections

The proposed project is anticipated to be constructed and occupied in the year 2023. As stated earlier in this report near-term growth in traffic is comprised of regional ambient growth and other area projects expected to be completed within the same timeframe. Ambient growth is estimated as a 3.5% annual increase.

### 5.2 Background Conditions (Year 2023) Traffic Analysis

The background condition traffic volumes are illustrated in **Figure 11**. Intersection capacity analysis for this scenario uses existing lanes geometries. The results of the analysis are shown in **Table 5-1** and provided in **Appendix B**.

Table 5-1: Intersection Capacity Analysis – Background Condition

Intersection	Intersection Control Type	AM Peak		PM Peak	
		Delay	LOS	Delay	LOS
1. Bear Valley Rd / Amethyst Rd	TS	43.8	D	41.1	D
2. Bear Valley Rd / Pluto Dr	SSSC	12.7	B	13.2	B
3. Bear Valley Rd / Pacoima Rd	SSSC	15.5	B	17.1	B
4. Amethysts Rd / Sierra Rd	SSSC/Dwy	10.4	B	12.4	B
5. Amethyst Rd / Project Dwy "B"	SSSC/Dwy	N/A			
6. Bear Valley Rd / Project Dwy "C"	SSSC/Dwy	N/A			
7. Bear Valley Rd / Project Dwy "D"	SSSC/Dwy	N/A			
Dwy – Driveway TS – Traffic Signal Controlled Intersection SSSC – Side Street Stop Controlled Intersection Delay – seconds per vehicle LOS – Level of Service 99.9* - Delay exceeds LOS F					

As presented in **Table 5-1**, under the Background Conditions, the study intersection is anticipated to continue to operate at LOS D or better.

### 5.3 Background Conditions Traffic Signal Warrant Analysis

A traffic signal warrant analysis (Warrant 3 - Peak Hour) was completed for the side street stop-controlled intersection of Bear Valley Road and Pluto Drive. The intersection does not meet the peak hour warrant under the background conditions scenario. The traffic signal warrant analyses are provided in **Appendix C**.



## 6 PROJECT TRAFFIC CONDITIONS

This scenario adds the project’s estimated traffic generation at buildout (2023) to the background conditions scenario described above. Level of service impacts identified in this scenario are considered “cumulative” impacts—impacts that the project contributes to, but does not solely cause, and may be responsible for a fair-share of the cost to implement any mitigation measures.

### 6.1 Project Traffic Analysis

The traffic volumes under this scenario are illustrated in **Figure 12**. Intersection capacity analysis for the study intersections uses existing lanes geometries and the proposed project-specific access, roadway, and off-site intersection improvements described earlier. The results of the analysis are shown in **Table 6-1** and provided in **Appendix B**.

Table 6-1: Intersection Capacity Analysis – Project Conditions

Intersection	Intersection Control Type	Background Conditions				Project Condition			
		AM Peak		PM Peak		AM Peak		PM Peak	
		Delay	LOS	Delay	LOS	Delay	LOS	Delay	LOS
1. Bear Valley Rd / Amethyst Rd	TS	43.8	D	41.1	D	42.3	D	41.3	D
2. Bear Valley Rd / Pluto Dr	SSSC	12.7	B	13.2	B	37.4	E	99.9*	F
3. Bear Valley Rd / Pacoima Rd	SSSC	15.5	B	17.1	B	21.8	C	25.1	C
4. Amethyst Rd / Sierra Rd/ Project Dwy “A”	SSSC/Dwy	10.4	B	12.4	B	13.2	B	15.8	C
5. Amethyst Rd / Project Dwy “B”	SSSC/Dwy	N/A				12.4	B	13.2	B
6. Bear Valley Rd / Project Dwy “C”	SSSC/Dwy	N/A				12.3	B	13.2	B
7. Bear Valley Rd / Project Dwy “D”	SSSC/Dwy	N/A				11.3	B	13.4	B
Dwy – Driveway RI/RO – Right in / Right out only access TS – Traffic Signal Controlled Intersection SSSC – Side Street Stop Controlled Intersection Delay – seconds per vehicle LOS – Level of Service 99.9* - Delay exceeds LOS F									

As presented in **Table 6-1**, under the Project Conditions, the study intersections would operate at LOS D or better except at Bear Valley Road / Pluto Drive. The construction of the south leg of the intersection and the addition of project traffic causes the PM peak hour to operate at LOS F for the worst movement from the stop-controlled side street (northbound through and left).

### 6.2 Project Conditions Traffic Signal Warrant Analysis

A traffic signal warrant analysis (Warrant 3 - Peak Hour) was completed for the side street stop-controlled intersection of Bear Valley Road and Pluto Drive. The intersection does not meet the peak hour warrant under the background conditions scenario. The traffic signal warrant analyses are provided in **Appendix C**.

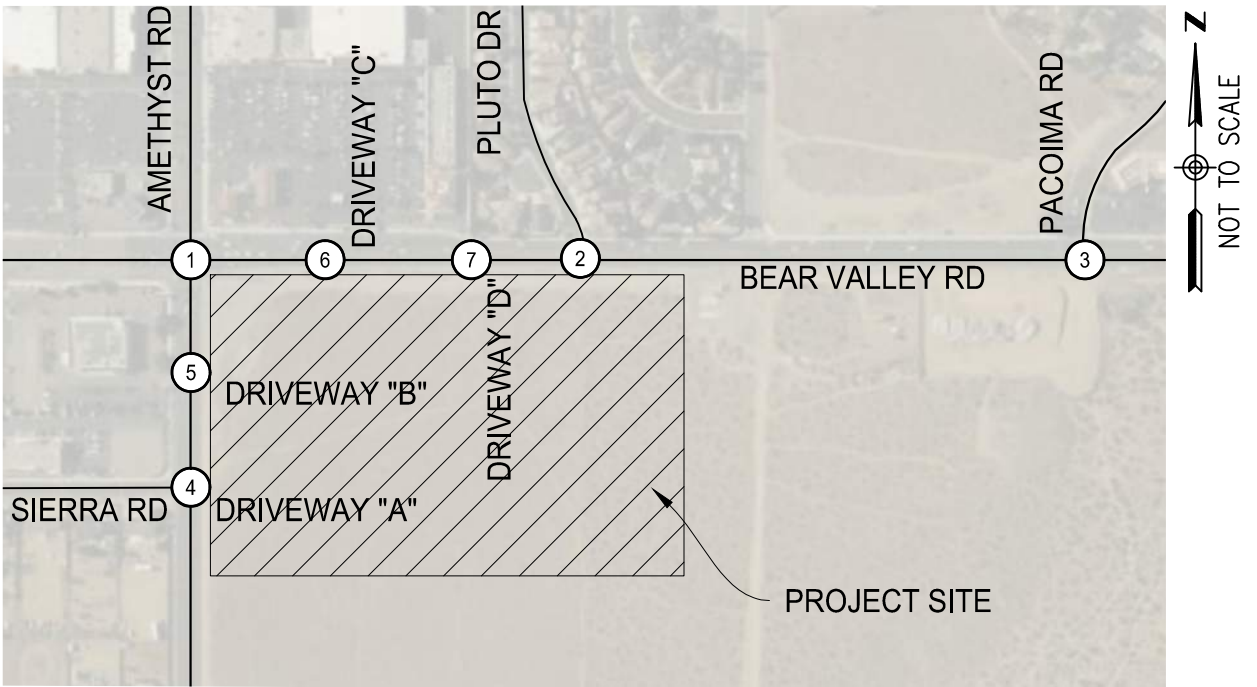
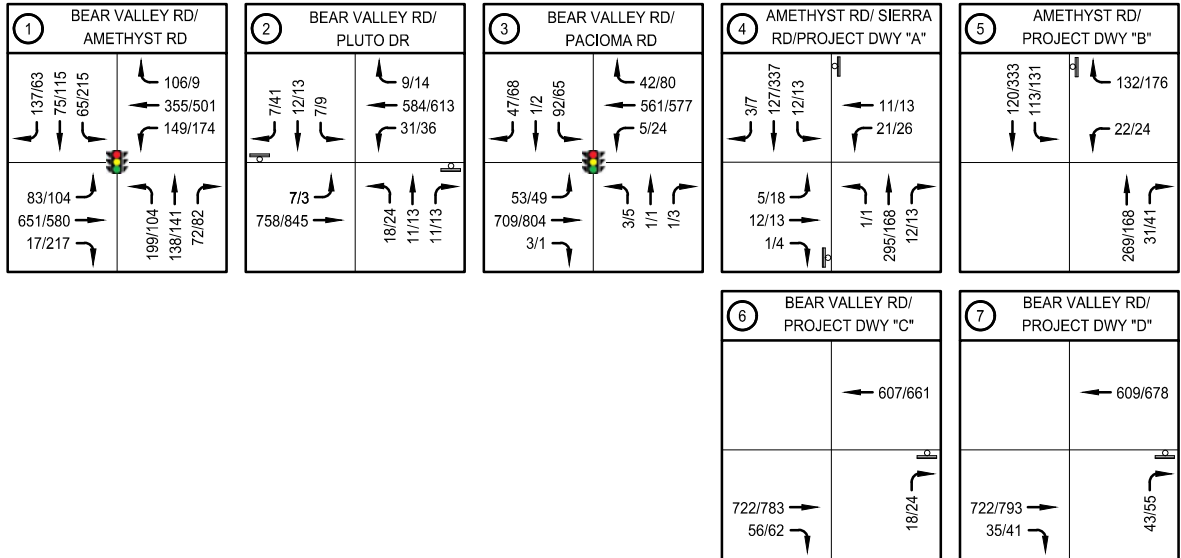

### LEGEND

- XX/XX ↗ - AM/PM PROJECT TRIP
- ⊕ - STUDY INTERSECTIONS
- 🚦 - SIGNALIZED INTERSECTION
- ⊥ - STOP CONTROLLED APPROACH

**FIGURE 12: PROJECT TRAFFIC VOLUMES  
AMETHYST CROSSING  
VICTORVILLE, CALIFORNIA**

## 7 FUTURE CONDITIONS (YEAR 2033)

The future conditions scenario represents conditions at the planning horizon year 2033 without traffic generated by the project. This scenario is comprised of an ambient growth—a general rate of growth in traffic reflecting regional growth but not specific to any nearby development (assumed to be 3.5% annually for this study).

### 7.1 Future Traffic Analysis

The future conditions (Year 2033) forecasted traffic volumes are illustrated in **Figure 13**. Intersection capacity analysis for the study intersections uses existing lanes geometries. The results of the analysis are shown in **Table 7-1** and provided in **Appendix B**.

Table 7-1: Intersection Capacity Analysis – Future Conditions (Year 2033)

Intersection	Intersection Control Type	AM Peak		PM Peak	
		Delay	LOS	Delay	LOS
1. Bear Valley Rd / Amethyst Rd	TS	44.2	D	41.4	D
2. Bear Valley Rd / Pluto Dr	SSSC	12.8	B	13.4	B
3. Bear Valley Rd / Pacoima Rd	SSSC	16.1	B	18.1	B
4. Amethysts Rd / Sierra Rd/ Project Dwy "A"	SSSC/Dwy	10.5	B	12.6	B
5. Amethyst Rd / Project Dwy "B"	SSSC/Dwy	N/A			
6. Bear Valley Rd / Project Dwy "C"	SSSC/Dwy	N/A			
7. Bear Valley Rd / Project Dwy "D"	SSSC/Dwy	N/A			
Dwy – Driveway TS – Traffic Signal Controlled Intersection SSSC – Side Street Stop Controlled Intersection Delay – seconds per vehicle LOS – Level of Service 99.9* - Delay exceeds LOS F					

As presented in under the **Table 7-1**, under the future conditions, the study intersections would operate at LOS D or better except Bear Valley Road and Pluto Drive.

### 7.2 Future Conditions Traffic Signal Warrant Analysis

A traffic signal warrant analysis was completed for the side street stop-controlled intersection of Bear Valley A traffic signal warrant analysis (Warrant 3 - Peak Hour) was completed for the side street stop-controlled intersection of Bear Valley Road and Pluto Drive. The intersection does not meet the peak hour warrant under the background conditions scenario. The traffic signal warrant analyses are provided in **Appendix C**.





## 8 FUTURE PLUS PROJECT CONDITIONS (YEAR 2033)

The future plus project conditions scenario adds the project’s estimated traffic generation to the future condition scenario described in **Chapter 7**. Impacts identified in this scenario are considered “cumulative” impacts—impacts that the project contributes to, but does not solely cause, and may be responsible for a fair-share of the cost to implement any mitigation measures.

### 8.1 Future Plus Project Traffic Analysis

The forecasted volumes for this scenario are illustrated in **Figure 14**. Intersection capacity analysis for the study intersections uses the existing lanes geometries and the proposed project-specific access, roadway, and off-site intersection improvements described earlier. Further, the analysis of this scenario assumes completion of a regional improvement to add an additional through lane on Bear Valley Road in each direction. This regional improvement is assumed to be implemented by others in the future but would not be possible without the right-of-way dedication and proposed widening of Bear Valley Road by the project. Therefore, this regional improvement is only assumed under future plus project conditions. **Figure 15** illustrates future plus project lane geometries used in the analysis. The results of the intersection capacity analysis are shown in **Table 8-1** and provided in **Appendix B**.

Table 8-1: Intersection Capacity Analysis – Future Plus Project Conditions (Year 2033)

Intersection	Intersection Control Type	Future Condition				Future + Project Condition			
		AM Peak		PM Peak		AM Peak		PM Peak	
		Delay	LOS	Delay	LOS	Delay	LOS	Delay	LOS
1. Bear Valley Rd / Amethyst Rd	TS	44.2	D	41.4	D	41.1	D	40.2	D
2. Bear Valley Rd / Pluto Dr	SSSC	12.8	B	13.4	B	33.8	D	99.99*	F
3. Bear Valley Rd / Pacoima Rd	SSSC	16.1	B	18.1	B	22.7	C	25.9	C
4. Amethyst Rd / Sierra Rd / Driveway “A”	SSSC/Driveway	10.5	B	12.6	B	13.2	B	15.4	C
5. Amethyst Rd / Driveway “B”	SSSC/Driveway	N/A				12.4	B	13.3	B
6. Bear Valley Rd / Driveway “C”	SSSC/Driveway	N/A				11.3	B	12.1	B
7. Bear Valley Rd / Driveway “D”	SSSC/Driveway	N/A				12.6	B	15.3	C
TS – Traffic Signal Controlled Intersection SSSC – Side Street Stop Controlled Intersection N/A – Not Applicable Future Intersection. Delay – seconds per vehicle LOS – Level of Service 99.99* - Delay exceeds LOS F									

As presented in **Table 8-1**, under future plus project conditions, the study intersections would operate at LOS D or better except Bear Valley Road and Pluto Drive. The construction of the south leg of the intersection and the addition of project traffic causes the PM peak hour to operate at LOS F for the worst movement from the stop-controlled side street (northbound through and left).

### 8.2 Future Plus Project Conditions Traffic Signal Warrant Analysis

A traffic signal warrant analysis was completed for the side street stop-controlled intersection of Bear Valley Road and Pluto Drive. A traffic signal warrant analysis (Warrant 3 - Peak Hour) was completed for the side street stop-controlled intersection of Bear Valley Road and Pluto Drive. The intersection does not meet the peak hour warrant under the background conditions scenario. The traffic signal warrant analyses are provided in **Appendix C**.

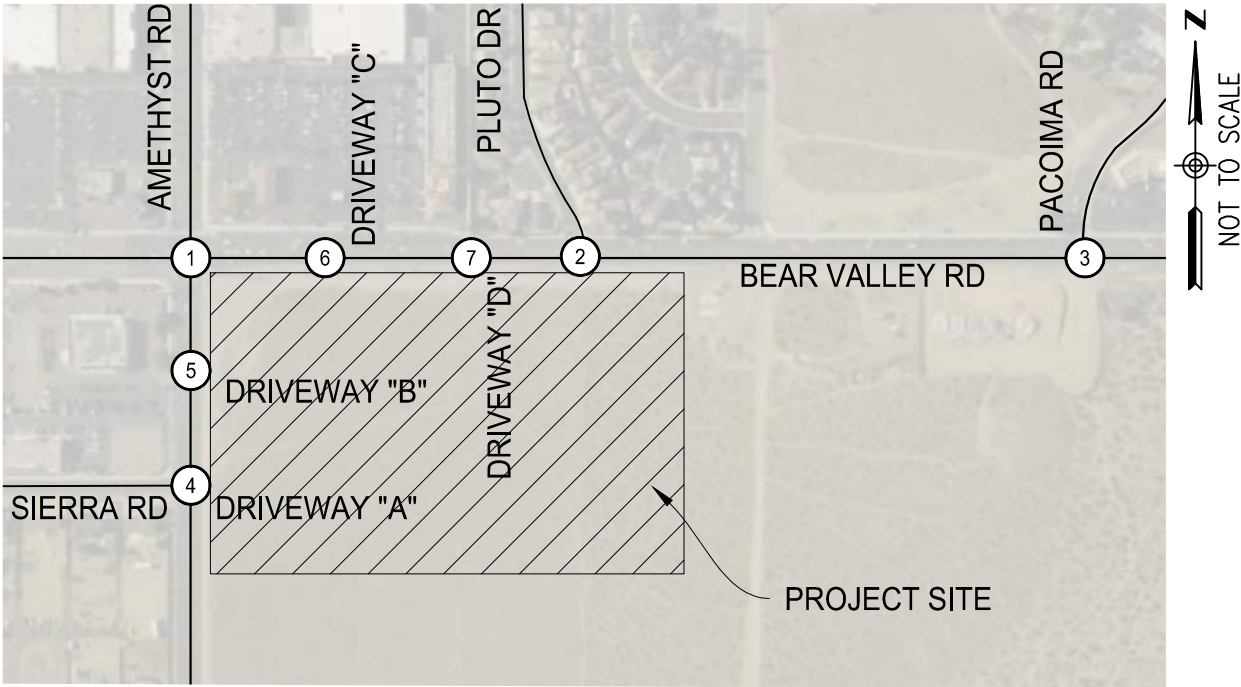
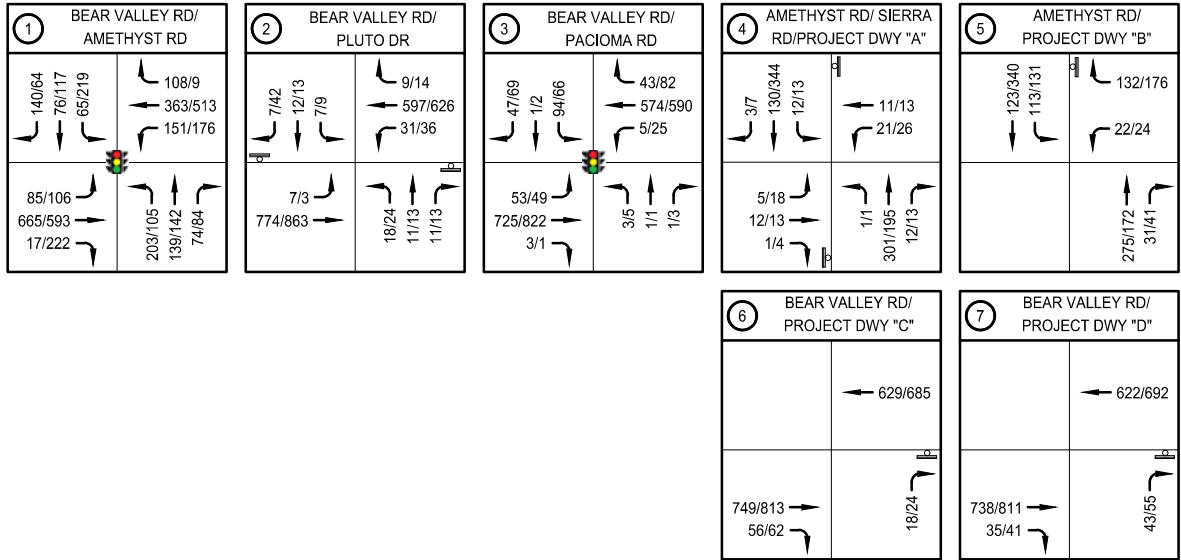



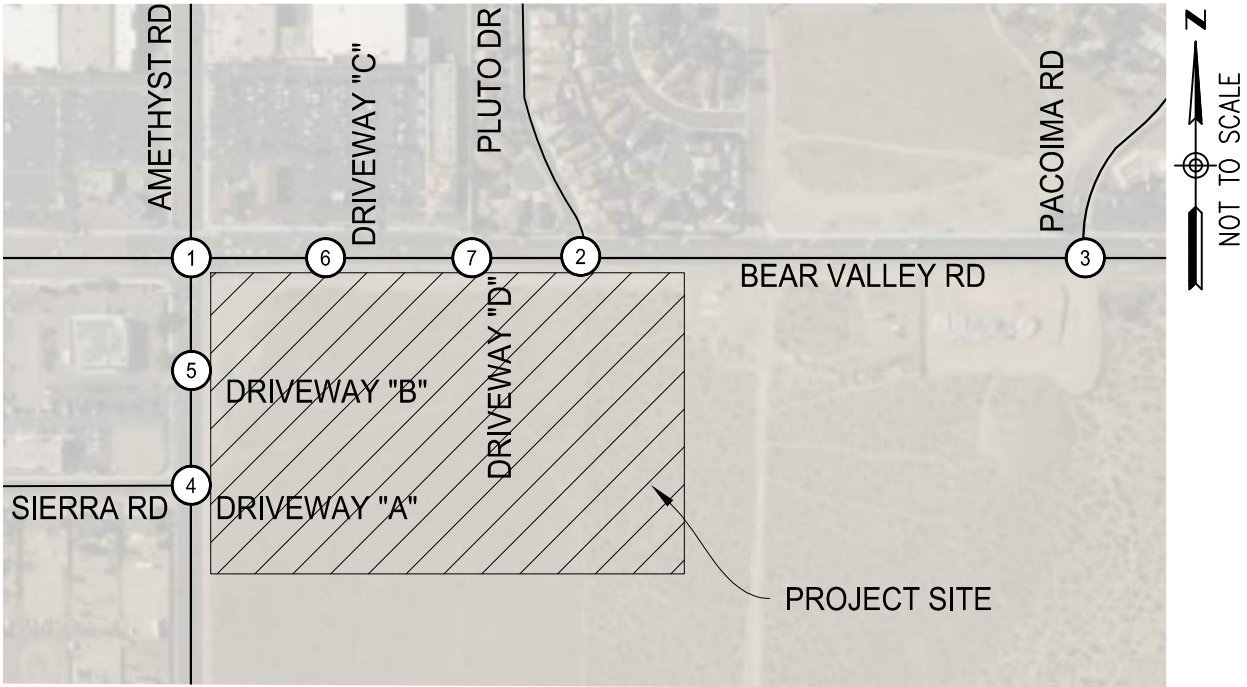
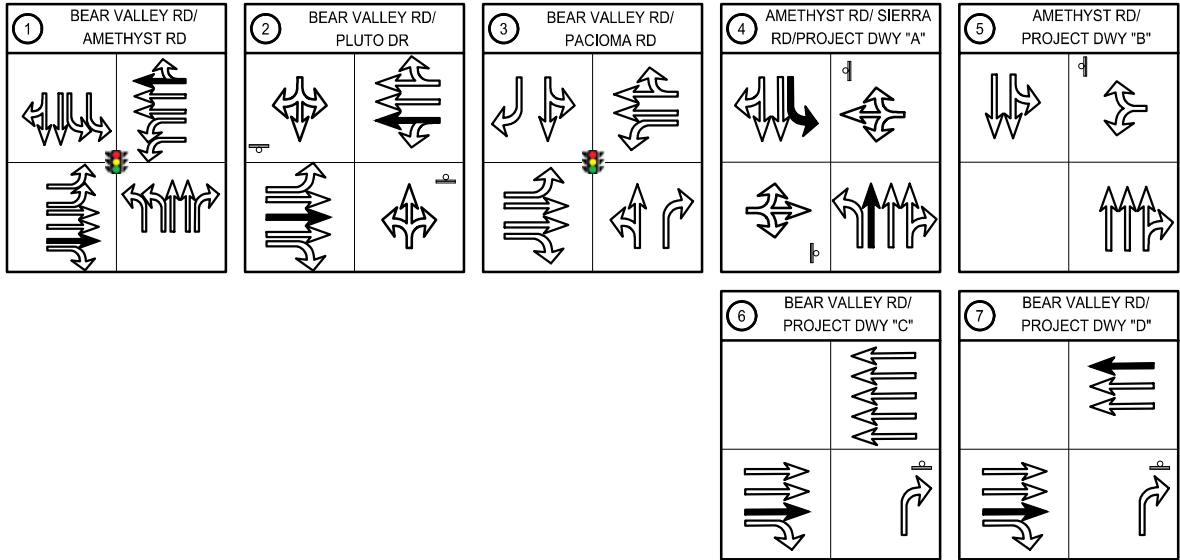

### LEGEND

- XX/XX ↗ - AM/PM PROJECT TRIP
- ⊕ - STUDY INTERSECTIONS
- 🚦 - SIGNALIZED INTERSECTION
- ⊥ - STOP CONTROLLED APPROACH

**FIGURE 14: FUTURE + PROJECT TRAFFIC VOLUMES  
AMETHYST CROSSING  
VICTORVILLE, CALIFORNIA**



**LEGEND**

-  - EXISTING GEOMETRICS
-  - PROPOSED GEOMETRICS
-  - STUDY INTERSECTIONS
-  - SIGNALIZED INTERSECTION
-  - STOP CONTROLLED APPROACH

**FIGURE 15: FUTURE PLUS PROJECT INTERSECTION GEOMETRICS AMETHYST CROSSING VICTORVILLE, CALIFORNIA**



## 9 APPENDICES

**Appendix A: Turn Movement Count Volumes**

**Appendix B: Intersection Capacity Analysis Calculations**

**Appendix C: Traffic Signal Warrant Worksheets**



## Appendix A: Turn Movement Count Volumes

**SANBAG CLASSIFICATION SUMMARY**  
**NORTH-SOUTH STREET : AMETHYST RD**      **VICTORVILLE**  
**EAST-WEST STREET : BEAR VALLEY RD**      **08-18-21**  
**BEGINNING TIME : 07:00AM**

AUTOS			LARGE 2 AXLE			3 AXLE			4 (+) AXLE			TOTALS
RT	THRU	LT	RT	THRU	LT	RT	THRU	LT	RT	THRU	LT	
<b>NORTH LEG</b>												
22	1	13	2	1	1	0	1	0	0	0	0	41
42	8	2	1	1	1	0	1	0	0	1	0	57
29	10	1	0	0	2	1	0	1	0	0	0	44
35	7	1	0	0	1	0	0	0	0	0	0	44
31	2	2	0	0	0	0	1	0	0	3	0	39
26	4	6	0	0	0	1	1	1	0	1	0	40
35	7	2	0	0	1	0	2	1	0	8	0	56
33	15	3	0	0	1	0	0	0	0	0	0	52
253	54	30	3	2	7	2	6	3	0	13	0	373
<b>SOUTH LEG</b>												
23	1	14	1	1	0	0	1	0	0	0	0	41
16	4	56	2	3	0	0	2	0	0	2	0	85
29	10	5	1	0	0	0	0	0	0	0	0	45
35	7	4	0	0	0	0	0	0	0	0	0	46
12	20	44	1	0	0	0	1	0	0	0	1	79
17	14	42	0	1	0	0	0	0	0	0	0	74
0	15	48	2	1	0	0	0	0	0	0	0	66
3	20	48	0	0	0	0	0	0	0	0	0	71
135	91	261	7	6	0	0	4	0	0	2	1	507
<b>EAST LEG</b>												
31	70	10	0	1	0	0	2	0	0	5	0	119
20	53	15	0	1	0	0	2	0	0	10	0	101
13	51	3	0	1	0	0	0	1	0	9	0	78
21	59	15	0	1	0	0	2	1	0	12	0	111
29	83	13	1	1	0	0	1	0	0	4	0	132
22	76	24	0	4	0	0	2	0	0	10	0	138
23	63	22	0	0	0	0	0	0	0	20	0	128
39	47	24	0	0	0	0	0	0	0	10	0	120
198	502	126	1	9	0	0	9	2	0	80	0	927
<b>WEST LEG</b>												
2	105	10	0	1	1	0	0	0	0	6	0	125
0	157	22	0	5	1	0	0	0	0	7	0	192
1	125	22	0	5	0	0	1	0	0	2	0	156
0	146	17	1	0	0	0	0	0	0	22	0	186
0	102	20	0	5	0	0	1	0	0	5	0	133
2	114	20	0	0	2	0	0	0	0	10	0	148
2	123	19	0	0	0	0	0	0	0	11	0	155
7	116	9	0	0	0	0	0	0	0	0	0	132
14	988	139	1	16	4	0	2	0	0	63	0	1227

**SANBAG CLASSIFICATION SUMMARY**  
**NORTH-SOUTH STREET : AMETHYST RD**  
**EAST-WEST STREET : BEAR VALLEY RD**  
**BEGINNING TIME : 04:00PM**

**VICTORVILLE**  
**08-18-21**

AUTOS			LARGE 2 AXLE			3 AXLE			4 (+) AXLE			TOTALS
RT	THRU	LT	RT	THRU	LT	RT	THRU	LT	RT	THRU	LT	
<b>NORTH LEG</b>												
15	12	13	0	0	0	0	0	0	0	0	0	40
13	17	15	0	0	0	0	0	0	0	0	0	45
24	9	28	1	0	0	0	0	0	0	1	0	63
8	13	37	2	0	0	0	0	0	0	0	0	60
17	18	48	0	0	0	0	1	0	0	0	0	84
17	17	48	0	0	0	1	0	0	0	0	0	83
12	22	62	0	0	0	1	0	0	0	0	0	97
11	14	47	0	0	0	0	0	0	0	0	0	72
117	122	298	3	0	0	2	1	0	0	1	0	544
<b>SOUTH LEG</b>												
17	12	3	0	0	0	0	0	0	0	0	0	32
4	6	24	0	0	0	0	0	1	0	0	1	36
21	10	2	1	1	0	0	0	0	0	0	0	35
17	9	4	0	1	0	0	0	0	0	0	0	31
33	13	7	0	1	0	0	0	0	0	0	0	54
20	13	12	0	0	0	0	0	0	0	0	0	45
26	13	11	0	0	0	0	0	0	0	0	0	50
24	7	3	0	0	0	0	0	0	0	0	0	34
162	83	66	1	3	0	0	0	1	0	0	1	317
<b>EAST LEG</b>												
2	92	20	0	0	0	0	0	0	0	0	0	114
0	133	23	1	1	0	0	1	0	0	0	0	159
22	125	27	0	0	0	0	0	0	0	2	0	176
20	122	22	0	0	0	0	0	0	0	0	0	164
1	90	28	0	0	1	0	0	0	0	0	1	121
1	147	18	0	3	0	0	0	0	0	0	0	169
2	136	25	0	1	0	0	0	0	0	0	0	164
4	118	13	0	1	0	0	0	0	0	0	0	136
52	963	176	1	6	1	0	1	0	0	2	1	1203
<b>WEST LEG</b>												
43	134	17	0	0	0	0	0	0	0	0	0	194
56	164	28	0	0	0	0	0	0	0	0	0	248
29	128	16	1	0	0	0	0	0	0	2	0	176
25	122	15	0	0	0	0	0	0	0	0	0	162
62	173	22	0	0	0	0	0	0	0	0	0	257
48	182	20	0	0	0	0	0	0	0	0	0	250
41	192	28	0	0	0	0	0	0	0	0	0	261
40	148	27	0	0	0	0	0	0	0	0	0	215
344	1243	173	1	0	0	0	0	0	0	2	0	1763

SANBAG CLASSIFICATION SUMMARY  
 NORTH-SOUTH STREET : PLUTO DR  
 EAST-WEST STREET : BEAR VALLEY RD  
 BEGINNING TIME : 07:00AM

VICTORVILLE  
 08-19-21

AUTOS			LARGE 2 AXLE			3 AXLE			4 (+) AXLE			TOTALS
RT	THRU	LT	RT	THRU	LT	RT	THRU	LT	RT	THRU	LT	
NORTH LEG												
0	0	2	0	0	0	0	0	0	0	0	0	2
0	0	1	0	0	0	0	0	0	0	0	0	1
0	0	1	0	0	0	0	0	0	0	0	0	1
0	0	1	0	0	0	0	0	0	0	0	0	1
0	0	1	0	0	0	0	0	0	0	0	0	1
0	0	1	0	0	0	0	0	0	0	0	0	1
0	0	2	0	0	0	0	0	0	0	0	0	2
0	0	3	0	0	0	0	0	0	0	0	0	3
0	0	12	0	0	0	0	0	0	0	0	0	12
SOUTH LEG												
0	0	0	0	0	0	0	0	0	0	0	0	0
0	0	0	0	0	0	0	0	0	0	0	0	0
0	0	0	0	0	0	0	0	0	0	0	0	0
0	0	0	0	0	0	0	0	0	0	0	0	0
0	0	0	0	0	0	0	0	0	0	0	0	0
0	0	0	0	0	0	0	0	0	0	0	0	0
0	0	0	0	0	0	0	0	0	0	0	0	0
0	0	0	0	0	0	0	0	0	0	0	0	0
0	0	0	0	0	0	0	0	0	0	0	0	0
EAST LEG												
0	79	0	0	4	0	0	3	0	0	9	0	95
2	92	0	0	5	0	0	0	0	0	7	0	106
1	100	0	0	3	0	0	1	0	0	7	0	112
0	104	0	0	7	0	0	0	0	0	6	0	117
3	119	0	0	4	0	0	0	0	0	10	0	136
2	106	0	0	6	0	0	2	0	0	11	0	127
3	144	0	0	3	0	0	0	0	0	7	0	157
2	119	0	0	2	0	0	0	0	0	7	0	130
13	863	0	0	34	0	0	6	0	0	64	0	980
WEST LEG												
0	183	1	0	4	0	0	1	0	0	10	0	199
0	256	0	0	3	0	0	0	0	0	9	0	268
0	260	0	0	4	0	0	1	0	0	4	0	269
0	195	1	0	5	0	0	0	0	0	7	0	208
0	226	1	0	3	0	0	2	0	0	5	0	237
0	151	0	0	6	0	0	1	0	0	8	0	166
0	197	0	0	7	0	0	1	0	0	5	0	210
0	149	0	0	5	0	0	1	0	0	11	0	166
0	1617	3	0	37	0	0	7	0	0	59	0	1723



**SANBAG CLASSIFICATION SUMMARY**  
**NORTH-SOUTH STREET : PLUTO DR**  
**EAST-WEST STREET : BEAR VALLEY RD**  
**BEGINNING TIME : 04:00PM**

**VICTORVILLE**  
**08-19-21**

AUTOS			LARGE 2 AXLE			3 AXLE			4 (+) AXLE			TOTALS
RT	THRU	LT	RT	THRU	LT	RT	THRU	LT	RT	THRU	LT	
<b>NORTH LEG</b>												
2	0	1	0	0	0	0	0	0	0	0	0	3
0	0	0	0	0	0	0	0	0	0	0	0	0
2	0	2	0	0	0	0	0	0	0	0	0	4
3	0	1	0	0	0	0	0	0	0	0	0	4
0	0	0	0	0	0	0	0	0	0	0	0	0
1	0	2	0	0	0	0	0	0	0	0	0	3
2	0	3	0	0	0	0	0	0	0	0	0	5
1	0	1	0	0	0	0	0	0	0	0	0	2
11	0	10	0	0	0	0	0	0	0	0	0	21
<b>SOUTH LEG</b>												
0	0	0	0	0	0	0	0	0	0	0	0	0
0	0	0	0	0	0	0	0	0	0	0	0	0
0	0	0	0	0	0	0	0	0	0	0	0	0
0	0	0	0	0	0	0	0	0	0	0	0	0
0	0	0	0	0	0	0	0	0	0	0	0	0
0	0	0	0	0	0	0	0	0	0	0	0	0
0	0	0	0	0	0	0	0	0	0	0	0	0
0	0	0	0	0	0	0	0	0	0	0	0	0
0	0	0	0	0	0	0	0	0	0	0	0	0
<b>EAST LEG</b>												
6	105	0	0	2	0	0	1	0	0	3	0	117
2	92	0	0	1	0	0	0	0	0	6	0	101
3	137	0	0	2	0	0	2	0	0	3	0	147
4	137	0	0	3	0	0	0	0	0	4	0	148
6	102	0	0	1	0	0	3	0	0	2	0	114
1	77	0	0	2	0	0	1	0	0	3	0	84
3	98	0	0	3	0	0	0	0	0	4	0	108
3	132	0	0	2	0	0	0	0	0	2	0	139
28	880	0	0	16	0	0	7	0	0	27	0	958
<b>WEST LEG</b>												
0	146	6	0	2	0	0	1	0	0	6	0	161
0	98	0	0	1	0	0	0	0	0	3	0	102
0	176	2	0	1	0	0	1	0	0	4	0	184
0	154	1	0	1	0	0	1	0	0	5	0	162
0	168	1	0	3	0	0	0	0	0	2	0	174
0	167	0	0	3	0	0	0	0	0	4	0	174
0	183	1	0	2	0	0	1	0	0	3	0	190
0	184	1	0	1	0	0	1	0	0	4	0	191
0	1276	12	0	14	0	0	5	0	0	31	0	1338

**SANBAG CLASSIFICATION SUMMARY**  
 NORTH-SOUTH STREET : PACOIMA RD  
 EAST-WEST STREET : BEAR VALLEY RD  
 BEGINNING TIME : 07:00AM

VICTORVILLE  
 08-18-21

AUTOS			LARGE 2 AXLE			3 AXLE			4 (+) AXLE			TOTALS
RT	THRU	LT	RT	THRU	LT	RT	THRU	LT	RT	THRU	LT	
<b>NORTH LEG</b>												
4	1	4	0	0	0	0	0	0	0	0	0	9
3	0	17	0	0	0	0	0	0	0	0	0	20
4	0	17	0	0	0	0	0	0	0	0	0	21
3	0	26	0	0	0	0	0	0	0	0	0	29
6	0	24	0	0	1	0	0	0	0	0	0	31
0	0	22	0	0	0	0	0	0	0	0	0	22
1	0	13	0	0	0	0	0	0	0	0	0	14
3	0	14	0	0	0	0	0	0	0	0	0	17
24	1	137	0	0	1	0	0	0	0	0	0	163
<b>SOUTH LEG</b>												
0	0	0	0	0	0	0	0	0	0	0	0	0
0	0	0	0	0	0	0	0	0	0	0	0	0
0	0	0	0	0	0	0	0	0	0	0	0	0
0	0	1	0	0	0	0	0	0	0	0	0	1
0	0	0	0	0	0	0	0	0	0	0	0	0
0	0	1	0	0	0	0	0	0	0	0	0	1
1	1	1	0	0	0	0	0	0	0	0	0	3
2	0	1	0	0	0	0	0	0	0	0	0	3
3	1	4	0	0	0	0	0	0	0	0	0	8
<b>EAST LEG</b>												
7	77	0	0	7	0	0	1	0	0	8	0	100
7	84	1	0	5	0	0	1	0	0	15	0	113
5	72	0	0	2	0	0	1	0	0	13	0	93
8	132	0	0	2	0	0	1	0	0	9	0	152
12	124	0	0	2	0	0	0	0	0	12	0	150
9	114	2	1	6	0	0	0	0	0	9	0	141
9	94	3	0	2	0	0	0	0	0	6	0	114
8	69	2	0	6	0	0	0	0	0	4	0	89
65	766	8	1	32	0	0	4	0	0	76	0	952
<b>WEST LEG</b>												
0	176	5	0	3	0	0	1	0	0	8	0	193
0	198	1	0	10	0	0	0	0	0	15	0	224
0	138	4	0	5	0	0	1	0	0	12	0	160
0	130	6	0	5	0	0	3	0	0	10	0	154
0	113	6	0	5	0	0	0	0	0	13	0	137
2	158	4	0	7	0	0	3	0	0	14	0	188
1	168	4	0	6	0	0	3	0	0	14	0	196
3	144	2	0	3	0	0	3	0	0	6	0	161
6	1225	32	0	44	0	0	14	0	0	92	0	1413

**SANBAG CLASSIFICATION SUMMARY**

NORTH-SOUTH STREET : PACOIMA RD VICTORVILLE  
 EAST-WEST STREET : BEAR VALLEY RD 08-18-21  
 BEGINNING TIME : 04:00PM

AUTOS			LARGE 2 AXLE			3 AXLE			4 (+) AXLE			TOTALS
RT	THRU	LT	RT	THRU	LT	RT	THRU	LT	RT	THRU	LT	
NORTH LEG												
5	0	21	0	0	0	0	0	0	0	0	0	26
7	0	13	0	0	0	0	0	0	0	0	0	20
2	2	28	0	0	0	0	0	0	0	0	0	32
5	0	31	0	0	0	0	0	0	0	0	0	36
7	0	19	0	0	0	0	0	0	0	0	0	26
8	0	12	0	0	0	0	0	0	0	0	0	20
9	1	11	0	0	0	0	0	0	0	0	0	21
4	1	19	0	0	0	0	0	0	0	0	0	24
47	4	154	0	0	0	0	0	0	0	0	0	205
SOUTH LEG												
2	0	1	0	0	0	0	0	0	0	0	0	3
3	0	5	0	0	0	0	0	0	0	0	0	8
6	1	3	0	0	0	0	0	0	0	0	0	10
1	0	1	0	0	0	0	0	0	0	0	0	2
1	0	2	1	0	0	0	0	0	0	0	0	4
0	0	0	0	0	0	0	0	0	0	0	0	0
1	1	3	0	0	0	0	0	0	0	0	0	5
0	0	0	0	0	0	0	0	0	0	0	0	0
14	2	15	1	0	0	0	0	0	0	0	0	32
EAST LEG												
14	92	2	0	3	0	0	0	0	0	1	0	112
22	120	5	0	1	0	0	0	0	0	2	0	150
19	168	2	0	1	0	0	1	0	0	2	0	193
16	144	1	0	2	0	0	0	0	0	1	0	164
21	91	8	0	1	0	0	0	0	0	2	0	123
20	141	4	0	0	0	0	1	0	0	3	0	169
22	182	4	0	1	0	0	1	0	0	1	0	211
12	101	6	0	0	0	0	0	0	0	2	0	121
146	1039	32	0	9	0	0	3	0	0	14	0	1243
WEST LEG												
0	195	0	0	1	0	0	3	0	0	2	0	201
0	130	0	0	2	0	0	2	0	0	5	0	139
1	108	5	0	1	0	0	3	0	0	3	0	121
2	168	5	0	1	0	0	0	0	0	1	0	177
1	150	1	0	1	0	0	0	0	0	1	0	154
0	212	5	0	1	0	0	0	0	0	1	0	219
0	225	1	0	1	0	0	1	0	0	5	0	233
0	134	2	0	3	0	0	1	0	0	3	0	143
4	1322	19	0	11	0	0	10	0	0	21	0	1387

SANBAG CLASSIFICATION SUMMARY

NORTH-SOUTH STREET : AMETHYST RD      VICTORVILLE

EAST-WEST STREET : SIERRA RD      08-18-21

BEGINNING TIME : 07:00AM

AUTOS			LARGE 2 AXLE			3 AXLE			4 (+) AXLE			TOTALS
RT	THRU	LT	RT	THRU	LT	RT	THRU	LT	RT	THRU	LT	
NORTH LEG												
0	13	0	0	0	0	0	1	0	0	0	0	14
0	21	0	0	2	0	0	1	0	0	1	0	25
0	12	0	0	1	0	0	1	0	0	0	0	14
2	20	0	0	1	0	0	1	0	0	0	0	24
0	11	0	0	2	0	0	1	0	1	2	0	17
0	28	0	0	0	0	0	1	0	0	1	0	30
0	30	0	0	0	0	0	2	0	0	8	0	40
0	43	0	0	0	0	0	0	0	0	0	0	43
2	178	0	0	6	0	0	8	0	1	12	0	207
SOUTH LEG												
0	37	0	0	0	0	0	1	0	0	0	0	38
0	72	0	0	4	0	0	2	0	0	2	0	80
0	34	0	0	1	0	0	0	0	0	0	0	35
0	41	0	0	0	0	0	0	0	0	0	0	41
0	74	0	0	1	0	0	1	0	0	1	0	77
0	71	0	0	1	0	0	0	0	0	0	0	72
0	62	0	0	1	0	0	0	0	0	0	0	63
0	70	1	0	0	0	0	0	0	0	0	0	71
0	461	1	0	8	0	0	4	0	0	3	0	477
EAST LEG												
0	0	0	0	0	0	0	0	0	0	0	0	0
0	0	0	0	0	0	0	0	0	0	0	0	0
0	0	0	0	0	0	0	0	0	0	0	0	0
0	0	0	0	0	0	0	0	0	0	0	0	0
0	0	0	0	0	0	0	0	0	0	0	0	0
0	0	0	0	0	0	0	0	0	0	0	0	0
0	0	0	0	0	0	0	0	0	0	0	0	0
0	0	0	0	0	0	0	0	0	0	0	0	0
0	0	0	0	0	0	0	0	0	0	0	0	0
WEST LEG												
0	0	2	0	0	0	0	0	0	0	0	0	2
1	0	2	0	0	1	0	0	0	0	0	0	4
1	0	7	0	0	0	0	0	0	0	0	0	8
0	0	3	0	0	0	0	0	0	0	0	0	3
1	0	1	0	0	0	0	0	0	0	0	0	2
0	0	0	0	0	0	0	0	0	0	0	0	0
0	0	0	0	0	1	0	0	0	0	0	0	1
0	0	0	0	0	0	0	0	0	0	0	0	0
3	0	15	0	0	2	0	0	0	0	0	0	20

SANBAG CLASSIFICATION SUMMARY  
 NORTH-SOUTH STREET : AMETHYST RD  
 EAST-WEST STREET : SIERRA RD  
 BEGINNING TIME : 04:00PM

VICTORVILLE  
 08-18-21

AUTOS			LARGE 2 AXLE			3 AXLE			4 (+) AXLE			TOTALS
RT	THRU	LT	RT	THRU	LT	RT	THRU	LT	RT	THRU	LT	
NORTH LEG												
4	66	0	0	0	0	0	0	0	0	0	0	70
5	84	0	0	0	0	0	0	0	0	0	0	89
8	49	0	0	1	0	0	0	0	0	1	0	59
3	55	0	0	0	0	0	0	0	0	0	0	58
0	96	0	0	1	0	0	1	0	0	1	0	99
2	76	0	0	0	0	0	0	0	0	0	0	78
2	73	0	0	0	0	0	0	0	0	0	0	75
1	56	0	0	0	0	0	0	0	0	0	0	57
25	555	0	0	2	0	0	1	0	0	2	0	585
SOUTH LEG												
0	22	0	0	0	0	0	0	0	0	0	0	22
0	23	0	0	0	0	0	1	0	0	1	0	25
0	29	1	0	1	0	0	0	0	0	0	0	31
0	21	0	0	1	0	0	0	0	0	0	0	22
0	51	0	0	0	0	0	0	0	0	0	0	51
0	44	0	0	0	0	0	0	0	0	0	0	44
0	38	0	0	0	0	0	0	0	0	0	0	38
0	25	0	0	0	0	0	0	0	0	0	0	25
0	253	1	0	2	0	0	1	0	0	1	0	258
EAST LEG												
0	0	0	0	0	0	0	0	0	0	0	0	0
0	0	0	0	0	0	0	0	0	0	0	0	0
0	0	0	0	0	0	0	0	0	0	0	0	0
0	0	0	0	0	0	0	0	0	0	0	0	0
0	0	0	0	0	0	0	0	0	0	0	0	0
0	0	0	0	0	0	0	0	0	0	0	0	0
0	0	0	0	0	0	0	0	0	0	0	0	0
0	0	0	0	0	0	0	0	0	0	0	0	0
0	0	0	0	0	0	0	0	0	0	0	0	0
WEST LEG												
0	0	7	0	0	0	0	0	0	0	0	0	7
0	0	7	0	0	0	0	0	0	0	0	0	7
1	0	2	0	0	0	0	0	0	0	0	0	3
1	0	4	0	0	0	0	0	0	0	0	0	5
0	0	2	0	0	1	0	0	0	0	0	0	3
0	0	5	0	0	0	0	0	0	0	0	0	5
3	0	5	0	0	0	0	0	0	0	0	0	8
0	0	3	0	0	0	0	0	0	0	0	0	3
5	0	35	0	0	1	0	0	0	0	0	0	41



## Appendix B: Intersection Capacity Analysis Calculations

SUBJECT	BY	DATE	JOB NO.	SHEET	OF
TURN MOVEMENTS	TM	8-Sep-21	HIGP0000-0002	1	OF 2

E/W STREET : BEAR VALLEY RD  
N/S STREET : AMETHYST RD  
CONDITION : AM PEAK HOUR

INTERSECTION : 1  
PROJECTED GROWTH : 3.5%  
PER YEAR :

### CONDITION DIAGRAMS

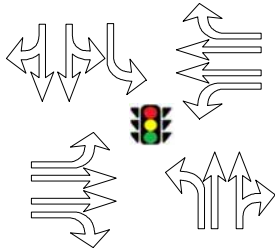

**EXISTING GEOMETRICS**

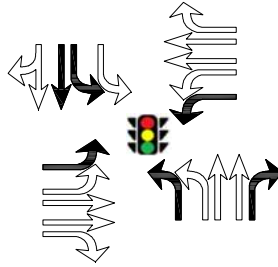

**PROJECT GEOMETRICS**

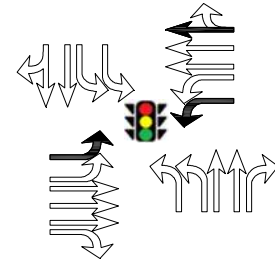

**ULTIMATE GEOMETRICS**

### TURN MOVEMENTS

Condition	Existing Condition	Project Trips	Existing + Project Condition	Year 2023 Ambient Growth	Background Condition	Project Condition	Year 2033 Ambient Growth	Future Condition	Future + Project Condition
Scenario #	1		3		5	7		9	11

### BEAR VALLEY RD

EB LEFT	78	0	78	5	83	83	2	85	85
EB THRU	586	24	610	41	627	651	14	641	665
EB RIGHT	5	12	17	0	5	17	0	5	17
WB LEFT	78	66	144	5	83	149	2	85	151
WB THRU	349	-18	331	24	373	355	8	381	363
WB RIGHT	99	0	99	7	106	106	2	108	108

### AMETHYST RD

NB LEFT	139	50	189	10	149	199	4	153	203
NB THRU	59	75	134	4	63	138	1	64	139
NB RIGHT	67	0	67	5	72	72	2	74	74
SB LEFT	15	49	64	1	16	65	0	16	65
SB THRU	36	36	72	3	39	75	1	40	76
SB RIGHT	128	0	128	9	137	137	3	140	140
<b>TOTALS</b>	<b>1639</b>	<b>294</b>	<b>1933</b>	<b>114</b>	<b>1753</b>	<b>2047</b>	<b>39</b>	<b>1792</b>	<b>2086</b>



SUBJECT	BY	DATE	JOB NO.	SHEET	OF
TURN VOLUME SUMMARY	TM	8-Sep-21	HIGP0000-0002	2	OF 2

E/W STREET : BEAR VALLEY RD                      N/S STREET : AMETHYST RD  
CONDITION : AM PEAK HOUR                      PHF : 0.97

NORTH LEG											
AUTO			LARGE 2 AXLE			LARGE 3 AXLE			LARGE 4(+) AXLE		
RT	THRU	LT	RT	THRU	LT	RT	THRU	LT	RT	THRU	LT
35	7	1	0	0	1	0	0	0	0	0	0
31	2	2	0	0	0	0	1	0	0	3	0
26	4	6	0	0	0	1	1	1	0	1	0
35	7	2	0	0	1	0	2	1	0	8	0

SOUTH LEG											
AUTO			LARGE 2 AXLE			LARGE 3 AXLE			LARGE 4(+) AXLE		
RT	THRU	LT	RT	THRU	LT	RT	THRU	LT	RT	THRU	LT
35	7	4	0	0	0	0	0	0	0	0	0
12	20	44	1	0	0	0	1	0	0	0	1
17	14	42	0	1	0	0	0	0	0	0	0
0	15	48	2	1	0	0	0	0	0	0	0

EAST LEG											
AUTO			LARGE 2 AXLE			LARGE 3 AXLE			LARGE 4(+) AXLE		
RT	THRU	LT	RT	THRU	LT	RT	THRU	LT	RT	THRU	LT
21	59	15	0	1	0	0	2	1	0	12	0
29	83	13	1	1	0	0	1	0	0	4	0
22	76	24	0	4	0	0	2	0	0	10	0
23	63	22	0	0	0	0	0	0	0	20	0

WEST LEG											
AUTO			LARGE 2 AXLE			LARGE 3 AXLE			LARGE 4(+) AXLE		
RT	THRU	LT	RT	THRU	LT	RT	THRU	LT	RT	THRU	LT
0	146	17	1	0	0	0	0	0	0	22	0
0	102	20	0	5	0	0	1	0	0	5	0
2	114	20	0	0	2	0	0	0	0	10	0
2	123	19	0	0	0	0	0	0	0	11	0

Truck Volumes	Auto Volumes	Totals	Truck Percentage	Balanced Totals
---------------	--------------	--------	------------------	-----------------

**BEAR VALLEY RD**

EB LEFT	2	76	<b>78</b>	<b>3%</b>	<b>78</b>
EB THRU	54	485	<b>539</b>	<b>10%</b>	<b>586</b>
EB RIGHT	1	4	<b>5</b>	<b>20%</b>	<b>5</b>
WB LEFT	1	74	<b>75</b>	<b>1%</b>	<b>78</b>
WB THRU	57	281	<b>338</b>	<b>17%</b>	<b>349</b>
WB RIGHT	1	95	<b>96</b>	<b>1%</b>	<b>99</b>

**AMETHYST RD**

NB LEFT	1	138	<b>139</b>	<b>1%</b>	<b>139</b>
NB THRU	3	56	<b>59</b>	<b>5%</b>	<b>59</b>
NB RIGHT	3	64	<b>67</b>	<b>4%</b>	<b>67</b>
SB LEFT	4	11	<b>15</b>	<b>27%</b>	<b>15</b>
SB THRU	16	20	<b>36</b>	<b>44%</b>	<b>36</b>
SB RIGHT	1	127	<b>128</b>	<b>1%</b>	<b>128</b>



HCM 6th Signalized Intersection Summary  
1: Amethyst Rd & Bear Valley Rd



Movement	EBL	EBT	EBR	WBL	WBT	WBR	NBL	NBT	NBR	SBL	SBT	SBR
Lane Configurations	↗	↑↑	↖	↗	↑↑	↖	↗	↑↑		↗	↖	
Traffic Volume (veh/h)	78	586	5	78	349	99	139	59	67	15	36	128
Future Volume (veh/h)	78	586	5	78	349	99	139	59	67	15	36	128
Initial Q (Qb), veh	0	0	0	0	0	0	0	0	0	0	0	0
Ped-Bike Adj(A_pbT)	1.00		1.00	1.00		1.00	1.00		1.00	1.00		1.00
Parking Bus, Adj	1.00	1.00	1.00	1.00	1.00	1.00	1.00	1.00	1.00	1.00	1.00	1.00
Work Zone On Approach		No			No			No			No	
Adj Sat Flow, veh/h/ln	1856	1752	1604	1885	1648	1885	1885	1826	1841	1500	1248	1885
Adj Flow Rate, veh/h	80	604	5	80	360	102	143	61	69	15	37	132
Peak Hour Factor	0.97	0.97	0.97	0.97	0.97	0.97	0.97	0.97	0.97	0.97	0.97	0.97
Percent Heavy Veh, %	3	10	20	1	17	1	1	5	4	27	44	1
Cap, veh/h	101	1092	446	101	1026	523	249	240	214	505	442	374
Arrive On Green	0.06	0.33	0.33	0.06	0.33	0.33	0.14	0.14	0.14	0.35	0.35	0.35
Sat Flow, veh/h	1767	3328	1359	1795	3131	1598	1795	1735	1547	1428	1248	1058
Grp Volume(v), veh/h	80	604	5	80	360	102	143	61	69	15	37	132
Grp Sat Flow(s),veh/h/ln	1767	1664	1359	1795	1566	1598	1795	1735	1547	1428	1248	1058
Q Serve(g_s), s	5.8	19.4	0.3	5.7	11.4	6.0	9.7	4.1	5.2	0.9	2.6	12.0
Cycle Q Clear(g_c), s	5.8	19.4	0.3	5.7	11.4	6.0	9.7	4.1	5.2	0.9	2.6	12.0
Prop In Lane	1.00		1.00	1.00		1.00	1.00		1.00	1.00		1.00
Lane Grp Cap(c), veh/h	101	1092	446	101	1026	523	249	240	214	505	442	374
V/C Ratio(X)	0.79	0.55	0.01	0.79	0.35	0.19	0.58	0.25	0.32	0.03	0.08	0.35
Avail Cap(c_a), veh/h	163	1092	446	166	1026	523	249	240	214	505	442	374
HCM Platoon Ratio	1.00	1.00	1.00	1.00	1.00	1.00	1.00	1.00	1.00	1.00	1.00	1.00
Upstream Filter(I)	1.00	1.00	1.00	1.00	1.00	1.00	1.00	1.00	1.00	1.00	1.00	1.00
Uniform Delay (d), s/veh	60.5	35.8	29.4	60.6	33.2	31.4	52.4	50.0	50.5	27.4	28.0	31.0
Incr Delay (d2), s/veh	13.0	2.0	0.0	12.7	0.9	0.8	9.3	2.5	3.9	0.1	0.4	2.6
Initial Q Delay(d3),s/veh	0.0	0.0	0.0	0.0	0.0	0.0	0.0	0.0	0.0	0.0	0.0	0.0
%ile BackOfQ(50%),veh/ln	2.9	7.9	0.1	2.9	4.3	2.4	4.9	1.9	2.2	0.3	0.8	3.2
Unsig. Movement Delay, s/veh												
LnGrp Delay(d),s/veh	73.5	37.9	29.5	73.3	34.2	32.2	61.8	52.5	54.4	27.5	28.3	33.6
LnGrp LOS	E	D	C	E	C	C	E	D	D	C	C	C
Approach Vol, veh/h		689			542			273			184	
Approach Delay, s/veh		41.9			39.6			57.9			32.1	
Approach LOS		D			D			E			C	
Timer - Assigned Phs	1	2		4	5	6		8				
Phs Duration (G+Y+Rc), s	11.3	46.7		50.0	11.4	46.6		22.0				
Change Period (Y+Rc), s	4.0	4.0		4.0	4.0	4.0		4.0				
Max Green Setting (Gmax), s	12.0	38.0		46.0	12.0	38.0		18.0				
Max Q Clear Time (g_c+I1), s	7.7	21.4		14.0	7.8	13.4		11.7				
Green Ext Time (p_c), s	0.0	3.3		1.0	0.0	2.4		0.5				

Intersection Summary

HCM 6th Ctrl Delay	42.7
HCM 6th LOS	D

Notes

User approved volume balancing among the lanes for turning movement.

HCM 6th Signalized Intersection Summary  
1: Amethyst Rd & Bear Valley Rd

Synchro 11 Report  
09/03/2021



Movement	EBL	EBT	EBR	WBL	WBT	WBR	NBL	NBT	NBR	SBL	SBT	SBR
Lane Configurations	↗	↗↗	↗	↗	↗↗	↗	↗	↗↗		↗	↗↗	
Traffic Volume (veh/h)	78	610	17	144	331	99	189	134	67	64	72	128
Future Volume (veh/h)	78	610	17	144	331	99	189	134	67	64	72	128
Initial Q (Qb), veh	0	0	0	0	0	0	0	0	0	0	0	0
Ped-Bike Adj(A_pbT)	1.00		1.00	1.00		1.00	1.00		1.00	1.00		1.00
Parking Bus, Adj	1.00	1.00	1.00	1.00	1.00	1.00	1.00	1.00	1.00	1.00	1.00	1.00
Work Zone On Approach		No			No			No			No	
Adj Sat Flow, veh/h/ln	1856	1752	1604	1885	1648	1885	1885	1826	1841	1500	1248	1885
Adj Flow Rate, veh/h	80	629	18	148	341	102	195	138	69	66	74	132
Peak Hour Factor	0.97	0.97	0.97	0.97	0.97	0.97	0.97	0.97	0.97	0.97	0.97	0.97
Percent Heavy Veh, %	3	10	20	1	17	1	1	5	4	27	44	1
Cap, veh/h	101	973	397	166	1026	523	249	316	150	505	442	374
Arrive On Green	0.06	0.29	0.29	0.09	0.33	0.33	0.14	0.14	0.14	0.35	0.35	0.35
Sat Flow, veh/h	1767	3328	1359	1795	3131	1598	1795	2282	1084	1428	1248	1058
Grp Volume(v), veh/h	80	629	18	148	341	102	195	103	104	66	74	132
Grp Sat Flow(s),veh/h/ln	1767	1664	1359	1795	1566	1598	1795	1735	1631	1428	1248	1058
Q Serve(g_s), s	5.8	21.4	1.2	10.6	10.7	6.0	13.6	7.1	7.6	4.1	5.3	12.0
Cycle Q Clear(g_c), s	5.8	21.4	1.2	10.6	10.7	6.0	13.6	7.1	7.6	4.1	5.3	12.0
Prop In Lane	1.00		1.00	1.00		1.00	1.00		0.66	1.00		1.00
Lane Grp Cap(c), veh/h	101	973	397	166	1026	523	249	240	226	505	442	374
V/C Ratio(X)	0.79	0.65	0.05	0.89	0.33	0.19	0.78	0.43	0.46	0.13	0.17	0.35
Avail Cap(c_a), veh/h	163	973	397	166	1026	523	249	240	226	505	442	374
HCM Platoon Ratio	1.00	1.00	1.00	1.00	1.00	1.00	1.00	1.00	1.00	1.00	1.00	1.00
Upstream Filter(I)	1.00	1.00	1.00	1.00	1.00	1.00	1.00	1.00	1.00	1.00	1.00	1.00
Uniform Delay (d), s/veh	60.5	40.1	33.0	58.4	33.0	31.4	54.1	51.3	51.5	28.5	28.8	31.0
Incr Delay (d2), s/veh	13.0	3.3	0.2	40.8	0.9	0.8	21.6	5.5	6.6	0.5	0.8	2.6
Initial Q Delay(d3),s/veh	0.0	0.0	0.0	0.0	0.0	0.0	0.0	0.0	0.0	0.0	0.0	0.0
%ile BackOfQ(50%),veh/ln	2.9	8.9	0.4	6.6	4.0	2.4	7.5	3.4	3.5	1.4	1.7	3.2
Unsig. Movement Delay, s/veh												
LnGrp Delay(d),s/veh	73.5	43.5	33.2	99.2	33.9	32.2	75.7	56.8	58.1	29.0	29.7	33.6
LnGrp LOS	E	D	C	F	C	C	E	E	E	C	C	C
Approach Vol, veh/h		727			591			402			272	
Approach Delay, s/veh		46.5			49.9			66.3			31.4	
Approach LOS		D			D			E			C	
Timer - Assigned Phs	1	2		4	5	6		8				
Phs Duration (G+Y+Rc), s	16.0	42.0		50.0	11.4	46.6		22.0				
Change Period (Y+Rc), s	4.0	4.0		4.0	4.0	4.0		4.0				
Max Green Setting (Gmax), s	12.0	38.0		46.0	12.0	38.0		18.0				
Max Q Clear Time (g_c+I1), s	12.6	23.4		14.0	7.8	12.7		15.6				
Green Ext Time (p_c), s	0.0	3.3		1.4	0.0	2.3		0.4				

Intersection Summary

HCM 6th Ctrl Delay	49.5
HCM 6th LOS	D

Notes

User approved volume balancing among the lanes for turning movement.

HCM 6th Signalized Intersection Summary  
1: Amethyst Rd & Bear Valley Rd



Movement	EBL	EBT	EBR	WBL	WBT	WBR	NBL	NBT	NBR	SBL	SBT	SBR
Lane Configurations	↗↘	↕	↖	↗↘	↕	↖	↗↘	↕	↖	↗↘	↕	↖
Traffic Volume (veh/h)	78	610	17	144	331	99	189	134	67	64	72	128
Future Volume (veh/h)	78	610	17	144	331	99	189	134	67	64	72	128
Initial Q (Qb), veh	0	0	0	0	0	0	0	0	0	0	0	0
Ped-Bike Adj(A_pbT)	1.00		1.00	1.00		1.00	1.00		1.00	1.00		1.00
Parking Bus, Adj	1.00	1.00	1.00	1.00	1.00	1.00	1.00	1.00	1.00	1.00	1.00	1.00
Work Zone On Approach		No			No			No			No	
Adj Sat Flow, veh/h/ln	1856	1752	1604	1885	1648	1885	1885	1826	1841	1500	1248	1885
Adj Flow Rate, veh/h	80	629	18	148	341	102	195	138	69	66	74	132
Peak Hour Factor	0.97	0.97	0.97	0.97	0.97	0.97	0.97	0.97	0.97	0.97	0.97	0.97
Percent Heavy Veh, %	3	10	20	1	17	1	1	5	4	27	44	1
Cap, veh/h	125	1114	455	201	1114	568	455	454	204	981	419	374
Arrive On Green	0.04	0.33	0.33	0.06	0.36	0.36	0.13	0.13	0.13	0.35	0.35	0.35
Sat Flow, veh/h	3428	3328	1359	3483	3131	1598	3483	3469	1560	2771	1186	1058
Grp Volume(v), veh/h	80	629	18	148	341	102	195	138	69	66	74	132
Grp Sat Flow(s),veh/h/ln	1714	1664	1359	1742	1566	1598	1742	1735	1560	1386	1186	1058
Q Serve(g_s), s	3.0	20.2	1.2	5.4	10.2	5.7	6.7	4.7	5.2	2.0	5.6	12.0
Cycle Q Clear(g_c), s	3.0	20.2	1.2	5.4	10.2	5.7	6.7	4.7	5.2	2.0	5.6	12.0
Prop In Lane	1.00		1.00	1.00		1.00	1.00		1.00	1.00		1.00
Lane Grp Cap(c), veh/h	125	1114	455	201	1114	568	455	454	204	981	419	374
V/C Ratio(X)	0.64	0.56	0.04	0.74	0.31	0.18	0.43	0.30	0.34	0.07	0.18	0.35
Avail Cap(c_a), veh/h	185	1114	455	268	1114	568	455	454	204	981	419	374
HCM Platoon Ratio	1.00	1.00	1.00	1.00	1.00	1.00	1.00	1.00	1.00	1.00	1.00	1.00
Upstream Filter(I)	1.00	1.00	1.00	1.00	1.00	1.00	1.00	1.00	1.00	1.00	1.00	1.00
Uniform Delay (d), s/veh	61.8	35.5	29.2	60.3	30.3	28.8	52.0	51.1	51.4	27.8	28.9	31.0
Incr Delay (d2), s/veh	5.3	2.1	0.2	7.1	0.7	0.7	2.9	1.7	4.4	0.1	0.9	2.6
Initial Q Delay(d3),s/veh	0.0	0.0	0.0	0.0	0.0	0.0	0.0	0.0	0.0	0.0	0.0	0.0
%ile BackOfQ(50%),veh/ln	1.4	8.2	0.4	2.5	3.8	2.3	3.1	2.1	2.3	0.7	1.7	3.2
Unsig. Movement Delay, s/veh												
LnGrp Delay(d),s/veh	67.1	37.6	29.3	67.4	31.0	29.5	54.9	52.9	55.8	27.9	29.9	33.6
LnGrp LOS	E	D	C	E	C	C	D	D	E	C	C	C
Approach Vol, veh/h		727			591			402			272	
Approach Delay, s/veh		40.6			39.8			54.4			31.2	
Approach LOS		D			D			D			C	
Timer - Assigned Phs	1	2	3	4	5	6	7	8				
Phs Duration (G+Y+Rc), s	11.5	47.5	21.0	50.0	8.7	50.3	50.0	21.0				
Change Period (Y+Rc), s	4.0	4.0	4.0	4.0	4.0	4.0	4.0	4.0				
Max Green Setting (Gmax), s	10.0	41.0	17.0	46.0	7.0	44.0	46.0	17.0				
Max Q Clear Time (g_c+I1), s	7.4	22.2	8.7	14.0	5.0	12.2	4.0	7.2				
Green Ext Time (p_c), s	0.1	3.7	0.4	1.2	0.0	2.4	0.2	0.6				

Intersection Summary

HCM 6th Ctrl Delay	41.9
HCM 6th LOS	D

HCM 6th Signalized Intersection Summary  
1: Amethyst Rd & Bear Valley Rd



Movement	EBL	EBT	EBR	WBL	WBT	WBR	NBL	NBT	NBR	SBL	SBT	SBR
Lane Configurations	↘	↑↑	↗	↘	↑↑	↗	↘	↑↑		↘	↑↑	
Traffic Volume (veh/h)	83	627	5	83	373	106	149	63	72	16	39	137
Future Volume (veh/h)	83	627	5	83	373	106	149	63	72	16	39	137
Initial Q (Qb), veh	0	0	0	0	0	0	0	0	0	0	0	0
Ped-Bike Adj(A_pbT)	1.00		1.00	1.00		1.00	1.00		1.00	1.00		1.00
Parking Bus, Adj	1.00	1.00	1.00	1.00	1.00	1.00	1.00	1.00	1.00	1.00	1.00	1.00
Work Zone On Approach		No			No			No			No	
Adj Sat Flow, veh/h/ln	1856	1752	1604	1885	1648	1885	1885	1826	1841	1500	1248	1885
Adj Flow Rate, veh/h	86	646	5	86	385	109	154	65	74	16	40	141
Peak Hour Factor	0.97	0.97	0.97	0.97	0.97	0.97	0.97	0.97	0.97	0.97	0.97	0.97
Percent Heavy Veh, %	3	10	20	1	17	1	1	5	4	27	44	1
Cap, veh/h	108	1080	441	108	1014	517	249	240	214	505	442	374
Arrive On Green	0.06	0.32	0.32	0.06	0.32	0.32	0.14	0.14	0.14	0.35	0.35	0.35
Sat Flow, veh/h	1767	3328	1359	1795	3131	1598	1795	1735	1547	1428	1248	1058
Grp Volume(v), veh/h	86	646	5	86	385	109	154	65	74	16	40	141
Grp Sat Flow(s),veh/h/ln	1767	1664	1359	1795	1566	1598	1795	1735	1547	1428	1248	1058
Q Serve(g_s), s	6.2	21.2	0.3	6.1	12.3	6.4	10.5	4.4	5.6	1.0	2.8	12.9
Cycle Q Clear(g_c), s	6.2	21.2	0.3	6.1	12.3	6.4	10.5	4.4	5.6	1.0	2.8	12.9
Prop In Lane	1.00		1.00	1.00		1.00	1.00		1.00	1.00		1.00
Lane Grp Cap(c), veh/h	108	1080	441	108	1014	517	249	240	214	505	442	374
V/C Ratio(X)	0.80	0.60	0.01	0.80	0.38	0.21	0.62	0.27	0.35	0.03	0.09	0.38
Avail Cap(c_a), veh/h	163	1080	441	166	1014	517	249	240	214	505	442	374
HCM Platoon Ratio	1.00	1.00	1.00	1.00	1.00	1.00	1.00	1.00	1.00	1.00	1.00	1.00
Upstream Filter(I)	1.00	1.00	1.00	1.00	1.00	1.00	1.00	1.00	1.00	1.00	1.00	1.00
Uniform Delay (d), s/veh	60.3	36.8	29.8	60.3	33.9	31.9	52.8	50.1	50.7	27.4	28.0	31.3
Incr Delay (d2), s/veh	14.7	2.4	0.0	13.8	1.1	0.9	11.1	2.8	4.4	0.1	0.4	2.9
Initial Q Delay(d3),s/veh	0.0	0.0	0.0	0.0	0.0	0.0	0.0	0.0	0.0	0.0	0.0	0.0
%ile BackOfQ(50%),veh/ln	3.2	8.6	0.1	3.1	4.7	2.5	5.4	2.0	2.4	0.3	0.9	3.5
Unsig. Movement Delay, s/veh												
LnGrp Delay(d),s/veh	75.0	39.3	29.8	74.1	35.0	32.8	63.8	52.9	55.0	27.6	28.4	34.2
LnGrp LOS	E	D	C	E	C	C	E	D	E	C	C	C
Approach Vol, veh/h		737			580			293			197	
Approach Delay, s/veh		43.4			40.4			59.2			32.5	
Approach LOS		D			D			E			C	
Timer - Assigned Phs	1	2		4	5	6		8				
Phs Duration (G+Y+Rc), s	11.8	46.2		50.0	11.9	46.1		22.0				
Change Period (Y+Rc), s	4.0	4.0		4.0	4.0	4.0		4.0				
Max Green Setting (Gmax), s	12.0	38.0		46.0	12.0	38.0		18.0				
Max Q Clear Time (g_c+I1), s	8.1	23.2		14.9	8.2	14.3		12.5				
Green Ext Time (p_c), s	0.0	3.4		1.1	0.0	2.6		0.5				

Intersection Summary

HCM 6th Ctrl Delay	43.8
HCM 6th LOS	D

Notes

User approved volume balancing among the lanes for turning movement.

HCM 6th Signalized Intersection Summary  
1: Amethyst Rd & Bear Valley Rd



Movement	EBL	EBT	EBR	WBL	WBT	WBR	NBL	NBT	NBR	SBL	SBT	SBR
Lane Configurations	↗	↑↑	↖	↗	↑↑	↖	↗	↑↑		↗	↖	
Traffic Volume (veh/h)	83	651	17	149	355	106	199	138	72	65	75	137
Future Volume (veh/h)	83	651	17	149	355	106	199	138	72	65	75	137
Initial Q (Qb), veh	0	0	0	0	0	0	0	0	0	0	0	0
Ped-Bike Adj(A_pbT)	1.00		1.00	1.00		1.00	1.00		1.00	1.00		1.00
Parking Bus, Adj	1.00	1.00	1.00	1.00	1.00	1.00	1.00	1.00	1.00	1.00	1.00	1.00
Work Zone On Approach		No			No			No			No	
Adj Sat Flow, veh/h/ln	1856	1752	1604	1885	1648	1885	1885	1826	1841	1500	1248	1885
Adj Flow Rate, veh/h	86	671	18	154	366	109	205	142	74	67	77	141
Peak Hour Factor	0.97	0.97	0.97	0.97	0.97	0.97	0.97	0.97	0.97	0.97	0.97	0.97
Percent Heavy Veh, %	3	10	20	1	17	1	1	5	4	27	44	1
Cap, veh/h	108	973	397	166	1014	517	249	311	154	505	442	374
Arrive On Green	0.06	0.29	0.29	0.09	0.32	0.32	0.14	0.14	0.14	0.35	0.35	0.35
Sat Flow, veh/h	1767	3328	1359	1795	3131	1598	1795	2249	1112	1428	1248	1058
Grp Volume(v), veh/h	86	671	18	154	366	109	205	108	108	67	77	141
Grp Sat Flow(s),veh/h/ln	1767	1664	1359	1795	1566	1598	1795	1735	1626	1428	1248	1058
Q Serve(g_s), s	6.2	23.2	1.2	11.1	11.6	6.4	14.4	7.4	8.0	4.1	5.5	12.9
Cycle Q Clear(g_c), s	6.2	23.2	1.2	11.1	11.6	6.4	14.4	7.4	8.0	4.1	5.5	12.9
Prop In Lane	1.00		1.00	1.00		1.00	1.00		0.68	1.00		1.00
Lane Grp Cap(c), veh/h	108	973	397	166	1014	517	249	240	225	505	442	374
V/C Ratio(X)	0.80	0.69	0.05	0.93	0.36	0.21	0.82	0.45	0.48	0.13	0.17	0.38
Avail Cap(c_a), veh/h	163	973	397	166	1014	517	249	240	225	505	442	374
HCM Platoon Ratio	1.00	1.00	1.00	1.00	1.00	1.00	1.00	1.00	1.00	1.00	1.00	1.00
Upstream Filter(I)	1.00	1.00	1.00	1.00	1.00	1.00	1.00	1.00	1.00	1.00	1.00	1.00
Uniform Delay (d), s/veh	60.3	40.8	33.0	58.6	33.7	31.9	54.5	51.4	51.7	28.5	28.9	31.3
Incr Delay (d2), s/veh	14.7	4.0	0.2	49.6	1.0	0.9	25.7	6.0	7.2	0.5	0.9	2.9
Initial Q Delay(d3),s/veh	0.0	0.0	0.0	0.0	0.0	0.0	0.0	0.0	0.0	0.0	0.0	0.0
%ile BackOfQ(50%),veh/ln	3.2	9.7	0.4	7.2	4.4	2.5	8.1	3.6	3.6	1.5	1.7	3.5
Unsig. Movement Delay, s/veh												
LnGrp Delay(d),s/veh	75.0	44.8	33.2	108.2	34.7	32.8	80.2	57.4	58.9	29.0	29.8	34.2
LnGrp LOS	E	D	C	F	C	C	F	E	E	C	C	C
Approach Vol, veh/h		775			629			421			285	
Approach Delay, s/veh		47.9			52.3			68.9			31.8	
Approach LOS		D			D			E			C	
Timer - Assigned Phs	1	2		4	5	6		8				
Phs Duration (G+Y+Rc), s	16.0	42.0		50.0	11.9	46.1		22.0				
Change Period (Y+Rc), s	4.0	4.0		4.0	4.0	4.0		4.0				
Max Green Setting (Gmax), s	12.0	38.0		46.0	12.0	38.0		18.0				
Max Q Clear Time (g_c+I1), s	13.1	25.2		14.9	8.2	13.6		16.4				
Green Ext Time (p_c), s	0.0	3.3		1.5	0.0	2.5		0.3				

Intersection Summary

HCM 6th Ctrl Delay	51.2
HCM 6th LOS	D

Notes

User approved volume balancing among the lanes for turning movement.

HCM 6th Signalized Intersection Summary  
 1: Amethyst Rd & Bear Valley Rd



Movement	EBL	EBT	EBR	WBL	WBT	WBR	NBL	NBT	NBR	SBL	SBT	SBR
Lane Configurations	↖↗	↑↑	↖	↖↗	↑↑	↖	↖↗	↑↑	↖	↖↗	↑↘	
Traffic Volume (veh/h)	83	651	17	149	355	106	199	138	72	65	75	137
Future Volume (veh/h)	83	651	17	149	355	106	199	138	72	65	75	137
Initial Q (Qb), veh	0	0	0	0	0	0	0	0	0	0	0	0
Ped-Bike Adj(A_pbT)	1.00		1.00	1.00		1.00	1.00		1.00	1.00		1.00
Parking Bus, Adj	1.00	1.00	1.00	1.00	1.00	1.00	1.00	1.00	1.00	1.00	1.00	1.00
Work Zone On Approach		No			No			No			No	
Adj Sat Flow, veh/h/ln	1856	1752	1604	1885	1648	1885	1885	1826	1841	1500	1248	1885
Adj Flow Rate, veh/h	86	671	18	154	366	109	205	142	74	67	77	141
Peak Hour Factor	0.97	0.97	0.97	0.97	0.97	0.97	0.97	0.97	0.97	0.97	0.97	0.97
Percent Heavy Veh, %	3	10	20	1	17	1	1	5	4	27	44	1
Cap, veh/h	132	1134	463	207	1132	577	429	427	192	981	419	374
Arrive On Green	0.04	0.34	0.34	0.06	0.36	0.36	0.12	0.12	0.12	0.35	0.35	0.35
Sat Flow, veh/h	3428	3328	1359	3483	3131	1598	3483	3469	1560	2771	1186	1058
Grp Volume(v), veh/h	86	671	18	154	366	109	205	142	74	67	77	141
Grp Sat Flow(s),veh/h/ln	1714	1664	1359	1742	1566	1598	1742	1735	1560	1386	1186	1058
Q Serve(g_s), s	3.2	21.6	1.2	5.7	11.0	6.1	7.1	4.9	5.7	2.1	5.8	12.9
Cycle Q Clear(g_c), s	3.2	21.6	1.2	5.7	11.0	6.1	7.1	4.9	5.7	2.1	5.8	12.9
Prop In Lane	1.00		1.00	1.00		1.00	1.00		1.00	1.00		1.00
Lane Grp Cap(c), veh/h	132	1134	463	207	1132	577	429	427	192	981	419	374
V/C Ratio(X)	0.65	0.59	0.04	0.74	0.32	0.19	0.48	0.33	0.39	0.07	0.18	0.38
Avail Cap(c_a), veh/h	185	1134	463	268	1132	577	429	427	192	981	419	374
HCM Platoon Ratio	1.00	1.00	1.00	1.00	1.00	1.00	1.00	1.00	1.00	1.00	1.00	1.00
Upstream Filter(I)	1.00	1.00	1.00	1.00	1.00	1.00	1.00	1.00	1.00	1.00	1.00	1.00
Uniform Delay (d), s/veh	61.6	35.4	28.6	60.2	30.0	28.4	53.1	52.1	52.5	27.8	29.0	31.3
Incr Delay (d2), s/veh	5.3	2.3	0.2	7.9	0.8	0.7	3.8	2.1	5.8	0.1	1.0	2.9
Initial Q Delay(d3),s/veh	0.0	0.0	0.0	0.0	0.0	0.0	0.0	0.0	0.0	0.0	0.0	0.0
%ile BackOfQ(50%),veh/ln	1.5	8.8	0.4	2.7	4.1	2.4	3.3	2.2	2.5	0.7	1.7	3.5
Unsig. Movement Delay, s/veh												
LnGrp Delay(d),s/veh	66.9	37.7	28.8	68.1	30.8	29.2	56.9	54.2	58.2	27.9	30.0	34.2
LnGrp LOS	E	D	C	E	C	C	E	D	E	C	C	C
Approach Vol, veh/h		775			629			421			285	
Approach Delay, s/veh		40.7			39.6			56.2			31.6	
Approach LOS		D			D			E			C	
Timer - Assigned Phs	1	2	3	4	5	6	7	8				
Phs Duration (G+Y+Rc), s	11.7	48.3	20.0	50.0	9.0	51.0	50.0	20.0				
Change Period (Y+Rc), s	4.0	4.0	4.0	4.0	4.0	4.0	4.0	4.0				
Max Green Setting (Gmax), s	10.0	42.0	16.0	46.0	7.0	45.0	46.0	16.0				
Max Q Clear Time (g_c+I1), s	7.7	23.6	9.1	14.9	5.2	13.0	4.1	7.7				
Green Ext Time (p_c), s	0.1	3.9	0.3	1.3	0.0	2.6	0.2	0.6				

Intersection Summary

HCM 6th Ctrl Delay	42.3
HCM 6th LOS	D

HCM 6th Signalized Intersection Summary  
1: Amethyst Rd & Bear Valley Rd



Movement	EBL	EBT	EBR	WBL	WBT	WBR	NBL	NBT	NBR	SBL	SBT	SBR
Lane Configurations	↘	↑↑	↗	↘	↑↑	↗	↘	↑↑		↘	↑↑	
Traffic Volume (veh/h)	85	641	5	85	381	108	153	64	74	16	40	140
Future Volume (veh/h)	85	641	5	85	381	108	153	64	74	16	40	140
Initial Q (Qb), veh	0	0	0	0	0	0	0	0	0	0	0	0
Ped-Bike Adj(A_pbT)	1.00		1.00	1.00		1.00	1.00		1.00	1.00		1.00
Parking Bus, Adj	1.00	1.00	1.00	1.00	1.00	1.00	1.00	1.00	1.00	1.00	1.00	1.00
Work Zone On Approach		No			No			No			No	
Adj Sat Flow, veh/h/ln	1856	1752	1604	1885	1648	1885	1885	1826	1841	1500	1248	1885
Adj Flow Rate, veh/h	88	661	5	88	393	111	158	66	76	16	41	144
Peak Hour Factor	0.97	0.97	0.97	0.97	0.97	0.97	0.97	0.97	0.97	0.97	0.97	0.97
Percent Heavy Veh, %	3	10	20	1	17	1	1	5	4	27	44	1
Cap, veh/h	110	1076	439	110	1010	515	249	240	214	505	442	374
Arrive On Green	0.06	0.32	0.32	0.06	0.32	0.32	0.14	0.14	0.14	0.35	0.35	0.35
Sat Flow, veh/h	1767	3328	1359	1795	3131	1598	1795	1735	1547	1428	1248	1058
Grp Volume(v), veh/h	88	661	5	88	393	111	158	66	76	16	41	144
Grp Sat Flow(s),veh/h/ln	1767	1664	1359	1795	1566	1598	1795	1735	1547	1428	1248	1058
Q Serve(g_s), s	6.4	21.8	0.3	6.3	12.6	6.6	10.8	4.4	5.8	1.0	2.9	13.2
Cycle Q Clear(g_c), s	6.4	21.8	0.3	6.3	12.6	6.6	10.8	4.4	5.8	1.0	2.9	13.2
Prop In Lane	1.00		1.00	1.00		1.00	1.00		1.00	1.00		1.00
Lane Grp Cap(c), veh/h	110	1076	439	110	1010	515	249	240	214	505	442	374
V/C Ratio(X)	0.80	0.61	0.01	0.80	0.39	0.22	0.64	0.27	0.35	0.03	0.09	0.38
Avail Cap(c_a), veh/h	163	1076	439	166	1010	515	249	240	214	505	442	374
HCM Platoon Ratio	1.00	1.00	1.00	1.00	1.00	1.00	1.00	1.00	1.00	1.00	1.00	1.00
Upstream Filter(I)	1.00	1.00	1.00	1.00	1.00	1.00	1.00	1.00	1.00	1.00	1.00	1.00
Uniform Delay (d), s/veh	60.2	37.2	29.9	60.2	34.1	32.1	52.9	50.2	50.7	27.4	28.1	31.4
Incr Delay (d2), s/veh	15.6	2.6	0.0	14.6	1.1	1.0	11.8	2.8	4.5	0.1	0.4	3.0
Initial Q Delay(d3),s/veh	0.0	0.0	0.0	0.0	0.0	0.0	0.0	0.0	0.0	0.0	0.0	0.0
%ile BackOfQ(50%),veh/ln	3.3	8.9	0.1	3.2	4.8	2.6	5.6	2.1	2.5	0.3	0.9	3.6
Unsig. Movement Delay, s/veh												
LnGrp Delay(d),s/veh	75.7	39.8	29.9	74.8	35.3	33.0	64.7	53.0	55.3	27.6	28.5	34.4
LnGrp LOS	E	D	C	E	D	C	E	D	E	C	C	C
Approach Vol, veh/h		754			592			300			201	
Approach Delay, s/veh		43.9			40.7			59.7			32.6	
Approach LOS		D			D			E			C	
Timer - Assigned Phs	1	2		4	5	6		8				
Phs Duration (G+Y+Rc), s	12.0	46.0		50.0	12.1	45.9		22.0				
Change Period (Y+Rc), s	4.0	4.0		4.0	4.0	4.0		4.0				
Max Green Setting (Gmax), s	12.0	38.0		46.0	12.0	38.0		18.0				
Max Q Clear Time (g_c+I1), s	8.3	23.8		15.2	8.4	14.6		12.8				
Green Ext Time (p_c), s	0.0	3.4		1.1	0.0	2.6		0.5				

Intersection Summary

HCM 6th Ctrl Delay	44.2
HCM 6th LOS	D

Notes

User approved volume balancing among the lanes for turning movement.

HCM 6th Signalized Intersection Summary  
1: Amethyst Rd & Bear Valley Rd



Movement	EBL	EBT	EBR	WBL	WBT	WBR	NBL	NBT	NBR	SBL	SBT	SBR
Lane Configurations	↘	↗↗	↘	↘	↗↗	↘	↘	↗↗		↘	↗↗	
Traffic Volume (veh/h)	85	665	17	151	363	108	203	139	74	65	76	140
Future Volume (veh/h)	85	665	17	151	363	108	203	139	74	65	76	140
Initial Q (Qb), veh	0	0	0	0	0	0	0	0	0	0	0	0
Ped-Bike Adj(A_pbT)	1.00		1.00	1.00		1.00	1.00		1.00	1.00		1.00
Parking Bus, Adj	1.00	1.00	1.00	1.00	1.00	1.00	1.00	1.00	1.00	1.00	1.00	1.00
Work Zone On Approach		No			No			No			No	
Adj Sat Flow, veh/h/ln	1856	1752	1604	1885	1648	1885	1885	1826	1841	1500	1248	1885
Adj Flow Rate, veh/h	88	686	18	156	374	111	209	143	76	67	78	144
Peak Hour Factor	0.97	0.97	0.97	0.97	0.97	0.97	0.97	0.97	0.97	0.97	0.97	0.97
Percent Heavy Veh, %	3	10	20	1	17	1	1	5	4	27	44	1
Cap, veh/h	110	973	397	166	1010	515	249	309	156	505	442	374
Arrive On Green	0.06	0.29	0.29	0.09	0.32	0.32	0.14	0.14	0.14	0.35	0.35	0.35
Sat Flow, veh/h	1767	3328	1359	1795	3131	1598	1795	2233	1125	1428	1248	1058
Grp Volume(v), veh/h	88	686	18	156	374	111	209	109	110	67	78	144
Grp Sat Flow(s),veh/h/ln	1767	1664	1359	1795	1566	1598	1795	1735	1623	1428	1248	1058
Q Serve(g_s), s	6.4	23.9	1.2	11.2	11.9	6.6	14.8	7.5	8.1	4.1	5.6	13.2
Cycle Q Clear(g_c), s	6.4	23.9	1.2	11.2	11.9	6.6	14.8	7.5	8.1	4.1	5.6	13.2
Prop In Lane	1.00		1.00	1.00		1.00	1.00		0.69	1.00		1.00
Lane Grp Cap(c), veh/h	110	973	397	166	1010	515	249	240	225	505	442	374
V/C Ratio(X)	0.80	0.71	0.05	0.94	0.37	0.22	0.84	0.46	0.49	0.13	0.18	0.38
Avail Cap(c_a), veh/h	163	973	397	166	1010	515	249	240	225	505	442	374
HCM Platoon Ratio	1.00	1.00	1.00	1.00	1.00	1.00	1.00	1.00	1.00	1.00	1.00	1.00
Upstream Filter(I)	1.00	1.00	1.00	1.00	1.00	1.00	1.00	1.00	1.00	1.00	1.00	1.00
Uniform Delay (d), s/veh	60.2	41.0	33.0	58.6	33.9	32.1	54.6	51.5	51.7	28.5	28.9	31.4
Incr Delay (d2), s/veh	15.6	4.3	0.2	52.8	1.0	1.0	27.6	6.1	7.4	0.5	0.9	3.0
Initial Q Delay(d3),s/veh	0.0	0.0	0.0	0.0	0.0	0.0	0.0	0.0	0.0	0.0	0.0	0.0
%ile BackOfQ(50%),veh/ln	3.3	10.0	0.4	7.4	4.5	2.6	8.4	3.6	3.7	1.5	1.8	3.6
Unsig. Movement Delay, s/veh												
LnGrp Delay(d),s/veh	75.7	45.3	33.2	111.4	34.9	33.0	82.2	57.6	59.1	29.0	29.8	34.4
LnGrp LOS	E	D	C	F	C	C	F	E	E	C	C	C
Approach Vol, veh/h		792			641			428			289	
Approach Delay, s/veh		48.4			53.2			70.0			31.9	
Approach LOS		D			D			E			C	
Timer - Assigned Phs	1	2		4	5	6		8				
Phs Duration (G+Y+Rc), s	16.0	42.0		50.0	12.1	45.9		22.0				
Change Period (Y+Rc), s	4.0	4.0		4.0	4.0	4.0		4.0				
Max Green Setting (Gmax), s	12.0	38.0		46.0	12.0	38.0		18.0				
Max Q Clear Time (g_c+I1), s	13.2	25.9		15.2	8.4	13.9		16.8				
Green Ext Time (p_c), s	0.0	3.3		1.5	0.0	2.5		0.2				

Intersection Summary

HCM 6th Ctrl Delay	51.9
HCM 6th LOS	D

Notes

User approved volume balancing among the lanes for turning movement.



HCM 6th Signalized Intersection Summary  
1: Amethyst Rd & Bear Valley Rd



Movement	EBL	EBT	EBR	WBL	WBT	WBR	NBL	NBT	NBR	SBL	SBT	SBR
Lane Configurations	↖↗	↑↑↑	↖	↖↗	↑↑↑		↖↗	↑↑	↖	↖↗	↑↘	
Traffic Volume (veh/h)	85	665	17	151	363	108	203	139	74	65	76	140
Future Volume (veh/h)	85	665	17	151	363	108	203	139	74	65	76	140
Initial Q (Qb), veh	0	0	0	0	0	0	0	0	0	0	0	0
Ped-Bike Adj(A_pbT)	1.00		1.00	1.00		1.00	1.00		1.00	1.00		1.00
Parking Bus, Adj	1.00	1.00	1.00	1.00	1.00	1.00	1.00	1.00	1.00	1.00	1.00	1.00
Work Zone On Approach		No			No			No			No	
Adj Sat Flow, veh/h/ln	1856	1752	1604	1885	1648	1885	1885	1826	1841	1500	1248	1885
Adj Flow Rate, veh/h	88	686	18	156	374	111	209	143	76	67	78	144
Peak Hour Factor	0.97	0.97	0.97	0.97	0.97	0.97	0.97	0.97	0.97	0.97	0.97	0.97
Percent Heavy Veh, %	3	10	20	1	17	1	1	5	4	27	44	1
Cap, veh/h	134	1587	451	211	1229	349	455	454	204	981	419	374
Arrive On Green	0.04	0.33	0.33	0.06	0.35	0.35	0.13	0.13	0.13	0.35	0.35	0.35
Sat Flow, veh/h	3428	4782	1359	3483	3480	990	3483	3469	1560	2771	1186	1058
Grp Volume(v), veh/h	88	686	18	156	320	165	209	143	76	67	78	144
Grp Sat Flow(s),veh/h/ln	1714	1594	1359	1742	1500	1470	1742	1735	1560	1386	1186	1058
Q Serve(g_s), s	3.3	14.5	1.2	5.7	10.0	10.6	7.2	4.9	5.8	2.1	5.9	13.2
Cycle Q Clear(g_c), s	3.3	14.5	1.2	5.7	10.0	10.6	7.2	4.9	5.8	2.1	5.9	13.2
Prop In Lane	1.00		1.00	1.00		0.67	1.00		1.00	1.00		1.00
Lane Grp Cap(c), veh/h	134	1587	451	211	1059	519	455	454	204	981	419	374
V/C Ratio(X)	0.65	0.43	0.04	0.74	0.30	0.32	0.46	0.32	0.37	0.07	0.19	0.38
Avail Cap(c_a), veh/h	185	1587	451	322	1059	519	455	454	204	981	419	374
HCM Platoon Ratio	1.00	1.00	1.00	1.00	1.00	1.00	1.00	1.00	1.00	1.00	1.00	1.00
Upstream Filter(I)	1.00	1.00	1.00	1.00	1.00	1.00	1.00	1.00	1.00	1.00	1.00	1.00
Uniform Delay (d), s/veh	61.6	33.9	29.4	60.1	30.5	30.6	52.2	51.2	51.6	27.8	29.0	31.4
Incr Delay (d2), s/veh	5.3	0.9	0.2	5.1	0.7	1.6	3.3	1.8	5.1	0.1	1.0	3.0
Initial Q Delay(d3),s/veh	0.0	0.0	0.0	0.0	0.0	0.0	0.0	0.0	0.0	0.0	0.0	0.0
%ile BackOfQ(50%),veh/ln	1.5	5.6	0.4	2.6	3.6	3.9	3.3	2.2	2.5	0.7	1.8	3.6
Unsig. Movement Delay, s/veh												
LnGrp Delay(d),s/veh	66.9	34.7	29.6	65.1	31.2	32.2	55.6	53.0	56.8	27.9	30.0	34.4
LnGrp LOS	E	C	C	E	C	C	E	D	E	C	C	C
Approach Vol, veh/h		792			641			428			289	
Approach Delay, s/veh		38.2			39.7			54.9			31.7	
Approach LOS		D			D			D			C	
Timer - Assigned Phs	1	2	3	4	5	6	7	8				
Phs Duration (G+Y+Rc), s	11.9	47.1	21.0	50.0	9.1	49.9	50.0	21.0				
Change Period (Y+Rc), s	4.0	4.0	4.0	4.0	4.0	4.0	4.0	4.0				
Max Green Setting (Gmax), s	12.0	39.0	17.0	46.0	7.0	44.0	46.0	17.0				
Max Q Clear Time (g_c+I1), s	7.7	16.5	9.2	15.2	5.3	12.6	4.1	7.8				
Green Ext Time (p_c), s	0.2	4.3	0.4	1.3	0.0	2.9	0.2	0.6				

Intersection Summary

HCM 6th Ctrl Delay	41.1
HCM 6th LOS	D



SUBJECT	BY	DATE	JOB NO.	SHEET	OF
TURN MOVEMENTS	TM	8-Sep-21	HIGP0000-0002	1	OF 2

E/W STREET : BEAR VALLEY RD  
N/S STREET : AMETHYST RD  
CONDITION : PM PEAK HOUR

INTERSECTION : 1  
PROJECTED GROWTH : 3.5%  
PER YEAR :

**TURN MOVEMENTS**

Condition	Existing Condition	Project Trips	Existing + Project Condition	Year 2023 Ambient Growth	Background Condition	Project Condition	Year 2033 Ambient Growth	Future Condition	Future + Project Condition
Scenario #	2		4		6	8		10	12

**BEAR VALLEY RD**

EB LEFT	97	0	97	7	104	104	2	106	106
EB THRU	519	25	544	36	555	580	13	568	593
EB RIGHT	191	13	204	13	204	217	5	209	222
WB LEFT	86	82	168	6	92	174	2	94	176
WB THRU	496	-30	466	35	531	501	12	543	513
WB RIGHT	8	0	8	1	9	9	0	9	9

**AMETHYST RD**

NB LEFT	33	69	102	2	35	104	1	36	105
NB THRU	47	91	138	3	50	141	1	51	142
NB RIGHT	77	0	77	5	82	82	2	84	84
SB LEFT	153	51	204	11	164	215	4	168	219
SB THRU	72	38	110	5	77	115	2	79	117
SB RIGHT	59	0	59	4	63	63	1	64	64
<b>TOTALS</b>	<b>1838</b>	<b>339</b>	<b>2177</b>	<b>128</b>	<b>1966</b>	<b>2305</b>	<b>45</b>	<b>2011</b>	<b>2350</b>



SUBJECT	BY	DATE	JOB NO.	SHEET	OF
TURN VOLUME SUMMARY	TM	8-Sep-21	HIGP0000-0002	2	OF 2

E/W STREET : BEAR VALLEY RD                      N/S STREET : AMETHYST RD  
CONDITION : PM PEAK HOUR                      PHF : 0.91

NORTH LEG											
AUTO			LARGE 2 AXLE			LARGE 3 AXLE			LARGE 4(+) AXLE		
RT	THRU	LT	RT	THRU	LT	RT	THRU	LT	RT	THRU	LT
17	18	48	0	0	0	0	1	0	0	0	0
17	17	48	0	0	0	1	0	0	0	0	0
12	22	62	0	0	0	1	0	0	0	0	0
11	14	47	0	0	0	0	0	0	0	0	0

SOUTH LEG											
AUTO			LARGE 2 AXLE			LARGE 3 AXLE			LARGE 4(+) AXLE		
RT	THRU	LT	RT	THRU	LT	RT	THRU	LT	RT	THRU	LT
33	13	7	0	1	0	0	0	0	0	0	0
20	13	12	0	0	0	0	0	0	0	0	0
26	13	11	0	0	0	0	0	0	0	0	0
24	7	3	0	0	0	0	0	0	0	0	0

EAST LEG											
AUTO			LARGE 2 AXLE			LARGE 3 AXLE			LARGE 4(+) AXLE		
RT	THRU	LT	RT	THRU	LT	RT	THRU	LT	RT	THRU	LT
1	90	28	0	0	1	0	0	0	0	0	1
1	147	18	0	3	0	0	0	0	0	0	0
2	136	25	0	1	0	0	0	0	0	0	0
4	118	13	0	1	0	0	0	0	0	0	0

WEST LEG											
AUTO			LARGE 2 AXLE			LARGE 3 AXLE			LARGE 4(+) AXLE		
RT	THRU	LT	RT	THRU	LT	RT	THRU	LT	RT	THRU	LT
62	173	22	0	0	0	0	0	0	0	0	0
48	182	20	0	0	0	0	0	0	0	0	0
41	192	28	0	0	0	0	0	0	0	0	0
40	148	27	0	0	0	0	0	0	0	0	0

Truck Volumes	Auto Volumes	Totals	Truck Percentage	Balanced Totals
---------------	--------------	--------	------------------	-----------------

**BEAR VALLEY RD**

EB LEFT	0	97	<b>97</b>	1%	<b>97</b>
EB THRU	0	695	<b>695</b>	1%	<b>519</b>
EB RIGHT	0	191	<b>191</b>	1%	<b>191</b>
WB LEFT	2	84	<b>86</b>	2%	<b>86</b>
WB THRU	5	491	<b>496</b>	1%	<b>496</b>
WB RIGHT	0	8	<b>8</b>	1%	<b>8</b>

**AMETHYST RD**

NB LEFT	0	33	<b>33</b>	1%	<b>33</b>
NB THRU	1	46	<b>47</b>	2%	<b>47</b>
NB RIGHT	0	103	<b>103</b>	1%	<b>77</b>
SB LEFT	0	205	<b>205</b>	1%	<b>153</b>
SB THRU	1	71	<b>72</b>	1%	<b>72</b>
SB RIGHT	2	57	<b>59</b>	3%	<b>59</b>

HCM 6th Signalized Intersection Summary  
1: Amethyst Rd & Bear Valley Rd



Movement	EBL	EBT	EBR	WBL	WBT	WBR	NBL	NBT	NBR	SBL	SBT	SBR
Lane Configurations	↘	↑↑	↗	↘	↑↑	↗	↘	↑↑		↘	↑↑	
Traffic Volume (veh/h)	97	519	191	86	496	8	33	47	77	153	72	59
Future Volume (veh/h)	97	519	191	86	496	8	33	47	77	153	72	59
Initial Q (Qb), veh	0	0	0	0	0	0	0	0	0	0	0	0
Ped-Bike Adj(A_pbT)	1.00		1.00	1.00		1.00	1.00		1.00	1.00		1.00
Parking Bus, Adj	1.00	1.00	1.00	1.00	1.00	1.00	1.00	1.00	1.00	1.00	1.00	1.00
Work Zone On Approach		No			No			No			No	
Adj Sat Flow, veh/h/ln	1885	1885	1885	1870	1885	1885	1885	1870	1885	1885	1885	1856
Adj Flow Rate, veh/h	107	570	210	95	545	9	36	52	85	104	169	65
Peak Hour Factor	0.91	0.91	0.91	0.91	0.91	0.91	0.91	0.91	0.91	0.91	0.91	0.91
Percent Heavy Veh, %	1	1	1	2	1	1	1	2	1	1	1	3
Cap, veh/h	132	1195	533	118	1170	522	221	219	195	635	929	344
Arrive On Green	0.07	0.33	0.33	0.07	0.33	0.33	0.12	0.12	0.12	0.35	0.35	0.35
Sat Flow, veh/h	1795	3582	1598	1781	3582	1598	1795	1777	1585	1795	2625	971
Grp Volume(v), veh/h	107	570	210	95	545	9	36	52	85	104	119	115
Grp Sat Flow(s),veh/h/ln	1795	1791	1598	1781	1791	1598	1795	1777	1585	1795	1885	1710
Q Serve(g_s), s	7.6	16.4	13.1	6.8	15.7	0.5	2.3	3.4	6.5	5.2	5.7	6.0
Cycle Q Clear(g_c), s	7.6	16.4	13.1	6.8	15.7	0.5	2.3	3.4	6.5	5.2	5.7	6.0
Prop In Lane	1.00		1.00	1.00		1.00	1.00		1.00	1.00		0.57
Lane Grp Cap(c), veh/h	132	1195	533	118	1170	522	221	219	195	635	667	605
V/C Ratio(X)	0.81	0.48	0.39	0.81	0.47	0.02	0.16	0.24	0.44	0.16	0.18	0.19
Avail Cap(c_a), veh/h	207	1195	533	178	1170	522	221	219	195	635	667	605
HCM Platoon Ratio	1.00	1.00	1.00	1.00	1.00	1.00	1.00	1.00	1.00	1.00	1.00	1.00
Upstream Filter(I)	1.00	1.00	1.00	1.00	1.00	1.00	1.00	1.00	1.00	1.00	1.00	1.00
Uniform Delay (d), s/veh	59.4	34.3	33.2	59.9	34.8	29.6	51.0	51.5	52.8	28.8	29.0	29.1
Incr Delay (d2), s/veh	12.6	1.4	2.2	14.5	1.3	0.1	1.6	2.5	6.9	0.6	0.6	0.7
Initial Q Delay(d3),s/veh	0.0	0.0	0.0	0.0	0.0	0.0	0.0	0.0	0.0	0.0	0.0	0.0
%ile BackOfQ(50%),veh/ln	3.8	7.1	5.2	3.5	6.8	0.2	1.1	1.7	2.9	2.3	2.6	2.5
Unsig. Movement Delay, s/veh												
LnGrp Delay(d),s/veh	71.9	35.7	35.4	74.4	36.1	29.7	52.6	54.0	59.8	29.4	29.6	29.8
LnGrp LOS	E	D	D	E	D	C	D	D	E	C	C	C
Approach Vol, veh/h		887			649			173			338	
Approach Delay, s/veh		40.0			41.6			56.5			29.6	
Approach LOS		D			D			E			C	
Timer - Assigned Phs	1	2		4	5	6		8				
Phs Duration (G+Y+Rc), s	12.6	47.4		50.0	13.5	46.5		20.0				
Change Period (Y+Rc), s	4.0	4.0		4.0	4.0	4.0		4.0				
Max Green Setting (Gmax), s	13.0	39.0		46.0	15.0	37.0		16.0				
Max Q Clear Time (g_c+I1), s	8.8	18.4		8.0	9.6	17.7		8.5				
Green Ext Time (p_c), s	0.1	4.0		1.5	0.1	3.1		0.4				

Intersection Summary

HCM 6th Ctrl Delay	40.2
HCM 6th LOS	D

Notes

User approved volume balancing among the lanes for turning movement.

HCM 6th Signalized Intersection Summary  
1: Amethyst Rd & Bear Valley Rd



Movement	EBL	EBT	EBR	WBL	WBT	WBR	NBL	NBT	NBR	SBL	SBT	SBR
Lane Configurations	↖	↗	↘	↖	↗	↘	↖	↗	↘	↖	↗	↘
Traffic Volume (veh/h)	97	544	204	168	466	8	102	138	77	204	110	59
Future Volume (veh/h)	97	544	204	168	466	8	102	138	77	204	110	59
Initial Q (Qb), veh	0	0	0	0	0	0	0	0	0	0	0	0
Ped-Bike Adj(A_pbT)	1.00		1.00	1.00		1.00	1.00		1.00	1.00		1.00
Parking Bus, Adj	1.00	1.00	1.00	1.00	1.00	1.00	1.00	1.00	1.00	1.00	1.00	1.00
Work Zone On Approach		No			No			No			No	
Adj Sat Flow, veh/h/ln	1885	1885	1885	1870	1885	1885	1885	1870	1885	1885	1885	1856
Adj Flow Rate, veh/h	107	598	224	185	512	9	112	152	85	137	243	65
Peak Hour Factor	0.91	0.91	0.91	0.91	0.91	0.91	0.91	0.91	0.91	0.91	0.91	0.91
Percent Heavy Veh, %	1	1	1	2	1	1	1	2	1	1	1	3
Cap, veh/h	132	1075	479	178	1170	522	221	276	146	635	1019	267
Arrive On Green	0.07	0.30	0.30	0.10	0.33	0.33	0.12	0.12	0.12	0.35	0.35	0.35
Sat Flow, veh/h	1795	3582	1598	1781	3582	1598	1795	2244	1190	1795	2881	754
Grp Volume(v), veh/h	107	598	224	185	512	9	112	119	118	137	157	151
Grp Sat Flow(s),veh/h/ln	1795	1791	1598	1781	1791	1598	1795	1777	1656	1795	1885	1750
Q Serve(g_s), s	7.6	18.2	14.8	13.0	14.6	0.5	7.6	8.2	8.8	6.9	7.6	7.9
Cycle Q Clear(g_c), s	7.6	18.2	14.8	13.0	14.6	0.5	7.6	8.2	8.8	6.9	7.6	7.9
Prop In Lane	1.00		1.00	1.00		1.00	1.00		0.72	1.00		0.43
Lane Grp Cap(c), veh/h	132	1075	479	178	1170	522	221	219	204	635	667	619
V/C Ratio(X)	0.81	0.56	0.47	1.04	0.44	0.02	0.51	0.54	0.58	0.22	0.24	0.24
Avail Cap(c_a), veh/h	207	1075	479	178	1170	522	221	219	204	635	667	619
HCM Platoon Ratio	1.00	1.00	1.00	1.00	1.00	1.00	1.00	1.00	1.00	1.00	1.00	1.00
Upstream Filter(I)	1.00	1.00	1.00	1.00	1.00	1.00	1.00	1.00	1.00	1.00	1.00	1.00
Uniform Delay (d), s/veh	59.4	38.2	37.0	58.5	34.4	29.6	53.3	53.6	53.8	29.4	29.6	29.7
Incr Delay (d2), s/veh	12.6	2.1	3.3	77.9	1.2	0.1	8.1	9.3	11.5	0.8	0.8	0.9
Initial Q Delay(d3),s/veh	0.0	0.0	0.0	0.0	0.0	0.0	0.0	0.0	0.0	0.0	0.0	0.0
%ile BackOfQ(50%),veh/ln	3.8	8.0	6.0	9.5	6.3	0.2	3.9	4.1	4.2	3.1	3.5	3.4
Unsig. Movement Delay, s/veh												
LnGrp Delay(d),s/veh	71.9	40.3	40.3	136.4	35.6	29.7	61.4	62.9	65.4	30.2	30.4	30.6
LnGrp LOS	E	D	D	F	D	C	E	E	E	C	C	C
Approach Vol, veh/h		929			706			349			445	
Approach Delay, s/veh		44.0			61.9			63.2			30.4	
Approach LOS		D			E			E			C	
Timer - Assigned Phs	1	2		4	5	6		8				
Phs Duration (G+Y+Rc), s	17.0	43.0		50.0	13.5	46.5		20.0				
Change Period (Y+Rc), s	4.0	4.0		4.0	4.0	4.0		4.0				
Max Green Setting (Gmax), s	13.0	39.0		46.0	15.0	37.0		16.0				
Max Q Clear Time (g_c+I1), s	15.0	20.2		9.9	9.6	16.6		10.8				
Green Ext Time (p_c), s	0.0	4.1		2.1	0.1	2.9		0.7				

Intersection Summary

HCM 6th Ctrl Delay	49.5
HCM 6th LOS	D

Notes

User approved volume balancing among the lanes for turning movement.

HCM 6th Signalized Intersection Summary  
1: Amethyst Rd & Bear Valley Rd



Movement	EBL	EBT	EBR	WBL	WBT	WBR	NBL	NBT	NBR	SBL	SBT	SBR
Lane Configurations	↖↗	↖↖	↗	↖↗	↖↖	↗	↖↗	↖↖	↗	↖↗	↖↖	↗
Traffic Volume (veh/h)	97	544	204	168	466	8	102	138	77	204	110	59
Future Volume (veh/h)	97	544	204	168	466	8	102	138	77	204	110	59
Initial Q (Qb), veh	0	0	0	0	0	0	0	0	0	0	0	0
Ped-Bike Adj(A_pbT)	1.00		1.00	1.00		1.00	1.00		1.00	1.00		1.00
Parking Bus, Adj	1.00	1.00	1.00	1.00	1.00	1.00	1.00	1.00	1.00	1.00	1.00	1.00
Work Zone On Approach		No			No			No			No	
Adj Sat Flow, veh/h/ln	1885	1885	1885	1870	1885	1885	1885	1870	1885	1885	1885	1856
Adj Flow Rate, veh/h	107	598	224	185	512	9	112	152	85	224	121	65
Peak Hour Factor	0.91	0.91	0.91	0.91	0.91	0.91	0.91	0.91	0.91	0.91	0.91	0.91
Percent Heavy Veh, %	1	1	1	2	1	1	1	2	1	1	1	3
Cap, veh/h	157	1185	529	239	1271	567	429	437	197	1232	814	412
Arrive On Green	0.05	0.33	0.33	0.07	0.35	0.35	0.12	0.12	0.12	0.35	0.35	0.35
Sat Flow, veh/h	3483	3582	1598	3456	3582	1598	3483	3554	1598	3483	2301	1166
Grp Volume(v), veh/h	107	598	224	185	512	9	112	152	85	224	93	93
Grp Sat Flow(s),veh/h/ln	1742	1791	1598	1728	1791	1598	1742	1777	1598	1742	1791	1675
Q Serve(g_s), s	3.9	17.4	14.2	6.8	14.0	0.5	3.8	5.1	6.4	5.8	4.6	5.0
Cycle Q Clear(g_c), s	3.9	17.4	14.2	6.8	14.0	0.5	3.8	5.1	6.4	5.8	4.6	5.0
Prop In Lane	1.00		1.00	1.00		1.00	1.00		1.00	1.00		0.70
Lane Grp Cap(c), veh/h	157	1185	529	239	1271	567	429	437	197	1232	634	593
V/C Ratio(X)	0.68	0.50	0.42	0.77	0.40	0.02	0.26	0.35	0.43	0.18	0.15	0.16
Avail Cap(c_a), veh/h	214	1185	529	319	1271	567	429	437	197	1232	634	593
HCM Platoon Ratio	1.00	1.00	1.00	1.00	1.00	1.00	1.00	1.00	1.00	1.00	1.00	1.00
Upstream Filter(I)	1.00	1.00	1.00	1.00	1.00	1.00	1.00	1.00	1.00	1.00	1.00	1.00
Uniform Delay (d), s/veh	61.2	34.9	33.9	59.5	31.6	27.2	51.6	52.2	52.8	29.0	28.6	28.7
Incr Delay (d2), s/veh	5.1	1.5	2.5	8.2	1.0	0.1	1.5	2.2	6.8	0.3	0.5	0.6
Initial Q Delay(d3),s/veh	0.0	0.0	0.0	0.0	0.0	0.0	0.0	0.0	0.0	0.0	0.0	0.0
%ile BackOfQ(50%),veh/ln	1.8	7.6	5.7	3.2	6.0	0.2	1.7	2.4	2.9	2.4	2.0	2.0
Unsig. Movement Delay, s/veh												
LnGrp Delay(d),s/veh	66.3	36.5	36.3	67.7	32.5	27.2	53.1	54.4	59.6	29.3	29.1	29.3
LnGrp LOS	E	D	D	E	C	C	D	D	E	C	C	C
Approach Vol, veh/h		929			706			349			410	
Approach Delay, s/veh		39.9			41.7			55.3			29.3	
Approach LOS		D			D			E			C	
Timer - Assigned Phs	1	2	3	4	5	6	7	8				
Phs Duration (G+Y+Rc), s	13.0	47.0	20.0	50.0	9.9	50.1	50.0	20.0				
Change Period (Y+Rc), s	4.0	4.0	4.0	4.0	4.0	4.0	4.0	4.0				
Max Green Setting (Gmax), s	12.0	40.0	16.0	46.0	8.0	44.0	46.0	16.0				
Max Q Clear Time (g_c+I1), s	8.8	19.4	5.8	7.0	5.9	16.0	7.8	8.4				
Green Ext Time (p_c), s	0.2	4.2	0.2	1.0	0.0	3.1	0.7	0.6				

Intersection Summary

HCM 6th Ctrl Delay	40.8
HCM 6th LOS	D

HCM 6th Signalized Intersection Summary  
 1: Amethyst Rd & Bear Valley Rd



Movement	EBL	EBT	EBR	WBL	WBT	WBR	NBL	NBT	NBR	SBL	SBT	SBR
Lane Configurations	↘	↑↑	↗	↘	↑↑	↗	↘	↑↑		↘	↑↑	
Traffic Volume (veh/h)	104	555	204	92	531	9	35	50	82	164	77	63
Future Volume (veh/h)	104	555	204	92	531	9	35	50	82	164	77	63
Initial Q (Qb), veh	0	0	0	0	0	0	0	0	0	0	0	0
Ped-Bike Adj(A_pbT)	1.00		1.00	1.00		1.00	1.00		1.00	1.00		1.00
Parking Bus, Adj	1.00	1.00	1.00	1.00	1.00	1.00	1.00	1.00	1.00	1.00	1.00	1.00
Work Zone On Approach		No			No			No			No	
Adj Sat Flow, veh/h/ln	1885	1885	1885	1870	1885	1885	1885	1870	1885	1885	1885	1856
Adj Flow Rate, veh/h	114	610	224	101	584	10	38	55	90	111	181	69
Peak Hour Factor	0.91	0.91	0.91	0.91	0.91	0.91	0.91	0.91	0.91	0.91	0.91	0.91
Percent Heavy Veh, %	1	1	1	2	1	1	1	2	1	1	1	3
Cap, veh/h	139	1182	527	125	1156	515	221	219	195	635	931	342
Arrive On Green	0.08	0.33	0.33	0.07	0.32	0.32	0.12	0.12	0.12	0.35	0.35	0.35
Sat Flow, veh/h	1795	3582	1598	1781	3582	1598	1795	1777	1585	1795	2630	966
Grp Volume(v), veh/h	114	610	224	101	584	10	38	55	90	111	128	122
Grp Sat Flow(s),veh/h/ln	1795	1791	1598	1781	1791	1598	1795	1777	1585	1795	1885	1711
Q Serve(g_s), s	8.1	17.9	14.2	7.3	17.2	0.6	2.5	3.6	6.9	5.5	6.1	6.5
Cycle Q Clear(g_c), s	8.1	17.9	14.2	7.3	17.2	0.6	2.5	3.6	6.9	5.5	6.1	6.5
Prop In Lane	1.00		1.00	1.00		1.00	1.00		1.00	1.00		0.56
Lane Grp Cap(c), veh/h	139	1182	527	125	1156	515	221	219	195	635	667	606
V/C Ratio(X)	0.82	0.52	0.42	0.81	0.51	0.02	0.17	0.25	0.46	0.17	0.19	0.20
Avail Cap(c_a), veh/h	207	1182	527	178	1156	515	221	219	195	635	667	606
HCM Platoon Ratio	1.00	1.00	1.00	1.00	1.00	1.00	1.00	1.00	1.00	1.00	1.00	1.00
Upstream Filter(I)	1.00	1.00	1.00	1.00	1.00	1.00	1.00	1.00	1.00	1.00	1.00	1.00
Uniform Delay (d), s/veh	59.1	35.2	33.9	59.6	35.6	30.0	51.1	51.6	53.0	28.9	29.1	29.2
Incr Delay (d2), s/veh	14.8	1.6	2.5	16.7	1.6	0.1	1.7	2.7	7.7	0.6	0.6	0.8
Initial Q Delay(d3),s/veh	0.0	0.0	0.0	0.0	0.0	0.0	0.0	0.0	0.0	0.0	0.0	0.0
%ile BackOfQ(50%),veh/ln	4.2	7.8	5.7	3.8	7.5	0.2	1.2	1.8	3.1	2.4	2.8	2.7
Unsig. Movement Delay, s/veh												
LnGrp Delay(d),s/veh	73.9	36.8	36.4	76.3	37.2	30.1	52.7	54.3	60.7	29.5	29.7	30.0
LnGrp LOS	E	D	D	E	D	C	D	D	E	C	C	C
Approach Vol, veh/h		948			695			183			361	
Approach Delay, s/veh		41.1			42.8			57.1			29.8	
Approach LOS		D			D			E			C	
Timer - Assigned Phs	1	2		4	5	6		8				
Phs Duration (G+Y+Rc), s	13.1	46.9		50.0	14.1	45.9		20.0				
Change Period (Y+Rc), s	4.0	4.0		4.0	4.0	4.0		4.0				
Max Green Setting (Gmax), s	13.0	39.0		46.0	15.0	37.0		16.0				
Max Q Clear Time (g_c+I1), s	9.3	19.9		8.5	10.1	19.2		8.9				
Green Ext Time (p_c), s	0.1	4.2		1.7	0.1	3.2		0.4				

Intersection Summary

HCM 6th Ctrl Delay	41.1
HCM 6th LOS	D

Notes

User approved volume balancing among the lanes for turning movement.

HCM 6th Signalized Intersection Summary  
1: Amethyst Rd & Bear Valley Rd



Movement	EBL	EBT	EBR	WBL	WBT	WBR	NBL	NBT	NBR	SBL	SBT	SBR
Lane Configurations	↖	↑↑	↗	↖	↑↑	↗	↖	↑↑		↖	↗	
Traffic Volume (veh/h)	104	580	217	174	501	9	104	141	82	215	115	63
Future Volume (veh/h)	104	580	217	174	501	9	104	141	82	215	115	63
Initial Q (Qb), veh	0	0	0	0	0	0	0	0	0	0	0	0
Ped-Bike Adj(A_pbT)	1.00		1.00	1.00		1.00	1.00		1.00	1.00		1.00
Parking Bus, Adj	1.00	1.00	1.00	1.00	1.00	1.00	1.00	1.00	1.00	1.00	1.00	1.00
Work Zone On Approach		No			No			No			No	
Adj Sat Flow, veh/h/ln	1885	1885	1885	1870	1885	1885	1885	1870	1885	1885	1885	1856
Adj Flow Rate, veh/h	114	637	238	191	551	10	114	155	90	144	255	69
Peak Hour Factor	0.91	0.91	0.91	0.91	0.91	0.91	0.91	0.91	0.91	0.91	0.91	0.91
Percent Heavy Veh, %	1	1	1	2	1	1	1	2	1	1	1	3
Cap, veh/h	139	1075	479	178	1156	515	221	272	150	635	1016	269
Arrive On Green	0.08	0.30	0.30	0.10	0.32	0.32	0.12	0.12	0.12	0.35	0.35	0.35
Sat Flow, veh/h	1795	3582	1598	1781	3582	1598	1795	2212	1217	1795	2873	761
Grp Volume(v), veh/h	114	637	238	191	551	10	114	123	122	144	165	159
Grp Sat Flow(s),veh/h/ln	1795	1791	1598	1781	1791	1598	1795	1777	1651	1795	1885	1748
Q Serve(g_s), s	8.1	19.7	15.9	13.0	16.0	0.6	7.7	8.5	9.1	7.3	8.1	8.4
Cycle Q Clear(g_c), s	8.1	19.7	15.9	13.0	16.0	0.6	7.7	8.5	9.1	7.3	8.1	8.4
Prop In Lane	1.00		1.00	1.00		1.00	1.00		0.74	1.00		0.44
Lane Grp Cap(c), veh/h	139	1075	479	178	1156	515	221	219	203	635	667	619
V/C Ratio(X)	0.82	0.59	0.50	1.07	0.48	0.02	0.52	0.56	0.60	0.23	0.25	0.26
Avail Cap(c_a), veh/h	207	1075	479	178	1156	515	221	219	203	635	667	619
HCM Platoon Ratio	1.00	1.00	1.00	1.00	1.00	1.00	1.00	1.00	1.00	1.00	1.00	1.00
Upstream Filter(I)	1.00	1.00	1.00	1.00	1.00	1.00	1.00	1.00	1.00	1.00	1.00	1.00
Uniform Delay (d), s/veh	59.1	38.7	37.4	58.5	35.2	30.0	53.4	53.7	54.0	29.5	29.7	29.8
Incr Delay (d2), s/veh	14.8	2.4	3.6	88.0	1.4	0.1	8.4	10.0	12.5	0.8	0.9	1.0
Initial Q Delay(d3),s/veh	0.0	0.0	0.0	0.0	0.0	0.0	0.0	0.0	0.0	0.0	0.0	0.0
%ile BackOfQ(50%),veh/ln	4.2	8.7	6.5	10.0	7.0	0.2	3.9	4.3	4.4	3.2	3.7	3.6
Unsig. Movement Delay, s/veh												
LnGrp Delay(d),s/veh	73.9	41.1	41.1	146.5	36.7	30.1	61.7	63.7	66.5	30.3	30.6	30.8
LnGrp LOS	E	D	D	F	D	C	E	E	E	C	C	C
Approach Vol, veh/h		989			752			359			468	
Approach Delay, s/veh		44.9			64.5			64.0			30.6	
Approach LOS		D			E			E			C	
Timer - Assigned Phs	1	2		4	5	6		8				
Phs Duration (G+Y+Rc), s	17.0	43.0		50.0	14.1	45.9		20.0				
Change Period (Y+Rc), s	4.0	4.0		4.0	4.0	4.0		4.0				
Max Green Setting (Gmax), s	13.0	39.0		46.0	15.0	37.0		16.0				
Max Q Clear Time (g_c+I1), s	15.0	21.7		10.4	10.1	18.0		11.1				
Green Ext Time (p_c), s	0.0	4.3		2.2	0.1	3.1		0.7				

Intersection Summary

HCM 6th Ctrl Delay	50.7
HCM 6th LOS	D

Notes

User approved volume balancing among the lanes for turning movement.



HCM 6th Signalized Intersection Summary  
1: Amethyst Rd & Bear Valley Rd



Movement	EBL	EBT	EBR	WBL	WBT	WBR	NBL	NBT	NBR	SBL	SBT	SBR
Lane Configurations	↖↗	↕	↖	↖↗	↕	↖	↖↗	↕	↖	↖↗	↕	↖↗
Traffic Volume (veh/h)	104	580	217	174	501	9	104	141	82	215	115	63
Future Volume (veh/h)	104	580	217	174	501	9	104	141	82	215	115	63
Initial Q (Qb), veh	0	0	0	0	0	0	0	0	0	0	0	0
Ped-Bike Adj(A_pbT)	1.00		1.00	1.00		1.00	1.00		1.00	1.00		1.00
Parking Bus, Adj	1.00	1.00	1.00	1.00	1.00	1.00	1.00	1.00	1.00	1.00	1.00	1.00
Work Zone On Approach		No			No			No			No	
Adj Sat Flow, veh/h/ln	1885	1885	1885	1870	1885	1885	1885	1870	1885	1885	1885	1856
Adj Flow Rate, veh/h	114	637	238	191	551	10	114	155	90	236	126	69
Peak Hour Factor	0.91	0.91	0.91	0.91	0.91	0.91	0.91	0.91	0.91	0.91	0.91	0.91
Percent Heavy Veh, %	1	1	1	2	1	1	1	2	1	1	1	3
Cap, veh/h	164	1179	526	245	1264	564	429	437	197	1232	808	418
Arrive On Green	0.05	0.33	0.33	0.07	0.35	0.35	0.12	0.12	0.12	0.35	0.35	0.35
Sat Flow, veh/h	3483	3582	1598	3456	3582	1598	3483	3554	1598	3483	2284	1180
Grp Volume(v), veh/h	114	637	238	191	551	10	114	155	90	236	97	98
Grp Sat Flow(s),veh/h/ln	1742	1791	1598	1728	1791	1598	1742	1777	1598	1742	1791	1673
Q Serve(g_s), s	4.2	18.9	15.3	7.1	15.3	0.5	3.9	5.2	6.8	6.1	4.8	5.2
Cycle Q Clear(g_c), s	4.2	18.9	15.3	7.1	15.3	0.5	3.9	5.2	6.8	6.1	4.8	5.2
Prop In Lane	1.00		1.00	1.00		1.00	1.00		1.00	1.00		0.71
Lane Grp Cap(c), veh/h	164	1179	526	245	1264	564	429	437	197	1232	634	592
V/C Ratio(X)	0.69	0.54	0.45	0.78	0.44	0.02	0.27	0.35	0.46	0.19	0.15	0.17
Avail Cap(c_a), veh/h	214	1179	526	319	1264	564	429	437	197	1232	634	592
HCM Platoon Ratio	1.00	1.00	1.00	1.00	1.00	1.00	1.00	1.00	1.00	1.00	1.00	1.00
Upstream Filter(I)	1.00	1.00	1.00	1.00	1.00	1.00	1.00	1.00	1.00	1.00	1.00	1.00
Uniform Delay (d), s/veh	61.0	35.6	34.4	59.4	32.2	27.4	51.7	52.3	53.0	29.1	28.7	28.8
Incr Delay (d2), s/veh	6.3	1.8	2.8	8.9	1.1	0.1	1.5	2.2	7.5	0.3	0.5	0.6
Initial Q Delay(d3),s/veh	0.0	0.0	0.0	0.0	0.0	0.0	0.0	0.0	0.0	0.0	0.0	0.0
%ile BackOfQ(50%),veh/ln	1.9	8.2	6.2	3.3	6.6	0.2	1.7	2.4	3.1	2.6	2.1	2.2
Unsig. Movement Delay, s/veh												
LnGrp Delay(d),s/veh	67.3	37.4	37.2	68.3	33.3	27.5	53.2	54.5	60.5	29.5	29.2	29.4
LnGrp LOS	E	D	D	E	C	C	D	D	E	C	C	C
Approach Vol, veh/h		989			752			359				431
Approach Delay, s/veh		40.8			42.1			55.6				29.4
Approach LOS		D			D			E				C
Timer - Assigned Phs	1	2	3	4	5	6	7	8				
Phs Duration (G+Y+Rc), s	13.2	46.8	20.0	50.0	10.1	49.9	50.0	20.0				
Change Period (Y+Rc), s	4.0	4.0	4.0	4.0	4.0	4.0	4.0	4.0				
Max Green Setting (Gmax), s	12.0	40.0	16.0	46.0	8.0	44.0	46.0	16.0				
Max Q Clear Time (g_c+I1), s	9.1	20.9	5.9	7.2	6.2	17.3	8.1	8.8				
Green Ext Time (p_c), s	0.2	4.4	0.2	1.0	0.0	3.4	0.8	0.6				

Intersection Summary

HCM 6th Ctrl Delay	41.3
HCM 6th LOS	D

HCM 6th Signalized Intersection Summary  
1: Amethyst Rd & Bear Valley Rd



Movement	EBL	EBT	EBR	WBL	WBT	WBR	NBL	NBT	NBR	SBL	SBT	SBR
Lane Configurations	↘	↑↑	↗	↘	↑↑	↗	↘	↑↑		↘	↔	
Traffic Volume (veh/h)	106	568	209	94	543	9	36	51	84	168	79	64
Future Volume (veh/h)	106	568	209	94	543	9	36	51	84	168	79	64
Initial Q (Qb), veh	0	0	0	0	0	0	0	0	0	0	0	0
Ped-Bike Adj(A_pbT)	1.00		1.00	1.00		1.00	1.00		1.00	1.00		1.00
Parking Bus, Adj	1.00	1.00	1.00	1.00	1.00	1.00	1.00	1.00	1.00	1.00	1.00	1.00
Work Zone On Approach		No			No			No			No	
Adj Sat Flow, veh/h/ln	1885	1885	1885	1870	1885	1885	1885	1870	1885	1885	1885	1856
Adj Flow Rate, veh/h	116	624	230	103	597	10	40	56	92	114	186	70
Peak Hour Factor	0.91	0.91	0.91	0.91	0.91	0.91	0.91	0.91	0.91	0.91	0.91	0.91
Percent Heavy Veh, %	1	1	1	2	1	1	1	2	1	1	1	3
Cap, veh/h	141	1178	525	127	1151	514	221	219	195	635	934	339
Arrive On Green	0.08	0.33	0.33	0.07	0.32	0.32	0.12	0.12	0.12	0.35	0.35	0.35
Sat Flow, veh/h	1795	3582	1598	1781	3582	1598	1795	1777	1585	1795	2640	958
Grp Volume(v), veh/h	116	624	230	103	597	10	40	56	92	114	131	125
Grp Sat Flow(s),veh/h/ln	1795	1791	1598	1781	1791	1598	1795	1777	1585	1795	1885	1713
Q Serve(g_s), s	8.3	18.4	14.7	7.4	17.6	0.6	2.6	3.7	7.0	5.7	6.3	6.6
Cycle Q Clear(g_c), s	8.3	18.4	14.7	7.4	17.6	0.6	2.6	3.7	7.0	5.7	6.3	6.6
Prop In Lane	1.00		1.00	1.00		1.00	1.00		1.00	1.00		0.56
Lane Grp Cap(c), veh/h	141	1178	525	127	1151	514	221	219	195	635	667	606
V/C Ratio(X)	0.82	0.53	0.44	0.81	0.52	0.02	0.18	0.26	0.47	0.18	0.20	0.21
Avail Cap(c_a), veh/h	207	1178	525	178	1151	514	221	219	195	635	667	606
HCM Platoon Ratio	1.00	1.00	1.00	1.00	1.00	1.00	1.00	1.00	1.00	1.00	1.00	1.00
Upstream Filter(I)	1.00	1.00	1.00	1.00	1.00	1.00	1.00	1.00	1.00	1.00	1.00	1.00
Uniform Delay (d), s/veh	59.0	35.5	34.2	59.5	35.9	30.1	51.1	51.6	53.1	29.0	29.2	29.3
Incr Delay (d2), s/veh	15.4	1.7	2.6	17.4	1.7	0.1	1.8	2.8	8.0	0.6	0.7	0.8
Initial Q Delay(d3),s/veh	0.0	0.0	0.0	0.0	0.0	0.0	0.0	0.0	0.0	0.0	0.0	0.0
%ile BackOfQ(50%),veh/ln	4.3	8.0	5.9	3.9	7.7	0.2	1.3	1.8	3.2	2.5	2.9	2.8
Unsig. Movement Delay, s/veh												
LnGrp Delay(d),s/veh	74.4	37.2	36.8	76.9	37.6	30.2	52.9	54.4	61.0	29.6	29.8	30.0
LnGrp LOS	E	D	D	E	D	C	D	D	E	C	C	C
Approach Vol, veh/h		970			710			188			370	
Approach Delay, s/veh		41.5			43.2			57.3			29.8	
Approach LOS		D			D			E			C	
Timer - Assigned Phs	1	2		4	5	6		8				
Phs Duration (G+Y+Rc), s	13.2	46.8		50.0	14.2	45.8		20.0				
Change Period (Y+Rc), s	4.0	4.0		4.0	4.0	4.0		4.0				
Max Green Setting (Gmax), s	13.0	39.0		46.0	15.0	37.0		16.0				
Max Q Clear Time (g_c+I1), s	9.4	20.4		8.6	10.3	19.6		9.0				
Green Ext Time (p_c), s	0.1	4.3		1.7	0.1	3.3		0.4				

Intersection Summary

HCM 6th Ctrl Delay	41.4
HCM 6th LOS	D

Notes

User approved volume balancing among the lanes for turning movement.

HCM 6th Signalized Intersection Summary  
1: Amethyst Rd & Bear Valley Rd



Movement	EBL	EBT	EBR	WBL	WBT	WBR	NBL	NBT	NBR	SBL	SBT	SBR
Lane Configurations	↘	↑↑	↗	↘	↑↑	↗	↘	↑↑		↘	↑↑	
Traffic Volume (veh/h)	106	593	222	176	513	9	105	142	84	219	117	64
Future Volume (veh/h)	106	593	222	176	513	9	105	142	84	219	117	64
Initial Q (Qb), veh	0	0	0	0	0	0	0	0	0	0	0	0
Ped-Bike Adj(A_pbT)	1.00		1.00	1.00		1.00	1.00		1.00	1.00		1.00
Parking Bus, Adj	1.00	1.00	1.00	1.00	1.00	1.00	1.00	1.00	1.00	1.00	1.00	1.00
Work Zone On Approach		No			No			No			No	
Adj Sat Flow, veh/h/ln	1885	1885	1885	1870	1885	1885	1885	1870	1885	1885	1885	1856
Adj Flow Rate, veh/h	116	652	244	193	564	10	115	156	92	147	261	70
Peak Hour Factor	0.91	0.91	0.91	0.91	0.91	0.91	0.91	0.91	0.91	0.91	0.91	0.91
Percent Heavy Veh, %	1	1	1	2	1	1	1	2	1	1	1	3
Cap, veh/h	141	1075	479	178	1151	514	221	271	151	635	1018	268
Arrive On Green	0.08	0.30	0.30	0.10	0.32	0.32	0.12	0.12	0.12	0.35	0.35	0.35
Sat Flow, veh/h	1795	3582	1598	1781	3582	1598	1795	2198	1228	1795	2878	756
Grp Volume(v), veh/h	116	652	244	193	564	10	115	124	124	147	169	162
Grp Sat Flow(s),veh/h/ln	1795	1791	1598	1781	1791	1598	1795	1777	1649	1795	1885	1749
Q Serve(g_s), s	8.3	20.3	16.4	13.0	16.5	0.6	7.8	8.6	9.2	7.5	8.3	8.6
Cycle Q Clear(g_c), s	8.3	20.3	16.4	13.0	16.5	0.6	7.8	8.6	9.2	7.5	8.3	8.6
Prop In Lane	1.00		1.00	1.00		1.00	1.00		0.74	1.00		0.43
Lane Grp Cap(c), veh/h	141	1075	479	178	1151	514	221	219	203	635	667	619
V/C Ratio(X)	0.82	0.61	0.51	1.08	0.49	0.02	0.52	0.57	0.61	0.23	0.25	0.26
Avail Cap(c_a), veh/h	207	1075	479	178	1151	514	221	219	203	635	667	619
HCM Platoon Ratio	1.00	1.00	1.00	1.00	1.00	1.00	1.00	1.00	1.00	1.00	1.00	1.00
Upstream Filter(I)	1.00	1.00	1.00	1.00	1.00	1.00	1.00	1.00	1.00	1.00	1.00	1.00
Uniform Delay (d), s/veh	59.0	38.9	37.6	58.5	35.5	30.1	53.4	53.7	54.0	29.6	29.8	29.9
Incr Delay (d2), s/veh	15.4	2.5	3.8	91.4	1.5	0.1	8.5	10.3	12.9	0.9	0.9	1.0
Initial Q Delay(d3),s/veh	0.0	0.0	0.0	0.0	0.0	0.0	0.0	0.0	0.0	0.0	0.0	0.0
%ile BackOfQ(50%),veh/ln	4.3	8.9	6.7	10.2	7.2	0.2	4.0	4.4	4.5	3.3	3.8	3.7
Unsig. Movement Delay, s/veh												
LnGrp Delay(d),s/veh	74.4	41.5	41.4	149.9	37.0	30.2	61.9	64.1	66.9	30.4	30.7	30.9
LnGrp LOS	E	D	D	F	D	C	E	E	E	C	C	C
Approach Vol, veh/h		1012			767			363			478	
Approach Delay, s/veh		45.2			65.3			64.3			30.7	
Approach LOS		D			E			E			C	
Timer - Assigned Phs	1	2		4	5	6		8				
Phs Duration (G+Y+Rc), s	17.0	43.0		50.0	14.2	45.8		20.0				
Change Period (Y+Rc), s	4.0	4.0		4.0	4.0	4.0		4.0				
Max Green Setting (Gmax), s	13.0	39.0		46.0	15.0	37.0		16.0				
Max Q Clear Time (g_c+I1), s	15.0	22.3		10.6	10.3	18.5		11.2				
Green Ext Time (p_c), s	0.0	4.4		2.2	0.1	3.2		0.7				

Intersection Summary

HCM 6th Ctrl Delay	51.1
HCM 6th LOS	D

Notes

User approved volume balancing among the lanes for turning movement.

HCM 6th Signalized Intersection Summary  
1: Amethyst Rd & Bear Valley Rd

Synchro 11 Report  
09/03/2021



Movement	EBL	EBT	EBR	WBL	WBT	WBR	NBL	NBT	NBR	SBL	SBT	SBR
Lane Configurations	↔↔	↑↑↑	↗	↔↔	↑↑↑		↔↔	↑↑	↗	↔↔	↑↔	
Traffic Volume (veh/h)	106	593	222	176	513	9	105	142	84	219	117	64
Future Volume (veh/h)	106	593	222	176	513	9	105	142	84	219	117	64
Initial Q (Qb), veh	0	0	0	0	0	0	0	0	0	0	0	0
Ped-Bike Adj(A_pbT)	1.00		1.00	1.00		1.00	1.00		1.00	1.00		1.00
Parking Bus, Adj	1.00	1.00	1.00	1.00	1.00	1.00	1.00	1.00	1.00	1.00	1.00	1.00
Work Zone On Approach		No			No			No			No	
Adj Sat Flow, veh/h/ln	1885	1885	1885	1870	1885	1885	1885	1870	1885	1885	1885	1856
Adj Flow Rate, veh/h	116	652	244	193	564	10	115	156	92	241	129	70
Peak Hour Factor	0.91	0.91	0.91	0.91	0.91	0.91	0.91	0.91	0.91	0.91	0.91	0.91
Percent Heavy Veh, %	1	1	1	2	1	1	1	2	1	1	1	3
Cap, veh/h	167	1648	512	249	1793	32	429	465	209	1232	828	424
Arrive On Green	0.05	0.32	0.32	0.07	0.34	0.34	0.12	0.13	0.13	0.35	0.36	0.36
Sat Flow, veh/h	3483	5147	1598	3456	5207	92	3483	3554	1598	3483	2291	1174
Grp Volume(v), veh/h	116	652	244	193	371	203	115	156	92	241	99	100
Grp Sat Flow(s),veh/h/ln	1742	1716	1598	1728	1716	1869	1742	1777	1598	1742	1791	1674
Q Serve(g_s), s	4.3	12.8	15.9	7.1	10.3	10.4	3.9	5.2	6.9	6.2	4.9	5.3
Cycle Q Clear(g_c), s	4.3	12.8	15.9	7.1	10.3	10.4	3.9	5.2	6.9	6.2	4.9	5.3
Prop In Lane	1.00		1.00	1.00		0.05	1.00		1.00	1.00		0.70
Lane Grp Cap(c), veh/h	167	1648	512	249	1181	643	429	465	209	1232	647	605
V/C Ratio(X)	0.69	0.40	0.48	0.78	0.31	0.32	0.27	0.34	0.44	0.20	0.15	0.16
Avail Cap(c_a), veh/h	241	1648	512	372	1181	643	429	465	209	1232	647	605
HCM Platoon Ratio	1.00	1.00	1.00	1.00	1.00	1.00	1.00	1.00	1.00	1.00	1.00	1.00
Upstream Filter(I)	1.00	1.00	1.00	1.00	1.00	1.00	1.00	1.00	1.00	1.00	1.00	1.00
Uniform Delay (d), s/veh	60.9	34.4	35.4	59.3	31.3	31.3	51.7	51.4	52.1	29.2	28.0	28.2
Incr Delay (d2), s/veh	5.1	0.7	3.2	5.8	0.7	1.3	1.5	1.9	6.6	0.4	0.5	0.6
Initial Q Delay(d3),s/veh	0.0	0.0	0.0	0.0	0.0	0.0	0.0	0.0	0.0	0.0	0.0	0.0
%ile BackOfQ(50%),veh/ln	2.0	5.3	6.5	3.2	4.3	4.8	1.8	2.4	3.1	2.6	2.1	2.2
Unsig. Movement Delay, s/veh												
LnGrp Delay(d),s/veh	66.0	35.1	38.6	65.1	32.0	32.6	53.2	53.3	58.7	29.5	28.6	28.8
LnGrp LOS	E	D	D	E	C	C	D	D	E	C	C	C
Approach Vol, veh/h		1012			767			363			440	
Approach Delay, s/veh		39.5			40.5			54.7			29.1	
Approach LOS		D			D			D			C	
Timer - Assigned Phs	1	2	3	4	5	6	7	8				
Phs Duration (G+Y+Rc), s	13.4	45.6	20.0	51.0	10.2	48.8	50.0	21.0				
Change Period (Y+Rc), s	4.0	4.0	4.0	4.0	4.0	4.0	4.0	4.0				
Max Green Setting (Gmax), s	14.0	37.0	16.0	47.0	9.0	42.0	46.0	17.0				
Max Q Clear Time (g_c+I1), s	9.1	17.9	5.9	7.3	6.3	12.4	8.2	8.9				
Green Ext Time (p_c), s	0.2	4.6	0.2	1.1	0.1	3.3	0.8	0.7				

Intersection Summary

HCM 6th Ctrl Delay	40.2
HCM 6th LOS	D

SUBJECT	BY	DATE	JOB NO.	SHEET	OF
TURN MOVEMENTS	TM	8-Sep-21	HIGP0000-0002	1	OF 2

E/W STREET : BEAR VALLEY RD  
N/S STREET : PLUTO DR  
CONDITION : AM PEAK HOUR

INTERSECTION : 2  
PROJECTED GROWTH : 3.5%  
PER YEAR :

### CONDITION DIAGRAMS

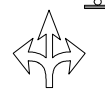
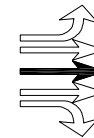
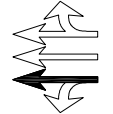
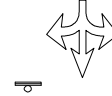
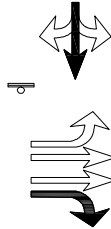
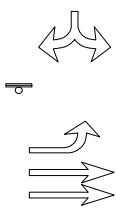

#### EXISTING GEOMETRICS

#### PROJECT GEOMETRICS

#### ULTIMATE GEOMETRICS

### TURN MOVEMENTS

Condition	Existing Condition	Project Trips	Existing + Project Condition	Year 2023 Ambient Growth	Background Condition	Project Condition	Year 2033 Ambient Growth	Future Condition	Future + Project Condition
Scenario #	1		3		5	7		9	11

#### BEAR VALLEY RD

EB LEFT	7	0	7	0	7	7	0	7	7
EB THRU	668	43	711	47	715	758	16	731	774
EB RIGHT	0	0	0	0	0	0	0	0	0
WB LEFT	0	31	31	0	0	31	0	0	31
WB THRU	518	30	548	36	554	584	13	567	597
WB RIGHT	8	0	8	1	9	9	0	9	9

#### PLUTO DR

NB LEFT	0	18	18	0	0	18	0	0	18
NB THRU	0	11	11	0	0	11	0	0	11
NB RIGHT	0	11	11	0	0	11	0	0	11
SB LEFT	7	0	7	0	7	7	0	7	7
SB THRU	0	12	12	0	0	12	0	0	12
SB RIGHT	7	0	7	0	7	7	0	7	7
<b>TOTALS</b>	<b>1215</b>	<b>156</b>	<b>1371</b>	<b>84</b>	<b>1299</b>	<b>1455</b>	<b>29</b>	<b>1328</b>	<b>1484</b>



SUBJECT	BY	DATE	JOB NO.	SHEET	OF
TURN VOLUME SUMMARY	TM	8-Sep-21	HIGP0000-0002	2	OF 2

E/W STREET : BEAR VALLEY RD                      N/S STREET : PLUTO DR  
CONDITION : AM PEAK HOUR                      PHF : 0.91

NORTH LEG											
AUTO			LARGE 2 AXLE			LARGE 3 AXLE			LARGE 4(+) AXLE		
RT	THRU	LT	RT	THRU	LT	RT	THRU	LT	RT	THRU	LT
0	0	1	0	0	0	0	0	0	0	0	0
0	0	1	0	0	0	0	0	0	0	0	0
0	0	1	0	0	0	0	0	0	0	0	0
0	0	2	0	0	0	0	0	0	0	0	0

SOUTH LEG											
AUTO			LARGE 2 AXLE			LARGE 3 AXLE			LARGE 4(+) AXLE		
RT	THRU	LT	RT	THRU	LT	RT	THRU	LT	RT	THRU	LT
0	0	0	0	0	0	0	0	0	0	0	0
0	0	0	0	0	0	0	0	0	0	0	0
0	0	0	0	0	0	0	0	0	0	0	0
0	0	0	0	0	0	0	0	0	0	0	0

EAST LEG											
AUTO			LARGE 2 AXLE			LARGE 3 AXLE			LARGE 4(+) AXLE		
RT	THRU	LT	RT	THRU	LT	RT	THRU	LT	RT	THRU	LT
0	104	0	0	7	0	0	0	0	0	6	0
3	119	0	0	4	0	0	0	0	0	10	0
2	106	0	0	6	0	0	2	0	0	11	0
3	144	0	0	3	0	0	0	0	0	7	0

WEST LEG											
AUTO			LARGE 2 AXLE			LARGE 3 AXLE			LARGE 4(+) AXLE		
RT	THRU	LT	RT	THRU	LT	RT	THRU	LT	RT	THRU	LT
0	195	1	0	5	0	0	0	0	0	7	0
0	226	1	0	3	0	0	2	0	0	5	0
0	151	0	0	6	0	0	1	0	0	8	0
0	197	0	0	7	0	0	1	0	0	5	0

Truck Volumes	Auto Volumes	Totals	Truck Percentage	Balanced Totals
---------------	--------------	--------	------------------	-----------------

**BEAR VALLEY RD**

EB LEFT	0	2	2	1%	7
EB THRU	50	769	819	6%	668
EB RIGHT	0	0	0	0%	0
WB LEFT	0	0	0	0%	0
WB THRU	56	473	529	11%	518
WB RIGHT	0	8	8	1%	8

**PLUTO DR**

NB LEFT	0	0	0	0%	0
NB THRU	0	0	0	0%	0
NB RIGHT	0	0	0	0%	0
SB LEFT	0	5	5	1%	7
SB THRU	0	0	0	0%	0
SB RIGHT	0	0	1	1%	7

Intersection						
Int Delay, s/veh	0.2					
Movement	EBL	EBT	WBT	WBR	SBL	SBR
Lane Configurations	↘	↑↑	↑↑		↘	
Traffic Vol, veh/h	7	668	518	8	7	7
Future Vol, veh/h	7	668	518	8	7	7
Conflicting Peds, #/hr	0	0	0	0	0	0
Sign Control	Free	Free	Free	Free	Stop	Stop
RT Channelized	-	None	-	None	-	None
Storage Length	100	-	-	-	0	-
Veh in Median Storage, #	-	0	0	-	0	-
Grade, %	-	0	0	-	0	-
Peak Hour Factor	94	94	94	94	94	94
Heavy Vehicles, %	1	12	10	1	1	1
Mvmt Flow	7	711	551	9	7	7

Major/Minor	Major1	Major2	Minor2		
Conflicting Flow All	560	0	-	0	926 280
Stage 1	-	-	-	-	556 -
Stage 2	-	-	-	-	370 -
Critical Hdwy	4.12	-	-	-	6.82 6.92
Critical Hdwy Stg 1	-	-	-	-	5.82 -
Critical Hdwy Stg 2	-	-	-	-	5.82 -
Follow-up Hdwy	2.21	-	-	-	3.51 3.31
Pot Cap-1 Maneuver	1014	-	-	-	269 720
Stage 1	-	-	-	-	541 -
Stage 2	-	-	-	-	672 -
Platoon blocked, %		-	-	-	
Mov Cap-1 Maneuver	1014	-	-	-	267 720
Mov Cap-2 Maneuver	-	-	-	-	392 -
Stage 1	-	-	-	-	537 -
Stage 2	-	-	-	-	672 -

Approach	EB	WB	SB
HCM Control Delay, s	0.1	0	12.3
HCM LOS			B

Minor Lane/Major Mvmt	EBL	EBT	WBT	WBR	SBLn1
Capacity (veh/h)	1014	-	-	-	508
HCM Lane V/C Ratio	0.007	-	-	-	0.029
HCM Control Delay (s)	8.6	-	-	-	12.3
HCM Lane LOS	A	-	-	-	B
HCM 95th %tile Q(veh)	0	-	-	-	0.1

Intersection												
Int Delay, s/veh	1.9											
Movement	EBL	EBT	EBR	WBL	WBT	WBR	NBL	NBT	NBR	SBL	SBT	SBR
Lane Configurations	↖	↗			↖↗			↔			↔	
Traffic Vol, veh/h	7	711	0	31	548	8	18	11	11	7	12	7
Future Vol, veh/h	7	711	0	31	548	8	18	11	11	7	12	7
Conflicting Peds, #/hr	0	0	0	0	0	0	0	0	0	0	0	0
Sign Control	Free	Free	Free	Free	Free	Free	Stop	Stop	Stop	Stop	Stop	Stop
RT Channelized	-	-	None	-	-	None	-	-	None	-	-	None
Storage Length	100	-	-	-	-	-	-	-	-	-	-	-
Veh in Median Storage, #	-	0	-	-	0	-	-	0	-	-	0	-
Grade, %	-	0	-	-	0	-	-	0	-	-	0	-
Peak Hour Factor	94	94	94	94	94	94	94	94	94	94	94	94
Heavy Vehicles, %	1	12	1	1	10	1	1	1	1	1	1	1
Mvmt Flow	7	756	0	33	583	9	19	12	12	7	13	7

Major/Minor	Major1			Major2			Minor1			Minor2		
Conflicting Flow All	592	0	0	756	0	0	1134	1428	378	1052	1424	296
Stage 1	-	-	-	-	-	-	770	770	-	654	654	-
Stage 2	-	-	-	-	-	-	364	658	-	398	770	-
Critical Hdwy	4.12	-	-	4.12	-	-	7.52	6.52	6.92	7.52	6.52	6.92
Critical Hdwy Stg 1	-	-	-	-	-	-	6.52	5.52	-	6.52	5.52	-
Critical Hdwy Stg 2	-	-	-	-	-	-	6.52	5.52	-	6.52	5.52	-
Follow-up Hdwy	2.21	-	-	2.21	-	-	3.51	4.01	3.31	3.51	4.01	3.31
Pot Cap-1 Maneuver	987	-	-	857	-	-	159	135	623	182	136	703
Stage 1	-	-	-	-	-	-	362	411	-	424	464	-
Stage 2	-	-	-	-	-	-	630	462	-	602	411	-
Platoon blocked, %	-	-	-	-	-	-	-	-	-	-	-	-
Mov Cap-1 Maneuver	987	-	-	857	-	-	138	126	623	158	127	703
Mov Cap-2 Maneuver	-	-	-	-	-	-	138	126	-	158	127	-
Stage 1	-	-	-	-	-	-	359	408	-	421	438	-
Stage 2	-	-	-	-	-	-	571	436	-	570	408	-

Approach	EB			WB			NB			SB		
HCM Control Delay, s	0.1			0.7			33.1			29.4		
HCM LOS							D			D		

Minor Lane/Major Mvmt	NBLn1	EBL	EBT	EBR	WBL	WBT	WBR	SBLn1
Capacity (veh/h)	170	987	-	-	857	-	-	175
HCM Lane V/C Ratio	0.25	0.008	-	-	0.038	-	-	0.158
HCM Control Delay (s)	33.1	8.7	-	-	9.4	0.2	-	29.4
HCM Lane LOS	D	A	-	-	A	A	-	D
HCM 95th %tile Q(veh)	0.9	0	-	-	0.1	-	-	0.5



Intersection												
Int Delay, s/veh	1.8											
Movement	EBL	EBT	EBR	WBL	WBT	WBR	NBL	NBT	NBR	SBL	SBT	SBR
Lane Configurations	↙	↑↑	↗	↙	↑↑			↕			↕	
Traffic Vol, veh/h	7	711	0	31	548	8	18	11	11	7	12	7
Future Vol, veh/h	7	711	0	31	548	8	18	11	11	7	12	7
Conflicting Peds, #/hr	0	0	0	0	0	0	0	0	0	0	0	0
Sign Control	Free	Free	Free	Free	Free	Free	Stop	Stop	Stop	Stop	Stop	Stop
RT Channelized	-	-	None	-	-	None	-	-	None	-	-	None
Storage Length	200	-	0	150	-	-	-	-	-	-	-	-
Veh in Median Storage, #	-	0	-	-	0	-	-	0	-	-	0	-
Grade, %	-	0	-	-	0	-	-	0	-	-	0	-
Peak Hour Factor	94	94	94	94	94	94	94	94	94	94	94	94
Heavy Vehicles, %	1	12	1	1	10	1	1	1	1	1	1	1
Mvmt Flow	7	756	0	33	583	9	19	12	12	7	13	7

Major/Minor	Major1			Major2			Minor1			Minor2		
Conflicting Flow All	592	0	0	756	0	0	1134	1428	378	1052	1424	296
Stage 1	-	-	-	-	-	-	770	770	-	654	654	-
Stage 2	-	-	-	-	-	-	364	658	-	398	770	-
Critical Hdwy	4.12	-	-	4.12	-	-	7.52	6.52	6.92	7.52	6.52	6.92
Critical Hdwy Stg 1	-	-	-	-	-	-	6.52	5.52	-	6.52	5.52	-
Critical Hdwy Stg 2	-	-	-	-	-	-	6.52	5.52	-	6.52	5.52	-
Follow-up Hdwy	2.21	-	-	2.21	-	-	3.51	4.01	3.31	3.51	4.01	3.31
Pot Cap-1 Maneuver	987	-	-	857	-	-	159	135	623	182	136	703
Stage 1	-	-	-	-	-	-	362	411	-	424	464	-
Stage 2	-	-	-	-	-	-	630	462	-	602	411	-
Platoon blocked, %	-	-	-	-	-	-	-	-	-	-	-	-
Mov Cap-1 Maneuver	987	-	-	857	-	-	141	129	623	161	130	703
Mov Cap-2 Maneuver	-	-	-	-	-	-	141	129	-	161	130	-
Stage 1	-	-	-	-	-	-	359	408	-	421	446	-
Stage 2	-	-	-	-	-	-	582	444	-	570	408	-

Approach	EB			WB			NB			SB		
HCM Control Delay, s	0.1			0.5			32.5			28.9		
HCM LOS							D			D		

Minor Lane/Major Mvmt	NBLn1	EBL	EBT	EBR	WBL	WBT	WBR	SBLn1
Capacity (veh/h)	173	987	-	-	857	-	-	178
HCM Lane V/C Ratio	0.246	0.008	-	-	0.038	-	-	0.155
HCM Control Delay (s)	32.5	8.7	-	-	9.4	-	-	28.9
HCM Lane LOS	D	A	-	-	A	-	-	D
HCM 95th %tile Q(veh)	0.9	0	-	-	0.1	-	-	0.5

Intersection						
Int Delay, s/veh	0.2					
Movement	EBL	EBT	WBT	WBR	SBL	SBR
Lane Configurations	↘	↑↑	↑↑		↘	
Traffic Vol, veh/h	7	715	554	9	7	7
Future Vol, veh/h	7	715	554	9	7	7
Conflicting Peds, #/hr	0	0	0	0	0	0
Sign Control	Free	Free	Free	Free	Stop	Stop
RT Channelized	-	None	-	None	-	None
Storage Length	100	-	-	-	0	-
Veh in Median Storage, #	-	0	0	-	0	-
Grade, %	-	0	0	-	0	-
Peak Hour Factor	94	94	94	94	94	94
Heavy Vehicles, %	1	12	10	1	1	1
Mvmt Flow	7	761	589	10	7	7

Major/Minor	Major1	Major2	Minor2		
Conflicting Flow All	599	0	-	0	989 300
Stage 1	-	-	-	-	594 -
Stage 2	-	-	-	-	395 -
Critical Hdwy	4.12	-	-	-	6.82 6.92
Critical Hdwy Stg 1	-	-	-	-	5.82 -
Critical Hdwy Stg 2	-	-	-	-	5.82 -
Follow-up Hdwy	2.21	-	-	-	3.51 3.31
Pot Cap-1 Maneuver	981	-	-	-	245 699
Stage 1	-	-	-	-	517 -
Stage 2	-	-	-	-	653 -
Platoon blocked, %		-	-	-	
Mov Cap-1 Maneuver	981	-	-	-	243 699
Mov Cap-2 Maneuver	-	-	-	-	370 -
Stage 1	-	-	-	-	513 -
Stage 2	-	-	-	-	653 -

Approach	EB	WB	SB
HCM Control Delay, s	0.1	0	12.7
HCM LOS			B

Minor Lane/Major Mvmt	EBL	EBT	WBT	WBR	SBLn1
Capacity (veh/h)	981	-	-	-	484
HCM Lane V/C Ratio	0.008	-	-	-	0.031
HCM Control Delay (s)	8.7	-	-	-	12.7
HCM Lane LOS	A	-	-	-	B
HCM 95th %tile Q(veh)	0	-	-	-	0.1

Intersection												
Int Delay, s/veh	2											
Movement	EBL	EBT	EBR	WBL	WBT	WBR	NBL	NBT	NBR	SBL	SBT	SBR
Lane Configurations	↖	↗			↖↗			↔			↔	
Traffic Vol, veh/h	7	758	0	31	584	9	18	11	11	7	12	7
Future Vol, veh/h	7	758	0	31	584	9	18	11	11	7	12	7
Conflicting Peds, #/hr	0	0	0	0	0	0	0	0	0	0	0	0
Sign Control	Free	Free	Free	Free	Free	Free	Stop	Stop	Stop	Stop	Stop	Stop
RT Channelized	-	-	None	-	-	None	-	-	None	-	-	None
Storage Length	100	-	-	-	-	-	-	-	-	-	-	-
Veh in Median Storage, #	-	0	-	-	0	-	-	0	-	-	0	-
Grade, %	-	0	-	-	0	-	-	0	-	-	0	-
Peak Hour Factor	94	94	94	94	94	94	94	94	94	94	94	94
Heavy Vehicles, %	1	12	1	1	10	1	1	1	1	1	1	1
Mvmt Flow	7	806	0	33	621	10	19	12	12	7	13	7

Major/Minor	Major1			Major2			Minor1			Minor2		
Conflicting Flow All	631	0	0	806	0	0	1203	1517	403	1115	1512	316
Stage 1	-	-	-	-	-	-	820	820	-	692	692	-
Stage 2	-	-	-	-	-	-	383	697	-	423	820	-
Critical Hdwy	4.12	-	-	4.12	-	-	7.52	6.52	6.92	7.52	6.52	6.92
Critical Hdwy Stg 1	-	-	-	-	-	-	6.52	5.52	-	6.52	5.52	-
Critical Hdwy Stg 2	-	-	-	-	-	-	6.52	5.52	-	6.52	5.52	-
Follow-up Hdwy	2.21	-	-	2.21	-	-	3.51	4.01	3.31	3.51	4.01	3.31
Pot Cap-1 Maneuver	954	-	-	821	-	-	141	119	600	164	120	683
Stage 1	-	-	-	-	-	-	337	389	-	403	446	-
Stage 2	-	-	-	-	-	-	614	443	-	582	389	-
Platoon blocked, %	-	-	-	-	-	-	-	-	-	-	-	-
Mov Cap-1 Maneuver	954	-	-	821	-	-	121	111	600	140	112	683
Mov Cap-2 Maneuver	-	-	-	-	-	-	121	111	-	140	112	-
Stage 1	-	-	-	-	-	-	335	386	-	400	418	-
Stage 2	-	-	-	-	-	-	552	416	-	549	386	-

Approach	EB	WB	NB	SB
HCM Control Delay, s	0.1	0.8	38.2	33.2
HCM LOS			E	D

Minor Lane/Major Mvmt	NBLn1	EBL	EBT	EBR	WBL	WBT	WBR	SBLn1
Capacity (veh/h)	150	954	-	-	821	-	-	155
HCM Lane V/C Ratio	0.284	0.008	-	-	0.04	-	-	0.178
HCM Control Delay (s)	38.2	8.8	-	-	9.6	0.3	-	33.2
HCM Lane LOS	E	A	-	-	A	A	-	D
HCM 95th %tile Q(veh)	1.1	0	-	-	0.1	-	-	0.6

Intersection												
Int Delay, s/veh	1.9											
Movement	EBL	EBT	EBR	WBL	WBT	WBR	NBL	NBT	NBR	SBL	SBT	SBR
Lane Configurations	↙	↑↑	↗	↙	↑↑			↕			↕	
Traffic Vol, veh/h	7	758	0	31	584	9	18	11	11	7	12	7
Future Vol, veh/h	7	758	0	31	584	9	18	11	11	7	12	7
Conflicting Peds, #/hr	0	0	0	0	0	0	0	0	0	0	0	0
Sign Control	Free	Free	Free	Free	Free	Free	Stop	Stop	Stop	Stop	Stop	Stop
RT Channelized	-	-	None	-	-	None	-	-	None	-	-	None
Storage Length	200	-	0	150	-	-	-	-	-	-	-	-
Veh in Median Storage, #	-	0	-	-	0	-	-	0	-	-	0	-
Grade, %	-	0	-	-	0	-	-	0	-	-	0	-
Peak Hour Factor	94	94	94	94	94	94	94	94	94	94	94	94
Heavy Vehicles, %	1	12	1	1	10	1	1	1	1	1	1	1
Mvmt Flow	7	806	0	33	621	10	19	12	12	7	13	7

Major/Minor	Major1			Major2			Minor1			Minor2		
Conflicting Flow All	631	0	0	806	0	0	1203	1517	403	1115	1512	316
Stage 1	-	-	-	-	-	-	820	820	-	692	692	-
Stage 2	-	-	-	-	-	-	383	697	-	423	820	-
Critical Hdwy	4.12	-	-	4.12	-	-	7.52	6.52	6.92	7.52	6.52	6.92
Critical Hdwy Stg 1	-	-	-	-	-	-	6.52	5.52	-	6.52	5.52	-
Critical Hdwy Stg 2	-	-	-	-	-	-	6.52	5.52	-	6.52	5.52	-
Follow-up Hdwy	2.21	-	-	2.21	-	-	3.51	4.01	3.31	3.51	4.01	3.31
Pot Cap-1 Maneuver	954	-	-	821	-	-	141	119	600	164	120	683
Stage 1	-	-	-	-	-	-	337	389	-	403	446	-
Stage 2	-	-	-	-	-	-	614	443	-	582	389	-
Platoon blocked, %	-	-	-	-	-	-	-	-	-	-	-	-
Mov Cap-1 Maneuver	954	-	-	821	-	-	123	113	600	143	114	683
Mov Cap-2 Maneuver	-	-	-	-	-	-	123	113	-	143	114	-
Stage 1	-	-	-	-	-	-	335	386	-	400	428	-
Stage 2	-	-	-	-	-	-	566	425	-	549	386	-

Approach	EB			WB			NB			SB		
HCM Control Delay, s	0.1			0.5			37.4			32.6		
HCM LOS							E			D		

Minor Lane/Major Mvmt	NBLn1	EBL	EBT	EBR	WBL	WBT	WBR	SBLn1
Capacity (veh/h)	153	954	-	-	821	-	-	158
HCM Lane V/C Ratio	0.278	0.008	-	-	0.04	-	-	0.175
HCM Control Delay (s)	37.4	8.8	-	-	9.6	-	-	32.6
HCM Lane LOS	E	A	-	-	A	-	-	D
HCM 95th %tile Q(veh)	1.1	0	-	-	0.1	-	-	0.6

Intersection						
Int Delay, s/veh	0.2					
Movement	EBL	EBT	WBT	WBR	SBL	SBR
Lane Configurations	↙	↑↑	↑↑		↘	
Traffic Vol, veh/h	7	731	567	9	7	7
Future Vol, veh/h	7	731	567	9	7	7
Conflicting Peds, #/hr	0	0	0	0	0	0
Sign Control	Free	Free	Free	Free	Stop	Stop
RT Channelized	-	None	-	None	-	None
Storage Length	100	-	-	-	0	-
Veh in Median Storage, #	-	0	0	-	0	-
Grade, %	-	0	0	-	0	-
Peak Hour Factor	94	94	94	94	94	94
Heavy Vehicles, %	1	12	10	1	1	1
Mvmt Flow	7	778	603	10	7	7

Major/Minor	Major1	Major2	Minor2		
Conflicting Flow All	613	0	-	0	1011 307
Stage 1	-	-	-	-	608 -
Stage 2	-	-	-	-	403 -
Critical Hdwy	4.12	-	-	-	6.82 6.92
Critical Hdwy Stg 1	-	-	-	-	5.82 -
Critical Hdwy Stg 2	-	-	-	-	5.82 -
Follow-up Hdwy	2.21	-	-	-	3.51 3.31
Pot Cap-1 Maneuver	969	-	-	-	238 692
Stage 1	-	-	-	-	509 -
Stage 2	-	-	-	-	647 -
Platoon blocked, %		-	-	-	
Mov Cap-1 Maneuver	969	-	-	-	236 692
Mov Cap-2 Maneuver	-	-	-	-	364 -
Stage 1	-	-	-	-	505 -
Stage 2	-	-	-	-	647 -

Approach	EB	WB	SB
HCM Control Delay, s	0.1	0	12.8
HCM LOS			B

Minor Lane/Major Mvmt	EBL	EBT	WBT	WBR	SBLn1
Capacity (veh/h)	969	-	-	-	477
HCM Lane V/C Ratio	0.008	-	-	-	0.031
HCM Control Delay (s)	8.7	-	-	-	12.8
HCM Lane LOS	A	-	-	-	B
HCM 95th %tile Q(veh)	0	-	-	-	0.1

Intersection												
Int Delay, s/veh	2.1											
Movement	EBL	EBT	EBR	WBL	WBT	WBR	NBL	NBT	NBR	SBL	SBT	SBR
Lane Configurations	↖	↗			↖↗			↕			↕	
Traffic Vol, veh/h	7	774	0	31	597	9	18	11	11	7	12	7
Future Vol, veh/h	7	774	0	31	597	9	18	11	11	7	12	7
Conflicting Peds, #/hr	0	0	0	0	0	0	0	0	0	0	0	0
Sign Control	Free	Free	Free	Free	Free	Free	Stop	Stop	Stop	Stop	Stop	Stop
RT Channelized	-	-	None	-	-	None	-	-	None	-	-	None
Storage Length	100	-	-	-	-	-	-	-	-	-	-	-
Veh in Median Storage, #	-	0	-	-	0	-	-	0	-	-	0	-
Grade, %	-	0	-	-	0	-	-	0	-	-	0	-
Peak Hour Factor	94	94	94	94	94	94	94	94	94	94	94	94
Heavy Vehicles, %	1	12	1	1	10	1	1	1	1	1	1	1
Mvmt Flow	7	823	0	33	635	10	19	12	12	7	13	7

Major/Minor	Major1			Major2			Minor1			Minor2		
Conflicting Flow All	645	0	0	823	0	0	1227	1548	412	1138	1543	323
Stage 1	-	-	-	-	-	-	837	837	-	706	706	-
Stage 2	-	-	-	-	-	-	390	711	-	432	837	-
Critical Hdwy	4.12	-	-	4.12	-	-	7.52	6.52	6.92	7.52	6.52	6.92
Critical Hdwy Stg 1	-	-	-	-	-	-	6.52	5.52	-	6.52	5.52	-
Critical Hdwy Stg 2	-	-	-	-	-	-	6.52	5.52	-	6.52	5.52	-
Follow-up Hdwy	2.21	-	-	2.21	-	-	3.51	4.01	3.31	3.51	4.01	3.31
Pot Cap-1 Maneuver	943	-	-	809	-	-	136	114	592	158	115	676
Stage 1	-	-	-	-	-	-	330	382	-	395	439	-
Stage 2	-	-	-	-	-	-	608	437	-	575	382	-
Platoon blocked, %	-	-	-	-	-	-	-	-	-	-	-	-
Mov Cap-1 Maneuver	943	-	-	809	-	-	116	106	592	134	107	676
Mov Cap-2 Maneuver	-	-	-	-	-	-	116	106	-	134	107	-
Stage 1	-	-	-	-	-	-	328	379	-	392	411	-
Stage 2	-	-	-	-	-	-	545	409	-	542	379	-

Approach	EB			WB			NB			SB		
HCM Control Delay, s	0.1			0.8			40.2			34.6		
HCM LOS							E			D		

Minor Lane/Major Mvmt	NBLn1	EBL	EBT	EBR	WBL	WBT	WBR	SBLn1
Capacity (veh/h)	144	943	-	-	809	-	-	149
HCM Lane V/C Ratio	0.296	0.008	-	-	0.041	-	-	0.186
HCM Control Delay (s)	40.2	8.8	-	-	9.6	0.3	-	34.6
HCM Lane LOS	E	A	-	-	A	A	-	D
HCM 95th %tile Q(veh)	1.2	0	-	-	0.1	-	-	0.7

Intersection												
Int Delay, s/veh	2											
Movement	EBL	EBT	EBR	WBL	WBT	WBR	NBL	NBT	NBR	SBL	SBT	SBR
Lane Configurations	↙	↑↑↑	↗	↙↑↑	↗			↕			↕	
Traffic Vol, veh/h	7	774	0	31	597	9	18	11	11	7	12	7
Future Vol, veh/h	7	774	0	31	597	9	18	11	11	7	12	7
Conflicting Peds, #/hr	0	0	0	0	0	0	0	0	0	0	0	0
Sign Control	Free	Free	Free	Free	Free	Free	Stop	Stop	Stop	Stop	Stop	Stop
RT Channelized	-	-	None	-	-	None	-	-	None	-	-	None
Storage Length	200	-	0	-	-	-	-	-	-	-	-	-
Veh in Median Storage, #	-	0	-	-	0	-	-	0	-	-	0	-
Grade, %	-	0	-	-	0	-	-	0	-	-	0	-
Peak Hour Factor	94	94	94	94	94	94	94	94	94	94	94	94
Heavy Vehicles, %	1	12	1	1	10	1	1	1	1	1	1	1
Mvmt Flow	7	823	0	33	635	10	19	12	12	7	13	7

Major/Minor	Major1			Major2			Minor1			Minor2		
Conflicting Flow All	645	0	0	823	0	0	1164	1548	412	1055	1543	323
Stage 1	-	-	-	-	-	-	837	837	-	706	706	-
Stage 2	-	-	-	-	-	-	327	711	-	349	837	-
Critical Hdwy	5.32	-	-	5.32	-	-	6.42	6.52	7.12	6.42	6.52	7.12
Critical Hdwy Stg 1	-	-	-	-	-	-	7.32	5.52	-	7.32	5.52	-
Critical Hdwy Stg 2	-	-	-	-	-	-	6.72	5.52	-	6.72	5.52	-
Follow-up Hdwy	3.11	-	-	3.11	-	-	3.81	4.01	3.91	3.81	4.01	3.91
Pot Cap-1 Maneuver	582	-	-	479	-	-	206	114	506	239	115	576
Stage 1	-	-	-	-	-	-	260	382	-	319	439	-
Stage 2	-	-	-	-	-	-	607	437	-	589	382	-
Platoon blocked, %	-	-	-	-	-	-	-	-	-	-	-	-
Mov Cap-1 Maneuver	582	-	-	479	-	-	167	100	506	194	101	576
Mov Cap-2 Maneuver	-	-	-	-	-	-	167	100	-	194	101	-
Stage 1	-	-	-	-	-	-	257	377	-	315	392	-
Stage 2	-	-	-	-	-	-	517	390	-	551	377	-

Approach	EB	WB	NB	SB
HCM Control Delay, s	0.1	1	33.8	33
HCM LOS			D	D

Minor Lane/Major Mvmt	NBLn1	EBL	EBT	EBR	WBL	WBT	WBR	SBLn1
Capacity (veh/h)	167	582	-	-	479	-	-	156
HCM Lane V/C Ratio	0.255	0.013	-	-	0.069	-	-	0.177
HCM Control Delay (s)	33.8	11.3	-	-	13.1	0.4	-	33
HCM Lane LOS	D	B	-	-	B	A	-	D
HCM 95th %tile Q(veh)	1	0	-	-	0.2	-	-	0.6



SUBJECT	BY	DATE	JOB NO.	SHEET	OF
TURN MOVEMENTS	TM	8-Sep-21	HIGP0000-0002	1	OF 2

E/W STREET : BEAR VALLEY RD  
N/S STREET : PLUTO DR  
CONDITION : PM PEAK HOUR

INTERSECTION : 2  
PROJECTED GROWTH : 3.5%  
PER YEAR :

**TURN MOVEMENTS**

Condition	Existing Condition	Project Trips	Existing + Project Condition	Year 2023 Ambient Growth	Background Condition	Project Condition	Year 2033 Ambient Growth	Future Condition	Future + Project Condition
Scenario #	2		3		5	7		9	11

**BEAR VALLEY RD**

EB LEFT	3	0	3	0	3	3	0	3	3
EB THRU	741	52	793	52	793	845	18	811	863
EB RIGHT	0	0	0	0	0	0	0	0	0
WB LEFT	0	36	36	0	0	36	0	0	36
WB THRU	547	28	575	38	585	613	13	598	626
WB RIGHT	13	0	13	1	14	14	0	14	14

**PLUTO DR**

NB LEFT	0	24	24	0	0	24	0	0	24
NB THRU	0	13	13	0	0	13	0	0	13
NB RIGHT	0	13	13	0	0	13	0	0	13
SB LEFT	8	0	8	1	9	9	0	9	9
SB THRU	0	13	13	0	0	13	0	0	13
SB RIGHT	38	0	38	3	41	41	1	42	42
<b>TOTALS</b>	<b>1350</b>	<b>179</b>	<b>1529</b>	<b>95</b>	<b>1445</b>	<b>1624</b>	<b>32</b>	<b>1477</b>	<b>1656</b>





SUBJECT	BY	DATE	JOB NO.	SHEET	OF
TURN VOLUME SUMMARY	TM	8-Sep-21	HIGP0000-0002	2	OF 2

E/W STREET : BEAR VALLEY RD                      N/S STREET : PLUTO DR  
CONDITION : PM PEAK HOUR                      PHF : 0.89

NORTH LEG											
AUTO			LARGE 2 AXLE			LARGE 3 AXLE			LARGE 4(+) AXLE		
RT	THRU	LT	RT	THRU	LT	RT	THRU	LT	RT	THRU	LT
0	0	0	0	0	0	0	0	0	0	0	0
1	0	2	0	0	0	0	0	0	0	0	0
2	0	3	0	0	0	0	0	0	0	0	0
1	0	1	0	0	0	0	0	0	0	0	0

SOUTH LEG											
AUTO			LARGE 2 AXLE			LARGE 3 AXLE			LARGE 4(+) AXLE		
RT	THRU	LT	RT	THRU	LT	RT	THRU	LT	RT	THRU	LT
0	0	0	0	0	0	0	0	0	0	0	0
0	0	0	0	0	0	0	0	0	0	0	0
0	0	0	0	0	0	0	0	0	0	0	0
0	0	0	0	0	0	0	0	0	0	0	0

EAST LEG											
AUTO			LARGE 2 AXLE			LARGE 3 AXLE			LARGE 4(+) AXLE		
RT	THRU	LT	RT	THRU	LT	RT	THRU	LT	RT	THRU	LT
6	102	0	0	1	0	0	3	0	0	2	0
1	77	0	0	2	0	0	1	0	0	3	0
3	98	0	0	3	0	0	0	0	0	4	0
3	132	0	0	2	0	0	0	0	0	2	0

WEST LEG											
AUTO			LARGE 2 AXLE			LARGE 3 AXLE			LARGE 4(+) AXLE		
RT	THRU	LT	RT	THRU	LT	RT	THRU	LT	RT	THRU	LT
0	168	1	0	3	0	0	0	0	0	2	0
0	167	0	0	3	0	0	0	0	0	4	0
0	183	1	0	2	0	0	1	0	0	3	0
0	184	1	0	1	0	0	1	0	0	4	0

Truck Volumes	Auto Volumes	Totals	Truck Percentage	Balanced Totals
---------------	--------------	--------	------------------	-----------------

**BEAR VALLEY RD**

EB LEFT	0	3	3	1%	3
EB THRU	24	702	726	3%	741
EB RIGHT	0	0	0	0%	0
WB LEFT	0	0	0	0%	0
WB THRU	23	409	432	5%	547
WB RIGHT	0	13	13	1%	13

**PLUTO DR**

NB LEFT	0	0	0	0%	0
NB THRU	0	0	0	0%	0
NB RIGHT	0	0	0	0%	0
SB LEFT	0	6	6	1%	8
SB THRU	0	0	0	0%	0
SB RIGHT	0	4	4	1%	38

Intersection						
Int Delay, s/veh	0.4					
Movement	EBL	EBT	WBT	WBR	SBL	SBR
Lane Configurations	↙	↑↑	↑↑		↘	
Traffic Vol, veh/h	3	741	547	13	8	38
Future Vol, veh/h	3	741	547	13	8	38
Conflicting Peds, #/hr	0	0	0	0	0	0
Sign Control	Free	Free	Free	Free	Stop	Stop
RT Channelized	-	None	-	None	-	None
Storage Length	100	-	-	-	0	-
Veh in Median Storage, #	-	0	0	-	0	-
Grade, %	-	0	0	-	0	-
Peak Hour Factor	76	76	76	76	76	76
Heavy Vehicles, %	1	3	3	1	1	1
Mvmt Flow	2	975	720	17	11	50

Major/Minor	Major1	Major2	Minor2		
Conflicting Flow All	737	0	-	0	1221 369
Stage 1	-	-	-	-	729 -
Stage 2	-	-	-	-	492 -
Critical Hdwy	4.12	-	-	-	6.82 6.92
Critical Hdwy Stg 1	-	-	-	-	5.82 -
Critical Hdwy Stg 2	-	-	-	-	5.82 -
Follow-up Hdwy	2.21	-	-	-	3.51 3.31
Pot Cap-1 Maneuver	871	-	-	-	174 631
Stage 1	-	-	-	-	441 -
Stage 2	-	-	-	-	583 -
Platoon blocked, %		-	-	-	
Mov Cap-1 Maneuver	871	-	-	-	174 631
Mov Cap-2 Maneuver	-	-	-	-	306 -
Stage 1	-	-	-	-	440 -
Stage 2	-	-	-	-	583 -

Approach	EB	WB	SB
HCM Control Delay, s	0	0	12.6
HCM LOS			B

Minor Lane/Major Mvmt	EBL	EBT	WBT	WBR	SBLn1
Capacity (veh/h)	871	-	-	-	533
HCM Lane V/C Ratio	0.002	-	-	-	0.114
HCM Control Delay (s)	9.1	-	-	-	12.6
HCM Lane LOS	A	-	-	-	B
HCM 95th %tile Q(veh)	0	-	-	-	0.4

Intersection												
Int Delay, s/veh	8.6											
Movement	EBL	EBT	EBR	WBL	WBT	WBR	NBL	NBT	NBR	SBL	SBT	SBR
Lane Configurations	↖	↗			↖↗			↖↗			↖↗	
Traffic Vol, veh/h	3	793	0	36	575	13	24	13	13	8	13	38
Future Vol, veh/h	3	793	0	36	575	13	24	13	13	8	13	38
Conflicting Peds, #/hr	0	0	0	0	0	0	0	0	0	0	0	0
Sign Control	Free	Free	Free	Free	Free	Free	Stop	Stop	Stop	Stop	Stop	Stop
RT Channelized	-	-	None	-	-	None	-	-	None	-	-	None
Storage Length	100	-	-	-	-	-	-	-	-	-	-	-
Veh in Median Storage, #	-	0	-	-	0	-	-	0	-	-	0	-
Grade, %	-	0	-	-	0	-	-	0	-	-	0	-
Peak Hour Factor	76	76	76	76	76	76	76	76	76	76	76	76
Heavy Vehicles, %	1	3	1	1	3	1	1	1	1	1	1	1
Mvmt Flow	2	1043	0	47	757	17	32	17	17	11	17	50

Major/Minor	Major1			Major2			Minor1			Minor2		
Conflicting Flow All	774	0	0	1043	0	0	1528	1915	522	1394	1907	387
Stage 1	-	-	-	-	-	-	1047	1047	-	860	860	-
Stage 2	-	-	-	-	-	-	481	868	-	534	1047	-
Critical Hdwy	4.12	-	-	4.12	-	-	7.52	6.52	6.92	7.52	6.52	6.92
Critical Hdwy Stg 1	-	-	-	-	-	-	6.52	5.52	-	6.52	5.52	-
Critical Hdwy Stg 2	-	-	-	-	-	-	6.52	5.52	-	6.52	5.52	-
Follow-up Hdwy	2.21	-	-	2.21	-	-	3.51	4.01	3.31	3.51	4.01	3.31
Pot Cap-1 Maneuver	844	-	-	669	-	-	81	68	502	102	68	614
Stage 1	-	-	-	-	-	-	246	305	-	319	373	-
Stage 2	-	-	-	-	-	-	538	370	-	500	305	-
Platoon blocked, %	-	-	-	-	-	-	-	-	-	-	-	-
Mov Cap-1 Maneuver	844	-	-	669	-	-	52	59	502	69	59	614
Mov Cap-2 Maneuver	-	-	-	-	-	-	52	59	-	69	59	-
Stage 1	-	-	-	-	-	-	246	304	-	318	327	-
Stage 2	-	-	-	-	-	-	410	324	-	455	304	-

Approach	EB			WB			NB			SB		
HCM Control Delay, s	0			1.2			185.5			53.4		
HCM LOS							F			F		

Minor Lane/Major Mvmt	NBLn1	EBL	EBT	EBR	WBL	WBT	WBR	SBLn1
Capacity (veh/h)	71	844	-	-	669	-	-	148
HCM Lane V/C Ratio	0.927	0.002	-	-	0.071	-	-	0.525
HCM Control Delay (s)	185.5	9.3	-	-	10.8	0.6	-	53.4
HCM Lane LOS	F	A	-	-	B	A	-	F
HCM 95th %tile Q(veh)	4.7	0	-	-	0.2	-	-	2.6

Intersection												
Int Delay, s/veh	7.4											
Movement	EBL	EBT	EBR	WBL	WBT	WBR	NBL	NBT	NBR	SBL	SBT	SBR
Lane Configurations	↘	↑↑	↗	↘	↑↑			↕			↕	
Traffic Vol, veh/h	3	793	0	36	575	13	24	13	13	8	13	38
Future Vol, veh/h	3	793	0	36	575	13	24	13	13	8	13	38
Conflicting Peds, #/hr	0	0	0	0	0	0	0	0	0	0	0	0
Sign Control	Free	Free	Free	Free	Free	Free	Stop	Stop	Stop	Stop	Stop	Stop
RT Channelized	-	-	None	-	-	None	-	-	None	-	-	None
Storage Length	100	-	0	0	-	-	-	-	-	-	-	-
Veh in Median Storage, #	-	0	-	-	0	-	-	0	-	-	0	-
Grade, %	-	0	-	-	0	-	-	0	-	-	0	-
Peak Hour Factor	76	76	76	76	76	76	76	76	76	76	76	76
Heavy Vehicles, %	1	3	1	1	3	1	1	1	1	1	1	1
Mvmt Flow	2	1043	0	47	757	17	32	17	17	11	17	50

Major/Minor	Major1			Major2			Minor1			Minor2		
Conflicting Flow All	774	0	0	1043	0	0	1528	1915	522	1394	1907	387
Stage 1	-	-	-	-	-	-	1047	1047	-	860	860	-
Stage 2	-	-	-	-	-	-	481	868	-	534	1047	-
Critical Hdwy	4.12	-	-	4.12	-	-	7.52	6.52	6.92	7.52	6.52	6.92
Critical Hdwy Stg 1	-	-	-	-	-	-	6.52	5.52	-	6.52	5.52	-
Critical Hdwy Stg 2	-	-	-	-	-	-	6.52	5.52	-	6.52	5.52	-
Follow-up Hdwy	2.21	-	-	2.21	-	-	3.51	4.01	3.31	3.51	4.01	3.31
Pot Cap-1 Maneuver	844	-	-	669	-	-	81	68	502	102	68	614
Stage 1	-	-	-	-	-	-	246	305	-	319	373	-
Stage 2	-	-	-	-	-	-	538	370	-	500	305	-
Platoon blocked, %	-	-	-	-	-	-	-	-	-	-	-	-
Mov Cap-1 Maneuver	844	-	-	669	-	-	56	63	502	74	63	614
Mov Cap-2 Maneuver	-	-	-	-	-	-	56	63	-	74	63	-
Stage 1	-	-	-	-	-	-	246	304	-	318	347	-
Stage 2	-	-	-	-	-	-	437	344	-	455	304	-

Approach	EB			WB			NB			SB		
HCM Control Delay, s	0			0.6			161.3			48.5		
HCM LOS							F			E		

Minor Lane/Major Mvmt	NBLn1	EBL	EBT	EBR	WBL	WBT	WBR	SBLn1
Capacity (veh/h)	76	844	-	-	669	-	-	157
HCM Lane V/C Ratio	0.866	0.002	-	-	0.071	-	-	0.494
HCM Control Delay (s)	161.3	9.3	-	-	10.8	-	-	48.5
HCM Lane LOS	F	A	-	-	B	-	-	E
HCM 95th %tile Q(veh)	4.4	0	-	-	0.2	-	-	2.4

Intersection						
Int Delay, s/veh	0.5					
Movement	EBL	EBT	WBT	WBR	SBL	SBR
Lane Configurations	↘	↑↑	↑↑		↘	
Traffic Vol, veh/h	3	793	585	14	9	41
Future Vol, veh/h	3	793	585	14	9	41
Conflicting Peds, #/hr	0	0	0	0	0	0
Sign Control	Free	Free	Free	Free	Stop	Stop
RT Channelized	-	None	-	None	-	None
Storage Length	100	-	-	-	0	-
Veh in Median Storage, #	-	0	0	-	0	-
Grade, %	-	0	0	-	0	-
Peak Hour Factor	76	76	76	76	76	76
Heavy Vehicles, %	1	3	3	1	1	1
Mvmt Flow	2	1043	770	18	12	54

Major/Minor	Major1	Major2	Minor2		
Conflicting Flow All	788	0	-	0	1305 394
Stage 1	-	-	-	-	779 -
Stage 2	-	-	-	-	526 -
Critical Hdwy	4.12	-	-	-	6.82 6.92
Critical Hdwy Stg 1	-	-	-	-	5.82 -
Critical Hdwy Stg 2	-	-	-	-	5.82 -
Follow-up Hdwy	2.21	-	-	-	3.51 3.31
Pot Cap-1 Maneuver	834	-	-	-	153 608
Stage 1	-	-	-	-	416 -
Stage 2	-	-	-	-	560 -
Platoon blocked, %		-	-	-	
Mov Cap-1 Maneuver	834	-	-	-	153 608
Mov Cap-2 Maneuver	-	-	-	-	285 -
Stage 1	-	-	-	-	415 -
Stage 2	-	-	-	-	560 -

Approach	EB	WB	SB
HCM Control Delay, s	0	0	13.2
HCM LOS			B

Minor Lane/Major Mvmt	EBL	EBT	WBT	WBR	SBLn1
Capacity (veh/h)	834	-	-	-	505
HCM Lane V/C Ratio	0.002	-	-	-	0.13
HCM Control Delay (s)	9.3	-	-	-	13.2
HCM Lane LOS	A	-	-	-	B
HCM 95th %tile Q(veh)	0	-	-	-	0.4

Intersection												
Int Delay, s/veh	12.2											
Movement	EBL	EBT	EBR	WBL	WBT	WBR	NBL	NBT	NBR	SBL	SBT	SBR
Lane Configurations	↖	↗			↖↗			↕			↕	
Traffic Vol, veh/h	3	845	0	36	613	14	24	13	13	9	13	41
Future Vol, veh/h	3	845	0	36	613	14	24	13	13	9	13	41
Conflicting Peds, #/hr	0	0	0	0	0	0	0	0	0	0	0	0
Sign Control	Free	Free	Free	Free	Free	Free	Stop	Stop	Stop	Stop	Stop	Stop
RT Channelized	-	-	None	-	-	None	-	-	None	-	-	None
Storage Length	100	-	-	-	-	-	-	-	-	-	-	-
Veh in Median Storage, #	-	0	-	-	0	-	-	0	-	-	0	-
Grade, %	-	0	-	-	0	-	-	0	-	-	0	-
Peak Hour Factor	76	76	76	76	76	76	76	76	76	76	76	76
Heavy Vehicles, %	1	3	1	1	3	1	1	1	1	1	1	1
Mvmt Flow	2	1112	0	47	807	18	32	17	17	12	17	54

Major/Minor	Major1			Major2			Minor1			Minor2		
Conflicting Flow All	825	0	0	1112	0	0	1622	2035	556	1479	2026	413
Stage 1	-	-	-	-	-	-	1116	1116	-	910	910	-
Stage 2	-	-	-	-	-	-	506	919	-	569	1116	-
Critical Hdwy	4.12	-	-	4.12	-	-	7.52	6.52	6.92	7.52	6.52	6.92
Critical Hdwy Stg 1	-	-	-	-	-	-	6.52	5.52	-	6.52	5.52	-
Critical Hdwy Stg 2	-	-	-	-	-	-	6.52	5.52	-	6.52	5.52	-
Follow-up Hdwy	2.21	-	-	2.21	-	-	3.51	4.01	3.31	3.51	4.01	3.31
Pot Cap-1 Maneuver	808	-	-	630	-	-	69	57	477	88	58	591
Stage 1	-	-	-	-	-	-	223	283	-	298	354	-
Stage 2	-	-	-	-	-	-	520	350	-	477	283	-
Platoon blocked, %	-	-	-	-	-	-	-	-	-	-	-	-
Mov Cap-1 Maneuver	808	-	-	630	-	-	41	49	477	56	50	591
Mov Cap-2 Maneuver	-	-	-	-	-	-	41	49	-	56	50	-
Stage 1	-	-	-	-	-	-	223	282	-	297	305	-
Stage 2	-	-	-	-	-	-	384	302	-	431	282	-

Approach	EB			WB			NB			SB		
HCM Control Delay, s	0			1.3			287.3			73.1		
HCM LOS							F			F		

Minor Lane/Major Mvmt	NBLn1	EBL	EBT	EBR	WBL	WBT	WBR	SBLn1
Capacity (veh/h)	57	808	-	-	630	-	-	129
HCM Lane V/C Ratio	1.154	0.002	-	-	0.075	-	-	0.643
HCM Control Delay (s)	287.3	9.5	-	-	11.2	0.7	-	73.1
HCM Lane LOS	F	A	-	-	B	A	-	F
HCM 95th %tile Q(veh)	5.5	0	-	-	0.2	-	-	3.4

Intersection												
Int Delay, s/veh	10.3											
Movement	EBL	EBT	EBR	WBL	WBT	WBR	NBL	NBT	NBR	SBL	SBT	SBR
Lane Configurations	↘	↑↑	↗	↘	↑↑			↔			↔	
Traffic Vol, veh/h	3	845	0	36	613	14	24	13	13	9	13	41
Future Vol, veh/h	3	845	0	36	613	14	24	13	13	9	13	41
Conflicting Peds, #/hr	0	0	0	0	0	0	0	0	0	0	0	0
Sign Control	Free	Free	Free	Free	Free	Free	Stop	Stop	Stop	Stop	Stop	Stop
RT Channelized	-	-	None	-	-	None	-	-	None	-	-	None
Storage Length	100	-	0	0	-	-	-	-	-	-	-	-
Veh in Median Storage, #	-	0	-	-	0	-	-	0	-	-	0	-
Grade, %	-	0	-	-	0	-	-	0	-	-	0	-
Peak Hour Factor	76	76	76	76	76	76	76	76	76	76	76	76
Heavy Vehicles, %	1	3	1	1	3	1	1	1	1	1	1	1
Mvmt Flow	2	1112	0	47	807	18	32	17	17	12	17	54

Major/Minor	Major1			Major2			Minor1			Minor2		
Conflicting Flow All	825	0	0	1112	0	0	1622	2035	556	1479	2026	413
Stage 1	-	-	-	-	-	-	1116	1116	-	910	910	-
Stage 2	-	-	-	-	-	-	506	919	-	569	1116	-
Critical Hdwy	4.12	-	-	4.12	-	-	7.52	6.52	6.92	7.52	6.52	6.92
Critical Hdwy Stg 1	-	-	-	-	-	-	6.52	5.52	-	6.52	5.52	-
Critical Hdwy Stg 2	-	-	-	-	-	-	6.52	5.52	-	6.52	5.52	-
Follow-up Hdwy	2.21	-	-	2.21	-	-	3.51	4.01	3.31	3.51	4.01	3.31
Pot Cap-1 Maneuver	808	-	-	630	-	-	69	57	477	88	58	591
Stage 1	-	-	-	-	-	-	223	283	-	298	354	-
Stage 2	-	-	-	-	-	-	520	350	-	477	283	-
Platoon blocked, %	-	-	-	-	-	-	-	-	-	-	-	-
Mov Cap-1 Maneuver	808	-	-	630	-	-	45	53	477	60	54	591
Mov Cap-2 Maneuver	-	-	-	-	-	-	45	53	-	60	54	-
Stage 1	-	-	-	-	-	-	223	282	-	297	327	-
Stage 2	-	-	-	-	-	-	414	324	-	431	282	-

Approach	EB			WB			NB			SB		
HCM Control Delay, s	0			0.6			243.9			65.1		
HCM LOS							F			F		

Minor Lane/Major Mvmt	NBLn1	EBL	EBT	EBR	WBL	WBT	WBR	SBLn1
Capacity (veh/h)	62	808	-	-	630	-	-	137
HCM Lane V/C Ratio	1.061	0.002	-	-	0.075	-	-	0.605
HCM Control Delay (s)	243.9	9.5	-	-	11.2	-	-	65.1
HCM Lane LOS	F	A	-	-	B	-	-	F
HCM 95th %tile Q(veh)	5.2	0	-	-	0.2	-	-	3.1

Intersection						
Int Delay, s/veh	0.5					
Movement	EBL	EBT	WBT	WBR	SBL	SBR
Lane Configurations	↘	↑↑	↑↑		↘	
Traffic Vol, veh/h	3	811	598	14	9	42
Future Vol, veh/h	3	811	598	14	9	42
Conflicting Peds, #/hr	0	0	0	0	0	0
Sign Control	Free	Free	Free	Free	Stop	Stop
RT Channelized	-	None	-	None	-	None
Storage Length	100	-	-	-	0	-
Veh in Median Storage, #	-	0	0	-	0	-
Grade, %	-	0	0	-	0	-
Peak Hour Factor	76	76	76	76	76	76
Heavy Vehicles, %	1	3	3	1	1	1
Mvmt Flow	2	1067	787	18	12	55

Major/Minor	Major1	Major2	Minor2		
Conflicting Flow All	805	0	-	0	1334 403
Stage 1	-	-	-	-	796 -
Stage 2	-	-	-	-	538 -
Critical Hdwy	4.12	-	-	-	6.82 6.92
Critical Hdwy Stg 1	-	-	-	-	5.82 -
Critical Hdwy Stg 2	-	-	-	-	5.82 -
Follow-up Hdwy	2.21	-	-	-	3.51 3.31
Pot Cap-1 Maneuver	822	-	-	-	146 600
Stage 1	-	-	-	-	407 -
Stage 2	-	-	-	-	552 -
Platoon blocked, %		-	-	-	
Mov Cap-1 Maneuver	822	-	-	-	146 600
Mov Cap-2 Maneuver	-	-	-	-	278 -
Stage 1	-	-	-	-	406 -
Stage 2	-	-	-	-	552 -

Approach	EB	WB	SB
HCM Control Delay, s	0	0	13.4
HCM LOS			B

Minor Lane/Major Mvmt	EBL	EBT	WBT	WBR	SBLn1
Capacity (veh/h)	822	-	-	-	498
HCM Lane V/C Ratio	0.002	-	-	-	0.135
HCM Control Delay (s)	9.4	-	-	-	13.4
HCM Lane LOS	A	-	-	-	B
HCM 95th %tile Q(veh)	0	-	-	-	0.5



Intersection												
Int Delay, s/veh	14.1											
Movement	EBL	EBT	EBR	WBL	WBT	WBR	NBL	NBT	NBR	SBL	SBT	SBR
Lane Configurations	↖	↕			↕			↕			↕	
Traffic Vol, veh/h	3	863	0	36	626	14	24	13	13	9	13	42
Future Vol, veh/h	3	863	0	36	626	14	24	13	13	9	13	42
Conflicting Peds, #/hr	0	0	0	0	0	0	0	0	0	0	0	0
Sign Control	Free	Free	Free	Free	Free	Free	Stop	Stop	Stop	Stop	Stop	Stop
RT Channelized	-	-	None	-	-	None	-	-	None	-	-	None
Storage Length	100	-	-	-	-	-	-	-	-	-	-	-
Veh in Median Storage, #	-	0	-	-	0	-	-	0	-	-	0	-
Grade, %	-	0	-	-	0	-	-	0	-	-	0	-
Peak Hour Factor	76	76	76	76	76	76	76	76	76	76	76	76
Heavy Vehicles, %	1	3	1	1	3	1	1	1	1	1	1	1
Mvmt Flow	2	1136	0	47	824	18	32	17	17	12	17	55

Major/Minor	Major1			Major2			Minor1			Minor2		
Conflicting Flow All	842	0	0	1136	0	0	1655	2076	568	1508	2067	421
Stage 1	-	-	-	-	-	-	1140	1140	-	927	927	-
Stage 2	-	-	-	-	-	-	515	936	-	581	1140	-
Critical Hdwy	4.12	-	-	4.12	-	-	7.52	6.52	6.92	7.52	6.52	6.92
Critical Hdwy Stg 1	-	-	-	-	-	-	6.52	5.52	-	6.52	5.52	-
Critical Hdwy Stg 2	-	-	-	-	-	-	6.52	5.52	-	6.52	5.52	-
Follow-up Hdwy	2.21	-	-	2.21	-	-	3.51	4.01	3.31	3.51	4.01	3.31
Pot Cap-1 Maneuver	796	-	-	617	-	-	65	54	469	84	54	584
Stage 1	-	-	-	-	-	-	216	276	-	291	347	-
Stage 2	-	-	-	-	-	-	513	344	-	469	276	-
Platoon blocked, %	-	-	-	-	-	-	-	-	-	-	-	-
Mov Cap-1 Maneuver	796	-	-	617	-	-	37	46	469	51	46	584
Mov Cap-2 Maneuver	-	-	-	-	-	-	37	46	-	51	46	-
Stage 1	-	-	-	-	-	-	215	275	-	290	297	-
Stage 2	-	-	-	-	-	-	375	294	-	423	275	-

Approach	EB	WB	NB	SB
HCM Control Delay, s	0	1.3	\$ 341.2	84.7
HCM LOS			F	F

Minor Lane/Major Mvmt	NBLn1	EBL	EBT	EBR	WBL	WBT	WBR	SBLn1
Capacity (veh/h)	52	796	-	-	617	-	-	121
HCM Lane V/C Ratio	1.265	0.002	-	-	0.077	-	-	0.696
HCM Control Delay (s)	\$ 341.2	9.5	-	-	11.3	0.7	-	84.7
HCM Lane LOS	F	A	-	-	B	A	-	F
HCM 95th %tile Q(veh)	5.9	0	-	-	0.2	-	-	3.8

Notes  
 ~: Volume exceeds capacity    \$: Delay exceeds 300s    +: Computation Not Defined    \*: All major volume in platoon

Intersection												
Int Delay, s/veh	11											
Movement	EBL	EBT	EBR	WBL	WBT	WBR	NBL	NBT	NBR	SBL	SBT	SBR
Lane Configurations	↘ ↑↑↑		↗	↘↑↑			↔			↔		
Traffic Vol, veh/h	3	863	0	36	626	14	24	13	13	9	13	42
Future Vol, veh/h	3	863	0	36	626	14	24	13	13	9	13	42
Conflicting Peds, #/hr	0	0	0	0	0	0	0	0	0	0	0	0
Sign Control	Free	Free	Free	Free	Free	Free	Stop	Stop	Stop	Stop	Stop	Stop
RT Channelized	-	-	None	-	-	None	-	-	None	-	-	None
Storage Length	100	-	0	-	-	-	-	-	-	-	-	-
Veh in Median Storage, #	-	0	-	-	0	-	-	0	-	-	0	-
Grade, %	-	0	-	-	0	-	-	0	-	-	0	-
Peak Hour Factor	76	76	76	76	76	76	76	76	76	76	76	76
Heavy Vehicles, %	1	3	1	1	3	1	1	1	1	1	1	1
Mvmt Flow	2	1136	0	47	824	18	32	17	17	12	17	55

Major/Minor	Major1			Major2			Minor1			Minor2		
Conflicting Flow All	842	0	0	1136	0	0	1572	2076	568	1394	2067	421
Stage 1	-	-	-	-	-	-	1140	1140	-	927	927	-
Stage 2	-	-	-	-	-	-	432	936	-	467	1140	-
Critical Hdwy	5.32	-	-	5.32	-	-	6.42	6.52	7.12	6.42	6.52	7.12
Critical Hdwy Stg 1	-	-	-	-	-	-	7.32	5.52	-	7.32	5.52	-
Critical Hdwy Stg 2	-	-	-	-	-	-	6.72	5.52	-	6.72	5.52	-
Follow-up Hdwy	3.11	-	-	3.11	-	-	3.81	4.01	3.91	3.81	4.01	3.91
Pot Cap-1 Maneuver	469	-	-	339	-	-	118	54	401	150	54	499
Stage 1	-	-	-	-	-	-	160	276	-	225	347	-
Stage 2	-	-	-	-	-	-	526	344	-	501	276	-
Platoon blocked, %	-	-	-	-	-	-	-	-	-	-	-	-
Mov Cap-1 Maneuver	469	-	-	339	-	-	57	40	401	78	40	499
Mov Cap-2 Maneuver	-	-	-	-	-	-	57	40	-	78	40	-
Stage 1	-	-	-	-	-	-	159	275	-	224	256	-
Stage 2	-	-	-	-	-	-	322	254	-	448	275	-

Approach	EB			WB			NB			SB		
HCM Control Delay, s	0			2.1			229			83.2		
HCM LOS							F			F		

Minor Lane/Major Mvmt	NBLn1	EBL	EBT	EBR	WBL	WBT	WBR	SBLn1
Capacity (veh/h)	64	469	-	-	339	-	-	122
HCM Lane V/C Ratio	1.028	0.004	-	-	0.14	-	-	0.69
HCM Control Delay (s)	229	12.7	-	-	17.3	1.3	-	83.2
HCM Lane LOS	F	B	-	-	C	A	-	F
HCM 95th %tile Q(veh)	5.1	0	-	-	0.5	-	-	3.7

SUBJECT	BY	DATE	JOB NO.	SHEET	OF
TURN MOVEMENTS	TM	8-Sep-21	HIGP0000-0002	1	OF 2

E/W STREET : BEAR VALLEY RD  
N/S STREET : PACOIMA RD  
CONDITION : AM PEAK HOUR

INTERSECTION : 3  
PROJECTED GROWTH : 3.5%  
PER YEAR :

### CONDITION DIAGRAMS

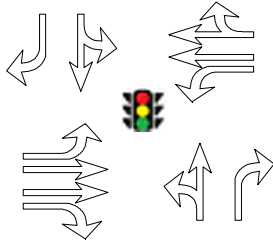

### EXISTING GEOMETRICS

### TURN MOVEMENTS

Condition	Existing Condition	Project Trips	Existing + Project Condition	Year 2023 Ambient Growth	Background Condition	Project Condition	Year 2033 Ambient Growth	Future Condition	Future + Project Condition
Scenario #	1		3		5	7		9	11

### BEAR VALLEY RD

EB LEFT	20	32	52	1	21	53	0	21	53
EB THRU	652	11	663	46	698	709	16	714	725
EB RIGHT	3	0	3	0	3	3	0	3	3
WB LEFT	5	0	5	0	5	5	0	5	5
WB THRU	513	12	525	36	549	561	13	562	574
WB RIGHT	39	0	39	3	42	42	1	43	43

### PACOIMA RD

NB LEFT	3	0	3	0	3	3	0	3	3
NB THRU	1	0	1	0	1	1	0	1	1
NB RIGHT	1	0	1	0	1	1	0	1	1
SB LEFT	86	0	86	6	92	92	2	94	94
SB THRU	1	0	1	0	1	1	0	1	1
SB RIGHT	10	36	46	1	11	47	0	11	47
<b>TOTALS</b>	<b>1334</b>	<b>91</b>	<b>1425</b>	<b>93</b>	<b>1427</b>	<b>1518</b>	<b>32</b>	<b>1459</b>	<b>1550</b>



SUBJECT	BY	DATE	JOB NO.	SHEET	OF
TURN VOLUME SUMMARY	TM	8-Sep-21	HIGP0000-0002	2	OF 2

E/W STREET : BEAR VALLEY RD                      N/S STREET : PACOIMA RD  
CONDITION : AM PEAK HOUR                      PHF : 0.95

NORTH LEG											
AUTO			LARGE 2 AXLE			LARGE 3 AXLE			LARGE 4(+) AXLE		
RT	THRU	LT	RT	THRU	LT	RT	THRU	LT	RT	THRU	LT
3	0	26	0	0	0	0	0	0	0	0	0
6	0	24	0	0	1	0	0	0	0	0	0
0	0	22	0	0	0	0	0	0	0	0	0
1	0	13	0	0	0	0	0	0	0	0	0

SOUTH LEG											
AUTO			LARGE 2 AXLE			LARGE 3 AXLE			LARGE 4(+) AXLE		
RT	THRU	LT	RT	THRU	LT	RT	THRU	LT	RT	THRU	LT
0	0	1	0	0	0	0	0	0	0	0	0
0	0	0	0	0	0	0	0	0	0	0	0
0	0	1	0	0	0	0	0	0	0	0	0
1	1	1	0	0	0	0	0	0	0	0	0

EAST LEG											
AUTO			LARGE 2 AXLE			LARGE 3 AXLE			LARGE 4(+) AXLE		
RT	THRU	LT	RT	THRU	LT	RT	THRU	LT	RT	THRU	LT
8	132	0	0	2	0	0	1	0	0	9	0
12	124	0	0	2	0	0	0	0	0	12	0
9	114	2	1	6	0	0	0	0	0	9	0
9	94	3	0	2	0	0	0	0	0	6	0

WEST LEG											
AUTO			LARGE 2 AXLE			LARGE 3 AXLE			LARGE 4(+) AXLE		
RT	THRU	LT	RT	THRU	LT	RT	THRU	LT	RT	THRU	LT
0	130	6	0	5	0	0	3	0	0	10	0
0	113	6	0	5	0	0	0	0	0	13	0
2	158	4	0	7	0	0	3	0	0	14	0
1	168	4	0	6	0	0	3	0	0	14	0

Truck Volumes	Auto Volumes	Totals	Truck Percentage	Balanced Totals
---------------	--------------	--------	------------------	-----------------

**BEAR VALLEY RD**

EB LEFT	0	20	<b>20</b>	1%	<b>20</b>
EB THRU	83	569	<b>652</b>	13%	<b>652</b>
EB RIGHT	0	3	<b>3</b>	1%	<b>3</b>
WB LEFT	0	5	<b>5</b>	1%	<b>5</b>
WB THRU	49	464	<b>513</b>	10%	<b>513</b>
WB RIGHT	1	38	<b>39</b>	3%	<b>39</b>

**PACOIMA RD**

NB LEFT	0	3	<b>3</b>	1%	<b>3</b>
NB THRU	0	1	<b>1</b>	1%	<b>1</b>
NB RIGHT	0	1	<b>1</b>	1%	<b>1</b>
SB LEFT	1	85	<b>86</b>	1%	<b>86</b>
SB THRU	0	0	<b>1</b>	1%	<b>1</b>
SB RIGHT	0	10	<b>10</b>	1%	<b>10</b>

HCM 6th Signalized Intersection Summary  
3: Pacoima Rd & Bear Valley Rd



Movement	EBL	EBT	EBR	WBL	WBT	WBR	NBL	NBT	NBR	SBL	SBT	SBR
Lane Configurations	↘	↑↑	↗	↘	↑↑			↘	↗		↘	↗
Traffic Volume (veh/h)	20	652	3	5	513	39	3	1	1	86	1	10
Future Volume (veh/h)	20	652	3	5	513	39	3	1	1	86	1	10
Initial Q (Qb), veh	0	0	0	0	0	0	0	0	0	0	0	0
Ped-Bike Adj(A_pbT)	1.00		1.00	1.00		1.00	1.00		1.00	1.00		1.00
Parking Bus, Adj	1.00	1.00	1.00	1.00	1.00	1.00	1.00	1.00	1.00	1.00	1.00	1.00
Work Zone On Approach		No			No			No			No	
Adj Sat Flow, veh/h/ln	1885	1707	1885	1885	1752	1856	1885	1885	1885	1885	1885	1885
Adj Flow Rate, veh/h	21	686	3	5	540	41	3	1	1	91	1	11
Peak Hour Factor	0.95	0.95	0.95	0.95	0.95	0.95	0.95	0.95	0.95	0.95	0.95	0.95
Percent Heavy Veh, %	1	13	1	1	10	3	1	1	1	1	1	1
Cap, veh/h	33	1973	972	9	1865	141	82	17	378	96	1	378
Arrive On Green	0.02	0.61	0.61	0.01	0.59	0.59	0.24	0.24	0.24	0.24	0.24	0.24
Sat Flow, veh/h	1795	3244	1598	1795	3136	238	12	71	1598	29	3	1598
Grp Volume(v), veh/h	21	686	3	5	286	295	4	0	1	92	0	11
Grp Sat Flow(s),veh/h/ln	1795	1622	1598	1795	1664	1709	83	0	1598	32	0	1598
Q Serve(g_s), s	0.9	8.4	0.1	0.2	6.7	6.8	0.0	0.0	0.0	0.4	0.0	0.4
Cycle Q Clear(g_c), s	0.9	8.4	0.1	0.2	6.7	6.8	18.8	0.0	0.0	18.9	0.0	0.4
Prop In Lane	1.00		1.00	1.00		0.14	0.75		1.00	0.99		1.00
Lane Grp Cap(c), veh/h	33	1973	972	9	990	1017	98	0	378	97	0	378
V/C Ratio(X)	0.63	0.35	0.00	0.53	0.29	0.29	0.04	0.00	0.00	0.95	0.00	0.03
Avail Cap(c_a), veh/h	135	1973	972	135	990	1017	345	0	639	331	0	639
HCM Platoon Ratio	1.00	1.00	1.00	1.00	1.00	1.00	1.00	1.00	1.00	1.00	1.00	1.00
Upstream Filter(I)	1.00	1.00	1.00	1.00	1.00	1.00	1.00	0.00	1.00	1.00	0.00	1.00
Uniform Delay (d), s/veh	39.0	7.8	6.1	39.7	7.9	7.9	25.4	0.0	23.3	39.9	0.0	23.5
Incr Delay (d2), s/veh	17.7	0.5	0.0	39.1	0.7	0.7	0.2	0.0	0.0	31.4	0.0	0.0
Initial Q Delay(d3),s/veh	0.0	0.0	0.0	0.0	0.0	0.0	0.0	0.0	0.0	0.0	0.0	0.0
%ile BackOfQ(50%),veh/ln	0.6	2.7	0.0	0.2	2.3	2.4	0.1	0.0	0.0	2.6	0.0	0.2
Unsig. Movement Delay, s/veh												
LnGrp Delay(d),s/veh	56.7	8.3	6.2	78.8	8.7	8.7	25.6	0.0	23.3	71.3	0.0	23.5
LnGrp LOS	E	A	A	E	A	A	C	A	C	E	A	C
Approach Vol, veh/h		710			586			5				103
Approach Delay, s/veh		9.7			9.3			25.1				66.2
Approach LOS		A			A			C				E
Timer - Assigned Phs	1	2		4	5	6		8				
Phs Duration (G+Y+Rc), s	4.4	52.5		23.1	5.5	51.4		23.1				
Change Period (Y+Rc), s	4.0	4.0		4.0	4.0	4.0		4.0				
Max Green Setting (Gmax), s	6.0	30.0		32.0	6.0	30.0		32.0				
Max Q Clear Time (g_c+I1), s	2.2	10.4		20.9	2.9	8.8		20.8				
Green Ext Time (p_c), s	0.0	4.7		0.3	0.0	3.6		0.0				

Intersection Summary

HCM 6th Ctrl Delay	13.7
HCM 6th LOS	B

HCM 6th Signalized Intersection Summary  
3: Pacoima Rd & Bear Valley Rd

Synchro 11 Report  
09/03/2021



Movement	EBL	EBT	EBR	WBL	WBT	WBR	NBL	NBT	NBR	SBL	SBT	SBR
Lane Configurations	↘	↑↑	↗	↘	↑↑			↘	↗		↘	↗
Traffic Volume (veh/h)	52	663	3	5	525	39	3	1	1	86	1	46
Future Volume (veh/h)	52	663	3	5	525	39	3	1	1	86	1	46
Initial Q (Qb), veh	0	0	0	0	0	0	0	0	0	0	0	0
Ped-Bike Adj(A_pbT)	1.00		1.00	1.00		1.00	1.00		1.00	1.00		1.00
Parking Bus, Adj	1.00	1.00	1.00	1.00	1.00	1.00	1.00	1.00	1.00	1.00	1.00	1.00
Work Zone On Approach		No			No			No			No	
Adj Sat Flow, veh/h/ln	1885	1707	1885	1885	1752	1856	1885	1885	1885	1885	1885	1885
Adj Flow Rate, veh/h	55	698	3	5	553	41	3	1	1	91	1	48
Peak Hour Factor	0.95	0.95	0.95	0.95	0.95	0.95	0.95	0.95	0.95	0.95	0.95	0.95
Percent Heavy Veh, %	1	13	1	1	10	3	1	1	1	1	1	1
Cap, veh/h	70	1600	788	9	1443	107	85	18	561	106	1	561
Arrive On Green	0.04	0.49	0.49	0.01	0.46	0.46	0.35	0.35	0.35	0.35	0.35	0.35
Sat Flow, veh/h	1795	3244	1598	1795	3142	232	19	51	1598	47	2	1598
Grp Volume(v), veh/h	55	698	3	5	292	302	4	0	1	92	0	48
Grp Sat Flow(s),veh/h/ln	1795	1622	1598	1795	1664	1710	70	0	1598	49	0	1598
Q Serve(g_s), s	2.4	11.1	0.1	0.2	9.2	9.3	0.1	0.0	0.0	0.9	0.0	1.6
Cycle Q Clear(g_c), s	2.4	11.1	0.1	0.2	9.2	9.3	27.7	0.0	0.0	28.1	0.0	1.6
Prop In Lane	1.00		1.00	1.00		0.14	0.75		1.00	0.99		1.00
Lane Grp Cap(c), veh/h	70	1600	788	9	765	786	103	0	561	107	0	561
V/C Ratio(X)	0.78	0.44	0.00	0.53	0.38	0.38	0.04	0.00	0.00	0.86	0.00	0.09
Avail Cap(c_a), veh/h	135	1600	788	135	765	786	175	0	639	176	0	639
HCM Platoon Ratio	1.00	1.00	1.00	1.00	1.00	1.00	1.00	1.00	1.00	1.00	1.00	1.00
Upstream Filter(I)	1.00	1.00	1.00	1.00	1.00	1.00	1.00	0.00	1.00	1.00	0.00	1.00
Uniform Delay (d), s/veh	38.1	13.1	10.3	39.7	14.2	14.2	21.4	0.0	16.8	39.8	0.0	17.3
Incr Delay (d2), s/veh	17.0	0.9	0.0	39.1	1.5	1.4	0.2	0.0	0.0	20.0	0.0	0.1
Initial Q Delay(d3),s/veh	0.0	0.0	0.0	0.0	0.0	0.0	0.0	0.0	0.0	0.0	0.0	0.0
%ile BackOfQ(50%),veh/ln	1.4	3.9	0.0	0.2	3.5	3.7	0.1	0.0	0.0	2.4	0.0	0.6
Unsig. Movement Delay, s/veh												
LnGrp Delay(d),s/veh	55.1	14.0	10.3	78.8	15.6	15.6	21.6	0.0	16.8	59.7	0.0	17.4
LnGrp LOS	E	B	B	E	B	B	C	A	B	E	A	B
Approach Vol, veh/h		756			599			5			140	
Approach Delay, s/veh		16.9			16.2			20.6			45.2	
Approach LOS		B			B			C			D	
Timer - Assigned Phs	1	2		4	5	6		8				
Phs Duration (G+Y+Rc), s	4.4	43.0		32.6	7.1	40.3		32.6				
Change Period (Y+Rc), s	4.0	4.0		4.0	4.0	4.0		4.0				
Max Green Setting (Gmax), s	6.0	30.0		32.0	6.0	30.0		32.0				
Max Q Clear Time (g_c+I1), s	2.2	13.1		30.1	4.4	11.3		29.7				
Green Ext Time (p_c), s	0.0	4.6		0.1	0.0	3.5		0.0				

Intersection Summary

HCM 6th Ctrl Delay	19.3
HCM 6th LOS	B

HCM 6th Signalized Intersection Summary  
3: Pacoima Rd & Bear Valley Rd

Synchro 11 Report  
09/03/2021



Movement	EBL	EBT	EBR	WBL	WBT	WBR	NBL	NBT	NBR	SBL	SBT	SBR
Lane Configurations	↘	↑↑	↗	↘	↑↑			↘	↗		↘	↗
Traffic Volume (veh/h)	52	663	3	5	525	39	3	1	1	86	1	46
Future Volume (veh/h)	52	663	3	5	525	39	3	1	1	86	1	46
Initial Q (Qb), veh	0	0	0	0	0	0	0	0	0	0	0	0
Ped-Bike Adj(A_pbT)	1.00		1.00	1.00		1.00	1.00		1.00	1.00		1.00
Parking Bus, Adj	1.00	1.00	1.00	1.00	1.00	1.00	1.00	1.00	1.00	1.00	1.00	1.00
Work Zone On Approach		No			No			No			No	
Adj Sat Flow, veh/h/ln	1885	1707	1885	1885	1752	1856	1885	1885	1885	1885	1885	1885
Adj Flow Rate, veh/h	55	698	3	5	553	41	3	1	1	91	1	48
Peak Hour Factor	0.95	0.95	0.95	0.95	0.95	0.95	0.95	0.95	0.95	0.95	0.95	0.95
Percent Heavy Veh, %	1	13	1	1	10	3	1	1	1	1	1	1
Cap, veh/h	70	1600	788	9	1443	107	85	18	561	106	1	561
Arrive On Green	0.04	0.49	0.49	0.01	0.46	0.46	0.35	0.35	0.35	0.35	0.35	0.35
Sat Flow, veh/h	1795	3244	1598	1795	3142	232	19	51	1598	47	2	1598
Grp Volume(v), veh/h	55	698	3	5	292	302	4	0	1	92	0	48
Grp Sat Flow(s),veh/h/ln	1795	1622	1598	1795	1664	1710	70	0	1598	49	0	1598
Q Serve(g_s), s	2.4	11.1	0.1	0.2	9.2	9.3	0.1	0.0	0.0	0.9	0.0	1.6
Cycle Q Clear(g_c), s	2.4	11.1	0.1	0.2	9.2	9.3	27.7	0.0	0.0	28.1	0.0	1.6
Prop In Lane	1.00		1.00	1.00		0.14	0.75		1.00	0.99		1.00
Lane Grp Cap(c), veh/h	70	1600	788	9	765	786	103	0	561	107	0	561
V/C Ratio(X)	0.78	0.44	0.00	0.53	0.38	0.38	0.04	0.00	0.00	0.86	0.00	0.09
Avail Cap(c_a), veh/h	135	1600	788	135	765	786	175	0	639	176	0	639
HCM Platoon Ratio	1.00	1.00	1.00	1.00	1.00	1.00	1.00	1.00	1.00	1.00	1.00	1.00
Upstream Filter(I)	1.00	1.00	1.00	1.00	1.00	1.00	1.00	0.00	1.00	1.00	0.00	1.00
Uniform Delay (d), s/veh	38.1	13.1	10.3	39.7	14.2	14.2	21.4	0.0	16.8	39.8	0.0	17.3
Incr Delay (d2), s/veh	17.0	0.9	0.0	39.1	1.5	1.4	0.2	0.0	0.0	20.0	0.0	0.1
Initial Q Delay(d3),s/veh	0.0	0.0	0.0	0.0	0.0	0.0	0.0	0.0	0.0	0.0	0.0	0.0
%ile BackOfQ(50%),veh/ln	1.4	3.9	0.0	0.2	3.5	3.7	0.1	0.0	0.0	2.4	0.0	0.6
Unsig. Movement Delay, s/veh												
LnGrp Delay(d),s/veh	55.1	14.0	10.3	78.8	15.6	15.6	21.6	0.0	16.8	59.7	0.0	17.4
LnGrp LOS	E	B	B	E	B	B	C	A	B	E	A	B
Approach Vol, veh/h		756			599			5				140
Approach Delay, s/veh		16.9			16.2			20.6				45.2
Approach LOS		B			B			C				D
Timer - Assigned Phs	1	2		4	5	6		8				
Phs Duration (G+Y+Rc), s	4.4	43.0		32.6	7.1	40.3		32.6				
Change Period (Y+Rc), s	4.0	4.0		4.0	4.0	4.0		4.0				
Max Green Setting (Gmax), s	6.0	30.0		32.0	6.0	30.0		32.0				
Max Q Clear Time (g_c+I1), s	2.2	13.1		30.1	4.4	11.3		29.7				
Green Ext Time (p_c), s	0.0	4.6		0.1	0.0	3.5		0.0				

Intersection Summary

HCM 6th Ctrl Delay	19.3
HCM 6th LOS	B

HCM 6th Signalized Intersection Summary  
3: Pacoima Rd & Bear Valley Rd

Synchro 11 Report  
09/03/2021



Movement	EBL	EBT	EBR	WBL	WBT	WBR	NBL	NBT	NBR	SBL	SBT	SBR
Lane Configurations												
Traffic Volume (veh/h)	21	698	3	5	549	42	3	1	1	92	1	11
Future Volume (veh/h)	21	698	3	5	549	42	3	1	1	92	1	11
Initial Q (Qb), veh	0	0	0	0	0	0	0	0	0	0	0	0
Ped-Bike Adj(A_pbT)	1.00		1.00	1.00		1.00	1.00		1.00	1.00		1.00
Parking Bus, Adj	1.00	1.00	1.00	1.00	1.00	1.00	1.00	1.00	1.00	1.00	1.00	1.00
Work Zone On Approach		No			No			No			No	
Adj Sat Flow, veh/h/ln	1885	1707	1885	1885	1752	1856	1885	1885	1885	1885	1885	1885
Adj Flow Rate, veh/h	22	735	3	5	578	44	3	1	1	97	1	12
Peak Hour Factor	0.95	0.95	0.95	0.95	0.95	0.95	0.95	0.95	0.95	0.95	0.95	0.95
Percent Heavy Veh, %	1	13	1	1	10	3	1	1	1	1	1	1
Cap, veh/h	35	1885	929	9	1778	135	82	17	421	98	1	421
Arrive On Green	0.02	0.58	0.58	0.01	0.57	0.57	0.26	0.26	0.26	0.26	0.26	0.26
Sat Flow, veh/h	1795	3244	1598	1795	3135	238	14	64	1598	32	2	1598
Grp Volume(v), veh/h	22	735	3	5	306	316	4	0	1	98	0	12
Grp Sat Flow(s),veh/h/ln	1795	1622	1598	1795	1664	1709	78	0	1598	35	0	1598
Q Serve(g_s), s	1.0	9.8	0.1	0.2	7.8	7.8	0.1	0.0	0.0	0.5	0.0	0.4
Cycle Q Clear(g_c), s	1.0	9.8	0.1	0.2	7.8	7.8	20.9	0.0	0.0	21.1	0.0	0.4
Prop In Lane	1.00		1.00	1.00		0.14	0.75		1.00	0.99		1.00
Lane Grp Cap(c), veh/h	35	1885	929	9	944	969	99	0	421	99	0	421
V/C Ratio(X)	0.63	0.39	0.00	0.53	0.32	0.33	0.04	0.00	0.00	0.99	0.00	0.03
Avail Cap(c_a), veh/h	135	1885	929	135	944	969	305	0	639	294	0	639
HCM Platoon Ratio	1.00	1.00	1.00	1.00	1.00	1.00	1.00	1.00	1.00	1.00	1.00	1.00
Upstream Filter(l)	1.00	1.00	1.00	1.00	1.00	1.00	1.00	0.00	1.00	1.00	0.00	1.00
Uniform Delay (d), s/veh	38.9	9.1	7.0	39.7	9.2	9.2	24.3	0.0	21.7	39.9	0.0	21.9
Incr Delay (d2), s/veh	17.5	0.6	0.0	39.1	0.9	0.9	0.2	0.0	0.0	40.5	0.0	0.0
Initial Q Delay(d3),s/veh	0.0	0.0	0.0	0.0	0.0	0.0	0.0	0.0	0.0	0.0	0.0	0.0
%ile BackOfQ(50%),veh/ln	0.6	3.2	0.0	0.2	2.8	2.9	0.1	0.0	0.0	3.0	0.0	0.2
Unsig. Movement Delay, s/veh												
LnGrp Delay(d),s/veh	56.5	9.7	7.0	78.8	10.1	10.1	24.5	0.0	21.7	80.3	0.0	21.9
LnGrp LOS	E	A	A	E	B	B	C	A	C	F	A	C
Approach Vol, veh/h		760			627			5				110
Approach Delay, s/veh		11.0			10.6			23.9				74.0
Approach LOS		B			B			C				E
Timer - Assigned Phs	1	2		4	5	6		8				
Phs Duration (G+Y+Rc), s	4.4	50.3		25.3	5.5	49.1		25.3				
Change Period (Y+Rc), s	4.0	4.0		4.0	4.0	4.0		4.0				
Max Green Setting (Gmax), s	6.0	30.0		32.0	6.0	30.0		32.0				
Max Q Clear Time (g_c+I1), s	2.2	11.8		23.1	3.0	9.8		22.9				
Green Ext Time (p_c), s	0.0	5.0		0.3	0.0	3.8		0.0				

Intersection Summary

HCM 6th Ctrl Delay	15.5
HCM 6th LOS	B



HCM 6th Signalized Intersection Summary  
3: Pacoima Rd & Bear Valley Rd

Synchro 11 Report  
9/03/2021



Movement	EBL	EBT	EBR	WBL	WBT	WBR	NBL	NBT	NBR	SBL	SBT	SBR
Lane Configurations	↘	↑↑	↗	↘	↑↑			↘	↗		↘	↗
Traffic Volume (veh/h)	53	709	3	5	561	42	3	1	1	92	1	47
Future Volume (veh/h)	53	709	3	5	561	42	3	1	1	92	1	47
Initial Q (Qb), veh	0	0	0	0	0	0	0	0	0	0	0	0
Ped-Bike Adj(A_pbT)	1.00		1.00	1.00		1.00	1.00		1.00	1.00		1.00
Parking Bus, Adj	1.00	1.00	1.00	1.00	1.00	1.00	1.00	1.00	1.00	1.00	1.00	1.00
Work Zone On Approach		No			No			No			No	
Adj Sat Flow, veh/h/ln	1885	1707	1885	1885	1752	1856	1885	1885	1885	1885	1885	1885
Adj Flow Rate, veh/h	56	746	3	5	591	44	3	1	1	97	1	49
Peak Hour Factor	0.95	0.95	0.95	0.95	0.95	0.95	0.95	0.95	0.95	0.95	0.95	0.95
Percent Heavy Veh, %	1	13	1	1	10	3	1	1	1	1	1	1
Cap, veh/h	72	1535	756	9	1377	102	86	18	594	107	1	594
Arrive On Green	0.04	0.47	0.47	0.01	0.44	0.44	0.37	0.37	0.37	0.37	0.37	0.37
Sat Flow, veh/h	1795	3244	1598	1795	3141	233	19	49	1598	47	2	1598
Grp Volume(v), veh/h	56	746	3	5	313	322	4	0	1	98	0	49
Grp Sat Flow(s),veh/h/ln	1795	1622	1598	1795	1664	1710	67	0	1598	49	0	1598
Q Serve(g_s), s	2.5	12.6	0.1	0.2	10.4	10.4	0.1	0.0	0.0	1.0	0.0	1.6
Cycle Q Clear(g_c), s	2.5	12.6	0.1	0.2	10.4	10.4	29.3	0.0	0.0	29.7	0.0	1.6
Prop In Lane	1.00		1.00	1.00		0.14	0.75		1.00	0.99		1.00
Lane Grp Cap(c), veh/h	72	1535	756	9	730	750	104	0	594	108	0	594
V/C Ratio(X)	0.78	0.49	0.00	0.53	0.43	0.43	0.04	0.00	0.00	0.91	0.00	0.08
Avail Cap(c_a), veh/h	135	1535	756	135	730	750	145	0	639	148	0	639
HCM Platoon Ratio	1.00	1.00	1.00	1.00	1.00	1.00	1.00	1.00	1.00	1.00	1.00	1.00
Upstream Filter(I)	1.00	1.00	1.00	1.00	1.00	1.00	1.00	0.00	1.00	1.00	0.00	1.00
Uniform Delay (d), s/veh	38.1	14.4	11.1	39.7	15.5	15.5	20.9	0.0	15.8	39.8	0.0	16.3
Incr Delay (d2), s/veh	16.6	1.1	0.0	39.1	1.8	1.8	0.2	0.0	0.0	39.9	0.0	0.1
Initial Q Delay(d3),s/veh	0.0	0.0	0.0	0.0	0.0	0.0	0.0	0.0	0.0	0.0	0.0	0.0
%ile BackOfQ(50%),veh/ln	1.4	4.5	0.0	0.2	4.1	4.2	0.0	0.0	0.0	3.1	0.0	0.6
Unsig. Movement Delay, s/veh												
LnGrp Delay(d),s/veh	54.7	15.5	11.1	78.8	17.4	17.3	21.1	0.0	15.8	79.7	0.0	16.4
LnGrp LOS	D	B	B	E	B	B	C	A	B	E	A	B
Approach Vol, veh/h		805			640			5			147	
Approach Delay, s/veh		18.2			17.8			20.0			58.6	
Approach LOS		B			B			C			E	
Timer - Assigned Phs	1	2		4	5	6		8				
Phs Duration (G+Y+Rc), s	4.4	41.4		34.2	7.2	38.6		34.2				
Change Period (Y+Rc), s	4.0	4.0		4.0	4.0	4.0		4.0				
Max Green Setting (Gmax), s	6.0	30.0		32.0	6.0	30.0		32.0				
Max Q Clear Time (g_c+I1), s	2.2	14.6		31.7	4.5	12.4		31.3				
Green Ext Time (p_c), s	0.0	4.7		0.0	0.0	3.7		0.0				

Intersection Summary

HCM 6th Ctrl Delay	21.8
HCM 6th LOS	C

HCM 6th Signalized Intersection Summary  
3: Pacoima Rd & Bear Valley Rd

Synchro 11 Report  
09/03/2021



Movement	EBL	EBT	EBR	WBL	WBT	WBR	NBL	NBT	NBR	SBL	SBT	SBR
Lane Configurations	↘	↑↑	↗	↘	↑↑			↘	↗		↘	↗
Traffic Volume (veh/h)	53	709	3	5	561	42	3	1	1	92	1	47
Future Volume (veh/h)	53	709	3	5	561	42	3	1	1	92	1	47
Initial Q (Qb), veh	0	0	0	0	0	0	0	0	0	0	0	0
Ped-Bike Adj(A_pbT)	1.00		1.00	1.00		1.00	1.00		1.00	1.00		1.00
Parking Bus, Adj	1.00	1.00	1.00	1.00	1.00	1.00	1.00	1.00	1.00	1.00	1.00	1.00
Work Zone On Approach		No			No			No			No	
Adj Sat Flow, veh/h/ln	1885	1707	1885	1885	1752	1856	1885	1885	1885	1885	1885	1885
Adj Flow Rate, veh/h	56	746	3	5	591	44	3	1	1	97	1	49
Peak Hour Factor	0.95	0.95	0.95	0.95	0.95	0.95	0.95	0.95	0.95	0.95	0.95	0.95
Percent Heavy Veh, %	1	13	1	1	10	3	1	1	1	1	1	1
Cap, veh/h	72	1535	756	9	1377	102	86	18	594	107	1	594
Arrive On Green	0.04	0.47	0.47	0.01	0.44	0.44	0.37	0.37	0.37	0.37	0.37	0.37
Sat Flow, veh/h	1795	3244	1598	1795	3141	233	19	49	1598	47	2	1598
Grp Volume(v), veh/h	56	746	3	5	313	322	4	0	1	98	0	49
Grp Sat Flow(s),veh/h/ln	1795	1622	1598	1795	1664	1710	67	0	1598	49	0	1598
Q Serve(g_s), s	2.5	12.6	0.1	0.2	10.4	10.4	0.1	0.0	0.0	1.0	0.0	1.6
Cycle Q Clear(g_c), s	2.5	12.6	0.1	0.2	10.4	10.4	29.3	0.0	0.0	29.7	0.0	1.6
Prop In Lane	1.00		1.00	1.00		0.14	0.75		1.00	0.99		1.00
Lane Grp Cap(c), veh/h	72	1535	756	9	730	750	104	0	594	108	0	594
V/C Ratio(X)	0.78	0.49	0.00	0.53	0.43	0.43	0.04	0.00	0.00	0.91	0.00	0.08
Avail Cap(c_a), veh/h	135	1535	756	135	730	750	145	0	639	148	0	639
HCM Platoon Ratio	1.00	1.00	1.00	1.00	1.00	1.00	1.00	1.00	1.00	1.00	1.00	1.00
Upstream Filter(I)	1.00	1.00	1.00	1.00	1.00	1.00	1.00	0.00	1.00	1.00	0.00	1.00
Uniform Delay (d), s/veh	38.1	14.4	11.1	39.7	15.5	15.5	20.9	0.0	15.8	39.8	0.0	16.3
Incr Delay (d2), s/veh	16.6	1.1	0.0	39.1	1.8	1.8	0.2	0.0	0.0	39.9	0.0	0.1
Initial Q Delay(d3),s/veh	0.0	0.0	0.0	0.0	0.0	0.0	0.0	0.0	0.0	0.0	0.0	0.0
%ile BackOfQ(50%),veh/ln	1.4	4.5	0.0	0.2	4.1	4.2	0.0	0.0	0.0	3.1	0.0	0.6
Unsig. Movement Delay, s/veh												
LnGrp Delay(d),s/veh	54.7	15.5	11.1	78.8	17.4	17.3	21.1	0.0	15.8	79.7	0.0	16.4
LnGrp LOS	D	B	B	E	B	B	C	A	B	E	A	B
Approach Vol, veh/h		805			640			5			147	
Approach Delay, s/veh		18.2			17.8			20.0			58.6	
Approach LOS		B			B			C			E	
Timer - Assigned Phs	1	2		4	5	6		8				
Phs Duration (G+Y+Rc), s	4.4	41.4		34.2	7.2	38.6		34.2				
Change Period (Y+Rc), s	4.0	4.0		4.0	4.0	4.0		4.0				
Max Green Setting (Gmax), s	6.0	30.0		32.0	6.0	30.0		32.0				
Max Q Clear Time (g_c+I1), s	2.2	14.6		31.7	4.5	12.4		31.3				
Green Ext Time (p_c), s	0.0	4.7		0.0	0.0	3.7		0.0				

Intersection Summary

HCM 6th Ctrl Delay	21.8
HCM 6th LOS	C

HCM 6th Signalized Intersection Summary  
3: Pacoima Rd & Bear Valley Rd



Movement	EBL	EBT	EBR	WBL	WBT	WBR	NBL	NBT	NBR	SBL	SBT	SBR
Lane Configurations	↘	↑↑	↗	↘	↑↑			↘	↗		↘	↗
Traffic Volume (veh/h)	21	714	3	5	562	43	3	1	1	94	1	11
Future Volume (veh/h)	21	714	3	5	562	43	3	1	1	94	1	11
Initial Q (Qb), veh	0	0	0	0	0	0	0	0	0	0	0	0
Ped-Bike Adj(A_pbT)	1.00		1.00	1.00		1.00	1.00		1.00	1.00		1.00
Parking Bus, Adj	1.00	1.00	1.00	1.00	1.00	1.00	1.00	1.00	1.00	1.00	1.00	1.00
Work Zone On Approach		No			No			No			No	
Adj Sat Flow, veh/h/ln	1885	1707	1885	1885	1752	1856	1885	1885	1885	1885	1885	1885
Adj Flow Rate, veh/h	22	752	3	5	592	45	3	1	1	99	1	12
Peak Hour Factor	0.95	0.95	0.95	0.95	0.95	0.95	0.95	0.95	0.95	0.95	0.95	0.95
Percent Heavy Veh, %	1	13	1	1	10	3	1	1	1	1	1	1
Cap, veh/h	35	1861	916	9	1754	133	83	17	433	99	1	433
Arrive On Green	0.02	0.57	0.57	0.01	0.56	0.56	0.27	0.27	0.27	0.27	0.27	0.27
Sat Flow, veh/h	1795	3244	1598	1795	3135	238	14	63	1598	33	2	1598
Grp Volume(v), veh/h	22	752	3	5	314	323	4	0	1	100	0	12
Grp Sat Flow(s),veh/h/ln	1795	1622	1598	1795	1664	1709	77	0	1598	35	0	1598
Q Serve(g_s), s	1.0	10.3	0.1	0.2	8.2	8.2	0.1	0.0	0.0	0.5	0.0	0.4
Cycle Q Clear(g_c), s	1.0	10.3	0.1	0.2	8.2	8.2	21.5	0.0	0.0	21.7	0.0	0.4
Prop In Lane	1.00		1.00	1.00		0.14	0.75		1.00	0.99		1.00
Lane Grp Cap(c), veh/h	35	1861	916	9	931	956	100	0	433	99	0	433
V/C Ratio(X)	0.63	0.40	0.00	0.53	0.34	0.34	0.04	0.00	0.00	1.01	0.00	0.03
Avail Cap(c_a), veh/h	135	1861	916	135	931	956	294	0	639	283	0	639
HCM Platoon Ratio	1.00	1.00	1.00	1.00	1.00	1.00	1.00	1.00	1.00	1.00	1.00	1.00
Upstream Filter(I)	1.00	1.00	1.00	1.00	1.00	1.00	1.00	0.00	1.00	1.00	0.00	1.00
Uniform Delay (d), s/veh	38.9	9.5	7.3	39.7	9.6	9.6	24.0	0.0	21.3	39.9	0.0	21.4
Incr Delay (d2), s/veh	17.5	0.7	0.0	39.1	1.0	1.0	0.2	0.0	0.0	44.1	0.0	0.0
Initial Q Delay(d3),s/veh	0.0	0.0	0.0	0.0	0.0	0.0	0.0	0.0	0.0	0.0	0.0	0.0
%ile BackOfQ(50%),veh/ln	0.6	3.4	0.0	0.2	2.9	3.0	0.1	0.0	0.0	3.1	0.0	0.2
Unsig. Movement Delay, s/veh												
LnGrp Delay(d),s/veh	56.5	10.1	7.3	78.8	10.5	10.5	24.2	0.0	21.3	84.0	0.0	21.4
LnGrp LOS	E	B	A	E	B	B	C	A	C	F	A	C
Approach Vol, veh/h		777			642			5				112
Approach Delay, s/veh		11.4			11.1			23.6				77.3
Approach LOS		B			B			C				E
Timer - Assigned Phs	1	2		4	5	6		8				
Phs Duration (G+Y+Rc), s	4.4	49.6		25.9	5.5	48.5		25.9				
Change Period (Y+Rc), s	4.0	4.0		4.0	4.0	4.0		4.0				
Max Green Setting (Gmax), s	6.0	30.0		32.0	6.0	30.0		32.0				
Max Q Clear Time (g_c+I1), s	2.2	12.3		23.7	3.0	10.2		23.5				
Green Ext Time (p_c), s	0.0	5.1		0.3	0.0	3.9		0.0				

Intersection Summary

HCM 6th Ctrl Delay	16.1
HCM 6th LOS	B

HCM 6th Signalized Intersection Summary  
3: Pacoima Rd & Bear Valley Rd

Synchro 11 Report  
09/03/2021



Movement	EBL	EBT	EBR	WBL	WBT	WBR	NBL	NBT	NBR	SBL	SBT	SBR
Lane Configurations	↘	↑↑	↗	↘	↑↑			↘	↗		↘	↗
Traffic Volume (veh/h)	53	725	3	5	574	43	3	1	1	94	1	47
Future Volume (veh/h)	53	725	3	5	574	43	3	1	1	94	1	47
Initial Q (Qb), veh	0	0	0	0	0	0	0	0	0	0	0	0
Ped-Bike Adj(A_pbT)	1.00		1.00	1.00		1.00	1.00		1.00	1.00		1.00
Parking Bus, Adj	1.00	1.00	1.00	1.00	1.00	1.00	1.00	1.00	1.00	1.00	1.00	1.00
Work Zone On Approach		No			No			No			No	
Adj Sat Flow, veh/h/ln	1885	1707	1885	1885	1752	1856	1885	1885	1885	1885	1885	1885
Adj Flow Rate, veh/h	56	763	3	5	604	45	3	1	1	99	1	49
Peak Hour Factor	0.95	0.95	0.95	0.95	0.95	0.95	0.95	0.95	0.95	0.95	0.95	0.95
Percent Heavy Veh, %	1	13	1	1	10	3	1	1	1	1	1	1
Cap, veh/h	72	1517	747	9	1359	101	86	18	603	107	1	603
Arrive On Green	0.04	0.47	0.47	0.01	0.43	0.43	0.38	0.38	0.38	0.38	0.38	0.38
Sat Flow, veh/h	1795	3244	1598	1795	3140	234	19	48	1598	47	2	1598
Grp Volume(v), veh/h	56	763	3	5	320	329	4	0	1	100	0	49
Grp Sat Flow(s),veh/h/ln	1795	1622	1598	1795	1664	1710	67	0	1598	49	0	1598
Q Serve(g_s), s	2.5	13.1	0.1	0.2	10.8	10.8	0.1	0.0	0.0	1.0	0.0	1.6
Cycle Q Clear(g_c), s	2.5	13.1	0.1	0.2	10.8	10.8	29.7	0.0	0.0	30.2	0.0	1.6
Prop In Lane	1.00		1.00	1.00		0.14	0.75		1.00	0.99		1.00
Lane Grp Cap(c), veh/h	72	1517	747	9	720	740	104	0	603	108	0	603
V/C Ratio(X)	0.78	0.50	0.00	0.53	0.44	0.44	0.04	0.00	0.00	0.93	0.00	0.08
Avail Cap(c_a), veh/h	135	1517	747	135	720	740	137	0	639	140	0	639
HCM Platoon Ratio	1.00	1.00	1.00	1.00	1.00	1.00	1.00	1.00	1.00	1.00	1.00	1.00
Upstream Filter(I)	1.00	1.00	1.00	1.00	1.00	1.00	1.00	0.00	1.00	1.00	0.00	1.00
Uniform Delay (d), s/veh	38.1	14.8	11.4	39.7	15.9	15.9	20.8	0.0	15.5	39.8	0.0	16.0
Incr Delay (d2), s/veh	16.6	1.2	0.0	39.1	2.0	1.9	0.1	0.0	0.0	47.6	0.0	0.1
Initial Q Delay(d3),s/veh	0.0	0.0	0.0	0.0	0.0	0.0	0.0	0.0	0.0	0.0	0.0	0.0
%ile BackOfQ(50%),veh/ln	1.4	4.7	0.0	0.2	4.2	4.4	0.0	0.0	0.0	3.4	0.0	0.6
Unsig. Movement Delay, s/veh												
LnGrp Delay(d),s/veh	54.7	16.0	11.4	78.8	17.9	17.9	21.0	0.0	15.5	87.3	0.0	16.1
LnGrp LOS	D	B	B	E	B	B	C	A	B	F	A	B
Approach Vol, veh/h		822			654			5				149
Approach Delay, s/veh		18.6			18.3			19.9				63.9
Approach LOS		B			B			B				E
Timer - Assigned Phs	1	2		4	5	6		8				
Phs Duration (G+Y+Rc), s	4.4	40.9		34.7	7.2	38.2		34.7				
Change Period (Y+Rc), s	4.0	4.0		4.0	4.0	4.0		4.0				
Max Green Setting (Gmax), s	6.0	30.0		32.0	6.0	30.0		32.0				
Max Q Clear Time (g_c+I1), s	2.2	15.1		32.2	4.5	12.8		31.7				
Green Ext Time (p_c), s	0.0	4.7		0.0	0.0	3.8		0.0				

Intersection Summary

HCM 6th Ctrl Delay	22.7
HCM 6th LOS	C

HCM 6th Signalized Intersection Summary  
3: Pacoima Rd & Bear Valley Rd

Synchro 11 Report  
09/03/2021



Movement	EBL	EBT	EBR	WBL	WBT	WBR	NBL	NBT	NBR	SBL	SBT	SBR
Lane Configurations	↘	↑↑	↗	↘	↑↑			↘	↗		↘	↗
Traffic Volume (veh/h)	53	725	3	5	574	43	3	1	1	94	1	47
Future Volume (veh/h)	53	725	3	5	574	43	3	1	1	94	1	47
Initial Q (Qb), veh	0	0	0	0	0	0	0	0	0	0	0	0
Ped-Bike Adj(A_pbT)	1.00		1.00	1.00		1.00	1.00		1.00	1.00		1.00
Parking Bus, Adj	1.00	1.00	1.00	1.00	1.00	1.00	1.00	1.00	1.00	1.00	1.00	1.00
Work Zone On Approach		No			No			No			No	
Adj Sat Flow, veh/h/ln	1885	1707	1885	1885	1752	1856	1885	1885	1885	1885	1885	1885
Adj Flow Rate, veh/h	56	763	3	5	604	45	3	1	1	99	1	49
Peak Hour Factor	0.95	0.95	0.95	0.95	0.95	0.95	0.95	0.95	0.95	0.95	0.95	0.95
Percent Heavy Veh, %	1	13	1	1	10	3	1	1	1	1	1	1
Cap, veh/h	72	1517	747	9	1359	101	86	18	603	107	1	603
Arrive On Green	0.04	0.47	0.47	0.01	0.43	0.43	0.38	0.38	0.38	0.38	0.38	0.38
Sat Flow, veh/h	1795	3244	1598	1795	3140	234	19	48	1598	47	2	1598
Grp Volume(v), veh/h	56	763	3	5	320	329	4	0	1	100	0	49
Grp Sat Flow(s),veh/h/ln	1795	1622	1598	1795	1664	1710	67	0	1598	49	0	1598
Q Serve(g_s), s	2.5	13.1	0.1	0.2	10.8	10.8	0.1	0.0	0.0	1.0	0.0	1.6
Cycle Q Clear(g_c), s	2.5	13.1	0.1	0.2	10.8	10.8	29.7	0.0	0.0	30.2	0.0	1.6
Prop In Lane	1.00		1.00	1.00		0.14	0.75		1.00	0.99		1.00
Lane Grp Cap(c), veh/h	72	1517	747	9	720	740	104	0	603	108	0	603
V/C Ratio(X)	0.78	0.50	0.00	0.53	0.44	0.44	0.04	0.00	0.00	0.93	0.00	0.08
Avail Cap(c_a), veh/h	135	1517	747	135	720	740	137	0	639	140	0	639
HCM Platoon Ratio	1.00	1.00	1.00	1.00	1.00	1.00	1.00	1.00	1.00	1.00	1.00	1.00
Upstream Filter(I)	1.00	1.00	1.00	1.00	1.00	1.00	1.00	0.00	1.00	1.00	0.00	1.00
Uniform Delay (d), s/veh	38.1	14.8	11.4	39.7	15.9	15.9	20.8	0.0	15.5	39.8	0.0	16.0
Incr Delay (d2), s/veh	16.6	1.2	0.0	39.1	2.0	1.9	0.1	0.0	0.0	47.6	0.0	0.1
Initial Q Delay(d3),s/veh	0.0	0.0	0.0	0.0	0.0	0.0	0.0	0.0	0.0	0.0	0.0	0.0
%ile BackOfQ(50%),veh/ln	1.4	4.7	0.0	0.2	4.2	4.4	0.0	0.0	0.0	3.4	0.0	0.6
Unsig. Movement Delay, s/veh												
LnGrp Delay(d),s/veh	54.7	16.0	11.4	78.8	17.9	17.9	21.0	0.0	15.5	87.3	0.0	16.1
LnGrp LOS	D	B	B	E	B	B	C	A	B	F	A	B
Approach Vol, veh/h		822			654			5				149
Approach Delay, s/veh		18.6			18.3			19.9				63.9
Approach LOS		B			B			B				E
Timer - Assigned Phs	1	2		4	5	6		8				
Phs Duration (G+Y+Rc), s	4.4	40.9		34.7	7.2	38.2		34.7				
Change Period (Y+Rc), s	4.0	4.0		4.0	4.0	4.0		4.0				
Max Green Setting (Gmax), s	6.0	30.0		32.0	6.0	30.0		32.0				
Max Q Clear Time (g_c+I1), s	2.2	15.1		32.2	4.5	12.8		31.7				
Green Ext Time (p_c), s	0.0	4.7		0.0	0.0	3.8		0.0				

Intersection Summary

HCM 6th Ctrl Delay	22.7
HCM 6th LOS	C



SUBJECT	BY	DATE	JOB NO.	SHEET	OF
TURN MOVEMENTS	TM	8-Sep-21	HIGP0000-0002	1	OF 2

E/W STREET : BEAR VALLEY RD  
N/S STREET : PACOIMA RD  
CONDITION : PM PEAK HOUR

INTERSECTION : 3  
PROJECTED GROWTH : 3.5%  
PER YEAR :

**TURN MOVEMENTS**

Condition	Existing Condition	Project Trips	Existing + Project Condition	Year 2023 Ambient Growth	Background Condition	Project Condition	Year 2033 Ambient Growth	Future Condition	Future + Project Condition
Scenario #	2		4		6	8		10	12

**BEAR VALLEY RD**

EB LEFT	9	39	48	1	10	49	0	10	49
EB THRU	739	13	752	52	791	804	18	809	822
EB RIGHT	1	0	1	0	1	1	0	1	1
WB LEFT	22	0	22	2	24	24	1	25	25
WB THRU	527	13	540	37	564	577	13	577	590
WB RIGHT	75	0	75	5	80	80	2	82	82

**PACOIMA RD**

NB LEFT	5	0	5	0	5	5	0	5	5
NB THRU	1	0	1	0	1	1	0	1	1
NB RIGHT	3	0	3	0	3	3	0	3	3
SB LEFT	61	0	61	4	65	65	1	66	66
SB THRU	2	0	2	0	2	2	0	2	2
SB RIGHT	28	38	66	2	30	68	1	31	69
<b>TOTALS</b>	<b>1473</b>	<b>103</b>	<b>1576</b>	<b>103</b>	<b>1576</b>	<b>1679</b>	<b>36</b>	<b>1612</b>	<b>1715</b>



SUBJECT	BY	DATE	JOB NO.	SHEET	OF
TURN VOLUME SUMMARY	TM	8-Sep-21	HIGP0000-0002	2	OF 2

E/W STREET : BEAR VALLEY RD                      N/S STREET : PACOIMA RD  
CONDITION : PM PEAK HOUR                      PHF : 0.78

NORTH LEG											
AUTO			LARGE 2 AXLE			LARGE 3 AXLE			LARGE 4(+) AXLE		
RT	THRU	LT	RT	THRU	LT	RT	THRU	LT	RT	THRU	LT
7	0	19	0	0	0	0	0	0	0	0	0
8	0	12	0	0	0	0	0	0	0	0	0
9	1	11	0	0	0	0	0	0	0	0	0
4	1	19	0	0	0	0	0	0	0	0	0

SOUTH LEG											
AUTO			LARGE 2 AXLE			LARGE 3 AXLE			LARGE 4(+) AXLE		
RT	THRU	LT	RT	THRU	LT	RT	THRU	LT	RT	THRU	LT
1	0	2	1	0	0	0	0	0	0	0	0
0	0	0	0	0	0	0	0	0	0	0	0
1	1	3	0	0	0	0	0	0	0	0	0
0	0	0	0	0	0	0	0	0	0	0	0

EAST LEG											
AUTO			LARGE 2 AXLE			LARGE 3 AXLE			LARGE 4(+) AXLE		
RT	THRU	LT	RT	THRU	LT	RT	THRU	LT	RT	THRU	LT
21	91	8	0	1	0	0	0	0	0	2	0
20	141	4	0	0	0	0	1	0	0	3	0
22	182	4	0	1	0	0	1	0	0	1	0
12	101	6	0	0	0	0	0	0	0	2	0

WEST LEG											
AUTO			LARGE 2 AXLE			LARGE 3 AXLE			LARGE 4(+) AXLE		
RT	THRU	LT	RT	THRU	LT	RT	THRU	LT	RT	THRU	LT
1	150	1	0	1	0	0	0	0	0	1	0
0	212	5	0	1	0	0	0	0	0	1	0
0	225	1	0	1	0	0	1	0	0	5	0
0	134	2	0	3	0	0	1	0	0	3	0

Truck Volumes	Auto Volumes	Totals	Truck Percentage	Balanced Totals
---------------	--------------	--------	------------------	-----------------

**BEAR VALLEY RD**

EB LEFT	0	9	<b>9</b>	1%	<b>9</b>
EB THRU	18	721	<b>739</b>	2%	<b>739</b>
EB RIGHT	0	1	<b>1</b>	1%	<b>1</b>
WB LEFT	0	22	<b>22</b>	1%	<b>22</b>
WB THRU	12	515	<b>527</b>	2%	<b>527</b>
WB RIGHT	0	75	<b>75</b>	1%	<b>75</b>

**PACOIMA RD**

NB LEFT	0	5	<b>5</b>	1%	<b>5</b>
NB THRU	0	1	<b>1</b>	1%	<b>1</b>
NB RIGHT	1	2	<b>3</b>	33%	<b>3</b>
SB LEFT	0	61	<b>61</b>	1%	<b>61</b>
SB THRU	0	2	<b>2</b>	1%	<b>2</b>
SB RIGHT	0	28	<b>28</b>	1%	<b>28</b>

HCM 6th Signalized Intersection Summary  
 3: Pacoima Rd & Bear Valley Rd



Movement	EBL	EBT	EBR	WBL	WBT	WBR	NBL	NBT	NBR	SBL	SBT	SBR
Lane Configurations	↘	↑↑	↗	↘	↑↑			↘	↗		↘	↗
Traffic Volume (veh/h)	9	739	1	22	527	75	5	1	3	61	2	28
Future Volume (veh/h)	9	739	1	22	527	75	5	1	3	61	2	28
Initial Q (Qb), veh	0	0	0	0	0	0	0	0	0	0	0	0
Ped-Bike Adj(A_pbT)	1.00		1.00	1.00		1.00	1.00		1.00	1.00		1.00
Parking Bus, Adj	1.00	1.00	1.00	1.00	1.00	1.00	1.00	1.00	1.00	1.00	1.00	1.00
Work Zone On Approach		No			No			No			No	
Adj Sat Flow, veh/h/ln	1885	1870	1885	1885	1870	1885	1885	1885	1411	1885	1885	1885
Adj Flow Rate, veh/h	12	947	1	28	676	96	6	1	4	78	3	36
Peak Hour Factor	0.78	0.78	0.78	0.78	0.78	0.78	0.78	0.78	0.78	0.78	0.78	0.78
Percent Heavy Veh, %	1	2	1	1	2	1	1	1	33	1	1	1
Cap, veh/h	21	1887	849	42	1695	240	89	9	354	100	2	472
Arrive On Green	0.01	0.53	0.53	0.02	0.54	0.54	0.30	0.30	0.30	0.30	0.30	0.30
Sat Flow, veh/h	1795	3554	1598	1795	3124	443	20	30	1196	40	8	1598
Grp Volume(v), veh/h	12	947	1	28	384	388	7	0	4	81	0	36
Grp Sat Flow(s),veh/h/ln	1795	1777	1598	1795	1777	1791	50	0	1196	48	0	1598
Q Serve(g_s), s	0.5	13.6	0.0	1.2	10.1	10.1	0.1	0.0	0.2	0.7	0.0	1.3
Cycle Q Clear(g_c), s	0.5	13.6	0.0	1.2	10.1	10.1	23.4	0.0	0.2	23.7	0.0	1.3
Prop In Lane	1.00		1.00	1.00		0.25	0.86		1.00	0.96		1.00
Lane Grp Cap(c), veh/h	21	1887	849	42	964	972	98	0	354	103	0	472
V/C Ratio(X)	0.57	0.50	0.00	0.67	0.40	0.40	0.07	0.00	0.01	0.79	0.00	0.08
Avail Cap(c_a), veh/h	135	1887	849	135	964	972	248	0	478	252	0	639
HCM Platoon Ratio	1.00	1.00	1.00	1.00	1.00	1.00	1.00	1.00	1.00	1.00	1.00	1.00
Upstream Filter(I)	1.00	1.00	1.00	1.00	1.00	1.00	1.00	0.00	1.00	1.00	0.00	1.00
Uniform Delay (d), s/veh	39.3	12.0	8.8	38.8	10.7	10.7	23.2	0.0	19.9	39.4	0.0	20.3
Incr Delay (d2), s/veh	22.1	1.0	0.0	17.2	1.2	1.2	0.3	0.0	0.0	12.6	0.0	0.1
Initial Q Delay(d3),s/veh	0.0	0.0	0.0	0.0	0.0	0.0	0.0	0.0	0.0	0.0	0.0	0.0
%ile BackOfQ(50%),veh/ln	0.4	5.1	0.0	0.7	3.9	3.9	0.1	0.0	0.1	1.9	0.0	0.5
Unsig. Movement Delay, s/veh												
LnGrp Delay(d),s/veh	61.4	12.9	8.8	56.0	11.9	11.9	23.5	0.0	19.9	52.0	0.0	20.4
LnGrp LOS	E	B	A	E	B	B	C	A	B	D	A	C
Approach Vol, veh/h		960			800			11				117
Approach Delay, s/veh		13.5			13.5			22.2				42.3
Approach LOS		B			B			C				D
Timer - Assigned Phs	1	2		4	5	6		8				
Phs Duration (G+Y+Rc), s	5.9	46.1		28.0	4.9	47.1		28.0				
Change Period (Y+Rc), s	4.0	4.0		4.0	4.0	4.0		4.0				
Max Green Setting (Gmax), s	6.0	30.0		32.0	6.0	30.0		32.0				
Max Q Clear Time (g_c+I1), s	3.2	15.6		25.7	2.5	12.1		25.4				
Green Ext Time (p_c), s	0.0	5.8		0.2	0.0	4.7		0.0				

Intersection Summary

HCM 6th Ctrl Delay	15.3
HCM 6th LOS	B



HCM 6th Signalized Intersection Summary  
3: Pacoima Rd & Bear Valley Rd

Synchro 11 Report  
09/03/2021



Movement	EBL	EBT	EBR	WBL	WBT	WBR	NBL	NBT	NBR	SBL	SBT	SBR
Lane Configurations	↘	↑↑	↗	↘	↑↑			↘	↗		↘	↗
Traffic Volume (veh/h)	48	752	1	22	540	75	5	1	3	61	2	66
Future Volume (veh/h)	48	752	1	22	540	75	5	1	3	61	2	66
Initial Q (Qb), veh	0	0	0	0	0	0	0	0	0	0	0	0
Ped-Bike Adj(A_pbT)	1.00		1.00	1.00		1.00	1.00		1.00	1.00		1.00
Parking Bus, Adj	1.00	1.00	1.00	1.00	1.00	1.00	1.00	1.00	1.00	1.00	1.00	1.00
Work Zone On Approach		No			No			No			No	
Adj Sat Flow, veh/h/ln	1885	1870	1885	1885	1870	1885	1885	1885	1411	1885	1885	1885
Adj Flow Rate, veh/h	62	964	1	28	692	96	6	1	4	78	3	85
Peak Hour Factor	0.78	0.78	0.78	0.78	0.78	0.78	0.78	0.78	0.78	0.78	0.78	0.78
Percent Heavy Veh, %	1	2	1	1	2	1	1	1	33	1	1	1
Cap, veh/h	80	1530	688	42	1283	178	90	9	474	106	2	633
Arrive On Green	0.04	0.43	0.43	0.02	0.41	0.41	0.40	0.40	0.40	0.40	0.40	0.40
Sat Flow, veh/h	1795	3554	1598	1795	3135	434	17	23	1196	44	6	1598
Grp Volume(v), veh/h	62	964	1	28	392	396	7	0	4	81	0	85
Grp Sat Flow(s),veh/h/ln	1795	1777	1598	1795	1777	1792	40	0	1196	50	0	1598
Q Serve(g_s), s	2.7	17.0	0.0	1.2	13.4	13.4	0.2	0.0	0.2	1.0	0.0	2.7
Cycle Q Clear(g_c), s	2.7	17.0	0.0	1.2	13.4	13.4	31.4	0.0	0.2	31.7	0.0	2.7
Prop In Lane	1.00		1.00	1.00		0.24	0.86		1.00	0.96		1.00
Lane Grp Cap(c), veh/h	80	1530	688	42	727	733	99	0	474	108	0	633
V/C Ratio(X)	0.78	0.63	0.00	0.67	0.54	0.54	0.07	0.00	0.01	0.75	0.00	0.13
Avail Cap(c_a), veh/h	135	1530	688	135	727	733	104	0	478	113	0	639
HCM Platoon Ratio	1.00	1.00	1.00	1.00	1.00	1.00	1.00	1.00	1.00	1.00	1.00	1.00
Upstream Filter(I)	1.00	1.00	1.00	1.00	1.00	1.00	1.00	0.00	1.00	1.00	0.00	1.00
Uniform Delay (d), s/veh	37.8	17.8	13.0	38.8	17.9	17.9	20.6	0.0	14.6	39.2	0.0	15.4
Incr Delay (d2), s/veh	14.9	2.0	0.0	17.2	2.9	2.8	0.3	0.0	0.0	22.8	0.0	0.1
Initial Q Delay(d3),s/veh	0.0	0.0	0.0	0.0	0.0	0.0	0.0	0.0	0.0	0.0	0.0	0.0
%ile BackOfQ(50%),veh/ln	1.5	6.9	0.0	0.7	5.7	5.8	0.1	0.0	0.0	2.2	0.0	1.0
Unsig. Movement Delay, s/veh												
LnGrp Delay(d),s/veh	52.8	19.8	13.0	56.0	20.8	20.8	20.9	0.0	14.6	62.0	0.0	15.5
LnGrp LOS	D	B	B	E	C	C	C	A	B	E	A	B
Approach Vol, veh/h		1027			816			11				166
Approach Delay, s/veh		21.8			22.0			18.6				38.2
Approach LOS		C			C			B				D
Timer - Assigned Phs	1	2		4	5	6		8				
Phs Duration (G+Y+Rc), s	5.9	38.3		35.9	7.5	36.6		35.9				
Change Period (Y+Rc), s	4.0	4.0		4.0	4.0	4.0		4.0				
Max Green Setting (Gmax), s	6.0	30.0		32.0	6.0	30.0		32.0				
Max Q Clear Time (g_c+I1), s	3.2	19.0		33.7	4.7	15.4		33.4				
Green Ext Time (p_c), s	0.0	5.0		0.0	0.0	4.4		0.0				

Intersection Summary

HCM 6th Ctrl Delay	23.2
HCM 6th LOS	C

HCM 6th Signalized Intersection Summary  
3: Pacoima Rd & Bear Valley Rd

Synchro 11 Report  
09/03/2021



Movement	EBL	EBT	EBR	WBL	WBT	WBR	NBL	NBT	NBR	SBL	SBT	SBR
Lane Configurations	↘	↑↑	↗	↘	↑↑			↘	↗		↘	↗
Traffic Volume (veh/h)	48	752	1	22	540	75	5	1	3	61	2	66
Future Volume (veh/h)	48	752	1	22	540	75	5	1	3	61	2	66
Initial Q (Qb), veh	0	0	0	0	0	0	0	0	0	0	0	0
Ped-Bike Adj(A_pbT)	1.00		1.00	1.00		1.00	1.00		1.00	1.00		1.00
Parking Bus, Adj	1.00	1.00	1.00	1.00	1.00	1.00	1.00	1.00	1.00	1.00	1.00	1.00
Work Zone On Approach		No			No			No			No	
Adj Sat Flow, veh/h/ln	1885	1870	1885	1885	1870	1885	1885	1885	1411	1885	1885	1885
Adj Flow Rate, veh/h	62	964	1	28	692	96	6	1	4	78	3	85
Peak Hour Factor	0.78	0.78	0.78	0.78	0.78	0.78	0.78	0.78	0.78	0.78	0.78	0.78
Percent Heavy Veh, %	1	2	1	1	2	1	1	1	33	1	1	1
Cap, veh/h	80	1530	688	42	1283	178	90	9	474	106	2	633
Arrive On Green	0.04	0.43	0.43	0.02	0.41	0.41	0.40	0.40	0.40	0.40	0.40	0.40
Sat Flow, veh/h	1795	3554	1598	1795	3135	434	17	23	1196	44	6	1598
Grp Volume(v), veh/h	62	964	1	28	392	396	7	0	4	81	0	85
Grp Sat Flow(s),veh/h/ln	1795	1777	1598	1795	1777	1792	40	0	1196	50	0	1598
Q Serve(g_s), s	2.7	17.0	0.0	1.2	13.4	13.4	0.2	0.0	0.2	1.0	0.0	2.7
Cycle Q Clear(g_c), s	2.7	17.0	0.0	1.2	13.4	13.4	31.4	0.0	0.2	31.7	0.0	2.7
Prop In Lane	1.00		1.00	1.00		0.24	0.86		1.00	0.96		1.00
Lane Grp Cap(c), veh/h	80	1530	688	42	727	733	99	0	474	108	0	633
V/C Ratio(X)	0.78	0.63	0.00	0.67	0.54	0.54	0.07	0.00	0.01	0.75	0.00	0.13
Avail Cap(c_a), veh/h	135	1530	688	135	727	733	104	0	478	113	0	639
HCM Platoon Ratio	1.00	1.00	1.00	1.00	1.00	1.00	1.00	1.00	1.00	1.00	1.00	1.00
Upstream Filter(I)	1.00	1.00	1.00	1.00	1.00	1.00	1.00	0.00	1.00	1.00	0.00	1.00
Uniform Delay (d), s/veh	37.8	17.8	13.0	38.8	17.9	17.9	20.6	0.0	14.6	39.2	0.0	15.4
Incr Delay (d2), s/veh	14.9	2.0	0.0	17.2	2.9	2.8	0.3	0.0	0.0	22.8	0.0	0.1
Initial Q Delay(d3),s/veh	0.0	0.0	0.0	0.0	0.0	0.0	0.0	0.0	0.0	0.0	0.0	0.0
%ile BackOfQ(50%),veh/ln	1.5	6.9	0.0	0.7	5.7	5.8	0.1	0.0	0.0	2.2	0.0	1.0
Unsig. Movement Delay, s/veh												
LnGrp Delay(d),s/veh	52.8	19.8	13.0	56.0	20.8	20.8	20.9	0.0	14.6	62.0	0.0	15.5
LnGrp LOS	D	B	B	E	C	C	C	A	B	E	A	B
Approach Vol, veh/h		1027			816			11				166
Approach Delay, s/veh		21.8			22.0			18.6				38.2
Approach LOS		C			C			B				D
Timer - Assigned Phs	1	2		4	5	6		8				
Phs Duration (G+Y+Rc), s	5.9	38.3		35.9	7.5	36.6		35.9				
Change Period (Y+Rc), s	4.0	4.0		4.0	4.0	4.0		4.0				
Max Green Setting (Gmax), s	6.0	30.0		32.0	6.0	30.0		32.0				
Max Q Clear Time (g_c+I1), s	3.2	19.0		33.7	4.7	15.4		33.4				
Green Ext Time (p_c), s	0.0	5.0		0.0	0.0	4.4		0.0				

Intersection Summary

HCM 6th Ctrl Delay	23.2
HCM 6th LOS	C

HCM 6th Signalized Intersection Summary  
3: Pacoima Rd & Bear Valley Rd



Movement	EBL	EBT	EBR	WBL	WBT	WBR	NBL	NBT	NBR	SBL	SBT	SBR
Lane Configurations	↘	↑↑	↗	↘	↑↑			↘	↗		↘	↗
Traffic Volume (veh/h)	10	791	1	24	564	80	5	1	3	65	2	30
Future Volume (veh/h)	10	791	1	24	564	80	5	1	3	65	2	30
Initial Q (Qb), veh	0	0	0	0	0	0	0	0	0	0	0	0
Ped-Bike Adj(A_pbT)	1.00		1.00	1.00		1.00	1.00		1.00	1.00		1.00
Parking Bus, Adj	1.00	1.00	1.00	1.00	1.00	1.00	1.00	1.00	1.00	1.00	1.00	1.00
Work Zone On Approach		No			No			No			No	
Adj Sat Flow, veh/h/ln	1885	1870	1885	1885	1870	1885	1885	1885	1411	1885	1885	1885
Adj Flow Rate, veh/h	13	1014	1	31	723	103	6	1	4	83	3	38
Peak Hour Factor	0.78	0.78	0.78	0.78	0.78	0.78	0.78	0.78	0.78	0.78	0.78	0.78
Percent Heavy Veh, %	1	2	1	1	2	1	1	1	33	1	1	1
Cap, veh/h	23	1797	808	45	1618	230	90	9	382	102	2	510
Arrive On Green	0.01	0.51	0.51	0.02	0.52	0.52	0.32	0.32	0.32	0.32	0.32	0.32
Sat Flow, veh/h	1795	3554	1598	1795	3123	445	21	28	1196	42	7	1598
Grp Volume(v), veh/h	13	1014	1	31	411	415	7	0	4	86	0	38
Grp Sat Flow(s),veh/h/ln	1795	1777	1598	1795	1777	1790	49	0	1196	49	0	1598
Q Serve(g_s), s	0.6	15.8	0.0	1.4	11.6	11.6	0.1	0.0	0.2	0.8	0.0	1.3
Cycle Q Clear(g_c), s	0.6	15.8	0.0	1.4	11.6	11.6	25.2	0.0	0.2	25.6	0.0	1.3
Prop In Lane	1.00		1.00	1.00		0.25	0.86		1.00	0.97		1.00
Lane Grp Cap(c), veh/h	23	1797	808	45	921	928	99	0	382	104	0	510
V/C Ratio(X)	0.58	0.56	0.00	0.69	0.45	0.45	0.07	0.00	0.01	0.83	0.00	0.07
Avail Cap(c_a), veh/h	135	1797	808	135	921	928	215	0	478	220	0	639
HCM Platoon Ratio	1.00	1.00	1.00	1.00	1.00	1.00	1.00	1.00	1.00	1.00	1.00	1.00
Upstream Filter(I)	1.00	1.00	1.00	1.00	1.00	1.00	1.00	0.00	1.00	1.00	0.00	1.00
Uniform Delay (d), s/veh	39.3	13.7	9.8	38.7	12.1	12.1	22.5	0.0	18.6	39.4	0.0	19.0
Incr Delay (d2), s/veh	21.2	1.3	0.0	17.5	1.6	1.6	0.3	0.0	0.0	15.0	0.0	0.1
Initial Q Delay(d3),s/veh	0.0	0.0	0.0	0.0	0.0	0.0	0.0	0.0	0.0	0.0	0.0	0.0
%ile BackOfQ(50%),veh/ln	0.4	6.1	0.0	0.8	4.6	4.6	0.1	0.0	0.1	2.1	0.0	0.5
Unsig. Movement Delay, s/veh												
LnGrp Delay(d),s/veh	60.5	15.0	9.8	56.2	13.7	13.7	22.8	0.0	18.6	54.4	0.0	19.0
LnGrp LOS	E	B	A	E	B	B	C	A	B	D	A	B
Approach Vol, veh/h		1028			857			11				124
Approach Delay, s/veh		15.5			15.2			21.2				43.6
Approach LOS		B			B			C				D
Timer - Assigned Phs	1	2		4	5	6		8				
Phs Duration (G+Y+Rc), s	6.0	44.1		29.9	5.0	45.1		29.9				
Change Period (Y+Rc), s	4.0	4.0		4.0	4.0	4.0		4.0				
Max Green Setting (Gmax), s	6.0	30.0		32.0	6.0	30.0		32.0				
Max Q Clear Time (g_c+I1), s	3.4	17.8		27.6	2.6	13.6		27.2				
Green Ext Time (p_c), s	0.0	5.7		0.2	0.0	4.9		0.0				

Intersection Summary

HCM 6th Ctrl Delay	17.1
HCM 6th LOS	B

HCM 6th Signalized Intersection Summary  
3: Pacoima Rd & Bear Valley Rd

Synchro 11 Report  
09/03/2021



Movement	EBL	EBT	EBR	WBL	WBT	WBR	NBL	NBT	NBR	SBL	SBT	SBR
Lane Configurations	↘	↑↑	↗	↘	↑↑			↘	↗		↘	↗
Traffic Volume (veh/h)	49	804	1	24	577	80	5	1	3	65	2	68
Future Volume (veh/h)	49	804	1	24	577	80	5	1	3	65	2	68
Initial Q (Qb), veh	0	0	0	0	0	0	0	0	0	0	0	0
Ped-Bike Adj(A_pbT)	1.00		1.00	1.00		1.00	1.00		1.00	1.00		1.00
Parking Bus, Adj	1.00	1.00	1.00	1.00	1.00	1.00	1.00	1.00	1.00	1.00	1.00	1.00
Work Zone On Approach		No			No			No			No	
Adj Sat Flow, veh/h/ln	1885	1870	1885	1885	1870	1885	1885	1885	1411	1885	1885	1885
Adj Flow Rate, veh/h	63	1031	1	31	740	103	6	1	4	83	3	87
Peak Hour Factor	0.78	0.78	0.78	0.78	0.78	0.78	0.78	0.78	0.78	0.78	0.78	0.78
Percent Heavy Veh, %	1	2	1	1	2	1	1	1	33	1	1	1
Cap, veh/h	81	1515	681	45	1272	177	87	8	477	98	2	637
Arrive On Green	0.05	0.43	0.43	0.02	0.41	0.41	0.40	0.40	0.40	0.40	0.40	0.40
Sat Flow, veh/h	1795	3554	1598	1795	3133	436	8	21	1196	25	5	1598
Grp Volume(v), veh/h	63	1031	1	31	420	423	7	0	4	86	0	87
Grp Sat Flow(s),veh/h/ln	1795	1777	1598	1795	1777	1792	29	0	1196	30	0	1598
Q Serve(g_s), s	2.8	18.8	0.0	1.4	14.7	14.7	0.2	0.0	0.2	0.6	0.0	2.8
Cycle Q Clear(g_c), s	2.8	18.8	0.0	1.4	14.7	14.7	31.8	0.0	0.2	31.9	0.0	2.8
Prop In Lane	1.00		1.00	1.00		0.24	0.86		1.00	0.97		1.00
Lane Grp Cap(c), veh/h	81	1515	681	45	721	728	95	0	477	101	0	637
V/C Ratio(X)	0.78	0.68	0.00	0.69	0.58	0.58	0.07	0.00	0.01	0.86	0.00	0.14
Avail Cap(c_a), veh/h	135	1515	681	135	721	728	97	0	478	102	0	639
HCM Platoon Ratio	1.00	1.00	1.00	1.00	1.00	1.00	1.00	1.00	1.00	1.00	1.00	1.00
Upstream Filter(I)	1.00	1.00	1.00	1.00	1.00	1.00	1.00	0.00	1.00	1.00	0.00	1.00
Uniform Delay (d), s/veh	37.8	18.6	13.2	38.7	18.5	18.5	20.7	0.0	14.5	39.3	0.0	15.3
Incr Delay (d2), s/veh	14.7	2.5	0.0	17.5	3.4	3.4	0.3	0.0	0.0	46.4	0.0	0.1
Initial Q Delay(d3),s/veh	0.0	0.0	0.0	0.0	0.0	0.0	0.0	0.0	0.0	0.0	0.0	0.0
%ile BackOfQ(50%),veh/ln	1.5	7.7	0.0	0.8	6.3	6.4	0.1	0.0	0.0	3.0	0.0	1.0
Unsig. Movement Delay, s/veh												
LnGrp Delay(d),s/veh	52.5	21.0	13.2	56.2	21.9	21.9	21.0	0.0	14.5	85.7	0.0	15.4
LnGrp LOS	D	C	B	E	C	C	C	A	B	F	A	B
Approach Vol, veh/h		1095			874			11				173
Approach Delay, s/veh		22.8			23.1			18.6				50.4
Approach LOS		C			C			B				D
Timer - Assigned Phs	1	2		4	5	6		8				
Phs Duration (G+Y+Rc), s	6.0	38.1		36.0	7.6	36.4		36.0				
Change Period (Y+Rc), s	4.0	4.0		4.0	4.0	4.0		4.0				
Max Green Setting (Gmax), s	6.0	30.0		32.0	6.0	30.0		32.0				
Max Q Clear Time (g_c+I1), s	3.4	20.8		33.9	4.8	16.7		33.8				
Green Ext Time (p_c), s	0.0	4.8		0.0	0.0	4.5		0.0				

Intersection Summary

HCM 6th Ctrl Delay	25.1
HCM 6th LOS	C

HCM 6th Signalized Intersection Summary  
3: Pacoima Rd & Bear Valley Rd

Synchro 11 Report  
09/03/2021



Movement	EBL	EBT	EBR	WBL	WBT	WBR	NBL	NBT	NBR	SBL	SBT	SBR
Lane Configurations	↘	↑↑	↗	↘	↑↑			↘	↗		↘	↗
Traffic Volume (veh/h)	49	804	1	24	577	80	5	1	3	65	2	68
Future Volume (veh/h)	49	804	1	24	577	80	5	1	3	65	2	68
Initial Q (Qb), veh	0	0	0	0	0	0	0	0	0	0	0	0
Ped-Bike Adj(A_pbT)	1.00		1.00	1.00		1.00	1.00		1.00	1.00		1.00
Parking Bus, Adj	1.00	1.00	1.00	1.00	1.00	1.00	1.00	1.00	1.00	1.00	1.00	1.00
Work Zone On Approach		No			No			No			No	
Adj Sat Flow, veh/h/ln	1885	1870	1885	1885	1870	1885	1885	1885	1411	1885	1885	1885
Adj Flow Rate, veh/h	63	1031	1	31	740	103	6	1	4	83	3	87
Peak Hour Factor	0.78	0.78	0.78	0.78	0.78	0.78	0.78	0.78	0.78	0.78	0.78	0.78
Percent Heavy Veh, %	1	2	1	1	2	1	1	1	33	1	1	1
Cap, veh/h	81	1515	681	45	1272	177	87	8	477	98	2	637
Arrive On Green	0.05	0.43	0.43	0.02	0.41	0.41	0.40	0.40	0.40	0.40	0.40	0.40
Sat Flow, veh/h	1795	3554	1598	1795	3133	436	8	21	1196	25	5	1598
Grp Volume(v), veh/h	63	1031	1	31	420	423	7	0	4	86	0	87
Grp Sat Flow(s),veh/h/ln	1795	1777	1598	1795	1777	1792	29	0	1196	30	0	1598
Q Serve(g_s), s	2.8	18.8	0.0	1.4	14.7	14.7	0.2	0.0	0.2	0.6	0.0	2.8
Cycle Q Clear(g_c), s	2.8	18.8	0.0	1.4	14.7	14.7	31.8	0.0	0.2	31.9	0.0	2.8
Prop In Lane	1.00		1.00	1.00		0.24	0.86		1.00	0.97		1.00
Lane Grp Cap(c), veh/h	81	1515	681	45	721	728	95	0	477	101	0	637
V/C Ratio(X)	0.78	0.68	0.00	0.69	0.58	0.58	0.07	0.00	0.01	0.86	0.00	0.14
Avail Cap(c_a), veh/h	135	1515	681	135	721	728	97	0	478	102	0	639
HCM Platoon Ratio	1.00	1.00	1.00	1.00	1.00	1.00	1.00	1.00	1.00	1.00	1.00	1.00
Upstream Filter(I)	1.00	1.00	1.00	1.00	1.00	1.00	1.00	0.00	1.00	1.00	0.00	1.00
Uniform Delay (d), s/veh	37.8	18.6	13.2	38.7	18.5	18.5	20.7	0.0	14.5	39.3	0.0	15.3
Incr Delay (d2), s/veh	14.7	2.5	0.0	17.5	3.4	3.4	0.3	0.0	0.0	46.4	0.0	0.1
Initial Q Delay(d3),s/veh	0.0	0.0	0.0	0.0	0.0	0.0	0.0	0.0	0.0	0.0	0.0	0.0
%ile BackOfQ(50%),veh/ln	1.5	7.7	0.0	0.8	6.3	6.4	0.1	0.0	0.0	3.0	0.0	1.0
Unsig. Movement Delay, s/veh												
LnGrp Delay(d),s/veh	52.5	21.0	13.2	56.2	21.9	21.9	21.0	0.0	14.5	85.7	0.0	15.4
LnGrp LOS	D	C	B	E	C	C	C	A	B	F	A	B
Approach Vol, veh/h		1095			874			11				173
Approach Delay, s/veh		22.8			23.1			18.6				50.4
Approach LOS		C			C			B				D
Timer - Assigned Phs	1	2		4	5	6		8				
Phs Duration (G+Y+Rc), s	6.0	38.1		36.0	7.6	36.4		36.0				
Change Period (Y+Rc), s	4.0	4.0		4.0	4.0	4.0		4.0				
Max Green Setting (Gmax), s	6.0	30.0		32.0	6.0	30.0		32.0				
Max Q Clear Time (g_c+I1), s	3.4	20.8		33.9	4.8	16.7		33.8				
Green Ext Time (p_c), s	0.0	4.8		0.0	0.0	4.5		0.0				

Intersection Summary

HCM 6th Ctrl Delay	25.1
HCM 6th LOS	C

HCM 6th Signalized Intersection Summary  
3: Pacoima Rd & Bear Valley Rd

Synchro 11 Report  
09/03/2021



Movement	EBL	EBT	EBR	WBL	WBT	WBR	NBL	NBT	NBR	SBL	SBT	SBR
Lane Configurations	↘	↑↑	↗	↘	↑↑			↘	↗		↘	↗
Traffic Volume (veh/h)	10	809	1	25	577	82	5	1	3	66	2	31
Future Volume (veh/h)	10	809	1	25	577	82	5	1	3	66	2	31
Initial Q (Qb), veh	0	0	0	0	0	0	0	0	0	0	0	0
Ped-Bike Adj(A_pbT)	1.00		1.00	1.00		1.00	1.00		1.00	1.00		1.00
Parking Bus, Adj	1.00	1.00	1.00	1.00	1.00	1.00	1.00	1.00	1.00	1.00	1.00	1.00
Work Zone On Approach		No			No			No			No	
Adj Sat Flow, veh/h/ln	1885	1870	1885	1885	1870	1885	1885	1885	1411	1885	1885	1885
Adj Flow Rate, veh/h	13	1037	1	32	740	105	6	1	4	85	3	40
Peak Hour Factor	0.78	0.78	0.78	0.78	0.78	0.78	0.78	0.78	0.78	0.78	0.78	0.78
Percent Heavy Veh, %	1	2	1	1	2	1	1	1	33	1	1	1
Cap, veh/h	23	1752	787	46	1580	224	91	9	397	103	2	530
Arrive On Green	0.01	0.49	0.49	0.03	0.51	0.51	0.33	0.33	0.33	0.33	0.33	0.33
Sat Flow, veh/h	1795	3554	1598	1795	3124	443	21	27	1196	43	7	1598
Grp Volume(v), veh/h	13	1037	1	32	421	424	7	0	4	88	0	40
Grp Sat Flow(s),veh/h/ln	1795	1777	1598	1795	1777	1791	48	0	1196	49	0	1598
Q Serve(g_s), s	0.6	16.7	0.0	1.4	12.3	12.3	0.1	0.0	0.2	0.8	0.0	1.4
Cycle Q Clear(g_c), s	0.6	16.7	0.0	1.4	12.3	12.3	26.2	0.0	0.2	26.5	0.0	1.4
Prop In Lane	1.00		1.00	1.00		0.25	0.86		1.00	0.97		1.00
Lane Grp Cap(c), veh/h	23	1752	787	46	899	906	100	0	397	105	0	530
V/C Ratio(X)	0.58	0.59	0.00	0.70	0.47	0.47	0.07	0.00	0.01	0.84	0.00	0.08
Avail Cap(c_a), veh/h	135	1752	787	135	899	906	197	0	478	203	0	639
HCM Platoon Ratio	1.00	1.00	1.00	1.00	1.00	1.00	1.00	1.00	1.00	1.00	1.00	1.00
Upstream Filter(I)	1.00	1.00	1.00	1.00	1.00	1.00	1.00	0.00	1.00	1.00	0.00	1.00
Uniform Delay (d), s/veh	39.3	14.5	10.3	38.7	12.8	12.8	22.1	0.0	17.9	39.4	0.0	18.3
Incr Delay (d2), s/veh	21.2	1.5	0.0	17.6	1.8	1.7	0.3	0.0	0.0	15.9	0.0	0.1
Initial Q Delay(d3),s/veh	0.0	0.0	0.0	0.0	0.0	0.0	0.0	0.0	0.0	0.0	0.0	0.0
%ile BackOfQ(50%),veh/ln	0.4	6.5	0.0	0.8	4.9	4.9	0.1	0.0	0.0	2.2	0.0	0.5
Unsig. Movement Delay, s/veh												
LnGrp Delay(d),s/veh	60.5	16.0	10.3	56.3	14.6	14.5	22.4	0.0	17.9	55.3	0.0	18.4
LnGrp LOS	E	B	B	E	B	B	C	A	B	E	A	B
Approach Vol, veh/h		1051			877			11				128
Approach Delay, s/veh		16.5			16.1			20.8				43.8
Approach LOS		B			B			C				D
Timer - Assigned Phs	1	2		4	5	6		8				
Phs Duration (G+Y+Rc), s	6.0	43.0		31.0	5.0	44.0		31.0				
Change Period (Y+Rc), s	4.0	4.0		4.0	4.0	4.0		4.0				
Max Green Setting (Gmax), s	6.0	30.0		32.0	6.0	30.0		32.0				
Max Q Clear Time (g_c+I1), s	3.4	18.7		28.5	2.6	14.3		28.2				
Green Ext Time (p_c), s	0.0	5.5		0.1	0.0	4.9		0.0				

Intersection Summary

HCM 6th Ctrl Delay	18.1
HCM 6th LOS	B

HCM 6th Signalized Intersection Summary  
3: Pacoima Rd & Bear Valley Rd

Synchro 11 Report  
09/03/2021



Movement	EBL	EBT	EBR	WBL	WBT	WBR	NBL	NBT	NBR	SBL	SBT	SBR
Lane Configurations												
Traffic Volume (veh/h)	49	822	1	25	590	82	5	1	3	66	2	69
Future Volume (veh/h)	49	822	1	25	590	82	5	1	3	66	2	69
Initial Q (Qb), veh	0	0	0	0	0	0	0	0	0	0	0	0
Ped-Bike Adj(A_pbT)	1.00		1.00	1.00		1.00	1.00		1.00	1.00		1.00
Parking Bus, Adj	1.00	1.00	1.00	1.00	1.00	1.00	1.00	1.00	1.00	1.00	1.00	1.00
Work Zone On Approach		No			No			No			No	
Adj Sat Flow, veh/h/ln	1885	1870	1885	1885	1870	1885	1885	1885	1411	1885	1885	1885
Adj Flow Rate, veh/h	63	1054	1	32	756	105	6	1	4	85	3	88
Peak Hour Factor	0.78	0.78	0.78	0.78	0.78	0.78	0.78	0.78	0.78	0.78	0.78	0.78
Percent Heavy Veh, %	1	2	1	1	2	1	1	1	33	1	1	1
Cap, veh/h	81	1512	680	46	1271	177	86	8	477	96	2	638
Arrive On Green	0.05	0.43	0.43	0.03	0.41	0.41	0.40	0.40	0.40	0.40	0.40	0.40
Sat Flow, veh/h	1795	3554	1598	1795	3134	435	6	21	1196	20	5	1598
Grp Volume(v), veh/h	63	1054	1	32	429	432	7	0	4	88	0	88
Grp Sat Flow(s),veh/h/ln	1795	1777	1598	1795	1777	1792	27	0	1196	24	0	1598
Q Serve(g_s), s	2.8	19.4	0.0	1.4	15.1	15.1	0.2	0.0	0.2	0.5	0.0	2.8
Cycle Q Clear(g_c), s	2.8	19.4	0.0	1.4	15.1	15.1	31.9	0.0	0.2	31.9	0.0	2.8
Prop In Lane	1.00		1.00	1.00		0.24	0.86		1.00	0.97		1.00
Lane Grp Cap(c), veh/h	81	1512	680	46	721	727	94	0	477	98	0	638
V/C Ratio(X)	0.78	0.70	0.00	0.70	0.59	0.59	0.07	0.00	0.01	0.90	0.00	0.14
Avail Cap(c_a), veh/h	135	1512	680	135	721	727	95	0	478	99	0	639
HCM Platoon Ratio	1.00	1.00	1.00	1.00	1.00	1.00	1.00	1.00	1.00	1.00	1.00	1.00
Upstream Filter(I)	1.00	1.00	1.00	1.00	1.00	1.00	1.00	0.00	1.00	1.00	0.00	1.00
Uniform Delay (d), s/veh	37.8	18.8	13.2	38.7	18.6	18.6	20.7	0.0	14.5	39.4	0.0	15.3
Incr Delay (d2), s/veh	14.7	2.7	0.0	17.6	3.6	3.6	0.3	0.0	0.0	58.0	0.0	0.1
Initial Q Delay(d3),s/veh	0.0	0.0	0.0	0.0	0.0	0.0	0.0	0.0	0.0	0.0	0.0	0.0
%ile BackOfQ(50%),veh/ln	1.5	8.0	0.0	0.8	6.6	6.6	0.1	0.0	0.0	3.3	0.0	1.0
Unsig. Movement Delay, s/veh												
LnGrp Delay(d),s/veh	52.5	21.5	13.2	56.3	22.2	22.2	21.0	0.0	14.5	97.3	0.0	15.4
LnGrp LOS	D	C	B	E	C	C	C	A	B	F	A	B
Approach Vol, veh/h		1118			893			11				176
Approach Delay, s/veh		23.2			23.4			18.7				56.4
Approach LOS		C			C			B				E
Timer - Assigned Phs	1	2		4	5	6		8				
Phs Duration (G+Y+Rc), s	6.0	38.0		36.0	7.6	36.4		36.0				
Change Period (Y+Rc), s	4.0	4.0		4.0	4.0	4.0		4.0				
Max Green Setting (Gmax), s	6.0	30.0		32.0	6.0	30.0		32.0				
Max Q Clear Time (g_c+I1), s	3.4	21.4		33.9	4.8	17.1		33.9				
Green Ext Time (p_c), s	0.0	4.6		0.0	0.0	4.6		0.0				

Intersection Summary

HCM 6th Ctrl Delay	25.9
HCM 6th LOS	C

HCM 6th Signalized Intersection Summary  
3: Pacoima Rd & Bear Valley Rd

Synchro 11 Report  
09/03/2021



Movement	EBL	EBT	EBR	WBL	WBT	WBR	NBL	NBT	NBR	SBL	SBT	SBR
Lane Configurations	↘	↑↑	↗	↘	↑↑			↘	↗		↘	↗
Traffic Volume (veh/h)	49	822	1	25	590	82	5	1	3	66	2	69
Future Volume (veh/h)	49	822	1	25	590	82	5	1	3	66	2	69
Initial Q (Qb), veh	0	0	0	0	0	0	0	0	0	0	0	0
Ped-Bike Adj(A_pbT)	1.00		1.00	1.00		1.00	1.00		1.00	1.00		1.00
Parking Bus, Adj	1.00	1.00	1.00	1.00	1.00	1.00	1.00	1.00	1.00	1.00	1.00	1.00
Work Zone On Approach		No			No			No			No	
Adj Sat Flow, veh/h/ln	1885	1870	1885	1885	1870	1885	1885	1885	1411	1885	1885	1885
Adj Flow Rate, veh/h	63	1054	1	32	756	105	6	1	4	85	3	88
Peak Hour Factor	0.78	0.78	0.78	0.78	0.78	0.78	0.78	0.78	0.78	0.78	0.78	0.78
Percent Heavy Veh, %	1	2	1	1	2	1	1	1	33	1	1	1
Cap, veh/h	81	1512	680	46	1271	177	86	8	477	96	2	638
Arrive On Green	0.05	0.43	0.43	0.03	0.41	0.41	0.40	0.40	0.40	0.40	0.40	0.40
Sat Flow, veh/h	1795	3554	1598	1795	3134	435	6	21	1196	20	5	1598
Grp Volume(v), veh/h	63	1054	1	32	429	432	7	0	4	88	0	88
Grp Sat Flow(s),veh/h/ln	1795	1777	1598	1795	1777	1792	27	0	1196	24	0	1598
Q Serve(g_s), s	2.8	19.4	0.0	1.4	15.1	15.1	0.2	0.0	0.2	0.5	0.0	2.8
Cycle Q Clear(g_c), s	2.8	19.4	0.0	1.4	15.1	15.1	31.9	0.0	0.2	31.9	0.0	2.8
Prop In Lane	1.00		1.00	1.00		0.24	0.86		1.00	0.97		1.00
Lane Grp Cap(c), veh/h	81	1512	680	46	721	727	94	0	477	98	0	638
V/C Ratio(X)	0.78	0.70	0.00	0.70	0.59	0.59	0.07	0.00	0.01	0.90	0.00	0.14
Avail Cap(c_a), veh/h	135	1512	680	135	721	727	95	0	478	99	0	639
HCM Platoon Ratio	1.00	1.00	1.00	1.00	1.00	1.00	1.00	1.00	1.00	1.00	1.00	1.00
Upstream Filter(I)	1.00	1.00	1.00	1.00	1.00	1.00	1.00	0.00	1.00	1.00	0.00	1.00
Uniform Delay (d), s/veh	37.8	18.8	13.2	38.7	18.6	18.6	20.7	0.0	14.5	39.4	0.0	15.3
Incr Delay (d2), s/veh	14.7	2.7	0.0	17.6	3.6	3.6	0.3	0.0	0.0	58.0	0.0	0.1
Initial Q Delay(d3),s/veh	0.0	0.0	0.0	0.0	0.0	0.0	0.0	0.0	0.0	0.0	0.0	0.0
%ile BackOfQ(50%),veh/ln	1.5	8.0	0.0	0.8	6.6	6.6	0.1	0.0	0.0	3.3	0.0	1.0
Unsig. Movement Delay, s/veh												
LnGrp Delay(d),s/veh	52.5	21.5	13.2	56.3	22.2	22.2	21.0	0.0	14.5	97.3	0.0	15.4
LnGrp LOS	D	C	B	E	C	C	C	A	B	F	A	B
Approach Vol, veh/h		1118			893			11				176
Approach Delay, s/veh		23.2			23.4			18.7				56.4
Approach LOS		C			C			B				E
Timer - Assigned Phs	1	2		4	5	6		8				
Phs Duration (G+Y+Rc), s	6.0	38.0		36.0	7.6	36.4		36.0				
Change Period (Y+Rc), s	4.0	4.0		4.0	4.0	4.0		4.0				
Max Green Setting (Gmax), s	6.0	30.0		32.0	6.0	30.0		32.0				
Max Q Clear Time (g_c+I1), s	3.4	21.4		33.9	4.8	17.1		33.9				
Green Ext Time (p_c), s	0.0	4.6		0.0	0.0	4.6		0.0				

Intersection Summary

HCM 6th Ctrl Delay	25.9
HCM 6th LOS	C



SUBJECT	BY	DATE	JOB NO.	SHEET	OF
TURN MOVEMENTS	TM	8-Sep-21	HIGP0000-0002	1	OF 2

E/W STREET : SIERRA RD  
N/S STREET : AMETHYST RD  
CONDITION : AM PEAK HOUR

INTERSECTION : 4  
PROJECTED GROWTH : 3.5%  
PER YEAR :

### CONDITION DIAGRAMS

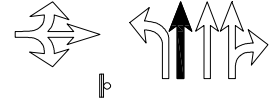
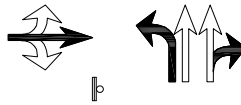
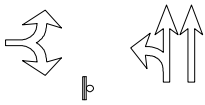
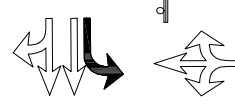
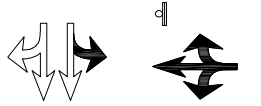

#### EXISTING GEOMETRICS

#### PROJECT GEOMETRICS

#### ULTIMATE GEOMETRICS

### TURN MOVEMENTS

Condition	Existing Condition	Project Trips	Existing + Project Condition	Year 2023 Ambient Growth	Background Condition	Project Condition	Year 2033 Ambient Growth	Future Condition	Future + Project Condition
Scenario #	1		3		5	7		9	11

#### SIERRA RD

EB LEFT	5	0	5	0	5	5	0	5	5
EB THRU	0	12	12	0	0	12	0	0	12
EB RIGHT	1	0	1	0	1	1	0	1	1
WB LEFT	0	21	21	0	0	21	0	0	21
WB THRU	0	11	11	0	0	11	0	0	11
WB RIGHT	0	0	0	0	0	0	0	0	0

#### AMETHYST RD

NB LEFT	1	0	1	0	1	1	0	1	1
NB THRU	253	24	277	18	271	295	6	277	301
NB RIGHT	0	12	12	0	0	12	0	0	12
SB LEFT	0	12	12	0	0	12	0	0	12
SB THRU	108	11	119	8	116	127	3	119	130
SB RIGHT	3	0	3	0	3	3	0	3	3
<b>TOTALS</b>	<b>371</b>	<b>103</b>	<b>474</b>	<b>26</b>	<b>397</b>	<b>500</b>	<b>9</b>	<b>406</b>	<b>509</b>



SUBJECT	BY	DATE	JOB NO.	SHEET	OF
TURN VOLUME SUMMARY	TM	8-Sep-21	HIGP0000-0002	2	OF 2

E/W STREET : SIERRA RD                      N/S STREET : AMETHYST RD  
CONDITION : AM PEAK HOUR                      PHF : 0.89

NORTH LEG											
AUTO			LARGE 2 AXLE			LARGE 3 AXLE			LARGE 4(+) AXLE		
RT	THRU	LT	RT	THRU	LT	RT	THRU	LT	RT	THRU	LT
2	20	0	0	1	0	0	1	0	0	0	0
0	11	0	0	2	0	0	1	0	1	2	0
0	28	0	0	0	0	0	1	0	0	1	0
0	30	0	0	0	0	0	2	0	0	8	0

SOUTH LEG											
AUTO			LARGE 2 AXLE			LARGE 3 AXLE			LARGE 4(+) AXLE		
RT	THRU	LT	RT	THRU	LT	RT	THRU	LT	RT	THRU	LT
0	41	0	0	0	0	0	0	0	0	0	0
0	74	0	0	1	0	0	1	0	0	1	0
0	71	0	0	1	0	0	0	0	0	0	0
0	62	0	0	1	0	0	0	0	0	0	0

EAST LEG											
AUTO			LARGE 2 AXLE			LARGE 3 AXLE			LARGE 4(+) AXLE		
RT	THRU	LT	RT	THRU	LT	RT	THRU	LT	RT	THRU	LT
0	0	0	0	0	0	0	0	0	0	0	0
0	0	0	0	0	0	0	0	0	0	0	0
0	0	0	0	0	0	0	0	0	0	0	0
0	0	0	0	0	0	0	0	0	0	0	0

WEST LEG											
AUTO			LARGE 2 AXLE			LARGE 3 AXLE			LARGE 4(+) AXLE		
RT	THRU	LT	RT	THRU	LT	RT	THRU	LT	RT	THRU	LT
0	0	3	0	0	0	0	0	0	0	0	0
1	0	1	0	0	0	0	0	0	0	0	0
0	0	0	0	0	0	0	0	0	0	0	0
0	0	0	0	0	1	0	0	0	0	0	0

Truck Volumes	Auto Volumes	Totals	Truck Percentage	Balanced Totals
---------------	--------------	--------	------------------	-----------------

**SIERRA RD**

EB LEFT	1	4	5	20%	5
EB THRU	0	0	0	0%	0
EB RIGHT	0	1	1	1%	1
WB LEFT	0	0	0	0%	0
WB THRU	0	0	0	0%	0
WB RIGHT	0	0	0	0%	0

**AMETHYST RD**

NB LEFT	0	0	1	1%	1
NB THRU	5	248	253	2%	253
NB RIGHT	0	0	0	0%	0
SB LEFT	0	0	0	0%	0
SB THRU	19	89	108	18%	108
SB RIGHT	1	2	3	33%	3

Intersection						
Int Delay, s/veh	0.2					
Movement	EBL	EBR	NBL	NBT	SBT	SBR
Lane Configurations	T			T		
Traffic Vol, veh/h	5	1	1	253	108	3
Future Vol, veh/h	5	1	1	253	108	3
Conflicting Peds, #/hr	0	0	0	0	0	0
Sign Control	Stop	Stop	Free	Free	Free	Free
RT Channelized	-	None	-	None	-	None
Storage Length	0	-	-	-	-	-
Veh in Median Storage, #	0	-	-	0	0	-
Grade, %	0	-	-	0	0	-
Peak Hour Factor	89	89	89	89	89	89
Heavy Vehicles, %	20	1	1	2	18	33
Mvmt Flow	6	1	1	284	121	3

Major/Minor	Minor2	Major1		Major2	
Conflicting Flow All	267	62	124	0	0
Stage 1	123	-	-	-	-
Stage 2	144	-	-	-	-
Critical Hdwy	7.2	6.92	4.12	-	-
Critical Hdwy Stg 1	6.2	-	-	-	-
Critical Hdwy Stg 2	6.2	-	-	-	-
Follow-up Hdwy	3.7	3.31	2.21	-	-
Pot Cap-1 Maneuver	652	993	1468	-	-
Stage 1	838	-	-	-	-
Stage 2	817	-	-	-	-
Platoon blocked, %				-	-
Mov Cap-1 Maneuver	651	993	1468	-	-
Mov Cap-2 Maneuver	651	-	-	-	-
Stage 1	837	-	-	-	-
Stage 2	817	-	-	-	-

Approach	EB	NB	SB
HCM Control Delay, s	10.3	0	0
HCM LOS	B		

Minor Lane/Major Mvmt	NBL	NBT	EBLn1	SBT	SBR
Capacity (veh/h)	1468	-	691	-	-
HCM Lane V/C Ratio	0.001	-	0.01	-	-
HCM Control Delay (s)	7.5	0	10.3	-	-
HCM Lane LOS	A	A	B	-	-
HCM 95th %tile Q(veh)	0	-	0	-	-

Intersection												
Int Delay, s/veh	1.5											
Movement	EBL	EBT	EBR	WBL	WBT	WBR	NBL	NBT	NBR	SBL	SBT	SBR
Lane Configurations		↕			↕			↕			↕	
Traffic Vol, veh/h	5	12	1	21	11	0	1	277	12	12	119	3
Future Vol, veh/h	5	12	1	21	11	0	1	277	12	12	119	3
Conflicting Peds, #/hr	0	0	0	0	0	0	0	0	0	0	0	0
Sign Control	Stop	Stop	Stop	Stop	Stop	Stop	Free	Free	Free	Free	Free	Free
RT Channelized	-	-	None	-	-	None	-	-	None	-	-	None
Storage Length	-	-	-	-	-	-	-	-	-	-	-	-
Veh in Median Storage, #	-	0	-	-	0	-	-	0	-	-	0	-
Grade, %	-	0	-	-	0	-	-	0	-	-	0	-
Peak Hour Factor	89	89	89	89	89	89	89	89	89	89	89	89
Heavy Vehicles, %	20	1	1	1	1	1	1	1	1	1	18	33
Mvmt Flow	6	13	1	24	12	0	1	311	13	13	134	3

Major/Minor	Minor2		Minor1		Major1			Major2				
Conflicting Flow All	326	488	69	420	483	162	137	0	0	324	0	0
Stage 1	162	162	-	320	320	-	-	-	-	-	-	-
Stage 2	164	326	-	100	163	-	-	-	-	-	-	-
Critical Hdwy	7.9	6.52	6.92	7.52	6.52	6.92	4.12	-	-	4.12	-	-
Critical Hdwy Stg 1	6.9	5.52	-	6.52	5.52	-	-	-	-	-	-	-
Critical Hdwy Stg 2	6.9	5.52	-	6.52	5.52	-	-	-	-	-	-	-
Follow-up Hdwy	3.7	4.01	3.31	3.51	4.01	3.31	2.21	-	-	2.21	-	-
Pot Cap-1 Maneuver	560	481	983	520	484	857	1452	-	-	1240	-	-
Stage 1	774	765	-	669	653	-	-	-	-	-	-	-
Stage 2	772	649	-	898	765	-	-	-	-	-	-	-
Platoon blocked, %								-	-	-	-	-
Mov Cap-1 Maneuver	544	475	983	503	478	857	1452	-	-	1240	-	-
Mov Cap-2 Maneuver	544	475	-	503	478	-	-	-	-	-	-	-
Stage 1	773	757	-	668	652	-	-	-	-	-	-	-
Stage 2	757	648	-	871	757	-	-	-	-	-	-	-

Approach	EB		WB		NB		SB	
HCM Control Delay, s	12.4		12.9		0		0.7	
HCM LOS	B		B					

Minor Lane/Major Mvmt	NBL	NBT	NBR	EBLn1WBLn1	SBL	SBT	SBR
Capacity (veh/h)	1452	-	-	507	494	1240	-
HCM Lane V/C Ratio	0.001	-	-	0.04	0.073	0.011	-
HCM Control Delay (s)	7.5	0	-	12.4	12.9	7.9	0
HCM Lane LOS	A	A	-	B	B	A	A
HCM 95th %tile Q(veh)	0	-	-	0.1	0.2	0	-

Intersection												
Int Delay, s/veh	1.5											
Movement	EBL	EBT	EBR	WBL	WBT	WBR	NBL	NBT	NBR	SBL	SBT	SBR
Lane Configurations		↕			↕		↕	↕			↕	
Traffic Vol, veh/h	5	12	1	21	11	0	1	277	12	12	119	3
Future Vol, veh/h	5	12	1	21	11	0	1	277	12	12	119	3
Conflicting Peds, #/hr	0	0	0	0	0	0	0	0	0	0	0	0
Sign Control	Stop	Stop	Stop	Stop	Stop	Stop	Free	Free	Free	Free	Free	Free
RT Channelized	-	-	None	-	-	None	-	-	None	-	-	None
Storage Length	-	-	-	-	-	-	135	-	-	-	-	-
Veh in Median Storage, #	-	0	-	-	0	-	-	0	-	-	0	-
Grade, %	-	0	-	-	0	-	-	0	-	-	0	-
Peak Hour Factor	89	89	89	89	89	89	89	89	89	89	89	89
Heavy Vehicles, %	20	1	1	1	1	1	1	1	1	1	18	33
Mvmt Flow	6	13	1	24	12	0	1	311	13	13	134	3

Major/Minor	Minor2		Minor1		Major1			Major2				
Conflicting Flow All	326	488	69	420	483	162	137	0	0	324	0	0
Stage 1	162	162	-	320	320	-	-	-	-	-	-	-
Stage 2	164	326	-	100	163	-	-	-	-	-	-	-
Critical Hdwy	7.9	6.52	6.92	7.52	6.52	6.92	4.12	-	-	4.12	-	-
Critical Hdwy Stg 1	6.9	5.52	-	6.52	5.52	-	-	-	-	-	-	-
Critical Hdwy Stg 2	6.9	5.52	-	6.52	5.52	-	-	-	-	-	-	-
Follow-up Hdwy	3.7	4.01	3.31	3.51	4.01	3.31	2.21	-	-	2.21	-	-
Pot Cap-1 Maneuver	560	481	983	520	484	857	1452	-	-	1240	-	-
Stage 1	774	765	-	669	653	-	-	-	-	-	-	-
Stage 2	772	649	-	898	765	-	-	-	-	-	-	-
Platoon blocked, %								-	-	-	-	-
Mov Cap-1 Maneuver	544	475	983	504	478	857	1452	-	-	1240	-	-
Mov Cap-2 Maneuver	544	475	-	504	478	-	-	-	-	-	-	-
Stage 1	773	757	-	668	652	-	-	-	-	-	-	-
Stage 2	757	648	-	871	757	-	-	-	-	-	-	-

Approach	EB		WB		NB		SB	
HCM Control Delay, s	12.4		12.8		0		0.7	
HCM LOS	B		B					

Minor Lane/Major Mvmt	NBL	NBT	NBR	EBLn1WBLn1	SBL	SBT	SBR
Capacity (veh/h)	1452	-	-	507	495	1240	-
HCM Lane V/C Ratio	0.001	-	-	0.04	0.073	0.011	-
HCM Control Delay (s)	7.5	-	-	12.4	12.8	7.9	0
HCM Lane LOS	A	-	-	B	B	A	A
HCM 95th %tile Q(veh)	0	-	-	0.1	0.2	0	-

Intersection						
Int Delay, s/veh	0.2					
Movement	EBL	EBR	NBL	NBT	SBT	SBR
Lane Configurations	T			T		
Traffic Vol, veh/h	5	1	1	271	116	3
Future Vol, veh/h	5	1	1	271	116	3
Conflicting Peds, #/hr	0	0	0	0	0	0
Sign Control	Stop	Stop	Free	Free	Free	Free
RT Channelized	-	None	-	None	-	None
Storage Length	0	-	-	-	-	-
Veh in Median Storage, #	0	-	-	0	0	-
Grade, %	0	-	-	0	0	-
Peak Hour Factor	89	89	89	89	89	89
Heavy Vehicles, %	20	1	1	2	18	33
Mvmt Flow	6	1	1	304	130	3

Major/Minor	Minor2	Major1		Major2	
Conflicting Flow All	286	67	133	0	0
Stage 1	132	-	-	-	-
Stage 2	154	-	-	-	-
Critical Hdwy	7.2	6.92	4.12	-	-
Critical Hdwy Stg 1	6.2	-	-	-	-
Critical Hdwy Stg 2	6.2	-	-	-	-
Follow-up Hdwy	3.7	3.31	2.21	-	-
Pot Cap-1 Maneuver	634	986	1457	-	-
Stage 1	829	-	-	-	-
Stage 2	807	-	-	-	-
Platoon blocked, %				-	-
Mov Cap-1 Maneuver	633	986	1457	-	-
Mov Cap-2 Maneuver	633	-	-	-	-
Stage 1	828	-	-	-	-
Stage 2	807	-	-	-	-

Approach	EB	NB	SB
HCM Control Delay, s	10.4	0	0
HCM LOS	B		

Minor Lane/Major Mvmt	NBL	NBT	EBLn1	SBT	SBR
Capacity (veh/h)	1457	-	673	-	-
HCM Lane V/C Ratio	0.001	-	0.01	-	-
HCM Control Delay (s)	7.5	0	10.4	-	-
HCM Lane LOS	A	A	B	-	-
HCM 95th %tile Q(veh)	0	-	0	-	-

Intersection												
Int Delay, s/veh	1.5											
Movement	EBL	EBT	EBR	WBL	WBT	WBR	NBL	NBT	NBR	SBL	SBT	SBR
Lane Configurations		↕			↕			↕			↕	
Traffic Vol, veh/h	5	12	1	21	11	0	1	295	12	12	127	3
Future Vol, veh/h	5	12	1	21	11	0	1	295	12	12	127	3
Conflicting Peds, #/hr	0	0	0	0	0	0	0	0	0	0	0	0
Sign Control	Stop	Stop	Stop	Stop	Stop	Stop	Free	Free	Free	Free	Free	Free
RT Channelized	-	-	None	-	-	None	-	-	None	-	-	None
Storage Length	-	-	-	-	-	-	-	-	-	-	-	-
Veh in Median Storage, #	-	0	-	-	0	-	-	0	-	-	0	-
Grade, %	-	0	-	-	0	-	-	0	-	-	0	-
Peak Hour Factor	89	89	89	89	89	89	89	89	89	89	89	89
Heavy Vehicles, %	20	1	1	1	1	1	1	1	1	1	18	33
Mvmt Flow	6	13	1	24	12	0	1	331	13	13	143	3

Major/Minor	Minor2		Minor1		Major1		Major2					
Conflicting Flow All	345	517	73	444	512	172	146	0	0	344	0	0
Stage 1	171	171	-	340	340	-	-	-	-	-	-	-
Stage 2	174	346	-	104	172	-	-	-	-	-	-	-
Critical Hdwy	7.9	6.52	6.92	7.52	6.52	6.92	4.12	-	-	4.12	-	-
Critical Hdwy Stg 1	6.9	5.52	-	6.52	5.52	-	-	-	-	-	-	-
Critical Hdwy Stg 2	6.9	5.52	-	6.52	5.52	-	-	-	-	-	-	-
Follow-up Hdwy	3.7	4.01	3.31	3.51	4.01	3.31	2.21	-	-	2.21	-	-
Pot Cap-1 Maneuver	542	463	977	500	466	845	1441	-	-	1219	-	-
Stage 1	764	759	-	651	640	-	-	-	-	-	-	-
Stage 2	761	636	-	893	758	-	-	-	-	-	-	-
Platoon blocked, %								-	-	-	-	-
Mov Cap-1 Maneuver	526	457	977	484	460	845	1441	-	-	1219	-	-
Mov Cap-2 Maneuver	526	457	-	484	460	-	-	-	-	-	-	-
Stage 1	763	750	-	650	639	-	-	-	-	-	-	-
Stage 2	746	635	-	865	749	-	-	-	-	-	-	-

Approach	EB		WB		NB		SB	
HCM Control Delay, s	12.7		13.2		0		0.7	
HCM LOS	B		B					

Minor Lane/Major Mvmt	NBL	NBT	NBR	EBLn1WBLn1	SBL	SBT	SBR
Capacity (veh/h)	1441	-	-	489	475	1219	-
HCM Lane V/C Ratio	0.001	-	-	0.041	0.076	0.011	-
HCM Control Delay (s)	7.5	0	-	12.7	13.2	8	0
HCM Lane LOS	A	A	-	B	B	A	A
HCM 95th %tile Q(veh)	0	-	-	0.1	0.2	0	-

Intersection												
Int Delay, s/veh	1.5											
Movement	EBL	EBT	EBR	WBL	WBT	WBR	NBL	NBT	NBR	SBL	SBT	SBR
Lane Configurations		↕			↕		↕	↕			↕	
Traffic Vol, veh/h	5	12	1	21	11	0	1	295	12	12	127	3
Future Vol, veh/h	5	12	1	21	11	0	1	295	12	12	127	3
Conflicting Peds, #/hr	0	0	0	0	0	0	0	0	0	0	0	0
Sign Control	Stop	Stop	Stop	Stop	Stop	Stop	Free	Free	Free	Free	Free	Free
RT Channelized	-	-	None	-	-	None	-	-	None	-	-	None
Storage Length	-	-	-	-	-	-	135	-	-	-	-	-
Veh in Median Storage, #	-	0	-	-	0	-	-	0	-	-	0	-
Grade, %	-	0	-	-	0	-	-	0	-	-	0	-
Peak Hour Factor	89	89	89	89	89	89	89	89	89	89	89	89
Heavy Vehicles, %	20	1	1	1	1	1	1	1	1	1	18	33
Mvmt Flow	6	13	1	24	12	0	1	331	13	13	143	3

Major/Minor	Minor2		Minor1		Major1			Major2				
Conflicting Flow All	345	517	73	444	512	172	146	0	0	344	0	0
Stage 1	171	171	-	340	340	-	-	-	-	-	-	-
Stage 2	174	346	-	104	172	-	-	-	-	-	-	-
Critical Hdwy	7.9	6.52	6.92	7.52	6.52	6.92	4.12	-	-	4.12	-	-
Critical Hdwy Stg 1	6.9	5.52	-	6.52	5.52	-	-	-	-	-	-	-
Critical Hdwy Stg 2	6.9	5.52	-	6.52	5.52	-	-	-	-	-	-	-
Follow-up Hdwy	3.7	4.01	3.31	3.51	4.01	3.31	2.21	-	-	2.21	-	-
Pot Cap-1 Maneuver	542	463	977	500	466	845	1441	-	-	1219	-	-
Stage 1	764	759	-	651	640	-	-	-	-	-	-	-
Stage 2	761	636	-	893	758	-	-	-	-	-	-	-
Platoon blocked, %								-	-	-	-	-
Mov Cap-1 Maneuver	526	457	977	484	460	845	1441	-	-	1219	-	-
Mov Cap-2 Maneuver	526	457	-	484	460	-	-	-	-	-	-	-
Stage 1	763	750	-	650	639	-	-	-	-	-	-	-
Stage 2	746	635	-	865	749	-	-	-	-	-	-	-

Approach	EB		WB		NB			SB		
HCM Control Delay, s	12.7		13.2		0			0.7		
HCM LOS	B		B							

Minor Lane/Major Mvmt	NBL	NBT	NBR	EBLn1WBLn1	SBL	SBT	SBR
Capacity (veh/h)	1441	-	-	489	475	1219	-
HCM Lane V/C Ratio	0.001	-	-	0.041	0.076	0.011	-
HCM Control Delay (s)	7.5	-	-	12.7	13.2	8	0
HCM Lane LOS	A	-	-	B	B	A	A
HCM 95th %tile Q(veh)	0	-	-	0.1	0.2	0	-



Intersection						
Int Delay, s/veh	0.2					
Movement	EBL	EBR	NBL	NBT	SBT	SBR
Lane Configurations	T			T		
Traffic Vol, veh/h	5	1	1	277	119	3
Future Vol, veh/h	5	1	1	277	119	3
Conflicting Peds, #/hr	0	0	0	0	0	0
Sign Control	Stop	Stop	Free	Free	Free	Free
RT Channelized	-	None	-	None	-	None
Storage Length	0	-	-	-	-	-
Veh in Median Storage, #	0	-	-	0	0	-
Grade, %	0	-	-	0	0	-
Peak Hour Factor	89	89	89	89	89	89
Heavy Vehicles, %	20	1	1	2	18	33
Mvmt Flow	6	1	1	311	134	3

Major/Minor	Minor2	Major1		Major2	
Conflicting Flow All	294	69	137	0	0
Stage 1	136	-	-	-	-
Stage 2	158	-	-	-	-
Critical Hdwy	7.2	6.92	4.12	-	-
Critical Hdwy Stg 1	6.2	-	-	-	-
Critical Hdwy Stg 2	6.2	-	-	-	-
Follow-up Hdwy	3.7	3.31	2.21	-	-
Pot Cap-1 Maneuver	626	983	1452	-	-
Stage 1	825	-	-	-	-
Stage 2	803	-	-	-	-
Platoon blocked, %				-	-
Mov Cap-1 Maneuver	625	983	1452	-	-
Mov Cap-2 Maneuver	625	-	-	-	-
Stage 1	824	-	-	-	-
Stage 2	803	-	-	-	-

Approach	EB	NB	SB
HCM Control Delay, s	10.5	0	0
HCM LOS	B		

Minor Lane/Major Mvmt	NBL	NBT	EBLn1	SBT	SBR
Capacity (veh/h)	1452	-	665	-	-
HCM Lane V/C Ratio	0.001	-	0.01	-	-
HCM Control Delay (s)	7.5	0	10.5	-	-
HCM Lane LOS	A	A	B	-	-
HCM 95th %tile Q(veh)	0	-	0	-	-

Intersection												
Int Delay, s/veh	1.5											
Movement	EBL	EBT	EBR	WBL	WBT	WBR	NBL	NBT	NBR	SBL	SBT	SBR
Lane Configurations		↕			↕			↕			↕	
Traffic Vol, veh/h	5	12	1	21	11	0	1	301	12	12	130	3
Future Vol, veh/h	5	12	1	21	11	0	1	301	12	12	130	3
Conflicting Peds, #/hr	0	0	0	0	0	0	0	0	0	0	0	0
Sign Control	Stop	Stop	Stop	Stop	Stop	Stop	Free	Free	Free	Free	Free	Free
RT Channelized	-	-	None	-	-	None	-	-	None	-	-	None
Storage Length	-	-	-	-	-	-	-	-	-	-	-	-
Veh in Median Storage, #	-	0	-	-	0	-	-	0	-	-	0	-
Grade, %	-	0	-	-	0	-	-	0	-	-	0	-
Peak Hour Factor	89	89	89	89	89	89	89	89	89	89	89	89
Heavy Vehicles, %	20	1	1	1	1	1	1	1	1	1	18	33
Mvmt Flow	6	13	1	24	12	0	1	338	13	13	146	3

Major/Minor	Minor2		Minor1		Major1			Major2				
Conflicting Flow All	351	527	75	453	522	176	149	0	0	351	0	0
Stage 1	174	174	-	347	347	-	-	-	-	-	-	-
Stage 2	177	353	-	106	175	-	-	-	-	-	-	-
Critical Hdwy	7.9	6.52	6.92	7.52	6.52	6.92	4.12	-	-	4.12	-	-
Critical Hdwy Stg 1	6.9	5.52	-	6.52	5.52	-	-	-	-	-	-	-
Critical Hdwy Stg 2	6.9	5.52	-	6.52	5.52	-	-	-	-	-	-	-
Follow-up Hdwy	3.7	4.01	3.31	3.51	4.01	3.31	2.21	-	-	2.21	-	-
Pot Cap-1 Maneuver	536	457	974	493	460	840	1437	-	-	1212	-	-
Stage 1	761	756	-	645	636	-	-	-	-	-	-	-
Stage 2	758	632	-	891	756	-	-	-	-	-	-	-
Platoon blocked, %								-	-	-	-	-
Mov Cap-1 Maneuver	520	451	974	476	454	840	1437	-	-	1212	-	-
Mov Cap-2 Maneuver	520	451	-	476	454	-	-	-	-	-	-	-
Stage 1	760	747	-	644	635	-	-	-	-	-	-	-
Stage 2	743	631	-	863	747	-	-	-	-	-	-	-

Approach	EB		WB		NB			SB		
HCM Control Delay, s	12.8		13.3		0			0.7		
HCM LOS	B		B							

Minor Lane/Major Mvmt	NBL	NBT	NBR	EBLn1WBLn1	SBL	SBT	SBR
Capacity (veh/h)	1437	-	-	483	468	1212	-
HCM Lane V/C Ratio	0.001	-	-	0.042	0.077	0.011	-
HCM Control Delay (s)	7.5	0	-	12.8	13.3	8	0
HCM Lane LOS	A	A	-	B	B	A	A
HCM 95th %tile Q(veh)	0	-	-	0.1	0.2	0	-

Intersection												
Int Delay, s/veh	1.5											
Movement	EBL	EBT	EBR	WBL	WBT	WBR	NBL	NBT	NBR	SBL	SBT	SBR
Lane Configurations		↕			↕		↕ ↑↑↑			↕	↑↑	
Traffic Vol, veh/h	5	12	1	21	11	0	1	301	12	12	130	3
Future Vol, veh/h	5	12	1	21	11	0	1	301	12	12	130	3
Conflicting Peds, #/hr	0	0	0	0	0	0	0	0	0	0	0	0
Sign Control	Stop	Stop	Stop	Stop	Stop	Stop	Free	Free	Free	Free	Free	Free
RT Channelized	-	-	None	-	-	None	-	-	None	-	-	None
Storage Length	-	-	-	-	-	-	135	-	-	135	-	-
Veh in Median Storage, #	-	0	-	-	0	-	-	0	-	-	0	-
Grade, %	-	0	-	-	0	-	-	0	-	-	0	-
Peak Hour Factor	89	89	89	89	89	89	89	89	89	89	89	89
Heavy Vehicles, %	20	1	1	1	1	1	1	1	1	1	18	33
Mvmt Flow	6	13	1	24	12	0	1	338	13	13	146	3

Major/Minor	Minor2		Minor1		Major1			Major2				
Conflicting Flow All	317	527	75	453	522	176	149	0	0	351	0	0
Stage 1	174	174	-	347	347	-	-	-	-	-	-	-
Stage 2	143	353	-	106	175	-	-	-	-	-	-	-
Critical Hdwy	7.35	6.52	6.92	6.97	6.52	7.12	4.12	-	-	5.32	-	-
Critical Hdwy Stg 1	6.9	5.52	-	7.32	5.52	-	-	-	-	-	-	-
Critical Hdwy Stg 2	7.1	5.52	-	6.52	5.52	-	-	-	-	-	-	-
Follow-up Hdwy	3.85	4.01	3.31	3.66	4.01	3.91	2.21	-	-	3.11	-	-
Pot Cap-1 Maneuver	577	457	974	511	460	714	1437	-	-	799	-	-
Stage 1	734	756	-	576	636	-	-	-	-	-	-	-
Stage 2	761	632	-	856	756	-	-	-	-	-	-	-
Platoon blocked, %								-	-	-	-	-
Mov Cap-1 Maneuver	558	449	974	492	452	714	1437	-	-	799	-	-
Mov Cap-2 Maneuver	558	449	-	492	452	-	-	-	-	-	-	-
Stage 1	733	744	-	575	635	-	-	-	-	-	-	-
Stage 2	746	631	-	826	744	-	-	-	-	-	-	-

Approach	EB		WB		NB			SB		
HCM Control Delay, s	12.7		13.2		0			0.8		
HCM LOS	B		B							

Minor Lane/Major Mvmt	NBL	NBT	NBR	EBLn1	WBLn1	SBL	SBT	SBR
Capacity (veh/h)	1437	-	-	490	477	799	-	-
HCM Lane V/C Ratio	0.001	-	-	0.041	0.075	0.017	-	-
HCM Control Delay (s)	7.5	-	-	12.7	13.2	9.6	-	-
HCM Lane LOS	A	-	-	B	B	A	-	-
HCM 95th %tile Q(veh)	0	-	-	0.1	0.2	0.1	-	-



SUBJECT	BY	DATE	JOB NO.	SHEET	OF
TURN MOVEMENTS	TM	8-Sep-21	HIGP0000-0002	1	OF 2

E/W STREET : SIERRA RD INTERSECTION : 4  
N/S STREET : AMETHYST RD PROJECTED GROWTH : 3.5%  
CONDITION : PM PEAK HOUR PER YEAR :

**TURN MOVEMENTS**

Condition	Existing Condition	Project Trips	Existing + Project Condition	Year 2023 Ambient Growth	Background Condition	Project Condition	Year 2033 Ambient Growth	Future Condition	Future + Project Condition
Scenario #	2		3		5	7		9	11

**SIERRA RD**

EB LEFT	17	0	17	1	18	18	0	18	18
EB THRU	0	13	13	0	0	13	0	0	13
EB RIGHT	4	0	4	0	4	4	0	4	4
WB LEFT	0	26	26	0	0	26	0	0	26
WB THRU	0	13	13	0	0	13	0	0	13
WB RIGHT	0	0	0	0	0	0	0	0	0

**AMETHYST RD**

NB LEFT	1	0	1	0	1	1	0	1	1
NB THRU	155	25	180	11	166	191	4	170	195
NB RIGHT	0	13	13	0	0	13	0	0	13
SB LEFT	0	13	13	0	0	13	0	0	13
SB THRU	303	13	316	21	324	337	7	331	344
SB RIGHT	7	0	7	0	7	7	0	7	7
<b>TOTALS</b>	<b>487</b>	<b>116</b>	<b>603</b>	<b>33</b>	<b>520</b>	<b>636</b>	<b>11</b>	<b>531</b>	<b>647</b>



SUBJECT	BY	DATE	JOB NO.	SHEET	OF
TURN VOLUME SUMMARY	TM	8-Sep-21	HIGP0000-0002	2	OF 2

E/W STREET : SIERRA RD                      N/S STREET : AMETHYST RD  
CONDITION : PM PEAK HOUR                      PHF : 0.79

NORTH LEG											
AUTO			LARGE 2 AXLE			LARGE 3 AXLE			LARGE 4(+) AXLE		
RT	THRU	LT	RT	THRU	LT	RT	THRU	LT	RT	THRU	LT
3	55	0	0	0	0	0	0	0	0	0	0
0	96	0	0	1	0	0	1	0	0	1	0
2	76	0	0	0	0	0	0	0	0	0	0
2	73	0	0	0	0	0	0	0	0	0	0

SOUTH LEG											
AUTO			LARGE 2 AXLE			LARGE 3 AXLE			LARGE 4(+) AXLE		
RT	THRU	LT	RT	THRU	LT	RT	THRU	LT	RT	THRU	LT
0	21	0	0	1	0	0	0	0	0	0	0
0	51	0	0	0	0	0	0	0	0	0	0
0	44	0	0	0	0	0	0	0	0	0	0
0	38	0	0	0	0	0	0	0	0	0	0

EAST LEG											
AUTO			LARGE 2 AXLE			LARGE 3 AXLE			LARGE 4(+) AXLE		
RT	THRU	LT	RT	THRU	LT	RT	THRU	LT	RT	THRU	LT
0	0	0	0	0	0	0	0	0	0	0	0
0	0	0	0	0	0	0	0	0	0	0	0
0	0	0	0	0	0	0	0	0	0	0	0
0	0	0	0	0	0	0	0	0	0	0	0

WEST LEG											
AUTO			LARGE 2 AXLE			LARGE 3 AXLE			LARGE 4(+) AXLE		
RT	THRU	LT	RT	THRU	LT	RT	THRU	LT	RT	THRU	LT
1	0	4	0	0	0	0	0	0	0	0	0
0	0	2	0	0	1	0	0	0	0	0	0
0	0	5	0	0	0	0	0	0	0	0	0
3	0	5	0	0	0	0	0	0	0	0	0

Truck Volumes	Auto Volumes	Totals	Truck Percentage	Balanced Totals
---------------	--------------	--------	------------------	-----------------

**SIERRA RD**

EB LEFT	1	16	17	6%	17
EB THRU	0	0	0	0%	0
EB RIGHT	0	4	4	1%	4
WB LEFT	0	0	0	0%	0
WB THRU	0	0	0	0%	0
WB RIGHT	0	0	0	0%	0

**AMETHYST RD**

NB LEFT	0	0	1	1%	1
NB THRU	1	154	155	1%	155
NB RIGHT	0	0	0	0%	0
SB LEFT	0	0	0	0%	0
SB THRU	3	300	303	1%	303
SB RIGHT	0	7	7	1%	7

Intersection						
Int Delay, s/veh	0.5					
Movement	EBL	EBR	NBL	NBT	SBT	SBR
Lane Configurations	T			T		
Traffic Vol, veh/h	17	4	1	155	303	7
Future Vol, veh/h	17	4	1	155	303	7
Conflicting Peds, #/hr	0	0	0	0	0	0
Sign Control	Stop	Stop	Free	Free	Free	Free
RT Channelized	-	None	-	None	-	None
Storage Length	0	-	-	-	-	-
Veh in Median Storage, #	0	-	-	0	0	-
Grade, %	0	-	-	0	0	-
Peak Hour Factor	79	79	79	79	79	79
Heavy Vehicles, %	6	1	1	1	1	1
Mvmt Flow	22	5	1	196	384	9

Major/Minor	Minor2	Major1	Major2			
Conflicting Flow All	489	197	393	0	-	0
Stage 1	389	-	-	-	-	-
Stage 2	100	-	-	-	-	-
Critical Hdwy	6.92	6.92	4.12	-	-	-
Critical Hdwy Stg 1	5.92	-	-	-	-	-
Critical Hdwy Stg 2	5.92	-	-	-	-	-
Follow-up Hdwy	3.56	3.31	2.21	-	-	-
Pot Cap-1 Maneuver	498	814	1169	-	-	-
Stage 1	643	-	-	-	-	-
Stage 2	901	-	-	-	-	-
Platoon blocked, %				-	-	-
Mov Cap-1 Maneuver	498	814	1169	-	-	-
Mov Cap-2 Maneuver	498	-	-	-	-	-
Stage 1	642	-	-	-	-	-
Stage 2	901	-	-	-	-	-

Approach	EB	NB	SB
HCM Control Delay, s	12	0.1	0
HCM LOS	B		

Minor Lane/Major Mvmt	NBL	NBT	EBLn1	SBT	SBR
Capacity (veh/h)	1169	-	538	-	-
HCM Lane V/C Ratio	0.001	-	0.049	-	-
HCM Control Delay (s)	8.1	0	12	-	-
HCM Lane LOS	A	A	B	-	-
HCM 95th %tile Q(veh)	0	-	0.2	-	-

Intersection												
Int Delay, s/veh	2											
Movement	EBL	EBT	EBR	WBL	WBT	WBR	NBL	NBT	NBR	SBL	SBT	SBR
Lane Configurations		↕			↕			↕			↕	
Traffic Vol, veh/h	17	13	4	26	13	0	1	180	13	13	316	7
Future Vol, veh/h	17	13	4	26	13	0	1	180	13	13	316	7
Conflicting Peds, #/hr	0	0	0	0	0	0	0	0	0	0	0	0
Sign Control	Stop	Stop	Stop	Stop	Stop	Stop	Free	Free	Free	Free	Free	Free
RT Channelized	-	-	None	-	-	None	-	-	None	-	-	None
Storage Length	-	-	-	-	-	-	-	-	-	-	-	-
Veh in Median Storage, #	-	0	-	-	0	-	-	0	-	-	0	-
Grade, %	-	0	-	-	0	-	-	0	-	-	0	-
Peak Hour Factor	79	79	79	79	79	79	79	79	79	79	79	79
Heavy Vehicles, %	6	1	1	1	1	1	1	1	1	1	1	1
Mvmt Flow	22	16	5	33	16	0	1	228	16	16	400	9

Major/Minor	Minor2		Minor1		Major1		Major2					
Conflicting Flow All	561	683	205	478	679	122	409	0	0	244	0	0
Stage 1	437	437	-	238	238	-	-	-	-	-	-	-
Stage 2	124	246	-	240	441	-	-	-	-	-	-	-
Critical Hdwy	7.62	6.52	6.92	7.52	6.52	6.92	4.12	-	-	4.12	-	-
Critical Hdwy Stg 1	6.62	5.52	-	6.52	5.52	-	-	-	-	-	-	-
Critical Hdwy Stg 2	6.62	5.52	-	6.52	5.52	-	-	-	-	-	-	-
Follow-up Hdwy	3.56	4.01	3.31	3.51	4.01	3.31	2.21	-	-	2.21	-	-
Pot Cap-1 Maneuver	402	372	805	473	374	909	1153	-	-	1327	-	-
Stage 1	558	580	-	747	710	-	-	-	-	-	-	-
Stage 2	855	704	-	745	578	-	-	-	-	-	-	-
Platoon blocked, %								-	-	-	-	-
Mov Cap-1 Maneuver	383	366	805	448	368	909	1153	-	-	1327	-	-
Mov Cap-2 Maneuver	383	366	-	448	368	-	-	-	-	-	-	-
Stage 1	557	571	-	746	709	-	-	-	-	-	-	-
Stage 2	834	703	-	707	569	-	-	-	-	-	-	-

Approach	EB		WB		NB		SB	
HCM Control Delay, s	15.1		14.8		0		0.4	
HCM LOS	C		B					

Minor Lane/Major Mvmt	NBL	NBT	NBR	EBLn1	WBLn1	SBL	SBT	SBR
Capacity (veh/h)	1153	-	-	401	418	1327	-	-
HCM Lane V/C Ratio	0.001	-	-	0.107	0.118	0.012	-	-
HCM Control Delay (s)	8.1	0	-	15.1	14.8	7.7	0.1	-
HCM Lane LOS	A	A	-	C	B	A	A	-
HCM 95th %tile Q(veh)	0	-	-	0.4	0.4	0	-	-

Intersection												
Int Delay, s/veh	2											
Movement	EBL	EBT	EBR	WBL	WBT	WBR	NBL	NBT	NBR	SBL	SBT	SBR
Lane Configurations		↕			↕		↕	↕			↕	
Traffic Vol, veh/h	17	13	4	26	13	0	1	180	13	13	316	7
Future Vol, veh/h	17	13	4	26	13	0	1	180	13	13	316	7
Conflicting Peds, #/hr	0	0	0	0	0	0	0	0	0	0	0	0
Sign Control	Stop	Stop	Stop	Stop	Stop	Stop	Free	Free	Free	Free	Free	Free
RT Channelized	-	-	None	-	-	None	-	-	None	-	-	None
Storage Length	-	-	-	-	-	-	0	-	-	-	-	-
Veh in Median Storage, #	-	0	-	-	0	-	-	0	-	-	0	-
Grade, %	-	0	-	-	0	-	-	0	-	-	0	-
Peak Hour Factor	79	79	79	79	79	79	79	79	79	79	79	79
Heavy Vehicles, %	6	1	1	1	1	1	1	1	1	1	1	1
Mvmt Flow	22	16	5	33	16	0	1	228	16	16	400	9

Major/Minor	Minor2		Minor1		Major1			Major2				
Conflicting Flow All	561	683	205	478	679	122	409	0	0	244	0	0
Stage 1	437	437	-	238	238	-	-	-	-	-	-	-
Stage 2	124	246	-	240	441	-	-	-	-	-	-	-
Critical Hdwy	7.62	6.52	6.92	7.52	6.52	6.92	4.12	-	-	4.12	-	-
Critical Hdwy Stg 1	6.62	5.52	-	6.52	5.52	-	-	-	-	-	-	-
Critical Hdwy Stg 2	6.62	5.52	-	6.52	5.52	-	-	-	-	-	-	-
Follow-up Hdwy	3.56	4.01	3.31	3.51	4.01	3.31	2.21	-	-	2.21	-	-
Pot Cap-1 Maneuver	402	372	805	473	374	909	1153	-	-	1327	-	-
Stage 1	558	580	-	747	710	-	-	-	-	-	-	-
Stage 2	855	704	-	745	578	-	-	-	-	-	-	-
Platoon blocked, %								-	-	-	-	-
Mov Cap-1 Maneuver	384	366	805	448	368	909	1153	-	-	1327	-	-
Mov Cap-2 Maneuver	384	366	-	448	368	-	-	-	-	-	-	-
Stage 1	557	571	-	746	709	-	-	-	-	-	-	-
Stage 2	834	703	-	707	569	-	-	-	-	-	-	-

Approach	EB	WB	NB	SB
HCM Control Delay, s	15.1	14.8	0	0.4
HCM LOS	C	B		

Minor Lane/Major Mvmt	NBL	NBT	NBR	EBLn1WBLn1	SBL	SBT	SBR
Capacity (veh/h)	1153	-	-	401	418	1327	-
HCM Lane V/C Ratio	0.001	-	-	0.107	0.118	0.012	-
HCM Control Delay (s)	8.1	-	-	15.1	14.8	7.7	0.1
HCM Lane LOS	A	-	-	C	B	A	A
HCM 95th %tile Q(veh)	0	-	-	0.4	0.4	0	-



Intersection						
Int Delay, s/veh	0.5					
Movement	EBL	EBR	NBL	NBT	SBT	SBR
Lane Configurations	T			T		
Traffic Vol, veh/h	18	4	1	166	324	7
Future Vol, veh/h	18	4	1	166	324	7
Conflicting Peds, #/hr	0	0	0	0	0	0
Sign Control	Stop	Stop	Free	Free	Free	Free
RT Channelized	-	None	-	None	-	None
Storage Length	0	-	-	-	-	-
Veh in Median Storage, #	0	-	-	0	0	-
Grade, %	0	-	-	0	0	-
Peak Hour Factor	79	79	79	79	79	79
Heavy Vehicles, %	6	1	1	1	1	1
Mvmt Flow	23	5	1	210	410	9

Major/Minor	Minor2	Major1	Major2			
Conflicting Flow All	522	210	419	0	-	0
Stage 1	415	-	-	-	-	-
Stage 2	107	-	-	-	-	-
Critical Hdwy	6.92	6.92	4.12	-	-	-
Critical Hdwy Stg 1	5.92	-	-	-	-	-
Critical Hdwy Stg 2	5.92	-	-	-	-	-
Follow-up Hdwy	3.56	3.31	2.21	-	-	-
Pot Cap-1 Maneuver	475	799	1144	-	-	-
Stage 1	623	-	-	-	-	-
Stage 2	894	-	-	-	-	-
Platoon blocked, %				-	-	-
Mov Cap-1 Maneuver	475	799	1144	-	-	-
Mov Cap-2 Maneuver	475	-	-	-	-	-
Stage 1	622	-	-	-	-	-
Stage 2	894	-	-	-	-	-

Approach	EB	NB	SB
HCM Control Delay, s	12.4	0	0
HCM LOS	B		

Minor Lane/Major Mvmt	NBL	NBT	EBLn1	SBT	SBR
Capacity (veh/h)	1144	-	513	-	-
HCM Lane V/C Ratio	0.001	-	0.054	-	-
HCM Control Delay (s)	8.2	0	12.4	-	-
HCM Lane LOS	A	A	B	-	-
HCM 95th %tile Q(veh)	0	-	0.2	-	-

Intersection												
Int Delay, s/veh	2											
Movement	EBL	EBT	EBR	WBL	WBT	WBR	NBL	NBT	NBR	SBL	SBT	SBR
Lane Configurations		↕			↕			↕			↕	
Traffic Vol, veh/h	18	13	4	26	13	0	1	191	13	13	337	7
Future Vol, veh/h	18	13	4	26	13	0	1	191	13	13	337	7
Conflicting Peds, #/hr	0	0	0	0	0	0	0	0	0	0	0	0
Sign Control	Stop	Stop	Stop	Stop	Stop	Stop	Free	Free	Free	Free	Free	Free
RT Channelized	-	-	None	-	-	None	-	-	None	-	-	None
Storage Length	-	-	-	-	-	-	-	-	-	-	-	-
Veh in Median Storage, #	-	0	-	-	0	-	-	0	-	-	0	-
Grade, %	-	0	-	-	0	-	-	0	-	-	0	-
Peak Hour Factor	79	79	79	79	79	79	79	79	79	79	79	79
Heavy Vehicles, %	6	1	1	1	1	1	1	1	1	1	1	1
Mvmt Flow	23	16	5	33	16	0	1	242	16	16	427	9

Major/Minor	Minor2		Minor1		Major1			Major2				
Conflicting Flow All	595	724	218	506	720	129	436	0	0	258	0	0
Stage 1	464	464	-	252	252	-	-	-	-	-	-	-
Stage 2	131	260	-	254	468	-	-	-	-	-	-	-
Critical Hdwy	7.62	6.52	6.92	7.52	6.52	6.92	4.12	-	-	4.12	-	-
Critical Hdwy Stg 1	6.62	5.52	-	6.52	5.52	-	-	-	-	-	-	-
Critical Hdwy Stg 2	6.62	5.52	-	6.52	5.52	-	-	-	-	-	-	-
Follow-up Hdwy	3.56	4.01	3.31	3.51	4.01	3.31	2.21	-	-	2.21	-	-
Pot Cap-1 Maneuver	380	352	789	452	354	900	1127	-	-	1311	-	-
Stage 1	537	564	-	733	700	-	-	-	-	-	-	-
Stage 2	847	694	-	731	562	-	-	-	-	-	-	-
Platoon blocked, %								-	-	-	-	-
Mov Cap-1 Maneuver	361	346	789	427	348	900	1127	-	-	1311	-	-
Mov Cap-2 Maneuver	361	346	-	427	348	-	-	-	-	-	-	-
Stage 1	536	555	-	732	699	-	-	-	-	-	-	-
Stage 2	826	693	-	693	553	-	-	-	-	-	-	-

Approach	EB		WB		NB		SB	
HCM Control Delay, s	15.8		15.4		0		0.4	
HCM LOS	C		C					

Minor Lane/Major Mvmt	NBL	NBT	NBR	EBLn1WBLn1	SBL	SBT	SBR
Capacity (veh/h)	1127	-	-	378	397	1311	-
HCM Lane V/C Ratio	0.001	-	-	0.117	0.124	0.013	-
HCM Control Delay (s)	8.2	0	-	15.8	15.4	7.8	0.1
HCM Lane LOS	A	A	-	C	C	A	A
HCM 95th %tile Q(veh)	0	-	-	0.4	0.4	0	-

Intersection												
Int Delay, s/veh	2											
Movement	EBL	EBT	EBR	WBL	WBT	WBR	NBL	NBT	NBR	SBL	SBT	SBR
Lane Configurations		↕			↕		↕	↕			↕	
Traffic Vol, veh/h	18	13	4	26	13	0	1	191	13	13	337	7
Future Vol, veh/h	18	13	4	26	13	0	1	191	13	13	337	7
Conflicting Peds, #/hr	0	0	0	0	0	0	0	0	0	0	0	0
Sign Control	Stop	Stop	Stop	Stop	Stop	Stop	Free	Free	Free	Free	Free	Free
RT Channelized	-	-	None	-	-	None	-	-	None	-	-	None
Storage Length	-	-	-	-	-	-	0	-	-	-	-	-
Veh in Median Storage, #	-	0	-	-	0	-	-	0	-	-	0	-
Grade, %	-	0	-	-	0	-	-	0	-	-	0	-
Peak Hour Factor	79	79	79	79	79	79	79	79	79	79	79	79
Heavy Vehicles, %	6	1	1	1	1	1	1	1	1	1	1	1
Mvmt Flow	23	16	5	33	16	0	1	242	16	16	427	9

Major/Minor	Minor2		Minor1		Major1			Major2				
Conflicting Flow All	595	724	218	506	720	129	436	0	0	258	0	0
Stage 1	464	464	-	252	252	-	-	-	-	-	-	-
Stage 2	131	260	-	254	468	-	-	-	-	-	-	-
Critical Hdwy	7.62	6.52	6.92	7.52	6.52	6.92	4.12	-	-	4.12	-	-
Critical Hdwy Stg 1	6.62	5.52	-	6.52	5.52	-	-	-	-	-	-	-
Critical Hdwy Stg 2	6.62	5.52	-	6.52	5.52	-	-	-	-	-	-	-
Follow-up Hdwy	3.56	4.01	3.31	3.51	4.01	3.31	2.21	-	-	2.21	-	-
Pot Cap-1 Maneuver	380	352	789	452	354	900	1127	-	-	1311	-	-
Stage 1	537	564	-	733	700	-	-	-	-	-	-	-
Stage 2	847	694	-	731	562	-	-	-	-	-	-	-
Platoon blocked, %								-	-	-	-	-
Mov Cap-1 Maneuver	362	346	789	427	348	900	1127	-	-	1311	-	-
Mov Cap-2 Maneuver	362	346	-	427	348	-	-	-	-	-	-	-
Stage 1	536	555	-	732	699	-	-	-	-	-	-	-
Stage 2	826	693	-	693	553	-	-	-	-	-	-	-

Approach	EB		WB		NB		SB	
HCM Control Delay, s	15.8		15.4		0		0.4	
HCM LOS	C		C					

Minor Lane/Major Mvmt	NBL	NBT	NBR	EBLn1WBLn1	SBL	SBT	SBR
Capacity (veh/h)	1127	-	-	379	397	1311	-
HCM Lane V/C Ratio	0.001	-	-	0.117	0.124	0.013	-
HCM Control Delay (s)	8.2	-	-	15.8	15.4	7.8	0.1
HCM Lane LOS	A	-	-	C	C	A	A
HCM 95th %tile Q(veh)	0	-	-	0.4	0.4	0	-

Intersection						
Int Delay, s/veh	0.5					
Movement	EBL	EBR	NBL	NBT	SBT	SBR
Lane Configurations	T			T		
Traffic Vol, veh/h	18	4	1	170	331	7
Future Vol, veh/h	18	4	1	170	331	7
Conflicting Peds, #/hr	0	0	0	0	0	0
Sign Control	Stop	Stop	Free	Free	Free	Free
RT Channelized	-	None	-	None	-	None
Storage Length	0	-	-	-	-	-
Veh in Median Storage, #	0	-	-	0	0	-
Grade, %	0	-	-	0	0	-
Peak Hour Factor	79	79	79	79	79	79
Heavy Vehicles, %	6	1	1	1	1	1
Mvmt Flow	23	5	1	215	419	9

Major/Minor	Minor2	Major1		Major2	
Conflicting Flow All	534	214	428	0	0
Stage 1	424	-	-	-	-
Stage 2	110	-	-	-	-
Critical Hdwy	6.92	6.92	4.12	-	-
Critical Hdwy Stg 1	5.92	-	-	-	-
Critical Hdwy Stg 2	5.92	-	-	-	-
Follow-up Hdwy	3.56	3.31	2.21	-	-
Pot Cap-1 Maneuver	466	794	1135	-	-
Stage 1	616	-	-	-	-
Stage 2	891	-	-	-	-
Platoon blocked, %				-	-
Mov Cap-1 Maneuver	466	794	1135	-	-
Mov Cap-2 Maneuver	466	-	-	-	-
Stage 1	615	-	-	-	-
Stage 2	891	-	-	-	-

Approach	EB	NB	SB
HCM Control Delay, s	12.6	0	0
HCM LOS	B		

Minor Lane/Major Mvmt	NBL	NBT	EBLn1	SBT	SBR
Capacity (veh/h)	1135	-	504	-	-
HCM Lane V/C Ratio	0.001	-	0.055	-	-
HCM Control Delay (s)	8.2	0	12.6	-	-
HCM Lane LOS	A	A	B	-	-
HCM 95th %tile Q(veh)	0	-	0.2	-	-

Intersection												
Int Delay, s/veh	2											
Movement	EBL	EBT	EBR	WBL	WBT	WBR	NBL	NBT	NBR	SBL	SBT	SBR
Lane Configurations		↕			↕			↕			↕	
Traffic Vol, veh/h	18	13	4	26	13	0	1	195	13	13	344	7
Future Vol, veh/h	18	13	4	26	13	0	1	195	13	13	344	7
Conflicting Peds, #/hr	0	0	0	0	0	0	0	0	0	0	0	0
Sign Control	Stop	Stop	Stop	Stop	Stop	Stop	Free	Free	Free	Free	Free	Free
RT Channelized	-	-	None	-	-	None	-	-	None	-	-	None
Storage Length	-	-	-	-	-	-	-	-	-	-	-	-
Veh in Median Storage, #	-	0	-	-	0	-	-	0	-	-	0	-
Grade, %	-	0	-	-	0	-	-	0	-	-	0	-
Peak Hour Factor	79	79	79	79	79	79	79	79	79	79	79	79
Heavy Vehicles, %	6	1	1	1	1	1	1	1	1	1	1	1
Mvmt Flow	23	16	5	33	16	0	1	247	16	16	435	9

Major/Minor	Minor2		Minor1		Major1			Major2				
Conflicting Flow All	606	737	222	515	733	132	444	0	0	263	0	0
Stage 1	472	472	-	257	257	-	-	-	-	-	-	-
Stage 2	134	265	-	258	476	-	-	-	-	-	-	-
Critical Hdwy	7.62	6.52	6.92	7.52	6.52	6.92	4.12	-	-	4.12	-	-
Critical Hdwy Stg 1	6.62	5.52	-	6.52	5.52	-	-	-	-	-	-	-
Critical Hdwy Stg 2	6.62	5.52	-	6.52	5.52	-	-	-	-	-	-	-
Follow-up Hdwy	3.56	4.01	3.31	3.51	4.01	3.31	2.21	-	-	2.21	-	-
Pot Cap-1 Maneuver	373	346	785	445	348	896	1120	-	-	1306	-	-
Stage 1	531	560	-	728	696	-	-	-	-	-	-	-
Stage 2	844	691	-	727	557	-	-	-	-	-	-	-
Platoon blocked, %								-	-	-	-	-
Mov Cap-1 Maneuver	355	340	785	421	342	896	1120	-	-	1306	-	-
Mov Cap-2 Maneuver	355	340	-	421	342	-	-	-	-	-	-	-
Stage 1	530	551	-	727	695	-	-	-	-	-	-	-
Stage 2	823	690	-	690	548	-	-	-	-	-	-	-

Approach	EB		WB		NB		SB	
HCM Control Delay, s	16		15.5		0		0.4	
HCM LOS	C		C					

Minor Lane/Major Mvmt	NBL	NBT	NBR	EBLn1WBLn1	SBL	SBT	SBR
Capacity (veh/h)	1120	-	-	372	391	1306	-
HCM Lane V/C Ratio	0.001	-	-	0.119	0.126	0.013	-
HCM Control Delay (s)	8.2	0	-	16	15.5	7.8	0.1
HCM Lane LOS	A	A	-	C	C	A	A
HCM 95th %tile Q(veh)	0	-	-	0.4	0.4	0	-

Intersection												
Int Delay, s/veh	1.9											
Movement	EBL	EBT	EBR	WBL	WBT	WBR	NBL	NBT	NBR	SBL	SBT	SBR
Lane Configurations		↕			↕		↕ ↑↑↑			↕	↑↑	
Traffic Vol, veh/h	18	13	4	26	13	0	1	195	13	13	344	7
Future Vol, veh/h	18	13	4	26	13	0	1	195	13	13	344	7
Conflicting Peds, #/hr	0	0	0	0	0	0	0	0	0	0	0	0
Sign Control	Stop	Stop	Stop	Stop	Stop	Stop	Free	Free	Free	Free	Free	Free
RT Channelized	-	-	None	-	-	None	-	-	None	-	-	None
Storage Length	-	-	-	-	-	-	135	-	-	135	-	-
Veh in Median Storage, #	-	0	-	-	0	-	-	0	-	-	0	-
Grade, %	-	0	-	-	0	-	-	0	-	-	0	-
Peak Hour Factor	79	79	79	79	79	79	79	79	79	79	79	79
Heavy Vehicles, %	6	1	1	1	1	1	1	1	1	1	1	1
Mvmt Flow	23	16	5	33	16	0	1	247	16	16	435	9

Major/Minor	Minor2		Minor1		Major1			Major2				
Conflicting Flow All	581	737	222	515	733	132	444	0	0	263	0	0
Stage 1	472	472	-	257	257	-	-	-	-	-	-	-
Stage 2	109	265	-	258	476	-	-	-	-	-	-	-
Critical Hdwy	7.07	6.52	6.92	6.97	6.52	7.12	4.12	-	-	5.32	-	-
Critical Hdwy Stg 1	6.62	5.52	-	7.32	5.52	-	-	-	-	-	-	-
Critical Hdwy Stg 2	6.82	5.52	-	6.52	5.52	-	-	-	-	-	-	-
Follow-up Hdwy	3.71	4.01	3.31	3.66	4.01	3.91	2.21	-	-	3.11	-	-
Pot Cap-1 Maneuver	412	346	785	466	348	761	1120	-	-	877	-	-
Stage 1	514	560	-	663	696	-	-	-	-	-	-	-
Stage 2	834	691	-	701	557	-	-	-	-	-	-	-
Platoon blocked, %								-	-	-	-	-
Mov Cap-1 Maneuver	391	339	785	439	341	761	1120	-	-	877	-	-
Mov Cap-2 Maneuver	391	339	-	439	341	-	-	-	-	-	-	-
Stage 1	513	550	-	662	695	-	-	-	-	-	-	-
Stage 2	814	690	-	663	547	-	-	-	-	-	-	-

Approach	EB		WB		NB		SB	
HCM Control Delay, s	15.4		15.2		0		0.3	
HCM LOS	C		C					

Minor Lane/Major Mvmt	NBL	NBT	NBR	EBLn1	WBLn1	SBL	SBT	SBR
Capacity (veh/h)	1120	-	-	391	401	877	-	-
HCM Lane V/C Ratio	0.001	-	-	0.113	0.123	0.019	-	-
HCM Control Delay (s)	8.2	-	-	15.4	15.2	9.2	-	-
HCM Lane LOS	A	-	-	C	C	A	-	-
HCM 95th %tile Q(veh)	0	-	-	0.4	0.4	0.1	-	-



SUBJECT	BY	DATE	JOB NO.	SHEET	OF
TURN MOVEMENTS	TM	8-Sep-21	PTCO0000-0001	1	OF 2

E/W STREET : PROJECT DRIVEWAY "B"  
N/S STREET : AMETHYST RD  
CONDITION : AM PEAK HOUR

INTERSECTION : 5  
PROJECTED GROWTH : 3.5%  
PER YEAR :

### CONDITION DIAGRAMS

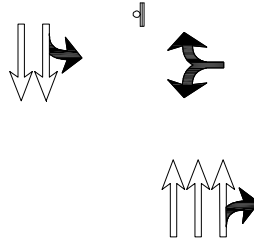

### PROJECT GEOMETRICS

### TURN MOVEMENTS

Condition	Existing Condition	Project Trips	Existing + Project Condition	Year 2023 Ambient Growth	Background Condition	Project Condition	Year 2033 Ambient Growth	Future Condition	Future + Project Condition
Scenario #	1		3		5	7		9	11

### PROJECT DRIVEWAY "B"

EB LEFT	0	0	0	0	0	0	0	0	0
EB THRU	0	0	0	0	0	0	0	0	0
EB RIGHT	0	0	0	0	0	0	0	0	0
WB LEFT	0	22	22	0	0	22	0	0	22
WB THRU	0	0	0	0	0	0	0	0	0
WB RIGHT	0	132	132	0	0	132	0	0	132

### AMETHYST RD

NB LEFT	0	0	0	0	0	0	0	0	0
NB THRU	258	-7	251	18	276	269	6	282	275
NB RIGHT	0	31	31	0	0	31	0	0	31
SB LEFT	0	113	113	0	0	113	0	0	113
SB THRU	111	1	112	8	119	120	3	122	123
SB RIGHT	0	0	0	0	0	0	0	0	0
<b>TOTALS</b>	<b>1575</b>	<b>206</b>	<b>1781</b>	<b>111</b>	<b>1686</b>	<b>1892</b>	<b>38</b>	<b>1724</b>	<b>1930</b>

Intersection						
Int Delay, s/veh	4.1					
Movement	WBL	WBR	NBT	NBR	SBL	SBT
Lane Configurations	Y		↑↑			↑↑
Traffic Vol, veh/h	22	132	251	31	113	112
Future Vol, veh/h	22	132	251	31	113	112
Conflicting Peds, #/hr	0	0	0	0	0	0
Sign Control	Stop	Stop	Free	Free	Free	Free
RT Channelized	-	None	-	None	-	None
Storage Length	0	-	-	-	-	-
Veh in Median Storage, #	0	-	0	-	-	0
Grade, %	0	-	0	-	-	0
Peak Hour Factor	89	89	89	89	89	89
Heavy Vehicles, %	1	1	2	2	10	10
Mvmt Flow	25	148	282	35	127	126

Major/Minor	Minor1	Major1	Major2		
Conflicting Flow All	617	159	0	0	317
Stage 1	300	-	-	-	-
Stage 2	317	-	-	-	-
Critical Hdwy	6.82	6.92	-	-	4.3
Critical Hdwy Stg 1	5.82	-	-	-	-
Critical Hdwy Stg 2	5.82	-	-	-	-
Follow-up Hdwy	3.51	3.31	-	-	2.3
Pot Cap-1 Maneuver	424	861	-	-	1184
Stage 1	728	-	-	-	-
Stage 2	714	-	-	-	-
Platoon blocked, %			-	-	-
Mov Cap-1 Maneuver	375	861	-	-	1184
Mov Cap-2 Maneuver	375	-	-	-	-
Stage 1	728	-	-	-	-
Stage 2	632	-	-	-	-

Approach	WB	NB	SB
HCM Control Delay, s	11.5	0	4.3
HCM LOS	B		

Minor Lane/Major Mvmt	NBT	NBRWBLn1	SBL	SBT
Capacity (veh/h)	-	-	726	1184
HCM Lane V/C Ratio	-	-	0.238	0.107
HCM Control Delay (s)	-	-	11.5	8.4
HCM Lane LOS	-	-	B	A
HCM 95th %tile Q(veh)	-	-	0.9	0.4



Intersection						
Int Delay, s/veh	4.7					
Movement	WBL	WBR	NBT	NBR	SBL	SBT
Lane Configurations	Y		↑↑↑			↑↑
Traffic Vol, veh/h	22	132	251	31	113	112
Future Vol, veh/h	22	132	251	31	113	112
Conflicting Peds, #/hr	0	0	0	0	0	0
Sign Control	Stop	Stop	Free	Free	Free	Free
RT Channelized	-	None	-	None	-	None
Storage Length	0	-	-	-	-	-
Veh in Median Storage, #	0	-	0	-	-	0
Grade, %	0	-	0	-	-	0
Peak Hour Factor	89	89	89	89	89	89
Heavy Vehicles, %	1	1	2	2	10	10
Mvmt Flow	25	148	282	35	127	126

Major/Minor	Minor1	Major1	Major2			
Conflicting Flow All	617	159	0	0	317	0
Stage 1	300	-	-	-	-	-
Stage 2	317	-	-	-	-	-
Critical Hdwy	6.27	7.12	-	-	5.5	-
Critical Hdwy Stg 1	6.62	-	-	-	-	-
Critical Hdwy Stg 2	5.82	-	-	-	-	-
Follow-up Hdwy	3.66	3.91	-	-	3.2	-
Pot Cap-1 Maneuver	452	732	-	-	795	-
Stage 1	657	-	-	-	-	-
Stage 2	689	-	-	-	-	-
Platoon blocked, %			-	-		
Mov Cap-1 Maneuver	374	732	-	-	795	-
Mov Cap-2 Maneuver	447	-	-	-	-	-
Stage 1	657	-	-	-	-	-
Stage 2	570	-	-	-	-	-

Approach	WB	NB	SB
HCM Control Delay, s	12.2	0	5.4
HCM LOS	B		

Minor Lane/Major Mvmt	NBT	NBRWBLn1	SBL	SBT
Capacity (veh/h)	-	-	671	795
HCM Lane V/C Ratio	-	-	0.258	0.16
HCM Control Delay (s)	-	-	12.2	10.4
HCM Lane LOS	-	-	B	A
HCM 95th %tile Q(veh)	-	-	1	0.6

Intersection						
Int Delay, s/veh	4					
Movement	WBL	WBR	NBT	NBR	SBL	SBT
Lane Configurations	Y		↑↓			↑↓
Traffic Vol, veh/h	22	132	269	31	113	120
Future Vol, veh/h	22	132	269	31	113	120
Conflicting Peds, #/hr	0	0	0	0	0	0
Sign Control	Stop	Stop	Free	Free	Free	Free
RT Channelized	-	None	-	None	-	None
Storage Length	0	-	-	-	-	-
Veh in Median Storage, #	0	-	0	-	-	0
Grade, %	0	-	0	-	-	0
Peak Hour Factor	89	89	89	89	89	89
Heavy Vehicles, %	1	1	2	2	10	10
Mvmt Flow	25	148	302	35	127	135

Major/Minor	Minor1	Major1	Major2		
Conflicting Flow All	642	169	0	0	337
Stage 1	320	-	-	-	-
Stage 2	322	-	-	-	-
Critical Hdwy	6.82	6.92	-	-	4.3
Critical Hdwy Stg 1	5.82	-	-	-	-
Critical Hdwy Stg 2	5.82	-	-	-	-
Follow-up Hdwy	3.51	3.31	-	-	2.3
Pot Cap-1 Maneuver	409	849	-	-	1163
Stage 1	712	-	-	-	-
Stage 2	710	-	-	-	-
Platoon blocked, %					
Mov Cap-1 Maneuver	361	849	-	-	1163
Mov Cap-2 Maneuver	361	-	-	-	-
Stage 1	712	-	-	-	-
Stage 2	626	-	-	-	-

Approach	WB	NB	SB
HCM Control Delay, s	11.7	0	4.2
HCM LOS	B		

Minor Lane/Major Mvmt	NBT	NBRWBLn1	SBL	SBT
Capacity (veh/h)	-	-	712	1163
HCM Lane V/C Ratio	-	-	0.243	0.109
HCM Control Delay (s)	-	-	11.7	8.5
HCM Lane LOS	-	-	B	A
HCM 95th %tile Q(veh)	-	-	0.9	0.4

Intersection						
Int Delay, s/veh	4.6					
Movement	WBL	WBR	NBT	NBR	SBL	SBT
Lane Configurations	Y		↑↑↑			↑↑
Traffic Vol, veh/h	22	132	269	31	113	120
Future Vol, veh/h	22	132	269	31	113	120
Conflicting Peds, #/hr	0	0	0	0	0	0
Sign Control	Stop	Stop	Free	Free	Free	Free
RT Channelized	-	None	-	None	-	None
Storage Length	0	-	-	-	-	-
Veh in Median Storage, #	0	-	0	-	-	0
Grade, %	0	-	0	-	-	0
Peak Hour Factor	89	89	89	89	89	89
Heavy Vehicles, %	1	1	2	2	10	10
Mvmt Flow	25	148	302	35	127	135

Major/Minor	Minor1	Major1	Major2			
Conflicting Flow All	642	169	0	0	337	0
Stage 1	320	-	-	-	-	-
Stage 2	322	-	-	-	-	-
Critical Hdwy	6.27	7.12	-	-	5.5	-
Critical Hdwy Stg 1	6.62	-	-	-	-	-
Critical Hdwy Stg 2	5.82	-	-	-	-	-
Follow-up Hdwy	3.66	3.91	-	-	3.2	-
Pot Cap-1 Maneuver	438	721	-	-	778	-
Stage 1	640	-	-	-	-	-
Stage 2	685	-	-	-	-	-
Platoon blocked, %			-	-		-
Mov Cap-1 Maneuver	361	721	-	-	778	-
Mov Cap-2 Maneuver	437	-	-	-	-	-
Stage 1	640	-	-	-	-	-
Stage 2	564	-	-	-	-	-

Approach	WB	NB	SB
HCM Control Delay, s	12.4	0	5.3
HCM LOS	B		

Minor Lane/Major Mvmt	NBT	NBRWBLn1	SBL	SBT
Capacity (veh/h)	-	-	660	778
HCM Lane V/C Ratio	-	-	0.262	0.163
HCM Control Delay (s)	-	-	12.4	10.5
HCM Lane LOS	-	-	B	A
HCM 95th %tile Q(veh)	-	-	1	0.6

Intersection						
Int Delay, s/veh	4					
Movement	WBL	WBR	NBT	NBR	SBL	SBT
Lane Configurations	Y		↑↓			↑↓
Traffic Vol, veh/h	22	132	275	31	113	123
Future Vol, veh/h	22	132	275	31	113	123
Conflicting Peds, #/hr	0	0	0	0	0	0
Sign Control	Stop	Stop	Free	Free	Free	Free
RT Channelized	-	None	-	None	-	None
Storage Length	0	-	-	-	-	-
Veh in Median Storage, #	0	-	0	-	-	0
Grade, %	0	-	0	-	-	0
Peak Hour Factor	89	89	89	89	89	89
Heavy Vehicles, %	1	1	2	2	10	10
Mvmt Flow	25	148	309	35	127	138

Major/Minor	Minor1	Major1	Major2		
Conflicting Flow All	650	172	0	0	344
Stage 1	327	-	-	-	-
Stage 2	323	-	-	-	-
Critical Hdwy	6.82	6.92	-	-	4.3
Critical Hdwy Stg 1	5.82	-	-	-	-
Critical Hdwy Stg 2	5.82	-	-	-	-
Follow-up Hdwy	3.51	3.31	-	-	2.3
Pot Cap-1 Maneuver	404	845	-	-	1156
Stage 1	706	-	-	-	-
Stage 2	709	-	-	-	-
Platoon blocked, %			-	-	-
Mov Cap-1 Maneuver	356	845	-	-	1156
Mov Cap-2 Maneuver	356	-	-	-	-
Stage 1	706	-	-	-	-
Stage 2	625	-	-	-	-

Approach	WB	NB	SB
HCM Control Delay, s	11.7	0	4.2
HCM LOS	B		

Minor Lane/Major Mvmt	NBT	NBRWBLn1	SBL	SBT
Capacity (veh/h)	-	-	706	1156
HCM Lane V/C Ratio	-	-	0.245	0.11
HCM Control Delay (s)	-	-	11.7	8.5
HCM Lane LOS	-	-	B	A
HCM 95th %tile Q(veh)	-	-	1	0.4

Intersection						
Int Delay, s/veh	4.5					
Movement	WBL	WBR	NBT	NBR	SBL	SBT
Lane Configurations	T		↑↑↑		↑↑	
Traffic Vol, veh/h	22	132	275	31	113	123
Future Vol, veh/h	22	132	275	31	113	123
Conflicting Peds, #/hr	0	0	0	0	0	0
Sign Control	Stop	Stop	Free	Free	Free	Free
RT Channelized	-	None	-	None	-	None
Storage Length	0	-	-	-	-	-
Veh in Median Storage, #	0	-	0	-	-	0
Grade, %	0	-	0	-	-	0
Peak Hour Factor	89	89	89	89	89	89
Heavy Vehicles, %	1	1	2	2	10	10
Mvmt Flow	25	148	309	35	127	138

Major/Minor	Minor1	Major1	Major2		
Conflicting Flow All	650	172	0	0	344
Stage 1	327	-	-	-	-
Stage 2	323	-	-	-	-
Critical Hdwy	6.27	7.12	-	-	5.5
Critical Hdwy Stg 1	6.62	-	-	-	-
Critical Hdwy Stg 2	5.82	-	-	-	-
Follow-up Hdwy	3.66	3.91	-	-	3.2
Pot Cap-1 Maneuver	433	718	-	-	772
Stage 1	634	-	-	-	-
Stage 2	685	-	-	-	-
Platoon blocked, %			-	-	-
Mov Cap-1 Maneuver	356	718	-	-	772
Mov Cap-2 Maneuver	433	-	-	-	-
Stage 1	634	-	-	-	-
Stage 2	563	-	-	-	-

Approach	WB	NB	SB
HCM Control Delay, s	12.4	0	5.2
HCM LOS	B		

Minor Lane/Major Mvmt	NBT	NBRWBLn1	SBL	SBT
Capacity (veh/h)	-	-	656	772
HCM Lane V/C Ratio	-	-	0.264	0.164
HCM Control Delay (s)	-	-	12.4	10.6
HCM Lane LOS	-	-	B	A
HCM 95th %tile Q(veh)	-	-	1.1	0.6



SUBJECT	BY	DATE	JOB NO.	SHEET	OF
TURN MOVEMENTS	TM	8-Sep-21	PTCO0000-0001	1	OF 2

E/W STREET : PROJECT DRIVEWAY "B"  
N/S STREET : AMETHYST RD  
CONDITION : PM PEAK HOUR

INTERSECTION : 5  
PROJECTED GROWTH : 3.5%  
PER YEAR :

**TURN MOVEMENTS**

Condition	Existing Condition	Project Trips	Existing + Project Condition	Year 2023 Ambient Growth	Background Condition	Project Condition	Year 2033 Ambient Growth	Future Condition	Future + Project Condition
Scenario #	2		4		6	8		10	12

**PROJECT DRIVEWAY "B"**

EB LEFT	0	0	0	0	0	0	0	0	0
EB THRU	0	0	0	0	0	0	0	0	0
EB RIGHT	0	0	0	0	0	0	0	0	0
WB LEFT	0	24	24	0	0	24	0	0	24
WB THRU	0	0	0	0	0	0	0	0	0
WB RIGHT	0	176	176	0	0	176	0	0	176

**AMETHYST RD**

NB LEFT	0	0	0	0	0	0	0	0	0
NB THRU	172	-16	156	12	184	168	4	188	172
NB RIGHT	0	41	41	0	0	41	0	0	41
SB LEFT	0	131	131	0	0	131	0	0	131
SB THRU	310	2	312	21	331	333	7	338	340
SB RIGHT	0	0	0	0	0	0	0	0	0
<b>TOTALS</b>	<b>1575</b>	<b>206</b>	<b>1781</b>	<b>111</b>	<b>1686</b>	<b>1892</b>	<b>38</b>	<b>1724</b>	<b>1930</b>

Intersection						
Int Delay, s/veh	5.5					
Movement	WBL	WBR	NBT	NBR	SBL	SBT
Lane Configurations	T		T		T	
Traffic Vol, veh/h	24	176	156	41	131	112
Future Vol, veh/h	24	176	156	41	131	112
Conflicting Peds, #/hr	0	0	0	0	0	0
Sign Control	Stop	Stop	Free	Free	Free	Free
RT Channelized	-	None	-	None	-	None
Storage Length	0	-	-	-	-	-
Veh in Median Storage, #	0	-	0	-	-	0
Grade, %	0	-	0	-	-	0
Peak Hour Factor	79	79	79	79	79	79
Heavy Vehicles, %	1	1	1	1	1	1
Mvmt Flow	30	223	197	52	166	142

Major/Minor	Minor1	Major1	Major2		
Conflicting Flow All	626	125	0	0	249
Stage 1	223	-	-	-	-
Stage 2	403	-	-	-	-
Critical Hdwy	6.82	6.92	-	-	4.12
Critical Hdwy Stg 1	5.82	-	-	-	-
Critical Hdwy Stg 2	5.82	-	-	-	-
Follow-up Hdwy	3.51	3.31	-	-	2.21
Pot Cap-1 Maneuver	419	905	-	-	1321
Stage 1	796	-	-	-	-
Stage 2	647	-	-	-	-
Platoon blocked, %					
Mov Cap-1 Maneuver	362	905	-	-	1321
Mov Cap-2 Maneuver	362	-	-	-	-
Stage 1	796	-	-	-	-
Stage 2	559	-	-	-	-

Approach	WB	NB	SB
HCM Control Delay, s	12	0	4.5
HCM LOS	B		

Minor Lane/Major Mvmt	NBT	NBRWBLn1	SBL	SBT
Capacity (veh/h)	-	-	767	1321
HCM Lane V/C Ratio	-	-	0.33	0.126
HCM Control Delay (s)	-	-	12	8.1
HCM Lane LOS	-	-	B	A
HCM 95th %tile Q(veh)	-	-	1.4	0.4

Intersection						
Int Delay, s/veh	6.2					
Movement	WBL	WBR	NBT	NBR	SBL	SBT
Lane Configurations	T		T		T	
Traffic Vol, veh/h	24	176	156	41	131	112
Future Vol, veh/h	24	176	156	41	131	112
Conflicting Peds, #/hr	0	0	0	0	0	0
Sign Control	Stop	Stop	Free	Free	Free	Free
RT Channelized	-	None	-	None	-	None
Storage Length	0	-	-	-	-	-
Veh in Median Storage, #	0	-	0	-	-	0
Grade, %	0	-	0	-	-	0
Peak Hour Factor	79	79	79	79	79	79
Heavy Vehicles, %	1	1	1	1	1	1
Mvmt Flow	30	223	197	52	166	142

Major/Minor	Minor1	Major1	Major2		
Conflicting Flow All	626	125	0	0	249
Stage 1	223	-	-	-	-
Stage 2	403	-	-	-	-
Critical Hdwy	6.27	7.12	-	-	5.32
Critical Hdwy Stg 1	6.62	-	-	-	-
Critical Hdwy Stg 2	5.82	-	-	-	-
Follow-up Hdwy	3.66	3.91	-	-	3.11
Pot Cap-1 Maneuver	447	769	-	-	890
Stage 1	730	-	-	-	-
Stage 2	625	-	-	-	-
Platoon blocked, %					
Mov Cap-1 Maneuver	357	769	-	-	890
Mov Cap-2 Maneuver	420	-	-	-	-
Stage 1	730	-	-	-	-
Stage 2	499	-	-	-	-

Approach	WB	NB	SB
HCM Control Delay, s	13	0	5.5
HCM LOS	B		

Minor Lane/Major Mvmt	NBT	NBRWBLn1	SBL	SBT
Capacity (veh/h)	-	-	699	890
HCM Lane V/C Ratio	-	-	0.362	0.186
HCM Control Delay (s)	-	-	13	10
HCM Lane LOS	-	-	B	A
HCM 95th %tile Q(veh)	-	-	1.7	0.7



Intersection						
Int Delay, s/veh	5.4					
Movement	WBL	WBR	NBT	NBR	SBL	SBT
Lane Configurations	Y		↑↓			↑↓
Traffic Vol, veh/h	24	176	168	41	131	120
Future Vol, veh/h	24	176	168	41	131	120
Conflicting Peds, #/hr	0	0	0	0	0	0
Sign Control	Stop	Stop	Free	Free	Free	Free
RT Channelized	-	None	-	None	-	None
Storage Length	0	-	-	-	-	-
Veh in Median Storage, #	0	-	0	-	-	0
Grade, %	0	-	0	-	-	0
Peak Hour Factor	79	79	79	79	79	79
Heavy Vehicles, %	1	1	1	1	1	1
Mvmt Flow	30	223	213	52	166	152

Major/Minor	Minor1	Major1	Major2			
Conflicting Flow All	647	133	0	0	265	0
Stage 1	239	-	-	-	-	-
Stage 2	408	-	-	-	-	-
Critical Hdwy	6.82	6.92	-	-	4.12	-
Critical Hdwy Stg 1	5.82	-	-	-	-	-
Critical Hdwy Stg 2	5.82	-	-	-	-	-
Follow-up Hdwy	3.51	3.31	-	-	2.21	-
Pot Cap-1 Maneuver	406	895	-	-	1303	-
Stage 1	781	-	-	-	-	-
Stage 2	643	-	-	-	-	-
Platoon blocked, %			-	-	-	-
Mov Cap-1 Maneuver	350	895	-	-	1303	-
Mov Cap-2 Maneuver	350	-	-	-	-	-
Stage 1	781	-	-	-	-	-
Stage 2	554	-	-	-	-	-

Approach	WB	NB	SB
HCM Control Delay, s	12.2	0	4.4
HCM LOS	B		

Minor Lane/Major Mvmt	NBT	NBRWBLn1	SBL	SBT
Capacity (veh/h)	-	-	754	1303
HCM Lane V/C Ratio	-	-	0.336	0.127
HCM Control Delay (s)	-	-	12.2	8.2
HCM Lane LOS	-	-	B	A
HCM 95th %tile Q(veh)	-	-	1.5	0.4

Intersection						
Int Delay, s/veh	6.1					
Movement	WBL	WBR	NBT	NBR	SBL	SBT
Lane Configurations	T		↑↑↑		↑↑	
Traffic Vol, veh/h	24	176	168	41	131	120
Future Vol, veh/h	24	176	168	41	131	120
Conflicting Peds, #/hr	0	0	0	0	0	0
Sign Control	Stop	Stop	Free	Free	Free	Free
RT Channelized	-	None	-	None	-	None
Storage Length	0	-	-	-	-	-
Veh in Median Storage, #	0	-	0	-	-	0
Grade, %	0	-	0	-	-	0
Peak Hour Factor	79	79	79	79	79	79
Heavy Vehicles, %	1	1	1	1	1	1
Mvmt Flow	30	223	213	52	166	152

Major/Minor	Minor1	Major1	Major2		
Conflicting Flow All	647	133	0	0	265
Stage 1	239	-	-	-	-
Stage 2	408	-	-	-	-
Critical Hdwy	6.27	7.12	-	-	5.32
Critical Hdwy Stg 1	6.62	-	-	-	-
Critical Hdwy Stg 2	5.82	-	-	-	-
Follow-up Hdwy	3.66	3.91	-	-	3.11
Pot Cap-1 Maneuver	435	760	-	-	875
Stage 1	714	-	-	-	-
Stage 2	621	-	-	-	-
Platoon blocked, %					
Mov Cap-1 Maneuver	345	760	-	-	875
Mov Cap-2 Maneuver	411	-	-	-	-
Stage 1	714	-	-	-	-
Stage 2	492	-	-	-	-

Approach	WB	NB	SB
HCM Control Delay, s	13.2	0	5.4
HCM LOS	B		

Minor Lane/Major Mvmt	NBT	NBRWBLn1	SBL	SBT
Capacity (veh/h)	-	-	690	875
HCM Lane V/C Ratio	-	-	0.367	0.19
HCM Control Delay (s)	-	-	13.2	10.1
HCM Lane LOS	-	-	B	A
HCM 95th %tile Q(veh)	-	-	1.7	0.7

Intersection						
Int Delay, s/veh	5.3					
Movement	WBL	WBR	NBT	NBR	SBL	SBT
Lane Configurations	Y		↑↓			↑↑
Traffic Vol, veh/h	24	176	172	41	131	123
Future Vol, veh/h	24	176	172	41	131	123
Conflicting Peds, #/hr	0	0	0	0	0	0
Sign Control	Stop	Stop	Free	Free	Free	Free
RT Channelized	-	None	-	None	-	None
Storage Length	0	-	-	-	-	-
Veh in Median Storage, #	0	-	0	-	-	0
Grade, %	0	-	0	-	-	0
Peak Hour Factor	79	79	79	79	79	79
Heavy Vehicles, %	1	1	1	1	1	1
Mvmt Flow	30	223	218	52	166	156

Major/Minor	Minor1	Major1	Major2			
Conflicting Flow All	654	135	0	0	270	0
Stage 1	244	-	-	-	-	-
Stage 2	410	-	-	-	-	-
Critical Hdwy	6.82	6.92	-	-	4.12	-
Critical Hdwy Stg 1	5.82	-	-	-	-	-
Critical Hdwy Stg 2	5.82	-	-	-	-	-
Follow-up Hdwy	3.51	3.31	-	-	2.21	-
Pot Cap-1 Maneuver	402	892	-	-	1298	-
Stage 1	777	-	-	-	-	-
Stage 2	641	-	-	-	-	-
Platoon blocked, %			-	-	-	-
Mov Cap-1 Maneuver	346	892	-	-	1298	-
Mov Cap-2 Maneuver	346	-	-	-	-	-
Stage 1	777	-	-	-	-	-
Stage 2	551	-	-	-	-	-

Approach	WB	NB	SB
HCM Control Delay, s	12.2	0	4.3
HCM LOS	B		

Minor Lane/Major Mvmt	NBT	NBRWBLn1	SBL	SBT
Capacity (veh/h)	-	-	750	1298
HCM Lane V/C Ratio	-	-	0.338	0.128
HCM Control Delay (s)	-	-	12.2	8.2
HCM Lane LOS	-	-	B	A
HCM 95th %tile Q(veh)	-	-	1.5	0.4

Intersection						
Int Delay, s/veh	6					
Movement	WBL	WBR	NBT	NBR	SBL	SBT
Lane Configurations	Y		↑↑↑			↑↑
Traffic Vol, veh/h	24	176	172	41	131	123
Future Vol, veh/h	24	176	172	41	131	123
Conflicting Peds, #/hr	0	0	0	0	0	0
Sign Control	Stop	Stop	Free	Free	Free	Free
RT Channelized	-	None	-	None	-	None
Storage Length	0	-	-	-	-	-
Veh in Median Storage, #	0	-	0	-	-	0
Grade, %	0	-	0	-	-	0
Peak Hour Factor	79	79	79	79	79	79
Heavy Vehicles, %	1	1	1	1	1	1
Mvmt Flow	30	223	218	52	166	156

Major/Minor	Minor1	Major1	Major2		
Conflicting Flow All	654	135	0	0	270
Stage 1	244	-	-	-	-
Stage 2	410	-	-	-	-
Critical Hdwy	6.27	7.12	-	-	5.32
Critical Hdwy Stg 1	6.62	-	-	-	-
Critical Hdwy Stg 2	5.82	-	-	-	-
Follow-up Hdwy	3.66	3.91	-	-	3.11
Pot Cap-1 Maneuver	431	758	-	-	871
Stage 1	709	-	-	-	-
Stage 2	620	-	-	-	-
Platoon blocked, %			-	-	-
Mov Cap-1 Maneuver	341	758	-	-	871
Mov Cap-2 Maneuver	408	-	-	-	-
Stage 1	709	-	-	-	-
Stage 2	490	-	-	-	-

Approach	WB	NB	SB
HCM Control Delay, s	13.3	0	5.4
HCM LOS	B		

Minor Lane/Major Mvmt	NBT	NBRWBLn1	SBL	SBT
Capacity (veh/h)	-	-	687	871
HCM Lane V/C Ratio	-	-	0.369	0.19
HCM Control Delay (s)	-	-	13.3	10.1
HCM Lane LOS	-	-	B	A
HCM 95th %tile Q(veh)	-	-	1.7	0.7

SUBJECT	BY	DATE	JOB NO.	SHEET	OF
TURN MOVEMENTS	TM	8-Sep-21	PTCO0000-0001	1	OF 2

E/W STREET : BEAR VALLEY RD  
N/S STREET : PROJECT DRIVEWAY "C"  
CONDITION : AM PEAK HOUR

INTERSECTION : 6  
PROJECTED GROWTH : 3.5%  
PER YEAR :

### CONDITION DIAGRAMS

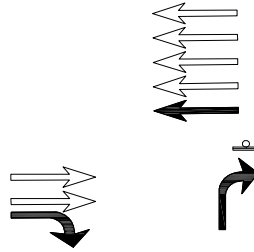

**PROJECT GEOMETRICS**

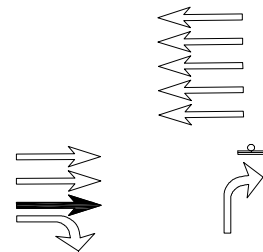

**ULTIMATE GEOMETRICS**

### TURN MOVEMENTS

Condition	Existing Condition	Project Trips	Existing + Project Condition	Year 2023 Ambient Growth	Background Condition	Project Condition	Year 2033 Ambient Growth	Future Condition	Future + Project Condition
Scenario #	1		3		5	7		9	11

### BEAR VALLEY RD

EB LEFT	0	0	0	0	0	0	0	0	0
EB THRU	659	17	676	46	705	722	27	732	749
EB RIGHT	0	56	56	0	0	56	0	0	56
WB LEFT	0	0	0	0	0	0	0	0	0
WB THRU	522	48	570	37	559	607	22	581	629
WB RIGHT	0	0	0	0	0	0	0	0	0

### PROJECT DRIVEWAY "C"

NB LEFT	0	0	0	0	0	0	0	0	0
NB THRU	0	0	0	0	0	0	0	0	0
NB RIGHT	0	18	18	0	0	18	0	0	18
SB LEFT	0	0	0	0	0	0	0	0	0
SB THRU	0	0	0	0	0	0	0	0	0
SB RIGHT	0	0	0	0	0	0	0	0	0
<b>TOTALS</b>	<b>1575</b>	<b>206</b>	<b>1781</b>	<b>111</b>	<b>1686</b>	<b>1892</b>	<b>38</b>	<b>1724</b>	<b>1930</b>

Intersection						
Int Delay, s/veh	0.2					
Movement	EBT	EBR	WBL	WBT	NBL	NBR
Lane Configurations	↑↑			↑↑↑		↑
Traffic Vol, veh/h	676	56	0	570	0	18
Future Vol, veh/h	676	56	0	570	0	18
Conflicting Peds, #/hr	0	0	0	0	0	0
Sign Control	Free	Free	Free	Free	Stop	Stop
RT Channelized	-	None	-	None	-	None
Storage Length	-	-	-	-	-	0
Veh in Median Storage, #	0	-	-	0	0	-
Grade, %	0	-	-	0	0	-
Peak Hour Factor	97	97	97	97	97	97
Heavy Vehicles, %	10	10	12	12	0	1
Mvmt Flow	697	58	0	588	0	19

Major/Minor	Major1	Major2	Minor1		
Conflicting Flow All	0	0	-	-	378
Stage 1	-	-	-	-	-
Stage 2	-	-	-	-	-
Critical Hdwy	-	-	-	-	6.92
Critical Hdwy Stg 1	-	-	-	-	-
Critical Hdwy Stg 2	-	-	-	-	-
Follow-up Hdwy	-	-	-	-	3.31
Pot Cap-1 Maneuver	-	-	0	-	623
Stage 1	-	-	0	-	-
Stage 2	-	-	0	-	-
Platoon blocked, %	-	-	-	-	-
Mov Cap-1 Maneuver	-	-	-	-	623
Mov Cap-2 Maneuver	-	-	-	-	-
Stage 1	-	-	-	-	-
Stage 2	-	-	-	-	-

Approach	EB	WB	NB
HCM Control Delay, s	0	0	11
HCM LOS			B

Minor Lane/Major Mvmt	NBLn1	EBT	EBR	WBT
Capacity (veh/h)	623	-	-	-
HCM Lane V/C Ratio	0.03	-	-	-
HCM Control Delay (s)	11	-	-	-
HCM Lane LOS	B	-	-	-
HCM 95th %tile Q(veh)	0.1	-	-	-

Intersection						
Int Delay, s/veh	0.2					
Movement	EBT	EBR	WBL	WBT	NBL	NBR
Lane Configurations	↑↑↑			↑↑↑		↑
Traffic Vol, veh/h	676	56	0	570	0	18
Future Vol, veh/h	676	56	0	570	0	18
Conflicting Peds, #/hr	0	0	0	0	0	0
Sign Control	Free	Free	Free	Free	Stop	Stop
RT Channelized	-	None	-	None	-	None
Storage Length	-	-	-	-	-	0
Veh in Median Storage, #	0	-	-	0	0	-
Grade, %	0	-	-	0	0	-
Peak Hour Factor	97	97	97	97	97	97
Heavy Vehicles, %	10	10	12	12	0	1
Mvmt Flow	697	58	0	588	0	19

Major/Minor	Major1	Major2	Minor1	Minor2	Minor3
Conflicting Flow All	0	0	-	-	378
Stage 1	-	-	-	-	-
Stage 2	-	-	-	-	-
Critical Hdwy	-	-	-	-	7.12
Critical Hdwy Stg 1	-	-	-	-	-
Critical Hdwy Stg 2	-	-	-	-	-
Follow-up Hdwy	-	-	-	-	3.91
Pot Cap-1 Maneuver	-	-	0	-	532
Stage 1	-	-	0	-	-
Stage 2	-	-	0	-	-
Platoon blocked, %	-	-	-	-	-
Mov Cap-1 Maneuver	-	-	-	-	532
Mov Cap-2 Maneuver	-	-	-	-	-
Stage 1	-	-	-	-	-
Stage 2	-	-	-	-	-

Approach	EB	WB	NB
HCM Control Delay, s	0	0	12
HCM LOS			B

Minor Lane/Major Mvmt	NBLn1	EBT	EBR	WBT
Capacity (veh/h)	532	-	-	-
HCM Lane V/C Ratio	0.035	-	-	-
HCM Control Delay (s)	12	-	-	-
HCM Lane LOS	B	-	-	-
HCM 95th %tile Q(veh)	0.1	-	-	-

Intersection						
Int Delay, s/veh	0.1					
Movement	EBT	EBR	WBL	WBT	NBL	NBR
Lane Configurations	↑↑			↑↑↑		↑
Traffic Vol, veh/h	722	56	0	607	0	18
Future Vol, veh/h	722	56	0	607	0	18
Conflicting Peds, #/hr	0	0	0	0	0	0
Sign Control	Free	Free	Free	Free	Stop	Stop
RT Channelized	-	None	-	None	-	None
Storage Length	-	-	-	-	-	0
Veh in Median Storage, #	0	-	-	0	0	-
Grade, %	0	-	-	0	0	-
Peak Hour Factor	97	97	97	97	97	97
Heavy Vehicles, %	10	10	12	12	0	1
Mvmt Flow	744	58	0	626	0	19

Major/Minor	Major1	Major2	Minor1		
Conflicting Flow All	0	0	-	-	401
Stage 1	-	-	-	-	-
Stage 2	-	-	-	-	-
Critical Hdwy	-	-	-	-	6.92
Critical Hdwy Stg 1	-	-	-	-	-
Critical Hdwy Stg 2	-	-	-	-	-
Follow-up Hdwy	-	-	-	-	3.31
Pot Cap-1 Maneuver	-	-	0	-	602
Stage 1	-	-	0	-	-
Stage 2	-	-	0	-	-
Platoon blocked, %	-	-	-	-	-
Mov Cap-1 Maneuver	-	-	-	-	602
Mov Cap-2 Maneuver	-	-	-	-	-
Stage 1	-	-	-	-	-
Stage 2	-	-	-	-	-

Approach	EB	WB	NB
HCM Control Delay, s	0	0	11.2
HCM LOS			B

Minor Lane/Major Mvmt	NBLn1	EBT	EBR	WBT
Capacity (veh/h)	602	-	-	-
HCM Lane V/C Ratio	0.031	-	-	-
HCM Control Delay (s)	11.2	-	-	-
HCM Lane LOS	B	-	-	-
HCM 95th %tile Q(veh)	0.1	-	-	-



Intersection						
Int Delay, s/veh	0.2					
Movement	EBT	EBR	WBL	WBT	NBL	NBR
Lane Configurations	↑↑↑			↑↑↑		↑
Traffic Vol, veh/h	722	56	0	607	0	18
Future Vol, veh/h	722	56	0	607	0	18
Conflicting Peds, #/hr	0	0	0	0	0	0
Sign Control	Free	Free	Free	Free	Stop	Stop
RT Channelized	-	None	-	None	-	None
Storage Length	-	-	-	-	-	0
Veh in Median Storage, #	0	-	-	0	0	-
Grade, %	0	-	-	0	0	-
Peak Hour Factor	97	97	97	97	97	97
Heavy Vehicles, %	10	10	12	12	0	1
Mvmt Flow	744	58	0	626	0	19

Major/Minor	Major1	Major2	Minor1		
Conflicting Flow All	0	0	-	-	401
Stage 1	-	-	-	-	-
Stage 2	-	-	-	-	-
Critical Hdwy	-	-	-	-	7.12
Critical Hdwy Stg 1	-	-	-	-	-
Critical Hdwy Stg 2	-	-	-	-	-
Follow-up Hdwy	-	-	-	-	3.91
Pot Cap-1 Maneuver	-	-	0	-	514
Stage 1	-	-	0	-	-
Stage 2	-	-	0	-	-
Platoon blocked, %	-	-	-	-	-
Mov Cap-1 Maneuver	-	-	-	-	514
Mov Cap-2 Maneuver	-	-	-	-	-
Stage 1	-	-	-	-	-
Stage 2	-	-	-	-	-

Approach	EB	WB	NB
HCM Control Delay, s	0	0	12.3
HCM LOS			B

Minor Lane/Major Mvmt	NBLn1	EBT	EBR	WBT
Capacity (veh/h)	514	-	-	-
HCM Lane V/C Ratio	0.036	-	-	-
HCM Control Delay (s)	12.3	-	-	-
HCM Lane LOS	B	-	-	-
HCM 95th %tile Q(veh)	0.1	-	-	-

Intersection						
Int Delay, s/veh	0.1					
Movement	EBT	EBR	WBL	WBT	NBL	NBR
Lane Configurations	↑↑			↑↑↑		↑
Traffic Vol, veh/h	749	56	0	629	0	18
Future Vol, veh/h	749	56	0	629	0	18
Conflicting Peds, #/hr	0	0	0	0	0	0
Sign Control	Free	Free	Free	Free	Stop	Stop
RT Channelized	-	None	-	None	-	None
Storage Length	-	-	-	-	-	0
Veh in Median Storage, #	0	-	-	0	0	-
Grade, %	0	-	-	0	0	-
Peak Hour Factor	97	97	97	97	97	97
Heavy Vehicles, %	10	10	12	12	0	1
Mvmt Flow	772	58	0	648	0	19

Major/Minor	Major1	Major2	Minor1		
Conflicting Flow All	0	0	-	-	415
Stage 1	-	-	-	-	-
Stage 2	-	-	-	-	-
Critical Hdwy	-	-	-	-	6.92
Critical Hdwy Stg 1	-	-	-	-	-
Critical Hdwy Stg 2	-	-	-	-	-
Follow-up Hdwy	-	-	-	-	3.31
Pot Cap-1 Maneuver	-	-	0	-	589
Stage 1	-	-	0	-	-
Stage 2	-	-	0	-	-
Platoon blocked, %	-	-	-	-	-
Mov Cap-1 Maneuver	-	-	-	-	589
Mov Cap-2 Maneuver	-	-	-	-	-
Stage 1	-	-	-	-	-
Stage 2	-	-	-	-	-

Approach	EB	WB	NB
HCM Control Delay, s	0	0	11.3
HCM LOS			B

Minor Lane/Major Mvmt	NBLn1	EBT	EBR	WBT
Capacity (veh/h)	589	-	-	-
HCM Lane V/C Ratio	0.032	-	-	-
HCM Control Delay (s)	11.3	-	-	-
HCM Lane LOS	B	-	-	-
HCM 95th %tile Q(veh)	0.1	-	-	-



SUBJECT	BY	DATE	JOB NO.	SHEET	OF
TURN MOVEMENTS	TM	8-Sep-21	PTCO0000-0001	1	OF 2

E/W STREET : BEAR VALLEY RD INTERSECTION : 6  
N/S STREET : PROJECT DRIVEWAY "C" PROJECTED GROWTH : 3.5%  
CONDITION : PM PEAK HOUR PER YEAR :

**TURN MOVEMENTS**

Condition	Existing Condition	Project Trips	Existing + Project Condition	Year 2023 Ambient Growth	Background Condition	Project Condition	Year 2033 Ambient Growth	Future Condition	Future + Project Condition
Scenario #	2		4		6	8		10	12

**BEAR VALLEY RD**

EB LEFT	0	0	0	0	0	0	0	0	0
EB THRU	719	14	733	50	769	783	30	799	813
EB RIGHT	0	62	62	0	0	62	0	0	62
WB LEFT	0	0	0	0	0	0	0	0	0
WB THRU	569	52	621	40	609	661	24	633	685
WB RIGHT	0	0	0	0	0	0	0	0	0

**PROJECT DRIVEWAY "C"**

NB LEFT	0	0	0	0	0	0	0	0	0
NB THRU	0	0	0	0	0	0	0	0	0
NB RIGHT	0	24	24	0	0	24	0	0	24
SB LEFT	0	0	0	0	0	0	0	0	0
SB THRU	0	0	0	0	0	0	0	0	0
SB RIGHT	0	0	0	0	0	0	0	0	0
<b>TOTALS</b>	<b>1575</b>	<b>206</b>	<b>1781</b>	<b>111</b>	<b>1686</b>	<b>1892</b>	<b>38</b>	<b>1724</b>	<b>1930</b>

Intersection						
Int Delay, s/veh	0.2					
Movement	EBT	EBR	WBL	WBT	NBL	NBR
Lane Configurations	↑↑			↑↑↑		↑
Traffic Vol, veh/h	733	62	0	621	0	24
Future Vol, veh/h	733	62	0	621	0	24
Conflicting Peds, #/hr	0	0	0	0	0	0
Sign Control	Free	Free	Free	Free	Stop	Stop
RT Channelized	-	None	-	None	-	None
Storage Length	-	-	-	-	-	0
Veh in Median Storage, #	0	-	-	0	0	-
Grade, %	0	-	-	0	0	-
Peak Hour Factor	91	91	91	91	91	91
Heavy Vehicles, %	1	1	1	1	0	1
Mvmt Flow	805	68	0	682	0	26

Major/Minor	Major1	Major2	Minor1		
Conflicting Flow All	0	0	-	-	437
Stage 1	-	-	-	-	-
Stage 2	-	-	-	-	-
Critical Hdwy	-	-	-	-	6.92
Critical Hdwy Stg 1	-	-	-	-	-
Critical Hdwy Stg 2	-	-	-	-	-
Follow-up Hdwy	-	-	-	-	3.31
Pot Cap-1 Maneuver	-	-	0	-	570
Stage 1	-	-	0	-	-
Stage 2	-	-	0	-	-
Platoon blocked, %	-	-	-	-	-
Mov Cap-1 Maneuver	-	-	-	-	570
Mov Cap-2 Maneuver	-	-	-	-	-
Stage 1	-	-	-	-	-
Stage 2	-	-	-	-	-

Approach	EB	WB	NB
HCM Control Delay, s	0	0	11.6
HCM LOS			B

Minor Lane/Major Mvmt	NBLn1	EBT	EBR	WBT
Capacity (veh/h)	570	-	-	-
HCM Lane V/C Ratio	0.046	-	-	-
HCM Control Delay (s)	11.6	-	-	-
HCM Lane LOS	B	-	-	-
HCM 95th %tile Q(veh)	0.1	-	-	-

Intersection						
Int Delay, s/veh	0.2					
Movement	EBT	EBR	WBL	WBT	NBL	NBR
Lane Configurations	↑↑↑			↑↑↑		↑
Traffic Vol, veh/h	733	62	0	621	0	24
Future Vol, veh/h	733	62	0	621	0	24
Conflicting Peds, #/hr	0	0	0	0	0	0
Sign Control	Free	Free	Free	Free	Stop	Stop
RT Channelized	-	None	-	None	-	None
Storage Length	-	-	-	-	-	0
Veh in Median Storage, #	0	-	-	0	0	-
Grade, %	0	-	-	0	0	-
Peak Hour Factor	91	91	91	91	91	91
Heavy Vehicles, %	1	1	1	1	0	1
Mvmt Flow	805	68	0	682	0	26

Major/Minor	Major1	Major2	Minor1		
Conflicting Flow All	0	0	-	-	437
Stage 1	-	-	-	-	-
Stage 2	-	-	-	-	-
Critical Hdwy	-	-	-	-	7.12
Critical Hdwy Stg 1	-	-	-	-	-
Critical Hdwy Stg 2	-	-	-	-	-
Follow-up Hdwy	-	-	-	-	3.91
Pot Cap-1 Maneuver	-	-	0	-	487
Stage 1	-	-	0	-	-
Stage 2	-	-	0	-	-
Platoon blocked, %	-	-	-	-	-
Mov Cap-1 Maneuver	-	-	-	-	487
Mov Cap-2 Maneuver	-	-	-	-	-
Stage 1	-	-	-	-	-
Stage 2	-	-	-	-	-

Approach	EB	WB	NB
HCM Control Delay, s	0	0	12.8
HCM LOS			B

Minor Lane/Major Mvmt	NBLn1	EBT	EBR	WBT
Capacity (veh/h)	487	-	-	-
HCM Lane V/C Ratio	0.054	-	-	-
HCM Control Delay (s)	12.8	-	-	-
HCM Lane LOS	B	-	-	-
HCM 95th %tile Q(veh)	0.2	-	-	-

Intersection						
Int Delay, s/veh	0.2					
Movement	EBT	EBR	WBL	WBT	NBL	NBR
Lane Configurations	↑↑			↑↑↑		↑
Traffic Vol, veh/h	783	62	0	661	0	24
Future Vol, veh/h	783	62	0	661	0	24
Conflicting Peds, #/hr	0	0	0	0	0	0
Sign Control	Free	Free	Free	Free	Stop	Stop
RT Channelized	-	None	-	None	-	None
Storage Length	-	-	-	-	-	0
Veh in Median Storage, #	0	-	-	0	0	-
Grade, %	0	-	-	0	0	-
Peak Hour Factor	91	91	91	91	91	91
Heavy Vehicles, %	1	1	1	1	0	1
Mvmt Flow	860	68	0	726	0	26

Major/Minor	Major1	Major2	Minor1		
Conflicting Flow All	0	0	-	-	464
Stage 1	-	-	-	-	-
Stage 2	-	-	-	-	-
Critical Hdwy	-	-	-	-	6.92
Critical Hdwy Stg 1	-	-	-	-	-
Critical Hdwy Stg 2	-	-	-	-	-
Follow-up Hdwy	-	-	-	-	3.31
Pot Cap-1 Maneuver	-	-	0	-	548
Stage 1	-	-	0	-	-
Stage 2	-	-	0	-	-
Platoon blocked, %	-	-	-	-	-
Mov Cap-1 Maneuver	-	-	-	-	548
Mov Cap-2 Maneuver	-	-	-	-	-
Stage 1	-	-	-	-	-
Stage 2	-	-	-	-	-

Approach	EB	WB	NB
HCM Control Delay, s	0	0	11.9
HCM LOS			B

Minor Lane/Major Mvmt	NBLn1	EBT	EBR	WBT
Capacity (veh/h)	548	-	-	-
HCM Lane V/C Ratio	0.048	-	-	-
HCM Control Delay (s)	11.9	-	-	-
HCM Lane LOS	B	-	-	-
HCM 95th %tile Q(veh)	0.2	-	-	-

Intersection						
Int Delay, s/veh	0.2					
Movement	EBT	EBR	WBL	WBT	NBL	NBR
Lane Configurations	↑↑↑			↑↑↑		↑
Traffic Vol, veh/h	783	62	0	661	0	24
Future Vol, veh/h	783	62	0	661	0	24
Conflicting Peds, #/hr	0	0	0	0	0	0
Sign Control	Free	Free	Free	Free	Stop	Stop
RT Channelized	-	None	-	None	-	None
Storage Length	-	-	-	-	-	0
Veh in Median Storage, #	0	-	-	0	0	-
Grade, %	0	-	-	0	0	-
Peak Hour Factor	91	91	91	91	91	91
Heavy Vehicles, %	1	1	1	1	0	1
Mvmt Flow	860	68	0	726	0	26

Major/Minor	Major1	Major2	Minor1		
Conflicting Flow All	0	0	-	-	464
Stage 1	-	-	-	-	-
Stage 2	-	-	-	-	-
Critical Hdwy	-	-	-	-	7.12
Critical Hdwy Stg 1	-	-	-	-	-
Critical Hdwy Stg 2	-	-	-	-	-
Follow-up Hdwy	-	-	-	-	3.91
Pot Cap-1 Maneuver	-	-	0	-	468
Stage 1	-	-	0	-	-
Stage 2	-	-	0	-	-
Platoon blocked, %	-	-	-	-	-
Mov Cap-1 Maneuver	-	-	-	-	468
Mov Cap-2 Maneuver	-	-	-	-	-
Stage 1	-	-	-	-	-
Stage 2	-	-	-	-	-

Approach	EB	WB	NB
HCM Control Delay, s	0	0	13.2
HCM LOS			B

Minor Lane/Major Mvmt	NBLn1	EBT	EBR	WBT
Capacity (veh/h)	468	-	-	-
HCM Lane V/C Ratio	0.056	-	-	-
HCM Control Delay (s)	13.2	-	-	-
HCM Lane LOS	B	-	-	-
HCM 95th %tile Q(veh)	0.2	-	-	-

Intersection						
Int Delay, s/veh	0.2					
Movement	EBT	EBR	WBL	WBT	NBL	NBR
Lane Configurations	↑↑			↑↑↑		↑
Traffic Vol, veh/h	813	62	0	685	0	24
Future Vol, veh/h	813	62	0	685	0	24
Conflicting Peds, #/hr	0	0	0	0	0	0
Sign Control	Free	Free	Free	Free	Stop	Stop
RT Channelized	-	None	-	None	-	None
Storage Length	-	-	-	-	-	0
Veh in Median Storage, #	0	-	-	0	0	-
Grade, %	0	-	-	0	0	-
Peak Hour Factor	91	91	91	91	91	91
Heavy Vehicles, %	1	1	1	1	0	1
Mvmt Flow	893	68	0	753	0	26

Major/Minor	Major1	Major2	Minor1		
Conflicting Flow All	0	0	-	-	481
Stage 1	-	-	-	-	-
Stage 2	-	-	-	-	-
Critical Hdwy	-	-	-	-	6.92
Critical Hdwy Stg 1	-	-	-	-	-
Critical Hdwy Stg 2	-	-	-	-	-
Follow-up Hdwy	-	-	-	-	3.31
Pot Cap-1 Maneuver	-	-	0	-	534
Stage 1	-	-	0	-	-
Stage 2	-	-	0	-	-
Platoon blocked, %	-	-	-	-	-
Mov Cap-1 Maneuver	-	-	-	-	534
Mov Cap-2 Maneuver	-	-	-	-	-
Stage 1	-	-	-	-	-
Stage 2	-	-	-	-	-

Approach	EB	WB	NB
HCM Control Delay, s	0	0	12.1
HCM LOS			B

Minor Lane/Major Mvmt	NBLn1	EBT	EBR	WBT
Capacity (veh/h)	534	-	-	-
HCM Lane V/C Ratio	0.049	-	-	-
HCM Control Delay (s)	12.1	-	-	-
HCM Lane LOS	B	-	-	-
HCM 95th %tile Q(veh)	0.2	-	-	-



SUBJECT	BY	DATE	JOB NO.	SHEET	OF
TURN MOVEMENTS	TM	8-Sep-21	PTCO0000-0001	1	OF 2

E/W STREET : BEAR VALLEY RD

N/S STREET : PROJECT DRIVEWAY "D"

CONDITION : AM PEAK HOUR

INTERSECTION : 7

PROJECTED GROWTH : 3.5%

PER YEAR :

## CONDITION DIAGRAMS



**PROJECT GEOMETRICS**

**ULTIMATE GEOMETRICS**

## TURN MOVEMENTS

Condition	Existing Condition	Project Trips	Existing + Project Condition	Year 2023 Ambient Growth	Background Condition	Project Condition	Year 2033 Ambient Growth	Future Condition	Future + Project Condition
Scenario #	1		3		5	7		9	11

### BEAR VALLEY RD

EB LEFT	0	0	0	0	0	0	0	0	0
EB THRU	675	0	675	47	722	722	16	738	738
EB RIGHT	0	35	35	0	0	35	0	0	35
WB LEFT	0	0	0	0	0	0	0	0	0
WB THRU	525	48	573	36	561	609	13	574	622
WB RIGHT	0	0	0	0	0	0	0	0	0

### PROJECT DRIVEWAY "D"

NB LEFT	0	0	0	0	0	0	0	0	0
NB THRU	0	0	0	0	0	0	0	0	0
NB RIGHT	0	43	43	0	0	43	0	0	43
SB LEFT	0	0	0	0	0	0	0	0	0
SB THRU	0	0	0	0	0	0	0	0	0
SB RIGHT	0	0	0	0	0	0	0	0	0
<b>TOTALS</b>	<b>1575</b>	<b>206</b>	<b>1781</b>	<b>111</b>	<b>1686</b>	<b>1892</b>	<b>38</b>	<b>1724</b>	<b>1930</b>

Intersection						
Int Delay, s/veh	0.4					
Movement	EBT	EBR	WBL	WBT	NBL	NBR
Lane Configurations	↑↑			↑↑		↑
Traffic Vol, veh/h	675	35	0	573	0	43
Future Vol, veh/h	675	35	0	573	0	43
Conflicting Peds, #/hr	0	0	0	0	0	0
Sign Control	Free	Free	Free	Free	Stop	Stop
RT Channelized	-	None	-	None	-	None
Storage Length	-	-	-	-	-	0
Veh in Median Storage, #	0	-	-	0	0	-
Grade, %	0	-	-	0	0	-
Peak Hour Factor	94	94	94	94	94	94
Heavy Vehicles, %	12	12	10	10	0	1
Mvmt Flow	718	37	0	610	0	46

Major/Minor	Major1	Major2	Minor1		
Conflicting Flow All	0	0	-	-	378
Stage 1	-	-	-	-	-
Stage 2	-	-	-	-	-
Critical Hdwy	-	-	-	-	6.92
Critical Hdwy Stg 1	-	-	-	-	-
Critical Hdwy Stg 2	-	-	-	-	-
Follow-up Hdwy	-	-	-	-	3.31
Pot Cap-1 Maneuver	-	-	0	-	623
Stage 1	-	-	0	-	-
Stage 2	-	-	0	-	-
Platoon blocked, %	-	-	-	-	-
Mov Cap-1 Maneuver	-	-	-	-	623
Mov Cap-2 Maneuver	-	-	-	-	-
Stage 1	-	-	-	-	-
Stage 2	-	-	-	-	-

Approach	EB	WB	NB
HCM Control Delay, s	0	0	11.2
HCM LOS			B

Minor Lane/Major Mvmt	NBLn1	EBT	EBR	WBT
Capacity (veh/h)	623	-	-	-
HCM Lane V/C Ratio	0.073	-	-	-
HCM Control Delay (s)	11.2	-	-	-
HCM Lane LOS	B	-	-	-
HCM 95th %tile Q(veh)	0.2	-	-	-

Intersection						
Int Delay, s/veh	0.4					
Movement	EBT	EBR	WBL	WBT	NBL	NBR
Lane Configurations	↑↑	↑		↑↑		↑
Traffic Vol, veh/h	675	35	0	573	0	43
Future Vol, veh/h	675	35	0	573	0	43
Conflicting Peds, #/hr	0	0	0	0	0	0
Sign Control	Free	Free	Free	Free	Stop	Stop
RT Channelized	-	None	-	None	-	None
Storage Length	-	0	-	-	-	0
Veh in Median Storage, #	0	-	-	0	0	-
Grade, %	0	-	-	0	0	-
Peak Hour Factor	94	94	94	94	94	94
Heavy Vehicles, %	12	12	10	10	0	1
Mvmt Flow	718	37	0	610	0	46

Major/Minor	Major1	Major2	Minor1		
Conflicting Flow All	0	0	-	-	359
Stage 1	-	-	-	-	-
Stage 2	-	-	-	-	-
Critical Hdwy	-	-	-	-	6.92
Critical Hdwy Stg 1	-	-	-	-	-
Critical Hdwy Stg 2	-	-	-	-	-
Follow-up Hdwy	-	-	-	-	3.31
Pot Cap-1 Maneuver	-	-	0	-	640
Stage 1	-	-	0	-	-
Stage 2	-	-	0	-	-
Platoon blocked, %	-	-	-	-	-
Mov Cap-1 Maneuver	-	-	-	-	640
Mov Cap-2 Maneuver	-	-	-	-	-
Stage 1	-	-	-	-	-
Stage 2	-	-	-	-	-

Approach	EB	WB	NB
HCM Control Delay, s	0	0	11.1
HCM LOS			B

Minor Lane/Major Mvmt	NBLn1	EBT	EBR	WBT
Capacity (veh/h)	640	-	-	-
HCM Lane V/C Ratio	0.071	-	-	-
HCM Control Delay (s)	11.1	-	-	-
HCM Lane LOS	B	-	-	-
HCM 95th %tile Q(veh)	0.2	-	-	-

Intersection						
Int Delay, s/veh	0.4					
Movement	EBT	EBR	WBL	WBT	NBL	NBR
Lane Configurations	↑↑			↑↑		↑
Traffic Vol, veh/h	722	35	0	609	0	43
Future Vol, veh/h	722	35	0	609	0	43
Conflicting Peds, #/hr	0	0	0	0	0	0
Sign Control	Free	Free	Free	Free	Stop	Stop
RT Channelized	-	None	-	None	-	None
Storage Length	-	-	-	-	-	0
Veh in Median Storage, #	0	-	-	0	0	-
Grade, %	0	-	-	0	0	-
Peak Hour Factor	94	94	94	94	94	94
Heavy Vehicles, %	12	12	10	10	0	1
Mvmt Flow	768	37	0	648	0	46

Major/Minor	Major1	Major2	Minor1		
Conflicting Flow All	0	0	-	-	403
Stage 1	-	-	-	-	-
Stage 2	-	-	-	-	-
Critical Hdwy	-	-	-	-	6.92
Critical Hdwy Stg 1	-	-	-	-	-
Critical Hdwy Stg 2	-	-	-	-	-
Follow-up Hdwy	-	-	-	-	3.31
Pot Cap-1 Maneuver	-	-	0	-	600
Stage 1	-	-	0	-	-
Stage 2	-	-	0	-	-
Platoon blocked, %	-	-	-	-	-
Mov Cap-1 Maneuver	-	-	-	-	600
Mov Cap-2 Maneuver	-	-	-	-	-
Stage 1	-	-	-	-	-
Stage 2	-	-	-	-	-

Approach	EB	WB	NB
HCM Control Delay, s	0	0	11.5
HCM LOS			B

Minor Lane/Major Mvmt	NBLn1	EBT	EBR	WBT
Capacity (veh/h)	600	-	-	-
HCM Lane V/C Ratio	0.076	-	-	-
HCM Control Delay (s)	11.5	-	-	-
HCM Lane LOS	B	-	-	-
HCM 95th %tile Q(veh)	0.2	-	-	-

Intersection						
Int Delay, s/veh	0.3					
Movement	EBT	EBR	WBL	WBT	NBL	NBR
Lane Configurations	↑↑	↑		↑↑		↑
Traffic Vol, veh/h	722	35	0	609	0	43
Future Vol, veh/h	722	35	0	609	0	43
Conflicting Peds, #/hr	0	0	0	0	0	0
Sign Control	Free	Free	Free	Free	Stop	Stop
RT Channelized	-	None	-	None	-	None
Storage Length	-	0	-	-	-	0
Veh in Median Storage, #	0	-	-	0	0	-
Grade, %	0	-	-	0	0	-
Peak Hour Factor	94	94	94	94	94	94
Heavy Vehicles, %	12	12	10	10	0	1
Mvmt Flow	768	37	0	648	0	46

Major/Minor	Major1	Major2	Minor1		
Conflicting Flow All	0	0	-	-	384
Stage 1	-	-	-	-	-
Stage 2	-	-	-	-	-
Critical Hdwy	-	-	-	-	6.92
Critical Hdwy Stg 1	-	-	-	-	-
Critical Hdwy Stg 2	-	-	-	-	-
Follow-up Hdwy	-	-	-	-	3.31
Pot Cap-1 Maneuver	-	-	0	-	617
Stage 1	-	-	0	-	-
Stage 2	-	-	0	-	-
Platoon blocked, %	-	-	-	-	-
Mov Cap-1 Maneuver	-	-	-	-	617
Mov Cap-2 Maneuver	-	-	-	-	-
Stage 1	-	-	-	-	-
Stage 2	-	-	-	-	-

Approach	EB	WB	NB
HCM Control Delay, s	0	0	11.3
HCM LOS			B

Minor Lane/Major Mvmt	NBLn1	EBT	EBR	WBT
Capacity (veh/h)	617	-	-	-
HCM Lane V/C Ratio	0.074	-	-	-
HCM Control Delay (s)	11.3	-	-	-
HCM Lane LOS	B	-	-	-
HCM 95th %tile Q(veh)	0.2	-	-	-

Intersection						
Int Delay, s/veh	0.3					
Movement	EBT	EBR	WBL	WBT	NBL	NBR
Lane Configurations	↑↑			↑↑		↑
Traffic Vol, veh/h	738	35	0	622	0	43
Future Vol, veh/h	738	35	0	622	0	43
Conflicting Peds, #/hr	0	0	0	0	0	0
Sign Control	Free	Free	Free	Free	Stop	Stop
RT Channelized	-	None	-	None	-	None
Storage Length	-	-	-	-	-	0
Veh in Median Storage, #	0	-	-	0	0	-
Grade, %	0	-	-	0	0	-
Peak Hour Factor	94	94	94	94	94	94
Heavy Vehicles, %	12	12	10	10	0	1
Mvmt Flow	785	37	0	662	0	46

Major/Minor	Major1	Major2	Minor1		
Conflicting Flow All	0	0	-	-	411
Stage 1	-	-	-	-	-
Stage 2	-	-	-	-	-
Critical Hdwy	-	-	-	-	6.92
Critical Hdwy Stg 1	-	-	-	-	-
Critical Hdwy Stg 2	-	-	-	-	-
Follow-up Hdwy	-	-	-	-	3.31
Pot Cap-1 Maneuver	-	-	0	-	593
Stage 1	-	-	0	-	-
Stage 2	-	-	0	-	-
Platoon blocked, %	-	-	-	-	-
Mov Cap-1 Maneuver	-	-	-	-	593
Mov Cap-2 Maneuver	-	-	-	-	-
Stage 1	-	-	-	-	-
Stage 2	-	-	-	-	-

Approach	EB	WB	NB
HCM Control Delay, s	0	0	11.6
HCM LOS			B

Minor Lane/Major Mvmt	NBLn1	EBT	EBR	WBT
Capacity (veh/h)	593	-	-	-
HCM Lane V/C Ratio	0.077	-	-	-
HCM Control Delay (s)	11.6	-	-	-
HCM Lane LOS	B	-	-	-
HCM 95th %tile Q(veh)	0.2	-	-	-

Intersection						
Int Delay, s/veh	0.4					
Movement	EBT	EBR	WBL	WBT	NBL	NBR
Lane Configurations	↑↑↑	↑		↑↑↑		↑
Traffic Vol, veh/h	738	35	0	622	0	43
Future Vol, veh/h	738	35	0	622	0	43
Conflicting Peds, #/hr	0	0	0	0	0	0
Sign Control	Free	Free	Free	Free	Stop	Stop
RT Channelized	-	None	-	None	-	None
Storage Length	-	0	-	-	-	0
Veh in Median Storage, #	0	-	-	0	0	-
Grade, %	0	-	-	0	0	-
Peak Hour Factor	94	94	94	94	94	94
Heavy Vehicles, %	12	12	10	10	0	1
Mvmt Flow	785	37	0	662	0	46

Major/Minor	Major1	Major2	Minor1		
Conflicting Flow All	0	0	-	-	393
Stage 1	-	-	-	-	-
Stage 2	-	-	-	-	-
Critical Hdwy	-	-	-	-	7.12
Critical Hdwy Stg 1	-	-	-	-	-
Critical Hdwy Stg 2	-	-	-	-	-
Follow-up Hdwy	-	-	-	-	3.91
Pot Cap-1 Maneuver	-	-	0	-	520
Stage 1	-	-	0	-	-
Stage 2	-	-	0	-	-
Platoon blocked, %	-	-	-	-	-
Mov Cap-1 Maneuver	-	-	-	-	520
Mov Cap-2 Maneuver	-	-	-	-	-
Stage 1	-	-	-	-	-
Stage 2	-	-	-	-	-

Approach	EB	WB	NB
HCM Control Delay, s	0	0	12.6
HCM LOS			B

Minor Lane/Major Mvmt	NBLn1	EBT	EBR	WBT
Capacity (veh/h)	520	-	-	-
HCM Lane V/C Ratio	0.088	-	-	-
HCM Control Delay (s)	12.6	-	-	-
HCM Lane LOS	B	-	-	-
HCM 95th %tile Q(veh)	0.3	-	-	-



SUBJECT	BY	DATE	JOB NO.	SHEET	OF
TURN MOVEMENTS	TM	8-Sep-21	PTCO0000-0001	1	OF 2

E/W STREET : BEAR VALLEY RD

INTERSECTION : 7

N/S STREET : PROJECT DRIVEWAY "D"

PROJECTED GROWTH : 3.5%

CONDITION : PM PEAK HOUR

PER YEAR :

**TURN MOVEMENTS**

Condition	Existing Condition	Project Trips	Existing + Project Condition	Year 2023 Ambient Growth	Background Condition	Project Condition	Year 2033 Ambient Growth	Future Condition	Future + Project Condition
Scenario #	2		4		6	8		10	12

**BEAR VALLEY RD**

EB LEFT	0	0	0	0	0	0	0	0	0
EB THRU	744	-3	741	52	796	793	18	814	811
EB RIGHT	0	41	41	0	0	41	0	0	41
WB LEFT	0	0	0	0	0	0	0	0	0
WB THRU	585	52	637	41	626	678	14	640	692
WB RIGHT	0	0	0	0	0	0	0	0	0

**PROJECT DRIVEWAY "D"**

NB LEFT	0	0	0	0	0	0	0	0	0
NB THRU	0	0	0	0	0	0	0	0	0
NB RIGHT	0	55	55	0	0	55	0	0	55
SB LEFT	0	0	0	0	0	0	0	0	0
SB THRU	0	0	0	0	0	0	0	0	0
SB RIGHT	0	0	0	0	0	0	0	0	0
<b>TOTALS</b>	<b>1575</b>	<b>206</b>	<b>1781</b>	<b>111</b>	<b>1686</b>	<b>1892</b>	<b>38</b>	<b>1724</b>	<b>1930</b>



Intersection						
Int Delay, s/veh	0.5					
Movement	EBT	EBR	WBL	WBT	NBL	NBR
Lane Configurations	↑↑			↑↑		↑
Traffic Vol, veh/h	741	41	0	637	0	55
Future Vol, veh/h	741	41	0	637	0	55
Conflicting Peds, #/hr	0	0	0	0	0	0
Sign Control	Free	Free	Free	Free	Stop	Stop
RT Channelized	-	None	-	None	-	None
Storage Length	-	-	-	-	-	0
Veh in Median Storage, #	0	-	-	0	0	-
Grade, %	0	-	-	0	0	-
Peak Hour Factor	76	76	76	76	76	76
Heavy Vehicles, %	3	3	3	3	0	1
Mvmt Flow	975	54	0	838	0	72

Major/Minor	Major1	Major2	Minor1			
Conflicting Flow All	0	0	-	-	-	515
Stage 1	-	-	-	-	-	-
Stage 2	-	-	-	-	-	-
Critical Hdwy	-	-	-	-	-	6.92
Critical Hdwy Stg 1	-	-	-	-	-	-
Critical Hdwy Stg 2	-	-	-	-	-	-
Follow-up Hdwy	-	-	-	-	-	3.31
Pot Cap-1 Maneuver	-	-	0	-	0	507
Stage 1	-	-	0	-	0	-
Stage 2	-	-	0	-	0	-
Platoon blocked, %	-	-	-	-	-	-
Mov Cap-1 Maneuver	-	-	-	-	-	507
Mov Cap-2 Maneuver	-	-	-	-	-	-
Stage 1	-	-	-	-	-	-
Stage 2	-	-	-	-	-	-

Approach	EB	WB	NB
HCM Control Delay, s	0	0	13.3
HCM LOS			B

Minor Lane/Major Mvmt	NBLn1	EBT	EBR	WBT
Capacity (veh/h)	507	-	-	-
HCM Lane V/C Ratio	0.143	-	-	-
HCM Control Delay (s)	13.3	-	-	-
HCM Lane LOS	B	-	-	-
HCM 95th %tile Q(veh)	0.5	-	-	-

Intersection						
Int Delay, s/veh	0.5					
Movement	EBT	EBR	WBL	WBT	NBL	NBR
Lane Configurations	↑↑	↑		↑↑		↑
Traffic Vol, veh/h	741	41	0	637	0	55
Future Vol, veh/h	741	41	0	637	0	55
Conflicting Peds, #/hr	0	0	0	0	0	0
Sign Control	Free	Free	Free	Free	Stop	Stop
RT Channelized	-	None	-	None	-	None
Storage Length	-	0	-	-	-	0
Veh in Median Storage, #	0	-	-	0	0	-
Grade, %	0	-	-	0	0	-
Peak Hour Factor	76	76	76	76	76	76
Heavy Vehicles, %	3	3	3	3	0	1
Mvmt Flow	975	54	0	838	0	72

Major/Minor	Major1	Major2	Minor1		
Conflicting Flow All	0	0	-	-	488
Stage 1	-	-	-	-	-
Stage 2	-	-	-	-	-
Critical Hdwy	-	-	-	-	6.92
Critical Hdwy Stg 1	-	-	-	-	-
Critical Hdwy Stg 2	-	-	-	-	-
Follow-up Hdwy	-	-	-	-	3.31
Pot Cap-1 Maneuver	-	-	0	-	528
Stage 1	-	-	0	-	-
Stage 2	-	-	0	-	-
Platoon blocked, %	-	-	-	-	-
Mov Cap-1 Maneuver	-	-	-	-	528
Mov Cap-2 Maneuver	-	-	-	-	-
Stage 1	-	-	-	-	-
Stage 2	-	-	-	-	-

Approach	EB	WB	NB
HCM Control Delay, s	0	0	12.9
HCM LOS			B

Minor Lane/Major Mvmt	NBLn1	EBT	EBR	WBT
Capacity (veh/h)	528	-	-	-
HCM Lane V/C Ratio	0.137	-	-	-
HCM Control Delay (s)	12.9	-	-	-
HCM Lane LOS	B	-	-	-
HCM 95th %tile Q(veh)	0.5	-	-	-

Intersection						
Int Delay, s/veh	0.5					
Movement	EBT	EBR	WBL	WBT	NBL	NBR
Lane Configurations	↑↑			↑↑		↑
Traffic Vol, veh/h	793	41	0	678	0	55
Future Vol, veh/h	793	41	0	678	0	55
Conflicting Peds, #/hr	0	0	0	0	0	0
Sign Control	Free	Free	Free	Free	Stop	Stop
RT Channelized	-	None	-	None	-	None
Storage Length	-	-	-	-	-	0
Veh in Median Storage, #	0	-	-	0	0	-
Grade, %	0	-	-	0	0	-
Peak Hour Factor	76	76	76	76	76	76
Heavy Vehicles, %	3	3	3	3	0	1
Mvmt Flow	1043	54	0	892	0	72

Major/Minor	Major1	Major2	Minor1		
Conflicting Flow All	0	0	-	-	549
Stage 1	-	-	-	-	-
Stage 2	-	-	-	-	-
Critical Hdwy	-	-	-	-	6.92
Critical Hdwy Stg 1	-	-	-	-	-
Critical Hdwy Stg 2	-	-	-	-	-
Follow-up Hdwy	-	-	-	-	3.31
Pot Cap-1 Maneuver	-	-	0	-	482
Stage 1	-	-	0	-	-
Stage 2	-	-	0	-	-
Platoon blocked, %	-	-	-	-	-
Mov Cap-1 Maneuver	-	-	-	-	482
Mov Cap-2 Maneuver	-	-	-	-	-
Stage 1	-	-	-	-	-
Stage 2	-	-	-	-	-

Approach	EB	WB	NB
HCM Control Delay, s	0	0	13.8
HCM LOS			B

Minor Lane/Major Mvmt	NBLn1	EBT	EBR	WBT
Capacity (veh/h)	482	-	-	-
HCM Lane V/C Ratio	0.15	-	-	-
HCM Control Delay (s)	13.8	-	-	-
HCM Lane LOS	B	-	-	-
HCM 95th %tile Q(veh)	0.5	-	-	-

Intersection						
Int Delay, s/veh	0.5					
Movement	EBT	EBR	WBL	WBT	NBL	NBR
Lane Configurations	↑↑	↑		↑↑		↑
Traffic Vol, veh/h	793	41	0	678	0	55
Future Vol, veh/h	793	41	0	678	0	55
Conflicting Peds, #/hr	0	0	0	0	0	0
Sign Control	Free	Free	Free	Free	Stop	Stop
RT Channelized	-	None	-	None	-	None
Storage Length	-	0	-	-	-	0
Veh in Median Storage, #	0	-	-	0	0	-
Grade, %	0	-	-	0	0	-
Peak Hour Factor	76	76	76	76	76	76
Heavy Vehicles, %	3	3	3	3	0	1
Mvmt Flow	1043	54	0	892	0	72

Major/Minor	Major1	Major2	Minor1		
Conflicting Flow All	0	0	-	-	522
Stage 1	-	-	-	-	-
Stage 2	-	-	-	-	-
Critical Hdwy	-	-	-	-	6.92
Critical Hdwy Stg 1	-	-	-	-	-
Critical Hdwy Stg 2	-	-	-	-	-
Follow-up Hdwy	-	-	-	-	3.31
Pot Cap-1 Maneuver	-	-	0	-	502
Stage 1	-	-	0	-	-
Stage 2	-	-	0	-	-
Platoon blocked, %	-	-	-	-	-
Mov Cap-1 Maneuver	-	-	-	-	502
Mov Cap-2 Maneuver	-	-	-	-	-
Stage 1	-	-	-	-	-
Stage 2	-	-	-	-	-

Approach	EB	WB	NB
HCM Control Delay, s	0	0	13.4
HCM LOS			B

Minor Lane/Major Mvmt	NBLn1	EBT	EBR	WBT
Capacity (veh/h)	502	-	-	-
HCM Lane V/C Ratio	0.144	-	-	-
HCM Control Delay (s)	13.4	-	-	-
HCM Lane LOS	B	-	-	-
HCM 95th %tile Q(veh)	0.5	-	-	-

Intersection						
Int Delay, s/veh	0.5					
Movement	EBT	EBR	WBL	WBT	NBL	NBR
Lane Configurations	↑↑			↑↑		↑
Traffic Vol, veh/h	811	41	0	692	0	55
Future Vol, veh/h	811	41	0	692	0	55
Conflicting Peds, #/hr	0	0	0	0	0	0
Sign Control	Free	Free	Free	Free	Stop	Stop
RT Channelized	-	None	-	None	-	None
Storage Length	-	-	-	-	-	0
Veh in Median Storage, #	0	-	-	0	0	-
Grade, %	0	-	-	0	0	-
Peak Hour Factor	76	76	76	76	76	76
Heavy Vehicles, %	3	3	3	3	0	1
Mvmt Flow	1067	54	0	911	0	72

Major/Minor	Major1	Major2	Minor1		
Conflicting Flow All	0	0	-	-	561
Stage 1	-	-	-	-	-
Stage 2	-	-	-	-	-
Critical Hdwy	-	-	-	-	6.92
Critical Hdwy Stg 1	-	-	-	-	-
Critical Hdwy Stg 2	-	-	-	-	-
Follow-up Hdwy	-	-	-	-	3.31
Pot Cap-1 Maneuver	-	-	0	-	474
Stage 1	-	-	0	-	-
Stage 2	-	-	0	-	-
Platoon blocked, %	-	-	-	-	-
Mov Cap-1 Maneuver	-	-	-	-	474
Mov Cap-2 Maneuver	-	-	-	-	-
Stage 1	-	-	-	-	-
Stage 2	-	-	-	-	-

Approach	EB	WB	NB
HCM Control Delay, s	0	0	14
HCM LOS			B

Minor Lane/Major Mvmt	NBLn1	EBT	EBR	WBT
Capacity (veh/h)	474	-	-	-
HCM Lane V/C Ratio	0.153	-	-	-
HCM Control Delay (s)	14	-	-	-
HCM Lane LOS	B	-	-	-
HCM 95th %tile Q(veh)	0.5	-	-	-

Intersection						
Int Delay, s/veh	0.5					
Movement	EBT	EBR	WBL	WBT	NBL	NBR
Lane Configurations	↑↑↑	↑		↑↑↑		↑
Traffic Vol, veh/h	811	41	0	692	0	55
Future Vol, veh/h	811	41	0	692	0	55
Conflicting Peds, #/hr	0	0	0	0	0	0
Sign Control	Free	Free	Free	Free	Stop	Stop
RT Channelized	-	None	-	None	-	None
Storage Length	-	0	-	-	-	0
Veh in Median Storage, #	0	-	-	0	0	-
Grade, %	0	-	-	0	0	-
Peak Hour Factor	76	76	76	76	76	76
Heavy Vehicles, %	3	3	3	3	0	1
Mvmt Flow	1067	54	0	911	0	72

Major/Minor	Major1	Major2	Minor1		
Conflicting Flow All	0	0	-	-	534
Stage 1	-	-	-	-	-
Stage 2	-	-	-	-	-
Critical Hdwy	-	-	-	-	7.12
Critical Hdwy Stg 1	-	-	-	-	-
Critical Hdwy Stg 2	-	-	-	-	-
Follow-up Hdwy	-	-	-	-	3.91
Pot Cap-1 Maneuver	-	-	0	-	422
Stage 1	-	-	0	-	-
Stage 2	-	-	0	-	-
Platoon blocked, %	-	-	-	-	-
Mov Cap-1 Maneuver	-	-	-	-	422
Mov Cap-2 Maneuver	-	-	-	-	-
Stage 1	-	-	-	-	-
Stage 2	-	-	-	-	-

Approach	EB	WB	NB
HCM Control Delay, s	0	0	15.3
HCM LOS			C

Minor Lane/Major Mvmt	NBLn1	EBT	EBR	WBT
Capacity (veh/h)	422	-	-	-
HCM Lane V/C Ratio	0.171	-	-	-
HCM Control Delay (s)	15.3	-	-	-
HCM Lane LOS	C	-	-	-
HCM 95th %tile Q(veh)	0.6	-	-	-

**Figure 4C-101 (CA). Traffic Signal Warrants Worksheet (Sheet 1 of 5)**

COUNT DATE 8-18-21  
 CALC TNM DATE 9-2-21  
 CHK \_\_\_\_\_ DATE \_\_\_\_\_

DIST \_\_\_\_\_ CO \_\_\_\_\_ RTE \_\_\_\_\_ PM \_\_\_\_\_

Major St: BEAR VALLEY RD  
 Minor St: PLUTO DR

Critical Approach Speed 50 mph  
 Critical Approach Speed \_\_\_\_\_ mph

Speed limit or critical speed on major street traffic > 40 mph.....  or  } **RURAL (R)**  
 In built up area of isolated community of < 10,000 population.....  } **URBAN (U)**

**WARRANT 1 - Eight Hour Vehicular Volume** SATISFIED YES  NO  N/A   
 (Condition A or Condition B or combination of A and B must be satisfied)

**Condition A - Minimum Vehicle Volume** 100% SATISFIED YES  NO  N/A   
 80% SATISFIED YES  NO

APPROACH LANES	MINIMUM REQUIREMENTS (80% SHOWN IN BRACKETS)																		
	U		R		U		R												
	1				2 or More														
Both Approaches Major Street	500 (400)	350 (280)	600 (480)	420 (336)															
Highest Approach Minor Street	150 (120)	105 (84)	200 (160)	140 (112)															

**Condition B - Interruption of Continuous Traffic** 100% SATISFIED YES  NO  N/A   
 80% SATISFIED YES  NO

APPROACH LANES	MINIMUM REQUIREMENTS (80% SHOWN IN BRACKETS)																		
	U		R		U		R												
	1				2 or More														
Both Approaches Major Street	750 (600)	525 (420)	900 (720)	630 (504)															
Highest Approach Minor Street	75 (60)	53 (42)	100 (80)	70 (56)															

**Combination of Conditions A & B** SATISFIED YES  NO  N/A

REQUIREMENT	CONDITION	✓	FULFILLED
TWO CONDITIONS SATISFIED 80%	A. MINIMUM VEHICULAR VOLUME		Yes <input type="checkbox"/> No <input type="checkbox"/>
	AND, B. INTERRUPTION OF CONTINUOUS TRAFFIC		
AND, AN ADEQUATE TRIAL OF OTHER ALTERNATIVES THAT COULD CAUSE LESS DELAY AND INCONVENIENCE TO TRAFFIC HAS FAILED TO SOLVE THE TRAFFIC PROBLEMS			Yes <input type="checkbox"/> No <input type="checkbox"/>

The satisfaction of a traffic signal warrant or warrants shall not in itself require the installation of a traffic control signal.

**Figure 4C-101 (CA). Traffic Signal Warrants Worksheet (Sheet 2 of 5)**

**WARRANT 2 - Four Hour Vehicular Volume**

**SATISFIED\*** YES  NO  N/A

Record hourly vehicular volumes for any four hours of an average day.

APPROACH LANES			Hour		
	One	2 or More			
Both Approaches - Major Street					
Higher Approach - Minor Street					

*All plotted points fall above the applicable curve in Figure 4C-1. (URBAN AREAS)	Yes <input type="checkbox"/>	No <input type="checkbox"/>
<u>OR</u> , All plotted points fall above the applicable curve in Figure 4C-2. (RURAL AREAS)	Yes <input type="checkbox"/>	No <input type="checkbox"/>

**WARRANT 3 - Peak Hour  
 (Part A or Part B must be satisfied)**

**SATISFIED** YES  NO

**PART A**

**SATISFIED** YES  NO

(All parts 1, 2, and 3 below must be satisfied for the same one hour, for any four consecutive 15-minute periods)

1. The total delay experienced by traffic on one minor street approach (one direction only) controlled by a STOP sign equals or exceeds four vehicle-hours for a one-lane approach, or five vehicle-hours for a two-lane approach; <u>AND</u>	Yes <input type="checkbox"/>	No <input checked="" type="checkbox"/>
2. The volume on the same minor street approach (one direction only) equals or exceeds 100 vph for one moving lane of traffic or 150 vph for two moving lanes; <u>AND</u>	Yes <input type="checkbox"/>	No <input checked="" type="checkbox"/>
3. The total entering volume serviced during the hour equals or exceeds 800 vph for intersections with four or more approaches or 650 vph for intersections with three approaches.	Yes <input checked="" type="checkbox"/>	No <input type="checkbox"/>

**PART B**

**SATISFIED** YES  NO

APPROACH LANES			5-6 PM
	One	2 or More	Hour
Both Approaches - Major Street		X	1,304
Higher Approach - Minor Street	X		46

The plotted point falls above the applicable curve in Figure 4C-3. (URBAN AREAS)	Yes <input type="checkbox"/>	No <input type="checkbox"/>
<u>OR</u> , The plotted point falls above the applicable curve in Figure 4C-4. (RURAL AREAS)	Yes <input type="checkbox"/>	No <input checked="" type="checkbox"/>

The satisfaction of a traffic signal warrant or warrants shall not in itself require the installation of a traffic control signal.



**Figure 4C-101 (CA). Traffic Signal Warrants Worksheet (Sheet 3 of 5)**

**WARRANT 4 - Pedestrian Volume  
 (Parts 1 and 2 Must Be Satisfied)**

SATISFIED YES  NO

N/A

**Part 1 (Parts A or B must be satisfied)**

Hours -->

A.	Vehicles per hour for any 4 hours				
	Pedestrians per hour for any 4 hours				

Figure 4C-5 or Figure 4C-6  
 SATISFIED YES  NO

B.	Vehicles per hour for any 1 hour				
	Pedestrians per hour for any 1 hour				

Figure 4C-7 or Figure 4C-8  
 SATISFIED YES  NO

**Part 2**

SATISFIED YES  NO

<u>AND</u> , The distance to the nearest traffic signal along the major street is greater than 300 ft	Yes <input type="checkbox"/>	No <input type="checkbox"/>
<u>OR</u> , The proposed traffic signal will not restrict progressive traffic flow along the major street.	Yes <input type="checkbox"/>	No <input type="checkbox"/>

**WARRANT 5 - School Crossing  
 (Parts A and B Must Be Satisfied)**

SATISFIED YES  NO

N/A

**Part A**

Gap/Minutes and # of Children

SATISFIED YES  NO

Gaps vs Minutes	Minutes Children Using Crossing		Hour
	Number of Adequate Gaps		
School Age Pedestrians Crossing Street / hr			

Gaps < Minutes YES  NO

AND Children > 20/hr YES  NO

<u>AND</u> , Consideration has been given to less restrictive remedial measures.	Yes <input type="checkbox"/>	No <input type="checkbox"/>
--	------------------------------	-----------------------------

**Part B**

SATISFIED YES  NO

The distance to the nearest traffic signal along the major street is greater than 300 ft	Yes <input type="checkbox"/>	No <input type="checkbox"/>
<u>OR</u> , The proposed signal will not restrict the progressive movement of traffic.	Yes <input type="checkbox"/>	No <input type="checkbox"/>

The satisfaction of a traffic signal warrant or warrants shall not in itself require the installation of a traffic control signal.

**Figure 4C-101 (CA). Traffic Signal Warrants Worksheet (Sheet 4 of 5)**

**WARRANT 6 - Coordinated Signal System  
 (All Parts Must Be Satisfied)**

**SATISFIED YES  NO  N/A**

MINIMUM REQUIREMENTS	DISTANCE TO NEAREST SIGNAL	
≥ 1000 ft	N _____ ft, S _____ ft, E _____ ft, W _____ ft	Yes <input type="checkbox"/> No <input type="checkbox"/>
On a one-way street or a street that has traffic predominantly in one direction, the adjacent traffic control signals are so far apart that they do not provide the necessary degree of vehicular platooning.		Yes <input type="checkbox"/> No <input type="checkbox"/>
OR, On a two-way street, adjacent traffic control signals do not provide the necessary degree of platooning and the proposed and adjacent traffic control signals will collectively provide a progressive operation.		

**WARRANT 7 - Crash Experience Warrant  
 (All Parts Must Be Satisfied)**

**SATISFIED YES  NO**

Adequate trial of alternatives with satisfactory observance and enforcement has failed to reduce the crash frequency.		Yes <input type="checkbox"/> No <input checked="" type="checkbox"/>
REQUIREMENTS	Number of crashes reported within a 12 month period susceptible to correction by a traffic signal, and involving injury or damage exceeding the requirements for a reportable crash.	Yes <input type="checkbox"/> No <input checked="" type="checkbox"/>
5 OR MORE		
REQUIREMENTS	CONDITIONS	✓
ONE CONDITION SATISFIED 80%	Warrant 1, Condition A - Minimum Vehicular Volume	
	OR, Warrant 1, Condition B - Interruption of Continuous Traffic	Yes <input type="checkbox"/> No <input checked="" type="checkbox"/>
	OR, Warrant 4, Pedestrian Volume Condition Ped Vol ≥ 80% of Figure 4C-5 through Figure 4C-8	

**WARRANT 8 - Roadway Network  
 (All Parts Must Be Satisfied)**

**SATISFIED YES  NO  N/A**

MINIMUM VOLUME REQUIREMENTS	ENTERING VOLUMES - ALL APPROACHES	✓	FULFILLED
1000 Veh/Hr	During Typical Weekday Peak Hour _____ Veh/Hr and has 5-year projected traffic volumes that meet one or more of Warrants 1, 2, and 3 during an average weekday.		Yes <input type="checkbox"/> No <input type="checkbox"/>
	OR During Each of Any 5 Hrs. of a Sat. or Sun _____ Veh/Hr		
CHARACTERISTICS OF MAJOR ROUTES		MAJOR ROUTE A	MAJOR ROUTE B
Hwy. System Serving as Principal Network for Through Traffic			
Rural or Suburban Highway Outside Of, Entering, or Traversing a City			
Appears as Major Route on an Official Plan			
Any Major Route Characteristics Met, Both Streets		Yes <input type="checkbox"/> No <input type="checkbox"/>	

The satisfaction of a traffic signal warrant or warrants shall not in itself require the installation of a traffic control signal.

**Figure 4C-101 (CA). Traffic Signal Warrants Worksheet (Sheet 5 of 5)**

**WARRANT 9 - Intersection Near a Grade Crossing  
 (Both Parts A and B Must Be Satisfied)**

**SATISFIED YES  NO  N/A**

<p><b><u>PART A</u></b></p> <p>A grade crossing exists on an approach controlled by a STOP or YIELD sign and the center of the track nearest to the intersection is within 140 feet of the stop line or yield line on the approach. Track Center Line to Limit Line _____ ft</p>	<p>Yes <input type="checkbox"/> No <input type="checkbox"/></p>
<p><b><u>PART B</u></b></p> <p><b>There is one minor street approach lane at the track crossing</b> - During the highest traffic volume hour during which rail traffic uses the crossing, the plotted point falls above the applicable curve in Figure 4C-9.</p> <p>Major Street - Total of both approaches: _____ VPH                  Minor Street - Crosses the track (one direction only, approaching the intersection): _____ VPH X AF (Use Tables 4C-2, 3, &amp; 4 below to calculate AF) = _____ VPH</p>	<p>Yes <input type="checkbox"/> No <input type="checkbox"/></p>
<p><b><u>OR</u>, There are two or more minor street approach lanes at the track crossing</b> - During the highest traffic volume hour during which rail traffic uses the crossing, the plotted point falls above the applicable curve in Figure 4C-10.</p> <p>Major Street - Total of both approaches : _____ VPH                  Minor Street - Crosses the track (one direction only, approaching the intersection): _____ VPH X AF (Use Tables 4C-2, 3, &amp; 4 below to calculate AF) = _____ VPH</p>	<p>Yes <input type="checkbox"/> No <input type="checkbox"/></p>

The minor street approach volume may be multiplied by up to three following adjustment factors (AF) as described in Section 4C.10.

1- Number of Rail Traffic per Day \_\_\_\_\_ Adjustment factor from table 4C-2 \_\_\_\_\_

2- Percentage of High-Occupancy Buses on Minor Street Approach \_\_\_\_\_ Adjustment factor from table 4C-3 \_\_\_\_\_

3- Percentage of Tractor-Trailer Trucks on Minor Street Approach \_\_\_\_\_ Adjustment factor from table 4C-4 \_\_\_\_\_

NOTE: If no data is available or known, then use AF = 1 (no adjustment)

**Figure 4C-3. Warrant 3, Peak Hour**

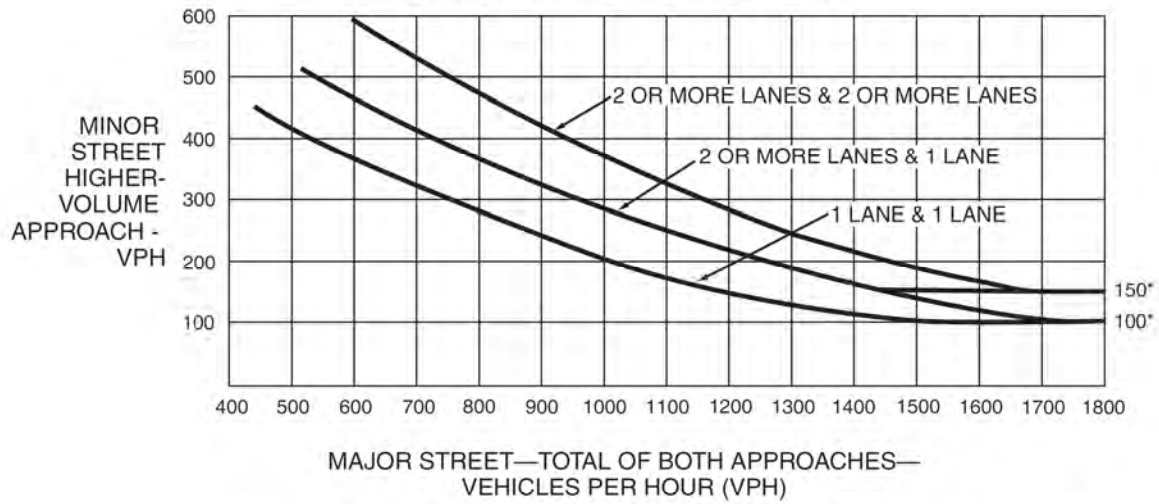

\*Note: 150 vph applies as the lower threshold volume for a minor-street approach with two or more lanes and 100 vph applies as the lower threshold volume for a minor-street approach with one lane.

**Figure 4C-4. Warrant 3, Peak Hour (70% Factor)**

(COMMUNITY LESS THAN 10,000 POPULATION OR ABOVE 40 MPH ON MAJOR STREET)

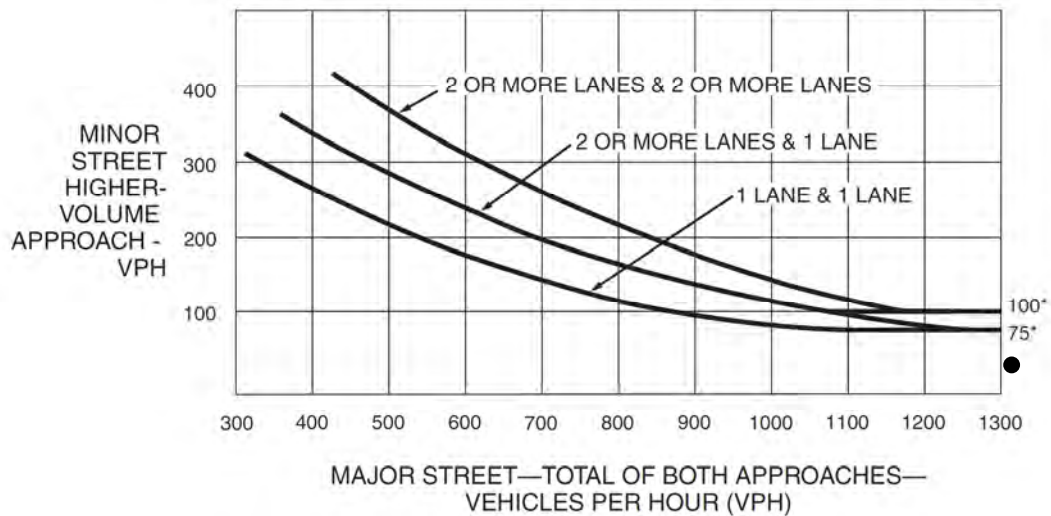

\*Note: 100 vph applies as the lower threshold volume for a minor-street approach with two or more lanes and 75 vph applies as the lower threshold volume for a minor-street approach with one lane.

**Figure 4C-101 (CA). Traffic Signal Warrants Worksheet (Sheet 2 of 5)**

**WARRANT 2 - Four Hour Vehicular Volume**

SATISFIED\* YES  NO  N/A

Record hourly vehicular volumes for any four hours of an average day.

APPROACH LANES			Hour		
	One	2 or More			
Both Approaches - Major Street					
Higher Approach - Minor Street					

*All plotted points fall above the applicable curve in Figure 4C-1. (URBAN AREAS)	Yes <input type="checkbox"/>	No <input type="checkbox"/>
<u>OR</u> , All plotted points fall above the applicable curve in Figure 4C-2. (RURAL AREAS)	Yes <input type="checkbox"/>	No <input type="checkbox"/>

**WARRANT 3 - Peak Hour  
 (Part A or Part B must be satisfied)**

SATISFIED YES  NO

**PART A**

SATISFIED YES  NO

(All parts 1, 2, and 3 below must be satisfied for the same one hour, for any four consecutive 15-minute periods)

1. The total delay experienced by traffic on one minor street approach (one direction only) controlled by a STOP sign equals or exceeds four vehicle-hours for a one-lane approach, or five vehicle-hours for a two-lane approach; <u>AND</u>	Yes <input type="checkbox"/>	No <input checked="" type="checkbox"/>
2. The volume on the same minor street approach (one direction only) equals or exceeds 100 vph for one moving lane of traffic or 150 vph for two moving lanes; <u>AND</u>	Yes <input type="checkbox"/>	No <input checked="" type="checkbox"/>
3. The total entering volume serviced during the hour equals or exceeds 800 vph for intersections with four or more approaches or 650 vph for intersections with three approaches.	Yes <input checked="" type="checkbox"/>	No <input type="checkbox"/>

**PART B**

SATISFIED YES  NO

APPROACH LANES			5-6 PM
	One	2 or More	Hour
Both Approaches - Major Street		X	1,420
Higher Approach - Minor Street	X		59

The plotted point falls above the applicable curve in Figure 4C-3. (URBAN AREAS)	Yes <input type="checkbox"/>	No <input type="checkbox"/>
<u>OR</u> , The plotted point falls above the applicable curve in Figure 4C-4. (RURAL AREAS)	Yes <input type="checkbox"/>	No <input checked="" type="checkbox"/>

The satisfaction of a traffic signal warrant or warrants shall not in itself require the installation of a traffic control signal.

**Figure 4C-3. Warrant 3, Peak Hour**

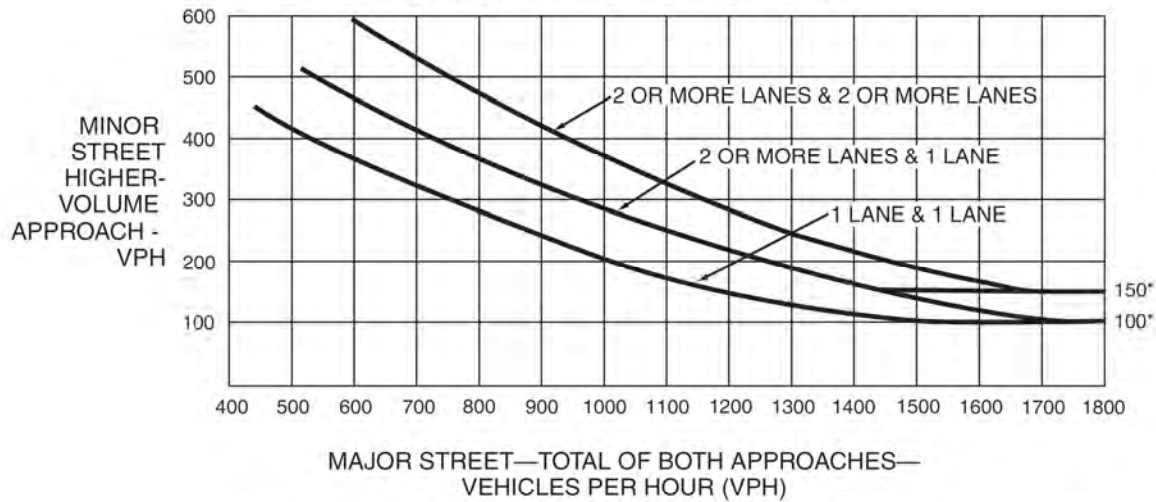

\*Note: 150 vph applies as the lower threshold volume for a minor-street approach with two or more lanes and 100 vph applies as the lower threshold volume for a minor-street approach with one lane.

**Figure 4C-4. Warrant 3, Peak Hour (70% Factor)**

(COMMUNITY LESS THAN 10,000 POPULATION OR ABOVE 40 MPH ON MAJOR STREET)

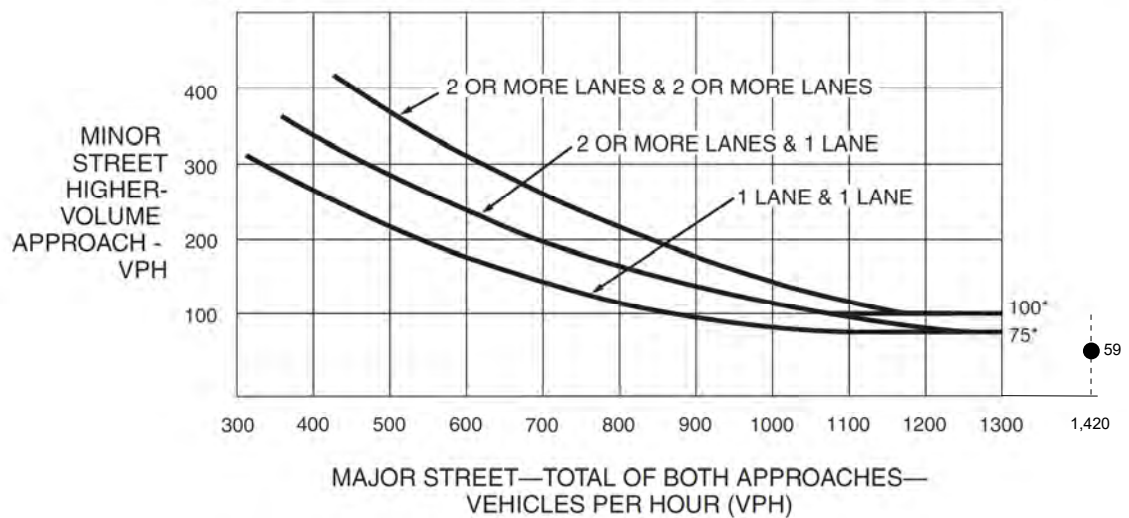

\*Note: 100 vph applies as the lower threshold volume for a minor-street approach with two or more lanes and 75 vph applies as the lower threshold volume for a minor-street approach with one lane.

Figure 4C-101 (CA). Traffic Signal Warrants Worksheet (Sheet 2 of 5)

**WARRANT 2 - Four Hour Vehicular Volume**

SATISFIED\* YES  NO  N/A

Record hourly vehicular volumes for any four hours of an average day.

APPROACH LANES			Hour			
	One	2 or More				
Both Approaches - Major Street						
Higher Approach - Minor Street						

*All plotted points fall above the applicable curve in Figure 4C-1. (URBAN AREAS)	Yes <input type="checkbox"/>	No <input type="checkbox"/>
<u>OR</u> , All plotted points fall above the applicable curve in Figure 4C-2. (RURAL AREAS)	Yes <input type="checkbox"/>	No <input type="checkbox"/>

**WARRANT 3 - Peak Hour  
 (Part A or Part B must be satisfied)**

SATISFIED YES  NO

**PART A**

SATISFIED YES  NO

(All parts 1, 2, and 3 below must be satisfied for the same one hour, for any four consecutive 15-minute periods)

1. The total delay experienced by traffic on one minor street approach (one direction only) controlled by a STOP sign equals or exceeds four vehicle-hours for a one-lane approach, or five vehicle-hours for a two-lane approach; <u>AND</u>	Yes <input type="checkbox"/>	No <input checked="" type="checkbox"/>
2. The volume on the same minor street approach (one direction only) equals or exceeds 100 vph for one moving lane of traffic or 150 vph for two moving lanes; <u>AND</u>	Yes <input type="checkbox"/>	No <input checked="" type="checkbox"/>
3. The total entering volume serviced during the hour equals or exceeds 800 vph for intersections with four or more approaches or 650 vph for intersections with three approaches.	Yes <input checked="" type="checkbox"/>	No <input type="checkbox"/>

**PART B**

SATISFIED YES  NO

APPROACH LANES			5-6 PM
	One	2 or More	Hour
Both Approaches - Major Street		X	1,395
Higher Approach - Minor Street	X		50

The plotted point falls above the applicable curve in Figure 4C-3. (URBAN AREAS)	Yes <input type="checkbox"/>	No <input type="checkbox"/>
<u>OR</u> , The plotted point falls above the applicable curve in Figure 4C-4. (RURAL AREAS)	Yes <input checked="" type="checkbox"/>	No <input type="checkbox"/>

The satisfaction of a traffic signal warrant or warrants shall not in itself require the installation of a traffic control signal.

**Figure 4C-3. Warrant 3, Peak Hour**

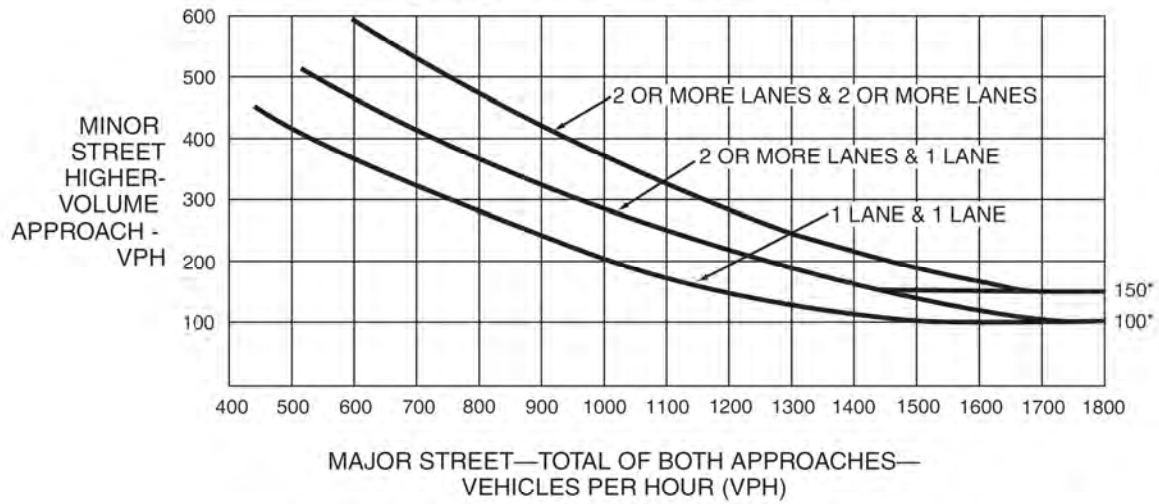

\*Note: 150 vph applies as the lower threshold volume for a minor-street approach with two or more lanes and 100 vph applies as the lower threshold volume for a minor-street approach with one lane.

**Figure 4C-4. Warrant 3, Peak Hour (70% Factor)**

(COMMUNITY LESS THAN 10,000 POPULATION OR ABOVE 40 MPH ON MAJOR STREET)

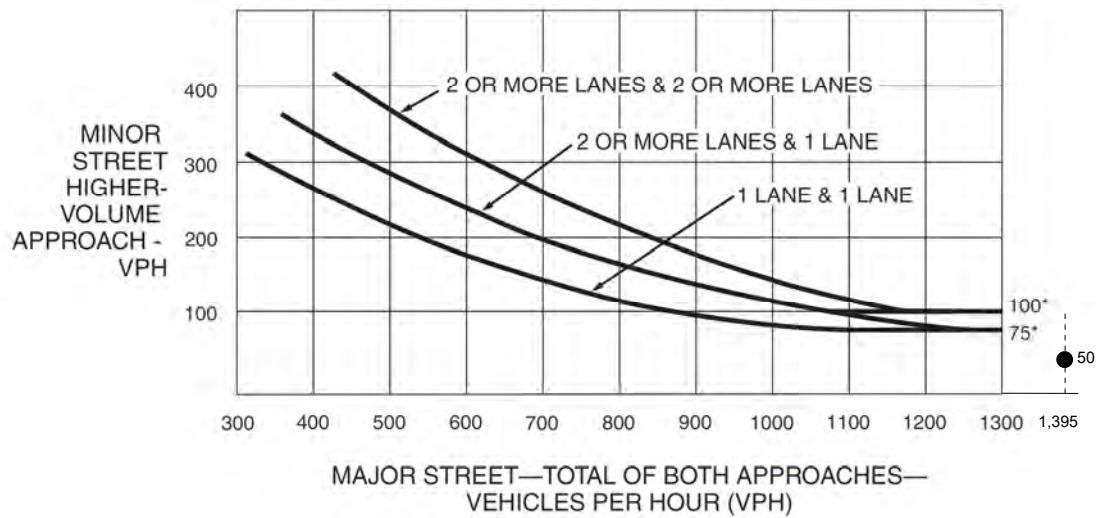

\*Note: 100 vph applies as the lower threshold volume for a minor-street approach with two or more lanes and 75 vph applies as the lower threshold volume for a minor-street approach with one lane.



**Figure 4C-101 (CA). Traffic Signal Warrants Worksheet (Sheet 2 of 5)**

**WARRANT 2 - Four Hour Vehicular Volume**

**SATISFIED\*** YES  NO  N/A

Record hourly vehicular volumes for any four hours of an average day.

APPROACH LANES			Hour		
	One	2 or More			
Both Approaches - Major Street					
Higher Approach - Minor Street					

*All plotted points fall above the applicable curve in Figure 4C-1. (URBAN AREAS)	Yes <input type="checkbox"/>	No <input type="checkbox"/>
<u>OR</u> , All plotted points fall above the applicable curve in Figure 4C-2. (RURAL AREAS)	Yes <input type="checkbox"/>	No <input type="checkbox"/>

**WARRANT 3 - Peak Hour  
 (Part A or Part B must be satisfied)**

**SATISFIED** YES  NO

**PART A**

**SATISFIED** YES  NO

(All parts 1, 2, and 3 below must be satisfied for the same one hour, for any four consecutive 15-minute periods)

1. The total delay experienced by traffic on one minor street approach (one direction only) controlled by a STOP sign equals or exceeds four vehicle-hours for a one-lane approach, or five vehicle-hours for a two-lane approach; <u>AND</u>	Yes <input type="checkbox"/>	No <input checked="" type="checkbox"/>
2. The volume on the same minor street approach (one direction only) equals or exceeds 100 vph for one moving lane of traffic or 150 vph for two moving lanes; <u>AND</u>	Yes <input type="checkbox"/>	No <input checked="" type="checkbox"/>
3. The total entering volume serviced during the hour equals or exceeds 800 vph for intersections with four or more approaches or 650 vph for intersections with three approaches.	Yes <input checked="" type="checkbox"/>	No <input type="checkbox"/>

**PART B**

**SATISFIED** YES  NO

APPROACH LANES			5-6 PM
	One	2 or More	Hour
Both Approaches - Major Street		X	1,511
Higher Approach - Minor Street	X		63

The plotted point falls above the applicable curve in Figure 4C-3. (URBAN AREAS)	Yes <input type="checkbox"/>	No <input type="checkbox"/>
<u>OR</u> , The plotted point falls above the applicable curve in Figure 4C-4. (RURAL AREAS)	Yes <input type="checkbox"/>	No <input checked="" type="checkbox"/>

The satisfaction of a traffic signal warrant or warrants shall not in itself require the installation of a traffic control signal.

**Figure 4C-3. Warrant 3, Peak Hour**

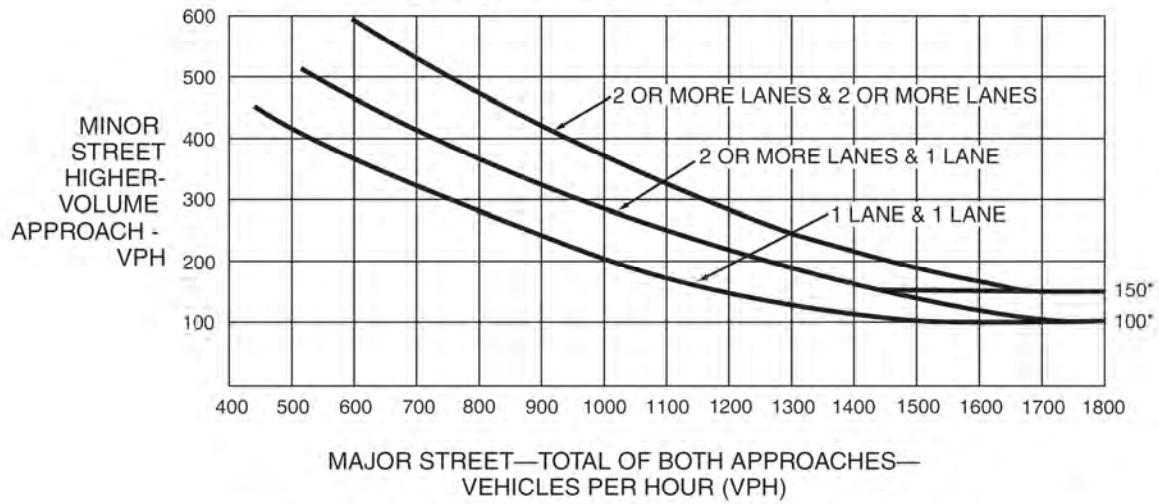

\*Note: 150 vph applies as the lower threshold volume for a minor-street approach with two or more lanes and 100 vph applies as the lower threshold volume for a minor-street approach with one lane.

**Figure 4C-4. Warrant 3, Peak Hour (70% Factor)**

(COMMUNITY LESS THAN 10,000 POPULATION OR ABOVE 40 MPH ON MAJOR STREET)

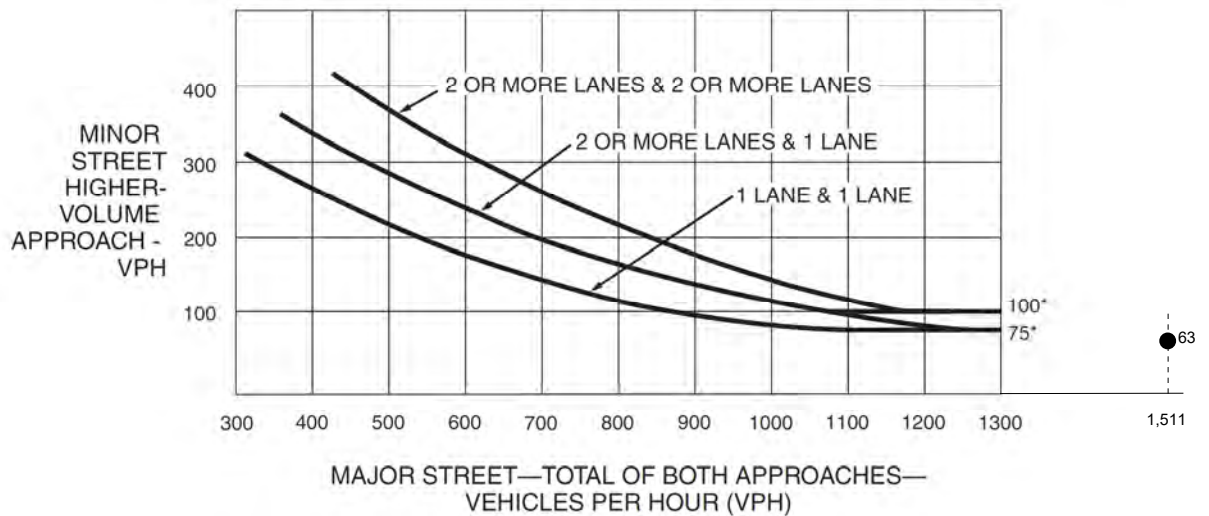

\*Note: 100 vph applies as the lower threshold volume for a minor-street approach with two or more lanes and 75 vph applies as the lower threshold volume for a minor-street approach with one lane.

**Figure 4C-101 (CA). Traffic Signal Warrants Worksheet (Sheet 2 of 5)**

**WARRANT 2 - Four Hour Vehicular Volume**

**SATISFIED\*** YES  NO  N/A

Record hourly vehicular volumes for any four hours of an average day.

APPROACH LANES			Hour		
	One	2 or More			
Both Approaches - Major Street					
Higher Approach - Minor Street					

*All plotted points fall above the applicable curve in Figure 4C-1. (URBAN AREAS)	Yes <input type="checkbox"/>	No <input type="checkbox"/>
<u>OR</u> , All plotted points fall above the applicable curve in Figure 4C-2. (RURAL AREAS)	Yes <input type="checkbox"/>	No <input type="checkbox"/>

**WARRANT 3 - Peak Hour  
 (Part A or Part B must be satisfied)**

**SATISFIED** YES  NO

**PART A**

**SATISFIED** YES  NO

(All parts 1, 2, and 3 below must be satisfied for the same one hour, for any four consecutive 15-minute periods)

1. The total delay experienced by traffic on one minor street approach (one direction only) controlled by a STOP sign equals or exceeds four vehicle-hours for a one-lane approach, or five vehicle-hours for a two-lane approach; <u>AND</u>	Yes <input type="checkbox"/>	No <input checked="" type="checkbox"/>
2. The volume on the same minor street approach (one direction only) equals or exceeds 100 vph for one moving lane of traffic or 150 vph for two moving lanes; <u>AND</u>	Yes <input type="checkbox"/>	No <input checked="" type="checkbox"/>
3. The total entering volume serviced during the hour equals or exceeds 800 vph for intersections with four or more approaches or 650 vph for intersections with three approaches.	Yes <input checked="" type="checkbox"/>	No <input type="checkbox"/>

**PART B**

**SATISFIED** YES  NO

APPROACH LANES			5-6 PM
	One	2 or More	Hour
Both Approaches - Major Street		X	1,426
Higher Approach - Minor Street	X		51

The plotted point falls above the applicable curve in Figure 4C-3. (URBAN AREAS)	Yes <input type="checkbox"/>	No <input type="checkbox"/>
<u>OR</u> , The plotted point falls above the applicable curve in Figure 4C-4. (RURAL AREAS)	Yes <input type="checkbox"/>	No <input checked="" type="checkbox"/>

The satisfaction of a traffic signal warrant or warrants shall not in itself require the installation of a traffic control signal.

**Figure 4C-3. Warrant 3, Peak Hour**

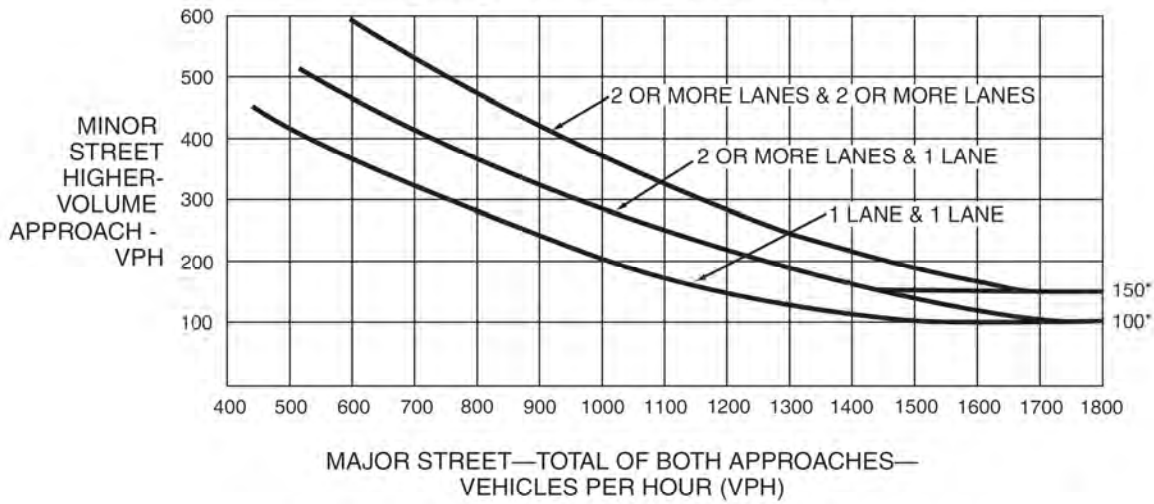

\*Note: 150 vph applies as the lower threshold volume for a minor-street approach with two or more lanes and 100 vph applies as the lower threshold volume for a minor-street approach with one lane.

**Figure 4C-4. Warrant 3, Peak Hour (70% Factor)**

(COMMUNITY LESS THAN 10,000 POPULATION OR ABOVE 40 MPH ON MAJOR STREET)

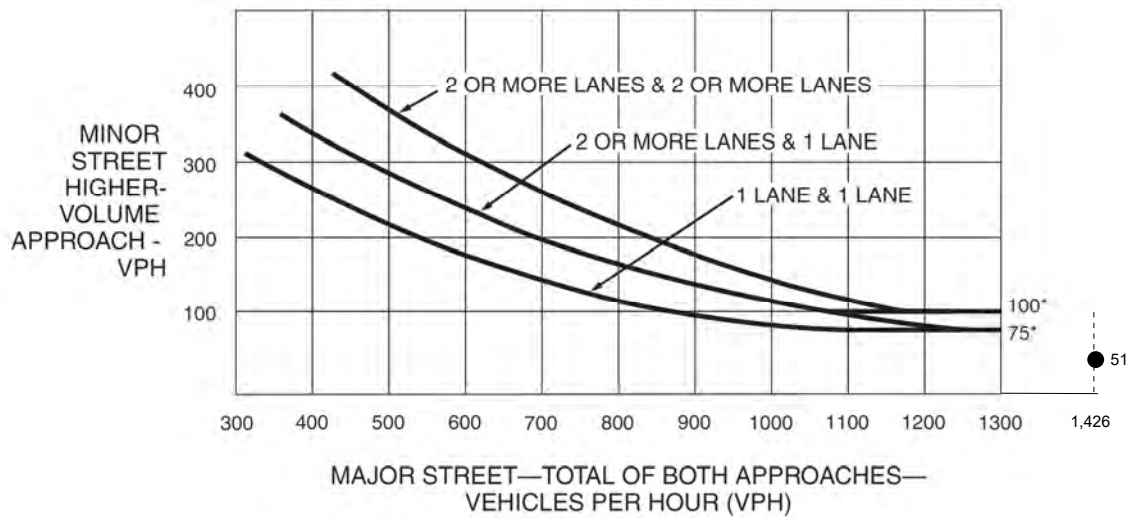

\*Note: 100 vph applies as the lower threshold volume for a minor-street approach with two or more lanes and 75 vph applies as the lower threshold volume for a minor-street approach with one lane.

**Figure 4C-101 (CA). Traffic Signal Warrants Worksheet (Sheet 2 of 5)**

**WARRANT 2 - Four Hour Vehicular Volume**

**SATISFIED\*** YES  NO  N/A

Record hourly vehicular volumes for any four hours of an average day.

APPROACH LANES			Hour			
	One	2 or More				
Both Approaches - Major Street						
Higher Approach - Minor Street						

*All plotted points fall above the applicable curve in Figure 4C-1. (URBAN AREAS)	Yes <input type="checkbox"/>	No <input type="checkbox"/>
<u>OR</u> , All plotted points fall above the applicable curve in Figure 4C-2. (RURAL AREAS)	Yes <input type="checkbox"/>	No <input type="checkbox"/>

**WARRANT 3 - Peak Hour  
 (Part A or Part B must be satisfied)**

**SATISFIED** YES  NO

**PART A**

**SATISFIED** YES  NO

(All parts 1, 2, and 3 below must be satisfied for the same one hour, for any four consecutive 15-minute periods)

1. The total delay experienced by traffic on one minor street approach (one direction only) controlled by a STOP sign equals or exceeds four vehicle-hours for a one-lane approach, or five vehicle-hours for a two-lane approach; <u>AND</u>	Yes <input checked="" type="checkbox"/>	No <input type="checkbox"/>
2. The volume on the same minor street approach (one direction only) equals or exceeds 100 vph for one moving lane of traffic or 150 vph for two moving lanes; <u>AND</u>	Yes <input type="checkbox"/>	No <input checked="" type="checkbox"/>
3. The total entering volume serviced during the hour equals or exceeds 800 vph for intersections with four or more approaches or 650 vph for intersections with three approaches.	Yes <input checked="" type="checkbox"/>	No <input type="checkbox"/>

**PART B**

**SATISFIED** YES  NO

APPROACH LANES			5-6 PM
	One	2 or More	Hour
Both Approaches - Major Street		X	1,542
Higher Approach - Minor Street	X		64

The plotted point falls above the applicable curve in Figure 4C-3. (URBAN AREAS)	Yes <input type="checkbox"/>	No <input type="checkbox"/>
<u>OR</u> , The plotted point falls above the applicable curve in Figure 4C-4. (RURAL AREAS)	Yes <input type="checkbox"/>	No <input checked="" type="checkbox"/>

The satisfaction of a traffic signal warrant or warrants shall not in itself require the installation of a traffic control signal.

**Figure 4C-3. Warrant 3, Peak Hour**

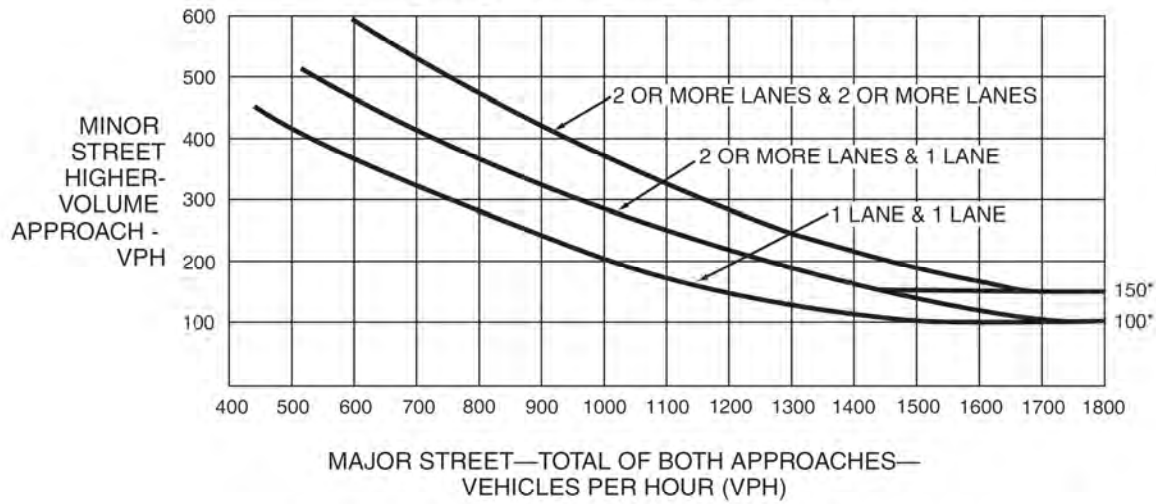

\*Note: 150 vph applies as the lower threshold volume for a minor-street approach with two or more lanes and 100 vph applies as the lower threshold volume for a minor-street approach with one lane.

**Figure 4C-4. Warrant 3, Peak Hour (70% Factor)**

(COMMUNITY LESS THAN 10,000 POPULATION OR ABOVE 40 MPH ON MAJOR STREET)

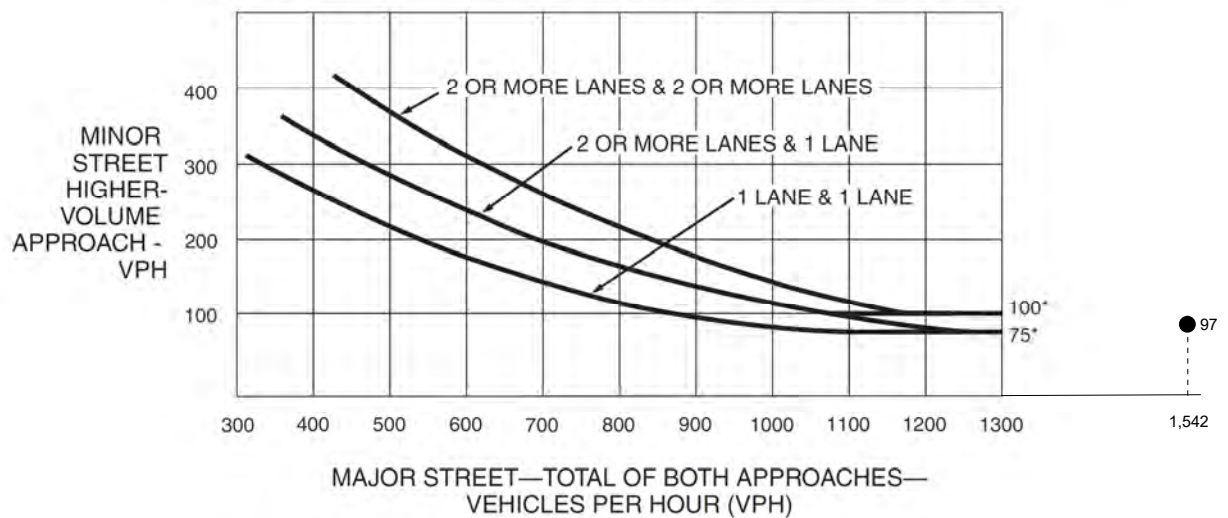

\*Note: 100 vph applies as the lower threshold volume for a minor-street approach with two or more lanes and 75 vph applies as the lower threshold volume for a minor-street approach with one lane.