

**Appendix C-1**  
**Recommendations Memo, Chattel Historic Preservation Consultants**

---





Chattel, Inc. | Historic Preservation Consultants

## MEMORANDUM

**DATE** November 15, 2021

**TO** Marcella Marlowe, Ph.D., City Manager  
Michael, Throne, PE, Parks and Public Works Director, City Engineer  
City of San Marino

**CC** Travis McGill, Director  
Julie Gilbert, Project Manager  
ELMT Consulting

**FROM** Robert Chattel, AIA, President  
Sydney Andrea Landers, Associate I  
Chattel, Inc. | Historic Preservation Consultants

**RE** San Marino Center (San Marino Women's Club)  
1800 Huntington Drive, San Marino, California  
Recommendations Memorandum

This memorandum describes existing conditions and provides recommendations for the City of San Marino (City) proposed exterior and interior work to the San Marino Center (San Marino Women's Club), 1800 Huntington Drive in San Marino, California (subject property or building) to ensure conformance with the *Secretary of the Interior's Standards for the Treatment of Historic Properties (Secretary's Standards)*. The subject property (Assessor Parcel No. 5334-024-903) is a one-story stucco-clad community building constructed in 1952 as the San Marino Women's Club designed by architect Marion J. Varner in the Ranch style.<sup>1</sup> The building is composed of a large auditorium, dining room, meeting room and office. Constructed as the San Marino Women's Club<sup>2</sup>, The building has been determined eligible for the National Register of Historic Places (National Register) and the California Register for Historic Places (California Register) for being the first community meeting center in San Marino.

The subject property was officially determined eligible for listing in the National Register of Historic Places (National Register) in a 2011 report prepared by San Buenaventura Research Associates for the City. It was subsequently surveyed in the 2020 Citywide Historic Resources Survey Report (Citywide survey) prepared by Architectural Resources Group that identified the subject property as an individual property determined eligible for the National Register by a consensus through Section 106 process. The subject property is thus listed in the California Register and is designated as a San

---

<sup>1</sup> The subject property was variously described in survey and in the determination of National Register eligibility as Modern Colonial Revival style but is more appropriately described as Ranch style.

<sup>2</sup> The building has been interchangeably referred to as the San Marino Women's or Woman's Club in existing documentation. For purposes of consistency, we have selected to refer to it as the San Marino Women's Club as that is how it is listed in the original 1951 building permit.

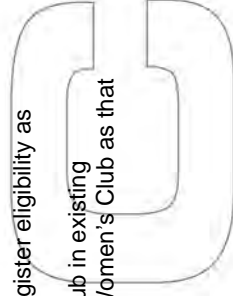

Marino Historic Landmark.<sup>3</sup> The subject property is significant for social history under National Register/California Register criterion A/1.



**Figure 1:** Architectural Rendering of the San Marino Women's Club (Pasadena Museum of History, 1951)

Designed as an early community building, its architectural expression imparts a residential character consistent the Ranch style that was at the height of its popularity. At the time of its design and construction, it was located in a residential zone and received a zoning variance. Characteristic features of the Ranch style include a low sloping, front facing cross gable roof clad in wood shake shingles, painted stucco, square steel porch columns with ornamental ironwork supporting the recessed porch, steel sash casement windows and Late Moderne style features such as the rectangular grid pattern on the high-volume auditorium exterior walls and bevel frames at some windows.

By 1958, two additions were made to the subject property. The east addition is a 100 square foot storage space that infilled a portion of the east elevation porch and the west addition is a 110 square foot office space that infilled the west elevation porch. Alterations include the raised windowsill at the large east elevation dining room window, sheet metal awnings added to the west elevation, an exit door added to the dining room at the south elevation, replacement of the entry door leaves, removal of a raised planter and extension of paved walkways at the north elevation. Consistent with previous evaluations, these are minor alterations, and the subject property retains integrity.

Proposed work plans to mesh the designs of the subject property with the adjacent Crowell Public Library (library), a building influenced by the Spanish-Mediterranean style, featuring characteristic elements of the style such as a terracotta tile roof, arches above windows and doors, stucco exterior and trellises. The project plans aim to rehabilitate and alter the subject property in a manner that would ensure the subject property and library read as one cohesive unit despite being on separate parcels and from different periods. The subject property, when compared to the adjacent library, appears dated and needs investment and repositioning to improve its functionality and use. The proposed work plans currently include replacing steel sash windows with insulated glazed aluminum frame windows, removing reveals and adding new stucco, adding new arches at the primary north elevation entry at the south elevation, adding wall and shade canopies, replacing the planter at the north elevation, replacing the square steel porch columns with ornamental ironwork for round stucco columns, replacing the wood shake roof with Mission or Spanish terracotta tile. The proposed work plans do not conform with the *Secretary's Standards for the Treatment of Historic Properties (Secretary's Standards)*.

---

<sup>3</sup> The San Marino Historic Preservation Ordinance (23.18.03.A) includes Automatic Designation as a local City landmark when a property is listed in the National Register or California Register.

To identify potential design alternatives that would be consistent with the Secretary's Standard's, Chattel, Inc. (Chattel) President Robert Chattel, AIA, and Associate I Sydney Andrea Landers conducted a site visit on October 20, 2021 with ELMT Project Manager Julie Gilbert and City Engineer Michael Throne. This memorandum summarizes Chattel's observations during the site visit, and provides recommendations based on limited historic image research (Attachment A), permit research (Attachment C), review of proposed site plan drawings drawn by Crane Architectural Group dated November 2020 (Attachment D), previous historic evaluation review (Attachment F), and discussion with the City Engineer. Attachment B includes contemporary photographs and Attachment F includes exterior elevations denoting where alterations have occurred.

## **Existing Conditions**

The subject property consists of a generally one-story building of rectangular massing, with two additions one in the front and one in the rear both dating to 1958. The front addition is to the east of the projecting wing and the rear addition is to the east of the auditorium. The front elevation takes on residential massing and features an L-shaped porch that wraps around the north elevation. The north elevation (primary façade) faces Huntington Drive (Huntington) (Images 1-6, 24-29), the east elevation directly abuts the adjacent building (library) (Images 7-14), the south elevation faces a surface parking lot shared by the library (Images 15-19) and the west elevation faces a surface parking lot (Images 20-23).

### *North Elevation (Façade)*

The north elevation (façade) is comprised of an L-shaped porch that wraps around the north and west elevations, an office addition on the west end of the porch and a projecting wing on the east end. The roof of the north elevation is front facing and cross gabled with wood shake shingles. The roof overhangs over the L-shaped porch as well as the east projecting wing. The office addition is approximately 100 sq ft and partially infilled the west end of the porch in 1958. The east projecting wing features a central 6x3 steel casement window surrounded by a painted wooden bevel frame. Intersecting the cross gabled roof is the auditorium's high volume stucco wall with a flat roof. The porch is lined by square steel porch columns with ornamental ironwork. The north facing side of the porch is lined with hedges. The double door entry is recessed into the inner corner of the porch. To the east of the recessed entry door are two metal double doors central with the walkway. To the west of the recessed entry is a 4x3 steel casement window. Original pavement along the north elevation is denoted by original red paint. This original pavement wraps the building's exterior walls and is mostly covered by a roof overhang. This elevation faces Huntington Drive and is highly visible from the public right of way.

### *East Elevation*

The east elevation is comprised of the east addition on the north end and a central north-facing porch entry to the dining hall. The east addition has one window facing north with metal bars and an aluminum frame. Adjacent to it, on the original building envelope, is a steel casement window with a wooden frame painted white. The roofline extends past the addition to create a covered porch with half of the original brick chimney exposed. The pavement underneath the roof overhang is original. Going south, the front addition has one wooden door with a window that faces east. Past this are two 3 panel steel sash windows underneath another roof overhang porch entry.

This entry faces north and consists of a large 4x4 wooden casement window framed by two narrow wooden doors with three windows and transoms. These doors are barely wider than the 28-inch variance permitted through the California Historic Building Code (CHBC).

Along the east elevation's south end, is a large three by six panel steel casement windows. This window is half of its original height, evident by markings on the stucco that extend from the window to the ground level. Chattel was informed that the bottom half of the window was filled in at an unknown date (likely soon after construction) due to drainage and flooding issues with having the window be at ground level. The roofline above this window is a false gable parapet over a flat roof. The rest of the east elevation's envelope is painted stucco and minimally detailed. This elevation is less visible from the public right of way as it directly faces the library.

*South Elevation*

The south elevation features two 2x4 pane steel sash windows that are central and evenly spaced in the dining hall. On the east end, there is an exit door and metal rail for the center's handicap entrance that was added in 1956. The roofline remains flat with an elevated parapet on the west end to cover mechanical equipment. The 1958 rear addition is half of the height of the high-volume auditorium is nestled in the L-shaped plan of the auditorium rear and dining hall. The rear of the auditorium features two exit doors: one at ground level and one at level with the auditorium with a concrete staircase and metal railing lining the side of the building. The rear of the auditorium remains unpainted and minimally altered. This elevation is not visible from the public right of way.

*West Elevation*

The west elevation is primarily composed of the flat roof high volume auditorium and a side gabled porch entry on the north end. Near the roofline, the exterior is adorned in a rectangular grid pattern on stucco, similar to the Late Moderne. The south end of the west elevation contains two narrow wooden sash windows covered by black metal bars. Below these windows is a chain link fence, a third of the building's height, that covers access to mechanical equipment. To the north of this fence is an elevator door entry with a concrete staircase and metal railing leading up to the building. The metal handrail was added in 1956. The central portion of the west elevation consists of three evenly spaced steel casement windows 6x6 pane steel sash windows that are covered by corrugated metal awnings with scalloped ends. The awnings have been painted white and feature similar ornamental ironwork as the square steel porch columns. The north end of the west elevation features a side gable wing that contains an office and the front porch of the subject property. This projecting gable includes two windows with metal awnings that face west and south respectively. The top of the gable includes a metal vent that has been painted to match the rest of the exterior envelope. At the north end, a three-step concrete staircase leads to the front porch and is covered by a green fabric awning that lists "San Marino Women's Center" in faded lettering. The porch is lined by a minimalistic metal baluster and railing. Much of the west elevation is obscured and lined by vegetation and trees on the property. This elevation is visible from the public right of way.

The table below summarizes major construction phases and additions identified in existing building permit records provided by the City of San Marino.

<b>Date</b>	<b>Permit Type/ Number</b>	<b>Architect/ Contractor</b>	<b>Value</b>	<b>Description</b>	<b>Notes</b>
06/08/1951	Building Permit 7772	Architect: Marion J. Varner	\$90,000	New construction of Women's Club	Zoning variance for use in residential neighborhood
08/28/1956	Building Permit 10522	Architect: Marion J. Varner	\$500	Alterations: Exit door in SE corner of dining room, exit	All on secondary, rear elevation

				lights, metal hand rail for stoop on rear west side	
07/30/1958	Building Permit 11468	Contractor: Norwood & Delong	\$5,000	Storage and office additions	Two additions infilling existing porch east and west, respectively
02/23/1960	Building Permit 15558	Contractor: Norwood & Delong	\$3500	New kitchenette and half bath	No structural changes

### Character-Defining Features

The subject property retains the following character-defining features of Ranch and Late Moderne styles:

- One-story rectangular massing with front facing and cross gable roofs;
- Stucco with rectangular grid reveals at parapet;
- Multi-light steel sash windows, wood grid windows, some with wood bevel frames;
- Square steel porch columns with ornamental ironwork; and,
- Fenestration pattern of windows and doors at north (primary), east, south (rear), and west elevations.

### Recommendations

The subject property lacks some aesthetic appeal of its original design due to two additions that infilled the primary north elevation porch on both the east and west, which altered its original massing, removal of the front planter, deterioration of the exterior stucco, and weathered wood shakes. Restoring the original footprint by removing both porch additions and rehabilitating character defining features would significantly enhance the aesthetic appeal of the building.

The goal of the revised design should be first and foremost to restore and rehabilitate the subject property's character defining features while allowing for subtle changes in massing, color, and landscaping to visually connect it with the library. Visual elements of the Spanish-Mediterranean style library can be integrated into the building by subtle changes to roof color and material, exterior paint color, hardscape, and landscaping to improve compatibility with the library.

We recommend referencing *Preservation Brief 22: The Preservation and Repair of Historic Stucco* and *Preservation Brief 13: The Repair and Thermal Upgrading of Historic Steel Windows* for any future rehabilitation work on these features.

To ensure that any revised design conforms with the *Secretary's Standards*, the design architect should work with a qualified historic preservation consultant through design collaboration.<sup>4</sup>

---

<sup>4</sup> A qualified historic preservation consultant must meet the *Secretary of the Interior's Professional Qualification Standards in architecture, historic architecture, or architectural history*.

Specifically, our recommendations are as follows and additional reference materials are provided in Attachment G:

At the north elevation:

- Retain and rehabilitate character-defining features to greatest extent feasible.
- Retain wood shake roof or replace with compatible replacement such as red asphalt shingle or flat terracotta tile.
- Patch, repair and repaint stucco, as necessary. Stucco can be painted to be compatible with the library.
- Retain and rehabilitate square steel porch columns and ornamental ironwork, repaint as necessary. Columns and ornamental ironwork can be painted brown to be compatible with trim of the library.
- Rehabilitate and repair steel sash windows, as necessary.
- Retain and rehabilitate original paving, as necessary.
- Restore original planter at north elevation, match vegetation with library.
- Remove two porch additions (east storage addition and west office addition). Ensure that brick chimney is not damaged in removal of east storage addition. Chemically remove overpaint on brick.
- Detail wall and shade canopy to not touch existing building ensuring reversibility, and revise wall and shade canopy design to be subordinate to existing building. Provide only minimal metal infill at existing porch to enclose courtyard.
- Replace existing primary north entry door leaves to match existing.

At the east elevation:

- Retain and rehabilitate character-defining features to greatest extent feasible.
- Patch, repair and repaint stucco, as necessary. Stucco can be painted to be compatible with the adjacent library.
- Rehabilitate and repair steel sash and wood grid windows, as necessary.
- Remove porch addition (east storage addition). Ensure that brick chimney is not damaged in removal of east storage addition. Chemically remove overpaint on brick. Restore steel sash doors that were removed to provide access into addition.

At the south elevation:

- Retain and rehabilitate character-defining features to greatest extent feasible.
- Patch, repair and repaint stucco, as necessary. Stucco can be painted to be compatible with the adjacent library.
- Rehabilitate and repair steel sash and wood grid windows, as necessary.
- Detail wall and shade canopy to not touch existing building ensuring reversibility. Simplify design of the screen wall and trellis to eliminate round arches and detail to be self-supporting and not attached to the existing building.

At the west elevation:

- Retain and rehabilitate character-defining features to greatest extent feasible.
- Patch, repair and repaint stucco, as necessary. Stucco can be painted to be compatible with the adjacent library.
- Rehabilitate and repair sheet metal window awnings, repaint as necessary.
- Rehabilitate and repair steel sash windows, as necessary.



- Remove porch addition (west office addition). Restore missing square steel porch columns with ornamental ironwork.

### **Attachments**

Attachment A: Historic Images  
Attachment B: Contemporary Images  
Attachment C: Original Permits  
Attachment D: Site Plan, Proposed Plans  
Attachment E: Exterior Elevations, Alterations denoted  
Attachment F: Previous Historic Evaluation  
Attachment G: Replacement Tile Examples

ATTACHMENT A:  
HISTORIC IMAGES  
SAN MARINO CENTER (SAN MARINO WOMEN'S CLUB)

**1800 HUNTINGTON DRIVE  
SAN MARINO, CALIFORNIA**

THIS PAGE INTENTIONALLY LEFT BLANK.

**1800 HUNTINGTON DRIVE, SAN MARINO, CALIFORNIA**  
ATTACHMENT A: HISTORIC IMAGES



**Image 1:** Architectural Rendering of San Marino Women's Club (1950) (Pasadena Museum of History)



**Image 2:** San Marino Women's Club, 1952. (1952) (University of Southern California Digital Collections)

**1800 HUNTINGTON DRIVE, SAN MARINO, CALIFORNIA**  
ATTACHMENT A: HISTORIC IMAGES



**Image 3:** San Marino Women's Club, 1952 (1952) (University of Southern California Digital Collections)

ATTACHMENT B:  
CONTEMPORARY IMAGES  
SAN MARINO CENTER (SAN MARINO WOMEN'S CLUB)

**1800 HUNTINGTON DRIVE  
SAN MARINO, CALIFORNIA**

THIS PAGE INTENTIONALLY LEFT BLANK.

**1800 HUNTINGTON DRIVE, SAN MARINO, CALIFORNIA**  
**ATTACHMENT B: CONTEMPORARY IMAGES**



**Image 1:** San Marino Center, north elevation (left) and west elevation (right), view southeast (Chattel, 2021)



**Image 2:** San Marino Center, north elevation, view southeast (Chattel, 2021)



**1800 HUNTINGTON DRIVE, SAN MARINO, CALIFORNIA**  
**ATTACHMENT B: CONTEMPORARY IMAGES**



**Image 3:** Entrance to the San Marino Center, north elevation, view south (Chattel, 2021)



**Image 4:** San Marino Center, north elevation, view south (Chattel, 2021)

**1800 HUNTINGTON DRIVE, SAN MARINO, CALIFORNIA**  
**ATTACHMENT B: CONTEMPORARY IMAGES**



**Image 5:** San Marino Center, north elevation, note steel sash windows with wooden bevel frame, view south (Chattel, 2021)



**Image 6:** San Marino Center, east elevation (left) and north elevation (right), view southwest (Chattel, 2021)

**1800 HUNTINGTON DRIVE, SAN MARINO, CALIFORNIA**  
ATTACHMENT B: CONTEMPORARY IMAGES



**Image 7:** San Marino Center, east elevation (far left) and north elevation (center), note brick chimney bisected by east storage addition and ornamental ironwork (Chattel, 2021)

**THIS SPACE INTENTIONALLY LEFT BLANK.**

**1800 HUNTINGTON DRIVE, SAN MARINO, CALIFORNIA**  
**ATTACHMENT B: CONTEMPORARY IMAGES**



**Image 8:** San Marino Center, north elevation (left) and east elevation (right), note recessed porch with original paving painted red, view west (Chattel, 2021)



**Image 9:** Detail of recessed porch on east elevation, note steel sash windows and original wooden doors, view west (Chattel, 2021)

**1800 HUNTINGTON DRIVE, SAN MARINO, CALIFORNIA**  
**ATTACHMENT B: CONTEMPORARY IMAGES**



**Image 10:** San Marino Center, east elevation, view southwest (Chattel, 2021)



**Image 11:** Detail of steel sash window on east elevation, note the tear in stucco where window originally extended to ground level and infilled at a unknown date, view southwest (Chattel, 2021)

**1800 HUNTINGTON DRIVE, SAN MARINO, CALIFORNIA**  
ATTACHMENT B: CONTEMPORARY IMAGES



**Image 12:** San Marino Center, south elevation (left) and east elevation (right), view northwest (Chattel, 2021)



**Image 13:** Detail of steel sash window on the south elevation, view north (Chattel, 2021)

**1800 HUNTINGTON DRIVE, SAN MARINO, CALIFORNIA**  
**ATTACHMENT B: CONTEMPORARY IMAGES**



**Image 14:** San Marino Center, south elevation, view northwest (Chattel, 2021)



**Image 15:** San Marino Center, south elevation, view north (Chattel, 2021)

**1800 HUNTINGTON DRIVE, SAN MARINO, CALIFORNIA**  
**ATTACHMENT B: CONTEMPORARY IMAGES**



**Image 16:** San Marino Center, south elevation, view north (Chattel, 2021)



**Image 17:** San Marino Center, west elevation, view northeast (Chattel, 2021)



**1800 HUNTINGTON DRIVE, SAN MARINO, CALIFORNIA**  
**ATTACHMENT B: CONTEMPORARY IMAGES**



**Image 18:** San Marino Center, west elevation, view east (Chattel, 2021)



**Image 19:** San Marino Center, west elevation, view east (Chattel, 2021)

**1800 HUNTINGTON DRIVE, SAN MARINO, CALIFORNIA**  
**ATTACHMENT B: CONTEMPORARY IMAGES**



**Image 20:** San Marino Center, west elevation, view east (Chattel, 2021)



**Image 21:** San Marino Center, north elevation, view southeast, note entry porch (Chattel, 2021)

**1800 HUNTINGTON DRIVE, SAN MARINO, CALIFORNIA**  
**ATTACHMENT B: CONTEMPORARY IMAGES**



**Image 22:** Detail of door and window of west office addition, north elevation, view south (Chattel, 2021)



**Image 23:** Detail of steel sash windows on west elevation, view southeast (Chattel, 2021)

**1800 HUNTINGTON DRIVE, SAN MARINO, CALIFORNIA**  
**ATTACHMENT B: CONTEMPORARY IMAGES**



**Image 24:** San Marino Center, north elevation, note entry double doors, view southeast (Chattel, 2021)



**Image 25:** Detail of cornerstone, north elevation, view east (Chattel, 2021)

**1800 HUNTINGTON DRIVE, SAN MARINO, CALIFORNIA**  
**ATTACHMENT B: CONTEMPORARY IMAGES**



**Image 26:** View of entry double doors from interior, view northeast (Chattel, 2021)



**Image 27:** View of interior lobby, view west



**Image 28:** Detail of commemorative tiles for the San Marino Women's Club (Chattel, 2021)

THIS SPACE INTENTIONALLY LEFT BLANK.

**1800 HUNTINGTON DRIVE, SAN MARINO, CALIFORNIA**  
**ATTACHMENT B: CONTEMPORARY IMAGES**



**Image 29:** View of auditorium, view southwest (Chattel, 2021)



**Image 30:** View of auditorium, view northeast (Chattel, 2021)

**1800 HUNTINGTON DRIVE, SAN MARINO, CALIFORNIA**  
**ATTACHMENT B: CONTEMPORARY IMAGES**



**Image 31:** View of adjoining dining hall, view northeast (Chattel, 2021)



**Image 32:** View of dining hall, view east (Chattel, 2021)





**Image 33:** View of dining hall, view south (Chattel, 2021)

**THIS SPACE INTENTIONALLY LEFT BLANK.**

**1800 HUNTINGTON DRIVE, SAN MARINO, CALIFORNIA**  
**ATTACHMENT B: CONTEMPORARY IMAGES**



**Image 34:** View of meeting room, view northeast (Chattel, 2021)



**Image 35:** View of meeting room, view southwest (Chattel, 2021)

ATTACHMENT C:  
ORIGINAL PERMITS  
SAN MARINO CENTER (SAN MARINO WOMEN'S CLUB)

**1800 HUNTINGTON DRIVE  
SAN MARINO, CALIFORNIA**

Permit No. 7772

Date Issued June 8, 1951

Application must be filled out by Applicant with ink or indelible pencil. Plans and specifications and other data must also be filed.

OFFICE OF BUILDING INSPECTOR
SAN MARINO, CALIF.

APPLICATION FOR BUILDING PERMIT

Application is hereby made for a permit to construct the building hereafter described at the point hereinafter specified.

Date Dec 14, 1950

PHONE 5/6816

(Sign here)

M J Warner Architect (Applicant)

- 1. Building to be erected on Lot No. 425 Block Porton Tract 425 Zone Porton
2. No. 100 HUNTINGTON DR. Street. Purpose of Building Commercial
3. Entire cost of proposed building \$90,000.00
4. Owner San Marino Womens Club Address 100 HUNTINGTON DRIVE
5. Architect MARION WARNER Address 35 W. Raymond Ave. Pasadena
6. Contractor NOT DECIDED KEMP BROS Address James Kemp or Clyde
7. Size of lot 132' x 200' Size of building 120' x 131'
8. Type of Architecture
9. Number of rooms 10 Will building be erected on front or rear of lot Rear
10. NUMBER OF STORIES IN HEIGHT 1 Height to highest point of roof 20'-6"
11. Height of first floor joist above curb level, or sur 18"
12. Character of ground; rock, clay, sand, filled, etc.
13. Of what material will FOUNDATION and cellar walls be built? CONCRETE
14. GIVE depth of FOUNDATION below surface of ground 18" minimum
15. GIVE dimensions of FOUNDATION and cellar wall FOOTINGS 10" x 24"
16. GIVE width of FOUNDATION and cellar walls at top
17. NUMBER and kind of chimneys 1 - BRICK Number of flues 1 FC
18. Number of inlets to each flue 1 Interior size of flues 9" min
19. Of what material will upper walls be constructed? WOOD & PLASTER
20. Are there any buildings within 30 feet of the proposed structure? No

Pleasant 1107



The figures on this chart show your set-back lines. There must be a clear air space of at least twenty-four inches

21. GIVE THICKNESS OF EXTERIOR WALLS:

Basement..... X ..... 5th story.....  
 1st story..... 7" MIN ..... 5th story.....  
 2nd story..... ..... 7th story.....  
 3rd story..... ..... 8th story.....  
 4th story..... ..... Fire Wall.....

22. GIVE MATERIAL, SIZE AND DISTANCE ON CENTERS OF FLOOR JOISTS:

1st story—material.....; Size..... x.....; distance on centers.....  
 2nd " " .....; " ..... x.....; " " " .....  
 3rd " " .....; " ..... x.....; " " " .....  
 4th " " .....; " ..... x.....; " " " .....  
 5th " " .....; " ..... x.....; " " " .....  
 6th " " .....; " ..... x.....; " " " .....  
 7th " " .....; " ..... x.....; " " " .....  
 8th " " .....; " ..... x.....; " " " .....  
 Ceiling Joists.....; " ..... x.....; " " " .....  
 Roof Rafters.....; " ..... x.....; " " " .....

23. Will any wall be supported on iron or steel girders or columns? Yes
24. Specify material of beams, girders or columns. STEEL, WOOD, CONC
25. Specify material and construction of floors. CONC SLAB 3/4" 4" GRAVEL BASE
26. Specify material of partitions. WOOD PLASTER
27. Specify material of roofing. WOOD SHAKES & COMPO
28. Specify material of stairways. WOOD & CONC
29. Specify material of elevator shaft, other shafts and chutes.....
30. Specify material and construction of cornices. WOOD
31. Specify number of fire escapes, where placed. 10 - all sides
32. Specify means of access to the roof. SCUTTLE
33. Specify size of vent shafts to water closet compartments. 4" MIN
34. Specify how halls will be lighted and ventilated. WINDOWS
35. Will metal lath be used? Specify where. NECESSARY
36. Will freight elevators be inclosed or provided with doors and fusible links? No

REMARKS.....

Permit No. 10522

Date Issued 8-22-56

Application must be filled out by Applicant with ink or indelible pencil. Plans and specifications and other data must also be filed.

OFFICE OF BUILDING INSPECTOR  
SAN MARINO, CALIF.

APPLICATION FOR BUILDING PERMIT

Application is hereby made for a permit to construct the building hereafter described at the point hereinafter specified.

Date 8-23-56

Telephone Number: 5Y-68116 (Sign here) marion glarue  
(Applicant)

1. Building to be erected on Lot No. \_\_\_\_\_ Block \_\_\_\_\_ Tract \_\_\_\_\_ Zone \_\_\_\_\_
2. No. 1800 Huntington Street. Purpose of Building ALTERATIONS
3. Entire cost of proposed building ALT - ABOUT \$500<sup>00</sup>
4. Owner SAN MARINO W.O. CLUB Address 1800 HUNTINGTON DR.
5. Architect MARION J. VARNER Address 35 NO. RAYMOND-PASA.  
LLOYD KITCHEL
6. Contractor OWNER Address BY DAY LABOR
7. Size of lot \_\_\_\_\_ Size of building \_\_\_\_\_
8. Type of Architecture EXISTING.
9. Number of rooms \_\_\_\_\_ Will building be erected on front or rear of lot \_\_\_\_\_
10. NUMBER OF STORIES IN HEIGHT \_\_\_\_\_ Height to highest point of roof \_\_\_\_\_
11. Height of first floor joist above curb level, or sur \_\_\_\_\_
12. Character of ground; rock, clay, sand, filled, etc. \_\_\_\_\_
13. Of what material will FOUNDATION and cellar walls be built? \_\_\_\_\_
14. GIVE depth of FOUNDATION below surface of ground \_\_\_\_\_
15. GIVE dimensions of FOUNDATION and cellar wall FOOTINGS \_\_\_\_\_
16. GIVE width of FOUNDATION and cellar walls at top \_\_\_\_\_
17. NUMBER and kind of chimneys \_\_\_\_\_ Number of flues \_\_\_\_\_
18. Number of inlets to each flue \_\_\_\_\_ Interior size of flues \_\_\_\_\_
19. Of what material will upper walls be constructed? \_\_\_\_\_
20. Are there any buildings within 30 feet of the proposed structure? \_\_\_\_\_

The figures on this chart show your set-back lines.



Square Feet in House \_\_\_\_\_

Wait for  
check  
#2. 75

57  
11 71

Permit No. 11768

Date Issued 7-30-58

Application must be filled out by Applicant with ink or indelible pencil. Plans and specifications and other data must also be filed.

OFFICE OF BUILDING INSPECTOR  
SAN MARINO, CALIF.

APPLICATION FOR BUILDING PERMIT

Application is hereby made for a permit to construct the building hereafter described at the point hereinafter specified.

Date July 30, 1958

Telephone

Number: Sy 55929 (Sign here)

Forward & De Longe  
by John W. De Longe  
(Applicant)

1. Building to be erected on Lot No. \_\_\_\_\_ Block CP Tract \_\_\_\_\_ Zone \_\_\_\_\_
2. No. 1800 Huntington Dr Street. Purpose of Building recip office & storage building
3. Entire cost of proposed building San Marino \$ 5000.00
4. Owner San Marino Women Club Address 1800 Huntington Drive, S.M.
5. Architect \_\_\_\_\_ Address \_\_\_\_\_
6. Contractor Forward & De Longe Address 1441 San Marino Ave, San Marino
7. Size of lot \_\_\_\_\_ Size of building \_\_\_\_\_
8. Type of Architecture modern colonial
9. Number of rooms 2 Will building be erected on front or rear of lot one - front one - rear
10. NUMBER OF STORIES IN HEIGHT one Height to highest point of roof 15'
11. Height of first floor joist above curb level, or sur 12" approx
12. Character of ground; rock, clay, sand, filled, etc. Sandy loam
13. Of what material will FOUNDATION and cellar walls be built? concrete
14. GIVE depth of FOUNDATION below surface of ground 12"
15. GIVE dimensions of FOUNDATION and cellar wall FOOTINGS see plan
16. GIVE width of FOUNDATION and cellar walls at top \_\_\_\_\_
17. NUMBER and kind of chimneys none Number of flues -
18. Number of inlets to each flue - Interior size of flues -
19. Of what material will upper walls be constructed? D.F. studs & stucco
20. Are there any buildings within 30 feet of the proposed structure? no



The figures on this chart show your set-back lines.

Permit No. 12258

Date Issued 2-23-60

Application must be filled out by Applicant with ink or indelible pencil. Plans and specifications and other data must also be filed.

OFFICE OF BUILDING INSPECTOR  
SAN MARINO, CALIF.

APPLICATION FOR BUILDING PERMIT

Application is hereby made for a permit to construct the building hereafter described at the point hereinafter specified.

Date 2/23/60

Telephone Number: Sy 55929

State Licensing # 83689 JMP  
Norwood + DeLonge  
Jacques Norwood  
(Applicant)

1. Building to be erected on Lot No. ~~425~~ Block \_\_\_\_\_ Tract ~~777~~ Zone C-1
2. No. 1800 Huntington <sup>or</sup> Street. Purpose of Building San Marino Women's Club
3. Entire cost of proposed building 3500.00
4. Owner San Marino Women's Club Address 1800 Huntington or
5. Architect \_\_\_\_\_ Address \_\_\_\_\_
6. Contractor Norwood + De Longe Address 1441 San Marino Ave, San Marino
7. Size of lot \_\_\_\_\_ Size of building \_\_\_\_\_
8. Type of Architecture \_\_\_\_\_
9. Number of rooms \_\_\_\_\_ Will building be erected on front or rear of lot \_\_\_\_\_
10. NUMBER OF STORIES IN HEIGHT \_\_\_\_\_ Height to highest point of roof \_\_\_\_\_
11. Height of first floor joist above curb level, or sur \_\_\_\_\_
12. Character of ground; rock, clay, sand, filled, etc. \_\_\_\_\_
13. Of what material will FOUNDATION and cellar walls be built? \_\_\_\_\_
14. GIVE depth of FOUNDATION below surface of ground \_\_\_\_\_
15. GIVE dimensions of FOUNDATION and cellar wall FOOTINGS \_\_\_\_\_
16. GIVE width of FOUNDATION and cellar walls at top \_\_\_\_\_
17. NUMBER and kind of chimneys \_\_\_\_\_ Number of flues \_\_\_\_\_
18. Number of inlets to each flue \_\_\_\_\_ Interior size of flues \_\_\_\_\_
19. Of what material will upper walls be constructed? \_\_\_\_\_
20. Are there any buildings within 30 feet of the proposed structure? \_\_\_\_\_

*New kitchenette  
& 1/2 bath  
no structural changes.*

The figures on this chart show your set-back lines.

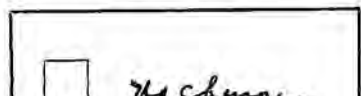



ATTACHMENT D:  
PROPOSED PLANS  
SAN MARINO CENTER (SAN MARINO WOMEN'S CLUB)

**1800 HUNTINGTON DRIVE  
SAN MARINO, CALIFORNIA**

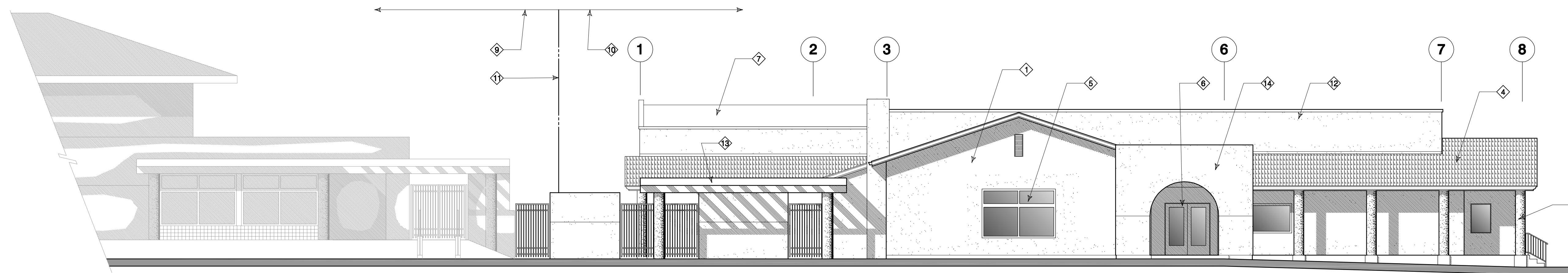

**NORTH ELEVATION**

SCALE 1/8"=1'-0"

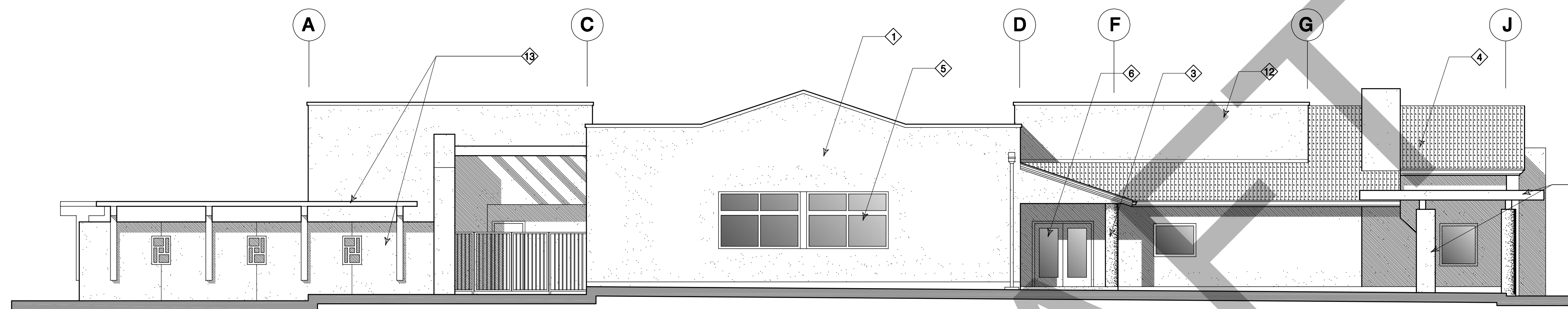

**EAST ELEVATION**

SCALE 1/8"=1'-0"

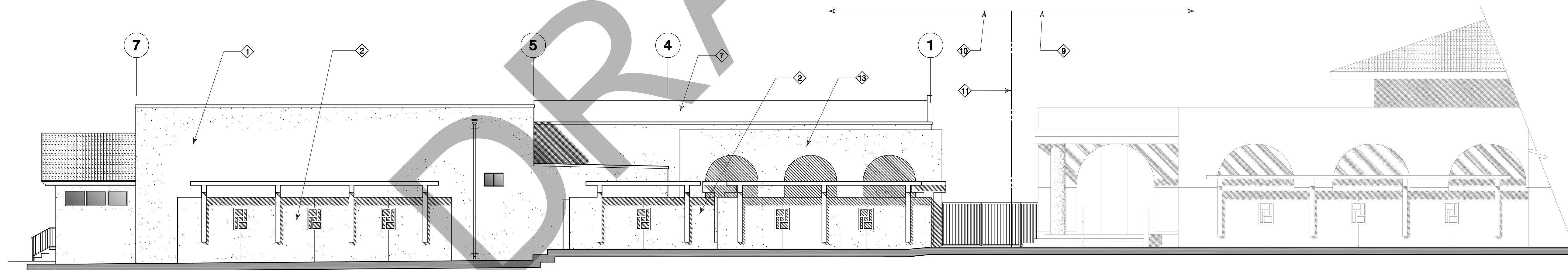

**SOUTH ELEVATION**

SCALE 1/8"=1'-0"

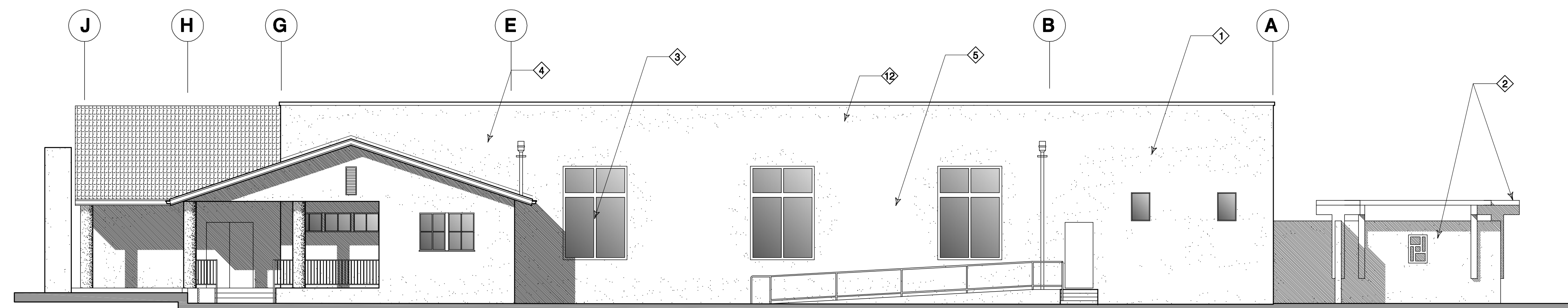

**WEST ELEVATION**

SCALE 1/8"=1'-0"

**ELEVATION KEYNOTES**

- ① NEW STUCCO FINISH COAT TO MATCH LIBRARY
- ② PROPOSED WALL AT NEW PATIO TO MATCH LIBRARY
- ③ REPLACE EXISTING COLUMNS WITH NEW TO MATCH LIBRARY
- ④ REPLACE ROOF TO MATCH LIBRARY (SPANISH TILE)
- ⑤ NEW DUAL GLAZED, ALUMINUM FRAME WINDOWS, TYP
- ⑥ NEW ALUMINUM FRAME STOREFRONT DOOR SYSTEM, TYP
- ⑦ SINGLE-PLY MEMBRANE ROOF
- ⑧ NOT USED
- ⑨ EXISTING LIBRARY
- ⑩ PROPOSED REMODEL TO COMMUNITY CENTER
- ⑪ PROPERTY LINE
- ⑫ REMOVE STUCCO REVEALS
- ⑬ PROPOSED WALL AND SHADE CANOPY TO MATCH LIBRARY
- ⑭ PROPOSED ARCHWAY TO MATCH LIBRARY

REVISIONS	BY

**CRANE ARCHITECTURAL GROUP**  
*Innovations in Architecture*  
 110 E. WILSHIRE AVE., SUITE 300, 714.955-0888  
 FULLERTON, CA 92632

**EXTERIOR ELEVATIONS**

PROJECT:  
 SAN MARINO CENTER  
 2200 HUNTINGTON DRIVE  
 SAN MARINO, CA 91108  
 CLIENT:  
 CITY OF SAN MARINO  
 2200 HUNTINGTON DRIVE  
 SAN MARINO, CA 91108

STAMP:

DRAWN  
**MTB**  
 CHECKED

DATE  
**11-10-20**

SCALE  
**AS NOTED**

JOB NO.  
**C19-103**

SHEET  
**A-2**

OF SHEETS

ATTACHMENT E:  
ORIGINAL ELEVATIONS WITH ALTERATIONS DENOTED  
SAN MARINO CENTER (SAN MARINO WOMEN'S CLUB)

**1800 HUNTINGTON DRIVE  
SAN MARINO, CALIFORNIA**

THIS PAGE INTENTIONALLY LEFT BLANK.



ATTACHMENT F:  
PREVIOUS HISTORIC EVALUATION  
SAN MARINO CENTER (SAN MARINO WOMEN'S CLUB)  
**1800 HUNTINGTON DRIVE**  
**SAN MARINO, CALIFORNIA**

**PRIMARY RECORD**

Primary  
HRI  
Trinomial  
NRHP Status Code 3S

Other Listing  
Review Code \_\_\_\_\_ Reviewer \_\_\_\_\_ Date \_\_\_\_\_

Page 1 of 3

Resource Name or #: (Assigned by recorder) San Marino Woman's Club

P1. Other Identifier:

P2. Location:  Not for Publication  Unrestricted a. County Los Angeles

and (P2b and P2c or P2d. Attach a Location Map as necessary.)

b. USGS 7.5' Quad El Monte Date 1966/81/94 ; R 1/4 of 1/4 of Sec B.M.

c. Address: 1800 Huntington Drive City San Marino Zip 91108

d. UTM: (Give more than one for large and/linear resources) ; mE/ mN

e. Other Locational Data (Enter Parcel #, legal description, directions to resource, elevation, etc., as appropriate)

APN 5334-024-903

P3. Description (Describe resource and its major elements. Include design, materials, condition, alterations, size, setting, and boundaries)

Located on Huntington Drive between the San Marino Library and the Henry E. Huntington School, the former San Marino Woman's Club building is a large primarily one story building with a flat roof and raised parapet along the rear and side elevations. The front elevation features a side-facing medium gable roof with an offset front gable wing. An l-shaped porch runs across the front elevation and is supported by decorative wrought iron posts. The roof is covered with wood shingles. A large multi-paned steel framed window is located below the main front gable. Underneath the window is brick trim. A tall exterior brick chimney is located on the northeast elevation. Windows are primarily multi-paned steel casements. Siding is stucco and foundation is concrete. The interior of the building when first built contained a large auditorium, dining room, meeting room and office.

P3b. Resource Attributes (List attributes and codes) HP13; HP38

P4. Resources Present  Building  Structure  Object  Site  District  Other (isolates, etc.)

P5a. Photograph or Drawing (Photograph required for buildings, structures, and objects)

P5b. Description of Photo: (View, date, accession #)  
front (northern) elevation, 13 July 2011



P6. Date Constructed/Age and Sources:  
 Prehistoric  Historic  Both  
1952-F - building permits

P7. Owner and Address  
City of San Marino  
2200 Huntington Drive  
San Marino, CA 91108

P8. Recorded by: (Name, affiliation and address)  
Judy Triem/San Buenaventura Research Assc.  
1328 Woodland Drive  
Santa Paula, CA 93060

P9. Date Recorded: 20 July 2011

P10. Survey Type: (Describe)  
Section 106 Review

P11. Report Citation: (Cite survey report and other sources, or enter "none")

Attachments  NONE  Continuation Sheet  District Record  Rock Art Record  Other (List)  
 Location Map  Building, Structure and Object Record  Linear Feature Record  Artifact Record  
 Sketch Map  Archaeological Record  Milling Station Record  Photograph Record

**BUILDING, STRUCTURE, AND OBJECT RECORD**

HRI #

Primary #

Page 2 of 3

NRHP Status Code

3S

Resource Name or #: (Assigned by recorder) San Marino Woman's Club

- B1. Historic Name: San Marino Woman's Club
- B2. Common Name: San Marino Community Center
- B3. Original Use: woman's club/community center
- B4. Present Use: community center
- B5. Architectural Style: Modern Colonial Revival
- B6. Construction History: (Construction date, alterations, and date of alterations)  
1952; two additions in 1958; separate modular building in rear, date unknown

B7. Moved?  No  Yes  Unknown Date: Original Location:

B8. Related Features:  
mature tree in front; parking area on side and rear

B9a. Architect: Marion J. Varner

b. Builder: unknown

B10. Significance: Theme Social history

Area: San Marino

Period of Significance: 1952 - 1958

Property Type: clubhouse

Applicable Criteria: A

(Discuss importance in terms of historical or architectural context as defined by theme, period and geographical scope. Also address integrity.)

The San Marino Woman's Club was organized in 1936 with 420 members and held its general meetings in the Henry E. Huntington School. In 1942 the club purchased the property at 1800 Huntington Drive for the purpose of building a much needed clubhouse for its growing membership. However, it was not until ten years later that the 15,720 square foot clubhouse was completed on the site.

When completed, the San Marino Woman's Club was the first meeting place to be built in the community. The building was constructed to serve the entire community, not just the Woman's Club, although they funded its construction. Members raised most of the funds to complete the clubhouse through bazaars, rummage sales, parties and various entertainment events over a ten year period. They also made an appeal to the public for funds.

Over the years, the club's charitable contributions have been numerous and include the endowment of a bed at the Orthopedic Hospital, nursing scholarships, Toys for Tots and others. They also provided help to the Assistance League, American Red Cross and the City of Hope. The building was made available to the community for meetings and events. After selling its building, the San Marino Woman's Club moved its organization to Pasadena in 2004. (cont'd.)

B11. Additional Resource Attributes (List attributes and codes) HP38

B12. References:

Balvin, Christie. "San Marino Woman's Club Creates \$1 Million Endowment with the Pasadena Community Foundation." Pasadena Community Foundation, May 25, 2007.

City of San Marino, building permits for San Marino Woman's Club, 6/8/1951, 7/30/1958. (Cont'd.)

B13. Remarks:

B14. Evaluator: San Buenaventura Research Associates

Date of Evaluation: 20 July 2011

(This space reserved for official comments.)

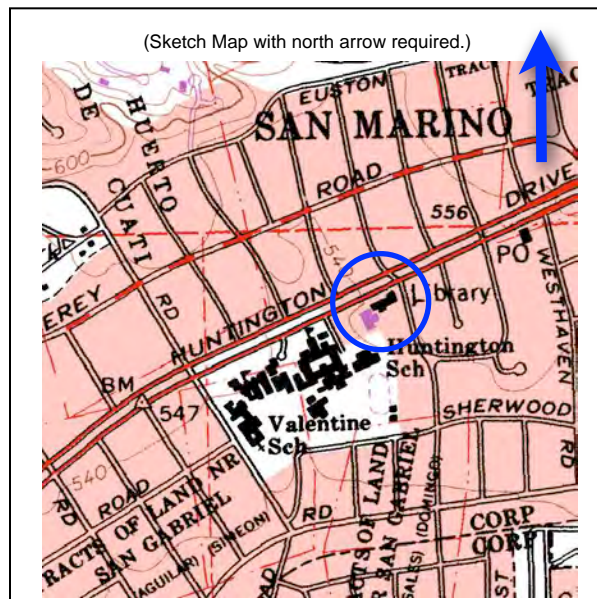



**CONTINUATION SHEET**

Primary #  
HRI #  
Trinomial

Page 3 of 3 Resource Name or #: (Assigned by recorder) San Marino Woman's Club

Recorded by: Judy Triem

Date 20 July 2011

Continuation  Update

B10. Significance

*Marion J. Varner, Architect*

Born February 8, 1912 in Kansas, Marion J. Varner moved to Pomona, California by 1920 with his parents Clarence and Mabel Varner and siblings. His father owned a plastering company. Marion lived with his family in 1930, and at age 18, was employed as a baker. Varner's educational background is unknown. The first known reference to his architecture career was in 1951 when the Los Angeles Times reported he designed 24 homes in the Anaheim Tract at the same time he was designing the San Marino Woman's Club. His office was located in Pasadena. Varner had a very prolific career designing primarily public buildings throughout Los Angeles County. Some of his major projects include Hawthorne Police Station, 1955; Torrance Fire Station, 1955; San Fernando Police Station, 1956; Compton Community Center, 1956; Gardena Medical Clinic, 1956; Glendora Hospital, 1956; El Segundo Fire Station, 1957; Hawthorne Fire Station, 1957; Downey Civic Center, 1958; San Gabriel Police Station, 1961; Gardena City Hall, police building and library, 1963 for which he received an award from the Society of American Registered Architects (SARA); Arcadia high-rise office, 1963; and Bell Gardens City Hall in 1966. Varner also won an award from SARA for his design for the Vernon City Hall and Police Station in 1975. In 1978 Varner joined W. Gayle Daniel and Samuel E. Hart of the SARA to design the first energy-effective case study house in Rancho California and the first to be sponsored by a chapter of a professional society. (Los Angeles Times, 1951-1978)

Varner was active professionally serving as president of the National Board of the Society of American Registered Architects and in 1968 he served as president of the local chapter. He died on April 10, 2005 in San Marino.

The San Marino Community Center, formerly the San Marino Woman's Club, is associated with an event (Criterion A) which is important to the history of the San Marino community. It apparently was the first community building constructed in San Marino and has served as a community focal point for many years while the club also pursued its charitable work. The building is not associated with any known individuals (Criterion B) important to the history of the San Marino community. The building does not embody the distinctive characteristics of a type, period or method of construction (Criterion C). The Woman's Club is an undistinguished example of the Modern Colonial style. It was designed by Pasadena architect Marion Varner and is one of his early designs. Varner was a prolific architect during the 1950s and 1960s designing numerous public buildings throughout Los Angeles County. Varner's work is not sufficiently documented to regard him as a Master architect. Criterion D refers to archaeology and is not addressed in this report.

*Integrity Discussion*

The property at 1800 Huntington Drive is in its original location. The original design of the 1952 building is primarily intact except for changes to the front entrance doors and two small additions in 1958 done in the same style. The historic setting of the property is partially intact. The relationship to the adjacent library and school remain. However, the original 1950 library was replaced with a new library building within the last few years. The integrity of materials is somewhat intact. The feeling and association as a woman's club is no longer intact since the building is now the San Marino Community Center, but it continues to function to serve the community. Overall, the integrity of the building appears sufficient for eligibility.

B12. References

*Los Angeles Times*, various articles, 1951 through 1978.

Los Angeles County Assessor's Property information

ATTACHMENT G:  
REPLACEMENT TILE EXAMPLES  
SAN MARINO CENTER (SAN MARINO WOMEN'S CLUB)  
**1800 HUNTINGTON DRIVE**  
**SAN MARINO, CALIFORNIA**

*Gladding, McBean*



PLACER INTERLOCKING CLAY ROOF TILE



*Presidio Blend*



*Monterey Blend*



*Spanish Bay Blend*

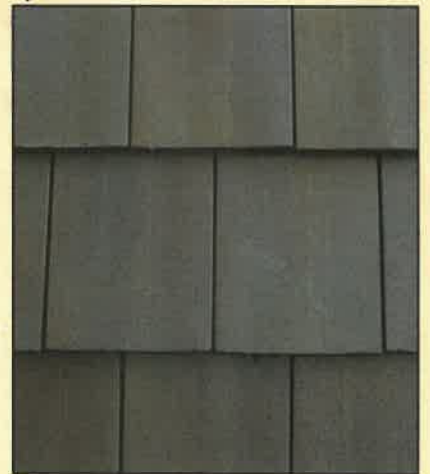

*Kiln-Run #8 Mix*



*Blended Red*



*Franciscan Blend*



# PLACER INTERLOCKING CLAY ROOF TILE

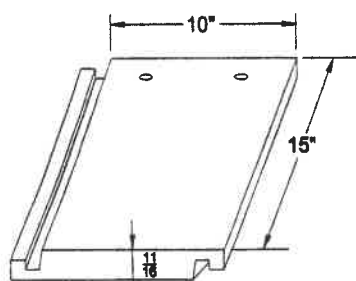

FIELD TILE

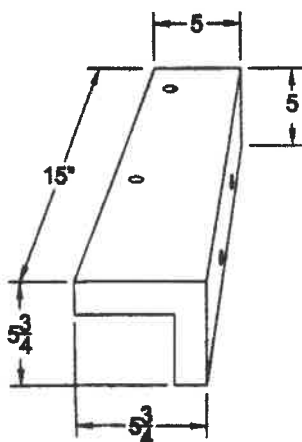

UNIVERSAL GABLE  
RAKE TILE

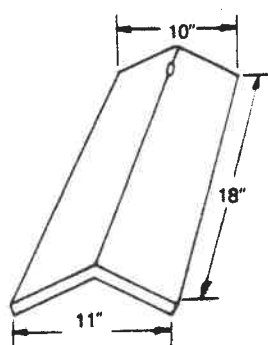

"V" RIDGE TILE

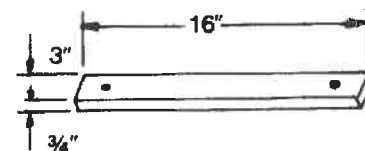

CLAY CANT STRIP

## "V" - TILE HIP & RIDGE

Angle	Roof Pitch
153 degrees	3/12
128 degrees	5.5/12
90 degrees	12/12

## SPECIFICATIONS

### A. MATERIALS

- There are 120 pieces of field tile per square weighing approximately 960 pounds.
- Roofing tile shall be Gladding, McBean Placer Interlocking Clay Tile 15" long to 10" wide, square butt and laid with an exposure of 12". Meeting requirements of ASTM C-1167, Grade 1.
- Under eave shall be (specify one):
  - Clay tile cant strip 3" x 16" x 3/4".
  - 1" x 2" wood cant strip.
- Hips and ridges shall be "V" type clay tile 18" long laid with an exposure of 14". (Specify pitch of roof.)
- Gable trim shall be a universal gable rake tile.
- Cement Mortar: The mortar used under the hip and ridge shall be Type M by proportions per U.B.C. Table 21A. This mix is basically (by volume) 1 part Type I cement (or masonry cement) to 3 parts damp plaster sand.

### B. COLOR shall be (specify one):

- Kiln-run #8 Mix
- Spanish Bay Blend
- Monterey Blend
- Blended Red
- Franciscan Blend

**C. UNDERLAY**—The underlayments described are very conventional and in accordance with many building code requirements including I.C.B.O. Uniform Building Code and the City of Los Angeles Building Code. Sweep roof surface broom clean. Cover knot holes with tin. Specify desired weight of underlay as follows:

#### For Pitches of less than 4/12:

- Lay two layers of 30# felt at right angles to roof surface, nail to secure in place as code requires. Mop solidly 25# per square between layers and on top of layers with hot asphalt.

#### For Pitches of 4/12 and greater:

- Lay one layer of 30# or 40# felt. Lay with 4" head lap and a 6" side lap. Nail to secure in place as code requires.

### D. TILE FASTENERS

- Tile shall be fastened by (specify one of the following):
- Nails—Noncorrosive. Sufficient length shall give 3/4" penetration. (Consult manufacturer of special roof deck materials for additional nailing specifications.)
  - Fasteners—To be installed per project specifications using applicable 300 series Stainless Steel or Galvanized Tyle Tye Systems, as manufactured by Newport Fasteners, per I.C.B.O. 3362 and provided by Gladding, McBean. Consult factory regarding applicable deck attachment and accessories.

### E. METHOD OF APPLICATION:

- Alternate rows shall be started at gable with half width field tile.
- All hip and ridge tile shall be set in cement mortar and fastened with noncorrosive nails. Refer to "Clay Roof Tile Specifications and Suggested Installation Details" showing desired construction of hips, ridges and gable rakes.
- All tile in contact with cement mortar shall be immersed in water for at least 2 minutes before laying to avoid drying out the mortar before setting and curing.

**Shade Blending:** After 75 to 100 tiles are installed, examine the application at a distance from ground level for straight, true lines and good color blend. This should be done at regular intervals during installation to insure an attractive and acceptable roof. Blending of shade is particularly important to avoid streaks or "hot spots." Acceptable blending cannot be done at the factory or on the ground, it can only be done as the tile is applied.

G110a 5,000 CP 05/12/04



**GLADDING, McBEAN**

a division of PABCO  
building products, LLC

601 7th Street / P.O. Box 97, Lincoln, CA 95648  
(800) 964-2529 Ext.204 (916) 645-3341 Ext.204  
Fax (916) 645-1723  
www.gladdingmcbean.com