



APPENDIX D

**TRAFFIC IMPACT STUDY - SAN MARINO IMPROVEMENT PROJECT,
FEBRUARY 23, 2022**

TRANSPORTATION IMPACT STUDY
SAN MARINO CENTER IMPROVEMENT PROJECT
City of San Marino, California
February 23, 2022

Prepared for:
ELMT Consulting
2201 N. Grand Avenue, #10098
Santa Ana, California 92711

LLG Ref. 1-20-4416-1



Prepared by:

Handwritten signature of Chin S. Tang in black ink.

Chin S. Tang, PTP, RSP1
Senior Transportation Planner

Under the Supervision of:

Handwritten signature of Clare M. Look-Jaeger in blue ink.

Clare M. Look-Jaeger, P.E.
Principal

**Linscott, Law &
Greenspan, Engineers**

600 S. Lake Avenue
Suite 500
Pasadena, CA 91106

626.796.2322 T
626.792.0941 F
www.llgengineers.com

TABLE OF CONTENTS

SECTION	PAGE
1.0 Introduction	1
1.1 Transportation Study Overview.....	1
1.2 Study Methodology	3
1.3 Los Angeles County Congestion Management Program Status.....	4
2.0 Project Description.....	5
2.1 Existing Project Site.....	5
2.2 Proposed Project Description	5
2.3 Project Site Access.....	5
2.3.1 Vehicular Site Access.....	5
2.3.2 Non-Vehicular Site Access	8
2.4 Existing Overall Site and Total Parking Supply	8
2.5 City Code Parking Requirements	11
2.6 Comparison of Industry Standard Parking Ratios.....	11
2.6.1 ITE Parking Demand Ratios	11
2.6.2 ULI Shared Parking Demand Concept and Analysis	12
2.7 Parking Management Strategies.....	14
2.8 Project Trip Generation and Distribution	17
2.8.1 Project Trip Generation.....	17
2.8.2 Weekday ITE Project Trip Generation Summary	18
2.8.3 Weekday Site-Specific Project Trip Generation Summary.....	18
2.8.4 Project Trip Distribution and Assignment	20
3.0 Project Site Context	25
3.1 Non-Vehicle Network.....	25
3.1.1 Pedestrian System	25
3.1.2 Bicycle System.....	25
3.2 Transit Network.....	26
3.3 Vehicle Network.....	26
3.3.1 Roadway Classifications	26
3.3.2 Regional Highway System.....	30
3.3.3 Roadway Descriptions	30
3.4 Traffic Count Data.....	30
3.5 Cumulative Development Projects.....	33
3.5.1 Related Projects.....	37
3.5.2 Ambient Traffic Growth Factor	37
4.0 CEQA Transportation Assessment.....	42
4.1 Vehicle Miles Traveled (VMT) Project Screening	42
4.1.1 Transit Priority Area Screening	42
4.1.2 Low VMT Area Screening.....	43
4.1.3 Project Type Screening	44
4.1.4 Summary of Screening Conclusions.....	44

TABLE OF CONTENTS *(continued)*

SECTION	PAGE
4.2 VMT Impact Conclusions	45
4.3 Active Transportation and Public Transit Analysis	45
4.3.1 Adopted Policies, Plans, or Programs	45
4.3.2 Qualitative Impact Conclusions	46
5.0 Non-CEQA Analysis	48
5.1 Analysis Methodology	48
5.2 Criteria for Non-CEQA Analysis	49
5.3 Analysis Scenarios	49
5.4 Existing Conditions	50
5.4.1 Existing Conditions	50
5.4.2 Existing With Project Conditions	50
5.5 Future Year 2024 Cumulative Conditions	50
5.5.1 Future Year 2024 Cumulative Without Project Conditions	50
5.5.2 Future Year 2024 Cumulative With Project Conditions	54
6.0 Summary and Conclusions	59

APPENDICES

APPENDIX
A. SMC Events/Programming Schedule Shared Parking Analysis Worksheets
B. Traffic, Pedestrian, and Bicycle Count Data
C. San Gabriel Valley COG Vehicle Miles Traveled Evaluation Tool Screening Worksheets
D. HCM and Levels of Service Explanation HCM Data Worksheets – Weekday AM and PM Peak Hours

TABLE OF CONTENTS *(continued)*

LIST OF FIGURES

SECTION—FIGURE #	PAGE
1-1 Vicinity Map	2
2-1 Aerial Photograph of Existing Project Site.....	6
2-2 Renovation Floor Plan	7
2-3 Existing On-Site Parking Supply	10
2-4 Project Trip Distribution – Weekday AM Peak Hour.....	21
2-5 Project Trip Distribution – Weekday PM Peak Hour.....	22
2-6 Project Traffic Volumes – Weekday AM Peak Hour.....	23
2-7 Project Traffic Volumes – Weekday PM Peak Hour	24
3-1 Existing and Proposed Bikeways.....	27
3-2 Existing Transit Routes.....	28
3-3 Existing Lane Configurations	31
3-4 Existing Traffic Volumes – Weekday AM Peak Hour	35
3-5 Existing Traffic Volumes – Weekday PM Peak Hour	36
3-6 Location of Related Projects.....	39
3-7 Related Projects Traffic Volumes – Weekday AM Peak Hour.....	40
3-8 Related Projects Traffic Volumes – Weekday PM Peak Hour	41
5-1 Existing With Project Traffic Volumes – Weekday AM Peak Hour.....	52
5-2 Existing With Project Traffic Volumes – Weekday PM Peak Hour.....	53
5-3 Future Without Project Traffic Volumes – Weekday AM Peak Hour.....	55
5-4 Future Without Project Traffic Volumes – Weekday PM Peak Hour	56
5-5 Future With Project Traffic Volumes – Weekday AM Peak Hour.....	57
5-6 Future With Project Traffic Volumes – Weekday PM Peak Hour.....	58

TABLE OF CONTENTS *(continued)*

LIST OF TABLES

SECTION—TABLE #	PAGE
2-1 Weekday Shared Parking Demand Analysis.....	15
2-2 Weekend Shared Parking Demand Analysis.....	16
2-3 Project Trip Generation Forecast.....	19
3-1 Existing Transit Routes.....	29
3-2 Existing Roadway Descriptions.....	32
3-3 Existing Traffic Volumes.....	34
3-4 Related Projects List and Trip Generation.....	38
5-1 Level of Service Criteria and Delay Characteristics.....	49
5-2 Summary of Delays and Levels of Service	51

TRANSPORTATION IMPACT STUDY
SAN MARINO CENTER IMPROVEMENT PROJECT
City of San Marino, California
February 23, 2022

1.0 INTRODUCTION

1.1 Transportation Study Overview

This transportation impact study has been conducted to identify and evaluate the potential transportation impacts of the proposed San Marino Center Improvement project (“proposed project”). The project site is located at 1800 Huntington Drive, along the south side of Huntington Drive, west of West Drive in the City of San Marino. The proposed project site is generally bounded by Huntington Drive to the north, the existing parking lot and tennis courts for Henry E. Huntington Middle School to the south and west, and the Crowell Public Library to the east. The project site and general vicinity are shown in *Figure 1-1*.

The transportation assessment follows the analysis methodology that is consistent with the *City of San Marino Citywide Traffic Circulation Study*¹. In compliance with the California Environmental Quality Act (CEQA) Sections 15064.3 and 15064.7, the City of San Marino has adopted Vehicle Miles Traveled (VMT) for the purpose of analyzing transportation impacts under CEQA. In addition, the City maintains vehicle Level of Service (LOS) standards for local transportation infrastructure. Therefore, the Guidelines identify both CEQA based analysis requirements and non-CEQA based analysis requirements for analyzing the potential transportation impacts of proposed development projects.

This study evaluates potential project-related VMT impacts pursuant to the screening criteria, analysis tools, and thresholds adopted and approved for use by the City of San Marino. The study also evaluates potential project-related effects on LOS at four (4) key intersections in the vicinity of the project site. The study intersections were determined in consultation with City of San Marino staff. The Highway Capacity Manual (HCM) method was used to determine LOS for the three (3) signalized intersections and one (1) unsignalized intersection.

This report (i) presents the proposed project’s existing transportation network context, (ii) presents existing traffic volumes, (iii) forecasts cumulative baseline conditions, (iv) forecasts project-generated traffic, (v) assesses the potential for project-related transportation impacts consistent with the CEQA compliant and non-CEQA compliant metrics set forth by the City of San Marino, and (vi) recommends transportation mitigation and/or improvement measures, where necessary.

¹ *City of San Marino Citywide Traffic Circulation Study*, prepared by Iteris, March 11, 2021.

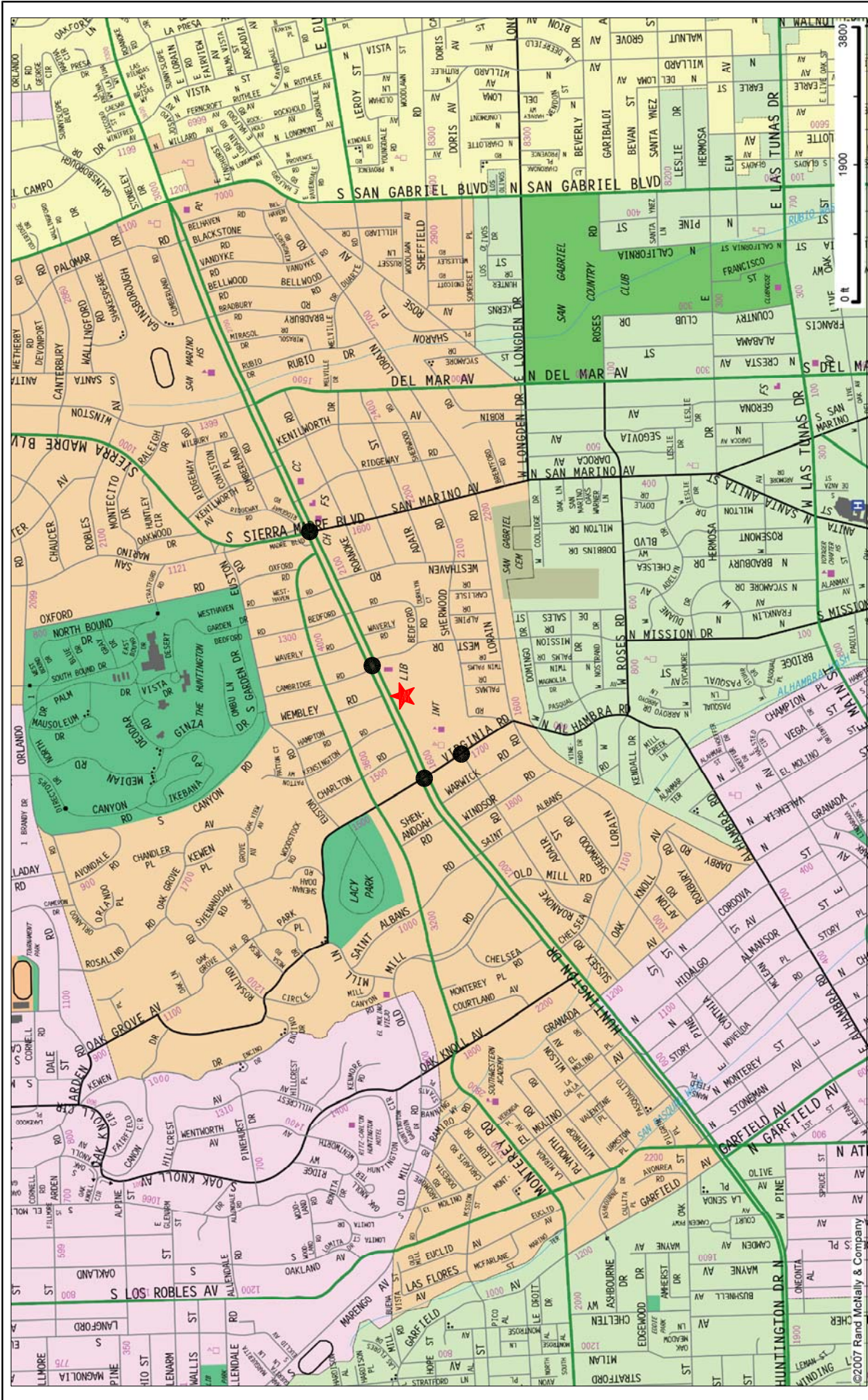

MAP SOURCE: RAND MCNALLY & COMPANY



- ★ Project Site
- Study Intersection



Figure 1-1
Vicinity Map

1.2 Study Methodology

The CEQA and non-CEQA analysis criteria for this transportation assessment were identified in consultation with City of San Marino staff. The analysis criteria were determined based on the City's Guidelines, the proposed project description and location, and the characteristics of the surrounding transportation system. As the Lead Agency under CEQA, the City of San Marino confirmed the appropriateness of the analysis criteria when it approved the transportation assessment Scope of Work Memorandum of Understanding (MOU).

On September 27, 2013, Governor Brown signed Senate Bill (SB) 743 (Steinberg, 2013). Among other things, SB 743 created a process to change the methodology to analyze transportation impacts under CEQA (Public Resources Code section 21000 and following) in order to promote: 1) the reduction of greenhouse gas emissions, 2) the development of multimodal transportation networks, and 3) a diversity of land uses. On December 30, 2013, the State of California Governor's Office of Planning and Research (OPR) released a preliminary evaluation of alternative methods of transportation analysis, which included analysis based on project VMT rather than impacts to intersection Level of Service. OPR issued other draft discussion documents in March 2015 and January 2016, suggesting some new revisions to the state CEQA Guidelines. In November 2017, OPR submitted the proposed amendments to the CEQA Guidelines to the State's Natural Resources Agency (that include a proposed new Guidelines section 15064.3 which governs how VMT-based analyses of potential traffic impacts should be conducted). On January 26, 2018, the Natural Resources Agency published a Notice of Rulemaking, commencing the formal rulemaking process for the amendments to the CEQA Guidelines. On December 28, 2018, the California Office of Administrative Law adopted the proposed amendments, formally implementing the use of VMT as the metric for transportation analysis under CEQA and providing a grace period allowing local agencies to opt-in to the new metrics. State-wide implementation of the new metric was required by July 1, 2020.

In anticipation of the mandated change to VMT, the San Gabriel Valley Council of Governments (SGVCOG), of which the City of San Marino is a participating agency, undertook the SGVCOG SB 743 Implementation Study to assist with answering important implementation questions about the methodology, thresholds, and mitigation approaches for VMT impact analysis in the member agencies. The City of San Marino utilized the information produced through the Implementation Study to adopt a methodology and significance thresholds for use in CEQA compliant transportation analyses. The new metric and thresholds of significance were formally adopted through City Council Resolution No. 20-18² on July 8, 2020. In alignment with the goals of SB 743, the City also requires an evaluation of a project's impact on the multi-modal pedestrian, bicycle, and transit network.

² Resolution No. 20-18, *A Resolution of the City Council of the City of San Marino, California, Adopting "Vehicle Miles Traveled" Thresholds of Significance for Purposes of Analyzing Transportation Impacts Under the California Environmental Quality Act*, adopted on July 8, 2020.

The City's Guidelines further note that SB 743 does not prevent agencies from continuing to analyze delay or LOS outside of CEQA review for other transportation planning or analysis purposes (i.e., general plans, impact fee programs, corridor studies, congestion reduction, or ongoing network monitoring). The City has LOS standards which local transportation infrastructure should strive to maintain. The LOS standards apply to discretionary approvals of new land use development projects. Therefore, the City's Guidelines also include requirements for non-CEQA analyses. Specifically, the City requires utilization of the latest version of the Highway Capacity Manual (HCM) methodology to evaluate LOS at signalized and unsignalized intersections.

The proposed project's CEQA transportation impacts have been evaluated based on the City of San Marino's adopted VMT screening criteria, methodology, and thresholds. In order to evaluate the proposed project's effect on local transportation infrastructure, a non-CEQA analysis of four (4) study intersections has been conducted for the weekday AM and PM peak hours, utilizing the HCM analysis methodologies for signalized and unsignalized intersections.

1.3 Los Angeles County Congestion Management Program Status

The Los Angeles County Congestion Management Program (CMP) was previously a state-mandated program that was enacted by the California State Legislature with the passage of Proposition 111 in 1990 that primarily utilized a level of service (LOS) performance metric. Pursuant to California Government Code §65088.3, local jurisdictions may opt out of the CMP requirement without penalty if a majority of the local jurisdictions representing a majority of the County's population formally adopt resolutions requesting to opt out of the program. As stated in a letter from the Los Angeles County Metropolitan Transportation Authority (Metro)³, by August 28, 2019, 57 local jurisdictions, which in total represent 8.5 million in population, had adopted resolutions electing to be exempt from the CMP. With the Los Angeles County region having reached the statutorily required threshold, the provisions of the CMP are no longer applicable to any of the 89 local jurisdictions within Los Angeles County, regardless of whether or not a jurisdiction adopted an opt-out resolution. Therefore, CMP Traffic Impact Analysis is no longer required in Environmental Impact Reports.

³ Kalieh Honish, Los Angeles County Metropolitan Transportation Authority, to Seleta Reynolds, City of Los Angeles Department of Transportation, "Re: Dissolution of the Congestion Management Program in Los Angeles County", August 28, 2019.

2.0 PROJECT DESCRIPTION

2.1 Existing Project Site

The project site is located at 1800 Huntington Drive, along the south side of Huntington Drive approximately 345 feet west of West Drive. The site is generally bounded by Huntington Drive to the north, the existing parking lot and tennis courts for Henry E. Huntington Middle School to the south and west, and the Crowell Public Library to the east. The proposed project site and general vicinity are shown in *Figure 1-1*.

The assessor's parcel number for the project site is 5334-024-903. The site is currently developed with the San Marino Center building which has been owned by the City since 2005 for community meetings and events. An aerial photograph of the existing project site is presented in *Figure 2-1*.

2.2 Proposed Project Description

The proposed project consists of revitalizing and updating the existing San Marino Center (SMC) including rehabilitation of the building interior to include additional offices to accommodate six (6) City Recreation Department staff, optimization of the interior public gathering space, replacement of the heating/air conditioning, plumbing and electrical systems and light fixtures to current building code standards, renovation of the building and grounds for compliance with the Americans with Disabilities Act (ADA), and building façade similar to that of the adjacent buildings. The SMC building totals 10,832 gross square feet of building floor area.

Vehicular access to the project site is planned to continue to be provided via Huntington Drive and West Drive. The building renovation floor plan is shown in *Figure 2-2*. The project build-out and occupancy year is anticipated by the year 2023.

2.3 Project Site Access

2.3.1 Vehicular Site Access

Direct vehicular access to the project site is planned to be accommodated by two (2) existing driveways on West Drive and two (2) existing driveways on Huntington Drive as shown in *Figure 2-1*. A third existing driveway on Huntington Drive is planned to be closed as part of the proposed project. Descriptions of the project site access points are provided in further detail below:

- Huntington Drive

Two existing driveways along the south side of Huntington Drive will continue to provide access to the on-site parking area/s. The westerly Huntington Drive driveway currently accommodates inbound movements only (i.e., right-turn ingress movements only) from Huntington Drive. The middle and easterly Huntington Drive driveways both accommodate restricted access (i.e., right-turn ingress and egress movements only) due to the existing raised median island on Huntington Drive.

o:\job_file\4416\dwg\12-1.dwg LDP 08:53:22 09/21/2021 rodriguez



Google Earth

MAP SOURCE: GOOGLE EARTH





-  Project Site
-  Existing Driveway
-  Driveway to be Closed by Project

Figure 2-1
Aerial Photograph of Existing Site

o:\job_file\4416\dwg\2-dwg LDP 08:49:47 08/06/2021 rodriguez



MAP SOURCE: CRANE ARCHITECTURAL GROUP

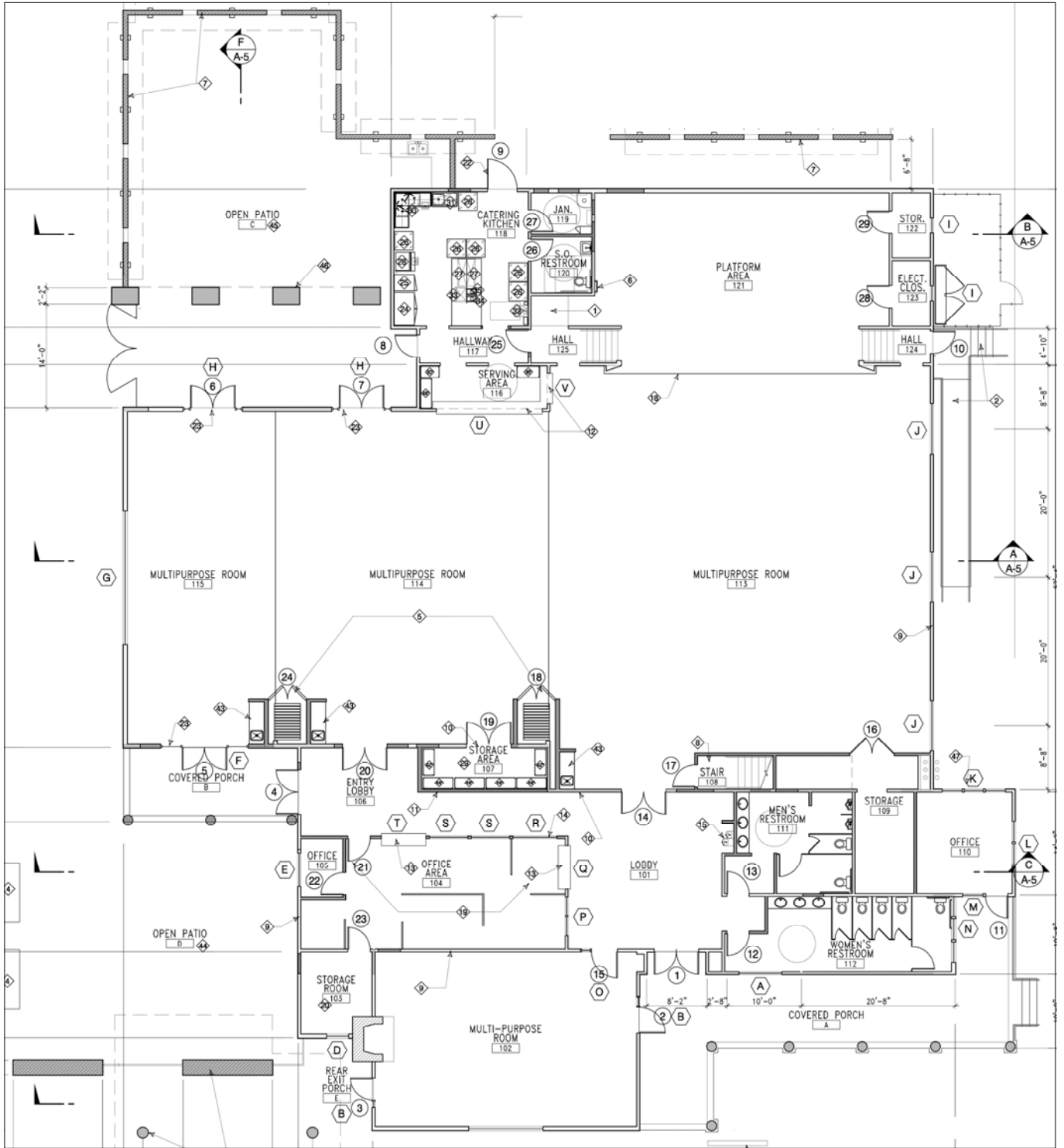

Figure 2-2
Renovation Floor Plan

San Marino Center Improvement Project

- West Drive

Two existing driveways along the west side of West Drive will continue to provide access to the on-site parking area/s. The northerly West Drive driveway accommodates outbound movements only (i.e., right-turn and left-turn egress movements). The southerly West Drive driveway accommodates restricted access during School days (i.e., northbound left-turn movement prohibited from 7:45 AM to 8:45 AM, and 2:45 PM to 3:30 PM).

Within the project site, vehicle circulation will be accommodated by the drive aisle situated in an east-west alignment in order for motorists to access the surface parking spaces located south and west of the SMC building.

2.3.2 Non-Vehicular Site Access

The project site is planned to accommodate non-vehicular access to the proposed SMC building. Pedestrian access within the project site will be accommodated by Americans with Disabilities Act (ADA) compliant walkways near the eastern portion of the site. New walkways will be provided to/from Huntington Drive which will interconnect with the building. These walkways will also provide exclusive pedestrian and bicycle access to/from the existing public sidewalk along the project site frontage. The walkways thus minimize the extent of pedestrian and bicycle interaction with vehicles at the site and provide a comfortable, convenient, and safe environment for pedestrians and bicyclists accessing the building from outside the project site.

2.4 Existing Overall Site and Total Parking Supply

Parking for the San Marino Center (SMC) exists on the west and south sides of the building, in the parking lot of the Henry E. Huntington Middle School, through a cooperative agreement with the San Marino Unified School District (SMUSD) for use of up to 48 spaces for both the SMC and the Crowell Public Library. The agreement between the City and the SMUSD was initiated in 2006 after the City purchased the building. In 2019, the shared parking use agreement for non-exclusive use of the 48 spaces was renewed for a 10-year term. The Huntington Middle School, located at 1700 Huntington Drive, is a public middle school in the SMUSD with an enrollment of approximately 650 students in 6th through 8th grades, with approximately 60 faculty/staff/administrators on-site. The regular day bell schedule is from 8:00 AM to 2:50 PM. Pick-up and drop-off operations for the Huntington Middle School is conducted within the surface parking lot with access via West Drive and Huntington Drive. In 2018, a traffic circulation review⁴ was prepared for Huntington Middle School as well as other schools within the SMUSD as an update to the prior circulation review that was conducted in 2014. The study included the following improvements both on the SMUSD property and those within the public right-of-way in order to better facilitate on-site circulation during the morning and afternoon school drop-off and pick-up activities. The following improvements were reviewed and do not impact the proposed circulation for the proposed SMC Improvement Project.

⁴ *Traffic Circulation Review for Huntington Middle School*, prepared by Albert Grover & Associates, July 31, 2018.

Improvements Recommended on District Property

- Remove approximately 140 feet of red zone along the west curb of the northern parking lot and install white passenger loading zone.
- Install “Drop Off Only” pavement legends within the striped lane adjacent to the west curb of the northern parking lot, to match the existing loading zone in the southern parking lot.

Improvements Recommended in City Right-of-Way

- Widen Huntington Drive by approximately 5 feet on the southern curb approaching the western driveway of the northern parking lot in order to install a 120-foot right-turn pocket.
- Relocate one street light pole five feet southerly to accommodate the roadway widening.
- Prohibit parking within the newly created right-turn pocket.
- Install appropriate lane line striping and arrows creating the right-turn pocket.
- Install a “Right Lane Must Turn Right” sign (R3-7R) indicating that all traffic in the right lane must turn into the northerly parking lot.

The Crowell Public Library, located at 1890 Huntington Drive, was renovated in 2006 to enhance the exterior, optimize interior space, and to replace lighting, internet, and other electrical and heating/air conditioning before reopening in 2008. The 33,906 square-foot library provides community meeting space, a conference room, separate young adult and children’s sections, a homework center, a computer training lab with 15 workstations, and room to expand the book collection. Current hours of operation for the Crowell Public Library are from 10:00 AM to 9:00 PM on Mondays through Thursdays, 10:00 AM to 5:00 PM on Fridays and Saturdays, and 1:00 PM to 5:00 PM on Sundays.

Figure 2-3 provides an aerial photograph illustration of the overall existing site as well as the various surface parking areas. As shown in *Figure 2-3*, the surface parking lot for the Huntington Middle School currently provides a total of 171 spaces (i.e., 95 standard spaces, 58 staff/PTA reserved spaces, 10 visitor spaces, 6 handicap accessible spaces, and 2 handicap van accessible spaces). Three (3) handicap accessible parking spaces are provided in close proximity to the SMC building. A surface parking lot located directly south of the Crowell Public Library currently has 18 spaces (i.e., 14 standard spaces, 3 handicap accessible spaces, and 1 handicap van accessible space). Altogether, the on-site parking supply totals 192 spaces (i.e., 109 standard spaces, 58 staff/PTA reserved spaces, 10 visitor spaces, 12 handicap accessible spaces, 3 handicap van accessible spaces).

In addition to the on-site parking spaces, a total of 12 angled parking spaces are provided along the Crowell Public Library frontage along Huntington Drive and five (5) marked parallel spaces are provided along the west side of West Drive, south of Huntington Drive. For purposes of this parking

o:\job_file\4416\dwg\12-3.dwg LDP 10/24/21 09/09/2021 rodriguez

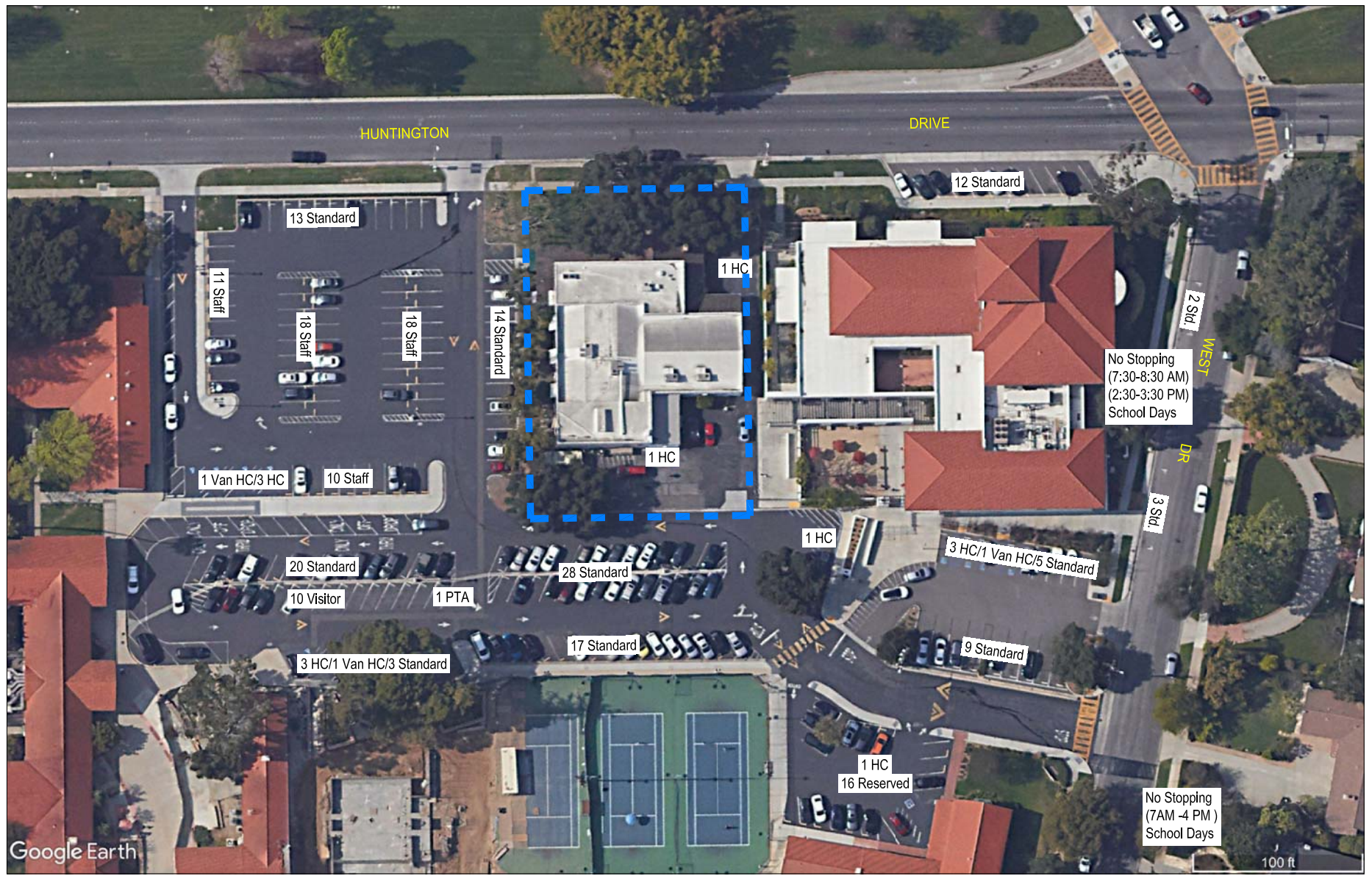

 Project Site

Figure 2-3
Existing On-Site Parking Supply

analysis, when accounting for the 17 on-street spaces, the total on-site and on-street supply consists of 209 spaces.

It should be noted that the SMUSD office parking lot which provides 17 spaces (i.e., 16 standard spaces, 1 handicap accessible space) is not included as part of this parking analysis.

2.5 City Code Parking Requirements

A calculation of the Code parking requirement was prepared in accordance with the City of San Marino Municipal Code off-street parking requirements (Section 23.10.03, Number of Parking Spaces Required). In accordance with the Municipal Code parking regulations, the following parking requirements most applicable to the proposed project are as follows:

- Office buildings For all buildings on Huntington Drive (including commercial areas on Chelsea Road, Granada Avenue, San Gabriel Boulevard and San Marino Avenue) existing on October 25, 2010:
1 space for every 350 square feet of gross floor area.

Source: City of San Marino Municipal Code (Section 23.10.03).

Through strict application of the Municipal Code parking regulations, the following parking requirement would be calculated for the proposed project if the community center is categorized as an existing office building on Huntington Drive. As noted previously in the project description, the total gross floor area of the building is 10,832 square feet:

- Community Center: $10,832 \text{ SF} \times 1.0 \text{ space}/350 \text{ SF} = \text{rounded to } 31 \text{ spaces}$
Total Code Required Project Parking = 31 spaces

As summarized above, the Code parking requirement for the proposed SMC Improvement Project totals 31 spaces.

2.6 Comparison of Industry Standard Parking Ratios

2.6.1 ITE Parking Demand Ratios

In addition to reviewing Code parking requirements, the average peak parking demand for various land uses are often estimated using parking ratios contained in other industry standard parking publications. First, LLG reviewed parking ratios contained in the Institute of Transportation Engineers' (ITE) *Parking Generation Manual*⁵ publication. The *Parking Generation Manual* presents the state-of-the-practice understanding of the relationship between parking demand and various characteristics associated with individual land use developments, based on parking studies

⁵ *Parking Generation Manual*, 5th Edition, Institute of Transportation Engineers, Washington D.C., January 2019.

conducted at locations throughout North America. While the *Parking Generation Manual* does not contain a parking ratio specifically for a community center, the two land uses most applicable are those for a government office building and a recreational community center. Specifically, the ITE Land Use 730 (Government Office Building) and ITE Land Use 495 (Recreational Community Center) average peak parking demand ratios were reviewed so that it could be compared with that expected through application of the Code parking requirements. When utilizing the ITE publication, the parking demand can be calculated through application of the average peak parking demand ratios based on the total building gross floor area. The average weekday parking demand ratios for the two land use types are summarized below:

- ITE Land Use Code 730 (Government Office Building) average weekday peak period parking demand ratio: 2.99 spaces for every 1,000 square feet of gross floor area (12 study sites, average building size: 113,000 SF)
- ITE Land Use Code 495 (Recreational Community Center) average weekday peak period parking demand ratio: 2.07 spaces for every 1,000 square feet of gross floor area (10 study sites, average building size: 57,000 SF)

Application of the two ITE published parking demand ratios above to the proposed SMC Improvement project would yield an average weekday peak parking demand of 32 spaces (i.e., 2.99 spaces/1,000 SF x 10,832 SF = 32 parking spaces) as a government office building. When the parking demand ratios for the recreational community center is applied, an average weekday peak parking demand of 22 spaces (i.e., 2.07 spaces/1,000 SF x 10,832 SF = 22 spaces) is forecast. The Code parking requirement for the proposed SMC Improvement project (i.e., 31 spaces) is less than the parking demand forecast utilizing the ITE parking demand ratios for a government office building (i.e., 32 spaces) but more than that forecast for a recreational community center (i.e., 22 spaces).

2.6.2 ULI Shared Parking Demand Concept and Analysis

LLG also reviewed the parking ratios as published by the Urban Land Institute (ULI) as contained in the third edition of the *Shared Parking* manual⁶. The concept of shared parking is widely recognized within the transportation planning industry and accounts for the changes in parking demand over time for different types of land uses within a project. Furthermore, accumulated experience in parking demand characteristics indicates that a mixing of land uses results in an overall parking need that is less than the sum of the individual peak requirements for each individual land use. Due to the multi-use characteristics of the adjacent surrounding uses (i.e., the Huntington Middle School and the Crowell Public Library) with the proposed project, opportunities to share parking can be expected as evident in the shared parking agreement between the SMUSD and the City.

⁶ *Shared Parking*, Third Edition, Urban Land Institute, ICSC, and National Parking Association, 2020.

This shared parking analysis has been prepared based on data contained in the *Shared Parking and Parking Generation* manuals as well as supplemented with site-specific programming information for SMC and Huntington Middle School in order to determine if there will be a sufficient number of parking spaces to adequately accommodate the future peak parking demand of the project in combination with the adjacent uses. The *Shared Parking* manual provides recommendations with respect to the following characteristics of parking demand:

- Hourly Parking Indices. The *Shared Parking* manual provides hourly parking indices for various land uses. The ULI hourly parking indices for the public library was utilized. The hourly parking indices for the SMC was based on event programming schedule/s and attendance figures provided for the weekday and weekend time periods as contained in *Appendix A*. For the Huntington Middle School, it was assumed that the faculty/staff spaces (i.e., 58 spaces) are reserved and not available for shared use during the weekday hours of operation for the School. Adjustments are made to the weekday late afternoons (i.e., after 3:00 PM) and weekend hourly parking indices due to other regularly scheduled sports activities/classes held at the school campus. The indices also show, for example, that the hourly parking demand for the Huntington Middle School (which generates its peak parking demand concentrated around the afternoon hours) is different than the parking demand associated with SMC (which generates its peak parking demand concentrated around the early evening periods). Thus, under the shared parking principle, a parking space that is used in the daytime by a faculty/staff member could be used again in the late afternoon/early evening period by a community center patron.
- Day of Week Parking Variations. The *Shared Parking* manual provides recommendations for day of week parking factors. For example, office and institutional uses experience their peak parking demands during weekdays and experience minimal parking demand during the weekends. However, based on the event schedules for the Huntington Middle School and the SMC, minimal weekday and weekend variations are expected as events/classes are contemplated to be scheduled during both weekdays and weekend time periods. The day of week parking factors for the public library land use type was utilized for the Crowell Public Library.

The peak parking ratios for the Huntington Middle School, the SMC, and Crowell Public Library are based on the *ITE Parking Generation* manual, the City of San Marino Municipal Code, and the ULI *Shared Parking* manual, respectively. For purposes of the shared parking analysis, the base parking ratio for the SMC applied the Code parking requirement for all new office buildings on Huntington Drive (i.e., 1 space for every 250 square feet) since this is slightly higher than if the community center is categorized as an existing office building on Huntington Drive (i.e., 1 space for every 350 square feet). Direct application of these peak parking demand ratios yields an unadjusted base parking demand of 203 spaces (84 spaces for the middle school, 43 spaces for the community center, and 76 spaces for the public library). While the library patrons may be expected to generate a significant degree of internal capture from the Huntington Middle School as well as walk-in patronage from surrounding residential uses in the area, no adjustment factor (reduction) was

employed so as to provide a conservative analysis. The shared parking analysis essentially only accounts for the variations in demand that occur based on the time of day and/or the day of week fluctuations between the various uses.

In order to determine the peak parking demand for the project, a shared parking demand model for the proposed project use and adjacent uses was developed. The ITE, Code, ULI parking ratios along with the hourly parking accumulation profiles for the middle school, community center, and library uses were applied to determine the forecast shared parking demand site wide. The weekday and weekend parking analyses utilizing the shared parking methodology and assuming the respective parking demand ratios, are summarized in *Tables 2-1* and *2-2*, respectively. *Appendix A* also contains the weekday and weekend day shared parking analysis calculation worksheets for the individual land use components.

When accounting for shared parking usage between the proposed SMC patrons, along with the school population and library patrons, a peak weekday parking demand of 200 spaces (95.7% utilization of the combined total of 209 spaces) is forecast to occur at 10:00 AM as shown in *Table 2-1*. The weekend peak shared parking demand for the project is forecast to be less than the weekday peak parking demand. As shown in *Table 2-2*, a peak parking demand of 198 spaces (94.7% utilization of the combined total of 209 spaces) is forecast to occur at 10:00 AM during a weekend day condition. As a result, the overall peak shared parking demand is forecast to total 200 parking spaces. Consequently, given the review of the shared parking demand analysis and comparisons with the parking supply, it can be concluded that surpluses of 9 and 11 parking spaces are forecast to occur during peak weekday and weekend conditions, respectively. As previously noted, this analysis assumes that the 17 on-street spaces along Huntington Drive and West Drive along the library frontages are available for shared use.

It should be noted that site-specific programming details including the frequency and attendance figures for each of the proposed classes/events were provided and reviewed for the Huntington Middle School and the SMC. It was determined that recurring daily and weekly classes/events would continue to be provided as part of the typical site operations. Less frequent special events/conferences (e.g., monthly and quarterly events) are not accounted for in the parking demand forecast as they do not occur with often regularity.

2.7 Parking Management Strategies

During times when the parking demand is high at the site or when less frequent special events/conferences are held, various parking management strategies are effective at managing these peak parking demands. Below are parking management strategies for consideration, specifically when special events are held concurrently at the SMC, the Huntington Middle School and/or the Crowell Public Library. The following elements should be considered by the Director of Community Development prior to issuance of the Certificate of Occupancy.

**Table 2-1
TYPICAL WEEKDAY SHARED PARKING DEMAND ANALYSIS [1]**

Land Use	Middle School [5]	Community Center [6]	Library [7]	Shared Parking Demand	Comparison w/ Parking Supply [8] 209 Spaces Surplus (Deficiency)
Size	60 Employees	10.8 KSF	33.9 KSF		
Peak Pkg Rate[2]	1.40 /Employee	4.0 /KSF	2.25 /KSF		
Weekday Pkg Rate[3]	1.40 /Employee	4.0 /KSF	2.25 /KSF		
Gross Spaces	84 Spc.	43 Spc.	76 Spc.		
Adjusted Gross Spaces[4]	84 Spc.	43 Spc.	76 Spc.		
Time of Day	Number of Spaces	Number of Spaces	Number of Spaces		
6:00 AM	0	0	0	0	209
7:00 AM	58	3	1	62	147
8:00 AM	63	18	4	85	124
9:00 AM	74	18	76	168	41
10:00 AM	84	40	76	200	9
11:00 AM	70	37	75	182	27
12:00 PM	62	23	75	160	49
1:00 PM	70	23	61	154	55
2:00 PM	83	23	57	163	46
3:00 PM	112	23	52	187	22
4:00 PM	104	6	56	166	43
5:00 PM	103	0	61	164	45
6:00 PM	43	19	47	109	100
7:00 PM	22	43	38	103	106
8:00 PM	21	43	29	93	116
9:00 PM	11	19	1	31	178
10:00 PM	0	19	0	19	190
11:00 PM	0	0	0	0	209
12:00 AM	0	0	0	0	209

Notes:

[1] Source: *Shared Parking*, Third Edition, Urban Land Institute, ICSC, and National Parking Association, 2020.

[2] Peak parking rates based on the ITE *Parking Generation Manual* for the middle school component, the City of San Marino Municipal Code off-street parking requirements for the community center, and the ULI *Shared Parking* manual for the public library.

[3] The weekday and weekend parking rates are based on the weekday vs. weekend parking variations for the public library land use for the Crowell Library as summarized in Figure 2-2 of the *Shared Parking* manual. For the Huntington Middle School and the San Marino Center, the weekend parking rates are assumed to be the same as the peak weekday rates given the various weekend classes, events, and sports activities scheduled at these facilities.

[4] Gross spaces not adjusted to reflect parking demand reduction due to captive market, internal capture, transit, and/or walk-in reduction.

[5] The number of employees (i.e., faculty/staff figures) at the Huntington Middle School consists of 60 employees as provided by the San Marino Unified School District staff.

[6] The square footage includes the renovated San Marino Center totaling 10,832 square feet of gross floor area.

[7] The square footage includes the Crowell Library totaling 33,906 square feet of gross floor area.

[8] The total parking supply of 209 spaces consists of parking spaces on-site (i.e., 192 spaces), the angled spaces on the south side of Huntington Drive (i.e., 12 spaces), and west side of West Drive (i.e., 5 spaces) along the Library frontages. For purposes of the shared parking analysis, the District Office parking lot (i.e., 17 spaces) is not included as part of the parking supply available for shared usage.

**Table 2-2
TYPICAL WEEKEND SHARED PARKING DEMAND ANALYSIS [1]**

Land Use	Middle School [5]	Community Center [6]	Library [7]	Shared Parking Demand	Comparison w/ Parking Supply [8] 209 Spaces Surplus (Deficiency)
Size	60 Employees	10.8 KSF	33.9 KSF		
Peak Pkg Rate[2]	1.40 /Employee	4.0 /KSF	2.25 /KSF		
Weekend Pkg Rate[3]	1.40 /Employee	4.0 /KSF	2.10 /KSF		
Gross Spaces	84 Spc.	43 Spc.	71 Spc.		
Adjusted Gross Spaces[4]	84 Spc.	43 Spc.	71 Spc.		
Time of Day	Number of Spaces	Number of Spaces	Number of Spaces		
6:00 AM	0	0	0	0	209
7:00 AM	42	0	0	42	167
8:00 AM	84	35	1	120	89
9:00 AM	84	43	4	131	78
10:00 AM	84	43	71	198	11
11:00 AM	84	43	65	192	17
12:00 PM	63	43	58	164	45
1:00 PM	63	43	49	155	54
2:00 PM	63	43	39	145	64
3:00 PM	63	35	26	124	85
4:00 PM	63	0	8	71	138
5:00 PM	63	0	4	67	142
6:00 PM	63	0	4	67	142
7:00 PM	63	0	1	64	145
8:00 PM	42	0	0	42	167
9:00 PM	0	0	0	0	209
10:00 PM	0	0	0	0	209
11:00 PM	0	0	0	0	209
12:00 AM	0	0	0	0	209

Notes:

[1] Source: *Shared Parking*, Third Edition, Urban Land Institute, ICSC, and National Parking Association, 2020.

[2] Peak parking rates based on the ITE Parking Generation Manual for the middle school component, the City of San Marino Municipal Code off-street parking requirements for the community center, and the ULI Shared Parking manual for the public library.

[3] The weekday and weekend parking rates are based on the weekday vs. weekend parking variations for the public library land use for the Crowell Library as summarized in Figure 2-2 of the *Shared Parking* manual. For the Huntington Middle School and the San Marino Center, the weekend parking rates are assumed to be the same as the peak weekday rates given the various weekend classes, events, and sports activities scheduled at these facilities.

[4] Gross spaces not adjusted to reflect parking demand reduction due to captive market, internal capture, transit, and/or walk-in reduction.

[5] The number of employees (i.e., faculty/staff figures) at the Huntington Middle School consists of 60 employees as provided by the San Marino Unified School District staff.

[6] The square footage includes the renovated San Marino Center totaling 10,832 square feet of gross floor area.

[7] The square footage includes the Crowell Library totaling 33,906 square feet of gross floor area.

[8] The total parking supply of 209 spaces consists of parking spaces on-site (i.e., 192 spaces), the angled spaces on the south side of Huntington Drive (i.e., 12 spaces), and west side of West Drive (i.e., 5 spaces) along the Library frontages. For purposes of the shared parking analysis, the District Office parking lot (i.e., 17 spaces) is not included as part of the parking supply available for shared usage.

- A requirement to maintain an events calendar that is accessible and shared with the Huntington Middle School and the Crowell Public Library, which would include the date, time and duration of the event, including the expected attendance figure for each event. Special SMC events/meetings where 40 attendees or more are expected would require further coordination with the Huntington Middle School and Crowell Public Library to ensure that any overlap of activities is minimized to the extent possible.
- Implementation of managed parking for some spaces within the on-site parking facility (i.e., both valet parking spaces and tandem parking spaces) which would increase the effective parking supply as valet-attended parking could occur within drive aisles located throughout the on-site parking areas or other nearby lots (i.e., District Office parking lot).
- A provision in the Rules and Regulations which would prohibit visitors/vendor employees from parking on surrounding streets that are not immediately adjacent to the site frontages. Consider, if needed and feasible, installation of additional parking spaces along the south side of Huntington Drive along the SMC frontage, similar to the spaces that are currently in front of the Crowell Public Library.
- To the extent feasible, classes/meetings/events held at the SMC and the Crowell Public Library shall not be scheduled to begin or end such that it overlaps with the morning drop-off and afternoon pick-up peak time periods at the Huntington Middle School.
- The SMC, Crowell Public Library and Huntington Middle School should encourage bicycle, transit, and ride-share opportunities to events where appropriate.
- A requirement to conduct a parking utilization monitoring study one year from issuance of the Project's Certificate of Occupancy. The parking utilization monitoring study must demonstrate that on-site parking is adequate to meet project demand during both weekday and weekend conditions. If the study shows that project parking demand exceeds the supply of parking within the project, the Applicant shall propose measures to reduce spillover parking impacts, subject to review and approval by the Director of Community Development. The parking reduction strategies may include, but are not limited to: 1) preparation of a Valet Parking Plan, 2) provision of transit passes and/or ride-share subsidies for employees, and/or 3) subsidized off-site parking options in order to minimize on-site employee parking demand, if necessary.

2.8 Project Trip Generation and Distribution

2.8.1 Project Trip Generation

Traffic generation is expressed in vehicle trip ends, defined as one-way vehicular movements, either entering or exiting the generating land use. Traffic volumes expected to be generated by the proposed project were estimated for the weekday commuter AM and PM peak hours, as well as over a 24-hour daily period, using trip generation rates provided in the Institute of Transportation

Engineers' (ITE) *Trip Generation Manual*⁷. The ITE document contains trip rates for a variety of land uses which have been derived based on traffic counts conducted at existing sites throughout California and the United States.

The trip generation rates and forecast of the vehicular trips anticipated to be generated by the proposed project are presented in *Table 2-3*. Traffic volumes expected to be generated by the proposed project were based upon rates per thousand square feet of gross floor area. The project trip generation forecast was submitted for review and approval by City staff as part of the Memorandum of Understanding scoping process. ITE Land Use Code 495 (Recreational Community Center) trip generation average rates were used to forecast the traffic volumes expected to be generated by the proposed project.

2.8.2 Weekday ITE Project Trip Generation Summary

As summarized in *Table 2-3*, the proposed project is expected to generate 19 new vehicle trips (13 inbound trips and 6 outbound trips) during the weekday AM peak hour. During the weekday PM peak hour, the proposed project is expected to generate 25 new vehicle trips (12 inbound trips and 13 outbound trips). Over a 24-hour period, the proposed project is forecast to generate approximately 312 new daily trip ends (156 inbound trips and 156 outbound trips) during a typical weekday.

2.8.3 Weekday Site-Specific Project Trip Generation Summary

Site-specific programming details including the frequency and attendance figures for each of the proposed classes/events was provided and reviewed. It was determined that recurring daily and weekly classes/events would continue to be provided as part of the typical site operations. Less frequent special events/conferences (e.g., monthly and quarterly events) are not accounted for in the trip generation forecast as they do not occur with often regularity. Based on the site-specific programming data and person trips forecast for the project, the number of vehicles has been estimated using an average vehicle ridership (AVR) of 1.135 persons per vehicle (as provided in the South Coast Air Quality Management District in its CEQA Air Quality Handbook). It is estimated that approximately 302 vehicle trips (i.e., 342 person trips/1.135 persons per vehicle = 151 inbound trips and 151 outbound trips) on a daily basis would be generated to/from the site. Using the site-specific data, the proposed project is expected to generate 18 new vehicle trips (12 inbound trips and 6 outbound trips) or 21 person trips/1.135 persons per vehicle during the weekday AM peak hour. During the weekday PM peak hour, the proposed project is expected to generate 16 new vehicle trips (5 inbound trips and 11 outbound trips) or 19 person trips/1.135 persons per vehicle. For purposes of the LOS analysis for the non-CEQA transportation assessment, the ITE trip generation forecast was utilized as it was slightly higher when compared to that based on the site-specific programming data.

⁷ Institute of Transportation Engineers *Trip Generation Manual*, 10th Edition, 2017.

**Table 2-3
PROJECT TRIP GENERATION [1]**

LAND USE	SIZE	DAILY TRIP ENDS [2]	AM PEAK HOUR VOLUMES [2]		PM PEAK HOUR VOLUMES [2]	
			IN	OUT	IN	OUT
<i>Proposed Use</i> Community Center [3]	10,832 GSF	312	13	6	12	13
TOTAL PROJECT TRIPS		312	13	6	12	13
						25

[1] Source: ITE "Trip Generation Manual", 10th Edition, 2017.

[2] Trips are one-way traffic movements, entering or leaving.

[3] ITE Land Use Code 495 (Recreational Community Center) trip generation average rates.

- Weekday Daily Trip Rate: 28.82 trips/1,000 SF of floor area; 50% inbound/50% outbound

- Weekday AM Peak Hour Trip Rate: 1.76 trips/1,000 SF of floor area; 66% inbound/34% outbound

- Weekday PM Peak Hour Trip Rate: 2.31 trips/1,000 SF of floor area; 47% inbound/53% outbound

2.8.4 Project Trip Distribution and Assignment

Project traffic volumes both entering and exiting the site have been distributed and assigned to the adjacent street system based on the following considerations:

- The site's proximity to major traffic corridors (i.e., Huntington Drive, Virginia Road, Sierra Madre Boulevard, etc.);
- Expected localized traffic flow patterns based on adjacent roadway channelization and presence of traffic signals;
- Existing intersection traffic volumes;
- Ingress/egress scheme planned for the proposed project;
- Nearby population and employment centers; and
- Input from City of San Marino Public Works Department staff.

The general, directional morning and afternoon traffic distribution patterns for the proposed project are presented in *Figures 2-4* and *2-5*, respectively. The forecast new weekday AM and PM peak hour project traffic volumes at the study intersections associated with the proposed project are presented in *Figures 2-6* and *2-7*, respectively. The traffic volume assignments presented in *Figures 2-6* and *2-7* reflect the traffic distribution characteristics shown in *Figures 2-4* and *2-5* and the project trip generation forecasts presented in *Table 2-3*.

o:\job_file\44116\dwg\12-4.dwg LDP 11:48:42 08/04/2021 rodriguez

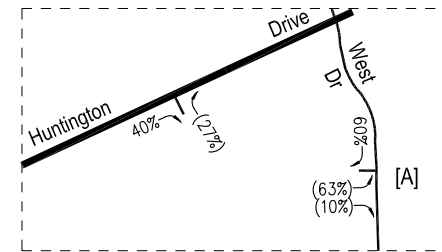
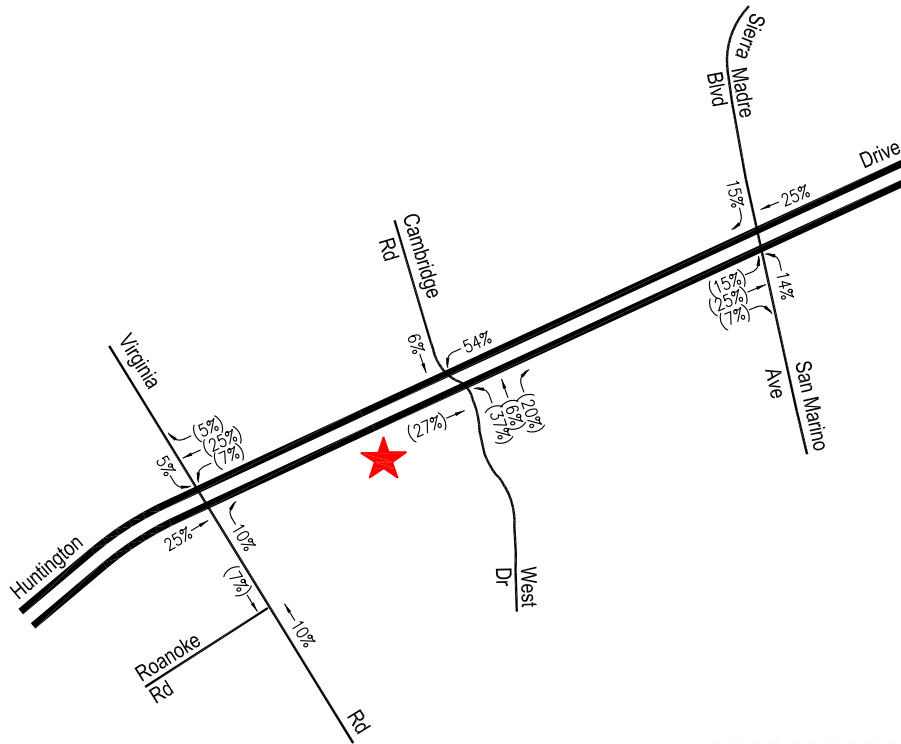

★ Project Site

XX = Inbound Percentage

(XX) = Outbound Percentage

[A] No Northbound Left-Turn (7:45-8:45 AM and 2:45-3:30 PM School Days)

Figure 2-4

Project Trip Distribution

Weekday AM Peak Hour

San Marino Center Improvement Project

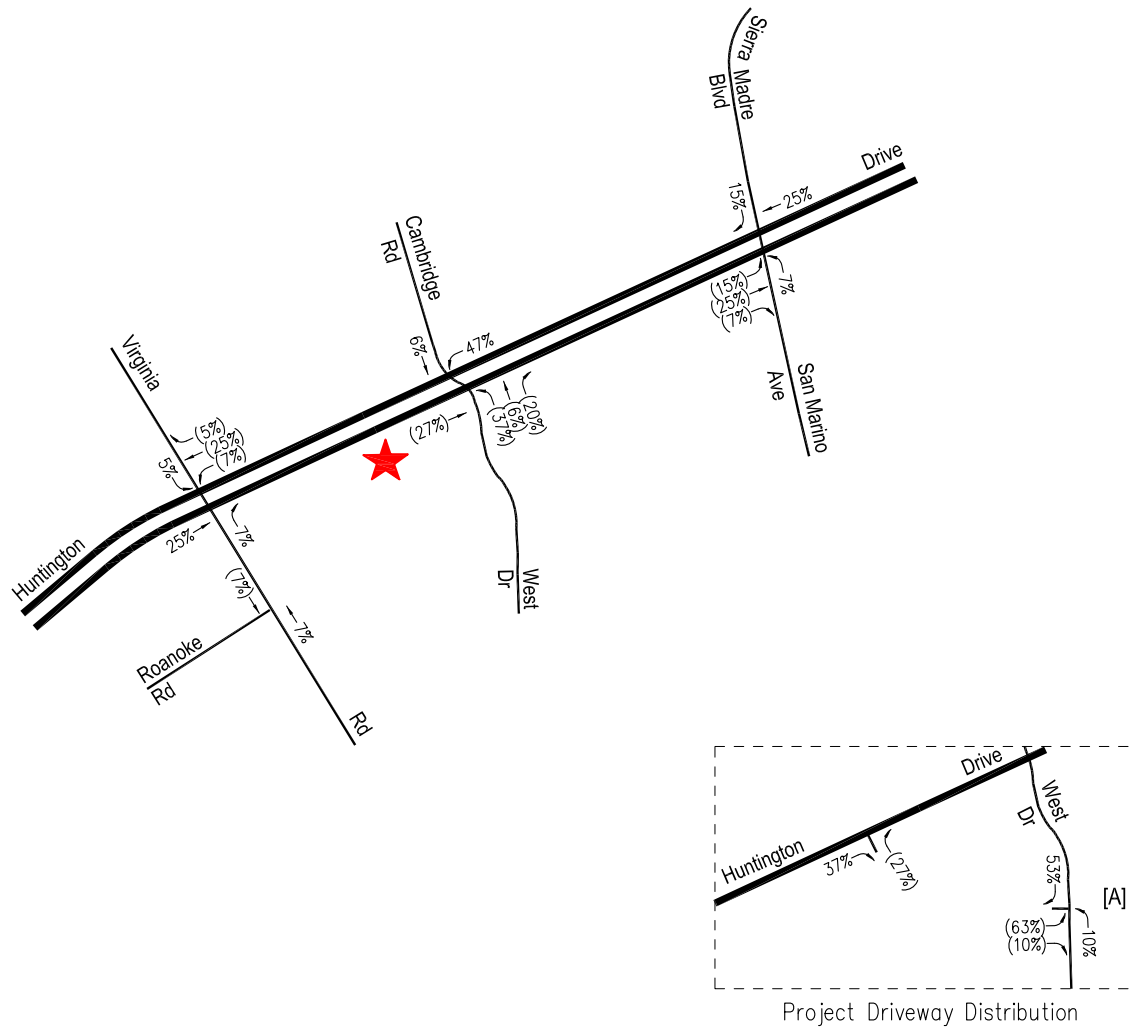

★ Project Site

XX = Inbound Percentage

(XX) = Outbound Percentage

[A] No Northbound Left-Turn (7:45-8:45 AM and 2:45-3:30 PM School Days)

Figure 2-5
Project Trip Distribution
Weekday PM Peak Hour
San Marino Center Improvement Project

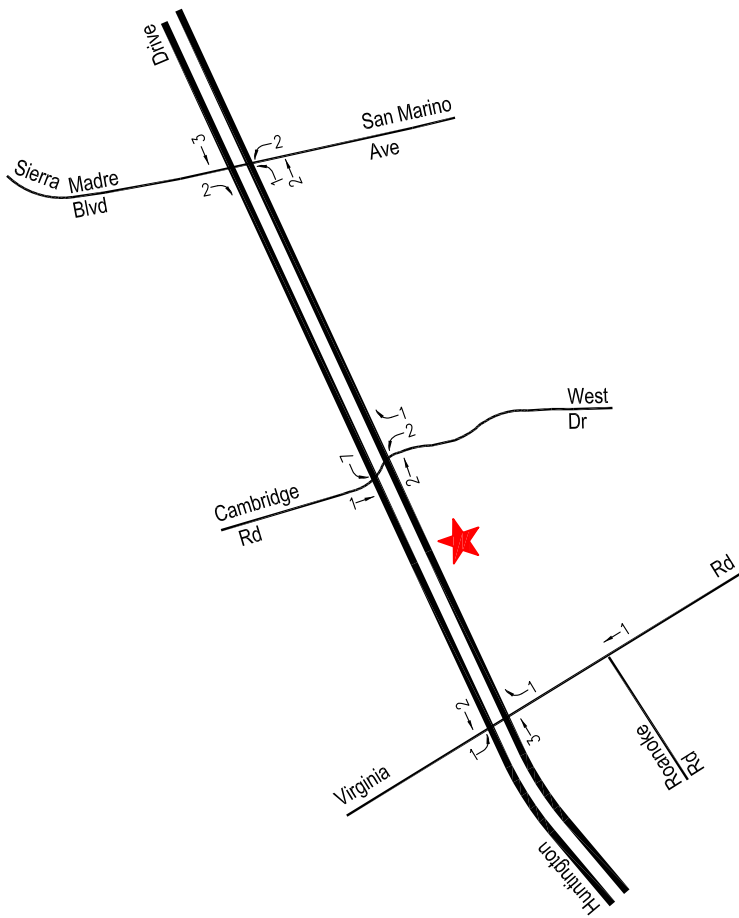

Project Site



Figure 2-6
 Project Traffic Volumes
 Weekday AM Peak Hour
 San Marino Center Improvement Project

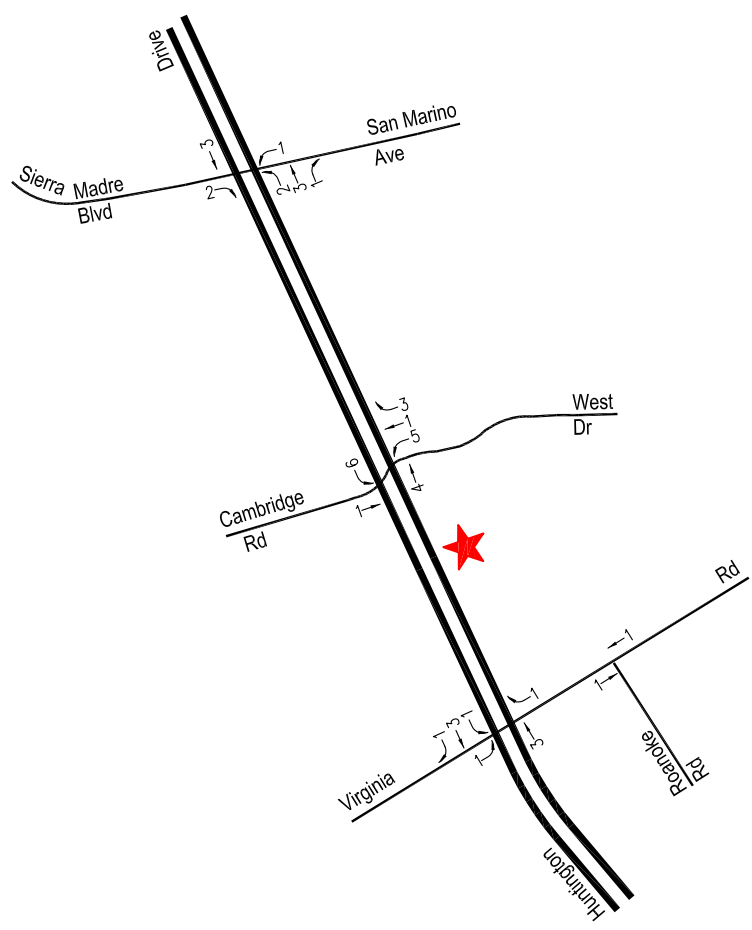

Project Site



Figure 2-7
 Project Traffic Volumes
 Weekday PM Peak Hour
 San Marino Center Improvement Project

3.0 PROJECT SITE CONTEXT

The project site is located within a well-established multi-modal transportation network maintained by the City of San Marino. The following sections will provide an overview of the transportation infrastructure in the vicinity of the proposed project, including infrastructure which supports both motorized and non-motorized transportation modes.

3.1 Non-Vehicle Network

Non-vehicular transportation generally encompasses walking, biking, and other active transportation modes. Distinct facilities are often provided for these non-vehicular modes. Most prominently, paved sidewalks are typically provided to facilitate pedestrian travel outside of the roadway. In some cases, bicycle facilities such as painted bike lanes or separated bike paths are provided within the roadway in order to separate bike traffic from vehicular traffic. Roadways which are designed to prioritize non-vehicular transportation modes utilize complimentary non-vehicular infrastructure in order to promote comfortable, safe travel for both pedestrians and bicyclists. A review of the pedestrian and bicycle infrastructure provided in the vicinity of the project site is provided below.

3.1.1 Pedestrian System

Pedestrian infrastructure consists of facilities such as sidewalks, crosswalks, pedestrian signals, curb access ramps, Americans with Disabilities Act (ADA) compliant tactile warning strips, and curb extensions, among other things. These facilities are widely provided within the study area. Sidewalks are currently provided along Huntington Drive and along other corridors near the site, including Virginia Road and West Drive. Marked crosswalks, pedestrian signals, and curb ramps are provided at the study intersections.

3.1.2 Bicycle System

Bicycle infrastructure consists of both facilities within the roadway as well as public bicycle parking spaces. The Federal and State transportation systems recognize three primary bikeway facilities: Bicycle Paths (Class I), Bicycle Lanes (Class II), and Bicycle Routes (Class III). Bicycle Paths (Class I) are exclusive car free facilities that are typically not located within a roadway area. Bicycle Lanes (Class II) are part of the street design that is dedicated only for bicycles and identified by a striped lane separating vehicle lanes from bicycle lanes. Bicycle Routes (Class III) are preferably located on collector and lower volume arterial streets.

As indicated in the *Huntington Drive Safe Streets Corridor Plan*, the only existing bicycle facility within the City of San Marino is a north-south Class II bike lane on Del Mar Avenue from Huntington Drive to the southerly City limits (0.70 miles). The *2014 Draft San Marino Bicycle and Pedestrian Plan* included proposed protected bicycle lanes along Huntington Drive. Adjoining jurisdictions have plans for Class II bicycle lanes along Huntington Drive east and west of the City of San Marino (i.e., Los Angeles County Bicycle Master Plan proposes Class II bicycle lanes on Huntington Drive in unincorporated East San Gabriel to the east of the project site and the *South*

Pasadena Bicycle Master Plan also proposes Class II bicycle lanes to the west of the site). The existing and proposed bicycle infrastructure in the City of San Marino is illustrated in **Figure 3-1**.

3.2 Transit Network

Public bus transit services are provided within the project study area by the Los Angeles County Metropolitan Transportation Authority (Metro) lines and the City of Montebello Bus Lines (MBL). The existing public transit routes in the vicinity of the project site are illustrated in **Figure 3-2**. A summary of the existing transit service in the vicinity of the project site is presented in **Table 3-1**.

As shown in *Figure 3-2*, public transit access to the project site is accommodated by Metro which runs one line along Huntington Drive at a frequency of approximately 60 minutes during weekday and Saturday peak service. The nearest bus stops for Metro Line 79 provide amenities including benches and trash receptacles east of the project site (i.e., along the north side of Huntington Drive west of West Drive and along the south side of Huntington Drive east of West Drive). Other bus stops for Metro bus lines with benches and trash receptacles are provided west of the project site (i.e., within approximately one-quarter of a mile of the project site) at the following locations: 1) along the north side of Huntington Drive west of Virginia Road, and 2) along the south side of Huntington Drive east of Virginia Road.

3.3 Vehicle Network

3.3.1 Roadway Classifications

The City of San Marino utilizes the roadway categories recognized by regional, state and federal transportation agencies. There are four categories in the roadway hierarchy, ranging from freeways with the highest capacity to two-lane undivided roadways with the lowest capacity. The roadway categories are summarized as follows:

- *Freeways* are limited-access and high speed travel ways included in the state and federal highway systems. Their purpose is to carry regional through-traffic. Access is provided by interchanges with typical spacing of one mile or greater. No local access is provided to adjacent land uses.
- *Arterial* roadways are major streets that primarily serve through-traffic and provide access to abutting properties as a secondary function. Arterials are generally designed with two to six travel lanes and their major intersections are signalized. This roadway type is divided into two categories: principal and minor arterials. Principal arterials are typically four-or-more lane roadways and serve both local and regional through-traffic. Minor arterials are typically two-to-four lane streets that service local and commuter traffic.
- *Collector* roadways are streets that provide access and traffic circulation within residential and non-residential (e.g., commercial and industrial) areas. Collector roadways connect local streets to arterials and are typically designed with two through travel lanes (i.e., one through

o:\job_file\4416\dwg\3-1.dwg LDP 15:49:17 06/15/2021 rodriguez

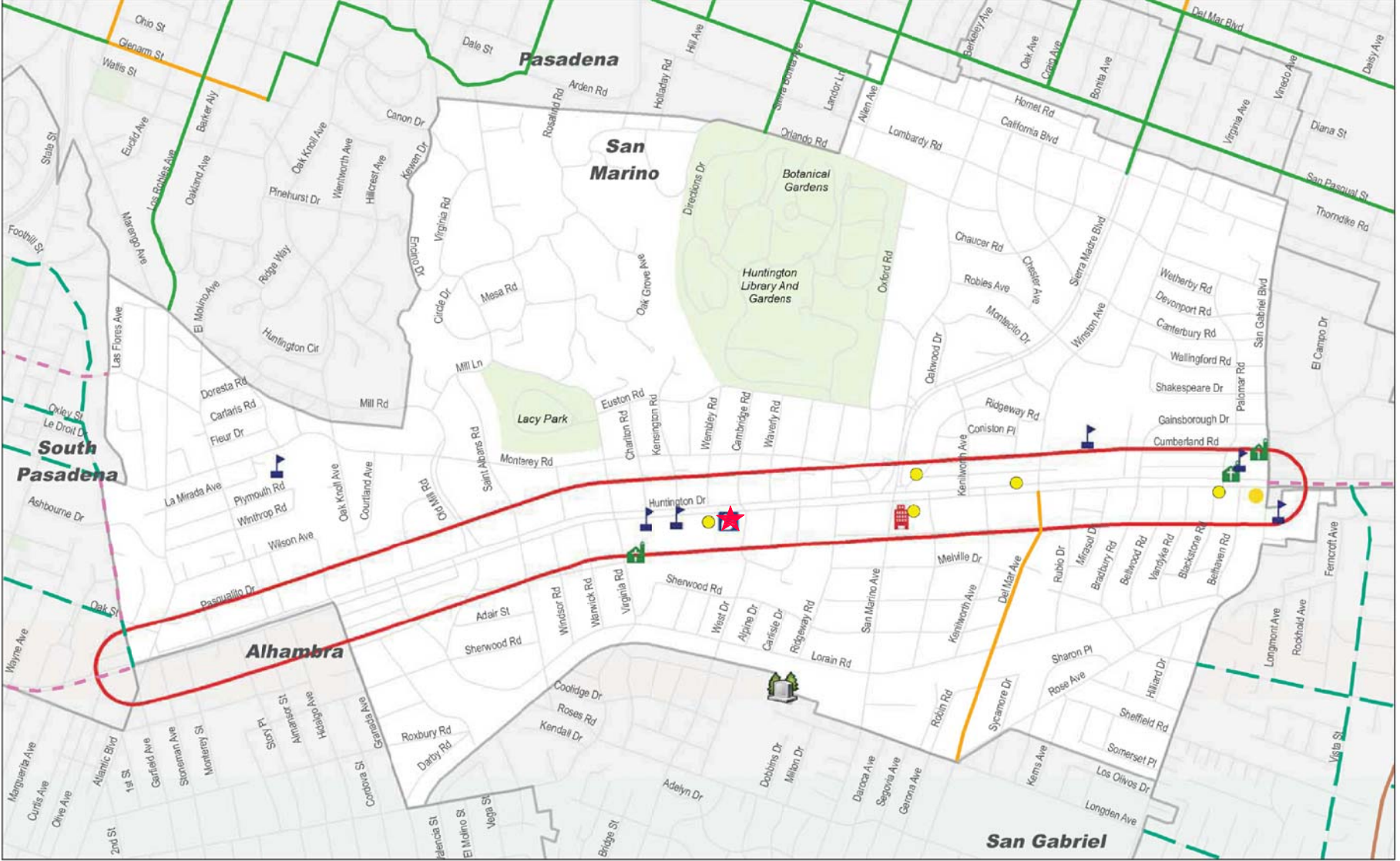

MAP SOURCE: CITY OF SAN MARINO HUNTINGTON DRIVE SAFE STREETS CORRIDOR PLAN DRAFT FEBRUARY 2018

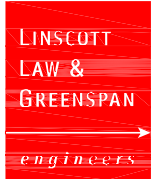

Project Site

Figure 3-1
Existing and Proposed Bikeways

**Table 3-1
EXISTING TRANSIT ROUTES [1]**

ROUTE	DESTINATIONS	ROADWAY(S) NEAR SITE	NO. OF BUSES DURING PEAK HOUR		
			DIR	AM	PM
Metro 79	Downtown Los Angeles to Arcadia via El Sereno, Alhambra and South Arcadia	Virginia Road, West Drive, Sierra Madre Boulevard, San Marino Avenue, Huntington Drive	EB WB	1 1	1 1
Metro 176	Highland Park to Montebello via South Pasadena, San Gabriel, Rosemead, El Monte and South El Monte	Garfield Avenue, Huntington Drive	EB WB	1 1	1 1
Metro 260	Altadena to Compton via Pasadena, Alhambra, East Los Angeles, Maywood and Lynwood	Garfield Avenue, Huntington Drive	NB SB	4 4	4 5
Metro 487	El Monte to Downtown Los Angeles via Arcadia, Pasadena, San Marino, Temple City and San Gabriel	San Gabriel Boulevard, Huntington Drive	EB WB	1 1	1 1
Montebello 30	San Marino to Bell Gardens via Alhambra, Monterey Park and Montebello	Garfield Avenue, Huntington Drive	EB WB	1 1	1 1
TOTAL				16	17

[1] Sources: Los Angeles County Metropolitan Transportation Authority (Metro) and City of Montebello Bus Lines (MBL) websites, 2021.

travel lane in each direction) that may accommodate on-street parking. They may also provide access to abutting properties.

- *Local* roadways distribute traffic within a neighborhood, or similar adjacent neighborhoods, and are not intended for use as a through-street or a link between higher capacity facilities such as collector or arterial roadways. Local streets are fronted by residential uses and do not typically serve commercial uses. Generally, travel lanes are not striped, and parking may be accommodated on one or both sides of the roadway.

3.3.2 Regional Highway System

Primary regional access is provided by the I-210 Freeway (approximately 2.5 miles north of the project site) and the I-10 Freeway (approximately 3.5 miles south of the project site). The *Foothill Freeway (I-210)* is a major east-west oriented freeway connecting the Golden State Freeway (I-5) in the San Fernando area to the Orange Freeway (SR 57) near San Dimas. The I-210 Freeway generally contains four mainline freeway lanes and one high occupancy vehicle lane in each direction near the study area. Full freeway connections (i.e., eastbound and westbound ramp connections) are provided at Sierra Madre Boulevard and Allen Avenue.

The *San Bernardino (I-10) Freeway* is a major east-west freeway connecting the City of Santa Monica with the City of Los Angeles and the municipalities of the San Gabriel Valley and San Bernardino County to the east. In the project vicinity, three to four mixed-flow freeway lanes are provided in each direction on the I-10 Freeway with auxiliary merge/weave lanes provided between some interchanges. Eastbound and westbound on/off ramps are provided to and from the I-10 Freeway at Del Mar Avenue and New Avenue.

3.3.3 Roadway Descriptions

The current lane configurations and traffic control measures at each study intersection is presented in **Figure 3-3**. Descriptions of the roadways which comprise the study area are provided in **Table 3-2**, including the roadway classification, number of lanes, median types, and speed limits designated by the City of San Marino.

3.4 Traffic Count Data

The traffic count data for the four (4) study intersections are based on the historical traffic count data utilized in the *Citywide Traffic Circulation Study*. The traffic counts for all of the study intersections were conducted during the weekday morning peak period (7:00 AM to 9:00 AM) and weekday evening peak period (4:00 PM to 6:00 PM) in November 2019. The year 2019 manual traffic count data has been adjusted by an annual ambient growth rate (i.e., 1.0 percent per year) to reflect year 2021 existing conditions. Traffic volumes at the study intersections show the weekday morning and weekday afternoon peak periods typically associated with peak commute hours in the metropolitan area.

o:\job_file\4416\dwg\13-3.dwg LDP 10:04:54 06/16/2021 rodriguez

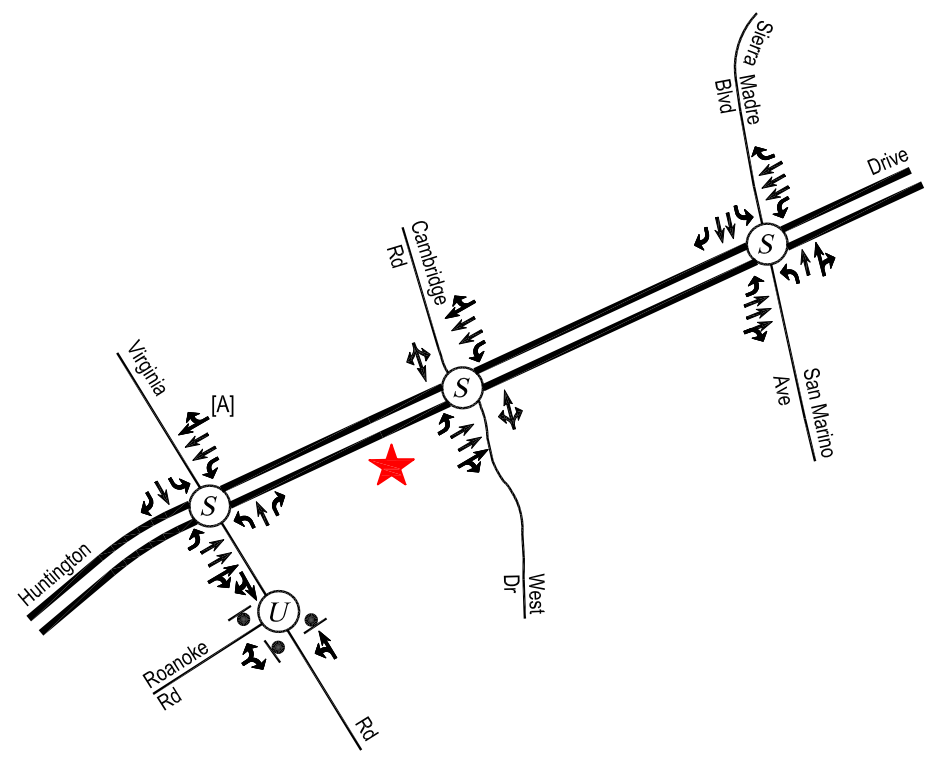

- Signalized Intersection
- Unsignalized Intersection
- Stop Sign

[A] No Right-Turn on Red (8-9 AM, 2-3:30 PM School Days)



Project Site

Figure 3-3
Existing Lane Configurations

**Table 3-2
EXISTING ROADWAY DESCRIPTIONS**

ROADWAY	CLASSIFICATION [1]	TRAVEL LANES		MEDIAN TYPES [4]	SPEED LIMIT
		DIRECTION [2]	NO. LANES [3]		
Virginia Road -North of Huntington Drive -South of Huntington Drive	Collector Local	NB-SB	2	N/A	25
		NB-SB	2	N/A	25
Cambridge Road	Local Street	NB-SB	2	N/A	25
West Drive	Local Street	NB-SB	2	N/A	35
San Marino Avenue -North of Huntington Drive -South of Huntington Drive	Parkway Collector	NB-SB	4	RMI	35
		NB-SB	2	N/A	25
Huntington Drive	Parkway	EB-WB	6	RMI	40
Roanoke Road	Local Street	EB-WB	2	N/A	25

Notes:

- [1] Roadway classifications obtained from the *City of San Marino Circulation Element*, adopted August 1995.
- [2] Direction of roadways in the project area: NB-SB = northbound and southbound; and EB-WB = eastbound and westbound.
- [3] Number of lanes in both directions on the roadway.
- [4] Median type of the road: RMI = Raised Median Island; 2WLT = 2-Way Left-Turn Lane; and N/A = Not Applicable.

It should also be noted that new traffic counts were not collected in the midst of the Covid-19 pandemic since it may represent atypical conditions. Thus, based on coordination with City staff, since historical traffic counts were available in the study area and for establishing existing conditions consistency with the *Citywide Traffic Circulation Study*, it was determined that the historical traffic count data at the four (4) study intersections would be appropriate and thus were utilized to determine the existing traffic conditions.

The existing weekday AM and weekday PM peak hour intersection traffic volumes by approach are summarized in **Table 3-3**. The existing vehicular turning movements at the study intersections during the weekday AM and weekday PM peak hours are shown in **Figures 3-4** and **3-5**, respectively. For each study intersection, the highest one-hour total traffic volumes (i.e., four consecutive 15-minute time intervals) traversing through the intersection during the 7:00 to 9:00 AM and 4:00 to 6:00 PM time periods were selected so as to determine the respective weekday AM and PM peak hour traffic volumes for each study intersection. For purposes of the traffic impact analysis, this common traffic engineering practice ensures that a more conservative (i.e., worst-case) assessment of existing operating conditions be attained for each study intersection. Therefore, the traffic volumes shown in **Figures 3-4** and **3-5** for the study intersections do not necessarily reflect the same exact one-hour time period during the morning and/or afternoon peak commuter conditions (i.e., one intersection's peak hour may have occurred between 7:30 and 8:30 AM, while another intersection's peak hour may have occurred between 7:45 and 8:45 AM). Summary data worksheets of the manual traffic counts of the study intersections are contained in **Appendix B**.

3.5 Cumulative Development Projects

The forecast of future pre-project conditions was prepared in accordance to procedures outlined in Section 15130 of the CEQA Guidelines. Specifically, the CEQA Guidelines provide two options for developing the future traffic volume forecast:

“(A) A list of past, present, and probable future projects producing related or cumulative impacts, including, if necessary, those projects outside the control of the [lead] agency, or

(B) A summary of projections contained in an adopted local, regional or statewide plan, or related planning document, that describes or evaluates conditions contributing to the cumulative effect. Such plans may include: a general plan, regional transportation plan, or plans for the reduction of greenhouse gas emissions. A summary of projections may also be contained in an adopted or certified prior environmental document for such a plan. Such projections may be supplemented with additional information such as a regional modeling program. Any such document shall be referenced and made available to the public at a location specified by the lead agency.”

Although the CEQA Guidelines do not strictly apply to the local transportation assessment required by the City of San Marino, this traffic analysis provides a highly conservative estimate of future pre-

**Table 3-3
EXISTING TRAFFIC VOLUMES [1]
WEEKDAY AM AND PM PEAK HOURS**

NO.	INTERSECTION	DATE	DIR	AM PEAK HOUR		PM PEAK HOUR	
				BEGAN	VOLUME	BEGAN	VOLUME
1	Virginia Road / Huntington Drive	11/07/2019	NB	8:15 AM	439	5:15 PM	177
			SB		192		456
			EB		1,251		1,827
			WB		1,886		1,477
2	Virginia Road / Roanoke Road	11/07/2019	NB	7:45 AM	424	5:15 PM	181
			SB		98		398
			EB		25		9
			WB		0		0
3	Cambridge Road - West Drive / Huntington Drive	11/07/2019	NB	7:45 AM	145	5:30 PM	159
			SB		150		164
			EB		1,458		1,992
			WB		1,874		1,511
4	Sierra Madre Boulevard- San Marino Avenue / Huntington Drive	11/07/2019	NB	8:00 AM	658	4:45 PM	389
			SB		833		1,179
			EB		1,417		1,942
			WB		1,391		1,107

[1] Counts conducted by IDAX Data. The traffic counts were adjusted by 1% per year to account for ambient growth in determining year 2021 conditions.

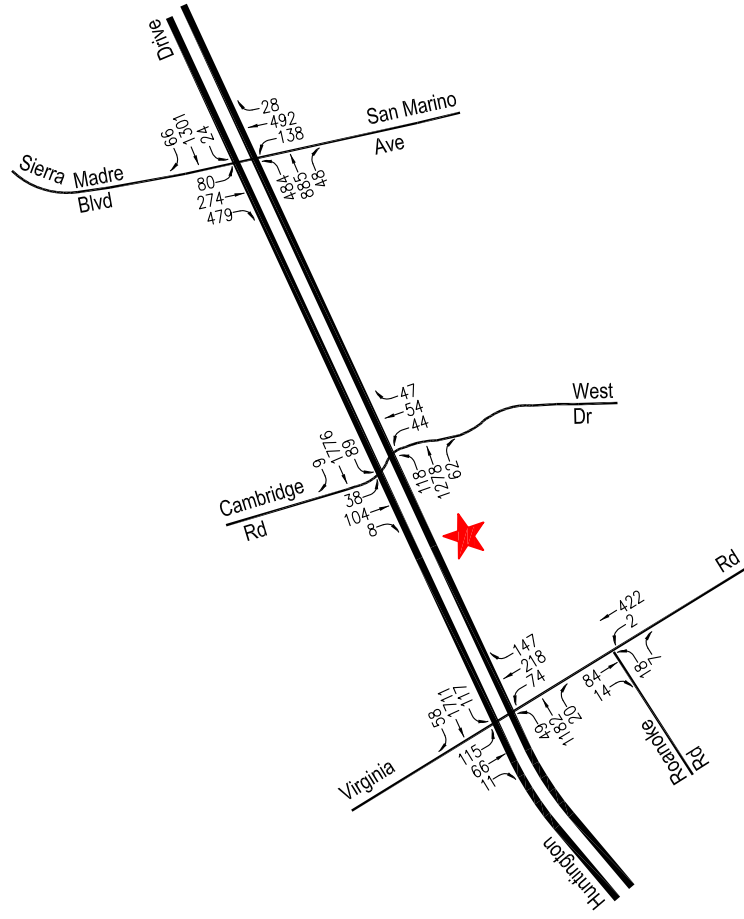

Project Site



Figure 3-4
Existing Traffic Volumes
 Weekday AM Peak Hour
 San Marino Center Improvement Project

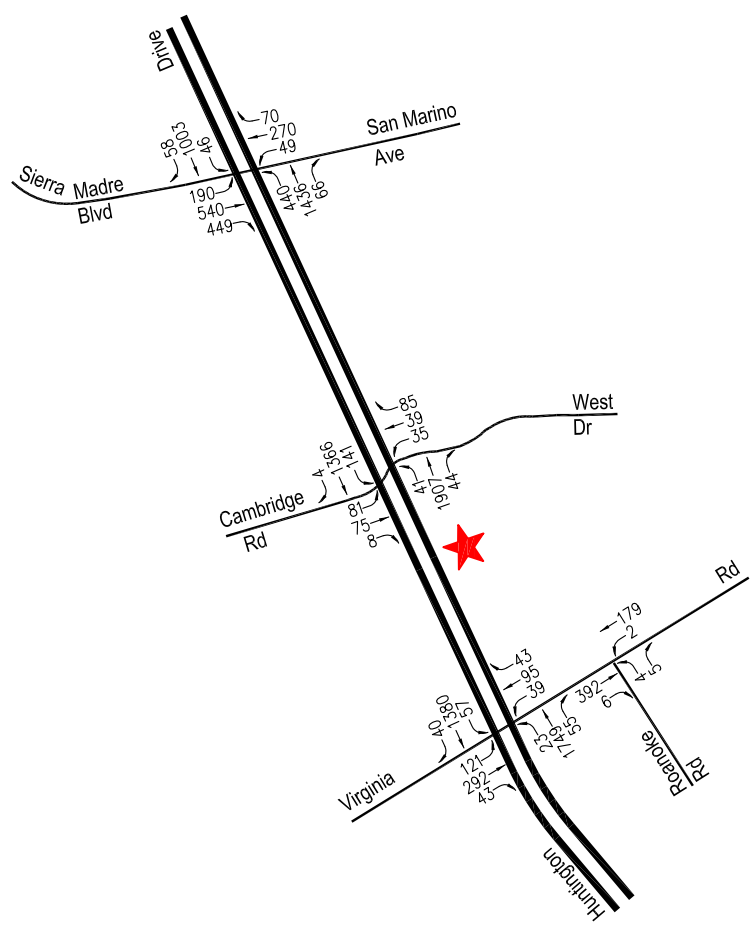

Figure 3-5
Existing Traffic Volumes
 Weekday PM Peak Hour
 San Marino Center Improvement Project

Project Site



project traffic volumes as it incorporates both the “A” and “B” options for purposes of developing the forecast.

3.5.1 Related Projects

A forecast of on-street traffic conditions prior to occupancy of the proposed project was prepared by incorporating the potential trips associated with other known development projects (related projects) in the area (i.e., within an approximate one-mile radius from the project site). With this information, the potential impact of the proposed project can be evaluated within the context of the cumulative impacts of all ongoing development. The related projects research was based on information on file with the City of San Marino and the City of Alhambra Community Development Departments. The list of related projects in the project site area is presented in *Table 3-4*. The location of the related projects is shown in *Figure 3-6*.

Traffic volumes expected to be generated by the related projects were calculated using rates provided in the Institute of Transportation Engineers’ (ITE) *Trip Generation Manual*⁸, or they were obtained from other traffic studies as sourced. The related projects’ respective traffic generation for the weekday AM and PM peak hours, as well as on a daily basis for a typical weekday, is summarized in *Table 3-4*. The related projects traffic volumes were distributed and assigned to the street system based on the projects’ locations in relation to the study intersections, their proximity to major traffic corridors, proposed land uses, nearby population and employment centers, etc. The anticipated distribution of the related projects traffic volumes to the study intersections during the weekday AM and weekday PM peak hours are displayed in *Figures 3-7* and *3-8*, respectively.

3.5.2 Ambient Traffic Growth Factor

Horizon year background traffic growth estimates have been calculated using an ambient traffic growth factor. The ambient traffic growth factor is intended to include unknown related projects in the study area as well as account for typical growth in traffic volumes due to the development of projects outside the study area. An annual growth rate of one percent (1.0%) per year was selected for this analysis in consultation with City of San Marino staff during the scoping process.

Therefore, application of this one percent (1.0%) ambient growth factor in addition to the forecast traffic generated by the related projects allows for a very conservative forecast of future traffic volumes in the project study area as incorporation of both (i.e., an ambient traffic growth rate and a detailed list of cumulative development projects) is expected to overstate potential future traffic volumes.

⁸ Institute of Transportation Engineers *Trip Generation Manual*, 10th Edition, Washington, D.C., 2017.

Table 3-4
RELATED PROJECTS LIST AND TRIP GENERATION [1]

MAP NO.	PROJECT STATUS	PROJECT NAME/NUMBER ADDRESS/LOCATION	LAND USE DATA		PROJECT DATA SOURCE	DAILY TRIP ENDS [2]	AM PEAK HOUR VOLUMES [2]			PM PEAK HOUR VOLUMES [2]		
			LAND-USE	SIZE			IN	OUT	TOTAL	IN	OUT	TOTAL
City of San Marino												
SM1	Under Construction	The Huntington Library, Art Museum, and Botanical Gardens 1151 Oxford Road	Rose Garden Tea Room Expansion	68 Seats	[3]	177	1	0	1	13	6	19
SM2	Under Construction	The Huntington Library, Art Museum, and Botanical Gardens 1151 Oxford Road	Japanese Heritage House Restoration & Relocation	--	--	Nom.	Nom.	Nom.	Nom.	Nom.	Nom.	Nom.
City of Alhambra												
A1	Proposed	1224 N. Atlantic Boulevard	Restaurant Retail	3,267 GSF 3,646 GLSF	[4] [5]	1,539 138	67 2	64 1	131 3	56 7	51 7	107 14
A2	Proposed	700 N. Stoneman Avenue	Condominium	79 DU	[6]	430	7	21	28	21	14	35
A3	Proposed	300 E. Alhambra Road	Condominium	6 DU	[7]	44	1	2	3	2	1	3
A4	Proposed	918 - 924 E. Main Street	Retail Office	2,899 GLSF 10,971 GSF	[5] [8]	109 107	2 11	1 2	3 13	5 2	6 11	11 13
TOTAL						2,544	91	91	182	106	96	202

[1] Sources: City of San Marino and the City of Alhambra Community Development Departments. ITE "Trip Generation Manual", 10th Edition, 2017.

[2] Trips are one-way traffic movements, entering or leaving.

[3] ITE Land Use Code 931 (Quality Restaurant) trip generation average rates.

[4] ITE Land Use Code 934 (Fast-Food Restaurant with Drive-Through) trip generation average rates.

[5] ITE Land Use Code 820 (Shopping Center) trip generation average rates.

[6] ITE Land Use Code 221 (Multifamily Housing [Mid-Rise]) trip generation average rates.

[7] ITE Land Use Code 220 (Multifamily Housing [Low-Rise]) trip generation average rates.

[8] ITE Land Use Code 710 (General Office) trip generation average rates.

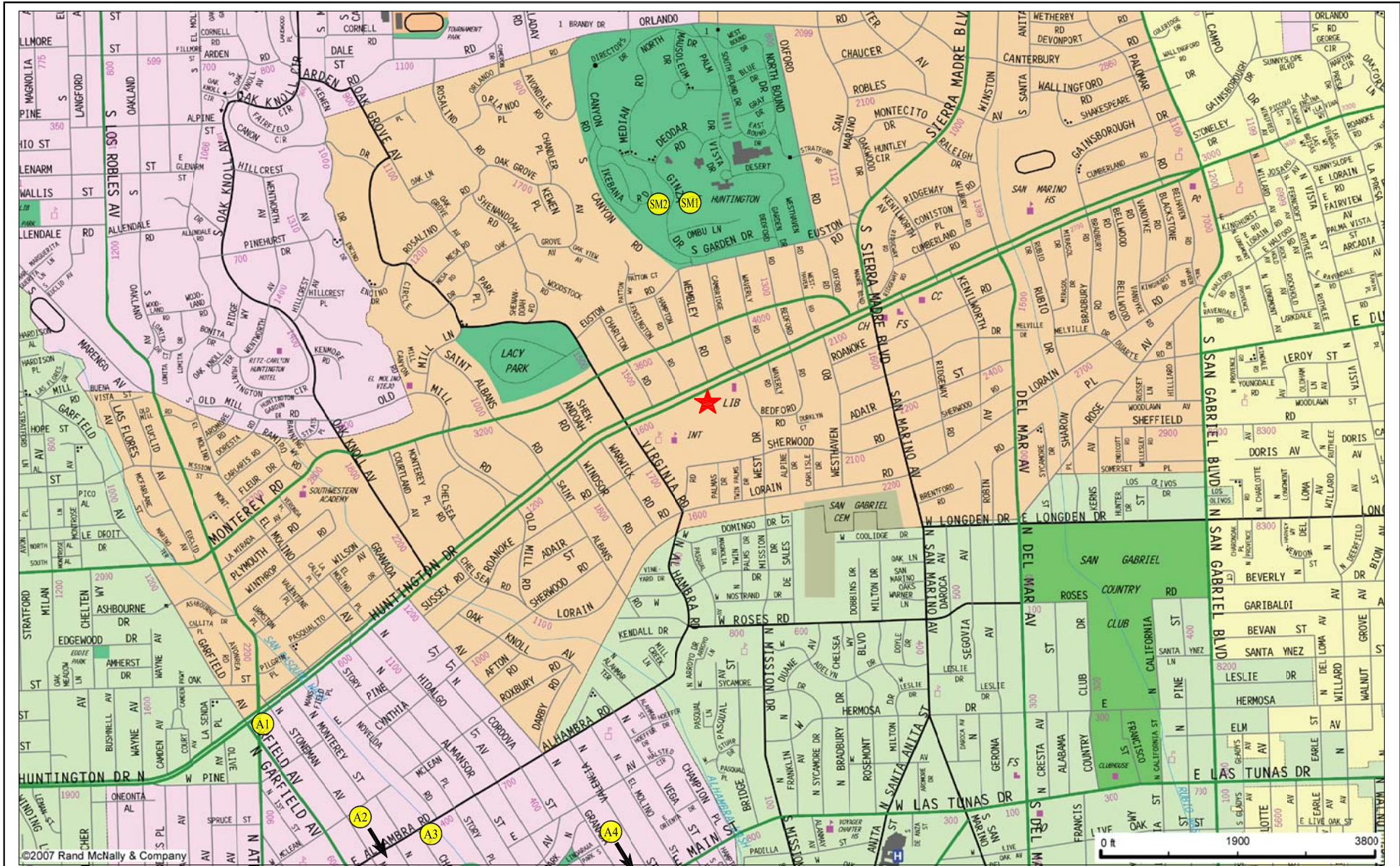

MAP SOURCE: RAND MCNALLY & COMPANY



- ★ Project Site
- SM City of San Marino Related Project
- A City of Alhambra Related Project

Figure 3-6
Location of Related Projects

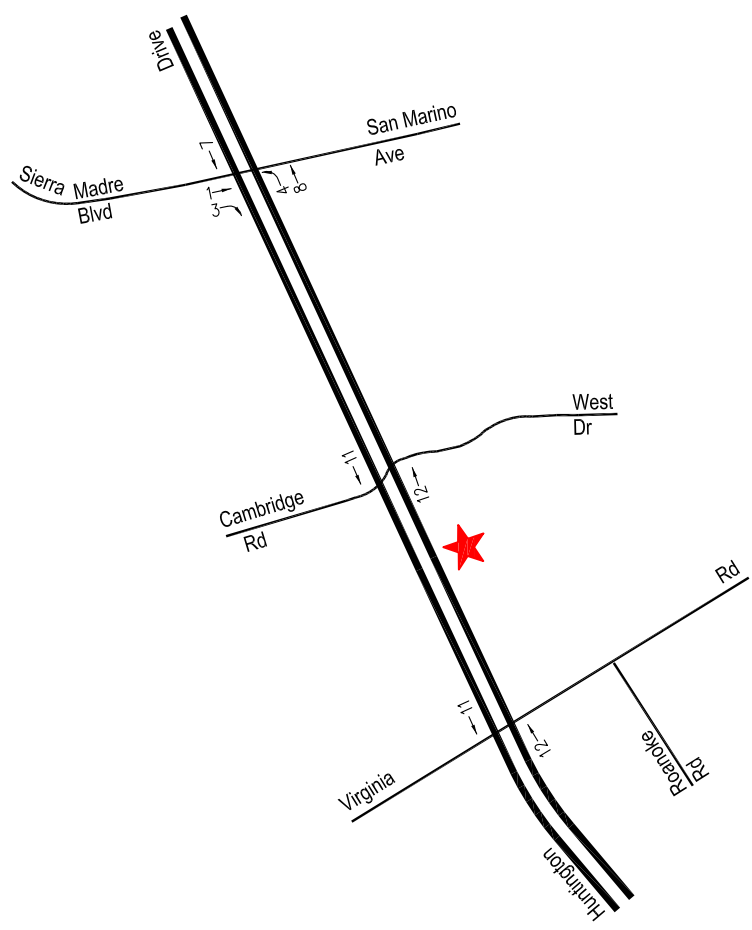

Project Site



Figure 3-7
 Related Projects Traffic Volumes
 Weekday AM Peak Hour
 San Marino Center Improvement Project

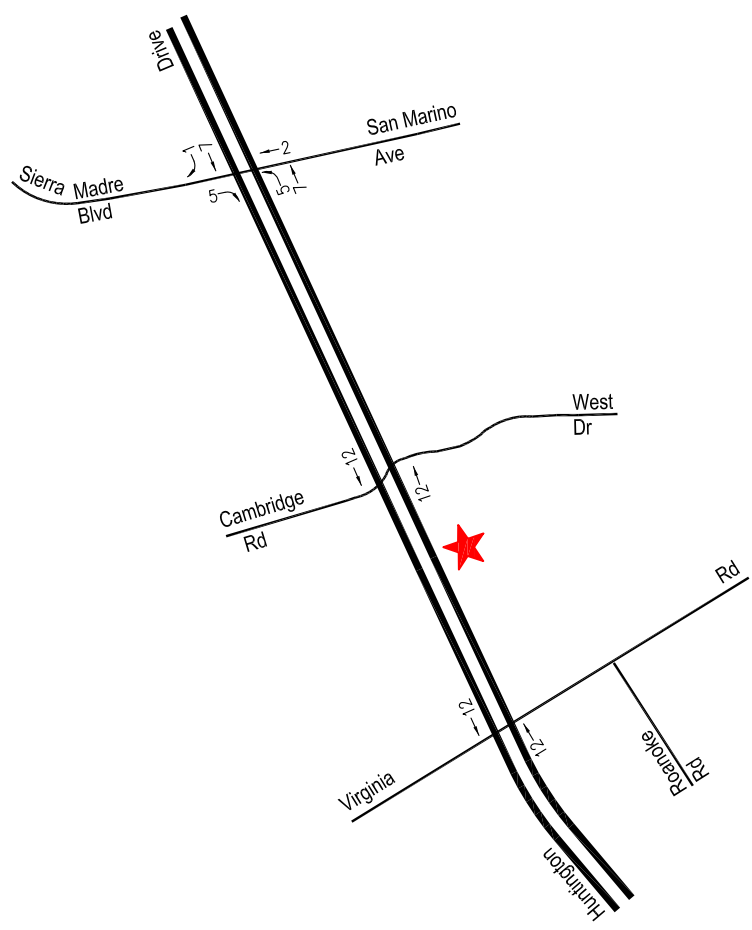

Project Site



Figure 3-8
Related Projects Traffic Volumes
 Weekday PM Peak Hour
 San Marino Center Improvement Project

4.0 CEQA TRANSPORTATION ASSESSMENT

The State of California Governor’s Office of Planning and Research (OPR) issued proposed updates to the CEQA Guidelines in November 2017 that amends the Appendix G question for transportation impacts to delete reference to vehicle delay and level of service and instead refer to Section 15064.3, subdivision (b)(1) of the CEQA Guidelines asking if the project will result in a substantial increase in vehicle miles traveled (VMT). The California Natural Resources Agency certified and adopted the revisions to the CEQA Guidelines in December of 2018, and as of July 1, 2020 the provisions of the new section are in effect statewide. Concurrently, OPR developed the *Technical Advisory on Evaluating Transportation Impacts in CEQA* (December 2018), which provides non-binding recommendations on the implementation of VMT methodology which has significantly informed the way VMT analyses are conducted in the State. Accordingly, for the purpose of environmental review under CEQA, the City of San Marino has adopted significance criteria for transportation impacts based on VMT for land use projects and plans which is generally consistent with the recommendations provided by OPR in the *Technical Advisory*.

4.1 Vehicle Miles Traveled (VMT) Project Screening

Traditionally, public agencies have set certain thresholds to determine whether a project requires detailed transportation analysis or if it could be assumed to have less than significant environmental impacts without additional study. The City of San Marino has adopted three (3) screening criteria which may be applied to screen proposed projects out of detailed VMT analysis. Proposed projects are not required to satisfy all of the screening criteria in order to screen out of further VMT analysis; satisfaction of one criterion is sufficient for screening purposes. The following sections provide a detailed explanation of each screening criteria as it relates to the proposed project.

4.1.1 Transit Priority Area Screening

CEQA Guidelines Section 15064.3(b)(1) states in part: “Generally, projects within one-half mile of either an existing major transit stop or a stop along an existing high-quality transit corridor should be presumed to cause a less than significant transportation impact.” In keeping with the statutory presumption of less than significant impacts due to nearby high-quality transit, the City of San Marino has adopted a transit priority area⁹ (TPA) screening criterion. Projects which are located within a TPA are presumed to have a less than significant impact, absent substantial evidence to the contrary. This presumption may not be appropriate if:

- The project has a floor area ratio (FAR) of less than 0.75.
- The project includes more parking for use by residents, customers, or employees of the project than required by the City.

⁹ Public Resources Code Section 21099(a)(7): ““Transit priority area” means an area within one-half mile of a major transit stop that is existing or planned, if the planned stop is scheduled to be completed within the planning horizon included in a Transportation Improvement Program or applicable regional transportation plan.”

- The project is inconsistent with the applicable Sustainable Communities Strategy (as determined by the lead agency, with input from the Southern California Association of Governments [SCAG]).
- The project replaces affordable residential units with a smaller number of moderate- or high-income residential units.

The San Gabriel Valley Council of Governments (SGVCOG) Vehicle Miles Traveled Evaluation Tool (“VMT Evaluation Tool”), which was developed by Fehr & Peers as part of the SB 743 VMT Implementation Study effort, was utilized to conduct TPA screening in the City of San Marino.

As described in *Section 3.2*, public transit service is provided in the vicinity of the proposed project. The Los Angeles County Metropolitan Transportation Authority (Metro) Transit line and the Montebello bus line which provide services in the immediate vicinity of the project site, do not meet the criteria for a high-quality transit corridor¹⁰. Based on a review of the existing transit service in the vicinity, the proposed project is not expected to screen out of VMT analysis due to being located within a TPA. The VMT Evaluation Tool likewise concludes that the project fails the TPA screening criterion. Screening worksheets generated by the tool for the proposed project are included in *Appendix C*.

4.1.2 Low VMT Area Screening

It is assumed that projects which will be located within areas which currently exhibit low VMT, and that incorporate similar features pertaining to density, land use mix, and transit availability, will tend to exhibit similarly low VMT. In areas where the existing VMT generation already falls below the applicable thresholds, and where projects are likely to generate similar levels of VMT, projects may be screened out of preparing detailed VMT analysis. OPR notes that such screening is appropriate for residential and office projects.

The City of San Marino has adopted a low VMT area screening criterion which may apply to residential, office, or other employment-related and mixed-use land use types. The SCAG Travel Demand Forecasting Model was used to establish VMT performance for individual Traffic Analysis Zones (TAZ). The VMT values for each TAZ are then compared to the applicable City thresholds (i.e., VMT per capita, per employee, or per service population) to determine if the TAZ can be considered a low VMT area. Locations within the City of San Marino which qualify for the low VMT area screening are to be identified through the VMT Evaluation Tool.

As reported in the screening worksheets provided in *Appendix C*, the project is situated within TAZ 22139300, which currently exhibits 27.95 total VMT per service population. The threshold for office project types is noted as 29.77 total VMT per service population. Therefore, the TAZ currently exhibit VMT below the applicable thresholds and could be considered a low VMT area. The proposed project site therefore meets the low VMT area screening criterion.

¹⁰ Public Resources Code Section 21155(b): “For purposes of this section, a high-quality transit corridor means a corridor with fixed route bus service with service intervals no longer than 15 minutes during peak commute hours.”

4.1.3 Project Type Screening

Consistent with the OPR's *Technical Advisory*, the City of San Marino has determined the following potential screening criteria for certain land development projects that may be presumed to result in a less than significant VMT impact as mentioned in the City's adopted Resolution No. 20-18, Exhibit 2:

- Local-serving retail less than 50,000 square feet, including gas stations, banks, restaurants, shopping center.
- Local-serving K-12 schools, local parks, daycare centers, etc.
- Local-serving hotels (e.g., non-destination hotels)
- Local-serving assembly uses (places of worship, community organizations)
- Community institutions (public libraries, fire stations, local government)
- Affordable, supportive, or transitional housing
- Assisted living facilities, senior housing
- Projects generating less than 110 daily vehicle trips
- Public parking garages and public parking lots

As mentioned in the City's Resolution and OPR's *Technical Advisory*, local serving uses typically redistributes and reroutes local trips rather than create new trips. By adding local serving opportunities into the urban fabric and thereby improving destination proximity, local-serving projects tends to shorten trips and reduce VMT. It is also noted that lead agencies may presume such local-serving projects create a less than significant transportation impact. Similarly, the proposed San Marino Center Improvement project will serve the local population and is considered a community institution, thereby shortening travel distances and reducing VMT. Thus, the proposed project can be presumed to result in a less than significant VMT impact based on State guidance because it would reduce VMT by shortening trip lengths, similar to local-serving retail developments and local-serving projects.

The City's VMT screening assessment worksheet is included in *Appendix C*. Therefore, the proposed project satisfies the criteria to be considered a local serving use and is screened out from further VMT analysis as it is presumed to cause less than significant transportation impacts.

4.1.4 Summary of Screening Conclusions

The City of San Marino has adopted three screening criteria which may be applied to screen proposed projects out of detailed VMT analysis. The project does not meet the criteria to be screened out of VMT analysis based on its location within a TPA. The project does, however, satisfy the criteria based on its location within a low VMT-generating area and based on the project land use type as a local serving use. Therefore, the project is screened out of further VMT analysis.

4.2 VMT Impact Conclusions

As described in *Section 4.1.4*, the project meets the criteria for a local serving project and is screened out of further VMT analysis. The screening criterion is based on the presumption that local serving projects will cause less than significant impacts. The project is also located within a low VMT-generating area. Therefore, through satisfaction of the screening criteria, the project is determined to result in a less than significant transportation impact.

4.3 Active Transportation and Public Transit Analysis

A significant impact may also occur “if the project conflicts with adopted policies, plans, or programs regarding public transit, bicycle, or pedestrian facilities, or otherwise decreases the performance or safety of such facilities”. The following section provides a brief review of the City’s adopted policies, plans, and programs pertaining to active transportation and public transit analysis.

4.3.1 Adopted Policies, Plans, or Programs

The City’s Circulation Element (1995) and the Final General Plan (2003) sets forth actions and policies pertaining to accident and traffic safety, transit and public transportation, ensuring easy and convenient access to the regional facilities, bicycle routes and pedestrian facilities, among other things. Relevant adopted policies include:

- Objective L.8: Huntington Drive – Designate areas for commercial use on Huntington Drive consistent with existing commercial locations.
- Policy 12: Develop and implement neighborhood traffic control plans which will reduce the speed and volume of traffic on residential streets to acceptable levels.
- Policy 17: Improve safety at school drop-off areas and employ appropriate traffic control measures in the vicinity of schools to maximize safety for school children walking or bicycling to/from school.
- Policy 18: The City shall work with public transit agencies to ensure that transit lines are routed on streets in accordance with the policies of [the] Circulation Element.
- Policy 23: The City shall develop a bicycle plan which provides opportunities for safe, recreational bike usage and provides continuity between land uses in San Marino.
- Policy 24: The City shall evaluate the sidewalk system throughout the City, in all neighborhoods, and where approval for sidewalk installation is provided by residents.
- Policy 25: In areas of the City, where commercial or public facilities are located, the City shall implement measures to enhance the pedestrian and bicycle environment, to attempt to slow passing vehicular traffic, and to ensure handicapped accessibility in accordance with the requirements of the Americans with Disabilities Act.

- Policy 26: Install pedestrian-activated signals, where appropriate, and crosswalks to provide safe, adequate pedestrian accessibility for shopping areas and residences.
- Policy 36: The City shall encourage its residents and employees to utilize alternative modes of transportation such as buses, light rail transit, carpools, Dial-A-Ride vehicles, bicycles and walking and shall take measures to ensure that these alternate modes are available in the City.
- Policy 37: The City shall encourage Transportation Demand Management programs as a mechanism to reduce parking demands in the City.

As mentioned previously, the *2014 Draft San Marino Bicycle and Pedestrian Plan* includes objectives pertaining to programs that support bicycling, including programs that introduce and promote education, encouragement, and outreach, and encourage non-motorized travel to shops and restaurants. The Plan also provides specific recommendations including several options for providing bike lanes and improved pedestrian crossing markings along the entire length of Huntington Drive in order to promote walking and bicycling activities within the City. The *San Marino Safe Routes to School Program (2012-2015)* involved collaboration between the City and schools to improve the safety of students traveling to/from school with an increased focus on students and road safety.

4.3.2 Qualitative Impact Conclusions

The proposed project is not expected to result in a significant impact on active transportation or public transit in the vicinity of the project site. As described in *Section 3.1* herein, the project site is planned to accommodate pedestrian and bicycle access via exclusive walkways which connect the site to the public sidewalks. The walkways minimize the extent of pedestrian and bicycle interaction with vehicles at the site and provide a comfortable, convenient, and safe environment which in turn can encourage use of active transportation modes. The project site is further planned to provide bicycle parking facilities for use by employees and the public. The proposed project is therefore found to be in alignment with the City's Circulation Element and Final General Plan as well as the other Plans' goals to promote pedestrian and bicycle safety and provide appropriate and supportive active multi-modal transportation infrastructure.

The proposed project is located adjacent to Huntington Drive, which is currently served by public bus transit service provided by Metro. As noted in *Section 3.2*, the project site is within walking distance from an existing bus stop located along Huntington Drive at West Drive. The proposed project is not expected to affect access or safety at the existing bus stops, nor is it expected to hinder public transit service along Huntington Drive. The proposed project is not expected to preclude the City from constructing bicycle facilities or pursuing bicycle network improvements along local roadways within the study area. Development of the proposed project will not prevent the City from completing any proposed transit, bicycle, or pedestrian facilities.

Since the proposed project is not found to result in conflicts with adopted policies, plans, or programs, nor is it expected to negatively affect the performance or safety of existing or planned

pedestrian, bicycle, or transit facilities, it is determined that the proposed project will have a less than significant impact on active transportation and public transit in the vicinity of the project site.

5.0 NON-CEQA ANALYSIS

The City of San Marino has established vehicle Level of Service (LOS) standards which local infrastructure will strive to maintain. The LOS standards apply to discretionary approvals of new land use projects. The following section presents the operational (i.e., Level of Service) analysis prepared for the proposed project pursuant to this requirement.

5.1 Analysis Methodology

In order to estimate the proposed project's effect on intersection operations, a multi-step process has been utilized. The first step is trip generation, which estimates the total arriving and departing traffic volumes on a peak hour and daily basis. The second step of the forecasting process is trip distribution, which identifies the origins and destinations of inbound and outbound project traffic volumes. These origins and destinations are typically based on demographics and existing/anticipated travel patterns in the study area. The third step is traffic assignment, which involves the allocation of project traffic to study area streets and intersections. Traffic distribution patterns are indicated by general percentage orientation, while traffic assignment allocates specific volume forecasts to individual roadway links and intersection turning movements throughout the study area. The proposed project's forecast trip generation, distribution, and assignment is presented in *Section 2.8* herein. With the forecasting process complete and project traffic assignments developed, the effect of the proposed project is isolated by comparing operational conditions at the selected study intersections using existing and expected future traffic volumes without and with forecast project traffic.

Intersection analyses were prepared utilizing the *Synchro 11* software package which implements the Highway Capacity Manual (HCM) operational method to determine delay values and corresponding Levels of Service (LOS) for the study intersections. For the HCM operational method of analysis, LOS for intersections is defined in terms of control delay, which is a measure of driver discomfort, frustration, fuel consumption, and lost travel time. The delay experienced by a motorist is made up of a number of factors that relate to control, geometries, traffic, and incidents. Total delay is the difference between the travel time actually experienced and the reference travel time that would result during ideal conditions: in the absence of traffic control, in the absence of geometric delay, in the absence of any incidents, and when there are no other vehicles on the road.

The HCM signalized methodology calculates the control delay for each of the subject traffic movements and determines the LOS for each constrained movement. The control delay for any particular movement is a function of the capacity of the approach and the degree of saturation. The overall control delay is measured in seconds per vehicle and the LOS is then determined. Intersection Levels of Service vary from LOS A (free flow condition) to LOS F (jammed condition). The six qualitative categories of Level of Service have been defined along with the corresponding HCM control delay value range and are shown in *Table 5-1*. Detailed description of the HCM operations method and corresponding Levels of Service is also provided in *Appendix D*.

**TABLE 5-1
LEVEL OF SERVICE CRITERIA AND DELAY CHARACTERISTICS**

Level of Service (LOS)	Control Delay (Sec/Veh)	Level of Service Description
A	≤ 10	This level of service occurs when progression is extremely favorable and most vehicles arrive during the green phase. Most vehicles do not stop at all. Short cycle lengths may also contribute to low delay values.
B	> 10 and ≤ 20	This level generally occurs with good progression, short cycle lengths, or both. More vehicles stop than with LOS A, causing higher levels of delay.
C	> 20 and ≤ 35	These higher delays may result from fair progression, longer cycle lengths, or both. Individual cycle failures may begin to appear at this level. The number of vehicles stopping is significant at this level, though many still pass through the intersection without stopping.
D	> 35 and ≤ 55	At LOS D, the influence of congestion becomes more noticeable. Longer delays may result from some combination of unfavorable progression, long cycle lengths, or high v/c ratios. Many vehicles stop, and the proportion of vehicles not stopping declines. Individual cycle failures are noticeable.
E	> 55 and ≤ 80	These high delay values generally indicate poor progression, long cycle lengths, and high v/c ratios. Individual cycle failures are frequent occurrences.
F	> 80	This level, considered to be unacceptable to most drivers, often occurs with oversaturation, that is, when arrival flow rates exceed the capacity of the lane groups. It may also occur at high v/c ratios with many individual cycle failures. Poor progression and long cycle lengths may also be major contributing factors to such delay levels.

5.2 Criteria for Non-CEQA Analysis

The relative effect of the added project traffic volumes to be generated by the proposed project during the weekday AM and PM peak hours was evaluated based on analysis of existing and future operating conditions at the study intersections, without and with the proposed project. The previously discussed capacity analysis procedures were utilized to evaluate the future v/c or delay relationships and service level characteristics at each study intersection. The effect of project-generated traffic at each study intersection was compared to the City of San Marino's intersection LOS standards. According to the *Citywide Traffic Circulation Study*, the acceptable LOS for intersections in the City is LOS D or better as established in the City's General Plan. It is assumed that the addition of project traffic to an intersection which results in the degradation of intersection operations from LOS D or better to LOS E or F operations is considered deficient and may require improvements.

5.3 Analysis Scenarios

In coordination with City staff, LOS calculations have been prepared for the following scenarios:

- [a] Existing conditions.

- [b] Existing with project conditions.
- [c] Condition [a] plus one percent (1.0%) per year annual ambient traffic growth through year 2023 and with completion and occupancy of the related projects (i.e., future without project conditions).
- [d] Condition [c] with completion and occupancy of the proposed project.
- [e] Condition [d] with implementation of intersection improvement measures, if necessary.

The weekday AM and PM peak hour LOS analysis prepared for the study intersections using the HCM methodology is summarized in **Table 5-2**. The HCM data worksheets for the analyzed intersections are provided in *Appendix D*.

5.4 Existing Conditions

5.4.1 Existing Conditions

As indicated in column [1] of *Table 5-2*, three of the four study intersections are presently operating at LOS D or better during the weekday AM and PM peak hours under existing conditions. One of the study intersections (i.e., Sierra Madre Boulevard-San Marino Avenue/Huntington Drive) currently operates at LOS F during both the weekday AM and PM peak hours. The existing traffic volumes at the study intersections during the weekday AM and PM peak hours was previously displayed in *Figures 3-4* and *3-5*, respectively.

5.4.2 Existing With Project Conditions

As shown in column [2] of *Table 5-2*, three of the four intersections are expected to continue operating at LOS D or better during the weekday AM and PM peak hours under the existing with project conditions. The LOS and delays at the study intersections incrementally increase with the addition of project-generated traffic. One of the study intersections (i.e., Sierra Madre Boulevard-San Marino Avenue/Huntington Drive) will continue to operate at LOS F during both the weekday AM and PM peak hours with the addition of project traffic. The proposed project is not expected to cause any of the study intersections to operate at a deficient LOS, therefore no project-specific intersection improvements or project-specific transportation demand management measures are proposed or required. **Figures 5-1** and **5-2** illustrate the existing with project traffic volumes at the study intersections during the weekday AM and PM peak hours, respectively.

5.5 Future Year 2024 Cumulative Conditions

5.5.1 Future Year 2024 Cumulative Without Project Conditions

The future cumulative baseline conditions were forecast based on the addition of traffic generated by the completion and occupancy of the related projects, as well as the growth in traffic due to the combined effects of continuing development, intensification of existing developments and other factors (i.e., ambient growth). The LOS and delays at the study intersections are incrementally

Table 5-2
SUMMARY OF DELAYS AND LEVELS OF SERVICE
WEEKDAY AM AND PM PEAK HOURS

NO.	INTERSECTION	TRAFFIC CONTROL	PEAK HOUR	[1]		[2]		[3]		[4]					
				YEAR 2021 EXISTING DELAY [a]	LOS [b]	YEAR 2021 EXISTING W/ PROJECT DELAY [a]	LOS [b]	CHANGE IN DELAY [(2)-(1)]	IMPACT [c]	YEAR 2023 PRE-PROJECT DELAY [a]	LOS [b]	YEAR 2023 FUTURE W/ PROJECT DELAY [a]	LOS [b]	CHANGE IN DELAY [(4)-(3)]	IMPACT [c]
1	Virginia Road/Huntington Drive	Signalized	AM PM	26.9 20.8	C C	27.0 20.9	C C	0.1 0.1	No No	27.5 21.3	C C	27.6 21.4	C C	0.1 0.1	No No
2	Virginia Road/Roanoke Road	All-Way Stop	AM PM	10.7 10.3	B B	10.7 10.3	B B	0.0 0.0	No No	10.9 10.5	B B	10.9 10.5	B B	0.0 0.0	No No
3	Cambridge Road-West Drive/Huntington Drive	Signalized	AM PM	41.7 44.2	D D	43.7 47.7	D D	2.0 3.5	No No	42.5 45.7	D D	44.8 48.7	D D	2.3 3.0	No No
4	Sierra Madre Blvd-San Marino Ave/Huntington Drive	Signalized	AM PM	176.4 152.7	F F	177.0 154.0	F F	0.6 1.3	No No	184.3 162.5	F F	185.1 164.4	F F	0.8 1.9	No No

[a] Intersection analysis based on the Highway Capacity Manual, 6th Edition operational analysis methodologies. Reported control delay values in seconds per vehicle.

[b] Intersection Levels of Service are based on the following criteria:

Signalized Intersection Control Delay (s/veh)	LOS
<= 10	A
> 10-20	B
> 20-35	C
> 35-55	D
> 55-80	E
> 80	F

[c] The acceptable LOS for intersections in the City is LOS D or better as established in the City's General Plan. The addition of project traffic to an intersection which results in the degradation of intersection operations from LOS D or better to LOS E or F is considered deficient.

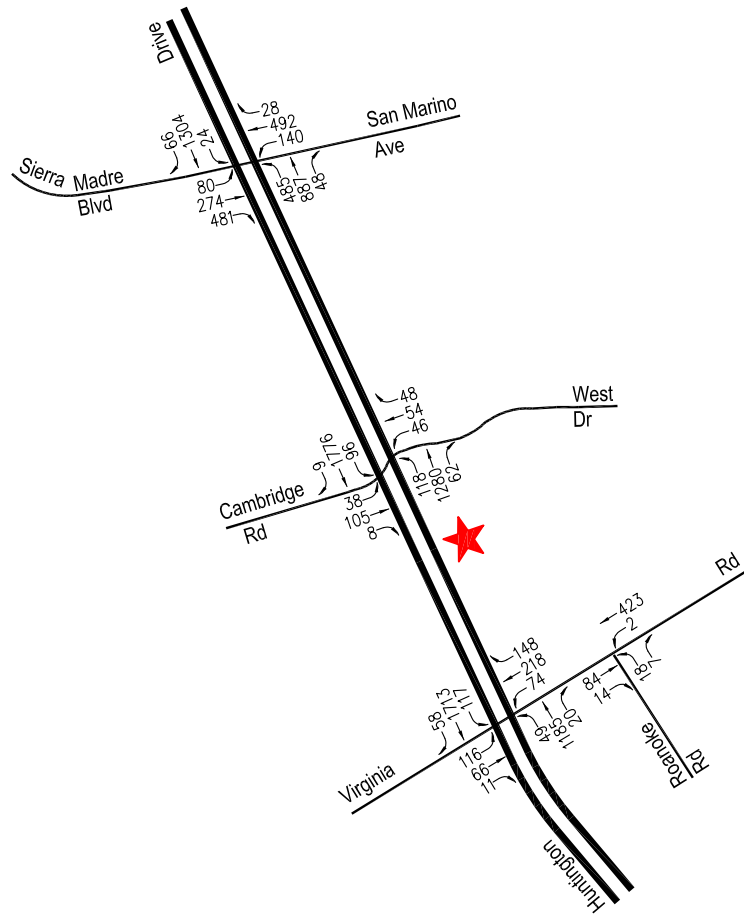

Project Site



Figure 5-1
Existing With Project Traffic Volumes
Weekday AM Peak Hour
San Marino Center Improvement Project

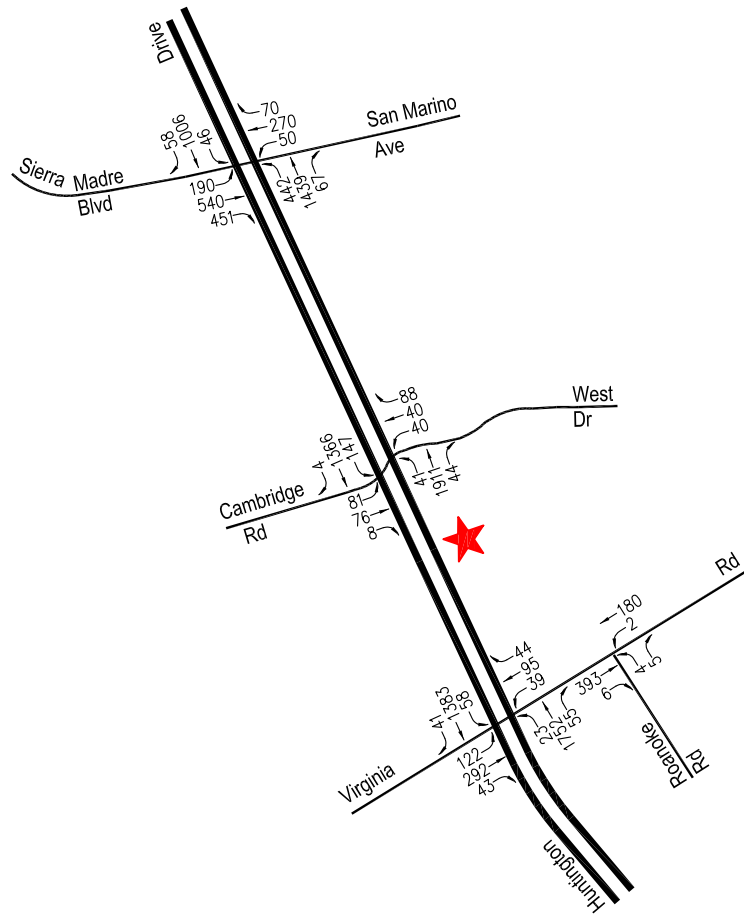

Project Site

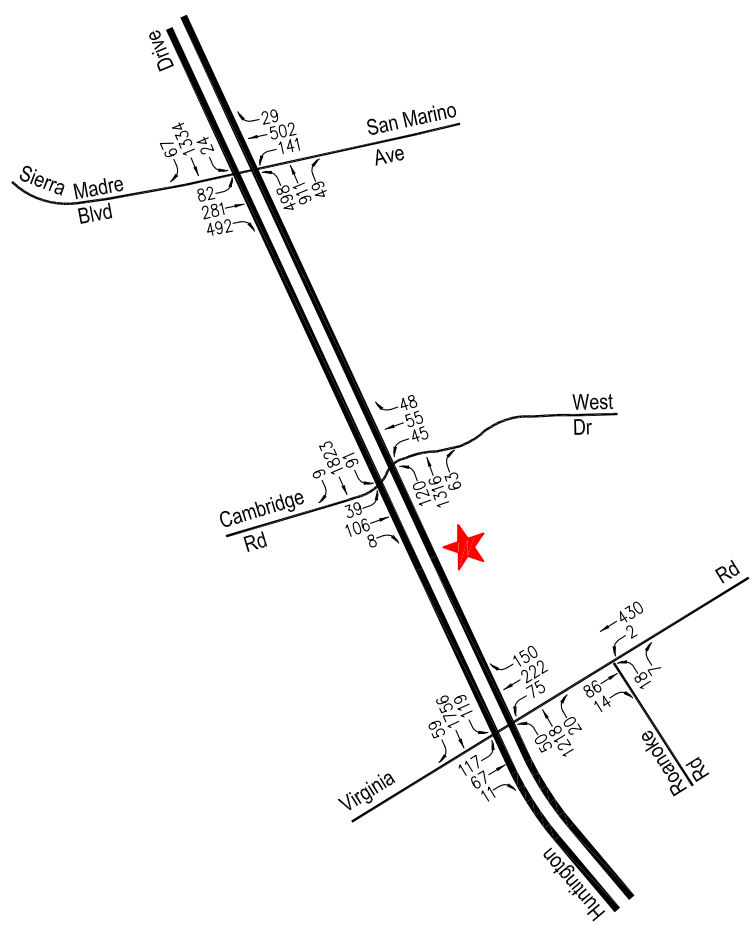

Figure 5-2
Existing With Project Traffic Volumes
Weekday PM Peak Hour
San Marino Center Improvement Project

increased with the addition of ambient traffic and traffic generated by the related projects listed in *Table 3-4*. As presented in column [3] of *Table 5-2*, three of the study intersections are expected to operate at LOS D or better during the weekday AM and weekday PM peak hours with the addition of growth in ambient traffic and related projects traffic under the future without project conditions. One of the study intersections (i.e., Sierra Madre Boulevard-San Marino Avenue/Huntington Drive) will continue to operate at LOS F during both the weekday AM and PM peak hours for the future cumulative without project condition. The future without project (existing, ambient growth and related projects) traffic volumes at the study intersections during the weekday AM and PM peak hours are presented in *Figures 5-3* and *5-4*, respectively.

5.5.2 Future Year 2024 Cumulative With Project Conditions

As shown in column [4] of *Table 5-2*, three of the study intersections are expected to continue operating at LOS D or better under the future with project condition. One of the study intersections (i.e., Sierra Madre Boulevard-San Marino Avenue/Huntington Drive) is expected to continue to operate at LOS F during both the weekday AM and PM peak hours for the future with project condition. The LOS and delays at the study intersections incrementally increase with the addition of project-generated traffic. The proposed project is not expected to cause any of the study intersections to operate at a deficient LOS, therefore no project-specific intersection improvements or project-specific transportation demand management measures are proposed or required. The future with project (existing, ambient growth, related projects and project) traffic volumes at the study intersections during the weekday AM and PM peak hours are presented in *Figures 5-5* and *5-6*, respectively.



Project Site



Figure 5-3
Future Without Project Traffic Volumes
 Weekday AM Peak Hour
 San Marino Center Improvement Project

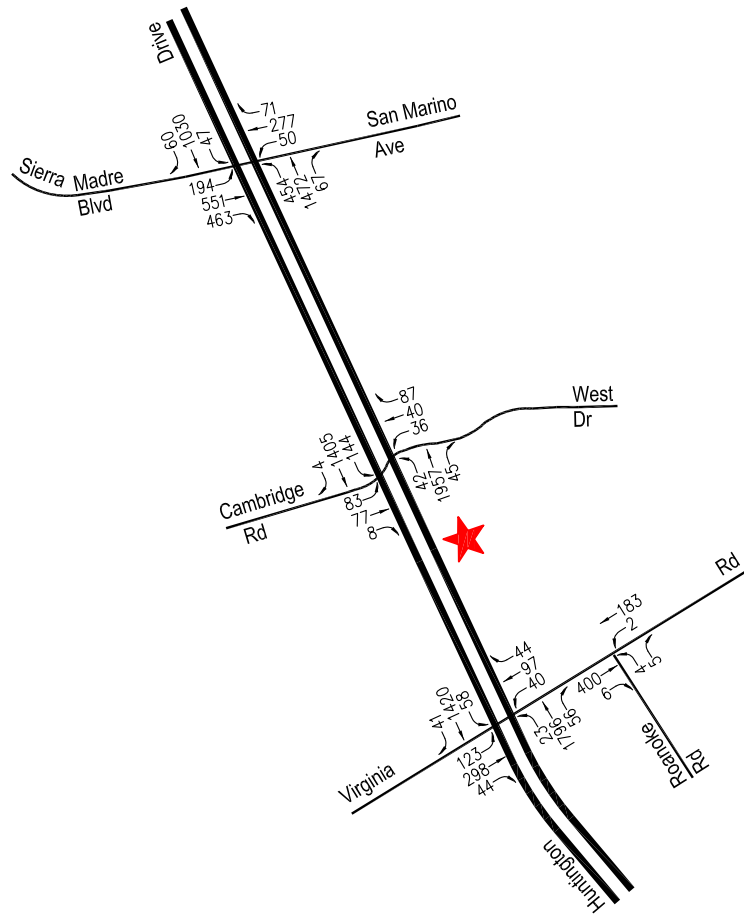

Project Site



Figure 5-4
 Future Without Project Traffic Volumes
 Weekday PM Peak Hour
 San Marino Center Improvement Project

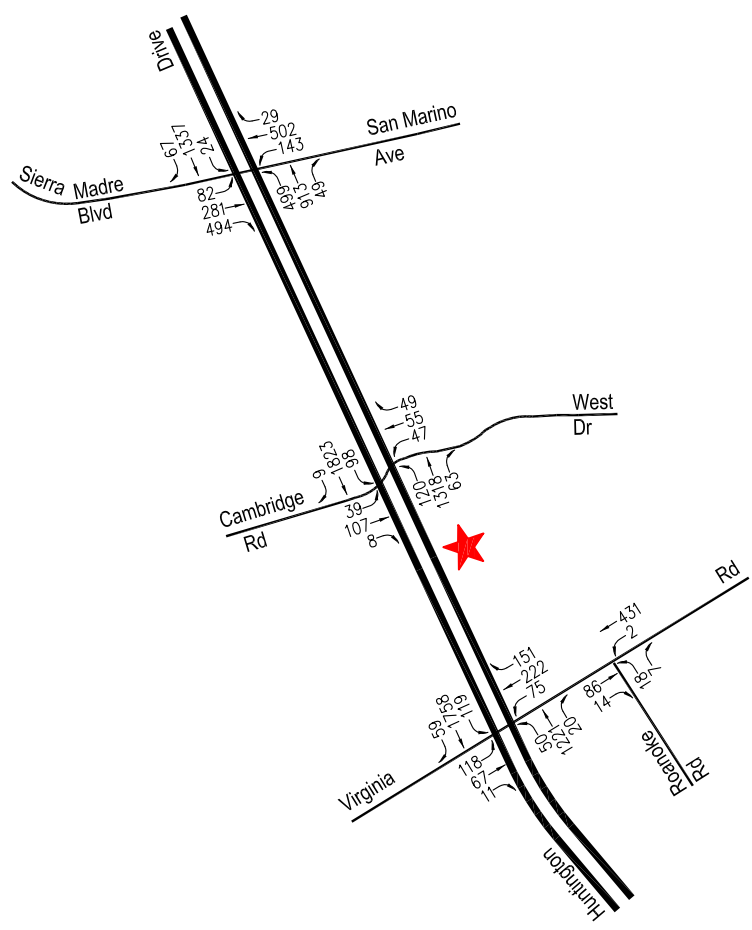

Project Site



Figure 5-5
Future With Project Traffic Volumes
 Weekday AM Peak Hour
 San Marino Center Improvement Project

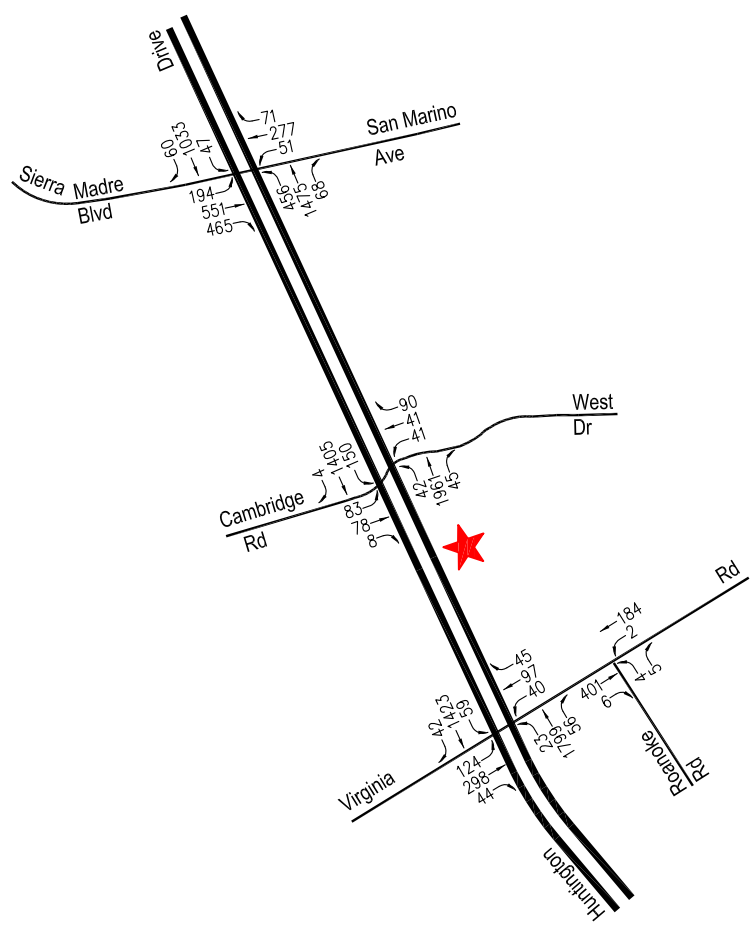

Project Site



Figure 5-6
 Future With Project Traffic Volumes
 Weekday PM Peak Hour
 San Marino Center Improvement Project

6.0 SUMMARY AND CONCLUSIONS

- **Project Description** – The project site is located at 1800 Huntington Drive, along the south side of Huntington Drive west of West Drive in the City of San Marino, California. The proposed project consists of revitalizing and updating the existing San Marino Center (SMC) including rehabilitation of the building interior to include additional offices to accommodate six (6) City Recreation Department staff, optimization of the interior public gathering space, replacement of the heating/air conditioning, plumbing and electrical systems and light fixtures to current building code standards, renovation of the building and grounds for compliance with the Americans with Disabilities Act (ADA), and building façade similar to that of the adjacent buildings. The SMC building totals 10,832 gross square feet of building floor area. The project build-out and occupancy year is anticipated by the year 2023.
- **Project Site Access** – Vehicular access to the project site is planned to be accommodated by two existing driveways on West Drive and two existing driveways on Huntington Drive. Pedestrian and bicycle access to the project site will be accommodated via exclusive walkways which connect from the public sidewalks to the facility.
- **Project Parking** – Parking for the San Marino Center exists on the west and south sides of the building, in the parking lot of the Henry E. Huntington Middle School, through a cooperative agreement with the San Marino Unified School District for use of up to 48 spaces for both the SMC and the Crowell Public Library. In 2019, the shared parking use agreement for non-exclusive use of the 48 spaces was renewed for a 10-year term. Given the review of the shared parking demand analysis and comparisons with the parking supply, it can be concluded that surpluses of 9 and 11 parking spaces are forecast to occur during peak weekday and weekend conditions, respectively, assuming that the 17 on-street spaces along Huntington Drive and West Drive along the library frontages are available for shared use.
- **Project Trip Generation** – The proposed project is expected to generate 19 new vehicle trips (13 inbound trips and 6 outbound trips) during the weekday AM peak hour. During the weekday PM peak hour, the proposed project is expected to generate 25 new vehicle trips (12 inbound trips and 13 outbound trips). Over a 24-hour period, the proposed project is forecast to generate approximately 312 new daily trip ends (156 inbound trips and 156 outbound trips) during a typical weekday. For purposes of the LOS analysis for the non-CEQA transportation assessment, the ITE trip generation forecast was utilized as it was slightly higher when compared to that based on the site-specific programming data.
- **CEQA Vehicle Miles Traveled Assessment** – Consistent with the requirements of CEQA Guidelines Section 15064.3, the City of San Marino has adopted significance criteria for transportation impacts based on vehicle miles traveled for land use development projects. The City has also adopted three criteria for screening projects out of detailed VMT analysis. The proposed San Marino Center Improvement project meets the criteria to be screened out of VMT analysis as it will serve the local population and is considered a community institution, thereby

shortening travel distances and reducing VMT. This screening criterion is based on the presumption that by adding opportunities into the urban fabric and improving destination proximity, local serving projects/developments tend to shorten trips and reduce VMT. The project is also located within a low VMT-generating area. Therefore, through satisfaction of the screening criteria, the proposed project is determined to have a less than significant transportation impact.

- ***CEQA Active Transportation and Public Transit Assessment*** – A significant impact may also occur “if the project conflicts with adopted policies, plans, or programs regarding public transit, bicycle, or pedestrian facilities, or otherwise decreases the performance or safety of such facilities”. The proposed project is found to be in alignment with the City’s Circulation Element, the Final General Plan, the 2014 Draft San Marino Bicycle and Pedestrian Plan, the San Marino Safe Routes to School Program, and the City of San Marino Huntington Drive Safe Streets Corridor Plan goals to promote pedestrian and bicycle safety and provide appropriate and supportive active transportation infrastructure. Further, development of the proposed project will not prevent the City from completing any proposed transit, bicycle, or pedestrian facilities. It is therefore determined that the proposed project will result in a less than significant impact on active transportation and public transit in the vicinity of the project site.
- ***Non-CEQA Analysis*** – Four study intersections were reviewed for consistency with the City of San Marino’s adopted Level of Service (LOS) standards. The study intersections were evaluated using the City-approved Highway Capacity Manual (HCM) methodology to determine the LOS under existing, existing with project, and future without and with project conditions. Based on application of the City’s LOS standards, the proposed project is not required to identify or construct intersection improvements at any of the study intersections.

APPENDIX A

SMC EVENTS/PROGRAMMING SCHEDULE SHARED PARKING ANALYSIS WORKSHEETS

**Appendix Table A-1
Proposed Programming/Events/Classes and Attendance Forecasts [1]
Typical Weekday and Weekend Schedules**

Time of Day	Weekdays							Weekend		Time of Day Percentages [2]	
	Monday	Tuesday	Wednesday	Thursday	Friday	Saturday	Sunday	Weekday	Weekend		
6:00 AM	Recreation Staff 7									0%	
7:00 AM	Recreation Staff 7		Human Resource Testing 30	Recreation Staff 7	Fit & Fab/Chair Fitness Class 7	Human Resource PD/FD Training 50				0%	
8:00 AM	Recreation Staff 7		30	Recreation Staff 7			Unit Bridge 50			83%	
9:00 AM	Recreation Staff 7	Gentle Yoga 7	30	Recreation Staff 7						100%	
10:00 AM	Recreation Staff 7	Gentle Yoga 75	30	Recreation Staff 7						100%	
11:00 AM	Recreation Staff 7		30	Recreation Staff 7						100%	
12:00 PM	Recreation Staff 7		30	Recreation Staff 7						100%	
1:00 PM	Recreation Staff 7		30	Recreation Staff 7						100%	
2:00 PM	Recreation Staff 7		30	Recreation Staff 7						100%	
3:00 PM	Recreation Staff 7		30	Recreation Staff 7						100%	
4:00 PM	Recreation Staff 7		30	Recreation Staff 7						100%	
5:00 PM	Recreation Commission 15		30	Recreation Staff 7						83%	
6:00 PM	Tai-Chi 15		30	Recreation Staff 7						0%	
7:00 PM	Tai-Chi 15		30	Recreation Staff 7						0%	
8:00 PM	Tai-Chi 15		30	Recreation Staff 7						0%	
9:00 PM			30	Recreation Staff 7						0%	
10:00 PM			30	Recreation Staff 7						0%	
11:00 PM			30	Recreation Staff 7						0%	

[1] Source for programming and attendance levels provided by the Project Applicant team in coordination with City staff. Large-scale events/programs are not included here as they do not occur on a regular basis.
 [2] The hourly attendance profile was determined based on the site-specific programming information and attendance levels for the weekday and weekend time periods.

Appendix Table A-2

MIDDLE SCHOOL
WEEKDAY SHARED PARKING DEMAND ANALYSIS [1]

Land Use	Middle School							Shared Parking Demand
Size	60 /Employees							
Peak Pkg Rate[2]	1.40 /Employee							
Weekday Pkg Rate[3]	1.40 /Employee							
Gross Spaces	84 Spaces							
Adjusted Gross Spaces[4]	1.00 84 Spaces							
Time of Day	% Of Peak	# Of Spaces	% Of Peak	# Of Spaces	% Of Peak	# Of Spaces		
6:00 AM	0%	0	0%	0	0%	0	0	
7:00 AM	1%	0	100%	58	0%	0	58	
8:00 AM	20%	5	100%	58	0%	0	63	
9:00 AM	60%	16	100%	58	0%	0	74	
10:00 AM	100%	26	100%	58	0%	0	84	
11:00 AM	45%	12	100%	58	0%	0	70	
12:00 PM	15%	4	100%	58	0%	0	62	
1:00 PM	45%	12	100%	58	0%	0	70	
2:00 PM	95%	25	100%	58	0%	0	83	
3:00 PM	45%	12	100%	58	100%	42	112	
4:00 PM	15%	4	100%	58	100%	42	104	
5:00 PM	10%	3	100%	58	100%	42	103	
6:00 PM	5%	1	0%	0	100%	42	43	
7:00 PM	2%	1	0%	0	50%	21	22	
8:00 PM	1%	0	0%	0	50%	21	21	
9:00 PM	0%	0	0%	0	25%	11	11	
10:00 PM	0%	0	0%	0	0%	0	0	
11:00 PM	0%	0	0%	0	0%	0	0	
12:00 AM	0%	0	0%	0	0%	0	0	

Notes:

[1] Source: "Shared Parking", Third Edition, Urban Land Institute, ICSC, and National Parking Association, 2020.

[2] Peak parking rates based on the ITE *Parking Generation Manual*, 5th Edition, average peak period parking demand ratio for the middle school/junior high school (Land Use Code 522).

[3] The weekend parking ratio was assumed to be similar to the weekday given the various weekend activities held at the Huntington Middle School (i.e., sports classes/competitions, Chinese School, etc.)

[4] Gross spaces not adjusted to reflect parking demand reduction due to captive market, internal capture, transit, and/or walk-in reduction.

Appendix Table A-2

MIDDLE SCHOOL
WEEKEND SHARED PARKING DEMAND ANALYSIS [1]

Land Use	Middle School							Shared Parking Demand
Size	60 /Employees							
Peak Pkg Rate[2]	1.40 /Employee							
Weekend Pkg Rate[3]	1.40 /Employee							
Gross Spaces	84 Spaces							
Adjusted Gross Spaces[4]	1.00 84 Spaces							
	0 Guest Spc.		0 Staff Spc.		84 Event Spc.			
Time of Day	% Of Peak	# Of Spaces	% Of Peak	# Of Spaces	% Of Peak	# Of Spaces		
6:00 AM	0%	0	0%	0	0%	0	0	
7:00 AM	0%	0	0%	0	50%	42	42	
8:00 AM	0%	0	0%	0	100%	84	84	
9:00 AM	0%	0	0%	0	100%	84	84	
10:00 AM	0%	0	0%	0	100%	84	84	
11:00 AM	0%	0	0%	0	100%	84	84	
12:00 PM	0%	0	0%	0	75%	63	63	
1:00 PM	0%	0	0%	0	75%	63	63	
2:00 PM	0%	0	0%	0	75%	63	63	
3:00 PM	0%	0	0%	0	75%	63	63	
4:00 PM	0%	0	0%	0	75%	63	63	
5:00 PM	0%	0	0%	0	75%	63	63	
6:00 PM	0%	0	0%	0	75%	63	63	
7:00 PM	0%	0	0%	0	75%	63	63	
8:00 PM	0%	0	0%	0	50%	42	42	
9:00 PM	0%	0	0%	0	0%	0	0	
10:00 PM	0%	0	0%	0	0%	0	0	
11:00 PM	0%	0	0%	0	0%	0	0	
12:00 AM	0%	0	0%	0	0%	0	0	

Notes:

[1] Source: "Shared Parking", Third Edition, Urban Land Institute, ICSC, and National Parking Association, 2020.

[2] Peak parking rates based on the ITE *Parking Generation Manual*, 5th Edition, average peak period parking demand ratio for the middle school/junior high school (Land Use Code 522).

[3] The weekend parking ratio was assumed to be similar to the weekday given the various weekend activities held at the Huntington Middle School (i.e., sports classes/competitions, Chinese School, etc.)

[4] Gross spaces not adjusted to reflect parking demand reduction due to captive market, internal capture, transit, and/or walk-in reduction.

Appendix Table A-3

COMMUNITY CENTER
WEEKDAY SHARED PARKING DEMAND ANALYSIS [1]

Land Use	Community Center				
Size	10.8 KSF				Shared Parking Demand
Peak Pkg Rate[2]	4.0 /KSF				
Weekday Pkg Rate[3]	4.0 /KSF				
Gross Spaces	43 Spaces				
Adjusted Gross Spaces[4]	1.00 43 Spaces				
	38 Visitor Spc.		5 Emp. Spc.		
Time of Day	% Of Peak[5]	# Of Spaces	% Of Peak[5]	# Of Spaces	
6:00 AM	0%	0	0%	0	0
7:00 AM	8%	3	8%	0	3
8:00 AM	41%	16	41%	2	18
9:00 AM	41%	16	41%	2	18
10:00 AM	91%	35	91%	5	40
11:00 AM	86%	33	86%	4	37
12:00 PM	52%	20	52%	3	23
1:00 PM	52%	20	52%	3	23
2:00 PM	52%	20	52%	3	23
3:00 PM	52%	20	52%	3	23
4:00 PM	14%	5	14%	1	6
5:00 PM	0%	0	0%	0	0
6:00 PM	44%	17	44%	2	19
7:00 PM	100%	38	100%	5	43
8:00 PM	100%	38	100%	5	43
9:00 PM	44%	17	44%	2	19
10:00 PM	44%	17	44%	2	19
11:00 PM	0%	0	0%	0	0
12:00 AM	0%	0	0%	0	0

Notes:

[1] Source: "Shared Parking", Third Edition, Urban Land Institute, ICSC, and National Parking Association, 2020.

[2] Peak parking rates based on the City of San Marino Municipal Code off-street parking requirements for new office buildings on Huntington Drive.

[3] No weekday vs. weekend parking variations are assumed in the base parking ratios.

[4] Gross spaces not adjusted to reflect parking demand reduction due to captive market, internal capture, transit, and/or walk-in reduction.

[5] The hourly parking profile was determined based on site-specific programming information for the weekday and weekend time periods as provided by the Project Applicant team.

Appendix Table A-3

COMMUNITY CENTER
WEEKEND SHARED PARKING DEMAND ANALYSIS [1]

Land Use	Community Center				
Size	10.8 KSF				Shared Parking Demand
Peak Pkg Rate[2]	4.0 /KSF				
Weekend Pkg Rate[3]	4.0 /KSF				
Gross Spaces	43 Spaces				
Adjusted Gross Spaces[4]	1.00 39 Spaces		4 Emp. Spc.		
	39 Visitor Spc.		4 Emp. Spc.		
Time of Day	% Of Peak[5]	# Of Spaces	% Of Peak[5]	# Of Spaces	
6:00 AM	0%	0	0%	0	0
7:00 AM	0%	0	0%	0	0
8:00 AM	83%	32	83%	3	35
9:00 AM	100%	39	100%	4	43
10:00 AM	100%	39	100%	4	43
11:00 AM	100%	39	100%	4	43
12:00 PM	100%	39	100%	4	43
1:00 PM	100%	39	100%	4	43
2:00 PM	100%	39	100%	4	43
3:00 PM	83%	32	83%	3	35
4:00 PM	0%	0	0%	0	0
5:00 PM	0%	0	0%	0	0
6:00 PM	0%	0	0%	0	0
7:00 PM	0%	0	0%	0	0
8:00 PM	0%	0	0%	0	0
9:00 PM	0%	0	0%	0	0
10:00 PM	0%	0	0%	0	0
11:00 PM	0%	0	0%	0	0
12:00 AM	0%	0	0%	0	0

Notes:

[1] Source: "Shared Parking", Third Edition, Urban Land Institute, ICSC, and National Parking Association, 2020.

[2] Peak parking rates based on the City of San Marino Municipal Code off-street parking requirements for new office buildings on Huntington Drive.

[3] No weekday vs. weekend parking variations are assumed in the base parking ratios.

[4] Gross spaces not adjusted to reflect parking demand reduction due to captive market, internal capture, transit, and/or walk-in reduction.

[5] The hourly parking profile was determined based on site-specific programming information for the weekday and weekend time periods as provided by the Project Applicant team.

Appendix Table A-4

LIBRARY
WEEKDAY SHARED PARKING DEMAND ANALYSIS [1]

Land Use	Library				
Size	33.9 KSF				Shared Parking Demand
Peak Pkg Rate[2]	2.25 /KSF				
Weekday Pkg Rate[3]	2.25 /KSF				
Gross Spaces	76 Spaces				
Adjusted Gross Spaces[4]	1.00 76 Spaces				
	68 Guest Spc.		8 Emp. Spc.		
Time of Day	% Of Peak	# Of Spaces	% Of Peak	# Of Spaces	
6:00 AM	0%	0	0%	0	0
7:00 AM	0%	0	10%	1	1
8:00 AM	0%	0	50%	4	4
9:00 AM	100%	68	100%	8	76
10:00 AM	100%	68	100%	8	76
11:00 AM	98%	67	100%	8	75
12:00 PM	98%	67	100%	8	75
1:00 PM	78%	53	100%	8	61
2:00 PM	72%	49	100%	8	57
3:00 PM	65%	44	100%	8	52
4:00 PM	70%	48	100%	8	56
5:00 PM	79%	54	90%	7	61
6:00 PM	60%	41	75%	6	47
7:00 PM	50%	34	50%	4	38
8:00 PM	40%	27	20%	2	29
9:00 PM	0%	0	10%	1	1
10:00 PM	0%	0	0%	0	0
11:00 PM	0%	0	0%	0	0
12:00 AM	0%	0	0%	0	0

Notes:

[1] Source: "Shared Parking", Third Edition, Urban Land Institute, ICSC, and National Parking Association, 2020.

[2] Peak parking rates based on the ULI Shared Parking base parking ratios for public library use as summarized in Figure 2-2.

[3] The weekday and weekend parking rates are based on the weekday vs. weekend parking variations as summarized in Figure 2-2 of the "Shared Parking" manual.

[4] Gross spaces not adjusted to reflect parking demand reduction due to captive market, internal capture, transit, and/or walk-in reduction.

Appendix Table A-4

LIBRARY
WEEKEND SHARED PARKING DEMAND ANALYSIS [1]

Land Use	Library				
Size	33.9 KSF				Shared Parking Demand
Peak Pkg Rate[2]	2.25 /KSF				
Weekend Pkg Rate[3]	2.10 /KSF				
Gross Spaces	71 Spaces				
Adjusted Gross Spaces[4]	1.00 64 Guest Spc.		7 Emp. Spc.		
Time of Day	% Of Peak	# Of Spaces	% Of Peak	# Of Spaces	
6:00 AM	0%	0	0%	0	0
7:00 AM	0%	0	0%	0	0
8:00 AM	0%	0	10%	1	1
9:00 AM	0%	0	50%	4	4
10:00 AM	100%	64	100%	7	71
11:00 AM	90%	58	100%	7	65
12:00 PM	80%	51	100%	7	58
1:00 PM	65%	42	100%	7	49
2:00 PM	50%	32	100%	7	39
3:00 PM	35%	22	50%	4	26
4:00 PM	11%	7	10%	1	8
5:00 PM	5%	3	10%	1	4
6:00 PM	5%	3	10%	1	4
7:00 PM	0%	0	10%	1	1
8:00 PM	0%	0	0%	0	0
9:00 PM	0%	0	0%	0	0
10:00 PM	0%	0	0%	0	0
11:00 PM	0%	0	0%	0	0
12:00 AM	0%	0	0%	0	0

Notes:

[1] Source: "Shared Parking", Third Edition, Urban Land Institute, ICSC, and National Parking Association, 2020.

[2] Peak parking rates based on the ULI Shared Parking base parking ratios for public library use as summarized in Figure 2-2.

[3] The weekday and weekend parking rates are based on the weekday vs. weekend parking variations as summarized in Figure 2-2 of the "Shared Parking" manual.

[4] Gross spaces not adjusted to reflect parking demand reduction due to captive market, internal capture, transit, and/or walk-in reduction.

APPENDIX B
TRAFFIC, PEDESTRIAN, AND BICYCLE COUNT DATA

Virginia Rd Huntington Dr



Peak Hour

Date: 11-07-2019
Count Period: 7:00 AM to 9:00 AM
Peak Hour: 7:30 AM to 8:30 AM

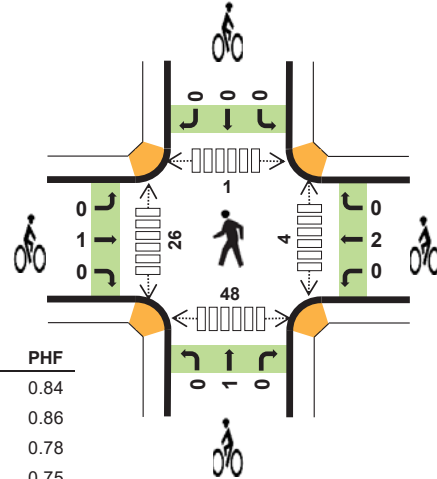
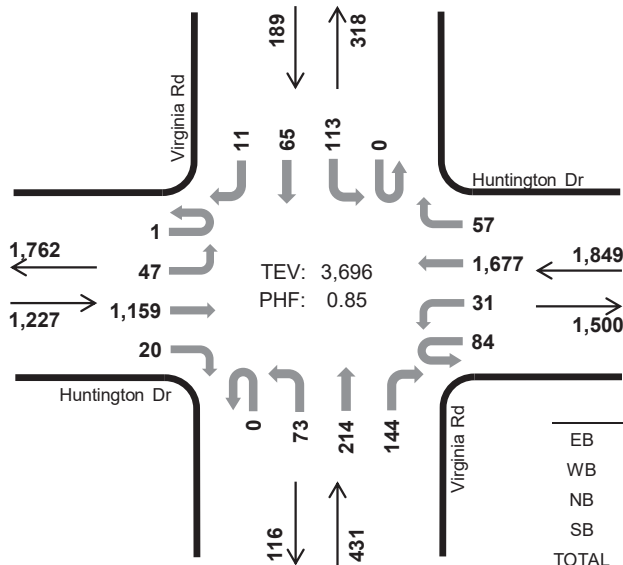

	HV %:	PHF
EB	1.3%	0.84
WB	0.7%	0.86
NB	0.5%	0.78
SB	1.1%	0.75
TOTAL	0.9%	0.85

Two-Hour Count Summaries

Interval Start	Huntington Dr Eastbound				Huntington Dr Westbound				Virginia Rd Northbound				Virginia Rd Southbound				15-min Total	Rolling One Hour	
	UT	LT	TH	RT	UT	LT	TH	RT	UT	LT	TH	RT	UT	LT	TH	RT			
7:00 AM	0	2	167	1	5	5	409	10	0	12	25	7	0	8	8	1	660	0	
7:15 AM	0	7	197	3	1	4	440	9	0	17	36	6	0	6	8	2	736	0	
7:30 AM	0	11	255	2	13	1	447	10	0	12	59	12	0	18	10	0	850	0	
7:45 AM	0	9	325	7	18	9	380	12	0	21	72	46	0	44	13	6	962	3,208	
8:00 AM	0	15	232	4	18	15	376	13	0	19	44	32	0	12	20	3	803	3,351	
8:15 AM	1	12	347	7	35	6	474	22	0	21	39	54	0	39	22	2	1,081	3,696	
8:30 AM	1	11	249	1	11	10	384	14	0	16	43	21	0	5	17	3	786	3,632	
8:45 AM	0	6	248	3	1	13	379	14	0	9	43	5	0	12	15	4	752	3,422	
Count Total	2	73	2,020	28	102	63	3,289	104	0	127	361	183	0	144	113	21	6,630	0	
Peak Hour	All	1	47	1,159	20	84	31	1,677	57	0	73	214	144	0	113	65	11	3,696	0
	HV	0	2	14	0	0	0	13	0	0	0	2	0	0	1	1	0	33	0
	HV%	0%	4%	1%	0%	0%	0%	1%	0%	-	0%	1%	0%	-	1%	2%	0%	1%	0

Note: Two-hour count summary volumes include heavy vehicles but exclude bicycles in overall count.

Interval Start	Heavy Vehicle Totals					Bicycles					Pedestrians (Crossing Leg)				
	EB	WB	NB	SB	Total	EB	WB	NB	SB	Total	East	West	North	South	Total
7:00 AM	4	4	0	0	8	3	0	0	0	3	0	2	0	0	2
7:15 AM	2	6	0	0	8	1	0	0	0	1	1	1	2	2	6
7:30 AM	2	6	0	0	8	0	1	0	0	1	0	5	0	6	11
7:45 AM	5	2	0	1	8	0	1	0	0	1	1	11	0	10	22
8:00 AM	3	2	2	0	7	1	0	1	0	2	0	4	0	7	11
8:15 AM	6	3	0	1	10	0	0	0	0	0	3	6	1	25	35
8:30 AM	3	6	0	0	9	0	0	0	0	0	0	1	1	2	4
8:45 AM	3	4	0	0	7	1	0	0	0	1	1	4	1	2	8
Count Total	28	33	2	2	65	6	2	1	0	9	6	34	5	54	99
Peak Hour	16	13	2	2	33	1	2	1	0	4	4	26	1	48	79

Two-Hour Count Summaries - Heavy Vehicles																		
Interval Start	Huntington Dr				Huntington Dr				Virginia Rd				Virginia Rd				15-min Total	Rolling One Hour
	Eastbound				Westbound				Northbound				Southbound					
	UT	LT	TH	RT	UT	LT	TH	RT	UT	LT	TH	RT	UT	LT	TH	RT		
7:00 AM	0	0	4	0	0	0	4	0	0	0	0	0	0	0	0	0	8	0
7:15 AM	0	0	2	0	0	0	4	2	0	0	0	0	0	0	0	0	8	0
7:30 AM	0	0	2	0	0	0	6	0	0	0	0	0	0	0	0	0	8	0
7:45 AM	0	1	4	0	0	0	2	0	0	0	0	0	0	0	1	0	8	32
8:00 AM	0	1	2	0	0	0	2	0	0	0	2	0	0	0	0	0	7	31
8:15 AM	0	0	6	0	0	0	3	0	0	0	0	0	0	0	1	0	10	33
8:30 AM	0	0	3	0	0	0	6	0	0	0	0	0	0	0	0	0	9	34
8:45 AM	0	0	3	0	0	0	4	0	0	0	0	0	0	0	0	0	7	33
Count Total	0	2	26	0	0	0	31	2	0	0	2	0	0	1	1	0	65	0
Peak Hour	0	2	14	0	0	0	13	0	0	0	2	0	0	1	1	0	33	0
Two-Hour Count Summaries - Bikes																		
Interval Start	Huntington Dr			Huntington Dr			Virginia Rd			Virginia Rd			15-min Total	Rolling One Hour				
	Eastbound			Westbound			Northbound			Southbound								
	LT	TH	RT	LT	TH	RT	LT	TH	RT	LT	TH	RT						
7:00 AM	0	2	1	0	0	0	0	0	0	0	0	0	0	0	3	0		
7:15 AM	0	1	0	0	0	0	0	0	0	0	0	0	0	0	1	0		
7:30 AM	0	0	0	0	1	0	0	0	0	0	0	0	0	0	1	0		
7:45 AM	0	0	0	0	1	0	0	0	0	0	0	0	0	0	1	6		
8:00 AM	0	1	0	0	0	0	0	0	1	0	0	0	0	0	2	5		
8:15 AM	0	0	0	0	0	0	0	0	0	0	0	0	0	0	0	4		
8:30 AM	0	0	0	0	0	0	0	0	0	0	0	0	0	0	0	3		
8:45 AM	1	0	0	0	0	0	0	0	0	0	0	0	0	0	1	3		
Count Total	1	4	1	0	2	0	0	1	0	0	0	0	0	0	9	0		
Peak Hour	0	1	0	0	2	0	0	1	0	0	0	0	0	0	4	0		
<i>Note: U-Turn volumes for bikes are included in Left-Turn, if any.</i>																		

Virginia Rd Huntington Dr



Peak Hour

Date: 11-07-2019
Count Period: 4:00 PM to 6:00 PM
Peak Hour: 5:00 PM to 6:00 PM

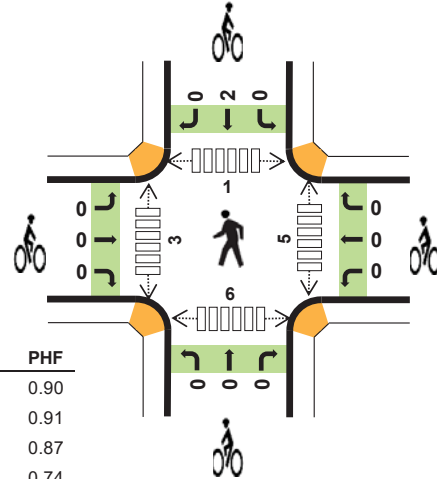
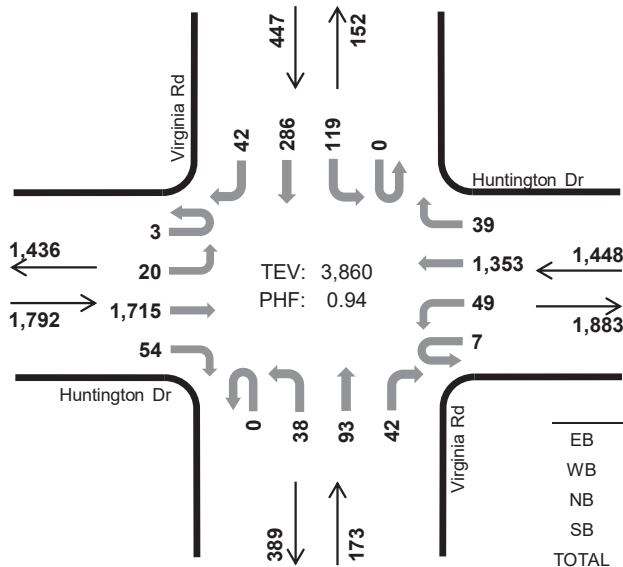

	HV %:	PHF
EB	0.3%	0.90
WB	0.3%	0.91
NB	0.0%	0.87
SB	1.3%	0.74
TOTAL	0.4%	0.94

Two-Hour Count Summaries

Interval Start	Huntington Dr Eastbound				Huntington Dr Westbound				Virginia Rd Northbound				Virginia Rd Southbound				15-min Total	Rolling One Hour	
	UT	LT	TH	RT	UT	LT	TH	RT	UT	LT	TH	RT	UT	LT	TH	RT			
4:00 PM	1	7	373	10	0	9	261	9	0	4	22	9	0	36	60	6	807	0	
4:15 PM	1	8	416	21	1	7	312	13	0	5	15	10	0	32	58	4	903	0	
4:30 PM	1	12	396	9	7	11	277	11	0	13	25	8	0	23	76	9	878	0	
4:45 PM	0	5	463	11	2	9	296	11	0	3	26	10	0	21	57	9	923	3,511	
5:00 PM	0	11	411	15	1	10	330	7	0	8	28	9	0	26	74	13	943	3,647	
5:15 PM	0	5	405	14	1	15	372	12	0	13	27	10	0	40	94	18	1,026	3,770	
5:30 PM	2	2	418	12	3	12	331	8	0	10	22	13	0	32	71	7	943	3,835	
5:45 PM	1	2	481	13	2	12	320	12	0	7	16	10	0	21	47	4	948	3,860	
Count Total	6	52	3,363	105	17	85	2,499	83	0	63	181	79	0	231	537	70	7,371	0	
Peak Hour	All	3	20	1,715	54	7	49	1,353	39	0	38	93	42	0	119	286	42	3,860	0
	HV	0	0	4	1	0	0	5	0	0	0	0	0	0	2	1	3	16	0
	HV%	0%	0%	0%	2%	0%	0%	0%	0%	-	0%	0%	0%	-	2%	0%	7%	0%	0

Note: Two-hour count summary volumes include heavy vehicles but exclude bicycles in overall count.

Interval Start	Heavy Vehicle Totals					Bicycles					Pedestrians (Crossing Leg)				
	EB	WB	NB	SB	Total	EB	WB	NB	SB	Total	East	West	North	South	Total
4:00 PM	3	3	0	2	8	0	0	0	0	0	2	10	1	10	23
4:15 PM	4	3	0	0	7	0	0	0	1	1	2	9	0	8	19
4:30 PM	2	6	0	1	9	2	0	0	0	2	0	6	0	4	10
4:45 PM	4	0	0	0	4	1	0	0	0	1	0	3	0	0	3
5:00 PM	0	1	0	1	2	0	0	0	1	1	0	1	0	3	4
5:15 PM	0	1	0	1	2	0	0	0	0	0	1	1	1	1	4
5:30 PM	3	1	0	4	8	0	0	0	1	1	0	1	0	1	2
5:45 PM	2	2	0	0	4	0	0	0	0	0	4	0	0	1	5
Count Total	18	17	0	9	44	3	0	0	3	6	9	31	2	28	70
Peak Hour	5	5	0	6	16	0	0	0	2	2	5	3	1	6	15

Two-Hour Count Summaries - Heavy Vehicles																		
Interval Start	Huntington Dr				Huntington Dr				Virginia Rd				Virginia Rd				15-min Total	Rolling One Hour
	Eastbound				Westbound				Northbound				Southbound					
	UT	LT	TH	RT	UT	LT	TH	RT	UT	LT	TH	RT	UT	LT	TH	RT		
4:00 PM	0	0	3	0	0	0	2	1	0	0	0	0	0	1	1	0	8	0
4:15 PM	0	0	4	0	0	0	2	1	0	0	0	0	0	0	0	0	7	0
4:30 PM	0	0	2	0	0	1	5	0	0	0	0	0	0	0	1	0	9	0
4:45 PM	0	0	3	1	0	0	0	0	0	0	0	0	0	0	0	0	4	28
5:00 PM	0	0	0	0	0	0	1	0	0	0	0	0	0	0	0	1	2	22
5:15 PM	0	0	0	0	0	0	1	0	0	0	0	0	0	0	0	1	2	17
5:30 PM	0	0	3	0	0	0	1	0	0	0	0	0	0	2	1	1	8	16
5:45 PM	0	0	1	1	0	0	2	0	0	0	0	0	0	0	0	0	4	16
Count Total	0	0	16	2	0	1	14	2	0	0	0	0	0	3	3	3	44	0
Peak Hour	0	0	4	1	0	0	5	0	0	0	0	0	0	2	1	3	16	0
Two-Hour Count Summaries - Bikes																		
Interval Start	Huntington Dr			Huntington Dr			Virginia Rd			Virginia Rd			15-min Total	Rolling One Hour				
	Eastbound			Westbound			Northbound			Southbound								
	LT	TH	RT	LT	TH	RT	LT	TH	RT	LT	TH	RT						
4:00 PM	0	0	0	0	0	0	0	0	0	0	0	0	0	0	0	0	0	0
4:15 PM	0	0	0	0	0	0	0	0	0	0	0	0	1	0	0	1	0	0
4:30 PM	0	2	0	0	0	0	0	0	0	0	0	0	0	0	0	2	0	0
4:45 PM	0	1	0	0	0	0	0	0	0	0	0	0	0	0	0	1	4	4
5:00 PM	0	0	0	0	0	0	0	0	0	0	0	0	1	0	0	1	5	5
5:15 PM	0	0	0	0	0	0	0	0	0	0	0	0	0	0	0	0	4	4
5:30 PM	0	0	0	0	0	0	0	0	0	0	0	0	1	0	0	1	3	3
5:45 PM	0	0	0	0	0	0	0	0	0	0	0	0	0	0	0	0	2	2
Count Total	0	3	0	0	0	0	0	0	0	0	0	0	3	0	0	6	0	0
Peak Hour	0	0	0	0	0	0	0	0	0	0	0	0	2	0	0	2	0	0
<i>Note: U-Turn volumes for bikes are included in Left-Turn, if any.</i>																		

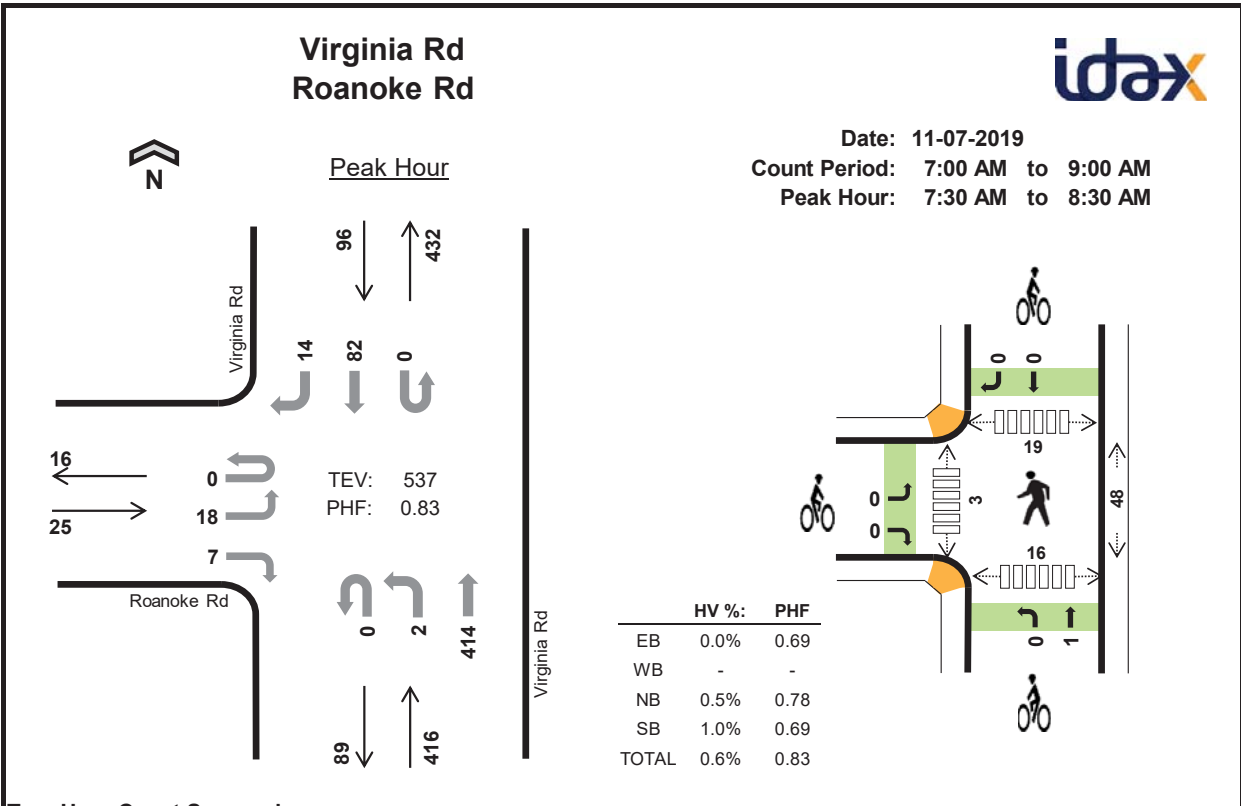

Two-Hour Count Summaries

Interval Start	Roanoke Rd				n/a				Virginia Rd				Virginia Rd				15-min Total	Rolling One Hour	
	Eastbound				Westbound				Northbound				Southbound						
	UT	LT	TH	RT	UT	LT	TH	RT	UT	LT	TH	RT	UT	LT	TH	RT			
7:00 AM	0	2	0	0	0	0	0	0	0	0	41	0	0	0	11	0	54	0	
7:15 AM	0	3	0	0	0	0	0	0	0	0	57	0	1	0	8	2	71	0	
7:30 AM	0	2	0	1	0	0	0	0	0	0	91	0	0	0	13	0	107	0	
7:45 AM	0	8	0	1	0	0	0	0	0	1	133	0	0	0	18	1	162	394	
8:00 AM	0	6	0	2	0	0	0	0	0	1	97	0	0	0	27	2	135	475	
8:15 AM	0	2	0	3	0	0	0	0	0	0	93	0	0	0	24	11	133	537	
8:30 AM	0	2	0	1	0	0	0	0	0	2	60	0	0	0	24	7	96	526	
8:45 AM	0	1	0	2	0	0	0	0	0	1	57	0	0	0	25	3	89	453	
Count Total	0	26	0	10	0	0	0	0	0	5	629	0	1	0	150	26	847	0	
Peak Hour	All	0	18	0	7	0	0	0	0	0	2	414	0	0	0	82	14	537	0
	HV	0	0	0	0	0	0	0	0	0	0	2	0	0	0	1	0	3	0
	HV%	-	0%	-	0%	-	-	-	-	-	0%	0%	-	-	-	1%	0%	1%	0

Note: Two-hour count summary volumes include heavy vehicles but exclude bicycles in overall count.

Interval Start	Heavy Vehicle Totals					Bicycles					Pedestrians (Crossing Leg)				
	EB	WB	NB	SB	Total	EB	WB	NB	SB	Total	East	West	North	South	Total
7:00 AM	0	0	0	0	0	0	0	0	1	1	3	1	1	1	6
7:15 AM	0	0	0	0	0	0	0	0	0	0	4	0	2	2	8
7:30 AM	0	0	0	0	0	0	0	0	0	0	2	2	2	2	8
7:45 AM	0	0	0	0	0	0	0	0	0	0	4	0	8	0	12
8:00 AM	0	0	2	0	2	0	0	1	0	1	8	0	0	5	13
8:15 AM	0	0	0	1	1	0	0	0	0	0	34	1	9	9	53
8:30 AM	0	0	0	0	0	0	0	0	0	0	13	1	2	2	18
8:45 AM	0	0	0	0	0	0	0	0	0	0	4	0	0	5	9
Count Total	0	0	2	1	3	0	0	1	1	2	72	5	24	26	127
Peak Hr	0	0	2	1	3	0	0	1	0	1	48	3	19	16	86

Two-Hour Count Summaries - Heavy Vehicles																		
Interval Start	Roanoke Rd				n/a				Virginia Rd				Virginia Rd				15-min Total	Rolling One Hour
	Eastbound				Westbound				Northbound				Southbound					
	UT	LT	TH	RT	UT	LT	TH	RT	UT	LT	TH	RT	UT	LT	TH	RT		
7:00 AM	0	0	0	0	0	0	0	0	0	0	0	0	0	0	0	0	0	
7:15 AM	0	0	0	0	0	0	0	0	0	0	0	0	0	0	0	0	0	
7:30 AM	0	0	0	0	0	0	0	0	0	0	0	0	0	0	0	0	0	
7:45 AM	0	0	0	0	0	0	0	0	0	0	0	0	0	0	0	0	0	
8:00 AM	0	0	0	0	0	0	0	0	0	0	2	0	0	0	0	0	2	
8:15 AM	0	0	0	0	0	0	0	0	0	0	0	0	0	0	1	0	3	
8:30 AM	0	0	0	0	0	0	0	0	0	0	0	0	0	0	0	0	3	
8:45 AM	0	0	0	0	0	0	0	0	0	0	0	0	0	0	0	0	3	
Count Total	0	0	0	0	0	0	0	0	0	0	2	0	0	0	1	0	3	
Peak Hour	0	0	0	0	0	0	0	0	0	0	2	0	0	0	1	0	3	

Two-Hour Count Summaries - Bikes																	
Interval Start	Roanoke Rd			n/a			Virginia Rd			Virginia Rd			15-min Total	Rolling One Hour			
	Eastbound			Westbound			Northbound			Southbound							
	LT	TH	RT	LT	TH	RT	LT	TH	RT	LT	TH	RT					
7:00 AM	0	0	0	0	0	0	0	0	0	0	1	0	1	0			
7:15 AM	0	0	0	0	0	0	0	0	0	0	0	0	0	0			
7:30 AM	0	0	0	0	0	0	0	0	0	0	0	0	0	0			
7:45 AM	0	0	0	0	0	0	0	0	0	0	0	0	0	1			
8:00 AM	0	0	0	0	0	0	0	0	1	0	0	0	1	1			
8:15 AM	0	0	0	0	0	0	0	0	0	0	0	0	0	1			
8:30 AM	0	0	0	0	0	0	0	0	0	0	0	0	0	1			
8:45 AM	0	0	0	0	0	0	0	0	0	0	0	0	0	1			
Count Total	0	0	0	0	0	0	0	0	1	0	0	1	0	2			
Peak Hour	0	0	0	0	0	0	0	0	1	0	0	0	0	1			

Note: U-Turn volumes for bikes are included in Left-Turn, if any.

Virginia Rd Roanoke Rd



Date: 11-07-2019
 Count Period: 4:00 PM to 6:00 PM
 Peak Hour: 4:30 PM to 5:30 PM

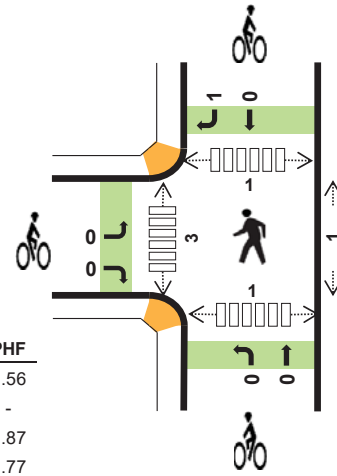
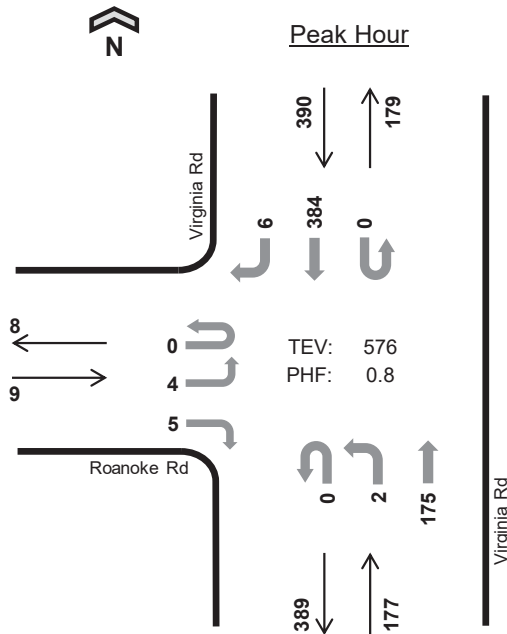

	HV %:	PHF
EB	0.0%	0.56
WB	-	-
NB	0.0%	0.87
SB	0.8%	0.77
TOTAL	0.5%	0.80

Two-Hour Count Summaries

Interval Start	Roanoke Rd				n/a				Virginia Rd				Virginia Rd				15-min Total	Rolling One Hour	
	Eastbound				Westbound				Northbound				Southbound						
	UT	LT	TH	RT	UT	LT	TH	RT	UT	LT	TH	RT	UT	LT	TH	RT			
4:00 PM	0	1	0	0	0	0	0	0	0	1	28	0	0	0	73	1	104	0	
4:15 PM	0	3	0	2	0	0	0	0	0	0	27	0	0	0	91	2	125	0	
4:30 PM	0	0	0	1	0	0	0	0	0	1	43	0	0	0	92	0	137	0	
4:45 PM	0	1	0	3	0	0	0	0	0	1	38	0	0	0	75	3	121	487	
5:00 PM	0	1	0	0	0	0	0	0	0	0	43	0	0	0	94	0	138	521	
5:15 PM	0	2	0	1	0	0	0	0	0	0	51	0	0	0	123	3	180	576	
5:30 PM	0	0	0	1	0	0	0	0	0	1	33	0	0	0	85	1	121	560	
5:45 PM	0	0	0	2	0	0	0	0	0	1	37	0	0	0	78	1	119	558	
Count Total	0	8	0	10	0	0	0	0	0	5	300	0	0	0	711	11	1,045	0	
Peak Hour	All	0	4	0	5	0	0	0	0	0	2	175	0	0	0	384	6	576	0
	HV	0	0	0	0	0	0	0	0	0	0	0	0	0	0	3	0	3	0
	HV%	-	0%	-	0%	-	-	-	-	-	0%	0%	-	-	-	1%	0%	1%	0

Note: Two-hour count summary volumes include heavy vehicles but exclude bicycles in overall count.

Interval Start	Heavy Vehicle Totals					Bicycles					Pedestrians (Crossing Leg)				
	EB	WB	NB	SB	Total	EB	WB	NB	SB	Total	East	West	North	South	Total
4:00 PM	0	0	0	0	0	1	0	0	0	1	0	1	5	1	7
4:15 PM	0	0	0	1	1	0	0	0	1	1	4	2	1	3	10
4:30 PM	0	0	0	1	1	0	0	0	0	0	0	2	1	1	4
4:45 PM	0	0	0	1	1	0	0	0	0	0	0	1	0	0	1
5:00 PM	0	0	0	1	1	0	0	0	1	1	1	0	0	0	1
5:15 PM	0	0	0	0	0	0	0	0	0	0	0	0	0	0	0
5:30 PM	0	0	0	1	1	0	0	0	1	1	0	1	0	1	2
5:45 PM	0	0	0	1	1	0	0	0	0	0	0	0	0	1	1
Count Total	0	0	0	6	6	1	0	0	3	4	5	7	7	7	26
Peak Hr	0	0	0	3	3	0	0	0	1	1	1	3	1	1	6

Two-Hour Count Summaries - Heavy Vehicles																		
Interval Start	Roanoke Rd				n/a				Virginia Rd				Virginia Rd				15-min Total	Rolling One Hour
	Eastbound				Westbound				Northbound				Southbound					
	UT	LT	TH	RT	UT	LT	TH	RT	UT	LT	TH	RT	UT	LT	TH	RT		
4:00 PM	0	0	0	0	0	0	0	0	0	0	0	0	0	0	0	0	0	
4:15 PM	0	0	0	0	0	0	0	0	0	0	0	0	0	0	0	1	0	
4:30 PM	0	0	0	0	0	0	0	0	0	0	0	0	0	0	0	1	0	
4:45 PM	0	0	0	0	0	0	0	0	0	0	0	0	0	0	0	1	0	
5:00 PM	0	0	0	0	0	0	0	0	0	0	0	0	0	0	0	1	0	
5:15 PM	0	0	0	0	0	0	0	0	0	0	0	0	0	0	0	0	0	
5:30 PM	0	0	0	0	0	0	0	0	0	0	0	0	0	0	0	1	0	
5:45 PM	0	0	0	0	0	0	0	0	0	0	0	0	0	0	0	1	0	
Count Total	0	0	0	0	0	0	0	0	0	0	0	0	0	0	0	6	0	
Peak Hour	0	0	0	0	0	0	0	0	0	0	0	0	0	0	0	3	0	
Two-Hour Count Summaries - Bikes																		
Interval Start	Roanoke Rd			n/a			Virginia Rd			Virginia Rd			15-min Total	Rolling One Hour				
	Eastbound			Westbound			Northbound			Southbound								
	LT	TH	RT	LT	TH	RT	LT	TH	RT	LT	TH	RT						
4:00 PM	0	0	1	0	0	0	0	0	0	0	0	0	0	1	0			
4:15 PM	0	0	0	0	0	0	0	0	0	0	0	0	0	0	0	1	0	
4:30 PM	0	0	0	0	0	0	0	0	0	0	0	0	0	0	0	0	0	
4:45 PM	0	0	0	0	0	0	0	0	0	0	0	0	0	0	0	0	0	
5:00 PM	0	0	0	0	0	0	0	0	0	0	0	0	0	0	0	1	0	
5:15 PM	0	0	0	0	0	0	0	0	0	0	0	0	0	0	0	0	0	
5:30 PM	0	0	0	0	0	0	0	0	0	0	0	0	0	0	1	0	0	
5:45 PM	0	0	0	0	0	0	0	0	0	0	0	0	0	0	0	0	0	
Count Total	0	0	1	0	0	0	0	0	0	0	0	0	0	0	1	2	0	
Peak Hour	0	0	0	0	0	0	0	0	0	0	0	0	0	0	0	1	0	
<i>Note: U-Turn volumes for bikes are included in Left-Turn, if any.</i>																		

West Dr Huntington Dr



Date: 11-07-2019
 Count Period: 7:00 AM to 9:00 AM
 Peak Hour: 7:30 AM to 8:30 AM

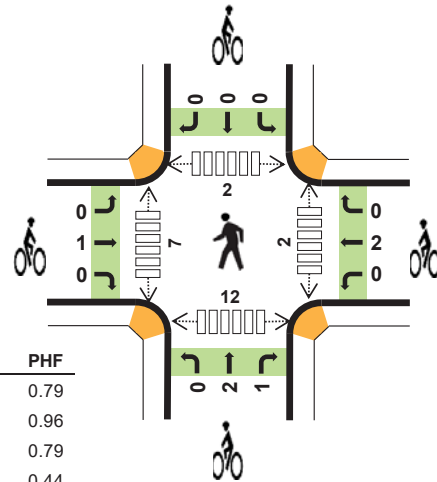
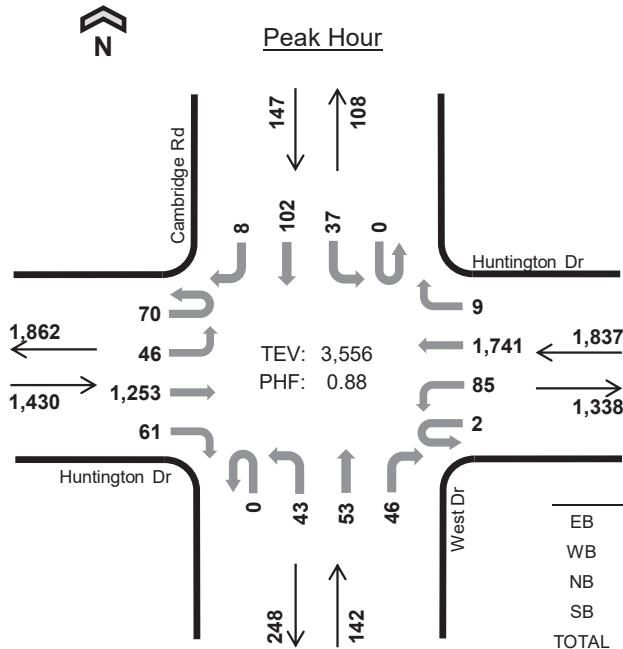

	HV %:	PHF
EB	0.9%	0.79
WB	0.7%	0.96
NB	0.0%	0.79
SB	0.7%	0.44
TOTAL	0.7%	0.88

Two-Hour Count Summaries

Interval Start	Huntington Dr Eastbound				Huntington Dr Westbound				West Dr Northbound				Cambridge Rd Southbound				15-min Total	Rolling One Hour	
	UT	LT	TH	RT	UT	LT	TH	RT	UT	LT	TH	RT	UT	LT	TH	RT			
7:00 AM	9	5	180	4	0	5	408	0	0	4	6	6	0	2	2	0	631	0	
7:15 AM	1	2	173	1	0	6	439	1	0	5	7	5	0	0	3	2	645	0	
7:30 AM	8	5	250	4	0	28	450	1	0	11	15	19	0	9	22	3	825	0	
7:45 AM	20	11	407	16	0	32	401	2	0	6	19	16	0	15	68	0	1,013	3,114	
8:00 AM	7	8	246	13	2	19	449	4	0	13	12	5	0	7	4	4	793	3,276	
8:15 AM	35	22	350	28	0	6	441	2	0	13	7	6	0	6	8	1	925	3,556	
8:30 AM	18	7	312	12	0	16	371	0	0	16	11	12	0	9	5	2	791	3,522	
8:45 AM	1	2	259	9	0	8	397	2	0	8	12	6	0	7	5	0	716	3,225	
Count Total	99	62	2,177	87	2	120	3,356	12	0	76	89	75	0	55	117	12	6,339	0	
Peak Hour	All	70	46	1,253	61	2	85	1,741	9	0	43	53	46	0	37	102	8	3,556	0
	HV	0	0	13	0	0	0	12	0	0	0	0	0	0	1	0	0	26	0
	HV%	0%	0%	1%	0%	0%	0%	1%	0%	-	0%	0%	0%	-	3%	0%	0%	1%	0

Note: Two-hour count summary volumes include heavy vehicles but exclude bicycles in overall count.

Interval Start	Heavy Vehicle Totals					Bicycles					Pedestrians (Crossing Leg)				
	EB	WB	NB	SB	Total	EB	WB	NB	SB	Total	East	West	North	South	Total
7:00 AM	4	5	0	0	9	1	0	0	0	1	0	0	0	0	0
7:15 AM	4	3	0	0	7	0	0	1	0	1	0	0	0	0	5
7:30 AM	1	5	0	0	6	0	1	1	0	2	2	3	0	3	8
7:45 AM	6	3	0	0	9	1	1	1	0	3	0	4	2	4	10
8:00 AM	2	1	0	0	3	0	0	0	0	0	0	0	0	4	4
8:15 AM	4	3	0	1	8	0	0	1	0	1	0	0	0	1	1
8:30 AM	5	6	0	0	11	0	0	0	0	0	1	2	0	4	7
8:45 AM	3	3	1	0	7	0	0	0	0	0	2	0	0	0	2
Count Total	29	29	1	1	60	2	2	4	0	8	5	9	2	21	37
Peak Hour	13	12	0	1	26	1	2	3	0	6	2	7	2	12	23

Two-Hour Count Summaries - Heavy Vehicles																		
Interval Start	Huntington Dr				Huntington Dr				West Dr				Cambridge Rd				15-min Total	Rolling One Hour
	Eastbound				Westbound				Northbound				Southbound					
	UT	LT	TH	RT	UT	LT	TH	RT	UT	LT	TH	RT	UT	LT	TH	RT		
7:00 AM	0	0	4	0	0	0	5	0	0	0	0	0	0	0	0	0	9	0
7:15 AM	0	0	4	0	0	0	3	0	0	0	0	0	0	0	0	0	7	0
7:30 AM	0	0	1	0	0	0	5	0	0	0	0	0	0	0	0	0	6	0
7:45 AM	0	0	6	0	0	0	3	0	0	0	0	0	0	0	0	0	9	31
8:00 AM	0	0	2	0	0	0	1	0	0	0	0	0	0	0	0	0	3	25
8:15 AM	0	0	4	0	0	0	3	0	0	0	0	0	0	0	1	0	8	26
8:30 AM	0	0	5	0	0	0	6	0	0	0	0	0	0	0	0	0	11	31
8:45 AM	0	0	3	0	0	0	3	0	0	0	0	1	0	0	0	0	7	29
Count Total	0	0	29	0	0	0	29	0	0	0	0	1	0	1	0	0	60	0
Peak Hour	0	0	13	0	0	0	12	0	0	0	0	0	0	1	0	0	26	0
Two-Hour Count Summaries - Bikes																		
Interval Start	Huntington Dr			Huntington Dr			West Dr			Cambridge Rd			15-min Total	Rolling One Hour				
	Eastbound			Westbound			Northbound			Southbound								
	LT	TH	RT	LT	TH	RT	LT	TH	RT	LT	TH	RT						
7:00 AM	0	1	0	0	0	0	0	0	0	0	0	0	0	1	0			
7:15 AM	0	0	0	0	0	0	0	0	1	0	0	0	0	1	0			
7:30 AM	0	0	0	0	1	0	0	1	0	0	0	0	0	2	0			
7:45 AM	0	1	0	0	1	0	0	0	1	0	0	0	0	3	7			
8:00 AM	0	0	0	0	0	0	0	0	0	0	0	0	0	0	6			
8:15 AM	0	0	0	0	0	0	0	1	0	0	0	0	0	1	6			
8:30 AM	0	0	0	0	0	0	0	0	0	0	0	0	0	0	4			
8:45 AM	0	0	0	0	0	0	0	0	0	0	0	0	0	0	1			
Count Total	0	2	0	0	2	0	0	3	1	0	0	0	0	8	0			
Peak Hour	0	1	0	0	2	0	0	2	1	0	0	0	0	6	0			
<i>Note: U-Turn volumes for bikes are included in Left-Turn, if any.</i>																		

West Dr Huntington Dr



Date: 11-07-2019
 Count Period: 4:00 PM to 6:00 PM
 Peak Hour: 5:00 PM to 6:00 PM

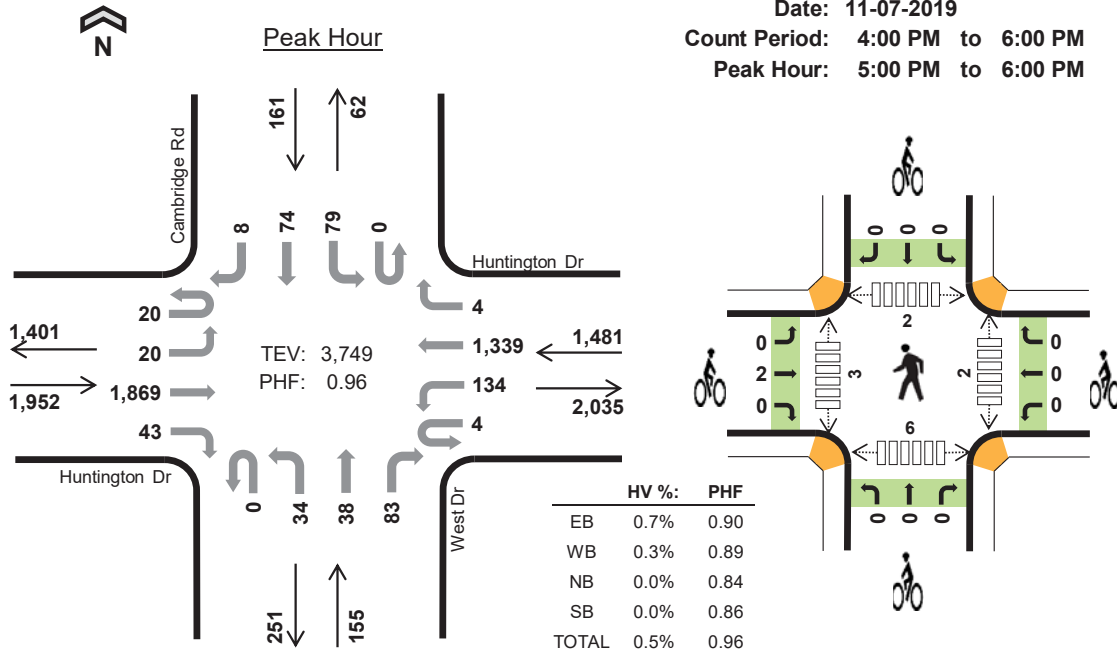

Two-Hour Count Summaries

Interval Start	Huntington Dr Eastbound				Huntington Dr Westbound				West Dr Northbound				Cambridge Rd Southbound				15-min Total	Rolling One Hour	
	UT	LT	TH	RT	UT	LT	TH	RT	UT	LT	TH	RT	UT	LT	TH	RT			
4:00 PM	2	7	394	10	4	14	269	1	0	10	9	13	0	9	7	3	752	0	
4:15 PM	4	1	454	7	1	24	324	2	0	5	8	16	0	13	10	0	869	0	
4:30 PM	0	4	428	7	3	28	284	0	0	15	8	15	0	17	11	0	820	0	
4:45 PM	10	2	466	12	0	25	312	1	0	15	8	18	0	15	13	1	898	3,339	
5:00 PM	8	8	443	13	1	37	307	0	0	16	6	24	0	17	19	0	899	3,486	
5:15 PM	0	5	420	8	0	40	375	3	0	6	15	18	0	20	23	4	937	3,554	
5:30 PM	2	2	490	9	3	30	361	1	0	5	10	25	0	22	14	3	977	3,711	
5:45 PM	10	5	516	13	0	27	296	0	0	7	7	16	0	20	18	1	936	3,749	
Count Total	36	34	3,611	79	12	225	2,528	8	0	79	71	145	0	133	115	12	7,088	0	
Peak Hour	All	20	20	1,869	43	4	134	1,339	4	0	34	38	83	0	79	74	8	3,749	0
	HV	0	0	12	1	0	1	4	0	0	0	0	0	0	0	0	0	18	0
	HV%	0%	0%	1%	2%	0%	1%	0%	0%	-	0%	0%	0%	-	0%	0%	0%	0%	0

Note: Two-hour count summary volumes include heavy vehicles but exclude bicycles in overall count.

Interval Start	Heavy Vehicle Totals					Bicycles					Pedestrians (Crossing Leg)				
	EB	WB	NB	SB	Total	EB	WB	NB	SB	Total	East	West	North	South	Total
4:00 PM	5	3	0	0	8	0	1	0	0	1	0	1	0	3	4
4:15 PM	4	3	0	0	7	0	0	0	0	0	0	0	0	5	5
4:30 PM	2	6	0	0	8	1	0	0	0	1	0	0	0	3	3
4:45 PM	1	0	0	0	1	0	0	0	0	0	0	1	1	3	5
5:00 PM	3	2	0	0	5	1	0	0	0	1	0	0	0	1	1
5:15 PM	3	1	0	0	4	1	0	0	0	1	0	3	2	0	5
5:30 PM	5	1	0	0	6	0	0	0	0	0	2	0	0	1	3
5:45 PM	2	1	0	0	3	0	0	0	0	0	0	0	0	4	4
Count Total	25	17	0	0	42	3	1	0	0	4	2	5	3	20	30
Peak Hour	13	5	0	0	18	2	0	0	0	2	2	3	2	6	13

Two-Hour Count Summaries - Heavy Vehicles																		
Interval Start	Huntington Dr				Huntington Dr				West Dr				Cambridge Rd				15-min Total	Rolling One Hour
	Eastbound				Westbound				Northbound				Southbound					
	UT	LT	TH	RT	UT	LT	TH	RT	UT	LT	TH	RT	UT	LT	TH	RT		
4:00 PM	0	0	5	0	0	0	3	0	0	0	0	0	0	0	0	0	8	0
4:15 PM	0	0	4	0	0	0	3	0	0	0	0	0	0	0	0	0	7	0
4:30 PM	0	0	2	0	0	0	6	0	0	0	0	0	0	0	0	0	8	0
4:45 PM	0	0	1	0	0	0	0	0	0	0	0	0	0	0	0	0	1	24
5:00 PM	0	0	3	0	0	1	1	0	0	0	0	0	0	0	0	0	5	21
5:15 PM	0	0	3	0	0	0	1	0	0	0	0	0	0	0	0	0	4	18
5:30 PM	0	0	5	0	0	0	1	0	0	0	0	0	0	0	0	0	6	16
5:45 PM	0	0	1	1	0	0	1	0	0	0	0	0	0	0	0	0	3	18
Count Total	0	0	24	1	0	1	16	0	0	0	0	0	0	0	0	0	42	0
Peak Hour	0	0	12	1	0	1	4	0	0	0	0	0	0	0	0	0	18	0
Two-Hour Count Summaries - Bikes																		
Interval Start	Huntington Dr			Huntington Dr			West Dr			Cambridge Rd			15-min Total	Rolling One Hour				
	Eastbound			Westbound			Northbound			Southbound								
	LT	TH	RT	LT	TH	RT	LT	TH	RT	LT	TH	RT						
4:00 PM	0	0	0	0	1	0	0	0	0	0	0	0	0	0	1	0		
4:15 PM	0	0	0	0	0	0	0	0	0	0	0	0	0	0	0	0		
4:30 PM	0	1	0	0	0	0	0	0	0	0	0	0	0	0	1	0		
4:45 PM	0	0	0	0	0	0	0	0	0	0	0	0	0	0	0	2		
5:00 PM	0	1	0	0	0	0	0	0	0	0	0	0	0	0	1	2		
5:15 PM	0	1	0	0	0	0	0	0	0	0	0	0	0	0	1	3		
5:30 PM	0	0	0	0	0	0	0	0	0	0	0	0	0	0	0	2		
5:45 PM	0	0	0	0	0	0	0	0	0	0	0	0	0	0	0	2		
Count Total	0	3	0	0	1	0	0	0	0	0	0	0	0	0	4	0		
Peak Hour	0	2	0	0	0	0	0	0	0	0	0	0	0	0	2	0		
<i>Note: U-Turn volumes for bikes are included in Left-Turn, if any.</i>																		

Two-Hour Count Summaries - Heavy Vehicles																		
Interval Start	Huntington Dr				Huntington Dr				San Marino Ave				San Marino Ave				15-min Total	Rolling One Hour
	Eastbound				Westbound				Northbound				Southbound					
	UT	LT	TH	RT	UT	LT	TH	RT	UT	LT	TH	RT	UT	LT	TH	RT		
7:00 AM	0	3	1	0	0	0	6	2	0	0	1	0	0	0	1	1	15	0
7:15 AM	0	1	3	0	0	0	3	0	0	1	1	0	0	1	2	0	12	0
7:30 AM	0	0	0	0	0	0	7	0	0	0	2	0	0	0	0	1	10	0
7:45 AM	0	2	2	0	0	0	3	0	0	0	0	0	0	0	0	0	7	44
8:00 AM	0	1	2	0	0	0	2	0	0	1	0	0	0	0	0	0	6	35
8:15 AM	0	1	2	0	0	0	2	0	0	0	1	0	0	0	1	1	8	31
8:30 AM	0	0	2	0	0	1	5	0	0	0	2	0	0	0	0	1	11	32
8:45 AM	0	1	1	0	0	0	6	0	0	0	0	0	0	0	1	1	10	35
Count Total	0	9	13	0	0	1	34	2	0	2	7	0	0	1	5	5	79	0
Peak Hour	0	4	8	0	0	1	12	0	0	1	3	0	0	0	1	2	32	0
Two-Hour Count Summaries - Bikes																		
Interval Start	Huntington Dr			Huntington Dr			San Marino Ave			San Marino Ave			15-min Total	Rolling One Hour				
	Eastbound			Westbound			Northbound			Southbound								
	LT	TH	RT	LT	TH	RT	LT	TH	RT	LT	TH	RT						
7:00 AM	0	0	0	0	0	0	0	0	0	0	0	0	0	0	0	0	0	0
7:15 AM	0	0	0	0	0	0	0	0	0	0	0	0	0	0	0	0	0	0
7:30 AM	0	0	0	0	0	0	0	0	0	0	0	0	0	0	0	0	0	0
7:45 AM	0	0	0	0	1	0	0	0	0	0	0	0	0	0	0	1	1	1
8:00 AM	0	0	0	0	0	0	0	0	0	0	0	0	0	0	0	0	0	1
8:15 AM	0	0	0	1	0	0	0	0	0	0	0	0	0	0	0	0	1	2
8:30 AM	0	0	0	0	0	0	0	0	0	0	0	0	0	0	0	0	0	2
8:45 AM	0	0	0	0	0	0	0	0	0	0	0	0	0	0	0	0	0	1
Count Total	0	0	0	1	1	0	0	0	0	0	0	0	0	0	0	0	2	0
Peak Hour	0	0	0	1	1	0	0	0	0	0	0	0	0	0	0	0	2	0
<i>Note: U-Turn volumes for bikes are included in Left-Turn, if any.</i>																		

San Marino Ave Huntington Dr



Peak Hour

Date: 11-07-2019
Count Period: 4:00 PM to 6:00 PM
Peak Hour: 5:00 PM to 6:00 PM

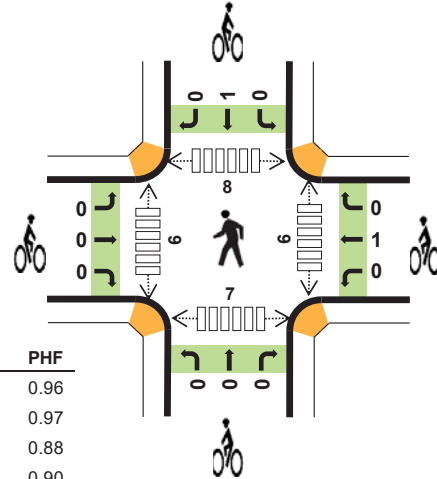
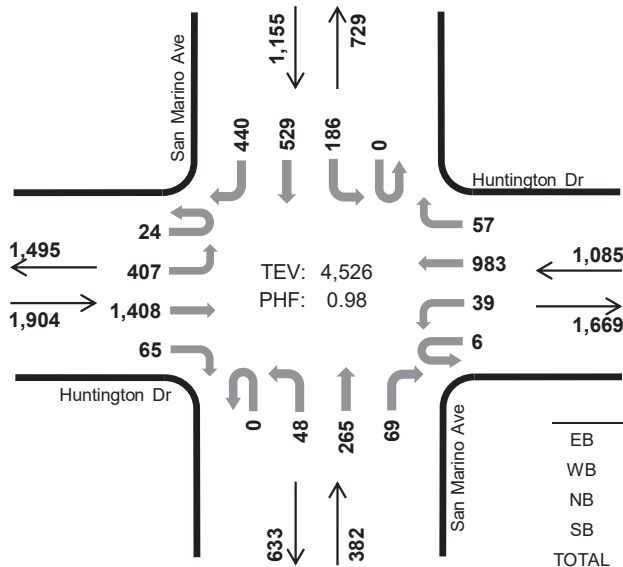

	HV %:	PHF
EB	0.6%	0.96
WB	0.5%	0.97
NB	0.0%	0.88
SB	0.3%	0.90
TOTAL	0.4%	0.98

Two-Hour Count Summaries

Interval Start	Huntington Dr Eastbound				Huntington Dr Westbound				San Marino Ave Northbound				San Marino Ave Southbound				15-min Total	Rolling One Hour	
	UT	LT	TH	RT	UT	LT	TH	RT	UT	LT	TH	RT	UT	LT	TH	RT			
4:00 PM	8	99	293	10	1	14	166	17	0	17	53	14	0	35	135	106	968	0	
4:15 PM	1	66	333	18	1	7	236	19	0	21	61	6	0	47	150	97	1,063	0	
4:30 PM	4	103	367	20	4	11	221	10	0	12	60	9	0	52	123	75	1,071	0	
4:45 PM	7	109	320	14	2	11	227	16	0	17	65	14	0	63	136	96	1,097	4,199	
5:00 PM	2	89	375	17	1	8	223	20	0	13	62	13	0	48	144	116	1,131	4,362	
5:15 PM	8	102	309	21	1	11	254	12	0	11	68	9	0	44	158	120	1,128	4,427	
5:30 PM	7	102	364	13	1	11	252	15	0	12	75	22	0	54	124	103	1,155	4,511	
5:45 PM	7	114	360	14	3	9	254	10	0	12	60	25	0	40	103	101	1,112	4,526	
Count Total	44	784	2,721	127	14	82	1,833	119	0	115	504	112	0	383	1,073	814	8,725	0	
Peak Hour	All	24	407	1,408	65	6	39	983	57	0	48	265	69	0	186	529	440	4,526	0
	HV	1	0	10	0	0	0	5	0	0	0	0	0	0	1	0	3	20	0
	HV%	4%	0%	1%	0%	0%	0%	1%	0%	-	0%	0%	0%	-	1%	0%	1%	0%	0

Note: Two-hour count summary volumes include heavy vehicles but exclude bicycles in overall count.

Interval Start	Heavy Vehicle Totals					Bicycles					Pedestrians (Crossing Leg)				
	EB	WB	NB	SB	Total	EB	WB	NB	SB	Total	East	West	North	South	Total
4:00 PM	5	4	1	1	11	0	0	0	0	0	3	0	6	1	10
4:15 PM	3	4	1	2	10	0	0	0	0	0	2	3	9	0	14
4:30 PM	3	3	0	2	8	0	0	0	0	0	0	3	2	0	5
4:45 PM	1	1	0	1	3	0	0	1	1	2	0	1	2	2	5
5:00 PM	4	0	0	2	6	0	0	0	1	1	2	4	4	2	12
5:15 PM	1	1	0	2	4	0	0	0	0	0	2	1	1	2	6
5:30 PM	4	2	0	0	6	0	0	0	0	0	1	1	2	1	5
5:45 PM	2	2	0	0	4	0	1	0	0	1	1	0	1	2	4
Count Total	23	17	2	10	52	0	1	1	2	4	11	13	27	10	61
Peak Hour	11	5	0	4	20	0	1	0	1	2	6	6	8	7	27

Two-Hour Count Summaries - Heavy Vehicles																		
Interval Start	Huntington Dr				Huntington Dr				San Marino Ave				San Marino Ave				15-min Total	Rolling One Hour
	Eastbound				Westbound				Northbound				Southbound					
	UT	LT	TH	RT	UT	LT	TH	RT	UT	LT	TH	RT	UT	LT	TH	RT		
4:00 PM	0	1	3	1	0	0	4	0	0	0	0	1	0	0	1	0	11	0
4:15 PM	0	1	2	0	1	0	3	0	0	0	1	0	0	1	0	1	10	0
4:30 PM	0	0	3	0	0	1	2	0	0	0	0	0	0	2	0	0	8	0
4:45 PM	0	0	1	0	0	0	1	0	0	0	0	0	0	0	1	0	3	32
5:00 PM	0	0	4	0	0	0	0	0	0	0	0	0	0	0	0	2	6	27
5:15 PM	0	0	1	0	0	0	1	0	0	0	0	0	0	1	0	1	4	21
5:30 PM	0	0	4	0	0	0	2	0	0	0	0	0	0	0	0	0	6	19
5:45 PM	1	0	1	0	0	0	2	0	0	0	0	0	0	0	0	0	4	20
Count Total	1	2	19	1	1	1	15	0	0	0	1	1	0	4	2	4	52	0
Peak Hour	1	0	10	0	0	0	5	0	0	0	0	0	0	1	0	3	20	0
Two-Hour Count Summaries - Bikes																		
Interval Start	Huntington Dr			Huntington Dr			San Marino Ave			San Marino Ave			15-min Total	Rolling One Hour				
	Eastbound			Westbound			Northbound			Southbound								
	LT	TH	RT	LT	TH	RT	LT	TH	RT	LT	TH	RT						
4:00 PM	0	0	0	0	0	0	0	0	0	0	0	0	0	0	0	0	0	0
4:15 PM	0	0	0	0	0	0	0	0	0	0	0	0	0	0	0	0	0	0
4:30 PM	0	0	0	0	0	0	0	0	0	0	0	0	0	0	0	0	0	0
4:45 PM	0	0	0	0	0	0	0	0	0	1	0	0	0	1	0	2	2	2
5:00 PM	0	0	0	0	0	0	0	0	0	0	0	0	0	1	0	1	3	3
5:15 PM	0	0	0	0	0	0	0	0	0	0	0	0	0	0	0	0	0	3
5:30 PM	0	0	0	0	0	0	0	0	0	0	0	0	0	0	0	0	0	3
5:45 PM	0	0	0	0	0	1	0	0	0	0	0	0	0	0	0	1	2	2
Count Total	0	0	0	0	0	1	0	0	1	0	0	2	0	0	2	0	4	0
Peak Hour	0	0	0	0	0	1	0	0	0	0	0	1	0	0	1	0	2	0
Note: U-Turn volumes for bikes are included in Left-Turn, if any.																		

APPENDIX C
**SAN GABRIEL VALLEY COG VEHICLE MILES
TRAVELED EVALUATION TOOL SCREENING
WORKSHEETS**

Project Details

Timestamp of Analysis: August 30, 2021, 11:05:15 AM

Project Name: San Marino Center Improvement Project

Project Description: The proposed project consists of revitalizing and updating the existing San Marino Center (SMC) building facade similar to that of the adjacent buildings.

Project Location

Jurisdiction:	APN	TAZ
San Marino	5334-024-903	22139300

Inside a TPA?
No (Fail)

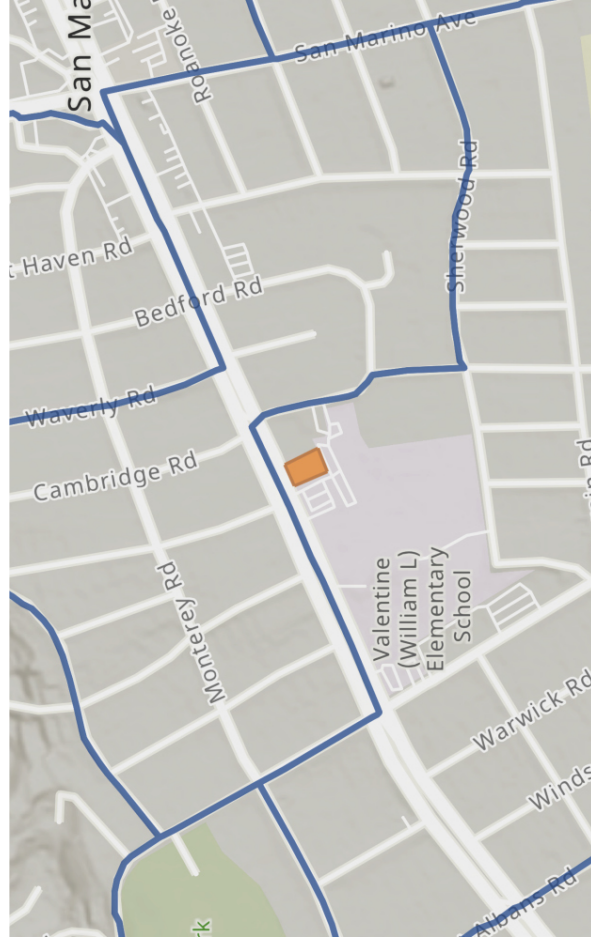

Analysis Details

Data Version: SCAG Regional Travel Demand Model
2016 RTP Base Year 2012

Analysis Methodology: TAZ

Baseline Year: 2021

Project Land Use

Residential:

Single Family DU:

Multifamily DU:

Total DUs: **0**

Non-Residential:

Office KSF:

Local Serving Retail KSF:

Industrial KSF:

Residential Affordability (percent of all units):

Extremely Low Income: **0 %**

Very Low Income: **0 %**

Low Income: **0 %**

Parking:

Motor Vehicle Parking:

Bicycle Parking:

Office Vehicle Miles Traveled (VMT) Screening Results

Land Use Type 1:	Office
VMT Without Project 1:	Total VMT per Service Population
VMT Baseline Description 1:	SGVCOG Average
VMT Baseline Value 1:	35.02
VMT Threshold Description 1:	-15%
Land Use 1 has been Pre-Screened by the Local Jurisdiction:	N/A

	Without Project	With Project & Tier 1-3 VMT Reductions	With Project & All VMT Reductions
Project Generated Vehicle Miles Traveled (VMT) Rate	27.95	null	null
Low VMT Screening Analysis	Yes (Pass)	null	null

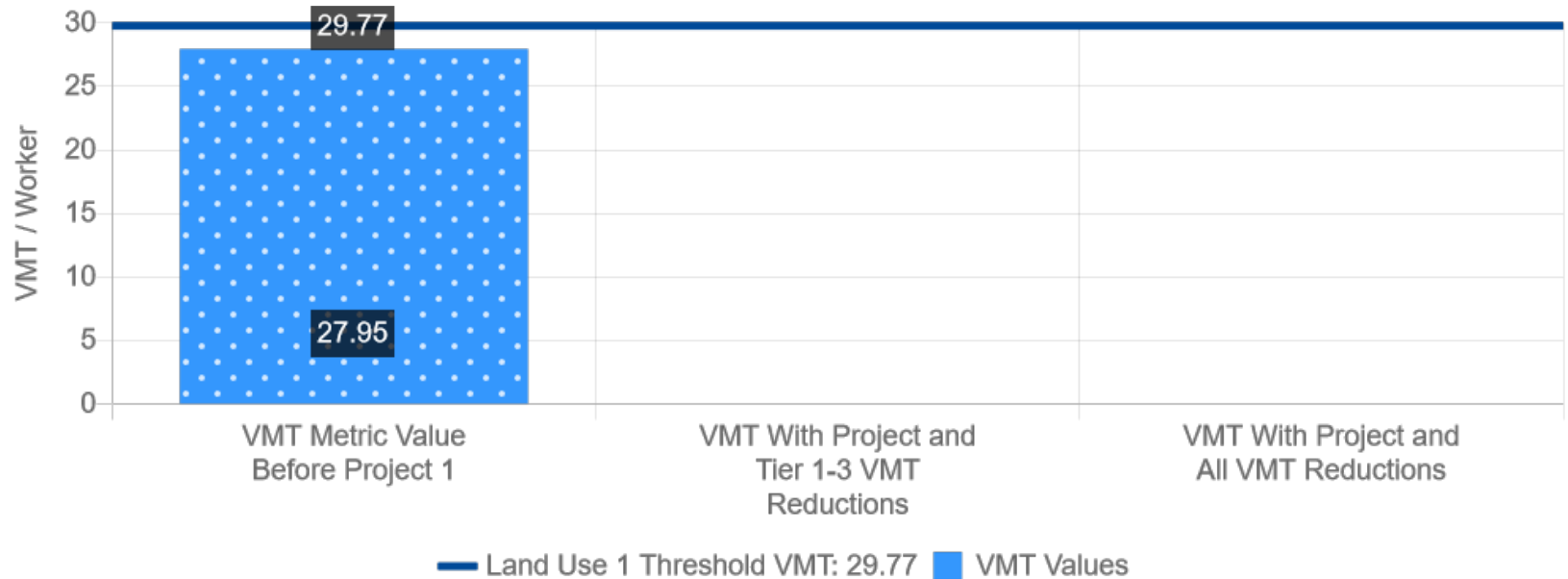

APPENDIX D

HCM AND LEVELS OF SERVICE EXPLANATION HCM DATA WORKSHEETS – WEEKDAY AM AND PM PEAK HOURS

LEVEL OF SERVICE FOR SIGNALIZED INTERSECTIONS

In the *Highway Capacity Manual (HCM)*, published by the Transportation Research Board, 2000, level of service for signalized intersections is defined in terms of delay, which is a measure of driver discomfort, frustration, fuel consumption, and increased travel time. The delay experienced by a motorist is made up of a number of factors that relate to control, geometrics, traffic, and incidents. Total delay is the difference between the travel time actually experienced and the reference travel time that would result during base conditions: in the absence of traffic control, in the absence of geometric delay, in the absence of incidents, and when there are no other vehicles on the road. Only the portion of total delay attributed to the control facility is quantified. This delay is called *control delay*. Control delay includes initial deceleration delay, queue move-up time, stopped delay, and final acceleration delay.

Level of Service criteria for traffic signals are stated in terms of the average control delay per vehicle. Delay is a complex measure and is dependent on a number of variables, including the quality of progression, the cycle length, the green ratio, and the v/c ratio for the lane group in question.

Level of Service Criteria for Signalized Intersections	
Level of Service	Control Delay (Sec/Veh)
A	≤ 10
B	> 10 and ≤ 20
C	> 20 and ≤ 35
D	> 35 and ≤ 55
E	> 55 and ≤ 80
F	> 80

Level of Service (LOS) values are used to describe intersection operations with service levels varying from LOS A (free flow) to LOS F (jammed condition). The following descriptions summarize *HCM* criteria for each level of service:

LOS A describes operations with very low control delay, up to 10 seconds per vehicle. This level of service occurs when progression is extremely favorable and most vehicles arrive during the green phase. Most vehicles do not stop at all. Short cycle lengths may also contribute to low delay values.

LOS B describes operations with control delay greater than 10 and up to 20 seconds per vehicle. This level generally occurs with good progression, short cycle lengths, or both. More vehicles stop than with LOS A, causing higher levels of delay.

LOS C describes operations with control delay greater than 20 and up to 35 seconds per vehicle. These higher delays may result from fair progression, longer cycle lengths, or both. Individual cycle failures may begin to appear at this level. The number of vehicles stopping is significant at this level, though many still pass through the intersection without stopping.

LOS D describes operations with control delay greater than 35 and up to 55 seconds per vehicle. At LOS D, the influence of congestion becomes more noticeable. Longer delays may result from some combination of unfavorable progression, long cycle lengths, or high v/c ratios. Many vehicles stop, and the proportion of vehicles not stopping declines. Individual cycle failures are noticeable.

LOS E describes operations with control delay greater than 55 and up to 80 seconds per vehicle. This level is considered by many agencies to be the limit of acceptable delay. These high delay values generally indicate poor progression, long cycle lengths, and high v/c ratios. Individual cycle failures are frequent occurrences.

LOS F describes operations with control delay in excess of 80 seconds per vehicle. This level, considered to be unacceptable to most drivers, often occurs with oversaturation, that is, when arrival flow rates exceed the capacity of the lane groups. It may also occur at high v/c ratios with many individual cycle failures. Poor progression and long cycle lengths may also be major contributing factors to such delay levels.

























HCM 6th Signalized Intersection Summary
 1: Virginia Rd & Huntington Dr

Existing Conditions
 Weekday AM Peak Hour

Movement	EBL	EBT	EBR	WBL	WBT	WBR	NBL	NBT	NBR	SBL	SBT	SBR
Lane Configurations												
Traffic Volume (veh/h)	49	1182	20	117	1711	58	74	218	147	115	66	11
Future Volume (veh/h)	49	1182	20	117	1711	58	74	218	147	115	66	11
Initial Q (Qb), veh	0	0	0	0	0	0	0	0	0	0	0	0
Ped-Bike Adj(A_pbT)	1.00		1.00	1.00		1.00	1.00		1.00	1.00		1.00
Parking Bus, Adj	1.00	1.00	1.00	1.00	1.00	1.00	1.00	1.00	1.00	1.00	1.00	1.00
Work Zone On Approach	No			No			No			No		
Adj Sat Flow, veh/h/ln	1870	1870	1945	1870	1870	1945	1870	1870	1870	1870	1870	1870
Adj Flow Rate, veh/h	53	1285	22	127	1860	63	80	237	160	125	72	12
Peak Hour Factor	0.92	0.92	0.92	0.92	0.92	0.92	0.92	0.92	0.92	0.92	0.92	0.92
Percent Heavy Veh, %	2	2	2	2	2	2	2	2	2	2	2	2
Cap, veh/h	68	2839	49	119	2930	99	350	469	398	200	469	398
Arrive On Green	0.04	0.55	0.55	0.07	0.58	0.58	0.25	0.25	0.25	0.25	0.25	0.25
Sat Flow, veh/h	1781	5170	89	1781	5072	172	1314	1870	1585	987	1870	1585
Grp Volume(v), veh/h	53	846	461	127	1248	675	80	237	160	125	72	12
Grp Sat Flow(s),veh/h/ln	1781	1702	1854	1781	1702	1839	1314	1870	1585	987	1870	1585
Q Serve(g_s), s	3.5	17.9	17.9	8.0	29.3	29.4	6.1	13.0	10.1	14.9	3.6	0.7
Cycle Q Clear(g_c), s	3.5	17.9	17.9	8.0	29.3	29.4	9.7	13.0	10.1	28.0	3.6	0.7
Prop In Lane	1.00		0.05	1.00		0.09	1.00		1.00	1.00		1.00
Lane Grp Cap(c), veh/h	68	1870	1018	119	1966	1062	350	469	398	200	469	398
V/C Ratio(X)	0.78	0.45	0.45	1.07	0.63	0.64	0.23	0.51	0.40	0.62	0.15	0.03
Avail Cap(c_a), veh/h	119	1870	1018	119	1966	1062	524	717	608	331	717	608
HCM Platoon Ratio	1.00	1.00	1.00	1.00	1.00	1.00	1.00	1.00	1.00	1.00	1.00	1.00
Upstream Filter(I)	1.00	1.00	1.00	1.00	1.00	1.00	1.00	1.00	1.00	1.00	1.00	1.00
Uniform Delay (d), s/veh	57.2	16.2	16.2	56.0	16.9	16.9	38.8	38.6	37.5	50.6	35.0	33.9
Incr Delay (d2), s/veh	6.9	0.8	1.5	102.5	1.6	2.9	0.1	0.3	0.2	1.2	0.1	0.0
Initial Q Delay(d3),s/veh	0.0	0.0	0.0	0.0	0.0	0.0	0.0	0.0	0.0	0.0	0.0	0.0
%ile BackOfQ(95%),veh/ln	3.1	11.4	12.4	11.5	17.0	18.7	3.6	10.1	7.1	6.7	3.0	0.5
Unsig. Movement Delay, s/veh												
LnGrp Delay(d),s/veh	64.1	17.0	17.7	158.5	18.5	19.8	38.9	38.9	37.7	51.7	35.1	33.9
LnGrp LOS	E	B	B	F	B	B	D	D	D	D	D	C
Approach Vol, veh/h	1360			2050			477			209		
Approach Delay, s/veh	19.1			27.6			38.5			45.0		
Approach LOS	B			C			D			D		
Timer - Assigned Phs	1	2	4			5	6	8				
Phs Duration (G+Y+Rc), s	8.6	74.3	37.1			12.0	70.9	37.1				
Change Period (Y+Rc), s	4.0	5.0	7.0			4.0	5.0	7.0				
Max Green Setting (Gmax), s	8.0	50.0	46.0			8.0	50.0	46.0				
Max Q Clear Time (g_c+I1), s	5.5	31.4	15.0			10.0	19.9	30.0				
Green Ext Time (p_c), s	0.0	3.0	0.2			0.0	1.8	0.1				
Intersection Summary												
HCM 6th Ctrl Delay	26.9											
HCM 6th LOS	C											

























HCM 6th Signalized Intersection Summary
 1: Virginia Rd & Huntington Dr

Existing Conditions
 Weekday PM Peak Hour

												
Movement	EBL	EBT	EBR	WBL	WBT	WBR	NBL	NBT	NBR	SBL	SBT	SBR
Lane Configurations		 			 						 	
Traffic Volume (veh/h)	23	1749	55	57	1380	40	39	95	43	121	292	43
Future Volume (veh/h)	23	1749	55	57	1380	40	39	95	43	121	292	43
Initial Q (Qb), veh	0	0	0	0	0	0	0	0	0	0	0	0
Ped-Bike Adj(A_pbT)	1.00		1.00	1.00		1.00	1.00		1.00	1.00		1.00
Parking Bus, Adj	1.00	1.00	1.00	1.00	1.00	1.00	1.00	1.00	1.00	1.00	1.00	1.00
Work Zone On Approach	No			No			No			No		
Adj Sat Flow, veh/h/ln	1870	1870	1945	1870	1870	1945	1870	1870	1870	1870	1870	1870
Adj Flow Rate, veh/h	25	1901	60	62	1500	43	42	103	47	132	317	47
Peak Hour Factor	0.92	0.92	0.92	0.92	0.92	0.92	0.92	0.92	0.92	0.92	0.92	0.92
Percent Heavy Veh, %	2	2	2	2	2	2	2	2	2	2	2	2
Cap, veh/h	42	3073	97	80	3191	91	119	407	345	273	407	345
Arrive On Green	0.02	0.60	0.60	0.04	0.63	0.63	0.22	0.22	0.22	0.22	0.22	0.22
Sat Flow, veh/h	1781	5085	160	1781	5102	146	1018	1870	1585	1237	1870	1585
Grp Volume(v), veh/h	25	1272	689	62	1001	542	42	103	47	132	317	47
Grp Sat Flow(s),veh/h/ln	1781	1702	1842	1781	1702	1844	1018	1870	1585	1237	1870	1585
Q Serve(g_s), s	1.7	28.3	28.4	4.1	18.7	18.7	4.9	5.5	2.9	11.9	19.2	2.9
Cycle Q Clear(g_c), s	1.7	28.3	28.4	4.1	18.7	18.7	24.0	5.5	2.9	17.3	19.2	2.9
Prop In Lane	1.00		0.09	1.00		0.08	1.00		1.00	1.00		1.00
Lane Grp Cap(c), veh/h	42	2057	1113	80	2129	1153	119	407	345	273	407	345
V/C Ratio(X)	0.60	0.62	0.62	0.78	0.47	0.47	0.35	0.25	0.14	0.48	0.78	0.14
Avail Cap(c_a), veh/h	119	2057	1113	119	2129	1153	288	717	608	478	717	608
HCM Platoon Ratio	1.00	1.00	1.00	1.00	1.00	1.00	1.00	1.00	1.00	1.00	1.00	1.00
Upstream Filter(I)	1.00	1.00	1.00	1.00	1.00	1.00	1.00	1.00	1.00	1.00	1.00	1.00
Uniform Delay (d), s/veh	58.0	15.0	15.0	56.7	11.9	11.9	55.5	38.9	37.8	46.0	44.2	37.8
Incr Delay (d2), s/veh	4.9	1.4	2.6	8.9	0.7	1.4	0.7	0.1	0.1	0.5	1.2	0.1
Initial Q Delay(d3),s/veh	0.0	0.0	0.0	0.0	0.0	0.0	0.0	0.0	0.0	0.0	0.0	0.0
%ile BackOfQ(95%),veh/ln	1.5	16.3	17.8	3.7	11.4	12.4	2.3	4.6	2.0	6.6	13.9	2.0
Unsig. Movement Delay, s/veh												
LnGrp Delay(d),s/veh	62.9	16.4	17.6	65.6	12.7	13.3	56.2	39.0	37.9	46.5	45.4	37.9
LnGrp LOS	E	B	B	E	B	B	E	D	D	D	D	D
Approach Vol, veh/h	1986			1605			192			496		
Approach Delay, s/veh	17.4			14.9			42.5			45.0		
Approach LOS	B			B			D			D		
Timer - Assigned Phs	1	2		4	5	6		8				
Phs Duration (G+Y+Rc), s	6.8	80.0		33.1	9.4	77.5		33.1				
Change Period (Y+Rc), s	4.0	5.0		7.0	4.0	5.0		7.0				
Max Green Setting (Gmax), s	8.0	50.0		46.0	8.0	50.0		46.0				
Max Q Clear Time (g_c+I1), s	3.7	20.7		26.0	6.1	30.4		21.2				
Green Ext Time (p_c), s	0.0	2.3		0.1	0.0	3.1		0.3				
Intersection Summary												
HCM 6th Ctrl Delay				20.8								
HCM 6th LOS				C								

























HCM 6th Signalized Intersection Summary
 1: Virginia Rd & Huntington Dr

Existing + Project Conditions
 Weekday AM Peak Hour

												
Movement	EBL	EBT	EBR	WBL	WBT	WBR	NBL	NBT	NBR	SBL	SBT	SBR
Lane Configurations		 			 						 	
Traffic Volume (veh/h)	49	1185	20	117	1713	58	74	218	148	116	66	11
Future Volume (veh/h)	49	1185	20	117	1713	58	74	218	148	116	66	11
Initial Q (Qb), veh	0	0	0	0	0	0	0	0	0	0	0	0
Ped-Bike Adj(A_pbT)	1.00		1.00	1.00		1.00	1.00		1.00	1.00		1.00
Parking Bus, Adj	1.00	1.00	1.00	1.00	1.00	1.00	1.00	1.00	1.00	1.00	1.00	1.00
Work Zone On Approach	No			No			No			No		
Adj Sat Flow, veh/h/ln	1870	1870	1945	1870	1870	1945	1870	1870	1870	1870	1870	1870
Adj Flow Rate, veh/h	53	1288	22	127	1862	63	80	237	161	126	72	12
Peak Hour Factor	0.92	0.92	0.92	0.92	0.92	0.92	0.92	0.92	0.92	0.92	0.92	0.92
Percent Heavy Veh, %	2	2	2	2	2	2	2	2	2	2	2	2
Cap, veh/h	68	2835	48	119	2925	99	351	471	399	201	471	399
Arrive On Green	0.04	0.55	0.55	0.07	0.58	0.58	0.25	0.25	0.25	0.25	0.25	0.25
Sat Flow, veh/h	1781	5170	88	1781	5072	171	1314	1870	1585	987	1870	1585
Grp Volume(v), veh/h	53	848	462	127	1249	676	80	237	161	126	72	12
Grp Sat Flow(s),veh/h/ln	1781	1702	1854	1781	1702	1840	1314	1870	1585	987	1870	1585
Q Serve(g_s), s	3.5	18.0	18.0	8.0	29.4	29.5	6.1	13.0	10.2	15.1	3.6	0.7
Cycle Q Clear(g_c), s	3.5	18.0	18.0	8.0	29.4	29.5	9.6	13.0	10.2	28.1	3.6	0.7
Prop In Lane	1.00		0.05	1.00		0.09	1.00		1.00	1.00		1.00
Lane Grp Cap(c), veh/h	68	1866	1017	119	1963	1061	351	471	399	201	471	399
V/C Ratio(X)	0.78	0.45	0.45	1.07	0.64	0.64	0.23	0.50	0.40	0.63	0.15	0.03
Avail Cap(c_a), veh/h	119	1866	1017	119	1963	1061	524	717	608	331	717	608
HCM Platoon Ratio	1.00	1.00	1.00	1.00	1.00	1.00	1.00	1.00	1.00	1.00	1.00	1.00
Upstream Filter(I)	1.00	1.00	1.00	1.00	1.00	1.00	1.00	1.00	1.00	1.00	1.00	1.00
Uniform Delay (d), s/veh	57.2	16.3	16.3	56.0	17.0	17.0	38.7	38.5	37.4	50.5	34.9	33.8
Incr Delay (d2), s/veh	6.9	0.8	1.5	102.5	1.6	2.9	0.1	0.3	0.2	1.2	0.1	0.0
Initial Q Delay(d3),s/veh	0.0	0.0	0.0	0.0	0.0	0.0	0.0	0.0	0.0	0.0	0.0	0.0
%ile BackOfQ(95%),veh/ln	3.1	11.5	12.5	11.5	17.1	18.8	3.6	10.1	7.2	6.8	3.0	0.5
Unsig. Movement Delay, s/veh												
LnGrp Delay(d),s/veh	64.1	17.1	17.8	158.5	18.6	19.9	38.8	38.8	37.6	51.7	35.0	33.9
LnGrp LOS	E	B	B	F	B	B	D	D	D	D	C	C
Approach Vol, veh/h	1363			2052			478			210		
Approach Delay, s/veh	19.2			27.7			38.4			44.9		
Approach LOS	B			C			D			D		
Timer - Assigned Phs	1	2	4			5	6	8				
Phs Duration (G+Y+Rc), s	8.6	74.2	37.2			12.0	70.8	37.2				
Change Period (Y+Rc), s	4.0	5.0	7.0			4.0	5.0	7.0				
Max Green Setting (Gmax), s	8.0	50.0	46.0			8.0	50.0	46.0				
Max Q Clear Time (g_c+I1), s	5.5	31.5	15.0			10.0	20.0	30.1				
Green Ext Time (p_c), s	0.0	3.0	0.2			0.0	1.8	0.1				
Intersection Summary												
HCM 6th Ctrl Delay				27.0								
HCM 6th LOS				C								

HCM 6th Signalized Intersection Summary
 1: Virginia Rd & Huntington Dr

Existing Plus Conditions
 Weekday PM Peak Hour

												
Movement	EBL	EBT	EBR	WBL	WBT	WBR	NBL	NBT	NBR	SBL	SBT	SBR
Lane Configurations												
Traffic Volume (veh/h)	23	1752	55	58	1383	41	39	95	44	122	292	43
Future Volume (veh/h)	23	1752	55	58	1383	41	39	95	44	122	292	43
Initial Q (Qb), veh	0	0	0	0	0	0	0	0	0	0	0	0
Ped-Bike Adj(A_pbT)	1.00		1.00	1.00		1.00	1.00		1.00	1.00		1.00
Parking Bus, Adj	1.00	1.00	1.00	1.00	1.00	1.00	1.00	1.00	1.00	1.00	1.00	1.00
Work Zone On Approach	No			No			No			No		
Adj Sat Flow, veh/h/ln	1870	1870	1945	1870	1870	1945	1870	1870	1870	1870	1870	1870
Adj Flow Rate, veh/h	25	1904	60	63	1503	45	42	103	48	133	317	47
Peak Hour Factor	0.92	0.92	0.92	0.92	0.92	0.92	0.92	0.92	0.92	0.92	0.92	0.92
Percent Heavy Veh, %	2	2	2	2	2	2	2	2	2	2	2	2
Cap, veh/h	42	3070	97	81	3186	95	119	407	345	273	407	345
Arrive On Green	0.02	0.60	0.60	0.05	0.63	0.63	0.22	0.22	0.22	0.22	0.22	0.22
Sat Flow, veh/h	1781	5086	160	1781	5094	153	1018	1870	1585	1236	1870	1585
Grp Volume(v), veh/h	25	1274	690	63	1004	544	42	103	48	133	317	47
Grp Sat Flow(s),veh/h/ln	1781	1702	1842	1781	1702	1843	1018	1870	1585	1236	1870	1585
Q Serve(g_s), s	1.7	28.4	28.5	4.2	18.8	18.8	4.9	5.5	2.9	12.0	19.2	2.9
Cycle Q Clear(g_c), s	1.7	28.4	28.5	4.2	18.8	18.8	24.0	5.5	2.9	17.4	19.2	2.9
Prop In Lane	1.00		0.09	1.00		0.08	1.00		1.00	1.00		1.00
Lane Grp Cap(c), veh/h	42	2055	1112	81	2129	1153	119	407	345	273	407	345
V/C Ratio(X)	0.60	0.62	0.62	0.78	0.47	0.47	0.35	0.25	0.14	0.49	0.78	0.14
Avail Cap(c_a), veh/h	119	2055	1112	119	2129	1153	288	717	608	478	717	608
HCM Platoon Ratio	1.00	1.00	1.00	1.00	1.00	1.00	1.00	1.00	1.00	1.00	1.00	1.00
Upstream Filter(I)	1.00	1.00	1.00	1.00	1.00	1.00	1.00	1.00	1.00	1.00	1.00	1.00
Uniform Delay (d), s/veh	58.0	15.1	15.1	56.7	11.9	11.9	55.5	38.9	37.9	46.1	44.2	37.8
Incr Delay (d2), s/veh	4.9	1.4	2.6	9.8	0.8	1.4	0.7	0.1	0.1	0.5	1.2	0.1
Initial Q Delay(d3),s/veh	0.0	0.0	0.0	0.0	0.0	0.0	0.0	0.0	0.0	0.0	0.0	0.0
%ile BackOfQ(95%),veh/ln	1.5	16.3	17.9	3.8	11.4	12.4	2.3	4.6	2.1	6.7	13.9	2.0
Unsig. Movement Delay, s/veh												
LnGrp Delay(d),s/veh	62.9	16.5	17.7	66.5	12.7	13.3	56.2	39.0	37.9	46.6	45.4	37.9
LnGrp LOS	E	B	B	E	B	B	E	D	D	D	D	D
Approach Vol, veh/h	1989			1611			193			497		
Approach Delay, s/veh	17.5			15.0			42.5			45.0		
Approach LOS	B			B			D			D		
Timer - Assigned Phs	1	2	4			5	6	8				
Phs Duration (G+Y+Rc), s	6.8	80.0	33.1			9.4	77.4	33.1				
Change Period (Y+Rc), s	4.0	5.0	7.0			4.0	5.0	7.0				
Max Green Setting (Gmax), s	8.0	50.0	46.0			8.0	50.0	46.0				
Max Q Clear Time (g_c+I1), s	3.7	20.8	26.0			6.2	30.5	21.2				
Green Ext Time (p_c), s	0.0	2.3	0.1			0.0	3.1	0.3				
Intersection Summary												
HCM 6th Ctrl Delay	20.9											
HCM 6th LOS	C											

























HCM 6th Signalized Intersection Summary
 1: Virginia Rd & Huntington Dr

Future Pre Project Conditions
 Weekday AM Peak Hour

Movement	EBL	EBT	EBR	WBL	WBT	WBR	NBL	NBT	NBR	SBL	SBT	SBR
Lane Configurations												
Traffic Volume (veh/h)	50	1218	20	119	1756	59	75	222	150	117	67	11
Future Volume (veh/h)	50	1218	20	119	1756	59	75	222	150	117	67	11
Initial Q (Qb), veh	0	0	0	0	0	0	0	0	0	0	0	0
Ped-Bike Adj(A_pbT)	1.00		1.00	1.00		1.00	1.00		1.00	1.00		1.00
Parking Bus, Adj	1.00	1.00	1.00	1.00	1.00	1.00	1.00	1.00	1.00	1.00	1.00	1.00
Work Zone On Approach	No			No			No			No		
Adj Sat Flow, veh/h/ln	1870	1870	1945	1870	1870	1945	1870	1870	1870	1870	1870	1870
Adj Flow Rate, veh/h	54	1324	22	129	1909	64	82	241	163	127	73	12
Peak Hour Factor	0.92	0.92	0.92	0.92	0.92	0.92	0.92	0.92	0.92	0.92	0.92	0.92
Percent Heavy Veh, %	2	2	2	2	2	2	2	2	2	2	2	2
Cap, veh/h	69	2819	47	119	2905	97	355	477	404	202	477	404
Arrive On Green	0.04	0.54	0.54	0.07	0.57	0.57	0.26	0.26	0.26	0.26	0.26	0.26
Sat Flow, veh/h	1781	5173	86	1781	5074	170	1313	1870	1585	981	1870	1585
Grp Volume(v), veh/h	54	871	475	129	1280	693	82	241	163	127	73	12
Grp Sat Flow(s),veh/h/ln	1781	1702	1855	1781	1702	1840	1313	1870	1585	981	1870	1585
Q Serve(g_s), s	3.6	18.8	18.8	8.0	30.9	31.0	6.2	13.2	10.2	15.3	3.6	0.7
Cycle Q Clear(g_c), s	3.6	18.8	18.8	8.0	30.9	31.0	9.8	13.2	10.2	28.5	3.6	0.7
Prop In Lane	1.00		0.05	1.00		0.09	1.00		1.00	1.00		1.00
Lane Grp Cap(c), veh/h	69	1855	1011	119	1949	1053	355	477	404	202	477	404
V/C Ratio(X)	0.78	0.47	0.47	1.09	0.66	0.66	0.23	0.51	0.40	0.63	0.15	0.03
Avail Cap(c_a), veh/h	119	1855	1011	119	1949	1053	523	717	608	328	717	608
HCM Platoon Ratio	1.00	1.00	1.00	1.00	1.00	1.00	1.00	1.00	1.00	1.00	1.00	1.00
Upstream Filter(I)	1.00	1.00	1.00	1.00	1.00	1.00	1.00	1.00	1.00	1.00	1.00	1.00
Uniform Delay (d), s/veh	57.1	16.7	16.7	56.0	17.6	17.6	38.5	38.2	37.1	50.4	34.6	33.5
Incr Delay (d2), s/veh	6.8	0.9	1.6	107.7	1.7	3.2	0.1	0.3	0.2	1.2	0.1	0.0
Initial Q Delay(d3),s/veh	0.0	0.0	0.0	0.0	0.0	0.0	0.0	0.0	0.0	0.0	0.0	0.0
%ile BackOfQ(95%),veh/ln	3.2	11.9	13.0	11.8	17.8	19.6	3.6	10.2	7.2	6.9	3.0	0.5
Unsig. Movement Delay, s/veh												
LnGrp Delay(d),s/veh	63.9	17.6	18.3	163.7	19.3	20.8	38.6	38.5	37.4	51.6	34.7	33.6
LnGrp LOS	E	B	B	F	B	C	D	D	D	D	C	C
Approach Vol, veh/h	1400			2102			486			212		
Approach Delay, s/veh	19.6			28.7			38.1			44.8		
Approach LOS	B			C			D			D		
Timer - Assigned Phs	1	2	4			5	6	8				
Phs Duration (G+Y+Rc), s	8.7	73.7	37.6			12.0	70.4	37.6				
Change Period (Y+Rc), s	4.0	5.0	7.0			4.0	5.0	7.0				
Max Green Setting (Gmax), s	8.0	50.0	46.0			8.0	50.0	46.0				
Max Q Clear Time (g_c+I1), s	5.6	33.0	15.2			10.0	20.8	30.5				
Green Ext Time (p_c), s	0.0	3.1	0.2			0.0	1.9	0.1				
Intersection Summary												
HCM 6th Ctrl Delay				27.5								
HCM 6th LOS				C								

HCM 6th Signalized Intersection Summary
 1: Virginia Rd & Huntington Dr

Future Pre Project Conditions
 Weekday PM Peak Hour

												
Movement	EBL	EBT	EBR	WBL	WBT	WBR	NBL	NBT	NBR	SBL	SBT	SBR
Lane Configurations		 			 						 	
Traffic Volume (veh/h)	23	1796	56	58	1420	41	40	97	44	123	298	44
Future Volume (veh/h)	23	1796	56	58	1420	41	40	97	44	123	298	44
Initial Q (Qb), veh	0	0	0	0	0	0	0	0	0	0	0	0
Ped-Bike Adj(A_pbT)	1.00		1.00	1.00		1.00	1.00		1.00	1.00		1.00
Parking Bus, Adj	1.00	1.00	1.00	1.00	1.00	1.00	1.00	1.00	1.00	1.00	1.00	1.00
Work Zone On Approach	No			No			No			No		
Adj Sat Flow, veh/h/ln	1870	1870	1945	1870	1870	1945	1870	1870	1870	1870	1870	1870
Adj Flow Rate, veh/h	25	1952	61	63	1543	45	43	105	48	134	324	48
Peak Hour Factor	0.92	0.92	0.92	0.92	0.92	0.92	0.92	0.92	0.92	0.92	0.92	0.92
Percent Heavy Veh, %	2	2	2	2	2	2	2	2	2	2	2	2
Cap, veh/h	42	3047	95	81	3165	92	120	416	352	277	416	352
Arrive On Green	0.02	0.60	0.60	0.05	0.62	0.62	0.22	0.22	0.22	0.22	0.22	0.22
Sat Flow, veh/h	1781	5087	159	1781	5099	149	1010	1870	1585	1234	1870	1585
Grp Volume(v), veh/h	25	1305	708	63	1030	558	43	105	48	134	324	48
Grp Sat Flow(s),veh/h/ln	1781	1702	1842	1781	1702	1844	1010	1870	1585	1234	1870	1585
Q Serve(g_s), s	1.7	29.9	30.0	4.2	19.7	19.7	5.0	5.6	2.9	12.0	19.6	2.9
Cycle Q Clear(g_c), s	1.7	29.9	30.0	4.2	19.7	19.7	24.6	5.6	2.9	17.6	19.6	2.9
Prop In Lane	1.00		0.09	1.00		0.08	1.00		1.00	1.00		1.00
Lane Grp Cap(c), veh/h	42	2039	1103	81	2113	1144	120	416	352	277	416	352
V/C Ratio(X)	0.60	0.64	0.64	0.78	0.49	0.49	0.36	0.25	0.14	0.48	0.78	0.14
Avail Cap(c_a), veh/h	119	2039	1103	119	2113	1144	283	717	608	476	717	608
HCM Platoon Ratio	1.00	1.00	1.00	1.00	1.00	1.00	1.00	1.00	1.00	1.00	1.00	1.00
Upstream Filter(I)	1.00	1.00	1.00	1.00	1.00	1.00	1.00	1.00	1.00	1.00	1.00	1.00
Uniform Delay (d), s/veh	58.0	15.6	15.7	56.7	12.4	12.4	55.4	38.4	37.4	45.7	43.9	37.4
Incr Delay (d2), s/veh	4.9	1.6	2.9	9.8	0.8	1.5	0.7	0.1	0.1	0.5	1.2	0.1
Initial Q Delay(d3),s/veh	0.0	0.0	0.0	0.0	0.0	0.0	0.0	0.0	0.0	0.0	0.0	0.0
%ile BackOfQ(95%),veh/ln	1.5	17.1	18.8	3.8	11.9	13.0	2.3	4.6	2.1	6.7	14.1	2.1
Unsig. Movement Delay, s/veh												
LnGrp Delay(d),s/veh	62.9	17.2	18.5	66.5	13.2	13.9	56.1	38.6	37.5	46.2	45.1	37.5
LnGrp LOS	E	B	B	E	B	B	E	D	D	D	D	D
Approach Vol, veh/h	2038			1651			196			506		
Approach Delay, s/veh	18.2			15.4			42.1			44.7		
Approach LOS	B			B			D			D		
Timer - Assigned Phs	1	2	4			5	6	8				
Phs Duration (G+Y+Rc), s	6.8	79.5	33.7			9.4	76.9	33.7				
Change Period (Y+Rc), s	4.0	5.0	7.0			4.0	5.0	7.0				
Max Green Setting (Gmax), s	8.0	50.0	46.0			8.0	50.0	46.0				
Max Q Clear Time (g_c+I1), s	3.7	21.7	26.6			6.2	32.0	21.6				
Green Ext Time (p_c), s	0.0	2.4	0.1			0.0	3.2	0.3				
Intersection Summary												
HCM 6th Ctrl Delay				21.3								
HCM 6th LOS				C								

























HCM 6th Signalized Intersection Summary
 1: Virginia Rd & Huntington Dr

Future With Project Conditions
 Weekday AM Peak Hour

Movement	EBL	EBT	EBR	WBL	WBT	WBR	NBL	NBT	NBR	SBL	SBT	SBR
Lane Configurations												
Traffic Volume (veh/h)	50	1221	20	119	1758	59	75	222	151	118	67	11
Future Volume (veh/h)	50	1221	20	119	1758	59	75	222	151	118	67	11
Initial Q (Qb), veh	0	0	0	0	0	0	0	0	0	0	0	0
Ped-Bike Adj(A_pbT)	1.00		1.00	1.00		1.00	1.00		1.00	1.00		1.00
Parking Bus, Adj	1.00	1.00	1.00	1.00	1.00	1.00	1.00	1.00	1.00	1.00	1.00	1.00
Work Zone On Approach	No			No			No			No		
Adj Sat Flow, veh/h/ln	1870	1870	1945	1870	1870	1945	1870	1870	1870	1870	1870	1870
Adj Flow Rate, veh/h	54	1327	22	129	1911	64	82	241	164	128	73	12
Peak Hour Factor	0.92	0.92	0.92	0.92	0.92	0.92	0.92	0.92	0.92	0.92	0.92	0.92
Percent Heavy Veh, %	2	2	2	2	2	2	2	2	2	2	2	2
Cap, veh/h	69	2814	47	119	2900	97	356	479	406	203	479	406
Arrive On Green	0.04	0.54	0.54	0.07	0.57	0.57	0.26	0.26	0.26	0.26	0.26	0.26
Sat Flow, veh/h	1781	5173	86	1781	5074	170	1313	1870	1585	980	1870	1585
Grp Volume(v), veh/h	54	873	476	129	1281	694	82	241	164	128	73	12
Grp Sat Flow(s),veh/h/ln	1781	1702	1855	1781	1702	1840	1313	1870	1585	980	1870	1585
Q Serve(g_s), s	3.6	18.9	18.9	8.0	31.0	31.1	6.2	13.2	10.3	15.4	3.6	0.7
Cycle Q Clear(g_c), s	3.6	18.9	18.9	8.0	31.0	31.1	9.8	13.2	10.3	28.6	3.6	0.7
Prop In Lane	1.00		0.05	1.00		0.09	1.00		1.00	1.00		1.00
Lane Grp Cap(c), veh/h	69	1852	1009	119	1946	1052	356	479	406	203	479	406
V/C Ratio(X)	0.78	0.47	0.47	1.09	0.66	0.66	0.23	0.50	0.40	0.63	0.15	0.03
Avail Cap(c_a), veh/h	119	1852	1009	119	1946	1052	524	717	608	328	717	608
HCM Platoon Ratio	1.00	1.00	1.00	1.00	1.00	1.00	1.00	1.00	1.00	1.00	1.00	1.00
Upstream Filter(I)	1.00	1.00	1.00	1.00	1.00	1.00	1.00	1.00	1.00	1.00	1.00	1.00
Uniform Delay (d), s/veh	57.1	16.8	16.8	56.0	17.7	17.7	38.4	38.1	37.0	50.3	34.6	33.5
Incr Delay (d2), s/veh	6.8	0.9	1.6	107.7	1.8	3.3	0.1	0.3	0.2	1.2	0.1	0.0
Initial Q Delay(d3),s/veh	0.0	0.0	0.0	0.0	0.0	0.0	0.0	0.0	0.0	0.0	0.0	0.0
%ile BackOfQ(95%),veh/ln	3.2	11.9	13.1	11.8	17.9	19.7	3.6	10.1	7.3	6.9	3.0	0.5
Unsig. Movement Delay, s/veh												
LnGrp Delay(d),s/veh	63.9	17.6	18.4	163.7	19.4	20.9	38.5	38.4	37.3	51.5	34.6	33.5
LnGrp LOS	E	B	B	F	B	C	D	D	D	D	C	C
Approach Vol, veh/h	1403			2104			487			213		
Approach Delay, s/veh	19.7			28.8			38.0			44.7		
Approach LOS	B			C			D			D		
Timer - Assigned Phs	1	2	4		5	6	8					
Phs Duration (G+Y+Rc), s	8.7	73.6	37.7		12.0	70.3	37.7					
Change Period (Y+Rc), s	4.0	5.0	7.0		4.0	5.0	7.0					
Max Green Setting (Gmax), s	8.0	50.0	46.0		8.0	50.0	46.0					
Max Q Clear Time (g_c+I1), s	5.6	33.1	15.2		10.0	20.9	30.6					
Green Ext Time (p_c), s	0.0	3.1	0.2		0.0	1.9	0.1					
Intersection Summary												
HCM 6th Ctrl Delay				27.6								
HCM 6th LOS				C								

HCM 6th Signalized Intersection Summary
1: Virginia Rd & Huntington Dr

Future With Project Conditions
Weekday PM Peak Hour

												
Movement	EBL	EBT	EBR	WBL	WBT	WBR	NBL	NBT	NBR	SBL	SBT	SBR
Lane Configurations		 			 						 	
Traffic Volume (veh/h)	23	1799	56	59	1423	42	40	97	45	124	298	44
Future Volume (veh/h)	23	1799	56	59	1423	42	40	97	45	124	298	44
Initial Q (Qb), veh	0	0	0	0	0	0	0	0	0	0	0	0
Ped-Bike Adj(A_pbT)	1.00		1.00	1.00		1.00	1.00		1.00	1.00		1.00
Parking Bus, Adj	1.00	1.00	1.00	1.00	1.00	1.00	1.00	1.00	1.00	1.00	1.00	1.00
Work Zone On Approach	No			No			No			No		
Adj Sat Flow, veh/h/ln	1870	1870	1945	1870	1870	1945	1870	1870	1870	1870	1870	1870
Adj Flow Rate, veh/h	25	1955	61	64	1547	46	43	105	49	135	324	48
Peak Hour Factor	0.92	0.92	0.92	0.92	0.92	0.92	0.92	0.92	0.92	0.92	0.92	0.92
Percent Heavy Veh, %	2	2	2	2	2	2	2	2	2	2	2	2
Cap, veh/h	42	3044	95	82	3163	94	120	416	352	277	416	352
Arrive On Green	0.02	0.60	0.60	0.05	0.62	0.62	0.22	0.22	0.22	0.22	0.22	0.22
Sat Flow, veh/h	1781	5087	159	1781	5096	152	1010	1870	1585	1233	1870	1585
Grp Volume(v), veh/h	25	1307	709	64	1033	560	43	105	49	135	324	48
Grp Sat Flow(s),veh/h/ln	1781	1702	1842	1781	1702	1843	1010	1870	1585	1233	1870	1585
Q Serve(g_s), s	1.7	30.0	30.2	4.3	19.8	19.8	5.0	5.6	3.0	12.2	19.6	2.9
Cycle Q Clear(g_c), s	1.7	30.0	30.2	4.3	19.8	19.8	24.6	5.6	3.0	17.7	19.6	2.9
Prop In Lane	1.00		0.09	1.00		0.08	1.00		1.00	1.00		1.00
Lane Grp Cap(c), veh/h	42	2037	1102	82	2113	1144	120	416	352	277	416	352
V/C Ratio(X)	0.60	0.64	0.64	0.78	0.49	0.49	0.36	0.25	0.14	0.49	0.78	0.14
Avail Cap(c_a), veh/h	119	2037	1102	119	2113	1144	283	717	608	476	717	608
HCM Platoon Ratio	1.00	1.00	1.00	1.00	1.00	1.00	1.00	1.00	1.00	1.00	1.00	1.00
Upstream Filter(I)	1.00	1.00	1.00	1.00	1.00	1.00	1.00	1.00	1.00	1.00	1.00	1.00
Uniform Delay (d), s/veh	58.0	15.7	15.7	56.6	12.4	12.4	55.4	38.4	37.4	45.7	43.9	37.4
Incr Delay (d2), s/veh	4.9	1.6	2.9	10.7	0.8	1.5	0.7	0.1	0.1	0.5	1.2	0.1
Initial Q Delay(d3),s/veh	0.0	0.0	0.0	0.0	0.0	0.0	0.0	0.0	0.0	0.0	0.0	0.0
%ile BackOfQ(95%),veh/ln	1.5	17.2	18.9	3.9	12.0	13.1	2.3	4.6	2.1	6.8	14.1	2.1
Unsig. Movement Delay, s/veh												
LnGrp Delay(d),s/veh	62.9	17.3	18.6	67.3	13.2	13.9	56.1	38.6	37.5	46.2	45.1	37.5
LnGrp LOS	E	B	B	E	B	B	E	D	D	D	D	D
Approach Vol, veh/h	2041			1657			197			507		
Approach Delay, s/veh	18.3			15.5			42.1			44.7		
Approach LOS	B			B			D			D		
Timer - Assigned Phs	1	2		4	5	6		8				
Phs Duration (G+Y+Rc), s	6.8	79.5		33.7	9.5	76.8		33.7				
Change Period (Y+Rc), s	4.0	5.0		7.0	4.0	5.0		7.0				
Max Green Setting (Gmax), s	8.0	50.0		46.0	8.0	50.0		46.0				
Max Q Clear Time (g_c+I1), s	3.7	21.8		26.6	6.3	32.2		21.6				
Green Ext Time (p_c), s	0.0	2.4		0.1	0.0	3.2		0.3				
Intersection Summary												
HCM 6th Ctrl Delay				21.4								
HCM 6th LOS				C								

Intersection	
Intersection Delay, s/veh	10.7
Intersection LOS	B

Movement	EBL	EBR	NBL	NBT	SBT	SBR
Lane Configurations	W			↑	↑	
Traffic Vol, veh/h	18	7	2	422	84	14
Future Vol, veh/h	18	7	2	422	84	14
Peak Hour Factor	0.92	0.92	0.92	0.92	0.92	0.92
Heavy Vehicles, %	2	2	2	2	2	2
Mvmt Flow	20	8	2	459	91	15
Number of Lanes	1	0	0	1	1	0

Approach	EB	NB	SB
Opposing Approach		SB	NB
Opposing Lanes	0	1	1
Conflicting Approach Left	SB	EB	
Conflicting Lanes Left	1	1	0
Conflicting Approach Right	NB		EB
Conflicting Lanes Right	1	0	1
HCM Control Delay	8.3	11.5	8
HCM LOS	A	B	A

Lane	NBLn1	EBLn1	SBLn1
Vol Left, %	0%	72%	0%
Vol Thru, %	100%	0%	86%
Vol Right, %	0%	28%	14%
Sign Control	Stop	Stop	Stop
Traffic Vol by Lane	424	25	98
LT Vol	2	18	0
Through Vol	422	0	84
RT Vol	0	7	14
Lane Flow Rate	461	27	107
Geometry Grp	1	1	1
Degree of Util (X)	0.52	0.039	0.129
Departure Headway (Hd)	4.062	5.125	4.362
Convergence, Y/N	Yes	Yes	Yes
Cap	880	702	827
Service Time	2.121	3.132	2.366
HCM Lane V/C Ratio	0.524	0.038	0.129
HCM Control Delay	11.5	8.3	8
HCM Lane LOS	B	A	A
HCM 95th-tile Q	3.1	0.1	0.4

Intersection						
Intersection Delay, s/veh	10.3					
Intersection LOS	B					
Movement	EBL	EBR	NBL	NBT	SBT	SBR
Lane Configurations	W			W	W	
Traffic Vol, veh/h	4	5	2	179	392	6
Future Vol, veh/h	4	5	2	179	392	6
Peak Hour Factor	0.92	0.92	0.92	0.92	0.92	0.92
Heavy Vehicles, %	2	2	2	2	2	2
Mvmt Flow	4	5	2	195	426	7
Number of Lanes	1	0	0	1	1	0
Approach	EB	NB		SB		
Opposing Approach		SB		NB		
Opposing Lanes	0	1		1		
Conflicting Approach Left	SB	EB				
Conflicting Lanes Left	1	1		0		
Conflicting Approach Right	NB			EB		
Conflicting Lanes Right	1	0		1		
HCM Control Delay	8.1	8.7		11.1		
HCM LOS	A	A		B		
Lane	NBLn1	EBLn1	SBLn1			
Vol Left, %	1%	44%	0%			
Vol Thru, %	99%	0%	98%			
Vol Right, %	0%	56%	2%			
Sign Control	Stop	Stop	Stop			
Traffic Vol by Lane	181	9	398			
LT Vol	2	4	0			
Through Vol	179	0	392			
RT Vol	0	5	6			
Lane Flow Rate	197	10	433			
Geometry Grp	1	1	1			
Degree of Util (X)	0.239	0.014	0.491			
Departure Headway (Hd)	4.376	5.025	4.089			
Convergence, Y/N	Yes	Yes	Yes			
Cap	826	715	874			
Service Time	2.376	3.033	2.153			
HCM Lane V/C Ratio	0.238	0.014	0.495			
HCM Control Delay	8.7	8.1	11.1			
HCM Lane LOS	A	A	B			
HCM 95th-tile Q	0.9	0	2.8			

Intersection	
Intersection Delay, s/veh	10.7
Intersection LOS	B

Movement	EBL	EBR	NBL	NBT	SBT	SBR
Lane Configurations	W			W	W	
Traffic Vol, veh/h	18	7	2	423	84	14
Future Vol, veh/h	18	7	2	423	84	14
Peak Hour Factor	0.92	0.92	0.92	0.92	0.92	0.92
Heavy Vehicles, %	2	2	2	2	2	2
Mvmt Flow	20	8	2	460	91	15
Number of Lanes	1	0	0	1	1	0

Approach	EB	NB	SB
Opposing Approach		SB	NB
Opposing Lanes	0	1	1
Conflicting Approach Left	SB	EB	
Conflicting Lanes Left	1	1	0
Conflicting Approach Right	NB		EB
Conflicting Lanes Right	1	0	1
HCM Control Delay	8.3	11.5	8
HCM LOS	A	B	A

Lane	NBLn1	EBLn1	SBLn1
Vol Left, %	0%	72%	0%
Vol Thru, %	100%	0%	86%
Vol Right, %	0%	28%	14%
Sign Control	Stop	Stop	Stop
Traffic Vol by Lane	425	25	98
LT Vol	2	18	0
Through Vol	423	0	84
RT Vol	0	7	14
Lane Flow Rate	462	27	107
Geometry Grp	1	1	1
Degree of Util (X)	0.521	0.039	0.129
Departure Headway (Hd)	4.062	5.129	4.363
Convergence, Y/N	Yes	Yes	Yes
Cap	882	702	826
Service Time	2.121	3.134	2.367
HCM Lane V/C Ratio	0.524	0.038	0.13
HCM Control Delay	11.5	8.3	8
HCM Lane LOS	B	A	A
HCM 95th-tile Q	3.1	0.1	0.4

Intersection	
Intersection Delay, s/veh	10.3
Intersection LOS	B

Movement	EBL	EBR	NBL	NBT	SBT	SBR
Lane Configurations	W			↑	↓	
Traffic Vol, veh/h	4	5	2	180	393	6
Future Vol, veh/h	4	5	2	180	393	6
Peak Hour Factor	0.92	0.92	0.92	0.92	0.92	0.92
Heavy Vehicles, %	2	2	2	2	2	2
Mvmt Flow	4	5	2	196	427	7
Number of Lanes	1	0	0	1	1	0

Approach	EB	NB	SB
Opposing Approach		SB	NB
Opposing Lanes	0	1	1
Conflicting Approach Left	SB	EB	
Conflicting Lanes Left	1	1	0
Conflicting Approach Right	NB		EB
Conflicting Lanes Right	1	0	1
HCM Control Delay	8.1	8.7	11.1
HCM LOS	A	A	B

Lane	NBLn1	EBLn1	SBLn1
Vol Left, %	1%	44%	0%
Vol Thru, %	99%	0%	98%
Vol Right, %	0%	56%	2%
Sign Control	Stop	Stop	Stop
Traffic Vol by Lane	182	9	399
LT Vol	2	4	0
Through Vol	180	0	393
RT Vol	0	5	6
Lane Flow Rate	198	10	434
Geometry Grp	1	1	1
Degree of Util (X)	0.235	0.014	0.493
Departure Headway (Hd)	4.277	5.03	4.09
Convergence, Y/N	Yes	Yes	Yes
Cap	825	716	876
Service Time	2.377	3.03	2.15
HCM Lane V/C Ratio	0.24	0.014	0.495
HCM Control Delay	8.7	8.1	11.1
HCM Lane LOS	A	A	B
HCM 95th-tile Q	0.9	0	2.8

Intersection	
Intersection Delay, s/veh	10.9
Intersection LOS	B

Movement	EBL	EBR	NBL	NBT	SBT	SBR
Lane Configurations	W			W	W	
Traffic Vol, veh/h	18	7	2	430	86	14
Future Vol, veh/h	18	7	2	430	86	14
Peak Hour Factor	0.92	0.92	0.92	0.92	0.92	0.92
Heavy Vehicles, %	2	2	2	2	2	2
Mvmt Flow	20	8	2	467	93	15
Number of Lanes	1	0	0	1	1	0

Approach	EB	NB	SB
Opposing Approach		SB	NB
Opposing Lanes	0	1	1
Conflicting Approach Left	SB	EB	
Conflicting Lanes Left	1	1	0
Conflicting Approach Right	NB		EB
Conflicting Lanes Right	1	0	1
HCM Control Delay	8.4	11.7	8
HCM LOS	A	B	A

Lane	NBLn1	EBLn1	SBLn1
Vol Left, %	0%	72%	0%
Vol Thru, %	100%	0%	86%
Vol Right, %	0%	28%	14%
Sign Control	Stop	Stop	Stop
Traffic Vol by Lane	432	25	100
LT Vol	2	18	0
Through Vol	430	0	86
RT Vol	0	7	14
Lane Flow Rate	470	27	109
Geometry Grp	1	1	1
Degree of Util (X)	0.53	0.039	0.132
Departure Headway (Hd)	4.064	5.149	4.372
Convergence, Y/N	Yes	Yes	Yes
Cap	878	699	824
Service Time	2.124	3.155	2.377
HCM Lane V/C Ratio	0.535	0.039	0.132
HCM Control Delay	11.7	8.4	8
HCM Lane LOS	B	A	A
HCM 95th-tile Q	3.2	0.1	0.5

Intersection	
Intersection Delay, s/veh	10.5
Intersection LOS	B

Movement	EBL	EBR	NBL	NBT	SBT	SBR
Lane Configurations	W			W	W	
Traffic Vol, veh/h	4	5	2	183	400	6
Future Vol, veh/h	4	5	2	183	400	6
Peak Hour Factor	0.92	0.92	0.92	0.92	0.92	0.92
Heavy Vehicles, %	2	2	2	2	2	2
Mvmt Flow	4	5	2	199	435	7
Number of Lanes	1	0	0	1	1	0

Approach	EB	NB	SB
Opposing Approach		SB	NB
Opposing Lanes	0	1	1
Conflicting Approach Left	SB	EB	
Conflicting Lanes Left	1	1	0
Conflicting Approach Right	NB		EB
Conflicting Lanes Right	1	0	1
HCM Control Delay	8.1	8.8	11.3
HCM LOS	A	A	B

Lane	NBLn1	EBLn1	SBLn1
Vol Left, %	1%	44%	0%
Vol Thru, %	99%	0%	99%
Vol Right, %	0%	56%	1%
Sign Control	Stop	Stop	Stop
Traffic Vol by Lane	185	9	406
LT Vol	2	4	0
Through Vol	183	0	400
RT Vol	0	5	6
Lane Flow Rate	201	10	441
Geometry Grp	1	1	1
Degree of Util (X)	0.245	0.014	0.502
Departure Headway (Hd)	4.383	5.052	4.093
Convergence, Y/N	Yes	Yes	Yes
Cap	824	711	874
Service Time	2.385	3.062	2.158
HCM Lane V/C Ratio	0.244	0.014	0.505
HCM Control Delay	8.8	8.1	11.3
HCM Lane LOS	A	A	B
HCM 95th-tile Q	1	0	2.9

Intersection	
Intersection Delay, s/veh	10.9
Intersection LOS	B

Movement	EBL	EBR	NBL	NBT	SBT	SBR
Lane Configurations	W			↑	↓	
Traffic Vol, veh/h	18	7	2	431	86	14
Future Vol, veh/h	18	7	2	431	86	14
Peak Hour Factor	0.92	0.92	0.92	0.92	0.92	0.92
Heavy Vehicles, %	2	2	2	2	2	2
Mvmt Flow	20	8	2	468	93	15
Number of Lanes	1	0	0	1	1	0

Approach	EB	NB	SB
Opposing Approach		SB	NB
Opposing Lanes	0	1	1
Conflicting Approach Left	SB	EB	
Conflicting Lanes Left	1	1	0
Conflicting Approach Right	NB		EB
Conflicting Lanes Right	1	0	1
HCM Control Delay	8.4	11.7	8
HCM LOS	A	B	A

Lane	NBLn1	EBLn1	SBLn1
Vol Left, %	0%	72%	0%
Vol Thru, %	100%	0%	86%
Vol Right, %	0%	28%	14%
Sign Control	Stop	Stop	Stop
Traffic Vol by Lane	433	25	100
LT Vol	2	18	0
Through Vol	431	0	86
RT Vol	0	7	14
Lane Flow Rate	471	27	109
Geometry Grp	1	1	1
Degree of Util (X)	0.531	0.039	0.132
Departure Headway (Hd)	4.064	5.151	4.373
Convergence, Y/N	Yes	Yes	Yes
Cap	880	698	824
Service Time	2.124	3.157	2.377
HCM Lane V/C Ratio	0.535	0.039	0.132
HCM Control Delay	11.7	8.4	8
HCM Lane LOS	B	A	A
HCM 95th-tile Q	3.2	0.1	0.5

Intersection	
Intersection Delay, s/veh	10.5
Intersection LOS	B























Movement	EBL	EBR	NBL	NBT	SBT	SBR
Lane Configurations	W			↑	↓	
Traffic Vol, veh/h	4	5	2	184	401	6
Future Vol, veh/h	4	5	2	184	401	6
Peak Hour Factor	0.92	0.92	0.92	0.92	0.92	0.92
Heavy Vehicles, %	2	2	2	2	2	2
Mvmt Flow	4	5	2	200	436	7
Number of Lanes	1	0	0	1	1	0

Approach	EB	NB	SB
Opposing Approach		SB	NB
Opposing Lanes	0	1	1
Conflicting Approach Left	SB	EB	
Conflicting Lanes Left	1	1	0
Conflicting Approach Right	NB		EB
Conflicting Lanes Right	1	0	1
HCM Control Delay	8.1	8.8	11.3
HCM LOS	A	A	B

Lane	NBLn1	EBLn1	SBLn1
Vol Left, %	1%	44%	0%
Vol Thru, %	99%	0%	99%
Vol Right, %	0%	56%	1%
Sign Control	Stop	Stop	Stop
Traffic Vol by Lane	186	9	407
LT Vol	2	4	0
Through Vol	184	0	401
RT Vol	0	5	6
Lane Flow Rate	202	10	442
Geometry Grp	1	1	1
Degree of Util (X)	0.246	0.014	0.503
Departure Headway (Hd)	4.386	5.057	4.093
Convergence, Y/N	Yes	Yes	Yes
Cap	823	711	872
Service Time	2.386	3.065	2.159
HCM Lane V/C Ratio	0.245	0.014	0.507
HCM Control Delay	8.8	8.1	11.3
HCM Lane LOS	A	A	B
HCM 95th-tile Q	1	0	2.9























HCM 6th Signalized Intersection Summary
 3: West Dr/Cambridge Rd & Huntington Dr

Existing Conditions
 Weekday AM Peak Hour

												
Movement	EBL	EBT	EBR	WBL	WBT	WBR	NBL	NBT	NBR	SBL	SBT	SBR
Lane Configurations		 			 			 			 	
Traffic Volume (veh/h)	118	1278	62	89	1776	9	44	54	47	38	104	8
Future Volume (veh/h)	118	1278	62	89	1776	9	44	54	47	38	104	8
Initial Q (Qb), veh	0	0	0	0	0	0	0	0	0	0	0	0
Ped-Bike Adj(A_pbT)	1.00		1.00	1.00		1.00	1.00		1.00	1.00		1.00
Parking Bus, Adj	1.00	1.00	1.00	1.00	1.00	1.00	1.00	1.00	1.00	1.00	1.00	1.00
Work Zone On Approach		No			No			No			No	
Adj Sat Flow, veh/h/ln	1870	1870	1945	1870	1870	1945	1870	1945	1870	1870	1945	1870
Adj Flow Rate, veh/h	128	1389	67	97	1930	10	48	59	51	41	113	9
Peak Hour Factor	0.92	0.92	0.92	0.92	0.92	0.92	0.92	0.92	0.92	0.92	0.92	0.92
Percent Heavy Veh, %	2	2	2	2	2	2	2	2	2	2	2	2
Cap, veh/h	59	3588	173	59	3769	20	86	85	63	77	156	11
Arrive On Green	0.03	0.72	0.72	0.03	0.72	0.72	0.12	0.12	0.12	0.12	0.12	0.12
Sat Flow, veh/h	1781	4990	241	1781	5242	27	381	692	511	320	1275	93
Grp Volume(v), veh/h	128	947	509	97	1253	687	158	0	0	163	0	0
Grp Sat Flow(s),veh/h/ln	1781	1702	1827	1781	1702	1865	1584	0	0	1688	0	0
Q Serve(g_s), s	4.0	13.0	13.0	4.0	19.7	19.7	0.4	0.0	0.0	0.0	0.0	0.0
Cycle Q Clear(g_c), s	4.0	13.0	13.0	4.0	19.7	19.7	11.7	0.0	0.0	11.3	0.0	0.0
Prop In Lane	1.00		0.13	1.00		0.01	0.30		0.32	0.25		0.06
Lane Grp Cap(c), veh/h	59	2447	1313	59	2447	1341	234	0	0	245	0	0
V/C Ratio(X)	2.16	0.39	0.39	1.63	0.51	0.51	0.68	0.00	0.00	0.67	0.00	0.00
Avail Cap(c_a), veh/h	59	2447	1313	59	2447	1341	702	0	0	746	0	0
HCM Platoon Ratio	1.00	1.00	1.00	1.00	1.00	1.00	1.00	1.00	1.00	1.00	1.00	1.00
Upstream Filter(I)	1.00	1.00	1.00	1.00	1.00	1.00	1.00	0.00	0.00	1.00	0.00	0.00
Uniform Delay (d), s/veh	58.0	6.6	6.6	58.0	7.5	7.5	51.1	0.0	0.0	50.9	0.0	0.0
Incr Delay (d2), s/veh	571.5	0.5	0.9	349.0	0.8	1.4	3.4	0.0	0.0	3.1	0.0	0.0
Initial Q Delay(d3),s/veh	0.0	0.0	0.0	0.0	0.0	0.0	0.0	0.0	0.0	0.0	0.0	0.0
%ile BackOfQ(95%),veh/ln	18.9	7.9	8.5	13.3	10.9	12.1	8.5	0.0	0.0	8.6	0.0	0.0
Unsig. Movement Delay, s/veh												
LnGrp Delay(d),s/veh	629.5	7.0	7.4	407.0	8.3	8.9	54.5	0.0	0.0	54.0	0.0	0.0
LnGrp LOS	F	A	A	F	A	A	D	A	A	D	A	A
Approach Vol, veh/h		1584			2037			158			163	
Approach Delay, s/veh		57.5			27.5			54.5			54.0	
Approach LOS		E			C			D			D	
Timer - Assigned Phs	1	2		4	5	6		8				
Phs Duration (G+Y+Rc), s	8.0	90.8		21.2	8.0	90.8		21.2				
Change Period (Y+Rc), s	4.0	4.5		6.5	4.0	4.5		6.5				
Max Green Setting (Gmax), s	4.0	51.5		49.5	4.0	51.5		49.5				
Max Q Clear Time (g_c+I1), s	6.0	21.7		13.7	6.0	15.0		13.3				
Green Ext Time (p_c), s	0.0	24.4		1.0	0.0	21.6		1.0				
Intersection Summary												
HCM 6th Ctrl Delay				41.7								
HCM 6th LOS				D								

HCM 6th Signalized Intersection Summary
 3: West Dr/Cambridge Rd & Huntington Dr

Existing Conditions
 Weekday PM Peak Hour

												
Movement	EBL	EBT	EBR	WBL	WBT	WBR	NBL	NBT	NBR	SBL	SBT	SBR
Lane Configurations												
Traffic Volume (veh/h)	41	1907	44	141	1366	4	35	39	85	81	75	8
Future Volume (veh/h)	41	1907	44	141	1366	4	35	39	85	81	75	8
Initial Q (Qb), veh	0	0	0	0	0	0	0	0	0	0	0	0
Ped-Bike Adj(A_pbT)	1.00		1.00	1.00		1.00	1.00		1.00	1.00		1.00
Parking Bus, Adj	1.00	1.00	1.00	1.00	1.00	1.00	1.00	1.00	1.00	1.00	1.00	1.00
Work Zone On Approach	No			No			No			No		
Adj Sat Flow, veh/h/ln	1870	1870	1945	1870	1870	1945	1870	1945	1870	1870	1945	1870
Adj Flow Rate, veh/h	45	2073	48	153	1485	4	38	42	92	88	82	9
Peak Hour Factor	0.92	0.92	0.92	0.92	0.92	0.92	0.92	0.92	0.92	0.92	0.92	0.92
Percent Heavy Veh, %	2	2	2	2	2	2	2	2	2	2	2	2
Cap, veh/h	58	3531	82	59	3621	10	78	79	139	139	109	11
Arrive On Green	0.03	0.69	0.69	0.03	0.69	0.69	0.15	0.15	0.15	0.15	0.15	0.15
Sat Flow, veh/h	1781	5134	119	1781	5258	14	271	515	904	614	711	70
Grp Volume(v), veh/h	45	1373	748	153	961	528	172	0	0	179	0	0
Grp Sat Flow(s),veh/h/ln	1781	1702	1849	1781	1702	1868	1689	0	0	1395	0	0
Q Serve(g_s), s	3.0	25.3	25.4	4.0	14.7	14.7	0.0	0.0	0.0	4.0	0.0	0.0
Cycle Q Clear(g_c), s	3.0	25.3	25.4	4.0	14.7	14.7	11.3	0.0	0.0	15.4	0.0	0.0
Prop In Lane	1.00		0.06	1.00		0.01	0.22		0.53	0.49		0.05
Lane Grp Cap(c), veh/h	58	2341	1272	59	2344	1286	297	0	0	260	0	0
V/C Ratio(X)	0.78	0.59	0.59	2.58	0.41	0.41	0.58	0.00	0.00	0.69	0.00	0.00
Avail Cap(c_a), veh/h	59	2341	1272	59	2344	1286	719	0	0	662	0	0
HCM Platoon Ratio	1.00	1.00	1.00	1.00	1.00	1.00	1.00	1.00	1.00	1.00	1.00	1.00
Upstream Filter(I)	1.00	1.00	1.00	1.00	1.00	1.00	1.00	0.00	0.00	1.00	0.00	0.00
Uniform Delay (d), s/veh	57.6	9.8	9.8	58.0	8.1	8.1	47.7	0.0	0.0	49.5	0.0	0.0
Incr Delay (d2), s/veh	42.6	1.1	2.0	756.0	0.5	1.0	1.8	0.0	0.0	3.3	0.0	0.0
Initial Q Delay(d3),s/veh	0.0	0.0	0.0	0.0	0.0	0.0	0.0	0.0	0.0	0.0	0.0	0.0
%ile BackOfQ(95%),veh/ln	3.7	13.9	15.4	23.5	8.9	9.8	8.7	0.0	0.0	9.3	0.0	0.0
Unsig. Movement Delay, s/veh												
LnGrp Delay(d),s/veh	100.3	10.9	11.8	814.0	8.6	9.1	49.5	0.0	0.0	52.7	0.0	0.0
LnGrp LOS	F	B	B	F	A	A	D	A	A	D	A	A
Approach Vol, veh/h	2166			1642			172			179		
Approach Delay, s/veh	13.1			83.8			49.5			52.7		
Approach LOS	B			F			D			D		
Timer - Assigned Phs	1	2	4		5	6	8					
Phs Duration (G+Y+Rc), s	7.9	87.1	25.0		8.0	87.0	25.0					
Change Period (Y+Rc), s	4.0	4.5	6.5		4.0	4.5	6.5					
Max Green Setting (Gmax), s	4.0	51.5	49.5		4.0	51.5	49.5					
Max Q Clear Time (g_c+I1), s	5.0	16.7	13.3		6.0	27.4	17.4					
Green Ext Time (p_c), s	0.0	21.5	1.1		0.0	21.4	1.1					
Intersection Summary												
HCM 6th Ctrl Delay				44.2								
HCM 6th LOS				D								























HCM 6th Signalized Intersection Summary
 3: West Dr/Cambridge Rd & Huntington Dr

Existing + Project Conditions
 Weekday AM Peak Hour

Movement	EBL	EBT	EBR	WBL	WBT	WBR	NBL	NBT	NBR	SBL	SBT	SBR
Lane Configurations												
Traffic Volume (veh/h)	118	1280	62	96	1776	9	46	54	48	38	105	8
Future Volume (veh/h)	118	1280	62	96	1776	9	46	54	48	38	105	8
Initial Q (Qb), veh	0	0	0	0	0	0	0	0	0	0	0	0
Ped-Bike Adj(A_pbT)	1.00		1.00	1.00		1.00	1.00		1.00	1.00		1.00
Parking Bus, Adj	1.00	1.00	1.00	1.00	1.00	1.00	1.00	1.00	1.00	1.00	1.00	1.00
Work Zone On Approach		No			No			No			No	
Adj Sat Flow, veh/h/ln	1870	1870	1945	1870	1870	1945	1870	1945	1870	1870	1945	1870
Adj Flow Rate, veh/h	128	1391	67	104	1930	10	50	59	52	41	114	9
Peak Hour Factor	0.92	0.92	0.92	0.92	0.92	0.92	0.92	0.92	0.92	0.92	0.92	0.92
Percent Heavy Veh, %	2	2	2	2	2	2	2	2	2	2	2	2
Cap, veh/h	59	3575	172	59	3755	19	88	85	64	77	160	12
Arrive On Green	0.03	0.72	0.72	0.03	0.72	0.72	0.13	0.13	0.13	0.13	0.13	0.13
Sat Flow, veh/h	1781	4991	240	1781	5242	27	391	676	509	317	1278	93
Grp Volume(v), veh/h	128	949	509	104	1253	687	161	0	0	164	0	0
Grp Sat Flow(s),veh/h/ln	1781	1702	1827	1781	1702	1865	1575	0	0	1687	0	0
Q Serve(g_s), s	4.0	13.2	13.2	4.0	19.8	19.8	0.7	0.0	0.0	0.0	0.0	0.0
Cycle Q Clear(g_c), s	4.0	13.2	13.2	4.0	19.8	19.8	12.0	0.0	0.0	11.3	0.0	0.0
Prop In Lane	1.00		0.13	1.00		0.01	0.31		0.32	0.25		0.05
Lane Grp Cap(c), veh/h	59	2438	1309	59	2438	1336	237	0	0	249	0	0
V/C Ratio(X)	2.16	0.39	0.39	1.75	0.51	0.51	0.68	0.00	0.00	0.66	0.00	0.00
Avail Cap(c_a), veh/h	59	2438	1309	59	2438	1336	700	0	0	746	0	0
HCM Platoon Ratio	1.00	1.00	1.00	1.00	1.00	1.00	1.00	1.00	1.00	1.00	1.00	1.00
Upstream Filter(I)	1.00	1.00	1.00	1.00	1.00	1.00	1.00	0.00	0.00	1.00	0.00	0.00
Uniform Delay (d), s/veh	58.0	6.7	6.7	58.0	7.6	7.6	51.0	0.0	0.0	50.6	0.0	0.0
Incr Delay (d2), s/veh	571.5	0.5	0.9	398.2	0.8	1.4	3.4	0.0	0.0	3.0	0.0	0.0
Initial Q Delay(d3),s/veh	0.0	0.0	0.0	0.0	0.0	0.0	0.0	0.0	0.0	0.0	0.0	0.0
%ile BackOfQ(95%),veh/ln	18.9	8.0	8.6	14.5	11.1	12.2	8.6	0.0	0.0	8.6	0.0	0.0
Unsig. Movement Delay, s/veh												
LnGrp Delay(d),s/veh	629.5	7.2	7.6	456.2	8.4	9.1	54.4	0.0	0.0	53.6	0.0	0.0
LnGrp LOS	F	A	A	F	A	A	D	A	A	D	A	A
Approach Vol, veh/h		1586			2044			161			164	
Approach Delay, s/veh		57.5			31.4			54.4			53.6	
Approach LOS		E			C			D			D	
Timer - Assigned Phs	1	2		4	5	6		8				
Phs Duration (G+Y+Rc), s	8.0	90.5		21.5	8.0	90.5		21.5				
Change Period (Y+Rc), s	4.0	4.5		6.5	4.0	4.5		6.5				
Max Green Setting (Gmax), s	4.0	51.5		49.5	4.0	51.5		49.5				
Max Q Clear Time (g_c+I1), s	6.0	21.8		14.0	6.0	15.2		13.3				
Green Ext Time (p_c), s	0.0	24.3		1.0	0.0	21.6		1.0				
Intersection Summary												
HCM 6th Ctrl Delay				43.7								
HCM 6th LOS				D								





















HCM 6th Signalized Intersection Summary
 3: West Dr/Cambridge Rd & Huntington Dr

Existing Plus Conditions
 Weekday PM Peak Hour

												
Movement	EBL	EBT	EBR	WBL	WBT	WBR	NBL	NBT	NBR	SBL	SBT	SBR
Lane Configurations												
Traffic Volume (veh/h)	41	1911	44	147	1366	4	40	40	88	81	76	8
Future Volume (veh/h)	41	1911	44	147	1366	4	40	40	88	81	76	8
Initial Q (Qb), veh	0	0	0	0	0	0	0	0	0	0	0	0
Ped-Bike Adj(A_pbT)	1.00		1.00	1.00		1.00	1.00		1.00	1.00		1.00
Parking Bus, Adj	1.00	1.00	1.00	1.00	1.00	1.00	1.00	1.00	1.00	1.00	1.00	1.00
Work Zone On Approach	No			No			No			No		
Adj Sat Flow, veh/h/ln	1870	1870	1945	1870	1870	1945	1870	1945	1870	1870	1945	1870
Adj Flow Rate, veh/h	45	2077	48	160	1485	4	43	43	96	88	83	9
Peak Hour Factor	0.92	0.92	0.92	0.92	0.92	0.92	0.92	0.92	0.92	0.92	0.92	0.92
Percent Heavy Veh, %	2	2	2	2	2	2	2	2	2	2	2	2
Cap, veh/h	58	3512	81	59	3601	10	84	78	139	138	111	11
Arrive On Green	0.03	0.68	0.68	0.03	0.68	0.68	0.16	0.16	0.16	0.16	0.16	0.16
Sat Flow, veh/h	1781	5135	118	1781	5258	14	296	492	879	595	705	68
Grp Volume(v), veh/h	45	1376	749	160	961	528	182	0	0	180	0	0
Grp Sat Flow(s),veh/h/ln	1781	1702	1849	1781	1702	1868	1667	0	0	1369	0	0
Q Serve(g_s), s	3.0	25.7	25.8	4.0	14.9	14.9	0.0	0.0	0.0	3.6	0.0	0.0
Cycle Q Clear(g_c), s	3.0	25.7	25.8	4.0	14.9	14.9	12.2	0.0	0.0	15.8	0.0	0.0
Prop In Lane	1.00		0.06	1.00		0.01	0.24		0.53	0.49		0.05
Lane Grp Cap(c), veh/h	58	2328	1265	59	2332	1279	300	0	0	260	0	0
V/C Ratio(X)	0.78	0.59	0.59	2.69	0.41	0.41	0.61	0.00	0.00	0.69	0.00	0.00
Avail Cap(c_a), veh/h	59	2328	1265	59	2332	1279	714	0	0	656	0	0
HCM Platoon Ratio	1.00	1.00	1.00	1.00	1.00	1.00	1.00	1.00	1.00	1.00	1.00	1.00
Upstream Filter(I)	1.00	1.00	1.00	1.00	1.00	1.00	1.00	0.00	0.00	1.00	0.00	0.00
Uniform Delay (d), s/veh	57.6	10.1	10.1	58.0	8.3	8.3	47.6	0.0	0.0	49.2	0.0	0.0
Incr Delay (d2), s/veh	42.6	1.1	2.0	808.1	0.5	1.0	2.0	0.0	0.0	3.3	0.0	0.0
Initial Q Delay(d3),s/veh	0.0	0.0	0.0	0.0	0.0	0.0	0.0	0.0	0.0	0.0	0.0	0.0
%ile BackOfQ(95%),veh/ln	3.7	14.2	15.6	24.7	9.1	10.0	9.1	0.0	0.0	9.3	0.0	0.0
Unsig. Movement Delay, s/veh												
LnGrp Delay(d),s/veh	100.3	11.2	12.1	866.1	8.8	9.3	49.6	0.0	0.0	52.5	0.0	0.0
LnGrp LOS	F	B	B	F	A	A	D	A	A	D	A	A
Approach Vol, veh/h	2170			1649			182			180		
Approach Delay, s/veh	13.3			92.2			49.6			52.5		
Approach LOS	B			F			D			D		
Timer - Assigned Phs	1	2	4		5	6	8					
Phs Duration (G+Y+Rc), s	7.9	86.7	25.4		8.0	86.6	25.4					
Change Period (Y+Rc), s	4.0	4.5	6.5		4.0	4.5	6.5					
Max Green Setting (Gmax), s	4.0	51.5	49.5		4.0	51.5	49.5					
Max Q Clear Time (g_c+I1), s	5.0	16.9	14.2		6.0	27.8	17.8					
Green Ext Time (p_c), s	0.0	21.4	1.2		0.0	21.1	1.1					
Intersection Summary												
HCM 6th Ctrl Delay				47.7								
HCM 6th LOS				D								

HCM 6th Signalized Intersection Summary
 3: West Dr/Cambridge Rd & Huntington Dr

Future Pre Project Conditions
 Weekday AM Peak Hour

												
Movement	EBL	EBT	EBR	WBL	WBT	WBR	NBL	NBT	NBR	SBL	SBT	SBR
Lane Configurations												
Traffic Volume (veh/h)	120	1316	63	91	1823	9	45	55	48	39	106	8
Future Volume (veh/h)	120	1316	63	91	1823	9	45	55	48	39	106	8
Initial Q (Qb), veh	0	0	0	0	0	0	0	0	0	0	0	0
Ped-Bike Adj(A_pbT)	1.00		1.00	1.00		1.00	1.00		1.00	1.00		1.00
Parking Bus, Adj	1.00	1.00	1.00	1.00	1.00	1.00	1.00	1.00	1.00	1.00	1.00	1.00
Work Zone On Approach	No			No			No			No		
Adj Sat Flow, veh/h/ln	1870	1870	1945	1870	1870	1945	1870	1945	1870	1870	1945	1870
Adj Flow Rate, veh/h	130	1430	68	99	1982	10	49	60	52	42	115	9
Peak Hour Factor	0.92	0.92	0.92	0.92	0.92	0.92	0.92	0.92	0.92	0.92	0.92	0.92
Percent Heavy Veh, %	2	2	2	2	2	2	2	2	2	2	2	2
Cap, veh/h	59	3577	170	59	3755	19	87	86	64	78	159	11
Arrive On Green	0.03	0.72	0.72	0.03	0.72	0.72	0.13	0.13	0.13	0.13	0.13	0.13
Sat Flow, veh/h	1781	4994	237	1781	5243	26	380	686	509	321	1267	91
Grp Volume(v), veh/h	130	975	523	99	1287	705	161	0	0	166	0	0
Grp Sat Flow(s),veh/h/ln	1781	1702	1828	1781	1702	1866	1575	0	0	1679	0	0
Q Serve(g_s), s	4.0	13.7	13.7	4.0	20.7	20.7	0.5	0.0	0.0	0.0	0.0	0.0
Cycle Q Clear(g_c), s	4.0	13.7	13.7	4.0	20.7	20.7	12.0	0.0	0.0	11.6	0.0	0.0
Prop In Lane	1.00		0.13	1.00		0.01	0.30		0.32	0.25		0.05
Lane Grp Cap(c), veh/h	59	2438	1309	59	2438	1336	237	0	0	248	0	0
V/C Ratio(X)	2.19	0.40	0.40	1.67	0.53	0.53	0.68	0.00	0.00	0.67	0.00	0.00
Avail Cap(c_a), veh/h	59	2438	1309	59	2438	1336	701	0	0	744	0	0
HCM Platoon Ratio	1.00	1.00	1.00	1.00	1.00	1.00	1.00	1.00	1.00	1.00	1.00	1.00
Upstream Filter(I)	1.00	1.00	1.00	1.00	1.00	1.00	1.00	0.00	0.00	1.00	0.00	0.00
Uniform Delay (d), s/veh	58.0	6.8	6.8	58.0	7.8	7.8	50.9	0.0	0.0	50.7	0.0	0.0
Incr Delay (d2), s/veh	586.2	0.5	0.9	363.0	0.8	1.5	3.4	0.0	0.0	3.1	0.0	0.0
Initial Q Delay(d3),s/veh	0.0	0.0	0.0	0.0	0.0	0.0	0.0	0.0	0.0	0.0	0.0	0.0
%ile BackOfQ(95%),veh/ln	19.3	8.2	8.9	13.6	11.5	12.7	8.6	0.0	0.0	8.7	0.0	0.0
Unsig. Movement Delay, s/veh												
LnGrp Delay(d),s/veh	644.2	7.3	7.7	421.0	8.6	9.3	54.3	0.0	0.0	53.8	0.0	0.0
LnGrp LOS	F	A	A	F	A	A	D	A	A	D	A	A
Approach Vol, veh/h	1628			2091			161			166		
Approach Delay, s/veh	58.3			28.3			54.3			53.8		
Approach LOS	E			C			D			D		
Timer - Assigned Phs	1	2	4		5	6	8					
Phs Duration (G+Y+Rc), s	8.0	90.4	21.6		8.0	90.4	21.6					
Change Period (Y+Rc), s	4.0	4.5	6.5		4.0	4.5	6.5					
Max Green Setting (Gmax), s	4.0	51.5	49.5		4.0	51.5	49.5					
Max Q Clear Time (g_c+I1), s	6.0	22.7	14.0		6.0	15.7	13.6					
Green Ext Time (p_c), s	0.0	24.1	1.0		0.0	22.1	1.0					
Intersection Summary												
HCM 6th Ctrl Delay				42.5								
HCM 6th LOS				D								























HCM 6th Signalized Intersection Summary
 3: West Dr/Cambridge Rd & Huntington Dr

Future Pre Project Conditions
 Weekday PM Peak Hour

Movement	EBL	EBT	EBR	WBL	WBT	WBR	NBL	NBT	NBR	SBL	SBT	SBR
Lane Configurations												
Traffic Volume (veh/h)	42	1957	45	144	1405	4	36	40	87	83	77	8
Future Volume (veh/h)	42	1957	45	144	1405	4	36	40	87	83	77	8
Initial Q (Qb), veh	0	0	0	0	0	0	0	0	0	0	0	0
Ped-Bike Adj(A_pbT)	1.00		1.00	1.00		1.00	1.00		1.00	1.00		1.00
Parking Bus, Adj	1.00	1.00	1.00	1.00	1.00	1.00	1.00	1.00	1.00	1.00	1.00	1.00
Work Zone On Approach	No				No				No			
Adj Sat Flow, veh/h/ln	1870	1870	1945	1870	1870	1945	1870	1945	1870	1870	1945	1870
Adj Flow Rate, veh/h	46	2127	49	157	1527	4	39	43	95	90	84	9
Peak Hour Factor	0.92	0.92	0.92	0.92	0.92	0.92	0.92	0.92	0.92	0.92	0.92	0.92
Percent Heavy Veh, %	2	2	2	2	2	2	2	2	2	2	2	2
Cap, veh/h	59	3509	81	59	3594	9	79	81	143	141	112	11
Arrive On Green	0.03	0.68	0.68	0.03	0.68	0.68	0.16	0.16	0.16	0.16	0.16	0.16
Sat Flow, veh/h	1781	5135	118	1781	5258	14	271	510	905	609	705	68
Grp Volume(v), veh/h	46	1409	767	157	989	542	177	0	0	183	0	0
Grp Sat Flow(s),veh/h/ln	1781	1702	1849	1781	1702	1868	1685	0	0	1382	0	0
Q Serve(g_s), s	3.1	26.8	27.0	4.0	15.5	15.5	0.0	0.0	0.0	4.2	0.0	0.0
Cycle Q Clear(g_c), s	3.1	26.8	27.0	4.0	15.5	15.5	11.7	0.0	0.0	15.9	0.0	0.0
Prop In Lane	1.00		0.06	1.00		0.01	0.22		0.54	0.49		0.05
Lane Grp Cap(c), veh/h	59	2326	1264	59	2327	1277	304	0	0	264	0	0
V/C Ratio(X)	0.78	0.61	0.61	2.64	0.42	0.42	0.58	0.00	0.00	0.69	0.00	0.00
Avail Cap(c_a), veh/h	59	2326	1264	59	2327	1277	718	0	0	658	0	0
HCM Platoon Ratio	1.00	1.00	1.00	1.00	1.00	1.00	1.00	1.00	1.00	1.00	1.00	1.00
Upstream Filter(I)	1.00	1.00	1.00	1.00	1.00	1.00	1.00	0.00	0.00	1.00	0.00	0.00
Uniform Delay (d), s/veh	57.6	10.3	10.3	58.0	8.5	8.5	47.3	0.0	0.0	49.2	0.0	0.0
Incr Delay (d2), s/veh	43.6	1.2	2.2	785.8	0.6	1.0	1.8	0.0	0.0	3.3	0.0	0.0
Initial Q Delay(d3),s/veh	0.0	0.0	0.0	0.0	0.0	0.0	0.0	0.0	0.0	0.0	0.0	0.0
%ile BackOfQ(95%),veh/ln	3.8	14.7	16.2	24.2	9.4	10.3	8.8	0.0	0.0	9.4	0.0	0.0
Unsig. Movement Delay, s/veh												
LnGrp Delay(d),s/veh	101.2	11.4	12.5	843.8	9.0	9.5	49.1	0.0	0.0	52.5	0.0	0.0
LnGrp LOS	F	B	B	F	A	A	D	A	A	D	A	A
Approach Vol, veh/h	2222			1688				177			183	
Approach Delay, s/veh	13.7			86.8				49.1			52.5	
Approach LOS	B			F				D			D	
Timer - Assigned Phs	1	2	4		5	6	8					
Phs Duration (G+Y+Rc), s	8.0	86.5	25.5		8.0	86.5	25.5					
Change Period (Y+Rc), s	4.0	4.5	6.5		4.0	4.5	6.5					
Max Green Setting (Gmax), s	4.0	51.5	49.5		4.0	51.5	49.5					
Max Q Clear Time (g_c+I1), s	5.1	17.5	13.7		6.0	29.0	17.9					
Green Ext Time (p_c), s	0.0	21.8	1.2		0.0	20.4	1.1					
Intersection Summary												
HCM 6th Ctrl Delay				45.7								
HCM 6th LOS				D								























HCM 6th Signalized Intersection Summary
 3: West Dr/Cambridge Rd & Huntington Dr

Future With Project Conditions
 Weekday AM Peak Hour

												
Movement	EBL	EBT	EBR	WBL	WBT	WBR	NBL	NBT	NBR	SBL	SBT	SBR
Lane Configurations		 			 			 			 	
Traffic Volume (veh/h)	120	1318	63	98	1823	9	47	55	49	39	107	8
Future Volume (veh/h)	120	1318	63	98	1823	9	47	55	49	39	107	8
Initial Q (Qb), veh	0	0	0	0	0	0	0	0	0	0	0	0
Ped-Bike Adj(A_pbT)	1.00		1.00	1.00		1.00	1.00		1.00	1.00		1.00
Parking Bus, Adj	1.00	1.00	1.00	1.00	1.00	1.00	1.00	1.00	1.00	1.00	1.00	1.00
Work Zone On Approach		No			No			No			No	
Adj Sat Flow, veh/h/ln	1870	1870	1945	1870	1870	1945	1870	1945	1870	1870	1945	1870
Adj Flow Rate, veh/h	130	1433	68	107	1982	10	51	60	53	42	116	9
Peak Hour Factor	0.92	0.92	0.92	0.92	0.92	0.92	0.92	0.92	0.92	0.92	0.92	0.92
Percent Heavy Veh, %	2	2	2	2	2	2	2	2	2	2	2	2
Cap, veh/h	59	3564	169	59	3741	19	89	86	65	78	163	12
Arrive On Green	0.03	0.71	0.71	0.03	0.71	0.71	0.13	0.13	0.13	0.13	0.13	0.13
Sat Flow, veh/h	1781	4995	237	1781	5243	26	389	671	506	318	1270	90
Grp Volume(v), veh/h	130	977	524	107	1287	705	164	0	0	167	0	0
Grp Sat Flow(s),veh/h/ln	1781	1702	1828	1781	1702	1866	1566	0	0	1678	0	0
Q Serve(g_s), s	4.0	13.8	13.8	4.0	20.9	20.9	0.7	0.0	0.0	0.0	0.0	0.0
Cycle Q Clear(g_c), s	4.0	13.8	13.8	4.0	20.9	20.9	12.3	0.0	0.0	11.6	0.0	0.0
Prop In Lane	1.00		0.13	1.00		0.01	0.31		0.32	0.25		0.05
Lane Grp Cap(c), veh/h	59	2429	1304	59	2429	1331	240	0	0	253	0	0
V/C Ratio(X)	2.19	0.40	0.40	1.80	0.53	0.53	0.68	0.00	0.00	0.66	0.00	0.00
Avail Cap(c_a), veh/h	59	2429	1304	59	2429	1331	698	0	0	744	0	0
HCM Platoon Ratio	1.00	1.00	1.00	1.00	1.00	1.00	1.00	1.00	1.00	1.00	1.00	1.00
Upstream Filter(I)	1.00	1.00	1.00	1.00	1.00	1.00	1.00	0.00	0.00	1.00	0.00	0.00
Uniform Delay (d), s/veh	58.0	6.9	6.9	58.0	7.9	7.9	50.8	0.0	0.0	50.4	0.0	0.0
Incr Delay (d2), s/veh	586.2	0.5	0.9	419.5	0.8	1.5	3.4	0.0	0.0	3.0	0.0	0.0
Initial Q Delay(d3),s/veh	0.0	0.0	0.0	0.0	0.0	0.0	0.0	0.0	0.0	0.0	0.0	0.0
%ile BackOfQ(95%),veh/ln	19.3	8.3	9.0	15.1	11.5	12.8	8.7	0.0	0.0	8.7	0.0	0.0
Unsig. Movement Delay, s/veh												
LnGrp Delay(d),s/veh	644.2	7.4	7.8	477.5	8.7	9.4	54.2	0.0	0.0	53.4	0.0	0.0
LnGrp LOS	F	A	A	F	A	A	D	A	A	D	A	A
Approach Vol, veh/h		1631			2099			164			167	
Approach Delay, s/veh		58.3			32.9			54.2			53.4	
Approach LOS		E			C			D			D	
Timer - Assigned Phs	1	2		4	5	6		8				
Phs Duration (G+Y+Rc), s	8.0	90.1		21.9	8.0	90.1		21.9				
Change Period (Y+Rc), s	4.0	4.5		6.5	4.0	4.5		6.5				
Max Green Setting (Gmax), s	4.0	51.5		49.5	4.0	51.5		49.5				
Max Q Clear Time (g_c+I1), s	6.0	22.9		14.3	6.0	15.8		13.6				
Green Ext Time (p_c), s	0.0	24.0		1.0	0.0	22.1		1.0				
Intersection Summary												
HCM 6th Ctrl Delay	44.8											
HCM 6th LOS	D											

HCM 6th Signalized Intersection Summary
 3: West Dr/Cambridge Rd & Huntington Dr

Future With Project Conditions
 Weekday PM Peak Hour

												
Movement	EBL	EBT	EBR	WBL	WBT	WBR	NBL	NBT	NBR	SBL	SBT	SBR
Lane Configurations		 			 			 			 	
Traffic Volume (veh/h)	42	1961	45	150	1405	4	41	41	90	83	78	8
Future Volume (veh/h)	42	1961	45	150	1405	4	41	41	90	83	78	8
Initial Q (Qb), veh	0	0	0	0	0	0	0	0	0	0	0	0
Ped-Bike Adj(A_pbT)	1.00		1.00	1.00		1.00	1.00		1.00	1.00		1.00
Parking Bus, Adj	1.00	1.00	1.00	1.00	1.00	1.00	1.00	1.00	1.00	1.00	1.00	1.00
Work Zone On Approach	No			No			No			No		
Adj Sat Flow, veh/h/ln	1870	1870	1945	1870	1870	1945	1870	1945	1870	1870	1945	1870
Adj Flow Rate, veh/h	46	2132	49	163	1527	4	45	45	98	90	85	9
Peak Hour Factor	0.92	0.92	0.92	0.92	0.92	0.92	0.92	0.92	0.92	0.92	0.92	0.92
Percent Heavy Veh, %	2	2	2	2	2	2	2	2	2	2	2	2
Cap, veh/h	59	3489	80	59	3573	9	86	80	140	140	113	11
Arrive On Green	0.03	0.68	0.68	0.03	0.68	0.68	0.16	0.16	0.16	0.16	0.16	0.16
Sat Flow, veh/h	1781	5135	118	1781	5258	14	301	494	865	590	698	66
Grp Volume(v), veh/h	46	1412	769	163	989	542	188	0	0	184	0	0
Grp Sat Flow(s),veh/h/ln	1781	1702	1849	1781	1702	1868	1660	0	0	1354	0	0
Q Serve(g_s), s	3.1	27.3	27.4	4.0	15.7	15.7	0.0	0.0	0.0	3.7	0.0	0.0
Cycle Q Clear(g_c), s	3.1	27.3	27.4	4.0	15.7	15.7	12.7	0.0	0.0	16.3	0.0	0.0
Prop In Lane	1.00		0.06	1.00		0.01	0.24		0.52	0.49		0.05
Lane Grp Cap(c), veh/h	59	2312	1256	59	2313	1269	307	0	0	265	0	0
V/C Ratio(X)	0.78	0.61	0.61	2.75	0.43	0.43	0.61	0.00	0.00	0.70	0.00	0.00
Avail Cap(c_a), veh/h	59	2312	1256	59	2313	1269	713	0	0	652	0	0
HCM Platoon Ratio	1.00	1.00	1.00	1.00	1.00	1.00	1.00	1.00	1.00	1.00	1.00	1.00
Upstream Filter(I)	1.00	1.00	1.00	1.00	1.00	1.00	1.00	0.00	0.00	1.00	0.00	0.00
Uniform Delay (d), s/veh	57.6	10.5	10.6	58.0	8.7	8.7	47.3	0.0	0.0	49.0	0.0	0.0
Incr Delay (d2), s/veh	43.6	1.2	2.2	830.4	0.6	1.1	2.0	0.0	0.0	3.3	0.0	0.0
Initial Q Delay(d3),s/veh	0.0	0.0	0.0	0.0	0.0	0.0	0.0	0.0	0.0	0.0	0.0	0.0
%ile BackOfQ(95%),veh/ln	3.8	14.9	16.5	25.3	9.5	10.5	9.3	0.0	0.0	9.5	0.0	0.0
Unsig. Movement Delay, s/veh												
LnGrp Delay(d),s/veh	101.2	11.8	12.8	888.4	9.3	9.7	49.3	0.0	0.0	52.2	0.0	0.0
LnGrp LOS	F	B	B	F	A	A	D	A	A	D	A	A
Approach Vol, veh/h	2227			1694			188			184		
Approach Delay, s/veh	14.0			94.0			49.3			52.2		
Approach LOS	B			F			D			D		
Timer - Assigned Phs	1	2	4		5	6	8					
Phs Duration (G+Y+Rc), s	8.0	86.0	26.0		8.0	86.0	26.0					
Change Period (Y+Rc), s	4.0	4.5	6.5		4.0	4.5	6.5					
Max Green Setting (Gmax), s	4.0	51.5	49.5		4.0	51.5	49.5					
Max Q Clear Time (g_c+I1), s	5.1	17.7	14.7		6.0	29.4	18.3					
Green Ext Time (p_c), s	0.0	21.7	1.2		0.0	20.0	1.1					
Intersection Summary												
HCM 6th Ctrl Delay				48.7								
HCM 6th LOS				D								





























HCM 6th Signalized Intersection Summary
 4: San Marino Ave & Huntington Dr

Existing Conditions
 Weekday AM Peak Hour

Movement	EBL	EBT	EBR	WBL	WBT	WBR	NBL	NBT	NBR	SBL	SBT	SBR	
Lane Configurations													
Traffic Volume (veh/h)	484	885	48	24	1301	66	138	492	28	80	274	479	
Future Volume (veh/h)	484	885	48	24	1301	66	138	492	28	80	274	479	
Initial Q (Qb), veh	0	0	0	0	0	0	0	0	0	0	0	0	
Ped-Bike Adj(A_pbT)	1.00		1.00	1.00		1.00	1.00		1.00	1.00		1.00	
Parking Bus, Adj	1.00	1.00	1.00	1.00	1.00	1.00	1.00	1.00	1.00	1.00	1.00	1.00	
Work Zone On Approach	No				No				No				
Adj Sat Flow, veh/h/ln	1870	1870	1870	1870	1870	1870	1870	1870	1870	1870	1870	1870	
Adj Flow Rate, veh/h	526	962	52	26	1414	72	150	535	30	87	298	521	
Peak Hour Factor	0.92	0.92	0.92	0.92	0.92	0.92	0.92	0.92	0.92	0.92	0.92	0.92	
Percent Heavy Veh, %	2	2	2	2	2	2	2	2	2	2	2	2	
Cap, veh/h	153	1644	89	105	1557	483	165	1277	71	160	1315	587	
Arrive On Green	0.09	0.33	0.33	0.06	0.30	0.30	0.09	0.37	0.37	0.09	0.37	0.37	
Sat Flow, veh/h	1781	4959	268	1781	5106	1585	1781	3421	192	1781	3554	1585	
Grp Volume(v), veh/h	526	660	354	26	1414	72	150	277	288	87	298	521	
Grp Sat Flow(s),veh/h/ln	1781	1702	1822	1781	1702	1585	1781	1777	1836	1781	1777	1585	
Q Serve(g_s), s	12.0	22.5	22.6	2.0	37.3	4.6	11.7	16.2	16.3	6.5	8.1	43.2	
Cycle Q Clear(g_c), s	12.0	22.5	22.6	2.0	37.3	4.6	11.7	16.2	16.3	6.5	8.1	43.2	
Prop In Lane	1.00		0.15	1.00		1.00	1.00		0.10	1.00		1.00	
Lane Grp Cap(c), veh/h	153	1129	604	105	1557	483	165	663	685	160	1315	587	
V/C Ratio(X)	3.45	0.58	0.59	0.25	0.91	0.15	0.91	0.42	0.42	0.54	0.23	0.89	
Avail Cap(c_a), veh/h	153	1129	604	165	1557	483	165	812	839	165	1625	725	
HCM Platoon Ratio	1.00	1.00	1.00	1.00	1.00	1.00	1.00	1.00	1.00	1.00	1.00	1.00	
Upstream Filter(I)	1.00	1.00	1.00	1.00	1.00	1.00	1.00	1.00	1.00	1.00	1.00	1.00	
Uniform Delay (d), s/veh	64.0	38.8	38.8	62.9	46.8	35.4	62.9	32.6	32.6	61.0	30.3	41.4	
Incr Delay (d2), s/veh	1116.6	2.2	4.1	0.4	9.3	0.7	43.2	0.7	0.7	1.7	0.1	12.6	
Initial Q Delay(d3),s/veh	0.0	0.0	0.0	0.0	0.0	0.0	0.0	0.0	0.0	0.0	0.0	0.0	
%ile BackOfQ(95%),veh/ln	80.5	14.9	16.2	1.6	23.9	3.4	11.7	11.6	11.9	5.5	6.4	25.9	
Unsig. Movement Delay, s/veh													
LnGrp Delay(d),s/veh	1180.6	41.0	42.9	63.3	56.1	36.1	106.1	33.3	33.3	62.7	30.5	54.0	
LnGrp LOS	F	D	D	E	E	D	F	C	C	E	C	D	
Approach Vol, veh/h	1540			1512				715			906		
Approach Delay, s/veh	430.7			55.3				48.6			47.1		
Approach LOS	F			E				D			D		
Timer - Assigned Phs	1	2	3	4	5	6	7	8					
Phs Duration (G+Y+Rc), s	16.5	47.7	17.1	58.8	12.8	51.4	17.5	58.3					
Change Period (Y+Rc), s	4.5	5.0	4.5	6.5	4.5	5.0	4.5	6.5					
Max Green Setting (Gmax), s	12.0	30.5	13.0	64.0	13.0	29.5	13.0	64.0					
Max Q Clear Time (g_c+I1), s	14.0	39.3	8.5	18.3	4.0	24.6	13.7	45.2					
Green Ext Time (p_c), s	0.0	0.0	0.0	6.8	0.0	3.5	0.0	6.6					
Intersection Summary													
HCM 6th Ctrl Delay				176.4									
HCM 6th LOS				F									

HCM 6th Signalized Intersection Summary
 4: San Marino Ave & Huntington Dr

Existing Conditions
 Weekday PM Peak Hour

												
Movement	EBL	EBT	EBR	WBL	WBT	WBR	NBL	NBT	NBR	SBL	SBT	SBR
Lane Configurations		  			  			 	 		 	
Traffic Volume (veh/h)	440	1436	66	46	1003	58	49	270	70	190	540	449
Future Volume (veh/h)	440	1436	66	46	1003	58	49	270	70	190	540	449
Initial Q (Qb), veh	0	0	0	0	0	0	0	0	0	0	0	0
Ped-Bike Adj(A_pbT)	1.00		1.00	1.00		1.00	1.00		1.00	1.00		1.00
Parking Bus, Adj	1.00	1.00	1.00	1.00	1.00	1.00	1.00	1.00	1.00	1.00	1.00	1.00
Work Zone On Approach	No			No			No			No		
Adj Sat Flow, veh/h/ln	1870	1870	1870	1870	1870	1870	1870	1870	1870	1870	1870	1870
Adj Flow Rate, veh/h	478	1561	72	50	1090	63	53	293	76	207	587	488
Peak Hour Factor	0.92	0.92	0.92	0.92	0.92	0.92	0.92	0.92	0.92	0.92	0.92	0.92
Percent Heavy Veh, %	2	2	2	2	2	2	2	2	2	2	2	2
Cap, veh/h	153	1623	75	142	1625	505	144	1000	255	165	1310	584
Arrive On Green	0.09	0.32	0.32	0.08	0.32	0.32	0.08	0.36	0.36	0.09	0.37	0.37
Sat Flow, veh/h	1781	5002	231	1781	5106	1585	1781	2804	715	1781	3554	1585
Grp Volume(v), veh/h	478	1062	571	50	1090	63	53	184	185	207	587	488
Grp Sat Flow(s),veh/h/ln	1781	1702	1829	1781	1702	1585	1781	1777	1742	1781	1777	1585
Q Serve(g_s), s	12.0	42.9	42.9	3.7	25.9	4.0	3.9	10.4	10.7	13.0	17.5	39.3
Cycle Q Clear(g_c), s	12.0	42.9	42.9	3.7	25.9	4.0	3.9	10.4	10.7	13.0	17.5	39.3
Prop In Lane	1.00		0.13	1.00		1.00	1.00		0.41	1.00		1.00
Lane Grp Cap(c), veh/h	153	1104	593	142	1625	505	144	634	621	165	1310	584
V/C Ratio(X)	3.13	0.96	0.96	0.35	0.67	0.12	0.37	0.29	0.30	1.25	0.45	0.84
Avail Cap(c_a), veh/h	153	1104	593	165	1625	505	165	812	796	165	1625	725
HCM Platoon Ratio	1.00	1.00	1.00	1.00	1.00	1.00	1.00	1.00	1.00	1.00	1.00	1.00
Upstream Filter(I)	1.00	1.00	1.00	1.00	1.00	1.00	1.00	1.00	1.00	1.00	1.00	1.00
Uniform Delay (d), s/veh	64.0	46.4	46.4	61.0	41.4	33.9	60.9	32.3	32.4	63.5	33.4	40.3
Incr Delay (d2), s/veh	975.8	19.3	28.7	0.6	2.2	0.5	0.6	0.4	0.5	153.2	0.4	8.3
Initial Q Delay(d3),s/veh	0.0	0.0	0.0	0.0	0.0	0.0	0.0	0.0	0.0	0.0	0.0	0.0
%ile BackOfQ(95%),veh/ln	71.9	28.5	32.2	3.1	16.7	2.9	3.3	8.1	8.2	20.4	12.2	23.3
Unsig. Movement Delay, s/veh												
LnGrp Delay(d),s/veh	1039.8	65.8	75.1	61.6	43.6	34.4	61.5	32.7	32.9	216.7	33.8	48.6
LnGrp LOS	F	E	E	E	D	C	E	C	C	F	C	D
Approach Vol, veh/h	2111			1203			422			1282		
Approach Delay, s/veh	288.9			43.8			36.4			69.0		
Approach LOS	F			D			D			E		
Timer - Assigned Phs	1	2	3	4	5	6	7	8				
Phs Duration (G+Y+Rc), s	16.5	49.6	17.5	56.4	15.6	50.4	15.8	58.1				
Change Period (Y+Rc), s	4.5	5.0	4.5	6.5	4.5	5.0	4.5	6.5				
Max Green Setting (Gmax), s	12.0	30.5	13.0	64.0	13.0	29.5	13.0	64.0				
Max Q Clear Time (g_c+I1), s	14.0	27.9	15.0	12.7	5.7	44.9	5.9	41.3				
Green Ext Time (p_c), s	0.0	2.1	0.0	4.2	0.0	0.0	0.0	10.3				
Intersection Summary												
HCM 6th Ctrl Delay	152.7											
HCM 6th LOS	F											



























HCM 6th Signalized Intersection Summary
 4: San Marino Ave & Huntington Dr

Existing + Project Conditions
 Weekday AM Peak Hour

Movement	EBL	EBT	EBR	WBL	WBT	WBR	NBL	NBT	NBR	SBL	SBT	SBR
Lane Configurations												
Traffic Volume (veh/h)	485	887	48	24	1304	66	140	492	28	80	274	481
Future Volume (veh/h)	485	887	48	24	1304	66	140	492	28	80	274	481
Initial Q (Qb), veh	0	0	0	0	0	0	0	0	0	0	0	0
Ped-Bike Adj(A_pbT)	1.00		1.00	1.00		1.00	1.00		1.00	1.00		1.00
Parking Bus, Adj	1.00	1.00	1.00	1.00	1.00	1.00	1.00	1.00	1.00	1.00	1.00	1.00
Work Zone On Approach	No			No			No			No		
Adj Sat Flow, veh/h/ln	1870	1870	1870	1870	1870	1870	1870	1870	1870	1870	1870	1870
Adj Flow Rate, veh/h	527	964	52	26	1417	72	152	535	30	87	298	523
Peak Hour Factor	0.92	0.92	0.92	0.92	0.92	0.92	0.92	0.92	0.92	0.92	0.92	0.92
Percent Heavy Veh, %	2	2	2	2	2	2	2	2	2	2	2	2
Cap, veh/h	153	1639	88	105	1551	482	165	1281	72	160	1319	588
Arrive On Green	0.09	0.33	0.33	0.06	0.30	0.30	0.09	0.37	0.37	0.09	0.37	0.37
Sat Flow, veh/h	1781	4959	267	1781	5106	1585	1781	3421	192	1781	3554	1585
Grp Volume(v), veh/h	527	661	355	26	1417	72	152	277	288	87	298	523
Grp Sat Flow(s),veh/h/ln	1781	1702	1822	1781	1702	1585	1781	1777	1836	1781	1777	1585
Q Serve(g_s), s	12.0	22.6	22.7	2.0	37.4	4.6	11.8	16.2	16.3	6.5	8.1	43.4
Cycle Q Clear(g_c), s	12.0	22.6	22.7	2.0	37.4	4.6	11.8	16.2	16.3	6.5	8.1	43.4
Prop In Lane	1.00		0.15	1.00		1.00	1.00		0.10	1.00		1.00
Lane Grp Cap(c), veh/h	153	1125	602	105	1551	482	165	665	687	160	1319	588
V/C Ratio(X)	3.45	0.59	0.59	0.25	0.91	0.15	0.92	0.42	0.42	0.54	0.23	0.89
Avail Cap(c_a), veh/h	153	1125	602	165	1551	482	165	812	839	165	1625	725
HCM Platoon Ratio	1.00	1.00	1.00	1.00	1.00	1.00	1.00	1.00	1.00	1.00	1.00	1.00
Upstream Filter(I)	1.00	1.00	1.00	1.00	1.00	1.00	1.00	1.00	1.00	1.00	1.00	1.00
Uniform Delay (d), s/veh	64.0	38.9	39.0	62.9	47.0	35.5	63.0	32.5	32.5	61.0	30.2	41.3
Incr Delay (d2), s/veh	1119.6	2.3	4.2	0.4	9.8	0.7	46.3	0.7	0.7	1.7	0.1	12.7
Initial Q Delay(d3),s/veh	0.0	0.0	0.0	0.0	0.0	0.0	0.0	0.0	0.0	0.0	0.0	0.0
%ile BackOfQ(95%),veh/ln	80.7	15.0	16.3	1.6	24.0	3.4	12.0	11.6	11.9	5.5	6.4	26.0
Unsig. Movement Delay, s/veh												
LnGrp Delay(d),s/veh	1183.6	41.2	43.2	63.3	56.7	36.2	109.3	33.2	33.2	62.7	30.4	54.0
LnGrp LOS	F	D	D	E	E	D	F	C	C	E	C	D
Approach Vol, veh/h	1543			1515			717			908		
Approach Delay, s/veh	431.8			55.9			49.3			47.1		
Approach LOS	F			E			D			D		
Timer - Assigned Phs	1	2	3	4	5	6	7	8				
Phs Duration (G+Y+Rc), s	16.5	47.5	17.1	58.9	12.8	51.3	17.5	58.5				
Change Period (Y+Rc), s	4.5	5.0	4.5	6.5	4.5	5.0	4.5	6.5				
Max Green Setting (Gmax), s	12.0	30.5	13.0	64.0	13.0	29.5	13.0	64.0				
Max Q Clear Time (g_c+I1), s	14.0	39.4	8.5	18.3	4.0	24.7	13.8	45.4				
Green Ext Time (p_c), s	0.0	0.0	0.0	6.8	0.0	3.4	0.0	6.6				
Intersection Summary												
HCM 6th Ctrl Delay				177.0								
HCM 6th LOS				F								

HCM 6th Signalized Intersection Summary
 4: San Marino Ave & Huntington Dr

Existing Plus Conditions
 Weekday PM Peak Hour

												
Movement	EBL	EBT	EBR	WBL	WBT	WBR	NBL	NBT	NBR	SBL	SBT	SBR
Lane Configurations		 			 			 			 	
Traffic Volume (veh/h)	442	1439	67	46	1006	58	50	270	70	190	540	451
Future Volume (veh/h)	442	1439	67	46	1006	58	50	270	70	190	540	451
Initial Q (Qb), veh	0	0	0	0	0	0	0	0	0	0	0	0
Ped-Bike Adj(A_pbT)	1.00		1.00	1.00		1.00	1.00		1.00	1.00		1.00
Parking Bus, Adj	1.00	1.00	1.00	1.00	1.00	1.00	1.00	1.00	1.00	1.00	1.00	1.00
Work Zone On Approach	No			No			No			No		
Adj Sat Flow, veh/h/ln	1870	1870	1870	1870	1870	1870	1870	1870	1870	1870	1870	1870
Adj Flow Rate, veh/h	480	1564	73	50	1093	63	54	293	76	207	587	490
Peak Hour Factor	0.92	0.92	0.92	0.92	0.92	0.92	0.92	0.92	0.92	0.92	0.92	0.92
Percent Heavy Veh, %	2	2	2	2	2	2	2	2	2	2	2	2
Cap, veh/h	153	1614	75	142	1618	502	145	1004	256	165	1313	586
Arrive On Green	0.09	0.32	0.32	0.08	0.32	0.32	0.08	0.36	0.36	0.09	0.37	0.37
Sat Flow, veh/h	1781	4999	233	1781	5106	1585	1781	2804	715	1781	3554	1585
Grp Volume(v), veh/h	480	1065	572	50	1093	63	54	184	185	207	587	490
Grp Sat Flow(s),veh/h/ln	1781	1702	1828	1781	1702	1585	1781	1777	1742	1781	1777	1585
Q Serve(g_s), s	12.0	43.2	43.2	3.7	26.1	4.0	4.0	10.4	10.7	13.0	17.5	39.5
Cycle Q Clear(g_c), s	12.0	43.2	43.2	3.7	26.1	4.0	4.0	10.4	10.7	13.0	17.5	39.5
Prop In Lane	1.00		0.13	1.00		1.00	1.00		0.41	1.00		1.00
Lane Grp Cap(c), veh/h	153	1099	590	142	1618	502	145	636	624	165	1313	586
V/C Ratio(X)	3.14	0.97	0.97	0.35	0.68	0.13	0.37	0.29	0.30	1.25	0.45	0.84
Avail Cap(c_a), veh/h	153	1099	590	165	1618	502	165	812	796	165	1625	725
HCM Platoon Ratio	1.00	1.00	1.00	1.00	1.00	1.00	1.00	1.00	1.00	1.00	1.00	1.00
Upstream Filter(I)	1.00	1.00	1.00	1.00	1.00	1.00	1.00	1.00	1.00	1.00	1.00	1.00
Uniform Delay (d), s/veh	64.0	46.7	46.7	61.0	41.6	34.0	60.9	32.2	32.3	63.5	33.3	40.3
Incr Delay (d2), s/veh	981.7	20.6	30.1	0.6	2.3	0.5	0.6	0.4	0.5	153.2	0.4	8.4
Initial Q Delay(d3),s/veh	0.0	0.0	0.0	0.0	0.0	0.0	0.0	0.0	0.0	0.0	0.0	0.0
%ile BackOfQ(95%),veh/ln	72.3	28.9	32.6	3.1	16.8	2.9	3.3	8.1	8.2	20.4	12.2	23.4
Unsig. Movement Delay, s/veh												
LnGrp Delay(d),s/veh	1045.7	67.3	76.9	61.6	43.9	34.5	61.5	32.6	32.7	216.7	33.7	48.6
LnGrp LOS	F	E	E	E	D	C	E	C	C	F	C	D
Approach Vol, veh/h	2117			1206			423			1284		
Approach Delay, s/veh	291.7			44.1			36.3			68.9		
Approach LOS	F			D			D			E		
Timer - Assigned Phs	1	2	3	4	5	6	7	8				
Phs Duration (G+Y+Rc), s	16.5	49.4	17.5	56.6	15.6	50.2	15.9	58.2				
Change Period (Y+Rc), s	4.5	5.0	4.5	6.5	4.5	5.0	4.5	6.5				
Max Green Setting (Gmax), s	12.0	30.5	13.0	64.0	13.0	29.5	13.0	64.0				
Max Q Clear Time (g_c+I1), s	14.0	28.1	15.0	12.7	5.7	45.2	6.0	41.5				
Green Ext Time (p_c), s	0.0	2.0	0.0	4.2	0.0	0.0	0.0	10.2				
Intersection Summary												
HCM 6th Ctrl Delay	154.0											
HCM 6th LOS	F											































HCM 6th Signalized Intersection Summary
 4: San Marino Ave & Huntington Dr

Future Pre Project Conditions
 Weekday AM Peak Hour

Movement	EBL	EBT	EBR	WBL	WBT	WBR	NBL	NBT	NBR	SBL	SBT	SBR
Lane Configurations												
Traffic Volume (veh/h)	498	911	49	24	1334	67	141	502	29	82	281	492
Future Volume (veh/h)	498	911	49	24	1334	67	141	502	29	82	281	492
Initial Q (Qb), veh	0	0	0	0	0	0	0	0	0	0	0	0
Ped-Bike Adj(A_pbT)	1.00		1.00	1.00		1.00	1.00		1.00	1.00		1.00
Parking Bus, Adj	1.00	1.00	1.00	1.00	1.00	1.00	1.00	1.00	1.00	1.00	1.00	1.00
Work Zone On Approach	No			No			No			No		
Adj Sat Flow, veh/h/ln	1870	1870	1870	1870	1870	1870	1870	1870	1870	1870	1870	1870
Adj Flow Rate, veh/h	541	990	53	26	1450	73	153	546	32	89	305	535
Peak Hour Factor	0.92	0.92	0.92	0.92	0.92	0.92	0.92	0.92	0.92	0.92	0.92	0.92
Percent Heavy Veh, %	2	2	2	2	2	2	2	2	2	2	2	2
Cap, veh/h	153	1604	86	105	1515	470	165	1300	76	160	1344	600
Arrive On Green	0.09	0.32	0.32	0.06	0.30	0.30	0.09	0.38	0.38	0.09	0.38	0.38
Sat Flow, veh/h	1781	4961	265	1781	5106	1585	1781	3412	200	1781	3554	1585
Grp Volume(v), veh/h	541	679	364	26	1450	73	153	284	294	89	305	535
Grp Sat Flow(s),veh/h/ln	1781	1702	1823	1781	1702	1585	1781	1777	1834	1781	1777	1585
Q Serve(g_s), s	12.0	23.6	23.7	2.0	39.0	4.8	11.9	16.5	16.5	6.7	8.2	44.3
Cycle Q Clear(g_c), s	12.0	23.6	23.7	2.0	39.0	4.8	11.9	16.5	16.5	6.7	8.2	44.3
Prop In Lane	1.00		0.15	1.00		1.00	1.00		0.11	1.00		1.00
Lane Grp Cap(c), veh/h	153	1101	589	105	1515	470	165	677	699	160	1344	600
V/C Ratio(X)	3.54	0.62	0.62	0.25	0.96	0.16	0.92	0.42	0.42	0.56	0.23	0.89
Avail Cap(c_a), veh/h	153	1101	589	165	1515	470	165	812	839	165	1625	725
HCM Platoon Ratio	1.00	1.00	1.00	1.00	1.00	1.00	1.00	1.00	1.00	1.00	1.00	1.00
Upstream Filter(I)	1.00	1.00	1.00	1.00	1.00	1.00	1.00	1.00	1.00	1.00	1.00	1.00
Uniform Delay (d), s/veh	64.0	40.0	40.0	62.9	48.3	36.3	63.0	31.9	31.9	61.0	29.6	40.8
Incr Delay (d2), s/veh	1160.7	2.6	4.8	0.4	14.9	0.7	47.8	0.7	0.7	2.1	0.1	13.1
Initial Q Delay(d3),s/veh	0.0	0.0	0.0	0.0	0.0	0.0	0.0	0.0	0.0	0.0	0.0	0.0
%ile BackOfQ(95%),veh/ln	83.1	15.6	17.0	1.6	25.7	3.5	12.1	11.7	12.1	5.6	6.4	26.6
Unsig. Movement Delay, s/veh												
LnGrp Delay(d),s/veh	1224.7	42.6	44.9	63.3	63.3	37.0	110.9	32.6	32.6	63.1	29.7	54.0
LnGrp LOS	F	D	D	E	E	D	F	C	C	E	C	D
Approach Vol, veh/h	1584			1549			731			929		
Approach Delay, s/veh	446.9			62.0			49.0			46.9		
Approach LOS	F			E			D			D		
Timer - Assigned Phs	1	2	3	4	5	6	7	8				
Phs Duration (G+Y+Rc), s	16.5	46.5	17.1	59.9	12.8	50.3	17.5	59.5				
Change Period (Y+Rc), s	4.5	5.0	4.5	6.5	4.5	5.0	4.5	6.5				
Max Green Setting (Gmax), s	12.0	30.5	13.0	64.0	13.0	29.5	13.0	64.0				
Max Q Clear Time (g_c+I1), s	14.0	41.0	8.7	18.5	4.0	25.7	13.9	46.3				
Green Ext Time (p_c), s	0.0	0.0	0.0	7.0	0.0	2.8	0.0	6.6				
Intersection Summary												
HCM 6th Ctrl Delay	184.3											
HCM 6th LOS	F											



























HCM 6th Signalized Intersection Summary
 4: San Marino Ave & Huntington Dr

Future Pre Project Conditions
 Weekday PM Peak Hour

												
Movement	EBL	EBT	EBR	WBL	WBT	WBR	NBL	NBT	NBR	SBL	SBT	SBR
Lane Configurations		  			  			 	 		 	 
Traffic Volume (veh/h)	454	1472	67	47	1030	60	50	277	71	194	551	463
Future Volume (veh/h)	454	1472	67	47	1030	60	50	277	71	194	551	463
Initial Q (Qb), veh	0	0	0	0	0	0	0	0	0	0	0	0
Ped-Bike Adj(A_pbT)	1.00		1.00	1.00		1.00	1.00		1.00	1.00		1.00
Parking Bus, Adj	1.00	1.00	1.00	1.00	1.00	1.00	1.00	1.00	1.00	1.00	1.00	1.00
Work Zone On Approach	No			No			No			No		
Adj Sat Flow, veh/h/ln	1870	1870	1870	1870	1870	1870	1870	1870	1870	1870	1870	1870
Adj Flow Rate, veh/h	493	1600	73	51	1120	65	54	301	77	211	599	503
Peak Hour Factor	0.92	0.92	0.92	0.92	0.92	0.92	0.92	0.92	0.92	0.92	0.92	0.92
Percent Heavy Veh, %	2	2	2	2	2	2	2	2	2	2	2	2
Cap, veh/h	153	1577	72	143	1580	490	145	1028	259	165	1340	598
Arrive On Green	0.09	0.31	0.31	0.08	0.31	0.31	0.08	0.37	0.37	0.09	0.38	0.38
Sat Flow, veh/h	1781	5005	228	1781	5106	1585	1781	2812	708	1781	3554	1585
Grp Volume(v), veh/h	493	1088	585	51	1120	65	54	188	190	211	599	503
Grp Sat Flow(s),veh/h/ln	1781	1702	1829	1781	1702	1585	1781	1777	1743	1781	1777	1585
Q Serve(g_s), s	12.0	44.1	44.1	3.8	27.2	4.1	4.0	10.5	10.8	13.0	17.7	40.5
Cycle Q Clear(g_c), s	12.0	44.1	44.1	3.8	27.2	4.1	4.0	10.5	10.8	13.0	17.7	40.5
Prop In Lane	1.00		0.12	1.00		1.00	1.00		0.41	1.00		1.00
Lane Grp Cap(c), veh/h	153	1072	576	143	1580	490	145	650	637	165	1340	598
V/C Ratio(X)	3.23	1.01	1.02	0.36	0.71	0.13	0.37	0.29	0.30	1.28	0.45	0.84
Avail Cap(c_a), veh/h	153	1072	576	165	1580	490	165	812	797	165	1625	725
HCM Platoon Ratio	1.00	1.00	1.00	1.00	1.00	1.00	1.00	1.00	1.00	1.00	1.00	1.00
Upstream Filter(I)	1.00	1.00	1.00	1.00	1.00	1.00	1.00	1.00	1.00	1.00	1.00	1.00
Uniform Delay (d), s/veh	64.0	48.0	48.0	61.0	42.8	34.8	60.9	31.5	31.6	63.5	32.7	39.8
Incr Delay (d2), s/veh	1019.8	31.2	41.3	0.6	2.7	0.6	0.6	0.4	0.4	162.5	0.4	8.8
Initial Q Delay(d3),s/veh	0.0	0.0	0.0	0.0	0.0	0.0	0.0	0.0	0.0	0.0	0.0	0.0
%ile BackOfQ(95%),veh/ln	74.6	31.5	35.4	3.1	17.5	3.1	3.3	8.2	8.3	21.1	12.3	24.0
Unsig. Movement Delay, s/veh												
LnGrp Delay(d),s/veh	1083.8	79.1	89.3	61.5	45.5	35.4	61.5	31.9	32.1	226.0	33.1	48.6
LnGrp LOS	F	F	F	E	D	D	E	C	C	F	C	D
Approach Vol, veh/h	2166			1236			432			1313		
Approach Delay, s/veh	310.6			45.6			35.7			70.0		
Approach LOS	F			D			D			E		
Timer - Assigned Phs	1	2	3	4	5	6	7	8				
Phs Duration (G+Y+Rc), s	16.5	48.3	17.5	57.7	15.7	49.1	15.9	59.3				
Change Period (Y+Rc), s	4.5	5.0	4.5	6.5	4.5	5.0	4.5	6.5				
Max Green Setting (Gmax), s	12.0	30.5	13.0	64.0	13.0	29.5	13.0	64.0				
Max Q Clear Time (g_c+I1), s	14.0	29.2	15.0	12.8	5.8	46.1	6.0	42.5				
Green Ext Time (p_c), s	0.0	1.1	0.0	4.4	0.0	0.0	0.0	10.2				
Intersection Summary												
HCM 6th Ctrl Delay	162.5											
HCM 6th LOS	F											



























HCM 6th Signalized Intersection Summary
4: San Marino Ave & Huntington Dr

Future With Project Conditions
Weekday AM Peak Hour

												
Movement	EBL	EBT	EBR	WBL	WBT	WBR	NBL	NBT	NBR	SBL	SBT	SBR
Lane Configurations		 			 			 			 	
Traffic Volume (veh/h)	499	913	49	24	1337	67	143	502	29	82	281	494
Future Volume (veh/h)	499	913	49	24	1337	67	143	502	29	82	281	494
Initial Q (Qb), veh	0	0	0	0	0	0	0	0	0	0	0	0
Ped-Bike Adj(A_pbT)	1.00		1.00	1.00		1.00	1.00		1.00	1.00		1.00
Parking Bus, Adj	1.00	1.00	1.00	1.00	1.00	1.00	1.00	1.00	1.00	1.00	1.00	1.00
Work Zone On Approach		No			No			No			No	
Adj Sat Flow, veh/h/ln	1870	1870	1870	1870	1870	1870	1870	1870	1870	1870	1870	1870
Adj Flow Rate, veh/h	542	992	53	26	1453	73	155	546	32	89	305	537
Peak Hour Factor	0.92	0.92	0.92	0.92	0.92	0.92	0.92	0.92	0.92	0.92	0.92	0.92
Percent Heavy Veh, %	2	2	2	2	2	2	2	2	2	2	2	2
Cap, veh/h	153	1599	85	105	1510	469	165	1304	76	160	1348	601
Arrive On Green	0.09	0.32	0.32	0.06	0.30	0.30	0.09	0.38	0.38	0.09	0.38	0.38
Sat Flow, veh/h	1781	4962	265	1781	5106	1585	1781	3412	200	1781	3554	1585
Grp Volume(v), veh/h	542	680	365	26	1453	73	155	284	294	89	305	537
Grp Sat Flow(s),veh/h/ln	1781	1702	1823	1781	1702	1585	1781	1777	1834	1781	1777	1585
Q Serve(g_s), s	12.0	23.7	23.7	2.0	39.2	4.8	12.1	16.4	16.5	6.7	8.2	44.5
Cycle Q Clear(g_c), s	12.0	23.7	23.7	2.0	39.2	4.8	12.1	16.4	16.5	6.7	8.2	44.5
Prop In Lane	1.00		0.15	1.00		1.00	1.00		0.11	1.00		1.00
Lane Grp Cap(c), veh/h	153	1097	587	105	1510	469	165	679	701	160	1348	601
V/C Ratio(X)	3.55	0.62	0.62	0.25	0.96	0.16	0.94	0.42	0.42	0.56	0.23	0.89
Avail Cap(c_a), veh/h	153	1097	587	165	1510	469	165	812	839	165	1625	725
HCM Platoon Ratio	1.00	1.00	1.00	1.00	1.00	1.00	1.00	1.00	1.00	1.00	1.00	1.00
Upstream Filter(I)	1.00	1.00	1.00	1.00	1.00	1.00	1.00	1.00	1.00	1.00	1.00	1.00
Uniform Delay (d), s/veh	64.0	40.2	40.2	62.9	48.5	36.4	63.1	31.8	31.8	61.0	29.5	40.8
Incr Delay (d2), s/veh	1163.6	2.6	4.9	0.4	15.8	0.7	51.1	0.7	0.7	2.1	0.1	13.2
Initial Q Delay(d3),s/veh	0.0	0.0	0.0	0.0	0.0	0.0	0.0	0.0	0.0	0.0	0.0	0.0
%ile BackOfQ(95%),veh/ln	83.3	15.6	17.1	1.6	25.9	3.5	12.4	11.7	12.0	5.6	6.4	26.7
Unsig. Movement Delay, s/veh												
LnGrp Delay(d),s/veh	1227.6	42.8	45.1	63.3	64.3	37.1	114.2	32.5	32.5	63.1	29.6	54.0
LnGrp LOS	F	D	D	E	E	D	F	C	C	E	C	D
Approach Vol, veh/h		1587			1552			733			931	
Approach Delay, s/veh		448.0			63.0			49.8			46.9	
Approach LOS		F			E			D			D	
Timer - Assigned Phs	1	2	3	4	5	6	7	8				
Phs Duration (G+Y+Rc), s	16.5	46.4	17.1	60.0	12.8	50.1	17.5	59.6				
Change Period (Y+Rc), s	4.5	5.0	4.5	6.5	4.5	5.0	4.5	6.5				
Max Green Setting (Gmax), s	12.0	30.5	13.0	64.0	13.0	29.5	13.0	64.0				
Max Q Clear Time (g_c+I1), s	14.0	41.2	8.7	18.5	4.0	25.7	14.1	46.5				
Green Ext Time (p_c), s	0.0	0.0	0.0	7.0	0.0	2.7	0.0	6.6				
Intersection Summary												
HCM 6th Ctrl Delay	185.1											
HCM 6th LOS	F											

HCM 6th Signalized Intersection Summary
 4: San Marino Ave & Huntington Dr

Future With Project Conditions
 Weekday PM Peak Hour

												
Movement	EBL	EBT	EBR	WBL	WBT	WBR	NBL	NBT	NBR	SBL	SBT	SBR
Lane Configurations		 			 			 			 	
Traffic Volume (veh/h)	456	1475	68	47	1033	60	51	277	71	194	551	465
Future Volume (veh/h)	456	1475	68	47	1033	60	51	277	71	194	551	465
Initial Q (Qb), veh	0	0	0	0	0	0	0	0	0	0	0	0
Ped-Bike Adj(A_pbT)	1.00		1.00	1.00		1.00	1.00		1.00	1.00		1.00
Parking Bus, Adj	1.00	1.00	1.00	1.00	1.00	1.00	1.00	1.00	1.00	1.00	1.00	1.00
Work Zone On Approach	No			No			No			No		
Adj Sat Flow, veh/h/ln	1870	1870	1870	1870	1870	1870	1870	1870	1870	1870	1870	1870
Adj Flow Rate, veh/h	496	1603	74	51	1123	65	55	301	77	211	599	505
Peak Hour Factor	0.92	0.92	0.92	0.92	0.92	0.92	0.92	0.92	0.92	0.92	0.92	0.92
Percent Heavy Veh, %	2	2	2	2	2	2	2	2	2	2	2	2
Cap, veh/h	153	1568	72	143	1572	488	146	1032	260	165	1343	599
Arrive On Green	0.09	0.31	0.31	0.08	0.31	0.31	0.08	0.37	0.37	0.09	0.38	0.38
Sat Flow, veh/h	1781	5002	231	1781	5106	1585	1781	2812	708	1781	3554	1585
Grp Volume(v), veh/h	496	1091	586	51	1123	65	55	188	190	211	599	505
Grp Sat Flow(s),veh/h/ln	1781	1702	1829	1781	1702	1585	1781	1777	1743	1781	1777	1585
Q Serve(g_s), s	12.0	43.9	43.9	3.8	27.3	4.1	4.1	10.5	10.8	13.0	17.7	40.7
Cycle Q Clear(g_c), s	12.0	43.9	43.9	3.8	27.3	4.1	4.1	10.5	10.8	13.0	17.7	40.7
Prop In Lane	1.00		0.13	1.00		1.00	1.00		0.41	1.00		1.00
Lane Grp Cap(c), veh/h	153	1067	573	143	1572	488	146	652	640	165	1343	599
V/C Ratio(X)	3.25	1.02	1.02	0.36	0.71	0.13	0.38	0.29	0.30	1.28	0.45	0.84
Avail Cap(c_a), veh/h	153	1067	573	165	1572	488	165	812	797	165	1625	725
HCM Platoon Ratio	1.00	1.00	1.00	1.00	1.00	1.00	1.00	1.00	1.00	1.00	1.00	1.00
Upstream Filter(I)	1.00	1.00	1.00	1.00	1.00	1.00	1.00	1.00	1.00	1.00	1.00	1.00
Uniform Delay (d), s/veh	64.0	48.1	48.1	61.0	43.0	35.0	60.9	31.4	31.5	63.5	32.6	39.7
Incr Delay (d2), s/veh	1028.6	33.2	43.4	0.6	2.8	0.6	0.6	0.4	0.4	162.5	0.4	8.9
Initial Q Delay(d3),s/veh	0.0	0.0	0.0	0.0	0.0	0.0	0.0	0.0	0.0	0.0	0.0	0.0
%ile BackOfQ(95%),veh/ln	75.1	31.8	35.8	3.1	17.6	3.1	3.4	8.2	8.3	21.1	12.3	24.1
Unsig. Movement Delay, s/veh												
LnGrp Delay(d),s/veh	1092.6	81.3	91.4	61.5	45.8	35.5	61.5	31.8	31.9	226.0	33.0	48.6
LnGrp LOS	F	F	F	E	D	D	E	C	C	F	C	D
Approach Vol, veh/h	2173			1239			433			1315		
Approach Delay, s/veh	314.9			45.9			35.6			69.9		
Approach LOS	F			D			D			E		
Timer - Assigned Phs	1	2	3	4	5	6	7	8				
Phs Duration (G+Y+Rc), s	16.5	48.1	17.5	57.9	15.7	48.9	16.0	59.4				
Change Period (Y+Rc), s	4.5	5.0	4.5	6.5	4.5	5.0	4.5	6.5				
Max Green Setting (Gmax), s	12.0	30.5	13.0	64.0	13.0	29.5	13.0	64.0				
Max Q Clear Time (g_c+I1), s	14.0	29.3	15.0	12.8	5.8	45.9	6.1	42.7				
Green Ext Time (p_c), s	0.0	1.0	0.0	4.4	0.0	0.0	0.0	10.2				
Intersection Summary												
HCM 6th Ctrl Delay	164.4											
HCM 6th LOS	F											