

## **Appendix IS-11**

---

### Transportation Assessment

## **Appendix IS-11.1**

---

### Transportation Assessment



**TRANSPORTATION ASSESSMENT  
FOR THE  
8<sup>TH</sup> & ALAMEDA STUDIO PROJECT**

**LOS ANGELES, CALIFORNIA**

AUGUST 2021

PREPARED FOR  
**ATLAS CAPITAL GROUP**

PREPARED BY



**TRANSPORTATION ASSESSMENT  
FOR THE  
8<sup>TH</sup> & ALAMEDA STUDIO PROJECT  
LOS ANGELES, CALIFORNIA**

August 2021

Prepared for:

**ATLAS CAPITAL GROUP**

Prepared by:

**GIBSON TRANSPORTATION CONSULTING, INC.**

555 W. 5<sup>th</sup> Street, Suite 3375  
Los Angeles, California 90013  
(213) 683-0088

Ref: J1735

---

## Table of Contents

1.	Introduction.....	1
	Project Description.....	1
	Project Location.....	2
	Study Scope.....	2
	Organization of Report.....	3
2.	Project Context.....	6
	Study Area.....	6
	Existing Transportation Conditions.....	7
	Future Cumulative Transportation Conditions.....	13
3.	Project Traffic.....	35
	Project Trip Generation.....	35
	Project Trip Distribution.....	36
	Project Trip Assignment.....	36
4.	CEQA Analysis of Transportation Impacts.....	41
	Methodology.....	41
	Section 4A: Threshold T-1 – Consistency with Plans, Programs, Ordinances, or Policies Analysis.....	43
	Plans, Programs, Ordinances, and Policies.....	43
	Cumulative Analysis.....	48
	Section 4B: Threshold T-2.1 – Causing Substantial VMT Analysis.....	55
	VMT Methodology.....	55
	Project VMT Analysis.....	59
	Cumulative Analysis.....	61
	Section 4C: Threshold T-2.2 – Substantially Inducing Additional Automobile Travel Analysis.....	64
	Section 4D: Threshold T-3 – Substantially Increasing Hazards Due to a Geometric Design Feature or Incompatible Use Analysis.....	65
	Project Access Review.....	66
	Cumulative Analysis.....	68
	Section 4E: Freeway Safety Analysis.....	69
	Analysis Methodology.....	69
	Analysis Results.....	70

---

## **Table of Contents, cont.**

5.	Non-CEQA Transportation Analysis .....	71
	Section 5A – Pedestrian, Bicycle, and Transit Assessment .....	72
	Existing Facilities .....	72
	Intensification of Use.....	73
	Conclusion .....	74
	Section 5B – Project Access, Safety, and Circulation Assessment .....	75
	Project Access .....	75
	Operational Evaluation .....	76
	Intersection Queuing Analysis .....	80
	Recommended Actions .....	80
	Section 5C – Residential Street Cut-Through Analysis .....	86
	Section 5D – Project Construction Assessment.....	87
	Construction Evaluation Criteria .....	87
	Proposed Construction Schedule.....	88
	Existing Building and New Buildings Demolition Subphases and Parking Garage Grading & Utilities Subphase.....	88
	Existing Building and New Buildings Interior Subphases .....	89
	Potential Constraints on Access, Transit, and Parking.....	90
	Construction Management Plan .....	91
	Section 5E – Parking .....	93
	Vehicle Parking Code Requirements .....	93
	Bicycle Parking Code Requirements.....	93
6.	Summary & Conclusions.....	97

### *References*

Appendix A:	Memorandum of Understanding
Appendix B:	Traffic Volume Data
Appendix C:	CEQA T-1 Plans, Policies, Programs Consistency Worksheet
Appendix D:	VMT Analysis Worksheets
Appendix E:	Caltrans Freeway Off-Ramp Analysis Worksheets
Appendix F:	HCM Analysis Worksheets
Appendix G:	Signal Warrant Analysis

---

## **List of Figures**

### **NO.**

1	Project Site Plan.....	4
2	Project Site Location .....	5
3	Study Area & Analyzed Intersections.....	18
4	Intersection Lane Configurations .....	19
5	Existing Intersection Mobility Facilities.....	20
6	Mobility Plan Transportation Designations & Pedestrian Destinations.....	21
7	Existing Transit Service.....	22
8	Existing Conditions (Year 2021) Peak Hour Traffic Volumes.....	23
9	Locations of Related Projects .....	24
10	Related Project-Only Peak Hour Traffic Volumes .....	25
11	Future without Project Conditions (Year 2026) Peak Hour Traffic Volumes .....	26
12	Roadway Modal Priorities .....	27
13	Project Trip Distribution.....	37
14A	Existing Uses to be Removed Peak Hour Traffic Volumes .....	38
14B	Proposed Project-Only Peak Hour Traffic Volumes .....	39
15	Existing with Project Conditions (Year 2021) Peak Hour Traffic Volumes .....	81
16	Future with Project Conditions (Year 2026) Peak Hour Traffic Volumes .....	82

## **List of Tables**

### **NO.**

1	Study Intersections.....	28
2	Existing Transit Service.....	29
3A	Transit System Capacity in Study Area – Morning Peak Hour.....	30
3B	Transit System Capacity in Study Area – Afternoon Peak Hour .....	31
4	Related Projects List .....	32
5	Project Trip Generation .....	40
6	Project Consistency with Mobility Plan 2035.....	49
7	Project Consistency with Plan for a Healthy Los Angeles.....	52
8	Project Consistency with Central City Community Plan.....	53
9	Project Consistency with Citywide Design Guidelines .....	54
10A	VMT Trip Equivalency Development.....	62
10B	VMT Analysis Summary .....	63
11	Intersection Level of Service .....	83
12	Existing Conditions (Year 2021) Intersection Peak Hour Levels of Service.....	84
13	Future Conditions (Year 2026) Intersection Peak Hour Levels of Service .....	85
14	Vehicle Parking Code Requirements .....	95
15	Bicycle Parking Code Requirements.....	96

---

# **Chapter 1**

## **Introduction**

This study presents the transportation assessment for the proposed 8<sup>th</sup> & Alameda Studio Project (Project) located at 2000 E. 8<sup>th</sup> Street (Project Site) in the *Central City Community Plan* (City of Los Angeles, 2003) area of the City of Los Angeles, California (City). The methodology and base assumptions used in the analysis were established based on direction from the Los Angeles Department of Transportation (LADOT).

### **PROJECT DESCRIPTION**

The Project proposes a change of use/adaptive reuse of the existing Los Angeles Times production plant to approximately 639,840 square feet (sf) of studio, production support, office, and ancillary, circulation, and support uses. The Project would also include the construction of approximately 249,790 sf of new studio, production support, office, and ancillary uses.

The Project would provide a total of 1,665 parking spaces within surface lots throughout the Project Site and a new parking structure. The Project incorporates compliance with the City's Transportation Demand Management (TDM) ordinance. In addition, the Project design includes specific TDM measures, including Los Angeles Municipal Code (LAMC) required short-term and long-term bicycle parking spaces throughout the Project Site, as well as showers and other amenities for bicyclists.

Vehicular access would be provided via driveways along 8<sup>th</sup> Street, Lemon Street, and Hunter Street. The main gate driveway along 8<sup>th</sup> Street would provide full access (left and right-turn ingress and egress). A secondary outbound-only driveway from the parking structure would also be provided along 8<sup>th</sup> Street, along with two driveways along Hunter Street, which would provide egress from the surface parking lots. The existing exit gates on Lawrence Street and Olympic Boulevard would remain with the development of the Project; however, the gates would not be



---

utilized for regular vehicular access. Separate truck access would be provided via exclusive inbound-only and outbound-only driveways along Lemon Street.

The conceptual Project site plan is shown in Figure 1.

## **PROJECT LOCATION**

As illustrated in Figure 2, the Project Site, contained within Assessor Parcel Numbers 5166027014, 5166027001, 5166027002, 5166023016, 5166027014, 5166023010, and 5166028004, is located in downtown Los Angeles. The Project Site is generally bounded by 8<sup>th</sup> Street to the north, Lemon Street to the east, Olympic Boulevard and Hunter Street to the south, and Alameda Street and Lawrence Street to the west. The surrounding land uses include industrial, warehouse, and commercial uses.

The Project is located approximately 360 feet north of the Santa Monica Freeway (I-10), approximately one mile west of the Hollywood Freeway (US 101), and approximately one mile west of Santa Ana Freeway (I-5). The Project Site is primarily served by arterial streets including Alameda Street, Central Avenue, 7<sup>th</sup> Street, and Olympic Boulevard.

The Project is served by multiple bus lines operated by the Los Angeles County Metropolitan Transportation Authority (Metro) along 7<sup>th</sup> Street, Central Avenue, Olympic Boulevard, and Alameda Street.

## **STUDY SCOPE**

The scope of analysis for this study was developed in consultation with LADOT and is consistent with *Transportation Assessment Guidelines* (LADOT, July 2020) (TAG) and in compliance with CEQA and the CEQA Guidelines (California Code of Regulations, Title 14, Section 15000 and following).

The base assumptions and technical methodologies (i.e., vehicle miles traveled [VMT], trip generation, study locations, analysis methodology, etc.) were identified and agreed to in a Memorandum of Understanding (MOU), which was reviewed and approved by LADOT on March 9, 2021, and provided in Appendix A.

---

## **ORGANIZATION OF REPORT**

This report is divided into five chapters, including this introduction. Chapter 2 describes the Project context including the existing and future circulation system, traffic volumes, and traffic conditions in the Study Area. Chapter 3 presents the CEQA analysis of the Project's potential transportation impacts. Chapter 4 presents the non-CEQA transportation analyses. Chapter 5 summarizes the analyses and study conclusions. The appendices contain supporting documentation, including the MOU that outlines the study scope and assumptions, and additional details supporting the technical analyses.

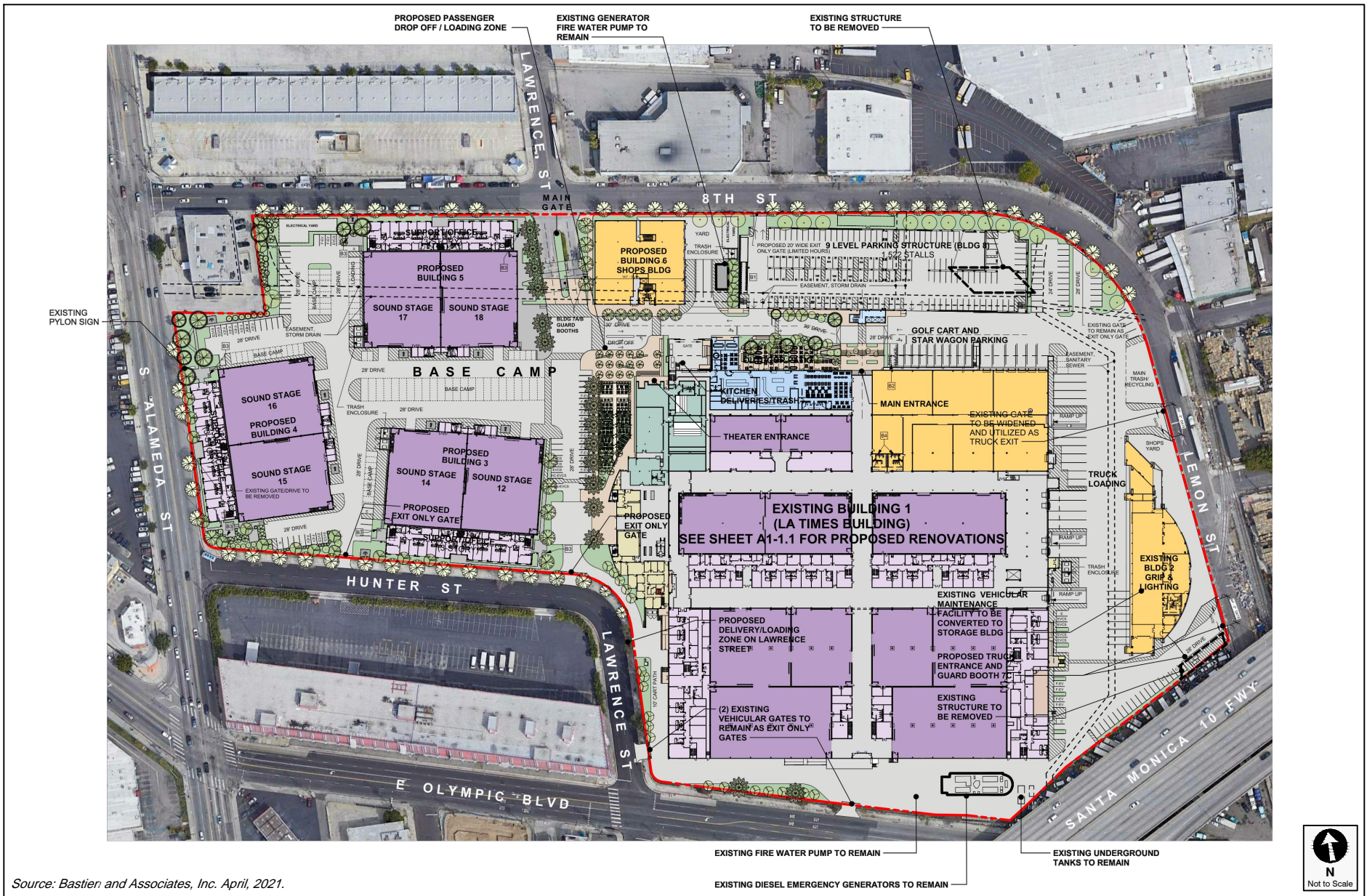

Source: Bastien and Associates, Inc. April, 2021.

PROJECT SITE PLAN

FIGURE  
1



PROJECT SITE LOCATION

FIGURE  
2

---

## **Chapter 2**

### **Project Context**

A comprehensive data collection effort was undertaken to develop a detailed description of existing and future conditions in the Study Area.

The Existing Conditions analysis includes an assessment of the existing transportation infrastructure and conditions of the Study Area including freeway and street systems and public transit service, as well as pedestrian and bicycle circulation, at the time of the issuance of the Notice of Preparation. An inventory of lane configurations, signal phasing, parking restrictions, etc., for the analyzed intersections was also collected. The traffic count worksheets are provided in Appendix B.

In addition, this Chapter contains a discussion of the future conditions detailing the assumptions used to develop the Future without Project Conditions in Year 2026, the Project's anticipated buildout year.

#### **STUDY AREA**

The Project's transportation analysis Study Area, shown in Figure 3, includes a geographic area that is generally bounded by 6<sup>th</sup> Street to the north, Mateo Street to the east, 18<sup>th</sup> Street to the south, and Central Avenue to the west. This Study Area was established in consultation with LADOT based on the following factors identified in the TAG:

1. Primary driveway(s) for the Project
2. Intersections at either end of the block on which the Project is located or up to 600 feet from the primary Project driveway(s)
3. Unsignalized intersections adjacent to the Project Site that are integral to the Project's site access and circulation plan

- 
4. Signalized intersections in proximity to the Project Site where 100 or more Project trips would be added

As listed in Table 1, a total of five Study Area intersections, including four signalized and one unsignalized, were identified for detailed analysis during the MOU process and are illustrated in Figure 3. The existing lane configurations at the analyzed intersections are provided in Figure 4.

## EXISTING TRANSPORTATION CONDITIONS

### Existing Street System

The existing street system in the Study Area consists of a regional roadway system including freeways, arterials, and collector and local streets that provide regional, sub-regional, or local access and circulation within the Study Area. These transportation facilities generally provide two to six travel lanes and usually allow parking on either side of the street. Typically, the speed limits range between 25 and 35 miles per hour (mph) on the streets and between 55 and 65 mph on freeways.

Street classifications are designated in *Mobility Plan 2035, An Element of the General Plan* (Los Angeles Department of City Planning [LADCP], September 2016) (Mobility Plan). The Mobility Plan defines specific street standards in an effort to provide an enhanced balance between traffic flow and other important street functions including transit routes and stops, pedestrian environments, bicycle routes, building design and site access, etc. Per the Mobility Plan, street classifications are defined as follows:

- Freeways are high-volume, high-speed roadways with limited access provided by interchanges that carry regional traffic through and do not provide local access to adjacent land uses.
- Arterial Streets are major streets that serve through traffic, as well as provide access to major commercial activity centers. Arterials are divided into two categories:
  - Boulevards represent the widest Arterial Streets that typically provide regional access to major destinations and include two categories:
    - Boulevard I provides up to four travel lanes in each direction with a target operating speed of 40 mph, and generally includes a right-of-way (ROW) width of 136 feet and pavement width of 100 feet.

- 
- Boulevard II provides up to three travel lanes in each direction with a target operating speed of 35 mph, and generally includes a ROW width of 110 feet, and pavement widths of 80 feet.
  - Avenues are typically narrow arterials that pass through both residential and commercial areas and include three categories:
    - Avenue I provides up to two travel lanes in each direction with a target operating speed of 35 mph, with a ROW width of 100 feet and pavement width of 70 feet.
    - Avenue II provides up to two travel lanes in each direction with a target operating speed of 30 mph, with a ROW width of 86 feet and pavement width of 56 feet.
    - Avenue III provides up to two travel lanes in each direction with a target operating speed of 25 mph, with a ROW width of 72 feet and pavement width of 46 feet.
  - Collector Streets are generally located in residential neighborhoods and provide access to and from Arterial Streets for local traffic and are not intended for cut-through traffic. They provide one travel lane in each direction with operating speed of 25 mph, with a ROW width generally at 66 feet and pavement width of 40 feet.
  - Local Streets are intended to accommodate lower volumes of vehicle traffic and provide parking on both sides of the street. They provide one travel lane in each direction with a target operating speed of 15 to 20 mph. Pavement widths may vary between 30-36 feet within a ROW width of 50-60 feet. Local Streets include two categories:
    - Continuous Local Streets connect to other streets at both ends
    - Non-continuous Local Streets lead to a dead-end

Primary regional access to the Project Site is provided by US 101, I-5, and I-10. The arterials providing access to the Project Site include 7<sup>th</sup> Street, Alameda Street, and Olympic Boulevard. The following is a brief description of the roadways in the Study Area, including their classifications under the Mobility Plan:

### **Freeways**

- US 101 – US 101 generally runs in the north-south direction and is located less than 1.0 miles east of the Project Site. In the vicinity of the Project Site, US 101 provides three travel lanes in each direction. Access to and from US 101 is available via interchanges at 7<sup>th</sup> Street.

- 
- I-5 – I-5 generally runs in the north-south direction and is located less than 1.0 miles east of the Project Site. In the vicinity of the Project Site, I-5 provides five travel lanes in each direction. Access to and from I-5 is available via interchanges at 7<sup>th</sup> Street.
  - I-10 – I-10 generally runs in the east-west direction and is located approximately 500 feet south of the Project Site. In the vicinity of the Project Site, I-10 provides three to five travel lanes in each direction. Access to and from I-10 is available via interchanges at 8<sup>th</sup> Street, Porter Street, and Alameda Street.

## **Roadways**

- Alameda Street – Alameda Street is a designated Avenue I. It travels in the north-south direction and is located adjacent to the western boundary of the Project Site. It provides four travel lanes, two in each direction, with left-turn lanes at intersections and a two-way left-turn median. Unmetered parking is available on both sides of the street between Bay Street and Center Street and on the west side of the street between 8<sup>th</sup> Street and Bay Street; elsewhere, parking is generally prohibited within the Study Area.
- Lawrence Street – Lawrence Street is a designated Collector Street. It travels in the north-south direction and is located toward the western boundary of the Project Site, aligned opposite the main gate driveway at 8<sup>th</sup> Street along the northern boundary of the Project Site. It provides two travel lanes, one in each direction. Unmetered parking is generally available on both sides of the street north of 8<sup>th</sup> Street and south of Olympic Boulevard within the Study Area.
- Lemon Street – Lemon Street is a designated Collector Street. It travels in the north-south direction and is located adjacent to the eastern boundary of the Project Site. It provides two travel lanes, one in each direction, and connects with 8<sup>th</sup> Street, north of Damon Street. Unmetered parking is generally available on the east side of the street north of Olympic Boulevard within the Study Area.
- Mateo Street – Mateo Street is a designated Avenue III. It travels in the north-south direction and is located east of the Project Site. It provides two travel lanes, one in each direction. Unmetered parking is generally available on both sides of the street north of Damon Street and on the west side of the street between Enterprise Street and Damon Street within the Study Area.
- 7<sup>th</sup> Street – 7<sup>th</sup> Street is a designated Avenue II. It travels in the east-west direction and is located north of the Project Site. It provides four travel lanes, two in each direction, with left-turn lanes at intersections. Unmetered parking is generally available on the south side of the street east of Mateo Street and on the north side of the street between Channing Street and Lawrence Street with passenger loading restrictions from 6:30 AM to 9:00 AM and 1:30 PM to 4:00 PM.
- 8<sup>th</sup> Street – 8<sup>th</sup> Street is a designated Avenue II west of Linden Street and a designated Collector Street east of Alameda Street within the Study Area. It travels in the east-west direction and is located adjacent to the northern boundary of the Project Site. It provides



---

four travel lanes, two in each direction, with left-turn lanes west of Central Avenue, and two travel lanes, one lane in each direction, west of Central Avenue within the Study Area. Parking is generally provided on the north side of the street east of Alameda Street and metered parking is generally available on both sides of the street west of Alameda Street.

- Hunter Street – Hunter Street is a designated Collector Street. It travels in the east-west direction and is located adjacent to the southern boundary of the Project Site. It provides two travel lanes, one in each direction. Unmetered parking is generally not available on either side of the street.
- Olympic Boulevard – Olympic Boulevard is a designated Avenue I that generally travels in the east-west direction and is located adjacent to the southern boundary of the Project Site. It provides four travel lanes, two in each direction, with left-turn lanes at intersections and a two-way left-turn median. Unmetered parking is generally available on both sides of the street between Hemlock Street and Naomi Avenue and on the north side of the street between Hooper Street and Alameda Street within the Study Area.

As required in the TAG, an inventory was conducted of facilities serving pedestrians, bicyclists, and transit riders. The existing mobility facilities at each of the analyzed Study Area intersections are detailed in Figure 5 and the existing transportation facilities within the Study Area are shown in Figure 6.

### **Existing Transit System**

Figure 7 illustrates the existing transit service and transit stops within the Study Area, which is served by bus lines operated by Metro. Table 2 summarizes the transit lines operating in the Study Area by Metro, the type of service (peak vs. off-peak, express vs. local), and the frequency of service. The average frequency of transit service during the peak hour was derived from schedule information for the stop nearest the Project Site, as well as detailed trip data from April 2019 provided by Metro.

Tables 3A and 3B summarize the available capacity of the Metro transit lines within 0.25 miles of the Project Site during the morning and afternoon peak hours, based on the frequency of service of each line, detailed ridership data provided by the transit provider, and the maximum seated and standing capacity. As shown, the Metro transit lines within 0.25 miles of the Project Site currently have available capacity for 1,011 additional riders during the morning peak hour and 949 additional riders during the afternoon peak hour.

---

## **Existing Bicycle System**

Based on *2010 Bicycle Plan, A Component of the City of Los Angeles Transportation Element* (LADCP, adopted March 1, 2011) (2010 Bicycle Plan), the existing bicycle system consists of a limited network of bicycle lanes (Class II) and bicycle routes (Class III). Class II bicycle lanes are a component of street design with dedicated striping, separating vehicular traffic from bicycle traffic. These facilities offer a safer environment for both cyclists and motorists. Class III bicycle routes and bicycle-friendly streets are those where motorists and cyclists share the roadway and there is no separated striping for bicycle travel. Bicycle routes and bicycle-friendly streets are preferably placed on Collector and lower volume Arterial Streets. Bicycle routes with shared lane markings, or “sharrows”, remind bicyclists to ride farther from parked cars to prevent collisions, increase awareness of motorists that bicycles may be in the travel lane, and shows bicyclists the correct direction of travel.

The components of the 2010 Bicycle Plan have been incorporated into the bicycle network of the Mobility Plan. The Mobility Plan consists of a Bicycle Enhanced System (Low-Stress Network) (BEN) and a Bicycle Lane Network (BLN). The BEN is a subset of and supplement to the 2010 Bicycle Plan and is comprised of a network of streets that prioritize bicyclists and provide bicycle paths and protected bicycle lanes (Class IV). Class IV protected bicycle lanes including cycle tracks, bicycle traffic signals, and demarcated areas to facilitate turns at intersections and along neighborhood streets, provide further protection from other travel lanes. These Class IV networks typically provide mini-roundabouts, cross-street stop signs, crossing islands at major intersection crossings, improved street lighting, bicycle boxes, and bicycle-only left-turn pockets. Once implemented, these facilities would offer a safer environment for both cyclists and motorists. The BLN consists of Class II bicycle lanes with striped separation. There are currently no bicycle facilities provided along corridors within the Study Area.

## **Existing Pedestrian Facilities**

The signalized intersections surrounding the Project Site provide pedestrian access in the vicinity of the Project Site. The signalized intersections provide pedestrian phasing, crosswalk striping, and Americans with Disabilities Act (ADA) accessible ramps at most crosswalks. Additional

---

pedestrian facilities, not immediately adjacent to the Project Site, are located within the Study Area and are further detailed in Figure 6.

### **Vision Zero**

As described in *Vision Zero: Eliminating Traffic Deaths in Los Angeles by 2025* (City of Los Angeles, August 2015), Vision Zero is a traffic safety policy that promotes strategies to eliminate transportation-related collisions that result in severe injury or death. Vision Zero has identified the High Injury Network (HIN), a network of streets included based on collision data from the last five years, where strategic investments will have the biggest impact in reducing death and severe injury. The Project Site is located along Olympic Boulevard, which is identified as part of the HIN but is not proposing access from Olympic Boulevard. The following streets in the Project Study Area have also been identified as part of the HIN:

- 7<sup>th</sup> Street west of Mateo Street
- Alameda Street both south of Olympic Boulevard and north of 6<sup>th</sup> Street
- Santa Fe Avenue between Olympic Boulevard and Hunter Street

### **Existing Traffic Volumes**

Due to the recent demolition of the 6<sup>th</sup> Street Viaduct and the resulting closure of 6<sup>th</sup> Street between Mateo Street and US 101, traffic traveling in the east/west direction has shifted to detour routes, specifically 4<sup>th</sup> Street and 7<sup>th</sup> Street. In addition, due to the current traffic conditions related to the State and City's response to COVID-19, LADOT has directed transportation assessments to utilize traffic counts collected prior to March 1, 2020. Thus, due to the on-going closures of 6<sup>th</sup> Street and given the uncertainty of the termination of the Safer-At-Home order, historical traffic count data from Years 2009 to 2019 were utilized for this analysis. Local schools were in session when these traffic counts were conducted. Traffic counts were conservatively increased at a rate of 1% per year to reflect regional growth and development between the year of the traffic count and the existing year. Although the turning movement counts were conducted during different days and months of the year, a review of the data and typical traffic conditions (i.e., prior to COVID-19) indicated that the traffic volume pattern and flow were consistent regardless of the traffic count collection date. Thus,

---

for the purposes of this analysis, the Existing Conditions traffic volumes represent Year 2021 conditions. The existing intersection peak hour traffic volumes are illustrated in Figure 8. The traffic count worksheets are provided in Appendix B.

## **FUTURE CUMULATIVE TRANSPORTATION CONDITIONS**

The forecast of Future without Project Conditions was prepared in accordance with procedures outlined in the TAG. Specifically, two requirements are provided for developing the cumulative traffic volume forecast:

“The Transportation Assessment must estimate ambient traffic conditions for the study horizon year selected during the scoping phase and recorded in the executed MOU. The study must clearly identify the horizon year and annual ambient growth rate used for the study. The horizon year should align with the development project’s expected completion year. For development projects constructed in phases over several years, the Transportation Assessment should analyze intermediary milestones before the buildout and completion of the project. The annual ambient growth rate shall be determined by LADOT staff during the scoping process and can be based on an adopted TSP, the most recent SCAG regional transportation model, the citywide transportation model, or other empirical information approved by LADOT.

“The Transportation Assessment must consider related projects. For related development projects, this should include the associated trip generation for known development projects within one-half mile (2,640 foot) radius of the project site and one-quarter mile (1,320 foot) radius of the farthest outlying study intersections. Consultation with the Department of City Planning and LADOT may be required to compile the related projects list. The City’s ZIMAS database can be used to assist in identifying development projects that have submitted applications to the City of Los Angeles. Project access and circulation constraints would be determined by adding project-generated trips to future base traffic volumes including ambient growth and related projects and conducting the operational analysis.”

As described in detail below, this analysis includes increases to traffic from future projects and from regional growth projections. The ambient growth factor discussed below likely includes some traffic increases resulting from the Related Projects. Therefore, through some inherent double-counting of vehicles, the traffic analysis provides a highly conservative estimate of Future without Project traffic volumes.

---

The Future without Project traffic volumes, therefore, include ambient growth, which reflects increases in traffic due to regional growth and development outside the Study Area, as well as traffic generated by ongoing or entitled projects near or within the Study Area.

### **Ambient Traffic Growth**

Traffic levels are expected to increase over time as a result of regional growth and development in and around the Study Area. Based on discussions with LADOT during the MOU process, a conservative ambient growth rate of 1% per year compounded annually was applied to the Existing Conditions traffic volumes to reflect Year 2026 (the estimated buildout year of the Project) conditions. The total adjustment applied over the five-year period was 5.10%. This growth factor accounts for increases in traffic due to potential projects plus projects not yet proposed and projects located outside the Study Area.

### **Related Projects**

In accordance with the TAG, this study also considered the effects of the Project in relation to other developments either proposed, approved, or under construction (collectively, the Related Projects). Including this analysis step, the potential impact of the Project was evaluated within the context of past, present, and probable future developments capable of producing cumulative impacts.

The list of Related Projects is based on information provided by LADCP and LADOT, as well as recent traffic studies prepared for projects in the area. The Related Projects are detailed in Table 4 and their approximate locations shown in Figure 9.

Though the buildout years of many of these Related Projects are uncertain and may be well beyond the buildout year of the Project, and notwithstanding that some may never be approved or developed, they were all considered as part of this study and conservatively assumed to be completed by the Project buildout Year 2026. Therefore, the traffic growth due to the development of Related Projects considered in this analysis is highly conservative and, by itself, is appropriately assumed to substantially overestimate the actual traffic volume growth in the Study Area that would

---

likely occur prior to Project buildout. With the addition of the 1% per year ambient growth factor previously discussed, the Future without Project cumulative condition is even more conservative.

Using these conservative assumptions, the potential transportation effects of the Project were evaluated. The development of estimated traffic volumes added to the Study Area as a result of Related Projects involves the use of a three-step process: trip generation, trip distribution, and trip assignment.

**Trip Generation.** Trip generation estimates for the Related Projects were provided by LADOT or were calculated using a combination of previous study findings and the trip generation rates contained in *Trip Generation Manual, 10<sup>th</sup> Edition* (Institute of Transportation Engineers, 2017). The Related Projects trip generation estimates summarized in Table 4 are conservative in that they do not in every case account for either the existing uses to be removed or the likely use of other travel modes (transit, walk, etc.). Further, such analysis is conservative because, in many cases, it does not account for the internal capture trips within a multi-use development, nor the interaction of trips between multiple Related Projects within the Study Area, in which one Related Project serves as the origin for a trip destined for another Related Project.

**Trip Distribution.** The geographic distribution of the traffic generated by the Related Projects is dependent on several factors. These include the type and density of the proposed land uses, the geographic distribution of the population from which the employees/residents and potential patrons of the proposed developments are drawn, and the location of these projects in relation to the surrounding street system. These factors are considered, along with logical travel routes through the street system, when developing a reasonable pattern of trip distribution.

**Trip Assignment.** The trip generation estimates for the Related Projects were assigned to the local street system using the trip distribution pattern described above. Figure 10 shows the peak hour traffic volumes associated with these Related Projects at the Study Area intersections.

### **Future without Project Traffic Volumes**

The Future without Project Condition traffic volumes were estimated by adding the Related Project volumes to the Existing Conditions traffic volumes with the aforementioned annual ambient growth

---

factor through the projected buildout year of 2026. As discussed above, this is a conservative approach as the traffic generated from many of the Related Projects may already be reflected in the ambient growth rate. The Future without Project Condition traffic volumes at the five Study Area intersections are shown in Figure 11.

### **Future Roadway Improvements**

The analysis of Future Conditions accounted for roadway improvements that are or would be funded and are reasonably expected to be implemented prior to the buildout of the Project in Year 2026. Any roadway improvement that would result in changes to the physical configuration in the Study Area were incorporated into the analysis. Other proposed traffic / trip reduction strategies such as TDM programs for individual buildings and developments were omitted from the Future Conditions analyses. Figure 12 illustrates the future transportation facilities improvements, including future transit, bicycle, and pedestrian facilities per the Mobility Plan, within the Study Area. The following projects were evaluated for their potential effects on the future roadway configurations.

**6<sup>th</sup> Street Viaduct Replacement Project.** Due to a rare chemical reaction in the cement supports and seismic vulnerability, the 6<sup>th</sup> Street Viaduct, which provided a connection between the Arts District and the Boyle Heights neighborhood, was demolished in early Year 2016 as part of the 6<sup>th</sup> Street Viaduct Replacement Project. As a result, 6<sup>th</sup> Street/Whittier Street between Mateo Street and US 101 is closed to through traffic. Construction of the new bridge is anticipated to be complete by Year 2022. The 6<sup>th</sup> Street Viaduct Replacement Project would not affect the street configurations of the Study Area or traffic distribution assumptions considered in the Future Conditions analyses and, therefore, was not incorporated into the analysis.

**Arts District/6<sup>th</sup> Street Station.** The Arts District/6<sup>th</sup> Street Station is a proposed rail station that would serve the Arts District and the surrounding neighborhoods. The Arts District/6<sup>th</sup> Street Station project is still in the preliminary planning stages, and public issuance of the Environmental Impact Report is anticipated in Year 2022. The Arts District/6<sup>th</sup> Street Station would not affect the street configurations of the Study Area or traffic distribution assumptions considered in the Future Conditions analyses and, therefore, was not incorporated into the analysis.

---

**Mobility Plan.** In the Mobility Plan, the City identifies key corridors as components of various “mobility-enhanced networks.” Each network is intended to focus on improving a particular aspect of urban mobility, including transit, neighborhood connectivity, bicycles, pedestrians, and vehicles. The specific improvements that may be implemented in those networks have not yet been identified, and there is no schedule for implementation; therefore, no changes to vehicular lane configurations were made or incorporated into the analysis as a result of the Mobility Plan. However, the following mobility-enhanced networks included corridors within the Study Area and depicted in Figure 12 for informational purposes:

- **Transit Enhanced Network (TEN):** The TEN aims to improve existing and future bus services through reliable and frequent transit service in order to increase transit ridership, reduce single-occupancy vehicle trips, and integrate transit infrastructure investments within the surrounding street system. The TEN has designated Olympic Boulevard within the Study Area as part of the network.
- **Neighborhood Enhanced Network (NEN):** The NEN reflects the synthesis of the bicycle and pedestrian networks and serves as a system of Local Streets that are slow moving and safe enough to connect neighborhoods through active transportation. The NEN has designated Santa Fe Avenue and Mateo Street north of Olympic Boulevard within the Study Area as part of the network.
- **BEN / BLN:** Within the Study Area, the Bicycle Enhanced Network designates Central Avenue as part of the BEN. Olympic Boulevard east of Central Avenue and 7<sup>th</sup> Street east of Central Avenue have been designated as part of the BLN within the Study Area.
- **Pedestrian Enhanced District (PED):** The Mobility Plan aims to promote walking to reduce the reliance on automobile travel by providing more attractive and pedestrian-friendly sidewalks, as well as adding pedestrian signalizations, street trees, and pedestrian-oriented design features. Alameda Street north of Bay Street, 7<sup>th</sup> Street west of Mill Street, and Central Avenue are identified as part of the PED.



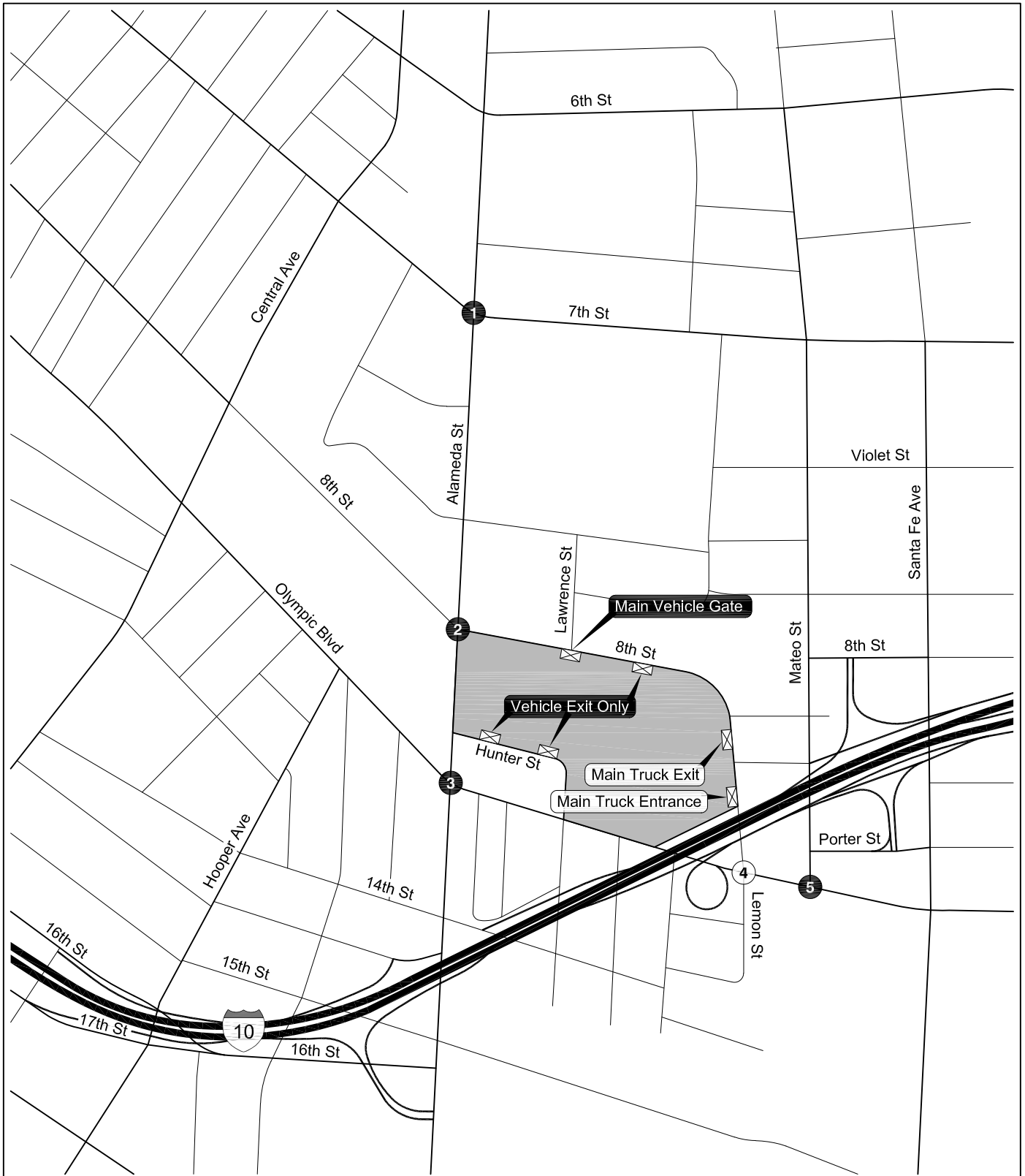

**LEGEND**

- Project Site
- Project Driveway
- # Signalized Intersection
- # Unsignalized Intersection



**STUDY AREA & ANALYZED INTERSECTIONS**

**FIGURE 3**

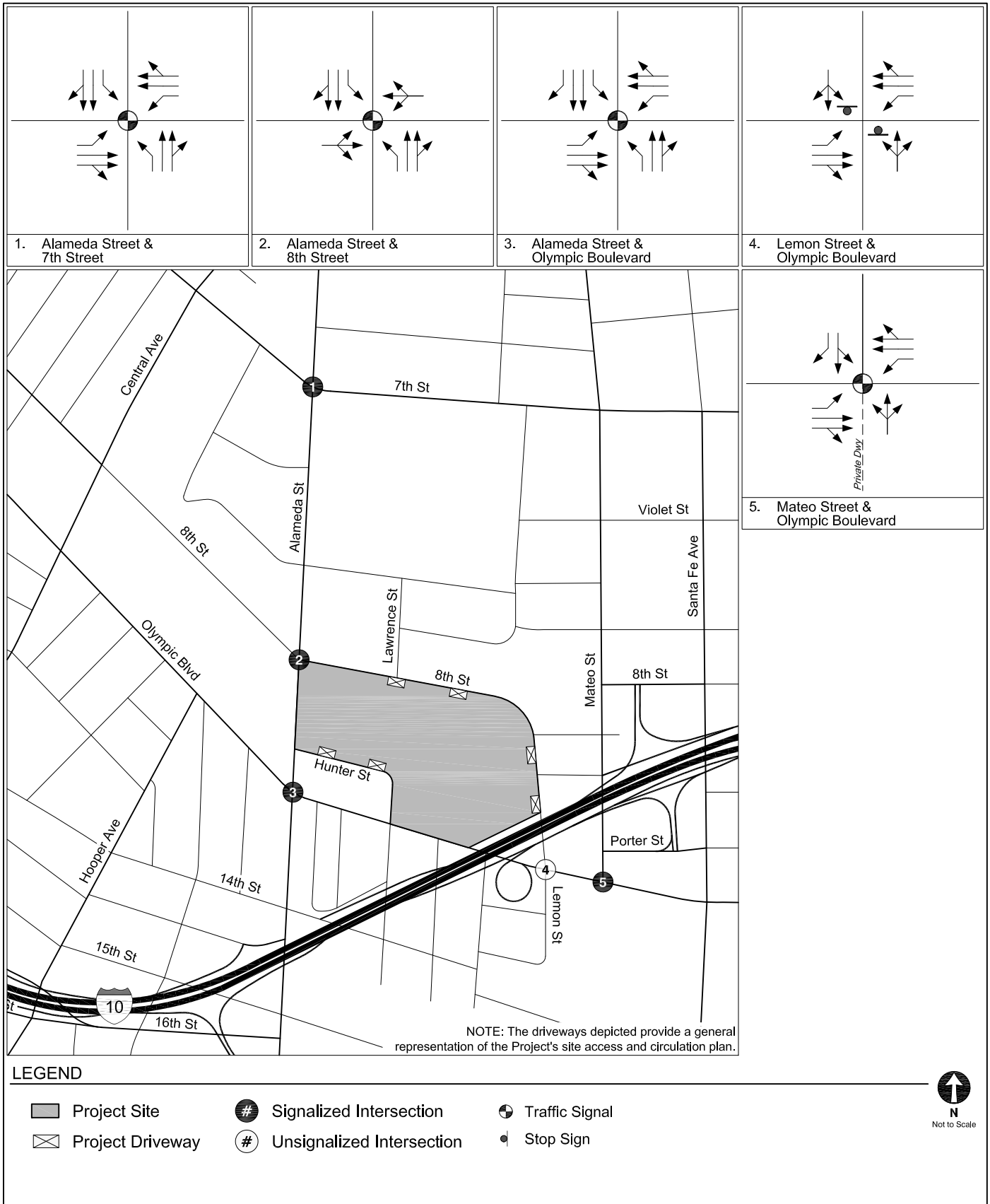

INTERSECTION LANE CONFIGURATIONS

FIGURE  
4

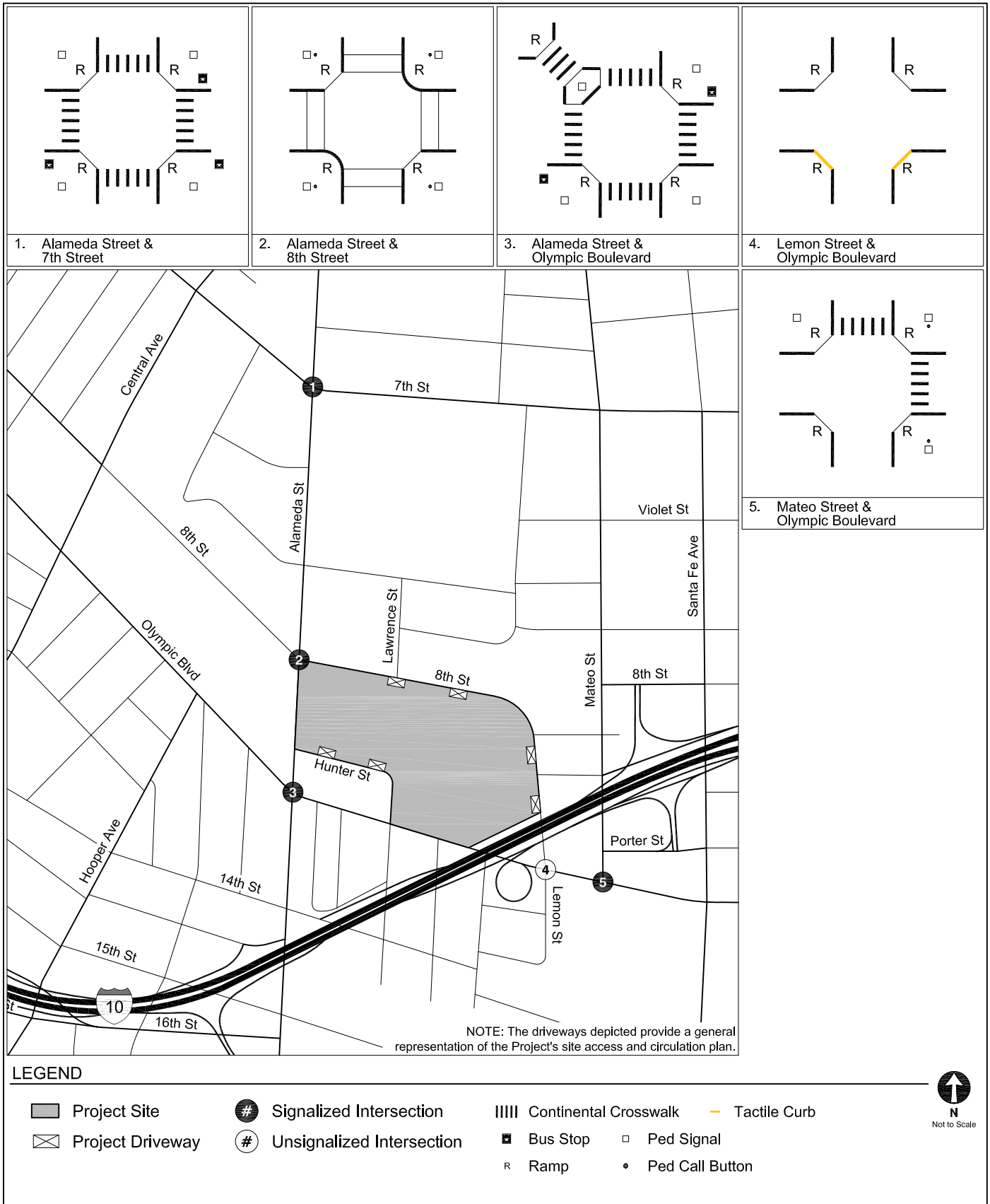

EXISTING INTERSECTION MOBILITY FACILITIES

FIGURE 5

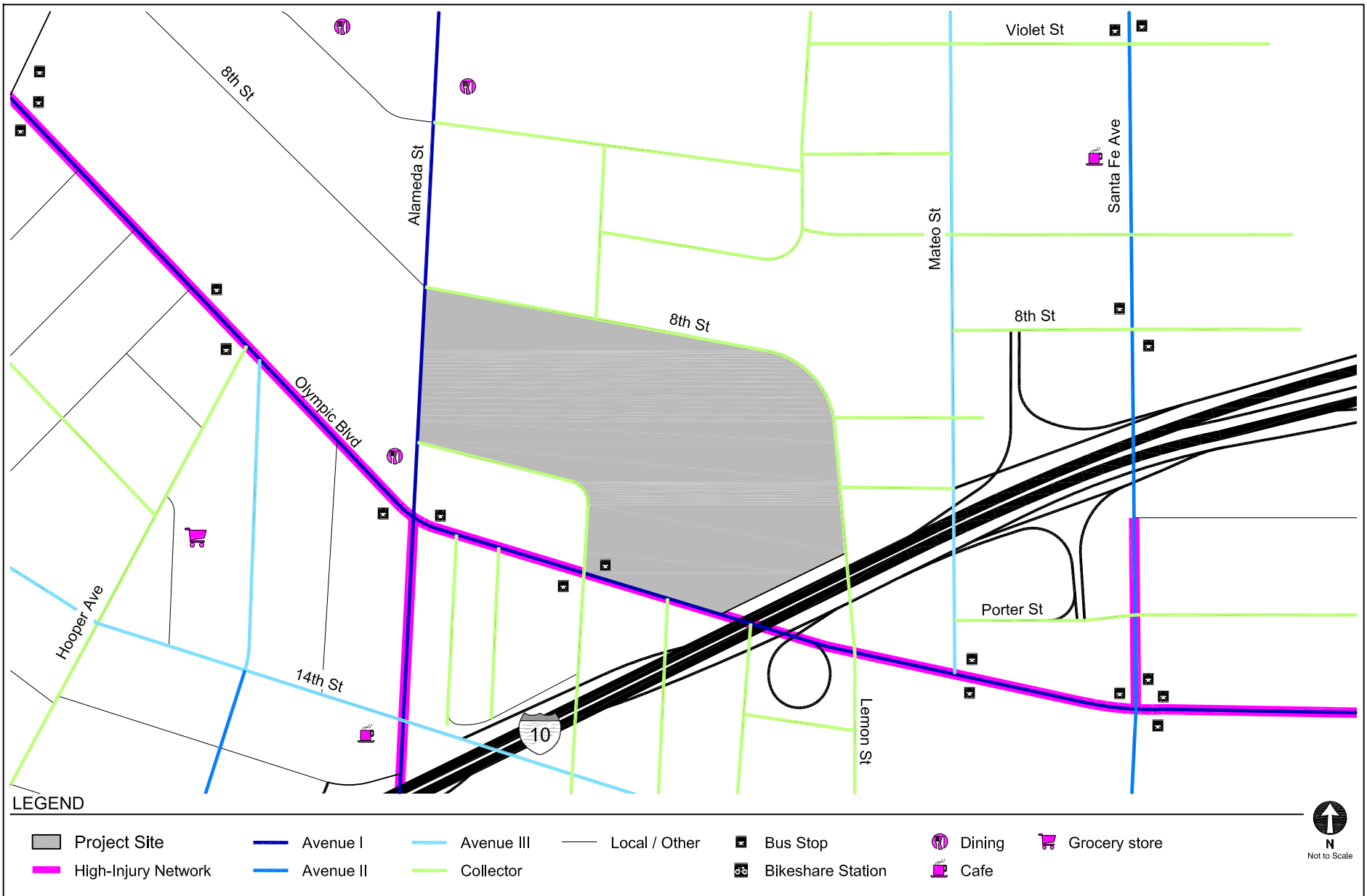

MOBILITY PLAN TRANSPORTATION DESIGNATIONS & PEDESTRIAN DESTINATIONS

FIGURE 6

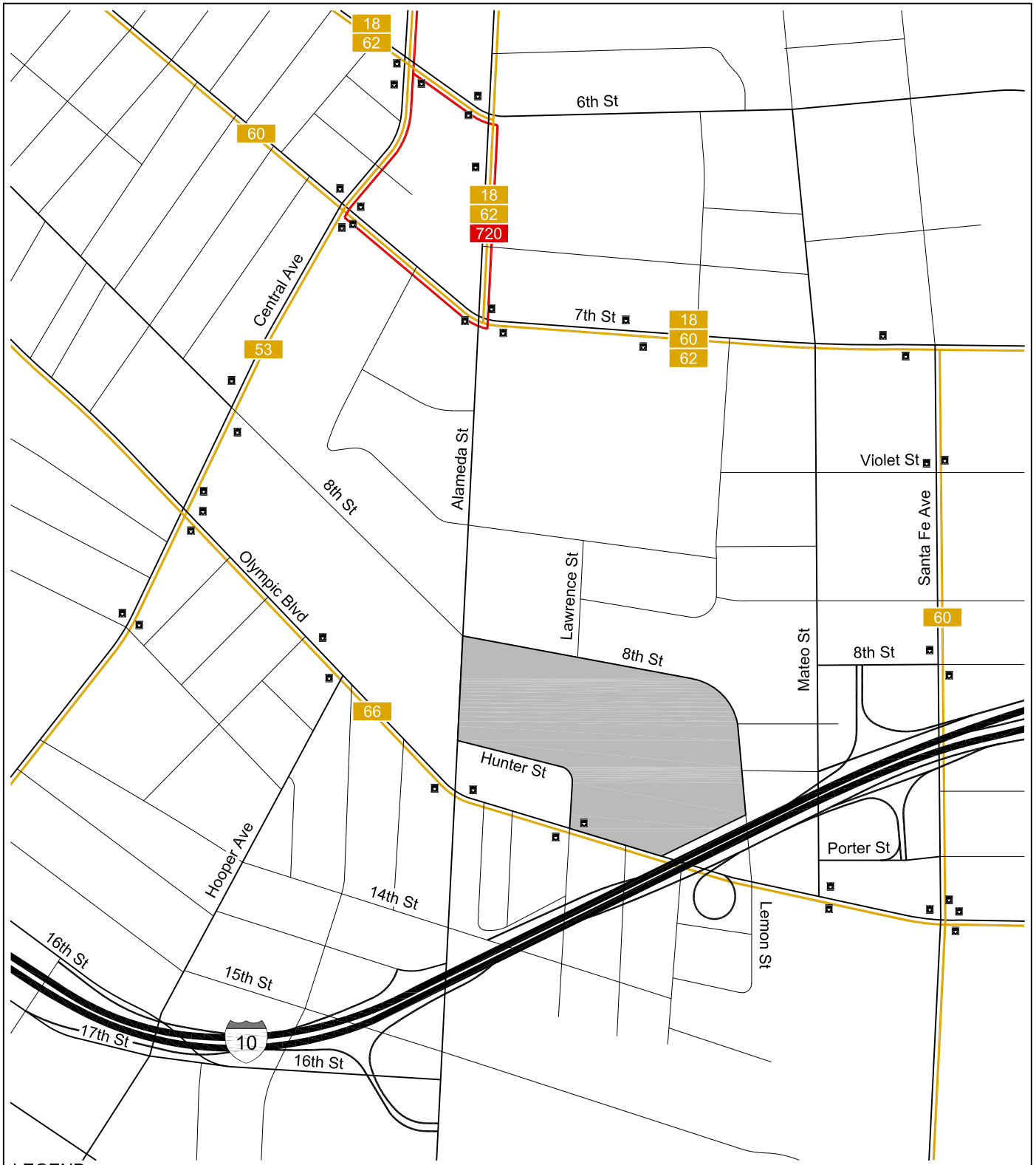

**LEGEND**

- Project Site
- Bus Stop
- Metro Local / Limited
- Metro Rapid



**EXISTING TRANSIT SERVICE**

**FIGURE 7**

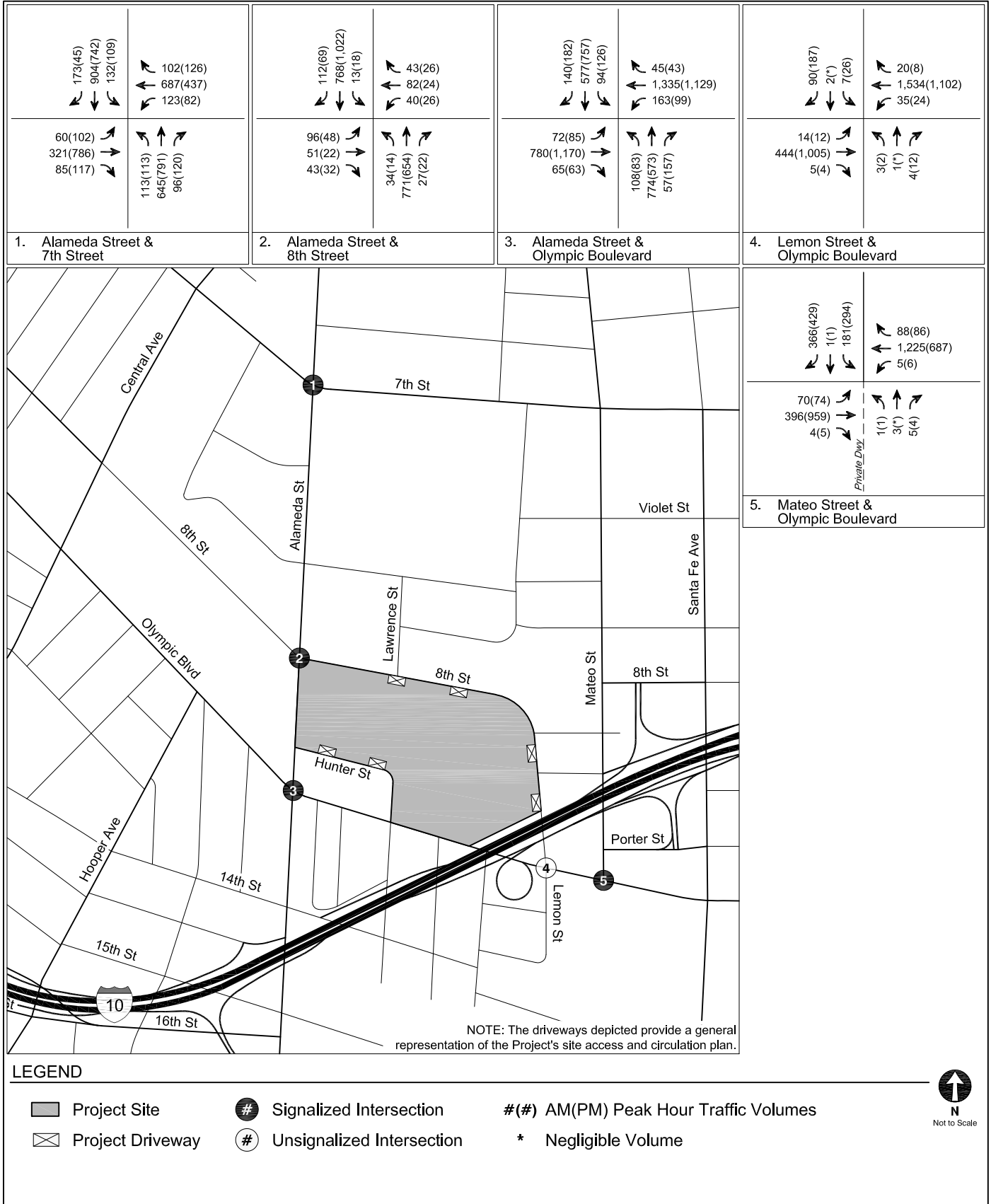

**LEGEND**

- Project Site
- Signalized Intersection
- Unsignalized Intersection
- Project Driveway
- #(#)** AM(PM) Peak Hour Traffic Volumes
- \*** Negligible Volume



**EXISTING CONDITIONS (YEAR 2021)  
PEAK HOUR TRAFFIC VOLUMES**

**FIGURE  
8**



LOCATIONS OF RELATED PROJECTS

FIGURE  
9

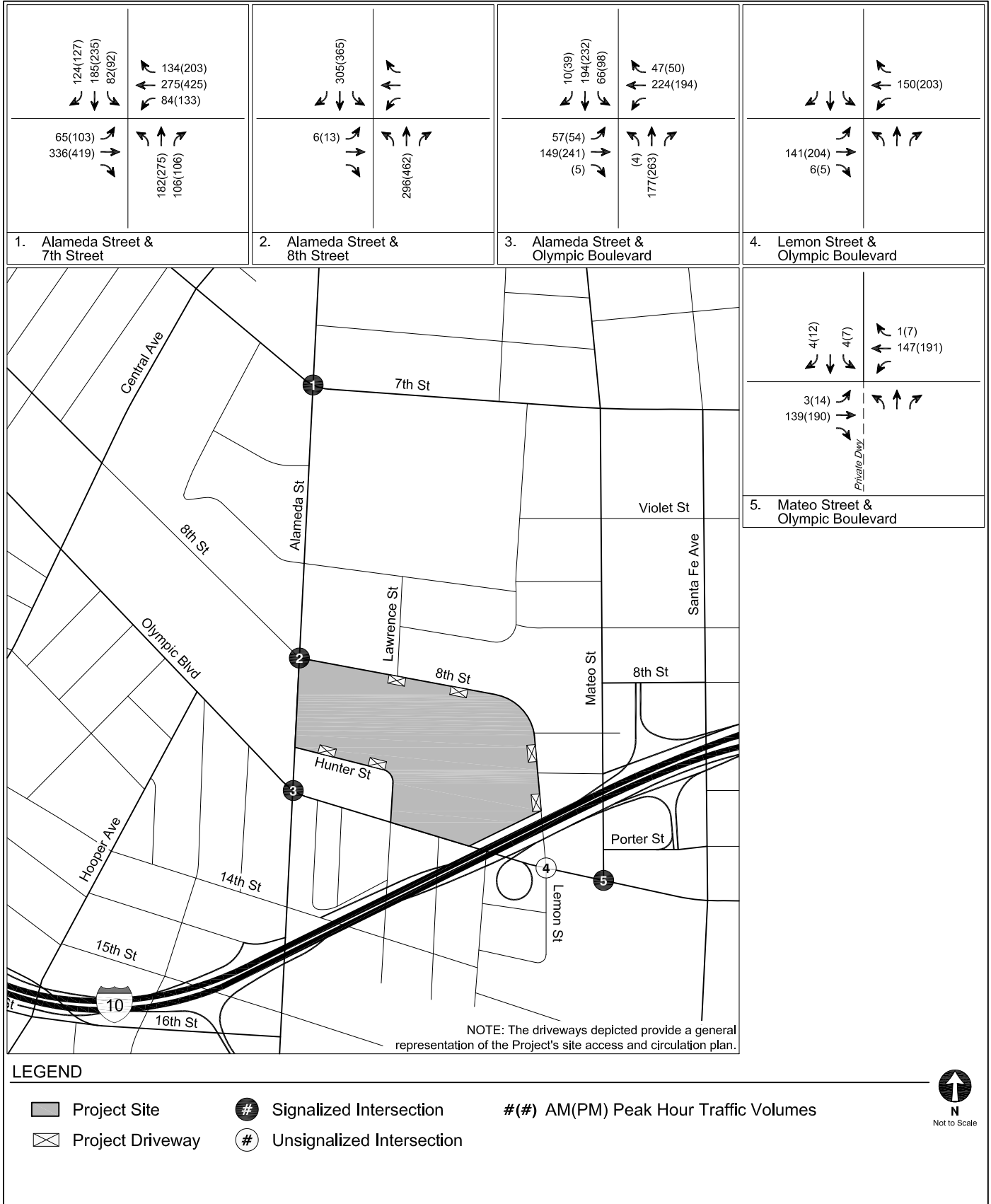

RELATED PROJECT-ONLY  
PEAK HOUR TRAFFIC VOLUMES

FIGURE  
10



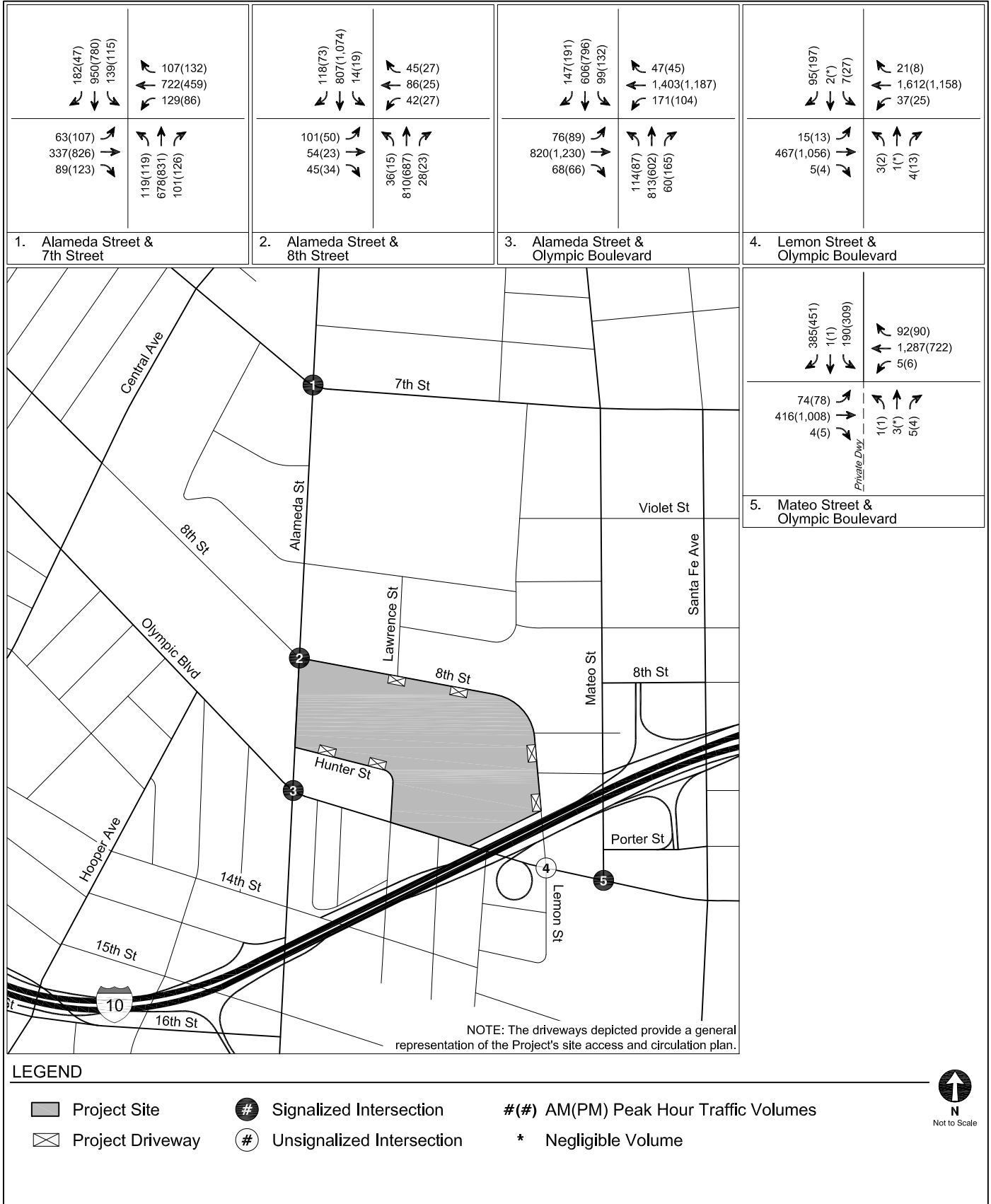

**FUTURE WITHOUT PROJECT CONDITIONS (YEAR 2026)  
PEAK HOUR TRAFFIC VOLUMES**

**FIGURE  
11**

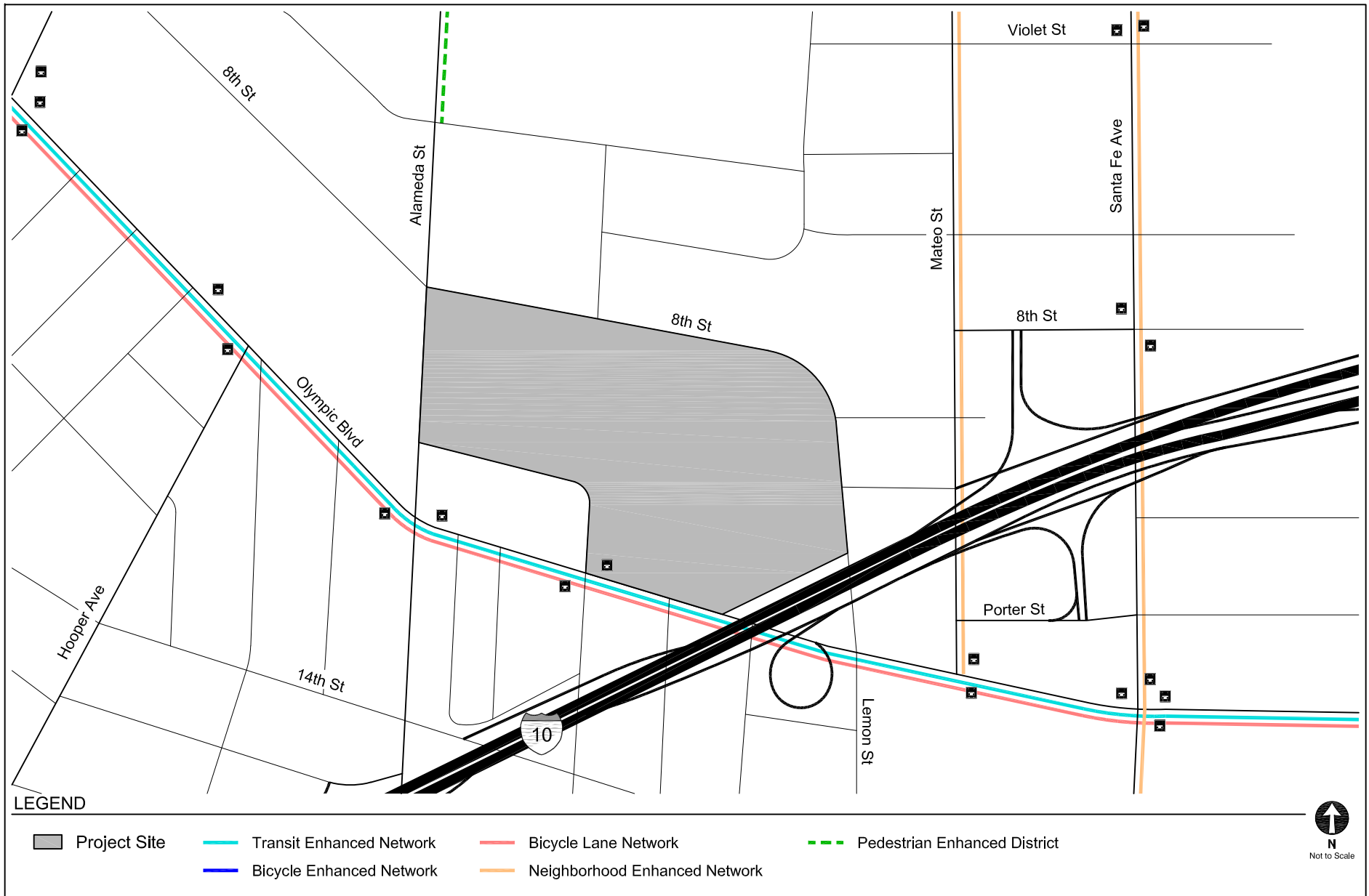

ROADWAY MODAL PRIORITIES

FIGURE 12

**TABLE 1  
STUDY INTERSECTIONS**

<b>No.</b>	<b>N/S Steet</b>	<b>E/W Street</b>
1.	Alameda Street	7th Street
2.	Alameda Street	8th Street
3.	Alameda Street	Olympic Boulevard
4. [a]	Lemon Street	Olympic Boulevard
5.	Mateo Street	Olympic Boulevard

Notes:

[a] Intersection is unsignalized.

**TABLE 2  
EXISTING TRANSIT SERVICE**

Provider, Route, and Service Area	Service Type	Hours of Operation	Average Headway (minutes)			
			AM Peak Period		PM Peak Period	
			NB/EB	SB/WB	NB/EB	SB/WB
<b>Metro</b>			<b>NB/EB</b>	<b>SB/WB</b>	<b>NB/EB</b>	<b>SB/WB</b>
18 Wilshire Center - Downtown Los Angeles - Montebello via 6th St and Whittier Blvd	Local	24-Hour	7	6	6	6
53 Downtown Los Angeles - CSU Domingues Hills via Central Ave	Local	4:45 AM - 12:15 AM	15	15	15	15
60 Downtown Los Angeles - Artesia Station via Long Beach Blvd	Local	24-Hour	7	6	7	6
62 Downtown Los Angeles - Hawaiian Gardens via Telegraph Rd	Local	5:00 AM - 12:15 AM	48	30	24	60
66 Wilshire Center - Downtown Los Angeles - Montebello via 8th St and Olympic Blvd	Local	4:15 A.M. - 1:30 A.M.	8	10	10	8
720 Santa Monica - Downtown Los Angeles via Wilshire Blvd	Rapid	4:15 AM - 1:30 AM	20	7	10	16

Notes

Metro: Los Angeles County Metropolitan Transportation Authority  
 AM Peak from 6-10 AM  
 PM Peak from 3-7 PM

**TABLE 3A  
TRANSIT SYSTEM CAPACITY IN STUDY AREA - MORNING PEAK HOUR**

Provider, Route, and Service Area	Capacity per Trip [a]	Peak Hour Ridership [b]				Average Remaining Capacity per Trip		Remaining Peak Hour Capacity		
		Peak Load		Average Load		NB/EB	SB/WB	NB/EB	SB/WB	
		NB/EB	SB/WB	NB/EB	SB/WB					
<b>Metro Bus Service</b>										
60	Downtown Los Angeles - Artesia Station via Long Beach Blvd	50	25	29	16	18	34	32	281	344
66	Wilshire Center - Downtown Los Angeles - Montebello via 8th St and Olympic Blvd	50	32	44	18	26	32	24	248	138
<b>Total Remaining Transit System Capacity</b>									<b>1,011</b>	

Notes

Metro: Los Angeles County Metropolitan Transportation Authority.

[a] Capacity assumptions:

Metro Regular Bus - 40 seated / 50 seated and standing.

Metro Articulated Bus - 66 seated / 75 seated and standing.

[b] Based on ridership data provided by Metro in 2019.

**TABLE 3B  
TRANSIT SYSTEM CAPACITY IN STUDY AREA - AFTERNOON PEAK HOUR**

Provider, Route, and Service Area	Capacity per Trip [a]	Peak Hour Ridership [b]				Average Remaining Capacity per Trip		Remaining Peak Hour Capacity		
		Peak Load		Average Load		NB/EB	SB/WB	NB/EB	SB/WB	
		NB/EB	SB/WB	NB/EB	SB/WB					
<b>Metro Bus Service</b>										
60	Downtown Los Angeles - Artesia Station via Long Beach Blvd	50	28	29	18	18	32	32	280	312
66	Wilshire Center - Downtown Los Angeles - Montebello via 8th St and Olympic Blvd	50	44	31	28	21	22	29	132	225
<b>Total Remaining Transit System Capacity</b>								<b>949</b>		

Notes

Metro: Los Angeles County Metropolitan Transportation Authority.

[a] Capacity assumptions:

Metro Regular Bus - 40 seated / 50 seated and standing.

Metro Articulated Bus - 66 seated / 75 seated and standing.

[b] Based on ridership data provided by Metro in 2019.

**TABLE 4  
RELATED PROJECTS LIST**

No.	Project	Address	Distance from Project Site	Description	Trip Generation [a]						
					Daily	Morning Peak Hour			Afternoon Peak Hour		
						In	Out	Total	In	Out	Total
1.	Office & Commercial	2159 E Bay St	0.6 miles	202,954 sf creative office, 3,235 sf meeting room space, 10,860 sf quality restaurant, and 10,860 sf high-turnover restaurant	4,417	193	27	220	115	245	360
2.	Rendon Hotel	2053 E 7th St	0.6 miles	103-room hotel	732	24	17	41	27	26	53
3.	676 Mateo St MU Project	676 S Mateo St	0.6 miles	159 apartment units, 26,093 sf office, 15,005 sf restaurant, and 8,375 sf retail	1,991	64	81	145	100	68	168
4.	Mixed-Use	2143 E Violet St	0.6 miles	347 apartment units, 21,858 sf restaurant, and 187,374 sf office	4,651	206	129	335	182	208	390
5.	ROW DTLA Mixed-Use	777 S Alameda St	0.4 miles	850,400 sf office, 117,700 sf restaurant, 66,200 sf retail, and 125 hotel rooms	916	(134)	(172)	(306)	(157)	35	(122)
6.	Mixed-Use	930 E 6th St	0.7 miles	236 apartment units and 12,000 sf retail	1,074	17	79	96	70	32	102
7.	6AM (6th & Alameda MU)	1206 E 6th St	0.6 miles	1,736 apartment units, 316,632 sf warehouse, 253,514 sf office, 45,278 sf restaurant, 82,332 sf retail, 22,429 sf art museum, 514 hotel rooms, 300-student school	14,258	437	585	1,022	710	642	1,352
8.	Municipal Solid Waste Facility	2001 E Washington Bl	0.6 miles	187,000 sf municipal solid waste material recovery facility	3,578	(27)	18	(9)	8	(18)	(10)
9.	Mixed-Use	640 S Sante Fe Ave	0.7 miles	91,185 sf office, 9,430 sf retail, and 6,550 sf restaurant	1,330	90	8	98	43	114	157
10.	Mixed-Use	641 S Imperial St	0.7 miles	140 live-work units and 14,750 sf commercial	1,245	44	61	105	66	60	126
11.	Restaurant	1722 E 16th St	0.5 miles	8,151 sf restaurant	592	(4)	2	(2)	36	11	47
12.	Mixed-Use (Revised)	1800 E 7th St	0.4 miles	122 apartment units, 3,245 sf retail, 4,605 sf restaurant, and 2,700 sf office	992	25	52	77	54	34	87
13.	2110 Bay Street	2110 Bay St	0.5 miles	110 live-work units, 113,350 sf office, and 43,657 sf retail	2,394	180	63	243	89	192	281
14.	Mixed-Use	668 S Alameda St	0.5 miles	475 live-work units, 33,100 sf office, 17,500 sf retail, 16,300 sf restaurant, and 15,300 sf supermarket	4,002	107	182	289	216	145	361
15.	1024 Mateo St MU	1024 S Mateo St	0.4 miles	106 apartment units, 2,250 sf live-work office, 92,740 sf office, 13,979 sf retail, and 13,126 sf restaurant	1,862	102	64	166	73	101	174
16.	Mesquit Mixed-Use	670 S Mesquit St	0.7 miles	944,055 sf office, 308 apartment units, 236 hotel rooms, 79,240 sf retail, 89,576 restaurant, 62,148 sf gym, 93,617 sf studio/museum/gallery, and 56,912 sf grocery store	22,845	1,258	321	1,579	640	1,195	1,835
17.	Camden Arts Mixed-Use	1525 E Industrial St	0.5 miles	328 apartment units, 27,300 sf office, 6,400 sf retail, and 5,700 sf restaurant	2,288	58	73	131	86	69	155
18.	Mixed-Use	2130 E Violet St	0.6 miles	94,000 sf office, 3,500 sf retail, and 4,000 sf restaurant	1,351	137	30	167	39	122	162
19.	Mixed-Use	1000 S Sante Fe St	0.5 miles	14,193 sf market, 6,793 sf health club, and 10,065 sf restaurant	966	36	38	74	49	20	69
20.	Hillcrest MU	1745 E 7th St	0.5 miles	57 apartment units, and 6,000 sf retail	635	10	25	35	34	23	57

**Notes**

[a] Source: Related project (within a one-mile radius) information based on available information provided by LADOT (January 11, 2020), Department of City Planning, and recent studies in the area.

**TABLE 4 (cont.)  
RELATED PROJECTS**

No.	Project	Address	Distance from Project Site	Description	Trip Generation [a]						
					Daily	Morning Peak Hour			Afternoon Peak Hour		
						In	Out	Total	In	Out	Total
21.	Mixed-Use (Old Ford Factory)	2030 E 7th St	0.5 miles	243,583 sf office and 40,000 sf retail	2,306	274	34	308	69	269	318
22.	Mixed-Use	2051 E 7th St	0.6 miles	320 apartment units, 5,000 sf restaurant, and 15,000 sf retail	2,310	17	127	144	145	64	208
23.	Mixed-Use	826 S Mateo St	0.4 miles	90 live-work units, 11,000 sf retail, and 5,600 sf restaurant	1,267	11	34	45	62	39	101
24.	SPR-Industrial Park	1005 S Mateo St	0.4 miles	94,849 sf industrial park	426	40	9	49	10	39	49
25.	The City Market (Mixed-Use)	1057 S San Pedro St	0.9 miles	945 residential units, 210-room hotel, 294,641 sf office, 224,862 sf retail, and 744-seat cinema	16,433	837	434	1,271	632	957	1,589
26.	Office	540 S Sante Fe Ave	0.9 miles	89,825 sf office	726	90	12	102	17	81	98
27.	310 Residential Apts + 26.7k Commercial	1147 E Palmetto St	0.8 miles	310 residential apartment units and 26,701 sf commercial	0	33	78	111	175	112	287
28.	Mixed-Use (Coca Cola)	963 E 4th St	1.0 mile	75,000 sf office, 25,000 sf retail, and 20,000 sf restaurant	2,512	106	22	128	113	138	251
29.	Retail (Palmetto & Mateo)	555 S Mateo St	0.8 miles	1,530,000 sf retail	4,300	5	30	35	220	205	425
30.	Mixed-Use	360 S Alameda St	1.0 mile	52 apartment units, 2,400 sf restaurant, and 6,900 sf creative office	648	42	33	57	33	28	61
31.	Arts District Center (Mixed-Use)	1129 E 5th St	0.9 miles	27,000 sf retail, 32,000 sf restaurant, 113-room hotel, 129 apartment units, 10,341 sf art gallery, and 3,430 design incubator	4,713	133	140	273	157	72	229
32.	Restaurant	500 S Mateo St	0.9 miles	12,682 sf high-turnover restaurant	1,052	48	41	89	50	31	81
33.	Mixed-Use	719 E 5th St	1.0 mile	160 apartment units and 7,500 sf retail	1,033	15	58	73	59	36	95
34.	520 Mateo St MU	520 S Mateo St	0.9 miles	600 apartment units, 120,000 sf office, 15,000 sf retail, and 15,000 sf restaurant	4,995	157	220	377	274	223	497
35.	4th & Hewitt MU	405 S Hewitt St	1.0 mile	311,682 sf office, and 81,49 sf retail	3,416	319	69	388	83	301	384
36.	Apartments	656 S Stanford Ave	0.8 miles	82 apartment units	1,463	8	34	42	33	18	51
37.	Weingart Projects (Affordable Housing)	554 S San Pedro St	1.0 mile	667 affordable housing units and 54,500 commercial on two sites	197	33	120	153	229	91	320
38.	San Pedro Tower (Affordable Housing)	600 S San Pedro St	1.0 mile	5 apartment units, 298 affordable housing units, and 19,909 sf commercial	636	38	25	63	30	37	67
39.	Sears MU Project	2650 E Olympic Bl	1.0 mile	1000 apartment units, 34,000 sf retail, 46,000 sf high-turnover restaurant, and 230,000 sf office	12,247	498	477	976	599	539	1,138
40.	Palmetto MU	527 S Colyton St	0.8 miles	275 apartment units, 35 affordable housing units, 11,375 sf retail, and 11,375 sf artist production	2,095	36	116	152	121	74	195

**Notes**

[a] Source: Related project (within a one-mile radius) information based on available information provided by LADOT (January 11, 2020), Department of City Planning, and recent studies in the area.



**TABLE 4 (cont.)  
RELATED PROJECTS**

No.	Project	Address	Distance from Project Site	Description	Trip Generation [a]						
					Daily	Morning Peak Hour			Afternoon Peak Hour		
						In	Out	Total	In	Out	Total
41.	Mixed-Use	609 E 5th St	1.0 mile	151 apartment units	1,004	15	62	77	61	33	94
42. [b]	Residential (Edward Hotel)	713 E 5th St	1.0 mile	50 affordable housing units and one apartment unit	208	15	10	25	9	8	17
43.	Office, Restaurant, Fast-Food	431 S Colyton St	0.9 miles	97,577 sf office, 10,739 sf restaurant, 1,977 sf fast-food restaurant	1,524	80	18	98	60	95	155
44.	1100 E 5th St MU Project	1100 E 5th St	0.9 miles	220 apartment units, 4,350 sf office, 17,810 sf general office, 19,609 sf restaurant, and 9,129 sf retail	2,556	78	107	185	130	80	210
45. [b]	Affordable Housing Development	508 E 4th St	1.0 mile	41 affordable housing units	167	8	12	20	8	6	14
46.	Clinic	649 S Wall St	1.0 mile	55 apartment units and 25,000 sf clinic	104	24	5	29	3	24	27
47.	400 S Alameda Hotel	400 S Alameda St	1.0 mile	66-room hotel, 2,130 sf restaurant, and 840 sf retail	512	20	18	38	23	14	37
48.	Greystar GP II	330 Alameda St	1.0 mile	186 apartment units and 22,000 sf commercial	1,662	36	76	112	91	65	156
49.	Mixed-Use	1000 S Mateo St	0.3 miles	113 apartment units and 134,000 sf commercial	2,238	153	83	236	90	131	221
50. [c]	Restaurant	605 E 4th St	1.0 mile	3,798 sf restaurant	426	21	17	38	23	14	37
51. [c]	Mixed-Use	1340 E 6th St	0.7 miles	193 live/work units and 255,088 sf commercial	11,469	190	177	367	550	554	1,104
52.	Mixed-Use	1200 S Santa Fe Ave	0.3 miles	53 apartment units and 13,000 sf retail	907	12	27	39	44	37	81
53.	Apartments	655 San Pedro St	0.9 miles	81 apartment units	539	8	33	41	33	17	50
54. [c]	Restaurant	634 S Mateo St	0.6 miles	499-seat restaurant	2,181	125	115	240	119	91	210
55. [c]	Affordable Housing Development	401 E 7th St	1.0 mile	99 affordable housing units	404	20	30	50	19	15	34

**Notes**

- [a] Source: Related project (within a one-mile radius) information based on available information provided by LADOT (January 11, 2020) , Department of City Planning, and recent studies in the area.
- [b] Although construction of the related project may be partially complete/entirely complete, the project was not fully occupied at the time of the NOP or when traffic counts were conducted. Therefore, the related project was considered and listed to provide a more conservative analysis.
- [c] Trip generation estimated using rates from Trip Generation, 10th Edition, Institute of Transportation Engineers, 2017.

---

## **Chapter 3**

### **Project Traffic**

This chapter describes the assumptions and methodology used in developing the traffic volumes associated with the Project within the Study Area.

#### **PROJECT TRIP GENERATION**

The number of trips expected to be generated by the Project was estimated using a combination of rates from published sources and empirical data. For the purposes of this assessment, the trip generation rates from *Trip Generation, 10<sup>th</sup> Edition* for general office uses were utilized to estimate the trip generation for the office components of the Project. These rates are based on surveys of similar land uses at sites around the country and are provided as both daily rates and morning and afternoon peak hour rates. They relate the number of vehicle trips traveling to and from the Project Site to the size of development of each land use. The rates for production support and sound stage uses were based on empirical trip generation studies at studios in Los Angeles.

In consultation with LADOT, trip generation reductions to account for public transit usage/walking arrivals were considered. The Project Site is located within 0.25 miles from Metro bus stops; therefore, a 5% transit/walk-in adjustment was applied to account for transit usage and walk-in arrivals from surrounding neighborhoods and adjacent commercial developments.

The number of trips currently generated by the existing uses of the Project Site was also estimated using the rates published in *Trip Generation, 10<sup>th</sup> Edition* for general light industrial uses. Based on a review of the current operations of the existing uses, no additional trip reductions to account for transit/walk-in trips were applied.

After accounting for the adjustments above and the removal of the existing uses, the Project is estimated to generate 316 net new morning peak hour trips (216 inbound, 100 outbound) and 402 net new afternoon peak hour trips (147 inbound, 255 outbound), as summarized in Table 5.

---

## **PROJECT TRIP DISTRIBUTION**

The geographic distribution of trips generated by the Project is dependent on the location of residential and commercial centers to and from which employees and visitors of the Project would be drawn, characteristics of the street system serving the Project Site, the location of the Project driveway(s), and existing traffic conditions.

Based on these considerations, traffic entering and exiting the Project Site was assigned to the surrounding street system. The intersection-level trip distribution pattern for Project traffic at the Study Area intersections is shown in Figure 13.

Generally, the regional pattern for the Project is as follows:

- 20% to/from the north
- 25% to/from the east
- 15% to/from the south
- 40% to/from the west

## **PROJECT TRIP ASSIGNMENT**

The Project trip generation estimates summarized in Table 5 and the trip distribution patterns shown in Figure 13 were used to assign the Project-generated traffic through the Study Area intersections. Figure 14A and 14B illustrate the existing trips uses to be removed from the Project Site and the total Project-only traffic volumes, respectively, at the Study Area intersections during typical weekday morning and afternoon peak hours.

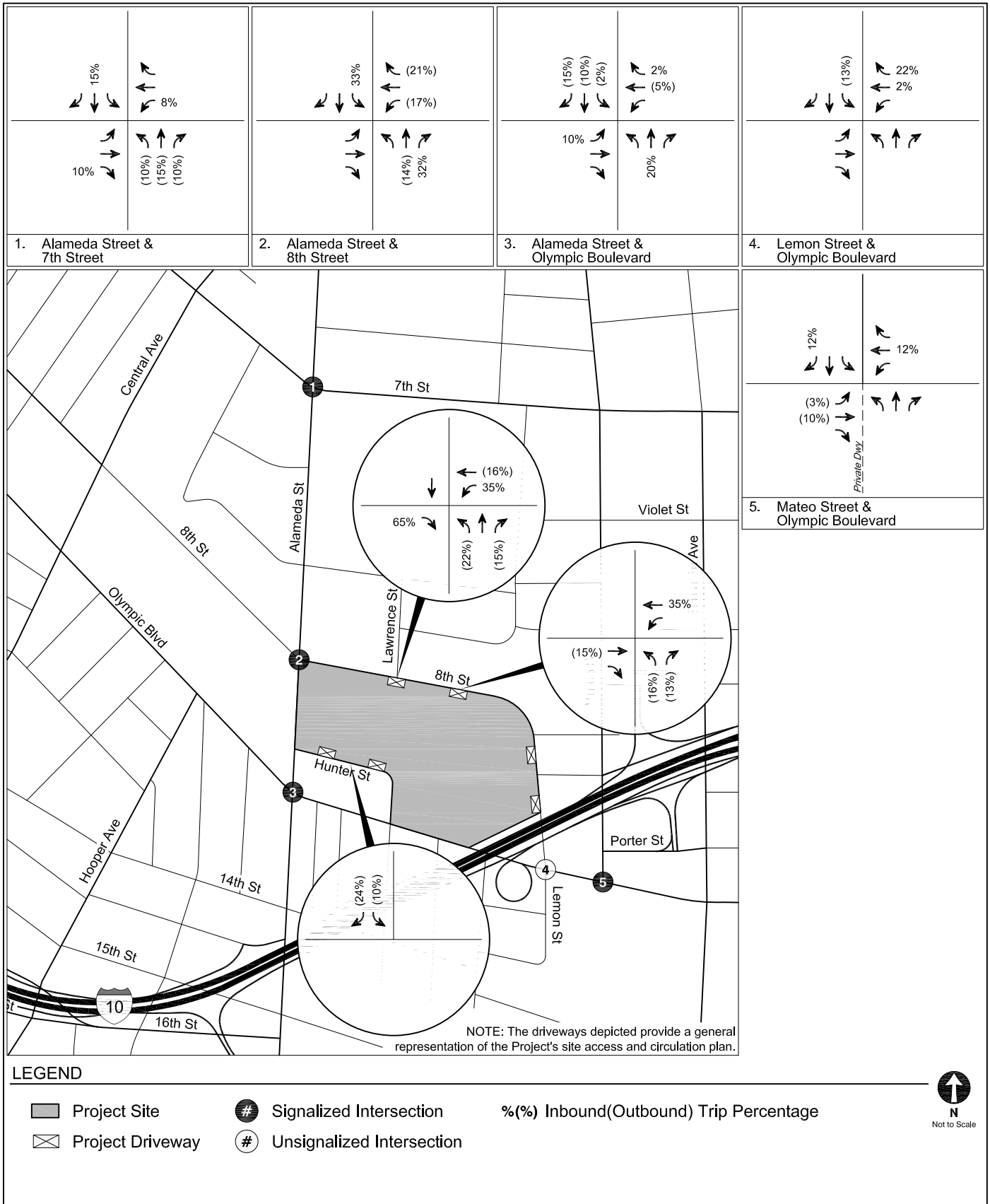

PROJECT TRIP DISTRIBUTION

FIGURE  
13

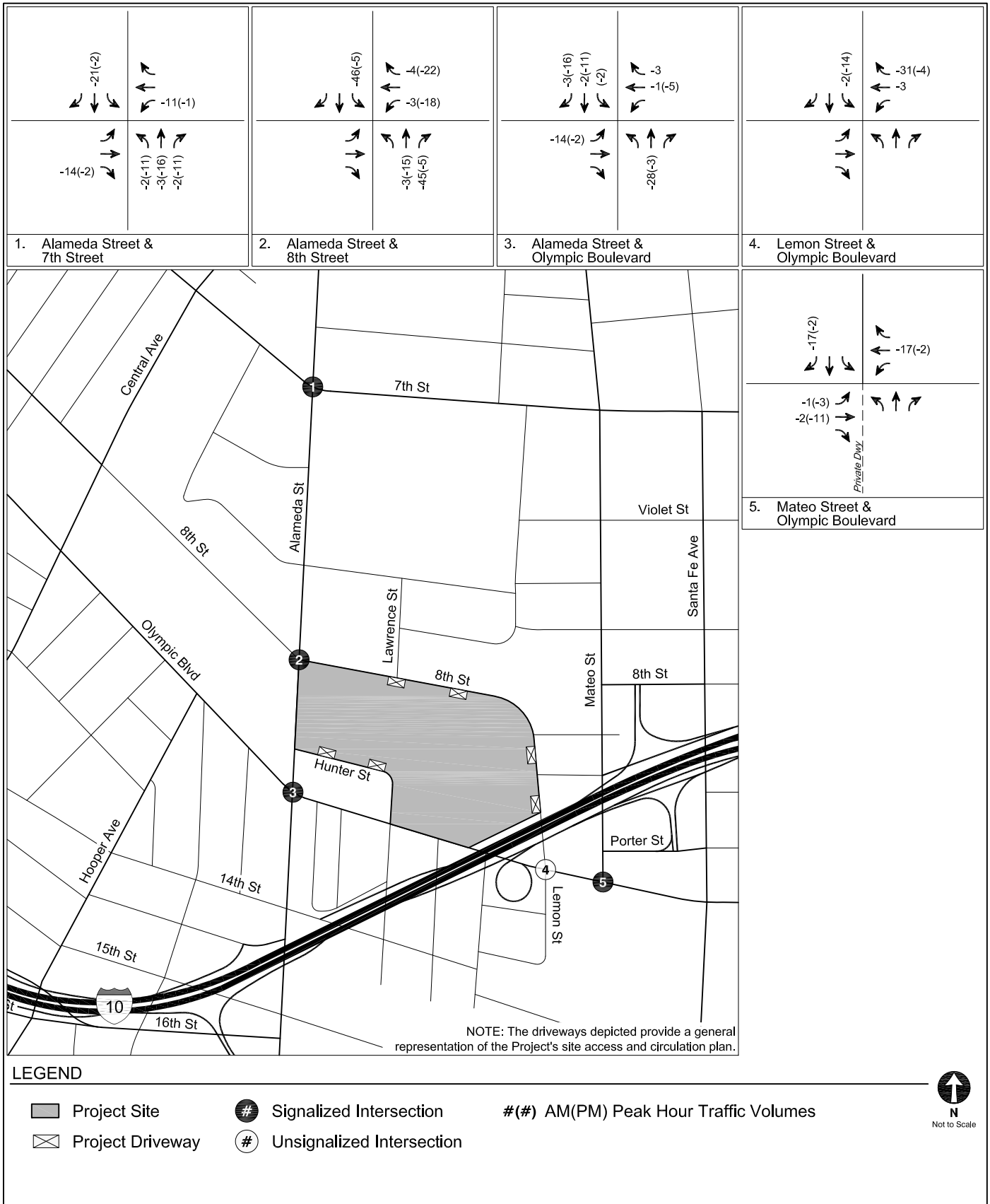

EXISTING USES TO BE REMOVED  
PEAK HOUR TRAFFIC VOLUMES

FIGURE  
14A

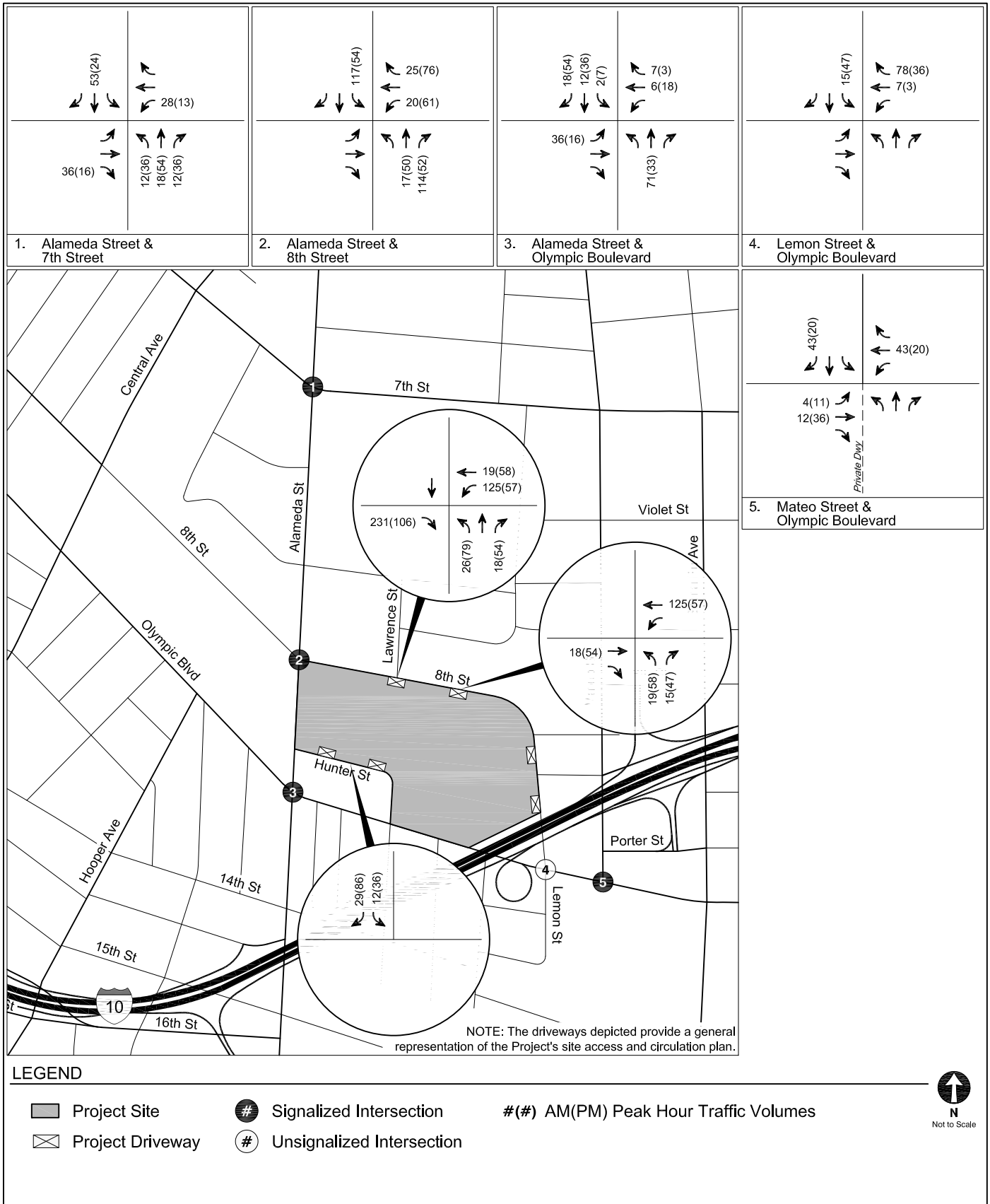

**PROPOSED PROJECT-ONLY  
PEAK HOUR TRAFFIC VOLUMES**

**FIGURE  
14B**

**TABLE 5  
PROJECT TRIP GENERATION**

TRIP GENERATION RATES [a]								
Land Use	ITE Land Use	Rate	Morning Peak Hour			Afternoon Peak Hour		
			In	Out	Total	In	Out	Total
Sound Stage	[b]	per ksf	63%	37%	0.20	40%	60%	0.43
Production Support	[b]	per ksf	65%	35%	0.61	45%	55%	0.57
General Light Industrial	110	per ksf	88%	12%	[c]	13%	87%	[c]
General Office	710	per ksf	86%	14%	1.16	16%	84%	1.15

TRIP GENERATION ESTIMATES								
Land Use	ITE Land Use	Size	Morning Peak Hour			Afternoon Peak Hour		
			In	Out	Total	In	Out	Total
<b><u>New Studio Construction</u> [d]</b>								
Sound Stage	[b]	116.40 ksf	14	9	23	20	30	50
Production Support	[b]	34.00 ksf	14	7	21	9	10	19
Mill/Shop	[b]	20.70 ksf	8	5	13	5	7	12
Mill/Shop Office	710	20.70 ksf	21	3	24	4	20	24
Transit/Walk-In Reduction [e]	5%		(1)	0	(1)	0	(1)	(1)
Executive Office	710	57.80 ksf	58	9	67	11	55	66
Transit/Walk-In Reduction [e]	5%		(3)	0	(3)	(1)	(3)	(4)
<b><u>Existing Building Renovation</u> [f]</b>								
Sound Stage	[b]	156.10 ksf	20	11	31	27	40	67
Production Support	[b]	251.55 ksf	99	54	153	64	79	143
Administrative Office	710	133.80 ksf	133	22	155	25	129	154
Transit/Walk-In Reduction [e]	5%		(7)	(1)	(8)	(1)	(6)	(7)
<b>TOTAL - PROPOSED PROJECT TRIPS</b>			<b>356</b>	<b>119</b>	<b>475</b>	<b>163</b>	<b>360</b>	<b>523</b>
<b><u>Existing Uses to Removed</u> [g]</b>								
General Light Industrial	110	558.9 ksf	140	19	159	16	105	121
<b>TOTAL - NET NEW PROJECT TRIPS</b>			<b>216</b>	<b>100</b>	<b>316</b>	<b>147</b>	<b>255</b>	<b>402</b>

**Notes:**

ksf = 1,000 square feet.

[a] Source: *Trip Generation, 10th Edition*, Institute of Transportation Engineers, 2017, unless as noted.

[b] Rate based on empirical rate from *Transportation Study for the NBC Universal Evolution Plan Environmental Impact Report*, Gibson Transportation Consulting, Inc. and Raju Associates, Inc., March 2010.

[c] The trip generation estimates for the existing uses were calculated based on the following best-fit curve equations for general light industrial uses (ITE Land Use Code 110):

$$\begin{aligned} \text{Daily: } T &= 3.79(X) + 57.96 \\ \text{AM: } \ln(T) &= 0.74 \ln(X) + 0.39 \\ \text{PM: } \ln(T) &= 0.69 \ln(X) + 0.43 \end{aligned}$$

[d] The total 249,790 sf of New Studio Construction includes a new 190 sf guard house, which was assumed to be an ancillary use of the Project and was not considered for trip generation purposes.

[e] The Project Site is located within walking distance of a Metro bus stop, therefore a 5% transit reduction is applied to account for transit usage and walking visitor arrivals from the adjacent commercial developments.

[f] The total 639,840 sf Existing Building Renovation includes amenities and supporting uses for the Project (i.e., 24,000 sf commissary and dining area, 57,400 sf mechanical rooms, 16,950 sf gym/spa/salon/restrooms). These uses were assumed to be ancillary to the studio, production, and office uses, and therefore, were not considered for trip generation purposes.

[g] The 558,900 sf existing light industrial use does not account for the existing 23,005 sf vehicular maintenance building, nor the demolition of the 150 sf guard house, 3,840 sf fuel station, and 1,476 sf drum storage. These uses were considered ancillary to the existing light industrial uses on-site. Therefore, no existing use trip reductions were applied for these uses.

---

## Chapter 4

### **CEQA Analysis of Transportation Impacts**

This chapter presents the results of an analysis of CEQA-related transportation impacts. The analysis identifies any potential conflicts the Project may have with adopted City plans and policies and the proposed improvements to address potential conflicts, as well as the results of a Project VMT analysis that satisfies State requirements under *State of California Senate Bill 743* (Steinberg, 2013) (SB 743).

#### **METHODOLOGY**

SB 743, made effective in January 2014, required the Governor's Office of Planning and Research (OPR) to change the CEQA guidelines regarding the analysis of transportation impacts. Under SB 743, the focus of transportation analyses shifted from driver delay (level of service [LOS]) to VMT, in order to reduce greenhouse gas emissions (GHG), create multimodal networks, and promote mixed-use developments. The TAG defines the methodology to be used for analyzing a project's transportation impacts in accordance with SB 743.

Per the TAG, the CEQA transportation analysis used the following thresholds for identifying significant impacts:

- Threshold T-1: Conflicting with Plans, Programs, Ordinances, or Policies
- Threshold T-2.1: Causing Substantial Vehicle Miles Traveled (VMT)
- Threshold T-2.2: Substantially Inducing Additional Automobile Travel
- Threshold T-3: Substantially Increasing Hazards Due to a Geometric Design Feature or Incompatible Use

The thresholds were reviewed and analyzed, as detailed in the following Sections 4A-4D.



---

Recently, LADOT issued *Interim Guidance for Freeway Safety Analysis* (LADOT, May 1, 2020) (Freeway Guidance) identifying City requirements for a CEQA safety analysis for the California Department of Transportation (Caltrans) freeway off-ramp facilities as part of a transportation assessment. This analysis includes identification of potential safety impacts at freeway off-ramps due to increased traffic from development projects. The freeway off-ramp safety analysis is provided in Section 4E.

---

## Section 4A: Threshold T-1

### Conflicting with Plans, Programs, Ordinances, or Policies Analysis

Threshold T-1 considers whether a project would conflict with a program, plan, ordinance, or policy addressing the circulation system, including transit, roadways, bicycle, and pedestrian facilities.

A project is considered to be consistent with a policy if it would generally be in conformance and would not obstruct the implementation of that policy or preclude future improvements. If a conflict is identified, mitigation measures would focus on improving access, comfort, and safety for all mobility types, especially pedestrians, bicyclists, and transit riders.

#### PLANS, PROGRAMS, ORDINANCES, AND POLICIES

Table 2.1-1 of the TAG identifies the City plans, policies, programs, ordinances, and standards relevant in determining project consistency. Attachment D of the TAG, *Plans, Policies, and Programs Consistency Worksheet*, provides a structured approach to evaluate whether a project conflicts with the City's plans, programs, ordinances, or policies and streamlines the review by highlighting the most relevant plans, policies, and programs for assessing potential impacts to the City's transportation system. The Plans, Policies, and Programs Consistency Worksheet was completed for the Project and is provided in Appendix C.

As stated in Section 2.1.4 of the TAG, a project that generally conforms with and does not obstruct the City's development policies and standards is considered to be consistent. As summarized below, the Project is consistent with the City documents listed in Table 2.1-1 of the TAG; therefore, the Project would not result in a significant impact under Threshold T-1. Detailed discussion of the Project's consistency with the applicable plans, programs, ordinances, or policies is provided below.

---

## **Mobility Plan**

The Mobility Plan combines “complete street” principles with the following five goals that define the City’s mobility priorities:

- **Safety First**: Design and operate streets in a way that enables safe access for all users, regardless of age, ability, or transportation mode of choice.
- **World Class Infrastructure**: A well-maintained and connected network of streets, paths, bikeways, trails, and more provides Angelenos with the optimum variety of mode choices.
- **Access for All Angelenos**: A fair and equitable system must be accessible to all and must pay particularly close attention to the most vulnerable users.
- **Collaboration, Communication, and Informed Choices**: The impact of new technologies on our day-to-day mobility demands will continue to become increasingly important to the future. The amount of information made available by new technologies must be managed responsibly in the future.
- **Clean Environments and Healthy Communities**: Active transportation modes such as bicycling and walking can significantly improve personal fitness and create new opportunities for social interaction, while lessening impacts on the environment.

A detailed analysis of the Project’s consistency with the Mobility Plan is provided in Table 6. As detailed in Chapter 2, the Mobility Plan identifies key corridors within the Study Area as components of various “mobility-enhanced networks.” Though no specific improvements have been identified adjacent to the Project Site or within the Study Area and, thus, there is no schedule for implementation, the mobility-enhanced networks represent a focus on improving a particular aspect of urban mobility, including transit, neighborhood connectivity, bicycles, pedestrians, and vehicles. The Project would be designed with the mobility-enhanced networks as a top priority.

Alameda Street is a designated Avenue I and 8<sup>th</sup> Street, Lemon Street, Hunter Street, and Lawrence Street are designated as Collector Streets in the Mobility Plan. The Project would provide adequate dedication and improvements to meet the Mobility Plan standards where required and seek Waivers of Dedication and Improvement where Mobility Plan standards cannot be satisfied.

The full access driveway on 8<sup>th</sup> Street and the truck outbound-only driveway on Lemon Street would utilize existing curb cuts. The outbound-only driveways on 8<sup>th</sup> Street and Hunter Street and the truck inbound-only driveway would require the installation of new curb cuts. The driveways

---

would be improved and designed in accordance with the standards set forth in *Manual of Policies and Procedures* (LADOT, December 2008). Appropriate access and safety measures would be placed to limit potential queue spillover into the public ROW that could interrupt pedestrian, bicycle, and vehicular flow. In addition, the driveways anticipated to provide truck access would be designed to adequately accommodate truck turning maneuvers without encroachment into the public ROW.

Separate pedestrian and bicycle access to the Project Site would be provided via entrances along 8<sup>th</sup> Street. In addition, the Project would also be designed in compliance with ADA standards to provide accessibility for all patrons of the Project.

As further detailed in Section 5E, the Project would provide off-street parking to satisfy the LAMC requirements. Secured bicycle parking facilities, as well as showers and amenities, within the Project Site would also be provided. These measures would promote active transportation modes such as biking and walking, thereby reducing the Project VMT per employee compared to the average for the area, as demonstrated in Section 4B. Further, the Project does not propose modifying, removing, or otherwise affecting existing bicycle infrastructure, and the Project driveways are not proposed along a street with an existing or proposed bicycle facility.

Thus, the Project would not conflict with the goals of the Mobility Plan.

### **Plan for a Healthy Los Angeles**

*Plan for a Healthy Los Angeles: A Health and Wellness Element of the General Plan* (LADCP, March 2015) (Plan for a Healthy Los Angeles) contains guidelines for the City to follow to enhance the City's position as a regional leader in health and equity, encourage healthy design and equitable access, and increase awareness of equity and environmental issues.

A detailed analysis of the Project's consistency with Plan for a Healthy Los Angeles is provided in Table 7. The Project prioritizes safety and access for all individuals utilizing the Project Site by complying with all ADA requirements and providing direct connections to pedestrian amenities with separate pedestrian and vehicle accesses and active street frontages. Further, the Project supports healthy lifestyles and encourages alternative modes of transport by locating jobs near

---

transit (Metro bus lines), providing bicycle amenities, and enhancing the pedestrian environment with shade trees and landscaping. The Project is also estimated to generate lower VMT per capita for employees than the areawide average, as demonstrated in Section 4B, which reduces GHG emissions.

Thus, the Project would be consistent with the goals of *Plan for a Healthy Los Angeles*.

### **Land Use Element of the General Plan**

The City General Plan's Land Use Element contains 35 Community Plans that establish specific goals and strategies for the various neighborhoods across Los Angeles. This Project falls within the boundaries of the *Central City Community Plan* (Community Plan).

A detailed analysis of the Project's consistency with the Community Plan is provided in Table 8. The Project would provide employment opportunities in an area characterized by industrial and warehouse uses that are located in close proximity to various transit options, including Metro bus lines. The Project's proximity to transit provides alternative modes of transportation for employees and visitors to travel to and from the Project Site and maximizes the development opportunities of the transit system. Thus, the Project promotes and encourages development consistent with the goals and objectives of the Community Plan.

### **LAMC Section 12.21.A.16 (Bicycle Parking)**

LAMC Section 12.21.A.16 details the bicycle parking requirements for new developments. As further detailed in Section 5E, the Project would provide short-term and long-term spaces to satisfy the LAMC requirements for on-site bicycle parking supply.

### **LAMC Section 12.26J (TDM Ordinance)**

LAMC Section 12.26J, the TDM Ordinance (1993) establishes TDM requirements for non-residential projects, in addition to non-residential components of the mixed-use projects, in excess

---

of 25,000 sf. The Project would incorporate TDM measures to encourage use of alternative transportation modes by providing on-site bicycle parking facilities and amenities, providing connection to off-site pedestrian facilities, and concentrating development in proximity to transit opportunities, consistent with the requirements set forth in the TDM Ordinance. In addition, the Project would implement parking management measures such as parking gate control technology to facilitate ingress and egress at the driveways to limit queue spillover and minimize traffic and parking-related impacts on the surrounding street system to the extent feasible.

### **Vision Zero Corridor Plans**

Vision Zero implements projects that are designed to increase safety on the most vulnerable City streets. The City has identified a number of streets as part of the HIN where City projects will be targeted. As previously detailed, the Project Site is located along Olympic Boulevard, which is identified as part of the HIN, but the Project does not propose vehicle access to Olympic Boulevard. The Project driveways and improvements to the pedestrian environment would not preclude or interfere with any Vision Zero safety improvements along Olympic Boulevard by the City. Thus, the Project would not conflict with Vision Zero.

### **Streetscape Plans**

There are no streetscape plans adjacent to the Project Site and, therefore, streetscape plans do not apply to the Project.

### **Citywide Design Guidelines**

The Pedestrian-First Design approach of the *Citywide Design Guidelines* (LADCP Urban Design Studio, October 2019) identifies design strategies that “create human-scale spaces in response to how people actually engage with their surroundings, by prioritizing active street frontages, clear paths of pedestrian travel, legible wayfinding, and enhanced connectivity. Pedestrian-First Design promotes healthy living, increases economic activity at the street level, enables social interaction, creates equitable and accessible public spaces, and improves public safety.”

---

The Pedestrian-First Design guidelines are as follows:

- *Guideline 1: Promote a safe, comfortable, and accessible pedestrian experience for all.*
- *Guideline 2: Carefully incorporate vehicular access such that it does not degrade the pedestrian experience.*
- *Guideline 3: Design projects to actively engage with streets and public space and maintain human scale.*

A detailed analysis of the Project's consistency with the guidelines of the Pedestrian-First Design approach is provided in Table 9.

The Project design includes accessible sidewalks, pedestrian amenities, and well-designed vehicular access driveways in accordance with the City's design guidelines. The Project would provide street trees uniformly within the sidewalk to provide overhead shade, as well as a more comfortable environment for pedestrians. Further, the Project would provide separate pedestrian entrances to ensure safe pedestrian access separate from vehicular activity. Thus, the Project would be consistent with the Pedestrian-First Design goal of *Citywide Design Guidelines*.

## **CUMULATIVE ANALYSIS**

In addition to potential Project-specific impacts, the TAG requires that the Project be reviewed in combination with nearby Related Projects to determine if the potential exists for a cumulatively significant impact resulting from inconsistency with a particular program, plan, policy, or ordinance. In accordance with the TAG, the cumulative analysis must include consideration of any Related Projects within 0.50 miles of the Project Site and any transportation system improvements in the vicinity. Table 4 identifies Related Projects within a 0.50-mile radius of the Project Site. Each of the Related Projects considered in this cumulative analysis of consistency with programs, plans, policies, and ordinances would be separately reviewed, including a check for their consistency with applicable policies, prior to approval by the City. Therefore, the Project, together with the Related Projects identified in Table 4, would neither create inconsistencies nor result in cumulative impacts with respect to the identified programs, plans, policies, and ordinances.

**TABLE 6  
PROJECT CONSISTENCY WITH MOBILITY PLAN 2035**

Objective, Policy, Program, or Plan [a]	Analysis of Project Consistency
<b>Chapter 1 - Safety First</b>	
<p><b><u>Policy 1.1 Roadway User Vulnerability</u></b> Design, plan, and operate streets to prioritize the safety of the most vulnerable roadway user.</p>	<p><b>Consistent.</b> Alameda Street is a designated Avenue I and 8th Street, Lemon Street, Hunter Street, and Lawrence Street are designated as Collector Streets in the Mobility Plan. The full access driveway on 8th Street and the truck outbound-only driveway on Lemon Street would utilize existing curb cuts. The outbound-only driveways on 8th Street and Hunter Street and the truck inbound-only driveway would require the installation of new curb cuts. Separate pedestrian and bicycle access to the Project Site would be provided via entrances along 8th Street. The driveways would be designed according to City standards and the Project would be designed in compliance with ADA standards. Off-street parking and bicycle parking would be provided per City code requirements as well.</p>
<p><b><u>Policy 1.6 Multi-Modal Detour Facilities</u></b> Design detour facilities to provide safe passage for all modes of travel.</p>	<p><b>Consistent.</b> Construction activities would be maintained on-site. Any impediments to the public right-of-way would be addressed with implementation of a Construction Management Plan.</p>
<b>Chapter 2 - World Class Infrastructure</b>	
<p><b><u>Policy 2.3 Pedestrian Infrastructure</u></b> Recognize walking as a component of every trip, and ensure high-quality pedestrian access in all site planning and public right-of-way modifications to provide a safe and comfortable walking environment.</p>	<p><b>Consistent.</b> Alameda Street north of Bay Street, 7th Street west of Mill Street, and Central Avenue within the Study Area are identified as part of the Mobility Plan's Pedestrian Enhanced District. The Project does not propose repurposing existing curb space and does not propose narrowing or shifting existing sidewalk placement or paving, narrowing, shifting, or removing an existing parkway. The Project is also proposing pedestrian improvements, such as landscaping, along the Project frontage on 8th Street, Alameda Street, and Hunter Street to meet the long-term mobility needs identified in the Mobility Plan.</p>
<p><b><u>Policy 2.4 Neighborhood Enhanced Network</u></b> Provide a slow speed network of locally serving streets.</p>	<p><b>Consistent.</b> No streets adjacent to the Project are identified as part of the Mobility Plan's Neighborhood Enhanced Network. The Project is proposing pedestrian improvements along the Project frontage to meet the long-term mobility needs identified in the Mobility Plan.</p>
<p><b><u>Policy 2.5 Transit Network</u></b> Improve the performance and reliability of existing and future bus service.</p>	<p><b>Consistent.</b> Olympic Boulevard adjacent to the Project Site is identified as part of the Mobility Plan's Transit Enhanced Network. The Project would encourage more transit usage by developing a studio/office project with convenient access to bus transit services.</p>
<p><b><u>Policy 2.6 Bicycle Networks</u></b> Provide safe, convenient, and comfortable local and regional bicycling facilities for people of all types and abilities. (Includes scooters, skateboards, rollerblades, etc.)</p>	<p><b>Consistent.</b> The Project does not propose modifying, removing, or otherwise affecting existing bicycle infrastructure, and the Project driveways are not proposed along a street with a bicycle facility. Bicycle parking would also be provided on-site in accordance with LAMC requirements.</p>

Notes:

[a] Objectives, Policies, Programs, or Plans based on information provided in *Mobility Plan 2035: An Element of the General Plan* (Los Angeles Department of City Planning, January 2016).



**TABLE 6 (CONT.)  
PROJECT CONSISTENCY WITH MOBILITY PLAN 2035**

Objective, Policy, Program, or Plan [a]	Analysis of Project Consistency
<p><b>Policy 2.10 Loading Areas</b> Facilitate the provision of adequate on and off-street loading areas.</p>	<p><b>Consistent.</b> All proposed delivery and ride share drop-off/loading zones would be provided on-site. The loading zones would be managed to facilitate safe loading operations and to limit vehicle queue spillovers into the travel lanes.</p>
<p><b>Chapter 3 - Access for All Angelenos</b></p>	
<p><b>Policy 3.1 Access for All</b> Recognize all modes of travel, including pedestrian, bicycle, transit, and vehicular modes – including goods movement – as integral components of the City’s transportation system.</p>	<p><b>Consistent.</b> The Project encourages multi-modal transportation alternatives and access for all travel modes to and from the Project Site. The Project provides separate pedestrian and bicycle entrances and bicycle infrastructure (short- and long-term bicycle parking) to encourage walking and bicycling. The Project encourages transit usage by developing a studio/office project located in proximity to transit.</p>
<p><b>Policy 3.2 People with Disabilities</b> Accommodate the needs of people with disabilities when modifying or installing infrastructure in the public right-of-way.</p>	<p><b>Consistent.</b> The Project’s vehicular and pedestrian entrances would be designed in accordance with LADOT standards and would comply with Americans with Disabilities Act (ADA) requirements. The Project design would also be in compliance with all ADA requirements and would provide direct connections to pedestrian amenities at adjacent intersections.</p>
<p><b>Policy 3.8 Bicycle Parking</b> Provide bicyclists with convenient, secure, and well-maintained bicycle parking facilities.</p>	<p><b>Consistent.</b> The Project provides infrastructure and services to encourage bicycling for employees and visitors to the Project Site.</p>
<p><b>Chapter 4 - Collaboration, Communication, &amp; Informed Choices</b></p>	
<p><b>Policy 4.5 Improved Communication</b> Facilitate communications between citizens and the City in reporting on and receiving responses to non-emergency street improvements.</p>	<p><b>Consistent.</b> As part of the Project’s Construction Management Plan, advance notification to the adjacent property owners and occupants of upcoming construction activities, including durations and daily hours of construction, would be provided.</p>
<p><b>Policy 4.8 Transportation Demand Management Strategies</b> Encourage greater utilization of Transportation Demand Management (TDM) strategies to reduce dependence on single-occupancy vehicles.</p>	<p><b>Consistent.</b> The Project incorporates several design features, which include TDM measures to reduce the number of single occupancy vehicle trips to the Project Site, including bike parking per LAMC requirements, including short-term and long-term parking facilities and bicycle amenities.</p>

Notes:

[a] Objectives, Policies, Programs, or Plans based on information provided in *Mobility Plan 2035: An Element of the General Plan* (Los Angeles Department of City Planning, January 2016).

**TABLE 6 (CONT.)  
PROJECT CONSISTENCY WITH MOBILITY PLAN 2035**

Objective, Policy, Program, or Plan [a]	Analysis of Project Consistency
<p><b><u>Policy 4.13 Parking and Land Use Management</u></b> Balance on-street and off-street parking supply with other transportation and land use objectives.</p>	<p><b>Consistent.</b> The Project would provide sufficient off-street parking to accommodate Project parking demand. No on-street parking would be provided adjacent to the Project.</p>
<p><b>Chapter 5 - Clean Environments &amp; Healthy Communities</b></p>	
<p><b><u>Policy 5.1 Sustainable Transportation</u></b> Encourage the development of a sustainable transportation system that promotes environmental and public health.</p>	<p><b>Consistent.</b> As part of the Project, secured bicycle parking facilities and pedestrian connections within the Project Site and connecting to off-site pedestrian facilities would be provided. This would promote active transportation modes such as biking and walking. Additionally, the Project is located adjacent to several Metro bus stops, providing employees and visitors to the Project with public transportation alternatives.</p>
<p><b><u>Policy 5.2 Vehicle Miles Traveled (VMT)</u></b> Support ways to reduce vehicle miles traveled (VMT) per capita.</p>	<p><b>Consistent.</b> The Project is estimated to generate lower VMT per employee for employees than the average for the area, as demonstrated in Section 4B. Additionally, the Project incorporates several TDM measures to reduce the number of single occupancy vehicle trips to the Project Site.</p>

Notes:

[a] Objectives, Policies, Programs, or Plans based on information provided in *Mobility Plan 2035: An Element of the General Plan* (Los Angeles Department of City Planning, January 2016).

**TABLE 7  
PROJECT CONSISTENCY WITH PLAN FOR A HEALTHY LOS ANGELES**

Objective, Policy, Program, or Plan [a]	Analysis of Project Consistency
<b>Chapter 1 - Los Angeles, a Leader in Health and Equity</b>	
<p><b><u>Policy 1.5 Plan for Health</u></b>            Improve Angelenos' health and well-being by incorporating a health perspective into land use, design, policy, and zoning decisions through existing tools, practices, and programs.</p>	<p><b>Consistent.</b> The Project prioritizes safety and access for all individuals utilizing the site by complying with all ADA requirements and providing direct connections to pedestrian amenities at adjacent intersections. Further, the Project supports healthy lifestyles by locating jobs adjacent to transit (Metro Local Bus Lines), providing bicycle parking, and enhancing the pedestrian environment by providing landscape elements for a more comfortable environment for pedestrians. Further, the Project supports healthy lifestyles by locating jobs near transit, providing bicycle parking, and enhancing the pedestrian environment with improved pedestrian pathways.</p>
<b>Chapter 2 - A City Built for Health</b>	
<p><b><u>Policy 2.8 Basic Amenities</u></b>            Promote increased access to basic amenities, which include public restrooms and free drinking water in public spaces, to support active living and access to health-promoting resources.</p>	<p><b>Consistent.</b> The Project would provide open space to support active living.</p>
<b>Chapter 5 - An Environment Where Life Thrives</b>	
<p><b><u>Policy 5.7 Land Use Planning for Public Health and GHG Emission Reduction</u></b>            Promote land use policies that reduce per capita greenhouse gas emissions, result in improved air quality and decreased air pollution, especially for children, seniors and others susceptible to respiratory diseases.</p>	<p><b>Consistent.</b> The Project is estimated to generate lower VMT per capita for residents than the average for the area, as demonstrated in Section 4B. Additionally, the Project incorporates several TDM measures to reduce the number of single occupancy vehicle trips to the Project Site, including short-term and long-term bike parking per LAMC. VMT directly contributes to GHG emissions, so a reduced VMT per capita also reduces GHG per capita.</p>

Notes:

[a] Objectives, Policies, Programs, or Plans based on information provided in *Plan for a Healthy Los Angeles: A Health and Wellness Element of the General Plan* (Los Angeles Department of City Planning, March 2015).

**TABLE 8  
PROJECT CONSISTENCY WITH CENTRAL CITY COMMUNITY PLAN**

Objective, Policy, Program, or Plan [a]	Analysis of Project Consistency
<p><b>Objective 4-4:</b> To encourage traditional and non-traditional sources of open space by recognizing and capitalizing on linkages with transit, parking, historic resources, cultural facilities, and social services programs.</p>	<p><b>Consistent.</b> The Project would improve the pedestrian environment within and around the Project Site by improving the adjacent sidewalks with enhanced landscaping and street trees. The Project would also incorporate open space throughout the Project Site to connect the various buildings of the Project. These open spaces would be open to Project employees and visitors.</p>
<p><b>Objective 11-6:</b> To accommodate pedestrian open space and usage in Central City.</p>	<p><b>Consistent.</b> The Project would provide a pedestrian-friendly environment with improved sidewalks along the Project frontage that would be landscaped with street trees. The open spaces would be open to Project employees and visitors.</p>
<p><b>Objective 11-7:</b> To provide sufficient parking to satisfy short-term retail/business users and visitors but still find ways to encourage long-term office commuters to use alternate modes of access.</p>	<p><b>Consistent.</b> Vehicular parking would be provided on-site to serve the various uses of the Project. The Project would also include bicycle parking facilities, as well as pedestrian network improvements, both connecting within the Project Site and connecting to off-site pedestrian facilities that would encourage alternate modes of access.</p>

Notes:

[a] Objectives, Policies, Programs, or Plans based on information provided in the *Central City Community Plan*, Los Angeles Department of City Planning, 2003.

**TABLE 9  
PROJECT CONSISTENCY WITH CITYWIDE DESIGN GUIDELINES**

Objective, Policy, Program, or Plan [a]	Analysis of Project Consistency
<i>Pedestrian-First Design</i>	
<p><b><u>Guideline 1: Promote a safe, comfortable, and accessible pedestrian experience for all</u></b></p> <p>Design projects to be safe and accessible and contribute to a better public right-of-way for people of all ages, genders, and abilities, especially the most vulnerable - children, seniors, and people with disabilities.</p> <p><b><u>Guideline 2: Carefully incorporate vehicular access such that it does not degrade the pedestrian experience</u></b></p> <p>Design to avoid pedestrian and vehicular conflicts and to create an inviting and comfortable public right-of-way. A pleasant and welcoming public realm reinforces walkability and improves the quality of life for users.</p> <p><b><u>Guideline 3: Design projects to actively engage with streets and public space and maintain human scale</u></b></p> <p>New projects should be designed to contribute to a vibrant and attractive public realm that promotes a sense of civic pride. Better connections within the built environment contribute to a livable and accessible city and a healthier public realm.</p>	<p><b>Consistent.</b> The Project design includes accessible sidewalks, pedestrian amenities, and well-designed vehicular access driveways in accordance with the City's design considerations. The Project would provide street trees within the sidewalk to provide for a more comfortable pedestrian environment. Further, the orientation of the Project pedestrian entrances ensures that the Project actively engages with the street activity and its surrounding uses.</p>

Notes:

[a] Objectives, Policies, Programs, or Plans based on information provided in the Citywide Design Guidelines (Los Angeles Department of City Planning, 2019).

---

## **Section 4B: Threshold T-2.1 Causing Substantial VMT Analysis**

Threshold T-2.1 in the TAG analyzes whether a project causes substantial VMT and is applied generally to land use projects. Specifically, Threshold T-2.1 inquires whether the project would conflict with or be inconsistent with CEQA Guidelines Section 15064.3, subdivision (b)(1). This subdivision states that (for land use projects) “vehicle miles travelled exceeding an applicable threshold of significance may indicate a significant impact.” This subdivision also states that a lead agency has discretion to choose the most appropriate method to evaluate the project’s VMT.

As the Lead Agency for this Project, the City uses the analytical methods established by LADOT to determine impacts. Section 2.2.3 of the TAG states that a residential project would result in a potential VMT impact if it would generate household VMT per capita exceeding 15% below the existing average household VMT per capita for the Area Planning Commission (APC) area in which a project is located. Similarly, a commercial project would result in a potential VMT impact if it would generate work VMT per employee exceeding 15% below the existing average work VMT per employee for the APC area in which the project is located.

The VMT analysis presented below was conducted in accordance with the TAG, which satisfies State requirements under SB 743.

### **VMT METHODOLOGY**

The following reviews the methodology for calculating vehicle trips and VMT using *City of Los Angeles VMT Calculator Version 1.3* (LADOT and LADCP, July 2020) (VMT Calculator), as detailed in *City of Los Angeles VMT Calculator Documentation* (LADOT and LADCP, May 2020). LADOT developed the VMT Calculator to estimate project-specific daily household VMT per capita and daily work VMT per employee for developments within City limits. The daily household VMT per capita and work VMT per employee are based on the following types of one-way trips:

- Home-Based Work Production: resident-driven trips originating from a residential use to a workplace destination
- Home-Based Other Production: resident-driven trips originating from a residential use to a non-workplace destination (e.g., retail, restaurant, etc.)
- Home-Based Work Attraction: employee-driven trips to a workplace destination originating from a residential use

As detailed in *City of Los Angeles VMT Calculator Documentation*, the household VMT per capita threshold is calculated based on Home-Based Work Production and Home-Based Other Production trips, and the work VMT per employee threshold is calculated based on Home-Based Work Attraction trips, as the location and characteristics of residences and workplaces are often the main drivers of VMT, as detailed in Appendix 1 of *Technical Advisory on Evaluating Transportation Impacts in CEQA* (Governor’s Office of Planning and Research, December 2018).

Table 2.2-1 of the TAG provides the following daily household VMT per capita and daily work VMT per employee impact thresholds for the APC areas:

<b>APC</b>	<b>Daily Household VMT per Capita</b>	<b>Daily Work VMT per Employee</b>
Central	6.0	7.6
East LA	7.2	12.7
Harbor	9.2	12.3
North Valley	9.2	15.0
South LA	6.0	11.6
South Valley	9.4	11.6
West LA	7.4	11.1

The Project Site is located in the Central APC area.

The VMT Calculator defines other types of trips generated by the Project, which include Non-Home-Based Other Production (trips to a non-residential destination originating from a non-residential use at the Project Site), Home-Based Other Attraction (trips to a non-workplace destination at the Project Site originating from a residential use), and Non-Home-Based Other Attraction (trips to a non-residential destination at the Project Site originating from a non-

---

residential use). These trip types are not factored into the VMT per capita and VMT per employee thresholds, because these trip types are typically localized and are assumed to have a negligible effect on the VMT impact assessment. However, to ensure a conservative analysis for the Project, these trip types were factored into the calculation of total Project VMT for screening purposes when determining whether VMT analysis for the Project would be required.

### **Travel Behavior Zone (TBZ)**

The City developed TBZ categories to determine the magnitude of VMT and vehicle trip reductions that could be achieved through TDM strategies. As detailed in *City of Los Angeles VMT Calculator Documentation*, the development of the TBZs considered the population density, land use density, intersection density, and proximity to transit of each Census tract in the City and are categorized as follows:

1. *Suburban (Zone 1): Very low-density primarily centered around single-family homes and minimally connected street network.*
2. *Suburban Center (Zone 2): Low-density developments with a mix of residential and commercial uses with larger blocks and lower intersection density.*
3. *Compact Infill (Zone 3): Higher density neighborhoods that include multi-story buildings and well-connected streets.*
4. *Urban (Zone 4): High-density neighborhoods characterized by multi-story buildings with a dense road network.*

The VMT Calculator determines a project's TBZ based on the latitude and longitude of a project address. The Project Site is located in a Suburban Center (Zone 2) TBZ.

### **Mixed-Use Development Methodology**

As detailed in *City of Los Angeles VMT Calculator Documentation*, the VMT Calculator accounts for the interaction of land uses within a mixed-use development and considers the following sociodemographic, land use, and built environment factors for a project area:



- 
- The project's jobs/housing balance
  - Land use density of the project
  - Transportation network connectivity
  - Availability of and proximity to transit
  - Proximity to retail and other destinations
  - Vehicle ownership rates
  - Household size

### **Trip Lengths**

The VMT Calculator estimates trip lengths based on information from the City's Travel Demand Forecasting (TDF) Model. The TDF Model considers the traffic analysis zones within 0.125 miles of where the project is located to determine the average trip length and trip type, which factor into the calculation of the project's VMT.

### **Population and Employment Assumptions**

As previously stated, the VMT thresholds identified in the TAG are based on household VMT per capita and work VMT per employee. Thus, the VMT Calculator contains population assumptions developed based on Census data for the City and employment assumptions derived from multiple data sources, including *2012 Developer Fee Justification Study* (Los Angeles Unified School District, 2012), the San Diego Association of Governments' Activity Based Model, *Trip Generation, 9<sup>th</sup> Edition* (Institute of Transportation Engineers, 2012), the United States Department of Energy, and other modeling resources. A summary of population and employment assumptions for various land uses is provided in Table 1 of *City of Los Angeles VMT Calculator Documentation*.

---

## **TDM Measures**

Additionally, the VMT Calculator measures the reduction in VMT resulting from a project's incorporation of TDM strategies as project design features or mitigation measures. The following seven categories of TDM strategies are included in the VMT Calculator:

1. Parking
2. Transit
3. Education and Encouragement
4. Commute Trip Reductions
5. Shared Mobility
6. Bicycle Infrastructure
7. Neighborhood Enhancement

TDM strategies within each of these categories have been empirically demonstrated to reduce trip-making or mode choice in such a way as to reduce VMT, as documented in *Quantifying Greenhouse Gas Mitigation Measures* (California Air Pollution Control Officers Association, 2010).

## **PROJECT VMT ANALYSIS**

The VMT Calculator was used to evaluate Project VMT for comparison to the VMT impact criteria. The Project proposes no residential units. Therefore, the Project would not generate any household VMT per capita and would not result in a significant household VMT impact.

## **Office Equivalency Assumptions**

The VMT Calculator was developed to estimate project-specific daily work VMT per employee for developments within City limits. Based on a review of relevant empirical and historical data, and in consultation with LADOT, it was determined that the daily trip generation characteristics and patterns of the Project's employee-based creative office and studio-related land uses were similar in scope and behavior to the characteristics of the general office land use in *Trip Generation*

---

*Manual, 10<sup>th</sup> Edition*. As such, in order to evaluate the VMT generated by the Project's studio-related land uses, which are not land use categories recognized within the VMT Calculator, an office floor area equivalency calculation was conducted based on a comparison of the daily trip generation estimates.

The empirical daily trip generation rates for the studio-related uses and the standard daily trip rates for the general office land use are detailed in Table 5. The results of the office equivalency calculation are detailed in Table 10A. As shown, the Project's proposed studio-related uses and office uses are equivalent to the daily trip generation estimates for 523,514 sf of general office use. Thus, upon completion, the Project's land uses would be similar in scope and behavior to 523,514 sf of general office use.

The VMT analysis results based on the Project's general office equivalency and the VMT Calculator are summarized in Table 10B. Detailed output from the VMT Calculator is provided in Appendix D.

### **Project VMT**

The Project includes several design features, which include measures to reduce the number of single occupancy vehicle trips to the Project Site. For the purposes of this analysis, the following TDM measures that are incorporated into the Project design were accounted for in the VMT evaluation:

- Bicycle parking supply per LAMC requirements, including short-term and long-term parking spaces
- Bicycle repair station and shower facilities

As noted in Section 4A and further detailed in Section 5B, the Project would include compliance with the requirements of the City's TDM ordinance and, therefore, a TDM program would be implemented as part of the Project, which would include the measures listed above, as well as additional measures. However, for the purposes of providing a more conservative analysis, no further VMT reductions were applied to account for the TDM strategies (e.g., education programs, incentive programs, transportation services, etc.) associated with the Project's TDM program. As

---

shown in Table 10B, the VMT Calculator estimates that the Project would generate 15,499 daily work VMT. Thus, the Project would generate an average work VMT per employee of 7.4, which falls below the significance thresholds for the Central APC (7.6 work VMT per employee). Therefore, no VMT-related mitigation measures would be required.

## **CUMULATIVE ANALYSIS**

Cumulative effects of development projects are determined based on their consistency with the air quality and GHG reduction goals of *Connect SoCal – The 2020-2045 Regional Transportation Plan / Sustainable Communities Strategy* (Southern California Association of Governments [SCAG], September 2020) (RTP/SCS) in terms of development location, density, and intensity. The RTP/SCS presents a long-term vision for the region's transportation system through Year 2045 and balances the region's future mobility and housing needs with economic, environmental, and public health goals. In addition, as detailed in the TAG, the RTP/SCS is the regional plan that demonstrates compliance with air quality conformity requirements and GHG reduction targets. As such, projects that are consistent with this plan in terms of development location, density, and intensity are part of the regional solution for meeting air pollution and GHG goals. Projects that are deemed to be consistent would have a less than significant cumulative impact on VMT. Thus, based on the conclusions above, the Project has a less than significant cumulative impact on VMT.

Moreover, as detailed above, the Project is designed to further reduce single occupancy trips to the Project Site because it encourages alternative transportation by providing bicycle parking facilities and amenities and because it locates employment in proximity to local transit. Thus, the Project encourages the use of a variety of transportation options in place of single-occupant vehicle use and is consistent with the RTP/SCS goal of maximizing mobility and accessibility in the region. The Project would also contribute to the productivity and use of the regional transportation system by providing employment near transit and would encourage active multi-modal transportation by providing new bicycle parking and facilities, consistent with RTP/SCS goals. Therefore, the Project would not result in a cumulative VMT impact under Threshold T-2.1, and no further evaluation or mitigation measures would be required.

**TABLE 10A  
VMT TRIP EQUIVALENCY DEVELOPMENT**

PROJECT TRIP GENERATION				OFFICE EQUIVALENCY			
Land Use	ITE Land Use [a]	Rate	Daily	Land Use	ITE Land Use	Rate	Daily
Sound Stage	[b]	per ksf	5.91	General Office	710	per ksf	9.74
Production Support	[b]	per ksf	4.14	<b><u>New Studio Construction</u></b>			
General Office	710	per ksf	9.74	Sound Stage - Office Equivalency	710	74.368 ksf	724
<b><u>New Studio Construction</u></b>				<i>Transit/Walk-In Reduction [c]</i> 5%			(36)
Sound Stage	[b]	116.40 ksf	688	Production Support - Office Equivalency	710	15.200 ksf	148
Production Support	[b]	34.00 ksf	141	<i>Transit/Walk-In Reduction [c]</i> 5%			(7)
Mill/Shop	[b]	20.70 ksf	86	Mill/Shop - Office Equivalency	710	9.371 ksf	91
Mill/Shop Office	710	20.70 ksf	202	<i>Transit/Walk-In Reduction [c]</i> 5%			(5)
<i>Transit/Walk-In Reduction [c]</i> 5%			(10)	Mill/Shop Office	710	20.700 ksf	202
Executive Office	710	57.80 ksf	563	<i>Transit/Walk-In Reduction [c]</i> 5%			(10)
<i>Transit/Walk-In Reduction [c]</i> 5%			(28)	Executive Office	710	57.800 ksf	563
				<i>Transit/Walk-In Reduction [c]</i> 5%			(28)
<b>Subtotal - New Studio Construction</b>			<b>1,642</b>	<b>Subtotal - New Studio Construction</b>			<b>1,642</b>
<b><u>Existing Building Renovation</u></b>				<b><u>Existing Building Renovation</u></b>			
Sound Stage	[b]	156.10 ksf	923	Sound Stage - Office Equivalency	710	99.752 ksf	972
Production Support	[b]	251.55 ksf	1,041	<i>Transit/Walk-In Reduction [c]</i> 5%			(49)
Administrative Office [d]	710	133.80 ksf	1,303	Production Support - Office Equivalency	710	112.523 ksf	1,096
<i>Transit/Walk-In Reduction [c]</i> 5%			(65)	<i>Transit/Walk-In Reduction [c]</i> 5%			(55)
<b>Subtotal - Existing Building Renovation</b>			<b>3,202</b>	Administrative Office [d]	710	133.800 ksf	1,303
				<i>Transit/Walk-In Reduction [c]</i> 5%			(65)
				<b>Subtotal - Existing Building Renovation</b>			<b>3,202</b>
<b>TOTAL - PROPOSED PROJECT TRIPS</b>		<b>791.05 ksf</b>	<b>4,844</b>	<b>TOTAL</b>		<b>523.514 ksf</b>	<b>4,844</b>

**Notes**

[a] Source: *Trip Generation, 10th Edition*, Institute of Transportation Engineers, 2017, unless as noted.

[b] Rate based on empirical rate from *Transportation Study for the NBC Universal Evolution Plan Environmental Impact Report*, Gibson Transportation Consulting, Inc. and Raju Associates, Inc., March 2010.

[d] The Project Site is located within walking distance of a Metro bus stop, therefore a 5% transit reduction is applied to account for transit usage and walking visitor arrivals from the adjacent commercial developments.

[e] Amenities and supporting uses for the Project (i.e., commissary, mechanical rooms, gym/spa/salon) were assumed to be ancillary to the studio, production, and office uses, and therefore, were not considered for trip generation purposes.

**TABLE 10B  
VMT ANALYSIS SUMMARY**

<b>Project Information</b>	
<b>Land Use [a]</b>	<b>Size</b>
Office   General Office	523,514 sf
<b>Project Analysis [b]</b>	
Project Area Planning Commission	Central
Travel Behavior Zone [c]	Suburban Center
Maximum Allowable VMT Reduction	20%
<b>VMT Analysis [d]</b>	
Daily Vehicle Trips	3,466
Daily VMT	27,418
Daily Work VMT	15,499
Work VMT per Employee [e]	7.4
Impact Threshold	7.6
Significant Impact	NO

Notes:

[a] In order to evaluate the VMT generated by the Project's studio-related land uses, which are not recognized within the VMT Calculator, an office floor area equivalency calculation was conducted based on a comparison of the daily trip generation estimates. As shown in Table 10A, the Project's proposed studio-related uses and office uses are equivalent to the daily trip generation estimates for 523,514 sf of general office use.

[b] Project Analysis based on the *City of Los Angeles VMT Calculator Version 1.3* (May 2020).

[c] A "Suburban Center" TBZ is characterized in *City of Los Angeles VMT Calculator Documentation* (LADOT and DCP, May 2020) as low-density development primarily centered around single-family homes and minimally connected street network.

[d] The following Project design features were accounted for in the VMT evaluation:

- Include bike parking per LAMC, including short-term and long-term parking facilities
- Provision of bicycle repair station and shower facilities

[e] Based on home-based work attraction trips only (see Appendix D, Report 4).

---

## **Section 4C: Threshold T-2.2**

### **Substantially Inducing Additional Automobile Travel Analysis**

Threshold T-2.2 applies to transportation projects. The TAG explains that transportation projects that increase vehicular capacity can lead to additional travel on the roadway network, which can include induced vehicle travel due to factors such as increased speeds and induced growth. The TAG also provides screening criteria and states that:

“[i]f the answer is no to the following question, further analysis will not be required for Threshold T-2.2, and a no impact determination can be made for that threshold:

“T-2.2: Would the project include the addition of through traffic lanes on existing or new highways, including general purpose lanes, high-occupancy vehicle (HOV) lanes, peak period lanes, auxiliary lanes, and lanes through grade-separated interchanges (except managed lanes, transit lanes, and auxiliary lanes of less than one mile in length designed to improve roadway safety)?”

The Project does not include additional through traffic lanes on existing or new highways, general purpose lanes, HOV lanes, peak period lanes, auxiliary lanes, or lanes through grade-separated interchanges. Accordingly, neither the Project nor any improvements associated with it are considered a transportation project. Therefore, Threshold T-2.2 does not apply to the Project and no further evaluation is required.

---

## **Section 4D: Threshold T-3**

### **Substantially Increasing Hazards Due to a Geometric Design Feature or Incompatible Use Analysis**

Impacts regarding the potential increase of hazards due to a geometric design feature generally relate to the design of access points to and from a project site, and may include safety, operational, or capacity impacts. Impacts can be related to vehicle/vehicle, vehicle/bicycle, or vehicle/pedestrian conflicts as well as to operational delays caused by vehicles slowing and/or queuing to access a project site. These conflicts may be created by the driveway configuration or through the placement of project driveway(s) in areas of inadequate visibility, adjacent to bicycle or pedestrian facilities, or too close to busy or congested intersections.

Further evaluation is required for projects that that require a discretionary action and (1) propose new driveways or introduce new vehicle access to the property from public ROW or (2) propose any voluntary or required modifications to the public ROW (i.e., street dedications, reconfigurations of curb line, etc.) The Project requires further evaluation based on these screening criteria. The threshold for determining impacts is whether the Project would substantially increase hazards due to a geometric design feature (e.g., sharp curves or dangerous intersections) or incompatible uses (e.g., farm equipment).

A review of Project access points, internal circulation, and parking access was performed to determine if the Project would substantially increase hazards due to geometric design features, including safety, operational, or capacity impacts. This analysis considered the following factors: (a) the relative amount of pedestrian activity at Project access points; (b) design features/physical configurations that affect the visibility of pedestrians and bicyclists to drivers entering and exiting the site, and the visibility of cars to pedestrians and bicyclists; (c) the type of bicycle facilities the Project driveway(s) crosses and the relative level of utilization; (d) the physical conditions of the site and surrounding area, such as curves, slopes, walks, landscaping or other barriers, that could result in vehicle/pedestrian, vehicle/bicycle, or vehicle/vehicle impacts; (e) the Project location, or Project-related changes to the public ROW, relative to proximity to the HIN or a Safe Routes to School (SRTS) program area; (f) any other conditions, including the approximate location of



---

incompatible uses that would substantially increase a transportation hazard. These factors are addressed below.

## **PROJECT ACCESS REVIEW**

### **Driveway Design Features**

As described in Chapter 1, primary vehicular access to the Project Site would be provided via driveways along 8<sup>th</sup> Street, Lemon Street, and Hunter Street, which are all designated Collector Streets. The main gate driveway, which provides full access to the Project Site, and the outbound-only driveway, which provides access from the parking structure, would be located on 8<sup>th</sup> Street. Two additional secondary outbound-only driveways would be located on Hunter Street. Separate truck-only inbound and outbound driveways are proposed on Lemon Street.

All driveways would be designed according to LADOT standards and reviewed by the City Bureau of Engineering during site plan review.

The main gate driveway along 8<sup>th</sup> Street and the truck-only outbound driveway along Lemon Street would improve existing curb cuts to meet City standards and Project needs. The truck-only inbound driveway along Lemon Street, as well as the outbound-only driveways along 8<sup>th</sup> Street and Hunter Street, would require the installation of new curb cuts. All driveways that provide truck access would be designed to adequately accommodate truck turning maneuvers without encroachment into the public ROW. The driveways and access control systems would be designed, placed, and configured to limit vehicle queues and bicycle/pedestrian-vehicle conflicts. In addition, minimal pedestrian and bicycle traffic around the Project perimeter is anticipated. Thus, the Project's driveway plans would not substantially increase vehicle-vehicle conflicts along 8<sup>th</sup> Street, Lemon Street, or Hunter Street, and based on the site plan review, would not present geometric design hazards as it relates to traffic movement.

---

## **Pedestrian and Bicycle Activity**

The Project would include landscaped setbacks along the entire Project perimeter to create a walkable and attractive pedestrian environment. In addition, separated pedestrian and bicycle access would be provided at the main gate along 8<sup>th</sup> Street. None of the Project driveways would cross any existing bicycle lanes or routes, as detailed in Figure 6. The Project driveways would be designed and placed to provide adequate sight distance and pedestrian refuge areas to limit potential vehicular-bicycle or vehicular-pedestrian conflicts. Based on the site plan review and design assumptions, the Project does not present geometric design hazards related to mobility or pedestrian accessibility.

## **Physical Terrain**

The proposed driveways to the Project Site would not be located along curved sections of the roadways that may limit sight distance. On-street parking adjacent to the driveways would continue to be prohibited, thus maximizing sight distance at the Project driveways. The Project frontages would be designed with landscaped setbacks to allow better visibility between vehicles accessing the driveways and pedestrians/bicyclists.

The Project would provide landscaped elements and street trees for shade along the Project perimeter and within the Project Site to create a walkable and attractive pedestrian environment. Pedestrian sidewalks would be improved to meet City standards and to provide continuous pedestrian connections along the Project frontage.

## **Project Location**

The Project Site does not propose any new driveways or curb cuts along any streets identified as part of the HIN. Additionally, the SRTS map does not identify any infrastructure improvement projects within the Study Area.

As previously detailed, the Project would require the installation of new curb cuts along 8<sup>th</sup> Street, Lemon Street, and Hunter Street. The driveways would be designed in accordance with City

---

design guidelines. The Project would be consistent with the designated driveway and roadway width requirements as indicated in the Mobility Plan, and the Project would not preclude future roadway improvements proposed in the Mobility Plan.

### **Incompatible Uses**

None of the Project design elements that are adjacent to the neighboring uses are considered incompatible. There are no unusual or new obstacles that would be considered hazardous to motorized vehicles, non-motorized vehicles, or pedestrians.

### **Summary**

Based on the site plan review and design assumptions, the Project does not present any geometric design hazards related to mobility or pedestrian accessibility.

### **CUMULATIVE ANALYSIS**

None of the Related Projects identified in Table 4 provides access along the same block as the Project. Thus, the Project and Related Projects would not result in a cumulative impact under Threshold T-3.

---

## Section 4E

### Freeway Safety Analysis

LADOT has issued Freeway Guidance identifying City requirements for a CEQA safety analysis of Caltrans freeway off-ramp facilities as part of a transportation assessment.

#### ANALYSIS METHODOLOGY

The Freeway Guidance relates to the identification of potential safety impacts at freeway off-ramps as a result of increased traffic from development projects. It provides a methodology and significance criteria for assessing whether additional vehicle queueing at off-ramps could result in a safety impact due to speed differentials between the mainline freeway lanes and the queued vehicles at the off-ramp.

Based on the Freeway Guidance, a transportation assessment for a development project must include analysis of any freeway off-ramp where the project adds 25 or more peak hour trips. A project would result in a significant impact at such a ramp if each of the following three criteria were met:

1. Under a scenario analyzing future conditions upon project buildout, with project traffic included, the off-ramp queue would extend to the mainline freeway lanes<sup>1</sup>.
2. A project would contribute at least two vehicle lengths (50 feet, assuming 25 feet per vehicle) to the queue.
3. The average speed of mainline freeway traffic adjacent to the off-ramp during the analyzed peak hour(s) is greater than 30 mph.

Should a significant impact be identified, mitigation measures to be considered include TDM measures to reduce a project's trip generation, investments in active transportation or transit system infrastructure to reduce a project's trip generation, changes to the traffic signal timing or

---

<sup>1</sup> If an auxiliary lane is provided on the freeway, then half the length of the auxiliary lane is added to the ramp storage length.

---

lane assignments at the ramp intersection, or physical changes to the off-ramp. Any physical change to the ramp would have to improve safety, not induce greater VMT, and not result in secondary environmental impacts.

## **ANALYSIS RESULTS**

Based on the Project's trip generation estimates and traffic distribution pattern detailed previously in Chapter 3, the Project would add 28 morning and 19 afternoon peak hour trips to the I-10 Westbound Off-Ramp to Enterprise Street.

In accordance with the Freeway Guidance, the 95<sup>th</sup> percentile ramp queue was calculated using the *Highway Capacity Manual, 6<sup>th</sup> Edition* (Transportation Research Board, 2016) (HCM) methodology. Conditions were analyzed both with and without Project traffic under future cumulative conditions for Year 2026, the anticipated Project buildout, and included ambient growth and traffic from other Related Projects. The summary of queue lengths and off-ramp storage length, along with the analysis worksheets, are provided in Appendix E.

As shown in Table E-1, under Future with Project Conditions, although the Project would add more than 50 feet to the off-ramp queue during both the morning and afternoon peak hours, the queues would not exceed the ramp storage length during either peak hour. Thus, the Project would not result in a significant freeway safety impact and no mitigation is required.

---

## **Chapter 5**

### ***Non-CEQA Transportation Analysis***

Section 3 of the TAG provides guidance for preparing additional transportation analyses that are not required to determine the CEQA impacts of the Project because VMT is the legally applicable methodology for analyzing traffic, circulation, and transportation impacts. This chapter summarizes the non-CEQA transportation analysis of the Project. It includes sections related to the Project traffic, proposed access provisions, safety, and circulation operations of the Project, and the adjacent pedestrian, bicycle, and transit facilities. This chapter also evaluates the Project's operational conditions, parking supply and requirements, and effects due to Project construction.

Per Section 3.1 of the TAG, any deficiencies identified based on the non-CEQA transportation analysis is "not intended to be interpreted as thresholds of significance, or significance criteria for purposes of CEQA review unless otherwise specifically identified in Section 2." Section 3 of the TAG identifies the following four non-CEQA transportation analyses for reviewing potential transportation deficiencies that may result from a development project:

- Pedestrian, Bicycle, and Transit Access Assessment
- Project Access, Safety, and Circulation Evaluation
- Residential Street Cut-Through Analysis
- Construction Analysis

The four non-CEQA transportation analyses were reviewed in detail in Sections 5A-5D. In addition, a review of the proposed parking and the City's parking requirement for the Project is provided in Section 5E.

---

## Section 5A

### Pedestrian, Bicycle, and Transit Assessment

This section assesses the Project's potential effect on pedestrian, bicycle, and transit facilities in the vicinity of the Project Site.

Factors to consider when assessing a project's potential effect on pedestrian, bicycle, and transit facilities, include the following:

- Would the project directly or indirectly result in a permanent removal or modification that would lead to the degradation of pedestrian, bicycle, or transit facilities?
- Would a project intensify use of existing pedestrian, bicycle, or transit facilities?

#### **EXISTING FACILITIES**

##### **Pedestrians and Bicycles**

Adjacent to the Project Site, 10-foot wide sidewalks are provided along 8<sup>th</sup> Street and Alameda Street and 11-foot wide sidewalks are provided along Hunter Street. Curb ramps for ADA accessibility are provided at the northwest and southwest corners of Alameda Street & Hunter Street as well as the northeast and northwest corners of Lawrence Street & Olympic Boulevard. The nearby signalized intersection of Alameda Street & Olympic Boulevard provides curb ramps for ADA accessibility, pedestrian push buttons, and continental crosswalks across all legs. Pedestrian push buttons and curb ramps for ADA are provided (except at the northeast and southwest corners) at Alameda Street & 8<sup>th</sup> Street. Figure 6 identifies commercial and institutional facilities within walking distance (0.25 miles) of the Project Site that could attract pedestrian activity.

No bicycle lanes or routes are provided within the vicinity of the Project Site.

---

## **Transit**

The Metro Route 66 bus stops are located immediately adjacent to the Project Site on Olympic Boulevard at Lawrence Street and Alameda Street. The following bus stops in the vicinity of the Project Site are equipped with transit amenities:

- Along eastbound Olympic Boulevard, the Metro Route 66 bus stop west of Alameda Street (approximately 340 feet southwest of the Project Site) provides a bus shelter and bench.
- Along westbound Olympic Boulevard, the Metro Route 66 bus stop immediately east of Alameda Street (approximately 280 feet southwest of the Project Site) provides benches.

## **INTENSIFICATION OF USE**

The Project would result in additional pedestrian, bicycle, and transit activity in the vicinity of the Project Site. However, the Project would enhance the pedestrian environment by providing a more comfortable pedestrian experience by maintaining accessible sidewalks along the Project frontage and would encourage alternative transportation modes by providing bicycle parking and amenities for employees and visitors. In addition, the Project is located within a 0.25-mile walking distance of numerous Metro bus stops.

Although the Project (and other Related Projects) will cumulatively add transit ridership, the Study Area is served by multiple bus lines operated by Metro. As shown in Tables 3A and 3B, the total residual capacity of the bus lines within a 0.25-mile walking distance of the Project Site during the morning and afternoon peak hours is approximately 1,011 additional riders during the morning peak hour and 949 additional riders during the afternoon peak hour. As shown in Table 5, transit usage for the Project accounts for the reduction of approximately 12 vehicle trips during both the morning and afternoon peak hours. Based on the average vehicle occupancy factor of 1.55 for all trip purposes in Los Angeles County as identified in *SCAG Regional Travel Demand Model and 2012 Model Validation* (SCAG, March 2016), the total Project vehicle-transit trips correspond to 19 person-transit trips during the morning and afternoon peak hours. This equates to approximately 2% of the total residual capacity of the transit lines within the Study Area during the morning and afternoon peak hours, confirming that the adjacent transit capacity can accommodate the intensification of transit usage attributable to the Project.



---

## **CONCLUSION**

The Project would result in some intensification of pedestrian, bicycle, and transit activity in the vicinity of the Project Site. However, given the Project Site's location near local bus services and its proximity to active commercial centers in the Arts District, it is ideally located to encourage non-automobile trips to and from those destinations and additional public transit routes. The amount of additional pedestrian, bicycle, and transit activity generated by the Project would not strain the capacity of facilities and operations dedicated to those modes.

---

## Section 5B

### Project Access, Safety, and Circulation Assessment

This section summarizes the site access, safety, and circulation of the Project Site. It includes a quantitative evaluation of the Project's access and circulation operations, as well as the anticipated LOS at the Study Area intersections and anticipated traffic queues.

#### PROJECT ACCESS

##### Vehicle Access and Internal Circulation

As described in Chapter 1, vehicular access to the Project Site would be provided via driveways along 8<sup>th</sup> Street, Lemon Street, and Hunter Street, which are designated Collector Streets. Primary access would be provided via the main driveway along 8<sup>th</sup> Street, which provides full access to the Project Site. Passenger loading would be accommodated on-site with access provided via the main gate driveway along 8<sup>th</sup> Street. Additional secondary outbound-only access would be provided via driveways along 8<sup>th</sup> Street and Hunter Street. Separate truck-only inbound and outbound driveways would be provided along Lemon Street. The Project would provide internal drive aisles that would accommodate passenger vehicle and truck circulation.

The driveways would be designed to LADOT standards under the review of City staff. Access control equipment would be designed and operated to limit delay at the driveways and queue spillover into the public ROW. The circulation aisle widths of the parking areas should be designed to allow adequate and safe circulation of vehicles and trucks without significant conflicts. The vehicular access points are adequate to serve the demand of the Project Site and no significant internal congestion is anticipated that would affect traffic flow on adjacent public streets. The detailed queue evaluation worksheets for the proposed Project driveways are provided in Appendix F.

---

## **Pedestrians and Bicycles**

Pedestrian access to the Project Site would be provided via a separate pedestrian entrance at the main gate along 8<sup>th</sup> Street, which would connect to internal walkways throughout the Project Site.

Employees and visitors arriving by bicycle would have the same access opportunities as pedestrian visitors.

None of the Project driveways would cross any existing bicycle lanes or routes. Therefore, given the limited access and minimal bicycle traffic, the driveway would not pose a safety hazard to bicyclists. The Project driveways would be designed and placed to provide adequate sight distance and pedestrian refuge areas to limit potential vehicular-bicycle or vehicular-pedestrian conflicts. In order to facilitate bicycle use, short-term and long-term bicycle parking spaces, along with showers and other amenities, would be provided, as detailed in Section 5E.

## **OPERATIONAL EVALUATION**

Intersection operations were evaluated for typical weekday morning (7:00 AM to 10:00 AM) and afternoon (3:00 PM to 6:00 PM) peak periods. A total of four signalized intersections and one unsignalized intersection in the vicinity of the Project Site were selected for detailed transportation analysis and are shown in Figure 3.

The following traffic conditions were developed and analyzed as part of this study:

- **Existing with Project Conditions**: This analysis condition estimates the potential intersection operating conditions that could be expected if the Project were built under existing conditions.
- **Future with Project Conditions (Year 2026)**: This analysis condition estimates the potential intersection operating conditions that could be expected if the Project were occupied in the projected buildout year. In this analysis, the Project-generated traffic is added to Future without Project Conditions (Year 2026).

---

## **Methodology**

In accordance with the TAG, the intersection delay and queue analyses for the operational evaluation were conducted using the HCM methodology, which was implemented using Synchro software with signal timing plans provided by the City to analyze intersection operating conditions. The HCM signalized methodology calculates the average delay, in seconds, for each vehicle passing through the intersections while the HCM unsignalized two-way stop-control methodology calculates the control delay, in seconds, for individual approaches of an intersection. Table 11 presents a description of the LOS categories, which range from excellent, nearly free-flow traffic at LOS A, to congested stop-and-go conditions at LOS F, for signalized intersections. The queue lengths were estimated using Synchro, which reports the 95<sup>th</sup> percentile queue length for each approach lane.

LOS and queuing worksheets for each scenario are provided in Appendix F.

## **Existing with Project Conditions**

**Traffic Volumes.** The morning and afternoon peak hour traffic volumes generated by the Project, as described in Chapter 3 and shown in Figures 14A-B, were added to the Existing Conditions morning and afternoon peak hour traffic volumes shown in Figure 8. The resulting volumes are illustrated in Figure 15 and represent Existing with Project Conditions, assuming Project operation under Existing Conditions.

**Intersection LOS.** Table 12 summarizes the weekday morning and afternoon peak hour LOS results for the Study Area intersections under Existing and Existing with Project Conditions. As shown in Table 12, four Study Area intersections operate at LOS D or better during both the morning and afternoon peak hours. The remaining intersection of Lemon Street & Olympic Boulevard (Intersection #4) is anticipated to operate at LOS D during the morning peak hour and at LOS F during the afternoon peak hour. It should be noted that the HCM Two-Way-Stop-Control (TWSC) unsignalized methodology calculates the control delay, in seconds, for each individual approach of an intersection. The reported control delay represents the worst-case approach, typically on the lower volume minor street, and does not account for traffic gaps created by adjacent traffic signals that allow turn movements to proceed from the minor street.

---

## **Future with Project Conditions**

All future cumulative traffic growth (i.e., ambient and Related Project traffic growth) and transportation infrastructure improvements described in Chapter 2 are incorporated into this analysis.

**Traffic Volumes.** The morning and afternoon peak hour traffic volumes generated by the Project described in Chapter 3 and shown in Figures 14A-B were added to the Future without Project Conditions (Year 2026) morning and afternoon peak hour traffic volumes shown in Figure 11. The resulting volumes are illustrated in Figure 16 and represent Future with Project Conditions after development of the Project in Year 2026.

**Intersection LOS.** Table 13 summarizes the results of the Future without Project (Year 2026) and Future with Project Conditions during the weekday morning and afternoon peak hours for the Study Area intersections. As shown in Table 13, three Study Area intersections operate at LOS D or better during both the morning and afternoon peak hours. The remaining two intersections are anticipated to operate as follows:

- Alameda Street & Olympic Boulevard (Intersection #3): LOS E (morning peak hour) and LOS D (afternoon peak hour)
- Lemon Street & Olympic Boulevard (Intersection #4): LOS D (morning peak hour) and LOS F (afternoon peak hour)

It should be noted that the HCM TWSC unsignalized methodology calculates the control delay, in seconds, for each individual approach of an intersection. The reported control delay represents the worst-case approach, typically on the lower volume minor street, and does not account for traffic gaps created by adjacent traffic signals that allow turn movements to proceed from the minor street.

## **Signal Warrant Analysis**

A signal warrant analysis was conducted to evaluate the potential installation of a new traffic signal at Lemon Street & Olympic Boulevard (Intersection #4). The signal warrant analyses follow the guidelines set forth in *Manual of Policies and Procedures* and *California Manual on Uniform*

---

*Traffic Control Devices* (Caltrans, 2012) (California MUTCD), by applying the thresholds from Warrant 3 (peak hour). The following methodology, as quoted from the California MUTCD, was used to evaluate signal warrants at the intersection.

**Warrant 3, Peak-Hour Vehicular Volume Warrant**

*Signal Warrant 3 is intended for use at a location where traffic conditions are such that for a minimum of one hour of an average day, the minor-street traffic suffers undue delay when entering or crossing the major street. Combined volumes for both approaches of the major street are included while only the volume from the higher minor street approach is included. At an intersection with a high volume of left-turn traffic from the major street, the analysis may include the major street left-turn volumes plus the minor street approach volume as the total “minor street” volume. The warrant is satisfied if traffic volumes for any one hour of an average day exceed the plotted lines shown in the following figure.*

As shown in Appendix G, the unsignalized intersection meets the minimum afternoon peak hour traffic volume threshold of Warrant 3 under Existing and Future Conditions, with or without the addition of Project traffic.

It should be noted that the determination that an unsignalized intersection meets the peak hour criteria of a traffic signal warrant does not in itself require the installation of a signal. Rather, the decision on whether a traffic signal should be installed is made by the governing jurisdictions taking into consideration other factors such as distance to adjacent signalized intersections, safety, and interruption to traffic flow along the major street.

The intersection of Lemon Street & Olympic Boulevard is located in close proximity (350 feet west) to the existing signalized intersection of Mateo Street & Olympic Boulevard. Thus, this close spacing of signalized intersections along an Olympic Boulevard, a designated Avenue I, would likely not be recommended or approved by LADOT.

---

## **INTERSECTION QUEUING ANALYSIS**

The queue lengths were estimated using Synchro software, which reports the 95<sup>th</sup> percentile queue length for signalized intersections at each approach lane. Synchro queue results that are reported in vehicle-length were converted to linear feet by multiplying each vehicle by 25 feet to account for the average length of a vehicle plus distance between vehicles in the queue. The reported queues are calculated using the HCM methodology.

As detailed in Appendix F, the Project would not cause or substantially extend queuing at any of the five Study Area intersections.

## **RECOMMENDED ACTIONS**

It is anticipated that the Project would contribute to cumulative traffic levels within the Study Area, as detailed in Table 13. However, as discussed in Sections 4A and 4B, the Project would implement a TDM program in accordance with the requirements of the TDM Ordinance to reduce single occupancy trips to the Project Site and Project traffic throughout the Study Area. Implementation of a TDM program could include a comprehensive program of Project design features, transportation services, education programs, and incentive programs intended to promote non-automobile travel and reduce single-occupant vehicle trips and traffic from employees and visitors to the Project Site during the most congested time periods of the day.

<p>173(45) 936(764) 132(109)</p> <p>102(126) 687(437) 140(94)</p>	<p>112(69) 768(1,022) 84(67)</p> <p>64(80) 82(24) 57(69)</p>	<p>155(220) 587(783) 96(131)</p> <p>49(46) 1,340(1,142) 163(99)</p>	<p>90(187) 2(*) 20(59)</p> <p>68(40) 1,538(1,105) 35(24)</p>
<p>60(102) 321(786) 107(132)</p> <p>123(139) 660(829) 106(146)</p>	<p>96(48) 51(22) 43(32)</p> <p>34(14) 785(690) 96(69)</p>	<p>94(100) 780(1,170) 65(63)</p> <p>108(83) 817(602) 57(157)</p>	<p>14(12) 444(1,005) 5(4)</p> <p>3(2) 1(*) 4(12)</p>
1. Alameda Street & 7th Street	2. Alameda Street & 8th Street	3. Alameda Street & Olympic Boulevard	4. Lemon Street & Olympic Boulevard

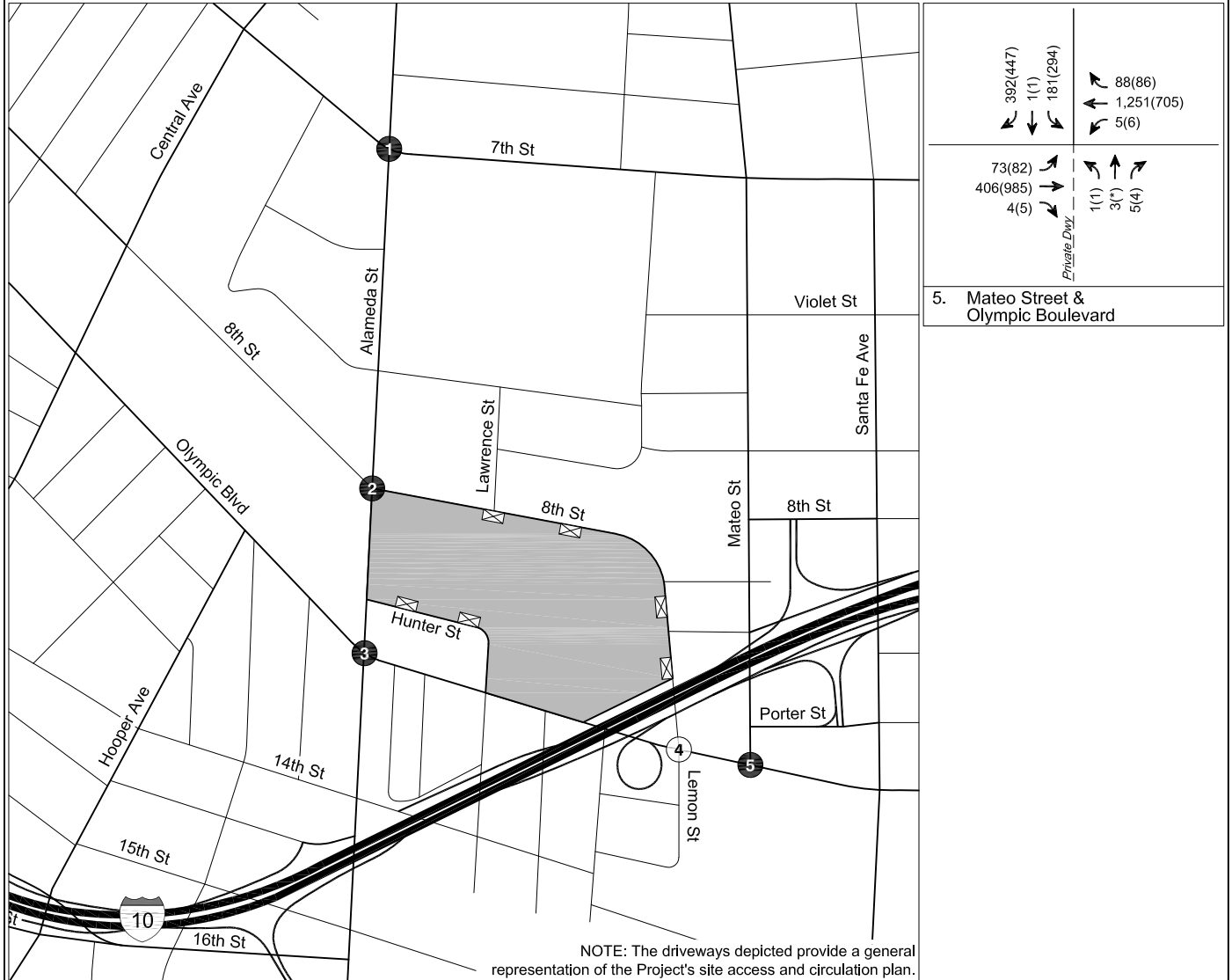

**LEGEND**

- Project Site
- Signalized Intersection
- Unsignalized Intersection
- Project Driveway
- #(#)** AM(PM) Peak Hour Traffic Volumes
- \*** Negligible Volume

N  
 Not to Scale

**EXISTING WITH PROJECT CONDITIONS (YEAR 2021)  
PEAK HOUR TRAFFIC VOLUMES**

**FIGURE  
15**



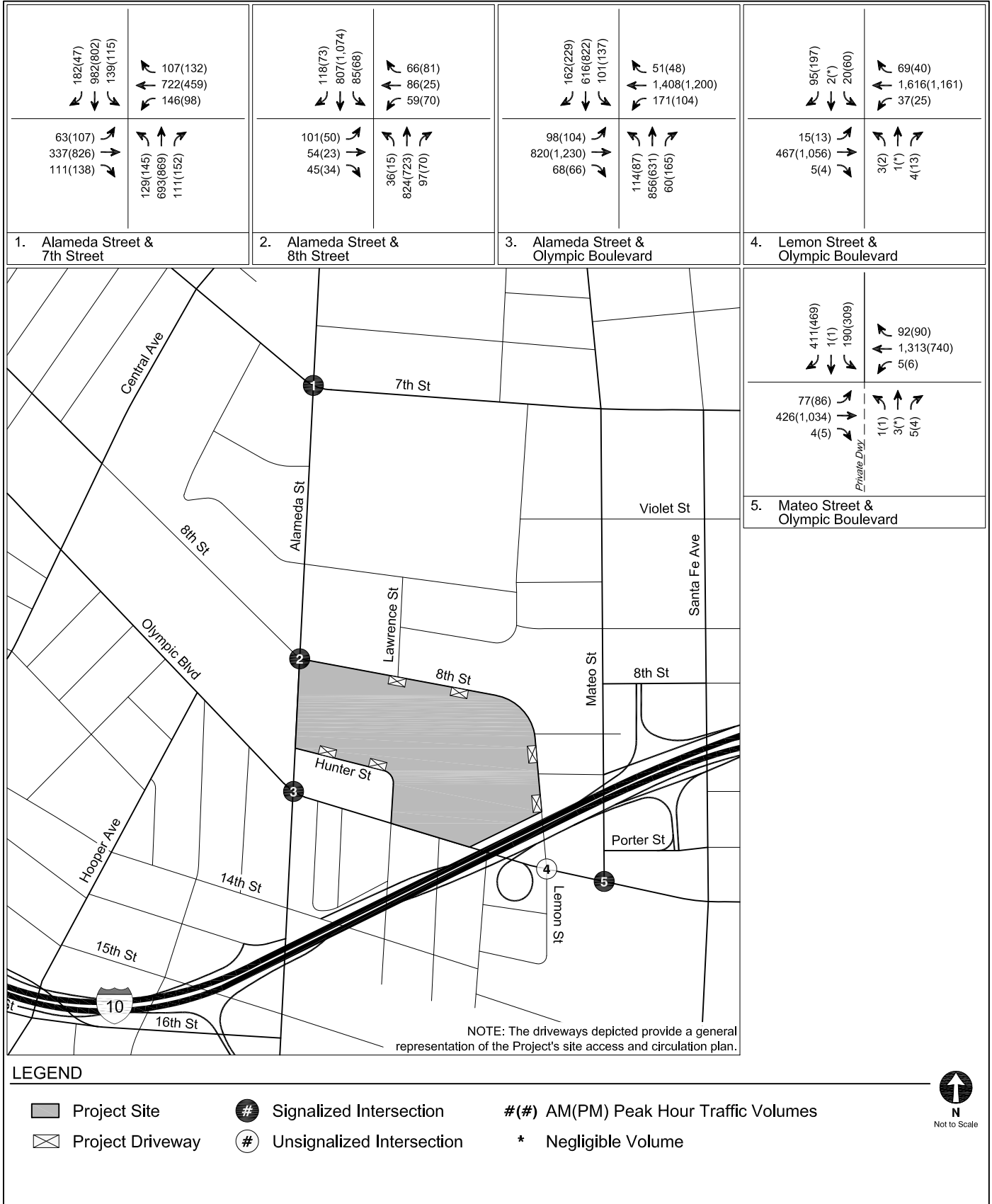

**FUTURE WITH PROJECT CONDITIONS (YEAR 2026)  
PEAK HOUR TRAFFIC VOLUMES**

**FIGURE  
16**

**TABLE 11  
INTERSECTION LEVEL OF SERVICE**

Level of Service	Description	Delay [a]	
		Signalized Intersections	Unsignalized Intersections
A	EXCELLENT. No vehicle waits longer than one red light and no approach phase is fully used.	≤ 10	≤ 10
B	VERY GOOD. An occasional approach phase is fully utilized; many drivers begin to feel somewhat restricted within groups of vehicles.	> 10 and ≤ 20	> 10 and ≤ 15
C	GOOD. Occasionally drivers may have to wait through more than one red light; backups may develop behind turning vehicles.	> 20 and ≤ 35	> 15 and ≤ 25
D	FAIR. Delays may be substantial during portions of the rush hours, but enough lower volume periods occur to permit clearing of developing lines, preventing excessive backups.	> 35 and ≤ 55	> 25 and ≤ 35
E	POOR. Represents the most vehicles intersection approaches can accommodate; may be long lines of waiting vehicles through several signal cycles.	> 55 and ≤ 80	> 35 and ≤ 50
F	FAILURE. Backups from nearby locations or on cross streets may restrict or prevent movement of vehicles out of the intersection approaches. Tremendous delays with continuously increasing queue lengths.	> 80	> 50

Notes

Source: *Highway Capacity Manual, 6th Edition* (Transportation Research Board, 2016).

[a] Measured in seconds.

**TABLE 12  
EXISTING WITH PROJECT CONDITIONS (YEAR 2021)  
INTERSECTION PEAK HOUR LEVELS OF SERVICE**

No.	Intersection	Peak Hour	Existing Conditions		Existing with Project Conditions	
			Delay	LOS	Delay	LOS
1. [a]	Alameda Street & 7th Street	AM	22.8	C	23.4	C
		PM	34.5	C	36.7	D
2. [a]	Alameda Street & 8th Street	AM	7.3	A	7.6	A
		PM	5.2	A	6.9	A
3. [a]	Alameda Street & Olympic Boulevard	AM	46.7	D	50.2	D
		PM	37.0	D	38.9	D
4. [b]	Lemon Street & Olympic Boulevard	AM	19.6	C	27.1	D
		PM	25.4	D	74.6	F
5. [a]	Mateo Street & Olympic Boulevard	AM	20.6	C	22.4	C
		PM	38.9	D	39.0	D

Notes:

Delay is measured in seconds per vehicle. LOS = Level of Service.

[a] Intersection analysis based on HCM 6th Edition Signalized methodology, which calculates the average intersection delay, in seconds, for each vehicle passing through the intersection.

[b] Intersection analysis based on the HCM 6th Edition Two-Way Stop Control Unsignalized methodology, which calculates the control delay, in seconds, for each individual approach of an intersection. The reported control delay represents the worst-case approach, and does not account for traffic gaps created by adjacent traffic signals.

**TABLE 13  
FUTURE WITH PROJECT CONDITIONS (YEAR 2026)  
INTERSECTION PEAK HOUR LEVELS OF SERVICE**

No.	Intersection	Peak Hour	Future without Project Conditions		Future with Project Conditions	
			Delay	LOS	Delay	LOS
1. [a]	Alameda Street & 7th Street	AM	23.8	C	24.4	C
		PM	36.5	D	39.4	D
2. [a]	Alameda Street & 8th Street	AM	7.3	A	7.7	A
		PM	5.2	A	7.0	A
3. [a]	Alameda Street & Olympic Boulevard	AM	53.9	D	59.0	E
		PM	46.2	D	48.8	D
4. [b]	Lemon Street & Olympic Boulevard	AM	22.9	C	35.0	D
		PM	34.6	D	119.1	F
5. [a]	Mateo Street & Olympic Boulevard	AM	22.1	C	24.6	C
		PM	42.5	D	42.6	D

Notes:

Delay is measured in seconds per vehicle. LOS = Level of Service.

[a] Intersection analysis based on HCM 6th Edition Signalized methodology, which calculates the average intersection delay, in seconds, for each vehicle passing through the intersection.

[b] Intersection analysis based on the HCM 6th Edition Two-Way Stop Control Unsignalized methodology, which calculates the control delay, in seconds, for each individual approach of an intersection. The reported control delay represents the worst-case approach, and does not account for traffic gaps created by adjacent traffic signals.

---

## **Section 5C**

### **Residential Street Cut-Through Analysis**

This section summarizes the residential street cut-through analysis for the Project. The residential street cut-through analysis determines potential increases in average daily traffic volumes on designated Local Streets, as classified in the Mobility Plan, that can be identified as cut-through trips generated by the Project, and that can adversely affect the character and function of those streets.

Section 3.5.2 of the TAG provides a list of questions to assess whether the Project would negatively affect residential streets. The Project is not projected to lead to trip diversion along residential Local Streets, nor is the Project projected to add a substantial amount of automobile traffic to congested Arterial Streets that could potentially cause a shift to residential Local Streets, as the surrounding area uses mainly consist of industrial and commercial uses. Thus, the Project is not required to conduct a Local Residential Street Cut-Through Analysis.

---

## **Section 5D**

### **Project Construction Assessment**

This section summarizes the construction schedule and construction impact analysis for the Project. The construction impact analysis relates to the temporary impacts that may result from the construction activities associated with the Project and was performed in accordance with Section 3.4 of the TAG.

#### **CONSTRUCTION EVALUATION CRITERIA**

Section 3.4.3 of the TAG identifies the following three types of in-street construction constraints that require further analysis to assess the effects of Project construction on the existing pedestrian, bicycle, transit, or vehicle circulation.

1. Temporary transportation constraints – potential effects on the transportation system
2. Temporary loss of access – potential effects on visitors entering and leaving sites
3. Temporary loss of bus stops or rerouting of bus lines – potential effects on bus travelers

The factors to be considered include the magnitude and duration of the temporary loss of access and transportation facilities, the potential inconvenience caused to users of the transportation system, and consideration for public safety. Construction activities could potentially interfere with pedestrian, bicycle, transit, or vehicle circulation and accessibility to adjoining areas. As detailed in Section 3.4.4 of the TAG, the proposed construction plans should be reviewed to determine whether construction activities would require any of the following actions within the public ROW:

- Street, sidewalk, or lane closures
- Block existing vehicle, bicycle, or pedestrian access along a street or to parcels fronting the street
- Modification of access to transit stations, stops, or facilities during revenue hours

- 
- Closure or movement of an existing bus stop or rerouting of an existing bus line
  - Creation of transportation hazards

## **PROPOSED CONSTRUCTION SCHEDULE**

The Project is anticipated to be constructed over a period of approximately 34 months, with an anticipated completion in Year 2026. The analysis conservatively assumes that typical construction activity would occur between 7:00 AM and 9:00 PM on weekdays and between 8:00 AM and 6:00 PM on Saturdays. However, the analysis also takes into account that haul truck activity is typically restricted to the non-commuter peak hours (e.g., 9:00 AM to 3:00 PM). The traffic constraints associated with construction workers depends on the number of construction workers employed during various subphases of construction, as well as the travel mode and travel time of the workers. In general, the hours of construction typically require workers to be on-site before the weekday morning commuter peak period and allow them to leave before or after the afternoon commuter peak period (i.e., arrive at the site prior to 7:00 AM and depart before 4:00 PM or after 6:00 PM). Therefore, most, if not all, construction worker trips would occur outside of the typical weekday commuter peak periods.

The construction period would include various sub-phases, with the highest haul truck activity occurring during the overlap of the demolition subphases for the existing building, new buildings, and parking garage, and the highest construction worker activity occurring during the overlap of the interior subphases for the existing building and new buildings. These overlapping subphases of construction were studied in greater detail and analyzed to ensure the analysis accounts for the maximum potential volume of trips associated with Project construction activities.

## **EXISTING BUILDING AND NEW BUILDINGS DEMOLITION SUBPHASES AND PARKING GARAGE GRADING & UTILITIES SUBPHASE**

The peak period of truck activity would occur during the overlap of the demolition subphases for the existing building and new buildings and the grading and utilities subphase for the parking garage. Haul trucks would travel on approved truck routes designated within the City. Given the Project Site's proximity to I-10, haul truck traffic would take the most direct route to the appropriate freeway ramps. The haul route will be reviewed and approved by the City.

---

Based on projections compiled for the Project, approximately 26,000 cubic yards of material would be removed from the Project Site during the overlap these subphases. During the overlap of the existing building and new buildings demolition subphases and the parking garage grading and subphase, 60 haul trucks per day are estimated to be generated to the Project Site. Thus, up to 120 daily truck trips (60 inbound, 60 outbound) are forecast to occur during this period.

Large trucks were converted into the equivalent value of passenger cars due to the slower headway and delay-creating effects of heavy vehicles. Table 8 of *Transportation Research Circular No. 212, Interim Materials on Highway Capacity* (Transportation Research Board, 1980) and Exhibit 12-25 of the HCM suggest that a passenger car equivalency (PCE) of one truck is equal to 2.0 commuter vehicles on level terrain. Assuming a PCE factor of 2.0, the 120 truck trips would be equivalent to 240 daily PCE trips.

In addition, a maximum of 80 construction workers would work at the Project Site during this phase. Assuming minimal carpooling amongst those workers, an average vehicle occupancy (AVO) of 1.135 persons per vehicle was applied, as provided in *CEQA Air Quality Handbook* (South Coast Air Quality Management District, 1993). Therefore, 80 workers would result in a total of 70 vehicles, or 140 trips (70 inbound and 70 outbound) to and from the Project Site on a daily basis.

With implementation of the Construction Management Plan, it is anticipated that almost all haul truck activity and worker trips would occur outside of the peak hours. Therefore, no peak hour construction traffic impacts are expected during the demolition subphases.

## **EXISTING BUILDING AND NEW BUILDINGS INTERIOR SUBPHASES**

According to construction projections prepared for the Project, the overlap of the existing building and new buildings interior subphases would employ the most construction workers, with a maximum of approximately 600 workers per day.

Assuming an AVO of 1.135 persons per vehicle, 600 workers would result in a total of 529 vehicles that would arrive and depart from the Project Site each day. The estimated number of daily trips



---

associated with the construction workers is approximately 1,058 (529 inbound and 529 outbound trips), but nearly all of those trips would occur outside of the peak hours, as described above. As such, the existing building and new buildings interior subphases are not expected to affect operations at any of the Study Area intersections.

During building construction, adequate parking for construction workers would be secured off-site at nearby parking lots. Restrictions on workers parking in the public ROW in the vicinity of (or adjacent to) the Project Site would be identified as part of the Construction Management Plan.

## **POTENTIAL CONSTRAINTS ON ACCESS, TRANSIT, AND PARKING**

Project construction is not expected to create hazards for roadway travelers, bus riders, or parkers, as long as commonly practiced safety procedures for construction are followed. Such procedures and other measures (e.g., to address temporary traffic control, lane closures, sidewalk closures, etc.) will be incorporated into the Construction Management Plan. The construction-related constraints associated with access and transit would be addressed with the implementation of the Construction Management Plan described below.

### **Access**

Construction activities are expected to be primarily contained within the Project Site boundary with no encroachment or closures on the public ROW (e.g., sidewalks and roadways) adjacent to the Project Site. The Project-adjacent parking lane and sidewalks along 8<sup>th</sup> Street and Hunter Street would not be affected by construction activities or the staging of construction materials and equipment.

### **Transit**

All construction is expected to occur on-site; therefore, transit operations would not be affected. An existing bus stop that serves the Metro Bus Route 66 at Olympic Boulevard & Lawrence Street would be maintained during construction.

---

## **Parking**

On-street parking is not provided along the Project frontage. Therefore, Project construction would not result in any temporary loss of street parking along the on-street parking spaces.

## **CONSTRUCTION MANAGEMENT PLAN**

A detailed Construction Management Plan, including haul routes and a staging plan, would be prepared and submitted to the City for review and approval, prior to commencing construction. The Construction Management Plan would formalize how construction would be carried out and identify specific actions that would be required to reduce effects on the surrounding community. The Construction Management Plan shall be based on the nature and timing of the specific construction activities and other projects in the vicinity of the Project Site, and shall include, but not be limited to, the following elements, as appropriate:

- Advance, bilingual notification of adjacent property owners and occupants of upcoming construction activities, including durations and daily hours of operation
- Prohibition of construction worker or equipment parking on adjacent streets
- Prohibition of haul truck staging on any streets adjacent to the Project, unless specifically approved as a condition of an approved haul route
- Scheduling of construction activities to reduce the effect on traffic flow on surrounding Arterial Streets
- Containment of construction activity within the Project Site boundaries
- Implementation of safety precautions for pedestrians and bicyclists through such measures as alternate routing and protection barriers
- Scheduling of construction-related deliveries, haul trips, etc., to occur outside the commuter peak hours
- Spacing of trucks so as to discourage a convoy effect
- Sufficient dampening of the construction area to control dust caused by grading and hauling and reasonable control at all times of dust caused by wind
- Maintenance of a log, available on the job site at all times, documenting the dates of hauling and the number of trips (i.e., trucks) per day

- 
- Identification of a construction manager and provision of a telephone number for any inquiries or complaints from residents regarding construction activities posted at the site readily visible to any interested party during site preparation, grading, and construction

It is likely that Construction Management Plans of the Related Projects would also be submitted for approval to the City prior to the start of construction activities. As part of the LADOT and/or Los Angeles Department of Building and Safety established review process of Construction Management Plans, potential overlapping construction activities and proposed haul routes would be reviewed to minimize the impacts of cumulative construction activities on any particular roadway.

---

## Section 5E Parking

This section provides an analysis of the proposed parking and the potential parking impacts of the Project.

### VEHICLE PARKING CODE REQUIREMENTS

The parking requirements of the Project are based on rates provided in LAMC Section 12.21.A4(x)(3) for projects within an Enterprise Zone, which requires commercial developments to provide two spaces per 1,000 sf, as detailed in Table 14.

As summarized in Table 14, the Project would require a total of 1,665 parking spaces. The Project's proposed parking supply would satisfy the LAMC parking requirement.

### BICYCLE PARKING CODE REQUIREMENTS

LAMC Section 12.21.A16 details the bicycle parking requirements for new developments. Per Section 12.21.A16(c), buildings undergoing a change of use, including adaptive reuse projects, are not required to provide bicycle parking. Thus, no bicycle parking is required for the Existing Building Renovation. The Code bicycle parking requirement of the New Studio Construction component of the Project is based on the following rates:

- Other Commercial Uses (Studio-Related Uses)
  - Short-Term
    - 1.0 space per 10,000 sf (minimum 2 spaces)
  - Long-Term
    - 1.0 space per 10,000 sf (minimum 2 spaces)

- 
- Office
    - Short-Term
      - 1.0 space per 10,000 sf (minimum 2 spaces)
    - Long-Term
      - 1.0 space per 5,000 sf (minimum 2 spaces)

Per the updated LAMC, the Project's New Studio Construction sound stage, production support, and ancillary uses would require 17 short-term and 17 long-term bicycle parking spaces, while the Project's office uses would require eight short-term and 16 long-term bicycle parking spaces.

As summarized in Table 15, the total LAMC bicycle requirement for the Project is 25 short-term and 33 long-term bicycle parking spaces. The Project would provide short-term and long-term bicycle parking that meets LAMC requirements.

**TABLE 14  
VEHICLE PARKING CODE REQUIREMENTS**

<b>Land Use</b>	<b>Size [a]</b>	<b>Code Requirement [b]</b>	<b>Parking Required</b>
New Studio Construction	249,600 sf	1.0 space / 500 sf	500 spaces
Ancillary Uses	190 sf	1.0 space / 500 sf	
Existing Building Renovation	541,450 sf	1.0 space / 500 sf	1,165 spaces
Ancillary Uses	40,950 sf	1.0 space / 500 sf	
<b>Total Code Parking Required</b>			<b>1,665 spaces</b>

Notes

[a] Per LAMC Section 12.21.A4, the vehicle code parking requirements consider the total floor area within the New Studio Construction and Existing Building Renovation, excluding mechanical areas.

[a] Commercial parking requirement per LAMC Section 12.21.A4(x)(3)(2) pursuant to the Project Site's location within a State Enterprise Zone.

**TABLE 15  
BICYCLE PARKING CODE REQUIREMENTS**

Land Use	Size	Short-Term		Long-Term	
		Rate [a]	Requirement	Rate [a]	Requirement
New Studio Construction					
Sound Stage	116,400 sf	1.0 sp / 10,000 sf	12 sp	1.0 sp / 10,000 sf	12 sp
Production Support	34,000 sf	1.0 sp / 10,000 sf	3 sp	1.0 sp / 10,000 sf	3 sp
Mill/Shop	20,700 sf	1.0 sp / 10,000 sf	2 sp	1.0 sp / 10,000 sf	2 sp
Mill/Shop Office	20,700 sf	1.0 sp / 10,000 sf	2 sp	1.0 sp / 5,000 sf	4 sp
Executive Office	57,800 sf	1.0 sp / 10,000 sf	6 sp	1.0 sp / 5,000 sf	12 sp
Ancillary Uses	190 sf	1.0 sp / 10,000 sf	0 sp	1.0 sp / 10,000 sf	0 sp
Existing Building Renovation	582,400 sf	--	[b]	--	[b]
<b>Total Bicycle Parking Requirements</b>			<b>Short-Term: 25 sp</b>		<b>Long-Term: 33 sp</b>
<b>Total Code Bicycle Parking Requirement</b>					<b>58 sp</b>

Notes

sp: spaces

[a] Bicycle requirements as calculated by Section 12.21.A.16 of the LAMC.

[b] Per Section 12.21.A16(c), buildings undergoing change of use, including adaptive reuse projects, are not required to provide bicycle parking.

---

## **Chapter 6**

### **Summary and Conclusions**

This study was undertaken to analyze the potential transportation impacts of the Project. The following summarizes the results of this analysis:

#### **Project Description**

- The Project proposes a change of use/adaptive reuse of the existing Los Angeles Times production plant to approximately 639,840 sf of studio, production support, office, and ancillary, circulation, and support uses. The Project would construct approximately 249,790 sf of new studio, production support, office, and ancillary uses. The Project is anticipated to be completed in Year 2026.
- Vehicular access to the Project Site would be provided via driveways along 8<sup>th</sup> Street, Lemon Street, and Hunter Street.
- The Project incorporates compliance with the City's TDM Ordinance. In addition, the Project design includes specific TDM measures, including bicycle parking as well as amenities and shower facilities for bicyclists.

#### **CEQA Analysis**

- The Project would be consistent with the City's plans, programs, ordinances, and polices and would not generate any geometric design hazard impacts. Therefore, the Project would result not result in a significant CEQA impact related to CEQA Threshold T-1 or CEQA Threshold T-3, and no mitigation would be required.
- The Project would result in a less than significant VMT impact (CEQA Threshold 2-1), and therefore, no mitigation would be required.

#### **Non-CEQA Analysis**

- After accounting for vehicle trips generated by the existing uses, the Project is estimated to generate 316 net new morning peak hour trips and 402 net new afternoon peak hour trips.
- The Project provides adequate internal circulation to accommodate vehicular, pedestrian, and bicycle traffic without impeding through traffic movements on City streets.



- 
- The Project incorporates compliance with the City's TDM Ordinance and would implement a TDM program in accordance with requirements of the TDM Ordinance to reduce single occupancy vehicle trips to the Project Site and throughout the Study Area.
  - The Project would meet LAMC-required vehicle and bicycle parking requirements and incorporate pedestrian and bicycle-friendly designs wider sidewalks and open spaces.
  - The Project would not adversely affect any residential Local Streets.
  - All construction activities would occur outside of the commuter morning and afternoon peak hours to the extent feasible and will not result in substantial interference. A Construction Management Plan will be prepared to ensure that construction impacts are less than significant.

---

## **References**

*2010 Bicycle Plan, A Component of the City of Los Angeles Transportation Element*, Los Angeles Department of City Planning, adopted March 1, 2011.

*2012 Developer Fee Justification Study*, Los Angeles Unified School District, 2012.

*California Manual on Uniform Traffic Control Devices*, California Department of Transportation, Rev. March 2020.

*Central City Community Plan*, City of Los Angeles, 2003.

California Code of Regulations, Title 14, Section 15000 and following.

*CEQA Air Quality Handbook*, South Coast Air Quality Management District, 1993.

*City of Los Angeles VMT Calculator Documentation*, Los Angeles Department of Transportation and Los Angeles Department of City Planning, May 2020.

*City of Los Angeles VMT Calculator Version 1.3*, Los Angeles Department of Transportation and Los Angeles Department of City Planning, July 2020.

*Citywide Design Guidelines*, Los Angeles City Planning Urban Design Studio, October 2019.

*Connect SoCal – The 2020-2045 Regional Transportation Plan / Sustainable Communities Strategy*, Southern California Association of Governments, September 2020.

*Highway Capacity Manual, 6<sup>th</sup> Edition*, Transportation Research Board, 2016.

*Interim Guidance for Freeway Safety Analysis*, Los Angeles Department of Transportation, May 2020

*Los Angeles Municipal Code*, City of Los Angeles.

*Manual of Policies and Procedures*, Los Angeles Department of Transportation, December 2008.

*Mobility Plan 2035, An Element of the General Plan*, Los Angeles Department of City Planning, September 2016.

*Plan for a Healthy Los Angeles: A Health and Wellness Element of the General Plan*, Los Angeles Department of City Planning, March 2015.

*Quantifying Greenhouse Gas Mitigation Measures*, California Air Pollution Control Officers Association, 2010.

---

## ***References, cont.***

*SCAG Regional Travel Demand Model and 2012 Model Validation*, Southern California Association of Governments, March 2016.

*State of California Senate Bill 743*, Steinberg, 2013.

*Technical Advisory on Evaluating Transportation Impacts in CEQA*, Governor's Office of Planning and Research, December 2018.

*Transportation Assessment Guidelines*, Los Angeles Department of Transportation, July 2020.

*Transportation Research Circular No. 212, Interim Materials on Highway Capacity*, Transportation Research Board, 1980

*Trip Generation, 9<sup>th</sup> Edition*, Institute of Transportation Engineers, 2012.

*Trip Generation, 10<sup>th</sup> Edition*, Institute of Transportation Engineers, 2017.

*Vision Zero: Eliminating Traffic Deaths in Los Angeles by 2025*, City of Los Angeles, August 2015.

***Appendix A***

***Memorandum of Understanding***

# Transportation Assessment Memorandum of Understanding (MOU)

This MOU acknowledges that the Transportation Assessment for the following Project will be prepared in accordance with the latest version of LADOT’s Transportation Assessment Guidelines:

**I. PROJECT INFORMATION**

Project Name: 8th & Alameda

Project Address: 2000 E. 8th Street, Los Angeles, CA 90021

Project Description: The Project proposes a change of use/adaptive reuse of the existing LA Times production plant to approximately 639,840 square feet (sf) of studio, production support, office, and ancillary/circulation/support uses, and the construction of approximately 249,790 sf of new studio, production support, office, and ancillary uses. Parking would be provided at grade throughout the site and in a new parking structure. See Figure 1.

LADOT Project Case Number: \_\_\_\_\_ Project Site Plan attached? (Required)  Yes  No

**II. TRANSPORTATION DEMAND MANAGEMENT (TDM) MEASURES**

Provide any transportation demand management measures that are being considered where the eligibility needs to be verified in advance (e.g. bike share kiosks, unbundled parking, microtransit service, etc.). Note that LADOT staff will make the final determination if TDM measures eligibility for a particular project. Please confirm eligibility with the LADOT Planning and Bureau staff assigned to your project.

- 1 \_\_\_\_\_ 4 \_\_\_\_\_
- 2 \_\_\_\_\_ 5 \_\_\_\_\_
- 3 \_\_\_\_\_ 6 \_\_\_\_\_

Select any TDM measures that are currently being considered that may be eligible as a Project Design Feature<sup>1</sup>:

<input type="checkbox"/>	Reduced Parking Supply <sup>2</sup>
<input checked="" type="checkbox"/>	Bicycle Parking and Amenities
<input type="checkbox"/>	Parking Cash Out

**III. TRIP GENERATION**

Trip Generation Rate(s) Source: ITE 10th Edition / Other ITE 10th Edition / Empirical Rates

Trip Generation Adjustment <i>(Exact amount of credit subject to approval by LADOT)</i>	Yes	No
Transit Usage	<input checked="" type="checkbox"/>	<input type="checkbox"/>
Existing Active or Previous Land Use	<input checked="" type="checkbox"/>	<input type="checkbox"/>
Internal Trip	<input type="checkbox"/>	<input checked="" type="checkbox"/>
Pass-By Trip	<input type="checkbox"/>	<input checked="" type="checkbox"/>
Transportation Demand Management (See above)	<input checked="" type="checkbox"/>	<input type="checkbox"/>

Trip generation table including a description of the existing and proposed land uses, rates, estimated morning and afternoon peak hour volumes (ins/outs/totals), proposed trip credits, etc. attached? (Required)  Yes  No

	<u>IN</u>	<u>OUT</u>	<u>TOTAL</u>
AM Trips	<u>216</u>	<u>100</u>	<u>316</u>
PM Trips	<u>147</u>	<u>255</u>	<u>402</u>

<b>NET Daily Vehicle Trips (DVT)</b>	
<u>578</u>	DVT (ITE <u>  </u> ed.)
<u>578</u>	DVT (VMT Calculator ver. <u>  </u> 1.3 )

<sup>1</sup> At this time Project Design Features are only those measures that are also shown to be needed to comply with a local ordinance, affordable housing incentive program, or state law.

<sup>2</sup>Select if reduced parking supply is pursued as a result of a parking incentive as permitted by the City’s Bicycle Parking Ordinance, State Density Bonus Law, or a the City/s Transit Oriented ted Community Guidelines.



**IV. STUDY AREA AND ASSUMPTIONS**

Project Buildout Year: 2026 Ambient Growth Rate: 1 % Per Yr.

Related Projects List, researched by the consultant and approved by LADOT, attached? (Required)  Yes  No

STUDY INTERSECTIONS and/or STREET SEGMENTS (May be subject to LADOT revision after access, safety and circulation evaluation)

1	<u>See Table 1</u>	4	_____
2	_____	5	_____
3	_____	6	_____

Is this Project located on a street within the High Injury Network?  Yes  No

**V. ACCESS ASSESSMENT**

- a. Does the project exceed 1,000 total DVT?  Yes  No
- b. Is the project's frontage 250 linear feet or more along an Avenue or Boulevard as classified by the City's General Plan?  Yes  No
- c. Is the project's building frontage encompassing an entire block along an Avenue or Boulevard as classified by the City's General Plan?  Yes  No

If questions a., b., or c. is Yes then complete Attachment C.1: Access Assessment Criteria.

**VI. SITE PLAN AND MAP OF STUDY AREA**

Does the attached site plan or map of study area show	Yes	No	Not Applicable
Each study intersection and/or street segment	<input checked="" type="checkbox"/>	<input type="checkbox"/>	<input type="checkbox"/>
Project Vehicle Peak Hour trips at each study intersection	<input checked="" type="checkbox"/>	<input type="checkbox"/>	<input type="checkbox"/>
Project Vehicle Peak Hour trips at each project access point	<input checked="" type="checkbox"/>	<input type="checkbox"/>	<input type="checkbox"/>
Project driveways (show widths and directions or lane assignment)	<input checked="" type="checkbox"/>	<input type="checkbox"/>	<input type="checkbox"/>
Pedestrian access points and any pedestrian paths	<input checked="" type="checkbox"/>	<input type="checkbox"/>	<input type="checkbox"/>
Pedestrian loading zones	<input checked="" type="checkbox"/>	<input type="checkbox"/>	<input type="checkbox"/>
Delivery loading zone or area	<input checked="" type="checkbox"/>	<input type="checkbox"/>	<input type="checkbox"/>
Bicycle parking onsite	<input checked="" type="checkbox"/>	<input type="checkbox"/>	<input type="checkbox"/>
Bicycle parking offsite (in public right-of-way)	<input type="checkbox"/>	<input type="checkbox"/>	<input checked="" type="checkbox"/>

**VII. CONTACT INFORMATION**

	<u>CONSULTANT</u>	<u>DEVELOPER</u>
Name:	<u>Gibson Transportation Consulting, Inc.</u>	<u>Jeffrey A. Goldberger, Atlas Capital Group</u>
Address:	<u>555 W. 5th St., Suite 3375, Los Angeles, CA 90013</u>	<u>450 Park Avenue, 4th Floor, New York, NY 10022</u>
Phone Number:	<u>(213) 683-0088</u>	_____
E-Mail:	<u>ewong@gibsontrans.com</u>	_____

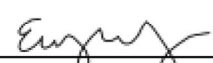
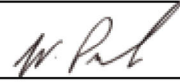
Approved by: x 	<u>3-8-21</u> Date	x 	<u>3-31-21</u> *Date
Consultant's Representative		LADOT Representative	*Date

\*MOUs are generally valid for two years after signing. If after two years a transportation assessment has not been submitted to LADOT, the developer's representative shall check with the appropriate LADOT office to determine if the terms of this MOU are still valid or if a new MOU is needed.

Attachment C.1: Access Assessment Criteria



### Access Assessment Criteria

This Criteria acknowledges that the Transportation Assessment for the following Project will be prepared in accordance with the latest version of LADOT’s Transportation Assessment Guidelines:

#### I. PROJECT INFORMATION

Project Name: 8th & Alameda

Project Address: 2000 E. 8th Street, Los Angeles, CA 90021

Project Description: The Project proposes a change of use/adaptive reuse of the existing LA Times production plant to approximately 639,840 square feet (sf) of studio, production support, office, and ancillary/circulation/support uses, and the construction of approximately 249,790 sf of new studio, production support, office, and ancillary uses. Parking would be provided at grade throughout the site and in a new parking structure. See Figure 1.

LADOT Project Case Number: \_\_\_\_\_

#### II. PEDESTRIAN/ PERSON TRIP GENERATION

Source of Pedestrian/Person Trip Generation Rate(s)?  VMT Calculator  ITE 10<sup>th</sup> Edition  Other:

	Land Use	Size/Unit	Daily Person Trips
Proposed	<b>To Be Provided</b>		
	<i>Total new trips:</i>		

Pedestrian/Person trip generation table including a description of the proposed land uses, trip credits, person trip assumptions, comparison studies used for reference, etc. attached?  Yes  No

#### III. PEDESTRIAN ATTRACTORS INVENTORY

Attach Pedestrian Map for the area (1,320 foot radius from edge of the project site) depicting:

- site pedestrian entrance(s)
- Existing or proposed passenger loading zones
- pedestrian generation/distribution values
  - Geographic Distribution: N 50 % S 15 % E 10 % W 25 %
- transit boarding and alighting of transit stops (should include Metro rail stations; Metro, DASH, and

other municipal bus stops)

- Key pedestrian destinations with hours of operation:
  - schools (school times)
  - government offices with a public counter or meeting room
  - senior citizen centers
  - recreation centers or playgrounds
  - public libraries
  - medical centers or clinics
  - child care facilities
  - post offices
  - places of worship
  - grocery stores
  - other facilities that attract pedestrian trips
- pedestrian walking routes to key destinations from project site

**Note:** Pedestrian Count Summary, Bicycle Count Summary, Manual Traffic Count Summary will need to be attached to the Transportation Assessment

#### IV. FACILITIES INVENTORY

Is a High Injury Network street located within 1,320 foot radius from the edge of the project site?  Yes  No

If yes, list streets and include distance from the project:

Olympic Boulevard	at <u>0</u> (feet)
Alameda Street	at <u>260</u> (feet)
Sante Fe Avenue	at <u>1,120</u> (feet)
_____	at _____ (feet)

Attach Radius Map for the area (1,320 foot radius from edge of the project site) depicting the following existing and proposed facilities:

- transit stops
- bike facilities
- traffic control devices for controlled crossings
- uncontrolled crosswalks
- location of any missing, damaged or substandard sidewalks

For a reference of planned facilities, see the [Transportation Assessment Support Map](#)



**Crossing Distances**

Does the project property have frontage along an arterial street (designated as either an Avenue or Boulevard?)

Yes  No

If yes, provide the distance between the crossing control devices (e.g. signalized crosswalk, or controlled mid-block crossing) along any arterial within 1,320 feet of the property.

343 (feet) at <u>Olympic Bl: Naomi Ave &amp; Hooper Ave</u>	650 (feet) at <u>Alameda St: Bay Street &amp; 8th Street</u>
910 (feet) at <u>Olympic Bl: Hooper Ave &amp; Alameda St</u>	880 (feet) at <u>Alameda St: Olympic Bl &amp; 8th Street</u>
640 (feet) at <u>Olympic Bl: Alameda St &amp; Lawrence St</u>	770 (feet) at <u>Alameda St: 14th St &amp; Olympic Blvd</u>
1,476 (feet) at <u>Olympic Bl: Lawrence St &amp; Mateo St</u>	_____ (feet) at _____
690 (feet) at <u>Olympic Bl: Mateo St &amp; Sante Fe Ave</u>	_____ (feet) at _____
660 (feet) at <u>Alameda St: Center St &amp; Bay Street</u>	_____ (feet) at _____

**V. Project Construction**

Will the project require any construction activity within the city right-of-way?  Yes  No

If yes, will the project require temporary closure of any of the following city facilities?

- sidewalk
- bike lane
- parking lane
- travel lane
- bus stop
- bicycle parking (racks or corrals)
- bike share or other micro-mobility station
- car share station
- parklet
- other: \_\_\_\_\_

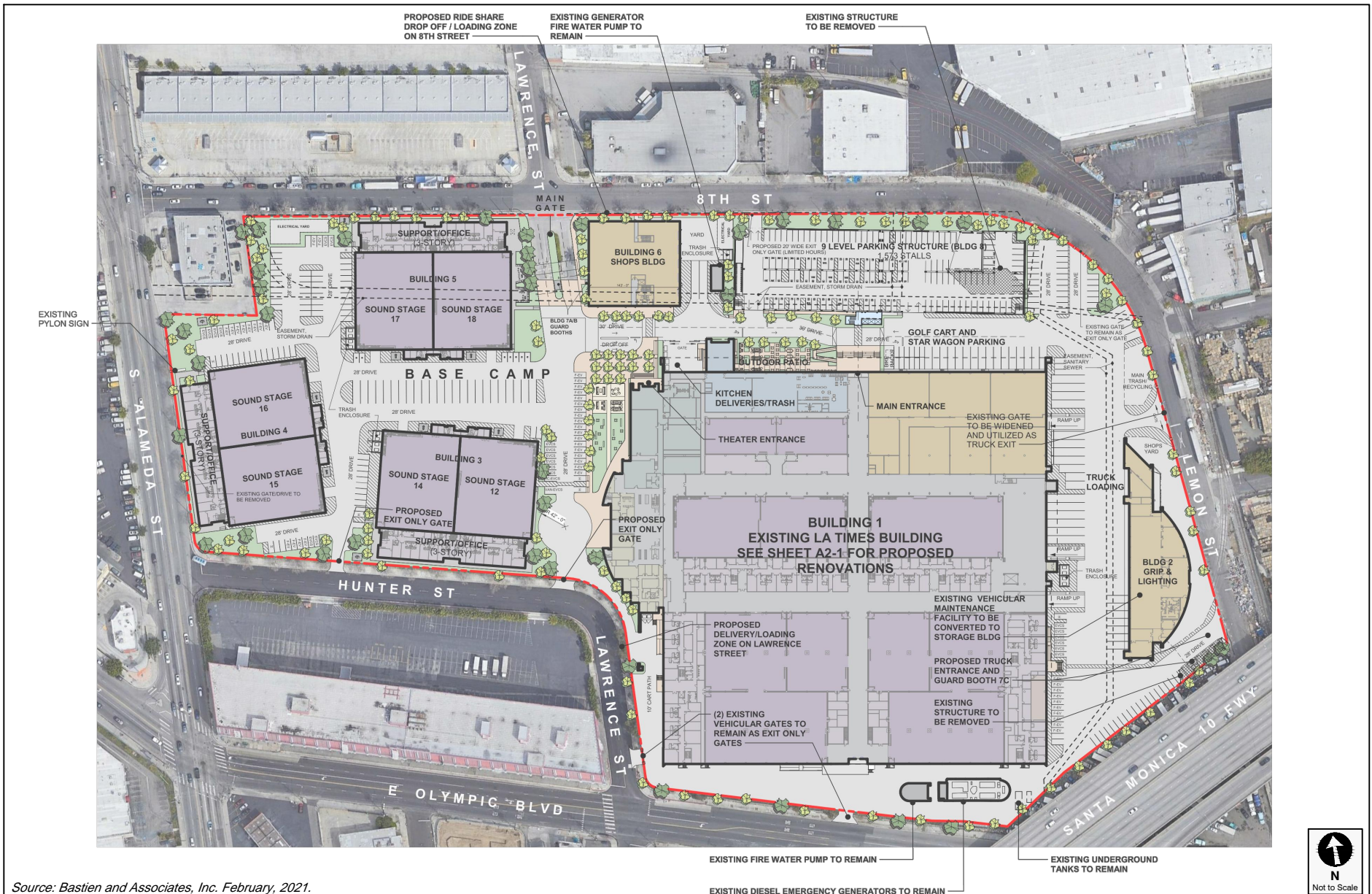

Source: Bastien and Associates, Inc. February, 2021.



PROJECT SITE PLAN

FIGURE  
1



PROJECT SITE LOCATION

FIGURE  
2

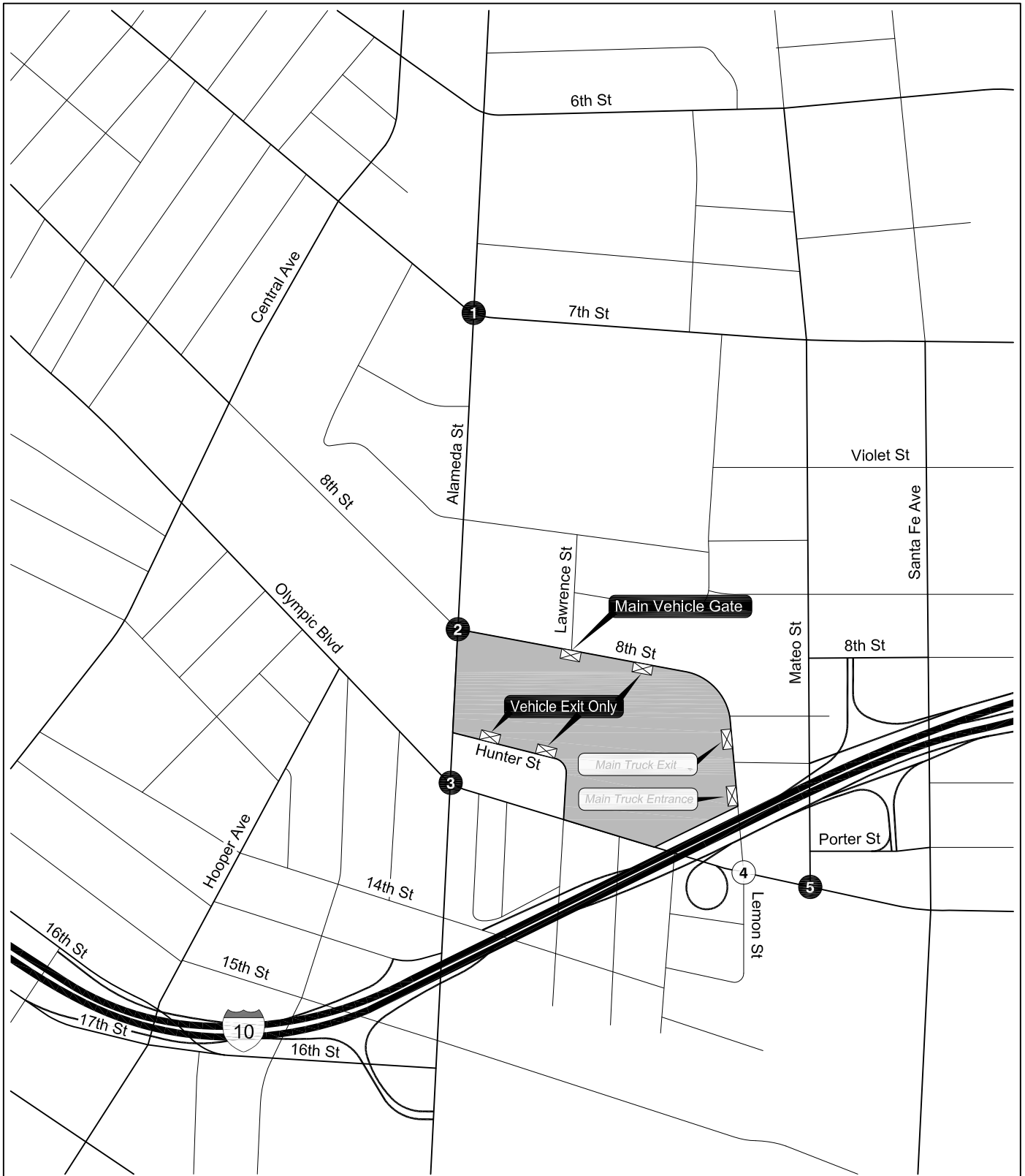

**LEGEND**

- Project Site
- Project Driveway
- # Signalized Intersection
- # Unsignalized Intersection



**STUDY AREA & ANALYZED INTERSECTIONS**

**FIGURE 3**

**TABLE 1  
STUDY INTERSECTIONS**

<b>No.</b>	<b>N/S Steet</b>	<b>E/W Street</b>
1.	Alameda Street	7th Street
2.	Alameda Street	8th Street
3.	Alameda Street	Olympic Boulevard
4. [a]	Lemon Street	Olympic Boulevard
5.	Mateo Street	Olympic Boulevard

Notes:

[a] Intersection is unsignalized.

**TABLE 2  
PROJECT TRIP GENERATION ESTIMATES**

TRIP GENERATION RATES [a]								
Land Use	ITE Land Use	Rate	Morning Peak Hour			Afternoon Peak Hour		
			In	Out	Total	In	Out	Total
Sound Stage	[b]	per ksf	63%	37%	0.20	40%	60%	0.43
Production Support	[b]	per ksf	65%	35%	0.61	45%	55%	0.57
General Light Industrial	110	per ksf	88%	12%	[c]	13%	87%	[c]
General Office	710	per ksf	86%	14%	1.16	16%	84%	1.15

TRIP GENERATION ESTIMATES								
Land Use	ITE Land Use	Size	Morning Peak Hour			Afternoon Peak Hour		
			In	Out	Total	In	Out	Total
<b><u>New Studio Construction</u> [d]</b>								
Sound Stage	[b]	116.40 ksf	14	9	23	20	30	50
Production Support	[b]	34.00 ksf	14	7	21	9	10	19
Mill/Shop	[b]	20.70 ksf	8	5	13	5	7	12
Mill/Shop Office	710	20.70 ksf	21	3	24	4	20	24
<i>Transit/Walk-In Reduction [e]</i>	5%		(1)	0	(1)	0	(1)	(1)
Executive Office	710	57.80 ksf	58	9	67	11	55	66
<i>Transit/Walk-In Reduction [e]</i>	5%		(3)	0	(3)	(1)	(3)	(4)
<b><u>Existing Building Renovation</u> [f]</b>								
Sound Stage	[b]	156.10 ksf	20	11	31	27	40	67
Production Support	[b]	251.55 ksf	99	54	153	64	79	143
Administrative Office	710	133.80 ksf	133	22	155	25	129	154
<i>Transit/Walk-In Reduction [e]</i>	5%		(7)	(1)	(8)	(1)	(6)	(7)
<b>TOTAL - PROPOSED PROJECT TRIPS</b>			<b>356</b>	<b>119</b>	<b>475</b>	<b>163</b>	<b>360</b>	<b>523</b>
<b><u>Existing Uses to Removed</u> [g]</b>								
General Light Industrial	110	558.9 ksf	140	19	159	16	105	121
<b>TOTAL - NET NEW PROJECT TRIPS</b>			<b>216</b>	<b>100</b>	<b>316</b>	<b>147</b>	<b>255</b>	<b>402</b>

**Notes:**

ksf = 1,000 square feet.

[a] Source: *Trip Generation, 10th Edition*, Institute of Transportation Engineers, 2017, unless as noted.

[b] Rate based on empirical rate from *Transportation Study for the NBC Universal Evolution Plan Environmental Impact Report*, Gibson Transportation Consulting, Inc. and Raju Associates, Inc., March 2010.

[c] The trip generation estimates for the existing uses were calculated based on the following best-fit curve equations for general light industrial uses (ITE Land Use Code 110):

$$\begin{aligned} \text{Daily: } & T = 3.79(X) + 57.96 \\ \text{AM: } & \ln(T) = 0.74 \ln(X) + 0.39 \\ \text{PM: } & \ln(T) = 0.69 \ln(X) + 0.43 \end{aligned}$$

[d] The total 249,790 sf of New Studio Construction includes a new 190 sf guard house, which was assumed to be an ancillary use of the Project and was not considered for trip generation purposes.

[e] The Project Site is located within walking distance of a Metro bus stop, therefore a 5% transit reduction is applied to account for transit usage and walking visitor arrivals from the adjacent commercial developments.

[f] The total 639,840 sf Existing Building Renovation includes amenities and supporting uses for the Project (i.e., 24,000 sf commissary and dining area, 57,400 sf mechanical rooms, 16,950 sf gym/spa/salon/restrooms). These uses were assumed to be ancillary to the studio, production, and office uses, and therefore, were not considered for trip generation purposes.

[g] The 558,900 sf existing light industrial use does not account for the existing 23,005 sf vehicular maintenance building, nor the demolition of the 150 sf guard house, 3,840 sf fuel station, and 1,476 sf drum storage. These uses were considered ancillary to the existing light industrial uses on-site. Therefore, no existing use trip reductions were applied for these uses.

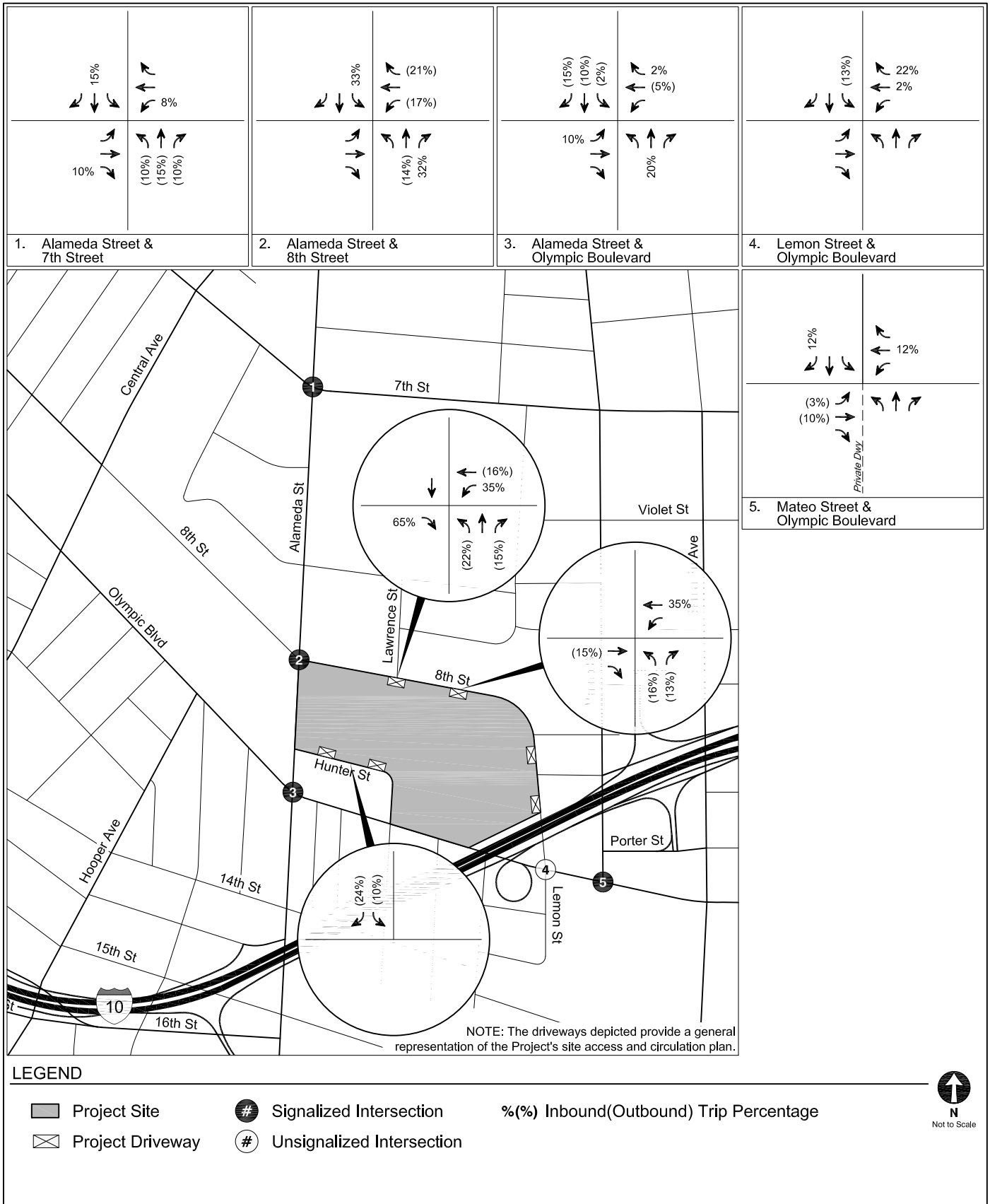

PROJECT TRIP DISTRIBUTION

FIGURE  
4

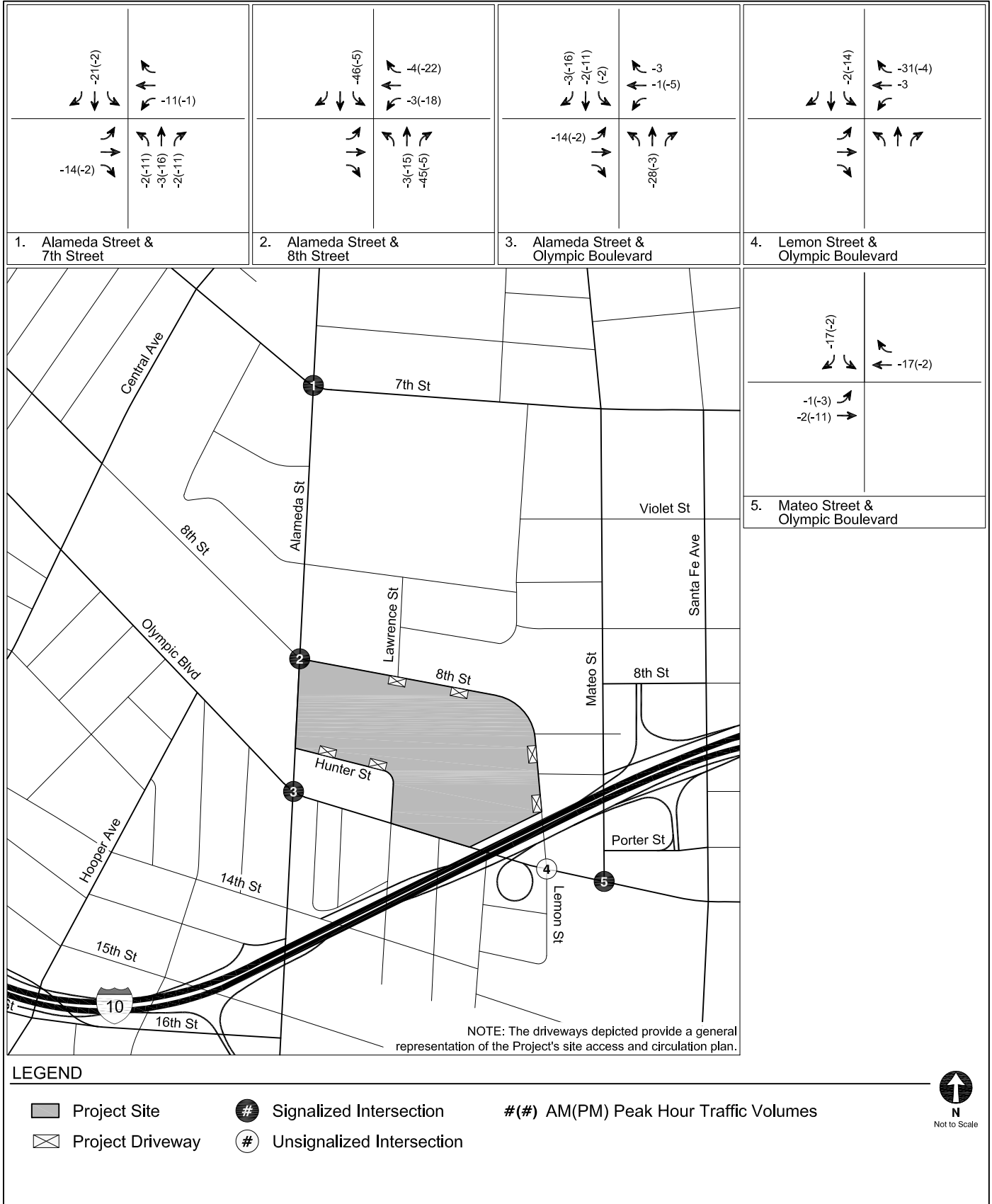

EXISTING USES TO BE REMOVED  
PEAK HOUR TRAFFIC VOLUMES

FIGURE  
5A



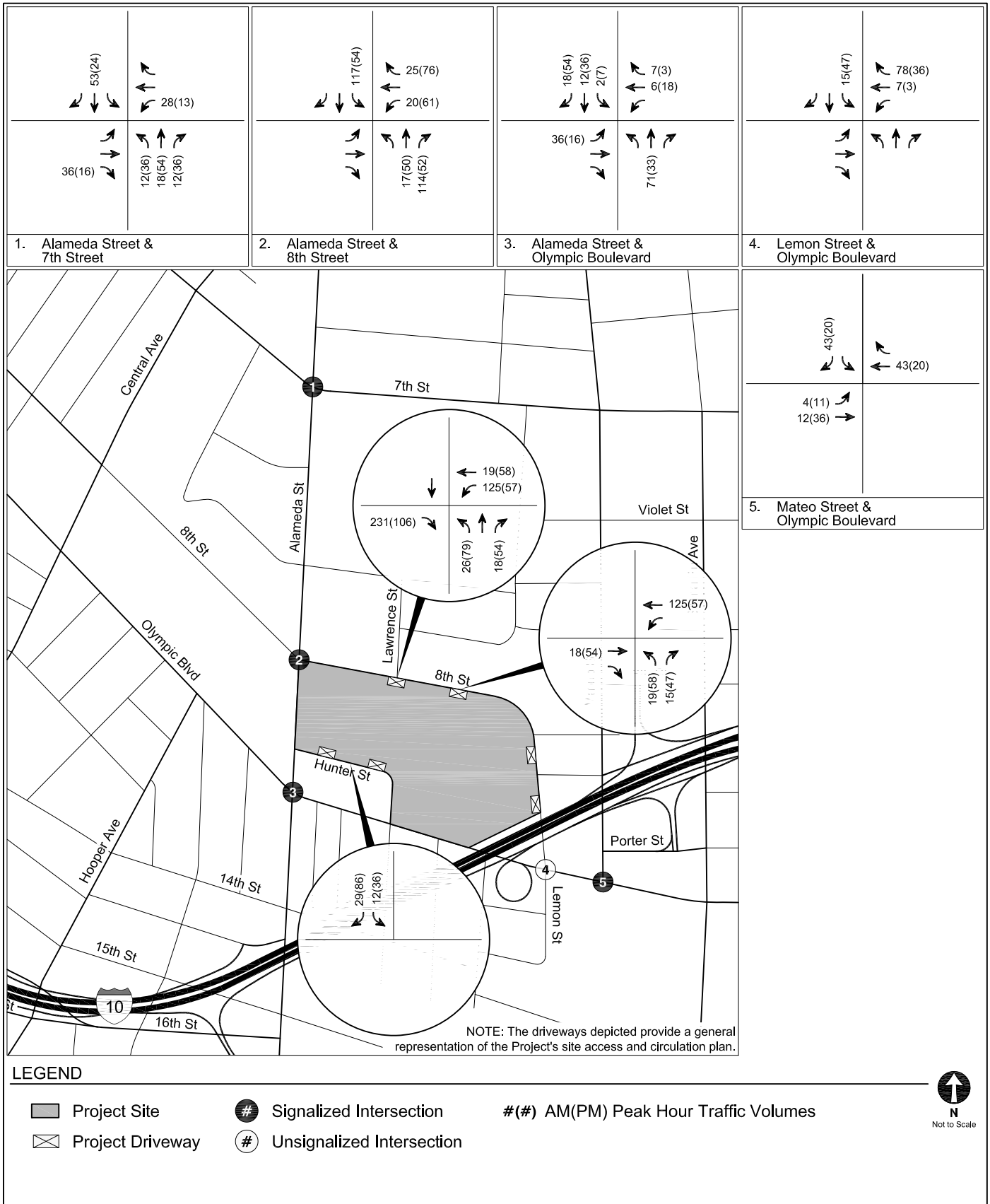

**LEGEND**

- Project Site
- Project Driveway

- Signalized Intersection
- Unsignalized Intersection

#(#) AM(PM) Peak Hour Traffic Volumes



**PROPOSED PROJECT-ONLY  
PEAK HOUR TRAFFIC VOLUMES**

**FIGURE  
5B**

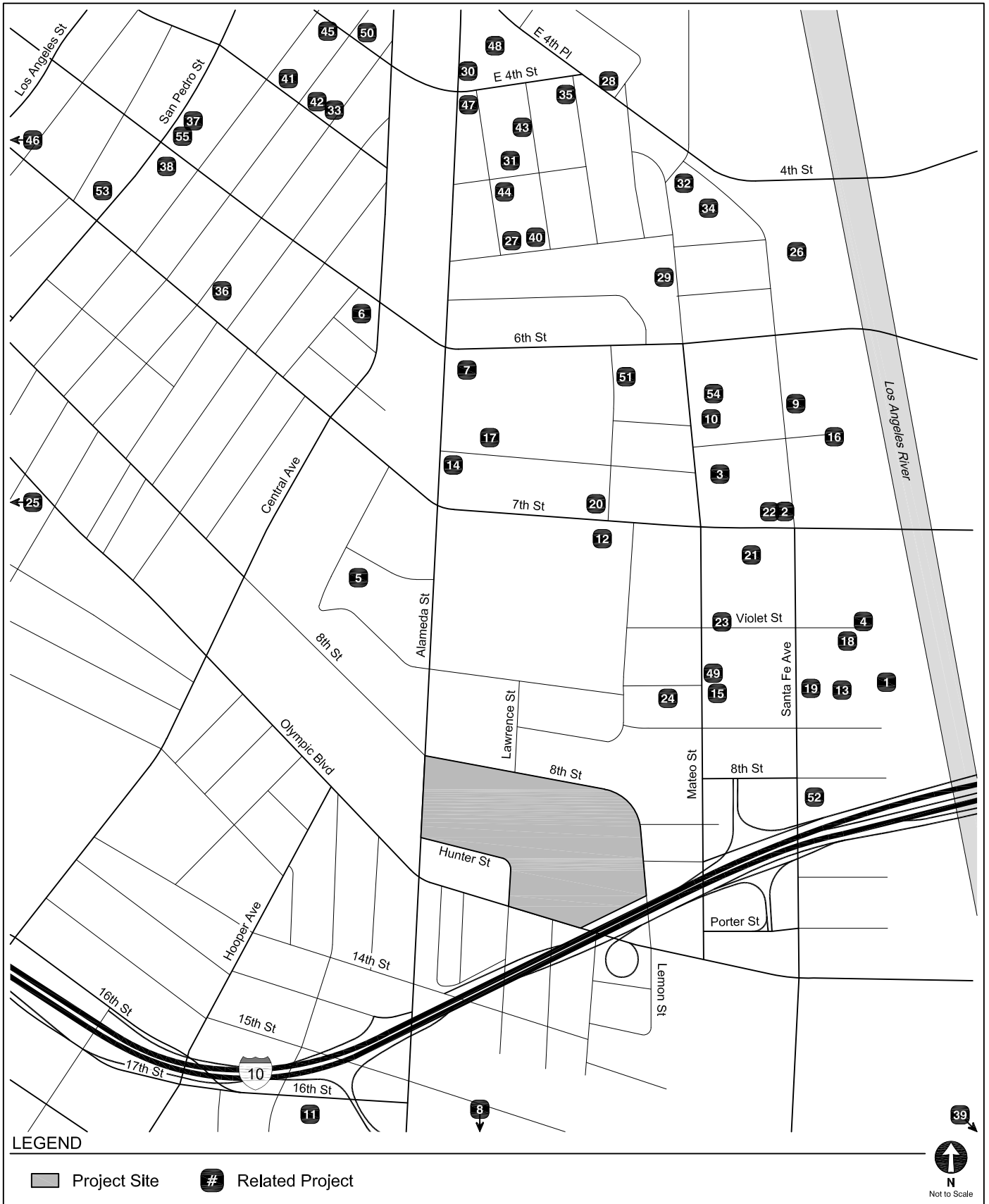

LOCATIONS OF RELATED PROJECTS

FIGURE 6

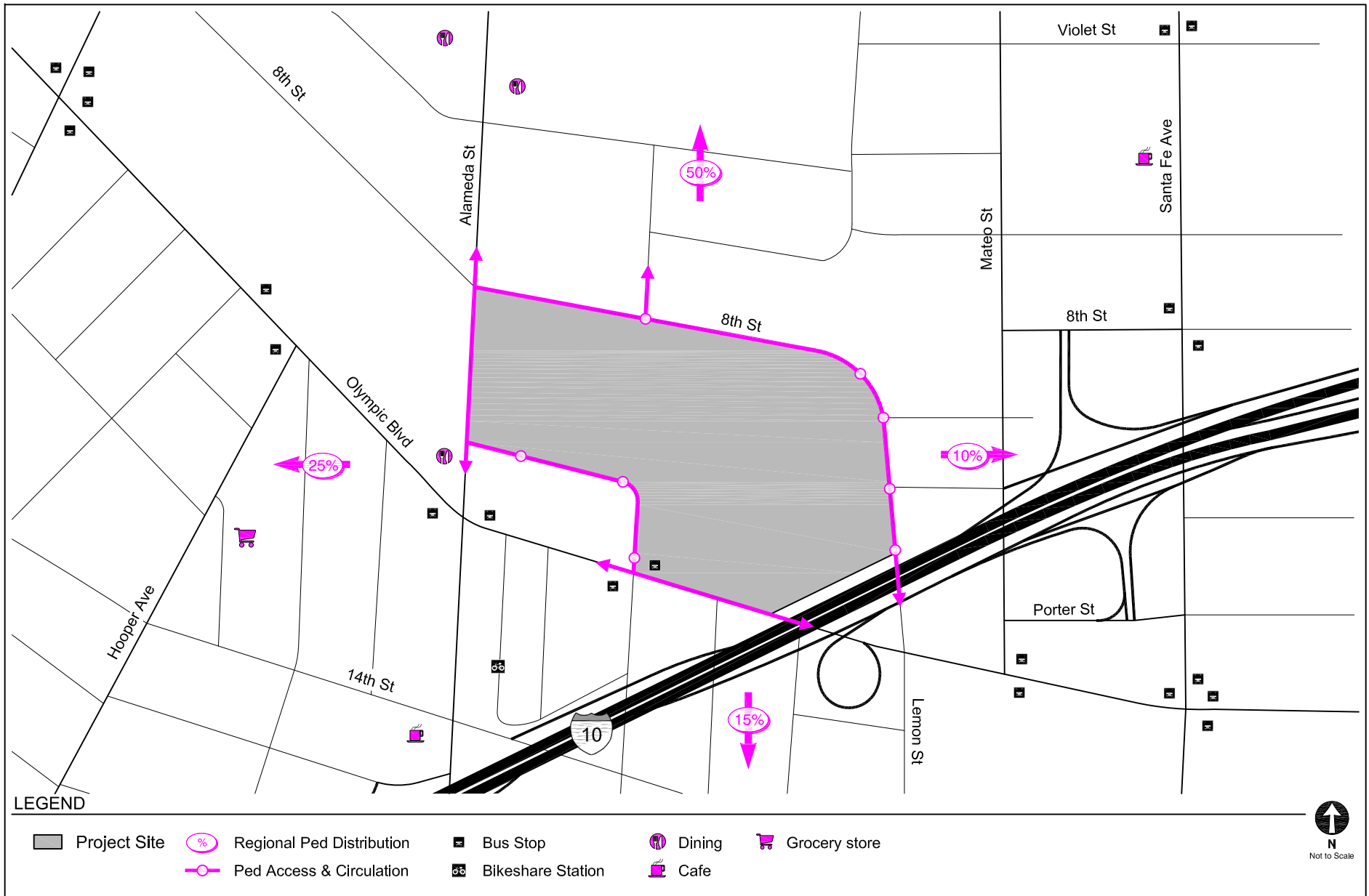

PEDESTRIAN DESTINATIONS INVENTORY

FIGURE 7

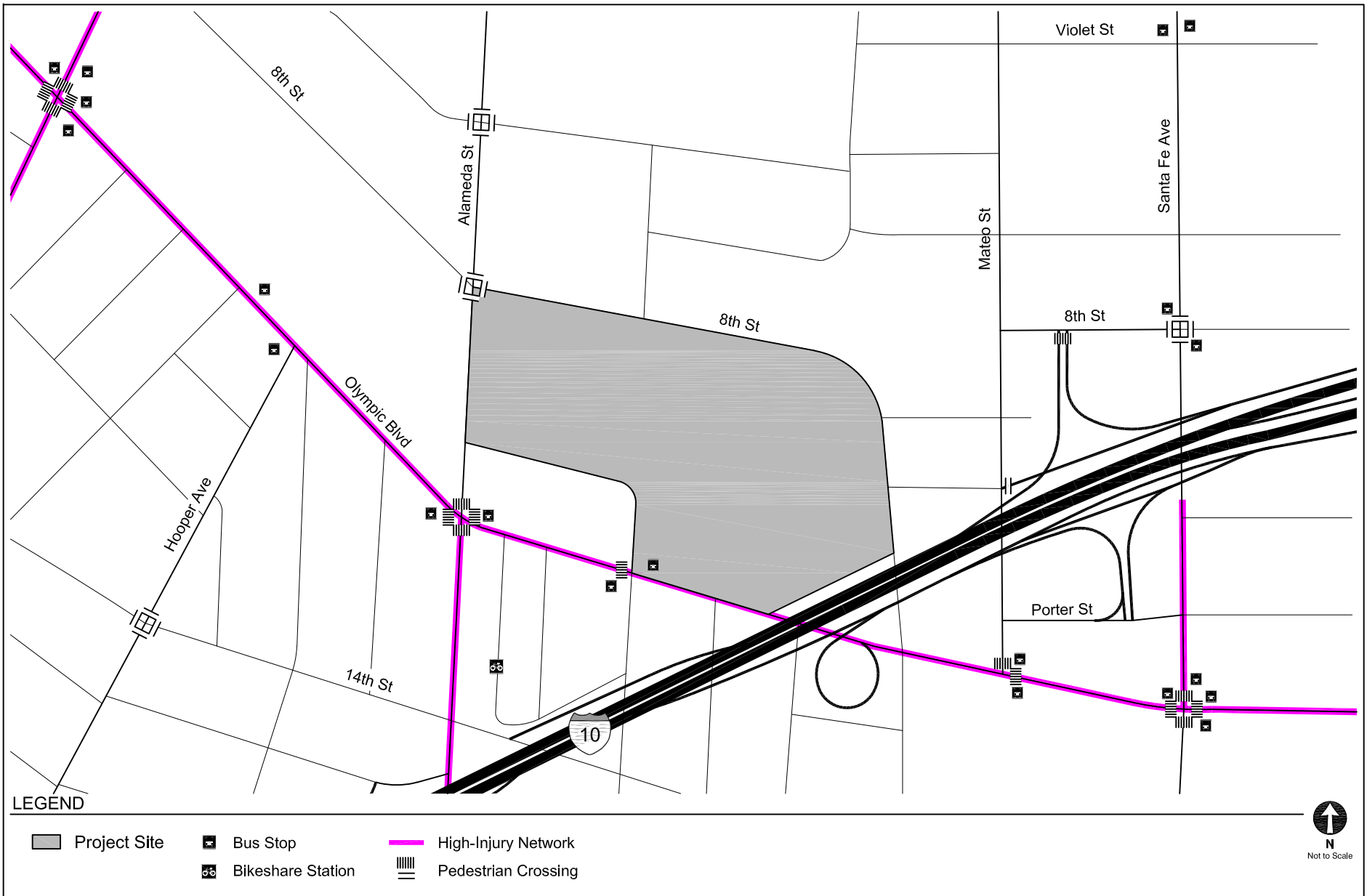

**LEGEND**

- Project Site
- x Bus Stop
- High-Injury Network
- 🚲 Bikeshare Station
- ||||| Pedestrian Crossing



Not to Scale

**EXISTING TRANSPORTATION FACILITIES**

**FIGURE 8**

**TABLE 3  
RELATED PROJECTS**

No.	Project	Address	Distance from Project Site	Description	Trip Generation [a]						
					Daily	Morning Peak Hour			Afternoon Peak Hour		
						In	Out	Total	In	Out	Total
1.	Office & Commercial	2159 E Bay St	0.6 miles	202,954 sf creative office, 3,235 sf meeting room space, 10,860 sf quality restaurant, and 10,860 sf high-turnover restaurant	4,417	193	27	220	115	245	360
2.	Rendon Hotel	2053 E 7th St	0.6 miles	103-room hotel	732	24	17	41	27	26	53
3.	676 Mateo St MU Project	676 S Mateo St	0.6 miles	159 apartment units, 26,093 sf office, 15,005 sf restaurant, and 8,375 sf retail	1,991	64	81	145	100	68	168
4.	Mixed-Use	2143 E Violet St	0.6 miles	347 apartment units, 21,858 sf restaurant, and 187,374 sf office	4,651	206	129	335	182	208	390
5.	ROW DTLA Mixed-Use	777 S Alameda St	0.4 miles	850,400 sf office, 117,700 sf restaurant, 66,200 sf retail, and 125 hotel rooms	916	(134)	(172)	(306)	(157)	35	(122)
6.	Mixed-Use	930 E 6th St	0.7 miles	236 apartment units and 12,000 sf retail	1,074	17	79	96	70	32	102
7.	6AM (6th & Alameda MU)	1206 E 6th St	0.6 miles	1,736 apartment units, 316,632 sf warehouse, 253,514 sf office, 45,278 sf restaurant, 82,332 sf retail, 22,429 sf art museum, 514 hotel rooms, 300-student school	14,258	437	585	1,022	710	642	1,352
8.	Municipal Solid Waste Facility	2001 E Washington Bl	0.6 miles	187,000 sf municipal solid waste material recovery facility	3,578	(27)	18	(9)	8	(18)	(10)
9.	Mixed-Use	640 S Sante Fe Ave	0.7 miles	91,185 sf office, 9,430 sf retail, and 6,550 sf restaurant	1,330	90	8	98	43	114	157
10.	Mixed-Use	641 S Imperial St	0.7 miles	140 live-work units and 14,750 sf commercial	1,245	44	61	105	66	60	126
11.	Restaurant	1722 E 16th St	0.5 miles	8,151 sf restaurant	592	(4)	2	(2)	36	11	47
12.	Mixed-Use (Revised)	1800 E 7th St	0.4 miles	122 apartment units, 3,245 sf retail, 4,605 sf restaurant, and 2,700 sf office	992	25	52	77	54	34	87
13.	2110 Bay Street	2110 Bay St	0.5 miles	110 live-work units, 113,350 sf office, and 43,657 sf retail	2,394	180	63	243	89	192	281
14.	Mixed-Use	668 S Alameda St	0.5 miles	475 live-work units, 33,100 sf office, 17,500 sf retail, 16,300 sf restaurant, and 15,300 sf supermarket	4,002	107	182	289	216	145	361
15.	1024 Mateo St MU	1024 S Mateo St	0.4 miles	106 apartment units, 2,250 sf live-work office, 92,740 sf office, 13,979 sf retail, and 13,126 sf restaurant	1,862	102	64	166	73	101	174
16.	Mesquit Mixed-Use	670 S Mesquit St	0.7 miles	944,055 sf office, 308 apartment units, 236 hotel rooms, 79,240 sf retail, 89,576 restaurant, 62,148 sf gym, 93,617 sf studio/museum/gallery, and 56,912 sf grocery store	22,845	1,258	321	1,579	640	1,195	1,835
17.	Camden Arts Mixed-Use	1525 E Industrial St	0.5 miles	328 apartment units, 27,300 sf office, 6,400 sf retail, and 5,700 sf restaurant	2,288	58	73	131	86	69	155
18.	Mixed-Use	2130 E Violet St	0.6 miles	94,000 sf office, 3,500 sf retail, and 4,000 sf restaurant	1,351	137	30	167	39	122	162
19.	Mixed-Use	1000 S Sante Fe St	0.5 miles	14,193 sf market, 6,793 sf health club, and 10,065 sf restaurant	966	36	38	74	49	20	69
20.	Hillcrest MU	1745 E 7th St	0.5 miles	57 apartment units, and 6,000 sf retail	635	10	25	35	34	23	57

**Notes**

[a] Source: Related project (within a one-mile radius) information based on available information provided by LADOT (January 11, 2020), Department of City Planning, and recent studies in the area.

**TABLE 3 (cont.)  
RELATED PROJECTS**

No.	Project	Address	Distance from Project Site	Description	Trip Generation [a]						
					Daily	Morning Peak Hour			Afternoon Peak Hour		
						In	Out	Total	In	Out	Total
21.	Mixed-Use (Old Ford Factory)	2030 E 7th St	0.5 miles	243,583 sf office and 40,000 sf retail	2,306	274	34	308	69	269	318
22.	Mixed-Use	2051 E 7th St	0.6 miles	320 apartment units, 5,000 sf restaurant, and 15,000 sf retail	2,310	17	127	144	145	64	208
23.	Mixed-Use	826 S Mateo St	0.4 miles	90 live-work units, 11,000 sf retail, and 5,600 sf restaurant	1,267	11	34	45	62	39	101
24.	SPR-Industrial Park	1005 S Mateo St	0.4 miles	94,849 sf industrial park	426	40	9	49	10	39	49
25.	The City Market (Mixed-Use)	1057 S San Pedro St	0.9 miles	945 residential units, 210-room hotel, 294,641 sf office, 224,862 sf retail, and 744-seat cinema	16,433	837	434	1,271	632	957	1,589
26.	Office	540 S Sante Fe Ave	0.9 miles	89,825 sf office	726	90	12	102	17	81	98
27.	310 Residential Apts + 26.7K Commercial	1147 E Palmetto St	0.8 miles	310 residential apartment units and 26,701 sf commercial	0	33	78	111	175	112	287
28.	Mixed-Use (Coca Cola)	963 E 4th St	1.0 mile	75,000 sf office, 25,000 sf retail, and 20,000 sf restaurant	2,512	106	22	128	113	138	251
29.	Retail (Palmetto & Mateo)	555 S Mateo St	0.8 miles	1,530,000 sf retail	4,300	5	30	35	220	205	425
30.	Mixed-Use	360 S Alameda St	1.0 mile	52 apartment units, 2,400 sf restaurant, and 6,900 sf creative office	648	42	33	57	33	28	61
31.	Arts District Center (Mixed-Use)	1129 E 5th St	0.9 miles	27,000 sf retail, 32,000 sf restaurant, 113-room hotel, 129 apartment units, 10,341 sf art gallery, and 3,430 design incubator	4,713	133	140	273	157	72	229
32.	Restaurant	500 S Mateo St	0.9 miles	12,682 sf high-turnover restaurant	1,052	48	41	89	50	31	81
33.	Mixed-Use	719 E 5th St	1.0 mile	160 apartment units and 7,500 sf retail	1,033	15	58	73	59	36	95
34.	520 Mateo St MU	520 S Mateo St	0.9 miles	600 apartment units, 120,000 sf office, 15,000 sf retail, and 15,000 sf restaurant	4,995	157	220	377	274	223	497
35.	4th & Hewitt MU	405 S Hewitt St	1.0 mile	311,682 sf office, and 81,49 sf retail	3,416	319	69	388	83	301	384
36.	Apartments	656 S Stanford Ave	0.8 miles	82 apartment units	1,463	8	34	42	33	18	51
37.	Weingart Projects (Affordable Housing)	554 S San Pedro St	1.0 mile	667 affordable housing units and 54,500 commercial on two sites	197	33	120	153	229	91	320
38.	San Pedro Tower (Affordable Housing)	600 S San Pedro St	1.0 mile	5 apartment units, 298 affordable housing units, and 19,909 sf commercial	636	38	25	63	30	37	67
39.	Sears MU Project	2650 E Olympic Bl	1.0 mile	1000 apartment units, 34,000 sf retail, 46,000 sf high-turnover restaurant, and 230,000 sf office	12,247	498	477	976	599	539	1,138
40.	Palmetto MU	527 S Colyton St	0.8 miles	275 apartment units, 35 affordable housing units, 11,375 sf retail, and 11,375 sf artist production	2,095	36	116	152	121	74	195

Notes

[a] Source: Related project (within a one-mile radius) information based on available information provided by LADOT (January 11, 2020), Department of City Planning, and recent studies in the area.

**TABLE 3 (cont.)  
RELATED PROJECTS**

No.	Project	Address	Distance from Project Site	Description	Trip Generation [a]						
					Daily	Morning Peak Hour			Afternoon Peak Hour		
						In	Out	Total	In	Out	Total
41.	Mixed-Use	609 E 5th St	1.0 mile	151 apartment units	1,004	15	62	77	61	33	94
42. [b]	Residential (Edward Hotel)	713 E 5th St	1.0 mile	50 affordable housing units and one apartment unit	208	15	10	25	9	8	17
43.	Office, Restaurant, Fast-Food	431 S Colyton St	0.9 miles	97,577 sf office, 10,739 sf restaurant, 1,977 sf fast-food restaurant	1,524	80	18	98	60	95	155
44.	1100 E 5th St MU Project	1100 E 5th St	0.9 miles	220 apartment units, 4,350 sf office, 17,810 sf general office, 19,609 sf restaurant, and 9,129 sf retail	2,556	78	107	185	130	80	210
45. [b]	Affordable Housing Development	508 E 4th St	1.0 mile	41 affordable housing units	167	8	12	20	8	6	14
46.	Clinic	649 S Wall St	1.0 mile	55 apartment units and 25,000 sf clinic	104	24	5	29	3	24	27
47.	400 S Alameda Hotel	400 S Alameda St	1.0 mile	66-room hotel, 2,130 sf restaurant, and 840 sf retail	512	20	18	38	23	14	37
48.	Greystar GP II	330 Alameda St	1.0 mile	186 apartment units and 22,000 sf commercial	1,662	36	76	112	91	65	156
49.	Mixed-Use	1000 S Mateo St	0.3 miles	113 apartment units and 134,000 sf commercial	2,238	153	83	236	90	131	221
50. [c]	Restaurant	605 E 4th St	1.0 mile	3,798 sf restaurant	426	21	17	38	23	14	37
51. [c]	Mixed-Use	1340 E 6th St	0.7 miles	193 live/work units and 255,088 sf commercial	11,469	190	177	367	550	554	1,104
52.	Mixed-Use	1200 S Santa Fe Ave	0.3 miles	53 apartment units and 13,000 sf retail	907	12	27	39	44	37	81
53.	Apartments	655 San Pedro St	0.9 miles	81 apartment units	539	8	33	41	33	17	50
54. [c]	Restaurant	634 S Mateo St	0.6 miles	499-seat restaurant	2,181	125	115	240	119	91	210
55. [c]	Affordable Housing Development	401 E 7th St	1.0 mile	99 affordable housing units	404	20	30	50	19	15	34

**Notes**

- [a] Source: Related project (within a one-mile radius) information based on available information provided by LADOT (January 11, 2020), Department of City Planning, and recent studies in the area.
- [b] Although construction of the related project may be partially complete/entirely complete, the project was not fully occupied at the time of the NOP or when traffic counts were conducted. Therefore, the related project was considered and listed to provide a more conservative analysis.
- [c] Trip generation estimated using rates from Trip Generation, 10th Edition, Institute of Transportation Engineers, 2017.

**TABLE 4  
FREEWAY OFF-RAMP SCREENING PROCESS**

Freeway Off-Ramp	Peak Hour	Project Traffic	Meets Screening Criteria? [a]
<b>US-101 Southbound</b>			
Off-ramp to 7th Street	AM	11	NO
	PM	7	NO
<b>I-10 Eastbound</b>			
Off-ramp to Alameda Street	AM	17	NO
	PM	12	NO
Off-ramp to Porter Street	AM	22	NO
	PM	15	NO
<b>I-10 Westbound</b>			
Off-ramp to Enterprise Street	AM	28	<b>YES</b>
	PM	19	NO

Notes

[a] Based on *Interim Guidance for Freeway Safety Analysis* (LADOT, 2020), a transportation assessment for a development project must include analysis of any freeway off-ramp where a project adds 25 or more peak hour trips.



**TABLE 5  
8TH & ALAMEDA STUDIOS  
VMT TRIP EQUIVALENCY DEVELOPMENT**

PROJECT TRIP GENERATION				OFFICE EQUIVALENCY			
Land Use	ITE Land Use [a]	Rate	Daily	Land Use	ITE Land Use	Rate	Daily
Sound Stage	[b]	per ksf	5.91	General Office	710	per ksf	9.74
Production Support	[b]	per ksf	4.14				
General Office	710	per ksf	9.74				
<b><u>New Studio Construction</u></b>				<b><u>New Studio Construction</u></b>			
Sound Stage	[b]	116.40 ksf	688	Sound Stage - Office Equivalency	710	74.368 ksf	724
Production Support	[b]	34.00 ksf	141	<i>Transit/Walk-In Reduction [c]</i> 5%			(36)
Mill/Shop	[b]	20.70 ksf	86	Production Support - Office Equivalency	710	15.200 ksf	148
Mill/Shop Office	710	20.70 ksf	202	<i>Transit/Walk-In Reduction [c]</i> 5%			(7)
<i>Transit/Walk-In Reduction [c]</i> 5%			(10)	Mill/Shop - Office Equivalency	710	9.371 ksf	91
Executive Office	710	57.80 ksf	563	<i>Transit/Walk-In Reduction [c]</i> 5%			(5)
<i>Transit/Walk-In Reduction [c]</i> 5%			(28)	Mill/Shop Office	710	20.700 ksf	202
				<i>Transit/Walk-In Reduction [c]</i> 5%			(10)
<b>Subtotal - New Studio Construction</b>			<b>1,642</b>	Executive Office	710	57.800 ksf	563
				<i>Transit/Walk-In Reduction [c]</i> 5%			(28)
				<b>Subtotal - New Studio Construction</b>			<b>1,642</b>
<b><u>Existing Building Renovation</u></b>				<b><u>Existing Building Renovation</u></b>			
Sound Stage	[b]	156.10 ksf	923	Sound Stage - Office Equivalency	710	99.752 ksf	972
Production Support	[b]	251.55 ksf	1,041	<i>Transit/Walk-In Reduction [c]</i> 5%			(49)
Administrative Office [d]	710	133.80 ksf	1,303	Production Support - Office Equivalency	710	112.523 ksf	1,096
<i>Transit/Walk-In Reduction [c]</i> 5%			(65)	<i>Transit/Walk-In Reduction [c]</i> 5%			(55)
<b>Subtotal - Existing Building Renovation</b>			<b>3,202</b>	Administrative Office [d]	710	133.800 ksf	1,303
				<i>Transit/Walk-In Reduction [c]</i> 5%			(65)
<b>TOTAL - PROPOSED PROJECT TRIPS</b>		<b>791.05 ksf</b>	<b>4,844</b>	<b>Subtotal - Existing Building Renovation</b>			<b>3,202</b>
				<b>TOTAL</b>		<b>523.514 ksf</b>	<b>4,844</b>

**Notes**

[a] Source: *Trip Generation, 10th Edition*, Institute of Transportation Engineers, 2017, unless as noted.

[b] Rate based on empirical rate from *Transportation Study for the NBC Universal Evolution Plan Environmental Impact Report*, Gibson Transportation Consulting, Inc. and Raju Associates, Inc., March 2010.

[d] The Project Site is located within walking distance of a Metro bus stop, therefore a 5% transit reduction is applied to account for transit usage and walking visitor arrivals from the adjacent commercial developments.

[e] Amenities and supporting uses for the Project (i.e., commissary, circulation areas, mechanical rooms, gym/spa/salon) were assumed to be ancillary to the studio, production, and office uses, and therefore, were not considered for trip generation purposes.

# CITY OF LOS ANGELES VMT CALCULATOR Version 1.3



*Project Screening Criteria: Is this project required to conduct a vehicle miles traveled analysis?*

## Project Information

**Project:** 8th & Alameda  
**Scenario:** Project  
**Address:** 2000 E 8TH ST, 90021

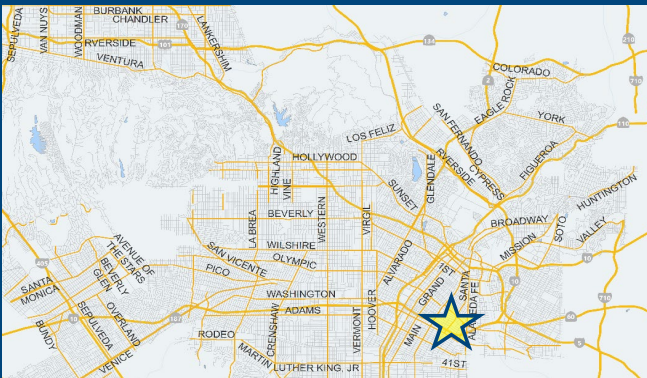

**Is the project replacing an existing number of residential units with a smaller number of residential units AND is located within one-half mile of a fixed-rail or fixed-guideway transit station?**

Yes  No

## Existing Land Use

Land Use Type	Value	Unit
Industrial   Light Industrial	558.918	ksf
Industrial   Light Industrial	558.918	ksf

Click here to add a single custom land use type (will be included in the above list)

## Proposed Project Land Use

Land Use Type	Value	Unit
Office   General Office	523.514	ksf
Office   General Office	523.514	ksf

Click here to add a single custom land use type (will be included in the above list)

## Project Screening Summary

Existing Land Use	Proposed
<b>2,933</b> Daily Vehicle Trips	<b>3,511</b> Daily Vehicle Trips
<b>22,382</b> Daily VMT	<b>27,764</b> Daily VMT
Tier 1 Screening Criteria	
Project will have less residential units compared to existing residential units & is within one-half mile of a fixed-rail station. <input type="checkbox"/>	
Tier 2 Screening Criteria	
The net increase in daily trips < 250 trips	<b>578</b> Net Daily Trips
The net increase in daily VMT ≤ 0	<b>5,382</b> Net Daily VMT
The proposed project consists of only retail land uses ≤ 50,000 square feet total.	<b>0.000</b> ksf
<b>The proposed project is required to perform VMT analysis.</b>	



## VMT Calculator User Agreement

The Los Angeles Department of Transportation (LADOT), in partnership with the Department of City Planning and Fehr & Peers, has developed the City of Los Angeles Vehicle Miles Traveled (VMT) Calculator to estimate project-specific daily household VMT per capita and daily work VMT per employee for land use development projects. This application, the VMT Calculator, has been provided to You, the User, to assess vehicle miles traveled (VMT) outcomes of land use projects within the City of Los Angeles. The term “City” as used below shall refer to the City of Los Angeles. The terms “City” and “Fehr & Peers” as used below shall include their respective affiliates, subconsultants, employees, and representatives.

The City is pleased to be able to provide this information to the public. The City believes that the public is most effectively served when they are provided access to the technical tools that inform the public review process of private and public land use investments. However, in using the VMT Calculator, You agree to be bound by this VMT Calculator User Agreement (this Agreement).

**VMT Calculator Application for the City of Los Angeles.** The City’s consultant calibrated the VMT Calculator’s parameters in 2018 to estimate travel patterns of locations in the City, and validated those outcomes against empirical data. However, this calibration process is limited to locations within the City, and practitioners applying the VMT Calculator outside of the City boundaries should not apply these estimates without further calibration and validation of travel patterns to verify the VMT Calculator’s accuracy in estimating VMT in such other locations.

**Limited License to Use.** This Agreement gives You a limited, non-transferrable, non-assignable, and non-exclusive license to use and execute a copy of the VMT Calculator on a computer system owned, leased or otherwise controlled by You in Your own facilities, as set out below, provided You do not use the VMT Calculator in an unauthorized manner, and that You do not republish, copy, distribute, reverse-engineer, modify, decompile, disassemble, transfer, or sell any part of the VMT Calculator, and provided that You know and follow the terms of this Agreement. Your failure to follow the terms of this Agreement shall automatically terminate this license and Your right to use the VMT Calculator.

**Ownership.** You understand and acknowledge that the City owns the VMT Calculator, and shall continue to own it through Your use of it, and that no transfer of ownership of any kind is intended in allowing You to use the VMT Calculator.

**Warranty Disclaimer.** In spite of the efforts of the City and Fehr & Peers, some information on the VMT Calculator may not be accurate. The VMT Calculator, OUTPUTS AND ASSOCIATED DATA ARE PROVIDED “as is” WITHOUT WARRANTY OF ANY KIND, whether expressed, implied, statutory, or otherwise including but not limited to, the implied warranties of merchantability and fitness for a particular purpose.

**Limitation of Liability.** It is understood that the VMT Calculator is provided without charge. Neither the City nor Fehr & Peers can be responsible or liable for any information derived from its use, or for any delays, inaccuracies, incompleteness, errors or omissions arising out of your use of the VMT Calculator or with respect to the material contained in the VMT Calculator. You understand and agree that Your sole remedy against the City or Fehr & Peers for loss or damage caused by any defect or failure of the

VMT Calculator, regardless of the form of action, whether in contract, tort, including negligence, strict liability or otherwise, shall be the repair or replacement of the VMT Calculator to the extent feasible as determined solely by the City. In no event shall the City or Fehr & Peers be responsible to You or anyone else for, or have liability for any special, indirect, incidental or consequential damages (including, without limitation, damages for loss of business profits or changes to businesses costs) or lost data or downtime, however caused, and on any theory of liability from the use of, or the inability to use, the VMT Calculator, whether the data, and/or formulas contained in the VMT Calculator are provided by the City or Fehr & Peers, or another third party, even if the City or Fehr & Peers have been advised of the possibility of such damages.

This Agreement and License shall be governed by the laws of the State of California without regard to their conflicts of law provisions, and shall be effective as of the date set forth below and, unless terminated in accordance with the above or extended by written amendment to this Agreement, shall terminate on the earlier of the date that You are not making use of the VMT Calculator or one year after the beginning of Your use of the VMT Calculator.

By using the VMT Calculator, You hereby waive and release all claims, responsibilities, liabilities, actions, damages, costs, and losses, known and unknown, against the City and Fehr & Peers for Your use of the VMT Calculator.

Before making decisions using the information provided in this application, contact City LADOT staff to confirm the validity of the data provided.

Print and sign below, and submit to LADOT along with the transportation assessment Memorandum of Understanding (MOU).

You, the User	
By:	<u>Janet Ye</u>
Print Name:	<u>Janet Ye</u>
Title:	<u>Associate</u>
Company:	<u>Gibson Transportation Consulting, Inc.</u>
Address:	<u>555 W. 5th St., Suite 3375</u> <u>Los Angeles, CA 90013</u>
Phone:	<u>(213) 683-0088</u>
Email Address:	<u>jye@gibsontrans.com</u>
Date:	<u>February 11, 2021</u>

***Appendix B***  
***Traffic Volume Data***

# ITM Peak Hour Summary

Prepared by:



National Data & Surveying Services

## Alameda St and 7th St, Los Angeles

Date: 1/15/2014

Day: Wednesday

Project #: 14-5018-002

City: Los Angeles

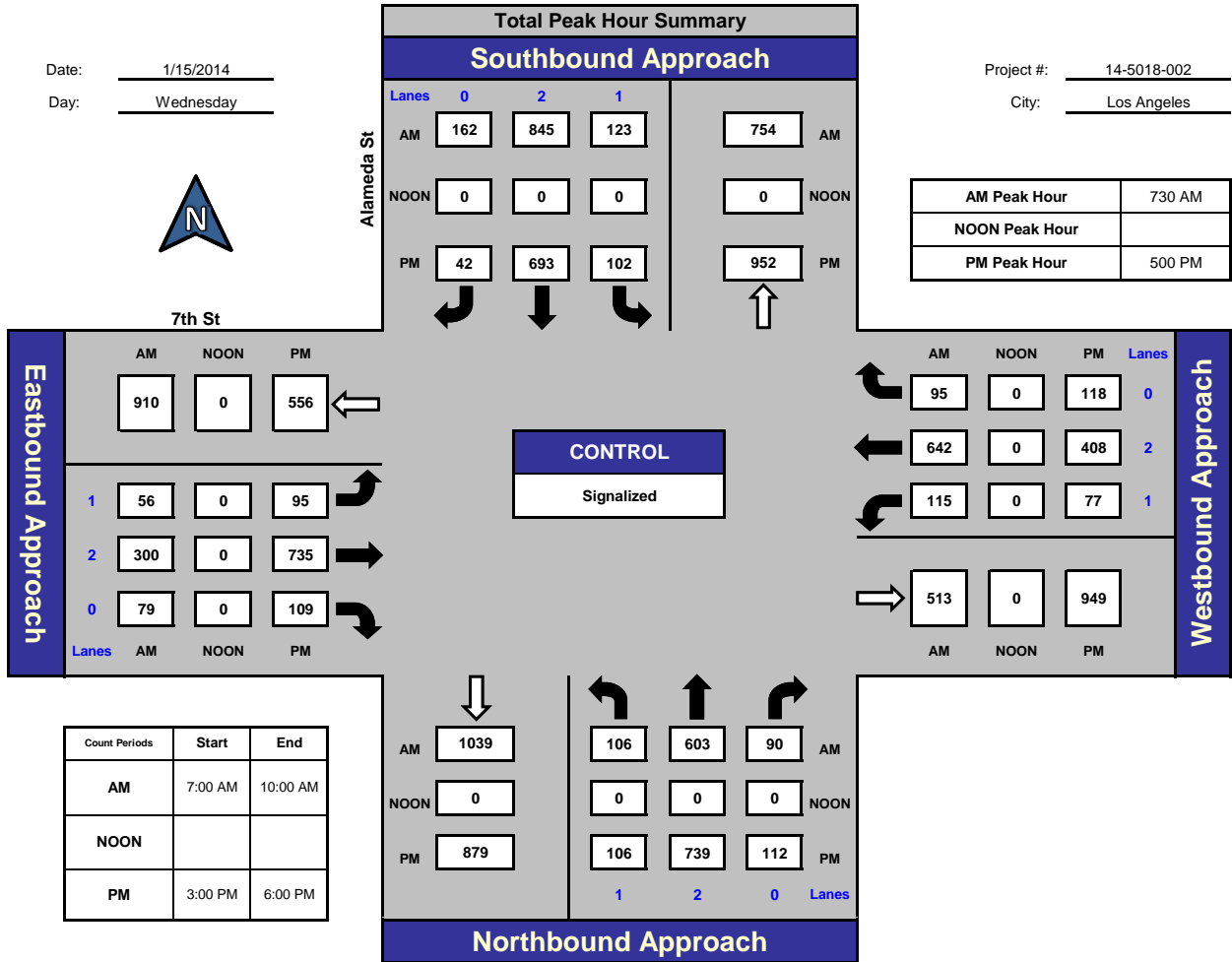

### Total Ins & Outs

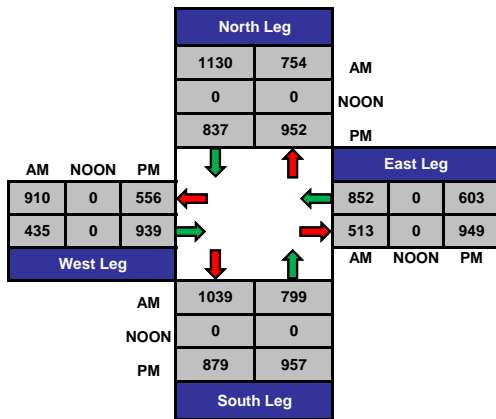

### Total Volume Per Leg

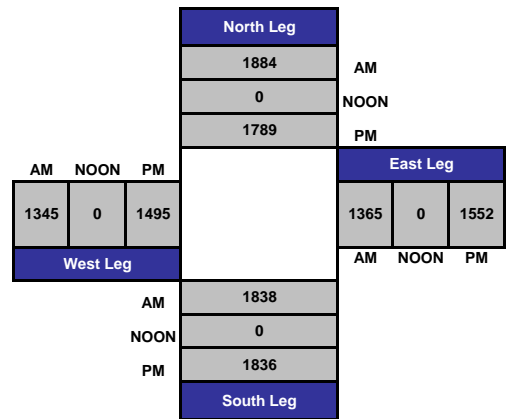

## INTERSECTION CAR/PED/BIKE TRAFFIC COUNT RESULTS SUMMARY

CLIENT: GIBSON TRANSPORTATION CONSULTING, INC.  
 PROJECT: ARTS DISTRICT DOWNTOWN LOS ANGELES  
 DATE: TUESDAY JUNE 25, 2019  
 PERIOD: 7:00 AM TO 10:00 AM  
 INTERSECTION: N/S ALAMEDA STREET  
 E/W 8TH STREET  
 CITY: LOS ANGELES

VEHICLE COUNTS																	
15 MIN COUNTS	1	2	3	3U	4	5	6	6U	7	8	9	9U	10	11	12	12U	TOTAL
PERIOD	SBRT	SBTH	SBLT	SBUT	WBRT	WBTH	WBLT	WBUT	NBRT	NBTH	NBLT	NBUT	EBRT	EBTH	EBLT	EBUT	
700-715	29	136	3	0	6	17	8	0	3	183	7	0	10	4	26	0	432
715-730	25	171	3	0	4	35	14	0	5	172	11	0	10	5	16	0	471
730-745	27	160	2	0	10	18	10	0	4	182	12	0	13	15	29	0	482
745-800	32	205	5	0	11	19	8	0	6	194	10	0	13	7	21	0	531
800-815	25	203	2	0	13	17	8	0	7	205	5	0	10	15	26	0	536
815-830	26	185	4	0	8	26	13	0	9	175	6	0	6	13	18	0	489
830-845	19	168	2	0	5	14	12	0	7	185	16	0	12	9	25	0	474
845-900	27	144	6	0	12	16	13	0	8	212	9	0	14	11	29	0	501
900-915	21	185	9	0	15	26	19	0	11	172	13	0	12	6	27	0	516
915-930	34	184	4	0	11	18	15	0	6	176	10	0	12	11	17	0	498
930-945	35	184	6	0	14	18	8	0	10	170	11	0	17	11	36	0	520
945-1000	36	181	9	0	10	17	8	0	13	168	16	0	19	9	13	0	499
HOOR TOTALS	1	2	3	3U	4	5	6	6U	7	8	9	9U	10	11	12	12U	TOTAL
PERIOD	SBRT	SBTH	SBLT	SBUT	WBRT	WBTH	WBLT	WBUT	NBRT	NBTH	NBLT	NBUT	EBRT	EBTH	EBLT	EBUT	
700-800	113	672	13	0	31	89	40	0	18	731	40	0	46	31	92	0	1916
715-815	109	739	12	0	38	89	40	0	22	753	38	0	46	42	92	0	2020
730-830	110	753	13	0	42	80	39	0	26	756	33	0	42	50	94	0	2038
745-845	102	761	13	0	37	76	41	0	29	759	37	0	41	44	90	0	2030
800-900	97	700	14	0	38	73	46	0	31	777	36	0	42	48	98	0	2000
815-915	93	682	21	0	40	82	57	0	35	744	44	0	44	39	99	0	1980
830-930	101	681	21	0	43	74	59	0	32	745	48	0	50	37	98	0	1989
845-945	117	697	25	0	52	78	55	0	35	730	43	0	55	39	109	0	2035
900-1000	126	734	28	0	50	79	50	0	40	686	50	0	60	37	93	0	2033

PEAK HOUR 730-830

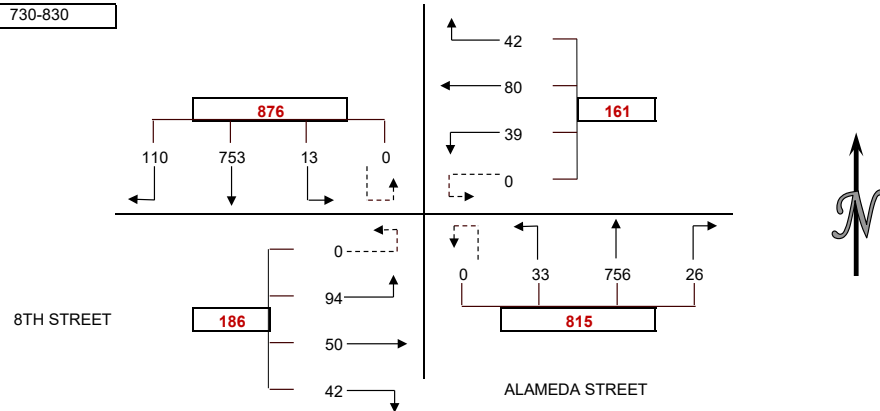

PEDESTRIAN COUNTS					
15 MIN COUNTS	NORTH	EAST	SOUTH	WEST	TOTAL
PERIOD	LEG	LEG	LEG	LEG	
700-715	1	1	3	3	8
715-730	0	0	2	4	6
730-745	1	1	3	7	12
745-800	2	2	2	6	12
800-815	2	2	1	8	13
815-830	1	1	5	7	14
830-845	1	1	0	13	15
845-900	0	0	3	10	13
900-915	1	1	1	13	16
915-930	1	1	6	6	14
930-945	1	1	2	19	23
945-1000	1	1	5	30	37
HOOR TOTALS	NORTH	EAST	SOUTH	WEST	TOTAL
PERIOD	LEG	LEG	LEG	LEG	
700-800	4	4	10	20	38
715-815	5	5	8	25	43
730-830	6	6	11	28	51
745-845	6	6	8	34	54
800-900	4	4	9	38	55
815-915	3	3	9	43	58
830-930	3	3	10	42	58
845-945	3	3	12	48	66
900-1000	4	4	14	68	90

BICYCLE COUNTS					
15 MIN COUNTS	NORTH	EAST	SOUTH	WEST	TOTAL
PERIOD	LEG	LEG	LEG	LEG	
700-715	1	3	0	0	4
715-730	0	1	0	1	2
730-745	0	0	0	1	1
745-800	0	1	0	2	3
800-815	0	0	1	3	4
815-830	0	1	0	3	4
830-845	0	0	0	1	1
845-900	1	0	0	2	3
900-915	0	2	1	1	4
915-930	0	0	1	0	1
930-945	0	2	0	2	4
945-1000	0	0	0	2	2
HOOR TOTALS	NORTH	EAST	SOUTH	WEST	TOTAL
PERIOD	LEG	LEG	LEG	LEG	
700-800	1	5	0	4	10
715-815	0	2	1	7	10
730-830	0	2	1	9	12
745-845	0	2	1	9	12
800-900	1	1	1	9	12
815-915	1	3	1	7	12
830-930	1	2	2	4	9
845-945	1	4	2	5	12
900-1000	0	4	2	5	11

APPROACH SUMMARIES											
	NORTH APRCH			EAST APRCH			SOUTH APRCH			WEST APRCH	
	APRCH	EXIT		APRCH	EXIT		APRCH	EXIT		APRCH	EXIT
700-800	798	854		160	62		789	758		169	242
715-815	860	883		167	76		813	825		180	236
730-830	876	892		161	89		815	834		186	223
745-845	876	886		154	86		825	843		175	215
800-900	811	913		157	93		844	788		188	206
815-915	796	883		179	95		823	783		182	219
830-930	803	886		176	90		825	790		185	223
845-945	839	891		185	99		808	807		203	238
900-1000	888	829		179	105		776	844		190	255



# WILTEC

Phone: (626) 564-1944 Fax: (626) 564-0969 info@wiltecusa.com

## INTERSECTION CAR/PED/BIKE TRAFFIC COUNT RESULTS SUMMARY

CLIENT: GIBSON TRANSPORTATION CONSULTING, INC.  
 PROJECT: ARTS DISTRICT DOWNTOWN LOS ANGELES  
 DATE: TUESDAY JUNE 25, 2019  
 PERIOD: 7:00 AM TO 10:00 AM  
 INTERSECTION: N/S ALAMEDA STREET  
 E/W OLYMPIC BOULEVARD  
 CITY: LOS ANGELES

VEHICLE COUNTS																	
15 MIN COUNTS	1	2	3	3U	4	5	6	6U	7	8	9	9U	10	11	12	12U	TOTAL
PERIOD	SBRT	SBTH	SBLT	SBUT	WBRT	WBTH	WBLT	WBUT	NBRT	NBTH	NBLT	NBUT	EBRT	EBTH	EBLT	EBUT	
700-715	14	114	18	0	18	298	45	0	8	151	22	0	7	115	15	0	825
715-730	26	138	23	0	23	283	36	0	15	170	22	0	18	105	12	0	871
730-745	27	123	17	0	23	338	32	0	12	156	29	0	9	132	15	0	913
745-800	42	154	25	0	25	338	31	0	11	170	22	0	7	171	19	0	1015
800-815	31	159	24	0	17	323	37	0	13	189	18	0	20	209	17	0	1057
815-830	34	143	24	0	2	349	54	0	9	188	27	0	15	189	13	0	1047
830-845	29	127	20	0	10	315	30	0	20	192	34	0	18	167	15	0	977
845-900	43	137	24	0	15	322	39	0	14	190	27	0	11	200	26	0	1048
900-915	38	157	25	0	19	307	37	0	18	175	25	0	15	167	16	0	999
915-930	41	128	28	0	24	311	26	0	16	145	26	0	14	148	29	0	936
930-945	35	169	38	0	18	299	28	0	15	157	23	0	19	179	17	0	997
945-1000	49	124	22	0	19	284	32	0	18	150	26	0	21	173	19	0	937
HOUR TOTALS	1	2	3	3U	4	5	6	6U	7	8	9	9U	10	11	12	12U	TOTAL
PERIOD	SBRT	SBTH	SBLT	SBUT	WBRT	WBTH	WBLT	WBUT	NBRT	NBTH	NBLT	NBUT	EBRT	EBTH	EBLT	EBUT	
700-800	109	529	83	0	89	1257	144	0	46	647	95	0	41	523	61	0	3624
715-815	126	574	89	0	88	1282	136	0	51	685	91	0	54	617	63	0	3856
730-830	134	579	90	0	67	1348	154	0	45	703	96	0	51	701	64	0	4032
745-845	136	583	93	0	54	1325	152	0	53	739	101	0	60	736	64	0	4096
800-900	137	566	92	0	44	1309	160	0	56	759	106	0	64	765	71	0	4129
815-915	144	564	93	0	46	1293	160	0	61	745	113	0	59	723	70	0	4071
830-930	151	549	97	0	68	1255	132	0	68	702	112	0	58	682	86	0	3960
845-945	157	591	115	0	76	1239	130	0	63	667	101	0	59	694	88	0	3980
900-1000	163	578	113	0	80	1201	123	0	67	627	100	0	69	667	81	0	3869

PEAK HOUR 800-900

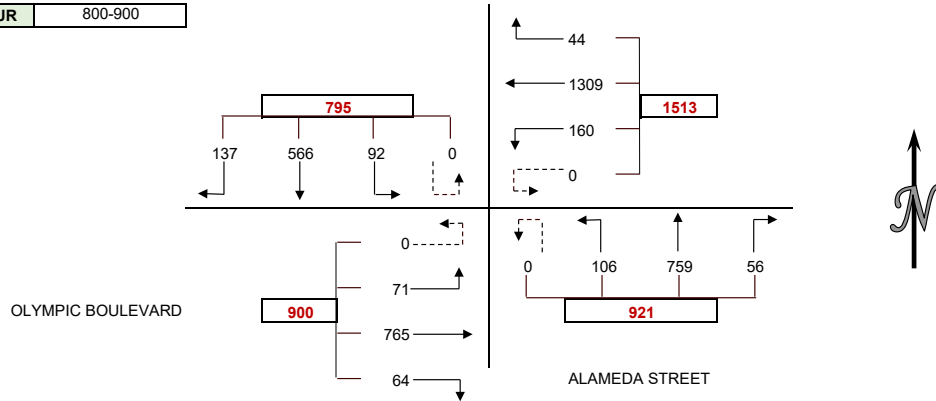

PEDESTRIAN COUNTS					
15 MIN COUNTS	NORTH	EAST	SOUTH	WEST	TOTAL
PERIOD	LEG	LEG	LEG	LEG	
700-715	3	3	10	16	32
715-730	5	5	7	6	23
730-745	4	4	6	4	18
745-800	7	7	11	13	38
800-815	7	7	12	13	39
815-830	5	5	2	2	14
830-845	3	3	2	3	11
845-900	7	7	2	1	17
900-915	3	3	-4	2	4
915-930	6	6	13	6	31
930-945	3	3	5	3	14
945-1000	2	2	3	1	8
HOUR TOTALS	NORTH	EAST	SOUTH	WEST	TOTAL
PERIOD	LEG	LEG	LEG	LEG	
700-800	19	19	34	39	111
715-815	23	23	36	36	118
730-830	23	23	31	32	109
745-845	22	22	27	31	102
800-900	22	22	18	19	81
815-915	18	18	2	8	46
830-930	19	19	13	12	63
845-945	19	19	16	12	66
900-1000	14	14	17	12	57

BICYCLE COUNTS					
15 MIN COUNTS	NORTH	EAST	SOUTH	WEST	TOTAL
PERIOD	LEG	LEG	LEG	LEG	
700-715	4	2	0	1	7
715-730	2	1	1	0	4
730-745	3	1	4	2	10
745-800	1	0	2	0	3
800-815	4	1	2	2	9
815-830	2	2	6	4	14
830-845	2	0	0	2	4
845-900	0	1	0	1	2
900-915	1	1	2	1	5
915-930	2	2	1	2	7
930-945	1	3	0	3	7
945-1000	0	1	1	2	4
HOUR TOTALS	NORTH	EAST	SOUTH	WEST	TOTAL
PERIOD	LEG	LEG	LEG	LEG	
700-800	10	4	7	3	24
715-815	10	3	9	4	26
730-830	10	4	14	8	36
745-845	9	3	10	8	30
800-900	8	4	8	9	29
815-915	5	4	8	8	25
830-930	5	4	3	6	18
845-945	4	7	3	7	21
900-1000	4	7	4	8	23

APPROACH SUMMARIES											
	NORTH APRCH			EAST APRCH			SOUTH APRCH			WEST APRCH	
	APRCH	EXIT		APRCH	EXIT		APRCH	EXIT		APRCH	EXIT
700-800	721	797		1490	652		788	714		625	1461
715-815	789	836		1506	757		827	764		734	1499
730-830	803	834		1569	836		844	784		816	1578
745-845	812	857		1531	882		893	795		860	1562
800-900	795	874		1513	913		921	790		900	1552
815-915	801	861		1499	877		919	783		852	1550
830-930	797	856		1455	847		882	739		826	1518
845-945	863	831		1445	872		831	780		841	1497
900-1000	854	788		1404	847		794	770		817	1464

## INTERSECTION CAR/PED/BIKE TRAFFIC COUNT RESULTS SUMMARY

CLIENT: GIBSON TRANSPORTATION CONSULTING, INC.  
 PROJECT: ARTS DISTRICT DOWNTOWN LOS ANGELES  
 DATE: TUESDAY JUNE 25, 2019  
 PERIOD: 7:00 AM TO 10:00 AM  
 INTERSECTION: N/S LEMON STREET  
 E/W OLYMPIC BOULEVARD  
 CITY: LOS ANGELES

VEHICLE COUNTS																	
15 MIN COUNTS	1	2	3	3U	4	5	6	6U	7	8	9	9U	10	11	12	12U	TOTAL
PERIOD	SBRT	SBTH	SBLT	SBUT	WBRT	WBTH	WBLT	WBUT	NBRT	NBTH	NBLT	NBUT	EBRT	EBTH	EBLT	EBUT	
700-715	35	3	2	0	4	371	6	0	1	0	1	0	2	87	3	0	515
715-730	36	0	0	0	3	377	8	0	1	1	0	0	0	84	2	0	512
730-745	27	1	0	0	2	378	6	0	1	0	0	0	0	95	1	0	511
745-800	25	0	5	1	7	360	8	0	1	0	2	0	0	104	4	0	517
800-815	17	0	1	0	5	381	9	0	1	0	0	0	0	123	3	0	540
815-830	30	1	1	0	5	370	7	0	0	1	0	0	1	98	7	0	521
830-845	23	0	1	0	6	380	7	1	0	0	2	0	1	112	1	0	534
845-900	18	1	4	0	4	373	10	0	3	0	1	0	3	102	3	0	522
900-915	15	0	4	0	7	354	10	0	2	0	1	0	0	104	6	0	503
915-930	15	0	5	0	8	349	9	0	2	0	4	0	1	102	7	0	502
930-945	11	0	0	0	3	306	4	0	3	0	3	0	2	107	5	0	444
945-1000	8	0	6	0	1	355	3	0	2	0	0	0	1	120	5	0	501
HOOR TOTALS	1	2	3	3U	4	5	6	6U	7	8	9	9U	10	11	12	12U	TOTAL
PERIOD	SBRT	SBTH	SBLT	SBUT	WBRT	WBTH	WBLT	WBUT	NBRT	NBTH	NBLT	NBUT	EBRT	EBTH	EBLT	EBUT	
700-800	123	4	7	1	16	1486	28	0	4	1	3	0	2	370	10	0	2055
715-815	105	1	6	1	17	1496	31	0	4	1	2	0	0	406	10	0	2080
730-830	99	2	7	1	19	1489	30	0	3	1	2	0	1	420	15	0	2089
745-845	95	1	8	1	23	1491	31	1	2	1	4	0	2	437	15	0	2112
800-900	88	2	7	0	20	1504	33	1	4	1	3	0	5	435	14	0	2117
815-915	86	2	10	0	22	1477	34	1	5	1	4	0	5	416	17	0	2080
830-930	71	1	14	0	25	1456	36	1	7	0	8	0	5	420	17	0	2061
845-945	59	1	13	0	22	1382	33	0	10	0	9	0	6	415	21	0	1971
900-1000	49	0	15	0	19	1364	26	0	9	0	8	0	4	433	23	0	1950

PEAK HOUR 800-900

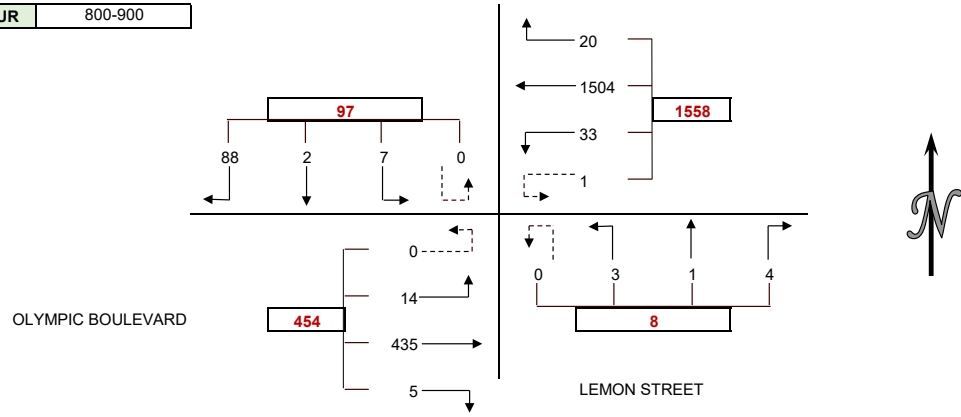

PEDESTRIAN COUNTS					
15 MIN COUNTS	NORTH	EAST	SOUTH	WEST	TOTAL
PERIOD	LEG	LEG	LEG	LEG	
700-715	0	0	0	0	0
715-730	3	3	0	2	8
730-745	3	3	2	0	8
745-800	2	2	0	0	4
800-815	2	2	0	1	5
815-830	2	2	0	1	5
830-845	0	0	3	0	3
845-900	2	2	2	2	8
900-915	0	0	1	1	2
915-930	1	1	0	0	2
930-945	3	3	0	0	6
945-1000	2	2	1	3	8
HOOR TOTALS	NORTH	EAST	SOUTH	WEST	TOTAL
PERIOD	LEG	LEG	LEG	LEG	
700-800	8	8	2	2	20
715-815	10	10	2	3	25
730-830	9	9	2	2	22
745-845	6	6	3	2	17
800-900	6	6	5	4	21
815-915	4	4	6	4	18
830-930	3	3	6	3	15
845-945	6	6	3	3	18
900-1000	6	6	2	4	18

BICYCLE COUNTS					
15 MIN COUNTS	NORTH	EAST	SOUTH	WEST	TOTAL
PERIOD	LEG	LEG	LEG	LEG	
700-715	4	3	2	0	9
715-730	2	1	3	0	6
730-745	5	1	2	0	8
745-800	1	0	0	0	1
800-815	2	0	0	0	2
815-830	3	1	3	0	7
830-845	2	0	0	0	2
845-900	1	1	1	0	3
900-915	1	1	2	0	4
915-930	1	0	0	0	1
930-945	1	0	0	0	1
945-1000	2	2	2	0	6
HOOR TOTALS	NORTH	EAST	SOUTH	WEST	TOTAL
PERIOD	LEG	LEG	LEG	LEG	
700-800	12	5	7	0	24
715-815	10	2	5	0	17
730-830	11	2	5	0	18
745-845	8	1	3	0	12
800-900	8	2	4	0	14
815-915	7	3	6	0	16
830-930	5	2	3	0	10
845-945	4	2	3	0	9
900-1000	5	3	4	0	12

APPROACH SUMMARIES											
	NORTH APRCH			EAST APRCH			SOUTH APRCH			WEST APRCH	
	APRCH	EXIT		APRCH	EXIT		APRCH	EXIT		APRCH	EXIT
700-800	135	28		1530	381		8	34		382	1612
715-815	113	29		1544	416		7	32		416	1603
730-830	109	36		1538	430		6	33		436	1590
745-845	105	40		1546	448		7	34		454	1590
800-900	97	35		1558	447		8	40		454	1595
815-915	98	40		1534	432		10	41		438	1567
830-930	86	42		1518	442		15	42		442	1535
845-945	73	43		1437	438		19	40		442	1450
900-1000	64	42		1409	457		17	30		460	1421

## INTERSECTION CAR/PED/BIKE TRAFFIC COUNT RESULTS SUMMARY

CLIENT: GIBSON TRANSPORTATION CONSULTING, INC.  
 PROJECT: ARTS DISTRICT DOWNTOWN LOS ANGELES  
 DATE: TUESDAY JUNE 25, 2019  
 PERIOD: 7:00 AM TO 10:00 AM  
 INTERSECTION: N/S MATEO STREET  
 E/W OLYMPIC BOULEVARD  
 CITY: LOS ANGELES

VEHICLE COUNTS																	
15 MIN COUNTS	1	2	3	3U	4	5	6	6U	7	8	9	9U	10	11	12	12U	TOTAL
PERIOD	SBRT	SBTH	SBLT	SBUT	WBRT	WBTH	WBLT	WBUT	NBRT	NBTH	NBLT	NBUT	EBRT	EBTH	EBLT	EBUT	
700-715	73	2	16	0	16	301	0	0	2	1	0	0	1	68	15	0	495
715-730	97	0	29	0	10	281	0	0	2	0	1	0	3	75	9	0	507
730-745	91	1	34	0	22	296	0	0	1	0	0	0	0	82	12	0	539
745-800	82	1	55	0	30	311	0	0	1	0	0	0	1	92	19	0	592
800-815	100	0	38	0	22	284	1	0	2	2	1	0	2	108	20	0	580
815-830	86	0	49	0	15	317	1	0	0	1	0	0	0	96	11	0	576
830-845	91	0	35	0	19	289	3	0	2	0	0	0	1	92	19	0	551
845-900	99	3	48	0	24	279	0	0	1	0	0	0	0	82	20	0	556
900-915	102	2	37	0	27	256	4	0	1	1	0	0	1	97	14	0	542
915-930	77	1	43	0	24	291	1	0	2	1	2	0	1	96	13	0	552
930-945	76	1	19	0	27	232	1	1	0	1	1	0	0	93	10	0	462
945-1000	84	0	30	0	22	270	1	0	0	2	0	0	0	112	27	0	548
HOURLY TOTALS	1	2	3	3U	4	5	6	6U	7	8	9	9U	10	11	12	12U	TOTAL
PERIOD	SBRT	SBTH	SBLT	SBUT	WBRT	WBTH	WBLT	WBUT	NBRT	NBTH	NBLT	NBUT	EBRT	EBTH	EBLT	EBUT	
700-800	343	4	134	0	78	1189	0	0	6	1	1	0	5	317	55	0	2133
715-815	370	2	156	0	84	1172	1	0	6	2	2	0	6	357	60	0	2218
730-830	359	2	176	0	89	1208	2	0	4	3	1	0	3	378	62	0	2287
745-845	359	1	177	0	86	1201	5	0	5	3	1	0	4	388	69	0	2299
800-900	376	3	170	0	80	1169	5	0	5	3	1	0	3	378	70	0	2263
815-915	378	5	169	0	85	1141	8	0	4	2	0	0	2	367	64	0	2225
830-930	369	6	163	0	94	1115	8	0	6	2	2	0	3	367	66	0	2201
845-945	354	7	147	0	102	1058	6	1	4	3	3	0	2	368	57	0	2112
900-1000	339	4	129	0	100	1049	7	1	3	5	3	0	2	398	64	0	2104

PEAK HOUR 745-845

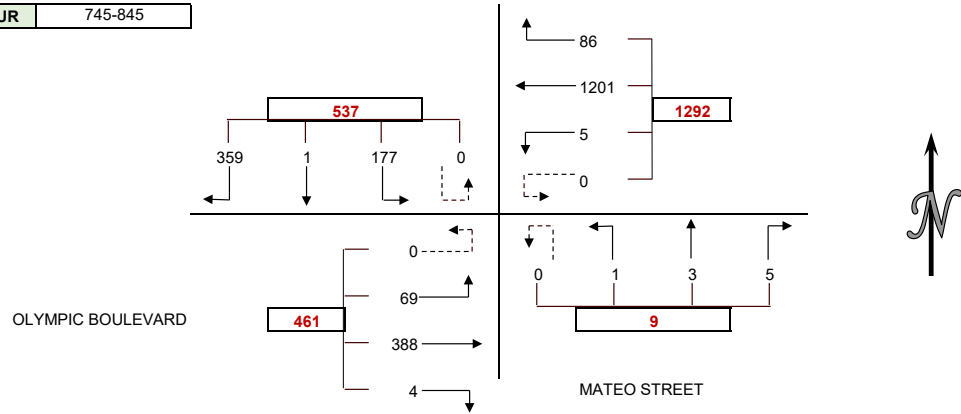

PEDESTRIAN COUNTS					
15 MIN COUNTS	NORTH	EAST	SOUTH	WEST	TOTAL
PERIOD	LEG	LEG	LEG	LEG	
700-715	2	2	2	4	10
715-730	0	0	1	1	2
730-745	2	2	0	1	5
745-800	3	3	8	1	15
800-815	3	3	2	2	10
815-830	1	1	3	0	5
830-845	2	2	0	2	6
845-900	7	7	3	3	20
900-915	2	2	1	3	8
915-930	2	2	0	0	4
930-945	3	3	0	0	6
945-1000	1	1	0	3	5
HOOR TOTALS	NORTH	EAST	SOUTH	WEST	TOTAL
PERIOD	LEG	LEG	LEG	LEG	
700-800	7	7	11	7	32
715-815	8	8	11	5	32
730-830	9	9	13	4	35
745-845	9	9	13	5	36
800-900	13	13	8	7	41
815-915	12	12	7	8	39
830-930	13	13	4	8	38
845-945	14	14	4	6	38
900-1000	8	8	1	6	23

BICYCLE COUNTS					
15 MIN COUNTS	NORTH	EAST	SOUTH	WEST	TOTAL
PERIOD	LEG	LEG	LEG	LEG	
700-715	2	0	0	0	2
715-730	1	0	2	0	3
730-745	3	0	1	1	5
745-800	1	0	1	0	2
800-815	4	1	1	0	6
815-830	2	1	3	0	6
830-845	2	0	1	0	3
845-900	0	0	0	0	0
900-915	1	0	1	1	3
915-930	1	0	0	0	1
930-945	1	1	1	0	3
945-1000	0	0	0	1	1
HOOR TOTALS	NORTH	EAST	SOUTH	WEST	TOTAL
PERIOD	LEG	LEG	LEG	LEG	
700-800	7	0	4	1	12
715-815	9	1	5	1	16
730-830	10	2	6	1	19
745-845	9	2	6	0	17
800-900	8	2	5	0	15
815-915	5	1	5	1	12
830-930	4	0	2	1	7
845-945	3	1	2	1	7
900-1000	3	1	2	2	8

APPROACH SUMMARIES											
	NORTH APRCH			EAST APRCH			SOUTH APRCH			WEST APRCH	
	APRCH	EXIT		APRCH	EXIT		APRCH	EXIT		APRCH	EXIT
700-800	481	134		1267	457		8	9		377	1533
715-815	528	146		1257	519		10	9		423	1544
730-830	537	154		1299	558		8	7		443	1568
745-845	537	158		1292	570		9	10		461	1561
800-900	549	153		1254	553		9	11		451	1546
815-915	552	151		1234	540		6	15		433	1519
830-930	538	162		1217	536		10	17		436	1486
845-945	508	162		1167	520		10	15		427	1415
900-1000	472	169		1157	531		11	13		464	1391

# WILTEC

Phone: (626) 564-1944 Fax: (626) 564-0969 info@wilt

## INTERSECTION CAR/PED/BIKE TRAFFIC COUNT RESULTS SUMMARY

CLIENT: GIBSON TRANSPORTATION CONSULTING, INC.  
 PROJECT: ARTS DISTRICT DOWNTOWN LOS ANGELES  
 DATE: TUESDAY JUNE 25, 2019  
 PERIOD: 3:000 TO 7:000 PM  
 INTERSECTION: N/S ALAMEDA STREET  
 E/W 8TH STREET  
 CITY: LOS ANGELES

### VEHICLE COUNTS

15 MIN COUNTS	1	2	3	3U	4	5	6	6U	7	8	9	9U	10	11	12	12U	TOTAL
PERIOD	SBRT	SBTH	SBLT	SBUT	WBRT	WBTH	WBLT	WBUT	NBRT	NBTH	NBLT	NBUT	EBRT	EBTH	EBLT	EBUT	TOTAL
300-315	20	183	5	0	10	6	4	0	9	157	2	0	13	6	14	0	429
315-330	19	216	7	0	4	3	12	0	6	160	6	0	9	5	16	0	463
330-345	19	248	4	0	6	5	6	0	3	141	4	0	7	5	13	0	461
345-400	17	236	5	0	9	5	4	0	2	172	4	0	9	1	10	0	474
400-415	24	218	4	0	4	8	4	0	8	173	2	0	5	4	11	0	465
415-430	12	254	4	0	6	6	5	0	5	162	3	0	11	12	12	0	492
430-445	18	208	3	0	5	4	12	0	4	166	4	2	4	2	8	0	440
445-500	16	252	4	0	4	8	4	0	5	154	3	0	10	2	12	0	474
500-515	22	288	7	0	10	6	4	0	8	159	2	0	6	6	15	0	533
515-530	29	217	10	0	4	3	12	0	6	161	6	0	11	2	7	0	468
530-545	29	218	10	0	6	5	6	0	3	141	3	0	9	2	8	0	440
545-600	17	212	2	0	9	5	4	0	2	172	3	0	9	3	9	0	447
600-615	14	232	7	0	4	8	4	0	8	171	1	0	7	4	11	0	471
615-630	11	220	3	0	6	6	5	0	5	161	3	0	5	1	7	0	433
630-645	7	191	4	0	4	4	5	0	4	174	1	0	3	2	5	0	404
645-700	8	192	3	0	4	3	11	0	4	122	2	0	5	0	4	0	358
HOURLY TOTALS	1	2	3	3U	4	5	6	6U	7	8	9	9U	10	11	12	12U	TOTAL
PERIOD	SBRT	SBTH	SBLT	SBUT	WBRT	WBTH	WBLT	WBUT	NBRT	NBTH	NBLT	NBUT	EBRT	EBTH	EBLT	EBUT	TOTAL
300-400	75	883	21	0	29	19	26	0	20	630	16	0	38	17	53	0	1827
315-415	79	918	20	0	23	21	26	0	19	646	16	0	30	15	50	0	1863
330-430	72	956	17	0	25	24	19	0	18	648	13	0	32	22	46	0	1892
345-445	71	916	16	0	24	23	25	0	19	673	13	2	29	19	41	0	1871
400-500	70	932	15	0	19	26	25	0	22	655	12	2	30	20	43	0	1871
415-515	68	1002	18	0	25	24	25	0	22	641	12	2	31	22	47	0	1939
430-530	85	965	24	0	23	21	32	0	23	640	15	2	31	12	42	0	1915
445-545	96	975	31	0	24	22	26	0	22	615	14	0	36	12	42	0	1915
500-600	97	935	29	0	29	19	26	0	19	633	14	0	35	13	39	0	1888
515-615	89	879	29	0	23	21	26	0	19	645	13	0	36	11	35	0	1826
530-630	71	882	22	0	25	24	19	0	18	645	10	0	30	10	35	0	1791
545-645	49	855	16	0	23	23	18	0	19	678	8	0	24	10	32	0	1755
600-700	40	835	17	0	18	21	25	0	21	628	7	0	20	7	27	0	1666

PEAK HOUR 415-515

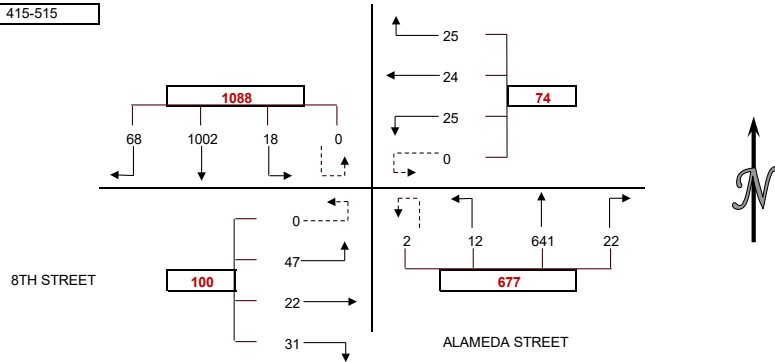

PEDESTRIAN COUNTS					
15 MIN COUNTS	NORTH	EAST	SOUTH	WEST	TOTAL
PERIOD	LEG	LEG	LEG	LEG	
300-315	2	2	1	5	10
315-330	3	3	2	2	10
330-345	0	0	3	2	5
345-400	0	0	2	2	4
400-415	0	0	0	5	5
415-430	0	0	0	2	2
430-445	5	5	5	3	18
445-500	0	0	0	5	5
500-515	0	0	1	5	6
515-530	0	0	2	2	4
530-545	0	0	3	2	5
545-600	1	1	2	2	6
600-615	0	0	0	5	5
615-630	0	0	0	2	2
630-645	0	0	3	0	3
645-700	0	0	0	1	1
HOUR TOTALS	NORTH	EAST	SOUTH	WEST	TOTAL
PERIOD	LEG	LEG	LEG	LEG	
300-400	5	5	8	11	29
315-415	3	3	7	11	24
330-430	0	0	5	11	16
345-445	5	5	7	12	29
400-500	5	5	5	15	30
415-515	5	5	6	15	31
430-530	5	5	8	15	33
445-545	0	0	6	14	20
500-600	1	1	8	11	21
515-615	1	1	7	11	20
530-630	1	1	5	11	18
545-645	1	1	5	9	16
600-700	0	0	3	8	11

BICYCLE COUNTS					
15 MIN COUNTS	NORTH	EAST	SOUTH	WEST	TOTAL
PERIOD	LEG	LEG	LEG	LEG	
300-315	0	0	0	4	4
315-330	0	1	0	2	3
330-345	0	0	0	2	2
345-400	0	0	2	1	3
400-415	1	1	0	2	4
415-430	0	0	1	2	3
430-445	0	0	2	0	2
445-500	2	0	1	0	3
500-515	1	0	0	3	4
515-530	0	1	0	1	2
530-545	1	0	2	0	3
545-600	1	0	1	2	4
600-615	0	1	0	3	4
615-630	0	0	1	1	2
630-645	0	1	0	0	1
645-700	0	2	0	0	2
HOUR TOTALS	NORTH	EAST	SOUTH	WEST	TOTAL
PERIOD	LEG	LEG	LEG	LEG	
300-400	0	1	2	9	12
315-415	1	2	2	7	12
330-430	1	1	3	7	12
345-445	1	1	5	5	12
400-500	3	1	4	4	12
415-515	3	0	4	5	12
430-530	3	1	3	4	11
445-545	4	1	3	4	12
500-600	3	1	3	6	13
515-615	2	2	3	6	13
530-630	2	1	4	6	13
545-645	1	2	2	6	11
600-700	0	4	1	4	9

APPROACH SUMMARIES											
	NORTH APRCH			EAST APRCH			SOUTH APRCH			WEST APRCH	
	APRCH	EXIT		APRCH	EXIT		APRCH	EXIT		APRCH	EXIT
300-400	979	712		74	58		666	947		108	110
315-415	1017	719		70	54		681	974		95	116
330-430	1045	719		68	57		679	1007		100	109
345-445	1003	738		72	54		707	972		89	107
400-500	1017	717		70	57		691	989		93	108
415-515	1088	713		74	62		677	1060		100	104
430-530	1074	705		76	59		680	1030		85	121
445-545	1102	681		72	65		651	1037		90	132
500-600	1061	701		74	61		666	996		87	130
515-615	997	703		70	59		677	941		82	123
530-630	975	705		68	50		673	931		75	105
545-645	920	733		64	45		705	897		66	80
600-700	892	673		64	45		656	880		54	68



# WILTEC

Phone: (626) 564-1944 Fax: (626) 564-0969 info@wilt

## INTERSECTION CAR/PED/BIKE TRAFFIC COUNT RESULTS SUMMARY

CLIENT: GIBSON TRANSPORTATION CONSULTING, INC.  
 PROJECT: ARTS DISTRICT DOWNTOWN LOS ANGELES  
 DATE: TUESDAY JUNE 25, 2019  
 PERIOD: 3:00 TO 7:00 PM  
 INTERSECTION: N/S ALAMEDA STREET  
 E/W OLYMPIC BOULEVARD  
 CITY: LOS ANGELES

VEHICLE COUNTS																	
15 MIN COUNTS	1	2	3	3U	4	5	6	6U	7	8	9	9U	10	11	12	12U	TOTAL
PERIOD	SBRT	SBTH	SBLT	SBUT	WBRT	WBTH	WBLT	WBUT	NBRT	NBTH	NBLT	NBUT	EBRT	EBTH	EBLT	EBUT	TOTAL
300-315	43	136	28	0	17	184	16	0	46	118	25	0	17	273	31	0	934
315-330	43	166	41	0	15	156	26	0	25	122	14	0	20	235	21	0	884
330-345	38	169	44	0	11	163	23	0	25	116	17	0	19	263	29	0	917
345-400	38	156	34	0	14	203	18	0	31	124	22	0	12	271	25	0	948
400-415	51	158	33	0	14	232	35	0	39	134	18	0	18	238	24	0	994
415-430	37	169	25	0	12	222	28	0	28	118	19	0	21	249	25	0	953
430-445	30	173	27	0	10	284	24	0	36	142	20	0	14	280	19	0	1059
445-500	39	192	36	0	13	248	24	0	34	121	21	0	22	279	27	0	1056
500-515	67	206	26	0	7	289	27	0	43	148	14	0	14	290	16	0	1147
515-530	42	171	35	0	12	286	22	0	41	151	26	0	12	298	21	0	1117
530-545	46	155	30	0	5	248	25	0	30	141	15	0	14	312	12	0	1033
545-600	55	141	27	0	17	251	24	0	29	124	24	0	13	327	8	0	1040
600-615	42	174	36	0	19	254	28	0	32	143	17	0	21	315	25	0	1106
615-630	37	153	29	0	17	249	19	0	34	136	24	0	13	297	19	0	1027
630-645	29	137	35	0	14	240	36	0	29	111	19	0	14	258	18	0	940
645-700	31	155	33	0	6	172	31	0	28	105	15	0	11	218	23	0	828
HOURLY TOTALS	1	2	3	3U	4	5	6	6U	7	8	9	9U	10	11	12	12U	TOTAL
PERIOD	SBRT	SBTH	SBLT	SBUT	WBRT	WBTH	WBLT	WBUT	NBRT	NBTH	NBLT	NBUT	EBRT	EBTH	EBLT	EBUT	TOTAL
300-400	162	627	147	0	57	706	83	0	127	480	78	0	68	1042	106	0	3683
315-415	170	649	152	0	54	754	102	0	120	496	71	0	69	1007	99	0	3743
330-430	164	652	136	0	51	820	104	0	123	492	76	0	70	1021	103	0	3812
345-445	156	656	119	0	50	941	105	0	134	518	79	0	65	1038	93	0	3954
400-500	157	692	121	0	49	986	111	0	137	515	78	0	75	1046	95	0	4062
415-515	173	740	114	0	42	1043	103	0	141	529	74	0	71	1098	87	0	4215
430-530	178	742	124	0	42	1107	97	0	154	562	81	0	62	1147	83	0	4379
445-545	194	724	127	0	37	1071	98	0	148	561	76	0	62	1179	76	0	4353
500-600	210	673	118	0	41	1074	98	0	143	564	79	0	53	1227	57	0	4337
515-615	185	641	128	0	53	1039	99	0	132	559	82	0	60	1252	66	0	4296
530-630	180	623	122	0	58	1002	96	0	125	544	80	0	61	1251	64	0	4206
545-645	163	605	127	0	67	994	107	0	124	514	84	0	61	1197	70	0	4113
600-700	139	619	133	0	56	915	114	0	123	495	75	0	59	1088	85	0	3901

PEAK HOUR 430-530

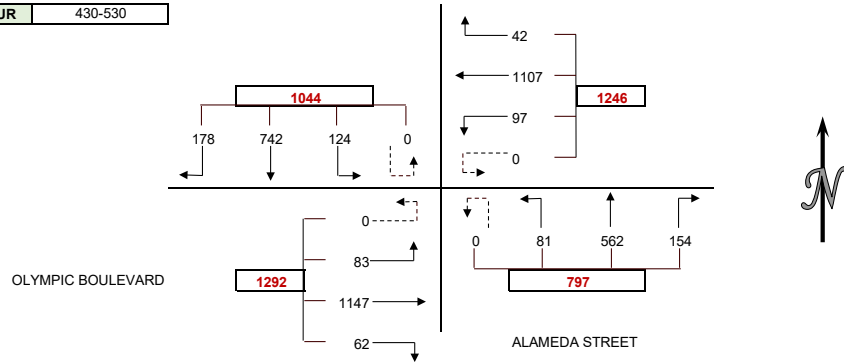

PEDESTRIAN COUNTS					
15 MIN COUNTS	NORTH	EAST	SOUTH	WEST	TOTAL
PERIOD	LEG	LEG	LEG	LEG	
300-315	1	1	2	0	4
315-330	3	3	2	4	12
330-345	1	1	1	1	4
345-400	3	3	3	5	14
400-415	3	3	7	4	17
415-430	5	5	6	2	18
430-445	3	3	16	4	26
445-500	5	5	3	6	19
500-515	10	10	6	5	31
515-530	6	6	5	5	22
530-545	7	7	9	8	31
545-600	2	2	2	12	18
600-615	21	21	6	4	52
615-630	15	15	0	6	36
630-645	11	11	7	3	32
645-700	8	8	3	6	25
HOUR TOTALS	NORTH	EAST	SOUTH	WEST	TOTAL
PERIOD	LEG	LEG	LEG	LEG	
300-400	8	8	8	10	34
315-415	10	10	13	14	47
330-430	12	12	17	12	53
345-445	14	14	32	15	75
400-500	16	16	32	16	80
415-515	23	23	31	17	94
430-530	24	24	30	20	98
445-545	28	28	23	24	103
500-600	25	25	22	30	102
515-615	36	36	22	29	123
530-630	45	45	17	30	137
545-645	49	49	15	25	138
600-700	55	55	16	19	145

BICYCLE COUNTS					
15 MIN COUNTS	NORTH	EAST	SOUTH	WEST	TOTAL
PERIOD	LEG	LEG	LEG	LEG	
300-315	1	0	1	1	3
315-330	1	0	2	1	4
330-345	1	3	2	1	7
345-400	1	0	2	1	4
400-415	2	0	1	1	4
415-430	0	1	1	2	4
430-445	7	1	1	2	11
445-500	0	1	0	1	2
500-515	6	1	3	4	14
515-530	3	3	1	0	7
530-545	2	2	4	2	10
545-600	1	1	1	1	4
600-615	3	2	2	2	9
615-630	1	1	1	2	5
630-645	0	0	1	1	2
645-700	1	0	2	1	4
HOUR TOTALS	NORTH	EAST	SOUTH	WEST	TOTAL
PERIOD	LEG	LEG	LEG	LEG	
300-400	4	3	7	4	18
315-415	5	3	7	4	19
330-430	4	4	6	5	19
345-445	10	2	5	6	23
400-500	9	3	3	6	21
415-515	13	4	5	9	31
430-530	16	6	5	7	34
445-545	11	7	8	7	33
500-600	12	7	9	7	35
515-615	9	8	8	5	30
530-630	7	6	8	7	28
545-645	5	4	5	6	20
600-700	5	3	6	6	20

APPROACH SUMMARIES									
	NORTH APRCH		EAST APRCH		SOUTH APRCH		WEST APRCH		
	APRCH	EXIT	APRCH	EXIT	APRCH	EXIT	APRCH	EXIT	
300-400	936	643	846	1316	685	778	1216	946	
315-415	971	649	910	1279	687	820	1175	995	
330-430	952	646	975	1280	691	826	1194	1060	
345-445	931	661	1096	1291	731	826	1196	1176	
400-500	970	659	1146	1304	730	878	1216	1221	
415-515	1027	658	1188	1353	744	914	1256	1290	
430-530	1044	687	1246	1425	797	901	1292	1366	
445-545	1045	674	1206	1454	785	884	1317	1341	
500-600	1001	662	1213	1488	786	824	1337	1363	
515-615	954	678	1191	1512	773	800	1378	1306	
530-630	925	666	1156	1498	749	780	1376	1262	
545-645	895	651	1168	1448	722	773	1328	1241	
600-700	891	636	1085	1344	693	792	1232	1129	

# WILTEC

Phone: (626) 564-1944 Fax: (626) 564-0969 info@wilt

## INTERSECTION CAR/PED/BIKE TRAFFIC COUNT RESULTS SUMMARY

CLIENT: GIBSON TRANSPORTATION CONSULTING, INC.  
 PROJECT: ARTS DISTRICT DOWNTOWN LOS ANGELES  
 DATE: TUESDAY JUNE 25, 2019  
 PERIOD: 3:00 TO 7:00 PM  
 INTERSECTION: N/S LEMON STREET  
 E/W OLYMPIC BOULEVARD  
 CITY: LOS ANGELES

### VEHICLE COUNTS

15 MIN COUNTS	1	2	3	3U	4	5	6	6U	7	8	9	9U	10	11	12	12U	TOTAL
PERIOD	SBRT	SBTH	SBLT	SBUT	WBRT	WBTH	WBLT	WBUT	NBRT	NBTH	NBLT	NBUT	EBRT	EBTH	EBLT	EBUT	TOTAL
300-315	5	0	6	0	0	200	10	0	4	0	0	0	2	231	5	1	464
315-330	7	1	5	0	3	181	5	1	1	0	1	0	0	229	2	0	436
330-345	21	1	3	0	4	196	4	0	2	0	0	0	2	227	1	0	461
345-400	22	1	1	0	1	234	9	0	8	1	0	0	3	235	3	0	518
400-415	32	3	4	0	5	209	8	1	4	0	1	0	3	235	3	1	509
415-430	32	0	2	0	0	248	3	0	1	0	1	0	0	229	2	0	518
430-445	49	0	0	0	1	223	7	0	1	0	0	0	0	256	1	0	538
445-500	32	0	4	0	3	278	4	0	1	0	0	0	0	241	0	0	563
500-515	63	0	6	0	3	291	11	0	3	0	1	0	0	230	2	1	611
515-530	41	0	5	0	1	260	5	0	4	0	0	0	0	269	3	0	588
530-545	42	0	7	0	4	259	5	1	4	0	1	0	3	230	0	0	556
545-600	37	0	7	0	0	270	2	0	1	0	0	0	1	256	6	0	580
600-615	29	2	8	0	4	279	5	0	3	0	0	0	1	254	3	0	588
615-630	33	1	5	0	1	259	8	0	1	0	0	0	0	249	3	0	560
630-645	30	0	2	0	2	239	6	0	1	0	1	0	0	215	0	0	496
645-700	29	1	4	0	1	192	2	0	0	0	1	0	0	178	1	1	410
<b>HOURLY TOTALS</b>	<b>1</b>	<b>2</b>	<b>3</b>	<b>3U</b>	<b>4</b>	<b>5</b>	<b>6</b>	<b>6U</b>	<b>7</b>	<b>8</b>	<b>9</b>	<b>9U</b>	<b>10</b>	<b>11</b>	<b>12</b>	<b>12U</b>	<b>TOTAL</b>
PERIOD	SBRT	SBTH	SBLT	SBUT	WBRT	WBTH	WBLT	WBUT	NBRT	NBTH	NBLT	NBUT	EBRT	EBTH	EBLT	EBUT	TOTAL
300-400	55	3	15	0	8	811	28	1	15	1	1	0	7	922	11	1	1879
315-415	82	6	13	0	13	820	26	2	15	1	2	0	8	926	9	1	1924
330-430	107	5	10	0	10	887	24	1	15	1	2	0	8	926	9	1	2006
345-445	135	4	7	0	7	914	27	1	14	1	2	0	6	955	9	1	2083
400-500	145	3	10	0	9	958	22	1	7	0	2	0	3	961	6	1	2128
415-515	176	0	12	0	7	1040	25	0	6	0	2	0	0	956	5	1	2230
430-530	185	0	15	0	8	1052	27	0	9	0	1	0	0	996	6	1	2300
445-545	178	0	22	0	11	1088	25	1	12	0	2	0	3	970	5	1	2318
500-600	183	0	25	0	8	1080	23	1	12	0	2	0	4	985	11	1	2335
515-615	149	2	27	0	9	1068	17	1	12	0	1	0	5	1009	12	0	2312
530-630	141	3	27	0	9	1067	20	1	9	0	1	0	5	989	12	0	2284
545-645	129	3	22	0	7	1047	21	0	6	0	1	0	2	974	12	0	2224
600-700	121	4	19	0	8	969	21	0	5	0	2	0	1	896	7	1	2054

PEAK HOUR 500-600

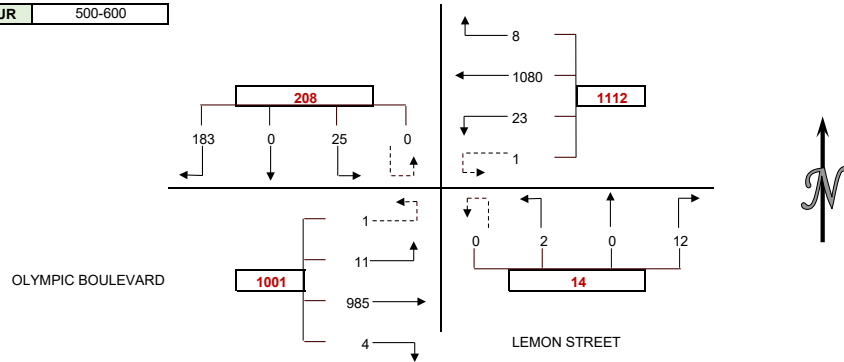

PEDESTRIAN COUNTS					
15 MIN COUNTS	NORTH	EAST	SOUTH	WEST	TOTAL
PERIOD	LEG	LEG	LEG	LEG	
300-315	0	0	0	1	1
315-330	2	2	2	1	7
330-345	1	1	1	2	5
345-400	1	1	0	1	3
400-415	1	1	0	0	2
415-430	1	1	0	1	3
430-445	1	1	0	3	5
445-500	0	0	0	4	4
500-515	2	2	1	2	7
515-530	1	1	0	0	2
530-545	2	2	0	3	7
545-600	4	4	0	0	8
600-615	1	1	1	3	6
615-630	3	3	0	2	8
630-645	2	2	1	3	8
645-700	0	0	0	0	0
HOUR TOTALS	NORTH	EAST	SOUTH	WEST	TOTAL
PERIOD	LEG	LEG	LEG	LEG	
300-400	4	4	3	5	16
315-415	5	5	3	4	17
330-430	4	4	1	4	13
345-445	4	4	0	5	13
400-500	3	3	0	8	14
415-515	4	4	1	10	19
430-530	4	4	1	9	18
445-545	5	5	1	9	20
500-600	9	9	1	5	24
515-615	8	8	1	6	23
530-630	10	10	1	8	29
545-645	10	10	2	8	30
600-700	6	6	2	8	22

BICYCLE COUNTS					
15 MIN COUNTS	NORTH	EAST	SOUTH	WEST	TOTAL
PERIOD	LEG	LEG	LEG	LEG	
300-315	2	3	5	0	10
315-330	2	0	0	0	2
330-345	2	0	0	0	2
345-400	3	1	2	0	6
400-415	1	0	2	0	3
415-430	0	0	1	0	1
430-445	3	0	1	0	4
445-500	2	0	2	0	4
500-515	8	0	1	0	9
515-530	2	0	3	0	5
530-545	1	3	3	0	7
545-600	4	1	0	0	5
600-615	1	1	3	0	5
615-630	2	0	2	0	4
630-645	1	1	1	0	3
645-700	4	1	1	0	6
HOUR TOTALS	NORTH	EAST	SOUTH	WEST	TOTAL
PERIOD	LEG	LEG	LEG	LEG	
300-400	9	4	7	0	20
315-415	8	1	4	0	13
330-430	6	1	5	0	12
345-445	7	1	6	0	14
400-500	6	0	6	0	12
415-515	13	0	5	0	18
430-530	15	0	7	0	22
445-545	13	3	9	0	25
500-600	15	4	7	0	26
515-615	8	5	9	0	22
530-630	8	5	8	0	21
545-645	8	3	6	0	17
600-700	8	3	7	0	18

APPROACH SUMMARIES											
	NORTH APRCH			EAST APRCH			SOUTH APRCH			WEST APRCH	
	APRCH	EXIT		APRCH	EXIT		APRCH	EXIT		APRCH	EXIT
300-400	73	20		848	953		17	38		941	868
315-415	101	23		861	956		18	40		944	905
330-430	122	20		922	952		18	37		944	997
345-445	146	17		949	977		17	37		971	1052
400-500	158	15		990	979		9	28		971	1106
415-515	188	12		1072	974		8	25		962	1219
430-530	200	14		1087	1020		10	27		1003	1239
445-545	200	16		1125	1005		14	28		979	1269
500-600	208	19		1112	1023		14	27		1001	1266
515-615	178	21		1095	1049		13	24		1026	1218
530-630	171	21		1097	1026		10	28		1006	1209
545-645	154	19		1075	1002		7	26		988	1177
600-700	144	15		998	920		7	26		905	1093

# WILTEC

Phone: (626) 564-1944 Fax: (626) 564-0969 info@wilt

## INTERSECTION CAR/PED/BIKE TRAFFIC COUNT RESULTS SUMMARY

CLIENT: GIBSON TRANSPORTATION CONSULTING, INC.  
 PROJECT: ARTS DISTRICT DOWNTOWN LOS ANGELES  
 DATE: TUESDAY JUNE 25, 2019  
 PERIOD: 3:00 TO 7:00 PM  
 INTERSECTION: N/S MATEO STREET  
 E/W OLYMPIC BOULEVARD  
 CITY: LOS ANGELES

VEHICLE COUNTS																	
15 MIN COUNTS	1	2	3	3U	4	5	6	6U	7	8	9	9U	10	11	12	12U	TOTAL
PERIOD	SBRT	SBTH	SBLT	SBUT	WBRT	WBTH	WBLT	WBUT	NBRT	NBTH	NBLT	NBUT	EBRT	EBTH	EBLT	EBUT	TOTAL
300-315	42	2	50	0	15	158	2	0	1	0	1	0	1	219	23	0	514
315-330	43	2	67	0	16	163	1	0	0	0	0	0	1	203	19	0	515
330-345	64	1	64	0	25	158	2	0	3	0	0	0	0	217	18	0	552
345-400	67	0	35	0	13	150	1	0	2	1	0	0	2	220	25	0	516
400-415	80	1	57	0	21	147	1	0	1	0	0	0	1	220	17	0	546
415-430	115	0	71	0	19	196	3	0	1	2	0	0	0	209	15	0	631
430-445	96	0	83	0	17	154	1	0	1	1	2	0	1	241	15	0	612
445-500	100	0	70	0	14	171	1	0	1	1	0	0	0	225	24	0	607
500-515	85	1	71	0	25	163	0	0	0	0	0	0	2	228	15	0	590
515-530	101	0	61	0	28	196	0	0	1	0	0	0	0	245	22	0	654
530-545	114	0	84	0	14	157	3	1	2	0	0	0	2	230	18	0	625
545-600	121	0	72	0	17	158	2	0	1	0	1	0	1	237	18	0	628
600-615	96	0	76	0	22	175	8	2	6	1	0	0	1	256	13	0	656
615-630	122	0	55	0	17	153	1	0	0	1	1	0	2	218	12	1	583
630-645	125	0	50	0	15	132	3	0	2	0	1	0	1	203	20	0	552
645-700	102	0	35	0	11	72	0	0	0	0	0	0	0	173	14	0	407
HOURLY TOTALS	1	2	3	3U	4	5	6	6U	7	8	9	9U	10	11	12	12U	TOTAL
PERIOD	SBRT	SBTH	SBLT	SBUT	WBRT	WBTH	WBLT	WBUT	NBRT	NBTH	NBLT	NBUT	EBRT	EBTH	EBLT	EBUT	TOTAL
300-400	216	5	216	0	69	629	6	0	6	1	1	0	4	859	85	0	2097
315-415	254	4	223	0	75	618	5	0	6	1	0	0	4	860	79	0	2129
330-430	326	2	227	0	78	651	7	0	7	3	0	0	3	866	75	0	2245
345-445	358	1	246	0	70	647	6	0	5	4	2	0	4	890	72	0	2305
400-500	391	1	281	0	71	668	6	0	4	4	2	0	2	895	71	0	2396
415-515	396	1	295	0	75	684	5	0	3	4	2	0	3	903	69	0	2440
430-530	382	1	285	0	84	684	2	0	3	2	2	0	3	939	76	0	2463
445-545	400	1	286	0	81	687	4	1	4	1	0	0	4	928	79	0	2476
500-600	421	1	288	0	84	674	5	1	4	0	1	0	5	940	73	0	2497
515-615	432	0	293	0	81	686	13	3	10	1	1	0	4	968	71	0	2563
530-630	453	0	287	0	70	643	14	3	9	2	2	0	6	941	61	1	2492
545-645	464	0	253	0	71	618	14	2	9	2	3	0	5	914	63	1	2419
600-700	445	0	216	0	65	532	12	2	8	2	2	0	4	850	59	1	2198

PEAK HOUR 500-600

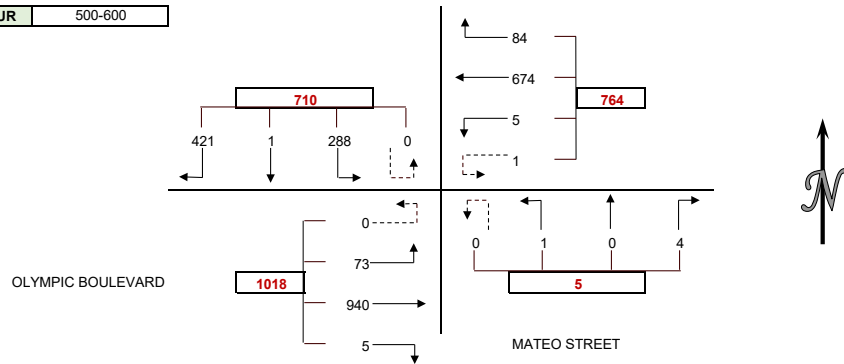

**PEDESTRIAN COUNTS**

15 MIN COUNTS PERIOD	NORTH LEG	EAST LEG	SOUTH LEG	WEST LEG	TOTAL
300-315	1	1	0	1	3
315-330	0	0	0	0	0
330-345	2	2	0	1	5
345-400	1	1	0	1	3
400-415	1	1	0	1	3
415-430	1	1	2	0	4
430-445	2	2	2	6	12
445-500	2	2	2	2	8
500-515	3	3	0	3	9
515-530	2	2	0	1	5
530-545	3	3	1	1	8
545-600	2	2	1	1	6
600-615	4	4	0	3	11
615-630	1	1	4	6	12
630-645	3	3	3	7	16
645-700	0	0	2	1	3
HOUR TOTALS PERIOD	NORTH LEG	EAST LEG	SOUTH LEG	WEST LEG	TOTAL
300-400	4	4	0	3	11
315-415	4	4	0	3	11
330-430	5	5	2	3	15
345-445	5	5	4	8	22
400-500	6	6	6	9	27
415-515	8	8	6	11	33
430-530	9	9	4	12	34
445-545	10	10	3	7	30
500-600	10	10	2	6	28
515-615	11	11	2	6	30
530-630	10	10	6	11	37
545-645	10	10	8	17	45
600-700	8	8	9	17	42

**BICYCLE COUNTS**

15 MIN COUNTS PERIOD	NORTH LEG	EAST LEG	SOUTH LEG	WEST LEG	TOTAL
300-315	0	0	2	0	2
315-330	2	0	0	0	2
330-345	0	0	1	2	3
345-400	2	0	0	0	2
400-415	1	0	2	0	3
415-430	1	0	0	0	1
430-445	3	0	0	0	3
445-500	0	0	0	0	0
500-515	5	0	1	0	6
515-530	5	1	1	0	7
530-545	3	2	3	0	8
545-600	2	1	0	0	3
600-615	0	0	3	0	3
615-630	5	0	1	0	6
630-645	0	0	1	0	1
645-700	2	0	1	0	3
HOUR TOTALS PERIOD	NORTH LEG	EAST LEG	SOUTH LEG	WEST LEG	TOTAL
300-400	4	0	3	2	9
315-415	5	0	3	2	10
330-430	4	0	3	2	9
345-445	7	0	2	0	9
400-500	5	0	2	0	7
415-515	9	0	1	0	10
430-530	13	1	2	0	16
445-545	13	3	5	0	21
500-600	15	4	5	0	24
515-615	10	4	7	0	21
530-630	10	3	7	0	20
545-645	7	1	5	0	13
600-700	7	0	6	0	13

**APPROACH SUMMARIES**

	NORTH APRCH		EAST APRCH		SOUTH APRCH		WEST APRCH	
	APRCH	EXIT	APRCH	EXIT	APRCH	EXIT	APRCH	EXIT
300-400	437	155	704	1081	8	15	948	846
315-415	481	155	698	1089	7	13	943	872
330-430	555	156	736	1100	10	12	944	977
345-445	605	146	723	1141	11	11	966	1007
400-500	673	146	745	1180	10	9	968	1061
415-515	692	148	764	1201	9	9	975	1082
430-530	668	162	770	1227	7	6	1018	1068
445-545	687	161	773	1219	5	9	1011	1087
500-600	710	157	764	1233	5	11	1018	1096
515-615	725	153	783	1274	12	17	1043	1119
530-630	740	133	730	1240	13	20	1009	1099
545-645	717	136	705	1178	14	19	983	1086
600-700	661	126	611	1076	12	16	914	980

***Appendix C***

***CEQA T-1 Plans, Policies, Programs Consistency Worksheet***

## Plans, Policies and Programs Consistency Worksheet

The worksheet provides a structured approach to evaluate the threshold T-1 question below, that asks whether a project conflicts with a program, plan, ordinance or policy addressing the circulation system. The intention of the worksheet is to streamline the project review by highlighting the most relevant plans, policies and programs when assessing potential impacts to the City’s circulation system.

Threshold T-1: Would the project conflict with a program, plan, ordinance, or policy addressing the circulation system, including transit, roadways, bicycle, and pedestrian facilities?

This worksheet does not include an exhaustive list of City policies, and does not include community plans, specific plans, or any area-specific regulatory overlays. The Department of City Planning project planner will need to be consulted to determine if the project would obstruct the City from carrying out a policy or program in a community plan, specific plan, streetscape plan, or regulatory overlay that was adopted to support multimodal transportation options or public safety. LADOT staff should be consulted if a project would lead to a conflict with a mobility investment in the Public Right of Way (PROW) that is currently undergoing planning, design, or delivery. This worksheet must be completed for all projects that meet the Section I. Screening Criteria. For description of the relevant planning documents, **see Attachment D.1.**

For any response to the following questions that checks the box in bold text ((i.e.  Yes or  No), further analysis is needed to demonstrate that the project does not conflict with a plan, policy, or program.

### I. SCREENING CRITERIA FOR POLICY ANALYSIS

If the answer is ‘yes’ to any of the following questions, further analysis will be required:

Does the project require a discretionary action that requires the decision maker to find that the project would substantially conform to the purpose, intent and provisions of the General Plan?

Yes  No

Is the project known to directly conflict with a transportation plan, policy, or program adopted to support multimodal transportation options or public safety?

Yes  No

Is the project required to or proposing to make any voluntary modifications to the public right-of-way (i.e., dedications and/or improvements in the right-of-way, reconfigurations of curb line, etc.)?

Yes  No

### II. PLAN CONSISTENCY ANALYSIS

*To be verified with Civil*

#### A. Mobility Plan 2035 PROW Classification Standards for Dedications and Improvements

These questions address potential conflict with:



**Mobility Plan 2035 Policy 2.1 – Adaptive Reuse of Streets.** Design, plan, and operate streets to serve multiple purposes and provide flexibility in design to adapt to future demands.

**Mobility Plan 2035 Policy 2.3 – Pedestrian Infrastructure.** Recognize walking as a component of every trip, and ensure high quality pedestrian access in all site planning and public right-of-way modifications to provide a safe and comfortable walking environment.

**Mobility Plan 2035 Policy 3.2 – People with Disabilities.** Accommodate the needs of people with disabilities when modifying or installing infrastructure in the public right-of-way.

**Mobility Plan 2035 Street Designations and Standard Roadway Dimensions**

A.1 Does the project include additions or new construction along a street designated as a Boulevard I, and II, and/or Avenue I, II, or III on property zoned for R3 or less restrictive zone?  Yes  No

A.2 If **A.1 is yes**, is the project required to make additional dedications or improvements to the Public Right of Way as demonstrated by the street designation.  Yes  No  N/A

A.3 If **A.2 is yes**, is the project making the dedications and improvements as necessary to meet the designated dimensions of the fronting street (Boulevard I, and II, or Avenue I, II, or III)?  Yes  No  N/A

If the answer is to **A.1 or A.2 is NO, or to A.1, A.2 and A.3. is YES**, then the project does not conflict with the dedication and improvement requirements that are needed to comply with the Mobility Plan 2035 Street Designations and Standard Roadway Dimensions.

A.4 If the answer to **A.3. is NO**, is the project applicant asking to waive from the dedication standards?  **Yes**  **No**  N/A

Lists any streets subject to dedications or voluntary dedications and include existing roadway and sidewalk widths, required roadway and sidewalk widths, and proposed roadway and sidewalk width or waivers.

**Alameda Street**

Frontage 1 Existing PROW'/Curb' : Existing \_\_\_\_\_ Required \_\_\_\_\_ Proposed \_\_\_\_\_

**8th Street**

Frontage 2 Existing PROW'/Curb' : Existing \_\_\_\_\_ Required \_\_\_\_\_ Proposed \_\_\_\_\_

Frontage 3 Existing PROW'/Curb' : Existing \_\_\_\_\_ Required \_\_\_\_\_ Proposed \_\_\_\_\_

Frontage 4 Existing PROW'/Curb' : Existing \_\_\_\_\_ Required \_\_\_\_\_ Proposed \_\_\_\_\_

If the answer to **A.4 is NO**, the project is inconsistent with Mobility Plan 2035 street designations and must file for a waiver of street dedication and improvement.

If the answer to **A.4 is YES**, additional analysis is necessary to determine if the dedication and/or improvements are necessary to meet the City's mobility needs for the next 20 years. The following factors may contribute to determine if the dedication or improvement is necessary:

Is the project site along any of the following networks identified in the City's Mobility Plan?

- Transit Enhanced Network
- Bicycle Enhanced Network
- Bicycle Lane Network
- Pedestrian Enhanced District
- Neighborhood Enhanced Network

To see the location of the above networks, see **Transportation Assessment Support Map**.<sup>1</sup>

Is the project within the service area of Metro Bike Share, or is there demonstrated demand for micro-mobility services?

If the project dedications and improvements asking to be waived are necessary to meet the City's mobility needs, the project may be found to conflict with a plan that is adopted to protect the environment.

## **B. Mobility Plan 2035 PROW Policy Alignment with Project-Initiated Changes**

### **B.1 Project-Initiated Changes to the PROW Dimensions**

These questions address potential conflict with:

***Mobility Plan 2035 Policy 2.1 – Adaptive Reuse of Streets. Design, plan, and operate streets to serve multiple purposes and provide flexibility in design to adapt to future demands.***

***Mobility Plan 2035 Policy 2.3 – Pedestrian Infrastructure. Recognize walking as a component of every trip, and ensure high quality pedestrian access in all site planning and public right-of-way modifications to provide a safe and comfortable walking environment.***

***Mobility Plan 2035 Policy 3.2 – People with Disabilities. Accommodate the needs of people with disabilities when modifying or installing infrastructure in the public right-of-way.***

***Mobility Plan 2035 Policy 2.10 – Loading Areas. Facilitate the provision of adequate on and off-site street loading areas.***

### **Mobility Plan 2035 Street Designations and Standard Roadway Dimensions**

---

<sup>1</sup> LADOT Transportation Assessment Support Map <https://arcg.is/fubbd>

B.1 Does the project physically modify the curb placement or turning radius and/or physically alter the sidewalk and parkways space that changes how people access a property?

Examples of physical changes to the public right-of-way include:

- widening the roadway,
- narrowing the sidewalk,
- adding space for vehicle turn outs or loading areas,
- removing bicycle lanes, bike share stations, or bicycle parking
- modifying existing bus stop, transit shelter, or other street furniture
- paving, narrowing, shifting or removing an existing parkway or tree well

Yes  No

**B.2 Driveway Access**

These questions address potential conflict with:

***Mobility Plan 2035 Policy 2.10 – Loading Areas. Facilitate the provision of adequate on and off-site street loading areas.***

***Mobility Plan 2035 Program PL.1. Driveway Access. Require driveway access to buildings from non-arterial streets or alleys (where feasible) in order to minimize interference with pedestrian access and vehicular movement.***

***Citywide Design Guidelines - Guideline 2: Carefully incorporate vehicular access such that it does not degrade the pedestrian experience.***

**Site Planning Best Practices:**

- *Prioritize pedestrian access first and automobile access second. Orient parking and driveways toward the rear or side of buildings and away from the public right-of-way. On corner lots, parking should be oriented as far from the corner as possible.*
- *Minimize both the number of driveway entrances and overall driveway widths.*
- *Do not locate drop-off/pick-up areas between principal building entrances and the adjoining sidewalks.*
- *Orient vehicular access as far from street intersections as possible.*
- *Place drive-thru elements away from intersections and avoid placing them so that they create a barrier between the sidewalk and building entrance(s).*
- *Ensure that loading areas do not interfere with on-site pedestrian and vehicular circulation by separating loading areas and larger commercial vehicles from areas that are used for public parking and public entrances.*

B.2 Does the project add new driveways along a street designated as an Avenue or a Boulevard that conflict with LADOT’s Driveway Design Guidelines (See Sec. 321 in the Manual of Policies and Procedures) by any of the following:

- locating new driveways for residential properties on an Avenue or Boulevard, and access is otherwise possible using an alley or a collector/local street, or
- locating new driveways for industrial or commercial properties on an Avenue or Boulevard and access is possible along a collector/local street, or

- the total number of new driveways exceeds 1 driveway per every 200 feet<sup>2</sup> along on the Avenue or Boulevard frontage, or
- locating new driveways on an Avenue or Boulevard within 150 feet from the intersecting street, or
- locating new driveways on a collector or local street within 75 feet from the intersecting street, or
- locating new driveways near mid-block crosswalks, requiring relocation of the mid-block crosswalk

Yes  No

If the answer to **B.1 and B.2 are both NO**, then the project would not conflict with a plan or policies that govern the PROW as a result of the project-initiated changes to the PROW.

**Impact Analysis**

If the answer to either **B.1 or B.2 are YES**, City plans and policies should be reviewed in light of the proposed physical changes to determine if the City would be obstructed from carrying out the plans and policies. The analysis should pay special consideration to substantial changes to the Public Right of Way that may either degrade existing facilities for people walking and bicycling (e.g., removing a bicycle lane), or preclude the City from completing complete street infrastructure as identified in the Mobility Plan 2035, especially if the physical changes are along streets that are on the High Injury Network (HIN). The analysis should also consider if the project is in a Transit Oriented Community (TOC) area, and would degrade or inhibit trips made by biking, walking and/ or transit ridership. The streets that need special consideration are those that are included on the following networks identified in the Mobility Plan 2035, or the HIN:

- Transit Enhanced Network
- Bicycle Enhanced Network
- Bicycle Lane Network
- Pedestrian Enhanced District
- Neighborhood Enhanced Network
- High Injury Network

To see the location of the above networks, see **Transportation Assessment Support Map**.<sup>3</sup>

Once the project is reviewed relevant to plans and policies, and existing facilities that may be impacted by the project, the analysis will need to answer the following two questions in concluding if there is an impact due to plan inconsistency.

B.2.1 Would the physical changes in the public right of way or new driveways that conflict with LADOT’s Driveway Design Guidelines degrade the experience of vulnerable roadway users such as modify, remove, or otherwise negatively impact existing bicycle, transit, and/or pedestrian infrastructure?

Yes  No  N/A

<sup>2</sup> for a project frontage that exceeds 400 feet along an Avenue or Boulevard, the incremental additional driveway above 2 is more than 1 driveway for every 400 additional feet.

<sup>3</sup> LADOT Transportation Assessment Support Map <https://arcg.is/fubbd>

B.2.2 Would the physical modifications or new driveways that conflict with LADOT’s Driveway Design Guidelines preclude the City from advancing the safety of vulnerable roadway users?

Yes  No  N/A

If either of the answers to either **B.2.1 or B.2.2 are YES**, the project may conflict with the Mobility Plan 2035, and therefore conflict with a plan that is adopted to protect the environment. If either of the answers to both **B.2.1. or B.2.2. are NO**, then the project would not be shown to conflict with plans or policies that govern the Public Right-of-Way.

### C. Network Access

#### C. 1 Alley, Street and Stairway Access

These questions address potential conflict with:

***Mobility Plan Policy 3.9 Increased Network Access: Discourage the vacation of public rights-of-way.***

C.1.1 Does the project propose to vacate or otherwise restrict public access to a street, alley, or public stairway?

Yes  No

C.1.2 If the answer to C.1.1 is Yes, will the project provide or maintain public access to people walking and biking on the street, alley or stairway?

Yes  No  N/A

#### C.2 New Cul-de-sacs

These questions address potential conflict with:

***Mobility Plan 2035 Policy 3.10 Cul-de-sacs: Discourage the use of cul-de-sacs that do not provide access for active transportation options.***

C.2.1 Does the project create a cul-de-sac or is the project located adjacent to an existing cul-de-sac?

Yes  No

C.2.2 If yes, will the cul-de-sac maintain convenient and direct public access to people walking and biking to the adjoining street network?

Yes  No  N/A

If the answers to either C.1.2 or C.2.2 are YES, then the project would not conflict with a plan or policies that ensures access for all modes of travel. If the answer to either **C.1.2 or C.2.2 are NO**, the project may conflict with a plan or policies that governs multimodal access to a property. Further analysis must assess to the degree that pedestrians and bicyclists have sufficient public access to the transportation network.

**D. Parking Supply and Transportation Demand Management**

These questions address potential conflict with:

***Mobility Plan 2035 Policy 3.8** – Bicycle Parking, Provide bicyclists with convenient, secure and well maintained bicycle parking facilities.*

***Mobility Plan 2035 Policy 4.8** – Transportation Demand Management Strategies. Encourage greater utilization of Transportation Demand Management Strategies to reduce dependence on single-occupancy vehicles.*

***Mobility Plan 2035 Policy 4.13** – Parking and Land Use Management: Balance on-street and off-street parking supply with other transportation and land use objectives.*

D.1 Would the project propose a supply of onsite parking that exceeds the baseline amount<sup>4</sup> as required in the Los Angeles Municipal Code or a Specific plan, whichever requirement prevails?  Yes  No

D.2 If the answer to D.1. is YES, would the project propose to actively manage the demand of parking by independently pricing the supply to all users (e.g. parking cash-out), or for residential properties, unbundle the supply from the lease or sale of residential units?  Yes  No  N/A

If the answer to **D.2. is NO** the project may conflict with parking management policies. Further analysis is needed to demonstrate how the supply of parking above city requirements will not result in additional (induced) drive-alone trips as compared to an alternative that provided no more parking than the baseline required by the LAMC or Specific Plan. If there is potential for the supply of parking to result in induced demand for drive-alone trips, the project should further explore transportation demand management (TDM) measures to further off-set the induced demands of driving and vehicle miles travelled (VMT) that may result from higher amounts of on-site parking. The TDM measures should specifically focus on strategies that encourage dynamic and context-sensitive pricing solutions and ensure the parking is efficiently allocated, such as providing real time information. Research has demonstrated that charging a user cost for parking or providing a ‘cash-out’ option in return for not using it is the most effective strategy to reduce the instances of drive-alone trips and increase non-auto mode share to further reduce VMT. To ensure the parking is efficiently managed and reduce the need to build parking for future uses, further strategies should include sharing parking with other properties and/or the general public.

D.3. Would the project provide the minimum on and off-site bicycle parking spaces as required by Section 12.21 A.16 of the LAMC?  Yes  No

---

<sup>4</sup> The baseline parking is defined here as the default parking requirements in section 12.21 A.4 of the Los Angeles Municipal Code or any applicable Specific Plan, whichever prevails, for each applicable use not taking into consideration other parking incentives to reduce the amount of required parking.

D.4. Does the Project include more than 25,000 square feet of gross floor area construction of new non-residential gross floor?

Yes  No

D.5 If the answer to D.4. is YES, does the project comply with the City's TDM Ordinance in Section 12.26 J of the LAMC?

Yes  No  N/A

If the answer to **D.3. or D.5. is NO** the project conflicts with LAMC code requirements of bicycle parking and TDM measures. If the project includes uses that require bicycle parking (Section 12.21 A.16) or TDM (Section 12.26 J), and the project does not comply with those Sections of the LAMC, further analysis is required to ensure that the project supports the intent of the two LAMC sections. To meet the intent of bicycle parking requirements, the analysis should identify how the project commits to providing safe access to those traveling by bicycle and accommodates storing their bicycle in locations that demonstrates priority over vehicle access.

Similarly, to meet the intent of the TDM requirements of Section 12.26 J of the LAMC, the analysis should identify how the project commits to providing effective strategies in either physical facilities or programs that encourage non-drive alone trips to and from the project site and changes in work schedule that move trips out of the peak period or eliminate them altogether (as in the case in telecommuting or compressed work weeks).

#### E. Consistency with Regional Plans

This section addresses potential inconsistencies with greenhouse gas (GHG) reduction targets forecasted in the Southern California Association of Governments (SCAG) Regional Transportation Plan (RTP) / Sustainable Communities Strategy (SCS).

E.1 Does the Project or Plan apply one the City's efficiency-based impact thresholds (i.e. VMT per capita, VMT per employee, or VMT per service population) as discussed in Section 2.2.3 of the TAG?

Yes  No

E.2 If the Answer to E.1 is YES, does the Project or Plan result in a significant VMT impact?

Yes  No  N/A

E.3 If the Answer to E.1 is NO, does the Project result in a net increase in VMT?

Yes  No  N/A

If the Answer to E.2 or E.3 is NO, then the Project or Plan is shown to align with the long-term VMT and GHG reduction goals of SCAG's RTP/SCS.

E.4 If the Answer to E.2 or E.3 is YES, then further evaluation would be necessary to determine whether such a project or land use plan would be shown to be consistent with VMT and GHG reduction goals of the SCAG RTP/SCS. For the purpose of making a finding that a project is consistent with the GHG reduction targets forecasted in the SCAG RTP/SCS, the project analyst should consult Section 2.2.4 of the Transportation Assessment Guidelines (TAG). Section 2.2.4 provides the methodology for evaluating a land use project's cumulative impacts to VMT, and the appropriate reliance on SCAG's most recently adopted RTP/SCS in reaching that conclusion.

The analysis methods therein can further support findings that the project is consistent with the general use designation, density, building intensity, and applicable policies specified for the project area in either a sustainable communities strategy or an alternative planning strategy for which the State Air Resources Board, pursuant to Section 65080(b)(2)(H) of the Government Code, has accepted a metropolitan planning organization's determination that the sustainable communities strategy or the alternative planning strategy would, if implemented, achieve the greenhouse gas emission reduction targets.

## References

BOE [Street Standard Dimensions S-470-1](http://eng2.lacity.org/techdocs/stdplans/s-400/S-470-1_20151021_150849.pdf) [http://eng2.lacity.org/techdocs/stdplans/s-400/S-470-1\\_20151021\\_150849.pdf](http://eng2.lacity.org/techdocs/stdplans/s-400/S-470-1_20151021_150849.pdf)

LADCP [Citywide Design Guidelines](https://planning.lacity.org/odocument/f6608be7-d5fe-4187-bea6-20618eec5049/Citywide_Design_Guidelines.pdf). [https://planning.lacity.org/odocument/f6608be7-d5fe-4187-bea6-20618eec5049/Citywide\\_Design\\_Guidelines.pdf](https://planning.lacity.org/odocument/f6608be7-d5fe-4187-bea6-20618eec5049/Citywide_Design_Guidelines.pdf)

LADOT Transportation Assessment Support Map <https://arcg.is/fubbD>

Mobility Plan 2035 [https://planning.lacity.org/odocument/523f2a95-9d72-41d7-aba5-1972f84c1d36/Mobility\\_Plan\\_2035.pdf](https://planning.lacity.org/odocument/523f2a95-9d72-41d7-aba5-1972f84c1d36/Mobility_Plan_2035.pdf)

SCAG. Connect SoCal, 2020-2045 RTP/SCS, <https://www.connectsocial.org/Pages/default.aspx>



## ***ATTACHMENT D.1: CITY PLAN, POLICIES AND GUIDELINES***

The Transportation Element of the City's General Plan, Mobility Plan 2035, established the "Complete Streets Design Guide" as the City's document to guide the operations and design of streets and other public rights-of-way. It lays out a vision for designing safer, more vibrant streets that are accessible to people, no matter what their mode choice. As a living document, it is intended to be frequently updated as City departments identify and implement street standards and experiment with different configurations to promote complete streets. The guide is meant to be a toolkit that provides numerous examples of what is possible in the public right-of-way and that provides guidance on context-sensitive design.

The Plan for A Healthy Los Angeles (March 2015) includes policies directing several City departments to develop plans that promote active transportation and safety.

The City of Los Angeles Community Plans, which make up the Land Use Element of the City's General Plan, guide the physical development of neighborhoods by establishing the goals and policies for land use. The 35 Community Plans provide specific, neighborhood-level detail for land uses and the transportation network, relevant policies, and implementation strategies necessary to achieve General Plan and community-specific objectives.

The stated goal of Vision Zero is to eliminate traffic-related deaths in Los Angeles by 2025 through a number of strategies, including modifying the design of streets to increase the safety of vulnerable road users. Extensive crash data analysis is conducted on an ongoing basis to prioritize intersections and corridors for implementation of projects that will have the greatest effect on overall fatality reduction. The City designs and deploys Vision Zero Corridor Plans as part of the implementation of Vision Zero. If a project is proposed whose site lies on the High Injury Network (HIN), the applicant should consult with LADOT to inform the project's site plan and to determine appropriate improvements, whether by funding their implementation in full or by making a contribution toward their implementation.

The Citywide Design Guidelines (October 24, 2019) includes sections relevant to development projects where improvements are proposed within the public realm. Specifically, Guidelines one through three provide building design strategies that support the pedestrian experience. The Guidelines provide best practices in designing that apply in three spatial categories of site planning, building design and public right of way. The Guidelines should be followed to ensure that the project design supports pedestrian safety, access and comfort as they access to and from the building and the immediate public right of way.

The City's Transportation Demand Management (TDM) Ordinance (LA Municipal Code 12.26.J) requires certain projects to incorporate strategies that reduce drive-alone vehicle trips and improve access to destinations and services. The ordinance is revised and updated periodically and should be reviewed for application to specific projects as they are reviewed.

The City's LAMC Section 12.37 (Waivers of Dedication and Improvement) requires certain projects to dedicate and/or implement improvements within the public right-of-way to meet the street designation standards of the Mobility Plan 2035.

The Bureau of Engineering (BOE) Street Standard Dimensions S-470-1 provides the specific street widths and public right of way dimensions associated with the City's street standards.

***Appendix D***

***VMT Analysis Worksheets***

# CITY OF LOS ANGELES VMT CALCULATOR Version 1.3



*Project Screening Criteria: Is this project required to conduct a vehicle miles traveled analysis?*

## Project Information

Project:

Scenario:

Address:

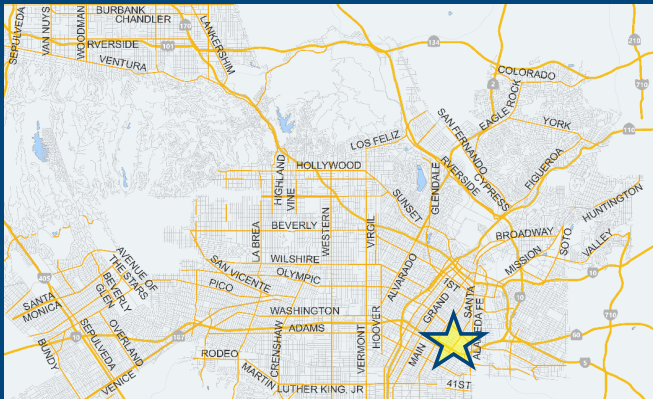

## Existing Land Use

Land Use Type	Value	Unit
Industrial   Light Industrial	558.918	ksf
Industrial   Light Industrial	558.918	ksf

Click here to add a single custom land use type (will be included in the above list)

## Proposed Project Land Use

Land Use Type	Value	Unit
Office   General Office	523.514	ksf
Office   General Office	523.514	ksf

Click here to add a single custom land use type (will be included in the above list)

## Project Screening Summary

Existing Land Use	Proposed Project
<b>2,933</b> Daily Vehicle Trips	<b>3,511</b> Daily Vehicle Trips
<b>22,382</b> Daily VMT	<b>27,764</b> Daily VMT
<b>Tier 1 Screening Criteria</b>	
Project will have less residential units compared to existing residential units & is within one-half mile of a fixed-rail station. <input type="checkbox"/>	
<b>Tier 2 Screening Criteria</b>	
The net increase in daily trips < 250 trips	<b>578</b> Net Daily Trips
The net increase in daily VMT ≤ 0	<b>5,382</b> Net Daily VMT
The proposed project consists of only retail land uses ≤ 50,000 square feet total.	<b>0.000</b> ksf
<b>The proposed project is required to perform VMT analysis.</b>	

Is the project replacing an existing number of residential units with a smaller number of residential units AND is located within one-half mile of a fixed-rail or fixed-guideway transit station?

Yes  No



# CITY OF LOS ANGELES VMT CALCULATOR Version 1.3



## Project Information

Project:

Scenario:

Address:

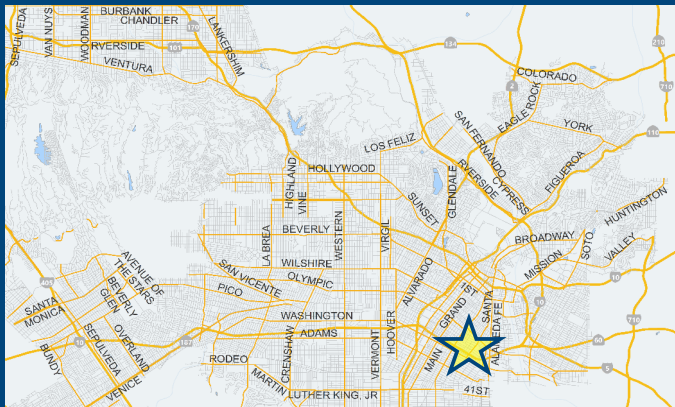

## TDM Strategies

Select each section to show individual strategies  
Use  to denote if the TDM strategy is part of the proposed project or is a mitigation strategy

	Proposed Project	With Mitigation
Max Home Based TDM Achieved?	No	No
Max Work Based TDM Achieved?	No	No
<b>A</b> Parking		
<b>B</b> Transit		
<b>C</b> Education & Encouragement		
<b>D</b> Commute Trip Reductions		
<b>E</b> Shared Mobility		
<b>F</b> Bicycle Infrastructure		
<b>G</b> Neighborhood Enhancement		
Traffic Calming Improvements	<input type="text" value="25"/>	<input type="text" value="25"/>
<input type="checkbox"/> Proposed Prj <input type="checkbox"/> Mitigation	percent of streets within project with traffic calming improvements	
<input type="checkbox"/> Proposed Prj <input type="checkbox"/> Mitigation	percent of intersections within project with traffic calming improvements	
Pedestrian Network Improvements	<input type="text" value="within project and connecting off-site"/>	
<input type="checkbox"/> Proposed Prj <input type="checkbox"/> Mitigation		

## Analysis Results

Proposed Project	With Mitigation
<b>3,466</b> Daily Vehicle Trips	<b>3,466</b> Daily Vehicle Trips
<b>27,418</b> Daily VMT	<b>27,418</b> Daily VMT
<b>0.0</b> Household VMT per Capita	<b>0.0</b> Household VMT per Capita
<b>7.4</b> Work VMT per Employee	<b>7.4</b> Work VMT per Employee
<b>Significant VMT Impact?</b>	
<b>Household: No</b> Threshold = 6.0 15% Below APC	<b>Household: No</b> Threshold = 6.0 15% Below APC
<b>Work: No</b> Threshold = 7.6 15% Below APC	<b>Work: No</b> Threshold = 7.6 15% Below APC

Proposed Project Land Use Type	Value	Unit
Office   General Office		



# CITY OF LOS ANGELES VMT CALCULATOR

## Report 1: Project & Analysis Overview

Date: March 17, 2021

Project Name: 8th & Alameda

Project Scenario: Project

Project Address: 2000 E 8TH ST, 90021



Version 1.3

Project Information			
Land Use Type		Value	Units
Housing	Single Family	0	DU
	Multi Family	0	DU
	Townhouse	0	DU
	Hotel	0	Rooms
	Motel	0	Rooms
Affordable Housing	Family	0	DU
	Senior	0	DU
	Special Needs	0	DU
	Permanent Supportive	0	DU
Retail	General Retail	0.000	ksf
	Furniture Store	0.000	ksf
	Pharmacy/Drugstore	0.000	ksf
	Supermarket	0.000	ksf
	Bank	0.000	ksf
	Health Club	0.000	ksf
	High-Turnover Sit-Down Restaurant	0.000	ksf
	Fast-Food Restaurant	0.000	ksf
	Quality Restaurant	0.000	ksf
	Auto Repair	0.000	ksf
	Home Improvement	0.000	ksf
	Free-Standing Discount	0.000	ksf
	Movie Theater	0	Seats
	Office	General Office	523.514
Medical Office		0.000	ksf
Industrial	Light Industrial	0.000	ksf
	Manufacturing	0.000	ksf
	Warehousing/Self-Storage	0.000	ksf
School	University	0	Students
	High School	0	Students
	Middle School	0	Students
	Elementary	0	Students
	Private School (K-12)	0	Students

# CITY OF LOS ANGELES VMT CALCULATOR

## Report 1: Project & Analysis Overview

Date: March 17, 2021

Project Name: 8th & Alameda

Project Scenario: Project

Project Address: 2000 E 8TH ST, 90021



Version 1.3

<i>Other</i>	<i>0</i>	<i>Trips</i>
--------------	----------	--------------

# CITY OF LOS ANGELES VMT CALCULATOR

## Report 1: Project & Analysis Overview

Date: March 17, 2021

Project Name: 8th & Alameda

Project Scenario: Project

Project Address: 2000 E 8TH ST, 90021



Version 1.3

<b>Analysis Results</b>			
Total Employees: 2,094			
Total Population: 0			
<b>Proposed Project</b>		<b>With Mitigation</b>	
3,466	Daily Vehicle Trips	3,466	Daily Vehicle Trips
27,418	Daily VMT	27,418	Daily VMT
0	Household VMT per Capita	0	Household VMT per Capita
7.4	Work VMT per Employee	7.4	Work VMT per Employee
<b>Significant VMT Impact?</b>			
<b>APC: Central</b>			
Impact Threshold: 15% Below APC Average			
Household = 6.0			
Work = 7.6			
<b>Proposed Project</b>		<b>With Mitigation</b>	
VMT Threshold	Impact	VMT Threshold	Impact
Household > 6.0	No	Household > 6.0	No
Work > 7.6	No	Work > 7.6	No

# CITY OF LOS ANGELES VMT CALCULATOR

## Report 2: TDM Inputs

Date: March 17, 2021

Project Name: 8th & Alameda

Project Scenario: Project

Project Address: 2000 E 8TH ST, 90021



Version 1.3

TDM Strategy Inputs			
Strategy Type	Description	Proposed Project	Mitigations
<b>Parking</b>	Reduce parking supply	City code parking provision (spaces)	0
		Actual parking provision (spaces)	0
	Unbundle parking	Monthly cost for parking (\$)	\$0
	Parking cash-out	Employees eligible (%)	0%
	Price workplace parking	Daily parking charge (\$)	\$0.00
		Employees subject to priced parking (%)	0%
	Residential area parking permits	Cost of annual permit (\$)	\$0
(cont. on following page)			



# CITY OF LOS ANGELES VMT CALCULATOR

## Report 2: TDM Inputs

Date: March 17, 2021

Project Name: 8th & Alameda

Project Scenario: Project

Project Address: 2000 E 8TH ST, 90021



Version 1.3

TDM Strategy Inputs, Cont.			
Strategy Type	Description	Proposed Project	Mitigations
<b>Transit</b>	<i>Reduce transit headways</i>	<i>Reduction in headways (increase in frequency) (%)</i>	0%
		<i>Existing transit mode share (as a percent of total daily trips) (%)</i>	0%
		<i>Lines within project site improved (&lt;50%, &gt;=50%)</i>	0
	<i>Implement neighborhood shuttle</i>	<i>Degree of implementation (low, medium, high)</i>	0
		<i>Employees and residents eligible (%)</i>	0%
	<i>Transit subsidies</i>	<i>Employees and residents eligible (%)</i>	0%
<i>Amount of transit subsidy per passenger (daily equivalent) (\$)</i>		\$0.00	
<b>Education &amp; Encouragement</b>	<i>Voluntary travel behavior change program</i>	<i>Employees and residents participating (%)</i>	0%
	<i>Promotions and marketing</i>	<i>Employees and residents participating (%)</i>	0%
(cont. on following page)			

# CITY OF LOS ANGELES VMT CALCULATOR

## Report 2: TDM Inputs

Date: March 17, 2021

Project Name: 8th & Alameda

Project Scenario: Project

Project Address: 2000 E 8TH ST, 90021



Version 1.3

TDM Strategy Inputs, Cont.				
Strategy Type	Description	Proposed Project	Mitigations	
<b>Commuter Trip Reductions</b>	<i>Required commute trip reduction program</i>	<i>Employees participating (%)</i>	0%	0%
	<i>Alternative Work Schedules and Telecommute</i>	<i>Employees participating (%)</i>	0%	0%
		<i>Type of program</i>	0	0
	<i>Employer sponsored vanpool or shuttle</i>	<i>Degree of implementation (low, medium, high)</i>	0	0
		<i>Employees eligible (%)</i>	0%	0%
		<i>Employer size (small, medium, large)</i>	0	0
<i>Ride-share program</i>	<i>Employees eligible (%)</i>	0%	0%	
<b>Shared Mobility</b>	<i>Car share</i>	<i>Car share project setting (Urban, Suburban, All Other)</i>	0	0
	<i>Bike share</i>	<i>Within 600 feet of existing bike share station - OR- implementing new bike share station (Yes/No)</i>	0	0
		<i>School carpool program</i>	<i>Level of implementation (Low, Medium, High)</i>	0
(cont. on following page)				

# CITY OF LOS ANGELES VMT CALCULATOR

## Report 2: TDM Inputs

Date: March 17, 2021

Project Name: 8th & Alameda

Project Scenario: Project

Project Address: 2000 E 8TH ST, 90021



Version 1.3

TDM Strategy Inputs, Cont.				
Strategy Type		Description	Proposed Project	Mitigations
<b>Bicycle Infrastructure</b>	<i>Implement/Improve on-street bicycle facility</i>	<i>Provide bicycle facility along site (Yes/No)</i>	0	0
	Include Bike parking per LAMC	Meets City Bike Parking Code (Yes/No)	Yes	Yes
	Include secure bike parking and showers	Includes indoor bike parking/lockers, showers, & repair station (Yes/No)	Yes	Yes
<b>Neighborhood Enhancement</b>	<i>Traffic calming improvements</i>	<i>Streets with traffic calming improvements (%)</i>	0%	0%
		<i>Intersections with traffic calming improvements (%)</i>	0%	0%
	<i>Pedestrian network improvements</i>	<i>Included (within project and connecting off-site/within project only)</i>	0	0

# CITY OF LOS ANGELES VMT CALCULATOR

## Report 3: TDM Outputs

Date: March 17, 2021  
 Project Name: 8th & Alameda  
 Project Scenario: Project  
 Project Address: 2000 E 8TH ST, 90021



Version 1.3

### TDM Adjustments by Trip Purpose & Strategy

Place type: Suburban Center

		Home Based Work Production		Home Based Work Attraction		Home Based Other Production		Home Based Other Attraction		Non-Home Based Other Production		Non-Home Based Other Attraction		Source
		Proposed	Mitigated	Proposed	Mitigated	Proposed	Mitigated	Proposed	Mitigated	Proposed	Mitigated	Proposed	Mitigated	
<b>Parking</b>	Reduce parking supply	0%	0%	0%	0%	0%	0%	0%	0%	0%	0%	0%	0%	TDM Strategy Appendix, Parking sections 1 - 5
	Unbundle parking	0%	0%	0%	0%	0%	0%	0%	0%	0%	0%	0%	0%	
	Parking cash-out	0%	0%	0%	0%	0%	0%	0%	0%	0%	0%	0%	0%	
	Price workplace parking	0%	0%	0%	0%	0%	0%	0%	0%	0%	0%	0%	0%	
	Residential area parking permits	0.00%	0.00%	0.00%	0.00%	0.00%	0.00%	0.00%	0.00%	0.00%	0.00%	0.00%	0.00%	
<b>Transit</b>	Reduce transit headways	0%	0%	0%	0%	0%	0%	0%	0%	0%	0%	0%	0%	TDM Strategy Appendix, Transit sections 1 - 3
	Implement neighborhood shuttle	0%	0%	0%	0%	0%	0%	0%	0%	0%	0%	0%	0%	
	Transit subsidies	0%	0%	0%	0%	0%	0%	0%	0%	0%	0%	0%	0%	
<b>Education &amp; Encouragement</b>	Voluntary travel behavior change program	0%	0%	0%	0%	0%	0%	0%	0%	0%	0%	0%	0%	TDM Strategy Appendix, Education & Encouragement sections 1 - 2
	Promotions and marketing	0%	0%	0%	0%	0%	0%	0%	0%	0%	0%	0%	0%	
<b>Commute Trip Reductions</b>	Required commute trip reduction program	0%	0%	0%	0%	0%	0%	0%	0%	0%	0%	0%	0%	TDM Strategy Appendix, Commute Trip Reductions sections 1 - 4
	Alternative Work Schedules and Telecommute Program	0%	0%	0%	0%	0%	0%	0%	0%	0%	0%	0%	0%	
	Employer sponsored vanpool or shuttle	0%	0%	0%	0%	0%	0%	0%	0%	0%	0%	0%	0%	
	Ride-share program	0%	0%	0%	0%	0%	0%	0%	0%	0%	0%	0%	0%	
<b>Shared Mobility</b>	Car-share	0.0%	0.0%	0.0%	0.0%	0.0%	0.0%	0.0%	0.0%	0.0%	0.0%	0.0%	0.0%	TDM Strategy Appendix, Shared Mobility sections 1 - 3
	Bike share	0.00%	0.00%	0.00%	0.00%	0.00%	0.00%	0.00%	0.00%	0.00%	0.00%	0.00%	0.00%	
	School carpool program	0.0%	0.0%	0.0%	0.0%	0.0%	0.0%	0.0%	0.0%	0.0%	0.0%	0.0%	0.0%	

# CITY OF LOS ANGELES VMT CALCULATOR

## Report 3: TDM Outputs

Date: March 17, 2021  
 Project Name: 8th & Alameda  
 Project Scenario: Project  
 Project Address: 2000 E 8TH ST, 90021



Version 1.3

### TDM Adjustments by Trip Purpose & Strategy, Cont.

Place type: Suburban Center

		Home Based Work Production		Home Based Work Attraction		Home Based Other Production		Home Based Other Attraction		Non-Home Based Other Production		Non-Home Based Other Attraction		Source
		Proposed	Mitigated	Proposed	Mitigated	Proposed	Mitigated	Proposed	Mitigated	Proposed	Mitigated	Proposed	Mitigated	
		<b>Bicycle Infrastructure</b>	Implement/ Improve on-street bicycle facility	0.0%	0.0%	0.0%	0.0%	0.0%	0.0%	0.0%	0.0%	0.0%	0.0%	
	Include Bike parking per LAMC	0.6%	0.6%	0.6%	0.6%	0.6%	0.6%	0.6%	0.6%	0.6%	0.6%	0.6%	0.6%	
	Include secure bike parking and showers	0.6%	0.6%	0.6%	0.6%	0.6%	0.6%	0.6%	0.6%	0.6%	0.6%	0.6%	0.6%	
<b>Neighborhood Enhancement</b>	Traffic calming improvements	0.0%	0.0%	0.0%	0.0%	0.0%	0.0%	0.0%	0.0%	0.0%	0.0%	0.0%	0.0%	TDM Strategy Appendix, Neighborhood Enhancement
	Pedestrian network improvements	0.0%	0.0%	0.0%	0.0%	0.0%	0.0%	0.0%	0.0%	0.0%	0.0%	0.0%	0.0%	

### Final Combined & Maximum TDM Effect

	Home Based Work Production		Home Based Work Attraction		Home Based Other Production		Home Based Other Attraction		Non-Home Based Other Production		Non-Home Based Other Attraction	
	Proposed	Mitigated	Proposed	Mitigated	Proposed	Mitigated	Proposed	Mitigated	Proposed	Mitigated	Proposed	Mitigated
	<b>COMBINED TOTAL</b>	1%	1%	1%	1%	1%	1%	1%	1%	1%	1%	1%
<b>MAX. TDM EFFECT</b>	1%	1%	1%	1%	1%	1%	1%	1%	1%	1%	1%	1%

$$= \text{Minimum}(X\%, 1 - [(1-A) * (1-B) \dots])$$

where X%=

<b>PLACE</b>	urban	75%
<b>TYPE</b>	compact infill	40%
<b>MAX:</b>	suburban center	20%
	suburban	15%

Note:  $(1 - [(1-A) * (1-B) \dots])$  reflects the dampened combined effectiveness of TDM Strategies (e.g., A, B, ...). See the TDM Strategy Appendix (*Transportation Assessment Guidelines Attachment G*) for further discussion of dampening.

# CITY OF LOS ANGELES VMT CALCULATOR

## Report 4: MXD Methodology

Date: March 17, 2021

Project Name: 8th & Alameda

Project Scenario: Project

Project Address: 2000 E 8TH ST, 90021



Version 1.3

### MXD Methodology - Project Without TDM

	Unadjusted Trips	MXD Adjustment	MXD Trips	Average Trip Length	Unadjusted VMT	MXD VMT
Home Based Work Production	0	0.0%	0	7.1	0	0
Home Based Other Production	0	0.0%	0	5.1	0	0
Non-Home Based Other Production	548	-4.4%	524	8.3	4,548	4,349
Home-Based Work Attraction	2,429	-22.1%	1,891	8.3	20,161	15,695
Home-Based Other Attraction	1,095	-47.8%	572	6.9	7,556	3,947
Non-Home Based Other Attraction	548	-4.4%	524	7.2	3,946	3,773

### MXD Methodology with TDM Measures

	<i>Proposed Project</i>			<i>Project with Mitigation Measures</i>		
	TDM Adjustment	Project Trips	Project VMT	TDM Adjustment	Mitigated Trips	Mitigated VMT
Home Based Work Production	-1.2%	0	0	-1.2%	0	0
Home Based Other Production	-1.2%	0	0	-1.2%	0	0
Non-Home Based Other Production	-1.2%	517	4,295	-1.2%	517	4,295
Home-Based Work Attraction	-1.2%	1,867	15,499	-1.2%	1,867	15,499
Home-Based Other Attraction	-1.2%	565	3,898	-1.2%	565	3,898
Non-Home Based Other Attraction	-1.2%	517	3,726	-1.2%	517	3,726

### MXD VMT Methodology Per Capita & Per Employee

Total Population: 0

Total Employees: 2,094

APC: Central

	<i>Proposed Project</i>	<i>Project with Mitigation Measures</i>
<i>Total Home Based Production VMT</i>	<b>0</b>	<b>0</b>
<i>Total Home Based Work Attraction VMT</i>	<b>15,499</b>	<b>15,499</b>
<i>Total Home Based VMT Per Capita</i>	<b>0.0</b>	<b>0.0</b>
<i>Total Work Based VMT Per Employee</i>	<b>7.4</b>	<b>7.4</b>

***Appendix E***

***Caltrans Freeway Off-Ramp Analysis Worksheets***

**TABLE E-1  
FREEWAY OFF-RAMP QUEUING SAFETY ANALYSIS**

Off-ramp	Ramp Storage Length			Peak Hour	95th Percentile Queue		Exceeds Ramp Storage [b]	Project Adds 50 Feet [c]	Requires Speed Analysis [d]
	Ramp	Auxiliary Lane	Total [a]		Future without Project Conditions	Future with Project Conditions			
I-10 West at Enterprise Street	800	0	800	AM	208	398	NO	YES	NO
				PM	305	455	NO	YES	NO

Notes:

Ramp storage length and 95th percentile queue reported in feet.

[a] Includes ramp length (from stop line to gore point) as well as half the length of any auxiliary lane, if provided.

[b] Based on Future with Project Conditions queue.

[c] The difference in queue length between Future with Project Conditions and Future without Project Conditions.

[d] Speed differential analysis is required if the ramp storage length is exceeded and the Project adds 50 or more feet to the queue length.



HCM 6th TWSC  
 2: Mateo St & Enterprise St/I-10 WB Off-Ramp

03/11/2021

Intersection												
Int Delay, s/veh	12.1											
Movement	EBL	EBT	EBR	WBL	WBT	WBR	NBL	NBT	NBR	SBL	SBT	SBR
Lane Configurations		↕			↕			↕			↕	
Traffic Vol, veh/h	3	0	0	102	0	349	0	169	0	0	576	0
Future Vol, veh/h	3	0	0	102	0	349	0	169	0	0	576	0
Conflicting Peds, #/hr	0	0	0	0	0	0	0	0	0	0	0	0
Sign Control	Stop	Stop	Stop	Stop	Stop	Stop	Free	Free	Free	Free	Free	Free
RT Channelized	-	-	None	-	-	None	-	-	None	-	-	None
Storage Length	-	-	-	-	-	-	-	-	-	-	-	-
Veh in Median Storage, #	-	0	-	-	0	-	-	0	-	-	0	-
Grade, %	-	0	-	-	0	-	-	0	-	-	0	-
Peak Hour Factor	92	92	92	92	92	92	92	92	92	92	92	92
Heavy Vehicles, %	2	2	2	2	2	2	2	2	2	2	2	2
Mvmt Flow	3	0	0	111	0	379	0	184	0	0	626	0

Major/Minor	Minor2		Minor1		Major1		Major2					
Conflicting Flow All	1000	810	626	810	810	184	626	0	-	-	-	0
Stage 1	626	626	-	184	184	-	-	-	-	-	-	-
Stage 2	374	184	-	626	626	-	-	-	-	-	-	-
Critical Hdwy	7.12	6.52	6.22	7.12	6.52	6.22	4.12	-	-	-	-	-
Critical Hdwy Stg 1	6.12	5.52	-	6.12	5.52	-	-	-	-	-	-	-
Critical Hdwy Stg 2	6.12	5.52	-	6.12	5.52	-	-	-	-	-	-	-
Follow-up Hdwy	3.518	4.018	3.318	3.518	4.018	3.318	2.218	-	-	-	-	-
Pot Cap-1 Maneuver	222	314	484	298	314	858	956	-	0	0	-	-
Stage 1	472	477	-	818	747	-	-	-	0	0	-	-
Stage 2	647	747	-	472	477	-	-	-	0	0	-	-
Platoon blocked, %								-			-	
Mov Cap-1 Maneuver	124	314	484	298	314	858	956	-	-	-	-	-
Mov Cap-2 Maneuver	124	314	-	298	314	-	-	-	-	-	-	-
Stage 1	472	477	-	818	747	-	-	-	-	-	-	-
Stage 2	361	747	-	472	477	-	-	-	-	-	-	-

Approach	EB		WB		NB		SB				
HCM Control Delay, s	34.8		31.9		0		0				
HCM LOS	D		D								

Minor Lane/Major Mvmt	NBL	NBT	EBLn1	WBLn1	SBT	SBR
Capacity (veh/h)	956	-	124	602	-	-
HCM Lane V/C Ratio	-	-	0.026	0.814	-	-
HCM Control Delay (s)	0	-	34.8	31.9	-	-
HCM Lane LOS	A	-	D	D	-	-
HCM 95th %tile Q(veh)	0	-	0.1	8.3	-	-

HCM 6th TWSC  
 2: Mateo St & Enterprise St/I-10 WB Off-Ramp

03/11/2021

Intersection												
Int Delay, s/veh	18											
Movement	EBL	EBT	EBR	WBL	WBT	WBR	NBL	NBT	NBR	SBL	SBT	SBR
Lane Configurations		↕			↕			↕			↕	
Traffic Vol, veh/h	5	0	0	88	0	398	0	168	0	0	761	0
Future Vol, veh/h	5	0	0	88	0	398	0	168	0	0	761	0
Conflicting Peds, #/hr	0	0	0	0	0	0	0	0	0	0	0	0
Sign Control	Stop	Stop	Stop	Stop	Stop	Stop	Free	Free	Free	Free	Free	Free
RT Channelized	-	-	None	-	-	None	-	-	None	-	-	None
Storage Length	-	-	-	-	-	-	-	-	-	-	-	-
Veh in Median Storage, #	-	0	-	-	0	-	-	0	-	-	0	-
Grade, %	-	0	-	-	0	-	-	0	-	-	0	-
Peak Hour Factor	92	92	92	92	92	92	92	92	92	92	92	92
Heavy Vehicles, %	2	2	2	2	2	2	2	2	2	2	2	2
Mvmt Flow	5	0	0	96	0	433	0	183	0	0	827	0

Major/Minor	Minor2		Minor1		Major1		Major2					
Conflicting Flow All	1227	1010	827	1010	1010	183	827	0	-	-	-	0
Stage 1	827	827	-	183	183	-	-	-	-	-	-	-
Stage 2	400	183	-	827	827	-	-	-	-	-	-	-
Critical Hdwy	7.12	6.52	6.22	7.12	6.52	6.22	4.12	-	-	-	-	-
Critical Hdwy Stg 1	6.12	5.52	-	6.12	5.52	-	-	-	-	-	-	-
Critical Hdwy Stg 2	6.12	5.52	-	6.12	5.52	-	-	-	-	-	-	-
Follow-up Hdwy	3.518	4.018	3.318	3.518	4.018	3.318	2.218	-	-	-	-	-
Pot Cap-1 Maneuver	155	240	371	218	240	859	804	-	0	0	-	-
Stage 1	366	386	-	819	748	-	-	-	0	0	-	-
Stage 2	626	748	-	366	386	-	-	-	0	0	-	-
Platoon blocked, %								-	-	-	-	-
Mov Cap-1 Maneuver	77	240	371	218	240	859	804	-	-	-	-	-
Mov Cap-2 Maneuver	77	240	-	218	240	-	-	-	-	-	-	-
Stage 1	366	386	-	819	748	-	-	-	-	-	-	-
Stage 2	311	748	-	366	386	-	-	-	-	-	-	-

Approach	EB		WB		NB		SB				
HCM Control Delay, s	55.3		52.1		0		0				
HCM LOS	F		F								

Minor Lane/Major Mvmt	NBL	NBT	EBLn1	WBLn1	SBT	SBR
Capacity (veh/h)	804	-	77	561	-	-
HCM Lane V/C Ratio	-	-	0.071	0.942	-	-
HCM Control Delay (s)	0	-	55.3	52.1	-	-
HCM Lane LOS	A	-	F	F	-	-
HCM 95th %tile Q(veh)	0	-	0.2	12.2	-	-

HCM 6th TWSC  
 2: Mateo St & Enterprise St/I-10 WB Off-Ramp

03/11/2021

Intersection												
Int Delay, s/veh	31.7											
Movement	EBL	EBT	EBR	WBL	WBT	WBR	NBL	NBT	NBR	SBL	SBT	SBR
Lane Configurations		↕			↕			↕			↕	
Traffic Vol, veh/h	3	0	7	138	11	349	0	205	0	0	576	0
Future Vol, veh/h	3	0	7	138	11	349	0	205	0	0	576	0
Conflicting Peds, #/hr	0	0	0	0	0	0	0	0	0	0	0	0
Sign Control	Stop	Stop	Stop	Stop	Stop	Stop	Free	Free	Free	Free	Free	Free
RT Channelized	-	-	None	-	-	None	-	-	None	-	-	None
Storage Length	-	-	-	-	-	-	-	-	-	-	-	-
Veh in Median Storage, #	-	0	-	-	0	-	-	0	-	-	0	-
Grade, %	-	0	-	-	0	-	-	0	-	-	0	-
Peak Hour Factor	92	92	92	92	92	92	92	92	92	92	92	92
Heavy Vehicles, %	2	2	2	2	2	2	2	2	2	2	2	2
Mvmt Flow	3	0	8	150	12	379	0	223	0	0	626	0

Major/Minor	Minor2		Minor1		Major1		Major2					
Conflicting Flow All	1045	849	626	853	849	223	626	0	-	-	-	0
Stage 1	626	626	-	223	223	-	-	-	-	-	-	-
Stage 2	419	223	-	630	626	-	-	-	-	-	-	-
Critical Hdwy	7.12	6.52	6.22	7.12	6.52	6.22	4.12	-	-	-	-	-
Critical Hdwy Stg 1	6.12	5.52	-	6.12	5.52	-	-	-	-	-	-	-
Critical Hdwy Stg 2	6.12	5.52	-	6.12	5.52	-	-	-	-	-	-	-
Follow-up Hdwy	3.518	4.018	3.318	3.518	4.018	3.318	2.218	-	-	-	-	-
Pot Cap-1 Maneuver	207	298	484	279	298	817	956	-	0	0	-	-
Stage 1	472	477	-	780	719	-	-	-	0	0	-	-
Stage 2	612	719	-	470	477	-	-	-	0	0	-	-
Platoon blocked, %								-	-	-	-	-
Mov Cap-1 Maneuver	107	298	484	275	298	817	956	-	-	-	-	-
Mov Cap-2 Maneuver	107	298	-	275	298	-	-	-	-	-	-	-
Stage 1	472	477	-	780	719	-	-	-	-	-	-	-
Stage 2	322	719	-	463	477	-	-	-	-	-	-	-

Approach	EB		WB		NB		SB				
HCM Control Delay, s	21.1		81.5		0		0				
HCM LOS	C		F								

Minor Lane/Major Mvmt	NBL	NBT	EBLn1	WBLn1	SBT	SBR
Capacity (veh/h)	956	-	235	516	-	-
HCM Lane V/C Ratio	-	-	0.046	1.049	-	-
HCM Control Delay (s)	0	-	21.1	81.5	-	-
HCM Lane LOS	A	-	C	F	-	-
HCM 95th %tile Q(veh)	0	-	0.1	15.9	-	-

HCM 6th TWSC  
 2: Mateo St & Enterprise St/I-10 WB Off-Ramp

03/11/2021

Intersection												
Int Delay, s/veh	35.2											
Movement	EBL	EBT	EBR	WBL	WBT	WBR	NBL	NBT	NBR	SBL	SBT	SBR
Lane Configurations		↕			↕			↕			↕	
Traffic Vol, veh/h	5	0	10	104	5	398	0	184	0	0	782	0
Future Vol, veh/h	5	0	10	104	5	398	0	184	0	0	782	0
Conflicting Peds, #/hr	0	0	0	0	0	0	0	0	0	0	0	0
Sign Control	Stop	Stop	Stop	Stop	Stop	Stop	Free	Free	Free	Free	Free	Free
RT Channelized	-	-	None	-	-	None	-	-	None	-	-	None
Storage Length	-	-	-	-	-	-	-	-	-	-	-	-
Veh in Median Storage, #	-	0	-	-	0	-	-	0	-	-	0	-
Grade, %	-	0	-	-	0	-	-	0	-	-	0	-
Peak Hour Factor	92	92	92	92	92	92	92	92	92	92	92	92
Heavy Vehicles, %	2	2	2	2	2	2	2	2	2	2	2	2
Mvmt Flow	5	0	11	113	5	433	0	200	0	0	850	0

Major/Minor	Minor2		Minor1		Major1		Major2					
Conflicting Flow All	1269	1050	850	1056	1050	200	850	0	-	-	-	0
Stage 1	850	850	-	200	200	-	-	-	-	-	-	-
Stage 2	419	200	-	856	850	-	-	-	-	-	-	-
Critical Hdwy	7.12	6.52	6.22	7.12	6.52	6.22	4.12	-	-	-	-	-
Critical Hdwy Stg 1	6.12	5.52	-	6.12	5.52	-	-	-	-	-	-	-
Critical Hdwy Stg 2	6.12	5.52	-	6.12	5.52	-	-	-	-	-	-	-
Follow-up Hdwy	3.518	4.018	3.318	3.518	4.018	3.318	2.218	-	-	-	-	-
Pot Cap-1 Maneuver	145	227	360	203	227	841	788	-	0	0	-	-
Stage 1	355	377	-	802	736	-	-	-	0	0	-	-
Stage 2	612	736	-	352	377	-	-	-	0	0	-	-
Platoon blocked, %								-	-	-	-	-
Mov Cap-1 Maneuver	69	227	360	197	227	841	788	-	-	-	-	-
Mov Cap-2 Maneuver	69	227	-	197	227	-	-	-	-	-	-	-
Stage 1	355	377	-	802	736	-	-	-	-	-	-	-
Stage 2	295	736	-	341	377	-	-	-	-	-	-	-

Approach	EB		WB		NB		SB				
HCM Control Delay, s	31.9		102.5		0		0				
HCM LOS	D		F								

Minor Lane/Major Mvmt	NBL	NBT	EBLn1	WBLn1	SBT	SBR
Capacity (veh/h)	788	-	150	496	-	-
HCM Lane V/C Ratio	-	-	0.109	1.111	-	-
HCM Control Delay (s)	0	-	31.9	102.5	-	-
HCM Lane LOS	A	-	D	F	-	-
HCM 95th %tile Q(veh)	0	-	0.4	18.2	-	-

***Appendix F***

***HCM Analysis Worksheets***

# HCM 6th Signalized Intersection Summary

## 1: Alameda St & 7th St

03/17/2021



Movement	EBL	EBT	EBR	WBL	WBT	WBR	NBL	NBT	NBR	SBL	SBT	SBR
Lane Configurations												
Traffic Volume (veh/h)	60	321	85	123	687	102	113	645	96	132	904	173
Future Volume (veh/h)	60	321	85	123	687	102	113	645	96	132	904	173
Initial Q (Qb), veh	0	0	0	0	0	0	0	0	0	0	0	0
Ped-Bike Adj(A_pbT)	1.00		1.00	1.00		1.00	1.00		1.00	1.00		1.00
Parking Bus, Adj	1.00	1.00	1.00	1.00	1.00	1.00	1.00	1.00	1.00	1.00	1.00	1.00
Work Zone On Approach		No			No			No			No	
Adj Sat Flow, veh/h/ln	1870	1870	1870	1870	1870	1870	1870	1870	1870	1870	1870	1870
Adj Flow Rate, veh/h	65	349	92	134	747	111	123	701	104	143	983	188
Peak Hour Factor	0.92	0.92	0.92	0.92	0.92	0.92	0.92	0.92	0.92	0.92	0.92	0.92
Percent Heavy Veh, %	2	2	2	2	2	2	2	2	2	2	2	2
Cap, veh/h	181	1003	261	333	1116	166	247	1080	160	342	1510	288
Arrive On Green	0.36	0.36	0.36	0.36	0.36	0.36	0.11	0.11	0.11	0.19	1.00	1.00
Sat Flow, veh/h	644	2791	726	948	3103	461	479	3104	460	1781	2976	568
Grp Volume(v), veh/h	65	221	220	134	428	430	123	401	404	143	586	585
Grp Sat Flow(s),veh/h/ln	644	1777	1740	948	1777	1787	479	1777	1788	1781	1777	1768
Q Serve(g_s), s	8.5	8.2	8.4	10.9	18.3	18.3	22.3	19.4	19.5	4.1	0.0	0.0
Cycle Q Clear(g_c), s	26.8	8.2	8.4	19.2	18.3	18.3	22.3	19.4	19.5	4.1	0.0	0.0
Prop In Lane	1.00		0.42	1.00		0.26	1.00		0.26	1.00		0.32
Lane Grp Cap(c), veh/h	181	639	625	333	639	643	247	618	622	342	901	897
V/C Ratio(X)	0.36	0.35	0.35	0.40	0.67	0.67	0.50	0.65	0.65	0.42	0.65	0.65
Avail Cap(c_a), veh/h	181	639	625	333	639	643	247	618	622	355	901	897
HCM Platoon Ratio	1.00	1.00	1.00	1.00	1.00	1.00	0.33	0.33	0.33	2.00	2.00	2.00
Upstream Filter(I)	0.97	0.97	0.97	1.00	1.00	1.00	0.94	0.94	0.94	0.84	0.84	0.84
Uniform Delay (d), s/veh	35.6	21.1	21.1	28.2	24.3	24.3	35.9	34.6	34.6	15.2	0.0	0.0
Incr Delay (d2), s/veh	5.3	1.4	1.5	3.6	5.5	5.5	6.6	4.9	4.9	0.7	3.1	3.1
Initial Q Delay(d3),s/veh	0.0	0.0	0.0	0.0	0.0	0.0	0.0	0.0	0.0	0.0	0.0	0.0
%ile BackOfQ(95%),veh/ln	2.9	6.4	6.4	4.9	13.1	13.2	5.9	15.0	15.1	2.7	1.4	1.4
Unsig. Movement Delay, s/veh												
LnGrp Delay(d),s/veh	41.0	22.5	22.7	31.8	29.8	29.8	42.5	39.5	39.5	15.9	3.1	3.1
LnGrp LOS	D	C	C	C	C	C	D	D	D	B	A	A
Approach Vol, veh/h		506			992			928			1314	
Approach Delay, s/veh		24.9			30.1			39.9			4.5	
Approach LOS		C			C			D			A	
Timer - Assigned Phs		2		4	5	6		8				
Phs Duration (G+Y+Rc), s		51.3		38.7	14.3	37.0		38.7				
Change Period (Y+Rc), s		* 5.7		* 6.3	5.6	* 5.7		* 6.3				
Max Green Setting (Gmax), s		* 44		* 32	9.4	* 31		* 31				
Max Q Clear Time (g_c+I1), s		2.0		21.2	6.1	24.3		28.8				
Green Ext Time (p_c), s		10.6		4.5	0.1	3.6		0.6				

### Intersection Summary

HCM 6th Ctrl Delay	22.8
HCM 6th LOS	C

### Notes

\* HCM 6th computational engine requires equal clearance times for the phases crossing the barrier.

# HCM 6th Signalized Intersection Summary

## 2: Alameda St & 8th St

03/17/2021



Movement	EBL	EBT	EBR	WBL	WBT	WBR	NBL	NBT	NBR	SBL	SBT	SBR
Lane Configurations		↕			↕		↙	↕		↙	↕	
Traffic Volume (veh/h)	96	51	43	40	82	43	34	771	27	13	768	112
Future Volume (veh/h)	96	51	43	40	82	43	34	771	27	13	768	112
Initial Q (Qb), veh	0	0	0	0	0	0	0	0	0	0	0	0
Ped-Bike Adj(A_pbT)	1.00		1.00	1.00		1.00	1.00		1.00	1.00		1.00
Parking Bus, Adj	1.00	1.00	1.00	1.00	1.00	1.00	1.00	1.00	1.00	1.00	1.00	1.00
Work Zone On Approach		No			No			No			No	
Adj Sat Flow, veh/h/ln	1870	1870	1870	1870	1870	1870	1870	1870	1870	1870	1870	1870
Adj Flow Rate, veh/h	104	55	47	43	89	47	37	838	29	14	835	122
Peak Hour Factor	0.92	0.92	0.92	0.92	0.92	0.92	0.92	0.92	0.92	0.92	0.92	0.92
Percent Heavy Veh, %	2	2	2	2	2	2	2	2	2	2	2	2
Cap, veh/h	173	80	57	99	167	77	490	2451	85	511	2176	318
Arrive On Green	0.18	0.18	0.18	0.18	0.18	0.18	0.93	0.93	0.93	1.00	1.00	1.00
Sat Flow, veh/h	646	454	325	283	954	440	587	3504	121	638	3111	455
Grp Volume(v), veh/h	206	0	0	179	0	0	37	425	442	14	477	480
Grp Sat Flow(s),veh/h/ln	1425	0	0	1677	0	0	587	1777	1849	638	1777	1789
Q Serve(g_s), s	4.0	0.0	0.0	0.0	0.0	0.0	0.4	2.2	2.2	0.1	0.0	0.0
Cycle Q Clear(g_c), s	12.6	0.0	0.0	8.7	0.0	0.0	0.4	2.2	2.2	2.3	0.0	0.0
Prop In Lane	0.50		0.23	0.24		0.26	1.00		0.07	1.00		0.25
Lane Grp Cap(c), veh/h	310	0	0	343	0	0	490	1243	1293	511	1243	1251
V/C Ratio(X)	0.66	0.00	0.00	0.52	0.00	0.00	0.08	0.34	0.34	0.03	0.38	0.38
Avail Cap(c_a), veh/h	609	0	0	677	0	0	490	1243	1293	511	1243	1251
HCM Platoon Ratio	1.00	1.00	1.00	1.00	1.00	1.00	1.33	1.33	1.33	2.00	2.00	2.00
Upstream Filter(I)	1.00	0.00	0.00	1.00	0.00	0.00	1.00	1.00	1.00	0.73	0.73	0.73
Uniform Delay (d), s/veh	35.7	0.0	0.0	34.1	0.0	0.0	1.0	1.0	1.0	0.0	0.0	0.0
Incr Delay (d2), s/veh	2.5	0.0	0.0	1.2	0.0	0.0	0.3	0.8	0.7	0.1	0.7	0.7
Initial Q Delay(d3),s/veh	0.0	0.0	0.0	0.0	0.0	0.0	0.0	0.0	0.0	0.0	0.0	0.0
%ile BackOfQ(95%),veh/ln	8.0	0.0	0.0	6.6	0.0	0.0	0.1	1.3	1.4	0.0	0.4	0.4
Unsig. Movement Delay, s/veh												
LnGrp Delay(d),s/veh	38.2	0.0	0.0	35.3	0.0	0.0	1.3	1.8	1.7	0.1	0.7	0.7
LnGrp LOS	D	A	A	D	A	A	A	A	A	A	A	A
Approach Vol, veh/h		206			179			904			971	
Approach Delay, s/veh		38.2			35.3			1.7			0.6	
Approach LOS		D			D			A			A	
Timer - Assigned Phs		2		4		6		8				
Phs Duration (G+Y+Rc), s		68.5		21.5		68.5		21.5				
Change Period (Y+Rc), s		5.6		5.7		5.6		5.7				
Max Green Setting (Gmax), s		44.4		34.3		44.4		34.3				
Max Q Clear Time (g_c+I1), s		4.2		14.6		4.3		10.7				
Green Ext Time (p_c), s		12.5		1.2		18.4		1.0				
<b>Intersection Summary</b>												
HCM 6th Ctrl Delay				7.3								
HCM 6th LOS				A								

# HCM 6th Signalized Intersection Summary

## 3: Alameda St & Olympic BI

03/17/2021



Movement	EBL	EBT	EBR	WBL	WBT	WBR	NBL	NBT	NBR	SBL	SBT	SBR
Lane Configurations	↖	↗		↖	↗		↖	↗		↖	↗	↖
Traffic Volume (veh/h)	72	780	65	163	1335	45	108	774	57	94	577	140
Future Volume (veh/h)	72	780	65	163	1335	45	108	774	57	94	577	140
Initial Q (Qb), veh	0	0	0	0	0	0	0	0	0	0	0	0
Ped-Bike Adj(A_pbT)	1.00		1.00	1.00		1.00	1.00		1.00	1.00		1.00
Parking Bus, Adj	1.00	1.00	1.00	1.00	1.00	1.00	1.00	1.00	1.00	1.00	1.00	1.00
Work Zone On Approach		No		No		No		No		No		No
Adj Sat Flow, veh/h/ln	1870	1870	1870	1870	1870	1870	1870	1870	1870	1870	1870	1870
Adj Flow Rate, veh/h	78	848	71	177	1451	49	117	841	62	102	627	0
Peak Hour Factor	0.92	0.92	0.92	0.92	0.92	0.92	0.92	0.92	0.92	0.92	0.92	0.92
Percent Heavy Veh, %	2	2	2	2	2	2	2	2	2	2	2	2
Cap, veh/h	80	1280	107	186	1352	46	413	1663	123	262	1761	
Arrive On Green	0.39	0.39	0.39	0.39	0.39	0.39	0.33	0.33	0.33	0.66	0.66	0.00
Sat Flow, veh/h	350	3319	278	608	3508	118	799	3355	247	617	3554	1585
Grp Volume(v), veh/h	78	454	465	177	734	766	117	445	458	102	627	0
Grp Sat Flow(s),veh/h/ln	350	1777	1820	608	1777	1849	799	1777	1826	617	1777	1585
Q Serve(g_s), s	0.0	19.0	19.0	15.7	34.7	34.7	10.5	18.1	18.1	11.6	7.1	0.0
Cycle Q Clear(g_c), s	34.7	19.0	19.0	34.7	34.7	34.7	17.6	18.1	18.1	29.7	7.1	0.0
Prop In Lane	1.00		0.15	1.00		0.06	1.00		0.14	1.00		1.00
Lane Grp Cap(c), veh/h	80	685	702	186	685	713	413	881	905	262	1761	
V/C Ratio(X)	0.97	0.66	0.66	0.95	1.07	1.07	0.28	0.51	0.51	0.39	0.36	
Avail Cap(c_a), veh/h	80	685	702	186	685	713	413	881	905	262	1761	
HCM Platoon Ratio	1.00	1.00	1.00	1.00	1.00	1.00	0.67	0.67	0.67	1.33	1.33	1.33
Upstream Filter(I)	1.00	1.00	1.00	1.00	1.00	1.00	0.77	0.77	0.77	1.00	1.00	0.00
Uniform Delay (d), s/veh	45.0	22.8	22.8	40.3	27.6	27.7	23.9	21.2	21.2	19.9	8.9	0.0
Incr Delay (d2), s/veh	91.9	2.4	2.3	51.6	55.0	55.6	1.3	1.6	1.6	4.3	0.6	0.0
Initial Q Delay(d3),s/veh	0.0	0.0	0.0	0.0	0.0	0.0	0.0	0.0	0.0	0.0	0.0	0.0
%ile BackOfQ(95%),veh/ln	6.8	12.7	13.0	10.8	34.1	35.5	4.0	12.4	12.7	3.2	4.5	0.0
Unsig. Movement Delay, s/veh												
LnGrp Delay(d),s/veh	136.9	25.2	25.2	91.9	82.7	83.2	25.2	22.8	22.8	24.2	9.5	0.0
LnGrp LOS	F	C	C	F	F	F	C	C	C	C	C	A
Approach Vol, veh/h		997		1677		1020		729		A		
Approach Delay, s/veh		33.9		83.9		23.1		11.6				
Approach LOS		C		F		C		B				
Timer - Assigned Phs		2		4		6		8				
Phs Duration (G+Y+Rc), s		50.0		40.0		50.0		40.0				
Change Period (Y+Rc), s		* 5.4		* 5.3		* 5.4		* 5.3				
Max Green Setting (Gmax), s		* 45		* 35		* 45		* 35				
Max Q Clear Time (g_c+I1), s		31.7		36.7		20.1		36.7				
Green Ext Time (p_c), s		4.3		0.0		7.3		0.0				

### Intersection Summary

HCM 6th Ctrl Delay	46.7
HCM 6th LOS	D

### Notes

\* HCM 6th computational engine requires equal clearance times for the phases crossing the barrier.  
 Unsignalized Delay for [SBR] is excluded from calculations of the approach delay and intersection delay.



HCM 6th TWSC  
4: Olympic Bl & Lemon St

03/17/2021

Intersection												
Int Delay, s/veh	1.2											
Movement	EBL	EBT	EBR	WBL	WBT	WBR	NBL	NBT	NBR	SBL	SBT	SBR
Lane Configurations	↖	↗		↖	↗			↕			↕	
Traffic Vol, veh/h	14	444	5	35	1534	20	3	1	4	7	2	90
Future Vol, veh/h	14	444	5	35	1534	20	3	1	4	7	2	90
Conflicting Peds, #/hr	0	0	0	0	0	0	0	0	0	0	0	0
Sign Control	Free	Free	Free	Free	Free	Free	Stop	Stop	Stop	Stop	Stop	Stop
RT Channelized	-	-	None	-	-	None	-	-	None	-	-	None
Storage Length	124	-	-	80	-	-	-	-	-	-	-	-
Veh in Median Storage, #	-	0	-	-	0	-	-	0	-	-	0	-
Grade, %	-	0	-	-	0	-	-	0	-	-	0	-
Peak Hour Factor	92	92	92	92	92	92	92	92	92	92	92	92
Heavy Vehicles, %	2	2	2	2	2	2	2	2	2	2	2	2
Mvmt Flow	15	483	5	38	1667	22	3	1	4	8	2	98

Major/Minor	Major1		Major2		Minor1		Minor2					
Conflicting Flow All	1689	0	0	488	0	0	1427	2281	244	2026	2272	845
Stage 1	-	-	-	-	-	-	516	516	-	1754	1754	-
Stage 2	-	-	-	-	-	-	911	1765	-	272	518	-
Critical Hdwy	4.14	-	-	4.14	-	-	7.54	6.54	6.94	7.54	6.54	6.94
Critical Hdwy Stg 1	-	-	-	-	-	-	6.54	5.54	-	6.54	5.54	-
Critical Hdwy Stg 2	-	-	-	-	-	-	6.54	5.54	-	6.54	5.54	-
Follow-up Hdwy	2.22	-	-	2.22	-	-	3.52	4.02	3.32	3.52	4.02	3.32
Pot Cap-1 Maneuver	*670	-	-	1071	-	-	*422	70	757	*148	*72	*448
Stage 1	-	-	-	-	-	-	*510	533	-	*422	*370	-
Stage 2	-	-	-	-	-	-	*422	365	-	*711	*531	-
Platoon blocked, %	1	-	-	-	-	-	1	1	-	1	1	1
Mov Cap-1 Maneuver	*670	-	-	1071	-	-	*308	66	757	*139	*68	*448
Mov Cap-2 Maneuver	-	-	-	-	-	-	*308	66	-	*139	*68	-
Stage 1	-	-	-	-	-	-	*499	521	-	*413	*357	-
Stage 2	-	-	-	-	-	-	*316	353	-	*690	*519	-

Approach	EB	WB	NB	SB
HCM Control Delay, s	0.3	0.2	19	19.6
HCM LOS			C	C

Minor Lane/Major Mvmt	NBLn1	EBL	EBT	EBR	WBL	WBT	WBR	SBLn1
Capacity (veh/h)	265	* 670	-	-	1071	-	-	353
HCM Lane V/C Ratio	0.033	0.023	-	-	0.036	-	-	0.305
HCM Control Delay (s)	19	10.5	-	-	8.5	-	-	19.6
HCM Lane LOS	C	B	-	-	A	-	-	C
HCM 95th %tile Q(veh)	0.1	0.1	-	-	0.1	-	-	1.3

Notes  
 -: Volume exceeds capacity    \$: Delay exceeds 300s    +: Computation Not Defined    \*: All major volume in platoon

HCM 6th Signalized Intersection Summary  
5: Olympic Bl & Mateo St

03/17/2021



Movement	EBL	EBT	EBR	WBL	WBT	WBR	NBL	NBT	NBR	SBL	SBT	SBR
Lane Configurations	↖	↗		↖	↗			↕			↖	↗
Traffic Volume (veh/h)	70	396	4	5	1225	88	1	3	5	181	1	366
Future Volume (veh/h)	70	396	4	5	1225	88	1	3	5	181	1	366
Initial Q (Qb), veh	0	0	0	0	0	0	0	0	0	0	0	0
Ped-Bike Adj(A_pbT)	1.00		1.00	1.00		1.00	1.00		1.00	1.00		1.00
Parking Bus, Adj	1.00	1.00	1.00	1.00	1.00	1.00	1.00	1.00	1.00	1.00	1.00	1.00
Work Zone On Approach		No			No			No			No	
Adj Sat Flow, veh/h/ln	1870	1870	1870	1870	1870	1870	1870	1870	1870	1870	1870	1870
Adj Flow Rate, veh/h	76	430	4	5	1332	96	1	3	5	197	1	398
Peak Hour Factor	0.92	0.92	0.92	0.92	0.92	0.92	0.92	0.92	0.92	0.92	0.92	0.92
Percent Heavy Veh, %	2	2	2	2	2	2	2	2	2	2	2	2
Cap, veh/h	210	2185	20	607	2036	146	71	184	262	488	2	460
Arrive On Green	0.61	0.61	0.61	0.61	0.61	0.61	0.29	0.29	0.29	0.29	0.29	0.29
Sat Flow, veh/h	375	3608	34	954	3362	242	90	633	904	1407	7	1585
Grp Volume(v), veh/h	76	212	222	5	702	726	9	0	0	198	0	398
Grp Sat Flow(s),veh/h/ln	375	1777	1864	954	1777	1827	1627	0	0	1414	0	1585
Q Serve(g_s), s	15.0	4.8	4.8	0.2	23.2	23.4	0.0	0.0	0.0	10.0	0.0	21.4
Cycle Q Clear(g_c), s	38.4	4.8	4.8	5.0	23.2	23.4	0.3	0.0	0.0	10.3	0.0	21.4
Prop In Lane	1.00		0.02	1.00		0.13	0.11		0.56	0.99		1.00
Lane Grp Cap(c), veh/h	210	1076	1129	607	1076	1106	516	0	0	490	0	460
V/C Ratio(X)	0.36	0.20	0.20	0.01	0.65	0.66	0.02	0.00	0.00	0.40	0.00	0.87
Avail Cap(c_a), veh/h	210	1076	1129	607	1076	1106	516	0	0	490	0	460
HCM Platoon Ratio	1.00	1.00	1.00	1.00	1.00	1.00	1.00	1.00	1.00	1.00	1.00	1.00
Upstream Filter(I)	1.00	1.00	1.00	1.00	1.00	1.00	1.00	0.00	0.00	1.00	0.00	1.00
Uniform Delay (d), s/veh	24.2	7.9	7.9	9.1	11.6	11.6	22.8	0.0	0.0	26.3	0.0	30.3
Incr Delay (d2), s/veh	4.8	0.4	0.4	0.0	3.1	3.0	0.1	0.0	0.0	2.5	0.0	19.2
Initial Q Delay(d3),s/veh	0.0	0.0	0.0	0.0	0.0	0.0	0.0	0.0	0.0	0.0	0.0	0.0
%ile BackOfQ(95%),veh/ln	2.8	3.2	3.4	0.1	13.9	14.3	0.3	0.0	0.0	6.8	0.0	15.6
Unsig. Movement Delay, s/veh												
LnGrp Delay(d),s/veh	29.0	8.4	8.3	9.1	14.7	14.7	22.9	0.0	0.0	28.8	0.0	49.5
LnGrp LOS	C	A	A	A	B	B	C	A	A	C	A	D
Approach Vol, veh/h		510			1433			9				596
Approach Delay, s/veh		11.4			14.6			22.9				42.6
Approach LOS		B			B			C				D
Timer - Assigned Phs		2		4		6		8				
Phs Duration (G+Y+Rc), s		59.0		31.0		59.0		31.0				
Change Period (Y+Rc), s		* 4.5		4.9		* 4.5		4.9				
Max Green Setting (Gmax), s		* 55		26.1		* 55		26.1				
Max Q Clear Time (g_c+I1), s		25.4		23.4		40.4		2.3				
Green Ext Time (p_c), s		12.7		0.8		3.3		0.0				

Intersection Summary

HCM 6th Ctrl Delay	20.6
HCM 6th LOS	C

Notes

\* HCM 6th computational engine requires equal clearance times for the phases crossing the barrier.

# HCM 6th Signalized Intersection Summary

## 1: Alameda St & 7th St

03/17/2021



Movement	EBL	EBT	EBR	WBL	WBT	WBR	NBL	NBT	NBR	SBL	SBT	SBR
Lane Configurations	↖	↗		↖	↗		↖	↗		↖	↗	
Traffic Volume (veh/h)	102	786	117	82	437	126	113	791	120	109	742	45
Future Volume (veh/h)	102	786	117	82	437	126	113	791	120	109	742	45
Initial Q (Qb), veh	0	0	0	0	0	0	0	0	0	0	0	0
Ped-Bike Adj(A_pbT)	1.00		1.00	1.00		1.00	1.00		1.00	1.00		1.00
Parking Bus, Adj	1.00	1.00	1.00	1.00	1.00	1.00	1.00	1.00	1.00	1.00	1.00	1.00
Work Zone On Approach		No			No			No			No	
Adj Sat Flow, veh/h/ln	1870	1870	1870	1870	1870	1870	1870	1870	1870	1870	1870	1870
Adj Flow Rate, veh/h	111	854	127	89	475	137	123	860	130	118	807	49
Peak Hour Factor	0.92	0.92	0.92	0.92	0.92	0.92	0.92	0.92	0.92	0.92	0.92	0.92
Percent Heavy Veh, %	2	2	2	2	2	2	2	2	2	2	2	2
Cap, veh/h	263	1123	167	149	986	283	267	1076	163	293	1718	104
Arrive On Green	0.36	0.36	0.36	0.36	0.36	0.36	0.11	0.11	0.11	0.03	0.17	0.17
Sat Flow, veh/h	810	3103	461	574	2726	781	645	3095	468	1781	3403	207
Grp Volume(v), veh/h	111	489	492	89	309	303	123	494	496	118	421	435
Grp Sat Flow(s),veh/h/ln	810	1777	1787	574	1777	1730	645	1777	1786	1781	1777	1833
Q Serve(g_s), s	11.1	21.8	21.8	10.8	12.1	12.2	16.6	24.4	24.4	3.5	19.3	19.3
Cycle Q Clear(g_c), s	23.3	21.8	21.8	32.6	12.1	12.2	21.7	24.4	24.4	3.5	19.3	19.3
Prop In Lane	1.00		0.26	1.00		0.45	1.00		0.26	1.00		0.11
Lane Grp Cap(c), veh/h	263	643	647	149	643	626	267	618	621	293	897	925
V/C Ratio(X)	0.42	0.76	0.76	0.60	0.48	0.48	0.46	0.80	0.80	0.40	0.47	0.47
Avail Cap(c_a), veh/h	263	643	647	149	643	626	267	618	621	310	897	925
HCM Platoon Ratio	1.00	1.00	1.00	1.00	1.00	1.00	0.33	0.33	0.33	0.33	0.33	0.33
Upstream Filter(I)	0.82	0.82	0.82	1.00	1.00	1.00	0.97	0.97	0.97	0.78	0.78	0.78
Uniform Delay (d), s/veh	31.2	25.3	25.3	40.9	22.2	22.2	38.1	36.8	36.8	20.1	26.6	26.6
Incr Delay (d2), s/veh	4.0	6.9	6.8	16.6	2.6	2.7	5.4	10.1	10.1	0.7	1.4	1.3
Initial Q Delay(d3),s/veh	0.0	0.0	0.0	0.0	0.0	0.0	0.0	0.0	0.0	0.0	0.0	0.0
%ile BackOfQ(95%),veh/ln	4.3	14.7	14.8	4.8	9.1	9.0	5.8	19.1	19.2	2.7	13.9	14.2
Unsig. Movement Delay, s/veh												
LnGrp Delay(d),s/veh	35.3	32.1	32.1	57.4	24.7	24.9	43.5	46.9	46.8	20.8	28.0	28.0
LnGrp LOS	D	C	C	E	C	C	D	D	D	C	C	C
Approach Vol, veh/h		1092			701			1113			974	
Approach Delay, s/veh		32.4			29.0			46.5			27.1	
Approach LOS		C			C			D			C	
Timer - Assigned Phs		2		4	5	6		8				
Phs Duration (G+Y+Rc), s		51.1		38.9	14.1	37.0		38.9				
Change Period (Y+Rc), s		* 5.7		* 6.3	5.6	* 5.7		* 6.3				
Max Green Setting (Gmax), s		* 44		* 32	9.4	* 31		* 31				
Max Q Clear Time (g_c+I1), s		21.3		34.6	5.5	26.4		25.3				
Green Ext Time (p_c), s		5.8		0.0	0.1	3.0		3.1				

### Intersection Summary

HCM 6th Ctrl Delay	34.5
HCM 6th LOS	C

### Notes

\* HCM 6th computational engine requires equal clearance times for the phases crossing the barrier.

# HCM 6th Signalized Intersection Summary

## 2: Alameda St & 8th St

03/17/2021



Movement	EBL	EBT	EBR	WBL	WBT	WBR	NBL	NBT	NBR	SBL	SBT	SBR
Lane Configurations		↕			↕		↙	↕		↙	↕	
Traffic Volume (veh/h)	48	22	32	26	24	26	14	654	22	18	1022	69
Future Volume (veh/h)	48	22	32	26	24	26	14	654	22	18	1022	69
Initial Q (Qb), veh	0	0	0	0	0	0	0	0	0	0	0	0
Ped-Bike Adj(A_pbT)	1.00		1.00	1.00		1.00	1.00		1.00	1.00		1.00
Parking Bus, Adj	1.00	1.00	1.00	1.00	1.00	1.00	1.00	1.00	1.00	1.00	1.00	1.00
Work Zone On Approach		No			No			No			No	
Adj Sat Flow, veh/h/ln	1870	1870	1870	1870	1870	1870	1870	1870	1870	1870	1870	1870
Adj Flow Rate, veh/h	52	24	35	28	26	28	15	711	24	20	1111	75
Peak Hour Factor	0.92	0.92	0.92	0.92	0.92	0.92	0.92	0.92	0.92	0.92	0.92	0.92
Percent Heavy Veh, %	2	2	2	2	2	2	2	2	2	2	2	2
Cap, veh/h	120	41	47	93	64	54	450	2749	93	606	2648	179
Arrive On Green	0.09	0.09	0.09	0.09	0.09	0.09	0.78	0.78	0.78	1.00	1.00	1.00
Sat Flow, veh/h	678	456	522	437	705	592	472	3508	118	722	3378	228
Grp Volume(v), veh/h	111	0	0	82	0	0	15	360	375	20	584	602
Grp Sat Flow(s),veh/h/ln	1656	0	0	1734	0	0	472	1777	1849	722	1777	1829
Q Serve(g_s), s	1.7	0.0	0.0	0.0	0.0	0.0	0.6	4.9	5.0	0.2	0.0	0.0
Cycle Q Clear(g_c), s	5.6	0.0	0.0	3.9	0.0	0.0	0.6	4.9	5.0	5.1	0.0	0.0
Prop In Lane	0.47		0.32	0.34		0.34	1.00		0.06	1.00		0.12
Lane Grp Cap(c), veh/h	209	0	0	211	0	0	450	1393	1449	606	1393	1434
V/C Ratio(X)	0.53	0.00	0.00	0.39	0.00	0.00	0.03	0.26	0.26	0.03	0.42	0.42
Avail Cap(c_a), veh/h	648	0	0	665	0	0	450	1393	1449	606	1393	1434
HCM Platoon Ratio	1.00	1.00	1.00	1.00	1.00	1.00	1.00	1.00	1.00	2.00	2.00	2.00
Upstream Filter(I)	1.00	0.00	0.00	1.00	0.00	0.00	1.00	1.00	1.00	0.84	0.84	0.84
Uniform Delay (d), s/veh	39.7	0.0	0.0	39.0	0.0	0.0	2.2	2.6	2.6	0.2	0.0	0.0
Incr Delay (d2), s/veh	2.1	0.0	0.0	1.2	0.0	0.0	0.1	0.5	0.4	0.1	0.8	0.8
Initial Q Delay(d3),s/veh	0.0	0.0	0.0	0.0	0.0	0.0	0.0	0.0	0.0	0.0	0.0	0.0
%ile BackOfQ(95%),veh/ln	4.5	0.0	0.0	3.2	0.0	0.0	0.1	2.4	2.5	0.0	0.5	0.5
Unsig. Movement Delay, s/veh												
LnGrp Delay(d),s/veh	41.8	0.0	0.0	40.2	0.0	0.0	2.3	3.1	3.1	0.3	0.8	0.8
LnGrp LOS	D	A	A	D	A	A	A	A	A	A	A	A
Approach Vol, veh/h		111			82			750			1206	
Approach Delay, s/veh		41.8			40.2			3.1			0.8	
Approach LOS		D			D			A			A	
Timer - Assigned Phs		2		4		6		8				
Phs Duration (G+Y+Rc), s		76.1		13.9		76.1		13.9				
Change Period (Y+Rc), s		5.6		5.7		5.6		5.7				
Max Green Setting (Gmax), s		44.4		34.3		44.4		34.3				
Max Q Clear Time (g_c+I1), s		7.0		7.6		7.1		5.9				
Green Ext Time (p_c), s		9.6		0.6		22.9		0.4				

### Intersection Summary

HCM 6th Ctrl Delay	5.2
HCM 6th LOS	A

# HCM 6th Signalized Intersection Summary

## 3: Alameda St & Olympic BI

03/17/2021



Movement	EBL	EBT	EBR	WBL	WBT	WBR	NBL	NBT	NBR	SBL	SBT	SBR
Lane Configurations	↖	↖↗		↖	↖↗		↖	↖↗		↖	↖↗	↖
Traffic Volume (veh/h)	85	1170	63	99	1129	43	83	573	157	126	757	182
Future Volume (veh/h)	85	1170	63	99	1129	43	83	573	157	126	757	182
Initial Q (Qb), veh	0	0	0	0	0	0	0	0	0	0	0	0
Ped-Bike Adj(A_pbT)	1.00		1.00	1.00		1.00	1.00		1.00	1.00		1.00
Parking Bus, Adj	1.00	1.00	1.00	1.00	1.00	1.00	1.00	1.00	1.00	1.00	1.00	1.00
Work Zone On Approach		No		No		No		No		No		No
Adj Sat Flow, veh/h/ln	1870	1870	1870	1870	1870	1870	1870	1870	1870	1870	1870	1870
Adj Flow Rate, veh/h	92	1272	68	108	1227	47	90	623	171	137	823	0
Peak Hour Factor	0.92	0.92	0.92	0.92	0.92	0.92	0.92	0.92	0.92	0.92	0.92	0.92
Percent Heavy Veh, %	2	2	2	2	2	2	2	2	2	2	2	2
Cap, veh/h	103	1323	71	89	1345	52	309	1366	374	416	1761	
Arrive On Green	0.39	0.39	0.39	0.39	0.39	0.39	0.99	0.99	0.99	0.50	0.50	0.00
Sat Flow, veh/h	434	3431	183	408	3490	134	665	2756	755	684	3554	1585
Grp Volume(v), veh/h	92	658	682	108	624	650	90	401	393	137	823	0
Grp Sat Flow(s),veh/h/ln	434	1777	1837	408	1777	1846	665	1777	1734	684	1777	1585
Q Serve(g_s), s	4.7	32.5	32.6	2.1	30.0	30.0	5.2	0.3	0.3	11.5	13.7	0.0
Cycle Q Clear(g_c), s	34.7	32.5	32.6	34.7	30.0	30.0	18.9	0.3	0.3	11.8	13.7	0.0
Prop In Lane	1.00		0.10	1.00		0.07	1.00		0.44	1.00		1.00
Lane Grp Cap(c), veh/h	103	685	708	89	685	712	309	881	859	416	1761	
V/C Ratio(X)	0.90	0.96	0.96	1.21	0.91	0.91	0.29	0.46	0.46	0.33	0.47	
Avail Cap(c_a), veh/h	103	685	708	89	685	712	309	881	859	416	1761	
HCM Platoon Ratio	1.00	1.00	1.00	1.00	1.00	1.00	2.00	2.00	2.00	1.00	1.00	1.00
Upstream Filter(I)	1.00	1.00	1.00	1.00	1.00	1.00	0.78	0.78	0.78	1.00	1.00	0.00
Uniform Delay (d), s/veh	44.4	27.0	27.0	44.9	26.2	26.2	3.2	0.2	0.2	14.5	14.9	0.0
Incr Delay (d2), s/veh	57.2	24.9	24.9	161.9	16.5	16.1	1.9	1.3	1.4	2.1	0.9	0.0
Initial Q Delay(d3),s/veh	0.0	0.0	0.0	0.0	0.0	0.0	0.0	0.0	0.0	0.0	0.0	0.0
%ile BackOfQ(95%),veh/ln	6.6	24.7	25.5	10.8	21.5	22.2	0.7	0.7	0.7	3.5	9.2	0.0
Unsig. Movement Delay, s/veh												
LnGrp Delay(d),s/veh	101.6	51.9	51.9	206.8	42.7	42.4	5.1	1.5	1.6	16.6	15.8	0.0
LnGrp LOS	F	D	D	F	D	D	A	A	A	B	B	
Approach Vol, veh/h		1432			1382			884			960	A
Approach Delay, s/veh		55.1			55.4			1.9			15.9	
Approach LOS		E			E			A			B	
Timer - Assigned Phs		2		4		6		8				
Phs Duration (G+Y+Rc), s		50.0		40.0		50.0		40.0				
Change Period (Y+Rc), s		* 5.4		* 5.3		* 5.4		* 5.3				
Max Green Setting (Gmax), s		* 45		* 35		* 45		* 35				
Max Q Clear Time (g_c+I1), s		15.7		36.7		20.9		36.7				
Green Ext Time (p_c), s		8.1		0.0		6.3		0.0				

### Intersection Summary

HCM 6th Ctrl Delay	37.0
HCM 6th LOS	D

### Notes

\* HCM 6th computational engine requires equal clearance times for the phases crossing the barrier.  
 Unsignalized Delay for [SBR] is excluded from calculations of the approach delay and intersection delay.

HCM 6th TWSC  
4: Olympic Bl & Lemon St

03/17/2021

Intersection												
Int Delay, s/veh	2.5											
Movement	EBL	EBT	EBR	WBL	WBT	WBR	NBL	NBT	NBR	SBL	SBT	SBR
Lane Configurations	↖	↕		↖	↕			↕			↕	
Traffic Vol, veh/h	12	1005	4	24	1102	8	2	0	12	26	0	187
Future Vol, veh/h	12	1005	4	24	1102	8	2	0	12	26	0	187
Conflicting Peds, #/hr	0	0	0	0	0	0	0	0	0	0	0	0
Sign Control	Free	Free	Free	Free	Free	Free	Stop	Stop	Stop	Stop	Stop	Stop
RT Channelized	-	-	None	-	-	None	-	-	None	-	-	None
Storage Length	124	-	-	80	-	-	-	-	-	-	-	-
Veh in Median Storage, #	-	0	-	-	0	-	-	0	-	-	0	-
Grade, %	-	0	-	-	0	-	-	0	-	-	0	-
Peak Hour Factor	92	92	92	92	92	92	92	92	92	92	92	92
Heavy Vehicles, %	2	2	2	2	2	2	2	2	2	2	2	2
Mvmt Flow	13	1092	4	26	1198	9	2	0	13	28	0	203

Major/Minor	Major1			Major2			Minor1			Minor2		
Conflicting Flow All	1207	0	0	1096	0	0	1771	2379	548	1827	2377	604
Stage 1	-	-	-	-	-	-	1120	1120	-	1255	1255	-
Stage 2	-	-	-	-	-	-	651	1259	-	572	1122	-
Critical Hdwy	4.14	-	-	4.14	-	-	7.54	6.54	6.94	7.54	6.54	6.94
Critical Hdwy Stg 1	-	-	-	-	-	-	6.54	5.54	-	6.54	5.54	-
Critical Hdwy Stg 2	-	-	-	-	-	-	6.54	5.54	-	6.54	5.54	-
Follow-up Hdwy	2.22	-	-	2.22	-	-	3.52	4.02	3.32	3.52	4.02	3.32
Pot Cap-1 Maneuver	*930	-	-	633	-	-	*143	*38	480	*122	*38	*621
Stage 1	-	-	-	-	-	-	*220	*280	-	*586	*514	-
Stage 2	-	-	-	-	-	-	*586	*514	-	*472	*279	-
Platoon blocked, %	1	-	-	-	-	-	1	1	-	1	1	1
Mov Cap-1 Maneuver	*930	-	-	633	-	-	*93	*36	480	*114	*36	*621
Mov Cap-2 Maneuver	-	-	-	-	-	-	*93	*36	-	*114	*36	-
Stage 1	-	-	-	-	-	-	*217	*276	-	*578	*492	-
Stage 2	-	-	-	-	-	-	*378	*492	-	*453	*275	-

Approach	EB			WB			NB			SB		
HCM Control Delay, s	0.1			0.2			17.6			25.4		
HCM LOS							C			D		

Minor Lane/Major Mvmt	NBLn1	EBL	EBT	EBR	WBL	WBT	WBR	SBLn1
Capacity (veh/h)	301	* 930	-	-	633	-	-	402
HCM Lane V/C Ratio	0.051	0.014	-	-	0.041	-	-	0.576
HCM Control Delay (s)	17.6	8.9	-	-	10.9	-	-	25.4
HCM Lane LOS	C	A	-	-	B	-	-	D
HCM 95th %tile Q(veh)	0.2	0	-	-	0.1	-	-	3.5

Notes  
 -: Volume exceeds capacity    \$: Delay exceeds 300s    +: Computation Not Defined    \*: All major volume in platoon

HCM 6th Signalized Intersection Summary  
5: Olympic Bl & Mateo St

03/17/2021



Movement	EBL	EBT	EBR	WBL	WBT	WBR	NBL	NBT	NBR	SBL	SBT	SBR
Lane Configurations												
Traffic Volume (veh/h)	74	959	5	6	687	86	1	0	4	294	1	429
Future Volume (veh/h)	74	959	5	6	687	86	1	0	4	294	1	429
Initial Q (Qb), veh	0	0	0	0	0	0	0	0	0	0	0	0
Ped-Bike Adj(A_pbT)	1.00		1.00	1.00		1.00	1.00		1.00	1.00		1.00
Parking Bus, Adj	1.00	1.00	1.00	1.00	1.00	1.00	1.00	1.00	1.00	1.00	1.00	1.00
Work Zone On Approach		No			No			No			No	
Adj Sat Flow, veh/h/ln	1870	1870	1870	1870	1870	1870	1870	1870	1870	1870	1870	1870
Adj Flow Rate, veh/h	80	1042	5	7	747	93	1	0	4	320	1	466
Peak Hour Factor	0.92	0.92	0.92	0.92	0.92	0.92	0.92	0.92	0.92	0.92	0.92	0.92
Percent Heavy Veh, %	2	2	2	2	2	2	2	2	2	2	2	2
Cap, veh/h	274	1672	8	211	1466	182	48	29	115	258	1	689
Arrive On Green	0.46	0.46	0.46	0.46	0.46	0.46	0.43	0.00	0.43	0.43	0.43	0.43
Sat Flow, veh/h	655	3627	17	539	3180	396	0	66	264	410	1	1585
Grp Volume(v), veh/h	80	511	536	7	417	423	5	0	0	321	0	466
Grp Sat Flow(s),veh/h/ln	655	1777	1867	539	1777	1799	330	0	0	411	0	1585
Q Serve(g_s), s	8.8	19.6	19.6	0.9	14.9	14.9	0.0	0.0	0.0	0.0	0.0	21.2
Cycle Q Clear(g_c), s	23.7	19.6	19.6	20.4	14.9	14.9	39.1	0.0	0.0	39.1	0.0	21.2
Prop In Lane	1.00		0.01	1.00		0.22	0.20		0.80	1.00		1.00
Lane Grp Cap(c), veh/h	274	819	861	211	819	830	191	0	0	259	0	689
V/C Ratio(X)	0.29	0.62	0.62	0.03	0.51	0.51	0.03	0.00	0.00	1.24	0.00	0.68
Avail Cap(c_a), veh/h	274	819	861	211	819	830	191	0	0	259	0	689
HCM Platoon Ratio	1.00	1.00	1.00	1.00	1.00	1.00	1.00	1.00	1.00	1.00	1.00	1.00
Upstream Filter(I)	1.00	1.00	1.00	1.00	1.00	1.00	1.00	0.00	0.00	1.00	0.00	1.00
Uniform Delay (d), s/veh	25.4	18.3	18.3	26.1	17.1	17.1	19.8	0.0	0.0	31.5	0.0	20.4
Incr Delay (d2), s/veh	2.7	3.6	3.4	0.3	2.3	2.2	0.3	0.0	0.0	136.9	0.0	5.3
Initial Q Delay(d3),s/veh	0.0	0.0	0.0	0.0	0.0	0.0	0.0	0.0	0.0	0.0	0.0	0.0
%ile BackOfQ(95%),veh/ln	2.8	13.1	13.6	0.2	10.4	10.5	0.1	0.0	0.0	25.1	0.0	13.2
Unsig. Movement Delay, s/veh												
LnGrp Delay(d),s/veh	28.1	21.9	21.7	26.4	19.3	19.3	20.1	0.0	0.0	168.4	0.0	25.7
LnGrp LOS	C	C	C	C	B	B	C	A	A	F	A	C
Approach Vol, veh/h		1127			847			5				787
Approach Delay, s/veh		22.3			19.4			20.1				83.9
Approach LOS		C			B			C				F
Timer - Assigned Phs		2		4		6		8				
Phs Duration (G+Y+Rc), s		46.0		44.0		46.0		44.0				
Change Period (Y+Rc), s		* 4.5		4.9		* 4.5		4.9				
Max Green Setting (Gmax), s		* 42		39.1		* 42		39.1				
Max Q Clear Time (g_c+I1), s		22.4		41.1		25.7		41.1				
Green Ext Time (p_c), s		5.4		0.0		6.9		0.0				

Intersection Summary

HCM 6th Ctrl Delay	38.9
HCM 6th LOS	D

Notes

\* HCM 6th computational engine requires equal clearance times for the phases crossing the barrier.

# HCM 6th Signalized Intersection Summary

## 1: Alameda St & 7th St

03/22/2021



Movement	EBL	EBT	EBR	WBL	WBT	WBR	NBL	NBT	NBR	SBL	SBT	SBR
Lane Configurations	↖	↗		↖	↗		↖	↗		↖	↗	
Traffic Volume (veh/h)	60	321	107	140	687	102	123	660	106	132	936	173
Future Volume (veh/h)	60	321	107	140	687	102	123	660	106	132	936	173
Initial Q (Qb), veh	0	0	0	0	0	0	0	0	0	0	0	0
Ped-Bike Adj(A_pbT)	1.00		1.00	1.00		1.00	1.00		1.00	1.00		1.00
Parking Bus, Adj	1.00	1.00	1.00	1.00	1.00	1.00	1.00	1.00	1.00	1.00	1.00	1.00
Work Zone On Approach		No			No			No			No	
Adj Sat Flow, veh/h/ln	1870	1870	1870	1870	1870	1870	1870	1870	1870	1870	1870	1870
Adj Flow Rate, veh/h	65	349	116	152	747	111	134	717	115	143	1017	188
Peak Hour Factor	0.92	0.92	0.92	0.92	0.92	0.92	0.92	0.92	0.92	0.92	0.92	0.92
Percent Heavy Veh, %	2	2	2	2	2	2	2	2	2	2	2	2
Cap, veh/h	181	946	310	321	1116	166	241	1067	171	335	1519	280
Arrive On Green	0.36	0.36	0.36	0.36	0.36	0.36	0.11	0.11	0.11	0.19	1.00	1.00
Sat Flow, veh/h	644	2631	861	928	3103	461	464	3067	492	1781	2995	553
Grp Volume(v), veh/h	65	234	231	152	428	430	134	415	417	143	603	602
Grp Sat Flow(s),veh/h/ln	644	1777	1715	928	1777	1787	464	1777	1782	1781	1777	1771
Q Serve(g_s), s	8.5	8.7	9.0	13.1	18.3	18.3	25.4	20.2	20.2	4.1	0.0	0.0
Cycle Q Clear(g_c), s	26.8	8.7	9.0	22.0	18.3	18.3	25.4	20.2	20.2	4.1	0.0	0.0
Prop In Lane	1.00		0.50	1.00		0.26	1.00		0.28	1.00		0.31
Lane Grp Cap(c), veh/h	181	639	617	321	639	643	241	618	620	335	901	898
V/C Ratio(X)	0.36	0.37	0.37	0.47	0.67	0.67	0.56	0.67	0.67	0.43	0.67	0.67
Avail Cap(c_a), veh/h	181	639	617	321	639	643	241	618	620	347	901	898
HCM Platoon Ratio	1.00	1.00	1.00	1.00	1.00	1.00	0.33	0.33	0.33	2.00	2.00	2.00
Upstream Filter(I)	0.97	0.97	0.97	1.00	1.00	1.00	0.92	0.92	0.92	0.84	0.84	0.84
Uniform Delay (d), s/veh	35.6	21.3	21.3	29.5	24.3	24.3	37.2	34.9	34.9	15.4	0.0	0.0
Incr Delay (d2), s/veh	5.3	1.6	1.7	4.9	5.5	5.5	8.2	5.3	5.3	0.7	3.3	3.4
Initial Q Delay(d3),s/veh	0.0	0.0	0.0	0.0	0.0	0.0	0.0	0.0	0.0	0.0	0.0	0.0
%ile BackOfQ(95%),veh/ln	2.9	6.9	6.8	5.9	13.1	13.2	6.6	15.5	15.6	2.7	1.5	1.5
Unsig. Movement Delay, s/veh												
LnGrp Delay(d),s/veh	41.0	22.8	23.0	34.4	29.8	29.8	45.5	40.2	40.2	16.1	3.3	3.4
LnGrp LOS	D	C	C	C	C	C	D	D	D	B	A	A
Approach Vol, veh/h		530			1010			966			1348	
Approach Delay, s/veh		25.1			30.5			40.9			4.7	
Approach LOS		C			C			D			A	
Timer - Assigned Phs		2		4	5	6		8				
Phs Duration (G+Y+Rc), s		51.3		38.7	14.3	37.0		38.7				
Change Period (Y+Rc), s		* 5.7		* 6.3	5.6	* 5.7		* 6.3				
Max Green Setting (Gmax), s		* 44		* 32	9.4	* 31		* 31				
Max Q Clear Time (g_c+I1), s		2.0		24.0	6.1	27.4		28.8				
Green Ext Time (p_c), s		11.1		3.7	0.1	2.3		0.6				

### Intersection Summary

HCM 6th Ctrl Delay	23.4
HCM 6th LOS	C

### Notes

\* HCM 6th computational engine requires equal clearance times for the phases crossing the barrier.



# HCM 6th Signalized Intersection Summary

## 2: Alameda St & 8th St

03/22/2021



Movement	EBL	EBT	EBR	WBL	WBT	WBR	NBL	NBT	NBR	SBL	SBT	SBR
Lane Configurations		↕			↕		↙	↕		↙	↕	
Traffic Volume (veh/h)	96	51	43	57	82	64	34	785	96	84	768	112
Future Volume (veh/h)	96	51	43	57	82	64	34	785	96	84	768	112
Initial Q (Qb), veh	0	0	0	0	0	0	0	0	0	0	0	0
Ped-Bike Adj(A_pbT)	1.00		1.00	1.00		1.00	1.00		1.00	1.00		1.00
Parking Bus, Adj	1.00	1.00	1.00	1.00	1.00	1.00	1.00	1.00	1.00	1.00	1.00	1.00
Work Zone On Approach		No			No			No			No	
Adj Sat Flow, veh/h/ln	1870	1870	1870	1870	1870	1870	1870	1870	1870	1870	1870	1870
Adj Flow Rate, veh/h	104	55	47	62	89	70	37	853	104	91	835	122
Peak Hour Factor	0.92	0.92	0.92	0.92	0.92	0.92	0.92	0.92	0.92	0.92	0.92	0.92
Percent Heavy Veh, %	2	2	2	2	2	2	2	2	2	2	2	2
Cap, veh/h	170	82	57	117	141	96	483	2188	267	461	2135	312
Arrive On Green	0.19	0.19	0.19	0.19	0.19	0.19	0.91	0.91	0.91	1.00	1.00	1.00
Sat Flow, veh/h	585	435	301	349	748	508	587	3188	389	587	3111	455
Grp Volume(v), veh/h	206	0	0	221	0	0	37	475	482	91	477	480
Grp Sat Flow(s),veh/h/ln	1321	0	0	1605	0	0	587	1777	1800	587	1777	1789
Q Serve(g_s), s	2.3	0.0	0.0	0.0	0.0	0.0	0.5	3.3	3.3	1.0	0.0	0.0
Cycle Q Clear(g_c), s	13.8	0.0	0.0	11.5	0.0	0.0	0.5	3.3	3.3	4.2	0.0	0.0
Prop In Lane	0.50		0.23	0.28		0.32	1.00		0.22	1.00		0.25
Lane Grp Cap(c), veh/h	309	0	0	353	0	0	483	1219	1235	461	1219	1227
V/C Ratio(X)	0.67	0.00	0.00	0.63	0.00	0.00	0.08	0.39	0.39	0.20	0.39	0.39
Avail Cap(c_a), veh/h	585	0	0	658	0	0	483	1219	1235	461	1219	1227
HCM Platoon Ratio	1.00	1.00	1.00	1.00	1.00	1.00	1.33	1.33	1.33	2.00	2.00	2.00
Upstream Filter(I)	1.00	0.00	0.00	1.00	0.00	0.00	1.00	1.00	1.00	0.71	0.71	0.71
Uniform Delay (d), s/veh	35.1	0.0	0.0	34.2	0.0	0.0	1.3	1.4	1.4	0.1	0.0	0.0
Incr Delay (d2), s/veh	2.5	0.0	0.0	1.8	0.0	0.0	0.3	0.9	0.9	0.7	0.7	0.7
Initial Q Delay(d3),s/veh	0.0	0.0	0.0	0.0	0.0	0.0	0.0	0.0	0.0	0.0	0.0	0.0
%ile BackOfQ(95%),veh/ln	8.0	0.0	0.0	8.2	0.0	0.0	0.2	1.9	1.9	0.2	0.4	0.4
Unsig. Movement Delay, s/veh												
LnGrp Delay(d),s/veh	37.6	0.0	0.0	36.0	0.0	0.0	1.6	2.3	2.3	0.8	0.7	0.7
LnGrp LOS	D	A	A	D	A	A	A	A	A	A	A	A
Approach Vol, veh/h		206			221			994			1048	
Approach Delay, s/veh		37.6			36.0			2.3			0.7	
Approach LOS		D			D			A			A	
Timer - Assigned Phs		2		4		6		8				
Phs Duration (G+Y+Rc), s		67.4		22.6		67.4		22.6				
Change Period (Y+Rc), s		5.6		5.7		5.6		5.7				
Max Green Setting (Gmax), s		44.4		34.3		44.4		34.3				
Max Q Clear Time (g_c+I1), s		5.3		15.8		6.2		13.5				
Green Ext Time (p_c), s		14.2		1.1		19.9		1.3				
<b>Intersection Summary</b>												
HCM 6th Ctrl Delay				7.6								
HCM 6th LOS				A								

# HCM 6th Signalized Intersection Summary

## 3: Alameda St & Olympic BI

03/22/2021



Movement	EBL	EBT	EBR	WBL	WBT	WBR	NBL	NBT	NBR	SBL	SBT	SBR
Lane Configurations	↖	↗		↖	↗		↖	↗		↖	↗	↖
Traffic Volume (veh/h)	94	780	65	163	1340	49	108	817	57	96	587	155
Future Volume (veh/h)	94	780	65	163	1340	49	108	817	57	96	587	155
Initial Q (Qb), veh	0	0	0	0	0	0	0	0	0	0	0	0
Ped-Bike Adj(A_pbT)	1.00		1.00	1.00		1.00	1.00		1.00	1.00		1.00
Parking Bus, Adj	1.00	1.00	1.00	1.00	1.00	1.00	1.00	1.00	1.00	1.00	1.00	1.00
Work Zone On Approach		No			No			No			No	
Adj Sat Flow, veh/h/ln	1870	1870	1870	1870	1870	1870	1870	1870	1870	1870	1870	1870
Adj Flow Rate, veh/h	102	848	71	177	1457	53	117	888	62	104	638	0
Peak Hour Factor	0.92	0.92	0.92	0.92	0.92	0.92	0.92	0.92	0.92	0.92	0.92	0.92
Percent Heavy Veh, %	2	2	2	2	2	2	2	2	2	2	2	2
Cap, veh/h	80	1280	107	186	1348	49	408	1670	117	246	1761	
Arrive On Green	0.39	0.39	0.39	0.39	0.39	0.39	0.33	0.33	0.33	0.66	0.66	0.00
Sat Flow, veh/h	347	3319	278	608	3497	127	790	3370	235	590	3554	1585
Grp Volume(v), veh/h	102	454	465	177	739	771	117	468	482	104	638	0
Grp Sat Flow(s),veh/h/ln	347	1777	1820	608	1777	1848	790	1777	1828	590	1777	1585
Q Serve(g_s), s	0.0	19.0	19.0	15.7	34.7	34.7	10.7	19.2	19.2	12.9	7.2	0.0
Cycle Q Clear(g_c), s	34.7	19.0	19.0	34.7	34.7	34.7	17.9	19.2	19.2	32.2	7.2	0.0
Prop In Lane	1.00		0.15	1.00		0.07	1.00		0.13	1.00		1.00
Lane Grp Cap(c), veh/h	80	685	702	186	685	712	408	881	906	246	1761	
V/C Ratio(X)	1.27	0.66	0.66	0.95	1.08	1.08	0.29	0.53	0.53	0.42	0.36	
Avail Cap(c_a), veh/h	80	685	702	186	685	712	408	881	906	246	1761	
HCM Platoon Ratio	1.00	1.00	1.00	1.00	1.00	1.00	0.67	0.67	0.67	1.33	1.33	1.33
Upstream Filter(I)	1.00	1.00	1.00	1.00	1.00	1.00	0.77	0.77	0.77	1.00	1.00	0.00
Uniform Delay (d), s/veh	45.0	22.8	22.8	40.3	27.6	27.7	24.0	21.6	21.6	21.1	9.0	0.0
Incr Delay (d2), s/veh	191.2	2.4	2.3	51.6	57.5	58.3	1.4	1.8	1.7	5.2	0.6	0.0
Initial Q Delay(d3),s/veh	0.0	0.0	0.0	0.0	0.0	0.0	0.0	0.0	0.0	0.0	0.0	0.0
%ile BackOfQ(95%),veh/ln	10.8	12.7	13.0	10.8	34.8	36.3	4.0	13.1	13.4	3.5	4.5	0.0
Unsig. Movement Delay, s/veh												
LnGrp Delay(d),s/veh	236.2	25.2	25.2	91.9	85.2	85.9	25.4	23.4	23.3	26.3	9.6	0.0
LnGrp LOS	F	C	C	F	F	F	C	C	C	C	C	A
Approach Vol, veh/h		1021			1687			1067			742	A
Approach Delay, s/veh		46.3			86.2			23.6			11.9	
Approach LOS		D			F			C			B	
Timer - Assigned Phs		2		4		6		8				
Phs Duration (G+Y+Rc), s		50.0		40.0		50.0		40.0				
Change Period (Y+Rc), s		* 5.4		* 5.3		* 5.4		* 5.3				
Max Green Setting (Gmax), s		* 45		* 35		* 45		* 35				
Max Q Clear Time (g_c+I1), s		34.2		36.7		21.2		36.7				
Green Ext Time (p_c), s		3.9		0.0		7.6		0.0				

### Intersection Summary

HCM 6th Ctrl Delay	50.2
HCM 6th LOS	D

### Notes

\* HCM 6th computational engine requires equal clearance times for the phases crossing the barrier.  
 Unsignalized Delay for [SBR] is excluded from calculations of the approach delay and intersection delay.

HCM 6th TWSC  
4: Olympic Bl & Lemon St

03/22/2021

Intersection												
Int Delay, s/veh	1.6											
Movement	EBL	EBT	EBR	WBL	WBT	WBR	NBL	NBT	NBR	SBL	SBT	SBR
Lane Configurations	↖	↗		↖	↗			↕			↕	
Traffic Vol, veh/h	14	444	5	35	1538	68	3	1	4	20	2	90
Future Vol, veh/h	14	444	5	35	1538	68	3	1	4	20	2	90
Conflicting Peds, #/hr	0	0	0	0	0	0	0	0	0	0	0	0
Sign Control	Free	Free	Free	Free	Free	Free	Stop	Stop	Stop	Stop	Stop	Stop
RT Channelized	-	-	None	-	-	None	-	-	None	-	-	None
Storage Length	124	-	-	80	-	-	-	-	-	-	-	-
Veh in Median Storage, #	-	0	-	-	0	-	-	0	-	-	0	-
Grade, %	-	0	-	-	0	-	-	0	-	-	0	-
Peak Hour Factor	92	92	92	92	92	92	92	92	92	92	92	92
Heavy Vehicles, %	2	2	2	2	2	2	2	2	2	2	2	2
Mvmt Flow	15	483	5	38	1672	74	3	1	4	22	2	98

Major/Minor	Major1			Major2			Minor1			Minor2		
Conflicting Flow All	1746	0	0	488	0	0	1429	2338	244	2057	2303	873
Stage 1	-	-	-	-	-	-	516	516	-	1785	1785	-
Stage 2	-	-	-	-	-	-	913	1822	-	272	518	-
Critical Hdwy	4.14	-	-	4.14	-	-	7.54	6.54	6.94	7.54	6.54	6.94
Critical Hdwy Stg 1	-	-	-	-	-	-	6.54	5.54	-	6.54	5.54	-
Critical Hdwy Stg 2	-	-	-	-	-	-	6.54	5.54	-	6.54	5.54	-
Follow-up Hdwy	2.22	-	-	2.22	-	-	3.52	4.02	3.32	3.52	4.02	3.32
Pot Cap-1 Maneuver	*670	-	-	1071	-	-	*422	57	757	131	65	*448
Stage 1	-	-	-	-	-	-	*510	533	-	390	349	-
Stage 2	-	-	-	-	-	-	*422	319	-	711	531	-
Platoon blocked, %	1	-	-	-	-	-	1	1	-	1	1	1
Mov Cap-1 Maneuver	*670	-	-	1071	-	-	*307	54	757	122	61	*448
Mov Cap-2 Maneuver	-	-	-	-	-	-	*307	54	-	122	61	-
Stage 1	-	-	-	-	-	-	*499	521	-	381	336	-
Stage 2	-	-	-	-	-	-	*316	308	-	690	519	-

Approach	EB			WB			NB			SB		
HCM Control Delay, s	0.3			0.2			20.7			27.1		
HCM LOS							C			D		

Minor Lane/Major Mvmt	NBLn1	EBL	EBT	EBR	WBL	WBT	WBR	SBLn1
Capacity (veh/h)	238	* 670	-	-	1071	-	-	282
HCM Lane V/C Ratio	0.037	0.023	-	-	0.036	-	-	0.432
HCM Control Delay (s)	20.7	10.5	-	-	8.5	-	-	27.1
HCM Lane LOS	C	B	-	-	A	-	-	D
HCM 95th %tile Q(veh)	0.1	0.1	-	-	0.1	-	-	2.1

Notes  
 -: Volume exceeds capacity    \$: Delay exceeds 300s    +: Computation Not Defined    \*: All major volume in platoon

HCM 6th Signalized Intersection Summary  
5: Olympic Bl & Mateo St

03/22/2021



Movement	EBL	EBT	EBR	WBL	WBT	WBR	NBL	NBT	NBR	SBL	SBT	SBR
Lane Configurations	↖	↗		↖	↗			↕			↖	↗
Traffic Volume (veh/h)	73	406	4	5	1251	88	1	3	5	181	1	392
Future Volume (veh/h)	73	406	4	5	1251	88	1	3	5	181	1	392
Initial Q (Qb), veh	0	0	0	0	0	0	0	0	0	0	0	0
Ped-Bike Adj(A_pbT)	1.00		1.00	1.00		1.00	1.00		1.00	1.00		1.00
Parking Bus, Adj	1.00	1.00	1.00	1.00	1.00	1.00	1.00	1.00	1.00	1.00	1.00	1.00
Work Zone On Approach		No			No			No			No	
Adj Sat Flow, veh/h/ln	1870	1870	1870	1870	1870	1870	1870	1870	1870	1870	1870	1870
Adj Flow Rate, veh/h	79	441	4	5	1360	96	1	3	5	197	1	426
Peak Hour Factor	0.92	0.92	0.92	0.92	0.92	0.92	0.92	0.92	0.92	0.92	0.92	0.92
Percent Heavy Veh, %	2	2	2	2	2	2	2	2	2	2	2	2
Cap, veh/h	203	2185	20	600	2039	144	70	183	262	488	2	460
Arrive On Green	0.61	0.61	0.61	0.61	0.61	0.61	0.29	0.29	0.29	0.29	0.29	0.29
Sat Flow, veh/h	365	3609	33	945	3368	237	89	632	902	1407	7	1585
Grp Volume(v), veh/h	79	217	228	5	716	740	9	0	0	198	0	426
Grp Sat Flow(s),veh/h/ln	365	1777	1864	945	1777	1828	1623	0	0	1414	0	1585
Q Serve(g_s), s	16.5	4.9	4.9	0.2	23.9	24.2	0.0	0.0	0.0	10.0	0.0	23.5
Cycle Q Clear(g_c), s	40.6	4.9	4.9	5.2	23.9	24.2	0.3	0.0	0.0	10.3	0.0	23.5
Prop In Lane	1.00		0.02	1.00		0.13	0.11		0.56	0.99		1.00
Lane Grp Cap(c), veh/h	203	1076	1129	600	1076	1107	515	0	0	490	0	460
V/C Ratio(X)	0.39	0.20	0.20	0.01	0.67	0.67	0.02	0.00	0.00	0.40	0.00	0.93
Avail Cap(c_a), veh/h	203	1076	1129	600	1076	1107	515	0	0	490	0	460
HCM Platoon Ratio	1.00	1.00	1.00	1.00	1.00	1.00	1.00	1.00	1.00	1.00	1.00	1.00
Upstream Filter(I)	1.00	1.00	1.00	1.00	1.00	1.00	1.00	0.00	0.00	1.00	0.00	1.00
Uniform Delay (d), s/veh	25.2	8.0	8.0	9.1	11.7	11.8	22.8	0.0	0.0	26.3	0.0	31.0
Incr Delay (d2), s/veh	5.5	0.4	0.4	0.0	3.3	3.2	0.1	0.0	0.0	2.5	0.0	27.2
Initial Q Delay(d3),s/veh	0.0	0.0	0.0	0.0	0.0	0.0	0.0	0.0	0.0	0.0	0.0	0.0
%ile BackOfQ(95%),veh/ln	3.0	3.3	3.5	0.1	14.3	14.7	0.3	0.0	0.0	6.8	0.0	17.8
Unsig. Movement Delay, s/veh												
LnGrp Delay(d),s/veh	30.8	8.4	8.4	9.2	15.0	15.0	22.9	0.0	0.0	28.8	0.0	58.2
LnGrp LOS	C	A	A	A	B	B	C	A	A	C	A	E
Approach Vol, veh/h		524			1461			9				624
Approach Delay, s/veh		11.8			15.0			22.9				48.9
Approach LOS		B			B			C				D
Timer - Assigned Phs		2		4		6		8				
Phs Duration (G+Y+Rc), s		59.0		31.0		59.0		31.0				
Change Period (Y+Rc), s		* 4.5		4.9		* 4.5		4.9				
Max Green Setting (Gmax), s		* 55		26.1		* 55		26.1				
Max Q Clear Time (g_c+I1), s		26.2		25.5		42.6		2.3				
Green Ext Time (p_c), s		12.9		0.2		3.1		0.0				

Intersection Summary

HCM 6th Ctrl Delay	22.4
HCM 6th LOS	C

Notes

\* HCM 6th computational engine requires equal clearance times for the phases crossing the barrier.

HCM 6th TWSC  
87: Project Dwy & 8th St

03/22/2021

Intersection												
Int Delay, s/veh	2.5											
Movement	EBL	EBT	EBR	WBL	WBT	WBR	NBL	NBT	NBR	SBL	SBT	SBR
Lane Configurations		↕			↕		↕	↕			↕	
Traffic Vol, veh/h	0	91	231	125	184	0	26	0	18	0	0	0
Future Vol, veh/h	0	91	231	125	184	0	26	0	18	0	0	0
Conflicting Peds, #/hr	0	0	0	0	0	0	0	0	0	0	0	0
Sign Control	Free	Free	Free	Free	Free	Free	Stop	Stop	Stop	Stop	Stop	Stop
RT Channelized	-	-	None	-	-	None	-	-	None	-	-	None
Storage Length	-	-	-	-	-	-	0	-	-	-	-	-
Veh in Median Storage, #	-	0	-	-	0	-	-	0	-	-	0	-
Grade, %	-	0	-	-	0	-	-	0	-	-	0	-
Peak Hour Factor	92	92	92	92	92	92	92	92	92	92	92	92
Heavy Vehicles, %	2	2	2	2	2	2	2	2	2	2	2	2
Mvmt Flow	0	99	251	136	200	0	28	0	20	0	0	0

Major/Minor	Major1			Major2			Minor1			Minor2		
Conflicting Flow All	200	0	0	350	0	0	697	697	225	707	822	200
Stage 1	-	-	-	-	-	-	225	225	-	472	472	-
Stage 2	-	-	-	-	-	-	472	472	-	235	350	-
Critical Hdwy	4.12	-	-	4.12	-	-	7.12	6.52	6.22	7.12	6.52	6.22
Critical Hdwy Stg 1	-	-	-	-	-	-	6.12	5.52	-	6.12	5.52	-
Critical Hdwy Stg 2	-	-	-	-	-	-	6.12	5.52	-	6.12	5.52	-
Follow-up Hdwy	2.218	-	-	2.218	-	-	3.518	4.018	3.318	3.518	4.018	3.318
Pot Cap-1 Maneuver	1372	-	-	1209	-	-	356	365	814	350	309	841
Stage 1	-	-	-	-	-	-	778	718	-	573	559	-
Stage 2	-	-	-	-	-	-	573	559	-	768	633	-
Platoon blocked, %	-	-	-	-	-	-	-	-	-	-	-	-
Mov Cap-1 Maneuver	1372	-	-	1209	-	-	321	319	814	308	270	841
Mov Cap-2 Maneuver	-	-	-	-	-	-	321	319	-	308	270	-
Stage 1	-	-	-	-	-	-	778	718	-	573	488	-
Stage 2	-	-	-	-	-	-	500	488	-	750	633	-

Approach	EB			WB			NB			SB		
HCM Control Delay, s	0			3.4			14.1			0		
HCM LOS							B			A		

Minor Lane/Major Mvmt	NBLn1	NBLn2	EBL	EBT	EBR	WBL	WBT	WBR	SBLn1
Capacity (veh/h)	321	814	1372	-	-	1209	-	-	-
HCM Lane V/C Ratio	0.088	0.024	-	-	-	0.112	-	-	-
HCM Control Delay (s)	17.3	9.5	0	-	-	8.4	0	-	0
HCM Lane LOS	C	A	A	-	-	A	A	-	A
HCM 95th %tile Q(veh)	0.3	0.1	0	-	-	0.4	-	-	-

Intersection						
Int Delay, s/veh	8.3					
Movement	EBL	EBT	WBT	WBR	SBL	SBR
Lane Configurations		↑	↑		↓	
Traffic Vol, veh/h	0	0	0	0	12	29
Future Vol, veh/h	0	0	0	0	12	29
Conflicting Peds, #/hr	0	0	0	0	0	0
Sign Control	Free	Free	Free	Free	Stop	Stop
RT Channelized	-	None	-	None	-	None
Storage Length	-	-	-	-	0	-
Veh in Median Storage, #	-	0	0	-	0	-
Grade, %	-	0	0	-	0	-
Peak Hour Factor	92	92	92	92	92	92
Heavy Vehicles, %	2	2	2	2	2	2
Mvmt Flow	0	0	0	0	13	32

Major/Minor	Major1	Major2	Minor2		
Conflicting Flow All	-	0	-	0	1
Stage 1	-	-	-	-	1
Stage 2	-	-	-	-	0
Critical Hdwy	-	-	-	-	6.42
Critical Hdwy Stg 1	-	-	-	-	5.42
Critical Hdwy Stg 2	-	-	-	-	5.42
Follow-up Hdwy	-	-	-	-	3.518
Pot Cap-1 Maneuver	0	-	-	0	1022
Stage 1	0	-	-	0	1022
Stage 2	0	-	-	0	-
Platoon blocked, %	-	-	-	-	-
Mov Cap-1 Maneuver	-	-	-	-	1022
Mov Cap-2 Maneuver	-	-	-	-	1022
Stage 1	-	-	-	-	1022
Stage 2	-	-	-	-	-

Approach	EB	WB	SB
HCM Control Delay, s	0	0	8.5
HCM LOS			A

Minor Lane/Major Mvmt	EBT	WBT	SBLn1
Capacity (veh/h)	-	-	1065
HCM Lane V/C Ratio	-	-	0.042
HCM Control Delay (s)	-	-	8.5
HCM Lane LOS	-	-	A
HCM 95th %tile Q(veh)	-	-	0.1

HCM 6th TWSC  
89: Garage Driveway & 8th St

03/22/2021

Intersection						
Int Delay, s/veh	0.8					
Movement	EBT	EBR	WBL	WBT	NBL	NBR
Lane Configurations	↑			↑	↑	
Traffic Vol, veh/h	109	0	0	290	19	15
Future Vol, veh/h	109	0	0	290	19	15
Conflicting Peds, #/hr	0	0	0	0	0	0
Sign Control	Free	Free	Free	Free	Stop	Stop
RT Channelized	-	None	-	None	-	None
Storage Length	-	-	-	-	0	-
Veh in Median Storage, #	0	-	-	0	0	-
Grade, %	0	-	-	0	0	-
Peak Hour Factor	92	92	92	92	92	92
Heavy Vehicles, %	2	2	2	2	2	2
Mvmt Flow	118	0	0	315	21	16

Major/Minor	Major1	Major2	Minor1		
Conflicting Flow All	0	-	-	-	433 118
Stage 1	-	-	-	-	118 -
Stage 2	-	-	-	-	315 -
Critical Hdwy	-	-	-	-	6.42 6.22
Critical Hdwy Stg 1	-	-	-	-	5.42 -
Critical Hdwy Stg 2	-	-	-	-	5.42 -
Follow-up Hdwy	-	-	-	-	3.518 3.318
Pot Cap-1 Maneuver	-	0	0	-	580 934
Stage 1	-	0	0	-	907 -
Stage 2	-	0	0	-	740 -
Platoon blocked, %	-	-	-	-	-
Mov Cap-1 Maneuver	-	-	-	-	580 934
Mov Cap-2 Maneuver	-	-	-	-	580 -
Stage 1	-	-	-	-	907 -
Stage 2	-	-	-	-	740 -

Approach	EB	WB	NB
HCM Control Delay, s	0	0	10.5
HCM LOS			B

Minor Lane/Major Mvmt	NBLn1	EBT	WBT
Capacity (veh/h)	696	-	-
HCM Lane V/C Ratio	0.053	-	-
HCM Control Delay (s)	10.5	-	-
HCM Lane LOS	B	-	-
HCM 95th %tile Q(veh)	0.2	-	-

# HCM 6th Signalized Intersection Summary

## 1: Alameda St & 7th St

03/22/2021



Movement	EBL	EBT	EBR	WBL	WBT	WBR	NBL	NBT	NBR	SBL	SBT	SBR
Lane Configurations	↖	↗		↖	↗		↖	↗		↖	↗	
Traffic Volume (veh/h)	102	786	132	94	437	126	139	829	146	109	764	45
Future Volume (veh/h)	102	786	132	94	437	126	139	829	146	109	764	45
Initial Q (Qb), veh	0	0	0	0	0	0	0	0	0	0	0	0
Ped-Bike Adj(A_pbT)	1.00		1.00	1.00		1.00	1.00		1.00	1.00		1.00
Parking Bus, Adj	1.00	1.00	1.00	1.00	1.00	1.00	1.00	1.00	1.00	1.00	1.00	1.00
Work Zone On Approach		No			No			No			No	
Adj Sat Flow, veh/h/ln	1870	1870	1870	1870	1870	1870	1870	1870	1870	1870	1870	1870
Adj Flow Rate, veh/h	111	854	143	102	475	137	151	901	159	118	830	49
Peak Hour Factor	0.92	0.92	0.92	0.92	0.92	0.92	0.92	0.92	0.92	0.92	0.92	0.92
Percent Heavy Veh, %	2	2	2	2	2	2	2	2	2	2	2	2
Cap, veh/h	263	1102	185	144	986	283	259	1050	185	278	1721	102
Arrive On Green	0.36	0.36	0.36	0.36	0.36	0.36	0.11	0.11	0.11	0.03	0.17	0.17
Sat Flow, veh/h	810	3045	510	565	2726	781	631	3019	533	1781	3410	201
Grp Volume(v), veh/h	111	498	499	102	309	303	151	530	530	118	432	447
Grp Sat Flow(s),veh/h/ln	810	1777	1779	565	1777	1730	631	1777	1774	1781	1777	1834
Q Serve(g_s), s	11.1	22.4	22.4	10.2	12.1	12.2	21.2	26.4	26.4	3.5	19.9	19.9
Cycle Q Clear(g_c), s	23.3	22.4	22.4	32.6	12.1	12.2	26.9	26.4	26.4	3.5	19.9	19.9
Prop In Lane	1.00		0.29	1.00		0.45	1.00		0.30	1.00		0.11
Lane Grp Cap(c), veh/h	263	643	644	144	643	626	259	618	617	278	897	926
V/C Ratio(X)	0.42	0.77	0.77	0.71	0.48	0.48	0.58	0.86	0.86	0.42	0.48	0.48
Avail Cap(c_a), veh/h	263	643	644	144	643	626	259	618	617	295	897	926
HCM Platoon Ratio	1.00	1.00	1.00	1.00	1.00	1.00	0.33	0.33	0.33	0.33	0.33	0.33
Upstream Filter(I)	0.82	0.82	0.82	1.00	1.00	1.00	0.95	0.95	0.95	0.78	0.78	0.78
Uniform Delay (d), s/veh	31.2	25.5	25.5	41.8	22.2	22.2	40.7	37.7	37.7	20.8	26.8	26.8
Incr Delay (d2), s/veh	4.0	7.4	7.4	25.4	2.6	2.7	8.8	13.8	13.8	0.8	1.4	1.4
Initial Q Delay(d3),s/veh	0.0	0.0	0.0	0.0	0.0	0.0	0.0	0.0	0.0	0.0	0.0	0.0
%ile BackOfQ(95%),veh/ln	4.3	15.1	15.2	5.9	9.1	9.0	7.5	21.0	21.0	2.7	14.2	14.6
Unsig. Movement Delay, s/veh												
LnGrp Delay(d),s/veh	35.3	32.8	32.8	67.3	24.7	24.9	49.5	51.4	51.5	21.6	28.3	28.3
LnGrp LOS	D	C	C	E	C	C	D	D	D	C	C	C
Approach Vol, veh/h		1108			714			1211			997	
Approach Delay, s/veh		33.1			30.9			51.2			27.5	
Approach LOS		C			C			D			C	
Timer - Assigned Phs		2		4	5	6		8				
Phs Duration (G+Y+Rc), s		51.1		38.9	14.1	37.0		38.9				
Change Period (Y+Rc), s		* 5.7		* 6.3	5.6	* 5.7		* 6.3				
Max Green Setting (Gmax), s		* 44		* 32	9.4	* 31		* 31				
Max Q Clear Time (g_c+I1), s		21.9		34.6	5.5	28.9		25.3				
Green Ext Time (p_c), s		5.9		0.0	0.1	1.7		3.2				

### Intersection Summary

HCM 6th Ctrl Delay	36.7
HCM 6th LOS	D

### Notes

\* HCM 6th computational engine requires equal clearance times for the phases crossing the barrier.



# HCM 6th Signalized Intersection Summary

## 2: Alameda St & 8th St

03/22/2021



Movement	EBL	EBT	EBR	WBL	WBT	WBR	NBL	NBT	NBR	SBL	SBT	SBR
Lane Configurations		↕			↕		↕	↕		↕	↕	
Traffic Volume (veh/h)	48	22	32	69	24	80	14	690	69	67	1022	69
Future Volume (veh/h)	48	22	32	69	24	80	14	690	69	67	1022	69
Initial Q (Qb), veh	0	0	0	0	0	0	0	0	0	0	0	0
Ped-Bike Adj(A_pbT)	1.00		1.00	1.00		1.00	1.00		1.00	1.00		1.00
Parking Bus, Adj	1.00	1.00	1.00	1.00	1.00	1.00	1.00	1.00	1.00	1.00	1.00	1.00
Work Zone On Approach		No			No			No			No	
Adj Sat Flow, veh/h/ln	1870	1870	1870	1870	1870	1870	1870	1870	1870	1870	1870	1870
Adj Flow Rate, veh/h	52	24	35	75	26	87	15	750	75	73	1111	75
Peak Hour Factor	0.92	0.92	0.92	0.92	0.92	0.92	0.92	0.92	0.92	0.92	0.92	0.92
Percent Heavy Veh, %	2	2	2	2	2	2	2	2	2	2	2	2
Cap, veh/h	139	67	68	137	44	108	425	2385	238	512	2470	167
Arrive On Green	0.14	0.14	0.14	0.14	0.14	0.14	0.73	0.73	0.73	1.00	1.00	1.00
Sat Flow, veh/h	559	468	473	563	310	752	472	3262	326	664	3378	228
Grp Volume(v), veh/h	111	0	0	188	0	0	15	408	417	73	584	602
Grp Sat Flow(s),veh/h/ln1500	0	0	0	1625	0	0	472	1777	1812	664	1777	1829
Q Serve(g_s), s	0.0	0.0	0.0	3.9	0.0	0.0	0.8	7.2	7.2	1.3	0.0	0.0
Cycle Q Clear(g_c), s	5.9	0.0	0.0	9.8	0.0	0.0	0.8	7.2	7.2	8.5	0.0	0.0
Prop In Lane	0.47		0.32	0.40		0.46	1.00		0.18	1.00		0.12
Lane Grp Cap(c), veh/h	274	0	0	289	0	0	425	1299	1324	512	1299	1337
V/C Ratio(X)	0.41	0.00	0.00	0.65	0.00	0.00	0.04	0.31	0.31	0.14	0.45	0.45
Avail Cap(c_a), veh/h	623	0	0	648	0	0	425	1299	1324	512	1299	1337
HCM Platoon Ratio	1.00	1.00	1.00	1.00	1.00	1.00	1.00	1.00	1.00	2.00	2.00	2.00
Upstream Filter(I)	1.00	0.00	0.00	1.00	0.00	0.00	1.00	1.00	1.00	0.81	0.81	0.81
Uniform Delay (d), s/veh	35.4	0.0	0.0	37.1	0.0	0.0	3.4	4.2	4.2	0.5	0.0	0.0
Incr Delay (d2), s/veh	1.0	0.0	0.0	2.5	0.0	0.0	0.2	0.6	0.6	0.5	0.9	0.9
Initial Q Delay(d3),s/veh	0.0	0.0	0.0	0.0	0.0	0.0	0.0	0.0	0.0	0.0	0.0	0.0
%ile BackOfQ(95%),veh/ln	1.1	0.0	0.0	7.4	0.0	0.0	0.1	4.1	4.2	0.1	0.6	0.6
Unsig. Movement Delay, s/veh												
LnGrp Delay(d),s/veh	36.4	0.0	0.0	39.5	0.0	0.0	3.5	4.9	4.8	0.9	0.9	0.9
LnGrp LOS	D	A	A	D	A	A	A	A	A	A	A	A
Approach Vol, veh/h		111			188			840			1259	
Approach Delay, s/veh		36.4			39.5			4.8			0.9	
Approach LOS		D			D			A			A	
Timer - Assigned Phs		2		4		6		8				
Phs Duration (G+Y+Rc), s		71.4		18.6		71.4		18.6				
Change Period (Y+Rc), s		5.6		5.7		5.6		5.7				
Max Green Setting (Gmax), s		44.4		34.3		44.4		34.3				
Max Q Clear Time (g_c+I1), s		9.2		7.9		10.5		11.8				
Green Ext Time (p_c), s		10.9		0.6		22.4		1.1				
<b>Intersection Summary</b>												
HCM 6th Ctrl Delay				6.9								
HCM 6th LOS				A								

# HCM 6th Signalized Intersection Summary

## 3: Alameda St & Olympic BI

03/22/2021



Movement	EBL	EBT	EBR	WBL	WBT	WBR	NBL	NBT	NBR	SBL	SBT	SBR
Lane Configurations	↖	↗		↖	↗		↖	↗		↖	↗	↖
Traffic Volume (veh/h)	100	1170	63	99	1142	46	83	602	157	131	783	220
Future Volume (veh/h)	100	1170	63	99	1142	46	83	602	157	131	783	220
Initial Q (Qb), veh	0	0	0	0	0	0	0	0	0	0	0	0
Ped-Bike Adj(A_pbT)	1.00		1.00	1.00		1.00	1.00		1.00	1.00		1.00
Parking Bus, Adj	1.00	1.00	1.00	1.00	1.00	1.00	1.00	1.00	1.00	1.00	1.00	1.00
Work Zone On Approach		No		No		No		No		No		No
Adj Sat Flow, veh/h/ln	1870	1870	1870	1870	1870	1870	1870	1870	1870	1870	1870	1870
Adj Flow Rate, veh/h	109	1272	68	108	1241	50	90	654	171	142	851	0
Peak Hour Factor	0.92	0.92	0.92	0.92	0.92	0.92	0.92	0.92	0.92	0.92	0.92	0.92
Percent Heavy Veh, %	2	2	2	2	2	2	2	2	2	2	2	2
Cap, veh/h	99	1323	71	89	1342	54	298	1382	361	406	1761	
Arrive On Green	0.39	0.39	0.39	0.39	0.39	0.39	0.99	0.99	0.99	0.50	0.50	0.00
Sat Flow, veh/h	427	3431	183	408	3482	140	648	2788	728	664	3554	1585
Grp Volume(v), veh/h	109	658	682	108	633	658	90	417	408	142	851	0
Grp Sat Flow(s),veh/h/ln	427	1777	1837	408	1777	1845	648	1777	1739	664	1777	1585
Q Serve(g_s), s	4.0	32.5	32.6	2.1	30.6	30.7	5.7	0.4	0.4	12.4	14.3	0.0
Cycle Q Clear(g_c), s	34.7	32.5	32.6	34.7	30.6	30.7	19.9	0.4	0.4	12.8	14.3	0.0
Prop In Lane	1.00		0.10	1.00		0.08	1.00		0.42	1.00		1.00
Lane Grp Cap(c), veh/h	99	685	708	89	685	711	298	881	862	406	1761	
V/C Ratio(X)	1.10	0.96	0.96	1.21	0.92	0.93	0.30	0.47	0.47	0.35	0.48	
Avail Cap(c_a), veh/h	99	685	708	89	685	711	298	881	862	406	1761	
HCM Platoon Ratio	1.00	1.00	1.00	1.00	1.00	1.00	2.00	2.00	2.00	1.00	1.00	1.00
Upstream Filter(I)	1.00	1.00	1.00	1.00	1.00	1.00	0.78	0.78	0.78	1.00	1.00	0.00
Uniform Delay (d), s/veh	44.6	27.0	27.0	44.9	26.4	26.4	3.5	0.2	0.2	14.8	15.1	0.0
Incr Delay (d2), s/veh	119.6	24.9	24.9	161.9	18.3	18.0	2.0	1.4	1.5	2.4	1.0	0.0
Initial Q Delay(d3),s/veh	0.0	0.0	0.0	0.0	0.0	0.0	0.0	0.0	0.0	0.0	0.0	0.0
%ile BackOfQ(95%),veh/ln	9.8	24.7	25.5	10.8	22.2	22.9	0.8	0.8	0.8	3.7	9.6	0.0
Unsig. Movement Delay, s/veh												
LnGrp Delay(d),s/veh	164.2	51.9	51.9	206.8	44.7	44.4	5.5	1.6	1.7	17.2	16.0	0.0
LnGrp LOS	F	D	D	F	D	D	A	A	A	B	B	
Approach Vol, veh/h		1449			1399			915			993	A
Approach Delay, s/veh		60.4			57.1			2.0			16.2	
Approach LOS		E			E			A			B	
Timer - Assigned Phs		2		4		6		8				
Phs Duration (G+Y+Rc), s		50.0		40.0		50.0		40.0				
Change Period (Y+Rc), s		* 5.4		* 5.3		* 5.4		* 5.3				
Max Green Setting (Gmax), s		* 45		* 35		* 45		* 35				
Max Q Clear Time (g_c+I1), s		16.3		36.7		21.9		36.7				
Green Ext Time (p_c), s		8.4		0.0		6.5		0.0				

### Intersection Summary

HCM 6th Ctrl Delay	38.9
HCM 6th LOS	D

### Notes

\* HCM 6th computational engine requires equal clearance times for the phases crossing the barrier.  
 Unsignalized Delay for [SBR] is excluded from calculations of the approach delay and intersection delay.

HCM 6th TWSC  
4: Olympic Bl & Lemon St

03/22/2021

Intersection												
Int Delay, s/veh	7.7											
Movement	EBL	EBT	EBR	WBL	WBT	WBR	NBL	NBT	NBR	SBL	SBT	SBR
Lane Configurations	↖	↕		↖	↕			↕			↕	
Traffic Vol, veh/h	12	1005	4	24	1105	40	2	0	12	59	0	187
Future Vol, veh/h	12	1005	4	24	1105	40	2	0	12	59	0	187
Conflicting Peds, #/hr	0	0	0	0	0	0	0	0	0	0	0	0
Sign Control	Free	Free	Free	Free	Free	Free	Stop	Stop	Stop	Stop	Stop	Stop
RT Channelized	-	-	None	-	-	None	-	-	None	-	-	None
Storage Length	124	-	-	80	-	-	-	-	-	-	-	-
Veh in Median Storage, #	-	0	-	-	0	-	-	0	-	-	0	-
Grade, %	-	0	-	-	0	-	-	0	-	-	0	-
Peak Hour Factor	92	92	92	92	92	92	92	92	92	92	92	92
Heavy Vehicles, %	2	2	2	2	2	2	2	2	2	2	2	2
Mvmt Flow	13	1092	4	26	1201	43	2	0	13	64	0	203

Major/Minor	Major1			Major2			Minor1			Minor2		
Conflicting Flow All	1244	0	0	1096	0	0	1773	2416	548	1847	2397	622
Stage 1	-	-	-	-	-	-	1120	1120	-	1275	1275	-
Stage 2	-	-	-	-	-	-	653	1296	-	572	1122	-
Critical Hdwy	4.14	-	-	4.14	-	-	7.54	6.54	6.94	7.54	6.54	6.94
Critical Hdwy Stg 1	-	-	-	-	-	-	6.54	5.54	-	6.54	5.54	-
Critical Hdwy Stg 2	-	-	-	-	-	-	6.54	5.54	-	6.54	5.54	-
Follow-up Hdwy	2.22	-	-	2.22	-	-	3.52	4.02	3.32	3.52	4.02	3.32
Pot Cap-1 Maneuver	*930	-	-	633	-	-	*143	35	480	*115	*37	*621
Stage 1	-	-	-	-	-	-	*220	280	-	*586	*514	-
Stage 2	-	-	-	-	-	-	*586	499	-	*472	*279	-
Platoon blocked, %	1	-	-	-	-	-	1	1	-	1	1	1
Mov Cap-1 Maneuver	*930	-	-	633	-	-	*92	33	480	*107	*35	*621
Mov Cap-2 Maneuver	-	-	-	-	-	-	*92	33	-	*107	*35	-
Stage 1	-	-	-	-	-	-	*217	276	-	*578	*492	-
Stage 2	-	-	-	-	-	-	*378	478	-	*453	*275	-

Approach	EB			WB			NB			SB		
HCM Control Delay, s	0.1			0.2			17.6			74.6		
HCM LOS							C			F		

Minor Lane/Major Mvmt	NBLn1	EBL	EBT	EBR	WBL	WBT	WBR	SBLn1
Capacity (veh/h)	300	* 930	-	-	633	-	-	289
HCM Lane V/C Ratio	0.051	0.014	-	-	0.041	-	-	0.925
HCM Control Delay (s)	17.6	8.9	-	-	10.9	-	-	74.6
HCM Lane LOS	C	A	-	-	B	-	-	F
HCM 95th %tile Q(veh)	0.2	0	-	-	0.1	-	-	8.8

Notes  
 -: Volume exceeds capacity    \$: Delay exceeds 300s    +: Computation Not Defined    \*: All major volume in platoon

# HCM 6th Signalized Intersection Summary

## 5: Olympic Bl & Mateo St

03/22/2021



Movement	EBL	EBT	EBR	WBL	WBT	WBR	NBL	NBT	NBR	SBL	SBT	SBR
Lane Configurations	↗	↗↘		↗	↗↘			↕			↖	↖↗
Traffic Volume (veh/h)	82	985	5	6	705	86	1	0	4	294	1	447
Future Volume (veh/h)	82	985	5	6	705	86	1	0	4	294	1	447
Initial Q (Qb), veh	0	0	0	0	0	0	0	0	0	0	0	0
Ped-Bike Adj(A_pbT)	1.00		1.00	1.00		1.00	1.00		1.00	1.00		1.00
Parking Bus, Adj	1.00	1.00	1.00	1.00	1.00	1.00	1.00	1.00	1.00	1.00	1.00	1.00
Work Zone On Approach		No			No			No			No	
Adj Sat Flow, veh/h/ln	1870	1870	1870	1870	1870	1870	1870	1870	1870	1870	1870	1870
Adj Flow Rate, veh/h	89	1071	5	7	766	93	1	0	4	320	1	486
Peak Hour Factor	0.92	0.92	0.92	0.92	0.92	0.92	0.92	0.92	0.92	0.92	0.92	0.92
Percent Heavy Veh, %	2	2	2	2	2	2	2	2	2	2	2	2
Cap, veh/h	267	1673	8	203	1471	179	48	29	115	258	1	689
Arrive On Green	0.46	0.46	0.46	0.46	0.46	0.46	0.43	0.00	0.43	0.43	0.43	0.43
Sat Flow, veh/h	643	3627	17	524	3190	387	0	66	264	410	1	1585
Grp Volume(v), veh/h	89	525	551	7	427	432	5	0	0	321	0	486
Grp Sat Flow(s),veh/h/ln	643	1777	1867	524	1777	1801	330	0	0	411	0	1585
Q Serve(g_s), s	10.3	20.3	20.3	0.9	15.3	15.3	0.0	0.0	0.0	0.0	0.0	22.5
Cycle Q Clear(g_c), s	25.6	20.3	20.3	21.3	15.3	15.3	39.1	0.0	0.0	39.1	0.0	22.5
Prop In Lane	1.00		0.01	1.00		0.22	0.20		0.80	1.00		1.00
Lane Grp Cap(c), veh/h	267	819	861	203	819	830	191	0	0	259	0	689
V/C Ratio(X)	0.33	0.64	0.64	0.03	0.52	0.52	0.03	0.00	0.00	1.24	0.00	0.71
Avail Cap(c_a), veh/h	267	819	861	203	819	830	191	0	0	259	0	689
HCM Platoon Ratio	1.00	1.00	1.00	1.00	1.00	1.00	1.00	1.00	1.00	1.00	1.00	1.00
Upstream Filter(I)	1.00	1.00	1.00	1.00	1.00	1.00	1.00	0.00	0.00	1.00	0.00	1.00
Uniform Delay (d), s/veh	26.3	18.5	18.5	26.7	17.2	17.2	19.8	0.0	0.0	31.5	0.0	20.8
Incr Delay (d2), s/veh	3.3	3.8	3.6	0.3	2.4	2.3	0.3	0.0	0.0	136.9	0.0	6.0
Initial Q Delay(d3),s/veh	0.0	0.0	0.0	0.0	0.0	0.0	0.0	0.0	0.0	0.0	0.0	0.0
%ile BackOfQ(95%),veh/ln	3.2	13.6	14.1	0.2	10.6	10.8	0.1	0.0	0.0	25.1	0.0	14.0
Unsig. Movement Delay, s/veh												
LnGrp Delay(d),s/veh	29.6	22.4	22.2	27.0	19.6	19.5	20.1	0.0	0.0	168.4	0.0	26.8
LnGrp LOS	C	C	C	C	B	B	C	A	A	F	A	C
Approach Vol, veh/h		1165			866			5				807
Approach Delay, s/veh		22.8			19.6			20.1				83.1
Approach LOS		C			B			C				F
Timer - Assigned Phs		2		4		6		8				
Phs Duration (G+Y+Rc), s		46.0		44.0		46.0		44.0				
Change Period (Y+Rc), s		* 4.5		4.9		* 4.5		4.9				
Max Green Setting (Gmax), s		* 42		39.1		* 42		39.1				
Max Q Clear Time (g_c+I1), s		23.3		41.1		27.6		41.1				
Green Ext Time (p_c), s		5.5		0.0		6.7		0.0				

### Intersection Summary

HCM 6th Ctrl Delay	39.0
HCM 6th LOS	D

### Notes

\* HCM 6th computational engine requires equal clearance times for the phases crossing the barrier.

HCM 6th TWSC  
87: Project Dwy & 8th St

03/22/2021

Intersection												
Int Delay, s/veh	4											
Movement	EBL	EBT	EBR	WBL	WBT	WBR	NBL	NBT	NBR	SBL	SBT	SBR
Lane Configurations		↕			↕		↕	↕			↕	
Traffic Vol, veh/h	0	62	106	57	134	0	79	0	54	0	0	0
Future Vol, veh/h	0	62	106	57	134	0	79	0	54	0	0	0
Conflicting Peds, #/hr	0	0	0	0	0	0	0	0	0	0	0	0
Sign Control	Free	Free	Free	Free	Free	Free	Stop	Stop	Stop	Stop	Stop	Stop
RT Channelized	-	-	None	-	-	None	-	-	None	-	-	None
Storage Length	-	-	-	-	-	-	0	-	-	-	-	-
Veh in Median Storage, #	-	0	-	-	0	-	-	0	-	-	0	-
Grade, %	-	0	-	-	0	-	-	0	-	-	0	-
Peak Hour Factor	92	92	92	92	92	92	92	92	92	92	92	92
Heavy Vehicles, %	2	2	2	2	2	2	2	2	2	2	2	2
Mvmt Flow	0	67	115	62	146	0	86	0	59	0	0	0
Major/Minor	Major1			Major2			Minor1			Minor2		
Conflicting Flow All	146	0	0	182	0	0	395	395	125	424	452	146
Stage 1	-	-	-	-	-	-	125	125	-	270	270	-
Stage 2	-	-	-	-	-	-	270	270	-	154	182	-
Critical Hdwy	4.12	-	-	4.12	-	-	7.12	6.52	6.22	7.12	6.52	6.22
Critical Hdwy Stg 1	-	-	-	-	-	-	6.12	5.52	-	6.12	5.52	-
Critical Hdwy Stg 2	-	-	-	-	-	-	6.12	5.52	-	6.12	5.52	-
Follow-up Hdwy	2.218	-	-	2.218	-	-	3.518	4.018	3.318	3.518	4.018	3.318
Pot Cap-1 Maneuver	1436	-	-	1393	-	-	565	542	926	540	503	901
Stage 1	-	-	-	-	-	-	879	792	-	736	686	-
Stage 2	-	-	-	-	-	-	736	686	-	848	749	-
Platoon blocked, %	-	-	-	-	-	-	-	-	-	-	-	-
Mov Cap-1 Maneuver	1436	-	-	1393	-	-	544	516	926	487	479	901
Mov Cap-2 Maneuver	-	-	-	-	-	-	544	516	-	487	479	-
Stage 1	-	-	-	-	-	-	879	792	-	736	653	-
Stage 2	-	-	-	-	-	-	701	653	-	794	749	-
Approach	EB			WB			NB			SB		
HCM Control Delay, s	0			2.3			11.4			0		
HCM LOS							B			A		
Minor Lane/Major Mvmt	NBLn1	NBLn2	EBL	EBT	EBR	WBL	WBT	WBR	SBLn1			
Capacity (veh/h)	544	926	1436	-	-	1393	-	-	-			
HCM Lane V/C Ratio	0.158	0.063	-	-	-	0.044	-	-	-			
HCM Control Delay (s)	12.9	9.2	0	-	-	7.7	0	-	0			
HCM Lane LOS	B	A	A	-	-	A	A	-	A			
HCM 95th %tile Q(veh)	0.6	0.2	0	-	-	0.1	-	-	-			

Intersection						
Int Delay, s/veh	8.8					
Movement	EBL	EBT	WBT	WBR	SBL	SBR
Lane Configurations		↑	↑		↓	
Traffic Vol, veh/h	0	0	0	0	36	86
Future Vol, veh/h	0	0	0	0	36	86
Conflicting Peds, #/hr	0	0	0	0	0	0
Sign Control	Free	Free	Free	Free	Stop	Stop
RT Channelized	-	None	-	None	-	None
Storage Length	-	-	-	-	0	-
Veh in Median Storage, #	-	0	0	-	0	-
Grade, %	-	0	0	-	0	-
Peak Hour Factor	92	92	92	92	92	92
Heavy Vehicles, %	2	2	2	2	2	2
Mvmt Flow	0	0	0	0	39	93

Major/Minor	Major1	Major2	Minor2		
Conflicting Flow All	-	0	-	0	1
Stage 1	-	-	-	-	1
Stage 2	-	-	-	-	0
Critical Hdwy	-	-	-	-	6.42
Critical Hdwy Stg 1	-	-	-	-	5.42
Critical Hdwy Stg 2	-	-	-	-	5.42
Follow-up Hdwy	-	-	-	-	3.518
Pot Cap-1 Maneuver	0	-	-	0	1022
Stage 1	0	-	-	0	1022
Stage 2	0	-	-	0	-
Platoon blocked, %	-	-	-	-	-
Mov Cap-1 Maneuver	-	-	-	-	1022
Mov Cap-2 Maneuver	-	-	-	-	1022
Stage 1	-	-	-	-	1022
Stage 2	-	-	-	-	-

Approach	EB	WB	SB
HCM Control Delay, s	0	0	8.9
HCM LOS			A

Minor Lane/Major Mvmt	EBT	WBT	SBLn1
Capacity (veh/h)	-	-	1065
HCM Lane V/C Ratio	-	-	0.125
HCM Control Delay (s)	-	-	8.9
HCM Lane LOS	-	-	A
HCM 95th %tile Q(veh)	-	-	0.4

HCM 6th TWSC  
89: Garage Dwy & 8th St

03/22/2021

Intersection						
Int Delay, s/veh	3.1					
Movement	EBT	EBR	WBL	WBT	NBL	NBR
Lane Configurations	↑			↑	↑	↑
Traffic Vol, veh/h	116	0	0	133	58	47
Future Vol, veh/h	116	0	0	133	58	47
Conflicting Peds, #/hr	0	0	0	0	0	0
Sign Control	Free	Free	Free	Free	Stop	Stop
RT Channelized	-	None	-	None	-	None
Storage Length	-	-	-	-	0	-
Veh in Median Storage, #	0	-	-	0	0	-
Grade, %	0	-	-	0	0	-
Peak Hour Factor	92	92	92	92	92	92
Heavy Vehicles, %	2	2	2	2	2	2
Mvmt Flow	126	0	0	145	63	51

Major/Minor	Major1	Major2	Minor1		
Conflicting Flow All	0	-	-	-	271 126
Stage 1	-	-	-	-	126 -
Stage 2	-	-	-	-	145 -
Critical Hdwy	-	-	-	-	6.42 6.22
Critical Hdwy Stg 1	-	-	-	-	5.42 -
Critical Hdwy Stg 2	-	-	-	-	5.42 -
Follow-up Hdwy	-	-	-	-	3.518 3.318
Pot Cap-1 Maneuver	-	0	0	-	718 924
Stage 1	-	0	0	-	900 -
Stage 2	-	0	0	-	882 -
Platoon blocked, %	-	-	-	-	-
Mov Cap-1 Maneuver	-	-	-	-	718 924
Mov Cap-2 Maneuver	-	-	-	-	718 -
Stage 1	-	-	-	-	900 -
Stage 2	-	-	-	-	882 -

Approach	EB	WB	NB
HCM Control Delay, s	0	0	10.3
HCM LOS			B

Minor Lane/Major Mvmt	NBLn1	EBT	WBT
Capacity (veh/h)	798	-	-
HCM Lane V/C Ratio	0.143	-	-
HCM Control Delay (s)	10.3	-	-
HCM Lane LOS	B	-	-
HCM 95th %tile Q(veh)	0.5	-	-

# HCM 6th Signalized Intersection Summary

## 1: Alameda St & 7th St

03/17/2021



Movement	EBL	EBT	EBR	WBL	WBT	WBR	NBL	NBT	NBR	SBL	SBT	SBR
Lane Configurations	↖	↗		↖	↗		↖	↗		↖	↗	
Traffic Volume (veh/h)	63	337	89	129	722	107	119	678	101	139	950	182
Future Volume (veh/h)	63	337	89	129	722	107	119	678	101	139	950	182
Initial Q (Qb), veh	0	0	0	0	0	0	0	0	0	0	0	0
Ped-Bike Adj(A_pbT)	1.00		1.00	1.00		1.00	1.00		1.00	1.00		1.00
Parking Bus, Adj	1.00	1.00	1.00	1.00	1.00	1.00	1.00	1.00	1.00	1.00	1.00	1.00
Work Zone On Approach		No			No			No			No	
Adj Sat Flow, veh/h/ln	1870	1870	1870	1870	1870	1870	1870	1870	1870	1870	1870	1870
Adj Flow Rate, veh/h	68	366	97	140	785	116	129	737	110	151	1033	198
Peak Hour Factor	0.92	0.92	0.92	0.92	0.92	0.92	0.92	0.92	0.92	0.92	0.92	0.92
Percent Heavy Veh, %	2	2	2	2	2	2	2	2	2	2	2	2
Cap, veh/h	168	1000	262	322	1115	165	237	1079	161	332	1511	289
Arrive On Green	0.36	0.36	0.36	0.36	0.36	0.36	0.11	0.11	0.11	0.20	1.00	1.00
Sat Flow, veh/h	618	2786	729	929	3106	459	453	3101	463	1781	2976	569
Grp Volume(v), veh/h	68	232	231	140	449	452	129	422	425	151	616	615
Grp Sat Flow(s),veh/h/ln	618	1777	1739	929	1777	1788	453	1777	1787	1781	1777	1768
Q Serve(g_s), s	9.5	8.7	8.8	11.8	19.5	19.5	25.1	20.5	20.6	4.4	0.0	0.0
Cycle Q Clear(g_c), s	29.1	8.7	8.8	20.7	19.5	19.5	25.1	20.5	20.6	4.4	0.0	0.0
Prop In Lane	1.00		0.42	1.00		0.26	1.00		0.26	1.00		0.32
Lane Grp Cap(c), veh/h	168	638	624	322	638	642	237	618	622	332	902	898
V/C Ratio(X)	0.41	0.36	0.37	0.43	0.70	0.70	0.54	0.68	0.68	0.46	0.68	0.69
Avail Cap(c_a), veh/h	168	638	624	322	638	642	237	618	622	344	902	898
HCM Platoon Ratio	1.00	1.00	1.00	1.00	1.00	1.00	0.33	0.33	0.33	2.00	2.00	2.00
Upstream Filter(I)	0.97	0.97	0.97	1.00	1.00	1.00	0.93	0.93	0.93	0.84	0.84	0.84
Uniform Delay (d), s/veh	37.2	21.3	21.3	29.0	24.7	24.7	37.1	35.1	35.1	15.6	0.0	0.0
Incr Delay (d2), s/veh	6.9	1.6	1.6	4.2	6.4	6.4	8.1	5.6	5.6	0.8	3.5	3.6
Initial Q Delay(d3),s/veh	0.0	0.0	0.0	0.0	0.0	0.0	0.0	0.0	0.0	0.0	0.0	0.0
%ile BackOfQ(95%),veh/ln	3.1	6.8	6.8	5.3	13.9	14.0	6.4	15.8	15.9	2.9	1.6	1.6
Unsig. Movement Delay, s/veh												
LnGrp Delay(d),s/veh	44.1	22.8	23.0	33.2	31.2	31.1	45.1	40.7	40.7	16.4	3.5	3.6
LnGrp LOS	D	C	C	C	C	C	D	D	D	B	A	A
Approach Vol, veh/h		531			1041			976			1382	
Approach Delay, s/veh		25.6			31.4			41.3			5.0	
Approach LOS		C			C			D			A	
Timer - Assigned Phs		2		4	5	6		8				
Phs Duration (G+Y+Rc), s		51.4		38.6	14.4	37.0		38.6				
Change Period (Y+Rc), s		* 5.7		* 6.3	5.6	* 5.7		* 6.3				
Max Green Setting (Gmax), s		* 44		* 32	9.4	* 31		* 31				
Max Q Clear Time (g_c+I1), s		2.0		22.7	6.4	27.1		31.1				
Green Ext Time (p_c), s		11.5		4.3	0.1	2.5		0.0				

### Intersection Summary

HCM 6th Ctrl Delay	23.8
HCM 6th LOS	C

### Notes

\* HCM 6th computational engine requires equal clearance times for the phases crossing the barrier.



# HCM 6th Signalized Intersection Summary

## 2: Alameda St & 8th St

03/17/2021



Movement	EBL	EBT	EBR	WBL	WBT	WBR	NBL	NBT	NBR	SBL	SBT	SBR
Lane Configurations		↕			↕		↙	↕		↙	↕	
Traffic Volume (veh/h)	101	54	45	42	86	45	36	810	28	14	807	118
Future Volume (veh/h)	101	54	45	42	86	45	36	810	28	14	807	118
Initial Q (Qb), veh	0	0	0	0	0	0	0	0	0	0	0	0
Ped-Bike Adj(A_pbT)	1.00		1.00	1.00		1.00	1.00		1.00	1.00		1.00
Parking Bus, Adj	1.00	1.00	1.00	1.00	1.00	1.00	1.00	1.00	1.00	1.00	1.00	1.00
Work Zone On Approach		No			No			No			No	
Adj Sat Flow, veh/h/ln	1870	1870	1870	1870	1870	1870	1870	1870	1870	1870	1870	1870
Adj Flow Rate, veh/h	110	59	49	46	93	49	39	880	30	15	877	128
Peak Hour Factor	0.92	0.92	0.92	0.92	0.92	0.92	0.92	0.92	0.92	0.92	0.92	0.92
Percent Heavy Veh, %	2	2	2	2	2	2	2	2	2	2	2	2
Cap, veh/h	179	84	59	103	175	81	466	2413	82	483	2142	313
Arrive On Green	0.19	0.19	0.19	0.19	0.19	0.19	0.92	0.92	0.92	1.00	1.00	1.00
Sat Flow, veh/h	640	451	316	288	941	433	561	3506	120	613	3111	454
Grp Volume(v), veh/h	218	0	0	188	0	0	39	446	464	15	501	504
Grp Sat Flow(s),veh/h/ln	1407	0	0	1663	0	0	561	1777	1849	613	1777	1789
Q Serve(g_s), s	4.4	0.0	0.0	0.0	0.0	0.0	0.6	2.9	2.9	0.1	0.0	0.0
Cycle Q Clear(g_c), s	13.5	0.0	0.0	9.1	0.0	0.0	0.6	2.9	2.9	3.0	0.0	0.0
Prop In Lane	0.50		0.22	0.24		0.26	1.00		0.06	1.00		0.25
Lane Grp Cap(c), veh/h	322	0	0	359	0	0	466	1223	1273	483	1223	1231
V/C Ratio(X)	0.68	0.00	0.00	0.52	0.00	0.00	0.08	0.36	0.36	0.03	0.41	0.41
Avail Cap(c_a), veh/h	604	0	0	674	0	0	466	1223	1273	483	1223	1231
HCM Platoon Ratio	1.00	1.00	1.00	1.00	1.00	1.00	1.33	1.33	1.33	2.00	2.00	2.00
Upstream Filter(I)	1.00	0.00	0.00	1.00	0.00	0.00	1.00	1.00	1.00	0.69	0.69	0.69
Uniform Delay (d), s/veh	35.3	0.0	0.0	33.4	0.0	0.0	1.2	1.3	1.3	0.1	0.0	0.0
Incr Delay (d2), s/veh	2.5	0.0	0.0	1.2	0.0	0.0	0.4	0.8	0.8	0.1	0.7	0.7
Initial Q Delay(d3),s/veh	0.0	0.0	0.0	0.0	0.0	0.0	0.0	0.0	0.0	0.0	0.0	0.0
%ile BackOfQ(95%),veh/ln	8.3	0.0	0.0	6.8	0.0	0.0	0.2	1.7	1.7	0.0	0.4	0.4
Unsig. Movement Delay, s/veh												
LnGrp Delay(d),s/veh	37.7	0.0	0.0	34.6	0.0	0.0	1.6	2.1	2.1	0.2	0.7	0.7
LnGrp LOS	D	A	A	C	A	A	A	A	A	A	A	A
Approach Vol, veh/h		218			188			949			1020	
Approach Delay, s/veh		37.7			34.6			2.1			0.7	
Approach LOS		D			C			A			A	
Timer - Assigned Phs		2		4		6		8				
Phs Duration (G+Y+Rc), s		67.6		22.4		67.6		22.4				
Change Period (Y+Rc), s		5.6		5.7		5.6		5.7				
Max Green Setting (Gmax), s		44.4		34.3		44.4		34.3				
Max Q Clear Time (g_c+I1), s		4.9		15.5		5.0		11.1				
Green Ext Time (p_c), s		13.3		1.2		19.4		1.1				
<b>Intersection Summary</b>												
HCM 6th Ctrl Delay				7.3								
HCM 6th LOS				A								

# HCM 6th Signalized Intersection Summary

## 3: Alameda St & Olympic BI

03/17/2021



Movement	EBL	EBT	EBR	WBL	WBT	WBR	NBL	NBT	NBR	SBL	SBT	SBR
Lane Configurations	↖	↗		↖	↗		↖	↗		↖	↗	↖
Traffic Volume (veh/h)	76	820	68	171	1403	47	114	813	60	99	606	147
Future Volume (veh/h)	76	820	68	171	1403	47	114	813	60	99	606	147
Initial Q (Qb), veh	0	0	0	0	0	0	0	0	0	0	0	0
Ped-Bike Adj(A_pbT)	1.00		1.00	1.00		1.00	1.00		1.00	1.00		1.00
Parking Bus, Adj	1.00	1.00	1.00	1.00	1.00	1.00	1.00	1.00	1.00	1.00	1.00	1.00
Work Zone On Approach		No		No		No		No		No		No
Adj Sat Flow, veh/h/ln	1870	1870	1870	1870	1870	1870	1870	1870	1870	1870	1870	1870
Adj Flow Rate, veh/h	83	891	74	186	1525	51	124	884	65	108	659	0
Peak Hour Factor	0.92	0.92	0.92	0.92	0.92	0.92	0.92	0.92	0.92	0.92	0.92	0.92
Percent Heavy Veh, %	2	2	2	2	2	2	2	2	2	2	2	2
Cap, veh/h	80	1281	106	173	1353	45	462	1663	122	247	1761	
Arrive On Green	0.39	0.39	0.39	0.39	0.39	0.39	0.33	0.33	0.33	0.99	0.99	0.00
Sat Flow, veh/h	325	3322	276	582	3509	117	775	3356	247	591	3554	1585
Grp Volume(v), veh/h	83	477	488	186	771	805	124	468	481	108	659	0
Grp Sat Flow(s),veh/h/ln	325	1777	1821	582	1777	1849	775	1777	1826	591	1777	1585
Q Serve(g_s), s	0.0	20.3	20.3	14.4	34.7	34.7	10.8	19.2	19.2	11.3	0.2	0.0
Cycle Q Clear(g_c), s	34.7	20.3	20.3	34.7	34.7	34.7	11.0	19.2	19.2	30.5	0.2	0.0
Prop In Lane	1.00		0.15	1.00		0.06	1.00		0.14	1.00		1.00
Lane Grp Cap(c), veh/h	80	685	702	173	685	713	462	881	905	247	1761	
V/C Ratio(X)	1.04	0.70	0.70	1.07	1.12	1.13	0.27	0.53	0.53	0.44	0.37	
Avail Cap(c_a), veh/h	80	685	702	173	685	713	462	881	905	247	1761	
HCM Platoon Ratio	1.00	1.00	1.00	1.00	1.00	1.00	0.67	0.67	0.67	2.00	2.00	2.00
Upstream Filter(I)	1.00	1.00	1.00	1.00	1.00	1.00	0.77	0.77	0.77	1.00	1.00	0.00
Uniform Delay (d), s/veh	45.0	23.2	23.2	41.1	27.6	27.7	18.9	21.6	21.6	6.9	0.2	0.0
Incr Delay (d2), s/veh	111.3	3.1	3.0	89.1	74.1	75.4	1.1	1.8	1.7	5.6	0.6	0.0
Initial Q Delay(d3),s/veh	0.0	0.0	0.0	0.0	0.0	0.0	0.0	0.0	0.0	0.0	0.0	0.0
%ile BackOfQ(95%),veh/ln	7.6	13.5	13.8	13.3	39.7	41.6	3.9	13.1	13.4	2.3	0.4	0.0
Unsig. Movement Delay, s/veh												
LnGrp Delay(d),s/veh	156.3	26.3	26.2	130.2	101.7	103.0	20.0	23.4	23.3	12.5	0.8	0.0
LnGrp LOS	F	C	C	F	F	F	C	C	C	B	A	
Approach Vol, veh/h		1048			1762			1073			767	A
Approach Delay, s/veh		36.6			105.3			23.0			2.5	
Approach LOS		D			F			C			A	
Timer - Assigned Phs		2		4		6		8				
Phs Duration (G+Y+Rc), s		50.0		40.0		50.0		40.0				
Change Period (Y+Rc), s		* 5.4		* 5.3		* 5.4		* 5.3				
Max Green Setting (Gmax), s		* 45		* 35		* 45		* 35				
Max Q Clear Time (g_c+1), s		32.5		36.7		21.2		36.7				
Green Ext Time (p_c), s		4.4		0.0		7.7		0.0				

### Intersection Summary

HCM 6th Ctrl Delay	53.9
HCM 6th LOS	D

### Notes

\* HCM 6th computational engine requires equal clearance times for the phases crossing the barrier.  
 Unsignalized Delay for [SBR] is excluded from calculations of the approach delay and intersection delay.

HCM 6th TWSC  
4: Olympic Bl & Lemon St

03/17/2021

Intersection												
Int Delay, s/veh	1.3											
Movement	EBL	EBT	EBR	WBL	WBT	WBR	NBL	NBT	NBR	SBL	SBT	SBR
Lane Configurations	↖	↕		↖	↕			↕			↕	
Traffic Vol, veh/h	15	467	5	37	1612	21	3	1	4	7	2	95
Future Vol, veh/h	15	467	5	37	1612	21	3	1	4	7	2	95
Conflicting Peds, #/hr	0	0	0	0	0	0	0	0	0	0	0	0
Sign Control	Free	Free	Free	Free	Free	Free	Stop	Stop	Stop	Stop	Stop	Stop
RT Channelized	-	-	None	-	-	None	-	-	None	-	-	None
Storage Length	124	-	-	80	-	-	-	-	-	-	-	-
Veh in Median Storage, #	-	0	-	-	0	-	-	0	-	-	0	-
Grade, %	-	0	-	-	0	-	-	0	-	-	0	-
Peak Hour Factor	92	92	92	92	92	92	92	92	92	92	92	92
Heavy Vehicles, %	2	2	2	2	2	2	2	2	2	2	2	2
Mvmt Flow	16	508	5	40	1752	23	3	1	4	8	2	103

Major/Minor	Major1			Major2			Minor1			Minor2		
Conflicting Flow All	1775	0	0	513	0	0	1500	2398	257	2131	2389	888
Stage 1	-	-	-	-	-	-	543	543	-	1844	1844	-
Stage 2	-	-	-	-	-	-	957	1855	-	287	545	-
Critical Hdwy	4.14	-	-	4.14	-	-	7.54	6.54	6.94	7.54	6.54	6.94
Critical Hdwy Stg 1	-	-	-	-	-	-	6.54	5.54	-	6.54	5.54	-
Critical Hdwy Stg 2	-	-	-	-	-	-	6.54	5.54	-	6.54	5.54	-
Follow-up Hdwy	2.22	-	-	2.22	-	-	3.52	4.02	3.32	3.52	4.02	3.32
Pot Cap-1 Maneuver	*618	-	-	1049	-	-	*389	*51	742	*120	*53	*413
Stage 1	-	-	-	-	-	-	*492	*518	-	*389	*341	-
Stage 2	-	-	-	-	-	-	*389	*341	-	*696	*517	-
Platoon blocked, %	1	-	-	-	-	-	1	1	-	1	1	1
Mov Cap-1 Maneuver	*618	-	-	1049	-	-	*269	*48	742	*112	*50	*413
Mov Cap-2 Maneuver	-	-	-	-	-	-	*269	*48	-	*112	*50	-
Stage 1	-	-	-	-	-	-	*479	*505	-	*379	*328	-
Stage 2	-	-	-	-	-	-	*279	*328	-	*673	*504	-

Approach	EB			WB			NB			SB		
HCM Control Delay, s	0.3			0.2			22.5			22.9		
HCM LOS							C			C		

Minor Lane/Major Mvmt	NBLn1	EBL	EBT	EBR	WBL	WBT	WBR	SBLn1
Capacity (veh/h)	214	* 618	-	-	1049	-	-	313
HCM Lane V/C Ratio	0.041	0.026	-	-	0.038	-	-	0.361
HCM Control Delay (s)	22.5	11	-	-	8.6	-	-	22.9
HCM Lane LOS	C	B	-	-	A	-	-	C
HCM 95th %tile Q(veh)	0.1	0.1	-	-	0.1	-	-	1.6

Notes  
 -: Volume exceeds capacity    \$: Delay exceeds 300s    +: Computation Not Defined    \*: All major volume in platoon

# HCM 6th Signalized Intersection Summary

## 5: Olympic Bl & Mateo St

03/17/2021



Movement	EBL	EBT	EBR	WBL	WBT	WBR	NBL	NBT	NBR	SBL	SBT	SBR
Lane Configurations												
Traffic Volume (veh/h)	74	416	4	5	1287	92	1	3	5	190	1	385
Future Volume (veh/h)	74	416	4	5	1287	92	1	3	5	190	1	385
Initial Q (Qb), veh	0	0	0	0	0	0	0	0	0	0	0	0
Ped-Bike Adj(A_pbT)	1.00		1.00	1.00		1.00	1.00		1.00	1.00		1.00
Parking Bus, Adj	1.00	1.00	1.00	1.00	1.00	1.00	1.00	1.00	1.00	1.00	1.00	1.00
Work Zone On Approach		No			No			No			No	
Adj Sat Flow, veh/h/ln	1870	1870	1870	1870	1870	1870	1870	1870	1870	1870	1870	1870
Adj Flow Rate, veh/h	80	452	4	5	1399	100	1	3	5	207	1	418
Peak Hour Factor	0.92	0.92	0.92	0.92	0.92	0.92	0.92	0.92	0.92	0.92	0.92	0.92
Percent Heavy Veh, %	2	2	2	2	2	2	2	2	2	2	2	2
Cap, veh/h	193	2186	19	594	2037	145	70	183	262	488	2	460
Arrive On Green	0.61	0.61	0.61	0.61	0.61	0.61	0.29	0.29	0.29	0.29	0.29	0.29
Sat Flow, veh/h	350	3610	32	935	3364	240	90	632	902	1407	7	1585
Grp Volume(v), veh/h	80	222	234	5	736	763	9	0	0	208	0	418
Grp Sat Flow(s),veh/h/ln	350	1777	1865	935	1777	1827	1624	0	0	1414	0	1585
Q Serve(g_s), s	18.0	5.1	5.1	0.2	25.1	25.4	0.0	0.0	0.0	10.6	0.0	22.9
Cycle Q Clear(g_c), s	43.5	5.1	5.1	5.3	25.1	25.4	0.3	0.0	0.0	11.0	0.0	22.9
Prop In Lane	1.00		0.02	1.00		0.13	0.11		0.56	1.00		1.00
Lane Grp Cap(c), veh/h	193	1076	1129	594	1076	1106	516	0	0	490	0	460
V/C Ratio(X)	0.41	0.21	0.21	0.01	0.68	0.69	0.02	0.00	0.00	0.42	0.00	0.91
Avail Cap(c_a), veh/h	193	1076	1129	594	1076	1106	516	0	0	490	0	460
HCM Platoon Ratio	1.00	1.00	1.00	1.00	1.00	1.00	1.00	1.00	1.00	1.00	1.00	1.00
Upstream Filter(I)	1.00	1.00	1.00	1.00	1.00	1.00	1.00	0.00	0.00	1.00	0.00	1.00
Uniform Delay (d), s/veh	26.7	8.0	8.0	9.2	12.0	12.0	22.8	0.0	0.0	26.5	0.0	30.8
Incr Delay (d2), s/veh	6.4	0.4	0.4	0.0	3.5	3.5	0.1	0.0	0.0	2.7	0.0	24.5
Initial Q Delay(d3),s/veh	0.0	0.0	0.0	0.0	0.0	0.0	0.0	0.0	0.0	0.0	0.0	0.0
%ile BackOfQ(95%),veh/ln	3.2	3.4	3.6	0.1	15.0	15.4	0.3	0.0	0.0	7.2	0.0	17.1
Unsig. Movement Delay, s/veh												
LnGrp Delay(d),s/veh	33.2	8.4	8.4	9.2	15.5	15.5	22.9	0.0	0.0	29.2	0.0	55.3
LnGrp LOS	C	A	A	A	B	B	C	A	A	C	A	E
Approach Vol, veh/h		536			1504			9				626
Approach Delay, s/veh		12.1			15.5			22.9				46.7
Approach LOS		B			B			C				D
Timer - Assigned Phs		2		4		6		8				
Phs Duration (G+Y+Rc), s		59.0		31.0		59.0		31.0				
Change Period (Y+Rc), s		* 4.5		4.9		* 4.5		4.9				
Max Green Setting (Gmax), s		* 55		26.1		* 55		26.1				
Max Q Clear Time (g_c+I1), s		27.4		24.9		45.5		2.3				
Green Ext Time (p_c), s		13.2		0.4		2.7		0.0				

### Intersection Summary

HCM 6th Ctrl Delay	22.1
HCM 6th LOS	C

### Notes

\* HCM 6th computational engine requires equal clearance times for the phases crossing the barrier.

# HCM 6th Signalized Intersection Summary

## 1: Alameda St & 7th St

03/17/2021



Movement	EBL	EBT	EBR	WBL	WBT	WBR	NBL	NBT	NBR	SBL	SBT	SBR
Lane Configurations	↖	↖↗		↖	↖↗		↖	↖↗		↖	↖↗	
Traffic Volume (veh/h)	107	826	123	86	459	132	119	831	126	115	780	47
Future Volume (veh/h)	107	826	123	86	459	132	119	831	126	115	780	47
Initial Q (Qb), veh	0	0	0	0	0	0	0	0	0	0	0	0
Ped-Bike Adj(A_pbT)	1.00		1.00	1.00		1.00	1.00		1.00	1.00		1.00
Parking Bus, Adj	1.00	1.00	1.00	1.00	1.00	1.00	1.00	1.00	1.00	1.00	1.00	1.00
Work Zone On Approach		No			No			No			No	
Adj Sat Flow, veh/h/ln	1870	1870	1870	1870	1870	1870	1870	1870	1870	1870	1870	1870
Adj Flow Rate, veh/h	116	898	134	93	499	143	129	903	137	125	848	51
Peak Hour Factor	0.92	0.92	0.92	0.92	0.92	0.92	0.92	0.92	0.92	0.92	0.92	0.92
Percent Heavy Veh, %	2	2	2	2	2	2	2	2	2	2	2	2
Cap, veh/h	251	1120	167	135	985	281	253	1076	163	284	1722	104
Arrive On Green	0.36	0.36	0.36	0.36	0.36	0.36	0.11	0.11	0.11	0.03	0.17	0.17
Sat Flow, veh/h	787	3101	463	547	2729	778	619	3093	469	1781	3406	205
Grp Volume(v), veh/h	116	514	518	93	324	318	129	519	521	125	442	457
Grp Sat Flow(s),veh/h/ln	787	1777	1787	547	1777	1730	619	1777	1786	1781	1777	1833
Q Serve(g_s), s	12.2	23.4	23.4	9.1	12.8	13.0	18.3	25.7	25.7	3.7	20.3	20.3
Cycle Q Clear(g_c), s	25.1	23.4	23.4	32.5	12.8	13.0	24.4	25.7	25.7	3.7	20.3	20.3
Prop In Lane	1.00		0.26	1.00		0.45	1.00		0.26	1.00		0.11
Lane Grp Cap(c), veh/h	251	642	645	135	642	625	253	618	621	284	898	927
V/C Ratio(X)	0.46	0.80	0.80	0.69	0.50	0.51	0.51	0.84	0.84	0.44	0.49	0.49
Avail Cap(c_a), veh/h	251	642	645	135	642	625	253	618	621	300	898	927
HCM Platoon Ratio	1.00	1.00	1.00	1.00	1.00	1.00	0.33	0.33	0.33	0.33	0.33	0.33
Upstream Filter(I)	0.82	0.82	0.82	1.00	1.00	1.00	0.97	0.97	0.97	0.78	0.78	0.78
Uniform Delay (d), s/veh	32.3	25.9	25.9	42.3	22.5	22.5	39.8	37.4	37.4	20.7	27.0	27.0
Incr Delay (d2), s/veh	5.0	8.5	8.5	25.1	2.8	2.9	6.9	12.6	12.5	0.8	1.5	1.5
Initial Q Delay(d3),s/veh	0.0	0.0	0.0	0.0	0.0	0.0	0.0	0.0	0.0	0.0	0.0	0.0
%ile BackOfQ(95%),veh/ln	4.7	15.9	16.0	5.4	9.6	9.5	6.3	20.4	20.5	2.8	14.5	14.9
Unsig. Movement Delay, s/veh												
LnGrp Delay(d),s/veh	37.3	34.4	34.3	67.4	25.3	25.5	46.7	49.9	49.9	21.5	28.5	28.5
LnGrp LOS	D	C	C	E	C	C	D	D	D	C	C	C
Approach Vol, veh/h		1148			735			1169			1024	
Approach Delay, s/veh		34.6			30.7			49.6			27.6	
Approach LOS		C			C			D			C	
Timer - Assigned Phs		2		4	5	6		8				
Phs Duration (G+Y+Rc), s		51.2		38.8	14.2	37.0		38.8				
Change Period (Y+Rc), s		* 5.7		* 6.3	5.6	* 5.7		* 6.3				
Max Green Setting (Gmax), s		* 44		* 32	9.4	* 31		* 31				
Max Q Clear Time (g_c+I1), s		22.3		34.5	5.7	27.7		27.1				
Green Ext Time (p_c), s		6.1		0.0	0.1	2.4		2.3				

### Intersection Summary

HCM 6th Ctrl Delay	36.5
HCM 6th LOS	D

### Notes

\* HCM 6th computational engine requires equal clearance times for the phases crossing the barrier.

# HCM 6th Signalized Intersection Summary

## 2: Alameda St & 8th St

03/17/2021



Movement	EBL	EBT	EBR	WBL	WBT	WBR	NBL	NBT	NBR	SBL	SBT	SBR
Lane Configurations		↕			↕		↙	↕		↙	↕	
Traffic Volume (veh/h)	50	23	34	27	25	27	15	687	23	19	1074	73
Future Volume (veh/h)	50	23	34	27	25	27	15	687	23	19	1074	73
Initial Q (Qb), veh	0	0	0	0	0	0	0	0	0	0	0	0
Ped-Bike Adj(A_pbT)	1.00		1.00	1.00		1.00	1.00		1.00	1.00		1.00
Parking Bus, Adj	1.00	1.00	1.00	1.00	1.00	1.00	1.00	1.00	1.00	1.00	1.00	1.00
Work Zone On Approach		No			No			No			No	
Adj Sat Flow, veh/h/ln	1870	1870	1870	1870	1870	1870	1870	1870	1870	1870	1870	1870
Adj Flow Rate, veh/h	54	25	37	29	27	29	16	747	25	21	1167	79
Peak Hour Factor	0.92	0.92	0.92	0.92	0.92	0.92	0.92	0.92	0.92	0.92	0.92	0.92
Percent Heavy Veh, %	2	2	2	2	2	2	2	2	2	2	2	2
Cap, veh/h	122	43	50	95	67	56	428	2738	92	583	2636	178
Arrive On Green	0.09	0.09	0.09	0.09	0.09	0.09	0.78	0.78	0.78	1.00	1.00	1.00
Sat Flow, veh/h	674	454	528	436	707	592	446	3509	117	698	3378	228
Grp Volume(v), veh/h	116	0	0	85	0	0	16	378	394	21	613	633
Grp Sat Flow(s),veh/h/ln	1655	0	0	1736	0	0	446	1777	1849	698	1777	1829
Q Serve(g_s), s	1.9	0.0	0.0	0.0	0.0	0.0	0.7	5.3	5.3	0.2	0.0	0.0
Cycle Q Clear(g_c), s	5.9	0.0	0.0	4.0	0.0	0.0	0.7	5.3	5.3	5.6	0.0	0.0
Prop In Lane	0.47		0.32	0.34		0.34	1.00		0.06	1.00		0.12
Lane Grp Cap(c), veh/h	214	0	0	217	0	0	428	1387	1443	583	1387	1427
V/C Ratio(X)	0.54	0.00	0.00	0.39	0.00	0.00	0.04	0.27	0.27	0.04	0.44	0.44
Avail Cap(c_a), veh/h	648	0	0	666	0	0	428	1387	1443	583	1387	1427
HCM Platoon Ratio	1.00	1.00	1.00	1.00	1.00	1.00	1.00	1.00	1.00	2.00	2.00	2.00
Upstream Filter(I)	1.00	0.00	0.00	1.00	0.00	0.00	1.00	1.00	1.00	0.81	0.81	0.81
Uniform Delay (d), s/veh	39.5	0.0	0.0	38.8	0.0	0.0	2.3	2.8	2.8	0.2	0.0	0.0
Incr Delay (d2), s/veh	2.1	0.0	0.0	1.1	0.0	0.0	0.2	0.5	0.5	0.1	0.8	0.8
Initial Q Delay(d3),s/veh	0.0	0.0	0.0	0.0	0.0	0.0	0.0	0.0	0.0	0.0	0.0	0.0
%ile BackOfQ(95%),veh/ln	4.6	0.0	0.0	3.3	0.0	0.0	0.1	2.6	2.7	0.0	0.6	0.6
Unsig. Movement Delay, s/veh												
LnGrp Delay(d),s/veh	41.6	0.0	0.0	39.9	0.0	0.0	2.4	3.2	3.2	0.3	0.8	0.8
LnGrp LOS	D	A	A	D	A	A	A	A	A	A	A	A
Approach Vol, veh/h		116			85			788			1267	
Approach Delay, s/veh		41.6			39.9			3.2			0.8	
Approach LOS		D			D			A			A	
Timer - Assigned Phs		2		4		6		8				
Phs Duration (G+Y+Rc), s		75.8		14.2		75.8		14.2				
Change Period (Y+Rc), s		5.6		5.7		5.6		5.7				
Max Green Setting (Gmax), s		44.4		34.3		44.4		34.3				
Max Q Clear Time (g_c+I1), s		7.3		7.9		7.6		6.0				
Green Ext Time (p_c), s		10.2		0.6		24.0		0.4				
<b>Intersection Summary</b>												
HCM 6th Ctrl Delay				5.2								
HCM 6th LOS				A								

# HCM 6th Signalized Intersection Summary

## 3: Alameda St & Olympic BI

03/17/2021



Movement	EBL	EBT	EBR	WBL	WBT	WBR	NBL	NBT	NBR	SBL	SBT	SBR
Lane Configurations	↖	↖↗		↖	↖↗		↖	↖↗		↖	↖↗	↖
Traffic Volume (veh/h)	89	1230	66	104	1187	45	87	602	165	132	796	191
Future Volume (veh/h)	89	1230	66	104	1187	45	87	602	165	132	796	191
Initial Q (Qb), veh	0	0	0	0	0	0	0	0	0	0	0	0
Ped-Bike Adj(A_pbT)	1.00		1.00	1.00		1.00	1.00		1.00	1.00		1.00
Parking Bus, Adj	1.00	1.00	1.00	1.00	1.00	1.00	1.00	1.00	1.00	1.00	1.00	1.00
Work Zone On Approach		No			No			No			No	
Adj Sat Flow, veh/h/ln	1870	1870	1870	1870	1870	1870	1870	1870	1870	1870	1870	1870
Adj Flow Rate, veh/h	97	1337	72	113	1290	49	95	654	179	143	865	0
Peak Hour Factor	0.92	0.92	0.92	0.92	0.92	0.92	0.92	0.92	0.92	0.92	0.92	0.92
Percent Heavy Veh, %	2	2	2	2	2	2	2	2	2	2	2	2
Cap, veh/h	90	1322	71	80	1346	51	293	1366	374	404	1761	
Arrive On Green	0.39	0.39	0.39	0.39	0.39	0.39	0.99	0.99	0.99	0.50	0.50	0.00
Sat Flow, veh/h	408	3430	184	382	3491	132	640	2757	754	659	3554	1585
Grp Volume(v), veh/h	97	691	718	113	656	683	95	421	412	143	865	0
Grp Sat Flow(s),veh/h/ln	408	1777	1837	382	1777	1847	640	1777	1735	659	1777	1585
Q Serve(g_s), s	2.2	34.7	34.7	0.0	32.4	32.5	6.3	0.4	0.4	12.7	14.6	0.0
Cycle Q Clear(g_c), s	34.7	34.7	34.7	34.7	32.4	32.5	20.9	0.4	0.4	13.0	14.6	0.0
Prop In Lane	1.00		0.10	1.00		0.07	1.00		0.43	1.00		1.00
Lane Grp Cap(c), veh/h	90	685	708	80	685	712	293	881	860	404	1761	
V/C Ratio(X)	1.08	1.01	1.01	1.41	0.96	0.96	0.32	0.48	0.48	0.35	0.49	
Avail Cap(c_a), veh/h	90	685	708	80	685	712	293	881	860	404	1761	
HCM Platoon Ratio	1.00	1.00	1.00	1.00	1.00	1.00	2.00	2.00	2.00	1.00	1.00	1.00
Upstream Filter(I)	1.00	1.00	1.00	1.00	1.00	1.00	0.78	0.78	0.78	1.00	1.00	0.00
Uniform Delay (d), s/veh	44.9	27.6	27.7	45.0	26.9	27.0	3.8	0.2	0.2	14.9	15.1	0.0
Incr Delay (d2), s/veh	116.8	36.7	37.1	244.2	24.3	24.1	2.3	1.5	1.5	2.4	1.0	0.0
Initial Q Delay(d3),s/veh	0.0	0.0	0.0	0.0	0.0	0.0	0.0	0.0	0.0	0.0	0.0	0.0
%ile BackOfQ(95%),veh/ln	8.9	28.6	29.6	12.9	24.5	25.3	1.0	0.8	0.8	3.7	9.7	0.0
Unsig. Movement Delay, s/veh												
LnGrp Delay(d),s/veh	161.7	64.4	64.7	289.2	51.3	51.1	6.0	1.7	1.7	17.3	16.1	0.0
LnGrp LOS	F	F	F	F	D	D	A	A	A	B	B	
Approach Vol, veh/h		1506			1452			928			1008	A
Approach Delay, s/veh		70.8			69.7			2.1			16.3	
Approach LOS		E			E			A			B	
Timer - Assigned Phs		2		4		6		8				
Phs Duration (G+Y+Rc), s		50.0		40.0		50.0		40.0				
Change Period (Y+Rc), s		* 5.4		* 5.3		* 5.4		* 5.3				
Max Green Setting (Gmax), s		* 45		* 35		* 45		* 35				
Max Q Clear Time (g_c+I1), s		16.6		36.7		22.9		36.7				
Green Ext Time (p_c), s		8.6		0.0		6.6		0.0				

### Intersection Summary

HCM 6th Ctrl Delay	46.2
HCM 6th LOS	D

### Notes

\* HCM 6th computational engine requires equal clearance times for the phases crossing the barrier.  
 Unsignalized Delay for [SBR] is excluded from calculations of the approach delay and intersection delay.

HCM 6th TWSC  
4: Olympic Bl & Lemon St

03/17/2021

Intersection												
Int Delay, s/veh	3.4											
Movement	EBL	EBT	EBR	WBL	WBT	WBR	NBL	NBT	NBR	SBL	SBT	SBR
Lane Configurations	↖	↗		↖	↗			↕			↕	
Traffic Vol, veh/h	13	1056	4	25	1158	8	2	0	13	27	0	197
Future Vol, veh/h	13	1056	4	25	1158	8	2	0	13	27	0	197
Conflicting Peds, #/hr	0	0	0	0	0	0	0	0	0	0	0	0
Sign Control	Free	Free	Free	Free	Free	Free	Stop	Stop	Stop	Stop	Stop	Stop
RT Channelized	-	-	None	-	-	None	-	-	None	-	-	None
Storage Length	124	-	-	80	-	-	-	-	-	-	-	-
Veh in Median Storage, #	-	0	-	-	0	-	-	0	-	-	0	-
Grade, %	-	0	-	-	0	-	-	0	-	-	0	-
Peak Hour Factor	92	92	92	92	92	92	92	92	92	92	92	92
Heavy Vehicles, %	2	2	2	2	2	2	2	2	2	2	2	2
Mvmt Flow	14	1148	4	27	1259	9	2	0	14	29	0	214

Major/Minor	Major1			Major2			Minor1			Minor2		
Conflicting Flow All	1268	0	0	1152	0	0	1862	2500	576	1920	2498	634
Stage 1	-	-	-	-	-	-	1178	1178	-	1318	1318	-
Stage 2	-	-	-	-	-	-	684	1322	-	602	1180	-
Critical Hdwy	4.14	-	-	4.14	-	-	7.54	6.54	6.94	7.54	6.54	6.94
Critical Hdwy Stg 1	-	-	-	-	-	-	6.54	5.54	-	6.54	5.54	-
Critical Hdwy Stg 2	-	-	-	-	-	-	6.54	5.54	-	6.54	5.54	-
Follow-up Hdwy	2.22	-	-	2.22	-	-	3.52	4.02	3.32	3.52	4.02	3.32
Pot Cap-1 Maneuver	*930	-	-	602	-	-	*110	28	460	93	28	*621
Stage 1	-	-	-	-	-	-	*203	263	-	536	480	-
Stage 2	-	-	-	-	-	-	*586	477	-	453	262	-
Platoon blocked, %	1	-	-	-	-	-	1	1	-	1	1	1
Mov Cap-1 Maneuver	*930	-	-	602	-	-	*69	26	460	86	26	*621
Mov Cap-2 Maneuver	-	-	-	-	-	-	*69	26	-	86	26	-
Stage 1	-	-	-	-	-	-	*200	259	-	528	459	-
Stage 2	-	-	-	-	-	-	*367	455	-	432	258	-

Approach	EB			WB			NB			SB		
HCM Control Delay, s	0.1			0.2			19.7			34.6		
HCM LOS							C			D		

Minor Lane/Major Mvmt	NBLn1	EBL	EBT	EBR	WBL	WBT	WBR	SBLn1
Capacity (veh/h)	262	* 930	-	-	602	-	-	355
HCM Lane V/C Ratio	0.062	0.015	-	-	0.045	-	-	0.686
HCM Control Delay (s)	19.7	8.9	-	-	11.3	-	-	34.6
HCM Lane LOS	C	A	-	-	B	-	-	D
HCM 95th %tile Q(veh)	0.2	0	-	-	0.1	-	-	4.9

Notes  
 -: Volume exceeds capacity    \$: Delay exceeds 300s    +: Computation Not Defined    \*: All major volume in platoon



# HCM 6th Signalized Intersection Summary

## 5: Olympic Bl & Mateo St

03/17/2021



Movement	EBL	EBT	EBR	WBL	WBT	WBR	NBL	NBT	NBR	SBL	SBT	SBR
Lane Configurations												
Traffic Volume (veh/h)	78	1008	5	6	722	90	1	0	4	309	1	451
Future Volume (veh/h)	78	1008	5	6	722	90	1	0	4	309	1	451
Initial Q (Qb), veh	0	0	0	0	0	0	0	0	0	0	0	0
Ped-Bike Adj(A_pbT)	1.00		1.00	1.00		1.00	1.00		1.00	1.00		1.00
Parking Bus, Adj	1.00	1.00	1.00	1.00	1.00	1.00	1.00	1.00	1.00	1.00	1.00	1.00
Work Zone On Approach		No			No			No			No	
Adj Sat Flow, veh/h/ln	1870	1870	1870	1870	1870	1870	1870	1870	1870	1870	1870	1870
Adj Flow Rate, veh/h	85	1096	5	7	785	98	1	0	4	336	1	490
Peak Hour Factor	0.92	0.92	0.92	0.92	0.92	0.92	0.92	0.92	0.92	0.92	0.92	0.92
Percent Heavy Veh, %	2	2	2	2	2	2	2	2	2	2	2	2
Cap, veh/h	259	1673	8	197	1466	183	48	29	115	258	1	689
Arrive On Green	0.46	0.46	0.46	0.46	0.46	0.46	0.43	0.00	0.43	0.43	0.43	0.43
Sat Flow, veh/h	629	3628	17	512	3179	397	0	66	264	410	1	1585
Grp Volume(v), veh/h	85	537	564	7	439	444	5	0	0	337	0	490
Grp Sat Flow(s),veh/h/ln	629	1777	1867	512	1777	1799	330	0	0	411	0	1585
Q Serve(g_s), s	10.1	21.0	21.0	1.0	15.9	15.9	0.0	0.0	0.0	0.0	0.0	22.8
Cycle Q Clear(g_c), s	26.0	21.0	21.0	22.0	15.9	15.9	39.1	0.0	0.0	39.1	0.0	22.8
Prop In Lane	1.00		0.01	1.00		0.22	0.20		0.80	1.00		1.00
Lane Grp Cap(c), veh/h	259	819	861	197	819	830	191	0	0	259	0	689
V/C Ratio(X)	0.33	0.66	0.66	0.04	0.54	0.54	0.03	0.00	0.00	1.30	0.00	0.71
Avail Cap(c_a), veh/h	259	819	861	197	819	830	191	0	0	259	0	689
HCM Platoon Ratio	1.00	1.00	1.00	1.00	1.00	1.00	1.00	1.00	1.00	1.00	1.00	1.00
Upstream Filter(I)	1.00	1.00	1.00	1.00	1.00	1.00	1.00	0.00	0.00	1.00	0.00	1.00
Uniform Delay (d), s/veh	26.6	18.7	18.7	27.2	17.4	17.4	19.8	0.0	0.0	31.5	0.0	20.8
Incr Delay (d2), s/veh	3.4	4.1	3.9	0.3	2.5	2.5	0.3	0.0	0.0	161.7	0.0	6.2
Initial Q Delay(d3),s/veh	0.0	0.0	0.0	0.0	0.0	0.0	0.0	0.0	0.0	0.0	0.0	0.0
%ile BackOfQ(95%),veh/ln	3.1	14.0	14.5	0.2	11.0	11.1	0.1	0.0	0.0	28.2	0.0	14.1
Unsig. Movement Delay, s/veh												
LnGrp Delay(d),s/veh	30.0	22.8	22.6	27.5	19.9	19.8	20.1	0.0	0.0	193.2	0.0	27.0
LnGrp LOS	C	C	C	C	B	B	C	A	A	F	A	C
Approach Vol, veh/h		1186			890			5				827
Approach Delay, s/veh		23.2			19.9			20.1				94.7
Approach LOS		C			B			C				F
Timer - Assigned Phs		2		4		6		8				
Phs Duration (G+Y+Rc), s		46.0		44.0		46.0		44.0				
Change Period (Y+Rc), s		* 4.5		4.9		* 4.5		4.9				
Max Green Setting (Gmax), s		* 42		39.1		* 42		39.1				
Max Q Clear Time (g_c+I1), s		24.0		41.1		28.0		41.1				
Green Ext Time (p_c), s		5.5		0.0		6.7		0.0				

### Intersection Summary

HCM 6th Ctrl Delay	42.5
HCM 6th LOS	D

### Notes

\* HCM 6th computational engine requires equal clearance times for the phases crossing the barrier.

# HCM 6th Signalized Intersection Summary

## 1: Alameda St & 7th St

03/22/2021



Movement	EBL	EBT	EBR	WBL	WBT	WBR	NBL	NBT	NBR	SBL	SBT	SBR
Lane Configurations	↖	↗		↖	↗		↖	↗		↖	↗	
Traffic Volume (veh/h)	63	337	111	146	722	107	129	693	111	139	982	182
Future Volume (veh/h)	63	337	111	146	722	107	129	693	111	139	982	182
Initial Q (Qb), veh	0	0	0	0	0	0	0	0	0	0	0	0
Ped-Bike Adj(A_pbT)	1.00		1.00	1.00		1.00	1.00		1.00	1.00		1.00
Parking Bus, Adj	1.00	1.00	1.00	1.00	1.00	1.00	1.00	1.00	1.00	1.00	1.00	1.00
Work Zone On Approach		No			No			No			No	
Adj Sat Flow, veh/h/ln	1870	1870	1870	1870	1870	1870	1870	1870	1870	1870	1870	1870
Adj Flow Rate, veh/h	68	366	121	159	785	116	140	753	121	151	1067	198
Peak Hour Factor	0.92	0.92	0.92	0.92	0.92	0.92	0.92	0.92	0.92	0.92	0.92	0.92
Percent Heavy Veh, %	2	2	2	2	2	2	2	2	2	2	2	2
Cap, veh/h	168	945	308	311	1115	165	232	1066	171	325	1520	281
Arrive On Green	0.36	0.36	0.36	0.36	0.36	0.36	0.11	0.11	0.11	0.20	1.00	1.00
Sat Flow, veh/h	618	2634	859	909	3106	459	438	3066	493	1781	2994	554
Grp Volume(v), veh/h	68	245	242	159	449	452	140	436	438	151	632	633
Grp Sat Flow(s),veh/h/ln	618	1777	1716	909	1777	1788	438	1777	1782	1781	1777	1771
Q Serve(g_s), s	9.5	9.2	9.5	14.2	19.5	19.5	28.5	21.3	21.3	4.4	0.0	0.0
Cycle Q Clear(g_c), s	29.1	9.2	9.5	23.7	19.5	19.5	28.5	21.3	21.3	4.4	0.0	0.0
Prop In Lane	1.00		0.50	1.00		0.26	1.00		0.28	1.00		0.31
Lane Grp Cap(c), veh/h	168	638	616	311	638	642	232	618	620	325	902	899
V/C Ratio(X)	0.41	0.38	0.39	0.51	0.70	0.70	0.60	0.71	0.71	0.47	0.70	0.70
Avail Cap(c_a), veh/h	168	638	616	311	638	642	232	618	620	337	902	899
HCM Platoon Ratio	1.00	1.00	1.00	1.00	1.00	1.00	0.33	0.33	0.33	2.00	2.00	2.00
Upstream Filter(I)	0.97	0.97	0.97	1.00	1.00	1.00	0.90	0.90	0.90	0.84	0.84	0.84
Uniform Delay (d), s/veh	37.2	21.5	21.5	30.4	24.7	24.7	38.6	35.4	35.4	15.8	0.0	0.0
Incr Delay (d2), s/veh	6.9	1.7	1.8	5.9	6.4	6.4	10.0	6.0	6.0	0.9	3.8	3.9
Initial Q Delay(d3),s/veh	0.0	0.0	0.0	0.0	0.0	0.0	0.0	0.0	0.0	0.0	0.0	0.0
%ile BackOfQ(95%),veh/ln	3.1	7.3	7.2	6.4	13.9	14.0	7.1	16.3	16.3	2.9	1.7	1.7
Unsig. Movement Delay, s/veh												
LnGrp Delay(d),s/veh	44.1	23.2	23.3	36.3	31.2	31.1	48.6	41.4	41.4	16.7	3.8	3.9
LnGrp LOS	D	C	C	D	C	C	D	D	D	B	A	A
Approach Vol, veh/h		555			1060			1014			1416	
Approach Delay, s/veh		25.8			31.9			42.4			5.2	
Approach LOS		C			C			D			A	
Timer - Assigned Phs		2		4	5	6		8				
Phs Duration (G+Y+Rc), s		51.4		38.6	14.4	37.0		38.6				
Change Period (Y+Rc), s		* 5.7		* 6.3	5.6	* 5.7		* 6.3				
Max Green Setting (Gmax), s		* 44		* 32	9.4	* 31		* 31				
Max Q Clear Time (g_c+I1), s		2.0		25.7	6.4	30.5		31.1				
Green Ext Time (p_c), s		12.0		3.2	0.1	0.6		0.0				

### Intersection Summary

HCM 6th Ctrl Delay	24.4
HCM 6th LOS	C

### Notes

\* HCM 6th computational engine requires equal clearance times for the phases crossing the barrier.

# HCM 6th Signalized Intersection Summary

## 2: Alameda St & 8th St

03/22/2021



Movement	EBL	EBT	EBR	WBL	WBT	WBR	NBL	NBT	NBR	SBL	SBT	SBR
Lane Configurations		↕			↕		↙	↕		↙	↕	
Traffic Volume (veh/h)	101	54	45	59	86	66	36	824	97	85	807	118
Future Volume (veh/h)	101	54	45	59	86	66	36	824	97	85	807	118
Initial Q (Qb), veh	0	0	0	0	0	0	0	0	0	0	0	0
Ped-Bike Adj(A_pbT)	1.00		1.00	1.00		1.00	1.00		1.00	1.00		1.00
Parking Bus, Adj	1.00	1.00	1.00	1.00	1.00	1.00	1.00	1.00	1.00	1.00	1.00	1.00
Work Zone On Approach		No			No			No			No	
Adj Sat Flow, veh/h/ln	1870	1870	1870	1870	1870	1870	1870	1870	1870	1870	1870	1870
Adj Flow Rate, veh/h	110	59	49	64	93	72	39	896	105	92	877	128
Peak Hour Factor	0.92	0.92	0.92	0.92	0.92	0.92	0.92	0.92	0.92	0.92	0.92	0.92
Percent Heavy Veh, %	2	2	2	2	2	2	2	2	2	2	2	2
Cap, veh/h	176	86	59	120	149	100	459	2163	254	434	2101	307
Arrive On Green	0.20	0.20	0.20	0.20	0.20	0.20	0.90	0.90	0.90	1.00	1.00	1.00
Sat Flow, veh/h	584	432	294	346	749	502	561	3204	375	563	3111	454
Grp Volume(v), veh/h	218	0	0	229	0	0	39	497	504	92	501	504
Grp Sat Flow(s),veh/h/ln	1310	0	0	1597	0	0	561	1777	1803	563	1777	1789
Q Serve(g_s), s	2.8	0.0	0.0	0.0	0.0	0.0	0.7	4.1	4.1	1.3	0.0	0.0
Cycle Q Clear(g_c), s	14.7	0.0	0.0	11.9	0.0	0.0	0.7	4.1	4.1	5.4	0.0	0.0
Prop In Lane	0.50		0.22	0.28		0.31	1.00		0.21	1.00		0.25
Lane Grp Cap(c), veh/h	321	0	0	369	0	0	459	1200	1217	434	1200	1208
V/C Ratio(X)	0.68	0.00	0.00	0.62	0.00	0.00	0.09	0.41	0.41	0.21	0.42	0.42
Avail Cap(c_a), veh/h	581	0	0	657	0	0	459	1200	1217	434	1200	1208
HCM Platoon Ratio	1.00	1.00	1.00	1.00	1.00	1.00	1.33	1.33	1.33	2.00	2.00	2.00
Upstream Filter(I)	1.00	0.00	0.00	1.00	0.00	0.00	1.00	1.00	1.00	0.66	0.66	0.66
Uniform Delay (d), s/veh	34.7	0.0	0.0	33.5	0.0	0.0	1.5	1.7	1.7	0.2	0.0	0.0
Incr Delay (d2), s/veh	2.5	0.0	0.0	1.7	0.0	0.0	0.4	1.1	1.0	0.7	0.7	0.7
Initial Q Delay(d3),s/veh	0.0	0.0	0.0	0.0	0.0	0.0	0.0	0.0	0.0	0.0	0.0	0.0
%ile BackOfQ(95%),veh/ln	8.3	0.0	0.0	8.3	0.0	0.0	0.2	2.2	2.3	0.2	0.4	0.4
Unsig. Movement Delay, s/veh												
LnGrp Delay(d),s/veh	37.2	0.0	0.0	35.2	0.0	0.0	1.9	2.8	2.7	0.9	0.7	0.7
LnGrp LOS	D	A	A	D	A	A	A	A	A	A	A	A
Approach Vol, veh/h		218			229			1040			1097	
Approach Delay, s/veh		37.2			35.2			2.7			0.7	
Approach LOS		D			D			A			A	
Timer - Assigned Phs		2		4		6		8				
Phs Duration (G+Y+Rc), s		66.4		23.6		66.4		23.6				
Change Period (Y+Rc), s		5.6		5.7		5.6		5.7				
Max Green Setting (Gmax), s		44.4		34.3		44.4		34.3				
Max Q Clear Time (g_c+I1), s		6.1		16.7		7.4		13.9				
Green Ext Time (p_c), s		15.0		1.2		20.7		1.3				
<b>Intersection Summary</b>												
HCM 6th Ctrl Delay				7.7								
HCM 6th LOS				A								

# HCM 6th Signalized Intersection Summary

## 3: Alameda St & Olympic BI

03/22/2021



Movement	EBL	EBT	EBR	WBL	WBT	WBR	NBL	NBT	NBR	SBL	SBT	SBR
Lane Configurations	↖	↗		↖	↗		↖	↗		↖	↗	↖
Traffic Volume (veh/h)	98	820	68	171	1408	51	114	856	60	101	616	162
Future Volume (veh/h)	98	820	68	171	1408	51	114	856	60	101	616	162
Initial Q (Qb), veh	0	0	0	0	0	0	0	0	0	0	0	0
Ped-Bike Adj(A_pbT)	1.00		1.00	1.00		1.00	1.00		1.00	1.00		1.00
Parking Bus, Adj	1.00	1.00	1.00	1.00	1.00	1.00	1.00	1.00	1.00	1.00	1.00	1.00
Work Zone On Approach		No		No		No		No		No		No
Adj Sat Flow, veh/h/ln	1870	1870	1870	1870	1870	1870	1870	1870	1870	1870	1870	1870
Adj Flow Rate, veh/h	107	891	74	186	1530	55	124	930	65	110	670	0
Peak Hour Factor	0.92	0.92	0.92	0.92	0.92	0.92	0.92	0.92	0.92	0.92	0.92	0.92
Percent Heavy Veh, %	2	2	2	2	2	2	2	2	2	2	2	2
Cap, veh/h	80	1281	106	173	1349	48	458	1670	117	217	1761	
Arrive On Green	0.39	0.39	0.39	0.39	0.39	0.39	0.16	0.16	0.16	0.99	0.99	0.00
Sat Flow, veh/h	322	3322	276	582	3499	125	767	3369	235	566	3554	1585
Grp Volume(v), veh/h	107	477	488	186	775	810	124	490	505	110	670	0
Grp Sat Flow(s),veh/h/ln	322	1777	1821	582	1777	1848	767	1777	1828	566	1777	1585
Q Serve(g_s), s	0.0	20.3	20.3	14.4	34.7	34.7	12.9	22.9	22.9	14.8	0.2	0.0
Cycle Q Clear(g_c), s	34.7	20.3	20.3	34.7	34.7	34.7	13.1	22.9	22.9	37.7	0.2	0.0
Prop In Lane	1.00		0.15	1.00		0.07	1.00		0.13	1.00		1.00
Lane Grp Cap(c), veh/h	80	685	702	173	685	712	458	881	906	217	1761	
V/C Ratio(X)	1.34	0.70	0.70	1.07	1.13	1.14	0.27	0.56	0.56	0.51	0.38	
Avail Cap(c_a), veh/h	80	685	702	173	685	712	458	881	906	217	1761	
HCM Platoon Ratio	1.00	1.00	1.00	1.00	1.00	1.00	0.33	0.33	0.33	2.00	2.00	2.00
Upstream Filter(I)	1.00	1.00	1.00	1.00	1.00	1.00	0.77	0.77	0.77	1.00	1.00	0.00
Uniform Delay (d), s/veh	45.0	23.2	23.2	41.1	27.6	27.7	24.6	28.5	28.5	10.0	0.2	0.0
Incr Delay (d2), s/veh	214.9	3.1	3.0	89.1	76.6	78.1	1.1	2.0	1.9	8.3	0.6	0.0
Initial Q Delay(d3),s/veh	0.0	0.0	0.0	0.0	0.0	0.0	0.0	0.0	0.0	0.0	0.0	0.0
%ile BackOfQ(95%),veh/ln	11.8	13.5	13.8	13.3	40.5	42.4	5.0	16.1	16.5	3.2	0.4	0.0
Unsig. Movement Delay, s/veh												
LnGrp Delay(d),s/veh	259.9	26.3	26.2	130.2	104.2	105.8	25.7	30.5	30.5	18.3	0.8	0.0
LnGrp LOS	F	C	C	F	F	F	C	C	C	B	A	
Approach Vol, veh/h		1072			1771			1119			780	A
Approach Delay, s/veh		49.6			107.7			30.0			3.3	
Approach LOS		D			F			C			A	
Timer - Assigned Phs		2		4		6		8				
Phs Duration (G+Y+Rc), s		50.0		40.0		50.0		40.0				
Change Period (Y+Rc), s		* 5.4		* 5.3		* 5.4		* 5.3				
Max Green Setting (Gmax), s		* 45		* 35		* 45		* 35				
Max Q Clear Time (g_c+I1), s		39.7		36.7		24.9		36.7				
Green Ext Time (p_c), s		2.4		0.0		7.6		0.0				

### Intersection Summary

HCM 6th Ctrl Delay	59.0
HCM 6th LOS	E

### Notes

\* HCM 6th computational engine requires equal clearance times for the phases crossing the barrier.  
 Unsignalized Delay for [SBR] is excluded from calculations of the approach delay and intersection delay.

HCM 6th TWSC  
4: Olympic Bl & Lemon St

03/22/2021

Intersection												
Int Delay, s/veh	2.1											
Movement	EBL	EBT	EBR	WBL	WBT	WBR	NBL	NBT	NBR	SBL	SBT	SBR
Lane Configurations	↖	↗		↖	↗			↕			↕	
Traffic Vol, veh/h	15	467	5	37	1616	69	3	1	4	20	2	95
Future Vol, veh/h	15	467	5	37	1616	69	3	1	4	20	2	95
Conflicting Peds, #/hr	0	0	0	0	0	0	0	0	0	0	0	0
Sign Control	Free	Free	Free	Free	Free	Free	Stop	Stop	Stop	Stop	Stop	Stop
RT Channelized	-	-	None	-	-	None	-	-	None	-	-	None
Storage Length	124	-	-	80	-	-	-	-	-	-	-	-
Veh in Median Storage, #	-	0	-	-	0	-	-	0	-	-	0	-
Grade, %	-	0	-	-	0	-	-	0	-	-	0	-
Peak Hour Factor	92	92	92	92	92	92	92	92	92	92	92	92
Heavy Vehicles, %	2	2	2	2	2	2	2	2	2	2	2	2
Mvmt Flow	16	508	5	40	1757	75	3	1	4	22	2	103

Major/Minor	Major1			Major2			Minor1			Minor2		
Conflicting Flow All	1832	0	0	513	0	0	1503	2455	257	2162	2420	916
Stage 1	-	-	-	-	-	-	543	543	-	1875	1875	-
Stage 2	-	-	-	-	-	-	960	1912	-	287	545	-
Critical Hdwy	4.14	-	-	4.14	-	-	7.54	6.54	6.94	7.54	6.54	6.94
Critical Hdwy Stg 1	-	-	-	-	-	-	6.54	5.54	-	6.54	5.54	-
Critical Hdwy Stg 2	-	-	-	-	-	-	6.54	5.54	-	6.54	5.54	-
Follow-up Hdwy	2.22	-	-	2.22	-	-	3.52	4.02	3.32	3.52	4.02	3.32
Pot Cap-1 Maneuver	*618	-	-	1049	-	-	*389	42	742	105	48	*413
Stage 1	-	-	-	-	-	-	*492	518	-	365	325	-
Stage 2	-	-	-	-	-	-	*389	296	-	696	517	-
Platoon blocked, %	1	-	-	-	-	-	1	1	-	1	1	1
Mov Cap-1 Maneuver	*618	-	-	1049	-	-	*268	39	742	97	45	*413
Mov Cap-2 Maneuver	-	-	-	-	-	-	*268	39	-	97	45	-
Stage 1	-	-	-	-	-	-	*479	505	-	355	313	-
Stage 2	-	-	-	-	-	-	*279	284	-	673	504	-

Approach	EB			WB			NB			SB		
HCM Control Delay, s	0.3			0.2			25			35		
HCM LOS							D			E		

Minor Lane/Major Mvmt	NBLn1	EBL	EBT	EBR	WBL	WBT	WBR	SBLn1
Capacity (veh/h)	189	* 618	-	-	1049	-	-	243
HCM Lane V/C Ratio	0.046	0.026	-	-	0.038	-	-	0.523
HCM Control Delay (s)	25	11	-	-	8.6	-	-	35
HCM Lane LOS	D	B	-	-	A	-	-	E
HCM 95th %tile Q(veh)	0.1	0.1	-	-	0.1	-	-	2.8

Notes  
 -: Volume exceeds capacity    \$: Delay exceeds 300s    +: Computation Not Defined    \*: All major volume in platoon

# HCM 6th Signalized Intersection Summary

## 5: Olympic Bl & Mateo St

03/22/2021



Movement	EBL	EBT	EBR	WBL	WBT	WBR	NBL	NBT	NBR	SBL	SBT	SBR
Lane Configurations	↶	↷		↶	↷			↷			↷	↷
Traffic Volume (veh/h)	77	426	4	5	1313	92	1	3	5	190	1	411
Future Volume (veh/h)	77	426	4	5	1313	92	1	3	5	190	1	411
Initial Q (Qb), veh	0	0	0	0	0	0	0	0	0	0	0	0
Ped-Bike Adj(A_pbT)	1.00		1.00	1.00		1.00	1.00		1.00	1.00		1.00
Parking Bus, Adj	1.00	1.00	1.00	1.00	1.00	1.00	1.00	1.00	1.00	1.00	1.00	1.00
Work Zone On Approach		No			No			No			No	
Adj Sat Flow, veh/h/ln	1870	1870	1870	1870	1870	1870	1870	1870	1870	1870	1870	1870
Adj Flow Rate, veh/h	84	463	4	5	1427	100	1	3	5	207	1	447
Peak Hour Factor	0.92	0.92	0.92	0.92	0.92	0.92	0.92	0.92	0.92	0.92	0.92	0.92
Percent Heavy Veh, %	2	2	2	2	2	2	2	2	2	2	2	2
Cap, veh/h	187	2186	19	587	2041	142	70	183	261	488	2	460
Arrive On Green	0.61	0.61	0.61	0.61	0.61	0.61	0.29	0.29	0.29	0.29	0.29	0.29
Sat Flow, veh/h	341	3610	31	926	3370	235	89	631	900	1407	7	1585
Grp Volume(v), veh/h	84	228	239	5	750	777	9	0	0	208	0	447
Grp Sat Flow(s),veh/h/ln	341	1777	1865	926	1777	1828	1620	0	0	1414	0	1585
Q Serve(g_s), s	20.2	5.2	5.2	0.2	25.9	26.3	0.0	0.0	0.0	10.6	0.0	25.1
Cycle Q Clear(g_c), s	46.4	5.2	5.2	5.4	25.9	26.3	0.3	0.0	0.0	11.0	0.0	25.1
Prop In Lane	1.00		0.02	1.00		0.13	0.11		0.56	1.00		1.00
Lane Grp Cap(c), veh/h	187	1076	1129	587	1076	1107	514	0	0	490	0	460
V/C Ratio(X)	0.45	0.21	0.21	0.01	0.70	0.70	0.02	0.00	0.00	0.42	0.00	0.97
Avail Cap(c_a), veh/h	187	1076	1129	587	1076	1107	514	0	0	490	0	460
HCM Platoon Ratio	1.00	1.00	1.00	1.00	1.00	1.00	1.00	1.00	1.00	1.00	1.00	1.00
Upstream Filter(I)	1.00	1.00	1.00	1.00	1.00	1.00	1.00	0.00	0.00	1.00	0.00	1.00
Uniform Delay (d), s/veh	28.1	8.0	8.0	9.3	12.1	12.2	22.8	0.0	0.0	26.5	0.0	31.6
Incr Delay (d2), s/veh	7.6	0.4	0.4	0.0	3.7	3.7	0.1	0.0	0.0	2.7	0.0	35.7
Initial Q Delay(d3),s/veh	0.0	0.0	0.0	0.0	0.0	0.0	0.0	0.0	0.0	0.0	0.0	0.0
%ile BackOfQ(95%),veh/ln	3.6	3.5	3.7	0.1	15.4	15.9	0.3	0.0	0.0	7.2	0.0	19.9
Unsig. Movement Delay, s/veh												
LnGrp Delay(d),s/veh	35.7	8.5	8.5	9.3	15.9	15.9	22.9	0.0	0.0	29.2	0.0	67.3
LnGrp LOS	D	A	A	A	B	B	C	A	A	C	A	E
Approach Vol, veh/h		551			1532			9				655
Approach Delay, s/veh		12.6			15.9			22.9				55.2
Approach LOS		B			B			C				E
Timer - Assigned Phs		2		4		6		8				
Phs Duration (G+Y+Rc), s		59.0		31.0		59.0		31.0				
Change Period (Y+Rc), s		* 4.5		4.9		* 4.5		4.9				
Max Green Setting (Gmax), s		* 55		26.1		* 55		26.1				
Max Q Clear Time (g_c+I1), s		28.3		27.1		48.4		2.3				
Green Ext Time (p_c), s		13.3		0.0		2.1		0.0				

### Intersection Summary

HCM 6th Ctrl Delay	24.6
HCM 6th LOS	C

### Notes

\* HCM 6th computational engine requires equal clearance times for the phases crossing the barrier.

HCM 6th TWSC  
87: Project Dwy & 8th St

03/22/2021

Intersection												
Int Delay, s/veh	2.4											
Movement	EBL	EBT	EBR	WBL	WBT	WBR	NBL	NBT	NBR	SBL	SBT	SBR
Lane Configurations		↕			↕		↕	↕			↕	
Traffic Vol, veh/h	0	96	231	125	192	0	26	0	18	0	0	0
Future Vol, veh/h	0	96	231	125	192	0	26	0	18	0	0	0
Conflicting Peds, #/hr	0	0	0	0	0	0	0	0	0	0	0	0
Sign Control	Free	Free	Free	Free	Free	Free	Stop	Stop	Stop	Stop	Stop	Stop
RT Channelized	-	-	None	-	-	None	-	-	None	-	-	None
Storage Length	-	-	-	-	-	-	0	-	-	-	-	-
Veh in Median Storage, #	-	0	-	-	0	-	-	0	-	-	0	-
Grade, %	-	0	-	-	0	-	-	0	-	-	0	-
Peak Hour Factor	92	92	92	92	92	92	92	92	92	92	92	92
Heavy Vehicles, %	2	2	2	2	2	2	2	2	2	2	2	2
Mvmt Flow	0	104	251	136	209	0	28	0	20	0	0	0

Major/Minor	Major1			Major2			Minor1			Minor2		
Conflicting Flow All	209	0	0	355	0	0	711	711	230	721	836	209
Stage 1	-	-	-	-	-	-	230	230	-	481	481	-
Stage 2	-	-	-	-	-	-	481	481	-	240	355	-
Critical Hdwy	4.12	-	-	4.12	-	-	7.12	6.52	6.22	7.12	6.52	6.22
Critical Hdwy Stg 1	-	-	-	-	-	-	6.12	5.52	-	6.12	5.52	-
Critical Hdwy Stg 2	-	-	-	-	-	-	6.12	5.52	-	6.12	5.52	-
Follow-up Hdwy	2.218	-	-	2.218	-	-	3.518	4.018	3.318	3.518	4.018	3.318
Pot Cap-1 Maneuver	1362	-	-	1204	-	-	348	358	809	343	303	831
Stage 1	-	-	-	-	-	-	773	714	-	566	554	-
Stage 2	-	-	-	-	-	-	566	554	-	763	630	-
Platoon blocked, %	-	-	-	-	-	-	-	-	-	-	-	-
Mov Cap-1 Maneuver	1362	-	-	1204	-	-	314	312	809	302	264	831
Mov Cap-2 Maneuver	-	-	-	-	-	-	314	312	-	302	264	-
Stage 1	-	-	-	-	-	-	773	714	-	566	483	-
Stage 2	-	-	-	-	-	-	494	483	-	745	630	-

Approach	EB	WB	NB	SB
HCM Control Delay, s	0	3.3	14.3	0
HCM LOS			B	A

Minor Lane/Major Mvmt	NBLn1	NBLn2	EBL	EBT	EBR	WBL	WBT	WBR	SBLn1
Capacity (veh/h)	314	809	1362	-	-	1204	-	-	-
HCM Lane V/C Ratio	0.09	0.024	-	-	-	0.113	-	-	-
HCM Control Delay (s)	17.6	9.6	0	-	-	8.4	0	-	0
HCM Lane LOS	C	A	A	-	-	A	A	-	A
HCM 95th %tile Q(veh)	0.3	0.1	0	-	-	0.4	-	-	-

Intersection						
Int Delay, s/veh	8.3					
Movement	EBL	EBT	WBT	WBR	SBL	SBR
Lane Configurations		↑	↑		↓	
Traffic Vol, veh/h	0	0	0	0	12	29
Future Vol, veh/h	0	0	0	0	12	29
Conflicting Peds, #/hr	0	0	0	0	0	0
Sign Control	Free	Free	Free	Free	Stop	Stop
RT Channelized	-	None	-	None	-	None
Storage Length	-	-	-	-	0	-
Veh in Median Storage, #	-	0	0	-	0	-
Grade, %	-	0	0	-	0	-
Peak Hour Factor	92	92	92	92	92	92
Heavy Vehicles, %	2	2	2	2	2	2
Mvmt Flow	0	0	0	0	13	32

Major/Minor	Major1	Major2	Minor2		
Conflicting Flow All	-	0	-	0	1 1
Stage 1	-	-	-	-	1 -
Stage 2	-	-	-	-	0 -
Critical Hdwy	-	-	-	-	6.42 6.22
Critical Hdwy Stg 1	-	-	-	-	5.42 -
Critical Hdwy Stg 2	-	-	-	-	5.42 -
Follow-up Hdwy	-	-	-	-	3.518 3.318
Pot Cap-1 Maneuver	0	-	-	0	1022 1084
Stage 1	0	-	-	0	1022 -
Stage 2	0	-	-	0	- -
Platoon blocked, %	-	-	-	-	- -
Mov Cap-1 Maneuver	-	-	-	-	1022 1084
Mov Cap-2 Maneuver	-	-	-	-	1022 -
Stage 1	-	-	-	-	1022 -
Stage 2	-	-	-	-	- -

Approach	EB	WB	SB
HCM Control Delay, s	0	0	8.5
HCM LOS			A

Minor Lane/Major Mvmt	EBT	WBT	SBLn1
Capacity (veh/h)	-	-	1065
HCM Lane V/C Ratio	-	-	0.042
HCM Control Delay (s)	-	-	8.5
HCM Lane LOS	-	-	A
HCM 95th %tile Q(veh)	-	-	0.1



HCM 6th TWSC  
89: Garage Driveway & 8th St

03/22/2021

Intersection						
Int Delay, s/veh	0.8					
Movement	EBT	EBR	WBL	WBT	NBL	NBR
Lane Configurations	↑			↑	↑	
Traffic Vol, veh/h	114	0	0	298	19	15
Future Vol, veh/h	114	0	0	298	19	15
Conflicting Peds, #/hr	0	0	0	0	0	0
Sign Control	Free	Free	Free	Free	Stop	Stop
RT Channelized	-	None	-	None	-	None
Storage Length	-	-	-	-	0	-
Veh in Median Storage, #	0	-	-	0	0	-
Grade, %	0	-	-	0	0	-
Peak Hour Factor	92	92	92	92	92	92
Heavy Vehicles, %	2	2	2	2	2	2
Mvmt Flow	124	0	0	324	21	16

Major/Minor	Major1	Major2	Minor1		
Conflicting Flow All	0	-	-	-	448 124
Stage 1	-	-	-	-	124 -
Stage 2	-	-	-	-	324 -
Critical Hdwy	-	-	-	-	6.42 6.22
Critical Hdwy Stg 1	-	-	-	-	5.42 -
Critical Hdwy Stg 2	-	-	-	-	5.42 -
Follow-up Hdwy	-	-	-	-	3.518 3.318
Pot Cap-1 Maneuver	-	0	0	-	568 927
Stage 1	-	0	0	-	902 -
Stage 2	-	0	0	-	733 -
Platoon blocked, %	-	-	-	-	-
Mov Cap-1 Maneuver	-	-	-	-	568 927
Mov Cap-2 Maneuver	-	-	-	-	568 -
Stage 1	-	-	-	-	902 -
Stage 2	-	-	-	-	733 -

Approach	EB	WB	NB
HCM Control Delay, s	0	0	10.6
HCM LOS			B

Minor Lane/Major Mvmt	NBLn1	EBT	WBT
Capacity (veh/h)	685	-	-
HCM Lane V/C Ratio	0.054	-	-
HCM Control Delay (s)	10.6	-	-
HCM Lane LOS	B	-	-
HCM 95th %tile Q(veh)	0.2	-	-

# HCM 6th Signalized Intersection Summary

## 1: Alameda St & 7th St

03/22/2021



Movement	EBL	EBT	EBR	WBL	WBT	WBR	NBL	NBT	NBR	SBL	SBT	SBR
Lane Configurations	↖	↖↗		↖	↖↗		↖	↖↗		↖	↖↗	
Traffic Volume (veh/h)	107	826	138	98	459	132	145	869	152	115	802	47
Future Volume (veh/h)	107	826	138	98	459	132	145	869	152	115	802	47
Initial Q (Qb), veh	0	0	0	0	0	0	0	0	0	0	0	0
Ped-Bike Adj(A_pbT)	1.00		1.00	1.00		1.00	1.00		1.00	1.00		1.00
Parking Bus, Adj	1.00	1.00	1.00	1.00	1.00	1.00	1.00	1.00	1.00	1.00	1.00	1.00
Work Zone On Approach		No			No			No			No	
Adj Sat Flow, veh/h/ln	1870	1870	1870	1870	1870	1870	1870	1870	1870	1870	1870	1870
Adj Flow Rate, veh/h	116	898	150	107	499	143	158	945	165	125	872	51
Peak Hour Factor	0.92	0.92	0.92	0.92	0.92	0.92	0.92	0.92	0.92	0.92	0.92	0.92
Percent Heavy Veh, %	2	2	2	2	2	2	2	2	2	2	2	2
Cap, veh/h	251	1100	184	131	985	281	245	1052	184	270	1725	101
Arrive On Green	0.36	0.36	0.36	0.36	0.36	0.36	0.11	0.11	0.11	0.03	0.17	0.17
Sat Flow, veh/h	787	3047	509	538	2729	778	606	3024	528	1781	3412	200
Grp Volume(v), veh/h	116	524	524	107	324	318	158	555	555	125	454	469
Grp Sat Flow(s),veh/h/ln	787	1777	1779	538	1777	1730	606	1777	1775	1781	1777	1834
Q Serve(g_s), s	12.2	24.0	24.0	8.5	12.8	13.0	23.4	27.7	27.8	3.7	20.9	20.9
Cycle Q Clear(g_c), s	25.1	24.0	24.0	32.5	12.8	13.0	30.1	27.7	27.8	3.7	20.9	20.9
Prop In Lane	1.00		0.29	1.00		0.45	1.00		0.30	1.00		0.11
Lane Grp Cap(c), veh/h	251	642	642	131	642	625	245	618	617	270	898	928
V/C Ratio(X)	0.46	0.82	0.82	0.82	0.50	0.51	0.64	0.90	0.90	0.46	0.51	0.51
Avail Cap(c_a), veh/h	251	642	642	131	642	625	245	618	617	286	898	928
HCM Platoon Ratio	1.00	1.00	1.00	1.00	1.00	1.00	0.33	0.33	0.33	0.33	0.33	0.33
Upstream Filter(I)	0.82	0.82	0.82	1.00	1.00	1.00	0.95	0.95	0.95	0.78	0.78	0.78
Uniform Delay (d), s/veh	32.3	26.0	26.1	43.0	22.5	22.5	42.7	38.3	38.3	21.1	27.3	27.3
Incr Delay (d2), s/veh	5.0	9.2	9.2	41.4	2.8	2.9	11.7	17.6	17.7	1.0	1.6	1.5
Initial Q Delay(d3),s/veh	0.0	0.0	0.0	0.0	0.0	0.0	0.0	0.0	0.0	0.0	0.0	0.0
%ile BackOfQ(95%),veh/ln	4.7	16.4	16.4	7.0	9.6	9.5	8.0	22.5	22.6	2.8	14.9	15.3
Unsig. Movement Delay, s/veh												
LnGrp Delay(d),s/veh	37.3	35.2	35.2	84.4	25.3	25.5	54.4	55.9	56.0	22.1	28.8	28.8
LnGrp LOS	D	D	D	F	C	C	D	E	E	C	C	C
Approach Vol, veh/h		1164			749			1268			1048	
Approach Delay, s/veh		35.5			33.8			55.7			28.0	
Approach LOS		D			C			E			C	
Timer - Assigned Phs		2		4	5	6		8				
Phs Duration (G+Y+Rc), s		51.2		38.8	14.2	37.0		38.8				
Change Period (Y+Rc), s		* 5.7		* 6.3	5.6	* 5.7		* 6.3				
Max Green Setting (Gmax), s		* 44		* 32	9.4	* 31		* 31				
Max Q Clear Time (g_c+I1), s		22.9		34.5	5.7	32.1		27.1				
Green Ext Time (p_c), s		6.2		0.0	0.1	0.0		2.3				

### Intersection Summary

HCM 6th Ctrl Delay	39.4
HCM 6th LOS	D

### Notes

\* HCM 6th computational engine requires equal clearance times for the phases crossing the barrier.

# HCM 6th Signalized Intersection Summary

## 2: Alameda St & 8th St

03/22/2021



Movement	EBL	EBT	EBR	WBL	WBT	WBR	NBL	NBT	NBR	SBL	SBT	SBR
Lane Configurations		↕			↕		↙	↕		↙	↕	
Traffic Volume (veh/h)	50	23	34	70	25	81	15	723	70	68	1074	73
Future Volume (veh/h)	50	23	34	70	25	81	15	723	70	68	1074	73
Initial Q (Qb), veh	0	0	0	0	0	0	0	0	0	0	0	0
Ped-Bike Adj(A_pbT)	1.00		1.00	1.00		1.00	1.00		1.00	1.00		1.00
Parking Bus, Adj	1.00	1.00	1.00	1.00	1.00	1.00	1.00	1.00	1.00	1.00	1.00	1.00
Work Zone On Approach		No			No			No			No	
Adj Sat Flow, veh/h/ln	1870	1870	1870	1870	1870	1870	1870	1870	1870	1870	1870	1870
Adj Flow Rate, veh/h	54	25	37	76	27	88	16	786	76	74	1167	79
Peak Hour Factor	0.92	0.92	0.92	0.92	0.92	0.92	0.92	0.92	0.92	0.92	0.92	0.92
Percent Heavy Veh, %	2	2	2	2	2	2	2	2	2	2	2	2
Cap, veh/h	139	68	70	137	46	109	405	2385	231	492	2460	166
Arrive On Green	0.15	0.15	0.15	0.15	0.15	0.15	0.73	0.73	0.73	1.00	1.00	1.00
Sat Flow, veh/h	554	463	476	559	314	745	446	3274	316	641	3378	228
Grp Volume(v), veh/h	116	0	0	191	0	0	16	427	435	74	613	633
Grp Sat Flow(s),veh/h/ln	1493	0	0	1617	0	0	446	1777	1813	641	1777	1829
Q Serve(g_s), s	0.0	0.0	0.0	3.8	0.0	0.0	0.9	7.7	7.7	1.5	0.0	0.0
Cycle Q Clear(g_c), s	6.2	0.0	0.0	10.1	0.0	0.0	0.9	7.7	7.7	9.2	0.0	0.0
Prop In Lane	0.47		0.32	0.40		0.46	1.00		0.17	1.00		0.12
Lane Grp Cap(c), veh/h	277	0	0	292	0	0	405	1294	1321	492	1294	1332
V/C Ratio(X)	0.42	0.00	0.00	0.65	0.00	0.00	0.04	0.33	0.33	0.15	0.47	0.47
Avail Cap(c_a), veh/h	622	0	0	647	0	0	405	1294	1321	492	1294	1332
HCM Platoon Ratio	1.00	1.00	1.00	1.00	1.00	1.00	1.00	1.00	1.00	2.00	2.00	2.00
Upstream Filter(I)	1.00	0.00	0.00	1.00	0.00	0.00	1.00	1.00	1.00	0.78	0.78	0.78
Uniform Delay (d), s/veh	35.3	0.0	0.0	37.0	0.0	0.0	3.4	4.4	4.4	0.5	0.0	0.0
Incr Delay (d2), s/veh	1.0	0.0	0.0	2.5	0.0	0.0	0.2	0.7	0.7	0.5	1.0	0.9
Initial Q Delay(d3),s/veh	0.0	0.0	0.0	0.0	0.0	0.0	0.0	0.0	0.0	0.0	0.0	0.0
%ile BackOfQ(95%),veh/ln	4.3	0.0	0.0	7.5	0.0	0.0	0.2	4.4	4.5	0.1	0.6	0.6
Unsig. Movement Delay, s/veh												
LnGrp Delay(d),s/veh	36.3	0.0	0.0	39.4	0.0	0.0	3.6	5.0	5.0	1.0	1.0	0.9
LnGrp LOS	D	A	A	D	A	A	A	A	A	A	A	A
Approach Vol, veh/h		116			191			878			1320	
Approach Delay, s/veh		36.3			39.4			5.0			1.0	
Approach LOS		D			D			A			A	
Timer - Assigned Phs		2		4		6		8				
Phs Duration (G+Y+Rc), s		71.2		18.8		71.2		18.8				
Change Period (Y+Rc), s		5.6		5.7		5.6		5.7				
Max Green Setting (Gmax), s		44.4		34.3		44.4		34.3				
Max Q Clear Time (g_c+I1), s		9.7		8.2		11.2		12.1				
Green Ext Time (p_c), s		11.5		0.6		23.2		1.1				
<b>Intersection Summary</b>												
HCM 6th Ctrl Delay				7.0								
HCM 6th LOS				A								

# HCM 6th Signalized Intersection Summary

## 3: Alameda St & Olympic BI

03/22/2021



Movement	EBL	EBT	EBR	WBL	WBT	WBR	NBL	NBT	NBR	SBL	SBT	SBR
Lane Configurations	↖	↖↗		↖	↖↗		↖	↖↗		↖	↖↗	↖
Traffic Volume (veh/h)	104	1230	66	104	1200	48	87	631	165	137	822	229
Future Volume (veh/h)	104	1230	66	104	1200	48	87	631	165	137	822	229
Initial Q (Qb), veh	0	0	0	0	0	0	0	0	0	0	0	0
Ped-Bike Adj(A_pbT)	1.00		1.00	1.00		1.00	1.00		1.00	1.00		1.00
Parking Bus, Adj	1.00	1.00	1.00	1.00	1.00	1.00	1.00	1.00	1.00	1.00	1.00	1.00
Work Zone On Approach		No			No			No			No	
Adj Sat Flow, veh/h/ln	1870	1870	1870	1870	1870	1870	1870	1870	1870	1870	1870	1870
Adj Flow Rate, veh/h	113	1337	72	113	1304	52	95	686	179	149	893	0
Peak Hour Factor	0.92	0.92	0.92	0.92	0.92	0.92	0.92	0.92	0.92	0.92	0.92	0.92
Percent Heavy Veh, %	2	2	2	2	2	2	2	2	2	2	2	2
Cap, veh/h	87	1322	71	80	1343	54	283	1382	360	394	1761	
Arrive On Green	0.39	0.39	0.39	0.39	0.39	0.39	0.99	0.99	0.99	0.50	0.50	0.00
Sat Flow, veh/h	402	3430	184	382	3483	139	623	2789	727	640	3554	1585
Grp Volume(v), veh/h	113	691	718	113	664	692	95	437	428	149	893	0
Grp Sat Flow(s),veh/h/ln	402	1777	1837	382	1777	1845	623	1777	1739	640	1777	1585
Q Serve(g_s), s	1.6	34.7	34.7	0.0	33.0	33.1	6.9	0.4	0.4	13.9	15.2	0.0
Cycle Q Clear(g_c), s	34.7	34.7	34.7	34.7	33.0	33.1	22.1	0.4	0.4	14.3	15.2	0.0
Prop In Lane	1.00		0.10	1.00		0.08	1.00		0.42	1.00		1.00
Lane Grp Cap(c), veh/h	87	685	708	80	685	711	283	881	862	394	1761	
V/C Ratio(X)	1.30	1.01	1.01	1.41	0.97	0.97	0.34	0.50	0.50	0.38	0.51	
Avail Cap(c_a), veh/h	87	685	708	80	685	711	283	881	862	394	1761	
HCM Platoon Ratio	1.00	1.00	1.00	1.00	1.00	1.00	2.00	2.00	2.00	1.00	1.00	1.00
Upstream Filter(I)	1.00	1.00	1.00	1.00	1.00	1.00	0.78	0.78	0.78	1.00	1.00	0.00
Uniform Delay (d), s/veh	44.9	27.6	27.7	45.0	27.1	27.2	4.1	0.2	0.2	15.2	15.3	0.0
Incr Delay (d2), s/veh	196.4	36.7	37.1	244.2	27.0	26.8	2.5	1.6	1.6	2.7	1.0	0.0
Initial Q Delay(d3),s/veh	0.0	0.0	0.0	0.0	0.0	0.0	0.0	0.0	0.0	0.0	0.0	0.0
%ile BackOfQ(95%),veh/ln	12.0	28.6	29.6	12.9	25.4	26.3	1.1	0.8	0.8	4.0	10.1	0.0
Unsig. Movement Delay, s/veh												
LnGrp Delay(d),s/veh	241.4	64.4	64.7	289.2	54.1	54.0	6.6	1.8	1.8	17.9	16.3	0.0
LnGrp LOS	F	F	F	F	D	D	A	A	A	B	B	
Approach Vol, veh/h		1522			1469			960			1042	A
Approach Delay, s/veh		77.7			72.1			2.3			16.6	
Approach LOS		E			E			A			B	
Timer - Assigned Phs		2		4		6		8				
Phs Duration (G+Y+Rc), s		50.0		40.0		50.0		40.0				
Change Period (Y+Rc), s		* 5.4		* 5.3		* 5.4		* 5.3				
Max Green Setting (Gmax), s		* 45		* 35		* 45		* 35				
Max Q Clear Time (g_c+I1), s		17.2		36.7		24.1		36.7				
Green Ext Time (p_c), s		9.0		0.0		6.7		0.0				

### Intersection Summary

HCM 6th Ctrl Delay	48.8
HCM 6th LOS	D

### Notes

\* HCM 6th computational engine requires equal clearance times for the phases crossing the barrier.  
 Unsignalized Delay for [SBR] is excluded from calculations of the approach delay and intersection delay.

HCM 6th TWSC  
4: Olympic Bl & Lemon St

03/22/2021

Intersection												
Int Delay, s/veh	12.2											
Movement	EBL	EBT	EBR	WBL	WBT	WBR	NBL	NBT	NBR	SBL	SBT	SBR
Lane Configurations	↵	↕		↵	↕			↕			↕	
Traffic Vol, veh/h	13	1056	4	25	1161	40	2	0	13	60	0	197
Future Vol, veh/h	13	1056	4	25	1161	40	2	0	13	60	0	197
Conflicting Peds, #/hr	0	0	0	0	0	0	0	0	0	0	0	0
Sign Control	Free	Free	Free	Free	Free	Free	Stop	Stop	Stop	Stop	Stop	Stop
RT Channelized	-	-	None	-	-	None	-	-	None	-	-	None
Storage Length	124	-	-	80	-	-	-	-	-	-	-	-
Veh in Median Storage, #	-	0	-	-	0	-	-	0	-	-	0	-
Grade, %	-	0	-	-	0	-	-	0	-	-	0	-
Peak Hour Factor	92	92	92	92	92	92	92	92	92	92	92	92
Heavy Vehicles, %	2	2	2	2	2	2	2	2	2	2	2	2
Mvmt Flow	14	1148	4	27	1262	43	2	0	14	65	0	214

Major/Minor	Major1			Major2			Minor1			Minor2		
Conflicting Flow All	1305	0	0	1152	0	0	1863	2537	576	1940	2518	653
Stage 1	-	-	-	-	-	-	1178	1178	-	1338	1338	-
Stage 2	-	-	-	-	-	-	685	1359	-	602	1180	-
Critical Hdwy	4.14	-	-	4.14	-	-	7.54	6.54	6.94	7.54	6.54	6.94
Critical Hdwy Stg 1	-	-	-	-	-	-	6.54	5.54	-	6.54	5.54	-
Critical Hdwy Stg 2	-	-	-	-	-	-	6.54	5.54	-	6.54	5.54	-
Follow-up Hdwy	2.22	-	-	2.22	-	-	3.52	4.02	3.32	3.52	4.02	3.32
Pot Cap-1 Maneuver	*878	-	-	602	-	-	*126	*26	460	*100	*27	*587
Stage 1	-	-	-	-	-	-	*203	*263	-	*553	*485	-
Stage 2	-	-	-	-	-	-	*553	*485	-	*453	*262	-
Platoon blocked, %	1	-	-	-	-	-	1	1	-	1	1	1
Mov Cap-1 Maneuver	*878	-	-	602	-	-	*76	*24	460	*92	*25	*587
Mov Cap-2 Maneuver	-	-	-	-	-	-	*76	*24	-	*92	*25	-
Stage 1	-	-	-	-	-	-	*200	*259	-	*544	*463	-
Stage 2	-	-	-	-	-	-	*336	*463	-	*432	*258	-

Approach	EB			WB			NB			SB		
HCM Control Delay, s	0.1			0.2			18.9			119.1		
HCM LOS							C			F		

Minor Lane/Major Mvmt	NBLn1	EBL	EBT	EBR	WBL	WBT	WBR	SBLn1
Capacity (veh/h)	275	* 878	-	-	602	-	-	260
HCM Lane V/C Ratio	0.059	0.016	-	-	0.045	-	-	1.074
HCM Control Delay (s)	18.9	9.2	-	-	11.3	-	-	119.1
HCM Lane LOS	C	A	-	-	B	-	-	F
HCM 95th %tile Q(veh)	0.2	0	-	-	0.1	-	-	11.5

Notes  
 -: Volume exceeds capacity    \$: Delay exceeds 300s    +: Computation Not Defined    \*: All major volume in platoon

# HCM 6th Signalized Intersection Summary

## 5: Olympic Bl & Mateo St

03/22/2021



Movement	EBL	EBT	EBR	WBL	WBT	WBR	NBL	NBT	NBR	SBL	SBT	SBR
Lane Configurations	↖	↗		↖	↗			↕			↖	↗
Traffic Volume (veh/h)	86	1034	5	6	740	90	1	0	4	309	1	469
Future Volume (veh/h)	86	1034	5	6	740	90	1	0	4	309	1	469
Initial Q (Qb), veh	0	0	0	0	0	0	0	0	0	0	0	0
Ped-Bike Adj(A_pbT)	1.00		1.00	1.00		1.00	1.00		1.00	1.00		1.00
Parking Bus, Adj	1.00	1.00	1.00	1.00	1.00	1.00	1.00	1.00	1.00	1.00	1.00	1.00
Work Zone On Approach		No			No			No			No	
Adj Sat Flow, veh/h/ln	1870	1870	1870	1870	1870	1870	1870	1870	1870	1870	1870	1870
Adj Flow Rate, veh/h	93	1124	5	7	804	98	1	0	4	336	1	510
Peak Hour Factor	0.92	0.92	0.92	0.92	0.92	0.92	0.92	0.92	0.92	0.92	0.92	0.92
Percent Heavy Veh, %	2	2	2	2	2	2	2	2	2	2	2	2
Cap, veh/h	253	1673	7	189	1470	179	48	29	115	258	1	689
Arrive On Green	0.46	0.46	0.46	0.46	0.46	0.46	0.43	0.00	0.43	0.43	0.43	0.43
Sat Flow, veh/h	618	3628	16	499	3189	389	0	66	264	410	1	1585
Grp Volume(v), veh/h	93	550	579	7	448	454	5	0	0	337	0	510
Grp Sat Flow(s),veh/h/ln	618	1777	1867	499	1777	1800	330	0	0	411	0	1585
Q Serve(g_s), s	11.5	21.8	21.8	1.0	16.4	16.4	0.0	0.0	0.0	0.0	0.0	24.1
Cycle Q Clear(g_c), s	27.8	21.8	21.8	22.8	16.4	16.4	39.1	0.0	0.0	39.1	0.0	24.1
Prop In Lane	1.00		0.01	1.00		0.22	0.20		0.80	1.00		1.00
Lane Grp Cap(c), veh/h	253	819	861	189	819	830	191	0	0	259	0	689
V/C Ratio(X)	0.37	0.67	0.67	0.04	0.55	0.55	0.03	0.00	0.00	1.30	0.00	0.74
Avail Cap(c_a), veh/h	253	819	861	189	819	830	191	0	0	259	0	689
HCM Platoon Ratio	1.00	1.00	1.00	1.00	1.00	1.00	1.00	1.00	1.00	1.00	1.00	1.00
Upstream Filter(I)	1.00	1.00	1.00	1.00	1.00	1.00	1.00	0.00	0.00	1.00	0.00	1.00
Uniform Delay (d), s/veh	27.5	18.9	18.9	27.8	17.5	17.5	19.8	0.0	0.0	31.5	0.0	21.2
Incr Delay (d2), s/veh	4.1	4.4	4.2	0.4	2.6	2.6	0.3	0.0	0.0	161.7	0.0	7.0
Initial Q Delay(d3),s/veh	0.0	0.0	0.0	0.0	0.0	0.0	0.0	0.0	0.0	0.0	0.0	0.0
%ile BackOfQ(95%),veh/ln	3.5	14.5	15.0	0.2	11.2	11.4	0.1	0.0	0.0	28.2	0.0	14.9
Unsig. Movement Delay, s/veh												
LnGrp Delay(d),s/veh	31.6	23.3	23.1	28.2	20.1	20.1	20.1	0.0	0.0	193.2	0.0	28.3
LnGrp LOS	C	C	C	C	C	C	C	A	A	F	A	C
Approach Vol, veh/h		1222			909			5				847
Approach Delay, s/veh		23.8			20.1			20.1				93.9
Approach LOS		C			C			C				F
Timer - Assigned Phs		2		4		6		8				
Phs Duration (G+Y+Rc), s		46.0		44.0		46.0		44.0				
Change Period (Y+Rc), s		* 4.5		4.9		* 4.5		4.9				
Max Green Setting (Gmax), s		* 42		39.1		* 42		39.1				
Max Q Clear Time (g_c+I1), s		24.8		41.1		29.8		41.1				
Green Ext Time (p_c), s		5.6		0.0		6.3		0.0				

### Intersection Summary

HCM 6th Ctrl Delay	42.6
HCM 6th LOS	D

### Notes

\* HCM 6th computational engine requires equal clearance times for the phases crossing the barrier.

HCM 6th TWSC  
87: Project Dwy & 8th St

03/22/2021

Intersection												
Int Delay, s/veh	4											
Movement	EBL	EBT	EBR	WBL	WBT	WBR	NBL	NBT	NBR	SBL	SBT	SBR
Lane Configurations		↕			↕		↕	↕			↕	
Traffic Vol, veh/h	0	65	106	57	138	0	79	0	54	0	0	0
Future Vol, veh/h	0	65	106	57	138	0	79	0	54	0	0	0
Conflicting Peds, #/hr	0	0	0	0	0	0	0	0	0	0	0	0
Sign Control	Free	Free	Free	Free	Free	Free	Stop	Stop	Stop	Stop	Stop	Stop
RT Channelized	-	-	None	-	-	None	-	-	None	-	-	None
Storage Length	-	-	-	-	-	-	0	-	-	-	-	-
Veh in Median Storage, #	-	0	-	-	0	-	-	0	-	-	0	-
Grade, %	-	0	-	-	0	-	-	0	-	-	0	-
Peak Hour Factor	92	92	92	92	92	92	92	92	92	92	92	92
Heavy Vehicles, %	2	2	2	2	2	2	2	2	2	2	2	2
Mvmt Flow	0	71	115	62	150	0	86	0	59	0	0	0

Major/Minor	Major1			Major2			Minor1			Minor2		
Conflicting Flow All	150	0	0	186	0	0	403	403	129	432	460	150
Stage 1	-	-	-	-	-	-	129	129	-	274	274	-
Stage 2	-	-	-	-	-	-	274	274	-	158	186	-
Critical Hdwy	4.12	-	-	4.12	-	-	7.12	6.52	6.22	7.12	6.52	6.22
Critical Hdwy Stg 1	-	-	-	-	-	-	6.12	5.52	-	6.12	5.52	-
Critical Hdwy Stg 2	-	-	-	-	-	-	6.12	5.52	-	6.12	5.52	-
Follow-up Hdwy	2.218	-	-	2.218	-	-	3.518	4.018	3.318	3.518	4.018	3.318
Pot Cap-1 Maneuver	1431	-	-	1388	-	-	558	536	921	534	498	896
Stage 1	-	-	-	-	-	-	875	789	-	732	683	-
Stage 2	-	-	-	-	-	-	732	683	-	844	746	-
Platoon blocked, %	-	-	-	-	-	-	-	-	-	-	-	-
Mov Cap-1 Maneuver	1431	-	-	1388	-	-	537	510	921	481	474	896
Mov Cap-2 Maneuver	-	-	-	-	-	-	537	510	-	481	474	-
Stage 1	-	-	-	-	-	-	875	789	-	732	650	-
Stage 2	-	-	-	-	-	-	696	650	-	790	746	-

Approach	EB	WB	NB	SB
HCM Control Delay, s	0	2.3	11.5	0
HCM LOS			B	A

Minor Lane/Major Mvmt	NBLn1	NBLn2	EBL	EBT	EBR	WBL	WBT	WBR	SBLn1
Capacity (veh/h)	537	921	1431	-	-	1388	-	-	-
HCM Lane V/C Ratio	0.16	0.064	-	-	-	0.045	-	-	-
HCM Control Delay (s)	13	9.2	0	-	-	7.7	0	-	0
HCM Lane LOS	B	A	A	-	-	A	A	-	A
HCM 95th %tile Q(veh)	0.6	0.2	0	-	-	0.1	-	-	-

Intersection						
Int Delay, s/veh	8.8					
Movement	EBL	EBT	WBT	WBR	SBL	SBR
Lane Configurations		↑	↑		↓	
Traffic Vol, veh/h	0	0	0	0	36	86
Future Vol, veh/h	0	0	0	0	36	86
Conflicting Peds, #/hr	0	0	0	0	0	0
Sign Control	Free	Free	Free	Free	Stop	Stop
RT Channelized	-	None	-	None	-	None
Storage Length	-	-	-	-	0	-
Veh in Median Storage, #	-	0	0	-	0	-
Grade, %	-	0	0	-	0	-
Peak Hour Factor	92	92	92	92	92	92
Heavy Vehicles, %	2	2	2	2	2	2
Mvmt Flow	0	0	0	0	39	93

Major/Minor	Major1	Major2	Minor2		
Conflicting Flow All	-	0	-	0	1
Stage 1	-	-	-	-	1
Stage 2	-	-	-	-	0
Critical Hdwy	-	-	-	-	6.42
Critical Hdwy Stg 1	-	-	-	-	5.42
Critical Hdwy Stg 2	-	-	-	-	5.42
Follow-up Hdwy	-	-	-	-	3.518
Pot Cap-1 Maneuver	0	-	-	0	1022
Stage 1	0	-	-	0	1022
Stage 2	0	-	-	0	-
Platoon blocked, %	-	-	-	-	-
Mov Cap-1 Maneuver	-	-	-	-	1022
Mov Cap-2 Maneuver	-	-	-	-	1022
Stage 1	-	-	-	-	1022
Stage 2	-	-	-	-	-

Approach	EB	WB	SB
HCM Control Delay, s	0	0	8.9
HCM LOS			A

Minor Lane/Major Mvmt	EBT	WBT	SBLn1
Capacity (veh/h)	-	-	1065
HCM Lane V/C Ratio	-	-	0.125
HCM Control Delay (s)	-	-	8.9
HCM Lane LOS	-	-	A
HCM 95th %tile Q(veh)	-	-	0.4



HCM 6th TWSC  
89: Garage Dwy & 8th St

03/22/2021

Intersection						
Int Delay, s/veh	3					
Movement	EBT	EBR	WBL	WBT	NBL	NBR
Lane Configurations	↑			↑	↑	
Traffic Vol, veh/h	119	0	0	137	58	47
Future Vol, veh/h	119	0	0	137	58	47
Conflicting Peds, #/hr	0	0	0	0	0	0
Sign Control	Free	Free	Free	Free	Stop	Stop
RT Channelized	-	None	-	None	-	None
Storage Length	-	-	-	-	0	-
Veh in Median Storage, #	0	-	-	0	0	-
Grade, %	0	-	-	0	0	-
Peak Hour Factor	92	92	92	92	92	92
Heavy Vehicles, %	2	2	2	2	2	2
Mvmt Flow	129	0	0	149	63	51

Major/Minor	Major1	Major2	Minor1		
Conflicting Flow All	0	-	-	-	278 129
Stage 1	-	-	-	-	129 -
Stage 2	-	-	-	-	149 -
Critical Hdwy	-	-	-	-	6.42 6.22
Critical Hdwy Stg 1	-	-	-	-	5.42 -
Critical Hdwy Stg 2	-	-	-	-	5.42 -
Follow-up Hdwy	-	-	-	-	3.518 3.318
Pot Cap-1 Maneuver	-	0	0	-	712 921
Stage 1	-	0	0	-	897 -
Stage 2	-	0	0	-	879 -
Platoon blocked, %	-	-	-	-	-
Mov Cap-1 Maneuver	-	-	-	-	712 921
Mov Cap-2 Maneuver	-	-	-	-	712 -
Stage 1	-	-	-	-	897 -
Stage 2	-	-	-	-	879 -

Approach	EB	WB	NB
HCM Control Delay, s	0	0	10.3
HCM LOS			B

Minor Lane/Major Mvmt	NBLn1	EBT	WBT
Capacity (veh/h)	792	-	-
HCM Lane V/C Ratio	0.144	-	-
HCM Control Delay (s)	10.3	-	-
HCM Lane LOS	B	-	-
HCM 95th %tile Q(veh)	0.5	-	-

***Appendix G***

***Signal Warrant Analysis***



## Traffic Signal Warrants Worksheet

DATE 3/29/21 PREPARER GTC REVIEWER \_\_\_\_\_MAJOR ST: Olympic BoulevardMINOR ST: Lemon Street

Critical Approach Speed	} 	or	Speed Limit	} 

Speed limit or critical speed on major street traffic > 40 mph.....	<input type="checkbox"/>	} RURAL (R)	<input checked="" type="checkbox"/> URBAN (U)
In built up area of isolated community of < 10,000 population.....	<input type="checkbox"/>		

# Eight-Hour Vehicular Volume



N/A	<input checked="" type="checkbox"/>
SATISFIED	<input type="checkbox"/>
NO	<input type="checkbox"/>

★ The satisfaction of a traffic signal warrant or warrants shall not in itself require the installation of a traffic control signal ★

- Condition A or Condition B or combination of 80% of both parts A and B must be satisfied.
- A 6-hour Manual Count may be used in a determination that this warrant is not met. However, supplement manual counts should be taken during separate hours for a determination that this warrant is met.
- In applying each condition, the major street and minor street volumes shall be for the same hours. On the minor street, the higher volume does not need to be the same approach during each of the hours.
- The study should consider the effects of the right-turn vehicles from the minor-street approaches. Engineering judgment should be used to determine what, if any, portion of the right-turn traffic is subtracted from the minor-street traffic count.
- Figure 4C-103(CA) should be used for new intersections, significantly reconstructed intersections, where near-term land development will result in increased volumes, or where it is not reasonable to use current traffic volumes.
- Engineering judgment should also be used in applying various traffic signal warrants to cases where approaches consist of one lane plus one left-turn or right-turn lane. This site-specific traffic characteristics should dictate whether an approach is considered as one lane or two lanes. For example, for an approach with one lane for through and right-turning traffic plus a left-turn lane, if engineering judgment indicates that it should be considered a one-lane approach because the traffic using the left turn lane is minor, the total traffic volume approaching the intersection should be applied against the signal warrants as a one-lane approach. The approach should be considered two lanes if approximately half of the traffic on the approach turns left and the left-turn lane is of sufficient length to accommodate all left-turn vehicles. Similar engineering judgment and rationale should be applied to a street approach with one through/left-turn lane plus a right-turn lane. In this case, the degree of conflict of minor-street right-turn traffic with traffic on the major street should be considered. Thus, right-turn traffic should not be included in the minor-street volume if the movement enters the major street with minimal conflict. The approach should be evaluated as a one-lane approach with only the traffic volume in the through/left-turn lane considered.
- At an intersection with a high volume of left-turn traffic from the major street, the signal warrant analysis may be performed in a manner that considers the higher volume of the major-street left-turn volumes plus the higher volume minor-street approach as the "minor street" volume and both approaches of the major street minus the higher of the major-street left-turn volume as "major street" volume. In these cases, engineering judgment should be used to determine if left-turn phasing is necessary to accommodate the high volume of left-turn traffic.

# Eight-Hour Vehicular Volume

*(continued)*

★ The satisfaction of a traffic signal warrant or warrants shall not in itself require the installation of a traffic control signal ★

### Condition A

#### Minimum Vehicle Volume

SATISFIED	YES	NO
100%	<input type="checkbox"/>	<input type="checkbox"/>
80%	<input type="checkbox"/>	<input type="checkbox"/>

<b>RIGHT TURN REDUCTION APPLICATION MINOR STREET</b> (If Yes, fill in percentage)	<input type="checkbox"/> _____%
--	---------------------------------

MINIMUM REQUIREMENTS (80% SHOW IN BRACKETS)			
(U)	R	(U)	R

APPROACH LANES					Hours							
	1 ✓		2 or More ✓		07:00	08:00	09:00	15:00	16:00	17:00		
Both Approach Major Street	500 (400)	350 (280)	600 (480) ✓	420 (336)	1950	2051	1906	1822	1997	2153		
Highest Approach Minor Street	150 (120) ✓	105 (84)	200 (160)	140 (112)	136	99	65	74	161	213		

### Condition B

#### Interruption of Continuous Traffic

SATISFIED	YES	NO
100%	<input type="checkbox"/>	<input type="checkbox"/>
80%	<input type="checkbox"/>	<input type="checkbox"/>

<b>RIGHT TURN REDUCTION APPLICATION MINOR STREET</b> (If Yes, fill in percentage)	<input type="checkbox"/> _____%
--	---------------------------------

MINIMUM REQUIREMENTS (80% SHOW IN BRACKETS)			
(U)	R	(U)	R

APPROACH LANES					Hours							
	1 ✓		2 or More ✓		07:00	08:00	09:00	15:00	16:00	17:00		
Both Approach Major Street	750 (600)	525 (420)	900 ✓ (720)	630 (504)	1950	2051	1906	1822	1997	2153		
Highest Approach Minor Street	75 ✓ (60)	53 (42)	100 (80)	70 (56)	136	99	65	74	161	213		

### COMBINATION OF A & B

SATISFIED	YES	NO
	<input type="checkbox"/>	<input type="checkbox"/>

REQUIREMENT	CONDITION	✓	FULFILLED	
			YES	NO
TWO CONDITIONS SATISFIED 80%	A. MINIMUM VEHICULAR VOLUME			
	AND		<input type="checkbox"/>	<input type="checkbox"/>
	B. INTERRUPTION OF CONTINUOUS TRAFFIC			
	AND			
	AN ADEQUATE TRIAL OF OTHER ALTERNATIVES THAT COULD CAUSE LESS DELAY AND INCOVENIENCE TO TRAFFIC HAS FAILED TO SOLVE THE TRAFFIC PROBLEMS		<input type="checkbox"/>	<input type="checkbox"/>

# Eight-Hour Vehicular Volume

*(continued)*

★ The satisfaction of a traffic signal warrant or warrants shall not in itself require the installation of a traffic control signal ★

<b>Projected Volumes</b>	SATISFIED	N/A	<input checked="" type="checkbox"/>
		YES	NO
		<input type="checkbox"/>	<input type="checkbox"/>

**Figure 4C-103 (CA). Traffic Signal Warrants Worksheet (Average Traffic Estimate Form)**  
Based on Estimated Average Daily Traffic - see Note\*

URBAN <input type="checkbox"/>	RURAL <input type="checkbox"/>	Minimum Requirements Estimated Average Daily Traffic			
<b>CONDITION A - Minimum Vehicular Volume</b>		Vehicles Per Day On Major Street (Total of Both Approaches)		Vehicles Per Day On Higher-Volume Minor Street Approach (One Direction Only)	
Satisfied <input type="checkbox"/> Not Satisfied <input type="checkbox"/>					
Number of lanes for moving traffic on each approach		Urban	Rural	Urban	Rural
Major Street	Minor Street				
1.....	1.....	8,000	5,600	2,400	1,680
2 or More.....	1.....	9,600	6,720	2,400	1,680
2 or More.....	2 or More.....	9,600	6,720	3,200	2,240
1.....	2 or More.....	8,000	5,600	3,200	2,240
<b>CONDITION B - Interruption of Continuous Traffic</b>		Vehicles Per Day On Major Street (Total of Both Approaches)		Vehicles Per Day On Higher-Volume Minor Street Approach (One Direction Only)	
Satisfied <input type="checkbox"/> Not Satisfied <input type="checkbox"/>					
Number of lanes for moving traffic on each approach		Urban	Rural	Urban	Rural
Minor Street	Minor Street				
1.....	1.....	12,000	8,400	1,200	850
2 or More.....	1.....	14,400	10,080	1,200	850
2 or More.....	2 or More.....	14,400	10,080	1,600	1,120
1.....	2 or More.....	12,000	8,400	1,600	1,120
<b>Combination of CONDITIONS A + B</b>		2 CONDITIONS 80%		2 CONDITIONS 80%	
Satisfied <input type="checkbox"/> Not Satisfied <input type="checkbox"/>					
<u>No one condition satisfied</u> , but following conditions fulfilled 80% or more..... <u>        </u> <u>        </u> <span style="margin-left: 150px;">A</span> <span style="margin-left: 150px;">B</span>					

\* Note: To be used only for NEW INTERSECTIONS or other locations where it is not reasonable to count actual traffic volumes

# Four-Hour Vehicular Volume



N/A

SATISFIED YES

NO

★ The satisfaction of a traffic signal warrant or warrants shall not in itself require the installation of a traffic control signal ★

- a. Record hourly vehicle volumes for the highest four hours of an average day.
- b. In applying each condition, the major street and minor street volumes shall be for the same hours. On the minor street, the higher volume does not need to be the same approach during each of the hours.
- c. The study should consider the effects of the right-turn vehicles from the minor-street approaches. Engineering judgment should be used to determine what, if any, portion of the right-turn traffic is subtracted from the minor-street traffic count.
- d. Engineering judgment should also be used in applying various traffic signal warrants to cases where approaches consist of one lane plus one left-turn or right-turn lane. This site-specific traffic characteristics should dictate whether an approach is considered as one lane or two lanes. For example, for an approach with one lane for through and right-turning traffic plus a left-turn lane, if engineering judgment indicates that it should be considered a one-lane approach because the traffic using the left turn lane is minor, the total traffic volume approaching the intersection should be applied against the signal warrants as a one-lane approach. The approach should be considered two lanes if approximately half of the traffic on the approach turns left and the left-turn lane is of sufficient length to accommodate all left-turn vehicles. Similar engineering judgment and rationale should be applied to a street approach with one through/left-turn lane plus a right-turn lane. In this case, the degree of conflict of minor-street right-turn traffic with traffic on the major street should be considered. Thus, right-turn traffic should not be included in the minor-street volume if the movement enters the major street with minimal conflict. The approach should be evaluated as a one-lane approach with only the traffic volume in the through/left-turn lane considered.
- e. At an intersection with a high volume of left-turn traffic from the major street, the signal warrant analysis may be performed in a manner that considers the higher volume of the major-street left-turn volumes plus the higher volume minor-street approach as the "minor street" volume and both approaches of the major street minus the higher of the major-street left-turn volume as "major street" volume. In these cases, engineering judgment should be used to determine if left-turn phasing is necessary to accommodate the high volume of left-turn traffic.

APPROACH LANES	One	2 or More	Hours					YES	NO
			17:00	16:00	07:00	08:00			
Both Approaches - Major Street		✓	2153	1997	1950	2051	<b>RIGHT TURN REDUCTION APPLICATION MINOR STREET</b> (If Yes, fill in percentage)	<input type="checkbox"/>	<input type="checkbox"/>
Higher Approach - Minor Street	✓		213	161	136	99		_____ %	
* All plotted points fall above the applicable curve in Figure 4C-1. (URBAN AREAS)								<input type="checkbox"/>	<input type="checkbox"/>
<u>OR</u> , All plotted points fall above the applicable curve in Figure 4C-2. (RURAL AREAS)								<input type="checkbox"/>	<input type="checkbox"/>

# Four-Hour Vehicular Volume (continued)

★ The satisfaction of a traffic signal warrant or warrants shall not in itself require the installation of a traffic control signal ★

## URBAN

Figure 4C-1. Warrant 2, Four-Hour Vehicular Volume

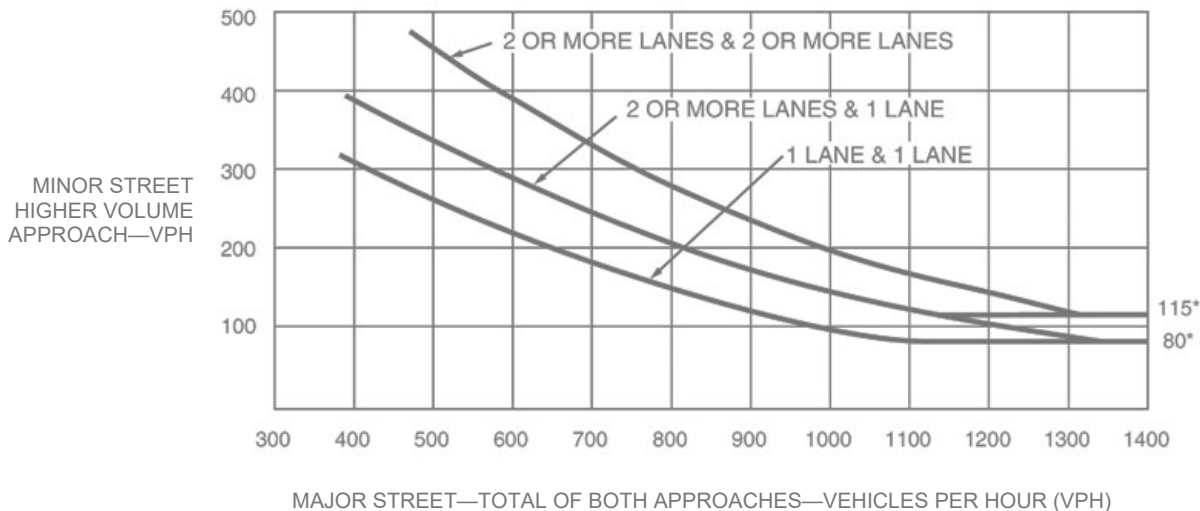

\*Note: 115 vph applies as the lower threshold volume for a minor-street approach with two or more lanes and 80 vph applies as the lower threshold volume for a minor-street approach with one lane.

## RURAL

Figure 4C-2. Warrant 2, Four-Hour Vehicular Volume (70% Factor)

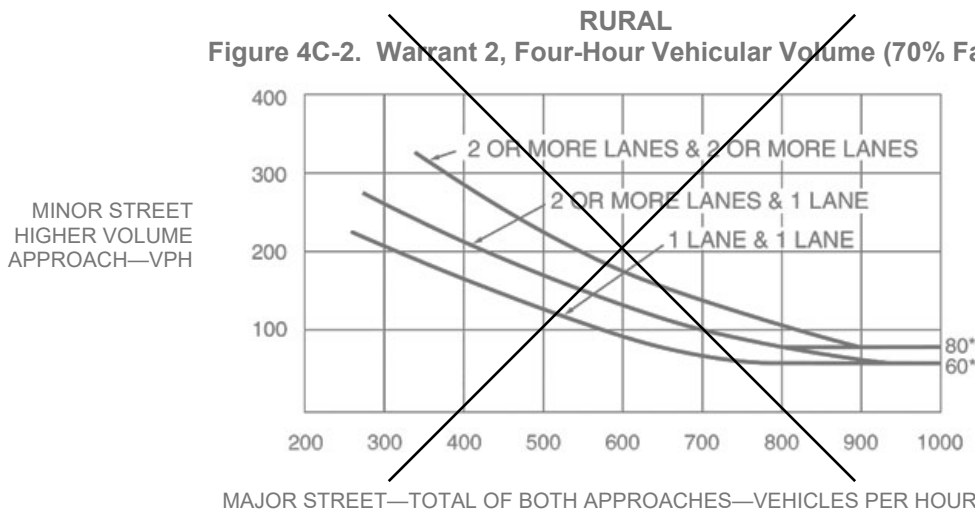

\*Note: 80 vph applies as the lower threshold volume for a minor-street approach with two or more lanes and 60 vph applies as the lower threshold volume for a minor-street approach with one lane.

Peak Hour

WARRANT  
3

N/A   
 SATISFIED YES   
 NO

\* The satisfaction of a traffic signal warrant or warrants shall not in itself require the installation of a traffic control signal \*

- a. Part A or Part B must be satisfied.
- b. In applying each condition, the major street and minor street volumes shall be for the same hours.
- c. The study should consider the effects of the right-turn vehicles from the minor-street approaches. Engineering judgment should be used to determine what, if any, portion of the right-turn traffic is subtracted from the minor-street traffic count.
- d. Estimated Peak Hour Volumes may be used for new intersections, significantly reconstructed intersections, or where near-term land development will result in increased volumes.
- e. Engineering judgment should also be used in applying various traffic signal warrants to cases where approaches consist of one lane plus one left-turn or right-turn lane. This site-specific traffic characteristics should dictate whether an approach is considered as one lane or two lanes. For example, for an approach with one lane for through and right-turning traffic plus a left-turn lane, if engineering judgment indicates that it should be considered a one-lane approach because the traffic using the left turn lane is minor, the total traffic volume approaching the intersection should be applied against the signal warrants as a one-lane approach. The approach should be considered two lanes if approximately half of the traffic on the approach turns left and the left-turn lane is of sufficient length to accommodate all left-turn vehicles. Similar engineering judgment and rationale should be applied to a street approach with one through/left-turn lane plus a right-turn lane. In this case, the degree of conflict of minor-street right-turn traffic with traffic on the major street should be considered. Thus, right-turn traffic should not be included in the minor-street volume if the movement enters the major street with minimal conflict. The approach should be evaluated as a one-lane approach with only the traffic volume in the through/left-turn lane considered.
- f. At an intersection with a high volume of left-turn traffic from the major street, the signal warrant analysis may be performed in a manner that considers the higher volume of the major-street left-turn volumes plus the higher volume minor-street approach as the "minor street" volume and both approaches of the major street minus the higher of the major-street left-turn volume as "major street" volume. In these cases, engineering judgment should be used to determine if left-turn phasing is necessary to accommodate the high volume of left-turn traffic.

**PART A**

*All parts 1, 2, and 3 below must be satisfied for the same one hour, for any four consecutive 15-minute periods)*

SATISFIED	YES	NO
	<input checked="" type="checkbox"/>	<input type="checkbox"/>

	YES	NO	N/A
1. The total delay experienced by traffic on one minor street approach (one direction only) controlled by a STOP sign equals or exceeds four vehicle-hours for a one-lane approach, or five vehicle-hours for a two-lane approach; <u>AND</u>	<input type="checkbox"/>	<input type="checkbox"/>	<input checked="" type="checkbox"/>
2. The volume on the same minor street approach (one direction only) equals or exceeds 100 vph for one moving lane of traffic or 150 vph for two moving lanes; <u>AND</u>	<input checked="" type="checkbox"/>	<input type="checkbox"/>	<input type="checkbox"/>
3. The total entering volume serviced during the hour equals or exceeds 800 vph for intersections with four or more approaches or 650 vph for intersections with three approaches.	<input checked="" type="checkbox"/>	<input type="checkbox"/>	<input type="checkbox"/>

**PART B**

SATISFIED	YES	NO
	<input checked="" type="checkbox"/>	<input type="checkbox"/>

APPROACH LANES	Hour		
	One	2 or More	
		17:00	
Both Approaches - Major Street		✓	2155
Higher Approach - Minor Street	✓		213

The plotted point falls above the applicable curve in Figure 4C-3. (URBAN AREAS)	<input checked="" type="checkbox"/>	<input type="checkbox"/>
<u>OR</u> , The plotted point falls above the applicable curve in Figure 4C-4. (RURAL AREAS)	<input checked="" type="checkbox"/>	<input type="checkbox"/>



# Peak Hour

*(continued)*

★ The satisfaction of a traffic signal warrant or warrants shall not in itself require the installation of a traffic control signal ★

**URBAN**  
**Figure 4C-3. Warrant 3, Peak Hour**

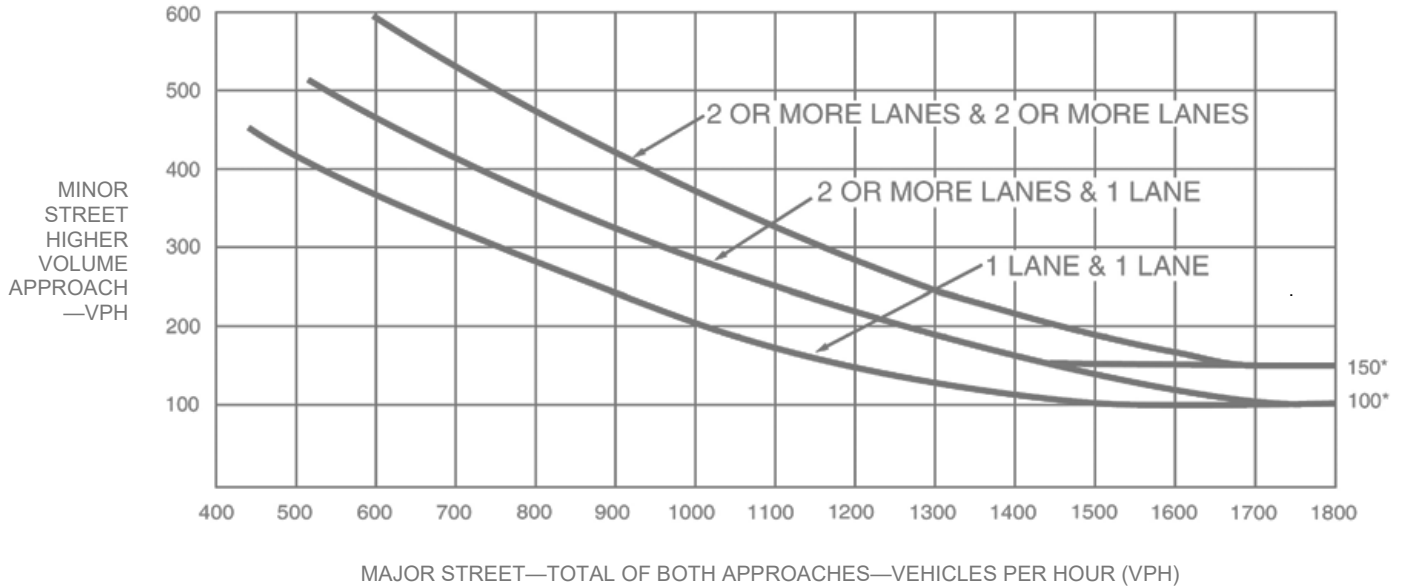

\* Note: 150 vph applies as the lower threshold volume for a minor street approach with two or more lanes and 100 vph applies as the lower threshold volume for a minor street approach with one lane.

**RURAL**  
**Figure 4C-4. Warrant 3, Peak Hour (70% Factor)**  
(COMMUNITY LESS THAN 10,000 POPULATION OR ABOVE 40 MPH ON MAJOR STREET)

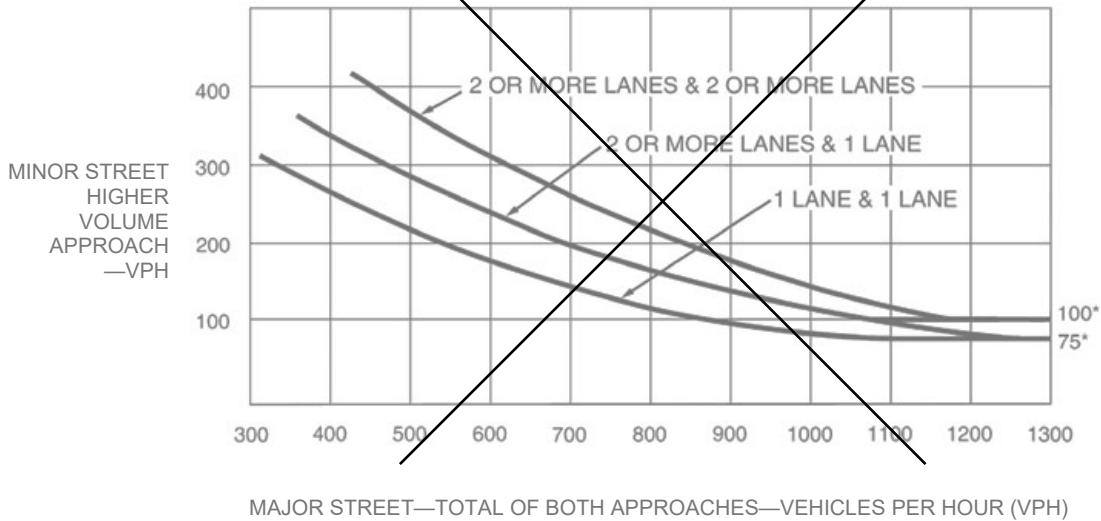

\* Note: 100 vph applies as the lower threshold volume for a minor street approach with two or more lanes and 75 vph applies as the lower threshold volume for a minor street approach with one lane.

# Pedestrian Volume



N/A	<input checked="" type="checkbox"/>
SATISFIED YES	<input type="checkbox"/>
NO	<input type="checkbox"/>

★ The satisfaction of a traffic signal warrant or warrants shall not in itself require the installation of a traffic control signal ★

- Parts 1 and 2 shall be satisfied.
- The pedestrian volume criterion may be reduced by as much as 50% if the 15th percentile speed of the pedestrians is less than 3.5 feet/second.
- Estimated pedestrian volumes may be used where nearby, near-term land use development has been approved for construction.
- In applying each condition, the total vehicles per hour on the major street (on both approaches) and the total pedestrians per hour crossing the major street shall be for the same hours.
- The Pedestrian Volume signal warrants shall not be applied at locations where the distance to the nearest traffic control signal or STOP sign controlling the street that pedestrians desire to cross is less than 300 feet, unless the proposed traffic control signal will not restrict the progressive movement of traffic.
- Traffic control signal may not be needed at the study location if adjacent coordinated traffic control signals consistently provide gaps of adequate length for pedestrians to cross the street.
- If it is considered at a non-intersection crossing, the traffic control signal should be installed at least 100 feet from side streets or driveways that are controlled by STOP or YIELD signs. If the traffic control signal is installed at a non-intersection crossing, at least one of the signal faces should be over the traveled way for each approach, parking and other sight obstructions should be prohibited for at least 100 feet in advance of and at least 20 feet beyond the crosswalk or site accommodations should be made through curb extensions or other techniques to provide adequate sight distance, and the installation should include suitable standard signs and pavement markings.
- Bicycles may be counted as pedestrians.

**PART 1 (A or B must be satisfied)**

SATISFIED	YES	NO
<input type="checkbox"/>	<input type="checkbox"/>	<input type="checkbox"/>

**A. FOUR-HOUR PEDESTRIAN VOLUMES**

	Hours			
Vehicles per hour on major street for 4 hours				
Pedestrians crossing major street per hour for highest 4 hours				

(FIGURE 4C-5 OR 4C-6 SATISFIED)

SATISFIED	YES	NO
100%	<input type="checkbox"/>	<input type="checkbox"/>
50%	<input type="checkbox"/>	<input type="checkbox"/>
15% WALKING RATE	_____ fps	

**B. ONE HOUR PEDESTRIAN VOLUMES**

	Hour
Vehicles per hour on major street for 1 hour	
Pedestrians crossing major street per hour for highest 1 hour	0

(FIGURE 4C-7 or 4C-8 SATISFIED)

SATISFIED	YES	NO
100%	<input type="checkbox"/>	<input type="checkbox"/>
50%	<input type="checkbox"/>	<input type="checkbox"/>
15% WALKING RATE	_____ fps	

**PART 2**

SATISFIED	YES	NO
<input type="checkbox"/>	<input type="checkbox"/>	<input type="checkbox"/>

	YES	NO
<u>AND</u> , The distance to the nearest traffic signal along the major street is greater than 300 ft	<input type="checkbox"/>	<input type="checkbox"/>
<u>OR</u> , The proposed traffic signal will not restrict progressive traffic flow along the major street	<input type="checkbox"/>	<input type="checkbox"/>

# Pedestrian Volume (continued)

★ The satisfaction of a traffic signal warrant or warrants shall not in itself require the installation of a traffic control signal ★

**SPEED ≤ 35 MPH**  
**Figure 4C-5. Warrant 4, Pedestrian Four-Hour Volume**

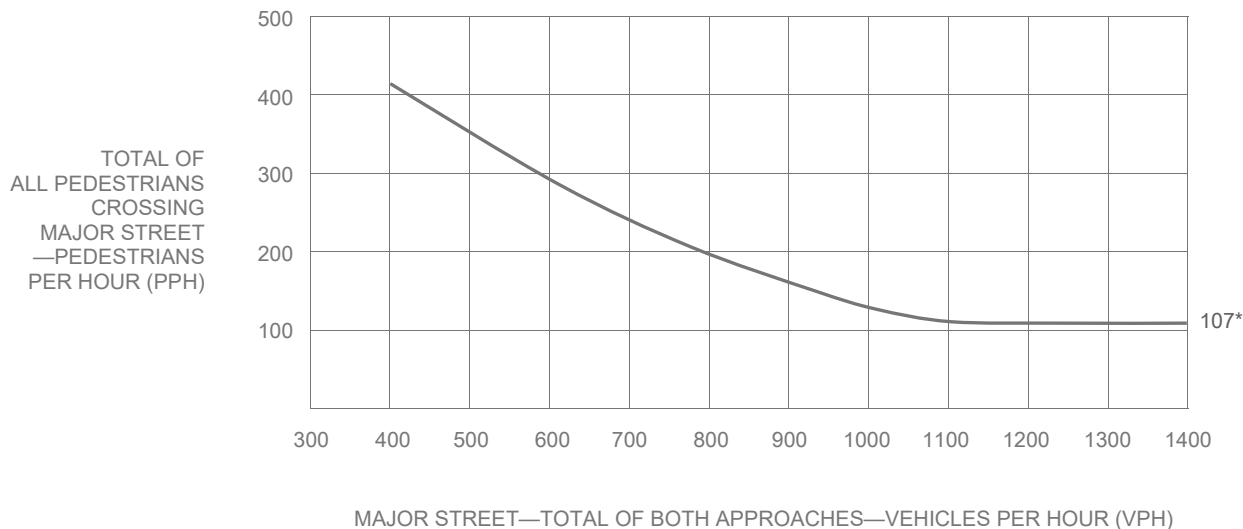

\* Note: 107 pph applies as the lower threshold volume

**SPEED > 35 MPH**  
**Figure 4C-6. Warrant 4, Pedestrian Four-Hour Volume (70% Factor)**

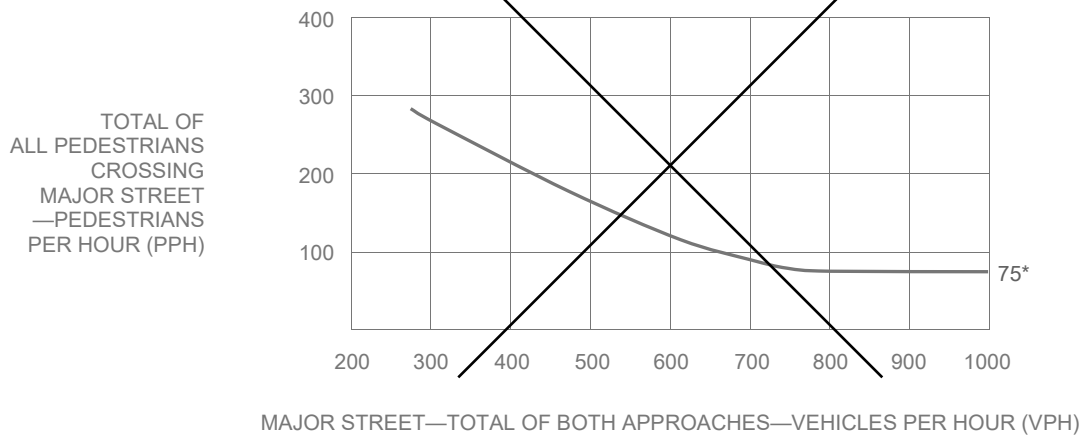

\* Note: 75 pph applies as the lower threshold volume

# Pedestrian Volume (continued)

\* The satisfaction of a traffic signal warrant or warrants shall not in itself require the installation of a traffic control signal \*

**SPEED ≤ 35 MPH**  
**Figure 4C-7. Warrant 4, Pedestrian Peak Hour**

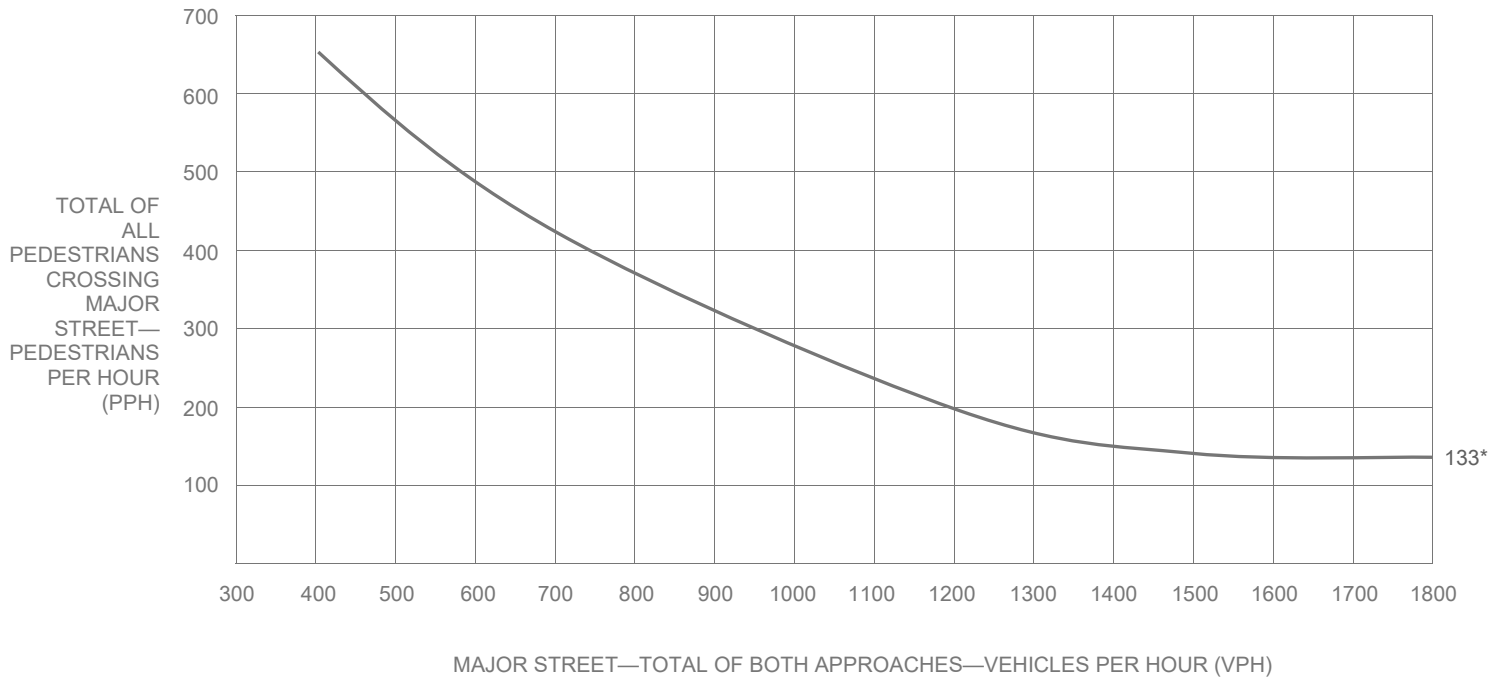

\* Note: 133 pph applies as the lower threshold volume

**SPEED > 35 MPH**  
**Figure 4C-8. Warrant 4, Pedestrian Peak Hour (70% Factor)**



\* Note: 93 pph applies as the lower threshold volume

# School Crossing

**WARRANT**  
5

N/A

SATISFIED YES

NO

★ The satisfaction of a traffic signal warrant or warrants shall not in itself require the installation of a traffic control signal ★

- a. Part A and Part B shall be satisfied.
- b. For purposes of this warrant, schoolchildren include elementary through high school students.
- c. Estimated schoolchildren volumes may be used where a new school or expanded school has been approved for construction.
- d. The need for a traffic control signal shall be considered when an engineering study of the frequency and adequacy of gaps in the vehicular traffic stream as related to the number and size of groups of schoolchildren at an established school crossing across the major street shows that the number of adequate gaps in the traffic stream during the period when the schoolchildren are using the crossing is less than the number of minutes in the same period and there are a minimum of 20 schoolchildren during the highest crossing hour.
- e. The School Crossing signal warrant shall not be applied at locations where the distance to the nearest traffic control signal along the major street is less than 300 feet, unless the proposed traffic control signal will not restrict the progressive movement of traffic.
- f. Non-intersectional schoolchildren crosswalk locations may be signalized when justified.

PART A				SATISFIED	YES	NO
				<input type="checkbox"/>	<input type="checkbox"/>	<input type="checkbox"/>
<b>Gap / Minutes and # of Children</b>			Hour	YES	NO	
Gaps vs Minutes	Minutes Children Using Crossing		Gaps < Minutes	<input type="checkbox"/>	<input type="checkbox"/>	
	Number of Adequate Gaps		<b>AND</b> Children ≥ 20/hr	<input type="checkbox"/>	<input type="checkbox"/>	
School Age Pedestrians Crossing Street / hr						
<b>AND</b> , Consideration has been given to less restrictive remedial measures				<input type="checkbox"/>	<input type="checkbox"/>	

PART B				SATISFIED	YES	NO
				<input type="checkbox"/>	<input type="checkbox"/>	<input type="checkbox"/>
				YES	NO	
The distance to the nearest traffic signal along the major street is greater than 300 ft				<input type="checkbox"/>	<input type="checkbox"/>	
<b>OR</b> , The proposed traffic signal will not restrict progressive movement of traffic				<input type="checkbox"/>	<input type="checkbox"/>	

# Coordinated Signal System

**WARRANT**  
6

N/A

SATISFIED YES

NO

★ The satisfaction of a traffic signal warrant or warrants shall not in itself require the installation of a traffic control signal ★

- a. The Coordinated Signal System signal warrant should not be applied where the resultant spacing of traffic control signals would be less than 1,000 feet.
- b. All Parts must be satisfied.

MINIMUM REQUIREMENTS	DISTANCE TO NEAREST SIGNAL	YES	NO
≥ 1000 ft	N _____ ft, S _____ ft, E _____ ft, W _____ ft	<input type="checkbox"/>	<input type="checkbox"/>
On a one-way street or a street that has traffic predominantly in one direction, the adjacent traffic control signals are so far apart that they do not provide the necessary degree of vehicular platooning.		<input type="checkbox"/>	<input type="checkbox"/>
<b>OR</b> , On a two-way street, adjacent traffic control signals do not provide the necessary degree of platooning and the proposed and adjacent traffic control signals will collectively provide a progressive operation.		<input type="checkbox"/>	<input type="checkbox"/>

# Crash Experience Warrant



N/A

SATISFIED YES

NO

★ The satisfaction of a traffic signal warrant or warrants shall not in itself require the installation of a traffic control signal ★

- a. All Parts must be satisfied.
- b. For locations that involve other agencies, crash data from other involved jurisdictions should be obtained.

		YES	NO
Adequate trial of alternatives with satisfactory observance and enforcement has failed to reduce the crash frequency		<input type="checkbox"/>	<input type="checkbox"/>
<b>REQUIREMENTS</b>	Number of crashes reported within a 12-month period susceptible to correction by a traffic signal:	<input type="checkbox"/>	<input type="checkbox"/>
<b>5 OR MORE</b>	Indicate Date(s):		
<b>REQUIREMENTS</b>	<b>CONDITIONS</b>	<input checked="" type="checkbox"/>	
<b>ONE CONDITION SATISFIED 80%</b>	Warrant 1, Condition A - Minimum Vehicular Volume		
	OR, Warrant 1, Condition B - Interruption of Continuous Traffic	<input type="checkbox"/>	<input type="checkbox"/>
	OR, Warrant 4, Pedestrian Volume Condition - Ped Vol ≥ 80% for ped volumes per Figures 4C-5 to 4C-8		

# Roadway Network



N/A

SATISFIED YES

NO

★ The satisfaction of a traffic signal warrant or warrants shall not in itself require the installation of a traffic control signal ★

- a. Existing traffic volumes with an ambient growth rate of 1% (or other LADOT approved ambient growth rate) may be used if projected volumes are not available.
- b. All Parts must be satisfied.

MINIMUM VOLUME REQUIREMENTS	ENTERING VOLUMES - ALL APPROACHES		✓	FULLFILLED	
				YES	NO
1000 Veh / Hr	During Typical Weekday Peak Hour _____ Veh/Hr AND has 5-year projected traffic volumes that meet one or more of Warrants 1, 2, and 3 during an average weekday.			<input type="checkbox"/>	<input type="checkbox"/>
	OR During Each of Any 5 Hrs. of a Saturday or Sunday _____ Veh / Hr				
	<b>CHARACTERISTICS OF MAJOR ROUTES</b>	<b>MAJOR ROUTE A</b>			
	Highway System Serving as Principal Network for Through Traffic				
	Rural or Suburban Highway Outside Of, Entering, or Traversing a City				
	Appears as Major Route on an Official Plan			YES	NO
	Any Major Route Characteristics Met, Both Streets			<input type="checkbox"/>	<input type="checkbox"/>

# Intersection Near a Grade Crossing



N/A

SATISFIED YES

NO

★ The satisfaction of a traffic signal warrant or warrants shall not in itself require the installation of a traffic control signal ★

- a. Both Parts A and B shall be satisfied.
- b. This Warrant shall only be applied after review and approval by the LADOT Railroad Crossing and Safety Section (RCOSS), subject to CPUC General Order approval.
- c. This Warrant does not apply for Pre-Signals and/or Queue-Cutter signals, as an alternative application of Pre-Signals (See 2012 CA MUTCD, Sec 8C.09). Pre-Signals shall only be applied after review and approval by RCOSS, subject to CPUC General Order approval.

	FULFILLED	
	YES	NO
<b>PART A</b> A grade crossing exists on an approach controlled by a STOP or YIELD sign and the center of the track nearest to the intersection is within 140 feet of the stop line or yield line on the approach. Track Center Line to Limit Line _____ ft	<input type="checkbox"/>	<input type="checkbox"/>
<b>PART B</b> <b>There is one minor street approach lane at the track crossing</b> - During the highest traffic volume hour during which rail traffic uses the crossing, the plotted point falls above the applicable curve in Figure 4C-9. Major Street - Total of both approaches: _____ VPH Minor Street - Crosses the track (one direction only, approaching the intersection): _____ VPH X AF (Use Tables 4C-2, 3, & 4 below to calculate AF) = _____ VPH	<input type="checkbox"/>	<input type="checkbox"/>
<b>OR, There are two or more minor street approach lanes at the track crossing</b> - During the highest traffic volume hour during which rail traffic uses the crossing, the plotted point falls above the applicable curve in Figure 4C-10. Major Street - Total of both approaches: _____ VPH Minor Street - Crosses the track (one direction only, approaching the intersection): _____ VPH X AF (Use Tables 4C-2, 3, & 4 below to calculate AF) = _____ VPH	<input type="checkbox"/>	<input type="checkbox"/>

The minor street approach volume may be multiplied by up to three following adjustment factors (AF) as described in Section 4C-10.

- 1. Number of Rail Traffic per Day \_\_\_\_\_ Adjustment factor from Table 4C-2 \_\_\_\_\_
- 2. Percentage of High-Occupancy Buses on Minor Street Approach \_\_\_\_\_ Adjustment factor from Table 4C-3 \_\_\_\_\_
- 3. Percentage of Tractor-Trailer Trucks on Minor Street Approach \_\_\_\_\_ Adjustment factor from Table 4C-4 \_\_\_\_\_

NOTE: If no data is available or known, then use AF = 1 (no adjustment)

**Table 4C-2. Warrant 9, Adjustment Factor for Daily Frequency of Rail Traffic**

Rail Traffic per Day	Adjustment Factor
1	0.67
2	0.91
3 to 5	1.00
6 to 8	1.18
9 to 11	1.25
12 or more	1.33

**Table 4C-3. Warrant 9, Adjustment Factor for Percentage of High-Occupancy Buses**

% of High-Occupancy Buses * on Minor-Street Approach	Adjustment Factor
0 %	1.00
2 %	1.09
4 %	1.19
6 % or more	1.32

\* A high-occupancy bus is defined as a bus occupied by at least 20 people

# Intersection Near a Grade Crossing *(continued)*

★ The satisfaction of a traffic signal warrant or warrants shall not in itself require the installation of a traffic control signal ★

**Table 4C-4. Warrant 9, Adjustment Factor for Percentage of Tractor-Trailer Trucks**

% of Tractor-Trailer Trucks on Minor-Street Approach	Adjustment Factor	
	D less than 70 feet	D of 70 feet or more
0% to 2.5%	0.50	0.50
2.6% to 7.5%	0.75	0.75
7.6% to 12.5%	1.00	1.00
12.6% to 17.5%	2.30	1.15
17.6% to 22.5%	2.70	1.35
22.6% to 27.5%	3.28	1.64
More than 27.5%	4.18	2.09

**Figure 4C-9. Warrant 9, Intersection Near a Grade Crossing (One Approach Lane at the Track Crossing)**

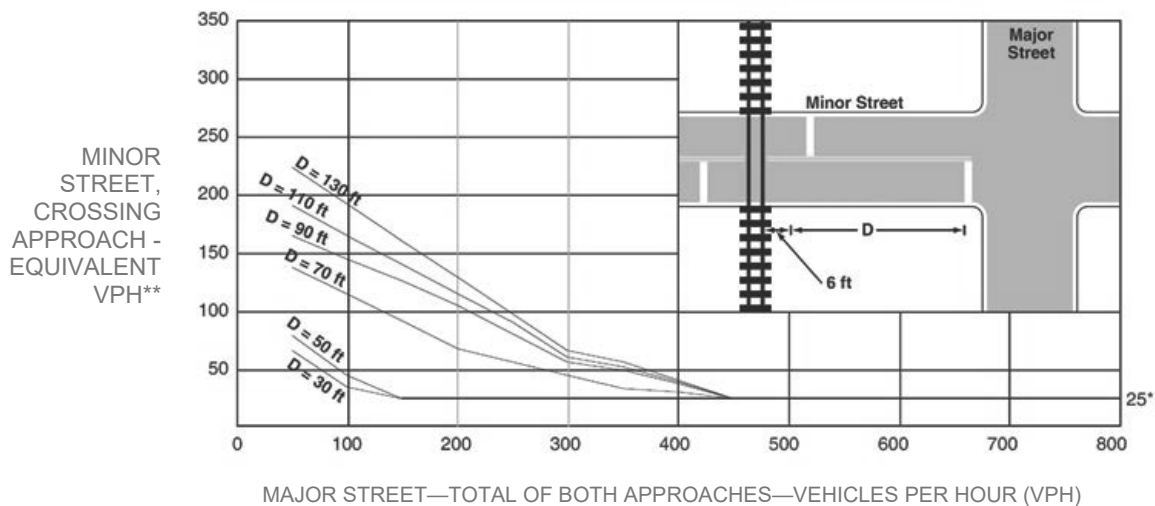

**Figure 4C-10. Warrant 9, Intersection Near a Grade Crossing (Two or More Approach Lanes at the Track Crossing)**

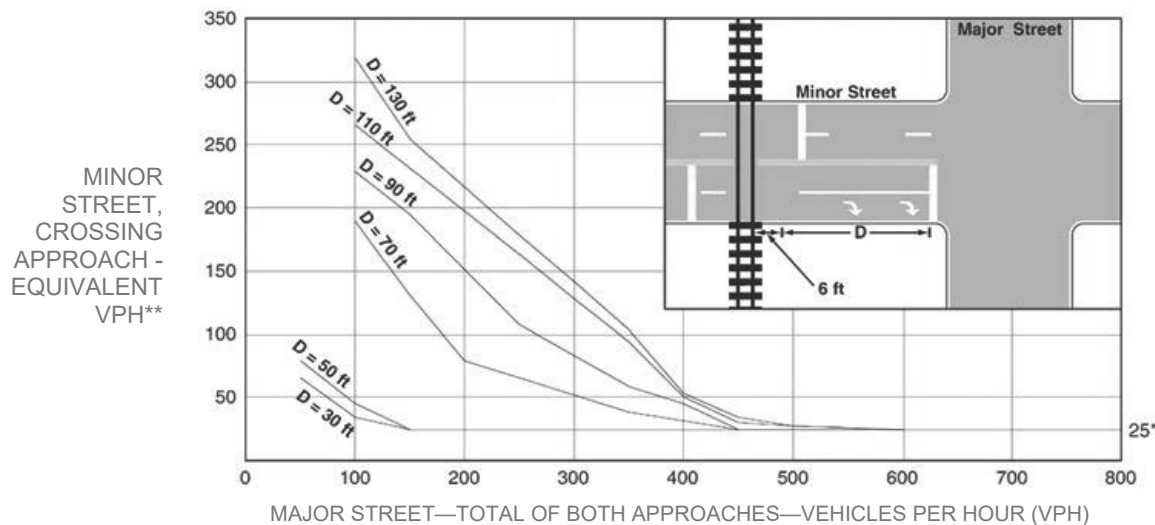

\* 25 vph applies as the lower threshold volume

\*\* VPH after applying the adjustment factors in Tables 4C-2, 4C-3, and/or 4C-4, if appropriate



Bicycles

WARRANT  
10

N/A   
 SATISFIED YES   
 NO

\* The satisfaction of a traffic signal warrant or warrants shall not in itself require the installation of a traffic control signal \*

- a. A bicycle signal should be considered for use only when the Volume requirement and Collision requirement have been met, or the Volume requirement and Geometry requirement have been met.
- b. Bicycle and vehicle volumes shall use the same peak hour.

		Hour	FULFILLED	
			YES	NO
VOLUME REQUIREMENT	One-Hour bicycle volume entering intersection B= _____			
	One-Hour vehicle volume entering intersection V= _____		<input type="checkbox"/>	<input type="checkbox"/>
	$B \times V = W$ W= <u>  0  </u>			
	$B \geq 50$ AND $W \geq 50,000$			
<b>AND</b>				
COLLISION REQUIREMENT	Two or more bicycle/vehicle collisions of types susceptible to correction by a bicycle signal over a 12-month period.		YES	NO
	DATES: _____ _____		<input type="checkbox"/>	<input type="checkbox"/>
<b>OR</b> GEOMETRY REQUIREMENT	A separate bicycle or multi-use path intersects roadway		<input type="checkbox"/>	<input type="checkbox"/>
	OR, is necessary to facilitate a bicycle movement that is not permitted by motor vehicles			

Activated Pedestrian Warning Device

WARRANT  
11

N/A   
 SATISFIED YES   
 NO

\* The satisfaction of a traffic signal warrant or warrants shall not in itself require the installation of a traffic control signal \*

- a. All Parts shall be satisfied.
- b. This warrant should be applied when an Activated Pedestrian Warning Device is recommended within 600 feet both upstream and downstream of existing traffic signals.

PART A	YES	NO
Location meets the guidelines for the installation of an Activated Pedestrian Warning Device as described in MPP section 354.	<input type="checkbox"/>	<input type="checkbox"/>

MINIMUM REQUIREMENTS	DISTANCE TO NEAREST SIGNALS	YES	NO
≤ 600 ft	N _____ ft, S _____ ft, E _____ ft, W _____ ft	<input type="checkbox"/>	<input type="checkbox"/>



## Traffic Signal Warrants Worksheet

DATE 3/29/21 PREPARER GTC REVIEWER \_\_\_\_\_MAJOR ST: Olympic BoulevardMINOR ST: Lemon Street

Critical Approach Speed



or

Speed Limit

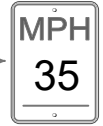

Speed limit or critical speed on major street traffic > 40 mph.....  or  } RURAL (R)       URBAN (U)

In built up area of isolated community of < 10,000 population.....

# Eight-Hour Vehicular Volume

N/A SATISFIED YES NO 

★ The satisfaction of a traffic signal warrant or warrants shall not in itself require the installation of a traffic control signal ★

- Condition A or Condition B or combination of 80% of both parts A and B must be satisfied.
- A 6-hour Manual Count may be used in a determination that this warrant is not met. However, supplement manual counts should be taken during separate hours for a determination that this warrant is met.
- In applying each condition, the major street and minor street volumes shall be for the same hours. On the minor street, the higher volume does not need to be the same approach during each of the hours.
- The study should consider the effects of the right-turn vehicles from the minor-street approaches. Engineering judgment should be used to determine what, if any, portion of the right-turn traffic is subtracted from the minor-street traffic count.
- Figure 4C-103(CA) should be used for new intersections, significantly reconstructed intersections, where near-term land development will result in increased volumes, or where it is not reasonable to use current traffic volumes.
- Engineering judgment should also be used in applying various traffic signal warrants to cases where approaches consist of one lane plus one left-turn or right-turn lane. This site-specific traffic characteristics should dictate whether an approach is considered as one lane or two lanes. For example, for an approach with one lane for through and right-turning traffic plus a left-turn lane, if engineering judgment indicates that it should be considered a one-lane approach because the traffic using the left turn lane is minor, the total traffic volume approaching the intersection should be applied against the signal warrants as a one-lane approach. The approach should be considered two lanes if approximately half of the traffic on the approach turns left and the left-turn lane is of sufficient length to accommodate all left-turn vehicles. Similar engineering judgment and rationale should be applied to a street approach with one through/left-turn lane plus a right-turn lane. In this case, the degree of conflict of minor-street right-turn traffic with traffic on the major street should be considered. Thus, right-turn traffic should not be included in the minor-street volume if the movement enters the major street with minimal conflict. The approach should be evaluated as a one-lane approach with only the traffic volume in the through/left-turn lane considered.
- At an intersection with a high volume of left-turn traffic from the major street, the signal warrant analysis may be performed in a manner that considers the higher volume of the major-street left-turn volumes plus the higher volume minor-street approach as the "minor street" volume and both approaches of the major street minus the higher of the major-street left-turn volume as "major street" volume. In these cases, engineering judgment should be used to determine if left-turn phasing is necessary to accommodate the high volume of left-turn traffic.

# Eight-Hour Vehicular Volume

*(continued)*

★ The satisfaction of a traffic signal warrant or warrants shall not in itself require the installation of a traffic control signal ★

### Condition A

#### Minimum Vehicle Volume

<b>SATISFIED</b>	<b>YES</b>	<b>NO</b>
100%	<input type="checkbox"/>	<input type="checkbox"/>
80%	<input type="checkbox"/>	<input type="checkbox"/>

<b>RIGHT TURN REDUCTION APPLICATION MINOR STREET</b> (If Yes, fill in percentage)	<input type="checkbox"/> _____%
--	---------------------------------

MINIMUM REQUIREMENTS (80% SHOW IN BRACKETS)			
(U)	R	(U)	R

APPROACH LANES	MINIMUM REQUIREMENTS				Hours							
	1 ✓		2 or More ✓		07:00	08:00	09:00	15:00	16:00	17:00		
Both Approach Major Street	500 (400)	350 (280)	600 ✓ (480)	420 (336)	1950	2051	1906	1822	1997	2190		
Highest Approach Minor Street	150 ✓ (120)	105 (84)	200 (160)	140 (112)	136	99	65	74	161	246		

### Condition B

#### Interruption of Continuous Traffic

<b>SATISFIED</b>	<b>YES</b>	<b>NO</b>
100%	<input type="checkbox"/>	<input type="checkbox"/>
80%	<input type="checkbox"/>	<input type="checkbox"/>

<b>RIGHT TURN REDUCTION APPLICATION MINOR STREET</b> (If Yes, fill in percentage)	<input type="checkbox"/> _____%
--	---------------------------------

MINIMUM REQUIREMENTS (80% SHOW IN BRACKETS)			
(U)	R	(U)	R

APPROACH LANES	MINIMUM REQUIREMENTS				Hours							
	1 ✓		2 or More ✓		07:00	08:00	09:00	15:00	16:00	17:00		
Both Approach Major Street	750 (600)	525 (420)	900 ✓ (720)	630 (504)	1950	2051	1906	1822	1997	2190		
Highest Approach Minor Street	75 ✓ (60)	53 (42)	100 (80)	70 (56)	136	99	65	74	161	246		

### COMBINATION OF A & B

<b>SATISFIED</b>	<b>YES</b>	<b>NO</b>
	<input type="checkbox"/>	<input type="checkbox"/>

REQUIREMENT	CONDITION	✓	FULFILLED	
			YES	NO
TWO CONDITIONS SATISFIED 80%	A. MINIMUM VEHICULAR VOLUME			
	AND		<input type="checkbox"/>	<input type="checkbox"/>
	B. INTERRUPTION OF CONTINUOUS TRAFFIC			
	AND		<input type="checkbox"/>	<input type="checkbox"/>
AN ADEQUATE TRIAL OF OTHER ALTERNATIVES THAT COULD CAUSE LESS DELAY AND INCOVENIENCE TO TRAFFIC HAS FAILED TO SOLVE THE TRAFFIC PROBLEMS			<input type="checkbox"/>	<input type="checkbox"/>

# Eight-Hour Vehicular Volume

*(continued)*

★ The satisfaction of a traffic signal warrant or warrants shall not in itself require the installation of a traffic control signal ★

<b>Projected Volumes</b>	Satisfied	YES	NO
	<input type="checkbox"/>	<input type="checkbox"/>	<input type="checkbox"/>

**Figure 4C-103 (CA). Traffic Signal Warrants Worksheet (Average Traffic Estimate Form)**  
Based on Estimated Average Daily Traffic - see Note\*

URBAN <input type="checkbox"/>	RURAL <input type="checkbox"/>	Minimum Requirements Estimated Average Daily Traffic			
<b>CONDITION A - Minimum Vehicular Volume</b>		Vehicles Per Day On Major Street (Total of Both Approaches)		Vehicles Per Day On Higher-Volume Minor Street Approach (One Direction Only)	
Satisfied <input type="checkbox"/> Not Satisfied <input type="checkbox"/>					
Number of lanes for moving traffic on each approach		Urban	Rural	Urban	Rural
Major Street	Minor Street				
1.....	1.....	8,000	5,600	2,400	1,680
2 or More.....	1.....	9,600	6,720	2,400	1,680
2 or More.....	2 or More.....	9,600	6,720	3,200	2,240
1.....	2 or More.....	8,000	5,600	3,200	2,240
<b>CONDITION B - Interruption of Continuous Traffic</b>		Vehicles Per Day On Major Street (Total of Both Approaches)		Vehicles Per Day On Higher-Volume Minor Street Approach (One Direction Only)	
Satisfied <input type="checkbox"/> Not Satisfied <input type="checkbox"/>					
Number of lanes for moving traffic on each approach		Urban	Rural	Urban	Rural
Minor Street	Minor Street				
1.....	1.....	12,000	8,400	1,200	850
2 or More.....	1.....	14,400	10,080	1,200	850
2 or More.....	2 or More.....	14,400	10,080	1,600	1,120
1.....	2 or More.....	12,000	8,400	1,600	1,120
<b>Combination of CONDITIONS A + B</b>		2 CONDITIONS 80%		2 CONDITIONS 80%	
Satisfied <input type="checkbox"/> Not Satisfied <input type="checkbox"/>					
<u>No one condition satisfied</u> , but following conditions fulfilled 80% or more..... <u>        </u> <u>        </u> <span style="margin-left: 100px;">A</span> <span style="margin-left: 100px;">B</span>					

\* Note: To be used only for NEW INTERSECTIONS or other locations where it is not reasonable to count actual traffic volumes

# Four-Hour Vehicular Volume



N/A

SATISFIED YES

NO

★ The satisfaction of a traffic signal warrant or warrants shall not in itself require the installation of a traffic control signal ★

- a. Record hourly vehicle volumes for the highest four hours of an average day.
- b. In applying each condition, the major street and minor street volumes shall be for the same hours. On the minor street, the higher volume does not need to be the same approach during each of the hours.
- c. The study should consider the effects of the right-turn vehicles from the minor-street approaches. Engineering judgment should be used to determine what, if any, portion of the right-turn traffic is subtracted from the minor-street traffic count.
- d. Engineering judgment should also be used in applying various traffic signal warrants to cases where approaches consist of one lane plus one left-turn or right-turn lane. This site-specific traffic characteristics should dictate whether an approach is considered as one lane or two lanes. For example, for an approach with one lane for through and right-turning traffic plus a left-turn lane, if engineering judgment indicates that it should be considered a one-lane approach because the traffic using the left turn lane is minor, the total traffic volume approaching the intersection should be applied against the signal warrants as a one-lane approach. The approach should be considered two lanes if approximately half of the traffic on the approach turns left and the left-turn lane is of sufficient length to accommodate all left-turn vehicles. Similar engineering judgment and rationale should be applied to a street approach with one through/left-turn lane plus a right-turn lane. In this case, the degree of conflict of minor-street right-turn traffic with traffic on the major street should be considered. Thus, right-turn traffic should not be included in the minor-street volume if the movement enters the major street with minimal conflict. The approach should be evaluated as a one-lane approach with only the traffic volume in the through/left-turn lane considered.
- e. At an intersection with a high volume of left-turn traffic from the major street, the signal warrant analysis may be performed in a manner that considers the higher volume of the major-street left-turn volumes plus the higher volume minor-street approach as the "minor street" volume and both approaches of the major street minus the higher of the major-street left-turn volume as "major street" volume. In these cases, engineering judgment should be used to determine if left-turn phasing is necessary to accommodate the high volume of left-turn traffic.

APPROACH LANES	One	2 or More	Hours					YES	NO
			17:00	16:00	07:00	08:00			
Both Approaches - Major Street		✓	2190	1997	1950	2051	<b>RIGHT TURN REDUCTION APPLICATION MINOR STREET</b> (If Yes, fill in percentage)	<input type="checkbox"/>	<input type="checkbox"/>
Higher Approach - Minor Street	✓		246	161	136	99		_____ %	
* All plotted points fall above the applicable curve in Figure 4C-1. (URBAN AREAS)								<input type="checkbox"/>	<input type="checkbox"/>
<u>OR</u> , All plotted points fall above the applicable curve in Figure 4C-2. (RURAL AREAS)								<input type="checkbox"/>	<input type="checkbox"/>

# Four-Hour Vehicular Volume (continued)

★ The satisfaction of a traffic signal warrant or warrants shall not in itself require the installation of a traffic control signal ★

## URBAN

Figure 4C-1. Warrant 2, Four-Hour Vehicular Volume

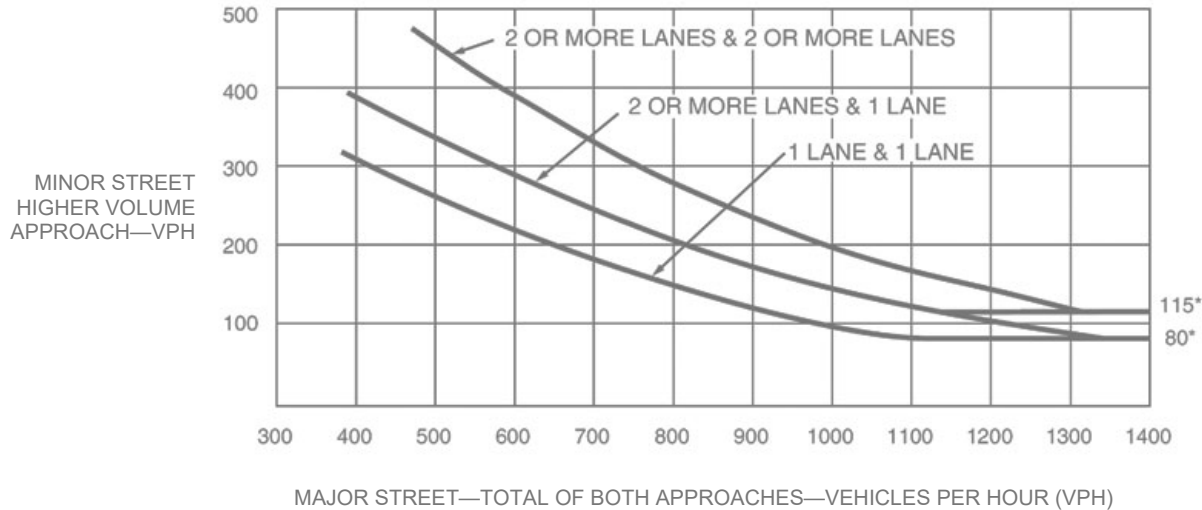

\*Note: 115 vph applies as the lower threshold volume for a minor-street approach with two or more lanes and 80 vph applies as the lower threshold volume for a minor-street approach with one lane.

## RURAL

Figure 4C-2. Warrant 2, Four-Hour Vehicular Volume (70% Factor)

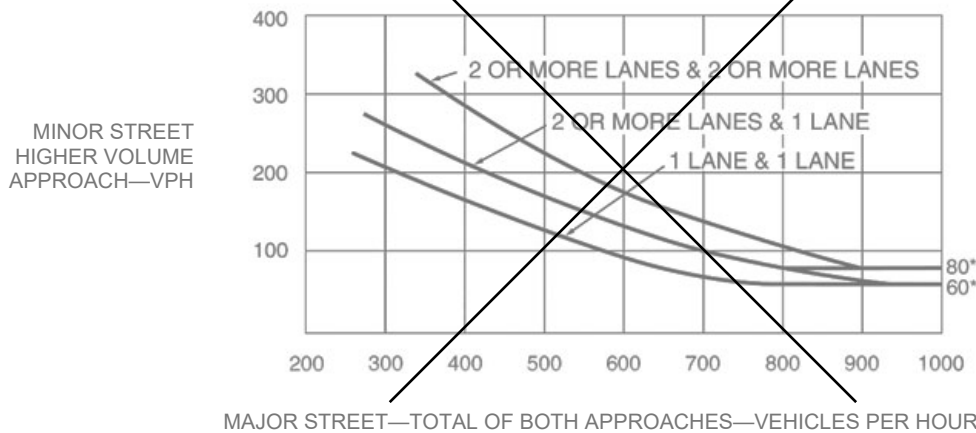

\*Note: 80 vph applies as the lower threshold volume for a minor-street approach with two or more lanes and 60 vph applies as the lower threshold volume for a minor-street approach with one lane.

Peak Hour

WARRANT  
3

N/A   
 SATISFIED YES   
 NO

\* The satisfaction of a traffic signal warrant or warrants shall not in itself require the installation of a traffic control signal \*

- a. Part A or Part B must be satisfied.
- b. In applying each condition, the major street and minor street volumes shall be for the same hours.
- c. The study should consider the effects of the right-turn vehicles from the minor-street approaches. Engineering judgment should be used to determine what, if any, portion of the right-turn traffic is subtracted from the minor-street traffic count.
- d. Estimated Peak Hour Volumes may be used for new intersections, significantly reconstructed intersections, or where near-term land development will result in increased volumes.
- e. Engineering judgment should also be used in applying various traffic signal warrants to cases where approaches consist of one lane plus one left-turn or right-turn lane. This site-specific traffic characteristics should dictate whether an approach is considered as one lane or two lanes. For example, for an approach with one lane for through and right-turning traffic plus a left-turn lane, if engineering judgment indicates that it should be considered a one-lane approach because the traffic using the left turn lane is minor, the total traffic volume approaching the intersection should be applied against the signal warrants as a one-lane approach. The approach should be considered two lanes if approximately half of the traffic on the approach turns left and the left-turn lane is of sufficient length to accommodate all left-turn vehicles. Similar engineering judgment and rationale should be applied to a street approach with one through/left-turn lane plus a right-turn lane. In this case, the degree of conflict of minor-street right-turn traffic with traffic on the major street should be considered. Thus, right-turn traffic should not be included in the minor-street volume if the movement enters the major street with minimal conflict. The approach should be evaluated as a one-lane approach with only the traffic volume in the through/left-turn lane considered.
- f. At an intersection with a high volume of left-turn traffic from the major street, the signal warrant analysis may be performed in a manner that considers the higher volume of the major-street left-turn volumes plus the higher volume minor-street approach as the "minor street" volume and both approaches of the major street minus the higher of the major-street left-turn volume as "major street" volume. In these cases, engineering judgment should be used to determine if left-turn phasing is necessary to accommodate the high volume of left-turn traffic.

**PART A**

*All parts 1, 2, and 3 below must be satisfied for the same one hour, for any four consecutive 15-minute periods)*

	SATISFIED	YES	NO
		<input checked="" type="checkbox"/>	<input type="checkbox"/>
		YES	NO
		YES	NO
		YES	NO

**PART B**

	SATISFIED	YES	NO
		<input checked="" type="checkbox"/>	<input type="checkbox"/>
Hour			
17:00			
APPROACH LANES			
One			
2 or More			
Both Approaches - Major Street		✓	2190
Higher Approach - Minor Street	✓		246
The plotted point falls above the applicable curve in Figure 4C-3. (URBAN AREAS)	<input checked="" type="checkbox"/>	<input checked="" type="checkbox"/>	<input checked="" type="checkbox"/>
<u>OR</u> , The plotted point falls above the applicable curve in Figure 4C-4. (RURAL AREAS)	<input checked="" type="checkbox"/>	<input type="checkbox"/>	

**Peak Hour** (continued)

★ The satisfaction of a traffic signal warrant or warrants shall not in itself require the installation of a traffic control signal ★

**URBAN**  
**Figure 4C-3. Warrant 3, Peak Hour**

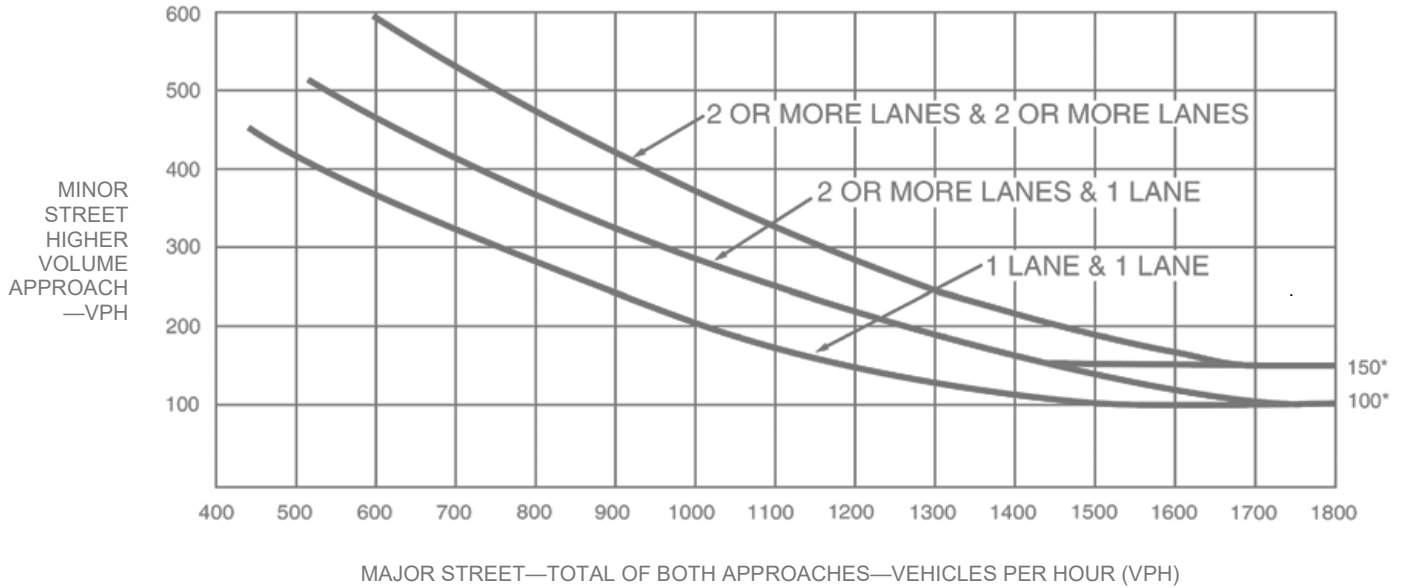

\* Note: 150 vph applies as the lower threshold volume for a minor street approach with two or more lanes and 100 vph applies as the lower threshold volume for a minor street approach with one lane.

**RURAL**  
**Figure 4C-4. Warrant 3, Peak Hour (70% Factor)**  
 (COMMUNITY LESS THAN 10,000 POPULATION OR ABOVE 40 MPH ON MAJOR STREET)

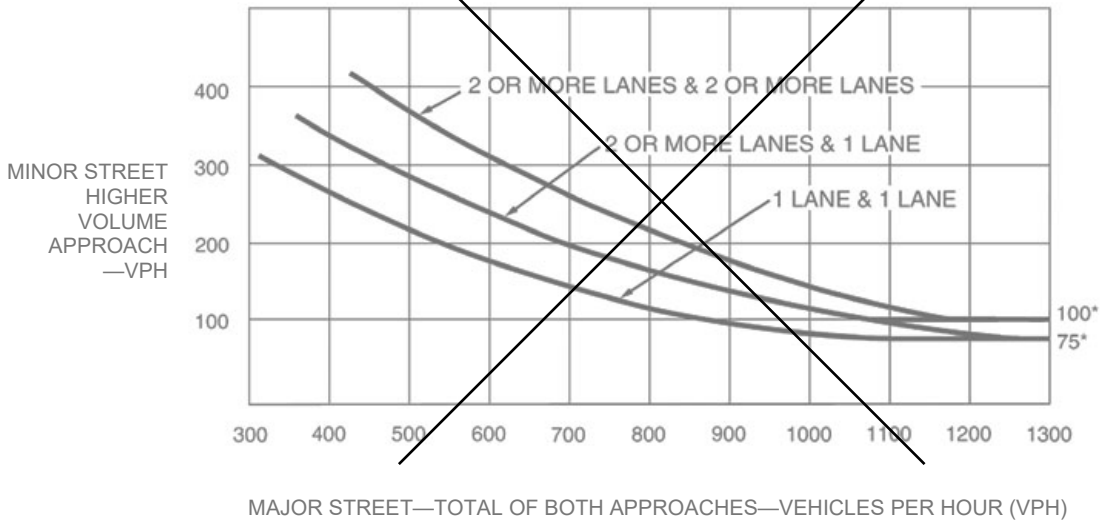

\* Note: 100 vph applies as the lower threshold volume for a minor street approach with two or more lanes and 75 vph applies as the lower threshold volume for a minor street approach with one lane.



# Pedestrian Volume



N/A	<input checked="" type="checkbox"/>
SATISFIED	YES <input type="checkbox"/>
	NO <input type="checkbox"/>

★ The satisfaction of a traffic signal warrant or warrants shall not in itself require the installation of a traffic control signal ★

- Parts 1 and 2 shall be satisfied.
- The pedestrian volume criterion may be reduced by as much as 50% if the 15th percentile speed of the pedestrians is less than 3.5 feet/second.
- Estimated pedestrian volumes may be used where nearby, near-term land use development has been approved for construction.
- In applying each condition, the total vehicles per hour on the major street (on both approaches) and the total pedestrians per hour crossing the major street shall be for the same hours.
- The Pedestrian Volume signal warrants shall not be applied at locations where the distance to the nearest traffic control signal or STOP sign controlling the street that pedestrians desire to cross is less than 300 feet, unless the proposed traffic control signal will not restrict the progressive movement of traffic.
- Traffic control signal may not be needed at the study location if adjacent coordinated traffic control signals consistently provide gaps of adequate length for pedestrians to cross the street.
- If it is considered at a non-intersection crossing, the traffic control signal should be installed at least 100 feet from side streets or driveways that are controlled by STOP or YIELD signs. If the traffic control signal is installed at a non-intersection crossing, at least one of the signal faces should be over the traveled way for each approach, parking and other sight obstructions should be prohibited for at least 100 feet in advance of and at least 20 feet beyond the crosswalk or site accommodations should be made through curb extensions or other techniques to provide adequate sight distance, and the installation should include suitable standard signs and pavement markings.
- Bicycles may be counted as pedestrians.

**PART 1 (A or B must be satisfied)**

SATISFIED	YES	NO
	<input type="checkbox"/>	<input type="checkbox"/>

**A. FOUR-HOUR PEDESTRIAN VOLUMES**

	Hours			
Vehicles per hour on major street for 4 hours				
Pedestrians crossing major street per hour for highest 4 hours				

(FIGURE 4C-5 OR 4C-6 SATISFIED)

SATISFIED	YES	NO
100%	<input type="checkbox"/>	<input type="checkbox"/>
50%	<input type="checkbox"/>	<input type="checkbox"/>
15% WALKING RATE	_____ fps	

**B. ONE HOUR PEDESTRIAN VOLUMES**

	Hour
Vehicles per hour on major street for 1 hour	
Pedestrians crossing major street per hour for highest 1 hour	0

(FIGURE 4C-7 or 4C-8 SATISFIED)

SATISFIED	YES	NO
100%	<input type="checkbox"/>	<input type="checkbox"/>
50%	<input type="checkbox"/>	<input type="checkbox"/>
15% WALKING RATE	_____ fps	

**PART 2**

SATISFIED	YES	NO
	<input type="checkbox"/>	<input type="checkbox"/>

	YES	NO
<u>AND</u> , The distance to the nearest traffic signal along the major street is greater than 300 ft	<input type="checkbox"/>	<input type="checkbox"/>
<u>OR</u> , The proposed traffic signal will not restrict progressive traffic flow along the major street	<input type="checkbox"/>	<input type="checkbox"/>

# Pedestrian Volume (continued)

\* The satisfaction of a traffic signal warrant or warrants shall not in itself require the installation of a traffic control signal \*

**SPEED ≤ 35 MPH**  
**Figure 4C-5. Warrant 4, Pedestrian Four-Hour Volume**

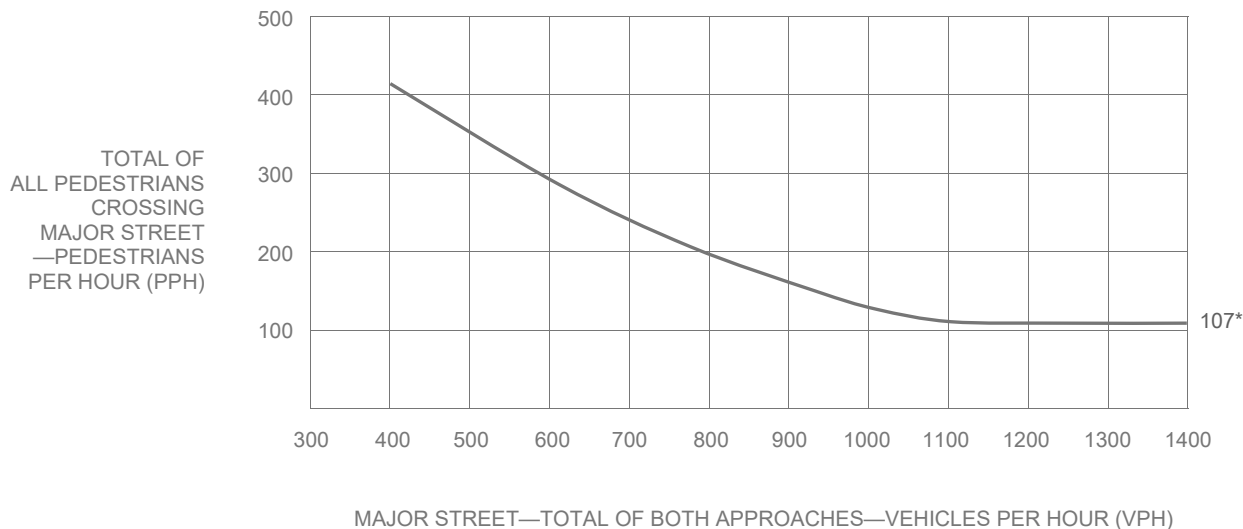

\* Note: 107 pph applies as the lower threshold volume

**SPEED > 35 MPH**  
**Figure 4C-6. Warrant 4, Pedestrian Four-Hour Volume (70% Factor)**

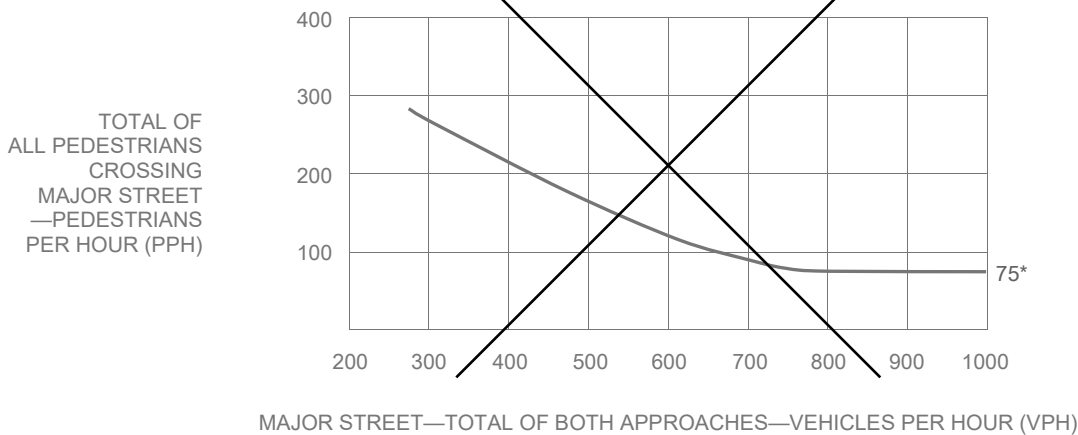

\* Note: 75 pph applies as the lower threshold volume

# Pedestrian Volume (continued)

\* The satisfaction of a traffic signal warrant or warrants shall not in itself require the installation of a traffic control signal \*

**SPEED ≤ 35 MPH**  
**Figure 4C-7. Warrant 4, Pedestrian Peak Hour**

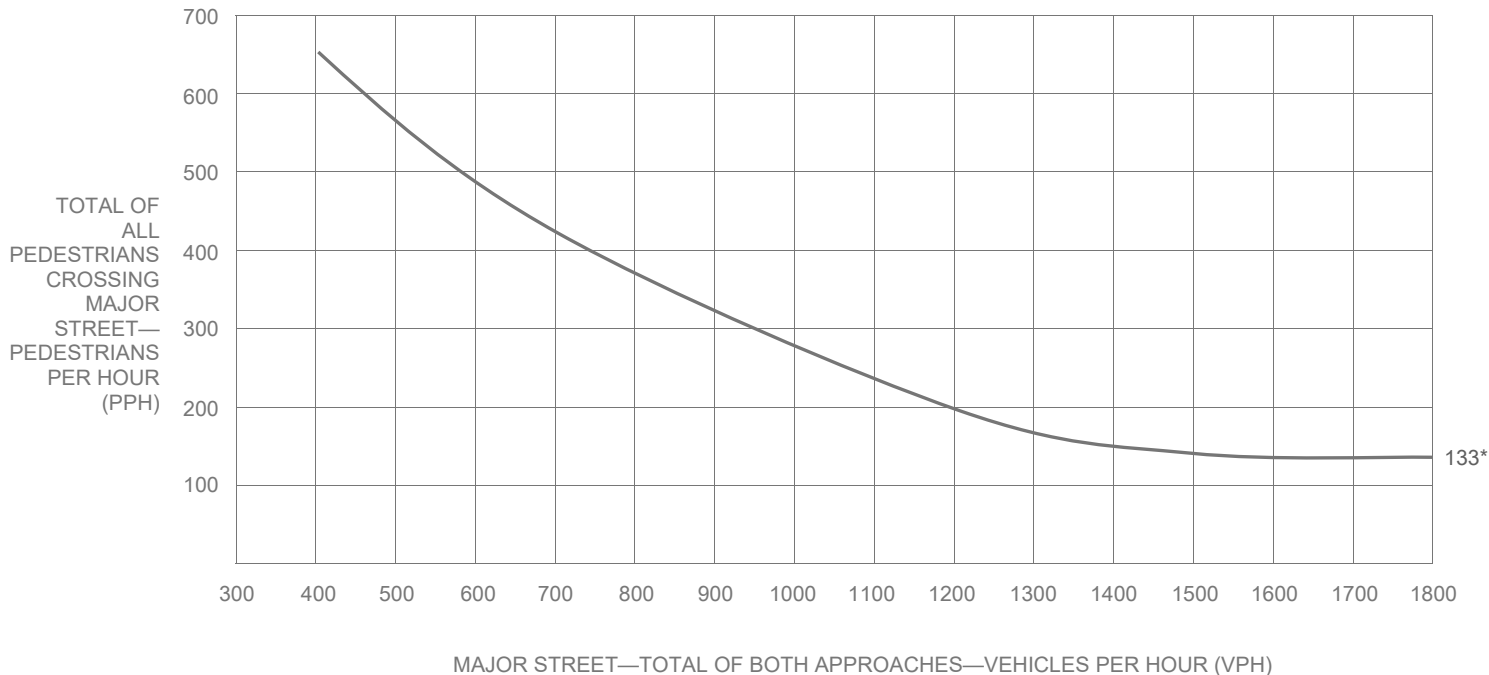

\* Note: 133 pph applies as the lower threshold volume

**SPEED > 35 MPH**  
**Figure 4C-8. Warrant 4, Pedestrian Peak Hour (70% Factor)**



\* Note: 93 pph applies as the lower threshold volume

# School Crossing

**WARRANT**  
5

N/A

SATISFIED YES

NO

★ The satisfaction of a traffic signal warrant or warrants shall not in itself require the installation of a traffic control signal ★

- a. Part A and Part B shall be satisfied.
- b. For purposes of this warrant, schoolchildren include elementary through high school students.
- c. Estimated schoolchildren volumes may be used where a new school or expanded school has been approved for construction.
- d. The need for a traffic control signal shall be considered when an engineering study of the frequency and adequacy of gaps in the vehicular traffic stream as related to the number and size of groups of schoolchildren at an established school crossing across the major street shows that the number of adequate gaps in the traffic stream during the period when the schoolchildren are using the crossing is less than the number of minutes in the same period and there are a minimum of 20 schoolchildren during the highest crossing hour.
- e. The School Crossing signal warrant shall not be applied at locations where the distance to the nearest traffic control signal along the major street is less than 300 feet, unless the proposed traffic control signal will not restrict the progressive movement of traffic.
- f. Non-intersectional schoolchildren crosswalk locations may be signalized when justified.

PART A				SATISFIED	YES	NO
				<input type="checkbox"/>	<input type="checkbox"/>	<input type="checkbox"/>
<b>Gap / Minutes and # of Children</b>			Hour	YES	NO	
Gaps vs Minutes	Minutes Children Using Crossing		Gaps < Minutes	<input type="checkbox"/>	<input type="checkbox"/>	
	Number of Adequate Gaps		<b>AND</b> Children ≥ 20/hr	<input type="checkbox"/>	<input type="checkbox"/>	
School Age Pedestrians Crossing Street / hr						
<b>AND</b> , Consideration has been given to less restrictive remedial measures				<input type="checkbox"/>	<input type="checkbox"/>	

PART B		SATISFIED	YES	NO
		<input type="checkbox"/>	<input type="checkbox"/>	<input type="checkbox"/>
		YES	NO	
The distance to the nearest traffic signal along the major street is greater than 300 ft		<input type="checkbox"/>	<input type="checkbox"/>	
<b>OR</b> , The proposed traffic signal will not restrict progressive movement of traffic		<input type="checkbox"/>	<input type="checkbox"/>	

# Coordinated Signal System

**WARRANT**  
6

N/A

SATISFIED YES

NO

★ The satisfaction of a traffic signal warrant or warrants shall not in itself require the installation of a traffic control signal ★

- a. The Coordinated Signal System signal warrant should not be applied where the resultant spacing of traffic control signals would be less than 1,000 feet.
- b. All Parts must be satisfied.

MINIMUM REQUIREMENTS	DISTANCE TO NEAREST SIGNAL	YES	NO
≥ 1000 ft	N _____ ft, S _____ ft, E _____ ft, W _____ ft	<input type="checkbox"/>	<input type="checkbox"/>
On a one-way street or a street that has traffic predominantly in one direction, the adjacent traffic control signals are so far apart that they do not provide the necessary degree of vehicular platooning.		<input type="checkbox"/>	<input type="checkbox"/>
<b>OR</b> , On a two-way street, adjacent traffic control signals do not provide the necessary degree of platooning and the proposed and adjacent traffic control signals will collectively provide a progressive operation.		<input type="checkbox"/>	<input type="checkbox"/>

# Crash Experience Warrant



N/A

SATISFIED YES

NO

★ The satisfaction of a traffic signal warrant or warrants shall not in itself require the installation of a traffic control signal ★

- a. All Parts must be satisfied.
- b. For locations that involve other agencies, crash data from other involved jurisdictions should be obtained.

		YES	NO
Adequate trial of alternatives with satisfactory observance and enforcement has failed to reduce the crash frequency		<input type="checkbox"/>	<input type="checkbox"/>
<b>REQUIREMENTS</b>	Number of crashes reported within a 12-month period susceptible to correction by a traffic signal:	<input type="checkbox"/>	<input type="checkbox"/>
<b>5 OR MORE</b>	Indicate Date(s):		
<b>REQUIREMENTS</b>	<b>CONDITIONS</b>	<input checked="" type="checkbox"/>	
<b>ONE CONDITION SATISFIED 80%</b>	Warrant 1, Condition A - Minimum Vehicular Volume		
	OR, Warrant 1, Condition B - Interruption of Continuous Traffic	<input type="checkbox"/>	<input type="checkbox"/>
	OR, Warrant 4, Pedestrian Volume Condition - Ped Vol ≥ 80% for ped volumes per Figures 4C-5 to 4C-8		

# Roadway Network



N/A

SATISFIED YES

NO

★ The satisfaction of a traffic signal warrant or warrants shall not in itself require the installation of a traffic control signal ★

- a. Existing traffic volumes with an ambient growth rate of 1% (or other LADOT approved ambient growth rate) may be used if projected volumes are not available.
- b. All Parts must be satisfied.

MINIMUM VOLUME REQUIREMENTS	ENTERING VOLUMES - ALL APPROACHES	✓	FULLFILLED	
			YES	NO
1000 Veh / Hr	During Typical Weekday Peak Hour _____ Veh/Hr <b>AND</b> has 5-year projected traffic volumes that meet one or more of Warrants 1,2, and 3 during an average weekday.  <b>OR</b> During Each of Any 5 Hrs. of a Saturday or Sunday _____ Veh / Hr		<input type="checkbox"/>	<input type="checkbox"/>
	<b>CHARACTERISTICS OF MAJOR ROUTES</b>			
	<b>MAJOR ROUTE A</b>			
	<b>MAJOR ROUTE B</b>			
	Highway System Serving as Principal Network for Through Traffic			
	Rural or Suburban Highway Outside Of, Entering, or Traversing a City			
	Appears as Major Route on an Official Plan		YES	NO
	Any Major Route Characteristics Met, Both Streets		<input type="checkbox"/>	<input type="checkbox"/>

# Intersection Near a Grade Crossing



N/A

SATISFIED YES

NO

★ The satisfaction of a traffic signal warrant or warrants shall not in itself require the installation of a traffic control signal ★

- a. Both Parts A and B shall be satisfied.
- b. This Warrant shall only be applied after review and approval by the LADOT Railroad Crossing and Safety Section (RCOSS), subject to CPUC General Order approval.
- c. This Warrant does not apply for Pre-Signals and/or Queue-Cutter signals, as an alternative application of Pre-Signals (See 2012 CA MUTCD, Sec 8C.09). Pre-Signals shall only be applied after review and approval by RCOSS, subject to CPUC General Order approval.

	FULFILLED	
	YES	NO
<b>PART A</b> A grade crossing exists on an approach controlled by a STOP or YIELD sign and the center of the track nearest to the intersection is within 140 feet of the stop line or yield line on the approach. Track Center Line to Limit Line _____ ft	<input type="checkbox"/>	<input type="checkbox"/>
<b>PART B</b> <b>There is one minor street approach lane at the track crossing</b> - During the highest traffic volume hour during which rail traffic uses the crossing, the plotted point falls above the applicable curve in Figure 4C-9. Major Street - Total of both approaches: _____ VPH Minor Street - Crosses the track (one direction only, approaching the intersection): _____ VPH X AF (Use Tables 4C-2, 3, & 4 below to calculate AF) = _____ VPH	<input type="checkbox"/>	<input type="checkbox"/>
<b>OR, There are two or more minor street approach lanes at the track crossing</b> - During the highest traffic volume hour during which rail traffic uses the crossing, the plotted point falls above the applicable curve in Figure 4C-10. Major Street - Total of both approaches: _____ VPH Minor Street - Crosses the track (one direction only, approaching the intersection): _____ VPH X AF (Use Tables 4C-2, 3, & 4 below to calculate AF) = _____ VPH	<input type="checkbox"/>	<input type="checkbox"/>

The minor street approach volume may be multiplied by up to three following adjustment factors (AF) as described in Section 4C-10.

- 1. Number of Rail Traffic per Day \_\_\_\_\_ Adjustment factor from Table 4C-2 \_\_\_\_\_
- 2. Percentage of High-Occupancy Buses on Minor Street Approach \_\_\_\_\_ Adjustment factor from Table 4C-3 \_\_\_\_\_
- 3. Percentage of Tractor-Trailer Trucks on Minor Street Approach \_\_\_\_\_ Adjustment factor from Table 4C-4 \_\_\_\_\_

NOTE: If no data is available or known, then use AF = 1 (no adjustment)

**Table 4C-2. Warrant 9, Adjustment Factor for Daily Frequency of Rail Traffic**

Rail Traffic per Day	Adjustment Factor
1	0.67
2	0.91
3 to 5	1.00
6 to 8	1.18
9 to 11	1.25
12 or more	1.33

**Table 4C-3. Warrant 9, Adjustment Factor for Percentage of High-Occupancy Buses**

% of High-Occupancy Buses * on Minor-Street Approach	Adjustment Factor
0 %	1.00
2 %	1.09
4 %	1.19
6 % or more	1.32

\* A high-occupancy bus is defined as a bus occupied by at least 20 people

# Intersection Near a Grade Crossing *(continued)*

★ The satisfaction of a traffic signal warrant or warrants shall not in itself require the installation of a traffic control signal ★

**Table 4C-4. Warrant 9, Adjustment Factor for Percentage of Tractor-Trailer Trucks**

% of Tractor-Trailer Trucks on Minor-Street Approach	Adjustment Factor	
	D less than 70 feet	D of 70 feet or more
0% to 2.5%	0.50	0.50
2.6% to 7.5%	0.75	0.75
7.6% to 12.5%	1.00	1.00
12.6% to 17.5%	2.30	1.15
17.6% to 22.5%	2.70	1.35
22.6% to 27.5%	3.28	1.64
More than 27.5%	4.18	2.09

**Figure 4C-9. Warrant 9, Intersection Near a Grade Crossing (One Approach Lane at the Track Crossing)**

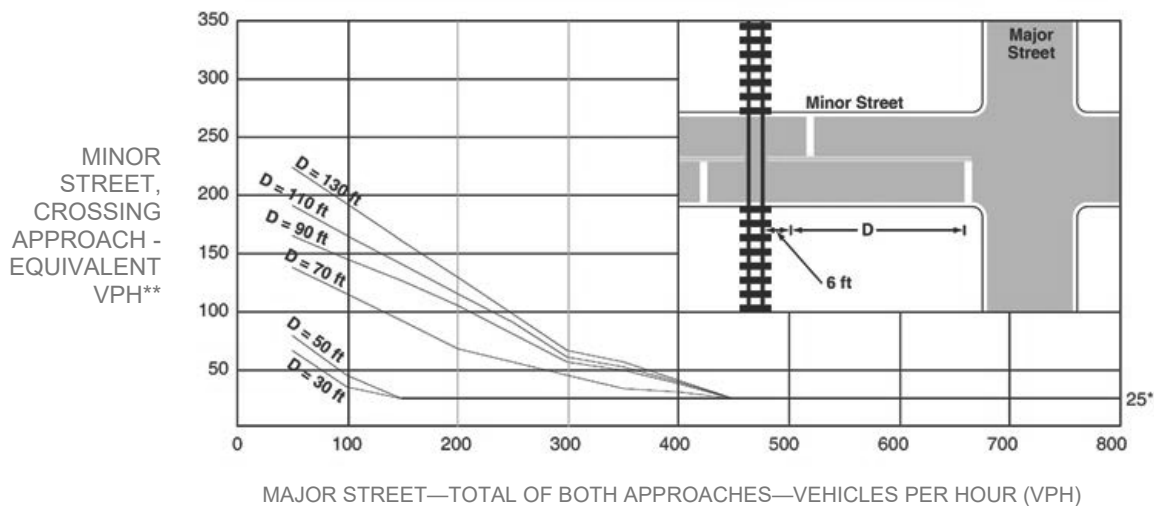

**Figure 4C-10. Warrant 9, Intersection Near a Grade Crossing (Two or More Approach Lanes at the Track Crossing)**

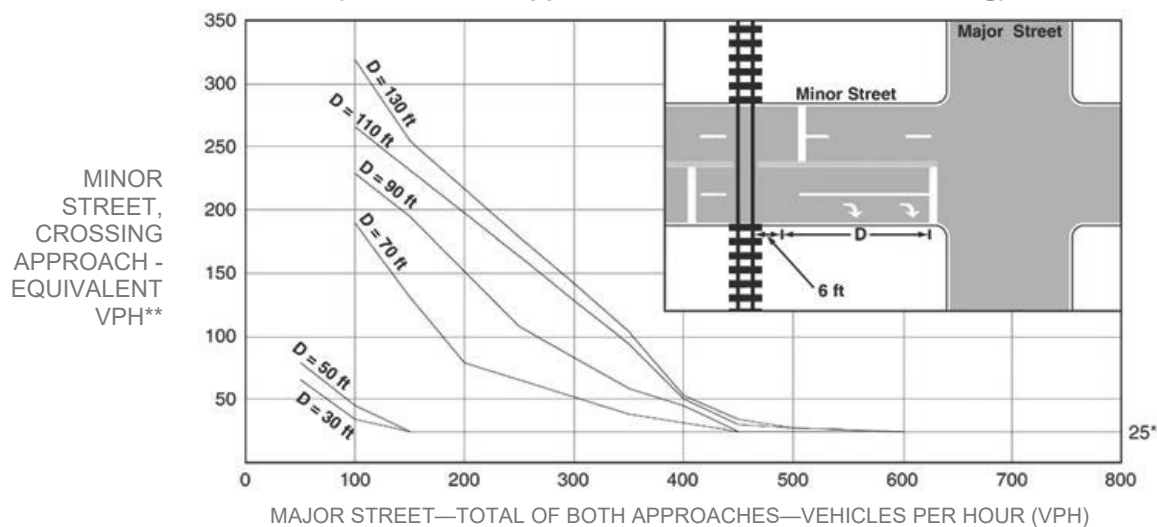

\* 25 vph applies as the lower threshold volume

\*\* VPH after applying the adjustment factors in Tables 4C-2, 4C-3, and/or 4C-4, if appropriate

Bicycles

WARRANT  
10

N/A   
 SATISFIED YES   
 NO

\* The satisfaction of a traffic signal warrant or warrants shall not in itself require the installation of a traffic control signal \*

- a. A bicycle signal should be considered for use only when the Volume requirement and Collision requirement have been met, or the Volume requirement and Geometry requirement have been met.
- b. Bicycle and vehicle volumes shall use the same peak hour.

		Hour	FULFILLED	
			YES	NO
VOLUME REQUIREMENT	One-Hour bicycle volume entering intersection B= _____			
	One-Hour vehicle volume entering intersection V= _____		<input type="checkbox"/>	<input type="checkbox"/>
	$B \times V = W$ W= <u>  0  </u>			
	$B \geq 50$ AND $W \geq 50,000$			
<b>AND</b>				
COLLISION REQUIREMENT	Two or more bicycle/vehicle collisions of types susceptible to correction by a bicycle signal over a 12-month period.		YES	NO
	DATES: _____		<input type="checkbox"/>	<input type="checkbox"/>
OR GEOMETRY REQUIREMENT	A separate bicycle or multi-use path intersects roadway		<input type="checkbox"/>	<input type="checkbox"/>
	OR, is necessary to facilitate a bicycle movement that is not permitted by motor vehicles			

Activated Pedestrian Warning Device

WARRANT  
11

N/A   
 SATISFIED YES   
 NO

\* The satisfaction of a traffic signal warrant or warrants shall not in itself require the installation of a traffic control signal \*

- a. All Parts shall be satisfied.
- b. This warrant should be applied when an Activated Pedestrian Warning Device is recommended within 600 feet both upstream and downstream of existing traffic signals.

PART A	YES	NO
Location meets the guidelines for the installation of an Activated Pedestrian Warning Device as described in MPP section 354.	<input type="checkbox"/>	<input type="checkbox"/>

MINIMUM REQUIREMENTS	DISTANCE TO NEAREST SIGNALS	YES	NO
≤ 600 ft	N _____ ft, S _____ ft, E _____ ft, W _____ ft	<input type="checkbox"/>	<input type="checkbox"/>





Traffic Signal Warrants Worksheet

DATE 3/29/21 PREPARER GTC REVIEWER \_\_\_\_\_

MAJOR ST: Olympic Boulevard

MINOR ST: Lemon Street

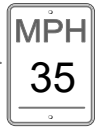
Critical Approach Speed }  *or* Speed Limit } 

Speed limit or critical speed on major street traffic > 40 mph.....  *or*  } RURAL (R)       URBAN (U)  
In built up area of isolated community of < 10,000 population.....

# Eight-Hour Vehicular Volume



N/A	<input checked="" type="checkbox"/>
SATISFIED	YES <input type="checkbox"/>
	NO <input type="checkbox"/>

★ The satisfaction of a traffic signal warrant or warrants shall not in itself require the installation of a traffic control signal ★

- Condition A or Condition B or combination of 80% of both parts A and B must be satisfied.
- A 6-hour Manual Count may be used in a determination that this warrant is not met. However, supplement manual counts should be taken during separate hours for a determination that this warrant is met.
- In applying each condition, the major street and minor street volumes shall be for the same hours. On the minor street, the higher volume does not need to be the same approach during each of the hours.
- The study should consider the effects of the right-turn vehicles from the minor-street approaches. Engineering judgment should be used to determine what, if any, portion of the right-turn traffic is subtracted from the minor-street traffic count.
- Figure 4C-103(CA) should be used for new intersections, significantly reconstructed intersections, where near-term land development will result in increased volumes, or where it is not reasonable to use current traffic volumes.
- Engineering judgment should also be used in applying various traffic signal warrants to cases where approaches consist of one lane plus one left-turn or right-turn lane. This site-specific traffic characteristics should dictate whether an approach is considered as one lane or two lanes. For example, for an approach with one lane for through and right-turning traffic plus a left-turn lane, if engineering judgment indicates that it should be considered a one-lane approach because the traffic using the left turn lane is minor, the total traffic volume approaching the intersection should be applied against the signal warrants as a one-lane approach. The approach should be considered two lanes if approximately half of the traffic on the approach turns left and the left-turn lane is of sufficient length to accommodate all left-turn vehicles. Similar engineering judgment and rationale should be applied to a street approach with one through/left-turn lane plus a right-turn lane. In this case, the degree of conflict of minor-street right-turn traffic with traffic on the major street should be considered. Thus, right-turn traffic should not be included in the minor-street volume if the movement enters the major street with minimal conflict. The approach should be evaluated as a one-lane approach with only the traffic volume in the through/left-turn lane considered.
- At an intersection with a high volume of left-turn traffic from the major street, the signal warrant analysis may be performed in a manner that considers the higher volume of the major-street left-turn volumes plus the higher volume minor-street approach as the "minor street" volume and both approaches of the major street minus the higher of the major-street left-turn volume as "major street" volume. In these cases, engineering judgment should be used to determine if left-turn phasing is necessary to accommodate the high volume of left-turn traffic.

# Eight-Hour Vehicular Volume

*(continued)*

★ The satisfaction of a traffic signal warrant or warrants shall not in itself require the installation of a traffic control signal ★

**Condition A**

**Minimum Vehicle Volume**

<b>SATISFIED</b>	<b>YES</b>	<b>NO</b>
100%	<input type="checkbox"/>	<input type="checkbox"/>
80%	<input type="checkbox"/>	<input type="checkbox"/>

<b>RIGHT TURN REDUCTION APPLICATION MINOR STREET</b> (If Yes, fill in percentage)	<input type="checkbox"/>	<input type="checkbox"/>
<input type="checkbox"/>	_____%	

MINIMUM REQUIREMENTS (80% SHOW IN BRACKETS)			
(U)	R	(U)	R

APPROACH LANES	MINIMUM REQUIREMENTS				Hours							
	1 ✓		2 or More ✓		07:00	08:00	09:00	15:00	16:00	17:00		
Both Approach Major Street	500 (400)	350 (280)	600 (480) ✓	420 (336)	1950	2051	1906	1822	1997	2153		
Highest Approach Minor Street	150 (120) ✓	105 (84)	200 (160)	140 (112)	136	99	65	74	161	213		

**Condition B**

**Interruption of Continuous Traffic**

<b>SATISFIED</b>	<b>YES</b>	<b>NO</b>
100%	<input type="checkbox"/>	<input type="checkbox"/>
80%	<input type="checkbox"/>	<input type="checkbox"/>

<b>RIGHT TURN REDUCTION APPLICATION MINOR STREET</b> (If Yes, fill in percentage)	<input type="checkbox"/>	<input type="checkbox"/>
<input type="checkbox"/>	_____%	

MINIMUM REQUIREMENTS (80% SHOW IN BRACKETS)			
(U)	R	(U)	R

APPROACH LANES	MINIMUM REQUIREMENTS				Hours							
	1 ✓		2 or More ✓		07:00	08:00	09:00	15:00	16:00	17:00		
Both Approach Major Street	750 (600)	525 (420)	900 ✓ (720)	630 (504)	1950	2051	1906	1822	1997	2153		
Highest Approach Minor Street	75 ✓ (60)	53 (42)	100 (80)	70 (56)	136	99	65	74	161	213		

**COMBINATION OF A & B**

<b>SATISFIED</b>	<b>YES</b>	<b>NO</b>
	<input type="checkbox"/>	<input type="checkbox"/>

REQUIREMENT	CONDITION	✓	FULFILLED	
			YES	NO
TWO CONDITIONS SATISFIED 80%	A. MINIMUM VEHICULAR VOLUME	<input type="checkbox"/>	<input type="checkbox"/>	<input type="checkbox"/>
	AND			
	B. INTERRUPTION OF CONTINUOUS TRAFFIC	<input type="checkbox"/>	<input type="checkbox"/>	<input type="checkbox"/>
	AND			
	AN ADEQUATE TRIAL OF OTHER ALTERNATIVES THAT COULD CAUSE LESS DELAY AND INCOVENIENCE TO TRAFFIC HAS FAILED TO SOLVE THE TRAFFIC PROBLEMS	<input type="checkbox"/>	<input type="checkbox"/>	<input type="checkbox"/>

# Eight-Hour Vehicular Volume

*(continued)*

★ The satisfaction of a traffic signal warrant or warrants shall not in itself require the installation of a traffic control signal ★

<b>Projected Volumes</b>	Satisfied	YES	NO
	<input type="checkbox"/>	<input type="checkbox"/>	<input type="checkbox"/>

**Figure 4C-103 (CA). Traffic Signal Warrants Worksheet (Average Traffic Estimate Form)**  
Based on Estimated Average Daily Traffic - see Note\*

URBAN <input type="checkbox"/>	RURAL <input type="checkbox"/>	Minimum Requirements Estimated Average Daily Traffic			
<b>CONDITION A - Minimum Vehicular Volume</b>		Vehicles Per Day On Major Street (Total of Both Approaches)		Vehicles Per Day On Higher-Volume Minor Street Approach (One Direction Only)	
Satisfied <input type="checkbox"/> Not Satisfied <input type="checkbox"/>					
Number of lanes for moving traffic on each approach		Urban	Rural	Urban	Rural
Major Street	Minor Street				
1.....	1.....	8,000	5,600	2,400	1,680
2 or More.....	1.....	9,600	6,720	2,400	1,680
2 or More.....	2 or More.....	9,600	6,720	3,200	2,240
1.....	2 or More.....	8,000	5,600	3,200	2,240
<b>CONDITION B - Interruption of Continuous Traffic</b>		Vehicles Per Day On Major Street (Total of Both Approaches)		Vehicles Per Day On Higher-Volume Minor Street Approach (One Direction Only)	
Satisfied <input type="checkbox"/> Not Satisfied <input type="checkbox"/>					
Number of lanes for moving traffic on each approach		Urban	Rural	Urban	Rural
Minor Street	Minor Street				
1.....	1.....	12,000	8,400	1,200	850
2 or More.....	1.....	14,400	10,080	1,200	850
2 or More.....	2 or More.....	14,400	10,080	1,600	1,120
1.....	2 or More.....	12,000	8,400	1,600	1,120
<b>Combination of CONDITIONS A + B</b>		2 CONDITIONS 80%		2 CONDITIONS 80%	
Satisfied <input type="checkbox"/> Not Satisfied <input type="checkbox"/>					
<u>No one condition satisfied</u> , but following conditions fulfilled 80% or more..... <u>        </u> <u>        </u> <span style="margin-left: 150px;">A</span> <span style="margin-left: 150px;">B</span>					

\* Note: To be used only for NEW INTERSECTIONS or other locations where it is not reasonable to count actual traffic volumes

# Four-Hour Vehicular Volume



N/A

SATISFIED YES

NO

★ The satisfaction of a traffic signal warrant or warrants shall not in itself require the installation of a traffic control signal ★

- a. Record hourly vehicle volumes for the highest four hours of an average day.
- b. In applying each condition, the major street and minor street volumes shall be for the same hours. On the minor street, the higher volume does not need to be the same approach during each of the hours.
- c. The study should consider the effects of the right-turn vehicles from the minor-street approaches. Engineering judgment should be used to determine what, if any, portion of the right-turn traffic is subtracted from the minor-street traffic count.
- d. Engineering judgment should also be used in applying various traffic signal warrants to cases where approaches consist of one lane plus one left-turn or right-turn lane. This site-specific traffic characteristics should dictate whether an approach is considered as one lane or two lanes. For example, for an approach with one lane for through and right-turning traffic plus a left-turn lane, if engineering judgment indicates that it should be considered a one-lane approach because the traffic using the left turn lane is minor, the total traffic volume approaching the intersection should be applied against the signal warrants as a one-lane approach. The approach should be considered two lanes if approximately half of the traffic on the approach turns left and the left-turn lane is of sufficient length to accommodate all left-turn vehicles. Similar engineering judgment and rationale should be applied to a street approach with one through/left-turn lane plus a right-turn lane. In this case, the degree of conflict of minor-street right-turn traffic with traffic on the major street should be considered. Thus, right-turn traffic should not be included in the minor-street volume if the movement enters the major street with minimal conflict. The approach should be evaluated as a one-lane approach with only the traffic volume in the through/left-turn lane considered.
- e. At an intersection with a high volume of left-turn traffic from the major street, the signal warrant analysis may be performed in a manner that considers the higher volume of the major-street left-turn volumes plus the higher volume minor-street approach as the "minor street" volume and both approaches of the major street minus the higher of the major-street left-turn volume as "major street" volume. In these cases, engineering judgment should be used to determine if left-turn phasing is necessary to accommodate the high volume of left-turn traffic.

APPROACH LANES	One	2 or More	Hours					YES	NO
			17:00	16:00	07:00	08:00			
Both Approaches - Major Street		✓	2153	1997	1950	2051	<b>RIGHT TURN REDUCTION APPLICATION MINOR STREET</b> (If Yes, fill in percentage)	<input type="checkbox"/>	<input type="checkbox"/>
Higher Approach - Minor Street	✓		213	161	136	99		_____ %	
* All plotted points fall above the applicable curve in Figure 4C-1. (URBAN AREAS)								<input type="checkbox"/>	<input type="checkbox"/>
<u>OR</u> , All plotted points fall above the applicable curve in Figure 4C-2. (RURAL AREAS)								<input type="checkbox"/>	<input type="checkbox"/>

# Four-Hour Vehicular Volume (continued)

★ The satisfaction of a traffic signal warrant or warrants shall not in itself require the installation of a traffic control signal ★

## URBAN

Figure 4C-1. Warrant 2, Four-Hour Vehicular Volume

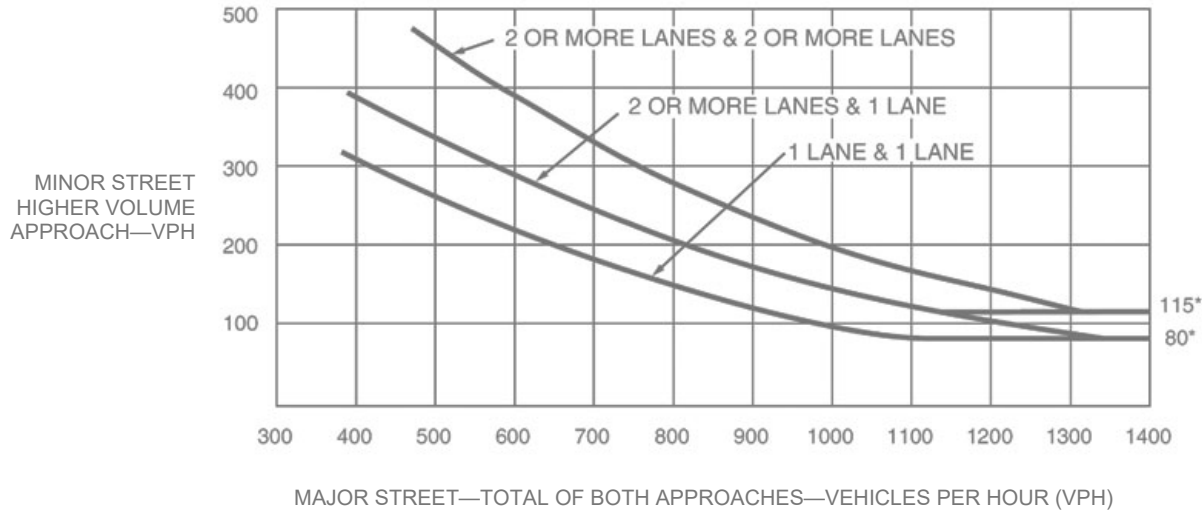

\*Note: 115 vph applies as the lower threshold volume for a minor-street approach with two or more lanes and 80 vph applies as the lower threshold volume for a minor-street approach with one lane.

## RURAL

Figure 4C-2. Warrant 2, Four-Hour Vehicular Volume (70% Factor)

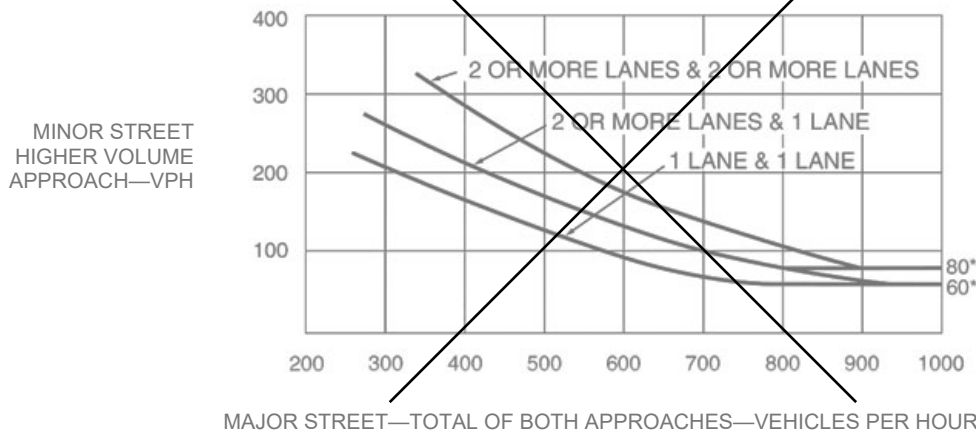

\*Note: 80 vph applies as the lower threshold volume for a minor-street approach with two or more lanes and 60 vph applies as the lower threshold volume for a minor-street approach with one lane.

Peak Hour

WARRANT  
3

N/A   
 SATISFIED YES   
 NO

\* The satisfaction of a traffic signal warrant or warrants shall not in itself require the installation of a traffic control signal \*

- a. Part A or Part B must be satisfied.
- b. In applying each condition, the major street and minor street volumes shall be for the same hours.
- c. The study should consider the effects of the right-turn vehicles from the minor-street approaches. Engineering judgment should be used to determine what, if any, portion of the right-turn traffic is subtracted from the minor-street traffic count.
- d. Estimated Peak Hour Volumes may be used for new intersections, significantly reconstructed intersections, or where near-term land development will result in increased volumes.
- e. Engineering judgment should also be used in applying various traffic signal warrants to cases where approaches consist of one lane plus one left-turn or right-turn lane. This site-specific traffic characteristics should dictate whether an approach is considered as one lane or two lanes. For example, for an approach with one lane for through and right-turning traffic plus a left-turn lane, if engineering judgment indicates that it should be considered a one-lane approach because the traffic using the left turn lane is minor, the total traffic volume approaching the intersection should be applied against the signal warrants as a one-lane approach. The approach should be considered two lanes if approximately half of the traffic on the approach turns left and the left-turn lane is of sufficient length to accommodate all left-turn vehicles. Similar engineering judgment and rationale should be applied to a street approach with one through/left-turn lane plus a right-turn lane. In this case, the degree of conflict of minor-street right-turn traffic with traffic on the major street should be considered. Thus, right-turn traffic should not be included in the minor-street volume if the movement enters the major street with minimal conflict. The approach should be evaluated as a one-lane approach with only the traffic volume in the through/left-turn lane considered.
- f. At an intersection with a high volume of left-turn traffic from the major street, the signal warrant analysis may be performed in a manner that considers the higher volume of the major-street left-turn volumes plus the higher volume minor-street approach as the "minor street" volume and both approaches of the major street minus the higher of the major-street left-turn volume as "major street" volume. In these cases, engineering judgment should be used to determine if left-turn phasing is necessary to accommodate the high volume of left-turn traffic.

**PART A**

*All parts 1, 2, and 3 below must be satisfied for the same one hour, for any four consecutive 15-minute periods)*

	SATISFIED	YES	NO
		<input checked="" type="checkbox"/>	<input type="checkbox"/>
	YES	NO	N/A
1. The total delay experienced by traffic on one minor street approach (one direction only) controlled by a STOP sign equals or exceeds four vehicle-hours for a one-lane approach, or five vehicle-hours for a two-lane approach; <u>AND</u>	<input type="checkbox"/>	<input type="checkbox"/>	<input checked="" type="checkbox"/>
2. The volume on the same minor street approach (one direction only) equals or exceeds 100 vph for one moving lane of traffic or 150 vph for two moving lanes; <u>AND</u>	<input checked="" type="checkbox"/>	<input type="checkbox"/>	<input type="checkbox"/>
3. The total entering volume serviced during the hour equals or exceeds 800 vph for intersections with four or more approaches or 650 vph for intersections with three approaches.	<input checked="" type="checkbox"/>	<input type="checkbox"/>	<input type="checkbox"/>

**PART B**

	SATISFIED	YES	NO
		<input checked="" type="checkbox"/>	<input type="checkbox"/>
Hour 17:00			
APPROACH LANES	One	2 or More	
Both Approaches - Major Street		✓	2264
Higher Approach - Minor Street	✓		213
The plotted point falls above the applicable curve in Figure 4C-3. (URBAN AREAS)	<input checked="" type="checkbox"/>	<input checked="" type="checkbox"/>	<input checked="" type="checkbox"/>
<u>OR</u> , The plotted point falls above the applicable curve in Figure 4C-4. (RURAL AREAS)	<input checked="" type="checkbox"/>	<input type="checkbox"/>	

**Peak Hour** (continued)

★ The satisfaction of a traffic signal warrant or warrants shall not in itself require the installation of a traffic control signal ★

**URBAN**  
**Figure 4C-3. Warrant 3, Peak Hour**

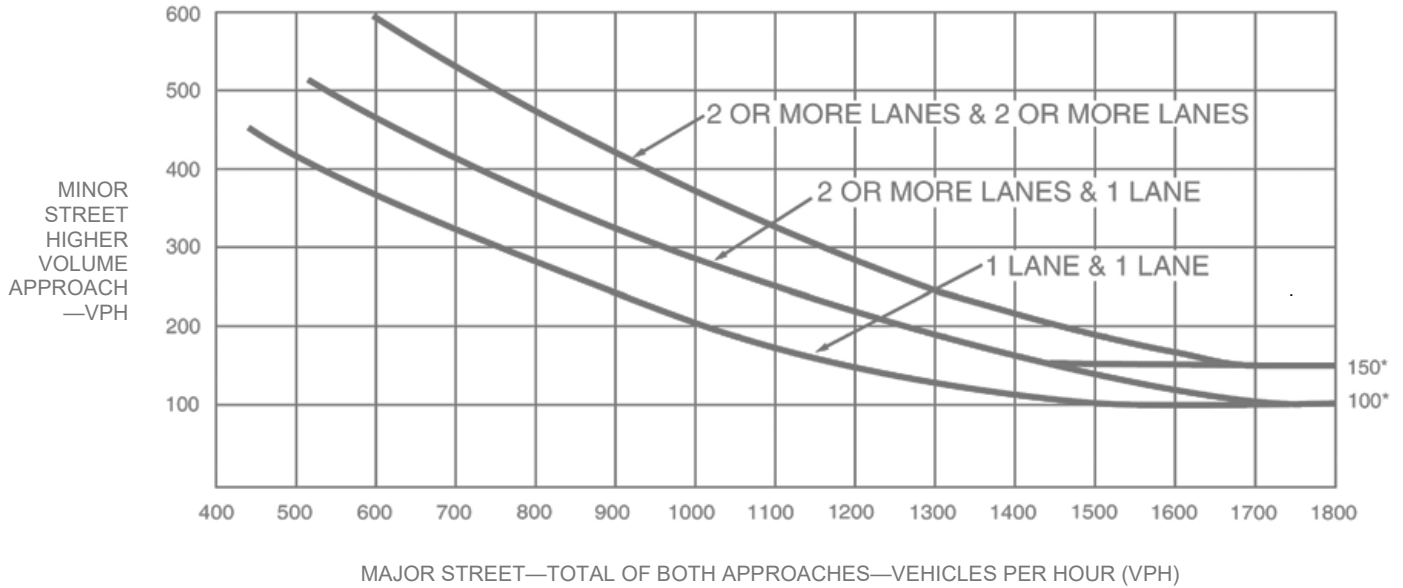

\* Note: 150 vph applies as the lower threshold volume for a minor street approach with two or more lanes and 100 vph applies as the lower threshold volume for a minor street approach with one lane.

**RURAL**  
**Figure 4C-4. Warrant 3, Peak Hour (70% Factor)**  
 (COMMUNITY LESS THAN 10,000 POPULATION OR ABOVE 40 MPH ON MAJOR STREET)

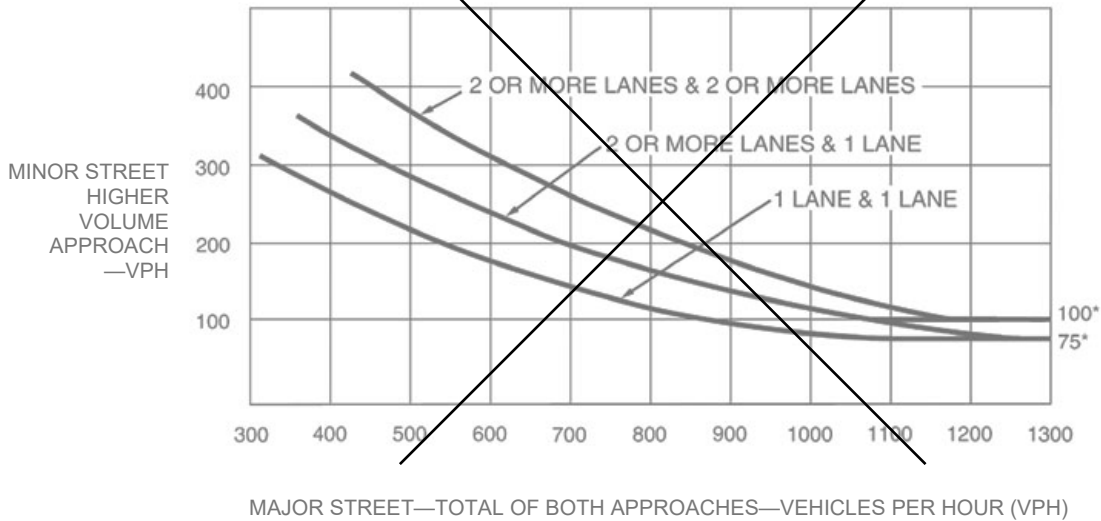

\* Note: 100 vph applies as the lower threshold volume for a minor street approach with two or more lanes and 75 vph applies as the lower threshold volume for a minor street approach with one lane.

# Pedestrian Volume

**WARRANT**  
4

N/A	<input checked="" type="checkbox"/>
SATISFIED	YES <input type="checkbox"/>
	NO <input type="checkbox"/>

★ The satisfaction of a traffic signal warrant or warrants shall not in itself require the installation of a traffic control signal ★

- a. Parts 1 and 2 shall be satisfied.
- b. The pedestrian volume criterion may be reduced by as much as 50% if the 15th percentile speed of the pedestrians is less than 3.5 feet/second.
- c. Estimated pedestrian volumes may be used where nearby, near-term land use development has been approved for construction.
- d. In applying each condition, the total vehicles per hour on the major street (on both approaches) and the total pedestrians per hour crossing the major street shall be for the same hours.
- e. The Pedestrian Volume signal warrants shall not be applied at locations where the distance to the nearest traffic control signal or STOP sign controlling the street that pedestrians desire to cross is less than 300 feet, unless the proposed traffic control signal will not restrict the progressive movement of traffic.
- f. Traffic control signal may not be needed at the study location if adjacent coordinated traffic control signals consistently provide gaps of adequate length for pedestrians to cross the street.
- g. If it is considered at a non-intersection crossing, the traffic control signal should be installed at least 100 feet from side streets or driveways that are controlled by STOP or YIELD signs. If the traffic control signal is installed at a non-intersection crossing, at least one of the signal faces should be over the traveled way for each approach, parking and other sight obstructions should be prohibited for at least 100 feet in advance of and at least 20 feet beyond the crosswalk or site accommodations should be made through curb extensions or other techniques to provide adequate sight distance, and the installation should include suitable standard signs and pavement markings.
- h. Bicycles may be counted as pedestrians.

**PART 1 (A or B must be satisfied)**

SATISFIED	YES	NO
<input type="checkbox"/>	<input type="checkbox"/>	<input type="checkbox"/>

**A. FOUR-HOUR PEDESTRIAN VOLUMES**

	Hours			
Vehicles per hour on major street for 4 hours				
Pedestrians crossing major street per hour for highest 4 hours				

(FIGURE 4C-5 OR 4C-6 SATISFIED)

SATISFIED	YES	NO
100%	<input type="checkbox"/>	<input type="checkbox"/>
50%	<input type="checkbox"/>	<input type="checkbox"/>

15% WALKING RATE \_\_\_\_\_ fps

**B. ONE HOUR PEDESTRIAN VOLUMES**

	Hour
Vehicles per hour on major street for 1 hour	
Pedestrians crossing major street per hour for highest 1 hour	0

(FIGURE 4C-7 or 4C-8 SATISFIED)

SATISFIED	YES	NO
100%	<input type="checkbox"/>	<input type="checkbox"/>
50%	<input type="checkbox"/>	<input type="checkbox"/>

15% WALKING RATE \_\_\_\_\_ fps

**PART 2**

SATISFIED	YES	NO
<input type="checkbox"/>	<input type="checkbox"/>	<input type="checkbox"/>

	YES	NO
<u>AND</u> , The distance to the nearest traffic signal along the major street is greater than 300 ft	<input type="checkbox"/>	<input type="checkbox"/>
<u>OR</u> , The proposed traffic signal will not restrict progressive traffic flow along the major street	<input type="checkbox"/>	<input type="checkbox"/>



# Pedestrian Volume (continued)

★ The satisfaction of a traffic signal warrant or warrants shall not in itself require the installation of a traffic control signal ★

**SPEED ≤ 35 MPH**  
**Figure 4C-5. Warrant 4, Pedestrian Four-Hour Volume**

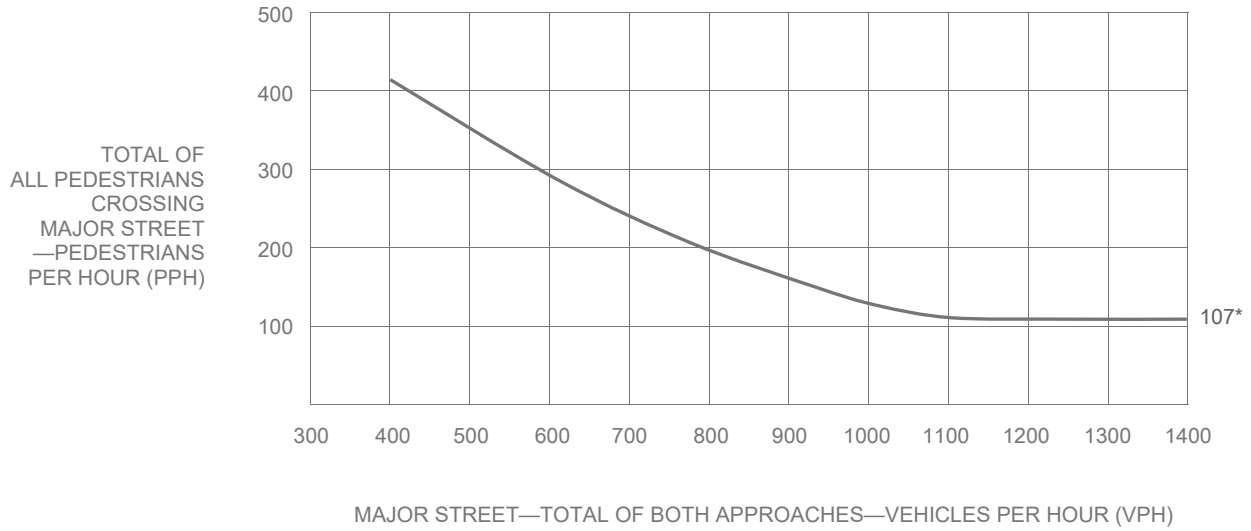

\* Note: 107 pph applies as the lower threshold volume

**SPEED > 35 MPH**  
**Figure 4C-6. Warrant 4, Pedestrian Four-Hour Volume (70% Factor)**

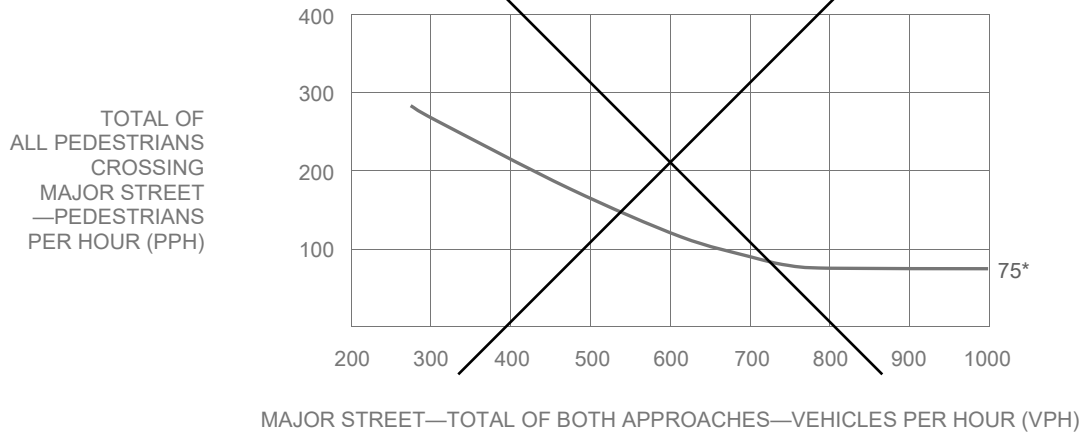

\* Note: 75 pph applies as the lower threshold volume

# Pedestrian Volume (continued)

\* The satisfaction of a traffic signal warrant or warrants shall not in itself require the installation of a traffic control signal \*

**SPEED ≤ 35 MPH**  
**Figure 4C-7. Warrant 4, Pedestrian Peak Hour**

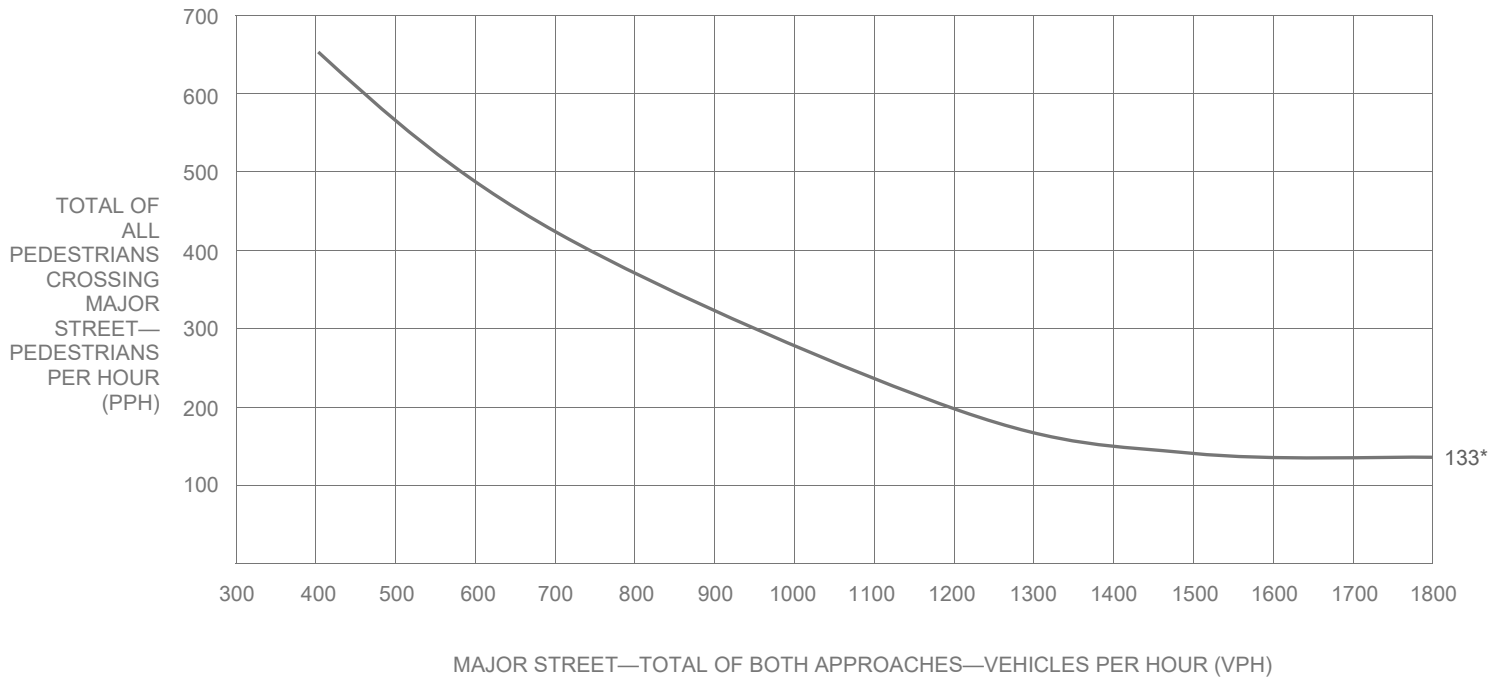

\* Note: 133 pph applies as the lower threshold volume

**SPEED > 35 MPH**  
**Figure 4C-8. Warrant 4, Pedestrian Peak Hour (70% Factor)**



\* Note: 93 pph applies as the lower threshold volume

# School Crossing

**WARRANT**  
5

N/A

SATISFIED YES

NO

★ The satisfaction of a traffic signal warrant or warrants shall not in itself require the installation of a traffic control signal ★

- a. Part A and Part B shall be satisfied.
- b. For purposes of this warrant, schoolchildren include elementary through high school students.
- c. Estimated schoolchildren volumes may be used where a new school or expanded school has been approved for construction.
- d. The need for a traffic control signal shall be considered when an engineering study of the frequency and adequacy of gaps in the vehicular traffic stream as related to the number and size of groups of schoolchildren at an established school crossing across the major street shows that the number of adequate gaps in the traffic stream during the period when the schoolchildren are using the crossing is less than the number of minutes in the same period and there are a minimum of 20 schoolchildren during the highest crossing hour.
- e. The School Crossing signal warrant shall not be applied at locations where the distance to the nearest traffic control signal along the major street is less than 300 feet, unless the proposed traffic control signal will not restrict the progressive movement of traffic.
- f. Non-intersectional schoolchildren crosswalk locations may be signalized when justified.

PART A				SATISFIED	YES	NO																				
<table border="1" style="width: 100%; border-collapse: collapse;"> <tr> <td style="width: 15%;"></td> <td style="width: 35%;"></td> <td style="width: 15%; text-align: center;">Hour</td> <td style="width: 35%;"></td> </tr> <tr> <td colspan="4" style="text-align: left; padding: 5px;"><b>Gap / Minutes and # of Children</b></td> </tr> <tr> <td style="text-align: center; padding: 5px;">Gaps vs Minutes</td> <td style="padding: 5px;">Minutes Children Using Crossing</td> <td style="width: 15%;"></td> <td style="padding: 5px;">Gaps &lt; Minutes</td> </tr> <tr> <td></td> <td style="padding: 5px;">Number of Adequate Gaps</td> <td></td> <td style="padding: 5px;"><b>AND</b> Children ≥ 20/hr</td> </tr> <tr> <td colspan="4" style="padding: 5px;">School Age Pedestrians Crossing Street / hr</td> </tr> </table>						Hour		<b>Gap / Minutes and # of Children</b>				Gaps vs Minutes	Minutes Children Using Crossing		Gaps < Minutes		Number of Adequate Gaps		<b>AND</b> Children ≥ 20/hr	School Age Pedestrians Crossing Street / hr				<input type="checkbox"/>	<input type="checkbox"/>	<input type="checkbox"/>
		Hour																								
<b>Gap / Minutes and # of Children</b>																										
Gaps vs Minutes	Minutes Children Using Crossing		Gaps < Minutes																							
	Number of Adequate Gaps		<b>AND</b> Children ≥ 20/hr																							
School Age Pedestrians Crossing Street / hr																										
<b>AND</b> , Consideration has been given to less restrictive remedial measures				<input type="checkbox"/>	<input type="checkbox"/>	<input type="checkbox"/>																				

PART B				SATISFIED	YES	NO
The distance to the nearest traffic signal along the major street is greater than 300 ft				<input type="checkbox"/>	<input type="checkbox"/>	<input type="checkbox"/>
<b>OR</b> , The proposed traffic signal will not restrict progressive movement of traffic				<input type="checkbox"/>	<input type="checkbox"/>	<input type="checkbox"/>

# Coordinated Signal System

**WARRANT**  
6

N/A

SATISFIED YES

NO

★ The satisfaction of a traffic signal warrant or warrants shall not in itself require the installation of a traffic control signal ★

- a. The Coordinated Signal System signal warrant should not be applied where the resultant spacing of traffic control signals would be less than 1,000 feet.
- b. All Parts must be satisfied.

MINIMUM REQUIREMENTS	DISTANCE TO NEAREST SIGNAL	YES	NO
≥ 1000 ft	N _____ ft, S _____ ft, E _____ ft, W _____ ft	<input type="checkbox"/>	<input type="checkbox"/>
On a one-way street or a street that has traffic predominantly in one direction, the adjacent traffic control signals are so far apart that they do not provide the necessary degree of vehicular platooning.		<input type="checkbox"/>	<input type="checkbox"/>
<b>OR</b> , On a two-way street, adjacent traffic control signals do not provide the necessary degree of platooning and the proposed and adjacent traffic control signals will collectively provide a progressive operation.		<input type="checkbox"/>	<input type="checkbox"/>

# Crash Experience Warrant



N/A   
 SATISFIED YES   
 NO

★ The satisfaction of a traffic signal warrant or warrants shall not in itself require the installation of a traffic control signal ★

- a. All Parts must be satisfied.
- b. For locations that involve other agencies, crash data from other involved jurisdictions should be obtained.

		YES	NO
Adequate trial of alternatives with satisfactory observance and enforcement has failed to reduce the crash frequency		<input type="checkbox"/>	<input type="checkbox"/>
<b>REQUIREMENTS</b>	Number of crashes reported within a 12-month period susceptible to correction by a traffic signal:	<input type="checkbox"/>	<input type="checkbox"/>
<b>5 OR MORE</b>	Indicate Date(s):		
<b>REQUIREMENTS</b>	<b>CONDITIONS</b>	<input checked="" type="checkbox"/>	
<b>ONE CONDITION SATISFIED 80%</b>	Warrant 1, Condition A - Minimum Vehicular Volume		
	OR, Warrant 1, Condition B - Interruption of Continuous Traffic	<input type="checkbox"/>	<input type="checkbox"/>
	OR, Warrant 4, Pedestrian Volume Condition - Ped Vol ≥ 80% for ped volumes per Figures 4C-5 to 4C-8		

# Roadway Network



N/A   
 SATISFIED YES   
 NO

★ The satisfaction of a traffic signal warrant or warrants shall not in itself require the installation of a traffic control signal ★

- a. Existing traffic volumes with an ambient growth rate of 1% (or other LADOT approved ambient growth rate) may be used if projected volumes are not available.
- b. All Parts must be satisfied.

MINIMUM VOLUME REQUIREMENTS	ENTERING VOLUMES - ALL APPROACHES		✓	FULLFILLED	
				YES	NO
1000 Veh / Hr	During Typical Weekday Peak Hour _____ Veh/Hr AND has 5-year projected traffic volumes that meet one or more of Warrants 1,2, and 3 during an average weekday.			<input type="checkbox"/>	<input type="checkbox"/>
	OR During Each of Any 5 Hrs. of a Saturday or Sunday _____ Veh / Hr				
	<b>CHARACTERISTICS OF MAJOR ROUTES</b>	<b>MAJOR ROUTE A</b>		<b>YES</b>	<b>NO</b>
	Highway System Serving as Principal Network for Through Traffic				
	Rural or Suburban Highway Outside Of, Entering, or Traversing a City				
	Appears as Major Route on an Official Plan				
Any Major Route Characteristics Met, Both Streets				<input type="checkbox"/>	<input type="checkbox"/>

# Intersection Near a Grade Crossing



N/A

SATISFIED YES

NO

★ The satisfaction of a traffic signal warrant or warrants shall not in itself require the installation of a traffic control signal ★

- a. Both Parts A and B shall be satisfied.
- b. This Warrant shall only be applied after review and approval by the LADOT Railroad Crossing and Safety Section (RCOSS), subject to CPUC General Order approval.
- c. This Warrant does not apply for Pre-Signals and/or Queue-Cutter signals, as an alternative application of Pre-Signals (See 2012 CA MUTCD, Sec 8C.09). Pre-Signals shall only be applied after review and approval by RCOSS, subject to CPUC General Order approval.

	FULFILLED	
	YES	NO
<p><b>PART A</b></p> <p>A grade crossing exists on an approach controlled by a STOP or YIELD sign and the center of the track nearest to the intersection is within 140 feet of the stop line or yield line on the approach. Track Center Line to Limit Line _____ ft</p>	<input type="checkbox"/>	<input type="checkbox"/>
<p><b>PART B</b></p> <p><b>There is one minor street approach lane at the track crossing</b> - During the highest traffic volume hour during which rail traffic uses the crossing, the plotted point falls above the applicable curve in Figure 4C-9.</p> <p>Major Street - Total of both approaches: _____ VPH                      Minor Street - Crosses the track (one direction only, approaching the intersection): _____ VPH                      X AF (Use Tables 4C-2, 3, &amp; 4 below to calculate AF) = _____ VPH</p> <hr style="border-top: 1px dashed black;"/> <p><b>OR, There are two or more minor street approach lanes at the track crossing</b> - During the highest traffic volume hour during which rail traffic uses the crossing, the plotted point falls above the applicable curve in Figure 4C-10.</p> <p>Major Street - Total of both approaches: _____ VPH                      Minor Street - Crosses the track (one direction only, approaching the intersection): _____ VPH                      X AF (Use Tables 4C-2, 3, &amp; 4 below to calculate AF) = _____ VPH</p>	<input type="checkbox"/>	<input type="checkbox"/>

The minor street approach volume may be multiplied by up to three following adjustment factors (AF) as described in Section 4C-10.

- 1. Number of Rail Traffic per Day \_\_\_\_\_ Adjustment factor from Table 4C-2 \_\_\_\_\_
- 2. Percentage of High-Occupancy Buses on Minor Street Approach \_\_\_\_\_ Adjustment factor from Table 4C-3 \_\_\_\_\_
- 3. Percentage of Tractor-Trailer Trucks on Minor Street Approach \_\_\_\_\_ Adjustment factor from Table 4C-4 \_\_\_\_\_

NOTE: If no data is available or known, then use AF = 1 (no adjustment)

**Table 4C-2. Warrant 9, Adjustment Factor for Daily Frequency of Rail Traffic**

Rail Traffic per Day	Adjustment Factor
1	0.67
2	0.91
3 to 5	1.00
6 to 8	1.18
9 to 11	1.25
12 or more	1.33

**Table 4C-3. Warrant 9, Adjustment Factor for Percentage of High-Occupancy Buses**

% of High-Occupancy Buses * on Minor-Street Approach	Adjustment Factor
0 %	1.00
2 %	1.09
4 %	1.19
6 % or more	1.32

\* A high-occupancy bus is defined as a bus occupied by at least 20 people

# Intersection Near a Grade Crossing *(continued)*

★ The satisfaction of a traffic signal warrant or warrants shall not in itself require the installation of a traffic control signal ★

**Table 4C-4. Warrant 9, Adjustment Factor for Percentage of Tractor-Trailer Trucks**

% of Tractor-Trailer Trucks on Minor-Street Approach	Adjustment Factor	
	D less than 70 feet	D of 70 feet or more
0% to 2.5%	0.50	0.50
2.6% to 7.5%	0.75	0.75
7.6% to 12.5%	1.00	1.00
12.6% to 17.5%	2.30	1.15
17.6% to 22.5%	2.70	1.35
22.6% to 27.5%	3.28	1.64
More than 27.5%	4.18	2.09

**Figure 4C-9. Warrant 9, Intersection Near a Grade Crossing (One Approach Lane at the Track Crossing)**

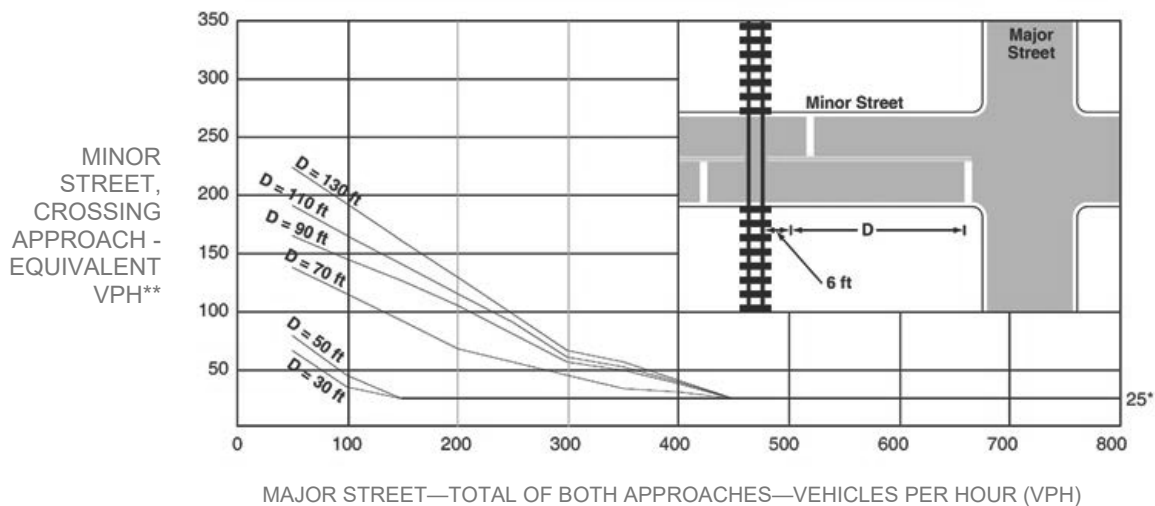

**Figure 4C-10. Warrant 9, Intersection Near a Grade Crossing (Two or More Approach Lanes at the Track Crossing)**

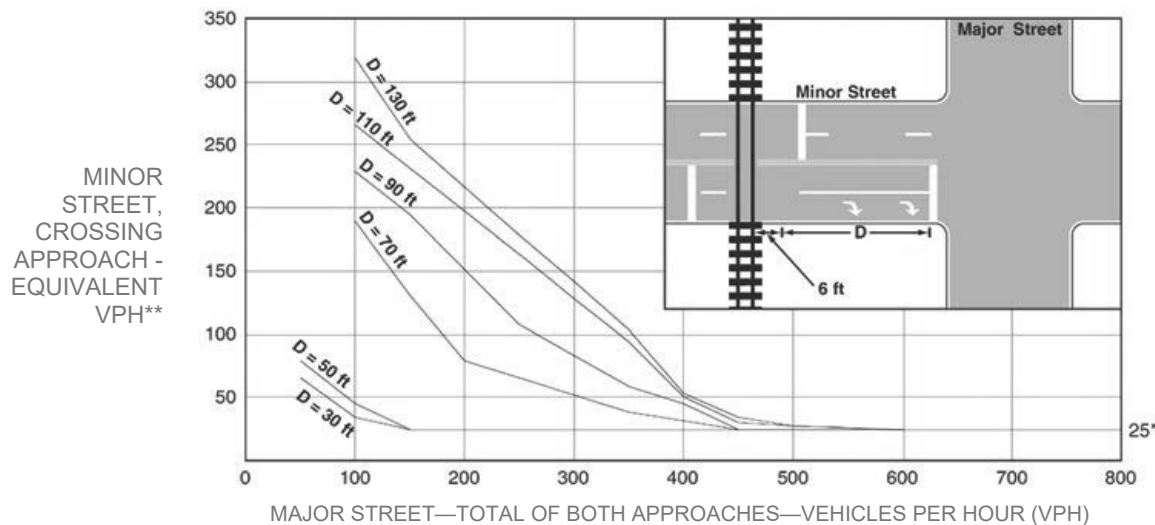

\* 25 vph applies as the lower threshold volume

\*\* VPH after applying the adjustment factors in Tables 4C-2, 4C-3, and/or 4C-4, if appropriate

Bicycles

WARRANT  
10

N/A   
 SATISFIED YES   
 NO

\* The satisfaction of a traffic signal warrant or warrants shall not in itself require the installation of a traffic control signal \*

- a. A bicycle signal should be considered for use only when the Volume requirement and Collision requirement have been met, or the Volume requirement and Geometry requirement have been met.
- b. Bicycle and vehicle volumes shall use the same peak hour.

		Hour	FULFILLED	
			YES	NO
VOLUME REQUIREMENT	One-Hour bicycle volume entering intersection B= _____			
	One-Hour vehicle volume entering intersection V= _____		<input type="checkbox"/>	<input type="checkbox"/>
	$B \times V = W$ W= <u>  0  </u>			
	$B \geq 50$ AND $W \geq 50,000$			
<b>AND</b>				
COLLISION REQUIREMENT	Two or more bicycle/vehicle collisions of types susceptible to correction by a bicycle signal over a 12-month period.		YES	NO
	DATES: _____ _____		<input type="checkbox"/>	<input type="checkbox"/>
OR GEOMETRY REQUIREMENT	A separate bicycle or multi-use path intersects roadway		<input type="checkbox"/>	<input type="checkbox"/>
	OR, is necessary to facilitate a bicycle movement that is not permitted by motor vehicles			

Activated Pedestrian Warning Device

WARRANT  
11

N/A   
 SATISFIED YES   
 NO

\* The satisfaction of a traffic signal warrant or warrants shall not in itself require the installation of a traffic control signal \*

- a. All Parts shall be satisfied.
- b. This warrant should be applied when an Activated Pedestrian Warning Device is recommended within 600 feet both upstream and downstream of existing traffic signals.

PART A	YES	NO
Location meets the guidelines for the installation of an Activated Pedestrian Warning Device as described in MPP section 354.	<input type="checkbox"/>	<input type="checkbox"/>

MINIMUM REQUIREMENTS	DISTANCE TO NEAREST SIGNALS	YES	NO
≤ 600 ft	N _____ ft, S _____ ft, E _____ ft, W _____ ft	<input type="checkbox"/>	<input type="checkbox"/>



Traffic Signal Warrants Worksheet

DATE 3/29/21 PREPARER GTC REVIEWER \_\_\_\_\_

MAJOR ST: Olympic Boulevard

MINOR ST: Lemon Street

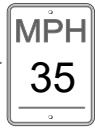
Critical Approach Speed }  *or* Speed Limit } 

Speed limit or critical speed on major street traffic > 40 mph.....  *or*  } RURAL (R)       URBAN (U)  
In built up area of isolated community of < 10,000 population.....

# Eight-Hour Vehicular Volume



N/A	<input checked="" type="checkbox"/>
SATISFIED	YES <input type="checkbox"/>
	NO <input type="checkbox"/>

★ *The satisfaction of a traffic signal warrant or warrants shall not in itself require the installation of a traffic control signal* ★

- Condition A or Condition B or combination of 80% of both parts A and B must be satisfied.
- A 6-hour Manual Count may be used in a determination that this warrant is not met. However, supplement manual counts should be taken during separate hours for a determination that this warrant is met.
- In applying each condition, the major street and minor street volumes shall be for the same hours. On the minor street, the higher volume does not need to be the same approach during each of the hours.
- The study should consider the effects of the right-turn vehicles from the minor-street approaches. Engineering judgment should be used to determine what, if any, portion of the right-turn traffic is subtracted from the minor-street traffic count.
- Figure 4C-103(CA) should be used for new intersections, significantly reconstructed intersections, where near-term land development will result in increased volumes, or where it is not reasonable to use current traffic volumes.
- Engineering judgment should also be used in applying various traffic signal warrants to cases where approaches consist of one lane plus one left-turn or right-turn lane. This site-specific traffic characteristics should dictate whether an approach is considered as one lane or two lanes. For example, for an approach with one lane for through and right-turning traffic plus a left-turn lane, if engineering judgment indicates that it should be considered a one-lane approach because the traffic using the left turn lane is minor, the total traffic volume approaching the intersection should be applied against the signal warrants as a one-lane approach. The approach should be considered two lanes if approximately half of the traffic on the approach turns left and the left-turn lane is of sufficient length to accommodate all left-turn vehicles. Similar engineering judgment and rationale should be applied to a street approach with one through/left-turn lane plus a right-turn lane. In this case, the degree of conflict of minor-street right-turn traffic with traffic on the major street should be considered. Thus, right-turn traffic should not be included in the minor-street volume if the movement enters the major street with minimal conflict. The approach should be evaluated as a one-lane approach with only the traffic volume in the through/left-turn lane considered.
- At an intersection with a high volume of left-turn traffic from the major street, the signal warrant analysis may be performed in a manner that considers the higher volume of the major-street left-turn volumes plus the higher volume minor-street approach as the "minor street" volume and both approaches of the major street minus the higher of the major-street left-turn volume as "major street" volume. In these cases, engineering judgment should be used to determine if left-turn phasing is necessary to accommodate the high volume of left-turn traffic.



# Eight-Hour Vehicular Volume

*(continued)*

★ The satisfaction of a traffic signal warrant or warrants shall not in itself require the installation of a traffic control signal ★

### Condition A

#### Minimum Vehicle Volume

SATISFIED	YES	NO
100%	<input type="checkbox"/>	<input type="checkbox"/>
80%	<input type="checkbox"/>	<input type="checkbox"/>

<b>RIGHT TURN REDUCTION APPLICATION MINOR STREET</b> <i>(If Yes, fill in percentage)</i>	<input type="checkbox"/> <input type="checkbox"/> %
---	---

MINIMUM REQUIREMENTS (80% SHOW IN BRACKETS)			
U	R	U	R

APPROACH LANES	MINIMUM REQUIREMENTS (80% SHOW IN BRACKETS)				Hours							
	1 ✓		2 or More ✓		07:00	08:00	09:00	15:00	16:00	17:00		
Both Approach Major Street	500 (400)	350 (280)	600 ✓ (480)	420 (336)	1950	2051	1906	1822	1997	2190		
Highest Approach Minor Street	150 ✓ (120)	105 (84)	200 (160)	140 (112)	136	99	65	74	161	246		

### Condition B

#### Interruption of Continuous Traffic

SATISFIED	YES	NO
100%	<input type="checkbox"/>	<input type="checkbox"/>
80%	<input type="checkbox"/>	<input type="checkbox"/>

<b>RIGHT TURN REDUCTION APPLICATION MINOR STREET</b> <i>(If Yes, fill in percentage)</i>	<input type="checkbox"/> <input type="checkbox"/> %
---	---

MINIMUM REQUIREMENTS (80% SHOW IN BRACKETS)			
U	R	U	R

APPROACH LANES	MINIMUM REQUIREMENTS (80% SHOW IN BRACKETS)				Hours							
	1 ✓		2 or More ✓		07:00	08:00	09:00	15:00	16:00	17:00		
Both Approach Major Street	750 (600)	525 (420)	900 ✓ (720)	630 (504)	1950	2051	1906	1822	1997	2190		
Highest Approach Minor Street	75 ✓ (60)	53 (42)	100 (80)	70 (56)	136	99	65	74	161	246		

### COMBINATION OF A & B

SATISFIED	YES	NO
	<input type="checkbox"/>	<input type="checkbox"/>

REQUIREMENT	CONDITION	✓	FULFILLED	
			YES	NO
TWO CONDITIONS SATISFIED 80%	A. MINIMUM VEHICULAR VOLUME			
	AND		<input type="checkbox"/>	<input type="checkbox"/>
	B. INTERRUPTION OF CONTINUOUS TRAFFIC			
	AND		<input type="checkbox"/>	<input type="checkbox"/>
AN ADEQUATE TRIAL OF OTHER ALTERNATIVES THAT COULD CAUSE LESS DELAY AND INCOVENIENCE TO TRAFFIC HAS FAILED TO SOLVE THE TRAFFIC PROBLEMS			<input type="checkbox"/>	<input type="checkbox"/>

# Eight-Hour Vehicular Volume

*(continued)*

★ The satisfaction of a traffic signal warrant or warrants shall not in itself require the installation of a traffic control signal ★

<b>Projected Volumes</b>	SATISFIED	N/A	<input checked="" type="checkbox"/>
		YES	NO
		<input type="checkbox"/>	<input type="checkbox"/>

**Figure 4C-103 (CA). Traffic Signal Warrants Worksheet (Average Traffic Estimate Form)**  
Based on Estimated Average Daily Traffic - see Note\*

URBAN <input type="checkbox"/>	RURAL <input type="checkbox"/>	Minimum Requirements Estimated Average Daily Traffic			
<b>CONDITION A - Minimum Vehicular Volume</b>		Vehicles Per Day On Major Street (Total of Both Approaches)		Vehicles Per Day On Higher-Volume Minor Street Approach (One Direction Only)	
Satisfied <input type="checkbox"/> Not Satisfied <input type="checkbox"/>					
Number of lanes for moving traffic on each approach		Urban	Rural	Urban	Rural
Major Street	Minor Street				
1.....	1.....	8,000	5,600	2,400	1,680
2 or More.....	1.....	9,600	6,720	2,400	1,680
2 or More.....	2 or More.....	9,600	6,720	3,200	2,240
1.....	2 or More.....	8,000	5,600	3,200	2,240
<b>CONDITION B - Interruption of Continuous Traffic</b>		Vehicles Per Day On Major Street (Total of Both Approaches)		Vehicles Per Day On Higher-Volume Minor Street Approach (One Direction Only)	
Satisfied <input type="checkbox"/> Not Satisfied <input type="checkbox"/>					
Number of lanes for moving traffic on each approach		Urban	Rural	Urban	Rural
Minor Street	Minor Street				
1.....	1.....	12,000	8,400	1,200	850
2 or More.....	1.....	14,400	10,080	1,200	850
2 or More.....	2 or More.....	14,400	10,080	1,600	1,120
1.....	2 or More.....	12,000	8,400	1,600	1,120
<b>Combination of CONDITIONS A + B</b>		2 CONDITIONS 80%		2 CONDITIONS 80%	
Satisfied <input type="checkbox"/> Not Satisfied <input type="checkbox"/>					
<u>No one condition satisfied</u> , but following conditions fulfilled 80% or more..... <u>        </u> <u>        </u> <span style="margin-left: 150px;">A</span> <span style="margin-left: 100px;">B</span>					

\* Note: To be used only for NEW INTERSECTIONS or other locations where it is not reasonable to count actual traffic volumes

# Four-Hour Vehicular Volume



N/A

SATISFIED YES

NO

★ The satisfaction of a traffic signal warrant or warrants shall not in itself require the installation of a traffic control signal ★

- a. Record hourly vehicle volumes for the highest four hours of an average day.
- b. In applying each condition, the major street and minor street volumes shall be for the same hours. On the minor street, the higher volume does not need to be the same approach during each of the hours.
- c. The study should consider the effects of the right-turn vehicles from the minor-street approaches. Engineering judgment should be used to determine what, if any, portion of the right-turn traffic is subtracted from the minor-street traffic count.
- d. Engineering judgment should also be used in applying various traffic signal warrants to cases where approaches consist of one lane plus one left-turn or right-turn lane. This site-specific traffic characteristics should dictate whether an approach is considered as one lane or two lanes. For example, for an approach with one lane for through and right-turning traffic plus a left-turn lane, if engineering judgment indicates that it should be considered a one-lane approach because the traffic using the left turn lane is minor, the total traffic volume approaching the intersection should be applied against the signal warrants as a one-lane approach. The approach should be considered two lanes if approximately half of the traffic on the approach turns left and the left-turn lane is of sufficient length to accommodate all left-turn vehicles. Similar engineering judgment and rationale should be applied to a street approach with one through/left-turn lane plus a right-turn lane. In this case, the degree of conflict of minor-street right-turn traffic with traffic on the major street should be considered. Thus, right-turn traffic should not be included in the minor-street volume if the movement enters the major street with minimal conflict. The approach should be evaluated as a one-lane approach with only the traffic volume in the through/left-turn lane considered.
- e. At an intersection with a high volume of left-turn traffic from the major street, the signal warrant analysis may be performed in a manner that considers the higher volume of the major-street left-turn volumes plus the higher volume minor-street approach as the "minor street" volume and both approaches of the major street minus the higher of the major-street left-turn volume as "major street" volume. In these cases, engineering judgment should be used to determine if left-turn phasing is necessary to accommodate the high volume of left-turn traffic.

APPROACH LANES	One	2 or More	Hours					YES	NO
			17:00	16:00	07:00	08:00			
Both Approaches - Major Street		✓	2190	1997	1950	2051	<b>RIGHT TURN REDUCTION APPLICATION MINOR STREET</b> (If Yes, fill in percentage)	<input type="checkbox"/>	<input type="checkbox"/>
Higher Approach - Minor Street	✓		246	161	136	99		_____ %	
* All plotted points fall above the applicable curve in Figure 4C-1. (URBAN AREAS)								<input type="checkbox"/>	<input type="checkbox"/>
<u>OR</u> , All plotted points fall above the applicable curve in Figure 4C-2. (RURAL AREAS)								<input type="checkbox"/>	<input type="checkbox"/>

# Four-Hour Vehicular Volume (continued)

★ The satisfaction of a traffic signal warrant or warrants shall not in itself require the installation of a traffic control signal ★

## URBAN

Figure 4C-1. Warrant 2, Four-Hour Vehicular Volume

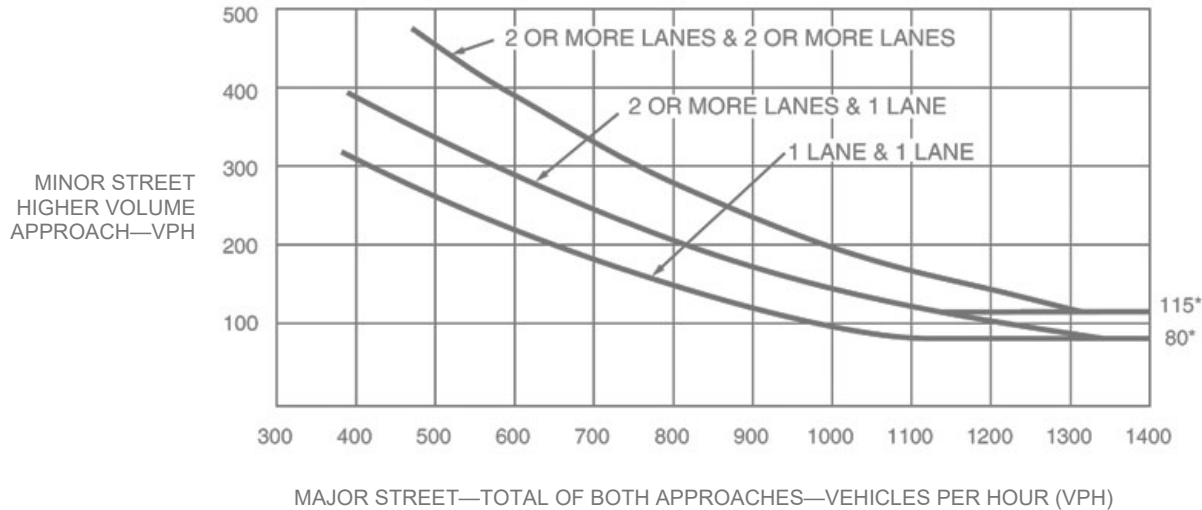

\*Note: 115 vph applies as the lower threshold volume for a minor-street approach with two or more lanes and 80 vph applies as the lower threshold volume for a minor-street approach with one lane.

## RURAL

Figure 4C-2. Warrant 2, Four-Hour Vehicular Volume (70% Factor)

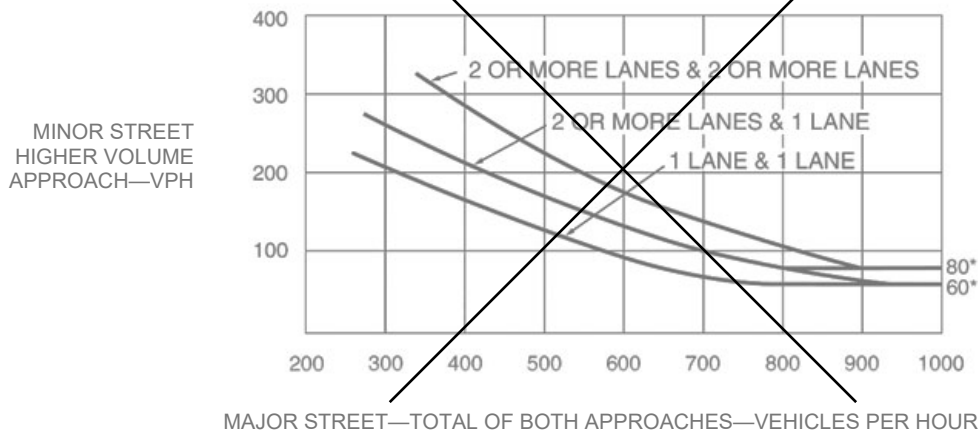

\*Note: 80 vph applies as the lower threshold volume for a minor-street approach with two or more lanes and 60 vph applies as the lower threshold volume for a minor-street approach with one lane.

Peak Hour

WARRANT  
3

N/A   
 SATISFIED YES   
 NO

\* The satisfaction of a traffic signal warrant or warrants shall not in itself require the installation of a traffic control signal \*

- a. Part A or Part B must be satisfied.
- b. In applying each condition, the major street and minor street volumes shall be for the same hours.
- c. The study should consider the effects of the right-turn vehicles from the minor-street approaches. Engineering judgment should be used to determine what, if any, portion of the right-turn traffic is subtracted from the minor-street traffic count.
- d. Estimated Peak Hour Volumes may be used for new intersections, significantly reconstructed intersections, or where near-term land development will result in increased volumes.
- e. Engineering judgment should also be used in applying various traffic signal warrants to cases where approaches consist of one lane plus one left-turn or right-turn lane. This site-specific traffic characteristics should dictate whether an approach is considered as one lane or two lanes. For example, for an approach with one lane for through and right-turning traffic plus a left-turn lane, if engineering judgment indicates that it should be considered a one-lane approach because the traffic using the left turn lane is minor, the total traffic volume approaching the intersection should be applied against the signal warrants as a one-lane approach. The approach should be considered two lanes if approximately half of the traffic on the approach turns left and the left-turn lane is of sufficient length to accommodate all left-turn vehicles. Similar engineering judgment and rationale should be applied to a street approach with one through/left-turn lane plus a right-turn lane. In this case, the degree of conflict of minor-street right-turn traffic with traffic on the major street should be considered. Thus, right-turn traffic should not be included in the minor-street volume if the movement enters the major street with minimal conflict. The approach should be evaluated as a one-lane approach with only the traffic volume in the through/left-turn lane considered.
- f. At an intersection with a high volume of left-turn traffic from the major street, the signal warrant analysis may be performed in a manner that considers the higher volume of the major-street left-turn volumes plus the higher volume minor-street approach as the "minor street" volume and both approaches of the major street minus the higher of the major-street left-turn volume as "major street" volume. In these cases, engineering judgment should be used to determine if left-turn phasing is necessary to accommodate the high volume of left-turn traffic.

**PART A**

*All parts 1, 2, and 3 below must be satisfied for the same one hour, for any four consecutive 15-minute periods)*

	SATISFIED	YES	NO
		<input checked="" type="checkbox"/>	<input type="checkbox"/>
	YES	NO	N/A
1. The total delay experienced by traffic on one minor street approach (one direction only) controlled by a STOP sign equals or exceeds four vehicle-hours for a one-lane approach, or five vehicle-hours for a two-lane approach; <u>AND</u>	<input type="checkbox"/>	<input type="checkbox"/>	<input checked="" type="checkbox"/>
2. The volume on the same minor street approach (one direction only) equals or exceeds 100 vph for one moving lane of traffic or 150 vph for two moving lanes; <u>AND</u>	<input checked="" type="checkbox"/>	<input type="checkbox"/>	<input type="checkbox"/>
3. The total entering volume serviced during the hour equals or exceeds 800 vph for intersections with four or more approaches or 650 vph for intersections with three approaches.	<input checked="" type="checkbox"/>	<input type="checkbox"/>	<input type="checkbox"/>

**PART B**

	SATISFIED	YES	NO
		<input checked="" type="checkbox"/>	<input type="checkbox"/>
Hour 17:00			
APPROACH LANES	One	2 or More	
Both Approaches - Major Street		✓	2299
Higher Approach - Minor Street	✓		246
The plotted point falls above the applicable curve in Figure 4C-3. (URBAN AREAS)	<input checked="" type="checkbox"/>	<input checked="" type="checkbox"/>	<input checked="" type="checkbox"/>
<u>OR</u> , The plotted point falls above the applicable curve in Figure 4C-4. (RURAL AREAS)	<input checked="" type="checkbox"/>	<input type="checkbox"/>	

**Peak Hour** (continued)

★ The satisfaction of a traffic signal warrant or warrants shall not in itself require the installation of a traffic control signal ★

**URBAN**  
**Figure 4C-3. Warrant 3, Peak Hour**

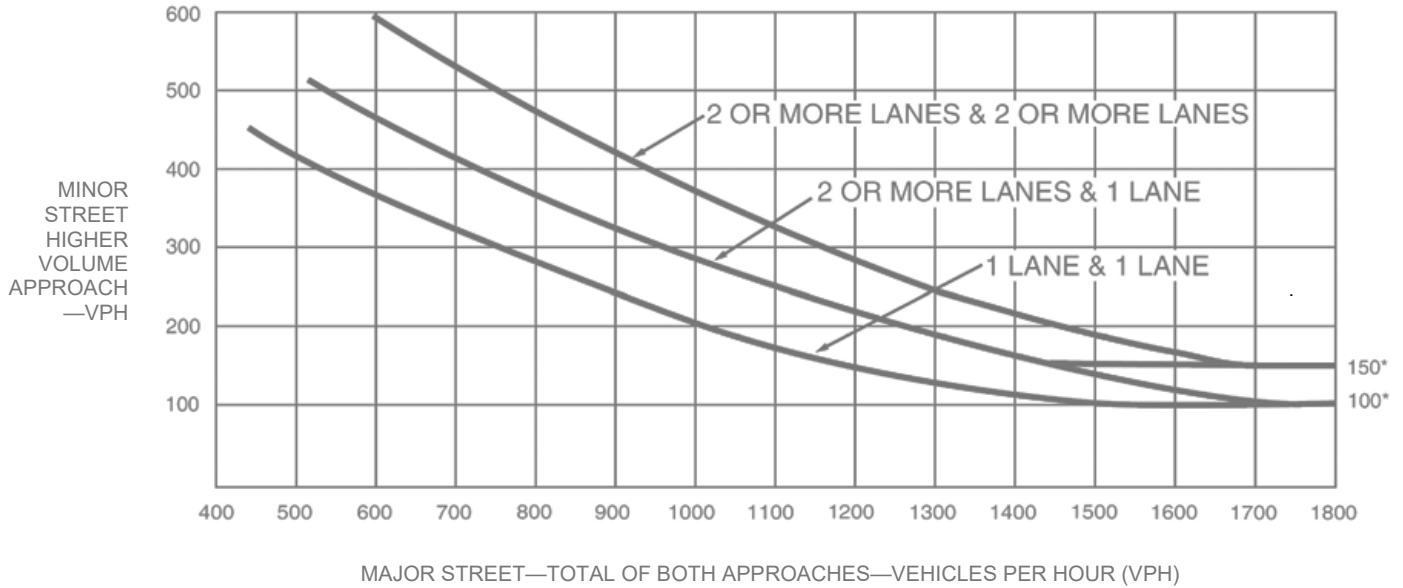

\* Note: 150 vph applies as the lower threshold volume for a minor street approach with two or more lanes and 100 vph applies as the lower threshold volume for a minor street approach with one lane.

**RURAL**  
**Figure 4C-4. Warrant 3, Peak Hour (70% Factor)**  
 (COMMUNITY LESS THAN 10,000 POPULATION OR ABOVE 40 MPH ON MAJOR STREET)

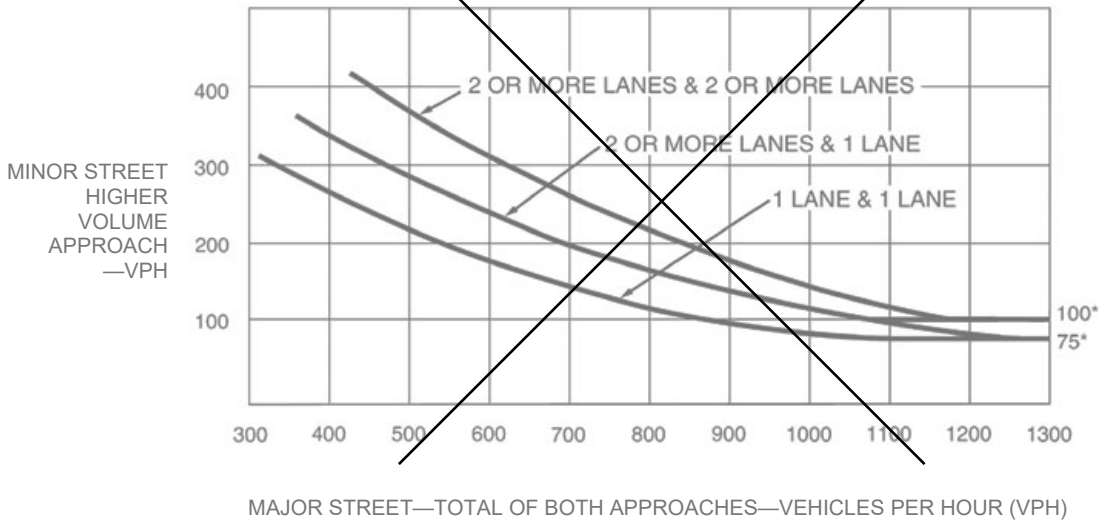

\* Note: 100 vph applies as the lower threshold volume for a minor street approach with two or more lanes and 75 vph applies as the lower threshold volume for a minor street approach with one lane.

# Pedestrian Volume

**WARRANT**  
4

N/A	<input checked="" type="checkbox"/>
SATISFIED	YES <input type="checkbox"/>
	NO <input type="checkbox"/>

★ The satisfaction of a traffic signal warrant or warrants shall not in itself require the installation of a traffic control signal ★

- a. Parts 1 and 2 shall be satisfied.
- b. The pedestrian volume criterion may be reduced by as much as 50% if the 15th percentile speed of the pedestrians is less than 3.5 feet/second.
- c. Estimated pedestrian volumes may be used where nearby, near-term land use development has been approved for construction.
- d. In applying each condition, the total vehicles per hour on the major street (on both approaches) and the total pedestrians per hour crossing the major street shall be for the same hours.
- e. The Pedestrian Volume signal warrants shall not be applied at locations where the distance to the nearest traffic control signal or STOP sign controlling the street that pedestrians desire to cross is less than 300 feet, unless the proposed traffic control signal will not restrict the progressive movement of traffic.
- f. Traffic control signal may not be needed at the study location if adjacent coordinated traffic control signals consistently provide gaps of adequate length for pedestrians to cross the street.
- g. If it is considered at a non-intersection crossing, the traffic control signal should be installed at least 100 feet from side streets or driveways that are controlled by STOP or YIELD signs. If the traffic control signal is installed at a non-intersection crossing, at least one of the signal faces should be over the traveled way for each approach, parking and other sight obstructions should be prohibited for at least 100 feet in advance of and at least 20 feet beyond the crosswalk or site accommodations should be made through curb extensions or other techniques to provide adequate sight distance, and the installation should include suitable standard signs and pavement markings.
- h. Bicycles may be counted as pedestrians.

**PART 1 (A or B must be satisfied)**

SATISFIED	YES	NO
	<input type="checkbox"/>	<input type="checkbox"/>

**A. FOUR-HOUR PEDESTRIAN VOLUMES**

	Hours			
Vehicles per hour on major street for 4 hours				
Pedestrians crossing major street per hour for highest 4 hours				

(FIGURE 4C-5 OR 4C-6 SATISFIED)

SATISFIED	YES	NO
100%	<input type="checkbox"/>	<input type="checkbox"/>
50%	<input type="checkbox"/>	<input type="checkbox"/>

15% WALKING RATE \_\_\_\_\_ fps

**B. ONE HOUR PEDESTRIAN VOLUMES**

	Hour
Vehicles per hour on major street for 1 hour	
Pedestrians crossing major street per hour for highest 1 hour	0

(FIGURE 4C-7 or 4C-8 SATISFIED)

SATISFIED	YES	NO
100%	<input type="checkbox"/>	<input type="checkbox"/>
50%	<input type="checkbox"/>	<input type="checkbox"/>

15% WALKING RATE \_\_\_\_\_ fps

**PART 2**

SATISFIED	YES	NO
	<input type="checkbox"/>	<input type="checkbox"/>

	YES	NO
<u>AND</u> , The distance to the nearest traffic signal along the major street is greater than 300 ft	<input type="checkbox"/>	<input type="checkbox"/>
<u>OR</u> , The proposed traffic signal will not restrict progressive traffic flow along the major street	<input type="checkbox"/>	<input type="checkbox"/>

# Pedestrian Volume (continued)

★ The satisfaction of a traffic signal warrant or warrants shall not in itself require the installation of a traffic control signal ★

**SPEED ≤ 35 MPH**  
**Figure 4C-5. Warrant 4, Pedestrian Four-Hour Volume**

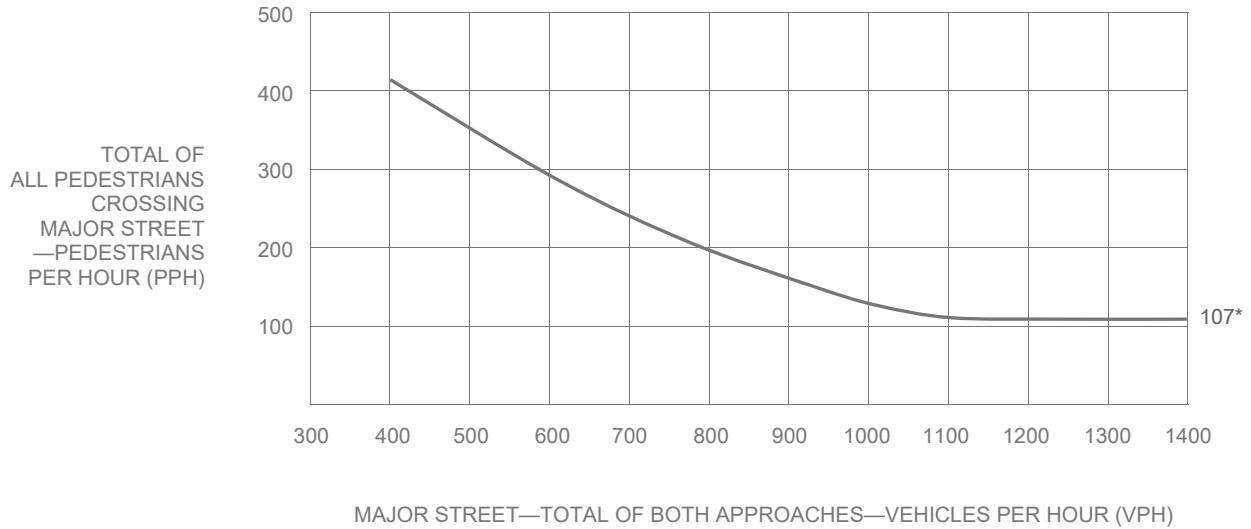

\* Note: 107 pph applies as the lower threshold volume

**SPEED > 35 MPH**  
**Figure 4C-6. Warrant 4, Pedestrian Four-Hour Volume (70% Factor)**

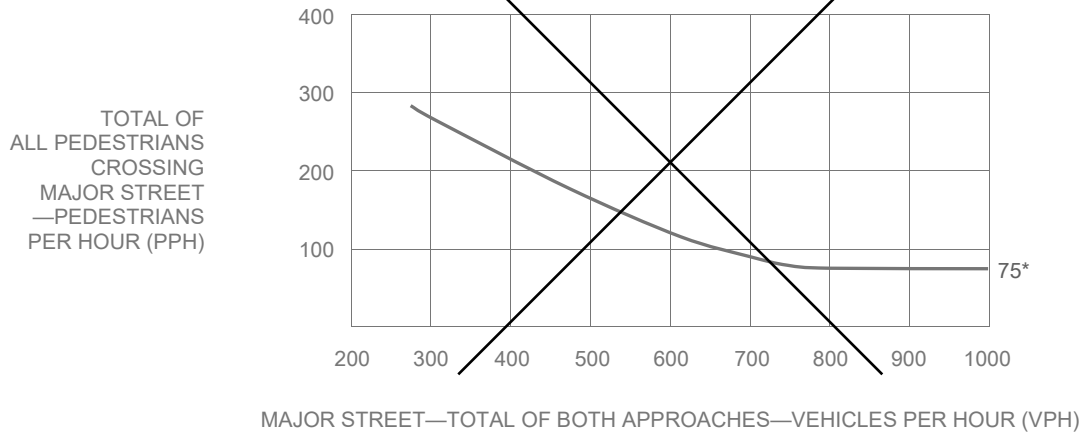

\* Note: 75 pph applies as the lower threshold volume



# Pedestrian Volume (continued)

\* The satisfaction of a traffic signal warrant or warrants shall not in itself require the installation of a traffic control signal \*

**SPEED ≤ 35 MPH**  
**Figure 4C-7. Warrant 4, Pedestrian Peak Hour**

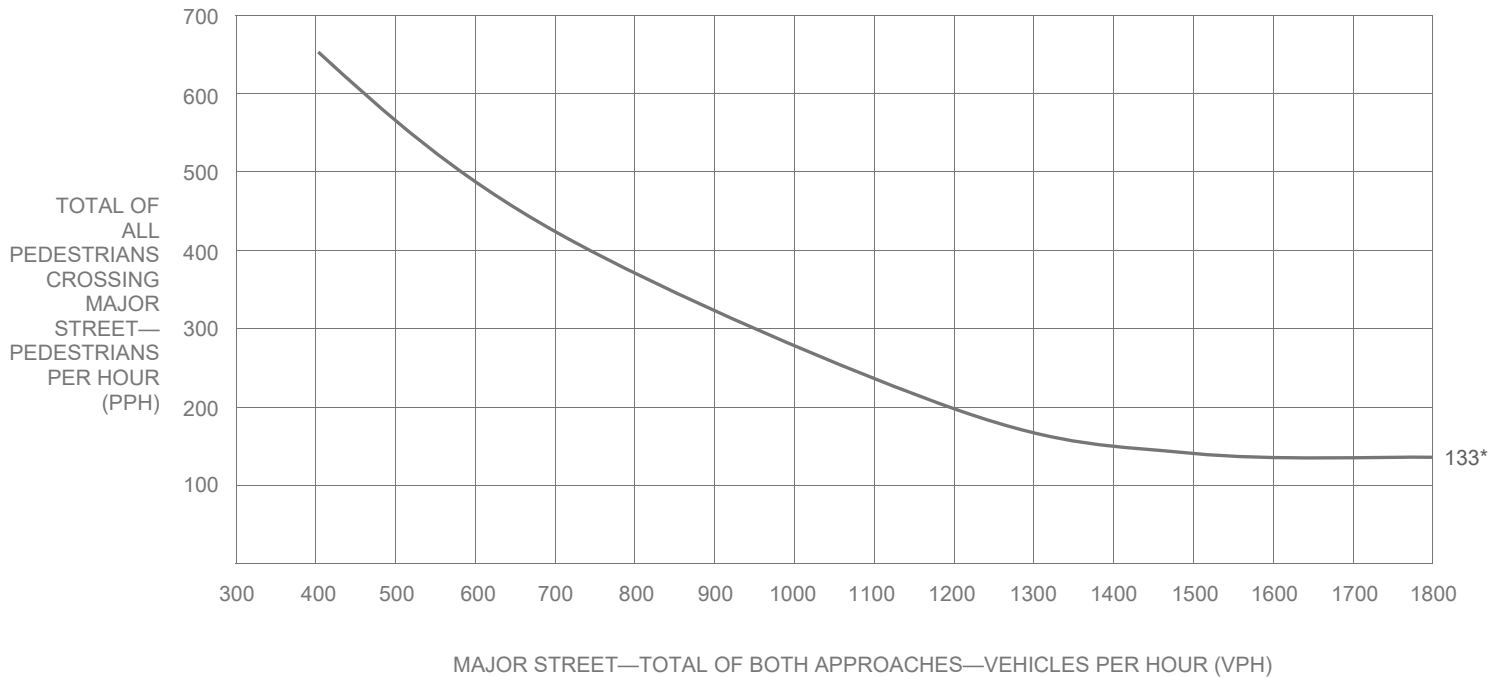

\* Note: 133 pph applies as the lower threshold volume

**SPEED > 35 MPH**  
**Figure 4C-8. Warrant 4, Pedestrian Peak Hour (70% Factor)**

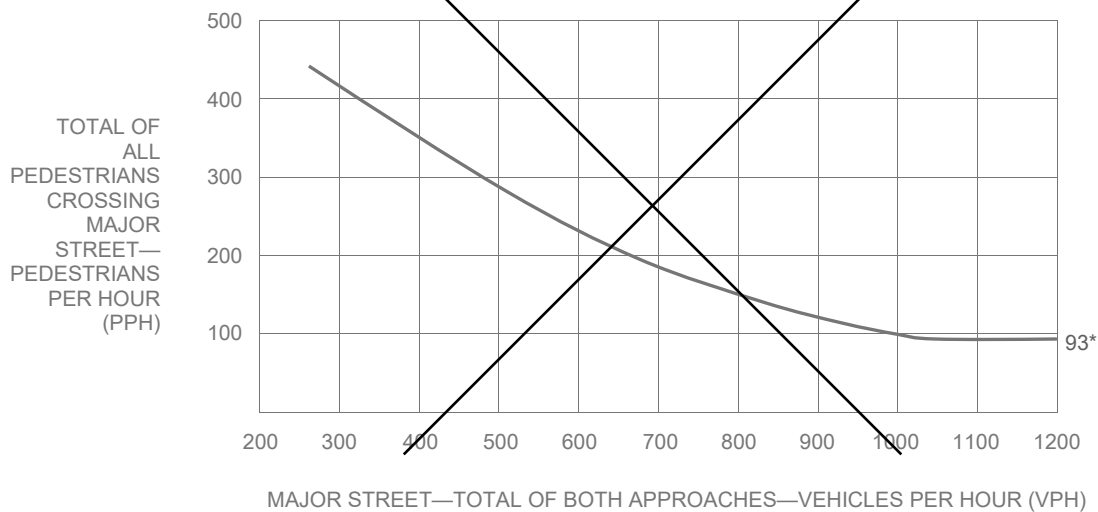

\* Note: 93 pph applies as the lower threshold volume

# School Crossing

**WARRANT**  
5

N/A

SATISFIED YES

NO

★ The satisfaction of a traffic signal warrant or warrants shall not in itself require the installation of a traffic control signal ★

- a. Part A and Part B shall be satisfied.
- b. For purposes of this warrant, schoolchildren include elementary through high school students.
- c. Estimated schoolchildren volumes may be used where a new school or expanded school has been approved for construction.
- d. The need for a traffic control signal shall be considered when an engineering study of the frequency and adequacy of gaps in the vehicular traffic stream as related to the number and size of groups of schoolchildren at an established school crossing across the major street shows that the number of adequate gaps in the traffic stream during the period when the schoolchildren are using the crossing is less than the number of minutes in the same period and there are a minimum of 20 schoolchildren during the highest crossing hour.
- e. The School Crossing signal warrant shall not be applied at locations where the distance to the nearest traffic control signal along the major street is less than 300 feet, unless the proposed traffic control signal will not restrict the progressive movement of traffic.
- f. Non-intersectional schoolchildren crosswalk locations may be signalized when justified.

PART A				SATISFIED	YES	NO
				<input type="checkbox"/>	<input type="checkbox"/>	<input type="checkbox"/>
<b>Gap / Minutes and # of Children</b>			Hour	YES	NO	
Gaps vs Minutes	Minutes Children Using Crossing		Gaps < Minutes	<input type="checkbox"/>	<input type="checkbox"/>	
	Number of Adequate Gaps		<b>AND</b> Children ≥ 20/hr	<input type="checkbox"/>	<input type="checkbox"/>	
School Age Pedestrians Crossing Street / hr						
<b>AND</b> , Consideration has been given to less restrictive remedial measures				<input type="checkbox"/>	<input type="checkbox"/>	

PART B		SATISFIED	YES	NO
		<input type="checkbox"/>	<input type="checkbox"/>	<input type="checkbox"/>
		YES	NO	
The distance to the nearest traffic signal along the major street is greater than 300 ft		<input type="checkbox"/>	<input type="checkbox"/>	
<b>OR</b> , The proposed traffic signal will not restrict progressive movement of traffic		<input type="checkbox"/>	<input type="checkbox"/>	

# Coordinated Signal System

**WARRANT**  
6

N/A

SATISFIED YES

NO

★ The satisfaction of a traffic signal warrant or warrants shall not in itself require the installation of a traffic control signal ★

- a. The Coordinated Signal System signal warrant should not be applied where the resultant spacing of traffic control signals would be less than 1,000 feet.
- b. All Parts must be satisfied.

MINIMUM REQUIREMENTS	DISTANCE TO NEAREST SIGNAL	YES	NO
≥ 1000 ft	N _____ ft, S _____ ft, E _____ ft, W _____ ft	<input type="checkbox"/>	<input type="checkbox"/>
On a one-way street or a street that has traffic predominantly in one direction, the adjacent traffic control signals are so far apart that they do not provide the necessary degree of vehicular platooning.		<input type="checkbox"/>	<input type="checkbox"/>
<b>OR</b> , On a two-way street, adjacent traffic control signals do not provide the necessary degree of platooning and the proposed and adjacent traffic control signals will collectively provide a progressive operation.		<input type="checkbox"/>	<input type="checkbox"/>

# Crash Experience Warrant



N/A

SATISFIED YES

NO

★ The satisfaction of a traffic signal warrant or warrants shall not in itself require the installation of a traffic control signal ★

- a. All Parts must be satisfied.
- b. For locations that involve other agencies, crash data from other involved jurisdictions should be obtained.

		YES	NO
Adequate trial of alternatives with satisfactory observance and enforcement has failed to reduce the crash frequency		<input type="checkbox"/>	<input type="checkbox"/>
<b>REQUIREMENTS</b>	Number of crashes reported within a 12-month period susceptible to correction by a traffic signal:	<input type="checkbox"/>	<input type="checkbox"/>
<b>5 OR MORE</b>	Indicate Date(s):		
<b>REQUIREMENTS</b>	<b>CONDITIONS</b>	<input checked="" type="checkbox"/>	
<b>ONE CONDITION SATISFIED 80%</b>	Warrant 1, Condition A - Minimum Vehicular Volume		
	OR, Warrant 1, Condition B - Interruption of Continuous Traffic	<input type="checkbox"/>	<input type="checkbox"/>
	OR, Warrant 4, Pedestrian Volume Condition - Ped Vol ≥ 80% for ped volumes per Figures 4C-5 to 4C-8		

# Roadway Network



N/A

SATISFIED YES

NO

★ The satisfaction of a traffic signal warrant or warrants shall not in itself require the installation of a traffic control signal ★

- a. Existing traffic volumes with an ambient growth rate of 1% (or other LADOT approved ambient growth rate) may be used if projected volumes are not available.
- b. All Parts must be satisfied.

MINIMUM VOLUME REQUIREMENTS	ENTERING VOLUMES - ALL APPROACHES		✓	FULLFILLED	
				YES	NO
1000 Veh / Hr	During Typical Weekday Peak Hour _____ Veh/Hr AND has 5-year projected traffic volumes that meet one or more of Warrants 1, 2, and 3 during an average weekday.			<input type="checkbox"/>	<input type="checkbox"/>
	OR During Each of Any 5 Hrs. of a Saturday or Sunday _____ Veh / Hr				
	<b>CHARACTERISTICS OF MAJOR ROUTES</b>	<b>MAJOR ROUTE A</b>	<b>MAJOR ROUTE B</b>		
	Highway System Serving as Principal Network for Through Traffic				
	Rural or Suburban Highway Outside Of, Entering, or Traversing a City				
	Appears as Major Route on an Official Plan			YES	NO
	Any Major Route Characteristics Met, Both Streets			<input type="checkbox"/>	<input type="checkbox"/>

# Intersection Near a Grade Crossing



N/A

SATISFIED YES

NO

★ The satisfaction of a traffic signal warrant or warrants shall not in itself require the installation of a traffic control signal ★

- a. Both Parts A and B shall be satisfied.
- b. This Warrant shall only be applied after review and approval by the LADOT Railroad Crossing and Safety Section (RCOSS), subject to CPUC General Order approval.
- c. This Warrant does not apply for Pre-Signals and/or Queue-Cutter signals, as an alternative application of Pre-Signals (See 2012 CA MUTCD, Sec 8C.09). Pre-Signals shall only be applied after review and approval by RCOSS, subject to CPUC General Order approval.

	FULFILLED	
	YES	NO
<b>PART A</b> A grade crossing exists on an approach controlled by a STOP or YIELD sign and the center of the track nearest to the intersection is within 140 feet of the stop line or yield line on the approach. Track Center Line to Limit Line _____ ft	<input type="checkbox"/>	<input type="checkbox"/>
<b>PART B</b> <b>There is one minor street approach lane at the track crossing</b> - During the highest traffic volume hour during which rail traffic uses the crossing, the plotted point falls above the applicable curve in Figure 4C-9. Major Street - Total of both approaches: _____ VPH Minor Street - Crosses the track (one direction only, approaching the intersection): _____ VPH X AF (Use Tables 4C-2, 3, & 4 below to calculate AF) = _____ VPH	<input type="checkbox"/>	<input type="checkbox"/>
<b>OR, There are two or more minor street approach lanes at the track crossing</b> - During the highest traffic volume hour during which rail traffic uses the crossing, the plotted point falls above the applicable curve in Figure 4C-10. Major Street - Total of both approaches: _____ VPH Minor Street - Crosses the track (one direction only, approaching the intersection): _____ VPH X AF (Use Tables 4C-2, 3, & 4 below to calculate AF) = _____ VPH	<input type="checkbox"/>	<input type="checkbox"/>

The minor street approach volume may be multiplied by up to three following adjustment factors (AF) as described in Section 4C-10.

- 1. Number of Rail Traffic per Day \_\_\_\_\_ Adjustment factor from Table 4C-2 \_\_\_\_\_
- 2. Percentage of High-Occupancy Buses on Minor Street Approach \_\_\_\_\_ Adjustment factor from Table 4C-3 \_\_\_\_\_
- 3. Percentage of Tractor-Trailer Trucks on Minor Street Approach \_\_\_\_\_ Adjustment factor from Table 4C-4 \_\_\_\_\_

NOTE: If no data is available or known, then use AF = 1 (no adjustment)

**Table 4C-2. Warrant 9, Adjustment Factor for Daily Frequency of Rail Traffic**

Rail Traffic per Day	Adjustment Factor
1	0.67
2	0.91
3 to 5	1.00
6 to 8	1.18
9 to 11	1.25
12 or more	1.33

**Table 4C-3. Warrant 9, Adjustment Factor for Percentage of High-Occupancy Buses**

% of High-Occupancy Buses * on Minor-Street Approach	Adjustment Factor
0 %	1.00
2 %	1.09
4 %	1.19
6 % or more	1.32

\* A high-occupancy bus is defined as a bus occupied by at least 20 people

# Intersection Near a Grade Crossing *(continued)*

★ The satisfaction of a traffic signal warrant or warrants shall not in itself require the installation of a traffic control signal ★

**Table 4C-4. Warrant 9, Adjustment Factor for Percentage of Tractor-Trailer Trucks**

% of Tractor-Trailer Trucks on Minor-Street Approach	Adjustment Factor	
	D less than 70 feet	D of 70 feet or more
0% to 2.5%	0.50	0.50
2.6% to 7.5%	0.75	0.75
7.6% to 12.5%	1.00	1.00
12.6% to 17.5%	2.30	1.15
17.6% to 22.5%	2.70	1.35
22.6% to 27.5%	3.28	1.64
More than 27.5%	4.18	2.09

**Figure 4C-9. Warrant 9, Intersection Near a Grade Crossing (One Approach Lane at the Track Crossing)**

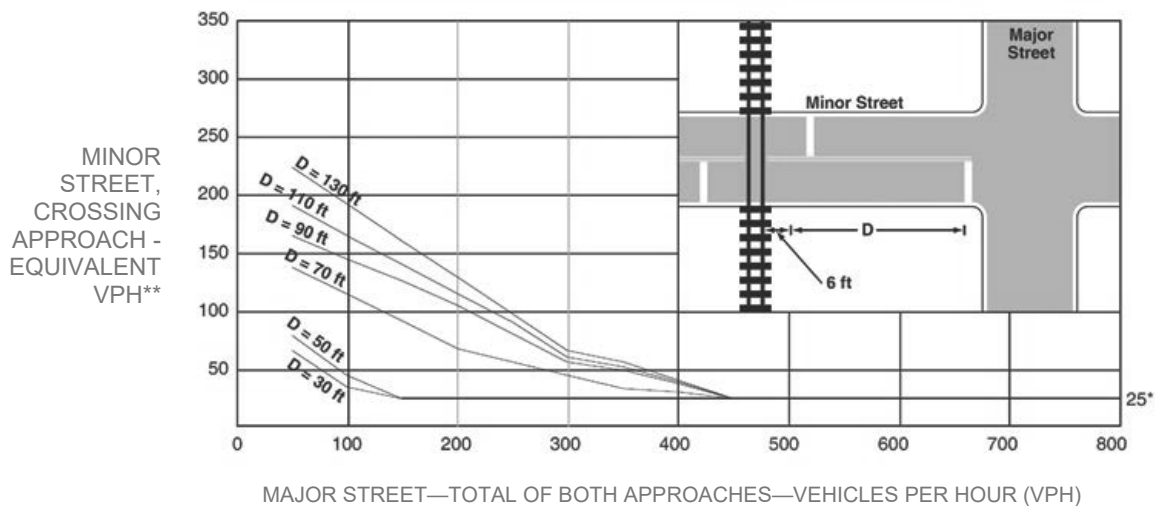

**Figure 4C-10. Warrant 9, Intersection Near a Grade Crossing (Two or More Approach Lanes at the Track Crossing)**

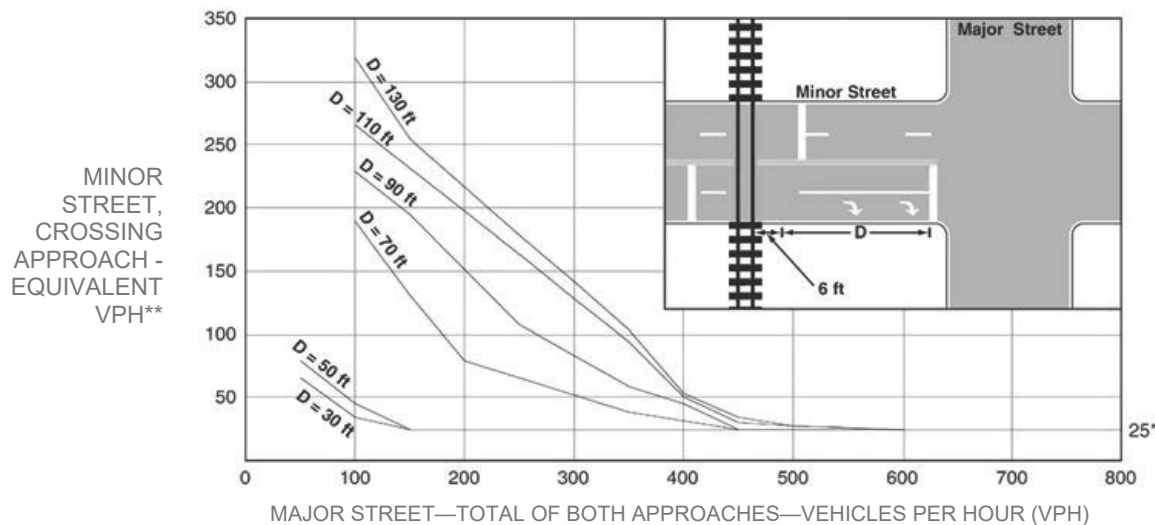

\* 25 vph applies as the lower threshold volume

\*\* VPH after applying the adjustment factors in Tables 4C-2, 4C-3, and/or 4C-4, if appropriate

Bicycles

WARRANT  
10

N/A

SATISFIED YES

NO

\* The satisfaction of a traffic signal warrant or warrants shall not in itself require the installation of a traffic control signal \*

- a. A bicycle signal should be considered for use only when the Volume requirement and Collision requirement have been met, or the Volume requirement and Geometry requirement have been met.
- b. Bicycle and vehicle volumes shall use the same peak hour.

		Hour	FULFILLED	
			YES	NO
VOLUME REQUIREMENT	One-Hour bicycle volume entering intersection B= _____			
	One-Hour vehicle volume entering intersection V= _____		<input type="checkbox"/>	<input type="checkbox"/>
	$B \times V = W$ W= <u>  0  </u>			
	$B \geq 50$ AND $W \geq 50,000$			
<b>AND</b>				
COLLISION REQUIREMENT	Two or more bicycle/vehicle collisions of types susceptible to correction by a bicycle signal over a 12-month period.		YES	NO
	DATES: _____ _____		<input type="checkbox"/>	<input type="checkbox"/>
OR GEOMETRY REQUIREMENT	A separate bicycle or multi-use path intersects roadway		<input type="checkbox"/>	<input type="checkbox"/>
	OR, is necessary to facilitate a bicycle movement that is not permitted by motor vehicles			

Activated Pedestrian Warning Device

WARRANT  
11

N/A

SATISFIED YES

NO

\* The satisfaction of a traffic signal warrant or warrants shall not in itself require the installation of a traffic control signal \*

- a. All Parts shall be satisfied.
- b. This warrant should be applied when an Activated Pedestrian Warning Device is recommended within 600 feet both upstream and downstream of existing traffic signals.

PART A	YES	NO
Location meets the guidelines for the installation of an Activated Pedestrian Warning Device as described in MPP section 354.	<input type="checkbox"/>	<input type="checkbox"/>

MINIMUM REQUIREMENTS	DISTANCE TO NEAREST SIGNALS	YES	NO
$\leq 600$ ft	N _____ ft, S _____ ft, E _____ ft, W _____ ft	<input type="checkbox"/>	<input type="checkbox"/>

## **Appendix IS-11.2**

---

LADOT Approval Letter

**CITY OF LOS ANGELES**  
**INTER-DEPARTMENTAL CORRESPONDENCE**

2000 E 8<sup>th</sup> St  
 DOT Case No. CEN21-51107

Date: August 27, 2021

To: Susan Jiménez, Administrative Clerk  
 Department of City Planning

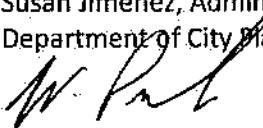
From:   
 Wes Pringle, Transportation Engineer  
 Department of Transportation

Subject: **TRANSPORTATION ASSESSMENT FOR THE PROPOSED 8<sup>th</sup> AND ALAMEDA STUDIO PROJECT LOCATED AT 2000 EAST 8<sup>th</sup> STREET (ENV-2021-4260-EAF/VTT-83418)**

The Los Angeles Department of Transportation (LADOT) has reviewed the transportation assessment prepared by Gibson Transportation Consulting, Inc., dated August 2021, for the proposed studio project located at 2000 East 8<sup>th</sup> Street within the Central City Community Plan Area and the Central Area Planning Commission (APC). In compliance with Senate Bill (SB) 743 and the California Environmental Quality Act (CEQA), a vehicle miles traveled (VMT) analysis is required to identify the project's ability to promote the reduction of green-house gas emissions, the access to diverse land uses, and the development of multi-modal networks. The significance of a project's impact in this regard is measured against the VMT thresholds established in LADOT's Transportation Assessment Guidelines (TAG), as described below.

**DISCUSSION AND FINDINGS**

A. Project Description

The 8<sup>th</sup> and Alameda Studio project proposes a change of use/adaptive reuse of the existing Los Angeles Times production plant to 639,840 square feet of studio, production support, office, and ancillary, circulation, and support uses on the block bounded by 8<sup>th</sup> Street to the north, Lemon Street to the east, Olympic Boulevard and Hunter Street to the south, and Alameda Street and Lawrence Street to the west. The development includes the construction of approximately 249,790 square feet of new studio, production support, office, and ancillary uses, a total of 58 (33 long-term and 25 short-term) bicycle parking spaces, and 1,665 vehicle parking spaces within a new parking structure and surface lots throughout the project site. The development will be accessed via driveways along 8<sup>th</sup> Street, Lemon Street, Hunter Street and Olympic Boulevard as illustrated in **Attachment A**. The main project access is along 8<sup>th</sup> Street via a full-access driveway to the project site and an egress only driveway from the parking structure. Access for trucks would be provided along Lemon Street via ingress and egress driveways. Additional gated egress driveways would be located along the project site's southern frontage on Hunter Street, Lawrence Street, and Olympic Boulevard. The new gated driveways on Hunter Street would provide egress from the surface parking lots. The existing gated driveways on Lawrence Street and Olympic Boulevard driveways would remain but would not be regularly used. Separate pedestrian and bicycle access would be provided at the main gate along 8<sup>th</sup> Street. Passenger loading and all proposed delivery will occur onsite. The project is expected to be completed by 2026.

B. Freeway Safety Analysis

Per the Interim Guidance for Freeway Safety Analysis memorandum issued by LADOT on May 1, 2020 to address Caltrans safety concerns on freeways, the study addresses the project's effects



on vehicle queuing on freeway off-ramps. Such an evaluation measures the project's potential to lengthen a forecasted off-ramp queue and create speed differentials between vehicles exiting the freeway off-ramps and vehicles operating on the freeway mainline.

The evaluation identified the number of project trips expected to be added to nearby freeway off-ramps serving the project site. It was determined that project traffic at the I-10 westbound off-ramp to Enterprise Street would exceed 25 peak hour trips. Therefore, the assessment included a freeway ramp analysis which determined that the project would cause a less than significant freeway impact.

C. CEQA Screening Threshold

Prior to accounting for trip reductions resulting from the application of Transportation Demand Management (TDM) strategies, a trip generation analysis was conducted to determine if the project would exceed the net 250 daily vehicle trips screening threshold. Using the City of Los Angeles VMT Calculator tool, which draws upon trip rate estimates published in the Institute of Transportation Engineers (ITE) Trip Generation Manual, 9<sup>th</sup> Edition as well as applying trip generation adjustments when applicable, based on sociodemographic data and the built environment factors of the project's surroundings, it was determined that the project does exceed the net 250 daily vehicle trips threshold.

Additionally, the analysis included further discussion of the transportation impact thresholds:

- T-1 Conflicting with plans, programs, ordinances, or policies
- T-2.1 Causing substantial vehicle miles traveled
- T-3 Substantially increasing hazards due to a geometric design feature or incompatible use.

The assessment determined that the project would not have a significant transportation impact under Thresholds T-1 and T-3. A project's impacts per Threshold T-2.1 is determined by using the VMT calculator and is discussed further below. A copy of the VMT Calculator summary report is provided as **Attachment B** to this report.

D. Transportation Impacts

On July 30, 2019, pursuant to SB 743 and the recent changes to Section 15064.03 of the State's CEQA Guidelines, the City of Los Angeles adopted VMT as criteria in determining transportation impacts under CEQA. The new LADOT TAG provide instructions on preparing transportation assessments for land use proposals and defines the significant impact thresholds.

The LADOT VMT Calculator tool measures project impact in terms of Household VMT per Capita and Work VMT per Employee. LADOT identified distinct thresholds for significant VMT impacts for each of the seven APC areas in the City. For the Central APC area, in which the project is located, the following thresholds have been established:

- Household VMT per Capita: 6.0
- Work VMT per Employee: 7.6

As cited in the VMT Analysis report, prepared by Gibson Transportation Consulting, Inc., the project proposes to incorporate the TDM strategies of Include Bike parking per Los Angeles Municipal Code (LAMC), secure bike parking and showers as project design features. With the application of these TDM measures, the proposed project is projected to have no Household

VMT and a Work VMT per employee of 7.4. Therefore, it is concluded that implementation of the Project would result in no significant VMT impact. A copy of the VMT Calculator summary report is provided as **Attachment B**.

E. Access and Circulation

During preparation of the new CEQA guidelines, the State's Office of Planning and Research stressed that lead agencies can continue to apply traditional operational analysis requirements to inform land use decisions provided that such analyses were outside of the CEQA process. The authority for requiring non-CEQA transportation analysis and requiring improvements to address potential circulation deficiencies, lies in the City of Los Angeles' Site Plan Review authority as established in Section 16.05 of the LAMC. Therefore, LADOT continues to require and review a project's site access, circulation, and operational plan to determine if any access enhancements, transit amenities, intersection improvements, traffic signal upgrades, neighborhood traffic calming, or other improvements are needed. In accordance with this authority, the project has completed a circulation analysis using a "level of service" screening methodology that indicates that the trips generated by the proposed development will not likely result in adverse circulation conditions at several locations. Access to the project will be provided along 8<sup>th</sup> Street, Lemon Street, Hunter Street, Lawrence Street and Olympic Boulevard. LADOT has reviewed this analysis and determined that it adequately discloses operational concerns. A copy of the circulation analysis table that summarizes these potential deficiencies is provided as **Attachment C** to this report.

## **PROJECT REQUIREMENTS**

### Non-CEQA-Related Requirements and Considerations

To comply with transportation and mobility goals and provisions of adopted City plans and ordinances, the applicant should be required to implement the following:

1. Parking Requirements

The project would provide parking for 1,665 vehicles and 58 bicycles onsite. The applicant should check with the Departments of Building and Safety and City Planning on the number of parking spaces required for this project.

2. Highway Dedication and Street Widening Requirements

Per the Mobility Element of the General Plan, **8<sup>th</sup> Street, Lemon Street, Hunter Street, and Lawrence Street**, which are designated as Collectors, would require a 20-foot half-width roadway within a 33-foot half-width right-of-way and **Olympic Boulevard and Alameda Street**, which are designated as Avenue I, would require a 35-foot half-width roadway within a 50-foot half-width right-of-way. The applicant should check with the Bureau of Engineering's Land Development Group to determine if there are any other applicable highway dedication, street widening and/or sidewalk requirements for this project.

3. Project Access and Circulation

The conceptual site plan for the project (see **Attachment A**) is acceptable to LADOT. The project main gate would be accessed via a full-access driveway along 8<sup>th</sup> Street and a secondary driveway along 8<sup>th</sup> Street would provide egress from the parking structure, while two driveways along Hunter Street would provide egress from the surface parking lots. The existing exit gates along Lawrence Street and Olympic Boulevard would remain but would not be utilized by regular vehicle access. Separate truck access would be provided via exclusive ingress and egress

driveways along Lemon Street. Pedestrian and bicycle access would be provided via a separate pedestrian entrance at the main gate along 8<sup>th</sup> Street. All delivery and Passenger loading and drop offs for ride share services is expected to occur onsite. Review of this study does not constitute approval of the dimensions for any new proposed driveway. Review and approval of the driveway should be coordinated with LADOT's Citywide Planning Coordination Section (201 North Figueroa Street, 5th Floor, Room 550, at 213-482-7024). In order to minimize and prevent last minute building design changes, the applicant should contact LADOT for driveway width and internal circulation requirements prior to the commencement of building or parking layout design. The applicant should check with City Planning regarding the project's driveway placement and design.

4. Worksite Traffic Control Requirements

LADOT recommends that a construction work site traffic control plan be submitted to LADOT's Citywide Temporary Traffic Control Section or Permit Plan Review Section for review and approval prior to the start of any construction work. Refer to <http://ladot.lacity.org/businesses/temporary-traffic-control-plans> to determine which section to coordinate review of the work site traffic control plan. The plan should show the location of any roadway or sidewalk closures, traffic detours, haul routes, hours of operation, protective devices, warning signs and access to abutting properties. LADOT also recommends that all construction related truck traffic be restricted to off-peak hours to the extent feasible.

5. TDM Ordinance Requirements

The TDM Ordinance (LAMC 12.26 J) is currently being updated. The updated ordinance, which is currently progressing through the City's approval process, will:

- Expand the reach and application of TDM strategies to more land uses and neighborhoods,
- Rely on a broader range of strategies that can be updated to keep pace with technology, and
- Provide flexibility for developments and communities to choose strategies that work best for their neighborhood context.

Although not yet adopted, LADOT recommends that the applicant be subject to the terms of the proposed TDM Ordinance update which is expected to be completed prior to the anticipated construction of this project, if approved.

6. Development Review Fees

Section 19.15 of the LAMC identifies specific fees for traffic study review, condition clearance, and permit issuance. The applicant shall comply with any applicable fees per this ordinance.

If you have any questions, please contact Jimmy Vivar of my staff at (213) 972-4993.

Attachments

*K:\Letters\2021\CEN21-51107\_2000 E 8<sup>th</sup> St\_ 8<sup>th</sup> and Alameda Studio\_Itr.docx*

- c: Emma Howard/Nate Hayward, Council District 14  
Matthew Masuda, Central District, BOE  
Tina Huang, Central District, DOT  
Taimour Tanavoli, Case Management Office, DOT  
Emily Wong, Gibson Transportation Consulting, Inc.

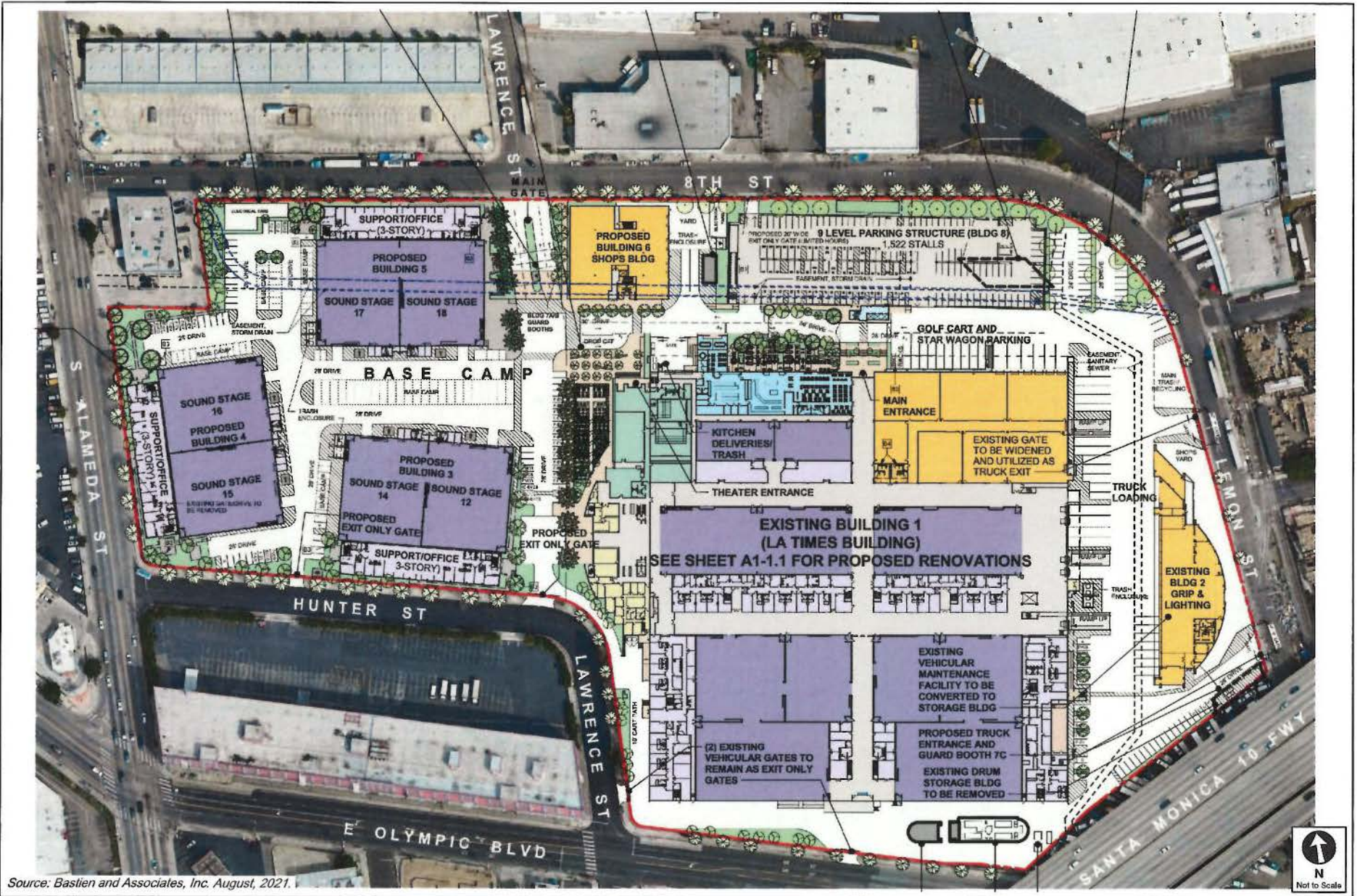

PROJECT SITE PLAN

FIGURE  
1

# CITY OF LOS ANGELES VMT CALCULATOR Version 1.3



*Project Screening Criteria: Is this project required to conduct a vehicle miles traveled analysis?*

## Project Information

Project:

Scenario:

Address:



## Existing Land Use

Land Use Type	Value	Unit
Industrial   Light Industrial	558.918	ksf
Industrial   Light Industrial	558.918	ksf

Click here to add a single custom land use type (will be included in the above list)

## Proposed Project Land Use

Land Use Type	Value	Unit
Office   General Office	523.514	ksf
Office   General Office	523.514	ksf

Click here to add a single custom land use type (will be included in the above list)

Is the project replacing an existing number of residential units with a smaller number of residential units AND is located within one-half mile of a fixed-rail or fixed-guideway transit station?

Yes  No

## Project Screening Summary

Existing Land Use	Proposed Project
2,933 Daily Vehicle Trips	3,511 Daily Vehicle Trips
22,382 Daily VMT	27,764 Daily VMT
<b>Tier 1 Screening Criteria</b>	
Project will have less residential units compared to existing residential units & is within one-half mile of a fixed-rail station. <input type="checkbox"/>	
<b>Tier 2 Screening Criteria</b>	
The net increase in daily trips < 250 trips	578 Net Daily Trips
The net increase in daily VMT ≤ 0	5,382 Net Daily VMT
The proposed project consists of only retail land uses ≤ 50,000 square feet total.	0.000 ksf
<b>The proposed project is required to perform VMT analysis.</b>	



# CITY OF LOS ANGELES VMT CALCULATOR Version 1.3



## Project Information

Project:

Scenario:

Address:

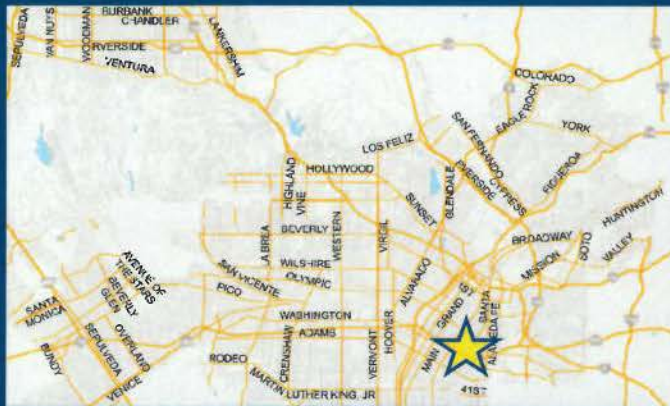

## TDM Strategies

Select each section to show individual strategies  
 Use  to denote if the TDM strategy is part of the proposed project or is a mitigation strategy

	Proposed Project	With Mitigation
Max Home Based TDM Achieved?	No	No
Max Work Based TDM Achieved?	No	No
<b>A</b> Parking		
<b>B</b> Transit		
<b>C</b> Education & Encouragement		
<b>D</b> Commute Trip Reductions		
<b>E</b> Shared Mobility		
<b>F</b> Bicycle Infrastructure		
<b>G</b> Neighborhood Enhancement		
Traffic Calming Improvements	<input type="checkbox"/> Proposed Prj <input type="checkbox"/> Mitigation	
<input type="text" value="25"/> percent of streets within project with traffic calming improvements <input type="text" value="25"/> percent of intersections within project with traffic calming improvements		
Pedestrian Network Improvements	<input type="checkbox"/> Proposed Prj <input type="checkbox"/> Mitigation	
<input type="text" value="within project and connecting off-site"/>		

Proposed Project Land Use Type	Value	Unit
Office   General Office		

## Analysis Results

Proposed Project	With Mitigation
<b>3,466</b> Daily Vehicle Trips	<b>3,466</b> Daily Vehicle Trips
<b>27,418</b> Daily VMT	<b>27,418</b> Daily VMT
<b>0.0</b> Household VMT per Capita	<b>0.0</b> Household VMT per Capita
<b>7.4</b> Work VMT per Employee	<b>7.4</b> Work VMT per Employee
<b>Significant VMT Impact?</b>	
<b>Household: No</b> Threshold = 6.0 15% Below APC	<b>Household: No</b> Threshold = 6.0 15% Below APC
<b>Work: No</b> Threshold = 7.6 15% Below APC	<b>Work: No</b> Threshold = 7.6 15% Below APC



# CITY OF LOS ANGELES VMT CALCULATOR

## Report 1: Project & Analysis Overview

Date: March 17, 2021

Project Name: 8th & Alameda

Project Scenario: Project

Project Address: 2000 E 8TH ST, 90021



Version 1.3

Project Information			
Land Use Type	Value	Units	
Housing	Single Family	0	DU
	Multi Family	0	DU
	Townhouse	0	DU
	Hotel	0	Rooms
	Motel	0	Rooms
Affordable Housing	Family	0	DU
	Senior	0	DU
	Special Needs	0	DU
	Permanent Supportive	0	DU
Retail	General Retail	0.000	ksf
	Furniture Store	0.000	ksf
	Pharmacy/Drugstore	0.000	ksf
	Supermarket	0.000	ksf
	Bank	0.000	ksf
	Health Club	0.000	ksf
	High-Turnover Sit-Down Restaurant	0.000	ksf
	Fast-Food Restaurant	0.000	ksf
	Quality Restaurant	0.000	ksf
	Auto Repair	0.000	ksf
	Home Improvement	0.000	ksf
	Free-Standing Discount	0.000	ksf
	Movie Theater	0	Seats
	Office	General Office	523.514
Medical Office		0.000	ksf
Industrial	Light Industrial	0.000	ksf
	Manufacturing	0.000	ksf
	Warehousing/Self-Storage	0.000	ksf
School	University	0	Students
	High School	0	Students
	Middle School	0	Students
	Elementary	0	Students
	Private School (K-12)	0	Students

# CITY OF LOS ANGELES VMT CALCULATOR

## Report 1: Project & Analysis Overview

Date: March 17, 2021

Project Name: 8th & Alameda

Project Scenario: Project

Project Address: 2000 E 8TH ST, 90021



Version 1.3

<i>Other</i>	<i>0</i>	<i>Trips</i>
--------------	----------	--------------



# CITY OF LOS ANGELES VMT CALCULATOR

## Report 1: Project & Analysis Overview

Date: March 17, 2021

Project Name: 8th & Alameda

Project Scenario: Project

Project Address: 2000 E 8TH ST, 90021



Version 1.3

<b>Analysis Results</b>			
Total Employees: 2,094			
Total Population: 0			
<b>Proposed Project</b>		<b>With Mitigation</b>	
3,466	Daily Vehicle Trips	3,466	Daily Vehicle Trips
27,418	Daily VMT	27,418	Daily VMT
0	Household VMT per Capita	0	Household VMT per Capita
7.4	Work VMT per Employee	7.4	Work VMT per Employee
<b>Significant VMT Impact?</b>			
<b>APC: Central</b>			
Impact Threshold: 15% Below APC Average			
Household = 6.0			
Work = 7.6			
<b>Proposed Project</b>		<b>With Mitigation</b>	
VMT Threshold	Impact	VMT Threshold	Impact
Household > 6.0	No	Household > 6.0	No
Work > 7.6	No	Work > 7.6	No

# CITY OF LOS ANGELES VMT CALCULATOR

## Report 2: TDM Inputs

Date: March 17, 2021

Project Name: 8th & Alameda

Project Scenario: Project

Project Address: 2000 E 8TH ST, 90021



Version 1.3

TDM Strategy Inputs			
Strategy Type	Description	Proposed Project	Mitigations
Parking	City code parking provision (spaces)	0	0
	Reduce parking supply		
	Actual parking provision (spaces)	0	0
	Unbundle parking		
	Monthly cost for parking (\$)	\$0	\$0
	Parking cash-out		
	Employees eligible (%)	0%	0%
Price workplace parking	Daily parking charge (\$)	\$0.00	\$0.00
	Employees subject to priced parking (%)	0%	0%
Residential area parking permits	Cost of annual permit (\$)	\$0	\$0
(cont. on following page)			

# CITY OF LOS ANGELES VMT CALCULATOR

## Report 2: TDM Inputs

Date: March 17, 2021

Project Name: 8th & Alameda

Project Scenario: Project

Project Address: 2000 E 8TH ST, 90021



Version 1.3

TDM Strategy Inputs, Cont.				
Strategy Type	Description	Proposed Project	Mitigations	
<b>Transit</b>	Reduction in headways (increase in frequency) (%)	0%	0%	
	Reduce transit headways	Existing transit mode share (as a percent of total daily trips) (%)	0%	0%
	Implement neighborhood shuttle	Lines within project site improved (<50%, >=50%)	0	0
		Degree of implementation (low, medium, high)	0	0
		Employees and residents eligible (%)	0%	0%
	Transit subsidies	Employees and residents eligible (%)	0%	0%
	Amount of transit subsidy per passenger (daily equivalent) (\$)	\$0.00	\$0.00	
<b>Education &amp; Encouragement</b>	Voluntary travel behavior change program	Employees and residents participating (%)	0%	0%
	Promotions and marketing	Employees and residents participating (%)	0%	0%
(cont. on following page)				

# CITY OF LOS ANGELES VMT CALCULATOR

## Report 2: TDM Inputs

Date: March 17, 2021

Project Name: 8th & Alameda

Project Scenario: Project

Project Address: 2000 E 8TH ST, 90021



Version 1.3

TDM Strategy Inputs, Cont.			
Strategy Type	Description	Proposed Project	Mitigations
<b>Commuter Trip Reductions</b>	<i>Required commute trip reduction program</i>	<i>Employees participating (%)</i>	0%
	<i>Alternative Work Schedules and Telecommute</i>	<i>Employees participating (%)</i>	0%
		<i>Type of program</i>	0
		<i>Degree of implementation (low, medium, high)</i>	0
	<i>Employer sponsored vanpool or shuttle</i>	<i>Employees eligible (%)</i>	0%
		<i>Employer size (small, medium, large)</i>	0
	<i>Ride-share program</i>	<i>Employees eligible (%)</i>	0%
<b>Shared Mobility</b>	<i>Car share</i>	<i>Car share project setting (Urban, Suburban, All Other)</i>	0
	<i>bike share</i>	<i>Within 600 feet of existing bike share station - OR - implementing new bike share station (Yes/No)</i>	0
	<i>School carpool program</i>	<i>Level of implementation (Low, Medium, High)</i>	0
(cont. on following page)			

# CITY OF LOS ANGELES VMT CALCULATOR

## Report 2: TDM Inputs

Date: March 17, 2021

Project Name: 8th & Alameda

Project Scenario: Project

Project Address: 2000 E 8TH ST, 90021



Version 1.3

TDM Strategy Inputs, Cont.			
Strategy Type	Description	Proposed Project	Mitigations
<b>Bicycle Infrastructure</b>	<i>Implement/improve on-street bicycle facility</i>	<i>Provide bicycle facility along site (Yes/No)</i>	0
	Include Bike parking per LAMC	Meets City Bike Parking Code (Yes/No)	Yes
	Include secure bike parking and showers	Includes indoor bike parking/lockers, showers, & repair station (Yes/No)	Yes
<b>Neighborhood Enhancement</b>	<i>Traffic calming improvements</i>	<i>Streets with traffic calming improvements (%)</i>	0%
		<i>Intersections with traffic calming improvements (%)</i>	0%
	<i>Pedestrian network improvements</i>	<i>Included (within project and connecting off-site/within project only)</i>	0

# CITY OF LOS ANGELES VMT CALCULATOR

## Report 3: TDM Outputs

Date: March 17, 2021  
 Project Name: 8th & Alameda  
 Project Scenario: Project  
 Project Address: 2000 E 8TH ST, 90021



Version 1.3

### TDM Adjustments by Trip Purpose & Strategy

Place type: Suburban Center

		Home Based Work Production		Home Based Work Attraction		Home Based Other Production		Home Based Other Attraction		Non-Home Based Other Production		Non-Home Based Other Attraction		Source
		Proposed	Mitigated	Proposed	Mitigated	Proposed	Mitigated	Proposed	Mitigated	Proposed	Mitigated	Proposed	Mitigated	
<b>Parking</b>	Reduce parking supply	0%	0%	0%	0%	0%	0%	0%	0%	0%	0%	0%	0%	TDM Strategy Appendix, Parking sections 1 - 5
	Debundle parking	0%	0%	0%	0%	0%	0%	0%	0%	0%	0%	0%	0%	
	Parking cash-out	0%	0%	0%	0%	0%	0%	0%	0%	0%	0%	0%	0%	
	Price workplace parking	0%	0%	0%	0%	0%	0%	0%	0%	0%	0%	0%	0%	
	Residential area parking permits	0.00%	0.00%	0.00%	0.00%	0.00%	0.00%	0.00%	0.00%	0.00%	0.00%	0.00%	0.00%	
<b>Transit</b>	Reduce transit roadways	0%	0%	0%	0%	0%	0%	0%	0%	0%	0%	0%	0%	TDM Strategy Appendix, Transit sections 1 - 3
	Implement neighborhood shuttle	0%	0%	0%	0%	0%	0%	0%	0%	0%	0%	0%	0%	
	Transit subsidies	0%	0%	0%	0%	0%	0%	0%	0%	0%	0%	0%	0%	
<b>Education &amp; Encouragement</b>	Voluntary travel behavior change program	0%	0%	0%	0%	0%	0%	0%	0%	0%	0%	0%	0%	TDM Strategy Appendix, Education & Encouragement sections 1 - 2
	Promotions and marketing	0%	0%	0%	0%	0%	0%	0%	0%	0%	0%	0%	0%	
<b>Commute Trip Reductions</b>	Required commute trip reduction program	0%	0%	0%	0%	0%	0%	0%	0%	0%	0%	0%	0%	TDM Strategy Appendix, Commute Trip Reductions sections 1 - 4
	Alternative Work Schedules and Telecommute Program	0%	0%	0%	0%	0%	0%	0%	0%	0%	0%	0%	0%	
	Employer sponsored vanpool or shuttle	0%	0%	0%	0%	0%	0%	0%	0%	0%	0%	0%	0%	
	Ride-share program	0%	0%	0%	0%	0%	0%	0%	0%	0%	0%	0%	0%	
<b>Shared Mobility</b>	Car-share	0.0%	0.0%	0.0%	0.0%	0.0%	0.0%	0.0%	0.0%	0.0%	0.0%	0.0%	0.0%	TDM Strategy Appendix, Shared Mobility sections 1 - 3
	Bike share	0.00%	0.00%	0.00%	0.00%	0.00%	0.00%	0.00%	0.00%	0.00%	0.00%	0.00%	0.00%	
	School carpool program	0.0%	0.0%	0.0%	0.0%	0.0%	0.0%	0.0%	0.0%	0.0%	0.0%	0.0%	0.0%	



### TDM Adjustments by Trip Purpose & Strategy, Cont.

#### Place type: Suburban Center

		Home Based Work Production		Home Based Work Attraction		Home Based Other Production		Home Based Other Attraction		Non-Home Based Other Production		Non-Home Based Other Attraction		Source
		Proposed	Mitigated	Proposed	Mitigated	Proposed	Mitigated	Proposed	Mitigated	Proposed	Mitigated	Proposed	Mitigated	
		<b>Bicycle Infrastructure</b>	Implement/improve on-street bicycle facility	0.0%	0.0%	0.0%	0.0%	0.0%	0.0%	0.0%	0.0%	0.0%	0.0%	
	Include Bike parking per LAMC	0.6%	0.6%	0.6%	0.6%	0.6%	0.6%	0.6%	0.6%	0.6%	0.6%	0.6%	0.6%	
	Include secure bike parking and showers	0.6%	0.6%	0.6%	0.6%	0.6%	0.6%	0.6%	0.6%	0.6%	0.6%	0.6%	0.6%	
<b>Neighborhood Enhancement</b>	Traffic calming improvements	0.0%	0.0%	0.0%	0.0%	0.0%	0.0%	0.0%	0.0%	0.0%	0.0%	0.0%	0.0%	TDM Strategy Appendix, Neighborhood Enhancement
	Pedestrian network improvements	0.0%	0.0%	0.0%	0.0%	0.0%	0.0%	0.0%	0.0%	0.0%	0.0%	0.0%	0.0%	

### Final Combined & Maximum TDM Effect

	Home Based Work Production		Home Based Work Attraction		Home Based Other Production		Home Based Other Attraction		Non-Home Based Other Production		Non-Home Based Other Attraction	
	Proposed	Mitigated	Proposed	Mitigated	Proposed	Mitigated	Proposed	Mitigated	Proposed	Mitigated	Proposed	Mitigated
	<b>COMBINED TOTAL</b>	1%	1%	1%	1%	1%	1%	1%	1%	1%	1%	1%
<b>MAX. TDM EFFECT</b>	1%	1%	1%	1%	1%	1%	1%	1%	1%	1%	1%	1%

$$= \text{Minimum}(X\%, 1 - [(1-A) * (1-B) \dots])$$

where X% =

<b>PLACE</b>	urban	75%
<b>TYPE</b>	compact infill	40%
<b>MAX:</b>	suburban center	20%
	suburban	15%

Note:  $(1 - [(1-A) * (1-B) \dots])$  reflects the dampened combined effectiveness of TDM Strategies (e.g., A, B, ...). See the TDM Strategy Appendix (*Transportation Assessment Guidelines Attachment G*) for further discussion of dampening.

# CITY OF LOS ANGELES VMT CALCULATOR

## Report 4: MXD Methodology

Date: March 17, 2021

Project Name: 8th & Alameda

Project Scenario: Project

Project Address: 2000 E 8TH ST, 90021



Version 1.3

### MXD Methodology - Project Without TDM

	Unadjusted Trips	MXD Adjustment	MXD Trips	Average Trip Length	Unadjusted VMT	MXD VMT
Home Based Work Production	0	0.0%	0	7.1	0	0
Home Based Other Production	0	0.0%	0	5.1	0	0
Non-Home Based Other Production	548	-4.4%	524	8.3	4,548	4,349
Home-Based Work Attraction	2,429	-22.1%	1,891	8.3	20,161	15,695
Home-Based Other Attraction	1,095	-47.8%	572	6.9	7,556	3,947
Non-Home Based Other Attraction	548	-4.4%	524	7.2	3,946	3,773

### MXD Methodology with TDM Measures

	Proposed Project			Project with Mitigation Measures		
	TDM Adjustment	Project Trips	Project VMT	TDM Adjustment	Mitigated Trips	Mitigated VMT
Home Based Work Production	-1.2%	0	0	-1.2%	0	0
Home Based Other Production	-1.2%	0	0	-1.2%	0	0
Non-Home Based Other Production	-1.2%	517	4,295	-1.2%	517	4,295
Home-Based Work Attraction	-1.2%	1,867	15,499	-1.2%	1,867	15,499
Home-Based Other Attraction	-1.2%	565	3,898	-1.2%	565	3,898
Non-Home Based Other Attraction	-1.2%	517	3,726	-1.2%	517	3,726

### MXD VMT Methodology Per Capita & Per Employee

Total Population: 0

Total Employees: 2,094

APC: Central

	Proposed Project	Project with Mitigation Measures
Total Home Based Production VMT	0	0
Total Home Based Work Attraction VMT	15,499	15,499
Total Home Based VMT Per Capita	0.0	0.0
Total Work Based VMT Per Employee	7.4	7.4



**Attachment C**  
**CEN21-51107\_2000 E 8th St**

**TABLE 13**  
**FUTURE WITH PROJECT CONDITIONS (YEAR 2026)**  
**INTERSECTION PEAK HOUR LEVELS OF SERVICE**

No.	Intersection	Peak Hour	Future without Project Conditions		Future with Project Conditions	
			Delay	LOS	Delay	LOS
1. [a]	Alameda Street & 7th Street	AM	23.8	C	24.4	C
		PM	36.5	D	39.4	D
2. [a]	Alameda Street & 8th Street	AM	7.3	A	7.7	A
		PM	5.2	A	7.0	A
3. [a]	Alameda Street & Olympic Boulevard	AM	53.9	D	59.0	E
		PM	46.2	D	48.8	D
4. [b]	Lemon Street & Olympic Boulevard	AM	22.9	C	35.0	D
		PM	34.6	D	119.1	F
5. [a]	Mateo Street & Olympic Boulevard	AM	22.1	C	24.6	C
		PM	42.5	D	42.6	D

**Notes:**

Delay is measured in seconds per vehicle, LOS = Level of Service.

[a] Intersection analysis based on HCM 6th Edition Signalized methodology, which calculates the average intersection delay, in seconds, for each vehicle passing through the intersection.

[b] Intersection analysis based on the HCM 6th Edition Two-Way Stop Control Unsignalized methodology, which calculates the control delay, in seconds, for each individual approach of an intersection. The reported control delay represents the worst-case approach, and does not account for traffic gaps created by adjacent traffic signals.