

OLD 215 FRONTAGE ROAD BUSINESS PARK

TRAFFIC IMPACT ANALYSIS

AUGUST 5, 2021

PREPARED FOR:

Phelan Development Company
450 Newport Center Drive, Suite
405
Newport Beach, California 92660

PREPARED BY:

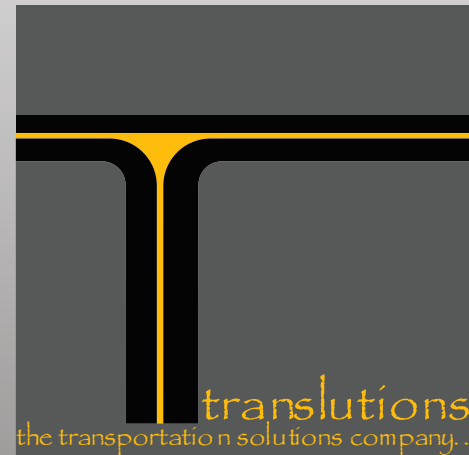

translutions, inc.

17632 Irvine Boulevard, Suite 200
Tustin, California 92780
(949) 656-3131



TABLE OF CONTENTS

1.0 INTRODUCTION 1
 1.1 Purpose of the Traffic Study and Study Objectives 1
 1.2 Project Location & Study Area..... 1
 1.3 Analysis Scenarios 1
2.0 PROJECT DESCRIPTION 1
 2.1 Project Trip Generation 5
 2.2 Project Trip Distribution & Assignment 5
3.0 LOS DEFINITIONS, PROCEDURES, AND THRESHOLDS 5
 3.1 Intersection Levels of Service 5
 3.2 Levels of Service Standards 5
4.0 VOLUME DEVELOPMENT METHODOLOGY 15
 4.1 Existing Without Project Traffic Volumes 15
 4.2 Project Completion Without Project Traffic Volumes 15
 4.3 With Project Traffic Volumes 15
5.0 EXISTING CONDITIONS 15
 5.1 Existing Roadway Conditions 15
 5.2 Existing Transit Service 15
 5.3 Existing Pedestrian & Bicycle Facilities 18
 5.4 Existing Levels of Service 18
6.0 PROJECT COMPLETION CONDITIONS 18
 6.1 Project Completion Roadway Conditions 18
 6.2 Project Completion Transit Service 25
 6.3 Project Completion Pedestrian & Bicycle Facilities 25
 6.4 Project Completion Without Project Levels of Service 25
 6.5 Project Completion With Project Levels of Service 25
8.0 VEHICLE MILES TRAVELED (VMT) SCREENING ANALYSIS 25
9.0 IMPACT CRITERIA FOR CEQA DETERMINATION 25
10.0 SUMMARY & CONCLUSIONS 31

APPENDICES

Appendix A: Scoping Agreement

Appendix B: Traffic Counts

Appendix C: Detailed Volume Development Worksheets

Appendix D: Level of Service Worksheets

FIGURES AND TABLES

FIGURES

Figure 1: Regional Project Location2
Figure 2: Study Area Intersections3
Figure 3: Site Plan.....4
Figure 4: Project Trip Distribution (Passenger Vehicles).....9
Figure 5: Project Trip Distribution (Trucks).....10
Figure 6: Project Trip Assignment (Passenger Vehicles)11
Figure 7: Project Trip Assignment (Trucks)12
Figure 8: Total Project Trip Assignment13
Figure 9: Cumulative Project Locations16
Figure 10: Transit19
Figure 11: Bike Lanes20
Figure 12: Pedestrian Facilities21
Figure 13: Existing Intersection Geometrics and Stop Control.....22
Figure 14: Existing Peak Hour Traffic Volumes23
Figure 15: City of Moreno Valley Recommend Bike Lanes26
Figure 16: Project Completion Without Project Peak Hour Traffic Volumes27
Figure 17: Project Completion With Project Peak Hour Traffic Volumes29
Figure 18: WRCOG Low VMT Screening Area30

TABLES

Table A: Total Project Trip Generation Summary (General Light Industrial and Warehousing)6
Table B: Project Trip Generation (General Light Industrial)7
Table C: Project Trip Generation (Warehousing)8
Table D: Level of Service Criteria14
Table E: Cumulative Projects Trip Generation17
Table F: Existing Levels of Service24
Table G: Project Completion Levels of Service28

1.0 INTRODUCTION

This report presents the methodology, findings and conclusions of the traffic impact analysis (TIA) prepared for the proposed Old 215 Frontage Road Business Park development project. The proposed project site is located on Old 215 Frontage Road between Bay Avenue and Alessandro Boulevard, in the City of Moreno Valley (City). The project proposes the construction of 94,022 square feet of warehousing and 102,974 square feet of Light Industrial uses.

1.1 Purpose of the Traffic Study and Study Objectives

This report is intended to satisfy the requirements for a TIA established by the City of Moreno Valley *Transportation Impact Analysis Preparation Guide for Vehicles Miles Traveled and Level of Service Assessment*, (June 2020), as well as the requirements for the disclosure of potential impacts and mitigation measures per the California Environmental Quality Act (CEQA). The study area, analysis scenarios, and analysis methodologies are based on discussion with City staff and included in the approved Scoping Agreement. Appendix A includes the approved Scoping Agreement.

1.2 Project Location & Study Area

The project is located on the eastside of Old 215 Frontage Road between Bay Avenue and Alessandro Boulevard. The project proposes the construction of 94,022 square feet of warehousing and 102,974 square feet of Light Industrial uses. Figure 1 shows the regional location of the project. The project opening year is 2023.

Consistent with City Guidelines, this report analyzes intersections of "Collector" or higher classification, at which the project will add 50 or more peak hour trips. The following five intersections were evaluated for traffic operations:

1. Old 215 Frontage Road and Cottonwood Avenue.
2. Old 215 Frontage Road and Bay Avenue.
3. Old 215 Frontage Road and Driveway 1.
4. Old 215 Frontage Road and Driveway 2.
5. Old 215 Frontage Road and Alessandro Boulevard.

The study area intersections are shown in Figure 2.

This report analyzes weekday a.m. and p.m. peak hour conditions. The a.m. peak hour is defined as the one hour of highest traffic volumes occurring between 7:00 a.m. and 9:00 a.m. The p.m. peak hour is defined as the one hour of highest traffic volumes occurring between 4:00 and 6:00 p.m.

1.3 Analysis Scenarios

Based on the City of Moreno Valley Guidelines, this report analyzes traffic conditions for the following scenarios:

1. Existing Conditions.
2. Project Completion Without Project Conditions.
3. Project Completion With Project Conditions.

Consistent with the CMP, this report analyzes weekday daily, a.m., and p.m. peak hour conditions. The a.m. peak hour is defined as the one hour of highest traffic volumes occurring between 7:00 a.m. and 9:00 a.m. The p.m. peak hour is defined as the one hour of highest traffic volumes occurring between 4:00 and 6:00 p.m.

2.0 PROJECT DESCRIPTION

The project proposes the construction of 94,022 square feet of warehousing and 102,974 square feet of Light Industrial uses. Access to the project will be provided by two right-in/right-out access driveways on Old 215 Frontage Road. The site plan for the proposed project is illustrated in Figure 3.

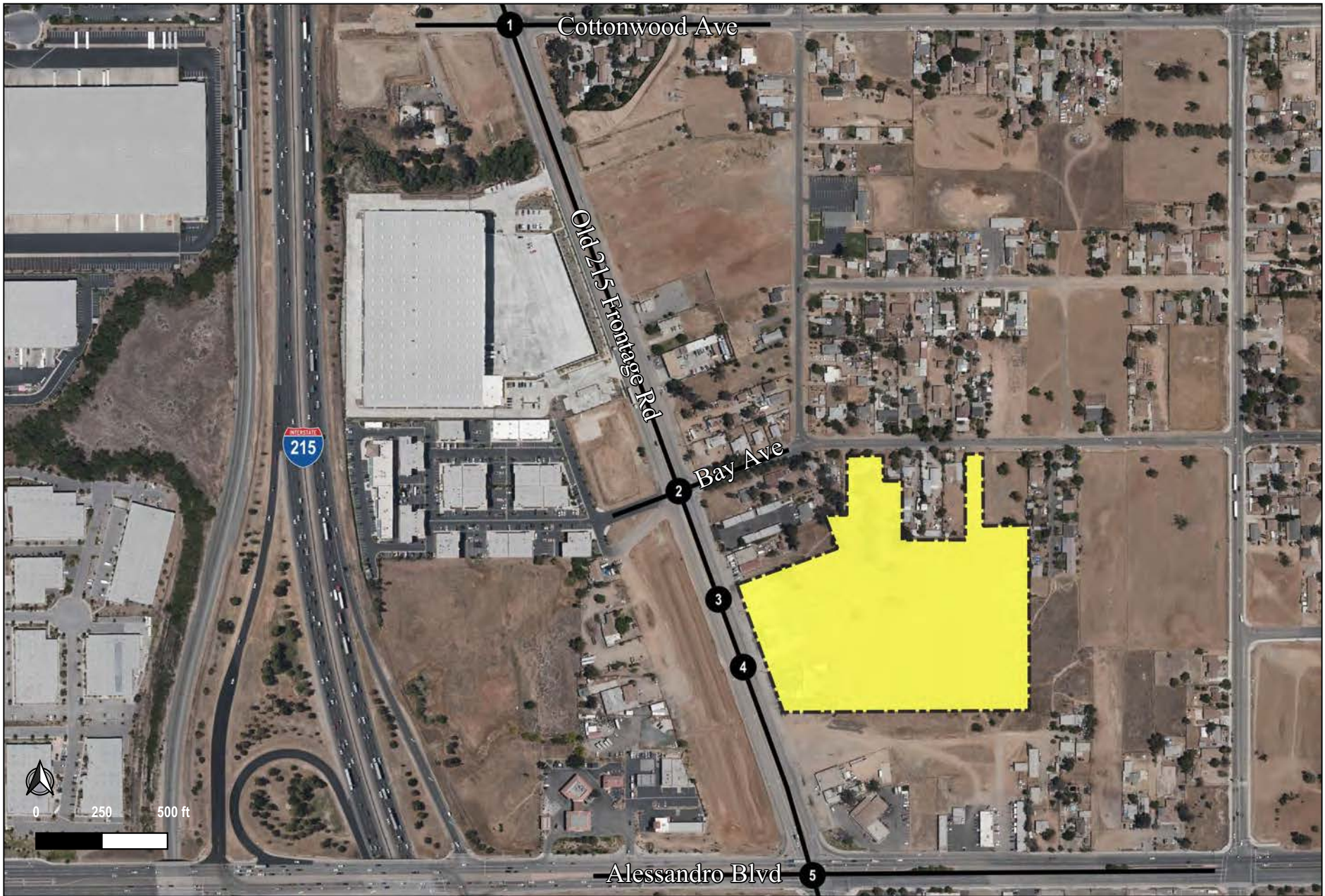

FIGURE 1

Legend
 Project Boundary

**Old 215 Frontage Road Business Park
 Regional Project Location**





Legend

- Project Boundary
- Study Area Intersections

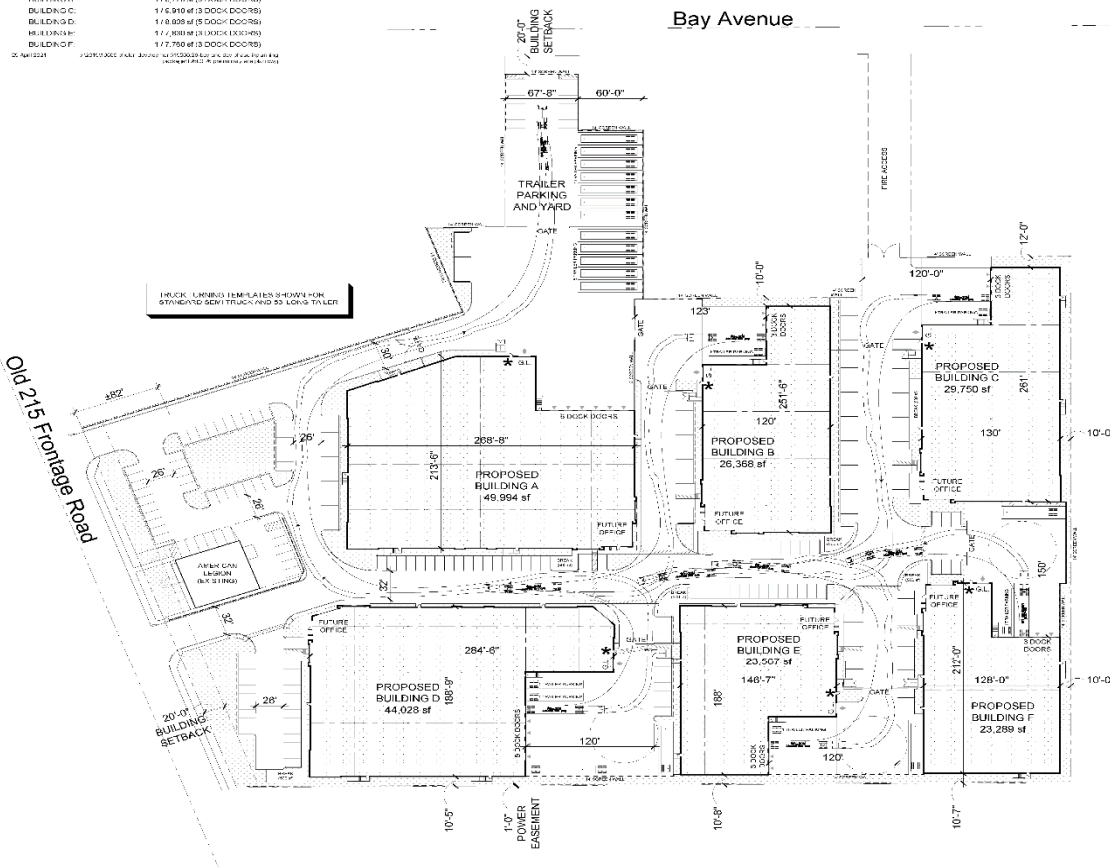

FIGURE 2
Old 215 Frontage Road Business Park
Study Area Intersections

GROSS LOT AREA:	499,225 sf ±
NET LOT AREA:	11.46 acres
TOTAL BUILDING AREA:	488,721 sf ±
BUILDING A:	49,994 sf
WAREHOUSE:	40,004 sf
OFFICE:	9,990 sf
BUILDING B:	26,368 sf
WAREHOUSE:	25,868 sf
OFFICE:	5,000 sf
BUILDING C:	29,750 sf
WAREHOUSE:	27,240 sf
OFFICE:	2,500 sf
BUILDING D:	44,028 sf
WAREHOUSE:	41,028 sf
OFFICE:	3,000 sf
BUILDING E:	23,507 sf
WAREHOUSE:	21,507 sf
OFFICE:	2,000 sf
BUILDING F:	23,298 sf
WAREHOUSE:	21,798 sf
OFFICE:	1,500 sf

SITE COVERAGE (on net):	40.3 %
PARKING REQUIRED	225 spaces
OFFICES (1250 sf of gross floor area)	18 spaces
WAREHOUSE (1250 sf of gross floor area)	18 spaces
BUILDING A:	58 spaces
WAREHOUSE:	32 spaces
OFFICE:	18 spaces
BUILDING B:	32 spaces
WAREHOUSE:	22 spaces
OFFICE:	10 spaces
BUILDING C:	38 spaces
WAREHOUSE:	24 spaces
OFFICE:	14 spaces
BUILDING D:	31 spaces
WAREHOUSE:	18 spaces
OFFICE:	13 spaces
BUILDING E:	32 spaces
WAREHOUSE:	22 spaces
OFFICE:	10 spaces
BUILDING F:	32 spaces
WAREHOUSE:	22 spaces
OFFICE:	10 spaces
PARKING PROVIDED:	235 spaces
STANDARD:	220 spaces
ACCESSIBLE:	15 spaces
TRAILER PARKING REQUIRED:	23 spaces
(1 SPACE PER DOCK DOOR)	
TRAILER PARKING PROVIDED:	23 spaces
LANDSCAPE PROVIDED (10.3% of Net Lot Area)	50,402 sf

DOCK DOOR RATIO:	1 / 8,565 sf (23 DOCK DOORS)
BUILDING A:	1 / 8,332 sf (18 DOCK DOORS)
BUILDING B:	1 / 8,778 sf (13 DOCK DOORS)
BUILDING C:	1 / 8,940 sf (13 DOCK DOORS)
BUILDING D:	1 / 8,028 sf (5 DOCK DOORS)
BUILDING E:	1 / 7,300 sf (13 DOCK DOORS)
BUILDING F:	1 / 7,700 sf (13 DOCK DOORS)



- * ACCESSIBLE BUILDING EXIT WITH EXTERIOR AREA FOR ACCESSIBLE ROUTE
- ACCESSIBLE PATH OF TRAVEL
- DRIVE-IN OVERHEAD DOOR AT GRADE LEVEL
- + OVERHEAD DOOR AT LOADING DOCK

LEGEND

PRELIMINARY SITE PLAN (TRUCK TURNING)

April 29, 2021

Old 215 Frontage Road and Bay Avenue
Moreno Valley, California



A-2A
PHELAN
 DEVELOPMENT
 450 Newport, Cranford, NJ 07016
 Newport Beach, CA 92660

Carille Coatsworth Architects, Inc.
 10000 W. 16th Ave., Suite 100, Denver, CO 80202

FIGURE 3

Old 215 Frontage Road Business Park
Site Plan



2.1 Project Trip Generation

Trip generation for the project is based on trip generation rates from the Institute of Transportation Engineers' (ITE) Trip Generation (10th Edition) and are based on Land Use 110 "General Light Industrial" and Land Use 150 "Warehousing". Further, the City Guidelines require projects with truck intensive uses account for truck traffic. Truck percentages are based on discussion with City staff. In addition, the guidelines require trucks to be converted to passenger car equivalents (PCEs). The truck trips were converted to PCEs using the City conversion rates of 1.5 for 2-axle trucks, 2.0 for 3-axle trucks and 3.0 for 4+ axle trucks. Table A shows a summary of the total project trip generation for both the General Light Industrial and Warehouse uses. As shown in Table A, the total project is anticipated to generate 89 total trips during the a.m. peak hour, 83 total trips during the p.m. peak hour, and 675 total daily trips. After converting to PCEs, the total project is anticipated to generate 116 PCE trips during the a.m. peak hour, 106 PCE trips during the p.m. peak hour, and 894 daily PCE trips. Table B shows the breakdown of the trip generation for the General Light Industrial and short-term storage use. Table C shows the breakdown of the trip generation for the warehouse use.

2.2 Project Trip Distribution & Assignment

Project trip distribution patterns for the proposed project were developed separately for autos and trucks based on location of local and regional destinations. The project trip generation was applied to the trip distribution patterns for the project to develop trip assignments for project trips. Figure 4 shows the trip distribution for passenger vehicles and Figure 5 shows the trip distribution for trucks. Figure 6 shows the trip assignment for passenger vehicles and Figure 7 shows the trip assignment for trucks. The total project trip assignment is shown in Figure 8.

3.0 LOS DEFINITIONS, PROCEDURES, AND THRESHOLDS

Level of service (LOS) is a measure of the quality of operational conditions within a traffic stream, and is generally expressed in terms of such measures as speed and travel time, freedom to maneuver, traffic interruptions, and comfort and convenience. Levels range from A to F, with LOS A representing excellent (free-flow) conditions and LOS F representing extreme congestion. Consistent with City guidelines, the Highway Capacity Manual (HCM) procedures have been used to evaluate levels of service. This section discusses the LOS definitions, procedures, and thresholds used in this report.

3.1 Intersection Levels of Service

The analysis of traffic operations at intersections was conducted according to the Highway Capacity Manual 6th Edition (HCM) delay methodologies using Synchro 11 software, which is described in the Highway Capacity Manual (Transportation Research Board, Washington, D.C., November 2016). Under the HCM methodology, LOS for signalized intersections is based on the average delay experienced by vehicles traveling through an intersection, whereas for un-signalized intersections, the LOS is based on the worst approach where the minor leg has a shared lane and on the worst movement where the minor leg has dedicated turn lanes. Table D presents a brief description of each level of service letter grade, as well as the range of delays associated with each grade.

3.2 Levels of Service Standards

The City of Moreno Valley General Plan has established minimum Level of Service standards for its roadway network. LOS D is applicable to intersections that are adjacent to freeway on/off ramps and adjacent to employment generating lands uses. LOS C is applicable to all other intersections. For boundary intersections, LOS D is assumed to be acceptable. Further, the City of Moreno Valley identifies the following signalized intersection operating requirements:

- Any signalized study intersection operating at acceptable LOS without project traffic in which the addition of project traffic causes the intersection to degrade to unacceptable LOS shall identify improvements to provide acceptable LOS.

Table A - Total Project Trip Generation Summary (General Light Industrial and Warehousing)

Land Use	Units	Peak Hour						Daily
		AM Peak Hour			PM Peak Hour			
		In	Out	Total	In	Out	Total	
Total Project Trip Generation (Trips, By Vehicle Type)								
General Light Industrial and Warehouse								
Passenger Cars		59	10	68	11	54	65	512
2-Axle Trucks		6	1	7	1	6	6	50
3-Axle Trucks		3	0	4	0	3	4	31
4+ Axle Trucks		8	2	10	2	7	8	82
All Trucks		17	3	21	3	16	18	163
Total Vehicles		76	13	89	14	70	83	675
Total Project Trip Generation (Passenger Car Equivalent Trips, By Vehicle Type)								
Passenger Cars		59	10	68	11	54	65	512
Truck PCE								
2-Axle Trucks		9	1	10	1	8	9	75
3-Axle Trucks		7	1	8	1	5	7	62
4+ Axle Trucks		25	4	30	4	21	25	245
Total Truck PCE		41	6	48	6	34	41	382
Total PCE		100	16	116	17	88	106	894

¹ Rates based on Land Use 110 "General Light Industrial" and Land Use 150 "Warehousing" from Institute of Transportation Engineers (ITE) *Trip Generation* (10th Ed.)

² Truck percentages are based on discussion with City staff.

³ Recommended PCE Factor per City of Moreno Valley *Transportation Impact Analysis Preparation Guide for Vehicle Miles Traveled and Level of Service Assessment* (June 2020).

Table B: Project Trip Generation (General Light Industrial)

Land Use	Units	Peak Hour						Daily	
		AM Peak Hour			PM Peak Hour				
		In	Out	Total	In	Out	Total		
Total Vehicle Rates									
Trip Generation Rates ¹	102.974	TSF	0.616	0.084	0.700	0.082	0.548	0.630	4.960
PCE Inbound/Outbound Splits			88%	12%	100%	13%	87%	100%	100%
Trip Rate by Vehicle Classification									
Passenger Cars									
Classification Percentage ²			78.60%	78.60%	78.60%	78.60%	78.60%	78.60%	78.60%
Rate			0.484	0.066	0.550	0.064	0.431	0.495	3.899
2-Axle Trucks									
Classification Percentage ²			8.00%	8.00%	8.00%	8.00%	8.00%	8.00%	8.00%
Rate			0.049	0.007	0.056	0.007	0.044	0.050	0.397
3-Axle Trucks									
Classification Percentage ²			3.90%	3.90%	3.90%	3.90%	3.90%	3.90%	3.90%
Rate			0.024	0.003	0.027	0.003	0.021	0.025	0.193
4-Axle Trucks									
Classification Percentage ²			9.50%	9.50%	9.50%	9.50%	9.50%	9.50%	9.50%
Rate			0.059	0.008	0.067	0.008	0.052	0.060	0.471
Total Project Trip Generation (Trips, By Vehicle Type)									
Passenger Cars									
Trips			50	7	57	7	44	51	401
2-Axle Trucks									
Trips			5	1	6	1	5	5	41
3-Axle Trucks									
Trips			2	0	3	0	2	3	20
4-Axle Trucks									
Trips			6	1	7	1	5	6	49
All Trucks			13	2	16	2	12	14	110
Total Vehicles			63	9	73	9	56	65	511
Total Project Trip Generation (Passenger Car Equivalent Trips, By Vehicle Type)									
Passenger Cars									
PCE Factor ³			1.0	1.0	1.0	1.0	1.0	1.0	1.0
PCEs			50	7	57	7	44	51	401
2-Axle Trucks									
PCE Factor ³			1.5	1.5	1.5	1.5	1.5	1.5	1.5
PCEs			8	1	9	1	7	8	61
3-Axle Trucks									
PCE Factor ³			2.0	2.0	2.0	2.0	2.0	2.0	2.0
PCEs			5	1	6	1	4	5	40
4-Axle Trucks									
PCE Factor ³			3.0	3.0	3.0	3.0	3.0	3.0	3.0
PCEs			18	2	21	2	16	18	146
Total Truck PCE			31	4	36	4	27	31	247
Total PCE			81	11	93	11	71	82	648

¹ Rates based on Land Use 110 "General Light Industrial" from Institute of Transportation Engineers (ITE) Trip Generation (10th Ed+Supplement.).

² Truck percentage are based on discussion with City staff.

³ PCE Factor per *City of Moreno Valley Transportation Impact Analysis Preparation Guide for Vehicle Miles Traveled and Level of Service Assessment* (June 2020).

Table C: Project Trip Generation (Warehousing)

Land Use	Units	Peak Hour						Daily	
		AM Peak Hour			PM Peak Hour				
		In	Out	Total	In	Out	Total		
Total Vehicle Rates									
Trip Generation Rates ¹	94.022	TSF	0.131	0.039	0.170	0.051	0.139	0.190	1.740
PCE Inbound/Outbound Splits			77%	23%	100%	27%	73%	100%	100%
Trip Rate by Vehicle Classification									
Passenger Cars									
Classification Percentage ²			69.20%	69.20%	69.20%	78.30%	78.30%	78.30%	67.80%
Rate			0.091	0.027	0.118	0.040	0.109	0.149	1.180
2-Axle Trucks									
Classification Percentage ²			5.15%	5.15%	5.15%	3.63%	3.63%	3.63%	5.39%
Rate			0.007	0.002	0.009	0.002	0.005	0.007	0.094
3-Axle Trucks									
Classification Percentage ²			6.38%	6.38%	6.38%	4.50%	4.50%	4.50%	6.67%
Rate			0.008	0.002	0.011	0.002	0.006	0.009	0.116
4-Axle Trucks									
Classification Percentage ²			19.26%	19.26%	19.26%	13.57%	13.57%	13.57%	20.14%
Rate			0.025	0.008	0.033	0.007	0.019	0.026	0.350
Total Project Trip Generation (Trips, By Vehicle Type)									
Passenger Cars									
Trips			9	3	11	4	10	14	111
2-Axle Trucks									
Trips			1	0	1	0	1	1	9
3-Axle Trucks									
Trips			1	0	1	0	1	1	11
4-Axle Trucks									
Trips			2	1	3	1	2	2	33
All Trucks			4	1	5	1	4	4	53
Total Vehicles			13	4	16	5	14	18	164
Total Project Trip Generation (Passenger Car Equivalent Trips, By Vehicle Type)									
Passenger Cars									
PCE Factor ³			1.0	1.0	1.0	1.0	1.0	1.0	1.0
PCEs			9	3	11	4	10	14	111
2-Axle Trucks									
PCE Factor ³			1.5	1.5	1.5	1.5	1.5	1.5	1.5
PCEs			1	0	1	0	1	1	14
3-Axle Trucks									
PCE Factor ³			2.0	2.0	2.0	2.0	2.0	2.0	2.0
PCEs			2	0	2	0	1	2	22
4-Axle Trucks									
PCE Factor ³			3.0	3.0	3.0	3.0	3.0	3.0	3.0
PCEs			7	2	9	2	5	7	99
Total Truck PCE			10	2	12	2	7	10	135
Total PCE			19	5	23	6	17	24	246

¹ Rates based on Land Use 150 "Warehousing" from Institute of Transportation Engineers (ITE) Trip Generation (10th Ed+Supplement.).

² Truck percentages are based on discussion with City staff.

³ PCE Factor per *City of Moreno Valley Transportation Impact Analysis Preparation Guide for Vehicle Miles Traveled and Level of Service Assessment* (June 2020).

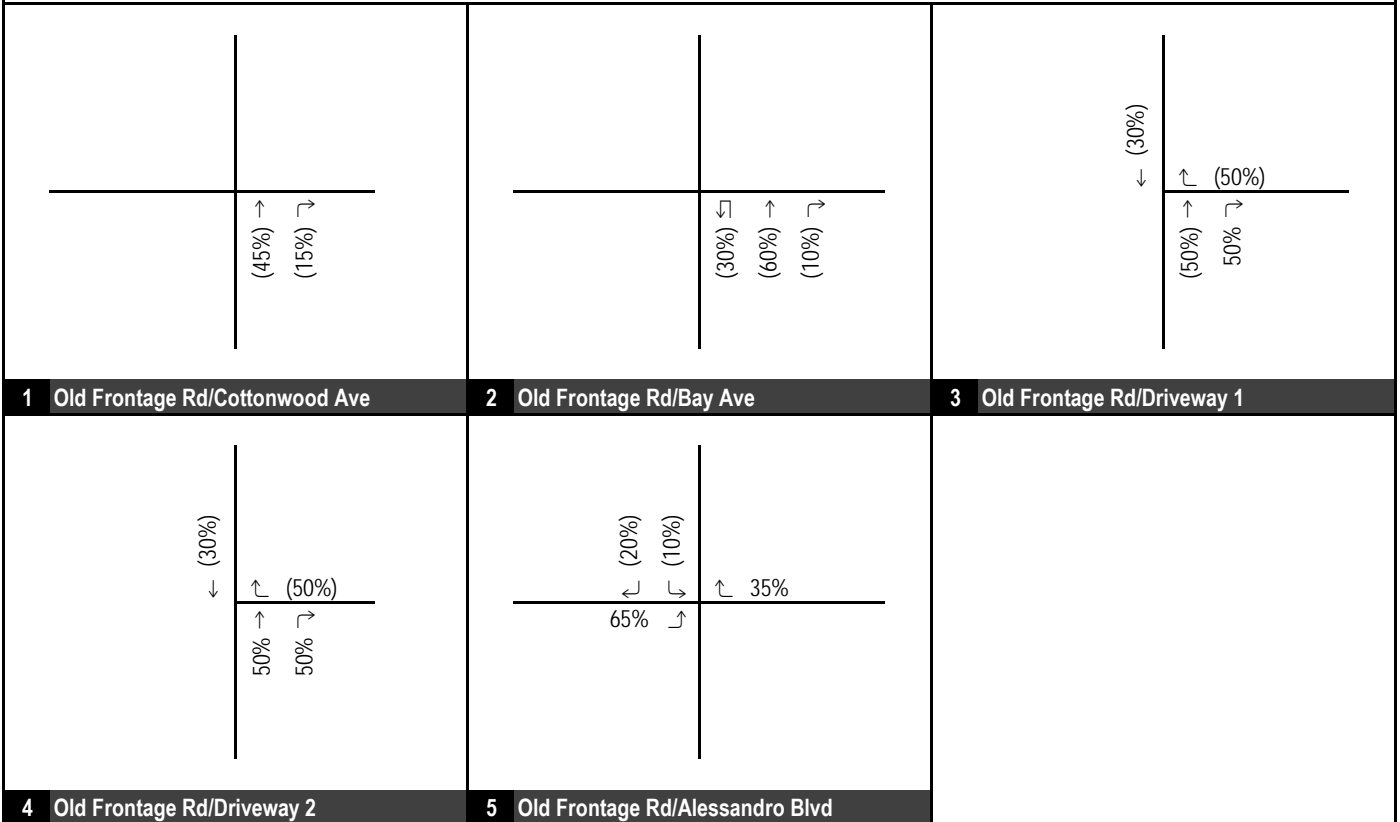
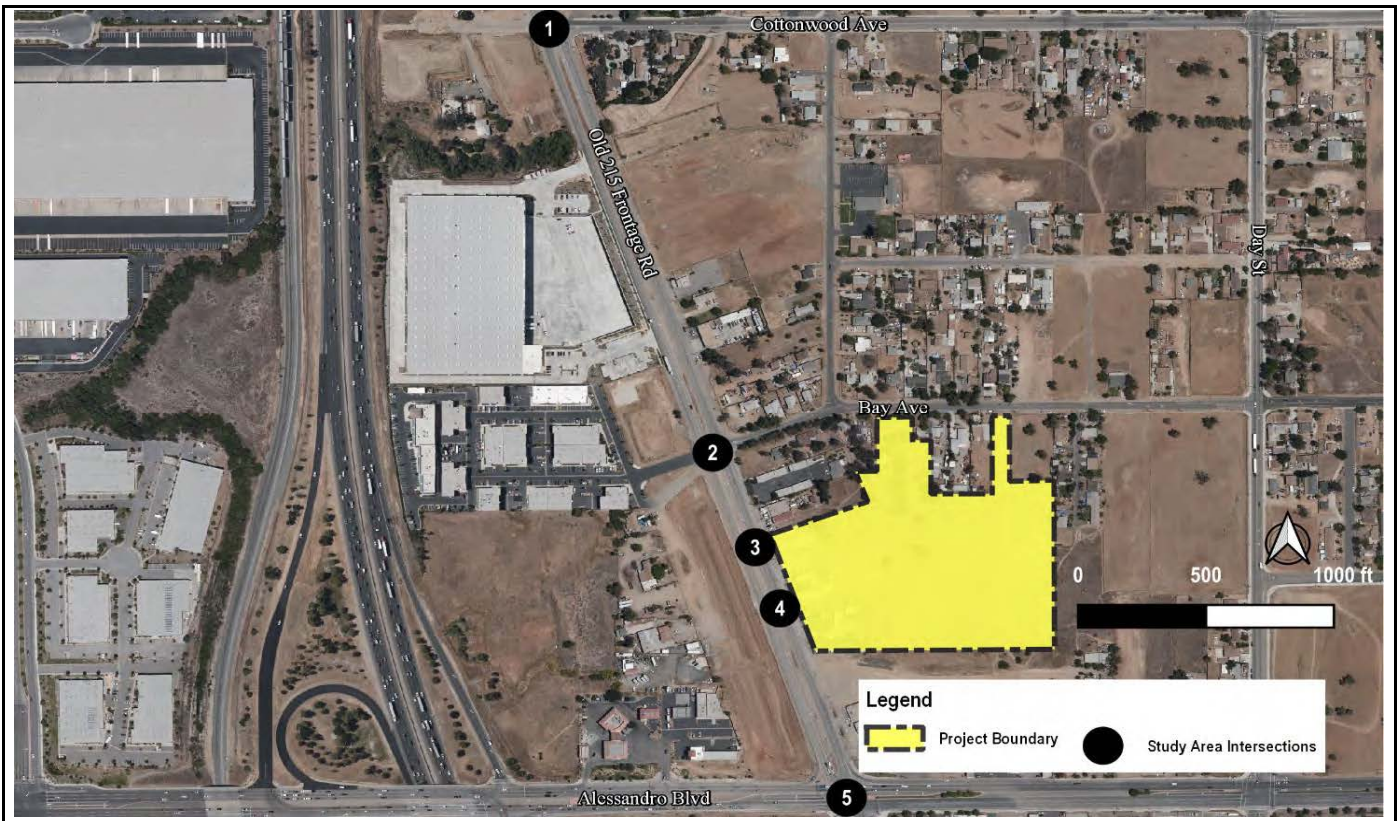

FIGURE 4

XXX%(YYY%) Inbound%(Outbound%) Percent



**Old 215 Frontage Road Business Park
Project Trip Distribution (Autos)**

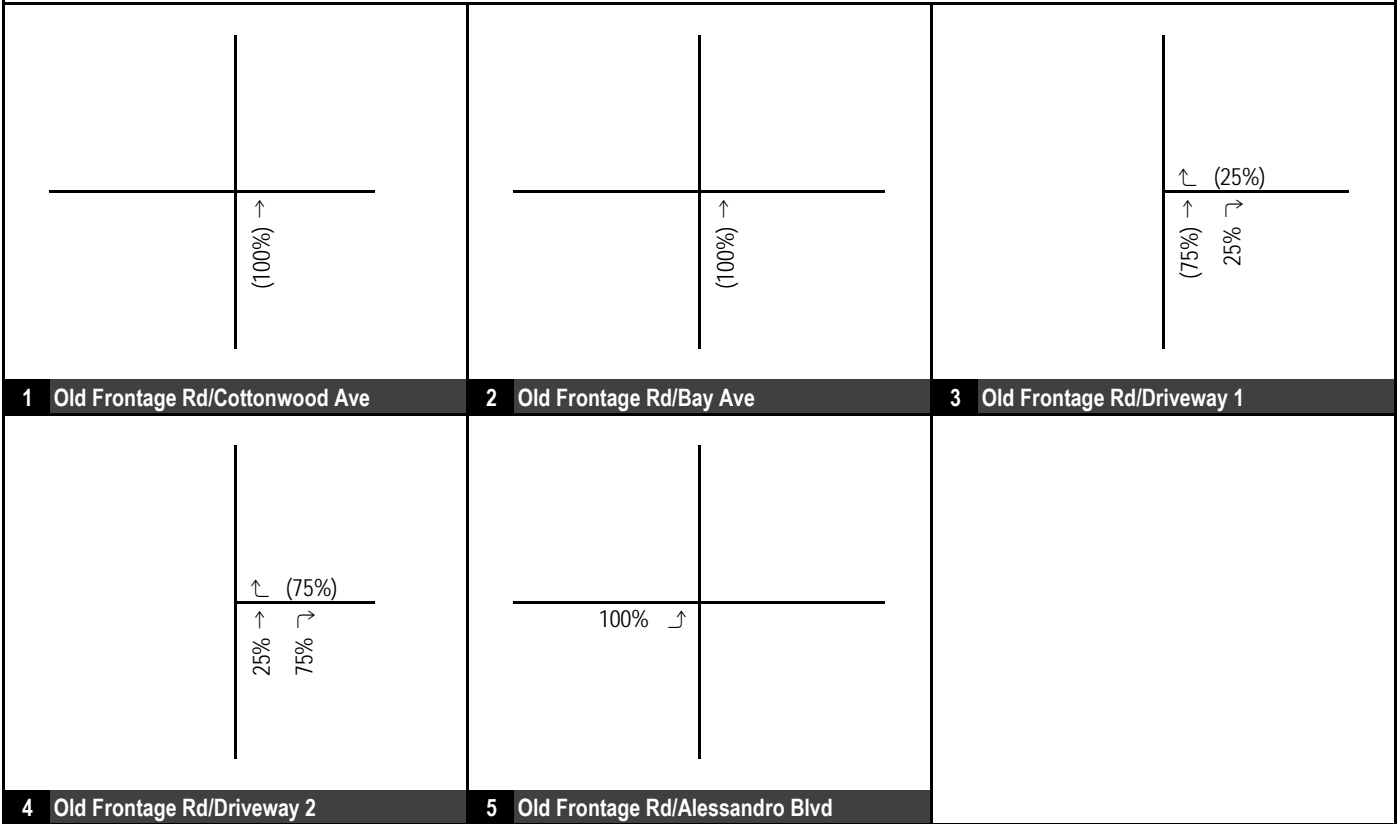
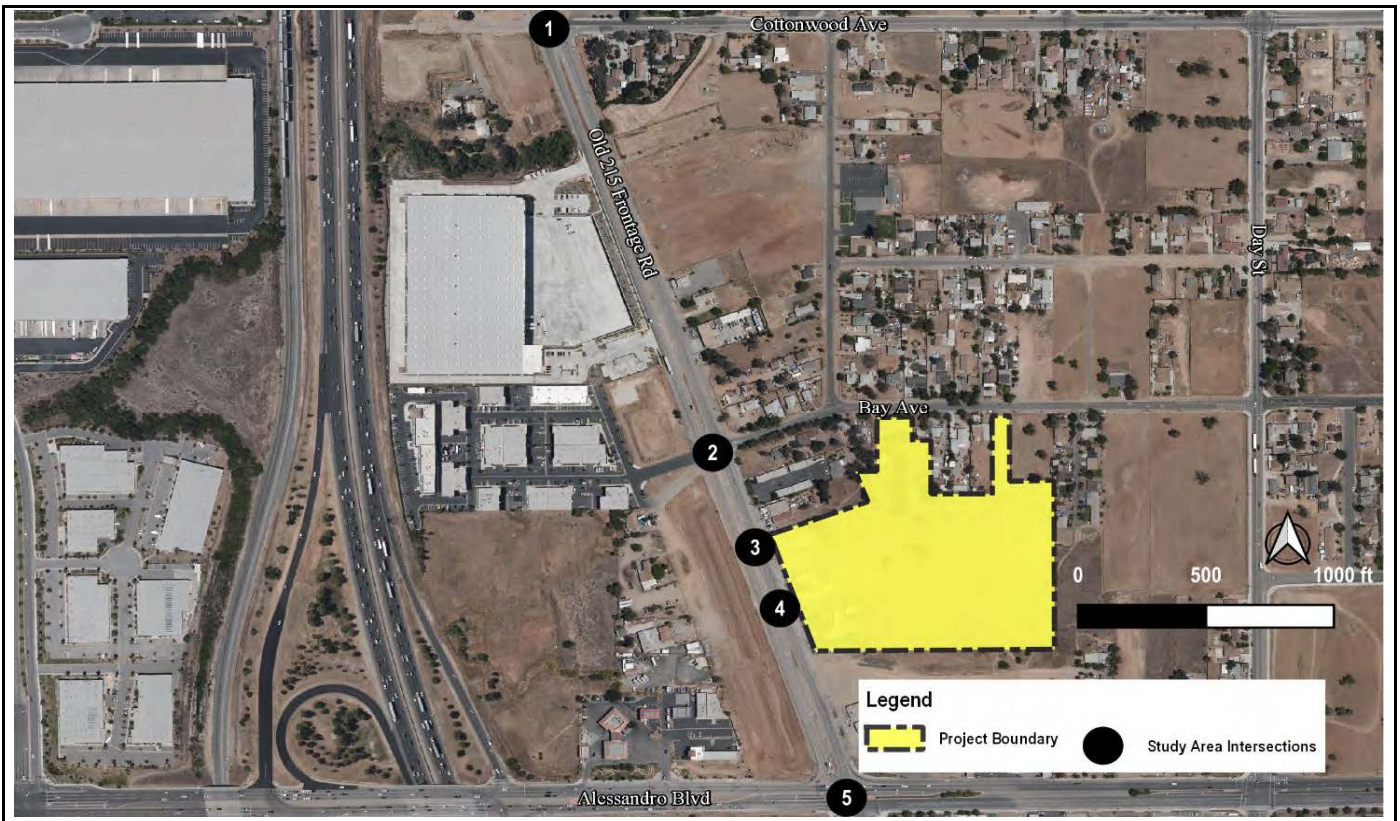

FIGURE 5

XXX%(YYY%) Inbound%(Outbound%) Percent



**Old 215 Frontage Road Business Park
Project Trip Distribution (Trucks)**

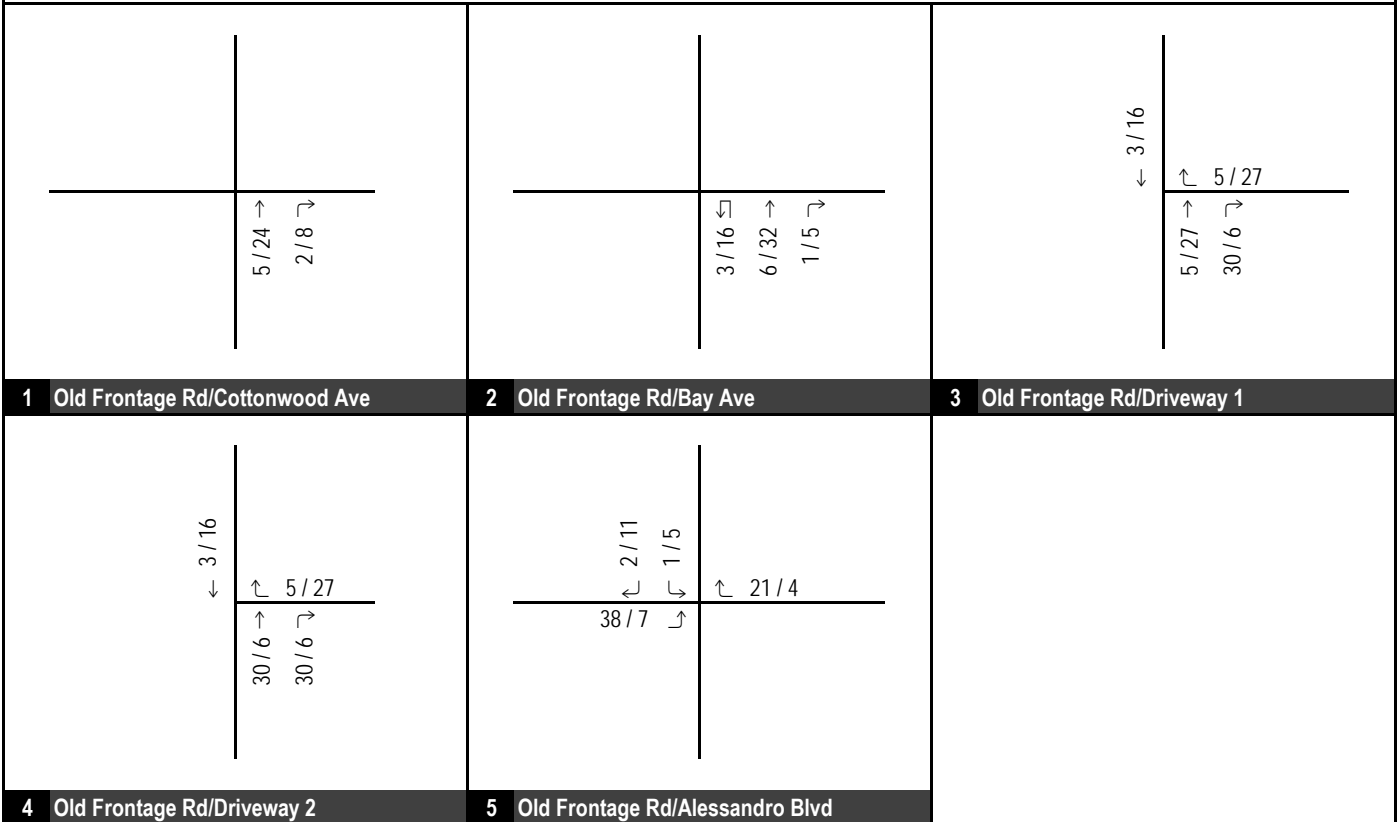
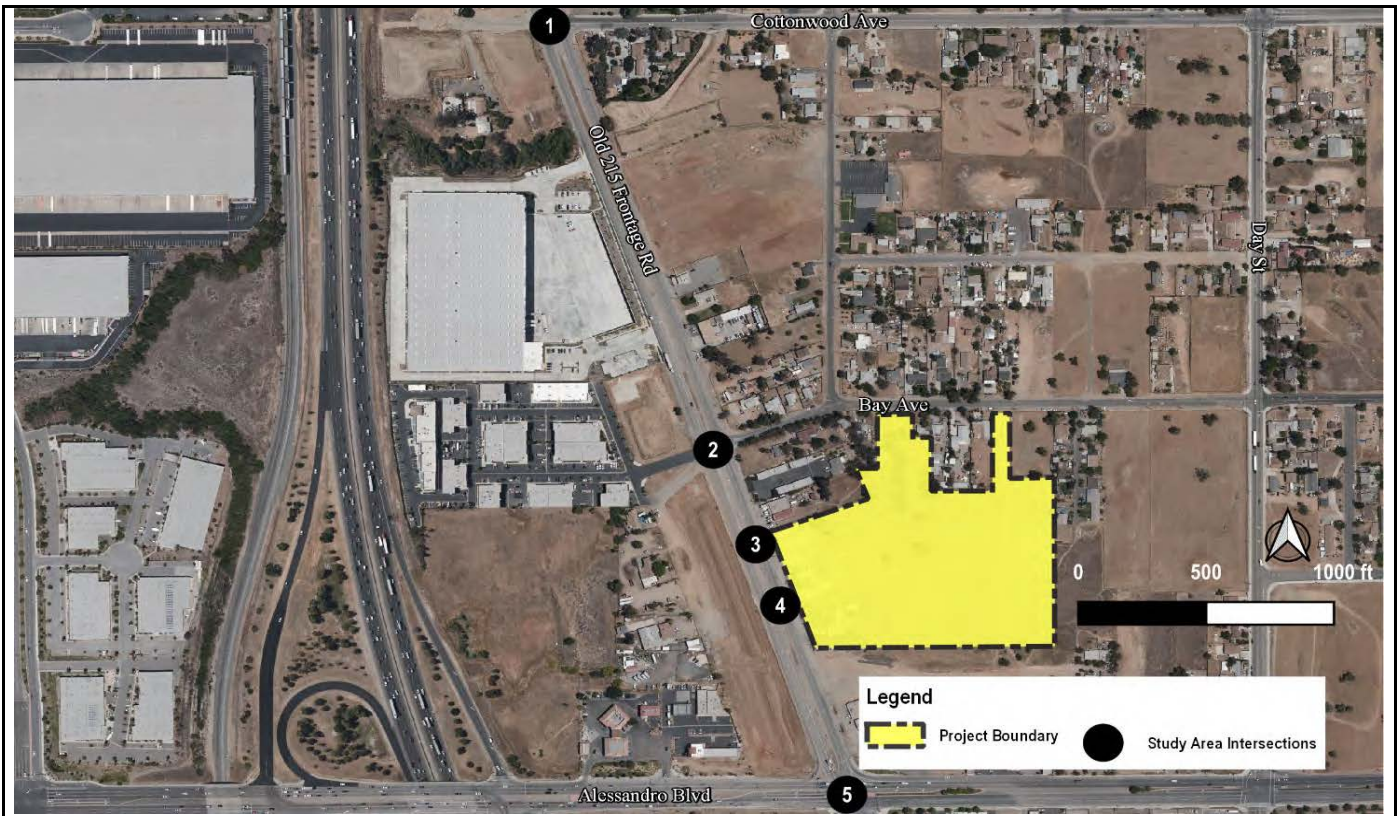

FIGURE 6

XXX / YYY AM / PM Peak Hour Trips



**Old 215 Frontage Road Business Park
Project Trip Assignment (Autos)**

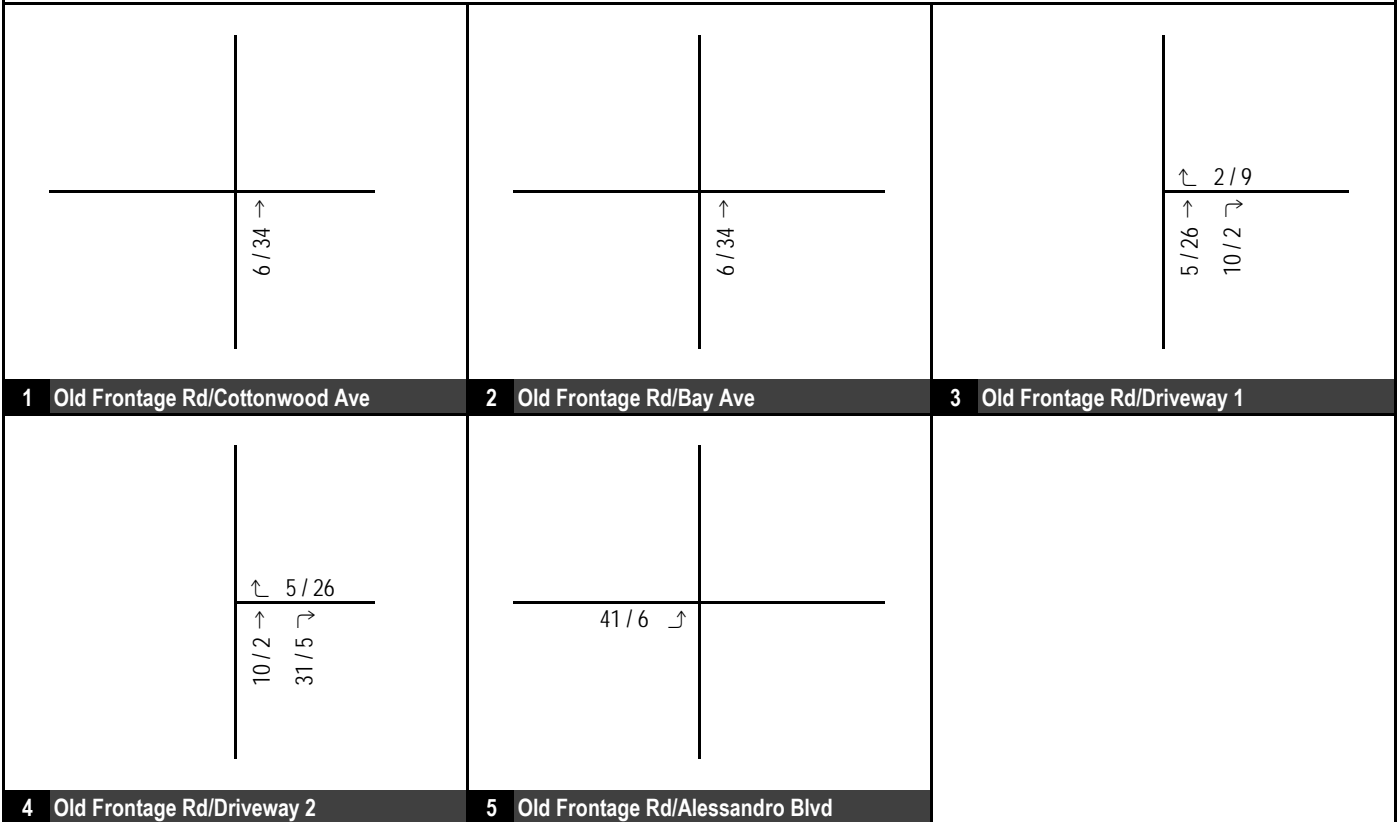
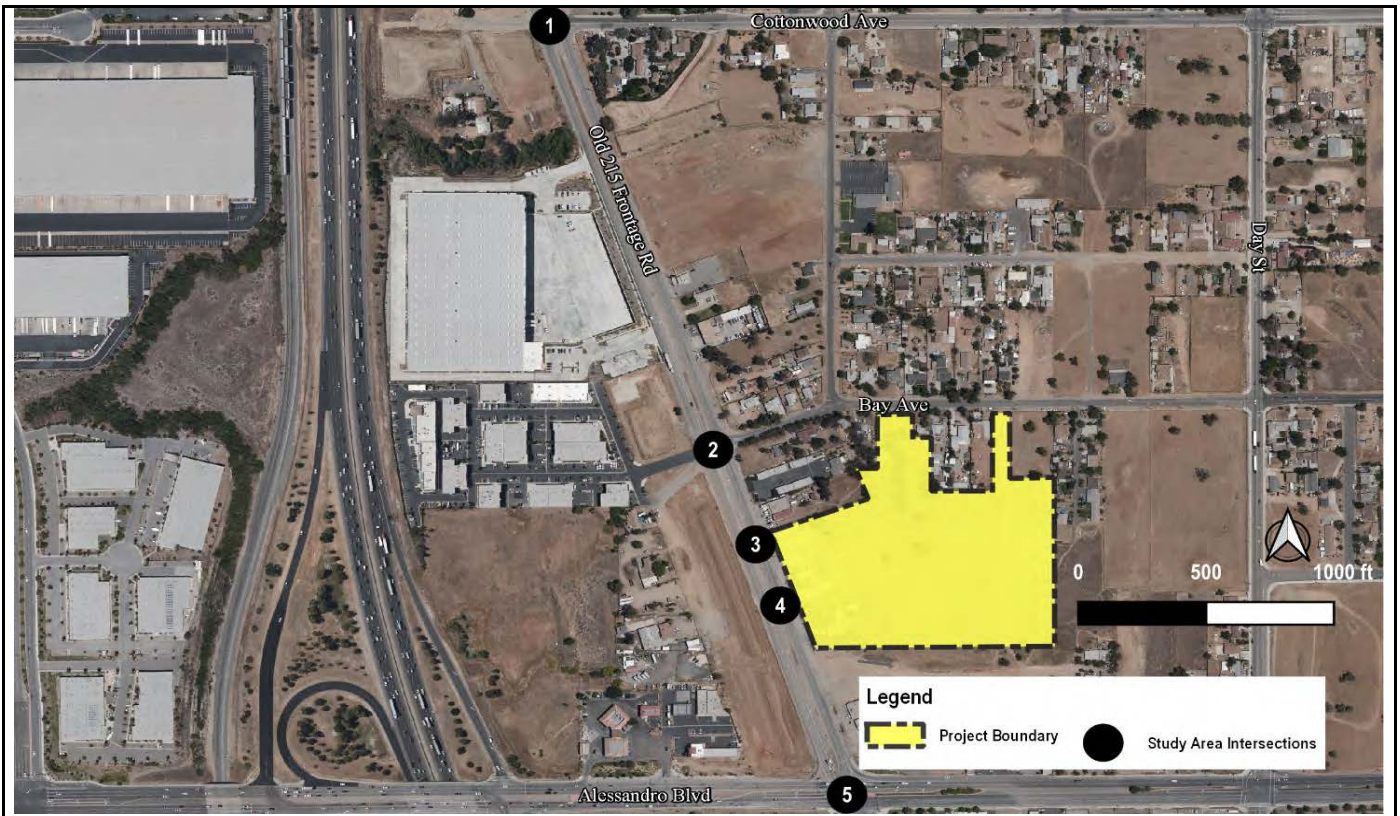

FIGURE 7

XXX / YYY AM / PM Peak Hour Trips



**Old 215 Frontage Road Business Park
Project Trip Assignment (Trucks)**

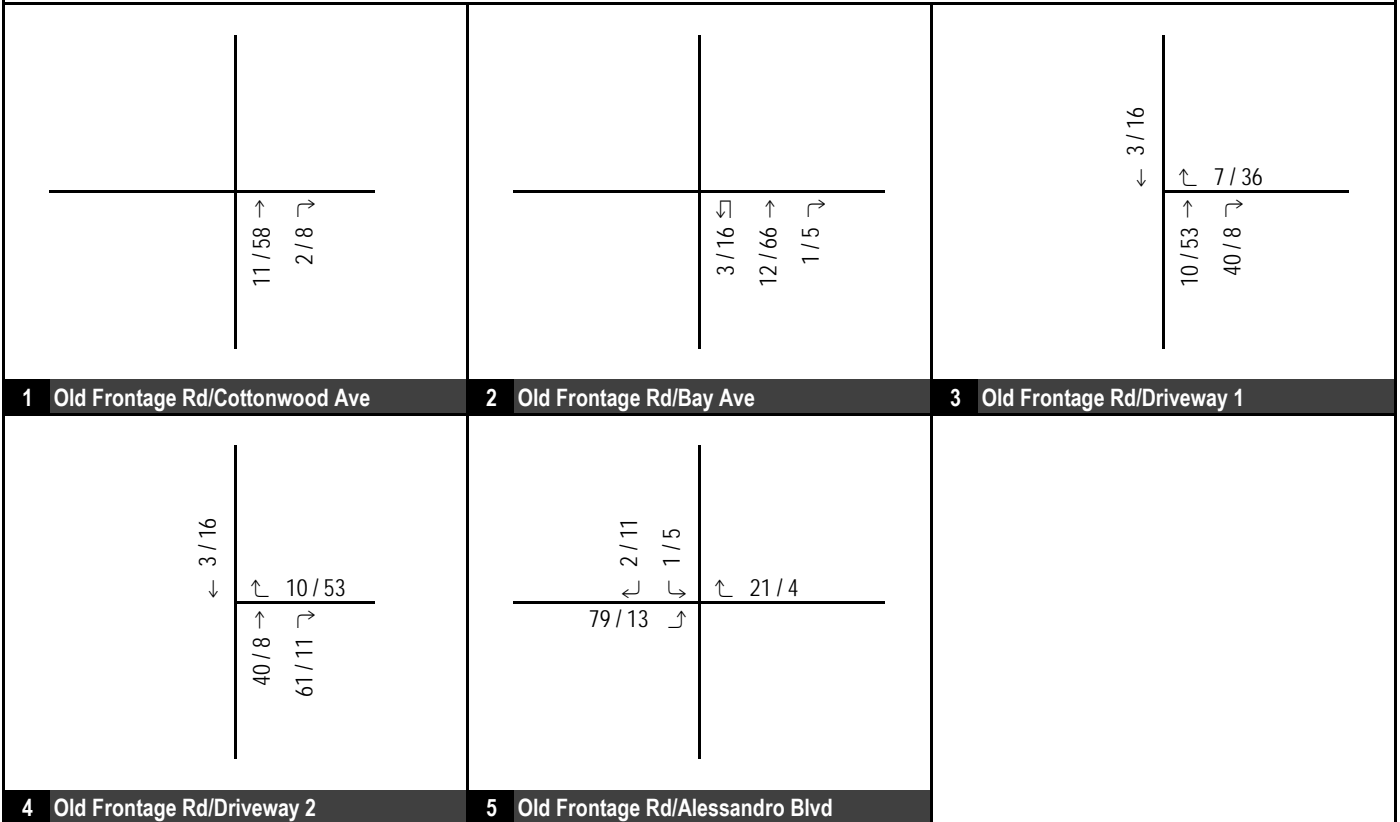
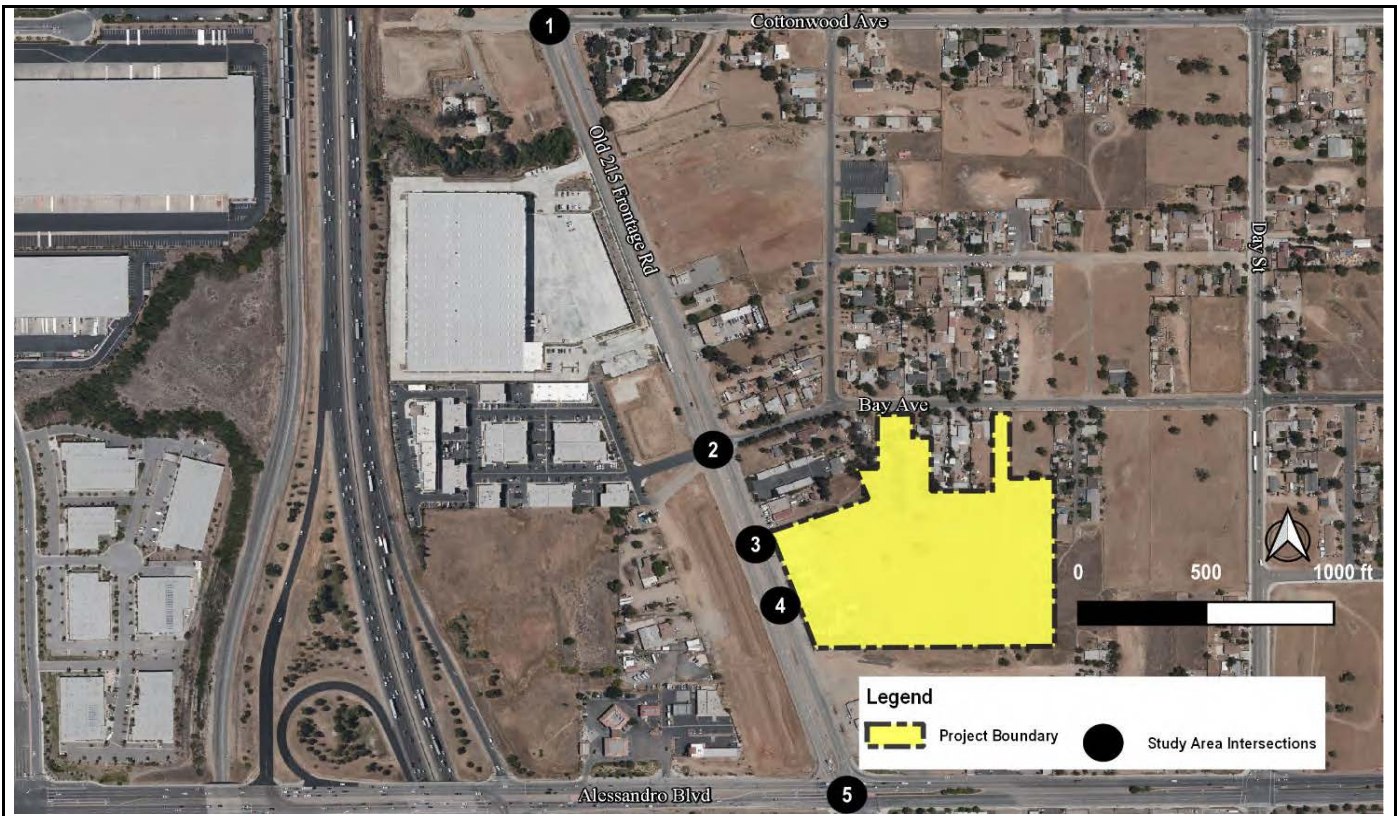

FIGURE 8

XXX / YYY AM / PM Peak Hour Trips



**Old 215 Frontage Road Business Park
Total Project Trip Assignment**

Table D: Level of Service Criteria

LOS	Description of Drivers' Perception and Traffic Operation	HCM (Delay in Seconds)	
		Unsignalized	Signalized
A	This level is typically assigned when the volume-to-capacity ratio is low and either progression is exceptionally favorable or the cycle length is very short. If it is due to favorable progression, most vehicles arrive during the green indication and travel through the intersection without stopping.	≤ 10	≤ 10
B	This level is assigned when the volume-to-capacity ratio is low and either progression is highly favorable or the cycle length is short. More vehicles stop than with LOS A.	> 10 and ≤ 15	> 10 and ≤ 20
C	This level is typically assigned when progression is favorable or the cycle length is moderate. Individual cycle failures (i.e., one or more queued vehicles are not able to depart as a result of insufficient capacity during the cycle) may begin to appear at this level. The number of vehicles stopping is significant, although many vehicles still pass through the intersection without stopping.	> 15 and ≤ 25	> 20 and ≤ 35
D	This level is typically assigned when the volume-to-capacity ratio is high and either progression is ineffective or the cycle length is long. Many vehicles stop and individual cycle failures are noticeable.	> 25 and ≤ 35	> 35 and ≤ 55
E	This level is typically assigned when the volume-to-capacity ratio is high, progression is unfavorable, and the cycle length is long. Individual cycle failures are frequent.	> 35 and ≤ 50	> 55 and ≤ 80
F	This level is typically assigned when the volume-to-capacity ratio is very high, progression is very poor, and the cycle length is long. Most cycles fail to clear the queue.	> 50	> 80

Source: *Highway Capacity Manual 6th Edition*

- Any signalized study intersection that is operating at unacceptable LOS without project traffic where the project increases delay by 5.0 or more seconds shall identify improvements to offset the increase in delay.

For unsignalized intersections, the following criteria shall be used when identifying operational deficiencies. An operation improvement would be required if the study determines that either section a) or both sections b) and c) occur:

- a) The addition of project traffic causes the intersection to degrade from an acceptable LOS to unacceptable LOS.

OR

- b) The project adds 5.0 seconds or more of delay to an intersection that is already projected to operate without project at unacceptable LOS.

AND

- c) The intersection meets the peak hour traffic signal warrant after the addition of project traffic.

4.0 VOLUME DEVELOPMENT METHODOLOGY

Forecast traffic volumes at study intersections were developed consistent with the City's guidelines. This section discusses the volume development methodology used to forecast future traffic volumes.

4.1 Existing Without Project Traffic Volumes

Existing traffic volumes are based on peak hour intersection turn movement counts collected by Counts Unlimited Inc. in July 2021. Count sheets are contained in Appendix B. Detailed volume development worksheets are included in Appendix C.

4.2 Project Completion Without Project Traffic Volumes

Project Completion without project peak hour traffic volumes were developed by applying an annual growth rate of 2 percent per year for 2 years to the existing volumes and adding cumulative project trips. The cumulative projects included in the analysis are illustrated in Figure 9. Table E lists the cumulative projects included in the analysis. The cumulative projects are anticipated to generate 866 a.m. peak hour PCE trips, 947 p.m. peak hour PCE trips, and 10,800 daily PCE trips.

4.3 Project Completion With Project Traffic Volumes

Project completion with project conditions were developed by adding the trip assignment to the project completion without project peak hour traffic volumes.

5.0 EXISTING CONDITIONS

This section discusses the existing transportation conditions in the study area.

5.1 Existing Roadway Conditions

Regional access to the project site is provided by Interstate 215 to the west. Local access to the project will be provided by the following roadways:

- **Old 215 Frontage Road** is oriented in the north-south direction and is a 4-lane roadway within the project study area. The City's circulation plan designates Old 215 Frontage Road as a "Arterial".
- **Cottonwood Avenue** is oriented in the east-west direction and is a 2-lane roadway within the project study area. The City's circulation plan designates Cottonwood Avenue as a "Minor Arterial".
- **Alessandro Boulevard** is oriented in the east-west direction and is a 5-lane roadway within the project study area. The City's circulation plan designates Alessandro Boulevard as a "Divided Major Arterial".

5.2 Existing Transit Service

Public transportation services within the City of Moreno Valley includes bus transit service provided by the Riverside Transit Agency (RTA) and commuter rail transportation (Metrolink). These services are further described below.

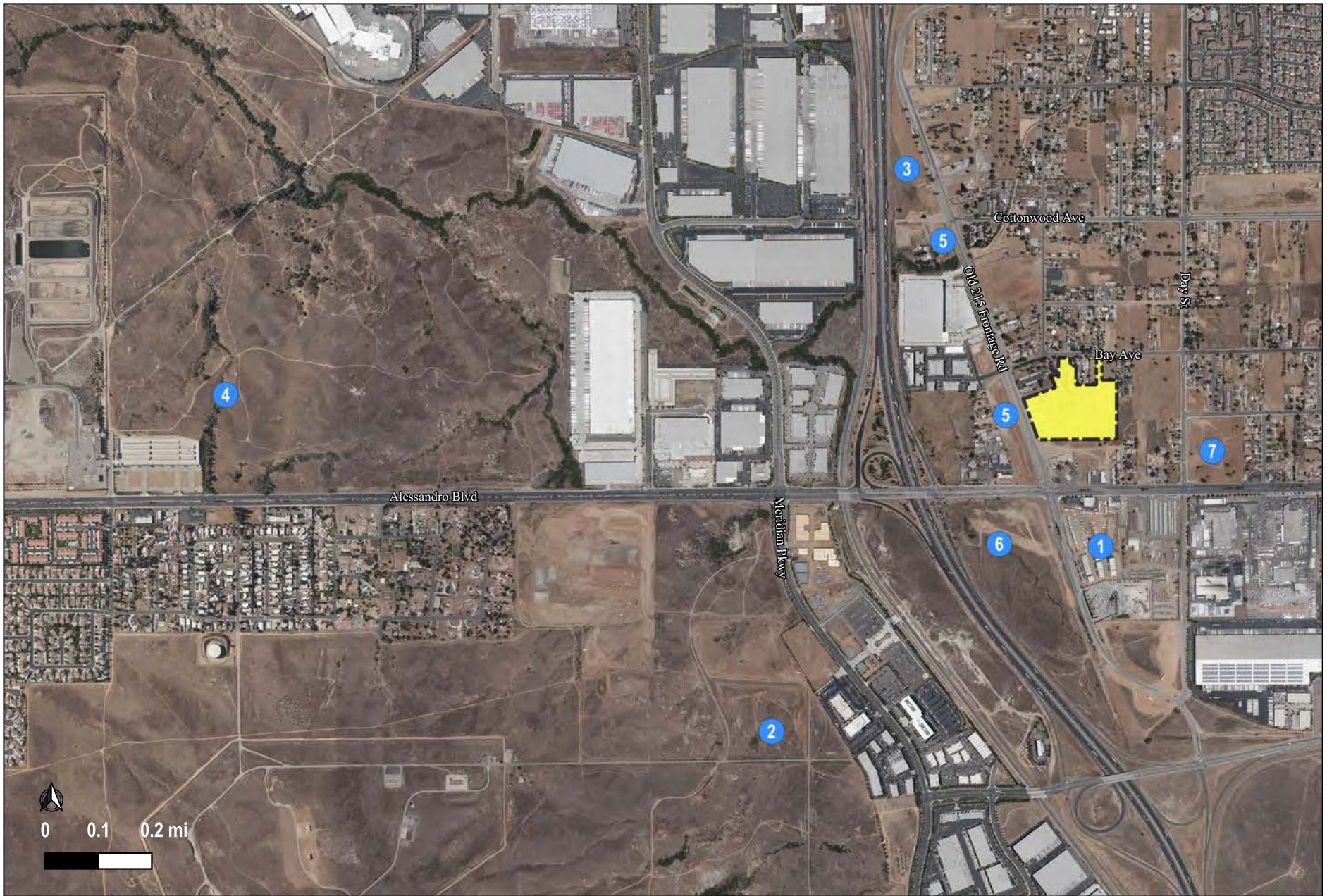

Legend

- Project Boundary
- Cumulative Projects



FIGURE 9

Old 215 Frontage Road Business Park
Cumulative Project Locations

Table E: Cumulative Projects Trip Generation

Project Number	Project and Location	Land Use	Quantity	Units	A.M. Peak Hour			P.M. Peak Hour			Daily
					In	Out	Total	In	Out	Total	
1	Gateway Business Park. South of Alessandro Blvd. between Old Frontage Rd. & Day St.	Light Industrial ¹									
		Passenger Cars			89	12	101	12	79	91	717
		Truck PCEs			55	7	62	7	49	56	441
		Total PCE Trip Generation	184.00	TSF	144	19	163	19	128	147	1,158
2	Meridian Business Park (West Campus) South of Alessandro Blvd., west of Meridian Pkwy.	Light Industrial/Business Park/Warehouse ²									
		Passenger Cars			505	108	613	128	497	625	5,954
		Truck PCEs			284	66	350	85	312	397	4,315
		Total PCE Trip Generation	2,285.85	TSF	789	174	963	213	809	1,022	10,269
3	Old 215 Frontage Road Warehouse NWC of Old 215 Frontage Rd./Cottonwood Ave.	Warehouse ³									
		Passenger Cars			11	3	14	5	13	18	140
		Truck PCEs			12	4	17	3	9	12	170
		Total PCE Trip Generation	119	TSF	23	7	31	8	22	30	310
4	Sycamore Hills Distribution Center North of Alessandro Blvd., east of Barton St.	Warehouse ⁴									
		Passenger Cars			26	8	34	14	34	48	573
		Truck PCEs			31	10	41	13	28	39	693
		Total PCE Trip Generation	603	TSF	57	18	75	27	62	87	1,266
5	Rev Wheel Industrial Park West of Old 215 Frontage Rd., between Cottonwood Ave. & Alessandro Blvd.	Light Industrial ⁵									
		Passenger Cars			34	9	43	11	34	45	510
		Truck PCEs			19	3	22	7	19	26	284
		Total PCE Trip Generation	176	TSF	53	12	65	18	53	71	794
6	Freeway Business Center SWC of Old 215 Frontage Rd./Alessandro Blvd.	Warehouse ⁶									
		Passenger Cars			39	18	57	18	39	57	737
		Truck PCEs			37	16	53	22	49	71	1,132
		Total PCE Trip Generation	709	TSF	76	34	110	39	88	127	1,869
7	Day St. Apartments SWC of Old 215 Frontage Rd./Alessandro Blvd.	Apartments ⁷									
		Trip Generation Rates			0.09	0.27	0.36	0.27	0.17	0.44	5.44
		Trip Generation	200	DU	19	53	72	54	34	88	1,088
					656	209	866	250	699	947	10,800

¹ Rates based on Land Use 110 "General Light Industrial" from Institute of Transportation Engineers (ITE) Trip Generation (10th Edition Supplement). Truck percentage per ITE 10th Edition Supplement

² Trip Generation from "Meridian Business Park (West Campus) Traffic Impact Analysis" from Urban Crossroads (September 2016)

³ Rates based on Land Use 150 "Warehousing" from Institute of Transportation Engineers (ITE) Trip Generation (10th Edition Supplement). Truck percentage per ITE 10th Edition Supplement.

⁴ Trip Generation from "Sycamore Hills Distribution Center Traffic Operations Analysis" from Urban Crossroads (September 2020)

⁵ Trip Generation from "Kunzman Associates Traffic Impact Analysis" from Kunzman Associates (July 2017)

⁶ Trip Generation from "Freeway Business Center Traffic Impact Analysis" from Urban Crossroads (March 2015)

⁷ Trip Generation from "Day Street Multi-Family Housing Complex Traffic Impact Analysis" from Translutions (August 2018)

Bus Service. Public transportation in the City of Moreno Valley is provided by RTA, which is the regional transit operator in Riverside County.

- **Route 20** provides transit service on Alessandro Boulevard. Route 20 has major stops at the Moreno Valley/March Field Metrolink Station, Riverside University Medical Center, Kaiser Permanente Hospital, and Moreno Valley College. Route 20 operates at 45–60-minute headways on weekdays and weekends.

Commuter Rail Service. Commuter rail service is provided by Metrolink, which is operated by the Southern California Regional Rail Authority (SCRRA). Metrolink train service is available between the counties of Ventura, Los Angeles, San Bernardino, Orange, Riverside, and north San Diego. The area is served by the Moreno Valley/March Field Metrolink Station. The Moreno Valley/March Field Station is the nearest Metrolink station to the project site and is approximately 0.5 miles southwest of the project site.

Figure 10 illustrates the existing transit services. As shown in Figure 10, the closest transit route to the project is located on Alessandro Boulevard via Route 20.

5.3 Existing Pedestrian & Bicycle Facilities

The City's Bicycle Master Plan includes three types of facilities and are discussed below:

- **Class I Multi-use Paths** Class I facilities are physically separated from motor vehicle routes, with exclusive rights-of-way for non-motorized users like cyclists and pedestrians and with motor vehicle cross flows kept to a minimum. Class I facilities are often important commuter connections, and any proposed paths must be designed for multipurpose use.
- **Class II Bicycle Lanes** Class II facilities provide an exclusive roadway space for cyclists, demarcated through pavement marking and signage. Bicycle lanes must be one-way facilities and carry bicycle traffic in the same direction as the adjacent motor vehicle traffic. They are typically located along the right side of the street, between the adjacent travel lane and curb, road edge or parking lane.
- **Class III Bicycle Routes** Class III facilities are suggested bicycle routes marked by signs designating a preferred route between destinations. They are recommended where traffic volumes and roadway speeds are fairly low.

Figure 11 illustrates the existing bicycle facilities within the City. As shown in Figure 11, there are existing non-contiguous Class II bike lanes on Alessandro Boulevard and Old 215 Frontage Road. Pedestrian circulation in Moreno Valley is primarily provided via trails and sidewalks. The existing pedestrian sidewalks adjacent to the project are illustrated in Figure 12. As illustrated in Figure 12, there are no sidewalks on the east side of Old 215 Frontage Road near the project site.

5.4 Existing Levels of Service

An intersection level of service analysis was conducted for existing conditions to determine current circulation system performance. Figure 13 shows the existing lane geometrics and stop controls at the study intersections. The existing traffic volumes at study intersections are illustrated in Figure 14. Detailed volume development worksheets are included in Appendix C. The existing levels of service for the study area intersections are summarized in Table F. Level of service calculation worksheets are contained in Appendix D. As shown in Table F, all study area intersections are currently operating at satisfactory levels of service. It should be noted that all queues fit within the available storage lengths for the left/right-turn lanes.

6.0 PROJECT COMPLETION CONDITIONS

This section discusses project completion transportation conditions in the study area. It is anticipated that the project will open in 2023.

6.1 Project Completion Roadway Conditions

Project completion roadway conditions are assumed to be the same as those under existing conditions.

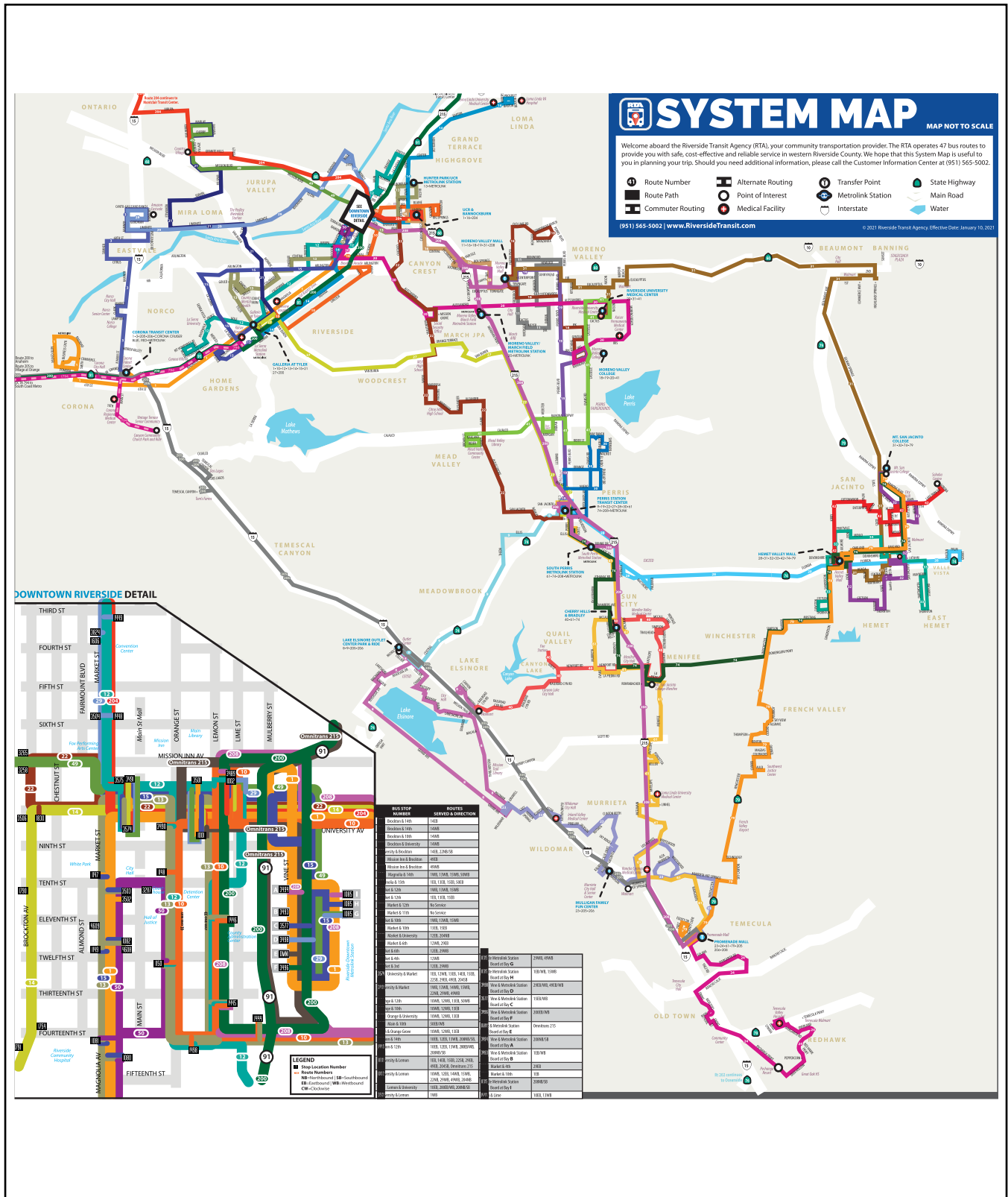

Source: RTA (January,2020)

FIGURE 10



Old 215 Frontage Road Business Park
Transit

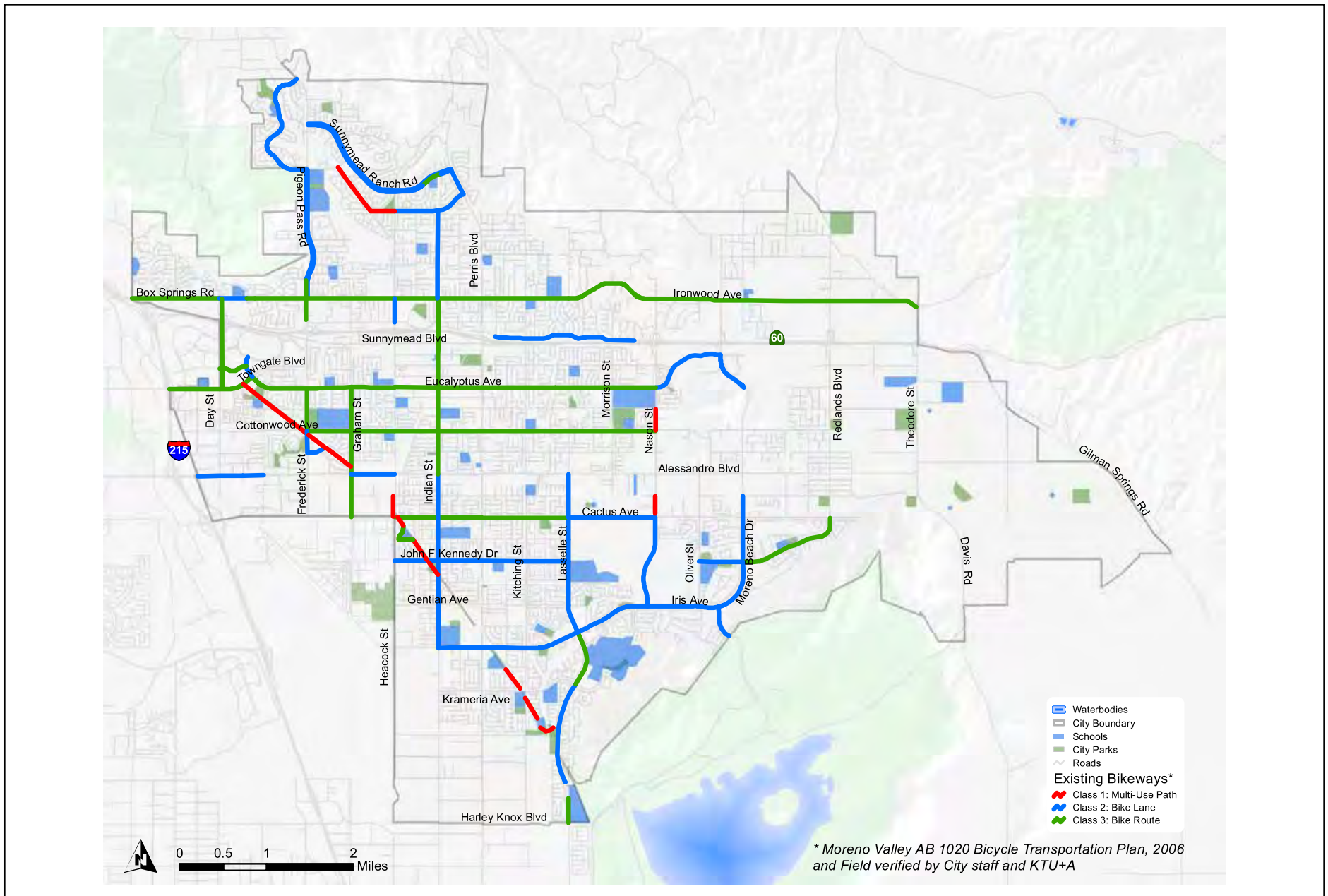

Source: City of Moreno Valley Bicycle Master Plan

FIGURE 11

Old 215 Frontage Road Business Park
Bike Lanes

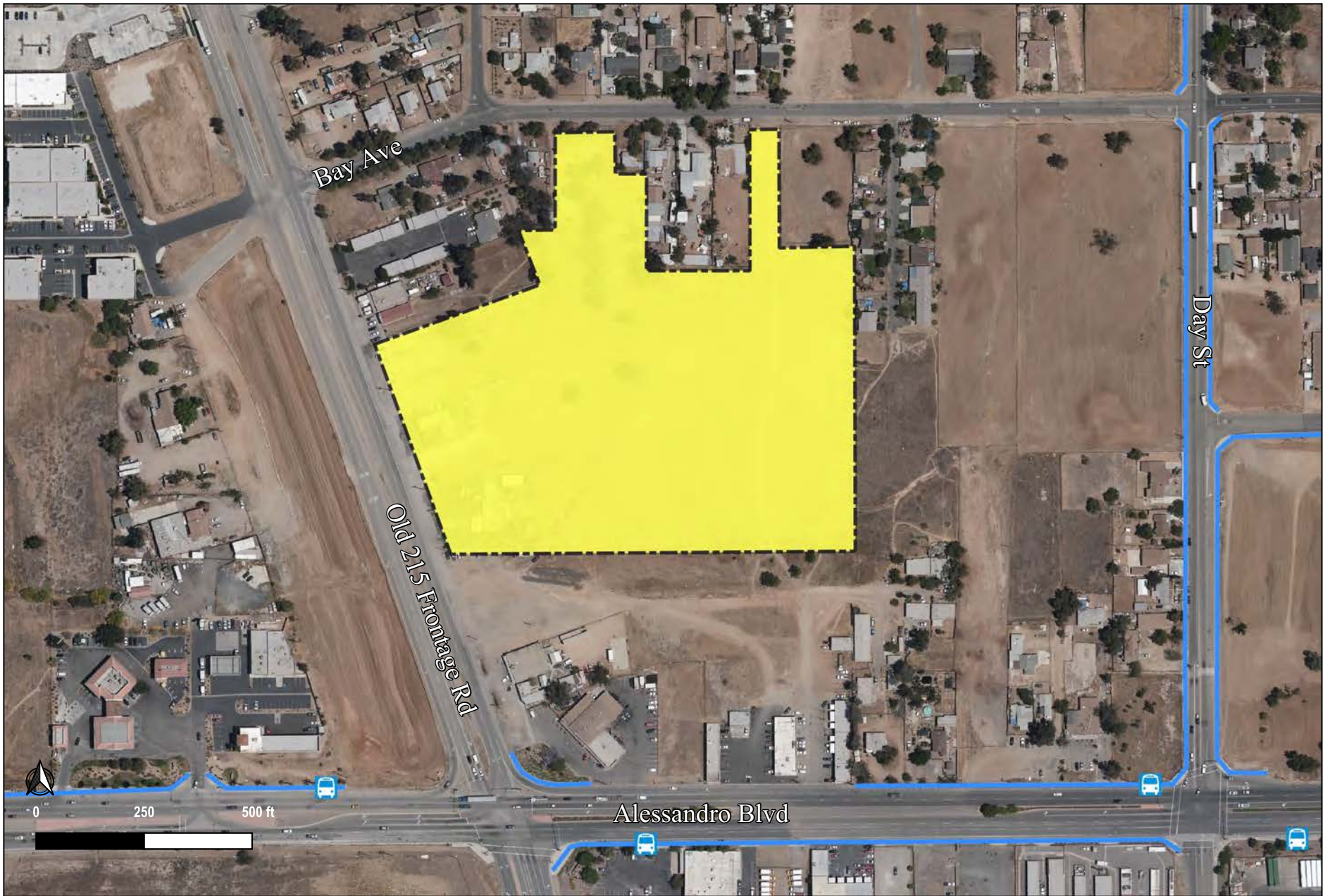

Legend
 Project Boundary
 Sidewalks
 Bus Stops



FIGURE 9

**Old 215 Frontage Road Business Park
 Pedestrian Facilities**

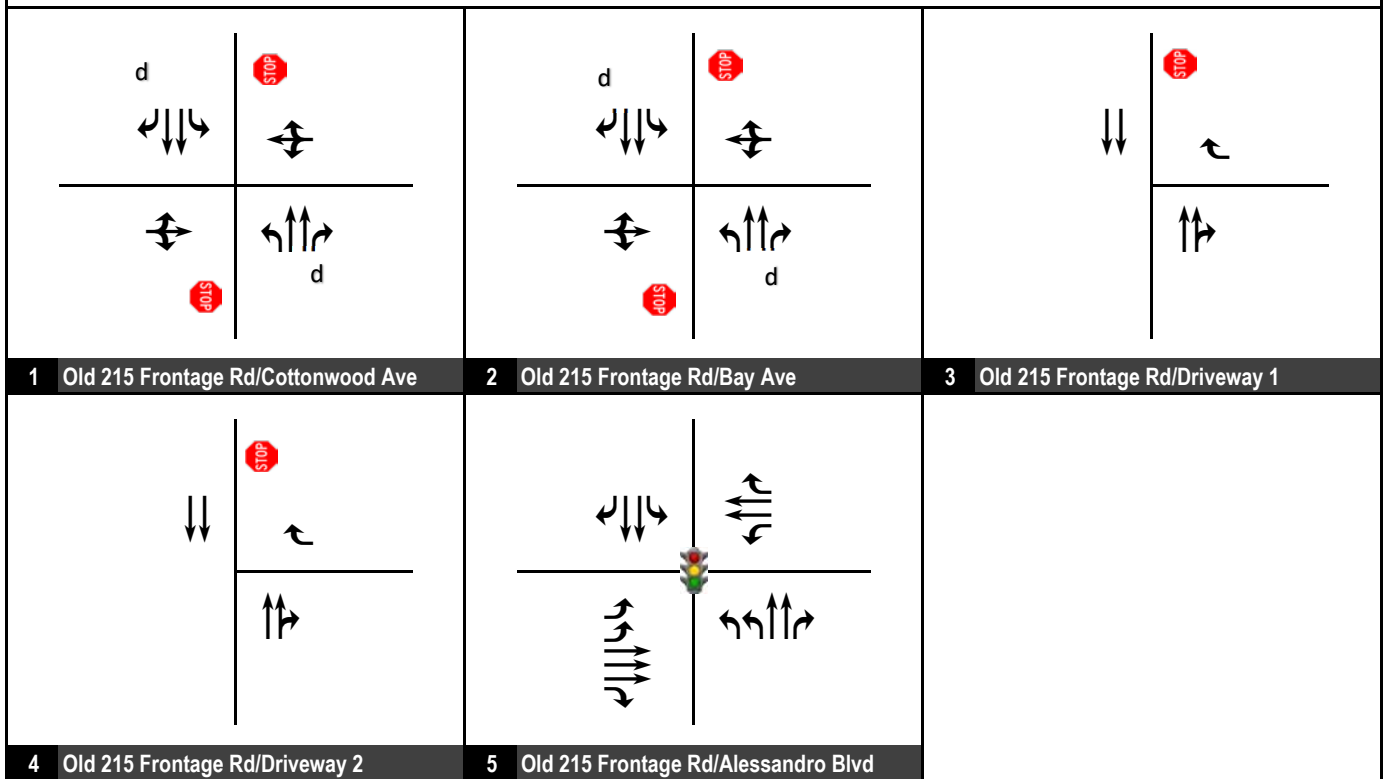
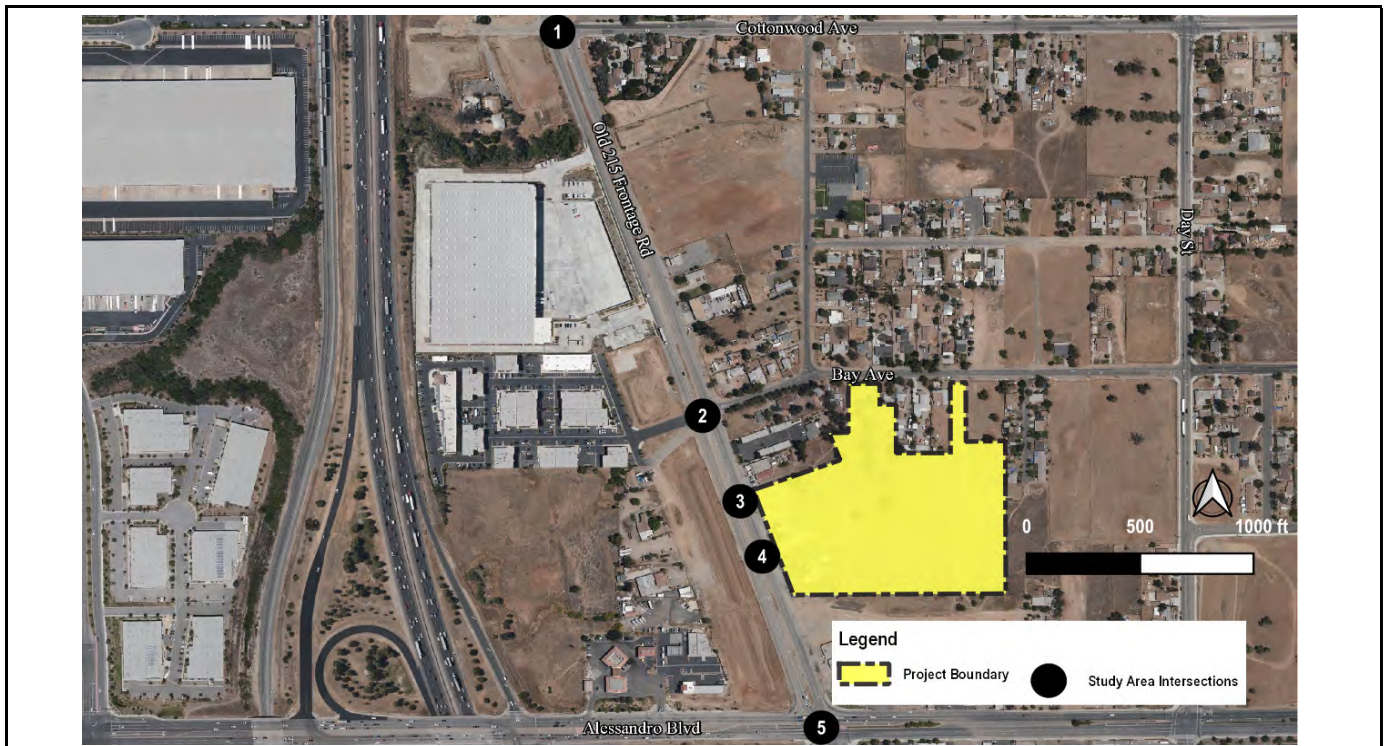

FIGURE 13

Legend

-  Signal
-  Stop Sign

Old 215 Frontage Road Business Park
Existing Intersection Lane Geometrics and Stop Control



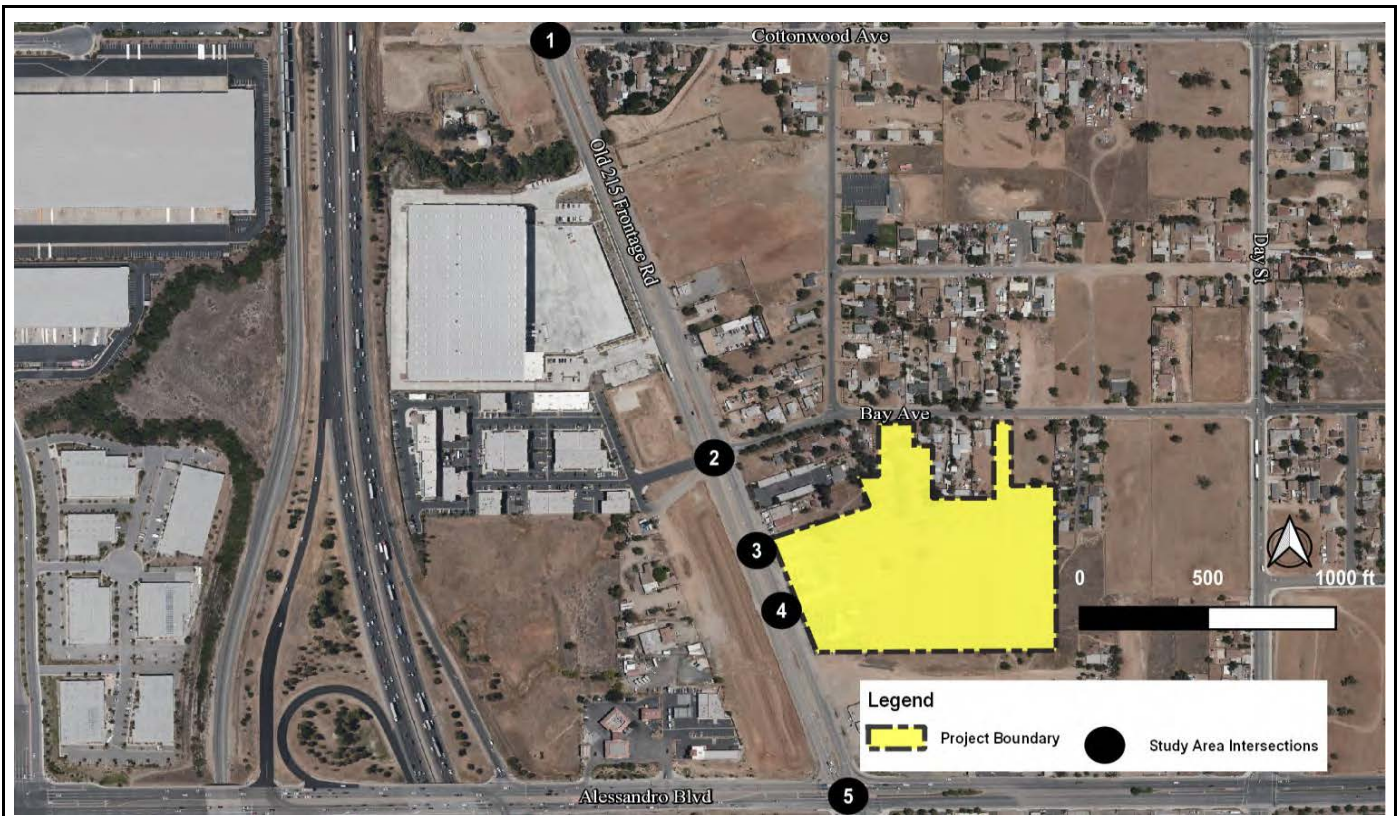

<table border="1"> <tr> <td>↖ 1/0</td> <td>↘ 106/316</td> <td>↙ 12/53</td> <td>↗ 43/35</td> </tr> <tr> <td>↖ 3/6</td> <td>↘ 2/1</td> <td>↙ 0/2</td> <td>↗ 78/34</td> </tr> <tr> <td>↖ 8/5</td> <td>↘ 328/504</td> <td>↙ 11/50</td> <td>↗ 3/0</td> </tr> </table>	↖ 1/0	↘ 106/316	↙ 12/53	↗ 43/35	↖ 3/6	↘ 2/1	↙ 0/2	↗ 78/34	↖ 8/5	↘ 328/504	↙ 11/50	↗ 3/0	<table border="1"> <tr> <td>↖ 7/1</td> <td>↘ 168/369</td> <td>↙ 16/57</td> <td>↗ 31/15</td> </tr> <tr> <td>↖ 4/12</td> <td>↘ 1/1</td> <td>↙ 12/21</td> <td>↗ 44/17</td> </tr> <tr> <td>↖ 25/14</td> <td>↘ 290/441</td> <td>↙ 8/30</td> <td>↗ 1/0</td> </tr> </table>	↖ 7/1	↘ 168/369	↙ 16/57	↗ 31/15	↖ 4/12	↘ 1/1	↙ 12/21	↗ 44/17	↖ 25/14	↘ 290/441	↙ 8/30	↗ 1/0	<p>Future Intersection</p>
↖ 1/0	↘ 106/316	↙ 12/53	↗ 43/35																							
↖ 3/6	↘ 2/1	↙ 0/2	↗ 78/34																							
↖ 8/5	↘ 328/504	↙ 11/50	↗ 3/0																							
↖ 7/1	↘ 168/369	↙ 16/57	↗ 31/15																							
↖ 4/12	↘ 1/1	↙ 12/21	↗ 44/17																							
↖ 25/14	↘ 290/441	↙ 8/30	↗ 1/0																							
<p>1 Old 215 Frontage Rd/Cottonwood Ave</p>	<p>2 Old 215 Frontage Rd/Bay Ave</p>	<p>3 Old 215 Frontage Rd/Driveway 1</p>																								
<p>Future Intersection</p>	<table border="1"> <tr> <td>↖ 143/200</td> <td>↘ 34/115</td> <td>↙ 22/58</td> <td>↗ 40/67</td> </tr> <tr> <td>↖ 174/318</td> <td>↘ 547/1245</td> <td>↙ 22/90</td> <td>↗ 613/671</td> </tr> <tr> <td>↖ 32/49</td> <td>↘ 144/123</td> <td>↙ 11/12</td> <td>↗ 8/4</td> </tr> </table>	↖ 143/200	↘ 34/115	↙ 22/58	↗ 40/67	↖ 174/318	↘ 547/1245	↙ 22/90	↗ 613/671	↖ 32/49	↘ 144/123	↙ 11/12	↗ 8/4	<p>Future Intersection</p>												
↖ 143/200	↘ 34/115	↙ 22/58	↗ 40/67																							
↖ 174/318	↘ 547/1245	↙ 22/90	↗ 613/671																							
↖ 32/49	↘ 144/123	↙ 11/12	↗ 8/4																							
<p>4 Old 215 Frontage Rd/Driveway 2</p>	<p>5 Old 215 Frontage Rd/Alessandro Blvd</p>																									

FIGURE 14

* Includes U-Turns

XXXX / YYYY AM / PM Peak Hour Traffic Volumes

Old 215 Frontage Road Business Park
Existing Peak Hour Traffic Volumes



Table F: Existing Levels of Service

Intersection	LOS Std.	Control	Without Project			
			AM Peak Hour		PM Peak Hour	
			Delay	LOS	Delay	LOS
1 . Old 215 Frontage Rd/Cottonwood Ave	D	TWSC	13.1	B	17.4	C
2 . Old 215 Frontage Rd/Bay Ave	D	TWSC	12.2	B	17.7	C
3 . Old 215 Frontage Rd/Driveway 1	D	TWSC	Future Intersection			
4 . Old 215 Frontage Rd/Driveway 2	D	TWSC	Future Intersection			
5 . Old 215 Frontage Rd/Alessandro Blvd	D	Signal	19.4	B	25	C

Notes:

* Exceeds LOS Standard

TWSC = Two-Way Stop Control; For TWSC intersections, reported delay is for worst-case movement.

LOS = Level of Service

6.2 Project Completion Transit Service

Transit service under project completion conditions is anticipated to remain the same as under existing conditions.

6.3 Project Completion Pedestrian & Bicycle Facilities

Pedestrian and bicycle facilities under project completion conditions are anticipated to remain the same as under existing conditions, however, the City of Moreno Valley bicycle master plan is proposing a Class II Bike Lanes on Old 215 Frontage Road and Class III Bike Routes on Day Street. Figure 15 shows the City's proposed bicycle lanes.

6.4 Project Completion Without Project Levels of Service

An intersection level of service analysis was conducted for project completion without project conditions to determine circulation system performance. Project completion without project traffic volumes at study intersections are shown in Figure 16. Project completion without project levels of service for the study area intersections are summarized in Table G. Detailed volume development worksheets are included in Appendix C. Level of service calculation worksheets are contained in Appendix D. As shown in Table G, all study area intersections are forecast to operate at satisfactory levels of service. It should be noted that all queues fit within the available storage lengths for the left/right-turn lanes.

6.5 Project Completion With Project Levels of Service

An intersection level of service analysis was conducted for project completion with project conditions to determine circulation system performance. Project completion with project traffic volumes at study intersections are shown in Figure 17. The project completion with project levels of service for the study area intersections are summarized in Table G. Detailed volume development worksheets are included in Appendix C. Level of service calculation worksheets are contained in Appendix D. As shown in Table G, all study intersections are forecast to operate at satisfactory levels of service. It should be noted that all queues fit within the available storage lengths for the left/right-turn lanes.

8.0 VEHICLE MILES TRAVELED (VMT) SCREENING ANALYSIS

Based on the City of Moreno Valley *Transportation Impact Analysis Preparation Guide for Vehicles Miles Traveled and Level of Service Assessment*, (June 2020), a project located in a low VMT area can be effectively screened out from a project-level VMT assessment. To identify if the project is in a low VMT-generating area, the WRCOG screening tool was applied using VMT per employee. The project is located in Traffic Analysis Zone 3,670. Figure 18 shows the low VMT screening area for the project. As shown in Figure 18, the project TAZ based VMT per employee is 10.23 miles. The jurisdictional VMT per employee is 11.01 miles. Since the project TAZ VMT per employee is lower than the City's VMT per employee, the project is located in a low VMT area and a full VMT analysis is not needed. Therefore, the project is presumed to have a less than significant impact on VMT.

9.0 IMPACT CRITERIA FOR CEQA DETERMINATION

This section evaluates the CEQA checklist for impact evaluation.

A. Conflict with a program, plan, ordinance, or policy addressing the circulation system, including transit, roadway, bicycle and pedestrian facilities?

The project is consistent with the City's adopted plans and policies. The project would not conflict with adopted policies supporting alternative transportation modes. The project will not change roadway designations from those in the City's General Plan. The project will also not result in removal of any of the facilities listed above. Therefore, the project impact is considered less than significant.

B. Conflict or be inconsistent with CEQA Guidelines 15064.3, subdivision (b)?

Based on the City's Low VMT Screening Tool, the project will not require a full VMT analysis and is presumed to have a less than significant impact under CEQA.

C. Substantially increase hazards due to a geometric design feature (e.g., sharp curves or dangerous intersections) or incompatible uses (e.g., farm equipment)?

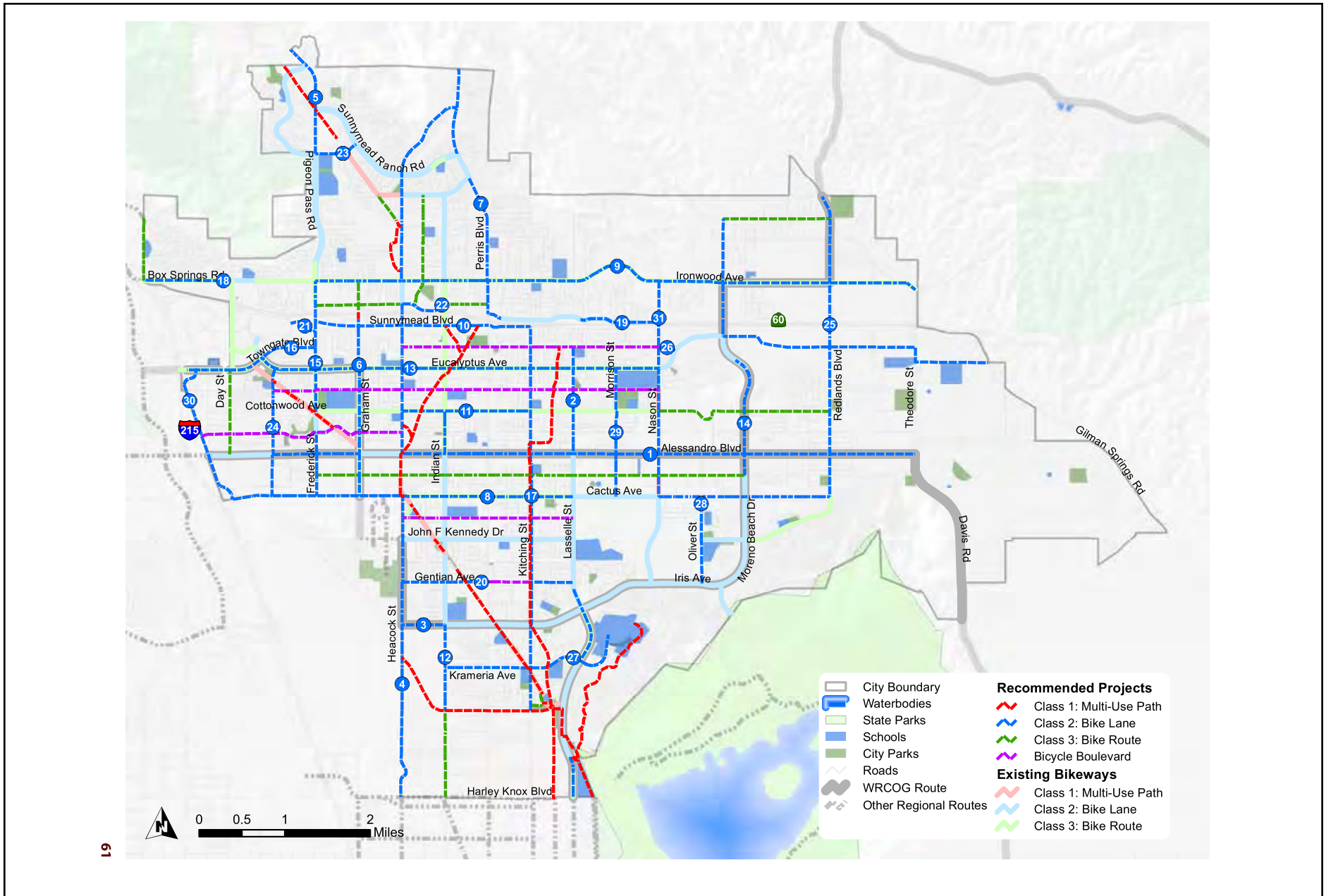

Source: City of Moreno Valley Bicycle Master Plan

FIGURE 15

Old 215 Frontage Road Business Park
City of Moreno Valley Recommended Bike Lanes



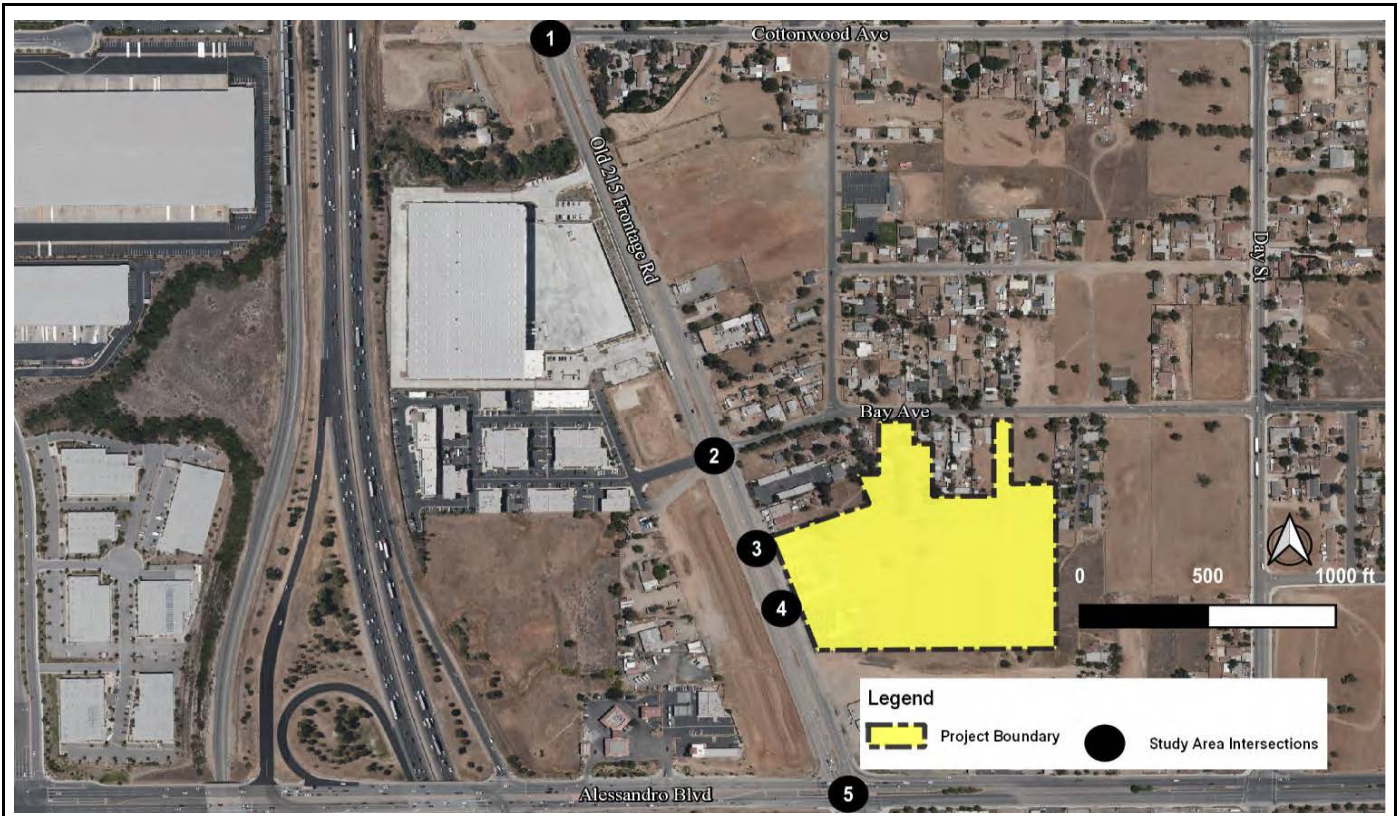

<table border="1"> <tr> <td>↖ 24 / 7</td> <td>↘ 136 / 341</td> <td>↙ 12 / 55</td> <td>↗ 45 / 36</td> </tr> <tr> <td>↖ 12 / 36</td> <td>↘ 2 / 1</td> <td>↙ 2 / 10</td> <td>↗ 3 / 0</td> </tr> <tr> <td>↖ 19 / 10</td> <td>↘ 347 / 547</td> <td>↙ 11 / 52</td> <td>↗ 81 / 35</td> </tr> </table>	↖ 24 / 7	↘ 136 / 341	↙ 12 / 55	↗ 45 / 36	↖ 12 / 36	↘ 2 / 1	↙ 2 / 10	↗ 3 / 0	↖ 19 / 10	↘ 347 / 547	↙ 11 / 52	↗ 81 / 35	<table border="1"> <tr> <td>↖ 15 / 4</td> <td>↘ 195 / 402</td> <td>↙ 17 / 59</td> <td>↗ 32 / 16</td> </tr> <tr> <td>↖ 6 / 20</td> <td>↘ 1 / 1</td> <td>↙ 14 / 29</td> <td>↗ 1 / 0</td> </tr> <tr> <td>↖ 47 / 22</td> <td>↘ 317 / 479</td> <td>↙ 8 / 31</td> <td>↗ 46 / 18</td> </tr> </table> <p>* Includes U-turns</p>	↖ 15 / 4	↘ 195 / 402	↙ 17 / 59	↗ 32 / 16	↖ 6 / 20	↘ 1 / 1	↙ 14 / 29	↗ 1 / 0	↖ 47 / 22	↘ 317 / 479	↙ 8 / 31	↗ 46 / 18	<p>Future Intersection</p>
↖ 24 / 7	↘ 136 / 341	↙ 12 / 55	↗ 45 / 36																							
↖ 12 / 36	↘ 2 / 1	↙ 2 / 10	↗ 3 / 0																							
↖ 19 / 10	↘ 347 / 547	↙ 11 / 52	↗ 81 / 35																							
↖ 15 / 4	↘ 195 / 402	↙ 17 / 59	↗ 32 / 16																							
↖ 6 / 20	↘ 1 / 1	↙ 14 / 29	↗ 1 / 0																							
↖ 47 / 22	↘ 317 / 479	↙ 8 / 31	↗ 46 / 18																							
<p>1 Old 215 Frontage Rd/Cottonwood Ave</p>	<p>2 Old 215 Frontage Rd/Bay Ave</p>	<p>3 Old 215 Frontage Rd/Driveway 1</p>																								
<p>Future Intersection</p>	<table border="1"> <tr> <td>↖ 164 / 235</td> <td>↘ 45 / 122</td> <td>↙ 25 / 70</td> <td>↗ 51 / 74</td> </tr> <tr> <td>↖ 207 / 350</td> <td>↘ 604 / 1354</td> <td>↙ 82 / 120</td> <td>↗ 698 / 737</td> </tr> <tr> <td>↖ 55 / 119</td> <td>↘ 152 / 137</td> <td>↙ 14 / 25</td> <td>↗ 19 / 6</td> </tr> </table>	↖ 164 / 235	↘ 45 / 122	↙ 25 / 70	↗ 51 / 74	↖ 207 / 350	↘ 604 / 1354	↙ 82 / 120	↗ 698 / 737	↖ 55 / 119	↘ 152 / 137	↙ 14 / 25	↗ 19 / 6													
↖ 164 / 235	↘ 45 / 122	↙ 25 / 70	↗ 51 / 74																							
↖ 207 / 350	↘ 604 / 1354	↙ 82 / 120	↗ 698 / 737																							
↖ 55 / 119	↘ 152 / 137	↙ 14 / 25	↗ 19 / 6																							
<p>4 Old 215 Frontage Rd/Driveway 2</p>	<p>5 Old 215 Frontage Rd/Alessandro Blvd</p>																									

FIGURE 16

* Includes U-turns

XXXX / YYYY AM / PM Peak Hour Traffic Volumes

**Old 215 Frontage Road Business Park
Project Completion Without Project Peak Hour Traffic Volumes**



Table G: Project Completion Levels of Service

Intersection	LOS Std.	Control	Without Project				With Project			
			AM Peak Hour		PM Peak Hour		AM Peak Hour		PM Peak Hour	
			Delay	LOS	Delay	LOS	Delay	LOS	Delay	LOS
1 . Old 215 Frontage Rd/Cottonwood Ave	D	TWSC	14.1	B	19.6	C	14.4	B	21.7	C
2 . Old 215 Frontage Rd/Bay Ave	D	TWSC	13.3	B	20.2	C	13.6	B	24.1	C
3 . Old 215 Frontage Rd/Driveway 1	D	TWSC	Future Intersection				9.7	A	10.6	B
4 . Old 215 Frontage Rd/Driveway 2	D	TWSC	Future Intersection				9.9	A	10.6	B
5 . Old 215 Frontage Rd/Alessandro Blvd	D	Signal	25.9	C	29	C	26	C	30.9	C

Notes:

* Exceeds LOS Standard

TWSC = Two-Way Stop Control; For TWSC intersections, reported delay is for worst-case movement.

LOS = Level of Service

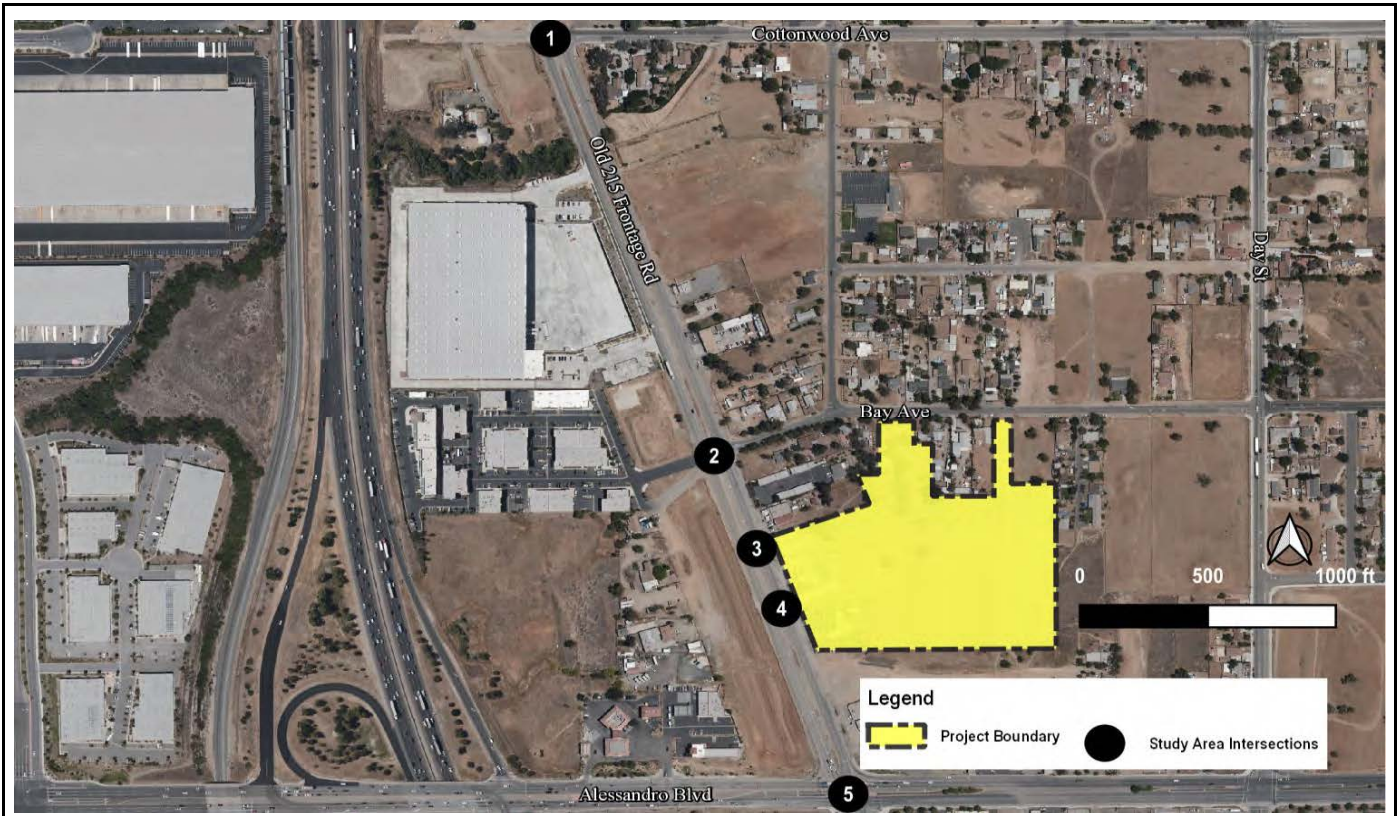

<table border="1"> <tr> <td>↖ 24 / 7</td> <td>↘ 136 / 341</td> <td>↙ 12 / 55</td> <td>↗ 45 / 36</td> </tr> <tr> <td>↖ 12 / 36</td> <td>↘ 2 / 1</td> <td>↙ 2 / 10</td> <td>↗ 3 / 0</td> </tr> <tr> <td>↖ 19 / 10</td> <td>↘ 358 / 605</td> <td>↙ 13 / 60</td> <td>↗ 81 / 35</td> </tr> </table>	↖ 24 / 7	↘ 136 / 341	↙ 12 / 55	↗ 45 / 36	↖ 12 / 36	↘ 2 / 1	↙ 2 / 10	↗ 3 / 0	↖ 19 / 10	↘ 358 / 605	↙ 13 / 60	↗ 81 / 35	<table border="1"> <tr> <td>↖ 15 / 4</td> <td>↘ 195 / 402</td> <td>↙ 17 / 59</td> <td>↗ 32 / 16</td> </tr> <tr> <td>↖ 6 / 20</td> <td>↘ 1 / 1</td> <td>↙ 14 / 29</td> <td>↗ 1 / 0</td> </tr> <tr> <td>↖ 50 / 38</td> <td>↘ 329 / 545</td> <td>↙ 9 / 36</td> <td>↗ 46 / 18</td> </tr> </table> <p>* Includes U-turns</p>	↖ 15 / 4	↘ 195 / 402	↙ 17 / 59	↗ 32 / 16	↖ 6 / 20	↘ 1 / 1	↙ 14 / 29	↗ 1 / 0	↖ 50 / 38	↘ 329 / 545	↙ 9 / 36	↗ 46 / 18	<table border="1"> <tr> <td>↖ 260 / 478</td> <td>↘ 7 / 36</td> </tr> <tr> <td>↖ 382 / 584</td> <td>↘ 40 / 8</td> </tr> </table>	↖ 260 / 478	↘ 7 / 36	↖ 382 / 584	↘ 40 / 8
↖ 24 / 7	↘ 136 / 341	↙ 12 / 55	↗ 45 / 36																											
↖ 12 / 36	↘ 2 / 1	↙ 2 / 10	↗ 3 / 0																											
↖ 19 / 10	↘ 358 / 605	↙ 13 / 60	↗ 81 / 35																											
↖ 15 / 4	↘ 195 / 402	↙ 17 / 59	↗ 32 / 16																											
↖ 6 / 20	↘ 1 / 1	↙ 14 / 29	↗ 1 / 0																											
↖ 50 / 38	↘ 329 / 545	↙ 9 / 36	↗ 46 / 18																											
↖ 260 / 478	↘ 7 / 36																													
↖ 382 / 584	↘ 40 / 8																													
<p>1 Old 215 Frontage Rd/Cottonwood Ave</p>	<p>2 Old 215 Frontage Rd/Bay Ave</p>	<p>3 Old 215 Frontage Rd/Driveway 1</p>																												
<table border="1"> <tr> <td>↖ 260 / 478</td> <td>↘ 10 / 53</td> </tr> <tr> <td>↖ 412 / 539</td> <td>↘ 61 / 11</td> </tr> </table>	↖ 260 / 478	↘ 10 / 53	↖ 412 / 539	↘ 61 / 11	<table border="1"> <tr> <td>↖ 166 / 246</td> <td>↘ 45 / 122</td> <td>↙ 26 / 75</td> <td>↗ 72 / 78</td> </tr> <tr> <td>↖ 286 / 363</td> <td>↘ 604 / 1354</td> <td>↙ 82 / 120</td> <td>↗ 19 / 6</td> </tr> <tr> <td>↖ 55 / 119</td> <td>↘ 152 / 137</td> <td>↙ 14 / 25</td> <td>↗ 698 / 737</td> </tr> </table>	↖ 166 / 246	↘ 45 / 122	↙ 26 / 75	↗ 72 / 78	↖ 286 / 363	↘ 604 / 1354	↙ 82 / 120	↗ 19 / 6	↖ 55 / 119	↘ 152 / 137	↙ 14 / 25	↗ 698 / 737													
↖ 260 / 478	↘ 10 / 53																													
↖ 412 / 539	↘ 61 / 11																													
↖ 166 / 246	↘ 45 / 122	↙ 26 / 75	↗ 72 / 78																											
↖ 286 / 363	↘ 604 / 1354	↙ 82 / 120	↗ 19 / 6																											
↖ 55 / 119	↘ 152 / 137	↙ 14 / 25	↗ 698 / 737																											
<p>4 Old 215 Frontage Rd/Driveway 2</p>	<p>5 Old 215 Frontage Rd/Alessandro Blvd</p>																													

FIGURE 17

* Includes U-turns

XXXX / YYYY AM / PM Peak Hour Traffic Volumes

**Old 215 Frontage Road Business Park
Project Completion With Project Peak Hour Traffic Volumes**



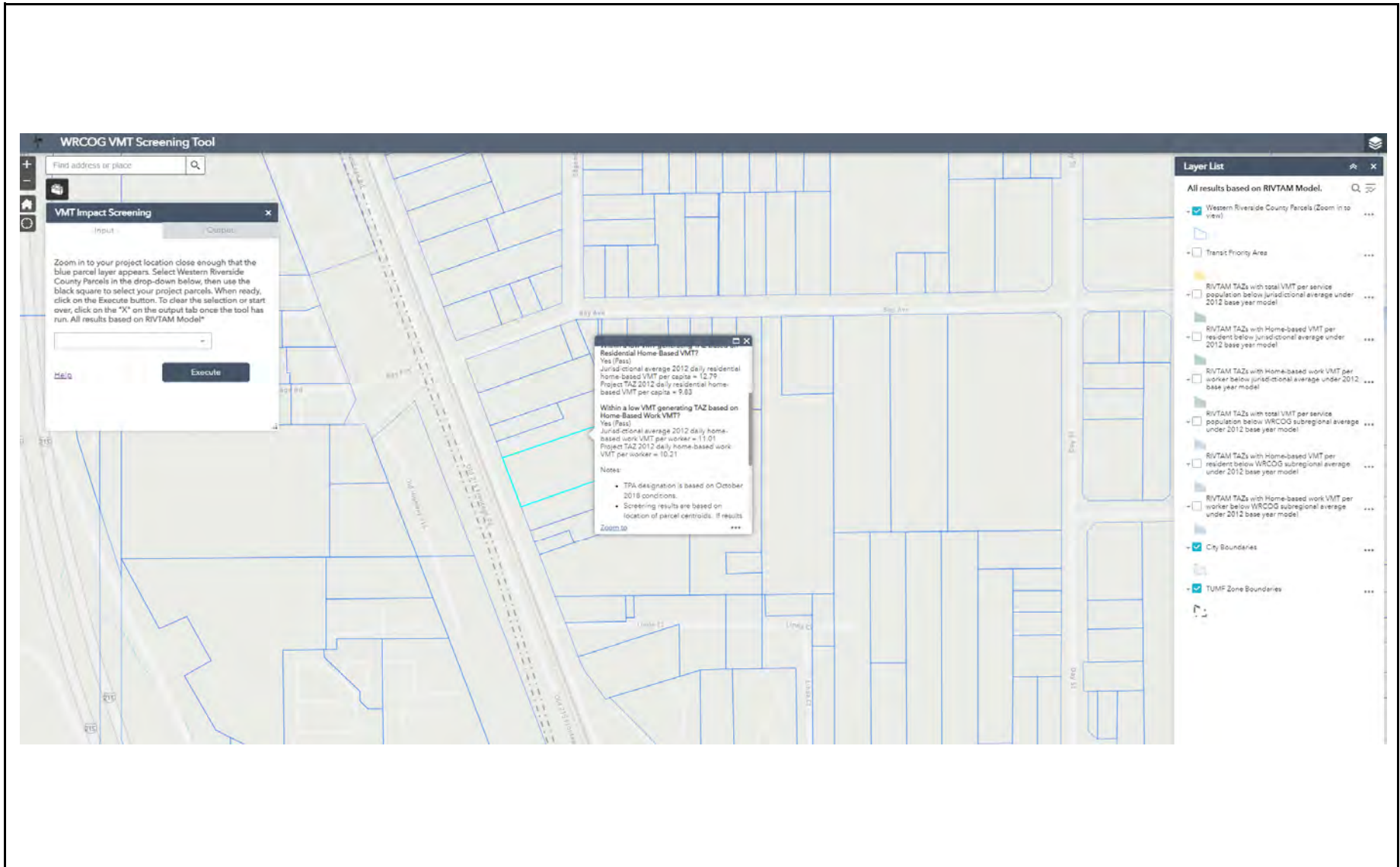

FIGURE 18

Old 215 Frontage Road Business Park
 WRCOG Low VMT Screening Area

The design of driveways and other project access locations will be based on City Code, which sets the standard for such design. It is not anticipated that traffic hazards will increase, therefore, the project impact is considered less than significant.

D. Result in inadequate emergency access?

The proposed driveways will be designed in accordance with all applicable design and safety standards required by adopted fire codes, safety codes, and building codes established by the City's Engineering and Fire Departments. The project will not increase delays on street segments substantially, therefore, the project will not result in inadequate emergency access, and the project impact is considered less than significant.

10.0 SUMMARY & CONCLUSIONS

The proposed project is forecast to generate 116 PCE trips in the a.m. peak hour, 106 PCE trips in the p.m. peak hour, and 894 daily PCE trips. Based on the intersection LOS analysis, the study intersections are forecast to operate at satisfactory levels of service under all without and with project scenarios. The project is located in a low VMT area and a full VMT analysis is not needed. Therefore, the project is presumed to have a less than significant impact on VMT.

APPENDIX A: SCOPING AGREEMENT

EXHIBIT A

Project Scoping Form

This scoping form shall be submitted to the Lead Agency to assist in identifying infrastructure improvements that may be required to support traffic from the proposed project.

Project Identification:

Stephen Z. Manganiello
 7/8/2021

Case Number:	PEN21-0105 thru PEN21-0110
Related Cases:	
SP No.	
EIR No.	
GPA No.	
CZ No.	
Project Name:	Bay Street and Old Frontage Road Business Park
Project Address:	East of Old Frontage Road and south of Bay Street.
Project Opening Year:	2023
Project Description:	The project will include construction of 94,022 square feet of Warehousing and 102,975 square feet of Light Industrial uses. Access will provided via two driveways on Old Frontage Road.

	Consultant:	Developer:
Name:	Translutions, Inc.	Phelan Development Company
Address:	17632 Irvine Blvd., #200 Tustin, CA 92780	450 Newport Center Drive, Suite 405 Newport Beach, CA 92660
Telephone:	949-656-3131	(949) 720-8050
Email:	sandipan@translutions.com	amckinley@phelandevco.com

Trip Generation Information:

Trip Generation Data Source: ITE 10th Edition, "Warehousing" and "General Light Industrial"

Current General Plan Land Use:

Business Park

Proposed General Plan Land Use:

Business Park

Current Zoning:

Business Park

Proposed Zoning:

Business Park

	Existing Trip Generation			Proposed Trip Generation		
	In	Out	Total	In	Out	Total
AM Trips				100	16	116
PM Trips				17	88	106

Trip Internalization: Yes No (_____% Trip Discount)

Pass-By Allowance: Yes No (_____% Trip Discount)

Potential Screening Checks

Is your project screened from specific analyses (see Page 3 of the guidelines related to LOS assessment and Pages 22-23 for VMT screening criteria).

Is the project screened from LOS assessment? Yes No

LOS screening justification (see Page 3 of the guidelines): _____

Is the project screened from VMT assessment? Yes No

VMT screening justification (see Pages 22-23 of the guidelines): _____ The project is located in a low VMT area based on worker VMT. Please see attached screening map. Jurisdictional average 2012 daily home-based work VMT per worker is 11.01 miles and that for Project TAZ is 10.21 miles. _____ _____ _____
--

Level of Service Scoping

- Proposed Trip Distribution (Attach Graphic for Detailed Distribution):

North	South	East	West
%	%	%	%

Link level of service and data collection:

will be required
 will not be required

- Attach list of study intersections (and roadway segments if applicable)
- Attach site plan
- Other specific items to be addressed:
 - Site access
 - On-site circulation
 - Parking
 - Consistency with Plans supporting Bikes/Peds/Transit
 - Other _____
- Date of Traffic Counts _____
- Attach proposed analysis scenarios (years plus proposed forecasting approach)
- Attach proposed phasing approach (if the project is phased)

VMT Scoping

For projects that are not screened, identify the following:

- Travel Demand Forecasting Model Used N/A
- Attach WRCOG Screening VMT Assessment output or describe why it is not appropriate for use
- Attach proposed Model Land Use Inputs and Assumed Conversion Factors (attach)

PROJECT DESCRIPTION

The project site is located east of Old Frontage Road and south of Bay Street in the City of Moreno Valley, in Riverside County. The project includes the construction of 94,022 square feet of Warehousing and 102,975 square feet of Light Industrial uses. Access will be provided via two right-in/right-out project driveways on Old Frontage Road.

SITE PLAN: Attached Figure 1

PROJECT TRIP GENERATION: Attached Tables A, B, and C

LOS ANALYSIS EVALUATION

Based on discussion with City staff, a focused traffic analysis will be conducted at the five study area intersections listed below:

1. Old Frontage Road/Cottonwood Avenue.
2. Old Frontage Road/Bay Avenue.
3. Old Frontage Road//Driveway 1.
4. Old Frontage Road//Driveway 2.
5. Old Frontage Road/Alessandro Boulevard.

The LOS analysis will be conducted for the following scenarios:

- Existing Conditions.
- Project Opening Year Without Project Conditions.
- Project Opening Year With Project Conditions.

The Synchro 11 software cannot analyze U-turns movements. A factor of 1.25 will be used to convert the U-turns to left-turn equivalents.

Table A: Project Trip Generation (General Light Industrial)

Land Use	Units	Peak Hour						Daily	
		AM Peak Hour			PM Peak Hour				
		In	Out	Total	In	Out	Total		
Total Vehicle Rates									
Trip Generation Rates ¹	102.974	TSF	0.616	0.084	0.700	0.082	0.548	0.630	4.960
PCE Inbound/Outbound Splits			88%	12%	100%	13%	87%	100%	100%
Trip Rate by Vehicle Classification									
Passenger Cars									
Classification Percentage ²			78.60%	78.60%	78.60%	78.60%	78.60%	78.60%	78.60%
Rate			0.484	0.066	0.550	0.064	0.431	0.495	3.899
2-Axle Trucks									
Classification Percentage ²			8.00%	8.00%	8.00%	8.00%	8.00%	8.00%	8.00%
Rate			0.049	0.007	0.056	0.007	0.044	0.050	0.397
3-Axle Trucks									
Classification Percentage ²			3.90%	3.90%	3.90%	3.90%	3.90%	3.90%	3.90%
Rate			0.024	0.003	0.027	0.003	0.021	0.025	0.193
4-Axle Trucks									
Classification Percentage ²			9.50%	9.50%	9.50%	9.50%	9.50%	9.50%	9.50%
Rate			0.059	0.008	0.067	0.008	0.052	0.060	0.471
Total Project Trip Generation (Trips, By Vehicle Type)									
Passenger Cars									
Trips			50	7	57	7	44	51	401
2-Axle Trucks									
Trips			5	1	6	1	5	5	41
3-Axle Trucks									
Trips			2	0	3	0	2	3	20
4-Axle Trucks									
Trips			6	1	7	1	5	6	49
All Trucks			13	2	16	2	12	14	110
Total Vehicles			63	9	73	9	56	65	511
Total Project Trip Generation (Passenger Car Equivalent Trips, By Vehicle Type)									
Passenger Cars									
PCE Factor ³			1.0	1.0	1.0	1.0	1.0	1.0	1.0
PCEs			50	7	57	7	44	51	401
2-Axle Trucks									
PCE Factor ³			1.5	1.5	1.5	1.5	1.5	1.5	1.5
PCEs			8	1	9	1	7	8	61
3-Axle Trucks									
PCE Factor ³			2.0	2.0	2.0	2.0	2.0	2.0	2.0
PCEs			5	1	6	1	4	5	40
4-Axle Trucks									
PCE Factor ³			3.0	3.0	3.0	3.0	3.0	3.0	3.0
PCEs			18	2	21	2	16	18	146
Total Truck PCE			31	4	36	4	27	31	247
Total PCE			81	11	93	11	71	82	648

¹ Rates based on Land Use 110 "General Light Industrial" from Institute of Transportation Engineers (ITE) Trip Generation (10th Ed+Supplement.).

² Truck percentage per ITE 10th Edition with truck type breakdown based on the 2003 Fontana Truck Trip Study.

³ PCE Factor per *City of Moreno Valley Transportation Impact Analysis Preparation Guide for Vehicle Miles Traveled and Level of Service Assessment* (June 2020).

Table B: Project Trip Generation (Warehousing)

Land Use	Units	Peak Hour						Daily	
		AM Peak Hour			PM Peak Hour				
		In	Out	Total	In	Out	Total		
Total Vehicle Rates									
Trip Generation Rates ¹	94.022	TSF	0.131	0.039	0.170	0.051	0.139	0.190	1.740
PCE Inbound/Outbound Splits			77%	23%	100%	27%	73%	100%	100%
Trip Rate by Vehicle Classification									
Passenger Cars									
Classification Percentage ²			69.20%	69.20%	69.20%	78.30%	78.30%	78.30%	67.80%
Rate			0.091	0.027	0.118	0.040	0.109	0.149	1.180
2-Axle Trucks									
Classification Percentage ²			5.15%	5.15%	5.15%	3.63%	3.63%	3.63%	5.39%
Rate			0.007	0.002	0.009	0.002	0.005	0.007	0.094
3-Axle Trucks									
Classification Percentage ²			6.38%	6.38%	6.38%	4.50%	4.50%	4.50%	6.67%
Rate			0.008	0.002	0.011	0.002	0.006	0.009	0.116
4-Axle Trucks									
Classification Percentage ²			19.26%	19.26%	19.26%	13.57%	13.57%	13.57%	20.14%
Rate			0.025	0.008	0.033	0.007	0.019	0.026	0.350
Total Project Trip Generation (Trips, By Vehicle Type)									
Passenger Cars									
Trips			9	3	11	4	10	14	111
2-Axle Trucks									
Trips			1	0	1	0	1	1	9
3-Axle Trucks									
Trips			1	0	1	0	1	1	11
4-Axle Trucks									
Trips			2	1	3	1	2	2	33
All Trucks			4	1	5	1	4	4	53
Total Vehicles			13	4	16	5	14	18	164
Total Project Trip Generation (Passenger Car Equivalent Trips, By Vehicle Type)									
Passenger Cars									
PCE Factor ³			1.0	1.0	1.0	1.0	1.0	1.0	1.0
PCEs			9	3	11	4	10	14	111
2-Axle Trucks									
PCE Factor ³			1.5	1.5	1.5	1.5	1.5	1.5	1.5
PCEs			1	0	1	0	1	1	14
3-Axle Trucks									
PCE Factor ³			2.0	2.0	2.0	2.0	2.0	2.0	2.0
PCEs			2	0	2	0	1	2	22
4-Axle Trucks									
PCE Factor ³			3.0	3.0	3.0	3.0	3.0	3.0	3.0
PCEs			7	2	9	2	5	7	99
Total Truck PCE			10	2	12	2	7	10	135
Total PCE			19	5	23	6	17	24	246

¹ Rates based on Land Use 150 "Warehousing" from Institute of Transportation Engineers (ITE) Trip Generation (10th Ed+Supplement.).

² Truck percentage per ITE 10th Edition with truck type breakdown based on the 2003 Fontana Truck Trip Study.

³ PCE Factor per *City of Moreno Valley Transportation Impact Analysis Preparation Guide for Vehicle Miles Traveled and Level of Service Assessment* (June 2020).

Table C - Total Project Trip Generation Summary (Warehouse and General Light Industrial)

Land Use	Units	Peak Hour						Daily
		AM Peak Hour			PM Peak Hour			
		In	Out	Total	In	Out	Total	
Total Project Trip Generation (Trips, By Vehicle Type)								
Light Industrial and Warehouse								
Passenger Cars		59	10	68	11	54	65	512
2-Axle Trucks		6	1	7	1	6	6	50
3-Axle Trucks		3	0	4	0	3	4	31
4+ Axle Trucks		8	2	10	2	7	8	82
All Trucks		17	3	21	3	16	18	163
Total Vehicles		76	13	89	14	70	83	675
Total Project Trip Generation (Passenger Car Equivalent Trips, By Vehicle Type)								
Passenger Cars		59	10	68	11	54	65	512
Truck PCE								
2-Axle Trucks		9	1	10	1	8	9	75
3-Axle Trucks		7	1	8	1	5	7	62
4+ Axle Trucks		25	4	30	4	21	25	245
Total Truck PCE		41	6	48	6	34	41	382
Total PCE		100	16	116	17	88	106	894

¹ Rates based on Land Use 110 "General Light Industrial" and Land Use 150 "Warehousing" from Institute of Transportation Engineers (ITE) *Trip Generation* (10th Ed.)

² Truck percentage per ITE 10th Edition with truck type breakdown based on the 2003 Fontana Truck Trip Study.

³ Recommended PCE Factor per City of Moreno Valley *Transportation Impact Analysis Preparation Guide for Vehicle Miles Traveled and Level of Service Assessment* (June 2020).

GROSS LOT AREA:	489,225 sf ±
NET LOT AREA:	11,46 acres 488,781 sf ± 11.22 acres
TOTAL BUILDING AREA:	198,025 sf
BUILDING A:	48,994 sf
WAREHOUSE:	48,994 sf
OFFICE:	4,000 sf
BUILDING B:	28,348 sf
WAREHOUSE:	23,348 sf
OFFICE:	5,000 sf
BUILDING C:	28,780 sf
WAREHOUSE:	27,280 sf
OFFICE:	2,500 sf
BUILDING D:	44,028 sf
WAREHOUSE:	41,028 sf
OFFICE:	4,000 sf
BUILDING E:	23,897 sf
WAREHOUSE:	11,087 sf
OFFICE:	2,800 sf
BUILDING F:	23,288 sf
WAREHOUSE:	23,288 sf
OFFICE:	2,000 sf
SITE COVERAGE (on net):	40.3 %
PARKING REQUIRED	225 spaces
OFFICES: 1/10th of gross floor area	
WAREHOUSE: 1/15th of 1st 80k sf, 1/28th 2nd 80k sf, 1/44th of over-40k sf	
BUILDING A:	48 spaces
WAREHOUSE:	22 spaces
OFFICE:	18 spaces
BUILDING B:	32 spaces
WAREHOUSE:	22 spaces
OFFICE:	10 spaces
BUILDING C:	34 spaces
WAREHOUSE:	24 spaces
OFFICE:	10 spaces
BUILDING D:	47 spaces
WAREHOUSE:	31 spaces
OFFICE:	16 spaces
BUILDING E:	32 spaces
WAREHOUSE:	22 spaces
OFFICE:	10 spaces
BUILDING F:	32 spaces
WAREHOUSE:	22 spaces
OFFICE:	10 spaces
PARKING PROVIDED:	235 spaces
STANDARD:	225 spaces
ACCESSIBLE:	10 spaces
TRAILER PARKING REQUIRED:	23 spaces
(1 SPACE PER DOCK DOOR)	
TRAILER PARKING PROVIDED:	23 spaces
LANDSCAPE PROVIDED: (10.3% of Net Lot Area)	50,402 sf

DOCK DOOR RATIO:	1 / 8,595 sf (23 DOCK DOORS)
BUILDING A:	1 / 8,252 sf (9 DOCK DOORS)
BUILDING B:	1 / 8,770 sf (9 DOCK DOORS)
BUILDING C:	1 / 8,910 sf (9 DOCK DOORS)
BUILDING D:	1 / 8,636 sf (9 DOCK DOORS)
BUILDING E:	1 / 7,288 sf (9 DOCK DOORS)
BUILDING F:	1 / 7,780 sf (9 DOCK DOORS)

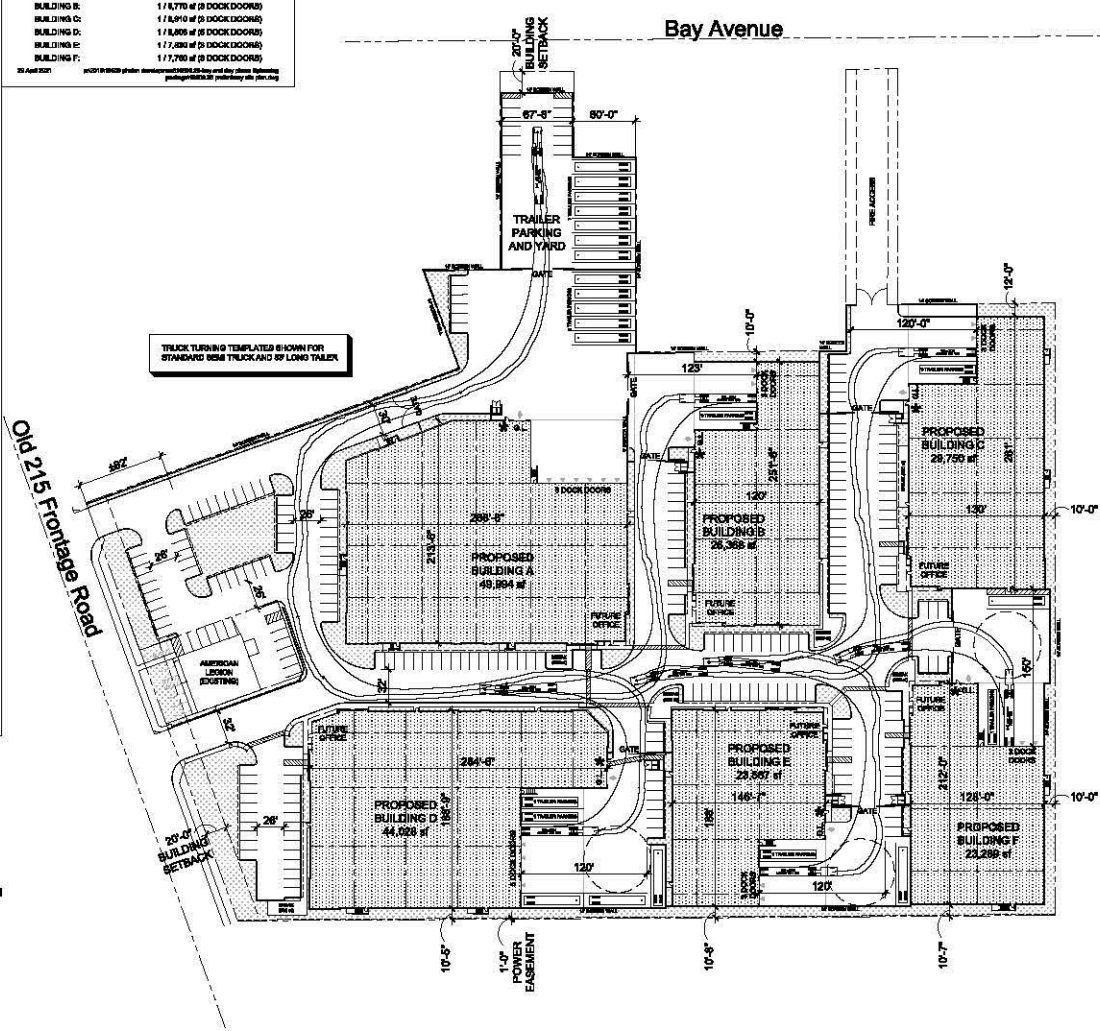

PRELIMINARY SITE PLAN (TRUCK TURNING)

April 29, 2021

Old 215 Frontage Road and Bay Avenue
Moreno Valley, California



A-2A

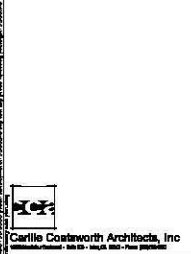

FIGURE 1

Bay Street and Old Frontage Road Warehouse Site Plan



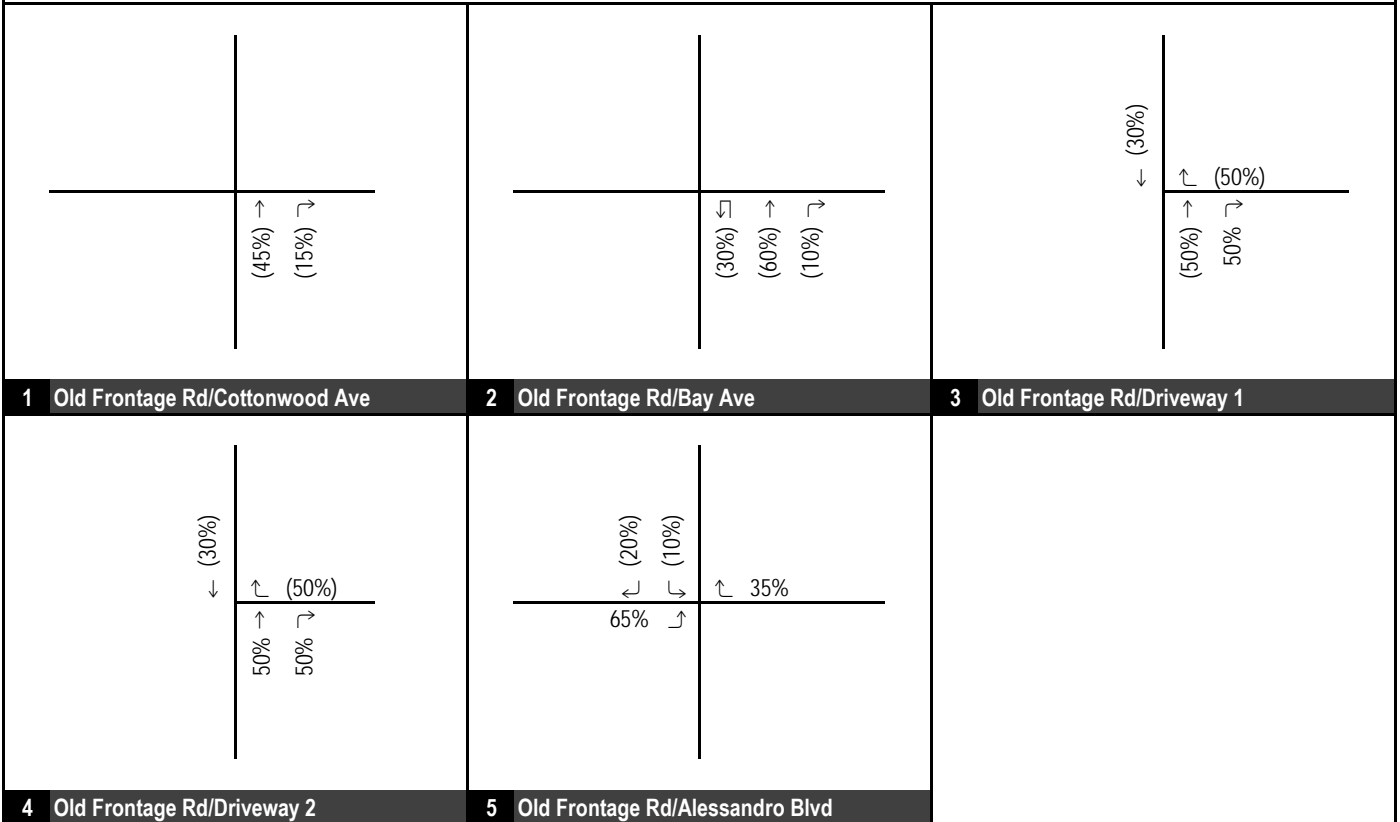
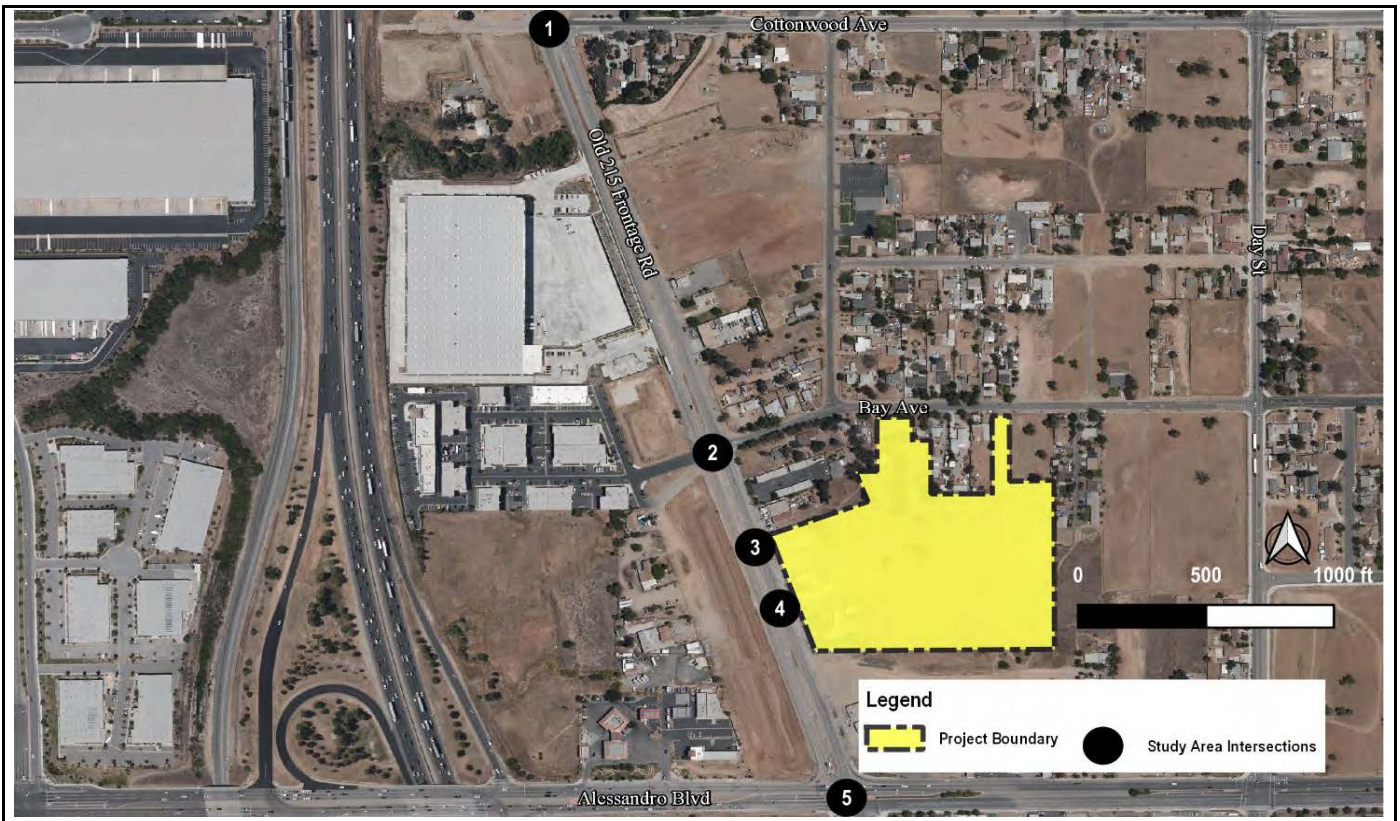

FIGURE 2

XXX%(YYY%) Inbound%(Outbound%) Percent



**Old Frontage Road Warehouse
Project Trip Distribution (Autos)**

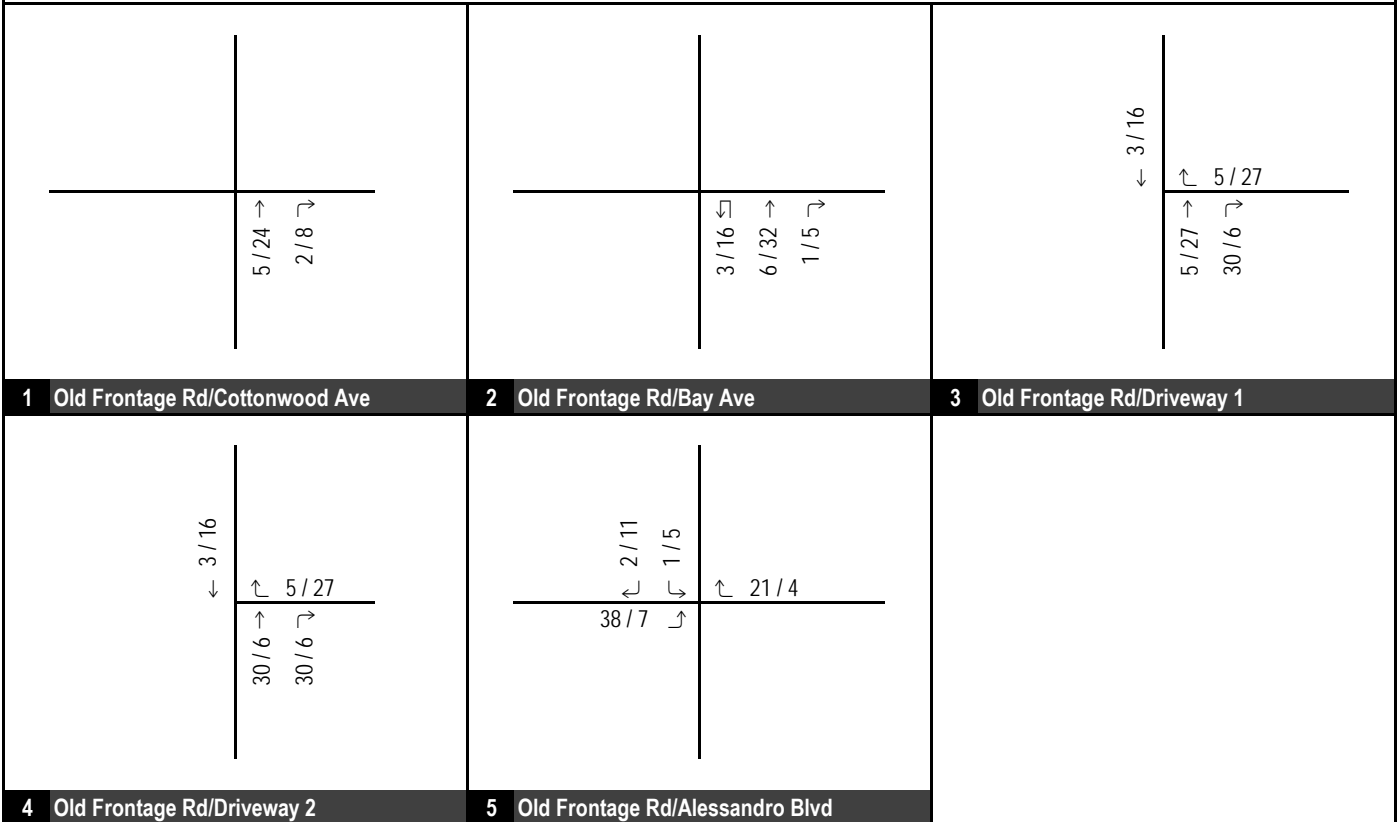
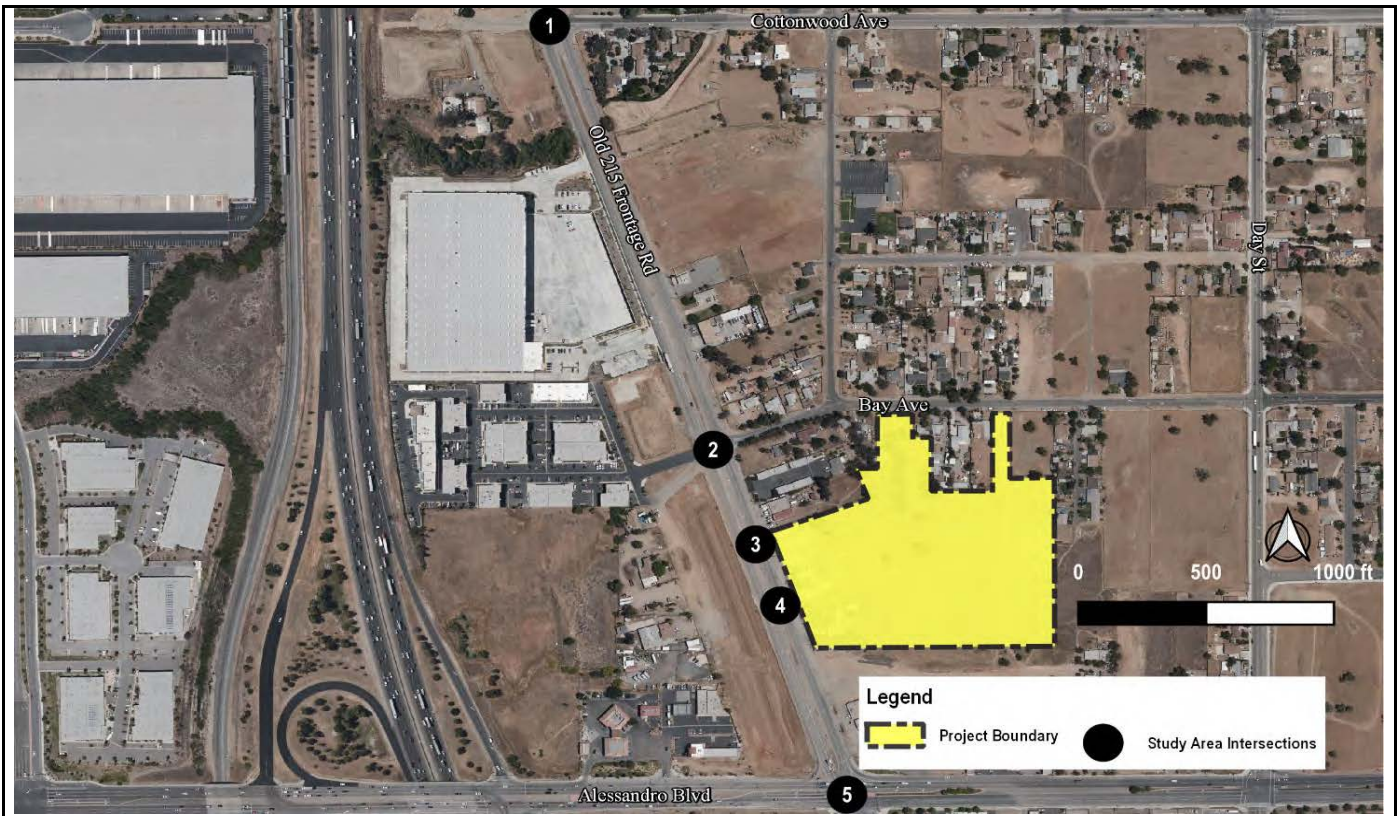

FIGURE 3

XXX / YYY AM / PM Peak Hour Trips



**Old Frontage Road Warehouse
Project Trip Assignment (Autos)**

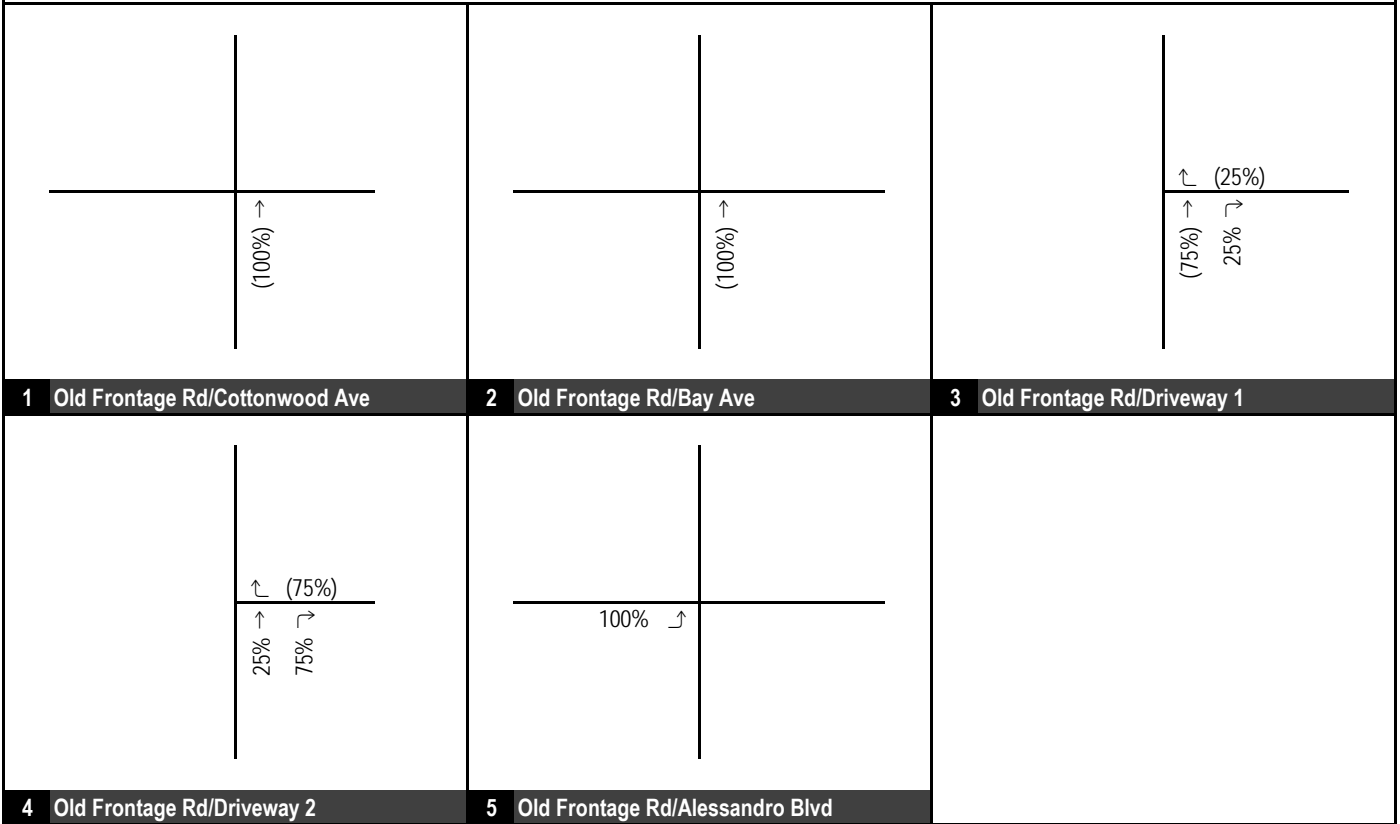
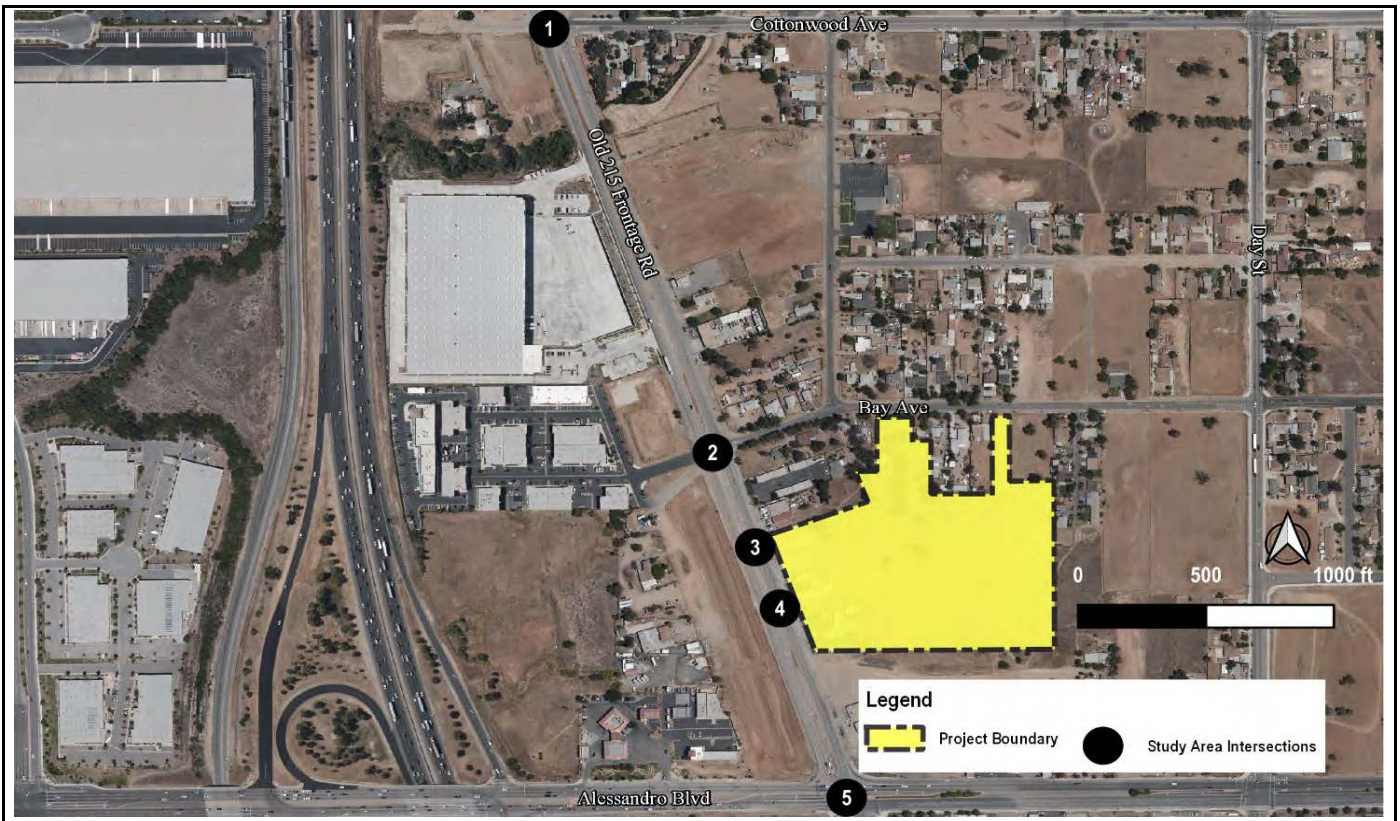

FIGURE 4

XXX%(YYY%) Inbound%(Outbound%) Percent



**Old Frontage Road Warehouse
Project Trip Distribution (Trucks)**

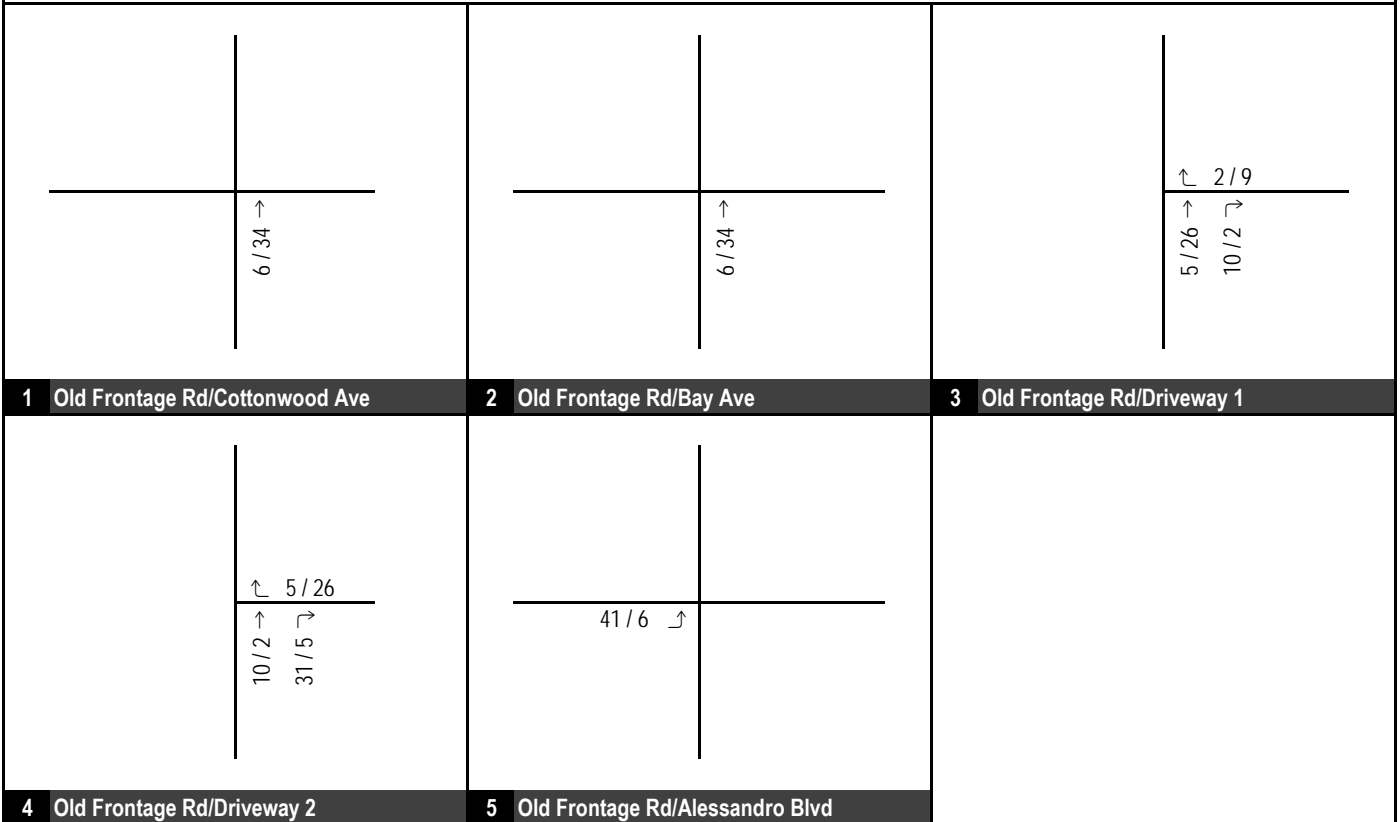
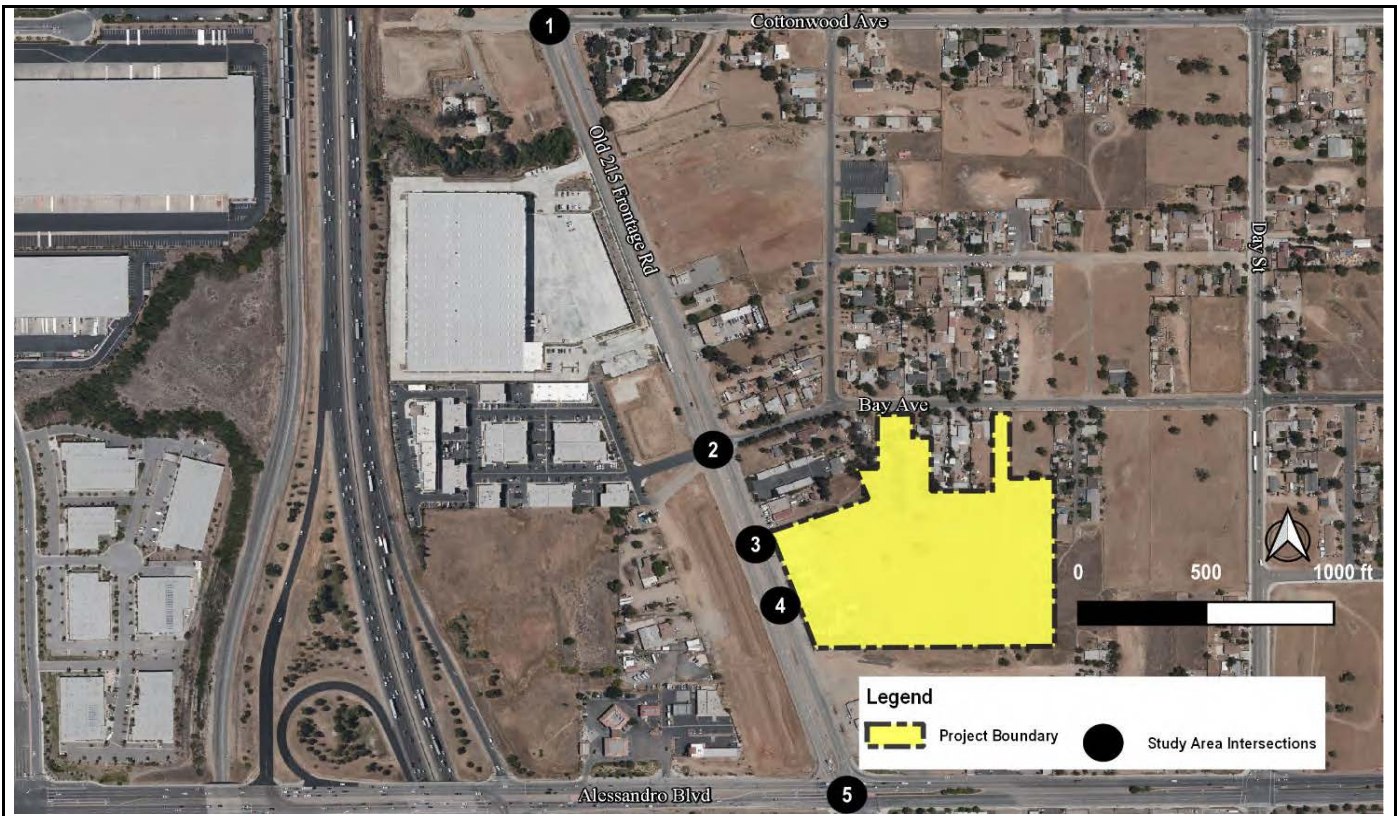

FIGURE 5

XXX / YYY AM / PM Peak Hour Trips



**Old Frontage Road Warehouse
Project Trip Assignment (Trucks)**

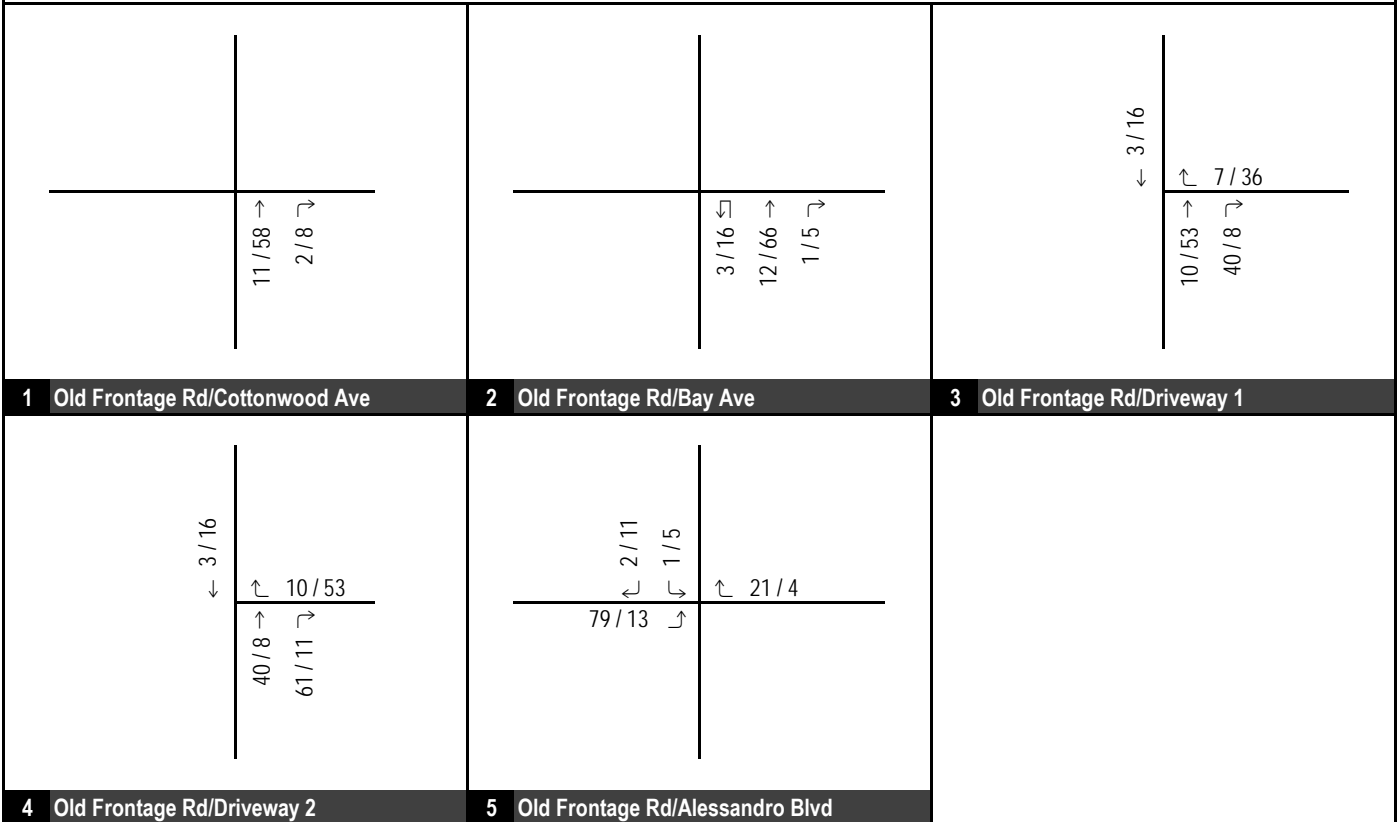
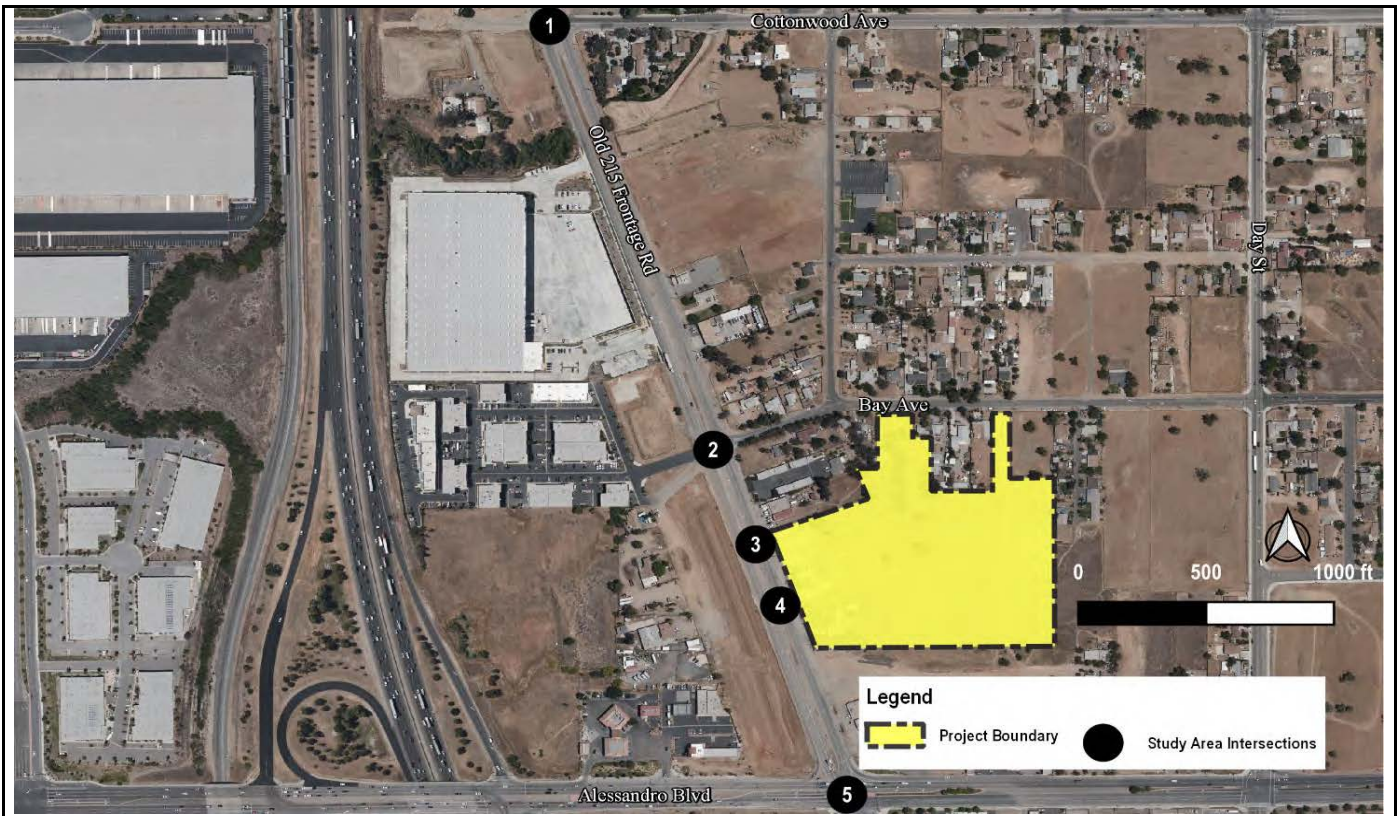

FIGURE 6

XXX / YYY AM / PM Peak Hour Trips



**Old Frontage Road Warehouse
Total Project Trip Assignment**

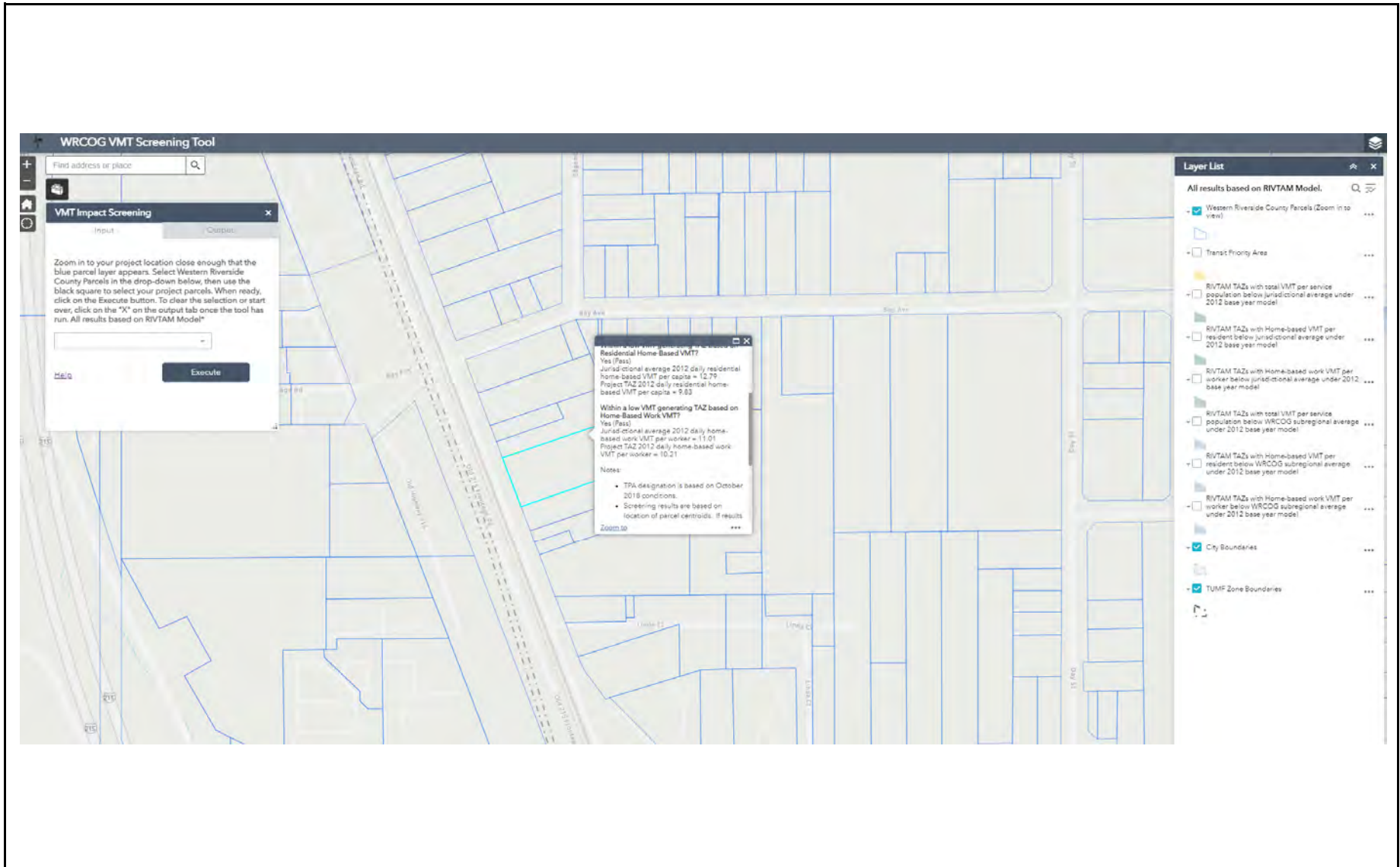

FIGURE 7

Old Frontage Road Warehouse
WRCOG Low VMT Screening Area

APPENDIX B: TRAFFIC COUNTS

City of Moreno Valley
 N/S: Old 215 Frontage Road
 E/W: Cottonwood Avenue
 Weather: Clear

File Name : 01_MR_V_Old 215_Cotton AM
 Site Code : 99921353
 Start Date : 7/14/2021
 Page No : 1

Groups Printed- Total Volume

Start Time	Old 215 Frontage Road Southbound				Cottonwood Avenue Westbound				Old 215 Frontage Road Northbound				Cottonwood Avenue Eastbound				Int. Total
	Left	Thru	Right	App. Total	Left	Thru	Right	App. Total	Left	Thru	Right	App. Total	Left	Thru	Right	App. Total	
07:00 AM	2	25	0	27	25	0	7	32	1	35	3	39	0	1	0	1	99
07:15 AM	1	19	0	20	19	0	15	34	1	55	3	59	1	0	0	1	114
07:30 AM	2	25	0	27	30	0	13	43	2	59	4	65	2	1	0	3	138
07:45 AM	4	29	0	33	22	2	12	36	1	88	3	92	0	0	0	0	161
Total	9	98	0	107	96	2	47	145	5	237	13	255	3	2	0	5	512
08:00 AM	1	32	1	34	14	1	4	19	3	93	4	100	1	0	0	1	154
08:15 AM	5	18	0	23	12	0	14	26	2	81	0	83	0	1	0	1	133
08:30 AM	3	29	0	32	8	1	9	18	3	70	1	74	0	0	0	0	124
08:45 AM	1	35	0	36	12	0	10	22	1	62	4	67	1	0	2	3	128
Total	10	114	1	125	46	2	37	85	9	306	9	324	2	1	2	5	539
Grand Total	19	212	1	232	142	4	84	230	14	543	22	579	5	3	2	10	1051
Apprch %	8.2	91.4	0.4		61.7	1.7	36.5		2.4	93.8	3.8		50	30	20		
Total %	1.8	20.2	0.1	22.1	13.5	0.4	8	21.9	1.3	51.7	2.1	55.1	0.5	0.3	0.2	1	

Start Time	Old 215 Frontage Road Southbound				Cottonwood Avenue Westbound				Old 215 Frontage Road Northbound				Cottonwood Avenue Eastbound				Int. Total
	Left	Thru	Right	App. Total	Left	Thru	Right	App. Total	Left	Thru	Right	App. Total	Left	Thru	Right	App. Total	
07:30 AM	2	25	0	27	30	0	13	43	2	59	4	65	2	1	0	3	138
07:45 AM	4	29	0	33	22	2	12	36	1	88	3	92	0	0	0	0	161
08:00 AM	1	32	1	34	14	1	4	19	3	93	4	100	1	0	0	1	154
08:15 AM	5	18	0	23	12	0	14	26	2	81	0	83	0	1	0	1	133
Total Volume	12	104	1	117	78	3	43	124	8	321	11	340	3	2	0	5	586
% App. Total	10.3	88.9	0.9		62.9	2.4	34.7		2.4	94.4	3.2		60	40	0		
PHF	.600	.813	.250	.860	.650	.375	.768	.721	.667	.863	.688	.850	.375	.500	.000	.417	.910

Peak Hour Analysis From 07:00 AM to 08:45 AM - Peak 1 of 1
 Peak Hour for Entire Intersection Begins at 07:30 AM

City of Moreno Valley
 N/S: Old 215 Frontage Road
 E/W: Cottonwood Avenue
 Weather: Clear

File Name : 01_MRV_Old 215_Cotton AM
 Site Code : 99921353
 Start Date : 7/14/2021
 Page No : 2

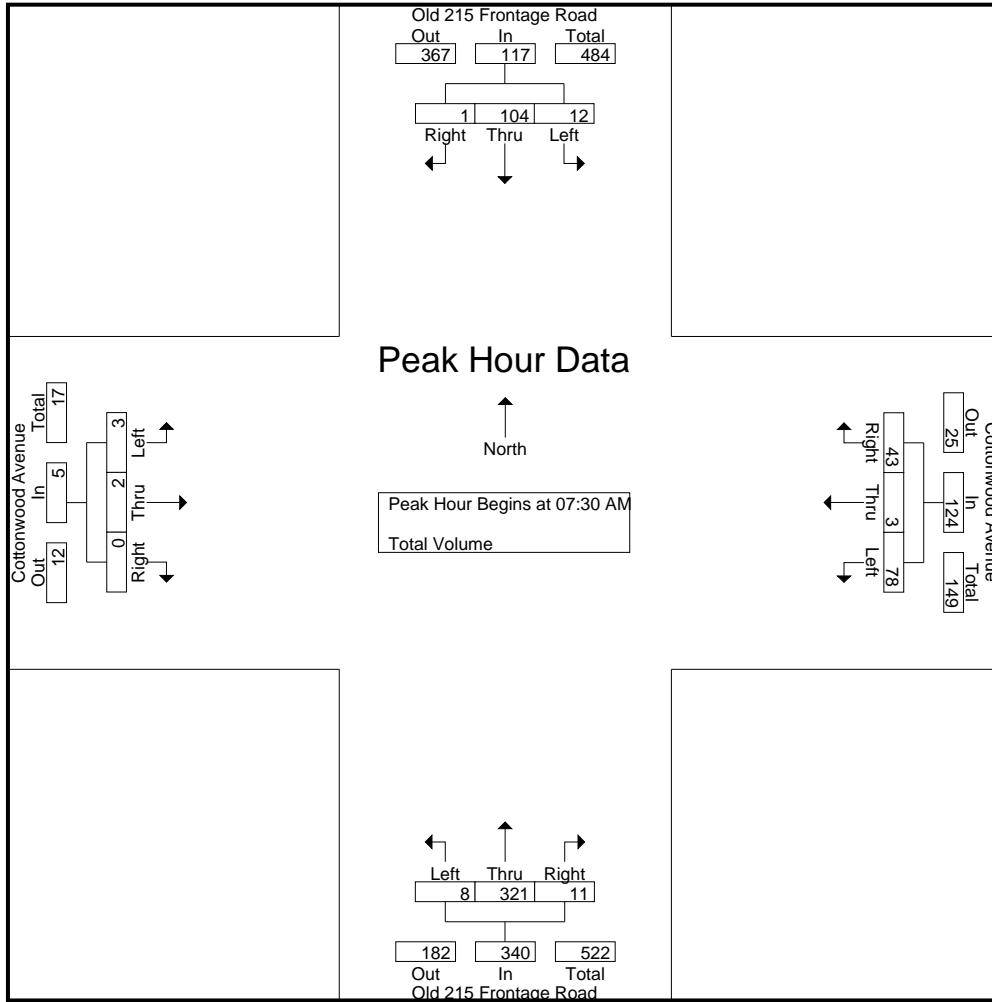

Peak Hour Analysis From 07:00 AM to 08:45 AM - Peak 1 of 1
 Peak Hour for Each Approach Begins at:

	08:00 AM				07:00 AM				07:45 AM				07:00 AM			
+0 mins.	1	32	1	34	25	0	7	32	1	88	3	92	0	1	0	1
+15 mins.	5	18	0	23	19	0	15	34	3	93	4	100	1	0	0	1
+30 mins.	3	29	0	32	30	0	13	43	2	81	0	83	2	1	0	3
+45 mins.	1	35	0	36	22	2	12	36	3	70	1	74	0	0	0	0
Total Volume	10	114	1	125	96	2	47	145	9	332	8	349	3	2	0	5
% App. Total	8	91.2	0.8		66.2	1.4	32.4		2.6	95.1	2.3		60	40	0	
PHF	.500	.814	.250	.868	.800	.250	.783	.843	.750	.892	.500	.873	.375	.500	.000	.417

City of Moreno Valley
 N/S: Old 215 Frontage Road
 E/W: Cottonwood Avenue
 Weather: Clear

File Name : 01_MRV_Old 215_Cotton PM
 Site Code : 99921353
 Start Date : 7/14/2021
 Page No : 1

Groups Printed- Total Volume

Start Time	Old 215 Frontage Road Southbound				Cottonwood Avenue Westbound				Old 215 Frontage Road Northbound				Cottonwood Avenue Eastbound				Int. Total
	Left	Thru	Right	App. Total	Left	Thru	Right	App. Total	Left	Thru	Right	App. Total	Left	Thru	Right	App. Total	
04:00 PM	8	73	0	81	6	0	12	18	0	127	14	141	2	0	1	3	243
04:15 PM	15	72	0	87	8	0	3	11	2	129	13	144	1	0	1	2	244
04:30 PM	19	88	0	107	12	0	10	22	0	97	12	109	3	1	0	4	242
04:45 PM	11	77	0	88	8	0	10	18	3	142	11	156	0	0	0	0	262
Total	53	310	0	363	34	0	35	69	5	495	50	550	6	1	2	9	991
05:00 PM	12	91	0	103	6	0	7	13	5	100	12	117	0	0	0	0	233
05:15 PM	9	104	0	113	17	0	11	28	2	81	13	96	0	0	1	1	238
05:30 PM	15	95	0	110	10	0	10	20	0	84	18	102	0	0	1	1	233
05:45 PM	20	80	0	100	8	0	8	16	2	74	19	95	0	0	2	2	213
Total	56	370	0	426	41	0	36	77	9	339	62	410	0	0	4	4	917
Grand Total	109	680	0	789	75	0	71	146	14	834	112	960	6	1	6	13	1908
Apprch %	13.8	86.2	0		51.4	0	48.6		1.5	86.9	11.7		46.2	7.7	46.2		
Total %	5.7	35.6	0	41.4	3.9	0	3.7	7.7	0.7	43.7	5.9	50.3	0.3	0.1	0.3	0.7	

Start Time	Old 215 Frontage Road Southbound				Cottonwood Avenue Westbound				Old 215 Frontage Road Northbound				Cottonwood Avenue Eastbound				Int. Total
	Left	Thru	Right	App. Total	Left	Thru	Right	App. Total	Left	Thru	Right	App. Total	Left	Thru	Right	App. Total	
04:00 PM	8	73	0	81	6	0	12	18	0	127	14	141	2	0	1	3	243
04:15 PM	15	72	0	87	8	0	3	11	2	129	13	144	1	0	1	2	244
04:30 PM	19	88	0	107	12	0	10	22	0	97	12	109	3	1	0	4	242
04:45 PM	11	77	0	88	8	0	10	18	3	142	11	156	0	0	0	0	262
Total Volume	53	310	0	363	34	0	35	69	5	495	50	550	6	1	2	9	991
% App. Total	14.6	85.4	0		49.3	0	50.7		0.9	90	9.1		66.7	11.1	22.2		
PHF	.697	.881	.000	.848	.708	.000	.729	.784	.417	.871	.893	.881	.500	.250	.500	.563	.946

Peak Hour Analysis From 04:00 PM to 05:45 PM - Peak 1 of 1
 Peak Hour for Entire Intersection Begins at 04:00 PM

City of Moreno Valley
 N/S: Old 215 Frontage Road
 E/W: Cottonwood Avenue
 Weather: Clear

File Name : 01_MRV_Old 215_Cotton PM
 Site Code : 99921353
 Start Date : 7/14/2021
 Page No : 2

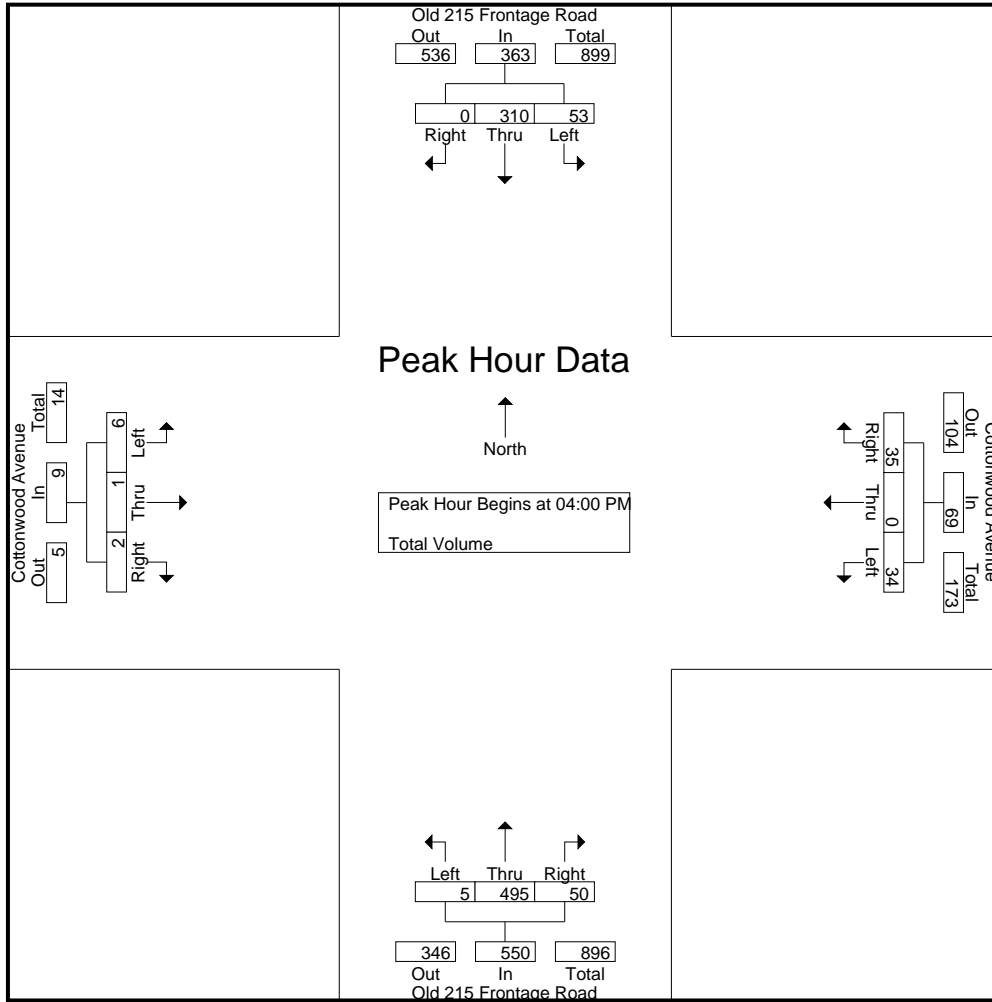

Peak Hour Analysis From 04:00 PM to 05:45 PM - Peak 1 of 1
 Peak Hour for Each Approach Begins at:

	05:00 PM				04:30 PM				04:00 PM				04:00 PM			
+0 mins.	12	91	0	103	12	0	10	22	0	127	14	141	2	0	1	3
+15 mins.	9	104	0	113	8	0	10	18	2	129	13	144	1	0	1	2
+30 mins.	15	95	0	110	6	0	7	13	0	97	12	109	3	1	0	4
+45 mins.	20	80	0	100	17	0	11	28	3	142	11	156	0	0	0	0
Total Volume	56	370	0	426	43	0	38	81	5	495	50	550	6	1	2	9
% App. Total	13.1	86.9	0		53.1	0	46.9		0.9	90	9.1		66.7	11.1	22.2	
PHF	.700	.889	.000	.942	.632	.000	.864	.723	.417	.871	.893	.881	.500	.250	.500	.563

City of Moreno Valley
 N/S: Old 215 Frontage Road
 E/W: Bay Avenue
 Weather: Clear

File Name : 02_MRV_Old 215_Bay AM
 Site Code : 99921353
 Start Date : 7/14/2021
 Page No : 1

Groups Printed- Total Volume

Start Time	Old 215 Frontage Road Southbound				Bay Avenue Westbound				Old 215 Frontage Road Northbound				Bay Avenue Eastbound				Int. Total
	Left	Thru	Right	App. Total	Left	Thru	Right	App. Total	Left	Thru	Right	App. Total	Left	Thru	Right	App. Total	
07:00 AM	4	40	4	48	10	1	2	13	4	35	0	39	1	0	3	4	104
07:15 AM	6	31	1	38	13	0	4	17	6	57	2	65	0	0	2	2	122
07:30 AM	0	50	2	52	12	0	9	21	4	58	2	64	2	1	4	7	144
07:45 AM	3	46	4	53	12	1	9	22	7	86	1	94	2	0	4	6	175
Total	13	167	11	191	47	2	24	73	21	236	5	262	5	1	13	19	545
08:00 AM	5	40	0	45	7	0	7	14	8	84	3	95	0	0	2	2	156
08:15 AM	3	27	0	30	6	0	2	8	2	77	1	80	1	0	2	3	121
08:30 AM	0	38	1	39	10	0	8	18	3	69	1	73	2	0	1	3	133
08:45 AM	1	43	3	47	6	0	7	13	8	63	1	72	0	0	4	4	136
Total	9	148	4	161	29	0	24	53	21	293	6	320	3	0	9	12	546
Grand Total	22	315	15	352	76	2	48	126	42	529	11	582	8	1	22	31	1091
Apprch %	6.2	89.5	4.3		60.3	1.6	38.1		7.2	90.9	1.9		25.8	3.2	71		
Total %	2	28.9	1.4	32.3	7	0.2	4.4	11.5	3.8	48.5	1	53.3	0.7	0.1	2	2.8	

Start Time	Old 215 Frontage Road Southbound				Bay Avenue Westbound				Old 215 Frontage Road Northbound				Bay Avenue Eastbound				Int. Total
	Left	Thru	Right	App. Total	Left	Thru	Right	App. Total	Left	Thru	Right	App. Total	Left	Thru	Right	App. Total	
07:15 AM	6	31	1	38	13	0	4	17	6	57	2	65	0	0	2	2	122
07:30 AM	0	50	2	52	12	0	9	21	4	58	2	64	2	1	4	7	144
07:45 AM	3	46	4	53	12	1	9	22	7	86	1	94	2	0	4	6	175
08:00 AM	5	40	0	45	7	0	7	14	8	84	3	95	0	0	2	2	156
Total Volume	14	167	7	188	44	1	29	74	25	285	8	318	4	1	12	17	597
% App. Total	7.4	88.8	3.7		59.5	1.4	39.2		7.9	89.6	2.5		23.5	5.9	70.6		
PHF	.583	.835	.438	.887	.846	.250	.806	.841	.781	.828	.667	.837	.500	.250	.750	.607	.853

Peak Hour Analysis From 07:00 AM to 08:45 AM - Peak 1 of 1

Peak Hour for Entire Intersection Begins at 07:15 AM

City of Moreno Valley
 N/S: Old 215 Frontage Road
 E/W: Bay Avenue
 Weather: Clear

File Name : 02_MRV_Old 215_Bay AM
 Site Code : 99921353
 Start Date : 7/14/2021
 Page No : 2

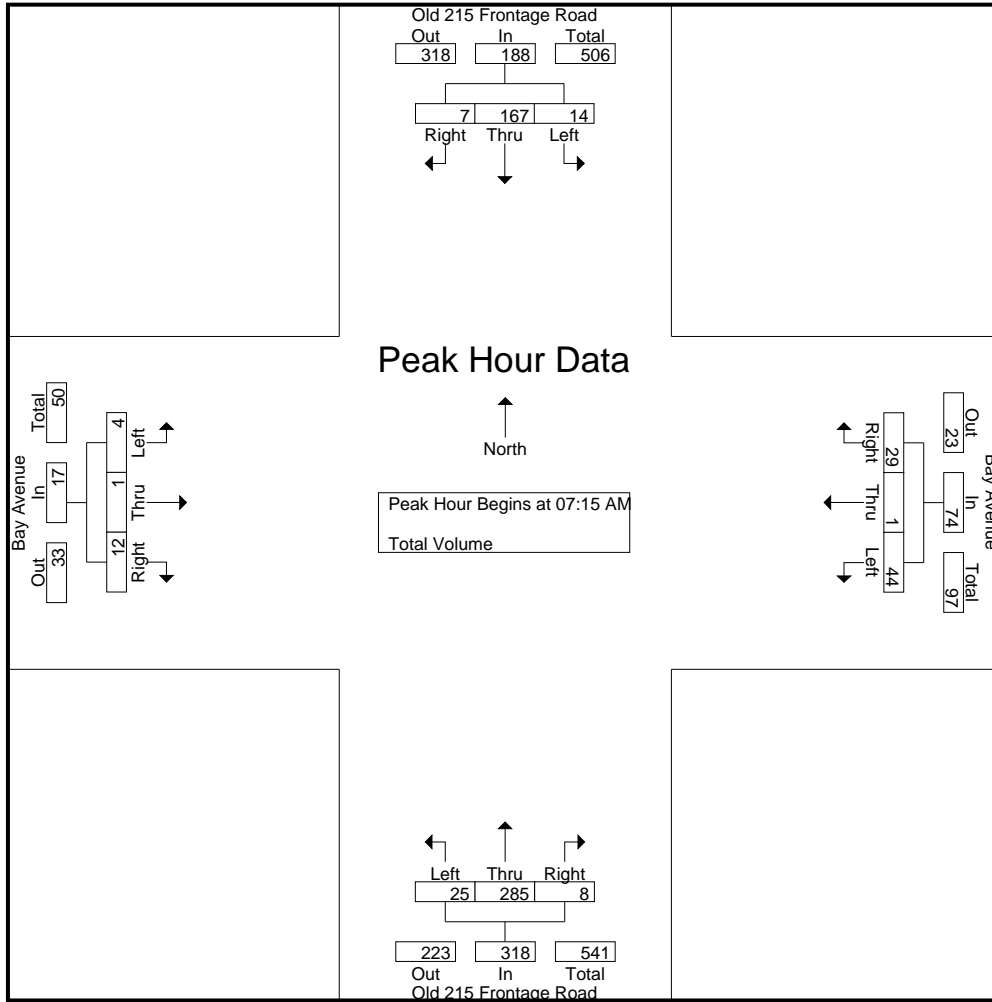

Peak Hour Analysis From 07:00 AM to 08:45 AM - Peak 1 of 1
 Peak Hour for Each Approach Begins at:

	07:00 AM				07:15 AM				07:45 AM				07:00 AM			
+0 mins.	4	40	4	48	13	0	4	17	7	86	1	94	1	0	3	4
+15 mins.	6	31	1	38	12	0	9	21	8	84	3	95	0	0	2	2
+30 mins.	0	50	2	52	12	1	9	22	2	77	1	80	2	1	4	7
+45 mins.	3	46	4	53	7	0	7	14	3	69	1	73	2	0	4	6
Total Volume	13	167	11	191	44	1	29	74	20	316	6	342	5	1	13	19
% App. Total	6.8	87.4	5.8		59.5	1.4	39.2		5.8	92.4	1.8		26.3	5.3	68.4	
PHF	.542	.835	.688	.901	.846	.250	.806	.841	.625	.919	.500	.900	.625	.250	.813	.679

City of Moreno Valley
 N/S: Old 215 Frontage Road
 E/W: Bay Avenue
 Weather: Clear

File Name : 02_MRV_Old 215_Bay PM
 Site Code : 99921353
 Start Date : 7/14/2021
 Page No : 1

Groups Printed- Total Volume

Start Time	Old 215 Frontage Road Southbound				Bay Avenue Westbound				Old 215 Frontage Road Northbound				Bay Avenue Eastbound				Int. Total
	Left	Thru	Right	App. Total	Left	Thru	Right	App. Total	Left	Thru	Right	App. Total	Left	Thru	Right	App. Total	
04:00 PM	15	77	2	94	4	0	5	9	3	147	9	159	4	0	1	5	267
04:15 PM	8	70	1	79	1	0	3	4	3	111	6	120	1	0	1	2	205
04:30 PM	16	91	0	107	7	0	3	10	3	105	10	118	4	0	5	9	244
04:45 PM	16	69	0	85	3	0	6	9	3	134	6	143	3	0	2	5	242
Total	55	307	3	365	15	0	17	32	12	497	31	540	12	0	9	21	958
05:00 PM	15	87	1	103	3	0	3	6	5	110	5	120	4	0	10	14	243
05:15 PM	10	115	0	125	4	0	3	7	3	84	9	96	1	1	4	6	234
05:30 PM	11	96	2	109	4	0	6	10	2	93	3	98	2	0	4	6	223
05:45 PM	7	83	2	92	4	0	5	9	1	87	13	101	1	0	2	3	205
Total	43	381	5	429	15	0	17	32	11	374	30	415	8	1	20	29	905
Grand Total	98	688	8	794	30	0	34	64	23	871	61	955	20	1	29	50	1863
Apprch %	12.3	86.6	1		46.9	0	53.1		2.4	91.2	6.4		40	2	58		
Total %	5.3	36.9	0.4	42.6	1.6	0	1.8	3.4	1.2	46.8	3.3	51.3	1.1	0.1	1.6	2.7	

Start Time	Old 215 Frontage Road Southbound				Bay Avenue Westbound				Old 215 Frontage Road Northbound				Bay Avenue Eastbound				Int. Total
	Left	Thru	Right	App. Total	Left	Thru	Right	App. Total	Left	Thru	Right	App. Total	Left	Thru	Right	App. Total	
04:30 PM	16	91	0	107	7	0	3	10	3	105	10	118	4	0	5	9	244
04:45 PM	16	69	0	85	3	0	6	9	3	134	6	143	3	0	2	5	242
05:00 PM	15	87	1	103	3	0	3	6	5	110	5	120	4	0	10	14	243
05:15 PM	10	115	0	125	4	0	3	7	3	84	9	96	1	1	4	6	234
Total Volume	57	362	1	420	17	0	15	32	14	433	30	477	12	1	21	34	963
% App. Total	13.6	86.2	0.2		53.1	0	46.9		2.9	90.8	6.3		35.3	2.9	61.8		
PHF	.891	.787	.250	.840	.607	.000	.625	.800	.700	.808	.750	.834	.750	.250	.525	.607	.987

Peak Hour Analysis From 04:00 PM to 05:45 PM - Peak 1 of 1

Peak Hour for Entire Intersection Begins at 04:30 PM

City of Moreno Valley
 N/S: Old 215 Frontage Road
 E/W: Bay Avenue
 Weather: Clear

File Name : 02_MRV_Old 215_Bay PM
 Site Code : 99921353
 Start Date : 7/14/2021
 Page No : 2

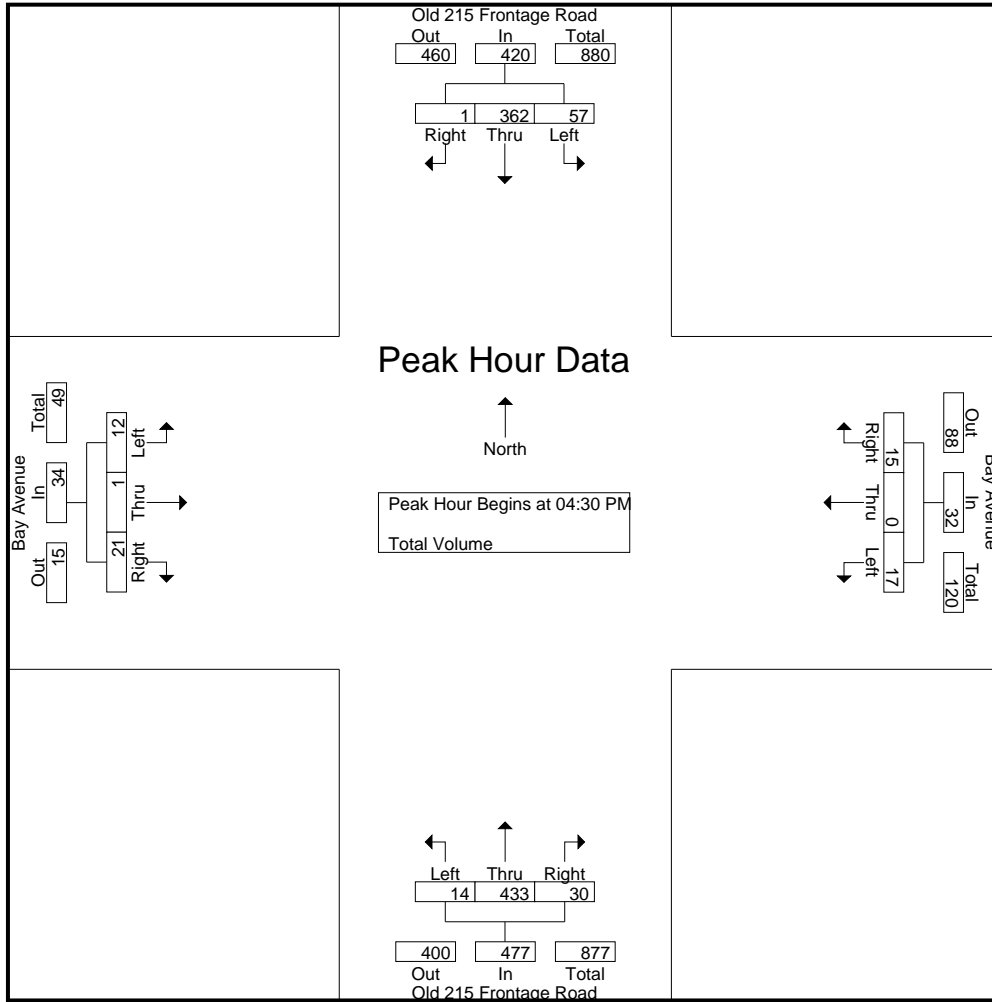

Peak Hour Analysis From 04:00 PM to 05:45 PM - Peak 1 of 1
 Peak Hour for Each Approach Begins at:

	05:00 PM				04:00 PM				04:00 PM				04:30 PM			
+0 mins.	15	87	1	103	4	0	5	9	3	147	9	159	4	0	5	9
+15 mins.	10	115	0	125	1	0	3	4	3	111	6	120	3	0	2	5
+30 mins.	11	96	2	109	7	0	3	10	3	105	10	118	4	0	10	14
+45 mins.	7	83	2	92	3	0	6	9	3	134	6	143	1	1	4	6
Total Volume	43	381	5	429	15	0	17	32	12	497	31	540	12	1	21	34
% App. Total	10	88.8	1.2		46.9	0	53.1		2.2	92	5.7		35.3	2.9	61.8	
PHF	.717	.828	.625	.858	.536	.000	.708	.800	1.000	.845	.775	.849	.750	.250	.525	.607

City of Moreno Valley
 N/S: Old 215 Frontage Road
 E/W: Alessandro Boulevard
 Weather: Clear

File Name : 03_MRV_Old 215_Aless AM
 Site Code : 99921353
 Start Date : 7/14/2021
 Page No : 1

Groups Printed- Total Volume

Start Time	Old 215 Frontage Road Southbound				Alessandro Boulevard Westbound				Old 215 Frontage Road Northbound				Alessandro Boulevard Eastbound				Int. Total
	Left	Thru	Right	App. Total	Left	Thru	Right	App. Total	Left	Thru	Right	App. Total	Left	Thru	Right	App. Total	
07:00 AM	2	6	40	48	1	176	3	180	8	17	1	26	15	93	7	115	369
07:15 AM	4	5	36	45	0	194	9	203	8	25	1	34	25	111	1	137	419
07:30 AM	5	8	54	67	0	147	5	152	8	27	1	36	30	108	9	147	402
07:45 AM	5	7	48	60	1	120	6	127	8	47	2	57	44	137	1	182	426
Total	16	26	178	220	2	637	23	662	32	116	5	153	114	449	18	581	1616
08:00 AM	8	8	37	53	0	171	7	178	10	42	2	54	46	120	6	172	457
08:15 AM	4	4	28	36	1	160	10	171	9	25	1	35	47	134	1	182	424
08:30 AM	3	14	28	45	3	140	14	157	4	24	3	31	34	131	5	170	403
08:45 AM	5	9	33	47	0	140	7	147	6	18	4	28	41	124	1	166	388
Total	20	35	126	181	4	611	38	653	29	109	10	148	168	509	13	690	1672
Grand Total	36	61	304	401	6	1248	61	1315	61	225	15	301	282	958	31	1271	3288
Apprch %	9	15.2	75.8		0.5	94.9	4.6		20.3	74.8	5		22.2	75.4	2.4		
Total %	1.1	1.9	9.2	12.2	0.2	38	1.9	40	1.9	6.8	0.5	9.2	8.6	29.1	0.9	38.7	

Start Time	Old 215 Frontage Road Southbound				Alessandro Boulevard Westbound				Old 215 Frontage Road Northbound				Alessandro Boulevard Eastbound				Int. Total
	Left	Thru	Right	App. Total	Left	Thru	Right	App. Total	Left	Thru	Right	App. Total	Left	Thru	Right	App. Total	
07:45 AM	5	7	48	60	1	120	6	127	8	47	2	57	44	137	1	182	426
08:00 AM	8	8	37	53	0	171	7	178	10	42	2	54	46	120	6	172	457
08:15 AM	4	4	28	36	1	160	10	171	9	25	1	35	47	134	1	182	424
08:30 AM	3	14	28	45	3	140	14	157	4	24	3	31	34	131	5	170	403
Total Volume	20	33	141	194	5	591	37	633	31	138	8	177	171	522	13	706	1710
% App. Total	10.3	17	72.7		0.8	93.4	5.8		17.5	78	4.5		24.2	73.9	1.8		
PHF	.625	.589	.734	.808	.417	.864	.661	.889	.775	.734	.667	.776	.910	.953	.542	.970	.935

Peak Hour Analysis From 07:00 AM to 08:45 AM - Peak 1 of 1
 Peak Hour for Entire Intersection Begins at 07:45 AM

City of Moreno Valley
 N/S: Old 215 Frontage Road
 E/W: Alessandro Boulevard
 Weather: Clear

File Name : 03_MRV_Old 215_Aless AM
 Site Code : 99921353
 Start Date : 7/14/2021
 Page No : 2

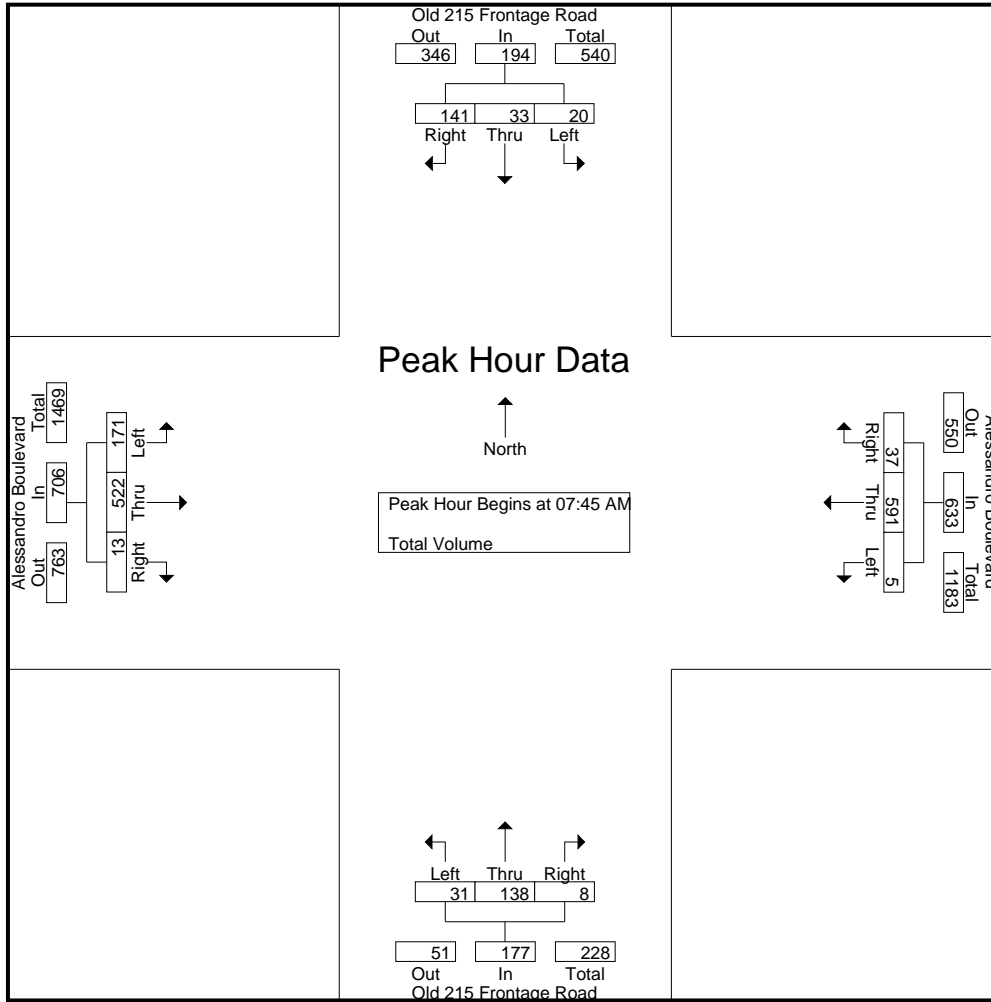

Peak Hour Analysis From 07:00 AM to 08:45 AM - Peak 1 of 1
 Peak Hour for Each Approach Begins at:

	07:15 AM				07:00 AM				07:30 AM				07:45 AM			
+0 mins.	4	5	36	45	1	176	3	180	8	27	1	36	44	137	1	182
+15 mins.	5	8	54	67	0	194	9	203	8	47	2	57	46	120	6	172
+30 mins.	5	7	48	60	0	147	5	152	10	42	2	54	47	134	1	182
+45 mins.	8	8	37	53	1	120	6	127	9	25	1	35	34	131	5	170
Total Volume	22	28	175	225	2	637	23	662	35	141	6	182	171	522	13	706
% App. Total	9.8	12.4	77.8		0.3	96.2	3.5		19.2	77.5	3.3		24.2	73.9	1.8	
PHF	.688	.875	.810	.840	.500	.821	.639	.815	.875	.750	.750	.798	.910	.953	.542	.970

City of Moreno Valley
 N/S: Old 215 Frontage Road
 E/W: Alessandro Boulevard
 Weather: Clear

File Name : 03_MRV_Old 215_Aless PM
 Site Code : 99921353
 Start Date : 7/14/2021
 Page No : 1

Groups Printed- Total Volume

Start Time	Old 215 Frontage Road Southbound				Alessandro Boulevard Westbound				Old 215 Frontage Road Northbound				Alessandro Boulevard Eastbound				Int. Total
	Left	Thru	Right	App. Total	Left	Thru	Right	App. Total	Left	Thru	Right	App. Total	Left	Thru	Right	App. Total	
04:00 PM	16	21	42	79	1	166	23	190	8	39	2	49	76	264	9	349	667
04:15 PM	12	24	41	77	0	143	9	152	3	34	3	40	92	329	8	429	698
04:30 PM	11	27	65	103	2	178	18	198	6	22	4	32	74	294	12	380	713
04:45 PM	18	30	36	84	1	148	18	167	11	40	2	53	86	322	22	430	734
Total	57	102	184	343	4	635	68	707	28	135	11	174	328	1209	51	1588	2812
05:00 PM	15	32	55	102	1	193	22	216	12	21	1	34	66	275	9	350	702
05:15 PM	22	53	44	119	2	169	12	183	5	26	0	31	58	246	10	314	647
05:30 PM	20	43	50	113	0	192	19	211	4	20	2	26	64	292	16	372	722
05:45 PM	14	36	32	82	3	158	18	179	5	15	1	21	61	273	16	350	632
Total	71	164	181	416	6	712	71	789	26	82	4	112	249	1086	51	1386	2703
Grand Total	128	266	365	759	10	1347	139	1496	54	217	15	286	577	2295	102	2974	5515
Apprch %	16.9	35	48.1		0.7	90	9.3		18.9	75.9	5.2		19.4	77.2	3.4		
Total %	2.3	4.8	6.6	13.8	0.2	24.4	2.5	27.1	1	3.9	0.3	5.2	10.5	41.6	1.8	53.9	

Start Time	Old 215 Frontage Road Southbound				Alessandro Boulevard Westbound				Old 215 Frontage Road Northbound				Alessandro Boulevard Eastbound				Int. Total
	Left	Thru	Right	App. Total	Left	Thru	Right	App. Total	Left	Thru	Right	App. Total	Left	Thru	Right	App. Total	
04:15 PM	12	24	41	77	0	143	9	152	3	34	3	40	92	329	8	429	698
04:30 PM	11	27	65	103	2	178	18	198	6	22	4	32	74	294	12	380	713
04:45 PM	18	30	36	84	1	148	18	167	11	40	2	53	86	322	22	430	734
05:00 PM	15	32	55	102	1	193	22	216	12	21	1	34	66	275	9	350	702
Total Volume	56	113	197	366	4	662	67	733	32	117	10	159	318	1220	51	1589	2847
% App. Total	15.3	30.9	53.8		0.5	90.3	9.1		20.1	73.6	6.3		20	76.8	3.2		
PHF	.778	.883	.758	.888	.500	.858	.761	.848	.667	.731	.625	.750	.864	.927	.580	.924	.970

Peak Hour Analysis From 04:00 PM to 05:45 PM - Peak 1 of 1
 Peak Hour for Entire Intersection Begins at 04:15 PM

City of Moreno Valley
 N/S: Old 215 Frontage Road
 E/W: Alessandro Boulevard
 Weather: Clear

File Name : 03_MRV_Old 215_Aless PM
 Site Code : 99921353
 Start Date : 7/14/2021
 Page No : 2

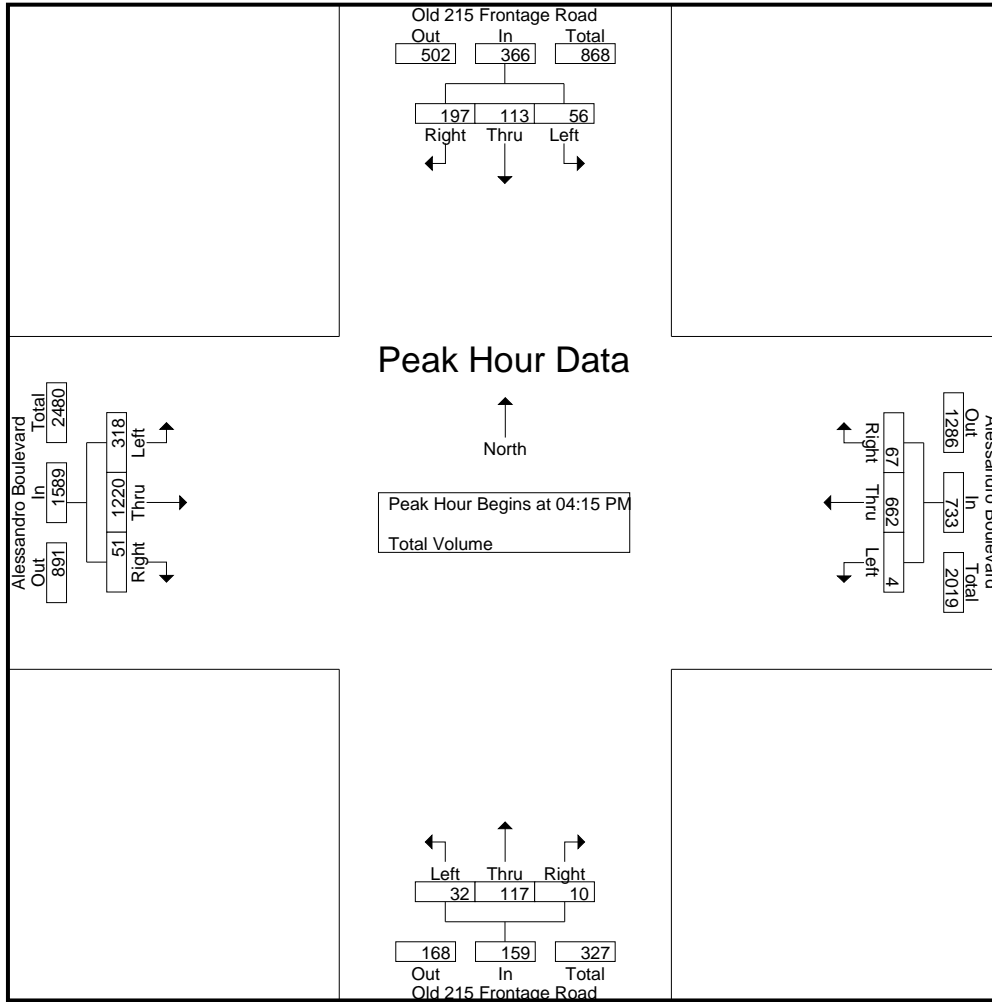

Peak Hour Analysis From 04:00 PM to 05:45 PM - Peak 1 of 1
 Peak Hour for Each Approach Begins at:

	04:45 PM				05:00 PM				04:00 PM				04:15 PM			
+0 mins.	18	30	36	84	1	193	22	216	8	39	2	49	92	329	8	429
+15 mins.	15	32	55	102	2	169	12	183	3	34	3	40	74	294	12	380
+30 mins.	22	53	44	119	0	192	19	211	6	22	4	32	86	322	22	430
+45 mins.	20	43	50	113	3	158	18	179	11	40	2	53	66	275	9	350
Total Volume	75	158	185	418	6	712	71	789	28	135	11	174	318	1220	51	1589
% App. Total	17.9	37.8	44.3		0.8	90.2	9		16.1	77.6	6.3		20	76.8	3.2	
PHF	.852	.745	.841	.878	.500	.922	.807	.913	.636	.844	.688	.821	.864	.927	.580	.924

APPENDIX C: VOLUME DEVELOPMENT WORKSHEETS

Table C-1 - Existing Peak Hour Volumes
(Intersections With Classification Counts)

	AM Peak Hour					PM Peak Hour						
	Pass. Veh.	Trucks			Total PCE Volume	Pass. Veh.	Trucks			Total PCE Volume		
		2 Axle	3 Axle	4 Axle			PCE	2 Axle	3 Axle		4 Axle	PCE
2 . Old 215 Frontage Rd/Bay Ave												
NBL	9	0	0	0	0	9	16	0	0	0	0	16
NBT	537	7	0	3	20	557	308	2	0	2	9	317
NBR	14	0	0	0	0	14	31	0	0	0	0	31
SBL	6	2	0	0	3	9	27	0	0	0	0	27
SBT	153	2	0	0	3	156	253	1	0	2	8	261
SBR	8	0	0	0	0	8	5	0	0	0	0	5
EBL	2	0	0	0	0	2	5	0	0	0	0	5
EBT	1	0	0	0	0	1	0	0	0	0	0	0
EBR	5	0	0	0	0	5	24	0	0	0	0	24
WBL	20	0	0	0	0	20	18	0	0	0	0	18
WBT	3	0	0	0	0	3	0	0	0	0	0	0
WBR	24	3	0	0	5	29	10	0	0	0	0	10
North Leg												
Approach	167	4	0	0	6	173	285	1	0	2	8	293
Departure	563	10	0	3	25	588	323	2	0	2	9	332
Total	730	14	0	3	31	761	608	3	0	4	17	625
South Leg												
Approach	560	7	0	3	20	580	355	2	0	2	9	364
Departure	178	2	0	0	3	181	295	1	0	2	8	303
Total	738	9	0	3	23	761	650	3	0	4	17	667
East Leg												
Approach	47	3	0	0	5	52	28	0	0	0	0	28
Departure	21	2	0	0	3	24	58	0	0	0	0	58
Total	68	5	0	0	8	76	86	0	0	0	0	86
West Leg												
Approach	8	0	0	0	0	8	29	0	0	0	0	29
Departure	20	0	0	0	0	20	21	0	0	0	0	21
Total	28	0	0	0	0	28	50	0	0	0	0	50
Total Approaches												
Approach	782	14	0	3	31	813	697	3	0	4	17	714
Departure	782	14	0	3	31	813	697	3	0	4	17	714
Total	1,564	28	0	6	62	1,626	1,394	6	0	8	34	1,428

**Table C-1 - Existing Peak Hour Volumes
(Intersections With Classification Counts)**

	AM Peak Hour					PM Peak Hour						
	Pass. Veh.	Trucks			Total PCE Volume	Pass. Veh.	Trucks			Total PCE Volume		
		2 Axle	3 Axle	4 Axle			PCE	2 Axle	3 Axle		4 Axle	PCE
5 . Old 215 Frontage Rd/Alessandro Blvd												
NBL	177	2	1	2	11	188	25	2	1	9	32	57
NBT	387	3	2	6	27	414	81	0	0	2	6	87
NBR	11	0	6	0	12	23	11	0	0	1	3	14
SBL	14	2	0	0	3	17	72	2	0	1	6	78
SBT	25	0	1	0	2	27	112	0	0	1	3	115
SBR	186	6	0	0	9	195	174	1	0	1	5	179
EBL	211	6	1	0	11	222	216	0	0	0	0	216
EBT	642	20	5	9	67	709	1,319	17	3	8	56	1,375
EBR	10	2	2	5	22	32	30	2	0	19	60	90
WBL	6	1	5	0	12	18	12	0	1	0	2	14
WBT	1,261	26	1	18	95	1,356	794	6	2	3	22	816
WBR	67	2	0	2	9	76	63	0	0	0	0	63
North Leg												
Approach	225	8	1	0	14	239	358	3	0	3	14	372
Departure	665	11	3	8	47	712	360	0	0	2	6	366
Total	890	19	4	8	61	951	718	3	0	5	20	738
South Leg												
Approach	575	5	9	8	50	625	117	2	1	12	41	158
Departure	41	3	8	5	36	77	154	2	1	20	65	219
Total	616	8	17	13	86	702	271	4	2	32	106	377
East Leg												
Approach	1,334	29	6	20	116	1,450	869	6	3	3	24	893
Departure	667	22	11	9	82	749	1,402	19	3	10	65	1,467
Total	2,001	51	17	29	198	2,199	2,271	25	6	13	89	2,360
West Leg												
Approach	863	28	8	14	100	963	1,565	19	3	27	116	1,681
Departure	1,624	34	2	20	115	1,739	993	9	3	13	59	1,052
Total	2,487	62	10	34	215	2,702	2,558	28	6	40	175	2,733
Total Approaches												
Approach	2,997	70	24	42	280	3,277	2,909	30	7	45	195	3,104
Departure	2,997	70	24	42	280	3,277	2,909	30	7	45	195	3,104
Total	5,994	140	48	84	560	6,554	5,818	60	14	90	390	6,208

Table C-2 - Existing Peak Hour Truck Percentages

	AM Peak Hour				PM Peak Hour			
	Passenger Vehicles	Total Trucks	Total Vehicle Volume	Truck %	Passenger Vehicles	Total Trucks	Total Vehicle Volume	Truck %
2 . Old 215 Frontage Rd/Bay Ave								
NBL	9	0	9	0.0%	16	0	16	0.0%
NBT	537	10	547	1.8%	308	4	312	1.3%
NBR	14	0	14	0.0%	31	0	31	0.0%
SBL	6	2	8	25.0%	27	0	27	0.0%
SBT	153	2	155	1.3%	253	3	256	1.2%
SBR	8	0	8	0.0%	5	0	5	0.0%
EBL	2	0	2	0.0%	5	0	5	0.0%
EBT	1	0	1	0.0%	0	0	0	0.0%
EBR	5	0	5	0.0%	24	0	24	0.0%
WBL	20	0	20	0.0%	18	0	18	0.0%
WBT	3	0	3	0.0%	0	0	0	0.0%
WBR	24	3	27	11.1%	10	0	10	0.0%
North Leg								
Approach	167	4	171	2.3%	285	3	288	1.0%
Departure	563	13	576	2.3%	323	4	327	1.2%
Total	730	17	747	2.3%	608	7	615	1.1%
South Leg								
Approach	560	10	570	1.8%	355	4	359	1.1%
Departure	178	2	180	1.1%	295	3	298	1.0%
Total	738	12	750	1.6%	650	7	657	1.1%
East Leg								
Approach	47	3	50	6.0%	28	0	28	0.0%
Departure	21	2	23	8.7%	58	0	58	0.0%
Total	68	5	73	6.8%	86	0	86	0.0%
West Leg								
Approach	8	0	8	0.0%	29	0	29	0.0%
Departure	20	0	20	0.0%	21	0	21	0.0%
Total	28	0	28	0.0%	50	0	50	0.0%
Total Approaches								
Approach	782	17	799		697	7	704	
Departure	782	17	799		697	7	704	
Total	1,564	34	1,598	2.1%	1,394	14	1,408	1.0%

Table C-2 - Existing Peak Hour Truck Percentages

	AM Peak Hour				PM Peak Hour			
	Passenger Vehicles	Total Trucks	Total Vehicle Volume	Truck %	Passenger Vehicles	Total Trucks	Total Vehicle Volume	Truck %
5 . Old 215 Frontage Rd/Alessandro Blvd								
NBL	177	5	182	2.7%	25	12	37	32.4%
NBT	387	11	398	2.8%	81	2	83	2.4%
NBR	11	6	17	35.3%	11	1	12	8.3%
SBL	14	2	16	12.5%	72	3	75	4.0%
SBT	25	1	26	3.8%	112	1	113	0.9%
SBR	186	6	192	3.1%	174	2	176	1.1%
EBL	211	7	218	3.2%	216	0	216	0.0%
EBT	642	34	676	5.0%	1,319	28	1,347	2.1%
EBR	10	9	19	47.4%	30	21	51	41.2%
WBL	6	6	12	50.0%	12	1	13	7.7%
WBT	1,261	45	1,306	3.4%	794	11	805	1.4%
WBR	67	4	71	5.6%	63	0	63	0.0%
North Leg								
Approach	225	9	234		358	6	364	
Departure	665	22	687		360	2	362	
Total	890	31	921	3.4%	718	8	726	1.1%
South Leg								
Approach	575	22	597		117	15	132	
Departure	41	16	57		154	23	177	
Total	616	38	654	5.8%	271	38	309	12.3%
East Leg								
Approach	1,334	55	1,389		869	12	881	
Departure	667	42	709		1,402	32	1,434	
Total	2,001	97	2,098	4.6%	2,271	44	2,315	1.9%
West Leg								
Approach	863	50	913		1,565	49	1,614	
Departure	1,624	56	1,680		993	25	1,018	
Total	2,487	106	2,593	4.1%	2,558	74	2,632	2.8%
Total Approaches								
Approach	2,997	136	3,133		2,909	82	2,991	
Departure	2,997	136	3,133		2,909	82	2,991	
Total	5,994	272	6,266	4.3%	5,818	164	5,982	2.7%

**Table C-3 - Existing Peak Hour Volumes
(Intersections Without Classification Counts)**

	AM Peak Hour					PM Peak Hour					Total PCE Vol	
	Total Veh.	Truck %	Pass. Veh.	Truck Truck	PCE	Total Veh.	Truck %	Pass. Veh.	Truck Truck	PCE		
1 . Old 215 Frontage Rd/Cottonwood Ave												
NBL	8	2.3%	8	0	0	8	5	1.1%	5	0	0	5
NBT	321	2.3%	313	8	15	328	495	1.1%	489	6	15	504
NBR	11	0.0%	11	0	0	11	50	0.0%	50	0	0	50
SBL	12	0.0%	12	0	0	12	53	0.0%	53	0	0	53
SBT	104	2.3%	102	2	4	106	310	1.1%	306	4	10	316
SBR	1	2.3%	1	0	0	1	0	1.1%	0	0	0	0
EBL	3	2.3%	3	0	0	3	6	1.1%	6	0	0	6
EBT	2	2.3%	2	0	0	2	1	1.1%	1	0	0	1
EBR	0	2.3%	0	0	0	0	2	1.1%	2	0	0	2
WBL	78		78	0	0	78	34	0.0%	34	0	0	34
WBT	3	2.3%	3	0	0	3	0	1.1%	0	0	0	0
WBR	43		43	0	0	43	35	0.0%	35	0	0	35
North Leg												
Approach	117		115	2	4	119	363		359	4	10	369
Departure	367		359	8	15	374	536		530	6	15	545
Total	484		474	10	19	493	899		889	10	25	914
South Leg												
Approach	340		332	8	15	347	550		544	6	15	559
Departure	182		180	2	4	184	346		342	4	10	352
Total	522		512	10	19	531	896		886	10	25	911
East Leg												
Approach	124		124	0	0	124	69		69	0	0	69
Departure	25		25	0	0	25	104		104	0	0	104
Total	149		149	0	0	149	173		173	0	0	173
West Leg												
Approach	5		5	0	0	5	9		9	0	0	9
Departure	12		12	0	0	12	5		5	0	0	5
Total	17		17	0	0	17	14		14	0	0	14
Total Approaches												
Approach	586		576	10	19	595	991		981	10	25	1,006
Departure	586		576	10	19	595	991		981	10	25	1,006
Total	1,172		1,152	20	38	1,190	1,982		1,962	20	50	2,012

**Table C-3 - Existing Peak Hour Volumes
(Intersections Without Classification Counts)**

	AM Peak Hour					PM Peak Hour						
	Total Veh.	Truck %	Pass. Veh.	Truck PCE	Total PCE Vol	Total Veh.	Truck %	Pass. Veh.	Truck PCE	Total PCE Vol		
2 . Old 215 Frontage Rd/Bay Ave												
NBL	25	0.0%	25	0	0	25	14	0.0%	14	0	0	14
NBT	285	1.8%	280	5	10	290	433	1.3%	427	6	14	441
NBR	8	0.0%	8	0	0	8	30	0.0%	30	0	0	30
SBL	14	25.0%	10	4	6	16	57	0.0%	57	0	0	57
SBT	167	1.3%	165	2	3	168	362	1.2%	358	4	11	369
SBR	7	0.0%	7	0	0	7	1	0.0%	1	0	0	1
EBL	4	0.0%	4	0	0	4	12	0.0%	12	0	0	12
EBT	1	0.0%	1	0	0	1	1	0.0%	1	0	0	1
EBR	12	0.0%	12	0	0	12	21	0.0%	21	0	0	21
WBL	44	0.0%	44	0	0	44	17	0.0%	17	0	0	17
WBT	1	0.0%	1	0	0	1	0	0.0%	0	0	0	0
WBR	29	11.1%	26	3	5	31	15	0.0%	15	0	0	15
North Leg												
Approach	188		182	6	9	191	420		416	4	11	427
Departure	318		310	8	15	325	460		454	6	14	468
Total	506		492	14	24	516	880		870	10	25	895
South Leg												
Approach	318		313	5	10	323	477		471	6	14	485
Departure	223		221	2	3	224	400		396	4	11	407
Total	541		534	7	13	547	877		867	10	25	892
East Leg												
Approach	74		71	3	5	76	32		32	0	0	32
Departure	23		19	4	6	25	88		88	0	0	88
Total	97		90	7	11	101	120		120	0	0	120
West Leg												
Approach	17		17	0	0	17	34		34	0	0	34
Departure	33		33	0	0	33	15		15	0	0	15
Total	50		50	0	0	50	49		49	0	0	49
Total Approaches												
Approach	597		583	14	24	607	963		953	10	25	978
Departure	597		583	14	24	607	963		953	10	25	978
Total	1,194		1,166	28	48	1,214	1,926		1,906	20	50	1,956

**Table C-3 - Existing Peak Hour Volumes
(Intersections Without Classification Counts)**

	AM Peak Hour						PM Peak Hour					
	Total Veh.	Truck %	Pass. Veh.	Truck	Truck PCE	Total PCE Vol	Total Veh.	Truck %	Pass. Veh.	Truck	Truck PCE	Total PCE Vol
5 . Old 215 Frontage Rd/Alessandro Blvd												
NBL	31	2.7%	30	1	2	32	32	32.4%	22	10	27	49
NBT	138	2.8%	134	4	10	144	117	2.4%	114	3	9	123
NBR	8	35.3%	5	3	6	11	10	8.3%	9	1	3	12
SBL	20	12.5%	17	3	5	22	56	4.0%	54	2	4	58
SBT	33	3.8%	32	1	2	34	113	0.9%	112	1	3	115
SBR	141	3.1%	137	4	6	143	197	1.1%	195	2	5	200
EBL	171	3.2%	166	5	8	174	318	0.0%	318	0	0	318
EBT	522	5.0%	496	26	51	547	1,220	2.1%	1,195	25	50	1,245
EBR	13	47.4%	7	6	15	22	51	41.2%	30	21	60	90
WBL	5	50.0%	2	3	6	8	4	7.7%	4	0	0	4
WBT	591	3.4%	571	20	42	613	662	1.4%	653	9	18	671
WBR	37	5.6%	35	2	5	40	67	0.0%	67	0	0	67
North Leg												
Approach	194		186	8	13	199	366		361	5	12	373
Departure	346		335	11	23	358	502		499	3	9	508
Total	540		521	19	36	557	868		860	8	21	881
South Leg												
Approach	177		169	8	18	187	159		145	14	39	184
Departure	51		41	10	23	64	168		146	22	63	209
Total	228		210	18	41	251	327		291	36	102	393
East Leg												
Approach	633		608	25	53	661	733		724	9	18	742
Departure	550		518	32	62	580	1,286		1,258	28	57	1,315
Total	1,183		1,126	57	115	1,241	2,019		1,982	37	75	2,057
West Leg												
Approach	706		669	37	74	743	1,589		1,543	46	110	1,653
Departure	763		738	25	50	788	891		870	21	50	920
Total	1,469		1,407	62	124	1,531	2,480		2,413	67	160	2,573
Total Approaches												
Approach	1,710		1,632	78	158	1,790	2,847		2,773	74	179	2,952
Departure	1,710		1,632	78	158	1,790	2,847		2,773	74	179	2,952
Total	3,420		3,264	156	316	3,580	5,694		5,546	148	358	5,904

Table C-4 - Existing Peak Hour PCE Volume Summary

	AM Peak Hour			PM Peak Hour		
	Existing Without Project	Project Trips	Existing With Project	Existing Without Project	Project Trips	Existing With Project
1 . Old 215 Frontage Rd/Cottonwood Ave						
NBL	8	0	8	5	0	5
NBT	328	11	339	504	58	562
NBR	11	2	13	50	8	58
SBL	12	0	12	53	0	53
SBT	106	0	106	316	0	316
SBR	1	0	1	0	0	0
EBL	3	0	3	6	0	6
EBT	2	0	2	1	0	1
EBR	0	0	0	2	0	2
WBL	78	0	78	34	0	34
WBT	3	0	3	0	0	0
WBR	43	0	43	35	0	35
North Leg						
Approach	119	0	119	369	0	369
Departure	374	11	385	545	58	603
Total	493	11	504	914	58	972
South Leg						
Approach	347	13	360	559	66	625
Departure	184	0	184	352	0	352
Total	531	13	544	911	66	977
East Leg						
Approach	124	0	124	69	0	69
Departure	25	2	27	104	8	112
Total	149	2	151	173	8	181
West Leg						
Approach	5	0	5	9	0	9
Departure	12	0	12	5	0	5
Total	17	0	17	14	0	14
Total Approaches						
Approach	595	13	608	1,006	66	1,072
Departure	595	13	608	1,006	66	1,072
Total	1,190	26	1,216	2,012	132	2,144

Table C-4 - Existing Peak Hour PCE Volume Summary

	AM Peak Hour			PM Peak Hour		
	Existing Without Project	Project Trips	Existing With Project	Existing Without Project	Project Trips	Existing With Project
2 Old 215 Frontage Rd/Bay Ave						
NBL	25	3	28	14	16	30
NBT	290	12	302	441	66	507
NBR	8	1	9	30	5	35
SBL	16	0	16	57	0	57
SBT	168	0	168	369	0	369
SBR	7	0	7	1	0	1
EBL	4	0	4	12	0	12
EBT	1	0	1	1	0	1
EBR	12	0	12	21	0	21
WBL	44	0	44	17	0	17
WBT	1	0	1	0	0	0
WBR	31	0	31	15	0	15
North Leg						
Approach	191	0	191	427	0	427
Departure	325	12	337	468	66	534
Total	516	12	528	895	66	961
South Leg						
Approach	323	16	339	485	87	572
Departure	224	0	224	407	0	407
Total	547	16	563	892	87	979
East Leg						
Approach	76	0	76	32	0	32
Departure	25	1	26	88	5	93
Total	101	1	102	120	5	125
West Leg						
Approach	17	0	17	34	0	34
Departure	33	3	36	15	16	31
Total	50	3	53	49	16	65
Total Approaches						
Approach	607	16	623	978	87	1,065
Departure	607	16	623	978	87	1,065
Total	1,214	32	1,246	1,956	174	2,130

Table C-4 - Existing Peak Hour PCE Volume Summary

	AM Peak Hour			PM Peak Hour		
	Existing Without Project	Project Trips	Existing With Project	Existing Without Project	Project Trips	Existing With Project
3 Old 215 Frontage Rd/Driveway 1						
NBL	0	0	0	0	0	0
NBT	323	10	333	485	53	538
NBR	0	40	40	0	8	8
SBL	0	0	0	0	0	0
SBT	224	3	227	407	16	423
SBR	0	0	0	0	0	0
EBL	0	0	0	0	0	0
EBT	0	0	0	0	0	0
EBR	0	0	0	0	0	0
WBL	0	0	0	0	0	0
WBT	0	0	0	0	0	0
WBR	0	7	7	0	36	36
North Leg						
Approach	224	3	227	407	16	423
Departure	323	17	340	485	89	574
Total	547	20	567	892	105	997
South Leg						
Approach	323	50	373	485	61	546
Departure	224	3	227	407	16	423
Total	547	53	600	892	77	969
East Leg						
Approach	0	7	7	0	36	36
Departure	0	40	40	0	8	8
Total	0	47	47	0	44	44
West Leg						
Approach	0	0	0	0	0	0
Departure	0	0	0	0	0	0
Total	0	0	0	0	0	0
Total Approaches						
Approach	547	60	607	892	113	1,005
Departure	547	60	607	892	113	1,005
Total	1,094	120	1,214	1,784	226	2,010

Table C-4 - Existing Peak Hour PCE Volume Summary

	AM Peak Hour			PM Peak Hour		
	Existing Without Project	Project Trips	Existing With Project	Existing Without Project	Project Trips	Existing With Project
4 Old 215 Frontage Rd/Driveway 2						
NBL	0	0	0	0	0	0
NBT	323	40	363	485	8	493
NBR	0	61	61	0	11	11
SBL	0	0	0	0	0	0
SBT	224	3	227	407	16	423
SBR	0	0	0	0	0	0
EBL	0	0	0	0	0	0
EBT	0	0	0	0	0	0
EBR	0	0	0	0	0	0
WBL	0	0	0	0	0	0
WBT	0	0	0	0	0	0
WBR	0	10	10	0	53	53
North Leg						
Approach	224	3	227	407	16	423
Departure	323	50	373	485	61	546
Total	547	53	600	892	77	969
South Leg						
Approach	323	101	424	485	19	504
Departure	224	3	227	407	16	423
Total	547	104	651	892	35	927
East Leg						
Approach	0	10	10	0	53	53
Departure	0	61	61	0	11	11
Total	0	71	71	0	64	64
West Leg						
Approach	0	0	0	0	0	0
Departure	0	0	0	0	0	0
Total	0	0	0	0	0	0
Total Approaches						
Approach	547	114	661	892	88	980
Departure	547	114	661	892	88	980
Total	1,094	228	1,322	1,784	176	1,960

Table C-4 - Existing Peak Hour PCE Volume Summary

	AM Peak Hour			PM Peak Hour		
	Existing Without Project	Project Trips	Existing With Project	Existing Without Project	Project Trips	Existing With Project
5 Old 215 Frontage Rd/Alessandro Blvd						
NBL	32	0	32	49	0	49
NBT	144	0	144	123	0	123
NBR	11	0	11	12	0	12
SBL	22	1	23	58	5	63
SBT	34	0	34	115	0	115
SBR	143	2	145	200	11	211
EBL	174	79	253	318	13	331
EBT	547	0	547	1,245	0	1,245
EBR	22	0	22	90	0	90
WBL	8	0	8	4	0	4
WBT	613	0	613	671	0	671
WBR	40	21	61	67	4	71
North Leg						
Approach	199	3	202	373	16	389
Departure	358	100	458	508	17	525
Total	557	103	660	881	33	914
South Leg						
Approach	187	0	187	184	0	184
Departure	64	0	64	209	0	209
Total	251	0	251	393	0	393
East Leg						
Approach	661	21	682	742	4	746
Departure	580	1	581	1,315	5	1,320
Total	1,241	22	1,263	2,057	9	2,066
West Leg						
Approach	743	79	822	1,653	13	1,666
Departure	788	2	790	920	11	931
Total	1,531	81	1,612	2,573	24	2,597
Total Approaches						
Approach	1,790	103	1,893	2,952	33	2,985
Departure	1,790	103	1,893	2,952	33	2,985
Total	3,580	206	3,786	5,904	66	5,970



Table C-5 - Project Completion Peak Hour Volume Summary

	AM Peak Hour							PM Peak Hour						
	Exist Volumes	Growth	OY Background	Cumul. Project Trips	OY NP	Project Trips	OY WP	Exist Volumes	Growth	OY Background	Cumul. Project Trips	OY NP	Project Trips	OY WP
1 . Old 215 Frontage Rd/Cottonwood Ave														
NBL	8	0	8	11	19	0	19	5	0	5	5	10	0	10
NBT	328	13	341	6	347	11	358	504	20	524	23	547	58	605
NBR	11	0	11	0	11	2	13	50	2	52	0	52	8	60
SBL	12	0	12	0	12	0	12	53	2	55	0	55	0	55
SBT	106	4	110	26	136	0	136	316	13	329	12	341	0	341
SBR	1	0	1	23	24	0	24	0	0	0	7	7	0	7
EBL	3	0	3	9	12	0	12	6	0	6	30	36	0	36
EBT	2	0	2	0	2	0	2	1	0	1	0	1	0	1
EBR	0	0	0	2	2	0	2	2	0	2	8	10	0	10
WBL	78	3	81	0	81	0	81	34	1	35	0	35	0	35
WBT	3	0	3	0	3	0	3	0	0	0	0	0	0	0
WBR	43	2	45	0	45	0	45	35	1	36	0	36	0	36
North Leg														
Approach	119	4	123	49	172	0	172	369	15	384	19	403	0	403
Departure	374	15	389	15	404	11	415	545	21	566	53	619	58	677
Total	493	19	512	64	576	11	587	914	36	950	72	1,022	58	1,080
South Leg														
Approach	347	13	360	17	377	13	390	559	22	581	28	609	66	675
Departure	184	7	191	28	219	0	219	352	14	366	20	386	0	386
Total	531	20	551	45	596	13	609	911	36	947	48	995	66	1,061
East Leg														
Approach	124	5	129	0	129	0	129	69	2	71	0	71	0	71
Departure	25	0	25	0	25	2	27	104	4	108	0	108	8	116
Total	149	5	154	0	154	2	156	173	6	179	0	179	8	187
West Leg														
Approach	5	0	5	11	16	0	16	9	0	9	38	47	0	47
Departure	12	0	12	34	46	0	46	5	0	5	12	17	0	17
Total	17	0	17	45	62	0	62	14	0	14	50	64	0	64
Total Approaches														
Approach	595	22	617	77	694	13	707	1,006	39	1,045	85	1,130	66	1,196
Departure	595	22	617	77	694	13	707	1,006	39	1,045	85	1,130	66	1,196
Total	1,190	44	1,234	154	1,388	26	1,414	2,012	78	2,090	170	2,260	132	2,392

Table C-5 - Project Completion Peak Hour Volume Summary

	AM Peak Hour							PM Peak Hour						
	Exist Volumes	Growth	OY Background	Cumul. Project Trips	OY NP	Project Trips	OY WP	Exist Volumes	Growth	OY Background	Cumul. Project Trips	OY NP	Project Trips	OY WP
2 Old 215 Frontage Rd/Bay Ave														
NBL	25	1	26	21	47	3	50	14	1	15	7	22	16	38
NBT	290	12	302	15	317	12	329	441	18	459	20	479	66	545
NBR	8	0	8	0	8	1	9	30	1	31	0	31	5	36
SBL	16	1	17	0	17	0	17	57	2	59	0	59	0	59
SBT	168	7	175	20	195	0	195	369	15	384	18	402	0	402
SBR	7	0	7	8	15	0	15	1	0	1	3	4	0	4
EBL	4	0	4	2	6	0	6	12	0	12	8	20	0	20
EBT	1	0	1	0	1	0	1	1	0	1	0	1	0	1
EBR	12	0	12	2	14	0	14	21	1	22	7	29	0	29
WBL	44	2	46	0	46	0	46	17	1	18	0	18	0	18
WBT	1	0	1	0	1	0	1	0	0	0	0	0	0	0
WBR	31	1	32	0	32	0	32	15	1	16	0	16	0	16
North Leg														
Approach	191	8	199	28	227	0	227	427	17	444	21	465	0	465
Departure	325	13	338	17	355	12	367	468	19	487	28	515	66	581
Total	516	21	537	45	582	12	594	895	36	931	49	980	66	1,046
South Leg														
Approach	323	13	336	36	372	16	388	485	20	505	27	532	87	619
Departure	224	9	233	22	255	0	255	407	17	424	25	449	0	449
Total	547	22	569	58	627	16	643	892	37	929	52	981	87	1,068
East Leg														
Approach	76	3	79	0	79	0	79	32	2	34	0	34	0	34
Departure	25	1	26	0	26	1	27	88	3	91	0	91	5	96
Total	101	4	105	0	105	1	106	120	5	125	0	125	5	130
West Leg														
Approach	17	0	17	4	21	0	21	34	1	35	15	50	0	50
Departure	33	1	34	29	63	3	66	15	1	16	10	26	16	42
Total	50	1	51	33	84	3	87	49	2	51	25	76	16	92
Total Approaches														
Approach	607	24	631	68	699	16	715	978	40	1,018	63	1,081	87	1,168
Departure	607	24	631	68	699	16	715	978	40	1,018	63	1,081	87	1,168
Total	1,214	48	1,262	136	1,398	32	1,430	1,956	80	2,036	126	2,162	174	2,336



Table C-5 - Project Completion Peak Hour Volume Summary

	AM Peak Hour							PM Peak Hour						
	Exist Volumes	Growth	OY Background	Cumul. Project Trips	OY NP	Project Trips	OY WP	Exist Volumes	Growth	OY Background	Cumul. Project Trips	OY NP	Project Trips	OY WP
3 Old 215 Frontage Rd/Driveway 1														
NBL	0	0	0	0	0	0	0	0	0	0	0	0	0	0
NBT	323	13	336	36	372	10	382	485	19	504	27	531	53	584
NBR	0	0	0	0	0	40	40	0	0	0	0	0	8	8
SBL	0	0	0	0	0	0	0	0	0	0	0	0	0	0
SBT	224	9	233	24	257	3	260	407	16	423	39	462	16	478
SBR	0	0	0	0	0	0	0	0	0	0	0	0	0	0
EBL	0	0	0	0	0	0	0	0	0	0	0	0	0	0
EBT	0	0	0	0	0	0	0	0	0	0	0	0	0	0
EBR	0	0	0	0	0	0	0	0	0	0	0	0	0	0
WBL	0	0	0	0	0	0	0	0	0	0	0	0	0	0
WBT	0	0	0	0	0	0	0	0	0	0	0	0	0	0
WBR	0	0	0	0	0	7	7	0	0	0	0	0	36	36
North Leg														
Approach	224	9	233	24	257	3	260	407	16	423	39	462	16	478
Departure	323	13	336	36	372	17	389	485	19	504	27	531	89	620
Total	547	22	569	60	629	20	649	892	35	927	66	993	105	1,098
South Leg														
Approach	323	13	336	36	372	50	422	485	19	504	27	531	61	592
Departure	224	9	233	24	257	3	260	407	16	423	39	462	16	478
Total	547	22	569	60	629	53	682	892	35	927	66	993	77	1,070
East Leg														
Approach	0	0	0	0	0	7	7	0	0	0	0	0	36	36
Departure	0	0	0	0	0	40	40	0	0	0	0	0	8	8
Total	0	0	0	0	0	47	47	0	0	0	0	0	44	44
West Leg														
Approach	0	0	0	0	0	0	0	0	0	0	0	0	0	0
Departure	0	0	0	0	0	0	0	0	0	0	0	0	0	0
Total	0	0	0	0	0	0	0	0	0	0	0	0	0	0
Total Approaches														
Approach	547	22	569	60	629	60	689	892	35	927	66	993	113	1,106
Departure	547	22	569	60	629	60	689	892	35	927	66	993	113	1,106
Total	1,094	44	1,138	120	1,258	120	1,378	1,784	70	1,854	132	1,986	226	2,212



Table C-5 - Project Completion Peak Hour Volume Summary

	AM Peak Hour							PM Peak Hour						
	Exist Volumes	Growth	OY Background	Cumul. Project Trips	OY NP	Project Trips	OY WP	Exist Volumes	Growth	OY Background	Cumul. Project Trips	OY NP	Project Trips	OY WP
4 Old 215 Frontage Rd/Driveway 2														
NBL	0	0	0	0	0	0	0	0	0	0	0	0	0	0
NBT	323	13	336	36	372	40	412	485	19	504	27	531	8	539
NBR	0	0	0	0	0	61	61	0	0	0	0	0	11	11
SBL	0	0	0	0	0	0	0	0	0	0	0	0	0	0
SBT	224	9	233	24	257	3	260	407	16	423	39	462	16	478
SBR	0	0	0	0	0	0	0	0	0	0	0	0	0	0
EBL	0	0	0	0	0	0	0	0	0	0	0	0	0	0
EBT	0	0	0	0	0	0	0	0	0	0	0	0	0	0
EBR	0	0	0	0	0	0	0	0	0	0	0	0	0	0
WBL	0	0	0	0	0	0	0	0	0	0	0	0	0	0
WBT	0	0	0	0	0	0	0	0	0	0	0	0	0	0
WBR	0	0	0	0	0	10	10	0	0	0	0	0	53	53
North Leg														
Approach	224	9	233	24	257	3	260	407	16	423	39	462	16	478
Departure	323	13	336	36	372	50	422	485	19	504	27	531	61	592
Total	547	22	569	60	629	53	682	892	35	927	66	993	77	1,070
South Leg														
Approach	323	13	336	36	372	101	473	485	19	504	27	531	19	550
Departure	224	9	233	24	257	3	260	407	16	423	39	462	16	478
Total	547	22	569	60	629	104	733	892	35	927	66	993	35	1,028
East Leg														
Approach	0	0	0	0	0	10	10	0	0	0	0	0	53	53
Departure	0	0	0	0	0	61	61	0	0	0	0	0	11	11
Total	0	0	0	0	0	71	71	0	0	0	0	0	64	64
West Leg														
Approach	0	0	0	0	0	0	0	0	0	0	0	0	0	0
Departure	0	0	0	0	0	0	0	0	0	0	0	0	0	0
Total	0	0	0	0	0	0	0	0	0	0	0	0	0	0
Total Approaches														
Approach	547	22	569	60	629	114	743	892	35	927	66	993	88	1,081
Departure	547	22	569	60	629	114	743	892	35	927	66	993	88	1,081
Total	1,094	44	1,138	120	1,258	228	1,486	1,784	70	1,854	132	1,986	176	2,162



Table C-5 - Project Completion Peak Hour Volume Summary

	AM Peak Hour							PM Peak Hour						
	Exist Volumes	Growth	OY Background	Cumul. Project Trips	OY NP	Project Trips	OY WP	Exist Volumes	Growth	OY Background	Cumul. Project Trips	OY NP	Project Trips	OY WP
5 Old 215 Frontage Rd/Alessandro Blvd														
NBL	32	1	33	22	55	0	55	49	2	51	68	119	0	119
NBT	144	6	150	2	152	0	152	123	5	128	9	137	0	137
NBR	11	0	11	3	14	0	14	12	0	12	13	25	0	25
SBL	22	1	23	2	25	1	26	58	2	60	10	70	5	75
SBT	34	1	35	10	45	0	45	115	5	120	2	122	0	122
SBR	143	6	149	15	164	2	166	200	8	208	27	235	11	246
EBL	174	7	181	26	207	79	286	318	13	331	19	350	13	363
EBT	547	22	569	35	604	0	604	1,245	50	1295	59	1354	0	1354
EBR	22	1	23	59	82	0	82	90	4	94	26	120	0	120
WBL	8	0	8	11	19	0	19	4	0	4	2	6	0	6
WBT	613	25	638	60	698	0	698	671	27	698	39	737	0	737
WBR	40	2	42	9	51	21	72	67	3	70	4	74	4	78
North Leg														
Approach	199	8	207	27	234	3	237	373	15	388	39	427	16	443
Departure	358	15	373	37	410	100	510	508	21	529	32	561	17	578
Total	557	23	580	64	644	103	747	881	36	917	71	988	33	1,021
South Leg														
Approach	187	7	194	27	221	0	221	184	7	191	90	281	0	281
Departure	64	2	66	80	146	0	146	209	9	218	30	248	0	248
Total	251	9	260	107	367	0	367	393	16	409	120	529	0	529
East Leg														
Approach	661	27	688	80	768	21	789	742	30	772	45	817	4	821
Departure	580	23	603	40	643	1	644	1,315	52	1,367	82	1,449	5	1,454
Total	1,241	50	1,291	120	1,411	22	1,433	2,057	82	2,139	127	2,266	9	2,275
West Leg														
Approach	743	30	773	120	893	79	972	1,653	67	1,720	104	1,824	13	1,837
Departure	788	32	820	97	917	2	919	920	37	957	134	1,091	11	1,102
Total	1,531	62	1,593	217	1,810	81	1,891	2,573	104	2,677	238	2,915	24	2,939
Total Approaches														
Approach	1,790	72	1,862	254	2,116	103	2,219	2,952	119	3,071	278	3,349	33	3,382
Departure	1,790	72	1,862	254	2,116	103	2,219	2,952	119	3,071	278	3,349	33	3,382
Total	3,580	144	3,724	508	4,232	206	4,438	5,904	238	6,142	556	6,698	66	6,764

APPENDIX D: LEVEL OF SERVICE WORKSHEETS

HCM 6th TWSC
1: Old 215 Frontage Rd & Cottonwood Ave

07/21/2021

Intersection												
Int Delay, s/veh	3.1											
Movement	EBL	EBT	EBR	WBL	WBT	WBR	NBL	NBT	NBR	SBL	SBT	SBR
Lane Configurations		↔			↔		↗	↑↑	↗	↗	↑↑	↗
Traffic Vol, veh/h	3	2	0	78	3	43	8	328	11	12	106	1
Future Vol, veh/h	3	2	0	78	3	43	8	328	11	12	106	1
Conflicting Peds, #/hr	0	0	0	0	0	0	0	0	0	0	0	0
Sign Control	Stop	Stop	Stop	Stop	Stop	Stop	Free	Free	Free	Free	Free	Free
RT Channelized	-	-	None	-	-	None	-	-	None	-	-	None
Storage Length	-	-	-	-	-	-	235	-	50	435	-	50
Veh in Median Storage, #	-	0	-	-	0	-	-	0	-	-	0	-
Grade, %	-	0	-	-	0	-	-	0	-	-	0	-
Peak Hour Factor	95	95	95	95	95	95	95	95	95	95	95	95
Heavy Vehicles, %	0	0	0	0	0	0	0	0	0	0	0	0
Mvmt Flow	3	2	0	82	3	45	8	345	12	13	112	1

Major/Minor	Minor2		Minor1			Major1			Major2			
Conflicting Flow All	328	511	56	444	500	173	113	0	0	357	0	0
Stage 1	138	138	-	361	361	-	-	-	-	-	-	-
Stage 2	190	373	-	83	139	-	-	-	-	-	-	-
Critical Hdwy	7.5	6.5	6.9	7.5	6.5	6.9	4.1	-	-	4.1	-	-
Critical Hdwy Stg 1	6.5	5.5	-	6.5	5.5	-	-	-	-	-	-	-
Critical Hdwy Stg 2	6.5	5.5	-	6.5	5.5	-	-	-	-	-	-	-
Follow-up Hdwy	3.5	4	3.3	3.5	4	3.3	2.2	-	-	2.2	-	-
Pot Cap-1 Maneuver	607	469	1005	502	476	847	1489	-	-	1213	-	-
Stage 1	857	786	-	636	629	-	-	-	-	-	-	-
Stage 2	799	622	-	922	785	-	-	-	-	-	-	-
Platoon blocked, %								-	-	-	-	-
Mov Cap-1 Maneuver	565	461	1005	494	468	847	1489	-	-	1213	-	-
Mov Cap-2 Maneuver	565	461	-	494	468	-	-	-	-	-	-	-
Stage 1	853	777	-	633	626	-	-	-	-	-	-	-
Stage 2	748	619	-	910	776	-	-	-	-	-	-	-

Approach	EB		WB			NB			SB		
HCM Control Delay, s	12		13.1			0.2			0.8		
HCM LOS	B		B								

Minor Lane/Major Mvmt	NBL	NBT	NBR	EBLn1WBLn1	SBL	SBT	SBR
Capacity (veh/h)	1489	-	-	518	577	1213	-
HCM Lane V/C Ratio	0.006	-	-	0.01	0.226	0.01	-
HCM Control Delay (s)	7.4	-	-	12	13.1	8	-
HCM Lane LOS	A	-	-	B	B	A	-
HCM 95th %tile Q(veh)	0	-	-	0	0.9	0	-

HCM 6th TWSC
2: Old 215 Frontage Rd & Bay Ave

07/21/2021

Intersection												
Int Delay, s/veh	2.3											
Movement	EBL	EBT	EBR	WBL	WBT	WBR	NBL	NBT	NBR	SBL	SBT	SBR
Lane Configurations		↕			↕		↗	↕	↗	↗	↗	↗
Traffic Vol, veh/h	4	1	12	44	1	31	25	290	8	16	168	7
Future Vol, veh/h	4	1	12	44	1	31	25	290	8	16	168	7
Conflicting Peds, #/hr	0	0	0	0	0	0	0	0	0	0	0	0
Sign Control	Stop	Stop	Stop	Stop	Stop	Stop	Free	Free	Free	Free	Free	Free
RT Channelized	-	-	None	-	-	None	-	-	None	-	-	None
Storage Length	-	-	-	-	-	-	225	-	50	450	-	50
Veh in Median Storage, #	-	0	-	-	0	-	-	0	-	-	0	-
Grade, %	-	0	-	-	0	-	-	0	-	-	0	-
Peak Hour Factor	99	99	99	99	99	99	99	99	99	99	99	99
Heavy Vehicles, %	0	0	0	0	0	0	0	0	0	0	0	0
Mvmt Flow	4	1	12	44	1	31	25	293	8	16	170	7

Major/Minor	Minor2		Minor1		Major1		Major2					
Conflicting Flow All	399	553	85	461	552	147	177	0	0	301	0	0
Stage 1	202	202	-	343	343	-	-	-	-	-	-	-
Stage 2	197	351	-	118	209	-	-	-	-	-	-	-
Critical Hdwy	7.5	6.5	6.9	7.5	6.5	6.9	4.1	-	-	4.1	-	-
Critical Hdwy Stg 1	6.5	5.5	-	6.5	5.5	-	-	-	-	-	-	-
Critical Hdwy Stg 2	6.5	5.5	-	6.5	5.5	-	-	-	-	-	-	-
Follow-up Hdwy	3.5	4	3.3	3.5	4	3.3	2.2	-	-	2.2	-	-
Pot Cap-1 Maneuver	540	444	963	488	444	880	1411	-	-	1272	-	-
Stage 1	787	738	-	651	641	-	-	-	-	-	-	-
Stage 2	792	636	-	880	733	-	-	-	-	-	-	-
Platoon blocked, %								-	-	-	-	-
Mov Cap-1 Maneuver	508	430	963	470	430	880	1411	-	-	1272	-	-
Mov Cap-2 Maneuver	508	430	-	470	430	-	-	-	-	-	-	-
Stage 1	773	728	-	639	629	-	-	-	-	-	-	-
Stage 2	749	625	-	857	723	-	-	-	-	-	-	-

Approach	EB		WB		NB		SB			
HCM Control Delay, s	9.9		12.2		0.6		0.7			
HCM LOS	A		B							

Minor Lane/Major Mvmt	NBL	NBT	NBR	EBLn1	WBLn1	SBL	SBT	SBR
Capacity (veh/h)	1411	-	-	750	579	1272	-	-
HCM Lane V/C Ratio	0.018	-	-	0.023	0.133	0.013	-	-
HCM Control Delay (s)	7.6	-	-	9.9	12.2	7.9	-	-
HCM Lane LOS	A	-	-	A	B	A	-	-
HCM 95th %tile Q(veh)	0.1	-	-	0.1	0.5	0	-	-

HCM 6th Signalized Intersection Summary

5: Old 215 Frontage Rd & Alessandro Blvd

07/21/2021



Movement	EBL	EBT	EBR	WBL	WBT	WBR	NBL	NBT	NBR	SBL	SBT	SBR
Lane Configurations	↖↗	↑↑↑	↖	↖	↑↑	↖	↖↗	↑↑	↖	↖	↑↑	↖
Traffic Volume (veh/h)	174	547	22	8	613	40	32	144	11	22	34	143
Future Volume (veh/h)	174	547	22	8	613	40	32	144	11	22	34	143
Initial Q (Qb), veh	0	0	0	0	0	0	0	0	0	0	0	0
Ped-Bike Adj(A_pbT)	1.00		1.00	1.00		1.00	1.00		1.00	1.00		1.00
Parking Bus, Adj	1.00	1.00	1.00	1.00	1.00	1.00	1.00	1.00	1.00	1.00	1.00	1.00
Work Zone On Approach		No			No			No			No	
Adj Sat Flow, veh/h/ln	1900	1900	1900	1900	1900	1900	1900	1900	1900	1900	1900	1900
Adj Flow Rate, veh/h	179	564	23	8	632	0	33	148	11	23	35	0
Peak Hour Factor	0.97	0.97	0.97	0.97	0.97	0.97	0.97	0.97	0.97	0.97	0.97	0.97
Percent Heavy Veh, %	0	0	0	0	0	0	0	0	0	0	0	0
Cap, veh/h	301	2482	771	26	1469		160	835	372	137	945	
Arrive On Green	0.09	0.48	0.48	0.01	0.41	0.00	0.05	0.23	0.23	0.08	0.26	0.00
Sat Flow, veh/h	3510	5187	1610	1810	3610	1610	3510	3610	1610	1810	3610	1610
Grp Volume(v), veh/h	179	564	23	8	632	0	33	148	11	23	35	0
Grp Sat Flow(s),veh/h/ln	1755	1729	1610	1810	1805	1610	1755	1805	1610	1810	1805	1610
Q Serve(g_s), s	3.9	5.1	0.6	0.4	10.1	0.0	0.7	2.6	0.4	1.0	0.6	0.0
Cycle Q Clear(g_c), s	3.9	5.1	0.6	0.4	10.1	0.0	0.7	2.6	0.4	1.0	0.6	0.0
Prop In Lane	1.00		1.00	1.00		1.00	1.00		1.00	1.00		1.00
Lane Grp Cap(c), veh/h	301	2482	771	26	1469		160	835	372	137	945	
V/C Ratio(X)	0.59	0.23	0.03	0.31	0.43		0.21	0.18	0.03	0.17	0.04	
Avail Cap(c_a), veh/h	307	2482	771	158	1469		307	835	372	418	1354	
HCM Platoon Ratio	1.00	1.00	1.00	1.00	1.00	1.00	1.00	1.00	1.00	1.00	1.00	1.00
Upstream Filter(I)	1.00	1.00	1.00	1.00	1.00	0.00	1.00	1.00	1.00	1.00	1.00	0.00
Uniform Delay (d), s/veh	35.2	12.2	11.0	39.0	17.1	0.0	36.8	24.6	23.8	34.6	22.0	0.0
Incr Delay (d2), s/veh	3.0	0.2	0.1	6.6	0.2	0.0	0.6	0.5	0.1	0.6	0.0	0.0
Initial Q Delay(d3),s/veh	0.0	0.0	0.0	0.0	0.0	0.0	0.0	0.0	0.0	0.0	0.0	0.0
%ile BackOfQ(50%),veh/ln	1.8	1.9	0.2	0.2	4.0	0.0	0.3	1.1	0.2	0.4	0.2	0.0
Unsig. Movement Delay, s/veh												
LnGrp Delay(d),s/veh	38.2	12.4	11.1	45.7	17.3	0.0	37.4	25.1	23.9	35.2	22.0	0.0
LnGrp LOS	D	B	B	D	B		D	C	C	D	C	
Approach Vol, veh/h		766			640	A		192			58	A
Approach Delay, s/veh		18.4			17.6			27.2			27.2	
Approach LOS		B			B			C			C	
Timer - Assigned Phs	1	2	3	4	5	6	7	8				
Phs Duration (G+Y+Rc), s	5.1	42.3	7.6	24.9	10.9	36.6	10.1	22.5				
Change Period (Y+Rc), s	4.0	4.0	4.0	4.0	4.0	4.0	4.0	4.0				
Max Green Setting (Gmax), s	7.0	20.0	7.0	30.0	7.0	20.0	18.5	18.5				
Max Q Clear Time (g_c+I1), s	2.4	7.1	2.7	2.6	5.9	12.1	3.0	4.6				
Green Ext Time (p_c), s	0.0	3.2	0.0	0.1	0.1	2.6	0.0	0.7				

Intersection Summary

HCM 6th Ctrl Delay	19.4
HCM 6th LOS	B

Notes

Unsignalized Delay for [WBR, SBR] is excluded from calculations of the approach delay and intersection delay.

HCM 6th TWSC
1: Old 215 Frontage Rd & Cottonwood Ave

07/21/2021

Intersection												
Int Delay, s/veh	1.9											
Movement	EBL	EBT	EBR	WBL	WBT	WBR	NBL	NBT	NBR	SBL	SBT	SBR
Lane Configurations		↕			↕		↗	↕	↗	↗	↕	↗
Traffic Vol, veh/h	6	1	2	34	0	35	5	504	50	53	316	0
Future Vol, veh/h	6	1	2	34	0	35	5	504	50	53	316	0
Conflicting Peds, #/hr	0	0	0	0	0	0	0	0	0	0	0	0
Sign Control	Stop	Stop	Stop	Stop	Stop	Stop	Free	Free	Free	Free	Free	Free
RT Channelized	-	-	None	-	-	None	-	-	None	-	-	None
Storage Length	-	-	-	-	-	-	235	-	50	435	-	50
Veh in Median Storage, #	-	0	-	-	0	-	-	0	-	-	0	-
Grade, %	-	0	-	-	0	-	-	0	-	-	0	-
Peak Hour Factor	91	91	91	91	91	91	91	91	91	91	91	91
Heavy Vehicles, %	0	0	0	0	0	0	0	0	0	0	0	0
Mvmt Flow	7	1	2	37	0	38	5	554	55	58	347	0

Major/Minor	Minor2		Minor1		Major1		Major2					
Conflicting Flow All	750	1082	174	854	1027	277	347	0	0	609	0	0
Stage 1	463	463	-	564	564	-	-	-	-	-	-	-
Stage 2	287	619	-	290	463	-	-	-	-	-	-	-
Critical Hdwy	7.5	6.5	6.9	7.5	6.5	6.9	4.1	-	-	4.1	-	-
Critical Hdwy Stg 1	6.5	5.5	-	6.5	5.5	-	-	-	-	-	-	-
Critical Hdwy Stg 2	6.5	5.5	-	6.5	5.5	-	-	-	-	-	-	-
Follow-up Hdwy	3.5	4	3.3	3.5	4	3.3	2.2	-	-	2.2	-	-
Pot Cap-1 Maneuver	304	219	846	256	236	726	1223	-	-	979	-	-
Stage 1	554	568	-	483	512	-	-	-	-	-	-	-
Stage 2	702	483	-	699	568	-	-	-	-	-	-	-
Platoon blocked, %								-	-	-	-	-
Mov Cap-1 Maneuver	274	205	846	242	221	726	1223	-	-	979	-	-
Mov Cap-2 Maneuver	274	205	-	242	221	-	-	-	-	-	-	-
Stage 1	552	534	-	481	510	-	-	-	-	-	-	-
Stage 2	662	481	-	655	534	-	-	-	-	-	-	-

Approach	EB		WB		NB		SB	
HCM Control Delay, s	17		17.4		0.1		1.3	
HCM LOS	C		C					

Minor Lane/Major Mvmt	NBL	NBT	NBR	EBLn1WBLn1	SBL	SBT	SBR
Capacity (veh/h)	1223	-	-	309	366	979	-
HCM Lane V/C Ratio	0.004	-	-	0.032	0.207	0.059	-
HCM Control Delay (s)	8	-	-	17	17.4	8.9	-
HCM Lane LOS	A	-	-	C	C	A	-
HCM 95th %tile Q(veh)	0	-	-	0.1	0.8	0.2	-

HCM 6th TWSC
2: Old 215 Frontage Rd & Bay Ave

07/21/2021

Intersection												
Int Delay, s/veh	1.7											
Movement	EBL	EBT	EBR	WBL	WBT	WBR	NBL	NBT	NBR	SBL	SBT	SBR
Lane Configurations		↕			↕		↕	↑↑	↕	↕	↑↑	↕
Traffic Vol, veh/h	12	1	21	17	0	15	14	441	30	57	369	1
Future Vol, veh/h	12	1	21	17	0	15	14	441	30	57	369	1
Conflicting Peds, #/hr	0	0	0	0	0	0	0	0	0	0	0	0
Sign Control	Stop	Stop	Stop	Stop	Stop	Stop	Free	Free	Free	Free	Free	Free
RT Channelized	-	-	None	-	-	None	-	-	None	-	-	None
Storage Length	-	-	-	-	-	-	225	-	50	450	-	50
Veh in Median Storage, #	-	0	-	-	0	-	-	0	-	-	0	-
Grade, %	-	0	-	-	0	-	-	0	-	-	0	-
Peak Hour Factor	85	85	85	85	85	85	85	85	85	85	85	85
Heavy Vehicles, %	0	0	0	0	0	0	0	0	0	0	0	0
Mvmt Flow	14	1	25	20	0	18	16	519	35	67	434	1

Major/Minor	Minor2		Minor1		Major1			Major2				
Conflicting Flow All	860	1154	217	903	1120	260	435	0	0	554	0	0
Stage 1	568	568	-	551	551	-	-	-	-	-	-	-
Stage 2	292	586	-	352	569	-	-	-	-	-	-	-
Critical Hdwy	7.5	6.5	6.9	7.5	6.5	6.9	4.1	-	-	4.1	-	-
Critical Hdwy Stg 1	6.5	5.5	-	6.5	5.5	-	-	-	-	-	-	-
Critical Hdwy Stg 2	6.5	5.5	-	6.5	5.5	-	-	-	-	-	-	-
Follow-up Hdwy	3.5	4	3.3	3.5	4	3.3	2.2	-	-	2.2	-	-
Pot Cap-1 Maneuver	253	199	794	236	208	745	1135	-	-	1026	-	-
Stage 1	480	510	-	491	519	-	-	-	-	-	-	-
Stage 2	697	500	-	643	509	-	-	-	-	-	-	-
Platoon blocked, %								-	-	-	-	-
Mov Cap-1 Maneuver	232	183	794	214	192	745	1135	-	-	1026	-	-
Mov Cap-2 Maneuver	232	183	-	214	192	-	-	-	-	-	-	-
Stage 1	473	477	-	484	512	-	-	-	-	-	-	-
Stage 2	671	493	-	581	476	-	-	-	-	-	-	-

Approach	EB		WB		NB		SB	
HCM Control Delay, s	14.8		17.7		0.2		1.2	
HCM LOS	B		C					

Minor Lane/Major Mvmt	NBL	NBT	NBR	EBLn1WBLn1	SBL	SBT	SBR
Capacity (veh/h)	1135	-	-	407	321	1026	-
HCM Lane V/C Ratio	0.015	-	-	0.098	0.117	0.065	-
HCM Control Delay (s)	8.2	-	-	14.8	17.7	8.8	-
HCM Lane LOS	A	-	-	B	C	A	-
HCM 95th %tile Q(veh)	0	-	-	0.3	0.4	0.2	-

HCM 6th Signalized Intersection Summary
5: Old 215 Frontage Rd & Alessandro Blvd

07/21/2021



Movement	EBL	EBT	EBR	WBL	WBT	WBR	NBL	NBT	NBR	SBL	SBT	SBR
Lane Configurations	↶↷	↶↷↶	↷	↶	↶↷	↷	↶↷	↶↷	↷	↶	↶↷	↷
Traffic Volume (veh/h)	318	1245	90	4	671	67	49	123	12	58	115	200
Future Volume (veh/h)	318	1245	90	4	671	67	49	123	12	58	115	200
Initial Q (Qb), veh	0	0	0	0	0	0	0	0	0	0	0	0
Ped-Bike Adj(A_pbT)	1.00		1.00	1.00		1.00	1.00		1.00	1.00		1.00
Parking Bus, Adj	1.00	1.00	1.00	1.00	1.00	1.00	1.00	1.00	1.00	1.00	1.00	1.00
Work Zone On Approach		No			No			No			No	
Adj Sat Flow, veh/h/ln	1900	1900	1900	1900	1900	1900	1900	1900	1900	1900	1900	1900
Adj Flow Rate, veh/h	338	1324	96	4	714	0	52	131	13	62	122	0
Peak Hour Factor	0.94	0.94	0.94	0.94	0.94	0.94	0.94	0.94	0.94	0.94	0.94	0.94
Percent Heavy Veh, %	0	0	0	0	0	0	0	0	0	0	0	0
Cap, veh/h	351	2460	764	13	1378		210	835	372	157	933	
Arrive On Green	0.10	0.47	0.47	0.01	0.38	0.00	0.06	0.23	0.23	0.09	0.26	0.00
Sat Flow, veh/h	3510	5187	1610	1810	3610	1610	3510	3610	1610	1810	3610	1610
Grp Volume(v), veh/h	338	1324	96	4	714	0	52	131	13	62	122	0
Grp Sat Flow(s),veh/h/ln	1755	1729	1610	1810	1805	1610	1755	1805	1610	1810	1805	1610
Q Serve(g_s), s	7.7	14.4	2.7	0.2	12.2	0.0	1.1	2.3	0.5	2.6	2.1	0.0
Cycle Q Clear(g_c), s	7.7	14.4	2.7	0.2	12.2	0.0	1.1	2.3	0.5	2.6	2.1	0.0
Prop In Lane	1.00		1.00	1.00		1.00	1.00		1.00	1.00		1.00
Lane Grp Cap(c), veh/h	351	2460	764	13	1378		210	835	372	157	933	
V/C Ratio(X)	0.96	0.54	0.13	0.30	0.52		0.25	0.16	0.03	0.39	0.13	
Avail Cap(c_a), veh/h	351	2460	764	158	1378		307	835	372	418	1354	
HCM Platoon Ratio	1.00	1.00	1.00	1.00	1.00	1.00	1.00	1.00	1.00	1.00	1.00	1.00
Upstream Filter(I)	1.00	1.00	1.00	1.00	1.00	0.00	1.00	1.00	1.00	1.00	1.00	0.00
Uniform Delay (d), s/veh	35.9	14.8	11.8	39.5	19.1	0.0	35.9	24.5	23.8	34.5	22.8	0.0
Incr Delay (d2), s/veh	38.1	0.8	0.3	11.8	0.3	0.0	0.6	0.4	0.2	1.6	0.1	0.0
Initial Q Delay(d3),s/veh	0.0	0.0	0.0	0.0	0.0	0.0	0.0	0.0	0.0	0.0	0.0	0.0
%ile BackOfQ(50%),veh/ln	5.1	5.4	1.0	0.1	4.9	0.0	0.5	1.0	0.2	1.2	0.9	0.0
Unsig. Movement Delay, s/veh												
LnGrp Delay(d),s/veh	74.0	15.7	12.1	51.3	19.4	0.0	36.5	24.9	24.0	36.1	22.8	0.0
LnGrp LOS	E	B	B	D	B		D	C	C	D	C	
Approach Vol, veh/h		1758			718	A		196			184	A
Approach Delay, s/veh		26.7			19.6			27.9			27.3	
Approach LOS		C			B			C			C	
Timer - Assigned Phs	1	2	3	4	5	6	7	8				
Phs Duration (G+Y+Rc), s	4.6	41.9	8.8	24.7	12.0	34.5	11.0	22.5				
Change Period (Y+Rc), s	4.0	4.0	4.0	4.0	4.0	4.0	4.0	4.0				
Max Green Setting (Gmax), s	7.0	20.0	7.0	30.0	8.0	19.0	18.5	18.5				
Max Q Clear Time (g_c+I1), s	2.2	16.4	3.1	4.1	9.7	14.2	4.6	4.3				
Green Ext Time (p_c), s	0.0	2.7	0.0	0.7	0.0	2.0	0.1	0.6				

Intersection Summary

HCM 6th Ctrl Delay	25.0
HCM 6th LOS	C

Notes

Unsignalized Delay for [WBR, SBR] is excluded from calculations of the approach delay and intersection delay.

HCM 6th TWSC
1: Old 215 Frontage Rd & Cottonwood Ave

07/21/2021

Intersection												
Int Delay, s/veh	3.3											
Movement	EBL	EBT	EBR	WBL	WBT	WBR	NBL	NBT	NBR	SBL	SBT	SBR
Lane Configurations		↕			↕		↕	↑↑	↕	↕	↑↑	↕
Traffic Vol, veh/h	12	2	2	81	3	45	19	347	11	12	136	24
Future Vol, veh/h	12	2	2	81	3	45	19	347	11	12	136	24
Conflicting Peds, #/hr	0	0	0	0	0	0	0	0	0	0	0	0
Sign Control	Stop	Stop	Stop	Stop	Stop	Stop	Free	Free	Free	Free	Free	Free
RT Channelized	-	-	None	-	-	None	-	-	None	-	-	None
Storage Length	-	-	-	-	-	-	235	-	50	435	-	50
Veh in Median Storage, #	-	0	-	-	0	-	-	0	-	-	0	-
Grade, %	-	0	-	-	0	-	-	0	-	-	0	-
Peak Hour Factor	95	95	95	95	95	95	95	95	95	95	95	95
Heavy Vehicles, %	0	0	0	0	0	0	0	0	0	0	0	0
Mvmt Flow	13	2	2	85	3	47	20	365	12	13	143	25

Major/Minor	Minor2		Minor1			Major1		Major2				
Conflicting Flow All	393	586	72	504	599	183	168	0	0	377	0	0
Stage 1	169	169	-	405	405	-	-	-	-	-	-	-
Stage 2	224	417	-	99	194	-	-	-	-	-	-	-
Critical Hdwy	7.5	6.5	6.9	7.5	6.5	6.9	4.1	-	-	4.1	-	-
Critical Hdwy Stg 1	6.5	5.5	-	6.5	5.5	-	-	-	-	-	-	-
Critical Hdwy Stg 2	6.5	5.5	-	6.5	5.5	-	-	-	-	-	-	-
Follow-up Hdwy	3.5	4	3.3	3.5	4	3.3	2.2	-	-	2.2	-	-
Pot Cap-1 Maneuver	546	425	982	455	418	834	1422	-	-	1193	-	-
Stage 1	822	763	-	599	602	-	-	-	-	-	-	-
Stage 2	764	595	-	902	744	-	-	-	-	-	-	-
Platoon blocked, %								-	-	-	-	-
Mov Cap-1 Maneuver	502	414	982	444	408	834	1422	-	-	1193	-	-
Mov Cap-2 Maneuver	502	414	-	444	408	-	-	-	-	-	-	-
Stage 1	810	755	-	591	594	-	-	-	-	-	-	-
Stage 2	707	587	-	888	736	-	-	-	-	-	-	-

Approach	EB		WB			NB		SB		
HCM Control Delay, s	12.2		14.1			0.4		0.6		
HCM LOS	B		B							

Minor Lane/Major Mvmt	NBL	NBT	NBR	EBLn1WBLn1	SBL	SBT	SBR
Capacity (veh/h)	1422	-	-	520	529	1193	-
HCM Lane V/C Ratio	0.014	-	-	0.032	0.257	0.011	-
HCM Control Delay (s)	7.6	-	-	12.2	14.1	8.1	-
HCM Lane LOS	A	-	-	B	B	A	-
HCM 95th %tile Q(veh)	0	-	-	0.1	1	0	-

HCM 6th TWSC
2: Old 215 Frontage Rd & Bay Ave

07/21/2021

Intersection												
Int Delay, s/veh	2.5											
Movement	EBL	EBT	EBR	WBL	WBT	WBR	NBL	NBT	NBR	SBL	SBT	SBR
Lane Configurations		↕			↕		↗	↕	↗	↗	↕	↗
Traffic Vol, veh/h	6	1	14	46	1	32	47	317	8	17	195	15
Future Vol, veh/h	6	1	14	46	1	32	47	317	8	17	195	15
Conflicting Peds, #/hr	0	0	0	0	0	0	0	0	0	0	0	0
Sign Control	Stop	Stop	Stop	Stop	Stop	Stop	Free	Free	Free	Free	Free	Free
RT Channelized	-	-	None	-	-	None	-	-	None	-	-	None
Storage Length	-	-	-	-	-	-	225	-	50	450	-	50
Veh in Median Storage, #	-	0	-	-	0	-	-	0	-	-	0	-
Grade, %	-	0	-	-	0	-	-	0	-	-	0	-
Peak Hour Factor	99	99	99	99	99	99	99	99	99	99	99	99
Heavy Vehicles, %	0	0	0	0	0	0	0	0	0	0	0	0
Mvmt Flow	6	1	14	46	1	32	47	320	8	17	197	15

Major/Minor	Minor2		Minor1		Major1			Major2				
Conflicting Flow All	486	653	99	547	660	160	212	0	0	328	0	0
Stage 1	231	231	-	414	414	-	-	-	-	-	-	-
Stage 2	255	422	-	133	246	-	-	-	-	-	-	-
Critical Hdwy	7.5	6.5	6.9	7.5	6.5	6.9	4.1	-	-	4.1	-	-
Critical Hdwy Stg 1	6.5	5.5	-	6.5	5.5	-	-	-	-	-	-	-
Critical Hdwy Stg 2	6.5	5.5	-	6.5	5.5	-	-	-	-	-	-	-
Follow-up Hdwy	3.5	4	3.3	3.5	4	3.3	2.2	-	-	2.2	-	-
Pot Cap-1 Maneuver	469	389	944	424	386	863	1370	-	-	1243	-	-
Stage 1	757	717	-	592	597	-	-	-	-	-	-	-
Stage 2	733	592	-	862	706	-	-	-	-	-	-	-
Platoon blocked, %								-	-	-	-	-
Mov Cap-1 Maneuver	434	370	944	402	367	863	1370	-	-	1243	-	-
Mov Cap-2 Maneuver	434	370	-	402	367	-	-	-	-	-	-	-
Stage 1	731	707	-	572	577	-	-	-	-	-	-	-
Stage 2	680	572	-	836	696	-	-	-	-	-	-	-

Approach	EB		WB		NB			SB		
HCM Control Delay, s	10.5		13.3		1			0.6		
HCM LOS	B		B							

Minor Lane/Major Mvmt	NBL	NBT	NBR	EBLn1WBLn1	SBL	SBT	SBR
Capacity (veh/h)	1370	-	-	670	512	1243	-
HCM Lane V/C Ratio	0.035	-	-	0.032	0.156	0.014	-
HCM Control Delay (s)	7.7	-	-	10.5	13.3	7.9	-
HCM Lane LOS	A	-	-	B	B	A	-
HCM 95th %tile Q(veh)	0.1	-	-	0.1	0.5	0	-

HCM 6th Signalized Intersection Summary
5: Old 215 Frontage Rd & Alessandro Blvd

07/21/2021



Movement	EBL	EBT	EBR	WBL	WBT	WBR	NBL	NBT	NBR	SBL	SBT	SBR
Lane Configurations	↔↔	↑↑↑	↔	↔	↑↑	↔	↔↔	↑↑	↔	↔	↑↑	↔
Traffic Volume (veh/h)	207	604	82	19	698	51	55	152	14	25	45	164
Future Volume (veh/h)	207	604	82	19	698	51	55	152	14	25	45	164
Initial Q (Qb), veh	0	0	0	0	0	0	0	0	0	0	0	0
Ped-Bike Adj(A_pbT)	1.00		1.00	1.00		1.00	1.00		1.00	1.00		1.00
Parking Bus, Adj	1.00	1.00	1.00	1.00	1.00	1.00	1.00	1.00	1.00	1.00	1.00	1.00
Work Zone On Approach		No			No			No			No	
Adj Sat Flow, veh/h/ln	1900	1900	1900	1900	1900	1900	1900	1900	1900	1900	1900	1900
Adj Flow Rate, veh/h	213	623	85	20	720	0	57	157	14	26	46	0
Peak Hour Factor	0.97	0.97	0.97	0.97	0.97	0.97	0.97	0.97	0.97	0.97	0.97	0.97
Percent Heavy Veh, %	0	0	0	0	0	0	0	0	0	0	0	0
Cap, veh/h	893	2359	732	57	837		221	835	372	149	906	
Arrive On Green	0.25	0.45	0.45	0.03	0.23	0.00	0.06	0.23	0.23	0.08	0.25	0.00
Sat Flow, veh/h	3510	5187	1610	1810	3610	1610	3510	3610	1610	1810	3610	1610
Grp Volume(v), veh/h	213	623	85	20	720	0	57	157	14	26	46	0
Grp Sat Flow(s),veh/h/ln	1755	1729	1610	1810	1805	1610	1755	1805	1610	1810	1805	1610
Q Serve(g_s), s	3.9	6.0	2.4	0.9	15.3	0.0	1.2	2.8	0.5	1.1	0.8	0.0
Cycle Q Clear(g_c), s	3.9	6.0	2.4	0.9	15.3	0.0	1.2	2.8	0.5	1.1	0.8	0.0
Prop In Lane	1.00		1.00	1.00		1.00	1.00		1.00	1.00		1.00
Lane Grp Cap(c), veh/h	893	2359	732	57	837		221	835	372	149	906	
V/C Ratio(X)	0.24	0.26	0.12	0.35	0.86		0.26	0.19	0.04	0.17	0.05	
Avail Cap(c_a), veh/h	893	2359	732	158	903		307	835	372	418	1354	
HCM Platoon Ratio	1.00	1.00	1.00	1.00	1.00	1.00	1.00	1.00	1.00	1.00	1.00	1.00
Upstream Filter(I)	1.00	1.00	1.00	1.00	1.00	0.00	1.00	1.00	1.00	1.00	1.00	0.00
Uniform Delay (d), s/veh	23.7	13.5	12.6	37.9	29.5	0.0	35.7	24.7	23.8	34.2	22.7	0.0
Incr Delay (d2), s/veh	0.1	0.3	0.3	3.7	8.0	0.0	0.6	0.5	0.2	0.5	0.0	0.0
Initial Q Delay(d3),s/veh	0.0	0.0	0.0	0.0	0.0	0.0	0.0	0.0	0.0	0.0	0.0	0.0
%ile BackOfQ(50%),veh/ln	1.6	2.2	0.9	0.4	7.3	0.0	0.5	1.2	0.2	0.5	0.3	0.0
Unsig. Movement Delay, s/veh												
LnGrp Delay(d),s/veh	23.8	13.8	12.9	41.6	37.5	0.0	36.3	25.2	24.0	34.7	22.8	0.0
LnGrp LOS	C	B	B	D	D		D	C	C	C	C	
Approach Vol, veh/h		921			740	A		228			72	A
Approach Delay, s/veh		16.0			37.6			27.9			27.1	
Approach LOS		B			D			C			C	
Timer - Assigned Phs	1	2	3	4	5	6	7	8				
Phs Duration (G+Y+Rc), s	6.5	40.4	9.0	24.1	24.3	22.6	10.6	22.5				
Change Period (Y+Rc), s	4.0	4.0	4.0	4.0	4.0	4.0	4.0	4.0				
Max Green Setting (Gmax), s	7.0	20.0	7.0	30.0	7.0	20.0	18.5	18.5				
Max Q Clear Time (g_c+I1), s	2.9	8.0	3.2	2.8	5.9	17.3	3.1	4.8				
Green Ext Time (p_c), s	0.0	3.6	0.0	0.2	0.1	1.3	0.0	0.7				

Intersection Summary

HCM 6th Ctrl Delay	25.9
HCM 6th LOS	C

Notes

Unsignalized Delay for [WBR, SBR] is excluded from calculations of the approach delay and intersection delay.

HCM 6th TWSC
1: Old 215 Frontage Rd & Cottonwood Ave

07/21/2021

Intersection												
Int Delay, s/veh	2.6											
Movement	EBL	EBT	EBR	WBL	WBT	WBR	NBL	NBT	NBR	SBL	SBT	SBR
Lane Configurations		↔			↔		↗	↗	↗	↗	↗	↗
Traffic Vol, veh/h	36	1	10	35	0	36	10	547	52	55	341	7
Future Vol, veh/h	36	1	10	35	0	36	10	547	52	55	341	7
Conflicting Peds, #/hr	0	0	0	0	0	0	0	0	0	0	0	0
Sign Control	Stop	Stop	Stop	Stop	Stop	Stop	Free	Free	Free	Free	Free	Free
RT Channelized	-	-	None	-	-	None	-	-	None	-	-	None
Storage Length	-	-	-	-	-	-	235	-	50	435	-	50
Veh in Median Storage, #	-	0	-	-	0	-	-	0	-	-	0	-
Grade, %	-	0	-	-	0	-	-	0	-	-	0	-
Peak Hour Factor	91	91	91	91	91	91	91	91	91	91	91	91
Heavy Vehicles, %	0	0	0	0	0	0	0	0	0	0	0	0
Mvmt Flow	40	1	11	38	0	40	11	601	57	60	375	8

Major/Minor	Minor2		Minor1		Major1		Major2					
Conflicting Flow All	818	1175	188	931	1126	301	383	0	0	658	0	0
Stage 1	495	495	-	623	623	-	-	-	-	-	-	-
Stage 2	323	680	-	308	503	-	-	-	-	-	-	-
Critical Hdwy	7.5	6.5	6.9	7.5	6.5	6.9	4.1	-	-	4.1	-	-
Critical Hdwy Stg 1	6.5	5.5	-	6.5	5.5	-	-	-	-	-	-	-
Critical Hdwy Stg 2	6.5	5.5	-	6.5	5.5	-	-	-	-	-	-	-
Follow-up Hdwy	3.5	4	3.3	3.5	4	3.3	2.2	-	-	2.2	-	-
Pot Cap-1 Maneuver	271	193	828	225	207	701	1187	-	-	939	-	-
Stage 1	530	549	-	445	481	-	-	-	-	-	-	-
Stage 2	669	454	-	683	545	-	-	-	-	-	-	-
Platoon blocked, %								-	-	-	-	-
Mov Cap-1 Maneuver	241	179	828	209	192	701	1187	-	-	939	-	-
Mov Cap-2 Maneuver	241	179	-	209	192	-	-	-	-	-	-	-
Stage 1	525	514	-	441	477	-	-	-	-	-	-	-
Stage 2	625	450	-	630	510	-	-	-	-	-	-	-

Approach	EB		WB		NB		SB			
HCM Control Delay, s	20.7		19.6		0.1		1.2			
HCM LOS	C		C							

Minor Lane/Major Mvmt	NBL	NBT	NBR	EBLn1WBLn1	SBL	SBT	SBR
Capacity (veh/h)	1187	-	-	281	324	939	-
HCM Lane V/C Ratio	0.009	-	-	0.184	0.241	0.064	-
HCM Control Delay (s)	8.1	-	-	20.7	19.6	9.1	-
HCM Lane LOS	A	-	-	C	C	A	-
HCM 95th %tile Q(veh)	0	-	-	0.7	0.9	0.2	-

HCM 6th TWSC
2: Old 215 Frontage Rd & Bay Ave

07/21/2021

Intersection												
Int Delay, s/veh	2.1											
Movement	EBL	EBT	EBR	WBL	WBT	WBR	NBL	NBT	NBR	SBL	SBT	SBR
Lane Configurations		↕			↕		↗	↕	↗	↗	↗	↗
Traffic Vol, veh/h	20	1	29	18	0	16	22	479	31	59	402	4
Future Vol, veh/h	20	1	29	18	0	16	22	479	31	59	402	4
Conflicting Peds, #/hr	0	0	0	0	0	0	0	0	0	0	0	0
Sign Control	Stop	Stop	Stop	Stop	Stop	Stop	Free	Free	Free	Free	Free	Free
RT Channelized	-	-	None	-	-	None	-	-	None	-	-	None
Storage Length	-	-	-	-	-	-	225	-	50	450	-	50
Veh in Median Storage, #	-	0	-	-	0	-	-	0	-	-	0	-
Grade, %	-	0	-	-	0	-	-	0	-	-	0	-
Peak Hour Factor	85	85	85	85	85	85	85	85	85	85	85	85
Heavy Vehicles, %	0	0	0	0	0	0	0	0	0	0	0	0
Mvmt Flow	24	1	34	21	0	19	26	564	36	69	473	5

Major/Minor	Minor2		Minor1		Major1			Major2				
Conflicting Flow All	945	1263	237	991	1232	282	478	0	0	600	0	0
Stage 1	611	611	-	616	616	-	-	-	-	-	-	-
Stage 2	334	652	-	375	616	-	-	-	-	-	-	-
Critical Hdwy	7.5	6.5	6.9	7.5	6.5	6.9	4.1	-	-	4.1	-	-
Critical Hdwy Stg 1	6.5	5.5	-	6.5	5.5	-	-	-	-	-	-	-
Critical Hdwy Stg 2	6.5	5.5	-	6.5	5.5	-	-	-	-	-	-	-
Follow-up Hdwy	3.5	4	3.3	3.5	4	3.3	2.2	-	-	2.2	-	-
Pot Cap-1 Maneuver	220	171	771	203	179	721	1095	-	-	987	-	-
Stage 1	453	487	-	450	485	-	-	-	-	-	-	-
Stage 2	659	467	-	624	485	-	-	-	-	-	-	-
Platoon blocked, %								-	-	-	-	-
Mov Cap-1 Maneuver	199	155	771	179	163	721	1095	-	-	987	-	-
Mov Cap-2 Maneuver	199	155	-	179	163	-	-	-	-	-	-	-
Stage 1	442	453	-	439	473	-	-	-	-	-	-	-
Stage 2	627	456	-	553	451	-	-	-	-	-	-	-

Approach	EB		WB		NB		SB	
HCM Control Delay, s	17.5		20.2		0.3		1.1	
HCM LOS	C		C					

Minor Lane/Major Mvmt	NBL	NBT	NBR	EBLn1WBLn1	SBL	SBT	SBR
Capacity (veh/h)	1095	-	-	346	277	987	-
HCM Lane V/C Ratio	0.024	-	-	0.17	0.144	0.07	-
HCM Control Delay (s)	8.4	-	-	17.5	20.2	8.9	-
HCM Lane LOS	A	-	-	C	C	A	-
HCM 95th %tile Q(veh)	0.1	-	-	0.6	0.5	0.2	-

HCM 6th Signalized Intersection Summary

5: Old 215 Frontage Rd & Alessandro Blvd

07/21/2021



Movement	EBL	EBT	EBR	WBL	WBT	WBR	NBL	NBT	NBR	SBL	SBT	SBR
Lane Configurations	↔↔	↑↑↑	↔	↔	↑↑	↔	↔↔	↑↑	↔	↔	↑↑	↔
Traffic Volume (veh/h)	350	1354	120	6	737	74	119	137	25	70	122	235
Future Volume (veh/h)	350	1354	120	6	737	74	119	137	25	70	122	235
Initial Q (Qb), veh	0	0	0	0	0	0	0	0	0	0	0	0
Ped-Bike Adj(A_pbT)	1.00		1.00	1.00		1.00	1.00		1.00	1.00		1.00
Parking Bus, Adj	1.00	1.00	1.00	1.00	1.00	1.00	1.00	1.00	1.00	1.00	1.00	1.00
Work Zone On Approach		No			No			No			No	
Adj Sat Flow, veh/h/ln	1900	1900	1900	1900	1900	1900	1900	1900	1900	1900	1900	1900
Adj Flow Rate, veh/h	372	1440	128	6	784	0	127	146	27	74	130	0
Peak Hour Factor	0.94	0.94	0.94	0.94	0.94	0.94	0.94	0.94	0.94	0.94	0.94	0.94
Percent Heavy Veh, %	0	0	0	0	0	0	0	0	0	0	0	0
Cap, veh/h	351	2440	757	20	1377		289	835	372	158	853	
Arrive On Green	0.10	0.47	0.47	0.01	0.38	0.00	0.08	0.23	0.23	0.09	0.24	0.00
Sat Flow, veh/h	3510	5187	1610	1810	3610	1610	3510	3610	1610	1810	3610	1610
Grp Volume(v), veh/h	372	1440	128	6	784	0	127	146	27	74	130	0
Grp Sat Flow(s),veh/h/ln	1755	1729	1610	1810	1805	1610	1755	1805	1610	1810	1805	1610
Q Serve(g_s), s	8.0	16.3	3.7	0.3	13.7	0.0	2.8	2.6	1.0	3.1	2.3	0.0
Cycle Q Clear(g_c), s	8.0	16.3	3.7	0.3	13.7	0.0	2.8	2.6	1.0	3.1	2.3	0.0
Prop In Lane	1.00		1.00	1.00		1.00	1.00		1.00	1.00		1.00
Lane Grp Cap(c), veh/h	351	2440	757	20	1377		289	835	372	158	853	
V/C Ratio(X)	1.06	0.59	0.17	0.30	0.57		0.44	0.17	0.07	0.47	0.15	
Avail Cap(c_a), veh/h	351	2440	757	158	1377		307	835	372	418	1354	
HCM Platoon Ratio	1.00	1.00	1.00	1.00	1.00	1.00	1.00	1.00	1.00	1.00	1.00	1.00
Upstream Filter(I)	1.00	1.00	1.00	1.00	1.00	0.00	1.00	1.00	1.00	1.00	1.00	0.00
Uniform Delay (d), s/veh	36.0	15.5	12.2	39.3	19.6	0.0	35.0	24.6	24.0	34.7	24.2	0.0
Incr Delay (d2), s/veh	64.7	1.1	0.5	8.4	0.6	0.0	1.1	0.5	0.4	2.1	0.1	0.0
Initial Q Delay(d3),s/veh	0.0	0.0	0.0	0.0	0.0	0.0	0.0	0.0	0.0	0.0	0.0	0.0
%ile BackOfQ(50%),veh/ln	6.5	6.1	1.3	0.2	5.5	0.0	1.2	1.1	0.4	1.4	1.0	0.0
Unsig. Movement Delay, s/veh												
LnGrp Delay(d),s/veh	100.7	16.6	12.7	47.6	20.1	0.0	36.0	25.1	24.4	36.9	24.3	0.0
LnGrp LOS	F	B	B	D	C		D	C	C	D	C	
Approach Vol, veh/h		1940			790	A		300			204	A
Approach Delay, s/veh		32.5			20.3			29.7			28.8	
Approach LOS		C			C			C			C	
Timer - Assigned Phs	1	2	3	4	5	6	7	8				
Phs Duration (G+Y+Rc), s	4.9	41.6	10.6	22.9	12.0	34.5	11.0	22.5				
Change Period (Y+Rc), s	4.0	4.0	4.0	4.0	4.0	4.0	4.0	4.0				
Max Green Setting (Gmax), s	7.0	20.0	7.0	30.0	8.0	19.0	18.5	18.5				
Max Q Clear Time (g_c+I1), s	2.3	18.3	4.8	4.3	10.0	15.7	5.1	4.6				
Green Ext Time (p_c), s	0.0	1.4	0.1	0.7	0.0	1.6	0.1	0.7				

Intersection Summary

HCM 6th Ctrl Delay	29.0
HCM 6th LOS	C

Notes

Unsignalized Delay for [WBR, SBR] is excluded from calculations of the approach delay and intersection delay.

HCM 6th TWSC
1: Old 215 Frontage Rd & Cottonwood Ave

07/21/2021

Intersection												
Int Delay, s/veh	3.3											
Movement	EBL	EBT	EBR	WBL	WBT	WBR	NBL	NBT	NBR	SBL	SBT	SBR
Lane Configurations		↕			↕		↗	↕	↗	↗	↕	↗
Traffic Vol, veh/h	12	2	2	81	3	45	19	358	13	12	136	24
Future Vol, veh/h	12	2	2	81	3	45	19	358	13	12	136	24
Conflicting Peds, #/hr	0	0	0	0	0	0	0	0	0	0	0	0
Sign Control	Stop	Stop	Stop	Stop	Stop	Stop	Free	Free	Free	Free	Free	Free
RT Channelized	-	-	None	-	-	None	-	-	None	-	-	None
Storage Length	-	-	-	-	-	-	235	-	50	435	-	50
Veh in Median Storage, #	-	0	-	-	0	-	-	0	-	-	0	-
Grade, %	-	0	-	-	0	-	-	0	-	-	0	-
Peak Hour Factor	95	95	95	95	95	95	95	95	95	95	95	95
Heavy Vehicles, %	0	0	0	0	0	0	0	0	0	0	0	0
Mvmt Flow	13	2	2	85	3	47	20	377	14	13	143	25

Major/Minor	Minor2		Minor1			Major1		Major2				
Conflicting Flow All	399	600	72	516	611	189	168	0	0	391	0	0
Stage 1	169	169	-	417	417	-	-	-	-	-	-	-
Stage 2	230	431	-	99	194	-	-	-	-	-	-	-
Critical Hdwy	7.5	6.5	6.9	7.5	6.5	6.9	4.1	-	-	4.1	-	-
Critical Hdwy Stg 1	6.5	5.5	-	6.5	5.5	-	-	-	-	-	-	-
Critical Hdwy Stg 2	6.5	5.5	-	6.5	5.5	-	-	-	-	-	-	-
Follow-up Hdwy	3.5	4	3.3	3.5	4	3.3	2.2	-	-	2.2	-	-
Pot Cap-1 Maneuver	540	417	982	446	411	827	1422	-	-	1179	-	-
Stage 1	822	763	-	589	595	-	-	-	-	-	-	-
Stage 2	758	586	-	902	744	-	-	-	-	-	-	-
Platoon blocked, %								-	-	-	-	-
Mov Cap-1 Maneuver	496	407	982	435	401	827	1422	-	-	1179	-	-
Mov Cap-2 Maneuver	496	407	-	435	401	-	-	-	-	-	-	-
Stage 1	810	755	-	581	587	-	-	-	-	-	-	-
Stage 2	701	578	-	888	736	-	-	-	-	-	-	-

Approach	EB		WB			NB		SB		
HCM Control Delay, s	12.2		14.4			0.4		0.6		
HCM LOS	B		B							

Minor Lane/Major Mvmt	NBL	NBT	NBR	EBLn1	WBLn1	SBL	SBT	SBR
Capacity (veh/h)	1422	-	-	514	520	1179	-	-
HCM Lane V/C Ratio	0.014	-	-	0.033	0.261	0.011	-	-
HCM Control Delay (s)	7.6	-	-	12.2	14.4	8.1	-	-
HCM Lane LOS	A	-	-	B	B	A	-	-
HCM 95th %tile Q(veh)	0	-	-	0.1	1	0	-	-

HCM 6th TWSC
2: Old 215 Frontage Rd & Bay Ave

07/21/2021

Intersection												
Int Delay, s/veh	2.5											
Movement	EBL	EBT	EBR	WBL	WBT	WBR	NBL	NBT	NBR	SBL	SBT	SBR
Lane Configurations		↕			↕		↗	↕	↗	↗	↕	↗
Traffic Vol, veh/h	6	1	14	46	1	32	51	329	9	17	195	15
Future Vol, veh/h	6	1	14	46	1	32	51	329	9	17	195	15
Conflicting Peds, #/hr	0	0	0	0	0	0	0	0	0	0	0	0
Sign Control	Stop	Stop	Stop	Stop	Stop	Stop	Free	Free	Free	Free	Free	Free
RT Channelized	-	-	None	-	-	None	-	-	None	-	-	None
Storage Length	-	-	-	-	-	-	225	-	50	450	-	50
Veh in Median Storage, #	-	0	-	-	0	-	-	0	-	-	0	-
Grade, %	-	0	-	-	0	-	-	0	-	-	0	-
Peak Hour Factor	99	99	99	99	99	99	99	99	99	99	99	99
Heavy Vehicles, %	0	0	0	0	0	0	0	0	0	0	0	0
Mvmt Flow	6	1	14	46	1	32	52	332	9	17	197	15

Major/Minor	Minor2		Minor1		Major1			Major2				
Conflicting Flow All	502	676	99	569	682	166	212	0	0	341	0	0
Stage 1	231	231	-	436	436	-	-	-	-	-	-	-
Stage 2	271	445	-	133	246	-	-	-	-	-	-	-
Critical Hdwy	7.5	6.5	6.9	7.5	6.5	6.9	4.1	-	-	4.1	-	-
Critical Hdwy Stg 1	6.5	5.5	-	6.5	5.5	-	-	-	-	-	-	-
Critical Hdwy Stg 2	6.5	5.5	-	6.5	5.5	-	-	-	-	-	-	-
Follow-up Hdwy	3.5	4	3.3	3.5	4	3.3	2.2	-	-	2.2	-	-
Pot Cap-1 Maneuver	457	378	944	409	375	856	1370	-	-	1229	-	-
Stage 1	757	717	-	574	583	-	-	-	-	-	-	-
Stage 2	717	578	-	862	706	-	-	-	-	-	-	-
Platoon blocked, %								-	-	-	-	-
Mov Cap-1 Maneuver	422	359	944	386	356	856	1370	-	-	1229	-	-
Mov Cap-2 Maneuver	422	359	-	386	356	-	-	-	-	-	-	-
Stage 1	728	707	-	552	561	-	-	-	-	-	-	-
Stage 2	663	556	-	836	696	-	-	-	-	-	-	-

Approach	EB		WB		NB			SB		
HCM Control Delay, s	10.6		13.6		1			0.6		
HCM LOS	B		B							

Minor Lane/Major Mvmt	NBL	NBT	NBR	EBLn1WBLn1	SBL	SBT	SBR
Capacity (veh/h)	1370	-	-	660	496	1229	-
HCM Lane V/C Ratio	0.038	-	-	0.032	0.161	0.014	-
HCM Control Delay (s)	7.7	-	-	10.6	13.6	8	-
HCM Lane LOS	A	-	-	B	B	A	-
HCM 95th %tile Q(veh)	0.1	-	-	0.1	0.6	0	-

HCM 6th TWSC
3: Old 215 Frontage Rd & Dwy 1

07/21/2021

Intersection						
Int Delay, s/veh	0.1					
Movement	WBL	WBR	NBT	NBR	SBL	SBT
Lane Configurations		↗	↕			↕
Traffic Vol, veh/h	0	7	382	40	0	260
Future Vol, veh/h	0	7	382	40	0	260
Conflicting Peds, #/hr	0	0	0	0	0	0
Sign Control	Stop	Stop	Free	Free	Free	Free
RT Channelized	-	None	-	None	-	None
Storage Length	-	0	-	-	-	-
Veh in Median Storage, #	0	-	0	-	-	0
Grade, %	0	-	0	-	-	0
Peak Hour Factor	92	92	92	92	92	92
Heavy Vehicles, %	0	0	0	0	0	0
Mvmt Flow	0	8	415	43	0	283

Major/Minor	Minor1	Major1	Major2		
Conflicting Flow All	-	229	0	0	-
Stage 1	-	-	-	-	-
Stage 2	-	-	-	-	-
Critical Hdwy	-	6.9	-	-	-
Critical Hdwy Stg 1	-	-	-	-	-
Critical Hdwy Stg 2	-	-	-	-	-
Follow-up Hdwy	-	3.3	-	-	-
Pot Cap-1 Maneuver	0	780	-	-	0
Stage 1	0	-	-	-	0
Stage 2	0	-	-	-	0
Platoon blocked, %			-	-	-
Mov Cap-1 Maneuver	-	780	-	-	-
Mov Cap-2 Maneuver	-	-	-	-	-
Stage 1	-	-	-	-	-
Stage 2	-	-	-	-	-

Approach	WB	NB	SB
HCM Control Delay, s	9.7	0	0
HCM LOS	A		

Minor Lane/Major Mvmt	NBT	NBRWBLn1	SBT
Capacity (veh/h)	-	-	780
HCM Lane V/C Ratio	-	-	0.01
HCM Control Delay (s)	-	-	9.7
HCM Lane LOS	-	-	A
HCM 95th %tile Q(veh)	-	-	0

HCM 6th TWSC
4: Old 215 Frontage Rd & Dwy 2

07/21/2021

Intersection						
Int Delay, s/veh	0.1					
Movement	WBL	WBR	NBT	NBR	SBL	SBT
Lane Configurations		↗	↕			↕
Traffic Vol, veh/h	0	10	412	61	0	260
Future Vol, veh/h	0	10	412	61	0	260
Conflicting Peds, #/hr	0	0	0	0	0	0
Sign Control	Stop	Stop	Free	Free	Free	Free
RT Channelized	-	None	-	None	-	None
Storage Length	-	0	-	-	-	-
Veh in Median Storage, #	0	-	0	-	-	0
Grade, %	0	-	0	-	-	0
Peak Hour Factor	92	92	92	92	92	92
Heavy Vehicles, %	0	0	0	0	0	0
Mvmt Flow	0	11	448	66	0	283

Major/Minor	Minor1	Major1	Major2		
Conflicting Flow All	-	257	0	0	-
Stage 1	-	-	-	-	-
Stage 2	-	-	-	-	-
Critical Hdwy	-	6.9	-	-	-
Critical Hdwy Stg 1	-	-	-	-	-
Critical Hdwy Stg 2	-	-	-	-	-
Follow-up Hdwy	-	3.3	-	-	-
Pot Cap-1 Maneuver	0	748	-	-	0
Stage 1	0	-	-	-	0
Stage 2	0	-	-	-	0
Platoon blocked, %			-	-	-
Mov Cap-1 Maneuver	-	748	-	-	-
Mov Cap-2 Maneuver	-	-	-	-	-
Stage 1	-	-	-	-	-
Stage 2	-	-	-	-	-

Approach	WB	NB	SB
HCM Control Delay, s	9.9	0	0
HCM LOS	A		

Minor Lane/Major Mvmt	NBT	NBRWBLn1	SBT
Capacity (veh/h)	-	-	748
HCM Lane V/C Ratio	-	-	0.015
HCM Control Delay (s)	-	-	9.9
HCM Lane LOS	-	-	A
HCM 95th %tile Q(veh)	-	-	0

HCM 6th Signalized Intersection Summary

5: Old 215 Frontage Rd & Alessandro Blvd

07/21/2021



Movement	EBL	EBT	EBR	WBL	WBT	WBR	NBL	NBT	NBR	SBL	SBT	SBR
Lane Configurations	↖↗	↑↑↑	↖	↖	↑↑	↖	↖↗	↑↑	↖	↖	↑↑	↖
Traffic Volume (veh/h)	286	604	82	19	698	72	55	152	14	26	45	166
Future Volume (veh/h)	286	604	82	19	698	72	55	152	14	26	45	166
Initial Q (Qb), veh	0	0	0	0	0	0	0	0	0	0	0	0
Ped-Bike Adj(A_pbT)	1.00		1.00	1.00		1.00	1.00		1.00	1.00		1.00
Parking Bus, Adj	1.00	1.00	1.00	1.00	1.00	1.00	1.00	1.00	1.00	1.00	1.00	1.00
Work Zone On Approach		No			No			No			No	
Adj Sat Flow, veh/h/ln	1900	1900	1900	1900	1900	1900	1900	1900	1900	1900	1900	1900
Adj Flow Rate, veh/h	295	623	85	20	720	0	57	157	14	27	46	0
Peak Hour Factor	0.97	0.97	0.97	0.97	0.97	0.97	0.97	0.97	0.97	0.97	0.97	0.97
Percent Heavy Veh, %	0	0	0	0	0	0	0	0	0	0	0	0
Cap, veh/h	892	2359	732	57	837		221	835	372	150	906	
Arrive On Green	0.25	0.45	0.45	0.03	0.23	0.00	0.06	0.23	0.23	0.08	0.25	0.00
Sat Flow, veh/h	3510	5187	1610	1810	3610	1610	3510	3610	1610	1810	3610	1610
Grp Volume(v), veh/h	295	623	85	20	720	0	57	157	14	27	46	0
Grp Sat Flow(s),veh/h/ln	1755	1729	1610	1810	1805	1610	1755	1805	1610	1810	1805	1610
Q Serve(g_s), s	5.5	6.0	2.4	0.9	15.3	0.0	1.2	2.8	0.5	1.1	0.8	0.0
Cycle Q Clear(g_c), s	5.5	6.0	2.4	0.9	15.3	0.0	1.2	2.8	0.5	1.1	0.8	0.0
Prop In Lane	1.00		1.00	1.00		1.00	1.00		1.00	1.00		1.00
Lane Grp Cap(c), veh/h	892	2359	732	57	837		221	835	372	150	906	
V/C Ratio(X)	0.33	0.26	0.12	0.35	0.86		0.26	0.19	0.04	0.18	0.05	
Avail Cap(c_a), veh/h	892	2359	732	158	903		307	835	372	418	1354	
HCM Platoon Ratio	1.00	1.00	1.00	1.00	1.00	1.00	1.00	1.00	1.00	1.00	1.00	1.00
Upstream Filter(I)	1.00	1.00	1.00	1.00	1.00	0.00	1.00	1.00	1.00	1.00	1.00	0.00
Uniform Delay (d), s/veh	24.3	13.5	12.6	37.9	29.5	0.0	35.7	24.7	23.8	34.2	22.7	0.0
Incr Delay (d2), s/veh	0.2	0.3	0.3	3.7	8.0	0.0	0.6	0.5	0.2	0.6	0.0	0.0
Initial Q Delay(d3),s/veh	0.0	0.0	0.0	0.0	0.0	0.0	0.0	0.0	0.0	0.0	0.0	0.0
%ile BackOfQ(50%),veh/ln	2.2	2.2	0.9	0.4	7.3	0.0	0.5	1.2	0.2	0.5	0.3	0.0
Unsig. Movement Delay, s/veh												
LnGrp Delay(d),s/veh	24.5	13.8	12.9	41.6	37.5	0.0	36.3	25.2	24.0	34.7	22.8	0.0
LnGrp LOS	C	B	B	D	D		D	C	C	C	C	
Approach Vol, veh/h		1003			740	A		228			73	A
Approach Delay, s/veh		16.9			37.6			27.9			27.2	
Approach LOS		B			D			C			C	
Timer - Assigned Phs	1	2	3	4	5	6	7	8				
Phs Duration (G+Y+Rc), s	6.5	40.4	9.0	24.1	24.3	22.6	10.6	22.5				
Change Period (Y+Rc), s	4.0	4.0	4.0	4.0	4.0	4.0	4.0	4.0				
Max Green Setting (Gmax), s	7.0	20.0	7.0	30.0	7.0	20.0	18.5	18.5				
Max Q Clear Time (g_c+I1), s	2.9	8.0	3.2	2.8	7.5	17.3	3.1	4.8				
Green Ext Time (p_c), s	0.0	3.6	0.0	0.2	0.0	1.3	0.0	0.7				

Intersection Summary

HCM 6th Ctrl Delay	26.0
HCM 6th LOS	C

Notes

Unsignalized Delay for [WBR, SBR] is excluded from calculations of the approach delay and intersection delay.

HCM 6th TWSC
1: Old 215 Frontage Rd & Cottonwood Ave

07/21/2021

Intersection												
Int Delay, s/veh	2.6											
Movement	EBL	EBT	EBR	WBL	WBT	WBR	NBL	NBT	NBR	SBL	SBT	SBR
Lane Configurations		↔			↔		↗	↑↑	↗	↗	↑↑	↗
Traffic Vol, veh/h	36	1	10	35	0	36	10	605	60	55	341	7
Future Vol, veh/h	36	1	10	35	0	36	10	605	60	55	341	7
Conflicting Peds, #/hr	0	0	0	0	0	0	0	0	0	0	0	0
Sign Control	Stop	Stop	Stop	Stop	Stop	Stop	Free	Free	Free	Free	Free	Free
RT Channelized	-	-	None	-	-	None	-	-	None	-	-	None
Storage Length	-	-	-	-	-	-	235	-	50	435	-	50
Veh in Median Storage, #	-	0	-	-	0	-	-	0	-	-	0	-
Grade, %	-	0	-	-	0	-	-	0	-	-	0	-
Peak Hour Factor	91	91	91	91	91	91	91	91	91	91	91	91
Heavy Vehicles, %	0	0	0	0	0	0	0	0	0	0	0	0
Mvmt Flow	40	1	11	38	0	40	11	665	66	60	375	8

Major/Minor	Minor2		Minor1		Major1		Major2					
Conflicting Flow All	850	1248	188	995	1190	333	383	0	0	731	0	0
Stage 1	495	495	-	687	687	-	-	-	-	-	-	-
Stage 2	355	753	-	308	503	-	-	-	-	-	-	-
Critical Hdwy	7.5	6.5	6.9	7.5	6.5	6.9	4.1	-	-	4.1	-	-
Critical Hdwy Stg 1	6.5	5.5	-	6.5	5.5	-	-	-	-	-	-	-
Critical Hdwy Stg 2	6.5	5.5	-	6.5	5.5	-	-	-	-	-	-	-
Follow-up Hdwy	3.5	4	3.3	3.5	4	3.3	2.2	-	-	2.2	-	-
Pot Cap-1 Maneuver	257	175	828	202	189	669	1187	-	-	883	-	-
Stage 1	530	549	-	408	450	-	-	-	-	-	-	-
Stage 2	641	420	-	683	545	-	-	-	-	-	-	-
Platoon blocked, %								-	-	-	-	-
Mov Cap-1 Maneuver	228	162	828	187	175	669	1187	-	-	883	-	-
Mov Cap-2 Maneuver	228	162	-	187	175	-	-	-	-	-	-	-
Stage 1	525	512	-	404	446	-	-	-	-	-	-	-
Stage 2	598	416	-	627	508	-	-	-	-	-	-	-

Approach	EB		WB		NB		SB			
HCM Control Delay, s	21.7		21.5		0.1		1.3			
HCM LOS	C		C							

Minor Lane/Major Mvmt	NBL	NBT	NBR	EBLn1WBLn1	SBL	SBT	SBR
Capacity (veh/h)	1187	-	-	267	295	883	-
HCM Lane V/C Ratio	0.009	-	-	0.193	0.264	0.068	-
HCM Control Delay (s)	8.1	-	-	21.7	21.5	9.4	-
HCM Lane LOS	A	-	-	C	C	A	-
HCM 95th %tile Q(veh)	0	-	-	0.7	1	0.2	-

HCM 6th TWSC
2: Old 215 Frontage Rd & Bay Ave

07/21/2021

Intersection												
Int Delay, s/veh	2.3											
Movement	EBL	EBT	EBR	WBL	WBT	WBR	NBL	NBT	NBR	SBL	SBT	SBR
Lane Configurations		↕			↕		↗	↗	↗	↗	↗	↗
Traffic Vol, veh/h	20	1	29	18	0	16	42	545	36	59	402	4
Future Vol, veh/h	20	1	29	18	0	16	42	545	36	59	402	4
Conflicting Peds, #/hr	0	0	0	0	0	0	0	0	0	0	0	0
Sign Control	Stop	Stop	Stop	Stop	Stop	Stop	Free	Free	Free	Free	Free	Free
RT Channelized	-	-	None	-	-	None	-	-	None	-	-	None
Storage Length	-	-	-	-	-	-	225	-	50	450	-	50
Veh in Median Storage, #	-	0	-	-	0	-	-	0	-	-	0	-
Grade, %	-	0	-	-	0	-	-	0	-	-	0	-
Peak Hour Factor	85	85	85	85	85	85	85	85	85	85	85	85
Heavy Vehicles, %	0	0	0	0	0	0	0	0	0	0	0	0
Mvmt Flow	24	1	34	21	0	19	49	641	42	69	473	5

Major/Minor	Minor2		Minor1		Major1		Major2					
Conflicting Flow All	1030	1392	237	1114	1355	321	478	0	0	683	0	0
Stage 1	611	611	-	739	739	-	-	-	-	-	-	-
Stage 2	419	781	-	375	616	-	-	-	-	-	-	-
Critical Hdwy	7.5	6.5	6.9	7.5	6.5	6.9	4.1	-	-	4.1	-	-
Critical Hdwy Stg 1	6.5	5.5	-	6.5	5.5	-	-	-	-	-	-	-
Critical Hdwy Stg 2	6.5	5.5	-	6.5	5.5	-	-	-	-	-	-	-
Follow-up Hdwy	3.5	4	3.3	3.5	4	3.3	2.2	-	-	2.2	-	-
Pot Cap-1 Maneuver	190	143	771	165	151	681	1095	-	-	919	-	-
Stage 1	453	487	-	380	427	-	-	-	-	-	-	-
Stage 2	588	408	-	624	485	-	-	-	-	-	-	-
Platoon blocked, %								-	-	-	-	-
Mov Cap-1 Maneuver	168	126	771	143	133	681	1095	-	-	919	-	-
Mov Cap-2 Maneuver	168	126	-	143	133	-	-	-	-	-	-	-
Stage 1	433	450	-	363	408	-	-	-	-	-	-	-
Stage 2	546	390	-	550	449	-	-	-	-	-	-	-

Approach	EB		WB		NB		SB	
HCM Control Delay, s	19.7		24.1		0.6		1.2	
HCM LOS	C		C					

Minor Lane/Major Mvmt	NBL	NBT	NBR	EBLn1WBLn1	SBL	SBT	SBR
Capacity (veh/h)	1095	-	-	304	228	919	-
HCM Lane V/C Ratio	0.045	-	-	0.193	0.175	0.076	-
HCM Control Delay (s)	8.4	-	-	19.7	24.1	9.2	-
HCM Lane LOS	A	-	-	C	C	A	-
HCM 95th %tile Q(veh)	0.1	-	-	0.7	0.6	0.2	-

HCM 6th TWSC
 3: Old 215 Frontage Rd & Dwy 1

07/21/2021

Intersection						
Int Delay, s/veh	0.3					
Movement	WBL	WBR	NBT	NBR	SBL	SBT
Lane Configurations		↗	↕			↕
Traffic Vol, veh/h	0	36	584	8	0	478
Future Vol, veh/h	0	36	584	8	0	478
Conflicting Peds, #/hr	0	0	0	0	0	0
Sign Control	Stop	Stop	Free	Free	Free	Free
RT Channelized	-	None	-	None	-	None
Storage Length	-	0	-	-	-	-
Veh in Median Storage, #	0	-	0	-	-	0
Grade, %	0	-	0	-	-	0
Peak Hour Factor	92	92	92	92	92	92
Heavy Vehicles, %	0	0	0	0	0	0
Mvmt Flow	0	39	635	9	0	520

Major/Minor	Minor1	Major1	Major2
Conflicting Flow All	-	322	0
Stage 1	-	-	-
Stage 2	-	-	-
Critical Hdwy	-	6.9	-
Critical Hdwy Stg 1	-	-	-
Critical Hdwy Stg 2	-	-	-
Follow-up Hdwy	-	3.3	-
Pot Cap-1 Maneuver	0	680	-
Stage 1	0	-	-
Stage 2	0	-	-
Platoon blocked, %			
Mov Cap-1 Maneuver	-	680	-
Mov Cap-2 Maneuver	-	-	-
Stage 1	-	-	-
Stage 2	-	-	-

Approach	WB	NB	SB
HCM Control Delay, s	10.6	0	0
HCM LOS	B		

Minor Lane/Major Mvmt	NBT	NBRWBLn1	SBT
Capacity (veh/h)	-	-	680
HCM Lane V/C Ratio	-	-	0.058
HCM Control Delay (s)	-	-	10.6
HCM Lane LOS	-	-	B
HCM 95th %tile Q(veh)	-	-	0.2

HCM 6th TWSC
4: Old 215 Frontage Rd & Dwy 2

07/21/2021

Intersection						
Int Delay, s/veh	0.5					
Movement	WBL	WBR	NBT	NBR	SBL	SBT
Lane Configurations		↗	↕			↕
Traffic Vol, veh/h	0	53	539	11	0	478
Future Vol, veh/h	0	53	539	11	0	478
Conflicting Peds, #/hr	0	0	0	0	0	0
Sign Control	Stop	Stop	Free	Free	Free	Free
RT Channelized	-	None	-	None	-	None
Storage Length	-	0	-	-	-	-
Veh in Median Storage, #	0	-	0	-	-	0
Grade, %	0	-	0	-	-	0
Peak Hour Factor	92	92	92	92	92	92
Heavy Vehicles, %	0	0	0	0	0	0
Mvmt Flow	0	58	586	12	0	520

Major/Minor	Minor1	Major1	Major2
Conflicting Flow All	-	299	0
Stage 1	-	-	-
Stage 2	-	-	-
Critical Hdwy	-	6.9	-
Critical Hdwy Stg 1	-	-	-
Critical Hdwy Stg 2	-	-	-
Follow-up Hdwy	-	3.3	-
Pot Cap-1 Maneuver	0	703	-
Stage 1	0	-	-
Stage 2	0	-	-
Platoon blocked, %			
Mov Cap-1 Maneuver	-	703	-
Mov Cap-2 Maneuver	-	-	-
Stage 1	-	-	-
Stage 2	-	-	-

Approach	WB	NB	SB
HCM Control Delay, s	10.6	0	0
HCM LOS	B		

Minor Lane/Major Mvmt	NBT	NBRWBLn1	SBT
Capacity (veh/h)	-	-	703
HCM Lane V/C Ratio	-	-	0.082
HCM Control Delay (s)	-	-	10.6
HCM Lane LOS	-	-	B
HCM 95th %tile Q(veh)	-	-	0.3

HCM 6th Signalized Intersection Summary

5: Old 215 Frontage Rd & Alessandro Blvd

07/21/2021



Movement	EBL	EBT	EBR	WBL	WBT	WBR	NBL	NBT	NBR	SBL	SBT	SBR
Lane Configurations	↗↘	↑↑↑	↗	↘	↑↑	↗	↗↘	↑↑	↗	↘	↑↑	↗
Traffic Volume (veh/h)	363	1354	120	6	737	78	119	137	25	75	122	246
Future Volume (veh/h)	363	1354	120	6	737	78	119	137	25	75	122	246
Initial Q (Qb), veh	0	0	0	0	0	0	0	0	0	0	0	0
Ped-Bike Adj(A_pbT)	1.00		1.00	1.00		1.00	1.00		1.00	1.00		1.00
Parking Bus, Adj	1.00	1.00	1.00	1.00	1.00	1.00	1.00	1.00	1.00	1.00	1.00	1.00
Work Zone On Approach		No			No			No			No	
Adj Sat Flow, veh/h/ln	1900	1900	1900	1900	1900	1900	1900	1900	1900	1900	1900	1900
Adj Flow Rate, veh/h	386	1440	128	6	784	0	127	146	27	80	130	0
Peak Hour Factor	0.94	0.94	0.94	0.94	0.94	0.94	0.94	0.94	0.94	0.94	0.94	0.94
Percent Heavy Veh, %	0	0	0	0	0	0	0	0	0	0	0	0
Cap, veh/h	351	2440	757	20	1376		289	835	372	158	853	
Arrive On Green	0.10	0.47	0.47	0.01	0.38	0.00	0.08	0.23	0.23	0.09	0.24	0.00
Sat Flow, veh/h	3510	5187	1610	1810	3610	1610	3510	3610	1610	1810	3610	1610
Grp Volume(v), veh/h	386	1440	128	6	784	0	127	146	27	80	130	0
Grp Sat Flow(s),veh/h/ln	1755	1729	1610	1810	1805	1610	1755	1805	1610	1810	1805	1610
Q Serve(g_s), s	8.0	16.3	3.7	0.3	13.7	0.0	2.8	2.6	1.0	3.4	2.3	0.0
Cycle Q Clear(g_c), s	8.0	16.3	3.7	0.3	13.7	0.0	2.8	2.6	1.0	3.4	2.3	0.0
Prop In Lane	1.00		1.00	1.00		1.00	1.00		1.00	1.00		1.00
Lane Grp Cap(c), veh/h	351	2440	757	20	1376		289	835	372	158	853	
V/C Ratio(X)	1.10	0.59	0.17	0.30	0.57		0.44	0.17	0.07	0.51	0.15	
Avail Cap(c_a), veh/h	351	2440	757	158	1376		307	835	372	418	1354	
HCM Platoon Ratio	1.00	1.00	1.00	1.00	1.00	1.00	1.00	1.00	1.00	1.00	1.00	1.00
Upstream Filter(I)	1.00	1.00	1.00	1.00	1.00	0.00	1.00	1.00	1.00	1.00	1.00	0.00
Uniform Delay (d), s/veh	36.0	15.5	12.2	39.3	19.6	0.0	35.0	24.6	24.0	34.9	24.2	0.0
Incr Delay (d2), s/veh	77.5	1.1	0.5	8.4	0.6	0.0	1.1	0.5	0.4	2.5	0.1	0.0
Initial Q Delay(d3),s/veh	0.0	0.0	0.0	0.0	0.0	0.0	0.0	0.0	0.0	0.0	0.0	0.0
%ile BackOfQ(50%),veh/ln	7.1	6.1	1.3	0.2	5.5	0.0	1.2	1.1	0.4	1.6	1.0	0.0
Unsig. Movement Delay, s/veh												
LnGrp Delay(d),s/veh	113.5	16.6	12.7	47.6	20.1	0.0	36.0	25.1	24.4	37.3	24.3	0.0
LnGrp LOS	F	B	B	D	C		D	C	C	D	C	
Approach Vol, veh/h		1954			790	A		300			210	A
Approach Delay, s/veh		35.5			20.3			29.7			29.3	
Approach LOS		D			C			C			C	
Timer - Assigned Phs	1	2	3	4	5	6	7	8				
Phs Duration (G+Y+Rc), s	4.9	41.6	10.6	22.9	12.0	34.5	11.0	22.5				
Change Period (Y+Rc), s	4.0	4.0	4.0	4.0	4.0	4.0	4.0	4.0				
Max Green Setting (Gmax), s	7.0	20.0	7.0	30.0	8.0	19.0	18.5	18.5				
Max Q Clear Time (g_c+I1), s	2.3	18.3	4.8	4.3	10.0	15.7	5.4	4.6				
Green Ext Time (p_c), s	0.0	1.4	0.1	0.7	0.0	1.6	0.1	0.7				

Intersection Summary

HCM 6th Ctrl Delay	30.9
HCM 6th LOS	C

Notes

Unsignalized Delay for [WBR, SBR] is excluded from calculations of the approach delay and intersection delay.

HCM 6th TWSC
1: Old 215 Frontage Rd & Cottonwood Ave

07/21/2021

Intersection												
Int Delay, s/veh	3.1											
Movement	EBL	EBT	EBR	WBL	WBT	WBR	NBL	NBT	NBR	SBL	SBT	SBR
Lane Configurations		↕			↕		↗	↕	↗	↗	↕	↗
Traffic Vol, veh/h	3	2	0	78	3	43	8	328	11	12	106	1
Future Vol, veh/h	3	2	0	78	3	43	8	328	11	12	106	1
Conflicting Peds, #/hr	0	0	0	0	0	0	0	0	0	0	0	0
Sign Control	Stop	Stop	Stop	Stop	Stop	Stop	Free	Free	Free	Free	Free	Free
RT Channelized	-	-	None	-	-	None	-	-	None	-	-	None
Storage Length	-	-	-	-	-	-	235	-	50	435	-	50
Veh in Median Storage, #	-	0	-	-	0	-	-	0	-	-	0	-
Grade, %	-	0	-	-	0	-	-	0	-	-	0	-
Peak Hour Factor	95	95	95	95	95	95	95	95	95	95	95	95
Heavy Vehicles, %	0	0	0	0	0	0	0	0	0	0	0	0
Mvmt Flow	3	2	0	82	3	45	8	345	12	13	112	1

Major/Minor	Minor2		Minor1			Major1			Major2			
Conflicting Flow All	328	511	56	444	500	173	113	0	0	357	0	0
Stage 1	138	138	-	361	361	-	-	-	-	-	-	-
Stage 2	190	373	-	83	139	-	-	-	-	-	-	-
Critical Hdwy	7.5	6.5	6.9	7.5	6.5	6.9	4.1	-	-	4.1	-	-
Critical Hdwy Stg 1	6.5	5.5	-	6.5	5.5	-	-	-	-	-	-	-
Critical Hdwy Stg 2	6.5	5.5	-	6.5	5.5	-	-	-	-	-	-	-
Follow-up Hdwy	3.5	4	3.3	3.5	4	3.3	2.2	-	-	2.2	-	-
Pot Cap-1 Maneuver	607	469	1005	502	476	847	1489	-	-	1213	-	-
Stage 1	857	786	-	636	629	-	-	-	-	-	-	-
Stage 2	799	622	-	922	785	-	-	-	-	-	-	-
Platoon blocked, %								-	-	-	-	-
Mov Cap-1 Maneuver	565	461	1005	494	468	847	1489	-	-	1213	-	-
Mov Cap-2 Maneuver	565	461	-	494	468	-	-	-	-	-	-	-
Stage 1	853	777	-	633	626	-	-	-	-	-	-	-
Stage 2	748	619	-	910	776	-	-	-	-	-	-	-

Approach	EB		WB			NB			SB		
HCM Control Delay, s	12		13.1			0.2			0.8		
HCM LOS	B		B								

Minor Lane/Major Mvmt	NBL	NBT	NBR	EBLn1	WBLn1	SBL	SBT	SBR
Capacity (veh/h)	1489	-	-	518	577	1213	-	-
HCM Lane V/C Ratio	0.006	-	-	0.01	0.226	0.01	-	-
HCM Control Delay (s)	7.4	-	-	12	13.1	8	-	-
HCM Lane LOS	A	-	-	B	B	A	-	-
HCM 95th %tile Q(veh)	0	-	-	0	0.9	0	-	-

HCM 6th TWSC
2: Old 215 Frontage Rd & Bay Ave

07/21/2021

Intersection												
Int Delay, s/veh	2.3											
Movement	EBL	EBT	EBR	WBL	WBT	WBR	NBL	NBT	NBR	SBL	SBT	SBR
Lane Configurations		↕			↕		↗	↕	↗	↗	↗	↗
Traffic Vol, veh/h	4	1	12	44	1	31	25	290	8	16	168	7
Future Vol, veh/h	4	1	12	44	1	31	25	290	8	16	168	7
Conflicting Peds, #/hr	0	0	0	0	0	0	0	0	0	0	0	0
Sign Control	Stop	Stop	Stop	Stop	Stop	Stop	Free	Free	Free	Free	Free	Free
RT Channelized	-	-	None	-	-	None	-	-	None	-	-	None
Storage Length	-	-	-	-	-	-	225	-	50	450	-	50
Veh in Median Storage, #	-	0	-	-	0	-	-	0	-	-	0	-
Grade, %	-	0	-	-	0	-	-	0	-	-	0	-
Peak Hour Factor	99	99	99	99	99	99	99	99	99	99	99	99
Heavy Vehicles, %	0	0	0	0	0	0	0	0	0	0	0	0
Mvmt Flow	4	1	12	44	1	31	25	293	8	16	170	7

Major/Minor	Minor2		Minor1		Major1		Major2					
Conflicting Flow All	399	553	85	461	552	147	177	0	0	301	0	0
Stage 1	202	202	-	343	343	-	-	-	-	-	-	-
Stage 2	197	351	-	118	209	-	-	-	-	-	-	-
Critical Hdwy	7.5	6.5	6.9	7.5	6.5	6.9	4.1	-	-	4.1	-	-
Critical Hdwy Stg 1	6.5	5.5	-	6.5	5.5	-	-	-	-	-	-	-
Critical Hdwy Stg 2	6.5	5.5	-	6.5	5.5	-	-	-	-	-	-	-
Follow-up Hdwy	3.5	4	3.3	3.5	4	3.3	2.2	-	-	2.2	-	-
Pot Cap-1 Maneuver	540	444	963	488	444	880	1411	-	-	1272	-	-
Stage 1	787	738	-	651	641	-	-	-	-	-	-	-
Stage 2	792	636	-	880	733	-	-	-	-	-	-	-
Platoon blocked, %								-	-	-	-	-
Mov Cap-1 Maneuver	508	430	963	470	430	880	1411	-	-	1272	-	-
Mov Cap-2 Maneuver	508	430	-	470	430	-	-	-	-	-	-	-
Stage 1	773	728	-	639	629	-	-	-	-	-	-	-
Stage 2	749	625	-	857	723	-	-	-	-	-	-	-

Approach	EB		WB		NB		SB			
HCM Control Delay, s	9.9		12.2		0.6		0.7			
HCM LOS	A		B							

Minor Lane/Major Mvmt	NBL	NBT	NBR	EBLn1	WBLn1	SBL	SBT	SBR
Capacity (veh/h)	1411	-	-	750	579	1272	-	-
HCM Lane V/C Ratio	0.018	-	-	0.023	0.133	0.013	-	-
HCM Control Delay (s)	7.6	-	-	9.9	12.2	7.9	-	-
HCM Lane LOS	A	-	-	A	B	A	-	-
HCM 95th %tile Q(veh)	0.1	-	-	0.1	0.5	0	-	-

HCM 6th Signalized Intersection Summary

5: Old 215 Frontage Rd & Alessandro Blvd

07/21/2021



Movement	EBL	EBT	EBR	WBL	WBT	WBR	NBL	NBT	NBR	SBL	SBT	SBR
Lane Configurations	↖↗	↑↑↑	↖	↖	↑↑	↖	↖↗	↑↑	↖	↖	↑↑	↖
Traffic Volume (veh/h)	174	547	22	8	613	40	32	144	11	22	34	143
Future Volume (veh/h)	174	547	22	8	613	40	32	144	11	22	34	143
Initial Q (Qb), veh	0	0	0	0	0	0	0	0	0	0	0	0
Ped-Bike Adj(A_pbT)	1.00		1.00	1.00		1.00	1.00		1.00	1.00		1.00
Parking Bus, Adj	1.00	1.00	1.00	1.00	1.00	1.00	1.00	1.00	1.00	1.00	1.00	1.00
Work Zone On Approach		No			No			No			No	
Adj Sat Flow, veh/h/ln	1900	1900	1900	1900	1900	1900	1900	1900	1900	1900	1900	1900
Adj Flow Rate, veh/h	179	564	23	8	632	0	33	148	11	23	35	0
Peak Hour Factor	0.97	0.97	0.97	0.97	0.97	0.97	0.97	0.97	0.97	0.97	0.97	0.97
Percent Heavy Veh, %	0	0	0	0	0	0	0	0	0	0	0	0
Cap, veh/h	301	2482	771	26	1469		160	835	372	137	945	
Arrive On Green	0.09	0.48	0.48	0.01	0.41	0.00	0.05	0.23	0.23	0.08	0.26	0.00
Sat Flow, veh/h	3510	5187	1610	1810	3610	1610	3510	3610	1610	1810	3610	1610
Grp Volume(v), veh/h	179	564	23	8	632	0	33	148	11	23	35	0
Grp Sat Flow(s),veh/h/ln	1755	1729	1610	1810	1805	1610	1755	1805	1610	1810	1805	1610
Q Serve(g_s), s	3.9	5.1	0.6	0.4	10.1	0.0	0.7	2.6	0.4	1.0	0.6	0.0
Cycle Q Clear(g_c), s	3.9	5.1	0.6	0.4	10.1	0.0	0.7	2.6	0.4	1.0	0.6	0.0
Prop In Lane	1.00		1.00	1.00		1.00	1.00		1.00	1.00		1.00
Lane Grp Cap(c), veh/h	301	2482	771	26	1469		160	835	372	137	945	
V/C Ratio(X)	0.59	0.23	0.03	0.31	0.43		0.21	0.18	0.03	0.17	0.04	
Avail Cap(c_a), veh/h	307	2482	771	158	1469		307	835	372	418	1354	
HCM Platoon Ratio	1.00	1.00	1.00	1.00	1.00	1.00	1.00	1.00	1.00	1.00	1.00	1.00
Upstream Filter(I)	1.00	1.00	1.00	1.00	1.00	0.00	1.00	1.00	1.00	1.00	1.00	0.00
Uniform Delay (d), s/veh	35.2	12.2	11.0	39.0	17.1	0.0	36.8	24.6	23.8	34.6	22.0	0.0
Incr Delay (d2), s/veh	3.0	0.2	0.1	6.6	0.2	0.0	0.6	0.5	0.1	0.6	0.0	0.0
Initial Q Delay(d3),s/veh	0.0	0.0	0.0	0.0	0.0	0.0	0.0	0.0	0.0	0.0	0.0	0.0
%ile BackOfQ(50%),veh/ln	1.8	1.9	0.2	0.2	4.0	0.0	0.3	1.1	0.2	0.4	0.2	0.0
Unsig. Movement Delay, s/veh												
LnGrp Delay(d),s/veh	38.2	12.4	11.1	45.7	17.3	0.0	37.4	25.1	23.9	35.2	22.0	0.0
LnGrp LOS	D	B	B	D	B		D	C	C	D	C	
Approach Vol, veh/h		766			640	A		192			58	A
Approach Delay, s/veh		18.4			17.6			27.2			27.2	
Approach LOS		B			B			C			C	
Timer - Assigned Phs	1	2	3	4	5	6	7	8				
Phs Duration (G+Y+Rc), s	5.1	42.3	7.6	24.9	10.9	36.6	10.1	22.5				
Change Period (Y+Rc), s	4.0	4.0	4.0	4.0	4.0	4.0	4.0	4.0				
Max Green Setting (Gmax), s	7.0	20.0	7.0	30.0	7.0	20.0	18.5	18.5				
Max Q Clear Time (g_c+I1), s	2.4	7.1	2.7	2.6	5.9	12.1	3.0	4.6				
Green Ext Time (p_c), s	0.0	3.2	0.0	0.1	0.1	2.6	0.0	0.7				

Intersection Summary

HCM 6th Ctrl Delay	19.4
HCM 6th LOS	B

Notes

Unsignalized Delay for [WBR, SBR] is excluded from calculations of the approach delay and intersection delay.

HCM 6th TWSC
1: Old 215 Frontage Rd & Cottonwood Ave

07/21/2021

Intersection												
Int Delay, s/veh	1.9											
Movement	EBL	EBT	EBR	WBL	WBT	WBR	NBL	NBT	NBR	SBL	SBT	SBR
Lane Configurations		↕			↕		↗	↕	↗	↗	↕	↗
Traffic Vol, veh/h	6	1	2	34	0	35	5	504	50	53	316	0
Future Vol, veh/h	6	1	2	34	0	35	5	504	50	53	316	0
Conflicting Peds, #/hr	0	0	0	0	0	0	0	0	0	0	0	0
Sign Control	Stop	Stop	Stop	Stop	Stop	Stop	Free	Free	Free	Free	Free	Free
RT Channelized	-	-	None	-	-	None	-	-	None	-	-	None
Storage Length	-	-	-	-	-	-	235	-	50	435	-	50
Veh in Median Storage, #	-	0	-	-	0	-	-	0	-	-	0	-
Grade, %	-	0	-	-	0	-	-	0	-	-	0	-
Peak Hour Factor	91	91	91	91	91	91	91	91	91	91	91	91
Heavy Vehicles, %	0	0	0	0	0	0	0	0	0	0	0	0
Mvmt Flow	7	1	2	37	0	38	5	554	55	58	347	0

Major/Minor	Minor2		Minor1		Major1		Major2					
Conflicting Flow All	750	1082	174	854	1027	277	347	0	0	609	0	0
Stage 1	463	463	-	564	564	-	-	-	-	-	-	-
Stage 2	287	619	-	290	463	-	-	-	-	-	-	-
Critical Hdwy	7.5	6.5	6.9	7.5	6.5	6.9	4.1	-	-	4.1	-	-
Critical Hdwy Stg 1	6.5	5.5	-	6.5	5.5	-	-	-	-	-	-	-
Critical Hdwy Stg 2	6.5	5.5	-	6.5	5.5	-	-	-	-	-	-	-
Follow-up Hdwy	3.5	4	3.3	3.5	4	3.3	2.2	-	-	2.2	-	-
Pot Cap-1 Maneuver	304	219	846	256	236	726	1223	-	-	979	-	-
Stage 1	554	568	-	483	512	-	-	-	-	-	-	-
Stage 2	702	483	-	699	568	-	-	-	-	-	-	-
Platoon blocked, %								-	-	-	-	-
Mov Cap-1 Maneuver	274	205	846	242	221	726	1223	-	-	979	-	-
Mov Cap-2 Maneuver	274	205	-	242	221	-	-	-	-	-	-	-
Stage 1	552	534	-	481	510	-	-	-	-	-	-	-
Stage 2	662	481	-	655	534	-	-	-	-	-	-	-

Approach	EB		WB		NB		SB	
HCM Control Delay, s	17		17.4		0.1		1.3	
HCM LOS	C		C					

Minor Lane/Major Mvmt	NBL	NBT	NBR	EBLn1WBLn1	SBL	SBT	SBR
Capacity (veh/h)	1223	-	-	309	366	979	-
HCM Lane V/C Ratio	0.004	-	-	0.032	0.207	0.059	-
HCM Control Delay (s)	8	-	-	17	17.4	8.9	-
HCM Lane LOS	A	-	-	C	C	A	-
HCM 95th %tile Q(veh)	0	-	-	0.1	0.8	0.2	-

HCM 6th TWSC
2: Old 215 Frontage Rd & Bay Ave

07/21/2021

Intersection												
Int Delay, s/veh	1.7											
Movement	EBL	EBT	EBR	WBL	WBT	WBR	NBL	NBT	NBR	SBL	SBT	SBR
Lane Configurations		↕			↕		↕	↑↑	↕	↕	↑↑	↕
Traffic Vol, veh/h	12	1	21	17	0	15	14	441	30	57	369	1
Future Vol, veh/h	12	1	21	17	0	15	14	441	30	57	369	1
Conflicting Peds, #/hr	0	0	0	0	0	0	0	0	0	0	0	0
Sign Control	Stop	Stop	Stop	Stop	Stop	Stop	Free	Free	Free	Free	Free	Free
RT Channelized	-	-	None	-	-	None	-	-	None	-	-	None
Storage Length	-	-	-	-	-	-	225	-	50	450	-	50
Veh in Median Storage, #	-	0	-	-	0	-	-	0	-	-	0	-
Grade, %	-	0	-	-	0	-	-	0	-	-	0	-
Peak Hour Factor	85	85	85	85	85	85	85	85	85	85	85	85
Heavy Vehicles, %	0	0	0	0	0	0	0	0	0	0	0	0
Mvmt Flow	14	1	25	20	0	18	16	519	35	67	434	1

Major/Minor	Minor2		Minor1		Major1			Major2				
Conflicting Flow All	860	1154	217	903	1120	260	435	0	0	554	0	0
Stage 1	568	568	-	551	551	-	-	-	-	-	-	-
Stage 2	292	586	-	352	569	-	-	-	-	-	-	-
Critical Hdwy	7.5	6.5	6.9	7.5	6.5	6.9	4.1	-	-	4.1	-	-
Critical Hdwy Stg 1	6.5	5.5	-	6.5	5.5	-	-	-	-	-	-	-
Critical Hdwy Stg 2	6.5	5.5	-	6.5	5.5	-	-	-	-	-	-	-
Follow-up Hdwy	3.5	4	3.3	3.5	4	3.3	2.2	-	-	2.2	-	-
Pot Cap-1 Maneuver	253	199	794	236	208	745	1135	-	-	1026	-	-
Stage 1	480	510	-	491	519	-	-	-	-	-	-	-
Stage 2	697	500	-	643	509	-	-	-	-	-	-	-
Platoon blocked, %								-	-	-	-	-
Mov Cap-1 Maneuver	232	183	794	214	192	745	1135	-	-	1026	-	-
Mov Cap-2 Maneuver	232	183	-	214	192	-	-	-	-	-	-	-
Stage 1	473	477	-	484	512	-	-	-	-	-	-	-
Stage 2	671	493	-	581	476	-	-	-	-	-	-	-

Approach	EB		WB		NB		SB	
HCM Control Delay, s	14.8		17.7		0.2		1.2	
HCM LOS	B		C					

Minor Lane/Major Mvmt	NBL	NBT	NBR	EBLn1WBLn1	SBL	SBT	SBR
Capacity (veh/h)	1135	-	-	407	321	1026	-
HCM Lane V/C Ratio	0.015	-	-	0.098	0.117	0.065	-
HCM Control Delay (s)	8.2	-	-	14.8	17.7	8.8	-
HCM Lane LOS	A	-	-	B	C	A	-
HCM 95th %tile Q(veh)	0	-	-	0.3	0.4	0.2	-

HCM 6th Signalized Intersection Summary
5: Old 215 Frontage Rd & Alessandro Blvd

07/21/2021



Movement	EBL	EBT	EBR	WBL	WBT	WBR	NBL	NBT	NBR	SBL	SBT	SBR
Lane Configurations	↔↔	↑↑↑	↔	↔	↑↑	↔	↔↔	↑↑	↔	↔	↑↑	↔
Traffic Volume (veh/h)	318	1245	90	4	671	67	49	123	12	58	115	200
Future Volume (veh/h)	318	1245	90	4	671	67	49	123	12	58	115	200
Initial Q (Qb), veh	0	0	0	0	0	0	0	0	0	0	0	0
Ped-Bike Adj(A_pbT)	1.00		1.00	1.00		1.00	1.00		1.00	1.00		1.00
Parking Bus, Adj	1.00	1.00	1.00	1.00	1.00	1.00	1.00	1.00	1.00	1.00	1.00	1.00
Work Zone On Approach		No			No			No			No	
Adj Sat Flow, veh/h/ln	1900	1900	1900	1900	1900	1900	1900	1900	1900	1900	1900	1900
Adj Flow Rate, veh/h	338	1324	96	4	714	0	52	131	13	62	122	0
Peak Hour Factor	0.94	0.94	0.94	0.94	0.94	0.94	0.94	0.94	0.94	0.94	0.94	0.94
Percent Heavy Veh, %	0	0	0	0	0	0	0	0	0	0	0	0
Cap, veh/h	351	2460	764	13	1378		210	835	372	157	933	
Arrive On Green	0.10	0.47	0.47	0.01	0.38	0.00	0.06	0.23	0.23	0.09	0.26	0.00
Sat Flow, veh/h	3510	5187	1610	1810	3610	1610	3510	3610	1610	1810	3610	1610
Grp Volume(v), veh/h	338	1324	96	4	714	0	52	131	13	62	122	0
Grp Sat Flow(s),veh/h/ln	1755	1729	1610	1810	1805	1610	1755	1805	1610	1810	1805	1610
Q Serve(g_s), s	7.7	14.4	2.7	0.2	12.2	0.0	1.1	2.3	0.5	2.6	2.1	0.0
Cycle Q Clear(g_c), s	7.7	14.4	2.7	0.2	12.2	0.0	1.1	2.3	0.5	2.6	2.1	0.0
Prop In Lane	1.00		1.00	1.00		1.00	1.00		1.00	1.00		1.00
Lane Grp Cap(c), veh/h	351	2460	764	13	1378		210	835	372	157	933	
V/C Ratio(X)	0.96	0.54	0.13	0.30	0.52		0.25	0.16	0.03	0.39	0.13	
Avail Cap(c_a), veh/h	351	2460	764	158	1378		307	835	372	418	1354	
HCM Platoon Ratio	1.00	1.00	1.00	1.00	1.00	1.00	1.00	1.00	1.00	1.00	1.00	1.00
Upstream Filter(I)	1.00	1.00	1.00	1.00	1.00	0.00	1.00	1.00	1.00	1.00	1.00	0.00
Uniform Delay (d), s/veh	35.9	14.8	11.8	39.5	19.1	0.0	35.9	24.5	23.8	34.5	22.8	0.0
Incr Delay (d2), s/veh	38.1	0.8	0.3	11.8	0.3	0.0	0.6	0.4	0.2	1.6	0.1	0.0
Initial Q Delay(d3),s/veh	0.0	0.0	0.0	0.0	0.0	0.0	0.0	0.0	0.0	0.0	0.0	0.0
%ile BackOfQ(50%),veh/ln	5.1	5.4	1.0	0.1	4.9	0.0	0.5	1.0	0.2	1.2	0.9	0.0
Unsig. Movement Delay, s/veh												
LnGrp Delay(d),s/veh	74.0	15.7	12.1	51.3	19.4	0.0	36.5	24.9	24.0	36.1	22.8	0.0
LnGrp LOS	E	B	B	D	B		D	C	C	D	C	
Approach Vol, veh/h		1758			718	A		196			184	A
Approach Delay, s/veh		26.7			19.6			27.9			27.3	
Approach LOS		C			B			C			C	
Timer - Assigned Phs	1	2	3	4	5	6	7	8				
Phs Duration (G+Y+Rc), s	4.6	41.9	8.8	24.7	12.0	34.5	11.0	22.5				
Change Period (Y+Rc), s	4.0	4.0	4.0	4.0	4.0	4.0	4.0	4.0				
Max Green Setting (Gmax), s	7.0	20.0	7.0	30.0	8.0	19.0	18.5	18.5				
Max Q Clear Time (g_c+I1), s	2.2	16.4	3.1	4.1	9.7	14.2	4.6	4.3				
Green Ext Time (p_c), s	0.0	2.7	0.0	0.7	0.0	2.0	0.1	0.6				

Intersection Summary

HCM 6th Ctrl Delay	25.0
HCM 6th LOS	C

Notes

Unsignalized Delay for [WBR, SBR] is excluded from calculations of the approach delay and intersection delay.

HCM 6th TWSC
1: Old 215 Frontage Rd & Cottonwood Ave

07/21/2021

Intersection												
Int Delay, s/veh	3.3											
Movement	EBL	EBT	EBR	WBL	WBT	WBR	NBL	NBT	NBR	SBL	SBT	SBR
Lane Configurations		↕			↕		↕	↑↑	↕	↕	↑↑	↕
Traffic Vol, veh/h	12	2	2	81	3	45	19	347	11	12	136	24
Future Vol, veh/h	12	2	2	81	3	45	19	347	11	12	136	24
Conflicting Peds, #/hr	0	0	0	0	0	0	0	0	0	0	0	0
Sign Control	Stop	Stop	Stop	Stop	Stop	Stop	Free	Free	Free	Free	Free	Free
RT Channelized	-	-	None	-	-	None	-	-	None	-	-	None
Storage Length	-	-	-	-	-	-	235	-	50	435	-	50
Veh in Median Storage, #	-	0	-	-	0	-	-	0	-	-	0	-
Grade, %	-	0	-	-	0	-	-	0	-	-	0	-
Peak Hour Factor	95	95	95	95	95	95	95	95	95	95	95	95
Heavy Vehicles, %	0	0	0	0	0	0	0	0	0	0	0	0
Mvmt Flow	13	2	2	85	3	47	20	365	12	13	143	25

Major/Minor	Minor2		Minor1			Major1		Major2				
Conflicting Flow All	393	586	72	504	599	183	168	0	0	377	0	0
Stage 1	169	169	-	405	405	-	-	-	-	-	-	-
Stage 2	224	417	-	99	194	-	-	-	-	-	-	-
Critical Hdwy	7.5	6.5	6.9	7.5	6.5	6.9	4.1	-	-	4.1	-	-
Critical Hdwy Stg 1	6.5	5.5	-	6.5	5.5	-	-	-	-	-	-	-
Critical Hdwy Stg 2	6.5	5.5	-	6.5	5.5	-	-	-	-	-	-	-
Follow-up Hdwy	3.5	4	3.3	3.5	4	3.3	2.2	-	-	2.2	-	-
Pot Cap-1 Maneuver	546	425	982	455	418	834	1422	-	-	1193	-	-
Stage 1	822	763	-	599	602	-	-	-	-	-	-	-
Stage 2	764	595	-	902	744	-	-	-	-	-	-	-
Platoon blocked, %								-	-	-	-	-
Mov Cap-1 Maneuver	502	414	982	444	408	834	1422	-	-	1193	-	-
Mov Cap-2 Maneuver	502	414	-	444	408	-	-	-	-	-	-	-
Stage 1	810	755	-	591	594	-	-	-	-	-	-	-
Stage 2	707	587	-	888	736	-	-	-	-	-	-	-

Approach	EB		WB			NB		SB		
HCM Control Delay, s	12.2		14.1			0.4		0.6		
HCM LOS	B		B							

Minor Lane/Major Mvmt	NBL	NBT	NBR	EBLn1WBLn1	SBL	SBT	SBR
Capacity (veh/h)	1422	-	-	520	529	1193	-
HCM Lane V/C Ratio	0.014	-	-	0.032	0.257	0.011	-
HCM Control Delay (s)	7.6	-	-	12.2	14.1	8.1	-
HCM Lane LOS	A	-	-	B	B	A	-
HCM 95th %tile Q(veh)	0	-	-	0.1	1	0	-

HCM 6th TWSC
2: Old 215 Frontage Rd & Bay Ave

07/21/2021

Intersection												
Int Delay, s/veh	2.5											
Movement	EBL	EBT	EBR	WBL	WBT	WBR	NBL	NBT	NBR	SBL	SBT	SBR
Lane Configurations		↕			↕		↕	↑↑	↕	↕	↑↑	↕
Traffic Vol, veh/h	6	1	14	46	1	32	47	317	8	17	195	15
Future Vol, veh/h	6	1	14	46	1	32	47	317	8	17	195	15
Conflicting Peds, #/hr	0	0	0	0	0	0	0	0	0	0	0	0
Sign Control	Stop	Stop	Stop	Stop	Stop	Stop	Free	Free	Free	Free	Free	Free
RT Channelized	-	-	None	-	-	None	-	-	None	-	-	None
Storage Length	-	-	-	-	-	-	225	-	50	450	-	50
Veh in Median Storage, #	-	0	-	-	0	-	-	0	-	-	0	-
Grade, %	-	0	-	-	0	-	-	0	-	-	0	-
Peak Hour Factor	99	99	99	99	99	99	99	99	99	99	99	99
Heavy Vehicles, %	0	0	0	0	0	0	0	0	0	0	0	0
Mvmt Flow	6	1	14	46	1	32	47	320	8	17	197	15

Major/Minor	Minor2		Minor1		Major1			Major2				
Conflicting Flow All	486	653	99	547	660	160	212	0	0	328	0	0
Stage 1	231	231	-	414	414	-	-	-	-	-	-	-
Stage 2	255	422	-	133	246	-	-	-	-	-	-	-
Critical Hdwy	7.5	6.5	6.9	7.5	6.5	6.9	4.1	-	-	4.1	-	-
Critical Hdwy Stg 1	6.5	5.5	-	6.5	5.5	-	-	-	-	-	-	-
Critical Hdwy Stg 2	6.5	5.5	-	6.5	5.5	-	-	-	-	-	-	-
Follow-up Hdwy	3.5	4	3.3	3.5	4	3.3	2.2	-	-	2.2	-	-
Pot Cap-1 Maneuver	469	389	944	424	386	863	1370	-	-	1243	-	-
Stage 1	757	717	-	592	597	-	-	-	-	-	-	-
Stage 2	733	592	-	862	706	-	-	-	-	-	-	-
Platoon blocked, %								-	-	-	-	-
Mov Cap-1 Maneuver	434	370	944	402	367	863	1370	-	-	1243	-	-
Mov Cap-2 Maneuver	434	370	-	402	367	-	-	-	-	-	-	-
Stage 1	731	707	-	572	577	-	-	-	-	-	-	-
Stage 2	680	572	-	836	696	-	-	-	-	-	-	-

Approach	EB		WB		NB			SB		
HCM Control Delay, s	10.5		13.3		1			0.6		
HCM LOS	B		B							

Minor Lane/Major Mvmt	NBL	NBT	NBR	EBLn1WBLn1	SBL	SBT	SBR
Capacity (veh/h)	1370	-	-	670	512	1243	-
HCM Lane V/C Ratio	0.035	-	-	0.032	0.156	0.014	-
HCM Control Delay (s)	7.7	-	-	10.5	13.3	7.9	-
HCM Lane LOS	A	-	-	B	B	A	-
HCM 95th %tile Q(veh)	0.1	-	-	0.1	0.5	0	-

HCM 6th Signalized Intersection Summary

5: Old 215 Frontage Rd & Alessandro Blvd

07/21/2021



Movement	EBL	EBT	EBR	WBL	WBT	WBR	NBL	NBT	NBR	SBL	SBT	SBR
Lane Configurations	↖↗	↑↑↑	↖	↖	↑↑	↖	↖↗	↑↑	↖	↖	↑↑	↖
Traffic Volume (veh/h)	207	604	82	19	698	51	55	152	14	25	45	164
Future Volume (veh/h)	207	604	82	19	698	51	55	152	14	25	45	164
Initial Q (Qb), veh	0	0	0	0	0	0	0	0	0	0	0	0
Ped-Bike Adj(A_pbT)	1.00		1.00	1.00		1.00	1.00		1.00	1.00		1.00
Parking Bus, Adj	1.00	1.00	1.00	1.00	1.00	1.00	1.00	1.00	1.00	1.00	1.00	1.00
Work Zone On Approach		No			No			No			No	
Adj Sat Flow, veh/h/ln	1900	1900	1900	1900	1900	1900	1900	1900	1900	1900	1900	1900
Adj Flow Rate, veh/h	213	623	85	20	720	0	57	157	14	26	46	0
Peak Hour Factor	0.97	0.97	0.97	0.97	0.97	0.97	0.97	0.97	0.97	0.97	0.97	0.97
Percent Heavy Veh, %	0	0	0	0	0	0	0	0	0	0	0	0
Cap, veh/h	893	2359	732	57	837		221	835	372	149	906	
Arrive On Green	0.25	0.45	0.45	0.03	0.23	0.00	0.06	0.23	0.23	0.08	0.25	0.00
Sat Flow, veh/h	3510	5187	1610	1810	3610	1610	3510	3610	1610	1810	3610	1610
Grp Volume(v), veh/h	213	623	85	20	720	0	57	157	14	26	46	0
Grp Sat Flow(s),veh/h/ln	1755	1729	1610	1810	1805	1610	1755	1805	1610	1810	1805	1610
Q Serve(g_s), s	3.9	6.0	2.4	0.9	15.3	0.0	1.2	2.8	0.5	1.1	0.8	0.0
Cycle Q Clear(g_c), s	3.9	6.0	2.4	0.9	15.3	0.0	1.2	2.8	0.5	1.1	0.8	0.0
Prop In Lane	1.00		1.00	1.00		1.00	1.00		1.00	1.00		1.00
Lane Grp Cap(c), veh/h	893	2359	732	57	837		221	835	372	149	906	
V/C Ratio(X)	0.24	0.26	0.12	0.35	0.86		0.26	0.19	0.04	0.17	0.05	
Avail Cap(c_a), veh/h	893	2359	732	158	903		307	835	372	418	1354	
HCM Platoon Ratio	1.00	1.00	1.00	1.00	1.00	1.00	1.00	1.00	1.00	1.00	1.00	1.00
Upstream Filter(I)	1.00	1.00	1.00	1.00	1.00	0.00	1.00	1.00	1.00	1.00	1.00	0.00
Uniform Delay (d), s/veh	23.7	13.5	12.6	37.9	29.5	0.0	35.7	24.7	23.8	34.2	22.7	0.0
Incr Delay (d2), s/veh	0.1	0.3	0.3	3.7	8.0	0.0	0.6	0.5	0.2	0.5	0.0	0.0
Initial Q Delay(d3),s/veh	0.0	0.0	0.0	0.0	0.0	0.0	0.0	0.0	0.0	0.0	0.0	0.0
%ile BackOfQ(50%),veh/ln	1.6	2.2	0.9	0.4	7.3	0.0	0.5	1.2	0.2	0.5	0.3	0.0
Unsig. Movement Delay, s/veh												
LnGrp Delay(d),s/veh	23.8	13.8	12.9	41.6	37.5	0.0	36.3	25.2	24.0	34.7	22.8	0.0
LnGrp LOS	C	B	B	D	D		D	C	C	C	C	
Approach Vol, veh/h		921			740	A		228			72	A
Approach Delay, s/veh		16.0			37.6			27.9			27.1	
Approach LOS		B			D			C			C	
Timer - Assigned Phs	1	2	3	4	5	6	7	8				
Phs Duration (G+Y+Rc), s	6.5	40.4	9.0	24.1	24.3	22.6	10.6	22.5				
Change Period (Y+Rc), s	4.0	4.0	4.0	4.0	4.0	4.0	4.0	4.0				
Max Green Setting (Gmax), s	7.0	20.0	7.0	30.0	7.0	20.0	18.5	18.5				
Max Q Clear Time (g_c+I1), s	2.9	8.0	3.2	2.8	5.9	17.3	3.1	4.8				
Green Ext Time (p_c), s	0.0	3.6	0.0	0.2	0.1	1.3	0.0	0.7				

Intersection Summary

HCM 6th Ctrl Delay	25.9
HCM 6th LOS	C

Notes

Unsignalized Delay for [WBR, SBR] is excluded from calculations of the approach delay and intersection delay.

HCM 6th TWSC
1: Old 215 Frontage Rd & Cottonwood Ave

07/21/2021

Intersection												
Int Delay, s/veh	2.6											
Movement	EBL	EBT	EBR	WBL	WBT	WBR	NBL	NBT	NBR	SBL	SBT	SBR
Lane Configurations		↕			↕		↗	↕	↗	↗	↕	↗
Traffic Vol, veh/h	36	1	10	35	0	36	10	547	52	55	341	7
Future Vol, veh/h	36	1	10	35	0	36	10	547	52	55	341	7
Conflicting Peds, #/hr	0	0	0	0	0	0	0	0	0	0	0	0
Sign Control	Stop	Stop	Stop	Stop	Stop	Stop	Free	Free	Free	Free	Free	Free
RT Channelized	-	-	None	-	-	None	-	-	None	-	-	None
Storage Length	-	-	-	-	-	-	235	-	50	435	-	50
Veh in Median Storage, #	-	0	-	-	0	-	-	0	-	-	0	-
Grade, %	-	0	-	-	0	-	-	0	-	-	0	-
Peak Hour Factor	91	91	91	91	91	91	91	91	91	91	91	91
Heavy Vehicles, %	0	0	0	0	0	0	0	0	0	0	0	0
Mvmt Flow	40	1	11	38	0	40	11	601	57	60	375	8

Major/Minor	Minor2		Minor1		Major1		Major2					
Conflicting Flow All	818	1175	188	931	1126	301	383	0	0	658	0	0
Stage 1	495	495	-	623	623	-	-	-	-	-	-	-
Stage 2	323	680	-	308	503	-	-	-	-	-	-	-
Critical Hdwy	7.5	6.5	6.9	7.5	6.5	6.9	4.1	-	-	4.1	-	-
Critical Hdwy Stg 1	6.5	5.5	-	6.5	5.5	-	-	-	-	-	-	-
Critical Hdwy Stg 2	6.5	5.5	-	6.5	5.5	-	-	-	-	-	-	-
Follow-up Hdwy	3.5	4	3.3	3.5	4	3.3	2.2	-	-	2.2	-	-
Pot Cap-1 Maneuver	271	193	828	225	207	701	1187	-	-	939	-	-
Stage 1	530	549	-	445	481	-	-	-	-	-	-	-
Stage 2	669	454	-	683	545	-	-	-	-	-	-	-
Platoon blocked, %								-	-	-	-	-
Mov Cap-1 Maneuver	241	179	828	209	192	701	1187	-	-	939	-	-
Mov Cap-2 Maneuver	241	179	-	209	192	-	-	-	-	-	-	-
Stage 1	525	514	-	441	477	-	-	-	-	-	-	-
Stage 2	625	450	-	630	510	-	-	-	-	-	-	-

Approach	EB		WB		NB		SB			
HCM Control Delay, s	20.7		19.6		0.1		1.2			
HCM LOS	C		C							

Minor Lane/Major Mvmt	NBL	NBT	NBR	EBLn1WBLn1	SBL	SBT	SBR
Capacity (veh/h)	1187	-	-	281	324	939	-
HCM Lane V/C Ratio	0.009	-	-	0.184	0.241	0.064	-
HCM Control Delay (s)	8.1	-	-	20.7	19.6	9.1	-
HCM Lane LOS	A	-	-	C	C	A	-
HCM 95th %tile Q(veh)	0	-	-	0.7	0.9	0.2	-

HCM 6th TWSC
2: Old 215 Frontage Rd & Bay Ave

07/21/2021

Intersection												
Int Delay, s/veh	2.1											
Movement	EBL	EBT	EBR	WBL	WBT	WBR	NBL	NBT	NBR	SBL	SBT	SBR
Lane Configurations		↕			↕		↗	↕	↗	↗	↕	↗
Traffic Vol, veh/h	20	1	29	18	0	16	22	479	31	59	402	4
Future Vol, veh/h	20	1	29	18	0	16	22	479	31	59	402	4
Conflicting Peds, #/hr	0	0	0	0	0	0	0	0	0	0	0	0
Sign Control	Stop	Stop	Stop	Stop	Stop	Stop	Free	Free	Free	Free	Free	Free
RT Channelized	-	-	None	-	-	None	-	-	None	-	-	None
Storage Length	-	-	-	-	-	-	225	-	50	450	-	50
Veh in Median Storage, #	-	0	-	-	0	-	-	0	-	-	0	-
Grade, %	-	0	-	-	0	-	-	0	-	-	0	-
Peak Hour Factor	85	85	85	85	85	85	85	85	85	85	85	85
Heavy Vehicles, %	0	0	0	0	0	0	0	0	0	0	0	0
Mvmt Flow	24	1	34	21	0	19	26	564	36	69	473	5

Major/Minor	Minor2		Minor1		Major1		Major2					
Conflicting Flow All	945	1263	237	991	1232	282	478	0	0	600	0	0
Stage 1	611	611	-	616	616	-	-	-	-	-	-	-
Stage 2	334	652	-	375	616	-	-	-	-	-	-	-
Critical Hdwy	7.5	6.5	6.9	7.5	6.5	6.9	4.1	-	-	4.1	-	-
Critical Hdwy Stg 1	6.5	5.5	-	6.5	5.5	-	-	-	-	-	-	-
Critical Hdwy Stg 2	6.5	5.5	-	6.5	5.5	-	-	-	-	-	-	-
Follow-up Hdwy	3.5	4	3.3	3.5	4	3.3	2.2	-	-	2.2	-	-
Pot Cap-1 Maneuver	220	171	771	203	179	721	1095	-	-	987	-	-
Stage 1	453	487	-	450	485	-	-	-	-	-	-	-
Stage 2	659	467	-	624	485	-	-	-	-	-	-	-
Platoon blocked, %								-	-	-	-	-
Mov Cap-1 Maneuver	199	155	771	179	163	721	1095	-	-	987	-	-
Mov Cap-2 Maneuver	199	155	-	179	163	-	-	-	-	-	-	-
Stage 1	442	453	-	439	473	-	-	-	-	-	-	-
Stage 2	627	456	-	553	451	-	-	-	-	-	-	-

Approach	EB		WB		NB		SB			
HCM Control Delay, s	17.5		20.2		0.3		1.1			
HCM LOS	C		C							

Minor Lane/Major Mvmt	NBL	NBT	NBR	EBLn1WBLn1	SBL	SBT	SBR
Capacity (veh/h)	1095	-	-	346	277	987	-
HCM Lane V/C Ratio	0.024	-	-	0.17	0.144	0.07	-
HCM Control Delay (s)	8.4	-	-	17.5	20.2	8.9	-
HCM Lane LOS	A	-	-	C	C	A	-
HCM 95th %tile Q(veh)	0.1	-	-	0.6	0.5	0.2	-

HCM 6th Signalized Intersection Summary

5: Old 215 Frontage Rd & Alessandro Blvd

07/21/2021



Movement	EBL	EBT	EBR	WBL	WBT	WBR	NBL	NBT	NBR	SBL	SBT	SBR
Lane Configurations	↔↔	↑↑↑	↔	↔	↑↑	↔	↔↔	↑↑	↔	↔	↑↑	↔
Traffic Volume (veh/h)	350	1354	120	6	737	74	119	137	25	70	122	235
Future Volume (veh/h)	350	1354	120	6	737	74	119	137	25	70	122	235
Initial Q (Qb), veh	0	0	0	0	0	0	0	0	0	0	0	0
Ped-Bike Adj(A_pbT)	1.00		1.00	1.00		1.00	1.00		1.00	1.00		1.00
Parking Bus, Adj	1.00	1.00	1.00	1.00	1.00	1.00	1.00	1.00	1.00	1.00	1.00	1.00
Work Zone On Approach		No			No			No			No	
Adj Sat Flow, veh/h/ln	1900	1900	1900	1900	1900	1900	1900	1900	1900	1900	1900	1900
Adj Flow Rate, veh/h	372	1440	128	6	784	0	127	146	27	74	130	0
Peak Hour Factor	0.94	0.94	0.94	0.94	0.94	0.94	0.94	0.94	0.94	0.94	0.94	0.94
Percent Heavy Veh, %	0	0	0	0	0	0	0	0	0	0	0	0
Cap, veh/h	351	2440	757	20	1377		289	835	372	158	853	
Arrive On Green	0.10	0.47	0.47	0.01	0.38	0.00	0.08	0.23	0.23	0.09	0.24	0.00
Sat Flow, veh/h	3510	5187	1610	1810	3610	1610	3510	3610	1610	1810	3610	1610
Grp Volume(v), veh/h	372	1440	128	6	784	0	127	146	27	74	130	0
Grp Sat Flow(s),veh/h/ln	1755	1729	1610	1810	1805	1610	1755	1805	1610	1810	1805	1610
Q Serve(g_s), s	8.0	16.3	3.7	0.3	13.7	0.0	2.8	2.6	1.0	3.1	2.3	0.0
Cycle Q Clear(g_c), s	8.0	16.3	3.7	0.3	13.7	0.0	2.8	2.6	1.0	3.1	2.3	0.0
Prop In Lane	1.00		1.00	1.00		1.00	1.00		1.00	1.00		1.00
Lane Grp Cap(c), veh/h	351	2440	757	20	1377		289	835	372	158	853	
V/C Ratio(X)	1.06	0.59	0.17	0.30	0.57		0.44	0.17	0.07	0.47	0.15	
Avail Cap(c_a), veh/h	351	2440	757	158	1377		307	835	372	418	1354	
HCM Platoon Ratio	1.00	1.00	1.00	1.00	1.00	1.00	1.00	1.00	1.00	1.00	1.00	1.00
Upstream Filter(I)	1.00	1.00	1.00	1.00	1.00	0.00	1.00	1.00	1.00	1.00	1.00	0.00
Uniform Delay (d), s/veh	36.0	15.5	12.2	39.3	19.6	0.0	35.0	24.6	24.0	34.7	24.2	0.0
Incr Delay (d2), s/veh	64.7	1.1	0.5	8.4	0.6	0.0	1.1	0.5	0.4	2.1	0.1	0.0
Initial Q Delay(d3),s/veh	0.0	0.0	0.0	0.0	0.0	0.0	0.0	0.0	0.0	0.0	0.0	0.0
%ile BackOfQ(50%),veh/ln	6.5	6.1	1.3	0.2	5.5	0.0	1.2	1.1	0.4	1.4	1.0	0.0
Unsig. Movement Delay, s/veh												
LnGrp Delay(d),s/veh	100.7	16.6	12.7	47.6	20.1	0.0	36.0	25.1	24.4	36.9	24.3	0.0
LnGrp LOS	F	B	B	D	C		D	C	C	D	C	
Approach Vol, veh/h		1940			790	A		300			204	A
Approach Delay, s/veh		32.5			20.3			29.7			28.8	
Approach LOS		C			C			C			C	
Timer - Assigned Phs	1	2	3	4	5	6	7	8				
Phs Duration (G+Y+Rc), s	4.9	41.6	10.6	22.9	12.0	34.5	11.0	22.5				
Change Period (Y+Rc), s	4.0	4.0	4.0	4.0	4.0	4.0	4.0	4.0				
Max Green Setting (Gmax), s	7.0	20.0	7.0	30.0	8.0	19.0	18.5	18.5				
Max Q Clear Time (g_c+I1), s	2.3	18.3	4.8	4.3	10.0	15.7	5.1	4.6				
Green Ext Time (p_c), s	0.0	1.4	0.1	0.7	0.0	1.6	0.1	0.7				

Intersection Summary

HCM 6th Ctrl Delay	29.0
HCM 6th LOS	C

Notes

Unsignalized Delay for [WBR, SBR] is excluded from calculations of the approach delay and intersection delay.

HCM 6th TWSC
 1: Old 215 Frontage Rd & Cottonwood Ave

07/21/2021

Intersection												
Int Delay, s/veh	3.3											
Movement	EBL	EBT	EBR	WBL	WBT	WBR	NBL	NBT	NBR	SBL	SBT	SBR
Lane Configurations		↕			↕		↕	↑↑	↕	↕	↑↑	↕
Traffic Vol, veh/h	12	2	2	81	3	45	19	358	13	12	136	24
Future Vol, veh/h	12	2	2	81	3	45	19	358	13	12	136	24
Conflicting Peds, #/hr	0	0	0	0	0	0	0	0	0	0	0	0
Sign Control	Stop	Stop	Stop	Stop	Stop	Stop	Free	Free	Free	Free	Free	Free
RT Channelized	-	-	None	-	-	None	-	-	None	-	-	None
Storage Length	-	-	-	-	-	-	235	-	50	435	-	50
Veh in Median Storage, #	-	0	-	-	0	-	-	0	-	-	0	-
Grade, %	-	0	-	-	0	-	-	0	-	-	0	-
Peak Hour Factor	95	95	95	95	95	95	95	95	95	95	95	95
Heavy Vehicles, %	0	0	0	0	0	0	0	0	0	0	0	0
Mvmt Flow	13	2	2	85	3	47	20	377	14	13	143	25

Major/Minor	Minor2		Minor1			Major1		Major2				
Conflicting Flow All	399	600	72	516	611	189	168	0	0	391	0	0
Stage 1	169	169	-	417	417	-	-	-	-	-	-	-
Stage 2	230	431	-	99	194	-	-	-	-	-	-	-
Critical Hdwy	7.5	6.5	6.9	7.5	6.5	6.9	4.1	-	-	4.1	-	-
Critical Hdwy Stg 1	6.5	5.5	-	6.5	5.5	-	-	-	-	-	-	-
Critical Hdwy Stg 2	6.5	5.5	-	6.5	5.5	-	-	-	-	-	-	-
Follow-up Hdwy	3.5	4	3.3	3.5	4	3.3	2.2	-	-	2.2	-	-
Pot Cap-1 Maneuver	540	417	982	446	411	827	1422	-	-	1179	-	-
Stage 1	822	763	-	589	595	-	-	-	-	-	-	-
Stage 2	758	586	-	902	744	-	-	-	-	-	-	-
Platoon blocked, %								-	-	-	-	-
Mov Cap-1 Maneuver	496	407	982	435	401	827	1422	-	-	1179	-	-
Mov Cap-2 Maneuver	496	407	-	435	401	-	-	-	-	-	-	-
Stage 1	810	755	-	581	587	-	-	-	-	-	-	-
Stage 2	701	578	-	888	736	-	-	-	-	-	-	-

Approach	EB		WB			NB		SB		
HCM Control Delay, s	12.2		14.4			0.4		0.6		
HCM LOS	B		B							

Minor Lane/Major Mvmt	NBL	NBT	NBR	EBLn1WBLn1	SBL	SBT	SBR
Capacity (veh/h)	1422	-	-	514	520	1179	-
HCM Lane V/C Ratio	0.014	-	-	0.033	0.261	0.011	-
HCM Control Delay (s)	7.6	-	-	12.2	14.4	8.1	-
HCM Lane LOS	A	-	-	B	B	A	-
HCM 95th %tile Q(veh)	0	-	-	0.1	1	0	-

HCM 6th TWSC
2: Old 215 Frontage Rd & Bay Ave

07/21/2021

Intersection												
Int Delay, s/veh	2.5											
Movement	EBL	EBT	EBR	WBL	WBT	WBR	NBL	NBT	NBR	SBL	SBT	SBR
Lane Configurations		↕			↕		↗	↕	↗	↗	↕	↗
Traffic Vol, veh/h	6	1	14	46	1	32	51	329	9	17	195	15
Future Vol, veh/h	6	1	14	46	1	32	51	329	9	17	195	15
Conflicting Peds, #/hr	0	0	0	0	0	0	0	0	0	0	0	0
Sign Control	Stop	Stop	Stop	Stop	Stop	Stop	Free	Free	Free	Free	Free	Free
RT Channelized	-	-	None	-	-	None	-	-	None	-	-	None
Storage Length	-	-	-	-	-	-	225	-	50	450	-	50
Veh in Median Storage, #	-	0	-	-	0	-	-	0	-	-	0	-
Grade, %	-	0	-	-	0	-	-	0	-	-	0	-
Peak Hour Factor	99	99	99	99	99	99	99	99	99	99	99	99
Heavy Vehicles, %	0	0	0	0	0	0	0	0	0	0	0	0
Mvmt Flow	6	1	14	46	1	32	52	332	9	17	197	15

Major/Minor	Minor2		Minor1		Major1			Major2				
Conflicting Flow All	502	676	99	569	682	166	212	0	0	341	0	0
Stage 1	231	231	-	436	436	-	-	-	-	-	-	-
Stage 2	271	445	-	133	246	-	-	-	-	-	-	-
Critical Hdwy	7.5	6.5	6.9	7.5	6.5	6.9	4.1	-	-	4.1	-	-
Critical Hdwy Stg 1	6.5	5.5	-	6.5	5.5	-	-	-	-	-	-	-
Critical Hdwy Stg 2	6.5	5.5	-	6.5	5.5	-	-	-	-	-	-	-
Follow-up Hdwy	3.5	4	3.3	3.5	4	3.3	2.2	-	-	2.2	-	-
Pot Cap-1 Maneuver	457	378	944	409	375	856	1370	-	-	1229	-	-
Stage 1	757	717	-	574	583	-	-	-	-	-	-	-
Stage 2	717	578	-	862	706	-	-	-	-	-	-	-
Platoon blocked, %								-	-	-	-	-
Mov Cap-1 Maneuver	422	359	944	386	356	856	1370	-	-	1229	-	-
Mov Cap-2 Maneuver	422	359	-	386	356	-	-	-	-	-	-	-
Stage 1	728	707	-	552	561	-	-	-	-	-	-	-
Stage 2	663	556	-	836	696	-	-	-	-	-	-	-

Approach	EB		WB		NB			SB		
HCM Control Delay, s	10.6		13.6		1			0.6		
HCM LOS	B		B							

Minor Lane/Major Mvmt	NBL	NBT	NBR	EBLn1WBLn1	SBL	SBT	SBR
Capacity (veh/h)	1370	-	-	660	496	1229	-
HCM Lane V/C Ratio	0.038	-	-	0.032	0.161	0.014	-
HCM Control Delay (s)	7.7	-	-	10.6	13.6	8	-
HCM Lane LOS	A	-	-	B	B	A	-
HCM 95th %tile Q(veh)	0.1	-	-	0.1	0.6	0	-

HCM 6th TWSC
 3: Old 215 Frontage Rd & Dwy 1

07/21/2021

Intersection						
Int Delay, s/veh	0.1					
Movement	WBL	WBR	NBT	NBR	SBL	SBT
Lane Configurations		↗	↕			↕
Traffic Vol, veh/h	0	7	382	40	0	260
Future Vol, veh/h	0	7	382	40	0	260
Conflicting Peds, #/hr	0	0	0	0	0	0
Sign Control	Stop	Stop	Free	Free	Free	Free
RT Channelized	-	None	-	None	-	None
Storage Length	-	0	-	-	-	-
Veh in Median Storage, #	0	-	0	-	-	0
Grade, %	0	-	0	-	-	0
Peak Hour Factor	92	92	92	92	92	92
Heavy Vehicles, %	0	0	0	0	0	0
Mvmt Flow	0	8	415	43	0	283

Major/Minor	Minor1	Major1	Major2		
Conflicting Flow All	-	229	0	0	-
Stage 1	-	-	-	-	-
Stage 2	-	-	-	-	-
Critical Hdwy	-	6.9	-	-	-
Critical Hdwy Stg 1	-	-	-	-	-
Critical Hdwy Stg 2	-	-	-	-	-
Follow-up Hdwy	-	3.3	-	-	-
Pot Cap-1 Maneuver	0	780	-	-	0
Stage 1	0	-	-	-	0
Stage 2	0	-	-	-	0
Platoon blocked, %			-	-	-
Mov Cap-1 Maneuver	-	780	-	-	-
Mov Cap-2 Maneuver	-	-	-	-	-
Stage 1	-	-	-	-	-
Stage 2	-	-	-	-	-

Approach	WB	NB	SB
HCM Control Delay, s	9.7	0	0
HCM LOS	A		

Minor Lane/Major Mvmt	NBT	NBRWBLn1	SBT
Capacity (veh/h)	-	-	780
HCM Lane V/C Ratio	-	-	0.01
HCM Control Delay (s)	-	-	9.7
HCM Lane LOS	-	-	A
HCM 95th %tile Q(veh)	-	-	0

HCM 6th TWSC
4: Old 215 Frontage Rd & Dwy 2

07/21/2021

Intersection						
Int Delay, s/veh	0.1					
Movement	WBL	WBR	NBT	NBR	SBL	SBT
Lane Configurations		↗	↕			↕
Traffic Vol, veh/h	0	10	412	61	0	260
Future Vol, veh/h	0	10	412	61	0	260
Conflicting Peds, #/hr	0	0	0	0	0	0
Sign Control	Stop	Stop	Free	Free	Free	Free
RT Channelized	-	None	-	None	-	None
Storage Length	-	0	-	-	-	-
Veh in Median Storage, #	0	-	0	-	-	0
Grade, %	0	-	0	-	-	0
Peak Hour Factor	92	92	92	92	92	92
Heavy Vehicles, %	0	0	0	0	0	0
Mvmt Flow	0	11	448	66	0	283

Major/Minor	Minor1	Major1	Major2		
Conflicting Flow All	-	257	0	0	-
Stage 1	-	-	-	-	-
Stage 2	-	-	-	-	-
Critical Hdwy	-	6.9	-	-	-
Critical Hdwy Stg 1	-	-	-	-	-
Critical Hdwy Stg 2	-	-	-	-	-
Follow-up Hdwy	-	3.3	-	-	-
Pot Cap-1 Maneuver	0	748	-	-	0
Stage 1	0	-	-	-	0
Stage 2	0	-	-	-	0
Platoon blocked, %			-	-	-
Mov Cap-1 Maneuver	-	748	-	-	-
Mov Cap-2 Maneuver	-	-	-	-	-
Stage 1	-	-	-	-	-
Stage 2	-	-	-	-	-

Approach	WB	NB	SB
HCM Control Delay, s	9.9	0	0
HCM LOS	A		

Minor Lane/Major Mvmt	NBT	NBRWBLn1	SBT
Capacity (veh/h)	-	-	748
HCM Lane V/C Ratio	-	-	0.015
HCM Control Delay (s)	-	-	9.9
HCM Lane LOS	-	-	A
HCM 95th %tile Q(veh)	-	-	0

HCM 6th Signalized Intersection Summary

5: Old 215 Frontage Rd & Alessandro Blvd

07/21/2021



Movement	EBL	EBT	EBR	WBL	WBT	WBR	NBL	NBT	NBR	SBL	SBT	SBR
Lane Configurations	↔↔	↑↑↑	↔	↔	↑↑	↔	↔↔	↑↑	↔	↔	↑↑	↔
Traffic Volume (veh/h)	286	604	82	19	698	72	55	152	14	26	45	166
Future Volume (veh/h)	286	604	82	19	698	72	55	152	14	26	45	166
Initial Q (Qb), veh	0	0	0	0	0	0	0	0	0	0	0	0
Ped-Bike Adj(A_pbT)	1.00		1.00	1.00		1.00	1.00		1.00	1.00		1.00
Parking Bus, Adj	1.00	1.00	1.00	1.00	1.00	1.00	1.00	1.00	1.00	1.00	1.00	1.00
Work Zone On Approach		No			No			No			No	
Adj Sat Flow, veh/h/ln	1900	1900	1900	1900	1900	1900	1900	1900	1900	1900	1900	1900
Adj Flow Rate, veh/h	295	623	85	20	720	0	57	157	14	27	46	0
Peak Hour Factor	0.97	0.97	0.97	0.97	0.97	0.97	0.97	0.97	0.97	0.97	0.97	0.97
Percent Heavy Veh, %	0	0	0	0	0	0	0	0	0	0	0	0
Cap, veh/h	892	2359	732	57	837		221	835	372	150	906	
Arrive On Green	0.25	0.45	0.45	0.03	0.23	0.00	0.06	0.23	0.23	0.08	0.25	0.00
Sat Flow, veh/h	3510	5187	1610	1810	3610	1610	3510	3610	1610	1810	3610	1610
Grp Volume(v), veh/h	295	623	85	20	720	0	57	157	14	27	46	0
Grp Sat Flow(s),veh/h/ln	1755	1729	1610	1810	1805	1610	1755	1805	1610	1810	1805	1610
Q Serve(g_s), s	5.5	6.0	2.4	0.9	15.3	0.0	1.2	2.8	0.5	1.1	0.8	0.0
Cycle Q Clear(g_c), s	5.5	6.0	2.4	0.9	15.3	0.0	1.2	2.8	0.5	1.1	0.8	0.0
Prop In Lane	1.00		1.00	1.00		1.00	1.00		1.00	1.00		1.00
Lane Grp Cap(c), veh/h	892	2359	732	57	837		221	835	372	150	906	
V/C Ratio(X)	0.33	0.26	0.12	0.35	0.86		0.26	0.19	0.04	0.18	0.05	
Avail Cap(c_a), veh/h	892	2359	732	158	903		307	835	372	418	1354	
HCM Platoon Ratio	1.00	1.00	1.00	1.00	1.00	1.00	1.00	1.00	1.00	1.00	1.00	1.00
Upstream Filter(I)	1.00	1.00	1.00	1.00	1.00	0.00	1.00	1.00	1.00	1.00	1.00	0.00
Uniform Delay (d), s/veh	24.3	13.5	12.6	37.9	29.5	0.0	35.7	24.7	23.8	34.2	22.7	0.0
Incr Delay (d2), s/veh	0.2	0.3	0.3	3.7	8.0	0.0	0.6	0.5	0.2	0.6	0.0	0.0
Initial Q Delay(d3),s/veh	0.0	0.0	0.0	0.0	0.0	0.0	0.0	0.0	0.0	0.0	0.0	0.0
%ile BackOfQ(50%),veh/ln	2.2	2.2	0.9	0.4	7.3	0.0	0.5	1.2	0.2	0.5	0.3	0.0
Unsig. Movement Delay, s/veh												
LnGrp Delay(d),s/veh	24.5	13.8	12.9	41.6	37.5	0.0	36.3	25.2	24.0	34.7	22.8	0.0
LnGrp LOS	C	B	B	D	D		D	C	C	C	C	
Approach Vol, veh/h		1003			740	A		228			73	A
Approach Delay, s/veh		16.9			37.6			27.9			27.2	
Approach LOS		B			D			C			C	
Timer - Assigned Phs	1	2	3	4	5	6	7	8				
Phs Duration (G+Y+Rc), s	6.5	40.4	9.0	24.1	24.3	22.6	10.6	22.5				
Change Period (Y+Rc), s	4.0	4.0	4.0	4.0	4.0	4.0	4.0	4.0				
Max Green Setting (Gmax), s	7.0	20.0	7.0	30.0	7.0	20.0	18.5	18.5				
Max Q Clear Time (g_c+I1), s	2.9	8.0	3.2	2.8	7.5	17.3	3.1	4.8				
Green Ext Time (p_c), s	0.0	3.6	0.0	0.2	0.0	1.3	0.0	0.7				

Intersection Summary

HCM 6th Ctrl Delay	26.0
HCM 6th LOS	C

Notes

Unsignalized Delay for [WBR, SBR] is excluded from calculations of the approach delay and intersection delay.

HCM 6th TWSC
1: Old 215 Frontage Rd & Cottonwood Ave

07/21/2021

Intersection												
Int Delay, s/veh	2.6											
Movement	EBL	EBT	EBR	WBL	WBT	WBR	NBL	NBT	NBR	SBL	SBT	SBR
Lane Configurations		↕			↕		↕	↑↑	↕	↕	↑↑	↕
Traffic Vol, veh/h	36	1	10	35	0	36	10	605	60	55	341	7
Future Vol, veh/h	36	1	10	35	0	36	10	605	60	55	341	7
Conflicting Peds, #/hr	0	0	0	0	0	0	0	0	0	0	0	0
Sign Control	Stop	Stop	Stop	Stop	Stop	Stop	Free	Free	Free	Free	Free	Free
RT Channelized	-	-	None	-	-	None	-	-	None	-	-	None
Storage Length	-	-	-	-	-	-	235	-	50	435	-	50
Veh in Median Storage, #	-	0	-	-	0	-	-	0	-	-	0	-
Grade, %	-	0	-	-	0	-	-	0	-	-	0	-
Peak Hour Factor	91	91	91	91	91	91	91	91	91	91	91	91
Heavy Vehicles, %	0	0	0	0	0	0	0	0	0	0	0	0
Mvmt Flow	40	1	11	38	0	40	11	665	66	60	375	8

Major/Minor	Minor2		Minor1		Major1		Major2					
Conflicting Flow All	850	1248	188	995	1190	333	383	0	0	731	0	0
Stage 1	495	495	-	687	687	-	-	-	-	-	-	-
Stage 2	355	753	-	308	503	-	-	-	-	-	-	-
Critical Hdwy	7.5	6.5	6.9	7.5	6.5	6.9	4.1	-	-	4.1	-	-
Critical Hdwy Stg 1	6.5	5.5	-	6.5	5.5	-	-	-	-	-	-	-
Critical Hdwy Stg 2	6.5	5.5	-	6.5	5.5	-	-	-	-	-	-	-
Follow-up Hdwy	3.5	4	3.3	3.5	4	3.3	2.2	-	-	2.2	-	-
Pot Cap-1 Maneuver	257	175	828	202	189	669	1187	-	-	883	-	-
Stage 1	530	549	-	408	450	-	-	-	-	-	-	-
Stage 2	641	420	-	683	545	-	-	-	-	-	-	-
Platoon blocked, %								-	-	-	-	-
Mov Cap-1 Maneuver	228	162	828	187	175	669	1187	-	-	883	-	-
Mov Cap-2 Maneuver	228	162	-	187	175	-	-	-	-	-	-	-
Stage 1	525	512	-	404	446	-	-	-	-	-	-	-
Stage 2	598	416	-	627	508	-	-	-	-	-	-	-

Approach	EB		WB		NB		SB			
HCM Control Delay, s	21.7		21.5		0.1		1.3			
HCM LOS	C		C							

Minor Lane/Major Mvmt	NBL	NBT	NBR	EBLn1WBLn1	SBL	SBT	SBR
Capacity (veh/h)	1187	-	-	267	295	883	-
HCM Lane V/C Ratio	0.009	-	-	0.193	0.264	0.068	-
HCM Control Delay (s)	8.1	-	-	21.7	21.5	9.4	-
HCM Lane LOS	A	-	-	C	C	A	-
HCM 95th %tile Q(veh)	0	-	-	0.7	1	0.2	-

HCM 6th TWSC
2: Old 215 Frontage Rd & Bay Ave

07/21/2021

Intersection												
Int Delay, s/veh	2.3											
Movement	EBL	EBT	EBR	WBL	WBT	WBR	NBL	NBT	NBR	SBL	SBT	SBR
Lane Configurations		↕			↕		↗	↕	↗	↗	↕	↗
Traffic Vol, veh/h	20	1	29	18	0	16	42	545	36	59	402	4
Future Vol, veh/h	20	1	29	18	0	16	42	545	36	59	402	4
Conflicting Peds, #/hr	0	0	0	0	0	0	0	0	0	0	0	0
Sign Control	Stop	Stop	Stop	Stop	Stop	Stop	Free	Free	Free	Free	Free	Free
RT Channelized	-	-	None	-	-	None	-	-	None	-	-	None
Storage Length	-	-	-	-	-	-	225	-	50	450	-	50
Veh in Median Storage, #	-	0	-	-	0	-	-	0	-	-	0	-
Grade, %	-	0	-	-	0	-	-	0	-	-	0	-
Peak Hour Factor	85	85	85	85	85	85	85	85	85	85	85	85
Heavy Vehicles, %	0	0	0	0	0	0	0	0	0	0	0	0
Mvmt Flow	24	1	34	21	0	19	49	641	42	69	473	5

Major/Minor	Minor2		Minor1		Major1		Major2					
Conflicting Flow All	1030	1392	237	1114	1355	321	478	0	0	683	0	0
Stage 1	611	611	-	739	739	-	-	-	-	-	-	-
Stage 2	419	781	-	375	616	-	-	-	-	-	-	-
Critical Hdwy	7.5	6.5	6.9	7.5	6.5	6.9	4.1	-	-	4.1	-	-
Critical Hdwy Stg 1	6.5	5.5	-	6.5	5.5	-	-	-	-	-	-	-
Critical Hdwy Stg 2	6.5	5.5	-	6.5	5.5	-	-	-	-	-	-	-
Follow-up Hdwy	3.5	4	3.3	3.5	4	3.3	2.2	-	-	2.2	-	-
Pot Cap-1 Maneuver	190	143	771	165	151	681	1095	-	-	919	-	-
Stage 1	453	487	-	380	427	-	-	-	-	-	-	-
Stage 2	588	408	-	624	485	-	-	-	-	-	-	-
Platoon blocked, %								-	-	-	-	-
Mov Cap-1 Maneuver	168	126	771	143	133	681	1095	-	-	919	-	-
Mov Cap-2 Maneuver	168	126	-	143	133	-	-	-	-	-	-	-
Stage 1	433	450	-	363	408	-	-	-	-	-	-	-
Stage 2	546	390	-	550	449	-	-	-	-	-	-	-

Approach	EB		WB		NB		SB	
HCM Control Delay, s	19.7		24.1		0.6		1.2	
HCM LOS	C		C					

Minor Lane/Major Mvmt	NBL	NBT	NBR	EBLn1WBLn1	SBL	SBT	SBR
Capacity (veh/h)	1095	-	-	304	228	919	-
HCM Lane V/C Ratio	0.045	-	-	0.193	0.175	0.076	-
HCM Control Delay (s)	8.4	-	-	19.7	24.1	9.2	-
HCM Lane LOS	A	-	-	C	C	A	-
HCM 95th %tile Q(veh)	0.1	-	-	0.7	0.6	0.2	-

HCM 6th TWSC
 3: Old 215 Frontage Rd & Dwy 1

07/21/2021

Intersection						
Int Delay, s/veh	0.3					
Movement	WBL	WBR	NBT	NBR	SBL	SBT
Lane Configurations		↗	↕			↕
Traffic Vol, veh/h	0	36	584	8	0	478
Future Vol, veh/h	0	36	584	8	0	478
Conflicting Peds, #/hr	0	0	0	0	0	0
Sign Control	Stop	Stop	Free	Free	Free	Free
RT Channelized	-	None	-	None	-	None
Storage Length	-	0	-	-	-	-
Veh in Median Storage, #	0	-	0	-	-	0
Grade, %	0	-	0	-	-	0
Peak Hour Factor	92	92	92	92	92	92
Heavy Vehicles, %	0	0	0	0	0	0
Mvmt Flow	0	39	635	9	0	520

Major/Minor	Minor1	Major1	Major2		
Conflicting Flow All	-	322	0	0	-
Stage 1	-	-	-	-	-
Stage 2	-	-	-	-	-
Critical Hdwy	-	6.9	-	-	-
Critical Hdwy Stg 1	-	-	-	-	-
Critical Hdwy Stg 2	-	-	-	-	-
Follow-up Hdwy	-	3.3	-	-	-
Pot Cap-1 Maneuver	0	680	-	-	0
Stage 1	0	-	-	-	0
Stage 2	0	-	-	-	0
Platoon blocked, %			-	-	-
Mov Cap-1 Maneuver	-	680	-	-	-
Mov Cap-2 Maneuver	-	-	-	-	-
Stage 1	-	-	-	-	-
Stage 2	-	-	-	-	-

Approach	WB	NB	SB
HCM Control Delay, s	10.6	0	0
HCM LOS	B		

Minor Lane/Major Mvmt	NBT	NBRWBLn1	SBT
Capacity (veh/h)	-	-	680
HCM Lane V/C Ratio	-	-	0.058
HCM Control Delay (s)	-	-	10.6
HCM Lane LOS	-	-	B
HCM 95th %tile Q(veh)	-	-	0.2

HCM 6th TWSC
4: Old 215 Frontage Rd & Dwy 2

07/21/2021

Intersection						
Int Delay, s/veh	0.5					
Movement	WBL	WBR	NBT	NBR	SBL	SBT
Lane Configurations		↗	↕			↕
Traffic Vol, veh/h	0	53	539	11	0	478
Future Vol, veh/h	0	53	539	11	0	478
Conflicting Peds, #/hr	0	0	0	0	0	0
Sign Control	Stop	Stop	Free	Free	Free	Free
RT Channelized	-	None	-	None	-	None
Storage Length	-	0	-	-	-	-
Veh in Median Storage, #	0	-	0	-	-	0
Grade, %	0	-	0	-	-	0
Peak Hour Factor	92	92	92	92	92	92
Heavy Vehicles, %	0	0	0	0	0	0
Mvmt Flow	0	58	586	12	0	520

Major/Minor	Minor1	Major1	Major2		
Conflicting Flow All	-	299	0	0	-
Stage 1	-	-	-	-	-
Stage 2	-	-	-	-	-
Critical Hdwy	-	6.9	-	-	-
Critical Hdwy Stg 1	-	-	-	-	-
Critical Hdwy Stg 2	-	-	-	-	-
Follow-up Hdwy	-	3.3	-	-	-
Pot Cap-1 Maneuver	0	703	-	-	0
Stage 1	0	-	-	-	0
Stage 2	0	-	-	-	0
Platoon blocked, %			-	-	-
Mov Cap-1 Maneuver	-	703	-	-	-
Mov Cap-2 Maneuver	-	-	-	-	-
Stage 1	-	-	-	-	-
Stage 2	-	-	-	-	-

Approach	WB	NB	SB
HCM Control Delay, s	10.6	0	0
HCM LOS	B		

Minor Lane/Major Mvmt	NBT	NBRWBLn1	SBT
Capacity (veh/h)	-	-	703
HCM Lane V/C Ratio	-	-	0.082
HCM Control Delay (s)	-	-	10.6
HCM Lane LOS	-	-	B
HCM 95th %tile Q(veh)	-	-	0.3

HCM 6th Signalized Intersection Summary

5: Old 215 Frontage Rd & Alessandro Blvd

07/21/2021



Movement	EBL	EBT	EBR	WBL	WBT	WBR	NBL	NBT	NBR	SBL	SBT	SBR
Lane Configurations	↗↘	↑↑↑	↗	↘	↑↑	↗	↗↘	↑↑	↗	↘	↑↑	↗
Traffic Volume (veh/h)	363	1354	120	6	737	78	119	137	25	75	122	246
Future Volume (veh/h)	363	1354	120	6	737	78	119	137	25	75	122	246
Initial Q (Qb), veh	0	0	0	0	0	0	0	0	0	0	0	0
Ped-Bike Adj(A_pbT)	1.00		1.00	1.00		1.00	1.00		1.00	1.00		1.00
Parking Bus, Adj	1.00	1.00	1.00	1.00	1.00	1.00	1.00	1.00	1.00	1.00	1.00	1.00
Work Zone On Approach		No			No			No			No	
Adj Sat Flow, veh/h/ln	1900	1900	1900	1900	1900	1900	1900	1900	1900	1900	1900	1900
Adj Flow Rate, veh/h	386	1440	128	6	784	0	127	146	27	80	130	0
Peak Hour Factor	0.94	0.94	0.94	0.94	0.94	0.94	0.94	0.94	0.94	0.94	0.94	0.94
Percent Heavy Veh, %	0	0	0	0	0	0	0	0	0	0	0	0
Cap, veh/h	351	2440	757	20	1376		289	835	372	158	853	
Arrive On Green	0.10	0.47	0.47	0.01	0.38	0.00	0.08	0.23	0.23	0.09	0.24	0.00
Sat Flow, veh/h	3510	5187	1610	1810	3610	1610	3510	3610	1610	1810	3610	1610
Grp Volume(v), veh/h	386	1440	128	6	784	0	127	146	27	80	130	0
Grp Sat Flow(s),veh/h/ln	1755	1729	1610	1810	1805	1610	1755	1805	1610	1810	1805	1610
Q Serve(g_s), s	8.0	16.3	3.7	0.3	13.7	0.0	2.8	2.6	1.0	3.4	2.3	0.0
Cycle Q Clear(g_c), s	8.0	16.3	3.7	0.3	13.7	0.0	2.8	2.6	1.0	3.4	2.3	0.0
Prop In Lane	1.00		1.00	1.00		1.00	1.00		1.00	1.00		1.00
Lane Grp Cap(c), veh/h	351	2440	757	20	1376		289	835	372	158	853	
V/C Ratio(X)	1.10	0.59	0.17	0.30	0.57		0.44	0.17	0.07	0.51	0.15	
Avail Cap(c_a), veh/h	351	2440	757	158	1376		307	835	372	418	1354	
HCM Platoon Ratio	1.00	1.00	1.00	1.00	1.00	1.00	1.00	1.00	1.00	1.00	1.00	1.00
Upstream Filter(I)	1.00	1.00	1.00	1.00	1.00	0.00	1.00	1.00	1.00	1.00	1.00	0.00
Uniform Delay (d), s/veh	36.0	15.5	12.2	39.3	19.6	0.0	35.0	24.6	24.0	34.9	24.2	0.0
Incr Delay (d2), s/veh	77.5	1.1	0.5	8.4	0.6	0.0	1.1	0.5	0.4	2.5	0.1	0.0
Initial Q Delay(d3),s/veh	0.0	0.0	0.0	0.0	0.0	0.0	0.0	0.0	0.0	0.0	0.0	0.0
%ile BackOfQ(50%),veh/ln	7.1	6.1	1.3	0.2	5.5	0.0	1.2	1.1	0.4	1.6	1.0	0.0
Unsig. Movement Delay, s/veh												
LnGrp Delay(d),s/veh	113.5	16.6	12.7	47.6	20.1	0.0	36.0	25.1	24.4	37.3	24.3	0.0
LnGrp LOS	F	B	B	D	C		D	C	C	D	C	
Approach Vol, veh/h		1954			790	A		300			210	A
Approach Delay, s/veh		35.5			20.3			29.7			29.3	
Approach LOS		D			C			C			C	
Timer - Assigned Phs	1	2	3	4	5	6	7	8				
Phs Duration (G+Y+Rc), s	4.9	41.6	10.6	22.9	12.0	34.5	11.0	22.5				
Change Period (Y+Rc), s	4.0	4.0	4.0	4.0	4.0	4.0	4.0	4.0				
Max Green Setting (Gmax), s	7.0	20.0	7.0	30.0	8.0	19.0	18.5	18.5				
Max Q Clear Time (g_c+I1), s	2.3	18.3	4.8	4.3	10.0	15.7	5.4	4.6				
Green Ext Time (p_c), s	0.0	1.4	0.1	0.7	0.0	1.6	0.1	0.7				

Intersection Summary

HCM 6th Ctrl Delay	30.9
HCM 6th LOS	C

Notes

Unsignalized Delay for [WBR, SBR] is excluded from calculations of the approach delay and intersection delay.

Queues

5: Old 215 Frontage Rd & Alessandro Blvd

08/04/2021



Lane Group	EBL	EBT	EBR	WBL	WBT	WBR	NBL	NBT	NBR	SBL	SBT	SBR
Lane Group Flow (vph)	179	564	23	8	632	41	33	148	11	23	35	147
v/c Ratio	0.58	0.30	0.03	0.05	0.70	0.08	0.11	0.09	0.01	0.14	0.02	0.18
Control Delay	43.4	19.8	0.1	34.4	32.2	0.3	34.6	14.3	0.0	35.4	14.3	3.8
Queue Delay	0.0	0.0	0.0	0.0	0.0	0.0	0.0	0.0	0.0	0.0	0.0	0.0
Total Delay	43.4	19.8	0.1	34.4	32.2	0.3	34.6	14.3	0.0	35.4	14.3	3.8
Queue Length 50th (ft)	45	69	0	4	151	0	8	18	0	11	4	0
Queue Length 95th (ft)	76	119	0	17	208	0	21	45	0	32	14	35
Internal Link Dist (ft)		445			1176			506			422	
Turn Bay Length (ft)	200		50	200		375	150		150	450		450
Base Capacity (vph)	306	1866	694	157	902	536	306	1639	829	417	1651	818
Starvation Cap Reductn	0	0	0	0	0	0	0	0	0	0	0	0
Spillback Cap Reductn	0	0	0	0	0	0	0	0	0	0	0	0
Storage Cap Reductn	0	0	0	0	0	0	0	0	0	0	0	0
Reduced v/c Ratio	0.58	0.30	0.03	0.05	0.70	0.08	0.11	0.09	0.01	0.06	0.02	0.18

Intersection Summary

Queues

5: Old 215 Frontage Rd & Alessandro Blvd

08/04/2021



Lane Group	EBL	EBT	EBR	WBL	WBT	WBR	NBL	NBT	NBR	SBL	SBT	SBR
Lane Group Flow (vph)	338	1324	96	4	714	71	52	131	13	62	122	213
v/c Ratio	0.97	0.71	0.14	0.03	0.83	0.14	0.17	0.09	0.02	0.32	0.08	0.26
Control Delay	78.6	26.2	0.6	33.8	39.2	0.6	35.3	17.7	0.1	37.2	15.3	3.6
Queue Delay	0.0	0.0	0.0	0.0	0.0	0.0	0.0	0.0	0.0	0.0	0.0	0.0
Total Delay	78.6	26.2	0.6	33.8	39.2	0.6	35.3	17.7	0.1	37.2	15.3	3.6
Queue Length 50th (ft)	88	194	0	2	178	0	12	22	0	29	20	0
Queue Length 95th (ft)	#169	#350	3	11	#266	0	29	43	0	63	37	41
Internal Link Dist (ft)		445			1176			506			422	
Turn Bay Length (ft)	200		50	200		375	150		150	450		450
Base Capacity (vph)	350	1866	694	157	857	518	306	1386	729	417	1552	815
Starvation Cap Reductn	0	0	0	0	0	0	0	0	0	0	0	0
Spillback Cap Reductn	0	0	0	0	0	0	0	0	0	0	0	0
Storage Cap Reductn	0	0	0	0	0	0	0	0	0	0	0	0
Reduced v/c Ratio	0.97	0.71	0.14	0.03	0.83	0.14	0.17	0.09	0.02	0.15	0.08	0.26

Intersection Summary

95th percentile volume exceeds capacity, queue may be longer.
 Queue shown is maximum after two cycles.

Queues

5: Old 215 Frontage Rd & Alessandro Blvd

08/04/2021



Lane Group	EBL	EBT	EBR	WBL	WBT	WBR	NBL	NBT	NBR	SBL	SBT	SBR
Lane Group Flow (vph)	213	623	85	20	720	53	57	157	14	26	46	169
v/c Ratio	0.64	0.36	0.13	0.13	0.82	0.10	0.19	0.10	0.02	0.16	0.03	0.21
Control Delay	45.5	22.2	0.4	35.7	37.7	0.4	35.5	14.4	0.0	35.5	15.4	3.4
Queue Delay	0.0	0.0	0.0	0.0	0.0	0.0	0.0	0.0	0.0	0.0	0.0	0.0
Total Delay	45.5	22.2	0.4	35.7	37.7	0.4	35.5	14.4	0.0	35.5	15.4	3.4
Queue Length 50th (ft)	54	77	0	9	177	0	13	20	0	12	7	0
Queue Length 95th (ft)	#100	131	0	30	#245	0	31	47	0	35	17	34
Internal Link Dist (ft)		445			1176			506			422	
Turn Bay Length (ft)	200		50	200		375	150		150	450		450
Base Capacity (vph)	331	1724	655	157	902	536	306	1635	858	417	1552	795
Starvation Cap Reductn	0	0	0	0	0	0	0	0	0	0	0	0
Spillback Cap Reductn	0	0	0	0	0	0	0	0	0	0	0	0
Storage Cap Reductn	0	0	0	0	0	0	0	0	0	0	0	0
Reduced v/c Ratio	0.64	0.36	0.13	0.13	0.80	0.10	0.19	0.10	0.02	0.06	0.03	0.21

Intersection Summary

95th percentile volume exceeds capacity, queue may be longer.
 Queue shown is maximum after two cycles.

Queues

5: Old 215 Frontage Rd & Alessandro Blvd

08/04/2021



Lane Group	EBL	EBT	EBR	WBL	WBT	WBR	NBL	NBT	NBR	SBL	SBT	SBR
Lane Group Flow (vph)	372	1440	128	6	784	79	127	146	27	74	130	250
v/c Ratio	1.06	0.77	0.18	0.04	0.91	0.15	0.42	0.11	0.04	0.37	0.09	0.31
Control Delay	103.0	27.9	2.3	34.2	47.0	0.6	39.0	18.1	0.1	37.6	16.2	3.6
Queue Delay	0.0	0.0	0.0	0.0	0.0	0.0	0.0	0.0	0.0	0.0	0.0	0.0
Total Delay	103.0	27.9	2.3	34.2	47.0	0.6	39.0	18.1	0.1	37.6	16.2	3.6
Queue Length 50th (ft)	~107	218	0	3	201	0	31	25	0	35	21	0
Queue Length 95th (ft)	#191	#396	20	14	#308	0	57	47	0	72	39	44
Internal Link Dist (ft)		445			1176			506			422	
Turn Bay Length (ft)	200		50	200		375	150		150	450		450
Base Capacity (vph)	350	1866	694	157	857	518	306	1366	721	417	1452	799
Starvation Cap Reductn	0	0	0	0	0	0	0	0	0	0	0	0
Spillback Cap Reductn	0	0	0	0	0	0	0	0	0	0	0	0
Storage Cap Reductn	0	0	0	0	0	0	0	0	0	0	0	0
Reduced v/c Ratio	1.06	0.77	0.18	0.04	0.91	0.15	0.42	0.11	0.04	0.18	0.09	0.31

Intersection Summary

~ Volume exceeds capacity, queue is theoretically infinite.

Queue shown is maximum after two cycles.

95th percentile volume exceeds capacity, queue may be longer.

Queue shown is maximum after two cycles.

Queues

5: Old 215 Frontage Rd & Alessandro Blvd

08/04/2021



Lane Group	EBL	EBT	EBR	WBL	WBT	WBR	NBL	NBT	NBR	SBL	SBT	SBR
Lane Group Flow (vph)	295	623	85	20	720	74	57	157	14	27	46	171
v/c Ratio	0.89	0.36	0.13	0.13	0.82	0.14	0.19	0.10	0.02	0.16	0.03	0.22
Control Delay	66.9	22.2	0.4	35.7	37.7	0.6	35.5	14.4	0.0	35.6	15.4	3.5
Queue Delay	0.0	0.0	0.0	0.0	0.0	0.0	0.0	0.0	0.0	0.0	0.0	0.0
Total Delay	66.9	22.2	0.4	35.7	37.7	0.6	35.5	14.4	0.0	35.6	15.4	3.5
Queue Length 50th (ft)	77	77	0	9	177	0	13	20	0	13	7	0
Queue Length 95th (ft)	#154	131	0	30	#245	0	31	47	0	36	17	35
Internal Link Dist (ft)		445			1176			506			422	
Turn Bay Length (ft)	200		50	200		375	150		150	450		450
Base Capacity (vph)	331	1724	655	157	902	536	306	1634	857	417	1552	795
Starvation Cap Reductn	0	0	0	0	0	0	0	0	0	0	0	0
Spillback Cap Reductn	0	0	0	0	0	0	0	0	0	0	0	0
Storage Cap Reductn	0	0	0	0	0	0	0	0	0	0	0	0
Reduced v/c Ratio	0.89	0.36	0.13	0.13	0.80	0.14	0.19	0.10	0.02	0.06	0.03	0.22

Intersection Summary

95th percentile volume exceeds capacity, queue may be longer.
 Queue shown is maximum after two cycles.

Queues

5: Old 215 Frontage Rd & Alessandro Blvd

08/04/2021



Lane Group	EBL	EBT	EBR	WBL	WBT	WBR	NBL	NBT	NBR	SBL	SBT	SBR
Lane Group Flow (vph)	386	1440	128	6	784	83	127	146	27	80	130	262
v/c Ratio	1.10	0.77	0.18	0.04	0.91	0.16	0.42	0.11	0.04	0.39	0.09	0.33
Control Delay	115.0	27.9	2.3	34.2	47.0	0.7	39.0	18.4	0.1	37.7	16.2	3.6
Queue Delay	0.0	0.0	0.0	0.0	0.0	0.0	0.0	0.0	0.0	0.0	0.0	0.0
Total Delay	115.0	27.9	2.3	34.2	47.0	0.7	39.0	18.4	0.1	37.7	16.2	3.6
Queue Length 50th (ft)	~114	218	0	3	201	0	31	25	0	38	21	0
Queue Length 95th (ft)	#200	#396	20	14	#308	0	57	48	0	76	39	45
Internal Link Dist (ft)		445			1176			506			422	
Turn Bay Length (ft)	200		50	200		375	150		150	450		450
Base Capacity (vph)	350	1866	694	157	857	518	306	1354	716	417	1452	806
Starvation Cap Reductn	0	0	0	0	0	0	0	0	0	0	0	0
Spillback Cap Reductn	0	0	0	0	0	0	0	0	0	0	0	0
Storage Cap Reductn	0	0	0	0	0	0	0	0	0	0	0	0
Reduced v/c Ratio	1.10	0.77	0.18	0.04	0.91	0.16	0.42	0.11	0.04	0.19	0.09	0.33

Intersection Summary

~ Volume exceeds capacity, queue is theoretically infinite.

Queue shown is maximum after two cycles.

95th percentile volume exceeds capacity, queue may be longer.

Queue shown is maximum after two cycles.