



## **GEOTECHNICAL INVESTIGATION**

Grand Avenue Units  
1011 Grand Avenue  
San Diego, California

*prepared for:*

Mr. Mike Turk  
KDTD, Inc.  
4641 Ingraham Street  
San Diego, CA 92109

*by:*

TerraPacific Consultants, Inc.  
4010 Morena Boulevard, Suite 108  
San Diego, CA 92117

September 1, 2020  
File No. 20-142



Mr. Mike Turk  
KDTD, Inc.  
4641 Ingraham Street  
San Diego, CA 92109

September 1, 2020  
File No. 20-142

Subject: **Geotechnical Investigation**  
Grand Avenue Units  
1011 Grand Avenue  
San Diego, California

Dear Mr. Turk:

In accordance with our proposal dated July 27, 2020, TerraPacific Consultants, Inc. (TCI) has prepared the following report presenting our findings and recommendations from a geotechnical investigation at the subject property. The purpose of the investigation was to evaluate the subsurface conditions at the site and provide recommendations and design parameters for the proposed construction. The following report contains a summary of our findings and recommendations.

We greatly appreciate the opportunity to be of service. If you should have any questions or comments regarding this report or our findings, please do not hesitate to call.

Sincerely,  
TerraPacific Consultants, Inc.



Cristopher C. O'Hern, CEG 2397  
Senior Engineering Geologist

Octavio Brambila, PE 70633  
Project Engineer

CCO/OB:gg

Distribution: (3) – Mr. Mike Turk, KDTD, Inc.





## TABLE OF CONTENTS

1.0	INTRODUCTION.....	1
1.1	General .....	1
1.2	Scope of Services.....	1
2.0	PROJECT BACKGROUND.....	2
2.1	Site Description and Development History .....	2
2.2	Proposed Development.....	2
3.0	SITE INVESTIGATION.....	2
3.1	Site Reconnaissance .....	2
3.2	Subsurface Exploration.....	2
3.3	Laboratory Testing .....	3
4.0	SITE GEOLOGY.....	3
4.1	Geologic Setting.....	3
4.2	Site Stratigraphy .....	4
4.3	Groundwater .....	4
5.0	SEISMICITY.....	5
5.1	Regional Seismicity.....	5
5.2	Probabilistic Ground Acceleration .....	5
5.3	Hazard Assessment.....	6
6.0	CONCLUSIONS.....	7
7.0	RECOMMENDATIONS.....	7
7.1	Site Preparation and Grading .....	8
7.1.1	Clearing/Grubbing.....	8
7.1.2	Site Grading.....	8
7.1.3	Fill Materials and Compaction Requirements .....	8
7.2	Temporary Excavations .....	8
7.3	Foundation Recommendations.....	9
7.4	Soil Design Criteria.....	9
7.5	Retaining Walls.....	10
7.6	Earthquake Design Parameters.....	11
7.7	Foundation and Retaining Wall Design Guidelines.....	11
7.8	Trench Backfill .....	13
7.9	Pavement.....	13
7.10	Site Drainage.....	14
7.11	Storm Water Infiltration / Percolation BMPs .....	15
7.12	Plan Review and Geotechnical Observation.....	15
8.0	CLOSURE.....	15
8.1	Limits of Investigation.....	15

### APPENDICES

- Appendix A: Figures
- Appendix B: References
- Appendix C: Subsurface Excavation Logs
- Appendix D: Laboratory Test Results
- Appendix E: Summary of Active Faults
- Appendix F: Infiltration Feasibility Condition Letter
- Appendix G: Standard Grading Guidelines



## 1.0 INTRODUCTION

### 1.1 General

The following report presents the findings of a geotechnical investigation performed at 1011 Grand Avenue in San Diego, California. The location of the property is presented on the Site Location Plan (Figure 1 in Appendix A). The purpose of the investigation was to evaluate the subsurface conditions at the site in order to provide recommendations and soil design parameters for the proposed construction.

### 1.2 Scope of Services

The scope of the investigation consisted of field reconnaissance, subsurface exploration, laboratory testing, and engineering and geologic analysis of the obtained data. The following tasks were performed during the investigation and production of this report:

- Site reconnaissance and review of published geologic, seismologic, and geotechnical reports and maps pertinent to the project. A list of references is provided in Appendix B;
- Logging/sampling of four small-diameter borings at the subject property. The Geotechnical Plan (Figure 2 in Appendix A) presents the approximate subsurface exploration locations. The excavation logs are presented in Appendix C;
- Collection of representative soil samples from selected depths within the excavations, which were transported to our laboratory for testing and analysis;
- Laboratory testing of samples collected from the test excavations. The testing included in-situ moisture and density, maximum dry density, direct shear, expansion index, hydro-response, and sulfate and chloride concentration. The laboratory data is presented in Appendix D;
- Engineering and geologic analysis of data acquired from the investigation, which provided the basis for our conclusions and recommendations; and
- Preparation of this report presenting our findings and recommendations.



## **2.0 PROJECT BACKGROUND**

### **2.1 Site Description and Development History**

The subject property is located on the south side of Grand Avenue in San Diego, California. The legal description of the property is APN 423-154-0200, BLK 257, LOT 8, Submap 854, Pacific Beach Amended Trustees Map. The rectangular-shaped lot is bordered by developed commercial properties to the east, an alleyway to the south, Grand Avenue to the north, and Cass Street to the west. The site is essentially flat with an estimate elevation of 20 mean sea level (msl). The lot is currently improved with commercial structures, asphalt and concrete pavements, and other associated appurtenances.

### **2.2 Proposed Development**

Based on our review of the current architectural plans, it is our understanding that the existing structure is to be razed, and the site will be developed to accommodate a mixed-use structure consisting of commercial space and parking on the ground floor and residential spaces on the second and third floors.

## **3.0 SITE INVESTIGATION**

The site investigation was conducted on August 14, 2020, and consisted of visual reconnaissance and subsurface exploration. The purpose of the investigation was to gain an understanding of the site configuration and subsurface conditions in the vicinity of the proposed construction.

### **3.1 Site Reconnaissance**

Our site reconnaissance consisted of walking the site to determine if any indications of adverse geologic conditions were present. No outward signs of distress indicating adverse geologic conditions were noted.

### **3.2 Subsurface Exploration**

The subsurface exploration consisted of four small-diameter borings excavated with a truck-mounted rig. The borings, B-1 through B-4, extended to depths of up to 20 feet below ground surface (bgs). The approximate excavation locations are presented on the Geotechnical Plan (Figure 2 in Appendix A). The borings were logged and sampled by a licensed professional from our office.



In general, the subsurface exploration revealed the site is mantled by undocumented fill soil, which is underlain by native marine terrace deposits identified as Old Paralic Deposits, Unit 6. Groundwater was not encountered within the depths of our excavations. Descriptions of each material are detailed in Section 4.2 Site Stratigraphy, and the subsurface excavation logs are provided in Appendix C.

### **3.3 Laboratory Testing**

Soil samples collected during the field exploration were transported to our laboratory for testing. The purpose of the testing was to characterize the soil types and evaluate the engineering properties of the soil. The laboratory testing included in-situ moisture and density, expansion index, maximum dry density, direct shear, hydro-response, and sulfate and chloride concentrations. Each of the laboratory tests was performed in accordance with ASTM specifications or other accepted testing procedures. The results of the laboratory tests are presented in Appendix D.

## **4.0 SITE GEOLOGY**

### **4.1 Geologic Setting**

The site is located within the coastal portion of the Peninsular Ranges Geomorphic Province of California. This province, which extends 900 miles from Southern California to the southern tip of Baja California, is characterized by northwest-trending structural blocks. The coastal portion of the province in San Diego County is typically comprised of upper Cretaceous-aged to Tertiary-aged (1.8 million to 65 million years) marine and non-marine sedimentary bedrock units that have been deposited within a northwest-trending basin known as the San Diego Embayment (Norris & Webb, 1976). Recent geologic uplift along the San Diego coastal margin, combined with sea level changes, have created marine terraces and associated deposits consisting of near-shore marine, beach estuarine, and lagoonal facies. These deposits range from early to mid-Quaternary-aged (45,000 to 1.5 million years) and are designated in geologic literature as Paralic Deposits.

According to geologic literature from the California Geological Survey (CGS), the site is underlain by Quaternary-aged surficial deposits designated as Old Paralic Deposits, Unit 6. The literature describes the paralic deposits as “poorly sorted, moderately permeable, reddish-brown, inter-fingered strandline, beach, estuarine and colluvial deposits composed of siltstone, sandstone and conglomerate” (Kennedy and Tan, 2008).



Based on the City of San Diego Seismic Safety Study Map, the site is located within a Zone 52 – “other level areas, gently sloping to steep terrain, favorable geologic structure, low risk.” The site is located on the Geologic Map (Figure 3 in Appendix A) and the Seismic Safety Study Map (Figure 4 in Appendix A).

#### **4.2 Site Stratigraphy**

The subsurface descriptions presented below are interpreted from the conditions exposed during the field investigation and/or inferred from local geologic literature. In addition to the following descriptions, detailed exploration logs are presented in Appendix C.

Fill Soil (Af) - Fill soil is earth material that has been placed using mechanical means, such as bulldozers or other large earthmovers. Typically, the fill soil has been removed from topographically high locations and placed in low-lying areas to create level building pads. When properly compacted, fill soil can be used to support structures. However, it is typically more compressible than natural formational soils. Fill soils placed without documentation of observation and testing are considered undocumented and are typically not suitable for foundation support.

Undocumented fill soils were encountered in each of the borings B-1 through B-4 from the ground surface to respective depths of 5.6, 5.1, 5.4, and 5.3 feet bgs. The fill soils were relatively consistent and generally described as medium gray-brown to red-brown, loose to medium dense, slightly moist, clayey to silty sand. Asphalt and concrete clasts were identified within the fill soil.

Old Paralic Deposits, Unit 6 (Qop6) – Marine terrace deposits designated Quaternary-aged Old Paralic Deposits, Unit 6, were encountered in each of the borings underlying the fill material. These deposits are associated with the Nestor marine terrace and are approximately 120,000 years old. The material encountered during our exploration was generally described as a medium red-brown to medium gray-brown, clayey to silty sandstone that was slightly moist, dense to very dense. Zones with high cobble content and friable sands were observed.

#### **4.3 Groundwater**

Groundwater was not encountered within the depths of our excavations, which extended to depths of 20.0 feet bgs. It should be noted that additional zones of perched groundwater could develop during periods of heavy or prolonged rainfall, and/or with changes in site improvements on the subject or adjacent lots, and/or changes in irrigation patterns on the subject or adjacent lots.



## 5.0 SEISMICITY

### 5.1 Regional Seismicity

Generally, the seismicity within California can be attributed to the regional tectonic movement taking place along the San Andreas Fault Zone, which includes the San Andreas Fault, and most parallel and sub-parallel faulting within the state. A majority of Southern California, which includes the subject site, is considered seismically active. Seismic hazards can be attributed to potential ground shaking from earthquake events along nearby faults or more distant faulting.

According to regional geologic literature, the closest known active faults are located within the Rose Canyon Fault Zone. The Rose Canyon fault zone consists of a complex zone of several en echelon strike slip, oblique, reverse, and normal faults, which extend onshore in this area from San Diego Bay north to La Jolla Bay. Several other potentially active and pre-Quaternary faults also occur within the regional vicinity. Currently, the geologic literature presents varying opinions regarding the seismicity of these faults. As such, the following Seismic Analysis only considers the effects of nearby faults currently considered active.

### 5.2 Probabilistic Ground Acceleration

A deterministic seismic hazard analysis was performed for the site using the computer program EQFault (Blake, 2000). The analysis considers the maximum movement magnitude earthquake for active faults within the specified search radius to provide a maximum expected earthquake event for the known tectonic structure. For this site, we specified a search radius of 62.4 miles (100 km) and the attenuation equation of Campbell & Bozorgnia (1997 Rev.) for soft rock. The analysis results for the faults most likely to affect the site are presented in Appendix E, Summary of Active Faults.

In addition to the deterministic analysis, a simplified probabilistic seismic hazard analysis was performed for the site. The California Geological Survey has a webpage that allows a user to calculate the ground motion at a site with either a 2 percent or 10 percent probability of exceedance in a 50-year period. The results of the output indicated the site had respectively calculated peak ground accelerations of 0.54g and 0.26g

The values provided above are for comparing the potential for seismic shaking due to fault activity most likely to affect the site. Other factors should be considered when completing seismic design, such as duration of shaking, period of the structure, design category, etc. The design structural engineer should consider the information provided herein and evaluate the structure(s) in accordance with the California Building Code and guidelines of the City of San Diego. The earthquake design parameters based on the 2019 CBC applicable to the site are provided in Section 7.6.





### 5.3 Hazard Assessment

Faulting/Fault Rupture Hazard - An “active” fault, as defined by the Alquist-Priolo Earthquake Fault Zoning Act, is a fault that has had surface rupture within Holocene time (the past 11,000 years). A “potentially active” fault is defined as any fault that showed evidence of surface displacement during Quaternary time (last approximate 1.6 million years), but not since Holocene time.

According to the City of San Diego Seismic Safety Study 2008 and the Quaternary Fault Map from the USGS Earthquake Hazards Program, the subject parcel is located approximately 2.2 miles southwest of an “active” portion of the Rose Canyon Fault Zone (Rose Canyon Fault). Several other unnamed faults are mapped nearby, these faults are considered to be older than Quaternary-aged and are classified on the City map as “potentially active, inactive, presumed inactive or activity unknown.” The site is not located within an Alquist-Priolo fault zone, and according to geologic literature, is not intersected by any faults. The site is depicted on the Seismic Safety Study Map (Figure 4 in Appendix A).

Seismically Induced Settlement - Within the depths of our exploration, the soils encountered consisted of relatively dense formational soils at shallow depths. Based on the anticipated earthquake effect and the stratigraphy of the site, seismically induced settlement is expected to be minor and within tolerable limits. Structures designed and constructed in accordance with applicable building codes are expected to perform well with respect to settlement associated with predictable seismic events.

Liquefaction - Liquefaction involves the substantial loss of shear strength in saturated soil, usually taking place within a saturated medium, exhibiting a uniform fine-grained characteristic, loose consistency, and low confining pressure when subjected to impact by seismic or dynamic loading. Based on the shallow depth to dense formational soil, the site is considered to have a negligible risk for liquefaction.

Lurching and Shallow Ground Rupture - Rupturing of the ground is not likely due to the absence of known active fault traces within the project limits. Due to the generally active seismicity of Southern California, however, the possibility for ground lurching or rupture cannot be completely ruled out. In this light, “flexible” design for on-site utility lines and connections should be considered.

Landsliding - Given the shallow topographic relief of the site and surrounding area, the possibility for landsliding is believed to be negligible. Furthermore, the San Diego Seismic Safety Study does not depict any known landslides in the vicinity of the site.



Tsunamis or Seiches – Tsunamis are great sea waves produced by seismic events. Given the site elevation of approximately 20 feet msl, it is not likely that a tsunami could impact the site. Historically, the magnitudes of tsunamis to impact the San Diego coastline have been fairly small, typically less than 1 meter in height. Recent studies into the possibility of offshore seismic events triggering tsunamis via fault movement or undersea landslides have experts of the opinion that Southern California is not free from tsunami risks (Krier, 2005). However, predicting the level of risk is difficult due to the lack of knowledge about the offshore fault system.

In our opinion, there is no practical approach for mitigating the potential impact to the site from a tsunami. This is an inherent risk for those living within the beach area. All residents in coastal areas should have an evacuation plan in place for a strong seismic event (i.e., typically 20 seconds or more of sturdy ground shaking) or when an official tsunami warning is issued.

## **6.0 CONCLUSIONS**

Based on the results of our geotechnical investigation, it is our opinion that the proposed development is feasible from a geotechnical standpoint, provided the recommendations presented in the following sections are adopted and incorporated into the project plans and specifications.

The following sections provide recommendations for the proposed site development. The civil and/or structural engineer should use this information during the planning and design of the proposed construction. Once the plans and details have been prepared, they should be forwarded to this office for review and comment.

The key aspect of the site, which will need to be considered during the design, is the presence of undocumented fill soil and/or weathered paralic deposits within the upper approximate 5 feet of the site. As a means to provide a uniform engineered fill pad for the site, it is recommended that all undocumented fill be removed, and the removals extend to a minimum depth of 2 feet below the deepest foundation. It is anticipated that these depths will be on the order of 5 feet below existing grade. As is always the case, localized areas of deeper removals may be required.

## **7.0 RECOMMENDATIONS**

The following sections provide our recommendations for site preparation, design, and construction of the proposed foundation systems. Once the plans and details have been prepared, they should be forwarded to this office for review and comment.



## **7.1 Site Preparation and Grading**

### **7.1.1 Clearing/Grubbing**

In order to prepare the site for the new construction, it is assumed that all of the existing improvements will be demolished and removed from the site. However, if unsuitable materials (e.g., construction debris, plant material, etc.) are encountered during the grading phase, they should be removed and properly disposed of off-site.

### **7.1.2 Site Grading**

Site grading should be conducted to remove the undocumented fill soils and provide a uniform fill mat extending 2 feet below foundation bottom for all structures. Removals on the order of 5 feet below grade are anticipated. Localized areas of deeper removals may be required.

The removals should extend a minimum of 5 feet beyond the structural footprint. This may be reduced due to property line constraints. Once the removal bottoms into competent parallel deposit soils have been established, the bottoms should be scarified a minimum of 6 inches, moisture-conditioned, and compacted to a minimum of 90 percent relative compaction.

### **7.1.3 Fill Materials and Compaction Requirements**

The on-site soil, less any organic debris, may be used for fill, provided that it is placed in thin lifts (not exceeding 8 inches in loose thickness). All soil should be properly moisture conditioned and mechanically compacted to a minimum of 90 percent of the laboratory maximum dry density, per ASTM D-1557, and at or slightly above optimum moisture condition. The removal bottoms, fill placement, and compaction should be observed and tested by the geotechnical consultant. Standard guidelines for grading are provided in Appendix G.

## **7.2 Temporary Excavations**

Foundation excavations, utility trenches, or other temporary vertical cuts may be conducted in fill or formational soils to a maximum height of 4 feet. Any temporary cuts beyond the above height restraint could experience sloughing or caving and, therefore, should be either shored or laid-back. Laid-back slopes should have a maximum inclination of 1:1 (horizontal:vertical) and not exceed a vertical height of 10 feet without further input from the geotechnical consultant. In addition, no excavation should undercut a 1:1 projection below the foundation for any existing improvements, i.e., existing building foundations both on and off-site. Regional safety measures should be enforced, and all excavations should be conducted in strict accordance with OSHA guidelines.



If deeper excavations are required or excavations encroach into a 1:1 projection from an existing structure, shoring will likely be required. We recommend using a triangular pressure distribution for calculating earth pressures for temporary excavations that will be shored but not braced with tiebacks or struts. Cantilevered shoring design may be based on an equivalent fluid pressure of 38 pcf for shoring of fill and native materials. Shoring design should also include any groundwater pressures that may be encountered in the excavation, and any additional surcharge loads resulting from loads placed above the excavation and within a 1:1 plane extending upward from the base of the excavation. For design of soldier piles, an allowable passive pressure of 350 psf per foot of embedment may be used.

Excavation spoils should not be stockpiled adjacent to excavations, as they can surcharge the soils and trigger failure. In addition, proper erosion protection, including runoff diversion, is recommended to reduce the possibility for erosion of slopes during grading and building construction. Ultimately, it is the contractor's responsibility to maintain safe working conditions for persons on-site and verify compliance with the project's BMPs.

### **7.3 Foundation Recommendations**

The following sections provide the soil parameters and general guidelines for foundation design and construction. It is anticipated that all new construction will be supported by conventional continuous and spread footings. As mentioned previously, the new foundations should be supported on competently engineered fill in accordance with Section 7.1. If additional parameters are desired, they can be provided on request.

The foundation design parameters and guidelines provided below are considered to be "minimums" in keeping with the current standard-of-practice. They do not preclude more restrictive criteria that may be required by the governing agency or structural engineer. The architect or structural engineer should evaluate the foundation configurations and reinforcement requirements for structural loading, concrete shrinkage, and temperature stress.

### **7.4 Soil Design Criteria**

The following separate soil design criteria are provided for design and construction of the conventional foundations for building structures. The parameters provided assume foundation embedment in competent engineered fill material with an expansion index classification as low.



Conventional Foundations

Allowable bearing capacity for square or continuous footings.....2,000 psf

Minimum embedment in competent engineered fill ..... 24 inches

Minimum width for continuous footings..... 18 inches

Minimum width for square footings ..... 3.0 feet

Note: The bearing capacity value may be increased by one-third for transient loads such as wind and seismic. In addition, the value provided may be increased by 500 psf for each additional foot of width or depth beyond the minimums provided. The increased bearing capacity should not exceed 4,000 psf.

Coefficient of friction against sliding ..... 0.35

Passive resistance .....250 psf/ft up to a maximum of 2,000 psf

**7.5 Retaining Walls**

Lateral Loading and Resistance Parameters

For retaining walls, the bearing capacity and foundation dimensions provided for Section 7.4 may be followed. Additional design parameters for lateral loading and resistance are provided below:

Active earth pressure for level backfill (non-restrained walls) ..... 40 psf/ft

At-rest earth pressure for level backfill (restrained walls) ..... 60 psf/ft

Note: The active and at-rest pressures are provided assuming granular soil is used for backfill. Backfill and subdrain recommendations are provided in the following sections.

Passive resistance in competent fill ..... 250 psf/ft

Coefficient of friction against sliding .....0.35

Note: The passive resistance and coefficient of friction may be used in combination if there is a fixed structure, such as a floor slab at the toe of the retaining wall. If the two values are used in combination, the passive resistance value should be reduced by one third.



## Earthquake Loads

Seismic loading for retaining walls with level backfill should be approximated by applying a 17 psf/ft in an inverse triangle shape, where the lateral force at the bottom of the wall is equal to zero, and the lateral force at the top of the retaining wall is equal to 17 psf times the height of the wall. The resultant seismic load should be applied from the bottom of the wall a distance of 0.6 times the overall height of the wall.

The seismic loads would be in addition to the normal earth pressure loads applied on the retaining walls, which are provided above. The structural engineer should evaluate the overall height of the wall and apply the appropriate retaining wall loading parameters to be used for analysis and design.

### **7.6 Earthquake Design Parameters**

Earthquake resistant design parameters may be determined from the California Building Code (2019 Edition). Based on our investigation and characterization of the site, the following design parameters may be adopted:

Site coordinates .....	Latitude: 32.7951 Longitude: -117.2507
Site classification .....	D
Site coefficient Fa.....	1.000
Site coefficient Fv.....	null
Spectral response acceleration at short periods Ss.....	1.318
Spectral response acceleration at 1-second period S1 .....	0.459
Maximum spectral response accelerations at short periods Sms.....	1.318
Maximum spectral response accelerations at 1-second period Sm1.....	null
Design spectral response accelerations at short periods Sds .....	0.879
Design spectral response accelerations at 1-second period Sd1 .....	null

### **7.7 Foundation and Retaining Wall Design Guidelines**

The following guidelines are provided for assistance in the design of the various foundation elements and are based on the anticipated low expansion potential of the bearing soils. As is always the case, where more restrictive, the structural and/or architectural design criteria should take precedent.



Foundations - Continuous exterior and interior footings for the buildings should be a minimum of 24 inches deep. Reinforcement should consist of a minimum of four No. 5 rebar, two placed at the top and two at the bottom of the footing. All footing embedments should be verified by the soil engineer.

Slabs-on-Grade - Interior and exterior slabs-on-grade should be a minimum of 5 inches thick (net) and reinforced with No. 4 rebar placed at a maximum spacing of 16 inches on center, each way. The steel reinforcement should be placed at the midpoint or slightly above the midpoint in the slab section. For exterior slabs, control joints should be installed at a maximum spacing of 10 feet in each direction. Prior to construction of slabs, the subgrade should be moistened to approximately 12 inches in depth at least 24 hours before placing the concrete.

All interior floor slabs should be underlain by 2 inches of clean sand, followed by a minimum 15-mil PVC vapor retarder (Stego Wrap or similar). The vapor retarder should be further underlain by a 4-inch thick layer of gravel or crushed rock. Also, the vapor retarder should be properly lapped and sealed around all plumbing penetrations.

Retaining Walls - Retaining walls should be provided with a gravel subdrain system. The drain system should start with a minimum 4-inch diameter perforated PVC Schedule 40 or ABS pipe, which is placed at the heel of the wall footing and below the adjacent slab level. The pipe should be sloped at least 1 percent to a suitable outlet, such as an approved site drainage system or off-site storm drain. The pipe should be surrounded by a gravel backfill consisting of tamped  $\frac{3}{4}$ -inch sized gravel. This gravel backfill zone should be a minimum of 12 inches wide and should extend from slightly below the drain pipe up to approximately two-thirds of wall height. The entire gravel section should be wrapped in a filter cloth such as Mirafi 140 NS or similar to prevent contamination with fines. Alternatively, walls can be drained using geo-composite panel drains that connect to a gravel sub-drain at the heel of the wall. In addition, the wall should be properly moisture-proofed per the project architect. See the Retaining Wall Drain Details (Figure 5 in Appendix A).

Foundation and Slab Concrete - The results of the corrosion tests indicate low levels of sulfates and chlorides within the on-site soils. However, due to the coastal location, it is recommended that the concrete used for foundation elements contain Type V cement. The concrete should be mixed and placed in accordance with ACI specifications. Water should not be added to the concrete at the site, as this can reduce the mix and lead to increased porosity and shrinkage cracking.



Proper curing techniques and a reduction in mixing water can help reduce cracking and concrete permeability. In order to further reduce shrinkage cracking and slab permeability, consideration should be given to using a concrete mix that possesses a maximum water-cement ratio of 0.5. The potential for shrinkage cracking within concrete flatwork elements cannot be completely ruled out and should be expected.

It should be noted that TCI does not consult in the field of corrosion engineering. Thus, the client project architect and project engineer should evaluate the level of corrosion protection required for the project and seek consultation from a qualified professional, as warranted.

Appurtenances - Other site appurtenances such as planter walls, site walls, etc., can be constructed on continuous footings. Footings for such appurtenances should be a minimum of 18 inches deep, 12 inches wide, and minimally reinforced with four No. 4 bars, two top, and two bottom. The bearing capacity for such appurtenances is 1,500 psf.

#### **7.8 Trench Backfill**

Trench excavations for utility lines should be properly backfilled and compacted. Utilities should be properly bedded and backfilled with clean sand or approved granular soil to a depth of at least 6 inches over the pipe. This backfill should be uniformly watered and compacted to a firm condition for both vertical and lateral pipe support. The remainder of the backfill may be typical on-site soil or low-expansive import placed near optimum moisture content in lifts not exceeding 8 inches in thickness and mechanically compacted to at least 90 percent relative compaction.

#### **7.9 Pavement**

The following pavement sections are provided for the new pavements associated with the proposed improvements. Subgrade preparation should be conducted immediately prior to placement of the pavement section. As a minimum, the upper 12 inches of subgrade in the area of the proposed pavement should be removed and properly re-compacted to 95 percent relative compaction and moisture-conditioned to at least 2 percent over the optimum moisture content (per ASTM D-1557).

It is assumed that the proposed driveway will receive light vehicle traffic, etc. The following pavement sections are recommended based on an assumed R-value of 10 and in accordance with the Caltrans Highway Design Manual and the Flexible Pavement Structural Section Design Guide for California Cities and Counties (3rd edition). Concrete pavement sections were determined utilizing the Design of Concrete Pavement for City Streets by Portland Cement Association.





Assumed Traffic Index	Assumed R-Value	Asphalt Concrete	Aggregate Base (Class II)
Asphalt Pavement Section - Driveway			
5.0	10	3.0 inches	9.0 inches
Concrete Pavement Section - Driveway			
5.0	10	6.0 inches	4.0 inches

Final pavement designs should be determined based on testing of the soils exposed at the completion of the finished grading.

Concrete should be reinforced at a minimum, with No. 4 rebar at 18 inches on center, each way, placed at the midpoint of the section. Additionally, control joints should be saw-cut 2.5 inches deep longitudinally at 10-foot maximum spacing, and transversely at 10-foot maximum spacing. The concrete should be placed in conformance with ACI standards and have a minimum modulus of rupture of 500 psi.

Aggregate base should conform to the specifications for crushed aggregate base, crushed miscellaneous base, or processed miscellaneous base as defined in Section 200-2 of the "Greenbook." Aggregate base should be compacted to at least 95 percent of maximum dry density based on ASTM D-1557 guidelines. Asphalt concrete should conform to "Greenbook" specifications. Asphalt concrete should be compacted to at least 95 percent based on the Hveem unit weight.

### **7.10 Site Drainage**

Drainage should be designed to direct surface water away from structures and on to an approved disposal area. For earth areas, a minimum gradient of 2 percent should be maintained, with drainage directed towards approved collection facilities. In order to reduce saturation of the building foundation soils, positive drainage should be maintained within an away gradient of at least 5 percent, for a minimum distance of 10 feet from foundations. Where property line constraints prohibit this distance, a 5 percent gradient to an approved drainage diversion (i.e., area drains or swales) should be provided. Impervious surfaces within 10 feet of the building foundation should be sloped a minimum of 2 percent away from the building. Drainage patterns approved after grading should be maintained throughout the life of the development. In addition, it is recommended that roof gutters be installed with downspouts tied into the tightlined area drain system.



### **7.11 Storm Water Infiltration / Percolation BMPs**

As is always the case, site infiltration near proposed improvements (structures and appurtenances) would have a negative impact in regards to potential settlement and/or heave of the supporting fill and underlying native soils. In addition, existing site conditions consist of undocumented fill soils in excess of 5-foot depths across the lot. Due to these potential negative impacts and the existing site conditions, the site is not considered feasible for infiltration. A Feasibility Condition Letter is provided within Appendix F.

### **7.12 Plan Review and Geotechnical Observation**

When the grading and foundation plans are completed, they should be reviewed by TCI for compliance with the recommendations herein. Observation by TCI or another company's geotechnical representative is essential during grading and/or construction to confirm conditions anticipated by the preliminary investigation, adjust designs to actual field conditions, and determine that grading is conducted in general accordance with our recommendations. In addition, all foundation excavations should be reviewed for conformance with the plans prior to the placement of forms, reinforcement, or concrete. Observation, testing, and engineering consulting services are provided by our firm and should be budgeted within the cost of development.

## **8.0 CLOSURE**

### **8.1 Limits of Investigation**

Our investigation was performed using the skill and degree of care ordinarily exercised, under similar circumstances, by reputable soils engineers and engineering geologists practicing in this or similar localities. No warranty, expressed or implied, is made as to the conclusions and professional advice in this report. This report is prepared for the sole use of our client and may not be assigned to others without the written consent of the client and TCI.

The samples taken and used for testing, and the observations made, are believed representative of the site conditions; however, soil and geologic conditions can vary significantly between test excavations and surface exposures. As in most projects, conditions revealed by construction excavations may vary with the preliminary findings. If this occurs, the geotechnical engineer should evaluate the changed conditions and adjust recommendations and designs, as necessary.



This report is issued with the understanding that it is the responsibility of the owner, or of their representative, to ensure that the information and recommendations contained herein are brought to the attention of the project architect and engineer. Appropriate recommendations should be incorporated into the structural plans and the necessary steps taken to see that the contractor and subcontractors carry out such recommendations in the field.

The findings of this report are valid as of the present date. However, the conditions can change with the passage of time, whether they are due to natural processes or the works of man. In addition, changes in applicable or appropriate standards may occur from legislation or the broadening of knowledge. Accordingly, the findings of this report may be invalidated wholly or partially by changes outside of our control. This report is subject to review and should be updated after a period of 3 years.

**\* \* \* TerraPacific Consultants, Inc. \* \* \***



## APPENDIX A

### Figures

LOCATION:  
1011 Grand Avenue,  
San Diego, CA

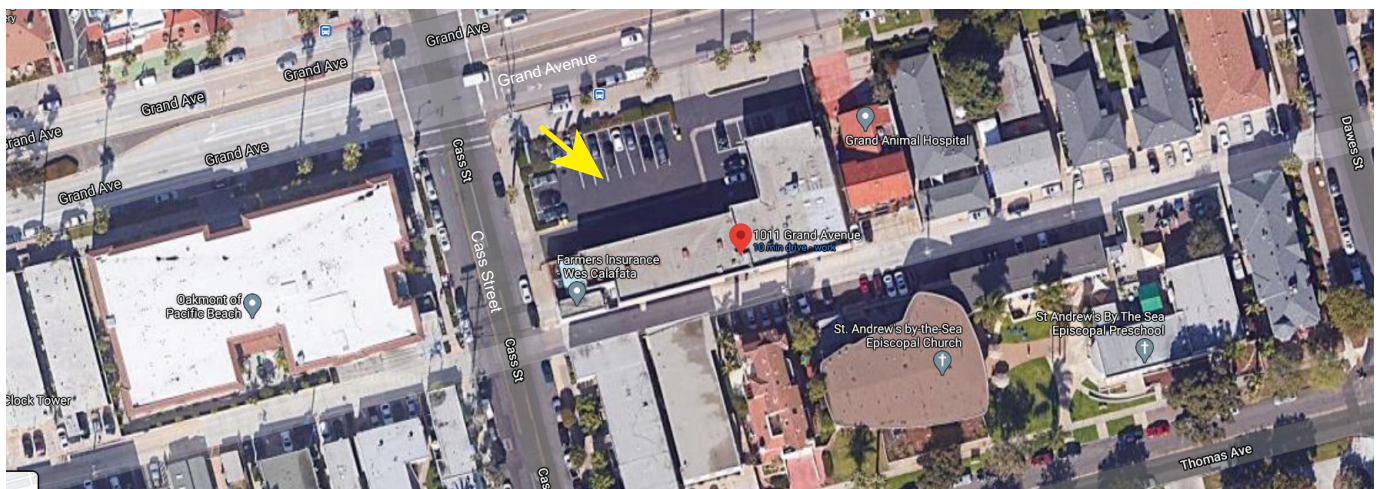
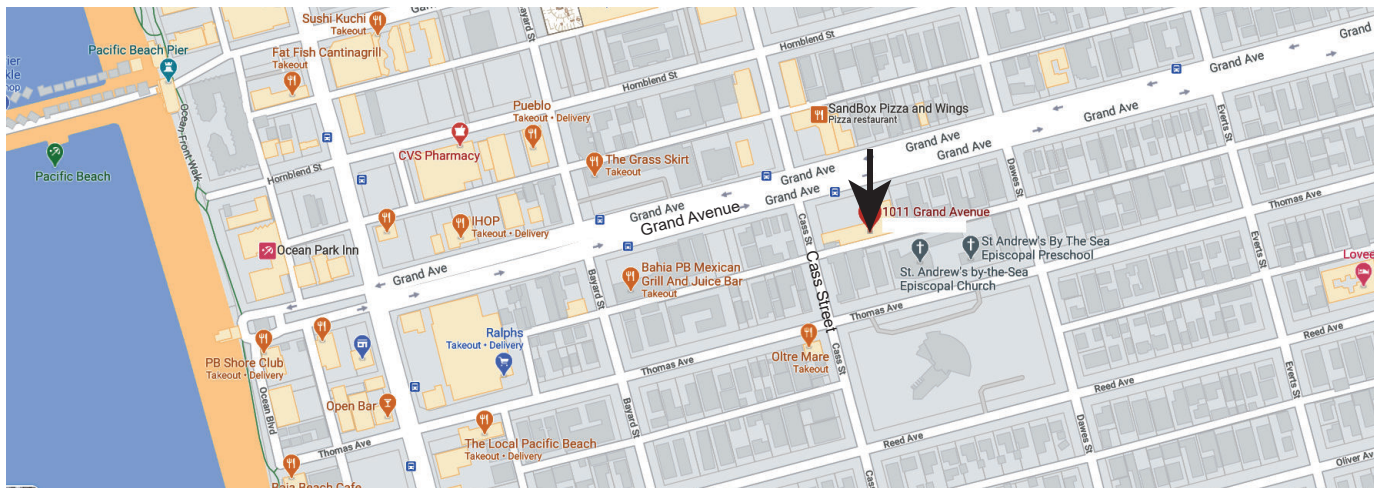
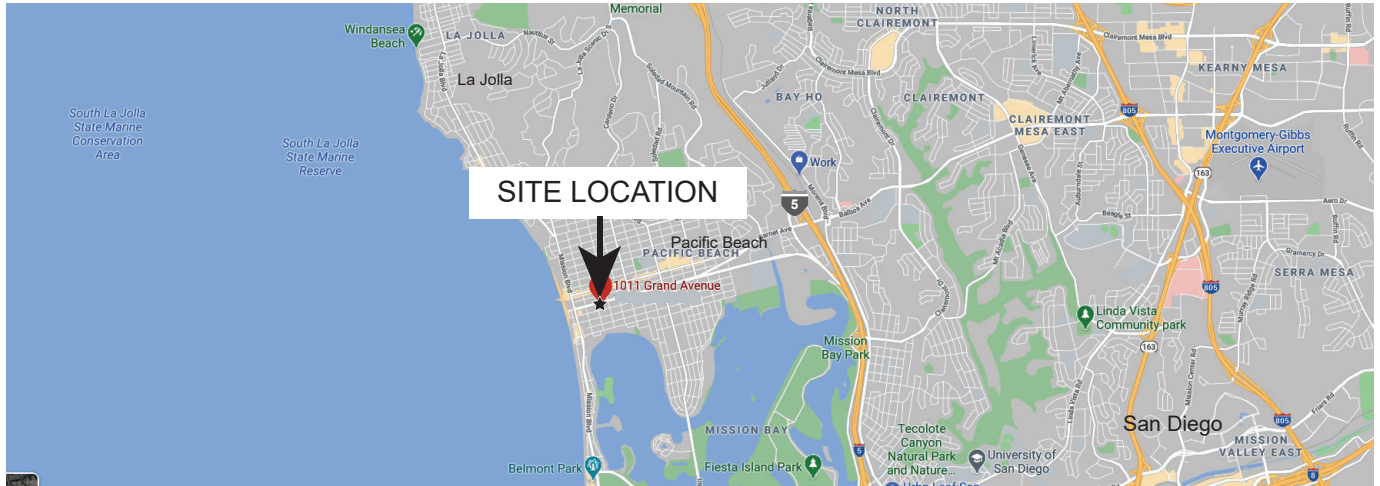

REFERENCE: Google Maps





REFERENCE:  
 1. Aerial image from Google Earth  
 2. 101 Grand 1st Floor Plan, prepared by Golba Architecture

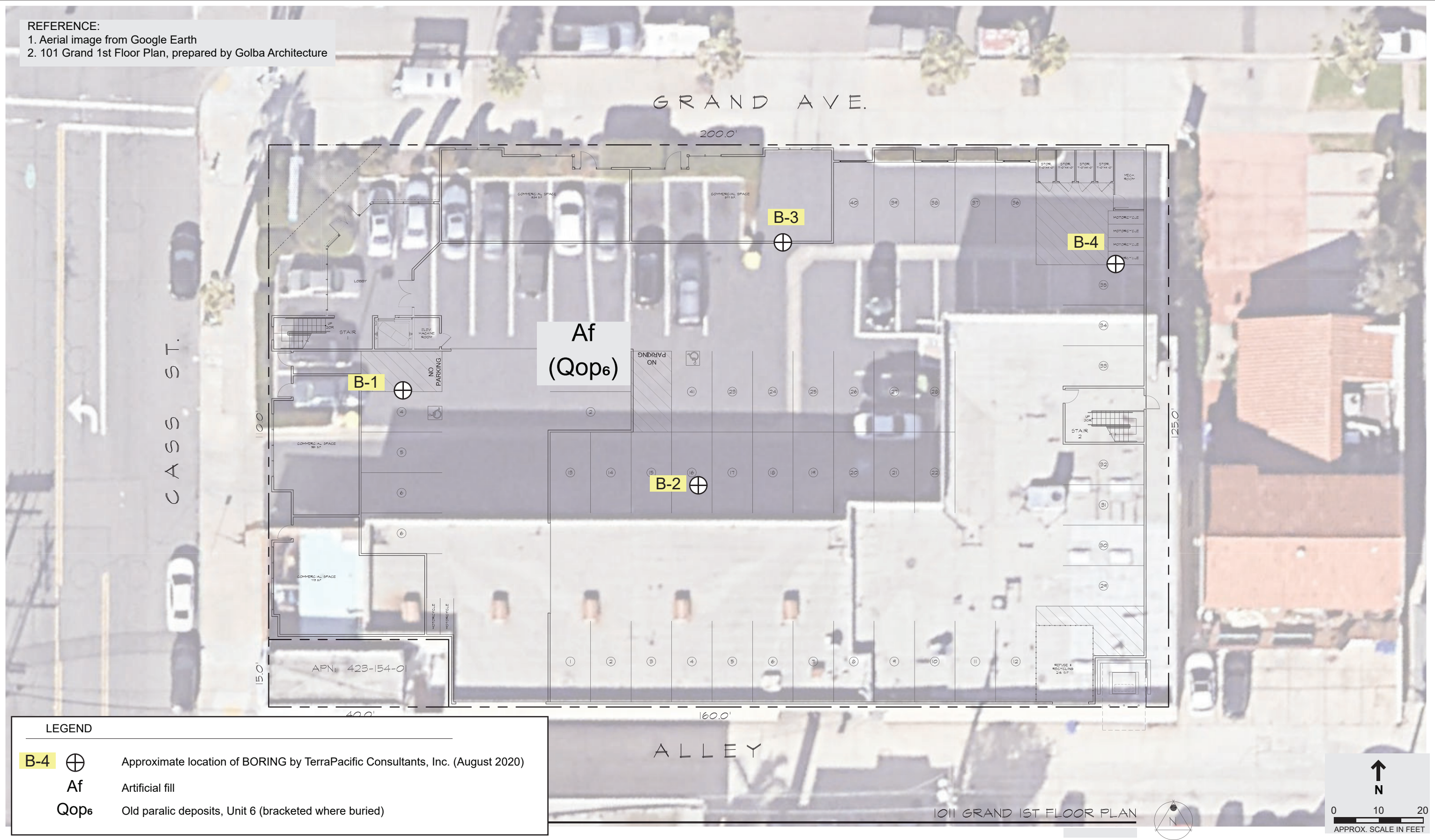

**LEGEND**

**B-4** ⊕ Approximate location of BORING by TerraPacific Consultants, Inc. (August 2020)

**Af** Artificial fill

**Qop<sub>6</sub>** Old paralic deposits, Unit 6 (bracketed where buried)



Compiled by  
 Michael P. Kennedy and Siang S. Tan  
 2008  
**San Diego Quadrangle**

*U.S. Geological Survey, Department of Earth Sciences, University of California, Riverside*

**Description of Map Units**

**Qop6**  
 Old paralic deposits, Unit 6 (late to middle Pleistocene)—Mostly poorly sorted, moderately permeable, reddish-brown, interfingering strandline, beach, estuarine and colluvial deposits composed of siltstone, sandstone and conglomerate. These deposits rest on the 22-23 m Nestor terrace (Fig. 3)

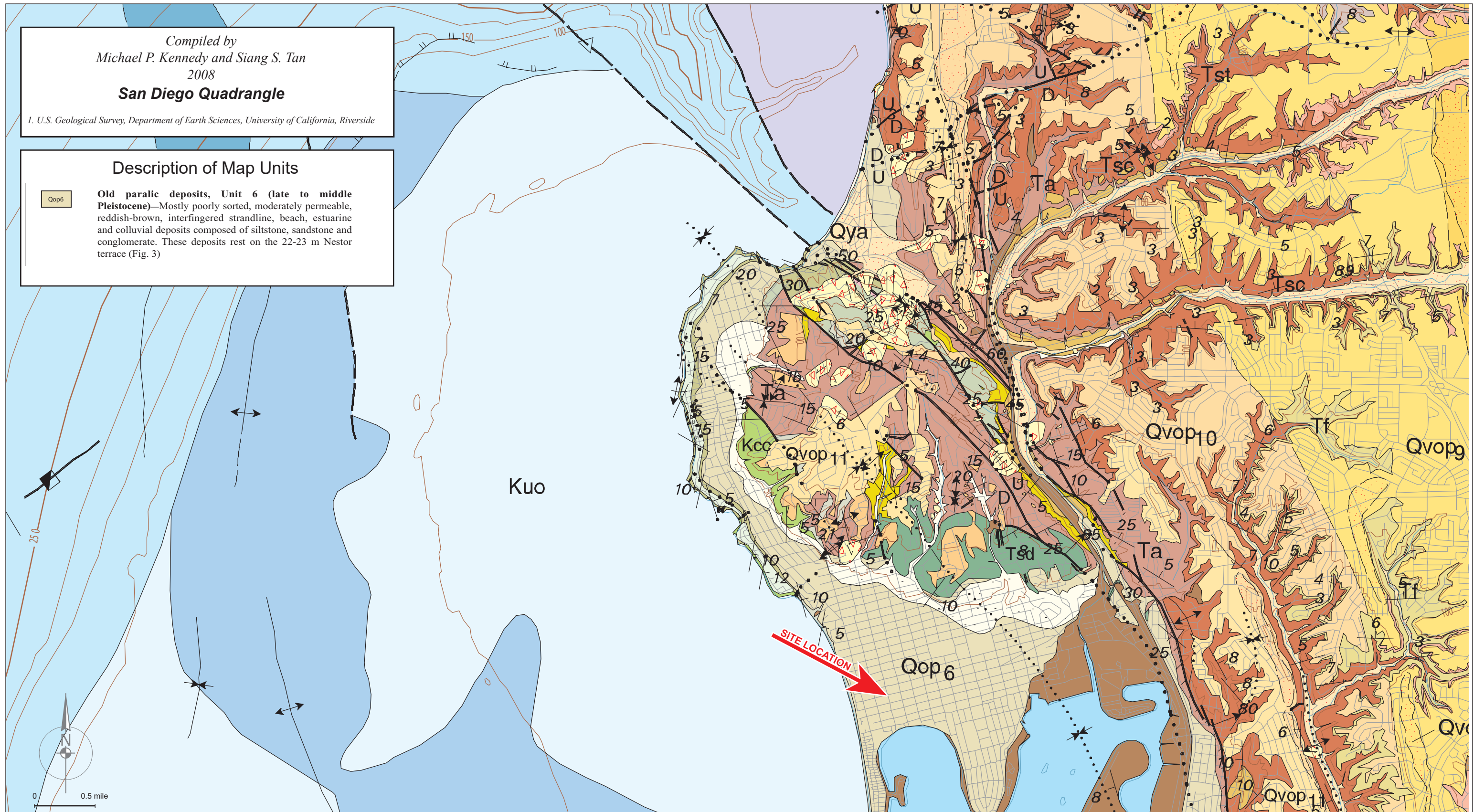



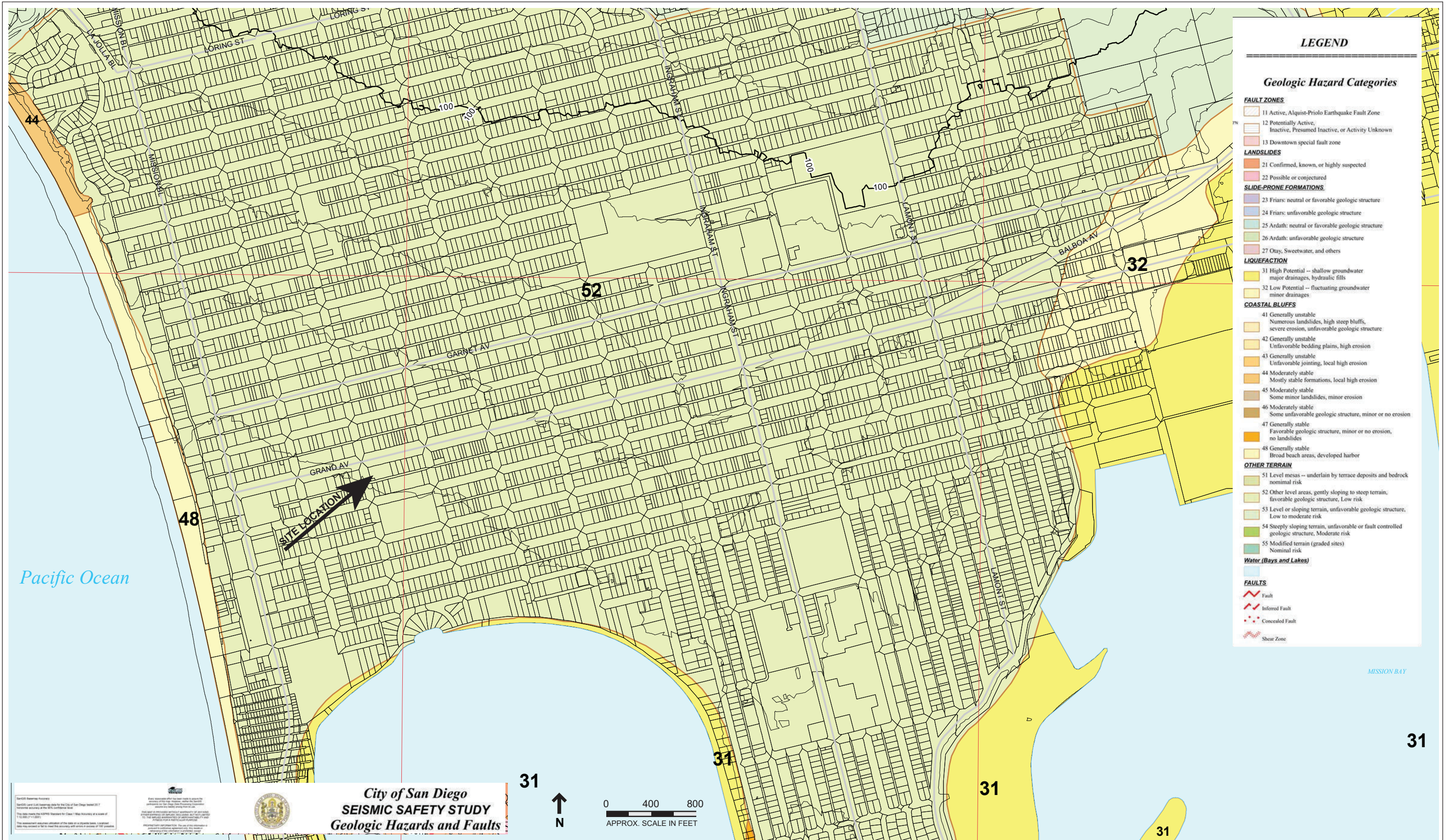

SanGIS Geospatial Information  
 SanGIS Level 100 Coverage Data for the City of San Diego (Scale 1:25,000)  
 This data was prepared by SanGIS for the City of San Diego. It is provided as a service to the City of San Diego and is not intended for use by any other entity.  
 This assessment reflects information of the task on a specific date. Conditions may have changed since the information was collected or since the information was last updated.

City of San Diego  
 Department of Public Works  
 Engineering Division  
 1201 La Jolla Village Drive, Suite 100  
 San Diego, CA 92161  
 619-594-2200



**City of San Diego  
 SEISMIC SAFETY STUDY  
 Geologic Hazards and Faults**

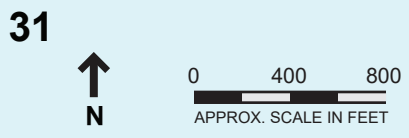



## ROCK & FABRIC ALTERNATIVE

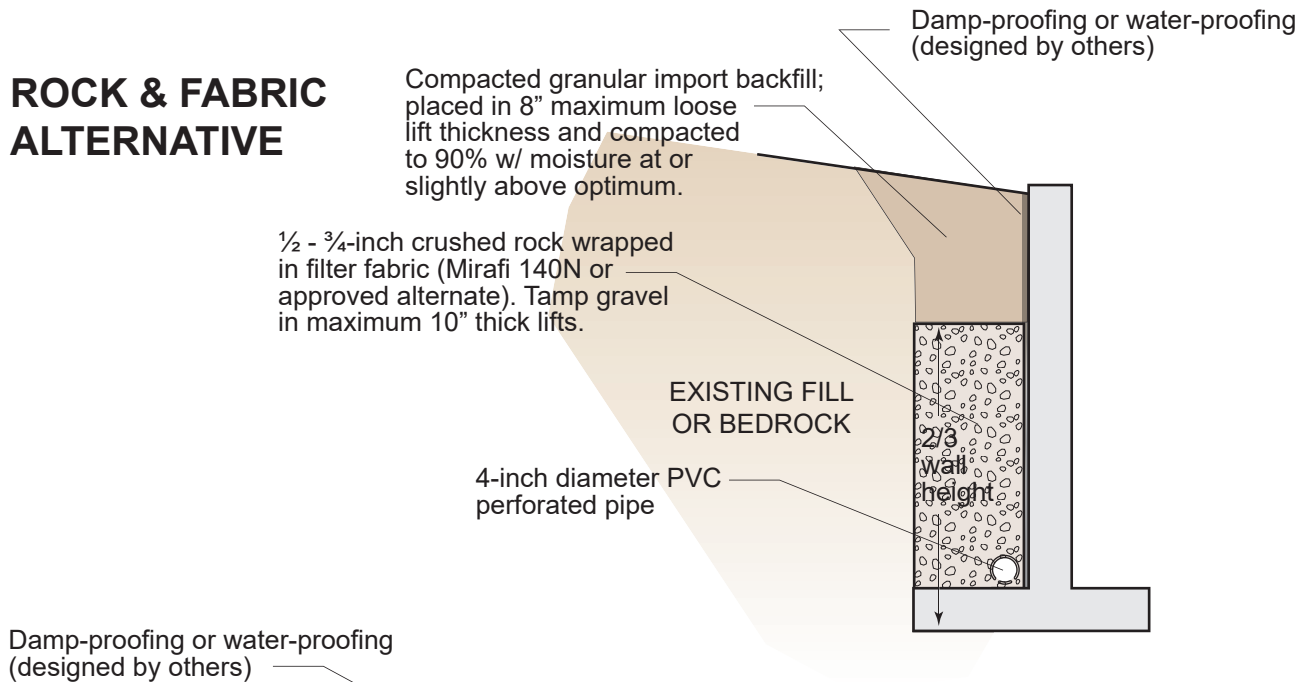

## PANEL DRAIN ALTERNATIVE

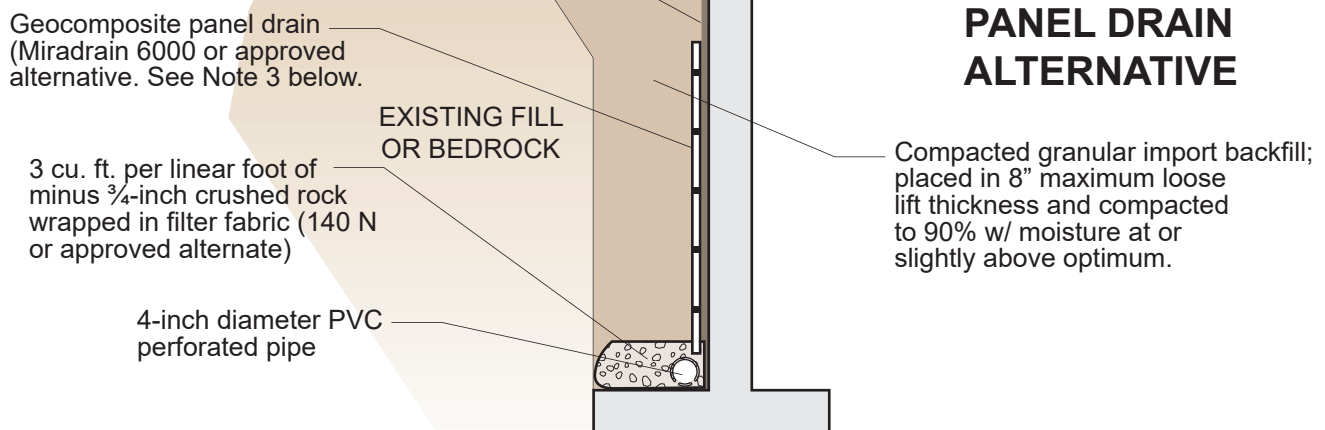

### NOTES:

- 1) Perforated pipe should outlet through to a solid pipe at maximum 25 foot centers to a free gravity outfall. Perforated pipe and outlet pipe should have a fall of at least 1%.
- 2) Filter fabric should consist of Mirafi 140N or similar approved fabric. Filter fabric should be overlapped at least 6-inches.
- 3) Geocomposite panel drain should consist of Miradrain 6000, Mirafi G100N, J-Drain 400, or approved similar product.
- 4) Drain installation should be observed by the geotechnical consultant prior to backfilling.

NOT TO SCALE



## **APPENDIX B**

### **References**

## REFERENCES



- 1) American Society of Civil Engineers, Minimum Design Loads for Buildings and Other Structures, ASCE Standard 7-05, 2006.
- 2) American Society for Testing and Materials, Annual Books of ASTM Standards, Section 4, Construction, Volume 04.08 Soil and Rock (I): D 420 – D 4914, West Conshohocken, PA, 2008.
- 3) Applied Technology Council, Seismic Design Maps, August 2020.
- 4) Bing or Google, 2020, Site Location Map for 1011 Grand Avenue, San Diego, CA 92109.
- 5) Blake, T.F., EQFAULT, EQSEARCH, FRISK: Computer Programs for Estimation of Peak Horizontal Acceleration from Southern California Historic Earthquakes, 2000.
- 6) Bowles, Joseph E., 1982, Foundation Analysis and Design, Third Edition.
- 7) City of San Diego Seismic Safety Study, 2008, Sheet 25.
- 8) City of San Diego, Guidelines for Geotechnical Reports, 2011.
- 9) California Building Standards Commission, California Building Code, 2019 Edition.
- 10) California Department of Conservation, Fault-Rupture Hazard Zones in California, Alquist-Priolo Earthquake Fault Zoning Act with Index to Earthquake Fault Zones Maps, Special Publication 42, California Geological Survey, Interim Revision 2007.
- 11) California Geological Survey, Guidelines for Evaluating and Mitigating Seismic Hazards in California, Special Publication 117, 2008.
- 12) California Geological Survey, Probabilistic Seismic Hazards Mapping Ground Motion Page, California Geological Survey website.
- 13) Coduto, Donald P., 2001, Foundation Design Principals and Practice, Second Edition.
- 14) Golba Architecture, Floor Plans, Grand Avenue Units, San Diego, California, undated.
- 15) Harden, D., California Geology, 1997.
- 16) Jennings, C.W., 1994, Fault Activity Map of California and Adjacent Areas, California Division of Mines and Geology, Map No. 6, Scale 1:750,000.
- 17) Kennedy, Michael P. and Peterson, G.L., 2001 Re-Print, Geology of San Diego Metropolitan Area, California, California Department of Conservatory Division of Mines and Geology, Bulletin 200.

## REFERENCES



- 18) Kennedy, M.P. and Tan, S.S., 2008, Geologic Map of the San Diego 30' by 60' Quadrangle, California, California Geological Survey, Regional Geologic Map Series, 1:100,000 Scale, Map No. 3, San Diego Quadrangle.
- 19) Krier, Robert, July 6, 2005, Wave Warning, Tsunami Risk on San Diego Coast Could Be Higher Than Previously Thought, San Diego Union Tribune Article.
- 20) Leyendecker, Frankel, and Rukstales, Earthquake Ground Motion Parameters Version 5.0.9a, dated November 13, 2009.
- 21) Norris, Robert M. and Webb, Robert W., 1976, Geology of California, John Wiley & Sons.
- 22) Structural Engineers Association of California, Seismic Design Maps, August 2020.
- 23) Treiman, J.A., The Rose Canyon Fault Zone, Southern California, California Department of Conservation, Division of Mines and Geology, DMG open-file report 93-02, 1993.
- 24) United States Geological Survey, California-Nevada Active Faults Index Map, <http://quake.wr.usgs.gov/info/faultmaps/index.html>.
- 25) United States Geological Survey, Earthquake Hazards Program, Seismic Hazards Maps and Data, <http://earthquake.usgs.gov/hazards>.
- 26) United States Geological Survey, Earthquake Hazards Program, 2010 Fault Activity Map of California, <http://www.quake.ca.gov/gmaps/FAM/faultactivitymap.html>.
- 27) Wesnousky, S.G., 1986, Earthquakes, Quaternary Faults and Seismic Hazard in California, Journal of Geophysical Research, Vol. 91, No. B12, pp. 2587-2631.



**APPENDIX C**

**Subsurface Excavation Logs**

## Subsurface Boring Log

**Boring No: B-1**

<b>Project No:</b> 20-142 <b>Project Name:</b> Grand Avenue Units <b>Location:</b> 1011 Grand Avenue <b>Sample Method:</b> Modified California Sampler <b>Instrumentation:</b> None installed <b>Elevation:</b> Pad	<b>Date:</b> 8/14/20 <b>Logged By:</b> C. O'Hern <b>Drilling Company:</b> Baja Exploration <b>Driller:</b> Billy <b>Drill Rig Type:</b> CME 75 <b>Hammer Wt. &amp; Drop:</b> 140 lbs. for 30"
--	--

Depth (ft)	Lithology	DESCRIPTION & REMARKS	USCS	Sample Type	Blow Counts (6", 12", 18")	Dry Density (pcf)	Moisture (%)
0		From 0.0', Asphalt section					
5		FILL: From 0.5', Clayey sand, medium to dark brown to red brown, slightly moist, medium dense, some asphalt and concrete clasts, some cobble		Bulk	--	--	--
5				Ring	14/19/23	--	--
10		NATIVE (Old Paralac Deposits, Unit 6), From 5.6', Clayey sandstone, medium red brown, slightly moist, medium dense to dense		Ring	12/15/15	120.1	10.6
10		From 8.7', Silty sandstone, medium red brown, slightly moist, dense, some cobble zones		SPT	8/10/10	--	--
15				Ring	37/50/50+	--	--
20				SPT	50+	--	--
25							

<b>Total Depth:</b> 20.0' <b>Water:</b> No <b>Caving:</b> No <b>Hole Diameter:</b> 8"	<b>Boring</b>  <b>B-1</b>  Page 1 of 1
--	--

## Subsurface Boring Log

**Boring No: B-2**

<b>Project No:</b> 20-142 <b>Project Name:</b> Grand Avenue Units <b>Location:</b> 1011 Grand Avenue <b>Sample Method:</b> Modified California Sampler <b>Instrumentation:</b> None installed <b>Elevation:</b> F.S.	<b>Date:</b> 8/14/20 <b>Logged By:</b> C. O'Hern <b>Drilling Company:</b> Baja Exploration <b>Driller:</b> Billy <b>Drill Rig Type:</b> CME 75 <b>Hammer Wt. &amp; Drop:</b> 140 lbs. for 30"
---	--

Depth (ft)	Lithology	DESCRIPTION & REMARKS	USCS	Sample Type	Blow Counts (6", 12", 18")	Dry Density (pcf)	Moisture (%)
0		From 0.0', Asphalt section					
5		FILL: From 0.5', Clayey sand, medium to dark gray brown to red brown, slightly moist, loose to medium dense		Ring	8/12/20	--	--
5		NATIVE (Old Paralic Deposits, Unit 6): From 5.1', Clayey sandstone, medium gray brown to red brown, slightly moist, loose to medium dense					
10		From 6.3', Silty sandstone, pale to medium red brown, slightly moist, dense, friable sand, some cobble beds		SPT	5/5/5	--	--
15				Ring	8/14/26	--	--
20							
25							

<b>Total Depth:</b> 14.0' <b>Water:</b> No <b>Caving:</b> No <b>Hole Diameter:</b> 8"	<b>Boring</b>  <b>B-2</b>  Page 1 of 1
--	--

## Subsurface Boring Log

**Boring No: B-3**

<b>Project No:</b> 20-142 <b>Project Name:</b> Grand Avenue Units <b>Location:</b> 1011 Grand Avenue <b>Sample Method:</b> Modified California Sampler <b>Instrumentation:</b> None installed <b>Elevation:</b> F.S.	<b>Date:</b> 8/14/20 <b>Logged By:</b> C. O'Hern <b>Drilling Company:</b> Baja Exploration <b>Driller:</b> Billy <b>Drill Rig Type:</b> CME 75 <b>Hammer Wt. &amp; Drop:</b> 140 lbs. for 30"
---	--

Depth (ft)	Lithology	DESCRIPTION & REMARKS	USCS	Sample Type	Blow Counts (6", 12", 18")	Dry Density (pcf)	Moisture (%)
0		From 0.0', Asphalt section					
5		FILL: From 0.5', Clayey to silty sand, medium to dark gray brown, slightly moist, loose to medium dense		Bulk	--	--	--
10		NATIVE (Old Paralic Deposits, Unit 6): From 5.4', Silty sand, medium red brown, slightly moist, dense, some friable sands and cobble zones		Ring	3/6/18	--	--
15		@ 14.2', Cobble bed, very difficult drilling, SPT sample attempt, no recovery @ 15.5', Partial drilling refusal on cobble		Ring	7/10/15	124.4	10.6
20							
25				SPT	18/50	--	--

<b>Total Depth:</b> 15.5' <b>Water:</b> -- <b>Caving:</b> -- <b>Hole Diameter:</b> --	<b>Boring</b>  <b>B-3</b>  Page 1 of 1
--	--



## Subsurface Boring Log

**Boring No: B-4**

<b>Project No:</b> 20-142 <b>Project Name:</b> Grand Avenue Units <b>Location:</b> 1011 Grand Avenue <b>Sample Method:</b> Modified California Sampler <b>Instrumentation:</b> None installed <b>Elevation:</b> F.S.	<b>Date:</b> 8/14/20 <b>Logged By:</b> C. O'Hern <b>Drilling Company:</b> Baja Exploration <b>Driller:</b> Billy <b>Drill Rig Type:</b> CME 75 <b>Hammer Wt. &amp; Drop:</b> 140 lbs. for 30"
---	--

Depth (ft)	Lithology	DESCRIPTION & REMARKS	USCS	Sample Type	Blow Counts (6", 12", 18")	Dry Density (pcf)	Moisture (%)
0		From 0.0', Asphalt section					
5		FILL: From 0.5', Clayey to silty sand, medium gray brown, slightly moist, loose to medium dense, some asphalt clasts		Ring	10/8/29	125.0	12.0
10		NATIVE (Old Paralic Deposits, Unit 6): From 5.3', Clayey sandstone, pale to medium red brown, slightly moist, dense		SPT	5/8/10	--	--
15		From 7.3', Silty sandstone, pale to medium red brown, slightly moist, dense, some friable sands, some cobble and coarse sand		Ring	--	--	--
20							
25							

<b>Total Depth:</b> 14.0' <b>Water:</b> No <b>Caving:</b> No <b>Hole Diameter:</b> 8"	<b>Boring</b>  <b>B-4</b>  Page 1 of 1
--	--



**APPENDIX D**

**Laboratory Test Results**

## Grand Avenue Units Summary of Laboratory Test Results

FN: 20-142

Sample Location			Corrosivity Series		ASTM D 1557		ASTM D 2937		ASTM D 3080		ASTM D 4829		ASTM D 4546	
			CTM422	CTM 417										
Location	Sample Depth	Sample Type	Chloride Content	Sulfate Content	Maximum Dry Density	Opt. Moist Content	Dry Density	Moisture Content	Peak $\phi$	Peak c	Expansion Index	Expansion Potential	Hydro Response	Normal Stress
B-1	1-4'	LB	--	--	129	7.5	--	--	30	200	35	Low	--	--
B-3	1-4'	LB	0.037	0.017	--	--	--	--	--	--	--	--	--	--
B-1	6'	Ring	--	--	--	--	120.1	10.6	--	--	--	--	-1.07	1500
B-3	10'	Ring	--	--	--	--	124.4	10.6	--	--	--	--	--	--
B-4	4'	Ring	--	--	--	--	125.0	12.0	--	--	--	--	--	--

# COMPACTION TEST

**ASTM D 1557  
Modified Proctor**

Project Name: Grand Ave Units  
 Project No. : 20-142  
 Boring No.: B-1 @ 0-4'  
 Technician: JMS  
 Date: 8/26/2020  
 Visual Sample Description: Medium Brown Clayey Sand

**X** Manual Ram

*Ram Weight 10 LBS Drop 18 inches*

TEST NO.		1	2	3	4	5	6
<b>A</b>	Wt. Comp. Soil + Mold (gm.)	3894.00	3932.00	3931.00	3835.00		
<b>B</b>	Wt. of Mold (gm.)	1794.00	1794.00	1794.00	1794.00		
<b>C</b>	Net Wt. of Soil (gm.)	A - B	2100.00	2138.00	2137.00	2041.00	
<b>D</b>	Wet Wt. of Soil + Cont. (gm.)	1834.4	1791.7	1474.1	1333.7		
<b>E</b>	Dry Wt. of Soil + Cont. (gm.)	1724.0	1656.5	1348.0	1275.1		
<b>F</b>	Wt. of Container (gm.)	143.2	186.6	187.8	187.5		
<b>G</b>	Moisture Content (%)	$\frac{[(D-F)-(E-F)]}{(E-F)}$	7.0	9.2	10.9	5.4	
<b>H</b>	Wet Density (pcf)	$\frac{C \cdot 29.76}{453.6}$	137.8	140.3	140.2	133.9	
<b>I</b>	Dry Density (pcf)	$\frac{H}{(1+G/100)}$	128.8	128.5	126.5	127.1	

Maximum Dry Density (pcf) **129.0**

**7.5**

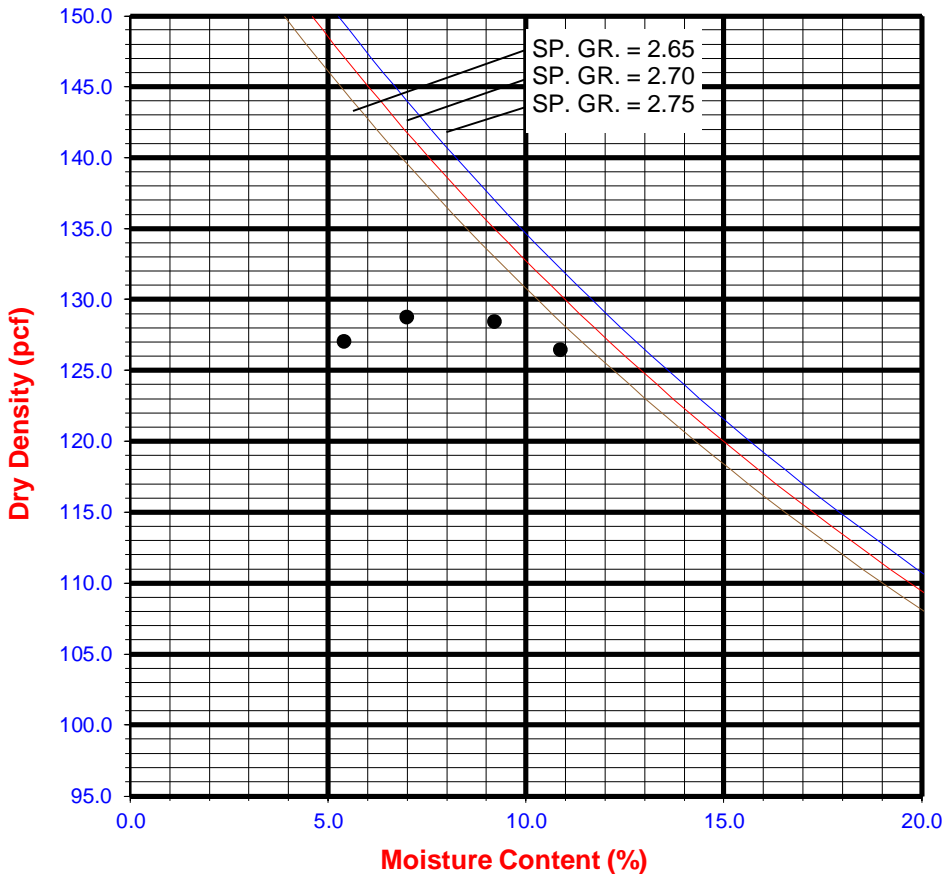

**PROCEDURE USED**  
 Procedure A

**DIRECT SHEAR TEST**  
**Laboratory Report**

File Name: Grand Ave Units  
 File No.: 20-142  
 Date: 8/28/2020  
 Technician: JMS

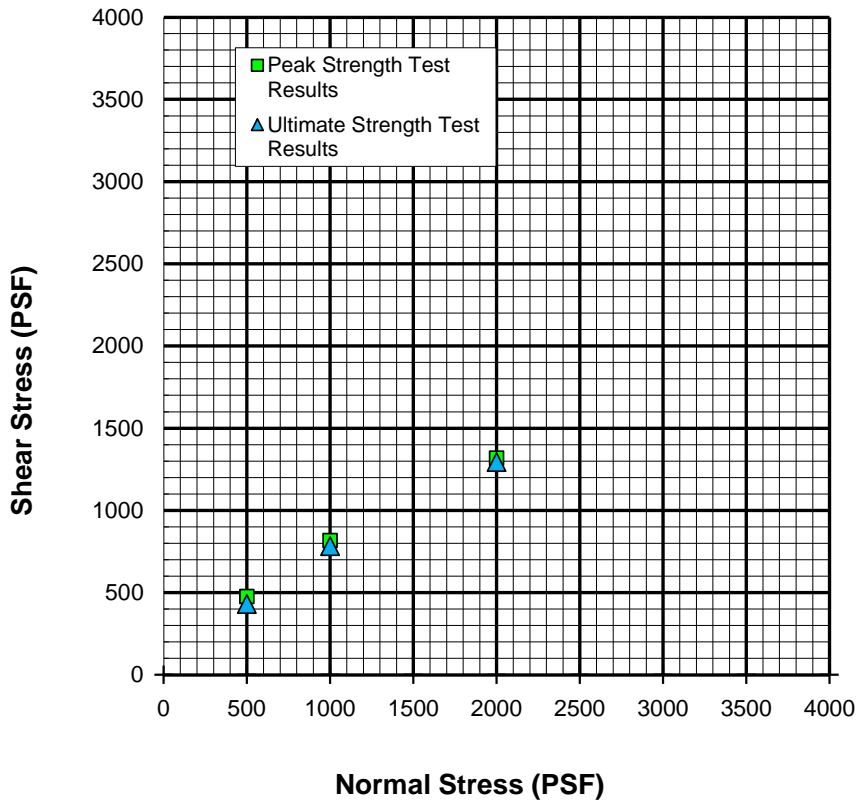
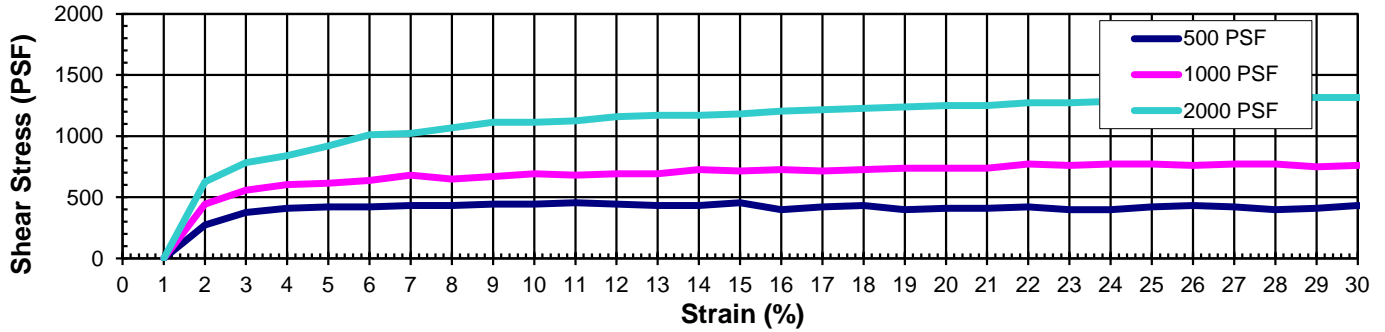

Sample No. & Location:	B-1 @ 1-4'
Soil Description:	Light Brown Silty Sand
Sample Type:	Intact
Specimen Preparation:	Inundated

	Peak	Ultimate
Friction Angle $\Phi'$ (deg)	30	30
Cohesion $C'$ (psf)	200	110



**APPENDIX E**

**Summary of Active Faults**

20-142.OUT

```
*****  
*           *  
*   E Q F A U L T   *  
*           *  
*   Version 3.00   *  
*           *  
*****
```

DETERMINISTIC ESTIMATION OF  
PEAK ACCELERATION FROM DIGITIZED FAULTS

JOB NUMBER: 20-142

DATE: 08-25-2020

JOB NAME: Grand Avenue Units

CALCULATION NAME: Test Run Analysis

FAULT-DATA-FILE NAME: C:\Program Files\EQFAULT1\CDMGFLTE\_new.dat

SITE COORDINATES:

SITE LATITUDE: 32.7951  
SITE LONGITUDE: 117.2507

SEARCH RADIUS: 62.4 mi

ATTENUATION RELATION: 15) Campbell & Bozorgnia (1997 Rev.) - Soft Rock  
UNCERTAINTY (M=Median, S=Sigma): M Number of Sigmas: 0.0  
DISTANCE MEASURE: cdist  
SCOND: 0  
Basement Depth: 5.00 km Campbell SSR: 1 Campbell SHR: 0  
COMPUTE PEAK HORIZONTAL ACCELERATION

FAULT-DATA FILE USED: C:\Program Files\EQFAULT1\CDMGFLTE\_new.dat

MINIMUM DEPTH VALUE (km): 3.0

-----  
EQFAULT SUMMARY  
-----

-----  
DETERMINISTIC SITE PARAMETERS  
-----

Page 1

ABBREVIATED FAULT NAME	APPROXIMATE DISTANCE mi (km)	ESTIMATED MAX. EARTHQUAKE EVENT		
		MAXIMUM EARTHQUAKE MAG. (Mw)	PEAK SITE ACCEL. g	EST. SITE INTENSITY MOD.MERC.
ROSE CANYON	2.2( 3.5)	7.2	0.625	X
CORONADO BANK	11.1( 17.9)	7.6	0.341	IX
NEWPORT-INGLEWOOD (offshore)	27.1( 43.6)	7.1	0.092	VII
ELSINORE-JULIAN	40.5( 65.1)	7.1	0.053	VI
ELSINORE-TEMECULA	42.6( 68.5)	6.8	0.038	V
EARTHQUAKE VALLEY	47.2( 76.0)	6.5	0.025	V
PALOS VERDES	52.3( 84.2)	7.1	0.036	V
ELSINORE-COYOTE MOUNTAIN	52.9( 85.2)	6.8	0.027	V
ELSINORE-GLEN IVY	58.9( 94.8)	6.8	0.023	IV

\*\*\*\*\*

-END OF SEARCH- 9 FAULTS FOUND WITHIN THE SPECIFIED SEARCH RADIUS.

THE ROSE CANYON FAULT IS CLOSEST TO THE SITE.  
IT IS ABOUT 2.2 MILES (3.5 km) AWAY.

LARGEST MAXIMUM-EARTHQUAKE SITE ACCELERATION: 0.6248 g



# CALIFORNIA FAULT MAP

Grand Avenue Units

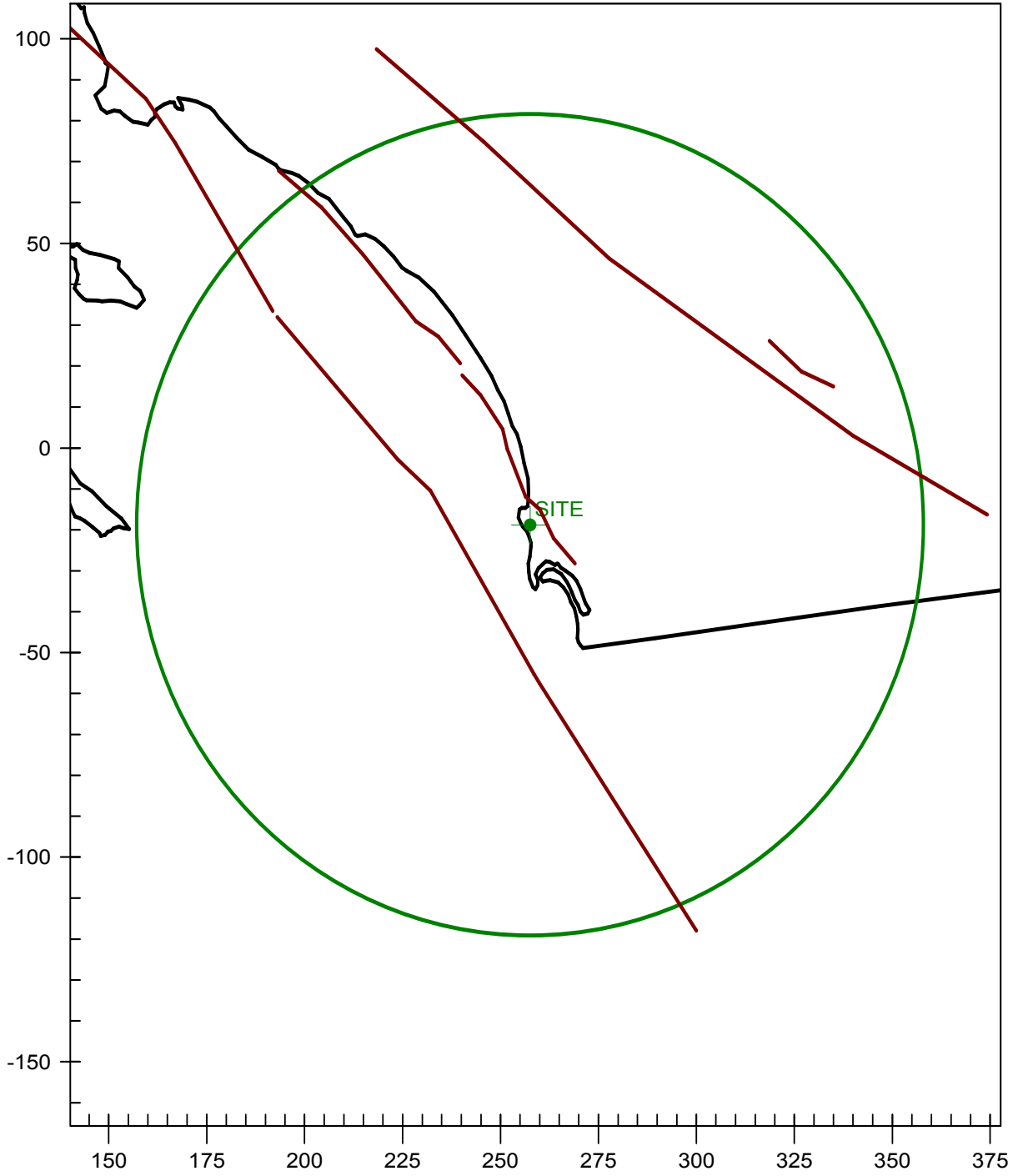



**APPENDIX F**

**Infiltration Feasibility Condition Letter**



Mr. Mike Turk  
KDTD, Inc.  
4641 Ingraham Street  
San Diego, CA 92109

September 1, 2020  
File No. 20-142

Subject: **Infiltration Feasibility Condition Letter**  
Grand Avenue Units  
1011 Grand Avenue  
San Diego, California

References: 1) "Geotechnical Investigation, Grand Avenue Units, 1011 Grand Avenue, San Diego, California," by TerraPacific Consultants, Inc., dated August 26, 2020.  
2) "Storm Water Standards," City of San Diego, dated October 2018.  
3) "Floor Plans, Grand Avenue Units, San Diego, California," by Golba Architecture.

Dear Mr. Turk:

The following updated letter provides our opinions regarding site infiltration for the proposed development at the subject project. For simplicity, we are addressing each bullet item as indicated in Section C.1.1, in the October 2018 edition of the City of San Diego Storm Water Standards BMP Design Manual.

- A preliminary geotechnical investigation was conducted by our firm during the initial design phase of the project; this investigation report is referenced above.
- The geotechnical investigation revealed site topography that is essentially flat. Site stratigraphy consists of undocumented fill soil mantling the site. Native paralic deposits underlie the surficial soils. Based on the site-specific exploration, which included numerous borings, existing undocumented fill soils in excess of 5 feet in thickness were encountered.
- The site is currently developed with structures and other appurtenances; undocumented fill soils from the initial site development blanket the site.
- The current design footprint is consistent with the initial concept design due to the limited lot size and dimensions. The proposed development will consist of multi-family structures over an on-grade parking garage and commercial units, which will utilize the entire lot.



- The physical impairment associated with the limited lot size and proposed improvement footprint prevents full/partial infiltration.
- The existing site configuration consists of undocumented fill soils blanketing the site. Undocumented fill soils with thicknesses in excess of 5 feet were encountered during our site-specific investigation, which included numerous borings. These soils are not considered suitable for support of the proposed improvements (structures and appurtenances). As is always the case, infiltration can induce soil settlement and volume change that would adversely impact the proposed improvements which utilize the entire lot footprint.
- The referenced floor plan was utilized as a base map for the Geotechnical Plan, Figure 1, attached to this letter.
- Based on our referenced site-specific geotechnical investigation, infiltration is not considered feasible from a geotechnical standpoint due to the negative impacts on proposed improvements (structures and appurtenances) that would result from infiltration and associated soil volume changes.
- The Geotechnical Plan, Figure 1, depicts the site design and is provided in the attachment within this letter.

We appreciate the opportunity to be of service. If you have any questions, please do not hesitate to call.

Respectfully submitted,  
**TerraPacific Consultants, Inc.**

Cristopher C. O'Hern, CEG 2397  
Senior Engineering Geologist



Octavio Brambila, PE 70633  
Project Engineer





**ATTACHMENT**

**Geotechnical Plan**

REFERENCE:  
 1. Aerial image from Google Earth  
 2. 101 Grand 1st Floor Plan, prepared by Golba Architecture

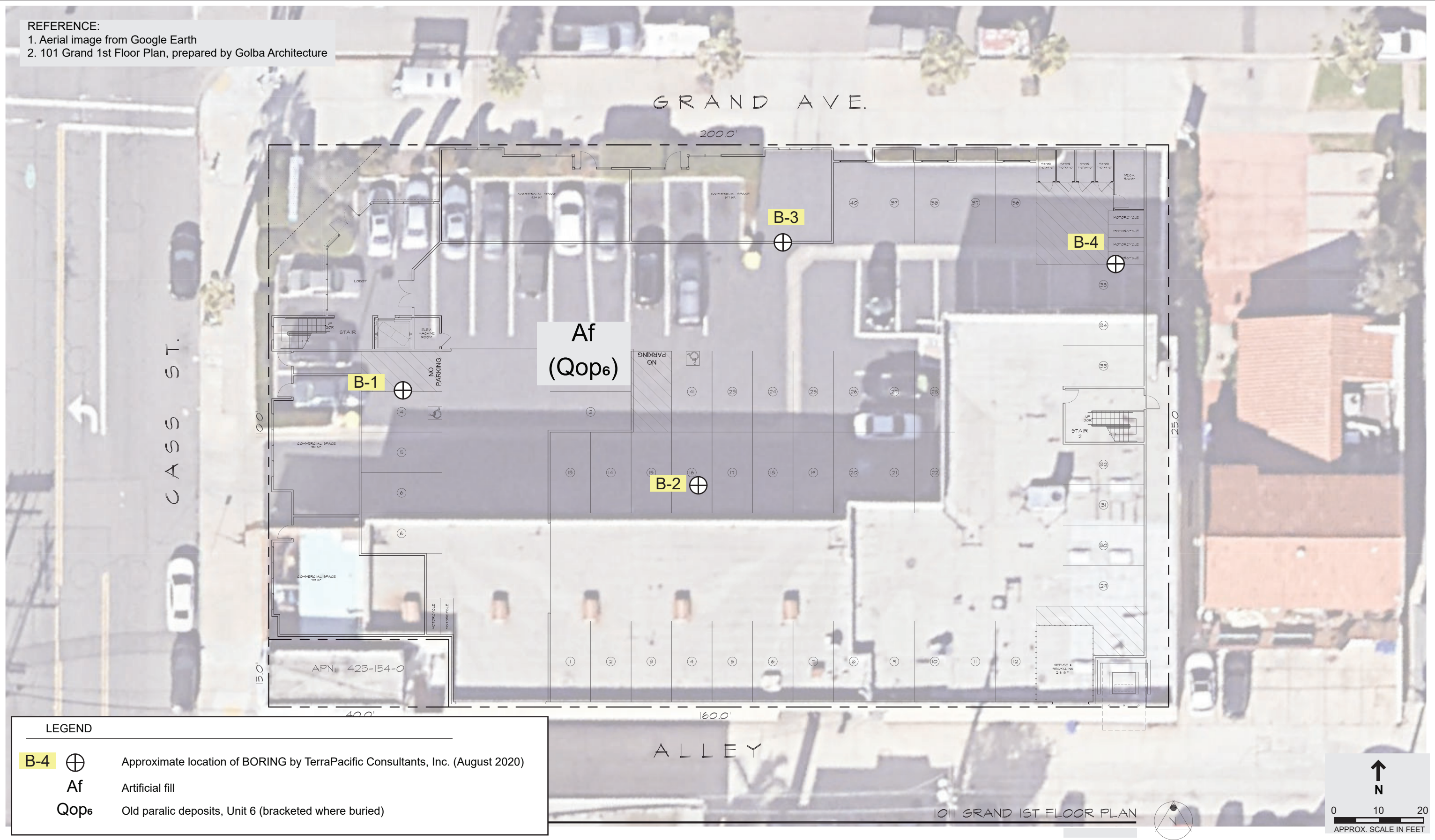

LEGEND	
<b>B-4</b> ⊕	Approximate location of BORING by TerraPacific Consultants, Inc. (August 2020)
<b>Af</b>	Artificial fill
<b>Qop<sub>6</sub></b>	Old paralac deposits, Unit 6 (bracketed where buried)



## **APPENDIX G**

### **Standard Grading Guidelines**



# STANDARD GUIDELINES FOR GRADING PROJECTS

## TABLE OF CONTENTS

	<u>Page</u>
GENERAL.....	G-1
DEFINITIONS OF TERMS.....	G-1
OBLIGATIONS OF PARTIES .....	G-4
SITE PREPARATION.....	G-4
SITE PROTECTION .....	G-5
EXCAVATIONS.....	G-6
Unsuitable Materials .....	G-6
Cut Slopes.....	G-6
Pad Areas.....	G-6
COMPACTED FILL .....	G-7
Placement .....	G-7
Moisture .....	G-8
Fill Material .....	G-8
Fill Slopes .....	G-10
Off-Site Fill .....	G-11
DRAINAGE.....	G-11
STAKING .....	G-11
SLOPE MAINTENANCE .....	G-12
Landscape Plants.....	G-12
Irrigation.....	G-12
Maintenance .....	G-12
Repairs .....	G-12
TRENCH BACKFILL .....	G-13
STATUS OF GRADING.....	G-13



## **GENERAL**

The guidelines contained herein and the standard details attached hereto represent this firm's standard recommendations for grading and other associated operations on construction projects. These guidelines should be considered a portion of the project specifications.

All plates attached hereto shall be considered as part of these guidelines.

The Contractor should not vary from these guidelines without prior recommendation by the Geotechnical Consultant and the approval of the Client or his authorized representative. Recommendation by the Geotechnical Consultant and/or Client should not be considered to preclude requirements for approval by the controlling agency prior to the execution of any changes.

These Standard Grading Guidelines and Standard Details may be modified and/or superseded by recommendations contained in the text of the preliminary geotechnical report and/or subsequent reports.

If disputes arise out of the interpretation of these grading guidelines or standard details, the Geotechnical Consultant shall provide the governing interpretation.

## **DEFINITIONS OF TERMS**

**ALLUVIUM** - Unconsolidated soil deposits resulting from flow of water, including sediments deposited in river beds, canyons, flood plains, lakes, fans and estuaries.

**AS-GRADED (AS-BUILT)** - The surface and subsurface conditions at completion of grading.

**BACKCUT** - A temporary construction slope at the rear of earth retaining structures such as buttresses, shear keys, stabilization fills or retaining walls.

**BACKDRAIN** - Generally a pipe and gravel or similar drainage system placed behind earth retaining structures such as buttresses, stabilization fills, and retaining walls.

**BEDROCK** - Relatively undisturbed formational rock, more or less solid, either at the surface or beneath superficial deposits of soil.

**BENCH** - A relatively level step and near vertical rise excavated into sloping ground on which fill is to be placed.

**BORROW (Import)** - Any fill material hauled to the project site from off-site areas.

**BUTTRESS FILL** - A fill mass, the configuration of which is designed by engineering calculations to retain slope conditions containing adverse geologic features. A buttress is generally specified by minimum key width and depth and by maximum backcut angle. A buttress normally contains a back-drainage system.

**CIVIL ENGINEER** - The Registered Civil Engineer or consulting firm responsible for preparation of the grading plans, surveying and verifying as-graded topographic conditions.

**CLIENT** - The Developer or his authorized representative who is chiefly in charge of the project. He shall have the responsibility of reviewing the findings and recommendations made by the Geotechnical Consultant and shall authorize the Contractor and/or other consultants to perform work and/or provide services.

**COLLUVIUM** - Generally loose deposits usually found near the base of slopes and brought there chiefly by gravity through slow continuous downhill creep (also see Slope Wash).

**COMPACTION** - Densification of man-placed fill by mechanical means.

**CONTRACTOR** - A person or company under contract or otherwise retained by the Client to perform demolition, grading and other site improvements.

**DEBRIS** - All products of clearing, grubbing, demolition, contaminated soil materials unsuitable for reuse as compacted fill and/or any other material so designated by the Geotechnical Consultant.

**ENGINEERING GEOLOGIST** - A licensed Engineering Geologist who applies scientific methods, engineering and geologic principles and professional experience to the acquisition, interpretation and use of knowledge of materials of the earth's crust for the evaluation of engineering problems. Geotechnical Engineering encompasses many of the engineering aspects of soil mechanics, rock mechanics, geology, geophysics, hydrology and related sciences.

**ENGINEERED FILL** - A fill of which the Geotechnical Consultant or his representative, during grading, has made sufficient tests to enable him to conclude that the fill has been placed in substantial compliance with the recommendations of the Geotechnical Consultant and the governing agency requirements.

**EROSION** - The wearing away of the ground surface as a result of the movement of wind and/or water.

**EXCAVATION** - The mechanical removal of earth materials.

**EXISTING GRADE** - The ground surface configuration prior to grading.

**FILL** - Any deposits of soil, rock, soil-rock blends or other similar materials placed by man.

**FINISH GRADE** - The ground surface configuration at which time the surface elevations conform to the approved plan.

**GEOFABRIC** - Any engineering textile utilized in geotechnical applications including subgrade stabilization and filtering.

**GEOLOGIST** - A representative of the Geotechnical Consultant educated and trained in the field of geology.

**GEOTECHNICAL CONSULTANT** - The Geotechnical Engineering and Engineering Geology consulting firm retained to provide technical services for the project. For the purpose of these specifications, observations by the Geotechnical Consultant include observations by the Soil Engineer, Geotechnical Engineer, Engineering Geologist and those performed by persons employed by and responsible to the Geotechnical Consultants.

**GEOTECHNICAL ENGINEER** - A licensed Geotechnical Engineer or Civil Engineer who applies scientific methods, engineering principles and professional experience to the acquisition, interpretation and use of knowledge of materials of the earth's crust for the evaluation of engineering problems. Geotechnical Engineering encompasses many of the engineering aspects of soil mechanics, rock mechanics, geology, geophysics, hydrology and related sciences.

**GRADING** - Any operation consisting of excavation, filling or combinations thereof and associated operations.

**LANDSLIDE DEBRIS** - Material, generally porous and of low density, produced from instability of natural or man-made slopes.

**MAXIMUM DENSITY** - Standard laboratory test for maximum dry unit weight. Unless otherwise specified, the maximum dry unit weight shall be determined in accordance with ASTM Method of Test D 1557-09.

**OPTIMUM MOISTURE** - Soil moisture content at the test maximum density.

**RELATIVE COMPACTION** - The degree of compaction (expressed as a percentage) of dry unit weight of a material as compared to the maximum dry unit weight of the material.

**ROUGH GRADE** - The ground surface configuration at which time the surface elevations approximately conform to the approved plan.

**SITE** - The particular parcel of land where grading is being performed.

**SHEAR KEY** - Similar to buttress, however, it is generally constructed by excavating a slot within a natural slope in order to stabilize the upper portion of the slope without grading encroaching into the lower portion of the slope.

**SLOPE** - An inclined ground surface the steepness of which is generally specified as a ratio of horizontal:vertical (e.g., 2:1).

**SLOPE WASH** - Soil and/or rock material that has been transported down a slope by action of gravity assisted by runoff water not confined by channels (also see Colluvium).

**SOIL** - Naturally occurring deposits of sand, silt, clay, etc., or combinations thereof.

**SOIL ENGINEER** - Licensed Geotechnical Engineer or Civil Engineer experienced in soil mechanics (also see Geotechnical Engineer).

**STABILIZATION FILL** - A fill mass, the configuration of which is typically related to slope height and is specified by the standards of practice for enhancing the stability of locally adverse conditions. A stabilization fill is normally specified by minimum key width and depth and by maximum backcut angle. A stabilization fill may or may not have a back drainage system specified.

**SUBDRAIN** - Generally a pipe and gravel or similar drainage system placed beneath a fill in the alignment of canyons or former drainage channels.

**SLOUGH** - Loose, non-compacted fill material generated during grading operations.

**TAILINGS** - Non-engineered fill which accumulates on or adjacent to equipment haul-roads.

**TERRACE** - Relatively level step constructed in the face of graded slope surface for drainage control and maintenance purposes.

**TOPSOIL** - The presumable fertile upper zone of soil which is usually darker in color and loose.

**WINDROW** - A string of large rocks buried within engineered fill in accordance with guidelines set forth by the Geotechnical Consultant.

## **OBLIGATIONS OF PARTIES**

The Geotechnical Consultant should provide observation and testing services and should make evaluations in order to advise the Client on geotechnical matters. The Geotechnical Consultant should report his findings and recommendations to the Client or his authorized representative.

The client should be chiefly responsible for all aspects of the project. He or his authorized representative has the responsibility of reviewing the findings and recommendations of the Geotechnical Consultant. He shall authorize or cause to have authorized the Contractor and/or other consultants to perform work and/or provide services. During grading the Client or his authorized representative should remain on-site or should remain reasonably accessible to all concerned parties in order to make decisions necessary to maintain the flow of the project.

The Contractor should be responsible for the safety of the project and satisfactory completion of all grading and other associated operations on construction projects, including but not limited to, earthwork in accordance with the project plans, specifications and controlling agency requirements. During grading, the Contractor or his authorized representative should remain on-site. Overnight and on days off, the Contractor should remain accessible.

## **SITE PREPARATION**

The Client, prior to any site preparation or grading, should arrange and attend a meeting among the Grading Contractor, the Design Engineer, the Geotechnical Consultant, representatives of the appropriate governing authorities as well as any other concerned parties. All parties should be given at least 48 hours notice.

Clearing and grubbing should consist of the removal of vegetation such as brush, grass, woods, stumps, trees, roots of trees and otherwise deleterious natural materials from the areas to be graded. Clearing and grubbing should extend to the outside of all proposed excavation and fill areas.

Demolition should include removal of buildings, structures, foundations, reservoirs, utilities (including underground pipelines, septic tanks, leach fields, seepage pits, cisterns, mining shafts, tunnels, etc.) and other man-made surface and subsurface improvements from the areas to be graded. Demolition of utilities should include proper capping and/or re-routing pipelines at the project perimeter and cutoff and capping of wells in accordance with the requirements of the governing authorities and the recommendations of the Geotechnical Consultant at the time of demolition.

Trees, plants or man-made improvements not planned to be removed or demolished should be protected by the Contractor from damage or injury.

Debris generated during clearing, grubbing and/or demolition operations should be wasted from areas to be graded and disposed off-site. Clearing, grubbing and demolition operations should be performed under the observation of the Geotechnical Consultant.

The Client or Contractor should obtain the required approvals from the controlling authorities for the project prior, during and/or after demolition, site preparation and removals, etc. The appropriate approvals should be obtained prior to proceeding with grading operations.

## **SITE PROTECTION**

Protection of the site during the period of grading should be the responsibility of the Contractor. Unless other provisions are made in writing and agreed upon among the concerned parties, completion of a portion of the project should not be considered to preclude that portion or adjacent areas from the requirements for site protection until such time as the entire project is complete as identified by the Geotechnical Consultant, the Client and the regulating agencies.

The Contractor should be responsible for the stability of all temporary excavations. Recommendations by the Geotechnical Consultant pertaining to temporary excavations (e.g., backcuts) are made in consideration of stability of the completed project and, therefore, should not be considered to preclude the responsibilities of the Contractor. Recommendations by the Geotechnical Consultant should not be considered to preclude more restrictive requirements by the regulating agencies.

Precautions should be taken during the performance of site clearing, excavations and grading to protect the work site from flooding, ponding, or inundation by poor or improper surface drainage. Temporary provisions should be made during the rainy season to adequately direct surface drainage away from and off the work site. Where low areas can not be avoided, pumps should be kept on hand to continually remove water during periods of rainfall.

During periods of rainfall, plastic sheeting should be kept reasonably accessible to prevent unprotected slopes from becoming saturated. Where necessary during periods of rainfall, the Contractor should install check dams, desilting basins, riprap, sand bags or other devices or methods necessary to control erosion and provide safe conditions.

During periods of rainfall, the Geotechnical Consultant should be kept informed by the Contractor as to the nature of remedial or preventative work being performed (e.g., pumping, placement of sandbags or plastic sheeting, other labor, dozing, etc.).

Following periods of rainfall, the Contractor should contact the Geotechnical Consultant and arrange a walk-over of the site in order to visually assess rain related damage. The Geotechnical Consultant may also recommend excavations and testing in order to aid in his assessments. At the request of the Geotechnical Consultant, the Contractor shall make excavations in order to evaluate the extent of rain related damage.

Rain related damage should be considered to include, but may not be limited to, erosion, silting, saturation, swelling, structural distress and other adverse conditions identified by the Geotechnical Consultant. Soil adversely affected should be classified as Unsuitable Materials and should be subject to over-excavation and replacement with compacted fill or other remedial grading as recommended by the Geotechnical Consultant.

Relatively level areas, where saturated soils and/or erosion gullies exist to depths of greater than 1-foot, should be over-excavated to unaffected, competent material. Where less than 1-foot in depth, unsuitable materials may be processed in-place to achieve near optimum moisture conditions, then thoroughly recompacted in accordance with the applicable specifications. If the desired results are not achieved, the affected materials should be over-excavated, then replaced in accordance with the applicable specifications.

In slope areas, where saturated soil and/or erosion gullies exist to depths of greater than 1 foot, they should be over-excavated and replaced as compacted fill in accordance with the applicable specifications. Where affected materials exist to depths of 1 foot or less below proposed finished grade, remedial grading by moisture conditioning in-place, followed by thorough recompaction in accordance with the applicable grading guidelines herein may be attempted. If the desired results are not achieved, all affected materials should be over-excavated and replaced as compacted fill in accordance with the slope repair recommendations herein. As field conditions dictate, other slope repair procedures may be recommended by the Geotechnical Consultant.

## **EXCAVATIONS**

### **Unsuitable Materials**

Materials which are unsuitable should be excavated under observation and recommendations of the Geotechnical Consultant. Unsuitable materials include, but may not be limited to, dry, loose, soft, wet, organic compressible natural soils and fractured, weathered, soft bedrock and non-engineered or otherwise deleterious fill materials.

Material identified by the Geotechnical Consultant as unsatisfactory due to its moisture conditions should be over-excavated, watered or dried, as needed, and thoroughly blended to a uniform near optimum moisture condition (per Moisture guidelines presented herein) prior to placement as compacted fill.

### **Cut Slopes**

Unless otherwise recommended by the Geotechnical Consultant and approved by the regulating agencies, permanent cut slopes should not be steeper than 2:1 (horizontal:vertical).

If excavations for cut slopes expose loose, cohesionless, significantly fractured or otherwise unsuitable material, over-excavation and replacement of the unsuitable materials with a compacted stabilization fill should be accomplished as recommended by the Geotechnical Consultant. Unless otherwise specified by the Geotechnical Consultant, stabilization fill construction should conform to the requirements of the Standard Details.

The Geotechnical Consultant should review cut slopes during excavation. The Geotechnical Consultant should be notified by the contractor prior to beginning slope excavations.

If, during the course of grading, adverse or potentially adverse geotechnical conditions are encountered which were not anticipated in the preliminary report, the Geotechnical Consultant should explore, analyze and make recommendations to treat these problems.

When cut slopes are made in the direction of the prevailing drainage, a non-erodible diversion swale (brow ditch) should be provided at the top-of-cut.

### **Pad Areas**

All lot pad areas, including side yard terraces, above stabilization fills or buttresses should be over-excavated to provide for a minimum of 3-feet (refer to Standard Details) of compacted fill over the entire pad area. Pad areas with both fill and cut materials exposed and pad areas containing both very shallow (less than 3-feet) and deeper fill should be over-excavated to provide for a uniform compacted fill blanket with a minimum of 3-feet in thickness (refer to Standard Details).

Cut areas exposing significantly varying material types should also be over-excavated to provide for at least a 3-foot thick compacted fill blanket. Geotechnical conditions may require greater depth of over-excavation. The actual depth should be delineated by the Geotechnical Consultant during grading.

For pad areas created above cut or natural slopes, positive drainage should be established away from the top-of-slope. This may be accomplished utilizing a berm and/or an appropriate pad gradient. A gradient in soil areas away from the top-of-slopes of 2 percent or greater is recommended.

### **COMPACTED FILL**

All fill materials should be compacted as specified below or by other methods specifically recommended by the Geotechnical Consultant. Unless otherwise specified, the minimum degree of compaction (relative compaction) should be 90 percent of the laboratory maximum density.

#### **Placement**

Prior to placement of compacted fill, the Contractor should request a review by the Geotechnical Consultant of the exposed ground surface. Unless otherwise recommended, the exposed ground surface should then be scarified (6-inches minimum), watered or dried as needed, thoroughly blended to achieve near optimum moisture conditions, then thoroughly compacted to a minimum of 90 percent of the maximum density. The review by the Geotechnical Consultant should not be considered to preclude requirements of inspection and approval by the governing agency.

Compacted fill should be placed in thin horizontal lifts not exceeding 8-inches in loose thickness prior to compaction. Each lift should be watered or dried as needed, thoroughly blended to achieve near optimum moisture conditions then thoroughly compacted by mechanical methods to a minimum of 90 percent of laboratory maximum dry density. Each lift should be treated in a like manner until the desired finished grades are achieved.

The Contractor should have suitable and sufficient mechanical compaction equipment and watering apparatus on the job site to handle the amount of fill being placed in consideration of moisture retention properties of the materials. If necessary, excavation equipment should be "shut down" temporarily in order to permit proper compaction of fills. Earth moving equipment should only be considered a supplement and not substituted for conventional compaction equipment.

When placing fill in horizontal lifts adjacent to areas sloping steeper than 5:1 (horizontal:vertical), horizontal keys and vertical benches should be excavated into the adjacent slope area. Keying and benching should be sufficient to provide at least 6-foot wide benches and minimum of 4-feet of vertical bench height within the firm natural ground, firm bedrock or engineered compacted fill. No compacted fill should be placed in an area subsequent to keying and benching until the area has been reviewed by the Geotechnical Consultant.

Material generated by the benching operation should be moved sufficiently away from the bench area to allow for the recommended review of the horizontal bench prior to placement of fill. Typical keying and benching details have been included within the accompanying Standard Details.

Within a single fill area where grading procedures dictate two or more separate fills, temporary slopes (false slopes) may be created. When placing fill adjacent to a false slope, benching should be conducted in the same manner as above described. At least a 3-foot vertical bench should be established within the firm core of adjacent approved compacted fill prior to placement of additional fill. Benching should proceed in at least 3-foot vertical increments until the desired finished grades are achieved.

Fill should be tested for compliance with the recommended relative compaction and moisture conditions. Field density testing should conform to ASTM Method of Test D 1556-07, and/or D 6938-10. Tests should be provided for about every 2 vertical feet or 1,000 cubic yards of fill placed. Actual test intervals may vary as field conditions dictate. Fill found not to be in conformance with the grading recommendations should be removed or otherwise handled as recommended by the Geotechnical Consultant.

The Contractor should assist the Geotechnical Consultant and/or his representative by digging test pits for removal determinations and/or for testing compacted fill.

As recommended by the Geotechnical Consultant, the Contractor should "shut down" or remove grading equipment from an area being tested.

The Geotechnical Consultant should maintain a plan with estimated locations of field tests. Unless the client provides for actual surveying of test locations, the estimated locations by the Geotechnical Consultant should only be considered rough estimates and should not be utilized for the purpose of preparing cross sections showing test locations or in any case for the purpose of after-the-fact evaluating of the sequence of fill placement.

### **Moisture**

For field testing purposes, "near optimum" moisture will vary with material type and other factors including compaction procedures. "Near optimum" may be specifically recommended in Preliminary Investigation Reports and/or may be evaluated during grading.

Prior to placement of additional compacted fill following an overnight or other grading delay, the exposed surface or previously compacted fill should be processed by scarification, watered or dried as needed, thoroughly blended to near-optimum moisture conditions, then recompacted to a minimum of 90 percent of laboratory maximum dry density. Where wet or other dry or other unsuitable materials exist to depths of greater than 1 foot, the unsuitable materials should be over-excavated.

Following a period of flooding, rainfall or overwatering by other means, no additional fill should be placed until damage assessments have been made and remedial grading performed as described herein.

### **Fill Material**

Excavated on-site materials which are acceptable to the Geotechnical Consultant may be utilized as compacted fill, provided trash, vegetation and other deleterious materials are removed prior to placement.

Where import materials are required for use on-site, the Geotechnical Consultant should be notified at least 72 hours in advance of importing, in order to sample and test materials from proposed borrow sites. No import materials should be delivered for use on-site without prior sampling and testing by Geotechnical Consultant.



Where oversized rock or similar irreducible material is generated during grading, it is recommended, where practical, to waste such material off-site or on-site in areas designated as "nonstructural rock disposal areas". Rock placed in disposal areas should be placed with sufficient fines to fill voids. The rock should be compacted in lifts to an unyielding condition. The disposal area should be covered with at least 3 feet of compacted fill which is free of oversized material. The upper 3 feet should be placed in accordance with the guidelines for compacted fill herein.

Rocks 8 inches in maximum dimension and smaller may be utilized within the compacted fill, provided they are placed in such a manner that nesting of the rock is avoided. Fill should be placed and thoroughly compacted over and around all rock. The amount of rock should not exceed 40 percent by dry weight passing the  $\frac{3}{4}$ -inch sieve size. The 12-inch and 40 percent recommendations herein may vary as field conditions dictate.

During the course of grading operations, rocks or similar irreducible materials greater than 8-inches maximum dimension (oversized material) may be generated. These rocks should not be placed within the compacted fill unless placed as recommended by the Geotechnical Consultant.

Where rocks or similar irreducible materials of greater than 8 inches but less than 4 feet of maximum dimension are generated during grading, or otherwise desired to be placed within an engineered fill, special handling in accordance with the accompanying Standard Details is recommended. Rocks greater than 4 feet should be broken down or disposed off-site. Rocks up to 4 feet maximum dimension should be placed below the upper 10 feet of any fill and should not be closer than 20-feet to any slope face. These recommendations could vary as locations of improvements dictate. Where practical, oversized material should not be placed below areas where structures or deep utilities are proposed.

Oversized material should be placed in windrows on a clean, over-excavated or unyielding compacted fill or firm natural ground surface. Select native or imported granular soil (S.E. 30 or higher) should be placed and thoroughly flooded over and around all windrowed rock, such that voids are filled. Windrows of oversized material should be staggered so that successive strata of oversized material are not in the same vertical plane.

It may be possible to dispose of individual larger rock as field conditions dictate and as recommended by the Geotechnical Consultant at the time of placement. Material that is considered unsuitable by the Geotechnical Consultant should not be utilized in the compacted fill.

During grading operations, placing and mixing the materials from the cut and/or borrow areas may result in soil mixtures which possess unique physical properties. Testing may be required of samples obtained directly from the fill areas in order to verify conformance with the specifications. Processing of these additional samples may take two or more working days. The Contractor may elect to move the operation to other areas within the project, or may continue placing compacted fill pending laboratory and field test results. Should he elect the second alternative, fill placed is done so at the Contractor's risk.

Any fill placed in areas not previously reviewed and evaluated by the Geotechnical Consultant, and/or in other areas, without prior notification to the Geotechnical Consultant may require removal and recompaction at the Contractor's expense. Determination of over-excavations should be made upon review of field conditions by the Geotechnical Consultant.

## **Fill Slopes**

Unless otherwise recommended by the Geotechnical Consultant and approved by the regulating agencies, permanent fill slopes should not be steeper than 2:1 (horizontal to vertical).

Except as specifically recommended otherwise or as otherwise provided for in these grading guidelines (Reference Fill Materials), compacted fill slopes should be overbuilt and cut back to grade, exposing the firm, compacted fill inner core. The actual amount of overbuilding may vary as field conditions dictate. If the desired results are not achieved, the existing slopes should be over-excavated and reconstructed under the guidelines of the Geotechnical Consultant. The degree of overbuilding shall be increased until the desired compacted slope surface condition is achieved. Care should be taken by the Contractor to provide thorough mechanical compaction to the outer edge of the overbuilt slope surface.

Although no construction procedure produces a slope free from risk of future movement, overfilling and cutting back of slope to a compacted inner core is, given no other constraints, the most desirable procedure. Other constraints, however, must often be considered. These constraints may include property line situations, access, the critical nature of the development and cost. Where such constraints are identified, slope face compaction may be attempted by conventional construction procedures including back rolling techniques upon specific recommendation by the Geotechnical Consultant.

As a second-best alternative for slopes of 2:1 (horizontal to vertical) or flatter, slope construction may be attempted as outlined herein. Fill placement should proceed in thin lifts, (i.e., 6 to 8-inch loose thickness). Each lift should be moisture conditioned and thoroughly compacted. The desired moisture condition should be maintained and/or reestablished, where necessary, during the period between successive lifts. Selected lifts should be tested to ascertain that desired compaction is being achieved. Care should be taken to extend compactive effort to the outer edge of the slope. Each lift should extend horizontally to the desired finished slope surface or more as needed to ultimately establish desired grades. Grade during construction should not be allowed to roll off at the edge of the slope. It may be helpful to elevate slightly the outer edge of the slope.

Slough resulting from the placement of individual lifts should not be allowed to drift down over previous lifts. At intervals not exceeding 4 feet in vertical slope height or the capability of available equipment, whichever is less, fill slopes should be thoroughly backrolled utilizing a conventional sheeps foot-type roller. Care should be taken to maintain the desired moisture conditions and/or reestablishing same as needed prior to backrolling. Upon achieving final grade, the slopes should again be moisture conditioned and thoroughly backrolled. The use of a side-boom roller will probably be necessary and vibratory methods are strongly recommended. Without delay, so as to avoid (if possible) further moisture conditioning, the slopes should then be grid-rolled to achieve a relatively smooth surface and uniformly compact condition.

In order to monitor slope construction procedures, moisture and density tests will be taken at regular intervals. Failure to achieve the desired results will likely result in a recommendation by the Geotechnical Consultant to over-excavate the slope surfaces followed by reconstruction of the slopes utilizing overfilling and cutting back procedures and/or further attempt at the conventional backrolling approach. Other recommendations may also be

provided which would be commensurate with field conditions.

Where placement of fill above a natural slope or above a cut slope is proposed, the fill slope configuration as presented in the accompanying Standard Details should be adopted.

For pad areas above fill slopes, positive drainage should be established away from the top-of-slope. This may be accomplished utilizing a berm and pad gradients of at least 2 percent in soil areas.

### **Off-Site Fill**

Off-site fill should be treated in the same manner as recommended in these specifications for site preparation, excavation, drains, compaction, etc.

Off-site canyon fill should be placed in preparation for future additional fill, as shown in the accompanying Standard Details.

Off-site fill subdrains temporarily terminated (up canyon) should be surveyed for future relocation and connection.

## **DRAINAGE**

Canyon subdrain systems specified by the Geotechnical Consultant should be installed in accordance with the Standard Details.

Typical subdrains for compacted fill buttresses, slope stabilization or sidehill masses, should be installed in accordance with the specifications of the accompanying Standard Details.

Roof, pad and slope drainage should be directed away from slopes and areas of structures to suitable disposal areas via non-erodible devices (i.e., gutters, downspouts, concrete swales).

For drainage over soil areas immediately away from structures (i.e., within 4 feet), a minimum of 4 percent gradient should be maintained. Pad drainage of at least 2 percent should be maintained over soil areas. Pad drainage may be reduced to at least 1 percent for projects where no slopes exist, either natural or man-made, or greater than 10-feet in height and where no slopes are planned, either natural or man-made, steeper than 2:1 (horizontal to vertical slope ratio).

Drainage patterns established at the time of fine grading should be maintained throughout the life of the project. Property owners should be made aware that altering drainage patterns can be detrimental to slope stability and foundation performance.

## **STAKING**

In all fill areas, the fill should be compacted prior to the placement of the stakes. This particularly is important on fill slopes. Slope stakes should not be placed until the slope is thoroughly compacted (backrolled). If stakes must be placed prior to the completion of compaction procedures, it must be recognized that they will be removed and/or demolished at such time as compaction procedures resume.

In order to allow for remedial grading operations, which could include over-excavations or slope stabilization, appropriate staking offsets should be provided. For finished slope and stabilization backcut areas, we recommend at least a 10-foot setback from proposed toes and tops-of-cut.

## **SLOPE MAINTENANCE**

### **Landscape Plants**

In order to enhance surficial slope stability, slope planting should be accomplished at the completion of grading. Slope planting should consist of deep-rooting vegetation requiring little watering. Plants native to the southern California area and plants relative to native plants are generally desirable. Plants native to other semi-arid and arid areas may also be appropriate. A Landscape Architect would be the best party to consult regarding actual types of plants and planting configuration.

### **Irrigation**

Irrigation pipes should be anchored to slope faces, not placed in trenches excavated into slope faces.

Slope irrigation should be minimized. If automatic timing devices are utilized on irrigation systems, provisions should be made for interrupting normal irrigation during periods of rainfall.

Though not a requirement, consideration should be given to the installation of near-surface moisture monitoring control devices. Such devices can aid in the maintenance of relatively uniform and reasonably constant moisture conditions.

Property owners should be made aware that overwatering of slopes is detrimental to slope stability.

### **Maintenance**

Periodic inspections of landscaped slope areas should be planned and appropriate measures should be taken to control weeds and enhance growth of the landscape plants. Some areas may require occasional replanting and/or reseeding.

Terrace drains and down drains should be periodically inspected and maintained free of debris. Damage to drainage improvements should be repaired immediately.

Property owners should be made aware that burrowing animals can be detrimental to slope stability. A preventative program should be established to control burrowing animals.

As a precautionary measure, plastic sheeting should be readily available, or kept on hand, to protect all slope areas from saturation by periods of heavy or prolonged rainfall. This measure is strongly recommended, beginning with the period of time prior to landscape planting.

### **Repairs**

If slope failures occur, the Geotechnical Consultant should be contacted for a field review of site conditions and development of recommendations for evaluation and repair.

If slope failures occur as a result of exposure to periods of heavy rainfall, the failure area and currently unaffected areas should be covered with plastic sheeting to protect against additional saturation.

In the accompanying Standard Details, appropriate repair procedures are illustrated for

superficial slope failures (i.e., occurring typically within the outer 1 foot to 3 feet of a slope face).

### **TRENCH BACKFILL**

Utility trench backfill should, unless otherwise recommended, be compacted by mechanical means. Unless otherwise recommended, the degree of compaction should be a minimum of 90 percent of the laboratory maximum density.

Backfill of exterior and interior trenches extending below a 1:1 projection from the outer edge of foundations should be mechanically compacted to a minimum of 90 percent of the laboratory maximum density.

In cases where clean granular materials are proposed for use in lieu of native materials or where flooding or jetting is proposed, the procedures should be considered subject to review by the Geotechnical Consultant.

Clean Granular backfill and/or bedding are not recommended in slope areas unless provisions are made for a drainage system to mitigate the potential build-up of seepage forces.

### **STATUS OF GRADING**

Prior of proceeding with any grading operation, the Geotechnical Consultant should be notified at least two working days in advance in order to schedule the necessary observation and testing services.

Prior to any significant expansion or cut back in the grading operation, the Geotechnical Consultant should be provided with adequate notice (i.e., two days) in order to make appropriate adjustments in observation and testing services.

Following completion of grading operations and/or between phases of a grading operation, the Geotechnical Consultant should be provided with at least two working days notice in advance of commencement of additional grading operations.

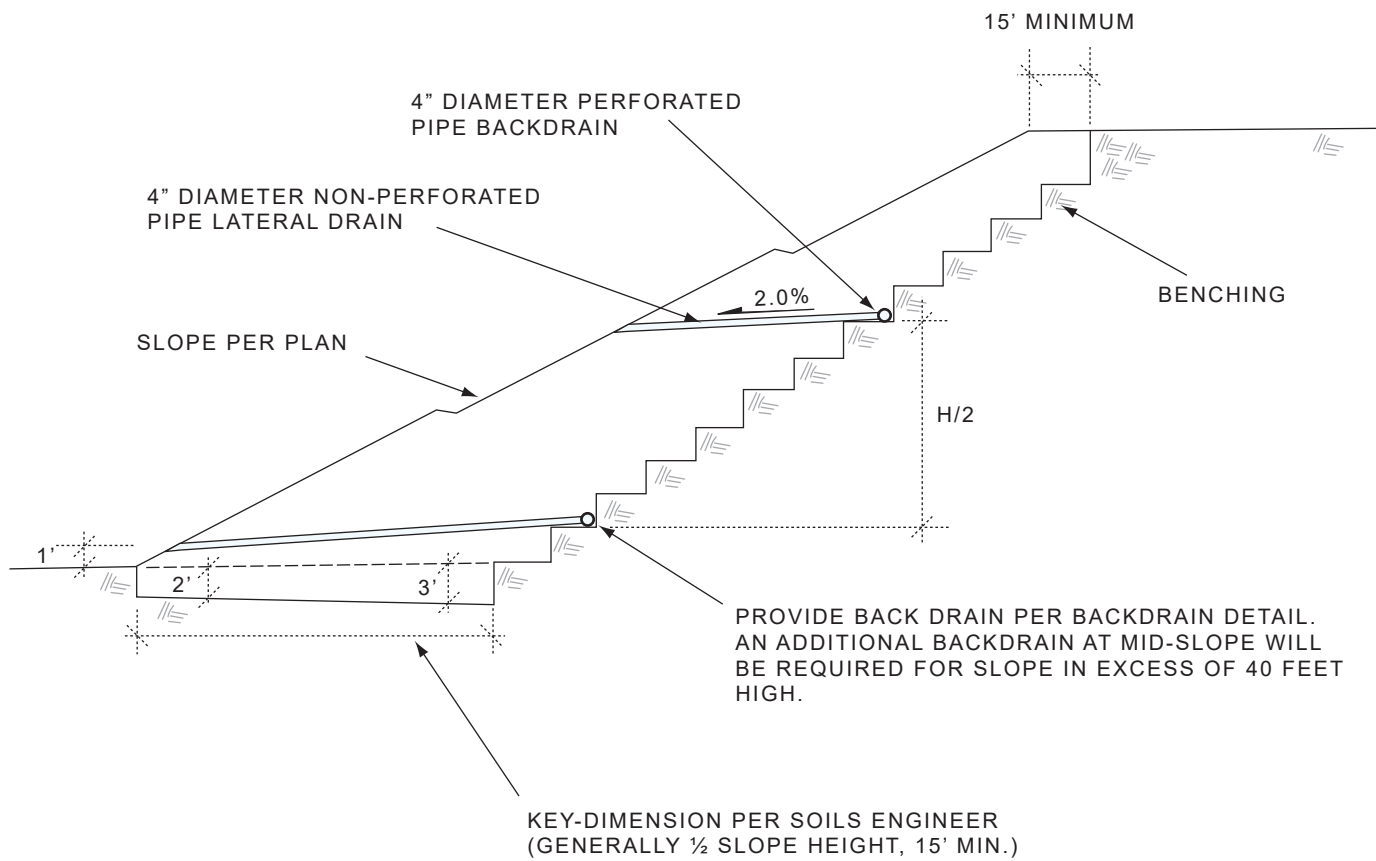

TYPICAL STABILIZATION FILL DETAIL

NOT TO SCALE

FIGURE 1

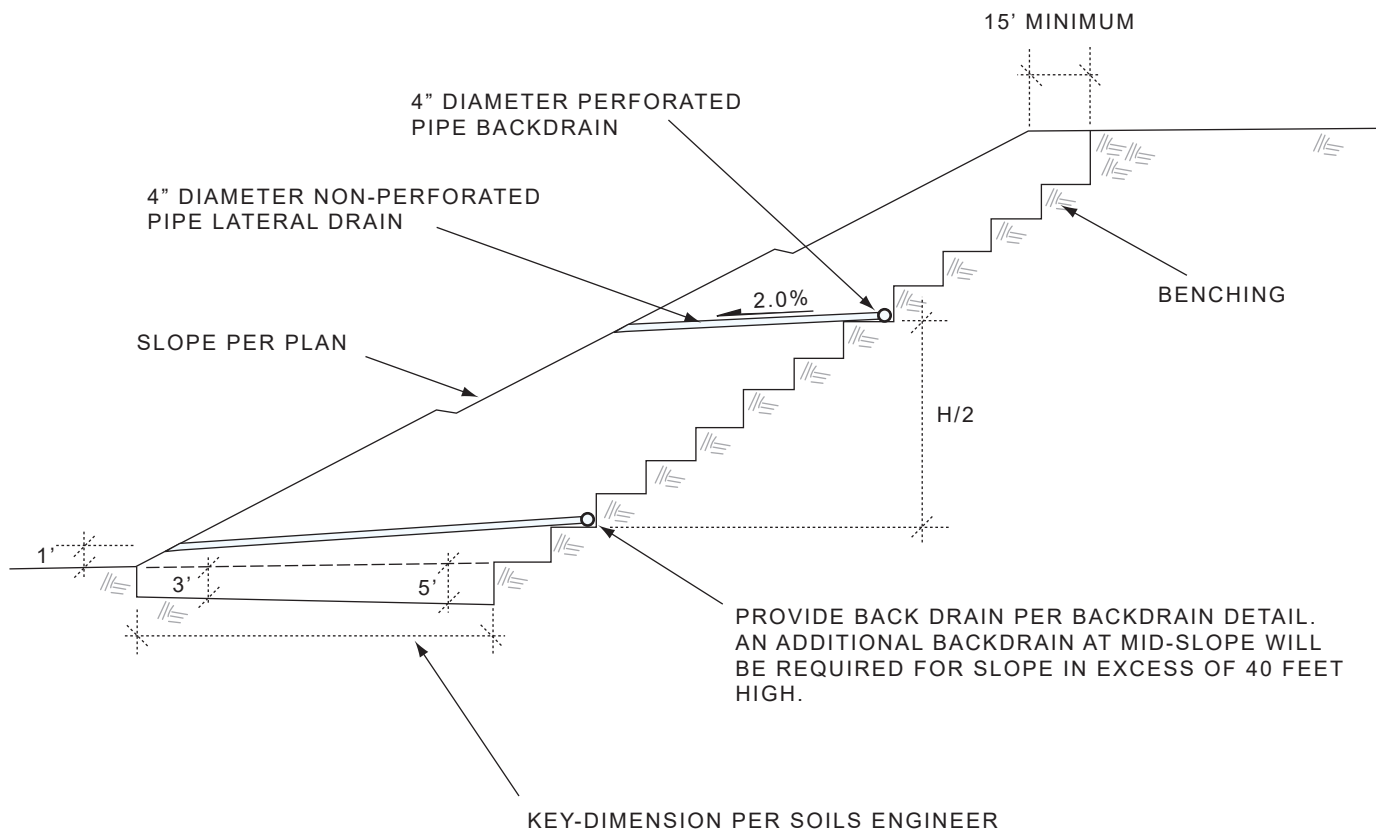

TYPICAL BUTTRESS FILL DETAIL

NOT TO SCALE

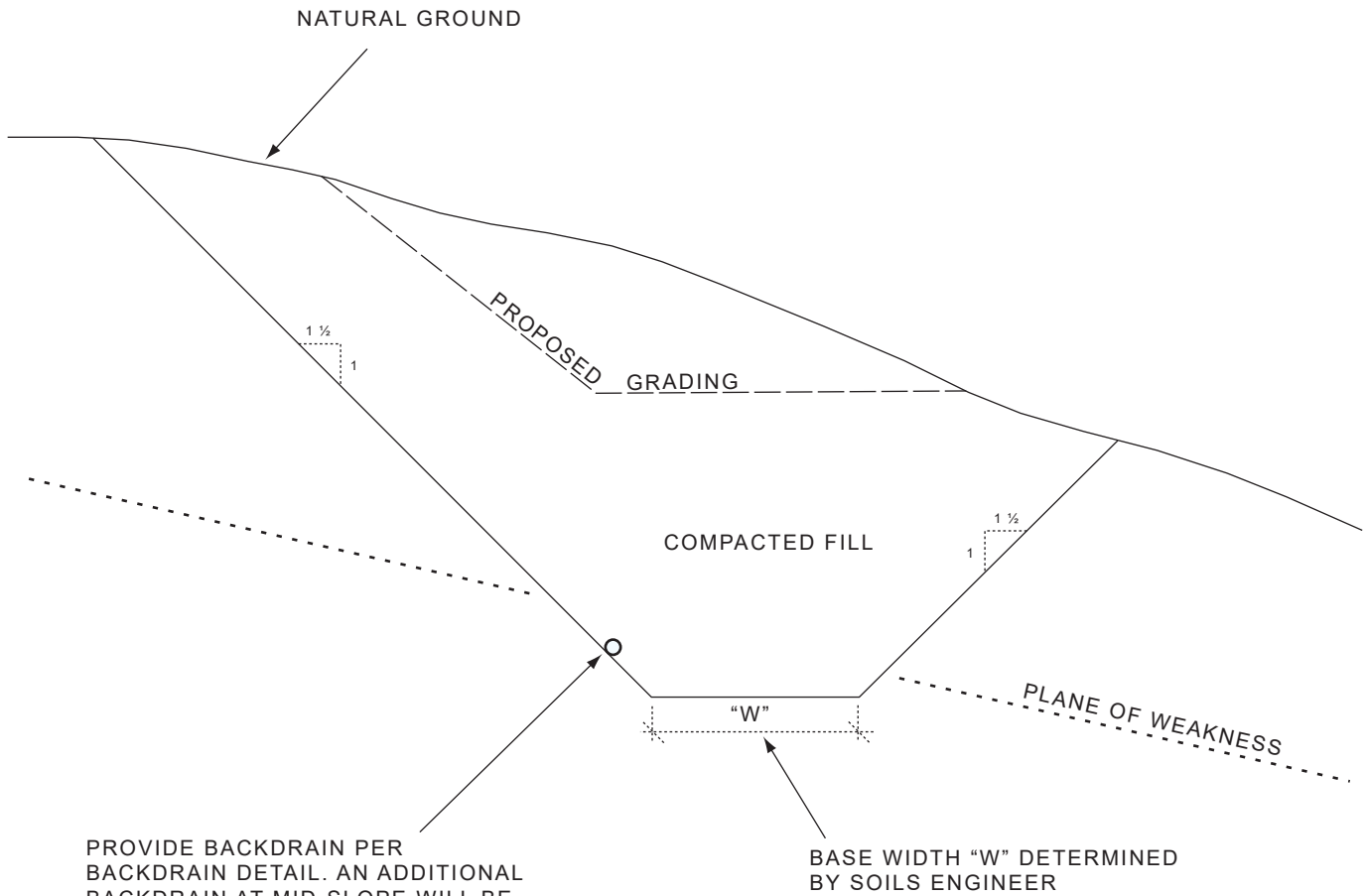

PROVIDE BACKDRAIN PER BACKDRAIN DETAIL. AN ADDITIONAL BACKDRAIN AT MID-SLOPE WILL BE REQUIRED FOR BACK SLOPES IN EXCESS OF 40 FEET HIGH. LOCATIONS OF BACKDRAINS AND OUTLETS PER SOILS ENGINEER AND/OR ENGINEERING GEOLOGIST DURING GRADING.

BASE WIDTH "W" DETERMINED BY SOILS ENGINEER

TYPICAL SHEAR KEY DETAIL

NOT TO SCALE

FIGURE 3



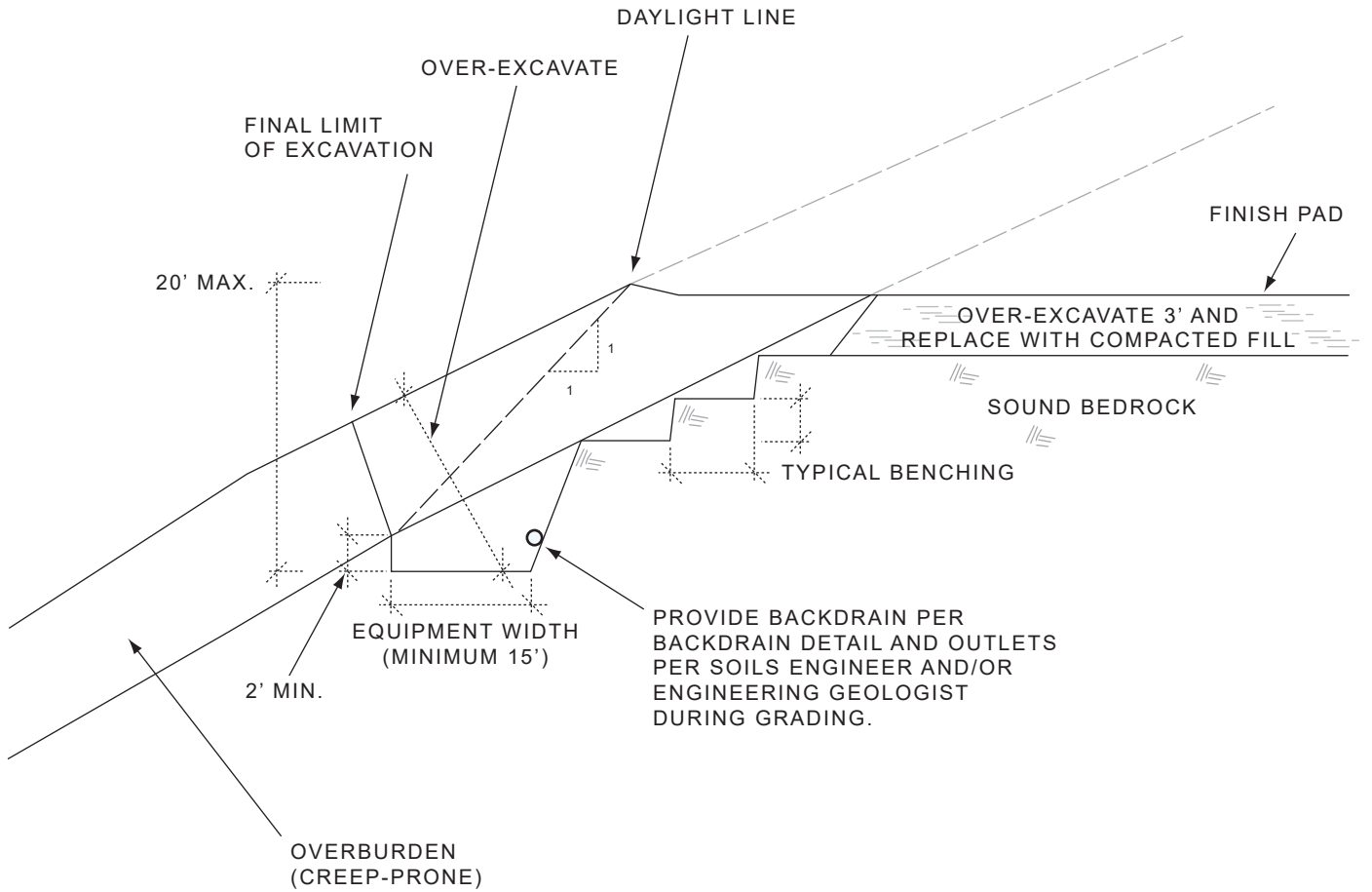

## DAYLIGHT SHEAR KEY DETAIL

NOT TO SCALE

FIGURE 4

## BENCHING FILL OVER NATURAL

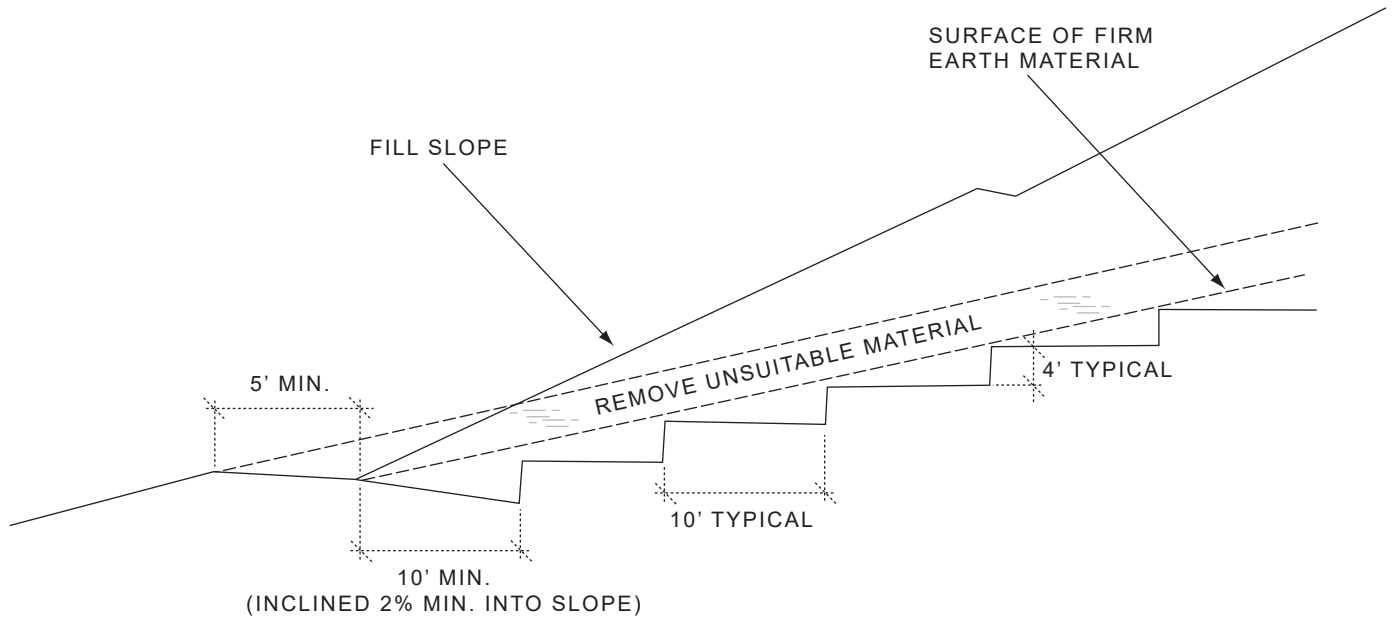

## BENCHING FILL OVER CUT

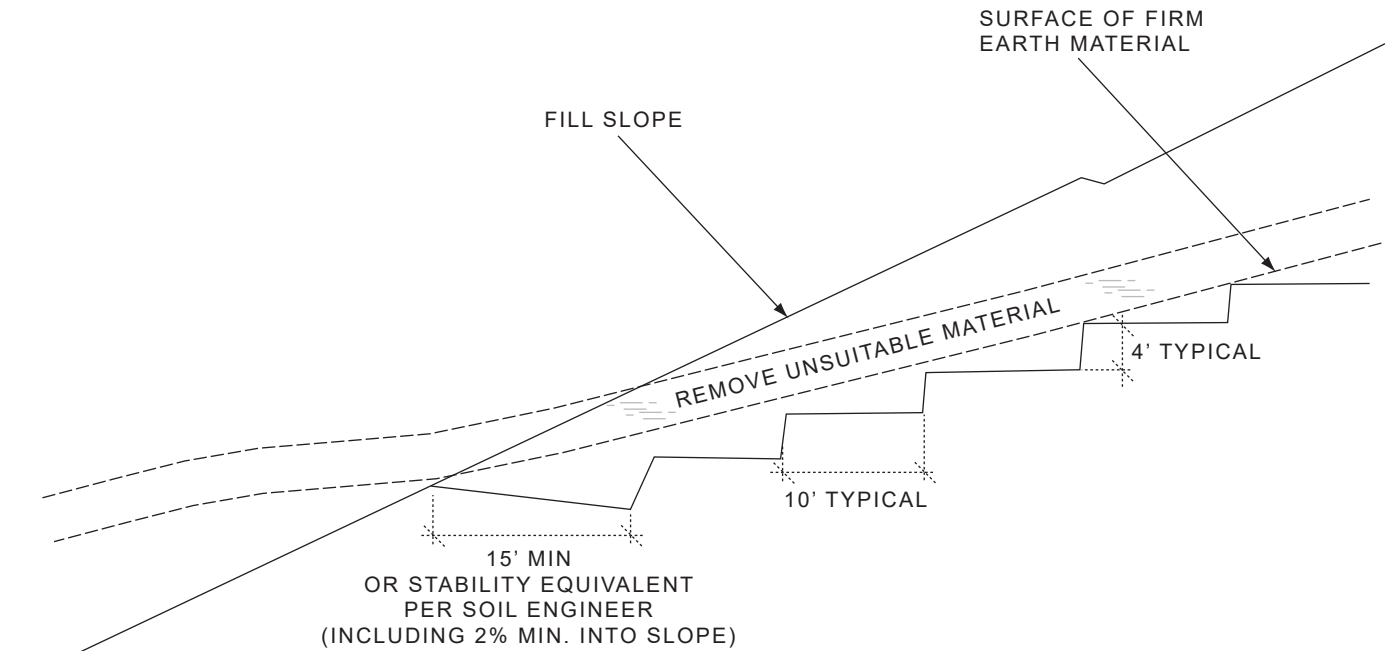

## BENCHING FOR COMPACTED FILL DETAIL

NOT TO SCALE

FIGURE 5

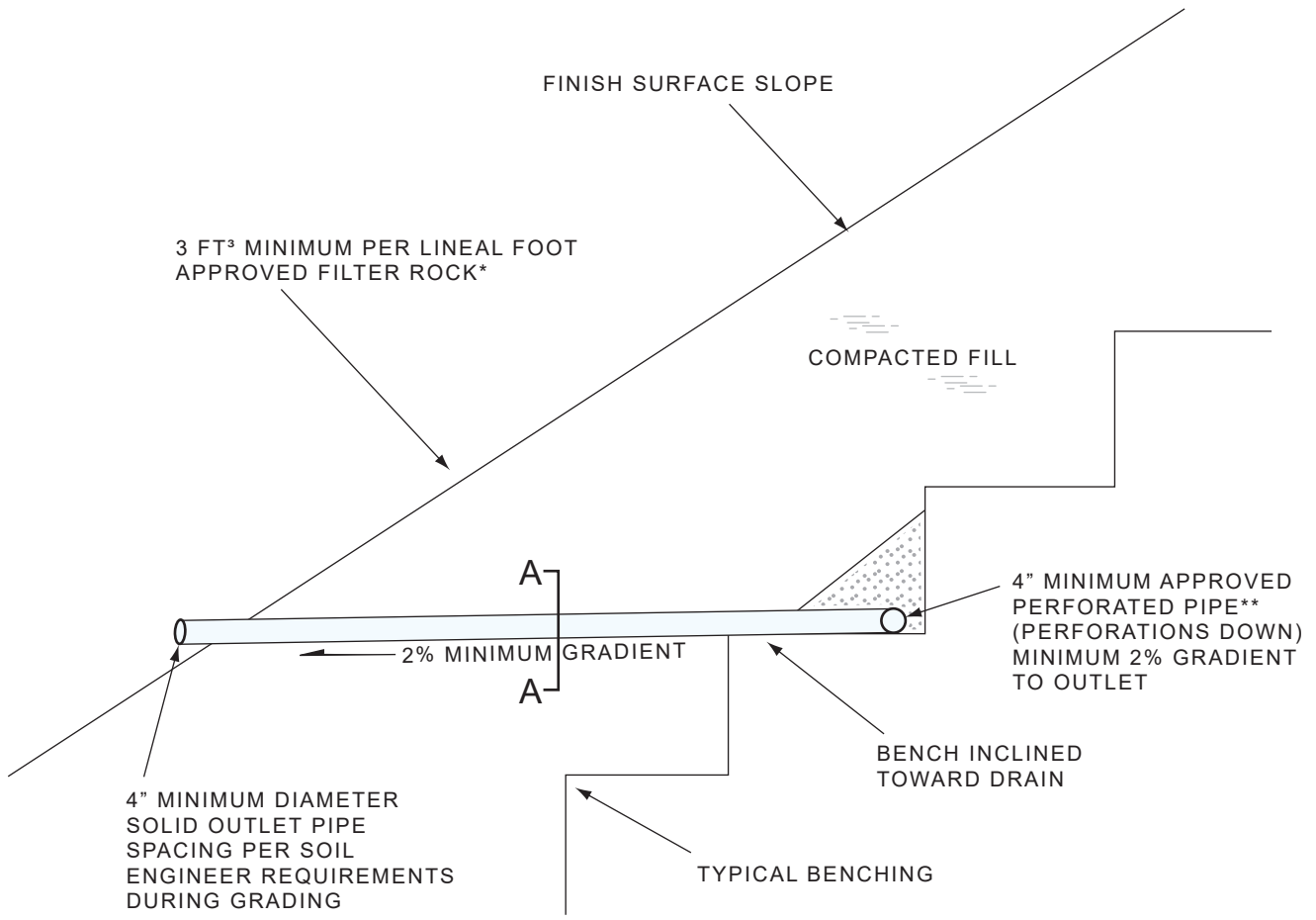

**DETAIL A-A**

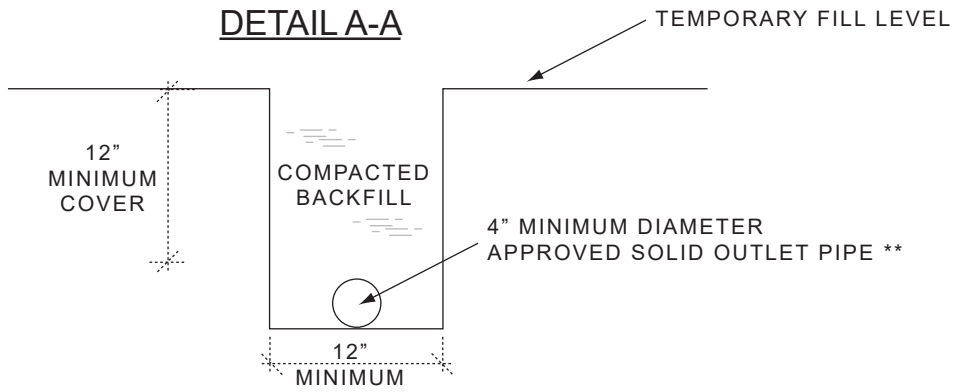

\* Filter rock to meet following specifications or approved equal.

Sieve	% Passing
1"	100
3/4"	90-100
3/8"	40-100
No.4	25-40
No.30	5-15
No.50	0-7
No.200	0-3

\*\* APPROVED PIPE TYPE

Schedule 40 polyvinyl chloride (P.V.C.) or approved equal. Min. crush strength 1000 PSI.

**TYPICAL BACKDRAIN DETAIL**

NOT TO SCALE

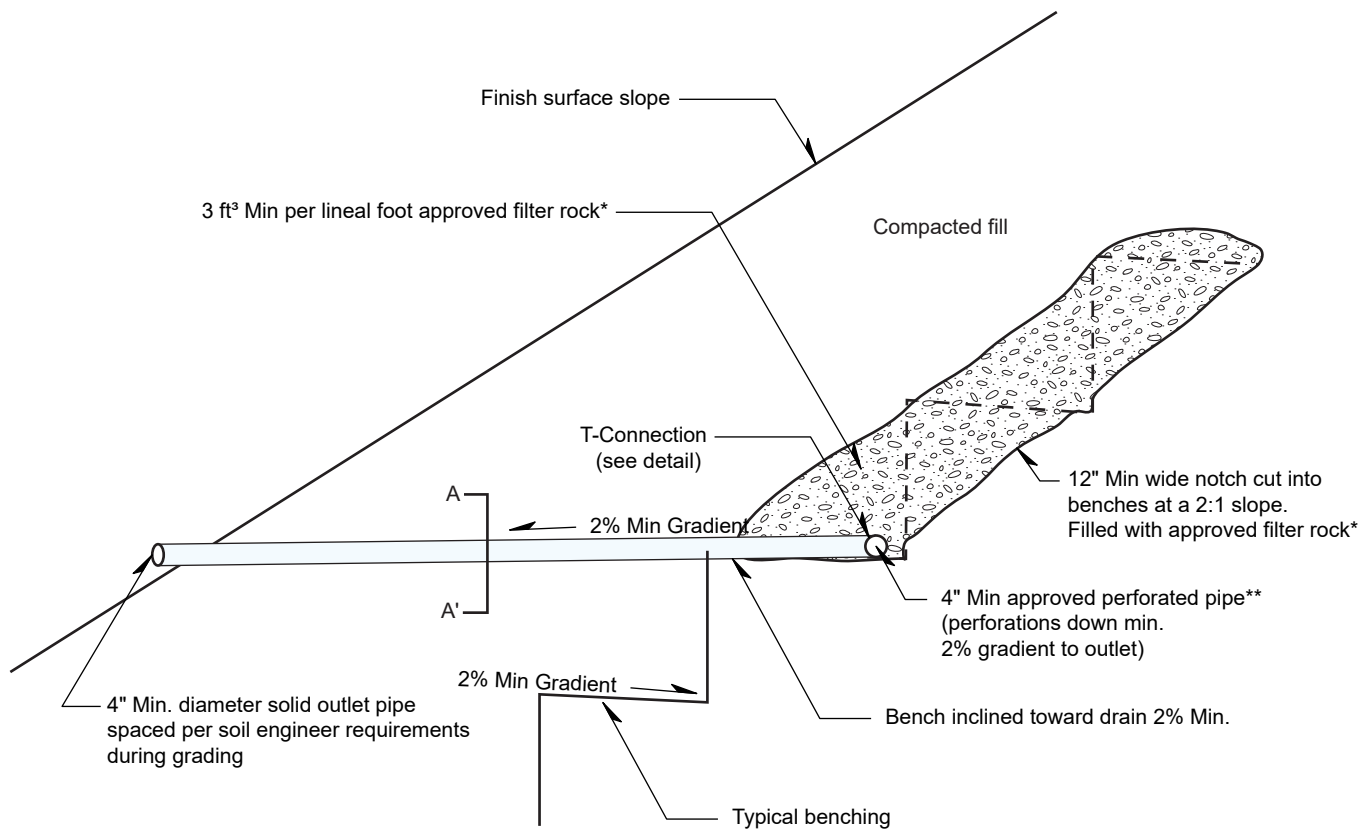

\* Filter rock to meet following specifications or approved equal.

Sieve	% Passing
1"	100
3/4"	90-100
3/8"	40-100
No.4	25-40
No.30	5-15
No.50	0-7
No.200	0-3

\*\* Approved pipe type:  
 Schedule 40 polyvinyl chloride (P.V.C.) or approved equal.  
 Min. crush strength 1000 PSI.

BACKDRAIN DETAIL (GEOFABRIC)

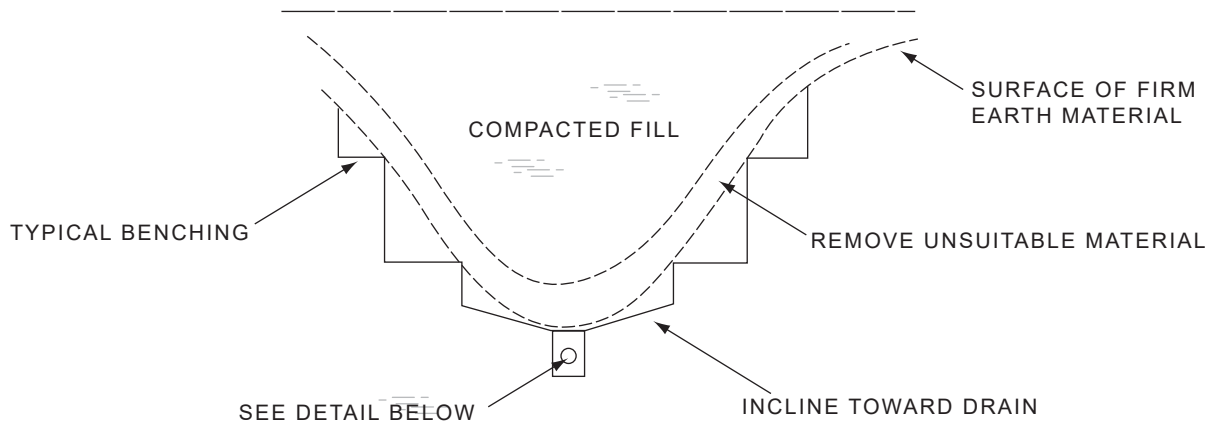

**DETAIL**

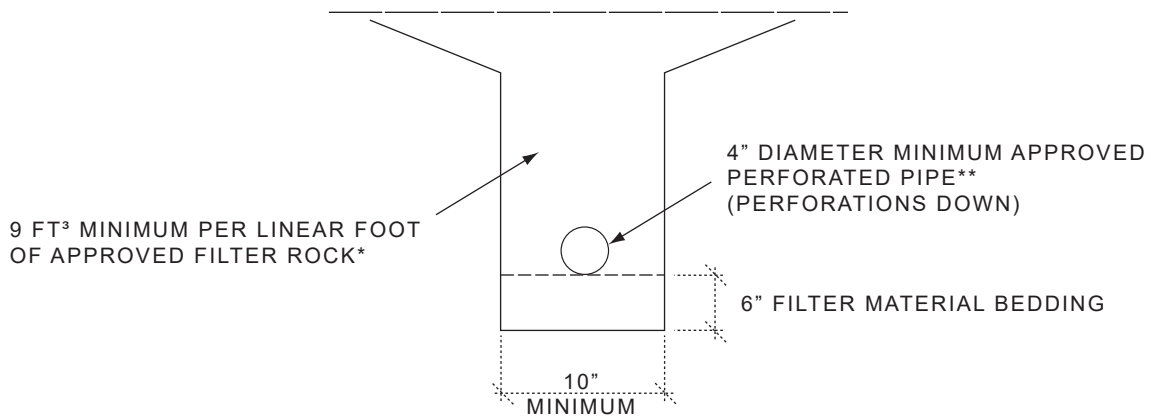

\* Filter rock to meet following specifications or approved equal.

<u>Sieve</u>	<u>% Passing</u>
1"	100
3/4"	90-100
3/8"	40-100
No.4	25-40
No.30	5-15
No.50	0-7
No.200	0-3

**\*\* APPROVED PIPE TYPE**

Schedule 40 polyvinyl chloride (P.V.C.) or approved equal. Min. crush strength 1000 PSI.

Pipe diameter to meet the following criteria. Subject to field review based on actual geotechnical conditions encountered during grading.

<u>Length of Run</u>	<u>Pipe Diameter</u>
Upper 500'	4"
Next 1000'	6"
>1500'	8"

**TYPICAL CANYON SUBDRAIN DETAIL**

NOT TO SCALE

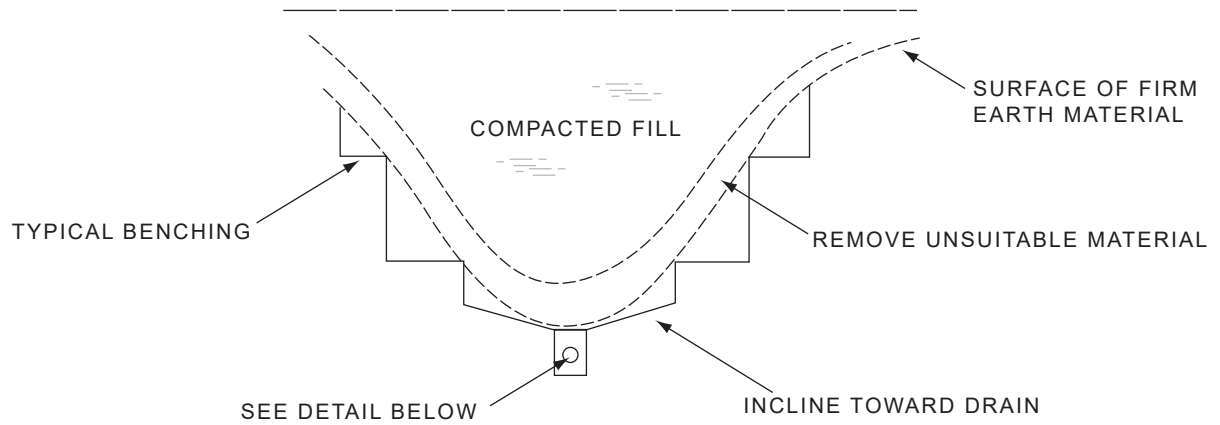

**TRENCH DETAIL**

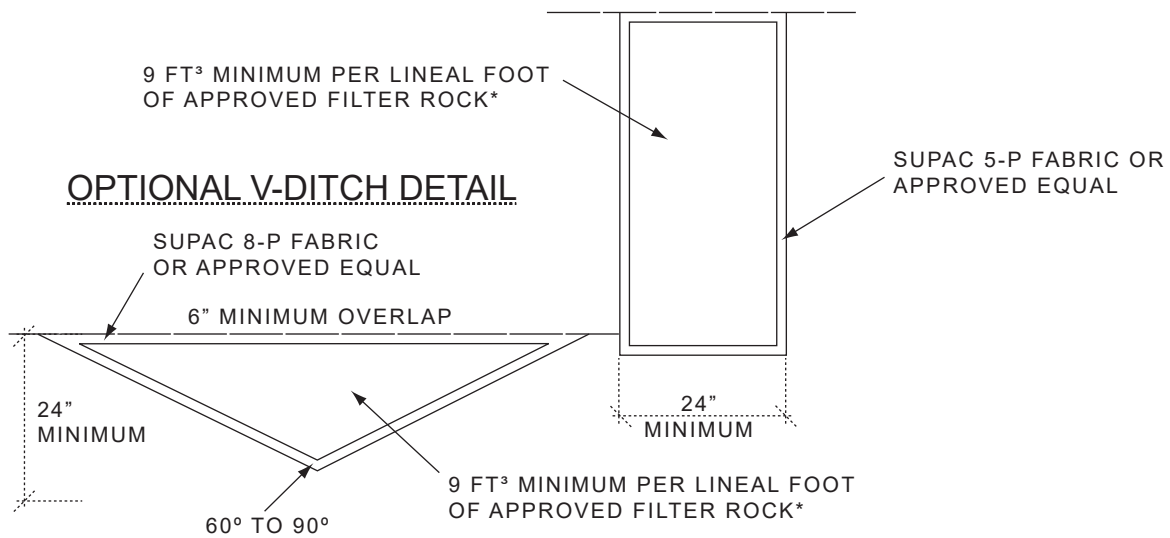

**OPTIONAL V-DITCH DETAIL**

\* Drainage material to meet following specifications or approved equal.

Sieve	% Passing
1 1/2"	88-100
1"	5-40
3/4"	0-17
3/8"	0-7
No.200	0-3

ADD MINIMUM 4" DIAMETER APPROVED PERFORATED PIPE WHEN GRADIENT IS LESS THAN 2%

APPROVED PIPE TO BE SCHEDULE 40 POLY-VINYL-CHLORIDE (P.V.C.) OR APPROVED EQUAL. MINIMUM CRUSH STRENGTH 1000 psi.

**GEOFABRIC SUBDRAIN**

NOT TO SCALE

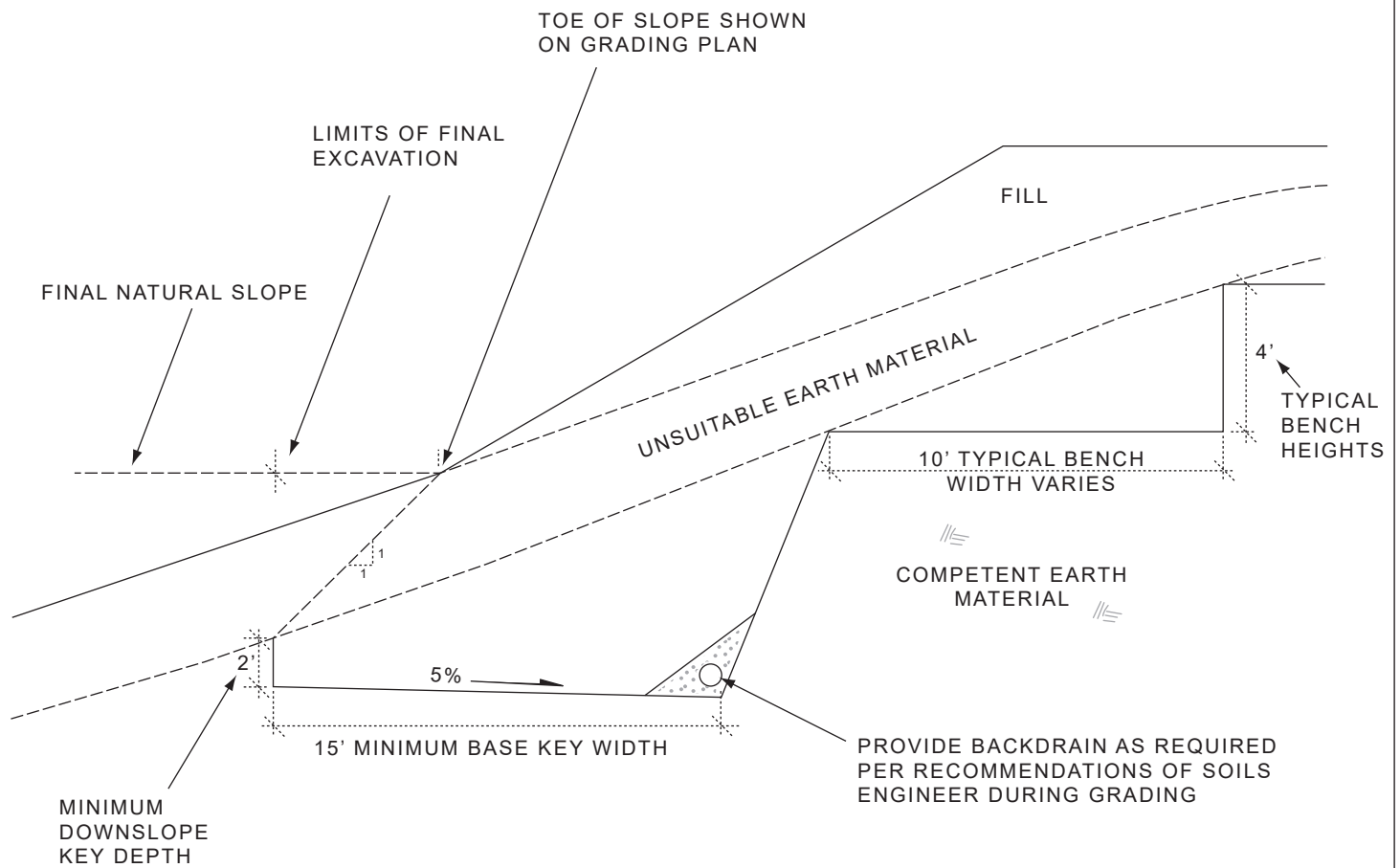

WHERE NATURAL SLOPE GRADIENT IS 5:1 OR LESS, BENCHING IS NOT NECESSARY. HOWEVER, FILL IS NOT TO BE PLACED ON COMPRESSIBLE OR UNSUITABLE MATERIAL.

## FILL SLOPE ABOVE NATURAL GROUND DETAIL

NOT TO SCALE

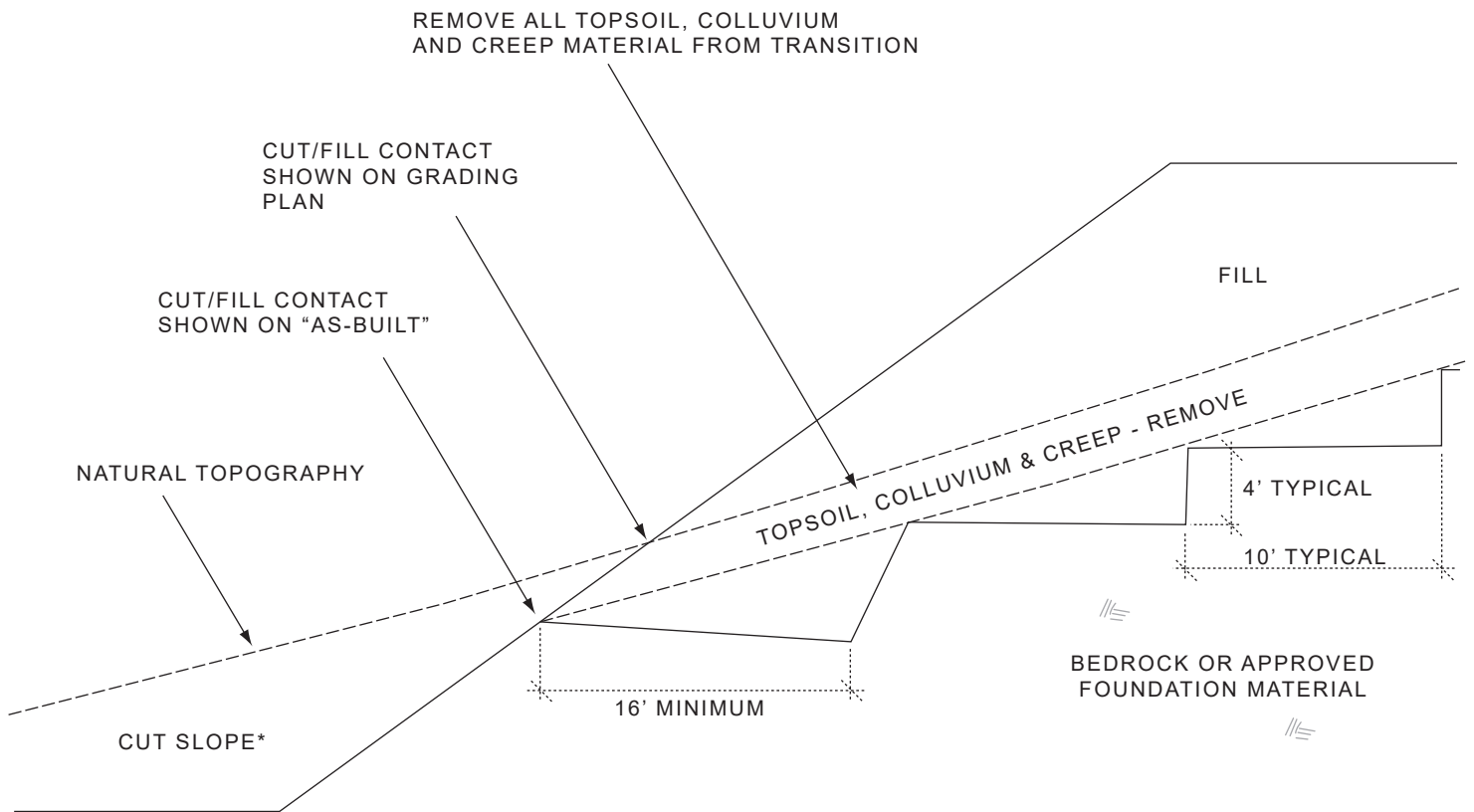

## FILL SLOPE ABOVE CUT SLOPE DETAIL

NOT TO SCALE



CUT LOT

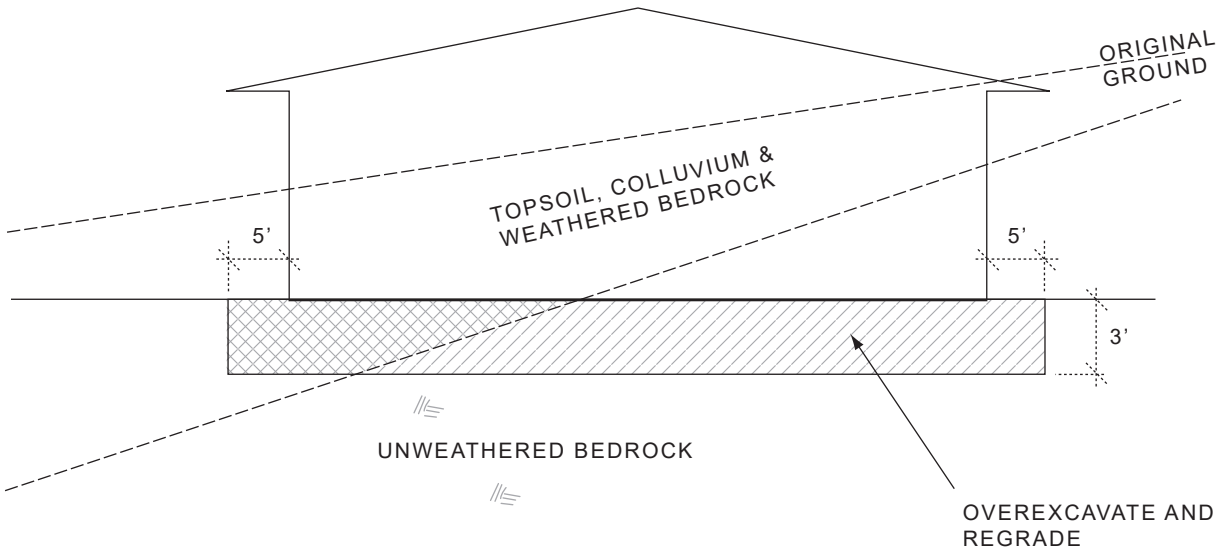

CUT/FILL LOT (TRANSITION)

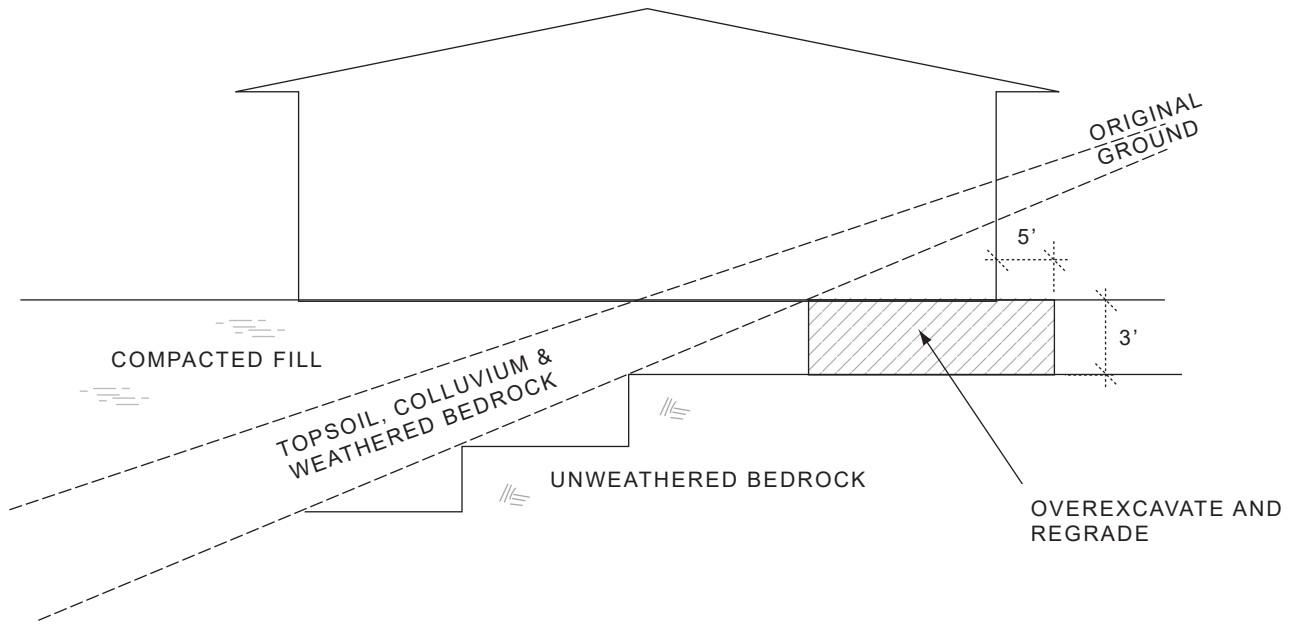

TRANSITION LOT DETAIL

NOT TO SCALE

FIGURE 12

# BUILDING

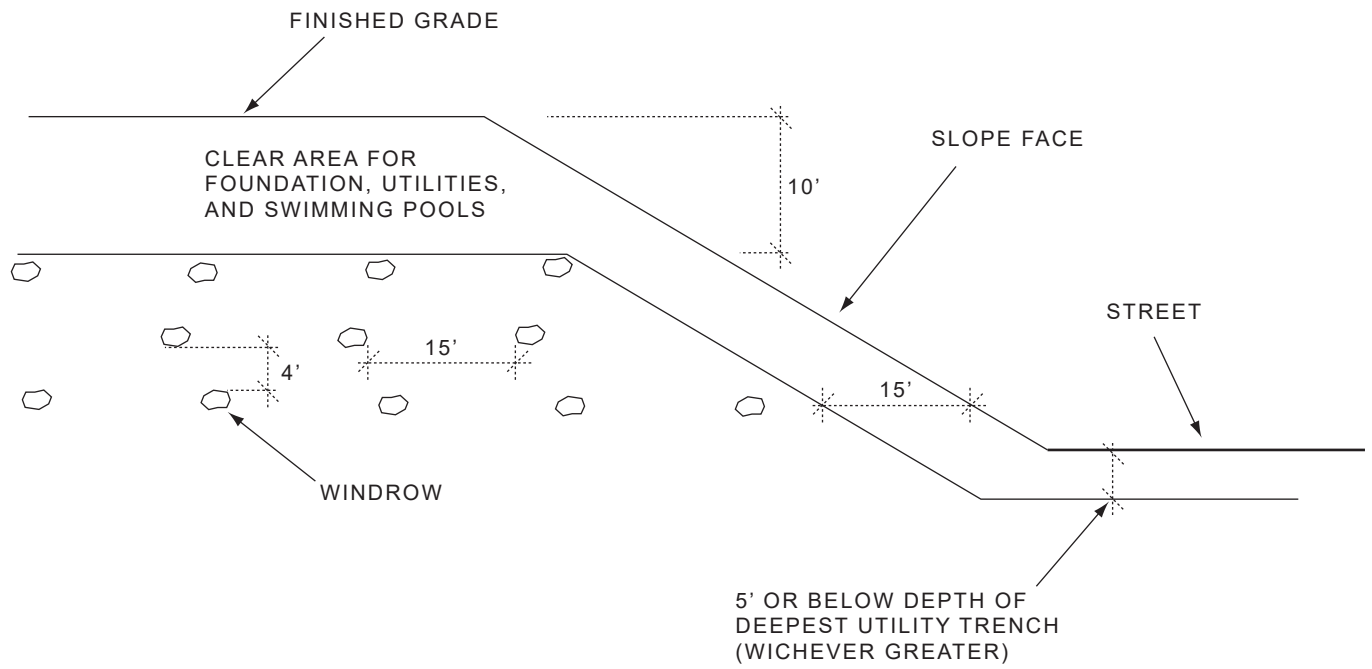

## TYPICAL WINDROW DETAIL (EDGE VIEW)

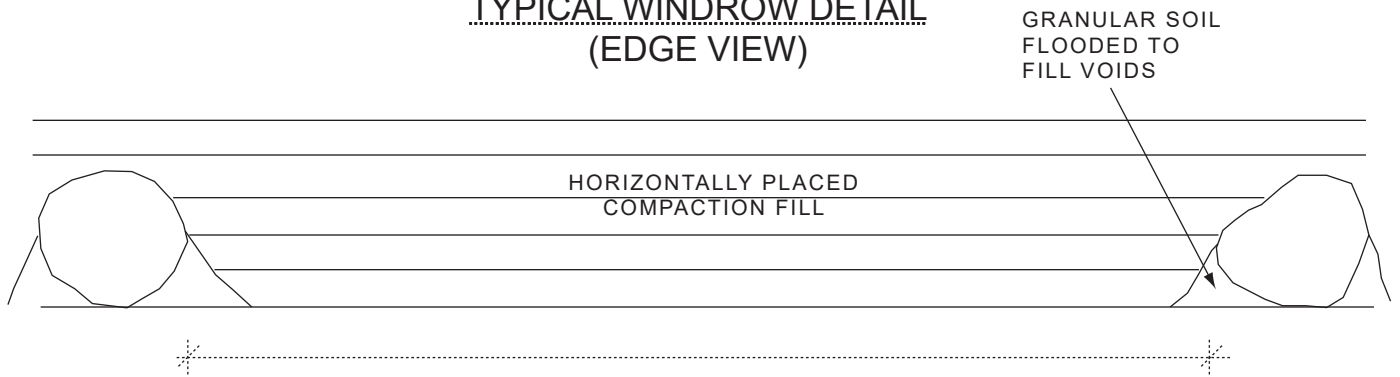

## (PROFILE VIEW)

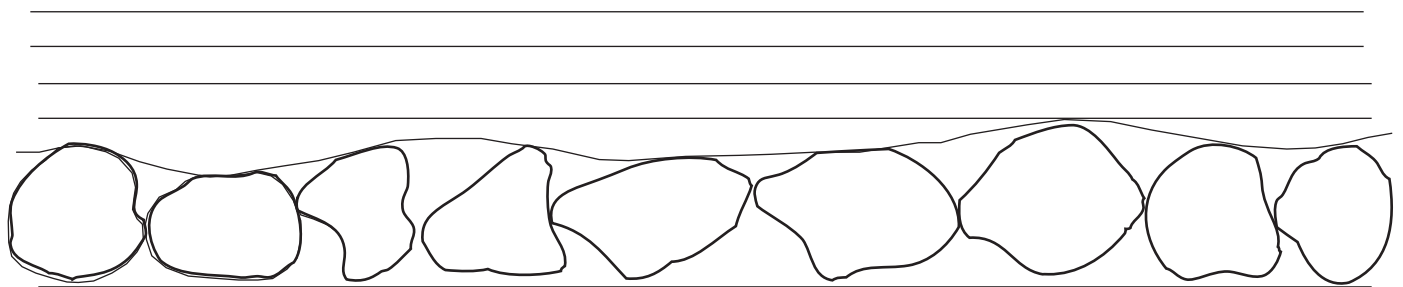

## ROCK DISPOSAL DETAIL

NOT TO SCALE